



U.S. Department  
of Transportation  
**Federal Railroad  
Administration**

# Ballast and Subgrade Requirements Study

---

Office of Research and  
Development  
Washington, DC 20590

## Railroad Track Substructure - Design and Performance Evaluation Practices

M.A. DiPilato  
E. I. Steinberg  
R.M. Simon, et al.

Goldberg-Zoino & Associates, Inc.  
30 Tower Road  
Newton Upper Falls, Massachusetts 02164

NOTICE

This document is disseminated under the sponsorship of the Department of Transportation in the interest of information exchange. The United States Government assumes no liability for its contents or use thereof.

NOTICE

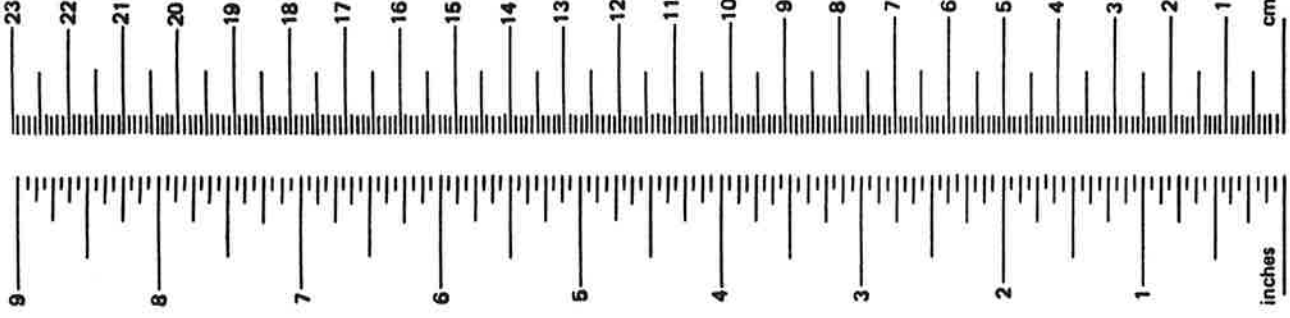
The United States Government does not endorse products or manufacturers. Trade or manufacturers' names appear herein solely because they are considered essential to the object of this report.

Technical Report Documentation Page

1. Report No. FRA/ORD-83/04.2		2. Government Accession No.		3. Recipient's Catalog No.	
4. Title and Subtitle BALLAST AND SUBGRADE REQUIREMENTS STUDY: RAILROAD TRACK SUBSTRUCTURE - DESIGN AND PERFORMANCE EVALUATION PRACTICES				5. Report Date June 1983	
				6. Performing Organization Code DTS-73	
				8. Performing Organization Report No. DOT-TSC-FRA-82-4	
7. Author(s) DiPilato, M.A.*, A.V. Levergood+, E.I. Steinberg*, and R.M. Simon*				10. Work Unit No. (TRAIS) RR019/RO 324	
9. Performing Organization Name and Address *Goldberg-Zoino & Associates, Inc. +Thomas K. Dyer, Inc. 30 Tower Road Newton Upper Falls, MA 02164				11. Contract or Grant No. DOT-TSC-1527	
				13. Type of Report and Period Covered Final Report July 1978 - January 1981	
12. Sponsoring Agency Name and Address U.S. Department of Transportation Federal Railroad Administration Office of Research and Development Washington, D.C. 20509				14. Sponsoring Agency Code RRD-10	
				15. Supplementary Notes *Under contract to: U.S. Department of Transportation Research and Special Program Administration, Transportation Systems Center Cambridge, Massachusetts 02142	
16. Abstract  Earth Materials - i.e., soil and rock - form the substructure (ballast, subballast, and subgrade) of all railroad track. In this report, the most suitable technology and design criteria as related to design of the substructure are identified based on a review of current track substructure design procedures employed in the United States and foreign countries.  A primary emphasis has been placed on identifying an approach for rational design of track to support vertical, lateral, and longitudinal loads. Principal design parameters and available analytic and empirical design procedures are discussed.					
17. Key Words Railroad Track, Ballast, Subgrade, Subballast, Substructure, Design, Analysis, Performance and Evaluation, Analytical Models, Permanent Deformation, Lateral Loads			18. Distribution Statement Document is available to the U.S. public through the National Technical Information Service, Springfield, Virginia, 22161		
19. Security Classif. (of this report) Unclassified		20. Security Classif. (of this page) Unclassified		21. No. of Pages 178	22. Price

# METRIC CONVERSION FACTORS

Approximate Conversions to Metric Measures		Approximate Conversions from Metric Measures		
Symbol	When You Know	Multiply by	To Find	Symbol
<b>LENGTH</b>				
in	inches	2.5	centimeters	mm
ft	feet	30	centimeters	cm
yd	yards	0.9	meters	m
mi	miles	1.6	kilometers	km
<b>AREA</b>				
in <sup>2</sup>	square inches	6.5	square centimeters	cm <sup>2</sup>
ft <sup>2</sup>	square feet	0.09	square meters	m <sup>2</sup>
yd <sup>2</sup>	square yards	0.8	square meters	m <sup>2</sup>
mi <sup>2</sup>	square miles	2.6	square kilometers	km <sup>2</sup>
	acres	0.4	hectares	ha
<b>MASS (weight)</b>				
oz	ounces	28	grams	g
lb	pounds	0.45	kilograms	kg
	short tons (2000 lb)	0.9	tonnes	t
<b>VOLUME</b>				
cup	teaspoons	5	milliliters	ml
Tbsp	tablespoons	15	milliliters	ml
fl oz	fluid ounces	30	milliliters	ml
c	cups	0.24	liters	l
pt	pints	0.47	liters	l
qt	quarts	0.96	liters	l
gal	gallons	3.8	liters	l
ft <sup>3</sup>	cubic feet	0.03	cubic meters	m <sup>3</sup>
yd <sup>3</sup>	cubic yards	0.76	cubic meters	m <sup>3</sup>
<b>TEMPERATURE (exact)</b>				
oF	Fahrenheit temperature	5/9 (after subtracting 32)	Celsius temperature	oC
<b>TEMPERATURE (exact)</b>				
oC	Celsius temperature	9/5 (then add 32)	Fahrenheit temperature	oF



\*1 in. = 2.54 cm (exactly). For other exact conversions and more detail tables see NBS Misc. Publ. 286, Units of Weight and Measures. Price \$2.25 SD Catalog No. C13 10 286.



## PREFACE

This work is part of a study of railroad ballast and subgrade requirements including synthesis of track substructure materials engineering and stabilization practices, and practices for the design of the substructure for conventional railroad tracks. This report concerns practices for the design of the substructure of conventional railroad track and performance evaluation practices. The study was conducted by Goldberg-Zoino & Associates, Inc. (GZA) of Newton, Massachusetts for the U.S. Department of Transportation's Transportation Systems Center (TSC) in Cambridge, Massachusetts, under Contract DOT-TSC-1527, and was sponsored by the Federal Railroad Administration (FRA), Office of Rail Safety Research, Improved Track Structures Research Division, Washington, D.C.

The TSC Technical Monitor for this project is Mr. James Lamond. The Principal Investigator for the study was Dr. Richard M. Simon, Senior Geotechnical Engineer at GZA. Mr. Mathew A. DiPilato, GZA, was the principal author of the report. Mr. Elliot I. Steinberg, GZA, headed the study of lateral and longitudinal loads. Mr. Alyn V. Levergood from the firm of Thomas K. Dyer, Inc. (TKD) of Lexington, Massachusetts contributed to the material on track geometry, drainage, and substructure evaluation methods. Messrs. Thomas K. Dyer, Raymond F. Sweeney and Russel W. Maccabe of TKD cooperated with us in development of this report. Mr. Donald T. Goldberg, GZA, served as overall project reviewer. Ms. Donna Meeker conducted an initial survey of the literature. Ms. Donna Comeau, GZA, prepared final documents.



## EXECUTIVE SUMMARY

Objective: The objective of this study is to review and synthesize the best available technology that might be applied to the design and construction of conventional railroad track substructure. The first phase of the study develops recommended practices for exploring, testing, classifying, and selecting earth materials for use in railroad track substructure--i.e., ballast, subballast, and subgrades. The second phase identifies available technologies for stabilizing and improving the performance level of track subgrade soils, whether to meet present loading demands of higher axle loads or more stringent operating criteria. The results of the first and second phases of this study have been presented in a separate report entitled "Ballast and Subgrade Requirements Study: Railroad Track Substructure - Materials Evaluation and Stabilization Practices." The final phase, covered in this report, surveys available methods for analysis, design, and performance evaluation of track substructures.

Scope of Study: The scope of this study has been to review available technology in the railroad engineering field, as well as technologies in highway and airfield pavement engineering, geology, foundation engineering, and related areas that can be directly applied to railroad substructure engineering. This review has included a broad survey of published literature, personal communications with practicing railroad engineers and researchers, and our own general experience in dealing with earth materials in civil engineering construction. Pertinent design and evaluation procedures that are discussed herein were selected primarily because they incorporate significant factors related to track design and because the methods can be easily applied and have been successfully used in practice. Shortcomings in some of the more popular analytical methods used in North America today are highlighted. In compiling potential performance evaluation parameters and methods, emphasis was placed on those parameters and methods that can provide data on an extensive length of track relatively quickly.

Research Justification: American railroads have been increasingly beset by financial difficulties. A major factor compounding the financial problems of many railroads is the increasing cost of maintenance. As costs and need for maintenance increase, it has been difficult to expand the maintenance funds to match the need, leading to increased deterioration of the track structure. In recent years, the railroad industry has fallen behind in maintenance work, and the serviceability of railroad tracks has decreased. A major factor contributing to increased track deterioration has been an increase in wheel loads over those the track structure was designed to handle. While superstructure components such as rails, ties, and fasteners have been upgraded to handle the higher stresses generated by these loads, little has been done to upgrade the track substructure, the ballast, subballast, and subgrade. One reason has been the lack of analytical or design methods available to evaluate the layer thicknesses

and material properties required. This study has collected the design methods available to perform these functions, along with new methods being developed.

Summary of Results: The trend in U.S. and Canada has been toward bigger cars and increased wheel loadings, with 100-ton and larger cars rapidly becoming the rule rather than the exception. In the period from 1955 to 1978, the average carrying capacity of cars increased by 43 percent. For the most part, these larger wheel loads are moving over track structures designed for significantly smaller wheel loads.

The wheels apply dynamic loads to the track structure. These dynamic loads are in two forms: 1) impact loads, such as truck-hunting, nosing, rock and roll, and vertical bounce; and 2) high frequency vibrations. Impact loads are normally considered in track design by doubling the design static wheel load. The effects of vibrations are poorly understood and generally not accounted for in track design. However, high frequency damping shields, such as hard rubber tie pads, are used to reduce vibration energies transferred through the track structure.

The ultimate objective of good track design is to maintain the required track geometry criteria for optimum train performance. Minimum geometry criteria for safe track performance have been established by the U.S. Federal Railroad Administration. Track geometry criteria for maintaining economical track performance established for the Northeast Corridor Improvement Project and by the Japanese and British railroads are presented.

Current design practice in the U.S. and Canada predominantly is based on experience. This experience has resulted in several North American railroads developing standard designs for ballast and subballast depths. Allowances for increases in ballast and subballast depth due to weak subgrade conditions are made. However, there is no standard practice to identify subgrade conditions where standard cross sections will not suffice, nor to evaluate how to modify the standard substructure design to compensate for weak subgrade conditions. Rational testing and analytical methods do not appear to be in use as much as they could be.

The beam-on-elastic foundation analysis method presented in the American Railway Engineering Association (AREA) Manual for Railway Engineering is the best known analytic method available for U.S. and Canadian railroads today. This method has several limitations in that it does not adequately represent the performance of individual track components, evaluates resilient stresses and deformations only, and does not consider repeated dynamic loading or residual displacement of components. The track modulus,  $u$ , is used to represent the stiffness of ties, ballast, subballast, and subgrade. Many factors affect the value of  $u$ , but these factors are difficult to isolate. Little attention is paid to determining the type, strength, and conditions of subgrade soils and to incorporating these properties into analysis and design.

The principal criterion for track substructure design today is limiting the pressure on the subgrade to an amount the subgrade can support; AREA

recommends a limit of 20 psi. This, however, may lead to performance difficulties in loose fine sands, clays, silts, and dumped uncompacted fills since the allowable bearing pressure of soils varies. In our opinion, this area of track substructure design requires further study.

As in U.S and Canadian practice, the principal criterion in European and Asian railroad design practices is to limit the resilient stresses on the track subgrade, so that bearing capacity failures and excessive permanent settlement are avoided. Also like North American practice, standard track sections have been developed, and experience plays a large role in determining which section to use depending on subgrade conditions. Additionally, practical analytical methods have been developed and are used for determining the required thickness of ballast and subballast layers, considering both the type and properties of local subgrade materials. In addition, after track sections are built or rehabilitated, track and substructure performance is monitored in order to evaluate the particular substructure design and design procedure.

Review of foreign practice has revealed three basic substructure analytical/design methods. They include: multi-layer elastic methods reported by railroads in West Germany, Hungary, Czechoslovakia, and Japan; the threshold stress approach used by British Railways; and an effective stress analysis used by the Indian State Railway to determine substructure layer thicknesses.

Comparison of standard wheel loads and substructure sections used in North America and foreign railways revealed that:

- a. North American track structures experience static loads 50 to 80 percent higher than do most foreign railroads.
- b. For these higher loads, North American railroads use thinner substructure sections, from 12 to 24 inches, as opposed to the 16 to 32 inches used by many foreign railroads.

Several analytical computer models which represent the individual track structure components have been developed over the past 10 years. The promise of analytic tools such as these is their ability to model the influence of different track structure conditions economically. They can be used to perform parameter studies to determine the effects of changing load, rail, tie, ballast, subballast, and subgrade properties on the performance of other track components and on the track structure as a whole. Few parameter studies of this nature are available. A method for predicting the residual deformation of the ballast has been developed. This method is in the preliminary stages of development and must be extended to predictions of subballast and subgrade deformations. Field data are necessary to validate theoretical deformation predictions. The method predicts uniform total deformations. However, it is differential settlement along the track that is of real interest to railroad engineers. With the accumulation of field settlement data, an empirical means of estimating differential settlement from average settlement could be developed.

G. P. Raymond has presented a rational, simplified design method for determining the depth of ballast plus subballast over the subgrade. The method was developed within the framework of current U.S. and Canadian design practices, modified using recent research findings, and updated for 100-ton car wheel loads. As such, it can be readily used by practicing engineers. In addition, Raymond outlines how to use the method to address soft subgrades and to upgrade track for higher load levels. The method is useful in that it allows a relatively simple, yet rational, approach for analyzing track substructure conditions by modifying current AREA standard practice. While the allowable subgrade pressures provided by Raymond appear reasonable for compacted subgrades, caution should be taken in applying them to unstabilized, natural soils.

Current North American practice of design for lateral loads is given by AREA in their standard ballast sections, requiring full tie embedment and 6-inch shoulders. Lateral loads determine the method for computing ballast shoulder width required to resist thermal loads.

A. D. Kerr has developed a design aid for assessing safe temperature increases in continuous welded rail (CWR). Using field data, the French railways have developed a method for determining the critical lateral force for occupied track subjected to vertical and lateral loadings. Mechanical ballast compaction has shown the potential to increase resistance to thermal buckling of CWR by 40 percent. Selection of certain tie types and reinforcements and improved CWR installation practice can increase the resistance of track to lateral loads.

No significant longitudinal load design criteria were found. Little work has been done to improve longitudinal loading design.

Drainage systems necessary to handle track surface runoff and subsurface drainage are generally those presented by AREA and are described herein.

Track substructure evaluation involves three steps:

1. Establishment of substructure performance criteria or standards
2. Observation of track conditions
3. Comparison of observations with performance criteria to develop an evaluation of the track.

Substructure performance criteria should be based on the three basic functions of the track substructure: maintaining geometry, providing a resilient support layer, and providing rapid drainage.

The purposes of track observation methods are to (1) identify safety-related track defects, (2) monitor general condition and changes in track conditions, (3) evaluate maximum service level of a track section, and/or (4) evaluate existing track performance in order to develop a design to upgrade performance.

Visual inspection is the most common observation method used today in the U.S. and Canada; however, it is subjective and based on the experience of the observer. Track geometry cars are becoming more widely used to supply track geometry data. Lateral load tests have been used infrequently to evaluate the lateral load resistance of track. Track modulus tests and various types of plate load tests have been used to measure substructure resilience, along with a dynamic system used on track geometry recorder cars.

No single method can satisfy the different requirements or purposes for substructure evaluation. Several methods are presented with the intent that each has its proper application. Further development and experience with these recommended methods are necessary before suggested guidelines for their application can be developed.

## TABLE OF CONTENTS

<u>Section</u>	<u>Page</u>
	Executive Summary
1	INTRODUCTION.....1
	1.1 The Track Structure.....1
	1.2 Report Organization.....6
2	TRACK LOADING CONDITIONS.....7
	2.1 Vertical Loading.....8
	2.2 Lateral Loading.....18
	2.3 Longitudinal Loading.....21
3	TRACK GEOMETRY.....24
	3.1 Definitions.....24
	3.2 Dynamic Track Response and Effect on Track Geometry....24
	3.3 Degradation of Track Structure Geometry.....25
	3.4 Track Geometry Criteria.....27
4	VERTICAL LOADING: PERFORMANCE, DESIGN, AND ANALYSIS.....31
	4.1 Substructure Material Behaviour.....32
	4.2 Current U.S. and Canadian Design Practice.....45
	4.3 Foreign Design Practices.....60
	4.4 Discussion: U.S., Canadian, and International Practices.74
	4.5 Recent Analytic and Design Developments.....76
5	LATERAL LOADING: PERFORMANCE, DESIGN, AND ANALYSIS.....93
	5.1 Introduction.....93
	5.2 Ballast Resistance Mechanisms and Response to Loading...94
	5.3 Ballast Resistance: Unoccupied Track.....100
	5.4 Ballast Resistance: Occupied Track.....108
	5.5 Lateral Loading Performance Characteristics.....112
	5.6 Current U.S. and Canadian Design Practice.....114
	5.7 Recent Analytic and Design Developments.....115
6	LONGITUDINAL LOADING: PERFORMANCE, DESIGN, AND ANALYSIS....119
	6.1 Longitudinal Resistance Mechanism and Response to Loading.....119
	6.2 Current North American Design Practice/Assessment.....120
7	DESIGN FOR DRAINAGE AND OTHER ENVIRONMENTAL CRITERIA.....121
	7.1 Drainage Structures.....122
	7.2 Environmental Considerations in Substructure Design....125



TABLE OF CONTENTS (CONTINUED)

<u>Section</u>		<u>Page</u>
8	EVALUATION OF TRACK SUBSTRUCTURE.....	130
	8.1 Substructure Performance Criteria.....	130
	8.2 Track Substructure Observation Methods.....	136
	8.3 Recommended Substructure Evaluation Methods.....	140
9	CONCLUSIONS.....	143
	APPENDIX A - REPORT OF NEW TECHNOLOGY.....	A-1
	Bibliography.....	Bib-1

## LIST OF ILLUSTRATIONS

<u>Figure</u>		<u>Page</u>
2-1	Values of K for Various Dynamic Load Formulas	16
3-1	Track Deflection Criteria for Durability	26
4-1	Typical Repeated Load Behavior of Substructure Materials	33
4-2	Typical Gauge Layout at FAST	38
4-3	Typical Dynamic Response of Substructure Inductance Coils at FAST	40
4-4	Typical Dynamic Response of Substructure Inductance Coils at FAST	41
4-5	Residual Deformations Measured in Substructure at FAST	42
4-6	Ballast Density Changes with Traffic Estimated From Initial Density and Ballast Strain	46
4-7	Flow Chart for Conventional At-Grade Track Structure Design	48
4-8	Japanese National Railways (JNR) Design Method	66
4-9	British Railways Threshold Stress Design Method	69
4-10	Indian State Railways Design Method	73
4-11	Typical Design Charts as Developed By So	81
4-12	Comparison of Predicted and Measured Values of Ballast Residual Strain	87
4-13	Simplified Design Method	91
5-1	Schematic Lateral Stiffness of Track Superstructure	95
5-2	Ballast Bed Resistance	98
5-3	Special Ties for Increased Lateral Resistance	102
5-4	Safety Cap Tie Reinforcement	103
5-5	Schematic Ballast Profiles	109
5-6	Typical Lateral Force/Displacement Curves for 3-Tie Track Panel	111
5-7	Apparatus for Measuring Lateral Ballast Resistance	113
5-8	Standard AREA Ballast Sections	116
7-1	Track Structure Cross Section	123
7-2	Buried Drain Cross Sections	124
7-3	Intercepting Ditches Required at Toe of Fill	126
7-4	Subsurface Drainage System to Lower Groundwater Table on Sidehill Cut	127
7-5	Subsurface Drainage System to Lower Groundwater Table in a Wet Cut	127

## LIST OF TABLES

<u>Table</u>		<u>Page</u>
2-1	Permissible Gross Weights and Nominal Car Capacities for Freight Cars in The U.S.	8
2-2	Serviceable Cars and Average Nominal Capacity - Owned or Leased and Private Cars on Line - 1955 to 1978	9
2-3	Weights of Typical Rolling Stock: North American and Foreign Railroads	10
2-4	Maximum Recommended Load on Wheels of Various Diameters	12
2-5	Maximum Load on Wheels of Various Diameters	12
2-6	Factors and Variables Influencing Response to Dynamic Loading	13
3-1	Summary of Typical Track Geometry Deviations	27
3-2	Parameters for Maintenance Scheduling and Quality Control Evaluation: Northeast Corridor Passenger Rail Service	29
3-3	Track Geometry Criteria for Japanese and British Railways	30
4-1	Response of Cohesionless Material (Ballast, Subballast, Sand and Gravel)	35
4-2	Response of Cohesive Materials (Fine Grained Soils With Silt and Clay)	36
4-3	Factors Affecting Substructure Response at FAST	39
4-4	Specification for Main Line Track Formation	56
4-5	Allowable Average Subgrade Bearing Pressures	59
4-6	Ideal, Good, and Bad Subgrade Materials According to Spang	64
4-7	Typical Foreign Substructure Sections	65
4-8	Analytical Models Developed in the United States and Canada	79
4-9	Effects of Substructure Properties on Track Components	82
5-1	Summary of Ballast Lateral Resistance Forces and Parameters	97
5-2	Contribution Toward Total Lateral Resistance of Various Ballast Resisting Forces	100
8-1	Track Geometry Criteria	132
8-2	Track Recording Car Descriptions Based on Manufacturer's Literature	138

## LIST OF SYMBOLS

A	=	irregularity of the track; area; Skempton's pore pressure parameter; cross-sectional area of rail
A <sub>b</sub>	=	effective tie bearing area on the ballast per rail seat
AAR	=	Association of American Railroads
AREA	=	American Railway Engineering Association
ARTS	=	Analysis of Rail Track Structures Model
ASCE	=	American Society of Civil Engineers
a	=	tie spacing
B	=	stiffness ratio; tie width; ballast bearing index; Skempton's pore pressure parameters
BCL	=	Battelle Columbus Laboratories
B&LE	=	Bessemer and Lake Erie Railroad
BR	=	British Railways
b	=	tie width
CBR	=	California Bearing Ratio
CH	=	inorganic clay of high plasticity according to Unified Soil Classification
CL	=	inorganic clay of low to medium plasticity according to Unified Soil Classification
CSD	=	Czechoslovakian State Railways
CSR	=	coefficient of subgrade reaction
CWR	=	Continuous Welded Rail
$\bar{c}$	=	Mohr - Coulomb cohesion intercept
cm/sec	=	centimeters per second
D	=	wheel diameter; deflection; ballast depth
D <sub>1</sub>	=	spring constant of rail support
D <sub>c</sub>	=	degree of track curvature (degrees)
DB	=	German Federal Railway (Deutsche Bundesbahn)
D&RGW	=	Denver & Rio Grande Western Railroad
ΔD	=	increase in ballast depth
E	=	Young's Modulus (modulus of elasticity)
E <sub>r</sub>	=	resilient Young's Modulus
E <sub>e</sub>	=	common modulus of elasticity (Hungarian)
E <sub>p</sub>	=	required deformation Modulus (Czech)
EI	=	vertical bending stiffness of the rail (Japanese); transverse rail rigidity, (French)
EJ	=	vertical rail rigidity, (French)
e	=	base of natural logarithms
FAST	=	Facility for Accelerated Service Testing
FRA	=	Federal Railroad Administration

LIST OF SYMBOLS (Continued)

°F	=	degrees Farenheit
G	=	maximum shear stress $(\sigma_1 - \sigma_3)/2$
GC	=	clayey gravels according to Unified Soil Classification
GEOTRACK	=	analytical track model developed at University of Massachusetts
GM	=	silty gravels according to Unified Soil Classification
GP	=	poorly graded gravels according to Unified Soil Classification
GW	=	well graded gravels according to Unified Soil Classification
H	=	total thickness of pavement (m)
H <sub>C</sub>	=	critical lateral force (French)
h	=	ballast depth
I	=	rail moment of inertia (in <sup>4</sup> )
ILLITRACK	=	analytical track model developed at Univeristy of Illinois
IUR	=	International Union of Railways
JNR	=	Japanese National Railways
K	=	total dynamic overload factor; speed effect factor; coefficient related to static rail values, axle loading, and dynamic factors, (Hungarian); empirical factor related to resilient Young's Modulus, E <sub>r</sub>
k <sub>0</sub>	=	coefficient of lateral stress at rest
k	=	track modulus, N/m <sup>2</sup> , (French); coefficient of permeability
k <sub>0</sub>	=	low track modulus, N/m <sup>2</sup> , (French)
k <sub>1,2,3</sub>	=	spring constants for Peterson's speed effects formula
K <sub>S</sub>	=	coefficient of tie spacing effect
kg/m	=	kilograms per meter
km/hr	=	kilometers per hour
kN	=	kilonewton
kN/m <sup>2</sup>	=	kilonewton per square meter (kilopascal, kPa)
kPa	=	kilopascal
L	=	rail length
LTPT	=	Lateral Tie Push Test
lb/in/in	=	pound per inch per inch of track
lb/in <sup>2</sup>	=	pounds per square inch
lb/yd	=	pound per yard
MAV	=	Hungarian State Railway
MGT	=	Million Gross Tons

## LIST OF SYMBOLS (Continued)

MH	=	inorganic elastic silts according to Unified Soil Classification
MN/m/m	=	meganewton per meter per meter of rail
MPa	=	megapascals
MULTA	=	Multi-Layer Track Analysis Model
m	=	meter
$m_0$	=	unsprung mass of a vehicle axle
mm	=	millimeter
m/hr	=	meters per hour
N	=	number of load cycles
$N_t$	=	induced compressive or tensile force
NECIP	=	Northeast Corridor Improvement Project
Nm	=	newton - meters
n	=	empirical coefficient related to Young's modulus, $E_r$
OH	=	organic clays of medium to high plasticity according to Unified Soil Classification
OL	=	organic silts of low plasticity according to Unified Soil Classification
ORE	=	Office for Research and Experiments
P	=	vertical load; vertical axle load, (French)
$\bar{P}$	=	average effective principal stress $(\bar{\sigma}_1 + \bar{\sigma}_3)/2$
$P_c$	=	subgrade pressure (psi)
$P_d$	=	dynamic wheel load (lbs)
$P_{dt}$	=	design dynamic rail seat load (lbs)
$P_f$	=	thermally induced lateral load per linear foot of track
$P_0$	=	track dead load, (French)
$P_s$	=	static wheel load (lbs)
PLT	=	Plate Load Test
P&Q	=	priority and quality index rating for overall track condition as used by Southern Railway
PSA	=	Prismatic Solid Analysis Model
p	=	traffic load
$P_m$	=	tie ballast bearing pressure
psi	=	pounds per square inch

## LIST OF SYMBOLS (Continued)

$q_0$	=	static rail seat load
$R$	=	radius of track curvature, (French)
$R_0$	=	empirical coefficient related to track curvature, $R$ , and temperature increase, $\Delta\theta$ , (French)
$r$	=	the radius of a circle whose area equals the tie ballast bearing area, $A_b$
$S$	=	rail cross-sectional area, $m^2$ , (French)
SC	=	clayey sands according to Unified Soil Classification
SM	=	silty sands according to Unified Soil Classification
SNCF	=	French National Railway
SP	=	poorly graded sands according to Unified Soil Classification
SR	=	Southern Railway
S/B	=	dynamic wheel load (Raymond)
SW	=	well-graded sands according to Unified Soil Classification
$s$	=	tie spacing
$T_0$	=	uniform temperature increase ( $^{\circ}F$ )
$\Delta T$	=	temperature change ( $^{\circ}F$ ) above rail laying temperature
$t$	=	time
$U$	=	Uniformity Coefficient
$u$	=	track modulus (psi)
$u_t$	=	total pore pressure
$\mu_s$	=	static pore pressure
$\Delta\mu$	=	pore pressure change
$v$	=	speed
$W_d$	=	dynamic wheel load
$W_s$	=	static wheel load
$\Delta W_s$	=	change in static wheel load
$W/D$	=	wheel load/ wheel diameter ratio
$x$	=	distance along the rail from the point of load application (in)
$y$	=	deflection of rail (in)
$y$	=	maximum deflection
$Z$	=	depth below tie bottom
$\alpha$	=	slope of Mohr-Coulomb failure envelope; empirical coefficient describing influence of ballast density (French); coefficient of linear thermal expansion

LIST OF SYMBOLS (Continued)

$\beta$	=	empirical coefficient describing thermal expansion of straight track, °C/m <sup>2</sup> , (French)
$\epsilon$	=	strain; coefficient related to influence of transverse and vertical rail rigidity, (French)
$\epsilon_1$	=	residual strain after the first cycle
$\epsilon_n$	=	residual strain after N cycles
$\epsilon_v$	=	total vertical strain after 1 cycle
$\Delta\epsilon_a$	=	change in axial strain
$\bar{\phi}$	=	friction angle based on effective stresses
$\sigma$	=	stress
$\sigma_1$	=	total vertical stress
$\bar{\sigma}_1$	=	effective vertical stress
$\Delta\sigma_1$	=	change in major principal stress (vertical)
$\sigma_3$	=	total lateral stress, confining pressure
$\bar{\sigma}_3$	=	effective lateral stress
$\Delta\sigma_3$	=	change in minor principal (lateral) stress
$\Delta\sigma_a$	=	change in axial stress
$\theta$	=	confining stress
$\Delta\theta$	=	increase in rail temperature above neutral temperature, °C, (French)



## 1. INTRODUCTION

The U.S. Department of Transportation's Transportation Systems Center (TSC) has undertaken the implementation of the Improved Track Structures Research Program for the Federal Railroad Administration (FRA). This program is aimed toward improving the safety of rail service in the United States. Among the major program goals are the identification of track-related causes of train accidents, development of guidelines for design of track, and development of analytic tools for the prediction of track system/track component performance and safe life.

A major component of the railroad track system is the track substructure (i.e., the ballast, subballast, subgrade, and foundation). Within the past decade, the FRA's program of substructure research has concentrated on the analytic and empirical means of developing pertinent substructure design criteria. To date, this work has concentrated on evaluating the properties of substructure materials under static and cyclic loading, and the development of computer models for analyzing substructure component response to static loads.

The present study has included a comprehensive review of current railroad substructure engineering practices and technologies and a review of the related engineering practices in the fields of soil and rock mechanics, geology, highway and airfield pavement design and evaluation, and associated geotechnical engineering fields. This report presents the technology and design criteria related to the track substructure design procedures judged most suitable for implementation based on a comprehensive review of design procedures used by railroads in the United States and Canada (North America) and by railroads in other countries to support vertical, lateral, and longitudinal loads. In addition, the results of recent research efforts and recently developed analytic and design methods have been reviewed. This includes computer modelling techniques to evaluate both resilient and residual track displacements. The goal of improved track design and evaluation methods is to improve the safety and economy of railroad operations and maintenance.

### 1.1 THE TRACK STRUCTURE

The purpose of the railroad track structure is to allow the safe and economical passage of trains. As such, its two principal functions are to provide a guideway controlling the vertical and horizontal alignment of the train and to receive rail vehicle wheel loads and distribute these loads to the natural soils underlying the track, remaining within the allowable working stresses of the soils.

The conventional railroad track structure is composed of many components, including rails, fasteners, crossties, tieplates, ballast, subballast, and

the subgrade. These components must perform as a system to properly achieve their functions. If one component of the system becomes defective, other components may become overstressed. The interactions among track components under load are extremely complex, making the study of each individual track component's role difficult.

To facilitate identification of the track structure components and to emphasize the earth materials as integral parts of the track structure, the terms superstructure and substructure are used. The track superstructure includes the rails, fasteners, tieplates, and crossties. The track substructure includes the ballast, subballast, and subgrade layers.

### Superstructure

Rails - The function of rails is to support and transfer the vehicle wheel loads to the underlying ties. Rails are flexible and will bend under load, distributing the imposed loading over several crossties. As a rail vehicle moves along the rails, the rails deflect and a wave motion is established in each rail. The wave action extends in both directions and moves along the rail with the wheel. If the wave action is excessive, two undesirable effects are produced:

- a. The vehicle wheels encounter excess rolling resistance.
- b. The wave action in the rail is transmitted to the ties and ballast under the ties, causing strain and deterioration of both materials<sup>1</sup>.

Increasing the rail size, thus providing greater girder strength, increases rail stiffness and its resistance to deflection under load. Increased stiffness enables the rail to distribute the wheel load over a greater number of crossties than a lighter rail section. With increased axle load and speeds, some consideration should be given to increasing rail stiffness and strength to control the maximum load transmitted to each tie, to reduce excessive wave action of the rail, and to extend the life of the entire track structure.

Track Fasteners - Track fasteners belong to a group termed "other track materials," usually referred to as OTM. These consist primarily of joint bars and track bolts, track spikes, clips and other rail anchors, and tie plates. The basic functions of track fasteners are to provide continuity of the rails (joint bars and bolts) and to secure the rails and hold the tie plate in position on the ties.

The primary function of tie plates is to distribute the rail load to the tie surface. Other functions include restraining rail movement through

---

<sup>1</sup>W. W. Hay, Railroad Engineering, Volume I, John Wiley and Sons, New York, 1953, pp. 195-226.

frictional resistance, assisting in maintaining track gauge, equalizing track spike holding power, and providing a canted surface to improve the contact between rail head and vehicle wheel tread. The vehicle wheel load on the rail head is distributed over the rail seat area of several tie plates. Load is transferred to the ties such that it is spread out over the area of contact between the tie plates and the ties. If the tie plate size is inadequate for the rail loading, the resulting pressure may exceed the wood fibre compressive strength and thus cause accelerated plate cutting and premature deterioration of the tie.

Ties - The rail distributes the wheel load over several tie plates, and each tie plate transfers its load to the tie. The primary functions of the ties are to maintain track gauge, to support the rails and distribute the wheel loads with diminished unit pressure to the ballast which supports the ties, and to restrain lateral, longitudinal and vertical movement of the rails by providing anchorage for the track superstructure in the ballast.

The tie directly under a wheel load receives the greatest percentage of the wheel load, and the balance of the load is distributed over adjacent ties. Tie performance is directly affected by the condition of the underlying ballast. In properly maintained track, the loads on each tie are transmitted to the tamped ballast concentrated under the rails. This type of tie-ballast stress distribution limits the bending stresses in the ties. However, over time the ballast beneath the rail seats will deform permanently. This will result in an increase in the ballast pressure at the center of the tie. The more uniform stress distribution beneath such "center bound" ties leads to greater bending stresses in the ties and premature tie failure.

### Substructure

The track substructure consists of the ballast, subballast, and subgrade.

Ballast - Ballast is any material that is spread over the subballast or subgrade to perform all of the following functions:

- a. Support the track structure and maintain alignment and grade.
- b. Provide a ready means for adjusting track geometry to reestablish line and grade.
- c. Distribute loads to underlying materials.
- d. Provide rapid drainage of the track and its substructure.
- e. Provide a resilient support layer for the track to limit transmission of dynamic wheel forces to the underlying subballast and subgrade.

f. Provide an insulating layer to limit frost penetration into the subgrade.

g. Provide a cover to inhibit growth of vegetation in the track.

The characteristics of ballast that quantify its performance are divided into five categories:

1. Mechanical--Related to the resistance of ballast to deformation and disintegration under single and repeated stresses

2. Environmental--Related to the resistance of ballast to alteration due to changes in temperature, water, or other nonmechanical factors

3. Permeability--Related to the passage of liquid (e.g., water) and solids (e.g., fine particles) through the ballast

4. Electrical--Related to electrical conductivity or resistivity of the ballast

5. Construction (Maintenance)--related to the ease with which tamping, lining, and other operations may be carried out on the track.

These characteristics are discussed in detail in the companion report of this study on substructure material evaluation practices.

Subballast - Subballast is the layer of material that is placed between the subgrade and ballast to perform the following functions:

a. Maintain the line and surface of the track.

b. Distribute traffic loads from the ballast to limit stress concentrations on the subgrade to an acceptable level.

c. Dampen or absorb vibrations generated by the rolling stock on the track structure.

d. Prevent mixing of the subgrade and ballast layers.

e. Intercept water draining from the ballast and direct it away from the subgrade to ditches at the sides of the track.

f. Reduce frost penetration into the subgrade.

Several of these functions are similar to top ballast functions. The main difference is the subballast's role as a filter material; that is, preventing mixing of ballast and subgrade materials. To accomplish this, subballast materials are usually well-graded, granular materials with grain sizes between those of the overlying ballast and underlying subgrade.

Two types of materials are used for subballast. By far the most common materials are naturally occurring or processed sand and gravels, and crushed natural aggregates or slags. These should be considered as a single class of cohesionless soils.

The other broad class of subballast behaves as cohesive or cemented soil. Clean, sandy materials may be stabilized with cohesive soil to form a stabilized sand-clay subbase material. Cement- or lime-stabilized soils taken from local borrows may be used for subballast if natural or processed aggregates are not economically available. Asphalt-stabilized soil is used for subballast in those rare instances when such a measure is justified economically.

Except for the electrical characteristics, the groups of performance characteristics for subballast are essentially the same as those for ballast listed previously. Subballast design criteria and performance characteristics are discussed in more detail in Sections 4 and 8 and in the materials evaluation and stabilization report (1).

Subgrade - In this report, subgrade soils are considered to be natural earth materials lying under the ballast and subballast. Placement and engineering properties of high fills beneath the subballast and stability of deep cuts are not covered.

Subgrade materials are expected to perform the following functions:

- a. Support the track structure, ballast, and subballast.
- b. Accommodate the stresses due to the superincumbent train loads with small vertical and horizontal deformations.
- c. Maintain a stable position over time that is unaffected by such environmental factors as freezing temperatures, moisture changes, and infiltration of soil particles.
- d. Provide a suitable working base for construction of the subballast and ballast.

Knowledge of the types of subgrade soils that lie under a railroad route and their engineering properties is necessary to:

- a. Determine whether or not subgrade soils will satisfactorily perform the previously mentioned functions.
- b. Design subballast and ballast sections that are compatible with subgrade soils and that will accommodate any deficiencies in the subgrade.
- c. Select and design, if appropriate, suitable subgrade stabilization measures for new track or to improve performance of in-service track.

---

<sup>1</sup>R.M. Simon, L. Edgers, J.V. Errico, "Ballast and Subgrade Requirements Study: Railroad Track Substructure - Materials Evaluation and Stabilization Practices," U.S. Dept. of Transportation, Federal Railroad Administration, Washington DC, 1983, FRA/ORD-83/04.1

d. Select the route, compatible with geotechnical and other requirements, with the most favorable subsurface conditions.

Inadequate consideration of the subgrade strength and deformation properties may result in overstressing the subgrade, significant ballast settlement into the subgrade, and accelerated deterioration of the track structure. Common subgrade problems that occur when the subgrade is not adequately considered in track design include subgrade pumping and fouled ballast, subgrade squeezes and water pockets, progressive settlement, erosion, strength failures, liquefaction, and track deformations due to frost action and swelling soils.

## 1.2 REPORT ORGANIZATION

Principal objectives of improved track substructure design are safety, economy of railroad operations, and track maintenance. Section 2 details the loading conditions--vertical, lateral, and longitudinal--that track must support and describes the procedures that have been developed to compute the loads. The ultimate objective of track design is to establish and maintain a track geometry appropriate for the level of service of the section of the track. Section 3 describes criteria for track geometry currently used.

In Sections 4, 5, and 6, the procedures for vertical, lateral, and longitudinal analysis and design of track structures are synthesized. These sections include a review of current North American design practice, a synthesis of foreign practice, and a description of recently developed analytic procedures.

Section 7 outlines design procedures for substructure drainage. Although drainage is considered separately from structural design of track substructure, the two are intimately connected, because water is a principal factor in determining substructure material mechanical performance. Section 8 outlines available methods for evaluation of substructure performance. This section reviews available substructure performance criteria and the methods that have been developed to observe compliance with potential criteria. Conclusions are set forth in Section 9.

## 2. TRACK LOADING CONDITIONS

Understanding the type and magnitude of loads the track substructure must support is basic to track substructure design. In this section the loading environment, load limitations, and dynamic forces generated and transmitted to the track structure are discussed. Types of loads imposed on the track structure are classified as mechanical, both static and dynamic, and thermal. The track structure must restrain repeated vertical, lateral, and longitudinal loads resulting from traffic and changing thermal loads. The combined vertical, lateral, and longitudinal live loads exerted by a train and transferred through the track superstructure to the substructure determine the dynamic loading environment that must be supported by the substructure.

Chapter 3 of the AREA Manual defines vertical, lateral, and longitudinal loads as follows:

**Vertical Load** - A load or vector component of a load at right angles to a line joining the two rail seats of the tie and normal to the longitudinal axis of the rail. The direction of vertical loads is a function of the cross level and grade of the track.

**Lateral Load** - A load or vector component of a load at the gauge corner of the rail parallel to the longitudinal axis of the tie, and perpendicular to the rail.

**Longitudinal Load** - A load or vector component of a load acting on the rail along the longitudinal axis of the rail.

The dynamic interactions between rail vehicle wheels and the rails are a function of track, vehicle, and train characteristics, operating conditions, and environmental conditions. Forces applied to the track by moving cars are a combination of a static load and a dynamic component superimposed on the static load. Maximum stresses and strains in the track system occur under this dynamic loading which is often expressed by a factor which increases the static load.

High frequency vibrations also result from dynamic loading. Vibrations can significantly affect track superstructure and substructure component performance, particularly at high speeds.

Temperature changes induce thermal stresses in the rail which cause expansion or contraction of the steel. Any restraint to the change in length, as in continuous welded rail, will set up internal stresses generally represented by a force acting in a longitudinal direction in the rail. Without sufficient resistance, track buckling can occur in a vertical or lateral direction due to the longitudinal forces in the rails.

## 2.1 VERTICAL LOADING

### 2.1.1 Static Loads and Live Loads

The static load is the vehicle load acting on the rail head with the vehicle stationary. The direction of the forces exerted by the vehicle wheels on the rails on well-maintained, tangent track is perpendicular to the rail head. On superelevated, curved track, the static load is exerted at an angle to the rail head.

As defined by the Association of American Railroads, the permissible gross rail load is the maximum loaded weight of a car permitted in a consist. The nominal capacity of a car indicates the approximate car capacity. The permissible gross weight on rail and nominal capacities for freight cars in the United States are listed in Table 2-1. The permissible gross rail load of most freight cars was increased in 1963. For example, the 210,000-pound gross rail load was increased to 220,000 pounds for a 70-ton (nominal capacity) car. The 70-ton car is now designated as a 77-ton car.

---

TABLE 2-1. PERMISSIBLE GROSS WEIGHTS AND NOMINAL CAR CAPACITIES  
FOR FREIGHT CARS IN THE U.S.

<u>Journal Size</u>	<u>Permissible Gross Weight On Rail</u> (4 axles per Car) pounds	<u>Nominal Car Capacity</u>	
		pounds	tons
5-1/2 x 10	177,000	110,000	55
6 x 11	220,000	154,000	77
6-1/2 x 12	263,000	200,000	100
7 x 12	315,000	250,000	125

---

The trend in North America has been toward bigger cars, increased wheel loadings and heavier trains. According to a review of railroad car orders made in 1979, approximately 75 percent of freight car orders are for cars of 100-ton capacity or greater<sup>1</sup>. As shown in Table 2-2, the average carrying capacity of the serviceable cars in the U.S. increased 43 percent for the period from 1955-1978. In 1978, W. So noted that a typical train operating on a main line has a consist of approximately 20 percent 100-ton cars and 50 percent 70-ton cars<sup>2</sup>.

---

<sup>1</sup>"Review of Car and Locomotive Orders," Railway Age, Vol. 180, No. 2, January 28, 1980, p. 28.

<sup>2</sup>W. So, "Track Structure Design Using Mathematical Models," U.S. Department of Transportation, Federal Railroad Administration, Washington, D.C., June 1978, FRA/ORD-78/08, p. 17.



TABLE 2-2. SERVICEABLE CARS AND AVERAGE NOMINAL CAPACITY - OWNED OR LEASED AND PRIVATE CARS ON LINE - 1955 TO 1978

<u>YEAR</u>	<u>TOTAL FREIGHT CARS (1,000)</u>	<u>AVERAGE CARRYING CAPACITY (TONS)</u>
1955	1,699	53.7
1960	1,658	55.4
1965	1,478	59.7
1970	1,671	67.2
1971	1,659	68.4
1972	1,638	69.6
1973	1,717	70.5
1974	1,711	71.6
1975	1,721	72.9
1976	1,724	73.8
1977	1,699	75.5
1978	1,653	76.7

Note - Does not include cars owned by Canadian Railroads  
Source - Association of American Railroads

The maximum weight on rail and the respective wheel loadings are listed in Table 2-3 for some of the typical freight cars and locomotives in North America. Several foreign railroad limits are listed, as well as a few heavy rail transit vehicles. The wheel load per inch of wheel diameter is shown, as this is a factor in the evaluation of rail head contact stresses.

### 2.1.2 Effects of Heavier Cars

The practical limit for car capacity has been studied intensely for several years. Some of the factors involved are:

- a. Vehicle and truck performance characteristics
- b. 2-axle versus 3-axle trucks
- c. Wheel loadings and their effects on the rail head contact and shear stresses
- d. The economics of larger cars, which involves fewer cars and operating department savings

TABLE 2-3. WEIGHTS OF TYPICAL ROLLING STOCK: NORTH AMERICAN & FOREIGN RAILROADS

VEHICLE	MAXIMUM WEIGHT ON RAIL (lbs)	WHEEL DIAMETER (inches)	MAXIMUM WHEEL LOAD (lbs)	LOAD PER WHEEL DIAMETER (lbs/inch)	AXLES PER VEHICLE	AXLE SPACING (WHEEL BASE)	TRUCK CENTERS (APPROX.)	REMARKS
<u>Freight Cars North America</u>								
125 ton	315,000	38	39,375	1,036	4	6'-0"	45'-3"	Maximum recommended -AAR-for Plate B or C width equipment. Cars such as high cube have truck centers of greater length.
100 ton	263,000	36	32,875	913	4	5'-10"	45'-3"	
77 ton	220,000	33	27,500	833	4	5'-8"	45'-3"	
<u>Locomotives North America</u>								
Typical 6-Axle Loco.	375,000	40	31,250	781	6	11'-2" 13'-7"	47' 41'-43.6"	3,000 to 3,600 HP Range
Typical 4-Axle Loco.	240,000	40	32,000	800	4	9'-4" 9'-0"	34'-36'	1,500 to 3,300 HP Range
<u>Foreign Railroads</u>								
British Rail			22,500					5,700 HP-Electric
Soviet Railways			25,300					
Japanese National Railway			19,800					
France-SNCF			25,300					
Germany-GFR			22,000					
Soviet Railways Loco.	282,000		23,500		6			
Australia (Ore RR)	263,000	36	32,800	910	4			
<u>MBTA</u>								
RT* No. 1	96,382	28	12,000	430	4	6'-10"	51'	
RT No. 4	132,000	28	16,500	590	4	6'-10"	31'	
NYCTA-R46	138,360	34	17,300	510	4	6'-10"	54'	
MARTA-RT	122,100	34	15,300	450	4	7'-3"	52'	
PATH-RT	81,500	28	10,200	365	4	6'-10"	33'	
WMATA-RT	108,000	28	13,500	485	4	7'-3"	52'	
<u>London Transport-RT</u>								
London Transport-RT	98,665	36	12,300	345	4	7'-6"	36'	
<u>AMTRAK Metroliner</u>								
AMTRAK Metroliner	170,000	36	21,300	590	4		60'	
<u>B&amp;M-RDC-1</u>								
B&M-RDC-1	131,900	33	16,500	500	4	8'-6"	60'	

\*RT = Heavy Rail Transit Vehicle

e. Additional maintenance of way costs because of the effects of the higher loads on the track structure.

Despite these studies, no final conclusions have been reached.

J. R. Sunnycard<sup>3</sup> noted that for some railroads the deterioration of the track structure is less dramatic if the addition of heavy cars on a line is gradual; however, if only heavy cars are moved, such as in a 100-ton unit train, the rate of wear and general track structure deterioration will be more rapid.

Engineering officers of several large railroads in North America and the AAR have expressed their opinions about the economic and physical relationships between heavy cars and the track structure. Their concerns are:

1. Increased rate of ballast settlement associated with fracturing of the sharp corners of the ballast material in the substructure
2. Increased rail wear because of plastic flow, especially at high speeds. Extent of work hardening prior to imposing 100-ton traffic is a factor
3. Increased rate of rail defect occurrence
4. Increased rate of crushing of wood caps on timber trestles.

One railroad spokesman estimated an overall track maintenance cost increase of approximately 20 percent attributed to 100-ton car traffic as compared to operation of cars having an average weight of 55 tons. The estimate was based on a study conducted in one railroad system<sup>4</sup>.

In 1958, a Joint Committee of AREA on the Relation between Track and Equipment was asked to submit a recommendation on the limitation of wheel loads for diesel and turbine locomotives. The Committee's modified recommendation was for both cars and locomotives and appears in Table 2-4. The table was developed based on consideration of worn wheels operating on worn rail. Computations in this table are based on a rail head allowable shearing stress of 50,000 psi and a static wheel load increased 50 percent for dynamic impact loading, according to C. J. Code<sup>5</sup>.

---

<sup>3</sup>J. R. Sunnycard, "Effect of Heavy Cars on Rail," Proceedings, Vol. 78, Bulletin, No. 663, AREA, June-July 1977, pp. 611-635.

<sup>4</sup>G. Welty, "Engineering for the Big Cars - What Kind of Track?," Railway Age, Vol. 178, No. 5, March 14, 1977, pp. 24-26.

<sup>5</sup>C. J. Code, "Wheel Load, Wheel Diameter and Rail Damage," Proceedings, AREA, Vol. 61, 1960, pp. 1219-1223.

---

TABLE 2-4. MAXIMUM RECOMMENDED LOAD ON WHEELS OF VARIOUS DIAMETERS

<u>Nominal Wheel Diameter (inches)</u>	<u>Wheel Load (lbs)</u>	<u>W/D (lbs/in)</u>
33	26,400	800
36	29,200	810
38	31,200	820
40	33,000	825
42	34,900	830

---

A comparison of these recommendations with actual present day wheel loads is shown in Table 2-5.

---

TABLE 2-5. MAXIMUM LOAD ON WHEELS OF VARIOUS DIAMETERS

<u>Nominal Wheel Diameter</u>	<u>1959-Recommended lbs/Wheel Load</u>		<u>Present Loads lbs/Wheel Load</u>		<u>Increase Over 1959 Recommendation</u>
	<u>inch</u>	<u>lbs</u>	<u>inch</u>	<u>lbs</u>	<u>%</u>
33	800	26,400	833	27,500	4
36	810	29,200	913	32,875	12.7
38	820	31,200	1036	39,375	26.3

---

### 2.1.3 Dynamic Effects

The track superstructure, substructure, and rail vehicles constitute a dynamic system. Dynamic forces result from the interaction among coupled vehicles in a moving train and from the interaction between the vehicles and the track system. Factors that influence dynamic response of the rail vehicles and track system, and thus determine track and train performance, are indicated in Table 2-6.

---

---

TABLE 2-6. FACTORS AND VARIABLES INFLUENCING RESPONSE TO DYNAMIC LOADING

- (1) Track Characteristics -
    - a. Geometry - gradient and curvature
    - b. Rail Type - jointed or continuous welded
    - c. Strength and condition - quality of maintenance
    - d. Stiffness - track modulus
  - (2) Vehicle Characteristics -
    - a. Equipment size, weight, and design
    - b. Truck design and spacing
    - c. Lading - Type, weight, and distribution
  - (3) Climate Conditions -
    - a. Temperature and moisture
  - (4) Operating Conditions -
    - a. Speed, acceleration, or deceleration
    - b. Use of helper units
    - c. Braking effort
  - (5) Train Characteristics -
    - a. Train length and action
    - b. Train tonnage
    - c. Train horsepower
    - d. Train consist
- 

Impact Loadings - Dynamic interactions produce large, low frequency vertical, lateral, and longitudinal impact loadings on the rail. Truck-hunting, nosing of diesel locomotives, rock-and-roll, and vertical bounce are examples of adverse dynamic behavior. Truck-hunting is vehicle truck instability that develops at high speed. The truck weaves or hunts as it moves along the track with the wheel flanges exerting lateral forces on the rails. This phenomenon is influenced by track lateral stiffness, track geometry, and truck characteristics. Nosing action produces lateral forces from the swaying or nosing of diesel locomotives. Rock-and-roll is an excessive lateral rocking of rail vehicles on jointed rail track at low speeds producing large dynamic vertical rail forces. In extreme situations, actual wheel lift may occur. Vertical bounce is a high speed instability caused by interaction of the vehicle suspension and the vertical track resilience. Impact loadings due to wheel flats also result in severe dynamic effects. Dynamic forces resulting

from these types of impact loadings are considered in track design by increasing the static axle load by a dynamic overload factor.

Vibrations - According to J. Spang<sup>7</sup>, the most important aspect of dynamic loading effects is the high frequency vibrations induced in the track structure. This is seldom addressed in track substructure design. Vibration from dynamic wheel loads causes permanent deformations in the substructure due to densification of ballast and loose granular soils and due to consolidation settlement of cohesive soils.

Vibrations are generated by the unsprung mass of train vehicle bodies and axles. Factors affecting substructure design are the energy and frequency of vibrations transmitted to the substructure. The response of a material to vibration is determined by its modulus and density and by the frequency and amplitude of vibrations transmitted to it. Vibration energy transmitted to the track superstructure increases with vehicle load and train speed. The energy transmitted to the substructure is affected by the rail and tie mass stiffness, and damping. Heavier rail and stiffer ties (e.g., concrete versus wood) transmit larger vibration energy to the substructure. Vibration is increased by resilient deformation of the substructure.

Vibration energy is damped by the substructure. Damping is due to both inelastic deformations and "system" damping due to radiation of energy into the substructure. Vibration waves attenuate rapidly in the subgrade, and their magnitude is only appreciable near the subgrade surface.

The frequency of vibrations transmitted to the substructure is determined by tie spacing, axle spacing, speed, and dynamic moduli of the various materials (wheels, rails, and ties). For example, at a speed of 75 mph and axle spacings of 100 and 125 inches, there are 10 to 13 load pulses per second or vibrations of 10 to 13 hertz (Hz).

Vibrations produced by train loadings fall into three frequency bands:

a. Inaudible low frequencies up to 16 Hz generated by the repeated static loadings; low frequency energy is not strongly damped in the ground.

b. Audible low frequencies from 16 Hz to 150 Hz generated by the vertical flexural vibrations of the axles and vibrations of vehicle wheels; they are audible as a low roaring sound through tunnels and are not strongly damped in the ground.

---

<sup>7</sup>J. Spang, "Deformation of Railroad Track Base and Its Stabilization," ETR-Eisenbahntechnische Rundschau, 376, Vol. 21, No. 10, 1972.

c. Audible frequencies around 150 Hz which are strongly damped by the substructure.

Vibrations of principal concern in track substructure design are those in the range up to 16 Hz. Vibrations up to 16 Hz fall in the range of the characteristic natural frequencies of substructure systems, and can, therefore, induce resonance and large dynamic displacements. Substructure design considerations for resistance to vibration effects are included in Section 5.6.

#### 2.1.4 Current Practice

Current track design practice does not consider explicitly the dynamic track loading environment. The nominal maximum static axle load is used as the fundamental parameter for track design. In North American design, the axle load is increased by a dynamic or speed effect factor in accordance with AREA recommendations to account for dynamic forces. Several empirical formulas relate dynamic track loading to speed, and a review of these early formulas was provided by Clarke in 1957<sup>8</sup>. Clarke considered formulas developed by the Indian Railways, AAR and Peterson. These formulas expressed the speed effect factor, K, in terms of the track modulus (u), speed (V), or wheel diameter (D), and are listed below:

Indian Railways Formula      $K = V/3\sqrt{u}$

AAR                              $K = 33V/100D$

Peterson                         $K = k_1 + k_2V + k_3V^2$

where  $k_1 = 0.1$  soft spring diesel or electric locomotives  
           $= 0.2$  to  $0.3$  stiff spring steam locomotive

$k_2 = 0.005$  to  $0.015$

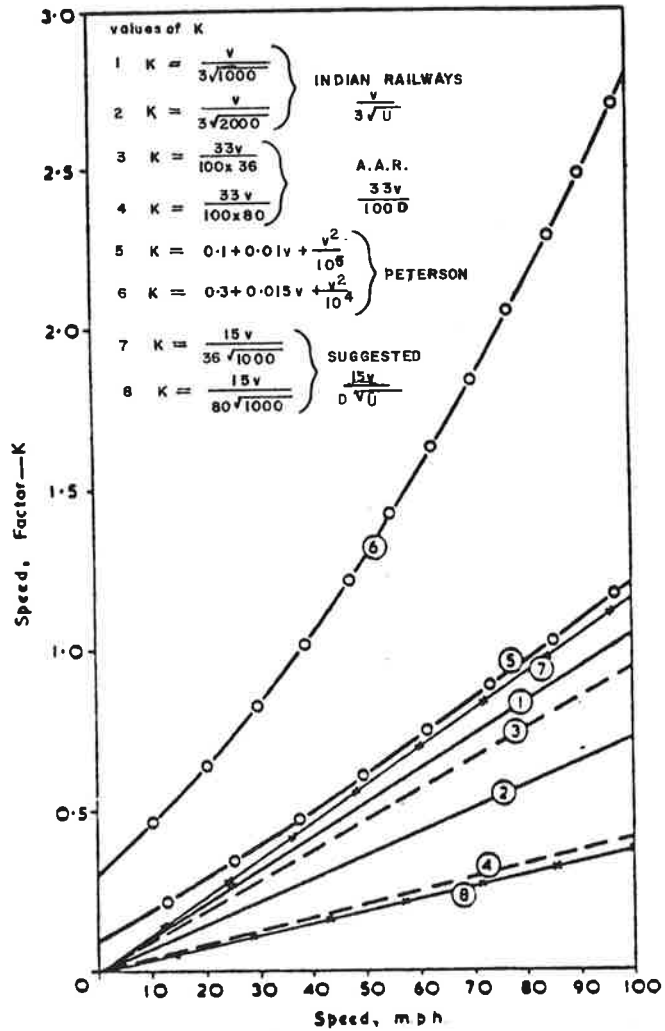
$k_3 = .0001$  for steam drivers  
           $= .00001$  for diesel or electric locomotives  
              and carrying wheels for steam locomotives

These factors are used to relate the dynamic increase in wheel load due to speed only. Clarke explained that they do not reflect dynamic increases due to other factors, such as wheel condition (wheel "flats"), rail joints, track surface and alignment irregularities, the type of driver (type of locomotive), and allowable flexural stress of rail steel.

Clarke compared K factors computed from the various formulas with the observed results of collected test data as shown in Figure 2-1. He observed that the speed effect varies inversely with both the track modulus and wheel

---

<sup>8</sup>C. W. Clarke, "Track Loading Fundamentals-7, Various Speed Effect Formulae," Railway Gazette, Vol. 106, No. 14, April 26, 1957, pp. 479-481.



Reproduced from "Track Loading Fundamentals - 7, Various Speed Effect Formulae", p. 480, by C. W. Clarke, by permission of the Edition of Railway Gazette. Year of first publication: 1957.

FIGURE 2-1. VALUES OF K FOR VARIOUS DYNAMIC LOAD FORMULAS



diameter, and that the Indian Railways and AAR formulas may be combined to give a suitable speed effect factor:

$$K = 15V/D\sqrt{u}$$

It should be noted that these formulas are empirical, not theoretical, and were developed for car loads of 55 tons or less. They should not be extrapolated to heavier car loads without development of further field data. However, the data are used by practicing railroad engineers designing track for heavy car loads. The AREA Manual recommends the AAR formula given previously to account for impact effects due to speed on conventional wood tie track. Review of Figure 2-1 shows that results using this formula compare well with Clarke's recommended formula.

For typical mainline freight operations, with line speeds of 40 mph to 70 mph and wheel diameters of 33 or 36 inches, K will vary from 0.37 to 0.70. To account for the other dynamic effects, this factor is usually increased to 1.00. Therefore, the maximum dynamic wheel load recommended by the AREA Manual for conventional wood tie track design is:

$$P_d = (1 + K) P_s = 2P_s$$

where:

$$\begin{aligned} P_d &= \text{dynamic wheel load} \\ K &= \text{total dynamic overload factor} \end{aligned}$$

For design of concrete tie track, the AREA Manual recommends that the total dynamic load be taken as 2.5 times the static load. The basis of this recommendation is empirical and is discussed further in Section 5.3.

Sato<sup>9</sup> reported on an equation developed and used by the Japanese National Railways to estimate the dynamic load imposed on the track. The approach assumes that track vibrations result from surface irregularities between wheel and rail. These vibrations depend on the vibration component, which occurs at a frequency of 30 to 80 hertz. Factors such as speed (V), the unsprung mass of a vehicle axle ( $m_0$ ), irregularity of the track (A), bending stiffness of the rail (EI), stiffness of the rail fastener (dynamic spring constant of rail support,  $D_1$ ), and tie spacing (a) are accounted for in the equation, which is given as:

$$\begin{aligned} W_D &= W_S \pm 2\sigma (\Delta W_S) \\ &= W_S \pm 5.5 \left( \frac{A}{\pi} \right)^{0.5} \cdot \left( \frac{m_0}{2} \right)^{0.5} \cdot (EI)^{0.125} \cdot \left( \frac{D_1}{a} \right)^{0.375} \cdot V \end{aligned}$$

---

<sup>9</sup>Y. Sato, "A Proposal of New Theory on Track Deterioration," Quarterly Reports, Japanese National Railways Technical Research Institute, Vol. 19, No. 1, March 1978, pp. 34-35.

The use of an equivalent static load to analyze the peak stresses in the subgrade may be appropriate. However, for analyzing the peak dynamic stresses in track components, such as the rail, tie, fasteners and ballast, a dynamic analysis should be used, as performed by Prause et al.<sup>10</sup>.

## 2.2 LATERAL LOADING

The track structure must resist thermal loading on unoccupied track and combined thermal and wheel loadings on occupied track. Thermal loadings are produced when continuous welded rail (CWR) and some jointed rail are exposed to ambient temperatures that are different from the installation temperature. If the temperature is above the installation temperature, compressive forces can cause the track to buckle, usually in the lateral or horizontal direction.

Lateral wheel loads are caused by the lateral component of the frictional force between the wheel and rail and by the lateral force applied by the wheel flange against the rail. If the lateral wheel loads exceed lateral track resistance, displacements of the track occur. This is a progressive problem because poorly aligned track will further encourage displacements through increased wheel-rail forces, lateral loads due to "hunting" of trucks, and lateral loads due to the "nosing action" of locomotives.

Occupied Track - From the mid-1950's until the late-1960's, French engineers<sup>11,12</sup> experimented with the "derailer wagon" to evaluate the behavior of occupied track subjected to combined lateral and vertical loadings. The lateral force at which permanent lateral deformation occurred was defined as the critical lateral force,  $H_c$ . The work resulted in an empirical expression to evaluate the critical lateral force as a function of vertical loading, temperature rise, track curvature, track modulus, and rigidity of the rail in the transverse and vertical directions. The expression is:

---

<sup>10</sup>R. H. Prause et al., "An Analytical and Experimental Evaluation of Cross Tie and Fastener Loads," U.S. Department of Transportation, Federal Railroad Administration, Washington, D.C., December 1977, FRA/ORD-77/71, pp. 53-58.

<sup>11</sup>F. Amans and R. Sauvage, "Railway Track Stability in Relation to Transverse Stresses Exerted by Rolling Stock. A Theoretical Study of Track Behavior. A Practical Method for Determining the Resistance of the Track to Transverse Stresses Exerted by Rolling Stock," Bulletin of the International Railway Congress Association, Vol. 46, No. 11, November 1969, pp. 685-716.

<sup>12</sup>M. A. Prud'homme and M. G. Janin, "The Stability of Tracks Laid with Long Welded Rails," Bulletin of the International Railway Congress Association, Vol. 46, No. 10, October 1969, pp. 601-620.

$$H_C = \alpha (P + P_0) \left[1 - \beta S \Delta \theta \left(1 - \frac{R_0}{R}\right)\right] (k/k_0)^{0.125} \cdot \epsilon \frac{(EI)^{0.25}}{(EJ)^{0.125}}$$

where:

- $\alpha (P + P_0)$  accounts for vertical loading
- $1 - \beta S \Delta \theta \left(1 - \frac{R_0}{R}\right)$  accounts for temperature rise ( $\Delta \theta$ ) and track curvature ( $R_0/R$ )
- $(k/k_0)^{0.125}$  represents the influence of track modulus ( $k/k_0$ )
- $\epsilon \frac{(EI)^{0.25}}{(EJ)^{0.125}}$  accounts for transverse (EJ) and vertical (EI) rail rigidity

It was concluded that for occupied track, the effects of axle force predominate, so that the above-described empirical expression could be reduced to  $H_C = 0.85(1 \times 10^4 + P/3)$ , with P and  $H_C$  expressed in newtons. The ratio  $H_C/P$  was used as a measure of lateral track behavior. Values of  $H_C/P$  were found to range from 0.40 to 1.10, where 0.40 corresponded to a track with wooden ties, loosened fasteners, and ballast in less than good condition. Higher values are representative of higher quality track.

With regard to occupied track, there appears to be no criterion in the AREA Manual that relates lateral loading to wheel loads.

Unoccupied Track - From 1973 to 1978, A. D. Kerr published several papers that dealt with thermal track buckling phenomena in unoccupied track. His 1978 publication, "Thermal Buckling of Straight-Tracks: Fundamentals, Analysis, and Preventive Measures," is a useful design aid for the practicing railroad engineer to evaluate safe temperature increase as a function of rail size and axial and lateral ballast resistance. For such analyses, ballast resistances were assumed to be determined experimentally or estimated. Solutions are given in terms of lateral displacement, axial force, and temperature increase above installation temperature. However, the magnitude of lateral loading induced by the axial compressive forces is not explicitly expressed as part of the solution.

In 1977, Prause and Kennedy, in Parametric Study of Track Resistance, refer to the following formula by Magee, 1965,<sup>13</sup> which has frequently been used to evaluate the lateral force induced by thermal loadings.

---

<sup>13</sup>G. M. Magee, "Welded Rail in Bridges," Railway Track and Structures, November 1965, pp. 24-26.

$$P_f = 0.441 (D_c) (\Delta T)$$

where:

$P_f$  = total lateral force (pounds per foot of track)

$D_c$  = degree of track curvature (degrees)

$\Delta T$  = temperature change ( $^{\circ}F$ ) above rail laying temperature

This formula shows that a perfectly straight track under thermal loads would not be subjected to lateral loads. This observation agrees with a statement by Prud'homme and Janin<sup>14</sup> that track cannot be deformed in the horizontal plane when subjected to thermal stresses unless there exist faults of alignment, crippled rails, or angular welds. This relation is useful for evaluating lateral thermal loads on curves. Its use is recommended in the AREA Manual to size ballast shoulders on curved CWR track.

The temperature at which CWR is laid, relative to the highest and lowest expected local temperatures, directly affects induced thermal loadings and, consequently, the susceptibility of the unoccupied track to thermal buckling and rail breaks. The general recommendations in the AREA Manual for rail laying temperature and for calculating thermally induced lateral loads may be sufficient in areas where there is not a wide variation of regional temperature or where the consequences of track buckling or rail breaks are not severe. However, for critical applications, a thorough investigation of the induced thermal loads and susceptibility of the track to thermal track buckling should be made. The extensive work by Kerr<sup>15,16,17</sup> provides a basis for evaluating thermal track buckling of unoccupied track.

---

<sup>14</sup>M. A. Prud'homme and M. G. Janin, "The Stability of Tracks Laid with Long Welded Rail," Bulletin of the International Railway Congress Association, Vol. 46, No. 7-8, July-August 1969, pp. 459-487.

<sup>15</sup>A. D. Kerr, "Lateral Buckling of Railroad Tracks Due to Constrained Thermal Expansions - A Critical Survey," Symposium on Railroad Track Mechanics and Technology, Princeton University, April 1975, A. D. Kerr, ed., Pergamon Press, New York, 1978, pp. 141-169.

<sup>16</sup>A. D. Kerr, "Analysis of Thermal Track Buckling in the Lateral Plane," Acta Mechanica, Vol. 30, 1978, pp. 17-50.

<sup>17</sup>A. D. Kerr, Thermal Buckling of Straight Tracks: Fundamentals, Analyses, and Preventive Measures, prepared for the U.S.D.O.T., Federal Railroad Administration, Report No. FRA/ORD-78/49, 1978, 58 pp. (PB-291929).

For occupied track, the empirical relationship developed by the French through field testing provides a reasonable relationship between  $H_c$ ,  $P$ , temperature rise, and other factors. However, its application to North American track design practices has not been tested.

## 2.3 LONGITUDINAL LOADING

The longitudinal load on a rail is defined as a load along the longitudinal axis of a rail. It is developed by a combination of train motion loads and thermal loads, the former of which include rail wave action, train brake effect, and tractive effort effect.

### 2.3.1 Train Motion Loads

Rail Wave Action - According to Clarke<sup>18</sup>, as each set of vehicle wheels passes a point on the track, a depression curve between vehicle wheels and forerunning rail wave will occur and thereby subject the track superstructure to longitudinal forces in the direction of traffic. The track superstructure also tends to lift some distance ahead of the rolling vehicle wheels due to the rail wave action. The cross ties in the lift area subsequently become unloaded or partially unloaded, and the frictional forces provided by the ballast to resist longitudinal and lateral movements are reduced.

Train Braking Action - From the formula  $F = ma$ , the force required to accelerate or decelerate a ton of weight at the rate of one mile per hour per second is 91.2 pounds. Thus, for a train to decelerate 0.5 mph per second on level and tangent track, the braking system must exert 4,560 pounds per 100 tons. The braking force at the wheel-rail contact tends to push the rail and track superstructure ahead, inducing longitudinal load. The dynamic condition of the train during this braking mode also causes a redistribution of weight among vehicle wheels, which further complicates the analysis of the track structure during the braking mode. The required forces will be increased if the train is descending a grade.

Tractive Effort Effect - A longitudinal load caused by tractive effort is imposed on the rail and transferred to the track structure by driving axles. The longitudinal load caused by braking will be larger than that caused by tractive effort. Since the two loads cannot occur together, only the larger or braking load need be considered in the analysis of forces exerted on the track structure.

---

<sup>18</sup>C. W. Clarke, "Track Loading Fundamentals, Part 1," Railway Gazette, January 1957, 26 pp.

### 2.3.2 Thermal Loads

Conventional Jointed Rail - Conventional jointed rails are usually installed with gaps between the rail ends. Thermal expansion of the rails amounting to 8 inches or more per mile of track can be tolerated before closure of the rail joint gaps. An unconstrained rail subjected to a temperature rise will increase in length by  $\Delta L$ , such that

$$\Delta L = \alpha L T_0$$

where:

$\alpha$  = coefficient of linear thermal expansion =  $6.5 \times 10^{-6}$  per °F

L = rail length

$T_0$  = uniform temperature increase (°F)

Using this formula, a 20°F increase in temperature above rail laying temperatures will cause approximately 8 inches of expansion per mile of track, therefore closing the rail joint gaps. Further rail temperature increases after the rail joint gaps are closed will cause thermal compressive stress to develop in the rail.

Without adequate ballast and rail anchorage, the rails will creep longitudinally in an irregular pattern due to expansion. This rail movement will concentrate compressive stresses in some locations and tensile stresses in other segments of the track structure. Irregular compressive and tensile stresses may also be due to variations in exposure of the rail to the sun through physical location, such as in a tunnel, under a bridge, or in a cut.

If rail creep is irregular and if thermal forces become excessive and concentrated at a location where ballast and tie restraint are inadequate, one of the following track structure failure mechanisms is possible:

- a. Excessive compressive stress in hot weather may cause the track to buckle out of line and surface.
- b. Excessive tensile stress in cold weather may cause the track bolts to shear in the rail joint or a rail to break because of a defective weld or other rail defect.

Such failures are infrequent due to the required combination of very large increases in temperature and poor restraint.

Continuous Welded Rail (CWR) - Continuous welded rail is constrained against thermal expansion or contraction. Therefore, when exposed to ambient temperatures that are different from the installation temperature, axial

stresses will be induced in the rails. As discussed by Kerr<sup>19</sup> the compressive or tensile axial stress thermally induced in CWR is:

$$\text{axial stress} = N_t/A = E\alpha T_0$$

where:

$N_t$  = induced compressive or tensile force

$A$  = cross-sectional area of rails

$E$  = Young's modulus for rail material

$\alpha$  = coefficient of linear thermal expansion =  $6.5 \times 10^{-6}$  per °F

$T_0$  = uniform temperature change (°F)

This stress is 195 psi for each degree Fahrenheit temperature change with respect to installation temperature. Kerr provides a methodology for evaluating a maximum safe temperature increase in CWR that will not cause thermal buckling and the corresponding thermally induced axial stresses.

---

<sup>19</sup>A. D. Kerr, "Thermal Buckling of Straight Tracks: Fundamentals, Analyses, and Preventive Measures," U.S. Department of Transportation, Federal Railroad Administration, Washington, D.C., September 1978, FRA/ORD-78/49, 58 pp.

### 3. TRACK GEOMETRY

The ultimate goal of track substructure design is to develop a track that will maintain optimum track geometry. Tests conducted by R. H. Prause on the Florida East Coast Railway indicated that one of the major modes of track degradation was permanent track geometry change<sup>1</sup>. Prause also found that long-term deterioration of track geometry was responsible for the major portion of track maintenance cost and for reduced safety factors.

#### 3.1 DEFINITIONS

The elements of track geometry are defined as follows:

Gauge - The distance between the two running rails of the track measured at right angles to the rail.

Cross level - The difference in elevation between opposite rails.

Superelevation - The cross level on curves designed to counteract vehicle overturning.

Profile - The relative vertical relationship of three equally spaced points along either of the two running rails.

Surface - The smoothness of the track, as described by the relation of opposite running rails to each other in cross level or superelevation and in profile.

Alignment - The horizontal location of the track superstructure.

#### 3.2 DYNAMIC TRACK RESPONSE AND EFFECT ON TRACK GEOMETRY

A railroad track has been described as a continuous beam on an elastic foundation. The rail is the beam supported on the elastic ties and substructure. The track structure may be considered approximately elastic because it deflects and then rebounds to essentially its original position on a cyclic basis with permanent deflection only occurring over the long term. A small deflection of the track structure as the vehicle moves along the rails is necessary and desirable and depends on the combined elasticity of the track materials.

---

<sup>1</sup>R. H. Prause et al., "An Analytical and Experimental Evaluation of Concrete Cross Tie and Fasteners Loads," U.S. Department of Transportation, Federal Railroad Administration, Washington, D.C., December 1977, FRA/ORD-77/71, pp. 77-84.



The resilient characteristics of the track structure absorb some of the energy transmitted to it. This energy absorption reduces the shock to the various track structure components and the rolling stock<sup>2</sup>. The track deflection that occurs under dynamic train loadings causes a deviation from the unloaded track surface geometry. According to Talbot, approximately 40 percent of the dynamic track deflection can be attributed to subgrade compression, another 40 percent to ballast compression, and the remainder to compression of superstructure components. In an analysis of Talbot's work, Lundgren<sup>3</sup> established the following limits for dynamic deflection:

- |                                  |                     |
|----------------------------------|---------------------|
| a. Indefinite track service life | 0.00-0.20 inch      |
| b. Acceptable range              | 0.12-0.25 inch      |
| c. Acceptable deflection limit   | 0.35 inch           |
| d. Rapid deterioration of track  | exceeding 0.40 inch |

Figure 3-1 indicates substructure response limits similar to those established by Lundgren et al. Dynamic track displacements above the acceptable limit cause permanent distortions of track geometry and contribute to fatigue failures of track superstructure components.

### 3.3 DEGRADATION OF TRACK STRUCTURE GEOMETRY

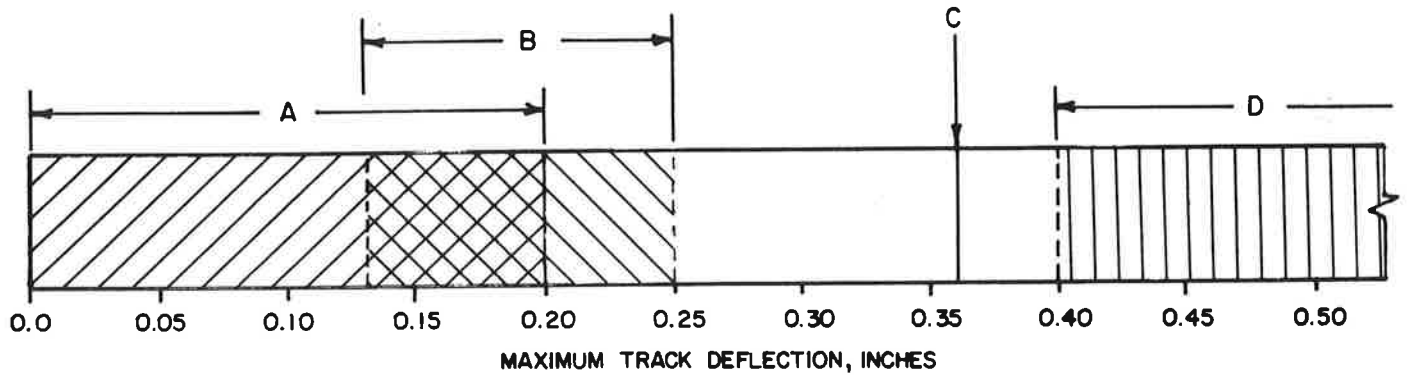
Track geometry defects that occur frequently and the principal causative factors for these defects are listed in Table 3-1. Geometry deterioration is progressive in that the deterioration of one geometry parameter will accelerate deterioration of the entire track structure by increased dynamic forces. As train speed increases, the effects of geometry deviations become more severe. Hay states that the shock effects of train speed may vary as the square of the velocity. Excessive geometry deviations lead to:

- a. Reduced service life of track superstructure components
- b. Poor riding quality
- c. Derailment caused by gauge widening, rail turnover, harmonic rocking or irregular surface conditions
- d. Increased maintenance frequency to keep track structure in repair
- e. Increased operating costs due to higher rolling resistance.

---

<sup>2</sup>W. W. Hay, "'Engineering Track' - Part II. Ballast Stability and Prolonged Rail Life," Progressive Railroading, Vol. 18, No. 4, April 1975, pp. 49-52.

<sup>3</sup>J. R. Lundgren, G. C. Martin, and W. W. Hay, A Simulation Model of Ballast Support and the Modulus of Track Elasticity, University of Illinois, Urbana, Illinois, September 1970, pp. 15-16.



RANGE	TRACK BEHAVIOR
A	Deflection range for track which will last indefinitely.
B	Normal maximum desirable deflection for heavy track to give requisite combination of flexibility and stiffness.
C	Limit of desirable deflection for track of light construction ( $\leq 100$ lb rail).
D	Weak or poorly maintained track which will deteriorate quickly.

Values of deflection are exclusive of any looseness or play between rail and plate or plate and tie and represent deflections under load.

Reproduced from "A Simulation Model of Ballast Support and the Modulus of Track Elasticity," p. 16, by Lundgren et al. Year of first publication: 1970.

FIGURE 3-1. TRACK DEFLECTION CRITERIA FOR DURABILITY

---

TABLE 3-1. SUMMARY OF TYPICAL TRACK GEOMETRY DEVIATIONS

<u>TRACK GEOMETRY DEVIATION</u>	<u>CAUSE OF DEVIATION</u>
Track Surface (Profile and Cross Level)	-Ballast Failure and Flow -Subballast Failure and Settlement -Poor Rail and Tie Condition -Dynamic Loadings -Excessive Train Speed -Inadequate Drainage -Improper Track Maintenance
Track Alignment	-Lateral Loadings -Dynamic Loadings -Rail Creepage -Longitudinal Loadings -Excessive Train Speed -Improper Track Maintenance
Wide Gauge	-Poor Tie Conditions -Lateral Loadings -Rail Creepage -Rail Wear -Frozen Ballast -Truck Hunting

---

### 3.4 TRACK GEOMETRY CRITERIA

Track geometry criteria have been established by the U.S. Dept. of Transportation, Federal Railroad Administration (Track Safety Standards); the American Railway Engineering Association (AREA Manual); individual railroad systems; and transit systems and groups. The FRA standards are minimum acceptable standards for safety regulations. Generally, geometry criteria of many railroads in the United States are directed at efficient train operations and are more stringent than those of the FRA.

Table 3-2 shows geometry tolerances established for construction and maintenance of the Northeast Corridor Project<sup>4</sup> and FRA minimum standards for 110 mph, Class 6 track. The report on the Northeast Corridor Project also describes the geometry criteria of the Japanese National Railways and British Railway systems for high speed operations, as shown in Table 3-3.

The limits listed in Tables 3-2 and 3-3 are used in establishing geometry during lining and tamping operations, to determine when maintenance of track geometry is required, or to evaluate when slow orders are necessary due to deteriorated track geometry. However, if the ultimate goal of track design is to develop a track structure that will maintain track geometry, there should be design procedures that relate permanent track geometry displacements to design parameters, and there must be design criteria in terms of acceptable permanent track displacements. Prause et al. reported in 1974 and 1977 that such criteria did not exist for either transit track design<sup>5</sup> or railroad track design<sup>6</sup>. Nothing discovered in this study indicates substantial progress toward design procedures or design criteria that are based on the ultimate goal of track design--maintenance of optimum track geometry.

<sup>4</sup>R. P. Howell et al., Northeast Corridor High-Speed Rail Passenger Service Improvement Study, Task 3 - Track and Structures Standard Development, prepared for U.S. Dept. of Transportation, Federal Railroad Administration, Report No. FRA-ONECD-75-3, September 1975, pp. 196.

<sup>5</sup>R. H. Prause, H. C. Meacham et al., Assessment of Design Tools and Criteria for Urban Rail Track Structures, Vol. I, At-Grade Tie-Ballast Track, prepared for U.S. Dept. of Transportation, Urban Mass Transportation Administration, Report No. UMTA-MA-06-0025-74-3, April 1974, 247 pp.

<sup>6</sup>R. H. Prause et al., An Analytical and Experimental Evaluation of Concrete Crosstie and Fastener Loads, prepared for U.S. Dept. of Transportation, Federal Railroad Administration, Report No. FRA/ORD 77/71, December 1977, 356 pp.

TABLE 3-2. PARAMETERS FOR MAINTENANCE SCHEDULING AND QUALITY CONTROL EVALUATION:  
NORTHEAST CORRIDOR PASSENGER RAIL SERVICE

<u>Parameter Description</u>	<u>Construction and Maintenance Quality Control Limit</u>	<u>Maintenance Program Demand Limit</u>	<u>Limit* Requiring Slow Order Consideration</u>
<u>TRACK SURFACE</u>			
Runoff in 31'	1/8"	3/8"	1/2"
Deviation in profile at mid-ordinate of 62'	1/8"	1/4"	1/2"
Deviation from designated elevation on spirals	1/8"	1/4"	1/2"
Variation in cross level in 31' on spirals	1/8"	3/8"	1/2"
Deviation from zero level on tangents or from designated elevation on curves	1/8"	3/8"	1/2"
Difference in cross level within 62' on tangents and curves	1/8"	3/8"	5/8"
<u>ALIGNMENT</u>			
Deviation of mid-offset from 62' line-tangent	1/8"	1/4"	1/2"
Deviation of mid-ordinate from 62' chord-curve	1/8"	1/4"	3/8"
Gauge (4'- 8 1/2")			
Tangent			
Minimum	4'8-3/8"	4'8-1/8"	4'8"
Maximum	4'8-9/16"	4'8-5/8"	4'8-3/4"
Curve			
Minimum	4'8-3/8"	4'8-1/8"	4'8"
Maximum	4'8-5/8"	4'8-7/8"	4'9"

\*Limits equivalent to tolerances for F.R.A. Track Safety Standards Class 6 Track, rated for 110 m.p.h. passenger and freight service.

Reproduced from Northeast Corridor High-Speed Rail Passenger Service Improvement Study, Task 3 - Track and Structures Standard Development, p. 115, by R. P. Howell et al., U.S. Dept. of Transportation, Federal Railroad Administration. Year of first publication: 1975.

TABLE 3-3. TRACK GEOMETRY CRITERIA FOR JAPANESE AND BRITISH RAILWAYS

Track Geometry Parameter	Japanese - 130-160 MPH Application						British Rail	
	Post Work Tolerance mm   in	Maint. Sched. mm   in	Work Tol. in	Good Ride Comfort mm   in	Slow Down Tolerance mm   in	Maximum Target in		
Longitudinal level, measured by 10m (32.8') chord	4   3/16	5-6	3/16-1/4	7   1/4	10   3/8	1 in 500 (over 10 ft.)		
Alignment measured by 10m (32.8') chord	3   1/8	3-4	1/8-3/16	4   3/16	7   1/4	±1/8	±3/32	
Alignment on curve measured by 10m (32.8') chord	3   1/8	-	-	-	-	±1/8	±3/32	
Alignment on curve measured by 20m (65.6') chord	-	4	3/16	5   3/16	8   5/16	-	-	
Gage	+2   +1/16 -2   -1/16	+5 -3	+3/16 -1/8	+6 -3	+10 -6	+1/8	±1/16	
Distortion measured by 2.5m (8.2') axis distance	3   1/8	3	1/8	5   3/16	5   3/16	-	-	
Cross Level	3   1/8	5	3/16	5   3/16	10   3/8	-	-	
Desirable X-Level over 10'	-	-	-	-	-	±1/8	±1/16	
Cant	-	-	-	-	-	+3/8	+1/4	
Joint Dips over Six Sleepers	-	-	-	-	-	-3/8	-1/4	

Reproduced from Northeast Corridor High-Speed Rail Passenger Service Improvement Study, Task 3 - Track and Structures Standards Development, p. 116, by R. P. Howell et al. Year of first publication: 1975.

#### 4. VERTICAL LOADING: PERFORMANCE, DESIGN, AND ANALYSIS

The effects of vertical loads have been studied more than any other aspect of substructure design. In this section the measured behavior of ballast, subballast, and subgrade layers under dynamic loading will be discussed briefly. Current track substructure design methods used by U.S., Canadian, and overseas railroads will be presented and compared. In addition, recently developed analytic and design methods will be presented, including computer models and methods for estimating the rate of accumulation of residual substructure deformation.

In order to develop design and performance criteria for the track substructure components, it is necessary to understand their behavior under loading. This includes defining and quantifying the parameters that describe substructure behavior and the methods available to measure the response of the individual substructure components under load. Laboratory measurements of substructure material properties have been reported by European railroads<sup>1</sup>. In North America, little or no work had been done along these lines until Knutson et al.<sup>2</sup> in 1977, Raymond et al.<sup>3,4</sup> in 1975 and 1976 and Selig et al.<sup>5</sup> in 1979 studied the mechanical properties of substructure materials, and Selig et al.<sup>6</sup> in 1979 measured the dynamic and static performance of

---

<sup>1</sup>International Union of Railways, Stresses in the Rails, the Ballast, and in the Formation Resulting from Traffic Loads, Question D71, Reports 1-13, and Optimum Adaptation of the Conventional Track to Future Traffic, Question D117, Reports 1-6, Utrecht, Holland, 1968-1975.

<sup>2</sup>R.M. Knutson et al., Materials Evaluation Study - Ballast and Foundation Materials Research Program, prepared for U.S. Dept. of Transportation, Federal Railroad Administration, Report No. FRA-ORD-77-02, January 1977, 202 pp.

<sup>3</sup>G.P. Raymond, et al., A Study of Stresses and Deformations Under Dynamic and Static Load Systems in Track Structure and Support, CIGGT Report No. 75-10, Queen's University, Kingston, Ontario, September 1975, 53 pp.

<sup>4</sup>G.P. Raymond et al., Stresses and Deformations in Railway Track, Canadian Institute of Guided Ground Transport, Report No. 76-11, November 1976, 171 pp.

<sup>5</sup>E.T. Selig et al., A Theory for Track Maintenance Life Prediction, prepared for U.S. Dept. of Transportation, Office of University Research, Report No. DOT/RSPA/DPB-50/79/22, August 1979, 183 pp.

<sup>6</sup>E.T. Selig et al., Status Report - Ballast Experiments, Intermediate (175 MGT) Substructure Stress and Strain Data prepared for U.S. Dept. of Transportation, Transportation Systems Center, Interim Report, September 1979, 88 pp.

various track substructure components at the U.S. Department of Transportation, Facility for Accelerated Service Testing (FAST) track in Pueblo, Colorado. In this section we will briefly describe the behavior of substructure materials under loading.

In this report the terms "resilient" and "residual" strains and displacement will be used to describe the response of substructure materials to dynamic loading. The terms "elastic," "recoverable" and "dynamic," which often are used instead of "resilient," will not be used in this context in this report. Likewise, "plastic," "irrecoverable" and "cumulative" will be described as "residual."

#### 4.1 SUBSTRUCTURE MATERIAL BEHAVIOR

Railroad track substructure experiences repeated, transient vertical loads from trains. However, the response of material to repeated loading received little attention until about twenty years ago. Since the early 1960's, cyclic behavior of granular earth materials has been studied intensively in relation to earthquake engineering and pavement design research. The results of these studies have been summarized in the state-of-the-art paper by Monismith and Finn<sup>7</sup>.

Borrowing from this data base and the earlier work of British Rail<sup>8</sup>, several North American investigators, including Knutson et al. at the University of Illinois; Raymond et al. at Queen's University, Ontario; and Selig et al. at the State University of New York at Buffalo, and later at the University of Massachusetts, performed extensive static and cyclic triaxial testing on ballast, subballast and subgrade materials. (See previously referenced work.) The overall result of these studies has been a basic understanding of the behavior of granular substructure materials under repeated loading.

##### 4.1.1 Laboratory Behavior of Substructure Materials

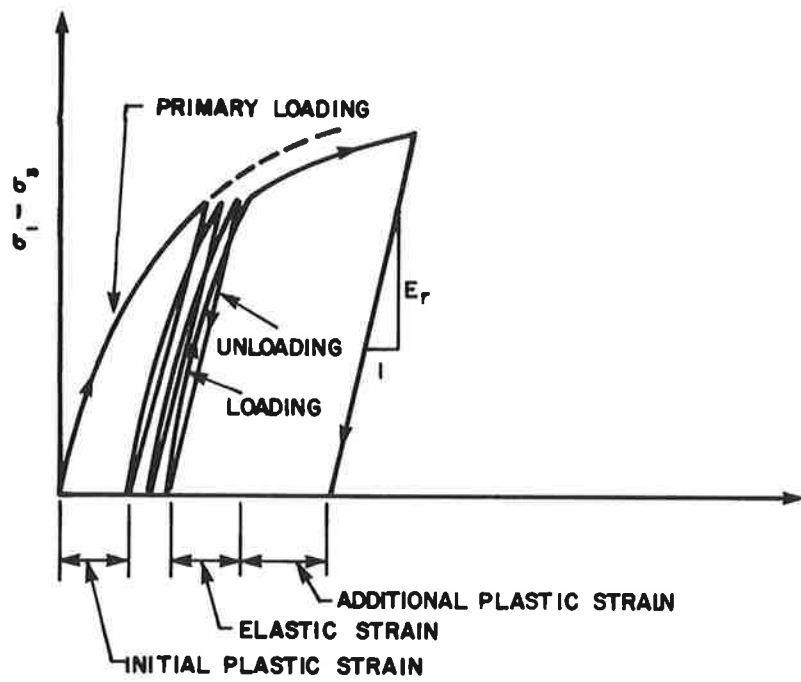
When subjected to repeated loads, granular materials such as railroad ballast and subballast undergo both resilient and residual deformations during each load cycle. This elasto-plastic behavior is illustrated in Figure 4-1, which shows a schematic of cyclic behavior for granular materials and actual results of a laboratory cyclic triaxial test of a railroad ballast material.

---

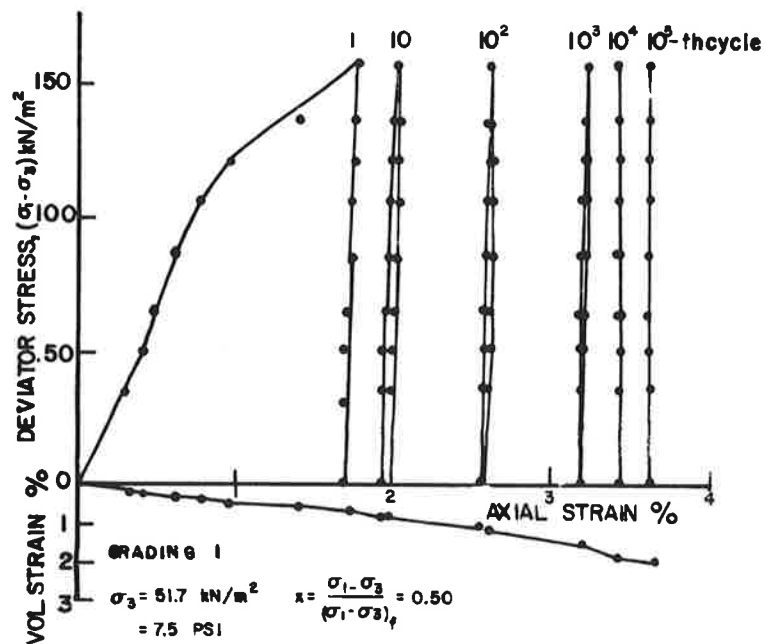
<sup>7</sup>C.L. Monismith and F.N. Finn, "Flexible Pavement Design: State of the Art - 1975," Transportation Engineering Journal, ASCE, Vol. 103, TE1, January 1977, pp. 1-53.

<sup>8</sup>Office of Research and Experiments, International Union of Railways, "Repeated Loading of Clay and Track Foundation Design," Question D71: Stresses in the Rails, the Ballast, and in the Formation Resulting from Traffic Loads, Report No. 10, Volumes 1 and 2, Utrecht, Holland, 1970.





(A) SCHEMATIC



(B) BALLAST REPEATED LOAD TEST RESULTS

Reproduced from A Theory for Track Maintenance Life Prediction, Final Report On Second Year of Study (Draft), p. 9, by E. T. Selig et al. Year of first publication: 1979.

FIGURE 4-1. TYPICAL REPEATED LOAD BEHAVIOR OF SUBSTRUCTURE MATERIALS

The essential material behavior observed in the laboratory tests by the different researchers indicates that nearly all of the vertical strain that occurs is resilient and is recovered after each load cycle. However, a small amount of residual strain is not recovered after each load cycle. The largest amount of residual strain takes place in the first load cycle when the material is loosest. After approximately 10 to 100 load cycles, the material behaves essentially elastically, although very small plastic strains still accumulate at a small and decreasing rate per cycle.

The resilient response of substructure materials to cyclic loading is most frequently described by the resilient Young's modulus,  $E_r$ , and the resilient Poisson's ratio,  $\nu_r$ . The resilient modulus is most conveniently determined in the laboratory cyclic triaxial test as the ratio of cyclic axial stress change to cyclic axial strain,  $E_r = \sigma_a / \epsilon_a$ , for a test in which the confining pressure,  $\sigma_3$ , is held constant. The Poisson's ratio is determined as the ratio of lateral strain to vertical strain.

There are a great many factors that can be varied in the laboratory tests. A summary of the influence of the different factors is presented in Table 4-1 for cohesionless materials, including ballast and aggregate subballast, and in Table 4-2 for cohesive soils, such as silt and clay subgrades.

The residual behavior of substructure materials is frequently represented by the residual axial strain that occurs after a given number of cycles for a particular set of test conditions. The influences of various factors on the observed residual material behavior are also set forth in Tables 4-1 and 4-2.

The significance of the resilient and residual material behavior measurements is that they form the input material parameters for the analyses of track displacements discussed further in Section 4, in particular Section 4.6. Although substructure material behavior is understood, at least qualitatively, further study is needed in order to establish definitive procedures for evaluation of material properties for use in analytic models.

#### 4.1.2 Field Measured Resilient and Residual Substructure Response

The cyclic substructure behavior described above has been observed in the field at the FAST track in Pueblo, Colorado. Selig et al.<sup>9</sup> measured the resilient and residual response of the ballast, subballast, and subgrade

---

<sup>9</sup>E.T. Selig et al., Status Report - Ballast Experiments, Intermediate (175 MGT) Substructure Stress and Strain Data, U.S. Dept. of Transportation, Transportation Systems Center, Interim Report, September 1979, pp. 3-79.

TABLE 4-1. RESPONSE OF COHESIONLESS MATERIALS  
(BALLAST, SUBBALLAST, SAND AND GRAVEL)

<u>Factor</u>	<u>Resilient Behavior</u>	<u>Residual Behavior</u>
Stress Level, Lateral Confining Stress	Significant <sup>1</sup>	-----
Deviator Stress	Modest <sup>2</sup>	Significant
Initial Density	Minor <sup>3</sup>	Very Significant
Loading Frequency	Insignificant	-----
Duration of Load	Insignificant	-----
Particle Shape, Roughness	Minor increase of $E_r$ with angularity	-----
Fines Content	$E_r$ decreases with increasing fines	-----
Water Content Saturation	Minor	Very Significant
Cyclic Stress History	Minor	Significant <sup>4</sup>
Static Stress History	Minor	Significant

---

<sup>1</sup>Resilient Modulus,  $E_r = K\theta^n$ , where  $\theta$  represents the confining stress and  $n$  is an empirical parameter in the range of 1/3 to 1.

<sup>2</sup>Modest increase of  $E_r$  with increase in applied deviator or shear stress until failure is reached.

<sup>3</sup>Density significant when due to tighter packing of coarse particles; less significant when higher density is caused by fines filling void space.

<sup>4</sup>Residual strains are smaller if deviator stress is applied at gradually increasing level rather than initial large magnitude.

TABLE 4-2. RESPONSE OF COHESIVE MATERIALS  
(FINE GRAINED SOILS, WITH SILT AND CLAY)

<u>Factor</u>	<u>Resilient Behavior</u>	<u>Residual Behavior</u>
Confining Stress	Insignificant <sup>1</sup>	Significant
Deviator Stress	Significant <sup>2</sup>	Significant
Initial Density	Minor	Questionable-Minor?
Loading Frequency	Insignificant	-----
Duration of Load	Insignificant	-----
Plasticity, Mineral Type	Significant	-----
Water Content, Saturation	Significant	Significant
Cyclic Stress History	Minor	Very Significant <sup>3</sup>
Static Stress History	Significant	Very Significant

---

<sup>1</sup>Provided increased confining stress does not lead to consolidation and reduced water content.

<sup>2</sup> $E_r$  decreases with increased deviator stress.

<sup>3</sup>A critical deviator stress exists, as a function of confining stress, below which residual strains are small and above which strains are large. See also Table 4-1, note 4.

layers to dynamic loading. Dynamic measurements were made after 3 and 75 MGT of traffic, and long-term settlement measurements were made through 175 MGT. As shown in Figure 4-2, vertical ballast and subballast strains were measured directly under both rails and at the center of the tie. Subgrade deformations were measured under both rails only. Details of the instrumentation program and a more detailed presentation of the results are presented by Selig et al. and by Adegoke<sup>10</sup>.

The purpose of obtaining these field measurements was twofold:

a. Quantify in track the resilient and residual deformation response of the individual substructure components to repeated dynamic wheel loads by measuring vertical strains in the ballast and subballast, total settlements in the subgrade, and vertical pressures on the subgrade.

b. Gain insight into the effects of varying track structure components on the development of stresses and strains in the substructure layers. Factors varied include tie type, ballast type, ballast depth, and track geometry (curved versus tangent track).

No record of this type of field measurements was found in the literature and, as such, these measurements have provided the first data on the actual response of substructure layers to dynamic loading. A general summary of some basic observations from this program is presented in Table 4-3. Some of the most significant observations include:

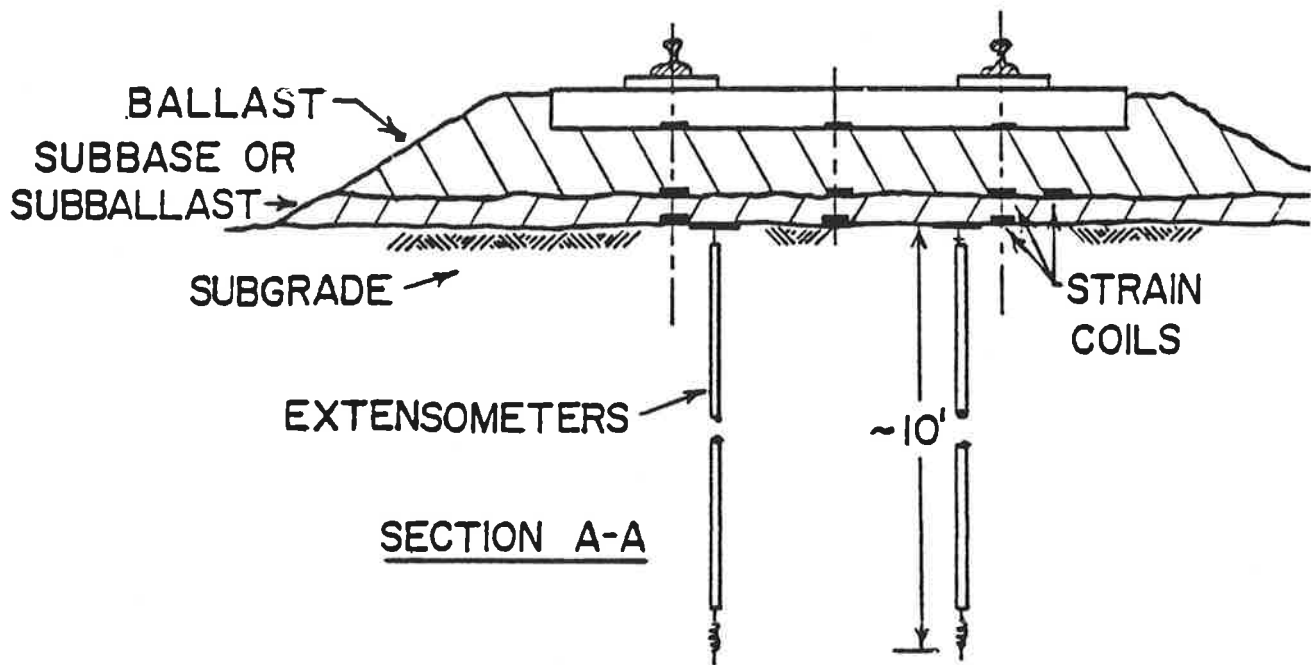
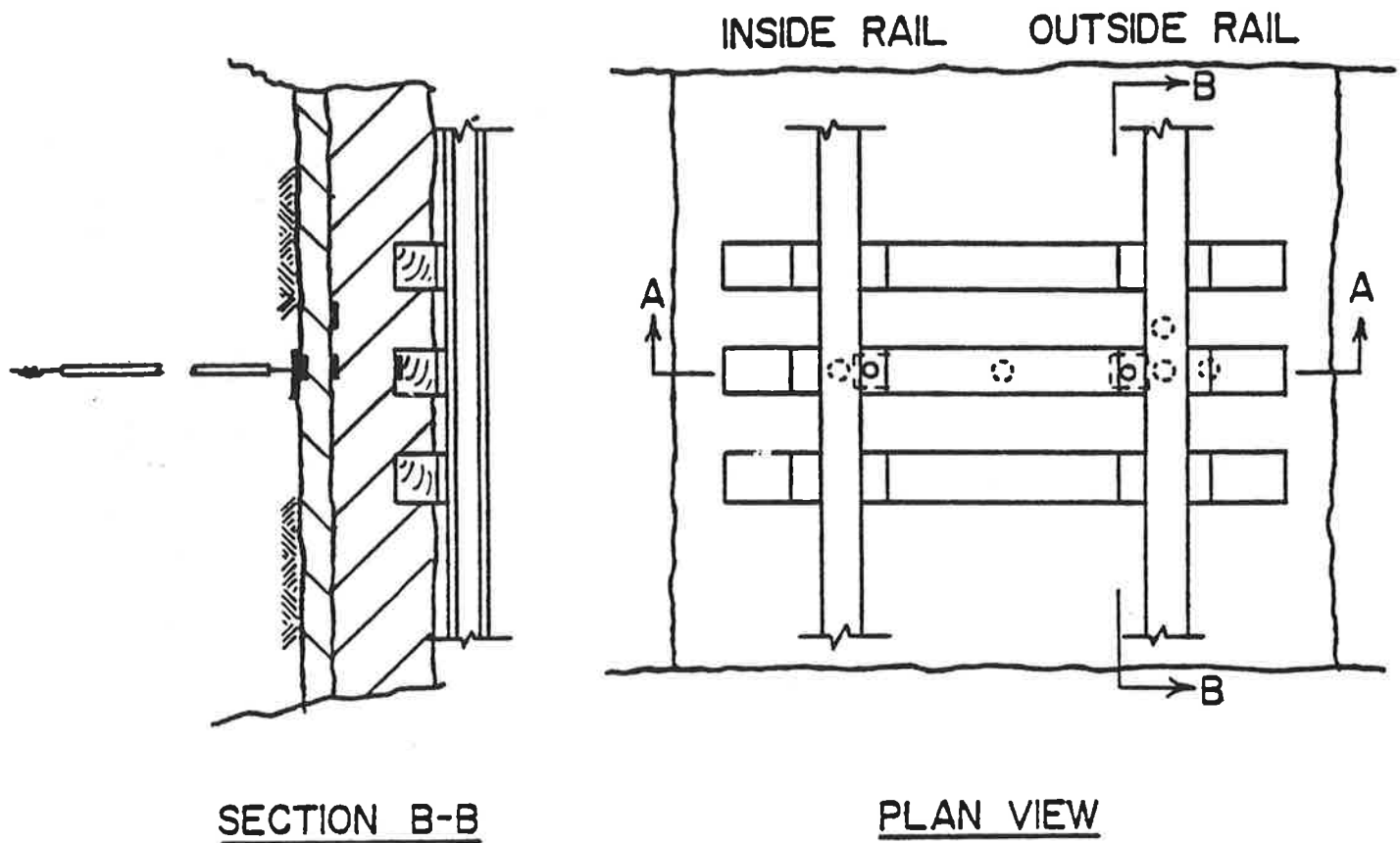
a. Vertical strains in the ballast and subballast and vertical deformations in the subgrade were almost completely recovered as indicated by no permanent set in the strip chart recorder base lines shown in Figure 4-3 and Figure 4-4.

b. Residual strains accumulated slowly in the ballast, subballast, and subgrade with accumulated traffic (Figure 4-5). In the early stages after track maintenance, the ballast, subballast, and subgrade strains increased more rapidly up until approximately 3 to 5 MGT of traffic, at which time the residual strains accumulated at a much slower, relatively constant rate.

c. The dominant cyclic load frequency observed was not due to the individual axle loads (odd numbered peaks on Figure 4-3), but rather the truck loading (peaks 1 through 3) or, in the case of adjacent trucks of different cars, the consecutive truck loading (peaks 5 through 11). The effect of varying train speed on this behavior has not been determined. Note that when the sensed tie was between truck axles (peak 2), the axle interactions produced a loading magnitude on the tie approximately equal to the single axle load directly over the tie (peaks 1 or 3).

---

<sup>10</sup>C.W. Adegoke, Elastic and Inelastic Deformation Response of Track Structure Under Train Loads, PhD Thesis, State University of New York at Buffalo, December 1978, pp. 3 to 26, 147 to 160.



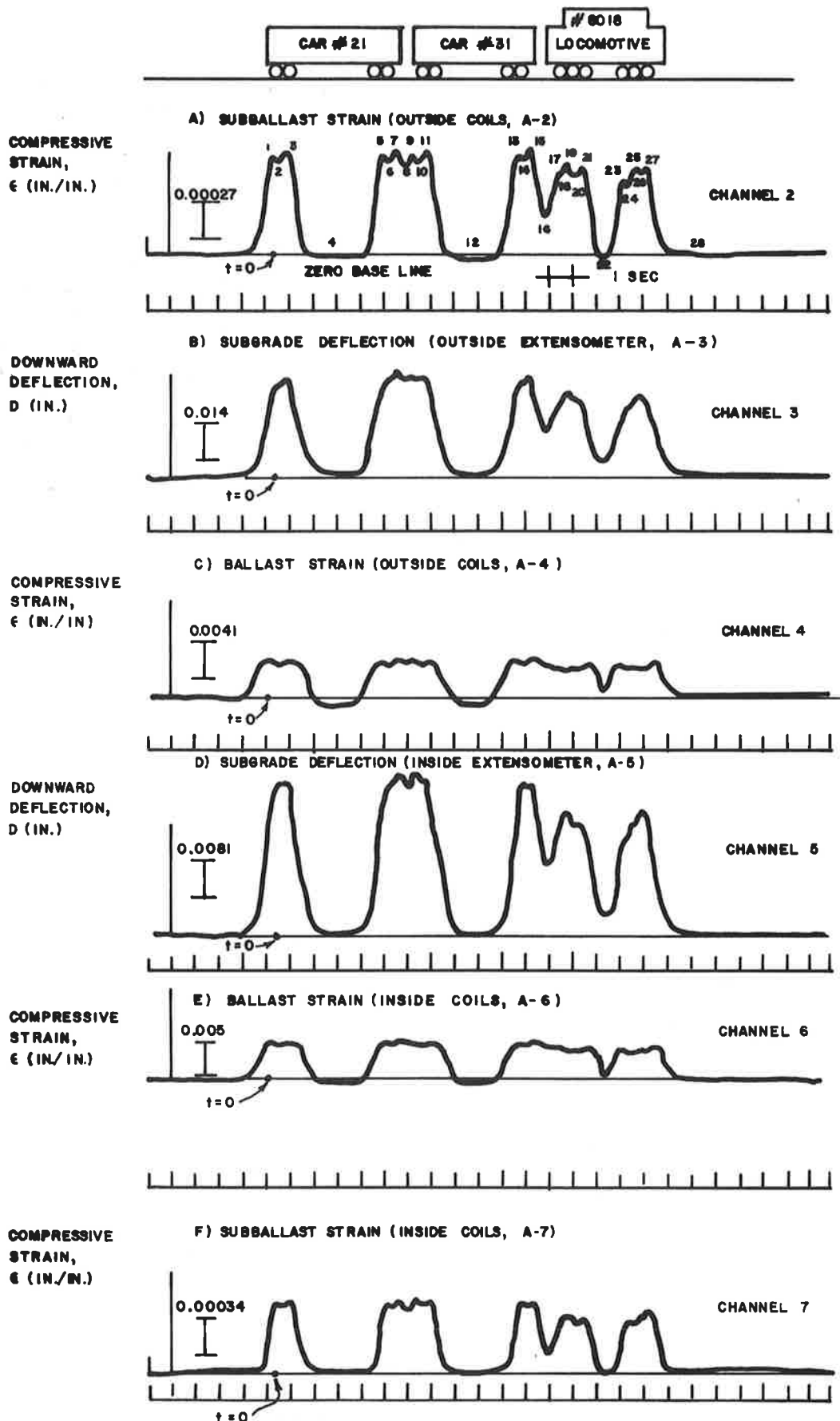
Reproduced from Status Report - Ballast Experiments, Intermediate (175 MGT) Substructure Stress and Strain Data, Interim Report, p. 8, by E. T. Selig et al. Year of first publication: 1979.

FIGURE 4-2. TYPICAL GAUGE LAYOUT AT FAST

TABLE 4-3. FACTORS AFFECTING SUBSTRUCTURE RESPONSE AT FAST

PARAMETERS	RESILIENT BEHAVIOR	RESIDUAL BEHAVIOR
Ballast Type Granite Limestone Traprock	Strains in granite and limestone ballast significantly higher than those in traprock ballast. Subballast strains below traprock higher than those below limestone or granite. Subgrade deflection below granite ballast less than below traprock or limestone.	Accumulated strains in ballast approximately equal for all three ballast types. Strains in subballast below traprock were higher than those below granite or limestone. Subgrade deflections approximately equal with those below granite highest.
Ballast Depth 15-inch vs. 21-inch	Strains in 21-inch ballast layer slightly higher than 15-inch layer. Subballast strain below 15-inch ballast layer slightly higher than 21-inch layer. Subgrade deflections approximately equal for both thicknesses.	Strains in 21-inch ballast layer from 0.5 to 0.8 higher than those in 15-inch layer. Subballast strains approximately equal below 15 and 21-inch ballast layers. Subgrade deflections approximately equal below both layers.
Tie Type * Concrete vs. Wood	Ballast strains below hardwood ties significantly higher. Subballast strains below concrete ties significantly higher. Subgrade deflections approximately equal.	Ballast strains approximately equal. Subballast strains approximately equal. Subgrade deflections approximately 1.7 to 1.9 higher below concrete ties.
Track Geometry Tangent vs. Curved	Ballast strains slightly higher below tangent track. Subballast strains significantly higher below tangent track. Subgrade deflections approximately equal.	Conflicting ballast strain data. Subballast strains approximately equal. Subgrade deflections approximately equal.

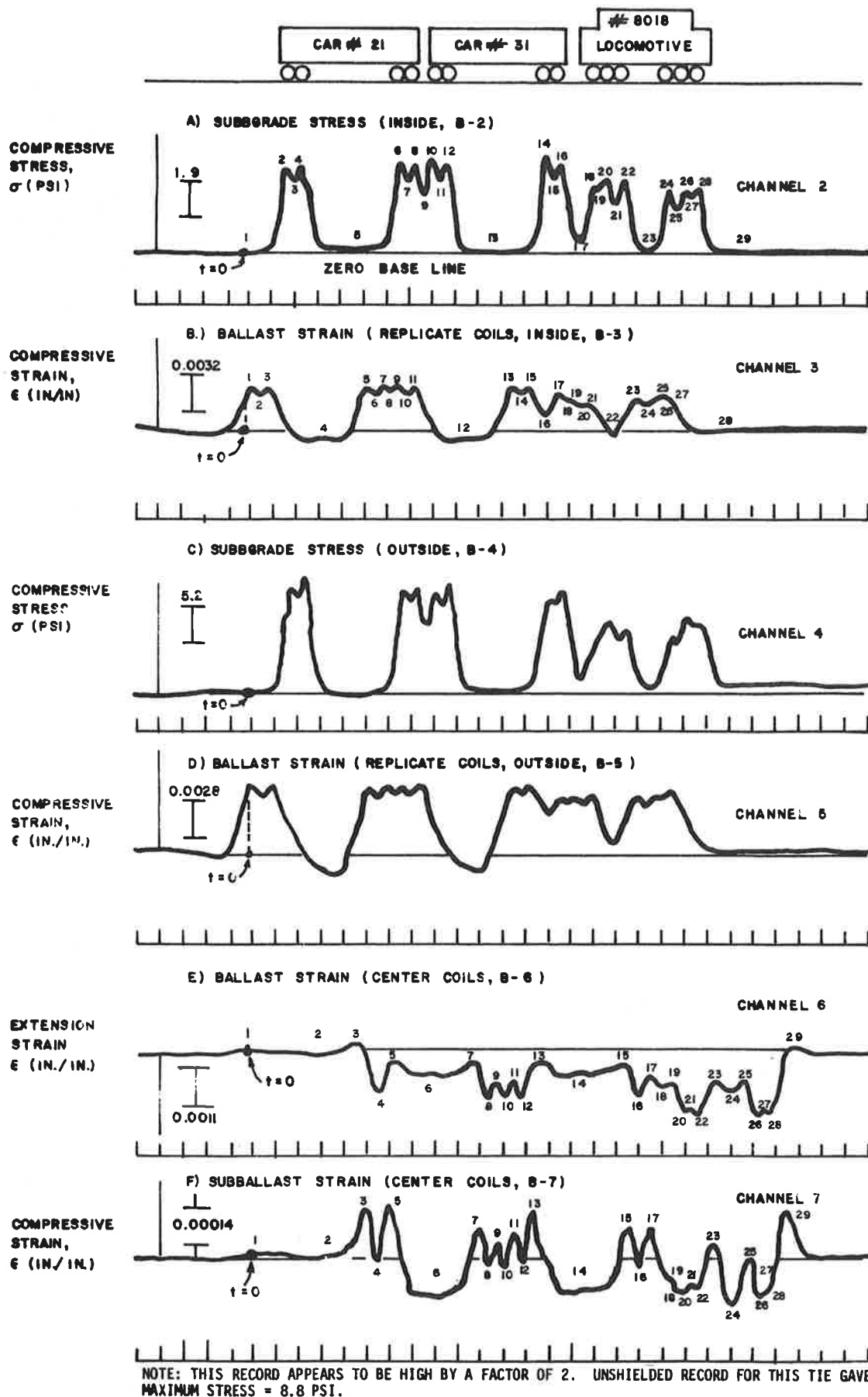
\* Note comparison not strictly valid since tie spacings and rail connections were different:  
Concrete ties : 24 inches center to center, CWR Rail; Wood ties : 19.5 inches center to center, Jointed Rail  
Source: "Elastic and Inelastic Deformation Response of Track Structure Under Train Loads," by C.W. Adegoke, Ph.D. Thesis, State University of New York at Buffalo, December 1978, pp. 148-157.



Reproduced from Status Report - Ballast Experiments, Intermediate (175 MGT) Substructure Stress and Strain Data, Interim Report, p. 14, by E. T. Selig et al. Year of first publication: 1979.

FIGURE 4-3. TYPICAL DYNAMIC RESPONSE OF SUBSTRUCTURE INDUCTANCE COILS AT FAST

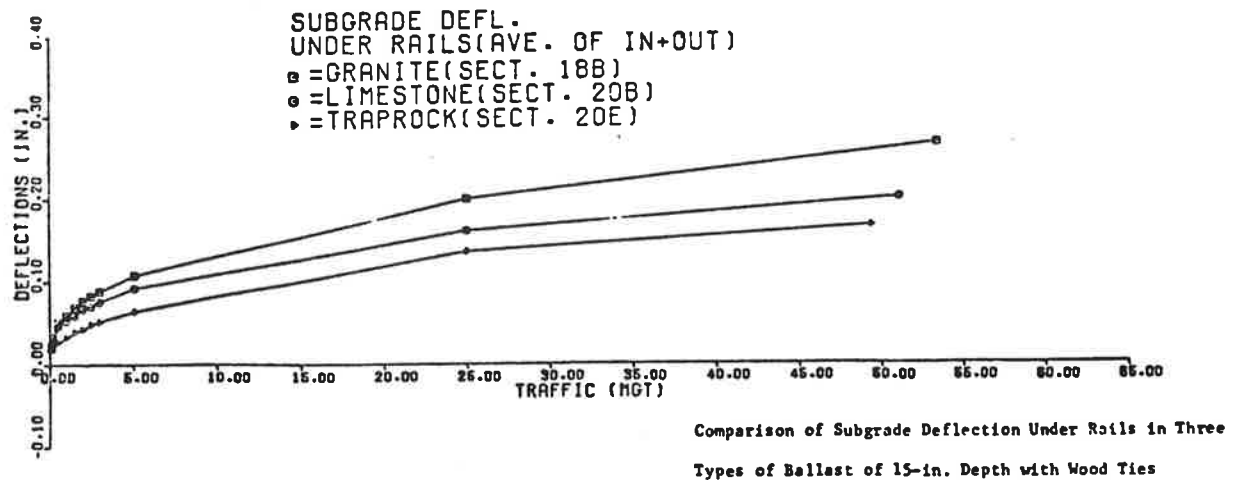
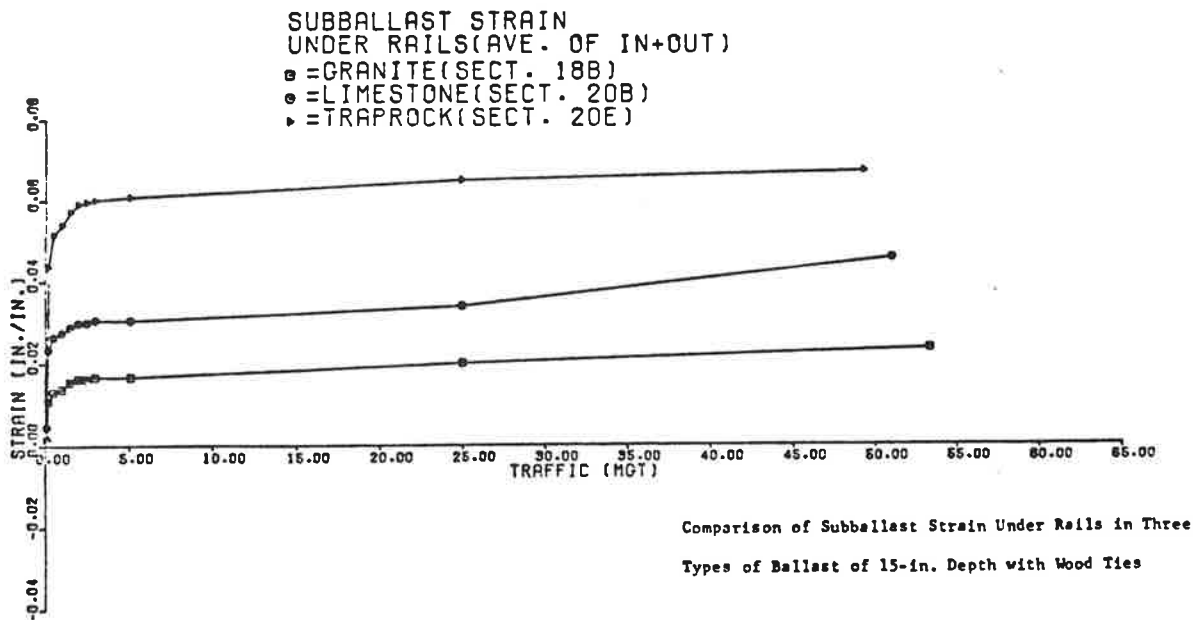
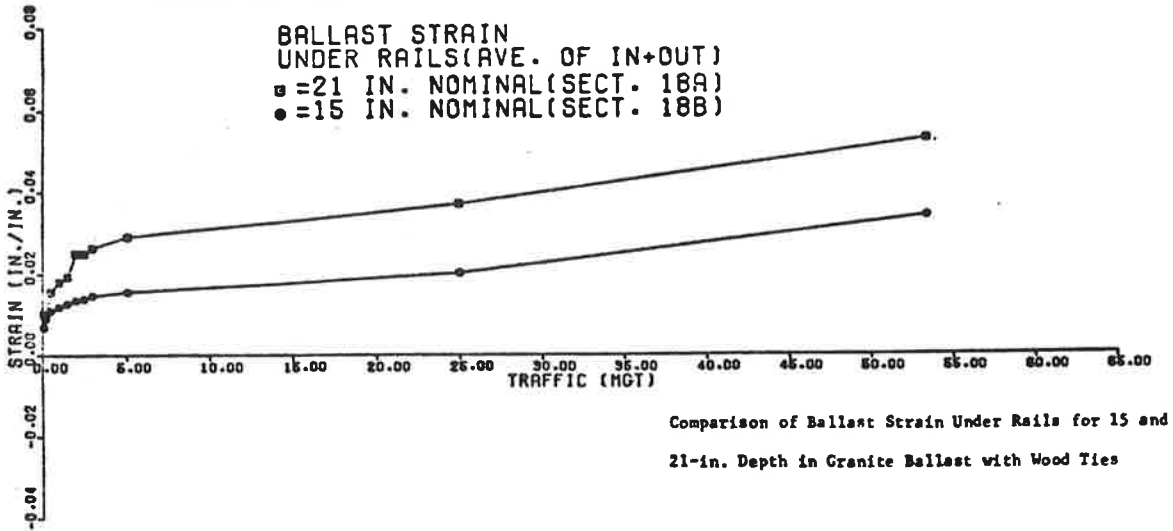




Reproduced from Status Report - Ballast Experiments, Intermediate (175 MGT) Substructure Stress and Strain Data, Interim Report, p. 15, by E. T. Selig et al. Year of first publication: 1979.

FIGURE 4-4. TYPICAL DYNAMIC RESPONSE OF SUBSTRUCTURE INDUCTANCE COILS AT FAST

### BALLAST DEPTH COMPARISON



Reproduced from Elastic and Inelastic Deformation Response of Track Structures Under Train Loads, 150-152 pp., by C. W. Adegoke. Year of first publication: 1978.

FIGURE 4-5. RESIDUAL DEFORMATIONS MEASURED IN SUBSTRUCTURE AT FAST

d. Both compressive and extension strains were developed in the ballast and subballast. Compressive deformations only were measured in the subgrade. However, these data are not conclusive. Measurements in the subgrade were made below the rails only and not below the center of the tie where it is most likely that extension strains would develop. Factors observed to affect the type of strains developed included wheel locations with respect to the tie, interactions between adjacent wheels (axles) and tie bending. The type of strains induced can significantly affect the stresses and strains in the tie, densification of ballast, and spreading of the ballast.

e. The behavior of ballast below the center of ties and below the rails was significantly different. Compressive strains were measured in the ballast and subballast below the inside and outside rails for all wheel locations except when the sensor was between trucks of the same car (peaks 4 and 12 of Figure 4-3). Very small extension strains were measured under these conditions, possibly due to the rail lift after passage of the wheels. Extension strains were measured in the ballast below tie centers for all wheel locations except the first and last wheel of a consist (peaks 3 and 29 of Figure 4-4). The largest extension strains were measured when the tie was between axles of the same truck (peaks 4 and 8). Selig hypothesized that tie bending was the principal cause of extension strains in the ballast.

f. The behavior of subballast below the tie centers and below the rails is similar. Compressive strains were developed in both areas except for extensional strains measured below tie centers between trucks of the same car (peaks 6 and 14 of Figure 4-4). Selig hypothesized that the horizontal stresses exceeded the vertical stresses in this region, leading to extension vertical strains in the subballast.

g. The residual strain data indicate that the three ballast types performed similarly.

h. Beyond a certain minimum thickness, the value of a thicker ballast layer is questionable. The resilient strain measurements indicated smaller strains and deflections in the subballast and subgrade below the 21-inch ballast layer; the residual strain data indicated generally the same magnitude of strains and deflections. Since the residual strains in the 21-inch ballast layer were significantly higher than in the 15-inch layer, the total settlements at the thicker ballast section locations should be higher.

i. No significant difference was observed in resilient data below concrete and wood ties. The residual data indicated ballast and subballast strains were approximately equal below both tie types, but subgrade deflections were significantly higher below concrete ties. Subgrade pressure cells indicated larger pressures transmitted to the subgrade below concrete ties, and therefore larger deflections would be expected.

j. Track maintenance was observed to have a profound effect on residual strain accumulation in the ballast and a lesser effect on the subballast. Tamping, surfacing, lining, and tie and fastener replacement loosened and

raised the track structure, inducing extension strains. Strain growth after maintenance was rapid. Collected data showed that the track sections with the highest degree of scatter between various measurement locations were the ones requiring the most frequent maintenance, and the section with the most uniform data required the least maintenance. This may indicate that variable ballast density causes variable ballast settlement, leading to faster deterioration of track geometry.

k. Unlike the ballast and subballast residual strains which accumulated quickly and then tended to level off after 50 MGT, the subgrade residual deformations accumulated gradually up to and beyond 50 MGT. The subgrade residual deformations were reasonably uniform within a section and were unaffected by maintenance activities.

Inconsistencies in some of the data made analysis of the effects of track parameters difficult. In addition, the firm or stiff nature of the granular subgrade at FAST made evaluation based on strain accumulation difficult, in that differences in pressures on the subgrade resulted in only small differences in subgrade deflection. While the FAST measurements provide significant insight into the behavior of substructure materials, an expanded data base, including measurements of the performance of different ballast and subballast materials and subgrade types, is required. Data on the performance of various types of cohesive subgrades is essential. These should include saturated, soft clays and silts, and dry, stiff clays. Data on a saturated, soft clay subgrade would be particularly useful because clay is often associated with unsatisfactory track conditions. Besides the actual residual strains generated in the clay layer, it would be useful to observe the effect of a soft subgrade on the strains generated in the ballast and subballast layers and stresses generated in the rails and ties.

#### 4.1.3 Practical Implications of Measured Substructure Behavior

Resilient Response - The data collected and interpretations of the various laboratory studies and the FAST experiment are significant contributions to the understanding of the behavior of substructure components under dynamic loading. Significant efforts have been made toward developing computer models to analyze the effects of different substructure parameters on the stresses, strains, displacements, and moments developed in rails, fasteners, and ties and the substructure. As discussed in Section 4.5, such models have been developed recently, but field data necessary to evaluate them have not been available. The FAST measurements have demonstrated that reliable data can be obtained. Field measurements for different track substructures with cohesive and granular subgrades are needed in order to develop a varied data base for validating laboratory testing procedures and analytic models and for studying track structure response. Development of such a data base will contribute to better, more rational methods of designing track structures and their components.

Long-Term Response - One of the main considerations in the design of ballast, subballast, and subgrade layers is their long-term behavior under loads. Those substructure materials that maintain their stability with the least amount of vertical, lateral, and longitudinal deformation require the least maintenance and are most desirable for use in the track structure.

The FAST residual response data provided insight into the effects of ballast density, track settlement, and track stability on long-term track performance. Selig et al. (1979) related changes in ballast strains to changes in ballast density (Figure 4-6). One of the factors the data confirmed is the large variation in density caused by maintenance procedures. Ballast looseness by itself is not necessarily a problem if it is homogeneous since the track would settle uniformly. However, with variable density the track settles differentially which causes track roughness. The effects of traffic densifying the ballast after maintenance, thereby increasing the track stability, and the effects of maintenance decreasing ballast density and track stability are shown dramatically in Figure 4-6. While densifying the ballast improves the long-term track stability, the differential settlement required to achieve that density can cause significant track geometry deterioration. Sufficient densification of the ballast after maintenance would reduce differential track settlement. Ballast compactors are being developed to provide this densification.

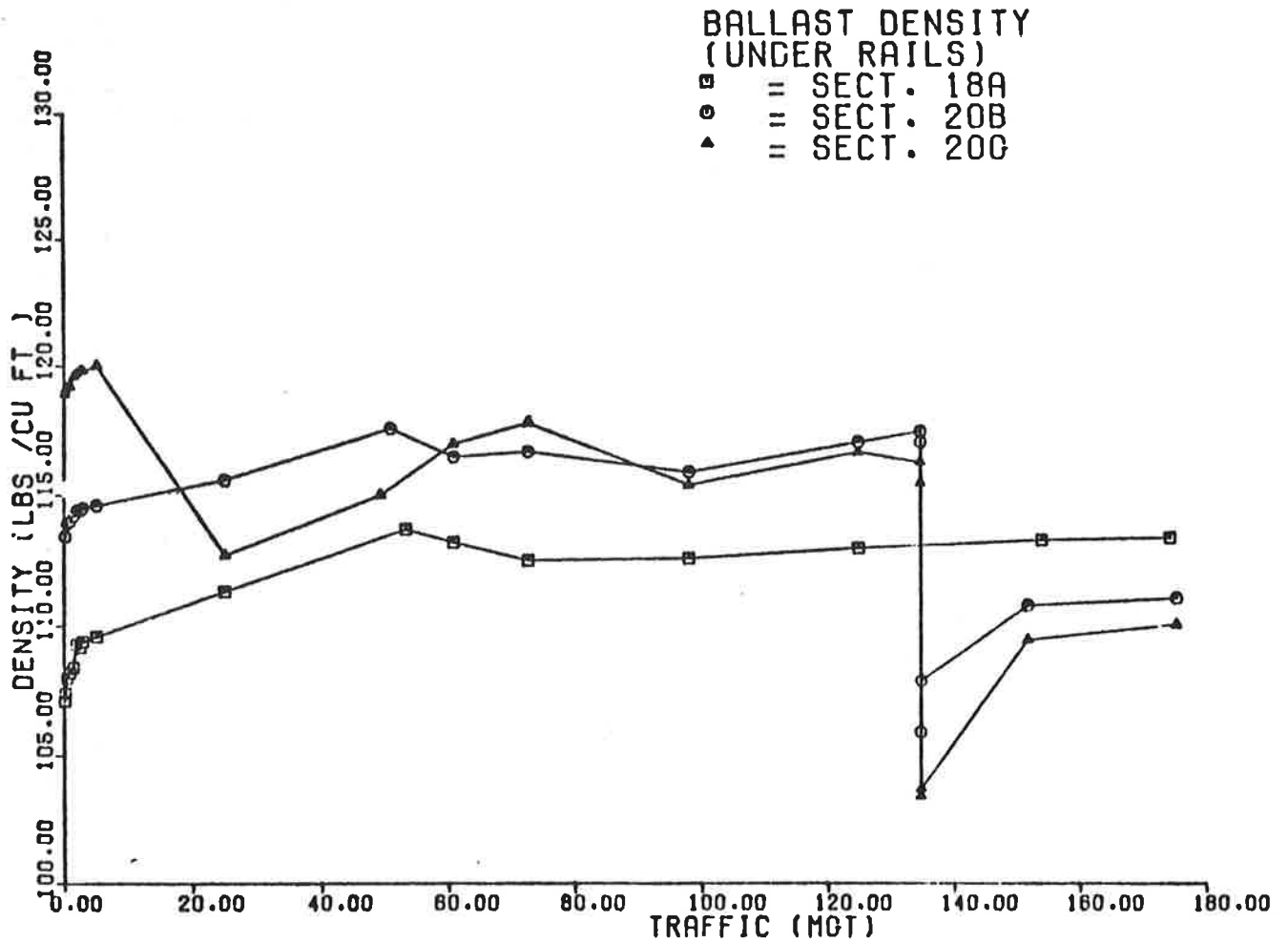
#### 4.2 CURRENT U.S. AND CANADIAN DESIGN PRACTICE

Track design should provide a railroad track that is safe and economical. To allow for a train operation, rails must be maintained at a geometry commensurate with the desired operating speed. The economic factors to be considered--according to Chapter 22, Part 3 of the 1976 AREA Manual for Railway Engineering--are cost of rail, ties, fasteners, ballast, and other track structure elements; rail wear and life expectancy; track maintenance; and salvage value of track elements. At a minimum, the track must support loads imposed by the trains without immediate structural failure. Track analysis procedures contained in the AREA Manual provide design guidance on these structural considerations. However, regarding track maintenance costs, the Manual only suggests, "These costs should reflect the railroad's own experience with the various classes of track."

The design process described below gives criteria for selecting rail size, tie size and spacing, and ballast thickness. Chapter 1 of the AREA Manual provides guidance in selecting ballast materials and design of the track substructure. The companion report of this study dealing with substructure material evaluation and stabilization practices provides additional guidance on the selection of substructure materials to meet design objectives<sup>11</sup>.

---

<sup>11</sup>R. M. Simon et al., Ballast and Subgrade Requirements Study: Railroad Track Substructure - Materials Evaluation and Stabilization Practices, prepared for U.S. Dept. of Transportation, Federal Railroad Administration, 1983, pp. 1-96.



Reproduced from Status Report - Ballast Experiments, Intermediate (175 MGT) Substructure Stress and Strain Data, Interim Report, p. 84, by E. T. Selig et al. Year of first publication: 1979.

FIGURE 4-6. BALLAST DENSITY CHANGES WITH TRAFFIC ESTIMATED FROM INITIAL DENSITY AND BALLAST STRAIN

#### 4.2.1 Total Design Process

As described in 1974 by R. H. Prause et al. in Assessment of Design Tools and Criteria for Urban Rail Track Structures, design of tie-ballast track is based on consideration of five criteria: bending stress in the rail and in the ties; contact pressure on the ballast; contact pressure on the subgrade; and resilient deflection of the track. Three design elements of track (rail, ties, and ballast thickness) are tested against these five criteria in the cycle outlined in Figure 4-7. The elements of the track are adjusted so that they develop an economical design that satisfies all the limit criteria.

Initially, track modulus, rail size, and tie size and spacing are assumed, and dynamic wheel loads are estimated. The four main limit tests (the diamond shapes of Figure 4-7) are made, and track components that meet all criteria are selected. Although this is basically a sound approach, in practice it has several major shortcomings which will be discussed at the end of this section. In the following pages, the major steps in the process, as related to selection of substructure components, will be described.

#### 4.2.2 Design Criteria and Analytic Methods

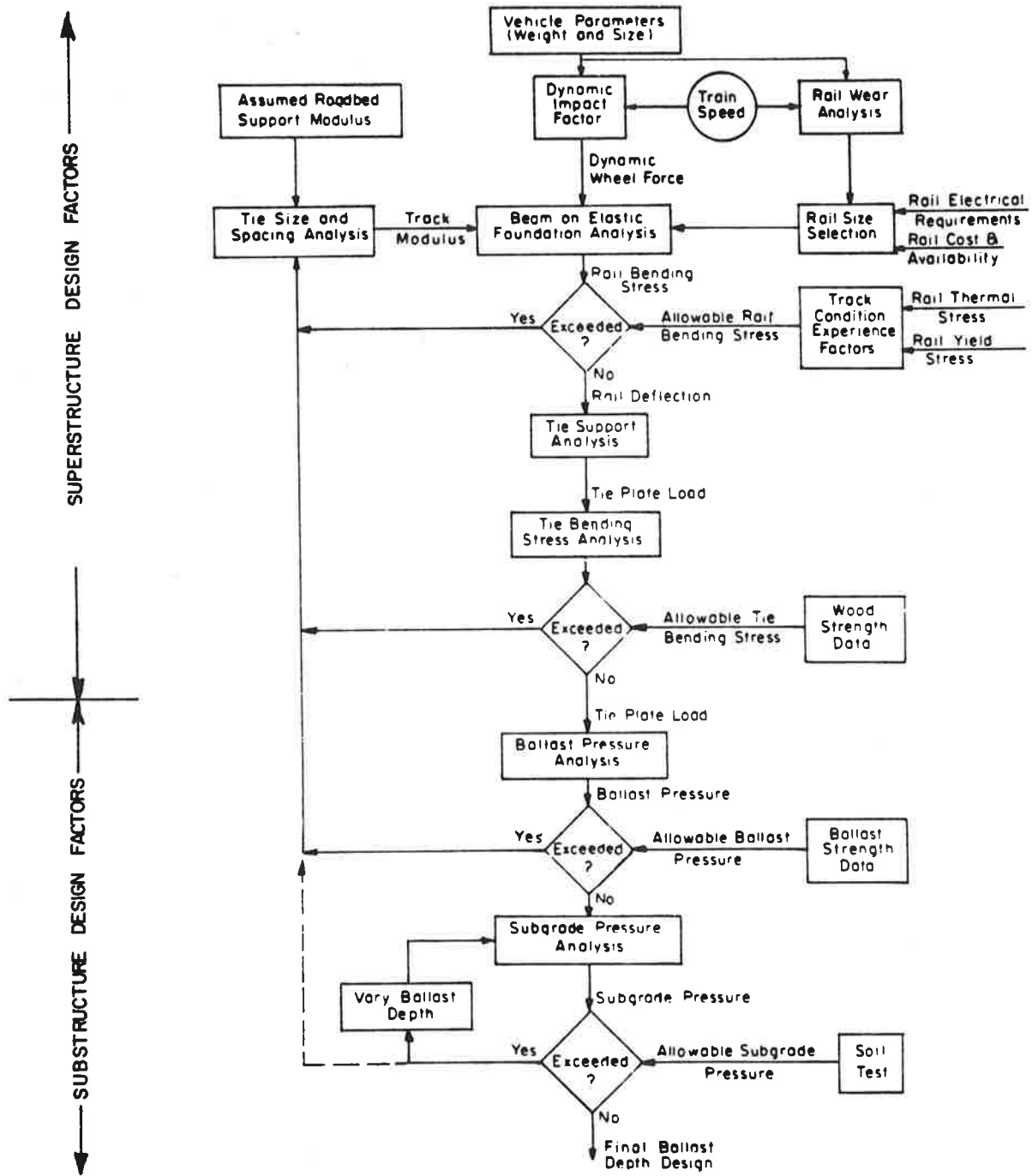
Design criteria and analytic methods provided by AREA in the Manual for Railway Engineering were developed primarily by Talbot and the AREA Special Committee on Stress in Railroad Track, as published in seven progress reports from 1918 to 1942<sup>12</sup>. The Talbot committee's work included theoretical studies and field and laboratory measurements of stresses and strains in track. Field and laboratory measurements included bending stresses in rail, contact loads between rails and ties, and contact pressure of ties on ballast. In 1957, C. W. Clarke summarized the results of these studies in "Track Loading Fundamentals."

Presently, many of the parameters used in analyzing substructure components are derived from beam-on-elastic-foundation theoretical results used to analyze superstructure components (rails and ties). Therefore, to understand the origin and use of these parameters in ballast and subgrade pressure design, equations for rail and tie loading are discussed below.

Background - As Figure 4-7 shows, present track structure design is based on the beam-on-elastic-foundation theory, also known as the "Winkler Beam" method. From its introduction in 1888 by H. Zimmermann, the method developed from a crude approximation to its current form. During that period,

---

<sup>12</sup>Recently republished: Stresses in Railroad Track - The Talbot Reports, AREA, Chicago, 1980, 350 pp.



Reproduced from *Assessment of Design Tools and Criteria For Urban Rail Track Structures, Volume I: At-Grade Tie-Ballast Track*, p. 11, by R. H. Prause et. al. Year of first publication: 1974.

FIGURE 4-7. FLOW CHART FOR CONVENTIONAL AT-GRADE TRACK STRUCTURE DESIGN



the track structure was first considered as a continuous beam supported on discrete, rigid supports. It was later determined that the ties, ballast, and subgrade were not rigid, and the revised method accounted for the elastic behavior of the supports.

After tests were conducted in 1937 by Talbot and his co-workers, the continuous elastic support model replaced the discrete support model. This form gained acceptance among domestic railroads and remains in use today. In this analysis, it is assumed that the reaction forces of the foundation are proportional at every point to the deflection of the beam at that point. The assumption can be envisioned as a foundation comprised of closely spaced but laterally disconnected springs. This analysis is approximate for beams on soil foundations because soil is a deformable solid in which deformations are not restricted only to the area directly beneath the load. However, observations of beams on soil foundations, including the Talbot committee work, indicated that the Winkler model provides satisfactory results. The classic work on this subject is the 1946 text by M. Hetenyi, Beams on Elastic Foundation.

Vertical Load on the Rails - Determination of the maximum vertical load on the rails is the subject of Section 2.1 and results in expressions for the maximum dynamic wheel load,  $P_d$ . A typical practice for wood ties is to adopt a design vertical load equal to twice the static load; however, the actual value is a function of speed and other factors.

The allowable maximum bending stress is a function of the yield stress of the steel. The AREA Manual recommends that the yield stress be reduced by 20,000 psi to account for thermal stresses, and that the remainder be divided by a factor of two to account for lateral bending, track condition, rail wear and corrosion, and unbalanced elevation of the track.

Design of concrete tie track is discussed in Chapter 10 of the 1980 AREA Manual. The dynamic impact factor for concrete tie track is assumed to be equal to 150 percent of the static load so that the total wheel load,  $P_d$ , for design of rails on concrete ties is 2.5 times the static load (this is 25 percent higher than for wood tie track). Recent field measurements may be used as a basis for a further increase in the dynamic overload factor for concrete ties above 150 percent.

Selection of Rail Size - Rail size selection is based, at a minimum, on providing sufficient bending capacity to keep rail stresses within safe limits. Three preliminary equations are provided in the 1975 AREA Manual<sup>13</sup>. Greater rail weights may be selected based on rail wear or other considerations.

---

<sup>13</sup>AREA, Manual for Railway Engineering, 1980, p. 22-3-6.

Vertical Load on Wood Ties - The load applied by the rail seat to wood ties is based on the solution to the beam-on-elastic-foundation problem. First the deflection of the rail-tie system is computed from the equation:

$$y = (P_d B/2u) e^{-Bx} (\cos Bx + \sin Bx)$$

where:  $y$  = deflection of rail (in)

$P_d$  = dynamic wheel load (pounds)

$B = \sqrt[4]{u/4EI}$  = stiffness ratio

$u$  = modulus of rail support or "track modulus" (lb/in/in)

$E$  = rail modulus of elasticity (psi)

$I$  = rail moment of inertia (in<sup>4</sup>)

$e$  = base of the natural logarithms (i.e., 2.7183)

$x$  = distance along the rail from the point of load application (in)

Deflection contributions due to the loads applied by adjacent wheels within the zone of influence are added to the deflection caused by the central wheel load in accordance with the principle of superposition for linear elastic systems. The zone of influence for adjacent wheel loads is determined by the distribution of displacements along the rail. For typical rail sections and modulus of track support,  $u$ , this distance is 17 feet to 20 feet, encompassing a two-truck consist for adjacent cars.

After the maximum rail/tie deflection has been determined for the combined effects of adjacent wheels, the value of maximum rail seat load to the ties is determined from:

$$P_{d_t} = \hat{y}su$$

where:

$P_{d_t}$  = dynamic load on tie at each rail seat (pounds)

$\hat{y}$  = maximum deflection (inches) (assumed equal to the average deflection over the length  $S$  along the track)

$u$  = track modulus (psi) (lb/in/in)

$s$  = tie spacing (inches)

The dynamic rail seat load is not proportional to the value of  $u$  used in the analysis, as would be indicated by the above equation. The value of  $u$  appears in the denominator of the former equation so that the two cancel out in the expression for the dynamic rail seat load. However,  $u$  does appear in the equation for the stiffness ratio,  $B$  (used in the previous equation), so that the value of  $u$  selected will have a nonlinear influence on the computed value of the rail seat load.

The track modulus,  $u$ , represents the combined stiffness of the ties, fasteners, ballast, subballast, and subgrade. It is affected by tie quality, size, and spacing; ballast and subballast density and thickness; and subgrade resilience. These factors are all affected by the type and frequency of maintenance and environmental conditions. The value of  $u$  typically varies from 400 lb/in/in (very soft) to 4,000 lb/in/in (very stiff). Track modulus is best determined by field testing in which measurements of deflection under load are made. However, for "typical" subgrades, AREA recommends use of an "average"  $u$  of 2000 lb/in/in when measurements cannot be made. This value is based on research performed by the Association of American Railroads for 7" x 9" x 8'-6" wood ties at 20-inch spacing. The average track modulus should be adjusted for particular conditions, since it is assumed to increase in proportion to the base area of the ties and to vary in inverse proportion to the tie spacing.

Vertical Load on Concrete Ties - Based on observed magnitudes of loads on test sections of concrete tie track, the maximum rail seat load on concrete tie track as recommended in the 1980 AREA Manual (Chapter 10, Part 1) is higher than for wood tie track. Including the 150 percent overload factor to account for dynamic effects, the total load applied to concrete ties is:

$$P_{dt} = 2.5k_s P_s$$

where:

$P_{dt}$  = dynamic concrete tie load per rail seat (pounds)

$k_s$  = coefficient of tie spacing effect (varies linearly from 0.45 for 20-inch tie spacing to 0.60 for 30-inch tie spacing)

$P_s$  = static wheel load (pounds)

This equation includes the effects of dynamic impact, tie spacing, and adjacent wheel loads. For typical 24-inch center-to-center spacing of concrete ties, the dynamic rail seat load is 1.28 times the static wheel load. For wood ties spaced at 20 inches, the rail seat load is typically 0.58 times the static wheel load. Even wood ties spaced 24 inches on center would receive only 0.70 times the static wheel load.

Pressure on the Ballast - The recommended limit on the wood tie-ballast contact pressure, as contained in Chapter 22 of the AREA Manual, is 65 psi. This limit pressure is compared with a tie bearing pressure computed as twice the static rail seat load divided by the effective bearing area of the tie beneath the rail seat. For wood ties, the effective tie bearing area is a function of the tie stiffness. For typical 7" x 9" x 8'-6" ties, the effective

length is 35 inches, or about one-third of the total tie length. The AREA Manual (page 22-3-15) recommends doubling the rail seat load to determine the maximum permissible tie spacing based on pressure on the ballast. This doubling of the rail seat load was recommended by the Talbot committee in its first progress report and is to account for load increases caused by play between the rail and tie, and variations in ballast and subgrade stiffness. It is accounted for when the static wheel load is doubled to include dynamic loading effects (including speed) and should not be doubled again. For the typical wood tie spacing of 20 inches center-to-center, the ballast bearing pressure under a 30,000-pound wheel load would be computed as follows:

$$P_{d_t} = 0.58 P_s = 17,400 \text{ pounds}$$

$$A_b = 35 \text{ inches} \times 9 \text{ inches} = 315 \text{ sq. in.}$$

$$P_m = P_{d_t} / A_b = 17,400 / 315 = 55 \text{ psi} \leq 65 \text{ psi}$$

where:

$$P_{d_t} = \text{design dynamic rail seat load}$$

$$A_b = \text{effective tie bearing area on the ballast per rail seat}$$

$$P_m = \text{tie-ballast bearing pressure}$$

For concrete ties, Chapter 10 of the AREA Manual recommends that the average tie-ballast bearing pressure be calculated as the rail seat load divided by one-half of the tie base area. The reasoning behind using one-half the tie bearing area (as opposed to the one-third used for wood ties) is that concrete ties are stiffer than wood and are better able to spread the rail seat load over a wider portion of the tie to the underlying ballast. The recommended limit on the ballast contact stress is 85 psi for high-quality, abrasion-resistant ballast.

Drawing from the previous example for typical 7" x 9" x 8'-6" concrete ties spaced 24 inches center-to-center and a 30,000-pound wheel load,

$$P_{d_t} = 2.5 \times 0.51 \times 30,000 = 38,250 \text{ pounds}$$

$$P_m = P_{d_t} / (9 \times 102 - 2) = 83 \text{ psi}$$

This pressure is just within the 85-psi limit recommended by AREA.

It is worthwhile to note that in the derivation of the 65-psi ballast pressure limit for wood ties, the crushing strength of the ballast was not the controlling criterion; rather, the ballast-tie pressure limit was derived from the flexural strength of the ties. Sixty-five psi was theoretically determined using the beam-on-elastic-foundation analysis, an empirically-determined effective bearing area, 8-inch-wide wood ties, and a 20-inch tie

spacing<sup>14</sup>. Although maintaining safe flexural stress in the tie is an important consideration, the mechanical properties of the ballast material should also be considered. In the third article of "Track Loading Fundamentals" (1957), C. W. Clarke stated the importance of maintaining a safe ballast pressure to prevent crushing or "undue attrition" of ballast. Although the basis of this statement is not clear, Clarke recommended a safe ballast surface pressure of 35 psi, almost half the 65 psi recommended in the AREA Manual.

Subgrade Loading and Ballast Depth - Four equations are presented in the AREA Manual that can be used to calculate the depth of ballast required to reduce the tie-ballast bearing pressure to an allowable pressure on the subgrade soil. In Chapter 22 of the Manual, AREA recommends an allowable subgrade bearing pressure of 20 psi for all subgrade soils. Equations listed in that chapter are as follows:

1. Talbot equation:

$$p_c = \frac{16.8 P_m}{h^{1.25}}$$

2. Japanese National Railways equation:

$$p_c = \frac{50 P_m}{10 + h^{1.35}} \quad (h \text{ in centimeters})$$

3. Boussinesq equation:

$$p_c = \frac{6 q_0}{2\pi h^2}$$

$q_0$  = static rail seat load;

4. Love's equation:

$$p_c = P_m \left[ 1 - \left( \frac{1}{1 + r^2/h^2} \right)^{3/2} \right]$$

where:

$p_c$  = subgrade pressure (psi)

$P_m$  = applied stress on ballast (psi)

$h$  = ballast depth (inches, except JNR in cm)

---

<sup>14</sup>G. M. Magee, "Current Status of Prestressed Concrete Ties on Railroads in the U.S.," Proceedings, Vol. 67, Bulletin, No. 600, AREA, June-July 1966, p. 622.

$q_0$  = static rail seat load (pounds)

$r$  = the radius of a circle whose area equals the tie ballast bearing area,  $A_b$  (inches).

The Talbot and the Japanese National Railways (JNR) equations are empirical. The JNR equation, while not so noted in the AREA Manual, was developed for narrow gage track. Talbot's formula was developed from a number of full-scale laboratory tests performed at the University of Illinois<sup>15</sup>. Several different types of ballast were tested, including sand, slag, crushed stone, and gravel, with pressures from applied static loads measured at various depths and locations under several ties. Wheel loads were not as large as those commonly encountered today.

The third and fourth equations are both based on the Boussinesq solution for stress in an elastic body due to an applied surface point load. Love's formula is an extension of the Boussinesq results, in which the load applied by the tie to the ballast is represented as a uniform pressure over a circular area equal to the tie bearing area,  $A_b$ .

Evaluation of the four equations can be based only on how well they might represent actual stresses in substructures measured in field experiments. The thickness of ballast below the ties required to reduce the maximum recommended tie-ballast bearing pressure of 65 psi on a 315-square-inch tie bearing area to the maximum recommended ballast-subgrade bearing pressure of 20 psi may be calculated by each of the formulas shown in the following table:

<u>Equation</u>	<u>Ballast Thickness, inches</u>
Talbot	24.5
Japanese National Railways	16.3
Boussinesq*	24.2
Love's	19.0

\*The computed thickness for the Boussinesq equation was reduced by 7 inches to account for the load-spreading action of the ties.

Ballast and subgrade pressure measurements available for comparison are those made in 1966 by M. T. Salem and W. W. Hay reported in Vertical Pressure Distribution in the Ballast Section and on the Subgrade Beneath Statically Loaded Ties and those reported in 1972 by British Railways in Advanced Transport Technology. These actual measurements indicate that the thickness of 16 inches obtained from the JNR equation is approximately correct.

A similar observation was reported in 1974 by R. H. Prause et al. in Assessment of Design Tools and Criteria for Urban Rail Track Structures. Based on these

---

<sup>15</sup>AREA-ASCE Special Committee on Stresses in Railroad Track, "First Progress Report," Bulletin, AREA, Vol. 19, No. 205, March 1918, 192 pp.

comparisons, it would seem that the JNR equation gives the best estimate of the subgrade pressure at depth; Love's formula is slightly conservative; and the Talbot and the Boussinesq formulas would indicate a required ballast thickness that is 50 to 100 percent too large.

#### 4.2.3 Discussion

In his standard engineering text, Railroad Engineering, Hay summarized the state of track design in the U.S. and Canada: "Track has not evolved through any process of rational design. The structure of today is the result of years of experience and of trial and error. The indeterminate character of the track components largely accounts for this situation. Almost nothing is known of the strengths and forces in the roadbed. What is known indicates a lack of uniformity in its strength, yieldability, and other characteristics. The same holds true for ballast and the tie pressures distributed through it. Ties possess the variability of all wood and are subjected to further changes with weathering and use. Nonuniformity of ballast reactions makes tie mechanics indeterminate. The rail itself is difficult to analyze especially in view of nonuniformity of support and variable loading applied to it." Although written in 1953, many of these comments still apply today.

Current design practices for railroad substructures in North America are based predominantly on experience. Our survey of several North American railroad systems indicated that design of ballast, subballast (if used), and subgrade layers is based on local performance experience adapted from basic design criteria provided by AREA. This experience has resulted in several North American railroads developing standard designs for ballast and subballast depth. These standards may be modified for local soil and environmental conditions in particular regions. Table 4-4 presents standard ballast and subballast depths for the two major Canadian railroads and six American railroads. The AREA-recommended minimum depths are also shown. AREA recommends, and most railroads allow for, increases in ballast or subballast depths for weak subgrade conditions such as soft plastic clays. The methods used by the railroads to evaluate whether and how much additional materials are needed are not clear. Our experience and study indicate that rational testing and analytical methods are seldom used; rather, the judgment of experienced maintenance-of-way and construction personnel forms the basis of subgrade evaluation and design modifications in practice.

The variations in the thickness of substructure sections among the different railroad organizations probably are due to different soil and environmental conditions in various regions. Raymond observed that the regions generally underlain by granular subgrades, such as those of the Seaboard Coast Line, Southern Pacific, and Union Pacific, had the smallest ballast and subballast depths; whereas those with cohesive subgrades, such as those of the Illinois Central Gulf and the Santa Fe, had the thickest ballast and subballast layers.

TABLE 4-4. SPECIFICATION FOR MAINLINE TRACK FORMATION

<u>RAILWAY</u>	<u>SUBBALLAST</u>	<u>BALLAST</u>
Canadian National Railway	Minimum of 12 in. (300 mm)	12 in. (300 mm)
Canadian Pacific Ltd.	--	12 in. (300 mm)
Southern Pacific Transportation Co.	Minimum of 6 in. (150 mm)	Minimum of 6 in. (150 mm)
The Atchison, Topeka and Santa Fe Railroad	12 in. (300 mm)	12 in. (300 mm)
Seaboard Coast Line Railroad	4 in. (100 mm)	Minimum of 6 in. (150 mm)
Union Pacific Railroad	6 in. (150 mm)	8 in. (200 mm)
Illinois Central	12 in. (300 mm)	12 in. (300 mm)
Southern Railway System	12 in. (305 mm)	12 in. (305 mm)
AREA Recom- mendations	Minimum of 6 in.	Minimum of 12 in. (Mainline Track) Minimum of 6 in. (Other Track)

Reproduced from "Design for Railroad Ballast and Subgrade Support," Journal of the Geotechnical Engineering Division, Vol. 104, GT1, p. 54, by G. P. Raymond, by permission of American Society of Civil Engineers. Year of first publication: 1978.



In addition, both Raymond<sup>16</sup> and Robnett<sup>17</sup> noted that the Santa Fe specifies from 6 inches to 12 inches of lime stabilization of cohesive subgrade surfaces prior to placing subballast. The depths indicated for both Canadian railroads are believed to be controlled by minimum frost cover requirements.

From a geotechnical engineering viewpoint, the major shortcomings of available analytic and design methods and current North American practice include the following:

a. The beam-on-elastic-foundation method for railroad track analysis does not adequately represent the performance of the individual substructure components. This has been recognized by many investigators, including Talbot (1918), Clarke (1957), Prause et al. (1974), Robnett et al. (1975), and Selig et al.<sup>18</sup>.

b. The beam-on-elastic-foundation approach evaluates only the resilient displacements and stresses but does not consider the effects of repeated dynamic loading or residual displacement of superstructure and substructure components.

c. Both in analytic methods and in actual track rehabilitation and design practice, little attention is paid to determining the type, strength, and condition of subgrade soil and to incorporating subgrade properties into design analyses. Instead, general allowable ballast and subgrade pressures are used for analysis, and standard ballast and subballast depth specifications are used in actual design practice.

The track structure below the rails is represented in current analysis methods by the track modulus,  $u$ . The track modulus represents the stiffness of the ties, ballast, subballast and subgrade. Its value is influenced by tie quality, size, and spacing; ballast and subballast thickness and density; and subgrade strength. With so many factors affecting its value, the causes of change in the value of  $u$  are not readily apparent.

One fundamental design criterion for track design today is limiting the pressure on the subgrade to an amount the subgrade can support without excessive strain or bearing failure. The AREA Manual states, "The generally

---

<sup>16</sup>G. P. Raymond, "Design for Railroad Ballast and Subgrade Support," Journal of the Geotechnical Engineering Division, ASCE, Vol. 104, No. GT 1, January 1978, pp. 45-60.

<sup>17</sup>Q. L. Robnett et al., Technical Data Bases Report, Ballast and Foundation Materials Research Program, prepared for U.S. Dept. of Transportation, Federal Railroad Administration, Report No. FRA-ORD-76-138, July 1975, 175 pp.

<sup>18</sup>E. T. Selig et al., A Theory for Track Maintenance Life Prediction, First Year Final Report, prepared for U.S. Dept. of Transportation, Office of University Research, Contract DOT/RSPA/DPB-50/79/22, August 1979, 183 pp.

accepted railroad practice of limiting subgrade pressures to 20 psi is recommended herein." In our opinion, current design practice should be modified to account for subgrade variability. In the third section of "Track Loading Fundamentals" (1957), C.W. Clarke stated that allowable track bearing pressures on soils should be only 60 percent of the normal allowable soil bearing pressures<sup>19</sup>. Clarke also stated that allowable soil bearing pressures should be based on measurements of shear strength, compaction, or bearing ratio to limit overstressing due to variations in the track structure. Clarke provided a table of allowable track bearing pressures for soils as shown in Table 4-5. Additional allowable bearing pressures from Milosovic's "Determining the Depth of Ballast" (1969) and the U.S. NAVFAC Soil Mechanics Design Manual are also shown in the table. The NAVFAC Design Manual values shown have been multiplied by 0.6 to account for variations in tie support as suggested by Clarke. As the table shows, adopting a universal allowable bearing pressure of 20 psi for subgrades can be expected to lead to performance difficulties on subgrades of loose, fine sands; clays; silts; and dumped (uncompacted) fills. Indeed, most problem track conditions are reported in areas where low-quality subgrades exist. Even Clarke's recommendations of a 12-psi limit on uncompacted subgrade would not appear to be satisfactory in the case of low-quality subgrades.

The adoption of standardized design track sections for track for various areas and loading conditions is a reasonable procedure in our opinion. However, it should be recognized that such standard designs should be considered as minimum acceptable designs. That is, as long as subgrade conditions exceed some level of performance, the standard design can be expected to provide a satisfactory track design. The principal challenge in applying this type of procedure is to identify conditions that fall below the minimum acceptable subgrade condition and to evaluate design modifications for substandard conditions.

Interviews with practicing railroad engineers indicate that little or no subsurface investigation is carried out prior to track rehabilitation or construction to determine what "average" conditions are--much less the worst conditions--along a proposed route or a track to be upgraded. The tools and methods to perform these investigations are used in geotechnical engineering practice today. They have been summarized by Simon et al.<sup>20</sup> in the companion report of this study.

Variations in the performance of the various track components caused by such conditions as deteriorated ties, poor rail fastener-tie connections, and in-situ density of the ballast are not readily accounted for by the beam-on-elastic-foundation approach.

---

<sup>19</sup>Clarke's 60 percent is for use in analyses using twice the static wheel load.

<sup>20</sup>R. M. Simon et al., "Ballast and Subgrade Requirements Study: Railroad Track Substructure - Materials Evaluation and Stabilization Practices," U.S. Dept. of Transportation, Federal Railroad Administration, Washington, DC, 1983, pp. 4-96.

TABLE 4-5. ALLOWABLE AVERAGE SUBGRADE BEARING PRESSURES

<u>SUBGRADE DESCRIPTION</u>	<u>ALLOWABLE PRESSURE BELOW TRACK (PSI)</u>
Alluvial Soils	Below 10
Made Grounds, Not Compacted	11 - 15
Soft Clay, Wet or Loose Sand	16 - 20
Dry Clay, Firm Sand, Sandy Clay	21 - 30
Dry Gravel Soils	31 - 40
Compacted Soils	41 and over

Source: C. W. Clarke, "Track Loading Fundamentals-3," The Railway Gazette, Vol. 106, February 8, 1957, p. 159.

<u>SUBGRADE DESCRIPTION</u>	<u>IN-PLACE CONSISTENCY</u>	<u>ALLOWABLE PRESSURE BELOW TRACK (PSI)</u>
Well graded mixture of fine and coarse grained soil: glacial till, hardpan, boulder clay (GW-GC, GC, SC).	Very Compact	65 - 100
Gravel, gravel-sand mixtures, boulder-gravel mixtures (GW, GP, SW, SP)	Very Compact	55 - 85
	Medium to Compact	40 - 60
	Loose	25 - 50
Coarse to medium sand, sand with little gravel (SW, SP)	Very Compact	30 - 50
	Medium to Compact	25 - 30
	Loose	15 - 25
Fine to medium sand, silty or clayey medium to coarse sand (SW, SM, SC)	Very Compact	25 - 40
	Medium to Compact	15 - 30
	Loose	8 - 15
Fine sand, silty or clayey medium to fine sand (SP, SM, SC)	Very Compact	25 - 30
	Medium to Compact	15 - 25
	Loose	8 - 15
Homogeneous inorganic clay, sandy or silty clay (CL, CH)	Very Stiff to Hard	25 - 50
	Medium to Stiff	8 - 25
	Soft	4 - 8
Inorganic silt, sandy or clayey silt, varved silt-clay-fine sand (ML, MH)	Very Stiff to Hard	15 - 30
	Medium to Stiff	8 - 25
	Soft	4 - 8

Source: Soil Mechanics, Foundations, and Earth Structures, pp. 7-11-12, U.S. NAVFAC Design Manual DM-7. Year of first publication: 1962.

<u>SUBGRADE DESCRIPTION</u>	<u>ALLOWABLE PRESSURE BELOW TRACK (PSI)</u>
Coherent or fragmented rock	57
Banks of boulders	50
Gravel	43
Dry Clay and pug	28 - 36
Fine sand	14 - 21
Wet clay and pug	11 - 14

Source: "Determining the Depth of Ballast", p. 142, by B. Milosevic. Year of first publication: 1960.

There is no established procedure for evaluation of the influence of the various track components on the appropriate value of track modulus,  $u$ . The only way to measure  $u$  is to build a trial track section and perform a full-scale load test. This is impractical and would give an answer only for a particular location. A more practical test is required to correlate results with a full-scale load test. There has been no general agreement on a test for providing design input for new construction.

### 4.3 FOREIGN DESIGN PRACTICE

Current methods for substructure analysis and design used by railroads in Japan, West Germany, Russia, Czechoslovakia, Hungary, India, Austria, and Great Britain were reviewed. The principal design criterion for these analysis methods is to limit the resilient stresses on the track subgrade to a magnitude that will avoid bearing capacity failure and will limit permanent subgrade settlement. This practice is similar to the procedures used by U.S. and Canadian railroads. However, unlike North American practice, practical analytical and experimental methods have been developed by these foreign railroads that are used for determining the required thickness of ballast and subballast layers considering both the type and properties of local subgrade materials. In addition, after track sections are built or rehabilitated, track and substructure performance is monitored so that proper evaluation of particular substructure design can be made.

In the following section, the various analytical methods are presented. This is followed by a discussion of how these methods are used in foreign practice. In particular, the standard substructure sections which have been developed using these methods are presented.

#### 4.3.1 Analytical and Design Methods

Review of foreign practice has revealed three basic substructure analytical/design methods. They include multi-layer elastic methods reported by the German, Hungarian, Czechoslovak, and Japanese railways; the threshold stress approach used by British Railways; and an effective stress analysis used by Indian State Railways to determine substructure layer thicknesses. These methods are described below.

Multi-layer Elastic Methods - J. Kraus<sup>21</sup> in 1976, L. Nagy<sup>22</sup> in 1977, J. Eisenmann<sup>23</sup> in 1969, and J. Spang<sup>24</sup> in 1972 reported on design and analysis methods used in Europe by the Czechoslovak State Railways (CSD), Hungarian State Railways (MAV), and the German Federal Railway (DB), respectively. These methods are similar in that they:

1. Are empirical methods based on highway flexible pavement design procedures that use the elastic properties of the various layers to determine the thickness of protection layers
2. Are based on the fundamental design criterion of limiting the stresses on the subgrade to those it can support with limited displacements
3. Evaluate the type, strength and elastic properties of subgrade materials using modern geotechnical engineering methods
4. Employ standard minimum ballast thicknesses with additional layers of high-strength materials to supply additional load spreading to the subgrade; the number, type, and thickness of layers depending on the type and strength of the subgrade
5. Select standard substructure sections based on the type and strength of the subgrade
6. Rely on experience gained from quantitative observations of substructure performance after construction or rehabilitation to evaluate substructure designs
7. Emphasize the importance of providing a high quality drainage system for removal of surface and subsurface water.

The Hungarian, Czechoslovak, and German railways use an approach in which the allowable pressure on the subgrade is determined by a trial-and-error approach as follows:

---

<sup>21</sup>J. Kraus, "New Design for Foundation Under Sleepers," OSSH D. zt., No. 2, 1976, pp. 1-4.

<sup>22</sup>L. Nagy, "New Methods Used by Hungarian State Railways for Increasing the Load Carrying Capacity of the Railway Permanent Way Formation," 1977, pp. 10-18.

<sup>23</sup>J. Eisenmann, "Stress Distribution in the Permanent Way Due to Heavy Axle Loads and High Speeds," Bulletin, No. 622, AREA, 1969, pp. 24-59.

<sup>24</sup>J. Spang, "Deformation of Railway Track Base and Its Stabilization," Eisenbahn-technische Rundschau, Vol. 21, No. 10, 1972.

1. Thicknesses of the ballast and subballast are selected based on experience. A standard ballast thickness of 30 cm (12 in) is used by the CSD and DB and 50 cm (20 in) by the MAV.

2. An equivalent modulus for the entire substructure is determined based on the elastic moduli of the various layers.

3. The vertical stress with depth below the tie is determined using single-layer elastic theory empirically modified by the different railroads.

4. The vertical subgrade stress is compared with allowable stresses determined for the subgrade along the track. If the stress is greater than that allowable, the protective layer thickness is increased, and the stress calculation is repeated.

The German and Hungarian railways consider additional design criteria for allowable pressures on the ballast and subballast. The German practice in 1969, using 98-lb rail and concrete ties spaced 25.6 inches on center, provided allowable vertical stresses at the tie-ballast interface of 28 psi and ballast-subgrade interface of 6 to 13 psi. The maximum allowable shear stress in the ballast is 8 psi and at the ballast-subgrade interface is 4 psi. Hungarian experience showed that vertical stresses on subgrades below wood ties spaced 25.6 inches on center often reached 10 to 17 psi; below concrete ties with the same spacing, the stress reached 28 psi.

Design of track substructure by the Hungarian State Railway is based on evaluation of subgrade strength and deformation properties using the California Bearing Ratio (CBR) test. The CBR is the ratio of the load causing penetration of the subgrade soil by a standard piston divided by the load required to penetrate a high quality, crushed stone material. Based on experience, the Hungarian Railways established the following CBR's as minimum requirements for the subgrade where a 20-inch ballast section is used:

Without protection (subballast) layer	minimum	CBR = 14%
With 12-inch protection layer	minimum	CBR = 6%

Adoption of subballast and subgrade stabilization procedures is based on visual classification of subgrade soil. Drainage is an important factor. Cement or bitumen stabilization is sometimes adopted. Subballast gradation with a wide range of particle sizes is desirable. Membranes are sometimes considered to prevent surface moisture from reaching the subgrade. However, groundwater must be kept well below the membrane to avoid softening the subgrade surface.

Kraus (1976) reported on detailed subsurface explorations in Czechoslovakian railways involving visual observations, test borings and test pits from which samples were taken for density and consistency tests. The deformation properties of the subgrade were measured by performing standardized 12-inch diameter plate load tests in the field to obtain the deformation modulus used in analysis. The German railway uses both the plate load test and the CBR test to evaluate

the deformation properties of subgrades. Plate load tests are performed during the worst seasonal condition, usually spring thaw, so that environmental factors are automatically considered. Traffic is considered in the design by requiring a higher track stiffness for higher traffic track. Stabilized layers are used to increase subgrade stiffness. Evaluation of substructure stiffness is made by multilayer elastic layer analysis.

Spang (1972) reported that German studies have shown that doubling the static load to reflect dynamic effects and speed is not satisfactory because permanent deformations are caused by vibrations and resilient strains. The DB densifies granular soils and stabilizes or replaces cohesive soils in the upper 1 meter of subgrade in order to resist vibration effects. Table 4-6 lists Spang's classification of "ideal", "good", and "bad" soils for track subgrades.

Based on observation of field performance of track substructures designed using these methods, the Hungarian, Czechoslovak, and German railways have developed standard track sections to handle various subgrade conditions. These sections are summarized in Table 4-7. Except for the highest quality sand and gravel subgrades, for which the Czechoslovak railway has a minimum 16-inch section, the total substructure section thicknesses are similar.

Japanese National Railways (JNR) Method - T. Ino<sup>25</sup> reported in "Reinforced Subgrade" in 1977 that the JNR is attempting to develop a "maintenance-free" track over their predominantly cohesive soil subgrades. The result has been a multi-layer track substructure as shown in Figure 4-8. The design method reported by Ino is similar to the three European methods previously discussed. It is an empirical method using a multi-layer flexible pavement design approach in combination with railroad experience. The fundamental design criterion is limiting stresses on the subgrade to levels that will restrict displacements. Subgrade deformation properties are determined by the CBR test. A standard 10-inch-thick ballast section is used with additional strength requirements provided by varying the thickness of the crushed stone subballast. Standard substructure sections have been developed, as summarized in Figure 4-8 and Table 4-7. Drainage systems that intercept, collect, and dispose of surface runoff and groundwater preserve the substructure properties.

The analysis method used by JNR to determine the subballast thickness required to reduce vertical stresses in the subgrade is simpler than the European approaches. The distributed vertical stress at the bottom of the ballast is determined as the Equivalent Railroad Distribution Load of Figure 4-8 so that highway flexible pavement design curves can be applied. Note that the static wheel load is increased by 50 percent to account for dynamic effects. With this vertical stress and the CBR of the subgrade, the chart

---

<sup>25</sup>T. Ino, "Reinforced Subgrade," Japanese Railway Engineering, Vol. 17, No. 1, 1977, pp. 22-23.

TABLE 4-6. IDEAL, GOOD, AND BAD SUBGRADE MATERIALS ACCORDING TO SPANG

PROPERTIES OF "IDEAL" SUBGRADE<sup>1</sup>

- a) Strong enough to support the static loads that are to be put on it, i.e., it has small settlement. Compressibility Modulus from field plate load test greater than 1,200 kp/cm<sup>2</sup> (17,000 psi)
- b) Strong enough to withstand the vibrations that occur, by virtue of its range of grain sizes, high structural resistance and good compaction, uniformity coefficient,  $C_u = d_{60}/d_{10} \geq 5$  for speeds  $\leq 160$  km/hr (100 mph),  $C_u \geq 7$  for speeds  $> 160$  km/hr
- c) Elastic
- d) Erosion-resistant
- e) Impervious to water or nearly so, coefficient of permeability,  $k \leq 1 \times 10^{-4}$  cm/sec
- f) Resistant to volume change and to penetration by the ballast or the subsoil under it (good filtering properties), satisfy Terzaghi's filter rule
- g) Frost-proof -- satisfies Casagrande's frost criterion: for  $C_u \leq 5$ , only 10% of material by weight has grain sizes  $< .02$ mm; for  $C_u \geq 15$ , only 3%
- h) Reasonable in cost of obtaining and laying

"GOOD" SUBGRADES<sup>2</sup>

- a) Impermeable solid rocks or fissured permeable solid rocks with weathering products either small in amount or noncohesive; permeable solid rocks, even if there is no drainage
- b) Continuous concrete floor without or with crushed rock bed (e.g., in tunnels) with an even subgrade sloped towards a drain
- c) Solid, lime-rich, impermeable, frost-proof, cohesive soils, e.g. marl, into which the ballast cannot penetrate or can penetrate only slightly

"BAD" SUBGRADES<sup>3</sup>

- a) Noncohesive, loosely bedded, uniformly graded granular soils; uniformity coefficient,  $C_u \leq 5$ ; without cohesion or with only apparent cohesion; sands are the chief examples
- b) Cohesive, soft to semi-firm mixed soils with a varied content of sand, silt, clay and water (therefore of varied consistency and plasticity)
- c) Solid rocks of nonuniform depth below the ties
- d) Solid rocks with cohesive decomposition products

---

<sup>1</sup>The ideal soil resists, by virtue of its special properties, the deformation of the subgrade by traffic loads -- including heavy, frequent and fast-moving loads -- despite precipitation and freezing and thawing weather, at least for the life of the ballast.

<sup>2</sup>Subgrades experiencing small deformations and requiring minimal maintenance.

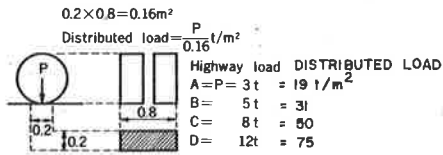
<sup>3</sup>Subgrades experiencing excessive deformation due to loading or environmental considerations and requiring excessive maintenance.



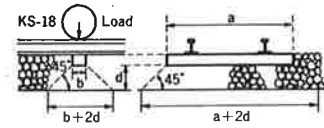
TABLE 4-7. TYPICAL FOREIGN SUBSTRUCTURE SECTIONS

Railroad	Static Wheel Load lbs.	Ballast Layer inches	Protective Layer inches	Stabilized Layer inches	Sealed Bitumen Layer inches	Concrete Slab inches	Total Thickness inches	
Hungarian State Railways (MAV)	-	20	4 to 14(3)	(1)	(1)	-	24 to 34	
Czechoslovak State Railways RR (CSB)	22,000	12	4 to 20(3)	-	-	-	16 to 32	
Type 1 (2)		12	4 to 8	6 to 8	-	-	22 to 28	
Type 2		12	4 to 8	-	4 to 6	-	20 to 26	
Type 3		12	2 to 4	-	-	2.5	16.5 to 18.5	
Type 4		12	10 to 12(4)	10(5)	-	-	22 to 34	
German Federal Railway (DB)	22,000	12	10 to 12(4)	10(5)	-	-	22 to 34	
Japanese National Railways (JNR)	19,800	CBR	Liquid Limit	Ballast	Slag	Crushed Stone	Sand Mat	Total
Sand I		2 to 4	-	10	6	10	-	26
Sand II		4 to 10	-	10	6	6	-	22
Sand III		10 to 20	-	10	6	0	-	16
Clay I		2 to 4	< 60	10	6	10	6	32
Clay II		4 to 10	> 60	10	6	6	6	28

- Notes:
1. Hungarian State Railways uses mechanical or cement stabilization, bitumen layers, and filter fabrics as required by subgrade soil conditions.
  2. Additional substructure specifications based on frost criteria.
  3. Actual protective layer thickness selected based on deformation properties of subgrade.
  4. For silty clay or clayey subgrades, 2.5 inch filter layer added to prevent mud pumping or fouling. Filter fabrics used also.
  5. Cement stabilization used for low strength cohesive subgrades.



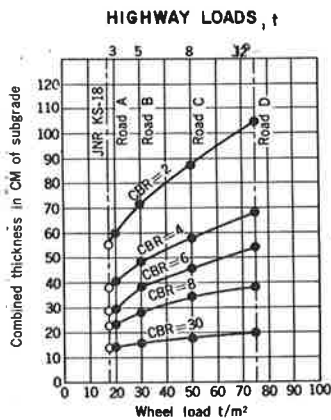
**HIGHWAY WHEEL LOAD**



$0.7 \times 2.6 = 1.82 \text{m}^2$   
 Railway load: KS-18 = 18t  
 Track load = 2.05t  
 Impact = 0.5  $18 \times 0.5 = 9\text{t}$   
 Distributed load =  $\frac{18+9+2.05}{1.82}$   
 $= 15.97 \text{t/m}^2$

$b+2d = 0.2 - 0.25 \times 2 = 0.7 \text{m}$   
 $a+2d = 2.1 + 0.25 \times 2 = 2.6 \text{m}$

**EQUIVALENT RAILROAD DISTRIBUTION LOAD**



**CHART FOR DETERMINING COMBINED SUBBALLAST THICKNESS (FROM FLEXIBLE PAVEMENT DESIGN)**

$$H = \frac{58.5 p^{0.4}}{\text{CBR}^{0.6}}$$

where H : total thickness of pavement (m)  
 p : traffic load (t)  
 CBR : California bearing ratio

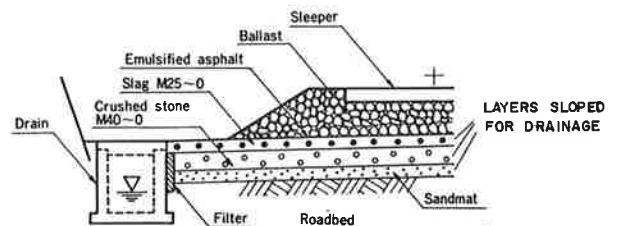
**FLEXIBLE PAVEMENT DESIGN EQUATION**

**Table 1. Design chart of reinforced subgrade**

Type	CBR	Liquid limit	Slag (M25-0)	Crushed stone (M40-0)	Sand mat	Coefficient of equivalent
Cut	Sand-I	2-4		15cm	25cm	Asphalt
	Sand-II	4-10		15	15	Concrete
	Sand-III	10-20		15	0	1.0
	Clay-I	(2-4)	60<	15	25	15cm
Bank	Clay-II	(4-10)	60>	15	15	0.45
	Sand			15	15	Crushed stone
	Clay			15	25	0.35

← COMBINED 'SUBBALLAST' →  
**STANDARD "SUBBALLAST" THICKNESSES**

$$\text{TOTAL THICKNESS} = \text{SLAG} + \text{CRUSHED STONE} + \text{SAND MAT}$$



Reproduced from "Reinforced Subgrade," pp. 22-23, by T. Ino, Japanese Railway Engineering. Year of first publication: 1977.

**FIGURE 4-8. JAPANESE NATIONAL RAILWAYS (JNR) DESIGN METHOD**

can be entered and the combined subballast layer thickness can be selected, including the emulsified asphalt, slag, crushed stone, and sandmat, if applicable.

JNR has found that the multi-layer subballast provides improved shear strength, less compression (settlement), improved insulation from frost, resilience for repeated loads, damping of vibrations, and improved subsurface drainage. The coagulated slag provides an impermeable layer to prevent surface water infiltration into the subgrade. JNR is undergoing further field studies of in-service track to evaluate their performance under long-term environmental conditions (frost, swell, moisture) as well as vertical loading in order to determine the maintenance required.

British Railways Method - The International Union of Railways in 1970<sup>26</sup> and D. L. Heath et al. in 1972<sup>27</sup> reported on a new design method developed by British Railways. It is a rationally based empirical and analytic method for determining the thickness of high strength materials required above certain clay subgrades.

The basic design criterion is to limit resilient strains and stresses on clay soil to less than a limiting "threshold" resilient stress in order to protect against failure of the clay subgrade by excessive residual deformation. The threshold stress is determined from cyclic triaxial tests on undisturbed clay samples. It is defined as the resilient stress level above which the soil deformation is very rapid and below which the deformation accumulation rate is very slow. Ten percent residual (cumulative) strain after 10,000 cycles is often the limit used in determining the threshold stress. The threshold stress of a clay soil is a function of confining stress. Prescribed test conditions are set forth for the cyclic triaxial tests.

The design method is based on four principal assumptions:

1. The threshold stress parameters that quantify the subgrade soil strength and deformation properties can be obtained using standard repeated load triaxial tests.
2. Simple elastic theory can be used to compute the stresses that occur in the subgrade from traffic loading.
3. The significant traffic stresses are those produced by the static effect of the heaviest commonly occurring axle load.

---

<sup>26</sup>International Union of Railways, Repeated Loading of Clay and Track Foundation Design, ORE, Report No. D71/RR12/E, Utrecht, 1970, 192 pp.

<sup>27</sup>D. L. Heath et al., "Design of Conventional Rail Track Foundations," Proceedings, Institute of Civil Engineers, Vol. 51, February 1972.

4. The groundwater table is at the top of the subgrade.

Two main tasks are performed in the method:

1. The stresses below the ties are determined using the Boussinesq elastic stress distribution.

2. Design charts to determine the ballast depth required are developed based on equating the stress below the tie with the threshold stress of the cohesive soil.

Based on analytic and field studies, British Railways researchers found that the simple Boussinesq theory for a semi-infinite elastic half-space adequately estimated the mean vertical stress below the tie if a distributed tie contact pressure was employed instead of a single point load. The authors found this simplified, approximate approach was justified since the measured scatter in the magnitude of subgrade stresses due to the variable ballast and subgrade stiffness and dynamic loading effects made the use of a more rigorous solution inappropriate.

The basis of the British Railways procedure is to equate the threshold shear stress determined from the standard laboratory cyclic test with the computed shear stress beneath the ties based on the Boussinesq distribution and the heaviest commonly occurring axle load. Figure 4-9A shows the shear stress versus depth distribution based on the Boussinesq equations (solid lines) and lines of standard threshold stress versus depth (dashed lines). The slopes of the threshold stress lines versus depth reflect the influence of confining stress. From this chart, Figure 4-9B was prepared which shows depth of combined ballast and subballast required to limit the shear stresses due to various axle loads to the allowable threshold stress. Individual charts must be prepared for different tie sizes and spacing. This design method was developed for wood and concrete ties and continuously welded rail. Caution should be exercised in applying the method to jointed track.

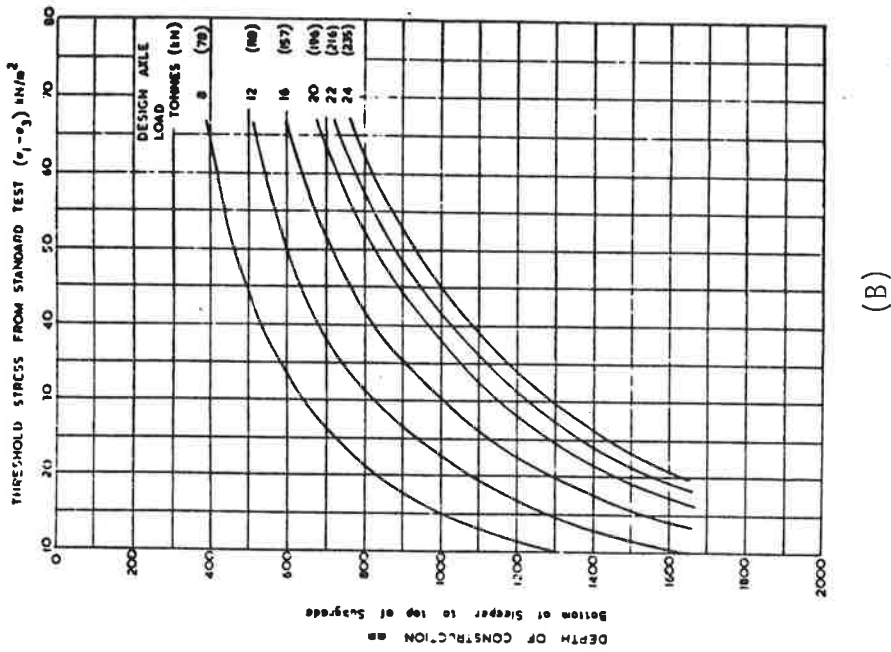
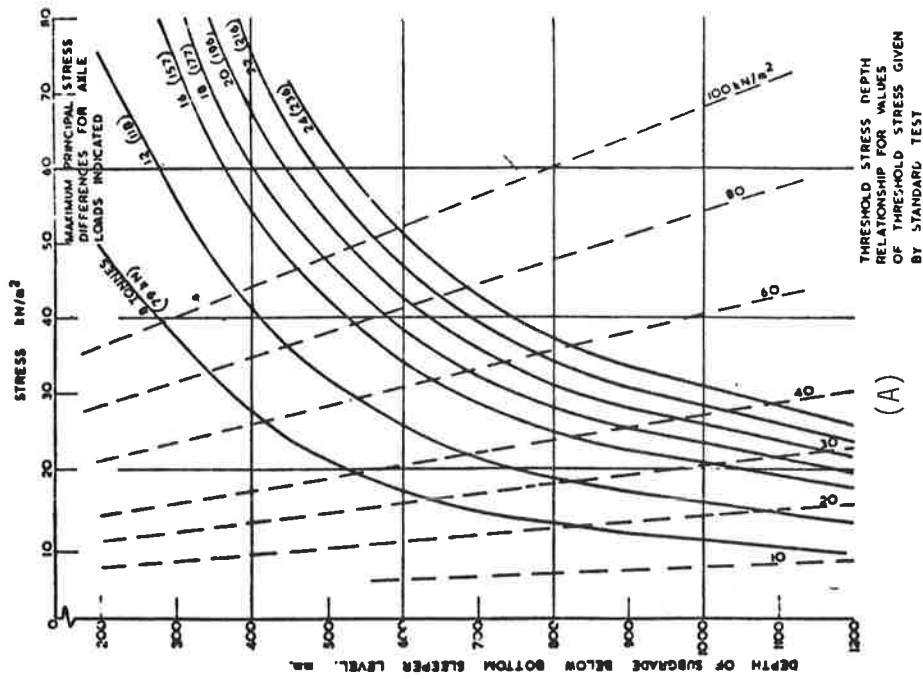
British Railways recognized several unsolved problems in developing this design method, the most significant being:

1. The validity of using the heaviest commonly occurring static axle load without increase for dynamic effects.

2. Use of a design loading condition that does not consider the number of axle load cycles at or near the design load; where the track has a very high proportion of axle loads near the design load, overstressing of the subgrade may occur.

3. The design method was used on stiff London clay from which good undisturbed samples could be obtained; its applicability to other clay subgrades or granular soils is questionable.

Studies of the dynamic behavior of granular and cohesive soils have indicated that it is the peak shear stresses and axle loads that control



DERIVATION OF DESIGN CHART, RELATIONSHIP BETWEEN INDUCED STRESSES AND SOIL STRENGTH

NOTE: DESIGN CURVES ARE DEVELOPED FOR PARTICULAR TRACK STRUCTURES OF SPECIFIED RAIL SIZE, TIE TYPE AND TIE SPACING

DESIGN CHART FOR DEPTH OF CONSTRUCTION FROM LABORATORY REPEATED LOAD TEST

Reproduced from "Repeated Loading of Clay and Track Foundation Design," Figures 28 and 29, by permission of International Union of Railways, ORE. Year of first publication: 1970.

FIGURE 4-9. BRITISH RAILWAYS THRESHOLD STRESS DESIGN METHOD

track settlement. Therefore, the use of the heaviest common axle load appears reasonable. However, some increase in design axle load due to dynamic effects is justified. Even without the dynamic increase, the method produces satisfactory to conservative design thicknesses.

British Railways' method was developed by tests on a highly plastic, stiff, fissured, London clay (liquid limit = 77, plasticity index = 47, undrained strength > 13.9 psi, Unified soil classification = CH). Additional tests were done on clay samples from six other sites and on a nonplastic sandy silt. Threshold stresses were determined for the highly plastic clays (liquid limits from 58 to 75, plasticity indices from 34 to 46, Unified classification = CH) and one low plasticity clay (liquid limit = 40, plasticity index = 18, Unified classification = CL); however, the nonplastic silt (plasticity index = 0, Unified classification = ML) did not exhibit a threshold stress, and the method could not be applied. This indicates that the British Rail method may be applicable only for plastic soils. Additional testing on different types of soil is necessary to further define the applicable range of soils.

Heath et al. (1972) reported that ballast sections calculated by this approach are extraordinarily thick, up to 60 inches. As pointed out by British Railways, this does not necessarily indicate that 5 feet of ballast is needed; rather, provide 5 feet of stabilized, high strength material that can sustain the dynamic stresses. This may consist of 12 inches of ballast immediately below the ties and 6 inches of well-graded subballast above the clay; however, the remaining material may consist of any granular material with sufficient compacted strength to transfer the tie load without being overstressed. The result is a multi-layer substructure.

Field data obtained by British Railways from performance evaluations at monitored sites confirm the design depths used. That is, sites with the computed design depth of stabilized soil/ballast performed acceptably, while those sites with less than the design depth experienced excessive subgrade settlements. British Railways also noted that small decreases in design depth resulted in large increases in settlement, while large increases above the design depth did not produce substantially less settlement. Based on these observations, British Railways cautioned that increases in wheel load would result in large increases in settlement rate for track at or close to the balanced design depth.

While this method does not appear applicable to granular soils, the basic approach used provides a good framework for developing a design method based on the repeated load behavior of granular soils. One such approach may be prediction of the rate of settlement accumulation, a preliminary approach for which is outlined in Section 4.5.2.

Indian State Railways Method - In 1975, Agarwal and Yog of the Indian State Railways proposed a method of track substructure thickness design in the paper, "New Approach to Design of Railway Track Foundations." This method uses calculations of track substructure stresses by elastic methods (based on the Boussinesq equation) and evaluations of allowable subgrade stresses

based on an effective stress, Mohr-Coulomb failure model of clay soil. The design treatment was developed for a 5'-6" rail spacing and 22.5-ton axle loads; however, sufficient information is given in the article to carry out the calculations for other track systems.

The authors point out that when saturated, normally consolidated clays are cyclically loaded below the yield stress, they develop positive excess pore pressures. The excess pore pressures dissipate as the soil drains over time, leading to a lower soil moisture content and a higher strength. At the lower water content, further cyclic loading induces smaller pore pressure development until the clay attains a "critical state" in which further cyclic stress induces no pore pressure buildup. Heavily overconsolidated clays exhibit the opposite behavior. Cyclic loading induces negative pore pressures that lead to swelling of the clay until the critical state is reached and no further cyclic pore suctions develop. For these reasons, design of the track substructure should be based on evaluation of the soil effective-stress strength parameters at the critical state condition.

The stress in the substructure is the sum of the static gravity stresses plus the dynamic train stresses. The Mohr-Coulomb failure criterion depends on the magnitude of both the vertical and horizontal stresses in the substructure. The static vertical stress is computed from the weight of the track structure and weight of the substructure materials. The horizontal stress is computed as the factor,  $K_0$ , times the vertical stress. The parameter,  $K_0$ , is defined as the coefficient of lateral stress at rest.  $K_0$  is the ratio of the horizontal effective stress in the ground at a certain depth divided by the vertical effective stress. The value of  $K_0$  ranges from 1.0 for dense, compacted clay fill to about 0.5 for soft clay fill that has been dumped and permitted to soften over the years. The value of  $K_0$  is important because it determines the initial shear stress in the substructure prior to application of the train load.

The live load horizontal and vertical stresses caused by the train are computed from an elastic stress distribution. The tie seat is represented as a rectangular footing about one third of the length of the tie. A value of Poisson's ratio of 0.5, which is appropriate for a saturated clay, is assumed for the live load calculations. The excess pore pressures induced by the live loads are evaluated using an empirical relation developed by Skempton<sup>28</sup> and commonly used in soil mechanics engineering. The excess pore pressure is calculated as:

$$\Delta u = B[ \Delta \sigma_3 + A (\Delta \sigma_1 - \Delta \sigma_3) ]$$

---

<sup>28</sup>A. W. Skempton, "The Pore Pressure Parameters A and B," Geotechnique, Vol. IV, No. 4, March 1954, pp. 143-147.

where:

$\Delta u$  = Excess pore pressure

$\Delta\sigma_1$  = Increase in major principal stress (vertical stress)

$\Delta\sigma_3$  = Increase in minor principal stress (lateral stress)

B = Pore water pressure parameter that is 1.0 for full saturation conditions and zero for a dry soil

A = Pore water pressure parameter that depends on the type of clay, shear stress and magnitude of strain.

The excess pore pressures are then used to calculate the effective vertical and lateral stresses,  $\bar{\sigma}_v$  and  $\bar{\sigma}_h$ , in the subgrade by the equations:

$$\bar{\sigma}_v = \sigma_v - u_t$$

$$\bar{\sigma}_h = \sigma_h - u_t$$

$$u_t = u_s + \Delta u$$

where:

$\bar{\sigma}_v, \bar{\sigma}_h$  = Effective vertical and lateral stresses at some depth

$\sigma_v, \sigma_h$  = Total (static plus dynamic) vertical and lateral stresses at that depth

$u_t$  = Total pore pressure at that depth

$u_s$  = Static pore pressure before loading

$\Delta u$  = Excess pore pressure due to loading.

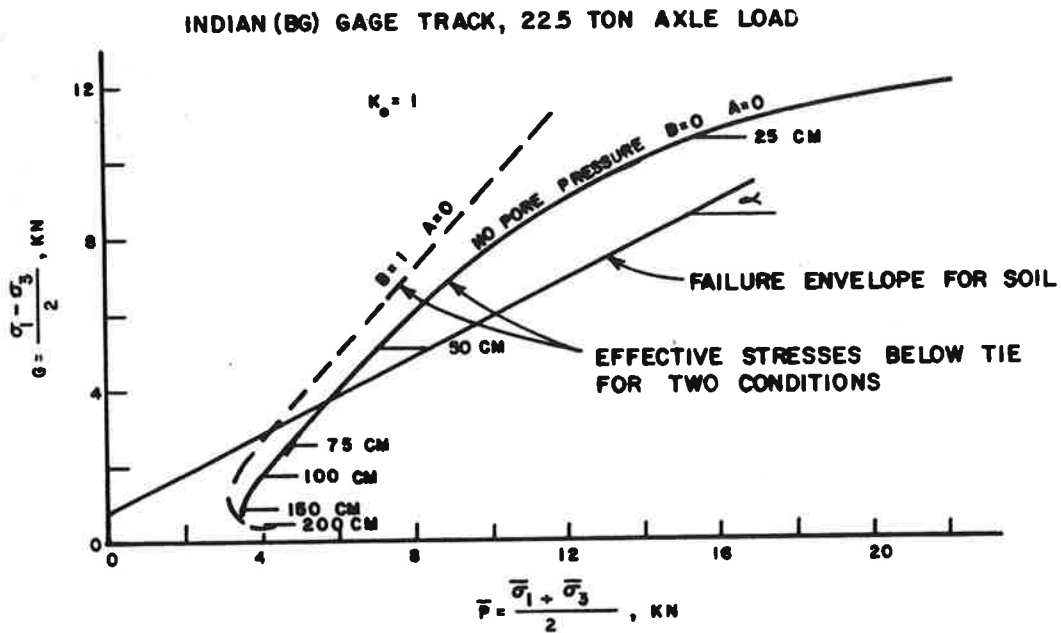
The calculated stresses on the substructure for  $K_0 = 1$  and an axle load of 22.5 tons are shown in Figure 4-10. The condition of no excess pore pressure corresponds to a well-drained granular subgrade ( $B=0, A=0$ ). The condition of ( $B=1, A=0$ ) corresponds to a saturated clay subgrade at the critical state.

To evaluate the shear strength of a compacted subgrade, the authors recommend that a compacted sample be tested in the laboratory, presumably by a triaxial test on saturated samples, at an overconsolidation ratio<sup>29</sup> of 4 to 5 to produce zero excess pore pressure at failure. Saturation induces the critical moisture condition, and the condition of zero excess pore pressure

---

<sup>29</sup>For discussion of overconsolidation, see the companion report on earth materials practices or any elementary soil engineering textbook.





NOTE: FOR THESE CONDITIONS (COMPACTED CLAY SUBGRADE), MINIMUM DESIGN THICKNESS OF COMBINED BALLAST PLUS SUBBALLAST LAYERS IS 60 CM (24 INCHES). THIS MAY BE INCREASED FOR ENVIRONMENTAL CONSIDERATIONS OR INCREASED FACTORS OF SAFETY.

After "New Approach to the Design of Railway Track Foundations", p. 74 by V.K. Agarwal and A.K. Yog. Year of first publication: 1975.

FIGURE 4-10. INDIAN STATE RAILWAYS DESIGN METHOD

at failure corresponds to the critical state. For subgrades of soft, uncompacted clay, effective shear strength parameters should be measured on undisturbed samples of the clay taken near the top of the subgrade. The failure envelope for a typical compacted clay subgrade is shown in Figure 4-10. The intersection of the state-of-stress relation for  $B=1$ ,  $A=0$ , with the failure envelope indicates the depth below which the stresses are less than failure. In this figure, the design depth is approximately 60 cm (24 inches). For a heavier axle load or weaker clay soil, the design thickness would be greater. To prevent overstressing the subgrade, at least this much combined ballast and subballast thickness should be provided.

The design considerations described above are intended to prevent strength failure of the subgrade due to overstressing. A separate failure mechanism that can develop, even though the overall strength of the subgrade is not exceeded, is termed an erosion failure caused by high local contact stresses between the subgrade and the ballast. This leads to the mud pumping phenomenon in which cohesive subgrade soil works into the rock ballast. To prevent this, the Indian Railway recommends a granular sand blanket that reduces stress concentrations and filters the subgrade soil. In order to satisfy both the filtering and strength criteria, a two-layer subballast may be required.

The procedure proposed by Agarwal and Yog<sup>30</sup> is attractive because it is based on fundamental principles of soil mechanics. The subgrade properties are based on effective stress considerations so that both cohesive and cohesionless soils can be considered. The method can be used to evaluate the required strength properties for the ballast and subballast as well as the thickness of these materials necessary to protect a given subgrade. Testing this method for North American track conditions would be a beneficial next step.

#### 4.4 DISCUSSION: U.S., CANADIAN, AND INTERNATIONAL DESIGN PRACTICES

In reviewing international substructure design practices, certain similarities were observed among the design methods used by the various railroads. These are summarized as follows:

a. Each railroad uses rationally based analytic methods to evaluate the thicknesses of ballast and subballast materials needed in the substructure. These methods are used with experience gained from quantitative observations and evaluations of in-service track performance to develop successful track and substructure designs. The design thicknesses are adjusted for environmental considerations (freeze-thaw, swell, moisture) based on field experience.

---

<sup>30</sup>v. K. Agarwal and A. K. Yog, "New Approach to the Design of Railway Track Foundations," Indian Railway Technical Bulletin, August 1975, pp. 66-78.

b. Each method is based on the fundamental design criterion of limiting the stresses on the subgrade soils to an allowable level that the subgrade can support without excessive deformations.

c. The Boussinesq elastic stress distribution for a semi-infinite half-space was judged adequate by the Hungarian, Czechoslovak, German, British, and Indian railways for estimating the stresses below the ties. A modified tie contact pressure distribution gave better results than a single point load. The justification for using the Boussinesq theory is that the variations in the magnitude of stresses measured in the substructure make a more rigorous solution unnecessary.

d. Each method emphasizes the importance of classifying the subgrade soils and determining their strength and deformation properties. Typical methods include field plate load and CBR tests and laboratory static and cyclic triaxial strength tests on undisturbed tube samples of subgrade soils. The field and laboratory tests are performed under "worst case" conditions, usually saturated spring-thaw for field tests and saturated, undrained tests in the laboratory.

e. Standard ballast sections with thicknesses ranging from 10 inches to 20 inches are used by each of the railroads. The thickness is based on the minimum amount needed to spread the loads to a granular subbase while providing sufficient resilience, drainage, and workability for maintenance purposes. Additional thicknesses of material needed for stress distribution purposes are provided by the subballast layers over lower quality subgrades.

f. Standard substructure sections were developed by each railroad using the analytic methods and experience. Some of these standard sections are summarized in Table 4-7. The standard sections are adjusted based on the type of subgrade soil, with thicker sections over weaker subgrades and with filter and stabilized layers over silty or cohesive subgrades.

As summarized in Section 4.2, current U.S. and Canadian practice is based primarily on experience with limited use of rational analytic methods. Standard sections have been developed by various railroads which are not related to the type of subgrade, its strength or deformation properties. While these standard sections work over "good" subgrades, they are unsuitable for poor quality subgrades.

Analytic methods used to determine required ballast and subballast thicknesses are often based on arbitrary allowable pressures on the ballast and subgrade rather than properties of the actual subgrade soils existing below track. Few cases were found in our studies where field or laboratory testing was performed by North American railroads to determine the type and properties of the subgrade soils.

It is interesting to compare the standard substructure sections given for U.S. and Canadian railroads in Table 4-4 and for international railroads in Table 4-7. As summarized in Table 2-3, the most common peak static wheel load on U.S. track today is 33,000 pounds for a 100-ton car. Loads of 39,400

pounds (125-ton car) and 27,500 pounds (77-ton car) are also encountered. This means that U.S. and Canadian track structures experience static loads 50 percent to 80 percent higher than the approximately 22,000-pound wheel load used by most other railroads. For these significantly larger loads, U.S. and Canadian railroads use substructures (ballast plus subballast) ranging from 12 inches to 24 inches in total thickness. European and Japanese railroads use substructure sections of 16 inches to 32 inches thick, with the smallest thicknesses corresponding to the highest quality subgrades (dense sand and gravel) and the largest thicknesses corresponding to the lowest quality subgrades (soft saturated clays).

#### 4.5 RECENT ANALYTIC AND DESIGN DEVELOPMENTS

In the past 10 years, several researchers developed computerized analytic procedures to model the complex resilient response of the track structure to vertical loading. It has been recognized that it is the gradual accumulation of small plastic displacement in the substructure that causes track geometry deterioration, poor track component performance, and sometimes failure. Recently, efforts have been made to develop a method to estimate the rate of residual deformation accumulation in the track substructure. In addition, a relatively simple method for track substructure analysis was developed based on an extension of pavement design procedures. The major aspects of these three recent developments are summarized in this section.

##### 4.5.1 Analytic Computer Models

In recent years, railroad track structures throughout the United States have been subject to heavier and more frequent heavy wheel loads due to the increase in the size of freight cars to 100 tons and above. In many cases, the track structure was constructed to handle a lower level of service loading, and the result has been a rapidly increased rate of deterioration of track geometry and track components such as rails, ties, and fasteners. The track geometry deterioration has been attributed predominantly to overstressing of track subgrades and to densification and breakdown of ballast particles.

Over the past 10 years, significant research funds have been invested in developing new analytic models in Europe, Canada, and particularly the United States. Using high speed computers and new analytical tools, such as the finite element method, relatively complete analytic models which represent many major components of the track structure system (rails, fasteners, ties, ballast, and subgrade) and various loading conditions (unequal wheel loads, multiple wheel loads, truck loading, etc.) have been developed.

Simultaneously, a better understanding of the actual response of various track structure components has been achieved, particularly through laboratory

testing and field instrumentation of track structures<sup>31,32</sup>. Component response investigations have been followed by more realistic analytic representations of track structure components, including substructure response characteristics and loading conditions, e.g., multi-axle truck loads<sup>33</sup>.

Most research efforts to date have studied the vertical resilient response of the track structures to vertical wheel or truck loading. Limited effort has been made toward developing a model for lateral track response<sup>34</sup>, and no analytical study of longitudinal track response was discovered. Efforts to model the long-term residual vertical displacement of the track substructure has been limited to date. Selig et al.<sup>35</sup> proposed an analytic approach to estimating inelastic vertical settlement based on methods developed for flexible pavement design. These methods are based on the theory of stress invariants and laboratory tests that emphasize duplication of in-situ stress history. The ability to predict cumulative inelastic settlement of the track substructure relates to the ultimate goal of track design and is essential for determining the maintenance life of track.

In this section, the history of resilient analytical model development will be traced. Emphasis is placed on those innovations judged to be the most significant analytical developments. Conclusions will be presented as to the state of analytical models today, their practical usefulness, and areas requiring further study.

---

<sup>31</sup>Q. L. Robnett et al., "Technical Data Bases Report, Ballast and Foundation Materials Research Program," prepared for U.S. Dept. of Transportation, Federal Railroad Administration, FRA/ORD-76-138, July 1975, 175 pp.

<sup>32</sup>C. W. Adegoke et al., "Study of Analytical Models for Track Support Systems," Transportation Research Record, No. 733, 1979, pp. 12-18.

<sup>33</sup>C. W. Adegoke, "Elastic and Inelastic Deformation Response of Track Structures Under Train Loads," Ph.D. Thesis, State University of New York at Buffalo, December 1978, 220 pp.

<sup>34</sup>W. So and G. C. Martin, "Finite Element Track Buckling Model," Proceedings of IEEE - ASME Joint Railroad Conference, Washington, D.C., April 1, 1977, Report No. 77-RT-5, New York, ASME, pp. 1-7.

<sup>35</sup>E. T. Selig et al., "A Theory for Track Maintenance Life Prediction, Second Year Final Report (Draft)," prepared for U.S. Dept. of Transportation, Office of University Research, Washington, D.C., December 1979, 160 pp.

Model Development History - Several investigators (Prause et al.<sup>36</sup>, Adegoke (1978), Robnett et al.(1975), Meacham et al.<sup>37</sup>, Kerr<sup>38</sup>) have reviewed the historical development of track analysis methods, and reference is made to their works for more detailed discussions of early analytic work. The infinite beam-on-elastic-foundation theory, or Winkler model, is the most frequently used track analysis method in the United States. It can adequately predict stresses and moments in the rails for simplified uniform conditions where values for the track support modulus,  $u$ , have been obtained from field measurements. However, the method gives a poor prediction of substructure stresses and displacements and is too simplified and awkward for today's general analytic requirements. Individual substructure layer properties are not characterized in the Winkler model, so the effects of substructure component properties cannot be evaluated.

Table 4-8 chronologically summarizes the important aspects of the various computerized analytic models that have been developed in U.S. and Canada. These models have become increasingly sophisticated, but at the same time, they have been made simpler, more efficient, and therefore less expensive.

The most recent models, such as AAR's Prismatic Solid Analysis (PSA) model, Battelle Columbus Laboratory's (BCL) Multi-layer Track Analysis (MULTA) model; and the University of Massachusetts' GEOTRACK model, include the important parameters that quantify track component behavior, such as loading conditions; rail size and stiffness; tie size, stiffness, spacing, and bending; ballast and subballast strength, stiffness, and thickness; and subgrade strength and stiffness. With such capabilities, they show promise as tools to be used in developing a more rational track design procedure in the United States.

Validation of Analytic Models - Evaluation of the models of the track is best made by comparison of analytic predictions with measurements of the performance of actual in-service track systems. Selig et al.<sup>39</sup> measured

---

<sup>36</sup>R. H. Prause et al., Assessment of Design Tools and Criteria for Urban Rail Track Structures, Volume I, At-Grade Tie-Ballast Track, prepared for U.S. Dept. of Transportation, Urban Mass Transportation Administration, Report No. UMTA-MA-06-0025-74-3, April 1976, 247 pp.

<sup>37</sup>H. C. Meacham et al., Studies of Rail Vehicle Track Structures, prepared for U.S. Dept. of Transportation, Office of High Speed Ground Treatment, Report No. FRA-RT-71-45, April 1970.

<sup>38</sup>A. D. Kerr, On the Stress Analysis of Rail and Ties (Draft), prepared for U.S. Dept. of Transportation, Transportation Systems Center, Contract No. DOT-TSC-900.

<sup>39</sup>E. T. Selig et al., Status Report - Ballast Experiments, Intermediate (175 MGT) Substructure Stress and Strain Data (Interim Report), prepared for U.S. Dept. of Transportation, Transportation Systems Center, September 1979, 88pp.

TABLE 4-8. ANALYTICAL MODELS DEVELOPED IN THE UNITED STATES AND CANADA

MODEL NAME	RESEARCHER(S)	MODEL DESCRIPTION	IMPORTANT FEATURES	REMARKS
Pyramid Model 1970	Meacham et al. (BCL)	Beam on elastic foundation analysis with modified track modulus, U	Used theoretical approach to determine U which included effects of rail type, tie type and width, tie bearing area, ballast type, depth and stiffness, and subgrade type and stiffness.	One of earliest attempts to rationally include the effects of substructure properties in track analysis. Poor correlation with field test results.
1970	Lundgren et al. (Illinois)	Two dimensional finite element model (FEM)	Analyzed longitudinal section along centerline of track. Plane strain behavior of substructure assumed.	Early forerunner of ILLITRACK. Poor correlation with measured results.
Analysis of Rail Track Structures (ARTS) 1978	Svec, Turcke, Raymond et al. (Queen's Univ.)	Three dimensional FEM. Beam elements for superstructure, hexahedral and tetrahedral elements for substructure.	Detailed description of physical track substructure. Stress path dependent and nonlinear elastic behavior of ballast, subballast, and subgrade accounted for using "bicubic spline" functions. No-tension capabilities of substructure materials accounted for.	Emphasized geotechnical aspects of track behavior. Bicubic spline functions developed from triaxial test data. Partially successful correlation with full-scale model data.
ILLI-TRACK 1976	Tayabji, Thompson and Robnett (Illinois)	Pseudo-three dimensional FEM. Two plane strain two dimensional FEM used in combination.	Element thickness increased with depth according to value $\phi$ in longitudinal analysis to represent transverse load spreading in plane strain analysis. Initial thickness of surface element made equal to effective tie bearing length, L to represent effective load transfer area between tie and ballast. Resilient modulus, $E_r$ used to represent nonlinear elastic behavior of ballast, subballast, and subgrade.	Emphasizes geotechnical aspects of track behavior. Attempts to simplify and reduce costs of analytical models.
(PSA, BURMISTER) Track Structure Models 1975	So, Ma and Martin (AAR)	Series of 15 computer models to predict stresses and strains in various track components. Multiple models (simple and sophisticated) to perform same task.	Multiple models (simple and sophisticated) developed to perform same task. Model used depends on degree of analysis (preliminary or detailed). BURMISTER multi-layer elastic model developed for substructure. Prismatic Solid Analysis (PSA), a three dimensional FEM developed for superstructure analysis.	Computational requirements minimized for type of analysis needed. Component interactions may be lost through model subdivisions. PSA and Burmister model results agreed well with field data from others. Models used to perform parametric studies and develop sample design charts.
Multi Layer Track Analysis Model (MULTA) 1978	Prause, Kennedy et al. (BCL)	Combination of two models developed by AAR. The three dimensional FEM called LAC for superstructure analysis, and the Burmister multi-layer elastic substructure model.	Includes essentially all important aspects of individual track component performance in analysis. Interactive approach used between LAC and Burmister models to solve for stresses and strains in crack structure components: -Wheel-rail, rail-tie, and tie-ballast reactions are obtained from LAC. -Influence coefficients generated by Burmister using uniformly loaded circular areas which represent the vertical pressure from equivalent tie bearing areas. -Influence coefficients used in LAC to generate rail-tie reactions, rail-tie displacements, and tie-ballast pressures. -Tie-ballast pressures used in Burmister to obtain stresses and displacements in substructure layers.	Allows the effects of changes in various track components on other components to be studied. No relative displacement between tie and ballast. Allows unrealistic tension to develop. Used homogeneous, isotropic, linearly elastic substructure properties. Substructure materials are nonlinear and stress dependent. Analytical results compared well with dynamic data from FAST.
GEOTRACK 1978	Adegoke, Chang and Selig (UMASS)	Modification of MULTA for studying substructure behavior.	Iterative procedure used to vary the resilient modulus, $E_r$ , for the stress state in each layer. Stresses and $E_r$ varied until a sufficiently converged solution is obtained.	Emphasizes geotechnical aspects of track behavior. Improved characterization of roadbed materials by including stress dependent, nonlinear behavior. Analytical results compared well with dynamic data from FAST. Uses truck loadings as opposed to axle loadings. Simplicity, efficiency, and cost improved from MULTA.

the behavior of track substructures at FAST as discussed in Section 5.2. Chang et al. (1979) used these data to perform validation studies of the ILLITRACK, PSA, MULTA, and GEOTRACK models. Their results have shown that PSA, MULTA, and GEOTRACK all correlated well with measured field data. With the modifications included in GEOTRACK, which more realistically represent substructure material properties and provide a simpler, more cost-effective analysis, GEOTRACK is judged well suited for parametric studies of track performance. However, GEOTRACK has been compared to field data from only one site, a site that has controlled conditions, an excellent granular subgrade, and no drainage problems. Before any analytic method can be confidently used to predict track structure performance, it must be validated with measured field data for various loading, superstructure, and substructure conditions. Measurement programs are now underway on several sections of revenue track in the United States.

Potential Use of Analytical Models - The promise of analytic tools such as GEOTRACK is their ability to analyze the influence of different track structure conditions economically. They can be used to perform parameter studies to determine the effects of changing load, rail, tie, ballast, subballast, and subgrade properties on the performance of other track components and on the track structure as a whole. Few parameter studies of this nature are available.

Using a validated analytic model, design curves should be developed from parameter studies to determine the effects of changing one parameter, such as ballast thickness, on the performance of a standard track structure under standard loads. W. So of the Association of American Railroads (AAR) reported on such a study in Design Charts Using Mathematical Models in 1978. So used the PSA and BURMISTER track structure models developed by the Association of American Railroads to demonstrate how design charts such as those shown in Figure 4-11 could be developed<sup>40</sup>. The sensitivity of various track components to changing substructure properties is shown in Table 4-9. Such charts could be combined with experience gained from quantitative in-service track performance observations to develop track structure designs for various subgrade conditions.

#### 4.5.2 Residual Substructure Deformation (Track Settlement)

Limiting the vertical stresses on the subgrade to levels below an "allowable bearing pressure" is the primary design criterion in track substructure design. However, the ultimate design goal is to limit track displacements. Even if adequately designed, residual deformations accumulate in the substructure with time due to repeated dynamic loading. Evaluation of track design and performance in practice is based on the rate of track deformation in comparison

---

<sup>40</sup>The validity of these charts has not been determined. They are presented here to demonstrate the method. They should not be used in track design without verification by field experience.



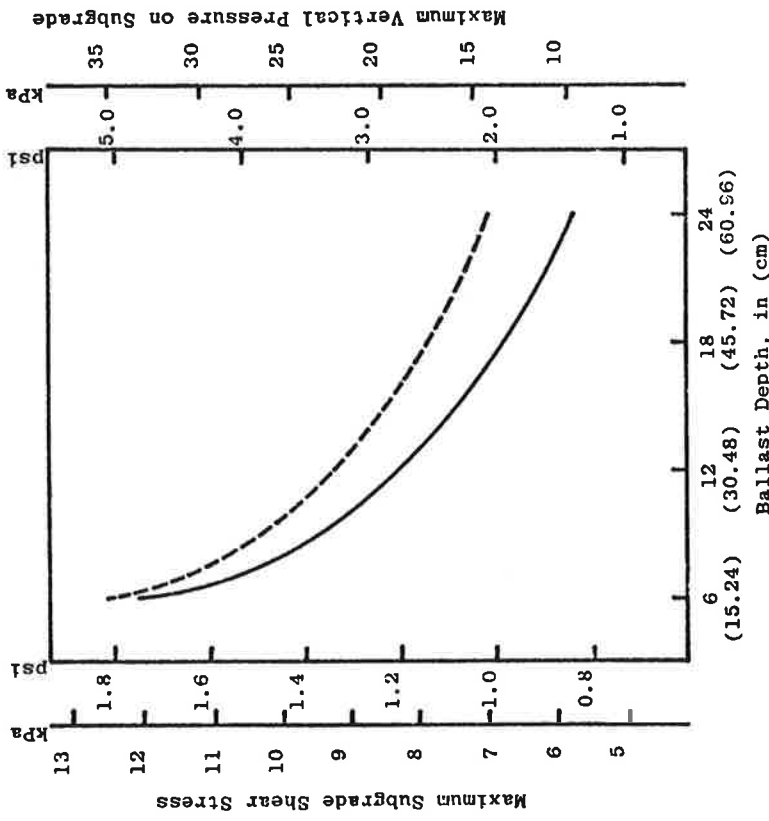


Figure 6.14. Maximum Subgrade Stresses due to Vertical Loads versus Ballast Depth

---Maximum Subgrade Shear Stress  
 ---Maximum Subgrade Vertical Pressure

Note: frequency of occurrence = frequency of car; minimum stress and pressure = 0

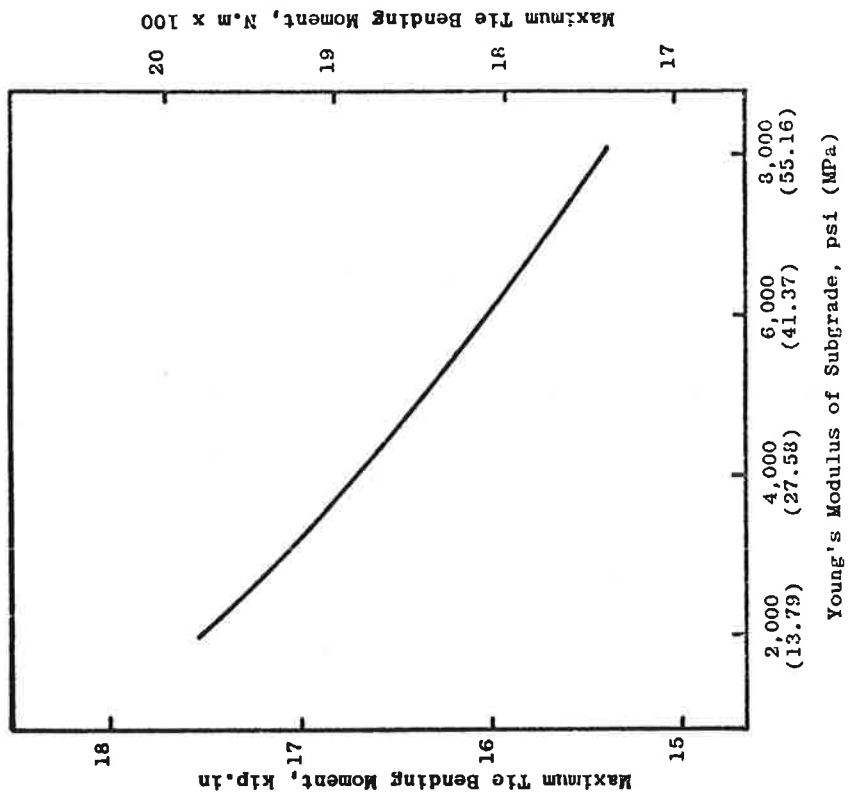


Figure 6.9. Maximum Tie Bending Moment versus Young's Modulus of Subgrade

Note: frequency of occurrence = frequency of car; minimum moment = 0

NOTE: CHARTS PRESENTED TO DEMONSTRATE METHOD: THEY ARE NOT FOR USE IN ACTUAL DESIGN.

Reproduced from Track Structure Design Using Mathematical Models, pp. 30-49, by W. So. Year of first publication: 1978.

FIGURE 4-11. TYPICAL DESIGN CHARTS AS DEVELOPED BY SO

TABLE 4-9. EFFECTS OF SUBSTRUCTURE PROPERTIES ON TRACK COMPONENTS

Substructure Property Change	Effect on Track Component			
	Rail Bending Moments	Tie Bending Moments	Subgrade Shear Stresses	Lateral Tie-Ballast Loading
Ballast Depth Increased from 6" to 12"	Insignificant	Insignificant	Decreased 40%	--
Ballast Depth Increased from 12" to 24"	Insignificant	Insignificant	Decreased 50%	--
Increased subgrade Young's modulus from 2,000 to 8,000 psi	Decreased 12%	Decreased 12%	Increased 40%*	--
Changing tie support condition from freshly tamped to end-bound and center-bound	Insignificant	Increased 74% (end-bound) Increased 140% (center-bound)	Insignificant	--
Tie spacing changed from 20" to 28"	Increased 5%	Increased 36%	Increased 10%	Increased 40%
Lateral tie-foundation stiffness increased from 500 lb/in/in to 1,500 lb/in/in	--	--	--	Increased 30%

\*Increased stresses accompanied by increased shear strength; therefore not necessarily an adverse effect.

From Track Structure Design Using Mathematical Models, pp. 22-49, by W. So. Year of first publication: 1978.

with the required quality of the track structure, magnitude and frequency of loading, and desired train speed. If "poor track" conditions develop, "slow orders" must be imposed until maintenance restores the track to acceptable track geometry for desired operations. Selig et al.<sup>41</sup> refer to this period of time between maintenance operations as the "maintenance life" of track.

Recent studies by Selig et al.<sup>42</sup>, Japanese National Railways<sup>43</sup> and others have shown that the primary sources of cumulative residual track settlement are the ballast, subballast and subgrade layers. Mechanisms causing track settlement in the substructure include (a) volume reduction by densification of ballast from particle rearrangement under repeated wheel loading, (b) volume reduction of ballast by particle breakdown caused by wheel loading and environmental factors, (c) inelastic behavior of cohesive soil subgrades upon unloading, the degree of which is a function of the stress path and stress state of the material, and (d) penetration of coarse ballast into finer subgrade soil. Figure 4-5 shows typical ballast and subballast residual strains and subgrade deformations measured under accumulated traffic for test sections at FAST.

For both track design and maintenance planning, it is important that railroad engineers be able to predict the maintenance life period for a substructure section and how much each substructure layer contributes to the total track settlement. Having such an analytic capability will contribute significantly to the railroad's ability to rationally evaluate the economic life of ballast and subballast materials under various loading conditions. Such an analytic capability does not presently exist. Studies have been undertaken by several investigators toward this objective, including Robnett et al.<sup>44</sup>,

---

<sup>41</sup>E. T. Selig et al., A Theory for Track Maintenance Life Prediction, First Year Final Report, prepared for U.S. Dept. of Transportation, Research and Special Programs Administration, Office of University Research, Report No. DOT/RSPA/DPB-50/79/22, August 1979, 183 pp.

<sup>42</sup>E. T. Selig et al., Status Report - Ballast Experiments, Intermediate (175 MGT) Substructure Stress and Strain Data, Interim Report, prepared for U.S. Dept. of Transportation, Transportation Systems Center, September 1979, 88 pp.

<sup>43</sup>Y. Sato, "A Proposal of New Theory on Track Deterioration," Japanese Railway Engineering, Quarterly Reports, Vol. 19, No. 1, 1978, pp. 34-35.

<sup>44</sup>Q. L. Robnett et al., Development of a Structural Model and Materials Evaluation Procedures, Ballast and Foundation Materials Research Program, University of Illinois, Report No. FRA-ORD-76-255, November 1975, 97 pp.

and Raymond and Turcke<sup>45</sup>. Recently, Selig et al.<sup>46</sup> at the University of Massachusetts have developed a methodology adapted from recent work in flexible pavement analysis. As these studies show, development of a predictive method requires an understanding of the behavior of substructure materials subjected to repeated loading.

Available methods for predicting the rate of residual deformation of track are presented in the following pages, along with comparisons of results with measured field data from FAST.

Flexible Pavement Analytical Method - Barksdale<sup>47</sup> developed a method for predicting the residual deformation (rutting) in flexible highway pavements. Barksdale's method is reviewed by Monismith and Finn<sup>48</sup>. Relationships between permanent strain and applied stress for a number of load cycles are developed from cyclic triaxial tests for each of the pavement materials. The major principal stress and confining pressures are determined at the center of each pavement layer using either a linear or nonlinear elastic layer theory analysis. The residual strain for a desired number of load cycles is calculated for each layer by comparing the applied stresses computed from elastic theory with the relationship between residual strain and applied stress developed from the triaxial test data for each material layer.

The total residual deformation in the entire pavement section is determined by summing the product of residual strain and layer thickness for all layers. The keys to this method are the development of relationships between residual axial strain caused by repeated loading and the state of stress in the triaxial test for each material layer and the ability to represent this relationship using a nonlinear, hyperbolic stress-strain model in the analytic procedure.

---

<sup>45</sup>G. P. Raymond and D. J. Turcke, Analysis of Rail Track Structures (ARTS), User's Manual, Canadian Institute for Guided Ground Transport, Report 78-8, April, 1978.

<sup>46</sup>E. T. Selig et al., A Theory for Track Maintenance Life Prediction, Second Year Final Report (Draft), prepared for U.S. Dept. of Transportation, Office of University Research, Contract DOT-OS-70058, December 1979, 160 pp.

<sup>47</sup>R. D. Barksdale, "Laboratory Evaluation of Rutting in Base Course Materials," Proceedings, Third International Conference on the Structural Design of Asphalt Pavements, London, 1972, pp. 161-174.

<sup>48</sup>C. L. Monismith and F. N. Finn, "Flexible Pavement Design: State of the Art, 1975" Transportation Engineering Journal, TE1, ASCE, January, 1975.

Residual Deformation Prediction Method for Railroad Substructures - Selig et al.<sup>49</sup> adapted the flexible pavement analytic method to one for predicting the vertical residual deformation in a track substructure system. This method is similar to work done by International Union of Railways (IUR)<sup>50</sup> and Shenton<sup>51</sup>.

The basis of Selig's approach was the use of the cyclic triaxial test to simulate track substructure material behavior under repeated loading. By testing ballast, subballast, and subgrade samples at stress levels similar to those experienced in the substructure, it was assumed that the materials strain in amounts similar to the strains beneath track. The stress levels used in the cyclic triaxial tests were determined by the analytic computer model GEOTRACK which has been described previously in Section 4.5.1. Results obtained from GEOTRACK were reported to give good agreement with measured field data of stresses and strains in the various substructure layers. The stresses determined by this method are the incremental stresses caused by wheel loadings to which are added the static stresses in the various substructure layers to obtain the total principal stresses. The total principal stresses are then used to develop the total octahedral normal and shear stresses. Octahedral stresses are used to account for the three dimensionality of the system to convert computed stresses from GEOTRACK to equivalent laboratory triaxial stresses for use in testing.

Based on extensive laboratory repeated load triaxial testing, Selig and his coworkers confirmed conclusions of earlier workers that residual strain after any number of load cycles could be estimated using the residual strain measured from the first cycle of a repeated load triaxial test. Two relationships for the residual strain after any number of load cycles, N, were presented -

$$\epsilon_N = \epsilon_1 (1 + 0.19 \log N)$$

$$\epsilon_N = \epsilon_1 (0.85 + 0.38 \log N) + \epsilon_1 (0.05 - 0.09 \log N)$$

where:

$\epsilon_N$  = Residual strain after N load cycles

$\epsilon_1$  = Residual strain after the first load cycle

N = Number of load cycles.

---

<sup>49</sup>E. T. Selig et al., Op. Cit., December 1979, 160 pp.

<sup>50</sup>International Union of Railways, Stresses in the Rails, the Ballast and in the Formation Resulting From Traffic Loads, Question D71, Report No. 10, Vols. I and II, Utrecht, Holland, 1970.

<sup>51</sup>M. J. Shenton, "Deformation of Railway Ballast Under Repeated Loading," Soil Mechanics Section, British Railways Research Department, 1974.

Selig also determined that the amount of residual deformation after one load cycle could be estimated using conventional single load triaxial test results. A relationship between the resilient strain after one load cycle and the cumulative strain after many load cycles was developed. The use of such a method limits the need for complex and expensive repeated load triaxial tests. A more detailed discussion of the laboratory relationships is given in Section 2, by Selig et al.<sup>52</sup>, and by Alva-Hurtado (1980)<sup>53</sup>.

Comparison With Field Data - Permanent ballast strains calculated by the methods described above were compared with ballast strains measured at FAST. Subballast and subgrade strains were not calculated, although such calculations are possible using this method.

As Figure 4-12 shows, the predicted deformations for both stress paths and both density states are consistently lower than measured deformations. Section 18B (wood ties, 15 inches of ballast) gave the closest agreement between computed and measured ballast strains, while 18A (wood ties, 21 inches of granite ballast) showed a wider spread, and Section 17E (concrete ties, 14 inches of limestone ballast) was considerably higher. According to Selig et al. (1979), the disparity between measured and calculated results was caused by the large variability in density and physical state in the substructure at FAST, scatter in field measurements, analytic difficulties with GEOTRACK concerning stress redistribution and reproducing the actual ballast stress paths, inability to reproduce partial unloading in triaxial test loading pulses, and difficulty in determining the highest stresses at a particular depth. This last point was demonstrated for concrete ties, where the highest computed stresses at the ballast mid-depth were found at the tie end and not under the rail, as in wooden ties. Using these higher stresses, Selig reanalyzed the concrete tie track and calculated significantly higher deformations (compare Figures 4-12c and d).

In spite of the difficulties, the comparisons appear reasonable, and several observations can be made:

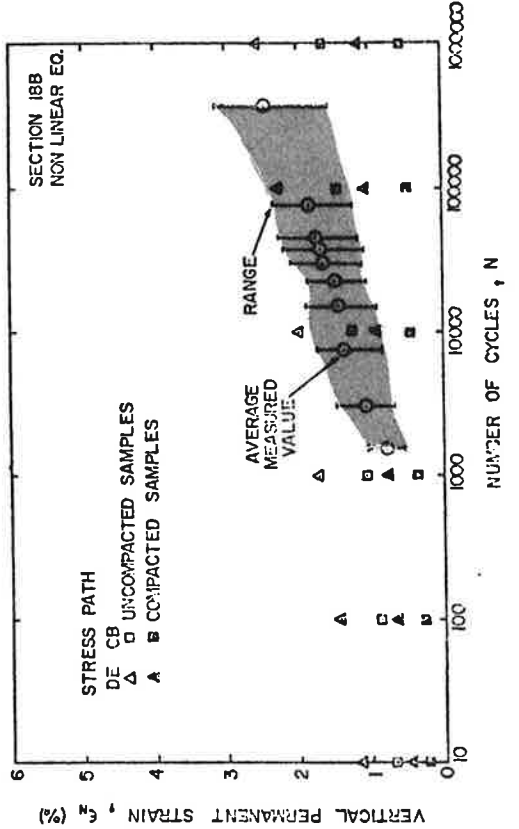
a. Both measured and predicted data indicate higher ballast strains generated in the concrete tie section than in either wood tie section, and higher strains in the 21-inch-thick ballast layer than in the 15-inch-thick ballast layer.

b. Figure 5-15 shows that, based on both the analytic and field results, the density state of the ballast significantly affects the amount of residual deformation accumulated.

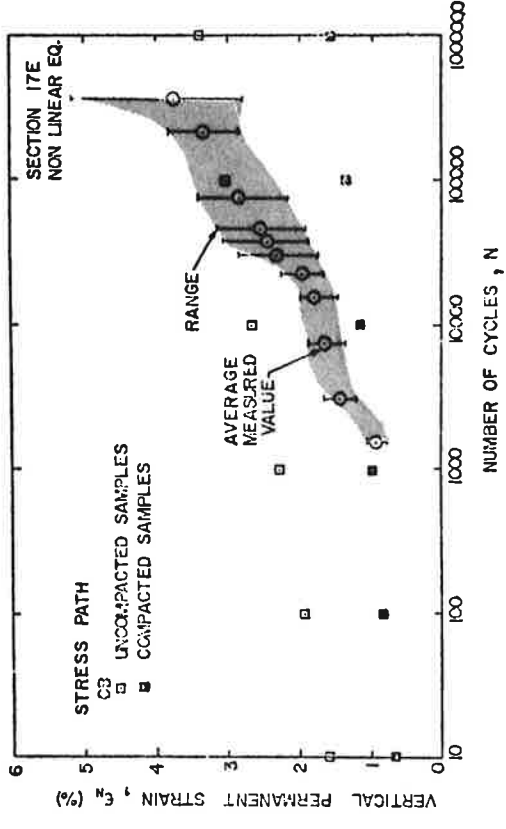
---

<sup>52</sup>E. T. Selig et al., Op. Cit., December 1979, 160 pp.

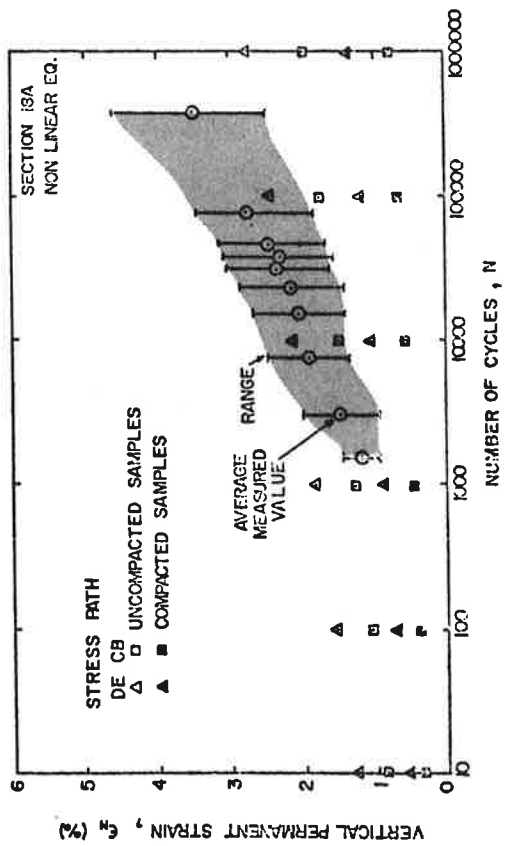
<sup>53</sup>J. E. D. Alva-Hurtado, "A Methodology to Predict the Elastic and Inelastic Behavior of Railroad Ballast," Ph.D. Thesis, University of Massachusetts, Amherst, Massachusetts, May 1980, 442 pp.



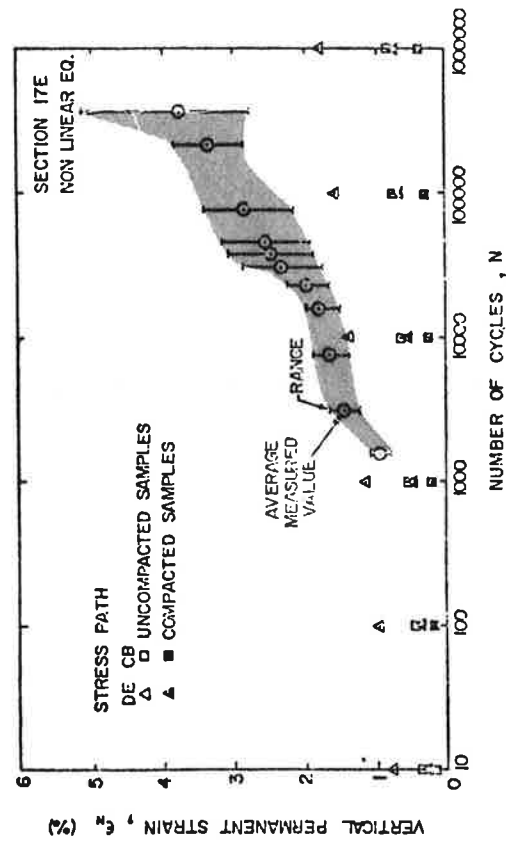
**b) SECTION 18B**



**d) SECTION 17E - POINT UNDER TIE ENDS**



**e) SECTION 18A**



**c) SECTION 17E**

Reproduced from A Methodology to Predict the Elastic and Inelastic Behavior of Railroad Ballast, pp. 372-380, by J. E. D. Alva-Hurtado, by permission of the author. Year of first publication: 1980.

FIGURE 4-12. COMPARISON OF PREDICTED AND MEASURED VALUES OF BALLAST RESIDUAL STRAIN

c. For both measured and analytic results, over 50 percent of the residual deformation that accumulated over the first 1,000,000 cycles took place in the first 10,000 cycles.

d. The slopes of the measured field data curves are significantly steeper than the analytic curves, indicating a faster rate of accumulation. More field data is needed in order to verify this trend. Factors other than cyclic loading influence the field settlement.

Potential Value of Method - The work performed by Selig et al. on ballast strains needs to be extended to subballast and subgrade materials since, as Sato<sup>54</sup> observed in JNR's work, most of the substructure residual deformation occurs in the subgrade. Developing the same methodology for these materials is essential to development of a complete analytic design capability. The methodology would be the same as for ballast except that the laboratory testing would be more conventional. In addition, a larger data base of material behavior properties should be available from similar testing in the flexible pavement field. The testing and analyses should be more straightforward than those for predicting ballast strains because three-dimensional effects are smaller and because the actual stress paths in the field are more nearly those simulated in the triaxial test.

The methodology presented for vertical permanent deformation only predicts uniform, total track settlement, not nonuniform or differential settlement within the structure. Differential settlement is the real cause of track performance deterioration of interest to railroad engineers. In the foundation engineering field, empirical relationships have been developed based on field data relating total and differential settlements of structures (Feld<sup>55</sup>, Skempton and MacDonald<sup>56</sup>). Differential settlement is kept within tolerable amounts by limiting the amount of total settlement of structures. This same approach may be applied to railroad track by measuring total and differential settlements and determining how much total settlement may be allowed to produce tolerable differential settlements. Selig and his coworkers are presently studying possible ways of predicting the nonuniform (differential) settlement behavior of railroad track. Track geometry cars provide only differential displacement parameters and will not themselves generate the necessary data.

---

<sup>54</sup>Y. Sato, "A Proposal of New Theory on Track Deterioration," Japanese Railway Engineering, Quarterly Reports, Vol. 19, No. 1, 1978, pp. 34-35.

<sup>55</sup>J. Feld, "Tolerance of Structures to Settlement," ASCE, JSMFD, May 1965, Vol. 91, SM3.

<sup>56</sup>A. W. Skempton and D. H. MacDonald, "Allowable Settlement of Buildings," Proceedings, Institution of Civil Engineers, Part III, Vol. 5, London, England, December 1956, p. 727.



#### 4.5.3 Simplified Design Method

G. P. Raymond<sup>57</sup> presented a rational, simplified design method for determining the depth of ballast plus subballast over the subgrade. The method was developed within the framework of current North American design practice, modified using recent research findings, and updated for 100-ton-car wheel loads. As such, it can readily be used by practicing engineers. In addition, Raymond outlines how to use the method to address soft subgrades and upgrading track to higher load levels.

The primary steps in the method are:

1. Determine the stress distribution with depth below the tie using Boussinesq elastic theory integrated for a rectangular, vertically loaded surface area. A uniform tie ballast contact pressure is used. Stresses from loads on adjacent ties on either side of the central tie are included.
2. From the allowable bearing pressure of the subgrade being considered, the stress distribution plot can be entered, and the required ballast plus subballast depth selected.

Raymond showed that, for determining the stresses on the subgrade, the type of tie/ballast contact pressure distribution used was not critical. Stress distributions with depth calculated using the Boussinesq method, integrated for the different contact pressure distributions, revealed that at a depth of two tie widths (16 inches), the difference in the stresses was only 20 percent, and at a depth of three tie widths (24 inches), they were approximately equal. For this reason the simple, uniform pressure distribution along the full length of the tie was used. Note that for tie design the actual contact pressure distribution is important, and this simple, uniform distribution is not appropriate.

The axle load is distributed such that the tie below the wheel carries 25 percent of the load and the ties on either side carry 12.5 percent of the load. Raymond points out that the actual distribution is very complex and based on many known factors (rail weight, tie weight and spacing) and unknown factors (loose fasteners and tie plates, play between tie and ballast). The uniform distribution is commonly considered a critical case. The percentages are doubled to account for wheel interactions only, so that 50 percent and 25 percent of the axle load are used, respectively.

The maximum average contact pressure was obtained using the standard AREA practice of calculating the maximum static rail seat load and doubling it. Raymond divided by the total tie base area in accordance with his uniform

---

<sup>57</sup>G. P. Raymond, "Design for Railroad Ballast and Subgrade Support," Journal of the Geotechnical Engineering Division, ASCE, Vol. 104, No. GT1, January 1978, pp. 45-60.

pressure distribution, rather than by the effective tie bearing area as recommended by AREA. For an 8-inch-wide by 7-inch-thick by 8.5-foot-long tie, the difference in bearing area is 32 percent, which results in approximately a 50-percent difference in contact pressure. As shown in Figure 4-13a, an example was developed for different rail sections, 8-inch-wide by 8.5-foot long ties at 20-inch spacings, 33,000-pound (100-ton-car) wheel loads increased 25 percent for wheel interactions, a 50 mph speed, and a range of track modulus values. The contact pressure was expressed in terms of a unit wheel load and tie spacing/tie breadth ratio. Using typical Canadian track moduli, an equivalent design wheel load of 25 tons was calculated. This resulted in a ballast contact pressure close to the 65 psi allowable given by AREA. As Figure 4-13a shows, the average contact pressure varies significantly depending on several factors, particularly the track modulus. Considering that changing environmental conditions (freeze, thaw, wet, dry) can cause the track modulus to vary by a factor of 5, careful consideration should be given to the value of track modulus used. Raymond reported that a track modulus greater than AREA's general recommendation of 2,000 psi is desirable for 100-ton cars.

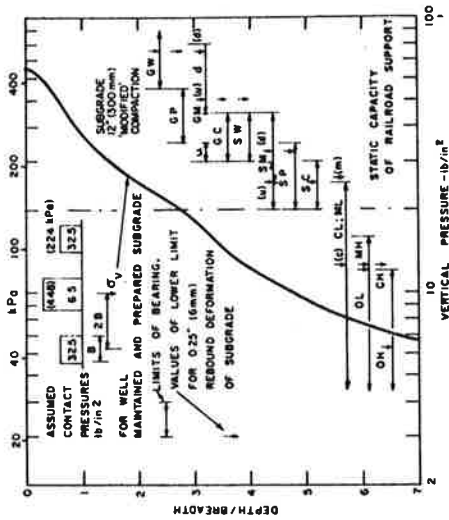
Figure 4-13b shows an example of the method used for 100-ton cars and the other conditions previously described. Raymond superimposed a range of allowable bearing pressures for various types of subgrade soils classified according to the Unified Soil Classification system. The bearing pressures were determined using California Bearing Ratio (CBR) test results on soaked, compacted soils reported by Casagrande<sup>58</sup>. These allowable pressures are generally appropriate for compacted subgrade soils, but extreme care should be exercised in using them for natural soils, particularly saturated cohesive soils. The soaked CBR's are appropriate in that they represent a worst case for strength of compacted soils.

Raymond noted that the figure indicates that most granular soil subgrades can carry 100-ton-car loads while meeting AREA's 20 psi allowable subgrade pressure recommendations. However, as Figure 4-13b indicates, many cohesive subgrades cannot accept a 20 psi bearing pressure with conventional substructure thicknesses. Eight-inch ties would require a combined ballast plus subballast thickness on the order of 24 to 48 inches, depending on the strength and stiffness of the cohesive subgrade.

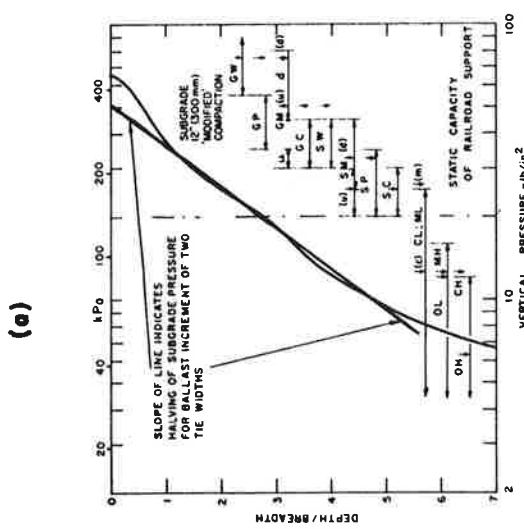
Raymond demonstrated the use of the method for correcting subgrade soft spots (Figure 4-13c) and upgrading 70-ton track to 100-ton or 125-ton (Figure 4-13d) for the track conditions previously established. For soft subgrades, the track moduli can be doubled and subgrade stresses halved by increasing the ballast or subballast depth by two tie widths (16 inches). Maintaining existing subgrade pressures and track moduli while upgrading track from 70-ton to 100-ton or 125-ton cars can be achieved by increasing ballast depths one-half tie width (4 inches) on "good" subgrades to one tie width (8 inches) on "poor" subgrades.

---

<sup>58</sup>A. Casagrande, "Classification and Identification of Soils," Transactions, ASCE, Vol. 113, Paper No. 2351, 1948, pp. 901-992.

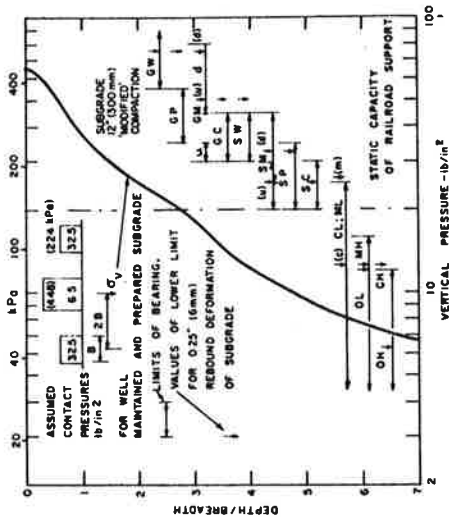


**Design Contact Pressures (Doubled Theoretical Values) for AREA Rail Sizes on 8-1/2-ft (2.59-m) Long Tie**

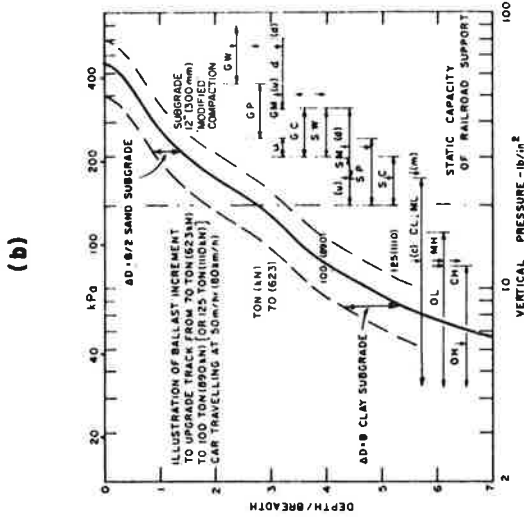


**Ballast Increment Requirement for Soft Spot Improvement**

**Ballast Increment Upgrading for Increased Wheel Loading**



**Track Support Ballast Design Depths on Soaked Compacted Subgrades**



**Ballast Increment Upgrading for Increased Wheel Loading**

FIGURE 4-13. SIMPLIFIED DESIGN METHOD

Reproduced from "Design for Railroad Ballast and Subgrade Support," pp. 51-55, Journal of the Geotechnical Engineering Division, ASCE, Vol. 104, No. 1, by G. P. Raymond, by permission of the American Society of Civil Engineers. Year of first publication: 1978.

The method is useful in that it allows a relatively simple, yet rational, approach for analyzing track substructure conditions by modifying current AREA standard practice. The method has been proposed for the Northeast Corridor Improvement Project (NECIP) to determine required ballast thicknesses on rehabilitated track. While the allowable subgrade pressures provided by Raymond appear reasonable for compacted subgrades, caution should be taken in applying them to unstabilized natural soils. Evaluation of subgrade strength and deformation properties should be based on field or laboratory strength and deformation tests performed for worst seasonal conditions.

#### 4.5.4 Design for Vibrations

The German Federal Railway (DB) has studied the effects of vibrations on track performance (Spang<sup>59</sup>, Eisenmann<sup>60</sup>). Transmission of vibrations to the substructure has been discussed in Section 2.2. The effects of vibrations on the substructure are discussed here.

Vibrations cause resilient deformations in the substructure that propagate as longitudinal waves downward and as transverse waves outward. The resilient deformations compact ballast, subballast, and granular subgrades, resulting in volume loss and settlement. In cohesive subgrades the vibrations can result in subgrade softening and in the development of troughs, water pockets, or mud pumping. As discussed in Section 2.2, the vibrations in the frequency range of zero to 16 Hz are of principal concern, since this is the range of characteristic natural frequencies of soils.

The effects of vibrations can be limited if the vibration energy is reduced by insulating the track with low frequency shields. The insulating body that supports the vibrating body must have a significantly lower characteristic frequency. Spang (1972) reports that a characteristic frequency of the insulating material of one quarter of the exciting frequency usually provides sufficient insulation. The DB has experimented with hard rubber tie pads between the ballast and tie and the rail and tie with good results. Work is being done by the Germans and others (Prause et al.<sup>61</sup>) to develop better insulating materials for rail fasteners and tie plates.

Spang (1972) reports that the effect of resonance can be reduced by "suitably selecting the surface area of the ties and track bearing plates," but does not expand on this. He also notes that additional study is necessary to better understand the factors affecting vibration propagation.

---

<sup>59</sup>J. Spang, "Deformation of Railroad Track Base and its Stabilization," Eisenbahntechnische Rundschau, p. 376, Vol. 21, No. 10, 1972.

<sup>60</sup>J. Eisenmann, "Stress Distribution in the Permanent Way Due to Heavy Axle Loads and High Speed," Proceedings, Bulletin 622, AREA, 1969, pp. 24-59.

<sup>61</sup>R. H. Prause et al., An Analytical and Experimental Evaluation of Concrete Cross Tie and Fastener Loads, prepared for U.S. Dept. of Transportation, Federal Railroad Administration, Report No. FRA/ORD 77/71, December 1977, 356 pp.

## 5. LATERAL LOADING: PERFORMANCE, DESIGN, AND ANALYSIS

### 5.1 INTRODUCTION

Proper horizontal alignment of railroad track is essential for maintaining a smooth ride, reducing wear on rail equipment, reducing track maintenance, and, most importantly, limiting the possibility of train derailments. From 1975 to 1978, over 1,000 derailments, causing an estimated \$21.6 million in damages, were attributed to improper track alignment<sup>1,2,3,4</sup>.

To maintain the horizontal alignment, the railroad track must have sufficient lateral strength to resist displacements due to thermal loadings on unoccupied track and due to the combined effect of thermal and wheel loadings on occupied track. Thermal loadings are produced when continuous welded rail (CWR) and frozen jointed rail are exposed to ambient temperatures that are different from the installation temperature and axial forces are induced in the rails. If the temperature is above the installation temperature, compressive forces can cause the track to buckle. According to field and test observations, cross tie track, when subjected to excessive temperature increases, usually buckles horizontally. Vertical buckling is rarely seen under normal conditions although, if lateral track movement is prevented either by an external structure or by large lateral rigidity in the rail-tie structure, the track can buckle vertically<sup>5</sup>. In conventional jointed track, thermal loads usually do not occur because a small gap is provided at each joint to allow for the thermal expansion of the rail.

Lateral wheel loads are caused by the lateral components of the frictional force between the wheel and rail and by the lateral force applied by the steel wheel flange against the rail. If the lateral wheel loads become excessive, lateral displacements of the track occur. This is a progressive problem because poorly aligned track will further encourage displacements through

---

<sup>1</sup>Accident/Incident Bulletin, No. 144, prepared for U.S. Dept. of Transportation, Federal Railroad Administration, 1975, pp. 2, 14.

<sup>2</sup>Accident/Incident Bulletin, No. 145, prepared for U.S. Dept. of Transportation, Federal Railroad Administration, 1976, pp. 2, 14.

<sup>3</sup>Accident/Incident Bulletin, No. 146, prepared for U.S. Dept. of Transportation, Federal Railroad Administration, 1977, pp. 2, 25.

<sup>4</sup>Accident/Incident Bulletin, No. 147, prepared for U.S. Dept. of Transportation, Federal Railroad Administration, 1978, pp. 23, 33.

<sup>5</sup>A. D. Kerr, "Analysis of Thermal Buckling in the Lateral Plane," Acta Mechanica, 30, 1978, pp. 17-50.

increased wheel-rail forces, lateral loads due to "hunting" of trucks, and lateral loads due to the "nosing action" of locomotives. Section 3.2 provides a detailed description of lateral load mechanisms.

Resistance to lateral loads can be provided by both the track superstructure and substructure. The track superstructure is comprised of rails, cross ties, tie plates, and rail-tie fasteners arranged in the form of a "ladder beam." Resistance to lateral force in this composite structure is provided by the lateral stiffness of the rails and ties and the resistance of the fasteners to rotation about a vertical axis. A distorted track panel schematically illustrates lateral stiffness of the rail-tie superstructure as shown in Figure 5-1.

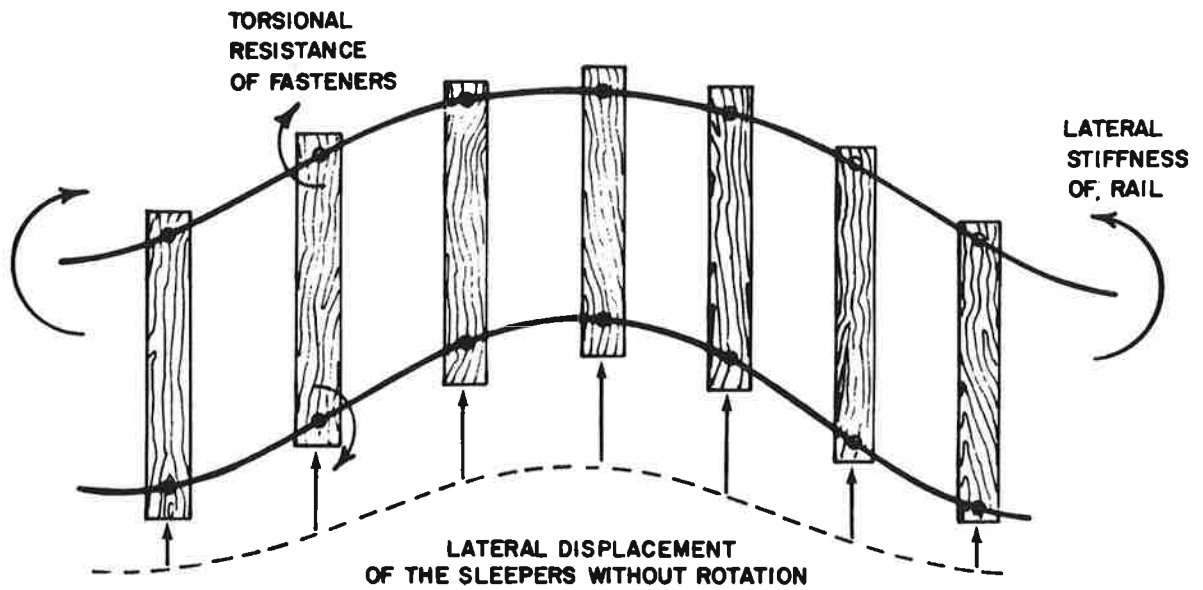
The track substructure is composed of the ballast in which the superstructure is embedded, the subballast, and the subgrade. Lateral loadings are transferred from the superstructure to the substructure in the ballast bed. The forces applied by the superstructure are resisted by ballast-tie friction along the bottom and along the two long sides of the tie and by a net passive pressure on the end-face of the tie. Lateral loads are transferred from the ballast bed to the subballast and then to the subgrade through shear stresses along the contacting surfaces.

## 5.2 BALLAST RESISTANCE MECHANISMS AND RESPONSE TO LOADING

The magnitude of lateral track resistance is controlled by the nature of the tie-ballast interaction primarily. Although rail stiffness and fastener resistance may provide up to approximately 20 percent of the total lateral resistance in unoccupied, well-maintained track, variations in track superstructure characteristics and subballast and subgrade properties have little influence on the observed magnitude of total lateral track resistance. Theoretical and experimental studies by Amans and Sauvage, 1969<sup>6</sup>, Prud'homme and

---

<sup>6</sup>F. Amans and R. Sauvage, "Railway Track Stability to Transverse Stresses Exerted by Rolling Stock. A Theoretical Study of Track Behavior. A Practical Method for Determining the Resistance of the Track to Transverse Stresses Exerted by Rolling Stock," Bulletin of the International Railway Congress Association, Vol. 46, No. 11, November 1969, pp. 685-716.



Adapted from "The Effect of Lateral Loads on Track Movement,"  
 p. 113, by C. O. Frederick. Year of first publication: 1978.

FIGURE 5-1. SCHEMATIC LATERAL STIFFNESS OF TRACK SUPERSTRUCTURE

Janin, 1969<sup>7,8</sup>, El-Aini, 1969<sup>9</sup>, Dogneton, 1978<sup>10</sup>, and Sonneville and Bentot, 1956<sup>11</sup>, 1957<sup>12</sup>, addressed the effects of track superstructure characteristics and subballast and subgrade properties on lateral track resistance. As an example, Amans and Sauvage, 1969, showed that the "critical lateral force," i.e., the force at which permanent lateral track displacement occurs, only increased by 9 percent when the vertical track modulus was increased from 2,900 psi (20MN/m) to 5,800 psi (40MN/m). Also, Dogneton, 1978, estimated that from among reviewed test data, any increase in lateral track resistance obtained by stiffening the superstructure was equivalent to a 10 percent increase in lateral ballast resistance. About two thirds of the lateral track resistance provided by the superstructure is attributed to torsional resistance of the fasteners. However, fasteners must be well maintained in order to provide any significant lateral resistance. This section focuses on the mechanisms for lateral ballast resistance--i.e., ballast-tie friction and ballast passive resistance--and the factors that affect these mechanisms. Table 5-1 summarizes this information.

Ballast-tie friction is caused by the frictional forces between the ballast and the tie bottom, and between the ballast and the two long tie sides (see Figure 5-2). Net ballast passive resistance is the force exerted by the ballast shoulder against the tie end face when the tie is laterally displaced. Test results show that the contribution of the various resisting forces to the total lateral resistance is dramatically influenced by whether the track is unoccupied or occupied by a moving train. Hence, these two loading conditions will be referred to as unoccupied and occupied track.

---

<sup>7</sup>M. A. Prud'homme and M. G. Janin, "The Stability of Tracks Laid with Long Welded Rails, Part I, Bulletin of the International Railway Congress Association, Vol. 46, No. 7-8, July-August 1969, pp. 459-487.

<sup>8</sup>M. A. Prud'homme and M. G. Janin, "The Stability of Tracks Laid with Long Welded Rails, Part II," Bulletin of the International Railway Congress Association, Vol. 46, No. 10, October 1969, p. 601-602.

<sup>9</sup>Y. M. El-Aini, "Effect of Foundation Stiffness on Track Buckling," Journal of the Engineering Mechanics Division, ASCE, Vol. 102, No. EM3, June 1976, pp. 531-545.

<sup>10</sup>P. Dogneton, "The Experimental Determination of the Axial and Lateral Track Ballast Resistance," Symposium on Railroad Track Mechanics and Technology, A. D. Kerr, ed., Princeton University, 1978, pp. 171-196.

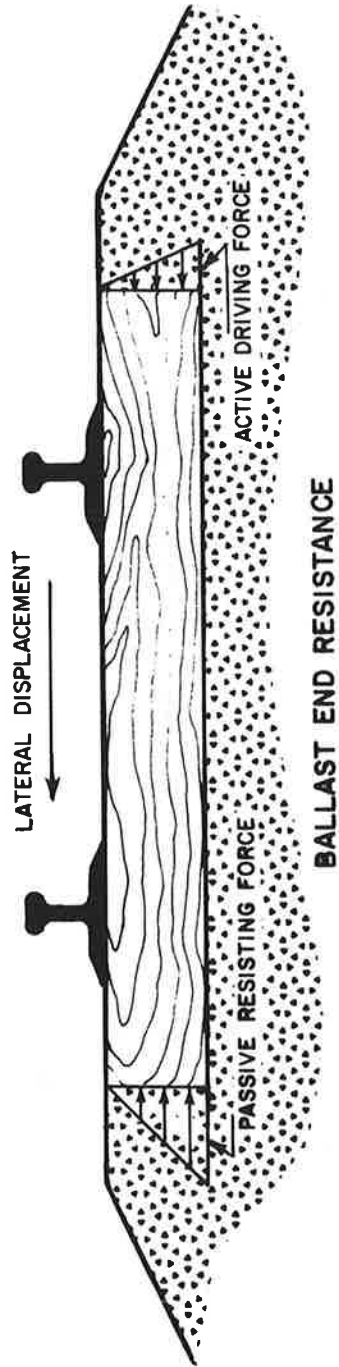
<sup>11</sup>R. Sonneville and A. Bentot, "Lateral Strength of Permanent Way When Free from Load" Bulletin of International Railway Congress Association, Vol. 33, No. 6, June 1956, pp. 481-491.

<sup>12</sup>R. Sonneville and A. Bentot, "Elasticity and Lateral Strength of the Permanent Way," Bulletin of the International Railway Congress Association, Vol. 32, No. 3, March 1955, pp. 184-208.

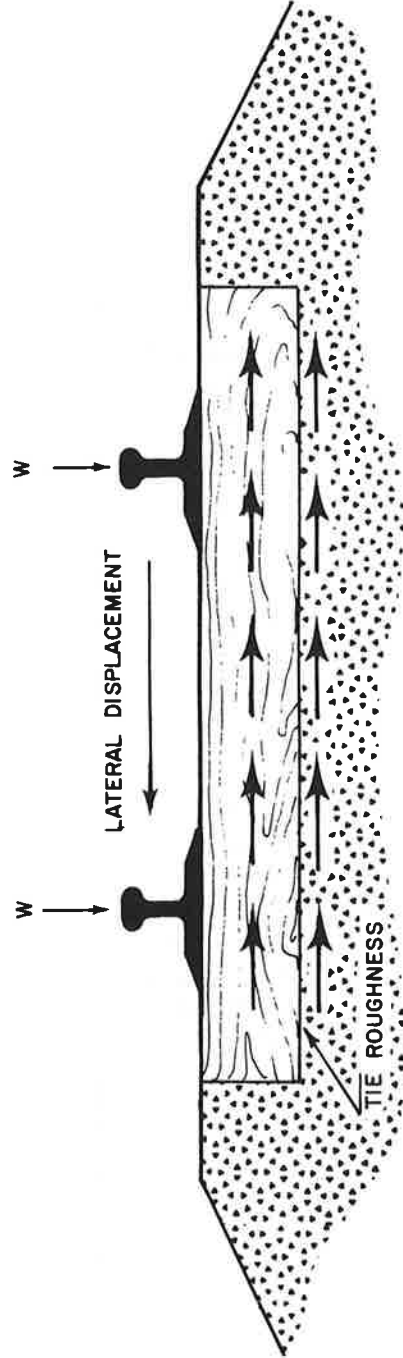


TABLE 5-1. SUMMARY OF BALLAST LATERAL RESISTANCE FORCES AND PARAMETERS

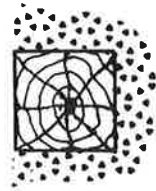
LOCATION OF RESISTING FORCES	RESISTING FORCES	PARAMETERS OF RESISTING FORCES	PARAMETER GROUPING
Tie Bottom	Ballast/Tie Friction ·Static friction @ small displacements ·Sliding friction @ large displacements	1. Ballast mat'l properties ·angularity, unit weight, particle strength 2. Ballast compaction ·maintenance activities ·MGT traffic	Ballast
		3. Contact area ·length, width of tie 4. Surface roughness ·tie mat'l type ·tie age 5. Normal force (vertical) ·superstructure weight  ·train weight      occupied track only ·rail lifting      track only	Ties
Tie Side	Ballast/Tie friction ·Static friction @ small displacement ·Sliding friction @ large displacements	1. Ballast mat'l properties ·angularity, unit weight, particle strength 2. Ballast compaction ·maintenance activities ·MGT traffic 3. Normal force (horizontal) ·ballast mat'l properties ·ballast compaction 4. Contact area ·height of ballast (above tie bottom)	Ballast
		·height, length of tie 5. Surface roughness ·tie mat'l type ·tie age	Tie
Tie End	Ballast Passive Resistance	1. Ballast mat'l properties ·angularity, unit weight, particle strength 2. Ballast compaction ·maintenance activities ·MGT traffic 3. Width of ballast shoulder 4. Contact area ·height of ballast (above tie bottom)	Ballast
		·height, width of tie	Ties



**BALLAST END RESISTANCE**



**BALLAST - TIE BOTTOM AND SIDE FRICTION**



Reproduced from Thermal Buckling of Straight Tracks; Fundamentals, Analyses and Preventive Measures, p. 22, by A.D. Kerr, Year of first publication: 1978.

FIGURE 5-2. BALLAST BED RESISTANCES

Table 5-2 is based on work by Amans and Sauvage, 1969; Prud'homme and Janin, 1969; Sonnevile and Bentot, 1955, 1956; Dogneton, 1978; Frederick, 1978<sup>13</sup>; Kerr, 1978<sup>14,15</sup>; Klugar, 1972<sup>16</sup>, 1974<sup>17</sup>, 1976<sup>18</sup>; Prud'homme, 1967<sup>19</sup>; Eisenmann, 1976<sup>20</sup>; and Prause and Kennedy, 1977<sup>21</sup>. The table shows that for unoccupied track, 50 percent to 60 percent of the total lateral resistance is derived from the frictional forces between the tie bottom and the ballast bed; 30 percent to 40 percent from passive end resistance; and 10 percent to 20 percent from frictional forces between the tie sides and the ballast bed. For occupied track, it appears that at least 95 percent of total lateral resistance is derived from the friction between the tie bottom and the ballast bed.

---

<sup>13</sup>C. O. Frederick, "The Effect of Lateral Loads on Track Movement," Symposium on Railroad Track Mechanics and Technology, A. D. Kerr, ed., Princeton University, 1978, pp. 109-140.

<sup>14</sup>A. D. Kerr, Thermal Buckling of Straight Tracks; Fundamentals, Analyses, and Preventive Measures, prepared for U.S. Dept. of Transportation, Federal Railroad Administration, Report No. FRA/ORD-78/49, September 1978, 58 pp.

<sup>15</sup>A. D. Kerr, "Lateral Buckling of Railroad Tracks Due to Constrained Thermal Expansions-A Critical Survey," Symposium on Railroad Track Maintenance and Technology, A. D. Kerr, ed., Princeton University, 1978.

<sup>16</sup>K. Klugar, "Effect of Raising the Track on the Track Lateral Strength," ETR-Eisenbahntechnische Rundschau, November 1972, pp. 446-449.

<sup>17</sup>K. Klugar, "Track Buckling Experiments of the Austrian Federal Railroads with New Types of Ties," ETR-Eisenbahntechnische Rundschau, Vol 25, No. 3, 1974, pp. 70-75.

<sup>18</sup>K. Klugar, "The Static Track Lateral Strength of Loaded Tracks," ETR-Eisenbahntechnische Rundschau, Vol. 25, No. 4, 1976, pp. 211-216.

<sup>19</sup>A. Prud'homme, "The Resistance of the Permanent Way to the Transversal Stresses Exerted by the Rolling Stock," Bulletin of the International Railway Congress Association, Vol. 44, No. 11, November 1967, pp. 731-766.

<sup>20</sup>J. Eisenmann, "The Significance of the Rail Lifting Wave," Rail International, No. 10, October 1976, pp. 576-581.

<sup>21</sup>R. H. Prause and J. C. Kennedy, Parametric Study of Track Response and Performance, prepared for U.S. Dept. of Transportation, Federal Railroad Administration, Report No. FRA/ORD-77/75, December 1977, 118 pp.

TABLE 5-2. CONTRIBUTION TOWARD TOTAL LATERAL RESISTANCE  
OF VARIOUS BALLAST RESISTING FORCES

<u>Lateral Resisting Force</u>	<u>Contribution Toward Total Lateral Resistance</u>	
	<u>Unoccupied Track</u>	<u>Occupied Track</u>
Tie Bottom/ Ballast Bed	50-60%	95-100%
Tie Side/ Ballast Bed	10-20%	0-5%
Passive End Resistance	30-40%	0-5%

### 5.3 BALLAST RESISTANCE: UNOCCUPIED TRACK

The following factors primarily determine the lateral resistance of unoccupied track.

#### 5.3.1 Passive End Resistance

Based on data compiled by Dogneton, 1978; Frederick, 1978; and Sonnevile and Bentot, 1956, passive-end resistance comprises approximately 30 percent to 40 percent of the total lateral resistance of unoccupied track. Furthermore, the results of Dogneton, 1978; Klugar, 1974; Kerr, 1978; Hay et al., 1977<sup>22</sup>; Prause and Kennedy, 1977; and Sonnevile and Bentot, 1956, indicate that the parameter which most strongly affects the magnitude of passive end resistance--and consequently the total lateral resistance--is the contact area available to develop end bearing, i.e., the height of the ballast shoulder above the tie bottom and the tie end surface area.

<sup>22</sup>W. W. Hay, H. C. Peterson, D. E. Plotkin, and P. T. Bakas, Lateral Stability of Ballast, Ballast and Foundation Materials Research Program, prepared for U.S. Dept. of Transportation, Federal Railroad Administration, Report No. FRA/ORD-77/61, September 1977, 54 pp.

Tie End Area - Klugar, 1974, and Riessberger, 1974<sup>23</sup> reported the results of Austrian field buckling tests that used two types of concrete ties and illustrated the significance of end bearing area relative to lateral track resistance. The two types of ties had similar cross sections; however, one type was equipped with "ears" or "wings" as shown in Figure 5-3. Test results showed that the "ear ties" provided lateral resistance 50 percent greater than the conventional ties. The importance of end bearing area was also brought out by Dogneton in 1978. He presented data which showed that discontinuous concrete block-type ties provided 40 to 50 percent greater lateral resistance than comparable monolithic-type ties. As shown on Figure 5-3, block-type ties provide an extra surface for end bearing by the nature of their design. Dogneton, 1978, also presented tests by German railroads that showed up to a 90 percent increase in lateral resistance by reinforcing ties with "safety caps." As shown in Figure 5-4, safety caps are bladelike devices that clamp onto the tie and extend below the tie into the ballast. In effect, the safety caps provide extra lateral area for end-bearing.

The adoption of "ear ties" or "safety caps" could add significantly to the lateral tie resistance during service. However, as pointed out in Chapter 3 of the AREA Manual, such devices may require extraordinary forces to realign the track. The gains in lateral track resistance may be offset by the difficulties in maintenance.

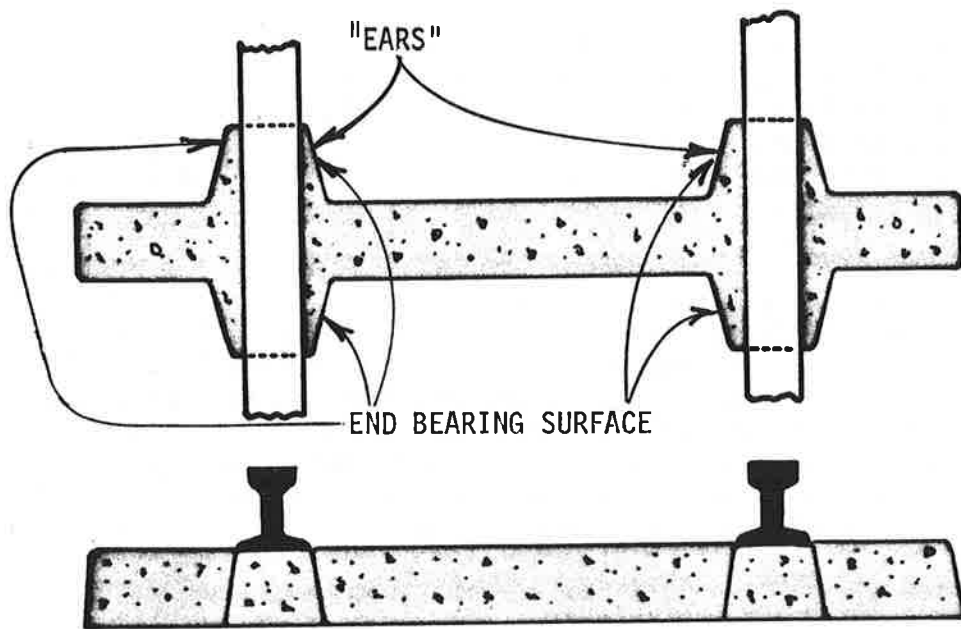
Other parameters influencing the magnitude of passive resistance, although to a lesser extent than contact area, are ballast material properties, ballast compaction, and mass or width of the ballast shoulder.

Material Properties - Investigations by Hay, 1977; Sonnevile and Bentot, 1956; Dogneton, 1978; Prause and Kennedy, 1977; and Prause et al., 1974<sup>24</sup>, have studied the effects of ballast type on lateral resistance, although little was reported specifically on the effects of ballast type on passive end resistance. These investigations indicated that, for the most part, ballast type did not significantly affect lateral resistance. However, among various ballast types (e.g., gravel, limestone, slag), a coarse, angular ballast stone that permitted good interlocking generally provided the best lateral stability. One study, as reported by Prause et al., 1974, revealed that a dry ash ballast provided only negligible passive end resistance. Because ballast type does not apparently produce a dramatic effect on lateral resistance, it can be concluded that, similarly, the effect of ballast type would not significantly influence that component of lateral track resistance attributed to passive end resistance.

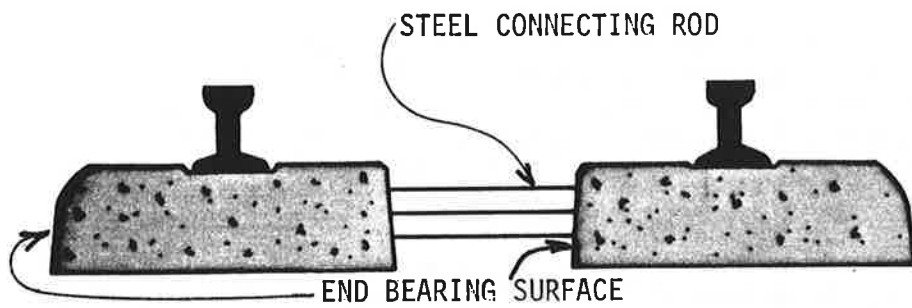
---

<sup>23</sup>K. H. Riessberger, "Means and Methods to Increase Track Stability," Proceedings, Vol. 75, Bulletin No. 648, AREA, 1974, pp. 797-811.

<sup>24</sup>R. H. Prause, H. C. Meacham, et al., Assessment of Design Tools and Criteria for Urban Rail Track Structures, Volume I. At-Grade Tie-Ballast Track, prepared for U.S. Dept. of Transportation, Urban Mass Transit Administration, Report No. UMTA-MA-06-0025-74-3, April 1974, 247 pp.

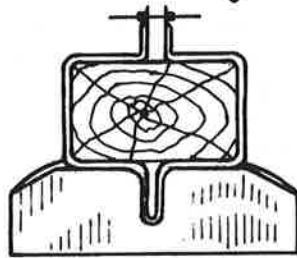
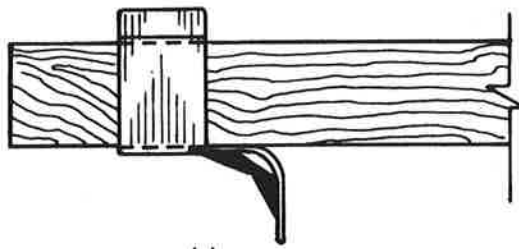


A. CONCRETE "EAR" TIE

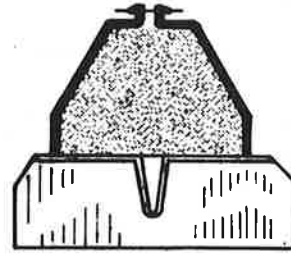


B. CONCRETE "BLOCK TYPE" TIE

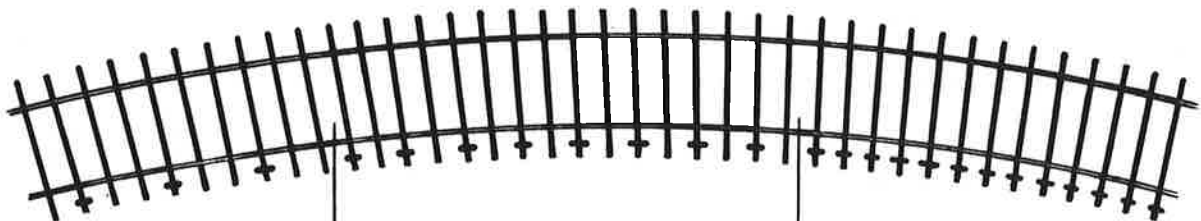
FIGURE 5-3. SPECIAL TIES FOR INCREASED LATERAL RESISTANCE



**WOODEN CROSS-TIES  
WITH SAFETY CAPS**



**CONCRETE CROSS-TIES  
WITH SAFETY CAPS**



**SAFETY CAPS  
EVERY 3rd CROSS-TIE**

**SAFETY CAPS  
EVERY 2nd CROSS-TIE**

**SAFETY CAPS  
EVERY CROSS-TIE**

Reproduced from "The Experimental Determination of Axial and Lateral Tracks-Ballast Resistance," p. 184, by P. Dogneton, by permission of Pergamon Press. Year of first publication: 1978.

**FIGURE 5-4. SAFETY CAP TIE REINFORCEMENT**

Ballast Compaction - Various investigators, including Klugar, 1972; Frederick, 1978; Dogneton, 1978; Sonnevile and Bentot, 1956; Reiner, 1977<sup>25</sup>; Cunney, 1977<sup>26</sup>; Selig et al., 1979<sup>27,28</sup>; and Matisa Materiel Industriel SA, 1972<sup>29</sup>, examined the effects of shoulder and crib ballast compaction on the overall lateral track resistance. However, it appears that few sources specifically looked at the influence of ballast shoulder compaction on passive end resistance. In general, their results showed that any track maintenance operation--such as tamping, track alignment, tie replacement, ballast cleaning, or ballast replacement--will loosen the ballast and, consequently, will reduce the lateral track resistance significantly. Lateral resistance of disturbed track was reported to be 30 percent to 70 percent of that for undisturbed, unloaded track. Mechanical ballast compaction after track maintenance was shown to restore lost density to the shoulder and crib and, consequently, immediately restore a portion of the lost lateral resistance. The magnitude of regained strength varied, depending upon such variables as types of maintenance activity, tie type, ballast material, degree of ballast fouling, magnitude of compactive effort, and type of subgrade. When compared as a percentage of the original undisturbed lateral resistance, track compacted after maintenance activities generally provided 5 percent to 20 percent greater lateral resistance than track not compacted following maintenance activities. The degree of ballast recompaction obtained was reported equivalent to approximately 0.2 to 0.5 MGT of traffic. After 2 to 7 MGT of traffic, no difference in overall lateral resistance was detected between track which had and which had not been given mechanical ballast compaction immediately following track maintenance activities. Traffic ranging from 20 to 200 MGT was reported necessary to bring the ballast layer back to the relatively dense, undisturbed state throughout.

---

<sup>25</sup>I. A. Reiner, Lateral Resistance of Railroad Track, prepared for U.S. Dept. of Transportation, Federal Railroad Administration, Report No. FRA/ORD-77/41, August 1977, 124 pp., (PB-275166).

<sup>26</sup>E. G. Cunney, J. T. May, and H. N. Jones, The Effects of Accelerated Ballast Consolidation, prepared for U.S. Dept. of Transportation, Federal Railroad Administration, Report No. FRA/ORD-76-274, March 1977, 184 pp., (PB-266447).

<sup>27</sup>E. T. Selig, Y. Tai-Sung, and C. M. Panuccio, Mechanics of Ballast Compaction-Phase I, Volume III, Technical Review of Ballast Compaction and Related Topics, prepared for U.S. Dept. of Transportation, Transportation Systems Center, Contract No. DOT/TSC/1115, January 1979, 287 pp.

<sup>28</sup>E. T. Selig, C. M. Panuccio, and Y. Tai-Sung, Mechanics of Ballast Compaction-Phase II, Volume IV, Summary Report, prepared for U.S. Dept. of Transportation, Transportation Systems Center, Contract No. DOT/TSC/1115, February 1979, 86 pp.

<sup>29</sup>Matisa Materiel Industriel SA, "Information Seminar - Crib and Shoulder Compaction," German Federal Railway, Mainz, October 1972, 15 pp.



Of the aforementioned studies, those by Klugar, 1972, and by Matisa Materiel Industriel SA, 1972, specifically examined the effects of shoulder compaction. Klugar found that, after tamping, shoulder and crib compaction provided only a 4 percent greater increase in lateral track resistance than did crib compaction alone (90 percent versus 86 percent of the lateral resistance of undisturbed track). He concluded that shoulder compaction had only a small influence on lateral resistance. A similar study by Matisa Materiel Industriel SA, 1972, showed that shoulder compaction alone after tamping increased lateral resistance by 20 percent over that of the tamped track (60 percent versus 40 percent of the lateral resistance of the previously undisturbed track).

Mass or Width of Shoulder - From the work of Dogneton, 1978; Hay, 1972; Kerr, 1978; and Prause and Kennedy, 1977, it appears that a minimum shoulder width is essential to developing passive end resistance; however, increasing the shoulder width beyond this minimum appears to improve lateral resistance to only a limited degree. It also appears that a maximum shoulder width exists, beyond which additional width will have no effect. These limits have not been clearly defined.

Prause and Kennedy, 1977, reported the results of British Railways tests that showed that, for uncompacted 1-1/2-inch to 2-inch crushed stone and slag ballasts, a 12-inch shoulder provided 30 percent to 40 percent greater lateral resistance than did a 7-inch shoulder. However, increasing the shoulder beyond about 12 inches to 14 inches provided only a negligible increase in lateral resistance.

Dogneton, 1978, reported data which showed that, for concrete tie track, a 16-inch shoulder provided only 10 percent greater lateral resistance than did a 6-inch shoulder. Riessberger, 1971<sup>30</sup>, also reported that increases in widths beyond 16 inches were ineffective.

Kerr, 1978, noted that 14-inch shoulders were used in certain European countries and the U.S.S.R. He recommended that, in the United States, the current standard 6-inch shoulder should be increased to approximately 15 inches to limit the occurrence of thermal buckling. Further tests were also suggested by Kerr to determine the optimum shoulder width for limiting both thermal buckling and required maintenance.

### 5.3.2 Ballast/Tie Bottom Friction

Based on data and conclusions reached by Sonneville and Bentot, 1956; Frederick, 1978; Dogneton, 1978; Kerr, 1978; Prause and Kennedy, 1977; and Klugar, 1972, 1976, it appears that 50 percent to 60 percent of the total lateral resistance of unloaded track is derived from the friction forces

---

<sup>30</sup>K. Riessberger, "Towards a More Stable Ballast Bed," Railway Gazette International, March 1977, pp. 99-102.

between the ballast and tie bottom. The magnitude of the ballast/tie bottom friction is strongly influenced by ballast compaction, tie normal force, and tie surface roughness.

Ballast Compaction - The work by Reiner, 1977; Klugar, 1972; Frederick, 1978; Cunney, 1977; Dogneton, 1978; Sonnevile and Bentot, 1955, 1956; and Selig et al., 1979, centered on the influence of ballast density and compaction on lateral resistance. The results showed that track maintenance activities such as track raising, tamping, lining, and surfacing loosened the ballast with a consequent reduction in overall lateral resistance ranging from 30 percent to 70 percent of the overall resistance for undisturbed, unloaded track. Furthermore, the magnitude of this reduction was influenced by factors such as the amount of track raise, lining and tamping, the type and age of ties, and conditions of the ballast, such as gradation, moisture content, and degree of fouling. Some examples of these influences are given below.

Klugar, 1972, studied the effects of track raising on lateral resistance. He found that tamping with a 2-cm (0.8-inch) track raise and subsequent crib and shoulder compaction resulted in lateral resistance equal to 90 percent of undisturbed track lateral resistance at lateral 2-mm displacements. However, tamping of the track with a 4-cm raise yielded lateral track strength equal to that of undisturbed track without bottom resistance (63 percent of the undisturbed lateral resistance). Subsequent shoulder and crib compaction restored a portion of the lost strength to yield a final lateral resistance of 72 percent of the undisturbed lateral resistance.

Tests performed by Reiner, 1977, in Sabot, Virginia, revealed the influence of the tie type on ballast compaction. His results showed that concrete ties were less susceptible than wood ties to reductions in lateral strength due to track maintenance activities.

From work by Reiner, 1977; Klugar, 1972; Frederick, 1978; Cunney, 1977; Dogneton, 1978; Riessberger, 1977; and Selig et al., 1979, it appears that after maintenance activities, normal train traffic will recompact the ballast layer and restore lost lateral resistance. Traffic ranging from 20 MGT to 200 MGT was reported necessary to bring the track back to a relatively dense, undisturbed state. During the reconsolidation period, lowered speed limits were required to accommodate the reduced lateral resistance, and the track vertical and horizontal alignments were likely to deteriorate rapidly until a stable ballast bed was obtained.

As previously discussed in Section 5.3.1, mechanical ballast compaction after track maintenance activities appears to restore a portion of the lost lateral resistance immediately. This may preclude the need for reduced speed limits during the reconsolidation period. Furthermore, a major advantage of mechanical ballast compaction is that a more uniform settlement occurs under traffic during the reconsolidation period; this reduces the deterioration in surface and alignment. According to Selig et al., 1979, and Riessberger, 1977, mechanical ballast compaction of the shoulder and crib does not provide substantial increases in ballast density beneath the ties but does provide

increased confinement for ballast beneath the ties, which leads to greater ballast strength and stiffness. End resistance is also increased.

Normal Force - The greatest portion of lateral resistance in unoccupied track is derived from the friction between the tie bottom and the ballast. The magnitude of frictional resistance is proportional to the normal force and the coefficient of sliding friction. Presumably, then, the greater the normal force--e.g., under heavier ties--the greater the bottom resistance and the higher the lateral resistance. This assumption has been borne out by Dogneton, 1978; Kerr, 1978; Prause and Kennedy, 1977; and Sonnevile and Bentot, 1956. Dogneton furnished data showing that concrete ties, which were 88 percent heavier than wood ties of comparable dimensions, provided 76 percent greater bottom resistance and 33 percent greater overall lateral resistance than the comparable wood ties.

In the same manner that increasing normal load improves tie bottom/ballast friction, decreasing normal load will adversely affect tie bottom/ballast friction. A decrease in normal load occurs if the track "lifts off" during buckling. This lifting phenomenon and its influence were discussed by Klugar, 1972, and Kerr, 1978.

Surface Roughness - The coefficient of friction is influenced by surface roughness and affects the lateral resistance resulting from bottom friction, according to results by Dogneton, 1978; Reiner, 1977; and Sonnevile and Bentot, 1956. Reiner, 1977, reported that track panels constructed with all-new wood ties exhibited lower lateral resistance than panels containing mostly old wood ties under similar conditions of ballast. It would appear that this difference is due to the bottom surface of wood ties becoming roughened with use due to scuffing and indentation of ballast particles. No comparisons were found that related surface roughness of new wood ties to that of new concrete ties, although the surface of concrete ties would depend on the type of forms used during fabrication. Sonnevile and Bentot, 1956, recommended that lateral resistance could be improved by impressing the underside of concrete ties during manufacture to avoid the underside being completely smooth. Modification of the bottoms of wood ties has also been suggested. Dogneton, 1978, reported that some railroads have increased the friction under wood tie bottoms by providing them with ribs. The magnitude of this increase is on the order of 15 percent to 20 percent.

Contact Surface - Available data surveyed imply that varying the contact area between the tie bottom and ballast will not strongly influence lateral resistance.

### 5.3.3 Ballast/Tie Side Friction

Data reported by Dogneton, 1978, and Frederick, 1978, indicated that, among the three components of lateral resistance, side friction contributed the smallest portion (between 10 percent and 20 percent) of the total lateral

resistance of unoccupied track. Furthermore, from data by Dogneton, 1978, and Selig et al., 1979, those parameters that most strongly affect side friction appear to be ballast compaction and contact area determined by the depth of the crib.

Contact Area - Dogneton, 1978, presented data that revealed the importance of maintaining a full ballast crib. The data revealed that, when the crib depth was increased from a "normal" profile with the ballast level below the top of the tie (as shown in Figure 5-5) to a "plain" profile with the ballast surface level with the top of the tie, the total lateral resistance increased approximately 20 percent.

Ballast Compaction - Based on work by Selig et al., 1979, it appears that the magnitude of ballast/tie side friction is a function of crib ballast compaction. However, their conclusions regarding the contribution of ballast/tie side friction toward the overall lateral resistance are somewhat controversial. Selig et al., 1979, deduced that crib ballast provides the predominant portion of the total lateral resistance after train traffic developed a high degree of interlocking in the crib ballast. As previously stated, this conclusion appears to contradict the consensus of findings reported by Prud'homme and Janin, 1969; Sonnevile and Bentot, 1956; Dogneton, 1978; Klugar, 1972, 1974; Prause and Kennedy, 1977; and Kerr, 1978.

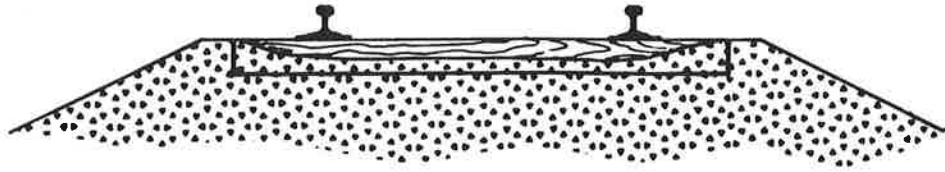
#### 5.4 BALLAST RESISTANCE: OCCUPIED TRACK

##### 5.4.1 Passive End Resistance

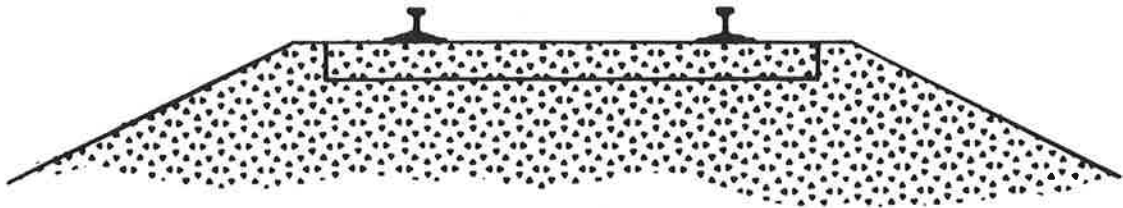
Test results presented by Hay, 1977; Sonnevile and Bentot, 1955; Prud'homme, 1976; and Frederick, 1978, indicate that the presence of a ballast shoulder provides no significant contribution to the lateral track resistance when the track is vertically loaded by the weight of a train. In fact, it appears that the lateral resistance provided by the ballast shoulder is inversely related to the vertical load. In a laboratory test of a three-tie panel under a 89-kN (20,000-pound) vertical load, Hay, 1977, found that a 12-inch shoulder provided no significant increase in lateral resistance over that of a 6-inch and even no shoulder. Clearly, the contribution of passive end resistance in the loaded condition contrasts that of the unloaded condition, where the ballast shoulder provides approximately 30 percent to 40 percent of the total lateral track resistance.

##### 5.4.2 Ballast/Tie Bottom Friction

The results of investigations by Prud'homme, 1976; Frederick, 1978; Eisenmann, 1976; Klugar, 1976; Sonnevile and Bentot, 1955; and Dogneton, 1978, showed that the lateral strength of loaded track is almost entirely



**NORMAL PROFILE**



**FULL PROFILE**

Adapted from "The Experimental Determination of Axial and Lateral Track-Ballast Resistance," p. 177, by P. Dogneton. Year of first publication: 1978.



**SUPERELEVATED PROFILE**

**FIGURE 5-5. SCHEMATIC BALLAST PROFILES**

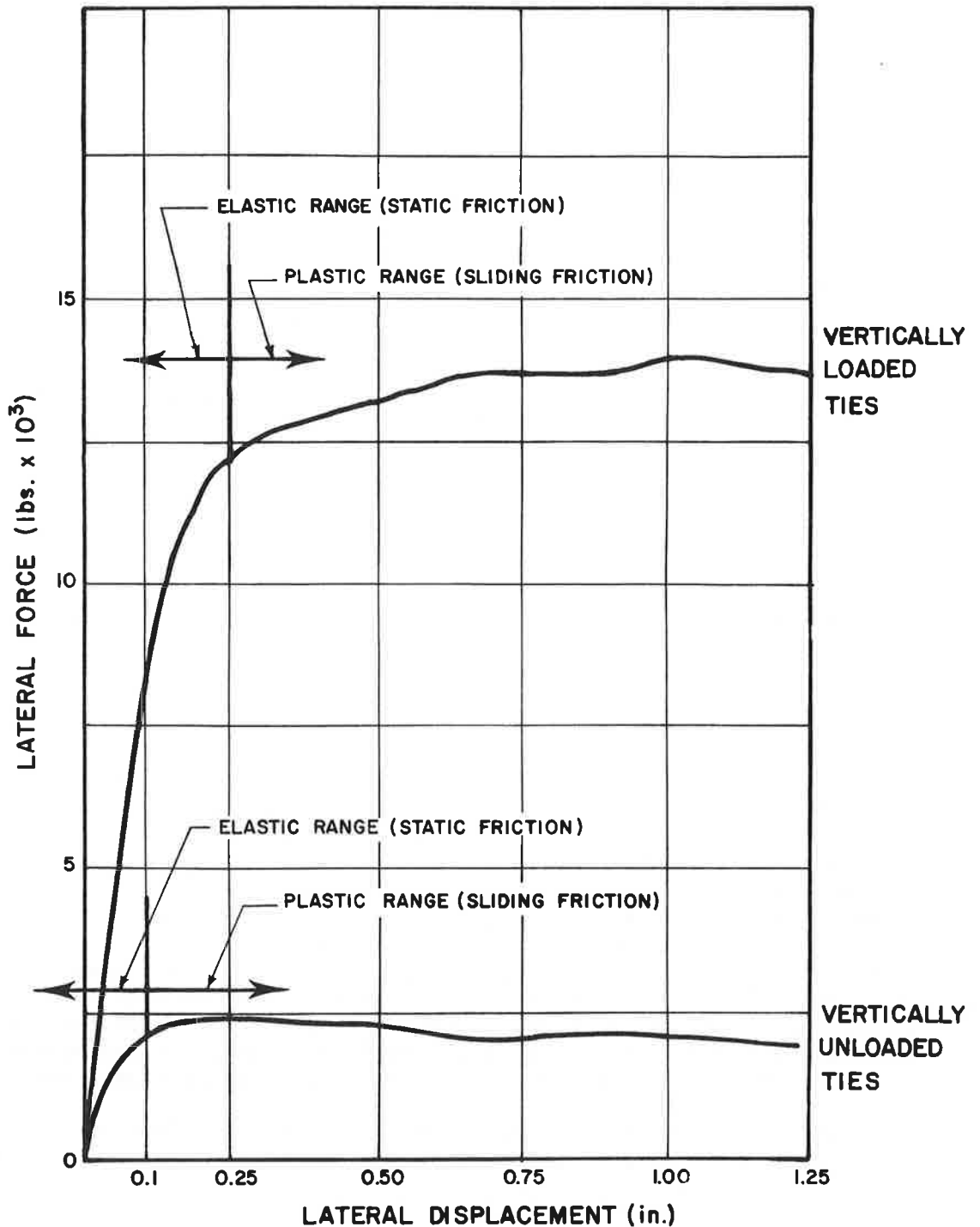
derived from the frictional forces between the tie bottom and the ballast bed. Furthermore, the magnitude of ballast/tie bottom friction was most strongly influenced by normal force, ballast compaction, and surface roughness.

**Normal Force** - As previously described in Section 5.3, a greater normal load will produce more frictional resistance between the tie bottom and the ballast bed. Considering that a track occupied by a train is twenty to thirty times heavier than unoccupied track, it follows that the corresponding ballast/tie bottom friction of occupied track, and consequently total lateral resistance, must also be significantly greater than with unoccupied track. Figure 5-6 illustrates force/displacement curves for both occupied (static) and unoccupied track. Clearly, the higher lateral resistance of occupied track resulted from the increased bottom friction which, in turn, was due to the greater normal load.

A moving train is accompanied by a rail-lifting wave due to elastic vertical distortion. This phenomenon was studied by Frederick, 1978; Eisenmann, 1976; and Klugar, 1974. Rail wave is capable of lifting the ties located in front of and behind the axles--and consequently decreasing the normal load, possibly to zero. The overall effect of this rail-lifting wave on lateral track resistance can be great. Frederick, 1978, reported that lateral track resistance under rolling train loads was one-third that of statically loaded track. It was suggested by Klugar, 1974, that only passive end resistance and lateral rigidity of the superstructure would contribute toward lateral track resistance where the ties were unstressed due to the rail-lifting wave.

To limit this reduction in lateral resistance due to rail wave, Eisenmann, 1976, recommended that the weight of the superstructure be increased. From the results reported by Prud'homme, 1976; Dogneton, 1978; and Sonnevile and Bentot, 1955, it appears that Eisenmann's, 1976, recommendations were appropriate. The results showed that, when subjected to rolling loads, track with the heaviest ties exhibited the highest lateral resistance. Metal tie track provided the greatest lateral resistance, whereas wood tie track provided the least. Concrete tie track furnished about 20 percent greater lateral resistance than did the wood tie track.

**Ballast Compaction** - The influence of ballast compaction on the magnitude of tie bottom/ballast friction for unloaded track was previously presented in Section 5.3. Any maintenance activity that loosens the ballast will reduce lateral resistance. Activities such as train traffic or mechanical ballast compaction, which densify the ballast, will improve lateral resistance. As a qualification to the effectiveness of mechanical ballast compaction on loaded track, Selig et al., 1979, concluded that mechanical ballast compaction would show higher increases in lateral resistances for unloaded track than would be experienced for loaded track. These conclusions are reasonable because mechanical ballast compaction, as practiced today in North America, does not significantly increase ballast density beneath the tie where it could affect ballast/tie bottom friction. A recently developed, European, rail vibrating procedure may achieve this effect.



Reproduced from Lateral Stability of Ballast, Ballast and Foundation Materials Research Program, p. 27, by W. W. Hay et al., U.S. Dept. of Transportation, Federal Railroad Administration. Year of first publication: 1977.

FIGURE 5-6. TYPICAL LATERAL FORCE/DISPLACEMENT CURVES FOR 3-TIE TEST PANEL

Surface Roughness - Although limited data were found that described the influence of tie bottom roughness on lateral track resistance, it appears that the effects of surface roughness on loaded track are similar to those on unloaded track. As reported by Sonneville and Bentot, 1955, ties with roughened bottoms provided greater lateral resistance than did ties with smooth bottoms.

Other Parameters - As was the case with the unloaded track, ballast material properties and tie contact area do not appear to strongly influence the lateral resistance of loaded track. This conclusion is based on data reported by Hay, 1977; Prud'homme, 1976; and Sonneville and Bentot, 1955.

#### 5.4.3 Ballast/Tie Side Friction

Very little data were found that described the influence of side friction on lateral resistance of loaded track. However, based on the previous discussion of side friction with unloaded track and the reportedly overwhelming influence of bottom friction on the lateral resistance of loaded track, it appears that side friction should not significantly affect lateral resistance.

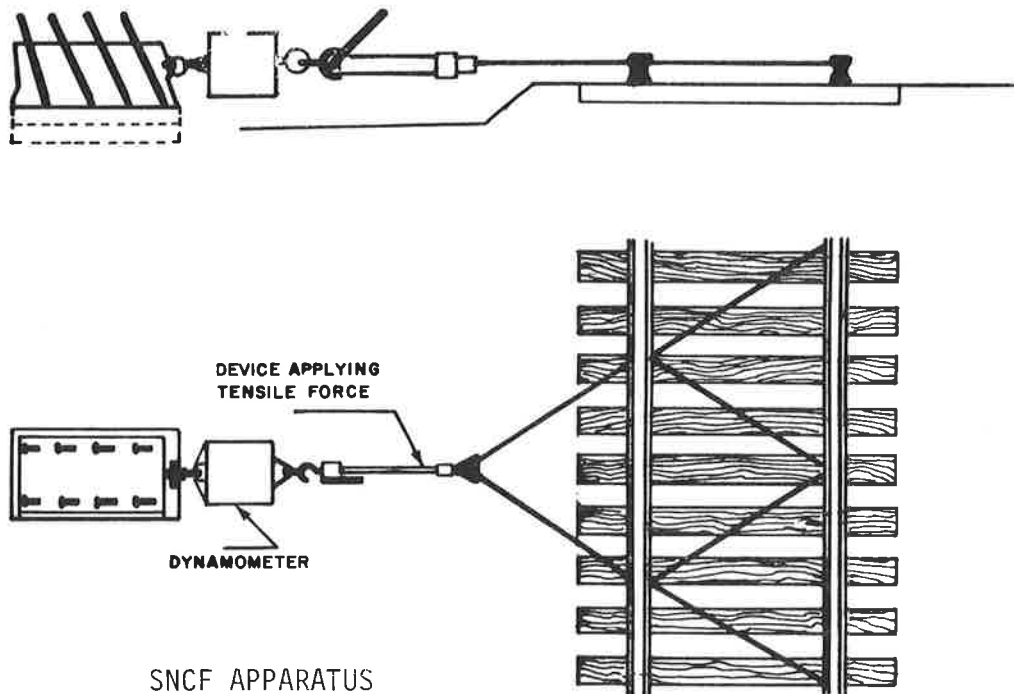
### 5.5 LATERAL LOADING PERFORMANCE CHARACTERISTICS

Various performance characteristics were used by investigators to describe the response of railroad track or track components to lateral loadings as described below.

Lateral Track Resistance - Lateral track resistance is defined as the force required to displace a track panel or an individual tie in a ballast bed perpendicular to the long axis of the rails. This measurement has been made in the field and in the laboratory. It has been found that lateral resistance is a function of displacement; therefore, lateral resistance must be expressed for a specific displacement. Various devices, such as those shown in Figure 5-7, have been used to measure this force in unoccupied track. Unfortunately, the magnitude of the measured lateral resistance varied depending upon the device used. Recently, Selig et al., 1979, developed a Lateral Tie Push Test (LTPT) procedure that measures the force required to displace an individual tie in the field using a device that has been designed to limit measurement error. It was Selig's intent to develop a standardized test with the LTPT so that an index for lateral ballast resistance could be developed.

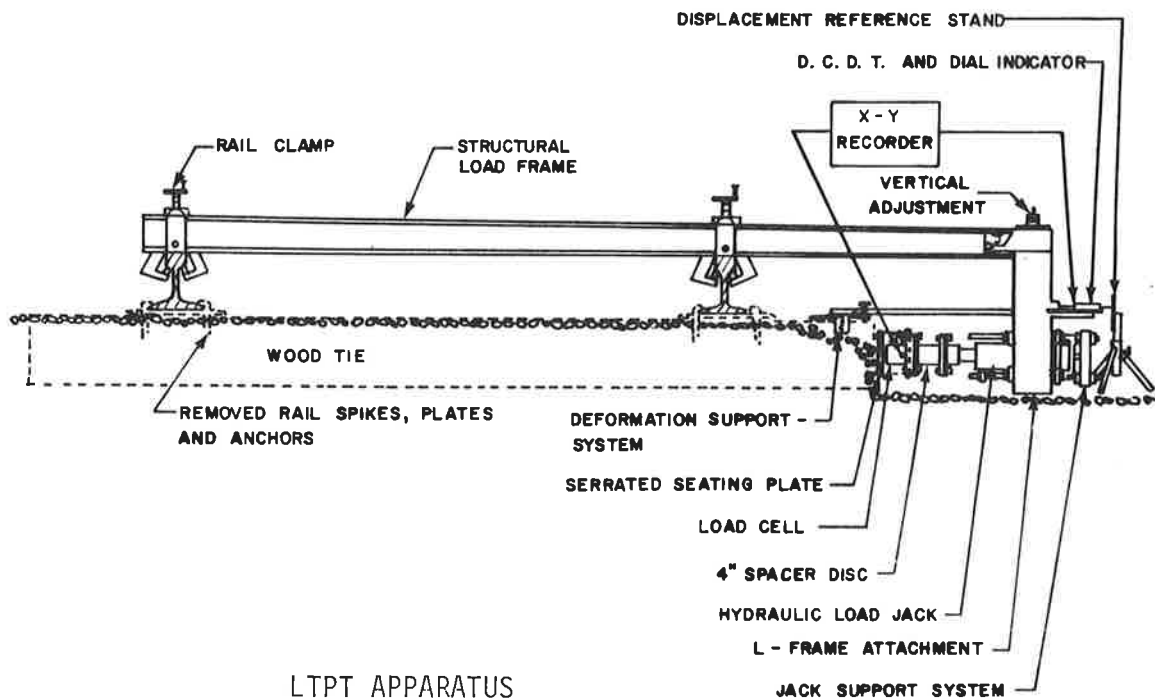
SNCF engineers (Sonneville and Bentot, 1955; Prud'homme, 1967; Amans and Sauvage, 1969) performed tests in the 1950s and 1960s to evaluate lateral track resistance under combined, moving, lateral and vertical loadings using a three-axle train car, the "derailer wagon." The lateral force at which permanent lateral deformation occurred was defined as the critical lateral force,  $H_C$ . The critical lateral force was found to be a function of the





SNCF APPARATUS

Reproduced from "The Experimental Determination of the Axial and Lateral Track - Ballast Resistance," p. 174, by P. Dogneton, by permission of Pergamon Press. Year of first publication: 1978.



LTPT APPARATUS

Reproduced from Field Test Results for Ballast Physical State Measurement, p. 111, by C. M. Panuccio et al. Year of first publication: 1978.

FIGURE 5-7. APPARATUS FOR MEASURING LATERAL BALLAST RESISTANCE

vertical load, P. For a comparison of track performance, the ratio  $H_c/P$  often was used. Section 2.2.1 comments further on the SNCF studies.

In the test measurements of lateral track resistance, several parameters have been adopted as characteristic measures. Hay, 1977, used the peak or ultimate lateral force as one measure of lateral track resistance. Hay also defined the yield force and yield displacement corresponding to the point beyond which permanent lateral displacement occurs. The yield force is similar to the critical lateral force defined in the SNCF tests.

Lateral track resistance may also be defined as the force required to achieve a specified lateral displacement. This parameter has been adopted by several European railroads, as reported in 1977 by Selig et al. in "Field Methods for Ballast Physical State Measurement." The force at 4 mm displacement is often reported. This measure appears to be associated with somewhat smaller measurement scatter than the maximum resistance according to data analysis carried out for this research study<sup>31</sup>.

In the 1979 report, "Technical Review of Ballast Compaction and Related Topics," Selig et al. report on several indirect measures to assess ballast physical state as it may influence lateral track resistance provided by the ballast. These measures included measurement of ballast in-place density, in-place density expressed as a percentage of the laboratory reference ballast density, and plate load test index of the ballast bed.

## 5.6 CURRENT U.S. AND CANADIAN DESIGN PRACTICE

Present practices are those standards presented in the AREA Manual as modified by local experience, and are described below.

Ballast Bed Cross Section - The standard ballast sections as presented in Chapter 1, Part 2, of the AREA Manual are shown in Figure 5-8. These sections provide for full embedment of the tie and 6-inch-wide ballast shoulders. In Chapter 22, Part 3, Page 22-3-23 of the AREA Manual, a supplementary design procedure is given for calculating the required ballast shoulder width based on the temperature rise above installation temperature, track curvature, and tie spacing. The procedure is based on the following reasoning:

---

<sup>31</sup>Goldberg-Zoino & Associates, Inc., "Single Lateral Tie Push Tests, Readville, Massachusetts, Data Analysis," unpublished report prepared for U.S. Dept. of Transportation, Transportation Systems Center, December 1980, 29 pp. (Report for DOT-TSC-1527).

1. The thermally induced lateral load per linear foot of curved track,  $P_f$ , can be evaluated by the procedure set forth by Magee, 1965<sup>32</sup>, previously discussed in Section 2.3.

2. The lateral load per tie equals  $P_f$  multiplied by the tie spacing.

3. Based on the presumption that a 6-inch shoulder can resist a lateral load of 300 pounds, the required ballast shoulder width is selected by proportioning the shoulder width by the ratio of the required lateral force.

Based on this procedure, one can evaluate the maximum degree of curvature for which the standard 6-inch shoulders are acceptable. For 19.5-inch tie spacing and a 65-degree temperature change, the maximum degree of curvature is 6.4 degrees per 100-foot chord. Presumably wider shoulders would be specified for sharper curves.

Track Maintenance and Construction - Track maintenance and construction specifications for jointed and CWR-type track are outlined in Chapter 5, Parts 4 and 5 of the AREA Manual. These specifications recommend use of the standard ballast section shown in Figure 5-8. In addition, procedures for tamping operations are specified. Ballast compaction following track maintenance is not recommended by AREA. Appendix I of Chapter 5, Part 4 of the AREA Manual recommends an optimum rail laying temperature that is within 10°F of the regional mean temperature. The intent of this specification is to limit thermal force in continuously welded rail.

Ties - Specifications for wood ties are given in Chapter 3, and for concrete ties in Chapter 10, of the AREA Manual. There are no specific criteria for selecting ties with regard to lateral resistance.

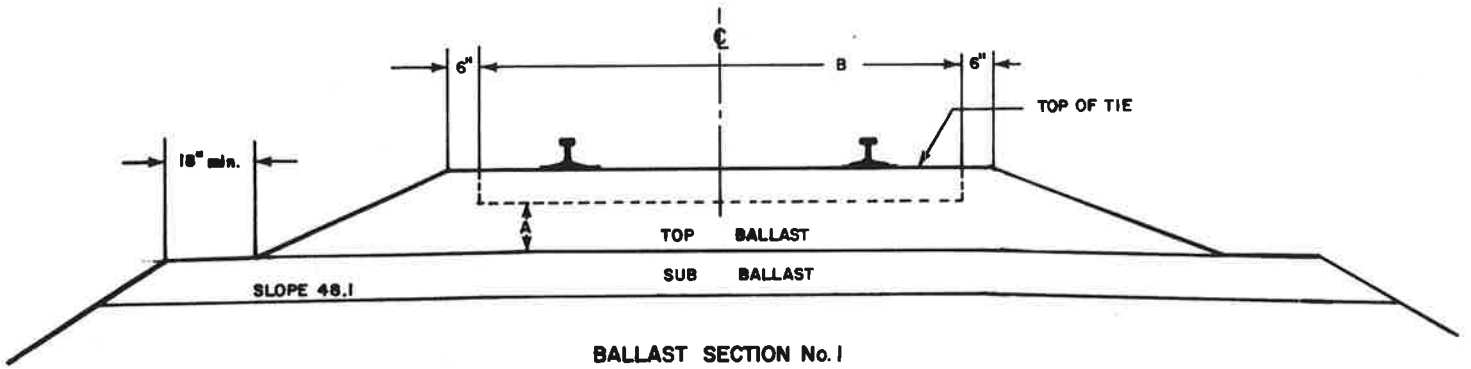
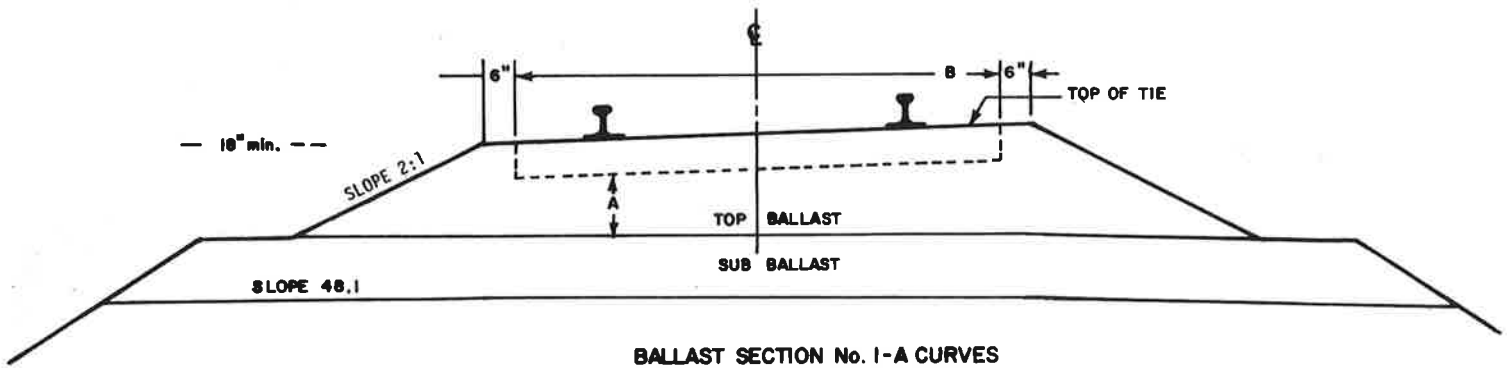
## 5.7 RECENT ANALYTIC AND DESIGN DEVELOPMENTS

Thermal Buckling - From 1973 to 1978, A.D. Kerr published several papers that dealt with thermal track buckling phenomena. The latest publication<sup>33</sup> is a useful design aid to the practicing railroad engineer for evaluating safe temperature increases in a specific rail size given values of anticipated axial and lateral ballast resistance. For such analyses, these resistances

---

<sup>32</sup>G. M. Magee, "Welded Rail in Bridges," Railway Track and Structures, November 1965, pp. 24-26.

<sup>33</sup>A. D. Kerr, Thermal Buckling of Straight Tracks; Fundamentals, Analyses, and Preventive Measures, prepared for U.S. Dept. of Transportation, Federal Railroad Administration, Report No. FRA/ORD-78/49, September 1978, 58 pp.



Reproduced from the Manual for Railway Engineering, p. 1-2-8, by permission of the American Railway Engineering Association. Year of first publication: 1980.

FIGURE 5-8. STANDARD AREA BALLAST SECTIONS

were assumed to be determined experimentally or estimated. Sample design curves are presented in the publication.

Evaluation of Critical Lateral Force,  $H_C$ , for Occupied Track - From the mid-1950s until the late-1960s, the French, as previously cited, have experimented with the "derailer wagon" to evaluate the behavior of occupied track subjected to combined lateral and vertical loadings. Resulting from their work was an empirical expression to evaluate the critical lateral force,  $H_C$ , as a function of vertical loading, temperature rise, track curvature, track modulus, and rigidity of the rail in the transverse and vertical directions. The expression is as follows:

$$H_C = \alpha(P + P_0) \left[ 1 - \beta \Delta\theta \left( 1 - \frac{R_0}{R} \right) \right] (k/k_0)^{0.125} \epsilon \frac{(EI)^{0.25}}{(EJ)^{0.25}}$$

where:

- $\alpha(P + P_0)$  describes vertical loading
- $\left[ 1 - \beta \Delta\theta \left( 1 - \frac{R_0}{R} \right) \right]$  takes into account temperature rise and track curvature,  $1/R$
- $(k/k_0)^{0.125}$  takes into account track modulus
- $\epsilon \frac{(EI)^{0.25}}{(EJ)^{0.125}}$  takes into account transverse and vertical rail rigidity

It was further concluded that, for occupied track, the effects on lateral force of track modulus, rail profile, temperature rise above that at which the track was laid, and curve radius were minimal and that the above-described empirical expression could be reduced simply to  $H_C = 0.85(1 \times 10^4 + P/3)$  with  $P$  and  $H_C$  expressed in newtons. It should be noted that the empirical expression was derived from a theoretical analysis of track behavior which had been verified by experimental "derailer car" data.

Tie End Bearing Area - Klugar, 1974; Riessberger, 1977; and Dogneton, 1978, reported the results of field tests which showed that increasing the tie end area available to develop end thrust--i.e. passive end resistance--would significantly increase the lateral resistance of unoccupied track. Klugar, 1974, and Riessberger, 1977, reported on tests on the "ear" or "wing" tie by the Austrian Federal Railroad. The "ear" tie is shown in Figure 5-3. Results of these tests showed that unoccupied track equipped with "ear" ties provided 50 percent greater lateral resistance than track equipped with similar ties but without "ears." Dogneton, 1978, reported on the use of safety cap reinforcement by the German Federal Railway. Results showed that, when one tie in three was reinforced with these bladeliike devices, the lateral resistance of unoccupied track was increased by 22 percent. When one tie in two was

reinforced, the lateral resistance was increased by 40 percent; and when all ties were reinforced, the lateral resistance was increased by 90 percent. Dogneton, 1978, also reported on the use of discontinuous concrete block-type ties. As compared with similar sized monolithic concrete ties, the block-type ties provided 40 percent to 50 percent higher lateral resistance to unoccupied track.

Mechanical Ballast Compaction - Cunney, 1977, reported the results of a mechanical ballast compaction program, the objective of which was to introduce the American rail industry to the use of mechanical ballast compaction and to demonstrate the advantages of its routine use. Using a Plasser-American Consolidator, Model CPM 800, tests were carried out on the Boston and Maine, Missouri Pacific, Penn Central, St. Louis and Southwestern, and the Southern railroads. The tests demonstrated that mechanical ballast compaction immediately following track maintenance activities and before exposure to train traffic would increase the lateral resistance of both individual ties and track panels by an average of 40 percent. Cunney concluded that the use of mechanical ballast compaction would be valuable on American railroads where high probability of thermal buckling following track maintenance existed.

## 6. LONGITUDINAL LOADING: PERFORMANCE, DESIGN, AND ANALYSIS

Longitudinal forces are developed in rail by train motion and by thermal effects. Resistance to longitudinal loads is controlled predominantly by the rail-tie fasteners and rail anchors, which restrict movements of the rail with respect to the ties, and by the ballast, which restricts movements of ties. Without sufficient resistance to longitudinal loads, rail creep, skewing of ties, buckled track, or broken rail could result.

Literature surveyed for this study did not specifically address substructure design with respect to longitudinal loadings. The following discussion is based on conclusions drawn from review of literature concerned primarily with lateral track resistance.

### 6.1 LONGITUDINAL RESISTANCE MECHANISM AND RESPONSE TO LOADING

The mechanism for resistance to longitudinal load is similar to that for lateral loads. The magnitude of longitudinal track resistance is controlled by the nature of tie-ballast interaction. Subballast and subgrade properties have little influence on longitudinal resistance. Compared to the longitudinal direction, the track superstructure is more flexible and lower ballast resistance is provided in the lateral direction. Thus it may be concluded that a ballast bed designed to resist lateral loads is adequate to resist longitudinal loads.

#### 6.1.1 Parameters of Longitudinal Resistance

**Superstructure** - In contrast to track response to lateral loads, variations in superstructure characteristics--namely, rail-tie fasteners and rail anchors--significantly influence the response of the track to longitudinal loads. Rail-tie fasteners and rail anchors are an essential part of the mechanism that transfers the longitudinal loads from the rail to ballast bed. These superstructure components provide the longitudinal load transfer to the ties, and the nature of the load transfer, rail creep, and tie skewing can be controlled by the fasteners.

**Ballast** - In a manner similar to that for lateral resistance, the ballast provides resistance to longitudinal loads through ballast/tie friction and by passive resistance. Passive ballast resistance develops along the long side of the tie which is pushed into the ballast by the longitudinal forces. For a typical 7" x 9" x 8'-6" wooden or monolithic concrete tie, the area available to develop passive resistance is more than ten times greater for longitudinal

loadings than for lateral loadings. As discussed in Section 5.3.1, this area significantly affects the magnitude of passive resistance developed by the ballast. In addition, the crib ballast is confined in the longitudinal direction by the adjacent tie, increasing the longitudinal passive resistance.

The resistance provided by ballast/tie bottom friction should be the same for both longitudinal and lateral loading conditions. Similarly, factors such as vertical load and ballast density which influence the magnitude of ballast/tie bottom friction for lateral loadings should affect the tie bottom resistance provided against longitudinal loads. Chapter 5 presents a complete discussion of these influences.

Without data, it is difficult to evaluate which of the two aforementioned resistance mechanisms plays the predominant role for the longitudinally loaded case.

## 6.2 CURRENT U.S. AND CANADIAN DESIGN PRACTICE/ASSESSMENT

Present U.S. and Canadian design practices are those standards presented in the AREA Manual, as modified by local experience, and are described below.

Track Maintenance and Construction - Appendix I of Chapter 5, Part 4, of the AREA Manual recommends an optimum rail laying temperature that is within 10°F of the regional mean temperature. The intent of this specification is to limit thermally induced longitudinal and lateral buckling loads in CWR. In Chapter 5, Part 5, of the AREA Manual, specifications for number and location of rail anchors are given. The intent of this section of the Manual is to limit rail creep and tie skewing.

No studies of longitudinal loading have been located probably because longitudinal problems can be fixed easily by installation of additional rail anchors. The rails are efficient in transferring longitudinal forces from tie to tie by axial rail stresses. Thus the longitudinal force per tie can be reduced as much as necessary. Starting with the AREA Manual recommendations, rail anchors can be added until creep and skewing are prevented.



## 7. DESIGN FOR DRAINAGE AND OTHER ENVIRONMENTAL CRITERIA

Simply stated by L. Stanley Crane, former President of the Southern Railway, "The first rule of good track maintenance is drainage, and the second rule is more drainage and the third rule is even more drainage<sup>1</sup>." Likewise, drainage is a principal factor in substructure design. Other than highly organic materials, any soil can serve as a suitable track subgrade provided that its moisture content is controlled by adequate drainage measures and that stresses imposed by the track are kept below the allowable soil bearing pressure.

The presence of moisture affects all portions of the substructure. Saturation of the ballast layer reduces the bulk strength and stiffness of the material. Poorly drained ballast contributes to tie deterioration. Breakdown of ballast particles due to loading occurs more rapidly when the ballast is saturated. If the ballast remains wet, chemical alteration due to weathering proceeds more rapidly, and wet ballast is subject to more rapid breakdown by freezing of water within the pores of the particles. Similar behavior is observed for materials commonly placed as subballast.

Subgrade soil performance is even more sensitive to moisture content than ballast. This is particularly true for cohesive soils (silts and clays) and for sands and gravels mixed with silt and clay. In compacted subgrade soil, the shear strength can be reduced to as little as 20 percent of the as-compacted shear strength if the soil becomes saturated. Recognizing this behavior, pavement design procedures that use the California Bearing Ratio (CBR) test as a measure of subgrade bearing strength require saturation of the compacted samples before measuring bearing resistance.

The major emphasis in rational track substructure design procedures is placed on determining the thickness and nature of the substructure layers necessary to accommodate the allowable subgrade bearing pressure. Since subsoil bearing resistance is strongly influenced by soil moisture content, the required substructure thickness could be reduced, or substructure performance improved, if the subgrade moisture content could be maintained at a low value at all times. It is more economical and more reliable to drain the subgrade properly than to increase the ballast thickness to accommodate the reduced allowable bearing pressure of a saturated subgrade. Drainage also helps control frost heaving and swelling of active clay soils. These factors are discussed in detail in the companion report entitled, Materials Evaluation and Stabilization Practices.

---

<sup>1</sup>J. H. Armstrong, "Southern lays a firm foundation for reliable service," Railway Age, October 9, 1979, p. 30.

Chapter I of the AREA Manual for Railroad Engineering provides some general criteria for design of track drainage systems. Detailed design practices for specific drainage structures are contained in drainage handbooks and hydraulics textbooks such as the U.S. military design manual on Dewatering and Groundwater Control for Deep Excavations<sup>2</sup>.

The following sections outline the important drainage considerations that should be incorporated in and interact with the entire track substructure design process.

## 7.1 DRAINAGE STRUCTURES

There are three general types of drainage structures used to remove water from track substructures: ditch drains, pipe drains, and French drains. Ditch drains are the most common type of drains associated with railroad tracks. As shown in Figure 7-1, they consist of a trapezoidal cross-section ditch used to remove surface water from the track structure and to intercept water, both surface and groundwater, flowing toward the track. The principal advantages of ditch drains are that they are economical to construct and can handle large flows required for storm water control. However, ditch drain geometry is restricted by the geometry of the track and the topography of the surrounding ground.

Pipe drains consist of a perforated pipe installed in a narrow trench surrounded by a filter medium, either properly graded sand and gravel or plastic filter fabric surrounding coarse stone or gravel. The filter zone collects the water and feeds it into the perforated pipe, and the pipe transmits the water along the length of the trench. Pipe drains are buried, so they are less affected by track and site topography, and can be installed beneath structures such as grade crossings, stations, and multi-track areas, and as cross drains beneath the track.

French drains are similar to pipe drains except that no pipe is included. The backfill must be protected from clogging with a filter. Flow along the drain is carried by seepage through the stone backfill. Therefore, French drains are applicable only in situations where limited flow capacity is required. Filter fabrics are often used to line trenches in construction of French drains. Cross sections of a pipe drain and a French drain are shown in Figure 7-2.

Lateral drains running parallel to the track are used to collect surface water drainage from the track structure, as shown in the cross section, Figure 7-1. The AREA Manual recommends that the bottom of lateral drains should be at least 4 feet below the track subgrade surface in order to limit rise of groundwater beneath the track, frost action, and pumping of water caused

---

<sup>2</sup>U.S. Army Technical Manual TM-818-5, 1971, pp. 187.

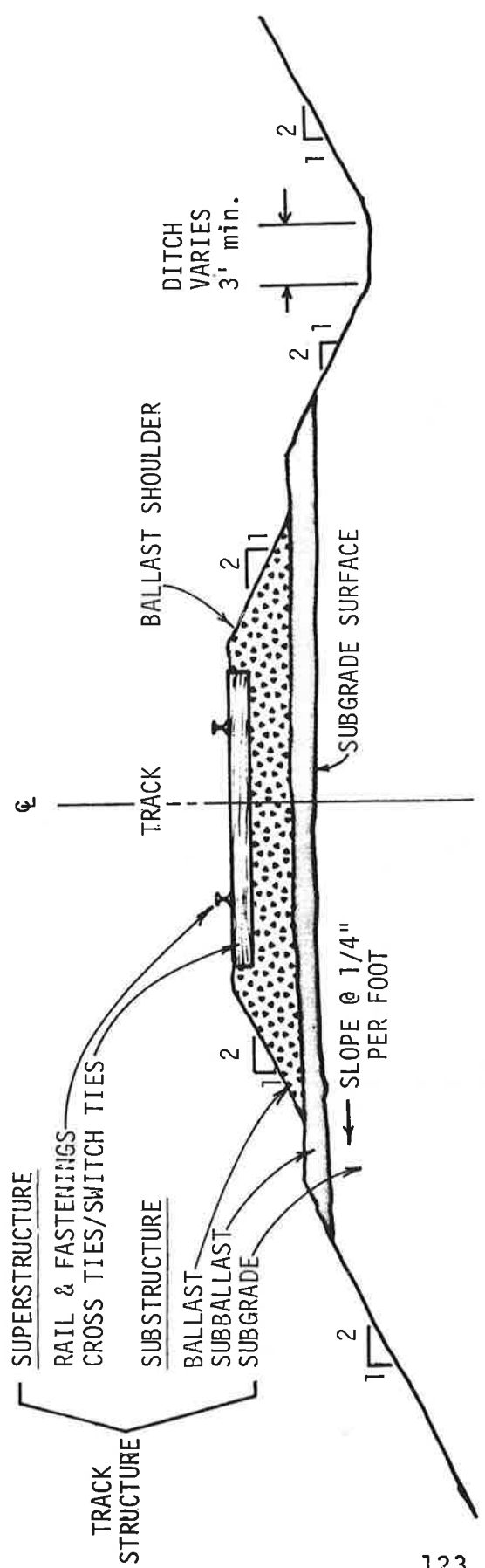
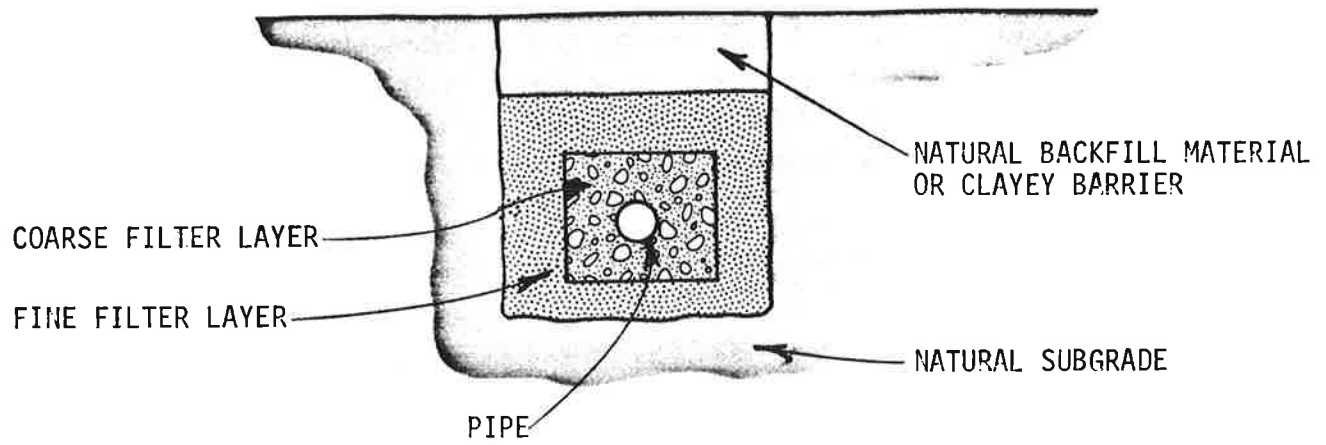
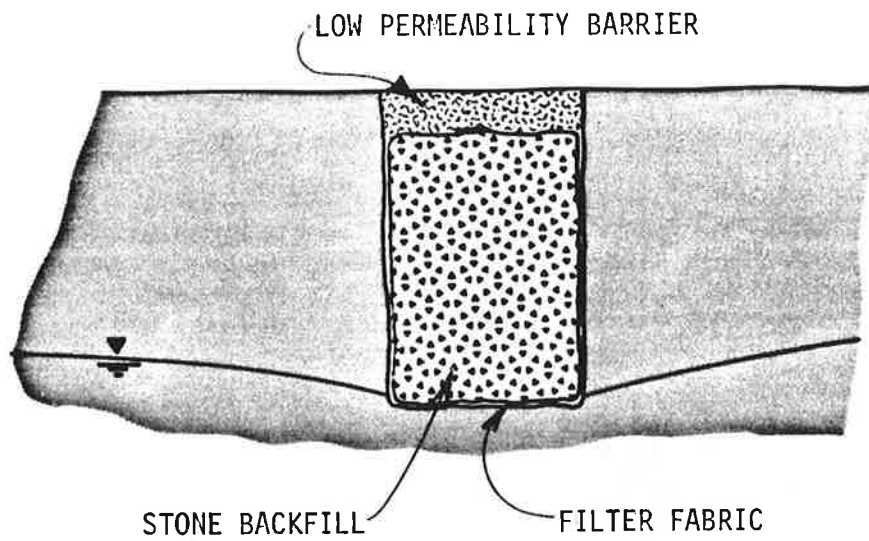


FIGURE 7-1. TRACK STRUCTURE CROSS SECTION



A. PIPE DRAIN



B. FRENCH DRAIN

FIGURE 7-2. BURIED DRAIN CROSS SECTIONS

by dynamic track loading. However, this general criterion may be too conservative for gravelly soils and insufficient for cohesive soils (silts and clays). Lateral drains are recommended in all cut and level areas where the grade of the track above surrounding ground is not sufficient to provide suitable lateral drainage. Lateral interceptors should be designed at the toe of embankment slopes to manage storm runoff, as shown in Figure 7-3. Side-hill cuts, as shown in Figure 7-4, are areas of special concern because slope and track surface drainage must be carefully handled to maintain the stability of the slope and the integrity of the subgrade. Ditch drains are commonly used for lateral drains, but pipe or French drains should be designed where geometry precludes ditch drains, such as in cuts and areas of special track, as shown in Figure 7-5.

Cross drains are sometimes installed beneath track where lateral drains are insufficient to control groundwater beneath the centerline of the track. However, use of cross drains for general groundwater control is probably impractical. In high permeability soils, i.e. sands and gravels, cross drains are rarely required. In fine-grained soils, the permeability is so low that the cross drains must be closely spaced to be effective. This is uneconomical. A better solution is to raise the track on a blanket of granular material or to overexcavate the natural subgrade in cuts and replace with granular material. In these ways, the lateral drains can control the flow. In wide areas, such as yards, cross drains may be economical.

Interceptor drains and drilled horizontal drains to control water in slopes are discussed in the companion report under "Subgrade Stabilization Measures<sup>3</sup>."

## 7.2 ENVIRONMENTAL CONSIDERATIONS IN SUBSTRUCTURE DESIGN

Drainage and environmental performance considerations should be incorporated in overall track substructure design. These include decisions on selection of materials and on the thickness and cross sections in which those materials are arranged. The companion report of this study discusses the selection of materials for use in railroad track substructures. This section outlines the conclusions of that report. The principal considerations are (1) drainage of precipitation from the track, (2) shear strength of the subgrade as affected by moisture, (3) limitation of frost action, and (4) maintenance of a stable moisture content in the near-surface subgrade soil to limit swelling. These design objectives are met in the following ways.

---

<sup>3</sup>R. M. Simon et al., Ballast and Subgrade Requirements Study: Railroad Track Substructure - Materials Evaluation and Stabilization Practices, prepared for U.S. Dept. of Transportation, Federal Railroad Administration, 1983, pp. 137-161.

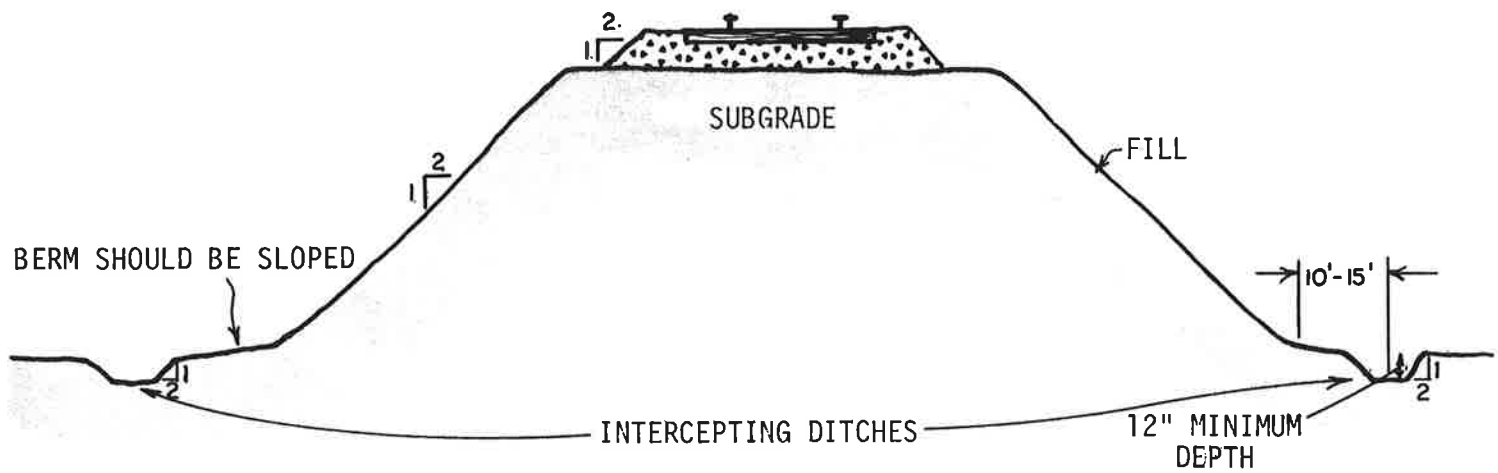


FIGURE 7-3. INTERCEPTING DITCHES REQUIRED AT TOE OF FILL

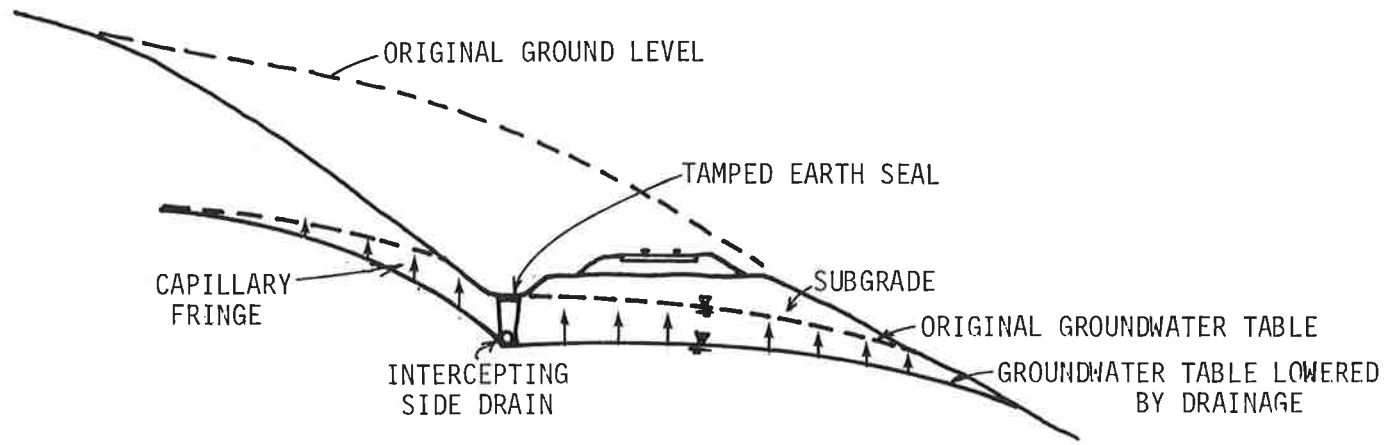


FIGURE 7-4. SUBSURFACE DRAINAGE INSTALLATION TO LOWER GROUNDWATER TABLE ON SIDEHILL CUT

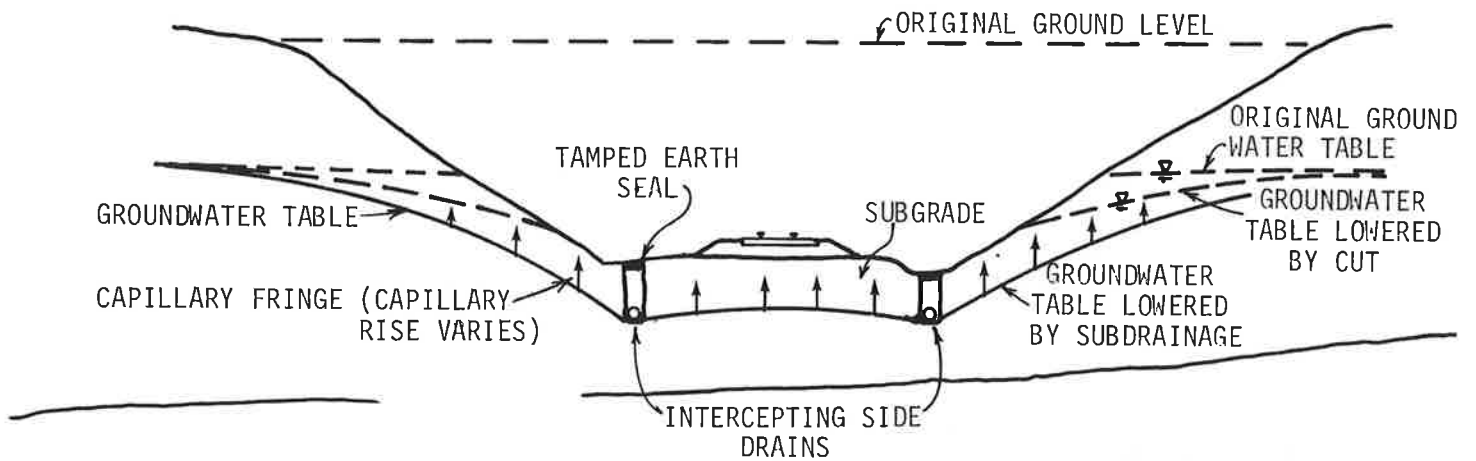


FIGURE 7-5. SUBSURFACE DRAINAGE SYSTEM TO LOWER GROUNDWATER TABLE IN A WET CUT

Ballast - The functions of ballast with respect to environmental factors are (1) to provide rapid drainage of the track and (2) to provide insulation to limit frost penetration. The drainage function is accomplished by choosing a ballast with few small particles and large, open voids. Nearly all gradation specifications for ballast exclude all but a small percentage of particles finer than 5mm to 10mm (No. 4 to 1/2-inch sieve). Ballast meeting these gradation criteria will provide rapid drainage of the track. More pertinent to the permeability issue is keeping fine particles out of the ballast. Fines may accumulate from breakdown of ballast particles, dropping of fines onto the top of the track by wind, and pumping of mud from the underlying subgrade. These factors are discussed in the companion report under "Material Practices<sup>4</sup>."

Selecting ballast that resists breakdown should be based on observations of in-service performance of ballast and correlations with material index properties. Limiting intrusions of fines from the top of the ballast may be controlled by selecting a widely graded ballast, as suggested in 1979 by G. P. Raymond<sup>5</sup>. However, the overall consequences of this recommendation have not been evaluated sufficiently in track. Preventing mud pumping is a function that is assigned to the subballast, or to filter fabric in some cases.

Providing an insulating blanket over the natural subgrade is accomplished by placing a thickness of non-frost-susceptible material over the subgrade. However, as a well-drained, open-void, granular layer, ballast has relatively poor insulating properties. Frost will penetrate through ballast more rapidly than through natural soil. Therefore, frost protection should consider that frost penetration will be deeper beneath track than below the surface of surrounding natural ground.

Subballast - The environmental functions of subballast are to (1) provide a filter layer to separate ballast and subgrade soil, (2) limit percolation or drainage of water from the surface to the subgrade while transferring the water to the sides of the track, and (3) limit frost penetration.

Ballast/subgrade separation can be accomplished by inserting, between the ballast and subgrade, a layer of material that satisfies the filter criteria set forth in the material practices report<sup>6</sup>. Sometimes, filter fabric is used to perform or augment this function. The drainage function is satisfied by selecting a subballast with a moderately low permeability-- $10^{-3}$  cm/sec to  $10^{-4}$  cm/sec--to prevent movement of water through the subballast, and

---

<sup>4</sup>R. M. Simon et al., Op. Cit., pp. 82-90.

<sup>5</sup>G. P. Raymond, "Ballast Properties that Affect Ballast Performance," AREA-Bulletin, Vol. 80, No. 673, June-July 1979, pp. 428-447.

<sup>6</sup>R. M. Simon et al., Op. Cit., pp. 130-135.



by establishing a substructure cross section that will transmit water to the sides of the track through the ballast. Frost considerations include (1) providing sufficient thickness of combined ballast and subballast to limit frost penetration into frost-susceptible subgrades, and (2) permitting only subballast materials that will be minimally affected by frost, generally meaning material with less than 10 percent by weight finer than a No. 200 sieve (0.075mm).

Subgrade - The environmental considerations for the subgrade are to limit access of water to the subgrade; to limit the effects of frost, clay swelling, and soil collapse; to provide erosion protection at the surface of slopes; and to intercept surface runoff that may affect track performance.

Drainage of water above the subgrade is handled by placing ballast and subballast layers that can handle the expected precipitation and to slope the surface of the subgrade and subballast to promote drainage, as shown in Figure 7-1. In areas where groundwater is shallow, evaporation and capillary action can carry water to the subgrade surface. This effect can be minimized by: 1) raising the track; 2) lowering the groundwater with a lateral ditch or with trench drains; or 3) installing a thickness of free-draining material below the track that will reduce the rise in water level.

Drainage and environmental factors affect design with respect to selection of total thickness of ballast and subballast, overexcavation of subgrade soil and replacement with satisfactory compacted fill, or construction of special stabilization measures as discussed in the companion report on stabilization practices<sup>7</sup>. The particulars of each site must be considered; general guidelines are not practical.

---

<sup>7</sup>R. M. Simon et al., Op. Cit., pp. 136-256.

## 8. EVALUATION OF TRACK SUBSTRUCTURE

Track substructure evaluation involves three steps:

1. Establishment of substructure performance criteria or standards
2. Observation of track conditions
3. Comparison of observations with performance criteria to develop an evaluation of the track.

The resulting evaluation may be of several forms, such as (a) the track is unsafe for passage of trains, (b) the track is safe for trains up to a limited speed, frequency, or axle weight, (c) the track is deteriorating rapidly and requires substructure stabilization to avoid unacceptable maintenance costs or frequency or to avoid development of a condition that is more expensive to repair than the present deficiency, or (d) the track requires upgrading to meet increased loading in terms of axle load, train frequency, or operating speed. These types of evaluations are set forth in order of increasing sophistication.

This section will begin with a discussion of performance measures presently used by U.S. railroads and some other criteria that may be useful track substructure performance measures. Section 8.2 describes methods that may be used to observe substructure performance. Section 8.3 lists those methods that are judged to be suitable and promising for development of performance criteria to be used in the evaluation of track substructures.

### 8.1 SUBSTRUCTURE PERFORMANCE CRITERIA

The basic functions of the track substructure are (a) to maintain the superstructure at the proper alignment and surface (grade), (b) to provide a resilient support layer to limit dynamic overstress in the track superstructure and in the rolling stock, and (c) to provide rapid drainage of the superstructure to limit deterioration of the materials.

#### 8.1.1 Geometry

The first function of the substructure relates directly to track geometry. The most frequently referred to criteria for acceptable track geometry were promulgated in 1971 in the Track Safety Standards by the U.S. Dept. of Transportation, Federal Railroad Administration. The Standards list the maximum allowable operating speeds for track meeting specified geometry criteria for loaded track with respect to gauge, alignment, surface, cross level, and superelevation

on curves. The Standards also describe in great detail defects in superstructure hardware requiring correction, but they provide only general statements on acceptability of ballast and drainage structures, facets that are related to the substructure.

The FRA Track Safety Standards are not the only geometry criteria in use. As stated by R.E. Ahlf<sup>1</sup>, track must be both safe and economical for its intended uses. The FRA Standards are minimum safety requirements, but they are not meant to give any insight into geometry criteria for economical train operation, track maintenance requirements, or criteria for track design or upgrading. They provide no guidelines for "preventive maintenance" for either safety or economy considerations.

Geometry criteria for very high speed operations were presented in Tables 3-2 and 3-3 for the Northeast Corridor, Japanese, and British railways. Geometry criteria have been developed by several railroads in association with the introduction of automated track geometry measuring cars. In 1969, Crane et al.<sup>2</sup> reviewed parameter tolerance limits adopted by Japanese, German, and British railways for other than very high speed lines. Derivation of criteria adopted at the time by the Southern Railway was also described. These criteria included both priority defect limits for identifying locations where immediate corrective actions were needed, as well as providing a priority and quality number or "P & Q Rating" that was used to quantify the overall condition of the track with respect to geometry factors. A summary of the geometry limit criteria is shown in Table 8-1.

The Southern's P&Q index was weighted one-third each on the twist and surface parameters and one-sixth each on the gauge and alignment parameters. In order to reflect both the magnitude and frequency of track irregularities, contributions to the index were exponentially weighted by magnitude of the geometry variation. The index represented the magnitude and frequency of defects measured at 1000 locations per track mile. The best jointed rail track had a P&Q number less than 75; the best welded rail index number was less than 40. Higher numbers indicated lower geometry quality.

In 1975, B.H. Price described in "FRA, D&RGW, B&LE Joint Study of Track Geometry and Track Degradation" several track index or geometry rating methods. The Profile Index is computed as the area between the measured vertical track profile and an ideal track profile. The index is expressed per quarter-mile section of track in units of square inches per quarter mile; the index for

---

<sup>1</sup>R. E. Ahlf, "Matching M/W practices to the required use of the track - Part 1: Curing the problems, not the symptoms," Railway Track and Structures, September 1979, pp. 35-36.

<sup>2</sup>L. S. Crane et al., "Development and Use of a Track Quality Index," Transactions of the ASME, Paper No. 69-RR-2, April 1969, pp. 4-7.

TABLE 8-1. TRACK GEOMETRY CRITERIA

<u>GAUGE</u>		<u>Close</u>	<u>Open</u>
Standard gauge = 56.5 inches			
FRA Safety Standards (FRA)*		0.50 in.	1.0 in.
Deutsche Bundesbahn (DB)†	main line	0.25 in.	1.0 in.
	branch	0.25 in.	1.25 in.
Japanese National Railways (JNR)†		0.16 in.	0.28 in.
British Railways (BR)†		0.12 in.	0.12 in.

TWIST  
(Sometimes called warp, distortion, or change of cross level over a fixed length of track)

DB	1/300
BR	1/300

SURFACE

FRA	1.25 in. in 62 ft.
DB	0.24 in. in 33 ft.
JNR (main lines)	0.35 in. in base**
(branch lines)	0.43 in. in base**
BR	0.38 in. in 31 ft.

SUPERELEVATION

FRA	1.00 in.
DB	0.08 in.
JNR	tangent track 0.31 in.
	curves <800m radius 0.35 in.
BR	0.38 in.

ALIGNMENT (based on a 59.5 foot chord)

FRA (62' chord)	tangent track	0.75 in.
	curve track	0.625 in.
DB		0.17 in.
JNR	tangent track	0.28 in.
	curves <800m radius	0.35 in.
BR		0.23 in.

\* Class 5 track - maximum speed 80 mph (freight) or 90 mph (passenger)

† Measured on unloaded track

\*\*These figures are approximations; actual figures are not known

CWR track will range from 600 to 2,000 square inches; the index for jointed track may be as high as 3,000 square inches.

The geometry car used by Price observes track gauge at approximately 550 discrete locations per quarter mile. Both average gauge and the gauge variance (statistical measure of data dispersion) have been used as indices. Mean gauge has proven difficult to use because changes in rail head profile, weather, and minor variations in the geometry car measurement system induced errors in absolute gauge reading greater than the year-to-year changes in gauge. The gauge variance has proven a more usable index of gauge quality since it is less influenced by absolute calibration errors.

Other indices have been developed for reducing the vast quantity of geometry data gathered from automated recorder cars. The significance of the index depends in part on the characteristics of the particular recorder car hardware system. No indices have been generally adopted.

### 8.1.2 Resilience

The resilience of track is responsible for damping dynamic forces generated by operating trains, described in Section 2. The dynamic forces stem from imperfections in track geometry, as described in the previous section, and from imperfections in car wheels. The most common imperfections are rail joints and corrugations and wheel flats.

If track is very stiff or rigid, these geometry imperfections produce very large dynamic forces that overstress the superstructure (rails, fasteners, and ties) and can also damage car trucks. On the other hand, if the track is very flexible, the track structure will be subjected to large dynamic displacements that can lead to track hardware failures by fatigue, ballast breakdown by internal abrasion, and increased rolling resistance. Observations of in-service track behavior and laboratory studies show that permanent or plastic track settlements increase with increasing resilient displacement<sup>3</sup>.

The classic measure of track resilience is by the track modulus. This concept is discussed in detail in Section 4.2. The track modulus is defined as the uniform load per unit length on a track, divided by the displacement of the track expressed in units of force per length squared, such as pounds per square inch. The AREA Manual for Railway Engineering, Section 22-3.2, recommends that track designs should be based on a track modulus value of 2000 psi. However, values of 400 psi to 4000 psi are expected in service. The track modulus reflects the resilience of all the substructure layers and the character and spacing of the ties.

---

<sup>3</sup>E. T. Selig et al., A Theory for Track Maintenance Life Prediction, prepared for U.S. Dept. of Transportation, Office of University Research, Report No. DOT/RSPA/DPB-50/79/22, August 1979, 183 pp.

The coefficient of subgrade reaction (CSR) is the measure of subgrade resilience that is used in design of rigid pavements, i.e. concrete slabs. The coefficient of subgrade reaction is the uniform stress applied to a rigid circular plate, divided by the displacement of the plate, expressed in units of force per length cubed, such as pounds per cubic inch. The CSR is influenced by the size and the embedment depth of the plate that is loaded. Standard practice for pavement design is to perform the plate load test (PLT) with a 30-inch-diameter plate but to express CSR for a 12-inch-diameter plate.

The CSR measured by a plate load test is influenced by the resilient properties of the material layers below the plate to a depth of about two plate diameters. Thus a plate load test conducted on the ballast at the base of the ties is influenced by performance of all substructure materials below the plate--ballast, subballast, and subgrade. The CSR is not affected by superstructure characteristics. It is possible to perform the PLT at different depths in order to separate the resilient performance of the individual substructure layers, and to use analytic solutions to separate out the effects of the different layers.

The most fundamental of substructure resilient properties are the elastic moduli, such as the Young's modulus and the shear modulus of the various substructure materials. These parameters are used to represent substructure resilient properties in most analytic and numerical methods for analyzing stresses and displacements of railroad track as described in Section 4.5. Resilient elastic parameters of substructure materials may be determined by laboratory tests, such as static or cyclic triaxial tests. The plate load test can be analyzed using analytical solutions to derive elastic moduli. However, a large number of assumptions are required to calculate moduli, such as the distribution of stresses beneath the plate in the layered medium and the nature of anisotropy in the substructure layers. Track geometry car measurements may be used to infer track stiffness.

### 8.1.3 Lateral and Longitudinal Resistance

Lateral resistance of track is responsible for maintaining alignment and preventing track buckling. Elements of lateral track resistance were discussed in Section 5. Lateral resistance can be measured both for single ties and for track panels. Several organizations have developed single lateral tie push test devices, but minor differences in these devices yield different measured results. Selig et al.<sup>4</sup> reported development of a device in 1977. This device has been used for measurements at the FAST track in Pueblo, Colorado, and some other locations. However, insufficient data have been gathered on which to base criteria for single lateral tie resistance.

---

<sup>4</sup>E. T. Selig et al., "Field Methods for Ballast Physical State Measurements," Mechanics of Ballast Compaction Study for U.S. Dept. of Transportation, Transportation Systems Center, November 1977, pp. 25-38, 96-125.

Longitudinal loading has been discussed in Section 6. In general, longitudinal resistance of the substructure is less critical than lateral resistance and has received little attention. Although longitudinal tie load tests have been carried out, they are difficult because the ties tend to roll over rather than slide on the ballast after the crib ballast has been removed as required to carry out the test. No criteria for acceptable longitudinal tie-substructure resistance have been developed.

#### 8.1.4 Drainage

Section 7 discusses this essential element of track design and performance. Water is a major factor affecting all aspects of substructure performance, including the ability of the substructure to preserve ties, to maintain track geometry, and to provide resilient track support.

The drainage functions of the substructure are (1) to remove surface water from the track to drainage facilities that can carry the water to natural water courses, (2) to limit surface water access to substructure materials that may be adversely affected, and (3) to control groundwater to maintain mechanical performance of the substructure. The first two functions require rapid lateral movement of water entering the surface of the track with little penetration of surface water into the subgrade. The third function is indicated by the depth of the groundwater level below the track. No quantitative criteria for surface water drainage have been discovered. Typical gradation criteria for ballast will provide a material with a very high permeability. In fact, the permeability of clean ballast is too high to be measured in any meaningful test. Rather, it is ballast fouling that reduces the permeability to levels which detract from overall track performance. Permeability of granular materials is strongly affected by the details of particle or soil structure. Therefore, the most meaningful measures of permeability are based on in-situ measurements. Criteria and observation procedures for in-situ ballast permeability have not been developed.

Limiting surface water access to the substructure is dependent upon the nature and configuration of the materials below the ballast. In a relatively new track, the subballast may be properly selected and the surface of the subballast sloped to promote lateral drainage and restrict vertical seepage. The more general case is where the track has been constructed some time ago, and the material below the top ballast is old, fouled ballast, cinder ballast, or other random quality material. More importantly, the irregular transition from ballast to subgrade may promote collection of surface water in depressions or ballast pockets, a serious substructure deficiency. One definitive criterion that is generally accepted is maintenance of a substructure cross section that promotes lateral drainage and precludes collection of water below the track.

The general criterion for control of groundwater below track is to keep the groundwater level at least four feet below the top of the subgrade. This universal criterion may be overly conservative for clean sand and gravel subgrades and insufficient in areas of silty fine sands and silts susceptible

to pumping and frost heave. The rise and effects of groundwater are dependent on many factors, including train length and frequency, winter temperatures, rainfall, and subgrade type. These many factors make development of usable yet definitive criteria difficult or impossible. Individual consideration of each location is necessary.

## 8.2 TRACK SUBSTRUCTURE OBSERVATION METHODS

In discussing track observation methods, it is important to consider the purpose of the observations. The purpose may be to: (1) identify safety-related track defects, (2) monitor general conditions and changes in track conditions, (3) evaluate maximum service level of a track section, or (4) evaluate existing track performance in order to develop a design to upgrade performance.

The most commonly used track observation method is visual inspection. In the United States, the FRA Track Safety Standards prescribe the minimum frequency of visual inspections of track and detail the factors to be observed. Inspection frequency ranges from twice weekly for main line track to monthly for light traffic branch lines. The FRA Standards provide definitive criteria on acceptable track geometry and operating speed and critical superstructure defects. The Standards provide only limited criteria related to the substructure. Drainage facilities must be maintained and kept free of obstructions. Ballast must be able to perform its intended functions.

For substructure evaluation, visual inspection is of limited value. Only the ballast can be observed beneath the track, although subgrade type may be identified by observations adjacent to the track. Gross deficiencies in adjacent slopes or erosion may be noted.

The quality of visual inspections depends on the experience of the observer and the means used for transportation. Walking inspections provide the greatest opportunity to view details of the track; slow speed observations from hi-rail vehicles permit greater ground coverage; viewing track from the rear platform of a moving train permits only cursory observations of track appearance but does provide an opportunity to experience the effect of track geometry on ride comfort.

If substructure conditions are to be observed, it is necessary to perform at least minor explorations below the surface of the ballast. A pick and a shovel may be satisfactory tools for examining shoulder and crib contamination below the ballast surface. Procedures for sampling and testing in-service substructure materials are described in the companion report<sup>5</sup>. Careful surface observations can provide indications of slope movement and blocked drainage ditches.

---

<sup>5</sup>R. M. Simon et al., Op. Cit., pp. 4-9, 44-60, 113-116.



In 1979, J. R. Lundien reported on work at the U.S. Army Corps of Engineers, Waterways Experiment Station, in a "Feasibility Study for Railroad Embankment Evaluation with Radar Measurements." This preliminary study evaluated whether the electrical characteristics of track substructure materials would provide meaningful information on substructure layering by subsurface radar profiling. The feasibility study was theoretical and did not include field testing. Preliminary conclusions indicated favorable prospects for the method. However, attempts to develop a prototype radar profiling system did not provide results that were usable to characterize the track substructure.

### 8.2.1 Track Geometry

An experienced observer can identify some geometry conditions that are beyond acceptable limits. Discrete measurements of gauge, surface, alignment, and cross level can be made to confirm and quantify visual interpretations. However, manual measurement of track geometry is time-consuming and therefore of limited usefulness in random surveys of lengths of track or in developing a quantitative geometry index for use in monitoring geometry changes over time. Visual observations are subjective and, therefore, of limited value in measuring track condition changes over time. Observations are primarily useful in identifying gross track defects, with emphasis on superstructure defects, and in exploring conditions at discrete locations, to a limited depth.

To provide frequent, repeatable, and uniform measurement of track geometry, track geometry cars were introduced in the early 1960's. These cars are self-propelled, or pulled by a hi-rail vehicle, or placed in a train consist. Using special sensors, the cars can measure gauge, surface, alignment, twist, curvature, and superelevation of the rails. There are several different cars in use, each with its own special characteristics, advantages, and disadvantages. In North America, most recorder cars determine the geometry of loaded track. A summary of track recorder car characteristics is shown in Table 8-2.

Recorder cars may provide the following types of data output:

- a. Graphic display of individual parameter measurement versus track location.
- b. Exception reports - locations where geometry parameters exceed acceptable limits established by the individual railroad or the FRA Standards.
- c. Indices representing either an individual geometry parameter or combination of parameters comprising a quality index, as discussed in Section 9.1. The graphics and exception reports are usually produced aboard the cars. Sometimes the data is recorded on magnetic tape for computer processing of indices at a later time.

TABLE 8-2. TRACK RECORDING CAR DESCRIPTIONS BASED ON MANUFACTURER'S LITERATURE

Make	Model	Type	Weight (kips)			Maximum Travel Speed (mph)	Measurements		
			Total	Driven Axle	Carrying or Running Axle		Number Axles	Direction	Type
1.a) MATISA	M422	Recording*	50.6	25	19.5	63	3	Both	7 Parameters: - Longitudinal level - 3 for twist - superelevation - gauge - versines
b) MATISA	WE200 (with B200 series tamper Table 6.5)	Recording	----	--	----	50	3	One	4 Parameters: superelevation twist, level & alignment
2. TAMPER	-----	Valuator**	----	--	----	--	3 pairs	----	7 Parameters: gauge, twist, superelevation, left & right surface left & right line Each three levels of deviation
3.a) PLASSER & THEURER	EM80	Measuring, Evaluation	70	35	33	up to 50	3 pairs	Both	12 Parameters: lateral acceleration of car body, gauge, vertical irregularities in the surface of both rails, superelevation, speed, mile post marker, special events marker, curvature, twist (or crosslevel), profile and alignment of both rails
b) PLASSER & THEURER	EM50	Measuring, Evaluation	--	--	--	--			1st track car
c) PLASSER & THEURER	EM100	"	70	35	33	70	3 pairs	Both	Same as EM80
d) "	EM40	"	--	--	--	25			Not for high measuring speeds
e) "	Track Testing Wagon	"				106			
4. TRANSMARK		Track Geometry	--	--	--	135			Parameters: top left & right, alignment, twist, crosslevel (normal), cant & dynamic, gauge, horizontal and vertical curvature, vertical slope longwave, equilibrium speed, vertical & lateral ride index, vertical slope left & right, horizontal slope, vertical & lateral bogie acceleration, distance traveled

\*Provides readout of geometry parameters

\*\*Provides geometry parameters and exceptions to acceptable geometry criteria

Reproduced from, "Technical Review of Ballast Compaction and Related Topics," p. 134, by E.T. Selig et al. Year of First publication: 1979.

Several studies have investigated different methods of representing geometry car data, including the report by G. H. Way<sup>6</sup>. Hamid et al.<sup>7</sup> carried out studies of track quality indices (TQI) derived from track geometry car data. They correlated TQI with ride quality, maintenance activities, and derailments and showed how TQI changed with time and traffic. No method has been generally accepted. Although the automated geometry cars permit economical, closely spaced surveys of track, they produce enormous quantities of data to be reviewed. Computers are used to help interpret the data. Experience with use of recorder car data is needed to develop easily interpreted yet sensitive and reliable indices based on recorder car geometry measurements.

### 8.2.2 Lateral and Longitudinal Resistance

Selig et al., 1977, reviewed the means of evaluating resistance of a cross tie to horizontal displacement. Longitudinal load tests may be carried out on individual ties, but meaningful results are difficult to obtain because the ties tend to tip or roll rather than to slide.

Lateral tie load tests have been developed by European railroads<sup>8</sup>. Selig reported the development of a new lateral load testing apparatus which is relatively fast and easy to use. The device has been used to test track at the FAST installation in Pueblo, Colorado. Tests were also carried out by the U.S. Dept. of Transportation, Transportation Systems Center, on an abandoned section of revenue-track. Analysis of these data carried out for this study<sup>9</sup> indicates that the variability of lateral resistance along a section of track can be very large (standard deviation equal to 20 percent of mean resistance). This may imply that a large number of tests are required to characterize lateral resistance of track, and the sensitivity of single tie lateral resistance may be insufficient to be a usable evaluation parameter. However, further study of this test is both needed and desirable in order to provide a suitable basis for judgment of this test as a track evaluation tool.

---

<sup>6</sup>G. H. Way, "Techniques of Track Geometry Measurement and Evaluation," Baltimore and Ohio Railway Co., Report No. 71-104, 1971, 151 pp.

<sup>7</sup>A. Hamid et al., A Prototype Maintenance-of-Way Planning System, Vol. I, prepared for U.S. Dept. of Transportation, Federal Railroad Administration, Report No. FRA/ORD-80/47.1, November 1980, 117 pp. (PB81-147159).

<sup>8</sup>Hofmann and Pfarrer, "Influence of Various Measures on the Lateral Displacement Resistance of the Unloaded Track," Report No. DT 44/d117/D, Research and Testing Laboratory of the International Railroad Association, 1976, 126 pp.

<sup>9</sup>Goldberg-Zoino & Associates, "Single Lateral Tie Push Tests, Readville, Massachusetts, Data Analysis," Interim Report prepared for U.S. Dept. of Transportation, Transportation Systems Center, Cambridge, Massachusetts, Contract No. DOT-TSC-1527, December 1980, 104 pp.

Talapatra and Corbin<sup>12</sup> propose to infer stiffness characteristics of track by the difference in measured vertical track profile between sensors mounted on loaded axles and sensors that measure the unloaded profile of the track. They derive an expression for the difference between the two measurements based on a beam-on-elastic-foundation analysis.

Further elaboration of the dual sensor system concept is reported by G. Hayes et al<sup>13</sup>.

#### 8.2.4 Drainage

No attempt to measure in-situ drainage characteristics of substructure materials has been discovered other than subjective visual assessments. Permeability test methods are impracticable for measurements in coarse ballast or at very shallow depth. A test that may be practicable and may yield significant results would be a version of the percolation test conventionally used to evaluate soils for development of sewage disposal leaching fields. However, this test has not been tried in a railroad application. It is probably sufficient for evaluation of track drainage to assess ballast and subballast permeability from correlations with measured grain size characteristics. Evaluation of substructure layering as it may affect drainage can be investigated by test pit or boring explorations or by a geophysical means such as the subsurface radar discussed earlier. The effectiveness of groundwater control is best determined by installation of observation wells below the track.

### 8.3 RECOMMENDED SUBSTRUCTURE EVALUATION METHODS

No single method can satisfy the different requirements or purposes for substructure evaluation. Several methods are recommended with the intent that each has its proper application. Further development and experience with these recommended methods is necessary before suggested guidelines for their application can be developed.

---

<sup>12</sup>D. C. Talapatra and J. C. Corbin, "A Feasibility Study of a Method for Observing Track Stiffness from Mid-Chord Offset and Profilometer Measurements," IAS 1975 Annual, No. 21-A, 1975, pp. 512-517.

<sup>13</sup>G. Hayes et al., "Track Stiffness Measurement System Evaluation Program," prepared for U.S. Dept. of Transportation, Federal Railroad Administration (ORSR), Report No. FRA/ORD-79/30, December 1979, 166 pp. (PB80-165293)

### 8.3.1 Visual Inspection

Visual inspection will continue as a primary means of screening and identifying areas of substructure deficiencies. First, visual inspection is required by FRA Track Safety Standards. Inspection by trained personnel is one of the best ways to identify urgent safety defects in both the superstructure and the substructure.

One of the most important and most reliable aspects of visual inspection is to explore the substructure below the surface. Since this is time-consuming, subsurface explorations are practical only at locations identified by surface observation or other methods. The principal disadvantage of visual observations of the surface is that they are subjective--dependent on the skill and experience of the observer. Observations may be complemented by measurements of track geometry parameters, but manual measurements are time-consuming and thus limited to relatively few locations. This makes comparison of observations over time and identification of gradual trends impractical.

### 8.3.2 Track Geometry Cars

Track geometry cars are the most effective means to survey track performance on a routine basis. They provide an objective, quantitative measure of track condition that relates directly to criteria for operation of trains.

The principal drawback to geometry cars is that they produce so much data that it is challenging to apply the output effectively. Many geometry car users have developed exception reports to pinpoint areas of track that require priority maintenance. However, development of a track quality index to monitor the gradual, overall displacement of the track over time or to evaluate field performance of different track designs requires further study.

Use of geometry car data to assess substructure performance requires an additional analysis step. Even though change in geometry may indicate the location of a track deficiency, it does not indicate the cause. With further study, it may be possible to associate some types of geometry distortions with particular substructure failure mechanisms, but such relations have not been developed.

### 8.3.3 Track Modulus

Design of track for vertical loading is typically based on analysis of resilient stresses and displacements. The track modulus test provides a direct measurement of mechanical performance in terms of a parameter usable in design. The test must be performed on track with a static setup, but if the single point displacement method is used, the test can be performed in a few minutes. Multiple tests can be carried out to study variation of track modulus along a section of track. This test is judged suitable for routine evaluation of track resilience. The principal drawback of this test is that it provides a parameter representative of the overall substructure behavior. It is impossible to separate the effects of the different substructure elements. This limitation might

be alleviated by measuring settlement versus depth in the substructure below the load. However, this will increase the complexity and time required for the test. No work along this line has been identified.

#### 8.3.4 Plate Load Test

The plate load test offers the advantage that the effects of different elements of the substructure can be separated by placing the plate at different depths. The small diameter plate proposed by Selig influences only a thickness of material of 5 inches to 12 inches below the plate, which helps separate the effects of the differential layers.

The principal drawback of this test is that it requires disassembly of the track if tests below the ties are desired. Therefore, this test is judged suitable only for special evaluation, such as to provide substructure engineering parameters for design of the substructure for increased track loading or other rehabilitation of the track.

#### 8.3.5 Dynamic Impedance

One of the most attractive of the newly developed ideas on track evaluation is the proposal by Talapatra and Corbin, 1975, to derive resilient properties of the track from geometry car measurements. The principal advantage is that additional information can be determined with little extra effort. However, the reliability and significance of this technique require additional study<sup>14,15,16</sup>.

None of these recommended evaluation methods have been applied sufficiently so that specific guidelines for track evaluation can be established. Even visual inspection of substructure elements has been lacking in the area of substructure evaluation. If the potential for these track evaluation methods is to be realized, field studies of these techniques on in-service track must be undertaken in the future.

---

<sup>14</sup>W. D. Kaiser et al., "A Review of Measurement Techniques, Requirements, and Available Data on the Dynamic Compliance of Railroad Track," prepared for U.S. Dept. of Transportation, Federal Railroad Administration, Report No. FRA/ORD 76-70, May 1975, 166 pp. (PB 250547).

<sup>15</sup>G. L. Nessler, "An Experimental Evaluation of Techniques for Measuring the Dynamic Compliance of Railroad Track," prepared for U.S. Dept. of Transportation, Federal Railroad Administration, Report No. FRA/ORD 78-25, July 1978, 189 pp. (PB 285559/AS).

<sup>16</sup>W. D. Kaiser et al., "Design and Analysis of a Track Compliance Measurement System," prepared for U.S. Dept. of Transportation, Federal Railroad Administration, Report No. FRA/ORD/78-57, November 1978, 154 pp. (PB 297005).

## 9. CONCLUSIONS

Although conventional railroad track structures have been constructed using cross-ties and ballast for more than 150 years, research and development of design procedures for track have been sporadic. In the early twentieth century, the joint AREA-ASCE Special Committee on Stress in Railroad Track, headed by Professor A. N. Talbot, carried out a comprehensive series of analytic studies and field measurements. This research resulted in a procedure for track analysis and design for vertical loading that remains the basis of standard track engineering practice in North America today, as described in Section 4 of this report. There are two aspects of this work to be considered: (1) the research preceded the development of soil mechanics as a scientifically based field of engineering, and (2) railroad car axle loads studied in the early twentieth century are about fifty percent of the loads commonly encountered today.

Recent development of analysis and design procedures has proceeded along two lines. Several design methods are available, as described in Section 4, that are based on relatively simple analytic procedures to compute track stresses and on in-situ or laboratory subgrade soil tests to evaluate the allowable vertical subgrade bearing pressure. Most of these procedures have been developed for European practice. There are few data that may be used to evaluate the effectiveness of these procedures for North American track with heavier axle loads than the European roads.

The second avenue has been development of computer programs that can model the complex interactions of the various elements of the track superstructure and substructure. These complex analytic procedures may be used to study the effects and interactions of various elements of the superstructure in parameter studies. The procedures require input of detailed representation of the mechanical performance characteristics of the substructure layers. Although the computer program procedures provide more detail about stresses and strains in both the super- and substructure, the simpler analytic procedures are judged to be more suitable for routine design of track substructure. However, before even the simpler procedures can be used with confidence in design of North American track, a comprehensive study program must be carried out to compare the various design computations with observed track performance under heavy axle loads over a broad range of subgrade soil types and environmental conditions. The properties of the subgrade should be explored by the means described in the materials evaluation report<sup>1</sup> and the methods described briefly in Section 8 herein. The track evaluation methods discussed should be used in the studies as a basis for assessing the overall performance of the track and evaluating the procedures used to make the assessment. In this manner, guidelines for track analysis and evaluation can be developed.

---

<sup>1</sup>R. M. Simon et al., Op. Cit., pp. 4-81.

Both the simplified analyses and the computer models are based on calculation of the peak dynamic stresses and resilient displacements. Measurements of resilient displacements and substructure stresses will provide the most direct comparison with computed results. Such measurements have been carried out at FAST. However, it is expected that future measurement programs will be less complex than the FAST experiments in order to cover a greater number of different conditions and to explore variability of observations along what might be considered a uniform section of track.

The computer analysis methods, in conjunction with field measurements and simplified analysis techniques, may offer the most efficient means for developing substructure design guidelines. The field measurements would provide benchmark points against which to calibrate and evaluate the analytic methods. After calibration, parameter studies using the computer analysis techniques can be used with some confidence to interpolate and extrapolate the findings at the instrumental sites to different ballast and subballast thicknesses and to different superstructure stiffness and subgrade conditions. From these types of studies, charts could be developed for design evaluations both for new construction and for track upgrading and rehabilitation.

Good analytic tools are available, including the procedure developed by Raymond, the Indian procedure presented by Agarwal and Yog, and practical computer programs, such as GEOTRACK. Several promising evaluation procedures are available, including geometry recorder cars, vertical modulus tests, and plate load tests. The next step in guideline development is to integrate the measurements and analytic procedures just described. This is no simple task, particularly as it requires gathering major quantities of field data on operating railroads, accompanied by detailed explorations of track substructure conditions at instrumented sites. However, it is believed that this is probably the only means to develop reliable substructure design and evaluation guidelines.



APPENDIX A  
REPORT OF NEW TECHNOLOGY

The findings of this study are based on a review of published literature, discussions with practicing engineers, and our own experience. As such, no new technologies have been developed.

This report contains a summary of track substructure design, as practiced in the United States, as well as the theoretical design basis. Substructure design procedures used by European and some other foreign railroads are described. Application of these procedures to U.S. railroads would represent extension of existing technology to new applications--in particular, to design for heavy axle loads on standard gauge track.



## BIBLIOGRAPHY

Adegoke, C. W., "Elastic and Inelastic Deformation Response of Track Structures Under Train Loads," Ph.D. Thesis, State University of New York at Buffalo, December 1978, 220 pp.

Adegoke, C. W., C. S. Chang, and E. T. Selig, "Study of Analytical Models for Track Support Systems," Transportation Research Record, No. 733, 1979, pp. 12-18.

Agarwal, V. K., and A. K. Yog, "New Approach to the Design of Railway Track Foundations," Indian Railway Technical Bulletin, August 1975, pp. 66-78.

Alva-Hurtado, J. E., A Methodology to Predict the Elastic and Inelastic Behavior of Railroad Ballast, Ph.D. Thesis, University of Massachusetts, Amherst, May 1980, 442 pp.

Alva-Hurtado, J. E., and E. T. Selig, "Static and Dynamic Properties of Railroad Ballast," Proceedings of the 6th Panamerican Conference on Soil Mechanics and Foundation Engineering, Lima, Peru, December 1979, 15 pp.

Amans, F. and R. Sauvage, "Railway Track Stability to Transverse Stresses Exerted by Rolling Stock. A Theoretical Study of Track Behavior. A Practical Method for Determining the Resistance of the Track to Transverse Stresses Exerted by Rolling Stock," Bulletin of the International Railway Congress Association, Vol. 46, No. 11, November 1969, pp. 685-716.

American Railway Engineering Association, Manual for Railway Engineering, American Railway Engineering Association, Chicago, 1980.

American Railway Engineering Association - American Society of Civil Engineers, Special Committee on Stresses in Railroad Track, "First Progress Report," Proceedings, Vol. 19, Bulletin No. 205, AREA, March 1918, 192 pp.

Anand, Y. P., "Fundamental Studies on the Permissible Intensities of Pressure on the Track Formation (BG)-Investigations on Trunk Routes of Eastern Railway," Indian Railway Technical Bulletin, February 1969, pp. 1-10.

Armstrong, J. H., "Southern Lays a Firm Foundation for Reliable Service," Railway Age, October 8, 1979, pp. 24-33.

Ahlf, R. E., "Matching M/W Practice to the Required Use of Track - Part I: Curing the Problems, Not the Symptoms," Railway Track and Structures, September 1979, pp 34-42.

Ahlf, R. E., "Matching M/W Practice to the Required Use of Track - Part II: Ties and Ballast," Railway Track and Structures, October 1979, pp. 81-86.

Ahlf, R. E., "Matching M/W Practice to the Required Use of Track - Part III: The Costs," Railway Track and Structures, January 1980, pp. 21-23.

Barden, L., "Distribution of Contact Pressure Under Foundations," Geotechnique, Vol. 12, No. 3, September 1962, pp. 181-198.

Barksdale, R. D., and R. G. Hicks, "Material Characterization and Layered Theory for Use in Fatigue Analysis," Structural Design of Asphalt Concrete Pavements to Prevent Fatigue Cracking, Special Report 140, Highway Research Board, Washington, D.C., 1973, pp. 20-48.

Blanchard, L. C., "The Basics of Track Inspection - Plus Other Helpful Knowledge for Those with New Responsibilities in Track Maintenance," Railway Track and Structures, June 1975, pp. 26-27.

Brown, R. M., "Railroad Track Structures - Current Progress and Future Plans," The Dynamics and Economics of Railway Track Systems, Railway Systems and Management Association, Chicago, February 1970, pp. 1-6.

Brown, S. F., "Computation of Stresses and Strains for the Design of Flexible Pavements," Highway Research Record, No. 407, 1972, pp. 55-64.

Brown, S. F., "Improved Framework for Predicting Permanent Deformation in Asphalt Layers," Transportation Research Record, No. 537, 1975, pp. 18-30.

Brown, S. F., and A. F. L. Hyde, "Significance of Cyclic Confining Stress in Repeated-Load Triaxial Testing of Granular Material," Transportation Research Record, No. 537, 1975, pp. 49-58.

Casagrande, A., "Classification and Identification of Soils," Transactions, ASCE, Vol. 113, Paper No. 2351, 1948, pp. 901-992.

Chu, K. H., et al., "Track Foundation Stresses Under Vertical Loading," Rail International, No. 12, December 1977, pp. 617-626.

Clarke, C. W., "Track Loading Fundamentals-1, Introduction: Track and Wheel Loading," Railway Gazette, Vol. 106, No. 2, January 11, 1957, pp. 45-48.

Clarke, C. W., "Track Loading Fundamentals-2, Determination of Rail Section," Railway Gazette, Vol. 106, No. 4, January 25, 1957, pp. 103-107.

Clarke, C. W., "Track Loading Fundamentals-3, Determination of Ballast Depth," Railway Gazette, Vol. 106, No. 6, February 8, 1957, pp. 157-160, 163.

Clarke, C. W., "Track Loading Fundamentals-4, Curved Track and Lateral Strength," Railway Gazette, Vol. 106, No. 8, February 22, 1957, pp. 220-221.

Clarke, C. W., "Track Loading Fundamentals-7, Various Speed Effect Formulae," Railway Gazette, Vol. 106, No. 14, April 26, 1957, pp. 479-481.

Code, C. J., "Wheel Load, Wheel Diameter and Rail Damage," Proceedings, Vol. 61, AREA, March 1960, pp. 1219-1223.

Crane, L. S., et al., "Development and Use of a Track Quality Index," Transactions of the ASME, Paper No. 69-RR-2, April 1969, pp. 1-10.

Crane, L. S., "Automated Track Inspection on the Southern Railway System," Proceedings, Vol. 69, AREA, 1968, pp. 775-785.

Cunney, E. G., J. T. May, and N. H. Jones, The Effects of Accelerated Ballast Consolidation, prepared for U.S. Dept. of Transportation, Federal Railroad Administration, Report No. FRA/ORD-76-274, March 1977, 184 pp. (PB-266447).

Desai, C. S., T. Kuppusamy, T. H. J. Siriwardane, and S. Sture, Interaction and Load Transfer in Vehicle Guide Way Systems, prepared for U.S. Dept. of Transportation, Office of University Research, Contract No. DOT-05-80013, October 1978, 79 pp.

Dogneton, P., "The Experimental Determination of the Axial and Lateral Track Ballast Resistance," Symposium on Railroad Track Mechanics and Technology, Princeton University, April 1975, A. D. Kerr, ed., Pergamon Press, New York, 1978, pp. 171-196.

El-Aini, Y. M., "Effect of Foundation Stiffness on Track Buckling," Journal of the Engineering Mechanics Division, ASCE, Vol. 102, No. EM3, June 1976, pp. 531-545.

Eisenmann, J., "Stress Distribution in the Permanent Way Due to Heavy Axle Loads and High Speeds," Bulletin, No. 622, AREA, 1969, pp. 24-59.

Eisenmann, J., "The Significance of the Rail Lifting Wave," Rail International, No. 10, October 1976, pp. 576-581.

Eisenmann, J., "Railroad Track Structures for High Speed Lines," Symposium on Railroad Track Mechanics and Technology, Princeton University, April 1975, A. D. Kerr, ed., Pergamon Press, New York, 1978, pp. 39-61.

Fastenrath, F., "German Federal Railways," The Dynamic and Economics of Railway Track Systems, Railway Systems and Management Association, Chicago, February 1970, pp. 71-90.

Feld, J., "Tolerance of Structures to Settlement," Journal of the Soil Mechanics and Foundation Division, ASCE, Vol. 91, No. SM3, May 1965, pp. 63-77.

Frederick, C. O., "The Effect of Lateral Loads on Track Movement," Symposium on Railroad Track Mechanics and Technology, Princeton University, April 1975, A. D. Kerr, ed., Pergamon Press, New York, 1978, pp. 109-140.

Goldberg, D. T., W. E. Jaworski, and M. D. Gordon, Lateral Support Systems and Underpinning, Vol. I, Design and Construction, prepared for U.S. Dept. of Transportation, Federal Highway Administration, Report No. FHWA-RD-75-128, April 1976, 324 pp. (PB 257210)

Goldberg, D. T., W. E. Jaworski, and M. D. Gordon, Lateral Support Systems and Underpinning, Vol. II, Design Fundamentals, prepared for U.S. Dept. of Transportation, Federal Highway Administration, Report No. FHWA-RD-75-129, April 1976, 249 pp. (PB 257211)

Goldberg, D. T., W. E. Jaworski, and M. D. Gordon, Lateral Support Systems and Underpinning, Vol. III, Construction Methods, prepared for U.S. Dept. of Transportation, Federal Highway Administration, Report No. FHWA-RD-75-130, April 1976, 477 pp. (PB 257212)

Goldberg-Zoino & Associates, "Single Lateral Tie Push Tests, Readville, Massachusetts, Data Analysis," Interim Report, prepared for U.S. Dept. of Transportation, Transportation Systems Center, Cambridge, Massachusetts, Contract No. DOT-TSC-1527, December 1980, 104 pp (unpublished).

Goldberg-Zoino & Associates, Railroad Safety and Substructure Problems, prepared for U.S. Dept. of Transportation, Transportation Systems Center, Cambridge, Massachusetts, Contract No. DOT-TSC-1527, October 1979, 20 pp (unpublished).

Hamid, A. et al., A Prototype Maintenance-of-Way Planning System, Vol. I, prepared for U.S. Dept. of Transportation, Federal Railroad Administration, Report No. FRA/ORD-80/47.1, November 1980, 117 pp. (PB81-147159).

Han, H. C. S., T. J. Hirst, and H. Y. Fang, "Determination of the Elastic Moduli of Flexible Pavement Components," (abridgement), Highway Research Record, No. 407, 1972, pp. 36-38.

Hanna, A. N., "Track-Structure Analysis: Methodology and Verifications," Transportation Research Record, No. 653, 1977, pp. 26-31.

Hardy, R. M., "Stress Distribution in Track Structure," Proceedings, Vol. 69, Bulletin, No. 614, June-July 1968, pp. 924-940.

Harrison, H. B., "General Computer Analysis of Beams on Elastic Foundations," Proceedings, Vol. 55, Part 2, Institution of Civil Engineers, London, September 1973, pp. 605-618.

Hay, W. W., "'Engineered Track'-Part I, Effective Subgrade and Ballast," Progressive Railroading, Vol. 18, No. 3, March 1975, pp. 42-48.

Hay, W. W., "'Engineered Track' - Part II. Ballast Stability and Prolonged Rail Life," Progressive Railroading, Vol. 18, No. 4, April 1975, pp. 49-52.

Hay, W. W., Railroad Engineering, Volume I, John Wiley and Sons, New York, 1953, pp. 406-413.

Hay, W. W., "Track Structures for Heavy Wheel Loads," Proceedings of the 12th Annual Railroad Engineering Conference, Pueblo, Colorado, prepared for U.S. Dept. of Transportation, Federal Railroad Administration, Report No. FRA/ORD 76-243, October 1975, pp. 27-36.

Hay, W. W., H. C. Peterson, D. E. Plotkin, and P. T. Bakas, Lateral Stability of Ballast, Ballast and Foundation Materials Research Program, prepared for U.S. Dept. of Transportation, Federal Railroad Administration, Report No. FRA/ORD-77/61, September 1977, 54 pp.

Hayes, G. et al., "Track Stiffness Measurement System Evaluation Program," prepared for U.S. Dept. of Transportation, Federal Railroad Administration, Report No. FRA/ORD-79/30, December 1979, 166 pp. (PB80-165293).

Heath, D. L., and M. Cottram, "Stresses Beneath a Railway Track," Railway Gazette, Vol. 122, December 1966, pp. 1001-1007.

Heath, D. L., et al., "Design of Conventional Rail Track Foundations," Proceedings, Vol. 51, Institution of Civil Engineers, London, February 1972, pp. 251-267.

Hetenyi, M., Beams on Elastic Foundations. Theory with Applications in the Fields of Civil and Mechanical Engineering, University of Michigan Press, Ann Arbor, Michigan, 1946, 255 pp.

Hicks, R. G., and C. L. Monismith, "Factors Influencing the Resilient Response of Granular Materials," Highway Research Record, No. 398, 1971, pp. 15-31.

Hofmann and Pfarrer, Influence of Various Measures on the Lateral Displacement Resistance of the Unloaded Track, Report No. DT 44/D117/D, Research and Testing Laboratory of the International Railroad Association, 1976, 126 pp.

Holt, R. W., "Track Geometry Car - Management Usage," Proceedings, Vol. 76, Bulletin, No. 653, AREA, July 1975, pp. 561-572.

Howell, R. P., et al., Northeast Corridor High-Speed Rail Passenger Service Improvement Study, Task 3 - Track and Structures Standard Development, prepared for U.S. Dept. of Transportation, Federal Railroad Administration, Report No. FRA-ONECD-75-3, September 1975.

Ino, T., "Reinforced Subgrade," Japanese Railway Engineering, Volume 17, No. 1, 1977, pp. 23-23.

International Union of Railways, Question D71; Stresses in the Rails, the Ballast, and in the Formation Resulting from Traffic Loads, Report No. 12; Repeated Loading of Clay and Track Foundation Design, Report No. D71/RP12/E, Office for Research and Experiments, Utrecht, Holland, 1970, 192 pp.

International Union of Railways, Question D71; Stresses in the Rails, the Ballast, and in the Formations Resulting from Traffic Loads, Reports No. 1 thru No. 13, Office for Research and Experiments, Utrecht, Holland, 1965-1970.

International Union of Railways, Question D117; Optimum Adaptation of the Conventional Track to Future Traffic, Reports No. 1 thru No. 6, Office for Research and Experiments, Utrecht, Holland, 1968-1975.

Ito, T., and K. Iwasaki, "Design and Earthwork of Cuts and Fills for Concrete Slab Track upon Subgrade," Quarterly Reports, Vol. 14, No. 2, Japanese National Railway Technical Research Institute, 1973, pp. 67-71.

Ireland, H. O., "Railroad Subgrade Stresses," Bulletin, No. 641, AREA, January-February, 1973, pp. 382-386.

Kaiser W.D., et al., A Review of Measurement Techniques, Requirements and Available Data on the Dynamic Compliance of Railroad Track, prepared for the U.S. Dept. of Transportation, Federal Railroad Administration, Report No. FRA/ORD 76-70, May 1975, 166 pp. (PB 250547)

Kaiser, W. D. et al., Design and Analyses of a Track Compliance Measurement System, prepared for U.S. Dept. of Transportation, Federal Railroad Administration, Report No. FRA/ORD 78-57, November 1978, 154 pp (PB 297005).

Kerr, A. D., "The Evolution of the Railroad Track and Related Research Activities," The Stress and Stability Analysis of Railroad Tracks, presented at ASME Annual Meeting, November 1974, New York, Journal of Applied Mechanics, December 1974, 9 pp.

Kerr, A. D., "Analysis of Thermal Buckling in the Lateral Plane," Acta Mechanica, Vol. 30, 1978, pp. 17-50.

Kerr, A. D., "Lateral Buckling of Railroad Tracks Due to Constrained Thermal Expansions - A Critical Survey," Symposium on Railroad Track Mechanics and Technology, Princeton University, April 1975, A. D. Kerr, ed., Pergamon Press, New York, 1978, pp. 141-169.

Kerr, A. D., "On the Stress Analysis of Rails and Ties (Draft)", prepared for U.S. Dept. of Transportation, Transportation Systems Center, Contract No. DOT-TSC-900, 1979.

Kerr, A. D., Thermal Buckling of Straight Tracks; Fundamentals, Analyses, and Preventive Measures, prepared for U.S. Dept. of Transportation, Federal Railroad Administration, Report No. FRA/ORD-78/49, September 1978, 58 pp. (PB-291929)



Kerr, A. D., "Problems and Needs in Track Structure Design and Analyses," Transportation Research Record, No. 653, 1977, pp. 38-44.

Klugar, K., "Effect of Raising the Track on the Track Lateral Strength," ETR-Eisenbahntechnische Rundschau, November 1972, pp. 446-449.

Klugar, K., "Effect of the Base Layout on the Load-Distribution Action of the Tie," Die Eisenbahntechnische Rundschau, Vol. 26, No. 12, 1978, pp. 507-510.

Klugar, K., "The Static Track Lateral Strength of Loaded Tracks," ETR Eisenbahntechnische Rundschau, Vol. 25, No. 4, 1976, pp. 211-216.

Klugar, K., "Basic Directives for Improving Track Quality," source unknown.

Klugar, K., "Track Buckling Experiments of the Austrian Federal Railroads with New Types of Ties," Eisenbahntechnische Rundschau, Vol. 25, No. 3, 1974, pp. 70-75.

Knutson, R. M., et al., Materials Evaluation Study - Ballast and Foundation Materials Research Program, prepared for U.S. Dept. of Transportation, Federal Railroad Administration, Report No. FRA-ORD-77-02, January 1977, 202 pp.

Kraus, J., "New Design for Foundation Under Sleepers," Railway Research and Engineering News, Section G, Translation Series No. 77/G/1, 1977, pp. 49-57. (Translation from OSSHd.Zt, No. 2, 1976, pp. 1-4).

Lade, P. M., and J. M. Duncan, "Stress-Path Dependent Behavior of Cohesionless Soil," Journal of the Geotechnical Engineering Division, ASCE, Vol. 102, No. GT1, January 1976, pp. 51-68.

Lundgren, J. R., G. C. Martin and W. W. Hay, A Simulation Model of Ballast Support and the Modulus of Track Elasticity, University of Illinois, Urbana, September 1970.

Lundgren, J. R., G. C. Martin, and W. W. Hay, A Simulation Model of Ballast Support and the Modulus of Track Elasticity, University of Illinois, Urbana, September 1970.

Lundgren, J.R., Feasibility Study for Railroad Embankment Evaluation with Radar Measurements, prepared for U.S. Dept. of Transportation, Federal Railroad Administration, Report No. FRA/ORD-79/08, February 1979, 44 pp.

Magee, G.M., "Welded Rail in Bridges," Railway Track and Structures, November 1965, pp. 24-26.

Magee, G.M., "Current Status of Prestressed Concrete Ties on Railroads in the U.S.," Proceedings, Vol. 67, Bulletin, No. 600, AREA, June-July 1966, pp. 622-641.

Margotev, A. N., "Calculation of the Thickness Required for the Ballast Layer Taking Account of the Resistance Qualities of the Track Bed," Vestnik, Vol. 35, No. 7, Moscow, 1976, pp. 45-48.

Matisa Materiel Industriel SA, "Information Seminar - Crib and Shoulder Compaction," German Federal Railway, Mainz, October 1972, 15 pp.

Maynard, A. L., "The Use of Track Analyser Car Data in Inspection of Track and Maintenance Planning," Proceedings, Vol. 76, Bulletin, No. 653, AREA, July 1975, pp. 573-575.

Meacham, H. C., et al., Studies of Rail Vehicle Track Structures, prepared for U.S. Dept. of Transportation, Office of High Speed Ground Transport, Report No. FRA-RT-71-45, April 1970, 208 pp.

Milosevic, B., "Determining the Depth of Ballast," Bulletin of International Railway Congress Association, Vol. XLVI, No. 2, February 1969, pp. 141-146.

Miyamoto, T., "Maintenance-Saving Track," Japanese Railway Engineering, Vol. 16, No. 2, 1976, pp. 10-13.

Monismith, C. L., "Pavement Design: The Fatigue Subsystem," Structural Design of Asphalt Concrete Pavements to Prevent Fatigue Cracking, Special Report 140, Highway Research Board, Washington, D.C., 1973, pp. 1-19.

Monismith, C. L., and F. N. Finn, "Flexible Pavement Design: State of the Art - 1975," Transportation Engineering Journal, Vol. 103, No. TE1, ASCE, January 1977, pp. 1-53.

Monismith, C. L., N. Ogawa, and C. R. Freeme, "Permanent Deformation Characteristics of Subgrade Soils Due to Repeated Loading," Transportation Research Record, No. 537, 1975, pp. 1-17.

Mueser, Rutledge, Johnston & DeSimone & Assoc., Report No. NEC-119S, Final Report - Roadbed Investigation, Ballast and Subgrade Design and Construction Considerations for NECIP Track Structures, Project Designation KHD, Northeast Corridor Improvement Project, Federal Railroad Administration, prepared for Deleuw, Cather/Parsons, Washington, D.C., September 1978, 10 pp.

Nagy, L., "New Methods Used by Hungarian State Railways for Increasing the Load Carrying Capacity of the Railway Permanent Way Formation," British Railways Translation, No. 46898, from unknown source, 1977, 7 pp.

Nessler, G. L., "An Experimental Evaluation of Techniques for Measuring the Dynamic Compliance of Railroad Track," prepared for U.S. Dept. of Transportation, Federal Railroad Administration, Report No. FRA/ORD 78-25, July 1978, 189 pp. (PB 285559/AS)

Nussbaum, E., "Track Structure at Facility for Accelerated Service Testing," Transportation Research Record, No. 653, 1977, pp. 32-37.

Ormiston, H., "Engineering a 200 km/h Line," Railway Engineer, Vol. 1, No. 5, September/October 1976, pp. 14-20.

O'Sullivan, W. B., "Unconventional Railway Track Support Systems," The Dynamics and Economics of Railway Track Systems, Railway Systems and Management Association, Chicago, February 1970, pp. 115-136.

Panuccio, C. M., et al., Mechanics of Ballast Compaction - Phase II, Vol. I, Field Test Results for Ballast Physical State Measurements, prepared for U.S. Dept. of Transportation, Transportation Systems Center, Contract No. DOT/TSC/1115, November 1978.

Paterson, A., "British Railways," The Dynamics and Economics of Railway Track Systems, Railway Systems and Management Association, Chicago, February 1970, pp. 91-114.

Prause, R. H., et al., An Analytical and Experimental Evaluation of Concrete Cross Tie and Fastener Loads, prepared for U.S. Dept. of Transportation, Federal Railroad Administration, Report No. FRA/ORD 77/71, December 1977, 356 pp.

Prause, R. H., and J. C. Kennedy, Parametric Study of Track Response and Performance, prepared for U.S. Dept. of Transportation, Federal Railroad Administration, Report No. FRA/ORD-77/75, December 1977, 118 pp.

Prause, R. H., H. C. Meacham, et al., Assessment of Design Tools and Criteria for Urban Rail Track Structures, Volume I. At-Grade Tie-Ballast Track, prepared for U.S. Dept. of Transportation, Urban Mass Transportation Administration, Report No. UMTA-MA-06-0025-74-3, April 1974, 247 pp.

Price, B. H., "FRA, D&RGW, B&LE Joint Study of Track Geometry and Track Degradation," Proceedings, Vol. 76, Bulletin, No. 653, AREA, July 1975, pp. 554-561.

Prud'homme, M. A., "The Resistance of the Permanent Way to the Transversal Stresses Exerted by the Rolling Stock," Bulletin of the International Railway Congress Association, Vol. 44, No. 11, November 1967, pp. 731-766.

Prud'homme, M. A., and M. G. Janin, "The Stability of Tracks Laid with Long Welded Rails, Part I," Bulletin of the International Railway Congress Association, Vol. 46, No. 7-8, July-August 1969, pp. 459-487.

Prud'homme, M. A., and M. G. Janin, "The Stability of Tracks Laid with Long Welded Rails, Part II," Bulletin of the International Railway Congress Association, Vol. 46, No. 10, October 1969, p. 601-602.

Raymond, G. P., "Railroad Wood Tie Design and Behavior," Transportation Engineering Journal, Vol. 103, No. TE4, July 1977, pp. 521-538.

Raymond, G. P., "Design for Railroad Ballast and Subgrade Support," Journal of the Geotechnical Engineering Division, ASCE, Vol. 104, No. GT 1, January 1978, pp. 45-60.

Raymond, G. P., "Improvement in Rail Support," Transportation Research Record, No. 653, 1977, pp. 11-20.

Raymond, G. P., "Ballast Properties that Affect Ballast Performance," Proceedings, Vol. 80, Bulletin, No. 673, AREA, June-July 1979, pp. 428-447.

Raymond, G. P., "Problems Associated with Railroad Fills and Supports," Proceedings, 5th Southeast Asian Conference on Soil Engineering, Bangkok, Thailand, July 1977, pp. 275-286.

Raymond, G. P., and J. R. Davies, "Triaxial Tests on Dolomite Railroad Ballast," Journal of the Geotechnical Engineering Division, ASCE, Vol. 104, No. GT6, June 1978, pp. 737-751.

Raymond, G. P., and D. J. Turcke, Analysis of Rail Track Structures (ARTS), User's Manual, Canadian Institute for Guided Ground Transport, CIGGT Report No. 78-8, Queen's University, Kingston, Ontario, April 1978, 70 pp.

Raymond, G. P., and D. R. Williams, "Repeated Load Triaxial Tests on a Dolomite Ballast," Journal of the Geotechnical Engineering Division, ASCE, Vol. 104, No. GT7, July 1978, pp. 1013-1029.

Raymond, G. P., et al., A Study of Stresses and Deformations Under Dynamic and Static Load Systems in Track Structure and Support, Canadian Institute of Guided Ground Transport, CIGGT Report No. 75-10, Queen's University, Kingston, Ontario, September 1975, 53 pp.

Raymond, G. P., et al., Stresses and Deformations in Railway Track, Canadian Institute of Guided Ground Transport, CIGGT Report No. 76-11, Queen's University, Kingston, Ontario, November 1976, 171 pp.

Raymond, G. P., et al., Stresses and Deformations in Railway Track, Canadian Institute of Guided Ground Transport, CIGGT Report NO. 77-15, Queen's University, Kingston, Ontario, November 1977, 105 pp.

Reiner, I. A., Lateral Resistance of Railroad Track, prepared for U.S. Dept. of Transportation, Federal Railroad Administration, Report No. FRA/ORD-77/41, August 1977, 124 pp., (PB-275166)

"Review of 1979 Car and Locomotive Orders," Railway Age, Vol. 180, No. 2, January 28, 1980.

Riessberger, K. H., "Means and Methods to Increase Track Stability," Proceedings, Vol. 75, Bulletin, No. 648, AREA, 1974, pp. 797-811.

Riessberger, K. H., "Towards a More Stable Ballast Bed," Railway Gazette International, March 1977, pp. 99-102.

Robnett, Q. L., et al., Technical Data Bases Report, Ballast and Foundation Materials Research Program, prepared for U.S. Dept. of Transportation, Federal Railroad Administration, Report No. FRA-ORD-76-138, July 1975, 175 pp.

Robnett, Q. L., et al., Development of a Structural Model and Materials Evaluation Procedures, Ballast and Foundation Materials Research Program, prepared for U.S. Dept. of Transportation, Federal Railroad Administration, Report No. FRA-ORD-76-255, November 1975, 97 pp.

Rostler, F. S., et al., Study of Methods of Stabilizing Conventional Ballast Using Polymers, Contract No. C-352-66, Materials Research and Development, Incorporated, Oakland, California, December 1966, 219 pp.

Sato, Y., "A Proposal of New Theory on Track Deterioration," Quarterly Reports, Vol. 19, No. 1, Japanese National Railway Technical Research Institute, March 1978, pp. 34-35.

Selig, E. T., T. S. Yoo and C. M. Panuccio, Field Methods for Ballast Physical State Measurements, Mechanics of Ballast Compaction, Vol. 2, prepared for U.S. Department of Transportation, Transportation Systems Center, March 1982, Report No. FRA/ORD-81/16.2 (PB82 192188)

Selig, E. T., C. S. Chang, C. W. Adegoke, and J. E. Alva-Hurtado, A Theory for Track Maintenance Life Prediction, First Year Final Report, prepared for U.S. Dept. of Transportation, Office of University Research, Report No. DOT-/RSPA/DPB-50/79/22, Contract No. DOT-OS-70058, August 1979, 183 pp.

Selig, E. T., C. S. Chang, J. E. Alva-Hurtado, and C. W. Adegoke, A Theory for Track Maintenance Life Prediction, Second Year Final Report, prepared for U.S. Dept. of Transportation, Office of University Research, Contract DOT-OS-70058, December 1979, 160 pp.

Selig, E. T., T. S. Yoo, C. W. Adegoke, and H. E. Stewart, Status Report - Ballast Experiments, Intermediate (175 MGT) Substructure Stress and Strain Data, Interim Report, prepared for U.S. Dept. of Transportation, Transportation Test Center, September 1979, 88 pp.

Selig, E. T., T. S. Yoo and C. M. Panuccio, Technical Review of Ballast Compaction and Related Topics, Mechanics of Ballast Compaction, Vol. 1, prepared for U.S. Department of Transportation, Transportation Systems Center, March 1982, Report No. FRA/ORD-81/16.1 (PB82 192170).

Selig, E. T., T. S. Yoo and C. M. Panuccio, Summary Report, Mechanics of Ballast Compaction, Vol. 5, prepared for U.S. Department of Transportation, Transportation Systems Center, March 1982, Report No. FRA/ORD-81/16.5 (PB82 192212).

Ballast Experiment Intermediate (175 MGT) Substructure Stress and Strain, Status Report, Federal Railroad Administration, Transportation Test Center, FRA/TTC-81/03, March 1981.

Shenton, M. J., "Deformation of Railway Ballast Under Repeated Loading," Symposium on Railroad Track Mechanics and Technology, Princeton University, April 1975, A. D. Kerr, ed., Pergamon Press, New York, 1978, pp. 405-425.

Shulman, A. E., Analysis of Nine Years of Personnel Casualty Data: 1966-1974, Association of American Railroads, Report No. R-252, Washington, D.C., November 1976, 52 pp.

Simon, R. M., L. Edgers, and J. V. Errico, Ballast and Subgrade Requirements Study: Railroad Track Substructure - Materials Evaluation and Stabilization Practices, prepared for U.S. Dept. of Transportation, Federal Railroad Administration, January 1983, 334 pp.

Skempton, A. W., "The Pore Pressure Parameters A and B," Geotechnique, Vol. IV, No. 4, March 1954, pp. 143-147.

Skempton, A. W., and D. H. MacDonald, "Allowable Settlement of Buildings," Proceedings, Part III, Vol. 5, Institution of Civil Engineers, London, December, 1956.

So, W., Track Structure Design Using Mathematical Models, prepared for the U.S. Dept. of Transportation, Federal Railroad Administration, Report No. FRA/ORD-78/08, June 1978, 64 pp.

So, W., and G. C. Martin, "Finite Element Track Buckling Model," Proceedings, IEEE - ASME Joint Railroad Conference, Washington, D.C., April 1, 1977, Report No. 77-RT-5, ASME, 7 pp.

Sonneville, R., and A. Bentot, "Elasticity and Lateral Strength of the Permanent Way," Bulletin of the International Railway Congress Association, Vol. 32, No. 3, March 1955, pp 184-208.

Sonneville, R. and A. Bentot, "Lateral Strength of Permanent Way When Free from Load," Bulletin of the International Railway Congress Association, Vol. 33, No. 6, June 1956, pp. 481-491.

Spang, J., "Deformation of Railway Track Base and Its Stabilization," ETR-Eisenbahntechnische Rundschau, 376, Vol. 21, No. 10, 1972. (Translation by Canadian Translation Bureau, Montreal, Bureau No. 3628869).

Stedef, "RS Concrete Cross Ties," Stedef, Inc., Falls, Church, VA, 1965, 23 pp.

"Stresses in Railroad Track," The Talbot Committee Reports, AREA, Chicago, 1980, 350 pp.

"Stresses in the Track Substructure Resulting from Traffic Loads," Rail International, Vol. 2, No. 5, May 1971, pp. 495-498.

Sunnygard, J. R., "Effect of Heavy Cars on Rail," Proceedings, Vol. 78, Bulletin, No. 663, AREA, June-July 1977, pp. 611-635.

Svec, O. J., et al., "Analytical and Experimental Investigation of a Rail Track Structure," Second Symposium on Applications of Solid Mechanics, McMaster University, Hamilton, Ontario, 1974.

Tayabji, S. D., and M. R. Thompson, "Effect of Design Parameters on Track Support Systems," Transportation Research Record, No. 653, 1977, pp. 2-10.

Tayabji, S. D., and M. R. Thompson, "Considerations in the Analysis of Conventional Railway Track Support System," Transportation Engineering Journal, Vol. 103, No. TE2, ASCE, March 1977, pp. 279-292.

Talapatra, D. C., and J. C. Corbin, "A Feasibility Study of a Method for Observing Track Stiffness from Mid-Chord Offset and Profilometer Measurements," IAS 1975 Annual, No. 21-A, 1975, pp. 512-517.

Thompson, M. R., and Q. L. Robnett, Resilient Properties of Subgrade Soils, Final Report, Project IHR-603, Transportation Research Laboratory, Department of Civil Engineering, University of Illinois, Urbana, June 1976.

Thompson, M. R., FAST Ballast and Subgrade Materials Evaluation -Ballast and Foundation Materials Research Program, prepared for U.S. Dept. of Transportation, Federal Railroad Administration, Report NO. FRA/ORD-77/32, December 1977, 40 pp.

Turcke, D. J., and G. P. Raymond, "Three-Dimensional Analysis of Rail Track Structure," Transportation Research Record, No. 733, 1979, pp. 1-5.

U.S. Army Technical Manual TM-818-5, 1971, pp. 187.

Waters, J. M., and M. J. Shenton, "Track Foundation Design," Railway Gazette, Vol. 124, October 1968, pp. 734-737.

Way, G. H., "Purposes and Requirements of Track Inspection and Measurement," Baltimore and Ohio Railway Co., Report No. 71-103, February 1971, 69 pp.

Way, G. H., "Techniques of Track Geometry Measurement and Evaluation," Baltimore and Ohio Railway Co., Report No. 71-104, February 1971, 151 pp.

Way, G. H., "Track Structure Systems," Transportation Research Record, No. 653, 1977, pp. 21-23.

Welty, G., "Engineering for the Big Cars - What kind of Track?" Railway Age, Vol. 178, No. 5, March 14, 1977, pp. 24-26.

Zarembski, A. M., and J. Choros, "On the Measurement and Calculation of Vertical Track Modulus," Proceedings, Vol. 81, Bulletin, No. 675, AREA, November-December 1979, pp. 156-173.

Zobrak, M. J., Track Rehabilitation and Maintenance Research Requirements, prepared for U.S. Dept. of Transportation, Federal Railroad Administration, Report No. FRA/OR&D-80/09, January 1980, 68 pp.

