

FRA-76-14. I  
REPORT NO. FRA/ORD 77-06, I

POTENTIAL MEANS OF COST REDUCTION IN  
GRADE CROSSING AUTOMATIC GATE SYSTEMS

Volume I: Overview and Low Cost Railroad/  
Highway Grade Crossing Gate Systems

Andrew St. Amant

MB Associates  
Bollinger Canyon Road  
San Ramon CA 94583



FEBRUARY 1977

FINAL REPORT

DOCUMENT IS AVAILABLE TO THE U.S. PUBLIC  
THROUGH THE NATIONAL TECHNICAL  
INFORMATION SERVICE, SPRINGFIELD,  
VIRGINIA 22161

Prepared for  
U.S. DEPARTMENT OF TRANSPORTATION  
FEDERAL RAILROAD ADMINISTRATION  
Research and Development  
Washington DC 20590

NOTICE

This document is disseminated under the sponsorship of the Department of Transportation in the interest of information exchange. The United States Government assumes no liability for its contents or use thereof.

NOTICE

The United States Government does not endorse products or manufacturers. Trade or manufacturers' names appear herein solely because they are considered essential to the object of this report.

1. Report No. FRA/ORD 77-06, I	2. Government Accession No.	3. Recipient's Catalog No.	
4. Title and Subtitle POTENTIAL MEANS OF COST REDUCTION IN GRADE CROSSING AUTOMATIC GATE SYSTEMS Volume I: Overview and Low Cost Railroad/Highway Grade Crossing Gate Systems		5. Report Date February 1977	
		6. Performing Organization Code	
7. Author(s) Andrew St. Amant		8. Performing Organization Report No. DOT-TSC-FRA-76-14, I	
9. Performing Organization Name and Address MB Associates* Bollinger Canyon Road San Ramon CA 94583		10. Work Unit No. (TRAIS) RR602/R7325	
		11. Contract or Grant No. DOT-TSC-859	
12. Sponsoring Agency Name and Address U.S. Department of Transportation Federal Railroad Administration Research and Development Washington DC 20590		13. Type of Report and Period Covered Final Report June 1974-March 1976	
		14. Sponsoring Agency Code	
15. Supplementary Notes *Under contract to: U.S. Department of Transportation Transportation Systems Center Kendall Square Cambridge MA 02142			
16. Abstract This report, Volume I of a two-volume study, examines the potential for reduction of the cost of installing and maintaining automatic gates at railroad-highway grade crossings. It comprises a general overview; a review of current practices, equipment, and standards; a consideration of modification of existing specifications to permit use of alternative technologies; the generation of design concepts for new gate systems or subsystems intended to offer significant economic benefits; an analysis and comparative evaluation of the more promising concepts; and conclusions concerning further design, development, and test activities. Concepts found to be particularly promising include a low-cost gate-drive mechanism utilizing high-reliability commercially available components; a swing-away, gravity resetting arm support intended to reduce the incidence of gate breakage; and a gate arm utilizing new materials to obtain resistance to breakage.			
17. Key Words Railroad/Highway Grade Crossing Gates; Gate Drive Mechanism; Arm Support; Gate Arm; Grade Crossing Gate Survey; Gate System Design Concepts; Gate System Model.		18. Distribution Statement DOCUMENT IS AVAILABLE TO THE U.S. PUBLIC THROUGH THE NATIONAL TECHNICAL INFORMATION SERVICE, SPRINGFIELD, VIRGINIA 22161	
19. Security Classif. (of this report) Unclassified	20. Security Classif. (of this page) Unclassified	21. No. of Pages 90	22. Price



## PREFACE

The work described in this report was carried out under the direction of the Transportation Systems Center to provide a technical basis for improvement of railroad-highway grade crossing safety. The program was sponsored by the Federal Railroad Administration, Office of Research and Development.

The overall project was based upon two contractor studies, one of which is reported here accompanied by an overview prepared by TSC; the second will be found in Volume II of this report.

Appreciation is expressed to the many individuals, both in government and industry who have contributed in great measure to the program effort. Individuals who have, to an unusual degree, helped to improve the study include R. Coulombre and M. Hazel of DOT Transportation Systems Center; H.M. Williamson, R.C. Nagel and C.P. Darrough of Southern Pacific; and A.W. Gebhardt, R.E. Harmon, D.D. Huffman, D.F. McNulty and H.C. Palmer who are associated with various railroad signal equipment manufacturing companies.

# METRIC CONVERSION FACTORS

Approximate Conversions to Metric Measures		Approximate Conversions from Metric Measures	
When You Know	Multiply by	When You Know	Multiply by
Symbol	To Find	Symbol	To Find
<b>LENGTH</b>			
inches	2.5	millimeters	0.04
feet	30	centimeters	0.4
yards	0.9	meters	3.3
miles	1.6	kilometers	1.1
			0.5
<b>AREA</b>			
square inches	6.5	square centimeters	0.16
square feet	0.09	square meters	1.2
square yards	0.8	square kilometers	0.4
square miles	2.6	hectares (10,000 m <sup>2</sup> )	2.5
acres	0.4		
<b>MASS (weight)</b>			
ounces	28	grams	0.035
pounds	0.45	kilograms	2.2
short tons (2000 lb)	0.9	tonnes (1000 kg)	1.1
<b>VOLUME</b>			
teaspoons	5	milliliters	0.03
tablespoons	15	liters	2.1
fluid ounces	30	quarts	1.06
cups	0.24	liters	0.26
pints	0.47	cubic meters	35
quarts	0.95	cubic meters	1.3
gallons	3.8		
cubic feet	0.03		
cubic yards	0.76		
<b>TEMPERATURE (exact)</b>			
Fahrenheit temperature	5/9 (after subtracting 32)	Celsius temperature	9/5 (then add 32)

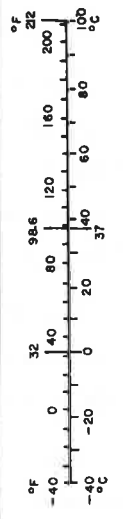
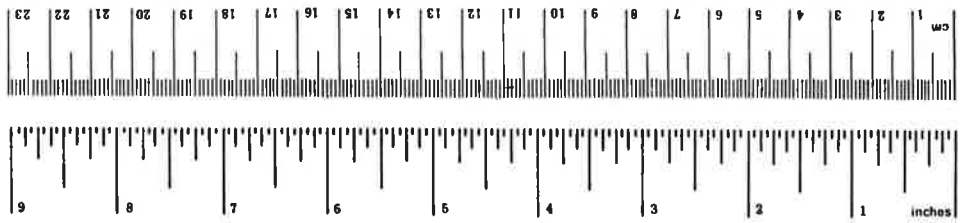

## TABLE OF CONTENTS

<u>Section</u>		<u>Page</u>
1.	OVERVIEW.....	1
2.	STUDY PURPOSE, BACKGROUND, AND SCOPE.....	6
	2.1 Purpose.....	6
	2.2 Background.....	6
	2.3 Scope.....	7
3.	SURVEY OF CURRENT PRACTICES AND REQUIREMENTS.....	9
	3.1 The Railroad Industry Associations.....	9
	3.2 State Regulatory Bodies.....	9
	3.3 Federal Regulatory Agencies.....	10
	3.4 ICC.....	10
	3.5 FRA.....	11
	3.6 FHWA.....	11
	3.7 Railroad Companies.....	11
	3.8 Signal Equipment Manufacturers.....	11
	3.9 Survey Conclusions.....	13
	3.10 Scheduled and Emergency Maintenance.....	15
	3.11 Gate Destruction.....	15
	3.12 Safety and Liability.....	16
4.	RECOMMENDED SPECIFICATION CHANGES.....	18
	4.1 Gate Arm Torque.....	19
	4.2 Mechanism Case.....	20
	4.3 Gears.....	20
	4.4 Terminal Boards and Binding Posts.....	20
	4.5 Dielectric Requirements.....	21
	4.6 Hold Clear Device.....	21
5.	DESIGN CONCEPTS.....	23
	5.1 Description, Analysis, and Evaluation.....	23
	5.2 Low Cost Grade Crossing Gate Drive Mechanism Concept.....	24
	5.3 Grade Crossing Gate Arm Concept.....	36
6.	CONCLUSIONS.....	66
	APPENDIX A: REPORT OF INVENTIONS.....	67
	APPENDIX B: BIBLIOGRAPHY.....	68
	APPENDIX C: INFORMATION CONCERNING STATE GRADE CROSSING REGULATIONS AS OF JANUARY 1975.....	69

## LIST OF ILLUSTRATIONS

<u>Figure</u>		<u>Page</u>
5-1	Low Cost Gate Mechanism.....	27
5-2	Wiring Diagram - Low Cost Gate Mechanism.....	28
5-3	Semi-Flexible Swing-Away Arm Support.....	37
5-4	Latch-Plunger-Spring Assembly.....	38
5-5	Multiple Expendable Arm.....	39
5-6	Conventional Shape With Low Cost Materials.....	40
5-7	Drive-Over Resetting Arm.....	46
5-8	Conventional Shape With New Materials.....	53
5-9	Schematic, Modular Arm With Moderate Cost.....	59

## LIST OF TABLES

<u>Table</u>		<u>Page</u>
3-1	RAILROAD COMPANY AND MANUFACTURER GATE SURVEY.....	12
3-2	GATE MECHANISMS SPECIFICATIONS.....	14
5-1	ENGINEERING DESIGN ANALYSIS.....	25
5-2	COST REDUCTION ANALYSIS.....	26
5-3	LIST OF SCALE MODEL PARTS.....	32
5-4	MODEL MECHANISM PARTS.....	34



## LIST OF ABBREVIATIONS AND SYMBOLS

A	Ampere
AAR	Association of American Railroads
AASHTO	Amer. Ass'n. of State Hwy & Transportation Officials
AREA	American Railway Engineering Association
BN	Burlington Northern, Inc.
B12	12 Volt Power from Signal Battery
COM	Common
ComCom	State Commerce Commission
CorpCom	State Corporation Commission
C&NW	Chicago and North Western Transportation Co.
C&O	Chesapeake and Ohio Railway Company
Dept of Hwys	Department of Highways
DivHwys	State Division of Highways
DOT	Department of Transportation
DPU	Department of Public Utilities
D&RG	Denver and Rio Grande Western R. R. Company
E-L	Erie-Lackawanna Railway Company
FHWA	Federal Highway Administration
FRA	Federal Railroad Administration
GRS	General Railway Signal Company
Hwy Admin	Highway Administration
HwyDept	State Highway Dept
ICC	Interstate Commerce Commission
K	Relay

MR	Milwaukee Road
MUTCD	Manual on Uniform Traffic Control Devices
NC	Normally Closed
NEMA	National Electrical Manufacturers Association
NO	Normally Open
N12	Negative of 12 Volt Systems
PC	Penn Central Transportation Company
PSB	Public Service Board
PSC	Public Service Commission
PUC	Public Utilities Commission
r	Registered Trademark
R	Resistor
S	Switch
SCL	Seaboard Coast Line R. R. Company
SFe	Atchison, Topeka and Santa Fe Railway
SP	Southern Pacific Transportation Company
ST	Safetran Systems Corporation
TransCom	Transportation Commission
TSC	Transportation Systems Center
UP	Union Pacific Railroad
UTCom	Utilities and Transportation System
V	Volt
WABCO	Westinghouse Air Brake Company
WC	Western-Cullen Div., Federal Sign and Signal Corp.
XG1	12 Volt Power from Track Battery

## EXECUTIVE SUMMARY

In recent years it has increasingly been recognized that automatically operated gates are the most effective motorist warning and deterrent to accidents at railroad-highway grade crossings. However, of the more than 50,000 U.S. crossings with train-activated systems, little more than 10,000 are equipped with gates, and only half of the new installations currently being made include them. One of the major factors which prevent more extensive gate use is the cost of original equipment, installation, and maintenance. A review of current practices and hardware, with special attention to the possible role of existing industry standards as impediments to beneficial design and component innovation, has been carried out. The major equipment design constraints are inherent requirements on performance and safety. However, existing standards, representing formal codification of practices developed over several decades, do appear to impose limitations which may discourage attempts to use more recent technological developments, and could slow the introduction of beneficial innovations. For example, a small number of changes have been identified, based upon replacement of detailed industry design specifications with functional requirements. These have made possible conceptual design of gate mechanisms utilizing standard, mass-produced low-maintenance and low cost components, rather than the nearly-custom made units now used.

Synthesis, analysis, and comparative evaluation of new concepts intended to offer significant potential for reduction of cost for grade-crossing gate systems have been undertaken. Concepts found to have promise include those that deal with the grade crossing gate drive mechanism, the arm support, and the gate arm. Substantial conceptual design has been carried out for a low cost grade crossing gate drive mechanism using highly reliable commercially available components to create reduction in costs associated with original purchase, installation, and maintenance. Another concept found to be of interest is a pneumatic gate drive mechanism,

which appears to have several advantages. However, a thorough preliminary design and engineering analysis will be necessary to determine the true practicality and cost-reduction potential of this approach.

The swing-away gate arm support concept suggested in the report is based on a semi-flexible arm supported by a pivoting mechanism to allow the arm to swing up out of the way when struck by a motor vehicle. The arm then returns by gravity to its original position, so that its function is not impaired. The result is a lessening of the maintenance problems associated with broken arms, and a decrease in damage to automobiles striking the arms.

In considering the gate arms alone, use of a conventional grade-crossing gate arm using new fabrication materials is estimated to offer substantial benefits. The new gate arm material recommended consists of a phenolic resin-impregnated honeycomb encased in a fiberglass-reinforced polyester tube. When this gate arm material is used with the swing-away resetting mechanism described above, the average life cycle cost reduction is expected to approach 50% for the arm and mechanism portion of the system.

The concepts described above were selected as the best of the many concepts shown in the report, and should be considered for detailed engineering design, development of field test units, and thorough laboratory and field evaluation.

## 1. OVERVIEW

Recent studies have indicated that the most effective means of increasing safety at railroad-highway grade crossings is installation and improvement of train-activated motorist-warning systems.\* These are generally either alternately-flashing red lights alone, or lights plus automatically-lowered gates. Investigation has shown that lights alone reduce accidents by approximately 60% to 70%, and gates are generally found to have an effectiveness of 90% to 95%. However, gates are also substantially more expensive; a complete flashing-light installation (not using cantilever mounting) can cost \$20,000 to \$30,000, whereas gated crossings are typically \$35,000 to \$50,000. Although this differential is partially due to the fact that gates are likely to be used at the more complex crossings (multi-lane, multi-track, etc.), gate hardware is not inexpensive, and may reach 10% to 20% of the total cost of the installation. In addition, maintenance costs are substantially higher also, and are generally estimated at \$1500 to \$2500 per year--twice the amount required for flashing lights alone. This is an especially important factor for the railroads, which normally bear part of all of the cost of maintenance. (Currently, installations are paid for largely by Federal and state funds.)

At the anticipated rate of 2,000 to 3,000 installations and major upgradings per year, with at least half involving gates, the cost of gate components alone will be in the range of \$5M to \$10M annually. If, as now seems probable, more than 20,000 crossings are upgraded to gates or receive new gate installations in the next ten years, the result would be an increase in annual maintenance expenditures of magnitude comparable to annual component

---

\*See, for example, California Public Utilities Commission, The Effectiveness of Automatic Protection in Reducing Accident Frequency and Severity at Public Grade Crossings in California, June 1974.

costs. A further problem is gate breakage. Either accidentally or deliberately, it is not uncommon for motor vehicles to drive through gates, or snag the tip in attempting to go around them. The result is a breakage rate which can exceed one gate arm per crossing per year for large jurisdictions, and may be far greater for particular crossings or areas. In part, this problem may arise from unnecessarily long activation times, or "false alarms" in which no train reaches the crossings at all. Resulting driver annoyance or frustration may lead to the decision to go through the gate, rather than around it. If the crossing activates just after a large trailer-truck, particularly one which has made a mandatory stop, has entered the crossing, the descending gate arm can catch on the vehicle and be damaged. Other sources of damage also exist, including vandalism and strong, gusty winds. Although certain of these problems can be alleviated through indirect means such as use of constant-warning-time train detection, there is no question that arm breakage is a significant problem. With gate arm prices of \$200 to \$300, plus substantial labor, often at overtime rates, the economic burden on railroads is, in many cases, substantial.

That this is a substantive problem may be inferred from the response of the supply industry, which has carried out significant research in this area. The traditional double wooden arm has been challenged by both fiberglass and aluminum alternatives, and recently a manufacturer not previously involved in this market has developed a polycarbonate (Lexan<sup>R</sup>) arm. Gate mountings which shear, permitting the arm to drop free rather than break, have come into widespread use. Nonetheless, the basic problem remains as a matter of real concern.

Even a crude definition of required or desirable arm characteristics is difficult to achieve, as opinions vary considerably. There are a number of features to be balanced, and constraints to be met. Too rigid an arm could cause a derailment if it were to be knocked onto the tracks. Some fear that an electrically conductive (metal) arm might pose a hazard if

it came into contact with power lines (when in a raised position). One must also balance economic and other factors in comparing resistance to initial breakage with ease of repair, unless both attributes can be combined.

The limited availability of industry research funds, and the relatively conservative nature of the market have discouraged extensive examination of more innovative and therefore speculative approaches. The modular Lexan<sup>R</sup> arm is an exception, generated from outside the traditional industry. Thus, one might anticipate significant improvements from a thorough examination of recent advances in both materials and structures.

The gate drive mechanism also is worthy of consideration. The present devices have an impressive record of performance and reliability, and are subjected to continual product engineering improvements by the manufacturers. However, a variety of factors, including existing industry standards, have tended to limit the range of alternative approaches and components utilized. For example, partially to assure adequate protection against electrical surges, the motor used is required to withstand a one-minute, 3,000 V.DC breakdown test. This rules out use of commercially available motors and requires the use of relatively expensive custom designs. (Recall that the total market volume is only a few thousand units per year, with several active manufacturers competing.) Thus, here also one might hope that application of recent technological advances would achieve significant economic benefits without in any way compromising performance, safety, reliability, or lifetime.

Given the safety importance of automatic gate systems, their economic impact, and the potential for meaningful advances through exploitation of recently-developed materials, structural concepts, and components, this was judged to be an appropriate subject for Federal research. (This finding is reinforced by the fact that the Federal Highway Trust Fund is the basic source of funding for most

of the gates now purchased.) Accordingly, the Federal Railroad Administration, acting through the Transportation Systems Center, carried out a competitive procurement for research in this area. In order to assure a comprehensive examination, two contracts were awarded, each calling for approximately one-half man-year of effort. The firms chosen to undertake the project were MB Associates, San Ramon, California and the Gulf + Western Advanced Development and Engineering Center, Swarthmore, Pennsylvania. The contract work statement in each case called for a sequence of tasks. The first task called for a thorough review of existing practices, specifications, and regulations, with the contractor assembling resultant overall specification of functional, electrical, mechanical, and environmental aspects. Economic characterization, in terms of 1974 dollars, was also a part of this task. This was to be followed by recommendations concerning areas in which modification of existing requirements might permit significant overall cost reduction without compromising safety or performance. The next task--the heart of the project--was to be generation of new concepts for gate systems which would offer marked economic benefits within a framework of the previously established requirements and constraints. These concepts were then to be subjected to as thorough an engineering and economic analysis as limited resources permitted, concluding with recommendations concerning possible development.

Both successful vendors were basically new to the grade crossing area (no traditional suppliers elected to submit proposals) so that a significant portion of the already-limited resources were necessarily devoted to achieving familiarity with the subject. However, both firms had good credentials in the design of electro-mechanical systems, and were able to bring to the project a fresh viewpoint and experience with a wide variety of technologies. Each also draw upon special consultants in railroad signaling and other relevant areas.

The final reports of each contractor are included in this report. They have been edited somewhat as to form and certain technical details, but no substantive changes have been made.



It should be noted that their conclusions and recommendations do not necessarily represent the views, policies, or intentions of the Department of Transportation, the Federal Railroad Administration, of the Transportation Systems Center. The very limited magnitude of the effort did not permit studies of sufficient depth to reach definite conclusions concerning the ultimate benefits and practicality of the recommended concepts. In the case of major components, such as the recommended mechanisms, a major design, engineering, test, and evaluation effort would be required to determine true viability. However, their findings do appear to validate and give direction to the initial premise that significant overall economic benefits may be obtainable through innovation in grade crossing automatic gate systems.

John B. Hopkins  
U.S. Department of Transportation  
Transportation Systems Center  
Cambridge MA 02142

## 2. STUDY PURPOSE, BACKGROUND, AND SCOPE

### 2.1 PURPOSE

The purpose of this study is to determine the technical and economic feasibility of developing a low cost automatic barrier (or gate) for active railroad-highway grade crossing protection. The study is further intended to form a basis for selection of promising concept(s).

### 2.2 BACKGROUND

In recent years there has been a trend toward the use of automatic gates as motorist warning devices at grade crossings. Studies have indicated that these devices can reduce accidents and casualties by 90% to 98% compared to passive warnings, and a substantially greater amount than flashing lights alone. However, only 10,000 gate installations have been made across the nation while approximately 223,000 public grade crossings and an almost as large number of private grade crossings exist in this country. One of the factors that prevents more extensive gate application is the cost of original equipment, installation, and maintenance. Improving these cost elements will improve benefit/cost considerations if the effectiveness of the resulting carrier remains at least as good as existing devices.

Specifications setting limitations that govern the design of automatic gates at the present time have parts that could possibly be modified without causing a change in effectiveness. Investigation of each such constraint in the existing specification could allow development of a modified specification providing the possibility of significant reduction of life-cycle costs. Other benefits may also be achievable within existing standards. For example, replacement of broken gate arms not only involves substantial expense to the railroad, but also results in periods of

exposure of traffic to a grade crossing without required motorist warning equipment. This condition raises serious safety and liability issues.

Although much has been done to improve the performance of gate arms through use of fiberglass, aluminum, and shear pin design techniques, further improvement may well be possible and is a subject of this study.

### 2.3 SCOPE

The study provided an opportunity to investigate concepts leading to an improved grade crossing gate with potential for lowering overall cost of original equipment, installation, maintenance and administration.

Scope of the study included generation and delineation of hardware concepts that will lead to new gate designs. As a target objective, the new concepts were to have original equipment, installation, maintenance and administration costs that, in total, are 30% less than those currently applicable for existing gate designs without significant degradation of function or reliability.

Original equipment cost refers to the manufactured cost of a complete gate mechanism. Installation cost includes all costs associated with installation of a gate mechanism. Maintenance costs refer to average annual cost of repairing a gate installation including gate arm breakage. Administrative costs include all clerical and inventory costs involved in purchase, installation and maintenance.

The study included an analysis of existing barrier functional requirements as established by the Association of American Railroads (AAR) and industry specifications. From these sources a modified specification was suggested reflecting six changes that impose functional rather than design requirements on the gate.

Based on the revised specification, concepts were synthesized that show promise of providing the cost reduction desired. Through economic and technical analysis, concepts with the greatest potential for cost reduction while meeting requirements of the modified specification were selected and recommended for test hardware development and evaluation.

Scale and full-size models of the recommended concepts were provided to demonstrate special features used for cost reduction.

### 3. SURVEY OF CURRENT PRACTICES AND REQUIREMENTS

#### 3.1 THE RAILROAD INDUSTRY ASSOCIATIONS

The AAR is universally accepted as the authority on grade crossing practices currently in effect. Its Bulletin No. 7 and Signal Manual Parts 110(1972), 148(1972), 150(1973), 186(Apr.1963), 189-Instructions 12, 13, 29, 30, 40, and 51 (Apr. 1956), 194 (1972), 204(Apr.1960), 263(Sep.1970), 274(1972), 276(Mar.1950), and 279 (Jan.1962) along with the Signal Manual Drawings which are referenced in the above publications, apply to crossing gate systems and the integral parts and materials of gate arms and drive mechanisms. Committee D of the AAR Communication & Signal Section deals with crossings exclusively.

Another organization which has been of immeasurable benefit to the railroad industry is the American Railway Engineering Association (AREA), which has a membership of individuals rather than private companies. It is an association of technical people engaged in railroad related functions and has published recommended standards for railroad construction. Its Committee 9 deals with highways and therefore has responsibilities in the area of grade crossings, but does not handle gate systems and signal details as the AAR does. This committee's interests are with grades, pavement, visibility, etc.

There are many other railroad associations, but the AAR was found to be the "authority of the industry" in matters relating to gate arms and mechanisms.

#### 3.2 STATE REGULATORY BODIES

The signal engineer or executive in charge of matters relating to railroad-highway grade crossing gate systems for the regulatory bodies of each of the 50 states was interviewed. In many cases, this was an extended face-to-face meeting; in most cases in-depth telephone conferences sufficed, and many times the individual was contacted additional times for clarification of a point or additional information. In no case were the mails used by survey

personnel to request facts about their grade crossings. In some instances, the state respondent sent a cover letter with the printed regulations, general orders or laws peculiar to that state.

The regulatory body's nomenclature varied from state to state. The names used include Department of Transportation (DOT), Public Utilities Commission (PUC), Public Service Commission (PSC), State Commerce Commission (ComCom), State Corporation Commission (CorpCom), Department of Public Utilities (DPU), Transportation Commission (TransCom), State Division of Highways (DivHwys), Highway Administration (Hwy Admin), State Highway Department (HwyDept), Department of Highways (Dept of Hwys), Utilities and Transportation System (UT Com), and Public Service Board (PSB), (see List of Abbreviations). In the interest of simplicity, any of these bodies will occasionally be referred to in this report as the "state agency" or merely the "state."

Much information was gained from this study and the major points are summarized in the appendix to this volume.

An activity in which many of these state bodies are deeply involved in the change from previously acceptable gate stripe colors, such as black and white or black and yellow, to the uniform standard of red and white. Several bodies are seeking grade crossing safety improvement by way of statistical analysis and study programs.

### 3.3 FEDERAL REGULATORY AGENCIES

The activities of many Federal Government agencies involve, to at least some extent, railroads in general and grade crossing warning systems in particular. The most important bodies to be considered, however, were those which deal with grade crossing gate systems in depth.

### 3.4 ICC

In the recent past, Federal regulatory power resided in the Bureau of Railroad Safety of the Interstate Commerce Commission (ICC). This function was transferred to U.S. DOT, effective 1 April 1967.

### 3.5 FRA

FRA regulates track safety, freight car safety, hazardous materials, etc., and is concerned in particular with Occupational Safety and Health Act (OSHA) standards as applied to railroads, but has joint powers with the Federal Highway Administration (FHWA) in the regulation of railroad-highway grade crossing standards and practices. As far as crossings are concerned, the FRA concentrates its efforts in the areas of track and signal circuits external to gate mechanism.

### 3.6 FHWA

FHWA supports the standards and practices derived from three sources: AAR, MUTCD and AASHTO.

### 3.7 RAILROAD COMPANIES

A brief survey, supported by discussions with railroad officials and others, made clear that virtually all U.S. railroads adhere to AAR Bulletin No. 7 and the applicable parts of the AAR Signal Manual.

### 3.8 SIGNAL EQUIPMENT MANUFACTURERS

There are many railroad signal equipment and component manufacturers, but prior to December, 1974, only four companies in the United States marketed completed railroad-highway grade crossing gate systems (mechanism, support and arm). A new gate system has very recently been introduced to the railroad industry by an experienced manufacturer which until this time had provided many other signal system items, but did not market an automatic gate system. The five gate system manufacturers, and a sixth company which manufactures arms only, are listed in Table 3-1. It should be noted that the first signal company listed is only a manufacturer and their two mechanism types are usually marketed by

TABLE 3-1. RAILROAD COMPANY AND MANUFACTURER GATE SURVEY

Company	AAR Bul. 7 Adherence	Gate Products
General Railway Signal Co. Rochester, New York	Yes	Type D Std. Wt. Type F Lt. Wt.
Harmon Electronics Co., Inc. Grain Valley, Missouri	Yes	Mod H100 Std. Wt.
National Electric Gate Co. Elk Grove Village, Illinois	Yes	Gate Arms Only
Safetran Systems Corp. Louisville, Kentucky	Yes	Mod. S Lt. Wt. Mod. EM Std. Wt. Mod. GS Hydraulic
WABCO-Union Switch and Signal Div. Swissvale, Pennsylvania	Yes	Mod. AL-70&3570 Lt. Wt. Mod. 3568 Std. Wt.
Western-Cullen Div., Fed. Sign and Signal Chicago, Illinois	Yes	Mod. 3590 Std. Wt.



the last listed company as Types 3567 and 3569. This last listed company also markets two mechanism made by the fourth listed company, Types 3568 and 3570. The fourth listed company only markets one model directly to the railroads. The last listed company also markets one model directly to the railroads. The last listed company also markets the Type 3590 which is of their own design and manufacture. The five manufacturers, combined, market ten different units. Typically, various types of gate arms are made available for any given mechanism by the manufacturer of the systems. A comparative summary of system specifications is shown in Table 3.2

The adherence of railroads to AAR standards assures that all manufacturers base their designs upon these constraints. This tends to reduce the negative effect of gaps, variations, and ambiguities in state regulations.

### 3.9 SURVEY CONCLUSIONS

Analysis leads to the conclusion that further improvement of automatic gate systems is possible and attractive, both from a cost-benefit and a safety standpoint. It was also found that modifications of specifications and practices would be likely to contribute to cost reduction.

The purchase price total to the railroad of the three assemblies which are included in a single basic gate, (i.e. mechanism, support and arm) varies from the most expensive of approximately \$3,000 to a low of \$1,500. The average price was found to be definitely on the low side, as the railroads are purchasing many more "light-weight" units than the more costly systems. It is estimated that presently the average is around \$2,000. It is conceivable that, with specification design improvements, this figure could be reduced to \$1,000. If size and weight were reduced, the shipping and warehousing cost factors would also show significant reduction.

TABLE 3-2. GATE MECHANISMS SPECIFICATIONS

Mfgr. & No.	Motor	Drive	Ratio	Torque	Amps	Clear Angle	Diesel Point	Brake Point	Stop Angle	Down Secs	Pickup Coil	Brake Point	Stop Angle	Clear Secs
GRS Type D	12vSer/Shunt	Gear	222:1	480	8-20	88°	50°	5°	0°Horiz	10-15	76°	85°	88°	6-10
GRS Type F	12vP. M.	Gear	132:1	200	5-14	88°	50°	5°	0°Horiz	10-15	76°	85°	88°	6-10
WABCO AL-70	12vDual Series	Gear	130:1	210	10-19	90°-70°	46°	10°	0°Horiz	8-15	Clutch	70°-90°	90°	6-13
SAFETLAN S	12vSeries	Gear	240:1	280	6-25	90°	45°	5°	0°Horiz	10-15	83°-87°	N/A	90°	6-12
SAFETLAN EM	12vDual Series	Gear	250:1	400	6-25	90°	45°	5°	0°Horiz	10-15	83°-87°	80°-90°	90°	5-7
SAFETLAN GS	12vP. M. w/pump	Hydr	550 psi	1200	15-30	90°	N/A	9°	0°Horiz	11-13	N/A	85°	90°	7
WEST CUL 3568	12vSer/Shunt	Gear	220:1	480	8-20	90°	45°	5°	0°Horiz	10-15	76°	85°	90°	6-10
AAR 189-51	11 to 20 VDC	Not Specified	Not Specified	10/ft	15- stall	Not specified	Not specified	Not specified	0°Horiz	10-15	Not Specified	Not Specified	Not Specified	8-12

### 3.10 SCHEDULED AND EMERGENCY MAINTENANCE

Scheduled maintenance costs are a function of the schedule required for the entire system which is maintained by the signal departments of the railroads; therefore, the reduction of maintenance on the gate system, which is a relatively small part of the entire system, would not make a large contribution to maintenance cost reduction. The unscheduled emergency maintenance costs, however, are a significant additional burden, and if cut to a small fraction of current experience, would make a noticeable improvement. With a reduction of one man allowed for the emergency repair crew, the costs could easily be reduced by 30%. This would be the case if the mechanism support and arm were much smaller and lighter in weight and also more easily adjustable because of simple design and construction.

### 3.11 GATE DESTRUCTION

The greatest cost to railroads, not counting original purchase and installation, is the total of labor and materials costs, over the years, due to destruction by accident and vandalism. It is also worth noting that several signal engineers, in observing what has occurred, firmly believe that impatient drivers of large vehicles, after what seems a long wait with no train in sight, barge through the lowered gate leaving it a shambles. Each of the large railroads suffers destruction, from several causes, of many hundreds of gates per year. Two large railroads operating in California claim gate arm replacement rates of 5% per year (about 164 per year) and a smaller railroad in California loses 12 per month. Another chief signal engineer said that, at "problem crossings," they had experienced averages of 3 to 4 per week. Assuming similar experience for all railroads in the U.S., the conclusion is reached that the yearly toll is between one and two thousand gate arms.

Gate arms presently cost from \$100 to \$300, or even more, depending upon construction and length. Some of the older type wooden units are very heavy, requiring several men for easy replacement. Even the latest light-weight types often require

more than one man to perform the replacement. Assuming a typical replacement cycle to require 4 hour of time from each man involved, the cost per gate replaced could be reduced by \$25 per hour for the reduction of 4 manhours to do the job. This would be accomplished if gate mechanisms supports and arms were lighter in weight, more compact, and simpler to adjust. With all costs considered, including parts, labor, overhead, overtime and occasion long travel distances, gate arms are presently costing between \$500 and \$800 each to replace when destroyed. This could probably be reduced to \$400 to \$700 just from savings in labor and brought down to \$350 to \$650 if a high strength, very low cost gate arm was available.

Costs due to gate destruction could be even more drastically reduced if the arm and its support were designed to receive typical vehicle impacts with very little chance of destruction.

To summarize, with new improved designs it is reasonable to expect a typical replacement cost to be reduced approximately 25% and this cost burden (75%) to occur much less often. Let us assume that, conservatively, the new arm is 4 times as resistant to destruction as present arms. This would effectively reduce the costs to 1/4 of the 75% figure or 19% of present costs.

### 3.12 SAFETY AND LIABILITY

Conversations with major railroad company attorneys lead to the conclusion that improvements could certainly be gained in two respects. One would be the safety improvement and, although small, liability reduction due to less chance of damage to highway vehicles. The other, possibly of greater benefit, would be safety improvement and liability reduction due to less interruption of warning at the grade crossing. These attorneys agreed that a history of safer operation would have to be proved statistically before there could be a reduction in liability coverage costs. Even then, the improved situation would not be felt by many railroads who have a large "deductible" value in their liability protection. This deductible amount can be as great as \$500,000 to \$1 million.

Without this history, it is not possible to quantify the liability reduction, except by engineering estimate.

#### 4. RECOMMENDED SPECIFICATION CHANGES

As a result of engineering analysis based upon a review of current practices and consideration of alternative concepts, six changes in gate specification are recommended for further consideration. These changes apply to both AAR Bulletin No. 7 (ANSI-D8. 1 1974) and AAR Signal Manual Parts which contain mandatory specification ("shall") concerning Gate Arm Torque, Mechanism Case, Gears, Binding Posts, Dielectric Requirements, and Hold Clear Device. Most of these recommendations are the result of a process involving five iterative phases: basic analysis, generation of new concepts, expert consultation, reanalysis of concepts and existing specifications and finally the choice of recommendations. In several of the recommendations, the basic principle upon which the recommendation is based is that the specification be rewritten to state the manner in which the mechanism must operate from a systems standpoint instead of how the system must be internally designed and constructed.

The basic analysis was of information obtained during and subsequent to the surveys. The survey indicated, for all practical purposes, 100% adherence to the AAR Standards. The products of the signal manufacturers were given thorough engineering evaluation, with characterization of the different systems, including assessment of compliance with AAR Standards.\* Where noncompliance seemed to exist additional information was obtained from gate mechanism component manufacturers (motors and relays). In some cases, noncompliance was confirmed by the manufacturer of the part. Some of the survey material obtained was statistical in nature, and was beneficial both in the origin and also development of new design concepts. Some verbal information from the survey gave greater insight into nonpublished facets of the gate problem which were of great interest. Examples of this were cases of large vehicles intentionally destroying gates, the questionable voltage rating of magnet wire used in most mechanisms, the questionable strength

---

\*This evaluation process was analytical rather than experimental; no actual mechanisms were subjected to testing.

of some arms in winds well below the 100 mph specification, and of special interest and importance, the large variation in expert opinion about the requirements for a new, improved gate system.

Any changes in specifications, such as suggested above, must be considered very carefully before implementation. They form part of the foundation on which our current system of grade crossing safety is based. If strong analytical study supported by laboratory and field test evidence shows that specific specifications can be modified without compromising safety, substantial cost advantage can result.

Each of the suggested changes in existing gate specification is outlined in the paragraphs that follow:

#### 4.1 GATE ARM TORQUE

Bulletin 7, page 11, paragraph 4, specified that "mechanism shall be" per "Part 194." Part 194 of the Signal Manual (on pages 1 and 2, "Gate Arm Torque and Support") specifies the foot-pounds of torque for the horizontal and vertical positions of the gate arm. The two values, 50 foot-pounds minimum for the horizontal position and 175 foot-pounds minimum for the vertical position, are restrictive to a degree which precludes the adoption of new fail safe designs which function automatically from the clear to the horizontal position using some principle of operation other than gravity. It rules out, for instance, various kinds of stored energy being used in the mechanism to produce a value of torque in the clear position so that the gate will lower automatically when external power or circuits fail.

It is suggested that (subject to prior demonstrated reliability under test) the specifications be modified to allow not only gravity powered gate descent, but also, other principles of fail safe lowering of the arm to be used. This could produce a superior specification because it will make mandatory the automatic lowering of the gate when any or all elements external to the mechanism fail without restricting the designer and manufacturer to costly back-drivable gears and heavy counterweight systems.

#### 4.2 MECHANISM CASE

Part 194-II-c of the Signal Manual specifies a "gasket" for the door and yet 194-11-d specifies "at least two ventilation openings."

It is suggested that (subject to prior demonstrated reliability under test) the specification be modified to allow use of a gate case or housing that will function as well as one using the gasketed door and vents required by the present specification. There are inexpensive NEMA enclosure designs which are sturdy and weather-proof, but they do not exactly meet the above referenced specifications. The gasket now specified doesn't seal the housing, since there are vents, so it may be logical to specify use of any rain and wind tight door closure to be acceptable.

#### 4.3 GEARS

Part 194-12-c of the Signal Manual states that gate mechanism gears "shall be readily accessible for lubrication and inspection." This specification seems to rule out the use of low cost, high reliability, gear boxes of modern design that are sealed from outside contamination and contain permanent wide temperature range oil or grease lubrication. It also rules out gears that are designed to operate with no lubricant.

It is suggested that (subject to prior demonstrated reliability under test) the gear specification paragraphs be modified to reflect possible use of state-of-the-technology, high quality sealed gear reducers to allow improvement of operation and reduction in size and cost of future designs.

#### 4.4 TERMINAL BOARDS AND BINDING POSTS

AAR Signal Manual Drawing 1070 as referenced in 1070 as referenced in Part 194-16 and 17 precludes the use of modern, high quality, low cost terminals and fasteners.



It is suggested that (subject to prior demonstrated reliability under test) substitution be allowed of suitable terminal board and binding post design such as those specified in MS (military standard) part standards.

#### 4.5 DIELECTRIC REQUIREMENTS

Part 194-19 of the Signal Manual specifies a "one minute" test and "3000 volts a.c." between parts of electric circuits, metallic parts and terminals.

It is suggested that the specification be modified to state the voltage, whether it is RMS or peak, the allowable microampere leadage current, the frequency of a.c. (60 Hz or other), the ambient test condition temperature and humidity, the insulation leadage resistance and the length of time. It is also suggested (subject to prior demonstrated reliability under test) that the dielectric test be applied only to the completed mechanism and that the individual internal components should be required to pass a test of substantially lower voltage (to be determined by analysis and test). This could allow use of commercially available internal components (motors, etc.) without resorting to specialty units and also would allow use of surge protection devices.

#### 4.6 HOLD CLEAR DEVICE

If a mechanism which meets all operational requirements of Bulletin 7 and Part 194 of the Signal Manual were designed, but it did not require a solenoid or coil-actuated ratchet and pawl to "hold clear" and then release automatically in the event of external circuit or battery failure, it still would not be acceptable because the Part 194-22 specification allows only two principles of operation. These are ratchet and pawl, and hydraulic valve. For example, it doesn't make allowance for currently available mechanisms which use an electromagnetic brake.

It is suggested that the Part 194-22 specification be modified to state the manner in which the mechanism must operate from a system standpoint; that is, state that when any element external to the mechanism fails or is interrupted, the mechanism must cause the gate to lower to a horizontal position, but must otherwise hold in the clear position. This change will allow use of other techniques to accomplish the same purpose.

Any specification change of this nature should be subject to prior demonstration by test showing that new concepts do have an equivalent level of reliability.

## 5. DESIGN CONCEPTS

### 5.1 DESCRIPTION, ANALYSIS, AND EVALUATION

A multi-disciplinary team, including experts in electro-mechanical devices, materials, structures, and railroad signaling and operations, was brought together to generate conceptual improvements for alternatives in gate systems.

Numerous ideas proposed were quickly eliminated as technically not feasible, impractical, excessively costly, or insufficiently safe. Those showing initial promise were subjected to sufficient engineering and economic analysis to permit meaningful estimation of performance characteristics and impact upon system costs. All concepts not ruled unacceptable at this stage were then rated according to relevant functional and cost aspects to allow comparative ranking. This last process is inherently somewhat subjective, particularly since it was based on analytical considerations, rather than experimental/developmental testing. However, the number of people involved and the relative simplicity of the concepts make possible considerable confidence in this process. Performance characterization is based upon ten factors: weight, strength, rigidity, durability, visibility (day and night), weather resistance, vandalism resistance, overall safety, simplicity of installation, and adherence to AAR standards. Potential cost reduction for each concept is divided into six categories: manufacturing, shipping, installation, maintenance, replacement, and liability. (The last term refers to damage to impacting vehicles, drivers, pedestrians, or adjacent railroad equipment as a result of striking the gate arm.)

In the remainder of this section, seven new grade crossing gate design concepts will be described, analyzed briefly, and evaluated in terms of the parameters indicated above. The discussion will be divided into two major categories:

1. Gate Drive Mechanism: Low Cost Grade Crossing Gate Drive Mechanism Concept

## 2. Grade Crossing Gate Arm Concepts

- a. Swing-away gate arm support
- b. Conventional gate arm shape using new materials
- c. Multiple/expendable gate arm
- d. Grade crossing drive-over/resetting mechanism
- e. Modular gate arm
- f. Conventional gate arm shape using low-cost foam materials.

Results of comparative engineering design analysis are presented in Table 5-1.

Cost reduction estimates are provided as a percentage of current costs and are summarized in Table 5-2.

### 5.2 LOW COST GRADE CROSSING GATE DRIVE MECHANISM CONCEPT

After an analysis of AAR recommended practices which apply, and a further investigation of presently used mechanisms and the details of their construction, a conceptual design of a low cost grade crossing gate drive mechanism was completed (see figures 5-1 and 5-2) and a scale model was constructed.

The design takes into consideration recommended practice changes. These changes deal with:

- a. Grade crossing gate arm torque requirements
- b. Grade crossing gate case sealing requirements
- c. Requirement for open gearing
- d. Terminal board/binding post requirements
- e. Dielectric requirements
- f. Hold clear device

The most important point emphasized by this study is that presently manufactured units, to a great extent, do not make maximum use of low cost "off-the-shelf" components and consequently have to sell at a higher price than would be the case if "off-the-shelf" components were utilized.

TABLE 5-1 ENGINEERING DESIGN ANALYSIS

Design Concept	Light Weight	High Strength	High Rigidity	10 Year Durability	Day & Night Visibility	Res. to Weather	Res. to Vandalism	Safety Hazard	Inst'n Simpl'y	Adheres to AAR	Rating Average
4.1.1 Drive-over Resetting	F	G	P	G	E	F	G	F	F	P	73.5
4.1.2 Swing-Away Re-setting	E	E	E	E	G	E	E	E	G	G	95.5
4.2.1 Multiple Expend-able	G	F	G	P	G	F	F	G	F	G	75.5
4.2.2 Conventional New Material	E	E	E	G	G	E	G	E	E	G	94
4.2.1 Modular Foam	G	G	P	P	E	E	F	G	G	G	79.5
4.3.2 Conventional Foam	E	G	P	G	E	G	P	E	E	E	85.5
4.4 Mech-anism	E	E	E	E	N/A	E	G	E	E	*	98.1

E - 100, G - 85, F - 70, P - 50 N/A - Not Applicable

\* - Adheres to Recommended Specification Changes

TABLE 5-2 COST REDUCTION ANALYSIS

Design Co. Concept	Manufacturing	Shipping*	Installation	Maintenance	Replacement	Liability	Average
4.1.1 Drive-over Resetting	0%	0%	0%	50%	80%	10%	22%
4.1.2 Swing-away Resetting	0%	0%	0%	0%	10%	10%	2%
4.2.1 Multiple Expendable	0%	0%	0%	0%	40%	5%	7%
4.2.2 Conventional New Material	60%	16%	50%	50%	80%	10%	41%
4.3.1 Modular Foam	50%	25%	0%	50%	50%	10%	26%
4.3.2 Conventional Foam	25%	16%	50%	50%	50%	10%	30%
4.4 Mechanism	60%	67%	50%	80%	0%	0%	34%

\* Estimated to total 1/5 the cost of any of the four high cost categories.

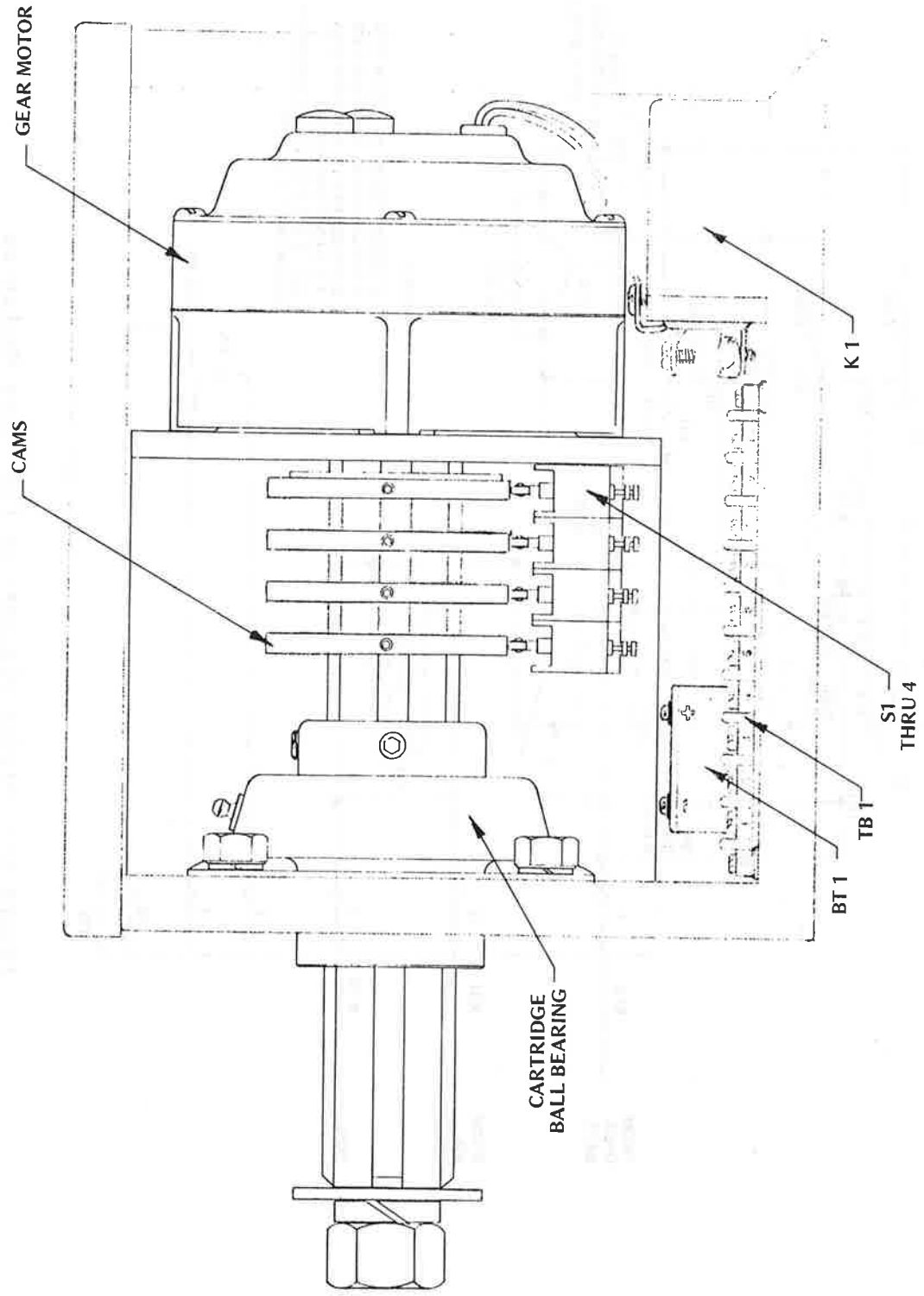

Figure 5-1 Low Cost Gate Mechanism





The second point of importance is simplicity. A simpler design helps to lower costs not only in the initial cost of manufacture and selling price, but also while in service, as a simple mechanism may be serviced more rapidly and is likely to be more reliable.

All of the components from which this conceptual mechanism is constructed are "off-the-shelf," low-cost units except the internal frame. It consists of a 7.5 inch x 19.75 inch x 3/8 inch thick plate, with 14 punched holes and 2 tapped holes, brake press formed into a 6.5 inch channel with 7.5 inch legs. Cost estimates for this frame have averaged \$11.00 when produced in quantities of several hundred.

The reason for new grade crossing gate drive mechanism concept is "low-cost" is because the components are almost 100% standard, high volume production types and the layout and quantity of parts has been kept at a minimum. The mechanism, housed in a 8 x 10 x 12 inch case, is compatible with most existing arm supports and mounts to either a 4 inch or 5 inch diameter mast as required to facilitate use of the unit with existing crossbuck/ flashing light installations.

The intent of AAR-recommended practices for the design and construction of drive mechanisms was taken into account in the design of this unit. The design does, however, follow the recommended specification changes as listed above and detailed in this report. All other applicable AAR-recommended practices discussed in this report are met by the new design.

The basic unit weighs 59 pounds, making possible installation of the mast of three steps. First, a support ring is firmly fastened to the mast at a point which will locate the mechanism at the desired height. Second, an assembly consisting of a U-bolt, strap and two nuts with washers is assembled loosely onto the mast and temporarily held by tape at a height several inches above the point where the top of the mechanism will be. Third, the mechanism is lifted into place against the mast and while holding the unit against the mast, the tape is broken and the U-bolt with strap

lowered to retain the upper projecting part of the 4 inch mounting channel. This channel serves as a saddle for mounting the mechanism internal frame solidly to the mast. After the U-bolt is in place, the unit may be released without danger of falling. A second U-bolt with strap is added just below the case and above the support ring. Both U-bolts are then tightened and the mounting procedure is complete.

If the assembly, as received from the manufacturer, has right hand configuration and operation, it can easily be disassembled and reassembled for left hand operation. With hole patterns in the housing for either mounting of the frame, the unused holes are covered by a cover plate. The only other changes necessary are reversal of two motor wires and readjustment of cams. It is estimated, based on actual test experience, that this reversing operation would require about one hour if done in the field. No special tools are required.

The layout view in Figure 5-1 shows the 10 inch x 12 inch face of the housing with the door removed. All of the components, except small electrical ones such as resistors, diodes and wiring, are shown. Figure 5-2 shows the wiring diagram for the unit. On this diagram, the relay and switches are shown in the "gate clear" (90°) condition, with relay K1 energized.

The function of the relay (K1) is to sense loss of 12 volts from the external track relay (XR) either due to normal conditions of a train entering the block or failure conditions of track relay, battery or wiring. Under any of these conditions, the relay deenergized and the circuit is completed by way of KL-A-NC to supply plus 12 volts from the operating battery (B12) to the gear motor. The circuit to return the gear motor to negative common is also completed by S2, the 6 Amp. diode, and KO-B-N.C. With this polarity of power to the motor, the gate is driven almost all the way down until the cam notch at 10° activates S2, thus removing power from the motor and connecting a dynamic braking resistor (snub) as a load across the motor terminals by way of K1-C-N.C. The motor, acting as a generator with a moderate torque load, decelerates until the gate reaches 0° at which point S3 is actuated by the notch in its cam, shorting out the snub resistor

and placing a very high torque load on the "generator." This short across the terminals of the motor causes an extreme braking action and in a few revolutions the motor comes to a stop. The gearbox has a very high ratio, greater than 2000:1, and is not backdrivable. The gate, therefore, stays in the horizontal position until the circuit configuration changes.

When 12 volts (XR) is resupplied to the coil of K1 by the reversal of any of the conditions states at the beginning of the above paragraph, K1-A-N.O. contacts complete the negative common circuit (N12) to the gearmotor, and the two contract sets K1-B-N.O. and K1-D.N.O. complete the plus 12 volt circuit (B12) of the other terminal of the motor by way of the 80° cam operated switch (S1), thus driving the gearmotor toward the gate clear position. This switch (S1) remains closed until the 80° almost clear, point at which time it opens, removing power from the motor. The weight of the gate and friction combine to stop the gate in the clear position as the 90° point is reached. Adjustment of the three cams on the main shaft is very easily accomplished making possible compensation for large ranges of gate weights and also choice of clear angle.

This mechanism, because it is not backdrivable, will not lower by gravitational force alone. If the motor and input gear friction is significantly reduced, however, the gearmotor becomes easily backdrivable by gravity. This is accomplished by the 6 volt cell (B11), which, upon loss of external operating battery power (B12) for any reason, will help gravity to drive the gate to the horizontal (0°) condition when the relay (K1) is de-energized. Note that the gate does not lower with loss only of B12. This is an advantage, as highway traffic will not be needlessly halted. Only when train enters the control block or an XR circuit failure occurs will the gate be driven down by gravity and the cell. The diode (6A100V) isolates the cell (BT1) from B12 when circuit conditions are normal.

Only when the operating power (B12) is interrupted does the energy from the cell appear at terminal 1 of TB-1. When the gate is in the clear position and B12 is in "normal" condition, the cell remains on continuous charge by way of the 5.6K resistor and the IN4002 diode.

The only maintenance requirement for the low cost gate drive mechanism is to fill the large (output shaft) ball bearing with a wide temperature range lubricant. All other parts are sealed or covered and need no attention. The gearbox contains Aeroshell #7 lubricant which is used in military gearboxes operating satisfactorily to 65° and +165°F.

Listed in Table 5-3 below are the major parts from which the scale model mechanism was constructed. Changes necessary for a full scale mechanism (with high torque capability) is the substitution of a Von Weise 2500:1 gear motor with a rating of 400 to 500 ft-lbs at 1 to 1.5 rpm. This gear box would have an integral 1-3/4 inch O.D. splined and roller bearing supported shaft. The shaft listed above, which exists separately in the model, would be replaced by an integral gear box shaft. This unit features

TABLE 5-3. LIST OF SCALE MODEL PARTS

<u>Part</u>	<u>Manufacturer and No.</u>
a) Enclosure, NEMA 3R	Gaylord 10128-14
b) Gear Motor, 150:1	PMI U9FG-150
c) Splined Shaft	Hub City 0332-00398
d) Ball Bearing Cartridge	Boston 06970-9F
e) Prec. Switches (4)	Micro BA-2SV22T
f) Relay, 25A Cont.	P-B PM17DY-12V
g) Gel/Cell 1 Ah, 6V	Globe GC-610-1A
h) Terminal Board	Cinch 355-31-10-001
i) Frame, 3/8	MBA

a high strength die cast housing, and incorporates four stages with high quality, high strength alloy gears. (The scale model uses a light weight gear box with a higher output speed and low torque capability for demonstration only.) The contacts of the cam operated switch are rated at 25 amperes and are constructed of silver-cadmium oxide. This is the same current rating and contact material as the relay.

Advantages and disadvantages of the low cost grade crossing gate drive mechanism are discussed below.

WEIGHT -- Excellent because presently used units weigh 180 pounds or more, some older designs a great deal more. This unit weighs only 59 pounds plus post mounting clamps.

STRENGTH -- Excellent because of the large ball and roller bearings, heavy shaft, high-performance sealed gearmotor and NEMA type enclosure. The frame, which is the main structural support, is made from 3/8 inch thick steel and no support forces are taken by the enclosure.

RIGIDITY -- Excellent because of the heavy frame, bearing and shaft design. The shaft is 1-3/4 inch O.D. splined and supported by a ball bearing which will support several times the static and dynamic loading which an arm could present to it under extreme conditions.

DURABILITY -- Excellent because of the high quality and long life expectancy of all off-the-shelf components selected for this design.

WEATHER -- Excellent because of the use of an industry standard housing which has been proven and accepted in the electrical industry and because of the use of internal components which are sealed.

VANDALS -- Good. The NEMA housing, although more than adequate for protection from the weather, might not be quite as impervious to vandalism as a heavy cast iron case. However, it would be better than cast iron in its resistance to breakage, since the cold-rolled sheet steel used would deform under impact rather than fracture.

SAFETY -- Excellent as it contains its own high reliability power source and will drive down many times without aid of the external operating battery circuits.

INSTALLATION -- Excellent because the design is simpler than existing systems and there is more working room inside the enclosure. The unit can be installed more easily as it only weights 59 pounds.

AAR COMPLIANCE -- This mechanism will comply with our interpretation of the AAR Standards with recommended specification changes as stated in Section 4 of this report.

Parts and weight for the low cost grade crossing gate drive mechanism are shown in Table 5-4 below.

TABLE 5-4. MODEL MECHANISM PARTS

<u>Item</u>	<u>Manufacturer &amp; No.</u>	<u>Weight (lbs.)</u>	<u>Cost+</u>
Enclosure, NEMA 3R	Gayloard 10128-14	10.9	\$ 13.50
Gear motor, 150:1	PMI U9FG 150	25.6*	100.00*
Splined Shaft	Hub City 0332-00398	(5.1)	(12.32)
Ball Bearing Cartridge	Boston 06970-9F	5.6	8.87
Prec. Switches (4)	Micro BA-2SV22T	0.1	4.42 ea.
Relay 25A Cont.	P-B PM17DY-12V	0.9	11.44
Cell/Cell <sup>r</sup> 1 AH, 6V	Globe GC-610-1A	0.7	5.50
Terminal Board	Cinch 355-31 10-001	0.4	1.60
Frame, 3/8	MBA	14.7	11.05
Misc. Electrical & Mechanical		5.0	25.00

<sup>+</sup>Approximate cost in 100 or greater quantity; 1974 prices

<sup>\*</sup>Weight of Von Weise 2500:1 gear box. Includes 5.1 lb shaft

MANUFACTURING -- The selling price to railroads of one of the lowest cost, most popular mechanisms on the market today is approximately \$1,160. The selling price of the mechanism concept suggested in this report which is constructed almost 100% from off-the-shelf high volume production components, will be approximately

\$464.00. This is a 60% reduction. The total cost of parts has been shown to be less than \$200, mechanical assembly 30 minutes, cable preparation 45 minutes, installation of cable and wires 20 minutes, continuity testing 15 minutes, functional adjustment and testing 30 minutes and shipping 15 minutes, giving a total of 2.6 manhours at \$5.75 per hour or \$15.00 total raw labor (1974 rates). To this is added overhead of \$30.00 (200%). This total of \$245.00 plus a \$219.00 gross profit (calculated at 47% of gross selling price) gives a total selling price of \$464.00. The above prices assume manufacture in quantity of 100 or more per production lot.

SHIPPING -- A popular grade crossing gate drive unit presently on the market and mentioned above weighs 180 pounds. The conceptual mechanism weighs 59 pounds, a reduction of 67% in weight and consequently shipping costs.

INSTALLATION -- Due to the light weight (59 pounds) of this mechanism, it is much easier to install.

MAINTENANCE -- There is no component in this mechanism which requires maintenance except for the heavy duty ball bearing on the output end of the shaft and the gelatinized electrolyte cell. With the use of high performance water resistant grease, the bearing will require lubrication (internal fitting) about once every 3 or 4 years. The gear box and motor are permanently lubricated and sealed, the switches are sealed, and the cell has a minimum life expectancy of 4 years. One year inspection intervals are suggested.

REPLACEMENT -- This mechanism is designed to have at least as long a life as those available on the market at the present time. The presently marketed units have an extremely long life and this mechanism will contribute no significant improvement in life expectancy.

LIABILITY -- Liability would not be changed significantly because both the traditional type mechanisms and this new concept are very similar in all respects which would affect liability.

The low cost grade crossing gate mechanism is recommended for test device development and evaluation. Comparative evaluation ratings for this concept are shown in tables 5-1 and 5-2.

### 5.3 GRADE CROSSING GATE ARM CONCEPT

Six different gate arm concepts were considered under this study. They have been subdivided into three classes as follows:

1. Class 1 - Normally Maintenance-Free Grade Crossing Gate Arm Concepts
2. Class 2 - Grade Crossing Gate Arm Concepts with Reduced Labor & Material Costs
3. Class 3 - Grade Crossing Gate Arm Concepts with Reduced Material Costs

#### 5.3.1 Class 1 - Normally Maintenance-Free Grade Crossing Gate Arm Concept

Arms of this class are maintenance-free to a degree that only under very unusual circumstances of vehicle-gate collision would the gate be damaged or destroyed.

##### 5.3.1.1 Grade Crossing Swing-Away Gate Arm Support Concept

This normally maintenance-free arm concept (see Figure 5-3) features two important operational characteristics. It is deflected away and up from the impacting highway vehicle. It is somewhat flexible and very strong so it will withstand point impact by a vehicle without shattering and with the desired swing-away motion on an angled axis. In the event a rail vehicle arrives simultaneously, it will not allow a 30 foot gate arm to come in contact with any portion of the train. The angle from vertical of the swing-away axis of the arm is 10°. This angle insures that, on impact with a vehicle, when the gate is partially deflected (45°) from its normal lowered position across the highway, the arm will provide a



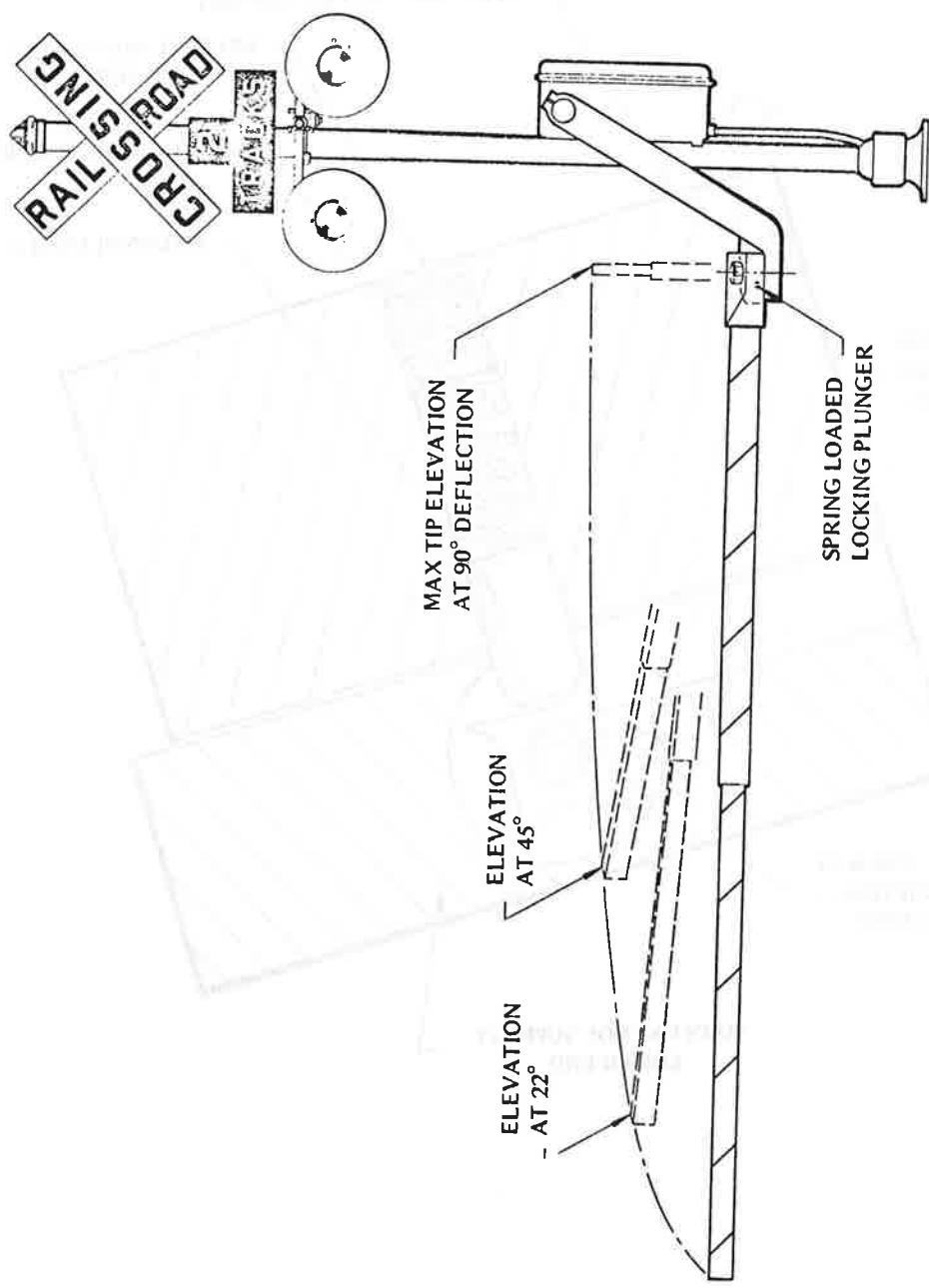

Figure 5-3. Semi-Flexible Swing-Away Arm Support

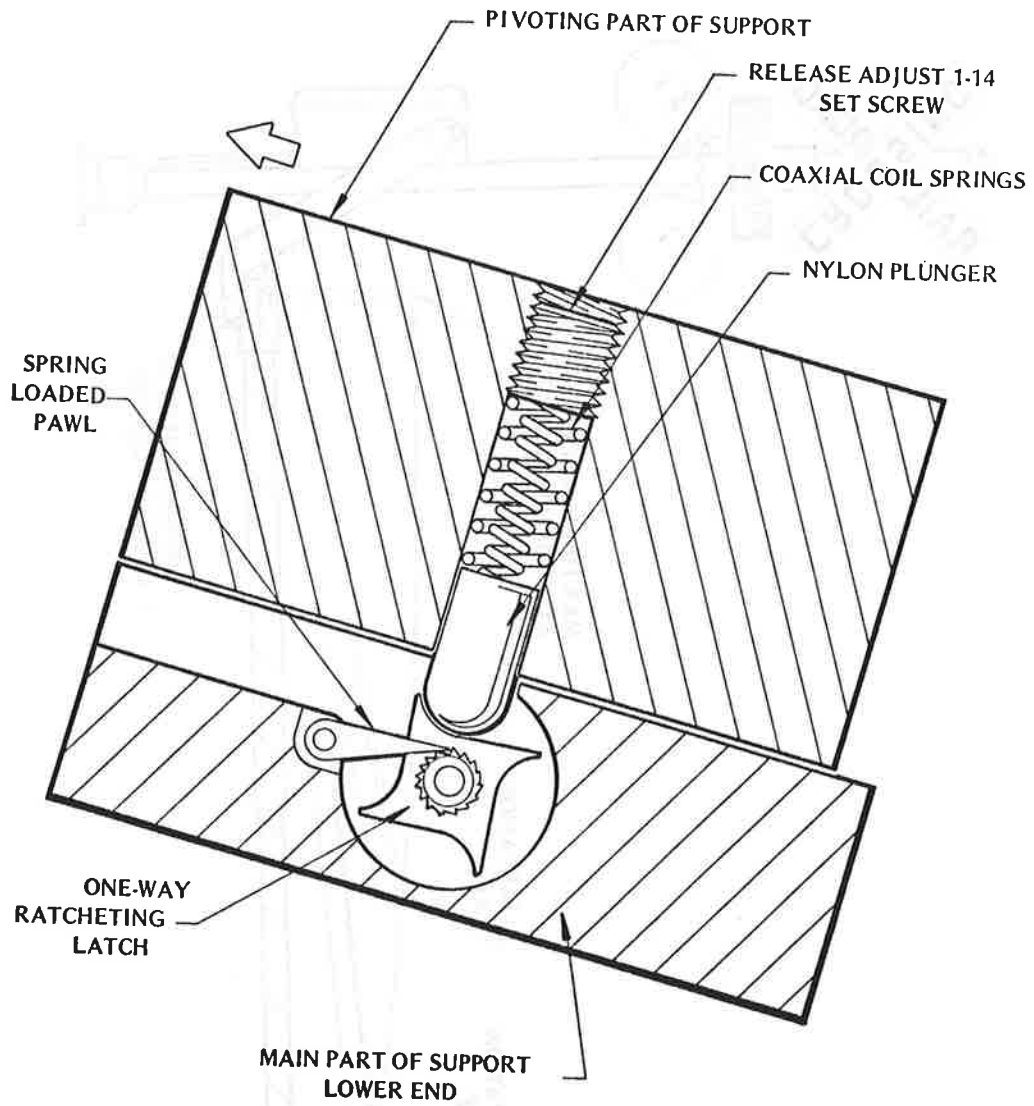

Figure 5-4. Latch-Plunger-Spring Assembly  
(Swing-Away Resetting Support)

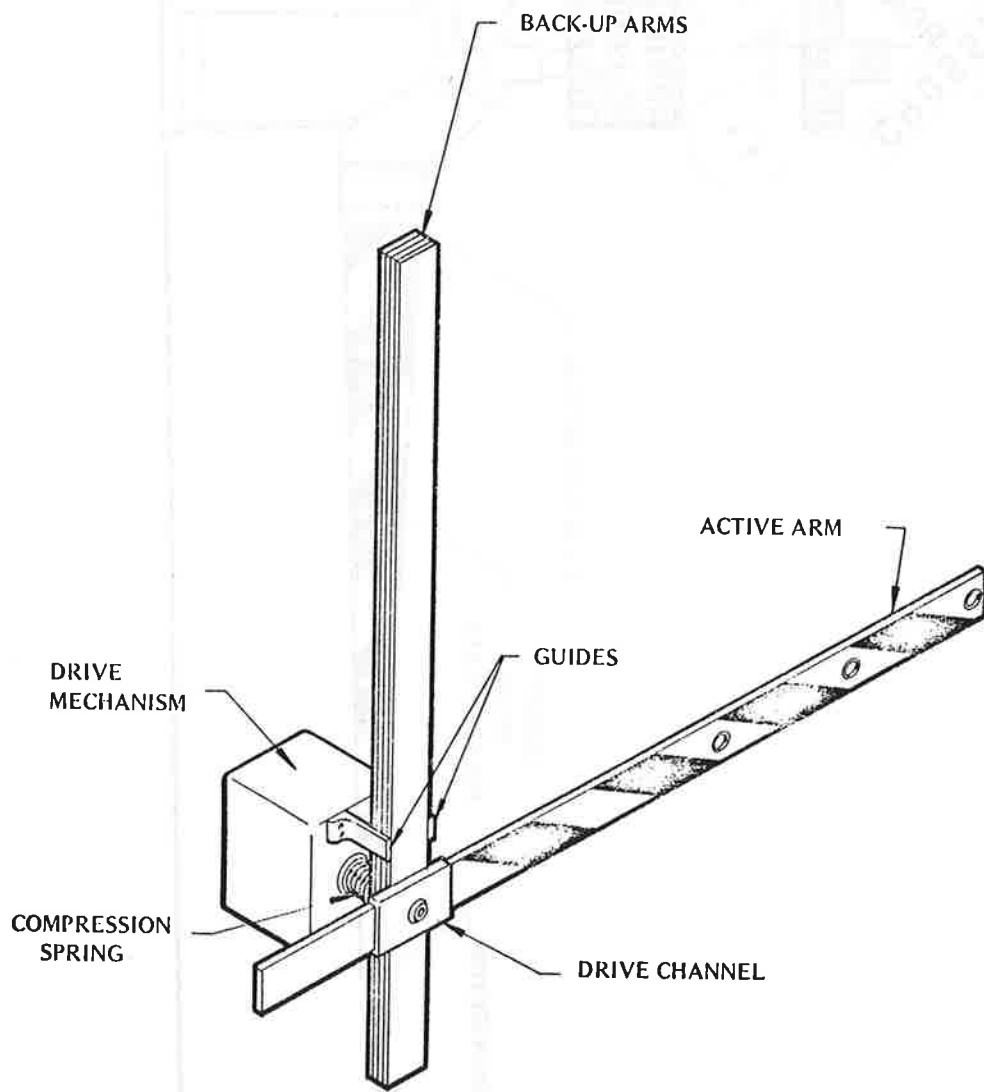

Figure 5-5. Multiple Expendable Arm

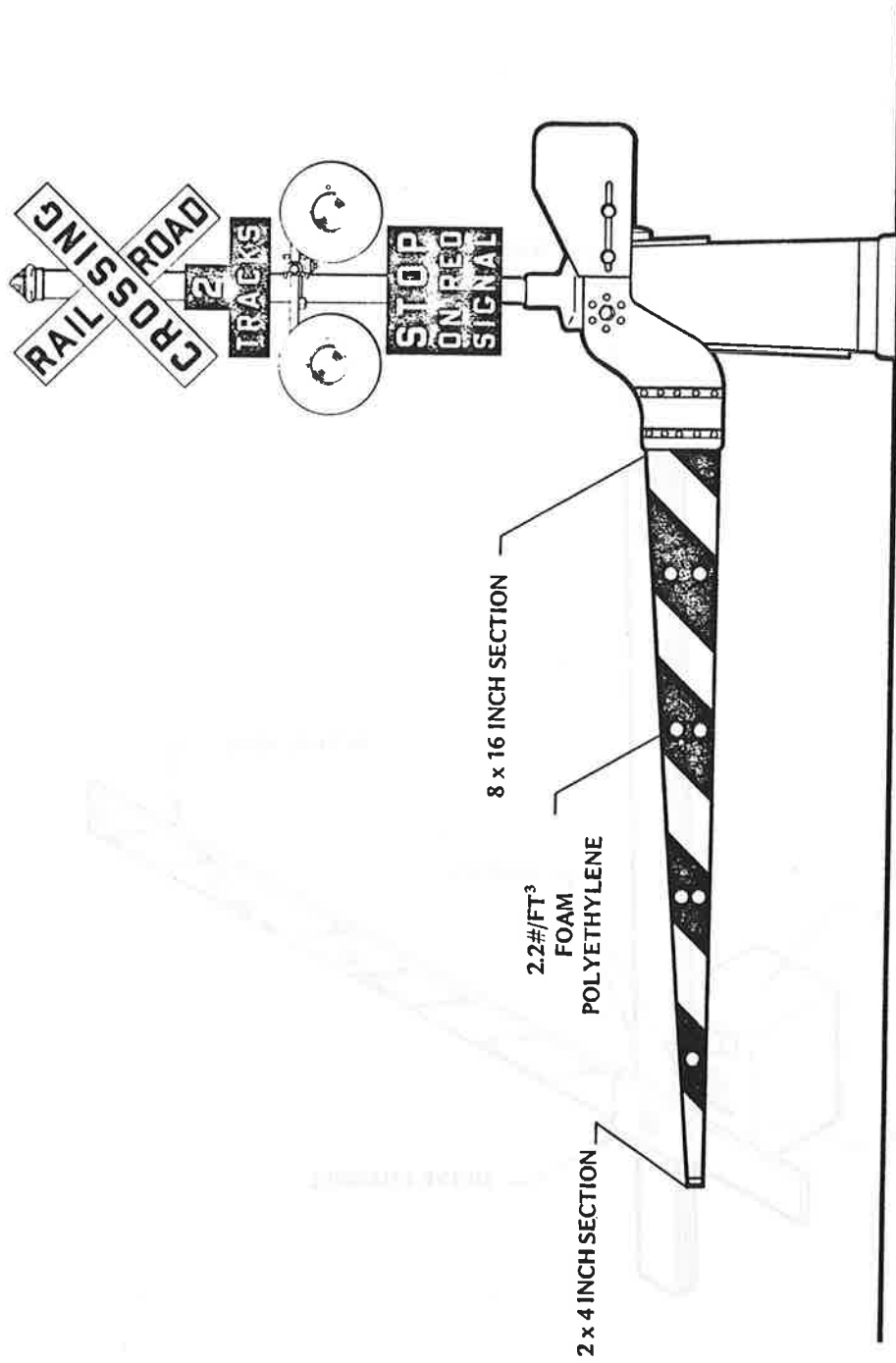

Figure 5-6. Conventional Shape With Low Cost Materials

nominal clearance of 6 feet above grade level. This is sufficient to allow all automobiles and many trucks to pass under the arm and clear of the crossing without damage to either vehicle or arm. When further deflected from its normal position ( $68^\circ$ ) this vertical clearance is increased to about 8 feet at the center of the lane nearest to the gate mechanism.

The break-away "unlocking" function occurs when a torque greater than would be produced by 100 mph winds is applied to the  $10^\circ$  pivot mechanism. A heavily spring-loaded plunger is forced by detent action to ride over a steeply ramped portion of a pawl in the mechanism (see Figure 5-9). This "unlocks" the  $10^\circ$  pivoted joint and allows the gate arm to swing freely away from the impacting vehicle. The plunger force is fully adjustable in the event the installation is in an area which never experiences very high winds. This adjustment feature may be used to reduce the force on the gate and vehicle during the break-away.

After the highway vehicle has passed clear of the arm, gravity returns the arm to the normal "locked" condition. The force required to reset and hold the end of the plunger captive is very low due to the spring loading of the pawl-like device which moves aside and allows the plunger to firmly seat and be held captive. At this point the cycle is complete with the plunger ready to again be forced over the one-way motion pawl device.

Ideally, the gate arm should be as lightweight and flexible as possible, but not to a degree which would allow undesirable resonant effects from buffeting winds or excessive curvature due to gravity when in the horizontal position. This is not meant to indicate that "standard" gate arms will not work with the above described swingway pivot support. As a matter of probability, the wood, aluminum or fiberglass gate arms presently used at most grade crossings could be used, but with more risk to the vehicle, train and arm. The presently used arms are not

lightweight enough to have a strength to inertia ratio that would insure survival of the device from many impacts. The lightweight feature also significantly reduces the amount of possible destruction to the highway vehicle. Perhaps the automobile paint might be scratched, but no window breakage, metal denting or interference with the control of the vehicle would be likely to occur, except at very high speeds.

The swing-away gate arm support assembly consists of a two piece aluminum arm support structure which attaches at one end to the drive mechanism output shaft and at the other end to the gate arm. The aluminum part to which the gate arm is bolted is mounted to the longer aluminum arm by a 10° inclined pivot and held in normal position by a detent device consisting of a threaded bore containing a 1-14 set screw, 7/8 inch diameter x 3 inch long co-axial dual coil spring adjustable to 100 pounds force and a 1 inch diameter x 2 inch long round nose nylon plunger.

The force of the spring seats the nose of the plunger in a recess formed by the aluminum on one side and a one-way latch on the other side against which the plunger is pressed when the gate is forced beyond lateral torque limits. This one-way latch is similar to the type latch most commonly used on doors, i.e., when small force is applied on one ramped face, the latch will easily move out of the way, but when great force is applied to the other side, it would break before it moved. This action forces the nylon plunger and the high force spring to move for a distance of about 1/2 inch before the plunger becomes released from the detent. At this point, the short aluminum gate support piece (with the gate arm attached) is free to move on the low friction pivot until the gate arm is clear of the impacting vehicle. The pivot pin is inclined 10° so that not only does the gate arm move away from the vehicle, but in an upward direction. After the vehicle has passed, gravity returns the arm to its original position, but in this

reverse direction of rotation about the pivot pin, the plunger does not have to exert the very high force which was required to free it from the detent. This is because of the operation of the one-way latch. The assembly is designed to break free with (adjustable) hundreds of foot-pounds of lateral torque, but to reset with only a few foot-pounds.

The plunger and latch mechanisms and the pivot bearing all use high performance plastic parts which require no lubrication.

A number of advantages and disadvantages are listed below for the swing-away arm support.

WEIGHT --- Excellent because to be most effective in operation, the arm itself is of very light, low inertia construction. The arm support, not carrying a great weight, is also lighter in weight than presently used arm supports.

STRENGTH --- Excellent because the mechanism will "unlock" upon impact before the strength of materials is exceeded and high strength alloys are used.

RIGIDITY --- Excellent because the structure is stiff enough to remain in a fixed position as well as the best of existing gates and only deflects upon peak impact loading. A 30-foot long arm may be deflected 9 feet at the tip without failure of the structure.

DURABILITY --- Excellent because the aluminum alloy support castings and the compatible lightweight fiberglass or foam polyethylene arm would both be highly resistant to degradation by weather, impact, vandals, etc.

VISIBILITY --- Good because the size and shape of its arm is similar to existing gate arms, therefore, it should be very similar in this respect.

WEATHER --- The alloy material has about the best resistance to deterioration of any similar light weight alloys.

VANDALS --- Excellent because it would reset automatically by gravitational force if vandals intentionally "unlocked" the detent. The tip swings upward, however, and with a few degrees of motion, would be beyond their reach.

SAFETY --- Excellent because of the very low inertia of the arm and consequent low probability of damage to highway vehicles. A motorcycle rider would also have more chance of surviving direct impact than he would with wood or aluminum arms.

INSTALLATION -- Good because its installation simplicity is equal to the best of the existing gates.

AAR COMPLIANCE --- Good because it can be completely compatible with construction and operational standards. It doesn't differ from existing structures as far as AAR specifications apply. Cost considerations applicable to the grade crossing swing-away gate arm support concept are discussed below.

MANUFACTURING --- There would be no cost reduction as the cost to manufacture would be about the same as existing arm supports. With the possible exception of the hydraulic type, the existing supports use counterweights. If a new type of mechanism did not require counterweights this support would weigh considerably less, but not cost less because of the addition of the pivoting and latching features of the swing-away part of the support assembly.

SHIPPING --- Weight and size would be approximately the same as existing supports, so there would be no saving.

INSTALLATION --- Any savings in installation would be a function of the weight of the arm with which this arm support interfaces, so there would be no savings due to the support. Installation costs should approximate existing units.

MAINTENANCE --- Practically zero maintenance is required by most existing supports and this unit should be no different in this respect.



REPLACEMENT --- In the cases where impact would damage the arm support as well as the arm, this support would be much more resistant to destruction than conventional nonbreaking types. There are no statistics available regarding arm support damage, so 10 percent is given as a reasonable estimate.

LIABILITY --- The savings are estimated at 10%.

The swing-away arm support concept illustrated in Figure 5-3 has important advantages and is recommended for development and evaluation.

#### 5.3.1.2 Grade Crossing Drive-Over Resetting Gate Arm

The drive-over resetting arm concept consists of a rigid arm support and a flexible flat arm with multiple flexible vertically oriented springs, each one of which supports a short portion of the horizontal 4 foot high visible reflective surface (alternate red and white). The long flat part of the arm is flexible enough so that it will assume the curvature of the "crown" of the road when fully deployed. (See Figure 5-7.)

In the event a highway vehicle does not stop when this gate is down, the individually spring-supported sections of the 4 foot high reflective part will be depressed in the direction of vehicle travel and downward as required to allow the vehicle to pass over with no destruction to either the arm or the vehicle.

A discussion of the pertinent features is included below.

WEIGHT --- Fair. The additional deflectable parts are attached to, and increase the weight of, an arm which would otherwise be about the same weight as conventional existing tubular arms.

STRENGTH --- Good. Although not high strength in the usual sense, it "gives with the punch" and therefore is resistant to damage.

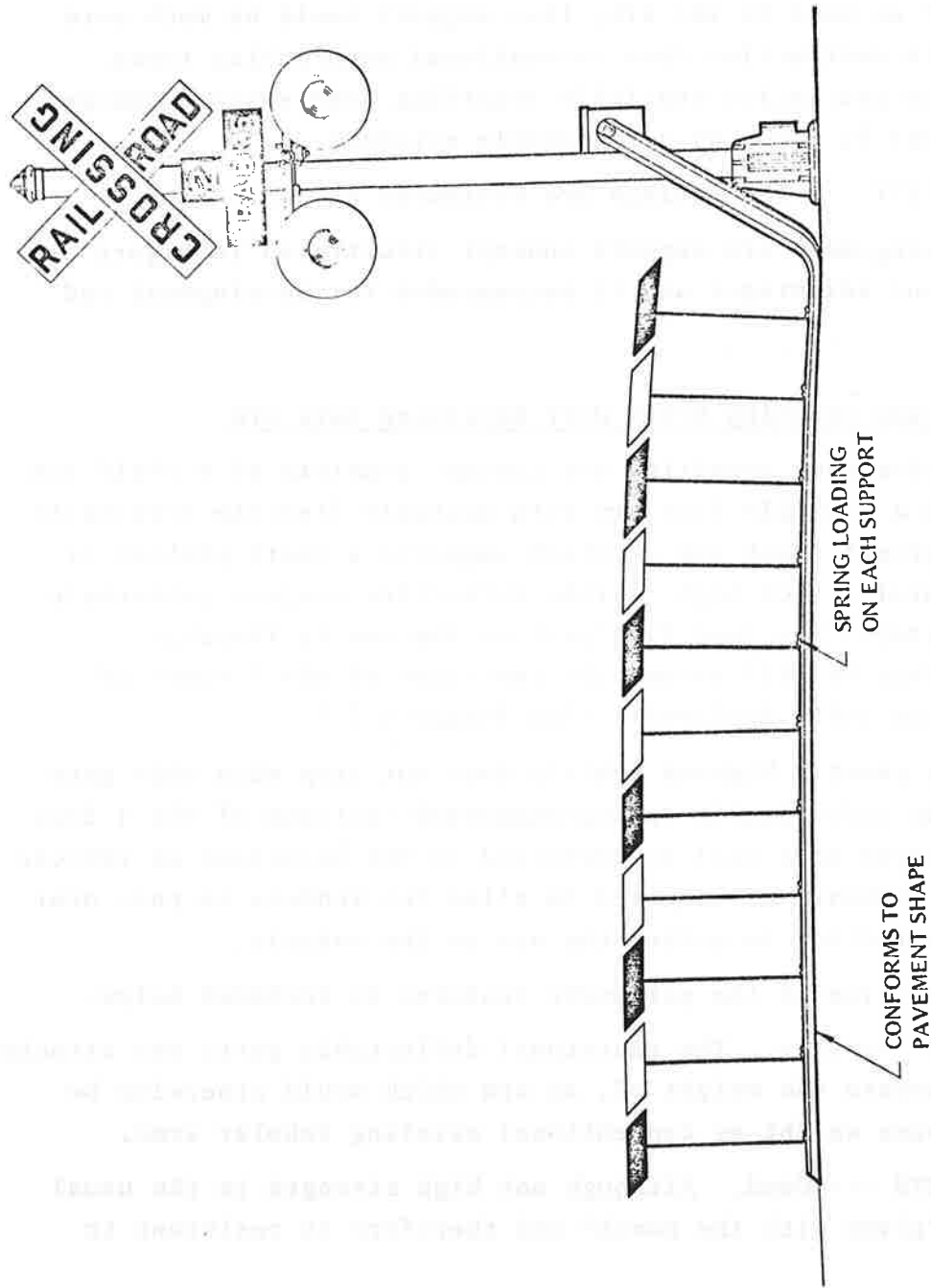

Figure 5-7. Drive-Over Resetting Arm

RIGIDITY --- Poor. In order to be sufficiently flexible to perform the two basic functions which distinguish the arm from others it must of necessity be less resistant to disturbance by winds. With further development work, however, a way of retaining the arm when in the clear position might be found and the practicability improved.

DURABILITY --- Good because, although not high strength in the usual sense, it "gives with the punch" and therefore is resistant to damage.

VISIBILITY --- Excellent because, with slight wind disturbance the individual reflective surfaces which are highly visible at night would move back and forth. This is an added attention-arresting characteristic which conventional arms do not have. In addition, the vertical, spring loaded supports could be coated with red and white reflective material, thus increasing visibility even more.

WEATHER --- Fair because of possible very deep snow on the road. The concept analyst has been assured by railroad experts, however, that this condition seldom exists, as the roads where gates would be located are kept cleared by highway department plows. The design is flexible enough to conform to several inches of hard packed snow or ice on the pavement. A large part of the country does not ever experience snow.

VANDALS --- Good because of its high strength and durability characteristics.

SAFETY --- Fair because of possible injury to motorcycle riders which might not be quite as likely to happen with an arm which was either extremely lightweight or at least deflected out of the way without entanglement.

INSTALLATION --- Fair because of the unwieldy nature of the structure. Probably an additional man or two would be required to install and adjust the arm.

AAR COMPLIANCE --- Poor because AAR specifications do not make allowance for any design except one "cantilevered four feet above the pavement."

Cost considerations for the grade crossing drive-over resetting gate arm are discussed below.

MANUFACTURING --- Zero percent cost reduction is indicated because the cost when manufactured in quantity would be about the same as wooden gates. Both are assembled from several pieces of relatively inexpensive materials. The cost saving with this type of arm would be in the areas of maintenance, replacement and liability.

SHIPPING AND INSTALLATION --- There would be no saving in shipping or installation as the attachment of the gate to the mechanism is similar to present systems and the unit weighs about the same.

MAINTENANCE --- Improved weather resistance will give this arm system a greater life expectancy. There would also be less need for the occasional adjustment which other arms require.

REPLACEMENT --- Statistics obtained from the California PUC and Southern Pacific Transportation Company indicate that for the year 1972, in this State there were 145 S.P. gate arms broken out of a total of 1,215 of the S.P. crossings which have gates. This indicates that, with at least 2.25 arms per crossing average, there were 2,734 arms installed at these crossings and the destruction per year was 5 percent. This would indicate a 50 percent destruction in 10 years. Because the concept arm would survive almost all impacts, 80 percent is a conservative estimate of the cost savings on a long term basis.

LIABILITY --- With a system which will not produce high impact forces which are experienced with currently used systems, the risk of damage to an impacting vehicle or driver would be reduced by a large factor. Ten percent is a conservative estimate of savings of cost for protection of the railroad against liability losses.

The grade crossing drive-over resetting gate arm illustrated in Figure 5-7 is not recommended for development.

### 5.3.2 Class II, Grade Crossing Gate Arm Concepts with Reduced Labor and Materials Cost

The following gate arm concepts will attain the goal of cost reduction by one or more of the following: reducing the purchase price expended per arm; reducing the number of service calls at a crossing; reducing the number of men required to install a gate; and by reduction in destruction of the gate arm when accidents occur.

#### 5.3.2.1 Multiple Expendable Grade Crossing Gate Arm

This gate arm system would reduce the purchase price per arm, reduce both the time and number of men required for installation of replacement arms and reduce damage to highway vehicles because of its very light weight. It is conceivable that an overall replacement cost savings of approximately 10 percent could be attained at crossings with a high gate destruction history.

Regardless of material and construction of the main part of the arm, the feature which distinguishes this design from presently used systems and other concepts presented in this report is the method of attachment to the mechanism output shaft and the fact that there is always a deployable arm attached to the drive with one or more "back-up" arms available and automatically brought into place upon destruction of the arm which had been in service.

The arms are constructed of very lightweight materials and are of very simple design. A number of arms are mounted on the output shaft of the mechanism by way of a simple round hole at the desired pivot point. All of the back-up arms are retained between fixed guides and oriented in the clear position. A large compression type coil spring surrounding the shaft and compressed between the mechanism and the inboard back-up arm forces the fixed back-up arm or arms against the active arm. This active arm, due to this rather large compressive force is held securely in a channel-shaped element with which the drive shaft is terminated.

Upon impact from a highway vehicle the force against the deployed arm will become great enough to fracture the arm at its weakest point, that is, at the webs on each side of the hole through which the drive shaft extends. Each of the two parted pieces are heavy enough to pull free of the drive shaft channel and fall to grade level.

At this instant, the force of the compression spring moves the outboard back-up arm against the inboard edges of the drive channel legs and upon automatic return of the mechanism shaft to the clear position the new active arm completes the axial travel on the shaft and pops into the channel. The new arm at the same instant becomes free of its former condition of being captive between the fixed guides.

During prototype development of such a system, it would be well to experiment with various means of insuring a dependable and clean parting of the arm into two pieces. A shallow groove across each side of the arm and in line with the hole would probably suffice.

Advantages and disadvantages that apply to the multiple expendable arm concept are discussed below.

WEIGHT --- Good because, after many gates are broken and automatic replacement has taken place, a service trip will eventually have to be made and many arms replaced onto the unit. Each arm is relatively lightweight. Although the lifting work done on this service trip might be much more than with presently used single arms, the total work on a long term basis would be much less.

STRENGTH --- Fair because, while strong enough to perform their normal function, the arms are intended to break under vehicle impact. It is conceivable that two or three vandals applying force laterally at the tip could break a unit just to see how it worked.

RIGIDITY --- Good because the arm could be made as rigid as desired below the peak force limit, at which point it would break.

DURABILITY --- Poor because the frangible elements are intended to be expendable and replacement parts cost would be significant.

VISIBILITY --- Good because it would be about the same size, shape and complexity as existing arms with essentially the same reflective surfaces.

WEATHER --- Fair because snow and ice conditions might interfere with the automatic replacement operation and the system at this point would be no better and no worse than presently used systems.

VANDALS --- Fair because the arm is intended to fail under high lateral loads. See comments on strength.

SAFETY --- Good because, although intended to fracture upon vehicle impact, it would break in a somewhat similar way producing one or more pieces which would constitute a hazard similar to existing arms.

INSTALLATION --- Fair because more than one man would probably be required to perform the work. Weight is an important factor during installation. See weight comments.

AAR COMPLIANCE --- Good because, as far as AAR Standards are concerned, the gates are very similar to existing gate arms.

Cost considerations for the grade crossing multiple expandable gate arm are discussed below.

MANUFACTURING --- Material costs would be approximately the same as with presently used arms. The number of service calls would be reduced, gate breakage still would occur, but with automatic replacement.

SHIPPING, INSTALLATION and MAINTENANCE --- Each of the individual arms would be of approximately the same size as existing light-weight types, and the complexity per arm would be about the same, so there would be little or no savings in these three categories.

REPLACEMENT --- A 40% cost-reduction would be experienced by the reduction in the required number of service trips per year to install replacement arms. The arms would still have to be purchased, so there would be minimal parts savings with this concept.

LIABILITY --- The inertia and resistance to deflection of an arm using this concept can be significantly lower than conventional, presently used arms; thus, reducing the risk which is an important factor in evaluating liability.

The multiple expendable gate arm concept has not been recommended for further development.

#### 5.3.2.2 Conventional Grade Crossing Gate Arm Shape Using New Materials

There are two basic shapes for arm construction that have worked well in the past and up to the present time. One is the all-wood type and usually it consists of two long thin tapered strips widely separated and attached to the metal gate arm support subassembly at the end toward the mechanism and separated by spacers and guy wires at intervals out to the tip at which point the strips are in close proximity to each other.

The other is of simpler construction, usually being tubular and of fiberglass reinforced polyester or aluminum formed to a rectangular or modified hexagonal section shape. Some designs have only a slight taper which is a function of the aluminum wall thickness and the fact that several sections telescope together to form an adjustable length arm.

The term "Conventional Shape" used in this section refers to the latter type of simple construction. The construction of the arm concept described below, however, is not conventional; the weight and cost are reduced significantly and the strength, durability, simplicity, and appearance are improved when compared to the existing wood, aluminum, or fiberglass/polyester arms.

A cross section of this arm concept is shown in Figure 5-8.



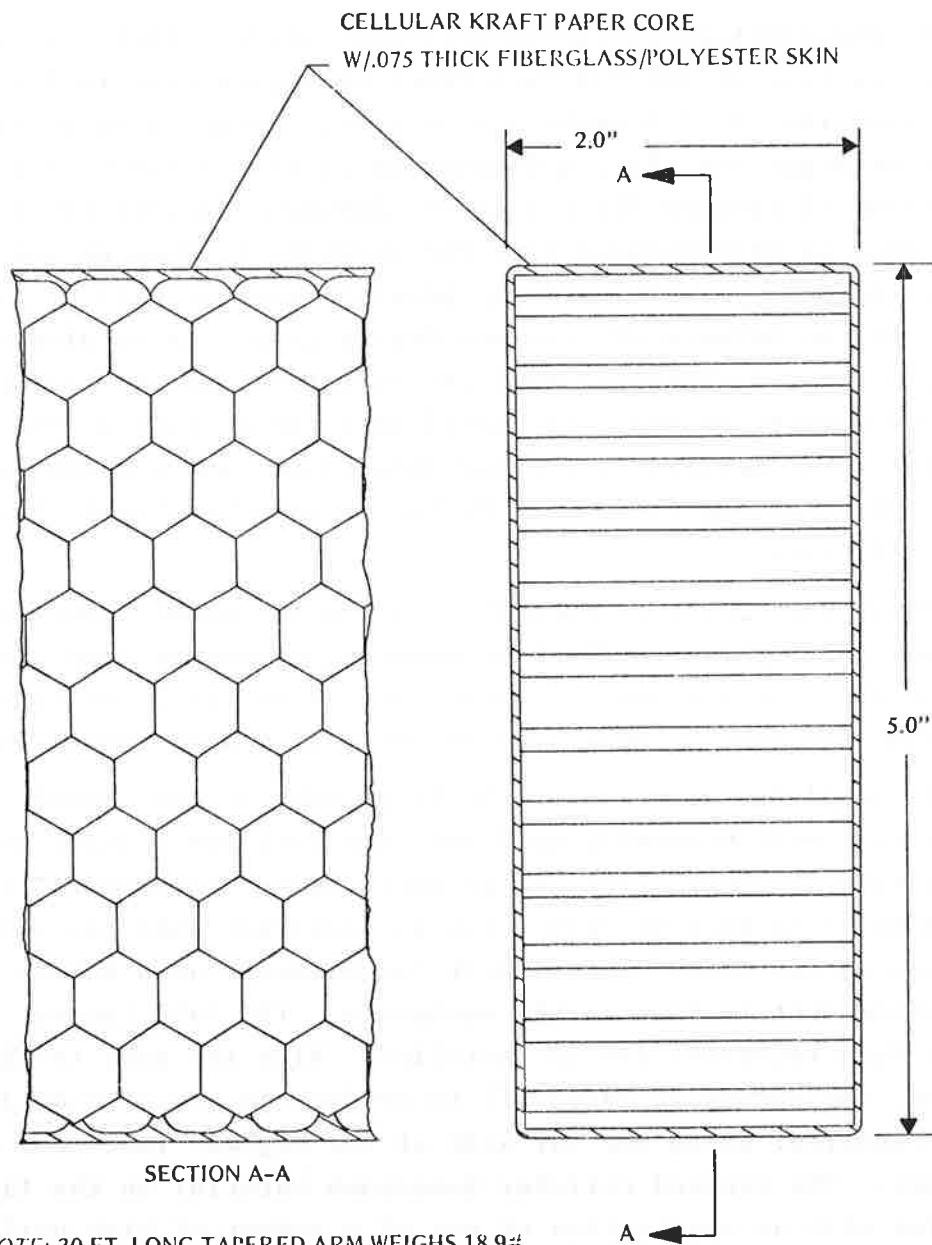

Figure 5-8. Conventional Shape With New Materials

Basically this arm is a tapered, rectangular fiberglass reinforced, polyester tube with an integral core made from phenolic resin impregnated kraft paper honeycomb.

The construction is low in cost and, stated simply, involves band saw cutting of the 1.8 inch thick honeycomb core to 4.8 inches (tapering to 2.8 inches) x 30 feet, laying it in a jig to keep it straight and flat, and spraying it with a 0.075 inch application of chopped fiberglass reinforced polyester resin. With a special multipronged jig, the spraying is done on all surfaces in one operation and any possible warpage will be avoided because of the balance of stresses during cure. As an alternate method, a long, inexpensive mold can form three of the surfaces. The glass-reinforced resin is coated onto these surfaces the honeycomb core immediately pressed into place, and a cloth lay-up and/or spray coating is applied to the exposed honeycomb, forming the fourth surface.

The resulting arm is then stripped in the usual manner with a red and white reflex reflective coating, necessary lamp assembly and support interface holes drilled, and it is ready for installation using the same methods used for presently used tubular arms.

The completed bare arm weighs 19 pounds, is considerably lighter than most presently used arms and will not require as much installation manpower. The arm is more easily "adjustable" (for any length of 30 feet or less which is required) than any which have been used in the past. This length "adjustment" need not be done before installation on the mechanism. The full length (longer than required) arm is installed. With the gate in the lowered position, the excess is sawed off to produce an arm of exactly the length required, using the far side of the highway lanes for a reference. The exposed cellular honeycomb material on the tip is protected with an application of any of a number of high performance mastic compounds such as RTV silicone rubber.

This conceptual design was planned in such a way that either rectangular aluminum tubing (6061-T655) or Tenzalloy castings may be used for the entire arm support structure except for the pivot (hinge) bearing and shaft and the detent plunger and latch. Tenzalloy is an aluminum casting alloy of exceptionally high strength. In its heat treated condition, it is superior to 6061-T6 in all respects except elongation.

A time analysis for installation, conducted during this study, shows that less than 14 minutes will be required for complete arm installation. To remove the broken stub of the old arm and install the new one complete with cable and lights in this small amount of time requires only one man having transported his tool box and a replacement arm to the site by motor truck. The 14 minutes includes the time required to remove the lights from the broken arm, remove the stub from the metal arm support, saw the arm to the desired length, seal the end with mastic and attach the salvaged (or a new replacement) cable with lights to the arm. Tools required will be a 3/4 inch socket wrench with ratchet handle, 5/16 inch blade screwdriver, 8 inch Vise Grip<sup>R</sup> pliers, hand saw, can of mastic compound and a spatula.

The only maintenance required by the Fiberglass-honeycomb assembly is the reflective surface and, of course, this is no different from that required with all gate arms.

Advantages and disadvantages of the conventional grade crossing gate arm shape using new materials are discussed below.

WEIGHT --- Excellent because a 30-foot long arm would weigh less than 19 pounds. The honeycomb core material on this length arm, with a section of 2 inches x 5 inches (tapering to 3 inches), weighs 2.71 pounds and the fiberglass skin weighs 16.2 pounds.

STRENGTH --- Excellent because the honeycomb core with integral skin concept produces one of the highest strength to weight ratios available for state-of-the-art designs. Many helicopter rotary wings use the same principle of construction.

RIGIDITY --- Excellent because the unit is of such light weight that some weight saving could be sacrificed and the added weight could be used to make possible an arm as heavy as existing types (such as wood) but much more rigid.

DURABILITY --- Good when properly supported, although the arm will break with high enough impact and so would have to be replaced. A concept which is complementary to this honeycomb arm is the semi-flexible swing-away support, to perform most satisfactorily, requires a high strength, low inertia, somewhat flexible arm.

VISIBILITY --- Good because it would be about the same size and shape as existing wood, aluminum or fiberglass arms. It would have the same size highly reflective surfaces and lighting.

WEATHER --- Excellent because the exposed glass-reinforced polyester resin will have the same properties as, for example, a pleasure boat hull which is continually exposed to strong sunlight, water and other harsh environmental conditions of a mechanical nature such as impact and abrasion. The honeycomb core is also highly resistant to damage from these causes, as it is impregnated with phenolic resin.

VANDALS --- Good because, although it would be possible for vandals to saw off the arm, or puncture the fiberglass wall with a sharp tool, it has higher beam and impact strength than existing arms. With a complementary pivoted support it would be very vandal-resistant.

SAFETY --- Excellent, because of the very low inertia of the arm and consequent low probability of damage to highway vehicles. With a pivoted support added, a motorcycle rider would also have more chance of surviving direct impact, than he would with wood or aluminum arms.

INSTALLATION --- Excellent because of the very light (19 pound) weight of a typical arm 30 feet long. Shorter arms would, of course, be lighter. One man can more easily and quickly install this type of arm than any other arm in existence. By actual test concept evaluation personnel determined that, without rushing, the removal of a similar broken arm and its replacement with a new

honeycomb/fiberglass unit can be accomplished in 14 minutes, complete with installation of lights.

AAR COMPLIANCE --- Good because, as far as AAR specifications this arm is very similar to existing arms.

Cost considerations for the conventional grade crossing arm shape using new materials (Figure 5-8 are outlined below.

MANUFACTURING --- The honeycomb core for a 30 foot long arm costs \$2.58 (1.9 cu ft)<sup>1</sup> and the fiberglass/polyster skin totaling 30 sq ft can be applied at an estimated cost of \$1.00 per square foot<sup>2</sup>. A cost of \$16 for reflectors<sup>3</sup> and mounting hole boring completes and basic arm. This totals less than \$50 per arm making possible a selling a price of between \$75 and \$100. A representative arm of tubular fiberglass presently sells for \$233.70<sup>4</sup>. Using \$88 as a median between \$75 and \$100, the honeycomb/fiberglass concept gate would offer a cost savings of 62%.

SHIPPING --- This basic 30 foot long arm weighs 19 pounds and a representative presently used light-weight unit weighs 22.5 pounds, a reduction of 16% in weight and consequent shipping costs.

INSTALLATION --- Due to its light weight, one man could install the arm.

MAINTENANCE --- Glass reinforced polyester has great resistance to deterioration due to weather effects. Its superior strength will also help to reduce maintenance costs.

REPLACEMENT --- As mentioned above, this structure has great strength and impact resistance. Ideally it would be supported by a swing type device such as the Swing-away Resetting Support

<sup>1</sup>From data furnished by Hexcel Commerical, Inc., LaMirada, California

<sup>2</sup>From Data furnished by American Fiberglass, Inc., Fremont, California and Acme Fiberglass, Inc., Hayward, California

<sup>3</sup>From data furnished by Hawkins and Hawkins Co., Inc., Berkeley, California

<sup>4</sup>From data furnished by National Electric Gate Co., Elk Grove Village, Illinois

(see Figure 4), or the existing shear pin type. The arm, when thus supported, will survive many vehicle impacts. A cost reduction estimate of 80% is justified by the above facts.

LIABILITY --- If supported as recommended above the chances of damage to either highway or rail vehicles will be significantly reduced, justifying a cost reduction estimate of at least 10%.

The conventional grade crossing gate arm shape using new materials (Figure 5-9) has been recommended for development.

### 5.3.3 Class III, Grade Crossing Gate Arm Concepts With Reduced Material Cost

Arms which are very similar in section shape to those presently used, but are not constructed from parallel strip elements (wood arms) or hollow tubes (aluminum and fiberglass) offer the possibility of cost reduction when manufactured in very large quantity. Some of these possibilities are described below.

#### 5.3.3.1 Modular Grade Crossing Gate Arm

This concept is for an arm made up of many short elements, all of which are identical. There is a product already in development by an eastern manufacturer which uses this principle. There appear to be several characteristics of existing modular type units that could be improved. Although the polycarbonate plastic from which the modules are manufactured is very impact-resistant it is relatively costly. Illumination of the arm by internal cabling may offer difficulties. The practice of supplying only one color, red or white, for a given module, might be improved by making each module red on one side and white on the other, reducing the required inventory.

The modular concept presented here is based upon assembly of each module onto threaded rod and nylon rope, as shown in the Figure 5-9. With addition of the end plate and nut, application of compression force seats the first module into the socket of the arm support, each succeeding module having seated into a mating socket on the adjacent module. With 2000 pounds of compression, the modules

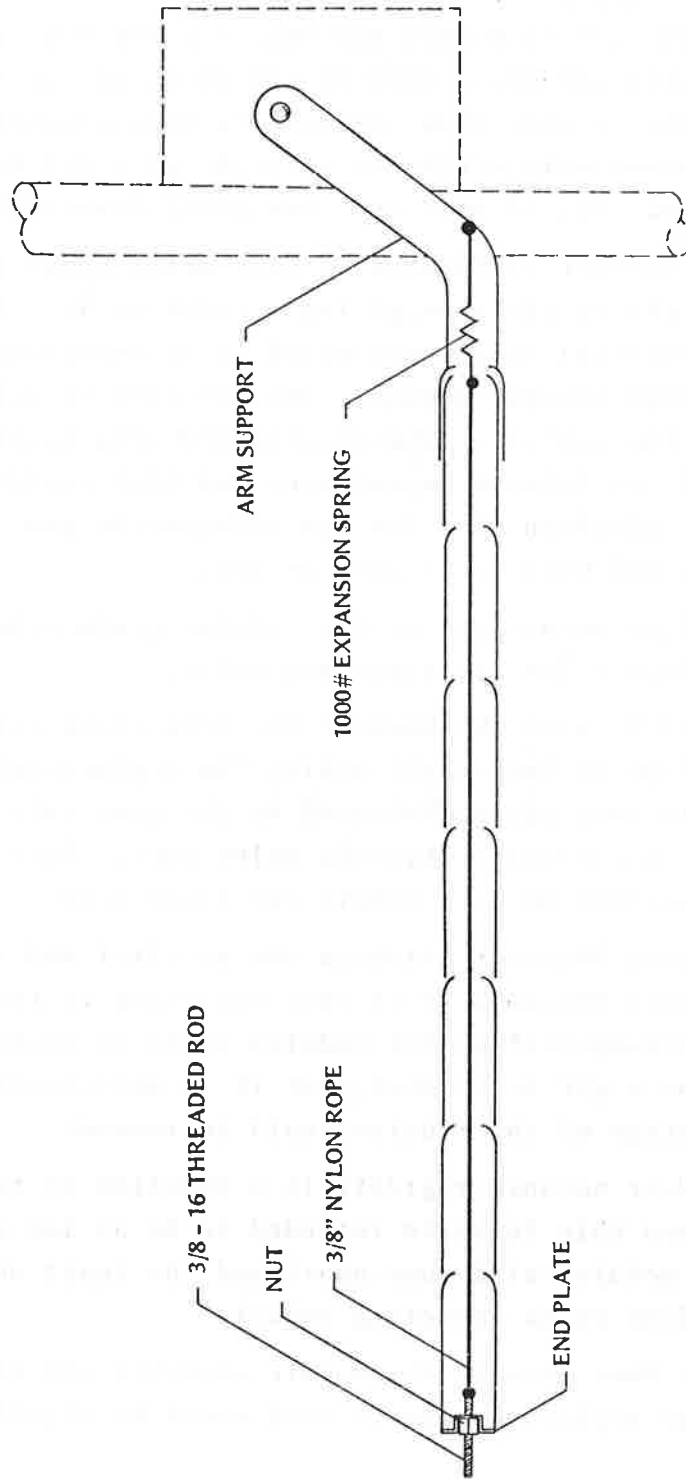

Figure 5-9. Schematic, Modular Arm With Moderate Cost

will be supported as if they are one continuous piece of rigid urethane foam. The butted ends of a 3 inch x 6 inch section would have an area of about 200 inch when the hole for the rope is subtracted. This will produce a compression of 10 psi on the interfaced surfaces. This is more than adequate to hold plastic material together which requires only a tensile strength of 8 psi to be self-supporting as an arm, if made as a one piece structure.

This arm in a 30 foot configuration will weigh about 15 pounds plus the weight of the rope giving a total of 17. There would be very low inertial forces presented to an impacting vehicle and consequent minimal damage. The arm will be deflected out of the path of the vehicle. The disarranged arm, after impact, might have some modules damaged beyond use, but most could be reused and with the addition of a few new modules the arm can be quickly reassembled and will be as good as new.

Advantages and disadvantages of the modular grade crossing gate arm shown in Figure 5-9 are discussed below.

WEIGHT --- Good because the modules are very light-weight, but the main advantage of low weight making the replacement quick and easy is to some extent defeated by the necessity of rethreading old and new modules onto the nylon rope. This will take longer than the installation of a simple one-piece gate.

STRENGTH --- Good because, although not as stiff and resistant to deflection as other designs, it is very resistant to total destruction. The arrangement of the modules would be disturbed upon impact and some might be crushed, but it is anticipated that a large percentage of the modules could be reused.

RIGIDITY --- Poor because rigidity is a function of the tension on the nylon rope and this force is intended to be as low as practicable so the modules will come apart and the least amount of damage will be done to an impacting vehicle.

DURABILITY --- Poor because the module elements are intended to be expendable and replacement parts cost would be significant.



VISIBILITY --- Excellent because, due to the low compression strength of the plastic foam used, the section dimensions in all directions must be relatively large. This provides a much larger surface for application of the reflex reflective red and white stripes. For maximum strength with minimum weight the section shape of the arm can be round and still the reflective surface will perform very efficiently.

WEATHER --- Excellent because the urethane foam from which the modules are molded has proven to be extremely resistant to sunlight, rain, snow, ice and other degrading environmental conditions.

VANDALS --- Fair because while strong enough as a deployed arm to perform its normal function as a gate, it is conceivable that two or three vandals applying lateral force at the tip could cause the separation and disarrangement of the modules.

SAFETY --- Good because, upon impact, the light weight modules would become disarranged and deflect away from the highway vehicle. The low inertia, low density foam would not constitute a great hazard, even if it directly struck a person at moderate speeds below 25 mph.

INSTALLATION --- Good because the threading and tensioning of modules can be performed by one man. See comments relative to weight.

AAR COMPLIANCE --- Good because the modular arm can be made to comply with all present specifications and by in accord with the intent of the standards.

Cost considerations for the modular grade crossing gate arm are outlined below.

MANUFACTURING --- The cost for each 16 inch long foam plastic module would be approximately \$2.40 times 23 modules, plus nylon rope, threaded rod and nut, and would total about \$60. This would make possible a selling price of \$120 which reflects a 49% reduction from the referenced gate price of \$233.70.

SHIPPING --- Not only is this type arm light weight, but the assembly may be shipped in a "knocked down" condition. A 30 foot arm would come in a 1.5 x 3 x 4 foot carton containing 23 16 inch long modules, with the one leftover module space occupied by the rope, threaded shaft, end plate, nut and spring. The packing space economies effected will make possible an estimated savings of 25% in shipping costs.

INSTALLATION --- A 50% reduction in installation manhours is estimated based on the usual two man team for existing very light-weight arms.

MAINTENANCE and REPLACEMENT --- The modular arm would require replacement of modules, not the whole gate, in the event of impact by a highway vehicle. This 50% replacement cost reduction reflects the low cost of materials and the one man required to put the gate back into service. Any required maintenance adjustments in tension can easily be performed by one man.

LIABILITY --- The costs will be an estimated 10% less because of the low inertia factor.

The modular grade crossing gate arm shown in Figure 5-9 is not recommended for further development.

#### 5.3.3.2 Conventional Shape Grade Crossing Gate Arm with Low Cost Materials

A one-piece gate arm similar to existing arms but with a constant stress taper greater than now used, could be molded from a flexible foam plastic product. The mold used would be expensive, but the resulting product manufactured in large volume could be relatively low in cost. The reason for the greater taper angle is to minimize weight. The taper selected would be a function of the strength properties of the particular foam product used.

As an illustration of this principle, foam polyethylene of about 2.2 pounds per cubic foot can be molded to a 30 foot length with a supported end section of 8 inches x 16 inches tapering to a tip section of 2 inches x 4 inches. This extreme taper would

give good wind and gravity resistance properties to the semi-flexible foam without excessive weight. Polyethylene foam is almost indestructible so this type of gate will survive many impacts. It could conceivably be destroyed on occasion if wedged into the structure of the vehicle and torn from its support. The 30 foot long gate described above will weigh only 26 pounds and can be installed by one man.

Advantages and disadvantages of the conventional shape grade crossing gate arm with low cost materials are discussed below.

WEIGHT --- Excellent because, although heavier than the 19 pounds that a honeycomb cored arm would weigh, this 100% polyethylene foam arm would be considerably lighter than most of the concepts and also existing arms. The arm inertia is low as the section is tapered and the entire mass of the arm doesn't have to deflect. This would be of great significance if the impact point was near the tip.

STRENGTH --- Good because its flexibility complements its moderate strength.

RIGIDITY --- Poor but this is not necessarily a great disadvantage as the flexible foam arm will "give with the punch".

DURABILITY --- Good because its strength, flexibility, low inertia and good weather resistance give the material long life expectancy.

VISIBILITY --- Excellent because the large surfaces will allow large areas of reflective coating or tape.

WEATHER --- Good because, although quite resistant to weather, it is not as resistant to sunlight as some of the other concept materials. The ultraviolet component of radiation causes the main degrading effect. An opaque protective coating or skin would solve the problem.

VANDALS --- Good because, the possibility of vandals chopping off part of the arm in order to obtain some free foam material would remove it from an otherwise Excellent category.

SAFETY --- Excellent because the flexibility and low inertia of this foam arm would not be liable to cause much damage at low speed to a vehicle or severe injury to the occupant even if he were a motorcycle rider.

INSTALLATION --- Excellent because of light weight which requires only one man using a wrench, pliers and screwdriver for installation.

AAR COMPLIANCE --- Excellent because the large surface affords room for even a greater area of AAR-recommended red and white reflex reflective coating than is possible on existing arms and, except for being thicker, the shape is the traditional taper used for years on wooded designs.

Cost considerations for the conventional shape grade crossing gate arm with low cost materials are discussed below.

MANUFACTURING --- Although made from very lightweight, flexible material the bulk required for stiffness entails a very large mold. Many hundreds of gates would have to be manufactured before mold costs were amortized to a point where a cost reduction could approach or possibly exceed the 50% stated for the modular foam design.

SHIPPING --- This arm would be of conventional shape but about 16% lighter in weight. This weight reduction would cause shipping costs to be less.

INSTALLATION --- Only one man of the usual two man team would be required for installation of this very light-weight unit.

MAINTENANCE --- The foam plastic has much greater stability, under adverse ambient conditions, than existing wood or aluminum units. It cannot be permanently bent as can an aluminum arm, or warped as happens to wood. The manhour savings can be 50% on a long term basis.

REPLACEMENT --- The replacement, because of light-weight construction, can be easily accomplished by one man. This is a 50% reduction of the usual two man team.

LIABILITY --- This arm also had the same low inertia as some of the other concepts described, and similarly justifies a liability cost reduction estimate of 10%.

The conventionally shaped grade crossing gate arm, using low cost materials, is not recommended for further development.

## APPENDIX B

### BIBLIOGRAPHY

"American Railway Signaling Principles and Practices," Chapter XXIII, Railroad-Highway Grade Crossing Protection, Association of American Railroads, Washington, D.C., May 1962.

"Annual Report of Railroad Accidents Reported under General Order No. 22-B for Year 1972," California, July 30, 1973. Commission, San Francisco, California, July 30, 1973.

"The Effectiveness of Automatic Protection in Reducing Accident Frequency and Severity at Public Grade Crossings in California," California Public Utilities Commission, San Francisco, California, June 1, 1973.

"Handbook of Highway Safety Design and Operating Practices," Federal Highway Administration, Washington, D.C. 1973.

Hopkins, J.B., and M.E. Hazel, "Technological Innovation in Grade Crossing Protective Systems," Federal Railroad Administration, Washington, D.C., June 1971, DOT-TSC-FRA-71-3.

"Manual of Recommended Practices, Signal Section," Association of American Railroads, Washington, D.C.

"Manual on Uniform Traffic Control Devices," National Joint Committee on Uniform Traffic Control Devices, Federal Highway Administration, Washington, D.C., 1971.

"The Model Traffic Ordinance for Municipalities," (Supplement to the "Uniform Vehicle Code"), National Committee on Uniform Traffic Laws and Ordinances, Washington, D.C., 1968.

"Railroad-Highway Grade Crossing Protection, Recommended Practices, Bulletin 6," Association of American Railroads, Washington, D.C., 1966.

"Railroad-Highway Grade Crossing Warning Systems, Recommended Practices, Bulletin No. 7," Association of American Railroads, Washington, D.C., 1974.

APPENDIX C  
INFORMATION CONCERNING STATE GRADE CROSSING REGULATIONS  
AS OF JANUARY 1975

C.1 ALABAMA (HWY DEPT)

The regulatory power is divided between the cities, counties and the State. There is no conflict with AAR practices, there are no regulations governing crossing gates, and the Highway Department is in the process of conducting grade crossing surveys using the diagnostic team approach. The State approves of the adherence to AAR Bulletin 7 by the railroads.

C.2 ALASKA (PSC)

There are approximately two dozen grade crossings in the entire State and the railroad is Federally owned and operated (USDOT). There are no State regulations and the State agency says there are no automatic gate systems, only crossbucks and flashing lights.

C.3 ARIZONA (CorpCom)

The only item shown in AAR Bulletin 7 not allowed by State law are exempt signs at crossings. The State has, in effect, General Order R-1 which is the only existing regulation governing crossings. It is similar to AAR recommended practices. Red and white stripes are being installed at crossings.

C.4 ARKANSAS (TransCom)

This State adheres to AAR Bulletin 6. There are no State regulations pertaining to grade crossings. The representative of the State agency said he knew of no reason the State would not adopt Bulletin 7 when they receive it.

C.5 CALIFORNIA (PUC)

The two State regulations existing are General Order 72-B and General Order 73-C. These State orders do not conflict with AAR practices and the State agency adheres to Bulletin 7. The State

treatment of grade crossings and Rules 360 through 368 apply to gate systems. Rule 361 states that gates shall conform to AAR specifications. Rule 362 stipulates red and white diagonal stripes on the gates. There are no conflicts with AAR Bulletin 7, but there is notable emphasis on the "GATES NOT WORKING" signs as stated by Rule 331,362.

C.14 INDIANA (PSC)

"AAR Bulletin 7 is adhered to."

C.15 IOWA (ComCom)

This State adheres in general to all AAR practices and Bulletin 7 in its entirety. Chapter 7 of the Commission regulations also applies. There are no conflicts with AAR Bulletin 7.

C.16 KANSAS (CorpCom)

AAR Bulletin 6 is currently being used, but 7 will probably be adopted "sometime in the future."

C.17 KENTUCKY (DOT)

The Kentucky Department of Transportation has some State regulations. Kentucky adheres to the recommendations of AAR Bulletin 7.

C.18 LOUISIANA (PSC)

The State takes no stand relative to AAR practices, but there is one law that applies. "All motor vehicles must stop at all railroad crossings" and then proceed when safe to do so, and then 'at your own risk.'

C.19 MAINE (PUC)

AAR Bulletin 6 was stipulated by the State to govern gates and crossing; it was anticipated that Bulletin 7 would be considered for adoption.

C.20 MARYLAND (HWYADMIN)

Maryland is adhering to AAR Bulletin 6 for existing crossings and Bulletin 7 for upgrading and new construction.



C.21 MASSACHUSETTS (DPU)

Many Massachusetts gate arms are painted yellow and black, but, in general, AAR Bulletin 6 is used to govern practices at crossings.

C.22 MICHIGAN (PSC)

State specifications do not explicitly refer to AAR standards, but agree with AAR practices and one drawing (Flashing Light Signal) references the rules of "the AAR Signal Section."

C.23 MINNESOTA (HWYDEPT)

Both Bulletins 6 and 7 are currently used as standards and sent by mail the "PSC Engineering Rules and Specifications, Chapter 8" which deals with crossings. In this specification the AAR and the Minnesota MUTCD are referenced as basic standards.

C.24 MISSISSIPPI (PSC)

AAR Bulletin 7 and its referenced Signal Manual Sections are used as standards "except when it was impractical." There are no State crossing regulations.

C.25 MISSOURI (PSC)

With the exception of the retention of "STOP ON FLASHING LIGHT" and "STOP ON RED SIGNAL" signs this State adheres to the recommendations of AAR Bulletin 6. Bulletin 7 is of recent issue and they have not adopted it yet.

C.26 MONTANA (DEPT OF HWYS)

There is one State modification to AAR practices. It is shown in Montana highways Drawing No. 88, and applies to guard rails. As stated on the drawing, Montana adheres to AAR Bulletin No. 6.

C-27 NEBRASKA (PSC)

State does not adhere to AAR Bulletins, but there is some State regulation of grade crossings contained in Statute no. 75-410 and 75-416. The statutes detail the State jurisdiction over crossings, but do not cite practices and specifications. They have been cooperating with a University of Illinois crossing improvement priority survey.

C.28 NEVADA (PSC)

Nevada does not reference AAR grade crossing standards or practices in any of its official regulations. The existing railroad regulations apply to such things as clearances. These are detailed in Nevada Public Service Commission Case No. 1159, May 28, 1947.

C.29 NEW HAMPSHIRE (PUC)

New Hampshire adheres to AAR Bulletin 6, but has no objections to 7 although none of the gates in the State have been changed to red and white. The Director of Transportation said that there was no official word as to when Bulletin 7 would be adopted, but he thought upgrading the gate colors would be slow as they do not have much gate breakage.

C.30 NEW JERSEY (DPU)

Bulletin 6 is the currently used standard for grade crossing practices, but there was no conflict with AAR Bulletin 7. No additional State grade crossing laws or regulations exist.

C.31 NEW MEXICO (CorpCom)

New Mexico uses AAR Bulletin 7 with no exceptions. There are no State regulations or laws in existence regarding grade crossing specifications or practices.

C.32 NEW YORK (DOT)

Bulletin 7 and the AAR Signal Manual are used as the governing standard for crossing practices and red reflective tape is being added to existing gate arms in order that they meet current specifications.

C.33 NORTH CAROLINA (DOT)

This State adheres to AAR Bulletin 7 and is changing to the red and white gates as specified. There are no special State laws or regulations regarding crossing gates.

C.34 NORTH DAKOTA (PSC)

The special State publication about grade crossing standards and practices is very interesting and quite complete. They have incorporated AAR Bulletin 4 and AREA Construction and Maintenance practices into one handy pocket size State standard publication. It contains 36 drawings with the associated text and, except for the fact that they have not updated it by substituting Bulletin 7 material, is one of the most useful of all the State publications.

C.35 OHIO (PUC)

Ohio adheres 100% to AAR Bulletin 7 and has no additional State regulations about grade crossing gates.

C.36 OKLAHOMA (CorpCom)

This State, in addition to using AAR Bulletin 6 as its basic grade crossing standard, has Corporation Commission Statutes, Title 17 and General Orders 54350 and 62082 governing the practices at grade crossings. These orders reference AAR Bulletins 5 and 6 respectively. The State does not recognize Bulletin 7, as yet.

C.37 OREGON (PUC)

AAR Bulletin 6 is referenced in Oregon Public Utility Commission Administrative Rules, Chapter 860 Subdivision 2(42-070) and the entire part pertaining to crossing gates is very similar to AAR practices. Oregon does not specifically adhere to AAR Bulletins 6 or 7.

C.38 PENNSYLVANIA (PUC)

This State complies with the practices as contained in AAR publications and Bulletin 7 in particular.

C.39 RHODE ISLAND (DOT)

This State uses AAR Bulletin 7 for grade crossing standards. There is only one basic State law that the railroads must place warning signs at all railroad crossings.

C.40 SOUTH CAROLINA (PSC)

There is only one State law concerning grade crossings, the railroad must install crossbucks at all crossings. They were governed by AAR Bulletin 7 for all crossing maintenance and new construction.

C.41 SOUTH DAKOTA (DOT)

The State of South Dakota has apparently taken an official stand, "Gate arm installations are not desirable in South Dakota." Both railroad and vehicle traffic is so low in speed and volume, and the number of crossings relatively so few, that the expense of the automatic gate installations is not justified. The State is not concerned with grade crossing standards; it is up to the railroads.

C.42 TENNESSEE (PSC)

There is only one Tennessee State law, and that can be paraphrased as; "crossbucks, the design of which is up to the railroad, must be placed at each railroad-highway grade crossing." This State officially adheres to AAR Bulletin 7 for Crossing practices.

C.43 TEXAS (HWYDEPT)

Texas is nearing completion of a program of upgrading all gate arms to the new red and white colors and, of course, all new installations are the same. The AAR Bulletin 7 is used to regulate the practices at all crossings. The State of Texas and also its educational institutions such as Texas A and M University (Texas Transportation Institute) have been very active in promoting improvements in grade crossing safety.

C.44 UTAH (PSC)

The State of Utah abides by AAR Bulletin 6 and also has generated its own General Order No. 61 to go with 6 and subsequent grade crossing bulletins as they occur. This General Order has, from time to time, been updated by referencing the latest AAR Bulletin by way of a "Supplement." The latest is Supplement No. IV.

C.45 VERMONT (PSB)

The gates at crossings in this State are being changed to red and white, they abide by AAR Bulletin 7, and there are no special State laws or regulations regarding gates.

C.46 VIRGINIA (HWYDEPT)

The Virginia Highway Department has sent a letter to all railroads operating in the State indicating a deadline of 21 December 1974 for all existing and new gates to be painted red and white. Virginia has no special State laws or regulations regarding crossing gates, but they do adhere to AAR Bulletin 7.

C.47 WASHINGTON (UTCom)

Washington adheres to AAR Bulletin 6 and is in the process of upgrading the gate colors to red and white so as to conform with 7. The only other exception to Bulletin 7 is the fact that Washington State Statutes do not allow "EXEMPT" signs. The personnel in the Utilities and Transportation Commission have been doing a large computer-aided study of grade crossing problems.

C.48 WEST VIRGINIA (DEPT OF HWYS)

West Virginia has adopted AAR Bulletin 7 in its entirety with a minor qualification regarding clearances of signal equipment and supports. Their position is that the AAR recommendations may very well be safe, but their own engineers should evaluate each clearance situation in question before the installation is approved by the State.

C.49 WISCONSIN (PSC)

The AAR Bulletin 6 recommendations are followed, but some red and white gate arms exist, mainly at new installations. The State has published a few PSC regulations, but they are not of the type found in Bulletin 7. A study of grade crossing accidents has been completed.

C.50 WYOMING (HWYDEPT)

The State of Wyoming adheres to AAR Bulletin 6 and also has some State regulations, none of which conflict with AAR recommendations.

STATE CROSSING GATE SURVEY

STATE	AGENCY	PHONE	CONTACT	AAR Bul.	State Regs	REMARKS
Alabama	PSC	205-269-6584	James Hooks	7		No regs
Alaska	PSC	907-465-3500	Robert Ditman, Gov's Legis Asst.			No regs, all US Gov RR. No gates, all flashing lights, only ten crossings.
Arizona	Corp Com	602-271-3316	W. E. Critchley		*	Gen. Order R-1 is only reg and is similar to Bul #7 (Red & Wh Refl Stripes)
Arkansas	Trans Com	501-371-1341	W. M. Buttram, Ch. Admin.	6		No regs
California	PUC	415-557-2641	E. C. Cole, Sr. Trans Eng'r	7	*	Gen. Order 72B & 75C are only regs
Colorado	PUC	303-892-3171	Jack Baier, R. R. Div. Eng'r	6		Branch or Spur may substitute standard Eagle Signal type lights for gate arms.
Connecticut	PUC	203-566-2048	Ken Faust, R. R. Des'n Eng'r	5		Bul. 6 & 7 by law are invalid; signs are retained. There are no state regs.
Delaware	Div Hwys	302-571-2623	Andy Rispoli, Ch. Admin	7		No regs
Florida	DOT	904-488-6721	Lamar Hargrove	7		Document to supplement Bul. 7 will be published.
Georgia	DOT	404-656-5450	Walter Anderson, Hwy Util. Eng'r	6&7		No regs but other relevant information
Hawaii	PUC	808-548-6590	Leroy Yuen	No		No regs and very few crossings
Idaho	PUC	208-384-3420	M. Bourner, Exec. Sec.	6	*	Pub. Util. Law Title 62, Chap. 3 is only reg and has to do with admin procedures
Illinois	Com'ce Com	217-782-7660	Dan Drewes, Sig. Eng'r	7	*	Gen. Order 138 is the only reg and it refers to the "current signal regulations of the AAR."
Indiana	PSC	317-633-4173	John Dring, Dir., RR Dept	7		AAR Bul #7 is "religiously adhered to"
Iowa	Com'ce Com	515-281-5844	Ralph Pilger, Eng'r, RR Div	7		Com'ce Com Law--Chap. 7 is only reg
Kansas	Corp Com	913-296-3320	R. R. McKinley, Dir of Trans	6		AAR Bul #7 will probably be used in the future
Kentucky	DOT	502-564-7650	Paul Hunley, Trans Att'y	7		No regs. They sent a copy of Bul 7
Louisiana	PSC	504-389-5867	J. W. Henderson, Ch Admin	No		Law requires--"Stop & Proceed at Your Own Risk" at all RR/highway crossings (antiquated)
Maine	PUC	207-289-3686	James McCabe, Sig. Insptr	6		AAR Bul #7 will be checked and possibly used
Maryland	Hwy Admin	301-383-4481	Thomas Hicks, Ch. Saf. Eng'r	6		New constructed and upgraded old Xings per Bul #7
Massachusetts	Dept of PU	617-727-3542	Jack McCabe, RR Ch. Insp	6		AAR Bul #6 does not conflict with any reg. Their gates are yellow & black
Michigan	PSC	517-373-3250	C. E. Magoon, Sup. RR Sect.	No	*	Their statutes not identical to AAR
Minnesota	Hwy Dept	612-296-2472	Merritt Linzie, RR Negoc Eng	6&7	*	PSC regs 220 to 225 apply to Xings
Mississippi	PSC	601-354-7582	G. D. Elliott, Dir of Trans	7		AAR Bul #7 used except when impractical
Missouri	PSC	314-751-4215	Gene Shackelford, RR Saf. Super	6		AAR Bul #6 used except "Stop on Flashing Light"

STATE CROSSING GATE SURVEY (CONTINUED)

STATE	AGENCY	PHONE	CONTACT	AAR State Bul. Regs	REMARKS
Montana	Dept of Hwys	406-449-2564	James W. Hahn, Ass't Ch P&R Bur	6 *	State regs only re: Guard rails; shown on Ref. Std Spec Sec 90, Dwg #88
Nebraska	PSC	402-475-2641	Arnold Reimer, Sig Eng'r	No *	Neb. Statute #75-410 & 416 gives state jurisdiction over all Xings but does not cite practices
Nevada	PSC	702-885-4180	C. Austin, Exec. Sec.	*	State regs apply to clearances only.
New Hampshire	PUC	603-271-1110	Winslow Melvin, Dir of Trans	6	No objection to 7 but not implemented, no R&W gates
New Jersey	Dept of PU	201-648-2343	Frank Lagana, Princ'l RR Insp	6	No conflicts with Bul #7, No regs on gates
New Mexico	Corp Com	505-827-2201	John Elliott, Dir of Pub Rel	7	No regs
New York	DOT	518-457-4430	Bill Hennessy, D. O. T.	7	No Gate regs, adding red tape to go w/7
North Carolina	DOT	919-829-3915	Jimmy Litch, Sig Eng'r	7	No regs. Are changing to Red & Wh Refl
North Dakota	PSC	701-224-2400	Walter Owen, RR Saf Eng'r	4 *	They have incorporated all of Bul #4 into State Stds.
Ohio	PUC	614-466-2304	Chas. R. Geer, Ch. RR Insp'r	7	No regs. Adhere 100% to Bul #7
Oklahoma	Corp Com	405-521-3407	T. Earl Curb, Att'y for Corp Com	6 *	CC regs, Title 17 & Gen Orders 54350 & 62082
Oregon	PUC	503-378-6351	David Astle, RR Div Admin	No *	PUC Admin Rules, Ch 860-Subdiv 2 is similar but not identical to AAR Bul #7
Pennsylvania	PUC	717-787-5188	Ray A. Peteritas, Sig. Eng'r	7	They handle each Xing on its own merit
Rhode Island	DOT	401-277-2481	Wendall Flanders, Assoc. Dir.	7	No regs. RRs must have signs.
South Carolina	PSC	803-758-2541	Ben Alverson, Ch. Rails & Tar.	7 *	Only one reg. RRs must place crossbucks
South Dakota	DOT	605-224-3567	Douglass Haeder, RR Saf Dir	No	"Gate Arm Installations are not desirable in S. D." D. H. sent copy of their response to Univ of Ill. survey
Tennessee	PSC	615-741-2754	W. B. Pemberton, RR Saf Dir	No	Only one reg, crossbucks must be placed the design of which is up to the RRs.
Texas	Hwy Dept	512-475-4662	John Dodson, Sup. RR Sect.	7 *	Most gates have been upgraded to R&W Refl
Utah	PSC	801-328-5511	Ron E. Casper, Exec. Sec.	7 *	Gen. Order #61 is Utah supplement to Bul #7
Vermont	PS Bd	802-888-3655	Silas Carpenter, Util. Eng'r	7	No regs. Gates are being changed to red and white.
Virginia	Hwy Dept	804-770-2934	Vernon King, RR Eng'r	7 *	No regs but have notified all RRs they will change all gates. Sample letter received
Washington	U&T Com	206-753-6423	Leon Kegley, RR Eng'r Sup.	6	No regs codified--doing computer study. New gates are red & wh. but exempt signs not allowed.
West Virginia	Dept of Hwys	304-348-3722	Ken F. Kobetsky, Dir Traf Eng	7	Recently adopted Bul #7 w/minor modifications. Kobetsky heads RR Xing Diagnostic Team Program.
Wisconsin	PSC	608-266-2321	Rex Montgomery, Dir RR Saf Bur	6 *	PSC regs. Some red & wh is being installed. Have done accident study.
Wyoming	Hwy Dept	307-777-7492	Peter Harrison, Sig Des'n Eng'r	6	

\* = Rec'd State Regulations