

FAA-75-8.II
REPORT NO. FAA-RD-75-120.II

AIRPORT SURFACE TRAFFIC CONTROL CONCEPT FORMULATION STUDY

VOLUME II - OPERATIONS ANALYSIS
OF O'HARE AIRPORT - PART I

F. D'ALESSANDRO
W. HEISER
G. KNIGHTS
P. MONTELEON
R. REFFELT
R. RUDMANN
W. WOLFF



JULY 1975
FINAL REPORT

DOCUMENT IS AVAILABLE TO THE PUBLIC
THROUGH THE NATIONAL TECHNICAL
INFORMATION SERVICE, SPRINGFIELD,
VIRGINIA 22161

Prepared for
U. S. DEPARTMENT OF TRANSPORTATION
FEDERAL AVIATION ADMINISTRATION
Systems Research and Development Service
Washington, D.C. 20591

1. Report No. FAA-RD-75-120. II		2. Government Accession No.		3. Recipient's Catalog No.	
4. Title and Subtitle AIRPORT SURFACE TRAFFIC CONTROL CONCEPT FORMULATION STUDY Volume II - Operations Analysis of O'Hare Airport-Part I				5. Report Date July 1975	
				6. Performing Organization Code	
7. Author(s) F. D'Alessandro, W. Heiser, G. Knights, P. Monteleon, R. Reffelt, R. Rudmann, W. Wolff				9. Performing Organization Report No. DOT-TSC-FAA-75-8. II	
				10. Work Unit No. (TRAIS) FA321/R6134	
9. Performing Organization Name and Address Computer Sciences Corporation* 6565 Arlington Boulevard Falls Church, VA 22046				11. Contract or Grant No. DOT-TSC-678	
				13. Type of Report and Period Covered Final Report September 1973-February 1975	
12. Sponsoring Agency Name and Address U. S. Department of Transportation Federal Aviation Administration Systems Research and Development Service Washington, DC 20591				14. Sponsoring Agency Code	
				15. Supplementary Notes *Under contract to: U. S. Department of Transportation Transportation Systems Center, Kendall Square, Cambridge MA 02142	
16. Abstract This four volume report presents system concepts for use in semi-automated airport surface traffic control at all positions in the tower cab of the major airports. The control functions and data requirements of a Ramp Control System, a Ground Control System, and a Local Control System are presented. The concept development process has been based upon an extensive study of cab operations at O'Hare Airport. This effort has included extensive delay analysis, study of communication tapes, and personal observations of the widely-varying situations that are faced by tower controllers. Following the Operations Analysis effort, a detailed study of requirements was performed and is presented in Volume IV of this report. This requirements effort provided an estimate of the performance requirements of a surveillance sensor that would be required in a TAGS (Tower Automated Ground Surveillance) system for use in both good and poor visibility conditions. Detailed studies were made of the complex type of conflicts to be solved by both the Ground and Local Controllers and operational levels and densities were developed. One particular TAGS system concept (employing an ATRBS Trilateration Surveillance Subsystem) is described in Volume I and an estimate is made of its deployment potential at major airports. Backup material on this concept in the form of a working paper is held by TSC. This working paper also includes synthetic digital display concepts for the three systems which have been summarized in Volume I.					
17. Key Words Airport delays, requirements capacity analysis, communications, synthetic displays, ATRBS Trilateration, deployment estimates			18. Distribution Statement DOCUMENT IS AVAILABLE TO THE PUBLIC THROUGH THE NATIONAL TECHNICAL INFORMATION SERVICE, SPRINGFIELD, VIRGINIA 22161		
19. Security Classif. (of this report) Unclassified		20. Security Classif. (of this page) Unclassified		21. No. of Pages 220	22. Price

PREFACE

At tower-equipped airports, the controllers in the tower cab are responsible for those aspects of Airport Surface Traffic Control (ASTC) requiring centralized management: issuing clearances for aircraft to land, taxi, or take off; establishing routing patterns for arriving and departing aircraft on the runway/taxiway network so as to minimize delays; sequencing aircraft movements on runways and taxiways and at critical intersections to ensure safety; and controlling the movements of service or emergency vehicles on the airport surface. Because of the expertise of the controllers and pilots, the ASTC system has worked well most of the time. However, the unfortunate incidents at Chicago-O'Hare (20 December 1972) and Boston-Logan (31 July 1973) have pointed out certain deficiencies; e.g., the system's surveillance capability when visibility is poor.

Initiated by the Federal Aviation Administration (FAA), the ASTC program is in the process of implementing several near-term system improvements. However, it is expected that these improvements, while adequate for the 1970's, will not be adequate to meet the more stringent long-term requirements of the 1980's.

The approach which has been taken in the present study is to concentrate on the Nation's most active and, in one sense, most mature airport; i.e., Chicago-O'Hare. In performing the study at O'Hare, the cooperation of the Airport Traffic Control Tower, the City of Chicago Department of Aviation, and the FAA Great Lakes Region was essential to the success of the effort. Mr. Paul S. Rempfer, of the Transportation Systems Center (TSC), acted as technical monitor for the Government. In addition, Messrs. Rempfer and L. Stevenson, also of TSC, performed the theoretical analysis of local area capacity which is presented in Section 5.3.3.1 of Volume III.

TABLE OF CONTENTS - VOLUME II

	<u>Page</u>
<u>Section 1 - Introduction</u>	1-1
1.1 General	1-1
1.2 Overview of Study	1-1
1.3 Description of Operations Analysis	1-4
<u>Section 2 - Operations Analysis Approach</u>	2-1
2.1 General	2-1
2.2 Establishing the Basis for Analysis	2-1
2.3 O'Hare Operations Effectiveness Analysis Approach	2-8
2.3.1 General	2-8
2.3.2 Fuel Consumption Assessment	2-9
2.3.3 Operating Cost	2-11
2.3.4 Passenger Inconvenience Assessment	2-12
2.3.5 Summary of Effectiveness Measures	2-14
2.4 Methodology for Functional Analysis of ASTC System Operation	2-16
2.4.1 Controller Task Analysis	2-19
2.4.2 Aircraft Flow Analysis	2-28
2.4.3 Airline Operations Analysis	2-36
2.4.4 Airport Management Operations Analysis	2-40
2.5 Projection of the Future Operating Environment at O'Hare Airport	2-41
<u>Section 3 - Airport Configuration Description</u>	3-1
3.1 General	3-1
3.2 Runway Configuration Description	3-1
3.2.1 Runway Descriptions	3-1
3.2.2 Runway Configuration Usage	3-6
3.3 Taxi Flow Patterns	3-23
3.3.1 Configuration 1	3-24
3.3.2 Configuration 2	3-29
3.3.3 Configuration 3	3-31
3.3.4 Configuration 4	3-33
3.3.5 Configuration 5	3-35
3.3.6 Configuration 6	3-37
3.3.7 Configuration 7	3-37
3.3.8 Configuration 8	3-40
3.3.9 Configuration 9	3-42
3.3.10 Configuration 10	3-44

TABLE OF CONTENTS - VOLUME II (Continued)

	<u>Page</u>
3.3.11 Configuration 11	3-44
3.4 Terminal Configuration Description	3-48
3.4.1 Terminal Gate Layout	3-48
3.4.2 Aircraft Docking at the Gates	3-51
3.4.3 Aircraft Movements and Control	3-51
3.4.4 Impact of Terminal Configuration on ASTC System Operation	3-52
<u>Section 4 - Functional Description of the O'Hare ASTC System</u>	4-1
4.1 General	4-1
4.2 FAA Airport Traffic Control Tower (ATCT) Functions	4-1
4.2.1 General Responsibilities	4-1
4.2.2 Tower Cab	4-2
4.2.3 TRACON	4-69
4.3 Airline Functions	4-74
4.3.1 General Responsibilities	4-74
4.3.2 Airline Terminal Operations	4-75
4.3.3 Flight Deck (Cockpit) Operations	4-84
4.4 Airport Management Functions	4-88
4.4.1 General Responsibilities	4-88
4.4.2 Airport Personnel Position Descriptions	4-88
4.4.3 Functional Operations Description	4-92
4.4.4 Emergency Operations	4-97

LIST OF ILLUSTRATIONS - VOLUME II

<u>Figure</u>		<u>Page</u>
1-1	Task Breakdown and Study Flow	1-2
1-2	Simplified O'Hare Operations Analysis Flow Diagram	1-5
2-1	Departure Flight Operations Flow	2-3
2-2	Arrival Flight Operations Flow	2-4
3-1	Current O'Hare Layout	3-2
3-2	Location of Departure Queues and Ground Control Handoff Areas at O'Hare	3-25
3-3	Aircraft Routes at O'Hare - Hangar, Cargo and Air Force Areas	3-26
3-4	Main Service Vehicle Roads at O'Hare Airport	3-27
3-5	Configuration 1	3-28
3-6	Configuration 2	3-30
3-7	Configuration 3	3-32
3-8	Configuration 4	3-34
3-9	Configuration 5	3-36
3-10	Configuration 6	3-38
3-11	Configuration 7	3-39
3-12	Configuration 8	3-41
3-13	Configuration 9	3-43
3-14	Configuration 10	3-45
3-15	Configuration 11	3-46
3-16	Gate Assignments	3-49
4-1	O'Hare Control Tower Floor Plan	4-3
4-2	Tower Cab Detail	4-4
4-3	Tower Cab Photographs	4-10
4-4	Visual Surveillance Limitations	4-30
4-5	Radar Coverage	4-32
4-6	Functional Flow of Major Flight Data Tasks	4-34
4-7	Functional Flow of Clearance Delivery Tasks	4-39
4-8	Functional Flow of Major Outbound Ground Tasks	4-45
4-9	Functional Flow for Major Inbound Ground Tasks	4-56
4-10	Functional Flow of Major Local Control Tasks	4-61
4-11	TRACON Room - O'Hare International Airport	4-70
4-12	United Airlines Gate Plan for O'Hare Airport	4-77
4-13	VHF Radios in Cockpit	4-85
4-14	Chicago - O'Hare International Airport Organization Chart	4-89

LIST OF TABLES - VOLUME II

<u>Table</u>		<u>Page</u>
2-1	Summary of Effectiveness Measures	2-15
2-2	Examination of Aircraft Flow Variables	2-27
2-3	Movement Events Measured for ASDE Film Analysis	2-30
3-1	Classification of Crossing Runway Configurations	3-3
3-2	Runway Landing Aids at O'Hare	3-5
3-3	Primary Runway Configurations Identified by ATCT	3-8
3-4	Runway Usage Minimums Under Low Visibility Conditions	3-11
3-5	O'Hare Runway Utilization CY-71	3-13
3-6	Seasonal Runway Configuration Usage (January and February 1973)	3-15
3-7	Seasonal Runway Configuration Usage (April and June 1973)	3-16
3-8	Profile of Runway Configurations Used in Clear and Calm Weather	3-19
3-9	Profile of Runway Configurations Used in Unclear and/or Windy Weather	3-20
3-10	Relative Usage of Various Runway Configuration Classes at O'Hare	3-22
3-11	Gate Assignments Vs Ramp Areas at O'Hare	3-50
4-1	Responsibilities and Duties of the Flight Data Position	4-16
4-2	Responsibilities and Duties of Clearance Delivery Position	4-17
4-3	Responsibilities and Duties of Outbound Ground Position	4-19
4-4	Responsibilities and Duties of Inbound Ground Position	4-21
4-5	Responsibilities of Local Control Position	4-23
4-6	Clearance Delivery Gate Marking	4-41
4-7	Predominantly Preferred Checkpoints for Position Reporting During Low Visibility Conditions	4-50
4-8	Specific Points or General Areas at Which Turnover to Local Control May be Made by Outbound Ground	4-53
4-9	Responsibilities and Duties of the Approach Control Position	4-71
4-10	Responsibilities and Duties of Departure Control Position	4-72
4-11	Responsibilities and Duties of Parallel Approach Monitor	4-73
4-12	Authorized Aircraft Parking -- O'Hare Passenger Terminal -- American Airlines	4-80

SECTION 1 - INTRODUCTION

1. 1 GENERAL

This working paper describes and presents the results of the first phase of the Advanced Airport Surface Traffic Control (ASTC) Systems Concept Formulation Study conducted for the Transportation Systems Center (TSC) under Contract DOT-TSC-678. The report describes the approach followed and the analysis techniques employed in the performance of the operations analysis of the current ASTC system for the baseline airport, O'Hare International Airport, Chicago, Illinois. It also describes the data resulting from this analysis to draw conclusions on the effectiveness of the current ASTC system operations at O'Hare and on the effectiveness of the system in projected future operational environments at O'Hare.

The remainder of this introductory section is intended to provide a reference for the descriptions of the study presented in Sections 2 through 6 and the summary and conclusions presented in Section 7. Section 1. 2 provides an overview description of the Concept Formulation Study to place the O'Hare Operations Analysis in context. Section 1. 3 then provides a brief description of the approach followed in the operations analysis.

1. 2 OVERVIEW OF STUDY

The basic objectives of the Concept Formulation Study are to:

1. Define and evaluate functional and design concepts for potential future ASTC systems configurations.
2. Estimate the potential for deployment of the alternative system configurations at airports in the National Airport Systems Plan (NASP).

The overall approach adopted for the study to achieve these objectives is illustrated in a simplified manner in Figure 1-1. This approach represents an organization of technical studies providing a logical and stepwise methodology for characterization of ASTC system concepts and evaluation of these concepts as a basis for estimation of the nature of systems which may be deployed at NASP airports in an orderly and cost-effective manner.

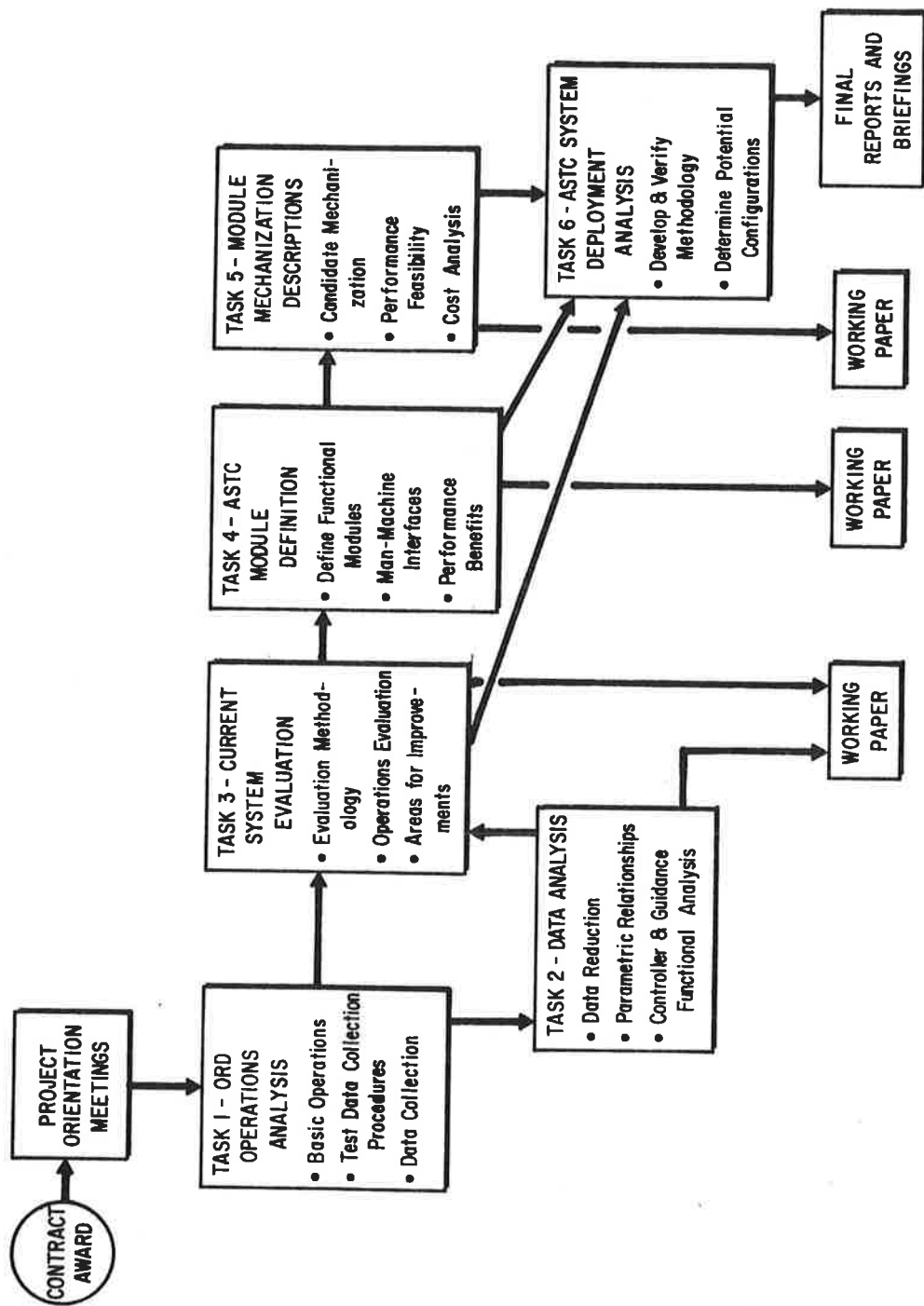

Figure 1-1. Task Breakdown and Study Flow

In essence, the study structure represents four technical analysis phases. The first three tasks shown comprise the airport operations analysis phase which is the subject of this working paper. This phase is intended to provide data from which an understanding of airport operations and operational needs can be developed. This includes a comprehensive and detailed characterization of the interrelationships between various organizations and individuals involved in airport operations and areas in which these interrelationships might be enhanced by future ASTC systems to increase the effectiveness of airport operations. Thus, this phase serves as a baseline for the subsequent study efforts.

The objective of the second phase of the study (Task 4 - Module Descriptions and Benefits Estimate) will be to define, examine, and evaluate functional performance concepts for potential ASTC system configurations. The understanding of airport operations and operational needs developed in Phase 1 provides a reference for definition of future ASTC systems on a modular configuration basis; that is, conceptual structuring of future systems as the integration of a number of system modules, each intended to support a specific functional performance requirement of an ASTC system. In addition, preliminary requirements analyses, system descriptions, and data collected at two other airports (Boston-Logan and Hartford-Bradley Field) already completed apart from this contract will be provided by the Government and utilized to avoid site specific modules. Each functional module will be defined in terms of the capabilities to be provided and its interrelationship with other system modules and external interfaces. Utilizing the quantitative data on system operations developed in Phase 1, estimates of the performance and economic benefits of the achievement of these functional capabilities will be developed.

The objective of the third phase (Task 5 - Mechanization Descriptions and Cost Estimates) will be to define, examine, and estimate the costs of functional design concepts for system modules; that is, conceptual structuring of the design of system modules as the integration of a number of hardware/software elements required to provide the functional capabilities defined for the modules in Phase 2.

Design concepts will be developed for mechanizing the system modules by alternative equipment technologies (for example, digitized radar or trilateration on ATCRBS transponders) and the costs associated with these alternative approaches estimated.

The objective of the fourth phase of the study (Task 6 - Deployment Analysis) will be to estimate the deployment potential for the various system design approaches defined in Phase 3; that is, estimation of the number of ASTC modules mechanized by each of the alternative equipment technologies that could be implemented at airports in the NASP on a cost-effective basis. This estimation will draw upon the understanding of airport operations and operational needs developed in Phase 1 to define ASTC functional capabilities that would be required at various NASP airports as a function of time. The estimation will also draw upon understanding of performance and economic benefits of various module functional capabilities developed in Phase 2 and the costs of achieving those functional capabilities by alternative technological approaches as defined in Phase 3. This background understanding and data base will be combined to identify the types of ASTC systems which would be implemented that would most cost-effectively meet the needs of various airports and from this the total development potential for implementation of system modules by the competing technologies.

1.3 DESCRIPTION OF OPERATIONS ANALYSIS

The technical approach taken in the O'Hare operations analysis is illustrated in a simplified manner in Figure 1-2.

As a point of departure for the operations analysis a preliminary examination of the ASTC system operation at O'Hare was performed using information readily available. Primary sources of this information were documentation and materials provided by TSC at the initiation of the contract including maps, ASDE films, and communications recording tapes made by TSC in February/March 1973, and a copy of the O'Hare Airport Air Traffic Control Tower (ATCT) Training Manual. The ASDE films were briefly reviewed to gain an impression of the

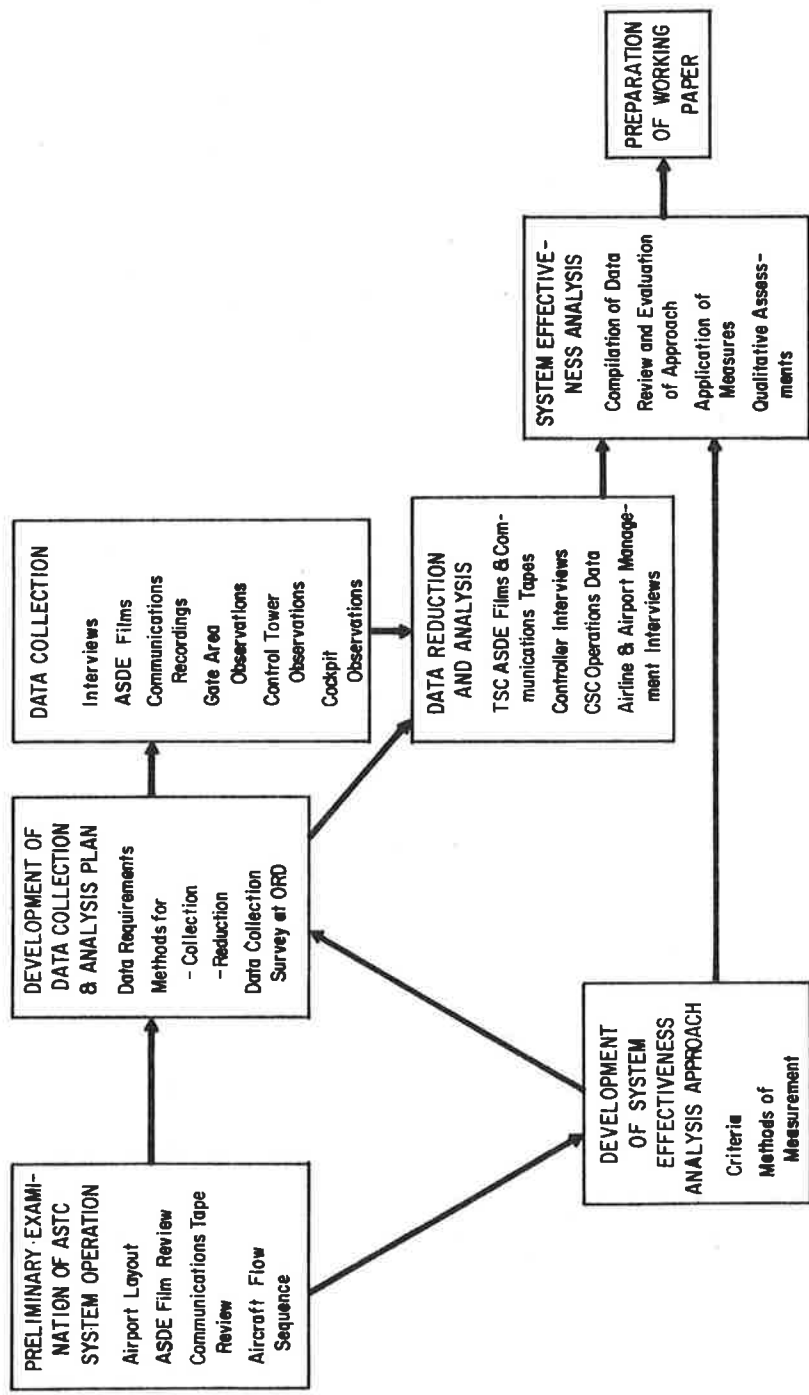

Figure 1-2. Simplified O'Hare Operations Analysis Flow Diagram

traffic flow patterns for the various runway configurations observed. Similarly, communications recordings for the several air traffic controller positions in the tower cab and airline company communications were listened to in order to gain an impression of the basic nature and noticeable differences in the manner in which aircraft movements were controlled. These reviews were made against the background of maps of airport surface configuration and the description of controller activities provided in the Training Manual. Based upon these activities, preliminary flow diagrams outlining the estimated flow sequence for departure and arrival aircraft were developed. The sequence definitions included the various communications and control actions that might be expected to occur in an aircraft's movements.

These preliminary operational definitions provided the basis for the definition of the approach to be followed in assessing the effectiveness of the O'Hare ASTC system. Criteria against which the system effectiveness would be evaluated were first identified. Various methods of measuring the effectiveness criteria were considered and the most practical measures selected. The resulting effectiveness criteria were divided into two groups, those which could be directly measured from operational flow data and those which could be measured indirectly (i. e. , as extrapolations of the directly measured criteria variables). Directly measurable criteria included: traffic flow statistics (e. g. , delay time per operation), controller workload (e. g. , communications channel occupancy time), and pilot workload (e. g. , communications time per operation). The decision was made to utilize traffic flow statistics as the directly measurable criteria for the extrapolation of indirectly measured effectiveness criteria. Thus, examples of these indirect criteria included operational cost increase (delay time x cost of operation per unit of time), incremental pollution emission (delay time x pollution emission rate per unit of time), passenger inconvenience (delay time x passengers delayed). It was also decided that accident risk represented an important variable for effectiveness evaluation but that a direct measurement of accident risk was not feasible. Therefore, accident risk was considered as an indirect criteria to be measured

in terms of such measurable parameters as the lack of visibility of operations in certain areas or number of missed instructions.

The two preceding activities served as the basis for development of a Data Collection and Analysis Plan. The plan identified the data required to support the effectiveness criteria measurement, the means for collection of the data, and the methods for extraction and reduction of the data collected. In developing the plan the TSC collected ASDE films and communications recordings were reviewed again in further depth to identify the data which could be extracted from each and the most logical procedures for this extraction and reduction. A determination was made that the collection of additional data was required for several reasons including: the need to obtain clear recordings of ground controller channels*, acquisition of data for periods of Category I and II operations, and the need to obtain data on aircraft movements within the ramp/gate areas (which could not be derived from the ASDE films). A brief survey visit was made to O'Hare to derive information needed for finalization of the plan. The major objectives of this survey were to:

1. Obtain brief descriptions of the general procedures followed by the various controller positions and identify areas in which specific information on the variations in general controller procedures must be obtained through controller interviews and observations in the tower cab.
2. Identify locations from which traffic movements within the ramp/gate areas could be observed and recorded.
3. Test various methods for improved communications channels recording as a basis for design and fabrication of any special equipments necessary for this purpose.

The Data Collection and Analysis Plan was then finalized and materials for the collection, extraction, and reduction of the data developed including:

*Because of the method of recording employed, there was substantial interference between Outbound (departure) Ground and Inbound (arrival) Ground or clearance delivery communications recorded on the tapes.

- Log forms for the extraction and reduction of data from ASDE films and communications tapes
- Log forms for observation/recording of system operations in the tower cab and ramp/gate area
- Preliminary controller interview questionnaire
- Questionnaires for interviews of airline gate scheduling/management personnel, pilots, and O'Hare Airport management personnel.

The Data Collection and Data Reduction and Analysis activities were then initiated in parallel. Within the Data Collection effort, considerable attention was devoted to detailed interviews with several tower cab controllers to obtain descriptions of the specific procedures followed in their operations at the various positions in the tower cab and their criteria for applying the procedures (e. g. , the criteria applied in routing aircraft to or from the runways in use where alternative routes are possible). In addition, the interviews were designed to solicit comments from the controllers on potential functional concepts for future ASTC systems for use in the second phase of the study.

1. The conduct of interviews with gate scheduling/control personnel pertaining to personnel responsibilities and procedures followed in managing gate operations.
2. The conduct of interviews with pilots pertaining to the responsibilities and procedures followed by flight officers in the operation of aircraft.
3. Utilization of United Airlines and American Airlines control towers for the observation of ramp/gate area traffic operations.
4. Flight Deck Authority for United Airlines aircraft for the purpose of observing cockpit operations at first hand.

Interviews were also conducted with O'Hare Airport management personnel to determine the responsibilities and procedures followed by functional units in maintaining the operating condition of the Airport and coordinating the operations of the units with the ATCT.

The additional operations data collection was performed and included periods of simultaneous ASDE film, controller communications recording, observation and recording of traffic movements in the ramp/gate areas, and observation and recording of controller activities in the tower cab.

The initial activities in Data Reduction and Analysis were directed toward the analysis of selected ASDE films and communications recordings made by TSC. Attention was focused on the analysis of selected periods with varying traffic operations rates under visual operation conditions for runway configurations representative of the normal easterly and westerly operations modes of the airport. The resultant data was intended to serve as a background for further analyses of the impact of weather conditions on O'Hare operations. As the information collected by CSC personnel in the field became available it was reduced and interpreted for application in developing narrative and quantitative descriptions of O'Hare operations.

The quantitative data developed in the preceding activity was compiled for application in the System Effective Analysis of the current O'Hare operating environment and projected future operating environments. A review of the approach defined earlier for the effectiveness analysis was made against the background of this data and other information acquired during the preceding efforts; in particular, a deeper understanding of the O'Hare operational processes and suitable adjustments to that approach were made.

Because reliable data on future changes to the operating environment at O'Hare could not be obtained in the form required for the planned approach, certain assumptions were made regarding future modification of the airport configuration. No attempt was made to quantitatively extrapolate the impact of these changes. However, qualitative assessments of the impact of these changes, particularly with respect to ground taxi and departure delays, were made.

With respect to the subject of accident risk, situations observed of the ASDE film analysis and the understanding of O'Hare operations developed through the field activities were drawn upon to develop qualitative assessments of potentially hazardous situations which merit attention and possible near term correction through ASTC system improvements.

The plans, procedures followed, and results developed in all the preceding activities served as the basis for the preparation of this working paper.

SECTION 2 - OPERATIONS ANALYSIS APPROACH

2.1 GENERAL

The purpose of this section is to describe in detail the technical approach followed in performing the operations analysis and effectiveness analysis for the O'Hare ASTC system and the rationale for this approach.

2.2 ESTABLISHING THE BASIS FOR ANALYSES

As the first step taken, a preliminary definition of the ASTC system operation was developed. Maps of the O'Hare Airport configuration were studied to become familiar with the layout of the runways and taxiway network.

The Chicago O'Hare Airport Air Traffic Control Tower (ATCT) Training Manual was reviewed to obtain a general understanding of the responsibilities and duties of the tower cab positions and of positions in the TRACON as they interface with the airport operations. The Manual includes maps illustrating a number of basic runway utilization configurations and associated taxi flow patterns which provided a basic understanding of operational flow patterns.

This understanding was further developed by review of a number of ASDE films taken by TSC in February and March, 1973. The films were studied to further examine the traffic flow for the various specific operational configurations in relation to:

1. Emanation of traffic from or exit to the passenger terminal
2. Taxi to and from the various runways in use
3. Aircraft delays or stops enroute to or from the runways
4. Departure aircraft queuing for the various runways
5. Interleaving of departures and arrivals in cases of mixed operations on the same runway and in separated operations on crossing runways

Controller and airline communications channel recordings made by TSC simultaneously with the ASDE films were reviewed to gain an impression of the communications between tower and airline personnel. Brief periods of the communications recording tapes for various controller positions and airline channels corresponding to the ASDE films previously reviewed, where available, were listened to for the purpose of generally classifying:

1. The stages in the aircraft flow in which communications take place with the various operational personnel
2. The nature of the communications control discipline followed
3. The nature of the information transmitted by the various personnel involved
4. Any distinctions between control procedures and associated communications arising from the operating configuration and conditions

Based upon the preceding activities, simplified flow charts illustrating the basic stages of the passage of aircraft through the system were developed for both departure and arrival operations. The flow charts are illustrated in Figures 2-1 and 2-2 for departure and arrival operations, respectively. Superimposed on these diagrams are indications of the controller positions involved in the processing of the aircraft throughout the various stages of operation.

The purposes in developing these flow charts were twofold. The first was to provide a continuing reference for project personnel in the subsequent investigations of the ASTC operation. The second, and more important, was to serve as the basis for defining the approach to be followed in studying the ASTC system and analyzing the effectiveness of its operations. The flow charts were examined to identify:

1. Stages at which the flight could experience delays in its processing.

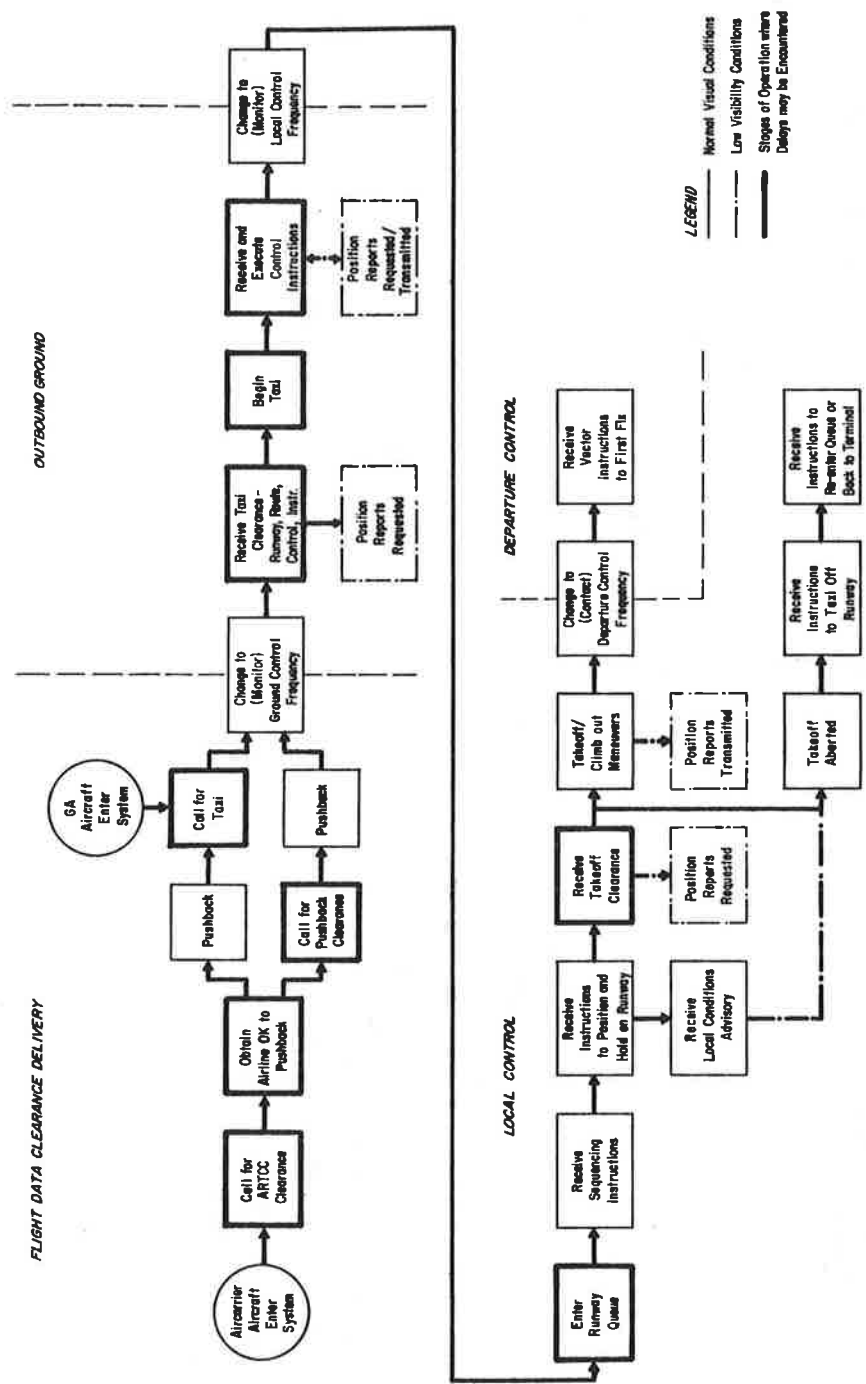

Figure 2-1. Departure Flight Operations Flow

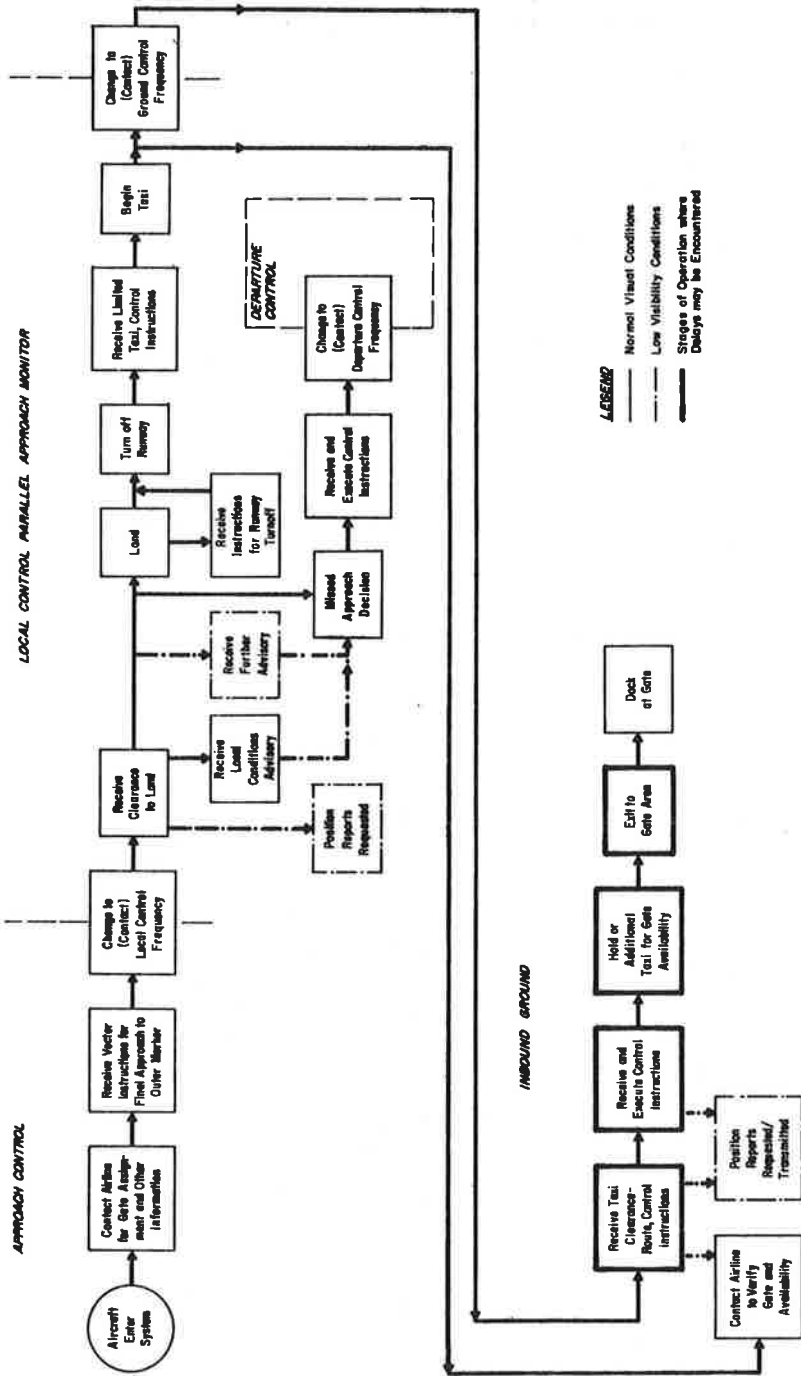

Figure 2-2. Arrival Flight Operations Flow

2. Areas in which detailed investigation of the procedures followed at controller positions was essential in understanding the ASTC system operation, developing qualitative workload estimates, and formulating concepts for future ASTC systems.
3. Areas in which detailed investigations of the procedures followed by airline operations and flight personnel were essential in understanding terminal facilities usage and pilot information requirements in relation to aircraft control, and in formulating concepts for future ASTC systems.
4. Stages of operation at which reduced visibility conditions impact on the system and specific areas of investigation to quantify this impact on various system operational personnel.
5. Stages of operation at which there is a risk of accident and specific areas of investigation to qualitatively or quantitatively examine the potential hazards.

As an example, the stages of operation at which aircraft could experience delays identified by the review are outlined heavily in Figures 2-1 and 2-2.

The results of the review then served as the basis for the following:

1. Preliminary definition of criteria and measures for assessment of the ASTC system effectiveness
2. Definition of the data required for the defined system effectiveness analysis approach
3. Preliminary identification of the appropriate sources of the data required and the means for extraction of the data from the sources
4. Identification of areas in which further clarification of operational procedures or potential data collection methods was necessary for finalization of the analysis plan.

A survey visit was then made to O'Hare Airport to satisfy the information requirements identified in 4 above. The survey activities included:

1. Discussions with O'Hare ATCT personnel to determine the actual procedural flow of task activities for each controller position in the tower cab. The discussions identified both the basic procedural flow for each position and areas in which there is some variability

in individual controller procedures which would have to be determined through personnel interviews and observations in the tower cab.

2. Discussion of the problems encountered in the use of the current ASDE Brite equipments. It was learned that the ATCT had previously determined the coverage limits of the equipments and that the results were presented on a map of the airport which would be provided for the study.
3. Testing of a new method for recording of controller communications channels directly from the communications equipment to eliminate the problem of overlap and interference between the Outbound (departure) Ground and Inbound (arrival) Ground communications encountered on the TSC recordings. The design requirements for the equipments that would be required to accomplish this without interference with FAA channels were worked out with ATCT personnel as inputs to the design and fabrication of the equipments.

Based upon the results of this survey a Data Collection Analysis Plan was finalized. The data collection and analysis procedures followed in the subsequent operations analysis based upon this plan are described in the following paragraphs.

A major aspect of the plans for analysis of the O'Hare ASTC system was a decision to examine the airport operations in terms of two modes of operation. Review of the ASDE films and associated data provided by TSC and the maps of runway/taxiway usage configurations provided in the ATCT Training Manual indicated that O'Hare operations could essentially be divided into two modes. These modes were "Arrivals from the East" and "Arrivals from the West." As informal discussions with ATCT personnel indicated that the arrival runways were selected first in determining the runway configurations to be employed under various operating conditions, this approach in defining the modes of operations in this manner was reasonable.

Thus, the ASTC system effectiveness analysis and supporting functional analysis approaches, described in the following Sections 2.3 and 2.4, were devised to provide an examination on this basis. Various TSC data collection runs and, subsequently, CSC data collection runs representing operations in these modes were selected for detailed analysis.

2.3 O'HARE OPERATIONS EFFECTIVENESS ANALYSIS APPROACH

2.3.1 General

This paragraph summarizes the approach and methodology developed to evaluate the effectiveness of ASTC Systems at O'Hare. The proposed methods have general applicability to other airports and will be useful in evaluating the effectiveness of new ASTC concepts and techniques. While the methods offer this broad capability for future evaluations, attempts to apply them must be accompanied by a rather extensive data collection program at the site under evaluation. Specifically, the data collection and reduction procedures used at O'Hare and discussed throughout this report must be employed to accomplish the effectiveness evaluation at other airports.

The objective of this analysis is to assess effectiveness by combining measured airport data with statistical considerations at O'Hare in order to evaluate the following derived effectiveness parameters:

- Fuel Consumption
- Operating Costs
- Passenger Inconvenience

This is accomplished by reducing raw data into a form which will provide a direct measure of:

- Airport surface holds, delays and service time
- Controller communications workload
- Cockpit crew communications workload
- Communications incidents

These direct measures are analyzed in conjunction with the following statistical considerations to determine a measure of effectiveness:

- Airport operational demand
- Airport weather profile
- Aircraft profile
- Airport operating modes
- Aircraft engine fuel consumption factor
- Aircraft operating cost factor
- Aircraft loading factor

This analysis permits the calculation of a numerical effectiveness score(s) for each derived parameter. Since these parameters are not independent and their relative significance is a highly subjective consideration, this methodology stops short of providing a composite effectiveness score. Nevertheless, a combinatory method could be added in the future if a composite score is desired. This would involve assigning subjective weighting factors for each effectiveness parameter, calculating a weighted score, and adding the weighted scores of each parameter.

The following paragraphs describe the general approach for the individual parameter analysis. Detailed calculations and measured data consistent with this approach are contained in Section 6 of this report.

2.3.2 Fuel Consumption Assessment

In view of the energy crisis, minimization of aircraft fuel consumption is a reasonable ASTC System goal. This parameter is directly related to measured and statistical factors which are related by the following overall formula

$$FC_{ACT} = [ST + HT] \times \left[\sum_i \left(\frac{n_i}{n} \times FF_i \right) \right] \quad (1)$$

where

FC_{ACT} = Estimated actual gallons of fuel consumed by aircraft on the airport surface during a one hour measurement period

ST = Measured total service time (i. e. , time for all AC to travel between ramp and runway or runway and ramp without stopping) during a one hour measurement period

HT = Measured total holding time (i. e. , time spent by aircraft in a holding status) during a one hour measurement period

$\frac{n_i}{n}$ = Ratio of a specific aircraft type to the total at O'Hare as determined from the aircraft profile

FF_i = Fuel factor (i. e. , the gallons of fuel consumed per idle engine minute for the ith aircraft type)

This calculation will determine the estimated fuel consumption during a specific measurement period.

It is important to specify the operating conditions which existed during the measurement period so that measured data which was obtained over a limited sampling period could be statistically extrapolated to an annual consumption factor.

The important operating conditions for this extrapolation are:

- Aircraft operations per hour (measured/desired)
- Weather conditions (good/poor)
- Runway modes (west/east arrivals)

By specifying the actual measurement conditions and by recognizing the probability of having various conditions during the year, the annual fuel consumption could be estimated.

Finally, it is important to identify the potential improvement which can be obtained through the use of an optimum ASTC System. This is accomplished by letting HT = 0 in equation (1) thereby providing an estimate of the minimum gallons of fuel required.

By forming the ratio of annual minimum fuel to annual estimated actual fuel the ASTC system can be given a fuel consumption effectiveness score which would optimally equal unity.

This analysis assumes a linear relationship between fuel consumption and aircraft surface travel delays. For the most part this assumption is reasonable; however, it is possible that an ASTC system could be devised wherein this was not the case (viz. , a system where tugs or cables transport aircraft to and from the runway). Another consideration is the fact that limited fuel supplies could make the impact of a fuel-saving ASTC System much more significant. For example, it could easily determine whether or not airlines could also determine the number of flights that an airline could schedule and thereby control its business potential. In summary, while the linear relationship is reasonably valid, the impact of fuel conservation measures could exhibit effectiveness discontinuities which make fuel-saving ASTC systems even more attractive than this methodology indicates.

2.3.3 Operating Cost

Airline operating costs are directly proportional to surface traffic delays since many of the elements which comprise this cost are based on the time between unblocking and blocking the aircraft at the gate, e.g. , crew hours, engine hours. To a certain degree surface traffic delays can be attributed to the airline itself as a result of ineffective gate control and scheduling. For the most part, however, these delays can be attributed to the ASTC System of the airport under evaluation. For this analysis airline operating costs will be estimated on a per aircraft type basis. These costs include: crew costs (salary/overhead), fuel and oil, insurance, taxes, air frame maintenance, engine maintenance, depreciation, rentals, maintenance burdens, and other miscellaneous expenses associated with the time an aircraft is in use. Not included are estimates for the ticketing system, reservation system, management, gate fees, etc. Airline operating cost will be computed from the formula:

$$OC_{ACT} = [ST + HT] \times \left[\sum_i \frac{n_i}{n} \times CF_i \right]$$

where

OC_{ACT} = Estimated total actual cost per test hour

and

CF_i = Average airline cost in dollars per block minute for the *i*th aircraft type

The estimated actual value for a specified measurement period was statistically extrapolated to an annual estimate. In addition, by letting $HT = 0$ in the formula, the minimum cost was determined such that the effectiveness score could be calculated as the ratio of the minimum to the actual annual cost.

2.3.4 Passenger Inconvenience Assessment

Passenger inconvenience is a difficult parameter to assess, since inconvenience can vary considerably among passengers based on individual circumstances. There are at least two airport surface travel factors which contribute to passenger inconvenience; however, the relative significance of these factors is not easily determinable. The general factors involved are:

- Inconvenience due to delays
- Inconvenience due to lack of comfort

The delay factor is assessed by measuring the total ground delay time during a test hour and by using the formula

$$PD_{ACT} = [HT] \times \left[\sum_i \frac{n_i}{n} \times PL_i \right]$$

where

PD_{ACT} = The total number of passenger delay minutes during the test hour

and

PL_i = The average passenger loading factor for the i th aircraft type

The passenger delay effectiveness score is assessed by calculating the estimated actual passenger ground travel minutes for the year using the formula

$$PT_{ACT} = [ST + HT] \times \left[\sum_i \frac{n_i}{n} \times PL_i \right]$$

and the statistical extrapolation factors. The minimum passenger travel minutes can be computed for the year by letting $HT = 0$. The effectiveness score is then determined as the ratio of the minimum to the actual annual passenger ground travel minutes.

The comfort factor is assessed by measuring the number of starts and stops which the aircraft makes during airport ground travel using the formula

$$PC_{ACT} = [2HN] \times \left[\sum_i \frac{n_i}{n} \times PL_i \right]$$

where

PC_{ACT} = Total number of passenger starts and stops during the test hour

and

HN = The number of aircraft holds during the test hour

Using the statistical extrapolation factors, the annual estimate for passenger starts and stops can be determined. The optimum value for this parameter is equal to zero.

2.3.5 Summary of Effectiveness Measures

Table 2-1 provides a summary of the derived effectiveness parameters included in this effectiveness assessment methodology. The key measurement factors, the effectiveness measures, and the optimum effectiveness scores are also included for consideration. Section 6 demonstrates the application of these concepts to the evaluation of O'Hare ASTC effectiveness.

Table 2-1. Summary of Effectiveness Measures

Derived Parameter	Measurement Factors	Effectiveness Measure	Optimum Effectiveness Values
Fuel Consumption (FE)	Service Time (ST) Holding Time (HT) Aircraft Fuel Factor (FF _i)	$\frac{FC_{min}}{FC_{ACT}}$	1.0
Operating Cost (OC)	Service Time (ST) Holding Time (HT) Aircraft Operating Cost Factor (CF _i)	$\frac{OC_{min}}{OC_{ACT}}$	1.0
Passenger Inconvenience ● Passenger Delay (PD) ● Passenger Comfort (PC)	Service Time (ST) Holding Time (HT) Number of Holds (HN) Aircraft Passenger Loading Factor (PL _i)	$\frac{PD_{min}}{PD_{ACT}}$ PC_{ACT}	1.0 0

2.4 METHODOLOGY FOR FUNCTIONAL ANALYSIS OF ASTC SYSTEM OPERATION

In performing the functional analysis of the O'Hare ASTC System operation, the analysis activities were primarily directed toward developing the data required to support the ASTC system effectiveness analysis approach previously described. In essence, this required more than just the derivation of quantitative data describing aircraft movements and communications. It also required the development of an understanding of the environments, constraints, and procedures followed by the various operational personnel involved in the passage of aircraft through the ASTC System as a background for meaningful interpretation of the quantitative data. Thus, the development of the information base for the functional analysis of the ASTC System consisted of the collection, reduction, and analysis of operational movements and communications data and the conduct and analysis of interviews with representative samples of the operational personnel.

The efforts in each of these areas for various aspects of the airport operation are described below.

2.4.1 Controller Task Analysis

The controller task analysis effort was effectively divided into three distinct but related areas: interviews with representative controller personnel; controller communications recordings analysis; observation and analysis of physical task activity.

2.4.1.1 Controller Interviews

Arrangements were made with the O'Hare ATCT and Great Lakes Region for the availability of a number of representative tower cab controller personnel to be available for in-depth interviews on traffic control procedures employed at the various controller positions.

A draft Controller Interview Questionnaire was developed. The interview was designed to incorporate questions covering the operational procedures

followed by the subject when operating the Clearance Delivery, Outbound Ground, Inbound Ground, and Local Control positions under normal (good) visibility conditions and poor visibility conditions. The opportunity was taken to include a number of questions intended to solicit controller opinions on potential functional performance and design concepts for future ASTC systems. The interview was designed to be conducted verbally and included use of graphical representations of selected future ASTC System concepts.

The draft interview was tested and recorded on tape for two controllers. However, the interview with the second controller was terminated because of shortcomings of the draft questionnaire. Based on the experience gained by the interviews and difficulties experienced in attempting to transcribe the recording for the first controller, it was determined that revisions to the questions asked and method of recording the responses were required. A revised interview questionnaire was developed. It consisted of two parts. The first was composed of questions to which simple responses could be expected and recorded directly on the interview form. The second was a written supplement composed of questions for which the responses could be expected to be more extensive or complex and on which the controller would record his responses. This revised interview format was then employed for the second test controller and eight additional controllers.

When completed, the interviews were analyzed to determine a composite of the results identifying the predominant response for the various questions and the percentage of controller interviews providing this response. In many areas the controller responses were found to indicate a high degree of standardization of procedures and decision criteria where alternative techniques might be applied.

The results of this analysis served as a baseline reference for the controller communications analysis and, most particularly, for the observations of controller activities in the tower cab.

A sample of the Controller Interview Questionnaire form employed is included in Appendix A. Completed interview questionnaires are included in the O'Hare Operations Analysis Data Supplement.

2.4.1.2 Controller Communications Recordings Analysis

Magnetic tape recordings of communications transactions between controllers and pilots (or surface vehicles) are uniquely useful in studying controller workload as these communications represent the major measurable element of his activity. Analyses of such recordings were performed to permit direct assessment of the controller communications activity and, in particular, for determination of the amount of time spent in communications to all aircraft and to individual aircraft. The analysis identified in detail the nature of the communications in terms of the information transmitted between controllers and pilots and the various types of control disciplines employed by the various positions. Further, the data was derived in such a form as to permit limited extrapolation of the resultant data at the observed traffic levels to higher traffic levels for use in the future O'Hare ASTC system effectiveness analysis.

To generate a data base for analysis, the tape recordings for various positions were examined in depth to classify the communications in terms of:

1. Individual communication transactions between controller and specific aircraft in chronological sequence. *
2. Message elements per communication transaction. The message element classifications were defined as the most descriptive regarding the nature of the information transmitted within the transaction.

*A communications transaction was defined to include all the transmissions of both the controller and pilot necessary to complete the communication and any pauses in the conversations prior to its completion.

3. Primary communication transaction designations, i. e., the primary function of the transaction in terms of the message elements communicated, wherever possible.

Message element classifications employed were derived from the communications analysis procedures currently in use by the FAA at NAFEC. These procedures are employed extensively in field studies of ATC facilities throughout the United States and in experimental studies at NAFEC. The rationale for selection of this approach is that it utilized well-defined standard definitions of ATC communications and would permit later comparison of the results of this study with studies of communications at other airports performed by NAFEC personnel. FAA message classification identifications were directly accepted or modified slightly to permit further refinements for the purposes of this study. For example, the basic FAA classification of a Control Instruction (Message Identification No. 110) was expanded to permit identification of aircraft sequence instructions or instructions related to penalty box holds by ground controllers as 111 and 112 identification numbers, respectively. The message element identifications and general classifications are listed below for the various controller positions.

Clearance Delivery

180A	Clearance requests by pilot
180B	Clearance repeat requests or checks by pilot
180	Clearance delivery
180S	Special clearance delivery (Communication contact by controller after initial contact)
150	Request to push back aircraft by pilot
210A	Broadcast call for clearance requests by controller
210B	Broadcast call for taxi requests by controller
230	Handover
310	Position reports
420	Taxi requests by pilots
450	Weather related communication

500 Communication incident (No response to call by controller or pilot)

Inbound Ground Control

110 Control instruction (other than hold)
111 Sequence instruction (Instruction to follow another aircraft)
112 Penalty box or holding area instruction and advisories
120 Hold instruction
140 Yield instruction* (Instruction to control movement to yield right of way to another aircraft)
150 Clearance to pilot to enter ground control system
160 Clearance to pilot to enter ground control combined with hold instruction
310 Position report (Controller request and pilot response)
311 Destination or gate of incoming aircraft (a specific type of position report)
410 Traffic advisories
420 Taxi request by pilot wishing to move aircraft between hangar and terminal, etc.
470 Gate status information
500 Communication incident

Outbound Ground Control

110 Control instruction
111 Sequence instruction
120 Hold instruction
140 Yield instruction
150 Clearance to pilot to enter ground control system

*In the NAFEC message classification system this message identification is used for Speed Control instructions. This classification was adopted for the Yield Instruction since it is essentially an instruction to the pilot to adjust the speed of his aircraft's movement so as to permit another aircraft the right of way at an intersection.

160	Clearance to pilot to enter ground control combined with hold instruction
230	Handover
310	Position reports
410	Traffic advisories
500	Communication incidents

Local Control

110	Control instruction (Runway turnoff or taxi)
120	Hold instruction
151	Takeoff clearance
152	Landing clearance
160	Clearance with runway hold (e. g. , position and hold)
230	Handover
310	Position reports
450	Weather reports (winds, visibility, etc.)
500	Communication incidents

Communication transactions were timed out for each magnetic tape recording, usually of one hour duration. During the early stages of the communications recording analysis an attempt was made to record the absolute start and stop time for each communications transaction. It was intended that these measurements would be used to: (1) compute the duration for each transaction; (2) provide a basis for statistical computation of the durations for various message types; (3) trace the aircraft between controller positions; and (4) match communications with air movements data in the ramp areas, taxiways, and runways. However, this was found to be extremely time consuming to accomplish satisfactorily and within the time and funds available. Thus, the procedure settled upon was to accumulate, using a stop watch, the times spent in all communications transactions over a test period. The total communications activity time was then divided by the total of transactions to compute the average duration of a communications transaction.

Examples of the communications transactions analysis form employed for each controller position is presented in Appendix A.

The data obtained in the above data base generation was reduced to form the following parameters:

1. Clearance Delivery

Average number of communication transactions (CT) required per aircraft (AC)

Average CT duration

Percentage channel occupancy time required by transactions

Average time lapse between first contact and handoff

2. Outbound Ground Control

Average number of communication transactions (CT) required per aircraft

Average CT duration

Percentage time occupancy required by transactions

Average number of required message elements per aircraft

Average number of required control type instructions required per aircraft

Number of departures per hour

3. Inbound Ground Control

Average number of transactions required per aircraft

Average CT duration

Percentage time occupancy required by transactions

Average number of message elements required per aircraft

Average number of control type instructions required per aircraft

Number of aircraft handled per hour

4. Local Control

Average number of transactions required per aircraft

Average CT duration

Percentage time occupancy required by transactions

Average number of message elements required per aircraft

Aircraft handled/hour

The large amount of magnetic tape data made available by TSC for February/March 1973 was collected when the traffic volume was high. Unfortunately, the data was subject to adjacent channel interference. This was particularly so for the Ground Control positions, rendering reduction to be extremely difficult or impossible with accuracy. Therefore, only TSC Run #33 was analyzed for the Inbound Ground Control position from this source of data.

Further recordings were made by CSC in January 1974 on smaller traffic volumes (due to reductions in scheduled operations based on the national fuel shortage). These recordings are the primary source of data for the Ground Control positions in this report.

2. 4. 1. 3 Tower Observation and Analysis of Controller Task and Non-Communication Activities

During several periods project analysts were stationed in the tower cab to observe and record the overall nature of operations in the cab and the specific task activities of the various controller positions.

General observations were made in relation to the observers' impressions of the working interface between control positions and the effect of the traffic environment and operating conditions on controller activities. During these periods a number of particularly significant events were observed and the actions

taken by controllers were noted. Where the situation permitted after the events were resolved the particular problems were discussed with the controllers affected. The information gained from these general observations primarily served to supplement the information on controller procedures obtained through the previously discussed controller interviews. In addition, it served to supplement the detailed observations of controller non-communication activities.

Several attempts were made to observe and chronologically record the activities of individual control positions in relation to all aircraft controlled over a period of one-half hour. However, these attempts were all unsuccessful for a number of reasons. Primarily, no position could be found where the observer could station himself such that he could accurately observe all activities and/or relate those activities to particular aircraft (as planned) without becoming an obstruction to the operations of the control position he was observing or of other control positions. Secondly, the short durations of the non-communications tasks being observed did not permit the recording of all the information desired, particularly the time involved, without missing or losing data for the next activity when they performed in immediate time sequence. Therefore, this approach was dropped.

Instead, a two-step approach to the recording of controller activities was adopted. In the first step, the analysts concentrated on observing and recording the performance times for one non-communications task activity at a time. For each task activity a number of stop watch measurements of the performance times were made for three different controllers. Since ground and local controllers were observed to be continually scanning the traffic situation visually or employing the ARTS or ASDE Brite display, no attempt was made to measure this type of non-communications activity.

In the second step, a number of departure and arrival flights were selected for a detailed Flight Trace. In performing the Flight Trace the particular flight was followed from its entry into the ASTC System to its exit from the System. For arrivals, the trace was started when the aircraft was established on the runway

course and was located at approximately the 10-mile marker ring on the Local Control ARTS Brite display. The trace was completed when the aircraft docked at its gate. For departures, the trace was started in all but one case when aircraft began its pushback; in the one case, the trace was started when the flight called for its clearance. The trace was completed when the flight was handed off to Departure Control and the flight strip dropped down the Flight Strip Tubes to Departure Control. The aircraft was followed through all control positions involved in its passage through the system and the activities, both communications and non-communications, of each controller with respect to the flight recorded.

The performance times measured for the various individual activities were utilized to derive statistical descriptions for the activities. These descriptions were used to compute total non-communications task activity times for each control position as a function of traffic volume.

2.4.2 Aircraft Flow Analysis

The aircraft flow analysis procedure was designed to examine the movements of aircraft traffic within three major areas of the airport. These included the ramp areas and the Ground Controllers' and Local Controllers' areas of responsibility. Each aircraft moves through these areas irrespective of whether it is a departure or arrival.

For the purposes of the analysis, these areas were defined as follows:

1. Ramp area - that area between the terminal concourses and inside a line defined by the outer edges of adjacent fingers.*

*It was not possible to examine with any accuracy traffic flow within the cargo or hangar areas.

2. Ground Controllers' area - that area traveled by an aircraft between the ramp area and end of the departure queue (waiting line) or exit from the landing runway. *
3. Local Controllers' area - the area including the departure queues and the active runways. *

The variables which have been considered in the aircraft flow analysis fall into two categories, namely, independent and dependent. The dependent variables which were measured include:

Runway operations time

Taxi service time (Nominal movement time excluding delays)

Delays

Safety (accident risk)

The independent variables which influence the above dependent parameters and which have been considered in this analysis include:

Runway (R/W) configuration - arrivals from the east vs arrivals from the west

Traffic Volume - operations/hour and other parameters to be defined later in this report

Weather (visibility) conditions

Gates - number, scheduling, availability

Routing procedures

Locations at which aircraft may be held because of the traffic flow pattern or gate unavailability for occupancy

Aircraft flight phase - arrival, departure

*It was recognized that these definitions may not reflect the actual division of aircraft control between these positions. However, the ASDE films which served as the major source of data for these analyses do not permit identification of the points at which actual transfer of control was accomplished in all cases.

Based upon these definitions of the areas of interest, the aircraft flow analysis was effectively divided into three distinct but related areas: interviews with ATCT personnel and review of ATCT records; detailed analysis of ASDE films; and direct observation and recording of traffic movements within selected ramp areas. The independent and dependent variables considered in each of the areas are summarized in Table 2-2.

Table 2-2. Examination of Aircraft Flow Variables

Aircraft Flow Variable	Flow Analysis Methodology Area		
	ATCT Interviews and Records	ASDE Film Analysis	Ramp Area Observations
<u>INDEPENDENT</u>			
Runway Configuration	x	x	
Traffic Volume	x	x	x
Weather Conditions	x	x	
Gates	x		x
Routing Procedures	x		
Aircraft Hold Locations	x	x	x
Aircraft Flight Phase	x	x	x
<u>DEPENDENT</u>			
Runway Operations Time		x	
Taxi Service Time		x	x
Delays		x	x
Safety (Accident Risk)		x	x

2. 4. 2. 1 ATCT Personnel Interviews and Records Review

Extensive interviews were conducted with ATCT personnel. These interviews were conducted with members of the operations planning staff and with Watch Supervisors. The objectives of these interviews were to determine:

1. The primary runway configurations employed at O'Hare
2. The criteria used in determining the runway configurations to be employed for operations under various operating conditions
3. The operating minimums for the various runways that influence their use during lower visibility conditions
4. The aircraft taxi routing patterns employed for the various primary runway configurations

With seven runways oriented in several compass directions there are a large number of potential combinations that could be employed to achieve configurations appropriate to a wide range of operating conditions. However, many of these potential configurations are essentially variations of the primary configurations to meet particular constraints, e. g. , runway closing for maintenance operations. Thus, the decision was made to focus on the 11 primary configurations identified by the ATCT personnel.

In deriving items 1, 2 and 4 above, specially prepared illustrations of the airport surface and passenger terminal layout were used. A separate illustration sheet was used for each configuration. The primary arrival and departure runways were noted as well as additional runway usage for departures and VF arrivals by general aviation and STOL commuter aircraft. Particular conditions affecting the choice of the configuration were also noted. Finally, the primary and alternate taxi routes for departure and arrival aircraft were traced on the illustration. The results of these interviews are provided in Section 3.

Arrangements were made for a review of ATCT records to determine the degree to which various runway configurations are employed by the ATCT. It

was determined that the ATCT did not compile its records in the manner desired and had not as yet compiled the runway usage data for FY1973 or calendar year 1973. Therefore, access was provided to the collection of Daily Work Summary sheets that would ordinarily be used to compile this data. Because of the volume of such data, it was determined that a sampling process would be employed. Summary sheets for at least one weekday in each week within a month were selected basically at random, with the one exception that care was taken to select sheets for different days of the week within each month. The following data was extracted from the summary sheets:

1. The runway configurations employed during the normal busy hours of 7 a. m. to 11 p. m.
2. The hours within which the various configurations were employed.
3. The arrival and departure traffic volumes for each different runway configuration period.

This data was employed to compile a summary of the easterly and westerly modes of operation for the airport.

2. 4. 2. 2 ASDE Film Analysis

Detailed analysis of the ASDE films provided by TSC and made during this study period served as the primary source of data for the analysis of aircraft traffic flow during the ground taxi, takeoff, and landing phases of operations. ASDE film analyses were performed in three steps with the first being a derivation of overall traffic flow statistics and the last two focusing on specific aspects of the flow process; i. e., causes and locations of aircraft holds and potentially hazardous incidents.

2. 4. 2. 2. 1 Aircraft Flow Statistics

The ASDE films were made using a time-exposure control camera. A frame was taken every two seconds; one second of exposure followed by a pause of one second. A digital clock was mounted on the ASDE monitor and within the area

of view. The films were then produced using a special film analysis projector providing variable speed and frame-by-frame control.

The method of data extraction involved examination of the operations for one runway at a time. Each arrival aircraft was identified during its approach phase and traced in time until it reached and entered the ramp area. The ASDE films did not permit accurate examination of the aircraft movements within the ramp area. For this reason it was necessary to treat departure aircraft as "arrivals in reverse" and to trace them backward in time from takeoff to emanation from the ramp area. Aircraft identity and, except in some cases (e. g. , 747s), aircraft equipment type could not be determined from the film. In addition, the precision of the films did not permit separation of traffic on the inner and outer circular taxiways, except in a few cases.

Table 2-3 illustrates the events for which times of occurrence were recorded for arrival and departure aircraft. It should be noted that it was not possible to obtain data on the movements of aircraft between the terminal ramp

Table 2-3. Movement Events Measured for ASDE Film Analysis

Arrivals	Departures
OL - Over Last Light	LR - Leave Ramp Area
TO - Turn Off Runway	HI/SI; H2/S2 - "Holds"
HI/SI; H2/S2 - "Holds"	EDQ/LDQ - Enter/Leave "Dept. Q"
HP/SP - Enter/Leave Penalty Box	RTR - Ready to Roll
ER - Enter Ramp Area*	STO - Start Takeoff

areas and the hangar/cargo areas. * The times recorded were used to compute the taxi service time and hold delay time for each aircraft.

As noted in Table 2-3 the beginning and end of each "Hold" was determined for each aircraft. These "Holds" included a "Penalty Box Hold" for some arrival aircraft. This delay is attributable to gate unavailability rather than surface traffic congestion and a method for identification and subtraction of this type of "Hold" time from the total delay was developed. The guidelines used for identification of Penalty Box Holds include location of "Hold" area associated with the following guidelines:

- Aircraft stops within known areas for holding of aircraft
- An arrival aircraft may occupy a holding area only once
- All "Holds" whose duration was in excess of 90 seconds were assumed to be of gate nature unless the ASDE films permitted assessment of another reason for the hold.

A copy of the form used for the reduction of the ASDE films is shown in Appendix B.

From the times computed for each aircraft observed in an analysis period, average taxi service times and delay times were derived for the analysis period. These values were then used to compute and/or plot the average times for various traffic levels for the two different modes of operation for the airport: arrivals from the east or west.

In addition, the measured data was employed to compute a value for the average number of aircraft under control in the Ground Controllers' and Local Controllers' areas using the relationship

*These aircraft are handled by the Arrival Ground Controller; the level of this ground movement activity appears to be less than 10 percent of the aircraft actually measured and may be determined from the analysis of the communication tape records for the above controller position.

$$Q = \frac{N_h}{1 + \frac{\Delta T}{\bar{T}_i}}$$

where

Q = Average aircraft density or number of aircraft under control

N_h = Total number of aircraft controlled during analysis period

ΔT = Duration of the analysis period (normally one hour)

\bar{T}_i = Average time under control for individual aircraft

2. 4. 2. 2. 2 Ground Taxi Hold Analysis

Following the derivation of the data for the aircraft flow statistics, the ASDE films were then subjected to further detailed analysis of the holds recorded (with the exception of "Penalty Box Holds"). The purpose of this analysis was to determine whether particular patterns relative to the locations at which aircraft holds are likely to occur could be discerned from the films to corroborate information developed in discussions with ATCT personnel.

To accomplish this a map of the airport surface configuration was utilized. Each surface intersection was given an identification number according to an assignment scheme which distinguished between intersections on the inner/outer circular taxiways, other taxiway/taxiway intersections, and taxiway/runway intersections. The circumstances associated with each hold (i. e., its location and the movements of other traffic relative to the holding aircraft) were studied and the location and (judged) probable cause or reason recorded, where it could be ascertained. The reason categories used included: (1) competing traffic; (2) runway crossing; (3) ramp congestion; (4) unknown; and (5) other.

The recorded data was compiled for each analysis period, and for each mode of airport operation. The results were analyzed to determine whether a particular pattern could be observed for each of the two modes of operation and combined operations.

2.4.2.3 Ramp Area Observations

It was determined that the only feasible way of collecting accurate data on aircraft movements within the terminal building ramp areas was by direct observation and recording of events of interest. In comparison with other data collection methods (e.g., ASDE photographic recording) the manual recording of ramp area activities presents certain constraints which should be recognized. First, the observer location dictates physical limits in the size of the area which can be viewed and accurate data collected.

Prior to the start of the data collection efforts, a data recording form was developed to facilitate the data collection process. A sample of this form is shown in Appendix B. The form provided for recording of the operating airline, aircraft type, gate number, the time of occurrence of various events in the movements of arrival and departure aircraft in the gate area (e.g., pushback, start to taxi, begin hold) and the apparent reason for any delays. In testing the data collection method it became apparent that it was not practical to readily identify the time at which a jetway was removed. Consequently, this item was omitted from further consideration. The use of 35 mm camera recording techniques was also investigated. However, due to the relatively restricted viewing area of a camera (even with a wide-angle lens) from feasible observation points on the airport, it was concluded that no significant advantage would result by this means.

Second, depending on the location of the observation point, the rapid identification of the specific gate at which an activity commences can at times be difficult due to obstructions (other aircraft blocking the view, for example) or due to the considerable distances and viewing angles involved.

Finally, when multiple aircraft are in various stages of arrival or departure simultaneously, the problems associated with noting a particular event and the time of the event and immediately recording this data for the correct aircraft became rather difficult in a short period of time.

The optimum method for dealing with these constraints during the observation period consisted of combinations of (1) limiting the area under observation, (2) proper location of the observation point, and (3) by working as a team with one observer noting the occurrence and time of an event and a second observer recording the data in the appropriate space on the data sheet.

2.4.2.3.1 Data Collection

Observations of aircraft movements were made from three different locations which permitted coverage of the individual ramp areas. United Airlines operates a ramp tower located on top of the intersection of the E and F concourses. From this location an unobstructed view is available for the ramp areas between the D-E, E-F, and F-G concourses. The second location was at the ramp tower located on top of the intersection of the H and K concourses. This tower is operated by American Airlines for control of their assigned gates. Due to the physical location of various offices within the ramp tower area (facing the H concourse), the view is restricted to the H-K and K ramp areas and the two AAL gates (H-1 and H-2) located on the inner edge of the H concourse. The third location selected for observation of the G-H ramp area was located within the main terminal approximately midway between the G and H concourses. In the case of observations of the G-H ramp area, it was absolutely essential to use the team approach for data collection as a result of an additional factor not mentioned above. This was due to the relative illumination levels of the area under observation and within the terminal building during the early morning and early evening hours which made observations much more difficult than those from the ramp control towers.

For arriving aircraft, the time of entry into the ramp area was recorded when the aircraft physically passed the outer edge of a particular concourse. In the event of an arrival hold, the times at which the aircraft stopped taxiing and began taxiing again were recorded. The docking time was recorded as that time when the aircraft came to a halt at the gate. Aircraft type, airline, and gate number were also recorded at that time.

For departing aircraft, aircraft type, airline, and gate number were recorded while the aircraft was still at the gate. Timing measurements began when the aircraft first began pushing back from the gate. Pushback was considered to be complete when the tow bar was physically removed from the aircraft and the time was then recorded. The time at which the aircraft began to taxi was recorded. In the event of a departure hold at any point in movements (e. g. , during pushback or after taxi was begun) the times at which the movement stopped and was reinitiated were recorded. The time of exit from the ramp area was recorded when the aircraft physically passed the outer edge of a particular concourse.

In the event of a movement hold for either arrival or departure, the apparent reason for the hold was recorded (if possible to ascertain).

2.4.2.3.2 Data Analysis

For arrival aircraft two movement characteristics were computed: Ramp Service Time and Arrival Hold Duration. Ramp Service Time for "Arrivals" was defined as the duration of the time interval between time of entry and docking, including holds, if any. Arrival Hold Duration consisted of the total of all holds in the ramp area while the aircraft was entering.

Ramp Service Time and Hold Duration were computed for departure aircraft as well. In addition, two other movement characteristics, Pushback Duration and Engine Start Time, were computed. Pushback Duration was defined as the time difference between the start of pushback and removal of the tow bar. Engine Start Time was defined as the time interval between completion of push-

back and the start of departure taxi. Departure Hold Durations included all periods during which the aircraft is stopped after the initial taxi operation began. Ramp Service Time, for departures, was defined as the total time interval between the start of pushback and the time the aircraft passed the outer edge of the finger.

For those aircraft which arrived and departed within the specific observation period, a "Gate Occupancy Time" was derived to provide data on the length of time the aircraft physically occupied the gate. This interval was determined from the time of docking to the time that pushback commenced.

The resulting data was used to develop statistical distributions of these various movement characteristics. In addition, an analysis of the data was made to determine the primary causative factors for aircraft delays within the gate area. An analysis was made to determine the average ramp density (number of aircraft in the area per minute) and the short-term effect of scheduling peaks on aircraft movements in the ramp area.

2. 4. 3 Airline Operations Analysis

The airline operations analysis was designed to examine those aspects of aircraft operator procedures that impact on the total operations at O'Hare and the operations of the ASTC System. The aspects of airline operations of interest include planning of aircraft schedules and gate assignment, control of gate operations, and aircraft flight crew operations. To study these aspects the airline operations analysis was divided into two distinct but related areas:

1. Interviews with airline terminal operations management personnel and observation of operational activities
2. Interviews with pilot personnel and in-flight observation of flight crew activities

2. 4. 3. 1 Gate/Planning Control Interviews and Observations

The specific objective of the interviews with airlines terminal operations personnel was to obtain information related to:

1. The manner in which flight schedule and gate assignment plans are developed.
2. The criteria employed in developing the gate assignment plan and making adjustments to that plan when gate delays are experienced.
3. The procedures employed in coordinating aircraft departure from and arrival at the gates.

The primary method of obtaining this information was interviews with personnel from three major airlines operating at O'Hare: American Airlines, TransWorld Airlines, and United Airlines. These airlines were selected because they were major operators at O'Hare, constituting more than 50 percent of all traffic; hence they could provide the most information on gate planning and control, they operated a variety of aircraft, and they were most subject to gate delay problems. The three airlines were contacted and arrangements for the interviews made. The principals interviewed for each of the airlines were:

American Airlines	-	Mr. Jack Woods
TransWorld Airlines	-	Mr. Peter Constantino
United Airlines	-	Mr. Michael Jankovich

A structured questionnaire was developed for use in these interviews. It incorporated a number of questions in each of the objective areas identified above and provided for recording of the responses directly on the form. In addition, the opportunity was taken to incorporate a number of questions soliciting the opinions of the interviewees on potential concepts for coordination of airline gate

planning/control functions with traffic control functions in future ASTC systems.

A copy of the questionnaire employed is included in Appendix C.

These interviews were supplemented by observations in the airlines' planning and control facilities to gain a first-hand impression of these operations.

The results of the activities were utilized to develop the functional description of the duties and responsibilities of airline personnel provided in paragraph 4.3.

2.4.3.2 Pilot Interviews and Cockpit Observations

The specific objective of the interviews with pilot personnel was to obtain information related to:

1. The division of functional responsibilities between the members of the flight deck (cockpit) crew.
2. The procedures followed in communications with the ATCT and airlines operations.
3. The procedures followed in controlling the movements of aircraft within all phases of the flight.
4. Attitudes toward the existing ASTC System at O'Hare including both control by the ATCT and visual ground aids.

Arrangements were made with American, TransWorld and United Airlines for access to a number of pilots, including both management and line pilots. In addition, with the assistance of two of these pilots, contact was established with two general aviation pilots who agreed to provide an interview. The pilots who participated in this activity include:

1. Robert Smith, Mgmt Pilot, AAL
2. John Hub, Line Pilot, AAL

3. John Rhodes, Mgmt Pilot, TWA
4. Curtis E. Rogers, Mgmt Pilot, TWA
5. H. A. Jacobsen, Mgmt Pilot, TWA
6. Bernard Sterner, Mgmt Pilot, UAL
7. Richard Schultz, Line Pilot, UAL
8. Raoul Castro, General Aviation Pilot (Corp)
9. Robert E. Riddle, General Aviation Pilot (Corp)

The structured questionnaire developed for use in these interviews was divided into two parts. The first which was completed by the pilots was a summary of his flight experience. In the second part of the interview the pilots were first asked to provide a narrative scenario of the functions performed by each flight officer during departure and arrival. This was followed by detailed questions and answers covering specific aspects of interest of crew activities not previously covered by the interviewee as well as pilot attitudes toward current ASTC System operations. In addition, the opportunity was taken to incorporate a number of questions to solicit pilot opinions pertaining to potential concepts for improved visual ground guidance and transmission of clearances and control instructions to aircraft in future ASTC systems. To assist in this latter area of the interview, illustrations of potential methods of providing this information to the cockpit crew were prepared as references for the questions asked. A copy of the questionnaire employed is presented in Appendix C.

These interviews were supplemented by in-cockpit observations by project staff members. Arrangements for Flight Deck Authority for two staff members were made with the assistance of United Air Lines for flights between O'Hare and Newark Airports. Depending on the availability of one or two observer seats in the cockpit for the flights flown, one or both of these staff members were in place in the cockpit to observe operations during departure and arrival phases of flight. Departure phase observations were made from the point at which the crew boarded the aircraft until the aircraft reached its enroute altitude. Arrival

phase observations were made from the point at which descent was initiated until the completion of flight check procedures following the docking of the aircraft. The equipments flown during these flights included DC-10, DC-8, and DC-8-60 series aircraft.

During the flights recordings were taped of the observers' impressions of the activities of the flight crew and the situations encountered. In a few flights, detailed records were made tracing the movements of the aircraft, the activities of the crew, and communications with ATC and airline operations in time sequence.

The results of the activities serve as the basis for the functional descriptions of flight crew responsibilities in Section 4.3 and the flight crew workload analysis in Section 5.4.

2.4.4 Airport Management Operations Analysis

The airport management operations analysis was designed to examine those aspects of the procedures followed by the O'Hare Airport management which impact on the total operations of O'Hare and the operations of the ASTC System. The aspects of airport management operations of interest included planning and coordination of airport maintenance operations, planning and coordination of snow removal operations, and coordination of emergency operations. This included coordination of these operations within the airport management organization and with the ATCT.

The information in these areas was derived through interviews with airport management personnel and through review of the O'Hare Operations Manual and Emergency Operations Manual provided by the Assistant Airport Manager.

A structured questionnaire was developed for use in the interviews. It incorporated questions covering each of the above areas of interest as well as the functional organization of the airport management. The opportunity was also taken to incorporate a number of questions to solicit the opinions of the interviewees on potential concepts for the interface between airport management and ATCT operations in future ASTC systems.

2.5 PROJECTION OF THE FUTURE OPERATING ENVIRONMENT AT O'HARE AIRPORT

An attempt was made to obtain detailed information pertaining to projections of the future operating environments of O'Hare Airport through 1985 for use in the future ASTC System effectiveness analysis. The information desired fell into the general categories of:

1. Runway construction
2. Taxiway construction
3. Terminal facilities construction
4. Traffic volumes
5. Aircraft fleet

It was not possible to obtain the desired information. Therefore, it became necessary to formulate a projected environment based upon certain reasonable assumptions.

Assumptions relative to future construction of runway, taxiway and terminal facilities were based upon discussions with ATCT, airline, and airport management personnel. In meetings with these personnel, various possible changes to the airport facilities which have been considered were discussed and those most probable of implementation noted. Therefore, for the purposes of the future ASTC system analysis the projected environment was assumed to include:

1. Construction of a new 9L-27R runway parallel to and north of the existing runway and use of the existing runway as a parallel taxiway
2. Construction of a new 4L-22R runway parallel to and northwest of the existing runway and use of the existing runway as a parallel taxiway
3. Construction of a new section of taxiway connecting the 14R-32L parallel taxiway to the 4L end of the existing 4L-22R runway or future parallel taxiway

4. Construction of a new International Terminal Complex on the current site of the USAF/Air National Guard terminal facility.

Another possible change in the airport facilities mentioned in discussions--the elimination of inner gates of the various terminal concourses and construction of underground facilities for passenger access to the remaining concourse areas--was rejected as being unreasonable for the foreseeable future. This is based upon the fact that gates represent revenue-producing elements for the airlines and airport and their elimination, particularly in view of revenue losses caused by the recent flight schedule cutback and increasing operating costs, would appear unlikely. In addition, prior to the cutback, operations at O'Hare were to some extent gate limited, i. e. , gate delay holds were frequently encountered by arrival aircraft during heavy traffic periods. Thus, if traffic volume increases of any significance are to be considered for future O'Hare operations, reduction in the current gate capacity would be counter-productive. In fact, in 1970-71 extension of the existing concourses to provide increased gate capacity was under consideration by the airport management.

SECTION 3 - AIRPORT CONFIGURATION DESCRIPTION

3.1 GENERAL

The purpose of this section is to provide a functional description of the physical configuration of O'Hare Airport as it affects traffic operations and flow. It is also intended to serve as a background reference for the functional description of the ASTC System operation in Section 4. The material in this section is divided into descriptions of the various runway configurations and usage patterns, taxi flow patterns in relation to runway configuration in use, and the terminal facilities configuration.

3.2 RUNWAY CONFIGURATION DESCRIPTION

3.2.1 Runway Descriptions

Figure 3-1 presents a plan view of O'Hare Airport. The north side of the field has four runway pavements; however, runway 18/36 is restricted to light aircraft departures. While the south side of the airport has the same number of major runway pavements (three) as the north side, the runway intersection ratios are appreciably different in the south than in the north. Each runway pavement, of course, can be used in two directions so that six major runways are available in each of the north and south areas. Runway identification is based upon the magnetic heading of the runway (to the nearest 10 degrees) with suffix "L" or "R" to distinguish between the "parallels" as viewed from the aircraft.

From 0800 to 2000, it is common for four primary runways to be in operation--an arrival/departure pair on the north side and one on the south side of the airport. From the layout of the runways shown in Figure 3-1, it is seen that most of the possible arrival/departure runway pairs involve intersecting runways. As will be shown in paragraph 5.3.3.1.3, the capacity of intersecting runways is determined by the ability of the controller to manage departure releases in the face of the incoming arrivals. Briefly, if the arrivals routinely cross the

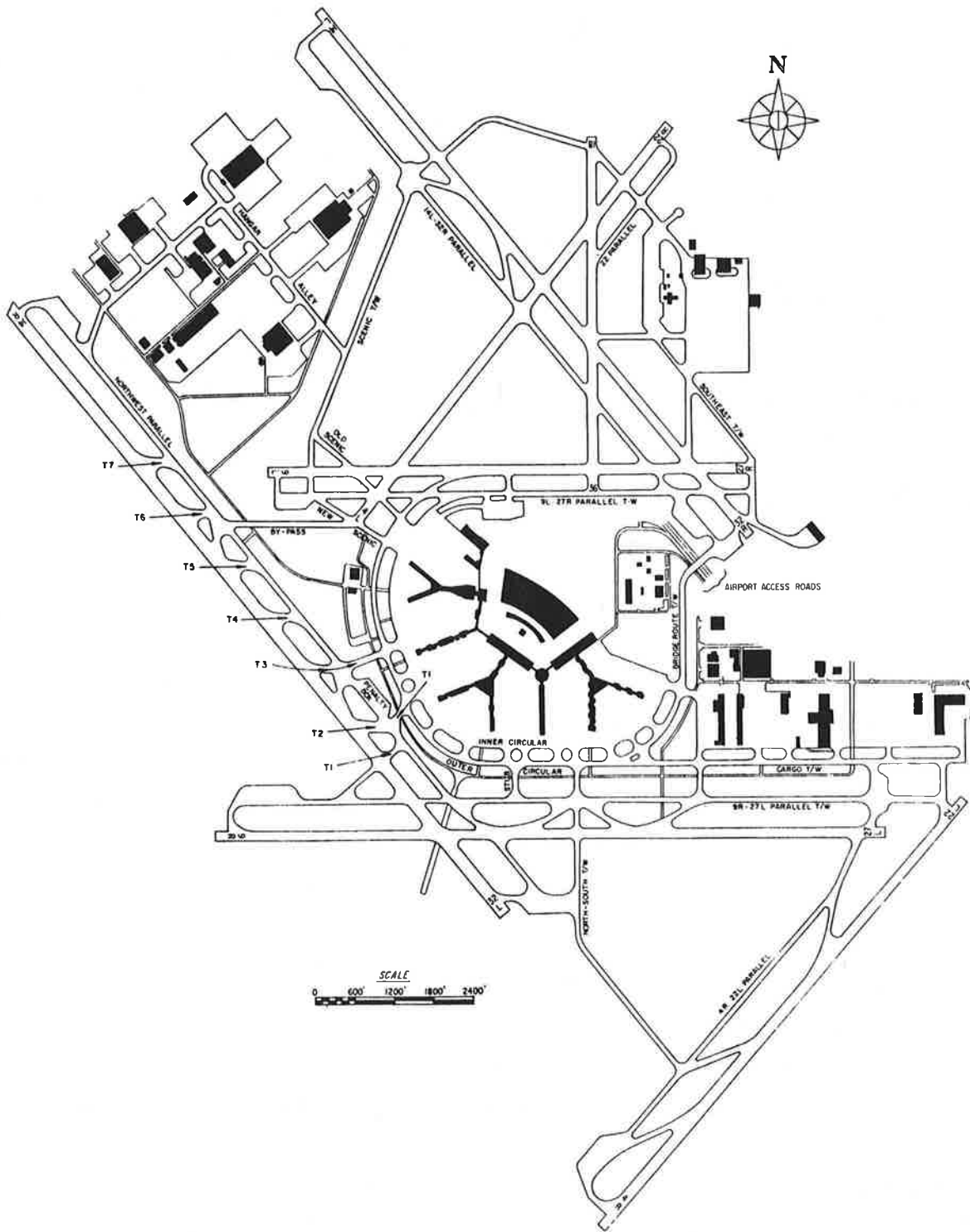

Figure 3-1. Current O'Hare Layout

departure runway prior to turnoff, then departure releases are keyed directly to the arrivals. The difficulty of the task depends on both how quickly the arrivals cross the intersection after touchdown and how quickly the departures clear the intersection after release. The farther down the runways the intersection occurs, the greater the dispersion on roll times to the critical intersection and the lower the capacity. On the other hand, if the arrivals routinely turn off prior to crossing the departure runway, then departure releases may be handled relatively independently of the arrival traffic. This results in a sharply increased capacity over the configuration in which both arrivals and departures have long rolls to the critical intersection. Because of the importance of configuration on the operation and capacity of intersecting runways, these runway combinations have been divided into four classes for the purposes of this working paper. These classes are presented in Table 3-1.

Table 3-1. Classification of Crossing Runway Configurations

Crossing Runway Configuration Classification	Arriving Aircraft Will Cross Departure Runway	Departing Aircraft Will Cross Arrival Runway	Examples (Arrival/Departure Runway)
Near-Near	While still in air or within 2000 ft from start of touchdown zone	Within 2000 ft from roll initiation	<ul style="list-style-type: none"> ● 27R/32R ● 9L/4L
Near-Far	Same as above	Roll to intersection > 2000 ft	● 32L/27L
Far-Far	Intersection beyond 2000 ft from start of touchdown zone <u>and</u> arrivals routinely cross departure runway prior to turn off	Same as above	● 14L/4L
Quasi-Independent	Arrivals routinely turn off prior to intersection <u>but</u> a missed approach initiated just prior to touchdown may pass over the departure runway	Not constrained	<ul style="list-style-type: none"> ● 14R/27L ● 14R/9R

Landing Aids

The following source data was used to identify the landing aids of

O'Hare:

1. Composite Utility Drawings (Revised July 1973)
2. Pavement and Taxiway Lips (Effective Nov. 18, 1972)
3. FAA Map (No date shown)
4. FAA Airport Master Record (Date of print 5/24/73)

Due to differing dates of the information sources shown, a number of possible conflicts/inconsistencies were noted and attempts made to resolve them. Although Source 3 is not dated, it does appear to be the most recent source in terms of ILS component location as well as actual runway taxiway configurations.

Table 3-2 provides a summary of both electronic as well as visual landing aids deployed for the various runways. For the purpose of this table, the Cat I ILS components consist of (1) Middle Marker, (2) Glide Slope, and (3) Localizer. The Cat II components are the same as for Cat I with the addition of an Inner Marker.

Based on the above components, substantial agreement between the various sources was noted; however, the following items could not be located on Source 1, an omission considered to be due to lack of complete updating:

<u>Runway</u>	<u>Missing ILS Component</u>
9R	Glide Slope
27L	Middle Marker
14R	Inner Marker
32L	Middle Marker
14L	Inner Marker
32R	Localizer
4L	Localizer

Table 3-2. Runway Landing Aids at O'Hare

Runway Identification	Electronic			Visual				
	Localizer Only	Category I	Category II	ALS ⁽¹⁾	Other ⁽¹⁾	RVR ⁽²⁾	Touch Down Zone	Center Line
		ILS	ILS					
<u>South Area</u>								
14R			x	ALS/SFL		2	x	x
32L		x		ALS/SFL		2		x
9R		x		MALS/RAIL		0		
27L		x		ALSF-1(REIL)		0		
4R	(Future)			VASI-4		0		
22L				VASI-4		0		
<u>North Area</u>								
14L			x	ALS/SFL		2	x	x
32R		x		ALS/SFL		2		x
9L						1		
27R		x		ALS/SFL		1		
4L	x			ALS/SFL		1		
22R				VASI-12/REIL		0		
18				VASI-2		0		
36						0		

NOTES

(1) Notation as shown on Source 3.

(2) Minimum number of units serving runway according to Source 3.

Visual landing aids were found to be in general agreement between Sources 3 and 4 with a single exception. For runway 4L, Source 3 indicates ALS/SFL while Source 4 indicates SALSF. In addition, it has been assumed that the acronym ALS/SFL used in Source 2 is identical to ALSAF used in Source 4 and may be due to changes in the manner of usage.

RVR instrumentation, as obtained from Source 3, is available as shown in the table. The only disagreement noted from Source 4 involves a single installation which serves runways 9L and 4L with an RVV.

3.2.2 Runway Configuration Usage

Identification of the usage patterns for the O'Hare runway configuration was based on five sources of data:*

1. Maps illustrating the primary runway usage/taxi flow configurations and runway operations counts for CY 1971. *
2. Discussions with O'Hare ATCT personnel.
3. Review of runway configurations observed on TSC and CSC ASDE films.
4. Review of ATCT summary Daily Work Sheet for a sample of days over a six month period, January to June 1973.
5. Chicago O'Hare Airport Air Traffic Control Tower Training Manual, Dept. of Transportation/Federal Aviation Administration, December 1973.

*The maps illustrating runway configurations provided in item 2 were estimated to be at least two years old and did not include any reference to runway 4R/22L which was not completed until late in 1971. Therefore, the effort under item 2 was essentially intended to determine recent configurations data.

3.2.2.1 Runway Configurations

The discussions with the ATCT resulted in the identification of eleven primary runway configurations for O'Hare operations. This does not in any way reflect all the possible configurations that could be employed where the situations dictate, e. g. , the closing of a runway requiring the use of a different configuration. Even within the eleven configurations a number of variations were identified, which basically involved the substitution of one runway for another for departures without changing the basic ground traffic flow pattern.

The configurations identified are presented in Table 3-3. It may be noted that, for each configuration, Table 3-3 also provides a classification of the basic mode of operation for the airport, the classification of the runway operations made, and the particular conditions under which this configuration may be employed.

In discussing the development of the study analysis approach in Section 2 it was indicated that two modes of operation of the airport seemed apparent, i. e. , Arrivals from the East and Arrivals from the West. This assumption appears to be borne out by the runway configurations shown in Table 3-3. In configurations 1 to 4 the approaches to the arrival runways indicated are essentially made from east to west, with departures also from east to west. In configurations 5 to 10 the approaches to the arrival runways (and departures) are essentially west to east. Configuration 11 has been classified as a mixed mode of airport operation since it incorporates arrivals and departures from both east to west and west to east. The significance for this configuration could not be ascertained by CSC.

The decision to classify the mode of airport operations in terms of arrival direction was further borne out in discussions with ATCT personnel relative to the manner in which the runway configuration to be used is chosen. It was indicated that the arrival runways were essentially chosen first based upon particular selection criteria and then the departure runways compatible with the arrival runway operations and local noise abatement requirements.

Table 3-3. Primary Runway Configurations Identified by ATCT

Configuration Number	Airport Operating Mode (Arrivals From _____)	Primary Runways (Arrival/Departure)		GA Dept.	Supplemental Runways		Runway Operations (Approach Mode)	Applicable Conditions [Ceiling (ft)/Visibility (mi)] and/or Winds (kts)
		South	North			VFR Arr.		
1	East	32L/27L	27R/32R	36	22R Hold Short 27R		Dual	>800/2 and <15 knots
2	East	32L/27L	32R/32R	36			Parallel	<800/2 and/or >15 knots from NW
3	East	27L/32L	27R/32R		22R Hold Short 27R		Parallel	<800/2 and/or >15 knots from W
4	East	27L/22L	22R/27R		14L Hold Short 22R		Dual	>800/2 and <15 knots
5	West	9R/9R or 14R	14L/9L		22R Hold Short 14L		Dual	>800/2 and <15 knots
6	West	14R/9R	14L/9L				Parallel	<800/2 (but above Cat. II) and/or >15 knots from SW
7	West	14R/14R	14L/14L				Parallel	Category II
8	West	9R/4R	9L/4L				Parallel	>800/2 (clear) and >>15 knots from E
9	West	14R/9R	14L/4L				Parallel	<800/2 and >15 knots from SW (if 9L not available)
10	West	4R/9R	4L/9L					<800/2 and >>15 knots from NE
11	Mixed	14R/27L	22R/9L or 14L		14L Hold Short 22R		Dual	>800/2 and <15 knots

In determining the runway configuration to be employed, the weather and wind conditions are the primary selection criteria. This gives rise to the runway operations mode classifications shown in Table 3-3. When weather conditions are above 800 feet ceiling and 2 miles visibility and wind velocity is low, i. e. , below 15 knots, the runways are operated in a "Dual" Approach Mode. In this mode headings for approaches to the arrival runways in the south or north areas are skewed with respect to one another as are departure runway headings. When weather conditions are below 800/2 and/or wind velocities are above 15 knots, the runways are operated in a Parallel Approach Mode; that is, approaches are made to parallel runways. It may be noted in Table 3-3 that several of the parallel approach mode operations also involve parallel departure runways.

It is also shown in Table 3-3 that, under VFR conditions--that is, ceiling and visibility above 3500 feet and 5 miles--visual approaches may be made to other than the primary northside runway subject to the restriction indicated.

3. 2. 2. 2 Limitations on Runway Usage

It should be noted that although arrivals to runways 4L/4R are shown in Table 3-3 for configuration 10, this configuration is avoided except when the winds are strong out of the northeast. This is because use of 4L causes a loss of service for 14R, the prime runway for the west mode of operation. In addition, approaches to 4R pass low over the railroad yards south of the airport and interfere with switching operations which are conducted by voice communications. For this same reason the use of configuration 4 involving 22L departures is avoided unless 32L is unavailable to allow use of configuration 1.

It was noted that configuration 9 was used if runway 9L was not available. Although the use of 4L for departures would eliminate the crossing of an active departure runway for arrivals on 14L to reach the terminal, such departures take flights over a densely populated area immediately after takeoff (resulting in noise complaints by residents).

Configuration 8, involving parallel 9L/9R arrivals, was noted to be used when winds are strong out of the east. However, this usage is different from other parallel operations which are employed when the ceiling and visibility are below 800 feet and 2 miles. For this configuration clear visual operating conditions are required because the approach lighting system available for 9R does not permit operations under lowered visual conditions.

It was noted for configuration 7, involving the use of only 14R/14L for both departure and arrival operations, that its use was limited to Category II conditions. As previously indicated in paragraph 3.2.1, these are the only runways instrumented for Category II operations. This subject of instrumentation leads to another limitation on runway configuration usage. By virtue of the nature of the instrumentation for the runways, primarily RVR and RVV, there are minimums below which they may not be employed. These minimums are summarized in Table 3-4. The values shown are taken from the Tower Training Manual for O'Hare. Discussions with ATCT personnel and observations indicated that low visibility operations below Cat I conditions are not conducted on other than the 14s. During an observation period when conditions changed from low Cat I (300 ft ceiling and 1/2 to 1 mile variable visibility) to Cat II, all arrival operations and departures waiting at 9L were routed to 14L.

Table 3-4. Runway Usage Minimums Under Low Visibility Conditions

Runway	Arrival* Minimum	Departure Minimum*
4L	400'-3/4	RVV = 1/4 mile
4R	500'-1	Prevailing visibility - 1/4 mile
9L	-	RVV = 1/4 mile
9R	200'-1/2	Prevailing visibility - 1/4 mile
14L	1200' RVR	700' Touchdown RVR 600' Rollout RVR
14R	1200' RVR	1200' Touchdown RVR 1000' Rollout RVR
22L	-	Prevailing visibility - 1/4 mile
22R	400'-1	Prevailing visibility - 1/4 mile
27L	200'-1/2	Prevailing visibility - 1/4 mile
27R	2400' RVR	1600' Touchdown RVR
32L	2400' RVR	1200' Touchdown RVR 1000' Rollout RVR
32R	2400' RVR	700' Touchdown RVR 600' Rollout RVR

*According to O'Hare Tower Training Manual,
December 1973.

From this table it may be noted that, in the case of runways 14R/14L, arrival minimums are identical but the departure minimums for 14L are lower. As noted during the observations referenced above, this differential resulted in the routing of traffic waiting for departure on 14R to 14L when severe fog caused the visibility conditions to go below the 14R minimums.

3.2.2.3 Runway Usage Records

Runway utilization records for 1971 provided by the ATCT are summarized in Table 3-5. The runway operations counts provided are shown in part (a) of the table. Part (b) represents a breakdown of the counts for these runways in terms of the two airport operating modes.

The above data did not provide any means for determining the specific runway configurations for which these operations took place or of the effect of seasonal weather variations on runway configuration selected. However, it is expected that seasonal weather variations will influence both the mode of airport operation and the most popular runway configurations used at different times of the year. Both the TSC and CSC surveys were taken primarily in the months of January and February and therefore do not reflect operations at other times of the year.

A short investigation was made of the runway configuration data kept on a daily basis by O'Hare. The following guidelines were used:

- Weekdays only; 12 hour period between 0800 and 2000
- Special situations (snow removal, etc.) eliminated.
- Configurations used for 30 minutes or less are excluded from data.

Four time periods in 1973 were selected, with eight sample days in each period, from records readily available from which the desired data could be obtained. These periods are as follows:

Table 3-5. O'Hare Runway Utilization CY-71

Runway	Departures	Arrivals
14R	17,663	73,423
14L	11,527	44,739
32R	58,668	9,985
32L	17,564	71,131
4R	4	
4L	6,892	555
22R	1,177	37,181
22L	639	255
27R	3,095	55,916
27L	121,964	14,585
9R	24,573	10,487
9L	47,794	2,119
18		85
36	4,561	
Totals	316,124	320,460

Helicopters — 4,857

a) Aircraft Count

	South Area						North Area					
Arrival from West Runways	14R		9R		4R		14L		9L		4L	
Arrival from East Runways		32L		27L		22L		32R		27R		22R
% of Arrivals	22.9	22.2	3.3	4.6	Probably opened only part of year		14.0	3.1	.7	17.4	.2	11.6
% of Departures	5.6	5.6	7.8	38.6			3.6	18.6	15.1	1.0	2.2	.4
% of Total	14.3	13.9	5.5	21.4			8.8	10.8	7.8	9.3	1.2	6.0

Estimated % arrivals from west ≈ 40%; from east ≈ 60%.

b) Percentage breakdown

<u>Nominal Time Period</u>	<u>Dates</u>
A - January	Jan. 2, 5, 8, 11, 16, 19, 22, 26
B - February	Jan. 30; Feb. 2, 6, 9, 12, 28; March 2, 5
C - April	Mar. 28; April 3, 11, 19, 27, 30; May 2, 8
D - June	May 14, 24, 29; June 1, 7, 12, 20, 25

The various runway configurations and the time interval of usage for a particular configuration were determined for the 96-hour sample comprising each time period. The data derived from this analysis are presented in Tables 3-6 and 3-7. Each runway configuration is identified by the primary arrival runway followed by the primary departure runway. The entries in each matrix element represent the continuous number of hours the particular configuration was observed before a change occurred. From this data we have also determined the "life", or duration, of a runway configuration.

The January and February data are combined in Table 3-6 and the April and June data are combined in Table 3-7. The top matrix in each table presents the configuration defined as "Arrivals from the East" while the lower matrix presents the "Arrivals from West" mode (in the upper left set of entries enclosed by the solid line) plus other "mixed" configurations. In these mixed configurations the use of runway 22R in the north side appears to be appreciably more popular in winter months. Note that while the "Arrivals from East" mode was used 63 percent ($1165 \div 187.25$) of the time in January and February, the "Arrival from the West" mode (excluding the mixed configurations) was only used 10 percent ($19 \div 187.25$) of the time. These results may be contrasted with those of Table 3-7 for April plus June where the east mode was used 46 percent, and the west mode 42 percent of the time while mixed modes dropped to 12 percent usage.

The "life" of a runway configuration was appreciably shorter in the winter months (4.6 hours) as contrasted with the April/June results of 5.8 hours, i. e., there are more runway changes in winter months. Using these results, it

Table 3-6. Seasonal Runway Configuration Usage
(January and February 1973)

ARRIVALS FROM EAST

		SOUTH SIDE								TOTAL HRS
		32L / 27L		32L / 32L		27L / 32L		27L / 22L OR 27L / 27L		
		JAN.	FEB.	JAN.	FEB.	JAN.	FEB.	JAN.	FEB.	
NORTH SIDE	27R/32R	3.5 12.0 12.0 12.0 11.0 3.5 7.25	2.0 1.5 2.0 11.5 12.0			--	1.25	--	2.25	93.75
	32R/32R	--	1.25 1.5 3.75 1.25	--	5.5 5.0					18.25
	22R/27R							--	2.25 2.25	4.50
TOTAL HRS		98		10.5		1.25		6.75		116.50

ARRIVALS FROM WEST AND OTHER RUNWAY CONFIGURATIONS

		SOUTH SIDE										TOTAL HRS		
		9R / 4R		9R / 9R		9R / 14R		14R / 14R -9R		14R / 27L OR 14R / 22L			9R / 22L	
		JAN.	FEB.	JAN.	FEB.	JAN.	FEB.	JAN.	FEB.	JAN.	FEB.		JAN.	FEB.
NORTH SIDE	14L/4L	--	.75 6.0											6.75
	14L/9L			1.25	--	--	6.0 4.25 1.75	.75	2.25	--	2.25			18.50
	14L/14L	"ARRIVALS FROM WEST" MODE								--	2.50			2.50
	22R/14L						3.0	--	12.00 1.75	7.75 2.75				27.25
	22R/9L								8.50 4.25 1.25	1.75				15.75
TOTAL HRS		6.75		1.25		15.0		45.50		2.25		70.75		

Average Interval Between R/W Configuration change = Total Time ÷ No. of observations = $\frac{187.25}{41} = 4.6$ hours

Table 3-7. Seasonal Runway Configuration Usage
(April and June 1973)

ARRIVALS FROM EAST

		SOUTH SIDE								TOTAL HRS
		32L / 27L		32L / 32L		27L / 32L		27L / 22L OR 27L / 27L		
		APR.	JUN.	APR.	JUN.	APR.	JUN.	APR.	JUN.	
NORTH SIDE	27R/32R	6.50 2.75 6.50	16.25 12.00					7.25	2.50	53.75
	32R/32R			1.0 3.0	--					4.00
	32R/4L	--	9.25							9.25
	22R/27R							12.00	6.75	18.75
TOTAL HRS		53.25		4.0				28.50		85.75

ARRIVALS FROM WEST AND OTHER RUNWAY CONFIGURATIONS

		SOUTH SIDE												TOTAL HRS			
		9R / 4R		9R / 9R		9R / 14R		14R / 14R -9R		14R / 14R		14R / 27L OR 14R / 22L			9R / 22L		
		APR.	JUN.	APR.	JUN.	APR.	JUN.	APR.	JUN.	APR.	JUN.	APR.	JUN.		APR.	JUN.	
NORTH SIDE	14L/4L	6.75 2.25 4.75	2.25 7.25						--	2.0						25;25	
	14L/9L			2.25	--	6.75	--	3.25	3.0			5.5	--			37.00	
	14L/14L							9.75	5.25								
	9L/4L	5.00 6.00	5.75 4.50	"ARRIVALS FROM WEST" MODE												21.25	
	22R/14L												--	5.25			5.25
	22R/9L												--	10.00			10.00
TOTAL HRS		44.50		2.25		6.75		22.50		2.0		20.75				98.75	

Average Interval Between R/W Configuration change = Total Time ÷ No. of observations = $\frac{187.5}{32} = 5.8$ hours

appears that there are many days wherein three runway configuration changes occur during the time period 0800-2000. These "changeover periods" can pose special problems to both the controllers and pilots.

Summation of all four time periods (a total of 32 days and about 370 hours) indicates the following:

1. The "Arrivals from East" mode occurs approximately 60 percent of the time over the six month period, which compares with the data provided in Table 3-5.
2. In the "Arrival from East" mode there is one predominant runway configuration. The most popular configuration (used in 75 percent of samples for this mode) was 32L/27L in the south and 27R/32R on the north side.
3. In the "Arrivals from West" mode, there is no similarly predominant runway configuration. On the north side the following combinations were used for the percent of hours listed:

14L/4L - 19 percent
14L/9L - 33 percent

On the south side the results were:

9R/4R - 30 percent
14R/9R - 22 percent

It would appear that in the north the 14L/9L combination is significantly more popular but there is no significantly popular combination in the south.

4. In the Mixed mode of operation, the configuration of 22R/14L in the north and 14R/22L or 27L in the south is the one most used. This agrees with the information provided by the ATCT in discussions on runway configurations in which the combination of 22R/14L and 14R/27L was identified as one of O'Hare's primary configurations.

Runway Configuration Profile

In summary, the operational runway configurations are characterized in Tables 3-8 and 3-9, for clear and calm weather operations and for unclear and/or windy weather operations respectively. These tables present the arrival runway configurations, the weather conditions under which the various arrival configurations are selected for operation, and the departure runway configurations used with each arrival configuration. The list of arrival and departure runway configurations was compiled from the O'Hare Control Tower Training Manual, from the Runway configuration Usage Survey presented in Tables 3-6 and 3-7, and from discussions with control tower personnel. Based on the runway configuration usage statistics, an estimate of the relative time in operation of the various arrival configurations is presented in Column 3; and an estimate of the relative usage of the departure configurations, associated with each arrival configuration, is presented in Column 9. Comparing these usage figures to the eleven primary configurations identified by ATCT personnel, Column 12, there is general agreement.

The estimates indicate that the clear and calm weather configurations are operated approximately 65 percent of the time and, of this time, the airport operates in the arrival from the East, West, and Mixed Modes roughly 40 percent, 10 percent, and 15 percent, respectively. The predominance of time spent in the East Arrival Mode will be shown in Section 5 to be due in large part to the smoothness of traffic flow both on the runways and in the taxiways. The six remaining arrival configurations are used in unclear and/or windy weather. The 14L/14R runways are certified for Cat II operations and make up the dominant arrival configuration for closing weather situations in which Cat II conditions are possible as well as for the low visibility operations themselves. These six parallel arrival pairs permit operations directly into the wind for each 45 degrees of the compass with the exception of winds directly out of the North or South. These six configurations together operate approximately 35 percent of the time. Of this percentage, the arrival from the East

Table 3-8. Profile of Runway Configurations Used in Clear and Calm Weather

Runways (South/ North)	Arrival Runway Configurations					Associated Departure Runway Configurations		Classification of Runway Configurations		CSC Config- uration No.	
	Hours Ob- served	% of Total (370 hrs)	Applicable Weather Conditions		Ap- proach Mode	Runways (South/North)	Relative Usage (%)	South	North		
			Ceiling (ft)	Visibility (mi)							Wind (knots)
32L/27R	134.25	36	>800	>2	<15	Dual East	27L/32R	100	Near-Far	Near-Near	1
14R/22R	58.25	16	>800	>2	<15	Dual Mixed	27L or 22L/14L 27L or 22L/9L 9R/14L 9R/9L	51 44 5 0	Quasi-Ind. Quasi-Ind. Quasi-Ind. Quasi-Ind.	Far-Far Far-Far Far-Far Far-Far	11 11
9R/14L	42.50	11	>800	>2	<15	Dual West	4R/4L 14R/9L 22L/9L 9R/9L 9R/4L	71 19 5 5 0	Quasi-Ind. Far-Far Quasi-Ind. Single Single	Far-Far Quasi-Ind. Quasi-Ind. Quasi-Ind. Far-Far	5 5 5
27L/22R	23.25	6	>800	>2	<15	Dual East	27L or 22L/27R 27L/32R	100 0	Single (Near-Near) Single	Far-Far Far-Far	4

Table 3-9. Profile of Runway Configurations Used in Unclear and/or Windy Weather

Runways (South/North)		Arrival Runway Configurations					Associated Departure Runway Configurations		Classification of Runway Configurations		CSC Configuration No.
		Hours Observed	% of Total (370 hrs)	Applicable Weather Conditions		Ap-proach Mode	Runways (South/North)	Relative Usage (%)	South	North	
				Ceiling (ft)	Visi-bility (mi)						
14R/14L	47.50	13	← CAT II → or <2	<800	>15 (SE)	Parallel West	9R/9L 27L or 22L/9L 27L or 22L/14L 14R/4L 14R/14L 9R/4L 14R/9L	73	Quasi-Ind. Quasi-Ind. Quasi-Ind. Single Single Quasi-Ind. Single	Quasi-Ind. Quasi-Ind. Single Far-Far Single Far-Far Quasi-Ind.	6
32L/32R	30.50	8	<2	<800	>15 (NW)	Parallel East	32L/32R 27L/4L 27L/32R	45 30 25	Single Near-Far Near-Far	Single Far-Far Single	2
9R/9L	21.25	6	>2	>800	>>15 (E)	Parallel West	4R/4L 9R/4L 9R/32R	100 0 0	Quasi-Ind. Single Single	Near-Near Near-Near Quasi-Ind.	8
27L/27R	13.25	4	<2	<800	>15 (W)	Parallel East	27L or 22L/32R 32L/32R	91 9	Single (Near-Near) Quasi-Ind.	Near-Near Near-Near Near-Near	3
4R/4L	Not ob-served	0	<2	<800	>>15 (NE)	Parallel West	9R/9L 9R/4L	- -	Quasi-Ind. Quasi-Ind.	Near-Near Single	10
22L/22R	Not ob-served	0	<2	<800	>15 (SW)	Parallel East	27L/27R	100	NA	Far-Far	

configurations operate 15 percent and the arrival from the West configurations operate 20 percent of the time--there is no Mixed Mode under these conditions. The West configurations dominate due to the inclusion of the low visibility arrival configuration--14L/14R.

The various runway configurations operated on the south and north sides of the airport are classified in Columns 10 and 11, respectively. There are five classes of runway configurations, Single runway and Near-Near, Near-Far, Far-Far, and Quasi-Independent crossing runways. Table 3-10 presents an estimation of the relative time each configuration is in operation on one of the two sides of the airport. This estimation is based on the statistics presented in Tables 3-6 and 3-7. The table indicates that, in clear and calm weather, there is no preference between the crossing runway configurations; but in cloudy and/or windy conditions, the airport is primarily operated in the Quasi-Independent runway configuration, which is the safest crossing runway configuration since arrival aircraft do not routinely cross the departure runway before turning off.

Table 3-10. Relative Usage of Various Runway Configuration Classes at O'Hare

Arrival Runway Configurations	Arrival/Departure Runway Configurations Class (Table 3-1)	Relative Usage of Classes (%)
Clear and Calm Weather	Near-Near	36
	Near-Far	36
	Far-Far	31
	Quasi-Independent	27
	Single	7
Unclear and/or Windy Weather	Near-Near	10
	Near-Far	4
	Far-Far	4
	Quasi-Independent	31
	Single	14

Note: Since two sets of runways operate at O'Hare, the total usage is 200%.

3.3 TAXI FLOW PATTERNS

The general flow of ground traffic at O'Hare is primarily related to the runways in use which determine the entry points into the taxiway network (i. e. , runway turnoffs) and the exit points (i. e. , departure queues). The orientation and primary use of runways is such that arrival aircraft generally land heading in the direction of the terminal while most departure queue locations are at the end of the runway nearest the terminal. Arrivals on 32R and departures on 14R, 14L, and 4R are exceptions.

The flow on the Inner and Outer circulars is directly related to the mode of runway operations. In the Arrivals from the East mode the Inner is clockwise and the Outer counterclockwise. These flows are reversed in the Arrivals from the West mode of operations. For the most part, departure traffic flows on the Outer and arrival traffic on the Inner. One major exception is that heavy aircraft cannot use the Inner due to space limitations.

The information presented here was acquired in discussions with ATCT personnel at O'Hare for the eleven runway configurations (including alternate departure runways for two configurations) considered the most commonly used patterns. Figures 3-2 to 3-5 depict the major flow patterns and alternates used in each configuration and a brief description of each is provided. The normal handoff areas used by Departure Ground Control are presented in Figure 3-2 along with the typical departure queue configurations used by Local Control for various departure runways.

While the information included here represents the primary patterns, it is important to note that many other runway configurations are also used depending on weather conditions, noise abatement procedures, airport conditions, and other factors. Of course, the surface traffic patterns will vary when these other configurations are in effect. Also, even in the major configurations presented, many other surface paths are possible in addition to those shown in the diagrams. The specific path for each individual aircraft is generally assigned according to

the specified flow patterns; however, depending on analysis of conditions, the controllers may, and often do, assign other paths in order to assure the most expeditious, orderly, safe flow of traffic. The surface traffic environment is an extremely dynamic one in which general flow patterns are constantly adjusted to changing conditions.

In addition to the flow of aircraft between the runways and terminal area, there are secondary aircraft traffic flows between the hangar and terminal areas, between the cargo area and the runways, and between the USAF area and the runways. The routes commonly used by these secondary traffic flows are shown in Figure 3-3. Superimposed on the taxiway network are 26 miles of service roads. The sections of the road interconnecting the hangar, terminal, and cargo areas are heavily traveled and require the flow of trucks and cars to cross the taxiway network at numerous places. Some of these intersections are also heavily traveled by aircraft, creating potentially hazardous situations, particularly during low visibility operations. In addition to this main artery, the service road network also permits access to the USAF area and to the various equipment sites on the airport surface. The service road network is presented in Figure 3-4.

3.3.1 Configuration 1

3.3.1.1 Runways

In this configuration, shown in Figure 3-5, runways 27R and 32L are used for arrivals with some VFR/STOL flights on 22R. Departures are on 32R for flights to the north and east, and also for flights to the west (DBQ departure fix) when traffic to the west is heavy. Runway 27L is used for flights to the south, west, and southwest. Runway 36 is available for general aviation flights.

3.3.1.2 Arrivals

Flights landing on 27R will generally turn off directly onto the Outer and go counterclockwise until reaching their ramps and then turn left across the Inner to the gate. Any flights landing on 22R will turn off at the Old Scenic onto

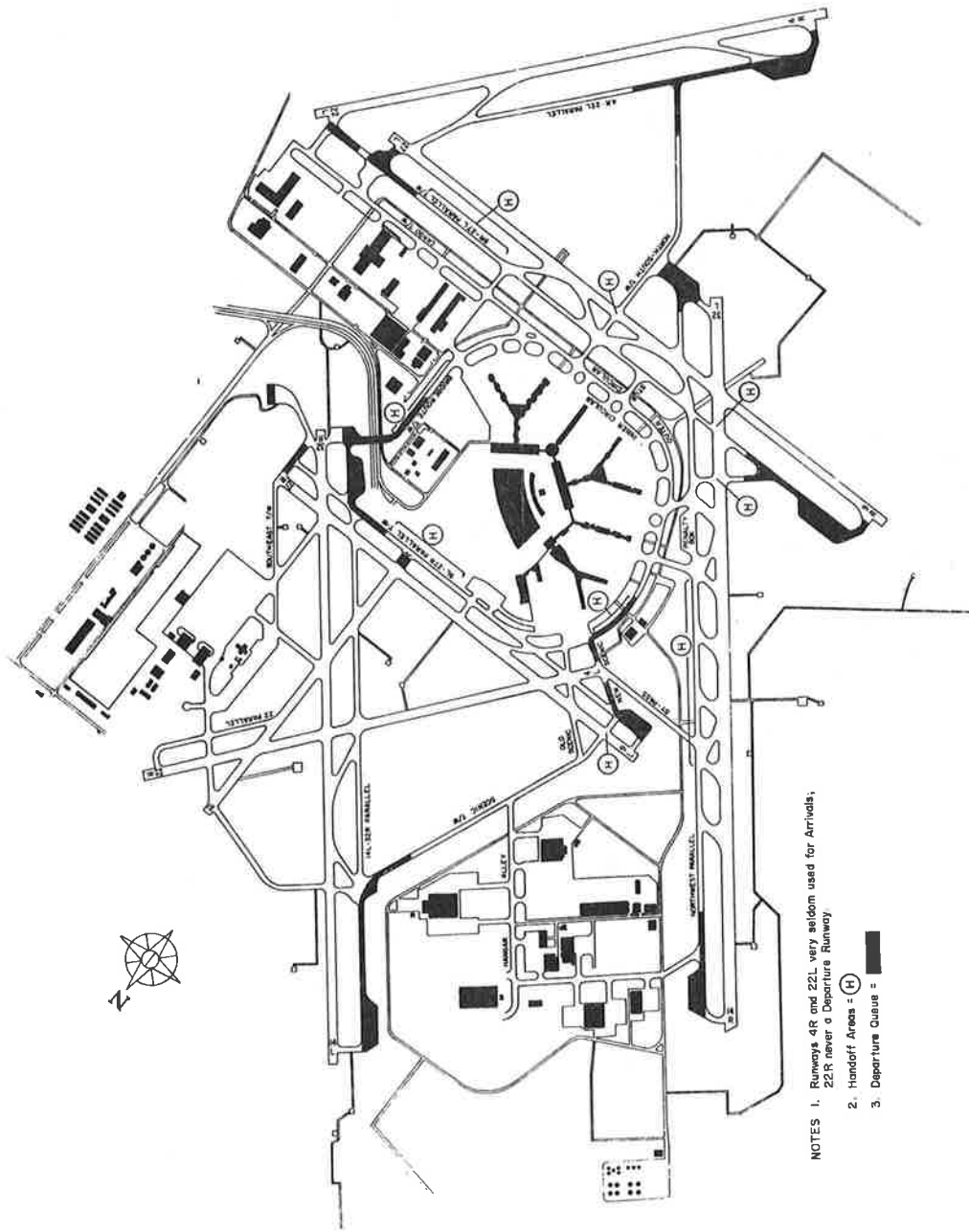

- NOTES
1. Runways 4R and 22L, very seldom used for Arrivals, 22R never a Departure Runway.
 2. Handoff Areas = (H)
 3. Departure Queue = [Solid Black Rectangle]

Figure 3-2. Location of Departure Queues and Ground Control Handoff Areas at O'Hare

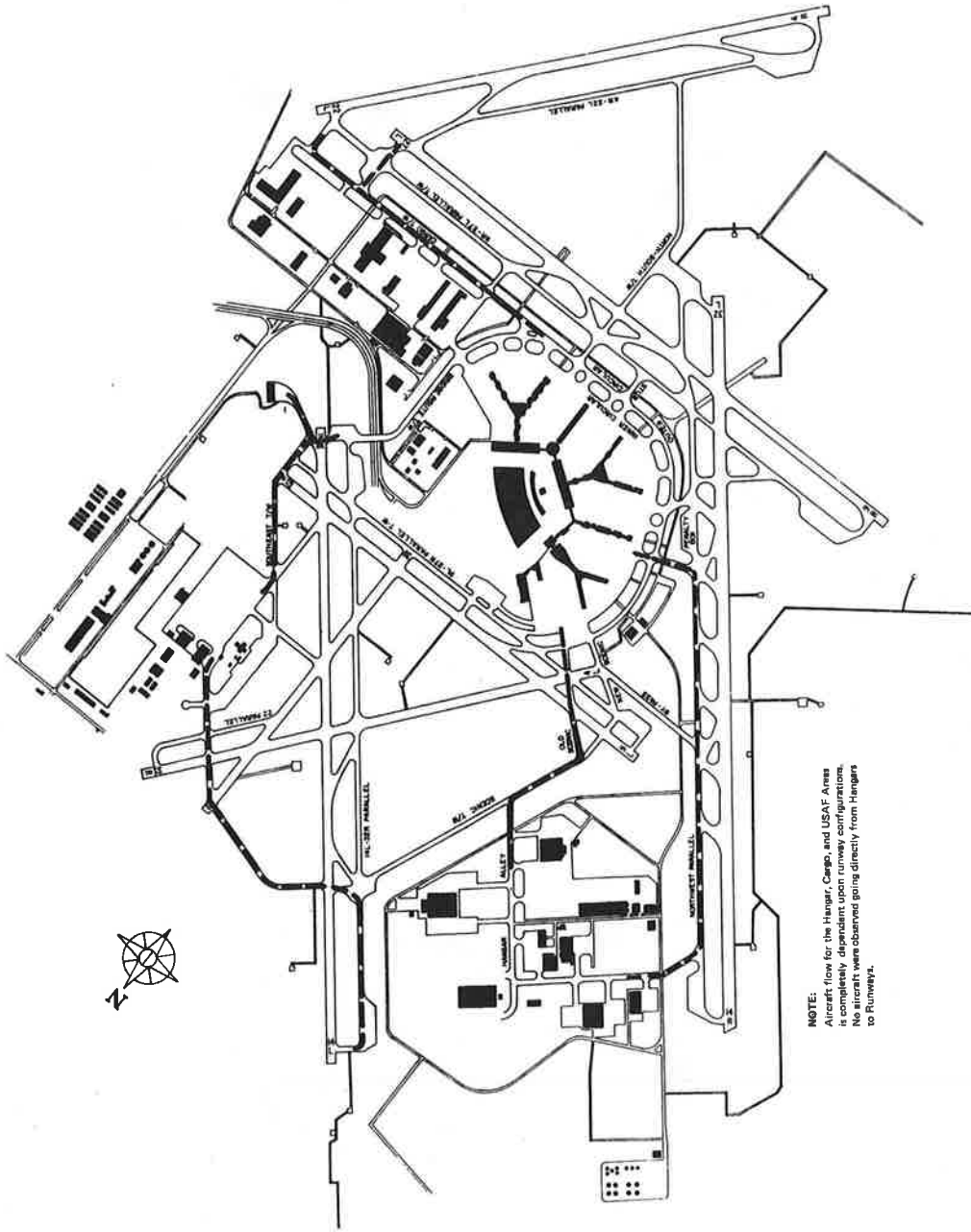

Figure 3-3. Aircraft Routes at O'Hare - Hangar, Cargo and Air Force Areas

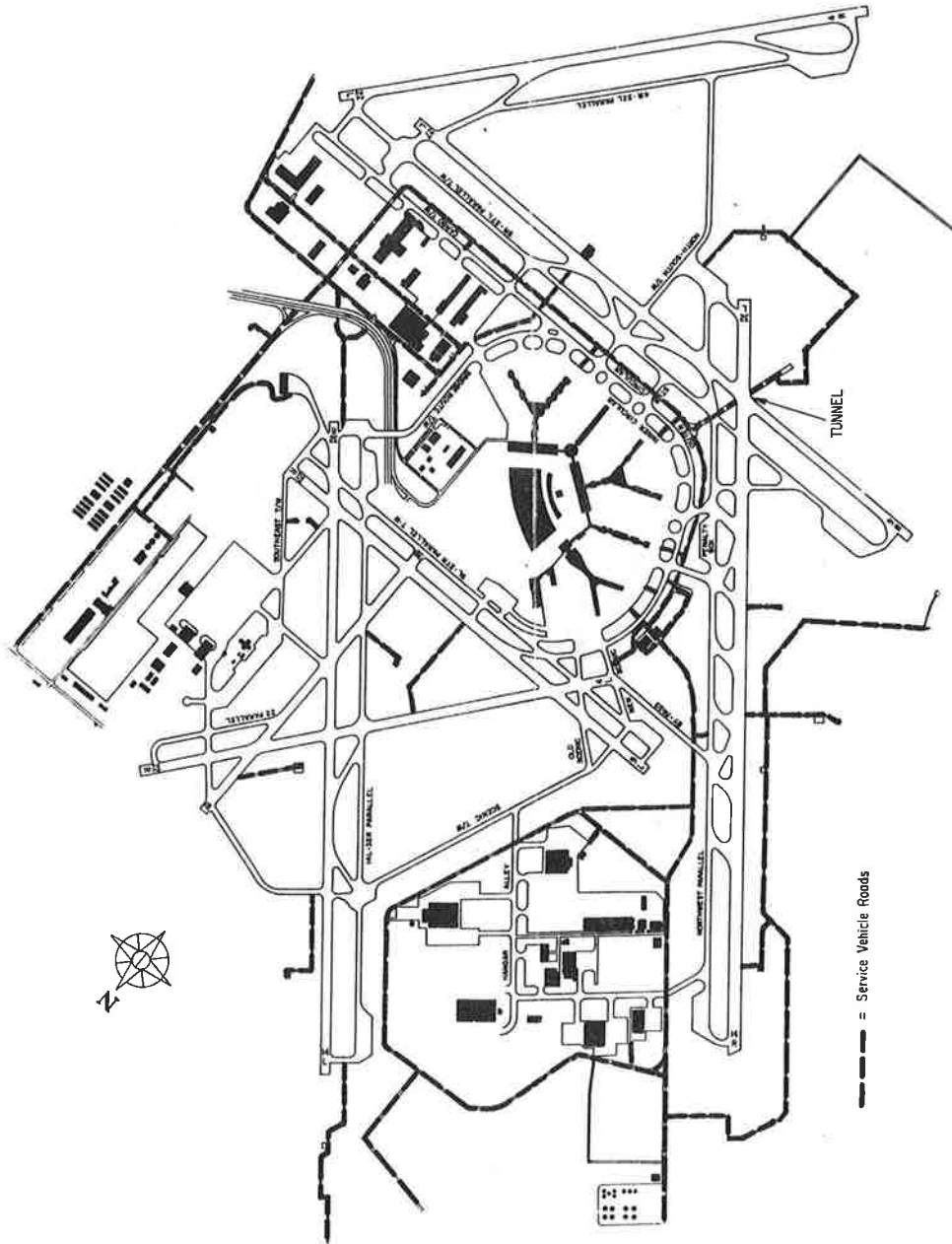

Figure 3-4. Main Service Vehicle Roads at O'Hare Airport

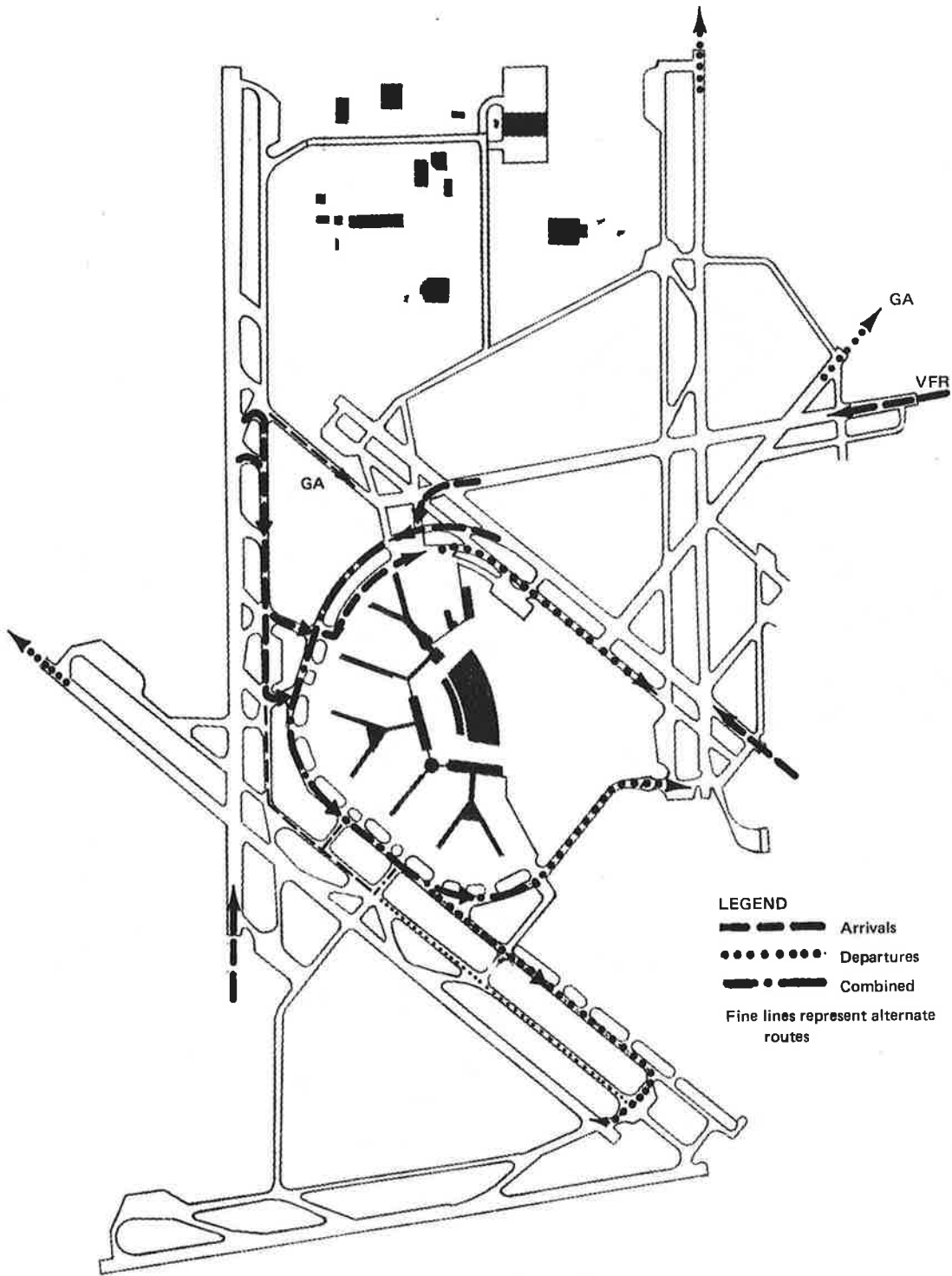

Figure 3-5. Configuration 1

the Outer and then proceed as above. From 32L arrival flights will turn off at T5 or T5 reverse and take the northwest parallel down to T3 or T1. Flights going to ramps A through E will cross to the Inner at T3 and proceed in a clockwise direction to their ramps. Flights on the east side of ramp E will cross to the Outer at T1 and join the counterclockwise flow to their ramps. When the Outer is congested flights from 32L going to ramps east of ramp F may be sent down the 14R/32L parallel to the 9R/27L parallel and then east to the stub or north-south taxiways where they will turn in toward the terminal area. General aviation flights landing on 32L may use the bypass and New Scenic to their terminal as an alternate.

3.3.1.3 Departures

Departure flights on 32R will go directly to the Outer upon leaving their ramp and proceed in a counterclockwise direction around the terminal area and over the Bridge. Flights leaving ramps west of the E concourse may be sent clockwise on the Inner and the 9L/27R parallel. When there is a backup at the Bridge, this alternate will also be used for flights with in-trail restrictions at the Departure Fix. General aviation flights for runway 36 will use the 9L/27R parallel. Flights for 27L will use the Outer and then the cargo taxiway. If in-trail restrictions are in effect at the departure fix, the 9R/27L parallel will be used instead of the cargo taxiway.

3.3.2 Configuration 2

3.3.2.1 Runways

The arrival runways in this configuration, shown in Figure 3-6, are 32L and 32R. Runway 32R is also used for departures going to the north and east while 27L is used for west, south, and southwest departures. General aviation flights may also use runway 36.

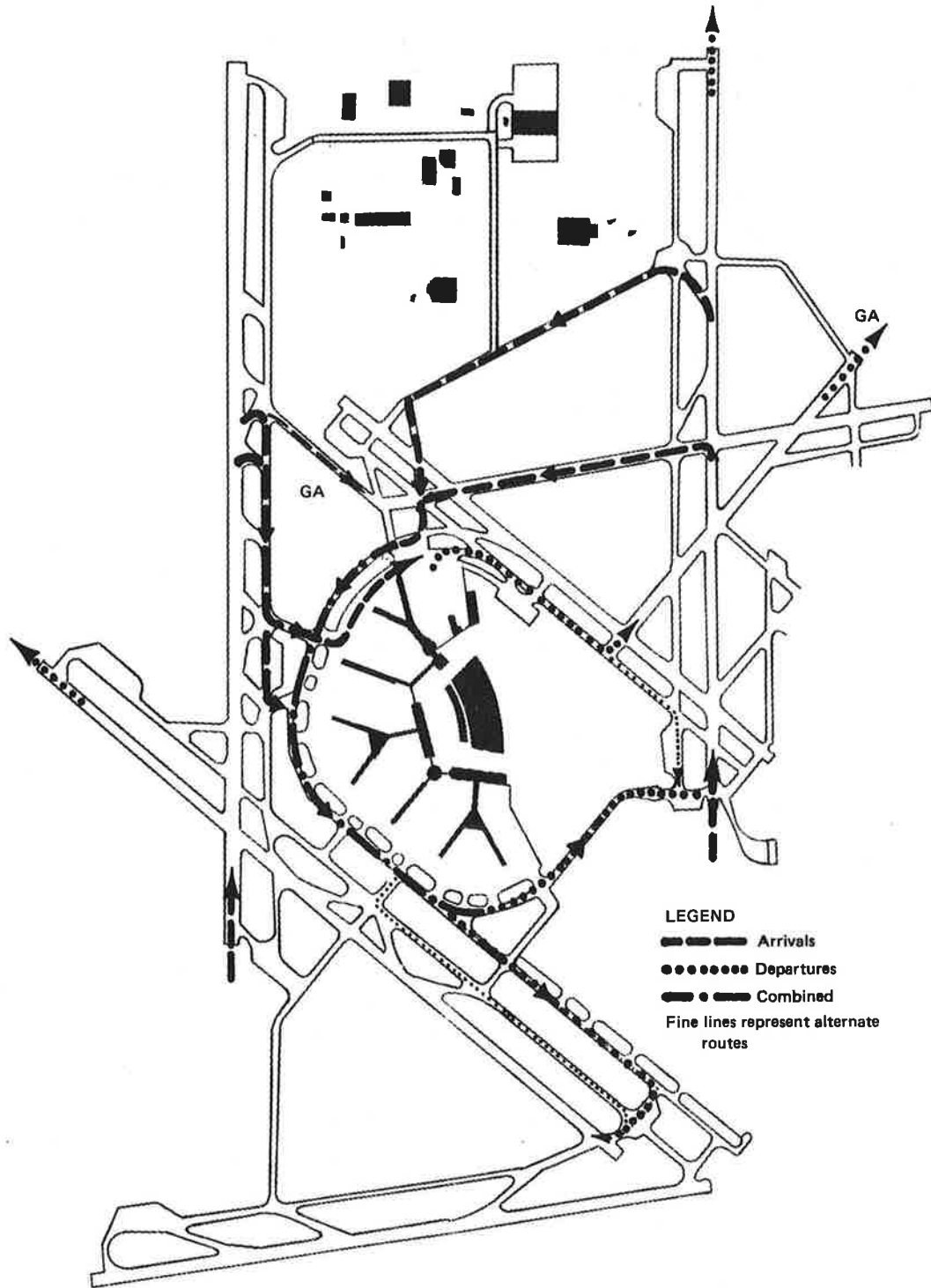

Figure 3-6. Configuration 2

3.3.2.2 Arrivals

Flights landing on 32L will follow the same basic path as in Configuration 1. However, the alternate routing along the 9R/27L parallel will not be used. Arrivals on 32R will turn off either at runway 22R or at the Scenic taxiway and travel southwest to the Old Scenic where they will turn on to the Outer and proceed in a counterclockwise direction to their ramps.

3.3.2.3 Departures

Flights departing on 27L and 32R will follow the same basic paths and alternates as in Configuration 1.

3.3.3 Configuration 3

3.3.3.1 Runways

This configuration, shown in Figure 3-7, uses runways 27R and 27L for arrivals with some STOL flights on 22R. Departures to the west and south use 32L while those to the north and east use 32R.

3.3.3.2 Arrivals

Flights landing on 27R or 22R will follow the same paths as in Configuration 1.

Flights landing on 27L will turn off and go toward the terminal area on either the north-south taxiway or the stub. They will turn onto the Outer if they must travel counterclockwise to their ramps or onto the Inner to go clockwise.

3.3.3.3 Departures

Flights departing on 32R will follow the same basic pattern and alternates as in Configurations 1 and 2.

On runway 32L departures will generally begin takeoff at intersection T1, rather than the end of the runway to avoid interference with arrivals on 27L. Aircraft at the west side of the terminal area will travel counterclockwise along

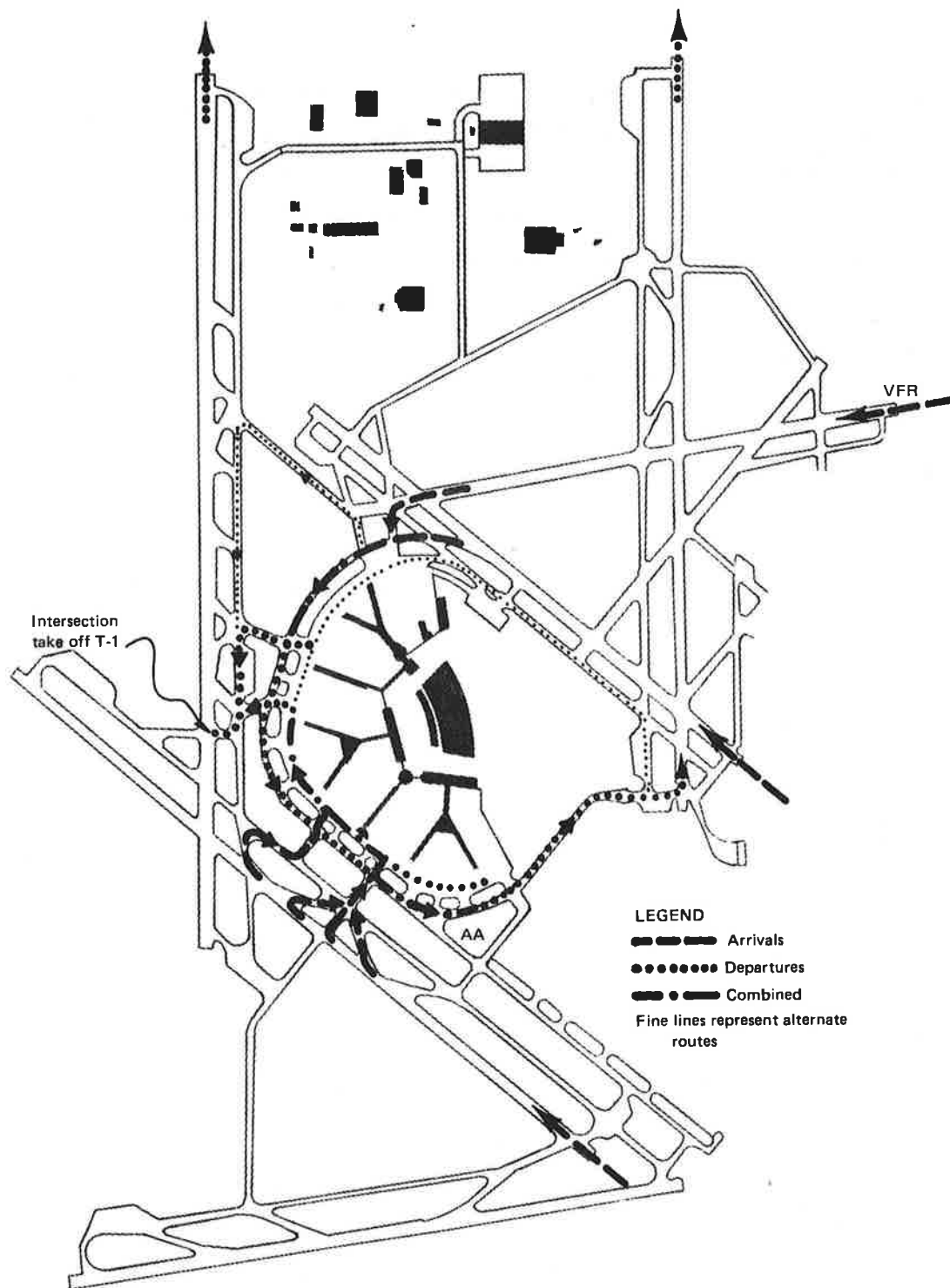

Figure 3-7. Configuration 3

the Outer to T3 and then turn onto the 14R/32L parallel and proceed down to T1. Other flights will use the Inner in a clockwise direction to T1 and cross the Outer and the parallel at that point to get to the T1 intersection on the runway. When there is heavy congestion crossing to the runway at T3 or T1, some aircraft may be routed via the New Scenic, the Bypass, and the 14L/32L parallel down to the T1 intersection. This alternate path is also used for flights with in-trail restrictions.

3.3.4 Configuration 4

3.3.4.1 Runways

In this configuration, shown in Figure 3-8, runways 22R and 27L are used for arrivals, runway 27R is used for departures to the north and east, and runway 22L is used for departures to the south and west.

3.3.4.2 Arrivals

Flights arriving on 22R cross to the Outer at the Old Scenic and travel in a counterclockwise direction on the Outer to their ramps. Flights from 27L use the north-south taxiway and then either turn east on the Outer or west on the Inner depending on the location of their ramps. Another turnoff is the 14R/32L parallel to T1 and then the Inner or Outer as appropriate.

3.3.4.3 Departures

Flights departing on 27R travel in a counterclockwise path around the terminal area, over the bridge and across the end of 32R to get to 27R. Flights to 22L use the Outer and the cargo taxiway. As an alternate, flights with in-trail restrictions may be sent to 22L along the 9R/27L parallel rather than the cargo taxiway.

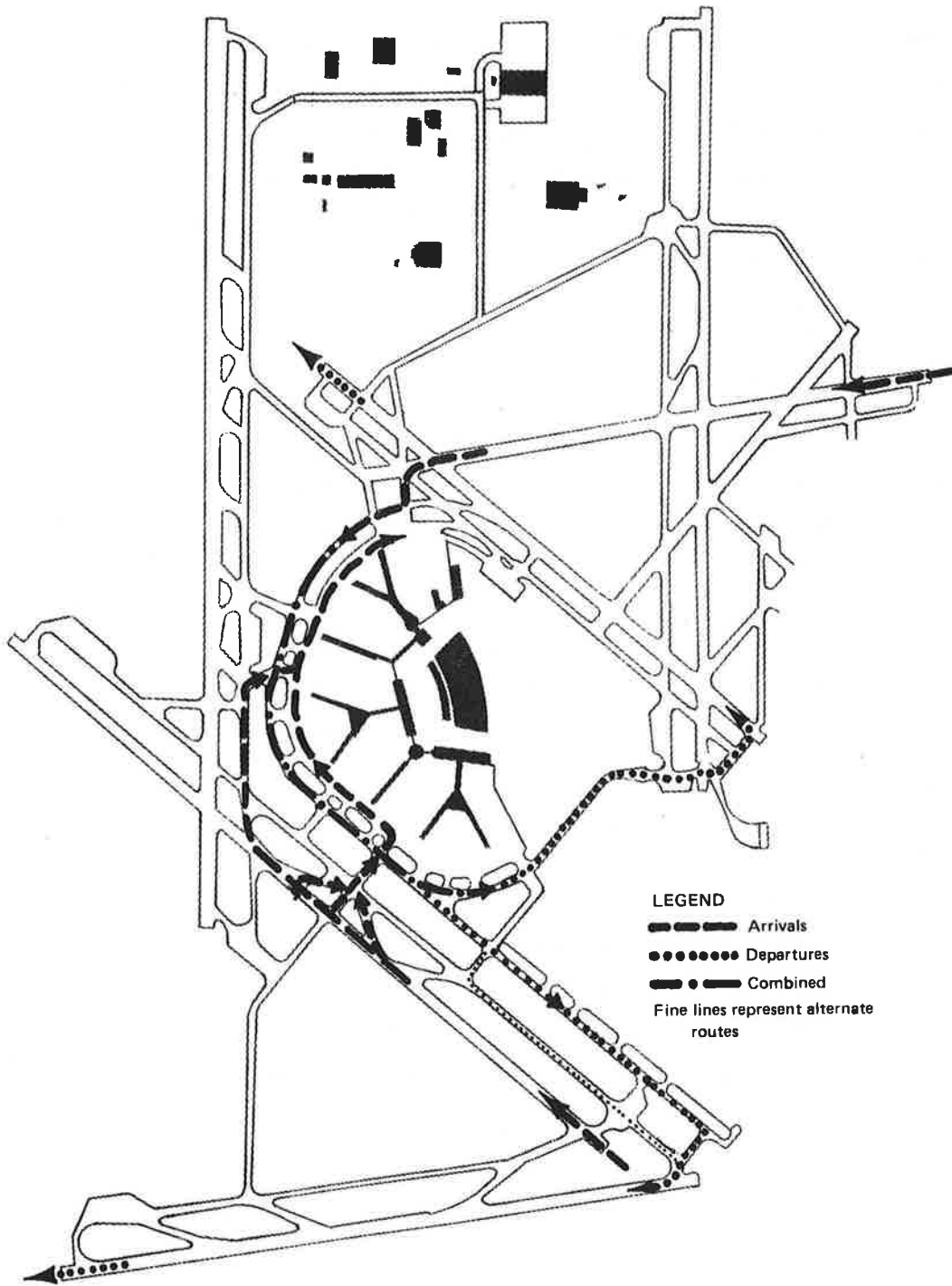

Figure 3-8. Configuration 4

3.3.5 Configuration 5

3.3.5.1 Runways

Runways 14L and 9R are used for arrivals in this configuration, shown in Figure 3-9. Departures to the north and east use 9L while departures to the west, south or southwest taxi to either 9R or 14R, whichever is in use.

3.3.5.2 Arrivals

Flights arriving on 14L will turn off at and taxi down 22R to the Old Scenic, cross to the Inner and proceed in a counterclockwise direction to their ramps. They may also turn off at and taxi down 18 to the 9L/27R parallel and proceed west on parallel and on to the Inner. As an alternate, 747s leaving 14L at 18 will take the 14L/32R parallel down to the bridge and onto the Outer since they cannot travel on the Inner. Some American Airlines flights will also use this path. A third path is followed mainly by 747 flights that go to the end of 14L, over the bridge and onto the Outer in a clockwise direction. Aircraft landing on 9R will take the north-south taxiway and then either the Outer clockwise or the Inner counterclockwise to the ramps. Some flights may turn off at the second high speed or the end of the runway and will travel west on the 9R/27L parallel to the north-south taxiway.

3.3.5.3 Departures

Departures on 9L travel clockwise around the terminal area on the Outer and across the New Scenic. When traffic on Outer becomes backed up and arrivals are light or arrivals on 14L are not turning off on 22R, an alternate is to continue some traffic on the Outer to the Old Scenic, up to the 9L/27R parallel and west to the runway.

Departures on 9R will travel clockwise on the Inner or counterclockwise on the Outer to T1 and then follow T1 across 14R to the 9R/27L parallel. These flights also may cross at the stub to the 9R/27L parallel and travel west to the runway, crossing 14R.

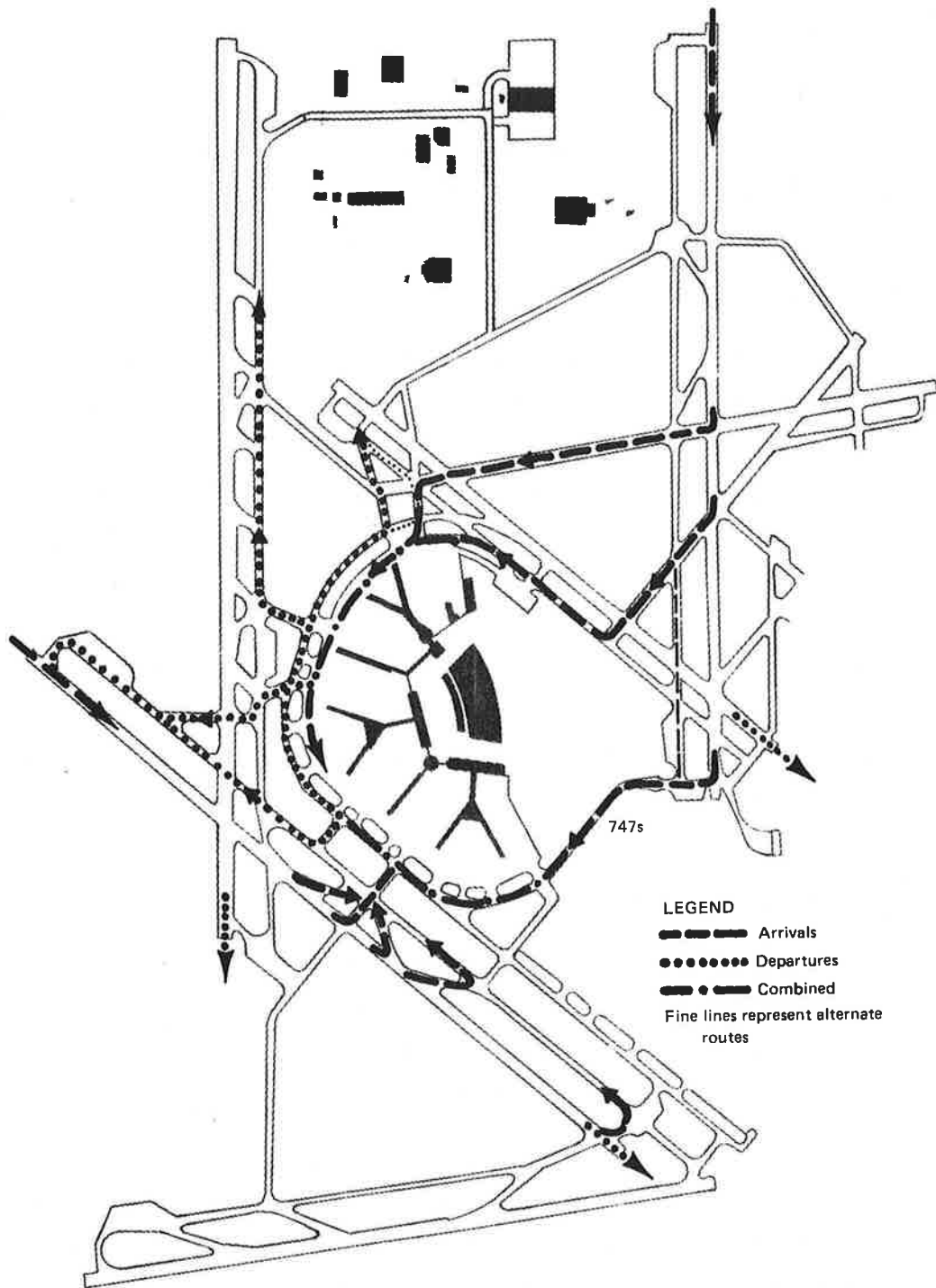

Figure 3-9. Configuration 5

When 14R is used for departures the path is via T3 to the 14R/32L parallel up to the end of the runway.

3.3.6 Configuration 6

3.3.6.1 Runways

Both 14L and 14R are used for arrivals in this configuration, shown in Figure 3-10, with 9L used for departures to the north and east and 9R for departures to the south and west.

3.3.6.2 Arrivals

Flights arriving on 14L will use the same basic pattern and alternatives as in Configuration 5.

Arrivals on 14R will take the 14R/32L parallel down to T3 and across to the Inner (counterclockwise) or to the Outer (clockwise) to their ramps.

3.3.6.3 Departures

Flights departing on 9L will use the Outer clockwise to the New Scenic. For 9R, T1 will be used across 14R and onto the 9R/27L parallel. As alternates, the stub or north-south taxiway may be used to get to the 9R/27L parallel when the outer is congested.

3.3.7 Configuration 7

3.3.7.1 Runways

In this configuration, shown on Figure 3-11, 14L and 14R are used for both arrivals and departures. Flights departing to the north and east use 14L and flights to the south and west use 14R.

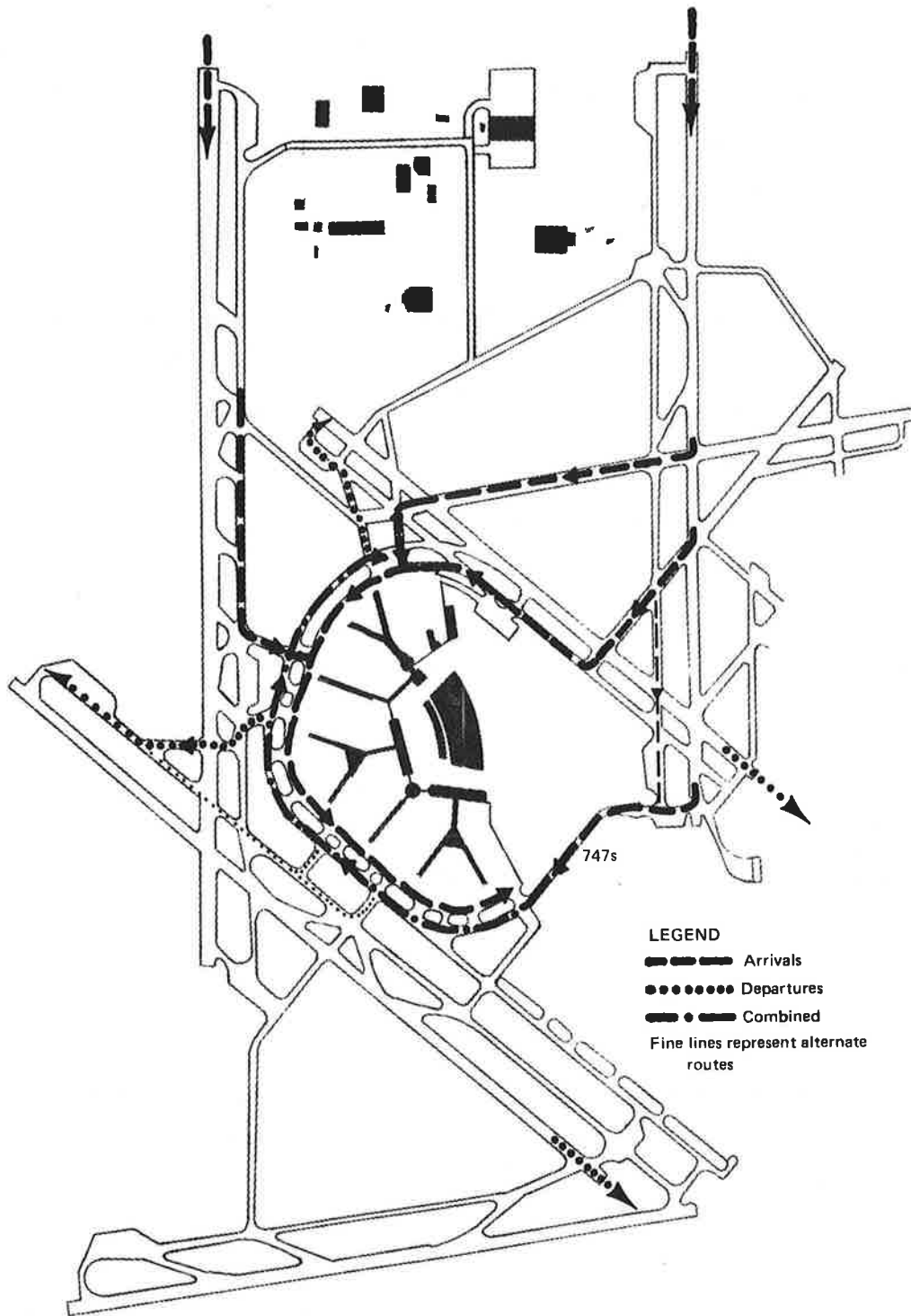

Figure 3-10. Configuration 6

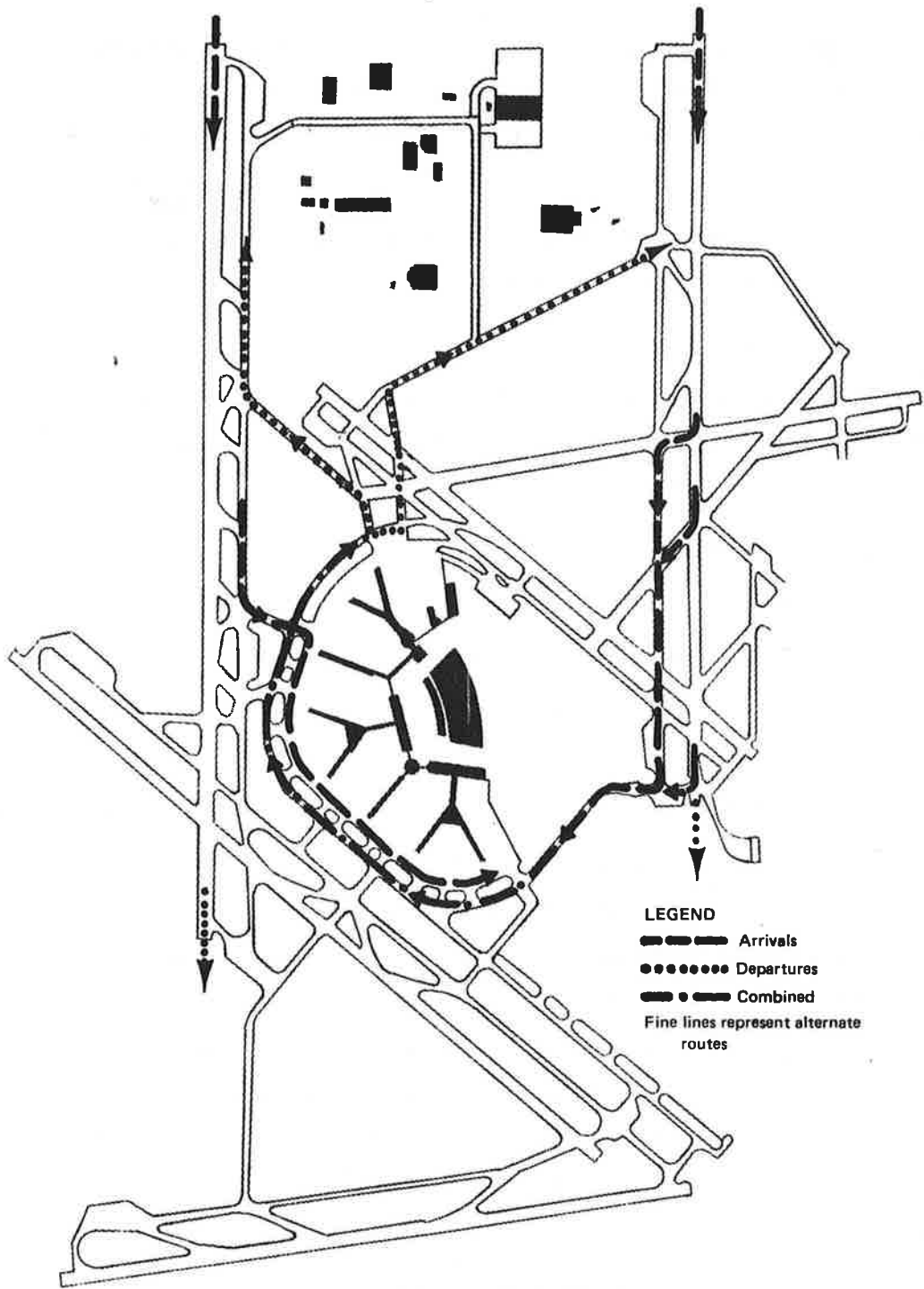

Figure 3-11. Configuration 7

3.3.7.2 Arrivals

Aircraft landing on 14L will turn off at either 22R or 18 and then take the 14L/32R parallel down to the bridge or go to the end of the runway and turn onto the bridge. From there, they proceed in a clockwise direction on the Outer to their ramps.

Flights arriving on 14R turn off and take the 14R/32L parallel to T3 and then go to the Inner (counterclockwise) or the Outer (clockwise) to their gates.

3.3.7.3 Departures

All departures travel clockwise on the Outer and then take the New Scenic, the bypass and the 14R/32L parallel to the end of 14L, or the Old Scenic, the Scenic and the 14L/32R parallel to the end of 14R.

3.3.8 Configuration 8

3.3.8.1 Runways

In this configuration, shown in Figure 3-12, runways 9L and 9R are used for arrivals with 4L for departures to the north and east, and 4R for departures to the west and south.

3.3.8.2 Arrivals

Flights landing on 9L will turn off at runway 18 and take the 9L/27R parallel to the 14L/32R parallel or turn off directly onto the 14L/32R parallel. In both cases they go via the bridge to the Outer and proceed clockwise around the terminal area to their ramps.

Arrivals on 9R turn off and take the north-south taxiway. If they exit at the second high speed or go to the end of the runway, they will travel west on the 9R/27L parallel to the north-south. From there they will take the Inner (counterclockwise) or the Outer (clockwise) to their gates.

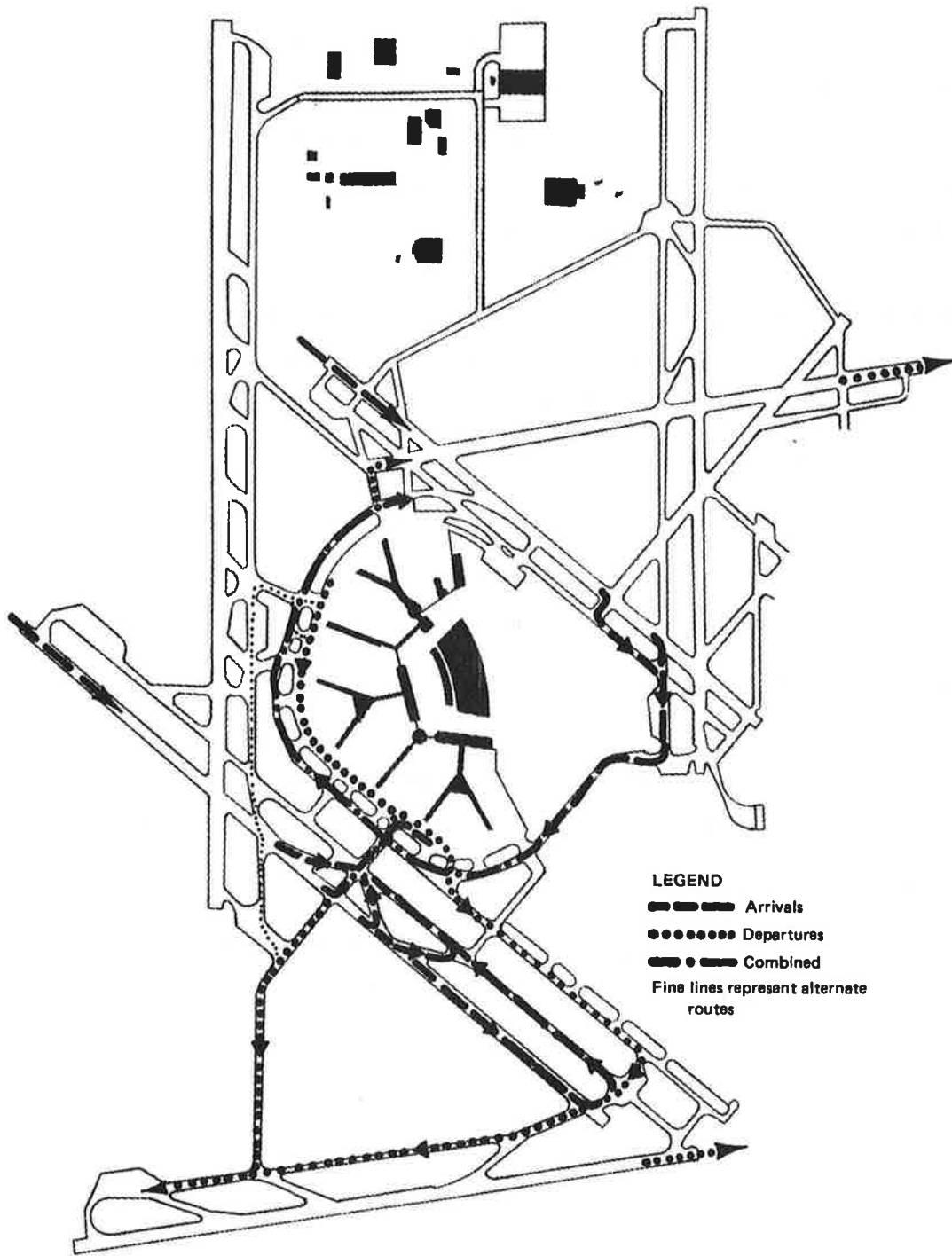

Figure 3-12. Configuration 8

3.3.8.3 Departures

Flights going to 4L will travel clockwise around the Outer to the New Scenic directly to the end of the runway.

Departures on 4R will go counterclockwise on the Inner and then take the cargo taxiway and the 4R/22L parallel to the end of the runway if arrivals are clearing early on 9R. If arrivals on 9R are clearing late (i. e. , at the second high speed or at the end of the runway) departures for 4R will use the north-south taxiway to the 4R/22L parallel instead. As an alternate, some aircraft from gates west of the E concourse may use T3 and then go down the 14R/32L parallel and the north-south to the 4R/22L parallel to get to 4R.

3.3.9 Configuration 9

3.3.9.1 Runways

This configuration, shown in Figure 3-13, is similar to Configuration 6 except that 4L replaces 9L as a departure runway.

3.3.9.2 Arrivals

Except for the fact that arrivals on 14L cannot turn off on 22R because 4L is being used for departures, the arrival patterns for this configuration are the same as for Configuration 6.

3.3.9.3 Departures

The basic departure patterns and alternates in this configuration are identical to those in Configuration 6.

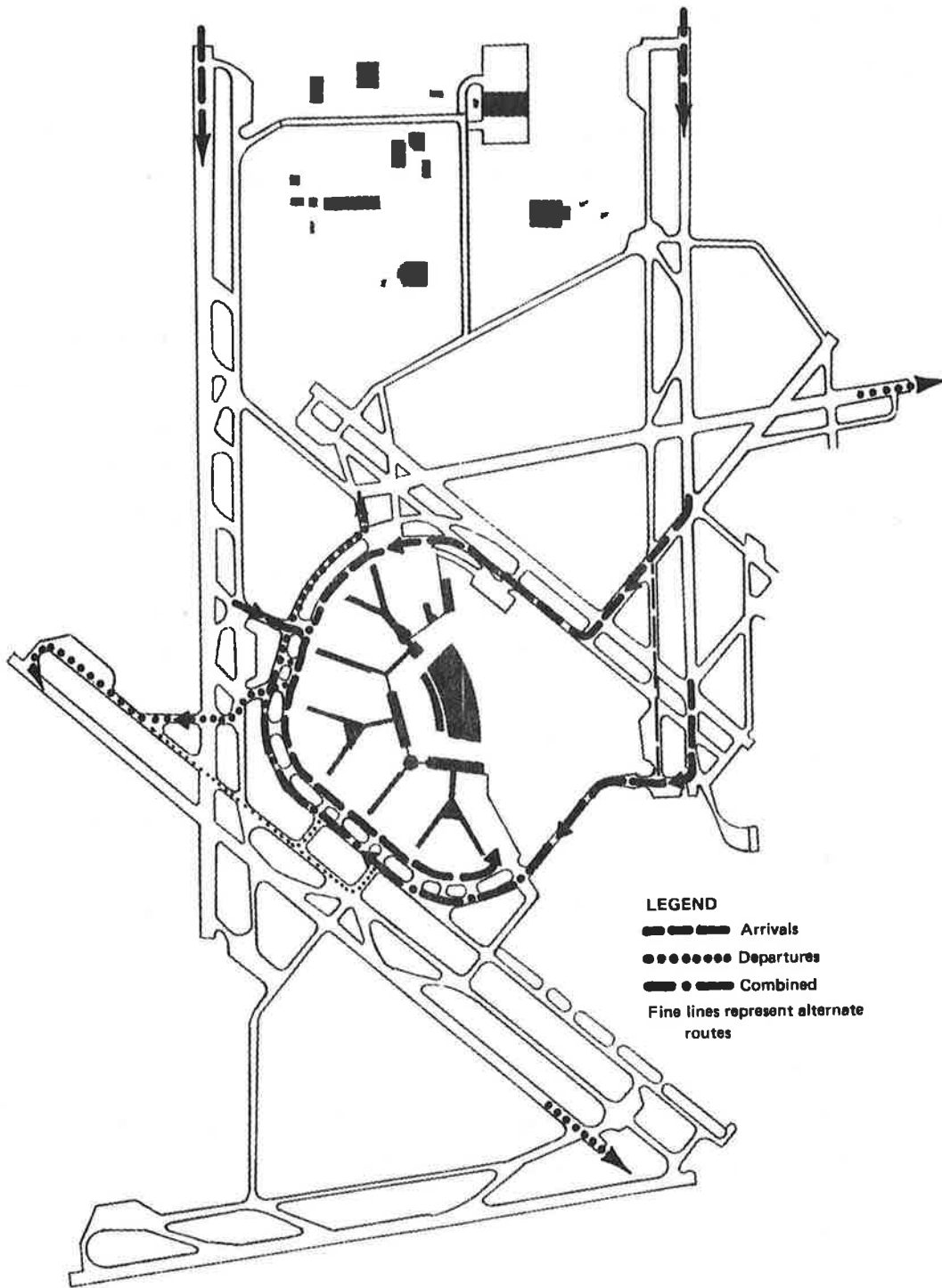

Figure 3-13. Configuration 9

3.3.10 Configuration 10

3.3.10.1 Runways

This configuration, shown in Figure 3-14, is used when there are strong northeast winds. Runways 4L and 4R are used for arrivals, with 9L and 9R used for departures.

3.3.10.2 Arrivals

Flights landing on 4L turn off at and go down 18 onto 14L to the bridge or turn off directly on to 14L. From the bridge they go clockwise around the Outer to the ramps. An alternate path is down 18 to the 9L/27R parallel, westward to the Inner, and around counterclockwise to the ramp. This is used for flights to gates west of the E concourse when there is heavy traffic on the Outer. It is not used by 747s.

On 4R, arrivals turn off at the end of the runway and take the cargo taxiway westward to the Outer. As an alternate they may take the high speed turn-off to the 4R/22L parallel to the cargo taxiway.

3.3.10.3 Departures

Flights departing on 9L go clockwise around the Outer to the New Scenic and across to the end of the runway. For 9R, flights proceed on the Inner or Outer to the north-south taxiway and on to the 9R/27L parallel westward to the runway.

3.3.11 Configuration 11

3.3.11.1 Runways

Runways 14R and 22R are used for arrivals with 27L and either 9L and 14L for departures in this configuration, shown in Figure 3-15.

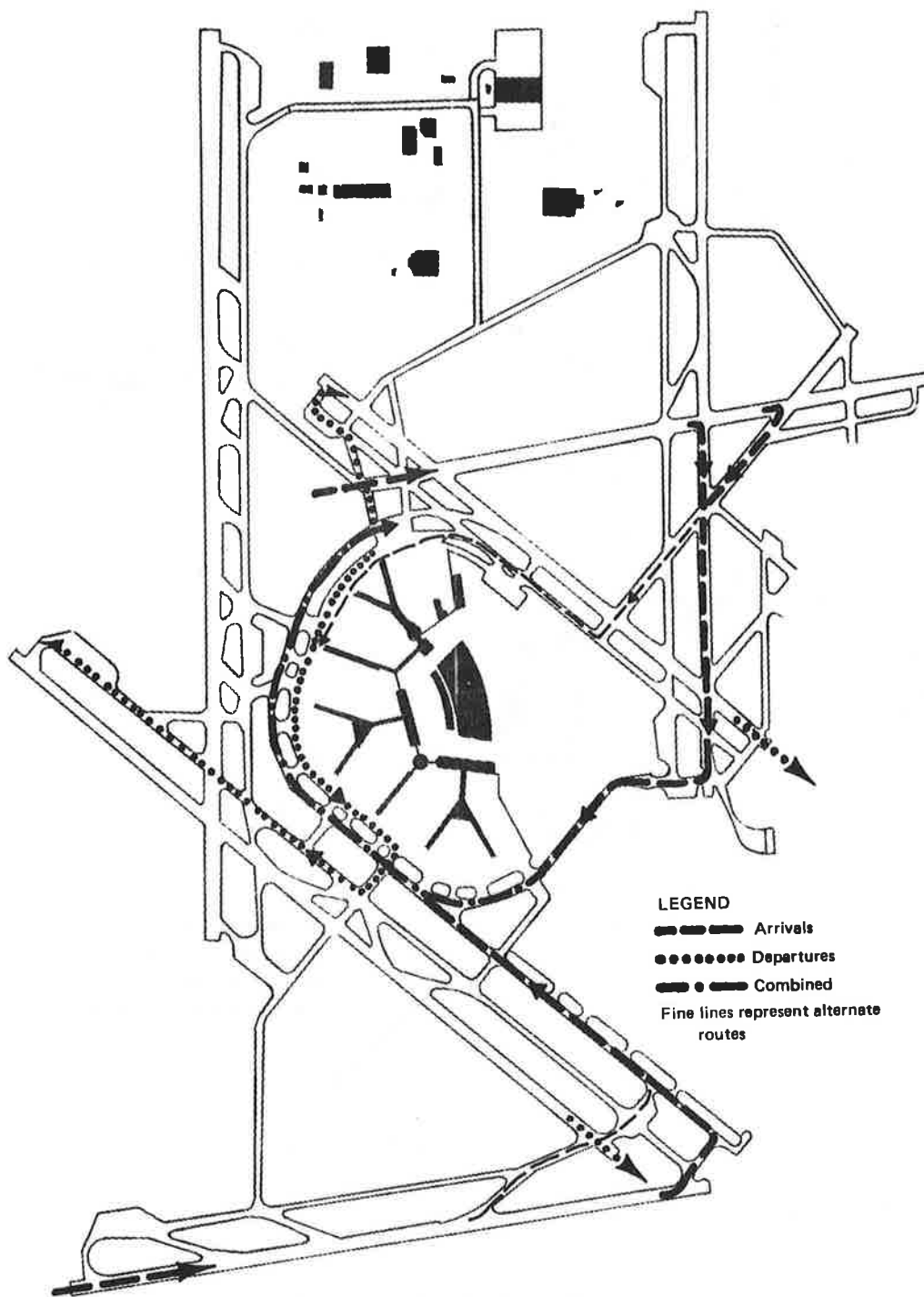

Figure 3-14. Configuration 10

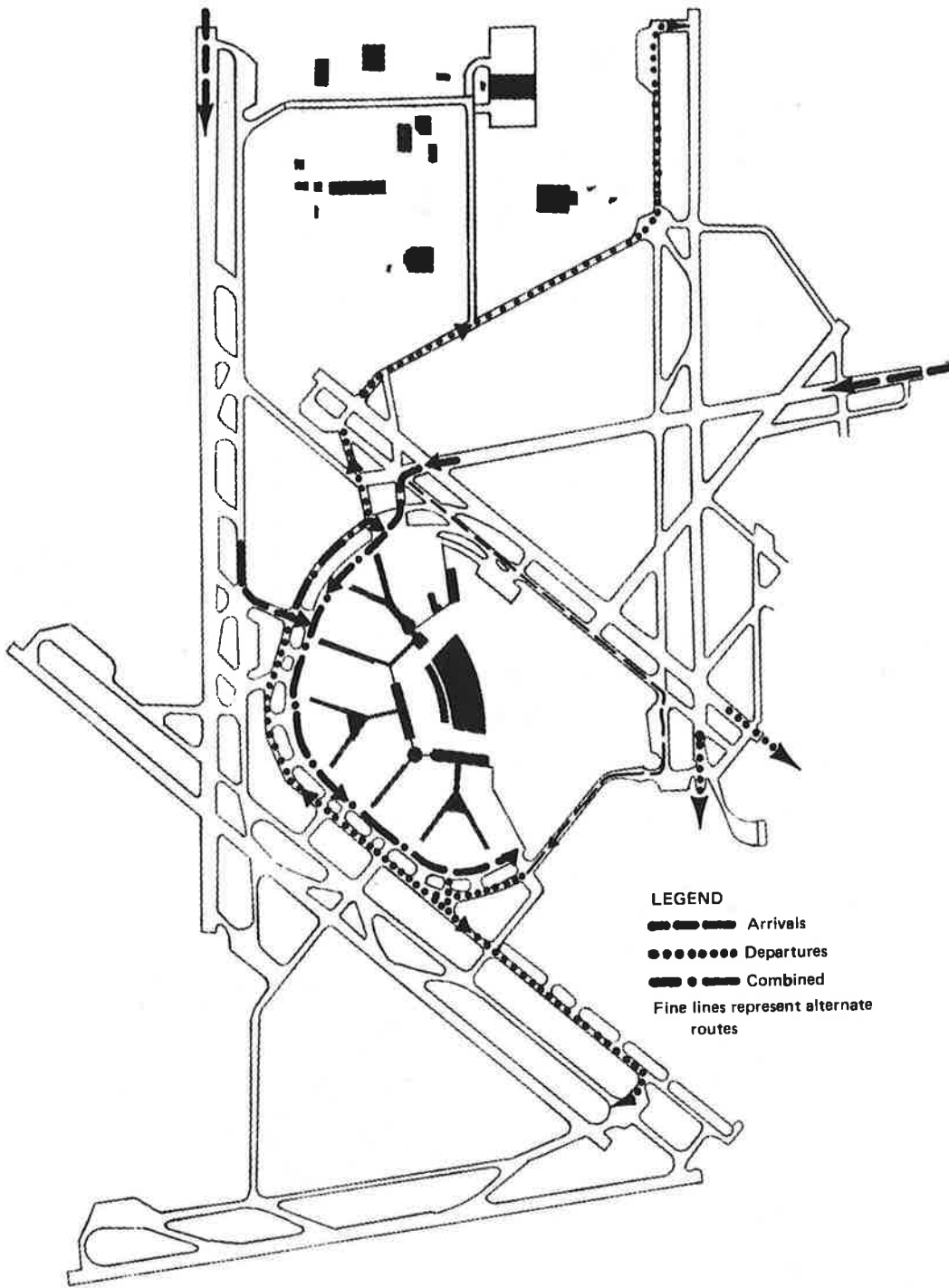

Figure 3-15. Configuration 11

3.3.11.2 Arrivals

From 14R, arrival flights use T3 to cross to the Inner (counterclockwise) or the Outer (clockwise) to their gates. From 22R the Old Scenic is used to cross to the Inner. For 747s an alternate turnoff is the 9L/27R parallel and then eastward and over the bridge to the Outer.

3.3.11.3 Departures

Departures for 27L travel counterclockwise on the Inner and cross to the cargo taxiway opposite the H-K ramp area and then eastward to the runway. The Outer (clockwise) and the New Scenic is the path used for 9L departures. The same path is used for 14L departures which continue across 9L on to the Scenic up to the 14L/32R parallel and to the runway.

3.4 TERMINAL CONFIGURATION DESCRIPTION

3.4.1 Terminal Gate Layout

The basic configuration of the terminal area at O'Hare consists of a series of alternating "straight" and "Y" shaped concourses originating from the main passenger terminals. A schematic representation of the terminal area with each concourse and the gate numbering scheme currently employed is shown in Figure 3-16. The gate assignments for the various carriers as well as the type of gate equipment physically existing at each gate area are also indicated.

Terminal area configuration drawings previously available from TSC were found to be outdated in terms of the actual gate facilities now existing. Therefore, the data shown in Figure 3-16 was obtained by physical inspection of each of the concourses by project staff personnel during the ramp data collection phase of this program.

It should be noted that, while some gates were served by two jetways, most of the gates operate with only a single jetway or other means to facilitate enplaning and deplaning of passengers. Since certain gates are exclusively assigned to wide-bodied aircraft, while others usually used for these aircraft may under varying circumstances be re-assigned temporarily to smaller aircraft, the precise number of gates available at any time for traffic operations is difficult to define.

In general, the "normal" number of gates which are considered to be available to each airline in the various ramp areas has been tabulated and shown in Table 3-11. Of the total of 94 gates normally available, 48 are assigned to either AAL, TWA, or UAL. Factors which influence the utilization of these gates are:

1. The type of aircraft, if any, planned for the neighboring gate.
2. Whether the aircraft planned for neighboring gates are to be angled or pointed normally to the finger.

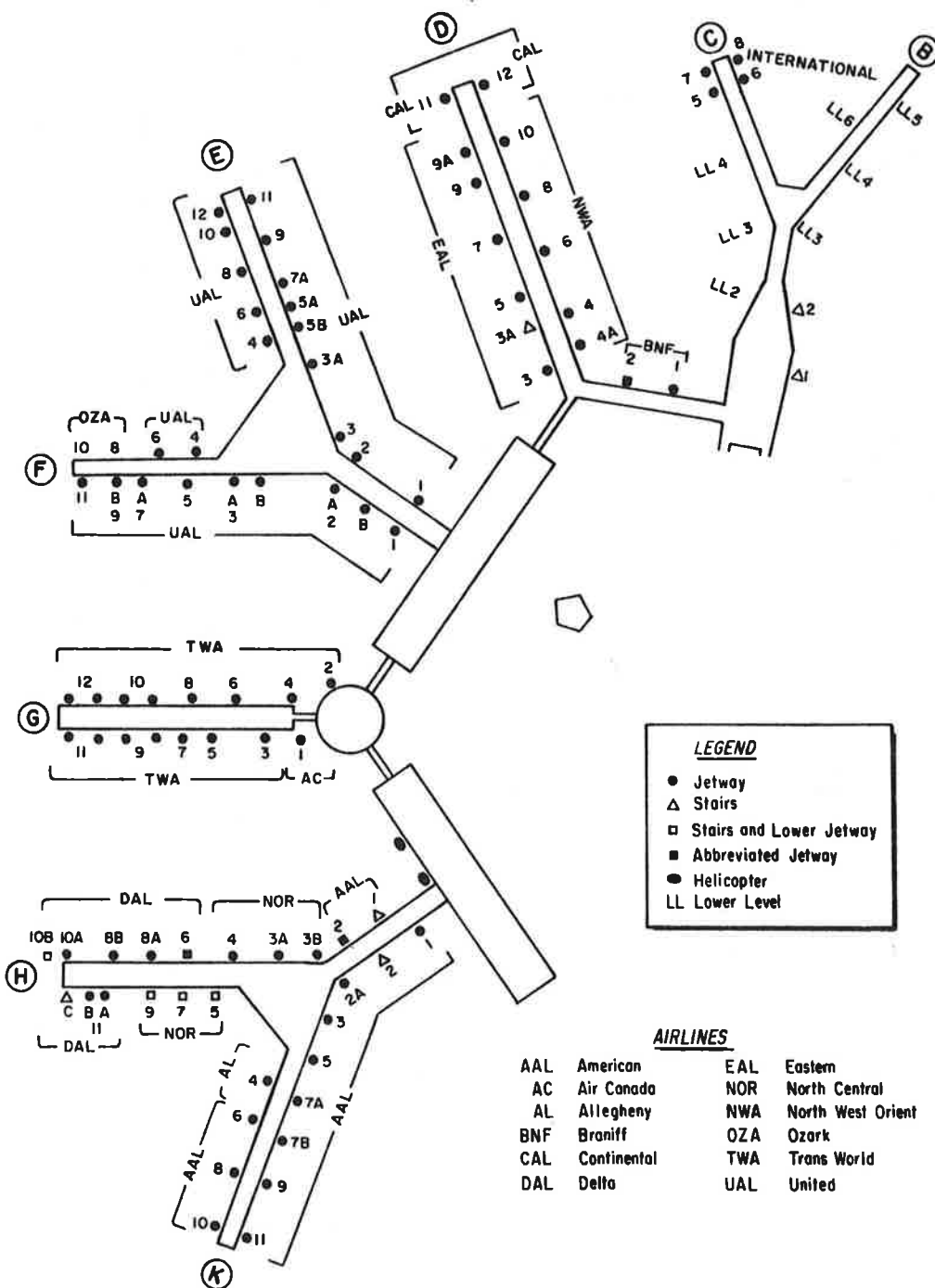

Figure 3-16. Gate Assignments

Table 3-11. Gate Assignments Vs Ramp Areas at O'Hare

Carrier	Ramp Area									Totals
	B	B-C	CD	DE	EF	FG	GH	HK	K	
AAL							2	3	9	14
AC							1			1
AL								1		1
BNF			2							2
CAL			1	1						2
DAL							5	3		8
EAL				6						6
NOR							3	3		6
NWA			5							5
OZA					2					2
TWA						6	5			11
UAL				8	7	8				23
International	5	3	5							13
TOTALS	5	3	13	15	9	14	16	10	9	94

3. The fuel port location in the ramp surface.
4. Type of fuel available in the fuel port.
5. Whether the scheduled aircraft will need fuel.
6. Whether gate jetways are required by the aircraft under consideration.
7. If gate jetways are required, what is the required jetway extension capability from the terminal finger.

Further discussions on the typical gate restrictions and the allowable aircraft configurations may be found in Section 4.3 describing airline gate scheduling and control functions.

3.4.2 Aircraft Docking at the Gates

Aircraft dock at the gates at various angles relative to the finger and, with very few exceptions, are in a "nose-in" position during the gate occupancy period. The aircraft, therefore, usually require a pushback from the gate upon departure. The major exception to these procedures is practiced by Ozark Airlines which operates with a fleet of smaller aircraft. All enplaning and deplaning is done from the surface of the ramp area via aircraft cabin access ladders. Although Ozark has only two nominal gate allocations, as many as seven aircraft were observed parked at these "two" gates. Thus, the number of aircraft docking spaces is somewhat of a variable and can be in excess of 100 as a result of the Ozark operation.

3.4.3 Aircraft Movements and Control

In general, aircraft movements within the ramps bounded by the fingers are either inbound or outbound. However, aircraft were observed to pass each other in the ramp areas between G/H, G/F, and E/D concourse if the aircraft equipments were of the smaller categories, i. e., 727 or smaller. Multiple operations were quite common and non-conflicting in the Y ramps between H/K and F/E concourse due to the large ramp openings provided by these Y configurations.

Only American Airlines and United Airlines have ramp control towers with ramp controllers exerting their influence on company operations in the K and H/K ramp areas (American), and G/F, F/E, and E/D ramp areas (United). Excluding the Y ramps, which appear to offer no particular problem, only the K ramp is wholly controlled by one company ramp controller.

As may be noted from Figure 3-16 and Table 3-11 the ramp area between the G/H concourses serves six carriers: Air Canada, American, Chicago Airways (helicopter), Delta, North Central, and TransWorld. Aircraft movements in this area are not usually controlled by the airlines as noted above for American and United.* As a result conflicts between movements in this area were observed as being rather numerous.

At times the helicopter was "trapped" by sudden pushback movements. As the helicopter is very light and literally flies about 2-3 feet above the ramp surface, helicopter operations in this ramp appear to be hazardous in the presence of jet engine blast. Some conflicts were also observed between TWA and United in the G/F ramp but virtually no inter-company conflicts were noted for the D/E ramp due primarily to the low level of operations of Eastern and Continental. Again, conflicts were noted in the D/C ramp between international carriers and Continental, Northwest, and Braniff.

The most numerous conflicts were evident for the H/G and G/F ramps which is consistent with the high traffic volume borne by these two ramps.

3. 4. 4 Impact of Terminal Configuration on ASTC System Operation

Conflicts involving blocking the movements of imminent arrivals to the ramp areas and departures from the ramp areas impact on the operations of the

*American control of aircraft for the H1 and H2 gates is performed with respect to intra-company or company-Chicago Airways operations since the ramp controller does not have visibility of the gates unless he leaves his work station.

A TCT Ground Control positions. Blocking of arrivals may result in the aircraft having to hold on the Inner/Outer taxiways until they can enter the ramp area or taxi to another exit point and wait off the ends of the concourses, if the type of aircraft equipment permits. Several such situations were observed. Alternately, blockage of a departure by another departure (pushing back) or by an arrival to the ramp area will delay the taxi for the aircraft if it has received its taxi clearance. In either, these situations are likely to cause additional controller communications to the aircraft involved (refer to Section 4. 2). In the case of departures, it is possible that the Outbound Ground Controller may delay issuing the taxi clearance to the flight until its way is clear.

Another factor that should be noted is that five of the airlines listed have gate assignments in more than one of the ramp areas identified in Figure 3-16. The Inbound Ground Controller must, therefore, ascertain the particular gate (actually the ramp area) assigned to that aircraft. For other carriers (with the exception of international flights and CAL whose gates are on the outer edge of the D concourse) the controller needs only the identity of the airline since this will determine the ramp area to which the "arrival" must be routed.

SECTION 4 - FUNCTIONAL DESCRIPTION OF THE
O'HARE ASTC SYSTEM

4.1 GENERAL

The purpose of this section is to provide a comprehensive functional description of the current O'Hare ASTC System in terms of the roles played by all parties involved in the operations of the airport. The material in this section is divided into descriptions of the functional responsibilities and procedures employed by FAA ATCT, airline gate management, airport management personnel.

4.2 FAA AIRPORT TRAFFIC CONTROL TOWER (ATCT) FUNCTIONS

4.2.1 General Responsibilities

The responsibilities of the FAA ATCT is to provide control of air traffic operations in the Chicago Terminal Control Area (TCA). This includes responsibilities for:

1. Arrival and departure control for flight operations for O'Hare Airport and North Satellite (NAS Glenview) and South Satellite (Midway and Meigs) airports as well as VFR operations for other airports within the TCA.
2. Arrival and departure operations and ground traffic control at O'Hare airport.
3. Control of non-arrival/departure flights operating within the TCA.

Execution of these responsibilities is divided between the TRACON and Tower Cab with the latter responsible for airport surface operations. The balance of this section is devoted to the description of the functional operations of Tower Cab personnel and to brief descriptions of the operations of TRACON as it interfaces with surface traffic operations.

4.2.2 Tower Cab

4.2.2.1 Tower Cab Position Descriptions

Seven positions are manned in the tower during normal busy hour operations (0700-2300). These include:

1. Flight Data
2. Clearance Delivery
3. Outbound (Departure) Ground
4. Inbound (Arrival) Ground
5. Local Control #1
6. Local Control #2
7. Watch Supervisor

The layout of the tower cab is shown in Figure 4-1, including the location of the controller stations. The layout of the individual controller stations identifying the various equipments is presented in Figure 4-2 (six sheets). Photographs of these stations are shown in Figure 4-3 (six sheets). Tables 4-1 through 4-5 provide summary descriptions of the responsibilities of these positions, associated duties, and equipments used in discharging these responsibilities.

As indicated in these tables, the Flight Data position serves primarily as an assistant to the Clearance Delivery position in discharging its responsibilities for delivering ARTCC clearances to departure aircraft. The FDEP printer and Flight Strip Bay located between the Flight Data and Clearance Delivery Positions are the major equipments employed to accomplish this. One of the major duties associated with this function is annotating the flight strips to reflect local restrictions and to assist the subsequent employment of the strips by the controller positions. The other major responsibility of this position is to disseminate information on the status of the operating conditions to both airport users and other controller positions. This is accomplished through employment of the Telautograph equipment to receive U. S. Weather Service reports and NOTAMs and to transmit operational status reports (e. g. , Gate Hold Procedures are in effect) to similar

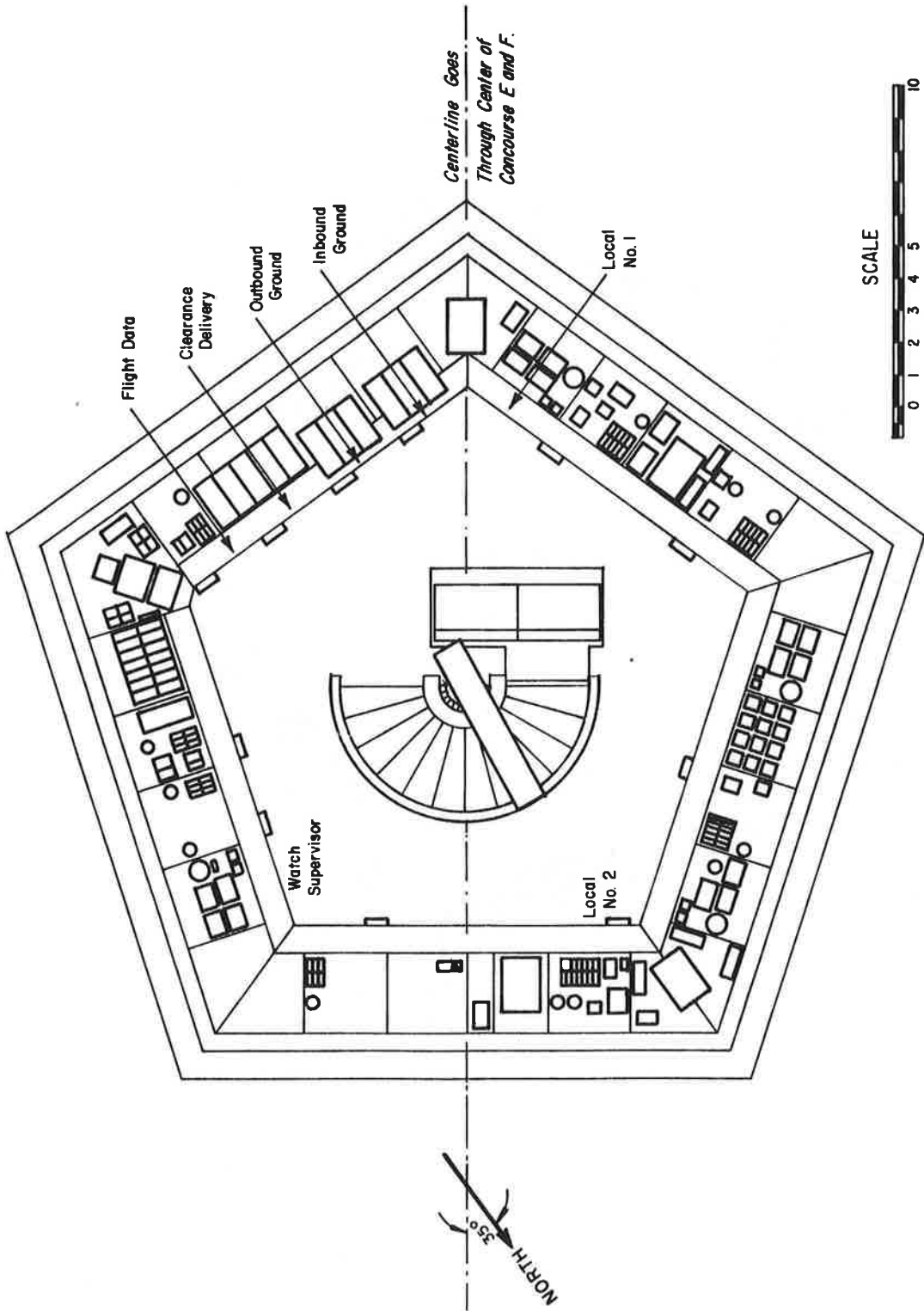

Figure 4-1. O'Hare Control Tower Floor Plan

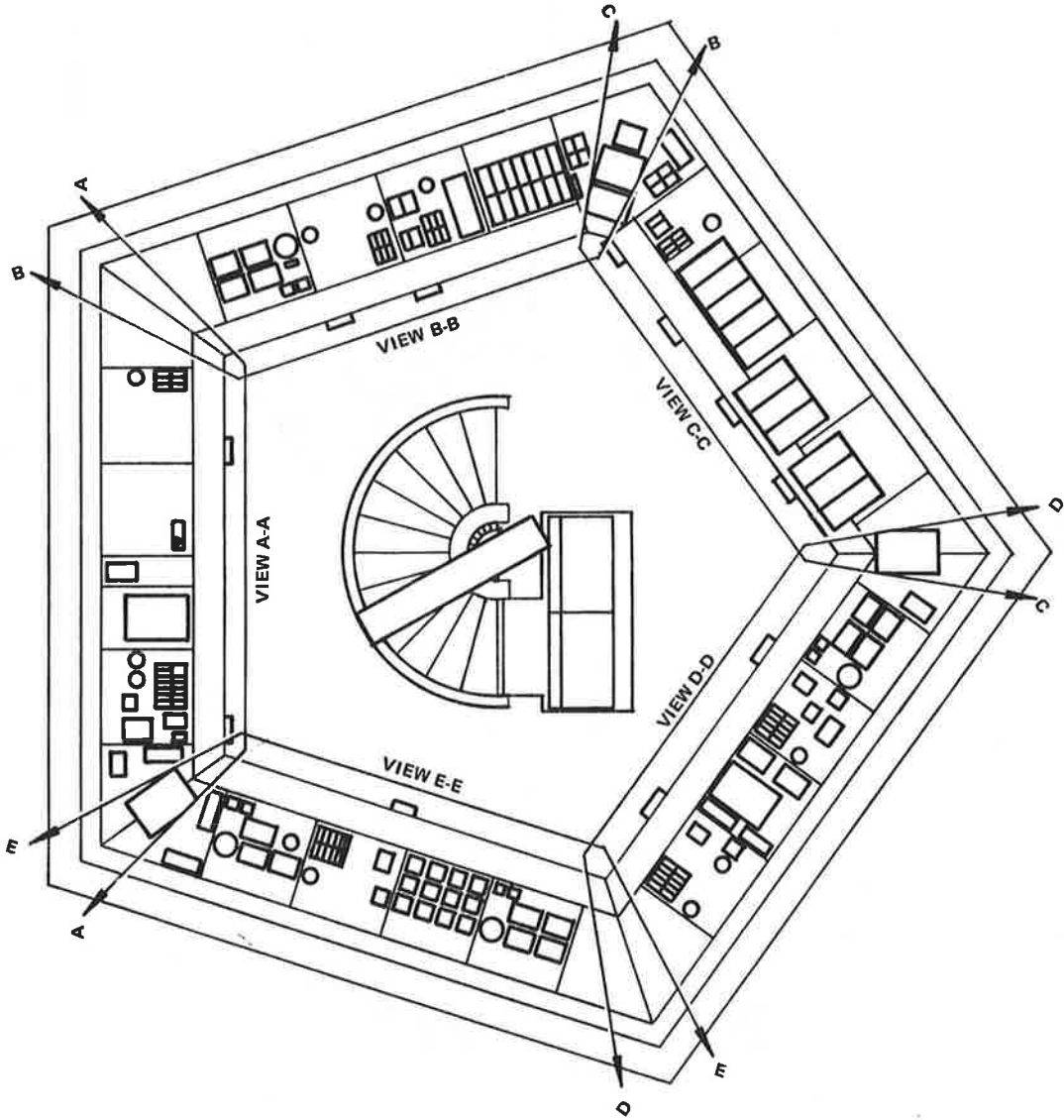

Figure 4-2. Tower Cab Detail (Sheet 1 - Key for Orientation)

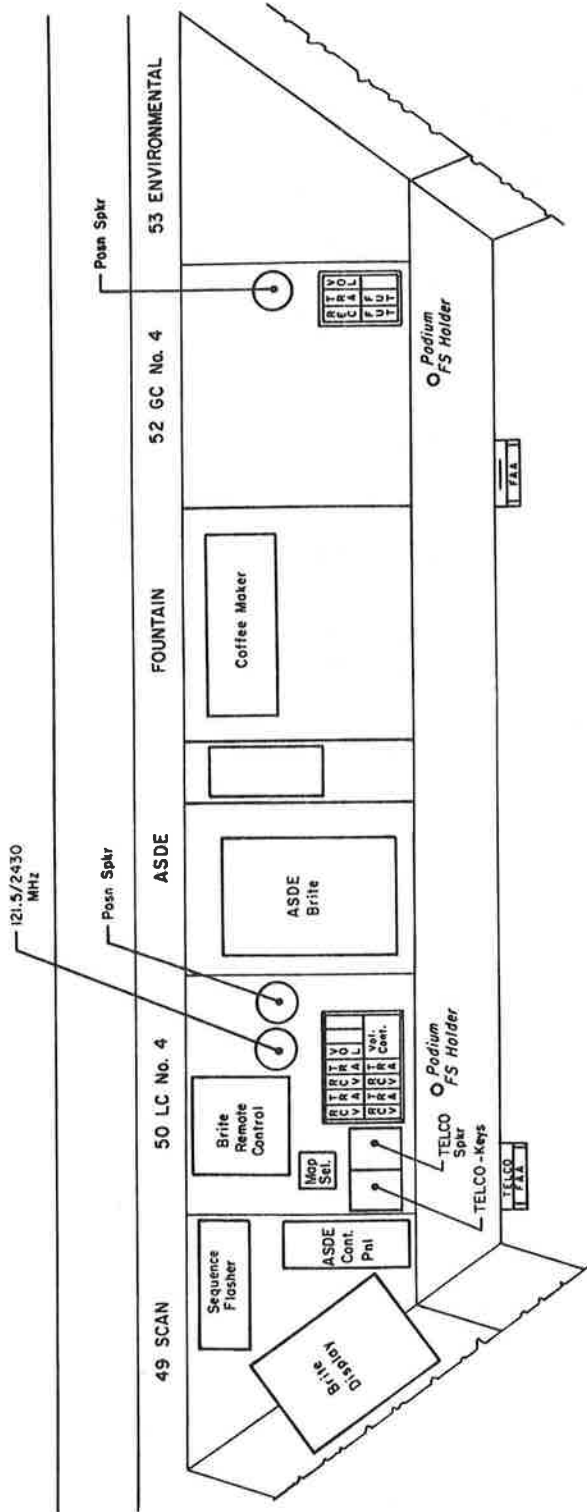

Figure 4-2. Tower Cab Detail
(Sheet 2 -- View A-A)

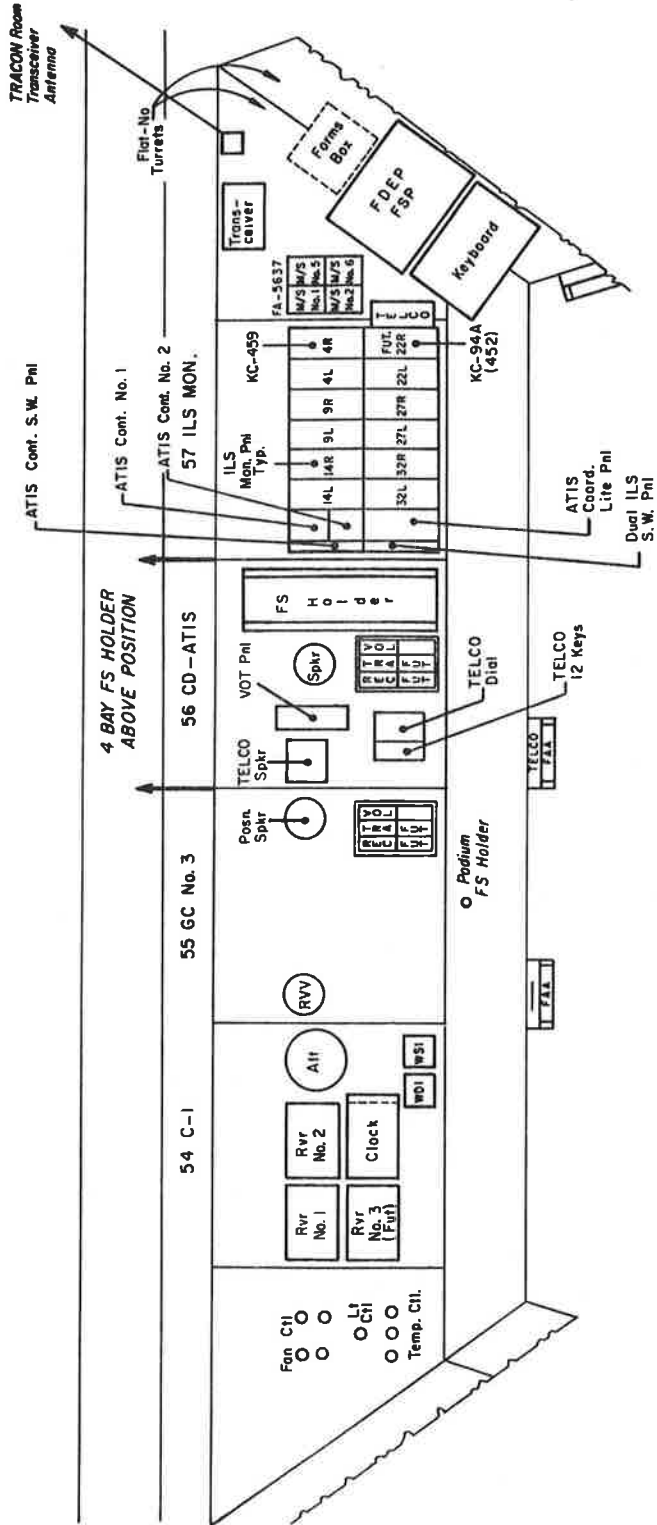

Figure 4-2. Tower Cab Detail
(Sheet 3 - View B-B)

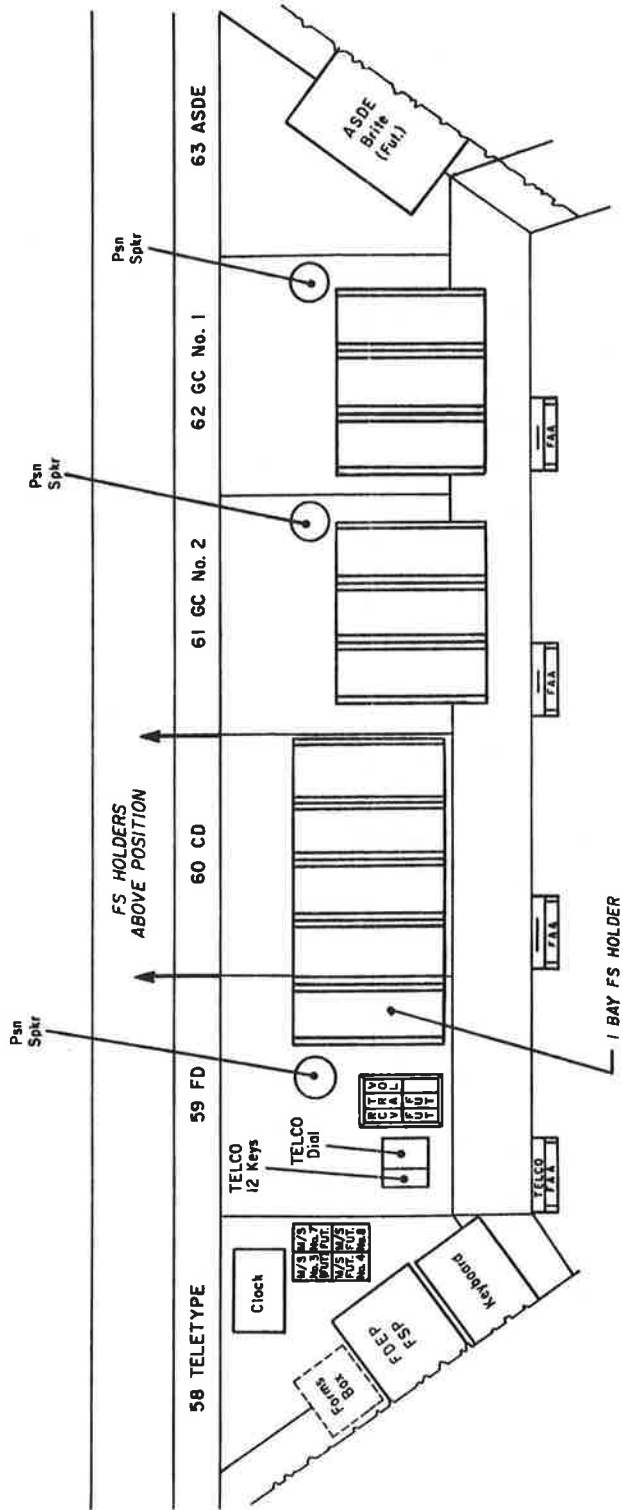

Figure 4-2. Tower Cab Detail
(Sheet 4 - View C-C)

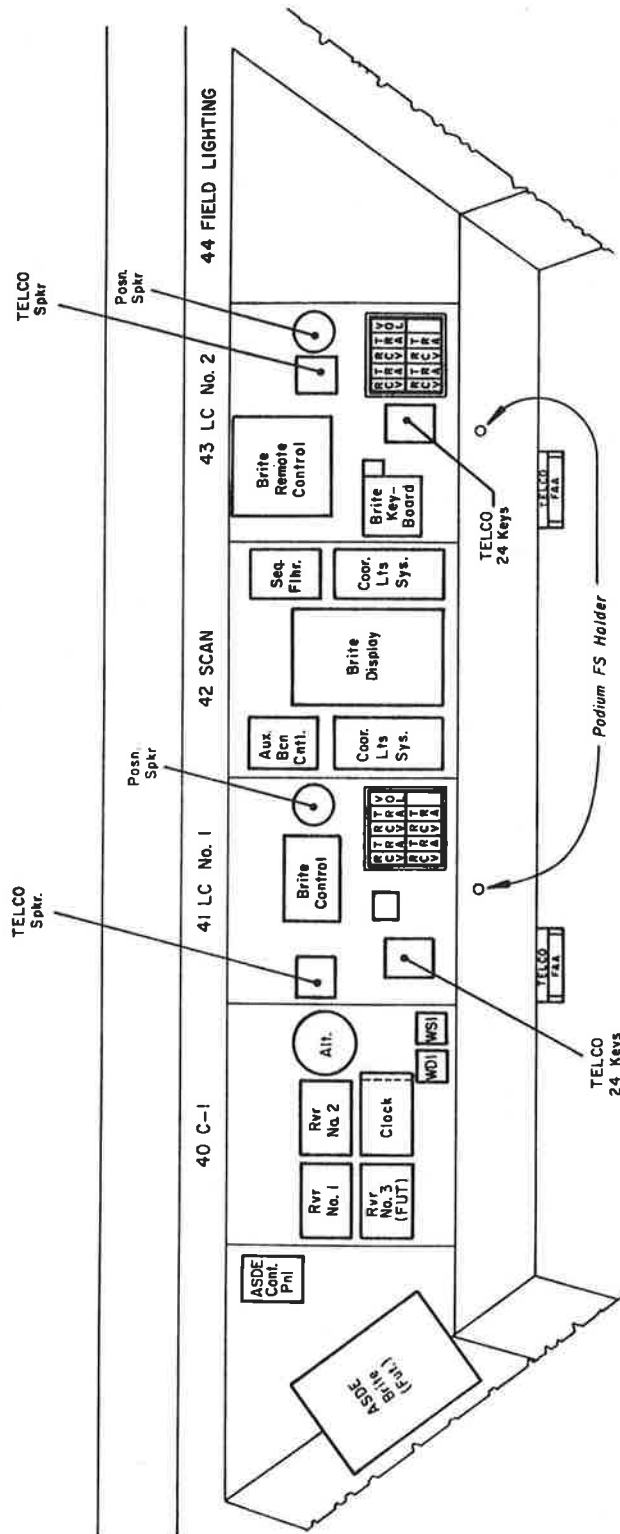

Figure 4-2. Tower Cab Detail
(Sheet 5 - View D-D)

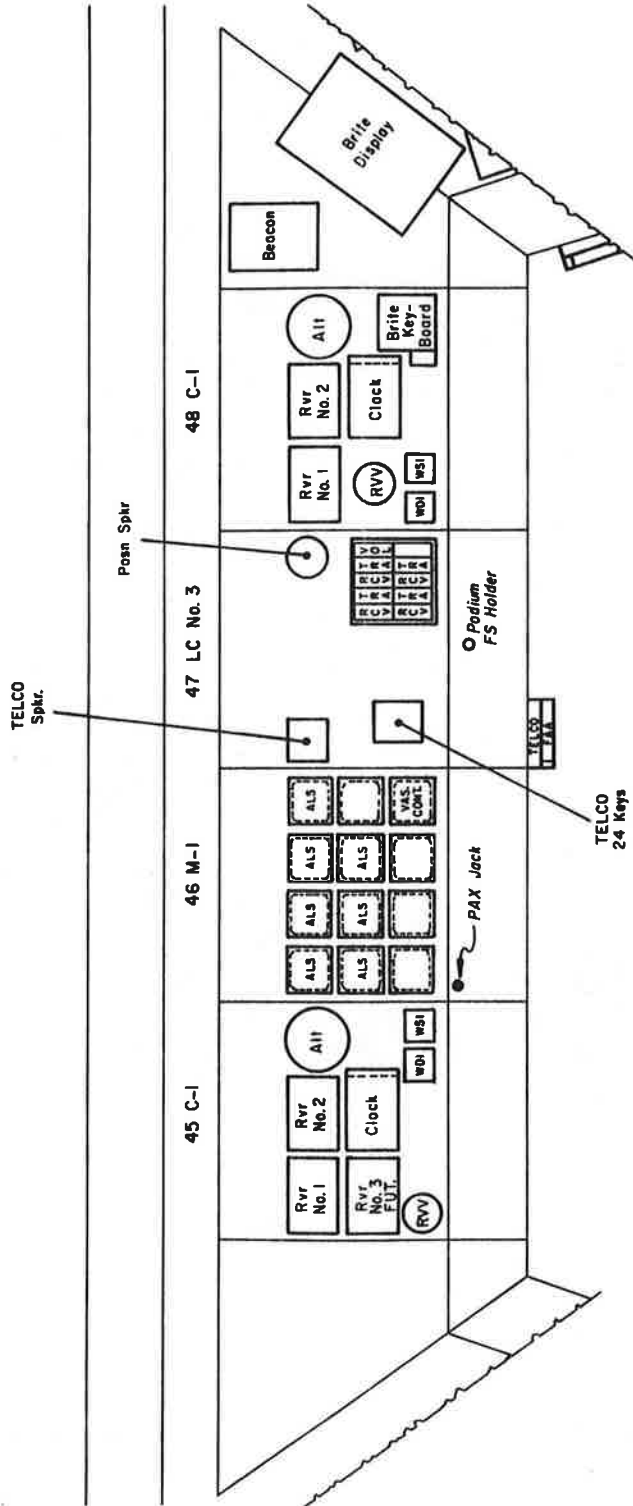
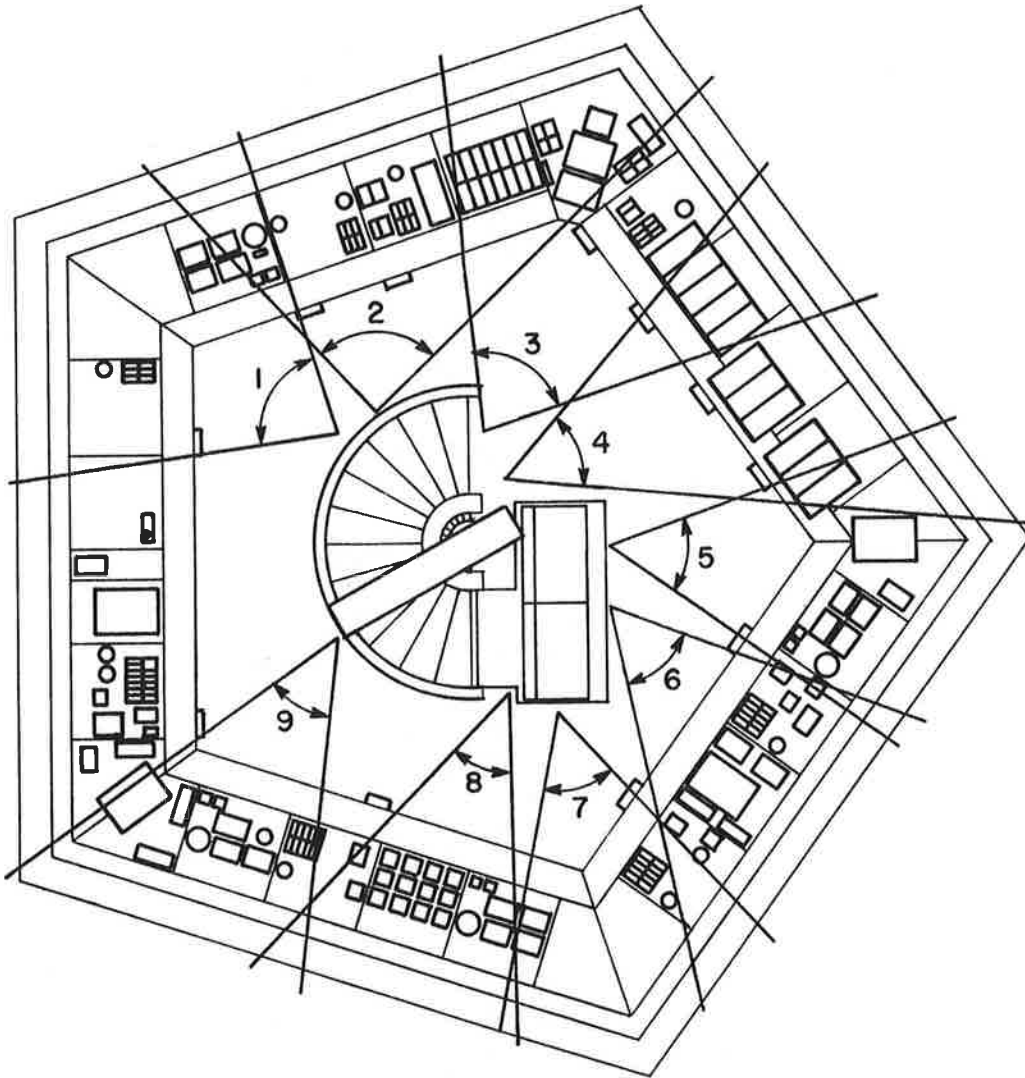
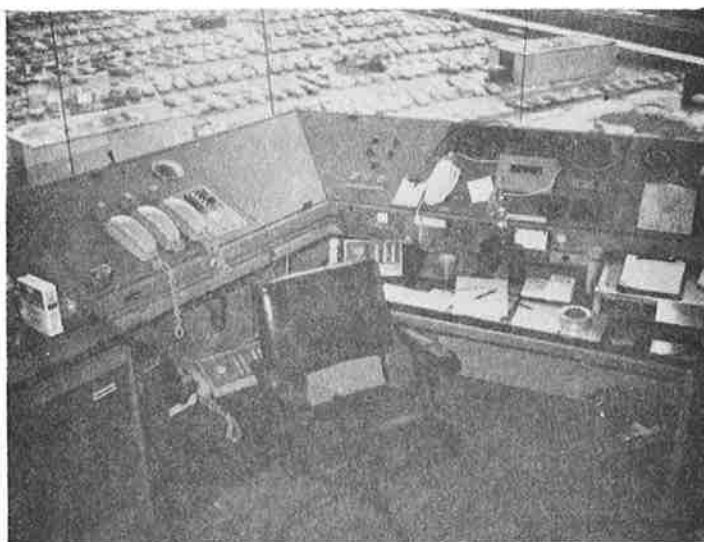

Figure 4-2. Tower Cab Detail
(Sheet 6 - View E-E)



indicates photographs on following pages.

Figure 4-3. Tower Cab Photographs (Sheet 1 - Key for Orientation)



Photograph 1

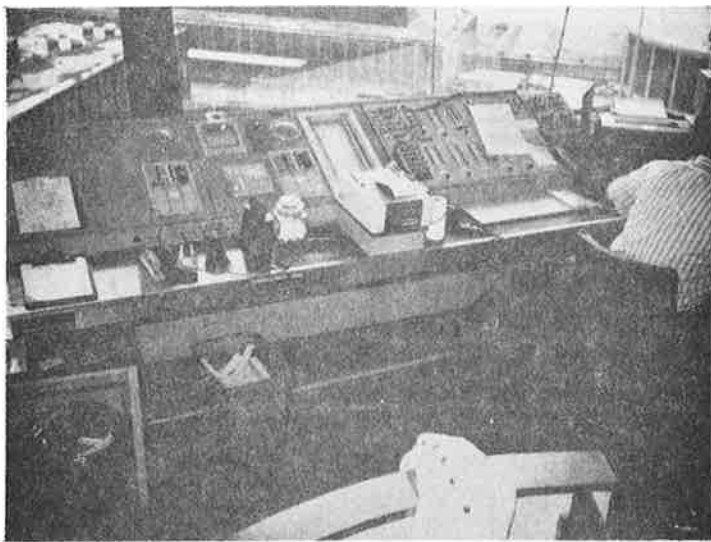

Photograph 2

Figure 4-3. Tower Cab Photographs (2 of 6)



Photograph 3

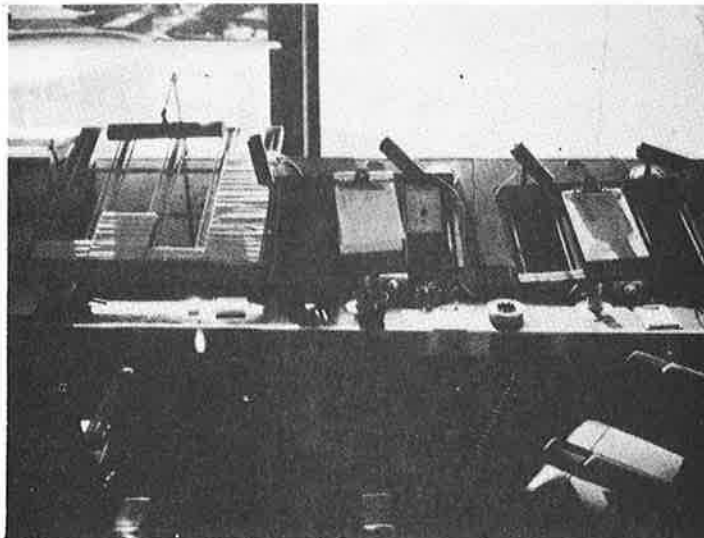

Photograph 4

Figure 4-3. Tower Cab Photographs (3 of 6)



Photograph 5

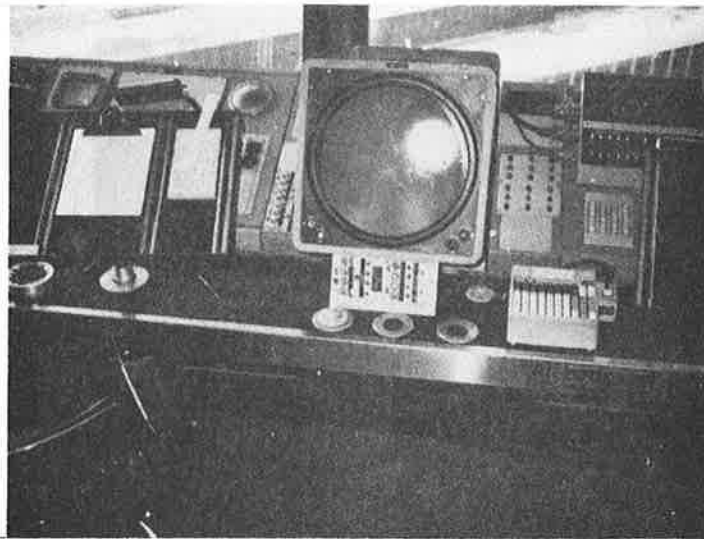

Photograph 6

Figure 4-3. Tower Cab Photographs (4 of 6)

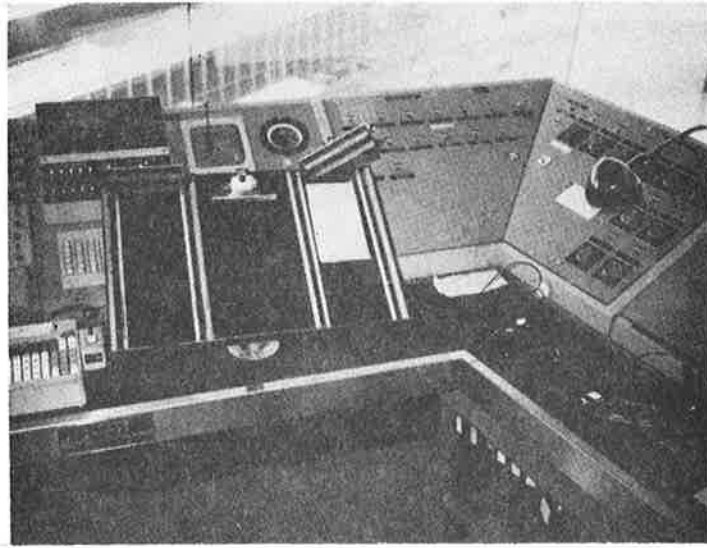

Photograph 7

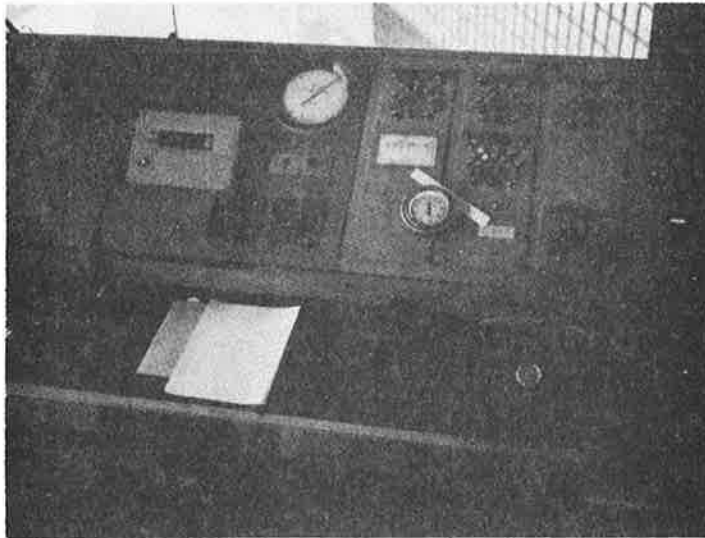

Photograph 8

Figure 4-3. Tower Cab Photographs (5 of 6)

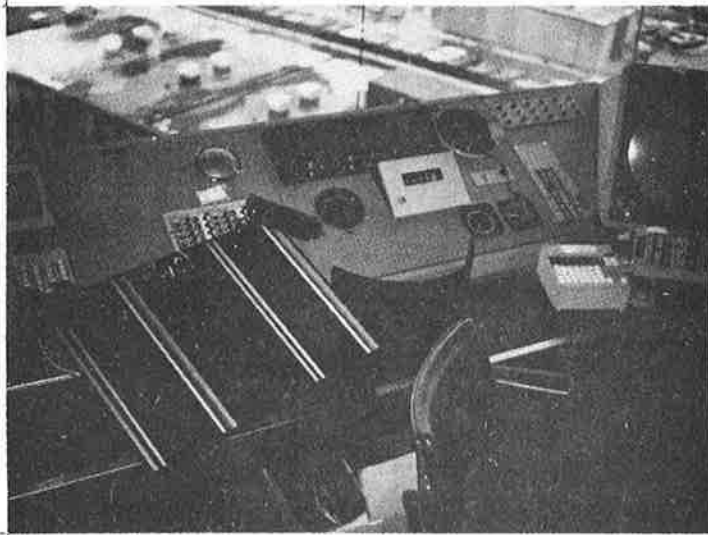

Photograph 9

Figure 4-3. Tower Cab Photographs (6 of 6)

Table 4-1. Responsibilities and Duties of the Flight Data Position

Responsibilities	Associated Duties	Equipment Used
Receive and Post Flight Strips	Retrieve strips from flight data (FDEP) Mount strips in holder Mark strips with local restrictions Post marked strips in flight strip boarded for clearance delivery Remove strips for cancelled flights	FDEP Flight Strip Board Flight Strips
Assist Clearance Delivery in Obtaining Clearances and/or ATCRBS Codes As Required	Check for clearance not yet received when aircraft calls Contact ARTCC for flight clearance and relay to clearance delivery Obtain codes for VFR departures from ARTS	Interphone ARTS Keyboard
Communication with Chicago ARTCC and FSSs	Contact ARTCC and/or FSSs as directed	Interphone
Keep Automatic Terminal Information Service (ATIS) Recording Current	Receive information regarding changes in weather, runways in use, etc., requiring update of ATIS Prepare and record new ATIS message	Telautograph ATIS Console
Receipt and Dissemination of Advisory Status Reports	Receive weather reports from U. S. Weather Service Receive NOTAMs for airport Post and/or advise other cab personnel of reports Transmit status reports to other airport operating elements (e.g., airlines, Butler Aviation)	Telautograph Interphone
Alert Airport Emergency (Crash-Rescue) Services	Contact and provide necessary information to Chicago and Air Force Fire Departments of ALERT, CRASH-FIRE, or SUSPICIOUS MATERIAL THREAT situations	Interphone

Table 4-2. Responsibilities and Duties of Clearance Delivery Position

Responsibilities	Associated Duties	Equipment Used
Issue IFR Clearances to Departure Aircraft	<p>Read IFR clearance from flight strip and verify pilot repeat</p> <p>Request flight data assistance in checking for clearances not received, obtaining clearance, or requesting change in clearance from ARTCC</p> <p>Mark aircraft gate as necessary</p> <p>Repost strip until aircraft ready to taxi</p>	<p>Flight Strip Board</p> <p>Flight Strips</p> <p>VHF Radio</p>
Issue TCA VFR Clearances to Departure Aircraft	<p>Ascertain heading and flight level out of TCA desired by pilot</p> <p>Issue TCA VFR clearance and ATCRBS code</p> <p>Request flight data assistance in obtaining code</p> <p>Manually prepare flight strip</p>	<p>Flight Strip Board</p> <p>Flight Strips</p> <p>VHF Radio</p>
Issue Handover to Ground Control for Taxi	<p>Receive notification that IFR/VFR departures are ready for taxi or pushback (where clearance is required)</p> <p>Advise aircraft to monitor appropriate ground control frequency¹</p> <p>Record time of aircraft called on flight strip</p> <p>Post strip in Outbound Ground strip board or pass strip to Inbound Ground when appropriate²</p>	<p>Flight Strip Board</p> <p>Flight Strips</p> <p>VHF Radio</p>
Issue Gate Hold Advisories	<p>Receive notification from watch supervisor that aircraft gate holds are in effect</p> <p>Advise aircraft during appropriate contact (clearance request or ready to taxi)</p> <p>Record time aircraft advised on flight strip and maintain cognizance of aircraft affected</p> <p>Issue handover to ground control when advised to release aircraft</p>	<p>Flight Strip Board</p> <p>Flight Strips</p> <p>VHF Radio</p>

Table 4-2 NOTES

1. Normally aircraft advised to monitor Outbound Ground frequency. However, aircraft going to the hangar or cargo areas and, under heavy traffic conditions, aircraft requiring pushback clearance are advised to monitor Inbound Ground frequency.
2. When traffic conditions require pushback clearance by Inbound Ground the flight strip is given to that position.

Table 4-3. Responsibilities and Duties of Outbound Ground Position

Responsibilities	Associated Duties	Equipment Used
Issue Taxi Clearance Instructions	<p>Issue taxi routing to appropriate departure runway</p> <p>Include any instructions for traffic flow control or sequencing (i. e., runway crossing holds, intersection passage priorities, traffic advisories)</p> <p>Mark destination runway on flight strip and special routing indication as necessary</p> <p>Post strip in appropriate flow sequence order</p>	<p>Flight Strip Board</p> <p>Flight Strips</p> <p>VHF Radio</p>
Maintain Safe Ground Traffic (Aircraft and Vehicular) Flow	<p>Keep continuous visual check on ground traffic flow or obtain verbal position reports when necessary</p> <p>Anticipate conflicts in traffic flow</p> <p>Issue appropriate control instruction to resolve conflicts (i. e., holds, give way)</p>	<p>VHF Radio</p>
Expedite Flow of Ground Traffic (Aircraft)	<p>Maintain cognizance of ground traffic flow and situations affecting established flow pattern or delaying aircraft in the pattern</p> <p>Determine adjustment to the sequence of aircraft in the flow pattern or to the traffic routing necessary to maintain continuous flow to the departure runways</p> <p>Issue appropriate control instructions to accomplish adjustments²</p>	<p>Flight Strip Board</p> <p>Flight Strips</p> <p>VHF Radio</p>
Assure Safe Crossing of Active Runways by Departure Aircraft	<p>Determine when it is safe to clear departure aircraft across an active runway when traffic pattern requires such a crossing</p> <p>Coordinate with appropriate local control as required</p> <p>Issue clearance to cross runway</p>	<p>Visual Reference to Local Control Operations</p> <p>VHF Radio</p>

Table 4-3 (Continued)

Responsibilities	Associated Duties	Equipment Used
Handover to Local Control	Determine when it is appropriate to turn departure flight over to local control for the destination runway Advise pilot to monitor appropriate local control frequency Pass strip to appropriate local control position	Flight Strips Flight Strip Board at Local #1 Flight Strip Chute for Local #2 VHF Radio
Issue Pushback Clearance to Departure Aircraft	Determine when it is appropriate to permit aircraft to pushback (i. e., when pushback will not conflict with other traffic on inner circular) Issue clearance to pushback	VHF Radio
Provide Assistance in Emergency Situations	Receive notification of emergency situation Ascertain location of aircraft involved Initiate emergency action Provide taxi instructions to appropriate holding area for aircraft as situation dictates Provide directions to emergency equipment	VHF Radio

NOTES

1. Although establishing aircraft in appropriate sequence for departure at the destination runways is not a required duty for this position, it is a normal part of Outbound Ground procedures when conditions permit (refer to paragraph 4.2.2.3.3 for further discussion).
2. Adjustments in the aircraft flow patterns may be accomplished by the issuance of taxi clearances to departing aircraft which result in a change in the sequence of aircraft or in taxiing aircraft to the destination runway by alternate routes when possible.
3. When traffic conditions permit, this position will issue pushback clearances in conjunction with taxi instructions; otherwise pushback clearances will be handled by Inbound Ground whose traffic is more likely to be affected.

Table 4-4. Responsibilities and Duties of Inbound Ground Position

Responsibilities	Associated Duties	Equipment Used
Issue Taxi Clearance Instructions	Ascertain location and destination of arrival aircraft, and location/destination of hangar/cargo area traffic Issue taxi routing to appropriate airport facility destination Record flight number and destination gate, as necessary	ASDE ¹ Scratch Pad VHF Radio
Accommodate Aircraft with Gate Availability Delays	Maintain cognizance of the status of gates ² Determine whether arrival aircraft gate is available If not available, issue taxi routing instructions to appropriate area When gate becomes available issue taxi instructions from holding area to gate	VHF Radio
Maintain Safe Ground Traffic (Aircraft and Vehicular) Flow	Same as for Outbound Ground	ASDE ¹ VHF Radio
Expedite Flow of Ground Traffic (Aircraft)	Same as for Outbound Ground ³	VHF Radio
Issue Pushback Clearances to Departure Aircraft ⁴	Determine when it is appropriate to permit aircraft to pushback (i. e., when pushback will not conflict with other traffic on inner circular) Issue pushback clearance Advise aircraft to monitor Outbound Ground frequency for taxi instructions Pass flight strip to Outbound Ground	VHF Radio
Provide Assistance in Emergency Situations	Same as for Outbound Ground	VHF Radio

Table 4-4 NOTES

1. Under poor visibility conditions ASDE may be utilized to ascertain/verify position reported by aircraft.
2. Although this is not a prescribed duty for this position it is a normal part of Inbound Ground procedures (Refer to paragraph 4.2.2.3.4).
3. Adjustments in ground traffic flow may become necessary when arrival aircraft entrance to appropriate ramp/gate area is blocked by conflicting traffic. May be accomplished by continuing aircraft taxi to an alternate exit from the inner/outer taxiways when appropriate.
4. When traffic conditions dictate, this position will issue pushback clearance and then turn aircraft over to Outbound Ground for taxi instructions.

Table 4-5. Responsibilities of Local Control Position

Responsibilities	Associated Duties	Equipment Used
Establish Sequence for Runway Operations	<p>Maintain cognizance of positions of arrival and departure aircraft</p> <p>Determine appropriate sequence for runway operations providing maximum flow rate for traffic</p> <p>Establish departure aircraft in appropriate positions to achieve desired flow rate</p> <p>Verify that safe separations will be achieved between consecutive runway operations (on the same or crossing runways)</p>	<p>ARTS Brite¹</p> <p>ASDE Brite¹</p> <p>VHF Radio</p>
Clear Arrival Aircraft for Landing	<p>Receive in-bound report from arrival flight at outer marker</p> <p>Advise aircraft of clearance to land or position in sequence</p> <p>Advise aircraft of local conditions (e.g., runway visibility, winds, surface conditions, turbulence) as required</p> <p>Ascertain whether aircraft will be able to complete approach and landing²</p> <p>Execute missed approach procedures, if necessary</p> <p>Advise aircraft of desired runway turnoff, as necessary</p> <p>Record aircraft on arrival log</p>	<p>ARTS Brite</p> <p>Weather Instruments¹</p> <p>ASDE Brite¹</p> <p>Arrival Log Form</p> <p>VHF Radio</p>
Clear Departure Aircraft Takeoff	<p>Keep continuous visual check on departure traffic flow and position or obtain position reports when necessary</p> <p>Establish aircraft in sequence for runway utilization</p> <p>Establish aircraft on runway for takeoff when appropriate to runway usage³</p> <p>Issue takeoff clearance⁴</p> <p>Advise aircraft of local conditions as required⁴</p>	<p>ASDE Brite¹</p> <p>Weather Instruments</p> <p>ARTS Brite</p> <p>Flight Strip Board</p> <p>Flight Strips</p> <p>VHF Radio</p>

Table 4-5 (Continued)

Responsibilities	Associated Duties	Equipment Used
Clear Departure Aircraft Takeoff (Continued)	Issue departure turn heading and record on flight strip ⁴ Ascertain whether aircraft will be able to complete takeoff and departure Execute appropriate control actions for aborted takeoffs/departures	
Handoff Aircraft to Inbound Ground	Keep continual visual check on movement of aircraft or obtain position reports when necessary Verify that aircraft has cleared runway Issue taxi instructions as necessary to assure that aircraft will not block runway exit for succeeding arrival Maintain control of aircraft until safely across last active runway under responsibility of position as runway configuration requires Advise aircraft to change to Inbound Ground frequency	ASDE Brite ¹ VHF Radio
Handoff Aircraft Departure Control	Keep continual visual check on maneuvers of aircraft or obtain position reports when necessary Verify that required separation of aircraft from other traffic will be achieved Issue control instructions as required to assure separation Advise aircraft to change to departure control frequency Pass flight strip to appropriate departure control position in TRACON (i. e., drop down appropriate tube) Coordinate with departure control as necessary to assure aircraft separation from other traffic	ARTS Brite Flight Strip Board Flight Strips VHF Radio Interphone

Table 4-5 (Continued)

Responsibilities	Associated Duties	Equipment Used
Execute Missed Approach	<p>Instruct aircraft to execute missed approach</p> <p>Issue appropriate heading/altitude instructions</p> <p>Verify air execution of instructions and separation from other traffic</p> <p>Advise aircraft to change to departure control frequency</p> <p>Prepare and pass flight strip to departure control</p>	<p>ARTS Brite</p> <p>Flight Strips</p> <p>VHF Radio</p>
Control of Aborted Departures (No Takeoff)	<p>Determine whether an emergency situation exists</p> <p>Initiate emergency action as necessary</p> <p>Clear aircraft from runway and verify that it has cleared if no emergency</p> <p>Ascertain pilots' intention</p> <p>Issue control instructions for re-entry of departure sequence or advise aircraft to change to Inbound Ground frequency for return to terminal, as appropriate</p>	<p>ASDE Brite¹</p> <p>VHF Radio</p>
Control of Aborted Departures (After Takeoff)	<p>Determine whether emergency situation exists</p> <p>Initiate emergency action as necessary</p> <p>Issue instructions for approach to runway under control⁵ of position as situation warrants and conditions permit</p> <p>Otherwise treat as missed approach and coordinate with departure control</p>	<p>ARTS Brite</p> <p>VHF Radio</p> <p>Interphone</p>
Provide Assistance in Emergency Situations	<p>Ascertain that emergency situation has occurred</p> <p>Ascertain location of aircraft involved</p> <p>Initiate emergency action</p> <p>Advise ground control of aircraft location</p>	<p>ASDE Brite¹</p> <p>VHF Radio</p>

Table 4-5 NOTES

1. During poor visibility conditions ASDE Brite may be used by position.
2. During low to poor visibility conditions potential for missed approach increases due to inability of pilots to visually acquire runway or differences in airport and airline minimums (refer to paragraph 4.2.2.3.5).
3. The point at which aircraft may be instructed to Position and Hold will differ when there are departures only on mixed operations on the runway.
4. Operating conditions and traffic levels whether and when local conditions, advisories and departure headings are provided to aircraft in takeoff instructions and may be included in or separate from "Cleared for Takeoff" instruction.
5. In cases of a serious emergency under good visibility and light-to-moderate traffic conditions, the local controller may vector the aircraft back for a visual approach.

equipments at airline and Butler Aviation operations desks. In addition, the weather reports are posted for other tower personnel and in conjunction with changes in airport runway configuration to prepare revised ATIS recordings.

The major responsibility of the Clearance Delivery position is to deliver the ARTCC IFR clearance to departure aircraft and to verify that the flight crew has properly received the clearance. In accomplishing this the Flight Strip Bay/flight strips and VHF radio serve as his primary equipments. In the case of VFR departures, the duties associated with this responsibility also include ascertaining the desired direction and altitude of exit from the TCA and preparation of a VFR flight strip. The other responsibility of this position is to receive notification that aircraft are ready for taxi or for pushback, where the situation requires clearance to do so, and to turn these aircraft over to the appropriate ground control position for these aircraft. The particular position will depend on whether or not the aircraft is a normal departure or a cargo/hangar area flight, whether or not the aircraft requires a pushback clearance, and the level of traffic at the time pushback is required.

The Outbound Ground position is responsible for issuing taxi clearances to departure aircraft, including the assignment of the departure runway and route to the runway, and assuring the safe and expeditious flow of the aircraft along the assigned route. The one exception to this responsibility for departure taxi clearance is helicopter flights which are the responsibility of the Inbound Ground position. During both the transmission of the taxi clearances and maintenance of the traffic flow, the Outbound Ground controller is responsible for monitoring the traffic flow through visual observations or pilot position reports and to transmit the necessary control instructions or traffic advisories to resolve potential conflicts between aircraft. This position is also responsible for turning these aircraft to the Local Control position responsible for the assigned runway when the aircraft is safely established on the taxi approach to the runway. This point will vary for various runways depending on the runway configuration in use and traffic flow associated

with this configuration. Under certain configurations this will require this position to assume responsibility for safely seeing aircraft across an active runway before the turnover is accomplished.

Similarly, the Inbound Ground position is responsible for issuing taxi clearances to arrival aircraft, including the route to their airport destination, and assuring the safe and expeditious flow of the aircraft along the route. In discharging this responsibility, this position is responsible for accommodating aircraft whose terminal gate is not available for occupancy. This requires ascertaining the availability of aircraft gates and routing affected aircraft to interim holding areas most suitable for rapid access to their gates when they become available. As noted above, this position has the responsibility for ground taxi of helicopter traffic, both departures and arrivals. In addition, the Inbound Ground position has responsibility for control of traffic between the passenger terminal and the hangar and cargo areas, in either direction. Similar to the Outbound Ground position, this position will monitor aircraft movements through visual observation or position reports to identify potential conflicts or delays in traffic flow and issue the control instructions and/or traffic advisories necessary to resolve them. However, unlike the Outbound Ground position, the Inbound Ground position has no flight strips for his traffic and has no responsibility for turning the aircraft over to another control position.

The major responsibility of the Local Control position is the establishment and maintenance of a safe and expeditious runway operations sequence. The Local Control #1 position has this responsibility for runways on the south side of the passenger terminals and the Local Control #2 position for runways on the north side of the terminals. The Local Control #2 position actually operates at the Local Control #4 work station. * In discharging this responsibility these positions are

*The tower cab layout provides a number of additional work stations to allow for future expansion of the tower staff in the event that it becomes necessary.

required to monitor the movements of arrival and departure aircraft visually or through position reports to determine that safe separations between arrivals and departures on the same or different runways are achieved without undue delays to these operations. This requires assuring that these operations will be completed taking the necessary control actions to maintain traffic flow when it becomes necessary to abort an operation. The second major responsibility of the Local Control position is to turn landed aircraft over to the Inbound Ground position for taxi to their airport destination when they are safely clear of other runway operations. In certain runway configurations this requires the Local Control position to maintain control of aircraft and provide the necessary taxi instructions to see the aircraft across the last active runway under his responsibility. This is more frequently required of the Local Control #2 position.

The Watch Supervisor is generally responsible for monitoring the status of surface operations and supervising the activities of the preceding control positions. Specifically, the Watch Supervisor is responsible for monitoring the local conditions affecting airport surface operations, selecting the most suitable runway configuration for use under these conditions, and coordinating this decision with the TRACON Watch Supervisor and tower cab controllers. In addition, under situations where weather or other conditions (local or external to O'Hare) result in problems of delay and surface congestion, the Watch Supervisor will determine whether departure aircraft must be held at their gates, arrivals held, or these operations carefully metered until the congestion is reduced. This decision will be coordinated with the TRACON Watch Supervisor and transmitted to tower cab personnel.

4.2.2.2 Visibility Constraints of Tower Operations

The operations of tower cab control positions are influenced by visibility conditions. The limits of visual coverage of surface operations are illustrated in Figure 4-4 under VFR and Category I conditions. Locations at which controller visual observation of aircraft movements or position on the surface

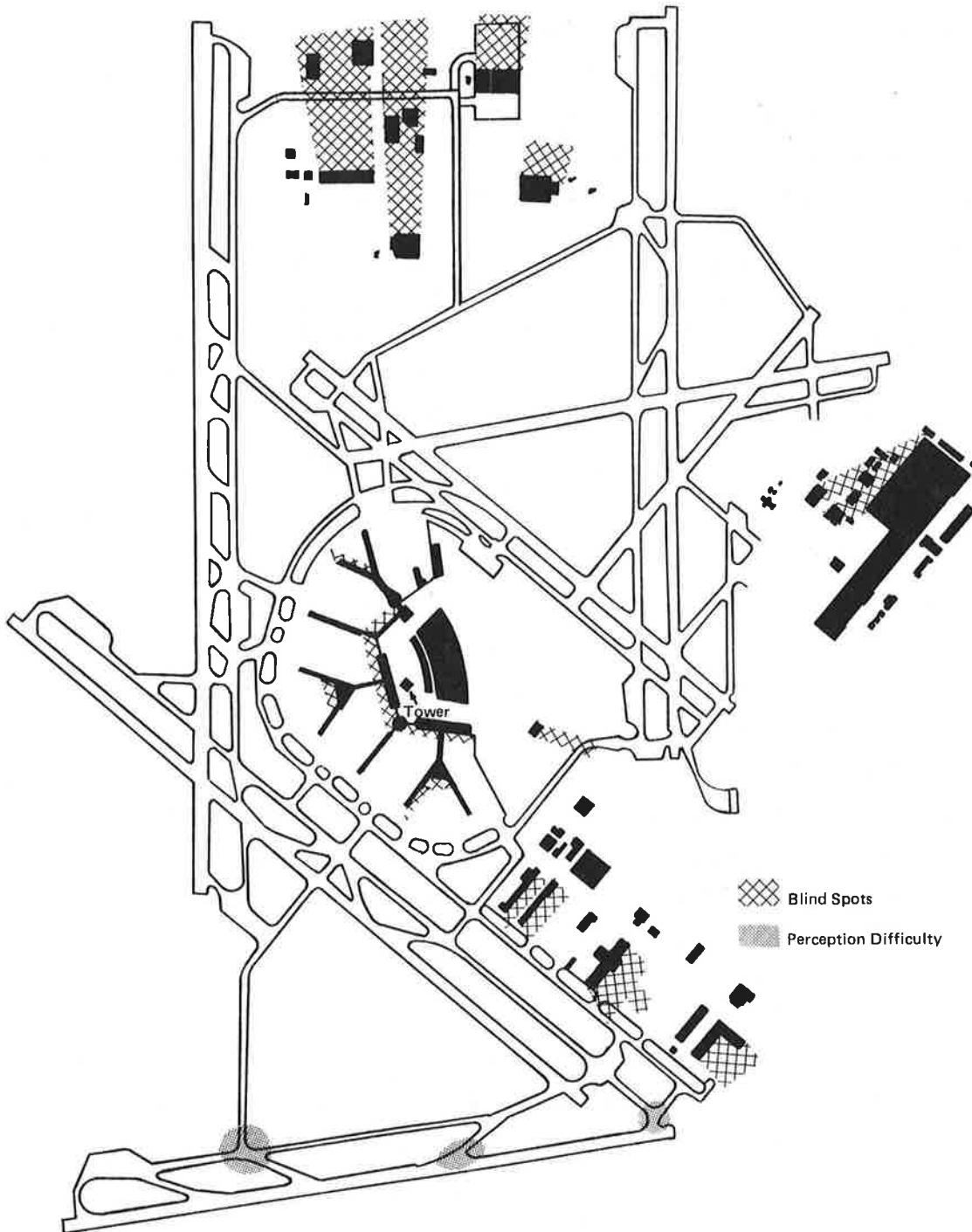

Figure 4-4. Visual Surveillance Limitations

is physically blocked by airport facilities are indicated. In addition, areas in which controller visual perception of the position of aircraft is reduced because of their location relative to the tower are also indicated.

The limits of visual coverage under Category II conditions are not indicated in this figure because of their variability. Under the best conditions when the fog is patchy, limited areas around the terminal gates may be visible. Under the worst conditions all visibility of operational areas may be lost. In addition, the visibility to flight crews of other aircraft around them may become quite limited as noted on one occasion during observations at O'Hare.

The limits of radar coverage of airport traffic available to the tower control positions via ARTS Brite and ASDE Brite displays are illustrated in Figure 4-5. The limits of ARTS coverage represents the ranges at which beacon tracking is terminated by the ARTS system. With respect to the ASDE coverage, the areas in which this coverage, has been classified as unreliable or of limited reliability are indicated. This determination was made through field tests by ATCT Operations and Airways Facilities Sector personnel. In addition, the height at which ASDE coverage is lost was indicated by the Airways Facilities Sector to be 20 feet at the extreme range of the O'Hare radar.

Essentially, the limits of visual coverage illustrated in Figure 4-4 have no impact on O'Hare operations. Aircraft movements within the cargo or hangar areas are not normally under control of Ground Control positions. The term normally is used because infrequently it may become necessary to move aircraft waiting for departure on 14R to another runway. Under these conditions, the aircraft may be routed through the hangar area if that is the most feasible path to the other runway, e.g., 14L. Where the visibility of the aircraft becomes blocked on the cargo taxiway, this situation exists only momentarily. Tower controller personnel have indicated that this blockage lasts only for about two seconds.

The major impact of lowered visibility conditions on the ASTC system occurs at lower end of Category I and during Category II. This impact is reflected

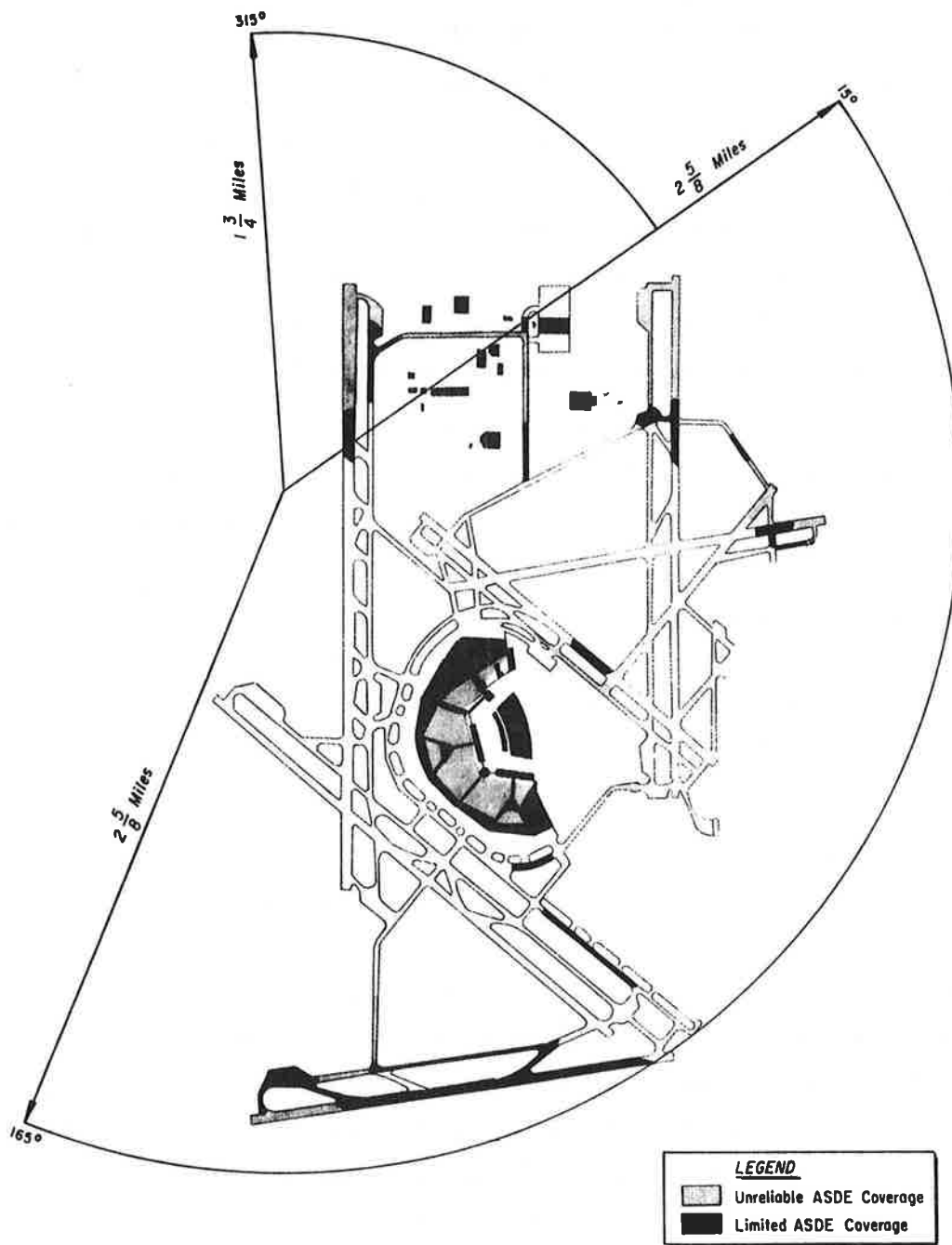

Figure 4-5. Radar Coverage

in the initiation of requests for position reports by both Ground and Local Control positions and the requirement for a transmission of runway RVR and/or rollout by Local Control. This is discussed in further detail in the following descriptions of controller procedures.

4.2.2.3 Controller Operational Procedures

Descriptions of the operational procedures employed by the various tower cab personnel, with the exception of the Watch Supervisor, are provided below. Flow diagrams for the major functional tasks performed by these positions are presented and serve as a reference for the discussion of the impact of weather and traffic conditions on controller operations.

4.2.2.3.1 Flight Data

Figure 4-6 illustrates the flow of the two major functional tasks of the Flight Data position.

The task activities shown in Figure 4-6(a) for the Posting of Flight Strips occupy the predominant part of the Flight Data position's time. Flight Strips are printed out approximately one hour before the Estimated Time of Departure (ETD) for the aircraft. Normally several flight strips are printed out at one time as well as notices for removal of strips for cancelled flights. The strips are removed from the printer and separated. Removal notices are set aside. The strips are then mounted in Flight Strip Holders so that they may be mounted in the Flight Strip Board.

Before posting, the strips are marked by Flight Data. Marking normally includes the following:

1. Correction of the flight level to 240, the clearance limit for O'Hare, for any flight with a ARTCC clearance above 24,000 feet.
2. Correction of the first fix to reflect the appropriate clearance limits for the ATCT.

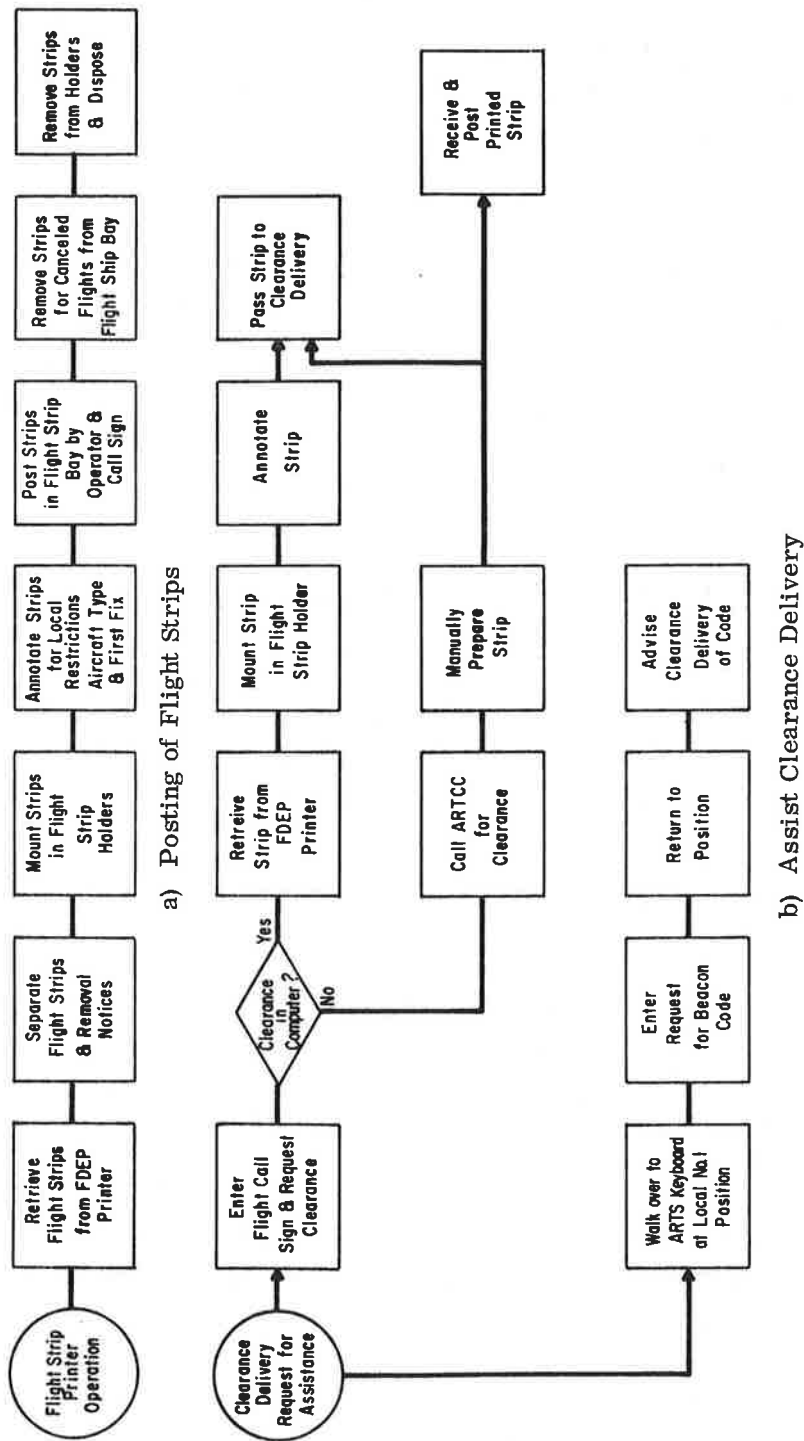

Figure 4-6. Functional Flow of Major Flight Data Tasks

3. Underlining the first fix to facilitate its recognition and use by the remaining controller positions.
4. Underlining or circling the aircraft type data item when the aircraft is a heavy, i. e. , takeoff weight over 300,000 lbs. This is indicated by an H in front of the equipment type (e. g. , "H/DC86/A" indicates a DC8-60 series aircraft. Aircraft considered as heavies include the B747, DC-10, L1011, DC8-60 series, and over-water versions of the B707.

In the case of United Airlines aircraft additional marking is performed by Flight Data. The Clearance Delivery position is required to mark the gate number for departures on the flight strips. Because United operates a substantial number of departures from gates in both the E and F terminal courses, Flight Data marks an F in the position where the gate is recorded. If the departure is from a gate in the F concourse, then Clearance Delivery is only required to record the gate number. If the departure is from an E concourse gate, then Clearance Delivery need only add the last stroke to complete the E and record the gate number. That has the effect of minimizing the activity of the Clearance Delivery position who may have to handle calls from aircraft in close succession at the expense of the Flight Data workload.

The annotated flight strips are posted in the Flight Strip Board. The strips are posted on the left side of the Board by Operator and Call Sign. For domestic passenger flights, the strips are ordered roughly alphabetically by airline and then in numerical order by flight number. The strips for Cargo, Butler Aviation, local commuter airlines and general aviation, and International Terminal Departures are posted in separate areas reserved for these operations also by alphanumeric flight identification.

When Flight Data has completed the posting of the departure flight strips, the strips for cancelled flights are removed from the Board and the Strip Holder is disposed of.

Figure 4-6(b) illustrates the task sequence when Flight Data is called upon to assist Clearance Delivery in obtaining a clearance for a flight which has not been received and posted by the time the pilot calls for his clearance and in obtaining a ATCRBS code for VFR departures. With respect to obtaining a clearance, Flight Data enters the flight ID on the FDEP keyboard and requests a clearance. If a clearance for the flight is in the ARTCC computer, a strip will be printed and Flight Data will perform the strip mounting and marking as described above. When there is no clearance in the computer, Flight Data must call the ARTCC via the interphone and request a clearance. He will then manually prepare a flight strip and pass it to Clearance Delivery. If the flight has not called for taxi by the time a printed strip is received, Flight Data will process the printed strip in the normal manner and replace the written strip with it.

When Flight Data is requested to obtain an ATCRBS code for a VFR departure, the code must be obtained from the ARTS computer. This requires Flight Data to walk over to the ARTS keyboard at the Local Control #1 position and enter a code request. Clearance delivery is then advised of the code for transmission to the departure. To minimize the requirements for repeated transit to the ARTS keyboard and the associated delay in providing the code to the departure, it is standard procedure for Flight Data to obtain several codes (normally 10 are requested) at one time. The list of available codes is given to Clearance Delivery for his use as required. When the list nears depletion or is depleted, Flight Data obtains another.

A third task of the Flight Data position not illustrated in Figure 4-6 is maintaining the currency of the ATIS. Weather reports are periodically received from the U. S. Weather Service via the Telautograph. These are normally received hourly but will be received more frequently (e. g. , every 15 minutes) under Category I and Category II conditions or when special conditions exist. Flight Data will review these reports to determine whether a new ATIS recording is required. In addition, when a decision is made to change the runway

configuration, the Watch Supervisor will advise Flight Data to prepare a new ATIS. Criteria requiring the preparation of a new ATIS include:

1. Ceiling changes of 1000 feet and all changes below 6000 feet.
2. Changes in visibility below six miles.
3. Changes in approaches or arrival runways.
4. Changes in departure runways.
5. Temperature changes of three degrees or more when the temperature is above 70°F.
6. Altimeter changes of three points.

Flight Data manually prepares the new ATIS and operates the ATIS console to make the new recordings. ATIS recordings are made for both departure and arrival operations.

Among Flight Data's other duties are:

1. Posting and advising other controller positions of newly received weather reports. Telautograph received weather reports are placed on the central column of the tower cab for review by other controllers.
2. Posting and advising other controller positions NOTAMs received, including confirmation of runway/taxiway closings for snow removal or maintenance operations and removal of these restrictions.
3. Dissemination of airport operations status information to aircraft operators. When operating conditions are such that aircraft operators must be advised of decisions regarding traffic operations (e. g. , gate holds have been instituted for all departures), Flight Data will transmit the advisory via the

Telautograph to similar equipments at the airlines and Butler Aviation operations desks.

4. 2. 2. 3. 2 Clearance Delivery

Figure 4-7 illustrates the flow sequence for the three functional tasks of the Clearance Delivery Position.

The task activities illustrated in Figure 4-7(a) for IFR Clearance Delivery occupy the predominant part of the Clearance Delivery position's time. The major portion of this time is spent in relation to air carrier passenger flight operations and is outlined in the figure in a reasonably straightforward manner. When, infrequently, no flight strip can be found for an aircraft, Clearance Delivery will advise the pilot "Standby . Your clearance is on request" and request assistance from Flight Data.

Normally the pilot will advise Clearance Delivery of the terminal gate from which the flight is departing. If this information is not given it will be requested. The gate number will be recorded on the flight strip to the right of the flight call sign and aircraft type. It should be noted that the gate number is not recorded for all departures. For airlines having a limited number of gates the number is not recorded. Table 4-6 summarizes the nature of gate marking for various airlines. This gate recording activity is shown sequentially in the figure for ease of illustration, but is actually performed in parallel with the reading/pilot repeat of the clearance.

The flight strip is then placed in the right hand bays of the Flight Strip Board. As in the case of the original strip posting by Flight Data, the strips are ordered alphanumerically by airline and flight number to facilitate their retrieval when the pilot calls for taxi.

In the case of commuter airlines or general aviation IFR departures, Clearance Delivery will advise the pilot to "Monitor Ground Control on 121. 75 (or point 75)" and the strip placed in the left side of the Outbound Ground Flight Strip Board.

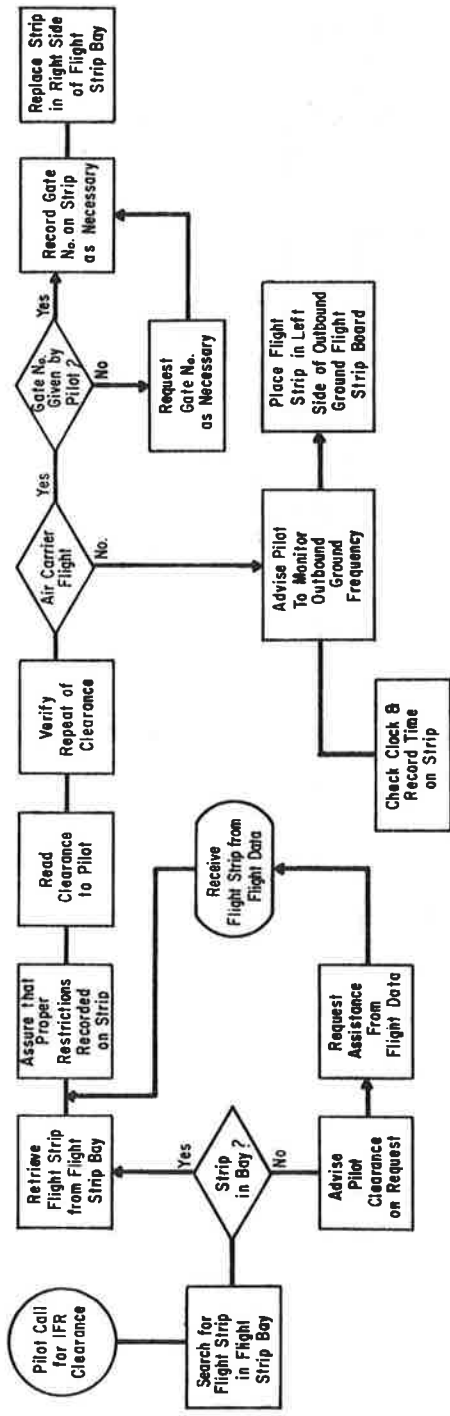

a) IFR Clearance Delivery

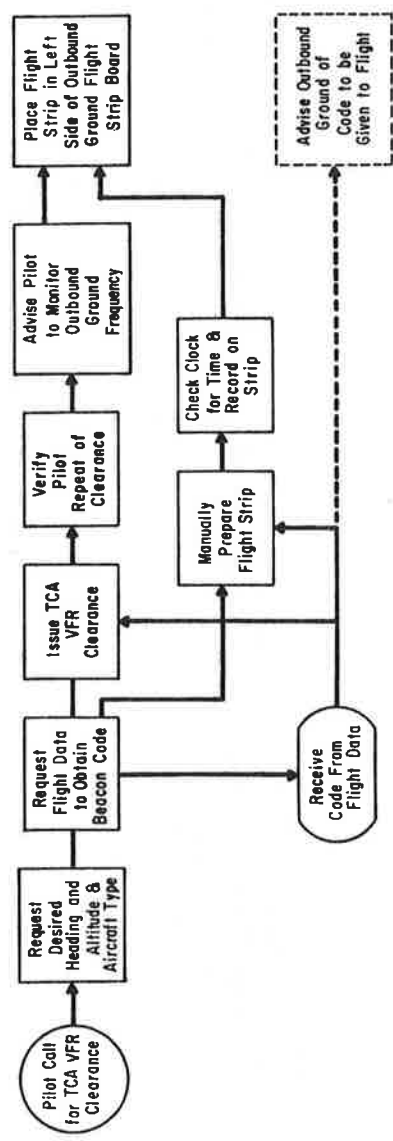

b) VFR Clearance Delivery

Figure 4-7. Functional Flow of Clearance Delivery Tasks (1 of 2)

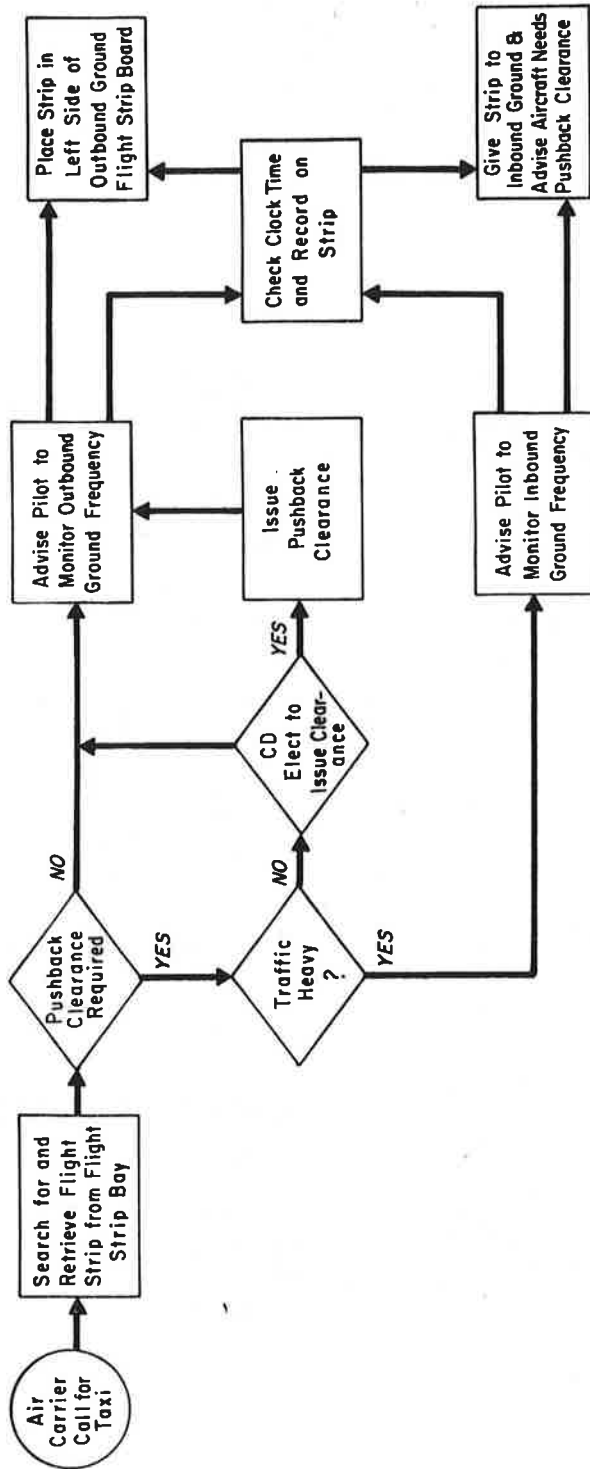

C) HANDOVER TO GROUND CONTROL

Figure 4-7. Functional Flow of Clearance Delivery Tasks (2 of 2)

Table 4-6. Clearance Delivery Gate Marking

Airline/Operator	Gate Locations		Marking Format
	No.	Concourse	
American	12	K	Number only
	2	H	H and Number
Air Canada	1	G	None
Allegheny	1	K	None
Braniff	2	Between C&D	None
Continental	2	D	None
Delta	8	H	Number only
Eastern	6	D	Number only
North Central	6	H	Number only
Northwest Orient	5	D	Number only
Ozark	2	F	None
Trans World	11	G	Number only
United	23	E & F	E or F and Number
International Carriers	13	B & C	B or C and Number
Commuter	-	Butler	None

The task sequence VFR Clearance Delivery is also reasonably straightforward as illustrated in Figure 4-7(b). For these flights Clearance Delivery must obtain the general heading and altitude at which the pilot wishes to fly out of the TCA. Normally, the departure will be cleared in accordance with the pilot's request except where the altitude is below or above the VFR clearance limits for the TCA (3000 and 8000 feet respectively) or where the general direction of flight is in conflict with the current flight operations pattern. Clearance Delivery manually prepares a flight strip including the:

1. Call sign
2. Aircraft type
3. ATCRBS code assigned
4. Direction of flight
5. Letters VFR in the center of the strip.

This is generally accomplished in parallel with the delivery/pilot repeat of the clearance. In the event that the ATCRBS code is not received by Clearance Delivery before the flight is turned over to Outbound Ground, he will advise Outbound Ground of the code for transmission to the pilot.

The task sequence followed for Handover to Ground Control is illustrated in Figure 4-7(c). When departures are ready for taxi Clearance Delivery is again called. In most cases the departure does not require pushback clearance and therefore has already pushed back. Clearance Delivery simply advises the pilot to monitor the Outbound Ground frequency and places the strip in the Outbound Ground Strip Board.

In those cases where a pushback clearance is required there is some variability in the actual procedure followed by Clearance Delivery. If traffic on the inner circular is light but Outbound Ground is busy and the individual manning this Clearance Delivery position has been checked out in the Outbound Ground Position, he may issue the pushback clearance and turn the aircraft over to Outbound Ground in the usual manner. Otherwise, with light traffic on the inner, he

instructs the pilot to monitor the Outbound Ground frequency and gives the strip to Outbound Ground, advising him that the aircraft needs a pushback clearance. However, if traffic on the inner is heavy, he will instruct the pilot to monitor the Inbound Ground frequency and gives the strip to Inbound Ground, advising him that the aircraft needs a pushback clearance. This is done because traffic on the inner is likely to be primarily arrival traffic and, therefore, delays caused by the departures pushback blocking the inner will impact primarily on Inbound Ground operations.

In each of the task sequences illustrated in Figure 4-7 it is shown that Clearance Delivery records the time (to the nearest minute) at which the aircraft calls for taxi. This activity is not performed for any specific traffic control function but for statistical recordkeeping purposes. The ATCT maintains records on the number of departures whose total operations time from ready-to-taxi to takeoff exceeds 30 minutes*.

An infrequent diversion from the procedures described above occurs in the case of the Chicago Airways Helicopter departures from gate H1. Normally the clearance for these operations is a standing one and the aircrafts make initial contact with Inbound Ground for taxi. However, under conditions where there are delays, the normal clearance for these operations may become invalid. In this situation the procedure for a general aviation IFR aircraft departure is followed.

Another infrequent diversion from normal Clearance Delivery operations occurs under low visibility conditions. When calling for clearance or taxi, air carrier pilots may request information on the current general visibility and RVR/rollout levels for the runway anticipated, and the prognosis for lifting of

*When the flight strip is subsequently received at a Departure Control position he will reference the recorded time to the current clock time and, allowing seven minutes for taxi (in accordance with current policy), determine whether the departure time exceeds the 30-minute criteria.

current conditions. If Clearance Delivery is not busy, as is usual under these conditions, he will try to oblige the pilot as this information may be important in the decision to depart the gate.* In doing so Clearance Delivery must walk over to the Local Control position for that runway to determine this information from the weather instrumentation at the position.

4.2.2.3.3 Outbound Ground

The flow of the major functional tasks performed by the Outbound Ground position is illustrated in Figure 4-8.

Figure 4-8(a) presents sequence of activities for the task of Issuing Taxi Clearance. Upon receiving the flight strip from Clearance Delivery, the Outbound Ground position will review the strip to determine the first fix, aircraft type and departure gate as the basis for selection of the departure runway and the primary basis for the selection of the routing to that runway. Although the review of other flights and visual check of aircraft positions are illustrated in the figure as sequential activities, they are essentially accomplished in parallel with the review of the new strip and contribute to the runway and routing selection, respectively. The reason for presenting these activities as sequential is that the departure runway assignment is essentially automatic based on the first fix and routing to that runway is dictated by the runway configuration. As indicated earlier in Section 3.2 aircraft departing to the north and east utilize the north-side departure runway while aircraft departing to the south, west, and southwest utilize the southside departure runway. Since each first fix is associated with a particular direction of flight, it serves as the primary basis for runway assignment. However, when review of the other strips (or the controllers recollection)

*Differences in airport and airline operating minimums frequently result in decisions to cancel at the gate or may result in the inability of the flight to take off when it reaches the departure runway. The latter effect is discussed in paragraph 4.2.2.3.5.

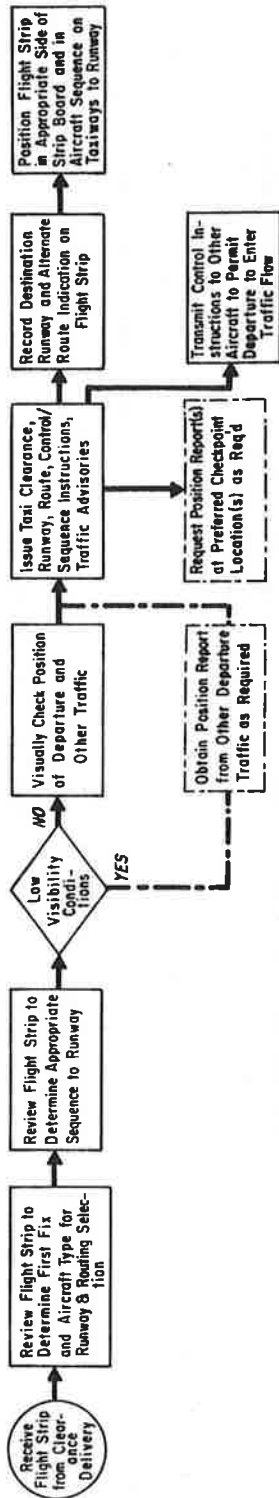

a) ISSUE TAXI CLEARANCE

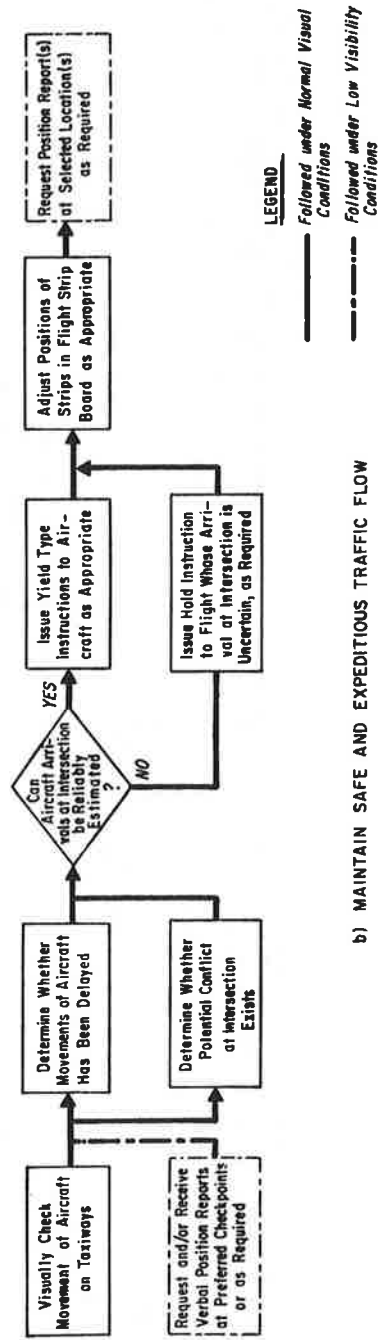

b) MAINTAIN SAFE AND EXPEDITIOUS TRAFFIC FLOW

LEGEND
 ————— Followed under Normal Visual Conditions
 - - - - - Followed under Low Visibility Conditions

Figure 4-8. Functional Flow of Major Outbound Ground Tasks (1 of 2)

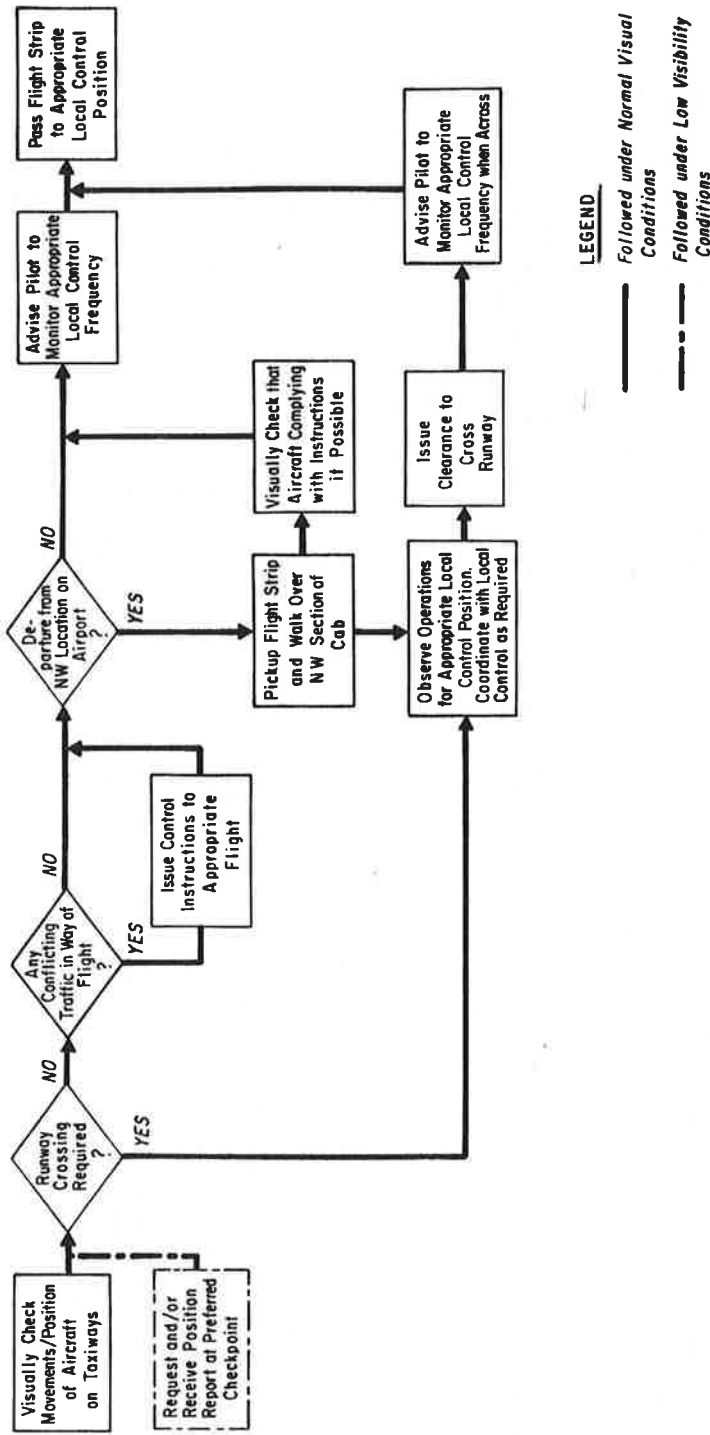

Figure 4-8. Functional Flow of Major Outbound Ground Tasks (2 of 2)

indicates a particular heavy level of departures to the west, westbounds with a Debuque (DBQ) first fix may be assigned to the northside departure runway.

As previously discussed in Section 3.3 routings to departure runways are basically standard for particular operating configurations. However, in certain configurations potential alternate routings to the departure runways exist as described in Section 4.3 (e.g., to 32R counterclockwise via the outer circular and 9L-27R parallel). Where these alternatives exist and traffic is heavy via the standard route, Outbound Ground may select the alternate routing for the new departure. The selection of this alternative depends on the location of departure gate and type of aircraft. For the above example of 32R departures the primary routing is via the outer and bridge. However, aircraft departing from the west-side of the E concourse and the B-D concourses could be routed via the inner and 9L/27R parallel alternate with one exception. Since 747s are not permitted on the inner, such aircraft from these gates would have to be routed via the primary route. Another factor contributing to the routing selection is the existence of in-trail restrictions for departures in a particular direction. When such conditions exist, and the runway/taxiway usage configuration permits, Outbound Ground normally routes the affected flights to the runway via an alternate that separates them from the non-restricted departures. Using 32R departures again as an example, non-restricted departures would be sent via the primary route and restricted departures would be sent via the alternate. The alternative routings for the various major runway configurations have been previously described in Section 3.3 and will not be repeated here.

The first fix also is a primary factor in the establishment of the aircraft sequence to the departure runway via the route selected. Although it is not prescribed for Outbound Ground to establish the sequence, it is normally performed as a means of assisting the Local Control positions for the departure runways. This is based on the fact that alternating departures by direction of flight after takeoff (e.g., northbound, eastbound, northbound for the northside runways)

contribute to the separation of traffic and, thereby, increase the operations rate for the departure runway. Since the first fix basically determines the direction of flight, it is utilized by Outbound Ground in sequencing or fitting the departure in- to position in the traffic flow to the aircraft. Thus, the first fixes for the aircraft already in the sequence, and their positions relative to the point at which the new departure will enter the inner/outer taxiways after taxiing out from this gate, are referenced to determine where in the sequence the aircraft may be fitted to maintain the alternating directions without adversely affecting the flow on the taxiway. When in-trail restrictions are in effect for particular directions of flight and where the runway/taxiway usage configuration does not easily permit the use of alternate routing for the restricted departures, Outbound Ground may attempt to sequence these aircraft in a manner that assists Local Control in achieving the restrictions (e. g. , northbound, northbound, eastbound where eastbounds are restricted). This may be particularly important, e. g. , in the case of northside departures on runway 4L where there is no runup pad in which Local Control #2 can pull off the restricted aircraft until it is appropriate to release them for takeoff. However, when traffic is heavy and Outbound Ground cannot afford the time, or when delaying the aircraft's entry into the flow will block arrival aircraft entry into the gate area from which it is departing, Outbound Ground would forego any attempt to accomplish this type of sequencing.

As indicated in Figure 4-8(a), when aircraft movements cannot be visibly observed during Category II conditions, position reports may be requested from other departure aircraft on the taxiways to determine their locations as an input to the sequencing decision.

When the runway, routing, and sequencing for the departing aircraft have been decided upon, Outbound Ground issues the taxi clearance for the aircraft. The clearance includes the destination runway and route, as a minimum, and then any control instructions pertinent to its entry into the taxi flow or holding at active runway crossings, where required by the operational configuration. The taxi clearance transmission may also include traffic advisories intended to facilitate

the compliance with the instructions provided. The clearance is provided tersely to minimize transmission time per aircraft. A few illustrative examples of typical taxi clearances are given below:

United 108 Heavy. Your runway is 32 Right via the outer and bridge. Hold short of the outer. Follow a Northwest trijet coming from your right.

Eastern 411. Runway 27 Left. Left on the outer. Right turn on the North-South and East on the 27 Parallel. If you taxi now you won't be blocked by a company heavy coming from the right.

Delta 112. Runway 4 Right. Via the North-South. Pass behind an Ozark DC-9 coming from your left. Hold short 9 Right.

During low visibility conditions, Outbound Ground may request position reports at selected checkpoints to assist him in maintaining cognizance of the traffic flow. Specific checkpoints are preferential to the individual manning the position. However, interviews with a number of controller personnel indicated a significant consistency among these reporting points. The predominant reporting points given for taxi to the various departure runways are identified in Table 4-7.

The runway to which the aircraft has been assigned is recorded by Outbound Ground in the lower right hand corner of the flight strip. If the departure has been sent to the runway by an alternate route, this is also recorded on the strip for use by Outbound Ground and subsequently by Local Control for that runway. The indication of alternate routing is marked next to the runway, e. g. , for aircraft routed to 32R or 27L on parallel taxiways the runway recording would appear as 32R 11 or 27L 11.

The flight strip is positioned in the Outbound Ground Strip Board on either the left or right side of the Board: left if the departure is going to a southside runway, right if the departure is going to a northside. The strip is positioned

Table 4-7. Predominantly Preferred Checkpoints for Position Reporting During Low Visibility Conditions

Destination Runway	Preferred Checkpoints
4L	Outer and T3 Intersection
4R	Outer and Past 9R on N-S Taxiway
9L	Outer and T3
9R	Outer and Holding #1 on T1 at 14R/32L
14L	Outer and T3
14R	Outer and T3
22L	Outer and On the Cargo Taxiway
22R	Short of 14L/32R
27L	Outer and On the Cargo Taxiway
27R	Outer and At the Bridge or 9L/27R Parallel (for alternate route)
32L	Outer and Holding #1 on N-S at 27L
32R	Outer and At the Bridge or 9L/27R Parallel
36	9L/27R Parallel

among the others on that side in accordance with its location in the sequence to the runway (with the bottom strip corresponding to the first flight in sequence.) By ordering the strips in this manner, Outbound Ground has a rapid reference to the order of the aircraft and to their call signs when they must be subsequently contacted.

The functional approach taken by Outbound Ground to the Maintenance of Safe and Expeditious Traffic Flow is illustrated in Figure 4-8(b). Visual observations of traffic movements and/or position reports received during low visibility conditions provide a basis for determination of potential conflict at an intersection or delays in the movement of his traffic (e. g. , an aircraft forced to stop momentarily behind an arrival aircraft waiting to turn off to its gate). Observation at O'Hare and review of communications recordings indicated that two distinctly different types of control approaches are employed by Outbound (as well as Inbound) Ground positions. The first may be considered to be singular control in which the controller unilaterally provides the separation or movement control required. This is accomplished by the controller issuing a "hold short" instruction to which the pilots respond by stopping their aircraft at the designated intersection. The second approach may be considered to be joint control in which both the controller and pilots share the responsibility for separation or movement control required. This is accomplished by the controller issuing a "yield type" instruction to which the pilots respond by adjusting their speed of taxi rather than stopping their aircraft. These instructions normally include the type of control response desired by the controller, identification of the aircraft to which the desired maneuver is referenced, and an advisory of the direction from which the aircraft is approaching the instructed pilot. Examples of such instructions include:

1. Yield to _____
2. Give way to _____
3. Follow _____
4. Pass behind _____

Interviews with controller personnel and review of communications recordings indicate a strong preference for the joint control approach. A major factor in the preferential use of the "yield" type instructions is that only one communication to the aircraft is required. In the case of the singular control approach the pilot must be instructed to begin taxiing again.

As indicated in the figure the major criteria in the decision to issue a hold or yield type instruction is the degree of certainty with which the aircraft arrivals at the intersection involved can be ascertained. When Outbound Ground is not sure of the intersection arrival time for an aircraft he may issue a hold instruction in place of a yield instruction. This same approach is followed in the inclusion of control instructions in the taxi clearances to departures.

Once the control instructions have been given or simultaneously with their transmission, the positions of the strips in the Flight Strip Board will be adjusted to reflect the new order of aircraft in the sequence to the runway.

The task sequence for aircraft handover to Local Control is illustrated in Figure 4-8(c). The basic philosophy underlying the performance of this task is that the turnover is made whenever there is no longer any requirement for Outbound Ground to work the aircraft, i. e., it has a clear roll to the runway or end of the departure queue. Table 4-8 summarizes the specific points at which, or general areas in which, the aircraft are likely to achieve this status and turnover can be made for the various runways.

Based upon this philosophy, the major determinants in the process are whether or not the departure must cross an active runway under the particular operating configuration or whether or not there is any conflicting (or blocking) traffic in its way. When a runway crossing is required, Outbound Ground observes the operations of the Local Control responsible for that runway and determines when it is appropriate to clear the departure across the runway. The pilot is normally advised to monitor Local Control frequency "when across" as part of the

Table 4-8. Specific Points or General Areas at Which Turnover to Local Control May be Made by Outbound Ground

Departure Runway	Specific Point	General Area
4L	Passing T3	
4R	Crossing 9R	
9L	New Scenic/4L Intersection	
9R	T1/14R Intersection	On 9R/27L Parallel if 14R not in use
14L	Crossing 9L	On 14L/32R Parallel or on New Scenic
14R	Old Scenic/Bypass Intersection	Bypass or 14R/32L parallel if 14R not used for arrivals
22L	Outer/Cargo Intersection	On cargo
22R	Across 14L	National Guard Ramp or Parallel
27L	Outer/Cargo Intersection	On cargo
27R	Bridge	On 9L/27R Parallel or 32R Pads
32L	Crossing 27L if departing from end of 32L	
	Outer/T1 Intersection otherwise	
32R	Bridge	On 9L/27R Parallel if alternate route
36	Inner/9L/27R Parallel	On 9L/27R Parallel

clearance transmission. Based upon the major runway configurations employed, this requirement mostly affects southside departures on runways 4R or 9R.

Observations in the tower cab indicated a significant distinction in the handling of traffic departing from a location northwest of the cab (i. e. , on runways 4L, 9L, 14L/R). From his work station location Outbound Ground cannot readily observe the movements of aircraft in the area in which the Old Scenic, New Scenic, and 9L/27R parallel taxiways intersect the inner/outer taxiways. Outbound Ground was observed to pick up the flight strips for aircraft routed to these runways via the Old or New Scenic and walk over to a position in the northwest part of the cab (usually behind the Local Control #1) from which he can observe that the traffic has complied with his taxi instructions. This action becomes particularly important when operating conditions are at the lower end of Category I and when aircraft are being sent to both 9L and 14R for takeoff. In the latter, departures for both runways use the Old Scenic until those for 14R can turn left at the Bypass taxiway to taxi to the 14R/32L parallel.

When Outbound Ground is assured that the traffic is free of any interference (e. g. , 14R departures turned onto the Bypass), he advises the pilot to monitor the appropriate Local Control frequency. Observations in the tower cab also indicated that this assurance involves a last check of the flight strip, usually with the controller holding the strip in his hand.

In passing the flight strips to the appropriate Local Control position, Outbound Ground is required to momentarily move away from his work station. He must walk over to the Local Control #1 position to place the strip in the Flight Strip Board. For the Local Control #2 position which is located diagonally across the cab from him, Outbound Ground must walk over to and place the strip on the Strip Slide behind him and to his right. In instances where he has walked over to the northwest part of the cab to observe the traffic, the strip is placed on the Flight Strip Board or Strip Slide on the way back to his position.

In discharging his duties as described above, Outbound is also responsible for assuring the separation of his traffic from vehicular traffic traveling on or crossing the taxiways. Since such vehicular traffic is under the control of Inbound Ground and normally yields to aircraft, Outbound Ground may issue an advisory. In addition, he must monitor the movements of his traffic to ensure that they do not enter areas closed for snow removal or maintenance operations.

4.2.2.3.4 Inbound Ground

The flow of the major functional tasks performed by the Inbound Ground Position are illustrated in Figure 4-9.

The sequence of activities for the task of Issuing Inbound Taxi Clearances is presented in Figure 4-9(a).

When Inbound Ground is contacted by arrival aircraft an inbound taxi clearance is issued. Under normal circumstances this includes the route to the aircraft gate and any control or sequencing instructions that are necessary to accomplish this taxi. Although it is not specifically included in the figure, in order to simplify the illustration, the determination of the position of the aircraft and other traffic by visual observation and/or position report is an input to the routing and control/sequencing instructions given. Existing traffic conditions on the Inner/Outer taxiways and the type of aircraft (particularly 747s and general aviation) may be factors in selecting an alternate route for the arrival, in much the same way they influenced the route selection by Outbound Ground. The routing alternatives for the various major runway configurations have been described in Section 3.3 and will not be discussed further here.

In addition, the relative positions and certainty of arrival at intersections are considerations in the nature of the control instructions given to the arrival. As an example, for an arrival on runway 32L exiting the runway at T5 or T6, the normal routing is south on the parallel, left on T3 to the outer, and thence by the inner or outer to its gate. If Inbound Ground is not certain of the time at

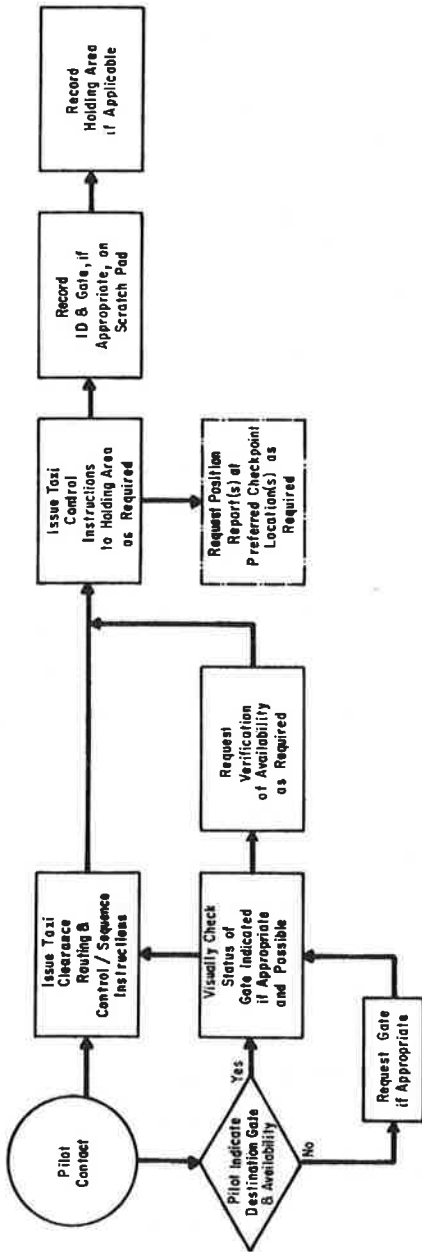

a) Issue Inbound Taxi Clearance

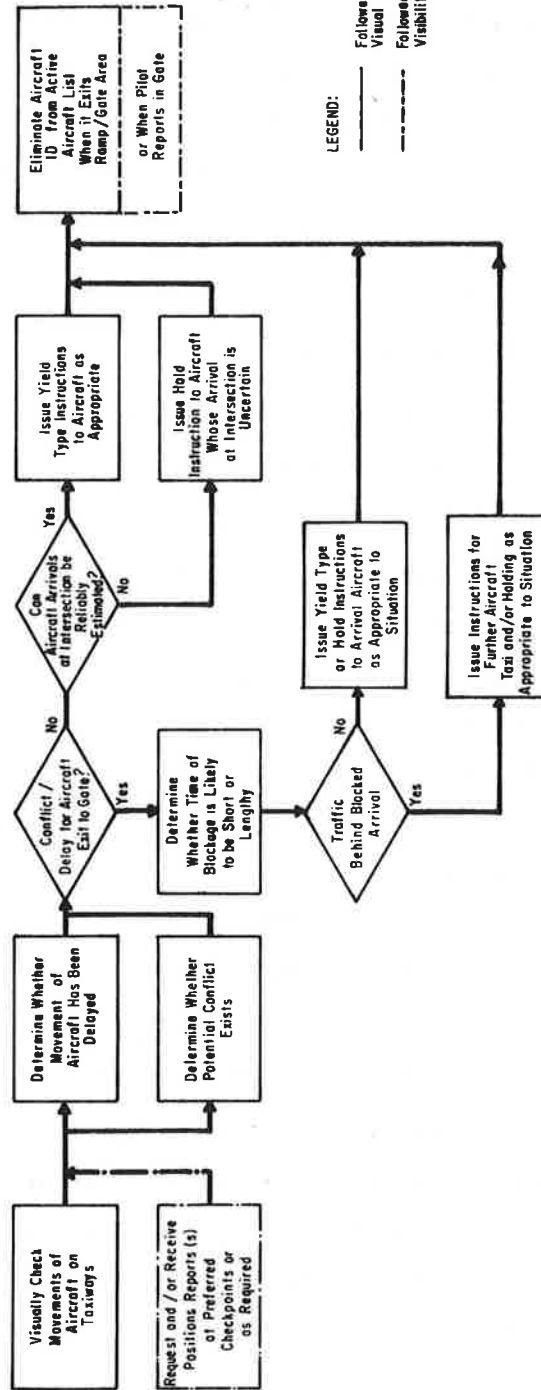

LEGEND:
 ————— Followed Under Normal Visual Conditions.
 - - - - - Followed Under Low Visibility Conditions

b) Maintain Safe and Expeditious Traffic Flow

Figure 4-9. Functional Flow for Major Inbound Ground Tasks

which the aircraft will reach the T3/Outer intersection to mix with the other traffic, he will instruct the aircraft to hold short of the Outer.

Although sequencing or ordering of arrivals in the traffic flow is not a requirement for Inbound Ground, it is performed by many of the controller personnel at O'Hare. When it is feasible to accomplish this, Inbound Ground attempts to reverse the order of the arrival traffic at which the aircraft will reach the points where they would exit the Inner/Outer to their gates. The object is to allow the aircraft to peel off from the traffic as they reach their gate exits and, thus, minimize the number of aircraft that might have to stop behind an arrival if its exit from the Inner/Outer is blocked momentarily by other traffic, primarily in the ramp area in which their gate is located. Observations and data collected at O'Hare have indicated that this is not an infrequent occurrence and in one instance resulted in six aircraft being stopped on the inner taxiway.

Ordinarily the Inbound Ground is provided by the arrival pilot with an indication of his location at the time initial contact is made. However, the controller interviews and analysis of communications revealed that such position reports must be obtained occasionally, and more often than infrequently, because they are not provided by the pilot. Under this situation the typical contact message is "O'Hare Ground. This is (aircraft call sign) with you off (runway)." When this occurs nearly simultaneously for two aircraft from the same airline the problem is compounded.

Aircraft destination gate and the availability of that gate are important factors in the taxi clearance and routing for arrivals. It is particularly important for those airlines which operate gates in more than one terminal building concourse or ramp area or which by experience are most likely to have gate unavailability problems during peak traffic periods and during or following periods of traffic delays due to poor weather/visibility. These airlines include American, Trans World, United, Delta, North Central and internationals, with the first three frequently subject to gate delays. If the pilot directly advises Inbound Ground that his gate is

unavailable, the aircraft will be routed to an appropriate holding area. If the gate given the arrival is one for the three major airlines subject to gate delays or if for other airlines there are aircraft already holding for gates, Inbound Ground normally checks to see that the gate is available. If the gate is not given, he will request the pilot to advise him of the gate. If the identified gate is observed to be occupied, he will ask the pilot to verify its availability and advise him. If the pilot then responds that there will be a delay the aircraft is routed to an appropriate holding area. Normally, the taxi instructions are given to start the aircraft toward its gate and the above inquiries made while he is taxiing.

The basic philosophy applied in assigning aircraft to particular waiting areas is to hold the aircraft as close to their gates as possible for the conditions and operating configurations. Therefore, within the framework of this philosophy, an attempt is made to reserve the use of the T3 penalty box for use for aircraft going to the gates at United and west of the United E concourse and to use the 9R/27L parallel stub and North-South taxiways for use for aircraft going to gates east of the United terminal, primarily American and Trans World. Where the operating configuration does not permit this approach or where the pilot has advised Inbound Ground that the delay will be lengthy, other locations may be used as holding areas. These areas include the run-up pads at 9L, 32R, 32L, 14R and the hangar area depending on the operating configuration. The one major rule followed in selecting a holding area for waiting aircraft is to avoid an area from which the aircraft must cross an active runway to taxi to his gate.

Because there are no flight strips for arrivals, Inbound Ground records the flight call sign and assigned gate, if pertinent, on a scratch pad. Two lists are maintained on the pad, one for arrivals from the southside runways and one for arrivals from the northside runways. In the event that it is necessary to hold an aircraft for a gate, the location at which it is holding is also recorded. For aircraft holding in the T3 penalty box, a box is simply drawn around its call sign. For aircraft waiting at other locations the specific location is recorded next to the call sign.

The functional sequence followed in the task of Maintaining Safe and Expeditious Traffic Flow is presented in Figure 4-9(b). Essentially, Inbound Ground operation observes the same principles in controlling the traffic flow as discussed for Outbound Ground, including the use of hold versus yield type instructions. The major difference in their performance of this task relates to the exiting of aircraft from the Inner/Outer taxiways to their gates. As noted earlier for this position, the aircraft's exit may be blocked by other aircraft, most frequently aircraft departing from gates in the same ramp area as the arrivals gate. The two factors influencing the actions taken by the Inbound Ground are the estimated time for which the blockage will exist and the amount of traffic behind the arrival. If the departure has already pushed back or is taxiing out, the delay is likely to be short and, if traffic behind the arrival is light, it may be instructed to hold or yield to the other aircraft at the exit intersection. However, if there is heavy traffic behind the arrival it may be instructed to taxi to and exit at the next intersection, if feasible for reaching its gate. When the departure is just pushing back or there are a number of departures in the ramp area, the delay is likely to be more lengthy and Inbound Ground may provide additional taxi instructions to take the aircraft in a circular path on the Inner and Outer or to take the aircraft to an area where it can hold momentarily out of the way of other traffic (e. g. , the stub or North-South taxiways between the Outer and 9R/27L Parallel).

When the arrival has cleared the Inner taxiway and entered the ramp or when under Category II conditions the pilot reports docking at the gate as requested, the aircraft is eliminated from the active lists on the scratch pad by Inbound Ground by striking out its call sign.

There are three other functions which are performed by Inbound that are not illustrated in Figure 4-9. The first is providing control of aircraft taxiing between the terminal gates and the cargo and hangar areas in either direction. Essentially, aircraft taxiing to the terminal are treated as if they are arrivals and are provided routing and control instructions, as appropriate, to their

destination gate as well as a control enroute. Aircraft taxiing from the terminal building are treated essentially as if they are departures with the exceptions that they are given clearances to the cargo or hangar area rather than a runway and fitted into the Inner/Outer traffic whenever and as soon as it is feasible to do so and controlled enroute.

The second additional function is issuance of pushback clearances. As previously explained in paragraph 4.2.2.3.1 this task is performed when the traffic on the Inner, which under normal conditions is predominantly arrivals, is heavy. In accomplishing this task Inbound Ground observes the traffic movements on the Inner visually, or may obtain a position report as required under Category II conditions, to determine where there is a sufficient gap in the traffic to permit the pushback without significantly delaying other traffic. The clearance to push back is given and the pilot advised to monitor the Outbound Ground frequency for taxi instructions. The flight strip for the aircraft is then placed in the Outbound Ground Flight Strip Board and Outbound Ground advised that the aircraft is pushing back.

The third additional function is assuring the separation of aircraft and vehicular traffic traveling on or crossing the runways. In most circumstances this will involve airport vehicles enroute or returning from snow removal or other maintenance operations on particular runways or taxiways or traveling from one work area to another. Since individual vehicles or at least the lead vehicle in an operating crew must be radio equipped, control instructions regarding these movements are provided via the radio channel. When the vehicles have reached or are within their work area, control is not normally exercised since the area will have previously been closed to aircraft traffic. However, Inbound Ground must monitor the movements of his traffic to ensure that they do not in error enter the closed area.

4.2.2.3.5 Local Control

The performance sequence for the major functional tasks of the Local Control position is illustrated in Figure 4-10.

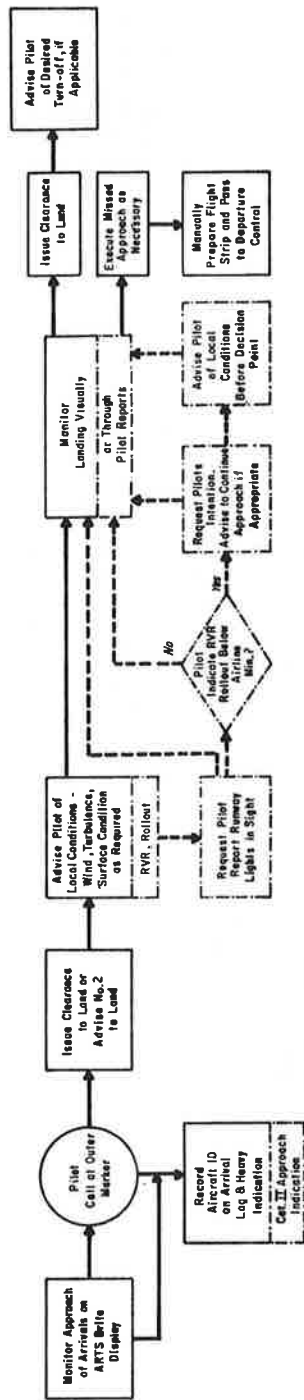

a) Clear Arrivals for Landing

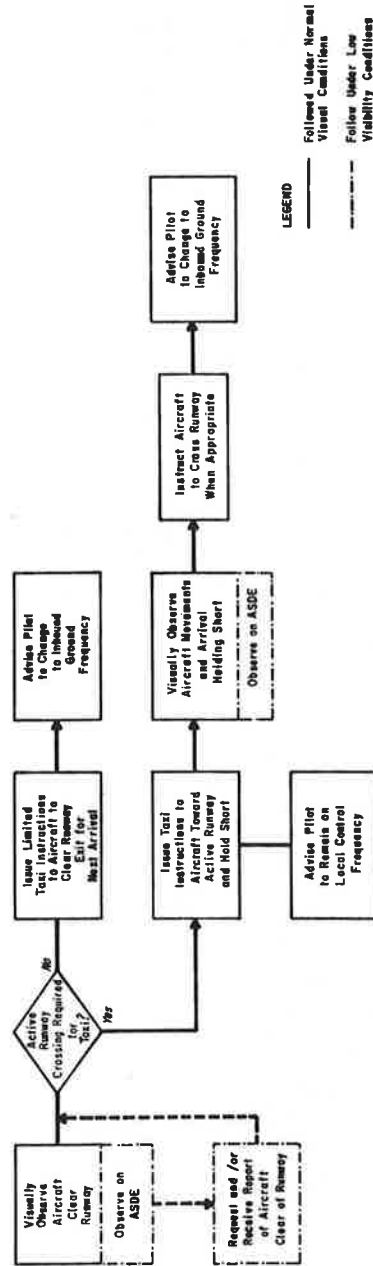

LEGEND
 - - - - - Followed Under Normal Visited Conditions
 - - - - - Follow Under Low Visibility Conditions

b) Handover to Inbound Ground

Figure 4-10. Functional Flow of Major Local Control Tasks (1 of 2)

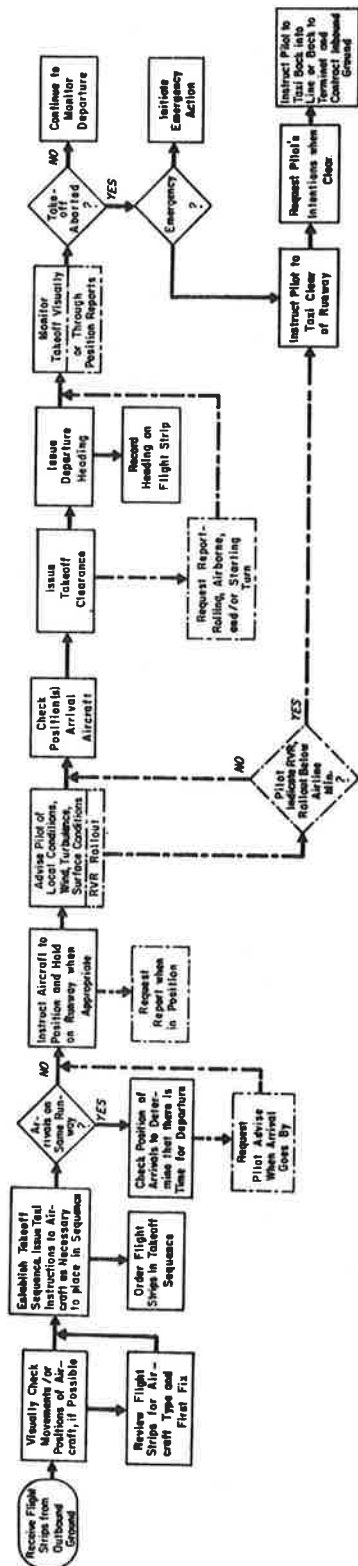

c) CLEAR DEPARTURES FOR TAKEOFF

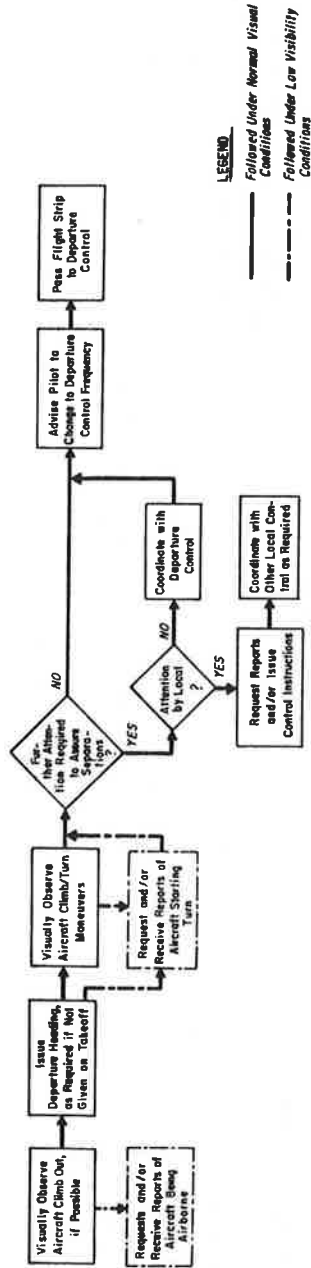

d) HANDOVER TO DEPARTURE CONTROL

Figure 4-10. Functional Flow of Major Local Control Tasks (2 of 2)

The functional sequence for the task of Clearing Arrivals for Landing is shown in Figure 4-10(a).

The approach of arrivals is monitored on the ARTS Brite Display. Depending on the activities of the Local Control the call sign of next arrival in the sequence may be recorded on the Arrival Log from this display prior to the pilot's contact at the outer marker or simultaneous with this contact. Where the aircraft is a "heavy" this fact is also recorded. When the approach is made under Category II conditions this fact is also recorded. This log is primarily maintained for statistical record-keeping purposes of the ATCT since no flights strips are available for arrivals. However, for this reason it is likely that at least the call sign and heavy indication would be recorded by Local Control to keep track of the aircraft he is working just as does the Inbound Ground position.

The operations of Local Control in performing this task are reasonably straightforward under good visibility conditions as shown in the figure. At the inbound contact the pilot is cleared to land and advised of local runway conditions such as winds (if sufficient to warrant it) and turbulence resulting from the immediately preceding landing or departure by a heavy aircraft. When the runway is wet or there is snow or ice the advisory may indicate poor braking conditions. Local Control visually monitors the landing to assure that it can be safely completed and if not to execute a missed approach. This would be required under the following conditions:

1. The preceding arrivals will not clear the runway in sufficient time.
2. The required separation between the preceding departure on the same runway or a crossing runway will not be achieved.
3. A departure on the runway was delayed because of late clearing by the preceding arrival and cannot itself clear the runway.
4. An aircraft crossing the runway will not clear in sufficient time.

With the exception of a missed approach, Local Control may not have further communications with the arrival unless, and until, he makes a request of the aircraft to clear the runway at a desired exit point. This request is usually made

only when the runway is being used for both arrivals and departures. In addition, this request is normally made after the aircraft has touched down.

If a missed approach is given by Local Control or declared by the pilot, Local Control issues the standard heading and altitude for the maneuver and advises the pilot to contact Departure Control. A minimum flight strip must be manually prepared and dropped down the Flight Strip Tubes to Departure Control.

As the visibility decreases, performance requirements for this task significantly increase. When Local Control can no longer visually observe the approach to the runway from the tower cab, he will begin requesting pilots to "Report the runway lights in sight during the initial contact." This situation may exist at low Category I as well as Category II conditions. The rationale given by controllers for this is that when the pilot can report seeing the lights he is more likely to be able to complete the landing and conversely when he cannot the potential for a missed approach increases.

In addition, when the RVR decreases below 6000 feet Local Control is required to advise the pilot of the measured RVR. When visibility further decreases and the measured rollout (RVR at other end of the runway) is below 2000 feet and less than the RVR it too must be given to the pilot. These advisories are also given during the initial contact.

At low Category II conditions another problem develops. Many of the airlines have established operating minimums which are below the permissible operating minimums for the aircraft. Thus, it is not unlikely for the pilot to inform Local Control that the advised minimums are below those of the airlines. When this occurs Local Control normally requests the pilot's intentions. If he indicates that he wants to wait for better conditions, Local Control will execute the missed approach procedure outlined above. Because the RVR and rollout can change rapidly this does not usually occur. Local Control usually, then, advises the pilot to "continue the approach and I will keep you advised". At about 1 mile from the runway, and usually before the aircraft disappears from the ARTS Brite, Local

Control will advise the pilot of the current RVR and rollout at which the pilot will elect to complete or abort the landing.

Under the lower visibility conditions Local Control may repeat the clearance to land when the pilot reports the lights or when the conditions have risen sufficiently to permit him to land.

The task activities in the next phase of the handling of arrivals by Local Control, Handover to Inbound Ground, is shown in Figure 4-10(b). Under normal conditions Local Control will visually observe the arrival clear the runway. The pilot is not required to report clear, although many do. Under Category II conditions Local Control may observe the aircraft clear on the ASDE Brite. However, because of the low reliability of the ASDE presentation as described in paragraph 4.2.2.2, most controllers request the aircraft to report clearing.

The manner in which the arrival is handled after clearing the runway differs depending on whether it must cross an active runway to taxi to the terminal gate or other destination. In those instances where there will be no runway crossing, Local Control, depending on the runway, may issue limited taxi instructions to the arrival to start it moving toward the terminal and avoid its blocking of that runway exit for the next arrival. At the same time the pilot is advised to contact Inbound Ground. As an example of this procedure, aircraft landing on 32L would be told "South on the parallel. Contact Ground on 121.9" after clearing the runway.

Where no limited taxi instructions are required the pilot would be advised simply to contact Ground after it has cleared. Frequently, Local Control may advise the pilot of the frequency change while the arrival is decelerating on the runway, e. g. , "(Aircraft Call Sign). Contact Ground Control on 121.9 when clear."

Where a runway crossing is required Local Control retains the arrival until it clears the last active runway under his control. This situation most frequently is faced by the Local Control #2 position when the airport is operating

in an "arrivals from the west, departures to the east" mode with 14L as the arrival runway. In this situation, the arrival is given instructions for taxi to and to hold short of the runway. In addition, Local Control normally advises the aircraft to remain on his frequency. An example of such instructions is "(aircraft call sign). Taxi south on 22 (or 18). Hold short of 9L. Stay with me."

When Local Control determines that it is safe to cross the arrival he clears it across the runway and advises the pilot to contact Inbound Ground when across.

The functional sequence for Clearing Departures for Takeoff is presented in Figure 4-10(c). When flights are received from Outbound Ground, Local Control will review them to identify the first fix, aircraft type, and whether the aircraft are taxiing to a runway by an alternate route. This action and visual observation of the aircraft movements serve as inputs to establishing the runway usage or takeoff sequence for the various departures. Taxi instructions are given as necessary to aircraft to establish the sequence and the flight strips are ordered in accordance with that sequence, with the order being from bottom to top in the Flight Strip Board.

Under normal visibility conditions, the manner in which the departures are handled is reasonably straightforward. The most significant consideration is whether the runway is being used for arrivals. In such situations, Local Control will check the positions of the arrivals to determine whether there will be time for the takeoff before instructing the pilot to position and hold on the runway. At the time the lead aircraft is given this instruction, the second aircraft in the sequence may be told to follow this aircraft. A procedure followed by most of the controllers observed to note they have given these instructions is to make a small mark next to the runway designation on the strip or the upper right hand corner of the strip.

When the pilot is instructed to position and hold he is also advised of local runway conditions as required by the situation, including turbulence from the preceding arrival on the runway or the crossing arrival runway.

The positions of arrival are checked to determine when the departure can be cleared for takeoff. When the runway is being used for arrivals and departures, the check is made to determine that the preceding arrival is clearing the runway in sufficient time to permit the takeoff with the required separation between the departure and succeeding arrival. If this is not the case, Local Control instructs the departure to taxi off the runway, if feasible, to allow the arrival to land or, if not feasible, instructs the arrival to execute a missed approach. When it is safe to do so the departure is cleared for takeoff.

The issuance and recording of the departure heading are shown in Figure 4-10(c) as sequentially following the takeoff clearance for ease of illustration. In actuality, the point at which this instruction is given to the departure or the heading recorded will vary with the operating situation and controller. When the departure is being used for departures only, the heading may be given to the pilot with the local conditions or as part of the takeoff clearance. The heading may be recorded on the strip (to the right of the runway notation) prior to or during its transmission. In some cases Local Control was observed recording the heading even before the departure was instructed to position and hold. However, if the runway is being used for mixed operations, it is more likely that the heading will be issued as part of the clearance to take off or when the departure is in the air (if the time available for takeoff is short) and the heading recorded at that time. In the latter case, Local Control normally advises the pilot "I will have a heading for you in the air" as part of the positioned hold/local conditions advisory communication.

Local Control monitors the takeoff visually to determine that it is being completed safely. In situations where the takeoff is aborted before the aircraft becomes airborne, he will determine from the pilot if an emergency exists and immediately initiate the necessary action. If there is no emergency he will instruct the pilot to taxi clear of the runway and after ascertaining the pilot's intentions either issue the necessary instruction to take the aircraft back into line for departure or start it back to the terminal.

As in the task of Clearing Arrivals for Departure, the performance requirements for this task increase significantly as the visibility conditions decrease. The first effect noted is that, when the departure runway is being used for arrivals as well, the pilot of the lead departure aircraft may be requested to advise Local Control "when the arrival is by" in order that he can instruct the pilot to position and hold. In addition, he is likely to request the pilot to report when in position. Under lowered visibility conditions RVR and rollout must be given to the pilot as part of the local conditions advisory. For the same reason discussed with respect to arrivals, the departure pilot may not be able to take off under the existing conditions. In this case, the flight is treated similarly to an aborted takeoff as shown in Figure 4-10(c). If the takeoff can be made, Local Control is most likely to request the pilot to report rolling, becoming airborne, and starting the turn to the departure heading as a means of monitoring the progress of the takeoff.

The task sequence for the next phase in the handling of the departure, Handover to Departure Control, is presented in Figure 4-10(d). Under normal visibility conditions, Local Control visually observes the aircraft climb out and turn maneuvers, issuing the departure heading if not given previously. Under low visibility conditions he will receive the airborne and starting turn reports from the pilot as a substitute. The latter report is most significant as it serves as cue to the issuance of the handover instructions.

When the aircraft is determined to be started toward its designed departure heading and no further attention is required, the pilot is instructed to contact Departure Control and the flight strip dropped down the Flight Strip Tubes to the Departure Control position in the TRACON. Observations in the tower cab indicated that, under normal visual operations, most controllers will pick up and hold the strip for a final check when issuing the frequency change.

Further attention may be required for a departure when there may be some possibility of safe separations between departures not being achieved. This may occur because of an unusual takeoff for the aircraft or where the departure path will take the

aircraft across the path of the departure for the other Local Control positions. This latter situation may occur, for example, where a westbound departure has been routed to the northside runway for reasons discussed earlier in connection with the Outbound Ground position. Where further attention is best provided by Departure Control, Local Control coordinates with Departure Control via the interphone when the aircraft is turned over. Otherwise, Local Control will request the necessary reports and/or issue the necessary instructions to resolve the problem and, where the situation requires, coordinate with the other Local Control position. A particularly significant situation in which this additional Local Control attention is required is that in which an arrival on the same runway or crossing runway must execute a missed approach and in which the heading for the standard missed approach is in roughly the same direction as the heading for the previous departure. In such situations, Local Control would be required to obtain frequent reports of the altitude status of the aircraft involved, with particular emphasis on the departure, to ensure that safe separations are maintained.

Quantitative measurements of the communications and physical task activities described in the preceding paragraphs are provided in Section 5.4.

4.2.3 TRACON

The TRACON includes 23 operating positions. The positions are basically divided into Departure Control and Approach Control. Associated with the Approach Control position is the Parallel Approach Monitor position. Its function is to monitor aircraft making parallel approaches on Runways 14, 32, and 27 when such approaches are in effect. Figure 4-11 is an illustration of the TRACON Room layout depicting the positions of the various controller positions.

Tables 4-9 through 4-11 illustrate the responsibilities and duties of arrival, departure and parallel monitor positions as they interface with O'Hare Airport operations.

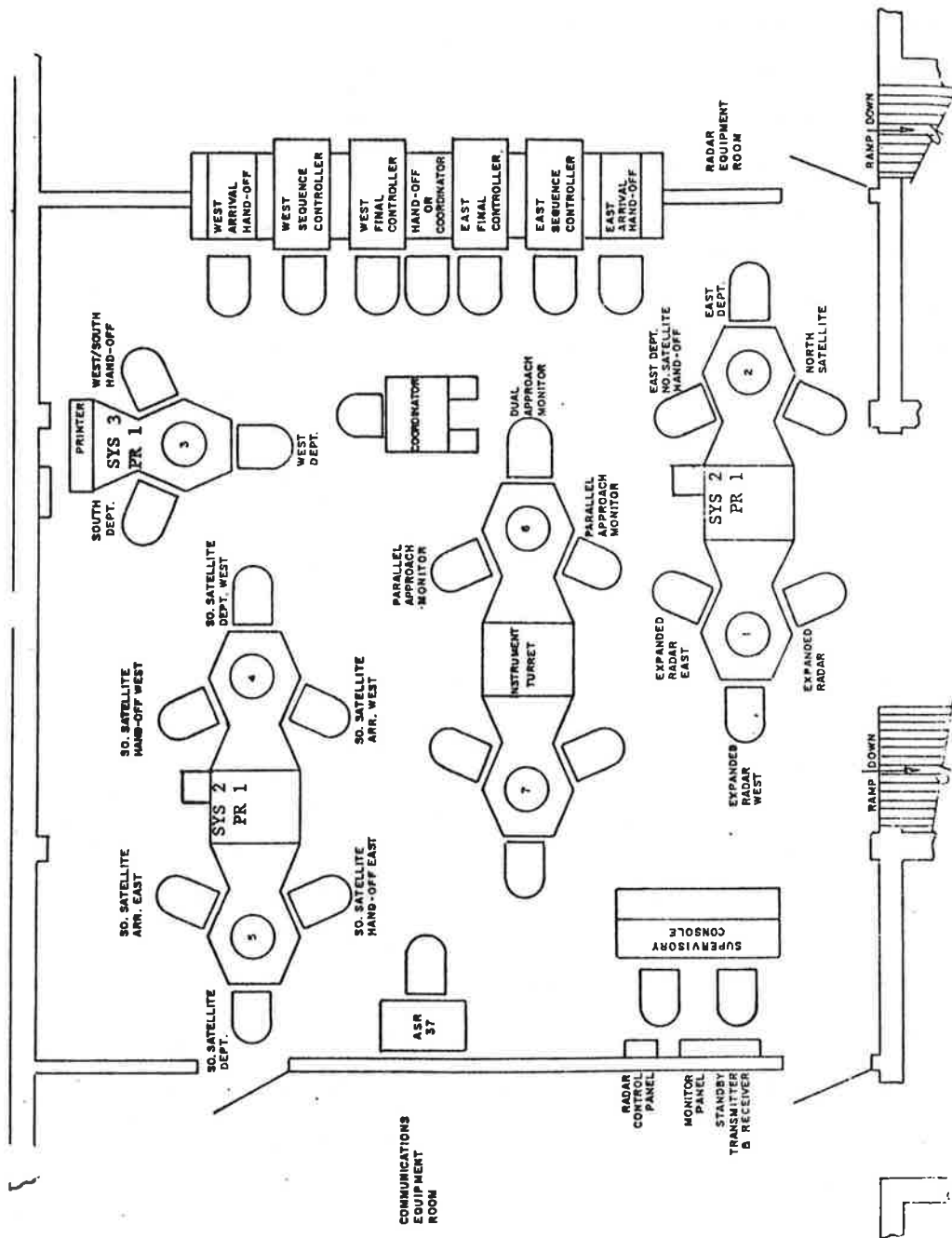

Figure 4-11. TRACON Room - O'Hare International Airport

Table 4-9. Responsibilities and Duties of the Approach Control Position

Responsibilities	Associated Duties	Equipment Used
Control the arrival flow into O'Hare Airport	<ul style="list-style-type: none"> ● Receive radar handoff from ARTCC (Center) ● Select arrival mode ● Issue descent clearance and vector aircraft to appropriate runway ● Establish aircraft on ILS course ● When clear of all traffic and established on the ILS course turn aircraft over to appropriate Local Controller 	ARTS Display VHF Radio Interphone

NOTE: Both Arrival and Departure controllers are responsible for the separation and control of satellite airports in their sectors.

Table 4-10. Responsibilities and Duties of Departure Control Position

Responsibilities	Associated Duties	Equipment Used
<p>Separate departure traffic flow from arrival traffic flow</p>	<ul style="list-style-type: none"> ● Receive aircraft from Local Controller ● Identify traffic on radar ● Issue climb instructions and vector aircraft through his sector to transition area ● Hand off aircraft to appropriate air route traffic control center sector ● Turn aircraft over to appropriate center frequency ● Check time aircraft called for clearance and aircraft's departure time. If more than 37 minutes, the Controller logs the time as a departure delay. 	<p>ARTS Display VHF Radio Interphone</p>

Table 4-11. Responsibilities and Duties of Parallel Approach Monitor ¹

Responsibilities	Associated Duties	Equipment Used
<p>Ensure that lateral and longitudinal separation is maintained during Parallel Runway Approaches</p>	<ul style="list-style-type: none"> ● Monitor final approaches of aircraft during Parallel Runway operations ● Assure lateral separation between aircraft on final approach ● Assure longitudinal separation between aircraft assigned on a specific runway on final approach ● Issue control instructions to aircraft on approach on the appropriate Local Control frequency ● Monitor Local Control frequency 	<p>ARTS Display VHF Radio (local frequency)</p>

NOTE

1. Two Parallel Approach Monitor positions are manned. Each is assigned specific responsibility for control of traffic on one of the runways in use.

4.3 AIRLINE FUNCTIONS

4.3.1 General Responsibilities

The airlines are the major source of aircraft traffic at O'Hare. The manner in which they discharge their responsibilities can significantly impact the operations of the overall ASTC System, and the performance requirements placed on control positions in the ATCT. This is particularly true in the case of the major airlines that contribute more than 50 percent of the traffic (i. e. , United, Trans World, and American) and those other airlines that operate a significant number of flights (i. e. , Delta, Eastern, North Central, Northwest Orient, and Ozark) from the passenger terminal. As an example, the impact of airline operations on the ASTC System is most felt when disruptions of flight schedules are experienced or delays in the scheduled departure of flights result in the unavailability of gates for arrival aircraft. The effect of gate unavailability on inbound ground operations was discussed in the previous section. Therefore, the following discussion is addressed primarily to these major organizations, with exceptions noted.

The responsibilities of the airlines include:

1. Establishment of a plan and schedule for the allocation of passenger terminal gates for departure and arrival operations (with the exception of Ozark which does not use nose-in parking at their two gates).
2. Monitoring adherence to this plan with respect to the basic flight operations schedule and the existing conditions and adaptation of the gate assignment plan as required.
3. Advising pilots on arriving flights of their assigned gates and occupancy availability.
4. Controlling the pushback and start-up departures and the movements of departure and arrival aircraft within the ramp areas.*

*This applies to all airlines.

5. Establishing contact with the ATCT for entry into and passage through the system. *
6. Advising the ATCT of the status of aircraft equipment and airline facilities that impact on the requirements for control of the aircraft. *
7. Adherence to control instructions provided by the ATCT. *
8. Adherence to rules governing the movements of service vehicles on the airport surface. *

Responsibilities 1 to 4 are discharged by operations personnel located within the terminal facility or at the gates. Responsibilities 5 to 7 are discharged by aircraft flight deck (cockpit) personnel. Responsibility 8 is discharged by the operators of service vehicles.

The remainder of this discussion of airline functions is related to terminal operations and flight deck personnel. The information related to terminal operations planning and control was obtained through interviews with the major carriers and observations of their facilities. Therefore, it may not reflect in all details the operations of other carriers. The information related to flight deck functions was also obtained through interviews with pilots for the major carriers. However, it is believed that the description of these functional operations reasonably reflects the operations of flight deck personnel in most respects.

4.3.2 Airline Terminal Operations

The airline terminal operations functions which are directly related to the planning and control of aircraft operations are gate scheduling and control and gate operations. These functions are normally performed by separate operating organizations whose activities are coordinated with one another by procedural methods. The performance of these functions by the various personnel involved is described below.

*This applies to all airlines.

4.3.2.1 Gate Scheduling and Control

Flight scheduling is essentially accomplished by schedule analysts working with information provided by the Marketing Department and with specific facilities criteria provided by the individual stations served by the carrier. The information thus developed provides the necessary input to determine the type of aircraft to be utilized and the specific schedules to be implemented for the various routes.

The operating units responsible for gate assignment at O'Hare are the Ramp Service Departments. These units are essentially responsible for planning and day-to-day management for the activities related to the various gate areas. Typical of these activities are passenger and cargo planning, gate/flight planning, load planning (weight and balance), passenger flight processing (including updating of the flight information displays within the terminals), advanced departure processing (including updating of the flight information displays within the terminals), advanced departure processing, maintaining and updating a gate assignment board, inbound flight monitoring, and ramp control operations.

Gate assignment/schedule planning is accomplished by manual means and, except for minor differences in requirements due to holidays, weekends, etc., these schedules remain essentially constant for extended periods of time. Major revisions have, in the past, been effected in the spring and fall when daylight saving time changes are instituted. Figure 4-12 illustrates a typical gate assignment plan for the hours 1400 to 2400 provided by United Airlines for the period beginning January 3, 1974.* The plan indicates the flight number, type of equipment (by the letters following the flight number), and whether the flight is an originating, terminating, or through flight. Originating flights are shown with no closing bracket on the right, terminating flights with no closing bracket on the left, and through flights with closing brackets on both ends. Where the aircraft

*Provided through the cooperation of United Airlines.

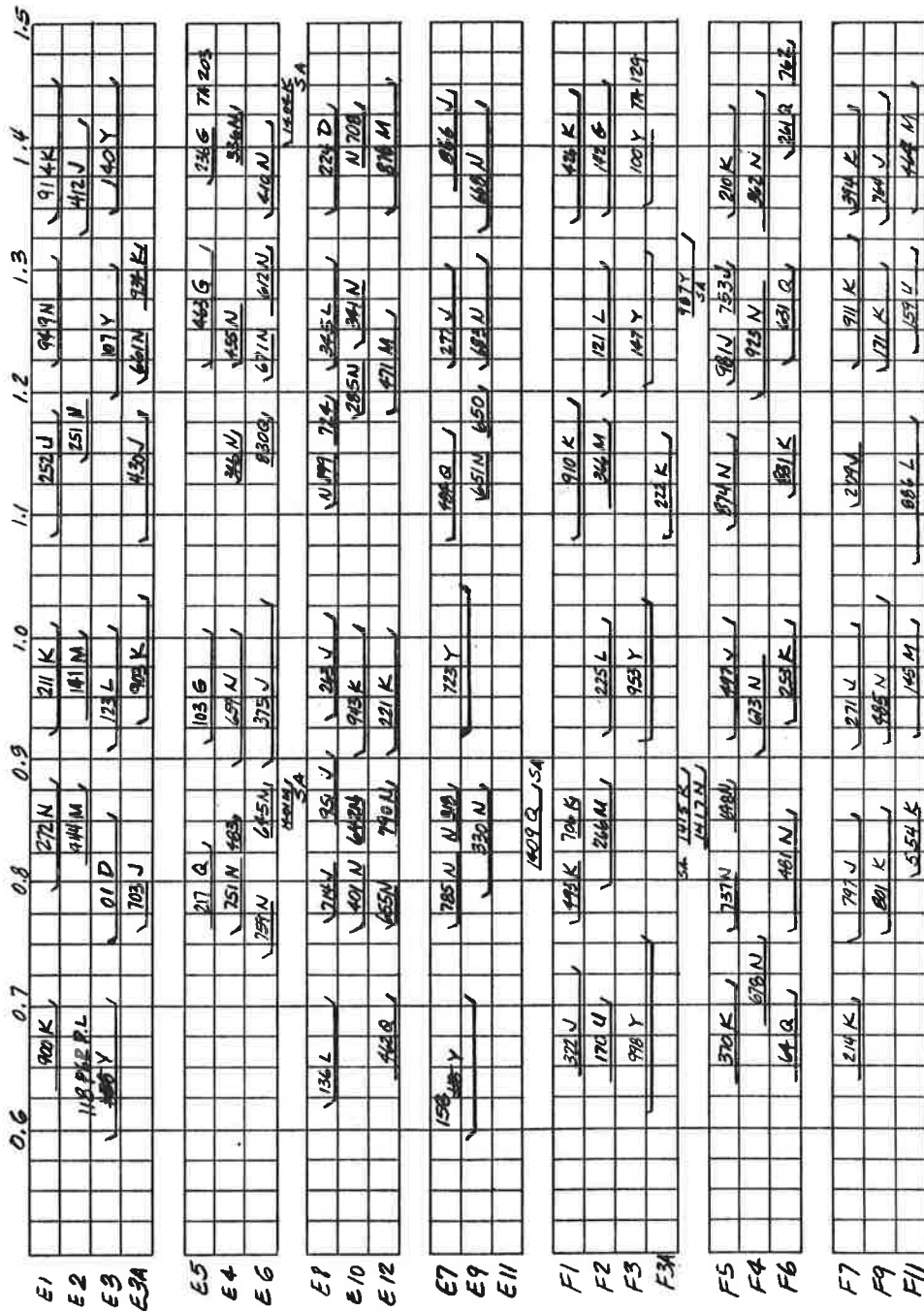

Figure 4-12. United Airlines Gate Plan for O'Hare Airport

equipment for a terminating flight remains at the gate for an extended period and then is used for an originating flight a dashed line is shown.

Examination of this schedule reveals that the predominant number of flights are through flights. This is true for the other major and significant carriers. Further examination of the schedule reveals that flight operations are scheduled around particular hours of the day. O'Hare Airport is referred to as a "bank station"; that is, aircraft operations are scheduled in banks to provide:

1. Service at the hours determined to be most desirable for passenger travel by the Marketing Department.
2. Optimum interconnection of flights to retain a desired share of the estimated interconnecting passenger market.

This "bank" operation is also characteristic of the schedules of the other major and significant carriers at O'Hare as well as United.

The factors considered to be most important in the planning of gate assignments are:

1. Aircraft size.
2. Preceding or next airport for the flight (with preferred market airports served primarily from the gates closest to the entrance of the concourse).
3. Aircraft servicing time (which is dependent on whether the flight is originating, terminating, or through).

Other factors which are considered in gate planning are gate size restrictions, spacing between departure and arrival aircraft at a specific gate, extra sections for holiday traffic, placement of connecting flights at gates in close proximity to each other, and passenger convenience.

Minimum time intervals between the scheduled departure of one aircraft and the scheduled arrival of another are currently on the order of 15 to 20 minutes for all except wide-bodied aircraft. For the latter, the interval is

generally scheduled for 25 to 30 minutes to allow for variations in the processing time of the large numbers of passengers involved. Prior to the reduction of flights in January due to the energy crisis, the schedules were somewhat tighter, with minimums ranging between 10 and 15 minutes.

Due to physical limitations in the availability of space in the gate areas and the general configuration of the lobby and gate equipment installations, a number of restrictions in the gate assignment procedures are necessary. These restrictions vary in complexity depending on the mix of aircraft types utilized by an airline and the number and physical configurations of the gate areas from which the airlines operate. Table 4-12 illustrates the considerations that are involved in gate planning by American Airlines based on aircraft size.* This tabulation pertains to American gates in the H and K ramp areas and indicates the allowable gate usage for various types of aircraft, the type of parking required, and the type of deplaning/enplaning employed at each gate under the various possible gate combination schemes. Similar plans of varying degrees of complexity are also in effect for the TWA and UAL gate areas.

4.3.2.2 Gate Operations

Management of gate operations and the organization of the units involved varies from airline to airline. At AAL, the Marketing Department is responsible for gate operations. The Passenger Services Division coordinates such activities as passenger processing, jetway operators, and closeup of aircraft. The Ramp Service Division is responsible for cargo and baggage loading, fueling, cabin servicing, and for providing weight and balance information. The Operations Department is responsible for aircraft maintenance, pushback operations for departing aircraft, and the parking of arrival aircraft.

The Ramp Services Department at TWA is responsible for gate operations. The individuals involved are the Manager of Ramp Services, Flight

*Provided through the cooperation of American Airlines.

Table 4-12. Authorized Aircraft Parking -- O'Hare
Passenger Terminal -- American Airlines

Gate	Type Parking	B727 100	B727 200	B707	B323	DC-10	B747	Type Deplaning/Enplaning
H-1	Guide-man	OK	OK					Ground level
H-2	Nose-in	OK	OK					2nd level
K-1	Nose-in	OK	OK	OK				2nd level
K-2R	All weather	OK	OK 13					Ground level
K-2	Nose-in Boom/Tgt	OK	OK	OK	OK	OK 11		2nd level
K-2A	Nose-in Boom/Tgt	OK 13	OK					2nd level
K-3	Nose-in Boom/Tgt	OK 13	OK	OK 1	OK 1	OK 11		2nd level
K-5	Nose-in HOLDS	OK	OK	OK	OK	OK		2nd level
K-6	Nose-in	OK	OK	OK	OK 2	OK 11 12		2nd level
K-7A	Nose-in Boom/Tgt		OK	OK 3	OK 3			2nd level
K-7B	Nose-in Boom Tgt	OK 5	OK 5			OK 4 11	OK 4	2nd level
K-8	Nose-in Boom/Tgt	OK	OK	OK	OK	OK 11	OK	2nd level
K-9	Nose-in Boom Tgt	OK 6	OK 6	OK 7	OK 7	OK 11		2nd level
K-10	Nose-in	OK	OK	OK	OK	OK 11 12		2nd level
K-11	Nose-in Boom Tgt	OK 9	OK 9	OK 9	OK 9	OK 8 11	OK 10	2nd level

Simultaneous occupancy of K-9, K-11 by DC-10s not preferred if other gates available.

B747 A/C use nose-in precision parking of fixed boom.

When B747 A/C use K-11, it is using both K-9 and K-11 facilities, hence is considered using one gate, K-11.

See explanatory notes on next page.

Table 4-12 NOTES

1. If K-2A not occupied.
2. Requires wingman if B747 on K-8.
3. If K-7B not occupied.
4. If K-7A not occupied.
5. If K-9 not occupied by B707 or DC-10, or, if K-7A not occupied by B707.
6. If K-11 not occupied by DC-10.
7. If K-7B not occupied by B727 A/C.
8. If K-9 not occupied by B727 A/C or B747.
9. If K-9 not occupied by B747.
10. K-9 gate is considered K-11 for B747 use only. Thus K-11 must be vacant.
11. DC-10 uses all WX parking.
12. If K-8 not occupied by B747.
13. Okay, but preferred on another B727 gate if available.

Information Coordination (FIC) and Manager-on-Duty. Upon completion of the loading processes and if no prior decision has been made by either the Manager-on-Duty or the FIC to hold an aircraft for connection passengers, the engines are started and the aircraft is dispatched. The FIC is then notified that the gate is ready for reassignment and a new aircraft is then assigned to the vacant gate.

At UAL, the operating unit responsible for gate operations is the Gate Operations Unit. The tower operator has an overview of all three ramp areas from which UAL operates and in this capacity he represents the "eyes" of operations under normal operating conditions. The tower operator is in radio contact with the aircraft and coordinates specific requests between the pilot and various operations in the gate area. For example, if an arriving passenger requires a wheelchair for deplaning, the tower operator passes on the request from the pilot to the appropriate personnel. He provides pushback clearance upon request from the pilot, or will delay the clearance if he observes other activity (arrival or departure) which will interfere with the pushback of that aircraft.

When gate problems become difficult due to excessive delays in releasing an aircraft, reassignments are handled by the Operations Agent working with Passenger Operations and the Irregularity Operations Message Position (located in the Planning Center in the main terminal building).

A Ramp Operations Supervisor is normally responsible for several gates and the operations at that gate and a Passenger Service Supervisor is responsible for two agents at an active gate. Maintenance Planning is in contact with the aircraft mechanic crews. However, Ramp Operations does not have good communications contact with the mechanics. Consequently, no single individual is cognizant of the full status of the aircraft at any given time.

Since aircraft delays can represent a significant cost element to an airline as well as inconvenience to the passengers, a number of steps have been taken by the airlines in an attempt to improve the efficiency of their operation by

minimizing controllable delays. AAL, TWA, and UAL have indicated that records are kept to indicate both the amount of delay and the causative factors. The most common causes of delay are attributed to late equipment arrival and maintenance activities as well as passenger services including cargo loading and passenger boarding.

Adherence to departure schedules and aircraft status checks are monitored either by means of radio or intercom facilities and by visual observation from the ramp control tower at AAL and UAL. If the scheduled departure time passes (within a minute or two) and the aircraft is still at the gate, calls are normally initiated to Ramp Operations or Passenger Services to determine the problem and to ascertain the estimated length of the delay. This is performed because any significant delay may have a serious impact on gate availability for arriving aircraft.

Both TWA and UAL indicated that their normal procedures for providing gate assignment information to arrival aircraft is some 20 to 30 minutes prior to landing. The gate assignment is confirmed once the aircraft has landed. At AAL, the normal procedure is to inform the pilot of the gate assignment only after he has landed and called in to the ramp control tower. It should be noted that AAL has a manned position for Inbound Flight Monitoring which permits the derivation of estimated arrival times as well as which runway will be utilized by an arriving aircraft. Thus, any difficulties in gate availability can be anticipated and usually resolved prior to the aircraft's landing and requesting of a gate number by the pilot. All three airlines attempt to provide information as to expected delays or firm gates at the initial contact from the aircraft.

Once the aircraft have landed, the pilots are advised if a gate is temporarily blocked. Judgment is used in estimating the difference in time between the expected availability of the gate and the amount of time required by the aircraft in taxiing from the runway to the ramp area. The pilot is advised of this condition for use in his communications with the ATCT.

In the event it is necessary to assign a different gate than originally scheduled, the impact of aircraft size, type of flight (terminating or through), final requirements, interconnection flight status and projected turn-around time of the aircraft are all evaluated before a new gate is assigned to ensure a minimum disruption to the overall operation. Observations of the activities in the AAL tower and UAL Planning Center indicated that rescheduling of gate assignments generally involves the need to adjust the schedule for several aircraft at a time.

4.3.3 Flight Deck (Cockpit) Operations

The flight deck functions which are directly related to the operations of aircraft within and in relation to the ASTC system include: pre-flight checkout, company communications, ATC communications, and aircraft movement control. Responsibility for the performance of the functions are shared between the flight officers.

On most jet aircraft, including any larger in size than the Boeing 727, there are three flight officers; that is, the Captain (Pilot), the First Officer (Pilot), and Second Officer (Flight Engineer). In most cases the Flight Engineer is also qualified as a pilot. On smaller aircraft there are generally only two flight officers, except where union agreements require a third officer.

The Captain is responsible for all functions performed on the aircraft. However, specific tasks are delegated in accordance with standard operating procedures or upon specific command by the Captain. Either the Captain or the First Officer will fly the aircraft. In cases of multileg flights (i. e. , flying between more than just two airports) or where the flight or crew returns to the previous departure airport, it is a common practice for the Captain to operate one leg and the First Officer to operate the next or return leg. The Second Officer is primarily concerned with assuring and maintaining the fitness of aircraft before, during, and after flight, and with company radio communications. For the purpose

of the following description of the activities of the flight officers, the discussion is presented in terms of the pilot-flying and pilot-not-flying.

Prior to pushback extensive check-out procedures are performed. The check-out requirements and procedures vary with the type of aircraft. However, in general they are accomplished by pairs of flight officers with one reading off the checklist and the other performing the checks. In aircraft with three officers, one set of checks is made by the First Officer and Second Officer and another by the two pilots. Following pushback and engine start additional checks will be made. Further pre-flight checks may be made during taxi to the runway and prior to takeoff, the latter primarily related to engine performance and setting of control surfaces. After takeoff another set of checks is made in relation to performance, flight settings, and wheels retracted.

During the arrival phase of flight other checklists are run through prior to landing (e. g. , performance, settings, flight control surfaces, wheels down and locked), after landing (e. g. , engine settings, flight control surfaces), and after docking at the gate (e. g. , engine shutdown, brakes locked, remaining fuel). Radio communication is accomplished with the cockpit via two tunable VHF radios, both of which can be alternately switched to two pretuned frequencies as shown in Figure 4-13. Typically, the pilots operate on Set 1 which is used for ATC and navigation purposes, while the Second Officer operates on Set 2 which is used for company communications and navigation backup.

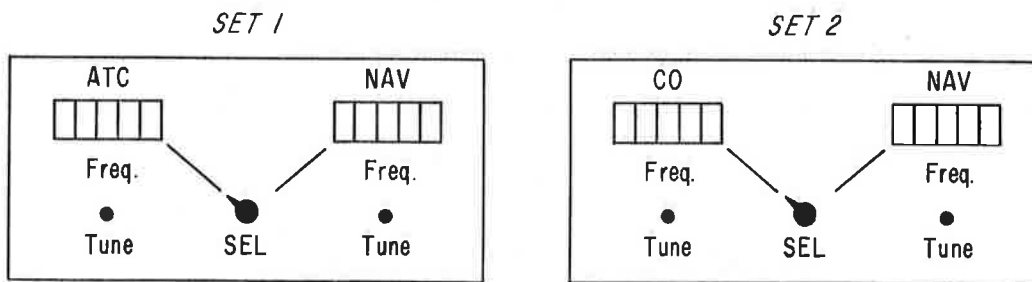

Figure 4-13. VHF Radios in Cockpit

A primary exception to this procedure occurs during pushback phase at which time the pilot-not-flying communicates with the company on Set 2. Ordinarily, this communication is performed to obtain clearance to push back. However, when the scheduled departure time has passed and equipments indicate that one or more of the aircraft doors (i. e. , cabin entrance, belly, service) are still open, the company may be called to determine what is delaying the departure and to obtain a new departure time. Interviews with pilots and observation in the cockpit clearly indicated that the flight officers are normally completely unaware of whether or not the flight will depart on schedule, except for those instances where the delay is due to equipment failures reported by them.

In addition to the radio equipment, there is a PA system on board which enables the pilot-flying to talk to the ground crew mechanic during pushback. It also allows internal communications with the flight attendants and the passengers.

Except for the pushback situation, both pilots will monitor the ATC frequency on Set 1 during taxi, takeoff, flight, and landing. The pilot-not-flying will acknowledge and initiate all communications transmitted from the aircraft. If the pilot-flying wishes to contact ATC, he will generally request the pilot-not-flying to do so.

The Second Officer maintains communications with the company for such purposes as gate status information and maintenance coordination during flight. As noted in the previous discussion of terminal operations, the company may be initially contacted when the aircraft is 20 to 30 minutes from arrival at O'Hare. However, during in-flight cockpit observations on UAL flights from O'Hare to Newark, it was noted that this contact was not made until later in the arrival phase. The reason given by the Second Officers was that, because of the interconnection flight planning at O'Hare, substantial information related to connecting flight gates is received at this time for announcement to the passengers. Since this situation does not exist at Newark pre-arrival contact was not necessary.

The pilot-flying is responsible for controlling the movements of the aircraft during ground taxi, takeoff, landing, and in-flight phases of operation. However, during all phases of the flight he may issue commands for actions by the pilot-not-flying required to control the movement and request readings of instruments being observed by the other officers. During ground phases the aircraft is normally taxied with the engines at idle power. Steering and forward movement is accomplished by the pilot-flying. However, both pilots share responsibilities for obtaining visual references external to the cockpit such as traffic conditions, lights, markers, signs, and building lines for use in controlling the movement of the aircraft and assuring the necessary forward and/or wing-tip clearance to other aircraft moving on the taxiways or parked at the terminal.

During takeoff the pilot-flying normally concentrates his attention on maintenance of the runway centerline and controlling the liftoff with the pilot-not-flying providing assistance in monitoring the engines and calling out the critical speeds. During landing the pilot-flying similarly concentrates his attention on maintenance of approach glide path and runway centerline and then on steering of the aircraft off the runway. The pilot-not-flying again provides assistance in engine/speed control. During the departure (climb and vector), enroute, approach (descent and vector) phases both pilots and, where necessary, the Second Officer share responsibility for visually locating aircraft for which the flight receives traffic advisories.

During in-flight observations the pilot-not-flying was observed to be controlling the throttle settings. In addition, a number of in-flight observations were made aboard DC-10 aircraft, including one landing at Newark under very poor visibility (i. e. , early evening and heavy blowing snow conditions) during which fully automated landings were made.

More detailed descriptions of the activities of flight officers are presented in Section 5.5 in relation to the cockpit crew workload analysis.

4.4 AIRPORT MANAGEMENT FUNCTIONS

4.4.1 General Responsibilities

O'Hare International Airport is an operating division of the Department of Aviation of the City of Chicago. The airport management itself is neither a source of aircraft traffic or involved in the direct control of their movements. However, it is responsible for the maintenance of major physical components of the operating environment (i. e. , runways, taxiways, ramps, lighting, signs). It is also a major source of vehicular traffic on the airport surface. Thus, the manner in which it discharges its responsibilities does have a significant impact on the operations of the ASTC system.

The overall operation of the airport is divided into four distinct areas of responsibilities: administration, aeronautical operations, skilled maintenance, and heating and refrigeration systems. These four areas function directly under the First Deputy Commissioner/Airport Manager and the Assistant Airport Manager. In addition, the Chicago Fire and Police Departments perform their respective functions for the airport on a daily basis and coordinate their activities with the Department of Aviation.

The various functions performed in each of these areas of responsibility as well as the overall organization chart for the airport operation is shown in Figure 4-14. The authorized personnel assignment levels in effect for the calendar year 1972 are shown in parentheses for each function.

The activities shown crosshatched in the figure are those which are primarily involved in operations that impact on the movement of aircraft through the airport and are the subject of the discussions that follow.

4.4.2 Airport Personnel Position Descriptions

The following are descriptions of key positions for both the Department of Aviation and the O'Hare Airport.

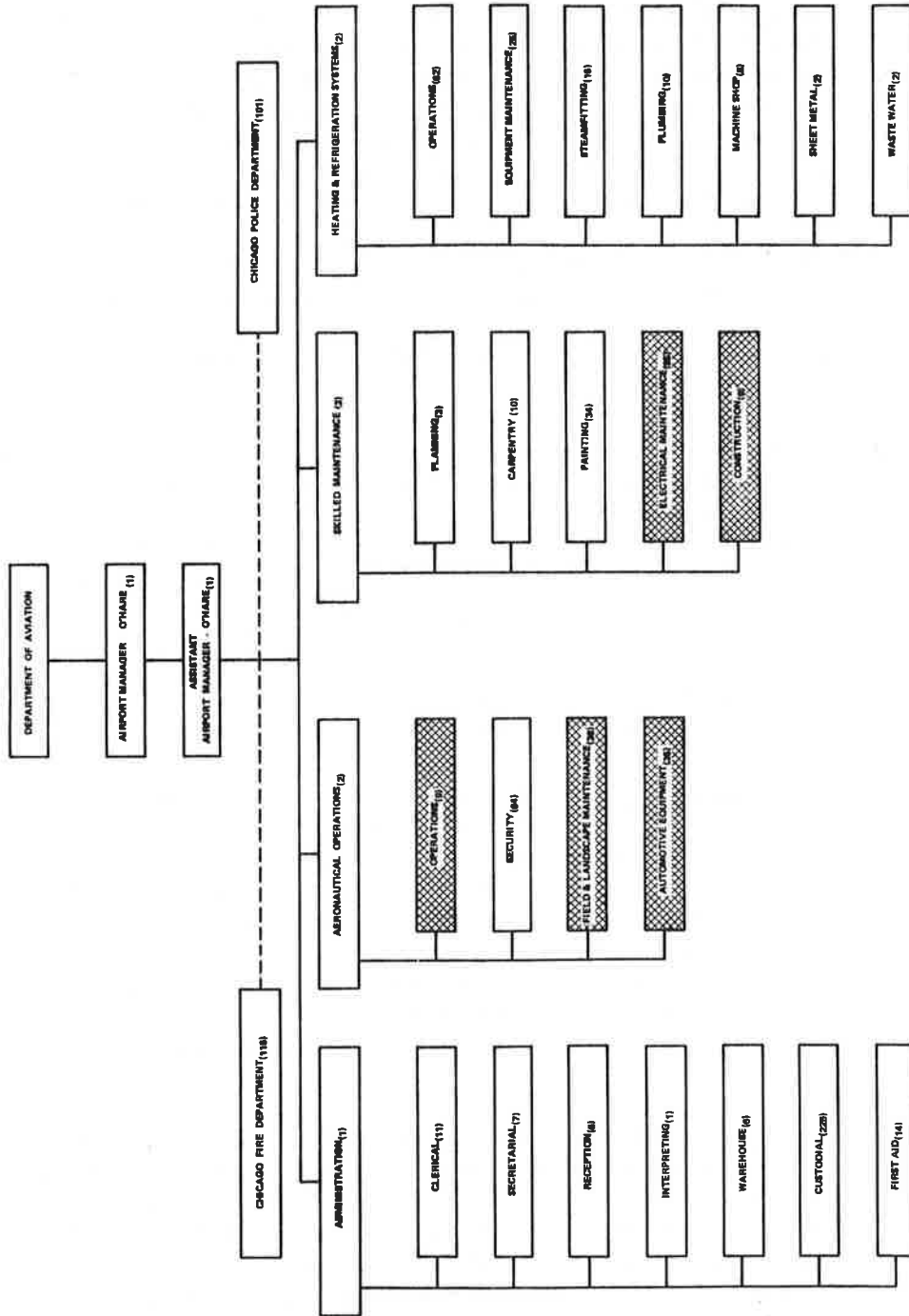

Figure 4-14. Chicago - O'Hare International Airport Organization Chart

- Commissioner of Aviation is a highly responsible position in the executive branch of City of Chicago government. The person holding this position reports directly to the Mayor and the City Council. He directs the overall fiscal, operational, and engineering activities of three airports as well as his department. He negotiates directly or through his representatives with airlines, other tenants, and local, state and federal officials in all matters relative to the airport. He also provides advice and recommendation on all aviation matters that affect the City of Chicago.
- First Deputy Commissioner of Aviation assists the Commissioner and acts for him in his absence. He provides executive direction on aviation matters relative to the City of Chicago. At the present time he is also acting manager of Chicago O'Hare International Airport.
- Chief of Aviation Planning is responsible for master planning of all airport facilities owned and operated by the City of Chicago. He directs preliminary design functions on all airport projects and initiates and monitors requests for Federal and State aid. He is responsible for reviewing all tenant plans that add to or modify existing airport facilities and monitors all tenant construction or alterations as they occur. He supervises all phases of engineering relative to airport maintenance and renders professional assistance to the skilled trades personnel as the need arises. He directs all surveys and studies directly related to airport facilities.
- Chief of Aviation Operations coordinates all safety practices and procedures for the airports owned and operated by the City and all heliports licensed by the City of Chicago. He provides recommendations relative to airport security, emergency procedures and custodial maintenance practices and coordinates the acquisition and applicable use of equipment required by security, emergency, maintenance, and operation functions at each airport. He supervises the inventory control function at each airport and is responsible for the maintenance of all traffic and accident records and reports.
- Aviation Safety Director assists the Chief of Aviation Operations in the performance of his duties. He performs specific functions relative to safety practices and procedures, recommendations on security, emergency procedures, and custodial maintenance practices, acquisition and application of equipment, recommendations to improve services, traffic and accident reports, or airport regulations as directed.

- Airport Manager (O'Hare), under the direction of the Commissioner of Aviation, and with staff assistance, advice, guidance and functional direction, is responsible for the operation of Chicago-O'Hare International Airport. He is primarily responsible for (1) regulating all airport users for compliance with applicable laws and airport regulations, and (2) directing the procedures and practices necessary to ensure all facilities are well maintained and in excellent repair.
- Assistant Airport Manager (O'Hare) assists the Airport Manager (O'Hare) and acts for him in his absence. Performs those functions designated by the Airport Manager (O'Hare).
- Airport Operations Supervisor II assists the Assistant Airport Manager (O'Hare) in direction and supervision of the functional operations and facilities maintenance. He is responsible for the physical condition of runways, ramps, and taxiways and coordinates the inspection and maintenance of airfield and terminal facilities. He supervises the operation of the airport security section. He maintains information regarding all field conditions for airmen, insures that airport tenants adhere to pertinent codes, rules, and regulations. He coordinates the work of lower level operations and maintenance personnel.
- Airport Operations Supervisor I assists the Airport Operations Supervisor II in supervision of the functional operations and facilities maintenance. He inspects facilities and equipment for needed maintenance, alteration, or repair. He issues notices of field conditions, maintains condition records for airlines and airport referral, and checks work of maintenance crews and lower level operational personnel.
- Supervisor of Skilled Maintenance directs and supervises all skilled trades except those mechanical trades assigned to the heating and refrigeration system. He assists in planning and schedules all maintenance work performed by the skilled trades he directs and supervises.
- Construction Superintendent assists in the planning and scheduling of all maintenance and construction work or projects undertaken at O'Hare. He reviews tenant plans for modification of existing facilities and monitors all tenant construction or alterations as it occurs. He monitors all airport construction projects.

- General Foreman of Motor Truck Drivers is responsible for allocating and assigning duties to subordinates in the automotive equipment section. He conducts training programs for snow removal operations and makes recommendations to the Airport Operations Supervisor II regarding personnel and equipment needs. He directs, supervises, or coordinates all functions that require the use or application of equipment or vehicles assigned to the automotive equipment section.
- Foreman of Electrical Mechanics (in Charge) directs, supervises, and coordinates the maintenance and repair of all electrical and related systems on the airport and makes recommendations to the Airport Manager (O'Hare) regarding personnel and equipment needs. He is responsible for allocating and assigning duties to subordinates in the electrical maintenance section. He assists in planning and scheduling construction, modification and maintenance projects that affect electrical and related systems.
- Lieutenant (Police Detail) directs, supervises, and coordinates all police activities and duties at the airport. He acts as liaison between the Airport Manager (O'Hare) and the Chicago Police Department and makes recommendations to the Airport Manager (O'Hare) regarding personnel and special equipment needs.
- Division Fire Marshal plans, organizes and directs airport fire and crash rescue activities, allocating duties and assigning subordinates to specific duties. He establishes crash and rescue procedures and techniques and conducts on-the-job training for fire and crash rescue personnel. He arranges for and directs the inspection of all airport premises from a standpoint of safety and fire potential, recommending corrective action where necessary. He monitors the operational status of fire fighting and rescue vehicles and provides prompt notification of inoperable vehicles and he coordinates the assignment of emergency duties.

4.4.3 Functional Operations Descriptions

This section of the report provides descriptions of the functional procedures employed in the coordination of airport operations within the airport organization and between the airport operations and the ATCT.

4.4.3.1 Coordination Center

O'Hare maintains an Airport Operations Coordination Center to serve as the monitoring and coordination arm of the Airport Operations Supervisor (AOS). The Coordination Center operates from the former ATCT which is located between gates D-3 and D-5 in the ramp area. The Center receives daily status information relative to runway and taxiway conditions and any discrepancy reports which necessitate deviations from normal operating procedures. Such discrepancies are reported to the AOS who initiates actions to correct them. Typically, any failures in the lighting systems and directional signs are reported to Electrical Maintenance, while deterioration of runway or taxi surfaces are reported to Construction for action. Field condition reports are also issued every two hours during normal conditions and every hour during snow conditions.

Any work activities being performed in operational areas are monitored to determine status and estimated completion time. The Center directs all snow removal operations as well as emergency situation operations and performs similar status monitoring functions during these operations.

The Center is normally manned by two people with a third position made active during snow conditions (Snow Desk). The facility is equipped with three telephone lines as well as two-way radio equipment for field activities. Two channels are currently in use; one is for general field communications and the other for operations involving city police, emergency, and snow removal. A third channel is being implemented and is expected to be operational by July 1974. This channel will permit the separation of snow removal and emergency operations from those requiring police coordination.

4.4.3.1.1 Coordination Center Interaction with Other Activities

The Center receives outage reports from the ATCT and, in the case of an emergency, is notified immediately after the situation is reported by the ATCT to Crash Rescue operations. The Center verifies when an out-of-service runway

or taxiway is ready to be returned to service and notifies the ATCT when normal service can be resumed.

Emergency operations advises the Center whether or not a particular incident requires that specific operational areas be closed to further operations. This is reported to the AOS who then initiates actions to notify the ATCT of the closing.

Maintenance operations notifies the Center when planned maintenance activities are to commence and status of the maintenance progress is monitored.

Contact with airline operations or other aircraft operators is established by means of telephones when particular problems arise due to their operations.

4.4.3.1.2 Impact of Visibility Conditions on Center Operations

The Coordination Center currently maintains moderate visual contact with airport operations vehicles. Consequently, visual obstructions between the Center and various parts of the airport surface as well as operations during low visibility conditions have no significant bearing on vehicle movement and operation. Radio contact is maintained with all vehicles or, in the case of a group of vehicles engaged in an activity in the same area, with a designated radio-equipped lead vehicle.

4.4.3.2 Snow Removal Operations

The responsibility for the movement of snow from runway and taxiway surfaces and the immediately adjacent areas rests with the Airport Manager and is delegated to the AOS. Based on weather forecasts which indicate that an appreciable accumulation is probable, the Airline Snow Advisory Committee is contacted by the Airport Manager or AOS on duty. They jointly determine when snow removal operations should commence and establish a priority in which the various areas are to be cleared.

The ATCT is advised of these decisions by telephone and the appropriate runways and taxiways closed down for snow operations. A written NOTAM is also issued describing existing conditions. The ATCT is advised as to both estimated and actual completion times for these operations which are directed by the Coordination Center. An information center (Snow Desk) is established to maintain regular inspections of the field conditions and to advise on the progress of snow removal operations to the airport users.

The vehicle complement employed in a single snow removal operation consists of a lead car and from six to seventeen snow removal vehicles. Personnel in the lead vehicle assign positions to each vehicle. These vehicles are normally based at the city maintenance yards.

Vehicle movements are coordinated with the control tower when vehicles are ready to leave the base area for the designated runways and taxiways as well as when moving from one operational area to another or returning to the base area. Movements within specified operations areas and within the ramp area are not under tower control. The operations are directed from the Snow Desk by means of a radio communications channel specifically for this type of operation. The lead car has two-way communications equipment while the remaining vehicles have only receiving equipment.

Typical problems encountered in snow removal operations are damage to centerline and touchdown zone lights and buried or damaged directional signs or edge lights. Existence of such problems is determined by a supervisor who makes a physical inspection of the cleared area after operations are completed.

4.4.3.3 Surface and Equipment Maintenance Operations

There are approximately one hundred radio equipped maintenance vehicles and eight grass cutters with radio equipment available for various maintenance activities at O'Hare. These vehicles are normally based at the automotive garage. In addition, contractor vehicles ranging from light pickup trucks to heavy

construction equipments may be brought in to facilitate maintenance activities. These vehicles must also be equipped with radio equipment or else must have an extra vehicle with radio equipment assigned to the same immediate work area.

Requirements for maintenance of airport surface areas are determined on the basis of daily surface condition reports or, in certain circumstances, based on notification by airport users of unusual conditions. Maintenance of visual ground aids are generally scheduled so as to have a minimum impact on traffic during these activities. These activities are not scheduled for Mondays, Fridays, and Sunday nights due to the higher traffic levels existing at these times.

When maintenance operations are scheduled for certain areas of the airport which impact on air traffic operations, the ATCT is advised by telephone and NOTAM as early as practical and advisories of progress and estimated completion times are issued at appropriate intervals. The Coordination Center monitors progress of the operations while active. For routine maintenance activities, the operations are directed by either the electrical maintenance or construction sections, depending on the nature of the work being performed. In the case of major projects, a Public Works Project Engineer maintains liaison with Operations. Operating crews maintain continuing communications with the Coordination Center as necessary for progress reporting and verifying that a NOTAM has been issued and is still in effect during the particular operation in progress.

As with the snow removal operations, all maintenance vehicle movements between the base and the maintenance area, between maintenance areas, and from the last maintenance area back to the base area are under ATCT control. Movements within a specific maintenance area are not controlled by the ATCT. The vehicles are required to travel on designated roads or taxiways and runways as necessary.

4.4.4 Emergency Operations

In accordance with Federal Aviation Regulations, Part 139.55, an Emergency Plan for the O'Hare Airport has been published as part of the Airport Operations Manual. This Emergency Plan enumerates the specific responsibilities of the various organizational elements and their employees and provides instructions as to the actions that are to be taken in the event of any of the emergencies identified in the Regulations. This Emergency Plan has been coordinated with law enforcement and firefighting and rescue agencies, medical resources, principal tenants at the airport, and a number of government and non-government organizations that may become involved in the event of an emergency.

A Central Control Point (CCP) will be established in the Airport Operations Office at the direction of the Manager in the event of a major emergency. The Airport Manager or his senior representative present will become the Emergency Control Officer (ECO) and directs the operation of the CCP in cooperation with the Senior Fire Officer at the scene.

The CCP will:

- Direct and/or coordinate all emergency response activities at the airport.
- Close the airport or runway(s) as appropriate or necessary.
- Ensure that the various departments and agencies involved have been notified and are performing their assigned functions.
- Relay or initiate requests for additional help or service as needed.
- Restore airport operations to the maximum extent possible after the emergency area is isolated; restore normal operations completely as soon as possible.
- Establish liaison between news media and representatives of departments or agencies involved in the emergency proceedings.

A Check-In Point will be established by the Manager, in the event of a major emergency. The operation of the Check-In Point will be the responsibility of the Chicago Police Department as directed by the ECO. The purpose of this Check-In Point is to:

- Insure that only authorized persons are admitted to the scene of emergency.
- Assist authorized persons to reach and return from their duty posts safely and quickly.
- Provide (from the Manager, if necessary) vehicles or convoys which can receive clearance from the ATCT to move authorized persons and equipment to where they are needed safely, quickly, and with minimum interference with airport operations.

An Emergency Communications Center will be established at the Central Control Point in the Airport Operations Office. A Mobile Communications Center will be located at the scene if the emergency is localized rather than general as would be the case in an aircraft incident as opposed to a snow storm. The Mobile Communications Center shall be Chicago Police Department patrol car "City 13" and/or the 25th Battalion Chief's car. The Mobile Communications Center shall be directed by the ECO.

The following paragraphs provide a brief synopsis of the emergency procedures followed for aircraft accident and bomb (Suspicious Material Threat) incidents. Since the promulgation of the emergency plan and direction of responses to incidents is the responsibility of the airport management, the descriptions include the procedures to be followed by the ATCT and airlines in relation to the airport management operations.

4.4.4.1 Aircraft Accident Emergency Procedures

In the event of aircraft incidents and accidents within the confines of O'Hare Airport, emergency procedures are initiated to alert the appropriate organizations and to take action in their specific areas of responsibility. The alert

will be initiated by various organizations depending on the nature of the incidents. Aircraft accidents on the surface or crashes may usually be first noted or reported by pilots to the ATCT. Alerts for airborne aircraft may be initiated by the ATCT or airline, whichever is first notified by the crew of the aircraft involved. The following outlines some of the more pertinent actions that are to be taken by the major elements involved.

4.4.4.1.1 ATCT

In the event of emergency situations first noted by or reported to the ATCT, the ATCT will first alert the Chicago Fire Department (Airport Battalion) and the Air Force Fire Department by use of the emergency drop line phone located in the tower cab. It will:

1. Advise the type of alarm - ALERT or CRASH-FIRE.
2. Advise, if it is an ALERT alarm, the runway which the airport will use.
3. Spot the scene of the accident on the airport. If it is a CRASH-FIRE alarm, the official grid map of the airport should be used in describing the location.
4. Request confirmation of the information transmitted.
5. Provide as much pertinent information as is available, and/or obtained from the aircraft operator or airline involved:

Aircraft identification

Type aircraft

Nature of emergency

Quantity of fuel on board

Runway to be used for landing

Number of occupants - passenger and crew

Presence of hazardous cargo or explosives

The location and, if appropriate, the estimated time of arrival of the aircraft.

6. Establish radio contact, 121.9, with the emergency equipment and monitor at all times during an emergency. "Charlie Fox Dog"

is used as the call sign for all communication with the Chicago Fire Department emergency crew after they have left their station. "Air Force Emergency" is used for such communication with the Air Force Fire Department.

After emergency personnel have been notified, the ATCT will then alert the Airport Operations Office Coordination Center using the phone located in the Tower cab. The Airport Operations Office is responsible for alerting other Department of Aviation personnel. Following this the ATCT will notify the aircraft operator or the airline involved by calling the appropriate flight dispatch office. Subsequently the ATCT will direct other air and ground traffic so as to avoid conflicts in the area of the emergency.

4.4.4.1.2 Chicago Fire Department (Airport Battalion)

The Fire Department will alert the ATCT if the ALERT was not reported by the ATCT. It responds to all emergency alerts on the airport. This includes:

1. Emergency Alert - upon being advised of this type of alarm, the emergency equipment proceeds directly to the scene by the most direct route.
2. Standby Alert - upon being advised of this type of alarm, the emergency equipment will take the standby positions for the runway to be used as prescribed by Headquarters, Chicago Fire Department directive dated June 12, 1972.

Fire Department leadership and operating vehicles will coordinate with ATCT Ground Control by means of two-way radio (121.9). "Charlie Fox Dog" will be used in all radio communications. The Department will assume primary responsibility at the immediate scene of any incident involving a civilian aircraft. (The Air Force Fire Department Chief will be in command if a military aircraft is involved.) It will perform the following functions:

1. Direct and control rescue and firefighting activities during the period of actual emergency.

2. Determine need for and request ambulance service and medical assistance as required.
3. Request additional firefighting and rescue or other equipment as needed.
4. Support the Chicago Police Department as needed in incidents for which they have responsibilities.
5. Confer with Tower and Emergency Control Officer regarding status of emergency, as appropriate.
6. Provide Battalion Chief's Car as a mobile communication center if required.

Off-Airport fire department emergency equipment responding to an emergency will be met by vehicles equipped with proper radios and will be escorted to the scene.

4.4.4.1.3 Airport Management

Upon notification of a major emergency situation the airport management will establish and operate the Central Control Point as previously described. The following functions will then be performed:

1. Notify the following of the location and nature of the emergency:
 - ORD Control Tower if the alert was not given by the Tower
 - Chicago Police Department (Airport Division)
 - Commissioner of Aviation
 - Aviation Safety Director
 - Airport Manager and other airport operations personnel as appropriate.
2. Dispatch the AOS to the scene and maintain overall control.
3. Secure and arrange for other City services as required.
4. Maintain a log of the emergency and any resulting actions at the duty desk at the CCP.

4.4.4.1.4 Chicago Police Department (Airport Division)

The Police Department responds to all emergencies on the airport with Police Squad Car, "City 13", which will take a position with the Chicago Fire Department equipment. This unit will function as a mobile communication center for all ALERT and CRASH-FIRE emergencies.

The Police Department will perform the following functions:

1. Notify and coordinate all emergency activities with the Airport Manager or Airport Operations Supervisor on duty.
2. Control crowd and traffic in the vicinity of the accident and lead-in roads to the airport. The highest ranking officer of the Chicago Police Department at the scene will be in charge.
3. Assist the movement of emergency vehicles and authorized persons to and from the crash or emergency site.
4. Secure the scene of the emergency from spectators and others not authorized to be there.
5. Establish and operate the Check-In Point to control the movement of people and equipment needed at the scene.
6. Provide temporary security for wreckage or any other property at an incident scene pending assumption of responsibilities by properly identified owner or other investigative agencies.
7. Request and coordinate the activities of other law enforcement agencies as needed.
8. Consult with the Emergency Control Officer regarding termination of the emergency.

Off-Airport Police Department emergency equipment responding to an emergency on the airport will be met by vehicles equipped with proper radios and will be escorted to the scene.

4.4.4.1.5 Airlines and Other Aircraft Operators

The individual airlines and operators are responsible for establishing their own emergency procedures in accordance with the O'Hare Emergency Operations Manual.

In the event that the airline/aircraft is first notified of the emergency situation it will alert the ATCT giving the following essential information:

1. Type of aircraft
2. Amount of fuel on board in gallons
3. Number of lives on board
4. Any unusual cargo on board, such as explosives, nuclear materials, etc.
5. Pilot intentions

The airline/aircraft operator will then perform the following functions:

1. Provide manpower and equipment for towing or other support as needed in incidents involving aircraft.
2. Provide for unloading, transportation, and accommodation of passengers, baggage, and cargo (including cattle and animals).
3. Notify the National Transportation Safety Board (NTSB).
4. Assure that only authorized personnel and equipments are sent to the scene of the incident. Each airline and operator will be responsible for securing and issuing identification (arm bands or other) to their personnel. Personnel proceeding to the scene will use service roads and taxiways wherever possible.
5. Provide for security and removal of equipment or wreckage upon termination of emergency and upon clearance from appropriate authorities.

4.4.4.1.6 Chicago Board of Health

The Chicago Board of Health is responsible for the coordination of all emergency medical services. In cooperation with the Chicago Fire Department and the Chicago Civil Defense Agency, it will mobilize a staff of physicians and nurses, with medical supplies, and arrange for hospitalization to care for victims requiring such treatment.

4.4.4.2 Bomb Incident Emergency Procedures

In the event bomb threats to aircraft are received, the ATCT or Airline immediately alerts the Fire Department. The ATCT then designates the search area to be used based on traffic patterns in effect at the time the information is received. The aircraft is moved at once to the designated area which can be one of the following:

1. Warmup pad adjacent to Runway 32L
2. Warmup pad and ramp between Runway 32R and the old Military Alert Hangars
3. Warmup pad adjacent to Runway 9L, especially for wide-bodied aircraft, if possible
4. Involved airline hangar area
5. Involved airline cargo area

Unlike the situation involving an aircraft accident, the vehicular activity in this case will be significantly less and can generally be expected to be confined to police, fire, and security departments stationed at the airport whose drivers are familiar with the airport ground traffic procedures to reach the designated areas.

4.4.4.3 Other Emergency Procedures

In the event of other emergencies such as structural fires, natural disasters, sabotage and radiological incidents, the degree of activity on the airport

surface and the extent of the affected areas can vary from a rather localized to a very complex and widespread level of effort. As with the previously described situations, vehicles will be required to have radio communications capability with the tower and varying degrees of control by tower personnel are needed to insure maximum operational capability during the particular event.

