

2

DOT/FAA/RD-91/15, I
DOT-VNTSC-FA1J1-91-7

Unified Methodology for Airport Pavement Analysis and Design

Research and
Development Service
Washington, D.C. 20591

Vol. I—State of the Art

AD-A238 812



John Zaniwski

Arizona State University
Tempe, AZ 85287

June 1991

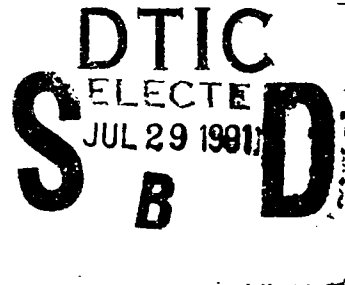

This document is available to the public
through the National Technical Information
Service, Springfield, Virginia 22161.

DISTRIBUTION STATEMENT A
Approved for public release;
Distribution Unlimited



U.S. Department of Transportation
Federal Aviation Administration

91-05839



91 7 27 038

NOTICE

This document is disseminated under the sponsorship of the Department of Transportation in the interest of information exchange. The United States Government assumes no liability for its contents or use thereof.

NOTICE

The United States Government does not endorse products or manufacturers. Trade or manufacturers' names appear herein solely because they are considered essential to the object of this report

1. Report No. DOT/FAA/RD-91/15, I		2. Government Accession No.		3. Recipient's Catalog No.	
4. Title and Subtitle Unified Methodology for Airport Pavement Analysis and Design Vol. I State of the Art				5. Report Date June 1991	
				6. Performing Organization Code DTS-77	
7. Author(s) John P. Zaniewski*				8. Performing Organization Report No. DOT-VNTSC-FA1J1-91-7	
9. Performing Organization Name and Address U.S. Department of Transportation John A. Volpe National Transportation Systems Center Research and Special Programs Administration Cambridge, MA 02142				10. Work Unit No. (TRAIS) FA1J1/A1063	
				11. Contract or Grant No.	
12. Sponsoring Agency Name and Address U.S. Department of Transportation Federal Aviation Administration Research and Development Service Washington, DC 20591				13. Type of Report and Period Covered Final Report January 1989 - January 1990	
				14. Sponsoring Agency Code ARD-240	
15. Supplementary Notes *Arizona State University Tempe, AZ 85287					
16. Abstract <p>This report presents an assessment of the state of the art of airport pavement analysis and design. The objective is to identify those areas in current airport pavement analysis methodology that need to be substantially improved from the perspective of airport pavement design and management needs. The foundations of current design practice are examined with emphasis on the last twenty years of research and advancement in the area of pavement response prediction and cross section/layer thickness design. The author presents a review of empirical methods of design for rigid and flexible pavement design, and quasi-mechanistic analyses that are based on layered-elastic theory or finite element methods. Weakness of current methods as applied to airport operational needs are discussed. The report presents a rational argument for developing a unified pavement analysis and design procedure that can be used for pavements of any material type and that are based on mathematical formulations of the actual stress/strain response processes in airport pavement materials.</p>					
17. Key Words Airport Pavements, Pavement Analysis Pavement Design			18. Distribution Statement DOCUMENT IS AVAILABLE TO THE PUBLIC THROUGH THE NATIONAL TECHNICAL INFORMATION SERVICE, SPRINGFIELD, VIRGINIA 22161		
19. Security Classif. (of this report) Unclassified		20. Security Classif. (of this page) Unclassified		21. No. of Pages 142	22. Price

PREFACE

Airport pavements are designed for a nominal life of twenty years; but most need major rehabilitation, reconstruction, or replacement before twelve to fourteen years have elapsed. Part of the problem stems from design procedures that are empirically based, not representing well the response of airport pavement to load or appropriate failure mechanisms. It is not possible with the existing pavement models to assess accurately the effect of incorporating new materials into pavement designs or the impact of changes in traffic - either increased number or weight of aircraft. Nearly one billion dollars is spent yearly in building, improving or maintaining airport runways, taxiways, and aprons. Producing a more accurate model of pavement response and design procedures in order that pavements achieve their design lives can result in significant savings.

This report reviews the state of the art of airport pavement analysis and design. The specific objective is to determine what areas need to be improved to meet the FAA's goals of improving the reliability of pavement analysis and design, and developing a tool that can be used to realistically study the effect of new pavement materials and changes in traffic.

A general framework for the design of airport pavements is portrayed. A more detailed examination of recent literature and research in analytical models is presented including a summary of elastic layer theory, viscoelastic layer analysis, thin plate theory, and numerical methods (including finite element representations). Available pavement distress models are also described and assessed. Finally, airport pavement design methods are reviewed.

It is concluded that accurate estimates of pavement response and subsequently of pavement distress and performance will require a new approach. This approach should be founded on three-dimensional finite element analysis, formulated with the

specific characteristics of pavement materials, i.e., the constitutive equations of the materials, with respect to elastic, plastic, and viscous behavior, properly represented. The task is a formidable one; but with recent advances in fracture mechanics and numerical analysis, and particularly with the advances in computational capabilities of personal computers, it is a task that can be successfully performed over the next several years.

This report was prepared for the Infrastructure Systems and Technology Division, John A. Volpe National Transportation Systems Center, Research and Special Programs Administration. The effort was sponsored by the Federal Aviation Administration, System Technology Division, Research and Development Service and the technical monitor was Dr. Aston McLaughlin.

Accession For	
NTIS GRA&I	<input checked="" type="checkbox"/>
DTIC TAB	<input type="checkbox"/>
Unannounced	<input type="checkbox"/>
Justification	
By _____	
Distribution/	
Availability Codes	
Dist	Avail and/or Special
A-1	

METRIC / ENGLISH CONVERSION FACTORS

ENGLISH TO METRIC

LENGTH (APPROXIMATE)

1 inch (in) = 2.5 centimeters (cm)
 1 foot (ft) = 30 centimeters (cm)
 1 yard (yd) = 0.9 meter (m)
 1 mile (mi) = 1.6 kilometers (km)

AREA (APPROXIMATE)

1 square inch (sq in, in²) = 6.5 square centimeters (cm²)
 1 square foot (sq ft, ft²) = 0.09 square meter (m²)
 1 square yard (sq yd, yd²) = 0.8 square meter (m²)
 1 square mile (sq mi, mi²) = 2.6 square kilometers (km²)
 1 acre = 0.4 hectares (he) = 4,000 square meters (m²)

MASS - WEIGHT (APPROXIMATE)

1 ounce (oz) = 28 grams (gr)
 1 pound (lb) = .45 kilogram (kg)
 1 short ton = 2,000 pounds (lb) = 0.9 tonne (t)

VOLUME (APPROXIMATE)

1 teaspoon (tsp) = 5 milliliters (ml)
 1 tablespoon (tbsp) = 15 milliliters (ml)
 1 fluid ounce (fl oz) = 30 milliliters (ml)
 1 cup (c) = 0.24 liter (l)
 1 pint (pt) = 0.47 liter (l)
 1 quart (qt) = 0.96 liter (l)
 1 gallon (gal) = 3.8 liters (l)
 1 cubic foot (cu ft, ft³) = 0.03 cubic meter (m³)
 1 cubic yard (cu yd, yd³) = 0.76 cubic meter (m³)

TEMPERATURE (EXACT)

$$[(x - 32) / 1.8] \text{ } ^\circ\text{F} = y \text{ } ^\circ\text{C}$$

METRIC TO ENGLISH

LENGTH (APPROXIMATE)

1 millimeter (mm) = 0.04 inch (in)
 1 centimeter (cm) = 0.4 inch (in)
 1 meter (m) = 3.3 feet (ft)
 1 meter (m) = 1.1 yards (yd)
 1 kilometer (km) = 0.6 mile (mi)

AREA (APPROXIMATE)

1 square centimeter (cm²) = 0.16 square inch (sq in, in²)
 1 square meter (m²) = 1.2 square yards (sq yd, yd²)
 1 square kilometer (km²) = 0.4 square mile (sq mi, mi²)
 1 hectare (he) = 10,000 square meters (m²) = 2.5 acres

MASS - WEIGHT (APPROXIMATE)

1 gram (gr) = 0.036 ounce (oz)
 1 kilogram (kg) = 2.2 pounds (lb)
 1 tonne (t) = 1,000 kilograms (kg) = 1.1 short tons

VOLUME (APPROXIMATE)

1 milliliter (ml) = 0.03 fluid ounce (fl oz)
 1 liter (l) = 2.1 pints (pt)
 1 liter (l) = 1.06 quarts (qt)
 1 liter (l) = 0.26 gallon (gal)
 1 cubic meter (m³) = 36 cubic feet (cu ft, ft³)
 1 cubic meter (m³) = 1.3 cubic yards (cu yd, yd³)

TEMPERATURE (EXACT)

$$[(9/5)y + 32] \text{ } ^\circ\text{C} = x \text{ } ^\circ\text{F}$$

QUICK INCH-CENTIMETER LENGTH CONVERSION

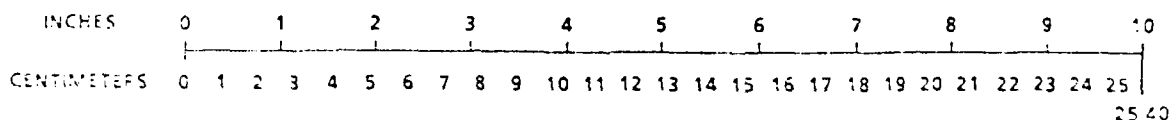

QUICK FAHRENHEIT-CELCIUS TEMPERATURE CONVERSION

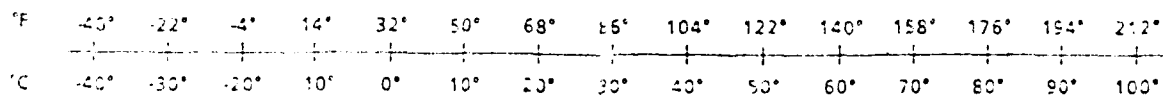

For more exact and/or other conversion factors, see NBS Miscellaneous Publication 286, Units of Weights and Measures. Price \$2.50. SO Catalog No. C13 10 286.

TABLE OF CONTENTS

<u>Section</u>	<u>Page</u>
1. THE AIRPORT PAVEMENT PROBLEM	1
1.1 Airport Pavement Types	3
1.1.1 Rigid Pavements	3
1.1.2 Flexible Pavements	6
1.2 Pavement Materials	6
1.2.1 Fundamental Material Characterization	7
1.2.2 Steel	12
1.2.3 Portland Cement Concrete	12
1.2.4 Asphalt Concrete	14
1.2.5 Stabilized Materials	19
1.2.6 Soils and Granular Materials	19
1.2.6.1 Cohesive Soils	21
1.2.6.2 Cohesionless Soils	21
1.2.6.3 Untreated Granular Materials	23
1.3 Aircraft Characteristics	26
1.4 Functional Areas of Airport Pavements	29
1.5 Environmental Effects	33
1.6 Interaction Effects	34
2. A GENERAL FRAMEWORK FOR THE DESIGN OF AIRPORT PAVEMENTS	37
3. ANALYSIS MODELS	47
3.1 Elastic Layer Theory - Static Loads	49
3.2 Viscoelastic Layer Analysis	55
3.3 Layer Analysis - Dynamic Loads	59
3.4 Thin Plate Theory.	63
3.5 Numerical Methods	64
3.6 Environmental Models	74
4. DISTRESS MODELS	79
4.1 Fracture	79
4.1.1 Phenomenological Model	80
4.1.2 Power Law	82
4.2 Deformations	83

TABLE OF CONTENTS (cont.)

<u>Section</u>	<u>Page</u>
5. AIRPORT PAVEMENT DESIGN METHODS	87
5.1 Federal Aviation Administration	87
5.1.1 FAA Flexible Pavement Design	89
5.1.2 FAA Rigid Pavement Design	90
5.2 Asphalt Institute	91
5.3 Portland Cement Association	93
5.4 Department of Defense Pavement Design Methods	96
5.4.1 Triservice Manual for Flexible Pavement Design	96
5.4.2 Army-Air Force Rigid Pavement Design	101
5.4.2.1 Plain Concrete Airfield Pavements	102
5.4.2.2 Reinforced Concrete Pavements	102
5.4.2.3 Fibrous Concrete Pavements	103
5.4.2.4 Prestressed Pavement Design	104
5.4.3 Navy Rigid Pavement Design	104
5.4.4 Army-Air Force Flexible Pavement Design - Elastic Layer Theory Method	105
6. DISCUSSION AND RECOMMENDATIONS	111
6.1 Discussion of the State Of The Art in Airport Pavement Analysis	112
6.2 Recommendations for Improving the State Of The Art in Airport Pavement Design and Analysis	115
LIST OF SYMBOLS	119
REFERENCES	R-1

LIST OF ILLUSTRATIONS

<u>Figure</u>	<u>Page</u>
1-1 PAVEMENT TYPES: (A) FLEXIBLF AND (B) RIGID	4
1-2 DEPENDENCE OF STIFFNESS ON ASPHALT CONCRETE TEMPERATURE AND TIME OF LOADING	17
1-3 RANGE OF STIFFNESS UNDER MOVING TRAFFIC FOR ASPHALT CONCRETE DEPENDING ON ENVIRONMENT, 12-INCH THICK ASPHALT BOUND LAYER	17
1-4 TYPICAL PLOT OF STRESS AND STRAIN VERSUS TIME DURING THE COMPLEX (DYNAMIC) MODULUS TEST.	20
1-5 TYPICAL PLOT OF LOAD AND DEFORMATION VERSUS TIME DURING RESILIENT MODULUS TEST.	20
1-6 TYPES OF GEAR ASSEMBLIES ON CIVILIAN AIRCRAFT	28
1-7 AIRCRAFT LANDING GEAR-TRUCK TYPES	28
1-8 TYPE IMPRINT AREA	30
1-9 AIRCRAFT GROUND OPERATION CYCLE	30
1-10 A STEREOGRAM OF CALCULATED MONTHLY AND HOURLY CHANGE OF FATIGUE DAMAGE OF ASPHALT PAVEMENT AT BOTTOM OF ASPHALT MIX LAYER	36
1-11 A STEREOGRAM OF CALCULATED MONTHLY AND HOURLY CHANGES OF FATIGUE DAMAGE OF ASPHALT PAVEMENT AT TOP OF ASPHALT MIX LAYER	36
2-1 MAJOR CLASSES OF ACTIVITIES IN A PAVEMENT MANAGEMENT SYSTEM	38
2-2 MAJOR PAVEMENT DESIGN COMPONENTS	40
2-3 BLOCK DIAGRAM OF PAVEMENT DESIGN SYSTEM	41
2-4 COMPONENTS OF A MECHANISTIC PAVEMENT DESIGN PROCEDURE	42
2-5 FLOW CHART FOR ESTIMATING FATIGUE DAMAGE OF ASPHALT PAVEMENTS	43

LIST OF ILLUSTRATIONS

<u>Figure</u>	<u>Page</u>
3-1 GENERALIZED MULTILAYER ELASTIC SYSTEM	50
3-2 SPRING-DASHPOT SINGLE DEGREE OF FREEDOM PAVEMENT MODEL	61
3-3 COUPLED MECHANICAL MODEL WITH SEVEN PARAMETERS	61
3-4 AXISYMMETRIC FINITE ELEMENT MODEL OF TWO LAYER SYSTEM	69
3-5 DEFLECTIONS OF A PAVEMENT SLAB FOR THE (A) WINKLER AND (B) ELASTIC CONTINUUM SUPPORT CONDITIONS	72
3-6 FINITE ELEMENT MODEL OF A THREE SLAB PAVEMENT SYSTEM .	73
3-7 STRESSES RESULTING FROM CONTRACTION DUE TO TEMPERATURE: (A) FORCES ACTING ON CONTRACTING SLAB; (B) VARIATION OF SUBGRADE RESISTANCE WITH LENGTH	76
5-1 FLOW OF ASPHALT INSTITUTE DESIGN PROCEDURE	92
5-2 AIR FORCE TRAFFIC AREAS, LIGHT-LOAD AIRFIELDS	97
5-3 AIR FORCE TRAFFIC AREAS, MEDIUM AND MODIFIED HEAVY LOAD AIRFIELDS	98
5-4 AIR FORCE TRAFFIC AREAS, HEAVY LOAD AIRFIELDS	99
5-5 ELASTIC LAYER THEORY DESIGN METHOD, CONVENTIONAL PAVEMENTS	106
5-6 ELASTIC LAYER THEORY DESIGN METHOD, PAVEMENTS WITH STABILIZED BASES	106
5-7 ELASTIC LAYER THEORY DESIGN METHOD, PAVEMENTS WITH STABILIZED SUBBASES.	107

LIST OF TABLES

<u>Table</u>		<u>Page</u>
1-1	EFFECT OF INCREASING VARIABLES ON THE STIFFNESS OF COHESIVE SOILS	22
1-2	EFFECT OF INCREASING VARIABLES ON THE STIFFNESS OF COHESIONLESS SOILS	24
1-3	EFFECT OF INCREASING VARIABLES ON THE STIFFNESS OF UNTREATED GRANULAR AGGREGATES.	25
1-4	ACTIVITIES OF AN AIRCRAFT IN ITS AIRPORT OPERATIONAL CYCLE	31
3-1	COMPARISON OF ELASTIC LAYER THEORY PROGRAMS	56
5-1	DESIGN WEIGHTS AND PASS LEVELS FOR AIRFIELD PAVEMENTS, AIR FORCE, (WEIGHTS IN 1000 POUNDS)	100

1. THE AIRPORT PAVEMENT PROBLEM

Air transportation is a vital component of interregional, interstate and international commerce and recreation of the United States. In the past two decades there has been a tremendous growth in air traffic. The construction of airport facilities during this time, however, has been virtually stagnant. As a result, the airport system has been stretched near its limits of capacity. Closure of a pavement, especially a runway at a major airport, can affect the operations of the entire airport system. Pavement reliability, therefore, is critical to air transportation convenience and dependability.

The need for reliable pavement design has long been recognized as integral to the smooth functioning of airports. However, the airport pavements that serve their original design life without extensive maintenance are the exception rather than the rule. One of the most prevalent problems in airport pavement design has been underestimating the rate of air traffic growth and hence the underdesign of the pavements.

Pavements are one of the most difficult design problems faced by civil engineers. Pavements are constructed with low-cost materials whose properties are highly variable and dependent on environmental and load conditions. Traffic loadings are difficult to forecast as air traffic growth frequently exceeds expectations and as new aircraft are introduced. Environmental conditions can be evaluated on a probabilistic basis from historical trends; however, the specific environment at a particular point in time can have a dramatic effect on the performance of the pavement.

One of the most difficult aspects of pavement analysis is the definition of pavement failure. Excess stress of the pavement structure results in fracture of the materials. However, cracking alone does not signify a failure of the pavement surface. Aircraft can traverse distressed pavements. In the highway, field pavement failure is defined in terms of the functional

characteristics of the pavement surface, primarily with respect to ride quality. There is not a comparable definition of failure for airport pavements. In airport pavements, the accumulated effect of different types of distress are of major concern to the pavement engineer. Toward this end, the pavement evaluation procedures and subsequent computation of a pavement condition index developed for the PAVER pavement management system^{1*} give guidance for determining when pavement rehabilitation and reconstruction is needed. The need for these treatments is indicative of pavement failure. The PAVER method is widely used for the evaluation of military airfields and civilian airports and, therefore, limits of the PAVER defined pavement condition index may become a de facto standard for the definition of airport pavement failure.

Due to the difficulty of the airport pavement analysis process, design methods have evolved in an empirical manner. While these methods produced workable designs, they have several shortcomings. There have been significant developments in the areas of engineering mechanics and materials evaluation that can provide the foundation for the development of improved airport pavement design procedures. The purpose of this report is to summarize the state of the art in airport pavement analysis models. This task does not have a clear boundary. There are models that have been used for many years for pavement design. There are also models that are applied only by engineers that are on the leading edge of technology for the design of pavement structures. Other models have been proposed by researchers but have not been used extensively for airport pavement analysis. Finally, there are models that have been developed in other engineering fields that can be applied to the analysis of airport pavements. This report attempts to span across all these levels of development.

* Numbers refer to reference list on pg. R-1.

This chapter presents a review of the factors affecting airport pavement performance as a means of establishing the foundation for the review of pavement analysis models. Included is a discussion of airport pavement types, pavement material characteristics, aircraft characteristics, functional areas of airport pavements, and environmental effects. While the complexity of these individual factors makes the development of pavement analysis models a difficult task, the interaction of these factors makes the modeling task even more challenging.

1.1 AIRPORT PAVEMENT TYPES

Pavements are generally classified as either rigid or flexible based on the manner they distribute the load over the subgrade². Rigid pavements use a stiff surface that carries the load in flexure, a major portion of the structural capacity is supplied by the surface. Flexible pavements use a lower modulus surface on base and subbase materials that distributes the load throughout the pavement structure such that the stresses on the subgrade do not exceed the strength of the subgrade. In general, rigid pavements have a portland cement concrete surface while flexible pavements have an asphalt concrete surface, as shown in Figure 1-1. Some authors have introduced a third type of pavement that has an asphalt concrete surface over a portland cement slab. This has been termed a composite pavement. Functionally, the composite pavement behaves as a rigid pavement.

1.1.1 Rigid Pavements

Since rigid pavements carry most of the load in the pavement surface, they may not need a base layer. The base layer of a rigid pavement can serve to control pumping, frost action, drainage, shrink and swell of the subgrade, and expedite construction². Depending on the function of the base, it may be stabilized with portland cement or asphalt cement.

Due to stresses developed during curing and temperature changes, large portland cement concrete slabs will crack. These

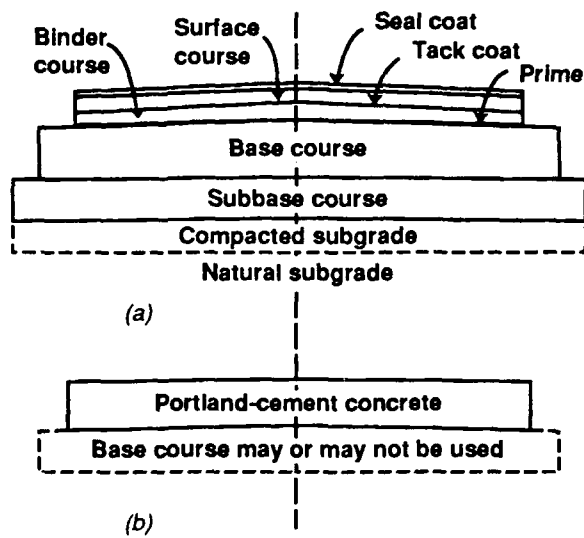

FIGURE 1-1. PAVEMENT TYPES: (A) FLEXIBLE AND (B) RIGID (YODER AND WITCZAK)

cracks can be controlled through the use of joints, reinforcement, or combinations of such.

In general, concrete pavement types are classified based on the type of reinforcing:

1. Jointed concrete pavements (JCP) are designed without reinforcement in the slab. The spacings of the joints are selected to keep the curing and temperature stresses below the working strength of the concrete. Due to the discontinuity in the slab at the joints, load transfer devices, such as dowel bars, are frequently but not always used with JCP.

2. Jointed reinforced concrete pavements (JRCP) are designed to have a greater spacing between the joints to reduce the discontinuities caused by the joints. However, due to the greater spacing between the joints, the slabs will crack. To combat this, reinforcing steel is used to hold these cracks tightly together such that aggregate interlock is maintained across the crack to provide load transfer. The amount of steel is designed for the control of the crack width rather than as a traffic load carrying element of the slab. Due to the distance between the joints, the joint movement of JRCP is greater than with JCP and therefore mechanical load transfer devices, such as dowel bars, are required.

3. Continuously reinforced concrete pavements (CRCP) are designed to eliminate the need for the joints. As with JRCP, the amount of steel is selected to control crack movement and maintain aggregate interlock across the cracks.

4. Prestressed concrete pavements (PCP) are designed to effectively use the high compressive strength of concrete to offset the inherent low flexural strength. Compressive

stresses in the pavement due to prestressing are cumulative, with the flexural strength to produce an increase in the stress range in the flexural zone³. Due to the greater range of allowable stresses in the flexural zone, PCP can be thinner than other concrete pavements. The prestressing is generally accomplished by post-tensioning steel strands. The size of slabs of prestressed pavements is limited by the ability to post-tension the steel strands.

1.1.2 Flexible Pavements

Traditional flexible pavements consist of a series of layers with the highest quality material at or near the pavement surface². For airport pavements, the surface layer of a flexible pavement is asphalt concrete. The base course can be aggregates or aggregates stabilized with cement, asphalt, or lime. Subbases are generally granular materials with a better quality than the subgrade. The Asphalt Institute promotes the use of full-depth asphalt concrete pavements without bases or subbases for some situations.

In certain situations, such as with full-depth asphalt concrete and pavements with stabilized bases, the pavement can behave like a rigid pavement and the classical methods for designing flexible pavements do not apply. In these cases, the concepts of rigid pavement design may apply².

1.2 PAVEMENT MATERIALS

As noted above, the primary materials used for pavement construction are the asphalt concrete or portland cement concrete surface, granular bases and subbases, asphalt, cement, and lime stabilized bases, and steel used for reinforcement and dowel bars in concrete pavements. In addition, due to the importance of the subgrade in the performance of pavements, a discussion of pavement materials needs to address subgrade properties.

There have been several reviews of the literature on material properties and the use of these characteristics for pavement design. Research specifically on airport pavement design has been performed at the Waterways Experiment Station under contract to the Federal Aviation Administration. In particular, Chou⁴ compiled material characteristics data for bituminous concrete, portland cement concrete, granular materials, stabilized soil and cohesive subgrade soils.

1.2.1 Fundamental Material Characterization

Many pavement design methods use the empirical tests of material quality as opposed to methods that quantify the engineering properties of the materials. Examples of empirical tests include the California Bearing Ratio (CBR) and the Marshall stability test. Empirical material characterization has many drawbacks, the primary one being the inability to extrapolate historical knowledge to changing conditions. Since pavement design is a dynamic process with new materials being introduced and changing traffic loads, there is increasing interest in the use of mechanistic analysis procedures. The purpose of the following discussion is to present background information regarding the engineering characteristics of materials to establish a foundation for the discussion of material characteristics.

Engineering evaluation of materials is generally concerned with the deformation response of a material subjected to loads. The deformation of the material is normalized with respect to the sample dimensions in order to define the strain tensor. The load is normalized with respect to the area of the sample to define stress. The accuracy attainable in modeling material properties depends on the complexity of the material response. Materials can be categorized by their primary response characteristics. The primary responses include linear or nonlinear and rate-dependent or rate-independent⁵ behavior.

Linear response indicates that the deformation, or strain, is proportional to the load or stress level (e.g., doubling the stress doubles the strain). Conversely, a nonlinear material would not demonstrate a proportional relationship between stress and strain.

If the response of the material is not affected by the loading rate, then the material is rate-independent. In other words, for a given magnitude of load the response of the material does not change if a test is performed rapidly or over an extended period of time.

There are three basic terms used to describe material behavior: elastic, plastic and viscous. **Elastic** response indicates deformation response is instantaneous and all of the deformation is recovered when the load or stress is removed. A **viscous** material has time-dependent response to load and does not demonstrate any recovery of the deformation when the load is removed. In general, viscous materials are rate-dependent and elastic materials are rate-independent. A **viscoelastic** material displays a rate-independent initial deformation when the load is first applied and a time-dependent deformation under sustained load; the rate-independent deformation recovers when the load is removed. If an elastic material is stressed beyond the yield point, **plastic** deformation will occur if the material is ductile, otherwise the material will fracture in a brittle mode. The plastic deformation is an instantaneous response to the load and is therefore rate-independent. However, the deformation of the material is not proportional to the load level and therefore plastic deformation is a nonlinear response. There is no recovery of plastic deformation when the load is removed.

An **isotropic** material demonstrates the same material properties regardless of the orientation of the material during testing. Finally, a **homogeneous** material has the same properties throughout the volume. Considering these definitions, the simplest material to model is linear, rate-independent, elastic,

isotropic and homogeneous. (As will be seen later, this set of material characteristics is frequently applied to the analysis of materials in pavement structures.)

No material is linear or rate-independent for all magnitudes and frequencies of loads⁵. Generally, tests for the characterization of material properties should be performed in a manner that reflects the in-service conditions in order to measure the properties of the materials in a specific application. However, in-service conditions can never be fully duplicated in the laboratory. Sentler⁶ states:

The strength characteristics of materials is to a large extent based on the results obtained in standardized tests. Such information is valuable because it is often the only information available. But very few structural members, if any, fail in a way which resembles a standardized test. Instead other types of failures like fatigue play a much more important role in practice. It is also obvious that the environmental influences have to be considered in a more appropriate manner.

For mechanistic analysis, the stress-strain characteristics of materials are defined by constitutive laws that describe the primary response behavior of the material when subjected to loads. The form of the constitutive relationship depends on the type of the material. A constitutive model formulates a mathematical functional form of the material behavior. The constant terms in the functional forms of the constitutive equations are the material properties that must be defined experimentally. Linear rate-independent materials are the easiest to quantify, while nonlinear rate-dependent are the most complex.

For linear-elastic isotropic materials, the generalized Hooke's law applies and the deformation response of the material is completely defined by the modulus of elasticity and Poisson's ratio. The modulus of elasticity, E , is the ratio of the stress-strain measurements and Poisson's ratio is the absolute

value of the ratio of transverse to longitudinal strains for a sample measured in uniaxial test condition:

$$E = \sigma / \epsilon$$

$$\mu = |\epsilon_t / \epsilon_l|$$

As the isotropic assumption is relaxed, the number of constants required to quantify the material properties rapidly increases. In the case where the material has three perpendicular planes of symmetry, nine material constants are required. When the symmetry condition is completely relaxed (i.e., an anisotropic material), 21 material constants are required⁵.

For linear rate-dependent materials, the behavior varies depending on the stress state of the test. Uniaxial tension or compression tests are common in some engineering fields. The tests are performed at either constant stress or constant strain. In the constant stress test, a stress is instantaneously applied to the sample and held constant over time. The resulting strain, $\epsilon(t)$ is measured and the normalized result forms the creep function:

$$J(t) = \epsilon(t) / \sigma_0$$

For constant strain or relaxation tests, an instantaneous strain is applied and maintained on the sample. The resulting uniaxial stress in the sample relaxes with respect to time. The normalized function defines the relaxation function:

$$G(t) = \sigma(t) / \epsilon_0$$

For linear isotropic materials, the volume and shear responses are independent⁵. This fact allows the three-dimensional characterization of these materials by performing creep tests in hydrostatic compression to define the volume creep function, $J_v(t)$, and creep or relaxation tests in pure shear to

define the shear creep function, $J_s(t)$. Superposition can be used to define the cumulative effect of these two creep functions, i.e., the total strain in the three-dimensional case is the addition of the strain due to volume and shear strains.

Nonlinear rate-independent materials can be modeled with either deformation or incremental laws⁵. The deformation law uses the results of experimental tests to quantify a functional form for the shape of the load-deformation or stress-strain curve. This may be thought of as fitting a nonlinear regression equation to the experimental results. The incremental law separates the measured strain into elastic and inelastic components. Elastic strains are estimated in the same manner as linear rate-independent materials, except the constitutive equations are developed for incremental form. The plastic strain is estimated based on the concept of a yield surface which expands as the stresses are incrementally increased in the model in the region of the yield surface. The amount of deformation depends on the flow rules that are used to formulate the model. There are many flow rules that capture the different plastic behavior of materials, such as strain-hardening, during the plastic deformation.

Characterization of the load-deformation behavior of nonlinear rate-dependent materials requires the most sophisticated constitutive laws. Whatever forms are ultimately selected must be reducible, in some sense, to each of the three previous classifications⁵. Since the exact form of these constitutive models is dependent on the modeling approach and since there are so many modeling approaches, the various forms of constitutive models for nonlinear, rate-dependent materials that exist in the literature are not presented at this point.

Also pertinent to a discussion of material characteristics are the effects of aging and temperature. As materials age, their material properties change due to ongoing chemical changes and environmental effects. Aging and temperature effects are difficult if not impossible to address in a constitutive model of

the material behavior. Generally, the aging and temperature effects are considered in an incremental manner in mechanistic analysis. The following discussion will address these characteristics for each of the materials. Discussion of the mechanistic models in subsequent chapters will address how these characteristics can be included in an incremental manner for estimating the performance of the pavements.

1.2.2 Steel

Steel is used for pavement reinforcement and load transfer devices. Steel has a lattice structure composed of iron and carbon atoms with other alloying agents used to impart special properties. Compared to other materials used in pavements, the properties of steel are relatively easy to quantify. For the conditions encountered in pavement performance, steel is a linear elastic material. Structural design of the steel in pavements is relatively straightforward as Hooke's law applies and the modulus of elasticity and Poisson's ratio are well-defined.

Generally, corrosion is the limiting factor in the performance of the steel used for reinforcing and load transfer devices in pavements. Epoxy coatings can be used to limit the corrosion of reinforcing steel. Load transfer devices can either be epoxy-coated or made with stainless steel.

1.2.3 Portland Cement Concrete

Although there are many types of cement, and therefore many types of concrete, the generic term concrete almost always refers to a material made with portland cement, aggregates, and water. In many cases, admixtures, including fly ash, are used with these basic ingredients to augment the properties of the concrete. The material characteristics of the concrete are strongly dependent on the proportions of the ingredients or the mix design. Simply altering the amount of water in the mix without changing the quantities of the other ingredients will have a major effect on the properties of the hardened concrete. In fact if all other

factors are equal, the strength of the concrete will be determined by the water-to-cement ratio.

Concrete is classified as a ceramic material. The hydration process, or the chemical reaction between the cement and water, causes the growth of calcium silicate hydrate crystals⁷. The amount of water required for hydration is approximately 30% of the weight of the cement. Excess water that cannot react with the cement will result in capillary cavities in the matrix of the concrete⁸ and therefore reduces the strength of the concrete, increasing permeability. Unfortunately, the workability and flow requirements for construction dictate the need for water in excess of the amount required for hydration. Recognition of the presence of the capillary cavities in the concrete structure is important for understanding the failure mechanisms.

Concrete can be considered a three-component composite material consisting of the matrix, the aggregates, and the matrix-aggregate interface (halo interface). Due to the nature of the crystal growth, the halo interface is the weakest portion of the concrete⁹. According to Derucher and Korfiatis, bond microcracks form during the hardening of the concrete in the halo interface due to shrinkage. Under load, the bond microcracks widen at stresses in the range of 15 to 20% of the ultimate strength of the concrete, f'_c . As the stress increases, the bond cracks bridge each other at 20% of f'_c . At 75% of f'_c the microcracks in the matrix begin to bridge together. At 90% of f'_c microcracks form in the aggregates.

This progression of the microcracks explains, to some extent, the load deformation response of concrete. In general, concrete behaves as a nonlinear elastic material with a brittle failure when the compressive strength is exceeded.

The failure mode of concrete depends on the stress state of the material. Uniaxial compressive tests are generally used in concrete design and quality control tests to determine the

ultimate compressive strength. (Shear stress in the sample as a result of the compression loading is actually responsible for the failure of the material at the conclusion of the test.) However, concrete is much weaker in tension than in compression. Since pavements carry traffic loads in a flexural mode, the tensile-flexural test is usually used for the design and quality control of concrete used in pavements.

In addition to mechanical failures, many concrete pavements fail due to deterioration of the concrete as a result of environmental and chemical attack. Freezing water in the pores and cavities of the concrete expands about 9% producing hydrostatic pressure⁷. Generally, an air entraining admixture is added to the concrete to provide protection against freeze-thaw deterioration. Deicing salts and chemicals can increase the water retention of the concrete and contribute to recrystallization and weathering. These effects will cause the properties of the concrete to vary with time.

1.2.4 Asphalt Concrete

Asphalt cement is blended with aggregates to make asphalt concrete. (It should be noted that tar and asphalt are different materials and have very different properties. Tar is used in Europe for some pavements, but the use in the United States is limited to some specific applications. Tar will not be considered in this report.) The quality of the asphalt concrete depends on both the quality of the asphalt cement and the aggregate characteristics.

Asphalt cement is a high molecular weight hydrocarbon. Naturally occurring asphalt cement deposits exist, but they are primarily used for specialty asphalt products. By a wide margin, most of the asphalt used for pavement construction is the by-product of the reduction of crude oil. Due to the variety of crude oil sources and refining processes, the chemical composition and the distribution of the molecular weights of hydrocarbon chains are highly variable as compared to steel and portland

cement whose chemical compositions are carefully controlled. In fact, ASTM specifications for asphalt cement are written around physical tests of characteristics rather than chemical composition. The grade of the asphalt is evaluated with viscosity tests.

Aggregates have a major effect on the quality of the asphalt concrete. In asphalt concrete, the asphalt cement acts as a binder to hold the aggregates together. Stresses generated by traffic loads are transmitted through the aggregates by aggregate interlock and friction. Hence, the gradation, shape, and texture of the aggregates are important for the stability of the mix.

Asphalt concrete mix design consists of selecting the aggregate gradation and asphalt content required to meet design criteria such as the stability, flow, and void content. Stability and flow are measured with the Marshall apparatus. This is an empirical test method in that the results of the method are only meaningful relative to the experience of the agency using the test. Monismith, Epps, and Finn¹⁰ have proposed a new mix design procedure based on engineering measures of the asphalt concrete properties. One of the unique features of the methods proposed by Monismith, Epps, and Finn is simultaneous consideration of the mix design and pavement design. In other words, greater consideration of the application of the material needs to be included in the mix design process. The mixture properties that should be considered during mix design include:

1. mixture stiffness;
2. resistance to permanent deformation;
3. durability;
4. fatigue resistance;
5. low temperature response (including stiffness at long loading times and fracture characteristics); and
6. permeability.

With the exception of durability and permeability, Monismith, Epps and Finn recommend measuring the properties of the mixes in a form which permits mechanistic analysis. For example, they recommend measuring the stiffness as:

$$S_{mix}(t, T) = \sigma / \epsilon$$

where:

$S_{mix}(t, T)$ = mixture stiffness at a particular time of loading, t , and temperature, T

σ, ϵ = applied stress and resulting strain

Figure 1-2 shows the dependence of modulus on time and loading temperature and Figure 1-3 shows the ranges of stiffness under highway traffic loadings for three environments in the United States. These curves would be flattened out for runway operations where the duration of the load varies from slow roll to takeoff speed. These figures demonstrate that asphalt concrete is a nonlinear viscoelastic material. In other words, this is an example of the most complex material type discussed in the section on material characterization.

In addition to the effect of temperature on the stiffness, there are a variety of environmental effects on the properties of asphalt. Solar radiation evaporates off the lighter molecular weight molecules increasing the stiffness of the asphalt and reducing the flexibility. Oxygen from the atmosphere can bond with the asphalt at the surface of the pavement altering the qualities of the asphalt. Water can penetrate into the asphalt concrete and can lead to debonding of the asphalt and stripping of the aggregates.

Since asphalt is a petroleum product, fuel spills can soften or even wash away the asphalt. Obviously this will ruin the structural capacity of the material and is a primary reason for the use of portland cement concrete in the fueling areas.

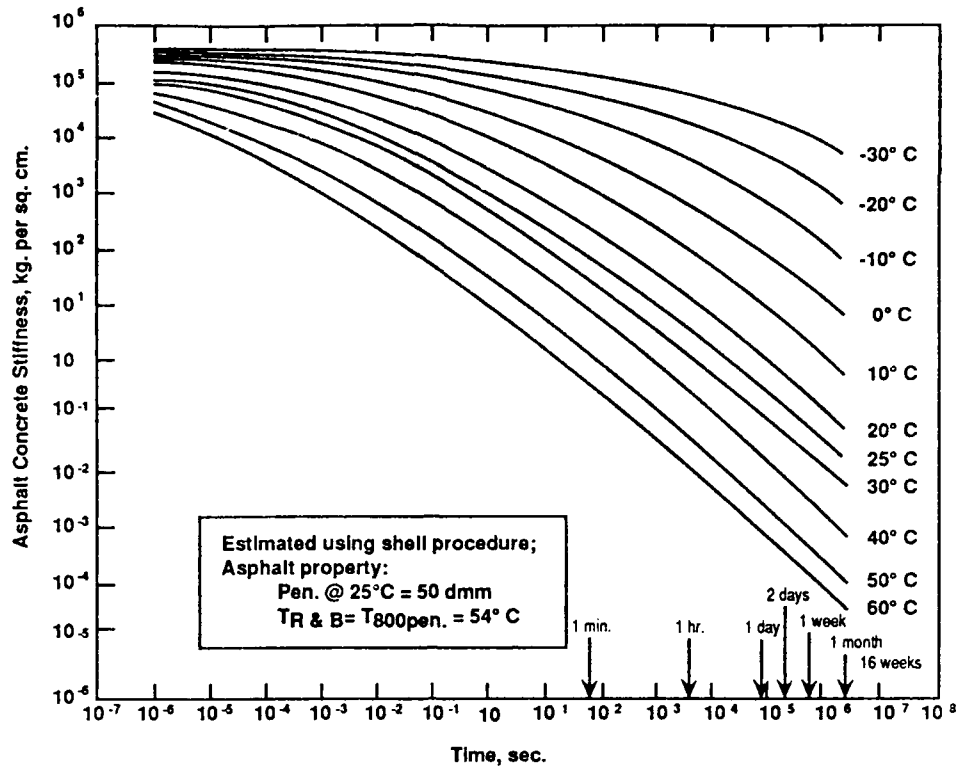

FIGURE 1-2. DEPENDENCE OF STIFFNESS ON ASPHALT CONCRETE TEMPERATURE AND TIME OF LOADING (MONISMITH, EPPS AND FINN)

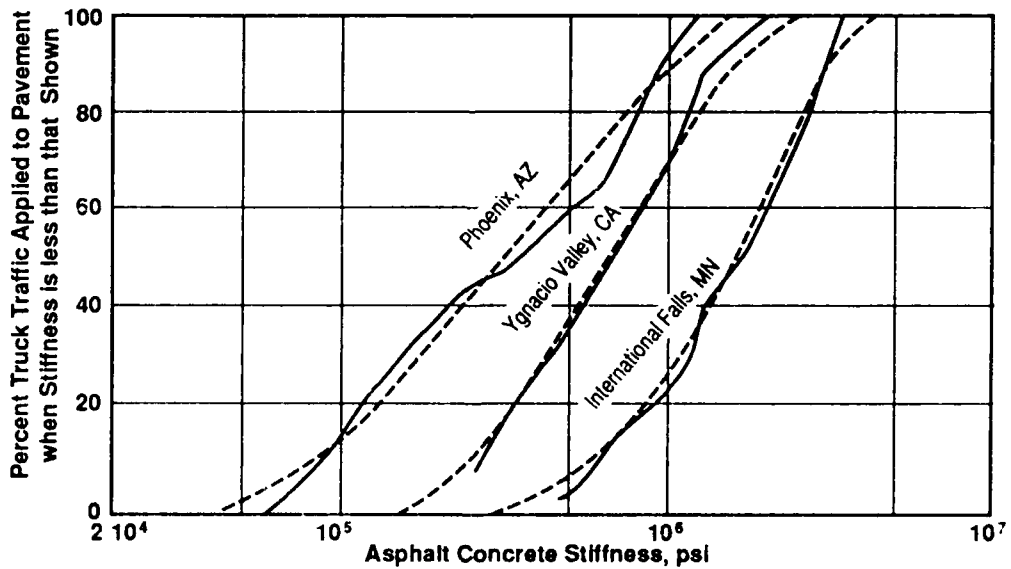

FIGURE 1-3. RANGE OF STIFFNESS UNDER MOVING TRAFFIC FOR ASPHALT CONCRETE DEPENDING ON ENVIRONMENT, 12-INCH THICK ASPHALT BOUND LAYER (MONISMITH, EPPS AND FINN)

The behavior of asphalt concrete is very complex and difficult to quantify. In the conclusion to an in-depth literature survey of asphalt material properties, Deacon¹¹ states:

This discussion indicates that one may characterize the behavior of pavement materials in numerous ways depending in part on the nature of the problem and in part on personal preferences. It must be emphasized, however, that in most cases pavement materials do not possess idealized properties and that the measured properties are often significantly influenced by the test procedures and equipment. It is important, therefore, for laboratory procedures to simulate to as great a degree as possible actual field loading conditions. Test procedures that result in nearly homogeneous stress and strain states are necessary to investigate the properties of a small volume element.

Although this statement was prepared almost 20 years ago, there is no evidence in the literature reviewed for this report indicating the situation has significantly changed.

Mamlouk and Sarofim¹² reviewed the state of the art in the measurement of asphalt concrete modulus for the design of pavement structures. There are two ASTM methods for determining the modulus of asphalt concrete: the complex modulus and the resilient modulus. The complex modulus uses measures of the strain response to a sinusoidal wave under uniaxial loading, as shown in Figure 1-4. The complex modulus is defined as:

$$E^* = \sigma_0 \sin(\omega t) / \{\epsilon_0 \sin(\omega t - \phi)\}$$

where:

E^* = Complex modulus

ω = angular frequency of the vibration

ϕ = phase difference between stress and strain

The resilient modulus is the other procedure for determining a modulus for asphalt. When asphalt is loaded and the load is

removed, most of the strain will be recovered (after sufficient conditioning), as shown on Figure 1-5. The resilient modulus is the ratio of repeated stress to the corresponding recoverable or resilient strain. The ASTM procedure for measuring resilient modulus uses a diametral test mode. Researchers have also used uniaxial and triaxial test modes.

1.2.5 Stabilized Materials

Granular materials can be stabilized with either portland cement, lime, or asphalt cement. Generally, the amount of cement used for stabilization and the specifications for the aggregate gradation are relaxed for the production of the stabilized materials. Therefore, the quality of the stabilized materials will not be equal to asphalt concrete or portland cement concrete. The functional behavior of these materials, however, is similar (e.g., cement stabilized bases are nonlinear elastic and asphalt stabilized bases are nonlinear viscoelastic).

1.2.6 Soils and Granular Materials

Aggregate bases are conglomerates of individual granular materials that meet specific gradation requirements. The properties of the granular materials depend on gradation, moisture content, density, stress state, and the aggregate shape and texture. Depending on the amount of fine material in the aggregates, they may be classified as either cohesive or cohesionless. From a general mechanistic response viewpoint, soils and aggregate materials can be combined into these two classifications.

The characteristics of aggregates and soils are strongly influenced by the moisture content. During construction, care is taken to compact these materials near the optimum moisture content. However, during the life of the pavement various mechanisms such as percolation of water through cracks in the pavement surface and capillary action tend to allow water to enter the base and the subgrade. As a result, many airport pavement foundations, even in arid regions, are near saturation for a major

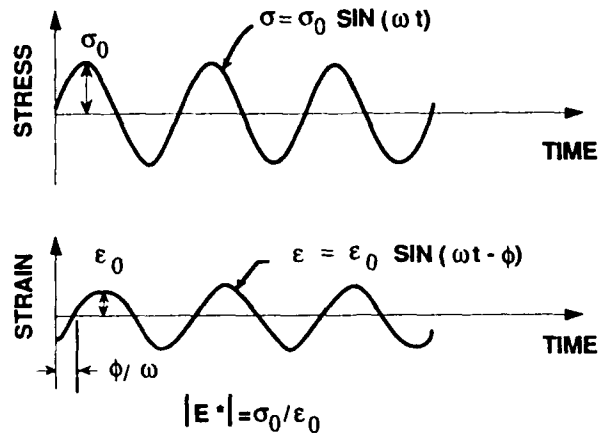

FIGURE 1-4. TYPICAL PLOT OF STRESS AND STRAIN VERSUS TIME DURING THE COMPLEX (DYNAMIC) MODULUS TEST (MAMLOUK AND SAROFIM)

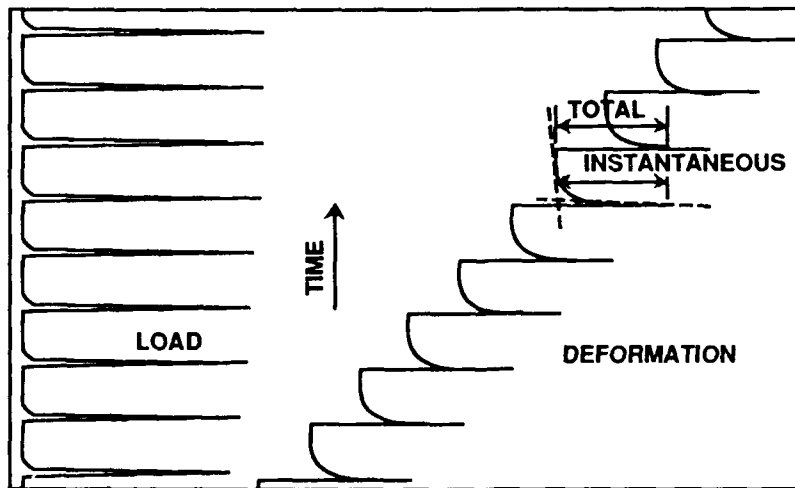

FIGURE 1-5. TYPICAL PLOT OF LOAD AND DEFORMATION VERSUS TIME DURING RESILIENT MODULUS TEST (MAMLOUK AND SAROFIM)

portion of the time. Many pavement design procedures recognize the problem with saturated bases, subbases and subgrades, and require material characterization be performed on saturated samples. Cedergren¹³ developed a damage factor for comparing the damage to pavements with saturated bases and subgrades to well-drained pavements. The damage factors ranged from 10 to 70,000. Cedergren also demonstrated that pavements can remain saturated for up to 20 days following a rainstorm.

1.2.6.1 Cohesive Soils - Deacon states that most investigators report the behavior of cohesive soils is highly nonlinear. Clays show immediate and time-dependent recoverable and permanent strains, the immediate strains being predominant under short duration loads and the permanent strain per cycle decreasing to an insignificant amount after many cycles of stress. Stress history may have a significant effect on the nonlinear response to load in two ways:

1. The stiffness of these materials is dependent on the initial stress state and increases as the effective mean principal stress increases.
2. The stiffness decreases with an increase in the incremental stress amplitude (increase of the deviator stress while maintaining the confining stress in the triaxial tests).

The effects of load, mixture features and environment on the stiffness of cohesive soils are summarized in Table 1-1¹¹. As this table indicates, the stiffness or load deformation characteristics of cohesive soils are very complex. In addition, cohesive soils can be cross isotropic (e.g., the horizontal stiffness can exceed the vertical stiffness).

1.2.6.2 Cohesionless Soils - The stiffness of cohesionless soils (sand) is affected by many of the same factors as cohesive soils.

TABLE 1-1. EFFECT OF INCREASING VARIABLES ON THE STIFFNESS OF COHESIVE SOILS (DEACON)

Variable	Effect on Stiffness	Remarks
Loading Number of cycles Incremental strain amplitude Effective mean initial principal stress Transverse stress Initial octahedral shear stress Frequency of loading Strain rate Overconsolidation ratio Stress path	Decrease Minimum Decrease Increase no effect effect negligible after 10 cycles Increase Effect minor above 10 cps Increase Increase	Minimum at 1 to 5000 cycles Rate of decrease depends on maximum stiffness and shear stress Effect depends on stress or strain amplitude no effect effect negligible after 10 cycles Effect minor above 10 cps Any effect can be explained on basis of effective pressure and void ratio Large dependency
Mixture Soil disturbance Void ratio Dispersion Structure Degree of saturation at compaction Plasticity Compaction Energy	Decrease Decrease Decrease Decrease Decrease Maximum	Maximum effect at low confining pressure At small strains Little effect on max. shear modulus Modulus of resilient deformation Impact compaction
Environmental Aging Degree of saturation Time (thixotropy) Densification Time (during secondary compression)	Increase Decrease Increase Increase Increase	Recovery after high amplitude cyclic loading or many load cycles Bentonite

However, the response to an increase in the number of cycles is different for cohesive and cohesionless soils. Table 1-2 is a summary of how the various factors affect the stiffness of cohesionless soils¹¹. Many investigators relate the stiffness of cohesionless soils to the mean effective stress σ_o as:

$$S = K \sigma_o^n$$

Where K and n are experimentally determined constants. Cohesionless soils, by definition, do not have tensile strength. However, they are probably more isotropic than other paving materials¹¹.

1.2.6.3 Untreated Granular Materials - The effects of various factors on the stiffness of granular materials are summarized in Table 1-3¹¹. The major effect is the initial confining pressure on the sample. The relationship between the modulus of resilient deformation, M_R , and the initial stress state is:

$$M_R = K\sigma_3^n$$

and

$$M_R = K\sigma_o^n$$

These equations are similar to the equations for cohesionless soil, except that σ_3 is the initial confining pressure in a triaxial test (rather than σ).

Deacon reported that one researcher, Hicks¹⁴ identified factors influencing Poisson's ratio of aggregate materials. Poisson's ratio increases with:

1. decreasing confining pressure;
2. increasing incremental stresses;
3. decreasing degree of saturation; and
4. decreasing fines.

TABLE 1-2. EFFECT OF INCREASING VARIABLES ON THE STIFFNESS OF COHESIONLESS SOILS (DEACON)

Variable	Effect on Stiffness	Remarks
Loading Number of cycles Incremental strain amplitude Incremental stress amplitude Load duration Load rate or frequency Initial effective Mean principal stress Initial octahedral shear stress cycles	Increase Decrease Decrease Decrease Constant Increase Decrease	Approaches a maximum Rapid decrease Pulsating loads No effect after the first few cycles Very small effect after 10 load
Mixture Void ratio	Decrease	
Environmental Degree of saturation	Constant	Effective stresses must be used

TABLE 1-3. EFFECT OF INCREASING VARIABLES ON THE STIFFNESS OF UNTREATED GRANULAR AGGREGATES (DEACON)

Variable	Effect on Stiffness	Remarks
Loading Number of cycles Initial confining pressure Initial effective mean principal stress Incremental stress level Load duration Load rate or frequency Drainage	Constant Increase Increase Constant to Increase Constant Increase Constant	After 50 to 100 cycles Triaxial compression Differences in literature, large effect if shear failure 0.1 to 0.25 sec. Small increase
Mixture Void ratio Angularity and surface roughness Fines Compaction water content	Decrease Increase Increase Decrease Decrease	At low moisture contents At high moisture contents Minor effect
Environmental Degree of saturation	Decrease	

1.3 AIRCRAFT CHARACTERISTICS

One of the primary differences between highway and airport pavements is the nature of the traffic loadings. Essentially, commercial airport pavements are designed for a fewer number of repetitions of heavier loads than highway pavements. However, the concept of fewer number of repetitions is a relative term. The 1974 FAA advisory circular for pavement design and evaluation (AC 150/5320-6B) had design curves for pavements receiving up to 25,000 annual departures. These curves were extrapolated in the 1978 report to cover up to 200,000 annual departures based on accelerated test data performed by the U.S. Corps of Engineers. However, Kohn and Bentsen¹⁵ report these test data were based on the equivalent of 17,400 passes of a dual-tandem gear. The Dallas - Ft. Worth Airport averaged 314,000 annual operations from 1974 to 1983 and Atlanta's Hartsfield Airport averaged 577,000 annual operations from 1984 to 1986.

Traffic loading factors that affect pavement analysis are:

1. total aircraft weight;
2. distribution of the aircraft load to the wheel assemblies;
3. geometry of the wheel assemblies and the distribution of the loads to the individual wheels;
4. characteristics of the tires, including inflation pressure;
5. lateral distribution of the load across the pavement structure;
6. duration of the load;
7. dynamic nature of the wheel loads; and
8. number of repetitions.

The first four parameters are defined by the design characteristics of aircraft. The other parameters are defined by the operational characteristics of the airport.

Aircraft characteristics are available in several references and are only briefly summarized here. As shown in Figure 1-6, there are three basic types of gear assemblies for civilian aircraft: single tricycle, single bicycle-tricycle combination, and double tricycle. The Boeing 727, McDonnell-Douglas DC-10 and the Boeing 747 respectively, are examples of each of these types of assemblies. There are several types of tire assemblies as shown in Figure 1-7. Nose gear assemblies are predominantly twin tire assemblies. The main truck assembly of the heavier aircraft are predominantly twin-twin tandems, e.g., B 747, B 707, DC 8 and some models of the L 1011 (model 1). The DC 10 has a twin-twin assembly under the wings and a twin gear in the center. The main truck of the lighter commercial jets, B 727, B 737 and DC 9 are twin tire assemblies.

The introduction of the wide-body aircraft greatly increased the maximum gross weight of aircraft during the 1970s. The Boeing 747-F is the heaviest civilian aircraft at 778,000 pounds. Boeing is in the process of developing a model of the B 747 estimated to have a maximum gross weight of 987,000 pounds.

Due to the load spreading effect of multiple gears and tires, the weight on the truck assembly and spacing of tires is of greater concern than the maximum gross weight of the aircraft. The DC-10-30 and 20 models have the highest maximum weight per tire of any civilian aircraft. These tires have a spacing of 54 inches whereas the B 727, also with a high tire pressure, has a tire spacing of 34 inches. This narrower spacing can result in a greater concentration of the stresses and in some cases the B 727 can actually cause greater damage to the pavement than the heavier aircraft.

The construction and pressure of the tire affect the contact stress on the pavement. In general, the contact pressure of

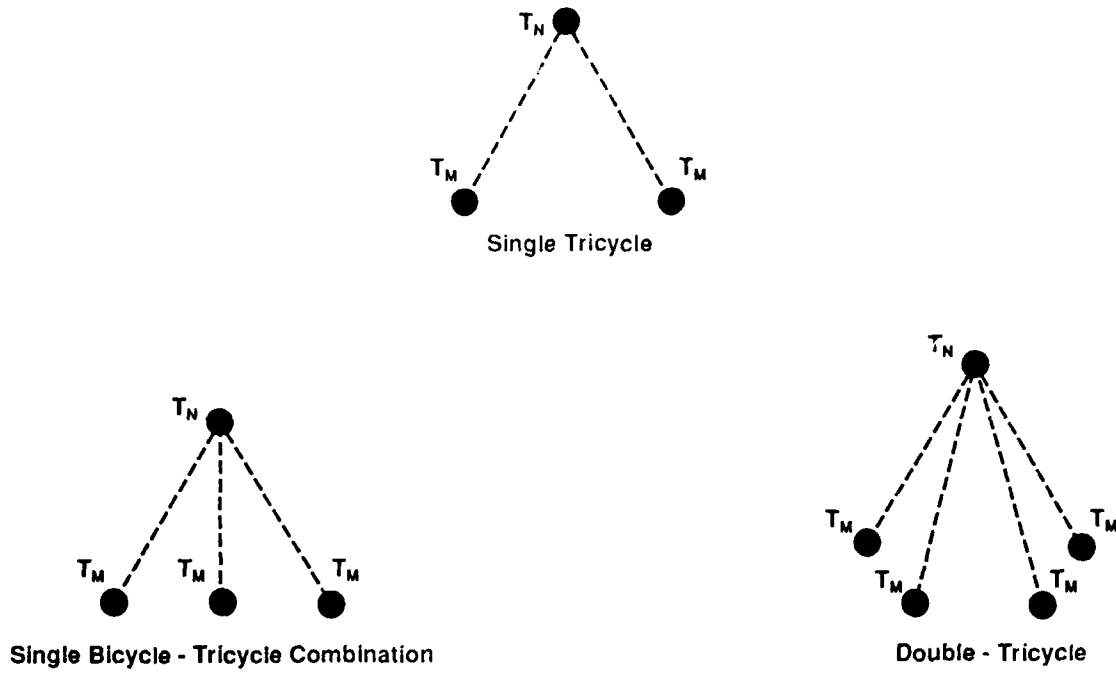

FIGURE 1-6. TYPES OF GEAR ASSEMBLIES ON CIVILIAN AIRCRAFT (SARGIOUS)

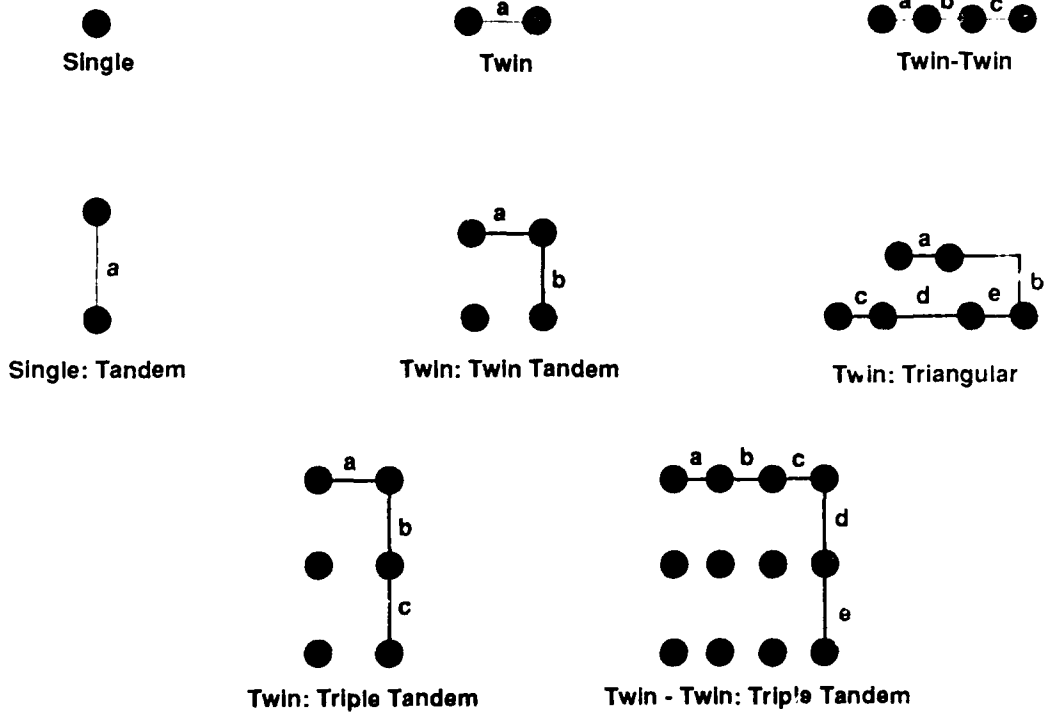

FIGURE 1-7. AIRCRAFT LANDING GEAR-TRUCK TYPES (SARGIOUS)

aircraft tires has the shape of an ellipse, as shown in Figure 1-8. The total contact area is determined as a function of the total weight on the tire and the tire pressure. Generally, the contact pressure between the tire and pavement is assumed to be uniform. Research has shown that contact pressure between truck tires and pavements is not uniform^{16,17,18,19}. The tire pressure of commercial aircraft tires is in the range of 100 to 180 psi.

1.4 FUNCTIONAL AREAS OF AIRPORT PAVEMENTS

Wignot et al.²⁰, as reported by Hightler and Harr²¹, developed Table 1-4 and Figure 1-9 to demonstrate the functional areas of aircraft activities. The majority of loads on an airport pavement are dynamic. Static loads only exist when the aircraft is parked. Horizontal loads are generated during turning and braking maneuvers. Turning maneuvers can be critical when the aircraft uses high exit taxiways as there is a transfer of load to the outer undercarriage of the aircraft gear. Dynamic loads are generated during the landing and takeoff operations.

Aircraft operations on runways, taxiways and aprons are highly channelized. Instruments on modern aircraft allow the pilots to accurately place the aircraft during landing. Due to lower speeds on taxiways, traffic is more highly concentrated. On aprons, care is taken to repeatedly place the aircraft at the same location to permit the concourse hookup. HoSang^{22,23} reported on the results of an FAA-sponsored study on the lateral distribution of aircraft at nine airports. Data were collected both day and night and for a range of winds and rain. HoSang reported the average offset to the nose gear from the center of the facility and the standard deviation:

Type of feature	Pavement width (m)	Average Offset (m)	Standard Deviation
Runway - landing	45.7	0.27 to 0.48	2.1 to 3.1
	61.0	0.27 to 0.70	2.7 to 3.4
takeoff	45.7	0.15 to 0.37	1.8 to 2.5
	61.0	0.70 to 0.76	2.3 to 2.5
Taxiway	22.8	0.64	0.76 to 1.2
	30.5	0.97	1.8
High speed exit	varies		2.4 to 3.2

TABLE 1-4. ACTIVITIES OF AN AIRCRAFT
IN ITS AIRPORT OPERATIONAL CYCLE (WIGNOT)

Departure	Arrival
Static (parked)	Landing impact
Low-speed taxiing	High-speed braking
Turning	Deceleration roll-out
Low-speed braking	Low-speed braking
Acceleration takeoff roll	Turning
Aborted takeoff roll (emergency operation infrequent use)	Low-speed taxi
Takeoff rotation	Static (parked)

Due to the width of airport pavements, edge loading is of less concern than it is on highway pavements. The outer wheels are usually more than 15 ft. from the pavement edge³.

The load duration of aircraft on pavements is highly variable depending on the functional class of the pavement. In the apron and maintenance areas, the aircraft are static for extended periods of time. On the runway, the load duration can be extremely short depending on the speed of the aircraft and the length of the tire contact area.

There is a complex interaction between the aircraft and pavement roughness. The aircraft characteristics that enter this interaction are weight, center of gravity, aerodynamic lift, landing gear configuration size and tire pressure (Wignot et al. cited by Hightner and Harr). The aircraft response to roughness continues for some time after its initiation causing the dynamic loads to vary. According to Hightner and Harr, the actual loads imposed on pavements defy anything more than qualitative description. These authors argue that pavement analysis methods that require precise knowledge of the induced loads have a small probability of success in predicting pavement performance. Ledbetter²⁴ reported on an experimental study of the effects of dynamic loads on airport pavements. Based on instrumentation of aircraft and pavements, Ledbetter reports:

1. None of the basic ground operations induced pavement responses greater than that for static loads, even when the dynamic load was 1.2 times greater than the static load.
2. Rough surfaces and stiff pavements could increase the importance of dynamic loads.
3. Elastic and inelastic responses of the pavement decrease at higher speeds.

4. High horizontal loads during turns produce responses that are temperature and rate of loading dependent.

1.5 ENVIRONMENTAL EFFECTS

As noted in the section on material characteristics, environmental conditions have a major influence on the characteristics of materials and the performance of pavements. The purpose of this section is to summarize the direct influences of the environment on pavements. The environmental factors that influence the pavement are rainfall or moisture, temperature and solar radiation.

Moisture in the pavement structure has the following effects:

1. concrete swell;
2. transport of the contaminants into cracks and joints;
3. reduction of the strength and stability of base, subbase and subgrade;
4. corrosion of reinforcing steel; and
5. promotes stripping of asphalt concrete.

Both low and high temperatures can have detrimental effects on the performance of pavements. High temperature produces the following effects:

1. expansion of concrete producing high compressive stresses at the joints and curling and warping stresses in the slab;
2. rapid curing of concrete;
3. softening of asphalt cement, reduction in the stiffness; and
4. reduction in the viscosity of asphalt cement contributing to bleeding.

Low temperatures promote the following effects:

1. widening of joints and cracks in concrete pavements;
2. thermal contraction stresses in both asphalt and concrete pavement;
3. increase on the modulus of asphalt concrete resulting in loss of flexibility; and
4. expansion of frozen moisture in concrete generating internal hydrostatic stresses in the pavement.

One of the most critical conditions that can develop in a pavement structure is the spring thaw process. Low temperatures freeze the moisture in the pavement structure. As the temperature rises, the pavement thaws from the top down. The ice in the lower areas of the pavement traps the water in the pavement structure greatly reducing its strength. Traffic on the pavement will then result in an excess amount of destruction to the pavement. The freeze-thaw problem is frequently the most damaging in moderate temperature areas where several cycles can occur annually.

The primary effect of solar radiation to pavement materials is the hardening of asphalt concrete surfaces. This is the result of volatilization of the light molecular weights portion of the asphalt cement, reducing the flexibility.

1.6 INTERACTION EFFECTS

Obviously the performance of pavements is a complex process affected by the interactions of the material properties, traffic loadings and environment. Static loadings on pavements softened by high temperatures can result in shoving and permanent deformation of the surface. Wheels crossing joints opened by low temperatures and subgrades saturated by moisture can cause thousands of times more damage than ideal conditions. Development of a uniform model of the performance of pavements must incorporate the combined effects of traffic, environment and materials, and their variation over the life of the pavement.

Methods are being developed that can be applied to the analysis of these complex interactions. Figures 1-10 and 1-11 demonstrate the results of pavement fatigue analysis that was developed at the University of Tokyo²⁵.

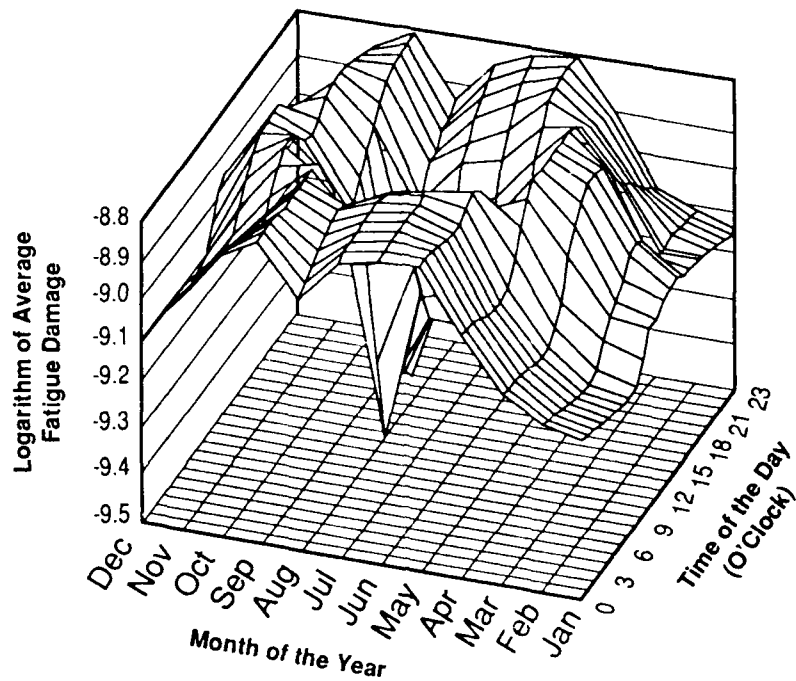

FIGURE 1-10. A STEREOGRAM OF CALCULATED MONTHLY AND HOURLY CHANGE OF FATIGUE DAMAGE OF ASPHALT PAVEMENT AT BOTTOM OF ASPHALT MIX LAYER (HIMENO ET AL.)

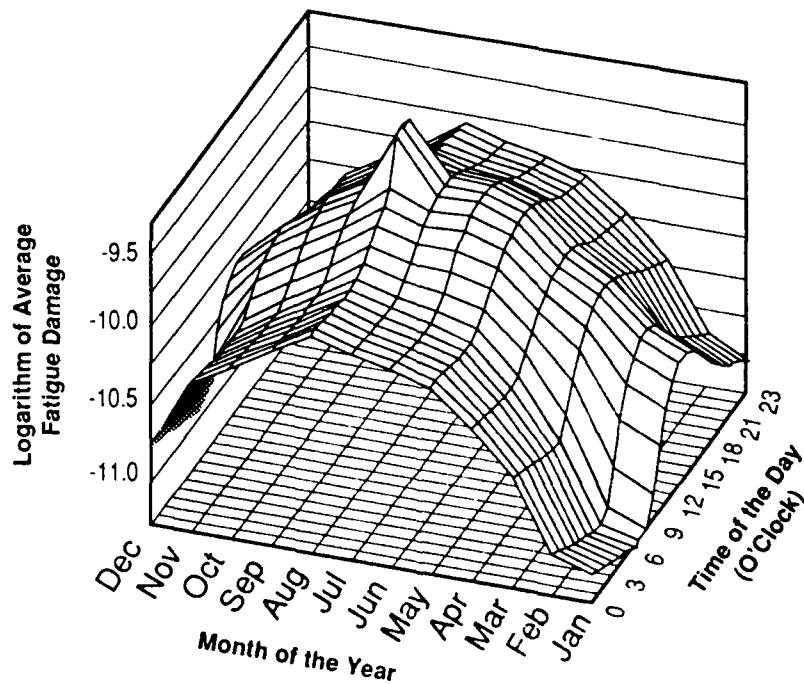

FIGURE 1-11. A STEREOGRAM OF CALCULATED MONTHLY AND HOURLY CHANGES OF FATIGUE DAMAGE OF ASPHALT PAVEMENT AT TOP OF ASPHALT MIX LAYER (HIMENO ET AL.)

2. A GENERAL FRAMEWORK FOR THE DESIGN OF AIRPORT PAVEMENTS

Traditionally, pavement design consists of the selection of layer materials and thicknesses. This straightforward task can be accomplished simply with any one of a number of pavement design procedures such as those reviewed in this paper. However, the straightforward application of these procedures have several drawbacks. There are vast differences between the actual performance of materials and the complexity of the traffic and environmental loading conditions, versus the simplifying assumptions used in the development of many airport pavement design procedures. Due to the complexity of the real-world conditions that affect pavement performance, the development of a pavement design method is a difficult task requiring a series of compromises between the true field conditions and the ability of engineers to develop accurate models and test methods to quantify their inputs. However, the development and verification of the models and test methods is a prerequisite for predicting pavement performance in the field.

It must be understood that the pavement design process is only one part of the universe of factors that affect pavement performance. Haas and Hudson²⁶ have defined six major classes of activities required for the management of pavements: 1) planning; 2) design; 3) construction; 4) maintenance; 5) pavement evaluation; and 6) research. As shown on Figure 2-1, these activities are interrelated and a failure to understand these relationships will affect the performance of the entire pavement system. For example, clearly the work of the pavement design engineer will be meaningless if the contractor fails to follow the design and specifications. Hence, a review of the pavement design methods, as a foundation for the development of a new method, must recognize the importance of the pavement construction, maintenance and evaluation process.

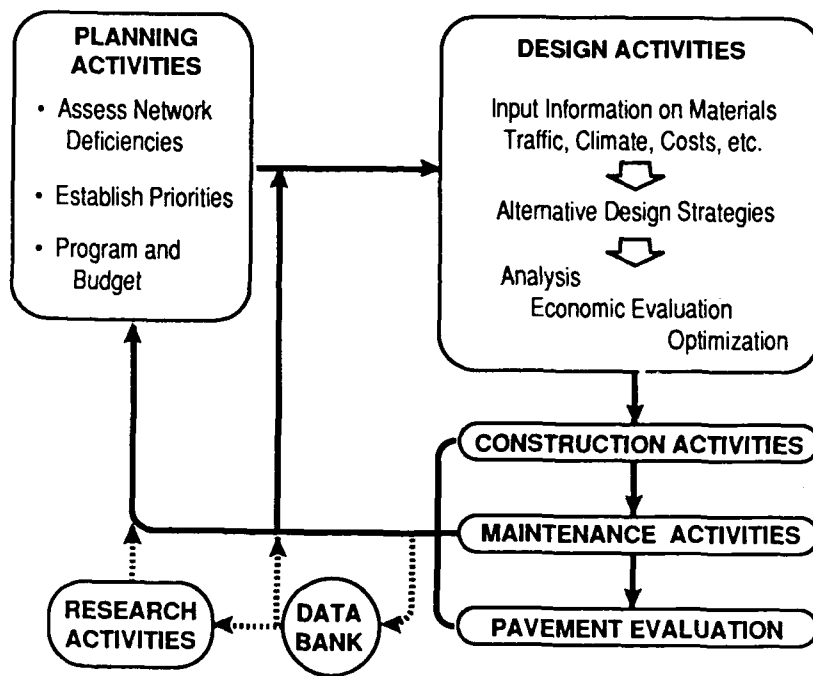

FIGURE 2-1. MAJOR CLASSES OF ACTIVITIES IN A PAVEMENT MANAGEMENT SYSTEM (HAAS AND HUDSON)

The main focus of this project is a review of pavement design and analysis methods. There are several pavement design methods available ranging from empirical procedures and guidelines to sophisticated analytical models. However, as shown on Figure 2-1, the design activities can basically be divided into three levels:

- 1) information needs relating to inputs, objectives, constraints, and so on;
- 2) the generation of alternative design strategies; and
- 3) the structural analysis, economic evaluation and optimization of the design strategies.

The three levels of pavement design activities are expanded in Figure 2-2²⁶. This figure is a generalized diagram of the activities required for many pavement design methods that are currently available, although not all of the design methods include all of these activities. Figure 2-3 presents a more specific formulation of the overall pavement design process formulated by Hudson and McCullough²⁷. The overall sequence of the pavement design process defined by McCullough and Hudson has been followed by several other researchers. Figure 2-4 defines the steps used by Gomez-Achecar and Thompson²⁸ at the University of Illinois, while Figure 2-5 presents a more detailed flow of the pavement analysis steps defined by Himeno et al.²⁴

The pavement design process consists of all of the activities shown in Figures 2-2 and 2-3. The top row of Figure 2-2 and the upper left portion of Figure 2-3 represent the information and analysis methods that should be available or acquired for the design process. Data on the available materials, expected traffic and climatic factors are often the first information items acquired. However, the specific data requirements are a function of the analysis model used in the design procedure. For example, traditional pavement design procedures use California Bearing Ratio (CBR) or plate bearing test results while mechanistic design methods require measures of the "elastic constants" of the materials.

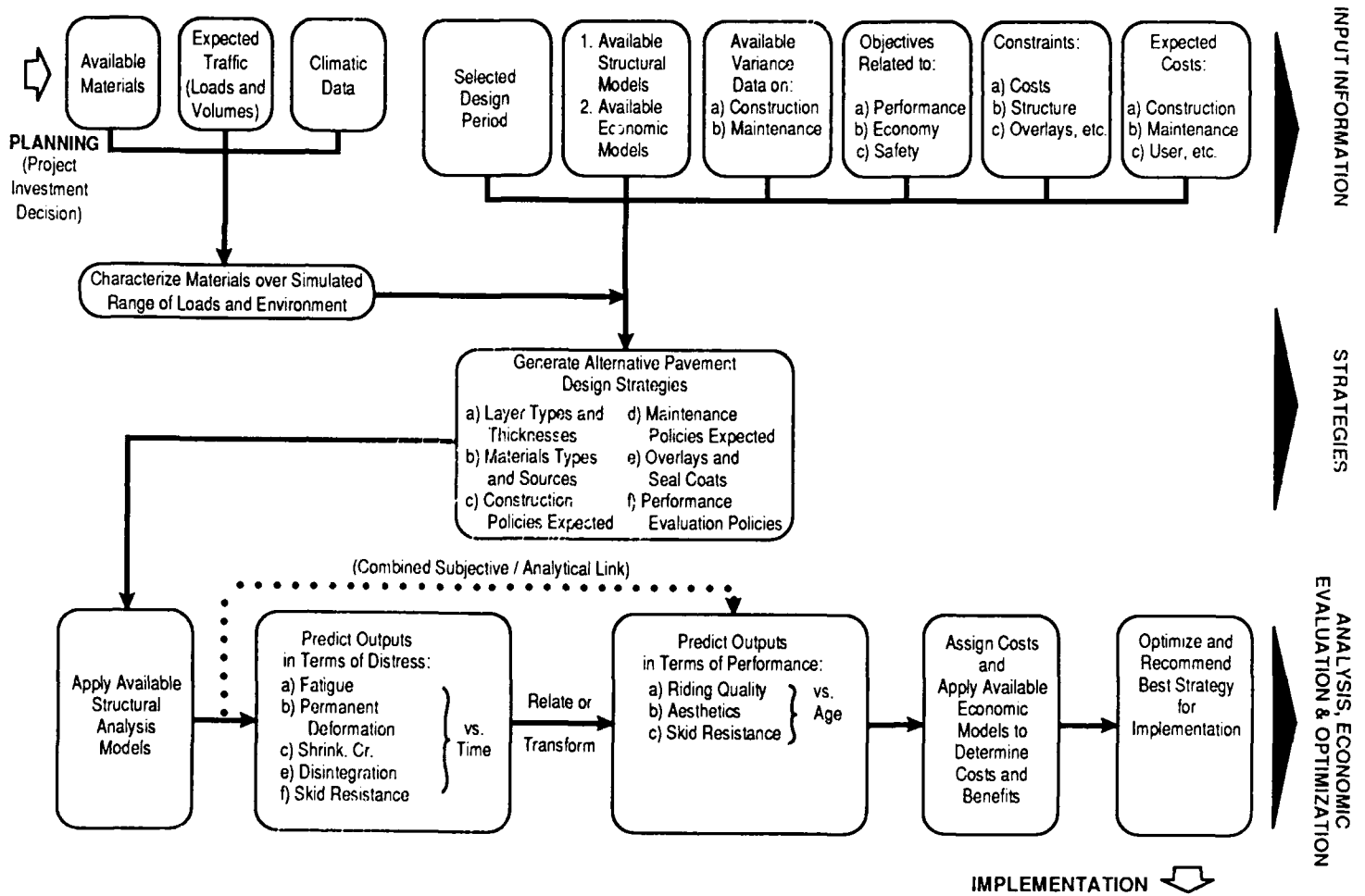

FIGURE 2-2. MAJOR PAVEMENT DESIGN COMPONENTS (HAAS AND HUDSON)

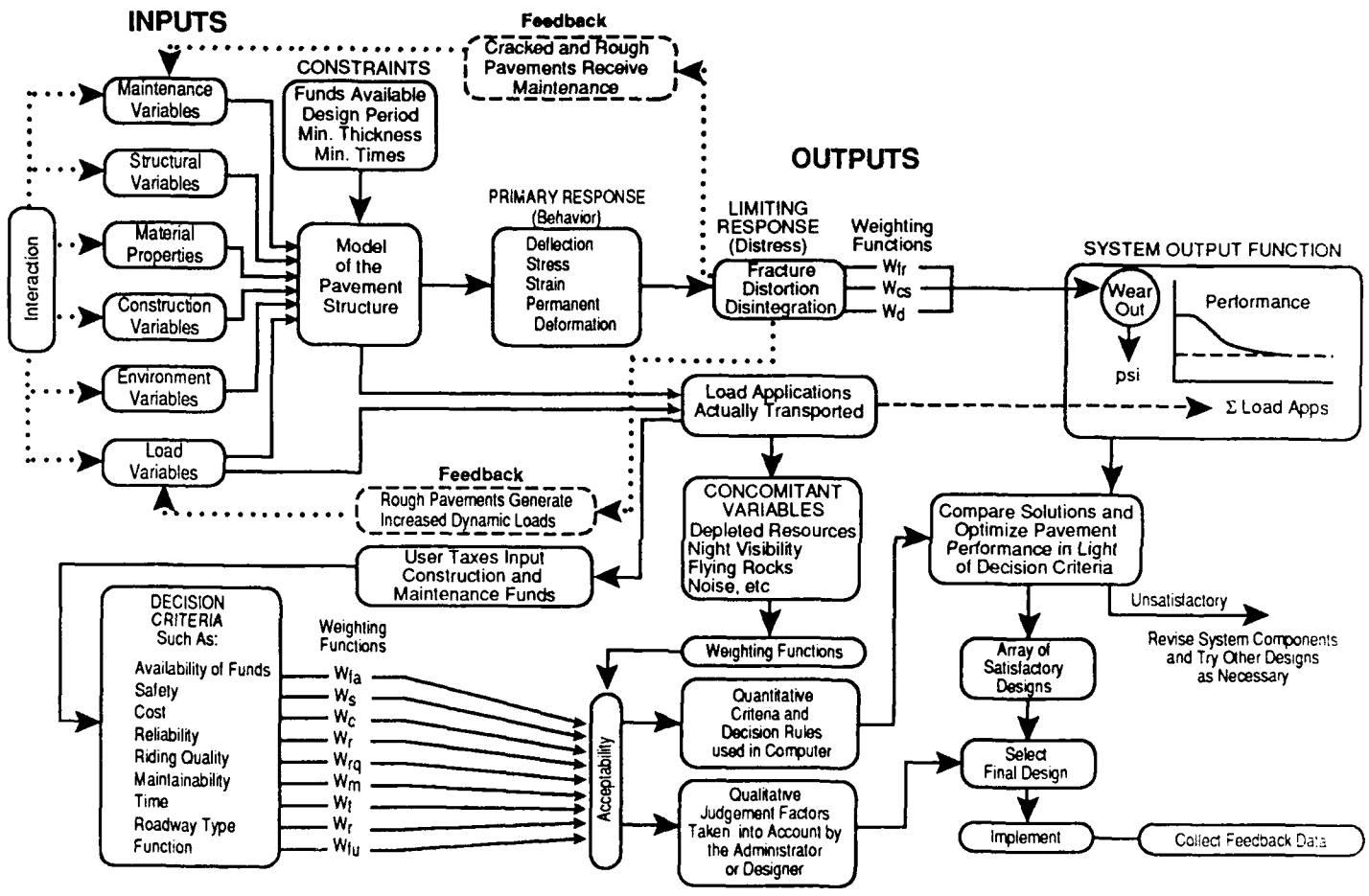

FIGURE 2-3. BLOCK DIAGRAM OF PAVEMENT DESIGN SYSTEM (HUDSON AND McCULLOUGH)

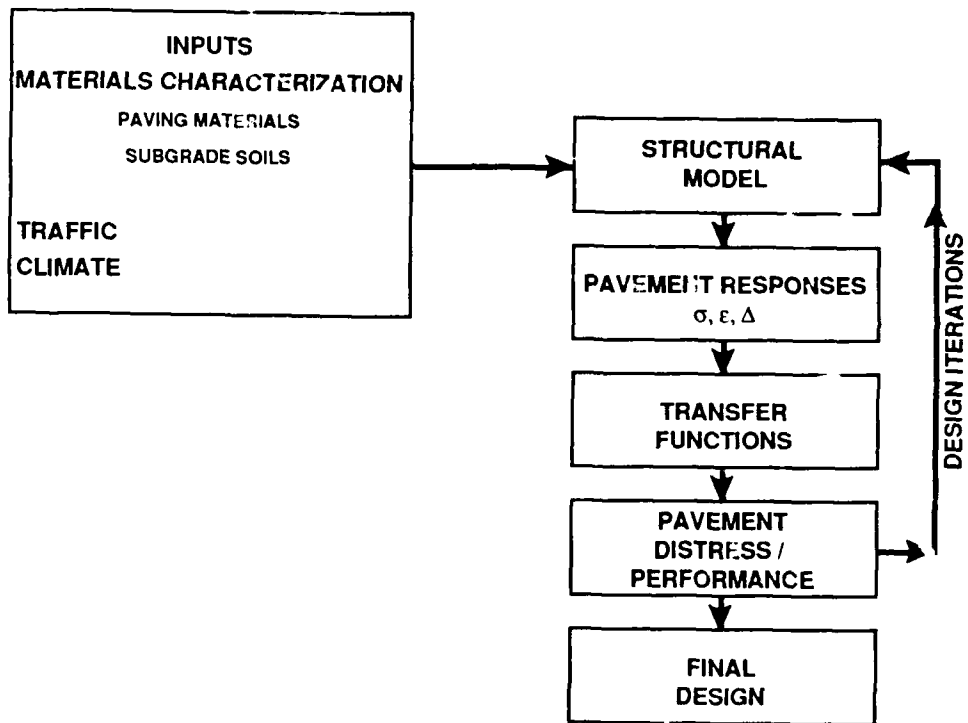

FIGURE 2-4. COMPONENTS OF A MECHANISTIC PAVEMENT DESIGN PROCEDURE (GOMEZ-ACHECAR AND THOMPSON)

While empirical pavement design methods were useful in their time, the dynamics of modern pavement design, including new materials, changing load conditions, and the need for greater reliability in the pavement design, have limited the utility of empirical methods. Thus, the focus of this project is on the development of mechanistic design methods. The primary distinction between the empirical and mechanistic methods is the use of traditional engineering analysis methods for estimating the performance of the pavements. The key feature of the mechanistic approach, as shown in the upper left portion of Figure 2-3, is the use of structural models of the pavement to predict the response of the pavement to traffic and environmental loading.

The central feature of a mechanistic analysis procedure is the structural model. Material characteristics and traffic and environmental loadings must be expressed in terms of the parameters required in the structural model. The structural model uses the input parameters to predict the primary response of the model in terms of stresses, strains and deflections of the pavement. However, these structural responses are not sufficient to predict the life of the pavement. Limiting response criteria are required for estimating distresses in the pavement as a function of the primary response of the pavement structure. As opposed to the majority of structures designed by civil engineers, pavements must be designed to withstand multiple load applications over an extended period of time. In other words, the limiting response or distress functions used for pavement design must capture the cumulative damage that results from the traffic and environmental loading and their interaction.

The basic idea of structural design, as stated by Sentler, is to ensure the load carrying capacity of the structure is larger than the anticipated loads that affect the structure²⁹. Although this concept is simple to state, it is difficult to quantify with theory and more difficult to translate into practice. Material characterization is largely performed with standardized test methods, but very few structural members fail in a way which

resembles a standardized test²⁹. Of particular concern is the long-term interaction between traffic and environmental loads and the characteristics of the materials. While the challenge is great, the application of advanced mechanistic models and test methods can be used to improve the state of the art in pavement design and yield greater reliability in the analysis.

3. ANALYSIS MODELS

The central feature of a mechanistic design method is the structural analysis model used for computing the response of the pavement with respect to the load and environmental inputs or stimulants. There are several excellent reviews of the various structural analysis models, such as those by Yoder and Witczak². In general these models can be separated into two groups: models for predicting traffic stresses and models for predicting environmental stresses.

The review of structural models poses a dilemma as to whether to strive for completeness of the theoretical aspects of the models or to address in broad terms the features and abilities of the models. The latter approach was selected for this review. A relatively brief review of the mathematical models would not be sufficient for those interested in the formulation of the models. Those interested in the models at this level of detail will be capable of retrieving the required information from the literature. Furthermore, the computer codes are available for all of the models described in this paper. This permits the application of the models by users without the mathematical sophistication required to understand some of the complex mathematical formulations. However, prior to application the users should understand the premise of the theories, the underlying assumptions, and be able to interpret the output of the models.

According to Nair³⁰, the formulation of mechanistic models of pavement response involves idealizing the real physical problem and casting it into mathematical form. The general mathematical form of pavement response models consists of a set of partial differential equations subjected to various initial and boundary conditions. The essential components of these models are the governing equations, constitutive equations, and boundary and

initial conditions. Nair describes the relationship of these components as:

For the analysis of pavements, the governing equations are the equations of equilibrium, motion (for dynamic problems) and compatibility. These equations are derived from the basic laws of classical physics and from continuity considerations in the material. Various approximations can be introduced at this level (e.g., small strains to obtain linearity and symmetry of the stress tensor). It should be recognized that the governing equations are independent of any material properties.

Constitutive equations are representations of the properties of the particular materials under consideration and represent idealizations of actual material behavior.

Boundary conditions may consist of prescribed displacements and stresses on various boundaries. (For thermal and hydro stresses it is necessary to define the temperature and moisture contents as functions of space and time.) For static problems this is sufficient: for dynamic problems it is necessary to specify the conditions at some arbitrary time, generally at $t = 0$, when they are called initial conditions. The governing and constitutive equations can only be solved in general terms; it is boundary and initial conditions that make the general solution specific for the problem under consideration. The boundary and initial conditions also represent various levels of idealization. For example, the actual time variation of load might be approximated by a simple analytic function (e.g., sine) or non-axisymmetric loads might be approximated by axisymmetric load distributions.

There are two basic approaches to the solution of the boundary value problems; analytical or classical methods and numerical or approximation techniques. The analytical techniques carry the development of the mathematical formulation of the problem as far as possible before resorting to numerical calculations. On the other hand, numerical techniques use a problem formulation directed toward a computational procedure from the outset³⁰. The elastic layer theory developed by Burmister³¹ and the thin plate solutions developed by Westergaard³² are examples of the analytical approach. Finite differences and finite element models are examples of the numerical approach.

Methods for the analysis of the pavement due to load will be presented first followed by a discussion of the models for analyzing environmentally induced stresses. The analytical solutions are the first load response models addressed including layer theories for elastic and viscoelastic materials and plate theory. This will be followed by a discussion of the finite differences and finite element numerical analysis methods. Models of environmentally induced stresses are then presented. The theories discussed in this chapter are for predicting the primary response (i.e., stresses, strains and displacements), of the pavements. Concepts for the analysis of the limiting response of the pavements (e.g., cracking) are discussed in the following chapter.

3.1 ELASTIC LAYER THEORY - STATIC LOADS

Burmister's solution of the elastic two-layer problem laid the foundation for the extension of the theory to multiple layers. The equations for the two-layer case are relatively simple and can be solved on a pocket calculator. However, the extension of the theory to multiple layers greatly complicates the problem and practical application of the theory requires computer analysis. Fortunately, there are several computer programs available for performing this analysis.

The general concept of elastic layer theory (ELT) is shown in Figure 3-1. Yoder and Witczak² state that the assumptions used for model development are:

1. homogeneous material properties;
2. finite layer thickness except for the bottom layer which is assumed to be infinite;
3. isotropic material properties;
4. full friction between the layers;

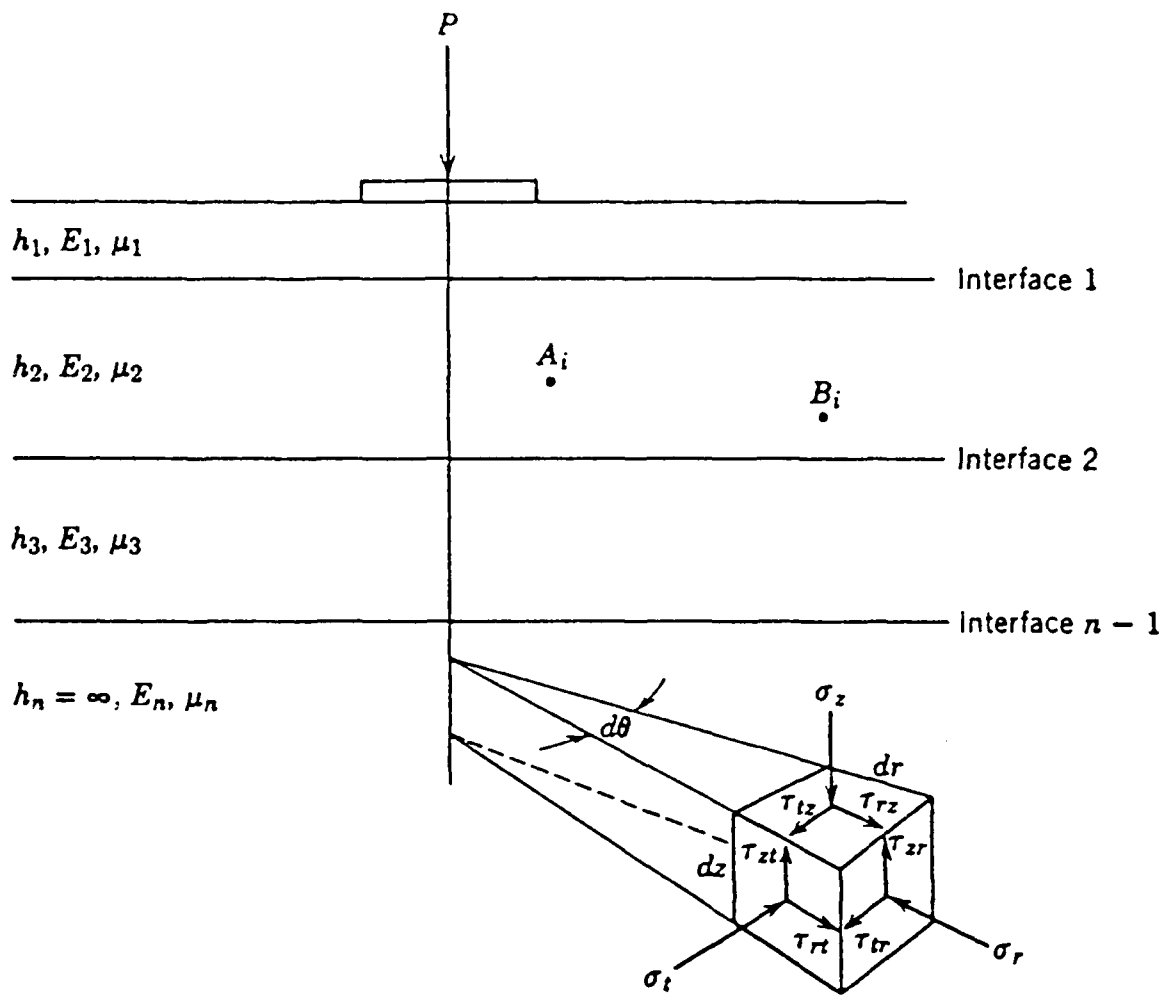

FIGURE 3-1. GENERALIZED MULTILAYER ELASTIC SYSTEM (YODER AND WITCZAK)

5. no shear stresses at the surface; and
6. materials are linear-elastic and obey Hooke's law, i.e., the constitutive behavior of the material is defined by the elastic modulus and Poisson's ratio.

In addition, the load is assumed to be uniformly distributed over a circular area and static. Some of these assumptions have been relaxed with the development of various elastic layer theory computer codes.

Strictly speaking, elastic layer theory is not always an accurate model of a pavement structure. Comparison of the material characteristics, pavement geometry, and traffic loading conditions described in Chapter 1 indicates that real pavement structures do not conform with the assumptions specified for the theory development. When the theory was introduced, engineers recognized the potential of the model, if properly applied, to improve the state of the art in pavement design. Numerous researchers investigated the effects of the differences between the theory and reality on the utility of elastic layer theory for pavement analysis.

Avramesco³³ concluded from a theoretical study that for elastic materials, if the speed of the load is a fraction of the Rayleigh wave velocity of the subgrade, the distribution of stresses and strains is equal to the static case. Comparison stresses and strains for a static load to values corresponding to vehicles with a speed of 270 mph resulted in a difference of less than 10%. Other studies reported at the Second International Conference on the Structural Design of Asphalt Pavement show that as the speed of the load increases, strains and deflections decrease and stresses increase. This is attributed to an increase in the modulus of asphalt concrete with decreasing load duration and stress relaxation with time. These studies suggest the assumption of static load can be compensated for by characterizing the properties of the asphalt concrete at a load duration equal to the field conditions.

Lister and Jones³⁴ studied the effect of nonuniform, noncircular loads and concluded that the net effect of these two assumptions resulted in an error of less than two percent under a whole range of realistic tire and load conditions. Gross overloading of a tire results in an error of about seven percent. Saraf et al.³⁵ concluded elastic layer theory overestimates the tensile strain at the bottom of the asphalt layer compared to a finite element analysis.

The principle of superposition is commonly used for the analysis of structures. Ahlvin et al.³⁶ presented experimental data supporting the use of this theory for pavement analysis.

McCullough³⁷ and Brown and Pell³⁸ concluded the assumption of continuity across the interface of the layers is valid for pavement analysis.

The assumption of infinite horizontal dimensions of the layers is a major drawback to the use of the model for pavement structures. Edges, joints and cracks in pavements increase the stresses generated by wheel loads. Since the interior loading condition is a more realistic assumption for flexible pavements than for concrete pavements. ELT has been more widely applied to flexible pavements.

Several investigators have demonstrated that the stresses and strains in a pavement are sensitive to the thickness of the subgrade. While determining the thickness of the subgrade is a concern, it is not a limitation of the model as a rigid layer can be simulated by using high modulus values to simulate the presence of a bed rock layer.

The material assumptions used in ELT are vastly different from the behavior of the material characteristics, especially for asphalt pavement. Therefore, there has been considerable research into the effects of these assumptions on the reliability of the

ELT analysis. Engineers that employ ELT for pavement analysis rely on measuring the material properties under simulated field conditions. Different test procedures will produce different measures of the material properties. This will result in different primary responses estimated by ELT and, therefore, when the primary responses are used in the limiting response functions, the prediction of distress may be in error due to the formulation of the analysis problem.

There are several computer codes for the solution of elastic layer theory equations. Three widely used programs in the United States are:

1. CHEV5L or LAYER developed by California Research Company³⁹, a division of Chevron Oil;
2. BISAR developed by Shell Oil Co.⁴⁰; and
3. ELSYM5 developed by Ahlborn⁴¹ at the University of California.

The Chevron program is capable of analyzing five layers and a single load. Input and output are in the radial coordinate system which complicates the interpretation of the data. The ELSYM5 program uses the same basic algorithm as CHEV5L for the solution of layer theory equations. However, an input and output processor are used to allow the use of rectangular coordinates. In addition to being more convenient to the user, the rectangular coordinate system permits the use of superposition to permit the analysis of multiple loads. ELSYM5 can analyze up to ten identical loads. As with CHEV5, ELSYM5 can analyze up to five layers. In addition, ELSYM5 permits the definition of a rigid layer under the five conventional layers. The interface at the rigid layer can be full friction or full slip.

The accuracy of these programs has been tested by several researchers with the conclusion that the programs faithfully perform the required calculations in most cases. However, there

are some problems near the pavement surface directly under the load. With respect to ELSYM5 Ahlborn states,

The program uses a truncated series for the integration process that leads to some approximations for the results at and near the surface and at some points out at some distance from the load.

The CHEV5L and ELSYM5 programs are widely available and are in the public domain. The Federal Highway Administration sponsored the modification of the program to operate on a microcomputer with a full screen editor for inputting the data. This program is available from the McTRANS⁴² Center at the University of Florida.

BISAR is the most powerful of the ELT programs. It can handle up to 10 layers and 10 different loads. Burmister's theory has been modified in this program to permit the analysis of shear loads at the pavement surface and varying interface continuity between the pavement layers ranging from full continuity to full slip. The mathematical techniques used in the BISAR programs are reported to be more sophisticated than the CHEV5L program⁴⁴. Shahin, Krichner, and Blackmon⁴³ demonstrated the application of the capability of the BISAR program for the analysis of slip between an overlay and the original pavement surface. Parker et al.⁴⁴ selected the BISAR program for use in a pavement design procedure developed by the Corps of Engineers. Reasons for this selection included the mathematical sophistication of the solution process and the ability to analyze varying interface conditions.

The capabilities of the CHEV5L program have been expanded by several researchers. Shahin⁴⁵ developed an iteration method for introducing stress sensitivity into the elastic layer theory analysis. Other modifications permit the analysis of up to 15 layers.

Zaniewski⁴⁶ compared the output of the three programs. As shown in Table 3-1, the surface deflection and horizontal strain at the bottom of the surface are equal for ELSYM5 and CHEV5L and are similar to the BISAR output. There are considerable differences in the computed strains at the top of the subgrade for the three different programs. Parker et al. also found significant differences in the computed deflections near the load although the stresses and strains were not very different between the BISAR and CHEV5L programs.

3.2 VISCOELASTIC LAYER ANALYSIS

There have been several theories proposed for the analysis of pavement structures. Aston and Moavenzadeh⁴⁷ reviewed the approaches to viscoelastic modeling, then continued with the development of the VESYS program for the Federal Highway Administration. The following discussion is based on information from Aston and Moavenzadeh. Viscoelastic models may be placed in two broad classes, rheological models and creep/relaxation functions.

The rheological approach uses discrete models of springs and dashpots in series and/or parallel to characterize the viscoelastic material behavior. Mathematical complexities arise when a large number of elements are used. Thus, models are limited to two to five elements that limit the ability of this approach to model the behavior of real materials.

Literature citations and comments by Aston and Moavenzadeh concerning the use of the rheological approach identified the state of the art in these models as of 1967 as:

Lee⁴⁸ illustrated the basic idea in his paper in 1955 with the solution for a fixed and moving point load on a viscoelastic half-space which was assumed to behave as a Voight model in shear, and to behave elastically in hydrostatic tension or compression. In 1961, Pister⁴⁹ presented the solution for a viscoelastic foundation under a uniform circular load where both the plate and the foundation were assumed to behave as incompressible

TABLE 3-1. COMPARISON OF ELASTIC LAYER THEORY PROGRAMS (ZANIEWSKI)

Pavement Properties	SECTION 1				SECTION 2				
	Thickness (in)	Modulus (psi)	Poisson's Ratio	Thickness (in)	Modulus (psi)	Poisson's Ratio	Thickness (in)	Modulus (psi)	Poisson's Ratio
Surface	2	128,000	.35	8	740,000	.30			
Base	10	20,000	.45	6	100,000	.35			
Subbase	18	40,000	.45	none	none	none			
Subgrade		14,490	.45		14,500	.45			
Computer Programs	Surface Deflection	Horizontal Strain Bottom of Surface	Vertical Strain Top of Subgrade	Surface Deflection	Horizontal Strain Bottom of Surface	Vertical Strain Top of Subgrade	Surface Deflection	Horizontal Strain Bottom of Surface	Vertical Strain Top of Subgrade
CHEV5L	$\times 10^{-3}$ 4.63	$\times 10^{-4}$ 4.23	$\times 10^{-5}$ -1.90 ²	$\times 10^{-4}$ 8.34	$\times 10^{-6}$ 7.99	$\times 10^{-5}$ -2.07 ²	$\times 10^{-4}$ 8.34	$\times 10^{-6}$ 7.99	$\times 10^{-5}$ -1.19
ELSYM5	4.63	4.23	-1.60	8.34	7.99	-1.59	9.24	7.26	-1.59
BISAR	4.75	4.22	-1.57	9.24	7.26	-1.59	9.24	7.26	-1.59
CRANLAY	1	1	1	-8.65	7.44	-1.46	-8.65	7.44	-1.46

¹CRANLAY not capable of this analysis in current form.
²Must be calculated manually from other output strains.
³Load, magnitude = 500 lbs, radius = 0.98 in.

Maxwell materials. In 1962, Pister and Westman⁵⁰ used a three-element model to characterize the behavior of a beam on a Winkler foundation, and analyzed this for a moving point load. Ishihara⁵¹ presented a solution in 1962 for a two-layer viscoelastic system in which he assumed that the layers were characterized as incompressible Voigt and Maxwell models. However, he examined the behavior only at zero and infinite times. Kraft presented an analysis of the deflection of a two-layered system in 1965 in which the layers were each composed of three-element models, and the volumetric behavior was assumed to be elastic.

Based on this review of the state of the art, Aston and Moavenzadeh rejected the use of the discrete rheological model approach in favor of the creep/relaxation method. Some of the limitations of the rheological models were attributed to limited computer capabilities at the time of the review. However, it appears the selection of the creep/relaxation method was selected based on the fundamental capabilities of the models rather than the computer capabilities.

Aston and Moavenzadeh attribute the development of the approach to Lee and Rogers⁵² who used numerical techniques suggested by Hopkins and Hamming⁵³. The model introduced by Aston and Moavenzadeh was refined and reported on by Moavenzadeh and Elliot⁵⁴. The viscoelastic model starts with the Burmister formulation of the primary response of the pavement system. Modifications are then introduced to model a limited time duration of the load and the viscoelastic form of the constitutive equation for the material characteristics. The creep compliance function used in this development was:

$$D_j = \sum G_i (e)^{-t} \delta_i \quad , \quad j = 1, 2, 3, \dots$$

where:

- D_j = the creep compliance function
- e = natural base
- t = time interval
- G_i = coefficient of the Dirichlet series
- δ_i = exponent of the Dirichlet series

G_i and δ_i require experimental determination of the complex modulus and the time temperature shift function of the asphalt concrete. Rauhut et al.⁵⁵ demonstrated that rutting predictions with the VESYS program developed for the Federal Highway Administration were very sensitive to these parameters. There have been several revisions to the VESYS model to refine capabilities. Hufferd and Lai⁵⁶ expanded the capabilities of the original program to include "N-layers" and reformulated the rut prediction procedure to reduce the complexity of the material characterization.

Khosla⁵⁷ described the inputs to the VESYS IIIA model as:

1. Geometry of the pavement system: the thickness of the first (N-1) layers with the thickness of the Nth layer being infinite.
2. Traffic loadings: number of 18,000 pound equivalent axle loads per day, intensity, and duration of loads.
3. Temperature: average seasonal temperature and winter design temperature.
4. Material Response Properties: modulus of resilience and Poisson's ratio of every layer for every season; these properties are needed in order to calculate the stresses, strains, and deflection response in a pavement system under the application of external loadings.
5. Material Damage Properties: fatigue coefficients of the surface layer and permanent deformation parameters of every layer; these coefficients and parameters together with the stress, strain, and deflection response in the pavement system are used to estimate the pavement damage in terms of cracking, rutting, and roughness under various stages of its life.

This list of input requirements demonstrates the VESYS model considers fatigue cracking as well as the rutting of the pavement from viscoelastic strains. The fatigue model will be addressed later.

Khosla concluded the structural subsystem of VESYS IIIA predicts pavement performance accurately and that the triaxial compression test can be used for measuring the material properties. In another paper presented at the same conference as the Khosla paper, Beckedahl et al.⁵⁸ criticized the ability of the VESYS model, particularly its characterization of the material properties. Beckedahl et al. proposed several improvements to the model including the development of procedures for capturing fluctuations in the material properties over the life of the pavement.

3.3 LAYER ANALYSIS - DYNAMIC LOADS

Research into the development of models that capture the dynamic nature of traffic loadings has been performed for many years. Many researchers have included dynamic analysis in models of viscoelastic behavior due to the need to include the duration and rate of loading for estimating viscoelastic deformations. Lattes, Lions, and Bonitzer⁵⁹ and Bastiani⁶⁰ presented analytical approaches for the calculation of the response of a pavement to dynamic loads. In both papers, extensive equations are presented for the dynamic analysis but numerical results are not available due to the complexity of the calculations and the lack of "large high capacity computers." Similarly, several authors at the Second International Conference on the Structural Design of Asphalt Concrete Pavements presented formulations for the dynamic analysis of pavements, including papers by Ishihara and Kimura⁶¹, and Perloff and Moavenzadeh⁶², and Avramesco³³.

Mamlouk⁶³ reported on the use of dynamic analysis of pavements, which is the source for the following discussion. Dynamic models capture the inertia components of the deflection of a pavement in response to moving loads. The simplest models use a single degree of freedom to represent the motion of the pavement while multiple degree of freedom models are more complete and necessarily more complex.

Single degree of freedom models developed by Weiss^{64,65} use a combination of masses, springs and dashpots to represent the pavement, as shown in Figure 3-2. The spring represents the stiffness of the pavement, the dashpot represents damping of the pavement materials and the mass represents the weight of the pavement. When a force is applied to the model, the mass deflects and may oscillate before coming to rest. Oscillations are a function of the relative magnitudes of the mass, spring stiffness, and dashpot dampening coefficient. If there was no mass in the system, there would be no vibration and, therefore, no dynamic response and the problem could be analyzed with static models. Since pavements have mass, there is an expectation of a difference in the dynamic and static response of the pavement. Although the single degree of freedom model considers the dynamics of pavement response, it is limited to vertical loads and responses. Thus, there is no consideration of the propagation of the response laterally through the pavement. Deflections at points away from the load cannot be modeled.

Earlier work by Szendrei and Freeme⁶⁶ presented a seven-parameter model of a pavement, as shown in Figure 3-3. This model uses a resistance component (Z_2 on Figure 3-3) to couple two masses, each with a spring and dashpot component. The researchers used a vibratory pavement deflection device to quantify the parameters of the model before developing equations for computing pavement response to an impulse traffic load. Data presented in the paper demonstrated good correlation between the pavement model and measured response.

A multidegree of freedom model can capture the inertial effects in three dimensions. Dynamic wheel loads are represented by a series of half sine waves. The wave (transient) mode of loading is represented by a series of harmonic loadings with different frequencies and magnitudes using Fourier transformations. Once the pavement response to harmonic loading as a function of the frequency and magnitude is evaluated, the response to any wave can be obtained.

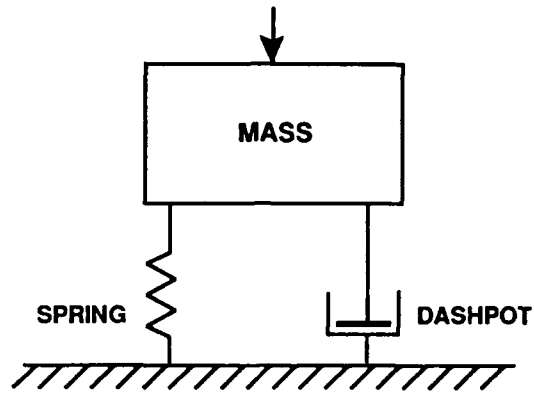

FIGURE 3-2. SPRING-DASHPOT SINGLE DEGREE OF FREEDOM PAVEMENT MODEL (MAMLOUK)

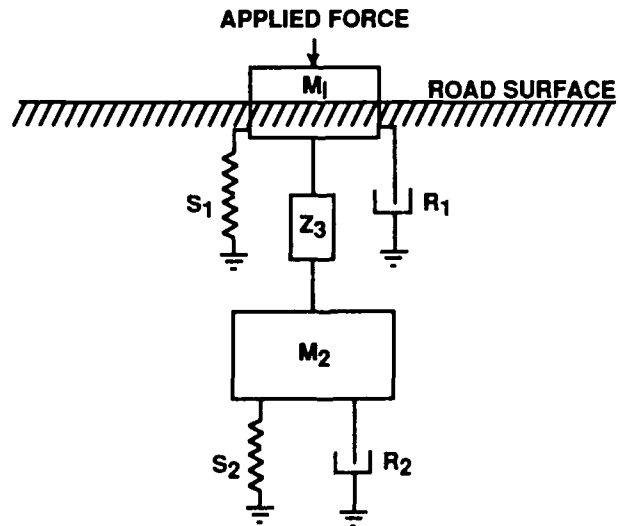

FIGURE 3-3. COUPLED MECHANICAL MODEL WITH SEVEN PARAMETERS (SZENDREI AND FREEME)

The single degree of freedom model considers the dynamics of pavement response, it is limited to vertical loads and responses. Thus, there is no consideration of the propagation of the response laterally through the pavement. Deflections at points away from the load cannot be modeled.

The governing equation for steady-state elastodynamics is the Helmholtz function⁶⁷ written in tensor form as:

$$(\mu)u_{i,jj} + (\epsilon + \mu)u_{j,ij} + \rho\omega^2u_i = 0$$

where:

ϵ, μ = Lamé's constants

ρ = mass density

ω = angular frequency of excitation and

u_i = i^{th} Cartesian component of the displacement vector

In the equation, the Cartesian indicial notation is assumed in which the subscripts range from 1 to 3, addition is implied over repeated subscripts and a comma denotes differentiation with respect to the space variable, i.e., $u_{i,j} = du_i/dx_j$. Thus, this tensor form differential equation is a short representation of a number of regular differential equations. The time displacement is also assumed to be a time harmonic.

Analytical or closed form solutions are not available for the solution of the displacement equation for layered systems. Kausel and Peek⁶⁸ developed a numerical solution, in the form of a computer model, based on the assumption that the displacement field is linear in the direction of layering between adjacent interfaces. This requires use of sufficiently thin layers to ensure the validity of this representation. This may require subdividing the pavement layers for the purposes of analysis.

The Kausel and Peek program computes displacements. This program was modified by Sebaaly⁶⁹ to include the calculation of stresses and strains.

3.4 THIN PLATE THEORY

As opposed to flexible pavements which distribute the load gradually through the pavement structure, rigid pavement slabs act as a structural element (a plate) resting on an elastic foundation. Since the deflection of rigid pavements is small relative to their thickness, they can be analyzed as thin plates³. The following approximations are required for the development of thin plate models:

1. There is no deformation in the middle plane of the slab; this plane remains neutral.
2. The planes in the slab initially normal to the middle plane of the slab remain normal after bending.
3. The normal stresses in the direction transverse to the plane of the slab can be ignored.

Sargious reports that the differential equation describing the deflected surface of a slab subjected to a uniform load was developed by LaGrange in 1811, and identifies Westergaard^{70,71} as the first to develop a theoretical solution for rigid pavement design. Sargious identifies the assumptions used in the development of the Westergaard equations as:

1. The concrete slab acts as a homogeneous elastic solid in equilibrium.
2. The reaction of the subgrade is solely vertical, and proportional to the deflection of the slab.
3. The reaction of the subgrade per unit area at any given point is equal to a constant, K (modulus of subgrade reaction), multiplied by the deflection at that point.
4. The thickness of the slab is uniform.

5. The load at the interior and at the corner of the slab is distributed uniformly over a circular contact area; for the corner loading the circumference of this circular area is tangential to the edge of the slab.
6. The load at the interior edge of the slab is distributed uniformly over a semicircular contact area, the diameter of the semicircle being along the edge of the slab.

Although not commonly stated, it should be noted that Westergaard also assumed a static load condition. Based on these assumptions, Westergaard developed equations for computing the stresses in the slab for the following cases:

1. Maximum tensile stress at the bottom of the slab due to central loading.
2. Maximum tensile stress at the bottom of the slab for an interior edge loading in a direction parallel to the edge.
3. Maximum tensile stress at the top of the slab in a direction parallel to the bisector of the corner angle for corner loading.

Subsequently, Westergaard modified the equations specifically for the analysis of airport pavements assuming elliptical load areas and load transfer across the joint or edge of the pavement. In 1951, Pickett presented equations for "protected" and "unprotected" corners. The Westergaard equations are widely used for the design of concrete pavements. Pickett and Ray⁷² developed influence charts for the solution of these equations and Packard^{73,74} incorporated them into a generalized program for the design of portland cement concrete pavements.

3.5 NUMERICAL METHODS

There are two basic numerical techniques that can be applied to the analysis of pavement structures: finite differences and finite elements. The application of finite difference methods for the analysis of rigid pavements was developed at the University of Texas in the 1960s and several successful computer programs were

produced⁷⁵. However, advances in the finite element method (FEM), along with the development of more powerful computers, have led researchers to concentrate on the development and application of the finite element method in preference to the finite difference method. This fulfills the prediction of Nair who stated in 1971,

The finite difference technique has been used fairly extensively in the analysis of plate problems. However, because of the difficulties in handling corners and because of the physically motivated formulation of the finite element method, most of the new developments in the analysis of plate problems are likely to be with the use of finite element techniques.

Several researchers have developed finite element computer code for a wide variety of pavement analysis problems. Due to the flexibility of the method, the applications will probably continue to grow. The flexibility of the FEM stems from the basic definition of the method as "a computer-aided mathematical technique for obtaining approximate numerical solutions to the abstract equations of calculus that predict the response of physical systems subjected to external influences"⁷⁶.

This is a very broad definition of the finite element method and is not necessarily common to all engineers that work in the area of numerical analysis methods. For example, Ioannides⁷⁷ developed a numerical analysis method for evaluation of slabs on grade that meets the Burnet's FEM definition, yet Ioannides claims the method is not a finite element solution.

Under Burnet's definition, FEM is not so much a model per se but rather an analytical technique for solving a problem once the proper equations have been formulated. However, use of the FEM required formulating the problem in a specific manner to promote the development of an accurate solution. Burnet points out that most people's contact with FEM will be as users rather than as developers of computer programs. Users do not become directly involved with the underlying mathematics. However, experience has

shown it is difficult to be an effective user of an FEM program without understanding some of the basic concepts and mathematical techniques employed by the method. In this vein, the Burnet's description of the salient features of every FEM is presented followed by a description of various applications to pavement analysis.

Burnet defines the system as the subject of the model; generally, but not always, the system is a physical object, such as a specific section of pavement. The domain is the region of space that is occupied by the system. It may also be an interval of time during which there are changes in the system. The governing equations describe a conservation or balance of a physical property such as mass, momentum, or energy. They may be differential or integral equations or constitutive equations that describe material behavior; these equations contain experimentally determined physical properties of the materials that constitute the system. Loading conditions are externally originating forces, temperature, etc., that interact with the system causing the state of the system to change. Loads acting in the interior of the domain (interior loads) are included in the governing equations. Loads acting on the boundary of the domain (boundary loads) appear in separate equations called boundary conditions.

The domain of the problem is divided into smaller regions called elements. The shapes of the elements are simplified as much as possible. The entire mosaic-like pattern is called a mesh. Mesh generation is generally performed by a preprocessor to the finite element analysis program based on the geometry of the domain and the accuracy of the required solution. There is a direct tradeoff between mesh size, accuracy of the solution, and the amount of computer time required for the solution.

In each element the governing equations, usually differential or variational form, are transformed into algebraic equations, called element equations, which are an approximation of the

governing equations. Algebraic equations are much easier to work with than calculus equations. Derivation of the element equations is a theoretical procedure performed by the analyst or program developer. The element equations are algebraically identical for all elements of the same type. Consequently, element equations usually need to be derived for only one or two typical elements, not every element in the mesh. In addition, since the element geometry is simple, derivation of the equations is usually straightforward. The analytical effort for the entire problem has been reduced to deriving a few algebraic equations for usually only one or two small elements.

The terms in the element equations are numerically evaluated for each element in the mesh (internally by the computer program). The results are assembled into a set or system of algebraic equations. This system of equations characterizes the response of the entire system and generally constitutes a very large number of equations. However, the solution of the equations is economical because the matrix of coefficients is "sparse."

The boundary conditions, including the external loadings, are then imposed by modifying the system equations. This involves adding values to existing terms and/or shifting terms from one side of the equations to the other.

Numerical analysis techniques are then applied to the solution of the equations. These techniques have been refined to take advantage of the formulation of the FE system equations to provide efficient solutions.

Post processing displays the solution of the equations in tabular, graphical or pictorial form. Post processing can also include the derivation of other meaningful quantities from the solution.

Much of the work described above needs to be performed only once, when developing the computer program. Application of an existing program requires supplying specific data on the constituent constants, mesh generation commands, and output specifications. Due to the popularity of FEM, there are many commercially available programs that provide a wide variety of capabilities.

Duncan, Monismith and Wilson⁷⁸ demonstrated the use of the linear elastic finite element model SAP for the analysis of pavements in 1968. Pichumani⁷⁹ compared two finite element programs with elastic layer theory models and concluded the models were almost identical with regard to stresses and strains, but there were slight differences in the computed deflections attributed to the differences in the boundary conditions. The FEM applications by these authors did not offer any advantage over the analytical solutions to elastic layer theory. However, they did demonstrate the applicability of this approach to the analysis of pavements.

Subsequent applications in the use of FEM for the analysis of pavements have permitted modeling of more complex material characteristics and pavement geometries than is possible with the analytical solution methods developed by Burmister and Westergaard. The FEM procedure has become very popular and there are numerous publications regarding its application. The following paragraphs discuss a number of these publications.

Raad and Figueroa⁸⁰ presented an FEM, ILLI-PAVE, for the analysis of flexible pavements. Gomez-Achecar and Thompson²⁸ summarize the characteristics of this model as:

1. an axisymmetric solid of revolution, e.g., Figure 3-4;
2. nonlinear, stress-dependent resilient modulus of layer materials; and

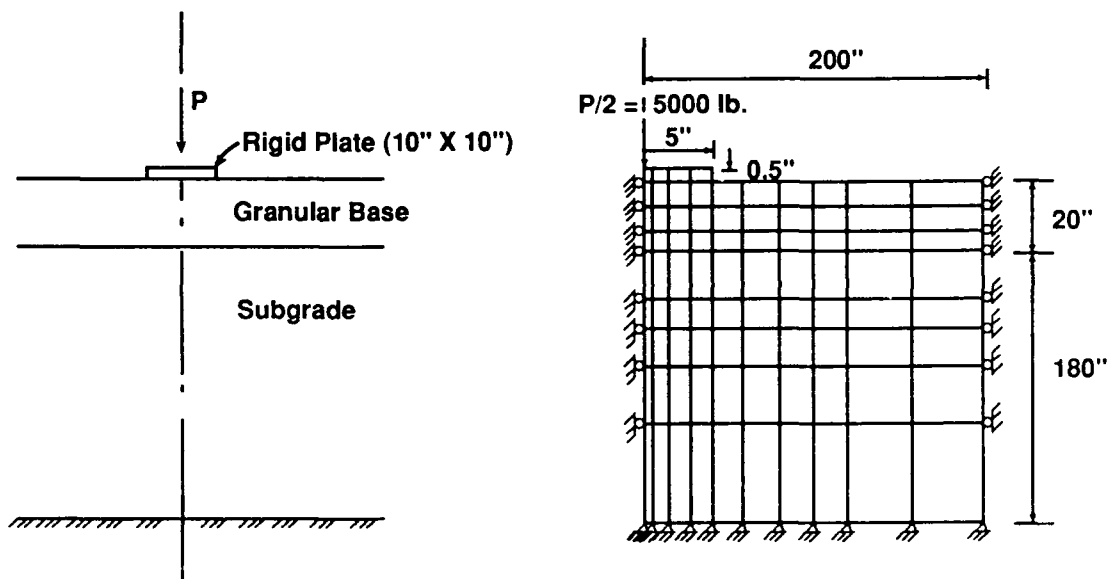

FIGURE 3-4. AXISYMMETRIC FINITE ELEMENT MODEL OF TWO LAYER SYSTEM (GOMEZ-ACHECAR AND THOMPSON)

3. limits on the principal stresses in granular and fine-grain soils so that they do not exceed the Mohr-Coulomb theory of failure.

Gomez-Achecar and Thompson report that several authors have tested the validity of the ILLI-PAVE program with favorable results.

MICH-PAVE, a nonlinear-anisotropic FEM for the analysis of flexible pavements was developed at Michigan State University⁸¹. The axisymmetrical formulation is capable of calculating stresses and strains and the surface deflections developed in a pavement section due to a wheel load.

Smith and Yandell⁸² present a discussion of a "mecho-lattice" FEM of elasto-plastic behavior applied to flexible pavements. This model considers different modulus values for the soil support in the loading and unloading modes. A dampening factor is used to capture the plastic behavior of the material. Transient wheel loadings are modeled by transferring the load across the surface nodes. Unbound material behavior can be modeled by permitting cracks to form when tensile stresses are computed in the material. The boundary conditions are described as follows:

All the joints on the top surface are free to move. Since the sides and approached end cross section are often within the deflection bowl, the theory of linear elasticity is used to designate boundary deflections. Provision is made for lateral and longitudinal continuity for each layer with plastic hystereses on the sides. The main conditions to be satisfied for the passed end cross section is that the residual longitudinal strain must equal zero whilst still allowing flow; also the vertical and lateral strain must tend not to vary at points that vary in the longitudinal coordinate only.

Lim and Yandell⁸³ used the mecho-lattice analysis procedure to reevaluate the Shell pavement design criteria. In this work, residual stresses were considered for the determination of rutting and fatigue cracking.

Sargious³ and Wang, Sargious, and Cheung⁸⁴ presented a general description of FEM for the analysis of concrete pavements. The foundation for the slab is modeled as either an elastic continuum or as a Winkler foundation. The differences in these foundation models are shown in Figure 3-5. The Winkler foundation, as also used in the Westergaard solution, consists of a series of springs having a constant modulus of reaction, K . The reaction of subgrade per unit area at any point is proportional to the vertical deflection at that point, but independent of the vertical deflection at any other point. The elastic continuum foundation is considered as an idealized half space. The flexibility matrix for the foundation is obtained by determining the deflections at all points for each location of a unit vertical point load.

The stiffness matrix of the foundation is obtained by inverting the flexibility matrix. It is then combined with the slab matrix to obtain the complete stiffness matrix.

Chou⁸⁵ describes two programs developed by the Corps of Engineers with similar formulation and capabilities. These are known as the WESLIQID and WESLAYER programs. Use of these programs to investigate the contact pressures under rigid pavements led Chou⁸⁶ to conclude subgrade support has a greater influence on pavement life than is indicated with the Westergaard formula.

The ILLI-SLAB⁸⁷ and FEACONS⁸⁸ are FEMs developed specifically for the analysis of rigid pavements. FEACONS uses a three-slab model as shown in Figure 3-6. The middle slab is of interest in the analysis; the outer slabs establish boundary conditions. A concrete slab is modeled as an assemblage of rectangular plate bending elements with three degrees of freedom at each node. The slab can be homogeneous or a composite slab consisting of two layers bound together. The subgrade is modeled with a Winkler foundation. Load transfer across the joints are modeled by shear and torsional springs. Frictional effects at the edges are

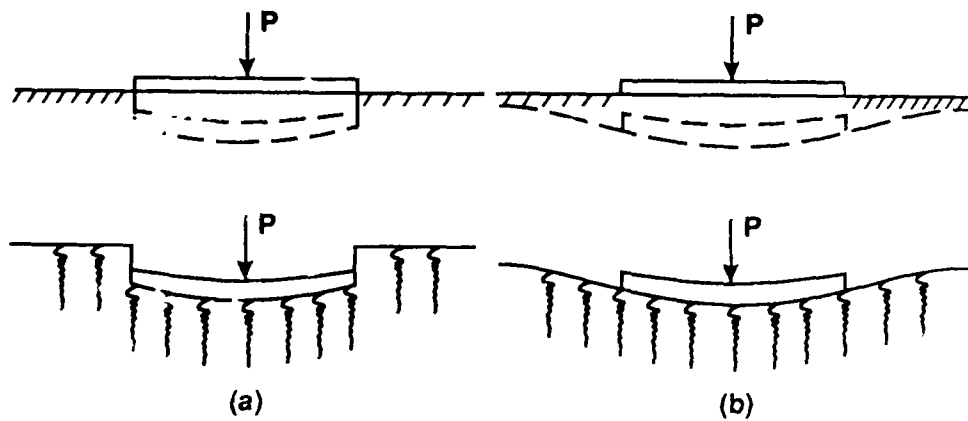

FIGURE 3-5. DEFLECTIONS OF ℓ PAVEMENT SLAB FOR THE (A) WINKLER AND (B) ELASTIC CONTINUUM SUPPORT CONDITIONS (SARGIOUS)

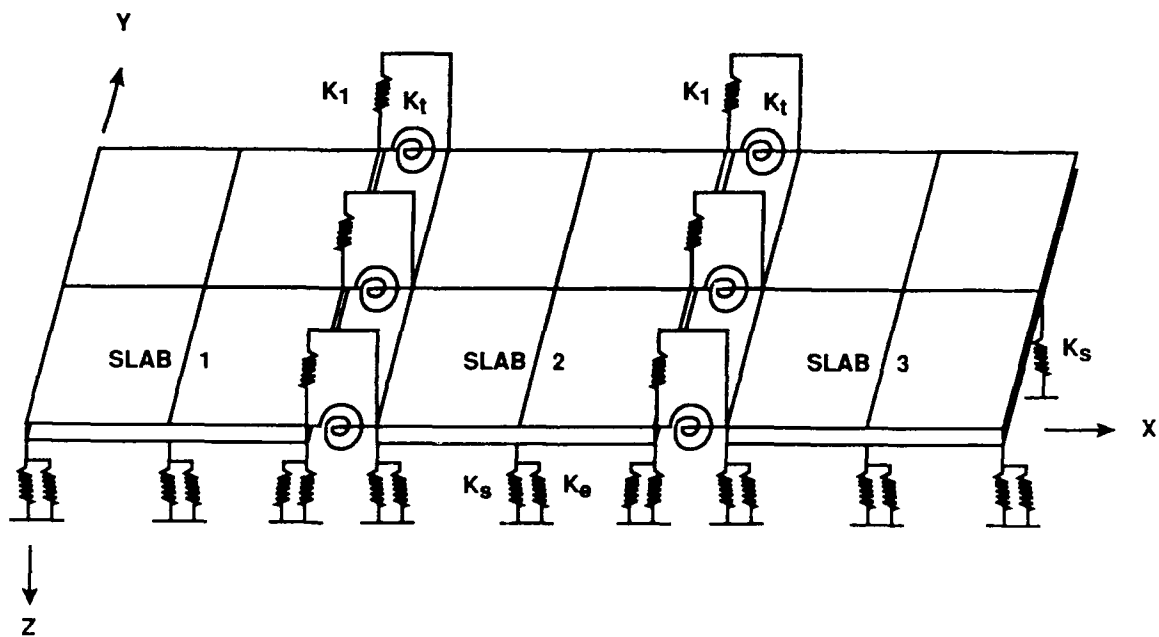

FIGURE 3-6. FINITE ELEMENT MODEL OF A THREE SLAB PAVEMENT SYSTEM (TIA)

modeled by shear springs along the edges. The concrete is modeled as linearly elastic and isotropic. Force vectors due to the weight of the slab, thermal gradient and loads are applied incrementally. The stiffness matrix is adjusted at the end on each increment according to the new subgrade support conditions.

Tirado-Crovetti et al.⁸⁹ demonstrated the use of FEM for the analysis of the stress intensity factor used in a fracture mechanics approach for the prediction of reflection cracking of asphalt concrete surfaces. A similar approach was applied by Majidzadeh et al.⁹⁰ for the analysis of reflection cracking of airfield pavements.

This brief review of some of the applications of FEM for the analysis of both flexible and rigid pavements demonstrates the flexibility of the analysis method. The fact that elemental models are available in the literature means that further application of the FEM for pavement analysis is a promising tool. It appears the main constraints to the application of this method will rest in the development of more constitutive equations to further relax the number of assumptions of material behavior. Development of these equations must be supported by the laboratory procedures to quantify the material behavior described by the equations.

Traditionally, the other constraint to the use of FEM has been computer costs. Numerical methods are more computationally intensive than analytical methods. However, consideration of the consequence on engineering decisions based on the output of the models would always favor the use of the most applicable theory for the analysis of pavements.

3.6 ENVIRONMENTAL MODELS

Materials reduce in volume as their temperature drops. Pavements resting on a base material are constrained by the weight of the pavement surface causing forces at the interface. When the temperature of the pavement drops, the constraint to movement

causes the development of stresses in the surface. When these stresses exceed the strength of the material, transverse cracks develop. This basic mechanism is the reason conventional concrete pavements are constructed with joints. The need for design models for the selection of joint spacings in concrete pavements has led to the development of models of the environmental stresses in concrete slabs. Although the mechanism also affects flexible pavements, there has been relatively little research into quantifying the effect.

The model developed for computing the stresses in a concrete slab due to friction is shown in Figure 3-7. Balancing the forces defined in the figure yields²:

$$\sigma_c = WLf/(24h)$$

where:

σ_c = "friction stress"

W = weight of the slab (psf)

L = length of slab, ft

f = average coefficient of subgrade resistance

h = depth of the slab, in.

The f term is sometimes called the friction between the slab and the subgrade. However, this is incorrect since the contraction of the slab results in shear forces that are transmitted into the subgrade².

For jointed concrete pavements, the stress due to friction can be computed and compared to the concrete strength. If the stress is excessive, a shorter slab is designed. For the design of continuously reinforced concrete pavements, there is no length of slab and distance between the cracks is unknown. McCullough et al.⁹¹ developed a numerical technique for the analysis of crack spacing in reinforced concrete pavements. This model estimates

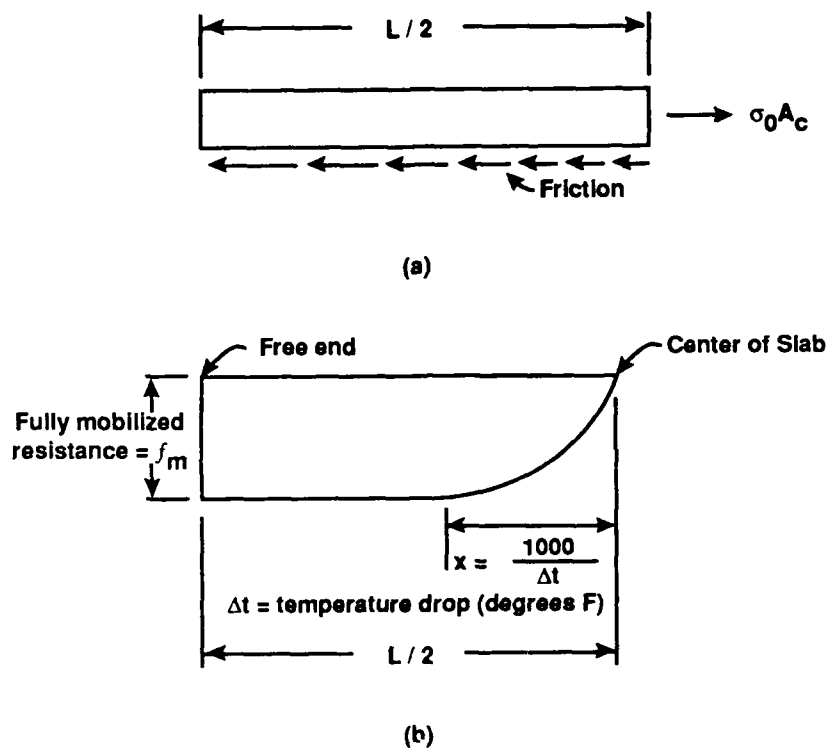

FIGURE 3-7. STRESSES RESULTING FROM CONTRACTION DUE TO TEMPERATURE: (A) FORCES ACTING ON CONTRACTING SLAB; (B) VARIATION OF SUBGRADE RESISTANCE WITH LENGTH (YODER AND WITCZAK)

crack spacing as a function of temperature drop, drying shrinkage, moisture change, wheel load, and coefficient of subgrade resistance.

Warping of a concrete slab is developed by a thermal gradient in the slab. Yoder and Witczak² presented equations formulated by Westergaard^{70,71} along with the solution developed by Bradbury⁹² as:

edge stress

$$\sigma = CE\alpha t/2$$

interior stress

$$\sigma = (E\alpha t/2) ((C_1 + \mu C_2) / (1 - \mu^2))$$

where:

C_1, C_2 = coefficients defined as functions of the relative stiffness of the slab

α = coefficient of thermal expansion of concrete

μ = Poisson's ratio

E = elastic modulus

t = temperature differential between the top and bottom of the slab

Traditionally, the principle of superposition is used to add the curling and traffic stresses to obtain the total stress in the pavement. However, Ioannides and Salsilli-Murua⁹³ report this principle does not apply due to the loss of support of the slab during curling. They resort to FEM for the analysis of the combined temperature and loading stresses due to the lack of a closed-form model.

4. DISTRESS MODELS

The mechanistic models described in the preceding chapter compute the response of the pavement to traffic and environmental loads. Relationships are now needed for using these responses to estimate the life of the pavement. Since pavements are designed for multiple applications of repeated loads, the distress models should capture the accumulated damage to the pavement materials. However, damage is a vague term. Pavements display many types of distress and, in general, damage functions must be developed for the prediction of specific distress types. In the related literature, there is a preponderance of information on two primary distress types:

1. fracture of the pavement surface due to repeated axle load applications, fatigue; and
2. distortion of the surface to repeated accumulation of plastic or viscous strains in the wheel path, rutting.

Several other distress types have also been examined in the literature including reflection cracking of asphalt overlays of jointed pavements and stripping of asphalt concrete.

4.1 FRACTURE

Fatigue is generally considered to be the fracture of the pavement surface due to the repeated application of traffic loads. Both asphalt and concrete pavements are subject to fatigue failure. Two basic approaches have been taken to the modeling of fatigue behavior: phenomenological and power law. In the phenomenological approach, the number of applications a pavement can carry prior to failure is estimated directly as a function of the stress or strain levels generated by the traffic loadings. The power law approach uses concepts developed in fracture mechanics to estimate the growth of a crack through the pavement layer.

The phenomenological approach has been widely applied in the analysis of pavement fatigue life. Although both asphalt and concrete pavements will fail in fatigue, the behavior of these materials with respect to repeated loads is very different in that concrete appears to have a "fatigue limit." It is generally assumed that concrete will not fail in fatigue if the stresses in the slab are kept below 50% of the modulus of rupture, as measured with the flexural test.

Conversely, asphalt concrete does not appear to have a fatigue limit. In other words, repeated application of even the smallest level of strain will eventually result in fatigue failure.

4.1.1 Phenomenological Model

The fatigue life of the asphalt is generally related to the strain in the pavement as:

$$N = a(1/\epsilon)^b$$

where:

N = the number of applications to failure

a,b = fatigue-life coefficients

ϵ = strain in the asphalt concrete

Some authors have modified this equation to include the stiffness of the asphalt and others substitute stress for the strain term. Laboratory tests have demonstrated that a and b coefficients are sensitive to mix design parameters, such as asphalt content, air voids, aggregate gradation, etc., and to the mode of testing. Attempts to compare the results of laboratory testing with field performance have demonstrated poor correlation. Generally, pavements last longer than laboratory fatigue testing and analysis predict. The difference between field performance and laboratory

estimates are expressed in terms of a shift factor. This shift factor is frequently in the range of 20 to 25, but factors as large as 1000 have been reported.

In addition to the problem of the correlation of laboratory and field testing, the variability of fatigue testing should be considered in the development of a design procedure based on the phenomenological approach. Navarro and Kennedy⁹⁴ reported the coefficient of variation of laboratory fatigue testing ranges from 53 to 73%.

There are many examples of the use of the phenomological approach for the prediction of the fatigue life of highway pavements. However, there are relatively few examples of the use of this approach for the design and analysis of airport pavements. Kelly and Thompson⁹⁵ used the ILLIPAVE program and a fatigue equation for the analysis of airfield pavements for F15 aircraft. Strain at the bottom of the asphalt concrete surface was computed with ILLIPAVE and the fatigue life was computed with the equation:

$$N = 259 (1/\epsilon)^{3.16} (1/E)^{1.4}$$

where:

N = number of estimated applications of strain

ϵ = strain at the bottom of the asphalt concrete layer

E = modulus of the asphalt concrete.

This equation was developed through an ILLIPAVE analysis of the AASHO Road Test⁹⁶.

The Waterways Experiment Station has developed an elastic layer theory method for the design of flexible pavements that uses the phenomenological approach for estimating the fatigue life of airfield pavements⁹⁷. This design procedure uses the equation:

$$N = 479 (1/\epsilon)^5 (1/E)^{2.665}$$

This equation was developed from an analysis of experimental pavement sections designed and tested to simulate airfield pavements⁹⁸.

While the WES and the Kelly-Thompson equations have the same form, the coefficients are considerably different. For a strain of 0.0005 in/in and a modulus of 500,000 psi, the WES equation estimates approximately 10,000 repetitions can be applied to the pavement while the Kelly-Thomas equation estimates in excess of 73,000 applications. This demonstrates the problem with the phenomenological approach to fatigue analysis. Prediction models developed by different researchers appear to be more a function of the analysis procedure used in the development than determined from the basic properties of the materials.

4.1.2 Power Law

A power law approach to the estimation of the fatigue life of a pavement was developed by Majidzadeh et al.^{99,100,101} and Ramsamooj¹⁰² based on the application of fracture mechanics. Fatigue is considered to be a process of accumulative damage where, under a given stress state, damage grows according to a crack propagation law from an initial state to a critical and final level. The form of the crack propagation law is:

$$dc/dN = Ak^n$$

where:

dc/dN = rate of crack propagation

A, n = material constants

k = stress intensity factor

This equation has the same basic form as the phenomenological equation. Thus, the primary differences between the two approaches are the calculation of the stress intensity factor at the crack tip and relating that to the local failure of the material, and the method for quantifying the material constants.

Determination of the stress intensity factor requires analysis of the discontinuity of the pavement material in the area of the crack. Currently, this requires the application of FEM to model both the material behavior and the stress intensity.

The material constants in the power law equation are related to the ability of the material to absorb energy before fracture. Jayawickrama and Lytton¹⁰³ have shown that for viscoelastic materials, n is inversely proportional to the slope of the stiffness-load time curve on a log-log scale and a linear relationship exists between n and $\log(A)$. This extension of fracture mechanics from linear elastic materials to viscoelastic materials is based on the work of Schaprey¹⁰⁴.

It should be noted that the power law predicts the growth of a crack rather than an instantaneous failure when a fixed number of strain applications have been applied. Actually modeling the growth of the crack is superior to the phenomenological approach in that the method is not limited to the analysis of the repeated load applications. Thus, the power law is applicable to a broad category of problems. Examples of applications of the fracture mechanics and power law relationship to pavement analysis include:

1. George¹⁰⁵ for the analysis of soil cement pavement layers.
2. Crockford and Little¹⁰⁶ also for the analysis of soil cement bases in pavements.
3. Majidzadeh et al.¹⁰⁷ for the analysis of reflection cracking of asphalt overlays on concrete pavements.

4.2 DEFORMATIONS

Plastic and viscous deformations of the pavement materials result in permanent deformations of the surface. Channelized traffic generates an accumulation of deformations in the wheel

paths of the vehicle or rutting. Three approaches have been defined for relating the primary response of pavements to rutting:

1. limiting the magnitude of the maximum vertical strain in the subgrade;
2. relating permanent strains to stresses or strains computed with elastic theories; and
3. direct estimates of permanent strains with viscoelastic models.

The limiting strain approach was first presented by Dorman¹⁰⁸ in 1962 and Klomp and Dorman¹⁰⁹ in 1964. It is currently used in the Asphalt Institute airfield pavement design method¹¹⁰ and the Joint Department of Army and Air Force elastic layer theory method for the design of flexible pavements. The basic hypothesis of this approach is that if the maximum compressive strain at the surface of the subgrade is less than a critical value, then excessive rutting will not occur for a specified number of repetitions. These relationships were developed based on analysis of the Corps of Engineers pavement design procedures.

The Army and Air Force elastic layer theory procedure for the design of flexible pavements uses limiting subgrade criteria for estimating the number of applications a pavement can withstand before excessive permanent deformation occurs. The criteria are specified by the equation:

$$N = 10,000 (A/S_s)^B$$

where:

N = number of applications the pavement can sustain at a given strain level

S_s = vertical compressive strain at the top of the subgrade

A = $0.000274 + 0.000245 \log M_R$

M_R = Modulus of the subgrade

B = $0.0658 (M_R)^{0.559}$

Relating permanent deformation to elastic stresses has been proposed by several researchers. Some have assumed a fundamental deformation law exists through which permanent strains can be predicted based on the stress state of the material. Other authors have used statistically formulated equations for relating the permanent and elastic strains. Neither method has been particularly successful since the concept, from a mechanistic aspect, is not fundamentally sound and there has not been an adequate database for developing the statistical models.

Calculation of permanent strains is incorporated in the constitutive equations of viscoelastic theory. By definition, rutting can be estimated directly from the application of this theory and thus several authors have dismissed the need for further model development in this area. To some extent this claim is justified by the verification studies of the VESYS IIIA program by Khosla¹¹¹ and Sneddon¹¹². This is not to say, however, that VESYS IIIA is the final answer to the prediction of permanent deformations since the response model is based on elastic layer theory.

5. AIRPORT PAVEMENT DESIGN METHODS

As described in the preceding chapters, pavements are complicated structures, composed of materials whose behavior is difficult to characterize. They are continually subjected to diverse traffic loadings and environmental conditions. The spectrum of factors affecting pavement performance has led engineers and researchers into the development of multiple theories for the analysis of pavements. This has also led to the development of multiple methods for airport pavement design. Methods have been developed by the Federal Aviation Administration, the Department of Defense, trade associations, and consultants and researchers.

The purpose of this chapter is to review several pavement design methods with respect to the theories and concepts used for the establishment of the design curves. For rigid pavements, only the pavement thickness design methods are reviewed. All of the rigid pavement design procedures also include the design of joint details and, in some cases, reinforcement design. It is not the intention of this chapter to present a detailed reproduction of the design methods since they are readily available in the literature.

5.1 FEDERAL AVIATION ADMINISTRATION

The Federal Aviation Administration pavement design procedure presents methods for the design of flexible and rigid pavements for light and heavy aircraft¹¹³. Only the procedure for heavy aircraft, weighing more than 30,000 pounds is reviewed here. The flexible pavement design procedure is based on the California Bearing Ratio (CBR), last. The rigid pavement design procedure is based on the Westergaard stress equation for joint edge stress.

All pavement designs are based on a 20-year design life and the traffic volume is expressed in terms of the annual number of departures. All departures are assumed to be at 95% of the maximum aircraft weight. The design curves are based on the

number of coverages of aircraft based on the statistical distribution of aircraft wander across the pavement rather than the actual number of departures. This modification to the number of applications is transparent to the designer and is documented in an appendix to the design procedure.

The traffic analysis procedure is common to the design of both flexible and rigid pavements. All classes of aircraft that will use the facility are reduced to the number of equivalent annual departures of a design aircraft. The design aircraft is defined as the aircraft that would require the greatest pavement thickness if it were the only aircraft using the facility. Since the pavement design charts consider both the number of applications and the aircraft weight, the design aircraft will not necessarily be the heaviest aircraft. In essence, determining the equivalent annual applications requires:

1. Converting all aircraft types to the gear type of the design aircraft by multiplying the number of annual applications for each aircraft type by equivalency factors.
2. Converting the number of adjusted annual applications to the equivalent number of design aircraft applications by using the equation:

$$\log(R_1) = (w_2/w_1)^{\frac{1}{2}} \log(R_2)$$

where:

R_1 = equivalent number of annual departures for the design aircraft

R_2 = annual departures expressed in design aircraft landing gear

w_1 = wheel load of design aircraft

w_2 = wheel load of the aircraft being analyzed (the wheel load for wide bodied aircraft is computed on the basis of 300,000 lbs maximum aircraft weight rather than the actual gross maximum weight)

3. The number of equivalent departures is summed to determine the total number of departures for use in design.

5.1.1 FAA Flexible Pavement Design

The essence of the CBR design procedure is the protection of the subgrade from overstressing by using layers of successively stronger materials. Separate design curves are available for single, dual, and dual tandem gears and for each of the wide body aircraft.

In this procedure, it is assumed the asphalt concrete will meet specified criteria in terms of mix design and construction quality. There is no method for adjusting the thicknesses based on the quality of the surface material. It is assumed the base will be a granular material with a CBR of 80.

Required layer thickness is determined by the following sequence of functional relationships:

$T_p = f(SG_{CBR}, W_D, N_E)$	1
$T_s = \text{Specified on the design charts}$	2
$T_{sbb} = f(SB_{CBR}, W_D, N_E)$	3
$T_{Bmin} = f(SG_{CBR}, T_p)$	4
$T_B = \max(T_{min}, T_{sbb})$	5
$T_{SB} = T_p - T_s - T_B$	6

Design charts are used to quantify equations 1, 3, and 4. In some cases, the thickness requirement for the subbase is adjusted if the upper portion of the subgrade has a thin layer of material near the surface.

The minimum thickness of the surface is 5 inches for wide bodied aircraft, 4 inches for all other aircraft in the critical areas, and 1 inch less for all other areas. The thickness of the surface is determined based on whether or not there are wide bodied aircraft and not on the design aircraft.

Stabilized bases are required for all airports serving jet aircraft weighing more than 100,000 pounds, unless there is a history of satisfactory performance of the locally available granular materials. Stabilized bases and subbases can also be used if there is an economic advantage in using these materials. A reduction in the thickness of the pavement is allowed for stabilized materials through the use of material equivalency factors. However, the design manual only provides ranges for the adjustment factors based on the type of the material. Selection of a specific material equivalency factor is left to the experience of the designer.

The design curves are limited to 25,000 applications. For a greater number of departures, the design is increased on a simple extrapolation. For high traffic volumes, the total pavement thickness is increased by a multiplier and the surface thickness is increased by 1 inch.

5.1.2 FAA Rigid Pavement Design

The slab thickness for a concrete pavement is determined from design charts based on the flexural strength of the concrete, the modulus of subgrade reaction, weight of the design aircraft, and equivalent number of applications. Subbase is required to be a minimum of 4 inches of granular material. If the airport serves aircraft with weights in excess of 100,000 pounds, then a stabilized base is required. The strength of the stabilized base can be used to increase the modulus of subgrade reaction and thereby reduces the thickness of the slab.

As with flexible pavements, the design curves are limited to 25,000 load applications and extrapolated; multiplying factors are used to increase the thickness of the slab. These factors are relatively insensitive to the number of applications. Increasing the number of applications from 25,000 to 50,000 only increases the thickness of the slab by 4%.

5.2 ASPHALT INSTITUTE

The pavement design charts for the Asphalt Institute¹¹⁰ design procedure for full-depth asphalt concrete pavements were developed based on elastic layer theory analysis and two distress types, fatigue and permanent deformation. The fatigue criteria are based on limiting the horizontal tensile strain at the bottom of the surface layer. The permanent deformation criteria is based on limiting the vertical compressive stress at the top of the subgrade. All aircraft classes are converted to the "standard aircraft"; the DC-8-63F was "arbitrarily" selected to be the standard. Taxiways are considered to be the critical portion of the airfield pavement. The design process is summarized in Figure 5-1.

The inputs to the design process are the mean annual air temperature, the design subgrade modulus, and the expected number of repetitions of each aircraft type. The design subgrade modulus requires performing a series of soils tests and selecting the 85 percentile value, e.g., only 15% of the subgrade tests have a lower value than the design value. The manual recommends laboratory evaluation of the modulus using the triaxial test procedure specified in the manual. Approximations are available for estimating the modulus from the CBR test, plate bearing test and the FAA Soil Classification. The manual provides specifications for the asphalt concrete but the properties of the asphalt concrete are not a direct input to the design process.

The procedure requires the development of curves for the allowable number of applications and the estimation of equivalent applications for both fatigue and plastic deformation. Design charts are used for selecting the allowable number of applications as a function of the subgrade modulus and the mean annual temperature. For a given subgrade modulus and temperature, the required thickness is determined for several different assumed traffic loadings and the results are plotted on a design graph for both the fatigue and plastic analysis. This establishes the allowable traffic curve.

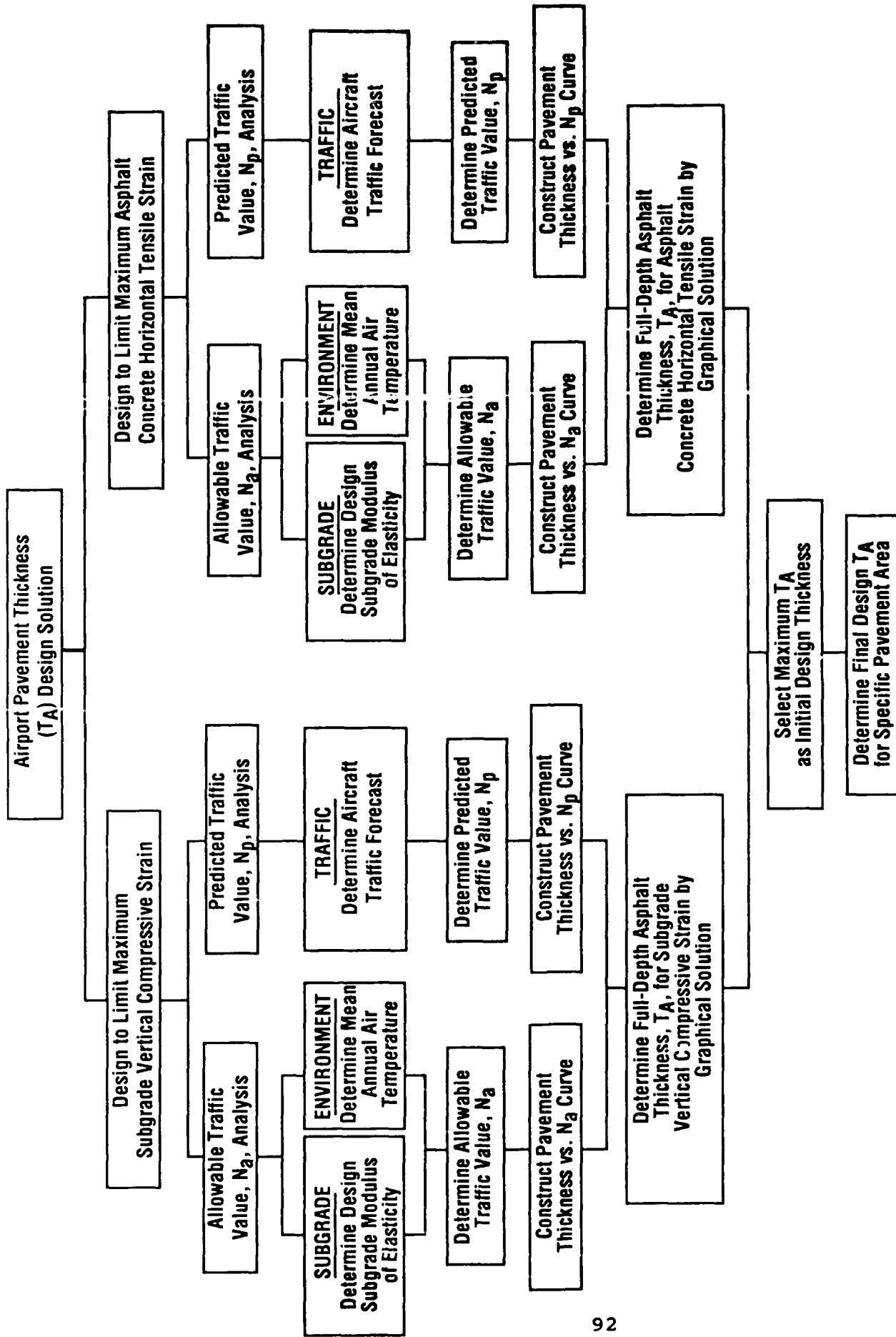

FIGURE 5-1. FLOW OF ASPHALT INSTITUTE DESIGN PROCEDURE

The traffic equivalency curves are then used to convert the number of aircraft loadings into equivalent loadings. Equivalencies are determined for four wheel paths and four different pavement thicknesses. For each assumed thickness, the critical wheel path is determined as the one with the greatest number of total equivalencies. The number of equivalencies and corresponding thicknesses are plotted on the design graph to establish the predicted traffic curve.

The intersection of the predicted and allowable traffic curves defines the required pavement thickness for each of the design modes. The final pavement thickness is the greater of the thicknesses required for either the fatigue or plastic deformation load.

That equivalency factors for each of the aircraft types is a function of the pavement thickness is a major difference between the Asphalt Institute method and the FAA procedure. Theory would favor the Asphalt Institute method since the relative damage caused by an aircraft is a function of the stiffness of the pavement and, therefore, the equivalency factors should consider the thickness of the pavements.

5.3 PORTLAND CEMENT ASSOCIATION

The Portland Cement Association design manual⁷⁴ for rigid pavements presents two design methods: one based on the critical aircraft that will use the facility and the other based on the fatigue life of the pavement. Both methods use the Westergaard theories for determining the stresses in the pavement structure.

The steps in the critical aircraft design method are:

1. Determine the k value of subgrade support with plate bearing tests or correlation to subgrade soil test data.
2. Select a safety factor based on the estimated operating and load conditions. The safety factor is the ratio of

the design modulus of rupture of the concrete to the working stress that will be used for design. The safety factor ranges from 1.7 to 2.0 for the critical areas, and 1.4 to 1.7 for noncritical areas. The critical areas are aprons, taxiways, hard stands, runway ends and hangar floors. The noncritical areas are the central portion of the runway and some high-speed exit taxiways. The selection of a specific safety factor for an aircraft depends on the expected number of loadings.

3. The working stress for the design is determined by dividing the modulus of rupture of the concrete by the chosen safety factor.
4. The required pavement thickness is determined from the design charts as a function of the working stress, gear load, and k value.
5. The process is repeated for other aircraft that can have critical loads. The safety factor is adjusted for each of the types of critical aircraft.

The PCA states that the fatigue method of design applies to:

1. Design for specific volumes of mixed traffic ;
2. Evaluation of future traffic capacity of existing pavements or of an existing pavement's capacity to carry a limited number of overloads;
3. Evaluation of the fatigue effects of future aircraft with complex gear arrangements; and
4. More precise definition of the comparative thicknesses of runways, taxiways, and other pavement areas depending on the operational characteristics.

The fatigue method introduces three additional design parameters:

1. Traffic width for taxiways, runways and ramps;
2. Variability of concrete strength; and
3. Downgrading of service life where a good subbase support is not provided.

The basic steps in the fatigue analysis method are:

1. Estimate the number of operations of each type of aircraft.
2. Use influence charts or the PCA computer program to estimate the stress each aircraft will cause in the pavement. For design, this requires assuming a thickness.
3. Estimate the design modulus of rupture, DMR, for the concrete as a function of the variability of the concrete:

$$\text{DMR} = \text{MR}_{90}(1-V/100)M$$

where:

MR_{90} = average modulus of rupture at 90 days

V = Coefficient of variation of modulus of rupture in percent (range 10 to 18%)

M = factor for the average modulus of rupture during design life, recognizing that concrete strength increases with age (typically 1.10).

4. Compute the stress ratio of the estimated stress for each aircraft to the design modulus of rupture.
5. Determine the load repetition factor (LRF) for each aircraft. LRF is determined from stresses, the fatigue curve and the probability distribution of aircraft wander. The design manual provides tabular values for LRF.
6. Determine the number of fatigue repetitions for each aircraft by multiplying the expected number of departures by the LRF.
7. Determine the number of allowable repetitions for each aircraft as a function of the stress ratio and the fatigue curve.
8. Determine the percent of structural capacity used by each aircraft as the ratio of the fatigue repetitions to the allowable repetitions. Sum the percent of structural capacity used by all of the aircraft. Adjust the percent of fatigue life used when the k value is less than 200 pci. This adjustment ranges from 8 for a k value of 50 to 1 for a k value of 200 pci. The adjusted percent of fatigue life should be close to but not exceed 100 percent.

The PCA manual addresses the design of continuously reinforced concrete pavements, but recommends that the thickness design be the same as for plain concrete pavements. This manual states that reducing the thickness can increase deflection and promote spalling of the joints.

5.4 DEPARTMENT OF DEFENSE PAVEMENT DESIGN METHODS

The Army and Air Force share a common procedure for the design of rigid pavements, while the Navy has a separate design procedure. A triservice manual is used for the design of flexible pavements for all services. In addition, the Army and Air Force have a manual for the design of flexible pavements using elastic layer theory.

Each of the pavement design manuals requires designing different pavement sections based on the airfield class and traffic areas. For example, the Air Force defines four pavement area types ranging from highly channelized traffic such as on primary taxiways, type A, to low volume and low weight traffic areas, type D. In addition, each airfield is designated as a light, medium and modified-heavy, heavy load, or short-field facility. The traffic area types for each facility are shown in Figures 5-2, 5-3 and 5-4¹¹⁴. The aircraft design loads and number of applications for Air Force pavement design are given in Table 5-1. The Army and Navy use a similar concept with different terminology for the airfield designations and traffic areas.

5.4.1 Triservice Manual for Flexible Pavement Design

The design of conventional flexible pavements and flexible pavements with stabilized bases and/or subbases are covered in reference¹¹⁵. The design process uses the CBR procedure for the distribution of stresses through the layered pavement section.

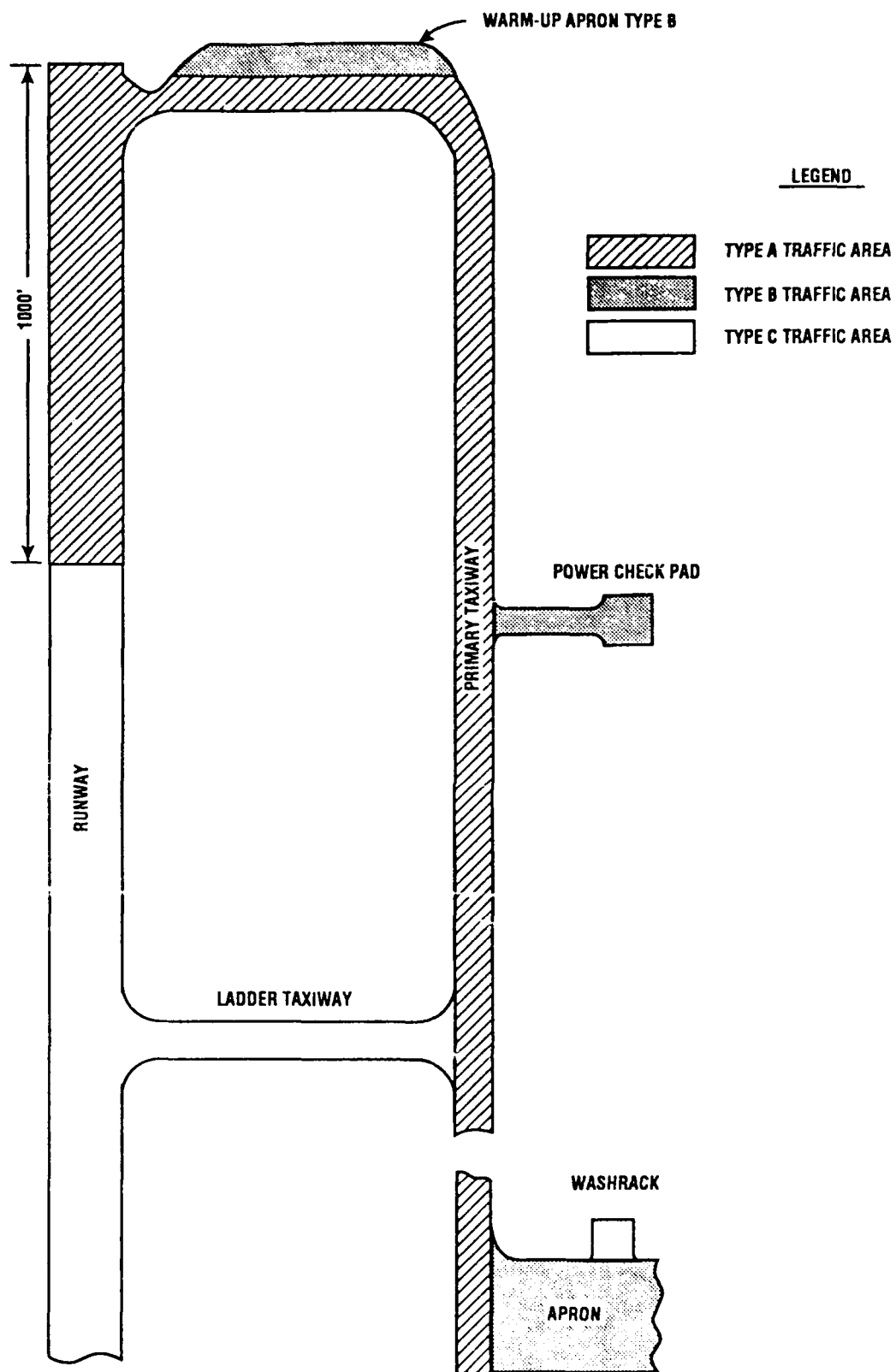

FIGURE 5-2. AIR FORCE TRAFFIC AREAS, LIGHT-LOAD AIRFIELDS

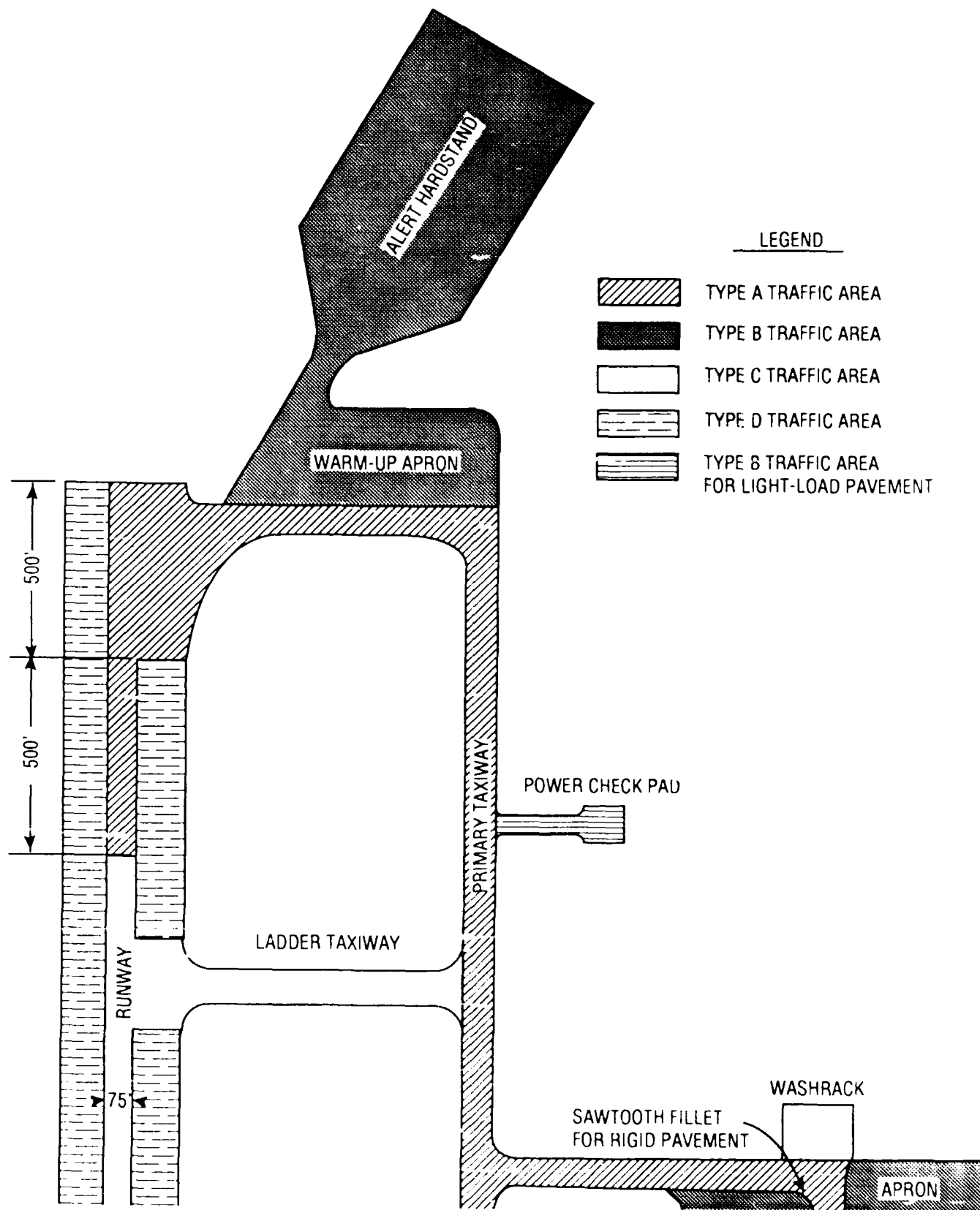

FIGURE 5-3. AIR FORCE TRAFFIC AREAS, MEDIUM AND MODIFIED HEAVY LOAD AIRFIELDS

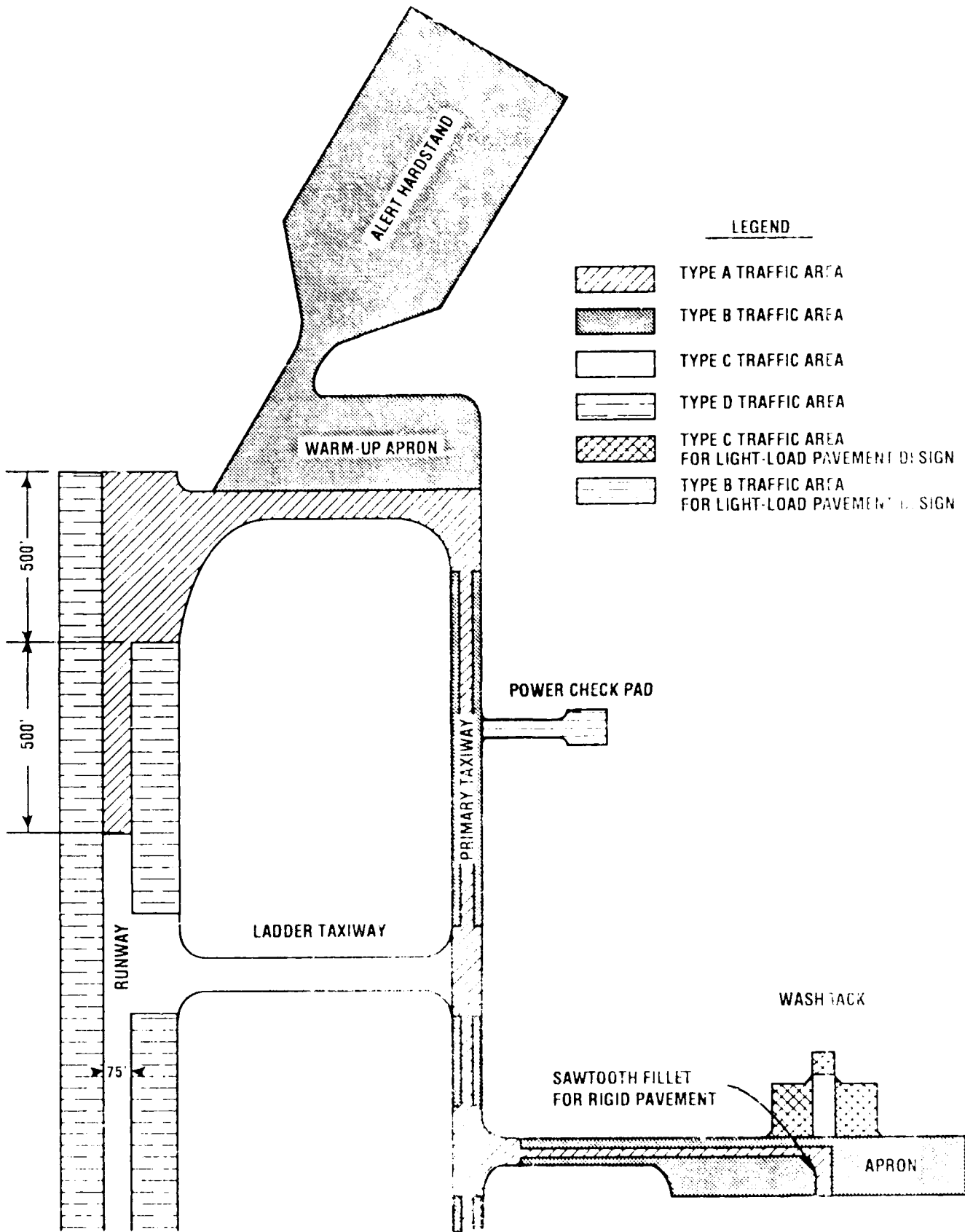

FIGURE 5-4. AIRFIELD TRAFFIC AREAS, HEAVY LOAD AIRCRAFT

TABLE 5-1. DESIGN WEIGHTS AND PASS LEVELS FOR AIRFIELD PAVEMENTS, AIR FORCE, (WEIGHTS IN 1000 POUNDS)

Aircraft Type	Design Aircraft	A Traffic Area		B Traffic Area		C Traffic Area		D Traffic Area		Overruns	
		Weight	Passes	Weight	Passes	Weight	Passes	Weight	Passes	Weight	Passes
Light	F-15 C/D	68	100000	68	10000	51	100000	NA	NA	51	1000
	C-141	345	100	345	100	258.75	100	258.75	100	258.75	1
Medium	F-15 E	81	25000	81	25000	60.75	25000	60.75	250	60.75	250
	C-141	345	100000	345	100000	258.75	100000	258.75	1000	258.75	1000
	B-52**	400	100	400	100	360	10	300	1	300	1
Heavy	F-15 E	81	25000	81	25000	60.75	25000	60.75	250	60.75	250
	C-141	345	50000	345	50000	258.75	50000	258.75	500	258.75	500
	B-52	480	30000	480	30000	360	30000	360	300	360	300
Modified Heavy	F-15 E	81	25000	81	25000	60.75	25000	60.75	250	60.75	250
	C-141	345	50000	345	50000	258.75	50000	258.75	500	258.75	500
	B-1	480	30000	480	30000	360	30000	360	300	360	300
Short-Field	C-130	175	50000	NA	NA	NA	NA	NA	NA	175	50000

PER SQUADRON

PER SQUADRON

**B-52 will not be included in the mixed traffic design of medium load airfields with less than 200 foot wide runways

Shoulders are designed to support 5,000 coverages of a 10,000 pound single wheel load having a tire pressure of 100 psi

Design of full-depth bituminous concrete pavements is beyond the scope of this report. The design sequence is:

1. Determine design CBR of the subgrade, depending on the variability of the subgrade. (Either distinct pavement design areas can be used, or the 85 percentile of the subgrade tests can be used.
2. Determine the total pavement thickness required based on the type of facility, subgrade CBR, gross aircraft weight and number of passes.
3. Determine the design CBR of the subbase.
4. Determine the thickness of surface and base required by entering the design curves with the subbase CBR.
5. Determine the minimum thickness of the surface from the appropriate table. Minimum base thicknesses are given for base materials with CBR values of 80 and 100 percent. There is no incentive in the design procedure for using a surface thickness greater than the minimum, so practical design would use the minimum surface thickness. The thickness of the base is the maximum of either the minimum required base thickness or the difference between the total pavement thickness and the minimum surface thickness.
6. The thickness of the subbase is equal to the difference between the total required thickness and the combined thickness of the surface and the base. If this produces a subbase thickness less than 6 inches, consideration should be given to increasing the thickness of the base and eliminating the subbase.

Design of pavements with stabilized base and subbases requires the design of a conventional pavement and then a reduction of the required thicknesses based on equivalency factors. There are a variety of rules that address the appropriate application of stabilization materials.

5.4.2 Army-Air Force Rigid Pavement Design

The Army-Air Force rigid pavement design manual presents procedures for the design of plain, jointed-reinforced, steel-fibrous, continuously reinforced and prestressed concrete pavements^{1,6}.

5.4.2.1 Plain Concrete Airfield Pavements - The edge stresses are reduced by 25% to account for load transfer afforded by the joint designs required. The flexural modulus of elasticity of the concrete is assumed to be 4,000,000 psi and Poisson's ratio is assumed to be 0.15. The design curves are available for light, medium, heavy and modified-heavy load pavements. Select pavement thickness is a function of the flexural strength of the concrete, modulus of subgrade reaction, and type of traffic area. The design curve for short-field pavements uses the gross weight of the aircraft and number of aircraft passes instead of the type of traffic area. The design thickness is rounded to the nearest half inch.

When the base or subgrade is stabilized, or the base is lean or existing concrete, the pavement slab is designed as an overlay using the equation:

$$h_o = ((h_d)^{1.4} - ((E_b/E_c)^{1/3}(h_b))^{1.4})^{1/1.4}$$

where:

h_o = required thickness of the plain concrete slab on a stabilized subgrade

h_d = thickness of plain slab that would be required if the slab was placed directly on the subgrade

E_b = modulus of elasticity of the base

E_c = modulus of elasticity of the concrete

h_b = thickness of stabilized layer or lean concrete base

5.4.2.2 Reinforced Concrete Pavements - Thickness design for both continuously and jointed reinforced concrete pavements is the same. Different procedures are used for designing the amount of steel. Design of a reinforced concrete pavement requires first selecting the thickness for a plain concrete pavement. A nomograph is then used for the selection of the reduced thickness of the reinforced pavement based on the thickness of slab required for a plain concrete pavement, the area of steel reinforcement, the percent of steel reinforcement and the length of the slab.

There is an interdependence between the amount of steel required, the size of the slab and the thickness, so designing the pavement requires assuming either a percent steel or reduced slab thickness and solving for the other value.

5.4.2.3 Fibrous Concrete Pavements - The design of Fibrous concrete pavements is based on limiting the ratio of the flexural strength and maximum tensile stress at the joint, with the load either parallel or normal to the pavement edge. The limiting criteria for the stress ratio is based on field experiments. These experiments were performed with steel fibers which limit the application of the design method. In addition, the design procedure limits the vertical deflection to prevent potential pumping, densification and/or shear failures of the subgrade.

Design curves are presented for each of the classes and types of Army and Air Force airfields. The Army design curves consider:

- flexural strength of the Fibrous concrete;
- modulus of subgrade reaction;
- aircraft gross weight;
- number of passes; and
- type of traffic area.

The Air Force design curves consider:

- flexural strength of the Fibrous concrete;
- modulus of subgrade reaction; and
- type of traffic area.

In the Air Force procedure, the aircraft weight and number of passes are defined by the traffic area, as shown in Table 5-1.

5.4.2.4 Prestressed Pavement Design - The design of prestressed concrete pavements requires balancing the level of prestressing with the thickness of the slab to obtain an economical design. The design equation is:

$$d_s = (6PNB/(w(h_p)^2)) - R + r_s + t_s$$

where:

d_s = design prestress required in the concrete

P = aircraft gear load

N = load repetition factor

B = load moment factor

w = ratio of multiple wheel gear load to single wheel gear load

h_p = design thickness of prestressed concrete

R = design flexural strength of concrete

r_s = foundation restraint stress

t_s = temperature warping stress

The design manual presents curves and equations for quantifying each of the design factors except for the design prestress and the thickness of the slab. The manual suggests the design prestress should be in the range of 100 to 400 psi and the minimum thickness of the slab is 6 inches.

5.4.3 Navy Rigid Pavement Design

The Navy design manual for rigid pavements¹¹⁷ is similar to the Portland Cement Association procedures. Westergaard's theory is used for computing the maximum stress in the pavement. The thickness is selected to keep the computed stress less than the working stress. The working stress is the flexural strength divided by a safety factor of 1.4 and 1.2 for primary and secondary traffic areas respectively. Design charts are presented for single, dual and dual-tandem gear types. The manual endorses the use of the PCA pavement design computer program when designing

for other gear types. The design curves are limited to modulus of subgrade reactions of 100 and 500 pci and interpolation is used for other k values.

5.4.4 Army-Air Force Flexible Pavement Design - Elastic Layer Theory Method

The Corps of Engineers has developed a mechanistic design procedure for flexible pavements⁹⁷. The analysis is performed with either CHEV5L or BISAR. As described in Chapter 4, two design criteria are used for the selection of the pavement thickness, fatigue of the asphalt surface or stabilized base layer, and subgrade strain criteria. The pavement designs are performed for the critical aircraft at the airfield rather than for a mix of aircraft.

The design procedure considers three design situations:

1. granular base and subbase;
2. stabilized base and granular subbase; and
3. stabilized base and subbase.

Several steps are required for the design process, as shown in Figures 5-5, 5-6, and 5-7. The variables used in these figures are defined as:

- ϵ_{B_c} modulus of the base course
- ϵ_{ALL} allowable strain, may be for either the subgrade strain criteria or the fatigue criteria depending on the step in the flow chart
- ϵ_h horizontal tensile strain at the bottom of the surface layer or stabilized base or subbase
- ϵ_v vertical compressive strain at the top of the subgrade
- n_i expected number of strain repetitions of traffic for the fatigue or subgrade strain analysis
- N_i allowable number of strain repetitions estimated from either the fatigue or subgrade strain criteria

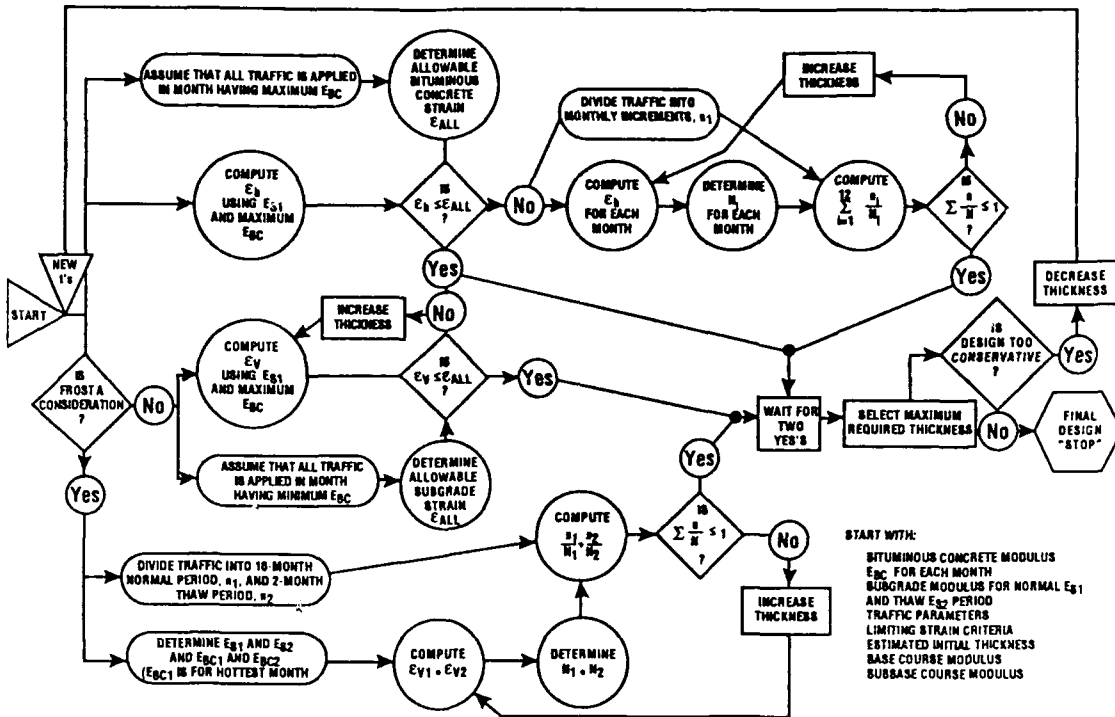

FIGURE 5-5. ELASTIC LAYER THEORY DESIGN METHOD, CONVENTIONAL PAVEMENTS

START WITH:

- BITUMINOUS CONCRETE MODULUS FOR EACH MONTH
- SUBGRADE MODULUS FOR NORMAL AND THAW PERIODS
- TRAFFIC PARAMETERS
- LIMITING STRAIN CRITERIA
- ESTIMATED INITIAL THICKNESS
- BASE COURSE MODULUS DETERMINED IN FLEXURE E_{bf}
- BASE COURSE MODULUS DETERMINED FROM EQUIVALENT CRACKED SECTION E_{bc}
- SUBBASE MODULUS

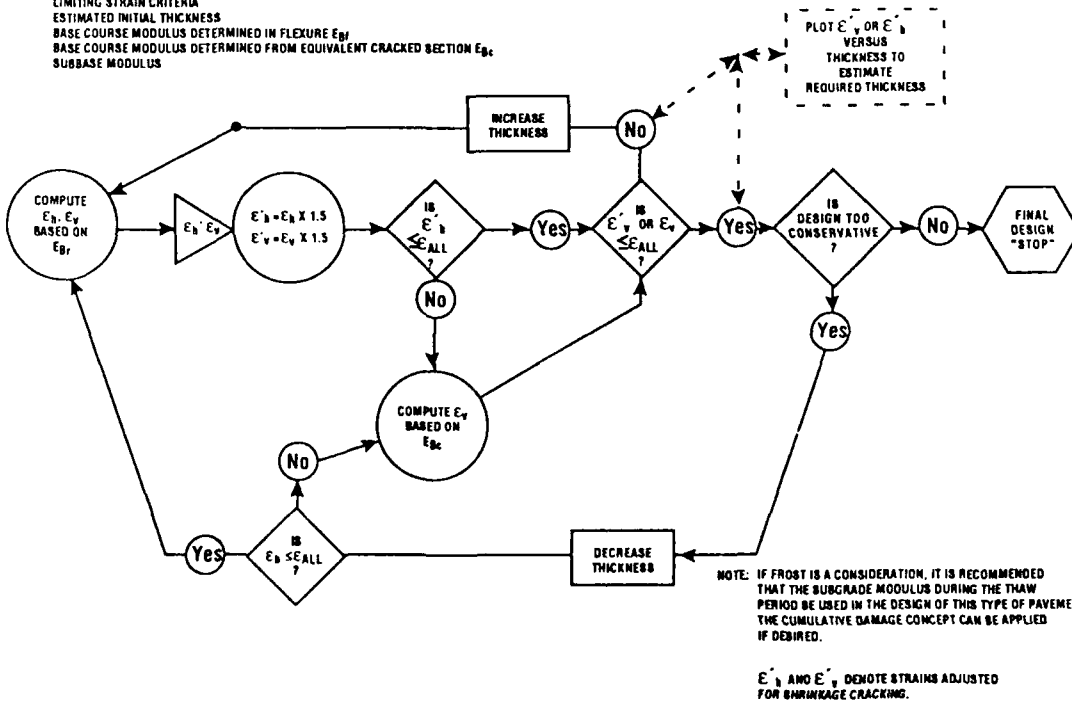

FIGURE 5-6. ELASTIC LAYER THEORY DESIGN METHOD, PAVEMENTS WITH STABILIZED BASES

START WITH:

BITUMINOUS CONCRETE MODULUS FOR EACH MONTH
 SUBGRADE MODULUS FOR NORMAL AND THAW PERIODS
 TRAFFIC PARAMETERS
 LIMITING STRAIN CRITERIA
 ESTIMATED INITIAL THICKNESS

BASE COURSE MODULUS DETERMINED IN FLEXURE E_{Bf}
 BASE COURSE MODULUS DETERMINED FROM EQUIVALENT CRACKED SECTION E_{Bc}
 SUBBASE COURSE MODULUS DETERMINED IN FLEXURE E_{SBf}
 SUBBASE COURSE MODULUS DETERMINED FROM EQUIVALENT CRACKED SECTION E_{SBc}

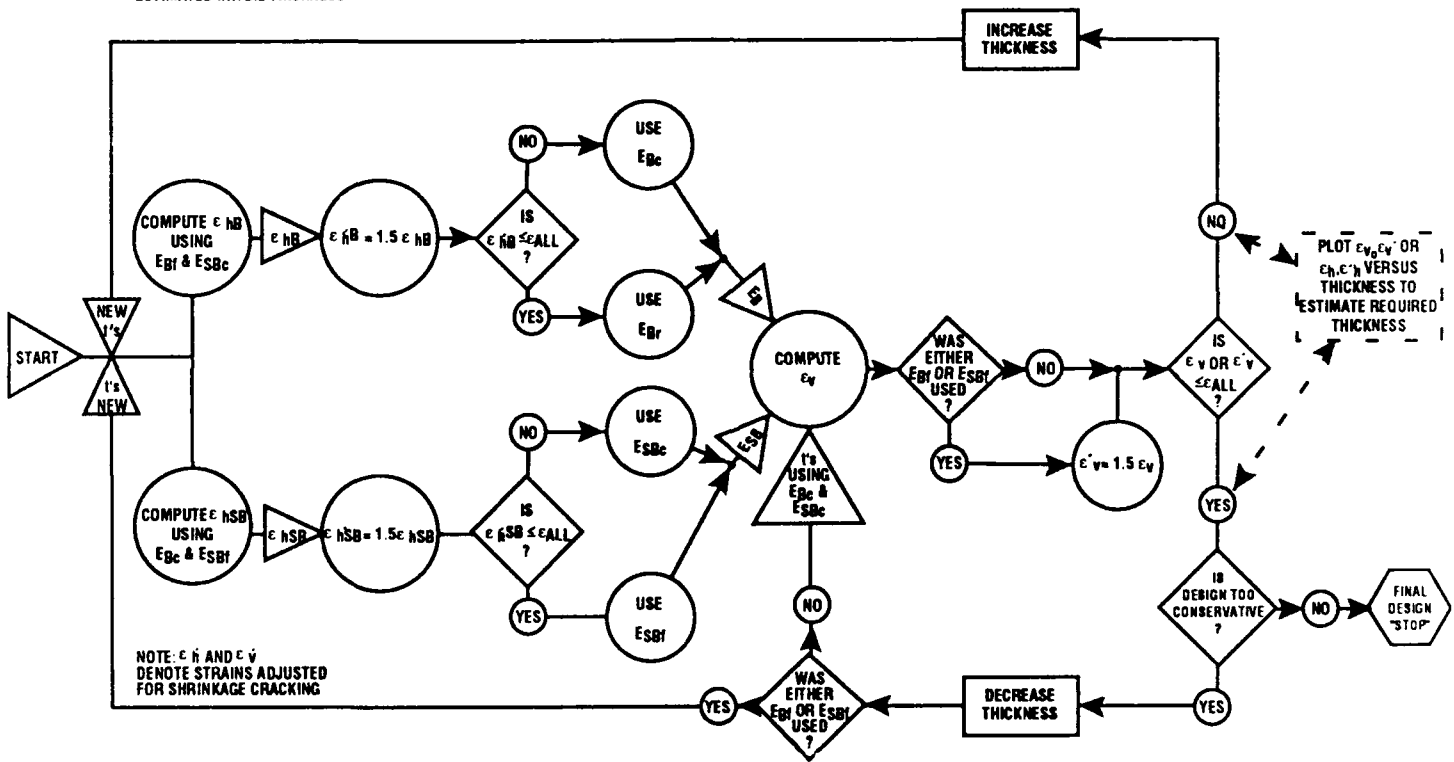

FIGURE 5-7. ELASTIC LAYER THEORY DESIGN METHOD, PAVEMENTS WITH STABILIZED SUBBASES

As demonstrated with the design procedure flow charts, many steps are required for designing a flexible pavement with this procedure. However, the procedure can be summarized in five steps.

1. Determine material properties.
2. Determine a trial pavement section.
3. Computation of the critical strains.
4. Determine expected number of applied strain repetitions.
5. Computation of damage factors and the cumulative damage.

Material characterization requires measurement of the modulus of elasticity for each layer in the pavement. In general, dynamic testing of the materials is required with the exception of granular materials where the manual states "an empirical based procedure was judged a better approach for obtaining usable material parameters." The subgrade modulus is determined with respect to the anticipated deviator stress on the subgrade. The modulus of the asphalt concrete must be determined for a variety of temperatures. In the design process, two temperatures are used for determining the asphalt concrete modulus for each month. For the fatigue analysis, a modulus is selected corresponding to the average daily maximum temperature. For the subgrade strain analysis, the average of the average daily mean temperature and the average daily maximum temperature is used to select the asphalt concrete modulus. These air temperatures are corrected to a design temperature of the pavement. If the temperature variations between months are relatively small, months can be grouped to reduce the calculation requirements.

To determine trial pavement design for analysis the procedure in TM 5-825-2/AFM 88-6, Ch. 2¹¹⁵ should be used. The mechanistic analysis procedure is then used to check the design of a thicker and thinner pavement structure to determine the optimum pavement design.

Strains in the pavement structure due to the design aircraft wheel loading are computed with an elastic layer theory program. These strains are input to the criteria equations for fatigue and subgrade strain to determine the allowable number of strain repetitions.

The expected number of passes on the pavement for the design aircraft is then reduced to the number of strain repetitions based on the configuration of the landing gear, tire imprint area and wander of the aircraft, and the thickness of the pavement. Design curves are presented for determining the percent of passes of an aircraft that produce strain repetitions based on the aircraft type and the thickness of the pavement. For aircraft with tandem tires, the number of strain repetitions can actually exceed the number of operations.

The final step in the design process is to compute the cumulative damage. Since only critical aircraft are considered in the design, the computation is required to account for the different strains resulting from changes in temperature.

As a final note, it should be emphasized that the design of conventional flexible pavements only considers the subgrade strain criteria. Fatigue criteria are not considered in the design. The stated reason for this limitation is:

Conventional pavements consist of relatively thick aggregate layers with a thin (3 to 5 inch) wearing course of bituminous concrete. In this type of pavement, the bituminous concrete structure is a minor structural element of the pavement and thus the temperature effects on the stiffness properties of the bituminous concrete may be neglected. Also, it must be assumed that if the minimum thickness of bituminous concrete is used as specified in TM 5-825-2/AFM 88-6, Ch. 2, then the fatigue cracking will not be considered. Thus, for a conventional pavement, the design problem is one of determining the thickness of pavement required to protect the subgrade.

6. DISCUSSION AND RECOMMENDATIONS

From the preceding chapters it is clear that pavements behave in an extremely complex manner. Material behaviors can be difficult to predict with respect to their response to load and environmental conditions. In addition, material characteristics change with time, environmental conditions and stress-strain history, further complicating the task of capturing the mechanistic response of the pavement. The process is further complicated when attempting to relate pavement response to pavement performance. Finally, there is no consensus definition of airport pavement failure.

Design procedures based on empirical methods or relationships, such as the CBR method, prescribe a pavement thickness for protecting the subgrade (and therefore, the pavement structure) from excessive deformation. However, there is no statement in these design procedures for pavement failure. Mechanistic-empirical methods that are based on fatigue cracking do not generally specify a level of cracking associated with pavement failure. Fatigue cracking of pavements is a relatively common occurrence. Pavement cracking alone, however, is not necessarily an indication of pavement failure. Similarly, other pavement distresses do not necessarily indicate that a pavement has "failed."

There is a general consensus that highway pavement failure is related to the quality of the service provided to its users. Under the concepts developed by Carey and Irigoin at the AASHO Road Test, pavement failure is defined with respect to the serviceability level of the pavement; a concept largely related to the roughness of the traveling surface. No comparable definition exists, however, for airport pavements.

Generally, maintenance can be divided into two categories: preventive and responsive. Since preventive maintenance is performed to reduce the occurrence of distress, it is not an indicator of pavement failure. Responsive maintenance, on the other hand, corrects distress conditions. Taken to an extreme, responsive maintenance can become cost prohibitive and rehabilitation or reconstruction may be required. If airport pavement maintenance is used as a failure criteria and if maintenance of the pavement is performed to correct the occurrence of distresses, then the prediction of pavement life is directly related to the prediction of pavement distress.

Conceptually, the use of pavement distress as the limiting criteria for determining the life of the pavement requires defining type, extent, and severity of distresses requiring maintenance. Prediction of type, severity, and extent of distress in a mechanistic manner requires predicting pavement response to load for a set of environmental conditions, followed by a relationship between pavement response and distress. The prediction of pavement response requires constitutive relationships defining the deformation response of the pavement to loading conditions for a set of environmental conditions. Use of the constitutive models requires quantification of the material behavior with respect to the material constants required by the models. In addition, the model must be capable of handling mixed traffic distributions both with respect to the type and frequency of aircraft.

6.1 DISCUSSION OF THE STATE OF THE ART IN AIRPORT PAVEMENT ANALYSIS

The state of the art in practical airport pavement analysis is limited to elastic theories of pavement response. Some of these models can account for the stress-sensitivity pavement materials. Furthermore, the prediction of distress from pavement response is accomplished with empirical

relationships developed primarily from laboratory and highway experience with limited calibration from airport pavement performance data. Thus, the state of the art of airport pavement design methodology falls far short of a true mechanistic analysis of pavement behavior and performance.

There are many models for pavement response that have been proposed by researchers and by advanced pavement engineers. Notably, the application of finite element models in conjunction with the fracture mechanics of crack growth and viscoelastic-plastic analysis for permanent deformation hold promise for improving the state of the art in the prediction of pavement performance. Conceptually, the finite element technique can be used for the solution of a broad class of material behavior, traffic loads and environmental conditions. As the flexibility of the finite element analysis process is increased, the need for computer storage and speed increases by a disproportionate amount. In addition, laboratory determination of the required material characteristics becomes increasingly complex as the number of constants required by the models increases. Furthermore, models have yet to be developed to define completely the response of pavement materials to all types of load conditions, material types and pavement geometries.

The types and capabilities of pavement models range widely from linear elastic response to viscoelastic models that include an element of fracture mechanics for the prediction of cracking. Many of the advanced models were developed for other engineering fields and their application to pavement design has been relatively limited. There is no uniform pavement analysis model that can be used for analyzing a pavement structure for all possible environmental and traffic load conditions. All pavement response models require a series of simplifying assumptions that consequently limit their universal applicability. Simplifying assumptions cover material behavior, traffic loadings, environmental

conditions, pavement geometry and the interaction of these factors.

Existing mechanistic models that are applied to the design of pavement structures are limited with respect to several considerations regarding the design and analysis of these structures. The models used for pavement analysis generally assume linear elastic behavior, whereas pavement structures are composed of materials that also display a viscous and plastic behavior. The models generally assume a uniform distribution of contact stress between the tire and pavement and do not account for the side wall stiffness of the tires.

Generally, the pavement structure is modeled as a uniform structure with homogeneous characteristics in all but the vertical direction, where distinctions in the properties of the layers are modeled. In actuality, material properties of pavement structures are not uniform nor homogeneous. Construction variability affects material characteristics in a random manner. Cracking and joints provide geometric discontinuities in the pavement structure.

One of the major areas of concern in the analysis of airport pavements is the treatment of mixed traffic effects. Current analytical procedures for the effect of mixed traffic is dependent on the application of Minor's hypothesis based on an accumulation of the incremental damage caused by each type of traffic loading. While this hypothesis has been verified on a statistical basis for laboratory conditions, there has not been a field experiment for either highway or airport pavements that verifies the applicability of Minor's hypothesis for pavement damage.

The above discussion has focused primarily on the design of new pavements. In the aging U.S. airport system, however, the greatest demand for pavement engineering is in the area

of preservation and restoration of existing pavements. In many ways, pavement preservation and restoration is more difficult than the design of new pavements. For the design of pavement preservation and restoration, the structural capacity and condition of the existing pavements must be evaluated. Deflection testing is the current practice for evaluating existing pavements. However, analysis of deflection data suffers from the same variances between pavement behavior and mechanistic models as is encountered for the design of new pavements (e.g., the discrepancies between the true behavior of the materials and the assumptions used in the analytical models, and the effects of environmental conditions on the behavior of the pavement).

Pavements fail in many ways as noted by the various types of distresses that are identified in pavement condition evaluation procedures. Some of these procedures define up to nineteen distress types for both asphalt and concrete pavements. Current mechanistic models are limited in the number of distress types that are simulated. Fatigue cracking is the most common distress type modeled with current mechanistic models. Other models estimate the development of rutting. Some model the development of reflection cracking. Arguably, these are the predominate distress types. However, the discrepancy between the number of distresses that exist on the pavements versus the distresses that are modeled emphasizes the shortcomings of the existing analysis procedures.

6.2 RECOMMENDATIONS FOR IMPROVING THE STATE OF THE ART IN AIRPORT PAVEMENT DESIGN AND ANALYSIS

The state of the art in pavement analysis has made considerable advance, particularly since the advent of powerful mainframe and microcomputers. However, the state of the practice in airport pavement design and analysis has not kept abreast of other advances in the air transportation industry. There are no constitutive models that can analyze

all pavement materials under all types of traffic loadings and environmental conditions. Even the most precise models fail to recognize the full range of behavior with respect to pavement conditions, material properties and environmental conditions.

Pavement response to load, in terms of stresses, strains and deformation is estimated with models that contain a great many assumptions regarding material behavior, environmental conditions, and load characteristics. Hence, pavement response estimates are approximations at best. Estimating the pavement response, however, is only a part of the requirement for a mechanistic analysis. Translation of pavement response into distress is an equally challenging task. The phenomenological approach that is widely used for the analysis of fatigue failure often does not capture the differences between specific materials at various airports. As demonstrated, different phenomenological equations can produce vastly different estimates of pavement life even when the same level of strain is used in the equation. In the past, pavement engineers have been able to use imprecise models due to the noncatastrophic nature of pavement failures. Generally, pavement failure does not result in loss of life or aircraft accidents. But, premature pavement failure generates tremendous economic and operational hardships for both the individual airport and the air transport industry in general.

Accurate estimates of pavement response and subsequently of pavement distress and performance will require a new approach to the design and analysis of airport pavements. Improving the sophistication of pavement analysis will likely require the use of three-dimensional finite element models that are formulated with specific characteristics of pavement materials with respect to elastic, viscous and plastic behavior. In addition, the constitutive equations in the three-dimensional analysis should capture the effect of

environmental conditions of the stress state of the materials and their properties. While three-dimensional finite element analysis is firmly entrenched in other areas of engineering, due to its complexity this technology has not been extended to the analysis of pavements. The intricacy of pavement materials, loading conditions and environmental effects makes pavements among the most complex structures designed and analyzed by engineers.

Development of an improved model of pavement behavior should follow the traditional approach to the development of new engineering methods. This would include the formal development of the problem statement, encompassing a definition of pavement performance and failure. At this point, analytical methods should be developed for modeling the pavement response to both environmental and traffic loading conditions. Laboratory testing would be necessary for defining the required material characteristics and failure or distress criteria. Finally, field verification and calibration of the models would be required.

To develop an improved model for pavement performance, attention must focus on the most critical elements of airport pavements. As earlier mentioned, the majority of U.S. airports are already in place and therefore, with regard to pavements, the area needing attention is preservation and restoration. Research in this area would include field evaluation of existing and future structural capacity of airport pavements. Currently, deflection testing is used for quantifying pavement structural capacity. While this form of testing is arguably superior to laboratory testing of the materials, it is limited by the inability of existing theories to describe the results of the deflection testing and the extrapolation of those results to the future performance of the pavements.

In addition, the existing shortage of quality virgin materials will lead to a greater emphasis being placed on the use of new materials, recycling and the use of marginal materials. The existing models and laboratory procedures are not adequate to determine the future response of new materials. This is a critical area demanding the development of the unified pavement theory. While field verification of material performance is always desirable, it can also impede the development and introduction of new materials. Normally, a pavement should perform for 20 years. Thus, it would take a minimum of 20 years to prove the value of a new material. A unified theory for the analysis of airport pavements, supported by appropriate laboratory testing, can provide a vehicle for the proof and acceptance of new materials in a timely manner.

The Federal Aviation Administration has essentially defined the steps required for the development of a unified theory for the design and analysis of airport pavement structures. Due to the importance of pavements to the air transportation industry and the importance of this industry to the economic development of the United States, an investment in pavement research that can lead to improved pavement performance is an investment that will deliver a large benefit-to-cost ratio.

LIST OF SYMBOLS

Symbol	Definition(s) as used in Report
a, b, n, A, k	constants
C_1, C_2	relative stiffness coefficients
C/S	design prestress in concrete
DMR	design modulus of rupture
D_j	creep compliance function
E	Young's modulus
E_R	resilient modulus
E^*	complex modulus
f	average subgrade coefficient
f'_e	ultimate strength of concrete
$G(t)$	relaxation function for a constant strain test
G_i	coefficient of the Dirichlet series
h_i	thickness of the 1 th layer
$J(t)$	creep function under constant stress
$J_v(t)$	volumetric creep function
k	stress intensity factor
L	length
M_i	mass of i
MR	modulus of rupture
MR_{90}	90 day average modulus of rupture
N	number of applications to failure
N_E	number of equivalent departures of design aircraft
P	vertical point load or aircraft gear load
v	(as subscript) radial direction
r_s	foundation restraint stress
R	design flexural strength of concrete
R_1	equivalent number of design aircraft annual departures
R_2	annual departures expressed in design aircraft landing gear
S	stiffness of cohesionless soils

$S_{mix}(t, T)$	asphalt mixture stiffness at time, t , and temperature, T
S_s	vertical compressive strain at top of subgrade
SG_{CBR}	subgrade California Bearing Ratio (CBR)
t	time, (as subscript) time, tangential or transverse
T_p, T_B, T_s, T_{SB}	thickness of, respectively, pavement, base, surface, and subbase. Total pavement thickness $T_p = T_s + T_B + T_{SB}$
μ_i	i^{th} component of the displacement vector in Cartesian coordinates
w	ratio of multiple wheel gear load to single wheel gear load
w_i	wheel load of the i^{th} wheel
W, W_D	weight, weight of design aircraft
α	coefficient of thermal expansion
δ_i	exponent of the Dirichlet series
ϵ	strain
ϵ_e	longitudinal strain
ϵ_o	initial and constant strains
$\epsilon(t)$	strain as a function of time
E	Lamés constant
μ	Poisson's ratio, Lamés constant
ϕ	phase difference between stress and strain
ρ	mass density
σ	stress
σ_c	"frictional" stress
σ_o	hydrostatic stress
σ_3	transverse principal stress
τ	shear stress
ω	angular frequency

REFERENCES

1. Shahin, M.Y., and Kohn, S.D., (1981) "Pavement Management System for Roads and Parking Lots," Technical Report M-294, U.S. Army Corps of Engineers Construction Engineering Research Laboratory, Champaign, IL.
2. Yoder, E.J., and Witczak, M.W. (1975) Principles of Pavement Design, John Wiley & Sons, New York
3. Sargious, M., (1975) Pavements and Surfacing for Highway and Airports, John Wiley and Sons, New York
4. Chou, Y.T. (1977) "Engineering Behavior of Pavement Materials: State of the Art," Federal Aviation Administration Report No. FAA-RD-77-37, Washington, DC
5. Westmann, R.A., (1971) "Fundamentals of Material Characterization," Structural Design of Asphalt Concrete Pavement Systems, Highway Research Board Special Report 126, Washington, DC
6. Sentler, L., (1987) "A Strength Theory for Viscoelastic Materials," Document D9:1987, Swedish Council for Building Research, Stockholm
7. Derucher, K.N., and Korfiatis, G.P. (1988) Materials for Civil and Highway Engineers, Prentice Hall, New Jersey
8. Cordon, W.A. (1979) Properties, Evaluation and Control of Engineering Materials, McGraw-Hill, Inc., New York
9. Mazaras, J., and Pijandier-Cabot, G. (1989) Continuum Damage Theory - Application to Concrete, Journal of Engineering Mechanics, Vol. 115(2) ASCE
10. Monismith, C., Epps, J.A., and Finn, F.N. (1985) "Improved Asphalt Concrete Mix Design," American Association of Asphalt Paving Technologist, Proceedings, Volume 54
11. Deacon, J.A. (1971) "Material Characterization - Experimental Behavior," Structural Design of Asphalt Concrete Pavement Systems, Highway Research Board Special Report 126, Washington, DC
12. Mamlouk, M., and Sarofim, R.T. (1988) "Modulus of Asphalt Mixtures - An Unresolved Dilemma," Transportation Research Board, Research Record 1171, p. 193, Washington, DC
13. Cedergren, H.R. (1988) "Why All Important Pavements Should Be Well Drained," Transportation Research Board, Research Record 1188, p. 56, Washington, DC

14. Hicks, R.G., (1977) Factors influencing the Resilient Properties of Granular Materials, Dissertation Series, University of California, Berkeley
15. Kohn, S.D., and Bentsen, R.A. (1987) "Performance of Flexible Airfield Pavements Subjected to High Traffic Volumes," p. 638 Proceedings, The Sixth International Conference Structural Design of Asphalt Pavements, Ann Arbor, Michigan
16. Saraf, C., Marshek, K., Chen, H., and Hudson, W.R., (1987) "The Effect of Truck Tire Contact Pressure Distribution of the Design of Flexible Pavements," Proceedings, The Sixth International Conference Structural Design of Asphalt Pavements, Ann Arbor, Michigan
17. Bonaquist, R., Surdahl, R., and Mogawer, W. (1989) "Effect of Tire Pressure on Flexible Pavement Response and Performance," Transportation Research Board, Research Record 1227, p. 97, Washington, DC
18. Huhatla, M., Pihlajamaki, J., and Pieninaki, M. (1989), "Effect of Tires and Tire Pressures on Road Pavements," Transportation Research Board, Research Record 1227, p. 107, Washington, DC
19. Sebaaly, P., and Tabatabaee, N. (1989), "Effect of Tire Pressure and Type on the Response of Flexible Pavements," Transportation Research Board, Research Record 1227, p. 115, Washington, DC
20. Wignot, J.E., Durup, P.C., Wittlin, G., Scott, R.B., and Gamom, M.A. (1970) "Aircraft Dynamic Wheel Load Effects on Airport Pavements," Federal Aviation Administration, Report No. FAA-RD-70-19, Washington, DC
21. Highter, W.H., and Harr, M.E. (1973) "Application of Energy Concepts to the Performance of Airfield Pavements," Air Force Weapons Laboratory, Technical Report Number AFWL-TR-72-225, Kirtland Air Force Base, New Mexico
22. HoSang, V.A. (1975) "Field Survey and Analysis of Aircraft Distribution on Airport Pavements," Federal Aviation Administration, Report FAA-RD-74-36, Washington, DC
23. HoSang, V.A. (1978) "Field Survey and Analysis of Aircraft Distribution on Airport Pavements," Transportation Research Board, Special Report 175, Washington, DC
24. Ledbetter, R.H. (1978) "Effects of Dynamic Loads on Airport Pavements," Transportation Research Board, Special Report 175, Washington, DC

25. Himeno, K., Watanabe, T., and Maruyama, T. (1987) "Estimation of Fatigue Life of Asphalt Pavement," p. 272, Proceedings, The Sixth International Conference Structural Design of Asphalt Pavements, Ann Arbor, Michigan
26. Haas, R.C.G., and Hudson, W.R. (1978) Pavement Management Systems, McGraw-Hill, Inc., New York
27. Hudson, W.R., and McCullough, B.F., (1973) "Flexible Pavement Design and Management: Systems Formulation," National Cooperative Highway Research Program Report 139
28. Gomez-Achecar, M. and Thompson, M.R. (1986) "ILLI-PAVE-Based Response Algorithms for Full-Depth Asphalt Concrete Flexible Pavements," p. 11, Transportation Research Board, Transportation Research Record 1095, Washington, DC
29. Sentler, L., (1987) "A Strength Theory for Viscoelastic Materials," Report D9:1987, Swedish Council for Building Research, Stockholm, Sweden
30. Nair, K. (1971), "Solutions and Solution Techniques for Boundary Value Problems," p. 103, Structural Design of Asphalt Concrete Pavement Systems, Highway Research Board, Special Report 126, Washington, DC
31. Burmister, D.M. (1945) "The General Theory of Stresses and Displacements in Layered Systems," Journal of Applied Physics, Vol. 16(2) p. 89, Vol. 16(3) p. 126, Vol. 16(5), p. 296
32. Westergaard, H.M. (1927), "Theory of Concrete Pavement Design," Proceedings, Highway Research Board
33. Avramesco, A., (1967) "Dynamic Phenomena in Pavements Considered as Elastic Layered Structures," Proceedings, The Second International Conference on the Structural Design of Asphalt Pavements, Ann Arbor, Michigan
34. Lister, N.W., and Jones, R. (1967), "The Behavior of Flexible Pavements Under Moving Wheel Loads," Proceedings, The Second International Conference on the Structural Design of Asphalt Pavements, Ann Arbor, Michigan
35. Saraf, C., Marshek, K., Chen, H., and Hudson, W.R., (1987) "The Effect of Truck Tire Contact Pressure Distribution of the Design of Flexible Pavements," Proceedings, The Sixth International Conference Structural Design of Asphalt Pavements, Ann Arbor, Michigan
36. Ahlvin, R.G., Chou, Y.T., and Hutchinson, R.L. (1973), "The Principle of Superposition in Pavement Analysis," Highway Research Board, Highway Research Record 466, p. 153, Washington, DC

37. McCullough, B.F. (1969) A Pavement Overlay Design System Considering Wheel Loads, Temperature Changes and Performance, Doctoral Dissertation, University of California, Berkeley
38. Brown, S.F., and Pell, P.S. (1967), "An Experimental Investigation of the Stresses, Strains and Deflections in a Layered Pavement Subjected to Dynamic Loads," Proceedings, The Second International Conference on the Structural Design of Asphalt Pavements, Ann Arbor, Michigan
39. Chevron Oil Company, (1963) development of the elastic layer theory program
40. De Jong, D.L., Peutz, M.G.F., and Korswagen, (1973) "Computer Program BISAR," External Report Koninklyke/Shell Laboratorium, Amsterdam, Holland
41. Ahlborn, G., (1972) "Elastic Layer System with Normal Loads," Institute for Transportation and Traffic Engineering, University of California, Berkeley
42. McTrans, The Center for Microcomputers in Transportation, The University of Florida, 512 Weil Hall, Gainesville, FL, 32611, (904) 392-0378
43. Shahin, M.Y., Kirchner, K., and Blackmon, E. (1987), "Analysis of Asphalt Concrete Layer Slippage and Its Effect on Pavement Performance," p. 958, Proceedings, Sixth International Conference on the Structural Design of Asphalt Concrete Pavements, Ann Arbor, Michigan
44. Parker, F., Barker, W.R., Gumkel, R.C., and Odom E.C. (1979) "Development of a Structural Design Procedure for Rigid Airport Pavements," Federal Aviation Administration Report No. FAA-RD-77-81, Washington, DC
45. Shahin, M.Y., (1971), "A Computer Program for an Iterative Method of Pavement Structural Analysis," Unpublished technical memorandum, Center for Highway Research, University of Texas, Austin
46. Zaniewski, J.P., (1978) Design Procedure for Asphalt Concrete Overlays of Flexible Pavements, Doctoral Dissertation, University of Texas, Austin
47. Aston, J.E., and Moavenzadeh, F. (1967), "Analysis of Stresses and Displacements in a Three-Layered Viscoelastic System," p. 149, Proceedings, Second International Conference on the Structural Design of Asphalt Concrete Pavements, Ann Arbor, Michigan
48. Lee, E.H. (1961), "Stress Analysis in Viscoelastic Materials," Journal of Applied Physics, Vol. 13(2) p. 183

49. Pister, K.S. (1961), "Viscoelastic Plates on Viscoelastic Foundations," Journal of the Engineering Mechanics Division, ASCE, p. 43
50. Pister, K.S., and Westman, R.A. (1962), "Analysis of Viscoelastic Pavements," p. 20, Proceedings, International Conference on the Structural Design of Asphalt Pavements, Ann Arbor, Michigan
51. Ishihara, K., (1962), "The General Theory of Stresses and Displacements in Two-Layer Viscoelastic Systems," The Japanese Society of Soil Mechanics and Foundations Engineering, Soils and Foundations, Vol. 2(2), Tokyo, Japan
52. Lee, E.H. and Rogers, T.G. (1961) "Solution of Viscoelastic Stress Analysis Problems Using Measured Creep or Relaxation Functions," Division of Applied Mathematics, Brown University
53. Hopkins, I.L. and Hamming, R.W. (1957), "On Creep and Relaxation," p. 906, Journal of Applied Physics, Vol. 28
54. Moavenzadeh, F., and Elliot, J.F. (1972), "A Stochastic Approach to Analysis and Design of Highway Pavements," Proceedings, Third International Conference on the Structural Design of Asphalt Pavements, London, England
55. Rauhut, J.B., et al. (1975), Sensitivity Analysis of VESYS, Austin Research Engineers, Final Report to the Federal Highway Administration
56. Hufferd, W.L. and Lai, J.S. (1978) "Analysis of N-Layered Viscoelastic Pavement Systems," Federal Highway Administration Report No. FHWA-RD-78-22, Washington, DC
57. Khosla, N.P. (1987), "A Field Verification of VESYS IIIA Structural Subsystems," p. 486, Proceedings, Sixth International Conference Structural Design of Asphalt Pavements, Ann Arbor, Michigan
58. Beckedahl, H., Gerlach, A., Lücke, H., and Schwaderer, W. (1987), "On Improvements of the Existing VESYS Concepts," p. 677, Proceedings, Sixth International Conference Structural Design of Asphalt Pavements, Ann Arbor, Michigan
59. Lattes, R., Lions, J.L., and Bonitzer, J. (1962), "Use of Galerkin's Method for the Study of Static and Dynamic Behavior of Road Structures," p. 238, Proceedings, International Conference on the Structural Design of Asphalt Pavements, Ann Arbor, Michigan

60. Bastiani, A. (1962), "The Explicit Solution of the Equations of the Elastic Deformations for a Stratified Road Under Given Stresses in the Dynamic Case," p. 351, Proceedings, International Conference on the Structural Design of Asphalt Pavements, Ann Arbor, Michigan
61. Ishihara, K., and Kimura, T. (1967), "The Theory of Viscoelastic Two-Layer Systems and Conception of Its Application to the Pavement Design," p. 189, Second International Conference on the Structural Design of Asphalt Concrete Pavements, Ann Arbor, Michigan
62. Perloff, W.H., and Moavenzadeh, F. (1967), "Deflection of Viscoelastic Medium Due to a Moving Load," p. 212, Second International Conference on the Structural Design of Asphalt Concrete Pavements, Ann Arbor, Michigan
63. Mamlouk, M.S. (1987), "Dynamic Analysis of Multilayered Pavement Structures - Theory, Significance and Verification," p. 466, Proceedings, Sixth International Conference on the Structural Design of Asphalt Concrete Pavements, Ann Arbor, Michigan
64. Weiss, R.A. (1977), "Subgrade Elastic Moduli Determined from Vibratory Testing of Pavements," U.S. Army Engineer, Waterways Experiment Station, Vicksburg, Miss.
65. Weiss, R.A. (1979), "Pavement Evaluation and Overlay Design: Method that Combines Layered-Elastic Theory and Vibratory Nondestructive Testing," Transportation Research Board, Research Record 700, p. 20, Washington, DC
66. Szendrei, M.E. and Freeme, C.R. (1967), "The Computation of Road Deflections Under Impulsive Loads from the Results of Vibration Measurements," p. 89, International Conference on the Structural Design of Asphalt Concrete Pavements, Ann Arbor, Michigan
67. Eringen, A.C. and Suhubi, E.S. (1975), Elastodynamics, Vol. 2, Linear Theory, Academic Press, New York
68. Kausel, E. and Peek, R. (1982) "Dynamic Loads in the Interior of a Layered Stratum: An Explicit Solution," p. 1459, Bulletin of the Seismological Society of America, Vol. 72(5)
69. Sebaaly, B.E. (1987), Dynamic Models for Pavement Analysis, " Doctoral Dissertation, Arizona State University, Tempe
70. Westergaard, H.M., (1927) "Theory of Concrete Pavement Design," Proceedings, Highway Research Board
71. Westergaard, H.M., (1948) "New Formulae for Stresses in Concrete Pavements of Airfields," Transactions, ASCE

72. Pickett, G., and Ray, G.K. (1951), "Influence Charts for Concrete Pavements," Transactions, ASCE
73. Packard, R.G., "Computer Program for Airport Pavement Design," Portland Cement Association, Skokie, IL.
74. Packard, R.G., (1973) "Design of Concrete Airport Pavement," Portland Cement Association, Skokie, IL.
75. Stelzer, C.F., and Hudson, W.R. (1967), "A Direct Computer Solution for Plates and Pavement Slabs," Research Report 569, Center for Highway Research, University of Texas, Austin
76. Burnet, D. (1987), Finite Element Analysis from Concepts to Applications, Addison-Wesley Publishing Co., Mass
77. Ioannides, A.M. (1987) "Axisymmetric Slabs of Finite Extent Solid," American Society of Civil Engineers, Journal of Transportation Engineering, Vol. 113, pp. 277-290
78. Duncan, J.M., Monismith, C.L., and Wilson, E.L. (1968), "Finite Element Analysis of Pavements," Highway Research Board, Highway Research Record 228, Washington, DC
79. Pichumani, R. (1972), "Application of Computer Codes to the Analysis of Flexible Pavement," Proceedings, Third International Conference on the Structural Design of Asphalt Pavements, London, England
80. Raad, L., and Figueroa, J.L. (1980), "Load Response of Transportation Support Systems," p. 111, Transportation Engineering Journal, ASCE, Vol. 106, No. TE1
81. Baladi, G. (1989), "Fatigue Life and Permanent Deformation Characteristics of Asphalt Concrete Mixes," p. 75, Transportation Research Board, Transportation Research Record 1227, Washington, DC
82. Smith, R.B., and Yandell, W.O. (1987), "Predicted and Field Performance of a Thin Full-Depth Asphalt Pavement Placed Over a Weak Subgrade," p. 443, Proceedings, Sixth International Conference on the Structural Design of Asphalt Concrete Pavements, Ann Arbor, Michigan
83. Lim, P.N., and Yandell, W.O. (1988) "Reevaluation of Shell Life by Mechano-Lattice Analysis," ASCE Journal of Transportation Engineering, Vol. 114, pp. 435-449
84. Wang, S.K., Sargious, M.A., and Cheung, Y.K., (1972) "Advanced Analysis of Rigid Pavements," ASCE, Transportation Engineering Journal

85. Chou, Y.T., (1981) "Structural Analysis Computer Programs for Rigid Multicomponent Pavement Structures with Discontinuities, WESLIQID and WESLAYER," U.S. Army Engineering Waterways Experiment Station, Technical Report, GL-81-6, Vicksburg, Mississippi
86. Chou, Y.T., (1983) "Subgrade Contact Pressures Under Rigid Pavements," ASCE Journal of Transportation Engineering, Vol. 109, pp. 363-379
87. Tabatabaie, A.M., and Barenberg, E.J. (1980), "Structural Analysis of Concrete Pavement Systems," p. 493, Transportation Engineering Journal, ASCE, Vol. 106, No. TE5
88. Tia, M., Arnaghani, J.M., Wu, C.L., Lei, S., and Toye, K.L. (1987), "FEACONS III Computer Program for an Analysis of Jointed Concrete Pavements," p. 12, Transportation Research Board, Transportation Research Record 1136, Washington, DC
89. Triado-Crovetti, M.R., Darter M.I., Jayawickrama, P.W., Smith, R.E., and Lytton, R.L. (1988), "ODE Computer Program: Mechanistic-Empirical Asphalt Concrete Overlay Design," p. 30, Transportation Research Board, Research Record 1207, Washington, DC
90. Majidzadeh, K., Abdulshafi, A., Ilves, G.J., and McLaughlin, A. (1987), "A Mechanistic Approach for Thermally Induced Reflection Cracking of Portland Cement Concrete Pavement with Reinforced Asphalt Overlay," p. 83, Transportation Research Board, Transportation Research Record 1117, Washington, DC
91. McCullough, B.F., Abou-Ayash, A., Hudson, W.R., and Randall, J.P. (1975), "Design of Continuously Reinforced Concrete Pavements for Highways," Final Report, NCHRP Project 1-15
92. Bradburu, R.D., (1938) "Reinforced Concrete Pavement," Wire Reinforced Institute
93. Ioannides, A.M., and Salsilli-Murua, R.A. (1989), "Temperature Curling in Rigid Pavements: An Application of Dimensional Analysis," p. 1, Transportation Research Board, Transportation Research Record 1227, Washington, DC
94. Navarro, D., and Kennedy, T.W. (1975), "Fatigue and Repeated Load Elastic Characteristics of Inservice Asphalt-Treated Materials," Center for Highway Research, University of Texas, Austin
95. Kelly, H.F., and Thompson, M.R. (1988) "Mechanistic Design Concepts for Heavyweight F15 Aircraft on Flexible Pavements," ASCE, Journal of Transportation Engineering, Vol. 114, pp. 323-340

96. "The AASHTO Road Test: Report 5 - Pavement Research," Highway Research Board, Special Report 61E, 1962
97. "Flexible Pavement Design Method for Airfields (Elastic Layer Method)," Joint Departments of the Army and Air Force, U.S.A., Report No. TM 5-825-2-11, AFM 88-6, Ch. 2, 1989
98. "Comparative Performance of Structural Layers in Pavement Systems, Vol. II, Analysis of Test Section Data and Presentation of Design and Construction Procedures," Federal Aviation Administration Report No. FAA-RD-73-198II, 1977
99. Majidzadeh, K., and Kauffmann, E.M. (1971) "Analysis of Fatigue and Fracture of Bituminous Pavement Mixtures," Final Report, Phases I and II, Project RF 2845, Ohio Research Foundation
100. Majidzadeh, K., Kauffmann, E.M., and Chang, C.W. (1973) "Verification of Fracture Mechanics Concepts to Predict Cracking of Flexible Pavement," FHWA Final Report No. FHWA-RD-73-91
101. Majidzadeh, K., Kauffmann, E.M., and Ramsamooj, D.J. (1971) "Application of Fracture Mechanics in the Analysis of Pavement Fatigue," Association of Asphalt Paving Technologist, Vol. 40
102. Ramsamooj, D.V. (1970) The Design and Analysis of Flexible Pavements, PHD Dissertation, Ohio State University
103. Jayawickrama, P.W., and Lytton, R.L. (1987), "Method for Predicting Asphalt Concrete Overlay Life Against Reflection Cracking," p. 913, Proceedings, Sixth International Conference Structural Design of Asphalt Concrete Pavements, Ann Arbor, Michigan
104. Schapery, R.A. (1975), "A Theory of Crack Initiation and Growth in Viscoelastic Media, II Approximate Methods of Analysis," p. 369, International Journal of Fracture, Netherlands
105. George, K.P. (1970) "Theory of Brittle Fracture Applied to Soil Cement," p. 991, Journal of Soil Mechanics and Foundation Engineering, ASCE Vol. 96(3)
106. Crockford, W.W., and Little, D.N. (1987), "Tensile Fracture and Fatigue of Cement-Stabilized Soil," p. 520, Journal of Transportation Engineering, ASCE, Vol. 113(5)

107. Majidzadeh, K., Abdulshafi, A., Ilves, G.J., and McLaughlin, A. (1987), "A Mechanistic Approach for Thermally Induced Reflection Cracking of Portland Cement Concrete Pavement with Reinforced Asphalt Overlay," p. 83, Transportation Research Board, Transportation Research Record 1117, Washington, DC
108. Dormon, G.M. (1962) "The Extension to Practice of a Fundamental Procedure for the Design of Flexible Pavements," International Conference on the Structural Design of Asphalt Pavements, University of Michigan, Ann Arbor
109. Klomp, A.J.G., and Dormon, G.M. (1964) "Stress Distributions and Dynamic Testing in Relation to Road Design," Australian Road Research Board
110. Asphalt Institute, (1973) "Full-Depth Asphalt Pavements for Air Carrier Airports," The Asphalt Institute, Manual Series No. 11
111. Khosla, N.P. (1987), "A Field Verification of VESYS IIIA Structural Subsystems," p. 486, Proceedings, Sixth International Conference Structural Design of Asphalt Pavements, Ann Arbor, Michigan
112. Sneddon, R.V. (1986) "Evaluation and Verification of the VESYS IIIA Structural Design System for Two Test Sites in Nebraska," p. 18, Transportation Research Board, Transportation Research Record 1095, Washington, DC
113. Federal Aviation Administration, (1978) "Airport Pavement Design and Evaluation," AC 150/5320-6C, with change 1.
114. General Provisions for Airfield Pavement Design, Department of Defense, TM 5-824-1/AFM 88-1, Ch. 1 (1987)
115. Flexible Pavement Design for Airfields (1978), Triservice manual, Navy DM 21.3, Army TM 5-825.2, Air Force AFM 88-6, Ch. 2
116. Rigid Pavements for Airfields (1988) Army TM 5-825-3, Air Force AFM 88-6, Ch. 3
117. Airfield Pavements, (1973) NAVFAC DM-21, with changes 1 and 2