

COPY 1

**ANALYTICAL INVESTIGATION OF TIME CORRECTION IN ALPHA-BETA
TRACKING FILTERS WITH APPLICATION TO EN ROUTE TRACKING**

7
8
47

Robert E. Lefferts

FEDERAL AVIATION ADMINISTRATION

MAY 11 1981

TECHNICAL CENTER LIBRARY
ATLANTIC CITY, N.J. 08405



FINAL REPORT

APRIL 1981

Document is available to the U.S. public through
the National Technical Information Service,
Springfield, Virginia 22161.

Prepared for

**U. S. DEPARTMENT OF TRANSPORTATION
FEDERAL AVIATION ADMINISTRATION
TECHNICAL CENTER
Atlantic City Airport, N.J. 08405**



00007359

NOTICE

This document is disseminated under the sponsorship of the Department of Transportation in the interest of information exchange. The United States Government assumes no liability for the contents or use thereof.

The United States Government does not endorse products or manufacturers. Trade or manufacturer's names appear herein solely because they are considered essential to the object of this report.

1. Report No. FAA-CT-80-47		2. Government Accession No.		3. Recipient's Catalog No.	
4. Title and Subtitle ANALYTICAL INVESTIGATION OF TIME CORRECTION IN ALPHA-BETA TRACKING FILTERS WITH APPLICATION TO EN ROUTE TRACKING				5. Report Date April 1981	
				6. Performing Organization Code ACT-220	
7. Author(s) Robert E. Lefferts				8. Performing Organization Report No. FAA-CT-80-47	
9. Performing Organization Name and Address Federal Aviation Administration Technical Center Atlantic City Airport, New Jersey 08405				10. Work Unit No. (TRAIS)	
				11. Contract or Grant No. 975-200-10A	
12. Sponsoring Agency Name and Address Federal Aviation Administration Technical Center Atlantic City Airport, New Jersey 08405				13. Type of Report and Period Covered Final March 1979 - March 1980	
				14. Sponsoring Agency Code ACT-1	
15. Supplementary Notes Vertical tracking is discussed in FAA-NA-79-47 (NTIS No. AD-A085-606).					
16. Abstract <p>In the analysis of the α-β tracking filter, it is normally assumed that the tracking filter and data source operate in synchronism at a constant data rate. An analytical solution is obtained for the case in which the tracking filter and data source operate asynchronously, thus violating the standard assumptions. To compensate for the asynchronous operation of the filter, the technique of time correction is used to adjust the measured data point via the estimated velocity which approximates the synchronous operation of the filter and data source. The tracking filter performance in the steady-state case where time correction is used is better than that obtained from a fixed-parameter tracking filter in which the actual random time intervals between measurements are used as the temporal basis of filter operation. To ensure no degradation in system performance for purposes of air traffic control, a system timing accuracy on the order of 0.05 second is required to preserve the position measurement accuracy rather than the presently used technique which yields a timing accuracy on the order of 0.8 second. If the specified level of timing accuracy is not achieved, then it is postulated that significant errors will be introduced in the predicted position for maneuvering targets. System timing errors are presently the limiting factor in providing accurate position measurements for en route purposes and will partially nullify the data accuracy which will be available in the future.</p>					
17. Key Words Tracking, Alpha-Beta Filters, Radar Tracking, Track-While-Scan Radar, Air Traffic Control, Digital Filtering			18. Distribution Statement Document is available to the U.S. public through the National Technical Information Service, Springfield, Virginia 22161		
19. Security Classif. (of this report) Unclassified		20. Security Classif. (of this page) Unclassified		21. No. of Pages 43	22. Price

METRIC CONVERSION FACTORS

Approximate Conversions to Metric Measures

Symbol	When You Know	Multiply by	To Find	Symbol
LENGTH				
in	inches	*2.5	centimeters	cm
ft	feet	30	centimeters	cm
yd	yards	0.9	meters	m
mi	miles	1.6	kilometers	km
AREA				
in ²	square inches	6.5	square centimeters	cm ²
ft ²	square feet	0.09	square meters	m ²
yd ²	square yards	0.8	square meters	m ²
mi ²	square miles	2.6	square kilometers	km ²
	acres	0.4	hectares	ha
MASS (weight)				
oz	ounces	28	grams	g
lb	pounds	0.45	kilograms	kg
	short tons (2000 lb)	0.9	tonnes	t
VOLUME				
tsp	teaspoons	5	milliliters	ml
Tbsp	tablespoons	15	milliliters	ml
fl oz	fluid ounces	30	milliliters	ml
c	cups	0.24	liters	l
pt	pints	0.47	liters	l
qt	quarts	0.95	liters	l
gal	gallons	3.8	liters	l
ft ³	cubic feet	0.03	cubic meters	m ³
yd ³	cubic yards	0.76	cubic meters	m ³
TEMPERATURE (exact)				
°F	Fahrenheit temperature	5/9 (after subtracting 32)	Celsius temperature	°C

*1 in. = 2.54 (exact). For other exact conversions and more detailed tables, see NBS Misc. Publ. 286, Units of Weights and Measures, Price \$2.25, SD Catalog No. C13.10/286.

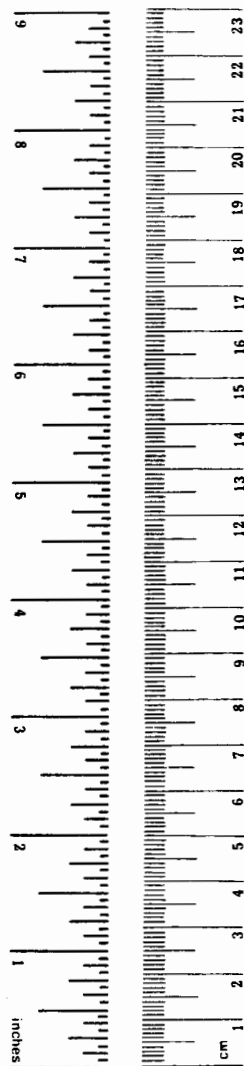

Approximate Conversions from Metric Measures

Symbol	When You Know	Multiply by	To Find	Symbol
LENGTH				
mm	millimeters	0.04	inches	in
cm	centimeters	0.4	inches	in
m	meters	3.3	feet	ft
m	meters	1.1	yards	yd
km	kilometers	0.6	miles	mi
AREA				
cm ²	square centimeters	0.16	square inches	in ²
m ²	square meters	1.2	square yards	yd ²
km ²	square kilometers	0.4	square miles	mi ²
ha	hectares (10,000 m ²)	2.5	acres	
MASS (weight)				
g	grams	0.035	ounces	oz
kg	kilograms	2.2	pounds	lb
t	tonnes (1000 kg)	1.1	short tons	
VOLUME				
ml	milliliters	0.03	fluid ounces	fl oz
l	liters	2.1	pints	pt
l	liters	1.06	quarts	qt
l	liters	0.26	gallons	gal
m ³	cubic meters	35	cubic feet	ft ³
m ³	cubic meters	1.3	cubic yards	yd ³
TEMPERATURE (exact)				
°C	Celsius temperature	9/5 (then add 32)	Fahrenheit temperature	°F

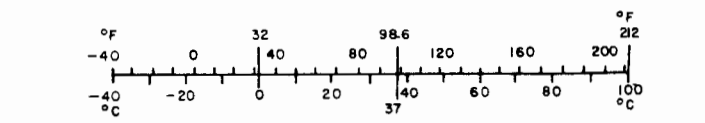

TABLE OF CONTENTS

	Page
EXECUTIVE SUMMARY	v
1. INTRODUCTION	1
2. MATHEMATICAL ANALYSIS	2
2.1 Definition of the α - β Tracking Filter	2
2.2 Variance Reduction Ratios for α - β Filters with a Constant Data Rate	5
2.3 Variance Reduction Ratios for α - β Filters with Fixed Time Correction and a Constant Data Rate	6
2.4 Variance Reduction Ratios for α - β Filters With Random Time Corrections and a Constant Average Data Rate	6
2.5 Variance Reduction Ratios for α - β Filters with Random Update Intervals	9
2.6 Geometrically Induced Timing Jitter	11
2.7 Influence of the Accuracy of Timing Measurements on Filter Performance	14
3. NUMERICAL RESULTS	16
3.1 Peak Magnitude of the Geometrically Induced Timing Jitter	17
3.2 Tracking Filter Performance for Fixed Time Correction Intervals	17
3.3 Tracking Filter Performance for Random Update Versus Random Time Correction	21
3.4 Influence of Time Quantization on Surveillance System Position Measurement Accuracy and Tracking Performance	26
4. SUMMARY	32
5. CONCLUSIONS	36
6. RECOMMENDATIONS	37
7. REFERENCES	37

LIST OF ILLUSTRATIONS

Figure		Page
1	Time Sequence of Events for Asynchronous Tracking Filter Operation	4
2	Geometrically Induced Timing Jitter	14
3	Input Data Errors for Asynchronous Filter without Time Correction	15
4	Input Data Errors for Asynchronous Filter with Time Correction	15
5	Peak Magnitude of Timing Jitter	18
6	Performance Ratios for 2-Minute Predictions	20
7	Performance Ratios for Smoothed Position	22
8	Performance Ratios for Random Update Versus Random Time Correction for $\Delta T=T/2$	24
9	Performance Ratios for Random Update Versus Random Time Correction with $\Delta T=T$	25
10	Position Errors Based on Geometrical Considerations	28
11	Relative Magnitude of Timing Induced Position Errors to DABS Range Measurement Error	30
12	Extended Time Interval Position Prediction Error for DABS	31

EXECUTIVE SUMMARY

All advanced air traffic control functions, such as Conflict Alert, are based on the ability to predict the position of an aircraft sufficiently far into the future so intervention by a controller is possible in situations in which this is warranted. The prediction of future position is based on velocity estimates obtained from a tracking filter which estimates, via numerical differentiation, the time derivatives of the position reports for a given aircraft. The purpose of the present study is to examine different techniques for processing the temporal data associated with the position measurements used in the tracking filter. In a multisensor environment, it is obvious that a tracking filter which operates at a fixed rate and simultaneously for all tracks cannot be synchronized with each individual sensor. As a result, the tracking filter must account for the differences in the time of receipt for the position data received for different tracks and by different sensors. Several alternative approaches have been developed for this purpose. Two basic questions to be answered are the following: (1) What quantitative difference in performance will be observed if the tracking filter operates at a fixed rate using time correction to adjust the measured data to a fixed point in time common to all tracks? (2) Should the tracking filter operate on an asynchronous basis using the random time intervals between position measurements as the temporal reference for smoothing and prediction?

The results of this study showed that the time correction process (which was used to adjust the measured data to compensate for the differences between the time of receipt and the reference time assumed in the tracking filter) yielded performance that was actually slightly better than that obtained using an asynchronous or random update approach with constant smoothing parameters. Although it is known from a previous study that the random update approach should be expected to provide better tracking performance than the time correction approach, it is necessary to use smoothing parameters which vary with the time interval between data points thus considerably increasing the computational requirements of the filter. It was also found that in most cases, the differences in the time intervals between position measurements are so small that it would be extremely difficult to justify the random update approach to tracking filter operation even if an improvement in performance was observed.

As part of the evaluation of alternative tracking techniques for performing smoothing and prediction in an asynchronous environment, the question of the accuracy of the time measurements necessary to support the tracking algorithm was examined. The main conclusion of this study is that the timing accuracy presently being used is insufficient for purposes of the advanced air traffic control functions in the Discrete Address Beacon System (DABS) environment. This conclusion was reached based on two separate observations. First, the position errors introduced by timing inaccuracy (quantization errors) are significantly larger than the measurement errors in the DABS range data. The DABS range accuracy will be lost before the data even reaches the tracking algorithm. Depending on the azimuthal accuracy of the DABS sensor, the system errors introduced by time quantization will constitute the predominant source of measurement error throughout a significant portion of the coverage area of the sensor. Second, the error in the 2-minute position prediction, as used in the advanced automation features, will be on the order of 1 to 3 nautical miles for a maneuvering target. This additional error is due solely to the inaccuracy in the time measurement. In order to totally eliminate timing errors as a source of system inaccuracy for purposes of air

traffic control, a time measurement accuracy on the order of 0.05 second is required to ensure the accuracy of the position data. This is at least an order of magnitude better than that presently used. Even if the random update approach to filtering had been found to be advantageous, the differences in the data intervals resulting from target motion over most of the sensor coverage area are so small that these differences could not be measured considering the present system timing accuracy. The performance degradation resulting from timing inaccuracy is independent of the filtering algorithm being used and will affect all algorithms in a similar manner. The timing accuracy presently in use is not sufficient to support the accuracy of the DABS data or the enhanced automation features. The timing accuracy must be improved to make effective use of the available data.

1. INTRODUCTION

The α - β tracking filter is a widely used technique for performing the operation of numerical differentiation to obtain velocity estimates from noisy position measurements. The simplicity of the algorithm and the limited computational requirements have resulted in the use of this filter in many practical situations. As a consequence, extensive analytical studies have been made of the α - β filter (e.g., references 1 through 16). In virtually all of the studies which have been performed to date, it has been assumed that the data are obtained at a constant rate. In general, however, this is an unrealistic assumption because even for a surveillance radar rotating at a constant rate, the targets are moving which means that the time intervals between position measurements will not be constant. A moving target will not necessarily be at the same angular location with respect to the antenna so, while the average data rate will stay constant, the actual time between samples will vary. As a result, most practical situations do not meet the assumption of a constant time interval between data points on which most α - β filter analyses are based. One particular study in which this assumption is not made is the work by Cantrell (references 13 and 14). The objective of the present study is to show how the results obtained by Cantrell can be applied to the analysis of the en route tracking algorithm (reference 17). These results have already been found useful in the analysis of the en route altitude tracking function (reference 18).

For the purposes of en route air traffic control there is an additional reason, beyond that arising as a result of moving targets, why the data samples will not be synchronized with the operation of the tracking algorithm. Since a particular air traffic control center may have from 10 to 15 different sensors providing surveillance information, the tracking algorithm can not operate synchronously with all at the same time. Instead, the tracking algorithm operates at fixed time intervals and processes the surveillance data which have been received since the previous operation of the tracking algorithm (reference 17).

The specific purpose of this study is to demonstrate the consequences of assuming that the position measurements and the tracking filter operate in a synchronous manner when, in fact, this is not true. If the situation above is recognized, then it is possible to compensate for the asynchronous operation of the tracking filter and data source by using the estimated velocity to adjust the measured data to compensate for the difference in time between the filter operation and the actual measurement time. In using such a procedure (time correction), the degree of success is dependent on (1) the ability of the tracking algorithm to provide accurate velocity estimates and (2) the degree to which the true target trajectory can be expressed as a first-order function of the time difference. An explicit quantitative analysis is given which will allow a comparative study to be made between a tracking algorithm in which the time-correction process is used and one in which it is not used. The performance statistics of interest in this study will be (1) the variance of the velocity estimates and (2) the accuracy of the extended time-interval position prediction. Both of these statistics are of considerable importance in determining the ability of the tracking algorithm to support functions such as Conflict Alert (reference 17).

If the tracking algorithm is not scheduled to operate on the surveillance data under the assumption of fixed time intervals, then it would be possible to avoid the use of time correction by having the smoothing and prediction calculations

based on the difference between the time of receipt of the previous measurement and the time of receipt of the present measurement. The use of the exact time interval (from measurement to measurement) in the tracking filter operation would avoid (1) the approximation introduced by time correction and (2) the use of the estimated velocity, which contains random errors. By using the exact time interval between measurements, it is conjectured that the accuracy of the estimated velocity, which is highly dependent on accurate measurement of the time intervals, would improve by a significant amount thus justifying the elimination of time correction. Since the actual operation of the tracking filter would become more complicated by the elimination of time correction, it would be necessary to achieve a substantial performance improvement in order to justify such a change.

2. MATHEMATICAL ANALYSIS

2.1 DEFINITION OF THE α - β TRACKING FILTER.

The α - β tracking algorithm is a recursive procedure which performs the operations of position smoothing, position prediction, and numerical differentiation for velocity estimation. It is specified by the equations:

$$\begin{aligned} X_s(k) &= X_p(k) + \alpha(X_m(k) - X_p(k)) \\ X_v(k) &= X_v(k-1) + (\beta/T)(X_m(k) - X_p(k)) \end{aligned} \quad (1)$$

$$X_p(k+1) = X_s(k) + TX_v(k)$$

where:

$X_s(k)$ = smoothed position at the k^{th} time epoch

$X_v(k)$ = velocity estimate

$X_p(k)$ = predicted position

$X_m(k)$ = measurement position

T = sampling period (assumed constant)

α, β = smoothing constants.

For the purposes of the tracking algorithm, it is only necessary to predict the future position of the target one time interval into the future. For the purposes of advanced air traffic control functions, however, it is necessary to make position predictions much farther into the future so that an extended time interval position prediction will be defined as:

$$X_p(k, T') = X_s(k) + T'X_v(k). \quad (2)$$

The time interval T' is arbitrary. The accuracy of the extended time interval position prediction is dependent on the accuracy of the tracking filter outputs, X_s and X_v , and also on the degree to which the actual flightpath follows the constant velocity, straight-line assumption inherent in (2).

In the algorithm, as defined by (1), it is assumed that all computations and measurements are coincident with the epoch times. In an asynchronous multisensor environment, however, data may be received at any time between the operations of the tracking algorithm. In such cases, it is necessary to assume a reference time for the smoothing and prediction process which may not necessarily be the time of operation of the tracking algorithm or the time of receipt of the measurement datum. In the case of the en route portion of the National Airspace System, the tracking function operates at a fixed rate, not necessarily that of the sensor, with the computation time taken as the midpoint of the tracking cycle operation (reference 17). The operation of the tracking algorithm is illustrated in figure 1. The smoothing and prediction process uses the center of the tracking cycle as the reference time, thus predicting from the center of the present cycle to the center of the succeeding cycle. As illustrated in figure 1, measurement data may not be received at the reference time used by the tracking algorithm. The estimated velocity from the previous cycle may be used to move the data point, either forward or backward in time, to make it appear as though the measurement datum was received in synchronism at the center of the cycle. This process is known as time correction.

In this case, the smoothing equations are

$$\begin{aligned} X_s(k) &= X_p(k) + \alpha(X_m(k) + \Delta T(k) X_v(k-1) - X_p(k)) \\ X_v(k) &= X_v(k-1) + (\beta/T) (X_m(k) + \Delta T(k) X_v(k-1) - X_p(k)) \end{aligned} \quad (3)$$

where

$$\Delta T(k) = kT - T_m(k), \quad (4)$$

with $T_m(k)$ being the actual time at which the position measurement was made. As a result of the time-correction process, it is not even necessary for data to be received every cycle, since if no datum is received in a particular cycle, the track (or assumed trajectory) is simply predicted ahead to the center of the next tracking cycle. (The opposite case in which multiple measurements are received within one cycle will not be considered.)

Via the process of time correction just described, it has been shown how it is possible for the tracking algorithm to operate at a fixed cyclic rate and yet the measurement data which are used by the algorithm may be obtained at a different data rate. The multiple sensor environment of the en route air traffic control system meets the conditions just described. If the measurements are obtained asynchronously and the time-correction process is not used, then this is equivalent to the introduction of an error equal to the difference between the measured position and the true position at the time the measurement should have been made if the requirement for synchronism between the data source and the tracking algorithm had been fulfilled. The elimination or omission of the time-correction process will introduce an additional source of error into the tracking algorithm which is unnecessary if the time of receipt of the measured position is known.

The errors (discussed above) that are introduced by the elimination of time correction can be avoided if the tracking algorithm is modified to use the time interval from the previous measurement to the present measurement. In this case, the sampling interval is no longer constant but is recomputed for each measurement

as $T_k = T_m(k) - T_m(k-1)$ which is used in the tracking equations as specified by (1). Note that in such situations the predicted position could not be computed until the time of receipt of the next measurement was known, but it would be possible to approximate the predicted position, if required, using the average period between measurements. This would mean a more complicated correlation scheme since the exact predicted position would not be used, but this would not be a problem for most beacon targets, especially those using a unique discrete address. The additional complication would be justified if a significant performance improvement could be obtained.

The statistical performance of the α - β tracking filter is usually expressed in terms of the variance reduction ratios which are the ratios of the error variances at the output of the filter to the variance of the errors at the input of the filter. The variance reduction ratios describe the performance of the tracking filter in a steady-state situation in which all transients have decayed. If transient errors are present, such as at the start of a maneuver, then errors significantly larger than those discussed in this report will be present. It can be shown, however, that the transient error for constant velocity targets will eventually decay to zero for the tracking filter regardless of whether or not time correction is used. Various techniques can be used to show that the mean error in position and velocity will be zero for all of the α - β tracking algorithms discussed in this report. The filter output will be unbiased for targets on a constant velocity trajectory. Since only the steady-state performance is presently of interest, the variance reduction ratios completely characterize the performance of the tracking algorithms for the purposes of this study. The variance reduction ratios for the particular α - β tracking algorithm formulations of interest in this study will be given in the following sections.

TRACKING ALGORITHM OPERATION

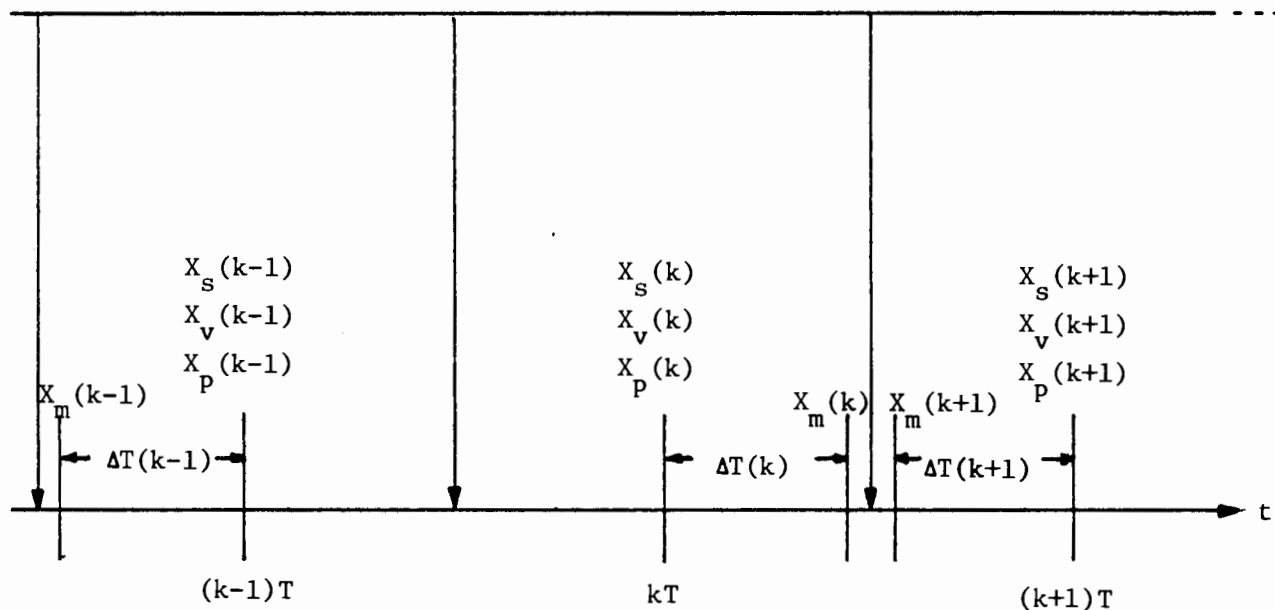

FIGURE 1. TIME SEQUENCE OF EVENTS FOR ASYNCHRONOUS TRACKING FILTER OPERATION

2.2 VARIANCE REDUCTION RATIOS FOR α - β FILTERS WITH A CONSTANT DATA RATE.

In the standard configuration of the α - β tracking filter, it is assumed that the tracking filter and data source operate in synchronism at a constant data rate. The tracking filter (in both dimensions) can be considered as a single input (X_m), multiple output (X_s, X_v, X_p) filter with the steady-state statistical characteristics completely expressed in terms of the normalized variance reduction ratios:

$$\begin{aligned}\sigma_s^2 &= K_s \sigma_x^2 \\ \sigma_v^2 &= K_v \sigma_x^2 \\ \sigma_p^2 &= K_p \sigma_x^2\end{aligned}\tag{5}$$

where K_s , K_v , and K_p are the normalized variance reduction ratios for X_s , X_v , and X_p , respectively, and σ_x^2 is the variance of the noise in the position measurements at the input of the filter. The variance reduction ratio K_p applies to the single scan prediction X_p . In cases such as Conflict Alert (reference 17), which depend on extended time-interval position predictions (i.e., (2)), a generalized variance reduction ratio for predicted positions can be defined as

$$K_p(T') = K_s + 2T'K_{vs} + (T')^2K_v\tag{6}$$

where T' is an arbitrary prediction interval. Since the three filter outputs are obtained from a common input, it would be expected that a nonzero correlation would exist between the various outputs. This relationship is defined by the covariance between the velocity and the smoothed position and is calculated from σ_x^2 using the normalized covariance reduction ratio K_{vs} . The normalized variance reduction ratios for a constant coefficient, isotropic α - β tracking filter, expressed in terms of the smoothing constants, are:

$$\begin{aligned}K_s(T) &= (2\alpha^2 + \beta(2-3\alpha))/D \\ K_v(T) &= 2(\beta/T)^2/D \\ K_p(T) &= (2\alpha^2 + \alpha\beta + 2\beta)/D \\ K_{vs}(T) &= (\beta(2\alpha-\beta))/TD \\ K_p(T, T') &= (2\alpha^2 - 3\alpha\beta + 2\beta + 2(T'/T)\beta(2\alpha-\beta) + 2(\beta T'/T)^2)/D\end{aligned}\tag{7}$$

where

$$D = \alpha(4-2\alpha-\beta)\tag{8}$$

and which are the results normally found (references 3, 12 through 16, 18, and 20). The above results are readily derived from (1) using standard z-transform techniques (e.g., reference 16). Since four specific formulations of the tracking filter will be examined in this report and the performance in each case will be specified by the normalized variance reduction ratios, it is important to note that

the arguments of the various reduction ratios will be used to designate the type of temporal dependency in the filter. For example, in the case of (7) and (8) only the constant sampling period, T, is required to specify the temporal characteristics of the filter.

2.3 VARIANCE REDUCTION RATIOS FOR α - β FILTERS WITH FIXED TIME CORRECTION AND A CONSTANT DATA RATE.

In the case where time correction is used in asynchronous tracking filters, the filter equations are given by (3) with the predicted position equations unchanged. In this section, only the simplest form of time correction will be considered—the case in which both the data source and the tracking algorithm operate at a constant rate but the actual position measurements are not made at the same time as the reference time used in the tracking filter. In all cases in this study, the reference time will be taken as the center of the tracking cycle. In effect, the sensor system and the tracking filter operate at the same frequency with a constant phase difference which is specified by a known constant, ΔT . This situation is similar to that illustrated in figure 1 with the exception that $\Delta T(k)$ is constant.

For the case in which a fixed time correction is used, the variance reduction ratios can be calculated using the standard z-transform approach (reference 16) as used previously. The resulting reduction ratios are:

$$\begin{aligned}
 K_s(T, \Delta T) &= (2\alpha^2 - 3\alpha\beta + 2\beta + \beta^2 \Delta T/T)/D \\
 K_v(T, \Delta T) &= 2(\beta/T)^2/D \\
 K_p(T, \Delta T) &= (2\alpha^2 + \alpha\beta + 2\beta + \beta^2 \Delta T/T)/D \\
 K_{vs}(T, \Delta T) &= (\beta(2\alpha - \beta))/TD \\
 K_p(T, T', \Delta T) &= (2\alpha^2 - 3\alpha\beta + 2\beta + \beta^2 \Delta T/T + 2(T'/T)\beta(2\alpha - \beta) + 2(\beta T'/T)^2)/D
 \end{aligned} \tag{9}$$

where

$$D = \alpha(4 - 2\alpha - \beta) - \beta(4 - 4\alpha - \beta)\Delta T/T - 2(\beta\Delta T/T)^2 \tag{10}$$

which reduces to the results given in section 2.2 when $\Delta T=0$. The results just given can also be used when ΔT is a random variable if the intended use of the results is such that a worst-case value can be used for the computations such as in the design of correlation regions (reference 20). However, if it is desired to determine the effect of a random variation in ΔT , which is the case in most practical situations, then the results just given are not applicable and an alternative approach must be used to derive the variance reduction ratios.

2.4 VARIANCE REDUCTION RATIOS FOR α - β FILTERS WITH RANDOM TIME CORRECTIONS AND A CONSTANT AVERAGE DATA RATE.

A surveillance radar rotating at a constant rate will not provide position measurement at a constant rate unless the targets under observation are stationary, moving radially, or circularly about the sensor. While the average data rate will remain constant, the normal movements of the targets will cause perturbation of the time intervals between measurements for each particular target. In the case of a multi-sensor system in which each target is observed primarily by one radar with others

used for back-ups (such as in the en route air traffic control system), the α - β tracking filter with a random time-correction factor and a constant average data rate corresponds most closely to the real world. Hence, the solution in this case is of great practical importance. The approach used in this case will generally follow that used by Cantrell (reference 13) for dealing with random temporal variation in the α - β tracking filter. Computation of the variance reduction ratios will be facilitated if the tracking algorithm equations are expressed in the matrix form:

$$\begin{bmatrix} X_s(k) \\ X_v(k) \end{bmatrix} = \begin{bmatrix} 1-\alpha & T(1+\alpha\Delta T/T-\alpha) \\ -\beta/T & (1+\beta\Delta T/T-\beta) \end{bmatrix} \begin{bmatrix} X_s(k-1) \\ X_v(k-1) \end{bmatrix} + \begin{bmatrix} \alpha \\ \beta/T \end{bmatrix} X_m(k) \quad (11)$$

or,

$$X(k) = A(T, \Delta T) X(k-1) + B(T) (u(k) + x(k)) \quad (12)$$

where:

$$X(k) = \begin{bmatrix} X_s(k) \\ X_v(k) \end{bmatrix} \quad (13)$$

$$A(T, \Delta T) = \begin{bmatrix} 1-\alpha & T(1+\alpha\Delta T/T-\alpha) \\ -\beta/T & (1+\beta\Delta T/T-\beta) \end{bmatrix}$$

and

$$B(T) = \begin{bmatrix} \alpha \\ \beta/T \end{bmatrix} .$$

The measurement datum, $X_m(k)$, is expressed as the sum of a true deterministic component, $u(k)$, and a random error component, $x(k)$, with variance σ_x^2 which will be assumed to be white stationary noise representing the measurement error.

The noise response of the filter is obtained in terms of the covariance matrix for the errors at the filter output. This response is given by

$$P(k+1) = A(T, \Delta T)P(k)A'(T, \Delta T) + B(T) \sigma_x^2 B'(T), \quad (14)$$

where σ_x^2 is the variance of the input noise (reference 19). All of the coefficients in (14) are constant with the exception of ΔT which is the random time correction factor. Cantrell has shown that in the case where matrices A and B are random variables which are identically distributed and independent from sample to sample, the covariance matrix is given by:

$$\overline{P(k+1)} = \overline{A(T, \Delta T)P(k)A'(T, \Delta T)} + \overline{B(T) \sigma_x^2 B'(T)}, \quad (15)$$

where the bar denotes the expected value, averaged over the random variable of interest, in this case ΔT (reference 13).

To solve for the variance reduction ratios, $A(T, \Delta T)$ and $B(T)$ are used in (15) with the resulting equations then being averaged over ΔT . By performing the required operations and noting that in the steady-state case

$$P(k+1) = P(k), \quad (16)$$

then (15) becomes, after some rearranging (assuming that $E(\Delta T) = 0$),

$$\begin{bmatrix} \alpha(2-\alpha) & -2T(1-\alpha)^2 & -T^2(1-2\alpha+\alpha^2(1+\sigma_{\Delta T}^2/T^2)) \\ \beta(1-\alpha)/T & 2\beta-2\alpha\beta+\alpha & -T(1-\alpha-\beta+\alpha\beta(1+\sigma_{\Delta T}^2/T^2)) \\ -(\beta/T)^2 & 2\beta(1-\beta)/T & 2\beta-\beta^2(1+\sigma_{\Delta T}^2/T^2) \end{bmatrix} \begin{bmatrix} P_{ss} \\ P_{vs} \\ P_{vv} \end{bmatrix} = \begin{bmatrix} \alpha^2 \\ \alpha\beta/T \\ (\beta/T)^2 \end{bmatrix} \sigma_x^2, \quad (17)$$

where: $\sigma_{\Delta T}^2 = E(\Delta T^2)$

P_{ss} = steady-state variance of the smoothed position, $X_s(k)$

P_{vs} = steady-state covariance of $X_v(k)$ and $X_s(k)$, and

P_{vv} = steady-state variance of $X_v(k)$.

Solving these equations simultaneously gives:

$$\begin{aligned} K_s(T, \sigma_{\Delta T}^2) &= (2\alpha^2 - 3\alpha\beta + 2\beta)/\Delta \\ K_{vs}(T, \sigma_{\Delta T}^2) &= \beta(2\alpha - \beta)/(T\Delta) \\ K_v(T, \sigma_{\Delta T}^2) &= 2(\beta/T)^2/\Delta \end{aligned} \quad (18)$$

with $\Delta = \alpha(4 - 2\alpha - \beta) - 2\sigma_{\Delta T}^2(\beta/T)^2$.

In the case where $\sigma_{\Delta T}^2=0$, these equations also reduce to the results given in section 2.2. Since the factor $\sigma_{\Delta T}^2$ tends to reduce the value of the denominator in the variance reduction ratios, it would appear that the time-correction factor would actually result in an increase in the noise at the output of a tracking filter in which time correction is used, but as it is shown elsewhere (reference 18), this is not the case. In the case of the predicted position, $X_p(k, T')$ given by (2), the variance reduction ratio can be derived using (6) and in this case,

$$K_p(T, T', \sigma_{\Delta T}^2) = (2\alpha^2 - 3\alpha\beta + 2\beta + 2(T'/T)\beta(2\alpha - \beta) + 2(\beta T'/T)^2) / \Delta \quad (19)$$

which reduces to $K_p(T)$ in (7) when $T'=T$ and $\sigma_{\Delta T}^2=0$.

In order to complete the analysis, it is necessary to assume something about the statistical characteristics of ΔT . For the purposes of this section, it will be assumed that the time-correction factors are uniformly distributed with a mean value of zero so that the variance is

$$\sigma_{\Delta T}^2 = (\Delta T)^2 / 12 \quad (20)$$

where now ΔT represents the width of the interval in which the time-correction factors are contained.

2.5 VARIANCE REDUCTION RATIOS FOR α - β FILTERS WITH RANDOM UPDATE INTERVALS.

The last class of α - β tracking filters to be considered is the random update filter, as used by Cantrell (reference 13), in which the reference time used in the smoothing and prediction process is the actual time at which the consecutive position measurements are made; i.e., (5) is used in (1). In this mode of operation, the time-correction process is not required but no errors are introduced in the filter operation since the proper time difference is always used in the velocity estimation equation. Because there is no longer a common reference time for all tracks under observation, certain changes in an operational situation may be required, such as the variation of T' to produce extended time position predictions to a common point in time; however, the modifications required are relatively trivial and would certainly be justified if a significant performance improvement could be demonstrated.

In the case of the random update filter, the equations specifying the filter can be placed in the form

$$X(k) = A(T_k) X(k-1) + B(T_k) (u(k) + x(k)) \quad (21)$$

where $X(k)$ is as specified previously and,

$$A(T_k) = \begin{bmatrix} 1-\alpha & T_k(1-\alpha) \\ -\beta/T_k & 1-\beta \end{bmatrix} \quad (22)$$

$$B(T_k) = \begin{bmatrix} \alpha \\ \beta/T_k \end{bmatrix}.$$

The performance of this filter can also be calculated in the same manner as that in the previous section; i.e., the relationship between the covariance matrix at stage $k+1$ and that at k is

$$P(k+1) = A(T_k) P(k) A'(T_k) + B(T_k) \sigma_x^2 B'(T_k) \quad (23)$$

which becomes (using (16))

$$\begin{bmatrix} P_{ss}(k) \\ P_{vs}(k) \\ P_{vv}(k) \end{bmatrix} = \begin{bmatrix} (1-\alpha)^2 & 2(1-\alpha)^2 E(T_k) & (1-\alpha)^2 E(T_k^2) \\ -\beta(1-\alpha)E(1/T_k) & (1-\alpha)(1-2\beta) & (1-\alpha)(1-\beta)E(T_k) \\ \beta^2 E(1/T_k^2) & -2\beta(1-\beta)E(1/T_k) & (1-\beta)^2 \end{bmatrix} \begin{bmatrix} P_{ss}(k) \\ P_{vs}(k) \\ P_{vv}(k) \end{bmatrix} \quad (24)$$

$$+ \begin{bmatrix} \alpha^2 \\ \alpha\beta E(1/T_k) \\ \beta^2 E(1/T_k^2) \end{bmatrix} \sigma_x^2$$

where $E(\bullet)$ denotes the expected value of the particular function of the separation time, T_k . Since the smoothing parameters of the filter are constant, the coefficients in (24) can be specified in terms of α and β and the expected values, $E(T_k)$, $E(T_k^2)$, $E(1/T_k)$, and $E(1/T_k^2)$. In order to calculate the expected values required, the statistical characteristics of T_k must be defined. For the purposes of this study, it will be assumed that the random variable T_k is uniformly distributed in an interval of width Δt which is centered on T ; i.e.,

$$T - \Delta t/2 \leq T_k \leq T + \Delta t/2 \quad (25)$$

so that the expected values required are given by:

$$\begin{aligned}
 E(T_k) &= T \\
 E(T_k^2) &= T + \Delta t^2/12 \\
 E(1/T_k) &= \Delta t^{-1} \ln \left\{ (T+\Delta t/2)/(T-\Delta t/2) \right\} \\
 E(1/T_k^2) &= 4/(4T^2 - \Delta t^2)
 \end{aligned} \tag{26}$$

where T is the average separation time between position measurements. Note that Δt in this section is similar in function to ΔT in section 2.4 with the difference being that Δt refers to the width of the interval of tracking cycle differences while ΔT refers to the width of the interval of time-correction differences.

The linear equations which specify the variance reduction ratios can be obtained by rearranging (24) to give,

$$\begin{bmatrix}
 \alpha(2-\alpha) & -2(1-\alpha)^2 E(T_k) & -(1-\alpha)^2 E(T_k^2) \\
 \beta(1-\alpha)E(1/T_k) & \alpha+2\beta(1-\alpha) & -(1-\alpha)(1-\beta)E(T_k) \\
 -\beta^2 E(1/T_k^2) & 2\beta(1-\beta)E(1/T_k) & \beta(2-\beta)
 \end{bmatrix}
 \begin{bmatrix}
 K_s(T, \Delta t) \\
 K_{vs}(T, \Delta t) \\
 K_v(T, \Delta t)
 \end{bmatrix}
 =
 \begin{bmatrix}
 \alpha^2 \\
 \alpha\beta E(1/T_k) \\
 \beta^2 E(1/T_k^2)
 \end{bmatrix} \tag{27}$$

which can be solved simultaneously for the three variables of interest. Unfortunately, the solutions to (27) do not reduce to any simple form, as was the case previously, so the explicit solutions will not be given. Note that in the limit as $\Delta t \rightarrow 0$ and $\Delta T \rightarrow 0$, the results in sections 2.3, 2.4, and 2.5 all approach the same limiting values; namely, the variance reduction ratios for the constant data rate case as given in section 2.2.

2.6 GEOMETRICALLY INDUCED TIMING JITTER.

As was stated previously, a radar with a constant rotation rate will not result in a constant data rate unless the target of interest is stationary, moving radially, or circularly about the sensor. If the target is moving in the direction of the scanning motion of the radar, then the time interval between measurements will be larger than the period of rotation; if the motion of the target is against the direction of scanning, then the time interval between measurements will be smaller than the period of rotation. Because timing jitter is so important in determining the variance reduction ratios, it would be useful to know the approximate magnitude of the jitter induced by the target motion. This is not the only source of timing jitter within the system—the stability of the scanning rate of the radar is also determined by the drive motor and the gear train coupling of the motor to the antenna. In measurements of an actual air route surveillance radar antenna, it was found that the jitter in the time interval between North marks (a measure of the mechanical stability of the system) was on the order of ± 0.01 (s) second from the nominal value, thus mechanically induced jitter will probably be negligible. Of course, the value just given applies only to radar antennas in radomes, otherwise the jitter will be considerably larger due to wind loading. In addition to the

jitter, there is also system induced jitter caused by the scheme used for interrogation of the aircraft transponder. As a result of the finite beamwidth of the antenna pattern, the target may be successfully interrogated over a finite time interval. Conceptually, the time of measurement should be taken as the time at which the center of the antenna pattern swept past the measured azimuth of the target. The use of this criterion for time measurement will ensure that the time of measurement for each target will be defined in a uniform manner regardless of whether the target was first detected on the leading or the trailing edge of the antenna pattern. Since the interrogation and detection scheme presently used requires repeated target interrogations before a target is declared, the uncertainty in time measurement is at least on the order of several interrogation periods. Assuming that the time of measurement is related to the azimuth of the target as specified previously, then the uncertainty in the time of measurement can be directly related to the azimuth accuracy of the system. The azimuth measurement in the en route system is specified to have a standard deviation of 3 Azimuth Change Pulses (ACP) (with 4096 ACP per 10-second antenna rotation). Using three standard deviations to define the limits of the timing error, the detection process results in an inherent system timing jitter of ± 9 ACP/409.6 ACP/s or ± 0.021 s which is on the same order of magnitude as the mechanically induced timing jitter.

The major source of timing jitter is the actual motion of the target. In some cases, the update interval between measurements can vary from significantly less than the period of rotation to as much as one and a half times the scan time (reference 21). The largest deviations from the period of rotation occur at points close to the radar. As the distance moved by the target between updates becomes small with respect to the distance to the radar, the update interval approaches the period of rotation. If it is assumed that the target flies in a straight-line, constant velocity trajectory, as illustrated in figure 2, then the update interval, τ , can be calculated from

$$\tan(2\pi(\tau-1)) = \tan \left\{ \tan^{-1} \left(\frac{x_a + \tau v_x}{y_a + \tau v_y} \right) - \tan^{-1} \left(\frac{x_a}{y_a} \right) \right\} \quad (28)$$

where

x_a, y_a = initial position coordinates

v_x, v_y = target velocities

and an iterative technique must be used to solve (28) (reference 21). For the purposes of this study, an exact solution to the update interval is not required; an approximation will be used to determine the magnitude of the deviations in the update interval. In this case,

$$\tau = T + \Delta T \quad (29)$$

where T is the period of rotation and ΔT is the deviation from the nominal value. If the radar is rotating at a constant rate, ω , then $\Delta\theta = \omega\Delta T$. An approximate solution for ΔT can be obtained by applying the Pythagorean theorem to the right triangle in figure 2 which yields

$$(\rho_1 \cos \Delta\theta)^2 + \left(\frac{|\vec{A} \times \vec{B}|}{\rho_1} \right)^2 = \rho_1^2 \quad (30)$$

where $\rho_1 = |\vec{A}|$ and $\rho_2 = |\vec{B}|$. The vector cross-product is used to determine the distance from point A to the vector \vec{B} (which can be derived from the formula for the area of the parallelogram defined by \vec{A} and \vec{B}). In all cases in which the update rate is considered, it will be assumed that all computations are performed using the ground range—the altitude of the aircraft can be ignored. Using the small angle approximation for the cosine and the fact that $\Delta T \ll T$ in most cases, (30) reduces to

$$\Delta T \cong \frac{T^2}{2\pi} \left\{ \frac{x_a v_y - y_a v_x}{((x_a^2 + y_a^2)(x_a^2 + y_a^2 + 2T(x_a v_x + y_a v_y) + T^2(v_x^2 + v_y^2)))^{1/2}} \right\} \quad (31)$$

which is valid for the case where the distance to the radar is much greater than the distance moved in one update interval. In the case when the numerator of (31) is zero; i.e.,

$$\frac{x_a}{y_a} = \frac{v_x}{v_y} \quad (32)$$

this implies that the cross product, $\vec{A} \times \vec{B}$, is zero or, equivalently, that the vectors \vec{A} and \vec{B} are parallel. In such a situation, the target is travelling along a radial path from the radar; the timing jitter factor should be zero, thus confirming the intuitive interpretation of the condition $\Delta T=0$. It has been implicitly assumed throughout the development of the equations above that the timing differences resulting from the difference in time required for the electromagnetic signals to propagate along the radials to the target are insignificant when compared to the differences resulting from the motion of the target. Since the minimum value of ΔT occurs for a target moving along a radial (in which case the two vectors \vec{A} and \vec{B} are parallel), it might be expected that the maximum value would occur for a target moving tangentially. This is not the case since the cross product is a maximum when the two vectors involved are perpendicular. This would imply an unreasonably high velocity target except at points close to the radar for which (31) is invalid in any case.

The value of ΔT computed using the above equations refers to the deviation from the nominal rotation period of the sensor. For the purposes of this study, however, it is the deviations from a constant rate which are important, whether or not that rate is the same as the rotation period; this is not the same as the quantity just computed. For example, a target moving at a constant speed in a circular trajectory centered on the radar will result in a constant data rate. This rate will not necessarily be the same as that of the sensor. Consequently, what is of interest is the variation in ΔT with a changing scenario and not the deviation from T as has been computed. Computation of this variation would be far more difficult but, as will be shown in section 3.1, the computation of ΔT is all that is required for the purposes of this study.

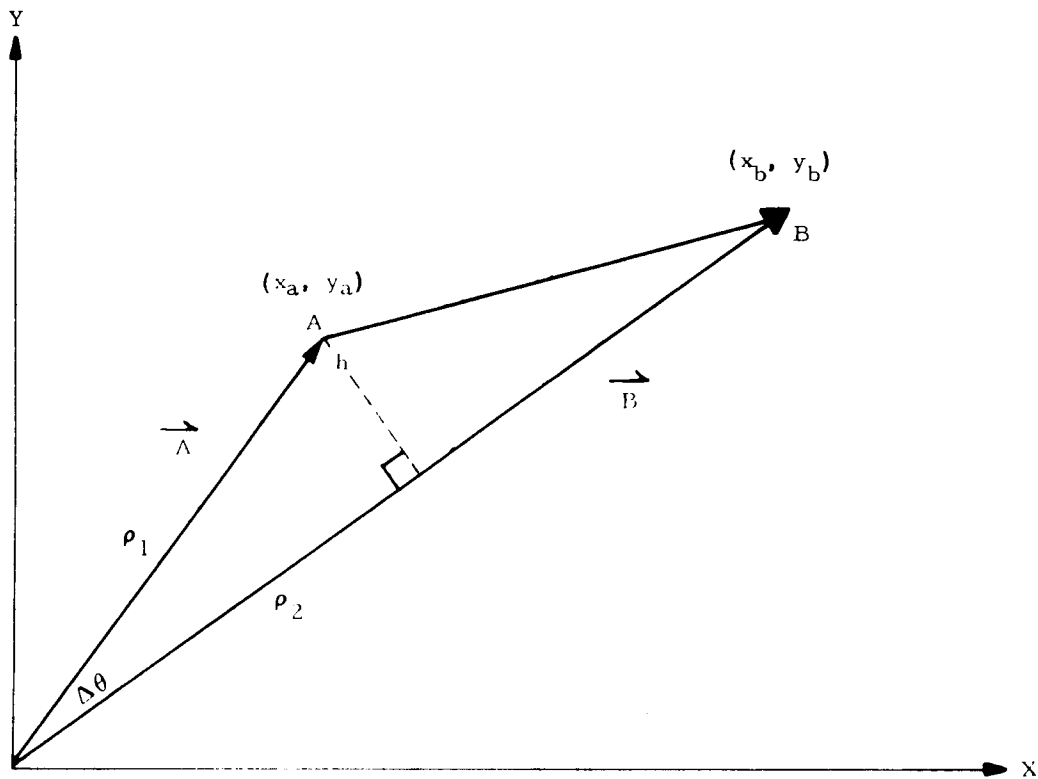

80-47-2

FIGURE 2. GEOMETRICALLY INDUCED TIMING JITTER

2.7 INFLUENCE OF THE ACCURACY OF TIMING MEASUREMENTS ON FILTER PERFORMANCE.

It has been assumed in the derivation of the results in the previous sections that when the time-correction process is used, the time of measurement is known exactly. Suppose, however, that the time-correction procedure is not performed in an asynchronous situation. This is equivalent to the introduction of an error equal to the difference between the measured position and the true position at the time at which the filter assumes the measurement to have been made. If the target is moving at a constant true velocity X_V , then the error which is introduced is equal to $\Delta T X_V$ so that the errors at the input to the filter can be considered as two additive errors as illustrated in figure 3. The error ΔX will be assumed to arise as a consequence of the measurement errors in the data.

It will be assumed in all cases that the measurement errors in the data and the timing errors (no matter what the source) are white and stochastically independent of one another. When time correction is used, the measurement time must be known. This situation is illustrated conceptually in figure 4. As seen in this figure, the time-correction process is a feedback loop in which the estimated velocity is multiplied by ΔT to form a corrected input. Since time is also quantized, a second noise source is needed so that instead of the error being $\Delta T X_V$, it is now $\Delta T_q X_V$ where ΔT_q is the time-quantization unit. The performance of the tracking filter, in the case where the only errors are those discussed above, can be written in terms of the appropriate variances and variance reduction ratios. For example,

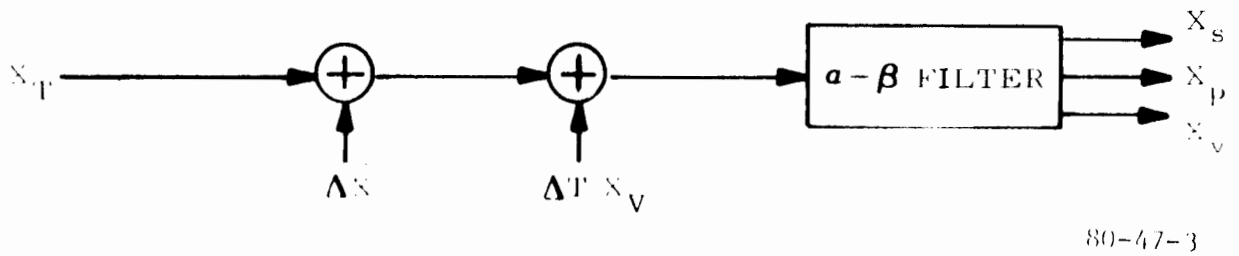

FIGURE 3. INPUT DATA ERRORS FOR ASYNCHRONOUS FILTER WITHOUT TIME CORRECTION

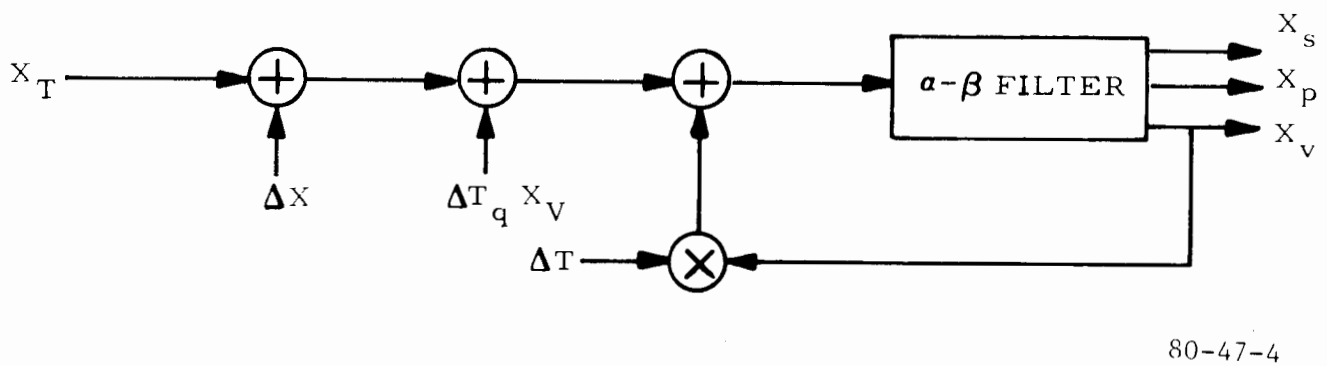

FIGURE 4. INPUT DATA ERRORS FOR ASYNCHRONOUS FILTER WITH TIME CORRECTION

in the case of the variance of the velocity errors, the filter performance without time correction is

$$P_{vv} = K_v(T)(\sigma_x^2 + X_v^2 \sigma_{\Delta T}^2) \quad (33)$$

where σ_x^2 = variance of measurement errors
 $\sigma_{\Delta T}^2$ = variance of time differences between assumed time of measurement and actual time of measurement.

and similarly for the other performance statistics computed using the variance reduction ratios. As $\sigma_{\Delta T}^2 \rightarrow 0$ the results specified by (33) approach the standard results given previously (i.e., (5)) in which the tracking filter and the position measurements operate exactly in synchronism at a fixed update interval.

For the case in which a random time correction is used, similar results are obtained; e.g.,

$$P_{vv} = K_v(T, \sigma_{\Delta T_q}^2) (\sigma_x^2 + X_v^2 \sigma_{\Delta T_q}^2) \quad (34)$$

where $\sigma_{\Delta T_q}^2$ is the variance of the time measurement errors. If the time of measurement is known exactly, then $\sigma_{\Delta T_q}^2 = 0$ and the results reduce to the standard case as specified previously. If the tracking filter does not use time correction but rather smooths from measurement time to measurement time, as in section 2.5, then the variance reduction ratios as defined by (27) should be used but the additive contribution from the time quantization, ΔT_q , will remain as in (34). All cases considered in this report assume that the time measurement errors are uniformly distributed with a mean of zero so that

$$\sigma_{\Delta T_q}^2 = (\Delta T_q)^2 / 12 \quad (35)$$

where now ΔT_q is the width of the interval in which the time measurement errors are contained.

3. NUMERICAL RESULTS

The analytical results developed in section 2 will now be used to evaluate several alternative tracking configurations and the effects of time correction on each. Some of the configurations chosen for comparative analysis correspond to the system as it is presently constituted while others correspond to configurations which might be applicable in the future.

3.1 PEAK MAGNITUDE OF THE GEOMETRICALLY INDUCED TIMING JITTER.

An estimate of the geometrically induced timing jitter may be obtained from (31) for cases where the distance moved by the target in one scan is much less than the distance to the radar. Since only the peak magnitude is of interest, a worst-case solution to (31) will suffice. The maximum value of (31) did not occur when the target is moving tangentially (see section 2.6), but when the target movement is small with respect to the distance to the sensor, the difference between the value of ΔT for a tangential velocity and the peak value is inconsequential for practical purposes. The difference in this case is quite similar to the difference between the arc length and the corresponding chord for small central angles. The numerical results in this case are given in figure 5 as a function of the range of the sensor and for a worst-case velocity of 600 knots. The rotation periods used for these results correspond to the nominal values which might be observed for the Air Traffic Control Radar Beacon System (ATCRBS) (reference 22) and for the DABS (reference 23). In the special case of a tangential velocity, a second approximation can be derived by equating the arc length and the chord length which gives

$$\Delta T = v T^2 / 2\pi r. \quad (36)$$

For a target at a range of 5 nautical miles (nmi) with 10-second radars, (36) gives $\Delta T=0.5305$ s, while (31) yields 0.5033 s. While the fact that these two approximations agree very well does not prove that either approximation is close to the true answer, the fact that the approximations agree so well at short ranges and that the accuracy of the approximations must increase with range does tend to indicate that these results are satisfactory for practical purposes. In the previous study in which the update interval was calculated, it was concluded that special consideration would only have to be given in cases where the range to the target was less than 5 nmi (reference 21). Since only a relatively few targets will be observed at ranges less than 5 nmi, the approximations just developed can be assumed to apply throughout the entire practical coverage area of the sensor.

As noted in section 2.6, it is not the deviations from the sensor rotation period which are important, but rather the deviation from a fixed rate whether or not that rate is the same as that of the sensor. In actuality, it is the variation in ΔT which is of importance rather than ΔT per se, but since the values of ΔT are so small (compared to T) the variations in ΔT are obviously of secondary importance in any case.

3.2 TRACKING FILTER PERFORMANCE FOR FIXED TIME CORRECTION INTERVALS.

The simplest case in which time correction is used is the case where the data source and tracking filter operate at the same rate but at a fixed time difference. The variance reduction ratios which are applicable in this case are given in section 2.3. In order to compare the performance of a tracking algorithm with time correction to one without, the ratio of the variance reduction ratios for a 2-minute position prediction was computed; i.e.,

$$r = K_p(T, T', \Delta T) / K_p(T, \Delta T') \quad (37)$$

where $T'=120$ s. T is the period between data points and ΔT is the time-correction factor. This particular performance statistic was chosen for convenience because it combines the position and velocity performance of the filter, via (6), while the 2-minute prediction is of considerable practical importance for the enhanced

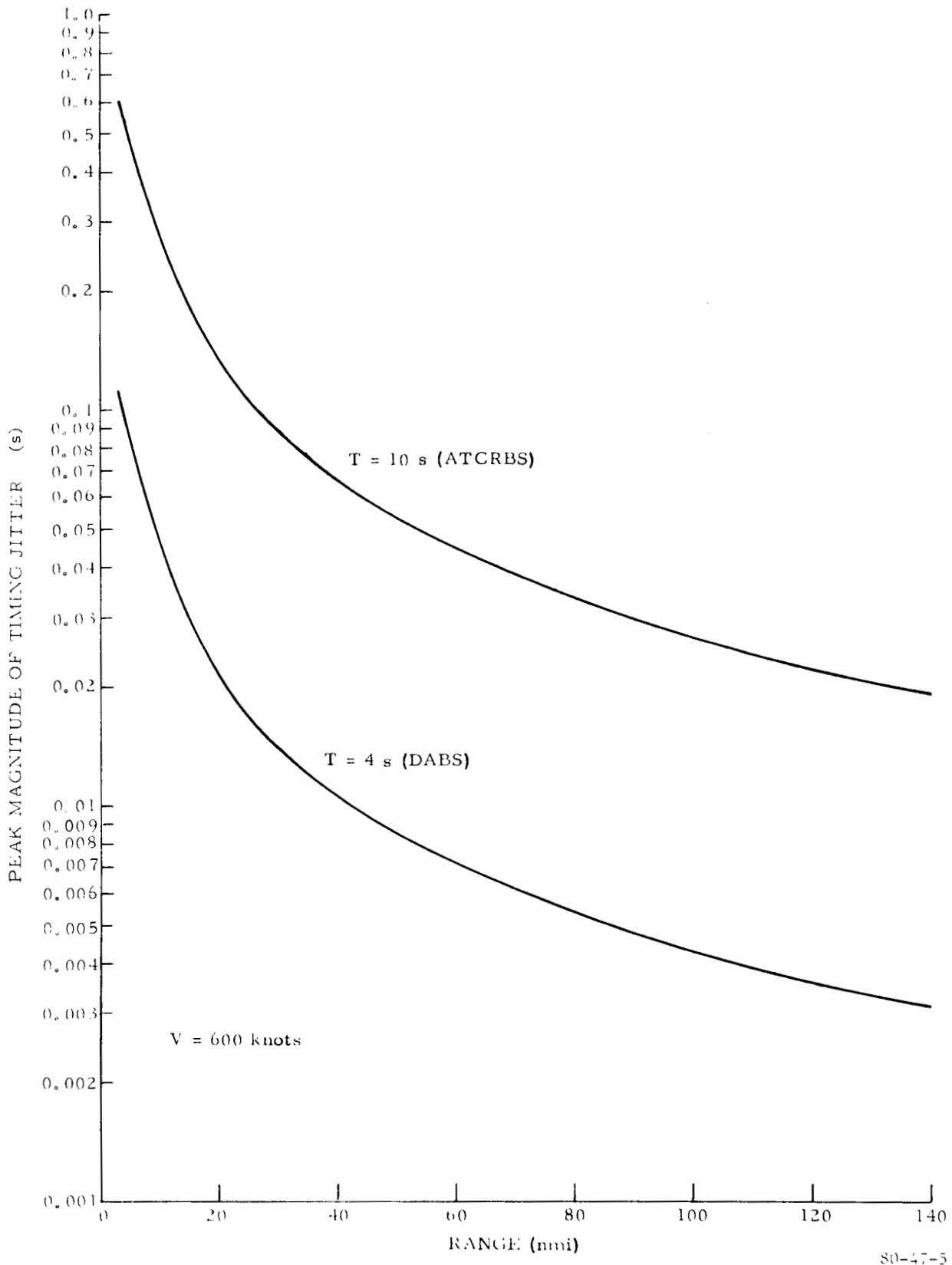

FIGURE 5. PEAK MAGNITUDE OF TIMING JITTER

automation features, such as Conflict Alert (reference 17). The results of these computations are given in figure 6 for a worst-case time correction equal to half the data interval; i.e., $\Delta T = \pm T/2$. Note that the results for $T=4$ and 10 s are so close that the differences are insignificant. For simplicity it was assumed that the α - β smoothing parameters were related by the Benedict-Bordner relationship (reference 3), $\beta = \alpha^2 / (2 - \alpha)$, so that only one parameter would be required to index the results. Equation (37) has the characteristic that $r \rightarrow 1$ as $\Delta T \rightarrow 0$, which is the expected result for this performance statistic as well as other performance statistics which might be defined using the variance reduction ratios (smoothed position, velocity, etc.).

The data presented in figure 6 demonstrates that throughout most of the range of parameters the deviations from a synchronous tracker ($\Delta T = 0$) are relatively small. Since the results presented are applicable to steady-state situations (i.e., no bias errors due to transients are present), it would be expected that only small values of the smoothing parameter would be of practical interest (in typical cases $\alpha < 1/2$). In this case the performance of the tracking algorithm with time correction ranges from 15 percent worse to 9 percent better than the baseline synchronous tracker. On an intuitive basis, the reason for the improvement observed for negative time corrections is that in this case the most recent data point actually occurred after the current time of interest so that the smoothing operation of the filter actually corresponds to an interpolation process. In the case of a positive time correction, the current time of interest is actually beyond the most recent data point so this case corresponds to an extrapolation process which is, in general, less accurate than an interpolation. If the time-correction factor for each track is a fixed value and the time-correction factors over the ensemble of tracks are uniformly distributed in the range $-T/2$ to $T/2$ (assuming that the center of the tracking cycle is used as the basis for the tracking computations), then the average degradation in tracking performance due to the use of time correction will be on the order of 2 to 3 percent for all smoothing parameters less than 0.5. In the $-T/2$ to $T/2$ range the degradation for positive time corrections is only slightly greater than the improvement for negative time corrections. The net result in this case is only a very slight degradation in average performance which for practical purposes is insignificant.

In the case where $\Delta T = -T/2$ and the position smoothing parameter approaches one, the performance ratio is asymptotic to infinity indicating an unsatisfactory parameter combination. An analysis of this case showed that for $\alpha = \beta = 1$ and $\Delta T = -T/2$ the poles of the z-transform are on the unit circle rather than inside as is required for system stability. However, such parameter values are of no practical interest in the steady-state case so this performance characteristic is of no concern. The Benedict-Bordner relationship (reference 3), used to express β as a function of α , is only strictly correct in the case where time correction is not used. It would be necessary to calculate α and β as a function of ΔT in order to maintain the same maneuver-following performance as was used to derive the original relationship between α and β . For simplicity, the smoothing parameters were fixed in this study unlike the approach taken elsewhere (e.g., reference 13). The α - β relationship just discussed is not the only possible one. Another widely known relationship has been derived by Sklansky (reference 1), based on a critically damped criterion,

$$\beta = 2 - \alpha - 2\sqrt{1 - \alpha} . \quad (38)$$

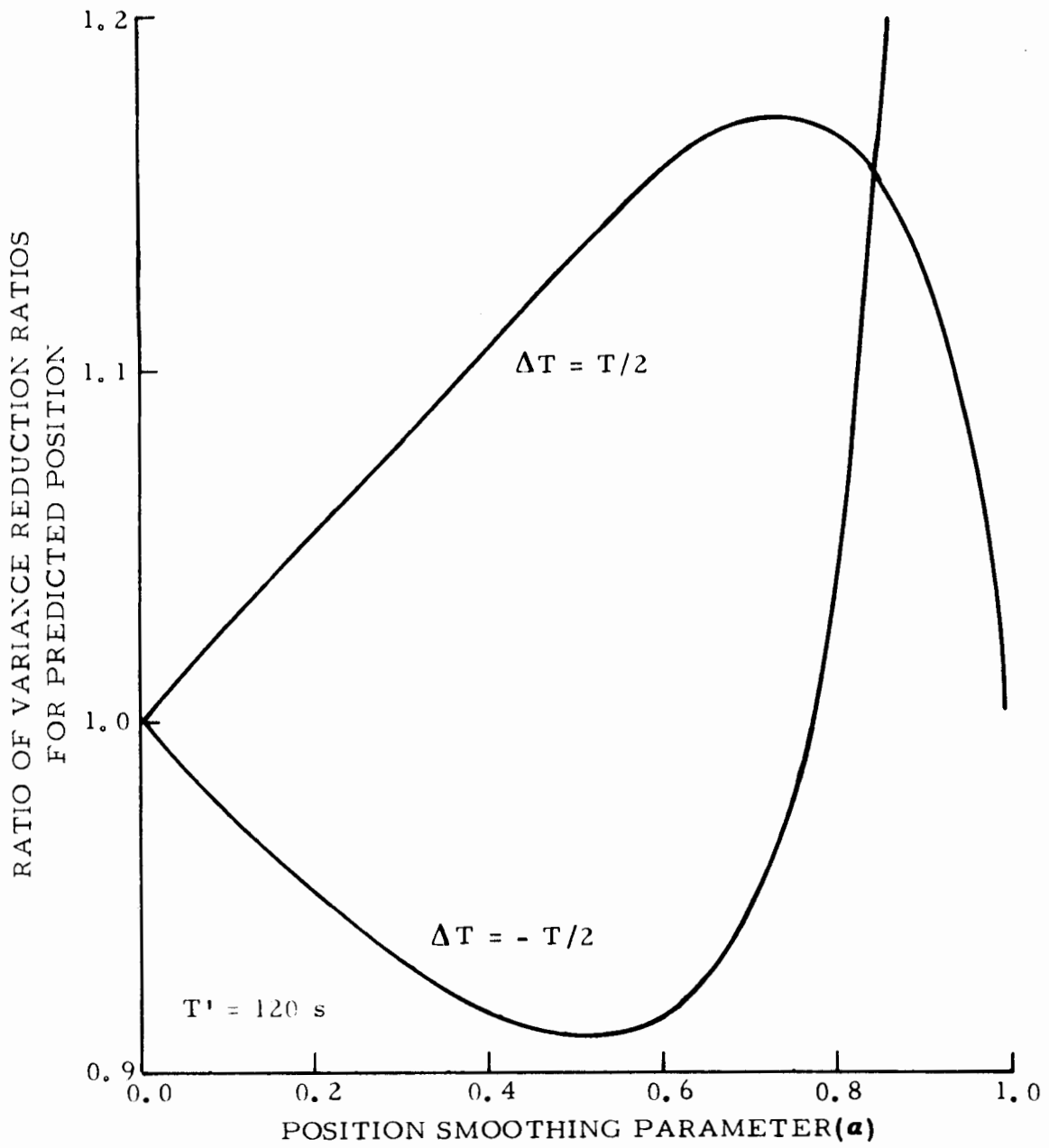

80-47-6

FIGURE 6. PERFORMANCE RATIOS FOR 2-MINUTE PREDICTIONS

The results obtained using (38) were also examined. For the critically damped parameter set, the performance results were insignificantly different from those found previously and followed the same general trends so the results were not included. As in the previous case the α - β relationship could be rederived to include a fixed time-correction factor but this was not done for the reason given above.

For illustration, the results of a second performance statistic are also included and are given in figure 7 in terms of the performance ratio for the smoothed position,

$$r_s = K_s(T, \Delta T) / K_s(T). \quad (39)$$

The performance ratio for smoothed position indicates that time correction results in a somewhat larger degradation for positive corrections than was the case previously for large values of α . However, for values of the position smoothing parameter in the range of practical interest ($\alpha < 0.5$) the net result is the same; namely, if the time-correction factor is uniformly distributed in the range $-T/2$ to $T/2$ over the ensemble of tracks, then the average system performance will be degraded by only a few percent as compared to a perfectly synchronized tracking algorithm. By comparing the constituent factors of (39) (i.e., (7) and (9)), it can be seen that these results depend only on the ratio $\Delta T/T$ so that the data in figure 7 is applicable to both 4- and 10-second radars since $\Delta T = \pm T/2$.

Implicit in the limitation imposed on the range of the time-correction factor is the assumption that there are no significant delays in the processing of the data by the sensor. While this is a reasonable assumption in the case of light or moderate target densities, in the case of heavy target loads, sensor delays in excess of one half the scan period may be observed thus leading to larger time-correction factors than those considered here.

3.3 TRACKING FILTER PERFORMANCE FOR RANDOM UPDATE VERSUS RANDOM TIME CORRECTION.

The results in the previous section were calculated assuming the time-correction factor was constant. In practice, as the results in section 3.1 show, there will be variations in the time interval between data points simply as a result of the motion of the target. As a consequence, it will be necessary to compensate in some manner for the variation in the time intervals between position measurements if an accurate estimation of velocity is to be obtained. In this section two possible techniques will be examined for compensating for the variation in the data interval. Using the time of receipt for each data point, a revised time correction can be computed for each data point resulting in a random time-correction factor as is discussed in section 2.4. Another possible technique is to use a random update interval (as discussed in section 2.5) in which the tracking filter operates from time of receipt of one datum to the time of receipt of the next, thus using the exact time interval for all computations. It might be expected that the latter technique would produce better results since it does not depend on the constant-velocity, straight-line trajectory assumption implicit in time correction which must be done when using the estimated velocity. As in the previous section it will be assumed that the α - β smoothing parameters are fixed and related by the Benedict-Bordner relationship (reference 3).

The performance measures used in this comparison will be the ratio of the variance reduction ratios for the 2-minute position prediction and the velocity; i.e.,

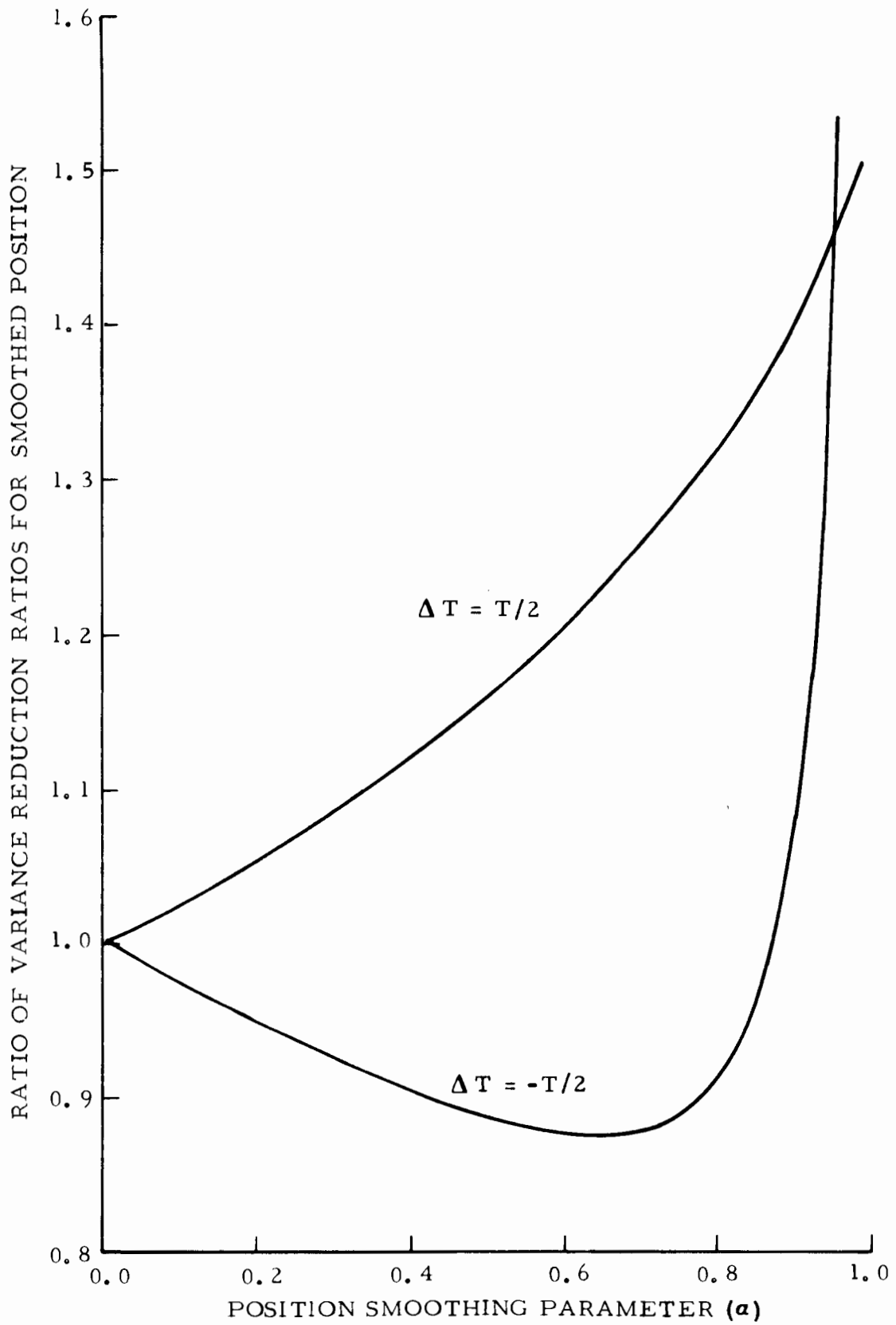

FIGURE 7. PERFORMANCE RATIOS FOR SMOOTHED POSITION

80-47-7

$$r_p = K_p(T, T', \Delta t) / K_p(T, T', \sigma_{\Delta T}^2) \quad (40)$$

and

$$r_v = K_v(T, \Delta t) / K_p(T, \sigma_{\Delta T}^2). \quad (41)$$

The velocity performance statistic was chosen for use in this case because the greatest impact of timing would be observed in the velocity errors. In consonance with the notation used previously, Δt will refer to the width of the interval (centered on T) in which the differences between the time of receipt of the data points are located while ΔT represents the width of the interval in which the time-correction factors are located. For the purposes of this section it will be assumed that $\Delta t = \Delta T$. While the performance ratios defined by (40) and (41) would be close to one for $\Delta T \ll T$, it would be expected that the largest differences would be observed when $\Delta T \approx T$ since the time-interval differences between position measurements could be quite large in this case.

The performance statistics r_p and r_v are given in figures 8 and 9 for $\Delta T = T/2$ and $\Delta T = T$. Note that because ΔT refers to the width of the interval, the time-correction factors in these two cases range from $-T/4$ to $T/4$ and $-T/2$ to $T/2$, respectively. As in the case of r_s in the previous section, the ratio r_v depends only on the $\Delta T/T$ ratio so that the results presented are applicable to both 4- and 10-second radars. In all cases, the results presented in figure 8 indicate that the performance of the random update filter is slightly worse than the tracking filter with random time correction. In general, this was also true of the other performance statistics which could be defined (r_s , r_{vs} , and r_p (single-scan)), except for some of the results for the smoothed position ($\alpha < 0.7$) in which case r_s was as low as 0.83. As noted in the previous section, values of the position smoothing constant greater than 0.7 are of no practical significance for a steady-state situation. The results in figure 9 for $\Delta T = T$ show a significant degradation of the performance of the random update filter as compared to the random time-correction filter. The reason for this result is the fact that as ΔT becomes larger the minimum random update interval becomes smaller. It has been shown in a previous study that for a fixed gain α - β filter as the minimum update interval decreases the variance at the output of the tracking filter increases (reference 13). In order to avoid the degradation in tracking performance as the minimum update interval decreases, it is necessary to adjust the α and β parameters as a function of the update interval. If $\alpha \rightarrow 0$ and $\beta \rightarrow 0$ as the update interval decreases then little weight will be given to data obtained over small time intervals. If the smoothing parameters are chosen in the proper manner, the performance of the filter will remain relatively constant as ΔT changes but at the expense of increased computational requirements. As stated previously, however, the case in which varying smoothing parameters are used will not be considered in this report. The case where $\Delta T = T$ implies a widely varying data interval; from the results presented in section 3.1, it is seen that variations of this order of magnitude will only be observed at distances very close to the radar. This constitutes only a very small portion of the radar coverage area. Even the case where $\Delta T = T/2$ will not occur with any great frequency so it is apparent that the random update filter has only a limited area of application, especially in light of the degradation in performance as compared to the tracking filter with random time correction. The results (not shown) for the case $\Delta T = 0.5$ s, which would include most of the coverage area of the sensor, showed a maximum degradation of only 0.65 percent for the random update filter as compared to the random time-correction filter. Performance differences of this level of magnitude are inconsequential for practical purposes.

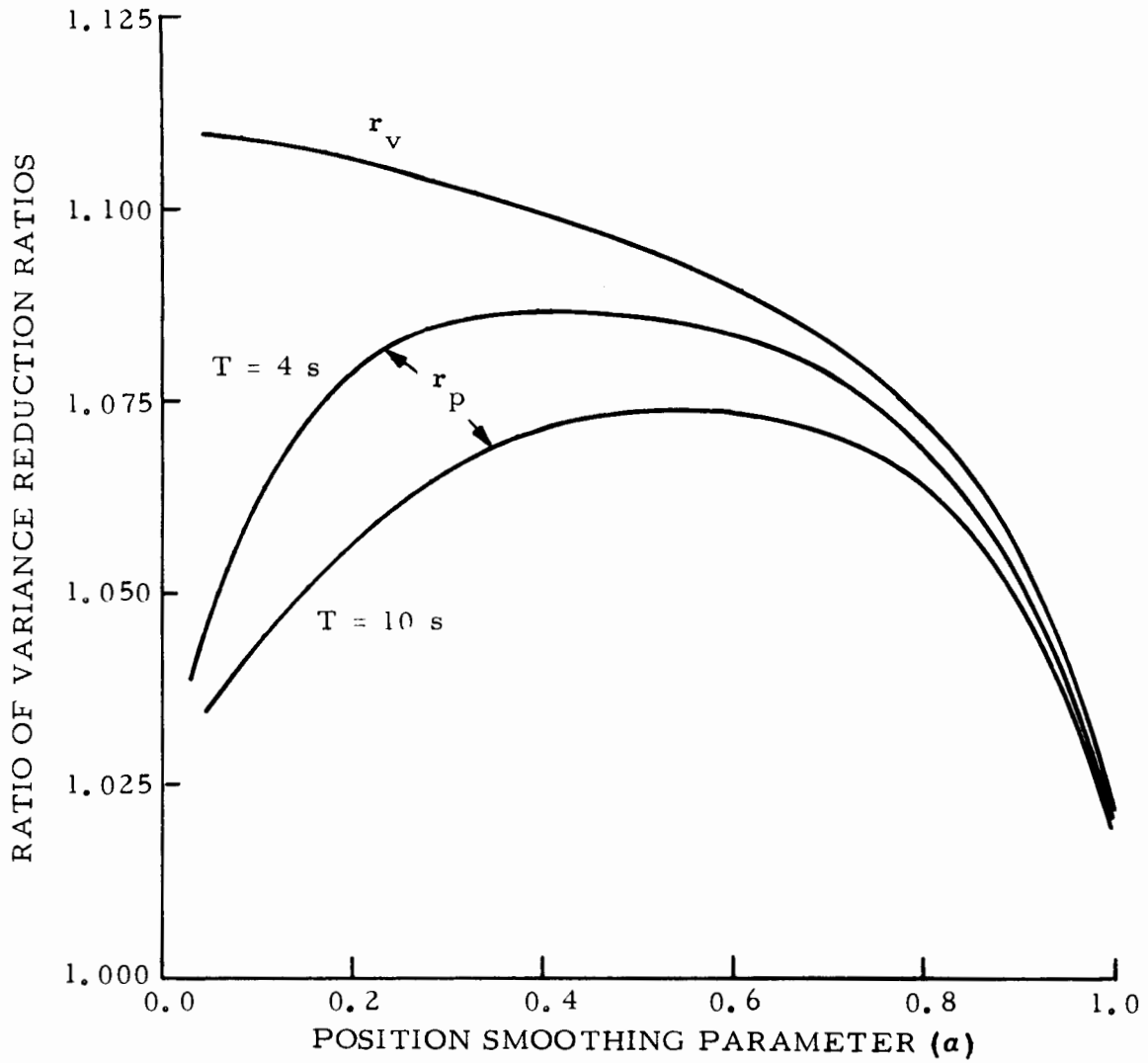

80-47-8

FIGURE 8. PERFORMANCE RATIOS FOR RANDOM UPDATE VERSUS RANDOM TIME CORRECTION FOR $\Delta t = T/2$

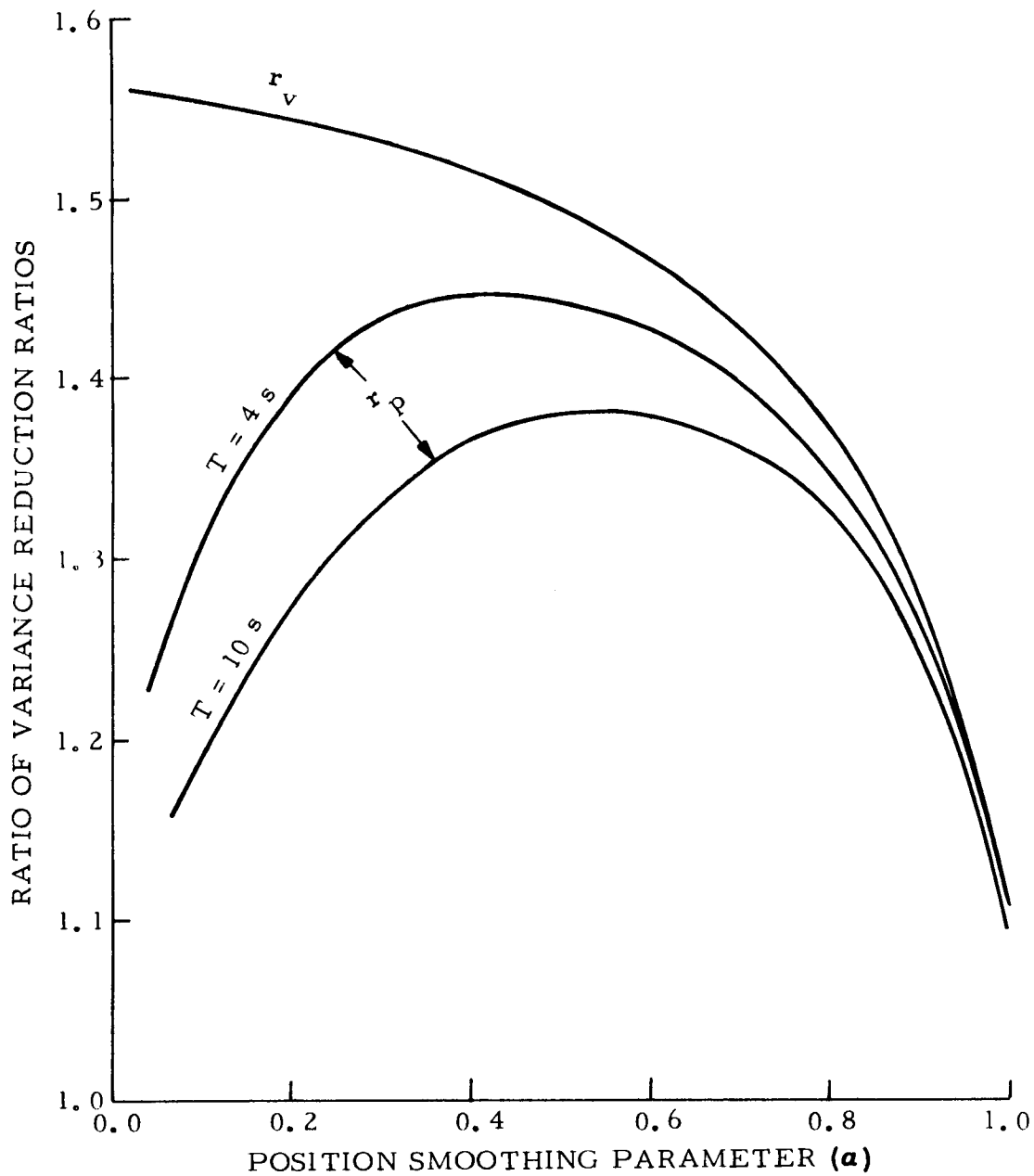

80-47-9

FIGURE 9. PERFORMANCE RATIOS FOR RANDOM UPDATE VERSUS RANDOM TIME CORRECTION WITH $\Delta T = T$

3.4 INFLUENCE OF TIME QUANTIZATION ON SURVEILLANCE SYSTEM POSITION MEASUREMENT ACCURACY AND TRACKING PERFORMANCE.

For the numerical results presented up to this point, the formulation of the performance statistics has been such that errors in timing applied equally to both tracking filters under consideration. Since the implementation of the tracking filter will be via a digital computer, it is obvious that time, like all other quantities, must be quantized for use in the filter with a specified granularity or precision. As explained in section 2.7, the time quantization introduces an additional source of error at the input of the digital filter. The additional errors are equal to the difference in the position at the actual time of measurement and the position where the target would have been located at the quantized time of measurement. In a previous study (reference 18), it has been shown how an excessively coarse time quantization resulted in a significant degradation in tracking filter performance as compared to the performance which would have been possible given position measurements of the same accuracy but using a significantly finer time quantization. Since the numerical differentiation performed in the tracking filter to estimate velocity requires an explicit knowledge of the time at which the position measurements are obtained, it is of considerable practical interest to know the time quantization required to insure that the accuracy of the position measurements is not measurably degraded due to timing errors. The timing errors are of equal significance no matter which approach is used to process data received at unequal time intervals. In view of the importance of timing errors, several approaches have been tried in the analysis of their significance.

3.4.1 Influence of Time Quantization from Geometrical Considerations.

Of the various possible approaches to the analysis of the influence of time quantization errors, the simplest approach is to compare the magnitude of the timing induced errors with other system quantization errors. In the case of time correction, as specified by (3), if the time-correction factor $\Delta T(k)X_v(k-1)$ is in error due to some quantization error in $\Delta T(k)$, then an additional random error component equal to the product of the velocity and the quantization error in $\Delta T(k)$ will be introduced. Since the velocity which must be used for this purposes is the estimated velocity, there will be an additional error due to this fact; this error will not be considered since it is a second-order quantity.

The range of the position errors for a specified range of timing errors is given in figure 10 for target velocities of 200, 400, and 600 knots. To illustrate the significance of these errors, a comparative scale is given based on the least significant bit (LSB) of the polar coordinates used for position measurement. (The LSB's used for this report are those applicable at the present time and are subject to change.) For the azimuth errors, the distance used is based on the arc length for the least significant bit at a range of 100 and 200 nmi. For the specific systems of interest in air traffic control, the least significant bits in azimuth are 1 ACP and 1/2 ACP for ATCRBS and DABS, respectively, with 4096 ACP per antenna revolution (reference 24). The least significant bits for the range errors are 1/8 and 1/128 nmi, respectively. For the present system, the datum is timed according to its time of receipt at the Air Route Traffic Control Center with the time measurements being quantized to 0.5 s. However, the data may be delayed in transmission at the sensor. This delay, or time in storage, is measured to 0.125 s; in actual usage, it is rounded-off to the nearest 0.5 s. This gives a maximum total timing error of approximately 0.75 s excluding any random delays which

may be encountered in the modems or connecting circuitry. The range of possible timing errors is thought to extend to 0.8 or 0.9 s, but it may be even larger.

From the results presented in figure 10, it is seen that the present system timing accuracy is not quite sufficient to maintain the LSB of the ATRBS range measurements in all cases since the timing induced errors are sometimes on the order of the LSB. In the case of the LSB of the DABS range measurements, it is seen that the timing induced position errors are far greater in magnitude, sometimes by an order of magnitude. This indicates that several of the lower order bits in the DABS range measurement are useless unless the system timing accuracy is improved. At distances close to the sensor (within a few tens of nautical miles), the time quantization errors will be the predominate source of system errors by exceeding both the errors in range and azimuth. It should be noted that since the analysis of the significance of timing errors just presented is based solely on geometrical arguments, these same results will apply regardless of the nature of the specified tracking algorithm.

3.4.2 Influence of Time Quantization on the Basis of Input Noise Considerations.

As shown in section 2.7, the additive contribution to the noise level at the input to the tracking filter is

$$\sigma_{\hat{x}}^2 = \sigma_x^2 + X_V^2 \sigma_{\Delta T_q}^2 \quad (42)$$

where:

$\sigma_{\hat{x}}^2$ = noise variance at filter input

σ_x^2 = measurement noise variance

X_V = true velocity

and $\sigma_{\Delta T_q}^2$ = variance of time quantization errors.

It is assumed in (42) that the position measurement errors and the time quantization errors are statistically independent. It will also be assumed that the time quantization errors are uniformly distributed so that the variance is given by (35). Since the results in the previous section showed that the errors induced by time quantization are significantly larger than the range errors, the variance of the noise at the input to the tracking filter relative to the range measurement errors will be used as the basis for comparison. The performance ratio r , given by

$$r = \sigma_{\hat{x}}^2 / \sigma_x^2 = 1 + X_V^2 \sigma_{\Delta T_q}^2 / \sigma_x^2, \quad (43)$$

represents the increase in the noise level at the filter input relative to the sensor range measurement errors. Since the azimuthal errors will predominate at most ranges of interest, if the contribution of time quantization errors is small relative to the range measurement error then the effect of timing errors would be insignificant throughout the entire coverage area of the sensor.

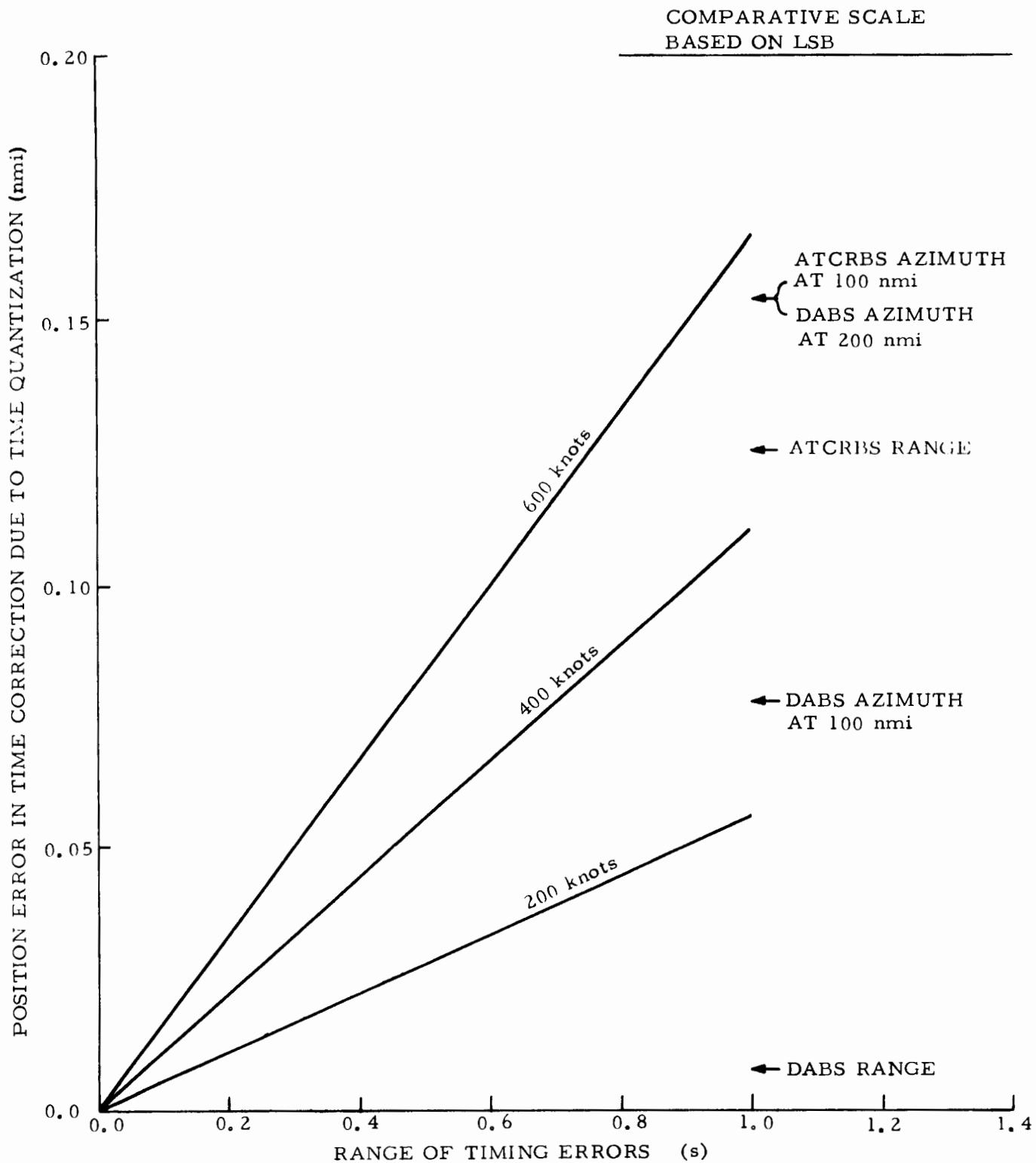

80-47-10

FIGURE 10. POSITION ERRORS BASED ON GEOMETRICAL CONSIDERATIONS

The results in this case are given in figure 11 in terms of the performance ratio r for the DABS sensor which is specified to have a standard deviation in range of 50 feet. In the case of ATCRBS, the standard deviation of the range measurement errors is specified as 0.125 nmi. Over the range of variables specified in figure 11, the maximum value of r was 1.15, which indicates a relatively insignificant increase due to time quantization errors. As a consequence, the results will not be shown. From the results in figure 11, it is seen that the same general conclusion can be reached as in the previous section; namely, that the errors introduced by the presently used level of time quantization are far more significant, due to the much larger magnitude, than the range measurement errors of the DABS sensor.

3.4.3 Implication Of Time Quantization Errors for the Extended Time Interval Position Prediction Used in Advanced Automation Features.

In order to express the effects of time quantization in a more operationally significant manner, the error in the 2-minute position prediction, as used for the enhanced automation features such as Conflict Alert (reference 17), was calculated as a function of the range of the timing quantization errors. The results are given in figure 12 in terms of the error at the 1-percent level assuming a Gaussian distribution and a worst-case target velocity of 600 knots. The error in this case was calculated assuming a constant data rate of 4 s and a random time-correction interval of 4 s, so that

$$e_p = 2.576 \left\{ K_p(T, T', \sigma_{\Delta T}^2) (\sigma_x^2 + X_V^2 \sigma_{\Delta T}^2) \right\}^{1/2} \quad (44)$$

where e_p is the prediction error, σ_x^2 is the variance of the range measurement errors and $K_p(T, T', \sigma_{\Delta T}^2)$ is given by (19). Naturally these results are lower bounds since the input to the tracking filter will also contain azimuth error components which will result in larger errors.

As the results in figure 12 show, there is, as would be expected from previous results, a substantial increase in the error in the 2-minute position prediction due to time quantization. For the timing accuracy presently used, this increase would amount to a few tenths of a nautical mile. As before, only the results for the DABS range errors are presented because even though the errors in the ATCRBS case were larger, the significance of timing errors was significantly less; e.g., for $\alpha=0.5$ the errors in the ATCRBS case increased from 0.93 to 1.0 nmi. While the prediction errors illustrated in this section are relatively small in size (perhaps on the order of 10 percent of the separation standards), it should be noted that there are many other sources of error throughout the surveillance system so that in the case of easily eliminated errors such as timing, it makes little sense to allow even small errors. However, there is another more significant reason to eliminate timing errors which is discussed in the following section.

3.4.4 Implication Of Timing Errors for Maneuvering Targets.

The previous results have all been derived under the assumption that all transients have been eliminated and the filter is operating in a steady-state mode. In the case of timing errors, however, another important case is the transient or maneuvering situation. One characteristic of the transient mode of operation is the fact that much larger smoothing parameters are used. In particular, if it is desired to avoid the large bias errors which are normally observed for maneuvering

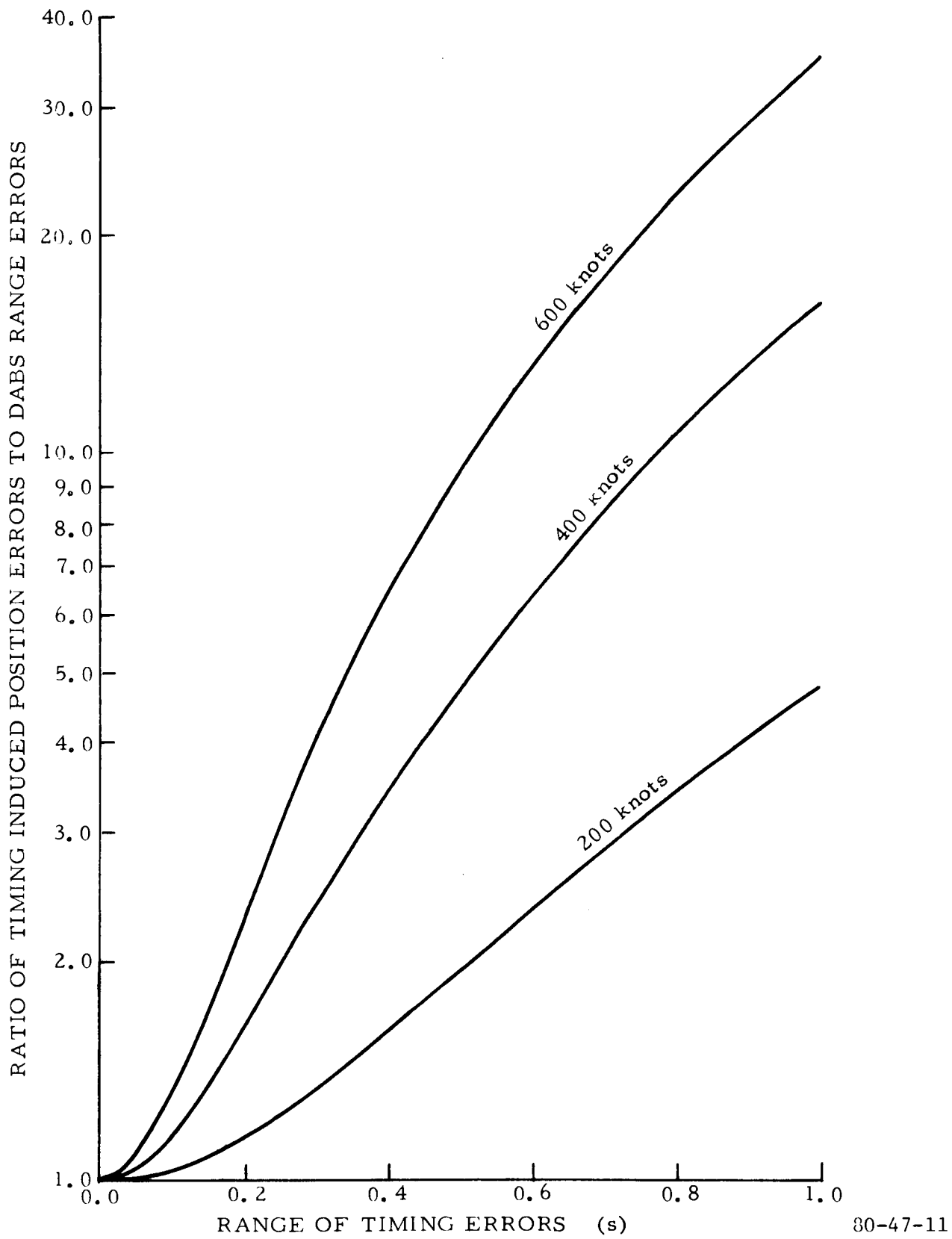

FIGURE 11. RELATIVE MAGNITUDE OF TIMING INDUCED POSITION ERRORS TO DABS RANGE MEASUREMENT ERROR

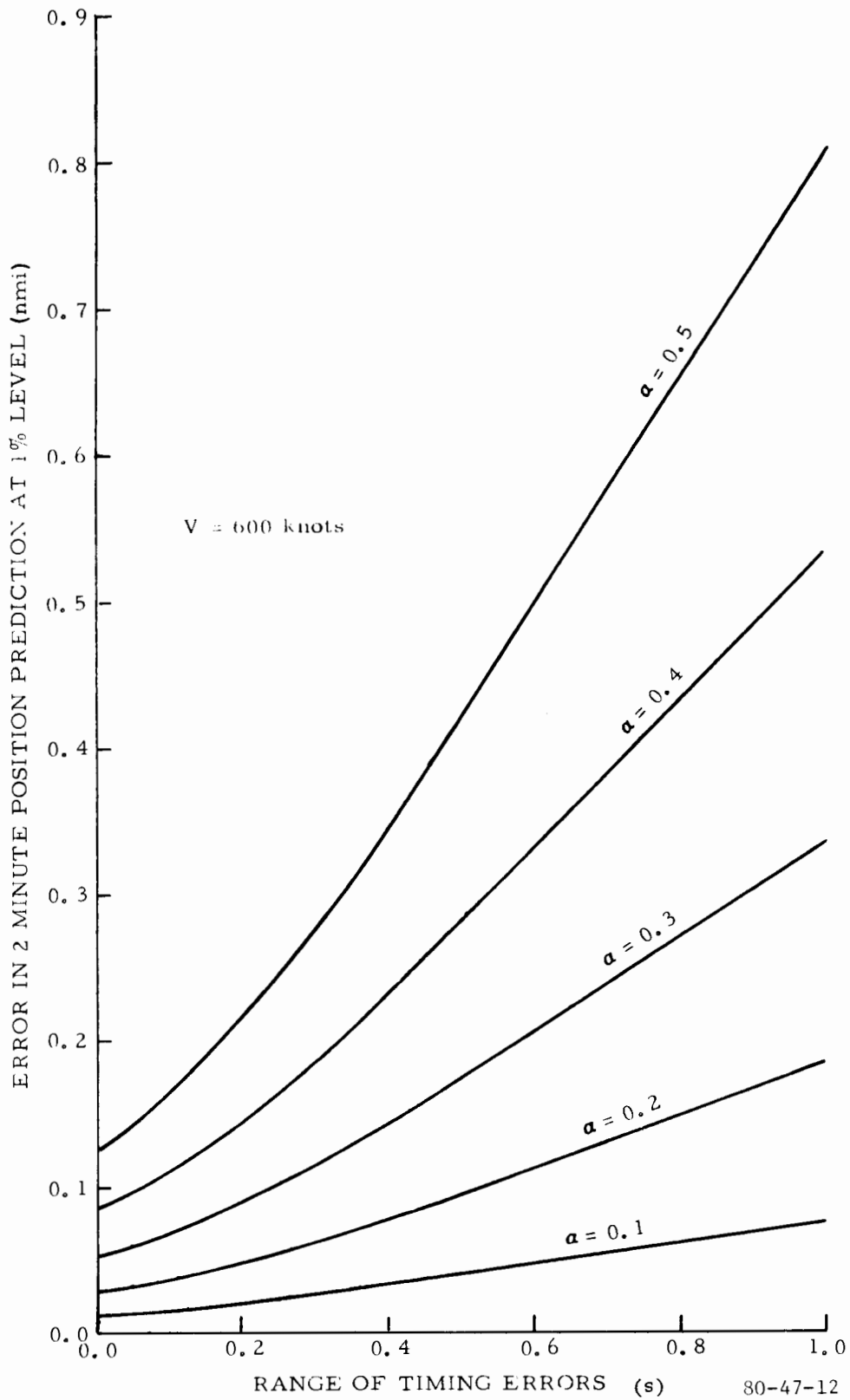

FIGURE 12. EXTENDED TIME INTERVAL POSITION PREDICTION ERROR FOR DABS

targets, then values of the velocity smoothing parameter (β) between 0.3 and 0.6 may be required. Values such as this are much larger than those considered previously and are much larger than those presently in operational use. It should be noted that the design of a practical tracking algorithm normally includes a switching function to choose between alternative sets of smoothing parameters. This function can be optimized to reduce the magnitude of the transient error (references 20 and 25).

The impact of increasing the velocity smoothing parameter can be assessed by observing the general form of the variance reduction ratio for the extended position prediction (see $K_p(T, T')$; e.g. (7), (9), or (19)). As the ratio of the prediction time to the tracking cycle (T'/T) increases, the largest factor in $K_p(T, T')$ will be due to the velocity variance reduction ratio. This was observed for the 2-minute prediction. Using this observation a "rule of thumb" can be developed which expresses the approximate relationship between the error at the input to the filter and the error in the predicted position. As a consequence of the domination of the velocity errors, it is seen that for cases in which the prediction time is much greater than the data interval

$$e_o \approx e_i \beta T'/T \quad (45)$$

where e_o is the error in the predicted position and e_i is the error at the input to the filter. The factor $\beta T'/T$ represents the amplification of the errors propagating through the tracking filter.

For the case of ATCRBS, the amplification factor $\beta T'/T$ would be in the range of 4 to 7 for a highly responsive tracker; for DABS this factor would be in the range of 10 to 20. Note that these ranges assume the use of isotropic smoothing. In the case of nonisotropic (i.e., track-oriented) smoothing, the maximum value of the amplification factor may be considerably higher (by as much as a factor of two). Considering the values just calculated for the amplification factors and the values of the errors in figure 10, it is seen that in the case of DABS if these errors are multiplied by a factor of 10 to 20 then the resulting errors in the predicted position may well be as large as 1 to 3 nautical miles. It is highly probable that timing errors in a maneuvering situation are of far greater importance than for the straight-line tracks. Since a maneuver is a transient situation which involves the nonlinear operation of switching the smoothing parameters, an exact calculation of the error cannot be made. However, on the basis of the simplified analysis just given, it must be concluded that timing errors may have a significant impact on the accuracy of the 2-minute position prediction in a maneuvering situation. The errors just discussed are present at the input of any type of tracking filter (as discussed in section 2.7) and have essentially the same impact no matter what type of tracking algorithm is used. Hence, the same errors in the predicted position will be observed whether the timing error represents an error in the calculation of the time-correction factor or in the calculation of the random update interval.

4. SUMMARY

The primary motivation for the use of a tracking algorithm is the need to estimate target velocity from position measurements. As a consequence, velocity is a derived rather than a measured quantity and is dependent on the process of

numerical differentiation performed by the tracking filter. An explicit part of the numerical differentiation process is the measurement of the time associated with each position measurement. The purpose of this report is to evaluate the procedure used for incorporation of the temporal data associated with the position measurements into the tracking process. As would be expected, there are various ways to incorporate the temporal data so the objective in this report is to evaluate the alternative approaches available and to ascertain which is optimum in the context of en route air traffic control. The major characteristic of the en route environment which necessitates such an analysis is the fact that moving targets are being observed by multiple sensors. Since different sensors cover different portions of the total surveillance volume, it is apparent that a tracking algorithm operating at a fixed rate in this environment cannot be synchronized with each sensor at the same time. In addition, the fact that the targets are moving means that the time intervals between position measurements for the same target will not be constant. As a result, consideration must be given as to how the temporal data associated with each measured position is to be used in the tracking filter.

The analytical solutions for the tracking filter performance in the various cases of interest are given in section 2. Four separate cases were considered. In the first case considered (section 2.2), the tracking filter and sensor operate at a constant rate and in perfect synchronism. This case is most commonly used for analytical studies and would only be found in an operational environment in which a single sensor observes a stationary target. In the second case considered (section 2.3), the tracking filter and sensor both operate at the same rate but with a constant time (or phase) difference between the times of operation. The estimated velocity is used to adjust or "correct" the measured position by an amount equal to the product of the estimated velocity and the difference in time between the reference time used by the tracking algorithm and the time of measurement as provided by the sensor. This process, known as "time correction," is used to make it appear to the tracking algorithm that the measured data from the sensor was actually synchronized in time with the operation of the tracking filter. The ability of the time-correction process to compensate for the asynchronous operation of the filter and sensor is dependent on (1) the accuracy of the velocity estimates and (2) the implicit assumption of a constant velocity, straight-line trajectory.

Since the previous two cases are unrealistic in an operational environment, two additional cases were examined. In the third case (section 2.4), it is assumed that the tracking filter operates at a fixed rate and the sensor supplies data at the same average rate so that the time-correction factor is random for each position measurement on a specified target. This corresponds most closely to the actual operational en route environment in which the tracking filter operates at fixed intervals, but the data for each track may have been received at any time within the tracking cycle. The time of receipt will change in relation to the reference time used by the tracker as the target moves. In all of the three cases discussed above, the predominant reference time was determined by the operation of the tracking filter.

An alternative approach (section 2.5) is to use the actual time of receipt of the measured position as the time of reference for the smoothing and prediction process performed by the tracking filter. In this case, the update interval of the filter will now be random and will correspond to the actual time period between consecutive position measurements on each target. It would be expected that since the

formulation of the tracking equations does not depend on the assumptions inherent in the time-correction process, the results in this case would yield better performance because the estimated velocity is no longer used in the smoothing process. Since each track will now have a separate reference time in the random update case, for functions such as Conflict Alert which depend on a common time reference, it will be necessary to create a common time reference. This will complicate the use of this approach in practice but such complications could be acceptable if the performance improvement warranted such action. The results show, however, that such a change is not warranted.

Some ancillary considerations which require analysis are discussed in sections 2.6 and 2.7. One question of particular interest is what variations in the data interval would be reasonable for nonstationary targets? An approximation was developed to evaluate the timing jitter observed for targets of arbitrary velocity. The approximation is valid when the distance moved between measurements is small relative to the distance from the sensor. A final item of consideration in all the variations of the tracking algorithm is the degree of accuracy of the time measurements necessary to support the operation of the tracking algorithm. An error in the time measurement translates directly into an additional source of error at the input to the tracking filter. This error is directly proportional to the velocity of the target under observation.

The numerical results based on the analyses just discussed are given in section 3. The first numerical results presented show the worst-case timing jitter which could reasonably be expected in the en route environment. It is shown that in the region beyond a range of 20 nautical miles, which is almost the entire coverage region of the sensor, the peak timing jitter induced by target motion will be less than about 0.02 and 0.15 seconds (s) for the Discrete Address Beacon System (DABS) and Air Traffic Control Radar Beacon System (ATCRBS) targets, respectively. It is only at distances very close to the sensor that the approximation used to obtain these results is invalid. It is only in this same region that extremely wide variations in the data intervals will be observed. The portion of the coverage region in which widely varying data intervals are observed is so small that any tracking algorithm which is specifically designed to handle large variations in the data interval would not be justified based on the frequency of occurrence of these variations.

Numerical results for the comparison between a tracking filter with a fixed time correction and tracking with a perfectly synchronous filter are given next. The objective here was to evaluate the process of time correction per se in the absence of any randomness in the time-correction factor. If it is assumed that while the time-correction factor for each track is constant, the time-correction factor over the entire ensemble of tracks is uniformly distributed over the entire tracking cycle (with the reference time at the center of the cycle), then for the range of the position smoothing parameter likely to be of interest in a steady-state situation, the overall impact of time correction on the ensemble of tracks is extremely small. The actual results showed only a 2- to 3-percent degradation in performance for the 2-minute position prediction as compared to the optimum in the synchronous case. Thus, the process of time correction introduces only a very slight reduction in overall system performance.

Since the scenario used to obtain the results discussed above does not include random time intervals between position measurements, a more realistic comparison was performed next between two tracking filters which process data received at

varying intervals. In this case, the comparison is between a tracking filter in which the time-correction factor is random over a specified interval as compared to the random update filter (with constant coefficients) in which the smoothing and prediction process uses the actual time of receipt of the data as the temporal reference of the filter. The performance results in this case showed that when a large variation exists in the data interval and the time-correction factor, that the performance of the fixed parameter random update filter was significantly worse than the tracking filter with a random time-correction factor. In the case of small variation in the data interval, which is the most realistic case as the timing jitter analysis shows, the performance differences between the two filters were negligible. Intuitively, it would be expected that the random update filter would yield improved performance. However, in the previous study in which this was considered (reference 13), the smoothing parameters were not fixed but were functions of the time interval between measurements. As a result, the only way the random update filter could yield improved performance is if the smoothing parameters are computed as a function of the data interval. This would considerably increase the computational requirements of the tracking filter. In addition to the increase in the computational requirements, there would also be the consequent operational changes required since a common time reference for all tracks no longer exists. It is concluded that the random update filter would not yield any significant practical benefits and would result in a degradation in performance unless the smoothing constants are variable resulting in additional computational requirements. Even if the additional complexity of the filter were not a problem, the relatively minor differences in the data intervals throughout most of the coverage area of the sensor means that the overall improvement in performance would be negligible.

It is clear that the performance differences between the two filters just discussed are insignificant over most of the sensor coverage area. The choice between the two can be made on the basis of the ease of implementation and operational considerations rather than on the basis of performance. For the multisensor environment of en route air traffic control, the fixed interval tracking filter with time correction is to be preferred over a random update approach since on the average there will be no benefit to using the latter approach.

The last item of interest in this report is the question of the timing accuracy needed to support the air traffic control system. In order to fully evaluate this question, four separate approaches were taken. The four approaches included: (1) a comparison of timing errors when the errors resulted from the quantization of other sensor data, (2) a comparison of the significance of timing induced errors with the range measurement errors at the input of the tracking filter, (3) an evaluation of the increase in the error in the 2-minute position prediction as a function of timing errors, and (4) an evaluation of the significance of timing errors for maneuvering targets.

In the first three approaches, the additional errors resulting from time quantization were compared in magnitude with the range measurement quantization errors. It was found that for DABS data in each case the result was the same; namely, that the time quantization errors introduce significant performance errors into the tracking algorithm. For example, the errors resulting from the time quantization presently used (0.5 s plus other errors) are frequently an order of magnitude greater than the DABS range quantization error (see figure 10). It is obvious that the range accuracy of the DABS data will be destroyed by timing errors before the data ever

reaches the tracking algorithm. In fact, depending on the azimuthal accuracy of the DABS sensor, the system errors introduced by time quantization may actually constitute the predominant source of position measurement error throughout a significant portion of the coverage area of the sensor since the timing induced errors may exceed both the range and azimuth measurement errors of the sensor. The obvious conclusion from these results is that the timing accuracy presently in use is incompatible with the accuracy of the data which is available from DABS. A similar conclusion was reached in a previous study (reference 26). In order to guarantee no measurable degradation in system performance resulting from time quantization errors, it would be necessary to measure time with an accuracy on the order of 0.05 s or about an order of magnitude better than at present.

Another consequence of the time quantization errors can be seen by comparing the worst-case timing jitter in the data interval, given in figure 5, with the 0.5 s quantization error. This comparison shows that even if the performance of the random update filter was significantly better, the use of this filter could not be justified since in most cases the time of receipt is not known accurately enough to make use of the random update approach. As a matter of fact, the jitter in the data interval as a result of the time quantization errors is, in most of the coverage area of the sensor, far greater than the jitter induced by target motion.

The fourth technique for evaluation of the significance of timing errors is based on the impact of these errors on the 2-minute predicted position for a maneuvering target. By using a highly simplified approximation to the performance of the tracking filter, it is shown that in the case of DABS the errors introduced into the 2-minute predicted position as a result of timing errors during a maneuver are on the order of 1 to 3 nautical miles which is a significant error considering the 3 nautical miles separation standard in certain situations.

5. CONCLUSIONS

As a result of the findings presented in this report, the following two conclusions are made:

1. The overall impact of time correction on the tracking algorithm is extremely small and introduces only a very slight reduction in total system performance. The variations in the time intervals between position measurements are so small in most cases that the use of a tracking algorithm specifically designed to handle large variations in the data interval would not be justified.
2. The process of time correction requires that the time of receipt of the position data be measured. The impact of the errors in the time measurements was evaluated using four approaches. In each case it was found that timing errors will introduce significant computational errors into the tracking algorithm. In the case of the Discrete Address Beacon System (DABS) the system errors resulting from timing inaccuracy will actually constitute the predominant source of measurement error as it exists in the Air Route Traffic Control Center (ARTCC) tracking algorithm. To eliminate the degradation in system performance resulting from timing errors, a time measurement accuracy of about 0.05 second will be required, as compared to the presently used technique which gives an accuracy of about 0.8 second.

6. RECOMMENDATIONS

As a result of the findings in this report the following two recommendations are made:

1. The use of a random update approach to the smoothing and filtering function in a multisensor environment was not found to yield any significant potential for improved system performance because the actual magnitude of the deviations in the data interval are small compared to the rotation period of the sensor. As a result, it is recommended that the concept of a fixed interval tracking algorithm, with time correction to compensate for the time of receipt of the data within the tracking cycle, be retained unless some basic change is made in the characteristics of the en route environment.

2. It is absolutely essential that the system timing accuracy be significantly improved to take advantage of the accuracy of the DABS data. An accuracy on the order of 0.05 second is recommended in order to ensure no measurable degradation in system performance as a consequence of timing errors. If the precision used for reporting the DABS data is increased, then the significance of timing errors will become even greater thus further justifying the use of more precise timing measurements.

It is important to note that the significance of the timing errors will be the same regardless of what tracking algorithm is used. This is additional justification for the improvement in the timing accuracy.

7. REFERENCES

1. Sklansky, J., Optimizing the Dynamic Performance of a Track-While-Scan System, RCA Review, Vol. 18, pp. 163-185, June 1957.
2. Levine, N., A New Technique for Increasing the Flexibility of Recursive Least Squares Data Smoothing, Bell System Technical Journal, Vol. 11, pp. 821-840, May 1961.
3. Benedict, T. R. and Bordner, G. W., Synthesis of an Optimal Set of Radar Track-While-Scan Smoothing Equations, IRE Trans. on Automatic Control, Vol. AC-7, pp. 27-32, July 1962.
4. Simpson, H. R., Performance Measures and Optimization Condition for a Third-Order Sampled-Data Tracker, IEEE Trans. on Automatic Control (Correspondence), Vol. AC-8, pp. 182-183, April 1963.
5. Neal, S. R., Discussion on Parametric Relations for the α - β - γ Filter Predictor, IEEE Trans. on Automatic Control (Correspondence), Vol. AC-12, pp. 315-317, June 1967.
6. Kanyuck, A. J., Transient Response of Tracking Filters With Randomly Interrupted Data, IEEE Trans. on Aerospace and Electronic Systems, Vol. AES-6, pp. 313-323, May 1960.

7. Singer, R. A. and Behnke, K. W., Real-Time Tracking Filter Evaluation and Selection for Tactical Applications, IEEE Trans. on Aerospace and Electronic Systems, Vol. AES-7, pp. 100-110, January 1971.
8. Wilson, K. C., An Optimal Control Approach to Designing Constant Gain Filters, IEEE Trans. on Aerospace and Electronic Systems, Vol. AES-8, pp. 836-842, November 1972.
9. Bhagavan, B. K. and Polge, R. J., Performance of the G-H Filter For Tracking Maneuvering Targets, IEEE Trans. On Aerospace and Electronic Systems (Correspondence), Vol. AES-10, pp. 864-866, November 1974.
10. Schooler, C. C., Optimal α - β Filters for Systems With Modeling Inaccuracies, IEEE Trans. on Aerospace and Electronic Systems, Vol. AES-11, pp. 1300-1306, November 1975.
11. Cantrell, B. H., Behavior of α - β Tracker for Maneuvering Targets Under Noise, False Target, and Fade Conditions, Naval Research Laboratory Report 7434, NTIS No. AD748-993, August 1972.
12. Cantrell, B. H., Description of An Alpha-Beta Filter In Cartesian Coordinates, Naval Research Laboratory Report 7548, NTIS No. AD759-011, March 1973.
13. Cantrell, B. H., Gain Adjustment Of An Alpha-Beta Filter With Random Updates, Naval Research Laboratory Report 7647, NTIS No. AD774-087, December 1973.
14. Cantrell, B. H., Adaptive Tracking Algorithm, Naval Research Laboratory Memorandum 3037, NTIS No. AD-A011-122, April 1975.
15. Navarro, A. M., General Properties of Alpha-Beta, and Alpha-Beta-Gamma Tracking Filters, Physics Laboratory Report PHL 1977-02, NTIS No. N77-24347, January 1977.
16. Cadzow, J. A., Discrete-Time Systems, Prentice-Hall, Englewood Cliffs, New Jersey, 1973.
17. Computer Program Functional Specifications: Automatic Tracking, NAS-MD-321, NAS Library No. 80-0798, April 1980.
18. Lefferts, R. E., Analytical Investigation Of Time Correction In Asynchronous Alpha-Beta Tracking Filters With Application To En Route Altitude Tracking, FAA Technical Center, Report No. FAA-NA-79-47, NTIS No. AD-A085-606, May 1980.
19. Meditch, J. S., Stochastic Optimal Linear Estimation and Control, McGraw-Hill, New York, N.Y., 1969.
20. Lefferts, R. E., Calculation of the Correlation Region Size for Use With Alpha-Beta Tracking Filters, FAA Technical Center, Report No. FAA-NA-79-15, NTIS No. AD-A072-083, April 1979.
21. Gertz, J. L., The ATCRBS Mode of DABS, Lincoln Laboratory Report ATC-65, Report No. FAA-RD-76-39, January 1977.

22. Shaw, N. K. and Simolunas, A. A., System Capability of Air Traffic Control Radar Beacon System, Proc. of the IEEE, Vol. 58, pp. 399-407, March 1970.
23. Drouilhet, P. R., DABS: A System Description, Lincoln Laboratory Report ATC-42, Report No. FAA-RD-74-189, NTIS No. AD-A005-056, November 1974.
24. Lautenschlager, R. W. and Miskill, D. K., Preliminary Functional Specification: En Route Multiple Radar Data Processing (MRDP) for the DABS/ATCRBS Surveillance Environment, The MITRE Corp., Atlantic City, N.J., MTR-7299, March 1977.
25. Lefferts, R. E., An Evaluation of Certain Selected Modifications to the National Airspace System Bimodal Tracking Algorithm, FAA Technical Center, Report No. FAA-NA-79-16, NTIS No. AD-A072-084, April 1979.
26. Lefferts, R. E., En Route Tracking of DABS Radar Data — Preliminary Study Results, The MITRE Corp., Atlantic City, N.J., WP-12571, September 1977.