

Bookcase 4

Shelf 5-

#2

REPORT NOS. DOT-TSC-MHISA-78-24

HS-803 289

ROADSIDE BARRIER EFFECTIVENESS
Noise Measurement Program

E.J. Rickley
U. Ingard
Y.C. Cho
R.W. Quinn

U.S. Department of Transportation
Transportation Systems Center
Kendall Square
Cambridge MA 02142



APRIL 1978

FINAL REPORT

DOCUMENT IS AVAILABLE TO THE U.S. PUBLIC
THROUGH THE NATIONAL TECHNICAL
INFORMATION SERVICE, SPRINGFIELD,
VIRGINIA 22161

Prepared for
U.S. DEPARTMENT OF TRANSPORTATION
NATIONAL HIGHWAY TRAFFIC SAFETY ADMINISTRATION
Office of Research and Development
Washington DC 20590

NOTICE

This document is disseminated under the sponsorship of the Department of Transportation in the interest of information exchange. The United States Government assumes no liability for its contents or use thereof.

NOTICE

The United States Government does not endorse products or manufacturers. Trade or manufacturers' names appear herein solely because they are considered essential to the object of this report.

1. Report No. HS-803 289		2. Government Accession No.		3. Recipient's Catalog No.	
4. Title and Subtitle ROADSIDE BARRIER EFFECTIVENESS Noise Measurement Program				5. Report Date April 1978	
				6. Performing Organization Code	
7. Author(s) E.J. Rickley, U. Ingard*, Y.C. Cho*, R.W. Quinn				8. Performing Organization Report No. DOT-TSC-NHTSA-78-24	
				10. Work Unit No. (TRAIS) OS807/R8509	
9. Performing Organization Name and Address U.S. Department of Transportation Transportation Systems Center Kendall Square Cambridge MA 02142				11. Contract or Grant No.	
				13. Type of Report and Period Covered Final Report September 1975-September 1976	
12. Sponsoring Agency Name and Address U.S. Department of Transportation National Highway Traffic Safety Administration Office of Research and Development Washington DC 20590				14. Sponsoring Agency Code	
				15. Supplementary Notes *Sonotech Inc. Tabor Hill Road Lincoln MA 01773	
16. Abstract A field noise measurement program was conducted to assess the performance of a variable height highway noise barrier with and without an acoustic lining material. The barrier site on Interstate I-93 in Andover MA was located adjacent to an acoustically similar unobstructed site. The noise emissions from a common stream of vehicular traffic were measured at both sites simultaneously and compared to evaluate the performance of the barrier. A 1000-foot-long barrier at effective heights of 2.8, 6.8, 10.8 and 14.8 feet was measured and evaluated. Included in this report is the statistical noise data from fourteen measuring systems for each barrier configuration along with spectral data, traffic information and meteorological conditions.					
17. Key Words Noise, Noise Barrier, Highway Noise, Noise Prediction				18. Distribution Statement DOCUMENT IS AVAILABLE TO THE U.S. PUBLIC THROUGH THE NATIONAL TECHNICAL INFORMATION SERVICE, SPRINGFIELD, VIRGINIA 22161	
19. Security Classif. (of this report) Unclassified		20. Security Classif. (of this page) Unclassified		21. No. of Pages 240	22. Price

PREFACE

This report documents the results of a field noise measurement program to assess the performance of a temporary highway noise barrier constructed to reduce community noise caused by vehicular traffic on a highway.

Data obtained from this program provides a basis for the optimization of highway noise barriers with regard to their height and distance from the roadway.

The program was sponsored by the U.S. Department of Transportation, Office of Noise Abatement.

Appreciation is expressed to Mr. C.F. Mistretta, District Highway Engineer, Department of Public Works of the Commonwealth of Massachusetts, for the necessary permits and approval for construction along the state right-of-way.

METRIC CONVERSION FACTORS

Approximate Conversions to Metric Measures				Approximate Conversions from Metric Measures			
Symbol	What You Know	Multiply by	To Find	Symbol	What You Know	Multiply by	To Find
LENGTH							
in	inches	2.5	centimeters	mm	millimeters	0.04	inches
ft	feet	30	centimeters	cm	centimeters	0.4	inches
yd	yards	0.9	meters	m	meters	3.3	feet
mi	miles	1.6	kilometers	km	kilometers	0.6	miles
AREA							
m ²	square inches	6.5	square centimeters	cm ²	square centimeters	0.16	square inches
ft ²	square feet	0.09	square meters	m ²	square meters	1.2	square yards
yd ²	square yards	0.8	square meters	km ²	square kilometers	0.4	square miles
mi ²	square miles	2.5	square kilometers	ha	Hectares (10,000 m ²)	2.5	acres
MASS (weight)							
oz	ounces	28	grams	g	grams	0.035	ounces
lb	pounds	0.45	kilograms	kg	kilograms	2.2	pounds
	short tons (2000 lb)	0.9	tonnes	t	tonnes (1000 kg)	1.1	short tons
VOLUME							
cup	teaspoons	5	milliliters	ml	milliliters	0.03	fluid ounces
fl oz	tablespoons	15	milliliters	l	liters	2.1	pints
c	fluid ounces	30	milliliters	l	liters	1.06	quarts
pt	Cups	0.24	liters	m ³	cubic meters	35	gallons
qt	pints	0.47	liters	m ³	cubic meters	1.3	cubic feet
gal	quarts	0.96	liters	m ³	cubic meters	1.3	cubic yards
cu ft	gallons	3.8	liters				
cu yd	cubic feet	0.03	cubic meters				
cu yd	cubic yards	0.76	cubic meters				
TEMPERATURE (exact)							
°F	Fahrenheit temperature	5/9 (after subtracting 32)	Celsius temperature	°C	Celsius temperature	9/5 (then add 32)	Fahrenheit temperature

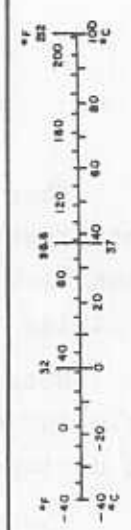
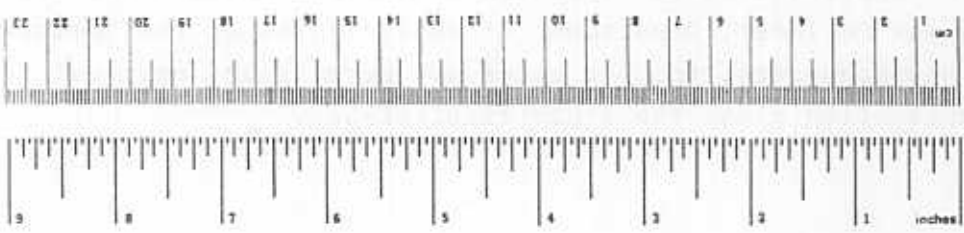

CONTENTS

<u>Section</u>	<u>Page</u>
1. INTRODUCTION.....	1
2. BACKGROUND.....	3
3. METHODS.....	4
3.1 Program Scope.....	4
3.2 Description of Test Site.....	4
3.3 Barrier Design and Construction.....	5
3.4 Instrumentation.....	8
3.4.1 Measurement Systems.....	8
3.4.2 On-Line Data Analysis and Recording System.....	13
3.4.3 Off-Line Data Reduction.....	16
3.5 Experimental Procedure.....	16
3.5.1 No Barrier.....	17
3.5.2 One-Thousand-Foot Barrier.....	17
3.5.3 Noise Reflections.....	21
4. DATA ANALYSIS.....	24
4.1 Discussion.....	24
4.2 Procedure.....	26
4.2.1 Barrier Insertion Loss.....	26
4.2.2 Noise Reduction Over Ground.....	26
4.3 Results of Data Analysis.....	45
4.3.1 $(IL)_{50}$ and $(IL)_{10}$	45
4.3.2 Effect of Absorptive Treatment.....	47
4.3.3 Insertion Loss vs. Barrier Height.....	47
4.3.4 Insertion Loss vs. Distance Behind the Barrier.....	48
4.3.5 Insertion Loss vs. Height of Observation Point.....	48
4.3.6 Predicted Insertion Loss.....	52
4.4 Summary.....	55
5. MEASUREMENT DATA.....	59
5.1 No Barrier.....	59
5.2 Barrier 2.8 Feet High.....	60

CONTENTS (CONTINUED)

<u>Section</u>	<u>Page</u>
5.3 Barrier 6.8 Feet High.....	60
5.4 Barrier 10.8 Feet High.....	61
5.5 Barrier 14.8 Feet High.....	61
5.6 Octave Band Frequency Spectra.....	62
 APPENDIX A TEMPORARY NOISE ATTENUATION BARRIER: DESIGN AND CONSTRUCTION.....	227
APPENDIX B REFERENCES.....	232
APPENDIX C BIBLIOGRAPHY.....	232

ILLUSTRATIONS

<u>Figure</u>	
1 Panoramic View of Barrier and Open Field Sites.....	6
2 Block Diagram of Acoustic Measuring Instrumentation..	9
3 Microphone Mast Structure at Measurement Location D..	10
4 Analysis and Recording System.....	14
5 Microphone Locations. No Barrier Present.....	18
6 Microphone Locations. Barrier Present.....	20
7-24 Insertion Loss vs. Barrier Height: Untreated and Absorptive Barriers; Various Observation Points.....	27-44
25 Insertion Loss vs. Observer-Barrier Distance D_b	49
26 Insertion Loss vs. Observer Height. Observer-Barrier Distance $D_B=55'$	50
27 Insertion Loss vs. Observer Height. Observer-Barrier Distance $D_B=100'$	51
28 Octave Band Noise Reduction Over Ground.....	54
29 Octave Band Noise Spectrum.....	56
A-1 Design for Noise Barrier.....	229

TABLES

<u>Table</u>		<u>Page</u>
1	MICROPHONE LOCATIONS (No Barrier Present).....	19
2	MICROPHONE LOCATIONS (Barrier Present).....	22
3	BARRIER CONFIGURATION.....	25
4	DESIGN GUIDE PREDICTED BARRIER INSERTION LOSS.....	53
5	DIFFERENCE BETWEEN PREDICTED AND MEASURED BARRIER INSERTION LOSS.....	57
6-12	NOISE DATA: OPEN FIELD MICROPHONES 1-14.....	63-69
13-23	NOISE DATA: FOUR FOOT ABSORPTIVE BARRIER; MICRO- PHONE CONFIGURATIONS B, C, D, E.....	70-80
24-36	NOISE DATA: FOUR FOOT REFLECTIVE BARRIER; MICRO- PHONE CONFIGURATIONS B, C, D, E.....	81-93
37-77	NOISE DATA: EIGHT FOOT ABSORPTIVE BARRIER; MICRO- PHONE CONFIGURATIONS B, C, D, E.....	94-101
45-56	NOISE DATA: EIGHT FOOT REFLECTIVE BARRIER; MICRO- PHONE CONFIGURATIONS B, C, D, E.....	102-113
57-68	NOISE DATA: TWELVE FOOT ABSORPTIVE BARRIER; MICRO- PHONE CONFIGURATIONS B, C, D, E.....	114-125
69-80	NOISE DATA: TWELVE FOOT REFLECTIVE BARRIER; MICRO- PHONE CONFIGURATIONS B, C, D, E.....	126-137
81-91	NOISE DATA: SIXTEEN FOOT ABSORPTIVE BARRIER; MICROPHONE CONFIGURATIONS B, C, D, E.....	138-148
92-123	NOISE DATA: SIXTEEN FOOT REFLECTIVE BARRIER; MICROPHONE CONFIGURATIONS B, C, D, E.....	149-180
124-134	METEOROLOGICAL DATA.....	181-191
135-164	TEN-MINUTE TRAFFIC SUMMARIES.....	192-221
165-168	OCTAVE BAND MEAN ENERGY DATA: REFLECTIVE BAR- RIERS AT FOUR, EIGHT, TWELVE, AND SIXTEEN FEET; MICROPHONE CONFIGURATIONS B, C, D, E.....	222-225

LIST OF SYMBOLS

A	Average sound level (arithmetic)	dB(A)
D_b	Distance from observation point to barrier	
D_n	Distance from observation point to the edge of the highway: $D_n = D_b + 30 \text{ ft}$	
E	Energy mean (L_{eq})	dB(A)
H_b	Barrier height	
H_0	Height of observation point	
IL	Insertion loss	
$(IL)_n$	Insertion loss based on the level L_n	
L	Noise level (dBA) (used interchangeably with sound level)	
L_{eq}	Mean energy noise level	
L_n	Noise level (dBA) exceeded n% of the measuring time	
M	Maximum level measured	dB(A)
N	Noise pollution level (NPL)	dB(A)
NR	Noise reduction	
NROG	Noise reduction over ground	
R	Range of data measured	dB(A)
S	Standard deviation	dB
TTST	Trailer truck single trailer	
δ	Difference in acoustic path length from source to receiver resulting from insertion of barrier	
1	L1, level exceeded 1% of time	dB(A)
10	L10, level exceeded 10% of time	dB(A)
50	L50, level exceeded 50% of time	dB(A)
90	L90, level exceeded 90% of time	dB(A)
99	L99, level exceeded 99% of time	dB(A)

1. INTRODUCTION

The U.S. Department of Transportation, Transportation Systems Center (TSC), Cambridge, Massachusetts, conducted a field measurement program from September 1975 to September 1976 to obtain baseline statistical data to assess the performance of barriers as a means of reducing wayside noise caused by high-density vehicular traffic.

Two highway sites were selected for the programs. The sites were adjacent to each other in a large flat open field with approximately 2000 feet frontage to Interstate 93 in Andover, Massachusetts. A temporary barrier 1000 feet long was constructed on one site. Measurements were obtained during different phases of construction to obtain variations due to barrier height. The second site was left in its natural state.

Prior to construction of the barrier, acoustical similarity was established between the two sites using a measurement grid composed of 14 microphone positions. After construction, measurements of the noise generated by a common stream of vehicular traffic were simultaneously made behind the barrier (site 1) and in the unobstructed site (site 2). Because of the similarity of the two sites, a direct comparison of noise levels from corresponding microphones provided insertion loss data for the barrier.

Some of the more important results obtained in the study can be summarized as follows:

a. Predicted insertion loss values, obtained using the method proposed by the Highway Research Board in Report 144 of the National Cooperative Highway Research Program are generally lower than those measured, except at the lowest observation height (three feet).

b. The effect on the insertion loss of the barrier by adding an absorptive treatment* (two inch fiberglass board) to the barrier is too small to be of practical significance for observation points behind the barrier.

* In this report the terms "absorptive" and "treated" are used interchangeably, as are the terms "reflective" and "untreated".

c. The largest measured value of insertion loss, based on L50 data was 13dB; this value was obtained 55 feet behind the barrier at a microphone height of 8 feet. The effective barrier height was 14.8 feet, the maximum height tested.

d. For barrier heights other than three feet, the largest insertion loss does not necessarily occur at the lowest observation point.

e. To improve the prediction procedure, more attention should be paid to the frequency dependence of the transmission characteristics along the path from source to receiver.

2. BACKGROUND

Increasing national concern for the environment has resulted in efforts to reduce the intrusion of traffic noise into our daily lives. Roadside barriers have been constructed in some states in the hopes of reducing excessive traffic noise. Assessment of the effectiveness of these barriers is difficult because of the high level of activity in the communities which they are to protect.

Analytical and field studies have demonstrated that barriers can reduce wayside noise from highways; however, a thorough performance evaluation under real traffic conditions, taking into account the effects of variations in height and of adding absorption to the face of an outdoor barrier, has not been investigated.

The primary purpose of this field measurement program was to obtain on-site data and perform a thorough assessment of the effects of height and absorption on the performance of an in-service roadside barrier, taking into account noise source location; traffic mix, speed and volume; and meteorological effects.

The acoustic consultant firm of Cambridge Collaborative (CC), Cambridge, Massachusetts, provided technical assistance in barrier design and developing the test plan. Data measured by TSC was also provided to CC for analysis and interpretation. Their analysis is to be published as a separate report⁽¹⁾

3. METHODS

3.1 PROGRAM SCOPE

Two adjacent highway sites were selected for this program where the noise caused by a common high-density stream of mixed vehicular traffic could be measured sequentially. A variable-height noise barrier was built at one of the sites. The second site provided control data with which to assess the barrier performance. Noise measurements were made at each of the sites prior to construction to determine the similarity of the noise environment at each site.

An acoustic consulting firm (Cambridge Collaborative Inc., Cambridge, MA) under contract to TSC, using on-site noise data and the best application of state-of-the-art barrier technology, designed and constructed (subject to TSC approval) a temporary variable-height noise barrier providing substantial noise reduction. In addition, the contractor assisted in developing a plan to test the barrier parametrically in its various configurations.

The TSC Noise Measurement and Assessment Laboratory made the actual field measurements and reduced all the data.

3.2 DESCRIPTION OF TEST SITE

The measurement program was conducted in Andover, Massachusetts on a site adjacent to the southbound lane of Interstate 93 (a six-lane divided highway).

The site selected was a large, flat open field with 2000 feet of frontage on I-93 (highway station markers 305 to 325) bounded to the north and west by tall forests. Sixty-five feet from the edge of the near traveled lane of the highway is a 20 foot wide line of widely spaced white pines (about 20 feet high) intermixed with deciduous shrubs and trees. Beyond this at 90 feet is a chain-link fence at which point the ground drops rapidly about three feet. Terrain beyond this point is essentially flat, made up of fine sandy soil covered with field grass and scattered with a few saplings.

The 1000 foot barrier was constructed between station markers 305 and 315, 30 feet offset and parallel to the edge of the near traveled lane. The area between station markers 315 and 325 was left in its natural state (see Figure 1).

3.3 BARRIER DESIGN AND CONSTRUCTION

A 16 foot high, 1000 foot long, horizontally straight, plain-faced barrier was constructed 30 feet offset from the edge of the near traveled lane. The barrier was constructed of 5/8 inch exterior grade plywood. These four-by-eight-foot panels of plywood were secured to a framework of two-by-six-inch wooden beams. The beams were secured to one-foot-diameter wooden posts eight feet on center. The framework provided stiffening and insured a positive acoustic seal at the joints of the plywood panels. The central 200 foot section of the barrier was constructed with two overlapping sheets of 5/8 inch plywood while the 400 foot sections at both ends were constructed with a single layer for economic reasons. Two inch thick semirigid glass fiber boards were to be applied to the source side of the barrier (facing the highway) to change the acoustic properties of barrier from reflective to absorptive.

The barrier was constructed in the sequence indicated below with acoustic measurements made at intermediate barrier heights of 4, 8, 12, and finally 16 feet. (Because of local grade conditions the effective barrier heights above the level of the near lane were 2.8, 6.8, 10.8, and 14.8 feet respectively.)

- a. Erect posts and install one row of panel - 2.8 ft reflective.
- b. Install one row glass fiber boards - 2.8 ft absorptive.
- c. Install second row of panels and glass fiber boards - 6.8 ft absorptive.
- d. Remove all glass fiber boards - 6.8 ft reflective.
- e. Install third row plywood panels - 10.8 ft reflective.
- f. Install three rows glass fiber boards - 10.8 ft absorptive.
- g. Install fourth row panels and glass fiber boards - 14.8 ft absorptive.
- h. Remove all glass fiber boards - 14.8 ft reflective.

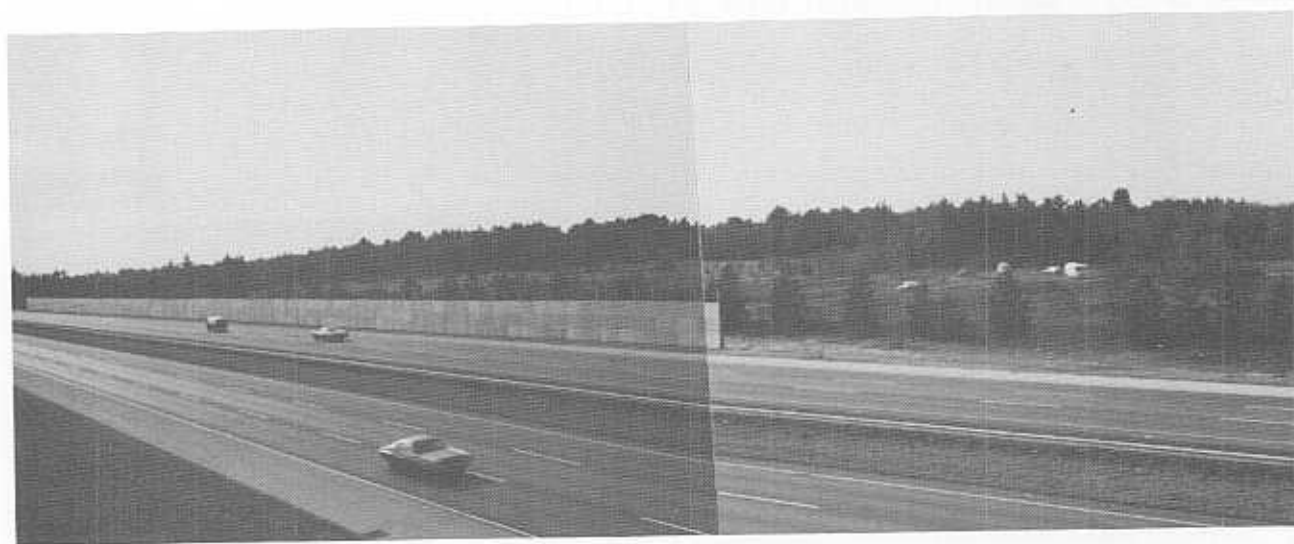

VIEW FROM ROAD (Barrier at left)

VIEW FROM BEHIND BARRIER (Open field at far left)

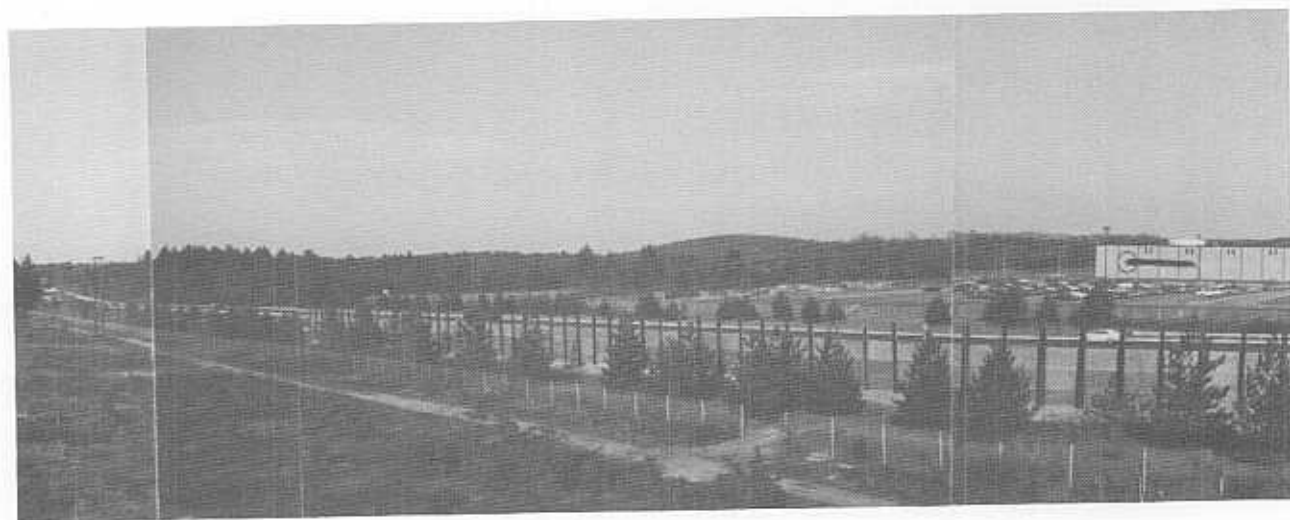
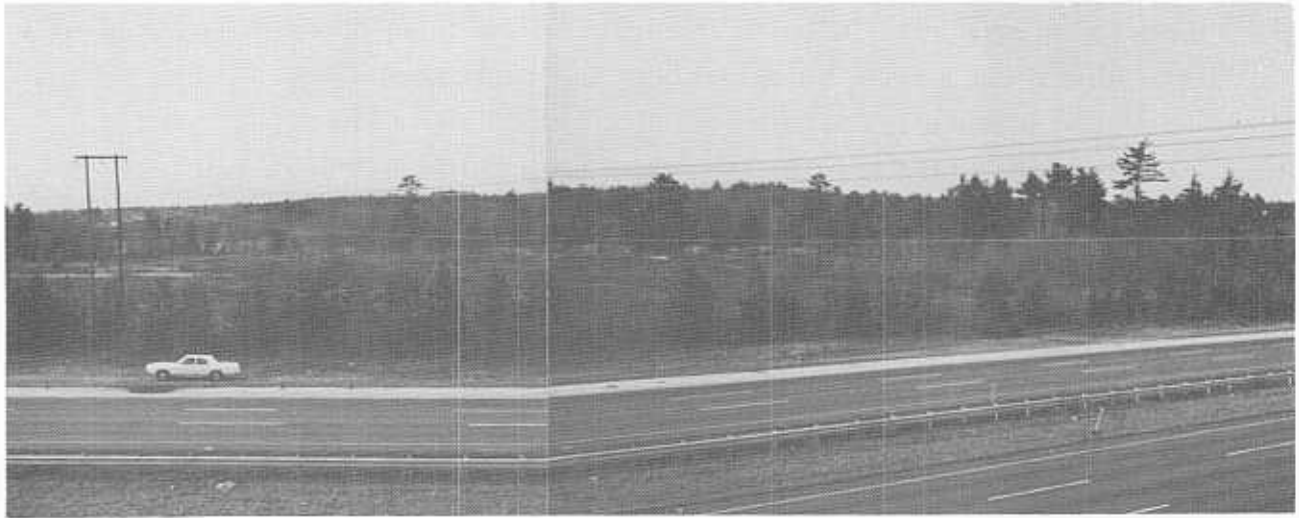
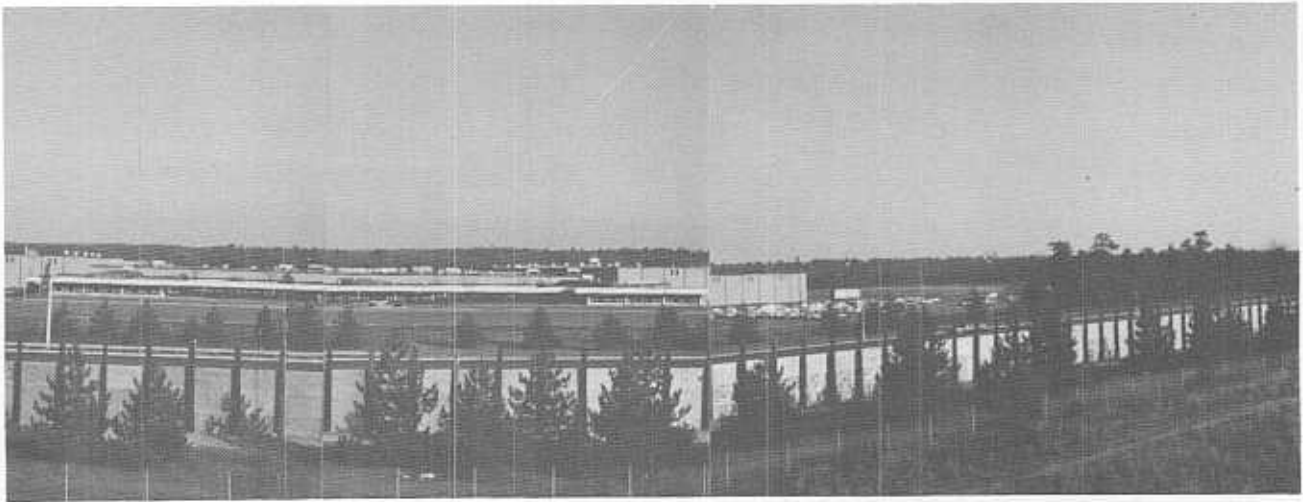

FIGURE 1. PANORAMIC VIEW OF BARRIER AND OPEN FIELD SITES



VIEW FROM ROAD (Open field)

VIEW FROM BEHIND BARRIER



A more complete description of the barrier design can be found in Appendix A.

3.4 INSTRUMENTATION

For this program, the TSC Mobile Noise Measurement Laboratory, (a fully equipped noise measurement and analysis laboratory) was used for on-line data collection and analysis. The laboratory was positioned at station marker 315 approximately 350 feet offset from the edge of the near traveled southbound lane of the highway.

3.4.1 Measurement Systems

Figure 2 depicts schematically the basic elements of one of the 14 noise data gathering systems deployed. Random incidence microphones were used on all systems. Data measured were fed through approximately 700 feet of cable to the mobile laboratory for recording and/or processing.

Microphones at the higher elevations were mounted on a mast structure of 1/2 inch thin walled electrical conduit supported with a tri-level arrangement of guy wires. The microphones were positioned one foot away from the mast and placed in its shadow as viewed from the roadway. This positioning insured minimum errors due to reflections from the mast structure. (See Figure 3.)

System calibration on-site was performed prior to each measurement run with three GR 1562A calibrators. These calibrators provide a signal of 1000 Hz at a level of 114dB re 20 micropascal. The signal is generated by a solid state oscillator driving a small magnetic loudspeaker. The levels of the three calibrators were compared with each other on microphone 1 prior to each use and again at microphone 14 after each use to insure their relative levels were stable. To avoid confusion and to control systematic errors, the calibrators were numbered and were always used on the same microphone system each time a calibration was performed. Also, a passive microphone simulator was substituted for the microphone to determine the minimum discernible sound pressure level (noise floor) of the system.

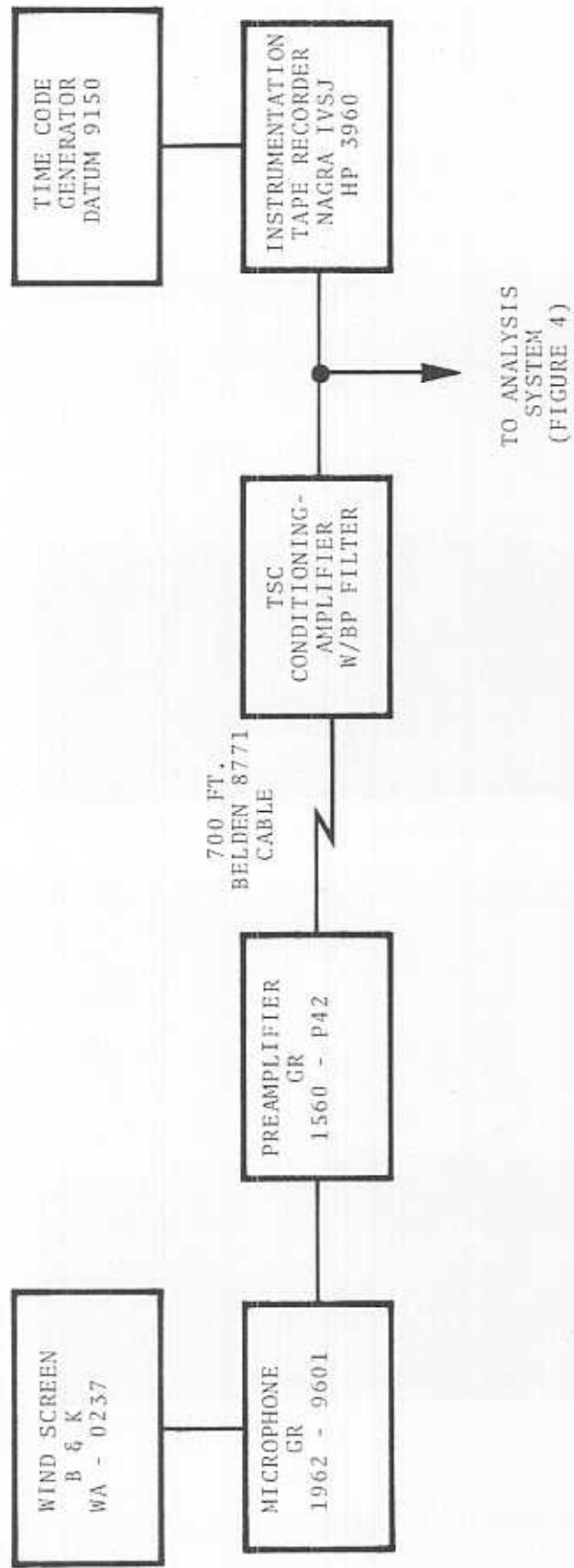
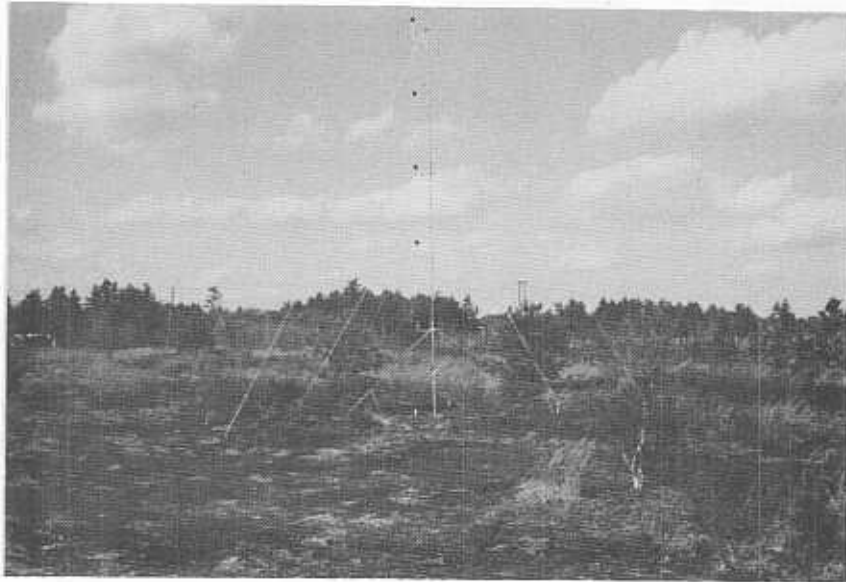
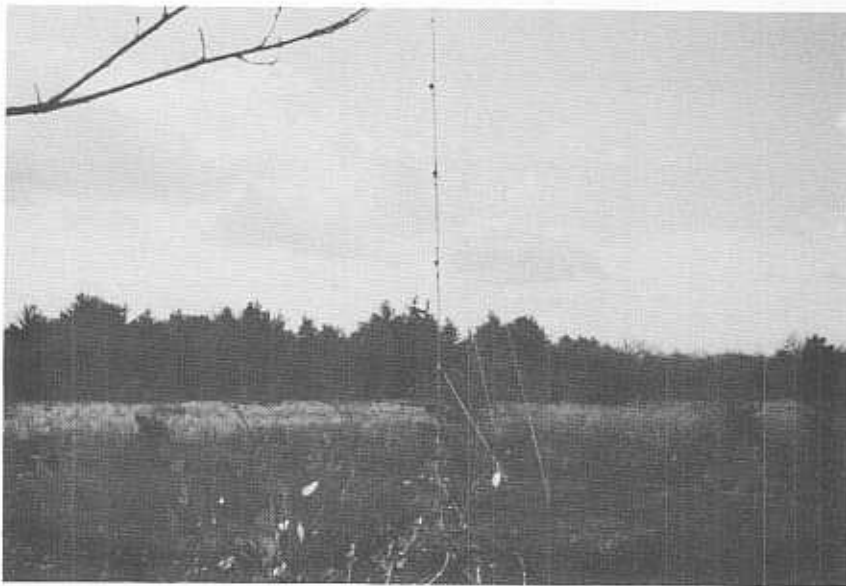

FIGURE 2. BLOCK DIAGRAM OF ACOUSTIC MEASURING INSTRUMENTATION



NORTH



WEST

FIGURE 3. MICROPHONE MAST STRUCTURE AT MEASUREMENT LOCATION D

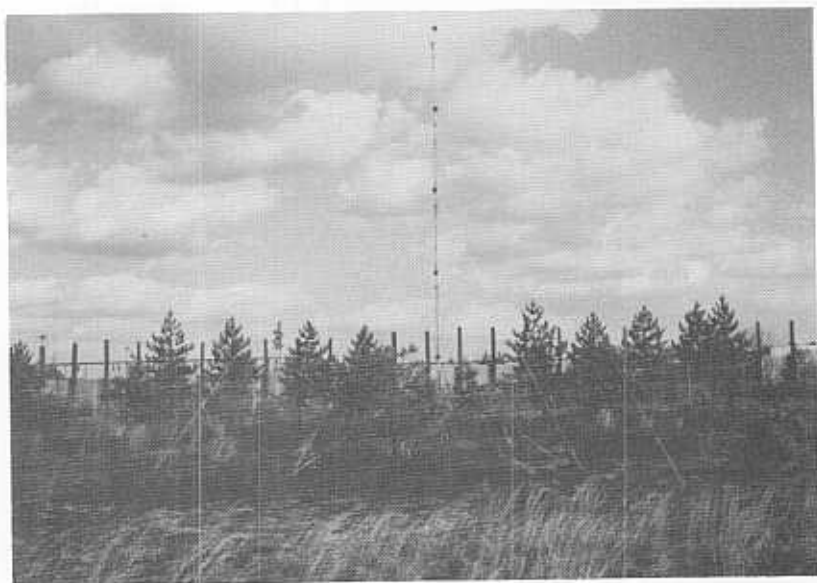

EAST

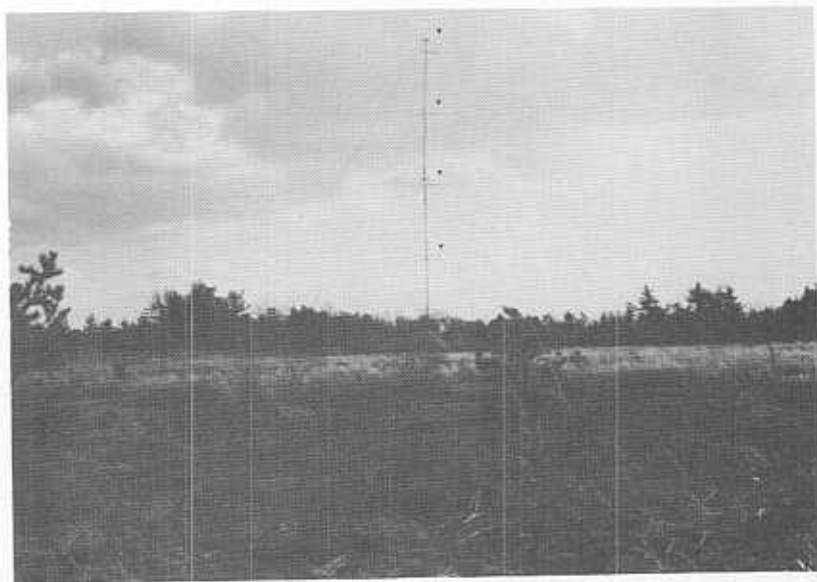

SOUTH



•
•
•
•
•
•
•
•

The calibration signals, where appropriate, were recorded on magnetic tape and were used as reference levels to adjust the absolute range of each channel of the analysis system.

A weather station was deployed at station marker 315 and offset 250 feet from the edge of the roadway to measure and continuously record temperature, humidity, wind speed, and direction. A wind cup anemometer was mounted ten feet above the ground. Temperature and humidity were measured five feet above the ground.

A doppler radar was set up at station marker 315 to measure the speed of traffic in the southbound lanes. Readings were manually taken from the doppler digital output and recorded every ten seconds.

3.4.2 On-Line Data Analysis and Recording System

Figure 4 depicts the on-line data analysis and recording system used for this program in the TSC Mobile Noise Laboratory. Data from the microphone systems were fed through up to 700 feet of cable to the laboratory for processing and recording.

Processing on-line was accomplished using a modified GR 1921 Real Time Analysis System made up of a GR 1925 Multifilter and GR 1926 Multichannel RMS Detector. The GR 1921 was modified to accept data simultaneously from the 14 microphone systems. Data from microphone 1 was fed to the GR 1925 Multifilter which contained nine parallel octave band filters from 31.5 Hz to 8 KHz plus an unfiltered channel with a flat frequency response between 25 Hz and 15 KHz, and a standard "A" weighted channel. The output from these eleven channels was fed to the GR 1926 Detector. In addition, the outputs of microphones 2 through 14 were fed through individual "A" weighting networks and matching circuitry to the GR 1926. Prior to A-weighting, the outputs of microphones 3, 4, 5, 8, 10, and 13 were fed to instrumentation grade magnetic tape recorders to preserve the data for future processing. A time code signal from the Datum 9150 Time Code Generator was also recorded on tape to provide synchronization between the recorded data and the data processed on-line.

FROM
MICROPHONE

GR 1921 REAL TIME ANALYZER (MOD)

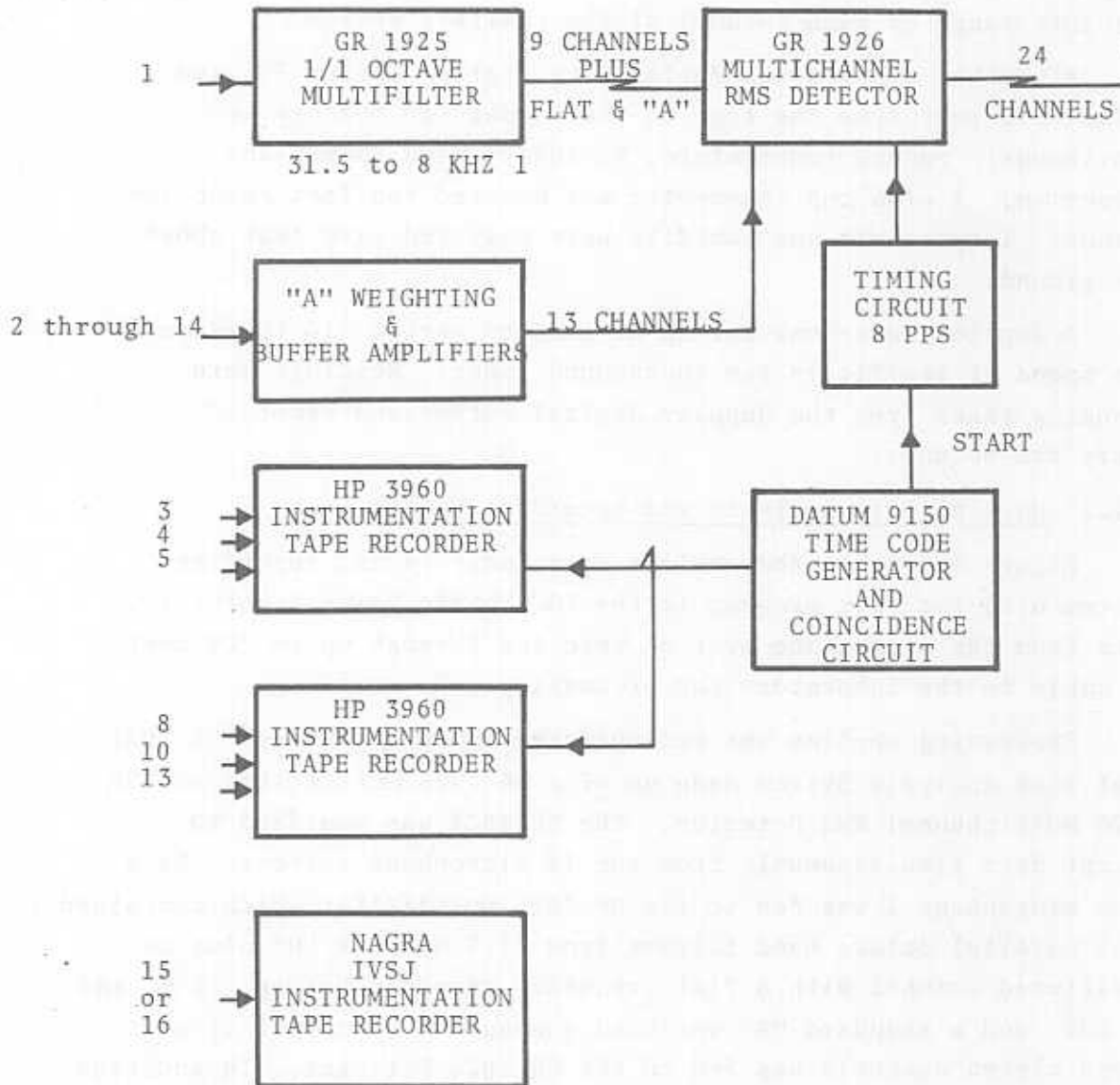
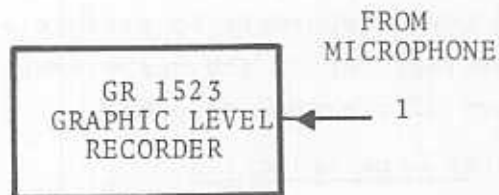
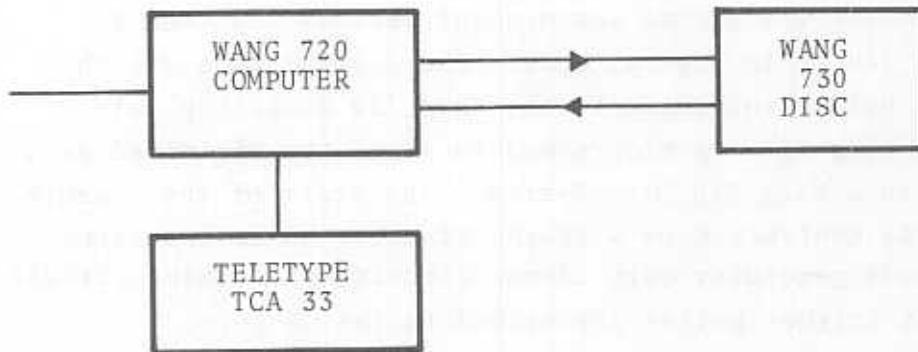

FIGURE 4. ANALYSIS AND RECORDING SYSTEM



The GR #1926 Detector was programmed to compute simultaneously the root-mean-square (rms) level in dB for each of the above 24 data channels over 1/8 second measurement periods and then to convert these levels to digital code. The digital code was then fed through a buffer interface to the Wang 720 computing calculator. The Wang 720 was programmed to store the digitized data sequentially on a Wang 730 Disc System. The start of the measurement period was controlled by a timing circuit. Once initiated by the time code generator coincidence circuit, the timing circuit provided eight trigger pulses per second to the GR 1926.

Data from microphone systems 2 and 14 were also fed to GR 1523 Graphic Level Recorders to produce sound level vs. time history recordings during the measurement period for on-line identification of extraneous sounds.

3.4.3 Off-Line Data Reduction

Recorded data from microphones 3, 4, 5, 8, 10, and 13 for selected runs and barrier configurations were analyzed off line. These data were reproduced one channel at a time and fed into the analysis system, described in subsection 3.4.2, in place of the microphone 1 input. In this manner octave band frequency data were also obtained for these six microphones. These data along with the on-line frequency data from microphone 1 already stored in the disc system, were processed, and a tabulation was prepared of the octave band energy mean measured during selected ten minute runs.

3.5 EXPERIMENTAL PROCEDURE

The test program was carried out in two parts: (1) in the no-barrier situation acoustical measurements were made in the two adjacent unobstructed sites to confirm the acoustic similarity of the two sites; and (2) after construction of the barrier, measurements were simultaneously made behind the barrier and at the adjacent unobstructed site.

3.5.1 No Barrier

To confirm the similarity of the two adjacent sites, a 14-microphone measurement system was deployed and measurements made over a two-day period (September 3-4, 1975) with the microphones arranged as shown in Figure 5. Microphones 1, 4, and 14 were placed 20 feet above grade level. All other microphones were placed five feet above grade level. Table 1 shows the microphone height relative to the edge of the near traveled southbound lane.

Thirteen measurement runs were made over a two-day period covering a variety of traffic conditions. Each run covered a period of ten minutes. During each run, traffic information was recorded for both the south- and the northbound lanes. Trucks and buses were separated into classes as determined by the number of axles and tires. Speed in the southbound lanes was measured using a doppler radar and manually recorded once every ten seconds.

Noise data from the fourteen measuring systems were reduced after each measurement run for immediate on-site comparison and analysis. Based on these data the height of microphones 5, 6, 7, 8, 9, and 13 were raised by one foot after the third measurement run on September 3, 1975 to compensate for the drop in grade level at these points. After this modification later runs showed a better statistical agreement between microphones, thus confirming the acoustic similarity of the two sites.

3.5.2 One-Thousand-Foot Barrier

With the similarity of the two adjacent sites confirmed, construction of the barrier was begun. For this phase of the measurement program the 14 microphone systems were redeployed. Four masts were required, two moveable and two permanently placed. As shown in Figure 6, the two permanent masts were placed at points A and A' with microphones 1 and 13 set 6 inches above the height of the barrier and microphones 2 and 14 set 20 feet above grade level. The two moveable masts, each with five microphones mounted five feet apart, were alternately placed at points B and B', C and C', D and D', and E and E', (mast configurations B, C, D and E

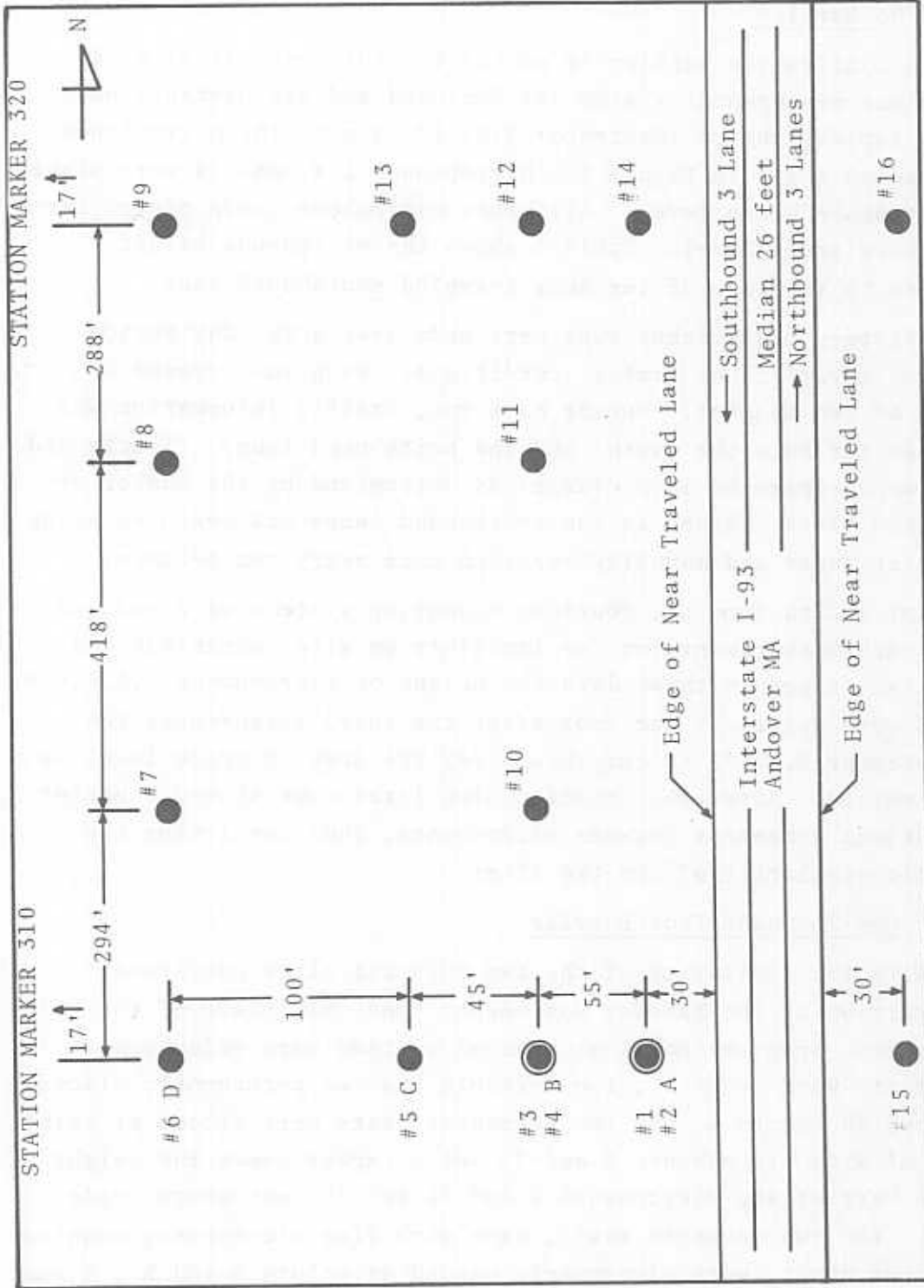

FIGURE 5. MICROPHONE LOCATIONS. NO BARRIER PRESENT

TABLE 1. MICROPHONE LOCATIONS (No barrier present)

MICROPHONE NUMBER	DISTANCE from NEAREST LANE (feet)	HEIGHT above GROUND (feet)	HEIGHT above EDGE NEAR LANE (feet)	DISTANCE from LINE AD * (feet)
1	30	20	18.3	0
2	30	5	3.3	0
3	85	5	4.1	0
4	85	20	19.1	0
5 (1)	130	5	0.8	0
6 (1)	230	5	1.2	0
7 (1)	230	5	2.3	294
8 (1)	230	5	2.7	712
9 (1),(2)	230	5	-1.9	1000
10	85	5	5.7	294
11	85	5	6.1	712
12	85	5	4.5	1000
13(1)	130	5	1.0	1000
14	30	20	18.1	1000
15	30	5	2.8	0
16	30	5	3.3	1000

* See Figure 5.

- (1) Microphone height increased by one foot for runs 4 and 5 on September 3, 1975, and all runs on September 4, 1975.
- (2) Microphone 9 moved 50 feet to south for runs 5 through 8 (September 4, 1975; height relative to roadway -0.7 feet).

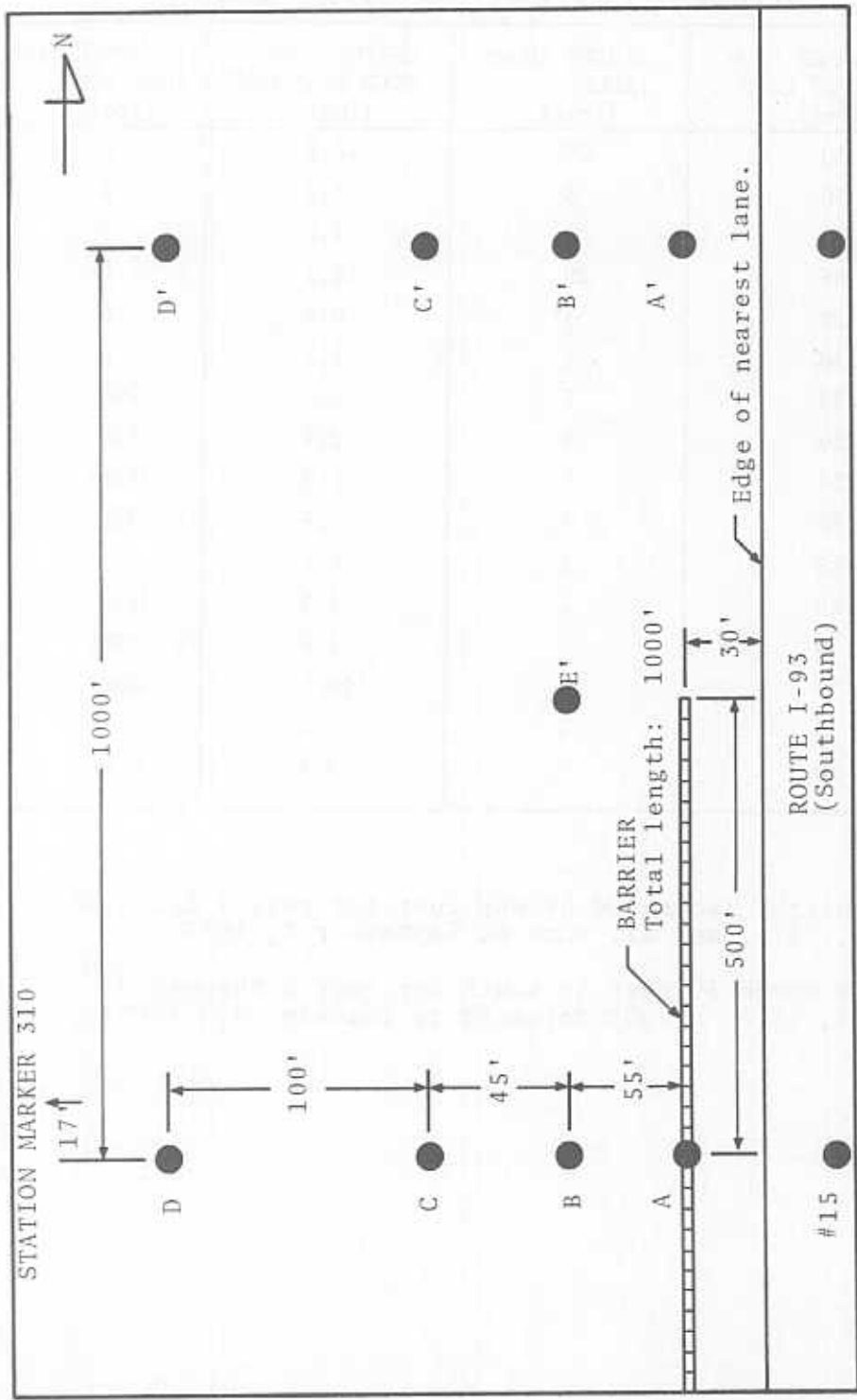

FIGURE 6. MICROPHONE LOCATIONS. BARRIER PRESENT

respectively). The lower sections of the moveable mast were adjustable so that the microphones on each mast were always set at 3,8,13,18 and 23 feet high relative to the Table 2 edge of the near southbound traveled lane regardless of the grade level at each of the measurement points. Table 2 shows the height of all microphones above grade level at each of the measurement points.

Measurements at each barrier height and configuration were taken over a three-day period. The ten-minute measurement runs separated by a period of ten minutes were performed at each measurement location starting the first day with microphone configuration B, and subsequently moving the mast to set up configurations C, D and ending at E'. To obtain a measure of the noise at each location during a variety of traffic conditions, the measurements on the second day were started with microphone configuration E and ended at D; the third day the measurements were started at configuration D and ended at C. Thus a total of approximately six ten-minute measurement runs were made at each microphone mast configuration for each barrier height in a variety of traffic conditions. A statistical "A" weighted analysis was performed for the 14 microphones (seven at each site) and comparisons made.

Each day the measurements were begun as close to the same time as practicable to obtain data at each location under similar traffic conditions. Traffic information and speed were recorded during each ten-minute measurement period. Weather data were continuously recorded.

3.5.3 Noise Reflections

To measure the effects, if any, of the noise reflections from the barrier on the source side of the roadway, a portable noise measuring system was positioned opposite the northbound lanes during selected measurement runs at station marker 310 (microphone 15 directly opposite the center of the barrier) and another at station marker 320 (microphone 16 directly opposite the open field site). These microphones were set three feet above the level of the near northbound lane and offset 30 feet from the edge of this

TABLE 2. MICROPHONE LOCATIONS (Barrier present)

MAST* NUMBER	MICROPHONE NUMBER	HEIGHT ABOVE GROUND AT MEASUREMENT POINTS A/A' B/B' C/C' D/D' B/E'					HEIGHT ROAD SURFACE (feet)	STATION**
		(feet)						
1	1	(***)					(***)	A
	2	20.0					18.3	
2	3		3.9	7.2	6.8	3.9	3	B,C or D
	4						8	
	5						15	
	6						18	
	7						25	
3	8		3.5	7.0	9.9	3.0	3	B',C',D' or E'
	9						8	
	10						15	
	11						18	
	12						25	
4	13	(***)					(***)	A'
	14	20.0					18.1	
	15						2.8	
	16						3.3	

*Masts No.2 and No.3 are stationed alternately at B and B', C and C', and D and D', or B and E'.

** See Figure 6 for mast distances from near lane.

*** Six inches above top of barrier. Height above road surface 3.3, 7.3, 11.3, 15.3 feet; height above ground 4.5, 8.5, 12.5 and 16.5 feet for barrier heights of 2.8, 6.8, 10.8 and 16.8 feet, respectively.

lane. Data were recorded on magnetic tape for a period of ten minutes, synchronized by radio with the 14 microphone on-line data gathering systems. Data were recorded during four consecutive runs for each of three barrier heights, 6.8, 10.8 and 14.8 feet). Data from locations 15 and 16 were used to determine any reflective characteristics.

4. DATA ANALYSIS

Data were obtained and analysed for nine barrier configurations (Table 3) and several observation point locations, corresponding to the five heights above the level of the roadway (3, 8, 13, 18, and 23 ft.) and the three distances from the barrier (55, 100, and 200 ft.). Fourteen microphones were used simultaneously at these locations, as indicated in Figures 5 and 6. (See Chapter 5 for data.)

4.1 DISCUSSION

At the test site the highway is straight and level, and the traffic volume, 40-80 cars per minute, is large enough to provide good data statistics over a ten-minute measurement period. The terrain surrounding the highway is also level and free from obstructions that affect sound transmission characteristics.

These conditions are consistent with those assumed in most procedures for the calculation of barrier insertion loss. One of the main objectives of the analysis is to compare the insertion loss values obtained from the experimental data with the values predicted according to the procedure described in the NCHRP Reports 117 and 144.^(2,3) This procedure shall be referred to as the Design Guide in this report.

The primary data analyzed here are L_{10} and L_{50} dB levels at various locations and times. They ranged in values from 60 to 85 dB(A).

The numerical results obtained from the data analysis are discussed and a series of graphs are presented showing the insertion loss as a function of barrier height, observation point height and distance from the barrier. The standard deviation of the insertion loss values in most cases is less than 1 dB and never exceeds 2 dB.

These insertion loss curves can be replotted in terms of the path length difference parameter δ if desired.^(4,5) In the graphs showing the insertion loss as a function of the barrier height

TABLE 3. BARRIER CONFIGURATION

TEST NO.	HEIGHT* (feet)	R/A**	TEST DATE***
1	0.		9/3 - 9/4
2	2.8	R	10/7 - 10/9
3	2.8	A	10/15 - 10/17
4	6.8	A	10/29 - 10/31
5	6.8	R	11/4 - 11/6
6	10.8	R	11/18 - 11/20
7	10.8	A	12/2 - 12/4
8	14.8	A	12/9 - 12/12
9	14.8	R	12/16 - 12/18

* Height measured from road surface.

** R for reflective barrier surface, and A for absorptive barrier surface.

*** All the measurements were made in 1975.

(Figures 7-24), we have included for comparison the results predicted from the Design Guide.

4.2 PROCEDURE

4.2.1 Barrier Insertion Loss

The insertion loss (IL) of a barrier at a certain point in space is defined as the difference between two sound pressure levels which are measured at the same point in space before and after a barrier is inserted between the measurement point and the noise source.

In determining insertion loss, it is important that the source of noise (traffic noise in this study) is constant for the measurements with and without the barrier. This stipulation is approximated by the measurement system shown in Figure 6. For example, the insertion loss at observation point B is determined by subtracting the statistical noise level data measured over a ten-minute period at location B' from the statistical data measured at location B during the same time period. Point B' of course (as well as other "primed" points in space) must be outside the shielded region of the barrier. The insertion loss is thus determined from the equation $IL = L'_B - L_B$, or more generally,

$$IL = L' - L \quad (4.1)$$

The insertion loss values thus obtained were averaged over four to six measurements, each measurement representing an average over a ten minute interval.

4.2.2 Noise Reduction Over Ground

As far as the measurements of insertion loss are concerned, as described in the previous section, it is not necessary to study separately the variation of noise level as a function of distance from the highway with no barrier present. However, in a complete theoretical analysis of barrier insertion loss, this transmission characteristic must be considered and is necessary when we attempt to understand the differences between measured values and Design Guide predictions.

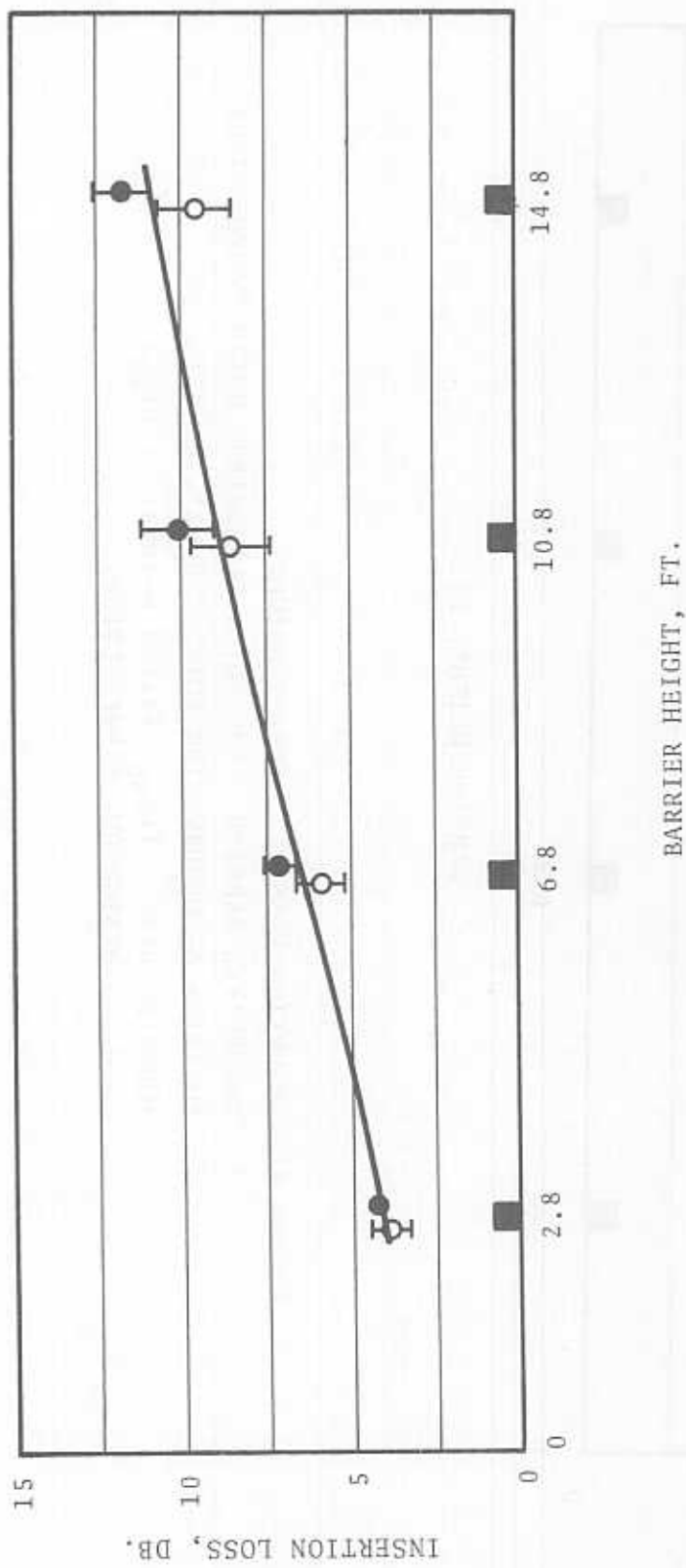
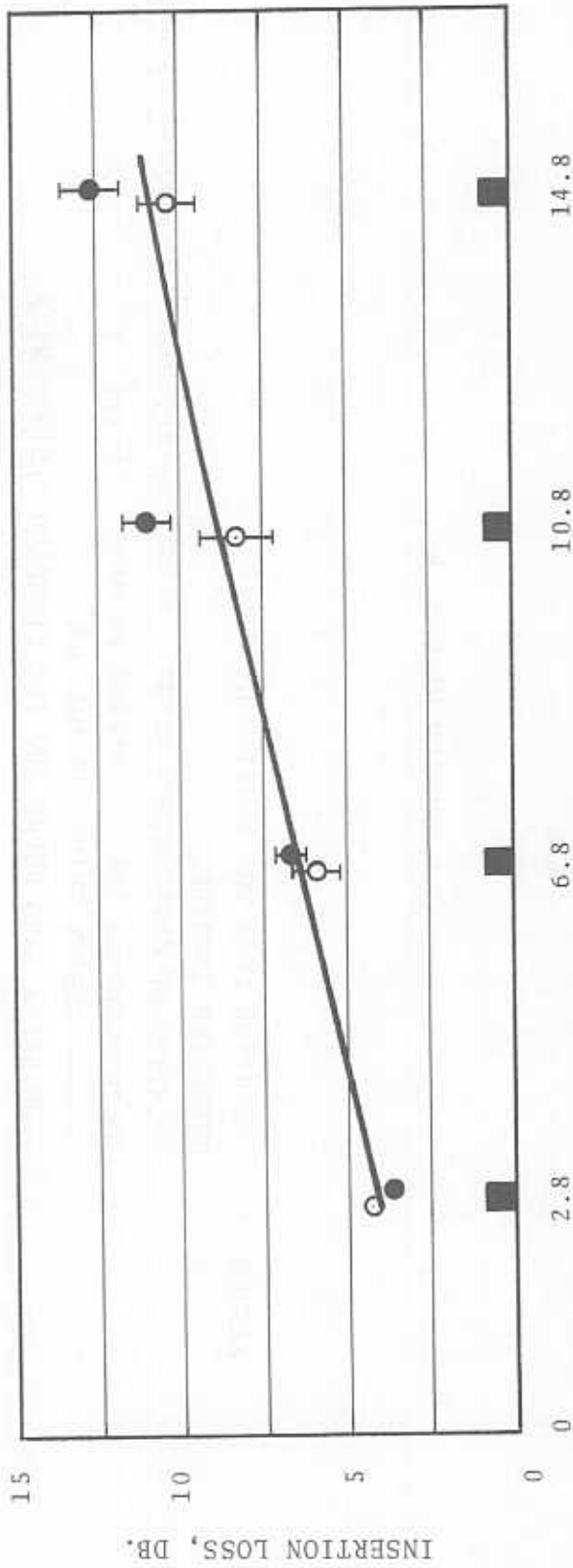

FIGURE 7. INSERTION LOSS VS. BARRIER HEIGHT.
 UNTREATED BARRIER.
 LOCATION OF OBSERVATION POINT: HEIGHT $H_0=3'$, DIST. TO BARRIER $D_B=55'$
 (Open points: $(IL)_{50}$; Filled points: $(IL)_{10}$)
 ——— DESIGN GUIDE PREDICTION.
 (THE ERROR BARS REPRESENT TWO STANDARD DEVIATIONS.)



BARRIER HEIGHT, FT.

FIGURE 8. INSERTION LOSS VS. BARRIER HEIGHT.
 ABSORPTIVE BARRIER. (2" THICK GLASSFIBER BOARD ON ONE SIDE)
 LOCATION OF OBSERVATION POINT: $H_o=3'$, $D_R=55'$
 (Open points: $(IL)_{50}$; Filled points: $(IL)_{10}$)
 ——— DESIGN GUIDE PREDICTION.

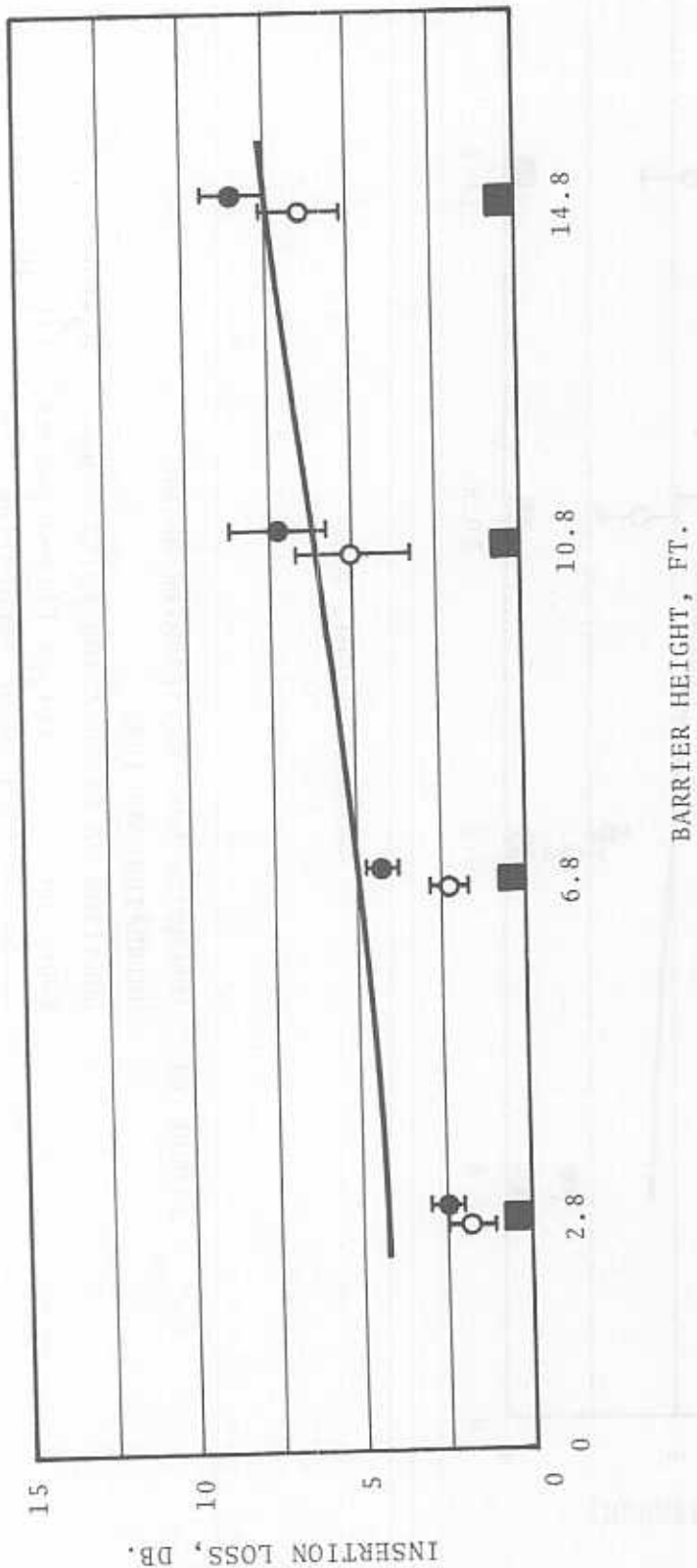

FIGURE 9. INSERTION LOSS VS. BARRIER HEIGHT.

ABSORPTIVE BARRIER.

LOCATION OF OBSERVATION POINT: $H_o = 5'$, $D_B = 100'$

(Open points: (IL)₅₀; Filled points: (IL)₁₀)

_____ DESIGN GUIDE PREDICTION.

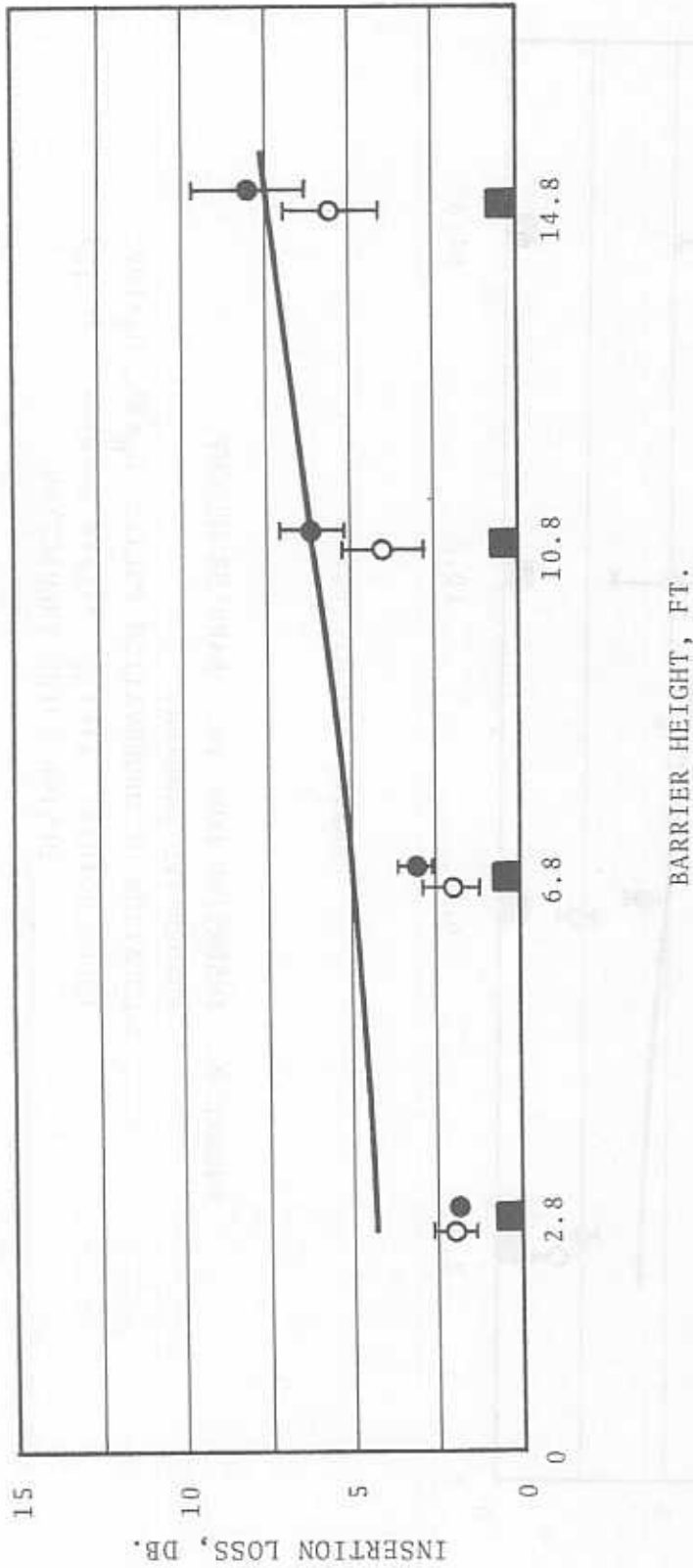

FIGURE 10. INSERTION LOSS VS. BARRIER HEIGHT.
UNTREATED BARRIER.

LOCATION OF OBSERVATION POINT: $H_0=3'$, $D_B=100'$
(Open points: $(IL)_{50}$; Filled points: $(IL)_{10}$)
———DESIGN GUIDE PREDICTION.

BARRIER HEIGHT, FT.

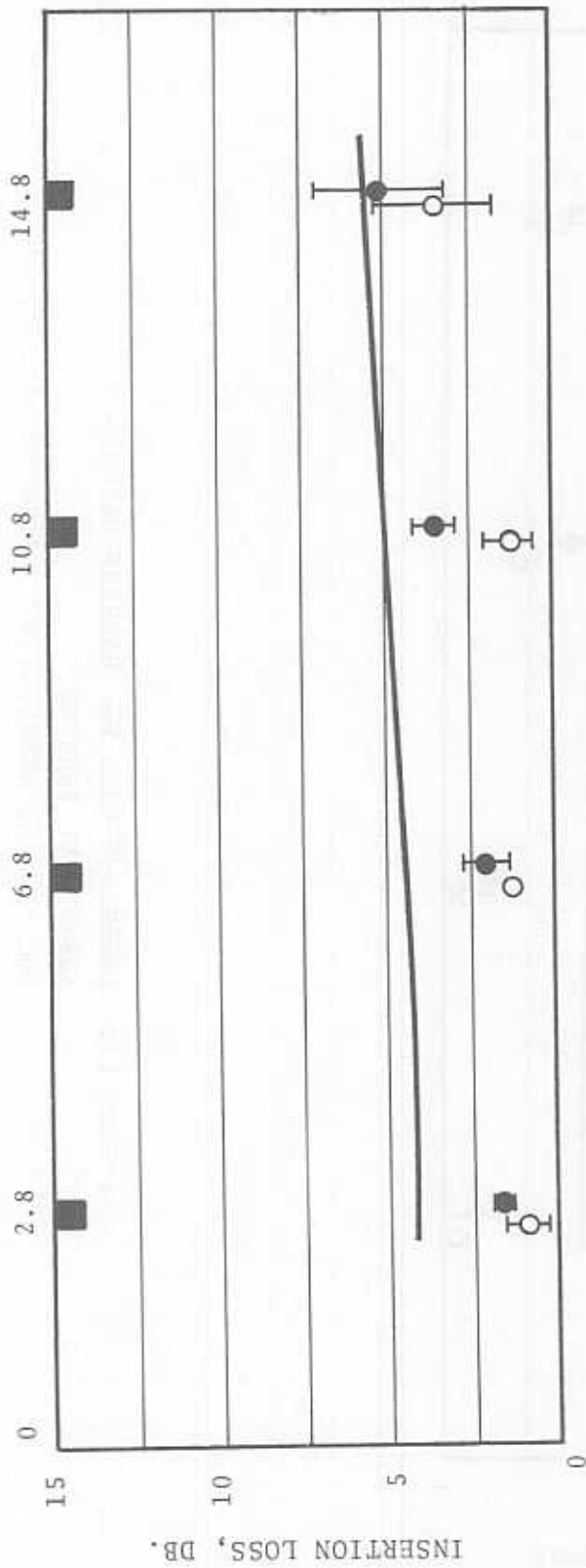

FIGURE 11. INSERTION LOSS VS. BARRIER HEIGHT.

UNTREATED BARRIER.

LOCATION OF OBSERVATION POINT: $H_0=3'$, $D_B=200'$

(Open points: $(IL)_{50}$; Filled points: $(IL)_{10}$)

————DESIGN GUIDE PREDICTION.

BARRIER HEIGHT, FT.

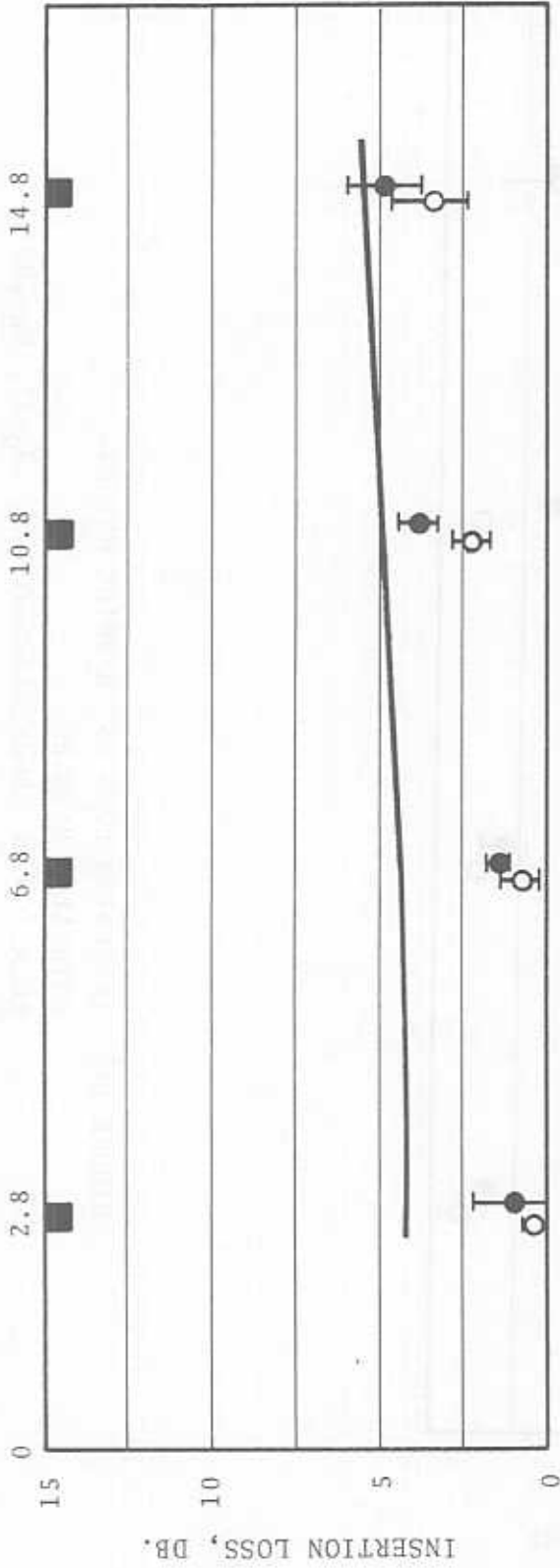

FIGURE 12. INSERTION LOSS VS. BARRIER HEIGHT.
 ABSORPTIVE BARRIER.

LOCATION OF OBSERVATION POINT: $H_0=3'$, $D_B=200'$

(Open points: (IL)50; Filled points: (IL)10)

———— DESIGN GUIDE PREDICTION.

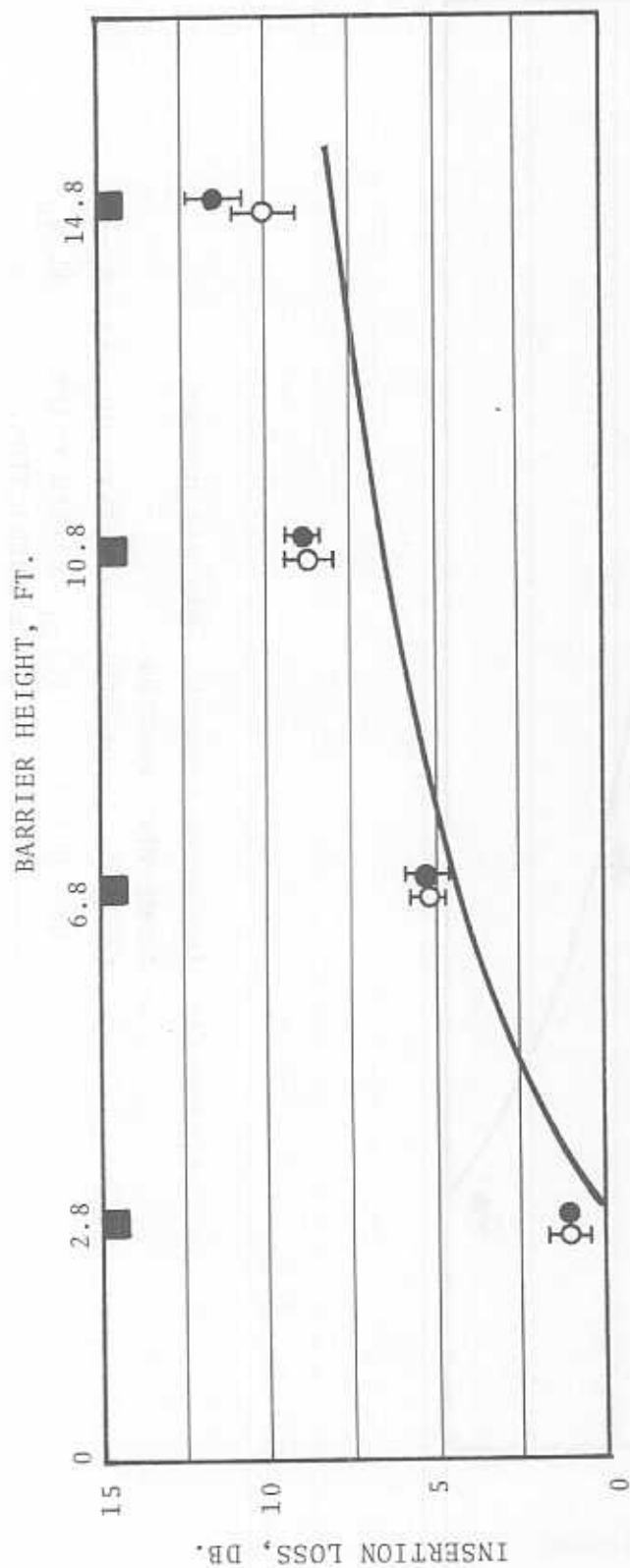

FIGURE 13. INSERTION LOSS VS. BARRIER HEIGHT.

UNTREATED BARRIER.

LOCATION OF OBSERVATION POINT: $H_0=13'$, $D_B=45'$

(Open points: (IL)₅₀; Filled points: (IL)₁₀)

———— DESIGN GUIDE PREDICTION.

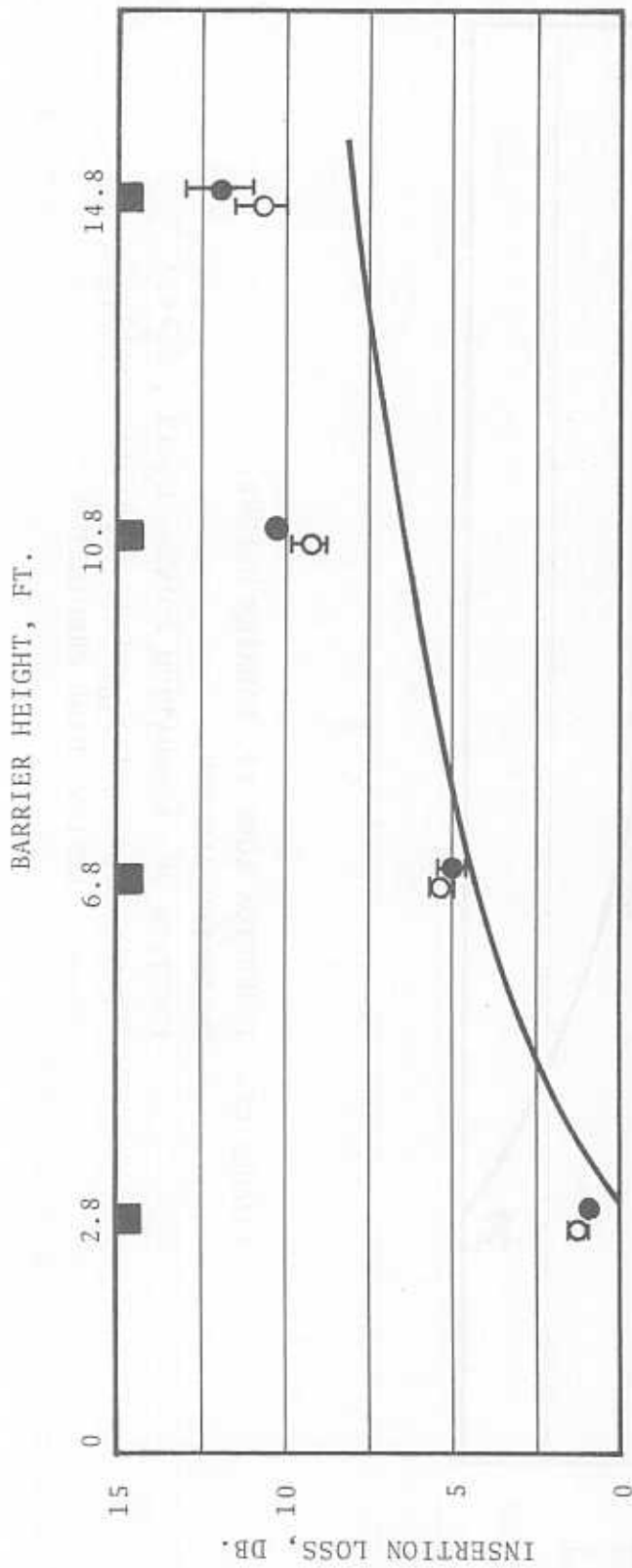

FIGURE 14. INSERTION LOSS VS. BARRIER HEIGHT.
 ABSORPTIVE BARRIER.

LOCATION OF OBSERVATION POINT: $H_O=13'$, $D_B=55'$
 (Open points: $(IL)_{50}$; Filled points: $(IL)_{10}$)
 ——— DESIGN GUIDE PREDICTION.

BARRIER HEIGHT, FT.

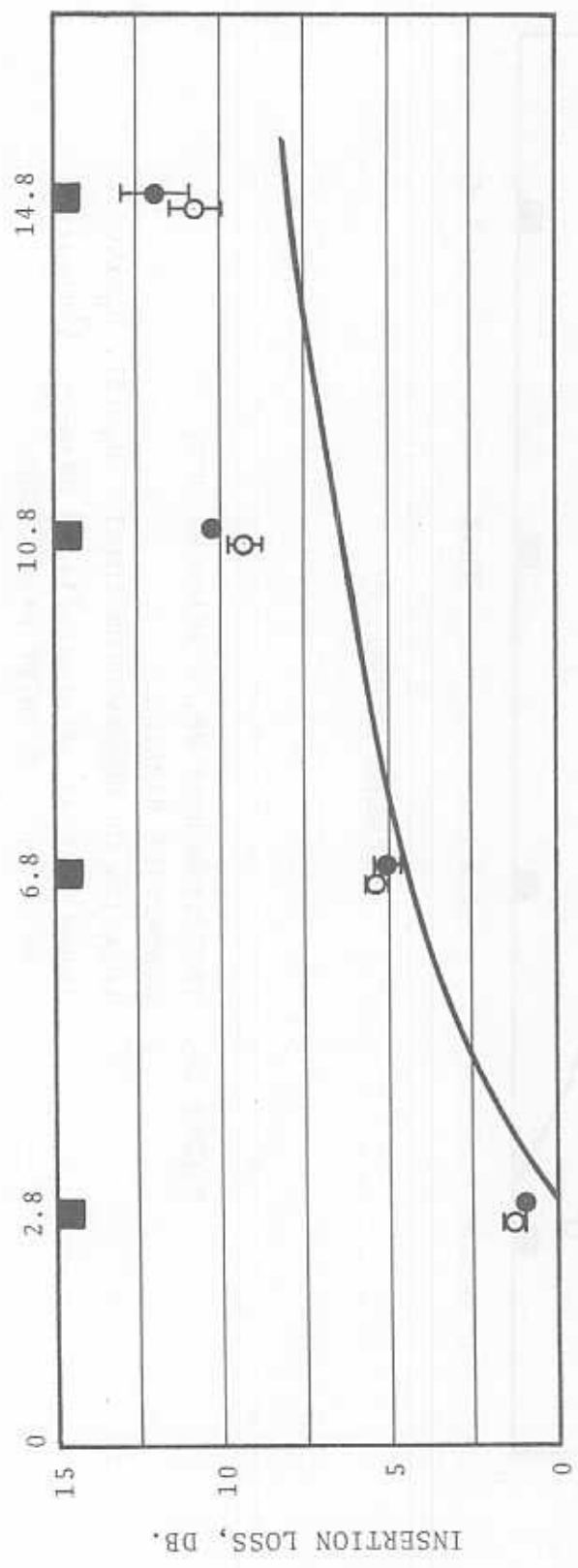

FIGURE 15. INSERTION LOSS VS. BARRIER HEIGHT

UNTREATED BARRIER.

LOCATION OF OBSERVATION POINT: $H_0=13'$, $D_B=100'$

(Open points: $(IL)_{50}$; Filled points: $(IL)_{10}$)

———— DESIGN GUIDE PREDICTION.

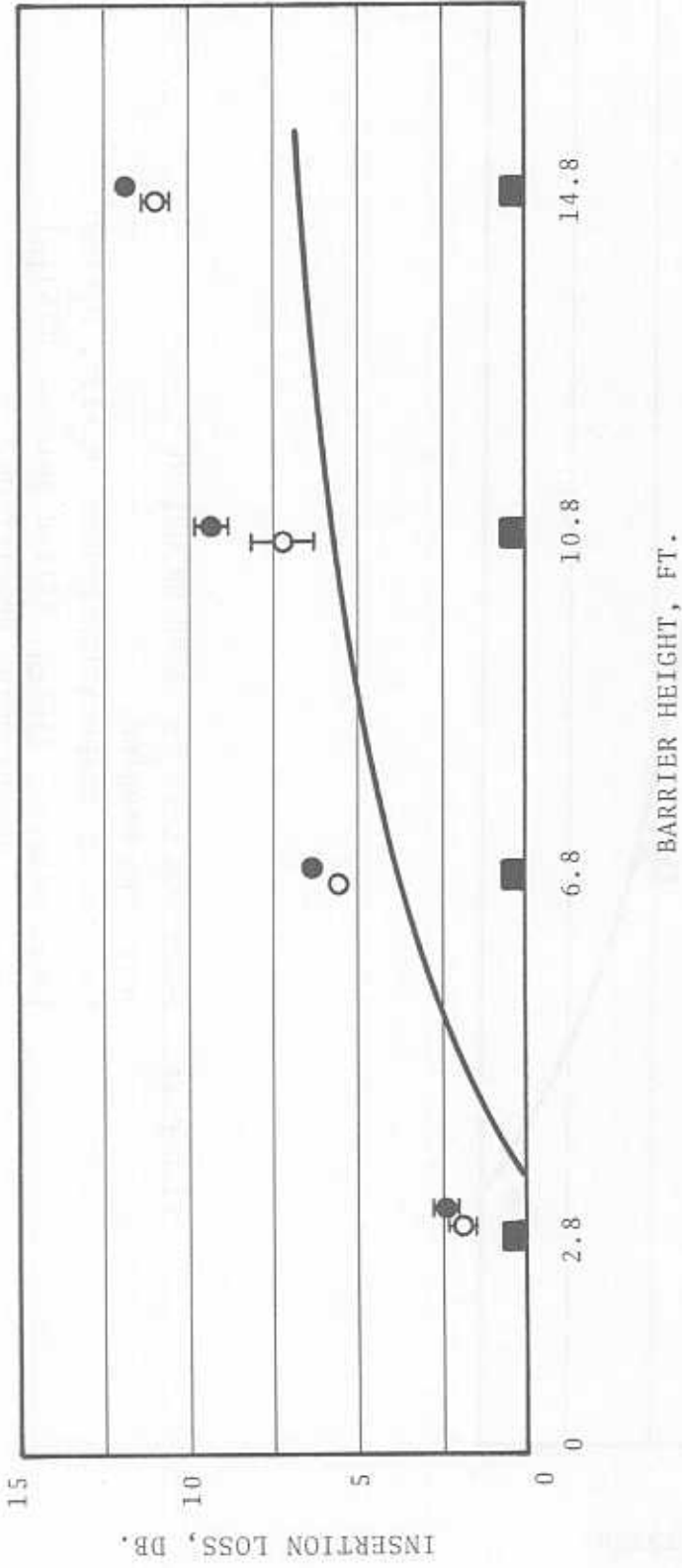

FIGURE 16. INSERTION LOSS VS. BARRIER HEIGHT.
 ABSORPTIVE BARRIER.

LOCATION OF OBSERVATION POINT: $H_0=13'$, $D_R=100'$
 (Open points: $(IL)_{50}$; Filled points: $(IL)_{10}$)

———— DESIGN GUIDE PREDICTION.

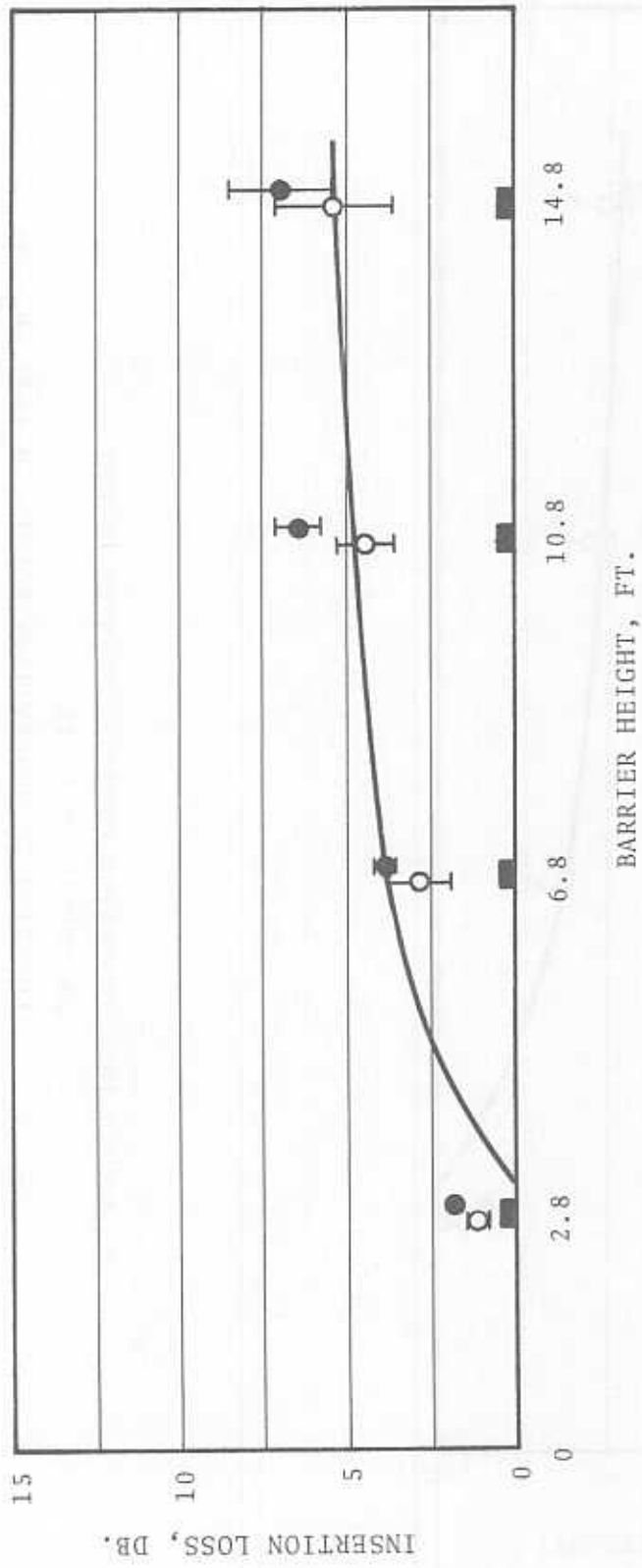

FIGURE 17. INSERTION LOSS VS. BARRIER HEIGHT.
 UNTREATED BARRIER.
 LOCATION OF OBSERVATION POINT: $H_0=13'$ $D_B=200'$
 (Open points: $(IL)_{50}$; Filled points: $(IL)_{10}$)
 ——— DESIGN GUIDE PREDICTION.

BARRIER HEIGHT, FT.

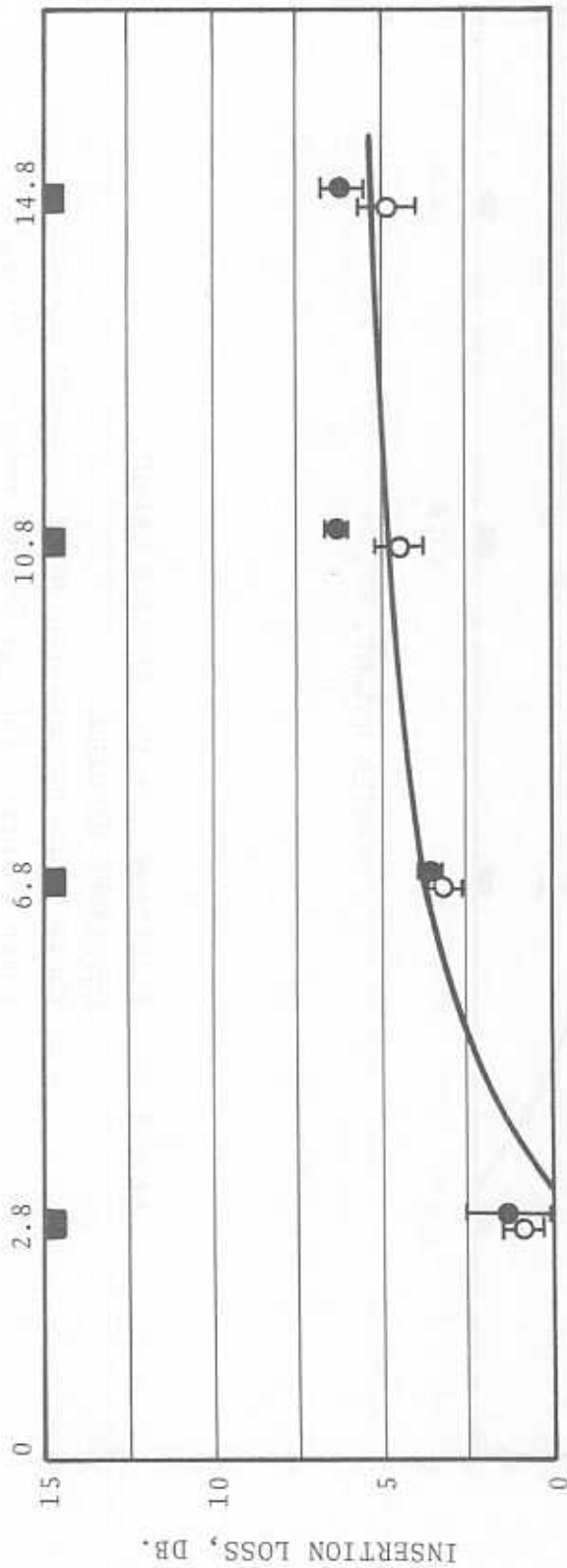

FIGURE 18. INSERTION LOSS VS. BARRIER HEIGHT.
ABSORPTIVE BARRIER.

LOCATION OF OBSERVATION POINT: $H_0=13'$, $D_B=200'$
(Open points: $(IL)_{50}$; Filled points: $(IL)_{10}$)
—— DESIGN GUIDE PREDICTION.

BARRIER HEIGHT, FT.

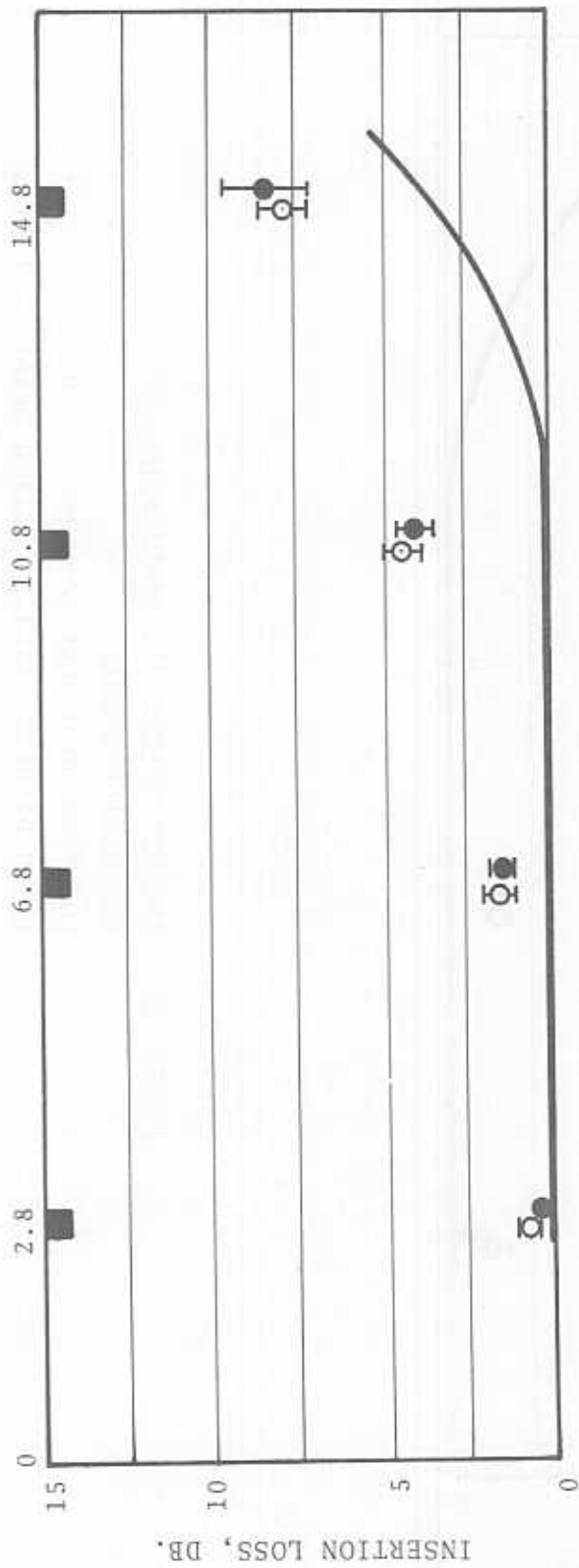

FIGURE 19. INSERTION LOSS VS. BARRIER HEIGHT.

UNTREATED BARRIER.

LOCATION OF OBSERVATION POINT: $H_0=23'$, $D_B=55'$

(Open points: (IL)₅₀; Filled points: (IL)₁₀)

———DESIGN GUIDE PREDICTION.

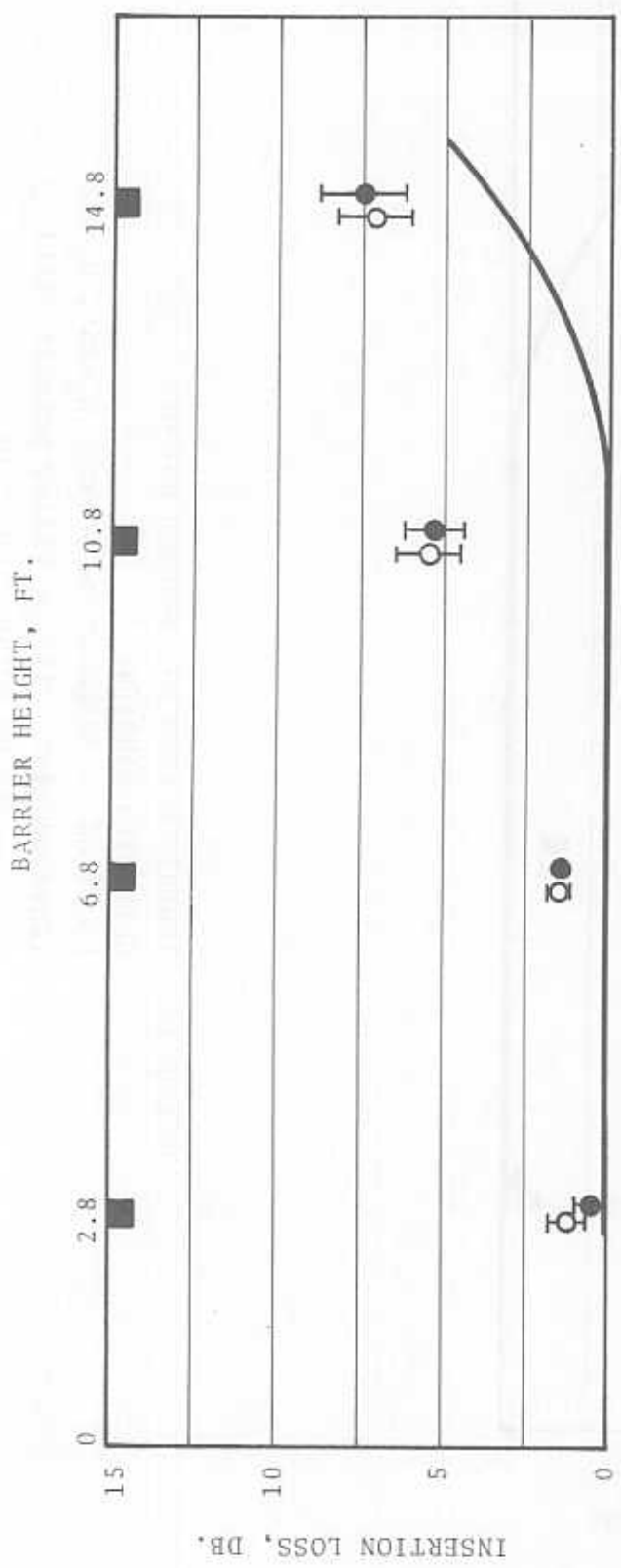

FIGURE 20. INSERTION LOSS VS. BARRIER HEIGHT.
 ABSORPTIVE BARRIER.
 LOCATION OF OBSERVATION POINT: $H_0=23'$ $D_g=55'$
 (Open points: $(IL)_{50}$; Filled points: $(IL)_{10}$)
 ——— DESIGN GUIDE PREDICTION.

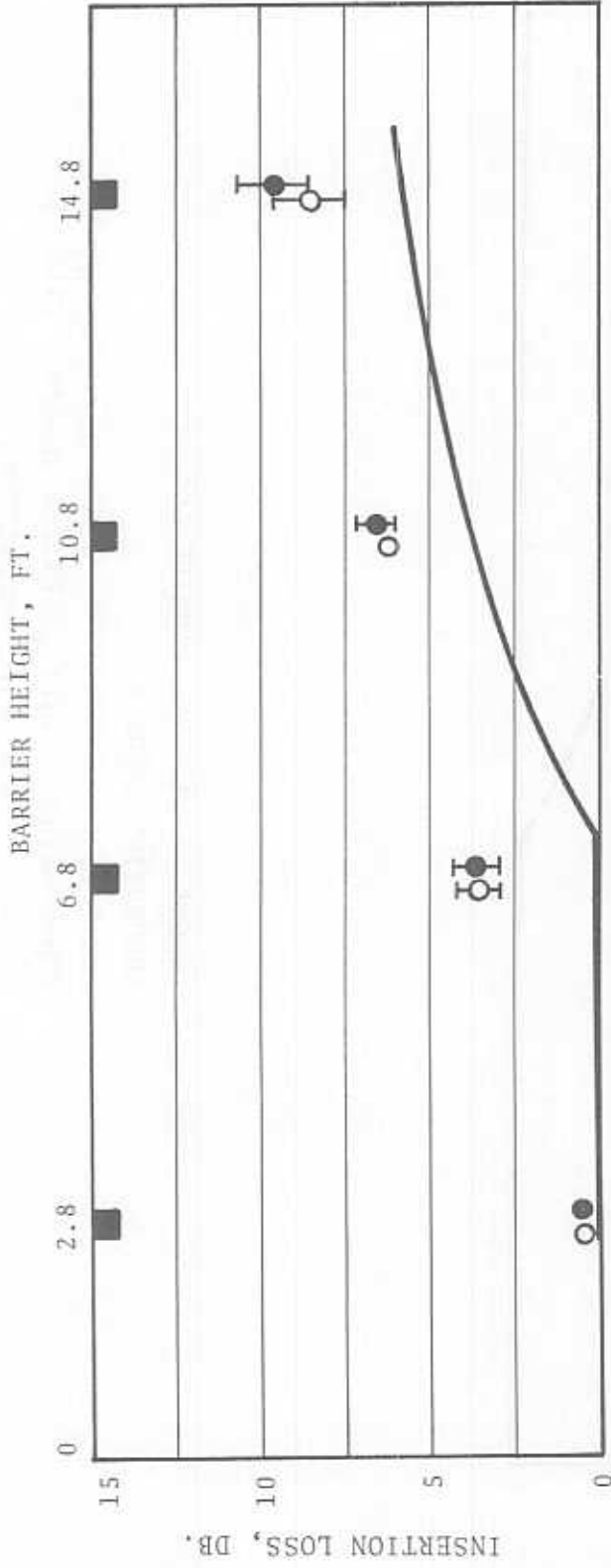

FIGURE 21. INSERTION LOSS VS. BARRIER HEIGHT.

UNTREATED BARRIER.

LOCATION OF OBSERVATION POINT: $H_0 = 23'$, $D_B = 100'$

(Open points: (IL)₅₀; Filled points: (IL)₁₀)

———— DESIGN GUIDE PREDICTION.

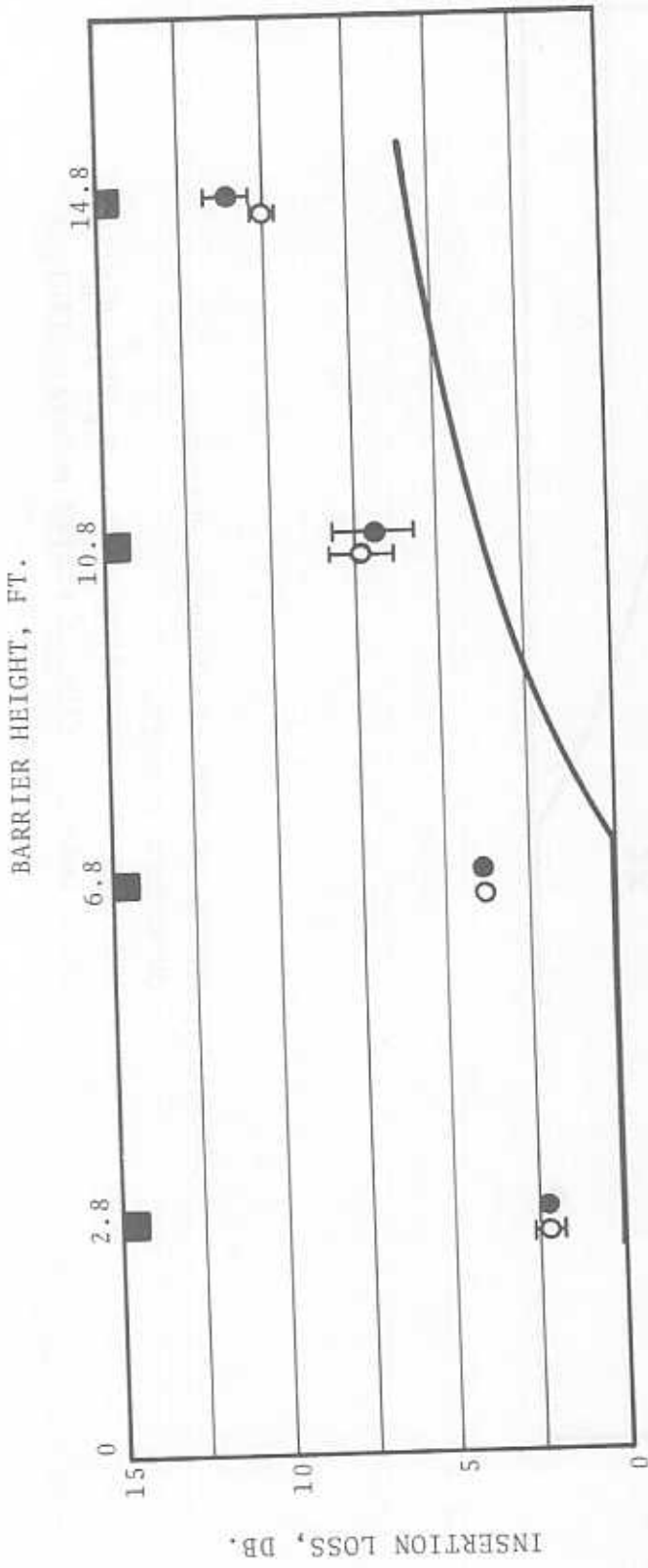

FIGURE 22. INSERTION LOSS VS. BARRIER HEIGHT.
 ABSORPTIVE BARRIER.
 LOCATION OF OBSERVATION POINT: $H_0=23'$, $D_B=100'$
 (Open points: (IL)₅₀; Filled points: (IL)₁₀)
 — DESIGN GUIDE PREDICTION.

BARRIER HEIGHT, FT.

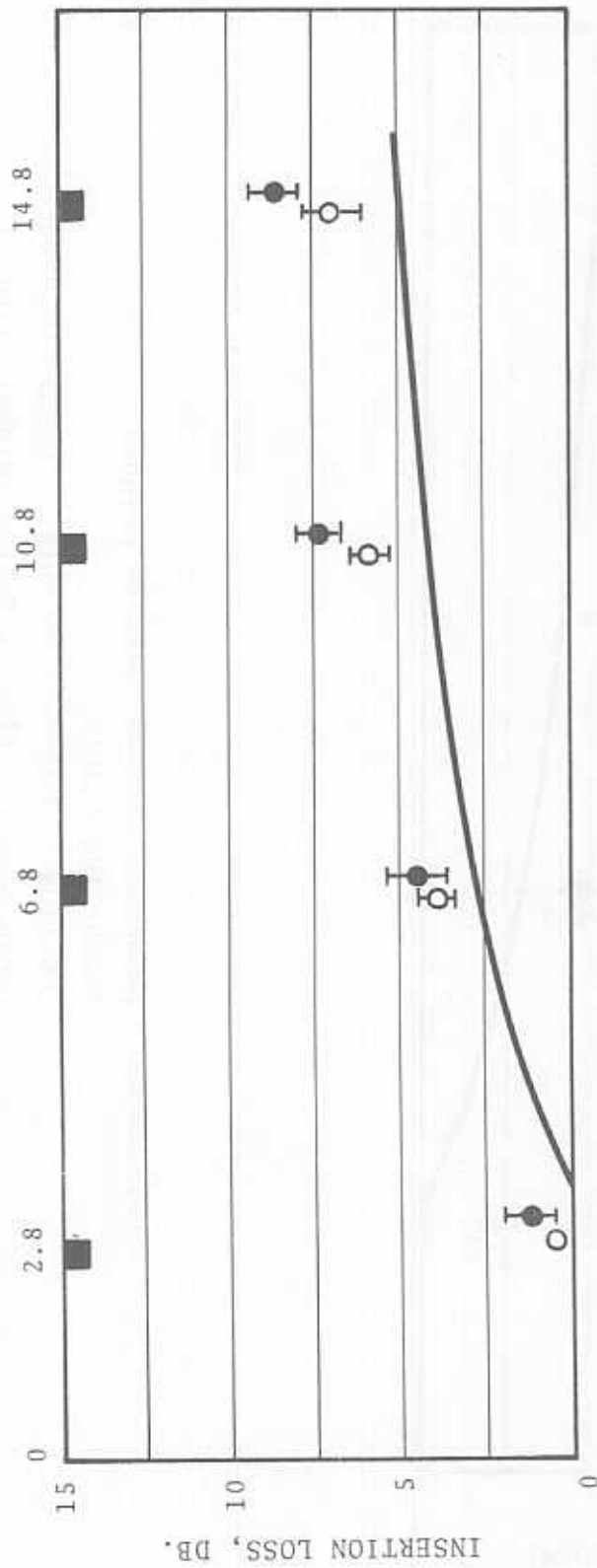

FIGURE 23. INSERTION LOSS VS. BARRIER HEIGHT.
UNTREATED BARRIER.

LOCATION OF OBSERVATION POINT: $H_0=23'$, $D_B=200'$
(Open points: (IL)₅₀; Filled points: (IL)₁₀)

———— DESIGN GUIDE PREDICTION.

BARRIER HEIGHT, FT.

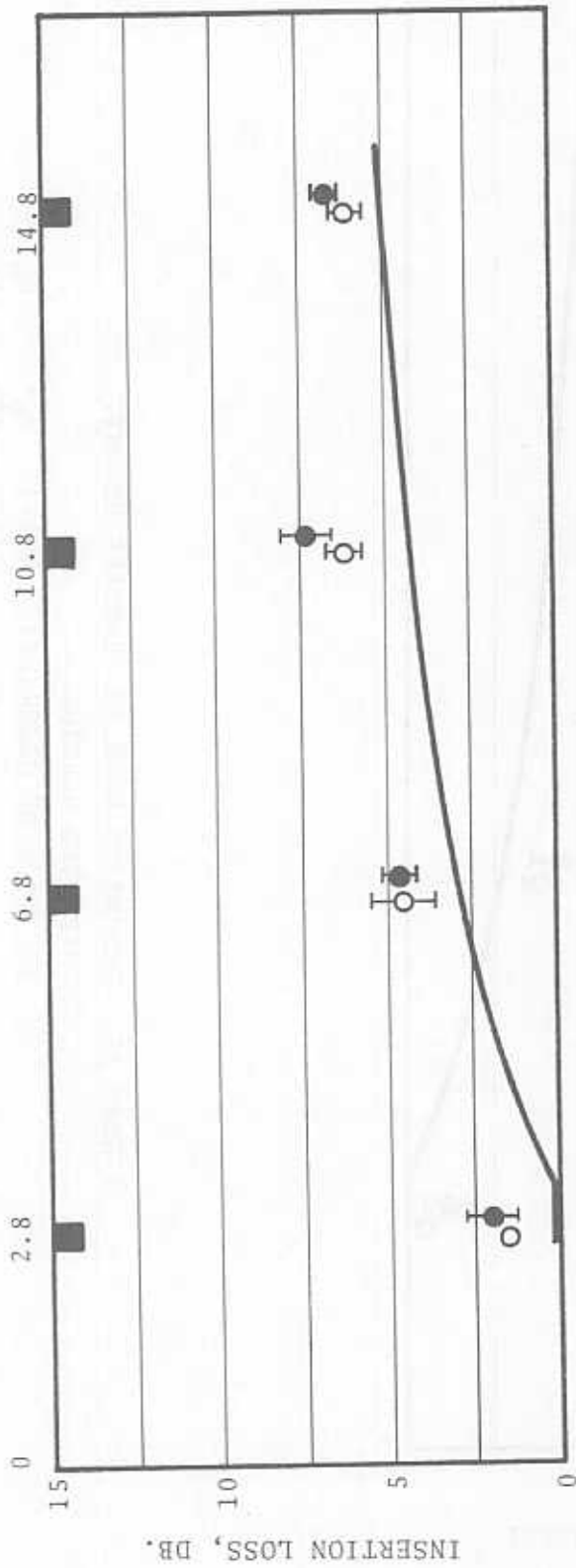

FIGURE 24. INSERTION LOSS VS. BARRIER HEIGHT.

ABSORPTIVE BARRIER

LOCATION OF OBSERVATION POINT: $H_0 = 23'$, $D_B = 200'$

(Open points: $(IL)_{50}$; Filled points: $(IL)_{10}$)

—— DESIGN GUIDE PREDICTION.

The data in this report, which concern sound transmission characteristics over ground, are based on measurements of noise reduction over ground (NROG) obtained as the difference between a reference sound level (L_{ref}), measured at three feet above ground and 30 feet from the edge of the highway, and the simultaneously measured sound level L at a point P farther from the highway.

$$(NROG) = L_{ref} - L \quad (4.2)$$

In this connection it should be mentioned that the noise reduction obtained from the sound level measurements at locations A' , B' , C' and D' in Figure 7, is in good agreement with the noise reduction obtained from the corresponding data in Figure 5 with no barrier present. This demonstrates that the locations A' , etc. in the open field site were sufficiently away from the barrier so that its presence did not affect the data at these points; this was an assumption implicit in the procedure used for the determination of the insertion loss in the previous section.

4.3 RESULTS OF DATA ANALYSIS

The insertion loss values are presented graphically in several different ways to show explicitly the dependence on barrier height, the distance of the observation point from the barrier, and the height of the observation point over ground. The insertion loss predicted from the Design Guide is included for comparison.

4.3.1 $(IL)_{50}$ and $(IL)_{10}$

The experimental values of the insertion loss were determined from both the L_{50} and the L_{10} statistical sound level data. As can be seen in Figures 7-24, the insertion loss $(IL)_{10}$, based on the L_{10} data, is consistently higher than the insertion loss $(IL)_{50}$ based on the L_{50} data.

This difference undoubtedly is related to the relative significance of the truck noise contribution to the L_{10} and L_{50} levels. The number of trucks involved in the present study typically was 5-15 percent of the number of passenger cars. The noise level of a truck is known to be about 10-15 dBA higher than

for a passenger car, and the relative contribution of the truck noise to L_{10} is expected to be greater than to L_{50} .

To attempt to explain the difference between $(IL)_{10}$ and $(IL)_{50}$ we must inquire about the difference in barrier insertion loss for truck noise and passenger car noise.

There are several factors to consider. The low frequency noise of a truck is higher than for a passenger car; also, the effective source height of a truck is likely to be greater than that for a passenger car. These two factors tend to make the barrier insertion loss for truck noise lower than for passenger car noise.

There are also two factors which have an opposite effect on the insertion loss and may more than compensate for the effect of those above.

The first of these involves the loss of excess ground attenuation. With no barrier present, vehicle noise is attenuated with distance by air and ground absorption. With the barrier inserted, this natural excess ground attenuation effect is lost. The effect is greatest on passenger car noise because of their associated high frequency content. Since passenger car noise controls the L_{50} levels, the relative L_{50} levels are in a sense penalized by the insertion of the barrier.

A second and more important factor relates to line and point source noise propagation. Because the distance between successive trucks is so large on the average, truck noise is better described as the noise from a single moving point source rather than from a line source. A comparison of these two source configurations shows that the insertion loss of a barrier of finite length is larger for the point source than for the line source, that is, a point source would actually see the barrier as being infinite.

Also noted in Figures 7-24 is that the difference between $(IL)_{10}$ and $(IL)_{50}$ increases with increasing insertion loss and reaches a maximum difference of about 2 dB. This phenomenon is related to source height and to the relative height of the barrier.

For a given source height, the barrier insertion loss will increase in barrier height up to some maximum value. Further increases in barrier height will have little or no effect; also, as the source height is increased the barrier height must be further increased to obtain the new maximum insertion loss value.

Since passenger cars control the L_{50} levels and trucks, which generally have a greater source height than passenger cars, control the L_{10} levels, it follows that as the barrier height is increased the $(IL)_{50}$ and $(IL)_{10}$ will both increase toward a maximum. The $(IL)_{50}$ will achieve its maximum first. Further increases in barrier height will have little effect on the $(IL)_{50}$, however the $(IL)_{10}$ will continue to increase up to its maximum value.

4.3.2 Effect of Absorptive Treatment

Insertion loss data were obtained for the barrier untreated as well as with the side facing the traffic covered with a two-inch-thick fiberglass panel.

As can be seen from the data presented here, the application of the absorptive treatment did not alter the insertion loss significantly (increase generally less than 1 dB).

It is interesting to note in this context that in an earlier study of the insertion loss of railroad retarder barriers,⁽⁶⁾ absorptive treatment was found to increase the insertion loss markedly. In that case, however, multiple reflections between the barrier and the side of the railroad car make the effect of the absorptive treatment considerably more pronounced.

Measurements were also made across the highway (microphone locations 15 and 16) to determine if the levels increased because of barrier reflectivity. Increases in the L_{10} and L_{50} of less than 2 dB were noted with the untreated barrier. A negligible change was noted after absorptive treatment.

4.3.3 Insertion Loss vs. Barrier Height

In Figures 7-24 the insertion loss is plotted as a function of the barrier height for both untreated and absorptive barriers

for different observation points.

To attempt to understand these results qualitatively, we note that in the shielding of a line source by a barrier of finite length there will be a direct line of sight between a portion of the line and the observation point, and the corresponding noise will reach the observer with little interference from the barrier. The significance of this noise "leakage," in comparison with the noise diffracted over the top of the barrier, increases with increasing barrier height, and therefore we expect that the rate of increase of the insertion loss with barrier height will level off at a certain barrier height, at which the leakage will be of the same order of magnitude as the noise diffracted over the barrier.

This critical barrier height of "diminishing return" depends, of course, on the location of the point of observation. This effect is clearly demonstrated by the results obtained. For example, for a point of observation specified by $D_b=100$ feet and $H_o=13$ feet, (Figure 15) the insertion loss vs. height curve starts to level off at a barrier height of about 10 feet, whereas for $D_b=200$ feet and $H_o=13$ feet (Figure 17), the corresponding height is about 7 feet.

4.3.4 Insertion Loss vs. Distance Behind the Barrier

In Figure 25 the insertion loss values have been plotted as a function of the distance of the observation point from the barrier with the height of the observation point as a parameter.

Generally the insertion loss decreases with the distance D_b . It is interesting to see, however, that for the observer height $H_o=23$ feet and barrier heights 14.8 and 10.8 feet, the data indicate a slight increase of the insertion loss in the range between $D_b=50$ and $D_b=100$ feet before the expected decrease with distance occurs.

4.3.5 Insertion Loss vs. Height of Observation Point

The dependence of the insertion loss on the height of the observation point, shown in Figures 26 and 27, is not as simple

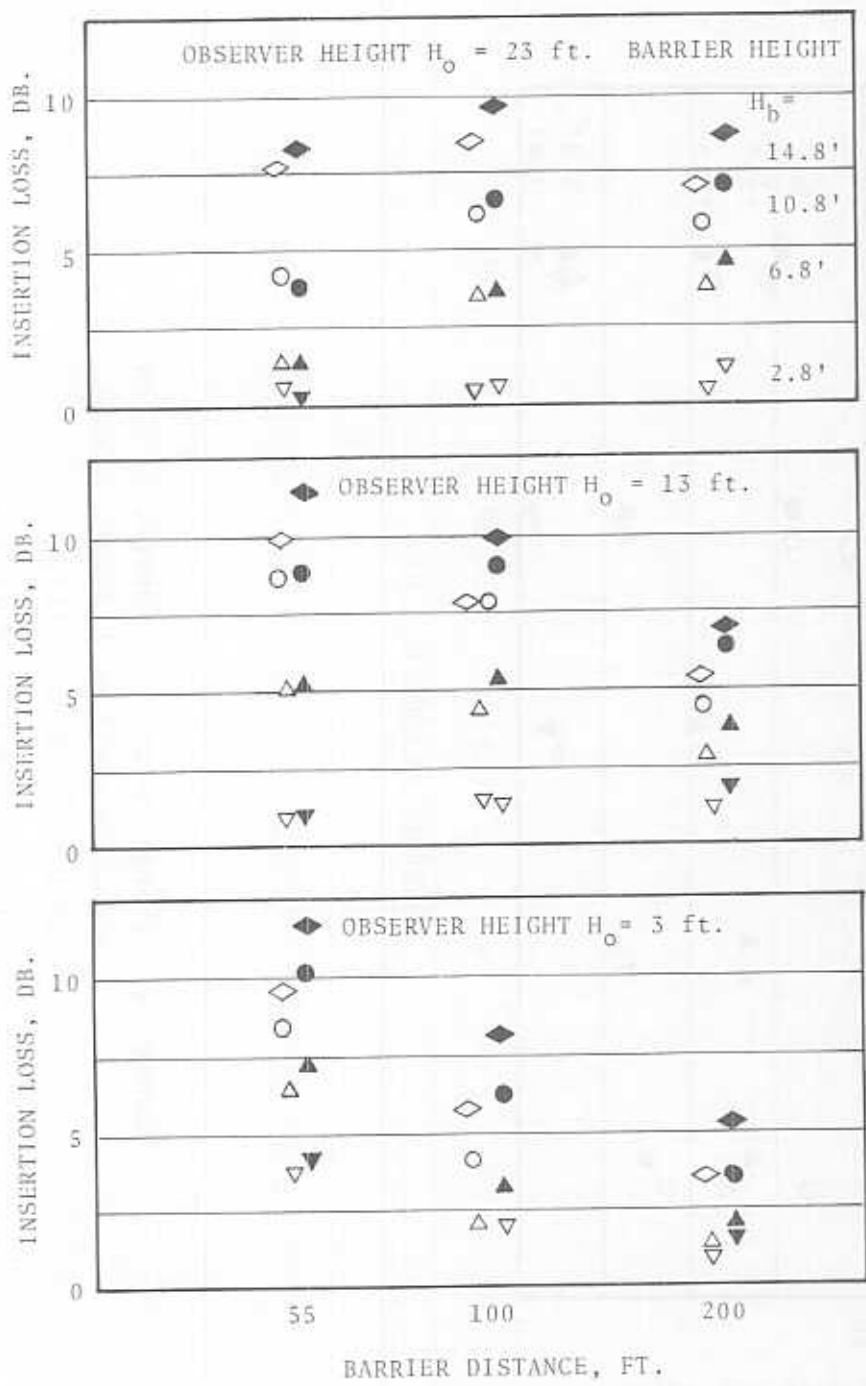

FIGURE 25. INSERTION LOSS VS. OBSERVER-BARRIER DISTANCE D_b
 OPEN DATA POINTS: $(IL)_{50}$
 FILLED DATA POINTS: $(IL)_{10}$

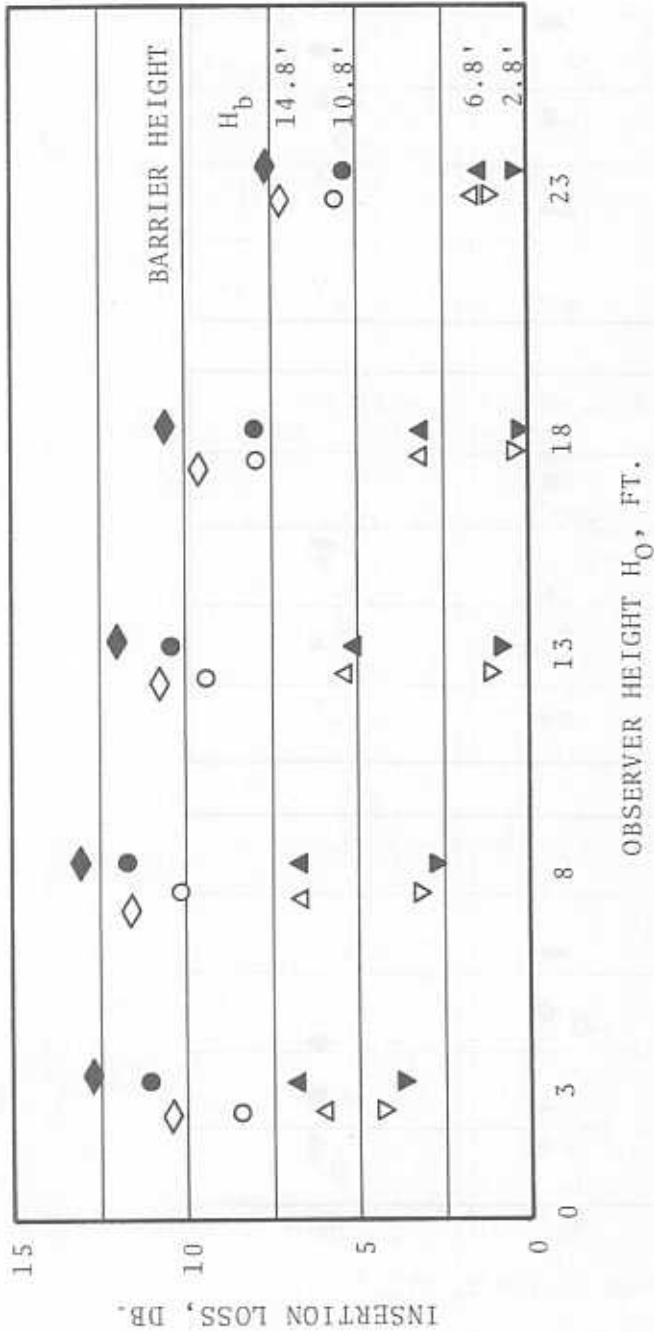

FIGURE 26. INSERTION LOSS VS. OBSERVER HEIGHT.
 OBSERVER-BARRIER DISTANCE $D_B = 55'$
 OPEN DATA POINTS (IL) 50
 FILLED DATA POINTS (IL) 10

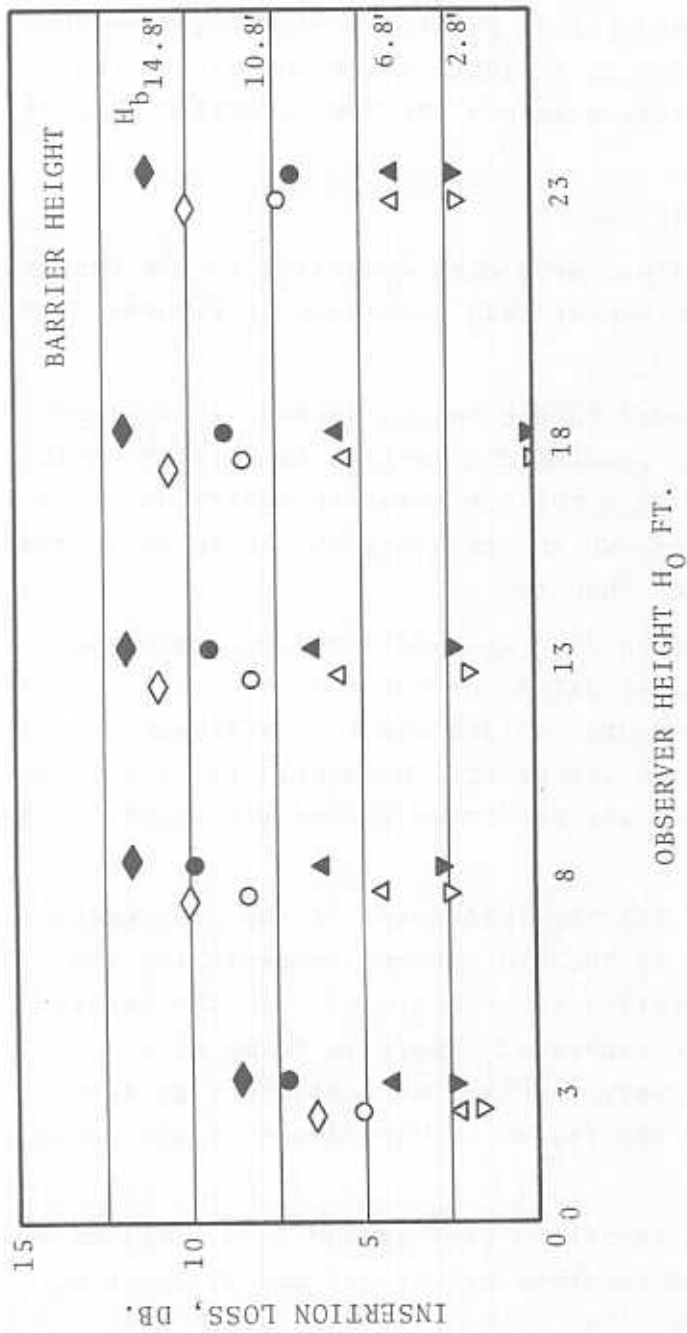

FIGURE 27. INSERTION LOSS VS. OBSERVER HEIGHT.
 OBSERVER-BARRIER DISTANCE $D_B = 100'$
 OPEN DATA POINTS (IL) 50
 FILLED DATA POINTS (IL) 10

as might be expected from the Design Guide prediction. Except for the barrier height 2.8 feet, the maximum insertion loss does not occur at the lowest observation point, as expected from the Design Guide. This behavior is a clear indication of the inadequacy of the current prediction scheme for the insertion loss of a finite highway barrier.

4.3.6 Predicted Insertion Loss

The insertion loss values predicted according to the Design Guide (Appendix C of NCHRP Report 144) are shown in Figures 7-24 and in Table 4.

A line source is assumed in the Design Guide. It is then appropriate to compare the predicted insertion loss values with the experimental $(IL)_{50}$ data since the relative contribution to L_{50} from the passenger cars (which are dense enough to be treated as a line source) is larger than to L_{10} .

We note from the data in Figures 7-24 and from the summary in Table 5 that the predicted values of the insertion loss generally are smaller than the measured values and the difference can be as large as 6 dB. There are exceptions, however. For the lowest observer height, $H_0=3$ feet, the predicted values are consistently higher than the measured.

One important reason for the inadequacy of the prediction procedure seems to be the failure to account properly for the noise transmission characteristics over ground. In the Design Guide the ground effect is expressed simply in terms of a 4.5 dB decrease in level for every doubling of distance from the source, without regard to the frequency dependence of the noise reduction.

In reality the noise reduction over ground is a complicated function of frequency, the observer height H_0 , and distance D_b from the barrier. This is illustrated by the results in Figure 28 of measurements of octave band noise reduction at various values of H_0 and D_b .

TABLE 4. DESIGN GUIDE PREDICTED BARRIER INSERTION LOSS

H _b (ft)	D _b (ft)	H _o				
		3ft	8ft	13ft	18ft	23ft
2.8	55	4.3(5.3)*	0.	0.	0.	0.
	100	4.3(5.6)	0.	0.	0.	0.
	200	3.7(5.7)	0.	0.	0.	0.
6.8	55	6.7(8.8)	5.4(6.3)	4.6(5.6)	0.	0.
	100	5.2(8.4)	4.5(7.1)	4.0(5.4)	3.9(5.0)	0.
	200	4.5(8.3)	4.2(7.5)	4.0(6.7)	3.6(5.5)	3.0(3.5)
10.8	55	9.0(11.6)	7.0(9.1)	6.0(7.1)	0.	0.
	100	6.3(10.6)	6.0(9.2)	5.2(8.3)	4.5(6.9)	3.9(5.0)
	200	5.1(10.2)	5.0(9.6)	4.9(8.9)	4.5(8.2)	4.2(7.4)
14.8	55	11.0(13.9)	9.0(11.9)	8.0(10.0)	6.2(7.8)	4.2(5.0)
	100	7.5(12.6)	7.0(11.4)	6.3(10.5)	6.0(9.4)	5.1(8.1)
	200	5.5(11.9)	5.4(11.3)	5.3(10.8)	5.1(10.0)	5.0(9.2)

* The figures within parenthesis refer to a barrier of infinite length.

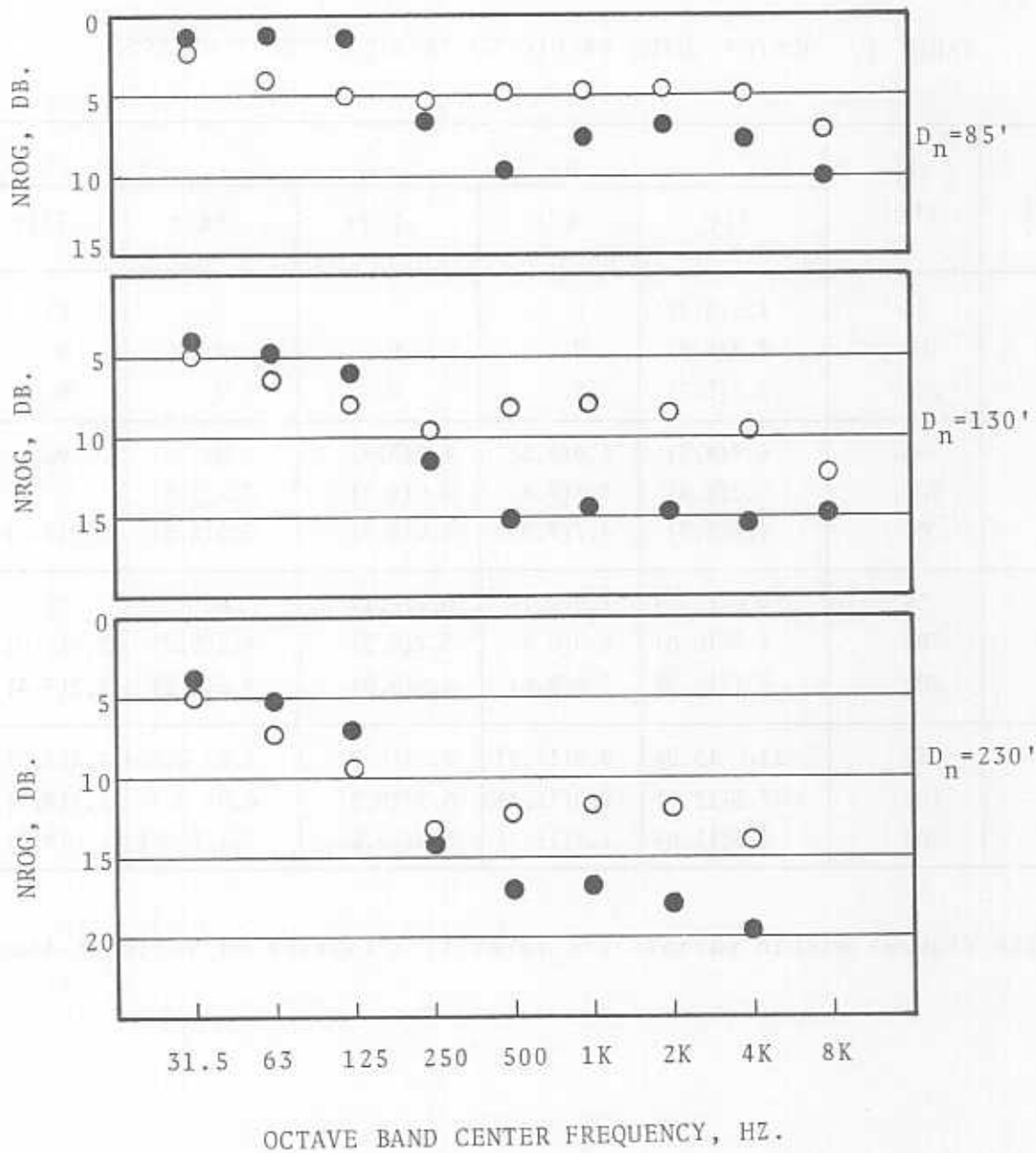

FIGURE 28. OCTAVE BAND NOISE REDUCTION OVER GROUND.
 OPEN DATA POINTS $H_0=13'$, FILLED POINTS $H_0=5'$
 $D_n=D_b+30$ ft.

As a result, the shape of the noise spectrum will change with distance from the source and there will be a corresponding change in the "average" frequency and wavelength of the spectrum. This is illustrated in the octave band noise spectra measured at several locations and heights as shown in Figure 29.

The Design Guide assumes a constant average frequency of 500 Hz independent of the location of the observer in its computations and may account for the difference between the measured and predicted insertion loss. This effect may be corrected by simply using a lower average frequency than 500 Hz when calculating the insertion loss at low observation points and a higher frequency than 500 Hz at high observation points. The crossover point would be somewhere between a receiver height of 3 and 8 feet as seen in Table 5.

4.4 SUMMARY

Some of the more important results obtained in the present study can be summarized as follows:

- a. The predicted insertion loss values generally are lower than the measured, except for the lowest height (3 feet) of the observation point. The difference between the predicted and the measured values are summarized in Table 5.
- b. The effect on the insertion loss of the barrier by adding an absorptive treatment (two-inch-thick fiberglass board) to the barrier is too small to be of practical significance. However, the absorptive treatment cancels out the slight increase (1-2 dB) in noise levels across the highway due to barrier reflectivity.
- c. The largest measured value of the insertion loss, based on data, was 13 dB, corresponding to a 14.8 foot high barrier and a location of the observation point specified by $H_0=8$ feet and $D_0=55$ feet.
- d. For barrier heights other than 3 feet, the largest insertion loss does not necessarily occur at the lowest observation point.

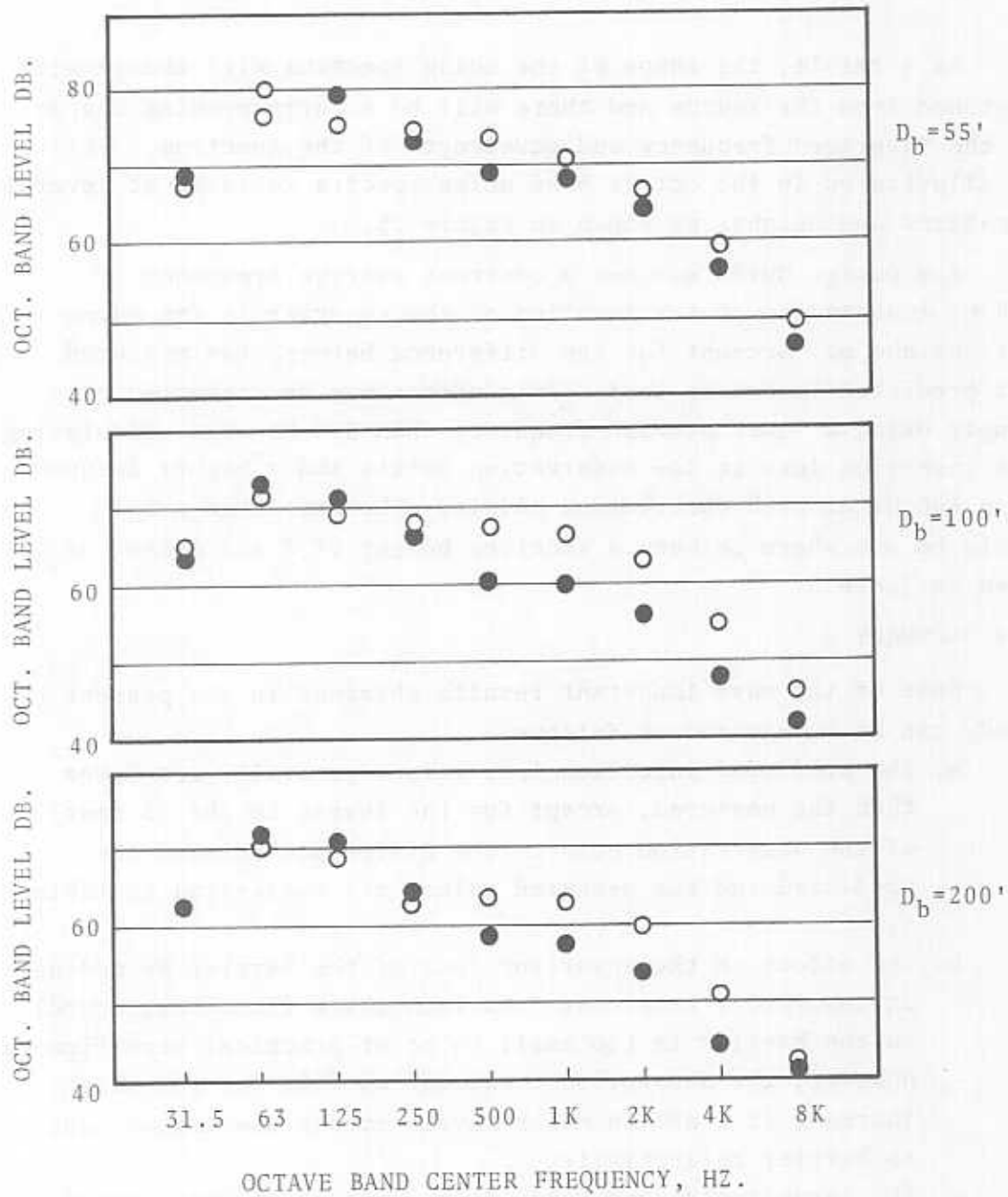

FIGURE 29. OCTAVE BAND NOISE SPECTRUM.
 OPEN DATA POINTS: $H_0 = 13'$,
 FILLED-POINTS: $H_0 = 5'$

TABLE 5. DIFFERENCE BETWEEN PREDICTED AND MEASURED
BARRIER INSERTION LOSS

H _b (ft)	D _b (ft)	H ₀				
		3ft	8ft	13ft	18ft	23ft
2.8	55	+0.5	-2.9*	-1.0	-0.4	-0.7
	100	+2.3	-2.3	-1.4	-1.0	-0.5
	200	+2.9	-1.0	-1.1	-0.9	-0.4
6.8	55	+0.9	-1.3	-0.5	-3.4	-1.5
	100	+3.2	+0.2	-0.4	-0.5	-3.5
	200	+3.3	+1.9	+1.2	-0.2	-0.8
10.8	55	+0.5	-2.5	-2.7	-6.8	-4.3
	100	+2.3	-1.3	-2.5	-2.8	-2.3
	200	+3.9	+2.1	+0.5	-1.0	-1.6
14.8	55	+1.4	-1.6	-2.0	-2.4	-3.5
	100	+1.9	-1.1	-1.6	-2.7	-3.5
	200	+2.1	+1.1	0.	-1.3	-2.0

*Negative values in the table are obtained when the predicted value is smaller than the measured.

- e. To improve the prediction procedure, more attention should be paid to the frequency dependence of the transmission characteristics along the path from source to receiver.

Although, qualitatively, the effect of spectrum shape and its variation with distance seems to correct the predicted insertion loss values in the right direction toward the experimental values, as indicated above, we have not studied this question quantitatively. We feel that if it is desired to improve upon the existing prediction procedure, such a quantitative study of the effect of spectrum shape should be undertaken. There exist extensive data on the transmission characteristics over ground, which could be used as a basis for such studies, and numerous theoretical investigations of this problem have also been made.

Another question which we have studied briefly during the course of the present work is the role of directivity of the traffic noise. It is clear that the directivity will influence the relative significance of the "leakage" noise, referred to in subsection 4.3.3, and the noise diffracted over the barrier. Furthermore, the shielding characteristics of the barrier will be asymmetrical with respect to the center plane perpendicular to the barrier, and such an asymmetry could influence the choice of location of the barrier with respect to the region to be shielded.

An exploratory study of this question should be undertaken to see whether the effect is large enough to warrant a more serious investigation.

5. MEASUREMENT DATA

Data from the 14 microphone systems deployed were fed through up to 700 feet of cable to the mobile noise laboratory for recording and/or on-line processing and storage in the Wang 720 computer system. At the conclusion of a ten-minute measurement run, the Wang 720 was programmed to separate the stored digital data and statistically analyze the ten minutes of data for each microphone (4800, 1/8-second "A" weighted data samples). The calculated results for each microphone were computed and are presented in tabular form. Definitions of calculated noise indexes given in Tables 6 through 123 are as follows:

<u>Band</u>	<u>Microphone Number</u>	
A	Average sound pressure level (arithmetic)	dB(A)
S	Standard deviation	dB
E	Energy mean (Leq)	dB(A)
N	Noise pollution level (NPL)	dB(A)
M	Maximum level measured	dB(A)
R	Range of data measured	dB(A)
1	L1, level exceeded 1% of time	dB(A)
10	L10, level exceeded 10% of time	dB(A)
50	L50, level exceeded 50% of time	dB(A)
90	L90, level exceeded 90% of time	dB(A)
99	L99, level exceeded 99% of time	dB(A)

5.1 NO BARRIER

Measurements were made on September 3 and 4, 1975, to determine the acoustic similarity of the two adjacent measuring sites. The fourteen microphone systems were deployed in the grid arrangement shown in Figure 5. One additional portable measuring system was deployed at location 15 for two successive runs on September 4, 1975.

Microphone height data is given in Table 1. Note that for runs 4 and 5 on September 3, 1975, and all runs on September 4, 1975, the height of microphones 5 through 9 and 13 were increased

from five to six feet above the ground to compensate for the grade. Also, for runs 5 through 8 on September 4, 1975, the location of microphone 9 was moved 50 feet to the south.

Tables 6 through 12 contain statistical noise data for all microphones for the thirteen 10-minute measurement runs made over the two-day period. Table 11 also includes data for microphone 15.

Weather data is summarized in Tables 124-134. Summary traffic data is given in Tables 135-164.

5.2 BARRIER 2.8 FEET HIGH

Measurements were made during the period October 7-9, 1975, on the 2.8 foot high barrier with reflective characteristics, and during the period October 15-17, 1975, on the 2.8 foot high barrier with absorptive characteristics. For these tests, microphones 1 and 13 (on permanent masts A/A') were set six inches above the height of the barrier (3.3 feet above the level of the edge of the near southbound lane). See Figure 7 for location of microphone masts and Table 2 for microphone height data.

Tables 13-25 contain noise data for twenty-one, 10-minute data runs for the 2.8 foot reflective barrier for all 14 microphone positions. Tables 26-36 contain noise data for twenty-two 10-minute data runs for the 2.8 foot absorptive barrier.

Weather data is summarized in Tables 126 and 127. Summary traffic data for each measurement run is given in Tables 137 through 142.

5.3 BARRIER 6.8 FEET HIGH

Measurements were made during the period October 29-31, 1975, on the 6.8 foot high absorptive barrier and during the period November 4-6, 1975, on the 6.8 foot high reflective barrier. For these tests, microphones 1 and 13 (on permanent masts A/A') were set six inches above the height of the barrier (7.3 feet above the level of the edge of the near southbound lane). Measurements were alternately made at locations 15 and 16 on October 31, and

November 4, 1975, during four consecutive runs. See Figure 7 for location of all microphones and Table 2 for microphone height data.

Tables 37-44 contain noise data for fifteen, 10-minute data runs for the 6.8 foot absorptive barrier. Tables 45-56 contain noise data for twenty-four, 10-minute data runs for the 6.8 foot reflective barrier. Tables 43, 44, 47 and 48 include data for microphones 15 and 16.

Weather data is summarized in Tables 127 and 128. Summary traffic data for each measurement run is given in Tables 143-147.

5.4 BARRIER 10.8 FEET HIGH

Measurements were made during the period November 18-20, 1975, on the 10.8 foot reflective barrier and during the period December 2-4, 1975, on the 10.8 foot absorptive barrier. For these tests, microphones 1 and 13 (on permanent masts A/A') were set six inches above the height of the barrier (11.3 feet above the level of the edge of the near southbound lane). Alternate measurements at locations 15 and 16 were made on November 18, 1975, and December 2, 1975, during four consecutive runs. See Figure 7 for location of all microphones and Table 2 for microphone height data.

Tables 57-68 contain noise data for twenty-four, 10-minute data runs for the 10.8 foot reflective barrier; Tables 69-80 contain noise data for twenty-four, 10-minute data run for the 10.8 foot absorptive barrier. Tables 59, 60, 70 and 71 include data for microphones 15 and 16.

Weather data is summarized in Tables 129 and 130; summary traffic data for each measurement run is given in Tables 148-153.

5.5 BARRIER 14.8 FEET HIGH

Measurements were made during the period December 9-12, 1975, on the 14.8 foot absorptive barrier and during the periods December 16-18, 1975; April 27-29, 1976; and September 14-16, 1976, on the 14.8 foot reflective barrier. The April and September 1976 measurements were carried out in the same manner as all previous measurements to detect seasonal changes, if any, in barrier

performance as a result of changes in groundcover. For these tests, as in previous tests on the 14.8 foot barrier, microphones 1 and 13 (on permanent masts A/A') were set six inches above the height of the barrier (15.3 feet above the level of the edge of the near southbound lane). Measurements were made alternately at microphone locations 15 and 16 during four consecutive runs on December 11 and 16, 1975. See Figure 7 for location of all microphones and Table 2 for microphone height data.

Tables 81-91 contain noise data for twenty-one, 10-minute data runs for the 14.8 foot absorptive barrier. Tables 92-123 contain noise data for sixty-four, 10-minute data runs for the 14.8 foot reflective barrier. Tables 86, 87, 94 and 95 include data for microphones 15 and 16.

Weather data is summarized in Tables 131-134; summary traffic data for each measurement run is given in Tables 154-164.

5.6 OCTAVE BAND FREQUENCY SPECTRA

To obtain a measure of the frequency dependence of the noise reduction characteristics of the barrier, the recorded data from selected measurement runs was reproduced and the mean energy measured for the 10-minute periods in each octave band from 31.5 Hz to 8 KHz plus the overall unweighted level. Mean energy frequency spectra are given in Tables 165-168 for each barrier height (reflective characteristics only) for microphones 1, 3, 4, 5, 8, 10 and 13 for microphone mast configurations B, C, D, and E. See Figure 7 for mast locations and Table 2 for microphone height data.

TABLES 6-12. NOISE DATA: OPEN FIELD MICROPHONES 1-14

TABLE NO. 6
 STATISTICAL NOISE DATA
 ROADSIDE BARRIER TEST SITE, ANDOVER, MA.

OPEN FIELD TEST, MICROPHONES 1 - 14

NOISE LEVEL - DBA RE 20 MICROPASCAL

9- 3- 75 1144 HOURS

BAND	A	S	E	N	M	R	1	10	50	90	99
1	75.3	5.4	78.9	92.9	93	33	89.3	82.8	75.7	68.9	64.0
2	72.9	6.4	78.1	94.4	94	36	89.7	81.3	73.5	65.3	60.7
3	68.1	5.0	71.2	83.8	84	30	80.6	75.7	68.4	62.2	58.0
4	71.8	4.9	74.6	87.1	86	28	83.5	79.1	72.1	65.9	61.7
5	64.1	4.0	66.1	76.4	79	26	74.8	70.1	64.2	59.7	56.6
6	62.1	3.7	64.0	73.3	77	23	72.9	67.6	62.3	58.3	55.7
7	62.8	3.5	64.5	73.3	81	26	72.7	67.9	62.9	59.1	57.1
8	62.2	3.4	63.9	72.7	81	28	72.6	66.8	62.7	58.4	55.5
9	59.7	3.2	61.1	69.4	72	20	69.1	64.4	60.0	56.3	53.5
10	67.8	4.8	70.8	83.0	84	28	80.5	75.1	68.0	62.2	59.2
11	69.4	5.0	72.8	85.7	87	29	82.9	77.3	69.5	63.5	60.5
12	69.1	5.1	72.6	85.6	86	30	82.9	76.9	69.2	63.2	59.8
13	62.8	3.8	64.8	74.5	78	24	74.5	68.6	62.8	59.0	56.0
14	75.8	5.3	79.5	93.0	94	33	90.5	83.2	76.0	69.9	65.1

N= 4780

9- 3- 75 1420 HOURS

BAND	A	S	E	N	M	R	1	10	50	90	99
1	75.8	5.6	81.0	95.2	99	38	94.0	83.6	75.6	70.0	65.2
2	73.6	6.4	80.5	96.9	100	40	93.7	82.3	73.7	66.3	62.7
3	68.4	5.4	73.3	87.1	91	33	86.0	76.8	67.5	63.3	60.2
4	72.0	5.3	76.4	90.1	92	34	88.4	79.8	71.5	66.6	62.0
5	64.4	4.4	67.7	79.1	82	26	78.8	71.4	63.6	60.5	58.6
6	61.5	3.9	63.8	73.7	76	22	73.3	68.1	61.1	57.9	56.1
7	61.9	3.5	63.5	72.4	75	20	71.9	67.4	61.8	58.5	57.0
8	61.1	3.4	62.7	71.5	77	24	71.2	66.4	61.1	57.6	56.0
9	59.1	3.5	60.8	69.7	74	23	69.9	64.4	58.9	55.6	53.7
10	68.8	5.2	73.7	87.0	90	32	86.5	76.7	68.0	64.1	61.2
11	68.3	5.2	73.1	86.4	91	33	86.0	76.3	67.8	63.1	60.1
12	67.6	5.5	72.5	86.5	89	33	85.0	75.8	67.5	61.9	58.4
13	61.8	4.4	64.8	76.0	78	25	76.0	68.6	61.2	57.6	55.5
14	75.3	5.5	80.6	94.8	99	37	92.8	82.9	75.4	69.3	65.3

N= 4780

TABLE NO. 7
 STATISTICAL NOISE DATA
 ROADSIDE BARRIER TEST SITE, ANDOVER, MA.

OPEN FIELD TEST, MICROPHONES 1 - 14

NOISE LEVEL - DBA RE 20 MICROPASCAL

BAND	A	S	E	N	M	R	1	10	50	90	99
1	76.6	3.8	78.7	88.4	91	28	88.7	81.9	76.8	72.6	69.3
2	74.8	3.8	77.3	87.2	95	25	88.3	79.8	75.0	70.7	70.1
3	68.1	3.6	70.1	79.3	86	26	79.6	73.3	68.2	64.5	62.0
4	72.6	3.4	74.2	82.9	85	21	82.8	77.7	72.7	69.1	66.4
5	63.4	3.0	64.6	72.1	77	20	72.5	67.9	63.4	60.5	58.7
6	61.4	2.7	62.4	69.3	75	20	70.4	65.5	61.6	58.8	57.0
7	61.5	2.7	62.5	69.4	72	17	70.0	65.7	61.6	59.0	57.2
8	61.6	2.2	62.2	67.7	72	15	68.7	64.9	61.8	59.5	58.1
9	58.9	2.0	59.5	64.6	69	16	65.4	62.1	59.2	57.1	55.6
10	68.6	3.6	70.6	79.9	84	24	80.2	74.0	68.6	65.0	62.3
11	68.6	3.7	70.7	80.2	86	26	80.5	74.2	68.6	64.7	62.3
12	68.2	3.6	70.2	79.5	82	23	79.8	73.7	68.3	64.6	61.5
13	62.5	2.6	63.4	70.0	75	19	70.9	66.5	62.6	60.1	58.3
14	76.2	3.9	78.3	88.2	93	28	88.0	81.5	76.4	72.2	68.5

N= 4785

9- 3- 75 1638 HOURS

BAND	A	S	E	N	M	R	1	10	50	90	99
1	77.0	4.1	79.7	90.3	97	32	89.9	82.8	77.2	73.0	67.9
2	73.9	5.5	78.2	92.2	97	36	89.5	81.2	74.5	67.2	63.3
3	68.5	4.1	71.1	81.5	87	29	81.1	74.6	68.5	64.3	61.1
4	72.2	3.9	74.4	84.5	89	28	83.5	78.1	72.2	68.3	64.2
5	64.7	3.6	66.5	75.6	80	23	76.1	70.0	64.7	61.1	58.9
6	62.7	3.0	63.9	71.6	75	19	72.4	67.3	62.8	59.6	57.9
7	62.8	2.9	64.0	71.4	74	18	72.3	67.1	63.0	59.9	58.0
8	62.6	2.8	63.6	70.7	73	17	70.9	66.9	62.8	59.7	58.2
9	60.8	2.8	61.8	69.0	71	18	69.8	65.0	60.9	58.1	56.0
10	69.9	4.1	72.6	83.2	89	28	82.5	76.3	69.9	65.6	63.0
11	68.9	4.2	71.5	82.4	87	28	81.4	75.2	68.9	64.3	61.3
12	67.9	4.3	70.5	81.6	86	30	80.2	74.3	68.1	63.2	59.2
13	64.3	3.5	66.0	75.0	80	25	75.3	69.5	64.3	60.9	58.3
14	76.8	4.3	79.5	90.5	97	34	89.4	82.9	77.0	72.2	67.8

N= 4780

MICROPHONE HEIGHT CHANGED FROM 4.5 FT TO 6 FT ON MICROPHONE NO'S.
 5,6,7,8,9, AND 13

TABLE NO. 8
 STATISTICAL NOISE DATA
 ROADSIDE BARRIER TEST SITE, ANDOVER, MA.

OPEN FIELD TEST, MICROPHONES 1 - 14

NOISE LEVEL - DBA RE 20 MICROPASCAL

9- 3- 75 1737 HOURS

BAND	A	S	E	N	M	R	1	10	50	90	99
1	75.2	4.0	77.6	87.9	91 27	88.7	80.5	75.5	71.1	67.5	
2	72.1	5.1	75.7	88.9	91 32	87.6	78.5	72.8	65.9	63.0	
3	66.8	3.9	69.1	79.2	84 27	79.8	72.0	67.0	62.5	59.9	
4	70.3	3.7	72.3	81.8	86 26	81.9	75.5	70.6	66.4	63.0	
5	62.9	3.2	64.5	72.7	77 21	74.5	67.6	62.9	59.9	57.6	
6	60.6	2.6	61.7	68.4	72 18	69.9	64.5	60.7	58.2	56.4	
7	61.2	2.6	62.2	68.8	73 18	70.6	64.9	61.3	58.8	57.2	
8	62.0	2.4	62.9	69.2	73 18	70.7	65.5	62.3	59.6	58.0	
9	59.6	2.6	60.6	67.3	72 19	69.1	63.0	59.8	57.2	55.3	
10	67.2	3.9	69.5	79.4	84 26	80.1	72.0	67.5	63.1	60.6	
11	67.4	3.8	69.6	79.2	83 25	79.9	72.5	67.7	63.4	60.7	
12	67.9	3.8	70.1	79.7	85 27	80.2	72.9	68.1	63.9	61.1	
13	63.1	3.1	64.6	72.6	80 24	74.2	67.5	63.2	60.1	58.0	
14	75.3	3.8	77.4	87.1	90 25	87.7	80.4	75.6	71.4	68.3	

N= 4780

TABLE NO. 9
 STATISTICAL NOISE DATA
 ROADSIDE BARRIER TEST SITE, ANDOVER, MA.

OPEN FIELD TEST, MICROPHONES 1 - 14
 NOISE LEVEL - DBA RE 20 MICROPASCAL

9- 4- 75 928 HOURS

BAND	A	S	E	N	M	R	1	10	50	90	99
1	74.8	5.1	78.6	91.6	96	36	89.8	81.8	75.0	69.1	64.8
2	71.7	6.3	77.4	93.5	96	39	89.6	79.6	72.3	64.2	59.4
3	66.9	4.9	70.4	82.9	87	33	80.7	74.2	66.9	61.9	57.9
4	71.1	4.8	74.2	86.5	89	32	84.0	78.3	71.1	66.1	60.9
5	63.2	4.3	66.0	77.0	81	28	75.6	69.8	63.1	59.0	56.1
6	61.0	3.7	62.9	72.4	75	22	71.8	66.9	60.9	57.1	55.2
7	61.1	3.7	63.1	72.5	77	23	71.7	67.1	61.1	57.3	55.6
8	61.1	3.5	62.8	71.6	75	21	71.5	66.4	61.2	57.5	55.4
9	58.9	3.3	60.5	69.0	74	23	68.9	64.1	59.0	55.4	53.3
10	67.0	5.1	70.7	83.7	86	31	81.7	74.5	67.0	61.5	58.0
11	66.8	5.2	70.5	83.8	87	33	81.3	73.9	67.0	60.7	56.6
12	67.0	5.2	70.7	84.0	87	33	81.5	74.4	67.1	61.0	56.9
13	62.9	3.8	65.2	75.0	81	27	74.7	69.0	62.7	59.2	56.8
14	75.0	5.4	79.0	92.8	97	39	90.0	82.4	75.4	68.7	62.2

N= 4780

9- 4- 75 1038 HOURS

BAND	A	S	E	N	M	R	1	10	50	90	99
1	75.8	5.5	80.6	94.7	100	38	92.1	83.3	76.1	69.3	65.7
2	72.3	7.0	79.3	97.2	99	43	91.7	81.5	73.2	63.5	60.1
3	67.7	5.5	72.8	87.0	91	37	86.0	76.1	67.6	61.7	58.3
4	72.3	5.3	76.4	89.8	93	35	88.5	79.7	72.4	66.3	62.1
5	63.9	4.6	67.5	79.3	84	30	79.4	71.0	63.4	59.5	57.1
6	61.3	3.9	63.8	73.9	79	26	73.7	67.5	60.9	57.6	55.7
7	61.3	3.8	63.8	73.5	80	27	74.1	67.2	61.0	58.0	55.4
8	61.5	3.8	64.3	74.0	79	26	76.3	66.4	61.5	58.1	55.8
9	59.4	3.9	62.3	72.3	78	28	74.2	64.6	59.3	55.9	53.2
10	68.0	5.6	73.1	87.5	90	34	86.1	76.0	67.9	62.0	58.3
11	68.0	5.8	73.2	88.1	90	36	86.4	76.2	68.0	61.5	57.4
12	68.7	5.8	73.8	88.6	91	39	86.7	77.1	68.7	62.4	56.0
13	63.7	4.6	67.6	79.4	84	30	80.5	70.2	63.2	59.4	56.5
14	76.3	5.6	81.1	95.3	99	39	92.8	83.5	76.6	70.0	64.2

N= 4785

TABLE NO. 10
 STATISTICAL NOISE DATA
 ROADSIDE BARRIER TEST SITE, ANDOVER, MA.

OPEN FIELD TEST, MICROPHONES 1 - 14

NOISE LEVEL - DBA RE 20 MICROPASCAL

9- 4- 75

1036 HOURS

BAND	A	S	E	N	M	R	1	10	50	90	99
1	75.4	5.3	79.0	92.6	94	35	89.6	82.8	75.7	69.7	62.3
2	71.6	6.7	77.2	94.4	95	39	88.8	80.3	72.4	63.1	68.1
3	67.2	5.1	70.6	83.6	84	30	80.7	74.8	67.2	61.5	57.1
4	71.5	4.8	74.3	86.7	88	32	83.9	78.3	71.7	66.1	60.3
5	63.6	4.1	65.9	76.5	78	23	74.9	70.1	63.4	59.3	57.0
6	61.6	3.3	63.1	71.6	73	20	70.8	66.9	61.8	58.2	55.5
7	61.8	3.3	63.2	71.5	74	19	70.9	66.7	62.1	58.2	56.0
8	62.0	3.4	63.5	72.2	73	19	71.1	67.2	62.4	58.1	55.8
9	59.8	3.4	61.2	69.8	72	20	69.6	64.8	59.9	56.1	53.4
10	68.5	5.1	71.9	84.9	85	29	81.8	76.4	68.3	63.0	58.5
11	67.3	5.2	70.6	83.9	85	32	80.6	75.1	67.4	61.5	57.1
12	67.9	5.3	71.3	84.9	86	32	81.1	75.7	68.2	61.8	56.5
13	63.1	4.1	65.1	75.5	77	24	73.8	69.2	63.2	58.6	55.9
14	75.6	5.2	79.0	92.3	94	33	89.5	82.9	75.9	69.7	64.5

N= 4780

9- 4- 75

1235 HOURS

BAND	A	S	E	N	M	R	1	10	50	90	99
1	75.4	5.4	79.2	92.9	95	33	90.2	82.8	75.8	68.9	64.8
2	70.8	7.1	77.2	95.4	94	37	89.1	80.5	71.4	62.0	58.4
3	65.9	5.6	70.2	84.5	85	32	80.7	74.6	65.9	59.4	56.0
4	71.5	4.9	74.6	87.2	88	29	84.0	79.0	71.7	65.6	61.9
5	61.8	4.5	64.7	76.3	79	27	74.7	68.9	61.4	57.3	54.7
6	59.0	3.2	60.5	68.8	75	24	68.7	63.9	59.0	55.9	53.3
7	60.4	2.8	61.6	68.9	75	20	69.7	64.9	60.3	57.8	56.1
8	60.1	2.9	61.4	68.8	74	20	69.9	64.5	59.9	57.4	55.5
9	58.2	3.0	59.6	67.2	73	20	68.5	62.9	58.0	55.6	54.1
10	66.5	5.4	70.6	84.4	86	31	81.0	74.9	66.5	60.5	57.4
11	66.7	5.1	70.5	83.6	86	32	81.0	74.7	66.5	61.5	57.7
12	67.1	5.3	71.0	84.7	86	30	81.8	75.6	66.9	61.1	57.9
13	62.4	3.7	64.5	74.0	80	25	74.3	68.5	62.0	59.1	57.0
14	75.3	4.9	79.0	91.5	96	34	89.8	82.4	75.3	70.2	66.5

N= 4780

TABLE NO. 11
 STATISTICAL NOISE DATA
 ROADSIDE BARRIER TEST SITE, ANDOVER, MA.

OPEN FIELD TEST, MICROPHONES 1 - 14

NOISE LEVEL - DBA RE 20 MICROPASCAL

9- 4- 75 1502 HOURS

BAND	A	S	E	N	M	R	I	10	50	90	99
1	75.7	4.4	78.1	89.4	90	25	87.5	82.0	76.0	70.5	67.0
2	72.1	6.1	76.2	91.7	89	32	86.7	79.9	73.1	64.2	60.2
3	66.1	4.5	68.6	80.1	79	24	77.6	72.9	66.2	61.0	57.4
4	71.1	4.1	72.9	83.3	82	23	80.5	77.2	71.5	66.3	62.3
5	61.9	3.7	63.7	73.1	76	22	72.0	68.0	61.7	58.2	56.2
6	59.0	2.4	59.7	65.9	68	15	65.7	63.1	59.1	56.7	55.3
7	59.0	2.7	60.0	67.0	71	18	67.1	63.5	59.0	56.4	54.7
8	60.5	1.9	61.0	65.9	69	15	66.5	63.8	60.7	59.1	57.1
9	57.8	2.3	58.5	64.4	67	14	64.9	61.7	57.9	55.6	54.1
10	67.1	4.5	69.6	81.1	80	25	78.6	74.0	67.3	61.8	58.0
11	66.9	4.3	69.4	80.3	80	22	78.2	73.8	66.9	62.3	59.8
12	67.8	4.6	70.4	82.1	81	26	79.4	74.8	68.1	62.6	59.0
13	61.2	3.3	62.8	71.2	79	24	70.8	66.8	60.9	58.1	56.4
14	75.2	4.4	77.7	89.0	90	28	87.3	81.6	75.4	70.3	66.4
15	74.0	4.5	76.9	88.4	91	30	88.2	79.7	74.3	69.2	64.4

N= 4780

9- 4- 75 1522 HOURS

BAND	A	S	E	N	M	R	I	10	50	90	99
1	75.1	4.1	78.6	89.2	94	30	88.8	81.7	76.4	71.9	67.3
2	72.5	5.5	76.7	90.9	94	36	88.2	79.1	73.3	66.1	60.1
3	66.1	4.2	68.9	79.7	84	28	79.5	72.4	65.9	62.1	58.4
4	71.5	3.8	73.4	83.1	85	26	82.9	77.0	71.7	67.8	62.6
5	61.4	3.3	63.2	71.8	77	22	73.1	66.7	61.2	58.5	56.9
6	58.5	2.3	59.2	65.0	69	15	66.1	62.0	58.6	56.4	55.2
7	59.3	2.3	60.0	65.8	70	16	67.3	62.8	59.4	57.3	56.1
8	59.9	2.0	60.4	65.5	70	15	66.9	62.8	60.2	58.1	56.2
9	57.6	2.4	58.4	64.5	69	18	65.7	61.3	57.7	55.4	53.9
10	67.3	4.1	69.9	80.3	85	27	80.3	73.3	67.4	63.1	60.4
11	66.9	4.1	69.5	80.0	85	28	80.7	72.8	67.1	62.7	59.2
12	68.0	4.5	70.9	82.3	86	31	82.0	74.2	68.5	62.6	58.4
13	60.9	3.4	62.8	71.4	77	22	73.1	66.1	60.8	57.8	56.1
14	75.7	4.3	78.3	89.3	93	30	88.9	81.0	76.2	70.5	66.0
15	76.8	4.5	79.5	91.0	96	31	89.1	82.9	77.3	71.5	67.6

N= 4780

MICROPHONE 9 POSITION CHANGED TO POINT 50 FT TO SOUTH

TABLE NO. 12
 STATISTICAL NOISE DATA
 ROADSIDE BARRIER TEST SITE, ANDOVER, MA.

OPEN FIELD TEST, MICROPHONES 1 - 14

NOISE LEVEL - DBA RE 20 MICROPASCAL

9- 4- 75 1620 HOURS

BAND	A	S	E	N	M	R	1	10	50	90	99
1	76.5	3.9	78.8	88.8	93	28	89.4	81.7	76.8	72.4	68.3
2	73.2	5.1	76.9	89.9	92	33	88.7	79.2	73.9	67.0	62.3
3	67.7	3.8	69.9	79.7	83	27	80.2	73.2	67.8	64.0	60.5
4	71.9	3.6	73.8	83.0	85	23	82.8	77.4	72.0	68.4	64.4
5	63.3	3.3	65.0	73.4	77	21	74.1	68.6	63.2	60.4	58.3
6	61.4	2.8	62.6	69.9	74	18	70.5	66.1	61.4	58.9	57.4
7	61.6	2.7	62.7	69.5	74	18	70.1	66.2	61.5	59.3	58.0
8	61.0	2.7	62.1	69.1	73	17	69.8	65.4	60.9	58.6	57.2
9	59.7	3.0	61.1	68.7	74	20	69.9	64.2	59.5	57.2	55.7
10	68.2	3.9	70.4	80.2	82	29	80.5	73.5	68.3	64.2	61.0
11	67.8	4.0	70.4	80.7	84	27	80.7	73.4	68.0	63.7	60.1
12	68.5	4.0	70.9	81.2	85	28	80.8	74.3	68.6	64.5	60.2
13											
14	76.4	4.1	79.0	89.5	97	47	89.4	81.7	76.5	72.2	68.2

N= 4785

9- 4- 75 1701 HOURS

BAND	A	S	E	N	M	R	1	10	50	90	99
1	76.2	3.5	78.0	87.1	93	27	87.3	81.2	76.4	72.5	69.6
2	72.4	4.9	75.7	88.3	94	35	86.4	78.6	73.1	66.3	62.6
3	66.4	4.0	68.9	79.1	85	29	78.7	72.1	66.6	62.4	58.9
4	71.5	3.3	73.0	81.6	86	25	81.2	76.7	71.6	68.2	65.0
5	61.8	3.3	63.7	72.1	81	26	73.3	66.6	61.6	59.0	57.0
6	59.8	2.1	60.3	65.8	75	20	67.2	62.7	59.9	58.2	57.0
7	58.0	2.8	59.5	66.6	77	25	67.4	61.8	58.1	55.6	54.1
8	59.7	1.9	60.4	65.3	75	19	68.2	62.3	59.8	58.3	57.2
9	57.7	2.3	58.7	64.5	76	23	66.9	61.0	57.7	56.0	54.6
10	67.0	4.0	69.4	79.6	85	29	79.0	72.3	67.3	62.7	59.0
11	67.2	3.7	69.3	78.7	85	26	78.7	72.1	67.5	63.3	61.1
12	67.4	3.8	69.7	79.3	85	26	79.2	72.4	67.6	63.5	61.0
13	61.5	3.1	63.3	71.2	80	24	72.2	65.9	61.3	58.9	57.4
14	75.8	3.6	77.8	87.1	94	27	87.6	80.6	76.0	71.9	69.3

N= 4780

TABLES 13-23. NOISE DATA: FOUR FOOT ABSORPTIVE BARRIER;
MICROPHONE CONFIGURATIONS B, C, D, E.

TABLE NO. 13
STATISTICAL NOISE DATA
ROADSIDE BARRIER TEST SITE, ANDOVER, MA.

BARRIER HGT 4 FT; ABSORPTIVE; MICROPHONE CONFIGURATION B

NOISE LEVEL - DBA RE 20 MICROPASCAL

10- 15- 75

953 HOURS

BAND	A	S	E	N	M	R	1	10	50	90	99
1	73.5	6.0	78.6	94.0	96	38	90.9	81.3	74.2	66.2	61.2
2	76.4	4.8	79.9	92.1	94	30	91.1	83.2	76.4	71.3	67.5
3	64.5	5.0	67.9	80.6	81	27	78.1	72.3	64.5	59.2	55.7
4	66.7	4.9	70.0	82.5	83	27	80.2	74.2	66.8	61.3	57.7
5	70.7	4.8	73.8	85.0	87	28	84.2	77.9	70.9	65.5	61.2
6	72.5	4.5	75.3	86.7	87	25	85.1	79.7	72.1	68.0	64.7
7	72.2	4.7	75.2	87.2	87	26	85.5	79.4	72.1	67.3	63.5
8	68.7	5.3	72.2	85.8	85	32	82.7	76.4	68.8	62.9	55.5
9	70.6	5.0	73.7	86.5	86	32	83.8	77.9	70.8	65.2	58.4
10	72.0	4.9	75.0	87.6	87	32	85.1	79.1	72.2	67.0	59.7
11	72.4	4.7	75.2	87.2	87	29	84.9	79.5	72.3	67.7	61.3
12	72.9	4.6	75.5	87.2	88	29	85.0	79.9	72.8	68.2	62.6
13	74.1	5.6	78.5	92.8	95	37	90.5	81.4	74.8	67.6	61.5
14											

N O D A T A

N= 4785

10- 15- 75

1013 HOURS

BAND	A	S	E	N	M	R	1	10	50	90	99
1	72.5	6.6	77.7	94.7	94	40	88.9	81.1	73.4	64.2	57.8
2	75.6	5.2	79.1	92.4	95	34	89.2	82.9	75.7	69.8	64.2
3	64.0	5.2	67.3	80.6	81	31	77.0	71.9	64.1	58.2	53.5
4	66.0	5.1	69.2	82.3	82	31	78.4	73.6	66.2	60.1	55.6
5	69.8	5.2	72.9	86.1	87	33	81.8	77.3	70.2	63.6	57.8
6	71.8	4.8	74.5	86.8	87	30	83.2	79.1	71.9	66.5	60.5
7	71.5	5.1	74.5	87.4	88	31	83.5	79.0	71.6	65.8	59.6
8	67.6	5.6	71.3	85.6	85	32	81.2	75.4	68.1	60.8	55.1
9	69.5	5.2	72.6	86.0	86	32	81.9	76.8	70.0	63.4	57.2
10	70.9	5.1	73.7	86.7	88	32	82.9	78.0	71.4	64.9	58.9
11	71.7	4.8	74.3	86.5	87	29	83.1	78.5	72.1	66.5	60.3
12	72.2	4.5	74.6	86.2	88	30	83.1	78.6	72.4	67.4	61.3
13	73.1	6.1	77.6	93.3	94	37	88.9	81.3	73.9	65.5	60.1
14											

N O D A T A

N= 4780

TABLE NO. 14
 STATISTICAL NOISE DATA
 ROADSIDE BARRIER TEST SITE, ANDOVER, MA.

BARRIER HGT 4 FT; ABSORPTIVE; MICROPHONE CONFIGURATION C

NOISE LEVEL - DBA RE 20 MICROPASCAL

10- 15- 75		1231 HOURS									
BAND	A	S	E	N	M	R	1	10	50	90	99
1	70.8	7.3	77.3	96.0	94	41	89.4	80.3	71.7	61.7	56.2
2	75.2	5.2	79.1	92.4	96	33	89.8	82.6	75.5	69.4	64.9
3	59.2	4.8	62.9	75.1	77	28	74.6	66.5	58.6	54.7	51.7
4	62.3	4.9	65.8	78.3	79	27	76.7	70.1	61.7	57.3	54.0
5	64.8	4.7	67.9	80.0	80	26	78.3	72.4	64.5	59.7	56.1
6	68.8	4.6	71.5	83.2	83	26	81.6	76.0	68.7	63.9	59.5
7	67.0	4.7	69.9	82.0	81	25	80.1	74.4	66.8	61.9	58.0
8	61.2	5.3	65.0	78.5	79	29	74.9	69.7	60.9	55.3	52.2
9	64.7	5.5	68.4	82.6	81	30	78.4	73.4	64.7	58.1	54.0
10	66.9	5.3	70.2	83.8	83	30	79.8	75.1	66.9	60.5	56.0
11	68.2	5.2	71.4	84.7	85	30	80.7	76.3	68.4	62.1	57.3
12	69.1	5.1	72.0	85.0	84	28	81.0	76.9	69.0	63.1	58.5
13	71.8	6.9	77.5	95.1	95	39	88.6	81.4	72.5	63.3	57.9
14	75.2	5.4	79.1	93.0	95	34	89.0	83.4	75.5	69.0	64.7

N= 3355

7 MINUTE RUN

10- 15- 75		1248 HOURS									
BAND	A	S	E	N	M	R	1	10	50	90	99
1	71.0	7.0	76.8	94.7	92	39	89.1	79.6	72.0	62.4	55.7
2	75.2	5.1	78.8	91.7	93	31	90.0	81.8	75.5	69.6	65.0
3	59.7	4.5	62.5	73.9	75	25	72.5	66.7	59.4	55.2	52.4
4	62.5	4.6	65.4	77.2	78	27	75.1	69.7	62.4	57.6	54.7
5	64.8	4.6	67.4	79.1	79	26	76.5	71.6	65.0	59.7	56.6
6	68.6	4.5	71.1	82.7	82	26	79.9	75.2	69.0	63.3	59.6
7	66.9	4.6	69.4	81.3	80	25	78.5	73.6	67.2	61.5	57.8
8	61.1	5.2	64.6	77.8	77	27	74.6	68.9	61.0	55.0	52.4
9	64.3	5.5	67.8	81.8	80	29	77.7	72.4	64.8	57.4	54.0
10	66.3	5.3	69.4	83.0	81	29	79.0	73.9	66.7	59.6	55.5
11	67.6	5.2	70.6	83.8	83	31	79.6	75.1	68.0	61.1	56.6
12	68.3	5.0	71.1	83.9	83	29	79.8	75.5	68.8	62.2	57.2
13	71.4	6.9	77.0	94.5	94	38	88.8	80.2	72.0	62.5	57.7
14	74.7	5.5	78.6	92.7	94	32	89.5	82.2	75.0	68.1	64.3

N= 4785

TABLE NO. 15
 STATISTICAL NOISE DATA
 ROADSIDE BARRIER TEST SITE, ANDOVER, MA.

BARRIER HGT 4 FT; ABSORPTIVE; MICROPHONE CONFIGURATION D
 NOISE LEVEL - DBA RE 20 MICROPASCAL

10- 15- 75 1455 HOURS

BAND	A	S	E	N	M	R	1	10	50	90	99
1	74.5	5.4	78.8	92.6	98	37	90.1	81.6	75.0	68.2	63.3
2	77.3	4.5	80.5	92.0	100	35	91.6	83.5	77.5	72.8	67.7
3	65.6	3.5	67.2	76.1	79	22	75.9	70.7	65.8	61.9	59.5
4	67.6	3.5	69.2	78.1	82	22	77.6	72.7	67.9	64.0	61.3
5	66.9	3.4	68.4	77.2	81	23	76.7	71.9	67.1	63.2	60.7
6	68.2	3.4	69.7	78.3	84	24	77.9	72.9	68.5	64.5	62.3
7	66.9	3.4	68.4	77.1	83	24	76.4	71.8	67.1	63.1	61.1
8	65.5	3.6	67.2	76.5	78	21	76.0	70.6	65.8	61.4	59.1
9	66.5	3.7	68.3	77.7	79	22	77.5	71.7	66.8	62.4	59.4
10	67.0	3.7	68.9	78.4	82	25	78.1	72.0	67.3	63.0	59.8
11	67.7	3.8	69.6	79.4	83	25	78.8	72.8	68.1	63.4	60.2
12	68.1	3.8	70.0	79.6	83	24	79.3	73.0	68.4	64.0	60.7
13	75.5	5.2	79.5	92.9	100	39	90.4	82.5	76.0	69.2	65.1
14	76.1	4.7	79.4	91.5	96	32	90.1	82.6	76.3	70.8	67.3

N= 4780

10- 15- 75 1515 HOURS

BAND	A	S	E	N	M	R	1	10	50	90	99
1	74.9	5.3	78.6	92.1	95	35	89.3	81.9	75.5	68.4	63.9
2	77.9	4.3	80.4	91.5	95	29	90.0	84.1	78.1	73.2	69.2
3	67.1	3.0	68.2	76.0	77	17	74.5	72.0	67.3	63.7	61.9
4	68.6	3.1	69.7	77.7	78	17	76.2	73.4	68.9	65.1	63.1
5	67.7	3.0	68.8	76.6	77	17	75.4	72.5	68.0	64.4	62.2
6	68.8	2.9	69.9	77.4	79	18	76.2	73.4	69.1	65.5	63.4
7	67.5	3.0	68.5	76.2	77	17	75.0	72.2	67.7	64.2	62.1
8	66.9	3.1	68.0	76.0	77	19	74.4	71.6	67.5	63.3	60.9
9	67.7	3.0	68.8	76.5	78	19	75.1	72.1	68.2	64.3	61.6
10	67.9	3.0	68.9	76.6	78	19	75.3	72.4	68.3	64.5	61.7
11	68.6	3.0	69.6	77.5	79	19	75.9	73.0	69.0	65.1	62.4
12	68.9	3.0	70.0	77.6	79	20	76.2	73.3	69.4	65.5	62.8
13	76.1	4.8	79.0	91.2	95	31	89.0	82.6	76.7	70.2	66.6
14	76.5	4.2	78.9	89.7	94	29	88.1	82.5	77.0	71.7	67.9

N= 4780

TABLE NO. 16
 STATISTICAL NOISE DATA
 ROADSIDE BARRIER TEST SITE, ANDOVER, MA.

BARRIER HGT 4 FT; ABSORPTIVE; MICROPHONE CONFIGURATION E
 NOISE LEVEL - DBA RE 20 MICROPASCAL

10- 15- 75

1609 HOURS

BAND	A	S	E	N	M	R	1	10	50	90	99
1	75.6	4.1	78.0	88.5	92	29	88.5	81.0	75.8	71.3	67.2
2	78.2	3.3	79.8	88.3	91	23	88.9	82.7	78.4	75.0	71.5
3	68.4	3.0	69.7	77.4	80	20	77.7	72.9	68.6	65.4	62.7
4	72.1	3.2	73.4	81.5	84	21	81.9	76.7	72.3	69.0	65.9
5	72.4	3.1	73.7	81.7	84	20	82.0	76.9	72.6	69.3	66.2
6	74.1	2.9	75.2	82.6	84	18	82.8	78.4	74.4	71.2	68.6
7	72.6	3.0	73.9	81.6	83	19	82.0	77.0	72.8	69.6	66.9
8	69.5	3.0	70.8	78.6	83	22	79.1	74.1	69.7	66.5	64.2
9	70.7	3.1	71.9	79.8	84	24	79.9	75.3	70.8	67.6	64.8
10	71.8	3.1	73.0	80.8	83	23	80.9	76.2	71.9	68.8	65.5
11	73.0	3.0	74.2	81.8	83	21	81.9	77.5	73.2	70.1	67.3
12	74.0	2.9	75.1	82.4	84	21	82.4	78.4	74.2	71.2	68.4
13	76.2	4.0	78.5	88.7	93	29	88.2	81.9	76.4	71.9	68.3
14	76.2	3.6	77.9	87.0	91	24	86.8	81.4	76.3	72.4	69.3

N= 4785

10- 15- 75

1629 HOURS

BAND	A	S	E	N	M	R	1	10	50	90	99
1	74.9	4.6	77.8	89.6	93	30	88.0	81.4	75.1	69.7	65.6
2	77.8	3.6	79.7	89.0	93	26	88.7	83.0	78.0	74.2	69.8
3	67.7	3.2	69.0	77.3	80	21	76.4	73.0	67.7	64.5	62.0
4	71.1	3.5	72.7	81.6	84	23	80.7	76.5	71.1	67.5	64.5
5	72.1	3.5	73.7	82.6	85	24	81.9	77.4	72.2	68.5	64.8
6	73.8	3.2	75.1	83.3	87	22	82.7	78.8	73.9	70.7	67.2
7	72.2	3.4	73.7	82.3	86	24	81.6	77.4	72.4	69.0	65.0
8	68.7	3.4	70.3	79.0	83	23	78.4	74.2	68.6	65.3	62.6
9	70.1	3.5	71.7	80.7	84	24	79.9	75.5	70.3	66.5	63.2
10	71.4	3.4	72.9	81.4	83	22	80.5	76.5	71.6	68.0	64.7
11	72.9	3.3	74.3	82.8	86	23	81.9	77.9	73.0	69.4	65.9
12	73.7	3.2	75.0	83.2	87	22	82.7	78.6	73.8	70.5	67.3
13	75.8	4.3	78.4	89.5	93	29	88.6	81.8	76.1	71.0	67.4
14	75.7	3.6	77.6	86.9	92	25	87.0	81.0	75.8	72.0	69.5

N= 4780

TABLE NO. 17
 STATISTICAL NOISE DATA
 ROADSIDE BARRIER TEST SITE, ANDOVER, MA.

BARRIER HGT 4 FT; ABSORPTIVE; MICROPHONE CONFIGURATION E

NOISE LEVEL - DBA RE 20 MICROPASCAL

10- 16- 75			912 HOURS									
BAND	A	S	E	N	M	R	1	10	50	90	99	
1												
2	78.9	4.7	82.2	94.2	97	29	92.8	86.3	78.6	74.1	71.1	
3	65.6	4.4	68.2	79.5	82	26	77.8	72.3	65.2	61.1	58.2	
4	69.0	4.5	71.8	83.3	85	27	81.8	75.9	68.8	64.4	61.2	
5	71.9	4.5	74.6	86.3	88	27	84.3	78.9	71.8	67.1	63.6	
6	74.2	4.3	76.7	87.7	90	26	85.8	80.8	74.0	69.7	66.9	
7	73.5	4.5	76.1	87.6	90	28	85.7	80.4	73.3	68.6	65.5	
8	68.3	4.9	71.6	84.1	88	32	82.1	75.8	68.2	63.0	59.7	
9	70.3	4.9	73.5	86.1	88	31	83.5	77.8	70.5	64.6	60.3	
10	72.1	4.8	74.9	87.1	88	30	84.4	79.1	72.3	66.6	62.2	
11	73.7	4.7	76.3	88.4	89	29	85.5	80.6	73.9	68.4	63.4	
12	74.3	4.6	76.8	88.6	89	27	85.9	81.0	74.4	69.1	64.7	
13												
14	77.9	4.9	81.2	93.7	97	32	91.8	85.2	77.8	72.8	68.3	

N= 4780

10- 16- 75			932 HOURS									
BAND	A	S	E	N	M	R	1	10	50	90	99	
1												
2	77.6	5.0	81.5	94.3	100	34	92.3	84.5	77.7	71.9	68.9	
3	64.0	5.0	68.4	81.2	88	34	79.0	71.6	63.6	59.0	56.2	
4	67.0	5.1	71.1	84.0	89	33	81.7	74.4	66.8	61.4	58.3	
5	70.5	5.0	74.1	86.9	91	33	84.9	77.8	70.6	64.6	61.2	
6	73.0	4.7	76.0	88.1	90	28	86.2	79.9	72.8	67.7	64.7	
7	72.1	4.9	75.5	88.1	90	29	86.0	79.4	72.2	66.2	63.0	
8	66.8	5.0	70.6	83.4	86	32	81.6	74.3	66.6	61.7	57.1	
9	68.7	5.2	72.5	85.8	87	32	83.0	76.5	68.6	63.2	57.6	
10	70.4	5.1	73.9	87.0	90	34	84.3	78.1	70.6	64.8	59.2	
11	72.2	5.0	75.5	88.3	91	33	85.8	79.6	72.2	66.8	61.2	
12	73.0	4.8	76.0	88.3	91	32	86.1	80.1	72.9	68.0	62.3	
13												
14	76.5	5.4	80.5	94.2	98	35	91.5	84.2	76.6	70.2	66.4	

N= 4780

MICROPHONE NO.14 SET AT 19' 4" HIGH AND 31 FT FROM EDGE OF NEAR LANE

TABLE NO. 18
 STATISTICAL NOISE DATA
 ROADSIDE BARRIER TEST SITE, ANDOVER, MA.

BARRIER HGT 4 FT; ABSORPTIVE; MICROPHONE CONFIGURATION B

NOISE LEVEL - DBA RE 20 MICROPASCAL

10- 16- 75

1014 HOURS

BAND	A	S	E	N	M	R	1	10	50	90	99
1											
					N O D A T A						
2	77.3	5.5	81.4	95.6	96	31	91.9	85.5	77.3	70.8	66.9
3	64.3	4.7	67.7	79.8	86	31	78.0	71.8	63.7	59.7	57.3
4	66.6	4.9	70.1	82.7	86	29	80.6	74.4	66.3	61.4	58.9
5	69.6	5.2	73.0	86.2	87	29	82.9	77.4	69.6	63.5	60.5
6	72.8	5.0	75.9	88.7	89	28	85.9	80.1	72.8	67.0	63.2
7	71.6	5.2	75.0	88.2	88	28	84.9	79.3	71.7	65.4	62.0
8	68.7	4.8	72.0	84.3	88	31	82.6	76.0	68.4	64.0	60.2
9	70.5	4.7	73.5	85.5	88	29	83.6	77.6	70.4	65.7	61.9
10	71.4	4.7	74.4	86.5	89	29	84.1	78.4	71.4	66.3	62.9
11	72.8	4.7	75.7	87.7	91	29	85.0	79.7	72.8	67.5	64.5
12	73.7	4.6	76.3	88.0	88	25	85.5	80.4	73.8	68.4	65.6
13					N O D A T A						
14	76.2	5.4	80.3	94.2	97	33	90.9	84.4	76.2	70.1	66.7

N= 4785

10- 16- 75

1034 HOURS

BAND	A	S	E	N	M	R	1	10	50	90	99
1											
					N O D A T A						
2	76.6	5.9	81.7	96.8	101	38	92.9	84.8	76.8	69.6	65.5
3	63.6	5.1	68.8	81.8	91	36	80.2	71.4	62.8	59.0	56.7
4	65.8	5.5	71.0	84.9	90	35	83.0	74.0	65.1	60.4	57.3
5	69.1	5.5	73.6	87.7	91	35	85.5	77.2	68.8	63.1	59.0
6	72.2	5.5	76.3	90.4	92	34	87.3	80.3	72.0	65.9	61.5
7	70.9	5.7	75.4	90.0	92	35	86.8	79.4	70.9	64.4	59.8
8	67.9	5.1	72.3	85.4	89	33	84.2	75.6	67.8	62.6	58.6
9	69.6	5.3	74.1	87.6	92	35	86.1	77.5	69.6	64.0	59.7
10	70.4	5.4	74.9	88.8	91	33	87.2	78.4	70.3	64.6	60.0
11	71.6	5.5	76.0	90.0	91	32	87.8	79.8	71.5	65.8	61.4
12	72.6	5.4	76.6	90.4	91	31	88.0	80.7	72.4	66.7	62.6
13					N O D A T A						
14	75.1	6.1	80.7	96.3	100	39	92.3	83.7	75.1	68.0	63.7

N= 4780

MICROPHONE NO.14 SET AT 19' 4" HIGH AND 31 FT FROM EDGE OF NEAR LANE

TABLE NO. 19
 STATISTICAL NOISE DATA
 ROADSIDE BARRIER TEST SITE, ANDOVER, MA.

BARRIER HGT 4 FT; ABSORPTIVE; MICROPHONE CONFIGURATION C
 NOISE LEVEL - DBA RE 20 MICROPASCAL

10- 16- 75

1147 HOURS

BAND	A	S	E	N	M	R	1	10	50	90	99
1	71.6	7.5	78.7	98.0	96	43	91.0	82.1	72.0	62.3	56.7
2	76.6	5.3	80.6	94.1	98	33	91.9	84.3	76.7	70.8	57.0
3	60.7	4.7	64.4	76.3	81	30	76.5	67.5	60.4	56.2	53.5
4	63.9	5.0	67.4	80.2	82	29	78.2	71.5	63.7	58.4	55.7
5	65.7	4.9	68.8	81.4	81	27	78.9	72.8	65.6	60.1	57.1
6	69.3	4.8	72.1	84.4	83	27	81.7	76.0	69.5	63.6	59.4
7	67.7	4.9	70.6	83.1	83	28	80.5	74.8	67.8	61.9	58.4
8	62.3	4.9	65.7	78.1	81	29	75.8	69.9	61.7	57.4	54.4
9	65.8	5.4	69.5	83.3	83	30	79.6	74.0	65.6	59.8	55.8
10	67.4	5.2	70.8	84.1	84	30	80.8	75.1	67.3	61.5	57.1
11	69.2	5.0	72.3	85.2	85	29	82.3	76.3	69.3	63.4	59.2
12	70.2	4.8	73.0	85.4	85	29	82.3	77.2	70.5	64.6	60.2
13	72.1	7.0	78.5	96.5	97	40	90.6	82.0	72.5	63.6	59.2
14	76.0	5.8	80.5	95.3	99	39	91.9	84.0	76.2	69.4	64.1

N= 4780

10- 16- 75

1207 HOURS

BAND	A	S	E	N	M	R	1	10	50	90	99
1	70.1	7.1	76.9	95.1	97	46	89.2	79.2	71.0	61.5	55.3
2	65.3	5.0	69.3	82.0	88	38	80.5	71.9	65.5	60.0	54.7
3	59.5	4.1	63.3	73.9	83	31	74.8	65.3	59.3	55.7	53.3
4	62.0	4.7	66.4	78.4	85	33	79.5	68.5	61.7	57.5	54.4
5	64.2	4.6	67.8	79.6	85	33	80.0	70.6	64.2	59.6	56.1
6	67.7	4.7	70.9	83.0	87	34	82.0	73.9	68.0	62.6	57.0
7	66.0	4.7	69.5	81.6	88	36	81.0	72.5	66.2	61.0	56.3
8	61.1	4.2	63.7	74.5	79	27	73.3	67.3	61.0	56.7	54.3
9	64.4	4.6	67.2	79.0	81	27	77.3	70.8	64.6	59.1	56.1
10	65.9	4.5	68.6	80.2	81	26	78.2	72.3	66.1	60.7	57.5
11	67.7	4.4	70.2	81.4	84	28	79.3	74.0	67.8	62.6	59.5
12	68.7	4.3	71.0	82.0	84	26	80.5	74.8	68.8	63.9	60.6
13	70.7	6.5	76.3	93.0	93	37	88.9	79.3	71.2	62.7	59.2
14	74.8	5.3	78.7	92.2	94	32	90.0	82.2	75.1	68.6	64.9

N= 4730

TABLE NO. 20
 STATISTICAL NOISE DATA
 ROADSIDE BARRIER TEST SITE, ANDOVER, MA.

BARRIER HGT 4 FT; ABSORPTIVE; MICROPHONE CONFIGURATION D
 NOISE LEVEL - DBA RE 20 MICROPASCAL

10- 16- 75

1456 HOURS

BAND	A	S	E	N	M	R	1	10	50	90	99
1	71.7	6.6	78.1	95.1	100	43	90.2	80.4	72.2	63.6	59.6
2	76.0	5.1	80.0	93.0	99	36	91.4	83.3	76.1	70.4	67.2
3	59.2	2.8	60.2	67.3	72	21	67.6	63.4	59.3	56.5	54.5
4	62.0	3.2	63.4	71.4	76	21	71.8	66.8	62.0	59.0	56.7
5	61.3	3.2	62.7	71.0	75	21	71.4	66.0	61.3	58.2	56.0
6	64.1	3.5	65.8	74.7	78	22	74.7	69.2	64.1	60.5	58.3
7	62.5	3.4	64.1	72.7	77	22	72.7	67.5	62.5	59.1	57.0
8	61.4	4.0	63.8	73.9	78	25	74.3	67.5	61.1	57.5	55.6
9	62.4	4.1	65.0	75.5	80	27	75.3	68.6	62.1	58.2	56.1
10	63.7	4.1	66.3	76.8	81	26	76.5	69.9	63.6	59.5	57.2
11	65.1	4.1	67.5	78.0	82	27	77.0	71.3	65.0	60.8	58.4
12	65.9	4.1	68.1	78.7	82	25	77.5	72.1	65.7	61.4	59.3
13	72.6	6.0	78.3	93.8	99	39	90.5	80.6	73.1	65.5	61.9
14	76.5	5.0	80.4	93.2	100	36	91.9	83.4	76.6	71.1	67.0

N= 4785

10- 16- 75

1516 HOURS

BAND	A	S	E	N	M	R	1	10	50	90	99
1	73.9	6.8	79.5	96.9	95	37	90.8	84.4	74.3	65.4	60.7
2	77.2	4.6	80.4	92.2	96	31	90.9	84.2	77.3	72.2	68.3
3	59.5	3.0	60.9	68.6	76	23	68.9	64.0	59.6	56.6	55.1
4	62.5	3.3	64.2	72.7	78	23	72.7	67.7	62.4	59.3	57.4
5	62.0	3.5	63.8	72.7	79	24	72.5	67.4	61.8	58.6	56.7
6	64.8	3.5	66.4	75.4	77	20	74.7	70.1	64.8	61.3	59.0
7	63.2	3.6	64.9	74.0	78	22	73.6	68.6	63.0	59.7	57.6
8	61.5	4.2	64.1	74.9	78	24	74.0	68.1	60.8	57.4	55.7
9	62.5	4.4	65.2	76.6	79	25	75.1	69.4	62.0	58.0	56.2
10	63.9	4.4	66.5	77.8	81	26	75.7	70.9	63.5	59.3	57.0
11	65.4	4.3	67.9	79.0	82	26	77.1	72.0	65.2	60.9	58.0
12	66.2	4.3	68.5	79.4	81	24	77.7	72.6	65.9	61.7	58.5
13	73.2	6.1	78.5	94.0	97	38	90.0	81.3	73.8	65.8	61.8
14	77.3	5.0	80.8	93.5	98	36	91.6	84.2	77.5	71.7	67.1

N= 4780

MICROPHONES 8, 9, 10, 11, AND 12 SET 40" HIGHER THAN SPECIFIED

TABLE NO. 21
 STATISTICAL NOISE DATA
 ROADSIDE BARRIER TEST SITE, ANDOVER, MA.

BARRIER HGT 4 FT; ABSORPTIVE; MICROPHONE CONFIGURATION D
 NOISE LEVEL - DBA RE 20 MICROPASCAL

10- 17- 75 917 HOURS

BAND	A	S	E	N	M	R	1	10	50	90	99
111	72.6	6.4	77.7	94.2	94	39	89.7	80.4	73.7	64.4	58.7
2	76.0	5.0	79.5	92.2	94	32	90.7	82.4	76.4	70.6	65.1
3	60.9	3.5	62.5	71.5	75	24	71.4	65.9	61.0	57.3	54.3
4	62.9	3.5	64.4	73.4	75	21	72.8	67.9	63.0	59.1	56.4
5	63.5	3.5	65.1	74.2	75	21	73.5	68.7	63.6	59.8	57.0
6	65.7	3.5	67.3	76.4	77	21	75.4	70.8	66.0	61.9	58.9
7	64.8	3.6	66.4	75.5	76	21	74.6	70.1	65.1	61.0	57.9
8	61.8	4.2	64.0	74.7	75	23	73.1	67.8	61.9	57.2	54.4
9	63.7	4.2	65.9	76.7	76	22	74.7	69.8	63.8	59.0	56.1
10	65.0	4.2	67.2	77.9	78	24	75.8	71.3	65.1	60.3	56.8
11	66.2	4.2	68.3	79.0	79	24	77.0	72.4	66.2	61.6	57.8
12	66.6	4.1	68.6	79.2	79	25	77.0	72.8	66.7	62.2	57.8
13	73.1	6.2	77.8	93.6	95	42	89.5	80.8	74.0	66.1	57.5
14	76.1	5.0	79.4	92.1	94	33	90.4	82.8	76.3	70.8	64.2

N= 4780

10- 17- 75 937 HOURS

BAND	A	S	E	N	M	R	1	10	50	90	99
1	73.7	6.5	79.1	95.8	97	46	90.8	82.4	74.6	65.7	59.4
2	77.4	5.0	80.9	93.7	98	35	91.3	84.6	77.5	71.8	67.6
3	61.8	3.7	63.8	73.3	77	25	74.5	66.5	62.0	58.1	54.2
4	63.7	3.7	65.5	75.0	77	24	75.3	68.7	64.1	59.8	55.4
5	64.8	3.7	66.5	75.9	79	26	75.5	69.9	65.2	61.1	56.1
6	67.1	3.5	68.6	77.6	79	23	76.8	72.1	67.4	63.3	58.4
7	66.2	3.5	67.7	76.8	78	22	76.2	71.3	66.6	62.6	57.6
8	62.4	4.4	64.9	76.1	78	25	75.6	68.8	62.3	57.7	54.7
9	64.6	4.3	67.0	78.1	81	27	76.7	70.9	64.7	59.8	56.6
10	66.0	4.3	68.3	79.4	80	24	77.5	72.3	66.3	61.1	58.0
11	67.4	4.2	69.5	80.4	81	24	78.4	73.5	67.7	62.5	59.5
12	67.9	4.2	69.9	80.7	82	24	78.4	73.9	68.2	63.0	60.2
13	74.5	6.1	79.3	94.8	95	35	90.9	82.6	75.1	66.8	62.5
14	77.4	4.9	81.0	93.6	98	32	91.8	84.6	77.3	72.0	68.8

N= 4730

TABLE NO. 22
 STATISTICAL NOISE DATA
 ROADSIDE BARRIER TEST SITE, ANDOVER, MA.

BARRIER HGT 4 FT; ABSORPTIVE; MICROPHONE CONFIGURATION B

NOISE LEVEL - DBA RE 20 MICROPASCAL

10- 17- 75

1201 HOURS

BAND	A	S	E	N	M	R	1	10	50	90	99
1	71.8	7.6	79.8	99.4	101	50	92.5	81.5	72.5	63.2	53.5
2	75.5	5.8	80.7	95.5	100	43	92.8	83.4	75.6	69.7	60.7
3	63.3	5.8	69.0	83.9	90	42	81.1	72.0	62.9	57.8	50.3
4	67.2	5.9	72.2	87.4	89	39	84.9	75.8	67.1	61.4	52.4
5	69.4	6.1	74.4	89.9	91	41	87.3	77.9	69.7	63.2	52.6
6	71.7	5.6	76.1	90.5	91	39	88.6	79.8	71.5	66.6	56.2
7	70.9	5.9	75.7	90.9	91	40	88.6	79.4	70.9	65.0	54.4
8	67.1	6.5	73.0	89.6	91	40	86.2	75.8	67.6	59.2	54.0
9	69.5	6.1	74.8	90.3	92	38	87.6	77.8	70.1	62.2	56.9
10	70.7	5.9	75.5	90.5	92	37	88.4	78.5	71.2	63.6	58.2
11	72.2	5.5	76.5	90.5	92	35	88.7	79.9	72.5	65.9	60.7
12	72.9	5.2	76.7	90.0	93	34	88.8	80.0	73.0	67.1	62.2
13	73.0	7.0	80.2	98.2	100	45	93.1	81.9	73.8	64.1	59.4
14	75.7	5.7	80.8	95.3	99	38	93.0	83.3	76.2	69.1	64.4

N= 4780

10- 17- 75

1221 HOURS

BAND	A	S	E	N	M	R	1	10	50	90	99
1	72.6	7.0	78.5	96.3	96	42	91.0	80.8	73.9	63.5	56.8
2	75.8	5.2	79.6	93.0	96	34	91.6	82.5	76.2	69.6	64.5
3	64.1	4.9	67.5	80.0	81	29	78.6	71.7	63.8	59.2	55.4
4	67.8	5.2	71.4	84.6	86	32	82.8	75.1	68.0	62.0	57.2
5	70.2	5.3	73.7	87.3	87	33	85.2	77.3	70.7	64.1	57.7
6	72.1	4.9	75.4	87.9	90	33	86.7	79.0	72.3	66.9	61.0
7	71.5	5.2	75.0	88.2	89	34	86.4	78.5	71.8	65.9	59.0
8	67.4	5.6	71.6	86.1	87	35	83.3	75.2	67.8	60.8	55.8
9	69.8	5.4	73.6	87.4	87	33	84.7	77.3	70.1	63.5	58.0
10	70.9	5.3	74.5	88.0	89	33	85.5	78.3	71.3	64.7	59.1
11	72.4	5.0	75.6	88.3	90	31	86.3	79.5	72.6	66.8	61.6
12	72.9	4.7	75.9	87.9	90	30	86.5	79.6	73.1	67.8	63.4
13	73.2	6.5	78.7	95.3	97	42	91.3	81.1	74.2	65.1	59.3
14	76.1	5.1	79.9	92.9	96	35	91.7	82.9	76.4	70.5	64.9

N= 4780

TABLE NO. 23
 STATISTICAL NOISE DATA
 ROADSIDE BARRIER TEST SITE, ANDOVER, MA.

BARRIER HGT 4 FT; ABSORPTIVE; MICROPHONE CONFIGURATION E

NOISE LEVEL - DBA RE 20 MICROPASCAL

10- 17- 75

1030 HOURS

BAND	A	S	E	N	M	R	1	10	50	90	99
1	73.2	6.8	79.1	96.5	99	45	91.1	81.8	74.3	64.4	59.2
2	76.9	5.3	80.8	94.3	98	39	91.8	83.8	77.4	71.3	62.4
3	65.6	4.9	69.3	81.8	87	34	79.9	72.3	65.7	60.2	56.2
4	68.3	5.1	71.8	84.7	87	33	82.9	75.2	68.5	62.7	56.8
5	71.0	5.3	74.5	87.9	91	37	85.5	77.7	71.5	65.0	57.2
6	72.5	4.9	75.5	88.0	90	34	85.9	79.2	72.8	67.3	58.8
7	72.1	5.2	75.5	88.7	91	37	85.9	79.0	72.5	66.3	57.7
8	68.0	5.1	71.8	84.8	89	34	83.0	75.0	68.1	62.5	58.2
9	69.5	5.1	73.0	86.0	91	35	84.2	76.3	69.8	64.0	58.4
10	71.0	5.0	74.3	87.2	90	33	85.0	77.8	71.3	65.6	59.5
11	72.0	4.9	75.2	87.8	90	33	85.8	78.9	72.2	66.6	61.0
12	72.4	4.8	75.5	87.6	89	31	86.1	79.0	72.6	67.5	61.8
13	73.9	6.1	79.1	94.8	99	42	90.6	81.9	74.5	66.5	61.9
14	76.9	5.0	80.6	93.3	99	35	91.8	83.7	77.2	71.4	66.5

N= 4730

10- 17- 75

1050 HOURS

BAND	A	S	E	N	M	R	1	10	50	90	99
1	74.1	6.0	78.4	93.7	94	35	89.4	82.4	74.6	66.7	62.0
2	77.4	4.7	80.5	92.6	93	27	90.5	84.9	77.3	72.4	68.8
3	66.1	4.6	68.7	80.3	80	25	77.8	73.4	66.0	61.3	57.0
4	68.6	4.7	71.4	83.5	85	29	80.9	75.9	68.5	63.6	58.9
5	71.3	4.8	74.1	86.3	87	29	83.6	78.6	71.3	66.1	60.9
6	72.6	4.5	75.2	86.7	87	28	84.3	79.7	72.6	67.9	63.5
7	72.3	4.7	75.0	87.0	87	29	84.4	79.4	72.4	67.2	62.2
8	68.1	4.7	71.0	83.0	85	29	80.5	75.2	68.2	63.1	58.9
9	69.9	4.7	72.5	84.5	87	31	81.5	76.6	70.1	64.9	59.2
10	71.3	4.7	73.9	85.8	87	30	83.0	78.0	71.6	66.4	60.2
11	72.3	4.6	74.8	86.5	87	29	84.0	78.8	72.5	67.6	61.5
12	72.9	4.4	75.2	86.5	87	28	83.8	79.3	73.0	68.2	62.2
13	74.6	5.5	78.6	92.8	95	38	89.7	82.3	75.0	68.3	63.1
14	77.6	4.8	80.6	92.9	96	33	90.7	84.6	77.6	72.4	67.0

N= 4730

TABLES 24-36. NOISE DATA: FOUR FOOT REFLECTIVE BARRIER;
MICROPHONE CONFIGURATIONS B, C, D, E.

TABLE NO. 24
STATISTICAL NOISE DATA
ROADSIDE BARRIER TEST SITE, ANDOVER, MA.

BARRIER HGT 4 FT; REFLECTIVE; MICROPHONE CONFIGURATION B
NOISE LEVEL - DBA RE 20 MICROPASCAL

10- 7- 75		1159 HOURS									
BAND	A	S	E	N	M	R	1	10	50	90	99
1	72.0	7.5	78.6	97.7	95	41	90.8	81.7	72.9	62.1	57.0
2	75.8	5.7	80.1	94.6	96	36	91.4	83.5	75.9	69.3	64.0
3	64.7	5.2	68.1	81.3	81	29	78.0	72.3	64.6	58.7	55.5
4	66.9	5.4	70.4	84.1	84	30	80.2	74.9	67.0	60.4	57.2
5	70.4	5.5	73.9	87.9	89	32	83.8	78.1	70.7	63.4	59.6
6	71.8	5.4	75.3	89.1	91	33	85.2	79.7	72.0	65.0	61.1
7	72.4	5.2	75.7	89.0	90	32	85.3	80.2	72.4	66.3	62.1
8	67.4	6.0	71.9	87.3	88	36	82.7	76.2	67.6	60.2	54.5
9	69.9	5.7	73.6	88.3	87	33	83.7	78.0	70.1	63.2	56.7
10	70.9	5.7	74.5	89.1	89	35	84.3	79.1	71.3	64.2	56.9
11	71.8	5.6	75.2	89.5	88	34	84.6	79.8	72.1	65.4	57.7
12	72.2	5.4	75.3	89.2	87	32	84.3	79.9	72.5	66.1	58.4
13	72.6	7.1	78.9	97.1	96	41	91.3	82.0	73.3	63.5	58.6
14	75.4	6.0	79.8	95.1	95	38	91.0	83.4	76.1	68.5	59.9

N= 4780

TABLE NO. 25
 STATISTICAL NOISE DATA
 ROADSIDE BARRIER TEST SITE, ANDOVER, MA.

BARRIER HGT 4 FT; REFLECTIVE; MICROPHONE CONFIGURATION C
 NOISE LEVEL - DBA RE 20 MICROPASCAL

10- 7- 75 1510 HOUR

BAND A S E N M R I 10 50 90 99

KEY SEARCH CL. X TO CLEAR HISTOS

1	73.1	6.5	78.2	94.9	93	42	89.8	81.7	73.8	65.3	55.5
2	76.0	5.2	79.4	92.7	93	37	90.3	83.1	76.1	70.9	61.0
3	62.1	4.1	64.3	74.9	77	27	74.0	68.0	62.1	58.0	53.2
4	65.4	4.3	67.6	78.5	80	28	76.8	71.7	65.4	61.2	55.7
5	66.5	4.3	68.6	79.5	80	28	77.4	72.5	66.8	62.2	55.3
6	68.2	4.2	70.2	81.0	82	29	79.0	74.2	68.4	63.7	56.5
7	69.6	4.2	71.6	82.2	83	28	80.1	75.7	69.7	65.1	58.6
8	63.9	4.1	66.1	76.5	78	24	75.6	70.0	64.0	59.4	56.4
9	67.4	4.2	69.7	80.5	82	27	79.3	73.5	67.5	62.8	58.6
10	68.4	4.1	70.5	81.1	82	26	80.0	74.4	68.5	64.0	59.8
11	69.7	4.0	71.7	81.9	83	25	80.6	75.5	69.8	65.5	61.3
12	70.2	3.9	72.1	82.1	83	24	80.7	75.9	70.3	66.2	61.9
13	73.5	5.9	78.0	93.0	93	36	89.4	81.5	74.2	66.5	61.4
14	76.0	4.7	79.0	90.9	93	33	89.6	82.7	76.1	71.2	66.3

N= 4780

TABLE NO. 26
 STATISTICAL NOISE DATA
 ROADSIDE BARRIER TEST SITE, ANDOVER, MA.

BARRIER HGT 4 FT; REFLECTIVE; MICROPHONE CONFIGURATION D

NOISE LEVEL - DBA RE 20 MICROPASCAL

10- 7- 75		17 HOURS									
BAND	A	S	E	N	M	R	1	10	50	90	99
1	74.5	6.1	80.0	95.6	99	39	91.7	82.7	75.1	67.1	63.1
2	77.2	4.7	81.2	93.3	100	33	92.1	84.2	77.1	72.4	69.5
3	60.6	3.7	62.5	71.9	77	24	72.0	65.8	60.8	56.6	54.7
4	62.7	3.6	64.5	73.7	78	23	74.5	67.9	62.7	58.8	56.8
5	63.4	3.7	65.3	74.7	79	23	75.2	68.9	63.4	59.5	57.4
6	64.8	3.7	66.8	76.2	81	24	76.8	70.4	64.8	61.1	59.0
7	66.5	3.6	68.4	77.6	83	24	78.2	71.9	66.4	63.0	61.1
8	60.9	4.1	63.5	74.0	79	27	74.8	67.0	60.8	56.6	54.3
9	63.0	4.3	65.7	76.7	83	30	77.3	69.1	62.8	58.6	55.4
10	64.5	4.3	67.4	78.4	84	30	79.1	70.6	64.3	60.3	56.4
11	66.1	4.2	69.0	79.8	86	30	80.7	72.0	66.0	62.0	58.1
12	66.7	4.2	69.5	80.2	86	29	81.2	72.6	66.6	62.6	58.6
13	74.2	6.1	80.1	95.7	102	43	91.2	82.6	74.7	66.8	61.8
14	76.6	4.9	80.9	93.5	101	37	91.5	83.9	76.4	71.6	66.6

N= 4785

TABLE NO. 27
 STATISTICAL NOISE DATA
 ROADSIDE BARRIER TEST SITE, ANDOVER, MA.

BARRIER HGT 4 FT; REFLECTIVE; MICROPHONE CONFIGURATION E
 NOISE LEVEL - DBA RE 20 MICROPASCAL

10- 7- 75		1759 HOURS									
BAND	A	S	E	N	M	R	I	10	50	90	99
1	73.8	5.2	77.7	91.1	95	35	89.5	80.1	74.3	67.8	63.6
2	40.0	.2	40.0	40.7	45	5	41.8	40.9	40.5	40.1	40.0
3	66.3	3.4	68.0	76.6	82	47	77.3	71.1	66.5	63.0	60.3
4	69.7	3.7	71.7	81.1	87	26	81.6	74.8	69.8	66.0	63.2
5	70.9	3.9	73.2	83.2	88	26	83.4	76.3	71.0	66.9	63.8
6	71.4	3.8	73.6	83.3	89	27	83.9	76.8	71.4	67.5	64.3
7	72.2	3.6	74.2	83.3	89	26	84.0	77.4	72.2	68.7	65.7
8	68.6	3.6	70.4	79.7	83	23	80.2	73.6	68.7	64.8	62.0
9	69.8	3.7	71.7	81.2	84	25	81.0	75.0	69.8	66.1	62.4
10	70.6	3.9	72.6	82.4	84	25	81.8	76.1	70.7	66.6	62.6
11	71.4	3.7	73.3	82.7	85	24	82.7	76.9	71.5	67.8	64.1
12	71.7	3.6	73.5	82.6	86	24	82.7	77.0	71.7	68.2	64.4
13	73.5	5.0	77.3	90.2	94	33	88.8	79.9	73.9	68.0	64.5
14	75.5	4.0	78.1	88.3	93	35	88.8	80.7	75.7	71.5	68.3

N= 4780

TABLE NO. 28
 STATISTICAL NOISE DATA
 ROADSIDE BARRIER TEST SITE, ANDOVER, MA.

BARRIER HGT 4 FT; REFLECTIVE; MICROPHONE CONFIGURATION E
 NOISE LEVEL - DBA RE 20 MICROPASCAL

10- 8- 75		1010 HOURS									
BAND	A	S	E	N	M	R	I	10	50	90	99
1	72.1	7.4	79.3	98.4	98	43	91.2	82.3	72.8	63.1	58.1
2					N O D A T A						
3	63.9	5.2	67.7	81.1	83	30	78.2	71.9	63.6	58.2	55.1
4	66.8	5.4	70.9	84.8	86	31	81.7	74.9	66.6	60.9	57.1
5	70.2	5.5	74.4	88.6	91	34	85.4	78.3	70.3	63.8	59.6
6					N O D A T A						
7	73.1	5.2	76.9	90.2	93	32	88.0	81.1	73.0	67.6	63.1
8	65.5	5.6	70.5	85.0	89	36	81.5	74.0	65.2	59.4	55.6
9	68.0	5.8	72.9	87.7	91	37	84.3	76.6	68.0	61.6	56.5
10	69.9	5.7	74.3	88.8	92	37	85.8	78.3	69.9	63.4	58.2
11	71.7	5.5	75.9	90.0	92	35	87.0	80.1	71.7	65.6	60.6
12	72.3	5.3	76.3	89.8	93	35	87.8	80.5	72.1	66.7	61.7
13	72.8	7.0	79.6	97.4	100	46	91.4	82.1	73.3	63.9	59.1
14	85.4	5.7	90.3	105.0	111	45	101.5	93.3	85.3	78.9	73.4

N= 4780

10- 8- 75		1032 HOURS									
BAND	A	S	E	N	M	R	I	10	50	90	99
1	72.8	6.5	78.0	94.7	97	42	89.3	81.3	73.7	64.4	58.8
2	76.2	5.0	79.7	92.4	98	36	89.8	83.1	76.6	70.6	65.5
3	64.5	4.8	67.7	79.9	85	34	78.3	71.0	64.7	59.2	54.0
4	67.0	4.9	70.3	82.8	87	34	80.4	73.7	67.5	61.4	56.2
5	70.6	4.9	73.8	86.4	91	35	83.9	77.3	71.3	64.7	59.3
6					N O D A T A						
7	73.2	4.5	76.0	87.6	93	32	85.7	79.5	73.6	68.1	63.5
8	66.6	5.1	70.3	83.3	88	34	80.6	73.8	67.0	60.5	56.9
9	68.7	5.2	72.4	85.6	91	37	82.7	75.8	69.2	62.3	57.9
10	70.4	5.0	73.6	86.4	91	36	83.6	77.2	71.1	64.4	59.5
11	71.6	4.8	74.8	87.2	92	35	85.0	78.2	72.1	65.9	61.1
12	72.2	4.6	75.0	86.8	92	34	84.2	78.6	72.6	66.7	62.2
13	73.1	6.4	78.4	94.7	99	40	89.0	81.6	73.7	64.9	60.8
14	75.6	5.0	79.3	92.2	101	39	89.8	82.6	76.0	69.7	65.3

N= 4780

TABLE NO. 29
 STATISTICAL NOISE DATA
 ROADSIDE BARRIER TEST SITE, ANDOVER, MA.

BARRIER HGT 4 FT; REFLECTIVE; MICROPHONE CONFIGURATION C

NOISE LEVEL - DBA RE 20 MICROPASCAL

10- 8- 75 1302 HOURS

BAND	A	S	E	N	M	R	1	10	50	90	99
1	71.6	7.2	77.9	96.4	96	44	89.8	81.1	72.5	62.1	57.6
2	75.9	5.5	80.0	94.2	97	37	90.5	83.8	76.1	69.6	65.0
3	60.7	5.1	64.4	77.4	82	32	74.3	68.6	60.2	55.4	53.0
4	64.1	5.2	67.7	81.1	83	31	77.3	72.3	63.9	58.4	55.5
5	65.8	5.1	68.9	81.9	82	29	78.1	73.6	65.8	60.0	57.0
6	68.0	4.9	70.9	83.5	83	30	80.0	75.5	68.1	62.3	59.0
7	69.4	4.9	72.2	84.7	85	31	80.7	76.8	69.5	63.8	60.1
8	62.2	5.2	66.2	79.4	83	32	75.8	70.6	61.7	56.9	54.3
9	66.0	5.2	69.6	83.0	84	29	79.2	74.5	65.7	60.2	56.8
10	67.2	4.9	70.4	83.0	84	28	79.9	75.2	67.1	61.9	58.4
11	69.1	4.7	72.0	84.2	85	28	81.3	76.7	68.9	64.1	60.5
12	70.4	4.5	73.1	84.7	86	28	82.4	77.6	70.1	65.6	62.1
13	72.4	6.7	78.3	95.3	96	39	90.1	81.6	72.9	64.5	60.2
14	75.5	5.3	79.7	93.3	97	33	90.4	83.5	75.4	69.7	66.7

N= 4780

10- 8- 75 1324 HOURS

BAND	A	S	E	N	M	R	1	10	50	90	99
1	71.6	6.4	77.3	93.8	99	45	88.7	79.6	72.5	63.4	58.0
2	75.6	4.9	79.1	91.6	99	37	89.4	82.4	76.0	70.0	65.3
3	61.4	4.0	63.7	74.0	78	25	72.7	67.3	61.5	57.0	54.7
4	64.7	4.3	67.2	78.2	84	30	76.1	70.8	64.9	59.7	57.0
5	66.5	4.3	68.9	79.8	85	30	77.8	72.5	66.7	61.6	58.2
6	68.5	4.3	71.0	82.0	88	31	80.3	74.5	68.7	63.5	59.7
7	69.6	4.2	72.1	82.9	88	31	81.4	75.5	69.8	64.8	60.8
8	63.0	4.0	65.7	75.9	83	29	76.3	68.8	62.7	59.1	56.4
9	66.5	4.2	69.4	80.1	87	31	79.5	72.3	66.6	62.2	58.4
10	67.5	4.1	70.2	80.8	88	31	79.9	73.1	67.7	63.1	59.7
11	69.1	4.1	71.7	82.2	90	33	81.3	74.8	69.2	64.8	61.0
12	70.2	4.0	72.6	82.8	88	30	81.9	75.7	70.4	66.1	62.1
13	72.1	6.0	77.4	92.7	100	44	88.6	79.2	73.0	64.7	59.5
14	75.1	4.8	78.6	91.0	99	37	89.4	81.4	75.3	69.7	64.7

N= 4780

TABLE NO. 30
 STATISTICAL NOISE DATA
 ROADSIDE BARRIER TEST SITE, ANDOVER, MA.

BARRIER HGT 4 FT; REFLECTIVE; MICROPHONE CONFIGURATION B
 NOISE LEVEL - DBA RE 20 MICROPASCAL

10- 8- 75 1149 HOURS

BAND	A	S	E	N	M	R	1	10	50	90	99
1	72.0	7.3	78.9	97.6	98	44	91.0	81.7	72.5	63.0	56.8
2	76.0	5.5	80.5	94.7	97	38	91.9	83.8	76.0	70.2	64.7
3	63.7	5.5	68.0	82.1	82	31	79.4	71.5	63.4	58.0	54.2
4	67.5	5.5	71.5	85.5	85	31	82.4	75.7	67.3	61.4	57.6
5	69.3	5.5	73.1	87.1	87	32	83.3	77.4	69.4	62.8	58.7
6	71.2	5.4	75.0	88.9	89	31	85.7	79.2	71.2	65.0	60.7
7	71.9	5.3	75.7	89.1	89	31	86.5	79.9	71.6	66.4	62.3
8	66.8	6.1	71.8	87.5	87	35	83.4	75.8	66.7	59.4	55.2
9	69.0	5.8	73.5	88.4	88	34	84.5	77.4	68.9	62.3	57.1
10	70.1	5.7	74.2	88.8	89	34	85.2	78.1	70.2	63.4	58.1
11	71.6	5.4	75.4	89.2	90	34	86.1	79.4	71.7	65.6	60.4
12	72.6	5.2	76.1	89.4	91	34	86.7	80.0	72.6	66.9	62.2
13	72.6	7.0	79.1	97.0	97	41	91.5	81.9	73.0	63.9	59.0
14	75.4	5.6	80.0	94.5	98	38	91.7	83.0	75.4	69.1	63.9

N= 4780

10- 8- 75 1210 HOURS

BAND	A	S	E	N	M	R	1	10	50	90	99
1	72.5	6.8	78.4	95.7	95	38	90.7	81.6	73.1	64.0	59.4
2	76.6	5.2	80.4	93.8	95	34	91.8	84.1	76.7	71.1	65.7
3	63.9	4.6	66.8	78.6	85	32	76.8	70.8	63.9	58.7	55.9
4	67.2	4.8	70.3	82.7	84	28	80.7	74.3	67.3	61.7	58.5
5	69.7	5.0	73.0	85.9	86	30	83.6	76.9	69.9	63.7	59.8
6	71.7	5.0	74.9	87.8	89	32	85.3	78.8	71.9	65.9	61.4
7	72.6	4.9	75.7	88.2	89	30	85.9	79.7	72.6	67.2	63.1
8	66.8	5.7	70.9	85.4	85	33	81.8	75.3	67.1	60.1	54.8
9	68.9	5.5	72.7	86.7	87	34	83.4	77.0	69.2	62.4	56.8
10	70.2	5.4	73.7	87.6	90	37	83.8	78.0	70.5	63.7	58.1
11	71.8	5.2	75.1	88.5	89	35	84.7	79.5	72.0	65.9	60.1
12	72.9	5.1	76.0	89.0	89	34	85.6	80.5	73.0	67.4	62.1
13	72.7	7.0	78.8	96.7	98	44	91.2	81.7	73.6	63.9	57.9
14	75.8	5.6	79.8	94.1	94	36	91.3	83.5	76.2	69.4	63.3

N= 4785

TABLE NO. 31
 STATISTICAL NOISE DATA
 ROADSIDE BARRIER TEST SITE, ANDOVER, MA.

BARRIER HGT 4 FT; REFLECTIVE; MICROPHONE CONFIGURATION D

NOISE LEVEL - DBA RE 20 MICROPASCAL

10- 8- 75 1620 HOURS

BAND	A	S	E	N	M	R	1	10	50	90	99
1	75.2	5.2	79.7	93.1	97	35	92.4	81.7	75.6	69.4	65.8
2	77.9	4.2	80.9	91.7	98	31	92.6	83.5	78.0	73.5	70.4
3	62.2	3.1	63.5	71.5	73	18	71.7	67.0	62.3	59.1	57.2
4	64.0	3.2	65.4	73.6	77	20	74.1	68.8	64.0	60.8	59.1
5	64.9	3.2	66.4	74.5	77	19	74.9	69.8	64.8	61.8	60.1
6	65.8	3.2	67.3	75.5	78	19	75.9	70.7	65.8	62.7	61.1
7	67.2	3.2	68.7	77.0	81	20	77.5	72.1	67.2	64.1	62.4
8	62.9	4.0	65.5	75.7	79	23	75.8	69.2	62.5	59.3	57.5
9	65.0	3.9	67.4	77.4	82	24	77.5	71.3	64.6	61.3	59.4
10	66.0	3.8	68.3	78.1	81	23	78.2	72.3	65.7	62.4	60.3
11	66.9	3.8	69.0	78.8	82	23	78.7	73.2	66.5	63.3	61.1
12	67.7	3.7	69.7	79.0	83	23	78.9	73.9	67.5	64.2	62.0
13	74.2	5.2	78.7	92.1	96	34	91.4	80.9	74.5	68.5	63.9
14	77.2	4.3	80.4	91.4	98	31	92.5	83.0	77.3	73.1	69.4

N= 4780

10- 8- 75 1640 HOURS

BAND	A	S	E	N	M	R	1	10	50	90	99
1	75.1	4.1	77.5	88.0	93	29	88.5	79.9	75.8	70.3	66.7
2	77.5	3.0	79.0	86.8	93	23	88.9	81.3	77.9	74.5	72.0
3	62.8	2.4	63.6	69.8	74	17	71.0	66.5	62.9	60.6	58.9
4	64.6	2.3	65.3	71.3	76	17	72.5	68.2	64.7	62.4	60.8
5	65.0	2.2	65.7	71.4	75	15	72.5	68.5	65.2	63.0	61.4
6	65.8	2.3	66.5	72.3	76	16	73.5	69.4	66.0	63.8	62.2
7	67.1	2.2	67.8	73.5	77	15	74.6	70.6	67.4	65.1	63.5
8	64.3	2.5	65.1	71.5	75	17	72.7	68.0	64.5	62.0	60.0
9	65.7	2.5	66.6	73.0	76	17	73.8	69.5	65.9	63.3	61.3
10	66.2	2.5	67.1	73.5	77	18	74.4	70.1	66.4	63.8	61.9
11	66.7	2.5	67.6	74.1	76	15	74.9	70.6	66.9	64.3	62.4
12	67.5	2.5	68.3	74.7	77	16	75.6	71.4	67.6	65.1	63.3
13	74.2	4.0	76.5	86.8	91	28	87.3	78.9	75.0	69.3	66.1
14	76.8	3.3	78.4	86.7	92	24	88.3	80.9	77.2	73.4	70.3

N= 4785

TABLE NO. 32
 STATISTICAL NOISE DATA
 ROADSIDE BARRIER TEST SITE, ANDOVER, MA.

BARRIER HGT 4 FT; REFLECTIVE; MICROPHONE CONFIGURATION D
 NOISE LEVEL - DBA RE 20 MICROPASCAL

10- 8- 75 1710 HOURS

BAND	A	S	E	N	M	R	1	10	50	90	99
1	74.7	4.4	77.4	88.7	94	31	87.6	80.2	75.3	69.5	65.4
2	77.3	3.3	79.0	87.6	94	28	88.2	82.0	77.6	74.1	70.9
3	61.3	2.7	62.3	69.3	75	19	69.3	66.0	61.3	58.8	57.2
4	62.9	2.8	64.0	71.1	77	19	71.1	67.7	62.9	60.4	59.1
5	63.7	2.8	64.8	71.9	76	18	71.9	68.5	63.7	61.2	59.8
6	64.8	2.7	65.9	72.9	78	19	73.0	69.6	64.7	62.3	61.0
7	66.4	2.7	67.5	74.4	79	18	74.8	71.1	66.4	64.1	62.4
8	63.2	3.0	64.5	72.1	75	19	72.7	68.1	63.1	60.4	58.3
9	64.8	3.0	66.1	73.9	77	20	73.9	69.9	64.7	62.0	59.7
10	65.6	3.0	66.9	74.6	77	18	74.7	70.6	65.6	62.8	60.7
11	66.4	3.0	67.7	75.3	78	20	75.6	71.3	66.4	63.6	61.5
12	67.2	2.9	68.4	75.9	78	17	76.2	72.0	67.2	64.5	62.6
13	73.8	4.6	76.8	88.5	94	33	87.4	79.6	74.4	68.4	65.1
14	76.7	3.6	78.8	88.0	95	28	88.8	81.6	77.0	73.0	70.1

N= 4780

TABLE NO. 33
 STATISTICAL NOISE DATA
 ROADSIDE BARRIER TEST SITE, ANDOVER, MA.

BARRIER HGT 4 FT; REFLECTIVE; MICROPHONE CONFIGURATION D
 NOISE LEVEL - DBA RE 20 MICROPASCAL

10- 9- 75 906 HOURS

BAND	A	S	E	N	M	R	1	10	50	90	99
1	76.2	5.8	81.1	95.9	98	39	92.9	83.9	76.5	69.6	64.1
2	78.8	4.9	82.5	95.2	100	36	94.0	85.5	78.8	73.6	69.1
3	64.0	4.0	66.1	76.3	79	24	75.2	70.0	64.0	59.8	57.4
4	65.6	3.9	67.6	77.5	79	21	76.5	71.4	65.8	61.3	59.2
5	66.7	3.7	68.5	78.0	80	21	77.2	72.2	66.9	62.5	60.3
6	68.0	3.7	69.7	79.2	81	22	78.3	73.5	68.3	64.0	61.2
7	68.5	3.7	70.2	79.7	82	22	78.8	73.9	68.7	64.5	61.7
8	64.4	4.5	66.9	78.4	78	24	76.1	71.2	64.5	59.3	56.2
9	67.0	4.4	69.3	80.6	80	25	78.2	73.5	67.1	61.9	58.5
10	67.4	4.4	69.7	80.9	80	25	78.6	73.8	67.5	62.4	59.0
11	68.2	4.3	70.4	81.5	81	25	79.3	74.6	68.2	63.4	60.0
12	68.9	4.2	71.0	81.8	83	26	79.8	75.1	69.0	64.2	60.8
13	76.6	5.7	81.2	95.8	99	37	93.1	84.2	77.1	69.5	65.0
14	77.3	5.2	81.3	94.7	98	33	92.7	84.5	77.4	71.2	67.6

N= 4780

10- 9- 75 926 HOURS

BAND	A	S	E	N	M	R	1	10	50	90	99
1	74.5	5.8	78.6	93.4	93	33	89.9	81.9	75.1	67.2	63.0
2	77.2	4.7	80.1	92.3	94	30	90.6	83.6	77.5	71.7	67.8
3	62.3	3.9	64.2	74.1	75	24	73.0	67.7	62.6	57.9	55.0
4	63.3	3.7	64.9	74.3	74	20	72.5	68.6	63.7	59.0	56.2
5	65.2	3.6	66.6	75.7	76	21	73.9	70.3	65.6	60.9	58.1
6	66.5	3.5	67.9	76.8	78	21	75.2	71.6	67.0	62.4	59.8
7	67.1	3.4	68.4	77.2	77	19	75.5	72.1	67.5	63.1	60.3
8	62.6	4.3	64.9	75.9	76	25	73.5	69.0	62.7	57.6	54.4
9	65.3	4.2	67.4	78.3	77	23	75.6	71.5	65.6	60.3	57.1
10	66.0	4.1	67.9	78.4	77	22	75.6	72.0	66.4	61.1	58.0
11	66.9	4.0	68.7	78.9	77	21	75.8	72.8	67.2	62.0	58.8
12	67.7	3.9	69.4	79.5	78	21	76.6	73.5	68.1	63.0	59.5
13	75.0	5.4	78.9	92.7	94	32	90.3	82.4	75.5	68.4	64.3
14	75.9	4.9	79.0	91.6	93	32	89.4	82.9	76.1	70.5	65.2

N= 4730

TABLE NO. 34
 STATISTICAL NOISE DATA
 ROADSIDE BARRIER TEST SITE, ANDOVER, MA.

BARRIER HGT 4 FT; REFLECTIVE; MICROPHONE CONFIGURATION E

NOISE LEVEL - DBA RE 20 MICROPASCAL

10- 9- 75 1020 HOUR

BAND	A	S	E	N	M	R	1	10	50	90	99
1	75.4	5.3	80.0	93.6	99	38	91.8	82.0	75.9	69.3	65.3
2	77.7	4.8	81.3	93.5	100	34	92.5	84.1	77.9	72.3	68.9
3	67.3	4.3	70.0	81.1	84	29	81.3	73.4	67.4	62.7	59.1
4	69.1	4.5	72.0	83.4	86	28	83.2	75.3	69.3	64.2	60.3
5	72.3	4.4	75.2	86.4	91	30	85.9	78.1	72.5	67.5	64.0
6	73.5	4.3	76.2	87.1	91	29	87.0	79.3	73.5	68.9	65.9
7	73.8	4.1	76.3	86.9	91	29	86.7	79.6	73.8	69.3	66.9
8	68.0	4.7	71.4	83.6	88	31	83.0	74.4	67.9	62.7	59.5
9	70.6	4.7	73.9	86.0	90	30	84.9	77.0	70.7	65.4	61.5
10	71.7	4.5	74.6	86.1	90	29	84.7	78.0	71.8	66.8	62.9
11	72.8	4.5	75.7	87.1	91	30	86.7	79.0	72.7	68.0	64.1
12	73.5	4.3	76.2	87.3	91	29	86.7	79.7	73.3	68.9	65.4
13	75.4	5.4	79.9	93.7	100	37	92.0	82.0	76.0	69.0	65.2
14	76.7	4.7	80.2	92.3	98	34	92.1	82.9	76.7	71.6	67.7

N= 4780

10- 9- 75 1040 HOURS

BAND	A	S	E	N	M	R	1	10	50	90	99
1	74.2	5.9	78.5	93.5	94	36	90.1	82.0	74.7	67.5	61.2
2	76.6	5.1	79.9	92.9	94	33	90.7	83.6	76.9	70.9	64.8
3	65.7	4.8	68.4	80.6	80	29	78.2	72.6	65.9	60.5	55.3
4	67.4	4.9	70.3	82.8	83	31	80.2	74.3	67.6	62.2	55.7
5	71.0	4.9	73.9	86.5	87	32	83.7	77.8	71.3	65.9	57.8
6	72.2	4.8	74.9	87.2	87	31	84.6	78.7	72.3	67.4	59.0
7	72.3	4.8	74.9	87.1	86	30	84.4	78.9	72.5	67.6	58.7
8	67.1	4.8	70.1	82.3	83	27	80.1	73.8	67.5	61.6	58.3
9	69.6	4.8	72.5	84.9	85	28	82.0	76.2	70.1	63.6	60.2
10	70.9	4.8	73.6	86.0	87	30	83.3	77.4	71.4	64.7	61.0
11	71.6	4.7	74.2	86.1	87	29	83.7	77.9	72.0	65.8	62.0
12	72.2	4.5	74.7	86.3	87	28	84.2	78.5	72.7	66.9	62.5
13	74.9	5.4	78.8	92.5	95	34	89.7	82.1	75.4	68.4	64.1
14	75.5	5.0	79.0	91.8	95	32	89.8	82.6	75.7	70.0	66.1

N= 4780

TABLE NO. 36
 STATISTICAL NOISE DATA
 ROADSIDE BARRIER TEST SITE, ANDOVER, MA.

BARRIER HGT 4 FT; REFLECTIVE; MICROPHONE CONFIGURATION C

NOISE LEVEL - DBA RE 20 MICROPASCAL

10- 9- 75

1511 HOURS

BAND	A	S	E	N	M	R	1	10	50	90	99
1	74.1	6.1	79.1	94.6	96	41	91.3	81.6	74.9	66.9	61.2
2	76.9	4.7	80.3	92.3	96	33	91.6	83.0	77.1	72.1	67.3
3	60.9	4.9	64.1	76.5	77	29	74.0	68.4	60.5	56.0	52.0
4	64.9	4.8	68.0	80.3	82	30	77.9	72.3	64.6	59.9	55.9
5	66.9	4.6	69.7	81.4	83	30	78.9	74.0	66.8	62.2	57.6
6	68.7	4.5	71.3	82.7	85	30	80.7	75.4	68.7	64.2	59.5
7	70.2	4.2	72.7	83.4	87	29	82.5	76.1	70.3	66.1	61.4
8	63.2	4.7	66.1	78.2	79	28	75.9	70.3	63.2	58.0	54.2
9	67.5	4.5	70.2	81.8	82	28	79.7	74.5	67.7	62.7	58.1
10	68.5	4.3	70.9	81.9	83	26	79.9	75.0	68.5	63.8	59.8
11	70.0	4.1	72.2	82.9	85	26	81.4	76.2	70.1	65.6	61.6
12	70.9	4.0	73.0	83.2	85	26	81.9	77.0	70.9	66.8	62.8
13	74.5	5.5	78.6	92.6	95	37	90.5	80.8	75.3	67.9	62.4
14	76.2	4.6	79.4	91.3	94	31	90.5	82.3	76.5	71.2	67.1

N= 4780

10- 9- 75

1531 HOURS

BAND	A	S	E	N	M	R	1	10	50	90	99
1	75.1	5.2	78.9	92.3	95	35	90.2	81.7	75.8	68.9	64.2
2	77.5	4.1	80.1	90.5	95	28	90.7	82.9	77.8	73.2	70.1
3	61.7	4.2	64.3	75.2	77	24	74.9	68.4	61.4	57.3	55.0
4	65.4	4.0	67.6	77.8	79	23	76.6	71.8	65.3	61.2	58.5
5	67.5	3.7	69.4	78.9	80	22	78.0	73.2	67.7	63.6	60.6
6	69.2	3.5	70.9	80.0	81	21	79.3	74.5	69.5	65.5	62.3
7	70.9	3.4	72.4	81.2	82	20	80.8	76.1	71.1	67.3	64.4
8	64.0	4.0	66.2	76.4	77	23	75.4	70.6	63.9	59.9	57.5
9	68.2	3.7	70.1	79.6	81	23	78.4	74.3	68.3	64.4	61.3
10	69.0	3.5	70.6	79.6	80	20	78.7	74.7	69.1	65.4	62.6
11	70.3	3.4	71.8	80.4	81	19	79.6	75.7	70.5	66.9	64.1
12	71.3	3.2	72.6	80.9	82	19	80.2	76.4	71.4	68.0	65.4
13	75.5	4.9	78.7	91.2	93	31	89.6	82.1	75.9	70.0	66.0
14	76.9	4.0	79.3	89.6	93	27	89.4	82.7	77.0	72.8	69.5

N= 4780

TABLES 37-44. NOISE DATA: EIGHT FOOT ABSORPTIVE BARRIER;
MICROPHONE CONFIGURATIONS B, C, D, E.

TABLE NO. 37
STATISTICAL NOISE DATA
ROADSIDE BARRIER TEST SITE, ANDOVER, MA.

BARRIER HGT 8 FT; ABSORPTIVE; MICROPHONE CONFIGURATION B
NOISE LEVEL - DBA RE 20 MICROPASCAL

10- 29- 75 985 HOURS

BAND	A	S	E	N	M	R	1	10	50	90	99
1	72.8	6.6	78.2	95.1	98	43	89.7	80.4	74.1	64.2	58.3
2	75.3	5.5	79.4	93.5	99	39	90.0	82.4	76.0	68.5	63.5
3	60.2	4.6	63.3	75.1	78	28	73.9	67.2	59.9	55.4	52.5
4	62.4	4.8	65.8	78.2	82	30	77.0	69.6	62.0	57.4	54.4
5	65.5	5.0	68.8	81.6	84	30	79.5	72.8	65.5	59.9	56.2
6	68.3	5.0	71.3	84.0	86	32	80.9	75.3	68.6	62.2	57.5
7	71.0	4.9	73.8	86.4	90	34	82.6	77.8	71.5	65.1	59.7
8	66.2	5.8	70.6	85.5	90	40	81.2	73.8	66.8	59.4	52.8
9	69.4	5.3	73.0	86.6	91	40	82.8	76.5	69.9	63.4	55.8
10	70.5	4.9	73.7	86.4	92	37	83.4	77.2	71.0	65.0	58.5
11	71.4	4.7	74.4	86.3	93	35	84.1	78.1	71.7	66.5	60.9
12	72.8	4.4	75.5	86.9	94	34	84.6	79.2	72.9	68.3	63.2
13	74.2	5.8	79.0	93.8	100	40	90.2	81.1	75.0	67.2	62.5
14	75.7	5.0	79.4	92.3	100	38	89.6	82.5	76.0	70.3	64.8

N= 4780

10- 29- 75 1005 HOURS

BAND	A	S	E	N	M	R	1	10	50	90	99
1	74.3	6.6	79.5	96.3	98	45	91.2	82.7	75.1	66.3	56.5
2	77.0	5.3	80.6	94.2	97	37	91.7	83.9	77.4	70.8	65.0
3	62.1	4.4	64.6	75.8	79	28	74.6	68.2	62.3	57.0	52.7
4	64.1	4.5	66.7	78.2	80	28	76.9	70.4	64.4	58.9	54.7
5	66.6	4.7	69.3	81.4	84	31	79.5	73.0	66.8	61.2	55.9
6	69.4	4.8	72.0	84.2	85	30	81.6	75.9	69.8	63.7	58.2
7	72.2	4.7	74.7	86.8	88	30	83.9	78.6	72.6	66.5	61.1
8	67.6	5.7	71.6	86.2	87	35	82.0	75.4	68.1	60.7	55.1
9	70.9	5.2	74.0	87.3	89	34	83.8	77.9	71.6	64.8	58.8
10	72.0	4.9	74.8	87.3	89	32	84.4	78.6	72.6	66.2	60.4
11	72.9	4.7	75.4	87.4	90	32	84.9	79.2	73.3	67.6	61.8
12	74.1	4.4	76.5	87.8	90	31	85.7	80.2	74.6	69.2	64.3
13	75.6	5.9	80.0	95.2	98	39	91.2	83.3	76.3	68.2	62.8
14	77.0	5.0	80.4	93.3	98	35	90.7	83.7	77.4	71.1	66.2

N= 4780

TABLE NO. 38
 STATISTICAL NOISE DATA
 ROADSIDE BARRIER TEST SITE, ANDOVER, MA.

BARRIER HGT 8 FT; ABSORPTIVE; MICROPHONE CONFIGURATION C
 NOISE LEVEL - DBA RE 20 MICROPASCAL

10- 29- 75 1131 HOURS

BAND	A	S	E	N	M	R	1	10	50	90	99
1	71.5	7.7	78.2	97.9	96	44	89.7	82.2	72.2	62.0	55.3
2	74.1	6.1	78.8	94.5	95	37	89.7	83.1	74.6	67.1	61.7
3	58.8	4.5	61.3	73.0	73	24	70.7	65.5	58.8	54.0	51.2
4	60.8	4.7	63.4	75.4	74	23	72.7	67.6	60.8	55.7	53.1
5	61.8	4.9	64.7	77.2	76	26	74.4	68.8	61.7	56.4	53.2
6	63.3	4.8	66.1	78.5	77	25	75.2	70.5	63.4	57.9	54.2
7	66.0	4.7	68.6	80.7	79	26	77.6	72.9	66.2	60.8	56.2
8	61.0	5.9	65.4	80.4	81	32	75.8	69.8	60.8	54.3	51.0
9	65.4	6.1	69.8	85.4	86	35	80.1	74.3	65.6	58.0	53.8
10	67.3	5.7	71.1	85.6	88	36	81.2	75.4	67.5	60.6	56.2
11	68.5	5.5	72.0	86.1	89	35	81.7	76.2	68.6	61.9	57.4
12	69.2	5.3	72.5	86.2	88	34	81.9	76.7	69.5	62.8	58.4
13	72.9	7.1	79.0	97.1	97	42	90.4	82.8	73.3	64.2	58.6
14	74.9	5.8	79.5	94.5	97	36	90.3	83.4	75.0	68.2	63.8

N= 4785

10- 29- 75 1151 HOURS

BAND	A	S	E	N	M	R	1	10	50	90	99
1	73.0	7.0	79.3	97.1	99	47	91.3	81.8	73.9	64.1	57.1
2	75.8	5.8	80.3	95.2	97	40	91.8	83.8	76.1	69.3	61.6
3	59.6	4.3	61.9	72.9	73	25	71.0	66.0	59.6	55.0	51.5
4	61.8	4.5	64.4	75.8	78	28	73.7	68.4	61.9	57.0	53.4
5	62.8	4.8	65.8	78.0	81	32	75.5	69.8	62.9	57.6	53.3
6	64.4	5.0	67.4	80.2	84	34	77.0	71.5	64.5	58.9	54.3
7	67.1	4.9	70.0	82.7	84	32	79.5	74.3	67.1	61.6	57.1
8	61.6	5.5	65.7	79.8	81	31	77.1	69.9	61.3	55.6	52.1
9	66.4	5.7	70.5	85.2	85	33	81.7	74.6	66.7	59.6	55.3
10	68.5	5.4	72.2	86.0	87	33	82.9	75.9	68.8	62.2	57.3
11	69.9	5.2	73.3	86.7	89	35	83.9	76.9	70.3	64.0	59.0
12	70.7	5.1	73.9	86.9	89	35	84.5	77.6	71.0	65.0	60.2
13	74.3	6.3	80.1	96.3	100	43	92.7	82.2	75.1	66.6	61.3
14	76.5	5.4	80.8	94.5	98	36	92.8	83.8	76.9	70.4	66.6

N= 4780

TABLE NO. 39
 STATISTICAL NOISE DATA
 ROADSIDE BARRIER TEST SITE, ANDOVER, MA.

BARRIER HGT 8 FT; ABSORPTIVE; MICROPHONE CONFIGURATION E

NOISE LEVEL - DBA RE 20 MICROPASCAL

10- 29- 75

1509 HOURS

BAND	A	S	E	N	M	R	1	10	50	90	99
1	75.7	5.2	79.4	92.7	95	34	90.4	82.6	76.2	69.8	64.4
2	77.8	4.3	80.5	91.5	95	29	90.4	84.0	77.9	73.3	69.3
3	63.5	3.7	65.3	74.8	76	21	73.7	69.2	63.7	59.5	57.2
4	65.4	3.9	67.4	77.3	81	24	76.0	71.3	65.5	61.3	58.9
5	67.5	4.0	69.6	79.8	83	26	78.2	73.5	67.6	63.2	60.3
6	70.1	4.0	72.1	82.3	86	28	80.3	76.0	70.2	65.8	62.2
7	72.4	3.9	74.4	84.3	88	28	82.5	78.2	72.6	68.2	64.7
8	66.9	4.3	69.9	81.0	90	35	80.3	72.9	67.0	62.6	58.6
9	68.6	4.3	71.3	82.1	89	32	81.0	74.4	68.8	64.1	59.7
10	70.1	4.0	72.4	82.6	90	32	81.8	75.5	70.4	66.0	61.4
11	71.7	3.8	73.8	83.6	90	30	82.9	77.0	71.9	67.8	63.4
12	72.9	3.8	74.9	84.6	90	30	83.7	78.5	73.1	69.1	65.1
13	76.7	4.7	80.1	92.3	101	37	90.6	83.0	77.2	71.4	67.1
14											

N O D A T A

N= 4780

10- 29- 75

1529 HOURS

BAND	A	S	E	N	M	R	1	10	50	90	99
1	76.3	4.7	79.6	91.7	94	31	90.8	82.7	76.6	71.8	66.3
2	77.9	4.0	80.3	90.6	94	26	90.6	83.8	77.8	73.8	70.7
3	63.0	3.4	64.5	73.1	76	20	72.6	68.3	63.0	59.6	58.0
4	64.8	3.5	66.4	75.3	76	19	74.3	70.4	64.8	61.2	59.4
5	66.9	3.6	68.6	77.7	79	20	77.0	72.7	66.7	63.3	61.2
6	69.6	3.6	71.4	80.6	83	22	80.0	75.4	69.5	66.2	63.6
7	72.2	3.5	73.9	83.0	84	20	82.5	77.9	72.2	68.6	66.2
8	66.9	4.3	69.7	80.6	84	27	80.6	72.8	67.0	62.3	59.7
9	68.5	4.2	71.1	81.9	85	27	81.7	74.2	68.7	63.8	60.8
10	70.0	4.0	72.2	82.4	84	23	82.3	75.5	70.3	65.8	62.6
11	71.6	3.8	73.7	83.4	86	24	83.2	77.3	71.8	67.7	64.9
12	73.0	3.7	74.9	84.3	86	22	83.9	78.6	73.1	69.1	66.6
13	76.5	4.8	79.9	92.1	95	32	91.4	82.9	77.0	71.0	66.7
14											

N O D A T A

N= 4785

TABLE NO. 40
 STATISTICAL NOISE DATA
 ROADSIDE BARRIER TEST SITE, ANDOVER, MA.

BARRIER HGT 8 FT; ABSORPTIVE, MICROPHONE CONFIGURATION D
 NOISE LEVEL - DBA RE 20 MICROPASCAL

10- 29- 75 1359 HOURS

BAND	A	S	E	N	M	R	1	10	50	90	99
1	73.1	6.7	78.4	95.6	95	40	90.1	81.8	73.9	64.7	58.8
2	75.8	5.4	79.5	93.4	94	33	90.1	83.5	76.1	69.3	64.6
3	57.4	3.7	59.1	68.7	70	20	67.3	63.2	57.3	53.3	51.3
4	59.6	3.8	61.4	71.1	72	21	69.7	65.5	59.5	55.4	53.4
5	59.9	3.8	61.8	71.6	73	22	70.2	65.9	59.9	55.8	53.2
6	60.2	4.0	62.2	72.3	73	23	71.0	66.1	60.1	56.1	53.0
7	61.4	4.0	63.4	73.6	75	23	72.1	67.4	61.5	57.2	53.9
8	58.2	4.5	60.6	72.0	73	26	69.8	64.4	58.6	52.9	49.9
9	60.5	4.7	62.9	75.0	73	25	71.7	67.0	61.0	54.8	51.0
10	63.0	4.8	65.4	77.6	75	25	73.6	69.5	63.7	56.9	52.6
11	65.1	4.8	67.3	79.5	76	24	75.2	71.4	66.1	58.9	54.4
12	66.5	4.7	68.7	80.8	79	25	76.2	72.7	67.5	60.3	55.6
13	74.1	6.6	79.0	95.8	95	38	90.1	82.5	75.5	65.1	60.6
14											

N O D A T A

N= 4780

TABLE NO. 41
 STATISTICAL NOISE DATA
 ROADSIDE BARRIER TEST SITE, ANDOVER, MA.

BARRIER HGT 8 FT; ABSORPTIVE; MICROPHONE CONFIGURATION E

NOISE LEVEL - DBA RE 20 MICROPASCAL

10- 31- 75

905 HOURS

BAND	A	S	E	N	M	R	1	10	50	90	99
1	73.8	6.8	79.0	96.5	96	42	91.1	82.0	75.2	64.3	58.1
2	76.2	5.5	80.1	94.1	96	36	91.4	83.1	76.8	69.7	63.5
3	63.6	4.3	66.5	77.5	82	28	77.2	69.9	63.3	59.4	56.5
4	65.8	4.4	68.7	79.9	83	27	79.1	72.5	65.5	61.4	58.8
5	67.2	4.7	70.3	82.2	85	29	80.5	74.1	67.2	62.2	59.0
6	70.4	5.0	73.3	86.2	86	29	82.9	77.2	71.1	64.1	60.1
7	72.0	4.9	74.9	87.4	89	30	85.0	78.6	72.4	66.0	61.8
8	67.8	5.1	71.6	84.8	88	33	82.8	74.5	68.2	61.7	57.8
9	69.4	5.2	73.0	86.2	90	35	83.8	76.0	69.9	63.1	59.1
10	69.5	5.1	73.0	86.1	90	35	83.8	76.0	69.9	63.4	58.7
11	70.7	5.0	74.0	86.7	89	34	84.7	77.5	71.1	65.1	59.3
12	71.8	4.8	74.6	86.9	89	33	84.9	78.3	72.1	66.5	60.0
13							N O D A T A				
14	76.0	5.3	79.8	93.3	96	36	90.9	82.9	76.4	69.7	63.6

N= 4780

10- 31- 75

925 HOURS

BAND	A	S	E	N	M	R	1	10	50	90	99
1	73.5	6.5	78.5	95.1	95	38	90.3	81.7	74.6	64.8	60.0
2	76.4	5.0	79.7	92.6	95	32	90.6	83.1	77.0	70.4	66.7
3	63.7	4.2	65.9	76.7	81	27	74.4	69.6	64.1	58.7	56.4
4	66.1	4.2	68.4	79.2	83	26	76.6	72.3	66.6	61.0	58.7
5	67.0	4.4	69.5	80.8	85	28	78.5	73.4	67.3	61.8	59.3
6	69.7	4.5	72.1	83.6	85	27	81.4	76.2	70.1	64.3	61.9
7	71.7	4.5	74.2	85.6	86	25	83.5	78.2	72.2	66.3	63.5
8	67.1	4.9	70.4	82.9	86	34	81.1	73.4	67.6	61.6	56.5
9	68.9	5.0	72.2	85.0	87	32	82.7	75.5	69.5	63.1	57.8
10	69.3	4.9	72.3	84.7	87	32	82.4	75.8	70.0	63.6	58.6
11	70.8	4.6	73.5	85.3	88	32	82.9	77.3	71.3	65.4	60.5
12	71.8	4.5	74.2	85.7	87	29	83.4	78.4	72.3	66.8	61.9
13							N O D A T A				
14	76.1	5.1	79.3	92.2	93	39	90.1	82.5	76.8	70.1	63.1

N= 4780

TABLE NO. 42
 STATISTICAL NOISE DATA
 ROADSIDE BARRIER TEST SITE, ANDOVER, MA.

BARRIER HGT 8 FT; ABSORPTIVE; MICROPHONE CONFIGURATION D

NOISE LEVEL - DBA RE 20 MICROPASCAL

10- 31- 75

1046 HOURS

BAND	A	S	E	N	M	R	1	10	50	90	99
1	73.9	6.8	79.9	97.4	99	44	92.2	82.1	75.1	65.1	58.6
2	76.6	5.5	80.6	94.7	98	37	91.8	83.9	77.1	70.2	64.8
3	60.8	3.2	62.1	70.4	71	20	69.6	65.8	61.1	57.5	54.5
4	63.4	3.3	64.7	73.1	75	20	72.1	68.2	63.7	59.7	57.1
5	62.3	3.5	63.9	72.9	76	22	71.8	67.5	62.8	58.4	55.6
6	62.9	3.6	64.5	73.8	76	22	72.5	68.3	63.3	58.8	56.2
7	64.1	3.6	65.7	75.1	77	22	73.5	69.3	64.6	59.9	57.2
8	62.1	4.0	64.5	74.8	78	25	74.5	67.7	62.2	57.8	55.2
9	64.6	4.3	67.1	78.0	81	27	77.1	70.5	64.8	60.0	56.9
10	65.6	4.2	68.0	78.7	83	28	77.7	71.3	66.0	61.0	57.0
11	67.1	4.2	69.5	80.3	84	28	79.6	72.7	67.5	62.3	58.3
12	68.0	4.2	70.3	81.2	84	27	80.6	73.7	68.5	63.2	59.1
13											
14	76.6	5.2	80.6	94.0	100	50	92.0	83.5	76.9	70.7	66.2

N= 4725

10- 31- 75

1123 HOURS

BAND	A	S	E	N	M	R	1	10	50	90	99
1	71.6	7.3	77.7	96.4	95	42	90.1	80.9	72.7	62.2	56.6
2	74.6	5.6	78.5	92.8	94	35	89.6	81.9	75.1	67.9	62.1
3	59.4	3.2	60.7	68.9	70	19	67.7	64.7	59.3	56.1	54.0
4	61.8	3.4	63.2	71.8	73	19	70.9	67.0	61.7	58.3	56.4
5	60.5	3.5	62.1	70.9	73	21	70.1	66.0	60.4	57.0	54.7
6	60.8	3.5	62.4	71.4	74	22	70.4	66.4	60.7	57.3	55.0
7	61.9	3.5	63.5	72.3	74	20	71.5	67.4	62.0	58.4	55.7
8	59.4	4.1	61.6	72.0	74	23	70.1	66.0	59.2	55.2	52.7
9	61.7	4.3	64.1	75.2	78	26	72.9	68.4	61.6	57.2	54.0
10	62.8	4.2	65.0	75.8	78	27	73.3	69.3	62.8	58.3	54.6
11	64.3	4.2	66.3	77.0	79	26	74.1	70.6	64.5	59.7	56.0
12	65.3	4.1	67.2	77.7	80	26	74.8	71.4	65.7	60.5	57.2
13	71.9	6.1	76.5	92.1	92	38	88.1	79.6	72.5	64.8	58.8
14											

N= 4780

TABLE NO. 43
 STATISTICAL NOISE DATA
 ROADSIDE BARRIER TEST SITE, ANDOVER, MA.

BARRIER HGT 8 FT; ABSORPTIVE; MICROPHONE CONFIGURATION C
 NOISE LEVEL - DBA RE 20 MICROPASCAL

10- 31- 75 1250 HOURS

BAND	A	S	E	N	M	R	1	10	50	90	99
1	72.9	7.4	80.0	98.9	98	45	92.7	82.3	73.8	63.7	58.2
2	75.4	5.8	80.6	95.5	98	38	92.7	83.3	75.6	69.1	63.0
3	61.1	4.4	64.0	75.2	78	26	74.3	67.5	61.0	56.6	53.6
4	64.2	4.5	67.3	79.0	82	27	77.9	70.9	64.1	59.5	57.0
5	63.7	4.8	67.2	79.6	83	29	78.2	70.8	63.4	58.7	56.1
6	64.8	4.8	68.3	80.6	83	29	79.2	72.0	64.5	59.8	56.9
7	66.8	4.7	70.0	82.2	85	30	80.5	74.0	66.7	61.8	58.4
8	64.4	5.1	68.3	81.5	85	33	79.0	72.3	64.2	59.0	55.1
9	68.4	5.3	72.3	85.8	87	32	82.9	76.7	68.4	62.6	58.5
10	68.9	5.2	72.6	86.0	89	34	83.0	77.1	68.9	63.1	58.4
11	69.9	5.2	73.5	86.7	90	33	83.7	77.7	70.1	64.1	59.2
12	70.7	5.0	74.0	86.8	89	32	83.9	78.3	70.9	65.1	60.1
13	74.0	6.7	80.1	97.2	99	42	92.6	82.4	74.9	66.0	60.0
14											
15	73.0	5.6	77.2	91.5	95	34	88.3	80.2	73.8	66.2	63.2
N=	4780										

10- 31- 75 1307 HOURS

BAND	A	S	E	N	M	R	1	10	50	90	99
1	73.8	7.5	80.9	100.1	98	43	93.2	84.6	74.3	64.9	58.8
2	76.3	6.0	81.4	96.8	100	38	92.9	85.2	76.1	70.0	64.7
3	61.6	4.1	64.0	74.6	78	26	73.3	67.8	61.5	57.3	54.8
4	64.7	4.2	67.1	77.9	81	26	76.7	71.1	64.5	60.3	57.7
5	64.1	4.6	67.1	78.8	83	29	77.3	71.0	63.9	59.4	56.6
6	65.3	4.6	68.3	80.2	84	30	78.6	72.3	65.1	60.4	57.4
7	67.2	4.6	70.2	82.0	84	28	80.3	74.3	67.1	62.4	58.7
8	64.0	5.1	67.7	80.7	84	31	78.5	71.6	63.5	58.8	56.0
9	68.4	5.4	72.3	86.0	88	32	82.9	76.6	68.1	62.5	59.0
10	69.4	5.2	73.1	86.5	89	32	84.0	77.2	69.2	63.7	60.0
11	70.6	5.1	74.1	87.2	90	32	84.7	78.0	70.4	65.0	61.3
12	71.5	4.9	74.8	87.4	90	31	85.4	78.5	71.4	66.1	62.4
13	74.8	6.6	80.7	97.6	99	39	92.5	84.1	75.1	66.9	63.3
14											
16	75.0	5.6	79.2	93.5	94	32	90.7	82.6	75.5	68.3	64.4
N=	4785										

TABLE NO. 44
 STATISTICAL NOISE DATA
 ROADSIDE BARRIER TEST SITE, ANDOVER, MA.

BARRIER HGT 8 FT; ABSORPTIVE; MICROPHONE CONFIGURATION B
 NOISE LEVEL - DBA RE 20 MICROPASCAL

10- 31- 75

1433 HOURS

BAND	A	S	E	N	M	R	1	10	50	90	99
1	76.0	5.6	79.7	94.0	95	37	90.4	83.3	76.7	69.1	62.6
2	77.8	4.5	80.4	91.9	95	31	90.2	84.0	78.2	72.8	67.7
3	63.8	3.3	65.1	73.4	75	19	72.5	68.9	63.9	60.3	58.1
4	66.3	3.4	67.6	76.2	78	20	75.0	71.4	66.4	62.6	60.5
5	67.5	3.5	69.0	78.0	79	22	76.5	72.8	67.8	63.4	60.6
6	70.4	3.7	72.0	81.4	82	23	79.5	75.7	70.9	66.1	62.0
7	72.5	3.8	74.1	83.8	84	24	81.8	78.0	72.9	68.3	63.7
8	68.6	4.7	71.3	83.3	85	31	80.8	75.3	68.8	63.1	58.7
9	71.1	4.4	73.3	84.6	85	30	81.7	77.4	71.6	65.9	62.0
10	71.6	4.2	73.7	84.4	85	28	81.9	77.7	72.1	66.7	62.7
11	72.9	4.1	74.9	85.3	87	28	83.0	78.8	73.3	68.2	64.4
12	73.6	3.9	75.4	85.4	87	26	83.3	79.3	73.9	69.0	65.6
13	75.3	5.2	78.7	91.9	93	34	88.9	82.0	76.1	68.9	64.4
14							N O D A T A				
16	77.8	5.8	81.9	96.7	98	34	92.8	85.8	78.3	70.4	66.3
N=	4780										

10- 31- 75

1453 HOURS

BAND	A	S	E	N	M	R	1	10	50	90	99
1	73.9	6.7	80.7	97.8	102	44	92.2	82.8	74.5	66.1	61.9
2	76.3	5.3	81.2	94.8	101	40	92.0	83.7	76.5	70.6	65.8
3	62.1	4.3	64.8	75.9	79	26	75.2	68.8	61.9	57.8	54.6
4	64.6	4.4	67.6	78.9	84	29	78.7	71.2	64.3	60.2	57.2
5	65.5	4.7	69.1	81.2	84	29	80.8	72.5	65.5	60.5	57.2
6	68.5	4.8	72.1	84.4	90	34	83.0	75.4	68.6	63.3	59.4
7	70.9	4.8	74.6	86.8	92	33	85.4	77.7	71.1	65.6	61.9
8	67.7	5.4	72.2	86.1	91	37	84.5	75.4	67.8	61.6	57.4
9	70.2	5.2	74.4	87.7	95	40	86.1	77.1	70.4	64.2	59.3
10	70.7	5.0	74.5	87.4	93	37	86.1	77.5	70.9	65.2	59.7
11	72.0	4.8	75.7	88.2	95	38	86.8	78.7	72.2	66.8	61.3
12	72.7	4.6	76.1	87.9	95	36	87.2	78.9	72.8	67.8	62.1
13	73.8	6.0	79.1	94.5	100	42	90.8	81.9	74.2	66.9	61.2
14							N O D A T A				
15	73.9	4.8	77.1	89.4	94	32	88.1	80.3	74.1	68.5	64.9
N=	4780										

TABLES 45-56. NOISE DATA: EIGHT FOOT REFLECTIVE BARRIER;
MICROPHONE CONFIGURATIONS B, C, D, E.

TABLE NO. 45
STATISTICAL NOISE DATA
ROADSIDE BARRIER TEST SITE, ANDOVER, MA.

BARRIER HGT 8 FT; REFLECTIVE; MICROPHONE CONFIGURATION B
NOISE LEVEL - DBA RE 20 MICROPASCAL

11- 4- 75 905 HOURS

BAND	A	S	E	N	M	R	1	10	50	90	99
1	73.8	5.4	77.6	91.5	93	35	88.8	80.3	74.7	66.9	62.1
2	75.8	4.5	78.5	90.1	91	29	88.8	81.9	76.1	70.6	66.4
3	61.7	3.7	63.4	72.8	76	22	72.1	67.0	61.8	57.7	55.5
4	63.1	4.0	65.2	75.3	77	22	74.2	69.1	63.2	58.9	56.8
5	66.1	4.2	68.4	79.2	80	23	77.2	72.6	66.3	61.4	59.0
6	69.0	4.4	71.3	82.4	82	24	79.7	75.6	69.1	63.9	60.9
7	71.3	4.3	73.4	84.4	83	23	81.8	77.6	71.6	66.2	62.5
8	67.7	4.4	70.3	81.5	84	27	80.3	73.7	68.1	62.6	59.2
9	69.6	4.3	71.9	82.8	83	24	81.2	75.7	70.0	64.7	61.2
10	70.7	4.1	72.8	83.4	84	26	81.8	76.7	71.0	66.0	62.4
11	71.8	4.0	73.9	84.1	84	24	82.6	77.9	72.0	67.5	63.8
12	72.8	3.9	74.7	84.6	85	25	82.8	78.8	72.9	68.7	64.9
13	73.6	4.9	76.9	89.5	92	32	87.8	79.9	74.3	67.6	64.0
14	75.9	4.6	80.3	92.1	105	42	89.3	81.9	76.2	70.8	66.3

N= 4780

11- 4- 75 925 HOURS

BAND	A	S	E	N	M	R	1	10	50	90	99
1	73.7	6.4	79.0	95.3	95	37	90.5	82.6	74.3	65.8	60.6
2	75.9	5.2	79.7	93.0	94	32	90.6	83.2	76.2	70.2	65.4
3	62.0	4.0	64.4	74.5	78	25	73.6	68.5	61.6	58.2	56.2
4	63.5	4.2	66.3	77.1	81	25	76.5	70.1	63.1	59.4	57.3
5	66.3	4.4	69.1	80.4	83	27	79.5	72.9	66.1	61.9	59.3
6	69.1	4.6	71.9	83.6	86	28	81.9	75.8	69.0	64.2	60.7
7	71.3	4.6	74.1	85.9	88	28	83.8	78.2	71.5	66.2	62.2
8	68.1	5.3	72.0	85.6	87	31	82.9	76.3	68.0	62.4	58.0
9	70.2	5.1	73.5	86.6	88	31	84.0	77.9	70.1	64.6	59.6
10	71.2	5.0	74.4	87.1	88	30	84.7	78.6	71.0	65.7	60.8
11	72.3	4.8	75.3	87.7	88	28	85.3	79.6	72.2	66.9	62.5
12	73.1	4.6	75.9	87.8	89	28	85.7	80.2	73.1	68.1	63.9
13	73.8	5.8	78.5	93.5	95	35	90.0	82.2	74.0	67.1	62.4
14	76.1	5.5	81.3	95.4	106	56	91.9	83.6	76.1	70.0	65.2

N= 4785

TABLE NO. 46
 STATISTICAL NOISE DATA
 ROADSIDE BARRIER TEST SITE, ANDOVER, MA.

BARRIER HGT 8 FT; REFLECTIVE; MICROPHONE CONFIGURATION C

NOISE LEVEL - DBA RE 20 MICROPASCAL

11- 4- 75

1117 HOURS

BAND	A	S	E	N	M	R	1	10	50	90	99
1	72.6	7.0	79.4	97.4	99	43	92.1	82.5	72.9	64.3	59.1
2					N O D A T A						
3	60.4	3.4	62.1	70.7	76	23	70.9	65.6	60.4	57.1	55.2
4	61.6	3.8	63.7	73.4	77	23	73.1	67.5	61.5	57.9	55.8
5	62.9	3.9	65.2	75.3	78	23	75.0	69.0	62.7	59.0	56.9
6	64.4	4.2	67.0	77.8	81	26	77.1	70.9	64.1	60.1	57.8
7	66.1	4.4	68.8	80.1	84	27	78.7	72.8	65.9	61.6	58.8
8	61.8	4.1	64.5	74.9	82	29	74.9	67.8	61.6	57.8	55.4
9	65.3	4.8	68.5	80.6	84	29	78.9	72.5	65.3	60.3	56.9
10	67.5	4.8	70.5	82.8	88	32	80.6	74.5	67.5	62.3	58.1
11	69.4	4.6	72.2	84.0	88	30	81.9	76.1	69.5	64.3	60.0
12	70.5	4.5	73.2	84.8	89	31	82.7	77.0	70.6	65.6	61.1
13	72.8	6.4	78.5	94.9	98	40	91.0	81.5	73.1	65.5	60.1
14	75.7	5.4	79.8	93.6	96	34	92.0	83.3	75.8	69.9	64.7

N= 4780

11- 4- 75

1137 HOURS

BAND	A	S	E	N	M	R	1	10	50	90	99
1	71.9	6.7	77.5	94.6	93	38	89.6	80.5	72.6	63.6	58.6
2	74.6	5.7	78.6	93.3	92	34	89.4	82.5	75.0	67.6	62.9
3	60.3	3.2	61.7	69.9	75	22	69.8	65.3	60.4	57.0	55.0
4	61.2	3.5	62.9	71.7	76	22	71.4	66.5	61.3	57.6	55.6
5	62.4	3.7	64.3	73.8	78	24	73.4	68.0	62.5	58.6	56.5
6	63.8	3.9	65.9	75.9	79	24	75.1	69.9	63.7	59.9	57.5
7	65.2	4.2	67.6	78.4	80	25	76.7	72.0	65.2	60.8	57.9
8	61.6	4.3	64.1	75.0	78	26	73.4	68.0	61.4	57.0	54.1
9	64.5	5.0	67.7	80.5	81	28	77.7	72.2	64.3	59.0	56.0
10	66.5	5.0	69.5	82.2	80	26	78.6	74.1	66.3	60.9	57.4
11	68.2	4.9	71.0	83.5	82	26	79.8	75.6	68.0	62.7	59.2
12	69.3	4.8	71.9	84.3	83	26	80.6	76.5	69.2	63.5	60.2
13	72.0	6.6	77.2	94.2	92	37	88.9	80.7	72.8	63.3	59.4
14	74.5	5.9	78.6	93.6	93	34	89.3	82.7	75.0	67.3	62.7

N= 4780

TABLE NO. 47
 STATISTICAL NOISE DATA
 ROADSIDE BARRIER TEST SITE, ANDOVER, MA.

BARRIER HGT 8 FT; REFLECTIVE; MICROPHONE CONFIGURATION D

NOISE LEVEL - DBA RE 20 MICROPASCAL

11- 4- 75

1236 HOURS

BAND	A	S	E	N	M	R	1	10	50	90	99
1	70.9	7.1	76.8	94.9	94	43	89.5	79.4	71.8	62.2	54.4
2	73.8	5.6	77.8	92.3	93	35	89.4	80.9	74.4	67.3	60.2
3	56.5	3.1	57.6	65.4	69	21	64.7	60.9	56.9	53.0	50.2
4	57.3	3.2	58.6	66.7	71	22	65.9	61.9	57.7	53.6	50.9
5	58.2	3.2	59.4	67.7	71	22	66.7	62.9	58.6	54.5	51.5
6	59.6	3.1	60.8	68.8	71	20	68.0	64.2	60.0	56.1	53.3
7	60.2	3.4	61.6	70.3	73	23	69.1	65.0	60.6	56.3	53.0
8	57.6	3.7	59.5	69.1	71	21	68.8	63.1	57.5	53.7	51.3
9	59.1	4.0	61.4	71.7	74	24	71.2	64.9	59.1	54.8	52.2
10	60.3	4.3	62.9	73.9	76	26	72.8	66.5	60.2	55.8	52.7
11	62.6	4.5	65.3	76.7	78	26	75.2	69.0	62.7	57.9	54.3
12	64.2	4.6	66.9	78.5	80	27	76.5	70.9	64.5	59.2	55.4
13	70.9	6.6	76.7	93.6	93	35	89.3	79.5	71.4	62.7	59.5
14	73.6	5.6	77.8	92.1	95	34	89.7	80.7	74.0	67.0	63.3
16	74.9	5.5	78.6	92.7	92	30	89.0	82.5	75.4	67.9	64.2

N= 4730

11- 4- 75

1256 HOURS

BAND	A	S	E	N	M	R	1	10	50	90	99
1	71.6	7.0	78.3	96.3	101	47	90.7	80.5	72.3	62.9	58.6
2	74.6	5.9	79.9	94.9	102	42	91.1	82.2	74.9	67.7	64.0
3	59.0	3.0	60.4	68.0	78	26	68.8	63.0	59.3	55.9	53.8
4	59.6	2.9	60.9	68.3	80	28	68.8	63.5	60.1	56.4	54.2
5	60.2	3.0	61.6	69.3	76	23	70.0	64.4	60.7	57.0	55.0
6	41.7	7.5	54.6	73.8	79	40	65.8	60.3	39.6	39.1	39.0
7	62.1	3.4	64.0	72.7	82	27	72.3	66.8	62.5	58.4	56.4
8	60.1	3.6	61.9	71.1	77	25	70.4	65.5	60.1	56.3	54.1
9	61.3	4.0	63.4	73.6	79	26	72.2	67.3	61.3	57.1	54.4
10	62.1	4.1	64.2	74.7	81	28	72.6	68.4	62.1	57.6	55.0
11	64.2	4.3	66.5	77.6	79	25	74.9	70.8	64.3	59.2	56.5
12	65.5	4.5	68.0	79.5	80	26	76.5	72.4	65.7	60.4	57.5
13	72.1	6.4	77.5	93.9	95	37	89.4	80.4	72.7	64.0	60.2
14	74.6	5.5	78.7	92.7	95	34	89.8	81.9	74.9	68.2	64.0
15	74.7	5.3	78.6	92.2	93	30	89.5	82.5	74.6	68.8	65.5

N= 4780

TABLE NO. 48
 STATISTICAL NOISE DATA
 ROADSIDE BARRIER TEST SITE, ANDOVER, MA.

BARRIER HGT 8 FT; REFLECTIVE; MICROPHONE CONFIGURATION E

NOISE LEVEL - DBA RE 20 MICROPASCAL

11- 4- 75

1437 HOURS

BAND	A	S	E	N	M	R	1	10	50	90	99
1	74.6	6.3	80.0	96.0	100	42	91.7	82.7	75.1	67.2	61.0
2	76.9	5.3	80.9	94.6	99	38	91.9	84.1	77.3	71.2	65.0
3	63.1	3.9	65.6	75.6	84	30	75.5	68.7	63.2	59.1	57.0
4	64.5	4.2	67.7	78.6	87	31	78.5	70.4	64.4	60.2	57.7
5	66.2	4.4	69.8	81.1	89	33	80.3	72.2	66.2	61.7	59.0
6	69.3	4.5	72.4	83.8	89	31	82.6	75.4	69.3	64.6	60.7
7	71.4	4.5	74.2	85.9	90	33	84.2	77.6	71.7	66.5	61.6
8	66.7	4.6	70.2	81.9	87	30	81.6	73.6	66.6	62.1	59.8
9	67.8	4.7	71.7	83.8	99	41	82.4	75.0	67.8	62.8	60.3
10	69.1	4.7	72.3	84.5	89	50	83.0	75.9	69.1	63.9	60.7
11	70.7	4.7	73.9	85.8	90	39	84.6	77.6	70.9	65.7	62.1
12	71.8	4.6	74.6	86.3	89	30	85.1	78.4	72.0	66.8	63.1
13	74.3	5.8	79.5	94.4	101	41	90.5	82.2	74.6	67.4	63.1
14	76.9	5.1	80.9	93.9	101	37	91.9	83.9	77.1	71.3	66.9
15	76.6	5.0	79.8	92.6	94	32	89.9	83.6	76.8	71.0	66.3
N=	4780										

11- 4- 75

1457 HOURS

BAND	A	S	E	N	M	R	1	10	50	90	99
1	74.1	6.7	80.1	97.4	99	40	92.3	83.2	74.8	65.5	61.5
2	76.7	5.5	81.1	95.2	99	36	92.4	84.6	76.9	70.3	66.4
3	62.9	3.6	64.7	73.8	77	21	73.8	68.5	62.8	59.3	57.3
4	64.3	4.0	66.8	77.1	82	26	77.5	70.2	64.0	60.3	58.2
5	65.7	4.3	68.8	79.9	85	28	80.1	72.2	65.4	61.5	59.3
6	68.5	4.5	71.7	83.4	88	29	82.5	75.4	68.2	63.9	61.4
7	70.7	4.7	73.9	85.9	89	29	84.7	77.8	70.6	65.5	62.7
8	66.1	4.9	70.1	82.7	88	32	81.6	73.2	65.9	61.0	58.2
9	67.3	5.0	71.1	84.0	87	30	82.1	74.8	67.2	61.9	58.9
10	68.6	5.0	72.2	85.0	87	29	82.7	76.0	68.6	63.2	59.8
11	70.2	4.8	73.5	85.8	88	29	83.8	77.5	70.2	64.9	61.5
12	71.4	4.7	74.4	86.4	89	28	84.9	78.4	71.3	66.2	62.7
13	74.0	6.2	79.5	95.5	101	41	91.7	82.5	74.5	66.5	61.8
14	76.7	5.4	80.9	94.6	101	38	92.4	83.9	76.9	70.6	66.2
16	77.3	4.9	80.6	93.1	97	36	91.4	84.0	77.5	72.0	67.3
N=	4785										

TABLE NO. 49
 STATISTICAL NOISE DATA
 ROADSIDE BARRIER TEST SITE, ANDOVER, MA.

BARRIER HGT 8 FT; REFLECTIVE; MICROPHONE CONFIGURATION E
 NOISE LEVEL - DBA RE 20 MICROPASCAL

11- 5- 75 848 HOURS

BAND	A	S	E	N	M	R	1	10	50	90	99
1	74.9	5.2	78.6	92.0	95	34	90.0	81.3	75.6	68.5	63.8
2	76.7	4.5	79.6	91.2	95	32	90.7	82.5	77.2	71.7	66.9
3	63.7	3.4	65.2	73.9	76	20	73.9	68.6	63.7	60.2	57.7
4	65.2	3.6	66.9	76.0	80	23	76.2	70.4	65.3	61.4	59.3
5	67.1	3.6	69.0	78.3	83	25	78.7	72.5	67.1	63.3	61.1
6	69.3	3.7	71.2	80.8	83	23	80.6	74.9	69.3	65.3	62.7
7	71.6	3.9	73.6	83.5	85	25	82.6	77.5	71.8	67.5	64.0
8	68.2	4.2	70.7	81.5	85	27	81.3	74.2	68.3	63.5	60.2
9	69.3	4.2	71.8	82.7	86	28	82.1	75.3	69.7	64.4	60.9
10	70.0	4.3	72.5	83.4	86	27	82.6	76.0	70.4	65.0	61.5
11	71.0	4.2	73.3	84.1	87	28	83.2	77.1	71.2	66.2	62.5
12	72.0	4.1	74.3	84.8	87	27	83.9	78.2	72.3	67.6	63.5
13	74.7	5.3	78.3	92.0	95	36	89.0	81.2	75.6	67.5	63.0
14							N O D A T A				

N= 4780

11- 5- 75 908 HOURS

BAND	A	S	E	N	M	R	1	10	50	90	99
1	74.9	5.5	79.1	93.3	96	36	90.6	82.6	75.3	68.1	63.5
2	76.8	4.7	79.9	92.0	95	33	90.2	83.6	77.0	71.6	67.3
3	63.7	3.3	65.0	73.5	75	19	72.5	68.8	63.8	60.2	58.1
4	65.3	3.6	67.0	76.2	80	23	75.4	70.9	65.4	61.6	59.2
5	67.3	3.8	69.3	79.0	81	23	78.3	73.0	67.4	63.3	60.5
6	69.6	4.0	71.7	81.9	84	26	80.6	75.6	69.7	65.3	62.1
7	71.8	4.1	73.9	84.3	86	27	82.6	78.1	72.0	67.3	63.8
8	68.4	4.2	70.8	81.4	85	27	80.8	74.2	68.6	63.8	60.3
9	69.7	4.2	72.1	83.0	87	28	82.2	75.7	70.0	64.9	61.4
10	70.3	4.2	72.7	83.6	87	28	82.4	76.4	70.7	65.5	61.7
11	71.3	4.3	73.7	84.6	88	28	83.4	77.5	71.6	66.5	62.5
12	72.3	4.3	74.6	85.6	88	28	83.8	78.6	72.6	67.4	63.4
13	74.8	5.3	78.7	92.2	95	33	89.8	81.9	75.3	68.4	64.2
14							N O D A T A				

N= 4780

TABLE NO. 50
 STATISTICAL NOISE DATA
 ROADSIDE BARRIER TEST SITE, ANDOVER, MA.

BARRIER HGT 8 FT; REFLECTIVE; MICROPHONE CONFIGURATION B

NOISE LEVEL - DBA RE 20 MICROPASCAL

11- 5- 75

1014 HOURS

BAND	A	S	E	N	M	R	1	10	50	90	99
1	73.4	6.6	78.7	95.4	95	38	90.6	81.7	74.2	65.0	60.0
2					N O D A T A						
3	62.5	3.6	64.3	73.6	76	22	72.9	67.9	62.7	58.6	56.0
4	64.0	4.0	66.1	76.3	80	26	75.8	69.8	64.2	59.7	57.0
5	65.9	4.4	68.5	79.7	82	27	78.4	72.7	66.0	61.1	57.8
6	68.3	4.7	71.2	83.3	84	28	81.3	75.6	68.4	63.1	59.2
7	70.9	4.8	73.7	86.1	87	30	83.6	78.2	71.1	65.3	60.7
8	67.9	4.7	71.0	83.0	86	31	80.9	75.0	67.9	62.9	59.1
9	70.4	4.6	73.2	84.9	87	31	83.2	77.2	70.5	65.4	61.3
10	71.4	4.6	74.1	85.7	87	30	83.9	78.3	71.5	66.4	61.8
11	72.6	4.5	75.1	86.7	88	29	84.7	79.2	72.7	67.6	62.9
12	72.8	4.5	75.3	86.8	88	29	84.8	79.5	72.9	67.9	63.4
13	73.9	5.6	78.1	92.4	94	35	89.6	81.4	74.3	67.3	63.2
14	75.9	5.1	79.4	92.4	93	31	89.9	83.1	76.2	70.2	65.4

N= 4780

11- 5- 75

1034 HOURS

BAND	A	S	E	N	M	R	1	10	50	90	99
1	73.5	6.8	80.0	97.3	98	39	92.3	82.2	73.9	65.2	61.0
2	75.7	5.7	80.5	95.0	97	34	92.1	83.5	76.0	69.1	65.5
3	62.8	4.1	65.1	75.5	77	25	74.2	69.3	62.9	58.5	55.3
4	64.1	4.4	66.9	78.1	82	29	76.9	70.8	63.9	59.7	56.2
5	65.9	4.5	68.9	80.5	83	28	79.7	72.8	65.7	61.4	58.0
6	68.4	4.8	71.6	83.9	86	29	82.0	75.8	68.2	63.3	60.2
7	71.4	5.0	74.8	87.5	89	29	85.0	78.8	71.5	65.9	62.7
8	67.4	5.7	72.3	86.8	88	33	84.1	75.8	67.4	61.0	57.8
9	69.8	5.6	74.2	88.6	90	33	85.5	78.1	69.9	63.4	59.5
10	70.8	5.5	75.0	89.1	90	33	86.4	78.9	70.8	64.5	60.4
11	72.0	5.4	76.0	89.8	91	32	87.2	80.1	71.9	65.9	62.0
12	72.2	5.2	76.0	89.4	91	32	87.0	80.1	72.2	66.5	62.4
13	72.7	6.7	79.1	96.3	97	40	91.9	81.6	73.0	64.5	60.3
14	75.3	5.9	80.5	95.7	98	37	92.5	83.4	75.5	68.4	64.6

N= 4785

TABLE NO. 51
 STATISTICAL NOISE DATA
 ROADSIDE BARRIER TEST SITE, ANDOVER, MA.

BARRIER HGT 8 FT; REFLECTIVE; MICROPHONE CONFIGURATION C

NOISE LEVEL - DBA RE 20 MICROPASCAL

11- 5- 75

1123 HOURS

BAND	A	S	E	N	M	R	1	10	50	90	99
1	75.2	6.4	80.6	96.9	98	38	91.9	84.8	75.3	67.6	63.0
2	77.0	5.6	81.0	95.2	98	35	91.6	85.2	77.1	70.4	65.9
3	62.1	3.7	63.7	73.0	75	23	71.8	67.4	62.5	58.0	54.7
4	63.4	3.9	65.3	75.3	78	25	73.8	68.9	63.8	59.0	55.7
5	64.8	4.1	66.9	77.4	80	26	75.6	70.7	65.3	60.2	56.5
6	66.4	4.2	68.5	79.4	83	28	77.1	72.3	66.9	61.4	57.6
7	68.2	4.3	70.4	81.4	84	28	78.8	74.2	68.7	63.2	59.3
8	63.5	5.1	66.7	79.8	87	37	76.6	70.5	64.2	57.7	52.2
9	67.2	5.4	70.4	84.3	86	36	80.5	74.7	67.6	61.2	53.1
10	68.8	5.3	71.8	85.4	85	36	81.2	76.1	69.2	63.4	53.8
11	70.5	5.3	73.4	86.9	87	36	83.1	77.6	70.8	65.2	55.7
12	70.9	5.2	73.8	87.0	88	37	83.5	78.0	71.2	65.9	56.3
13	74.2	6.7	79.4	96.5	95	42	90.4	83.7	74.6	66.3	57.6
14	76.3	6.1	80.6	96.2	97	43	91.0	84.8	76.5	69.7	59.7

N= 4780

11- 5- 75

1143 HOURS

BAND	A	S	E	N	M	R	1	10	50	90	99
1	73.8	6.4	80.1	96.4	102	46	91.7	81.9	74.5	66.3	59.6
2	75.4	5.6	80.4	94.6	100	39	91.5	82.8	75.7	69.1	64.2
3	60.5	4.3	63.8	74.9	85	35	73.9	66.4	60.4	56.1	52.8
4	61.8	4.6	65.6	77.4	85	34	76.0	68.2	61.8	57.1	54.2
5	63.3	4.7	67.0	79.0	86	33	77.5	69.9	63.2	58.2	55.9
6	64.9	4.8	68.4	80.8	86	32	78.9	71.8	64.8	59.7	57.1
7	66.8	4.9	70.2	82.7	87	31	80.4	73.8	66.6	61.6	58.3
8	63.2	4.7	67.7	79.6	88	35	80.0	69.9	63.0	58.7	55.8
9	66.7	4.9	70.9	83.4	89	34	83.6	73.6	66.6	61.6	58.0
10	68.0	4.7	71.8	83.9	89	32	84.0	74.8	67.9	63.0	59.8
11	69.5	4.7	73.2	85.2	92	34	84.8	76.1	69.5	64.4	61.2
12	69.8	4.6	73.2	85.0	92	34	84.5	76.3	69.7	65.0	61.5
13	73.0	6.2	78.8	94.7	100	43	89.5	81.0	73.6	65.4	60.5
14	75.2	5.5	80.2	94.3	102	40	90.8	82.9	75.4	69.0	64.6

N= 4780

TABLE NO. 52
 STATISTICAL NOISE DATA
 ROADSIDE BARRIER TEST SITE, ANDOVER, MA.

BARRIER HGT 8 FT; REFLECTIVE; MICROPHONE CONFIGURATION D
 NOISE LEVEL - DBA RE 20 MICROPASCAL

11- 5- 75

1317 HOURS

BAND	A	S	E	N	M	R	1	10	50	90	99
1	72.2	6.8	78.2	95.6	99	45	90.3	81.1	73.2	63.6	58.0
2	73.7	5.6	78.1	92.3	97	37	89.5	80.9	74.0	67.4	62.9
3	58.3	3.5	60.0	69.0	72	22	68.6	63.7	58.4	54.5	52.1
4	58.2	3.7	60.1	69.6	72	23	68.8	63.9	58.3	54.3	51.5
5	58.8	3.7	60.7	70.2	74	24	69.6	64.6	58.8	54.9	52.1
6	60.1	3.8	62.1	71.8	74	24	71.0	66.2	60.0	56.3	53.6
7	60.5	3.9	62.5	72.4	77	26	71.1	66.7	60.3	56.5	54.2
8	59.7	3.6	61.9	71.1	76	26	72.1	64.8	59.7	56.3	53.5
9	61.1	3.9	63.6	73.5	79	28	73.8	66.7	61.1	57.3	54.5
10	62.1	4.0	64.6	74.8	80	29	74.6	67.9	62.2	58.1	54.5
11	64.1	4.2	66.8	77.5	83	29	77.5	69.9	64.2	59.7	56.2
12	64.3	4.2	67.0	77.8	82	29	78.0	70.0	64.4	59.9	56.4
13	74.8	6.4	80.4	96.8	100	42	91.9	83.7	75.2	67.2	62.0
14	74.1	5.5	78.7	92.8	101	43	89.2	81.2	74.5	67.7	62.4

N= 4730

11- 5- 75

1348 HOURS

BAND	A	S	E	N	M	R	1	10	50	90	99
1	74.1	6.8	80.5	97.9	101	42	92.8	83.5	74.8	65.6	62.0
2	75.7	5.8	80.4	95.2	99	38	91.7	83.6	76.0	69.1	65.0
3	60.4	3.5	62.1	70.9	74	20	70.7	65.8	60.3	56.9	55.2
4	60.4	3.6	62.2	71.4	74	21	71.2	65.8	60.3	56.7	54.8
5	61.1	3.7	63.0	72.5	77	24	72.4	66.4	60.9	57.2	55.2
6	62.4	3.7	64.4	73.9	77	22	73.5	67.9	62.4	58.5	56.6
7	62.8	3.7	64.7	74.3	77	23	73.8	68.3	62.8	58.9	56.6
8	61.4	3.8	63.3	73.2	75	23	72.5	66.9	61.5	57.4	53.8
9	62.7	4.1	64.9	75.5	80	28	74.0	68.8	62.7	58.3	54.2
10	63.6	4.3	66.1	77.1	81	28	75.3	69.9	63.7	59.2	55.0
11	65.6	4.3	68.0	79.1	82	28	77.0	71.9	65.6	61.0	57.0
12	65.8	4.3	68.2	79.3	82	27	77.0	72.1	65.8	61.1	57.1
13	76.5	6.6	81.6	98.6	101	43	92.4	85.9	76.7	68.6	61.4
14	75.5	5.6	79.8	94.2	99	40	90.7	83.0	75.7	69.5	62.6

N= 4780

TABLE NO. 53
 STATISTICAL NOISE DATA
 ROADSIDE BARRIER TEST SITE, ANDOVER, MA.

BARRIER HGT 8 FT; REFLECTIVE; MICROPHONE CONFIGURATION D
 NOISE LEVEL - DBA RE 20 MICROPASCAL

11- 6- 75

850 HOURS

BAND	A	S	E	N	M	R	1	10	50	90	99
1	76.9	5.8	81.4	96.3	100	41	92.5	84.2	77.6	69.7	64.3
2	77.9	4.9	81.4	94.1	99	37	92.3	84.7	78.3	72.3	68.3
3	59.8	4.1	61.8	72.1	73	24	69.9	65.9	60.1	55.2	51.5
4	61.3	4.1	63.2	73.8	73	23	71.0	67.2	61.7	56.5	52.4
5	62.3	4.1	64.1	74.6	74	23	71.8	67.9	62.7	57.6	53.2
6	63.5	4.0	65.3	75.7	75	22	72.9	69.1	63.9	59.0	54.6
7	64.8	3.9	66.5	76.6	77	23	74.0	70.3	65.2	60.4	55.9
8	61.5	4.5	64.0	75.5	77	27	73.6	67.9	61.6	56.5	53.0
9	64.4	4.3	66.6	77.7	81	28	75.4	70.5	64.8	59.3	55.5
10	66.2	4.1	68.2	78.7	83	28	76.7	71.9	66.8	61.3	57.4
11	67.9	4.0	69.9	80.1	86	29	78.0	73.4	68.4	63.2	59.3
12	68.9	4.0	70.8	81.0	87	29	79.2	74.5	69.5	64.2	60.5
13	75.7	5.5	79.9	94.0	99	37	90.7	82.8	76.4	68.9	64.6
14	77.1	5.0	80.6	93.3	99	34	91.0	83.6	77.4	71.2	67.2

N= 4780

11- 6- 75

910 HOURS

BAND	A	S	E	N	M	R	1	10	50	90	99
1	76.0	5.3	79.4	92.9	95	35	89.9	83.0	76.7	69.1	64.6
2	77.3	4.5	79.9	91.5	95	31	89.7	83.5	77.7	72.0	67.9
3	57.9	3.2	59.2	67.4	70	20	67.0	62.7	58.2	54.5	52.3
4	59.5	3.3	60.8	69.1	71	20	68.6	64.4	59.7	56.0	53.7
5	60.7	3.3	62.1	70.4	72	19	69.9	65.6	61.0	57.2	55.0
6	62.1	3.3	63.5	71.9	73	19	71.4	66.8	62.5	58.5	56.1
7	63.3	3.3	64.6	73.1	75	20	72.6	68.0	63.6	59.6	57.2
8	59.8	3.7	61.5	70.9	73	23	70.2	65.5	59.7	56.1	54.1
9	62.6	3.6	64.3	73.6	75	22	72.4	68.2	62.7	58.7	56.7
10	64.7	3.5	66.2	75.2	76	19	74.0	70.0	64.9	60.8	58.7
11	66.7	3.4	68.1	76.8	77	18	75.7	71.9	66.9	63.0	60.6
12	68.0	3.3	69.3	77.7	78	18	76.8	72.9	68.2	64.4	62.2
13	75.3	4.8	78.4	90.8	95	32	88.7	81.9	75.8	69.6	65.7
14	76.6	4.4	79.1	90.2	94	28	88.7	82.8	76.9	71.7	68.3

N= 4785

TABLE NO. 54
 STATISTICAL NOISE DATA
 ROADSIDE BARRIER TEST SITE, ANDOVER, MA.

BARRIER HGT 8 FT; REFLECTIVE; MICROPHONE CONFIGURATION E
 NOISE LEVEL - DBA RE 20 MICROPASCAL

11- 6- 75 1018 HOURS

BAND	A	S	E	N	M	R	1	10	50	90	99
1	76.1	5.9	80.5	95.5	96	35	91.6	84.3	76.6	68.9	63.8
2					N O D A T A						
3	64.2	3.9	66.2	76.2	79	27	74.5	70.0	64.4	60.3	55.3
4	66.5	4.0	68.7	79.0	83	28	77.7	72.4	66.7	62.4	57.7
5	69.1	4.1	71.3	81.7	84	26	80.0	75.2	69.3	64.7	60.8
6	71.6	4.2	73.9	84.6	87	27	82.8	77.8	71.9	67.0	63.1
7	73.1	4.2	75.4	86.2	89	27	84.8	79.2	73.3	68.3	65.1
8	67.5	4.9	71.1	83.7	86	31	81.8	74.9	67.3	62.3	58.7
9	69.4	4.9	72.6	85.0	88	31	82.8	76.5	69.3	63.9	60.1
10	70.7	4.7	73.5	85.5	87	28	83.1	77.6	70.9	65.2	61.4
11	72.3	4.6	74.9	86.5	88	28	84.1	79.0	72.6	67.1	62.6
12	73.5	4.4	75.9	87.3	88	27	85.2	80.1	73.7	68.5	63.9
13	75.9	5.7	80.1	94.6	97	34	91.1	83.7	76.4	69.0	65.3
14	76.8	5.3	80.4	94.1	95	31	90.9	84.2	77.1	70.3	66.8

N= 4780

11- 6- 75 1038 HOURS

BAND	A	S	E	N	M	R	1	10	50	90	99
1	74.2	6.6	80.6	97.3	100	40	92.6	83.5	74.3	66.4	62.5
2	76.1	5.4	80.8	94.7	99	35	92.2	84.1	75.9	70.1	66.9
3	61.2	4.7	64.8	77.0	81	31	76.4	68.0	60.8	56.6	53.2
4	63.7	5.0	67.9	80.6	87	35	79.8	70.8	63.2	58.8	55.4
5	65.7	4.5	69.5	81.0	87	31	81.8	71.7	65.7	61.2	58.1
6	69.4	4.9	72.9	85.3	88	30	83.8	76.6	69.0	64.3	60.7
7	71.3	4.9	74.7	87.2	90	30	85.6	78.7	71.1	66.1	62.3
8	64.5	5.9	69.8	84.8	88	36	81.8	72.8	64.5	57.9	54.3
9	66.8	5.7	71.8	86.3	89	36	83.3	74.9	66.8	60.4	56.6
10	68.4	5.4	72.9	86.8	90	37	83.8	76.0	68.5	62.2	57.8
11	70.4	5.2	74.4	87.8	91	36	85.2	77.9	70.5	64.7	58.9
12	71.7	5.1	75.3	88.3	90	34	85.9	79.1	71.8	66.3	60.6
13	73.6	6.1	79.1	94.7	98	39	90.9	82.2	73.7	66.8	63.3
14	75.6	5.4	80.1	93.9	98	36	91.4	83.5	75.5	69.9	66.4

N= 4780

TABLE NO. 55
 STATISTICAL NOISE DATA
 ROADSIDE BARRIER TEST SITE, ANDOVER, MA.

BARRIER HGT 8 FT; REFLECTIVE; MICROPHONE CONFIGURATION B
 NOISE LEVEL - DBA RE 20 MICROPASCAL

11- 6- 75 1119 HOURS

BAND	A	S	E	N	M	R	1	10	50	90	99
1	73.3	6.6	78.8	95.7	97	41	90.3	82.0	74.0	64.6	60.0
2	75.2	5.6	79.3	93.6	97	37	89.9	82.7	75.4	68.6	64.1
3	59.8	4.8	62.7	75.1	76	27	72.3	66.9	60.0	53.9	50.8
4	61.9	5.2	65.2	78.5	80	30	75.2	69.7	62.0	55.6	52.6
5	64.8	5.2	68.0	81.4	81	29	77.5	72.5	64.8	58.4	54.8
6	68.0	5.2	71.1	84.3	84	29	80.1	75.6	68.1	61.7	57.6
7	70.2	5.1	73.2	86.3	87	31	82.5	77.6	70.4	63.8	59.5
8	66.3	5.7	70.4	85.1	85	33	81.7	74.1	66.7	59.5	54.2
9	69.4	5.4	72.8	86.6	87	33	83.0	76.7	69.8	63.1	56.8
10	70.5	5.1	73.6	86.6	87	31	83.9	77.5	71.0	64.7	58.5
11	71.7	4.8	74.4	86.6	88	30	84.3	78.4	72.0	66.2	60.7
12	72.5	4.5	75.0	86.4	88	29	84.8	78.8	72.7	67.6	62.5
13	73.7	5.9	78.3	93.4	95	37	89.7	81.5	74.3	66.6	61.1
14	75.5	5.2	79.1	92.4	95	35	90.2	82.6	75.7	69.6	64.5

N= 4780

11- 6- 75 1141 HOURS

BAND	A	S	E	N	M	R	1	10	50	90	99
1	74.2	6.6	79.9	96.8	99	40	91.9	82.8	74.8	66.0	61.6
2	76.2	5.7	80.4	95.0	97	34	91.8	83.8	76.6	69.4	64.8
3	62.1	4.7	64.9	76.9	79	28	74.8	68.5	62.5	56.7	53.8
4	64.6	4.8	67.5	79.7	82	29	78.2	71.0	64.9	59.0	55.8
5	67.2	4.9	70.2	82.8	84	30	80.4	74.2	67.6	61.4	57.7
6	70.0	5.1	72.9	85.9	85	29	82.5	77.1	70.5	64.1	59.5
7	71.8	5.1	74.7	87.7	88	30	84.3	78.8	72.3	65.9	61.0
8	67.8	6.0	72.0	87.4	87	34	83.3	75.8	68.4	60.2	55.5
9	70.6	5.6	74.2	88.5	88	32	84.6	78.3	71.2	64.0	58.3
10	71.4	5.4	74.9	88.8	89	34	85.1	78.8	71.9	65.3	58.7
11	72.5	5.3	75.7	89.2	90	35	85.6	79.8	72.9	66.6	59.3
12	73.3	5.0	76.2	89.1	90	34	85.6	80.3	73.6	67.6	60.5
13	74.0	6.3	79.2	95.5	98	40	91.3	82.4	74.7	66.5	60.8
14	76.2	5.8	80.4	95.1	98	39	91.7	83.9	76.6	69.4	63.3

N= 4785

TABLE NO. 56
 STATISTICAL NOISE DATA
 ROADSIDE BARRIER TEST SITE, ANDOVER, MA.

BARRIER HGT 8 FT; REFLECTIVE; MICROPHONE CONFIGURATION C

NOISE LEVEL - DBA RE 20 MICROPASCAL

11- 6- 75 1320 HOURS

BAND	A	S	E	N	M	R	1	10	50	90	99
1	74.3	6.6	79.1	96.1	94	38	90.2	83.2	75.1	65.9	58.5
2	75.8	5.5	79.4	93.4	94	33	89.9	83.4	76.2	69.5	63.6
3	59.8	3.8	61.6	71.5	73	24	70.0	65.4	60.1	55.7	51.5
4	61.2	4.1	63.2	73.7	75	25	71.8	67.0	61.4	56.7	52.3
5	63.1	4.2	65.2	76.0	77	25	73.8	69.2	63.3	58.6	54.0
6	64.9	4.4	67.2	78.3	79	26	75.9	71.1	65.1	60.2	55.5
7	66.6	4.4	68.9	80.2	80	27	77.6	72.9	66.8	61.8	57.0
8	61.8	4.5	64.3	75.8	76	25	72.8	68.7	61.9	56.9	53.3
9	65.8	5.0	68.6	81.4	84	33	77.4	73.1	66.0	60.3	54.5
10	67.4	4.9	70.0	82.6	83	32	78.4	74.5	67.6	62.0	55.2
11	68.8	4.8	71.3	83.5	84	32	79.6	75.7	69.0	63.7	56.3
12	69.7	4.7	72.0	84.0	83	29	80.3	76.5	70.1	64.8	56.9
13	73.8	6.2	78.3	94.1	92	34	89.2	82.6	74.1	66.5	61.2
14	75.1	5.6	78.9	93.2	93	37	89.4	83.2	75.4	69.1	61.4

N= 4780

11- 6- 75 1340 HOURS

BAND	A	S	E	N	M	R	1	10	50	90	99
1	75.2	6.4	80.1	96.5	94	38	92.1	83.8	75.9	67.2	61.3
2	76.7	5.4	80.5	94.3	95	33	91.7	84.0	77.0	70.4	64.9
3	61.4	4.1	63.4	74.0	75	24	71.8	67.3	61.8	56.5	53.4
4	62.6	4.3	64.9	75.8	78	25	73.5	68.8	62.9	57.8	54.6
5	64.5	4.4	66.9	78.2	80	26	75.0	70.9	64.8	59.5	56.2
6	66.1	4.5	68.6	80.1	82	28	76.8	72.6	66.4	61.0	57.3
7	67.7	4.4	70.0	81.4	82	27	78.3	74.2	67.9	62.6	58.5
8	65.2	3.9	67.1	77.2	80	26	75.4	71.2	65.4	60.9	57.2
9	68.4	4.2	70.5	81.4	81	26	79.1	74.8	68.5	63.8	59.5
10	69.4	4.3	71.6	82.6	82	26	80.4	75.7	69.6	64.7	59.5
11	70.4	4.3	72.6	83.6	84	27	81.2	76.7	70.7	65.8	59.7
12	71.2	4.2	73.2	84.1	84	27	81.7	77.4	71.4	66.7	60.4
13	75.3	5.6	79.4	93.6	94	34	91.2	82.8	75.8	68.8	64.4
14	76.7	5.1	80.2	93.3	95	33	91.4	83.7	77.0	71.1	65.6

N= 4780

TABLES 57-68. NOISE DATA: TWELVE FOOT ABSORPTIVE BARRIER;
MICROPHONE CONFIGURATIONS B, C, D, E.

TABLE NO. 57
STATISTICAL NOISE DATA
ROADSIDE BARRIER TEST SITE, ANDOVER, MA.

BARRIER HGT 12 FT; ABSORPTIVE; MICROPHONE CONFIGURATION B

NOISE LEVEL - DBA RE 20 MICROPASCAL

12- 2- 75		922 HOURS									
BAND	A	S	E	N	M	R	1	10	50	90	99
1	77.1	5.2	80.8	94.2	96	35	91.7	84.7	77.4	70.9	66.1
2	78.3	4.5	81.1	92.7	96	31	91.2	84.9	78.5	73.0	69.5
3	60.7	3.3	62.1	70.5	72	19	69.8	65.6	61.1	56.9	55.0
4	62.1	3.5	63.7	72.7	75	21	72.0	67.3	62.3	58.2	56.1
5	64.0	3.6	65.7	74.7	78	23	74.3	69.1	64.2	60.0	57.6
6	67.1	3.7	68.8	78.2	81	24	77.0	72.7	67.3	63.0	60.0
7	70.5	3.6	72.1	81.4	84	25	80.0	75.8	70.9	66.4	62.6
8	69.2	5.4	72.4	86.1	84	30	81.8	76.9	69.7	62.6	56.8
9	72.1	4.9	74.8	87.3	86	29	83.5	79.1	72.5	66.1	60.6
10	72.6	4.7	75.0	87.0	86	28	83.7	79.3	73.0	67.0	61.7
11	73.6	4.4	75.8	87.0	87	27	84.2	80.0	74.0	68.5	63.4
12	74.8	4.3	76.9	87.8	88	27	85.0	81.2	75.3	69.8	65.4
13	77.2	5.3	80.7	94.3	94	33	90.9	84.8	77.6	70.9	64.9
14	77.4	4.9	80.3	92.8	93	31	90.2	84.2	77.8	71.7	66.4

N= 4780

12- 2- 75		942 HOURS									
BAND	A	S	E	N	M	R	1	10	50	90	99
1	75.7	5.4	79.9	93.7	99	40	91.1	82.4	76.5	69.2	64.1
2	77.6	4.6	80.8	92.5	100	35	91.5	83.5	78.1	72.5	68.2
3	59.2	3.2	60.8	69.0	76	25	69.7	63.6	59.4	56.0	54.0
4	60.8	3.4	62.7	71.5	77	24	72.6	65.7	60.8	57.5	55.2
5	63.0	3.6	65.0	74.1	80	26	74.3	68.0	63.0	59.4	56.9
6	66.4	3.7	68.3	77.9	82	26	76.8	71.8	66.6	62.4	59.4
7	70.1	3.8	71.9	81.6	84	25	80.1	75.6	70.3	66.0	62.7
8	69.3	4.9	72.5	85.0	91	35	82.8	75.8	69.7	63.6	59.3
9	71.8	4.6	74.7	86.6	90	31	85.0	77.8	72.3	66.2	62.3
10	72.3	4.5	75.1	86.7	90	30	85.6	78.1	72.7	66.9	63.2
11	73.1	4.3	75.7	86.7	92	29	86.0	78.7	73.5	68.2	64.6
12	74.5	4.1	76.9	87.4	93	29	87.0	79.8	74.8	69.9	66.5
13	76.5	5.2	80.5	93.8	100	36	91.7	83.2	77.1	70.4	65.9
14	77.0	4.7	80.3	92.4	98	34	91.1	83.2	77.5	71.6	67.1

N= 4780

TABLE NO. 58
 STATISTICAL NOISE DATA
 ROADSIDE BARRIER TEST SITE, ANDOVER, MA.

BARRIER HGT 12 FT; ABSORPTIVE; MICROPHONE CONFIGURATION C
 NOISE LEVEL - DBA RE 20 MICROPASCAL

12- 2- 75 1045 HOURS

BAND	A	S	E	N	M	R	1	10	50	90	99
1	75.7	5.9	80.4	95.4	100	42	91.7	83.1	76.4	68.6	63.5
2	77.5	5.0	81.1	94.0	99	36	91.9	84.4	77.8	71.7	67.3
3	57.5	3.6	59.4	68.6	72	22	68.9	63.0	57.3	54.0	51.7
4	59.4	3.9	61.7	71.8	77	25	71.9	65.2	59.3	55.6	53.4
5	61.0	3.9	63.2	73.3	77	24	73.1	66.9	60.8	57.1	55.1
6	62.8	4.0	64.9	75.1	76	21	74.0	69.1	62.7	58.7	56.7
7	65.7	4.2	67.8	78.5	80	23	76.2	72.2	65.6	61.1	59.1
8	65.0	4.4	67.9	79.2	83	29	79.2	71.4	65.0	60.3	56.4
9	69.7	4.4	72.4	83.5	88	30	83.6	75.9	69.8	64.9	60.6
10	70.3	4.2	72.8	83.5	88	29	83.7	76.3	70.5	65.8	62.2
11	71.6	4.0	74.0	84.4	90	28	84.9	77.3	71.7	67.2	64.0
12	72.3	3.9	74.5	84.5	90	28	85.2	77.8	72.5	68.2	65.1
13	77.0	5.1	81.0	94.0	100	37	92.2	83.7	77.4	71.2	66.8
14	77.3	4.8	80.8	93.2	100	36	91.7	83.8	77.6	72.0	67.3

N= 4785

12- 2- 75 1105 HOURS

BAND	A	S	E	N	M	R	1	10	50	90	99
1	74.9	6.5	79.9	96.4	99	41	91.0	83.2	75.6	67.0	60.8
2	76.8	5.4	80.5	94.2	99	36	90.7	84.0	77.3	70.3	65.6
3	57.8	4.0	60.2	70.3	77	29	69.2	63.0	58.1	53.3	50.3
4	59.6	4.1	62.2	72.7	79	29	71.1	65.4	59.8	55.0	52.4
5	61.2	4.2	63.7	74.4	80	28	72.5	67.0	61.4	56.5	54.1
6	63.0	4.3	65.6	76.7	82	29	74.6	69.2	63.2	58.2	55.3
7	65.8	4.6	68.4	80.1	83	28	76.8	72.2	66.0	60.6	57.0
8	63.0	5.3	67.0	80.6	86	34	77.2	70.7	63.1	57.0	54.2
9	68.0	5.2	71.3	84.5	87	33	81.1	75.4	68.6	61.8	58.0
10	69.2	4.9	72.0	84.5	87	31	81.1	75.8	69.8	63.1	58.9
11	70.5	4.7	73.2	85.4	90	32	82.3	76.9	71.0	64.6	60.6
12	71.3	4.6	73.9	85.6	91	32	82.5	77.5	71.9	65.6	61.7
13	75.6	5.9	80.3	95.4	101	39	91.2	83.7	76.1	68.6	64.1
14	76.0	5.5	79.9	94.0	99	38	90.4	83.7	76.4	69.7	64.1

N= 4780

TABLE NO. 59
 STATISTICAL NOISE DATA
 ROADSIDE BARRIER TEST SITE, ANDOVER, MA.

BARRIER HGT 12 FT; ABSORPTIVE; MICROPHONE CONFIGURATION D
 NOISE LEVEL - DBA RE 20 MICROPASCAL

12- 2- 75 1152 HOURS

BAND	A	S	E	N	M	R	1	10	50	90	99
1	75.0	6.8	79.9	97.2	97	44	91.0	83.4	76.1	66.7	55.6
2	76.4	5.6	80.2	94.6	97	37	90.8	83.9	77.1	69.7	62.8
3	58.9	3.6	60.5	69.7	71	22	68.3	64.0	59.4	54.5	51.9
4	60.2	3.7	61.8	71.2	73	22	69.7	65.4	60.7	55.7	53.1
5	60.9	3.7	62.5	71.9	74	23	70.7	65.9	61.5	56.5	53.5
6	61.8	3.7	63.4	72.8	75	24	71.6	66.9	62.4	57.5	54.3
7	63.1	3.8	64.7	74.5	76	24	73.1	68.3	63.6	58.6	55.2
8	61.5	4.0	63.7	73.9	78	26	72.6	67.7	61.6	57.2	54.3
9	64.4	3.9	66.4	76.4	79	25	75.3	70.4	64.5	60.2	57.1
10	65.8	3.8	67.6	77.3	79	23	76.5	71.5	66.0	61.7	58.4
11	67.3	3.8	69.0	78.6	81	24	77.5	72.9	67.6	63.2	59.6
12	68.4	3.7	70.1	79.7	82	25	78.5	73.9	68.8	64.4	60.1
13	76.5	5.4	80.4	94.2	98	35	91.2	83.6	77.0	70.0	65.8
14	76.3	5.1	79.7	92.7	98	34	90.2	83.0	76.8	70.2	65.8
15	73.8	6.2	78.8	94.7	93	33	90.1	82.7	74.2	66.3	63.1
N=	4780										

12- 2- 75 1212 HOURS

BAND	A	S	E	N	M	R	1	10	50	90	99
1	75.2	5.8	79.7	94.6	98	38	90.3	82.7	75.9	67.8	63.4
2	76.7	4.9	80.0	92.5	99	35	89.9	83.3	77.2	70.7	66.4
3	57.9	3.3	59.3	67.7	70	19	67.4	62.7	58.1	54.2	52.3
4	59.3	3.1	60.5	68.4	70	18	67.9	63.9	59.5	55.8	53.9
5	60.0	2.9	61.1	68.6	71	18	68.2	64.5	60.2	56.8	55.0
6	61.0	2.9	62.0	69.4	71	17	69.3	65.5	61.2	57.9	56.0
7	62.3	2.9	63.4	71.0	73	18	70.6	66.9	62.6	59.2	57.2
8	59.4	4.4	61.8	73.1	74	25	70.7	66.1	59.6	54.6	52.3
9	62.5	4.2	64.6	75.3	76	25	73.4	68.6	62.8	57.9	54.7
10	64.1	4.1	66.0	76.5	78	26	74.3	69.9	64.5	59.5	55.3
11	65.6	4.0	67.5	77.8	80	26	75.8	71.2	66.1	61.1	56.6
12	67.0	4.0	68.8	79.0	82	27	77.3	72.4	67.5	62.5	57.6
13	75.6	5.6	79.8	94.2	98	38	90.5	83.1	76.1	69.1	64.3
14	75.7	5.2	79.2	92.6	97	37	89.4	82.7	76.1	69.9	64.0
16	76.5	6.0	80.9	96.3	98	38	92.0	84.6	77.0	69.5	63.2
N=	4780										

MICROPHONES 8,9,10,11,12 SET 2.9 FT LOW

TABLE NO. 60
 STATISTICAL NOISE DATA
 ROADSIDE BARRIER TEST SITE, ANDOVER, MA.

BARRIER HGT 12 FT; ABSORPTIVE; MICROPHONE CONFIGURATION E
 NOISE LEVEL - DBA RE 20 MICROPASCAL

12- 2- 75 1344 HOURS

BAND	A	S	E	N	M	R	1	10	50	90	99
1	75.8	5.8	80.0	94.8	96	35	91.2	83.8	76.2	69.2	63.6
2	77.3	5.0	80.7	93.6	96	32	91.4	84.5	77.4	71.5	67.2
3	61.0	3.3	62.3	70.8	73	21	69.9	65.8	61.3	57.4	54.3
4	63.0	3.5	64.7	73.7	78	24	73.1	68.0	63.2	59.3	56.2
5	65.0	3.9	67.0	76.9	80	24	75.9	70.4	65.2	61.0	57.5
6	67.6	4.2	69.9	80.8	83	26	79.4	73.7	67.7	63.1	59.2
7	70.4	4.3	72.7	83.7	85	26	81.7	76.5	70.4	65.7	61.4
8	66.2	5.2	70.3	83.6	87	33	81.7	73.8	66.0	60.7	56.7
9	67.7	5.2	71.5	84.7	89	34	82.5	75.3	67.8	62.0	57.9
10	68.5	4.9	71.9	84.5	89	32	82.4	75.5	68.7	62.9	59.4
11	70.5	4.6	73.4	85.2	89	30	83.0	77.2	70.7	65.3	62.0
12	72.1	4.3	74.5	85.7	87	26	83.8	78.5	72.3	67.3	63.9
13	76.3	5.6	80.2	94.4	96	32	91.2	83.8	77.0	69.1	66.0
14	76.4	5.4	80.1	94.0	95	31	90.7	83.8	77.0	69.5	66.3
16	76.6	6.4	82.0	98.4	99	35	94.1	85.5	77.1	69.1	65.5

N= 4785

12- 2- 75 1404 HOURS

BAND	A	S	E	N	M	R	1	10	50	90	99
1	75.5	5.0	79.3	92.1	98	35	90.5	81.6	76.2	69.6	65.4
2	76.7	4.3	79.7	90.8	98	31	90.3	82.1	77.2	71.3	68.4
3	59.9	2.9	61.2	68.6	74	21	69.8	63.9	60.1	57.0	55.1
4	61.9	3.2	63.5	71.7	77	24	72.2	66.6	62.1	58.7	56.4
5	64.1	3.4	65.7	74.4	78	23	74.3	69.2	64.2	60.6	58.3
6	66.7	3.6	68.4	77.7	82	27	76.9	72.0	66.9	62.8	60.2
7	69.6	3.7	71.3	80.7	84	26	79.9	74.9	69.9	65.4	62.6
8	65.4	4.7	69.1	81.0	88	34	80.9	71.3	65.6	60.2	56.7
9	67.1	4.6	70.7	82.5	91	34	81.8	73.0	67.5	61.8	58.9
10	67.9	4.4	71.0	82.2	89	32	81.7	73.5	68.3	62.8	60.0
11	69.9	4.0	72.5	82.8	90	31	82.4	75.1	70.2	65.4	62.1
12	71.5	3.8	73.6	83.4	90	30	83.2	76.5	71.8	67.4	63.7
13	76.2	4.5	79.5	91.2	99	36	90.6	81.9	76.6	71.3	66.9
14	76.3	4.3	79.2	90.2	98	36	90.0	81.7	76.6	71.9	66.9
15	73.7	5.3	77.5	91.1	95	33	88.1	81.0	73.9	67.4	64.3

N= 4780

TABLE NO. 61
 STATISTICAL NOISE DATA
 ROADSIDE BARRIER TEST SITE, ANDOVER, MA.

BARRIER HGT 12 FT; ABSORPTIVE; MICROPHONE CONFIGURATION D

NOISE LEVEL - DBA RE 20 MICROPASCAL

12- 3- 75

1306 HOURS

BAND	A	S	E	N	M	R	1	10	50	90	99
1	73.4	6.2	78.3	94.1	94	37	90.2	80.7	74.3	65.8	61.1
2	75.3	5.2	78.9	92.0	94	32	90.1	81.7	75.9	69.2	64.7
3	57.9	2.7	58.9	65.8	71	20	66.0	62.0	58.0	55.2	53.2
4	57.9	2.7	58.9	65.7	71	20	66.0	61.9	58.1	55.2	53.2
5	58.6	2.6	59.5	66.1	71	19	66.5	62.6	58.8	56.1	54.2
6	59.3	2.6	60.2	66.8	69	16	66.8	63.4	59.4	56.7	54.9
7	60.0	2.6	60.8	67.6	70	16	67.2	64.1	60.2	57.2	55.3
8	59.7	3.6	61.8	71.1	75	24	72.2	64.8	59.6	56.3	53.7
9	61.3	3.8	63.4	73.1	76	24	73.5	67.0	61.3	57.5	54.5
10	62.8	3.9	64.9	74.8	76	22	74.0	68.8	62.9	58.6	55.3
11	64.4	3.9	66.3	76.4	77	24	75.0	70.3	64.5	60.1	56.7
12	65.8	4.0	67.7	77.8	77	22	76.0	71.7	66.0	61.4	57.8
13	75.2	5.5	79.4	93.4	94	31	90.6	82.4	75.7	68.9	65.0
14	75.7	5.0	79.2	92.1	95	32	90.2	82.3	76.1	70.0	65.4

N= 4780

12- 3- 75

1326 HOURS

BAND	A	S	E	N	M	R	1	10	50	90	99
1	74.3	6.2	78.8	94.6	94	37	89.6	82.7	74.9	66.7	61.6
2	76.1	5.3	79.5	92.9	93	30	89.6	83.6	76.4	70.0	65.8
3	58.1	2.4	58.8	65.0	70	18	64.6	61.9	58.5	55.5	54.1
4	58.3	2.4	59.0	65.1	68	16	64.6	62.0	58.8	55.7	54.1
5	59.0	2.4	59.7	65.9	69	16	65.6	62.8	59.5	56.4	55.0
6	59.8	2.5	60.5	66.9	70	16	66.6	63.6	60.1	57.2	55.6
7	60.4	2.6	61.2	67.9	73	19	67.7	64.4	60.6	57.7	56.1
8	60.1	3.3	61.5	69.8	75	22	69.5	65.0	60.1	56.6	54.7
9	61.6	3.6	63.3	72.4	73	20	71.5	67.2	61.6	57.7	55.5
10	63.0	3.8	64.8	74.4	74	20	72.5	68.9	63.1	59.0	56.3
11	64.8	3.8	66.5	76.2	75	19	73.9	70.6	65.1	60.5	57.7
12	66.4	3.8	68.1	77.9	77	21	75.1	72.0	66.9	61.9	58.6
13	75.9	5.7	79.9	94.6	93	32	90.8	83.4	76.6	68.7	64.1
14	76.5	5.3	79.9	93.4	93	32	90.2	83.5	77.0	70.2	65.1

N= 4780

TABLE NO. 62
 STATISTICAL NOISE DATA
 ROADSIDE BARRIER TEST SITE, ANDOVER, MA.

BARRIER HGT 12 FT; ABSORPTIVE; MICROPHONE CONFIGURATION C

NOISE LEVEL - DBA RE 20 MICROPASCAL

12- 3- 75 1106 HOURS

BAND	A	S	E	N	M	R	1	10	50	90	99
1	73.8	6.8	78.9	96.3	94	38	90.0	82.7	75.0	64.8	59.7
2	75.7	5.6	79.4	93.9	93	32	89.9	83.4	76.3	68.5	64.3
3	58.3	2.8	59.3	66.5	68	17	65.6	62.7	58.7	55.1	53.0
4	58.8	3.0	59.9	67.5	68	18	66.3	63.5	59.2	55.4	53.1
5	60.2	3.1	61.3	69.3	71	19	67.9	65.0	60.5	56.6	54.4
6	60.9	3.3	62.2	70.7	73	20	68.9	66.1	61.2	57.1	54.9
7	62.5	3.6	64.0	73.1	73	20	71.0	68.1	62.7	58.4	56.1
8	61.8	4.4	64.6	75.9	80	28	74.6	68.7	61.7	57.3	54.4
9	65.5	5.0	68.5	81.2	82	29	77.7	73.0	65.6	59.7	56.1
10	67.4	4.9	70.1	82.6	82	28	78.8	74.5	67.8	61.6	57.5
11	69.1	4.7	71.5	83.4	83	27	79.9	75.7	69.6	63.5	59.2
12	70.4	4.5	72.6	84.1	83	25	80.8	76.7	71.1	65.0	60.7
13	75.2	6.1	79.5	95.1	95	37	90.2	83.2	75.9	67.8	61.4
14	75.8	5.5	79.4	93.5	96	37	89.7	83.1	76.3	69.5	63.4

N= 4785

12- 3- 75 1139 HOURS

BAND	A	S	E	N	M	R	1	10	50	90	99
1	73.8	6.1	78.0	93.5	93	35	89.2	81.4	74.8	65.8	61.5
2	75.4	5.1	78.5	91.5	93	30	89.0	82.1	76.0	69.1	65.4
3	59.1	2.7	60.3	67.2	77	25	67.6	62.9	59.4	56.4	54.3
4	59.3	2.6	60.2	67.0	72	20	67.5	63.2	59.7	56.6	54.5
5	60.5	2.7	61.6	68.6	73	19	69.2	64.6	60.8	57.7	55.9
6	61.2	3.0	62.4	70.0	75	22	70.3	65.7	61.3	58.2	56.2
7	62.8	3.4	64.4	73.1	77	22	73.0	68.0	62.7	59.4	57.3
8	62.0	3.8	64.3	74.0	80	26	74.7	67.4	61.9	58.4	55.8
9	65.4	4.3	68.0	79.0	81	27	78.0	71.4	65.7	60.6	57.5
10	67.3	4.3	69.6	80.5	83	28	78.9	73.3	67.7	62.4	58.9
11	69.1	4.1	71.2	81.6	83	25	79.9	75.0	69.4	64.4	60.8
12	70.3	3.9	72.1	82.1	83	24	80.7	75.9	70.6	65.9	62.1
13	75.1	5.4	78.7	92.6	92	32	89.7	82.4	75.8	68.3	64.0
14	75.7	4.9	78.7	91.2	93	30	88.9	82.4	76.2	69.9	65.6

N= 4780

TABLE NO. 63
 STATISTICAL NOISE DATA
 ROADSIDE BARRIER TEST SITE, ANDOVER, MA.

BARRIER HGT 12 FT; ABSORPTIVE; MICROPHONE CONFIGURATION B

NOISE LEVEL - DBA RE 20 MICROPASCAL

12- 3- 75 1002 HOURS

BAND	A	S	E	N	M	R	1	10	50	90	99
1	74.8	6.5	80.4	97.2	100	43	92.0	83.3	75.4	66.8	61.2
2	76.7	5.6	81.2	95.5	100	39	92.1	84.1	77.0	70.1	66.0
3	60.6	3.6	62.8	72.0	79	26	73.2	65.7	60.7	57.0	54.6
4	61.5	3.7	63.9	73.5	83	29	73.8	66.8	61.6	57.6	55.7
5	63.1	4.0	65.7	75.8	82	27	75.9	68.9	63.2	58.8	57.0
6	64.8	4.3	67.9	79.1	87	31	78.4	71.1	64.8	60.0	57.5
7	67.7	4.6	70.9	82.7	89	32	80.8	74.4	67.7	62.6	59.7
8	67.8	5.6	72.8	87.2	92	36	83.9	76.4	67.5	61.8	58.7
9	70.7	5.3	74.8	88.4	92	33	85.9	78.8	70.6	64.9	61.3
10	71.9	5.1	75.7	88.7	93	34	86.4	79.7	71.8	66.3	62.4
11	73.0	4.8	76.4	88.8	93	32	87.2	80.3	73.0	68.0	63.8
12	74.4	4.6	77.5	89.3	93	30	87.9	81.3	74.4	69.5	65.8
13	76.5	5.8	81.5	96.4	101	39	92.6	84.7	76.5	69.8	65.5
14	77.1	5.3	81.3	94.8	100	36	92.4	84.5	77.0	71.2	67.2

N= 4780

12- 3- 75 1022 HOURS

BAND	A	S	E	N	M	R	1	10	50	90	99
1	74.5	5.9	78.7	93.9	94	36	89.9	82.2	75.3	66.8	62.1
2	76.4	4.9	79.5	92.1	93	31	90.0	82.9	76.9	70.4	65.8
3	60.2	2.7	61.1	67.9	69	16	67.8	64.2	60.6	57.3	55.1
4	61.0	2.8	61.9	69.1	70	18	68.9	65.3	61.2	58.1	55.7
5	62.7	3.0	63.8	71.6	74	20	71.1	67.3	62.9	59.5	57.0
6	64.4	3.4	65.9	74.6	76	20	73.5	69.8	64.5	60.8	58.4
7	67.5	3.8	69.3	79.2	81	22	77.2	73.5	67.6	63.2	60.8
8	67.6	4.8	70.6	82.7	86	33	80.6	74.0	68.1	62.1	56.5
9	70.2	4.7	72.8	84.8	85	31	82.4	76.2	71.0	64.4	58.2
10	71.4	4.7	73.8	85.9	88	33	82.9	77.4	72.3	65.6	58.4
11	72.3	4.6	74.5	86.3	87	31	83.1	78.2	73.2	66.8	59.3
12	73.6	4.5	75.7	87.3	89	31	83.9	79.4	74.5	68.4	60.9
13	75.8	5.7	79.4	94.1	95	38	89.7	83.0	76.9	68.6	60.9
14	76.3	5.2	79.4	92.9	95	36	89.3	82.9	77.2	69.9	62.6

N= 4780

TABLE NO. 64
 STATISTICAL NOISE DATA
 ROADSIDE BARRIER TEST SITE, ANDOVER, MA.

BARRIER HGT 12 FT; ABSORPTIVE; MICROPHONE CONFIGURATION E

NOISE LEVEL - DBA RE 20 MICROPASCAL

12- 3- 75 841 HOURS

BAND	A	S	E	N	M	R	1	10	50	90	99
1	78.2	5.2	81.8	95.0	97	34	92.8	85.3	78.4	72.6	67.1
2	79.2	4.6	82.2	94.0	97	30	92.7	85.8	79.2	74.2	70.0
3	62.6	3.2	63.8	72.1	73	19	70.9	67.7	62.8	58.9	56.5
4	63.8	3.2	65.1	73.4	74	19	72.4	68.8	64.0	60.2	58.0
5	65.9	3.3	67.2	75.7	76	18	74.8	70.9	66.2	62.1	60.1
6	68.2	3.6	69.8	78.8	80	20	77.7	73.5	68.5	64.2	61.8
7	70.9	3.6	72.6	81.9	82	20	80.7	76.4	71.2	66.9	64.1
8	67.9	4.9	71.7	84.2	86	30	83.2	74.9	68.0	62.7	59.4
9	69.5	4.8	72.9	85.2	87	30	83.8	76.2	69.8	64.1	60.7
10	70.7	4.6	73.6	85.3	89	30	84.3	76.9	71.0	65.5	62.1
11	72.4	4.3	74.9	85.9	89	30	84.9	78.6	72.7	67.7	63.6
12	74.0	4.0	76.0	86.2	90	30	85.4	79.8	74.2	69.9	65.2
13	78.6	4.9	82.0	94.6	97	33	93.3	85.2	78.8	73.2	68.0
14	78.6	4.7	81.6	93.7	96	31	92.3	85.0	78.9	73.5	68.2

N= 4780

12- 3- 75 901 HOURS

BAND	A	S	E	N	M	R	1	10	50	90	99
1	76.4	5.5	80.3	94.5	96	36	91.7	83.4	77.2	69.7	62.7
2	77.7	4.9	80.9	93.4	97	33	91.6	84.3	78.2	72.2	66.7
3	60.9	3.6	62.7	72.0	75	23	71.8	66.5	60.8	57.2	54.6
4	62.0	3.5	63.7	72.7	75	22	71.5	67.7	62.0	58.4	56.0
5	64.0	3.7	65.8	75.2	76	21	74.3	69.8	63.9	60.2	57.4
6	66.4	4.0	68.4	78.6	81	24	77.3	72.3	66.4	62.1	58.7
7	69.3	4.1	71.4	82.0	83	26	80.2	75.5	69.6	64.6	60.7
8	66.2	5.1	70.0	82.9	86	32	81.4	73.5	66.2	60.9	56.6
9	67.8	4.9	71.2	83.8	87	32	82.1	74.7	68.0	62.3	57.6
10	68.9	4.8	72.1	84.3	88	32	82.7	75.5	69.2	63.7	58.9
11	70.7	4.4	73.3	84.7	87	29	83.0	77.0	70.9	66.0	61.0
12	72.4	4.2	74.6	85.3	88	29	83.6	78.5	72.6	68.0	62.7
13	77.3	5.1	80.7	93.6	98	37	92.0	83.8	77.8	71.6	65.4
14	77.6	4.8	80.5	92.7	97	36	91.0	83.8	78.0	72.3	66.0

N= 4730

TABLE NO. 65
 STATISTICAL NOISE DATA
 ROADSIDE BARRIER TEST SITE, ANDOVER, MA.

BARRIER HGT 12 FT; ABSORPTIVE; MICROPHONE CONFIGURATION C
 NOISE LEVEL - DBA RE 20 MICROPASCAL

12- 4- 75

1328 HOURS

BAND	A	S	E	N	M	R	1	10	50	90	99
1	73.4	6.3	79.1	95.2	100	42	90.3	81.5	74.1	65.6	60.7
2	75.3	5.4	79.8	93.6	100	38	90.9	82.4	75.7	69.0	65.0
3	56.5	3.1	58.0	65.9	73	24	66.9	60.8	56.8	53.4	51.2
4	57.7	3.2	59.3	67.6	75	24	68.6	62.2	57.8	54.4	52.4
5	58.6	3.4	60.4	69.0	76	25	69.8	63.3	58.8	55.3	53.3
6	59.5	3.6	61.5	70.8	75	23	71.2	64.6	59.6	56.0	54.1
7	61.7	3.9	64.0	74.0	79	25	73.8	67.2	61.8	57.6	55.8
8	62.1	4.4	64.8	76.1	78	26	74.8	68.9	62.0	57.3	54.3
9	66.2	4.6	68.8	80.6	82	27	78.5	72.8	66.7	60.7	57.6
10	67.1	4.4	69.4	80.7	82	27	78.4	73.4	67.7	61.7	58.3
11	68.6	4.3	70.8	81.7	83	26	79.6	74.6	69.3	63.3	59.9
12	69.6	4.2	71.6	82.3	85	27	80.2	75.4	70.1	64.4	61.1
13							89.0	81.9			
14							88.7	82.0			

N= 4785

12- 4- 75

1348 HOURS

BAND	A	S	E	N	M	R	1	10	50	90	99
1	74.4	5.6	77.9	92.2	94	35	87.7	81.8	75.4	67.1	62.6
2	76.2	4.6	78.7	90.6	94	30	87.8	82.3	77.0	70.3	66.5
3	57.6	2.7	58.4	65.4	68	19	64.5	61.5	58.1	54.6	51.2
4	58.7	2.8	59.6	66.8	68	18	65.7	62.8	59.2	55.6	52.2
5	60.1	2.8	61.0	68.2	69	18	67.3	64.1	60.6	56.9	54.1
6	61.5	3.0	62.6	70.2	71	19	68.9	66.0	62.0	58.2	55.7
7	64.2	3.3	65.5	73.8	73	17	72.1	69.1	64.5	60.6	58.1
8	64.4	3.8	66.0	75.7	77	23	73.2	69.9	64.8	60.2	56.2
9	67.6	4.0	69.4	79.6	79	23	76.5	73.5	68.3	63.0	58.6
10	68.0	3.9	69.5	79.4	78	22	76.3	73.5	68.6	63.2	59.2
11	69.2	3.8	70.7	80.4	80	23	77.4	74.6	69.8	64.3	60.4
12	69.9	3.7	71.3	80.8	81	22	77.9	75.2	70.6	65.3	61.2
13	5						87.9	82.6			
14							87.5	82.4			

N= 4780

TABLE NO. 66
 STATISTICAL NOISE DATA
 ROADSIDE BARRIER TEST SITE, ANDOVER, MA.

BARRIER HGT 12 FT; ABSORPTIVE; MICROPHONE CONFIGURATION B

NOISE LEVEL - DBA RE 20 MICROPASCAL

12- 4- 75

1129 HOURS

BAND	A	S	E	N	M	R	1	10	50	90	99
1	73.6	6.8	79.0	96.4	96	45	90.9	82.0	74.4	65.3	55.0
2	75.6	5.6	79.7	94.1	95	37	91.0	82.7	76.0	69.2	61.7
3	58.5	3.7	60.4	70.0	73	24	69.5	63.8	58.7	54.4	51.2
4	59.4	4.0	61.6	71.8	76	27	71.2	65.2	59.6	55.3	51.4
5	61.1	4.1	63.4	73.9	78	28	72.4	66.9	61.3	56.8	52.3
6	63.7	4.5	66.2	77.6	81	30	74.8	70.1	64.0	58.9	53.3
7	67.1	4.8	69.7	81.9	83	31	78.1	73.8	67.8	61.7	54.8
8	67.3	5.6	71.4	85.7	87	36	82.7	74.9	67.7	60.6	55.1
9	69.7	5.4	73.1	87.0	88	36	84.0	76.8	70.2	63.1	57.1
10	70.6	5.2	73.7	86.9	87	34	84.0	77.4	71.2	64.3	57.4
11	71.5	4.9	74.4	86.8	89	33	84.5	78.0	72.1	65.8	59.6
12	72.5	4.7	75.1	87.1	88	32	85.2	78.6	73.1	67.2	61.5
13	75.0	5.9	79.4	94.6	96	39	90.7	82.4	75.6	67.8	60.8
14	75.3	5.5	79.1	93.1	95	37	89.8	82.1	75.9	68.8	62.2

N= 4780

12- 4- 75

1149 HOURS

BAND	A	S	E	N	M	R	1	10	50	90	99
1	73.5	6.4	78.5	94.9	95	41	90.6	81.6	74.2	65.8	58.9
2	75.5	5.3	79.3	92.8	94	35	90.7	82.6	75.9	69.6	63.1
3	58.6	3.6	60.3	69.5	71	23	68.8	63.9	58.8	54.9	51.3
4	59.6	3.8	61.5	71.2	74	26	70.8	65.1	59.7	55.7	51.7
5	61.2	4.0	63.4	73.7	77	28	73.5	67.1	61.1	57.2	52.7
6	63.6	4.5	66.3	77.9	82	32	76.2	70.4	63.3	59.2	53.6
7	67.0	5.0	70.0	82.7	86	35	79.5	74.3	66.9	62.0	55.3
8	66.3	6.0	70.9	86.3	85	34	82.5	74.8	66.7	59.1	54.4
9	68.7	5.8	72.6	87.5	86	35	83.4	76.6	69.1	61.8	55.5
10	69.8	5.7	73.5	88.0	87	34	83.7	77.4	70.3	63.1	56.2
11	70.9	5.4	74.2	88.2	88	34	84.2	78.2	71.3	64.6	57.7
12	72.0	5.2	75.1	88.5	88	32	84.8	79.0	72.3	66.2	58.6
13	74.1	6.4	79.0	95.4	95	38	90.4	82.3	75.0	66.1	59.3
14	74.7	5.9	78.8	93.9	95	39	90.1	82.3	75.4	68.0	60.1

N= 4780

TABLE NO. 67
 STATISTICAL NOISE DATA
 ROADSIDE BARRIER TEST SITE, ANDOVER, MA.

BARRIER HGT 12 FT; ABSORPTIVE; MICROPHONE CONFIGURATION E
 NOISE LEVEL - DBA RE 20 MICROPASCAL

12- 4- 75		1040 HOURS									
BAND	A	S	E	N	M	R	1	10	50	90	99
1	73.7	6.9	79.0	96.5	95	45	90.4	82.9	74.5	65.3	56.9
2	76.0	5.4	79.7	93.7	95	45	90.4	83.5	76.4	69.6	62.9
3	58.3	3.9	67.2	77.2	103	59	69.4	64.3	58.3	54.2	51.9
4	59.0	4.0	61.3	71.6	74	28	70.4	65.5	59.0	54.8	52.2
5	60.8	4.1	63.1	73.6	75	33	72.6	67.1	60.7	56.5	53.5
6	63.4	4.3	65.8	76.8	78	36	75.0	69.9	63.4	58.8	55.2
7	67.9	4.4	70.1	81.3	82	40	78.7	74.4	68.2	62.8	58.4
8	65.2	5.7	69.7	84.4	85	43	81.4	73.4	65.3	58.7	55.5
9	66.7	5.7	70.8	85.3	85	44	81.9	74.7	67.0	59.8	56.2
10	67.7	5.6	71.6	85.9	87	45	82.3	75.4	68.2	60.9	56.6
11	68.7	5.3	72.1	85.6	85	43	82.6	75.9	69.1	62.4	57.6
12	70.3	4.9	74.0	86.6	103	61	82.9	77.2	70.6	64.5	59.4
13	75.2	5.9	79.6	94.7	95	45	90.7	83.4	75.7	68.2	63.4
14	75.6	5.3	79.3	92.9	95	45	90.3	83.0	76.0	69.5	65.0

N= 4780

12- 4- 75		1100 HOURS									
BAND	A	S	E	N	M	R	1	10	50	90	99
1	73.5	6.5	78.7	95.3	96	43	90.5	81.9	74.3	65.5	59.9
2	75.9	5.3	79.7	93.2	96	35	90.7	83.3	76.1	70.0	65.3
3	59.8	3.8	61.6	71.3	73	24	70.7	65.0	60.1	55.7	52.0
4	60.4	4.0	62.5	72.6	74	25	71.9	66.0	60.6	56.2	52.6
5	62.1	4.1	64.4	75.0	77	27	74.2	68.0	62.2	57.7	54.3
6	64.6	4.6	67.3	79.0	85	33	77.0	71.1	64.4	59.7	55.7
7	68.1	4.8	70.9	83.2	83	31	80.3	75.2	68.0	62.9	58.5
8	66.0	5.7	70.2	84.7	88	37	81.4	73.5	66.5	59.1	54.0
9	67.2	5.6	71.0	85.3	86	34	82.2	74.5	68.0	60.2	54.9
10	68.3	5.5	71.7	85.7	87	34	82.4	75.4	69.1	61.2	55.8
11	69.3	5.3	72.6	86.3	87	33	83.0	76.1	70.0	62.5	57.0
12	70.9	5.2	73.9	87.1	88	33	83.9	77.7	71.6	64.3	58.5
13	75.2	6.2	79.8	95.7	97	41	91.0	83.0	76.1	67.0	60.4
14	75.7	5.7	79.6	94.1	97	40	90.3	83.2	76.4	68.7	62.5

N= 4735

TABLE NO. 68
 STATISTICAL NOISE DATA
 ROADSIDE BARRIER TEST SITE, ANDOVER, MA.

BARRIER HGT 12 FT; ABSORPTIVE; MICROPHONE CONFIGURATION D
 NOISE LEVEL - DBA RE 20 MICROPASCAL

12- 4- 75

912 HOURS

BAND	A	S	E	N	M	R	1	10	50	90	99
1	75.3	6.2	79.7	95.7	96	42	91.0	83.2	76.3	68.1	57.7
2	76.7	5.2	80.2	93.5	95	34	91.2	83.4	77.3	70.8	64.6
3	58.7	2.7	59.6	66.5	70	19	66.5	62.6	59.1	55.8	53.2
4	59.0	2.7	59.9	66.8	69	19	66.5	63.0	59.4	56.0	53.7
5	59.9	2.6	60.8	67.4	69	17	66.8	63.9	60.3	57.2	54.4
6	60.0	2.7	60.9	67.7	71	20	67.2	64.0	60.4	57.1	54.5
7	60.9	2.7	61.8	68.7	70	19	68.1	65.0	61.3	57.9	55.2
8	61.3	3.8	63.2	72.8	74	24	71.7	67.0	61.4	57.2	54.0
9	63.4	3.9	65.2	75.2	74	23	73.5	69.3	63.6	59.0	55.7
10	64.9	3.9	66.7	76.8	76	23	74.7	70.8	65.3	60.3	57.1
11	66.2	3.8	67.9	77.7	78	24	75.6	71.8	66.5	61.7	58.4
12	67.5	3.7	69.0	78.5	79	24	76.5	72.9	67.9	63.2	59.8
13	76.6	5.3	80.2	93.8	95	35	90.9	83.8	77.2	70.1	65.1
14	76.7	4.9	79.8	92.3	95	33	90.1	83.5	77.2	71.2	66.2

N= 4785

12- 4- 75

932 HOURS

BAND	A	S	E	N	M	R	1	10	50	90	99
1	76.1	5.6	79.8	94.2	95	38	90.3	83.4	76.9	69.2	62.9
2	77.6	4.6	80.3	92.1	95	30	90.0	84.0	78.1	72.4	67.7
3	59.8	2.9	60.8	68.2	73	20	67.4	64.1	60.0	56.7	54.6
4	60.2	2.9	61.2	68.6	72	19	68.0	64.7	60.5	57.1	55.1
5	61.1	2.9	62.1	69.6	70	17	68.6	65.6	61.4	57.9	55.9
6	61.6	3.0	62.7	70.3	70	16	69.0	66.3	62.0	58.3	56.5
7	62.8	3.0	63.8	71.6	70	15	70.2	67.5	63.1	59.3	57.3
8	63.3	3.7	65.0	74.6	75	21	73.0	68.8	63.6	59.1	56.1
9	65.2	3.8	66.8	76.5	75	21	74.4	70.6	65.7	60.6	57.1
10	66.4	3.7	67.9	77.4	79	23	74.9	71.6	66.8	62.1	58.3
11	67.3	3.7	68.8	78.2	79	22	75.8	72.6	67.7	63.1	59.3
12	68.4	3.6	69.8	78.9	80	22	76.6	73.6	68.8	64.4	60.5
13	77.1	5.1	80.4	93.4	95	32	90.8	84.1	77.6	70.9	66.7
14	77.3	4.6	80.1	91.9	94	29	89.7	83.9	77.7	72.1	68.0

N= 4780

TABLES 69-80. NOISE DATA: TWELVE FOOT REFLECTIVE BARRIER;
MICROPHONE CONFIGURATIONS B, C, D, E.

TABLE NO. 69
STATISTICAL NOISE DATA
ROADSIDE BARRIER TEST SITE, ANDOVER, MA.

BARRIER HGT 12 FT; REFLECTIVE; MICROPHONE CONFIGURATION B

NOISE LEVEL - DBA RE 20 MICROPASCAL

11- 18- 75

916 HOURS

BAND	A	S	E	N	M	R	1	10	50	90	99
1	76.0	5.8	80.4	95.2	94	32	91.7	84.0	76.4	68.9	64.8
2	77.6	5.1	81.0	94.0	94	29	91.8	84.6	77.7	71.8	67.6
3	60.6	3.5	62.2	71.1	71	18	69.7	66.2	60.6	56.9	55.0
4	62.1	3.8	63.9	73.5	75	21	72.0	68.1	62.1	58.1	56.1
5	63.4	4.0	65.5	75.9	78	23	74.0	69.8	63.5	59.1	56.8
6	65.7	4.3	68.0	78.9	80	24	76.0	72.3	65.7	61.1	58.5
7	69.3	4.2	71.4	82.1	82	25	79.0	75.9	69.4	64.8	61.7
8	68.7	5.6	72.4	86.8	87	33	82.7	76.0	69.2	61.6	57.1
9	71.1	5.4	74.4	88.1	87	30	84.0	78.4	71.7	64.5	59.1
10	71.9	5.2	74.9	88.2	88	31	84.3	78.9	72.6	65.6	60.2
11	72.8	4.9	75.5	88.0	89	31	84.5	79.6	73.3	67.0	61.8
12	73.6	4.7	76.2	88.2	89	31	85.2	80.3	74.0	68.1	63.3
13	75.8	5.9	80.1	95.2	97	38	91.4	83.3	76.6	68.5	62.6
14	76.3	5.3	79.8	93.3	94	34	90.5	83.2	76.9	70.0	65.0

N= 4730

11- 18- 75

936 HOURS

BAND	A	S	E	N	M	R	1	10	50	90	99
1	76.4	5.6	80.8	95.1	100	42	92.0	83.8	76.7	70.4	63.8
2	77.9	5.0	81.5	94.3	99	38	92.4	84.7	78.1	72.7	65.9
3	61.7	3.4	63.2	71.9	75	22	71.5	66.8	61.9	58.1	55.1
4	62.9	3.7	64.8	74.2	78	24	74.3	68.4	63.0	59.1	56.0
5	64.2	3.8	66.3	76.1	81	27	75.7	69.8	64.2	60.2	56.7
6	66.4	4.0	68.5	78.9	81	26	77.9	72.3	66.5	62.3	57.6
7	69.9	4.1	72.0	82.4	86	29	80.8	75.8	70.0	65.8	60.2
8	69.5	5.2	73.1	86.4	92	40	83.1	76.7	69.8	64.2	55.5
9	71.7	5.0	74.9	87.7	92	37	84.7	78.5	72.1	66.7	57.4
10	72.6	4.9	75.6	88.1	91	36	85.0	79.1	73.0	67.7	59.3
11	73.5	4.6	76.2	88.0	92	36	85.6	79.7	73.8	69.0	61.0
12	74.3	4.4	76.9	88.3	93	35	85.9	80.3	74.6	70.0	61.7
13	76.5	5.4	80.6	94.3	99	40	91.5	83.5	76.9	70.7	61.9
14	77.0	5.0	80.4	93.1	98	39	91.2	83.3	77.3	71.8	63.6

N= 4780

TABLE NO. 70
 STATISTICAL NOISE DATA
 ROADSIDE BARRIER TEST SITE, ANDOVER, MA.

BARRIER HGT 12 FT; REFLECTIVE; MICROPHONE CONFIGURATION C
 NOISE LEVEL - DBA RE 20 MICROPASCAL

11- 18- 75		1043 HOURS									
BAND	A	S	E	N	M	R	1	10	50	90	99
1	75.3	5.6	79.2	93.6	93	34	90.2	82.9	75.9	68.7	62.3
2	76.4	4.9	79.4	91.9	92	30	90.0	83.0	76.8	70.8	65.9
3	59.5	2.9	60.6	68.0	71	19	67.9	63.9	59.7	56.5	54.5
4	60.6	3.0	61.8	69.4	71	18	68.9	65.2	60.8	57.5	55.5
5	61.8	3.0	62.9	70.5	72	17	69.9	66.4	62.0	58.6	56.5
6	63.2	3.1	64.5	72.4	75	19	72.0	67.9	63.5	59.8	57.4
7	65.1	3.4	66.5	75.1	77	22	74.5	69.8	65.5	61.4	58.4
8	65.0	3.9	66.9	76.9	76	22	75.4	70.8	65.4	60.5	57.2
9	68.7	4.0	70.6	80.9	80	22	78.6	74.7	69.1	64.0	60.6
10	69.5	3.9	71.2	81.2	81	22	78.7	75.3	70.0	65.0	61.7
11	70.6	3.9	72.3	82.2	83	24	79.8	76.2	70.9	66.0	63.0
12	71.6	3.8	73.2	82.8	83	22	80.4	77.1	72.0	67.2	64.4
13	76.1	4.9	79.2	91.8	94	31	89.6	83.1	76.5	70.3	66.4
14	76.4	4.5	79.1	90.6	93	28	88.7	83.0	76.7	71.2	67.8

N= 4780

11- 18- 75		1103 HOURS									
BAND	A	S	E	N	M	R	1	10	50	90	99
1	74.9	6.0	80.1	95.5	99	38	92.1	83.1	75.3	67.6	63.2
2	76.2	5.3	80.4	94.0	98	34	92.0	83.7	76.3	70.4	66.2
3	60.5	3.1	61.6	69.4	73	20	68.8	64.9	60.9	57.0	55.2
4	61.3	3.4	62.8	71.4	74	21	70.7	66.2	61.7	57.5	55.9
5	62.2	3.5	63.8	72.8	76	22	71.7	67.4	62.5	58.2	56.3
6	63.3	3.7	65.0	74.5	76	21	72.9	68.8	63.5	59.2	57.2
7	64.9	3.9	66.9	77.0	78	22	75.4	71.0	64.9	60.6	58.5
8	64.2	4.6	67.4	79.2	81	28	77.9	71.4	63.7	59.9	56.0
9	67.9	5.0	71.3	84.0	86	31	81.8	75.2	67.7	62.9	57.7
10	68.9	4.9	72.1	84.6	87	31	82.4	76.1	68.8	64.0	58.7
11	70.0	4.8	73.1	85.4	89	32	82.7	77.1	70.0	65.0	60.2
12	71.1	4.7	74.0	86.1	88	31	83.4	78.1	71.1	66.1	61.8
13	75.2	6.0	80.3	95.6	98	37	92.0	83.0	75.7	68.4	63.1
14	75.7	5.5	80.1	94.3	98	36	91.6	83.1	75.8	69.7	64.2

N= 4785

TABLE NO. 71
 STATISTICAL NOISE DATA
 ROADSIDE BARRIER TEST SITE, ANDOVER, MA.

BARRIER HGT 12 FT; REFLECTIVE; MICROPHONE CONFIGURATION D
 NOISE LEVEL - DBA RE 20 MICROPASCAL

11- 18- 75 1204 HOURS

BAND	A	S	E	N	M	R	1	10	50	90	99
1	74.2	6.4	80.0	96.5	99	42	91.6	83.0	74.4	67.1	60.0
2	75.5	5.7	80.1	94.6	98	37	91.2	83.5	75.6	69.3	63.3
3	58.8	3.1	59.9	67.8	71	22	67.3	63.0	59.3	55.2	52.4
4	59.4	3.1	60.6	68.6	71	21	68.6	63.8	59.8	55.7	53.3
5	59.9	3.1	61.2	69.1	72	20	69.2	64.3	60.3	56.3	54.0
6	60.7	3.2	62.0	70.1	73	20	70.1	65.2	61.0	56.9	54.6
7	61.4	3.2	62.7	70.9	73	20	70.7	66.1	61.8	57.6	55.3
8	60.4	4.4	62.9	74.1	77	28	73.0	66.7	60.6	55.6	52.2
9	62.7	4.7	65.5	77.4	79	28	75.9	69.5	62.8	57.6	54.0
10	64.3	4.7	67.1	79.3	81	29	77.6	71.0	64.4	58.9	54.7
11	66.0	4.7	68.8	80.9	83	30	79.5	72.5	66.3	60.6	56.3
12	67.4	4.7	70.3	82.3	84	29	81.1	73.8	67.8	62.1	57.4
13	74.8	6.1	80.2	95.8	100	42	90.9	83.3	75.0	67.9	62.3
14	75.3	5.7	79.9	94.4	100	41	90.0	83.5	75.5	68.9	63.0
15	73.3	5.2	77.1	90.4	94	33	88.7	80.7	73.6	67.2	63.2

N= 4780

11- 18- 75 1224 HOURS

BAND	A	S	E	N	M	R	1	10	50	90	99
1	73.8	5.7	78.6	93.2	95	36	91.2	80.7	74.1	67.5	62.3
2	75.3	5.0	79.1	91.9	95	33	90.9	81.9	75.5	69.9	65.5
3	59.0	3.0	60.2	68.0	73	20	67.5	63.9	58.8	56.1	54.4
4	59.5	2.9	60.6	68.0	73	19	68.2	64.1	59.4	56.8	55.3
5	60.1	2.9	61.2	68.5	72	17	68.8	64.6	60.0	57.3	56.0
6	60.8	2.9	62.0	69.5	73	18	69.4	65.5	60.8	57.9	56.3
7	61.6	3.0	62.7	70.3	73	18	70.3	66.1	61.6	58.5	57.1
8	60.9	4.3	63.8	74.8	77	25	74.9	67.6	60.6	56.9	54.2
9	62.9	4.4	65.8	77.0	80	27	76.2	69.6	62.7	58.6	55.5
10	64.2	4.4	66.9	78.2	80	26	76.8	70.9	64.0	59.8	56.5
11	65.7	4.4	68.3	79.5	81	25	77.7	72.4	65.5	61.2	58.1
12	67.0	4.3	69.5	80.5	82	25	79.0	73.6	66.8	62.5	59.7
13	74.2	5.7	79.1	93.7	97	37	91.5	81.5	74.3	68.1	63.6
14	74.8	5.2	79.0	92.2	95	34	90.7	81.6	74.8	69.5	64.9
16	75.4	5.2	79.1	92.4	94	30	90.4	82.6	75.8	69.4	66.0

N= 4780

TABLE NO. 72
 STATISTICAL NOISE DATA
 ROADSIDE BARRIER TEST SITE, ANDOVER, MA.

BARRIER HGT 12 FT; REFLECTIVE; MICROPHONE CONFIGURATION E
 NOISE LEVEL - DBA RE 20 MICROPASCAL

11- 18- 75 1348 HOURS

BAND	A	S	E	N	M	R	1	10	50	90	99
1	75.4	5.7	79.7	94.5	94	34	91.2	83.4	75.7	68.6	64.6
2	76.6	5.1	80.1	93.3	94	32	91.0	83.8	76.7	70.9	66.7
3	60.0	3.7	61.8	71.3	72	21	70.1	65.7	60.1	56.2	53.8
4	60.8	4.0	62.8	73.0	75	23	71.5	66.9	60.8	56.6	54.3
5	62.9	4.2	65.2	75.8	76	23	74.0	69.4	62.8	58.5	56.3
6	65.8	4.3	68.2	79.3	81	26	77.0	72.9	65.5	61.4	58.5
7	69.0	4.3	71.3	82.3	82	24	79.8	76.0	68.9	64.5	60.8
8	66.1	5.5	70.1	84.2	84	31	81.4	74.0	66.1	59.8	55.5
9	67.2	5.4	70.9	84.7	85	33	81.6	75.0	67.4	60.9	56.7
10	67.9	5.2	71.3	84.8	85	33	81.7	75.4	68.1	61.7	57.4
11	69.4	5.0	72.4	85.1	86	32	82.2	76.6	69.5	63.8	59.1
12	70.7	4.7	73.4	85.5	87	31	82.7	77.8	70.7	65.6	60.6
13	76.0	5.7	79.8	94.2	94	37	90.9	83.3	76.6	69.4	62.3
14	76.1	5.3	79.5	93.0	93	36	90.0	83.4	76.5	70.2	64.1
16	74.4	5.9	79.4	94.5	97	36	91.9	82.4	74.6	67.5	63.4

N= 4780

11- 18- 75 1408 HOURS

BAND	A	S	E	N	M	R	1	10	50	90	99
1	75.9	5.5	80.7	94.8	99	37	92.8	83.0	76.1	69.7	65.3
2	77.2	5.0	81.1	93.7	98	34	92.9	83.9	77.2	71.8	68.1
3	61.2	3.3	62.7	71.3	74	20	71.4	66.2	61.3	57.7	56.0
4	62.1	3.7	64.3	73.9	78	24	74.4	67.7	62.2	58.3	56.4
5	63.9	3.9	66.1	76.1	79	23	76.0	69.7	63.9	59.8	58.0
6	66.5	4.2	68.9	79.6	81	24	78.3	72.8	66.5	62.1	59.8
7	69.8	4.2	72.2	83.0	84	25	81.6	76.1	69.7	65.3	62.1
8	67.6	4.7	71.3	83.4	91	34	82.8	74.5	67.4	62.9	59.3
9	68.6	4.8	72.5	84.8	92	35	84.6	75.2	68.6	63.2	60.0
10	69.1	4.8	72.7	84.9	90	32	85.1	75.6	69.2	63.6	60.4
11	70.4	4.6	73.6	85.5	91	31	85.3	76.8	70.6	65.3	61.7
12	71.6	4.5	74.5	85.9	90	31	85.1	77.9	71.7	66.9	63.2
13	76.3	5.3	80.8	94.5	99	36	93.2	83.4	76.6	70.3	65.9
14	76.8	5.0	80.7	93.5	99	35	93.2	83.7	76.9	71.3	67.0
15	75.4	4.9	79.3	91.8	98	34	90.8	82.5	75.5	70.0	67.0

N= 4785

TABLE NO. 73
 STATISTICAL NOISE DATA
 ROADSIDE BARRIER TEST SITE, ANDOVER, MA.

BARRIER HGT 12 FT; REFLECTIVE; MICROPHONE CONFIGURATION E
 NOISE LEVEL - DBA RE 20 MICROPASCAL

11- 19- 75 855 HOURS

BAND	A	S	E	N	M	R	1	10	50	90	99
1	77.9	4.7	81.0	93.0	96	29	91.5	84.7	77.9	72.9	69.6
2	78.9	4.3	81.5	92.5	97	28	91.5	85.0	78.9	74.3	71.1
3	61.2	3.1	62.5	70.6	74	20	70.2	65.9	61.4	57.9	56.2
4	63.8	3.4	65.3	73.9	76	19	72.9	68.9	64.1	60.2	58.3
5	65.7	3.5	67.3	76.3	79	21	74.9	71.0	66.0	61.8	59.7
6	68.3	3.8	70.0	79.7	80	20	77.9	74.1	68.5	64.2	61.5
7	72.0	3.8	73.7	83.6	85	23	81.4	77.9	72.1	67.8	64.5
8	67.2	5.0	70.7	83.6	87	32	81.5	74.8	67.1	61.7	57.7
9	69.5	4.8	72.5	84.8	88	31	82.7	76.4	69.6	64.2	59.8
10	70.8	4.4	73.4	84.8	89	31	83.1	77.2	70.9	65.9	61.7
11	71.7	4.1	73.9	84.5	88	29	83.3	77.7	71.9	67.2	63.4
12	73.7	3.9	75.7	85.7	88	27	84.2	79.4	74.0	69.3	66.2
13	77.3	5.0	80.5	93.3	96	33	90.8	84.4	77.8	71.2	67.0
14	77.9	4.7	80.6	92.6	96	32	90.1	84.4	78.3	72.4	68.3

N= 4780

11- 19- 75 915 HOURS

BAND	A	S	E	N	M	R	1	10	50	90	99
1	76.5	5.8	80.8	95.6	98	37	92.0	84.3	77.0	69.8	64.4
2	77.8	5.3	81.4	95.0	98	34	92.2	84.9	78.2	71.7	66.7
3	60.6	4.1	62.8	73.4	75	24	71.4	66.7	60.9	55.7	53.2
4	62.4	4.3	64.7	75.8	77	25	73.6	68.8	62.8	57.4	54.3
5	64.4	4.4	66.8	78.0	80	27	75.7	70.7	64.8	59.4	55.6
6	67.1	4.5	69.5	81.1	84	29	78.3	73.6	67.4	62.0	57.7
7	71.2	4.5	73.5	84.9	86	29	82.2	77.6	71.4	66.3	60.8
8	66.0	6.0	70.8	86.1	88	37	82.3	74.5	66.3	58.9	54.6
9	68.4	5.7	72.4	87.0	88	35	83.0	76.3	69.0	61.4	56.7
10	69.9	5.4	73.5	87.3	89	34	83.9	77.3	70.5	63.3	58.5
11	71.0	5.0	74.0	86.8	89	33	83.9	77.9	71.4	64.9	60.1
12	73.3	4.6	75.8	87.5	89	30	85.1	79.8	73.6	68.1	63.5
13	76.5	5.5	80.5	94.6	97	34	91.8	84.4	76.7	70.0	66.0
14	77.5	5.1	80.9	93.9	97	31	91.4	84.6	77.6	71.4	68.2

N= 4780

TABLE NO. 74
 STATISTICAL NOISE DATA
 ROADSIDE BARRIER TEST SITE, ANDOVER, MA.

BARRIER HGT 12 FT; REFLECTIVE; MICROPHONE CONFIGURATION B
 NOISE LEVEL - DBA RE 20 MICROPASCAL

11- 19- 75 1016 HOURS

BAND	A	S	E	N	M	R	1	10	50	90	99
1	74.6	5.4	78.4	92.2	94	33	89.5	81.8	75.0	68.3	63.9
2	75.7	5.0	79.0	91.7	94	31	89.5	83.0	76.0	70.1	65.8
3	58.2	3.9	60.1	70.0	71	22	69.2	63.8	58.4	54.0	51.3
4	60.0	4.2	62.2	72.8	74	23	71.2	66.1	59.9	55.4	52.5
5	62.3	4.4	64.7	75.9	78	25	73.7	68.8	62.2	57.6	54.6
6	65.4	4.5	67.9	79.4	80	24	76.9	72.2	65.1	60.3	57.5
7	69.0	4.5	71.5	83.1	83	24	80.4	75.9	68.9	63.8	60.9
8	68.6	5.1	71.7	84.8	86	32	81.8	75.7	69.0	62.7	57.0
9	71.0	4.8	73.8	86.2	87	31	83.7	77.7	71.5	65.5	59.5
10	71.7	4.6	74.3	86.1	89	32	83.9	78.0	72.1	66.5	60.6
11	72.4	4.5	74.8	86.2	89	30	84.2	78.6	72.8	67.5	62.1
12	73.3	4.3	75.5	86.4	92	31	84.6	79.3	73.5	68.7	64.2
13	75.6	5.1	79.1	92.2	95	34	89.8	82.8	76.0	69.8	63.7
14	76.2	4.8	79.2	91.4	95	33	89.6	83.1	76.5	70.9	66.0

N= 4730

11- 19- 75 1036 HOURS

BAND	A	S	E	N	M	R	1	10	50	90	99
1	76.3	5.9	81.3	96.3	100	39	93.2	84.5	76.4	69.3	65.4
2	77.5	5.3	81.6	95.2	102	37	92.9	84.8	77.6	71.3	68.0
3	60.5	4.4	63.2	74.6	78	28	73.0	67.0	60.7	55.6	52.7
4	62.6	4.7	65.5	77.6	79	29	75.9	69.5	62.9	57.3	54.1
5	65.1	4.7	67.9	80.1	83	30	78.1	71.8	65.5	59.5	56.3
6	68.1	4.8	70.9	83.2	85	29	80.7	74.8	68.7	62.4	58.8
7	71.3	4.7	73.8	85.9	88	30	82.7	77.7	71.9	65.7	61.3
8	70.2	5.3	74.0	87.7	89	32	85.0	78.1	70.1	64.1	60.2
9	72.6	5.0	75.9	88.7	89	29	86.3	79.9	72.7	66.8	63.0
10	73.3	4.8	76.4	88.7	90	29	86.8	80.3	73.4	67.9	64.0
11	74.0	4.6	76.8	88.6	91	29	86.7	80.8	74.1	68.9	65.1
12	74.8	4.4	77.4	88.8	92	29	87.3	81.3	75.0	70.0	66.2
13	77.2	5.3	81.4	95.0	97	33	92.9	84.7	77.3	71.3	66.6
14	77.7	5.0	81.4	94.3	98	33	92.4	84.7	77.7	72.2	68.0

N= 4780

TABLE NO. 75
 STATISTICAL NOISE DATA
 ROADSIDE BARRIER TEST SITE, ANDOVER, MA.

BARRIER HGT 12 FT; REFLECTIVE; MICROPHONE CONFIGURATION C
 NOISE LEVEL - DBA RE 20 MICROPASCAL

11- 19- 75 1127 HOURS

BAND	A	S	E	N	M	R	1	10	50	90	99
1	75.5	5.8	80.1	95.0	101	43	90.7	83.3	76.1	68.7	61.8
2	76.4	5.3	80.3	93.9	101	40	90.5	83.5	76.9	70.4	64.2
3	58.4	4.0	60.5	70.9	74	26	69.1	64.3	58.9	53.8	50.2
4	59.8	4.1	62.0	72.5	75	25	70.4	65.7	60.2	55.0	52.0
5	61.6	4.1	63.6	74.1	76	25	71.9	67.5	61.9	56.8	53.8
6	63.4	4.2	65.5	76.1	78	25	73.7	69.5	63.7	58.7	55.0
7	66.3	4.3	68.4	79.3	82	27	76.0	72.5	66.5	61.5	56.9
8	63.2	5.5	66.7	80.7	82	35	76.0	71.1	63.3	57.2	50.6
9	67.9	5.3	71.2	84.8	88	38	79.0	75.6	68.4	62.0	54.8
10	69.5	4.9	72.4	85.0	88	35	80.6	76.4	69.9	64.1	57.4
11	70.3	4.7	73.0	85.2	89	34	81.5	77.0	70.7	65.0	58.9
12	71.6	4.5	74.1	85.7	89	32	81.9	78.1	71.9	66.5	60.9
13	75.8	5.6	80.2	94.5	102	43	90.0	83.4	76.3	69.2	63.2
14	76.3	5.3	80.0	93.5	100	39	89.7	83.6	76.8	70.3	64.0

N= 4780

11- 19- 75 1147 HOURS

BAND	A	S	E	N	M	R	1	10	50	90	99
1	73.5	6.4	78.7	94.9	96	39	90.5	81.8	74.2	65.8	60.1
2	74.6	5.8	78.9	93.7	96	36	90.4	81.9	75.2	67.7	62.2
3	57.0	4.1	59.1	69.5	71	24	68.1	63.0	57.0	52.5	49.6
4	58.2	4.2	60.4	71.2	71	22	69.2	64.7	58.2	53.5	51.0
5	59.9	4.2	62.2	73.0	73	22	71.0	66.3	59.9	55.2	52.9
6	61.6	4.4	64.0	75.1	75	22	72.7	68.2	61.6	56.7	54.2
7	64.3	4.5	66.7	78.3	78	24	75.4	70.9	64.3	59.2	56.1
8	62.2	5.1	65.7	78.7	82	32	75.9	69.9	62.1	56.6	53.0
9	66.8	5.0	70.0	82.8	84	31	79.7	74.2	66.8	61.2	56.5
10	68.4	4.7	71.2	83.3	84	28	80.2	75.4	68.4	63.1	58.7
11	69.3	4.5	71.9	83.5	84	27	80.8	75.9	69.3	64.1	60.4
12	70.6	4.3	72.9	84.0	85	25	81.8	76.9	70.5	65.7	62.1
13	74.5	5.7	78.9	93.5	95	36	90.6	82.2	74.8	67.9	62.4
14	75.2	5.3	79.0	92.5	96	35	90.2	82.4	75.4	69.2	64.3

N= 4785

TABLE NO. 76
 STATISTICAL NOISE DATA
 ROADSIDE BARRIER TEST SITE, ANDOVER, MA.

BARRIER HGT 12 FT; REFLECTIVE; MICROPHONE CONFIGURATION D

NOISE LEVEL - DBA RE 20 MICROPASCAL

11- 19- 75 1313 HOURS

BAND	A	S	E	N	M	R	1	10	50	90	99
1	74.4	5.5	77.9	91.9	93	36	88.8	81.1	75.3	67.3	60.7
2	75.3	5.0	78.2	91.0	94	35	88.3	81.7	76.0	69.0	62.8
3	57.2	2.8	58.2	65.4	69	20	65.2	61.1	57.7	54.0	51.3
4	58.1	2.8	59.0	66.2	68	19	65.7	62.0	58.7	54.8	52.0
5	58.8	2.9	59.8	67.2	68	18	65.9	63.0	59.4	55.5	52.6
6	59.6	2.9	60.6	68.0	70	20	67.0	63.8	60.1	56.3	53.4
7	60.9	3.0	61.9	69.7	75	23	68.7	65.3	61.3	57.4	54.5
8	57.4	4.1	59.8	70.3	75	27	70.7	63.1	57.3	53.0	50.2
9	59.8	4.1	62.2	72.7	75	25	71.7	66.0	59.8	55.4	52.1
10	62.1	4.0	64.1	74.4	76	24	72.6	68.2	62.2	57.7	54.1
11	64.4	3.9	66.1	76.1	77	23	74.1	70.3	64.5	60.1	56.7
12	66.0	3.7	67.7	77.3	77	21	75.3	71.6	66.3	61.9	58.7
13	74.3	5.4	77.8	91.5	94	34	88.4	81.5	75.0	67.8	62.5
14	75.1	4.9	78.1	90.8	93	31	87.8	81.9	75.6	69.3	64.5

N= 4780

11- 19- 75 1333 HOURS

BAND	A	S	E	N	M	R	1	10	50	90	99
1	75.5	5.8	80.5	95.3	101	43	91.4	84.0	75.6	69.1	64.3
2	76.3	5.3	80.5	94.1	100	40	91.3	84.1	76.4	70.7	65.4
3	56.3	3.5	57.9	66.9	71	24	66.8	61.2	56.6	52.3	49.9
4	57.0	3.7	58.7	68.2	72	23	67.6	62.3	57.2	52.8	50.5
5	57.7	3.6	59.4	68.6	71	22	67.7	62.9	58.1	53.6	51.4
6	58.6	3.6	60.3	69.7	71	21	68.7	63.8	59.0	54.4	52.3
7	60.1	3.7	61.8	71.1	72	20	69.7	65.4	60.5	55.8	53.6
8	58.3	4.8	61.3	73.5	77	30	71.4	65.4	58.2	52.9	49.8
9	61.0	4.8	64.0	76.4	79	29	74.2	68.2	61.1	55.5	51.6
10	63.3	4.7	66.0	78.0	80	29	75.5	70.1	63.4	58.0	53.6
11	65.5	4.5	68.0	79.6	82	28	77.0	71.9	65.6	60.3	56.3
12	67.1	4.3	69.5	80.6	84	28	78.2	73.3	67.3	62.2	58.4
13	75.5	5.9	80.4	95.5	101	42	91.0	83.9	75.9	68.9	63.2
14	76.3	5.4	80.3	94.0	99	37	91.1	83.8	76.6	70.2	65.1

N= 4780

TABLE NO. 77
 STATISTICAL NOISE DATA
 ROADSIDE BARRIER TEST SITE, ANDOVER, MA.

BARRIER HGT 12 FT; REFLECTIVE; MICROPHONE CONFIGURATION D
 NOISE LEVEL - DBA RE 20 MICROPASCAL

11- 20- 75 848 HOURS

BAND	A	S	E	N	M	R	1	10	50	90	99
1	76.6	5.1	80.2	93.2	99	38	91.5	82.9	77.2	70.7	64.3
2	77.6	4.6	80.6	92.4	98	34	91.4	83.5	78.1	72.4	67.2
3	60.3	2.8	61.4	68.5	72	19	69.0	64.6	60.5	57.5	55.6
4	61.2	2.8	62.3	69.4	72	18	69.6	65.7	61.4	58.4	56.6
5	61.6	2.8	62.6	69.9	73	18	70.0	66.1	61.7	58.8	57.1
6	62.1	2.9	63.2	70.6	73	17	70.8	66.7	62.2	59.2	57.3
7	63.6	3.0	64.7	72.3	75	19	72.5	68.3	63.7	60.6	58.3
8	62.8	3.7	65.1	74.4	81	26	75.0	68.1	62.7	59.3	57.1
9	65.2	3.5	67.1	76.2	81	24	77.0	70.4	65.2	61.7	59.4
10	67.0	3.4	68.7	77.5	82	23	78.2	72.0	67.1	63.5	61.3
11	68.0	3.4	69.6	78.3	82	23	78.6	73.1	68.1	64.4	62.3
12	69.2	3.4	70.7	79.3	83	21	80.0	74.2	69.2	65.7	63.5
13	76.7	4.8	80.3	92.5	101	36	91.2	82.7	77.1	71.2	67.8
14	76.9	4.4	80.0	91.4	98	32	90.3	82.7	77.2	71.9	68.4

N= 4780

11- 20- 75 908 HOURS

BAND	A	S	E	N	M	R	1	10	50	90	99
1	76.7	4.6	79.8	91.6	95	30	90.8	83.1	76.8	71.6	67.3
2	77.6	4.4	80.3	91.4	95	29	90.6	83.7	77.6	72.9	69.1
3	58.4	2.4	59.1	65.2	68	15	66.4	61.9	58.6	56.1	54.6
4	59.6	2.4	60.4	66.4	70	16	67.3	63.1	59.9	57.3	55.6
5	60.2	2.3	60.9	66.8	71	17	67.6	63.6	60.4	57.9	56.2
6	60.6	2.4	61.4	67.5	72	18	68.5	64.3	60.8	58.4	56.6
7	62.1	2.4	62.9	69.1	73	17	69.6	65.9	62.2	59.7	58.0
8	59.8	3.7	61.8	71.3	75	23	71.1	65.5	59.5	56.3	54.1
9	62.5	3.8	64.5	74.1	78	25	73.6	68.3	62.3	58.9	56.0
10	65.1	3.7	66.9	76.3	79	24	75.7	70.7	65.1	61.4	58.5
11	66.8	3.6	68.4	77.6	80	24	76.9	71.9	66.9	63.0	60.2
12	68.1	3.5	69.6	78.6	80	22	77.8	73.3	68.3	64.4	61.4
13	76.6	4.7	79.6	91.6	94	30	89.9	83.1	76.8	71.2	66.9
14	76.9	4.4	79.5	90.7	93	28	89.3	83.2	76.9	72.2	67.5

N= 4785

TABLE NO. 78
 STATISTICAL NOISE DATA
 ROADSIDE BARRIER TEST SITE, ANDOVER, MA.

BARRIER HGT 12 FT; REFLECTIVE; MICROPHONE CONFIGURATION E
 NOISE LEVEL - DBA RE 20 MICROPASCAL

11- 20- 75

1007 HOURS

BAND	A	S	E	N	M	R	1	10	50	90	99
1	75.5	5.5	79.4	93.6	95	37	90.4	83.2	75.8	69.0	63.1
2	76.4	5.3	79.8	93.4	94	34	90.3	83.7	76.8	70.3	63.0
3	59.5	4.2	61.5	72.2	72	22	70.1	65.6	59.9	54.3	51.7
4	61.1	4.2	63.2	73.9	75	24	71.7	67.3	61.5	55.9	53.4
5	62.8	4.3	65.0	76.0	78	25	73.7	69.1	63.2	57.6	55.0
6	65.5	4.5	67.8	79.3	79	24	76.6	72.0	66.0	60.2	56.9
7	68.7	4.6	71.1	82.9	82	26	79.9	75.3	69.2	63.2	59.1
8	65.0	5.7	69.4	84.1	84	33	80.5	73.5	65.0	58.6	54.2
9	66.9	5.5	70.7	84.8	84	30	81.2	75.2	67.1	60.4	56.4
10	68.1	5.2	71.5	84.7	84	30	81.6	75.8	68.5	62.0	58.0
11	70.0	4.7	72.8	84.8	85	27	82.2	77.0	70.1	64.7	60.7
12	71.7	4.3	74.0	85.1	86	26	82.7	78.4	71.8	67.0	63.1
13	75.6	5.5	79.5	93.7	93	31	90.1	83.6	76.0	69.2	64.2
14	76.3	5.1	79.6	92.8	93	31	89.7	83.8	76.6	70.7	65.1

N= 4780

11- 20- 75

1027 HOURS

BAND	A	S	E	N	M	R	1	10	50	90	99
1	75.2	5.7	80.0	94.6	98	36	91.7	83.3	75.5	68.7	64.7
2	76.5	5.1	80.2	93.2	96	31	91.4	83.6	76.9	70.7	67.4
3	59.9	4.0	62.1	72.3	74	22	71.6	65.9	60.1	55.5	53.5
4	61.7	4.1	64.3	74.8	81	28	73.7	67.7	61.9	57.1	55.1
5	63.5	4.1	65.9	76.5	83	28	75.9	69.3	63.8	58.8	56.6
6	66.2	4.2	68.7	79.5	84	27	78.4	72.0	66.6	61.6	59.1
7	69.7	4.2	71.9	82.5	84	25	81.0	75.6	70.0	65.1	62.1
8	64.8	5.9	70.2	85.2	89	38	82.2	72.9	64.8	58.5	53.8
9	66.7	5.7	71.3	85.9	89	38	83.0	74.6	66.7	60.5	55.4
10	68.0	5.3	71.9	85.6	89	37	83.3	75.3	68.2	62.2	56.5
11	70.0	4.9	73.2	85.8	88	34	83.8	76.7	70.2	64.7	59.2
12	71.8	4.4	74.5	85.8	89	32	84.1	78.1	71.9	67.1	62.2
13	75.4	5.5	79.9	94.0	99	38	92.0	82.9	75.6	69.0	63.9
14	76.4	4.9	79.9	92.4	96	33	91.3	83.1	76.6	71.1	66.5

N= 4780

TABLE NO. 79
 STATISTICAL NOISE DATA
 ROADSIDE BARRIER TEST SITE, ANDOVER, MA.

BARRIER HGT 12 FT; REFLECTIVE; MICROPHONE CONFIGURATION B
 NOISE LEVEL - DBA RE 20 MICROPASCAL

11- 20- 75		1112 HOURS									
BAND	A	S	E	N	M	R	1	10	50	90	99
1	75.7	4.8	78.9	91.3	94	31	89.9	82.2	76.0	70.1	66.0
2	76.6	4.5	79.4	90.9	93	28	89.7	82.8	76.8	71.6	67.6
3	61.5	3.1	62.8	70.8	72	18	70.5	66.3	61.6	58.4	55.9
4	63.2	3.2	64.6	72.9	75	20	72.0	68.5	63.3	60.1	57.1
5	64.6	3.5	66.2	75.1	76	20	74.3	70.0	64.6	61.1	58.5
6	67.3	3.9	69.3	79.3	79	21	78.0	73.3	67.4	63.1	61.0
7	70.2	4.1	72.4	83.0	84	24	81.5	76.3	70.4	65.7	63.1
8	68.8	4.7	71.6	83.7	85	29	81.7	75.0	69.4	63.0	58.7
9	71.4	4.3	73.6	84.7	86	27	82.7	77.3	72.0	66.3	61.7
10	72.1	4.2	74.3	85.2	87	28	83.1	77.9	72.7	67.1	62.3
11	73.0	4.2	75.0	85.6	87	27	83.6	78.7	73.5	68.1	63.6
12	73.8	4.0	75.7	86.1	87	25	83.9	79.4	74.3	69.2	64.6
13	75.7	4.9	78.8	91.3	94	32	89.8	82.2	76.2	70.1	64.9
14	76.3	4.7	79.1	91.1	94	31	89.5	82.6	76.8	70.8	66.1

N= 4730

11- 20- 75		1132 HOURS									
BAND	A	S	E	N	M	R	1	10	50	90	99
1	74.6	5.4	78.6	92.4	95	32	90.0	81.9	75.1	68.1	65.2
2	75.7	5.0	79.1	91.8	93	29	89.7	82.9	76.0	70.1	67.0
3	60.1	3.5	61.6	70.4	73	21	69.9	65.1	60.3	56.2	53.9
4	61.7	3.7	63.4	72.7	74	21	71.8	67.0	62.1	57.5	55.0
5	62.9	3.9	64.8	74.7	76	23	73.7	68.7	63.0	58.7	56.0
6	65.4	4.1	67.6	78.2	80	26	76.4	71.7	65.4	61.0	57.8
7	68.7	4.3	71.0	82.0	83	26	79.8	75.4	68.7	64.2	60.4
8	66.6	5.6	70.8	85.0	86	32	81.9	74.5	66.7	60.0	57.0
9	69.9	5.2	73.1	86.5	86	31	83.3	77.1	70.2	63.5	58.9
10	71.0	4.9	73.9	86.5	87	29	83.7	78.0	71.3	65.3	60.2
11	72.0	4.7	74.6	86.6	86	28	84.0	78.6	72.2	67.0	61.4
12	73.2	4.4	75.6	86.9	87	28	84.9	79.5	73.4	68.5	63.0
13	74.7	5.6	78.8	93.2	93	34	90.3	82.0	75.1	68.3	61.8
14	75.7	5.2	79.1	92.3	94	34	89.9	82.7	75.9	70.2	63.2

N= 4780

TABLE NO. 80
 STATISTICAL NOISE DATA
 ROADSIDE BARRIER TEST SITE, ANDOVER, MA.

BARRIER HGT 12 FT; REFLECTIVE; MICROPHONE CONFIGURATION C
 NOISE LEVEL - DBA RE 20 MICROPASCAL

11- 20- 75		1253 HOURS									
BAND	A	S	E	N	M	R	1	10	50	90	99
1	74.3	6.1	79.5	95.1	97	36	91.3	82.6	74.5	67.2	63.2
2	75.3	5.5	79.7	93.8	98	36	91.1	82.9	75.3	69.0	65.2
3	58.0	3.9	59.9	70.0	73	23	68.1	64.0	58.0	53.6	51.7
4	58.8	4.1	61.0	71.6	74	23	69.7	65.1	58.8	54.1	52.4
5	60.0	4.2	62.2	73.0	74	22	71.0	66.3	59.9	55.3	53.3
6	61.6	4.3	63.9	74.9	75	22	72.7	68.3	61.4	56.8	54.8
7	64.1	4.4	66.6	77.9	80	25	75.5	71.1	63.8	59.3	57.1
8	60.8	5.1	64.9	78.1	82	31	75.9	68.9	60.3	55.5	53.1
9	65.0	5.7	69.3	83.9	84	32	80.8	73.6	64.8	58.7	54.8
10	67.3	5.4	70.9	84.6	85	30	81.2	75.3	67.2	61.4	57.1
11	69.1	5.0	72.2	84.9	85	28	82.0	76.5	69.0	63.6	59.5
12	70.4	4.7	73.2	85.3	85	27	82.5	77.5	70.3	65.3	61.2
13	74.3	6.1	79.7	95.4	98	38	91.4	83.0	74.4	67.5	63.5
14	75.3	5.5	79.6	93.8	97	35	90.8	83.1	75.2	69.3	65.2

N= 4780

11- 20- 75		1313 HOURS									
BAND	A	S	E	N	M	R	1	10	50	90	99
1	74.7	5.4	78.2	91.9	92	32	88.8	81.6	75.4	68.1	63.4
2	75.8	5.0	78.7	91.5	92	31	88.7	82.3	76.3	69.5	64.5
3	58.2	3.2	59.6	67.7	75	23	67.3	63.3	58.2	54.9	53.2
4	59.1	3.2	60.4	68.5	77	25	67.6	64.1	59.3	55.8	53.8
5	60.2	3.1	61.4	69.5	73	20	68.6	65.0	60.5	56.9	54.6
6	61.7	3.2	62.9	71.2	74	20	70.0	66.5	62.1	58.2	55.6
7	64.2	3.4	65.6	74.4	74	19	72.7	69.3	64.6	60.4	57.5
8	61.2	4.4	63.7	75.0	74	23	72.8	67.7	61.6	56.1	53.1
9	65.6	4.9	68.3	80.8	79	26	77.2	72.7	66.2	59.8	54.9
10	67.7	4.4	69.9	81.3	80	26	78.0	74.2	68.3	62.6	57.1
11	69.4	4.2	71.3	82.0	81	24	78.9	75.4	70.0	64.4	60.0
12	70.6	4.0	72.4	82.5	81	22	79.8	76.3	71.2	66.0	61.7
13	75.0	5.4	78.6	92.4	93	33	89.3	82.0	75.8	68.5	63.4
14	75.8	4.9	78.8	91.4	93	32	88.9	82.5	76.4	70.2	65.4

N= 4780

TABLES 81-91. NOISE DATA: SIXTEEN FOOT ABSORPTIVE BARRIER;
MICROPHONE CONFIGURATIONS B, C, D, E.

TABLE NO. 81
STATISTICAL NOISE DATA
ROADSIDE BARRIER TEST SITE, ANDOVER, MA.

BARRIER HGT 16 FT; ABSORPTIVE; MICROPHONE CONFIGURATION B

NOISE LEVEL - DBA RE 20 MICROPASCAL

12- 9- 75 909 HOURS

BAND	A	S	E	N	M	R	1	10	50	90	99
1	77.2	4.4	79.6	90.8	93 30	88.8	82.9	77.8	72.0	67.2	
2	78.7	3.7	80.5	90.0	94 28	88.9	83.8	79.1	74.5	70.7	
3	59.7	2.2	60.3	65.9	69 16	66.0	63.1	60.1	57.4	55.3	
4	61.0	2.4	61.8	67.8	72 18	68.3	64.6	61.4	58.6	56.4	
5	62.5	2.4	63.3	69.5	73 17	69.7	66.0	63.0	59.9	57.9	
6	65.4	2.6	66.2	72.9	74 16	72.5	69.3	65.9	62.5	60.5	
7	68.7	3.0	69.7	77.5	78 17	75.9	73.2	69.1	65.2	62.4	
8	71.1	3.8	72.8	82.5	84 23	81.9	76.4	71.4	66.6	63.5	
9	73.1	3.7	74.7	84.1	85 22	83.0	78.2	73.6	68.8	65.3	
10	73.4	3.5	74.9	83.8	85 22	82.8	78.3	73.9	69.4	66.2	
11	74.2	3.3	75.5	83.8	86 21	83.2	78.9	74.6	70.5	67.6	
12	75.1	3.1	76.3	84.2	86 19	83.7	79.6	75.5	71.7	69.2	
13	78.0	4.0	80.0	90.2	92 25	89.2	83.5	78.4	73.4	69.7	
14	77.7	3.9	79.6	89.6	92 25	88.7	83.0	78.1	73.2	69.4	

N= 4780

12- 9- 75 1035 HOURS

BAND	A	S	E	N	M	R	1	10	50	90	99
1	78.1	5.1	81.4	94.5	96 32	91.5	85.2	78.6	72.1	67.5	
2	79.1	4.7	83.2	95.2	107 54	91.5	85.5	79.3	74.2	69.8	
3	62.1	2.9	63.2	70.6	76 22	70.3	66.4	62.5	59.0	56.5	
4	63.8	3.0	64.9	72.6	75 18	72.0	68.5	64.0	60.4	58.3	
5	64.9	3.2	66.2	74.4	77 20	73.6	70.0	65.0	61.5	59.3	
6	67.5	3.3	69.0	77.4	78 19	76.8	72.7	67.7	64.1	61.6	
7	69.9	3.7	71.7	81.1	83 24	80.2	75.4	70.1	66.1	62.8	
8	72.1	4.5	74.6	86.1	87 28	83.9	78.7	72.2	67.0	63.5	
9	74.2	4.2	76.4	87.3	88 26	85.5	80.3	74.5	69.3	65.8	
10	74.5	4.1	76.6	87.0	88 24	85.8	80.5	74.8	70.0	66.6	
11	75.3	3.9	77.3	87.3	89 25	86.3	81.2	75.5	71.2	67.4	
12	76.0	3.9	78.0	88.0	89 24	87.0	81.9	76.1	71.7	68.2	
13	78.7	4.9	82.0	94.5	96 32	92.5	85.9	78.8	73.5	68.4	
14	78.4	4.7	81.4	93.5	96 30	91.9	85.3	78.4	73.3	68.7	

N= 4780

TABLE NO. 82
 STATISTICAL NOISE DATA
 ROADSIDE BARRIER TEST SITE, ANDOVER, MA.

BARRIER HGT 16 FT; ABSORPTIVE; MICROPHONE CONFIGURATION B
 NOISE LEVEL - DBA RE 20 MICROPASCAL

12- 9- 75

1050 HOURS

BAND	A	S	E	N	M	R	1	10	50	90	99
1	78.4	5.4	82.1	95.8	98	35	93.3	85.5	79.0	72.0	65.7
2	79.3	4.9	83.5	95.9	97	52	94.1	85.5	79.8	74.0	69.5
3	62.1	3.0	63.3	71.0	75	21	71.0	66.6	62.4	59.0	56.4
4	63.8	3.2	65.1	73.3	75	20	72.8	68.8	64.1	60.3	58.1
5	65.0	3.3	66.3	74.7	78	21	74.1	69.7	65.3	61.4	59.1
6	67.9	3.2	69.2	77.4	81	21	76.7	72.5	68.4	64.3	61.7
7	70.1	3.9	71.8	81.8	83	23	79.6	75.6	70.6	65.2	62.1
8	71.6	4.7	74.5	86.6	89	31	85.2	77.9	72.0	66.1	62.3
9	73.9	4.6	76.5	88.2	91	29	87.2	79.9	74.4	68.5	64.6
10	74.4	4.3	76.8	88.0	92	29	87.3	80.0	74.9	69.3	66.0
11	75.3	4.2	77.6	88.3	92	26	87.9	80.9	75.7	70.4	67.5
12	76.0	4.1	78.3	88.8	93	28	88.3	81.6	76.5	71.2	68.3
13	78.6	4.9	81.9	94.5	99	32	92.3	85.4	79.0	72.6	69.6
14	78.3	4.9	81.4	93.9	97	30	91.7	84.9	78.7	72.4	69.3

N= 4785

TABLE NO. 83
 STATISTICAL NOISE DATA
 ROADSIDE BARRIER TEST SITE, ANDOVER, MA.

BARRIER HGT 16 FT; ABSORPTIVE; MICROPHONE CONFIGURATION D

NOISE LEVEL - DBA RE 20 MICROPASCAL

12- 9- 75

1145 HOURS

BAND	A	S	E	N	M	R	1	10	50	90	99
1	77.4	5.2	81.1	94.5	102	40	91.4	84.0	77.9	71.2	66.0
2	78.9	4.5	82.0	93.6	102	40	91.8	84.8	79.0	74.0	70.0
3	60.2	3.0	63.4	71.1	93	40	68.4	64.6	60.5	57.1	55.1
4	61.5	3.0	63.3	71.0	90	37	69.8	66.0	61.8	58.4	56.0
5	61.8	2.9	63.8	71.3	93	38	69.7	66.3	62.1	58.8	56.8
6	65.0	2.4	66.1	72.4	93	34	71.7	68.7	65.4	62.4	60.6
7	63.4	3.1	65.2	73.2	93	37	71.8	68.2	63.7	60.1	58.2
8	65.3	4.0	67.7	78.0	93	37	76.0	71.0	65.5	60.7	57.9
9	67.1	4.0	69.4	79.7	95	39	77.7	72.8	67.4	62.5	58.9
10	67.5	4.0	69.7	80.0	93	37	78.8	73.2	68.0	63.0	59.0
11	68.5	4.1	70.8	81.2	96	39	79.8	74.0	68.9	63.8	60.0
12	69.7	3.9	71.9	81.9	97	39	81.0	75.1	70.1	65.3	61.3
13	78.0	5.3	82.9	96.5	111	49	91.6	84.8	78.4	71.6	67.3
14	77.6	5.2	81.2	94.4	105	42	90.9	84.5	78.0	71.4	67.1

N= 4780

12- 9 75

1200 HOURS

BAND	A	S	E	N	M	R	1	10	50	90	99
1	77.4	4.4	79.7	90.9	91	30	89.4	83.0	78.1	72.3	67.5
2	78.8	3.8	81.3	90.9	93	34	89.5	83.7	79.2	74.5	72.0
3	60.6	2.5	61.4	67.8	71	19	67.6	64.4	61.0	58.1	54.9
4	62.0	2.5	62.8	69.2	72	18	68.9	65.8	62.5	59.4	56.6
5	62.4	2.5	63.2	69.5	73	19	69.6	66.0	62.8	59.9	56.9
6	65.2	2.0	65.7	70.8	74	15	70.9	68.4	65.6	63.2	61.2
7	64.2	2.5	64.9	71.3	74	18	70.8	67.9	64.6	61.6	58.7
8	65.1	3.1	66.2	74.0	75	18	72.7	69.7	65.5	61.7	59.2
9	66.9	3.1	68.1	76.1	76	18	74.5	71.7	67.4	63.4	60.4
10	67.4	3.2	68.5	76.7	77	18	74.9	72.0	67.8	63.8	60.8
11	68.3	3.1	69.4	77.5	78	19	75.7	73.0	68.8	64.8	62.0
12	69.6	3.1	70.7	78.7	79	19	76.8	74.3	70.1	66.1	63.0
13											
14	77.5	4.3	79.7	90.8	91	27	89.3	83.0	77.9	72.5	66.9

N= 4780

TABLE NO. 84
 STATISTICAL NOISE DATA
 ROADSIDE BARRIER TEST SITE, ANDOVER, MA.

BARRIER HGT 16 FT; ABSORPTIVE; MICROPHONE CONFIGURATION D
 NOISE LEVEL - DBA RE 20 MICROPASCAL

12- 11- 75 947 HOURS

BAND	A	S	E	N	M	R	1	10	50	90	99
1	75.6	5.7	80.2	94.7	99	41	92.0	83.3	75.9	69.1	64.0
2	78.1	4.9	81.7	94.3	98	35	92.4	85.0	78.3	72.7	68.5
3	59.6	2.9	60.8	68.2	76	23	68.8	63.9	59.7	57.0	55.0
4	60.3	2.8	61.4	68.5	74	21	68.6	64.7	60.4	57.7	55.5
5	61.0	2.7	61.9	68.8	73	19	68.9	65.2	61.2	58.3	56.3
6	60.8	2.7	61.8	68.7	73	20	68.7	64.9	61.0	58.0	56.0
7					N O D A T A						
8	62.2	3.9	64.2	74.1	76	22	72.8	68.3	62.4	57.9	55.7
9	64.3	4.0	66.4	76.7	77	22	74.8	70.6	64.5	59.8	57.3
10	65.9	4.1	67.9	78.4	80	23	76.1	72.0	66.1	61.3	58.8
11	67.5	4.0	69.5	79.8	80	24	77.9	73.6	67.8	63.0	60.3
12	69.0	3.9	70.9	80.9	82	24	79.3	74.9	69.3	64.5	61.8
13	77.6	5.2	81.3	94.6	97	32	92.3	84.8	77.8	71.5	67.7
14					N O D A T A						

N= 4730

12- 11- 75 1007 HOURS

BAND	A	S	E	N	M	R	1	10	50	90	99
1	74.3	5.6	79.4	93.6	101	41	89.7	81.3	74.7	67.9	62.5
2	77.2	4.8	81.1	93.5	101	37	92.3	83.6	77.5	71.7	67.2
3	59.7	3.3	61.4	69.7	75	22	71.3	64.3	59.7	56.6	54.5
4	60.4	3.1	61.9	69.9	76	23	71.1	64.8	60.4	57.3	55.4
5	61.3	3.0	62.7	70.3	79	25	71.0	65.5	61.3	58.4	56.4
6	60.5	3.1	62.1	70.0	78	25	70.1	65.0	60.6	57.4	55.7
7					N O D A T A						
8	61.7	4.0	64.3	74.4	79	27	75.5	67.5	61.6	58.0	55.1
9	63.5	4.2	66.3	77.1	81	27	77.6	69.4	63.3	59.3	56.4
10	64.8	4.3	67.6	78.5	82	27	79.1	70.7	65.0	60.4	57.3
11	66.3	4.2	69.0	79.8	86	30	80.1	71.9	66.4	61.9	58.3
12	67.6	4.2	70.2	80.9	85	28	81.3	73.2	67.9	63.1	59.8
13	76.4	5.2	80.4	93.8	100	39	91.5	83.2	76.8	70.3	65.3
14					N O D A T A						

N= 4780

TABLE NO. 85
 STATISTICAL NOISE DATA
 ROADSIDE BARRIER TEST SITE, ANDOVER, MA.

BARRIER HGT 16 FT; ABSORPTIVE; MICROPHONE CONFIGURATION E

NOISE LEVEL - DBA RE 20 MICROPASCAL

12- 11- 75 1143 HOURS

BAND	A	S	E	N	M	R	1	10	50	90	99
1	76.0	6.0	80.5	95.8	97	36	91.7	84.0	76.7	68.8	63.7
2	75.7	5.2	79.1	92.3	94	32	89.1	82.8	76.3	69.5	65.6
3	59.0	2.7	59.9	66.8	70	18	66.6	63.1	59.3	56.1	54.2
4	60.1	2.6	60.9	67.6	71	18	67.6	64.0	60.4	57.3	55.3
5	61.5	2.7	62.7	69.6	87	33	69.0	65.5	61.8	58.7	56.7
6	61.4	2.9	62.4	69.9	72	19	69.6	66.1	61.6	58.3	56.1
7	64.2	3.3	65.6	74.0	76	21	73.6	69.3	64.2	60.7	58.2
8	66.7	5.2	70.4	83.7	85	29	81.1	74.1	66.9	60.7	57.9
9	67.7	5.3	71.2	84.7	86	31	81.6	75.2	68.2	61.5	58.3
10	68.1	5.3	71.6	85.1	86	31	81.8	75.5	68.7	61.7	58.4
11	68.7	5.1	71.9	85.1	86	30	81.9	75.9	69.2	62.5	58.9
12	69.9	5.0	72.9	85.6	86	29	82.5	77.0	70.2	63.9	60.1
13	75.5	5.6	79.1	93.4	95	35	89.6	82.7	76.3	68.4	63.2
14											

N O D A T A

N= 4780

12- 11- 75 1203 HOURS

BAND	A	S	E	N	M	R	1	10	50	90	99
1	75.9	6.0	81.0	96.3	100	41	92.6	84.0	76.2	69.0	64.5
2	75.6	5.1	79.5	92.6	98	37	90.6	82.6	75.8	70.0	66.3
3	58.8	3.1	60.2	68.2	74	22	68.7	63.5	59.0	55.6	53.5
4	60.0	3.1	61.3	69.2	73	21	69.7	64.7	60.1	56.9	54.6
5	66.1	5.3	72.9	86.4	96	46	86.1	73.1	65.5	61.3	58.4
6	61.4	3.4	63.1	71.9	77	24	72.6	66.5	61.3	58.0	56.0
7	63.9	3.8	66.0	75.6	80	26	75.5	69.6	63.8	60.1	57.9
8	66.2	5.4	70.7	84.4	92	37	81.9	73.7	66.2	60.5	57.0
9	67.5	5.3	71.6	85.2	90	34	82.3	74.8	67.7	61.7	58.2
10	68.1	5.2	72.0	85.3	89	33	82.8	75.2	68.4	62.4	58.3
11	68.8	5.0	72.5	85.4	90	33	83.2	75.7	69.0	63.2	59.3
12	70.0	4.8	73.4	85.8	91	33	84.2	76.5	70.3	64.8	60.6
13	75.4	5.5	79.6	93.6	99	37	90.2	82.5	75.8	69.0	64.2

N= 4785

TABLE NO. 86
 STATISTICAL NOISE DATA
 ROADSIDE BARRIER TEST SITE, ANDOVER, MA.

BARRIER HGT 16 FT; ABSORPTIVE; MICROPHONE CONFIGURATION B
 NOISE LEVEL - DBA RE 20 MICROPASCAL

12- 11- 75		1244 HOURS									
BAND	A	S	E	N	M	R	1	10	50	90	99
1	75.6	5.6	80.1	94.6	96	35	91.4	83.4	75.7	69.2	65.1
2	76.4	5.0	80.0	92.7	96	33	90.7	83.6	76.4	71.1	67.5
3	59.4	3.1	60.7	68.6	75	23	68.2	64.0	59.7	56.1	54.0
4	60.6	3.1	61.8	69.7	75	21	69.0	65.2	60.9	57.3	55.3
5	62.0	3.1	63.3	71.2	76	22	71.0	66.5	62.2	58.7	56.6
6	62.0	3.3	63.5	71.8	76	22	71.6	66.8	62.2	58.6	56.6
7	64.5	3.7	66.3	75.7	78	23	74.9	70.1	64.7	60.6	58.6
8	68.7	4.9	71.9	84.5	85	31	81.8	76.0	68.9	63.3	58.9
9	71.2	4.7	74.0	86.0	87	30	83.1	78.2	71.4	66.1	61.3
10	72.1	4.6	74.8	86.5	88	30	83.9	79.0	72.3	67.1	62.4
11	72.6	4.4	75.1	86.5	88	29	84.1	79.4	72.7	67.9	63.2
12	73.5	4.3	75.9	86.8	88	28	84.9	80.0	73.7	68.9	64.1
13	76.1	5.2	79.7	93.1	96	34	90.2	83.3	76.5	70.1	65.5
14							N O D A T A				
15	75.2	5.3	78.7	92.3	93	29	88.5	82.7	75.4	69.0	66.1
N=	4780										

12- 11- 75		1305 HOURS									
BAND	A	S	E	N	M	R	1	10	50	90	99
1	74.8	5.9	79.3	94.4	94	34	90.8	82.6	75.2	67.7	63.9
2	75.7	5.3	79.3	92.9	93	31	90.0	82.8	76.1	69.6	65.4
3	59.1	2.7	60.0	67.0	70	17	66.7	63.4	59.4	56.3	54.3
4	60.2	2.8	61.2	68.2	72	18	68.1	64.4	60.4	57.3	55.3
5	60.9	2.9	62.1	69.4	80	26	69.6	65.3	61.1	58.1	56.1
6	61.6	3.0	62.8	70.6	74	20	70.3	66.4	61.7	58.4	56.4
7	64.1	3.4	65.7	74.5	75	21	73.6	69.6	64.1	60.6	57.9
8	67.8	5.5	71.6	85.7	84	29	81.8	76.3	67.9	61.6	57.7
9	70.6	5.2	73.8	87.3	85	27	83.2	78.6	70.8	64.3	60.3
10	71.7	5.1	74.7	87.9	86	28	83.8	79.4	72.0	65.5	61.3
11	72.4	4.9	75.1	87.7	87	29	83.8	79.7	72.7	66.4	61.8
12	73.4	4.8	76.0	88.2	87	28	84.6	80.5	73.8	67.9	62.4
13	75.9	5.7	79.7	94.2	93	32	90.2	83.5	76.4	69.0	63.7
16	76.9	5.3	80.6	94.2	96	41	91.4	84.3	77.1	70.9	66.8
N=	4780										

TABLE NO. 87
 STATISTICAL NOISE DATA
 ROADSIDE BARRIER TEST SITE, ANDOVER, MA.

BARRIER HGT 16 FT; ABSORPTIVE; MICROPHONE CONFIGURATION C

NOISE LEVEL - DBA RE 20 MICROPASCAL

12- 11- 75 1427 HOURS

BAND	A	S	E	N	M	R	1	10	50	90	99
1	77.6	5.6	82.0	96.2	101	40	93.9	84.5	78.2	71.0	64.3
2	77.2	5.0	80.7	93.4	98	35	91.7	83.5	77.7	71.4	65.6
3	59.1	2.8	60.0	67.1	70	18	66.7	63.2	59.5	56.3	53.5
4	60.0	2.9	61.0	68.4	74	21	67.9	64.3	60.2	57.1	54.4
5							N O	D A T A			
6	61.5	2.9	62.5	70.0	73	19	69.3	65.8	61.8	58.4	55.6
7	62.8	3.0	63.9	71.6	73	19	70.4	67.3	63.2	59.6	56.3
8	64.9	4.0	67.0	77.2	80	25	76.6	70.7	65.0	60.6	57.5
9	68.5	4.3	70.9	81.9	83	26	80.2	74.8	68.7	63.7	60.1
10	69.8	4.3	72.2	83.2	87	31	81.5	76.2	69.8	65.2	61.6
11	70.9	4.3	73.3	84.2	89	31	82.3	77.3	70.9	66.4	62.5
12	72.4	4.2	74.6	85.3	89	30	83.7	78.5	72.5	68.0	63.9
13	76.5	5.1	80.3	93.3	99	38	91.6	83.4	76.8	71.0	65.1
14							N O	D A T A			
16	77.8	5.5	81.6	95.7	99	35	92.3	85.4	78.4	71.3	66.5

N= 4785

12- 11- 75 1447 HOURS

BAND	A	S	E	N	M	R	1	10	50	90	99
1	78.8	5.1	82.5	95.7	100	35	93.0	86.0	79.2	72.9	68.5
2	78.4	4.6	81.4	93.2	98	31	91.6	84.8	78.8	73.2	69.3
3	59.8	2.5	60.6	67.0	70	17	66.7	63.7	60.1	57.1	55.3
4	60.2	2.6	61.1	67.7	72	18	67.4	64.1	60.6	57.3	55.4
5							N O	D A T A			
6	61.5	2.6	62.4	69.0	74	19	69.1	65.5	61.9	58.8	57.0
7	62.8	2.5	63.7	70.4	75	19	70.2	66.7	63.1	60.0	57.9
8	65.1	3.9	67.3	77.4	81	24	76.4	71.4	64.9	61.1	59.2
9	69.0	4.2	71.4	82.1	86	27	81.1	75.4	69.0	64.5	61.7
10	70.3	4.1	72.5	83.0	86	26	81.8	76.4	70.3	65.9	62.8
11	71.6	4.0	73.7	84.0	87	25	83.0	77.6	71.7	67.3	64.5
12	73.0	3.9	75.0	85.0	87	24	84.0	78.8	73.2	68.8	66.0
13	77.5	4.9	80.8	93.4	98	33	90.7	84.3	77.8	71.7	68.3
14							N O	D A T A			
16	77.3	4.4	79.7	91.0	92	28	89.0	83.6	77.5	72.5	68.1

N= 4780

TABLE NO. 88
 STATISTICAL NOISE DATA
 ROADSIDE BARRIER TEST SITE, ANDOVER, MA.

BARRIER HGT 16 FT; ABSORPTIVE; MICROPHONE CONFIGURATION E
 NOISE LEVEL - DBA RE 20 MICROPASCAL

12- 12- 75 854 HOURS

BAND	A	S	E	N	M	R	1	10	50	90	99
1	77.1	5.0	80.0	92.8	94	33	89.8	83.8	77.6	71.3	65.2
2	78.3	4.3	80.6	91.7	93	27	89.8	84.3	78.6	73.5	68.9
3	57.7	3.0	58.9	66.6	70	21	65.8	62.3	57.9	54.5	52.4
4	59.0	3.1	60.1	67.9	70	20	66.8	63.6	59.3	55.7	53.3
5	60.3	3.2	61.5	69.7	71	20	68.1	65.2	60.6	56.9	54.3
6	62.9	3.9	76.5	86.4	103	50	71.2	68.1	62.9	59.1	56.5
7	66.9	4.3	78.4	89.4	103	45	76.3	72.5	66.9	62.4	59.9
8	67.3	5.2	70.6	84.0	84	32	81.1	74.4	68.0	60.9	56.6
9	68.7	5.3	71.8	85.5	85	31	81.8	75.8	69.5	61.8	57.4
10	68.9	5.1	71.8	85.0	84	30	81.7	75.8	69.7	62.3	57.9
11	70.2	4.8	72.8	85.1	84	27	82.0	76.8	70.8	64.2	59.8
12	71.4	4.3	73.6	84.7	86	27	82.7	77.5	72.0	66.4	62.3
13	77.5	4.6	80.1	91.8	94	31	90.1	83.7	78.1	72.1	68.4
14	77.3	4.5	79.6	91.0	92	30	89.2	83.3	77.9	72.0	67.9

N= 4785

12- 12- 75 914 HOURS

BAND	A	S	E	N	M	R	1	10	50	90	99
1	75.5	6.2	79.8	95.7	96	42	91.2	83.2	76.4	68.1	60.1
2	77.0	5.3	80.5	94.0	96	36	91.2	84.1	77.4	71.0	64.8
3	57.0	3.7	58.9	68.3	73	27	67.5	62.5	57.0	53.2	50.1
4	58.2	3.7	60.1	69.7	74	27	69.0	63.6	58.2	54.4	51.3
5	59.6	3.9	61.7	71.6	75	27	70.8	65.4	59.5	55.7	52.2
6	61.9	4.0	64.1	74.3	77	28	73.0	68.1	61.3	57.9	54.3
7	65.4	4.2	67.8	78.6	80	28	77.0	71.8	65.5	61.0	57.0
8	66.0	5.9	70.5	85.7	86	36	82.0	74.2	66.6	58.7	54.1
9	67.3	6.1	71.7	87.2	87	37	82.7	75.4	68.4	59.6	54.0
10	67.6	5.8	71.6	86.4	87	37	82.6	75.3	68.4	60.2	55.0
11	69.2	5.4	72.7	86.5	87	35	83.3	76.3	69.8	62.5	57.5
12	70.2	4.9	73.1	85.7	87	33	83.0	77.0	70.6	64.3	58.6
13	76.4	5.2	80.1	93.4	95	31	90.9	83.8	76.7	70.3	66.6
14	76.2	5.2	79.6	92.8	94	31	90.2	83.4	76.6	70.0	66.3

N= 4730

TABLE NO. 89
 STATISTICAL NOISE DATA
 ROADSIDE BARRIER TEST SITE, ANDOVER, MA.

BARRIER HGT 16 FT; ABSORPTIVE; MICROPHONE CONFIGURATION B
 NOISE LEVEL - DBA RE 20 MICROPASCAL

12- 12- 75 1012 HOURS

BAND	A	S	E	N	M	R	1	10	50	90	99
1	77.0	6.0	82.1	97.5	100	42	93.8	85.2	77.3	70.0	63.8
2	78.7	5.4	82.9	96.8	100	39	94.3	86.3	78.9	72.6	67.7
3	59.3	4.1	61.8	72.3	78	29	71.6	64.9	59.5	55.1	50.7
4	60.3	4.1	62.8	73.2	79	29	72.8	66.0	60.5	56.1	52.4
5	61.9	4.1	64.3	74.7	78	27	73.9	67.7	62.1	57.5	53.9
6	63.9	4.1	66.1	76.7	80	27	75.4	69.9	64.1	59.4	56.1
7	67.3	4.2	69.5	80.3	83	28	78.3	73.5	67.5	62.5	59.1
8	70.7	5.8	75.0	90.0	91	38	86.0	78.5	71.0	63.7	57.7
9	73.1	5.4	76.9	90.8	93	37	87.8	79.9	73.5	66.8	60.4
10	73.7	5.2	77.1	90.5	93	36	87.9	80.4	74.1	68.0	61.2
11	75.2	4.9	78.4	91.0	95	37	88.8	81.4	75.6	69.8	63.4
12	75.0	4.7	78.0	90.2	94	35	88.2	81.2	75.4	70.0	63.8
13	78.1	5.3	82.5	96.1	101	36	94.1	85.4	78.1	72.2	68.1
14	78.2	5.2	82.2	95.4	99	34	93.7	85.2	78.5	72.4	67.8

N= 4780

12- 12- 75 1032 HOURS

BAND	A	S	E	N	M	R	1	10	50	90	99
1	76.3	5.6	80.6	94.9	99	41	92.1	83.4	77.0	70.1	62.2
2	77.8	5.0	81.3	94.2	98	37	92.3	84.2	78.2	72.3	66.0
3	58.8	3.4	60.4	69.1	76	26	69.2	63.6	59.0	55.4	52.5
4	59.9	3.4	61.4	70.1	74	23	69.8	64.8	60.1	56.4	53.6
5	61.3	3.3	62.9	71.4	80	27	71.6	66.1	61.5	57.9	55.1
6	63.2	3.5	64.7	73.6	78	25	73.0	68.2	63.4	59.5	56.3
7	66.7	3.7	68.3	77.9	81	27	75.9	72.0	67.0	62.7	57.9
8	69.6	5.3	73.2	86.8	91	35	83.0	77.3	69.7	63.2	58.7
9	72.3	4.9	75.3	87.8	90	32	85.3	79.2	72.5	66.5	62.2
10	72.9	4.7	75.7	87.7	90	30	85.3	79.4	73.1	67.6	63.0
11	74.1	4.4	76.6	87.9	89	27	86.3	80.5	74.3	69.1	65.5
12	74.3	4.2	76.6	87.5	90	27	86.2	80.5	74.3	69.6	66.1
13	77.1	5.1	81.0	94.1	100	35	91.7	84.2	77.3	71.2	67.4
14	77.3	5.0	80.7	93.4	98	34	91.1	84.1	77.5	71.6	67.3

N= 4780

TABLE NO. 90
 STATISTICAL NOISE DATA
 ROADSIDE BARRIER TEST SITE, ANDOVER, MA.

BARRIER HGT 16 FT; ABSORPTIVE; MICROPHONE CONFIGURATION C
 NOISE LEVEL - DBA RE 20 MICROPASCAL

12- 12- 75 1117 HOURS

BAND	A	S	E	N	M	R	1	10	50	90	99
1	76.0	5.7	79.6	94.1	92	38	89.9	83.2	76.9	68.8	61.5
2	77.1	5.1	80.0	93.0	91	33	89.8	83.6	77.8	70.7	64.9
3	57.2	3.3	58.8	67.3	72	24	67.9	62.0	57.4	53.8	50.6
4	58.2	3.3	59.6	68.0	73	24	68.8	62.8	58.4	54.8	51.7
5	59.3	3.2	60.8	69.0	74	24	69.6	64.0	59.5	56.1	53.1
6	60.4	3.3	62.0	70.4	75	23	70.8	65.3	60.6	57.1	54.3
7	62.3	3.4	64.0	72.8	78	24	72.6	67.3	62.6	58.6	56.3
8	65.4	4.6	67.9	79.7	82	29	76.8	71.9	65.7	60.0	55.4
9	69.7	4.4	71.8	83.1	85	29	79.7	75.7	70.4	64.3	59.2
10	70.3	4.2	72.2	82.9	84	27	80.1	75.8	70.9	65.2	60.3
11	71.7	4.0	73.6	83.9	86	27	81.1	77.1	72.4	66.9	62.0
12	72.3	3.9	73.9	83.8	85	25	81.0	77.5	72.9	67.8	62.7
13	77.1	5.0	80.0	92.9	92	30	89.7	84.1	77.6	70.8	66.2
14	77.3	4.8	80.0	92.2	92	28	89.1	84.0	78.0	71.2	66.8

N= 4785

12- 12- 75 1137 HOURS

BAND	A	S	E	N	M	R	1	10	50	90	99
1	74.8	6.5	80.0	96.7	101	49	91.6	82.1	76.0	66.9	56.8
2	75.8	5.9	80.4	95.5	100	43	91.9	82.7	76.8	68.4	60.7
3	56.0	3.6	57.7	67.0	72	24	66.4	61.4	56.2	52.0	49.7
4	57.1	3.5	58.8	67.9	72	23	67.3	62.7	57.2	53.3	51.2
5	58.5	3.4	60.1	68.8	72	21	68.5	63.8	58.6	54.9	53.0
6	59.2	3.3	60.7	69.2	74	22	68.9	64.2	59.3	55.7	53.7
7	61.0	3.4	62.6	71.4	74	21	71.1	66.1	61.1	57.5	55.0
8	63.0	5.2	66.9	80.2	84	35	78.1	70.4	63.1	57.2	53.0
9	67.9	5.2	71.5	84.7	89	36	81.8	74.9	68.4	61.9	57.1
10	68.7	5.0	72.0	84.7	90	37	82.3	75.5	69.1	63.0	58.5
11	70.1	4.7	73.2	85.3	90	34	83.1	76.5	70.5	64.7	60.5
12	71.0	4.6	73.8	85.5	92	34	83.5	77.2	71.4	65.8	61.5
13	75.6	5.6	80.4	94.6	102	41	91.9	82.8	76.1	69.2	64.3
14	76.1	5.3	80.2	93.8	100	39	91.0	82.7	76.6	69.9	64.4

N= 4780

TABLE NO. 91
 STATISTICAL NOISE DATA
 ROADSIDE BARRIER TEST SITE, ANDOVER, MA.

BARRIER HGT 16 FT; ABSORPTIVE; MICROPHONE CONFIGURATION D
 NOISE LEVEL - DBA RE 20 MICROPASCAL

12- 12- 75 1309 HOURS

BAND	A	S	E	N	M	R	1	10	50	90	99
1	75.7	5.2	79.2	92.4	92	31	90.2	82.3	76.2	69.6	65.2
2	66.7	4.6	69.7	81.4	84	28	80.2	72.9	67.1	61.5	58.3
3	56.2	2.5	57.1	63.6	69	19	63.6	60.1	56.3	53.7	52.2
4	55.9	3.1	57.1	65.1	68	20	64.5	60.5	56.2	52.3	50.3
5	56.2	3.1	57.3	65.1	68	20	64.4	60.7	56.5	52.6	50.5
6	57.1	3.0	58.1	65.8	69	20	64.9	61.6	57.4	53.7	51.5
7	57.9	3.0	59.0	66.6	70	20	65.5	62.5	58.3	54.6	52.4
8	58.9	4.4	61.4	72.8	73	28	70.1	66.1	58.6	54.4	49.5
9	60.0	4.4	62.4	73.8	74	28	71.1	67.1	59.8	55.5	49.8
10	63.6	4.3	65.9	77.0	76	28	74.1	70.5	63.7	59.1	53.5
11	65.5	4.2	67.6	78.3	78	28	75.6	71.8	65.7	61.0	55.5
12	66.9	4.1	68.8	79.3	79	27	76.8	73.1	67.2	62.5	57.6
13	74.9	5.4	78.7	92.7	96	37	90.0	82.0	75.5	68.2	63.7
14	75.8	5.3	79.3	92.8	94	34	90.1	82.5	76.6	69.1	65.1

N= 4780

12- 12- 75 1329 HOURS

BAND	A	S	E	N	M	R	1	10	50	90	99
1	76.0	5.7	80.6	95.3	101	41	91.4	83.6	76.7	69.1	63.1
2	77.4	5.1	81.3	94.3	102	38	91.7	84.6	77.7	71.7	67.0
3	57.9	2.4	58.7	64.8	72	21	65.4	61.4	58.3	55.7	53.4
4	58.2	2.7	59.2	66.1	74	24	66.0	61.9	58.6	55.4	52.8
5	58.4	2.7	59.3	66.1	72	21	66.1	62.2	58.9	55.7	53.1
6	59.1	2.5	59.9	66.4	70	18	66.1	62.9	59.5	56.4	54.2
7	60.0	2.5	60.7	67.1	72	19	66.8	63.7	60.4	57.3	55.4
8	61.8	3.9	63.8	73.6	78	27	72.8	67.2	62.1	57.5	54.4
9	62.5	3.9	64.7	74.6	79	26	74.5	68.0	62.9	58.2	55.3
10	65.5	3.9	67.6	77.6	82	27	77.4	71.0	66.0	61.1	58.2
11	67.3	3.9	69.3	79.3	84	27	78.8	72.8	67.7	62.8	59.8
12	68.4	3.9	70.4	80.4	84	27	80.4	73.8	68.8	63.9	60.9
13	76.2	5.2	80.3	93.7	101	40	90.3	83.2	76.5	70.3	65.3
14	76.7	5.0	80.3	93.2	100	37	90.4	83.5	77.0	71.0	65.9

N= 4780

TABLES 92-123. NOISE DATA: SIXTEEN FOOT REFLECTIVE BARRIER;
MICROPHONE CONFIGURATIONS B, C, D, E.

TABLE NO. 92
STATISTICAL NOISE DATA
ROADSIDE BARRIER TEST SITE, ANDOVER, MA.

BARRIER HGT 16 FT; REFLECTIVE; MICROPHONE CONFIGURATION B

NOISE LEVEL - DBA RE 20 MICROPASCAL

12- 16- 75 906 HOURS

BAND	A	S	E	N	M	R	1	10	50	90	99
1	77.0	4.8	80.6	92.8	100	37	90.6	83.3	77.4	71.7	66.8
2	77.6	4.5	80.8	92.3	100	35	90.8	83.6	77.9	72.8	68.0
3	59.4	3.2	61.1	69.3	77	25	70.0	63.9	59.5	56.2	54.3
4	60.6	3.3	62.4	70.8	79	27	71.6	65.2	60.7	57.3	55.0
5	61.7	3.4	63.7	72.3	81	27	73.1	66.6	61.7	58.5	56.0
6	63.7	3.4	65.6	74.4	81	26	73.9	68.7	63.6	60.3	57.5
7	67.2	3.7	69.1	78.5	84	28	77.7	72.7	67.2	63.4	60.1
8	70.6	4.9	74.1	86.7	91	36	84.7	77.2	70.8	65.3	59.1
9	72.3	4.7	75.3	87.3	93	36	85.7	78.5	72.5	67.3	61.1
10	73.0	4.5	75.9	87.5	93	35	85.6	79.0	73.3	68.4	61.8
11	73.7	4.2	76.1	86.9	93	33	85.3	79.5	73.9	69.4	63.4
12	74.8	4.0	77.0	87.3	92	30	85.8	80.5	74.9	70.8	65.3
13	76.6	5.1	80.5	93.5	102	41	90.8	83.4	76.9	71.1	64.6
14	77.1	4.9	80.4	92.9	100	39	90.5	83.4	77.5	71.8	65.1

N= 4785

12- 16- 75 926 HOURS

BAND	A	S	E	N	M	R	1	10	50	90	99
1	77.9	4.5	80.5	91.9	93	28	90.7	83.9	78.0	73.0	69.0
2	78.6	4.1	80.9	91.3	94	28	90.8	84.3	78.7	74.2	70.8
3	60.8	2.7	61.7	68.5	70	16	68.5	65.1	61.0	58.2	56.0
4	61.9	2.5	62.7	69.2	72	16	68.8	65.9	62.2	59.3	57.2
5	63.0	2.7	63.9	70.9	76	19	70.2	67.3	63.1	60.3	58.2
6	64.8	2.9	65.8	73.2	75	17	72.7	69.4	65.0	61.8	60.1
7	68.1	3.1	69.4	77.4	80	22	77.0	72.9	68.5	64.9	62.2
8	71.4	4.2	73.5	84.1	85	25	82.4	77.3	71.8	66.5	63.0
9	72.9	4.0	74.8	85.1	85	24	83.0	78.6	73.4	68.1	64.1
10	73.7	3.9	75.4	85.4	85	23	83.4	79.3	74.2	69.1	65.2
11	74.4	3.7	75.9	85.3	85	23	83.4	79.8	74.8	70.0	66.6
12	75.4	3.5	76.8	85.9	86	21	84.2	80.7	75.7	71.2	68.3
13	77.3	4.4	79.9	91.2	92	26	89.9	83.4	77.7	72.1	68.7
14	77.9	4.2	80.2	91.0	92	25	89.9	83.8	78.3	73.1	69.4

N= 4780

TABLE NO. 93
 STATISTICAL NOISE DATA
 ROADSIDE BARRIER TEST SITE, ANDOVER, MA.

BARRIER HGT 16 FT; REFLECTIVE; MICROPHONE CONFIGURATION C

NOISE LEVEL - DBA RE 20 MICROPASCAL

12- 16- 75		1002 HOURS									
BAND	A	S	E	N	M	R	1	10	50	90	99
1	76.5	5.4	80.7	94.4	96	34	92.5	83.2	76.7	70.3	66.1
2	77.4	5.0	81.1	94.0	96	32	92.8	83.8	77.6	71.7	67.7
3	60.0	2.7	61.0	68.0	72	19	68.6	64.0	60.2	57.2	55.4
4	60.8	2.9	61.9	69.4	74	20	69.8	64.9	61.0	57.8	56.1
5	61.5	3.1	62.8	70.7	74	20	70.9	66.1	61.6	58.4	56.5
6	62.2	3.3	63.7	72.1	75	20	71.8	67.1	62.3	59.0	57.0
7	63.7	3.5	65.3	74.2	76	20	73.4	69.0	63.7	60.0	58.2
8	66.7	4.2	69.3	80.1	83	29	79.3	72.7	66.8	62.2	59.1
9	69.8	4.3	72.4	83.4	84	27	82.3	75.9	70.0	65.3	61.3
10	70.5	4.1	72.9	83.4	85	26	82.5	76.3	70.7	66.2	62.6
11	71.8	4.1	74.1	84.5	86	25	83.8	77.6	71.9	67.5	64.1
12	73.0	4.0	75.1	85.3	86	25	84.5	78.6	73.1	68.8	65.5
13	76.5	5.2	80.5	93.9	97	35	92.0	83.4	76.6	71.0	65.6
14	77.3	5.0	80.8	93.6	95	32	91.7	83.9	77.5	71.8	66.3

N= 4780

12- 16- 75		1042 HOURS									
BAND	A	S	E	N	M	R	1	10	50	90	99
1	76.9	6.1	81.8	97.5	99	38	93.4	85.2	77.7	69.1	64.1
2	78.0	5.7	82.3	96.9	99	36	93.6	85.7	78.6	70.9	65.7
3	60.7	3.1	62.0	69.9	74	21	69.6	65.2	61.1	57.3	55.1
4	61.8	3.2	63.1	71.4	74	21	71.0	66.5	62.1	58.1	56.1
5	62.6	3.3	64.0	72.4	74	20	71.8	67.4	62.9	58.9	56.4
6	63.4	3.4	64.9	73.5	76	20	72.9	68.4	63.8	59.5	57.3
7	65.0	3.6	66.6	75.9	77	20	74.6	70.3	65.4	60.7	58.4
8	67.5	4.7	70.5	82.4	86	29	80.5	74.4	67.5	62.3	59.5
9	70.3	4.9	73.4	85.9	88	29	83.8	77.3	70.6	64.5	61.5
10	71.0	4.9	74.0	86.5	88	28	84.2	77.9	71.4	65.1	62.1
11	72.4	4.8	75.4	87.6	91	30	85.7	79.1	72.7	66.6	63.8
12	73.7	4.6	76.4	88.1	90	27	86.2	80.0	74.0	68.3	65.3
13	77.2	5.5	81.7	95.7	100	35	93.2	84.9	77.4	70.7	67.4
14	78.0	5.2	81.9	95.2	99	35	93.1	85.3	78.2	71.9	68.3

N= 4730

TABLE NO. 94
 STATISTICAL NOISE DATA
 ROADSIDE BARRIER TEST SITE, ANDOVER, MA.

BARRIER HGT 16 FT; REFLECTIVE; MICROPHONE CONFIGURATION D

NOISE LEVEL - DBA RE 20 MICROPASCAL

12- 16- 75		1122 HOURS									
BAND	A	S	E	N	M	R	1	10	50	90	99
1	76.6	5.0	80.1	93.0	99	35	90.0	83.4	77.2	70.6	67.2
2	77.5	4.7	80.5	92.5	99	32	90.1	83.9	77.8	72.0	68.9
3	60.5	2.5	61.4	67.8	74	20	68.4	64.1	60.8	58.0	55.9
4	61.4	2.6	62.3	68.9	73	18	69.7	65.1	61.7	58.6	56.6
5	61.9	2.7	62.8	69.7	75	20	70.1	65.7	62.3	59.0	57.1
6	62.0	2.6	62.8	69.4	72	17	69.6	65.8	62.4	59.2	57.3
7	62.7	2.5	63.5	69.9	71	15	69.6	66.5	63.1	59.9	58.1
8	63.1	3.4	64.5	73.3	77	22	71.7	68.2	63.4	59.2	56.5
9	64.5	3.6	66.1	75.3	79	24	73.1	69.8	65.0	60.4	57.4
10	65.7	3.8	67.4	77.2	80	25	74.9	71.0	66.2	61.2	57.6
11	67.5	4.0	69.3	79.4	83	26	76.3	72.8	68.1	62.7	58.7
12	69.0	3.9	70.7	80.8	84	27	77.8	74.3	69.6	64.3	59.9
13	77.2	5.2	80.7	93.9	101	40	90.0	84.2	77.8	71.1	66.0
15	77.1	5.1	80.8	93.9	94	27	91.7	84.6	77.1	71.4	68.6
N=		4780									
12- 16- 75		1142 HOURS									
BAND	A	S	E	N	M	R	1	10	50	90	99
1	76.3	5.7	81.4	96.1	100	40	93.3	84.0	76.5	70.1	64.6
2	77.2	5.3	81.6	95.3	99	37	93.3	84.4	77.2	71.3	66.2
3	60.1	2.8	61.2	68.4	78	25	68.9	64.2	60.2	57.4	55.3
4	60.8	2.8	61.9	69.1	73	19	69.8	65.0	60.9	58.1	55.9
5	61.2	2.8	62.3	69.3	75	21	69.6	65.4	61.4	58.4	56.3
6	61.2	2.7	62.2	69.1	73	18	69.6	65.3	61.5	58.5	56.5
7	61.6	2.7	62.6	69.4	74	20	69.6	65.6	61.9	58.9	56.9
8	62.8	3.9	65.0	75.0	78	23	74.6	69.0	62.5	59.1	57.0
9	64.2	4.1	66.7	77.3	82	27	76.8	70.3	63.9	60.0	57.7
10	65.3	4.3	67.9	79.1	83	27	78.0	71.7	65.3	60.6	58.3
11	67.0	4.4	69.7	80.9	84	26	79.7	73.4	67.1	62.3	59.7
12	68.4	4.4	71.2	82.5	87	28	81.4	74.8	68.5	63.6	61.0
13	76.5	6.1	82.1	97.8	100	37	94.2	84.8	76.7	69.2	65.5
14	76.7	5.9	81.6	96.8	99	37	93.4	84.5	77.0	69.8	65.1
16	77.1	5.2	80.8	94.1	99	34	91.0	84.4	77.2	71.0	67.9
N=		4780									

TABLE NO. 95
 STATISTICAL NOISE DATA
 ROADSIDE BARRIER TEST SITE, ANDOVER, MA.

BARRIER HGT 16 FT; REFLECTIVE; MICROPHONE CONFIGURATION E
 NOISE LEVEL - DBA RE 20 MICROPASCAL

12- 16- 75 1303 HOURS

BAND	A	S	E	N	M	R	1	10	50	90	99
1	74.8	5.6	79.1	93.4	95	36	91.1	82.0	75.4	68.2	63.3
2	75.8	5.2	79.5	92.7	94	32	91.2	82.4	76.3	70.2	65.3
3	59.3	3.0	60.4	68.1	71	19	68.4	63.6	59.6	56.1	53.7
4	60.2	2.9	61.3	68.8	71	19	69.0	64.4	60.6	57.0	54.6
5	61.1	3.0	62.3	70.0	72	19	70.4	65.3	61.4	57.8	55.2
6	62.4	3.1	63.7	71.6	75	21	71.9	66.7	62.7	59.1	56.3
7	64.3	3.3	65.7	74.2	77	22	73.9	68.9	64.6	60.7	57.9
8	66.8	4.9	70.3	82.8	87	31	81.4	73.5	66.9	61.4	58.4
9	67.8	5.0	71.2	84.0	88	32	82.2	74.6	68.2	62.1	58.8
10	68.3	5.1	71.7	84.7	88	31	82.0	75.1	68.9	62.3	59.2
11	69.1	5.0	72.4	85.2	87	30	83.1	75.7	69.7	63.2	59.7
12	70.1	4.8	73.2	85.5	88	29	83.7	76.6	70.6	64.4	60.7
13	75.7	5.6	79.8	94.0	96	35	91.4	82.8	76.3	68.9	64.1
14	75.7	5.4	79.4	93.1	96	34	91.0	82.4	76.4	69.1	64.4
16	76.7	5.5	80.4	94.5	95	32	91.2	84.2	77.3	69.9	66.2

N= 4785

12- 16- 75 1323 HOURS

BAND	A	S	E	N	M	R	1	10	50	90	99
1	74.7	5.3	78.1	91.7	92	33	88.4	82.1	75.3	68.3	63.3
2	75.7	4.9	78.7	91.2	92	31	88.8	82.5	76.2	70.0	65.3
3	59.1	2.3	59.7	65.5	68	17	65.8	62.5	59.5	56.9	54.5
4	60.1	2.3	60.7	66.6	71	18	66.7	63.6	60.4	57.8	55.2
5	60.9	2.5	61.7	68.2	74	22	68.2	64.8	61.2	58.4	55.6
6	62.0	2.6	62.8	69.6	71	18	69.5	65.9	62.4	59.3	56.2
7	63.7	2.9	64.7	72.0	74	20	71.8	67.9	64.0	60.6	57.6
8	67.0	4.6	69.8	81.6	83	27	80.1	73.6	67.2	61.7	58.4
9	67.8	4.7	70.6	82.6	84	27	80.7	74.5	68.1	62.2	59.1
10	68.2	4.7	71.0	83.1	85	28	81.0	74.9	68.6	62.5	59.3
11	68.9	4.6	71.5	83.3	84	26	81.1	75.4	69.3	63.2	60.1
12	69.8	4.5	72.3	83.7	84	26	81.8	76.2	70.2	64.5	61.2
13	75.5	5.4	78.9	92.7	93	32	89.0	82.7	76.1	68.9	64.3
14	75.4	5.2	78.5	92.0	92	32	88.3	82.5	76.2	69.1	63.4
15	75.4	5.0	79.1	91.9	95	33	89.8	82.6	75.6	69.8	65.8

N= 4780

TABLE NO. 96
 STATISTICAL NOISE DATA
 ROADSIDE BARRIER TEST SITE, ANDOVER, MA.

BARRIER HGT 16 FT; REFLECTIVE; MICROPHONE CONFIGURATION D
 NOISE LEVEL - DBA RE 20 MICROPASCAL

12- 17- 75 925 HOURS

BAND	A	S	E	N	M	R	1	10	50	90	99
1	77.6	4.6	80.5	92.4	96	31	91.1	83.5	78.0	72.1	68.1
2	78.0	4.4	80.6	91.9	96	29	90.9	83.7	78.4	72.9	69.3
3	56.9	2.8	57.8	65.0	66	17	64.0	61.1	57.3	53.8	51.6
4	58.7	2.6	59.5	66.3	66	15	65.3	62.7	59.0	55.8	53.9
5	59.4	2.4	60.1	66.3	68	15	65.7	63.2	59.8	56.7	55.1
6	60.5	2.3	61.2	67.1	69	15	66.6	64.1	60.9	58.0	56.3
7	61.2	2.4	61.9	68.0	69	16	67.5	65.0	61.6	58.8	56.7
8	63.4	3.6	65.0	74.1	76	25	72.6	68.9	63.6	59.7	55.4
9	65.9	3.4	67.3	76.0	76	22	74.7	71.1	66.1	62.4	58.1
10	67.4	3.3	68.7	77.3	79	23	75.9	72.5	67.7	64.0	59.7
11	68.4	3.3	69.7	78.2	80	23	77.2	73.4	68.7	65.1	61.0
12	69.7	3.2	71.0	79.2	81	22	78.1	74.6	69.9	66.4	62.4
13	77.6	4.8	80.7	93.1	95	34	91.2	84.1	77.9	72.4	66.7
14	76.9	4.7	79.8	91.8	95	36	89.9	83.2	77.2	71.7	65.8

N= 4780

12- 17- 75 945 HOURS

BAND	A	S	E	N	M	R	1	10	50	90	99
1	77.0	5.1	80.3	93.4	95	33	91.0	83.5	77.5	70.6	66.4
2	77.5	4.8	80.4	92.6	94	30	91.1	83.6	78.0	71.7	67.6
3	56.9	2.6	57.7	64.4	65	16	63.5	61.0	57.2	54.2	51.6
4	58.7	2.5	59.4	65.7	66	15	65.0	62.5	59.0	56.0	54.0
5	59.3	2.4	60.0	66.1	66	13	65.3	63.0	59.7	56.6	55.0
6	60.0	2.4	60.7	66.8	67	14	65.9	63.7	60.5	57.3	55.7
7	61.2	2.5	61.9	68.3	68	14	67.4	65.1	61.7	58.3	56.6
8	62.8	3.9	64.6	74.5	73	22	72.0	68.7	63.0	58.6	54.3
9	65.2	3.7	66.8	76.3	75	21	73.9	70.8	65.7	61.1	56.8
10	66.7	3.6	68.2	77.5	77	21	75.1	71.9	67.3	62.7	58.5
11	67.4	3.6	68.9	78.0	77	21	75.7	72.7	68.0	63.3	59.4
12	68.9	3.4	70.2	78.9	79	21	76.7	74.0	69.4	65.0	61.0
13	77.2	4.8	80.3	92.7	95	31	91.1	83.5	77.7	71.8	66.9
14	77.0	4.7	79.8	91.8	94	31	90.3	83.0	77.6	71.6	66.6

N= 4780

TABLE NO. 97
 STATISTICAL NOISE DATA
 ROADSIDE BARRIER TEST SITE, ANDOVER, MA.

BARRIER HGT 16 FT; REFLECTIVE; MICROPHONE CONFIGURATION E

NOISE LEVEL - DBA RE 20 MICROPASCAL

12- 17- 75 1054 HOURS

BAND	A	S	E	N	M	R	1	10	50	90	99
1	75.9	5.2	79.2	92.4	95	34	89.9	82.7	76.8	69.8	64.2
2	77.4	4.1	79.8	90.4	96	28	89.7	83.2	77.7	72.7	70.0
3	59.0	3.3	60.3	68.8	72	20	67.5	63.9	59.2	55.3	53.2
4	60.5	3.3	61.8	70.1	73	20	68.7	65.4	60.8	56.7	55.0
5	62.1	3.4	63.5	72.2	75	22	70.5	67.2	62.4	58.2	56.1
6	64.0	3.7	65.6	75.0	76	22	72.7	69.5	64.3	59.8	57.0
7	67.6	4.0	69.4	79.6	79	23	76.9	73.5	67.9	63.1	59.2
8	64.7	5.5	68.9	83.1	87	35	80.5	72.0	65.3	58.2	54.6
9	66.4	5.4	70.1	84.0	87	34	80.9	73.5	67.1	60.0	55.5
10	67.6	5.1	70.9	83.9	88	34	81.2	74.3	68.4	61.4	57.1
11	69.2	4.7	71.9	83.8	88	33	81.7	75.3	69.9	63.7	59.2
12	71.8	4.3	73.9	84.9	87	29	82.7	77.5	72.3	66.9	61.9
13	75.9	5.1	79.1	92.0	95	35	89.2	82.6	76.5	69.8	65.5
14	76.1	4.9	79.1	91.7	95	36	88.9	82.8	76.8	70.2	65.8

N= 4785

12- 17- 75 1133 HOURS

BAND	A	S	E	N	M	R	1	10	50	90	99
1	76.4	4.9	79.5	92.0	97	33	89.8	82.9	76.9	70.4	66.4
2	76.9	4.5	79.5	90.9	96	31	89.5	82.9	77.3	71.5	67.8
3	59.8	2.9	60.7	68.1	71	20	66.9	64.0	60.3	56.4	53.5
4	60.7	2.8	61.6	68.8	73	20	67.6	64.7	61.4	57.3	55.0
5	61.9	2.9	62.8	70.1	72	17	68.6	65.9	62.5	58.3	56.3
6	63.2	3.1	64.3	72.1	73	17	70.6	67.7	63.7	59.5	57.5
7	66.4	3.5	67.8	76.7	77	20	74.9	71.6	66.8	62.3	59.7
8	64.8	5.0	68.4	81.2	84	32	79.8	71.8	64.7	59.4	55.3
9	66.1	5.2	69.6	83.0	85	33	80.5	73.4	66.2	60.5	55.8
10	66.8	5.1	70.0	82.9	83	30	80.3	74.0	67.2	61.2	57.0
11	68.3	4.7	71.0	83.0	84	30	80.9	74.8	68.8	62.9	58.5
12	70.9	4.4	73.1	84.2	86	29	81.9	76.9	71.5	65.6	61.5
13	76.0	4.8	78.9	91.3	92	29	89.1	82.5	76.4	70.3	65.8
14	76.3	4.7	79.0	91.0	92	29	88.9	82.8	76.8	70.8	65.8

N= 4780

TABLE NO. 98
 STATISTICAL NOISE DATA
 ROADSIDE BARRIER TEST SITE, ANDOVER, MA.

BARRIER HGT 16 FT; REFLECTIVE; MICROPHONE CONFIGURATION B

NOISE LEVEL - DBA RE 20 MICROPASCAL

12- 17- 75 1209 HOURS

BAND	A	S	E	N	M	R	1	10	50	90	99
1	76.8	5.6	80.8	95.1	96	37	91.8	84.1	77.3	70.2	64.1
2	77.4	5.3	80.9	94.4	97	37	91.4	84.3	77.8	71.3	65.4
3	61.4	3.3	62.7	71.2	73	21	70.5	66.3	61.6	58.0	54.7
4	62.9	3.3	64.3	72.8	77	23	71.9	67.9	63.1	59.5	56.1
5	64.1	3.5	65.6	74.4	77	23	73.0	69.3	64.3	60.3	57.4
6	65.2	3.8	66.9	76.6	78	24	74.7	70.8	65.4	61.0	57.4
7	68.3	4.2	70.3	81.0	81	26	78.0	74.5	68.6	63.5	59.2
8	70.6	4.9	73.5	86.1	87	31	83.6	77.2	71.0	65.1	58.8
9	72.3	4.8	75.1	87.3	90	33	84.7	79.0	72.8	66.9	61.2
10	72.5	4.8	75.3	87.7	90	32	84.6	79.2	73.0	67.1	61.4
11	73.1	4.7	75.8	88.0	91	33	84.9	79.7	73.6	67.6	62.8
12	74.5	4.6	77.0	88.8	92	31	86.0	81.0	75.0	69.0	64.4
13	77.0	5.5	80.9	94.9	98	37	91.8	84.1	77.7	70.2	65.3
14	76.9	5.3	80.5	94.2	96	35	91.2	83.9	77.6	70.2	65.4

N= 4780

12- 17- 75 1229 HOURS

BAND	A	S	E	N	M	R	1	10	50	90	99
1	76.9	5.5	80.6	94.7	94	32	91.3	84.6	77.4	70.1	65.5
2	77.6	5.2	80.9	94.1	94	29	91.0	85.0	78.1	71.4	67.6
3	60.5	3.3	61.9	70.4	72	19	69.7	65.5	60.7	57.0	55.0
4	61.9	3.1	63.2	71.2	71	17	70.2	66.8	62.1	58.6	56.6
5	63.2	3.1	64.4	72.4	73	18	71.5	68.2	63.3	60.0	57.6
6	64.2	3.4	65.7	74.4	76	20	73.3	69.5	64.2	60.7	58.0
7	67.3	3.9	69.3	79.3	81	24	77.8	73.5	67.3	63.2	60.1
8	70.4	4.6	73.0	84.9	84	25	82.1	77.2	70.5	65.0	62.0
9	72.1	4.6	74.6	86.5	85	25	83.1	79.0	72.5	66.6	62.9
10	72.2	4.8	74.7	86.9	85	26	83.0	79.1	72.6	66.4	62.3
11	72.9	4.7	75.4	87.5	85	25	83.7	79.9	73.2	67.2	63.0
12	74.3	4.6	76.7	88.5	86	25	84.8	81.2	74.6	69.0	64.4
13	76.6	5.6	80.5	94.8	93	31	91.2	84.6	77.1	70.0	65.9
14	76.7	5.5	80.3	94.4	93	33	90.5	84.6	77.2	70.2	65.3

N= 4730

TABLE NO. 99
 STATISTICAL NOISE DATA
 ROADSIDE BARRIER TEST SITE, ANDOVER, MA.

BARRIER HGT 16 FT; REFLECTIVE; MICROPHONE CONFIGURATION C
 NOISE LEVEL - DBA RE 20 MICROPASCAL

12- 17- 75 1345 HOURS

BAND	A	S	E	N	M	R	1	10	50	90	99
1	76.5	4.8	79.6	91.8	94	32	90.8	82.6	77.0	70.8	67.0
2	77.8	4.4	80.5	91.8	95	30	91.4	83.5	78.3	72.7	69.2
3	61.1	2.6	61.8	68.4	73	19	67.6	64.9	61.6	58.3	55.6
4	62.2	2.7	63.0	69.8	73	19	68.9	66.2	62.7	59.3	56.6
5	63.2	2.7	64.0	70.9	73	18	70.0	67.2	63.6	60.2	57.7
6	63.9	2.8	64.8	71.9	73	18	71.0	68.1	64.2	60.8	58.5
7	65.4	3.0	66.4	74.1	76	18	72.9	69.9	65.7	62.0	59.4
8	67.9	3.7	69.6	79.0	80	23	77.9	73.5	68.1	64.1	59.5
9	70.0	3.8	71.7	81.4	81	23	79.8	75.6	70.3	66.1	61.5
10	70.1	3.8	71.8	81.7	82	26	79.8	75.7	70.5	66.1	61.1
11	71.0	3.8	72.8	82.6	82	25	80.6	76.5	71.4	67.0	61.6
12	71.8	3.8	73.5	83.3	84	26	81.5	77.3	72.2	67.7	62.4
13	76.3	4.9	79.4	91.9	95	36	90.4	82.7	76.8	70.9	63.9
14	76.8	4.8	79.7	92.0	95	36	90.1	83.1	77.4	71.4	64.5

N= 4780

12- 17- 75 1405 HOURS

BAND	A	S	E	N	M	R	1	10	50	90	99
1	77.6	5.0	80.8	93.4	97	36	90.9	84.4	78.0	71.9	66.4
2	78.6	4.5	81.3	92.9	97	31	91.0	85.0	78.9	73.6	68.9
3	60.6	2.5	61.3	67.8	70	16	67.0	64.2	61.1	57.6	55.5
4	62.0	2.6	62.8	69.5	73	18	69.3	65.8	62.5	59.0	57.1
5	63.2	2.6	64.0	70.6	72	17	70.5	66.9	63.7	60.2	58.2
6	63.6	2.6	64.5	71.2	73	17	71.1	67.4	64.0	60.7	58.6
7	64.9	2.8	65.9	73.2	76	19	73.5	68.9	65.4	62.0	59.3
8	68.0	4.0	70.0	80.1	83	25	78.6	74.2	67.9	63.6	61.0
9	70.5	4.0	72.5	82.7	84	24	80.9	76.6	70.7	66.2	62.7
10	70.8	4.0	72.8	83.0	84	23	81.3	76.8	71.1	66.3	62.9
11	72.1	4.0	74.1	84.2	86	25	82.8	78.0	72.3	67.6	64.0
12	72.8	3.9	74.7	84.5	87	24	83.4	78.5	73.1	68.4	65.2
13	77.4	4.9	80.8	93.4	97	31	90.9	84.1	77.7	71.5	68.5
14	78.0	4.8	81.1	93.4	97	31	91.2	84.5	78.4	72.3	68.8

N= 4780

TABLE NO. 100
 STATISTICAL NOISE DATA
 ROADSIDE BARRIER TEST SITE, ANDOVER, MA.

BARRIER HGT 16 FT; REFLECTIVE; MICROPHONE CONFIGURATION E
 NOISE LEVEL - DBA RE 20 MICROPASCAL

12- 18- 75 947 HOURS

BAND	A	S	E	N	M	R	1	10	50	90	99
1	76.7	5.1	80.9	94.1	99	35	92.6	83.1	77.2	70.7	66.8
2	77.7	4.8	81.3	93.6	99	34	92.6	83.7	78.0	72.3	68.5
3	59.9	3.4	61.5	70.2	78	26	70.5	64.4	60.2	56.3	54.2
4	60.8	3.3	62.3	70.7	76	23	70.6	65.5	61.2	57.3	55.0
5	62.3	3.3	63.8	72.2	77	23	72.3	66.9	62.6	58.9	56.7
6	63.4	3.4	64.9	73.5	79	24	73.8	68.2	63.5	59.9	57.5
7	66.0	3.5	67.6	76.5	83	26	76.3	71.1	66.0	62.4	59.9
8	68.3	4.9	71.5	84.2	87	32	82.0	74.8	68.8	62.3	58.1
9	69.2	5.2	72.7	85.9	90	35	83.5	75.9	69.9	62.7	59.0
10	69.8	5.2	73.3	86.7	89	34	84.6	76.3	70.4	63.1	58.9
11	70.3	5.0	73.7	86.4	90	33	85.2	76.4	70.8	64.4	59.9
12	71.4	4.5	74.4	86.0	91	33	85.5	77.0	71.8	66.3	61.9
13	77.1	5.3	81.3	94.8	100	38	92.6	83.9	77.5	71.2	66.0
14	77.4	5.0	81.0	93.8	98	35	92.1	83.8	77.8	72.0	66.3

N= 4785

12- 18- 75 1007 HOURS

BAND	A	S	E	N	M	R	1	10	50	90	99
1	76.8	4.9	80.9	93.6	100	35	92.6	83.2	77.0	71.4	67.5
2	77.8	4.6	81.4	93.0	100	34	92.8	83.8	77.9	73.1	69.4
3	60.6	3.0	62.0	69.6	77	23	70.2	65.0	60.8	57.6	56.0
4	61.4	2.9	62.7	70.2	79	24	70.9	65.6	61.6	58.5	56.7
5	62.8	2.9	64.0	71.5	77	21	72.8	67.0	63.0	59.9	58.1
6	63.6	3.0	65.0	72.8	80	24	74.3	67.9	63.8	60.6	58.5
7	66.0	3.3	67.6	76.0	81	24	77.2	70.7	66.2	62.8	60.5
8	68.1	4.8	71.6	83.9	91	36	82.8	74.3	68.5	62.2	58.8
9	69.2	4.9	72.9	85.5	93	37	83.6	75.4	69.7	63.1	59.2
10	69.8	5.0	73.5	86.2	93	37	84.2	75.9	70.4	63.7	59.5
11	70.4	4.8	74.1	86.2	94	36	84.5	76.4	70.9	64.7	60.8
12	71.5	4.5	74.9	86.5	95	35	86.1	77.3	71.9	66.5	62.5
13	76.8	5.2	81.2	94.6	101	38	92.4	83.6	77.2	70.9	66.1
14	77.2	5.0	81.1	93.9	99	36	92.2	83.7	77.6	71.4	66.8

N= 4780

TABLE NO. 101
 STATISTICAL NOISE DATA
 ROADSIDE BARRIER TEST SITE, ANDOVER, MA.

BARRIER HGT 16 FT; REFLECTIVE; MICROPHONE CONFIGURATION B
 NOISE LEVEL - DBA RE 20 MICROPASCAL

12- 18- 75 1058 HOURS

BAND	A	S	E	N	M	R	1	10	50	90	99
1	76.5	5.3	80.7	94.2	98	36	92.4	83.5	76.9	70.5	65.7
2	77.3	5.0	81.1	93.9	97	34	92.5	83.8	77.6	71.9	66.8
3	60.0	3.4	61.5	70.1	74	24	69.9	64.6	60.4	56.3	52.9
4	61.1	3.4	62.6	71.2	75	24	70.6	65.9	61.4	57.4	53.8
5	62.5	3.4	64.0	72.6	76	24	72.2	67.3	62.8	59.0	55.4
6	63.5	3.4	65.0	73.8	75	22	73.7	68.6	63.6	60.0	56.0
7	66.1	3.6	67.8	77.1	79	24	76.6	71.5	66.2	62.5	58.3
8	68.4	5.5	72.4	86.4	89	35	83.2	76.1	68.7	62.1	56.8
9	71.2	5.5	75.1	89.2	92	37	86.1	78.8	71.6	64.8	58.9
10	72.2	5.3	75.9	89.6	92	37	87.2	79.7	72.6	66.0	60.0
11	73.4	5.0	76.7	89.5	93	38	87.6	80.4	73.8	68.0	61.3
12	74.6	4.8	77.6	89.8	93	35	88.1	81.4	75.0	69.5	63.0
13	76.5	5.6	81.1	95.5	101	42	92.1	83.9	76.9	69.9	64.9
14	77.2	5.3	81.1	94.7	99	38	91.9	84.1	77.7	71.0	65.4

N= 4780

12- 18- 75 1118 HOURS

BAND	A	S	E	N	M	R	1	10	50	90	99
1	75.6	5.2	79.3	92.6	94	33	90.0	82.4	76.2	69.4	64.8
2	76.6	4.7	79.7	91.8	95	30	90.4	82.8	77.0	71.0	67.3
3	59.8	2.9	61.0	68.5	72	20	68.9	64.3	60.0	57.0	54.9
4	60.8	2.9	61.9	69.2	72	18	69.4	65.3	60.8	57.9	56.2
5	62.1	2.9	63.3	70.8	74	18	71.3	66.6	62.3	59.2	57.2
6	62.9	3.0	64.2	71.9	76	21	72.0	67.5	63.1	59.8	57.4
7	65.4	3.3	66.8	75.3	78	21	74.7	70.3	65.7	62.0	59.2
8	67.8	4.9	70.9	83.5	85	31	80.6	74.9	68.1	62.2	57.6
9	70.4	4.9	73.3	85.9	86	31	82.7	77.4	70.9	64.8	58.7
10	71.2	4.9	74.0	86.6	86	31	83.0	78.2	71.7	65.6	58.6
11	72.6	4.7	75.1	87.1	87	31	84.2	79.1	73.2	67.5	60.1
12	73.9	4.5	76.3	87.9	88	30	85.2	80.4	74.3	69.0	61.4
13	76.1	5.5	80.0	94.0	96	39	90.8	83.4	76.7	70.0	64.0
14	76.5	5.2	79.8	93.0	95	37	90.4	83.2	77.0	70.6	64.3

N= 4780

TABLE NO. 102
 STATISTICAL NOISE DATA
 ROADSIDE BARRIER TEST SITE, ANDOVER, MA.

BARRIER HGT 16 FT; REFLECTIVE; MICROPHONE CONFIGURATION C

NOISE LEVEL - DBA RE 20 MICROPASCAL

12- 18- 75 1201 HOURS

BAND	A	S	E	N	M	R	1	10	50	90	99
1	75.7	5.6	80.9	95.2	101	38	93.1	83.0	76.0	69.3	64.9
2	76.0	5.3	80.7	94.2	100	38	92.5	83.1	76.2	70.1	65.8
3	59.6	3.1	61.0	68.9	76	23	70.0	63.9	59.6	56.7	55.0
4	59.8	3.0	61.2	68.9	74	21	70.4	64.2	59.8	57.1	55.5
5	60.6	3.0	62.0	69.6	75	21	71.3	64.9	60.6	58.0	56.4
6	60.9	3.0	62.3	69.9	76	22	71.7	65.0	60.9	58.3	56.5
7	62.3	3.0	63.8	71.6	79	23	73.4	66.6	62.2	59.5	57.7
8	63.6	4.6	67.2	78.9	82	30	79.5	70.4	63.4	59.3	54.9
9	67.8	5.0	71.6	84.3	87	34	83.8	74.9	67.9	62.8	56.6
10	68.8	4.9	72.5	85.0	89	35	84.5	75.4	69.0	63.8	57.3
11	70.1	4.8	73.6	85.9	89	34	86.0	76.5	70.3	65.4	58.2
12	71.6	4.7	74.9	86.9	90	35	86.7	77.7	71.8	67.1	60.0
13	75.7	5.7	81.0	95.6	102	43	92.9	83.3	75.9	69.7	63.1
14	76.4	5.4	81.0	94.9	100	42	93.2	83.6	76.7	70.8	63.0

N= 4785

12- 18- 75 1221 HOURS

BAND	A	S	E	N	M	R	1	10	50	90	99
1	75.1	5.4	79.2	93.1	97	38	90.4	81.8	75.7	68.6	62.9
2	75.4	5.0	79.1	91.9	98	37	90.1	81.8	76.0	69.6	64.9
3	60.1	2.6	61.2	68.0	75	22	69.4	63.9	60.4	57.5	55.4
4	60.3	2.5	61.2	67.5	74	20	68.8	63.9	60.6	57.8	55.9
5	61.1	2.4	61.9	68.2	73	19	69.4	64.7	61.3	58.8	56.6
6	61.2	2.5	62.0	68.3	72	18	69.1	65.1	61.5	59.0	56.7
7	62.5	2.7	63.5	70.5	75	20	70.8	66.7	62.6	59.9	57.2
8	63.8	3.8	65.9	75.6	80	27	76.1	68.9	63.9	59.9	56.7
9	67.5	4.4	70.1	81.4	85	30	80.2	73.3	67.9	62.5	58.4
10	68.3	4.4	70.9	82.2	87	32	80.9	74.2	68.7	63.3	58.5
11	69.7	4.3	72.1	83.1	87	30	81.8	75.3	70.2	64.7	60.1
12	71.1	4.3	73.5	84.5	88	30	83.5	76.7	71.7	66.1	61.0
13	75.6	5.3	79.7	93.2	100	39	90.5	82.2	76.3	69.0	64.3
14	76.1	5.1	79.7	92.8	99	38	90.3	82.6	76.9	69.9	64.8

N= 4780

TABLE NO. 103
 STATISTICAL NOISE DATA
 ROADSIDE BARRIER TEST SITE, ANDOVER, MA.

BARRIER HGT 16 FT; REFLECTIVE; MICROPHONE CONFIGURATION D
 NOISE LEVEL - DBA RE 20 MICROPASCAL

12- 18- 75 1345 HOURS

BAND	A	S	E	N	M	R	1	10	50	90	99
1	75.9	5.1	79.1	92.3	93	31	88.9	83.2	76.5	69.7	65.6
2	77.0	4.7	79.7	91.9	94	30	89.2	83.7	77.6	71.3	67.4
3	58.9	2.5	59.8	66.1	71	18	67.3	62.6	59.2	56.5	54.7
4	59.4	2.3	60.1	65.9	76	23	66.7	62.7	59.7	57.2	55.3
5	59.8	2.3	60.5	66.3	71	18	67.1	63.1	60.1	57.6	55.6
6	59.6	2.2	60.2	65.7	70	17	66.0	62.8	60.0	57.4	55.4
7	60.3	2.3	61.0	66.8	72	19	67.3	63.6	60.7	58.1	56.1
8	60.2	3.2	61.4	69.5	70	19	68.6	64.9	60.5	56.6	54.3
9	62.1	3.5	63.5	72.3	74	22	70.9	67.2	62.6	57.8	55.2
10	63.5	3.6	65.1	74.4	75	22	72.8	68.7	64.2	58.9	56.0
11	65.4	3.8	67.0	76.6	77	22	74.4	70.6	66.1	60.6	57.1
12	66.7	3.7	68.2	77.8	78	24	75.3	71.9	67.4	62.2	57.8
13	76.4	5.2	79.6	92.8	93	32	89.3	83.7	77.0	70.2	65.0
14	76.8	4.9	79.5	92.1	92	31	88.9	83.5	77.4	70.7	65.0

N= 4780

12- 18- 75 1406 HOURS

BAND	A	S	E	N	M	R	1	10	50	90	99
1	76.0	5.3	80.3	93.8	99	37	91.1	83.3	76.3	70.1	65.5
2	77.1	5.0	81.0	93.9	101	37	91.7	83.9	77.4	71.4	67.2
3	59.0	3.1	60.6	68.5	77	25	69.4	63.4	59.1	56.1	54.6
4	59.9	2.9	61.2	68.5	76	23	69.2	64.0	59.9	57.1	55.3
5	59.8	2.8	61.1	68.4	75	22	69.4	64.0	59.9	57.2	55.5
6	59.7	2.7	60.8	67.8	74	21	68.6	63.8	59.7	57.1	55.3
7	60.5	2.8	61.6	68.7	72	18	69.6	64.7	60.5	57.9	56.1
8	61.3	3.7	63.4	72.9	81	27	73.0	66.8	61.2	57.5	55.3
9	62.7	3.9	65.0	75.0	79	25	75.2	68.7	62.6	58.7	56.3
10	63.8	4.1	66.3	76.7	82	28	76.0	69.9	63.8	59.7	57.1
11	65.5	4.1	67.9	78.2	84	28	77.8	71.4	65.5	61.2	58.3
12	66.5	4.2	69.0	79.7	84	27	78.8	72.6	66.6	62.0	59.3
13	76.3	5.3	80.8	94.4	102	39	91.6	83.3	76.7	70.0	66.9
14	76.8	5.0	80.7	93.5	101	37	91.3	83.3	77.3	70.9	67.6

N= 4730

TABLE NO. 104
 STATISTICAL NOISE DATA
 ROADSIDE BARRIER TEST SITE , ANDOVER MA.

BARRIER HGT 16 FT ; REFLECTIVE ; MICROPHONE CONFIGURATION B

NOISE LEVEL - DBA RE 20 MICROPASCAL

4- 27- 76 1005 HOURS

BAND	A	S	E	N	M	R	1	10	50	90	99
1	79.8	5.0	83.5	96.3	101	51	94.8	86.8	79.7	74.6	70.4
2	77.0	5.3	81.4	94.8	99	59	93.5	84.0	77.1	71.5	67.0
3	61.0	3.5	66.6	75.4	101	61	72.3	66.4	60.7	58.0	56.1
4	62.0	3.5	64.0	73.0	86	46	73.5	67.5	61.6	58.9	57.1
5	63.3	3.6	65.3	74.4	79	39	75.1	68.9	62.9	60.1	58.2
6	63.8	3.7	66.0	75.6	82	42	76.1	69.6	63.4	60.5	58.6
7	66.0	4.0	68.5	78.6	85	45	78.5	72.0	65.7	62.2	60.3
8	69.7	5.3	74.0	87.6	88	48	86.0	77.5	69.5	64.0	61.1
9	72.2	5.1	76.1	89.3	91	51	87.6	79.7	72.1	66.9	63.1
10	73.7	5.1	77.5	90.6	93	53	88.9	81.2	73.5	68.4	64.2
11	73.7	4.8	77.2	89.5	92	52	88.3	80.8	73.4	69.0	64.5
12	74.6	4.6	77.9	89.8	101	61	88.5	81.6	74.4	70.1	65.5
13	75.7	5.7	80.6	95.3	99	49	92.6	83.5	75.9	69.4	64.4
14	78.0	5.3	82.3	95.8	100	60	94.2	85.4	78.0	72.6	67.3

N= 4780

4- 27- 76 1025 HOURS

BAND	A	S	E	N	M	R	1	10	50	90	99
1	79.8	4.8	82.7	94.9	97	33	92.4	86.4	80.2	74.5	68.2
2	76.9	5.0	80.1	93.0	93	33	90.5	83.5	77.5	71.3	64.8
3	60.5	2.9	61.5	68.9	69	18	67.7	64.8	61.0	57.5	53.0
4	61.5	3.0	62.5	70.2	71	20	69.2	65.8	62.0	58.3	53.7
5	62.9	3.1	63.9	71.8	73	21	70.6	67.2	63.4	59.6	54.8
6	63.4	3.2	64.5	72.6	74	21	71.4	67.9	63.8	60.0	55.3
7	65.5	3.4	66.8	75.4	76	22	74.0	70.3	65.9	61.8	57.2
8	69.2	4.7	72.1	84.2	85	29	81.9	76.3	69.3	64.1	59.5
9	71.6	4.7	74.2	86.3	87	30	83.0	78.4	72.1	66.2	60.2
10	73.1	4.8	75.6	87.8	88	32	84.4	79.9	73.6	67.6	60.3
11	73.1	4.6	75.5	87.4	88	31	84.0	79.8	73.6	67.8	60.0
12	74.0	4.5	76.2	87.6	88	30	84.5	80.4	74.3	69.1	61.6
13	75.2	5.6	79.0	93.4	93	36	89.8	82.7	75.9	68.3	62.0
14	77.5	5.1	80.7	93.7	93	33	91.1	84.3	78.0	71.8	64.3

N= 4780

TABLE NO. 105
 STATISTICAL NOISE DATA
 ROADSIDE BARRIER TEST SITE , ANDOVER MA.

BARRIER HGT 16 FT ; REFLECTIVE ; MICROPHONE CONFIGURATION C
 NOISE LEVEL - DBA RE 20 MICROPASCAL

4- 27- 76 1150 HOURS

BAND	A	S	E	N	M	R	1	10	50	90	99
1	78.8	4.5	81.4	93.1	95	29	91.5	85.1	79.1	73.4	70.3
2	75.4	4.8	78.5	90.8	95	32	89.2	81.6	75.9	69.8	66.2
3	59.4	2.8	60.3	67.4	70	18	66.7	63.6	59.9	56.2	54.2
4	60.4	2.7	61.3	68.3	71	17	67.4	64.5	61.0	57.2	55.2
5	61.9	2.9	62.9	70.4	72	17	69.7	66.1	62.3	58.4	56.4
6	61.8	2.8	62.7	70.0	73	18	69.0	66.0	62.3	58.4	56.4
7	63.7	3.3	64.9	73.3	76	21	71.8	68.6	64.2	59.9	57.6
8	64.1	3.8	66.2	75.8	82	26	74.5	69.7	64.2	60.2	57.8
9	67.1	4.1	69.3	79.8	82	26	78.3	73.2	67.4	62.6	59.1
10	68.7	4.2	70.8	81.5	82	25	79.5	74.7	69.0	64.0	60.0
11	69.3	4.2	71.4	82.0	83	26	79.9	75.2	69.7	64.6	60.3
12	70.6	4.1	72.6	83.0	84	27	80.9	76.5	70.9	66.1	61.9
13	73.7	5.5	77.4	91.4	93	35	88.9	80.7	74.2	67.2	61.6
14	75.5	5.0	78.7	91.6	95	36	89.4	82.2	75.8	69.8	63.3

N= 4785

4- 27- 76 1210 HOURS

BAND	A	S	E	N	M	R	1	10	50	90	99
1	80.0	4.8	83.2	95.6	101	35	93.3	86.9	80.1	74.7	69.8
2	77.1	5.4	81.0	94.9	99	37	91.9	84.5	77.6	70.6	65.6
3	60.6	2.5	61.4	67.9	75	21	68.2	64.3	61.0	58.0	56.2
4	61.7	2.5	62.5	69.0	78	23	69.0	65.4	62.1	59.0	57.1
5	63.0	2.5	63.8	70.3	77	20	70.4	66.7	63.4	60.3	58.3
6	62.9	2.6	63.8	70.6	80	24	69.9	66.9	63.3	60.1	58.2
7	64.4	2.7	65.2	72.1	79	22	71.8	68.2	64.8	61.3	59.3
8	65.8	4.0	67.9	78.1	82	25	77.4	71.8	65.7	61.6	58.9
9	69.0	4.4	71.6	82.8	84	25	81.1	75.8	69.0	64.2	60.7
10	70.6	4.4	73.1	84.2	85	25	82.3	77.1	70.7	65.7	62.2
11	71.3	4.3	73.6	84.6	87	28	82.7	77.6	71.4	66.4	62.8
12	72.6	4.2	74.9	85.7	89	27	83.8	78.7	72.9	67.9	64.2
13	75.9	5.7	80.4	95.1	98	37	91.3	84.0	76.4	69.3	64.2
14	77.6	5.3	81.4	95.0	98	42	91.9	84.9	77.9	71.5	66.4

N= 4780

TABLE NO. 106
 STATISTICAL NOISE DATA
 ROADSIDE BARRIER TEST SITE , ANDOVER MA.

BARRIER HGT 16 FT ; REFLECTIVE ; MICROPHONE CONFIGURATION D

NOISE LEVEL - DBA RE 20 MICROPASCAL

4- 27- 76 1258 HOURS

BAND	A	S	E	N	M	R	1	10	50	90	99
1	77.9	4.9	80.9	93.5	94	28	91.3	84.3	78.5	71.8	68.2
2	77.3	4.7	79.8	91.9	93	31	89.4	83.4	78.2	71.4	66.4
3	58.3	2.8	59.4	66.7	72	21	67.2	62.3	58.6	55.3	53.0
4	59.1	2.8	60.2	67.5	73	21	68.0	63.2	59.3	56.2	53.7
5	60.0	2.8	61.1	68.4	73	20	68.7	64.1	60.3	57.2	54.6
6	59.7	2.8	60.7	67.9	73	21	67.8	63.9	60.1	56.7	54.3
7	60.5	2.9	61.6	68.9	73	20	68.6	64.8	60.9	57.4	55.1
8	61.2	3.3	62.5	70.9	72	19	69.7	66.4	61.4	57.7	55.1
9	63.2	3.6	64.8	74.1	74	20	72.3	68.8	63.4	59.2	56.2
10	65.0	3.9	66.7	76.6	76	21	74.4	70.8	65.4	60.4	57.2
11	66.0	3.9	67.7	77.7	78	22	75.6	71.8	66.5	61.4	58.1
12	67.4	3.8	69.0	78.7	78	22	76.2	73.0	68.0	62.9	59.4
13	74.8	5.4	78.3	92.2	94	34	89.0	81.8	75.5	68.1	63.3
14	76.6	4.9	79.5	92.0	94	36	89.4	83.0	77.0	71.0	65.4

N= 4780

4- 27- 76 1318 HOURS

BAND	A	S	E	N	M	R	1	10	50	90	99
1	79.1	5.1	82.9	96.0	98	30	94.0	86.6	79.0	73.5	70.1
2	40.0	1	40.0	40.3	43	3	41.0	40.9	40.5	40.1	40.0
3	59.2	2.7	60.2	67.1	73	21	67.3	63.3	59.4	56.5	54.2
4	60.0	2.8	61.1	68.2	71	18	68.5	64.3	60.2	57.3	55.1
5	61.1	2.8	62.1	69.2	73	19	69.5	65.4	61.2	58.3	56.2
6	60.7	2.6	61.7	68.4	75	21	68.8	64.7	60.9	58.1	56.0
7	61.7	2.7	62.7	69.6	75	20	69.7	65.9	61.9	59.0	56.8
8	61.5	4.2	63.9	74.6	75	22	73.1	68.2	61.3	57.1	54.7
9	63.5	4.4	66.0	77.4	78	24	75.0	70.5	63.4	58.7	56.2
10	65.4	4.6	68.0	79.7	79	25	76.8	72.6	65.4	60.3	57.6
11	66.5	4.6	69.1	81.0	80	23	77.8	73.7	66.6	61.2	58.3
12	68.2	4.6	70.8	82.7	84	27	80.1	74.9	68.2	62.9	59.8
13	75.8	6.2	80.9	96.7	97	37	92.9	84.3	76.3	68.5	62.7
14	77.6	5.5	81.8	96.0	97	35	93.4	85.6	77.7	71.7	65.5

N= 4780

TABLE NO. 107
 STATISTICAL NOISE DATA
 ROADSIDE BARRIER TEST SITE, ANDOVER MA.

BARRIER HGT 16 FT ; REFLECTIVE ; MICROPHONE CONFIGURATION E
 NOISE LEVEL - DBA RE 20 MICROPASCAL

4- 27- 76 1454 HOURS

BAND	A	S	E	N	M	R	1	10	50	90	99
1	79.1	4.4	82.1	93.4	100	33	92.7	85.1	79.4	74.2	70.0
2	77.4	4.3	80.4	91.4	99	36	91.1	82.9	77.6	72.9	68.1
3	59.2	2.9	60.4	67.8	75	22	68.5	63.4	59.2	56.5	54.8
4	60.4	2.9	61.5	68.8	74	20	69.4	64.6	60.5	57.6	55.7
5	61.7	2.9	62.9	70.3	76	22	71.1	65.8	61.8	58.9	57.0
6	62.7	3.0	64.0	71.7	76	21	72.4	67.1	62.8	59.7	57.5
7	65.6	3.2	67.0	75.3	80	23	75.0	70.5	65.8	62.3	59.8
8	67.1	4.8	70.9	83.3	90	34	81.9	73.6	67.3	61.7	58.9
9	68.7	4.7	72.3	84.3	92	35	83.0	74.8	69.1	63.3	59.7
10	70.0	4.5	73.1	84.7	91	33	83.7	75.9	70.6	64.6	61.0
11	70.1	4.4	73.0	84.2	91	32	83.0	75.8	70.5	65.0	61.2
12	71.3	4.1	73.9	84.4	92	32	84.0	76.8	71.7	66.7	62.9
13	76.0	5.0	79.7	92.4	100	38	90.3	82.4	76.4	70.3	65.1
14	77.7	4.3	80.7	91.8	99	44	90.9	83.4	78.0	73.3	68.2

N= 4785

4- 27- 76 1514 HOURS

BAND	A	S	E	N	M	R	1	10	50	90	99
1	81.4	4.5	84.7	96.3	100	30	95.8	88.2	81.1	76.9	73.4
2	79.2	4.5	82.7	94.2	98	31	94.5	85.9	79.1	75.0	71.0
3	61.2	2.9	62.4	69.9	75	20	71.6	65.2	61.4	58.2	56.2
4	62.3	2.9	63.5	70.9	74	19	71.3	66.6	62.6	59.4	57.4
5	63.6	3.0	64.9	72.5	76	19	73.5	68.0	63.8	60.6	58.9
6	64.8	3.1	66.2	74.1	78	21	75.0	69.3	64.8	61.7	59.9
7	67.3	3.2	68.8	77.1	82	22	77.8	72.1	67.4	64.2	62.0
8	69.5	4.7	72.9	84.9	90	31	83.6	76.4	69.3	64.4	61.2
9	70.7	4.8	74.3	86.6	92	33	85.9	77.5	70.8	65.5	61.5
10	71.7	4.7	75.0	86.9	91	31	86.6	78.2	71.7	66.6	62.3
11	71.6	4.5	74.8	86.4	91	31	86.4	78.1	71.7	66.8	62.6
12	72.7	4.3	75.7	86.8	92	32	87.5	78.9	72.7	68.2	64.5
13	77.7	5.1	81.6	94.6	100	36	92.6	84.9	77.8	72.1	67.2
14	79.2	4.5	82.5	94.1	101	33	92.9	85.6	79.3	74.5	70.3

N= 4780

TABLE NO. 108
 STATISTICAL NOISE DATA
 ROADSIDE BARRIER TEST SITE ; ANDOVER MA.

BARRIER HGT 16 FT ; REFLECTIVE ; MICROPHONE CONFIGURATION E
 NOISE LEVEL - DBA RE 20 MICROPASCAL

4- 28- 76 839 HOURS

BAND	A	S	E	N	M	R	1	10	50	90	99
1	80.9	4.3	83.4	94.5	97	29	93.2	87.0	81.1	76.3	71.5
2	79.6	4.2	81.9	92.7	95	28	91.3	85.5	79.9	75.0	70.3
3	60.2	2.9	61.3	68.7	73	21	68.9	64.6	60.3	57.4	54.7
4	61.6	2.9	62.7	70.0	75	21	69.8	66.0	61.7	58.9	55.8
5	63.2	2.9	64.3	71.7	74	19	71.3	67.8	63.4	60.4	57.2
6	64.7	3.1	65.8	73.7	76	20	72.7	69.5	64.8	61.6	58.2
7	67.8	3.3	69.1	77.6	78	20	76.7	72.9	67.9	64.5	60.7
8	68.0	5.0	71.2	84.0	85	28	81.7	74.8	68.5	61.8	59.1
9	70.4	4.7	73.1	85.1	85	27	83.0	76.8	71.0	64.6	61.3
10	71.4	4.4	73.9	85.1	86	26	83.3	77.5	71.9	66.2	62.9
11	71.7	4.1	73.8	84.2	86	25	82.7	77.7	72.0	67.2	63.4
12	73.4	3.7	75.2	84.7	86	24	83.7	78.9	73.7	69.4	66.0
13	77.9	4.3	80.4	91.4	93	29	90.0	84.0	78.2	73.3	68.4
14	79.1	4.0	81.3	91.5	95	34	90.4	84.8	79.4	75.1	70.1

N= 4780

4- 26- 76 859 HOURS

BAND	A	S	E	N	M	R	1	10	50	90	99
1	79.4	4.5	82.1	93.5	96	29	92.0	85.6	79.8	74.3	70.1
2	78.3	4.4	80.8	91.9	94	28	90.8	84.1	78.8	73.3	69.1
3	58.5	3.1	59.7	67.6	69	18	67.4	63.1	58.7	55.3	53.1
4	59.9	3.1	61.1	68.9	70	18	68.4	64.5	60.1	56.7	54.1
5	61.5	3.2	62.8	71.0	73	20	70.1	66.4	61.8	58.1	55.3
6	62.9	3.4	64.3	73.0	73	19	72.0	67.9	63.3	59.2	56.2
7	66.3	3.6	67.9	77.2	77	20	75.7	71.8	66.8	62.3	59.1
8	66.2	5.7	70.1	84.8	84	33	81.4	73.4	67.0	58.9	54.0
9	68.4	5.5	71.9	85.8	85	32	82.7	75.2	69.3	61.4	56.0
10	69.8	5.1	72.7	85.7	85	31	83.2	76.0	70.7	63.2	58.1
11	70.1	4.7	72.7	84.8	85	31	82.6	76.1	70.8	64.2	58.8
12	72.0	4.4	74.1	85.3	86	29	83.5	77.5	72.6	67.0	61.4
13	76.0	5.3	79.2	92.8	93	35	89.7	82.7	76.8	69.8	62.3
14	77.7	4.8	80.4	92.6	95	34	90.4	83.7	78.3	72.3	66.0

N= 4730

TABLE NO. 109
 STATISTICAL NOISE DATA
 ROADSIDE BARRIER TEST SITE , ANDOVER MA.

BARRIER HGT 16 FT ; REFLECTIVE ; MICROPHONE CONFIGURATION B
 NOISE LEVEL - DBA RE 20 MICROPASCAL

4- 28- 76 1007 HOURS

BAND	A	S	E	N	M	R	1	10	50	90	99
1	79.3	5.1	83.0	96.0	102	37	93.7	86.5	79.3	73.6	69.2
2	77.4	5.1	81.2	94.3	100	37	91.4	84.6	77.5	71.8	67.0
3	60.7	3.0	61.9	69.5	74	21	69.7	65.0	60.9	57.5	55.3
4	61.5	2.9	62.6	70.0	74	20	69.3	66.0	61.8	58.3	56.2
5	62.6	3.1	63.9	71.8	76	21	71.0	67.4	63.0	59.3	57.1
6	63.5	3.3	64.9	73.4	76	21	72.4	68.6	63.7	60.0	57.6
7	66.0	3.7	67.7	77.2	81	24	75.6	71.7	66.1	61.9	59.5
8	68.5	5.3	72.4	85.9	90	34	82.8	76.4	68.3	63.0	58.2
9	71.2	4.9	74.6	87.3	92	35	84.0	78.6	71.1	66.1	60.7
10	72.7	4.7	75.8	88.0	93	35	85.0	79.6	72.7	67.6	62.4
11	72.9	4.5	75.9	87.5	93	33	84.8	79.8	73.0	68.2	63.5
12	74.4	4.4	77.1	88.4	95	33	85.9	81.0	74.4	69.8	65.6
13	75.7	5.4	80.0	93.8	100	38	90.4	83.1	75.9	69.7	64.4
14	77.3	4.8	80.9	93.3	100	41	91.0	84.3	77.3	72.2	68.1

N= 4780

4- 28- 76 1027 HOURS

BAND	A	S	E	N	M	R	1	10	50	90	99
1	80.2	4.7	83.5	95.6	101	33	94.2	87.2	79.9	75.2	71.9
2	78.2	5.0	81.9	94.8	99	34	92.4	85.7	78.2	72.9	68.4
3	61.1	2.9	62.2	69.6	75	21	69.5	65.5	61.2	58.1	56.1
4	62.1	3.0	63.3	71.1	74	19	70.6	66.9	62.2	58.9	57.1
5	63.5	3.1	64.8	72.8	77	20	72.4	68.3	63.7	60.2	58.2
6	64.5	3.3	65.8	74.2	79	22	73.4	69.5	64.7	60.9	59.0
7	66.8	3.5	68.3	77.2	80	21	76.2	72.0	67.1	62.9	60.7
8	70.1	5.1	73.7	86.8	89	31	84.3	77.6	70.2	64.4	61.0
9	72.6	4.7	75.6	87.5	91	29	85.1	79.4	72.8	67.5	63.5
10	73.8	4.5	76.6	88.2	91	28	86.3	80.5	74.0	68.8	65.4
11	73.9	4.3	76.4	87.5	91	28	85.7	80.3	74.1	69.1	66.2
12	75.3	4.2	77.7	88.4	92	26	86.7	81.5	75.5	70.7	68.0
13	76.7	5.3	80.8	94.3	99	36	91.6	84.3	76.8	70.9	66.1
14	78.2	4.8	81.6	93.8	99	43	91.9	85.2	78.2	73.1	69.3

N= 4780

TABLE NO. 110
 STATISTICAL NOISE DATA
 ROADSIDE BARRIER TEST SITE , ANDOVER MA.

BARRIER HGT 16 FT ; REFLECTIVE ; MICROPHONE CONFIGURATION C
 NOISE LEVEL - DBA RE 20 MICROPASCAL

4- 28- 76

1112 HOURS

BAND	A	S	E	N	M	R	1	10	50	90	99
1	77.6	4.8	81.1	93.5	99	36	92.5	83.9	77.9	72.1	68.0
2	76.1	4.8	79.5	91.8	96	36	91.3	82.0	76.6	70.6	65.1
3	57.7	2.9	58.9	66.3	69	19	66.6	62.4	57.7	55.0	52.4
4	58.6	3.0	59.9	67.7	71	20	68.1	63.4	58.6	55.8	53.4
5	59.6	3.1	61.0	69.1	73	21	69.1	64.6	59.6	56.7	54.1
6	60.2	3.3	61.7	70.2	74	22	70.1	65.4	60.1	57.2	54.6
7	61.6	3.4	63.2	72.0	74	21	71.7	67.0	61.5	58.3	55.7
8	61.8	4.9	66.0	78.6	84	34	77.6	68.7	61.4	57.0	53.7
9	65.8	5.3	70.0	83.6	87	33	81.7	73.2	65.9	59.9	56.2
10	68.1	5.0	71.6	84.4	87	32	82.9	74.8	68.2	62.3	58.3
11	68.9	4.7	72.0	84.0	86	30	82.8	75.4	69.0	63.6	59.9
12	70.7	4.5	73.6	85.2	89	30	84.2	76.9	70.8	65.7	62.1
13	73.9	5.9	78.8	93.9	97	38	91.0	81.3	74.5	66.6	61.7
14	75.6	5.2	79.5	92.9	97	42	91.4	82.5	76.1	69.5	64.7

N= 4785

4- 28- 76

1132 HOURS

BAND	A	S	E	N	M	R	1	10	50	90	99
1	79.2	5.0	82.8	95.5	103	37	92.2	86.6	79.4	73.4	69.5
2	77.3	4.9	80.7	93.4	99	34	90.5	84.8	77.4	71.7	68.1
3	59.9	2.6	60.9	67.4	73	19	67.8	63.7	60.2	57.3	55.5
4	60.8	2.7	61.8	68.6	74	20	68.8	64.7	61.1	58.2	56.4
5	61.7	2.6	62.7	69.4	75	19	69.5	65.6	62.0	59.1	57.3
6	62.2	2.6	63.1	69.7	75	20	69.5	66.0	62.5	59.5	57.9
7	63.5	2.6	64.5	71.2	78	21	70.8	67.4	63.9	60.7	59.1
8	65.2	4.2	67.9	78.8	85	29	77.8	71.2	65.1	60.6	58.2
9	68.6	4.6	71.4	83.0	86	28	81.0	75.0	68.6	63.6	60.2
10	70.3	4.4	72.8	83.9	87	28	82.1	76.5	70.5	65.5	62.0
11	70.8	4.2	73.0	83.8	87	27	82.0	76.6	71.3	66.1	62.5
12	72.3	4.0	74.4	84.8	89	28	83.0	78.0	72.8	67.7	64.3
13	75.9	5.4	80.0	93.8	98	36	90.6	84.0	75.9	69.9	65.2
14	77.2	4.9	80.7	93.1	99	40	91.0	84.5	77.1	72.1	67.9

N= 4780

TABLE NO. 111
 STATISTICAL NOISE DATA
 ROADSIDE BARRIER TEST SITE , ANDOVER MA.

BARRIER HGT 16 FT ; REFLECTIVE ; MICROPHONE CONFIGURATION D

NOISE LEVEL - DBA RE 20 MICROPASCAL

4- 28- 76 1235 HOURS

BAND	A	S	E	N	M	R	1	10	50	90	99
1	77.4	4.8	80.5	92.7	94	29	91.1	83.8	77.6	72.1	68.2
2	76.0	4.7	78.9	91.1	93	31	89.1	82.4	76.2	70.6	65.8
3	57.8	2.3	58.5	64.4	69	17	64.6	61.4	58.1	55.4	54.0
4	58.5	2.2	59.1	64.6	66	13	64.5	61.9	58.8	56.3	54.6
5	59.2	2.2	59.7	65.4	67	14	65.3	62.7	59.5	57.0	55.2
6	59.5	2.3	60.1	65.9	70	16	65.9	63.0	59.8	57.2	55.4
7	60.0	2.3	60.7	66.5	71	17	66.3	63.6	60.4	57.6	55.9
8	60.7	3.6	62.4	71.6	73	20	71.1	66.0	61.2	56.7	54.2
9	62.7	3.8	64.4	74.2	76	24	73.0	68.1	63.1	58.3	55.2
10	64.4	3.9	66.2	76.0	77	23	74.7	69.8	64.9	60.0	56.3
11	65.3	3.9	67.1	77.1	78	24	75.0	70.8	65.9	60.8	56.7
12	67.0	3.9	68.7	78.6	79	23	76.5	72.3	67.6	62.4	58.2
13	73.6	5.7	77.4	92.0	93	34	88.0	81.2	74.4	66.5	61.1
14	76.0	5.0	79.0	91.9	94	36	89.1	82.7	76.6	69.8	64.3

N= 4780

4- 28- 76 1255 HOURS

BAND	A	S	E	N	M	R	1	10	50	90	99
1	79.5	4.9	82.5	95.1	96	30	92.4	86.5	79.9	73.7	69.5
2	77.5	4.7	80.2	92.2	93	29	89.6	83.9	78.1	71.8	67.9
3	59.4	3.1	60.5	68.4	70	19	67.7	63.8	60.0	55.8	53.8
4	60.2	3.0	61.2	68.8	70	19	67.8	64.4	60.8	56.6	54.4
5	61.2	3.1	62.3	70.2	72	19	69.5	65.5	61.7	57.5	55.3
6	61.4	2.9	62.4	70.0	71	17	69.2	65.7	62.0	57.8	55.7
7	62.3	3.3	66.9	75.5	101	47	71.8	66.8	62.8	58.3	56.1
8	63.0	3.5	64.3	73.2	73	20	70.7	68.0	63.5	58.7	55.8
9	64.8	3.6	66.1	75.3	74	21	72.4	69.9	65.3	60.5	57.2
10	66.5	3.7	67.9	77.3	75	20	74.1	71.7	67.1	62.2	58.3
11	67.1	3.7	68.6	78.1	77	22	75.0	72.4	67.8	62.8	58.7
12	68.6	3.7	70.0	79.4	78	21	76.3	73.6	69.3	64.2	59.9
13	75.5	5.1	78.5	91.7	91	33	87.9	82.5	76.3	69.3	64.1
14	77.6	4.6	80.1	91.8	91	29	89.2	83.9	78.1	72.4	66.8

N= 4780

TABLE NO. 112
 STATISTICAL NOISE DATA
 ROADSIDE BARRIER TEST SITE , ANDOVER MA.

BARRIER HGT 16 FT ; REFLECTIVE ; MICROPHONE CONFIGURATION D

NOISE LEVEL - DBA RE 20 MICROPASCAL

4- 29- 76 835 HOURS

BAND	A	S	E	N	M	R	1	10	50	90	99
1	81.3	4.3	83.8	94.8	96	26	93.2	88.0	81.2	76.8	73.8
2	80.0	4.3	82.5	93.5	95	27	92.0	86.7	79.9	75.5	71.7
3	60.0	2.2	60.6	66.3	70	16	66.6	63.4	60.3	57.7	56.1
4	60.2	2.2	60.8	66.5	69	15	66.7	63.7	60.5	57.9	56.3
5	61.4	2.2	62.0	67.7	70	14	67.6	64.9	61.6	59.1	57.5
6	61.4	2.3	62.1	67.9	69	14	67.6	65.1	61.7	59.2	57.5
7	62.0	2.3	62.7	68.5	70	14	68.0	65.8	62.3	59.8	58.1
8	64.7	3.6	66.2	75.4	75	19	73.3	70.2	64.9	60.7	58.1
9	66.9	3.6	68.4	77.5	78	21	74.9	72.4	67.2	63.0	59.9
10	68.8	3.5	70.2	79.2	80	22	76.8	74.0	69.1	64.9	61.3
11	69.9	3.5	71.3	80.2	81	22	77.7	75.1	70.3	66.0	62.5
12	71.0	3.4	72.3	81.1	83	22	78.6	76.0	71.4	67.0	63.7
13	78.6	4.6	81.5	93.4	94	29	91.4	85.6	78.8	73.5	69.4
14	80.0	4.3	82.5	93.5	94	26	92.0	86.5	80.1	75.4	72.0

N= 4785

4- 29- 76 855 HOURS

BAND	A	S	E	N	M	R	1	10	50	90	99
1	80.2	4.4	83.0	94.4	97	31	93.6	86.5	80.3	75.7	70.7
2	79.2	4.3	81.8	92.8	95	29	92.0	85.4	79.3	74.8	70.2
3	60.0	2.2	60.6	66.2	71	17	66.8	63.4	60.4	58.0	56.2
4	60.4	2.1	60.9	66.2	69	14	66.3	63.6	60.7	58.3	56.6
5	61.4	2.0	61.9	67.0	69	13	67.1	64.6	61.7	59.4	57.8
6	61.4	2.0	61.8	66.9	69	14	66.9	64.5	61.7	59.3	57.4
7	62.0	2.0	62.4	67.5	70	14	67.3	65.0	62.4	60.0	57.9
8	63.0	3.6	64.7	74.0	75	21	73.4	68.3	63.1	59.0	56.4
9	65.2	3.8	66.9	76.5	79	23	74.9	70.7	65.5	61.0	57.5
10	67.2	3.8	68.8	78.4	79	23	76.9	72.6	67.6	62.8	59.0
11	68.5	3.6	70.0	79.3	79	21	77.6	73.7	68.9	64.3	60.2
12	69.7	3.6	71.2	80.5	80	21	78.8	74.9	70.0	65.7	61.4
13	77.2	5.0	80.5	93.3	96	35	91.6	84.0	77.7	71.5	66.1
14	78.8	4.6	81.6	93.5	96	32	92.0	85.2	79.2	73.6	68.9

N= 4780

TABLE NO. 113
 STATISTICAL NOISE DATA
 ROADSIDE BARRIER TEST SITE , ANDOVER MA.

BARRIER HGT 16 FT ; REFLECTIVE ; MICROPHONE CONFIGURATION E
 NOISE LEVEL - DBA RE 20 MICROPASCAL

4- 29- 76 1005 HOURS

BAND	A	S	E	N	M	R	1	10	50	90	99
1	80.0	4.8	83.3	95.7	101	33	93.2	87.2	79.7	75.0	71.1
2	78.9	4.8	82.3	94.6	101	35	91.7	86.2	78.7	73.9	69.5
3	61.0	3.6	62.8	72.1	79	27	71.5	66.2	61.1	57.0	54.7
4	61.3	3.6	63.6	72.8	76	22	72.1	67.0	62.0	57.8	55.8
5	63.8	3.9	65.8	75.7	80	24	75.0	69.3	64.0	59.5	57.4
6	65.5	4.0	67.7	77.9	81	24	77.0	71.1	65.7	61.1	58.6
7	68.8	4.0	70.9	81.1	85	26	80.2	74.3	69.1	64.2	61.3
8	67.2	5.5	71.5	85.5	91	37	82.0	75.3	67.1	61.2	56.8
9	68.8	5.4	73.1	87.0	93	38	83.1	76.7	68.9	62.9	57.9
10	70.2	5.2	74.0	87.3	93	38	83.8	77.7	70.3	64.4	59.3
11	70.6	5.0	74.1	86.8	92	36	83.6	77.8	70.8	65.0	60.6
12	72.6	4.6	75.4	87.1	91	32	84.6	79.2	72.8	67.5	63.3
13	77.3	5.1	81.0	94.1	99	37	91.2	84.6	77.3	72.0	65.2
14	78.3	4.9	81.7	94.3	98	34	91.7	85.3	78.4	73.1	67.0

N= 4780

4- 29- 76 1025 HOURS

BAND	A	S	E	N	M	R	1	10	50	90	99
1	78.6	4.8	82.0	94.3	101	36	92.7	85.2	78.7	73.4	69.3
2	77.6	4.8	80.9	93.2	100	40	91.6	84.1	77.8	72.4	67.2
3	59.8	3.5	61.5	70.5	77	26	69.4	64.9	60.2	55.8	53.3
4	60.6	3.6	62.3	71.5	74	23	70.2	65.8	61.1	56.2	54.1
5	62.4	3.6	64.1	73.4	79	25	71.6	67.7	62.9	57.9	56.0
6	63.9	3.9	65.8	75.7	81	27	73.4	69.7	64.2	59.3	56.9
7	67.4	4.2	69.4	80.2	82	26	77.1	73.7	67.5	62.5	59.0
8	66.3	5.6	70.6	84.9	90	41	81.9	73.6	66.8	59.8	53.8
9	67.7	5.6	72.1	86.5	92	42	83.0	74.9	68.3	61.2	54.8
10	68.9	5.4	72.8	86.6	91	41	83.7	75.9	69.4	62.9	55.9
11	69.2	5.1	72.7	85.7	90	40	82.8	76.1	69.7	63.6	56.4
12	71.4	4.7	74.3	86.2	92	39	83.6	77.8	71.8	66.3	61.2
13	75.8	5.4	79.8	93.7	101	44	90.0	83.0	76.3	69.9	61.2
14	77.1	5.1	80.7	93.8	100	41	90.7	83.9	77.4	71.4	64.7

N= 4730

TABLE NO. 114
 STATISTICAL NOISE DATA
 ROADSIDE BARRIER TEST SITE , ANDOVER MA.

BARRIER HGT 16 FT ; REFLECTIVE ; MICROPHONE CONFIGURATION B
 NOISE LEVEL - DBA RE 20 MICROPASCAL

4- 29- 76 1055 HOURS

BAND	A	S	E	N	M	R	1	10	50	90	99
1	79.1	4.6	81.9	93.6	96	30	91.8	85.7	79.3	73.9	69.9
2	77.6	4.6	80.3	92.1	95	31	90.2	84.0	78.0	72.3	67.8
3	59.6	3.4	60.9	69.7	72	23	67.7	64.5	60.2	55.4	52.4
4	60.2	3.5	61.6	70.6	75	24	68.5	65.2	60.8	55.9	53.1
5	61.8	3.6	63.3	72.5	74	22	70.2	67.2	62.2	57.7	54.6
6	63.1	3.8	64.7	74.3	74	21	71.9	68.8	63.4	58.8	55.5
7	66.4	4.0	68.2	78.5	77	22	75.9	72.5	66.6	61.8	58.1
8	69.1	5.3	72.3	85.9	85	30	82.1	76.3	69.8	62.4	57.5
9	71.6	4.9	74.2	86.6	87	29	83.3	78.1	72.3	65.6	61.0
10	73.1	4.7	75.6	87.6	88	28	84.8	79.5	73.8	67.5	62.9
11	73.3	4.4	75.5	86.8	88	29	84.0	79.3	73.9	68.1	63.5
12	74.7	4.1	76.6	87.2	87	24	85.3	80.3	75.3	69.7	65.8
13	75.9	5.3	79.3	92.9	93	31	89.6	83.0	76.6	69.4	64.4
14	77.3	4.8	80.1	92.4	94	29	89.9	83.7	77.8	71.6	67.7

N= 4780

4- 29- 76 1115 HOURS

BAND	A	S	E	N	M	R	1	10	50	90	99
1	79.2	4.7	82.3	94.4	97	30	92.9	86.1	79.2	74.0	70.0
2	78.2	4.7	81.3	93.3	96	32	91.8	84.9	78.3	73.2	68.5
3	60.4	3.6	61.9	71.1	72	20	69.4	66.0	60.6	56.4	54.2
4	61.3	3.5	62.7	71.6	71	18	69.3	66.7	61.7	57.3	54.6
5	63.2	3.5	64.6	73.6	73	19	71.3	68.4	63.8	59.1	56.2
6	64.8	3.7	66.3	75.7	75	20	73.5	70.0	65.4	60.4	57.2
7	68.4	3.9	70.1	80.2	81	23	77.6	74.0	69.0	63.6	60.1
8	69.3	5.5	72.8	86.9	87	33	83.0	76.9	69.7	62.5	57.5
9	71.9	5.0	74.8	87.5	88	30	84.2	78.7	72.2	66.1	61.1
10	73.4	4.8	76.2	88.5	87	27	85.5	80.2	73.7	67.7	63.4
11	73.6	4.7	76.1	88.1	87	26	84.9	80.2	73.9	68.1	64.0
12	75.1	4.5	77.5	89.1	88	25	85.9	81.5	75.5	69.7	65.8
13	76.4	5.5	80.3	94.4	96	34	91.5	83.8	76.7	69.9	65.1
14	77.8	5.1	81.2	94.2	96	31	91.8	84.8	78.2	71.8	67.5

N= 4780

TABLE NO. 115
 STATISTICAL NOISE DATA
 ROADSIDE BARRIER TEST SITE , ANDOVER MA.

BARRIER HGT 16 FT ; REFLECTIVE ; MICROPHONE CONFIGURATION C
 NOISE LEVEL - DBA RE 20 MICROPASCAL

4- 29- 76 1215 HOURS

BAND	A	S	E	N	M	R	1	10	50	90	99
1	79.0	4.6	81.8	93.6	97	31	91.9	85.2	79.3	73.7	69.2
2	77.6	4.5	80.2	91.6	94	30	90.2	83.7	78.0	72.5	68.3
3	59.5	3.3	60.9	69.2	72	21	68.3	64.1	59.9	55.8	53.2
4	60.2	3.3	61.6	70.2	73	21	69.0	65.1	60.6	56.4	53.9
5	62.0	3.4	63.3	72.0	73	19	70.8	66.8	62.5	58.0	55.4
6	63.2	3.5	64.6	73.4	74	20	71.9	68.2	63.6	59.1	56.6
7	65.3	3.5	66.7	75.8	77	21	74.0	70.4	65.8	61.1	58.4
8	64.9	4.3	67.2	78.1	79	26	76.6	71.3	65.0	60.3	55.6
9	69.4	4.3	71.6	82.6	82	27	80.3	75.7	69.5	64.7	59.3
10	71.1	4.0	72.9	83.1	82	24	80.9	76.9	71.3	66.7	61.8
11	71.2	3.9	72.9	82.9	83	24	80.8	76.9	71.4	66.9	62.3
12	72.3	3.7	73.9	83.5	85	24	81.7	77.8	72.6	68.1	64.0
13	76.1	4.6	79.0	90.8	93	29	89.5	82.1	76.4	70.9	66.7
14	77.5	4.3	80.0	91.0	93	26	90.2	83.6	77.7	72.8	69.4

N= 4785

4- 29- 76 1235 HOURS

BAND	A	S	E	N	M	R	1	10	50	90	99
1	78.2	4.3	81.1	92.2	100	33	91.2	84.0	78.5	73.4	70.0
2	76.6	4.5	79.5	91.1	98	36	89.6	82.5	76.9	71.6	66.7
3	57.5	2.6	58.4	65.2	71	20	65.9	61.3	57.7	54.9	53.0
4	58.2	2.8	59.3	66.4	73	21	67.1	62.2	58.5	55.4	53.3
5	59.8	2.8	60.9	68.2	74	22	68.7	63.8	60.1	57.0	54.6
6	60.4	3.1	61.7	69.6	74	22	69.7	65.0	60.7	57.3	54.4
7	62.2	3.4	63.7	72.3	77	23	71.5	67.3	62.4	58.7	55.3
8	63.2	4.2	66.3	77.2	90	35	76.6	69.3	63.0	58.9	56.5
9	67.6	4.3	70.3	81.3	90	32	80.0	73.7	67.7	63.0	59.8
10	69.8	4.0	72.0	82.3	89	29	81.2	75.4	70.0	65.4	62.4
11	70.1	3.8	72.1	81.9	87	26	80.8	75.6	70.4	65.9	63.0
12	71.4	3.6	73.2	82.5	88	26	81.6	76.5	71.7	67.4	64.6
13	75.3	4.5	78.5	89.9	99	37	89.1	81.0	75.7	70.3	66.2
14	77.0	4.1	79.6	90.2	97	31	89.7	82.5	77.2	72.8	68.7

N= 4780

TABLE NO. 116
 STATISTICAL NOISE DATA
 ROADSIDE BARRIER TEST SITE, ANDOVER, MA.

BARRIER HGT 16 FT; REFLECTIVE; MICROPHONE CONFIGURATION B

NOISE LEVEL - DBA RE 20 MICROPASCAL

9- 14- 76 946 HOURS

BAND	A	S	E	N	M	R	1	10	50	90	99
1	77.4	4.9	80.9	93.5	96	30	91.8	84.6	77.2	72.3	68.3
2	77.8	4.8	81.1	93.4	97	30	91.9	85.0	77.7	72.6	69.6
3	59.3	3.4	60.9	69.6	75	23	69.6	64.4	59.3	55.7	54.1
4	60.6	3.4	62.1	70.8	73	20	70.4	65.8	60.7	57.1	54.8
5	62.4	3.5	64.1	73.1	77	23	72.7	67.7	62.5	58.7	56.4
6	63.4	3.7	65.2	74.6	80	27	73.8	68.8	63.4	59.5	57.0
7	66.5	3.9	68.5	78.4	80	24	77.3	72.5	66.5	62.5	59.4
8	67.6	5.3	71.4	85.0	86	32	81.9	75.7	67.5	61.7	57.3
9	71.5	4.8	74.4	86.6	88	30	84.0	78.6	71.5	66.2	61.7
10	72.3	4.5	74.9	86.5	88	28	84.1	79.2	72.4	67.3	63.1
11	72.9	4.3	75.3	86.3	89	27	84.2	79.5	72.8	68.2	64.9
12	74.1	4.0	76.3	86.6	90	26	85.1	80.4	74.0	69.8	66.9
13	76.0	5.0	79.5	92.3	95	32	90.4	83.3	76.1	70.5	66.7
14	76.1	4.6	79.0	90.8	93	27	89.3	82.8	76.1	71.3	68.0

N= 4780

9- 14- 76 1009 HOURS

BAND	A	S	E	N	M	R	1	10	50	90	99
1	75.9	5.4	79.6	93.4	94	33	90.8	83.6	76.2	69.7	64.0
2											
3	58.9	3.6	60.6	69.8	75	25	69.0	64.0	59.3	54.6	52.3
4	59.7	3.6	61.4	70.7	74	23	70.1	64.9	60.0	55.5	53.3
5	61.5	3.7	63.3	72.9	77	25	72.0	66.9	61.8	57.2	54.8
6	62.7	3.9	64.6	74.7	77	24	73.3	68.2	63.1	58.1	55.4
7	66.1	4.3	68.2	79.1	79	25	76.7	72.4	66.4	61.1	57.8
8	67.3	5.7	71.2	85.9	86	36	81.8	75.8	67.4	61.0	53.4
9	70.9	5.3	74.2	87.7	89	37	84.4	78.5	71.1	65.4	57.4
10	71.8	5.1	74.9	87.9	90	37	85.0	78.9	72.0	66.8	58.0
11	72.2	4.8	75.1	87.4	90	35	84.6	79.2	72.3	67.7	59.5
12	73.3	4.6	76.0	87.7	90	34	85.3	79.9	73.3	69.2	61.9
13	75.6	5.4	79.5	93.3	96	39	90.6	83.1	75.8	70.1	62.5
14	75.4	4.9	78.7	91.3	95	38	89.5	82.6	75.4	70.7	63.8

N= 4780

TABLE NO. 117
 STATISTICAL NOISE DATA
 ROADSIDE BARRIER TEST SITE, ANDOVER, MA.

BARRIER HGT 16 FT; REFLECTIVE; MICROPHONE CONFIGURATION C
 NOISE LEVEL - DBA RE 20 MICROPASCAL

9- 14- 76 1135 HOURS

BAND	A	S	E	N	M	R	1	10	50	90	99
1	77.0	5.7	81.6	96.1	101	40	91.9	85.2	77.0	70.7	65.3
2	76.6	5.5	81.0	95.1	101	40	91.0	84.6	76.6	70.4	65.6
3	57.2	3.7	58.8	68.2	72	23	66.4	62.6	57.3	52.8	51.1
4	57.7	3.7	59.4	68.9	73	24	66.9	63.2	57.8	53.3	51.3
5	58.6	3.8	60.5	70.4	75	25	68.1	64.4	58.7	54.1	52.0
6	60.0	4.0	61.9	72.2	76	25	69.5	65.9	60.1	55.1	53.0
7	61.6	4.2	63.7	74.3	77	25	71.7	67.7	61.7	56.5	54.1
8	62.8	5.1	66.1	79.1	80	28	76.7	70.2	62.7	57.2	54.3
9	67.0	5.4	70.3	84.2	84	31	79.7	74.7	67.3	60.5	55.5
10	69.3	5.1	72.2	85.2	83	29	80.9	76.5	69.8	63.3	57.8
11	70.2	4.8	72.7	85.1	83	28	81.0	76.9	70.7	64.5	59.3
12	71.7	4.6	74.0	85.6	88	31	81.9	78.1	72.1	66.5	61.4
13	75.9	5.8	80.1	95.0	97	39	90.8	83.9	76.2	69.3	61.4
14	76.1	5.4	79.7	93.5	97	39	90.1	83.7	76.2	70.2	62.4

N= 4785

9- 14- 76 1155 HOURS

BAND	A	S	E	N	M	R	1	10	50	90	99
1	76.1	5.7	81.3	95.8	99	38	93.1	84.3	76.1	70.0	65.5
2	75.8	5.5	80.8	95.0	100	38	92.3	83.9	75.7	70.1	65.7
3	56.1	3.9	58.4	68.3	72	24	68.1	61.8	56.0	52.2	50.3
4	57.0	4.1	59.5	70.0	75	26	69.6	62.9	57.0	52.7	50.9
5	57.9	4.2	60.5	71.1	76	26	70.4	63.9	58.1	53.4	51.6
6	58.8	4.2	61.4	72.1	75	25	71.2	64.9	58.9	54.2	52.3
7	61.0	4.3	63.6	74.7	79	27	73.6	67.1	61.0	56.1	54.0
8	61.3	5.3	66.1	79.8	85	33	77.4	70.0	60.0	56.5	54.6
9	65.2	5.8	69.9	84.8	86	32	81.0	74.4	64.4	58.9	56.0
10	67.5	5.6	71.7	86.0	87	33	82.2	76.1	67.0	61.4	57.2
11	68.3	5.4	72.1	86.0	87	32	82.2	76.6	67.9	62.5	57.7
12	69.9	5.2	73.4	86.8	88	31	83.6	77.8	69.5	64.4	59.5
13	74.2	6.1	79.9	95.5	98	39	91.7	83.2	74.3	67.5	62.3
14	74.6	5.6	79.5	93.7	99	37	91.1	82.9	74.4	68.8	64.3

N= 4780

TABLE NO. 118
 STATISTICAL NOISE DATA
 ROADSIDE BARRIER TEST SITE, ANDOVER, MA.

BARRIER HGT 16 FT; REFLECTIVE; MICROPHONE CONFIGURATION D
 NOISE LEVEL - DBA RE 20 MICROPASCAL

9- 14- 76 1257 HOURS

BAND	A	S	E	N	M	R	1	10	50	90	99
1	74.8	4.9	78.1	90.7	94	34	89.2	81.1	75.3	69.0	64.5
2	75.0	4.6	78.0	89.9	94	30	88.5	81.2	75.3	69.6	66.3
3	54.8	2.8	55.8	63.1	65	16	63.1	59.0	55.1	51.8	50.3
4	55.7	3.2	57.0	65.3	67	19	64.4	60.6	56.1	52.1	50.3
5	56.5	3.4	57.3	66.4	68	19	65.2	61.6	56.9	52.7	50.7
6	56.3	3.4	57.7	66.4	67	19	64.8	61.4	56.9	52.4	50.1
7	58.1	3.5	59.5	68.4	70	21	66.8	63.2	58.7	54.1	51.7
8	56.9	3.9	59.6	69.6	76	27	71.7	62.1	56.8	53.1	51.0
9	59.1	4.3	62.0	72.9	79	30	73.6	65.1	59.2	54.5	52.0
10	61.4	4.4	64.2	75.5	79	28	75.1	67.6	61.6	56.3	53.1
11	63.0	4.5	65.7	77.1	79	28	76.0	69.1	63.4	57.9	54.2
12	65.4	4.4	67.8	79.1	82	29	77.6	71.4	66.0	60.2	55.9
13	73.8	5.6	77.8	92.0	96	38	89.2	80.3	74.7	66.9	60.0
14	74.0	5.2	77.4	90.8	95	37	88.3	80.4	74.7	68.0	60.5

N= 4780

9- 14- 76 1317 HOURS

BAND	A	S	E	N	M	R	1	10	50	90	99
1	75.4	5.2	79.2	92.7	98	42	89.9	81.9	75.9	69.8	62.3
2	75.5	5.1	79.1	92.2	98	41	89.4	82.0	75.8	70.2	62.5
3	54.4	2.5	55.3	61.7	66	18	62.8	58.2	54.8	51.9	50.0
4	55.3	2.6	56.3	63.0	67	18	63.8	59.2	55.7	52.6	50.7
5	56.0	2.8	57.0	64.1	69	21	64.4	60.0	56.5	52.9	50.9
6	55.9	2.8	56.9	64.1	68	20	63.9	59.9	56.4	52.7	50.8
7	57.6	2.9	58.6	65.9	67	17	64.9	61.8	58.2	54.3	52.3
8	57.9	3.7	59.9	69.5	74	24	68.8	63.6	57.7	54.2	52.3
9	59.7	4.2	62.3	73.0	73	27	72.0	66.3	59.5	55.4	53.0
10	62.0	4.4	64.6	75.9	80	28	74.1	68.6	61.7	57.3	54.4
11	63.6	4.4	66.1	77.4	80	27	75.5	70.0	63.4	59.0	55.3
12	66.0	4.3	68.4	79.5	82	27	78.6	72.2	66.1	61.4	57.5
13	74.4	5.6	78.8	93.0	98	42	89.5	81.8	74.9	68.0	62.1
14	74.8	4.9	78.4	91.0	98	38	88.3	81.6	75.0	69.6	63.8

N= 4780

TABLE NO. 119
 STATISTICAL NOISE DATA
 ROADSIDE BARRIER TEST SITE, ANDOVER, MA.

BARRIER HGT 16 FT; REFLECTIVE; MICROPHONE CONFIGURATION E
 NOISE LEVEL - DBA RE 20 MICROPASCAL

9- 14- 76 1455 HOURS

BAND	A	S	E	N	M	R	1	10	50	90	99
1	76.5	5.0	80.0	92.9	94	30	90.6	84.2	76.4	70.9	67.4
2	76.8	4.9	80.1	92.8	94	30	90.5	84.3	76.6	71.5	67.2
3	58.5	3.3	60.0	68.5	71	20	68.1	63.6	58.8	55.1	52.2
4	59.8	3.3	61.1	69.6	73	21	68.8	64.8	60.0	56.3	53.5
5	61.1	3.4	62.5	71.2	73	21	70.2	66.3	61.3	57.4	54.6
6	62.1	3.5	63.7	72.6	75	22	71.9	67.4	62.3	58.4	55.8
7	65.4	3.6	67.0	76.2	78	22	75.2	70.8	65.6	61.6	58.9
8	65.1	4.9	69.1	81.8	86	32	80.5	72.7	64.7	60.5	57.3
9	66.3	5.3	70.5	84.2	87	32	81.3	74.5	66.2	60.5	57.6
10	67.7	5.2	71.6	85.0	87	31	82.7	75.9	67.7	61.9	58.4
11	68.8	5.0	72.2	84.9	87	30	83.0	76.3	68.7	63.3	59.9
12	70.3	4.6	73.2	84.9	86	27	83.5	77.3	70.1	65.5	62.0
13	76.0	5.4	79.9	93.7	95	33	90.4	84.1	76.4	69.6	65.4
14	76.4	4.8	79.6	91.9	94	30	89.8	83.6	76.6	71.0	66.7

N= 4785

9- 14- 76 1515 HOURS

BAND	A	S	E	N	M	R	1	10	50	90	99
1	76.9	4.3	79.6	90.6	96	32	89.8	82.6	77.0	72.4	67.5
2	77.1	4.2	79.7	90.5	94	31	89.8	82.9	77.3	72.7	68.0
3	59.2	3.1	60.4	68.3	70	18	67.8	64.0	59.2	56.0	54.2
4	60.4	3.0	61.5	69.2	73	19	68.4	64.9	60.4	57.3	55.5
5	61.4	3.0	62.6	70.3	74	19	69.6	66.1	61.5	58.3	56.5
6	62.8	3.1	64.0	71.9	76	20	71.0	67.6	63.1	59.6	57.9
7	66.1	3.2	67.4	75.6	77	20	74.6	70.9	66.4	62.6	60.5
8	65.6	4.3	68.6	79.6	83	27	79.8	71.8	65.5	61.4	58.6
9	66.8	4.5	69.8	81.3	84	27	80.4	73.1	66.9	61.8	58.8
10	67.9	4.4	70.6	81.9	85	28	80.9	74.1	68.1	63.0	59.2
11	69.4	4.1	71.8	82.1	85	27	81.5	75.1	69.6	65.0	61.7
12	70.8	3.7	72.7	82.1	85	25	81.6	76.1	71.0	67.0	63.7
13	76.3	4.6	79.1	90.8	91	31	89.7	82.2	76.8	71.2	65.5
14	76.4	4.1	78.6	89.2	91	27	88.8	81.9	76.8	71.9	67.0

N= 4780

TABLE NO. 120
 STATISTICAL NOISE DATA
 ROADSIDE BARRIER TEST SITE, ANDOVER, MA.

BARRIER HGT 16 FT; REFLECTIVE; MICROPHONE CONFIGURATION E
 NOISE LEVEL - DBA RE 20 MICROPASCAL

9- 15- 76 848 HOURS

BAND	A	S	E	N	M	R	1	10	50	90	99
1	77.7	4.4	80.5	91.3	96	31	91.0	84.4	77.7	73.2	69.2
2	78.4	4.3	81.1	92.1	95	28	91.4	85.0	78.4	73.9	70.8
3	60.2	2.9	61.3	63.8	71	16	69.2	64.7	60.2	57.3	55.9
4	61.7	2.6	62.8	70.0	73	17	70.0	66.1	61.8	58.9	57.4
5	62.9	2.9	64.0	71.6	74	17	71.5	67.4	63.0	60.0	58.3
6	64.9	3.2	66.2	74.4	76	18	74.0	69.8	64.9	61.6	60.0
7	67.9	3.5	69.5	75.4	79	19	77.4	73.5	67.8	64.4	62.2
8	66.9	4.3	70.3	82.5	84	25	81.2	73.7	67.0	61.7	57.5
9	68.8	4.3	72.0	84.3	86	29	82.6	75.6	69.1	63.4	59.9
10	69.6	4.6	72.8	84.6	86	28	83.3	76.5	70.0	64.7	61.3
11	71.0	4.2	73.5	84.4	87	27	83.7	77.3	71.1	66.4	63.3
12	72.5	4.0	74.6	85.0	87	27	83.9	78.6	72.5	68.2	65.2
13	77.2	4.6	80.2	91.9	95	30	90.8	83.7	77.1	72.4	68.7

N= 4780

9- 15- 76 906 HOURS

BAND	A	S	E	N	M	R	1	10	50	90	99
1	76.9	4.5	80.1	91.7	93	33	91.5	83.2	77.0	72.2	68.4
2	77.7	4.4	80.7	92.1	97	31	91.6	84.0	77.6	72.9	69.6
3	59.7	3.2	61.1	69.3	73	21	69.7	64.6	59.7	56.5	54.4
4	61.3	3.2	62.8	71.1	74	20	71.1	66.2	61.3	58.1	56.1
5	62.4	3.4	64.0	72.7	77	22	72.1	67.7	62.4	59.0	57.1
6	64.3	3.6	66.0	75.2	79	22	74.3	69.8	64.2	60.6	58.7
7	67.2	3.7	69.1	78.5	83	24	77.4	73.0	67.1	63.5	61.3
8	65.8	4.3	69.5	81.8	87	31	80.5	72.6	65.8	60.7	57.6
9	67.3	4.3	71.4	83.8	88	31	82.5	74.4	68.1	62.7	59.1
10	68.9	4.6	72.2	84.0	89	31	83.0	75.2	69.1	64.2	60.4
11	70.0	4.3	72.9	83.9	89	29	83.6	76.3	70.1	65.7	62.3
12	71.5	4.0	73.9	84.1	88	26	84.1	77.4	71.6	67.5	64.1
13	76.5	4.5	79.6	91.2	95	31	90.5	82.7	76.7	71.6	67.6

N= 4730

TABLE NO. 121
 STATISTICAL NOISE DATA
 ROADSIDE BARRIER TEST SITE, ANDOVER, MA.

BARRIER HGT 16 FT; REFLECTIVE; MICROPHONE CONFIGURATION B

NOISE LEVEL - DBA RE 20 MICROPASCAL

9- 15- 76 1022 HOURS

BAND	A	S	E	N	M	R	1	10	50	90	99
1	76.0	4.9	79.7	92.3	97	33	90.5	82.5	76.2	70.5	66.5
2	76.4	4.9	79.9	92.4	98	34	90.5	82.8	76.7	71.0	66.9
3	57.0	3.9	59.1	69.1	73	23	67.7	63.2	57.0	52.6	51.1
4	58.0	3.9	60.0	69.9	72	22	68.7	64.0	58.0	53.8	52.0
5	59.8	3.8	61.8	71.6	74	22	70.5	65.8	59.8	55.7	53.6
6	61.6	3.9	63.6	73.7	77	24	72.1	67.6	61.6	57.3	55.2
7	64.8	4.0	66.8	77.0	79	23	74.9	70.9	64.9	60.3	58.1
8	67.2	5.6	71.5	85.7	88	37	82.5	75.1	67.2	61.2	56.2
9	70.3	5.2	73.9	87.1	89	34	84.1	77.8	70.4	64.7	60.0
10	71.7	4.9	75.0	87.6	90	34	85.0	78.8	71.8	66.6	61.6
11	72.4	4.7	75.5	87.5	90	32	85.2	79.5	72.3	67.6	63.2
12	73.2	4.5	76.0	87.5	90	31	85.6	79.9	73.0	68.5	64.4
13	75.2	5.4	79.7	93.4	99	38	91.1	82.1	75.4	69.3	64.0
14	76.2	4.9	79.9	92.5	98	36	91.1	82.6	76.3	71.1	66.1

N= 4780

9- 15- 76 1042 HOURS

BAND	A	S	E	N	M	R	1	10	50	90	99
1	75.9	5.0	79.7	92.4	100	37	90.6	82.4	76.3	70.2	65.6
2	76.3	5.0	80.1	92.8	100	36	90.8	83.0	76.7	70.7	66.2
3	57.5	3.9	59.6	69.5	76	28	68.0	63.0	57.7	53.1	50.7
4	58.4	3.9	60.6	70.6	76	27	69.4	64.0	58.6	54.0	51.3
5	60.2	4.1	62.4	72.9	76	26	71.0	66.2	60.4	55.5	52.7
6	62.2	4.4	64.6	75.9	78	27	73.3	68.5	62.4	57.3	53.7
7	65.3	4.7	68.0	80.1	81	28	76.9	72.2	65.5	60.1	55.8
8	67.3	5.4	71.4	85.3	90	38	81.7	74.7	67.7	61.2	54.9
9	70.2	5.1	73.9	87.1	92	36	84.2	77.2	70.6	64.2	58.4
10	71.6	4.9	75.0	87.5	92	34	85.0	78.4	72.0	66.0	60.6
11	72.6	4.7	75.7	87.7	93	34	85.3	79.1	72.9	67.3	62.6
12	73.1	4.6	76.1	87.8	94	35	85.5	79.6	73.4	68.1	62.8
13	75.0	5.3	79.2	92.7	99	40	90.2	81.8	75.5	68.9	63.8
14	75.8	5.0	79.6	92.5	100	40	90.0	82.7	76.3	70.1	64.7

N= 4780

TABLE NO. 122
 STATISTICAL NOISE DATA
 ROADSIDE BARRIER TEST SITE, ANDOVER, MA.

BARRIER HGT 16 FT; REFLECTIVE; MICROPHONE CONFIGURATION C

NOISE LEVEL - DBA RE 20 MICROPASCAL

9- 15- 76 1136 HOURS

BAND	A	S	E	N	M	R	1	10	50	90	99
1	76.9	4.9	80.6	93.3	97	35	91.8	84.1	76.8	72.1	67.1
2	77.4	4.8	81.0	93.3	96	33	92.1	84.5	77.2	72.5	68.2
3	58.6	3.1	59.9	67.8	69	18	67.6	63.2	58.8	55.3	52.9
4	59.7	3.2	60.9	69.2	70	18	68.5	64.5	59.9	56.3	53.6
5	60.9	3.2	62.1	70.3	71	18	69.5	65.7	61.1	57.4	55.0
6	62.2	3.3	63.5	72.0	72	18	70.7	67.3	62.4	58.8	56.0
7	63.9	3.4	65.2	73.8	75	21	72.1	69.0	64.1	60.2	57.5
8	63.5	4.2	66.2	77.1	80	26	77.1	69.9	63.4	59.3	56.7
9	67.9	4.5	70.3	82.4	85	28	81.2	74.3	67.8	63.3	59.3
10	69.8	4.4	72.4	83.6	85	27	82.2	76.4	69.7	65.2	61.5
11	71.4	4.2	73.8	84.6	86	26	83.4	77.7	71.5	66.9	63.6
12	71.8	4.2	74.1	84.8	86	26	83.6	77.9	71.9	67.3	64.1
13	75.7	5.2	79.7	92.9	97	35	91.0	83.0	75.8	70.1	65.3
14	76.8	4.8	80.1	92.3	96	32	90.9	83.5	76.8	71.9	67.1

N= 4785

9- 15- 76 1156 HOURS

BAND	A	S	E	N	M	R	1	10	50	90	99
1	75.7	4.8	78.9	91.1	93	34	89.8	82.4	75.7	71.0	64.4
2	76.2	4.6	79.1	90.9	93	31	90.1	82.6	76.2	71.7	65.4
3	58.1	2.9	59.1	66.4	67	16	65.2	62.7	58.4	55.1	53.1
4	59.1	3.0	60.1	67.7	68	16	66.7	63.7	59.4	55.8	53.9
5	60.1	3.0	61.2	69.0	69	16	67.9	64.7	60.4	56.9	55.0
6	61.3	3.3	62.6	70.9	71	18	69.7	66.1	61.5	57.7	55.6
7	63.0	3.5	64.5	73.5	73	19	72.2	68.2	63.3	59.3	56.9
8	64.8	4.0	66.9	77.2	79	22	75.3	71.4	64.5	60.7	59.1
9	68.1	4.4	70.6	81.7	80	22	79.4	75.1	68.0	63.4	61.1
10	69.5	4.3	71.8	82.8	82	23	80.0	76.4	69.4	64.7	62.1
11	70.9	4.2	73.1	83.8	83	22	81.2	77.6	71.0	66.2	64.0
12	71.1	4.1	73.1	83.6	83	21	81.1	77.6	71.2	66.6	64.3
13	75.2	4.9	78.6	91.2	92	29	90.0	82.2	75.4	69.8	66.2
14	76.1	4.5	79.0	90.7	92	28	89.8	82.7	76.1	71.2	68.1

N= 4780

TABLE NO. 123
 STATISTICAL NOISE DATA
 ROADSIDE BARRIER TEST SITE, ANDOVER, MA.

BARRIER HGT 16 FT; REFLECTIVE; MICROPHONE CONFIGURATION D
 NOISE LEVEL - DBA RE 20 MICROPASCAL

9- 15- 76 1337 HOURS

BAND	A	S	E	N	M	R	I	10	50	90	99
1	77.7	5.2	81.7	95.1	99	36	92.7	85.5	77.6	72.2	67.5
2	78.2	5.2	82.1	95.3	99	35	93.0	85.8	78.1	72.6	68.2
3	58.2	2.4	58.9	65.0	67	15	64.5	61.9	58.6	55.6	53.5
4	59.0	2.5	59.7	66.1	69	16	65.5	62.9	59.4	56.3	54.2
5	59.6	2.5	60.3	66.6	70	17	66.1	63.5	59.9	56.9	54.9
6	60.0	2.6	60.8	67.3	68	15	66.6	64.0	60.3	57.3	55.1
7	61.1	2.6	61.9	63.6	69	15	67.7	65.2	61.4	58.3	55.9
8	61.8	3.9	63.8	73.7	75	22	72.3	67.4	61.9	57.7	54.6
9	64.6	4.1	65.6	77.0	78	24	75.2	70.6	64.7	60.2	56.5
10	66.4	4.1	68.4	78.9	80	24	76.8	72.4	66.6	61.9	57.8
11	68.3	4.1	70.2	80.6	81	23	78.4	74.2	68.7	63.7	59.8
12	69.5	4.0	71.4	81.7	83	25	79.0	75.2	69.8	64.9	61.1
13	77.4	5.2	81.5	94.9	100	35	92.7	85.0	77.5	71.6	67.4
14	78.0	4.9	81.5	94.2	99	36	92.2	85.0	78.0	72.7	68.3

N= 4780

9- 15- 76 1357 HOURS

BAND	A	S	E	N	M	R	I	10	50	90	99
1	77.5	5.2	81.4	94.6	98	35	92.1	85.0	77.2	72.0	67.4
2	77.6	5.0	81.3	94.1	98	34	91.8	84.8	77.5	72.3	67.9
3	57.9	2.3	58.6	64.5	68	16	65.5	61.3	58.2	55.6	54.0
4	59.0	2.5	59.9	66.4	70	17	67.3	62.7	59.3	56.4	54.7
5	59.4	2.6	60.3	66.9	71	18	67.9	63.2	59.7	56.8	55.3
6	59.5	2.6	60.4	67.0	71	18	67.8	63.4	59.7	56.9	55.2
7	60.5	2.5	61.4	67.9	71	17	68.2	64.4	60.8	58.0	56.2
8	61.6	3.8	63.5	73.3	75	21	72.7	67.3	61.6	57.5	56.1
9	64.0	4.0	66.2	76.5	79	23	75.7	69.8	64.1	59.5	57.8
10	65.8	4.1	68.0	78.6	81	25	77.6	71.6	66.1	61.0	58.9
11	67.4	4.1	69.5	79.9	83	26	79.1	72.9	67.7	62.6	59.8
12	68.7	4.1	70.8	81.3	84	26	80.2	74.2	69.0	63.8	61.1
13	76.9	5.4	81.0	94.7	99	37	91.5	84.8	77.2	70.8	66.0
14	77.5	4.9	81.0	93.6	98	34	91.3	84.7	77.7	72.0	67.6

N= 4780

TABLES 124-134. METEOROLOGICAL DATA

TABLE NO. 124
 METEOROLOGICAL DATA
 SITE I-53, ANDOVER, MASSACHUSETTS

Date 9/3-4/75

TIME (Hours)	TEMP. (°F)	BAR. PRESS. (mbars)	REL. HUM. (%)	WIND SPEED (mph)		WIND DIRECTION (Degrees)	REMARKS (P=pavement) (G=ground) (S=sky)
				Avg.	Max.		
9/3 1145	63	1009	60	7	12	315	P&G - DRY
1420	58	1010	62	6	12	315	S - PLY CLOUDY
1525	58	1010	62	5	10	315	
1640	60	1010	60	6	10	315	S - CLEAR
1740	60	1010	60	5	7	315	
7/4 0930	54	1013	80	6	10	0	P&G - DRY
1037	60	1012	70	6	12	0	S - CLEAR
1135	63	1012	62	7	10	0	
1235	67	1011	57	4	10	335	
1502	69	1011	52	5	10	335	
1532	70	1011	50	4	11	315	
1620	69	1010	49	6	8	335	
1700	68	1010	51	5	8	315	S - CLEAR

TABLE NO. 125
 METEOROLOGICAL DATA
 SITE I-93, ANDOVER, MASSACHUSETTS

Date 10/28-9/75

TIME (hours)	TEMP. (°F)	BAR. PRESS. (mbars)	REL. HUM. (%)	WIND SPEED (mph)		WIND DIRECTION (Degrees)	REMARKS (P=pavement) (G=ground) (S=sky)
				Ave.	Max.		
10/7 1159	55	1017	38	5	8	330	P&G - DRY
1510	56	1017	30	6	8	340	S - CLEAR
1611	56	1017	29	4	5	330	
1755	—	—	—	1	1	330	
10/8 1010	50	1018	40	4	5	330	P&G - DRY
1032	53	1018	34	3	6	330	S - CLEAR
1149	60	1017	25	4	7	310	
1210	60	1017	26	5	8	310	
1302	62	1017	27	4	7	320	S - PLY SUNNY
1324	62	1017	29	3	6	320	
1420	64	1017	30	3	7	330	
1640	62	1018	33	3	7	340	
1710	60	1018	39	3	5	340	S - CLEAR
10/9 0906	41	1026	77	3	4	220	P&G DRY
0926	41	1026	75	3	4	240	SKY - PLY CLOUDY
1020	48	1026	60	2	4	250	
1040	48	1026	57	2	4	320	S - OVERCAST
1205	51	1026	51	3	5	50	S - PLY CLOUDY
1225	50	1026	50	2	4	270	
1511	46	1025	46	2	4	90	S - OVERCAST
1531	48	1024	48	2	4	90	S - OVERCAST

TABLE NO. 126
 METEOROLOGICAL DATA
 SITE I 73, ANDOVER, MASSACHUSETTS

Date 10/15, 16, 17/75

TIME (Hours)	TEMP. (°F)	BAR. PRESS. (mbars)	REL. HUM. (%)	WIND SPEED (mph)		WIND DIRECTION (Degrees)	REMARKS (P=pavement) (G=ground) (S=sky)
				Ave.	Max.		
10/15 0953	62	1010	76	2	3	210	P/G - DRY
1013	61	1010	79	2	3	260	S - CLEAR
1231	72	1009	56	7	7	280	
1248	74	1008	53	4	6	280	
1455	70	1007	55	4	6	70	
1515	62	1007	63	5	8	80	
1609	64	1007	69	4	6	110	
1629	62	1007	71	4	6	110	S - CLEAR
10/16 0711	55	1007	65	5	8	280	P/G - DAY
0937	56	1007	61	6	8	300	S - CLEAR
1014	57	1007	52	7	10	290	
1034	57	1008	50	9	15	280	
1147	58	1008	40	7	10	290	
1207	60	1008	38	8	12	290	
1456	59	1009	37	7	11	300	
1516	59	1010	37	6	11	300	S - CLEAR
10/17 0917	42	1020	65	4	6	340	G - DAMP P - DAY
0937	42	1019	64	3	4	330	S - PTLY CLOUDY
1030	45	1020	50	4	6	330	G - DRY
1050	46	1020	52	4	7	340	
1201	50	1020	49	3	6	320	
1221	52	1020	42	4	6	330	S - PTLY SUNNY
1435	52	1020	43	3	7	330	S - OVERCAST

TABLE NO. 127
 METEOROLOGICAL DATA
 SITE I-93, ANDOVER, MASSACHUSETTS

Date 10/29, 31/75

TIME (Hours)	TEMP. (°F)	BAR. PRESS. (mbars)	REL. HUM. (%)	WIND SPEED (mph)	WIND DIRECTION (Degrees)	REMARKS (P=pavement) (G=ground) (S=sky)
				Ave. - Max.		
10/29 0945	55	1016	73	3 - 5	330	P-DRY G-DAMP
1005	57	1016	69	3 - 8	280	S-CLEAR
1131	62	1014	58	3 - 7	315	G-DRY
1151	—	—	—	3 - 8	290	
1335	64	1014	56	5 - 9	270	
1359	64	1014	57	5 - 10	260	
1509	64	1014	56	7 - 12	310	
1529	63	1014	56	7 - 12	310	S-CLEAR
10/31 0905	—	—	—	12 - 22	350	P&G-DRY
0925	33	51	1024	12 - 24	340	S-CLEAR
1046	33	51	1024	10 - 15	340	
1123	—	—	—	12 - 19	340	
1250	40	44	1023	11 - 15	320	
1307	40	43	1022	9 - 17	320	
1437	40	41	1022	7 - 14	330	
1453	40	41	1022	5 - 15	330	S-CLEAR

TABLE NO. 128
 METEOROLOGICAL DATA
 SITE I 93, ANDOVER, MASSACHUSETTS

Date 11/4, 5, 6/75

TIME (Hours)	TEMP. (°F)	BAR. PRESS. (mbars)	REL. HUM. (%)	WIND SPEED (mph)		WIND DIRECTION (Degrees)	REMARKS (P=pavement) (G=ground) (S=sky)
				Ave.	Max.		
11/4 0905	66	1012	68	5	12	270	P&G - DRY
0925				4	9	270	S - OVERCAST
1117				8	16	270	
1137	72	1012	58	12	20	315	
1236				9	18	270	
1256	71	1013	51	10	18	290	
1437	—	—	—	12	22	290	
1457	68	1013	42	12	20	290	S - OVERCAST
11/5 0848	52	1012	43	10	19	340	P&G - DRY
0908	52	1012	42	12	20	300	S - CLEAR
1014	54	1013	39	10	18	310	
1034	55	1013	37	10	16	300	
1123	56	1013	35	9	15	310	
1143	58	1013	34	8	15	340	
1317	66	1012	22	8	14	0	
1348	66	1012	22	9	16	0	S - CLEAR
11/6 0850	49	1023	48	0	1	220	P&G - DRY
0910	50	1023	48	0	1	220	S - CLEAR
1018	50	1023	48	1	3	200	
1038	51	1023	46	1	5	220	
1119	—	—	—	2	6	220	
1141	—	—	—	3	8	200	
1320	58	1022	37	4	8	220	
1340	59	1022	37	4	8	220	S - CLEAR

TABLE NO. 129
 METEOROLOGICAL DATA
 SITE I 93, ANDOVER, MASSACHUSETTE

Date 11/18, 19, 20/75

TIME (Hours)	TEMP. (°F)	BAR. PRESS. (mbars)	REL. HUM. (%)	WIND SPEED (mph)		WIND DIRECTION (Degrees)	REMARKS (P=pavement) (G=ground) (S=sky)
				Ave.	Max		
11/18 0916	54	1020	72	7	12	320	P-DRY G-DAMP
0936	56	1020	69	8	13	320	G-DRY S-CLEAR
1043	—	—	—	8	16	300	
1103	58	1020	59	9	14	290	
1204	57	1020	58	9	14	290	
1224	—	—	—	7	10	310	
1348	62	1020	43	5	9	300	
1408	62	1020	42	8	14	300	S-CLEAR
11/19 0855	50	1022	49	0	—	—	P-DRY G-DAMP
0915	52	1023	51	1	3	265	S-CLEAR
1016	50	1023	50	1	4	280	G-DRY
1036	50	1022	50	0	2	300	
1127	—	—	—	1	5	200	
1147	53	1022	43	1	5	200	
1313	55	1021	34	0	6	250	
1333	56	1021	30	0	3	250	S-CLEAR
11/20 0848	60	1017	59	0	0	—	P-DRY G-DAMP
0908	64	1017	63	1	6	340	S-CLEAR
1007	64	1017	63	4	8	270	G-DRY
1027	63	1017	62	4	8	280	
1112	—	—	—	2	8	270	
1132	—	—	—	2	7	260	
1253	65	1015	50	4	10	260	
1313	—	—	—	5	10	270	S-CLEAR

TABLE NO. 130
METEOROLOGICAL DATA
SITE I 93, ANDOVER, MASSACHUSETTS

Date 12/2, 3, 4/75

TIME (Hours)	TEMP. (°F)	BAR. PRESS. (mbars)	REL. HUM. (%)	WIND SPEED (mph)		WIND DIRECTION (Degrees)	REMARKS (P=pavement) (G=ground) (S=sky)
				Ave.	Max.		
12/2 0522	34	1019	64	2	6	350	P-DRY G-DAMP
0942	35	1019	62	1	5	340	S-CLEAR G-DRY
1045	37	1018	58	0	3	330	
1105	40	1018	55	0	0	—	
1152	40	1018	54	0	5	180	
1212	40	1016	52	0	3	180	
1344	39	1016	48	1	6	180	
1404	—	—	—	2	8	180	S-CLEAR
12/3 0541	37	1011	50	1	6	230	P-DRY G-DAMP
0901	36	1011	52	4	15	220	S-PTLY CLDY
1002	36	1011	54	8	21	240	G-DRY S-CLEAR
1022	37	1010	54	10	15	270	
1106	—	—	—	12	17	260	
1139	38	1010	52	13	25	270	S-PTLY CLDY
1306	38	1010	47	12	22	280	
1326	38	1010	46	12	16	280	S-PTLY CLDY
12/4 0712	27	1023	32	9	17	320	P-DRY G-FROZEN
0732	28	1022	34	7	17	340	S-CLEAR
1040	29	1022	36	8	13	320	
1100	30	1022	36	7	15	330	
1129	30	1023	37	10	18	320	
1148	—	—	—	10	18	320	
1328	32	1023	35	8	14	300	
1348	32	1023	35	6	13	340	S-CLEAR

TABLE NO. 131
METEOROLOGICAL DATA
SITE I 73, ANDOVER, MASSACHUSETTS

Date 12/9, 11, 12/75

TIME (Hours)	TEMP. (°F)	BAR. PRESS. (mbars)	REL. HUM. (%)	WIND SPEED (mph)		WIND DIRECTION (Degrees)	REMARKS (P=pavement) (G=ground) (S=sky)
				Ave.	Max.		
12/9 0707	31	1023	58	1	8	350	P-WET G-FROZEN
1035	31	1021	92	2	12	20	S-DRIZZLE
1050	32	1021	96	1	7	20	G-LT SNOW COVER
1145	32	1021	100	2	7	10	
1200	32	1021	100	2	7	10	S-FREEZING DRIZZLE
12/11 0942	40	1011	58	8	15	270	P-DRY G-DRY
1007	41	1010	59	10	16	280	S-CLEAR
1143	44	1011	57	12	20	300	
1203	45	1011	54	10	17	300	
1244	—	—	—	12	22	320	
1305	47	1012	53	12	21	300	
1427	46	1012	53	10	17	300	
1447	45	1014	52	9	15	300	S-CLEAR
12/12 0854	34	1027	26	2	12	0	P/C-DRY
0914	32	1027	27	1	3	0	S-PTLY SUNNY
1012	31	1027	29	2	9	0	
1032	32	1027	29	2	10	350	S-PTLY SUNNY
1117	—	—	—	1	6	350	
1137	—	—	—	1	7	350	
1309	—	—	—	1	7	340	
1329	—	—	—	0	5	350	

TABLE NO. 132
 METEOROLOGICAL DATA
 SITE I 93 - ANDOVER, MASSACHUSETTS

Date 12/16, 17, 18/75

TIME (Hours)	TEMP. (°F)	BAR. PRESS. (mbars)	REL. HUM. (%)	WIND SPEED (mph)		WIND DIRECTION (Degrees)	REMARKS (P=pavement) (G=ground) (S=sky)
				Ave.	Max.		
12/16 0206	39	1011	71	1	6	330	P&G-WET
0926	39	1011	75	8	13	330	S-OVERCAST LT SNOW
1022	39	1012	75	9	16	320	P-DRY
1042	—	—	—	10	20	320	
1122	41	1012	66	16	28	310	S-PTLY CLDY
1142	41	1012	63	14	25	300	
1303	42	1012	47	15	23	290	P-DRY S-CLEAR
1323	39	1017	44	13	22	290	S-CLEAR
12/17 0925	—	—	—	0	0	—	P&G-DRY
0945	25	1025	37	0	0	—	S-CLEAR
1054	32	1026	40	0	4	180	
1132	31	1025	41	4	8	180	
1209	—	—	—	4	8	180	
1229	—	—	—	4	9	190	
1345	35	1025	44	7	13	180	
1405	36	1024	46	6	15	190	S-CLEAR
12/18 0947	33	1007	73	10	18	310	G-SNOW COVERED
1007	33	1007	78	13	19	320	P-WET S-PTLY CLDY
1058	33	1007	82	10	18	310	
1118	32	1007	82	13	17	320	
1201	—	—	—	10	20	310	
1221	—	—	—	13	20	320	
1345	33	1007	63	12	20	300	P-DRY
1406	31	1007	61	14	25	300	S-PTLY CLDY

TABLE NO. 133
 METEOROLOGICAL DATA
 SITE I-93, Andover, Massachusetts

Date 4/27-29/76

TIME (Hours)	TEMP. (°F)	BAR. PRESS. (mbars)	REL. HUM. (%)	WIND SPEED (mph)		WIND DIRECTION (Degrees)	REMARKS (P=pavement) (G=ground) (S=sky)
				Ave	Max		
4/27 1005	47	1013	71	9	19	300	P+G - Dry S - Cloudy
1025	48		70	10	15	310	
1150	48		69	12	17	320	
1210	48	1013	68	10	15	310	
1258	47		68	8	13	310	S - Cloudy
1318	48		68	9	14	320	
1455	49		69	5	7	300	
1515	49	1013	69	4	6	300	S - Light Drizzle
4/28 0839	47	1020	88	3	5	300	P - Dry G - Wet S - Cloudy
0859	48		86	2	4	250	
1007	56		72	8	11	310	G - Damp
1027	56	1019	70	7	12	300	S - Partly Cldy
1112	59		61	8	13	300	
1132	58		60	10	14	320	
1235	59		58	7	12	300	
1255	57	1019	59	6	9	310	S - Light Rain
4/29 0835	49	1022	80	5	8	340	P+G - Dry S - Partly Cldy
0855	50		78	4	8	340	
1005	57		62	5	9	30	
1025	56	1021	60	6	11	20	
1055	58		55	7	9	330	S - Clear
1115	56		57	5	8	350	
1215	61		49	5	11	40	
1235	61	1020	50	7	11	350	S - Clear

TABLE NO. 134
 METEOROLOGICAL DATA
 SITE I-93, Andover, Massachusetts

Date 9/14-15/76

TIME (Hours)	TEMP. (°F)	BAR. PRESS. (mbars)	REL. HUM. (%)	WIND SPEED (mph)		WIND DIRECTION (Degrees)	REMARKS (P=pavement) (G=ground) (S=sky)
				Ave	Max		
9/14 0946	76	1012	61	3	6	250	G - Heavy Dew
1009	78		60	3	5	270	P - DRY
1135	82		47	4	7	310	S - Clear
1155	84		44	4	6	290	G - DRY
1257	85		42	4	6	260	
1317	86		42	3	6	280	
1455	90		46	5	8	270	
1515	91	1014	46	4	9	250	S - Clear
9/15 0848	65	1009	90	1	2	230	G+P - DRY
0908	67		88	2	3	200	S - Fog
1022	74		68	2	4	260	S - overcast
1042	75		66	2	4	290	
1136	77		64	3	4	280	S - light overcast
1156	78		65	3	5	200	
1337	80		64	3	6	230	
1357	80	1016	64	3	5	240	S - overcast

TABLES 135-164. TEN-MINUTE TRAFFIC SUMMARIES

TABLE NO. 135
 10 MINUTE TRAFFIC SUMMARY
 SITE I-93, Andover, Massachusetts

Date 9/3/75

Start Time	Direction	Pass. Cars 4 & 4 tired trucks	Single Unit Vehicles						TTST			Speed (mph)		
			2 axle busses	3 axle busses	4 axle busses	5 axle trucks	6 axle trucks	7 axle trucks	4 axle	5 axle	6 axle	Ave	Range	
<u>1145</u>	<u>SB</u>	<u>173</u>	—	—	10	2	—	2	7	10	—	—	<u>55</u>	<u>43-64</u>
—	<u>NB</u>	<u>173</u>	1	—	11	2	—	3	5	8	—	—	—	—
<u>1420</u>	<u>SB</u>	<u>220</u>	2	—	9	1	—	1	7	10	—	—	<u>54</u>	<u>38-65</u>
—	<u>NB</u>	<u>209</u>	1	—	10	3	—	—	7	8	—	—	—	—
<u>1525</u>	<u>SB</u>	<u>300</u>	—	—	7	3	—	1	4	5	—	—	<u>54</u>	<u>44-61</u>
—	<u>NB</u>	<u>337</u>	2	—	17	3	—	—	3	7	—	—	—	—
<u>1640</u>	<u>SB</u>	<u>308</u>	—	—	8	4	—	2	8	3	—	—	<u>54</u>	<u>41-66</u>
—	<u>NB</u>	<u>531</u>	1	—	8	5	—	—	5	3	—	—	—	—
<u>1740</u>	<u>SB</u>	<u>232</u>	—	—	5	1	—	—	5	4	—	—	<u>57</u>	<u>44-69</u>
—	<u>NB</u>	<u>475</u>	—	—	10	2	—	—	6	2	—	—	—	—

TABLE NO. 136
10 MINUTE TRAFFIC SUMMARY

SITE I 93, ANDOVER, MASSACHUSETTS

Date 9/4/75

Start Time	Direction	Pass. Cars & 4 tired trucks	Single Unit Vehicles						TISF			Speed (mph)		
			2 axle busses	3 axle busses	2 axle trucks	3 axle trucks	4 axle trucks	5 axle trucks	4 axle	5 axle	6 axle	Ave	Range	
0930	SB	198	—	—	5	2	—	—	15	8	—	—	57	43-71
—	NB	182	—	—	12	5	1	—	4	9	—	—	—	—
1037	SB	192	1	—	11	4	1	—	4	10	—	—	55	42-71
—	NB	207	1	—	10	1	2	—	3	8	—	—	—	—
1135	SB	158	—	—	12	2	1	—	7	8	—	—	57	42-71
—	NB	208	1	—	7	1	4	—	6	12	1	—	—	—
1235	SB	138	—	—	10	1	1	—	11	9	—	—	56	34-75
—	NB	299	2	—	9	1	—	—	4	8	—	—	—	—
1502	SB	264	3	—	10	—	2	—	5	7	—	—	53	36-73
—	NB	253	1	—	3	1	—	—	5	7	—	—	—	—
1532	SB	311	—	—	10	4	1	—	4	5	—	—	55	38-74
—	NB	280	2	—	15	2	—	—	4	10	—	—	—	—
1620	SB	409	4	—	7	—	3	—	6	3	—	—	54	38-70
—	NB	410	1	—	3	1	1	—	3	5	—	—	—	—
1700	SB	343	1	—	7	2	—	—	8	7	—	—	55	37-71
—	NB	628	—	—	15	1	—	—	10	9	—	—	—	—

TABLE NO. 137
10 MINUTE TRAFFIC SUMMARY

SITE I-93, Andover, Massachusetts

Date 10/7/75

Start Time	Direction	Single Unit Vehicles										TTST		Speed (mph)	
		Pass. Cars & 4 tired trucks	2 axle busses	3 axle busses	4 axle trucks	5 axle trucks	6 axle trucks	3 axle trucks	4 axle trucks	5 axle trucks	6 axle trucks	Ave	Range		
<u>1154</u>	<u>SB</u>	—	—	—	<u>12</u>	<u>6</u>	—	—	—	<u>3</u>	<u>15</u>	—	<u>56</u>	<u>41-70</u>	
—	<u>NB</u>	—	—	—	<u>12</u>	<u>1</u>	<u>1</u>	—	—	<u>6</u>	<u>10</u>	—	—	—	
<u>1570</u>	<u>SB</u>	—	—	<u>8</u>	<u>4</u>	—	—	—	—	<u>12</u>	<u>8</u>	—	<u>55</u>	<u>48-62</u>	
—	<u>NB</u>	<u>1</u>	—	<u>5</u>	<u>2</u>	—	—	—	—	<u>6</u>	<u>9</u>	—	<u>55</u>	<u>40-68</u>	
<u>1611</u>	<u>SB</u>	—	—	<u>12</u>	<u>6</u>	—	—	—	—	<u>4</u>	<u>3</u>	—	—	—	
—	<u>NB</u>	—	—	<u>8</u>	<u>3</u>	—	—	—	—	<u>4</u>	<u>5</u>	—	<u>56</u>	<u>47-64</u>	
<u>1757</u>	<u>SB</u>	—	—	<u>3</u>	<u>5</u>	—	—	—	—	<u>4</u>	<u>5</u>	—	—	—	
—	<u>NB</u>	—	—	<u>7</u>	—	—	—	—	<u>1</u>	<u>7</u>	<u>3</u>	—	—	—	

TABLE NO. 138
10 MINUTE TRAFFIC SUMMARY

SITE I 93, ANDOVER, MASSACHUSETTS

Date 10/8/75

Start Time	Direction	Pass. Cars & 4 tired trucks	Single Unit Vehicles						TTST			Speed (mph)	
			2 axle busses	3 axle busses	2 axle trucks	3 axle trucks	4 axle trucks	5 axle trucks	6 axle trucks	Ave	Range		
1010	SB	192	—	—	12	1	—	22	6	15	—	54	44-68
—	NB	152	—	1	12	4	—	13	2	10	—	—	—
1022	SB	180	—	—	21	5	—	18	6	10	—	56	46-72
—	NB	216	—	—	14	1	—	22	10	—	—	—	—
1145	SB	170	—	—	9	3	—	29	9	10	—	54	41-68
—	NB	163	—	—	10	2	—	16	6	—	—	—	—
1210	SB	187	—	—	14	1	—	19	9	10	—	54	31-69
—	NB	188	—	—	10	—	—	19	11	—	—	—	—
1302	SB	170	—	—	13	2	—	18	8	10	—	54	41-68
—	NR	158	—	—	12	—	—	16	5	—	—	—	—
1324	SB	161	—	—	13	1	—	13	5	7	—	53	37-63
—	NB	157	2	—	14	1	—	17	5	12	—	—	—
1420	SB	280	—	—	13	4	—	14	4	9	—	55	43-74
—	NB	481	—	—	11	1	—	10	7	—	—	—	—
1640	SB	330	—	—	9	3	—	7	2	1	—	54	47-61
—	NB	463	—	—	8	1	—	6	3	—	—	—	—
1710	SB	295	—	—	10	4	—	7	3	2	—	—	—
—	NB	622	—	—	9	—	—	7	5	—	—	—	—

TABLE NO. 139
10 MINUTE TRAFFIC SUMMARY

SITE I 93, ANDOVER, MASSACHUSETTS

Date 10/9/75

Start Time	Direction	Pass. Cars & 4 tired trucks	Single Unit Vehicles						TIST						Speed (mph)	
			2 axle busses	3 axle busses	4 axle trucks	5 axle trucks	6 axle trucks	7 axle trucks	4 axle	5 axle	6 axle	Ave	Range			
0906	SB	212	4	9	3	—	—	—	6	14	—	—	—	—	54	45-70
—	NB	107	2	6	1	2	—	—	2	12	—	—	—	—	—	
0926	SB	180	—	9	3	—	—	—	6	11	—	—	—	58	45-70	
—	NB	182	1	15	1	—	—	—	7	7	—	—	—	—	—	
1020	SB	191	1	10	2	—	—	—	3	14	—	—	—	55	44-64	
—	NB	204	—	14	1	2	—	—	7	16	—	—	—	—	—	
1040	SB	172	—	11	2	—	—	—	8	7	—	—	—	53	35-64	
—	NB	183	—	16	4	—	—	—	5	11	—	—	—	—	—	
1205	SB	176	—	7	2	—	—	—	4	6	—	—	—	53	37-62	
—	NB	181	—	12	—	—	—	—	5	15	—	—	—	—	—	
1235	SB	154	—	8	3	—	—	—	6	6	—	—	—	52	31-65	
—	NB	168	—	8	2	—	—	—	5	6	—	—	—	—	—	
1511	SB	241	1	5	2	2	8	—	—	6	—	—	—	55	45-66	
—	NB	256	—	12	2	—	—	—	3	5	—	—	—	—	—	
1531	SB	278	—	14	5	6	—	—	—	7	—	—	—	51	36-61	
—	NB	355	1	15	1	2	—	—	4	1	—	—	—	—	—	

TABLE NO. 140
10 MINUTE TRAFFIC SUMMARY

SITE I 93, ANDOVER, MASSACHUSETTS

Date 10/15/75

Start Time	Direction	Pass. Cars & 4 tired trucks	Single Unit Vehicles					TTST				Speed (mph)	
			2 axle busses	3 axle busses	2 axle trucks	3 axle trucks	4 axle trucks	4 axle	5 axle	6 axle	Ave	Range	
0753	SB	193	—	—	10	—	—	1	8	6	—	55	41-64
—	NB	163	2	—	7	3	—	1	4	10	—	—	—
1013	SB	190	—	—	12	4	—	—	9	8	—	52	35-61
—	NB	192	1	—	16	—	2	—	7	9	—	—	—
1231	SB	115	—	—	12	3	—	—	2	1	—	55	45-67
—	NB	128	—	—	10	3	—	1	4	7	—	—	—
1248	SB	153	—	—	5	3	—	—	11	3	—	54	34-72
—	NB	176	—	—	9	2	—	—	5	7	—	—	—
1455	SB	232	—	—	18	7	—	—	4	5	—	53	41-68
—	NB	228	—	—	17	3	—	2	8	3	—	—	—
1575	SB	263	—	—	10	3	—	—	6	8	—	50	43-64
—	NB	255	1	—	7	3	—	—	6	10	—	—	—
1609	SB	316	—	—	11	6	—	—	4	4	—	51	33-63
—	NB	479	—	—	16	1	—	—	5	7	—	—	—
1629	SB	326	—	—	8	1	—	—	9	6	—	50	37-61
—	NB	482	1	—	10	1	—	1	3	4	—	—	—

TABLE NO. 141
10 MINUTE TRAFFIC SUMMARY

SITE 193 - ANDOVER, MASSACHUSETTS

Date 10/16/75

Start Time	Direction	Pass. Cars & 4 tired trucks	Single Unit Vehicles						TTST			Speed (mph)		
			2 axle busses	3 axle busses	2 axle trucks	3 axle trucks	4 axle trucks	5 axle trucks	4 axle Ave	5 axle Ave	6 axle Ave	Range		
0911	SB	198	—	—	22	3	—	—	10	18	—	—	56	16-72
—	NB	207	1	—	8	2	—	1	7	7	—	—	—	—
0917	SB	218	—	—	12	2	—	—	9	9	—	—	55	43-66
—	NB	185	1	—	12	—	4	—	5	8	—	—	—	—
1014	SB	168	—	—	19	2	—	—	9	13	—	—	55	41-67
—	NB	171	—	—	11	3	—	2	5	13	—	—	—	—
1034	SB	162	—	—	8	5	—	—	8	7	—	—	56	42-68
—	NB	167	2	—	11	—	—	—	6	13	—	—	—	—
1147	SB	128	—	—	13	4	—	—	9	12	—	—	54	33-76
—	NB	148	—	—	8	3	—	1	4	13	—	—	—	—
1207	SB	163	—	—	14	1	—	—	5	4	—	—	53	26-77
—	NB	168	—	—	5	1	—	—	5	6	—	—	—	—
1456	SB	203	—	—	16	2	—	—	7	8	—	—	56	46-74
—	NB	217	—	—	10	2	—	1	3	3	—	—	—	—
1516	SB	221	—	—	9	4	—	—	2	19	—	—	53	47-64
—	NB	286	—	—	4	—	—	1	6	7	—	—	—	—

TABLE NO. 142
10 MINUTE TRAFFIC SUMMARY

SITE I-93 - ANDOVER, MASSACHUSETTS

Date 10/17/75

Start Time	Direction	Pass. Cars 4 4 tired trucks	Single Unit Vehicles						JTST		Speed (mph)	
			2 axle busses	3 axle busses	4 axle trucks	5 axle trucks	6 axle trucks	6 axle trucks	Ave	Range		
0917	SB	201	—	8	3	—	—	2	9	—	57	48-65
—	NB	158	1	8	2	—	—	2	10	—	—	—
0937	SB	184	—	15	4	—	—	8	7	—	54	41-63
—	NB	141	3	8	2	—	—	6	7	—	—	—
1030	SB	164	—	12	1	—	—	9	10	—	55	44-66
—	NB	209	1	10	3	—	2	9	9	—	—	—
1050	SB	177	—	7	4	—	—	10	7	—	55	38-67
—	NB	195	—	19	3	—	—	4	15	—	—	—
1201	SB	163	—	7	2	—	—	10	7	—	55	37-67
—	NB	176	—	9	2	—	—	6	5	—	—	—
1234	SB	214	—	10	1	—	—	8	5	—	56	44-71
—	NB	191	—	11	2	—	—	2	8	—	—	—
1435	SB	—	—	No.	DATA	—	—	—	—	—	—	—
—	NB	—	—	No.	DATA	—	—	—	—	—	—	—

TABLE NO. 143

10 MINUTE TRAFFIC SUMMARY

SITE I 93, ANDOVER, MASSACHUSETTS

Date 10-29-75

Start Time	Direction	Pass. Cars 6-4 tired trucks	Single Unit Vehicles						TTST			Speed (mph)	
			2 axle busses	3 axle busses	2 axle trucks	3 axle trucks	4 axle trucks	5 axle trucks	4 axle	5 axle	6 axle	Ave	Range
0945	SB	170	—	10	—	2	1	5	7	—	55	43-67	
—	NR	158	4	11	1	1	—	4	6	—	—	—	
1005	SB	171	—	17	—	4	—	8	10	—	54	45-63	
—	NR	150	—	15	2	2	—	1	13	—	—	—	
1131	SB	126	—	10	—	4	—	7	10	—	54	44-65	
—	NR	166	—	10	—	1	—	4	2	—	—	—	
1157	SB	157	—	9	—	3	—	3	8	—	55	44-64	
—	NR	137	—	9	1	1	—	9	16	—	—	—	
1335	SB	175	—	16	—	3	—	7	8	—	52	32-66	
—	NR	176	—	12	1	—	—	2	10	—	—	—	
1352	SB	182	—	12	—	6	—	3	8	—	52	34-77	
—	NR	180	—	13	1	—	—	4	14	—	—	—	
1505	SB	280	—	11	—	6	—	10	7	—	53	45-64	
—	NR	262	—	6	2	—	—	12	11	—	—	—	
1529	SB	313	—	18	—	2	—	6	6	—	53	36-65	
—	NR	355	—	10	5	1	—	4	9	—	—	—	

TABLE NO. 144
10 MINUTE TRAFFIC SUMMARY

SITE I-73, ANDOVER, MASSACHUSETTS

Date 10/31/75

Start Time	Direction	Pass. Cars & 4 tired trucks	Single Unit Vehicles						TTST			Speed (mph)	
			2 axle busses	3 axle busses	1 axle trucks	2 axle trucks	3 axle trucks	4 axle trucks	4 axle	5 axle	6 axle	Ave	Range
0905	SB	220	4	10	—	—	2	7	5	—	56	36-70	
—	NB	149	—	6	5	—	3	4	4	—	—	—	
0925	SB	186	1	9	1	—	1	7	8	—	54	34-70	
—	NB	172	1	13	—	—	1	7	12	—	—	—	
1046	SB	152	—	10	1	—	1	1	11	—	56	37-68	
—	NB	140	—	13	6	—	2	3	16	—	—	—	
1123	SB	162	—	10	5	—	—	4	8	—	54	38-65	
—	NB	136	—	10	1	—	—	7	11	—	—	—	
1200	SB	168	—	8	1	—	—	5	12	—	57	44-69	
—	NB	168	1	10	2	—	1	4	6	—	—	—	
1307	SB	163	—	15	2	—	—	8	12	—	55	10-68	
—	NB	179	—	9	1	—	—	5	9	—	—	—	
1433	SB	232	1	18	1	—	1	10	4	—	54	43-65	
—	NB	239	—	22	3	—	1	9	8	—	—	—	
1453	SB	235	1	19	—	—	1	5	7	—	56	48-68	
—	NB	187	—	18	—	—	—	5	7	—	—	—	

TABLE NO. 145
10 MINUTE TRAFFIC SUMMARY

SITE I-93, ANDOVER, MASSACHUSETTS

Date 11/4/75

Start Time	Direction	Pass. Cars & 4 tired trucks	Single Unit Vehicles						TTST			Speed (mph)		
			2 axle busses	3 axle busses	1 axle trucks	2 axle trucks	3 axle trucks	4 axle trucks	4 axle 5 axle trucks	5 axle trucks	6 axle trucks	Ave	Range	
0905	SB	191	—	3	7	1	—	—	—	6	3	—	57	40-79
—	NB	181	—	—	10	2	3	—	—	8	12	—	—	—
0925	SB	186	—	5	11	3	1	—	—	4	12	—	56	40-65
—	NB	185	1	—	5	—	—	—	—	10	5	—	—	—
1117	SB	139	—	—	19	3	—	—	—	3	7	—	56	43-71
—	NB	178	1	—	13	3	1	—	—	5	7	—	—	—
1137	SB	131	—	—	9	2	—	—	—	6	10	—	55	46-63
—	NB	144	—	—	10	—	—	3	—	6	11	—	—	—
1236	SB	148	—	—	5	4	—	—	—	4	6	—	57	47-67
—	NB	165	—	—	16	—	—	—	—	2	8	—	—	—
1256	SB	138	—	—	10	1	1	—	—	5	8	—	56	45-74
—	NB	146	—	1	7	3	—	—	—	6	9	—	—	—
1437	SB	192	—	1	18	—	—	—	—	8	10	—	56	44-66
—	NB	221	2	—	16	3	—	—	—	5	13	—	—	—
1457	SB	229	—	1	13	3	—	—	—	6	9	—	58	47-77
—	NB	268	—	—	8	4	—	—	—	8	8	—	—	—

TABLE NO. 146
10 MINUTE TRAFFIC SUMMARY

SITE I-93, ANDOVER, MASSACHUSETTS

Date 11/5/75

Start Time	Direction	Pass. Cars & 4 tired trucks	Single Unit Vehicles						TTST						Speed (mph)		
			2 axle busses	3 axle busses	4 axle trucks	5 axle trucks	6 axle trucks	7 axle trucks	4 axle	5 axle	6 axle	7 axle	Ave	Range			
0848	SB	272	—	—	—	8	—	—	—	—	—	6	8	—	—	58	48-72
—	NB	187	1	1	—	10	—	—	—	—	—	7	8	—	—	—	—
0908	SB	224	—	1	—	19	—	—	—	—	—	6	7	—	—	57	41-70
—	NB	158	—	—	—	10	1	—	—	—	—	7	11	—	—	—	—
1014	SB	186	—	—	—	7	1	—	—	—	—	10	6	—	—	57	51-68
—	NB	158	—	—	—	12	2	—	—	—	—	8	16	—	—	—	—
1034	SB	148	—	—	—	11	2	—	—	—	—	6	7	—	—	58	50-74
—	NB	154	—	—	—	7	—	—	—	—	—	5	10	—	—	—	—
1123	SB	173	—	1	—	18	1	—	—	—	—	9	7	—	—	58	47-66
—	NB	157	—	—	—	10	2	—	—	—	—	10	9	—	—	—	—
1143	SB	172	—	1	—	9	2	—	—	—	—	7	9	—	—	56	45-66
—	NB	122	—	—	—	8	1	—	—	—	—	4	10	—	—	—	—
1317	SB	176	—	—	—	8	2	—	—	—	—	2	6	—	—	57	50-65
—	NB	170	—	—	—	9	1	—	—	—	—	4	5	—	—	—	—
1348	SB	194	—	1	—	14	3	—	—	—	—	9	3	—	—	58	48-67
—	NB	179	—	—	—	11	1	—	—	—	—	6	8	—	—	—	—

TABLE NO. 147 0

10 MINUTE TRAFFIC SUMMARY

SITE I-73 - APPROX. MASSACHUSETTS

Date 11/6/75

Start Time	Direction	Pass. Cars & 4 tired trucks	Single Unit Vehicles						TTST			Speed (mph)	
			2 axle busses	3 axle busses	1 axle trucks	2 axle trucks	3 axle trucks	4 axle trucks	4 axle	5 axle	6 axle	Ave	Range
0850	SB	252	1	13	2	—	—	5	12	—	54	48-67	
—	NB	212	—	11	1	—	—	5	8	—	—	—	
0910	SB	224	3	12	1	—	—	4	5	—	52	44-63	
—	NB	178	1	11	—	3	—	9	9	—	—	—	
1018	SB	195	—	29	—	1	—	11	10	—	54	40-70	
—	NB	204	—	17	2	—	—	9	7	—	—	—	
1038	SB	142	—	12	—	—	—	8	9	—	55	41-66	
—	NB	134	—	14	1	—	—	4	8	—	—	—	
1119	SB	166	3	15	6	—	—	7	9	—	51	45-57	
—	NB	152	1	9	1	—	—	7	8	—	—	—	
1141	SB	131	1	12	4	—	—	4	8	—	55	44-66	
—	NB	202	1	8	3	—	—	16	15	—	—	—	
1320	SB	170	—	20	5	—	—	6	2	—	53	44-64	
—	NB	161	—	12	—	—	—	10	4	—	—	—	
1340	SB	184	1	12	2	—	—	9	8	—	54	44-68	
—	NB	171	1	17	2	—	—	3	11	—	—	—	

TABLE NO. 148
10 MINUTE TRAFFIC SUMMARY

SITE I73, ANDOVER, MASSACHUSETTS

Date 11/18/75

Start Time	Direction	Pass. Cars & 4 tired trucks	Single Unit Vehicles						TTST			Speed (mph)	
			2 axle busses	3 axle busses	2 axle tired trucks	3 axle tired trucks	4 axle trucks	5 axle trucks	6 axle trucks	Ave	Range		
0916	SB	199	1	13	—	—	—	5	12	—	55	44-66	
—	NB	208	1	9	—	—	—	5	10	—	—	—	
0936	SB	203	1	10	2	—	—	6	11	—	55	46-76	
—	NB	210	—	12	2	3	—	3	9	—	—	—	
1043	SB	177	—	16	2	1	3	3	8	—	54	41-62	
—	NB	147	—	10	2	—	—	8	6	—	—	—	
1103	SB	174	—	10	5	—	1	6	7	—	55	44-64	
—	NB	141	—	10	2	—	1	6	7	—	—	—	
1204	SB	148	1	7	2	—	1	6	12	—	54	45-66	
—	NB	164	—	9	1	—	—	3	9	—	—	—	
1224	SB	146	—	3	1	—	—	7	7	—	56	41-68	
—	NB	172	—	10	1	2	—	5	7	—	—	—	
1348	SB	175	1	12	2	—	—	10	8	—	55	45-70	
—	NB	167	—	10	—	—	1	1	7	—	—	—	
1408	SB	215	1	8	3	1	1	3	8	—	55	42-63	
—	NB	158	1	9	3	—	—	4	9	—	—	—	

TABLE NO. 149
10 MINUTE TRAFFIC SUMMARY

SITE I-93, ANDOVER, MASSACHUSETTS

Date 11/19/75

Start Time	Direction	Pass. Cars & 4 tired trucks	Single Unit Vehicles						TTST			Speed (mph)	
			2 axle busses	3 axle busses	4 axle trucks	5 axle trucks	6 axle trucks	7 axle trucks	Ave	Range			
0855	SB	242	7	19	1	3	7	8	55	46-66			
	NB	158		9	5	1	2	13					
0915	SB	208	4	11	5	3	5	11	54	43-65			
	NB	167	1	14	1	3	5	16					
1016	SB	152		15	2	2	3	5	55	48-67			
	NB	178		19	3		3	15					
1036	SB	155		14	3	2	5	12	56	47-71			
	NB	175		14		5	6	17	54	47-63			
1127	SB	199		13	2	2	7	10					
	NB	164		5	1		8	12					
1147	SB	141	1	11	4	1	5	4	54	45-62			
	NB	124		12		1	4	7					
1313	SB	183		10	3	1	2	3	54	46-70			
	NB	165	1	12	1		7	7					
1333	SB	167	1	19	2	2	9	8	55	44-71			
	NB	164		10	2		5	8					

TABLE NO. 150
10 MINUTE TRAFFIC SUMMARY

SITE I-93 - ANDOVER, MASSACHUSETTS

Date 11/20/75

Start Time	Direction	Pass. Cars & 4 tined trucks	Single Unit Vehicles						TTST			Speed (mph)	
			2 axle busses	3 axle busses	4 axle trucks	5 axle trucks	6 axle trucks	7 axle trucks	4 axle	5 axle	6 axle		Ave
0848	SB	265	—	12	2	—	—	18	4	—	—	56	45-66
—	NB	178	—	10	2	—	—	8	8	—	—	—	—
0908	SB	255	7	12	2	—	—	4	8	—	—	54	46-67
—	NB	211	—	11	—	—	—	6	12	—	—	—	—
1007	SB	187	—	13	3	—	—	7	10	—	—	55	46-71
—	NB	179	—	13	1	—	—	4	9	—	—	—	—
1027	SB	156	1	11	2	—	—	7	7	—	—	56	47-69
—	NB	199	—	11	1	—	—	6	10	—	—	—	—
1112	SB	165	1	13	1	—	3	5	7	—	—	54	44-66
—	NB	147	—	12	1	—	—	11	6	—	—	—	—
1132	SB	155	—	9	2	—	—	4	9	—	—	56	43-77
—	NB	171	—	8	1	—	3	3	11	—	—	—	—
1253	SB	131	—	10	2	—	—	12	5	—	—	56	44-89
—	NB	145	—	13	2	—	—	3	9	—	—	—	—
1313	SB	192	—	10	1	—	2	7	8	—	—	55	40-69
—	NB	193	2	10	1	—	1	6	15	—	—	—	—

TABLE NO. 151
10 MINUTE TRAFFIC SUMMARY

SITE I-73, ANDOVER, MASSACHUSETTS

Date 12/2/75

Start Time	Direction	Pass. Cars & 4 tired trucks	Single Unit Vehicles						TTST						Speed (mph)	
			2 axle busses	3 axle busses	2 axle trucks	3 axle trucks	4 axle trucks	5 axle trucks	4 axle	5 axle	6 axle	Ave	Range			
0922	SB	218	2	15	1	—	—	—	1	4	14	—	—	—	54	42-66
—	NB	168	—	11	3	—	—	2	6	7	—	—	—	—	—	—
0942	SB	189	1	12	—	—	—	2	5	8	—	—	—	53	35-64	
—	NB	162	2	11	3	—	—	2	10	6	—	—	—	—	—	
1045	SB	157	—	12	1	—	—	3	6	8	—	—	—	54	44-61	
—	NB	168	—	15	1	—	—	2	7	15	—	—	—	—	—	
1105	SB	144	—	14	1	—	—	1	6	10	—	—	—	54	40-74	
—	NB	140	—	18	—	—	—	1	3	11	—	—	—	—	—	
1152	SB	149	1	9	3	—	—	1	2	12	—	—	—	—	—	
—	NB	143	—	12	2	—	—	1	3	15	—	—	—	—	—	
1212	SB	131	—	9	5	—	—	1	4	5	—	—	—	54	42-69	
—	NB	157	—	16	3	—	—	1	8	9	—	—	—	—	—	
1344	SB	154	—	13	6	—	—	1	5	5	—	—	—	53	41-63	
—	NB	167	—	13	3	—	—	3	8	12	—	—	—	—	—	
1404	SB	156	—	6	1	—	—	1	4	6	—	—	—	53	30-63	
—	NB	181	1	16	3	—	—	—	4	4	—	—	—	—	—	

TABLE NO. 152
10 MINUTE TRAFFIC SUMMARY

SITE I 13 - ANDOVER, MASSACHUSETTS

Date 12/3/75

Start Time	Direction	Pass. Cars & 4 tired trucks	Single Unit Vehicles						TTST			Speed (mph)	
			2 axle busses	3 axle busses	4 axle trucks	5 axle trucks	6 axle trucks	7 axle trucks	4 axle	5 axle	6 axle	Ave	Range
0841	SB	287	—	13	1	—	—	10	13	1	54	35-68	
—	NB	188	1	9	4	—	—	4	9	—	—	—	
0901	SB	237	—	15	1	—	—	8	10	—	53	37-65	
—	NB	187	—	9	1	1	—	8	6	—	—	—	
1002	SB	160	1	10	—	1	—	5	16	—	54	41-66	
—	NB	133	—	12	2	1	—	6	12	—	—	—	
1022	SB	161	—	18	5	—	—	3	5	—	55	30-74	
—	NB	154	1	11	3	—	—	7	9	—	—	—	
1106	SB	167	—	17	6	1	—	9	13	—	55	27-67	
—	NB	141	—	15	—	2	—	3	13	—	—	—	
1135	SB	152	3	10	3	—	—	4	3	—	53	38-69	
—	NB	156	—	14	—	—	—	9	10	—	—	—	
1306	SB	103	—	4	1	—	—	7	6	—	55	32-71	
—	NB	148	—	15	—	—	—	10	6	—	—	—	
1326	SB	157	—	12	1	1	—	5	10	—	54	42-64	
—	NB	161	1	10	—	—	—	4	11	—	—	—	

153

TABLE NO.
10 MINUTE TRAFFIC SUMMARY

SITE I 93, ANDOVER, MASSACHUSETTS

Date 12/4/75

Shift Time	Direction	Pass. Cars & 4 tired trucks	Single Unit Vehicles						TTST			Speed (mph)	
			2 axle busses	3 axle busses	2 axle trucks	3 axle trucks	4 axle trucks	5 axle trucks	4 axle	5 axle	6 axle	Ave	Range
0912	SB	222	1	10	3	2	10	8	55	46-63			
	NB	152	1	10	1	1	5	2					
0933	SB	206	1	11	3	2	7	9	53	41-64			
	NB	153	1	11	3	1	7	11					
1040	SB	162		11	3		5	10	54	40-66			
	NB	148		9	2	2	3	4					
1100	SB	138	1	9	2	1	6	7	56	44-81			
	NB	157		12	1	2	5	13					
1125	SB	147	2	8	1		6	8	57	45-77			
	NB	130		9			5	10					
1142	SB	137	1	10		1	6	6	56	39-68			
	NB	147		12	1	2	5	11					
1228	SB	214		12	2	1	3	10	55	41-71			
	NB	152	1	15	2	1	11	6					
1240	SB	173		14	1	1	11	3	55	44-67			
	NB	139		10		1	8	12					

TABLE NO. 154
10 MINUTE TRAFFIC SUMMARY

SITE I 13 - ANDOVER, MASSACHUSETTS

Date 12/9/75

Start Time	Direction	Pass. Cars & 4 tired trucks	Single Unit Vehicles						TTST			Speed (mph) Ave Range
			2 axle busses	3 axle busses	2 axle 6 tired trucks	3 axle trucks	4 axle trucks	5 axle trucks	4 axle	5 axle	6 axle	
0905	SB	225	1	13	1	—	—	6	5	—	54	41-67
—	NB	168	2	9	3	—	—	5	3	—	—	—
1035	SB	145	1	11	—	—	3	12	8	—	51	39-62
—	NB	134	—	11	1	—	2	4	5	—	—	—
1050	SB	142	—	11	—	—	1	6	9	—	52	30-67
—	NB	106	—	13	1	—	—	9	8	—	—	—
1145	SB	144	1	9	2	—	4	1	7	—	51	31-63
—	NB	135	—	4	—	—	—	11	9	—	—	—
1200	SB	117	—	5	2	—	—	5	9	—	57	37-67
—	NB	165	—	12	—	—	2	7	8	—	—	—

TABLE NO. 155
10 MINUTE TRAFFIC SUMMARY

SITE I 93, AUDOVER, MASSACHUSETTS

Date 12/11/75

Start Time	Direction	Pass. Cars & 4 tired trucks	Single Unit Vehicles					TTST				Speed (mph)	
			2 axle busses	3 axle busses	2 axle trucks	3 axle trucks	4 axle trucks	4 axle	5 axle	6 axle	Ave	Range	
0847	SB	172	1	15	—	—	—	10	15	—	54	44-64	
—	NB	106	1	12	2	3	5	12	—	—	—	—	
1007	SB	163	—	16	2	2	2	7	8	—	55	42-67	
—	NB	142	—	9	2	2	9	8	—	—	—	—	
1143	SB	167	1	7	1	3	5	7	—	—	55	32-66	
—	NB	134	—	7	1	—	6	8	—	—	—	—	
1203	SB	150	—	13	1	1	4	12	—	—	54	36-77	
—	NB	158	—	13	1	—	2	5	—	—	—	—	
1244	SB	157	—	12	—	—	8	10	—	—	55	43-65	
—	NB	120	—	9	—	1	6	10	—	—	—	—	
1305	SB	153	—	12	1	1	6	13	—	—	54	37-68	
—	NB	136	—	7	2	1	5	9	—	—	—	—	
1427	SB	200	—	14	1	1	6	3	—	—	55	38-68	
—	NB	172	1	21	1	1	7	10	—	—	—	—	
1447	SB	225	—	20	—	2	10	8	—	—	55	42-66	
—	NB	227	2	15	1	2	6	6	—	—	—	—	

TABLE NO. 156
10 MINUTE TRAFFIC SUMMARY

SITE I-13 - ANDOVER, MASSACHUSETTS

Date 12/12/75

Start Time	Direction	Pass. Cars & 4 tired trucks	Single Unit Vehicles				TRUCKS				Speed (mph) Ave	Range		
			2 axle busses	3 axle busses	2 axle trucks	3 axle trucks	4 axle trucks	5 axle trucks	6 axle trucks					
0854	SB	253	—	—	14	1	—	3	1	5	13	—	55	45-63
—	NB	157	—	—	9	1	—	3	11	—	8	—	—	—
0914	SB	152	4	—	13	1	—	—	4	—	8	—	56	42-76
—	NB	129	1	—	10	2	—	—	4	3	—	—	56	45-74
1012	SB	174	—	—	13	4	—	1	9	17	—	—	—	—
—	NB	135	1	—	12	—	—	1	6	7	—	—	—	—
1032	SB	177	—	—	15	1	—	—	8	13	—	—	54	36-67
—	NB	175	—	—	10	7	—	2	8	10	—	—	—	—
1117	SB	160	—	—	10	2	—	1	5	7	—	—	53	34-67
—	NB	157	1	—	24	3	—	2	7	10	—	—	—	—
1137	SB	197	—	—	8	1	—	—	9	5	—	—	55	44-67
—	NB	174	—	—	15	2	—	—	6	10	—	—	—	—
1305	SB	192	—	—	6	2	—	—	4	8	—	—	57	44-71
—	NB	150	—	—	8	2	—	—	2	8	—	—	—	—
1325	SB	193	1	—	13	1	—	2	3	9	—	—	55	44-63
—	NB	189	1	—	10	1	—	—	4	10	—	—	—	—

TABLE NO. 157
10 MINUTE TRAFFIC SUMMARY

SITE I 93, ANDOVER, MASSACHUSETTS

Date 12/16/75

Start Time	Direction	Pass. Cars & 4 tired trucks	Single Unit Vehicles						TTST			Speed (mph)	
			2 axio busses	3 axio busses	2 axio trucks	3 axio trucks	4 axio trucks	5 axio trucks	4 axio	5 axio	6 axio	Ave	Range
0800	SB	228	1	—	7	2	—	1	5	9	—	55	37-62
—	NB	142	—	6	1	—	—	—	7	12	—	—	—
0916	SB	228	1	11	—	—	2	—	6	8	—	55	46-68
—	NB	152	—	15	1	—	—	—	8	7	—	—	—
1022	SB	182	—	9	5	—	—	—	5	10	—	55	43-65
—	NB	155	1	11	1	—	1	—	6	11	—	—	—
1042	SB	153	—	9	3	—	1	—	5	15	—	56	43-78
—	NB	190	—	12	1	—	—	—	6	13	—	—	—
1122	SB	163	—	15	1	—	—	—	6	7	—	54	41-68
—	NB	161	1	13	5	—	1	—	10	16	—	—	—
1142	SB	146	1	8	1	—	—	—	11	10	—	55	41-66
—	NB	150	—	15	2	—	5	—	4	8	—	—	—
1203	SB	167	—	13	4	—	—	—	6	7	—	55	32-69
—	NB	175	—	13	5	—	1	—	7	9	—	—	—
1223	SB	164	—	18	3	—	—	—	2	7	—	56	37-65
—	NB	152	1	6	4	—	2	—	8	8	—	—	—

TABLE NO. 158
10 MINUTE TRAFFIC SUMMARY

SITE I 93, ANDOVER, MASSACHUSETTS

Date 12/11/75

Start Time	Direction	Pass. Cars & 4 tired trucks	Single Unit Vehicles						TTST						Speed (mph)	
			2 axle busses	3 axle busses	2 axle trucks	3 axle trucks	4 axle trucks	5 axle trucks	4 axle	5 axle	6 axle	Ave	Range			
0725	SB	231	2	11	1	—	—	—	7	9	—	—	—	—	54	46-65
—	NB	165	—	14	3	—	—	3	7	8	—	—	—	—	—	—
0945	SB	210	—	10	—	—	—	—	6	10	—	—	—	56	26-66	
—	NB	159	—	13	—	—	—	1	2	15	—	—	—	—	—	
1054	SB	189	—	13	1	—	—	1	3	11	—	—	—	52	33-64	
—	NB	149	—	18	3	—	—	2	8	21	—	—	—	—	—	
1132	SB	176	2	10	—	—	—	1	6	4	—	—	—	54	31-67	
—	NB	153	—	7	—	—	—	—	9	8	—	—	—	—	—	
1209	SB	145	—	10	1	—	—	2	8	12	—	—	—	53	38-64	
—	NB	168	1	10	3	—	—	—	8	12	—	—	—	—	—	
1229	SB	155	—	5	2	—	—	4	5	13	—	—	—	54	41-63	
—	NB	155	1	6	3	—	—	—	4	15	—	—	—	—	—	
1345	SB	184	—	10	1	—	—	—	6	9	—	—	—	53	42-65	
—	NB	177	—	12	1	—	—	3	10	12	—	—	—	—	—	
1405	SB	196	1	10	3	—	—	1	8	10	—	—	—	54	34-69	
—	NB	198	—	7	1	—	—	—	4	10	—	—	—	—	—	

TABLE NO. 159
10 MINUTE TRAFFIC SUMMARY

SITE I 93, ANDOVER, MASSACHUSETTS

Date 12/18/75

Start Time	Direction	Pass. Cars & 4 tired trucks	Single Unit Vehicles						TTST			Speed (mph)		
			2 axle busses	3 axle busses	4 axle trucks	5 axle trucks	6 axle trucks	7 axle trucks	4 axle	5 axle	6 axle	Ave	Range	
0747	SB	207	—	—	—	16	1	1	1	1	11	—	53	41-65
—	NB	164	—	—	—	9	1	2	7	4	—	—	—	—
1007	SB	178	—	—	—	12	3	2	5	6	—	—	52	31-55
—	NB	146	—	—	—	21	—	1	3	10	—	—	—	—
1058	SB	178	—	—	—	10	—	1	5	12	—	—	52	30-62
—	NB	162	—	—	—	7	2	1	8	3	—	—	—	—
1118	SB	137	—	—	—	12	1	1	3	9	—	—	53	37-76
—	NB	156	—	—	—	11	2	2	8	7	—	—	—	—
1201	SB	141	—	—	—	8	2	1	5	7	—	—	53	33-64
—	NB	141	—	—	—	7	—	1	6	7	—	—	—	—
1221	SB	143	—	—	—	7	1	—	4	8	—	—	53	35-65
—	NB	150	—	—	—	10	—	—	8	7	—	—	—	—
1345	SB	182	—	—	—	14	1	1	6	8	—	—	53	41-68
—	NB	162	—	—	—	6	1	4	5	10	—	—	—	—
1406	SB	134	—	—	—	14	1	—	6	10	—	—	54	40-70
—	NB	172	—	—	—	8	1	—	5	9	—	—	—	—

TABLE NO. 160
10 MINUTE TRAFFIC SUMMARY

SITE I 23, AUDOVER MASSACHUSETTS

Date 4/27/76

Start Time	Direction	Pass. Cars & 4 tired trucks	Single Unit Vehicles						TOST			Speed (mph)		
			2 axle busses	3 axle busses	2 axle tired trucks	3 axle trucks	4 axle trucks	5 axle trucks	4 axle	5 axle	6 axle	Ave	Range	
1005	SB	137	—	—	5	1	—	—	7	11	—	—	54	20-67
—	NB	168	—	—	15	2	3	—	5	13	—	—	—	—
1025	SB	176	—	—	7	5	1	3	7	9	—	—	54	66-32
—	NB	173	—	1	15	1	—	2	8	12	—	—	—	—
1150	SB	153	—	—	7	1	—	—	3	5	—	—	53	37-68
—	NB	134	—	—	12	5	4	—	8	7	—	—	—	—
1210	SB	156	—	—	14	4	—	1	6	10	—	—	52	37-67
—	NB	155	2	—	14	3	—	—	7	10	—	—	—	—
1258	SB	167	—	—	15	1	—	1	2	5	—	—	55	35-68
—	NB	171	—	—	14	1	—	4	4	5	—	—	—	—
1318	SB	176	—	—	13	1	—	1	12	12	—	—	54	42-68
—	NB	167	2	—	6	1	—	3	7	7	—	—	—	—
1455	SB	238	1	—	13	2	—	—	5	7	—	—	51	40-62
—	NB	205	2	—	18	1	—	—	4	9	—	—	—	—
1515	SB	252	1	2	14	7	—	2	7	12	—	—	52	37-61
—	NB	271	—	—	9	1	—	2	2	8	—	—	—	—

TABLE NO. 161
10 MINUTE TRAFFIC SUMMARY

SITE I 93 - ANDOVER, MASSACHUSETTS

Date 9/22/76

Start Time	Direction	Pass. Cars & 4 tired trucks	Single Unit Vehicles						TJST			Speed (mph)	
			2 axle busses	3 axle busses	2 axle trucks	3 axle trucks	4 axle trucks	5 axle trucks	4 axle	5 axle	6 axle	Ave	Range
0839	SB	321	1	17	3	1	8	8	54	38-64			
	NB	185	1	9	2	1	7	8					
0857	SB	222		17	2		7	5	55	42-70			
	NB	165		23	5	4	5	13					
1007	SB	165		15	2		5	12	52	41-65			
	NB	153		14	1	1	3	13					
1027	SB	187		15	4	2	7	10	53	43-66			
	NB	176	2	11	2	3	7	17					
1117	SB	162		13		1	7	7	52	34-64			
	NB	181		12	6	2	5	8					
1132	SB	158		12	4	4	11	12	52	38-65			
	NB	162		8	4		7	12					
1235	SB	146	1	6	2	1	5	4	53	36-68			
	NB	135		18		1	7	10					
1255	SB	181		10	1	2	7	10	54	44-67			
	NB	170	1	10	2	1	11	10					

TABLE NO. 162
10 MINUTE TRAFFIC SUMMARY

SITE I 93 - ANDOVER, MASSACHUSETTS

Date 4-27-76

Start Time	Direction	Pass. Cars & 4 tired trucks	Single Unit Vehicles						TTST				Speed (mph)	
			2 axle busses	3 axle busses	2 axle trucks	3 axle trucks	4 axle trucks	5 axle trucks	4 axle	5 axle	6 axle	Ave	Range	
0835	SB	242	1	15	2	1	1	13	14	55	46-68			
	NB	203	1	12	3	1	1	7	4					
0855	SB	262	1	15	2	1	1	6	11	55	42-71			
	NB	151	1	10	2	3	8	11	8					
1005	SB	190	2	12	1	1	16	6	16	53	42-67			
	NB	172	1	15	2	1	10	3	10					
1025	SB	172		11	2		9	3	9	56	41-68			
	NB	144	1	16	3	2	6	6	6	52	38-69			
1055	SB	160	1	11	2		7	7	9					
	NB	166		14	1	1	11	11	11					
1115	SB	179		8	2	1	12	6	12	54	36-62			
	NB	155		14	3		7	7	20					
1215	SB	174		3	1		2	2	12	54	37-61			
	NB	140		12	2	1	10	10	14					
1235	SB	172		11	3		1	1	6	55	37-68			
	NB	160		9	2	1	6	6	16					

TABLE NO. 163
10 MINUTE TRAFFIC SUMMARY

SITE 193 - ANDOVER, MASSACHUSETTS

Date 9/14/76

Start Time	Direction	Pass. Cars & 4 tired trucks	Single Unit Vehicles						TTST			Speed (mph)	
			2 axle busses	3 axle busses	4 axle trucks	5 axle trucks	6 axle trucks	7 axle trucks	4 axle trucks	5 axle trucks	6 axle trucks	Ave	Range
0946	SB	105	—	1	16	1	—	—	2	21	—	55	39-70
—	NB	197	—	—	8	4	3	—	5	8	—	—	—
1009	SB	208	—	—	19	1	2	—	6	9	—	55	47-65
—	NB	171	—	—	18	1	1	—	5	9	—	—	—
1135	SB	194	2	—	12	2	1	—	8	14	—	53	31-64
—	NB	168	1	—	12	—	—	—	6	12	—	—	—
1155	SB	165	—	—	6	4	2	—	4	10	—	54	44-70
—	NB	181	—	—	8	—	2	—	2	10	—	—	—
1257	SB	172	—	—	9	—	1	—	4	5	—	53	41-67
—	NB	181	—	1	12	3	1	—	3	12	—	—	—
1317	SB	182	—	—	13	—	—	—	7	10	—	55	47-64
—	NB	210	—	—	13	—	3	—	7	10	—	—	—
1455	SB	220	1	—	6	3	1	—	11	12	—	52	40-66
—	NB	247	—	—	9	—	1	—	4	13	—	—	—
1515	SB	299	—	—	8	2	2	—	6	8	—	55	46-63
—	NB	318	—	—	11	—	1	—	6	8	—	—	—

TABLE NO. 164
10 MINUTE TRAFFIC SUMMARY

SITE I 93, Audover, Massachusetts

Date 9-15-76

Start Time	Direction	Pass. Cars & 4-tired trucks	Single Unit Vehicles						TTST			Speed (mph)	
			2 axle busses	3 axle busses	1 axle trucks	3 axle trucks	4 axle trucks	5 axle trucks	6 axle trucks	Ave	Range		
0848	SB	282	1	12	2	1	4	10	56	45-58			
	NB	225		13		1	12	8					
0908	SB	220		13		1	2	10	54	36-66			
	NB	182		16	1		4	5					
1022	SB	212	1	10	3		7	7	54	41-66			
	NB	199		11	3	2	6	6					
1042	SB	206		15			2	9	53	40-65			
	NB	199		10			3	16					
1136	SB	171		12	1		5	10	55	41-70			
	NB	219		18	5		10	9					
1156	SB	181		8			7	9	54	41-68			
	NB	201		12		2	11	7					
1337	SB	218	2	7	3		11	17	54	36-65			
	NB	203		11	2		6	12					
1357	SB	200	1	13	6		7	13	52	33-62			
	NB	240		16	1		5	5					

TABLES 165-168. OCTAVE BAND-MEAN ENERGY DATA: REFLECTIVE BARRIERS AT FOUR, EIGHT, TWELVE, AND SIXTEEN FEET; MICROPHONE CONFIGURATIONS B, C, D, E.

TABLE NO. 165
OCTAVE BAND- MEAN ENERGY DATA
ROADSIDE BARRIER TEST SITE, ANDOVER MA.
10-09- 75 ; BARRIER HGT 4 FT ; REFLECTIVE

MEAN ENERGY - DB RE 20 MICROPASCAL

MAST CONFIGURATION	FREQ HZ	MICROPHONE NO						
		1	3	4	5	8	10	13
"B" 1205 HOURS	31.5	67.9	65.2	68.9	64.0	64.8		65.5
	63	72.5	73.2	74.7	69.9	71.9		73.5
	125	76.9	74.0	74.4	70.1	73.4		77.6
	250	75.2	66.3	68.9	69.8	68.3		76.1
	500	74.6	61.5	68.9	69.7	66.1	No Data	75.6
	1K	72.6	62.3	66.5	67.6	65.3		73.2
	2K	70.3	58.7	62.2	64.6	62.6		70.1
	4K	64.5	52.6	54.6	57.9	53.8		64.4
	8K	58.0	46.7	47.3	50.0	50.0		56.6
OVER ALL	82.2	77.6	79.4	77.0	77.4		82.7	
"C" 1511 HOURS	31.5	69.8	64.3	67.5	63.7	65.7	63.9	67.3
	63	74.4	71.7	73.5	70.3	72.0	69.4	75.0
	125	77.6	71.5	72.5	69.7	72.8	69.9	77.7
	250	76.6	63.7	66.7	67.1	66.6	67.9	77.2
	500	75.8	60.3	66.1	67.4	62.8	68.5	76.2
	1K	74.5	59.3	64.3	65.7	62.2	67.0	74.4
	2K	72.5	56.7	59.0	62.4	58.7	63.0	72.0
	4K	66.9	49.6	50.6	55.8	50.6	54.6	66.4
	8K	59.6	45.1	44.2	48.2	51.0	48.2	57.7
OVER ALL	83.6	75.6	77.6	75.8	76.7	76.0	83.6	
"D" 0926 HOURS	31.5	70.1	63.3	65.8	62.9	62.3	62.1	68.2
	63	75.6	70.6	71.7	69.4	70.1	67.8	76.9
	125	78.0	69.3	69.4	67.5	70.8	67.8	78.9
	250	75.8	58.4	61.9	63.5	61.6	64.2	77.1
	500	75.2	59.1	63.2	64.4	61.6	65.1	76.1
	1K	73.7	61.0	61.5	62.9	61.4	64.1	74.2
	2K	72.7	57.8	57.4	60.0	58.8	61.1	72.6
	4K	66.6	49.2	48.3	52.4	50.6	52.0	66.6
	8K	60.2	44.5	43.9	46.6	50.3	47.1	58.8
OVER ALL	83.5	74.1	75.2	73.8	74.6	73.6	84.2	
"E" 1020 HOURS	31.5	69.8	67.4	69.3	66.5	67.2	66.0	66.8
	63	75.2	76.6	76.2	73.7	75.9	72.2	76.2
	125	78.8	77.0	75.2	72.9	77.5	72.8	79.8
	250	77.6	68.9	69.9	73.1	70.3	72.1	78.7
	500	77.1	65.1	70.7	73.6	68.8	72.0	77.6
	1K	76.0	66.8	68.7	71.8	67.9	71.2	75.6
	2K	72.8	62.6	63.8	68.0	64.4	67.3	72.2
	4K	66.6	55.2	55.8	60.9	56.5	60.7	66.1
	8K	59.7	47.9	47.2	51.6	51.3	51.9	58.0
OVER ALL	84.6	80.7	80.6	80.5	80.9	79.4	85.0	

TABLE NO. 166
 OCTAVE BAND- MEAN ENERGY DATA
 ROADSIDE BARRIER TEST SITE , ANDOVER MA.
 11-06-75 ; BARRIER HGT 8 FT ; REFLECTIVE

MEAN ENERGY - DB RE 20 MICROPASCAL

MAST CONFIGURATION	FREQ HZ	MICROPHONE NO						
		1	3	4	5	8	10	13
"B" 1141 HOURS	31.5	71.3	68.5	69.1	67.8	68.7	67.7	70.0
	63	78.1	77.4	76.4	75.2	79.2	76.5	80.5
	125	79.0	75.4	72.5	71.6	78.8	75.3	80.2
	250	78.8	67.0	67.7	71.7	73.3	74.5	79.6
	500	77.8	60.9	67.3	69.3	68.7	73.6	78.4
	1K	75.6	60.6	63.1	66.4	68.1	71.2	75.9
	2K	72.2	54.0	57.8	62.6	64.7	67.1	71.7
	4K	65.6	46.2	50.3	55.4	57.0	60.0	64.8
	8K	58.6	46.3	46.1	47.0	47.2	50.0	57.3
OVER ALL		85.4	80.1	79.2	79.2	83.0	81.8	86.3
"C" 1320 HOURS	31.5	71.0	65.0	64.8	63.7	64.8	63.9	68.7
	63	77.4	73.0	71.8	71.0	73.2	71.5	77.9
	125	77.1	69.1	67.0	66.3	71.3	69.3	77.4
	250	77.7	62.0	62.4	64.8	66.2	67.9	77.8
	500	76.3	58.0	61.7	63.8	60.7	67.7	76.0
	1K	74.5	57.9	59.0	60.7	59.9	66.2	74.4
	2K	72.1	52.8	54.3	56.8	56.5	62.7	71.3
	4K	65.9	44.5	45.9	48.5	48.3	55.0	64.8
	8K	58.4	46.2	44.6	43.6	42.6	45.1	57.6
OVER ALL		84.2	75.3	74.4	74.1	76.4	76.3	84.1
"D" 0910 HOURS	31.5	69.1	62.5	63.0	61.6	62.6	61.4	66.4
	63	75.9	70.3	69.6	68.7	71.4	69.2	76.6
	125	77.6	67.9	66.4	65.5	70.4	68.0	77.4
	250	77.8	58.6	59.2	61.4	63.4	64.1	77.4
	500	76.4	55.5	59.6	61.5	58.9	63.6	75.9
	1K	74.8	56.0	57.6	58.5	57.4	62.6	74.3
	2K	72.9	51.5	52.6	54.0	53.5	59.5	71.4
	4K	66.2	43.4	44.2	45.2	44.7	50.4	64.3
	8K	58.6	46.4	44.9	43.6	41.7	41.6	57.2
OVER ALL		84.1	73.1	72.5	72.0	74.7	73.6	83.7
"E" 1038 HOURS	31.5	70.4	67.1	67.9	66.1	66.8	66.2	68.3
	63	76.8	76.1	75.5	73.6	76.7	74.1	78.1
	125	77.0	72.6	70.1	69.0	74.8	71.3	77.6
	250	79.4	66.7	68.9	71.7	70.6	72.9	79.0
	500	78.3	60.9	67.4	68.9	67.9	71.3	77.8
	1K	76.0	60.8	63.4	65.9	65.8	68.9	75.7
	2K	73.2	55.2	58.7	62.2	61.6	65.2	72.2
	4K	66.4	47.8	50.8	54.7	54.6	57.7	65.0
	8K	58.7	46.7	46.1	46.3	46.1	48.0	57.2
OVER ALL		85.1	78.5	78.3	77.9	80.1	79.3	85.0

TABLE NO. 167
 OCTAVE BAND- MEAN ENERGY DATA
 ROADSIDE BARRIER TEST SITE , ANDOVER MA.
 11-20-75 ; BARRIER HGT 12 FT ; REFLECTIVE

MEAN ENERGY - DB RE 20 MICROPASCAL

MAST CONFIGURATION	FREQ HZ	MICROPHONE NO						
		1	3	4	5	8	10	13
"B" 1112 HOURS	31.5	68.5	66.4	66.9	64.6	67.4	66.7	66.4
	63	76.6	75.4	74.0	71.6	77.9	75.3	77.0
	125	77.6	72.9	69.5	68.7	76.6	73.7	77.8
	250	76.5	62.8	64.8	66.7	71.6	72.4	77.4
	500	74.7	58.2	62.6	63.8	66.6	71.1	75.6
	1K	74.3	58.3	59.8	61.7	66.6	70.3	75.0
	2K	72.9	54.9	56.6	58.6	65.2	67.9	73.0
	4K	66.5	49.2	50.2	51.9	58.8	61.9	66.7
	8K	59.2	53.8	52.5	50.5	53.3	55.7	59.4
OVER ALL		83.7	77.8	76.4	75.3	81.4	80.3	84.0
"C" 1253 HOURS	31.5	68.9	63.8	63.3	64.2	64.7	64.0	66.0
	63	75.7	71.8	70.4	73.3	73.3	71.9	76.5
	125	76.5	68.4	65.2	67.5	71.0	69.3	76.2
	250	76.7	60.1	59.7	62.3	66.8	68.2	76.9
	500	76.0	56.7	59.3	60.0	61.1	68.0	76.7
	1K	75.4	55.9	55.9	57.2	60.6	67.0	75.4
	2K	72.9	50.8	52.0	52.5	56.9	63.6	72.7
	4K	67.2	47.1	47.6	47.6	52.5	57.8	67.2
	8K	59.0	53.2	51.5	52.3	52.5	52.7	59.1
OVER ALL		83.9	74.3	72.8	75.1	76.4	76.6	83.7
"D" 0848 HOURS	31.5	69.2	63.9	64.1	62.6	63.4	62.9	66.5
	63	75.8	71.3	70.1	69.2	71.8	70.4	77.0
	125	77.3	69.1	66.2	65.9	70.7	68.6	77.4
	250	77.4	59.4	59.6	62.1	62.8	64.0	77.4
	500	76.2	57.3	60.1	61.2	60.3	65.1	76.7
	1K	75.9	58.7	58.7	59.0	61.4	65.0	76.1
	2K	73.8	54.0	54.8	54.9	58.3	62.3	73.7
	4K	68.0	48.9	49.8	49.4	52.4	54.9	67.7
	8K	61.1	53.9	53.0	51.0	51.2	49.0	60.6
OVER ALL		84.3	74.3	73.1	72.6	75.3	74.9	84.3
"E" 1007 HOURS	31.5	69.7	66.8	67.4	65.3	67.2	66.3	67.1
	63	77.6	76.2	75.0	72.9	77.8	74.8	78.0
	125	78.3	72.8	69.4	69.0	77.1	72.6	77.8
	250	76.1	62.0	63.7	65.9	70.1	69.5	76.6
	500	75.9	57.7	61.6	63.3	66.0	68.6	76.4
	1K	75.3	56.2	58.2	59.9	65.0	67.6	75.9
	2K	72.7	52.6	54.8	56.3	61.0	64.7	73.2
	4K	66.9	48.8	50.4	50.3	55.9	58.4	67.3
	8K	59.5	53.8	53.2	49.9	51.0	51.7	59.4
OVER ALL		84.3	78.2	76.9	75.7	81.1	78.7	84.4

TABLE NO. 168
 OCTAVE BAND- MEAN ENERGY DATA
 ROADSIDE BARRIER TEST SITE , ANDOVER MA.
 12-17-75 ; BARRIER HGT 16 FT ; REFLECTIVE

MEAN ENERGY - DB RE 20 MICROPASCAL

MAST CONFIGURATION	FREQ HZ	MICROPHONE NO						
		1	3	4	5	8	10	13
"B" 1209 HOURS	31.5	71.0	64.6	65.2	63.7	68.5	67.6	71.2
	63	76.7	73.6	72.1	70.2	78.9	76.1	81.4
	125	78.9	71.5	68.7	68.7	79.1	75.1	81.2
	250	79.4	62.6	66.5	67.5	74.0	74.8	80.8
	500	77.5	59.7	62.3	63.1	69.4	73.0	78.7
	1K	76.9	58.2	59.1	60.7	69.5	71.7	77.1
	2K	73.5	52.3	53.8	55.8	66.5	68.0	72.9
	4K	66.8	47.5	48.6	49.2	58.8	60.9	65.3
	8K	59.1	52.9	52.6	51.5	53.7	54.6	55.7
	OVER ALL		85.4	76.4	75.5	74.8	83.2	81.7
"C" 1345 HOURS	31.5	70.1	63.3	63.5	63.3	66.4	65.4	71.5
	63	75.4	71.6	70.9	70.2	74.8	72.6	79.7
	125	77.3	69.6	67.2	67.8	75.1	72.1	80.2
	250	76.7	61.8	64.0	66.1	68.6	70.1	79.1
	500	75.4	59.9	61.5	62.0	64.8	69.3	77.0
	1K	75.4	57.9	58.7	59.7	65.8	68.2	75.8
	2K	72.2	52.4	53.8	54.0	63.0	64.4	71.4
	4K	65.6	47.6	48.5	46.9	55.5	57.0	63.2
	8K	57.9	53.1	52.7	49.9	52.0	51.6	53.6
	OVER ALL		83.6	74.8	74.1	74.1	79.1	78.1
"D" 0945 HOURS	31.5	71.3	62.6	63.2	62.2	63.9	63.7	71.3
	63	82.3	68.7	68.1	66.8	70.6	68.8	79.2
	125	78.6	68.6	66.5	65.4	72.0	69.4	81.7
	250	78.6	58.0	58.9	60.9	63.3	64.6	79.4
	500	76.3	56.0	58.4	59.0	60.9	65.5	78.3
	1K	76.3	54.9	56.3	57.1	61.3	65.2	77.0
	2K	73.7	49.9	51.3	51.6	57.3	61.0	72.6
	4K	67.5	47.5	48.0	47.5	50.4	52.6	64.2
	8K	60.0	53.3	52.7	51.5	51.6	50.6	54.9
	OVER ALL		86.0	72.9	72.2	71.4	75.6	74.9
"E" 1054 HOURS	31.5	70.3	64.2	64.8	63.4	65.7	65.2	70.5
	63	76.9	73.0	71.6	70.0	75.3	72.1	79.5
	125	78.3	71.2	68.0	68.4	75.7	72.1	80.6
	250	76.8	60.6	63.8	65.1	70.4	70.6	78.9
	500	75.8	58.4	60.7	62.1	67.0	68.7	76.8
	1K	75.4	55.7	57.3	59.3	64.8	67.1	75.3
	2K	72.2	50.7	51.8	54.3	60.1	63.2	71.3
	4K	65.4	47.2	47.8	48.2	54.2	55.9	63.3
	8K	58.4	52.9	52.2	51.2	52.6	52.1	54.3
	OVER ALL		84.2	75.9	74.6	74.1	79.7	77.9

APPENDIX A TEMPORARY NOISE ATTENUATION BARRIER; DESIGN AND CONSTRUCTION

The purpose of this appendix is to describe the design and construction parameters and procedures as applicable to the temporary noise attenuation barrier; included is the as-built plan.

A.1 LAYOUT

The barrier is considered to be a temporary structure and is designed for easy removal after the acoustic test series are completed. As the expected life of the barrier is approximately one year, the materials used to comprise the barrier were not treated to obtain a long service life.

The barrier is 1000 feet long and 16 feet high and was constructed at a site selected by the U.S. Department of Transportation.

The barrier is located along the southbound side of Interstate Route 1-93 in Andover, Massachusetts. The face of the barrier was placed 30 feet from the edge of the nearest travel lane in order to adhere to the American Association of State Highway Transportation Officials (AASHTO) requirements for a safety setback to objects that would constitute a danger to out-of-control vehicles on interstate highways. The grade of the existing ground along the centerline of the barrier is approximately 0.7 percent or a difference of 7 feet in elevation between the beginning and end of the 1000 foot long barrier.

A.2 DESIGN AND CONSTRUCTION

The barrier was designed and constructed to prohibit light from passing through the barrier. The major loading applied to the structure was transverse wind. The magnitude and application of this loading was as specified in the AASHTO "Specifications for the Design and Construction of Structural Supports For Highway Signs."

The supporting elements for the barrier are untreated round timber posts spaced at 8'-0" on center. A single unpainted 16'-0" long 2" x 6" was attached to the face of each post to produce a compatible interface for the vertical wall panels (See Figure A-1).

The timber posts support the main portion of the barrier which was constructed using 4' x 8' x 5/8" plywood panels (unpainted grade C-D plugged with exterior glue). The plywood panels were placed with the 8 foot long edge placed horizontally and the 4 foot long edge placed vertically. To obtain the required 16 foot high barrier, four rows of plywood were required. The plywood panels were butted at the center of the 2' x 6" interface support and, while held in the proper alignment with wall-board nails, were fastened through the post with six 3/8", \emptyset x 6" zinc-plated lag screws with washers (3 screws and washers each end of the panels). The top of each plywood panel was placed horizontally. The tops of adjacent panels were placed with a slight differential in elevation between them. The introduction to the barrier of a slight saw-toothed top edge was necessary since the timber posts were placed plumb and the top edge of the plywood panels were placed horizontally. The sum of the difference in elevations between adjacent panels equals the approximate 7 foot difference in elevation between ends of the barrier.

The center 200 feet of the barrier consist of a double thickness of plywood with the top of the rear piece of plywood 3 inches higher than the front piece. The back-to-back plywood panels are fastened by nails.

The remaining 800 feet of the barrier consist of a single thickness of plywood with a 2' x 6" stiffener placed horizontally and centered along the top edge of each panel. The stiffener is attached to the vertical 2' x 6" at each post and the plywood panels are nailed to the horizontal 2' x 6" stiffener. To enhance the acoustic properties of the barrier, a 4' x 8' piece of fiberglass insulation board was attached to the front face of each panel using twelve #9 x 3" zinc-coated wood screws with 2" diameter x 1/16" thick polyethylene washers.

Excavated soil was used to fill any openings under the bottom row of panels.

The allowable stresses for the timber elements were determined per the requirements of the American Institute of Timber Construction. The embedment length of the timber posts was determined by the method developed by Professor R.C. Rutledge as described in "Pole-Type Building Design" published by the American Wood Preservers Institute.

As the prevalent soil at the site is a very sandy soil, it was easy to auger the holes for the timber posts. The posts were set in the holes and held in place by false-work bracing. The holes were then filled with 3000 psi cement concrete to the level of the existing ground surface.

A.3 WALL ERECTION FOR TESTING SEQUENCES

Two acoustic tests were performed after each horizontal row of plywood was in place. One of these tests was performed with the fiberglass insulation board attached to the barrier and the other test performed without the fiberglass attached to the barrier. The following construction sequence was developed and used:

- a. Erect timber posts and first 4 foot stage of plywood paneling.
- b. Add fiberglass to 4 foot plywood barrier.
- c. Add 4 foot plywood and 4 foot fiberglass panels to raise barrier height to 8 feet.
- d. Remove all fiberglass, leaving 8 foot height of plywood in place.
- e. Add 4 foot plywood panel to raise barrier height to 12 feet.
- f. Add 12 feet of fiberglass panels to barrier.
- g. Add 4 foot plywood and 4 foot fiberglass panels to raise barrier height to 16 feet.
- h. Remove and store all fiberglass.

After completion of the first step, each following step required approximately one week for construction and one week for acoustic testing.

A.4 PROJECT COST

The project was advertised and bid as a lump sum contract. The total in-place project cost is \$45,214.60 or \$2.80 per square foot of barrier vertical face area. Construction of the barrier proceeded smoothly without any costly change orders necessitated by construction problems. The completion date indicated in the contract specifications was extended because the time required to perform each set of acoustic tests was longer than anticipated.

The barrier was constructed without adversely affecting either the environment or the traffic flow on adjacent route I-93.

APPENDIX B REFERENCES

1. J.C. Manning, C.N. Blair and J.J. Fredbert, "Field Study of a Variable Height Highway Noise Barrier," Cambridge Collaborative, Report No. DOT-TSC-NHTSA-78-23 (1978).
2. C.G. Gordon, W.J. Galloway, B.A. Kugler, and D.L. Nelson, "Highway Noise: A Design Guide for Highway Engineers," NCHRP Report No. 117 (1971).
3. B.A. Kugler and A.G. Pierson, "Highway Noise: A Field Evaluation of Traffic Noise Reduction Measures," NCHRP Report No. 144 (1973).
4. Z. Maekawa, "Noise Reduction by Screens," Applied Acoustics, 1, 157-173 (1968).
5. U.J. Kurze and G.S. Andersen, "Sound Attenuation by Barriers," Applied Acoustics, 4, 35-53 (1971).
6. James A. Morgan, "Railroad Retarder Noise Reduction: A Study of Acoustical Barrier Configuraton," Burlington Northern report to DOT (1977), on file at the TSC Technical Information Center.

APPENDIX C BIBLIOGRAPHY

W.J. Galloway, W.Z. Clark and J.S. Kerrick, "Highway Noise: Measurement, Simulation, and Mixed Reactions," NCHRP Report No. 78 (1969).

U. Ingard, "The Physics of Outdoor Sound," Proc. 4th Annual National Noise Abatement Symposium, 4, 1-15 (1953).

H.G. Jonasson, "Sound Reduction by Barriers on the Ground," J. of Sound and Vibration, 25, 577-585 (1972).

U.S. GOVERNMENT PRINTING OFFICE: 1977-702-641/38