



U. S. Department
of Transportation
**Federal Railroad
Administration**

Safety of High Speed Guided Ground Transportation Systems

Office of Research
and Development
Washington, D. C. 20590

**Magnetic and Electric Field Testing
of the Amtrak Northeast Corridor and
New Jersey Transit/North Jersey Coast Line
Rail Systems**

Volume I: Analysis

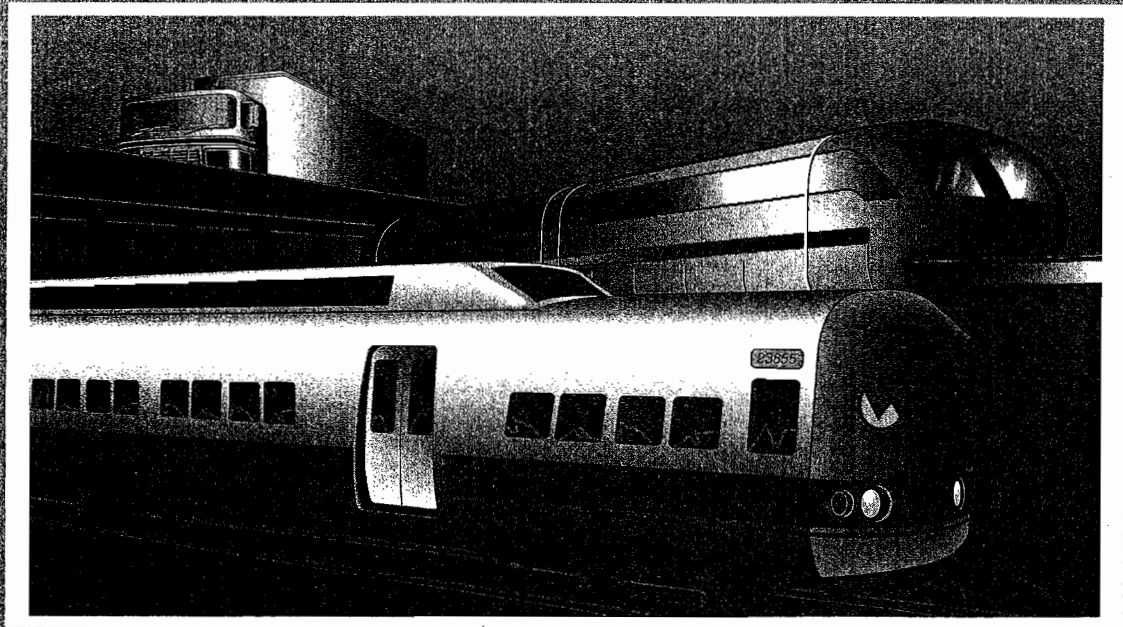

DOT/FRA/ORD-93/01.I
DOT-VNTSC-FRA-93-4.I

Final Report
April 1993

This document is available to the
public through the National Technical
Information Service, Springfield, VA 22161

REPORT DOCUMENTATION PAGE

Form Approved
OMB No. 0704-0188

Public reporting burden for this collection of information is estimated to average 1 hour per response, including the time for reviewing instructions, searching existing data sources, gathering and maintaining the data needed, and completing and reviewing the collection of information. Send comments regarding this burden estimate or any other aspect of this collection of information, including suggestions for reducing this burden, to Washington Headquarters Services, Directorate for Information Operations and Reports, 1215 Jefferson Davis Highway, Suite 1204, Arlington, VA 22202-4302, and to the Office of Management and Budget, Paperwork Reduction Project (0704-0188), Washington, DC 20503.

1. AGENCY USE ONLY (Leave blank)

2. REPORT DATE
April 1993

3. REPORT TYPE AND DATES COVERED
Final Report - May 1992-March 1993

4. TITLE AND SUBTITLE
MAGNETIC AND ELECTRIC FIELD TESTING OF THE AMTRAK NORTHEAST CORRIDOR, AND NEW JERSEY TRANSIT/ NORTH JERSEY COAST LINE RAIL SYSTEMS. VOLUME I. ANALYSIS

5. FUNDING NUMBERS
RR393/R3010

6. AUTHOR(S)
Fred M. Dietrich, William E. Feero, Petros N. Papas, George A. Steiner*

7. PERFORMING ORGANIZATION NAME(S) AND ADDRESS(ES)
Electric Research and Management, Inc.
P.O. Box 165
State College, PA 16804

8. PERFORMING ORGANIZATION REPORT NUMBER
DOT-VNTSC-FRA-93-4.1

9. SPONSORING/MONITORING AGENCY NAME(S) AND ADDRESS(ES)
U.S. Department of Transportation
Federal Railroad Administration
Office of Research and Development
400 7th St., S.W.
Washington, DC 20590

10. SPONSORING/MONITORING AGENCY REPORT NUMBER
DOT/FRA/ORD-93/01.1

11. SUPPLEMENTARY NOTES
*under contract to:
U.S. Department of Transportation
Research and Special Programs Administration
Volpe National Transportation Systems Center
Kendall Square, Cambridge, MA 02142

12a. DISTRIBUTION/AVAILABILITY STATEMENT
This document is available to the public through the National Technical Information Service, Springfield, VA 22161

12b. DISTRIBUTION CODE

13. ABSTRACT (Maximum 200 words)
The safety of magnetically levitated (maglev) and high speed rail (HSR) trains proposed for application in the United States is the responsibility of the Federal Railroad Administration (FRA). The characterization of electric and magnetic fields (EMF) produced by both steady (dc) and alternating currents (ac) at power frequency (50 Hz in Europe and 60 Hz in the U.S.) and above, in the Extreme Low Frequency (ELF) range (3-3000 Hz), is of interest with respect to any potential health effects these fields may have on the public and on transportation workers. An EMF survey of National Rail Passengers Corporation trains operating on the Northeast Corridor (NEC) was performed, as part of a comprehensive comparative safety assessment of the German Transrapid (TR-07) maglev system, and of existing (NEC and transit trains) and advanced rail systems (the French TGV). This report provides the analysis of results (Vol. I, Analysis), and detailed data summaries (Vol. II, Appendices) of representative EMF profiles for NEC rail technologies, facilities, operating conditions, and locations. A portable magnetic field monitoring system (augmented to include an electric fields probe) was used to sample, record and store three-axis static and ac magnetic fields waveforms simultaneously, at multiple locations. A real time Digital Audio Tape (DAT) recorder able to capture EMF transients, and two personal power-frequency magnetic field monitors were used to collect complementary data.

14. SUBJECT TERMS
Electric and Magnetic Fields (EMF); Static (or direct current, dc) Magnetic Field; Alternating Current (ac) Magnetic Field; Extreme Low Frequency (ELF); Power Frequency (PF); Harmonics; Transients; Fourier Analysis; North East Corridor (NEC); Electrified Rail; AMTRAK; Conventional Rail; Diesel Locomotive; Electric Locomotive; New Jersey Transit; Transit System; Trains; Railroad Stations; Power Substations; Catenary; EMDEX Personal Magnetic Field Exposure Monitor; Digital Audio Tape (DAT) Recorder; MultiWave Magnetic Field Recording System.

15. NUMBER OF PAGES

318

16. PRICE CODE

17. SECURITY CLASSIFICATION OF REPORT
Unclassified

18. SECURITY CLASSIFICATION OF THIS PAGE
Unclassified

19. SECURITY CLASSIFICATION OF ABSTRACT
Unclassified

20. LIMITATION OF ABSTRACT

**SYSTÈME INTERNATIONAL (SI) UNIT DEFINITIONS AND
CONVERSIONS USED IN THIS REPORT**

DISTANCE (ENGLISH-TO-SI CONVERSION):

1 inch (in)	= 2.54 centimeters (cm)	= 0.025 meters (m)
1 foot (ft)	= 30.5 centimeters (cm)	= 0.305 meters (m)
1 yard (yd)	= 91.4 centimeters (cm)	= 0.914 meters (m)
1 mile (mi)	= 1.61 kilometers (km)	= 1,610 meters (m)

ELECTRICAL QUANTITIES:

Electric Fields

1 Volt/meter (V/m)	= 0.01 Volts/centimeter (V/cm)
1 kiloVolt/meter (kV/m)	= 1000 Volts/meter (V/m)
1 kiloVolt/meter (kV/m)	= 10 Volts/centimeter (V/cm)

Magnetic Flux Densities (English-to-SI Conversion)

10,000 Gauss (G)	= 1 Tesla (T)
10 milliGauss (mG)	= 1 microTesla (μ T)
1 milliGauss (mG)	= .1 microTesla (μ T)
0.01 milliGauss (mG)	= 1 nanoTesla (nT)

Electromagnetic Frequency Bands

1 cycle per second	= 1 Hertz (Hz)
1,000 cycles per second	= 1 kiloHertz (kHz)
Ultra Low Frequency (ULF) Band	= 0 Hz to 3 Hz
Extreme Low Frequency (ELF) Band	= 3 Hz to 3 kHz
Very Low Frequency (VLF) Band	= 3 kHz to 30 kHz
Low Frequency (LF) Band	= 30 kHz to 300 kHz

PREFACE

The Federal Railroad Administration (FRA) has undertaken a series of studies to facilitate the introduction of advanced high speed guided ground transportation (HSGGT) technology to the US, including both magnetic levitation (maglev) and steel wheel on rail alternatives, such as the French Train a Grande Vitesse (TGV), the Swedish Tilt Train (X2000), or the German Intercity Express (ICE). HSGGT technology options can be expected to undergo public scrutiny and environmental assessment in order to convincingly establish their safety.

Timely development of technical information required for rulemaking initiatives is needed to ensure the public safety. An emerging concern that relates to the environment, worker's and public health and safety is that potentially adverse health effects of extra-low frequency (ELF) electric and magnetic fields (EMF) commonly associated with power transmission and distribution lines. Magnetic fields are of greater public concern, because they are pervasive, penetrate biological tissues without attenuation, and are more difficult to shield than electric fields.

To enable informed assessments and comparisons to be made amongst emerging and existing technologies, a thorough EMF characterization (frequency, intensity, spatial and temporal variability, source analysis) of all representative existing and advanced electrical transportation systems is needed. This report is one of a comprehensive series of studies and reports addressing the ELF EMF safety issues for candidate HSGGT technologies and systems. Electric Research and Management, Inc. (ERM) was engaged to measure, characterize and analyze the EMF for representative existing and advanced rail and transit systems.

This report presents data on static and alternating (AC) magnetic fields and AC electric fields obtained on rail systems operating along the Northeast Corridor (NEC), and on a branch of the New Jersey Transit commuter rail system (with electrification similar to that proposed for the northern part of the NEC). Volume I, Analysis presents a summary of representative EMF data on rail system components and facilities, over a full range of operating conditions, as well as a comparison with EMF produced by home appliances and common electric power distribution and transmission lines. Volume II, Appendices contains detailed EMF data files by location, time, and frequency range, as well as statistics.

This report was prepared by a team of Electric Research and Management, Inc. (ERM) personnel designated as authors for each volume, led by Fred M. Dietrich, Program Manager and William E. Feero, President. The technical monitor for this task and for the entire series of reports characterizing Extreme Low Frequency (ELF) Electric and Magnetic Fields (EMF) for rail technologies was Dr. Aviva Brecher of the DOT/RSPA John A. Volpe National Transportation Systems Center (VNTSC), who manages the FRA's EMF Research Program.

Guidance and program support was provided by Robert Dorer, the HSGGT Safety Program Manager at VNTSC. Arne Bang, Senior Manager of Special Programs and the FRA sponsor for this work is thanked for overall direction and oversight. Jim Smailes and Richard Cogswell of FRA also provided support and advice for the NEC EMF task. Valuable assistance with the measurements and logistics, as well as review comments were provided by Robert Verhelle and Ed Schnoering of Amtrak, and by Robert Falcon of the New Jersey Transit.

VOLUME I

TABLE OF CONTENTS

<u>Section</u>	<u>Page</u>
1. EXECUTIVE SUMMARY	1-1
1.1 Background	1-1
1.2 Measurement Approach	1-3
1.3 Summary of Electrified Railroad Field Levels	1-3
1.3.1 Coaches	1-3
1.3.2 Locomotive Cabs	1-5
1.3.3 Railroad Waysides	1-5
1.3.4 Station Platforms	1-6
1.3.5 Electric Power Substations	1-6
1.3.6 Control Facilities	1-7
1.4 Comparison of Electric and Magnetic Fields of Different Electro-Technologies	1-7
1.4.1 Static Fields	1-7
1.4.2 Frequency Spectrum	1-7
1.4.3 Time Characteristics	1-8
1.4.4 Amplitude Characteristics	1-8
1.4.4.1 Coaches	1-9
1.4.4.2 Locomotive Cabs	1-9
1.4.4.3 Wayside	1-9
1.4.4.4 Passenger Stations	1-14
1.4.4.5 Substations	1-14
2. OVERVIEW	2-1
2.1 Report Organization	2-1
2.2 Background	2-1
2.2.1 Natural Magnetic Field Characteristics	2-2
2.2.2 Technological Magnetic Field Perturbations	2-2
2.2.3 Electric and Magnetic Fields and Biological Effects	2-3
2.3 An Approach to Organizing Electromagnetic Data ...	2-4
2.4 Instrumentation	2-5
2.4.1 Portable Waveform Capture System	2-7
2.4.2 Digital Audio Tape Recorder	2-7
2.4.3 EMDEX-II Recorders	2-8
2.4.4 Magnetic Field Profiler	2-8
2.5 Repetitive Waveform Data	2-8

TABLE OF CONTENTS (CONT'D)

<u>Section</u>	<u>Page</u>
2.6	DAT Waveform Data 2-9
2.7	RMS Recorder Data 2-19
2.8	Overview of Railroad Facilities 2-19
2.8.1	Locomotives 2-19
2.8.2	Route 2-21
2.8.3	Electrification 2-22
3.	MEASUREMENTS ONBOARD COACH 3-1
3.1	Measurement Locations 3-2
3.2	Repetitive Waveform Datasets 3-5
3.3	Field Source Identification 3-5
3.4	DAT Waveform Data 3-23
3.5	RMS Recorder Data 3-25
3.6	Summary and Discussion of Magnetic Field Levels . 3-31
3.6.1	Magnetic Fields on the 25 Hz Section .. 3-37
3.6.2	Magnetic Fields on the 60 Hz Section .. 3-45
3.6.3	Magnetic Fields on the Non- Electrified Section 3-50
3.6.4	Magnetic Fields on the North Jersey Coast Line 3-55
3.6.5	Effects of Electrification Technology on Electric and Magnetic Fields 3-55
3.7	Electric Field Sources and Levels 3-71
4.	ENGINEER'S COMPARTMENT MEASUREMENTS 4-1
4.1	Measurement Locations 4-1
4.2	Repetitive Waveform Datasets 4-3
4.3	Field Source Identification 4-4
4.4	DAT Waveform Data 4-20
4.5	RMS Recorder Data 4-20
4.6	Summary of Magnetic Field Levels 4-23
4.6.1	Magnetic Fields on the 25 Hz Section .. 4-25
4.6.2	Magnetic Fields on the 60 Hz Section .. 4-25
4.6.3	Magnetic Fields on the Non- Electrified Section 4-31
4.6.4	Magnetic Fields on the North Jersey Coast Line 4-37
4.6.5	Effects of Electrification Technology 4-37
4.7	Summary of Electric Field Levels 4-53

TABLE OF CONTENTS (CONT'D)

<u>Section</u>	<u>Page</u>
5. ELECTRIC AND MAGNETIC FIELD MEASUREMENTS ALONG THE WAYSIDE	5-1
5.1 Measurement Locations	5-1
5.2 Repetitive Waveform Datasets	5-3
5.3 Field Source Identification	5-3
5.4 DAT Waveform Data	5-7
5.5 RMS Recorder Data	5-9
5.6 Summary of Magnetic Field Levels	5-10
5.6.1 Magnetic Fields on the 25 Hz Section ..	5-10
5.6.2 Magnetic Fields on the 60 Hz Section ..	5-12
5.6.3 Magnetic Fields on the North Jersey Coast Line	5-16
5.6.4 Magnetic Field Attenuation	5-21
5.6.5 Effects of Electrification Technology	5-27
5.7 Summary of Electric Field Levels	5-27
6. PASSENGER STATION ELECTRIC AND MAGNETIC FIELD MEASUREMENTS	6-1
6.1 Measurement Locations	6-1
6.2 Repetitive Waveform Datasets	6-4
6.3 Field Source Identification	6-4
6.4 DAT Waveform Data	6-6
6.5 RMS Recorder Data	6-9
6.6 Summary of Magnetic Field Levels	6-11
6.7 Summary of Electric Field Levels	6-18
7. ELECTRIC AND MAGNETIC FIELD MEASUREMENTS NEAR POWER SUBSTATIONS	7-1
7.1 Measurement Locations	7-1
7.2 Repetitive Waveform Datasets	7-4
7.3 Portable Profiler Data	7-4
7.4 Field Source Identification	7-6
7.5 RMS Recorder Data	7-17
7.6 Summary of Magnetic Field Levels	7-17
7.6.1 Princeton Junction 25 Hz Substation ...	7-17
7.6.2 Mt. Vernon 60 Hz Substation	7-19
7.6.3 Red Bank 60 Hz Substation	7-25
7.6.4 Effects of Electrification Technology .	7-25
7.7 Summary of Electric Field Levels	7-28

TABLE OF CONTENTS (CONT'D)

<u>Section</u>	<u>Page</u>
8. ELECTRIC AND MAGNETIC FIELD MEASUREMENTS IN RAIL TRAFFIC CONTROL FACILITIES	8-1
8.1 Measurement Locations	8-1
8.2 Repetitive Waveform Datasets	8-1
8.3 Field Source Identification	8-4
8.4 RMS Recorder Data	8-7
8.5 Summary of Magnetic Field Levels	8-7
8.6 Summary of Electric Field Levels	8-11
9. CONCLUSIONS	9-1
9.1 Summary of Electrified Railroad Field Levels	9-1
9.1.1 Coaches	9-2
9.1.2 Locomotive Cabs	9-2
9.1.3 Railroad Waysides	9-2
9.1.4 Station Platforms	9-3
9.1.5 Electric Power Substations	9-4
9.1.6 Control Facilities	9-4
9.2 Effects of Electrification Technology	9-4
9.3 Other Environmental Magnetic Field Levels	9-7
9.4 Comparison of Railroad Fields to Other Environmental Fields	9-11
9.4.1 Static Fields	9-11
9.4.2 Frequency Spectra	9-13
9.4.3 Time Characteristics	9-13
9.4.4 Amplitude Characteristics	9-14
9.4.4.1 Coaches	9-14
9.4.4.2 Locomotive Cabs	9-14
9.4.4.3 Wayside	9-14
9.4.4.4 Passenger Stations	9-18
9.4.4.5 Substations	9-23
9.4.4.6 Control Areas	9-23
9.5 Comparison of NEC Fields to Existing Standards ..	9-23
9.5.1 World Health Organization	9-23
9.5.2 International Radiation Protection Association	9-26
9.5.3 American Conference of Governmental Industrial Hygienists	9-27
9.5.4 State Power Line Limits	9-27
10. REFERENCES	10-1

VOLUME I

LIST OF FIGURES

<u>Figure</u>		<u>Page</u>
1-1	ROUTE OF THE AMTRAK AND METRO NORTH NORTHEAST CORRIDOR (NEC) PLUS THE NEW JERSEY TRANSIT (NJT) MATAWAN TO LONG BRANCH ROUTE	1-2
1-2	COMPARISON OF THE AVERAGE TIME-VARYING MAGNETIC FIELD LEVELS IN COACHES OPERATING ON VARIOUS SECTIONS OF THE NEC AND THE NORTH JERSEY COAST LINE MEASURED IN DIFFERENT WAYS	1-4
1-3	THE RANGE OF TOTAL TIME-VARYING MAGNETIC FIELD LEVELS IN PASSENGER COACHES COMPARED TO TYPICAL LEVELS OF POWER-FREQUENCY MAGNETIC FIELDS PRODUCED BY COMMON SOURCES	1-10
1-4	THE RANGE OF TOTAL TIME-VARYING MAGNETIC FIELD LEVELS IN THE CABS OF ELECTRIC LOCOMOTIVES COMPARED TO TYPICAL LEVELS OF POWER-FREQUENCY MAGNETIC FIELDS PRODUCED BY COMMON SOURCES	1-11
1-5	THE RANGE OF TOTAL TIME-VARYING MAGNETIC FIELD ALONG THE WAYSIDE OF ELECTRIFIED RAILROADS AT VARIOUS DISTANCES FROM THE NEAREST TRACK COMPARED TO TYPICAL LEVELS OF POWER-FREQUENCY MAGNETIC FIELDS PRODUCED BY COMMON SOURCES	1-12
1-6	MAXIMUM TIME-VARYING ELECTRIC FIELD AT THE WAYSIDE OF ELECTRIFIED RAILROADS AS A FUNCTION OF DISTANCE FROM THE NEAREST TRACK COMPARED TO TYPICAL LEVELS OF POWER-FREQUENCY ELECTRIC FIELDS PRODUCED BY COMMON SOURCES	1-13
2-1	MAGNETIC FIELD FLUX DENSITIES GROUPED BY FREQUENCY PARTITIONS WITHIN THE ELF BAND AND ULF BAND.....	2-6
3-1	REPETITIVE MAGNETIC FIELD WAVEFORM MEASUREMENT LOCATIONS IN AMTRAK COACHES	3-3
3-2	REPETITIVE MAGNETIC FIELD WAVEFORM MEASUREMENT LOCATIONS IN NEW JERSEY TRANSIT COACHES	3-4
3-3	MAGNETIC FIELD LEVEL AT TWO HEIGHTS ABOVE THE FLOOR IN A REAR COACH AS A FUNCTION OF FREQUENCY AND TIME	3-6
3-4	MAGNETIC FIELD LEVEL AT TWO HEIGHTS ABOVE THE FLOOR AT THE FRONT OF THE FIRST COACH AS A FUNCTION OF FREQUENCY AND TIME	3-8

LIST OF FIGURES (CONT'D)

<u>Figure</u>	<u>Page</u>
3-5 LOW FREQUENCY MAGNETIC FIELD LEVELS AT VARIOUS LOCATIONS ALONG THE 25 HZ NEC SEGMENT	3-9
3-6 POWER FREQUENCY MAGNETIC FIELD LEVELS AT VARIOUS LOCATIONS ALONG THE 25 HZ NEC SEGMENT	3-11
3-7 POWER FREQUENCY MAGNETIC FIELD LEVELS AT THE FRONT OF COACH 1 AT VARIOUS HEIGHTS ABOVE THE FLOOR FOR 25 HZ NEC SEGMENT	3-12
3-8 MEAN \pm STANDARD DEVIATION OF 60 HZ MAGNETIC FIELDS IN THE COACHES ON THE NON-ELECTRIFIED SECTION OF THE NORTHEAST CORRIDOR	3-13
3-9 MAGNETIC FIELD LEVELS IN THE POWER HARMONICS BAND (65-300 HZ)	3-15
3-10 MAGNETIC FIELD LEVELS IN THE HIGH FREQUENCY BAND (305-2560 HZ)	3-16
3-11 TOTAL TIME-VARYING MAGNETIC FIELD (5-2560 HZ) AT VARIOUS LOCATIONS	3-17
3-12 STATIC MAGNETIC FIELD AT VARIOUS LOCATIONS	3-18
3-13 VERTICAL PROFILE OF STATIC AND LOW FREQUENCY (5-45 HZ) MAGNETIC FIELDS OVER TIME AT THE FRONT OF THE FIRST COACH (25 HZ SECTION OF NEC)	3-19
3-14 VERTICAL PROFILE OF STATIC MAGNETIC FIELDS OVER TIME AT THE REAR OF COACH 1 AND MIDWAY THROUGH COACH 7	3-21
3-15 VERTICAL PROFILE OF MAGNETIC FIELD IN THE POWER FREQUENCY (50-60 HZ) BAND SHOWING INCREASE IN FIELD NEAR FLUORESCENT LIGHT AT THE TOP OF THE BULKHEAD	3-22
3-16 COMPARISON OF MAGNETIC FIELD MEASUREMENTS MADE CONTINUALLY WITH THE DIGITAL AUDIO TAPE RECORDER (TOP FRAME) AND THOSE MADE WITH THE REPETITIVE FIELD WAVEFORM RECORDING SYSTEM SAMPLING AT 5 SECOND INTERVALS (BOTTOM FRAME)	3-24
3-17 COMPARISON OF RMS RECORDER (TOP FRAME) AND REPETITIVE FIELD WAVEFORM RECORDING SYSTEM (BOTTOM FRAME) MEASUREMENTS OF MAGNETIC FIELD LEVELS WITHIN AN AMTRAK COACH ON 60 HZ AND NON-ELECTRIFIED PORTIONS OF THE NEC	3-27

LIST OF FIGURES (CONT'D)

<u>Figure</u>	<u>Page</u>
3-18 COMPARISON OF RMS RECORDER (TOP FRAME) AND REPETITIVE FIELD WAVEFORM RECORDING SYSTEM (BOTTOM FRAME) MEASUREMENTS OF MAGNETIC FIELD LEVELS IN AN AMTRAK COACH ON THE 25 HZ SECTION OF THE NEC	3-29
3-19 RMS RECORDING OF MAGNETIC FIELD LEVELS ENCOUNTERED BY A PASSENGER TRAVELING FROM WASHINGTON, DC TO BOSTON, MA. FIELD MEASUREMENTS ON THE 25 HZ SECTION OF THE TRIP ARE ERRONEOUS BECAUSE THE INSTRUMENT DOES NOT INCLUDE THE 25 HZ COMPONENT OF THE MAGNETIC FIELD	3-30
3-20 RMS RECORDING OF MAGNETIC FIELD LEVELS MEASURED BY A STATIONARY INSTRUMENT IN A COACH SEAT POCKET DURING A TRIP FROM WASHINGTON, DC TO BOSTON, MA. FIELD MEASUREMENTS ON THE 25 HZ SECTION OF THE TRIP ARE ERRONEOUS BECAUSE THE INSTRUMENT DOES NOT INCLUDE THE 25 HZ COMPONENT OF THE MAGNETIC FIELD	3-32
3-21 TOTAL RMS TIME-VARYING ELF MAGNETIC FIELD MEASURED IN A COACH SEAT ON THE NON-ELECTRIFIED PORTION OF THE NEC AS THE TRAIN PASSES AN APPARENT EXTERNAL MAGNETIC FIELD SOURCE BELIEVED TO BE AN ELECTRIC POWER TRANSMISSION LINE CROSSING THE TRACKS	3-54
3-22 COMPARISON OF AVERAGE STATIC MAGNETIC FIELD LEVELS IN COACHES ON VARIOUS SECTIONS OF THE NEC AND ON THE NORTH JERSEY COAST LINE	3-62
3-23 COMPARISON OF THE AVERAGE TIME-VARYING MAGNETIC FIELD LEVELS IN COACHES OPERATING ON VARIOUS SECTIONS OF THE NEC AND THE NORTH JERSEY COAST LINE MEASURED IN DIFFERENT WAYS	3-64
3-24 COMPARISON OF THE AVERAGE TIME-VARYING MAGNETIC FIELD LEVELS IN COACHES ON VARIOUS SECTIONS OF THE NEC AND ON THE NORTH JERSEY COAST LINE AND THEIR PRINCIPAL COMPONENT FREQUENCY RANGES	3-65
3-25 COMPARISON OF AVERAGE TIME-VARYING MAGNETIC FIELD LEVELS IN FOUR FREQUENCY BANDS IN THE COACHES ON VARIOUS SECTIONS OF THE NEC AND ON THE NORTH JERSEY COAST LINE	3-66
3-26 COMPARISON OF THE MAXIMUM TIME-VARYING MAGNETIC FIELD LEVELS IN COACHES ON VARIOUS SECTIONS OF THE NEC AND ON THE NORTH JERSEY COAST LINE MEASURED IN DIFFERENT WAYS	3-68

LIST OF FIGURES (CONT'D)

<u>Figure</u>	<u>Page</u>
3-27 COMPARISON OF THE MAXIMUM TIME-VARYING MAGNETIC FIELD LEVELS IN COACHES ON VARIOUS SECTIONS OF THE NEC AND ON THE NORTH JERSEY COAST LINE AND THEIR PRINCIPAL COMPONENT FREQUENCY RANGES	3-69
3-28 COMPARISON OF THE TIME-VARYING MAGNETIC FIELD LEVELS IN VARIOUS FREQUENCY BANDS DURING MAXIMUM FIELD CONDITIONS IN COACHES ON VARIOUS SECTIONS OF THE NEC AND ON THE NORTH JERSEY COAST LINE	3-70
4-1 REPETITIVE WAVEFORM MEASUREMENT LOCATIONS IN THE FRONT CAB OF THE DIESEL ELECTRIC LOCOMOTIVE (TOP FRAME) AND THE REAR CAB OF THE ELECTRIC LOCOMOTIVE (BOTTOM FRAME)	4-2
4-2 MAGNETIC FIELD LEVELS AT TWO HEIGHTS ABOVE THE FLOOR AT THE SIDE OF THE ENGINEER'S SEAT IN A LOCOMOTIVE ON THE 25 HZ SECTION OF THE NORTHEAST CORRIDOR	4-6
4-3 VERTICAL PROFILE OF LOW FREQUENCY MAGNETIC FIELD STRENGTH IN A LOCOMOTIVE CAB OPERATING ON THE 25 HZ SECTION OF THE NEC	4-7
4-4 VERTICAL PROFILE OF POWER FREQUENCY MAGNETIC FIELD STRENGTH IN A LOCOMOTIVE CAB OPERATING ON THE 25 HZ SECTION OF THE NEC	4-8
4-5 HORIZONTAL (AXIAL) PROFILE OF LOW FREQUENCY MAGNETIC FIELD STRENGTH 1 M (3.3 FT) ABOVE THE FLOOR OF THE CAB IN A LOCOMOTIVE OPERATING ON THE 25 HZ SECTION OF THE NEC	4-10
4-6 HORIZONTAL (AXIAL) PROFILE OF POWER FREQUENCY MAGNETIC FIELD STRENGTH 1.4 M (4.6 FT) ABOVE THE FLOOR OF THE CAB IN A LOCOMOTIVE OPERATING ON THE 25 HZ SECTION OF THE NEC	4-11
4-7 VERTICAL PROFILES OF POWER FREQUENCY MAGNETIC FIELD STRENGTH OVER TIME NEXT TO THE ENGINEER'S AND FIREMAN'S SEATS IN THE REAR CAB OF A LOCOMOTIVE OPERATING ON THE 60 HZ SECTION OF THE NEC.....	4-12
4-8 HORIZONTAL PROFILES OF POWER FREQUENCY (TOP FRAME) AND TOTAL ELF (BOTTOM FRAME) MAGNETIC FIELDS IN THE REAR CAB OF A LOCOMOTIVE OPERATING ON A 60 HZ SECTION OF THE NEC	4-14

LIST OF FIGURES (CONT'D)

<u>Figure</u>	<u>Page</u>
4-9 MAGNETIC FIELD FREQUENCY DISTRIBUTIONS IN THE REAR CAB OF A LOCOMOTIVE CROSSING FROM THE 60 HZ SECTION OF THE NEC ONTO THE 25 HZ SECTION	4-15
4-10 STATIC (TOP FRAME) AND TIME-VARYING (BOTTOM FRAME) MAGNETIC FIELD NEAR THE ENGINEER'S SEAT IN A DIESEL-ELECTRIC LOCOMOTIVE OPERATING ON THE NON-ELECTRIFIED PORTION OF THE NORTHEAST CORRIDOR (TRAIN STOPPED AT 12-13 MINUTES)	4-17
4-11 MAGNETIC FIELD FREQUENCY SPECTRUM NEAR THE ENGINEER'S SEAT IN A DIESEL-ELECTRIC LOCOMOTIVE OPERATING ON THE NON-ELECTRIFIED PORTION OF THE NORTHEAST CORRIDOR	4-18
4-12 MAGNETIC FIELD FREQUENCY SPECTRUM NEAR THE ENGINEER'S SEAT IN A DIESEL-ELECTRIC LOCOMOTIVE STOPPED AT A STATION	4-19
4-13 RMS RECORDINGS OF MAGNETIC FIELD LEVELS ENCOUNTERED BY A PERSON STANDING (RMS RECORDER 1) OR SEATED IN THE ENGINEER'S SEAT (RMS RECORDER 2) OF THE REAR CAB OF A LOCOMOTIVE ON THE 60 HZ SECTION OF THE NEC	4-22
4-14 VERTICAL PROFILE OF POWER FREQUENCY MAGNETIC FIELD STRENGTH IN THE LOCOMOTIVE CAB OPERATING ON THE 60 HZ SECTION OF THE NEC	4-33
4-15 VERTICAL PROFILE OF POWER FREQUENCY MAGNETIC FIELD STRENGTH IN THE REAR CAB OF A LOCOMOTIVE OPERATING ON THE 60 HZ SECTION OF THE NORTH JERSEY COAST LINE	4-39
4-16 VERTICAL PROFILE OF THE POWER FREQUENCY MAGNETIC FIELD STRENGTH IN THE REAR CAB OF A LOCOMOTIVE STANDING AT THE LONG BRANCH STATION ON THE 60 HZ SECTION OF THE NORTH JERSEY COAST LINE	4-41
4-17 COMPARISON OF THE AVERAGE STATIC MAGNETIC FIELD LEVELS IN CABS OF LOCOMOTIVES OPERATING ON VARIOUS SECTIONS OF THE NEC AND ON THE NORTH JERSEY COAST LINE	4-43
4-18 COMPARISON OF THE MAXIMUM STATIC MAGNETIC FIELD LEVEL TYPICAL FOR A LOCATION IN THE CABS OF LOCOMOTIVES OPERATING ON VARIOUS SECTIONS OF THE NORTHEAST CORRIDOR AND ON THE NORTH JERSEY COAST LINE	4-44

LIST OF FIGURES (CONT'D)

<u>Figure</u>	<u>Page</u>
4-19 COMPARISON OF THE AVERAGE TIME-VARYING MAGNETIC FIELD LEVELS IN CABS OF LOCOMOTIVES OPERATING ON VARIOUS SECTIONS OF THE NEC AND ON THE NORTH JERSEY COAST LINE MEASURED IN DIFFERENT WAYS	4-46
4-20 COMPARISON OF THE MAXIMUM TIME-VARYING MAGNETIC FIELD LEVELS AT TYPICAL LOCATIONS IN CABS OF LOCOMOTIVES OPERATING ON VARIOUS SECTIONS OF THE NEC AND THE NORTH JERSEY COAST LINE MEASURED IN DIFFERENT WAYS	4-47
4-21 COMPARISON OF THE AVERAGE TIME-VARYING MAGNETIC FIELD LEVELS IN CABS OF LOCOMOTIVES OPERATING ON VARIOUS SECTIONS OF THE NEC OR THE NORTH JERSEY COAST LINE AND THE PRINCIPAL COMPONENT FREQUENCY RANGES	4-48
4-22 COMPARISON OF THE MAXIMUM TIME-VARYING MAGNETIC FIELD LEVELS IN TYPICAL LOCATIONS IN CABS OF LOCOMOTIVES OPERATING ON VARIOUS SECTIONS OF THE NEC OR THE NORTH JERSEY COAST LINE AND THE PRINCIPAL COMPONENT FREQUENCY RANGES	4-49
4-23 COMPARISON OF AVERAGE TIME-VARYING MAGNETIC FIELD LEVELS IN THE FOUR FREQUENCY BANDS IN THE CABS OF LOCOMOTIVES OPERATING ON VARIOUS SECTIONS OF THE NEC OR THE NORTH JERSEY COAST LINE	4-51
4-24 COMPARISON OF MAXIMUM TIME-VARYING MAGNETIC FIELD LEVELS IN FOUR FREQUENCY BANDS AT TYPICAL LOCATIONS IN CABS OF LOCOMOTIVES OPERATING ON VARIOUS SECTIONS OF THE NEC OR ON THE NORTH JERSEY COAST LINE	4-52
5-1 REPETITIVE MAGNETIC FIELD WAVEFORM MEASUREMENT LOCATIONS AT THE WAYSIDE	5-2
5-2 MAGNETIC FIELD LEVEL BY FREQUENCY AND TIME 6.1 M (20 FT) FROM CENTERLINE OF THE NEAREST TRACK ALONG THE WAYSIDE OF THE NORTH JERSEY COAST LINE 2 MILES WEST OF RED BANK. THE STATIC FIELD IS SUPPRESSED IN THE BOTTOM FRAME TO SHOW THE TIME-VARYING FIELD COMPONENTS IN MORE DETAIL	5-5
5-3 MAGNETIC FIELD LEVEL BY FREQUENCY AND TIME 12.2 M (40 FT) FROM CENTERLINE OF THE NEAREST TRACK ALONG THE WAYSIDE OF THE NORTH JERSEY COAST LINE 2 MILES WEST OF RED BANK. THE STATIC FIELD IS SUPPRESSED IN THE BOTTOM FRAME TO SHOW THE TIME-VARYING FIELD COMPONENTS IN MORE DETAIL	5-6

LIST OF FIGURES (CONT'D)

<u>Figure</u>	<u>Page</u>
5-4 TIME-VARYING MAGNETIC FIELD LEVELS BY FREQUENCY AND TIME 12.2 M (40 FT) (TOP FRAME) AND 18.3 M (60 FT) (BOTTOM FRAME) FROM CENTERLINE OF THE NEAREST TRACK ALONG THE WAYSIDE OF THE 25 HZ SECTION OF THE NEC 610 M (2000 FT) NORTH OF THE PRINCETON JUNCTION STATION	5-8
5-5 HORIZONTAL PROFILE TOTAL ELF MAGNETIC FIELD STRENGTH AT THE WAYSIDE OF THE 25 HZ SECTION OF THE NEC NEAR PRINCETON JUNCTION, NJ	5-13
5-6 HORIZONTAL PROFILE OF TOTAL ELF MAGNETIC FIELD STRENGTH AT THE WAYSIDE OF THE 60 HZ SECTION OF THE NEC NEAR RYE, NEW YORK	5-15
5-7 HORIZONTAL PROFILE OF TOTAL ELF MAGNETIC FIELD STRENGTH AT THE WAYSIDE OF THE NORTH JERSEY COAST LINE NEAR RED BANK, NJ BASED ON POOLED DATASETS	5-18
5-8 HORIZONTAL PROFILE OF THE TOTAL ELF MAGNETIC FIELD STRENGTH AT THE WAYSIDE OF THE NORTH JERSEY COAST LINE NEAR RED BANK, NJ BASED ON DATASET NEC053	5-20
5-9 THEORETICAL ATTENUATION CURVES FITTED THROUGH THE AVERAGE AND MAXIMUM MAGNETIC FIELD VALUES MEASURED AT THE WAYSIDE OF THE 25 HZ SECTION OF THE NEC AT PRINCETON JUNCTION, NJ.....	5-22
5-10 THEORETICAL ATTENUATION CURVES FITTED THROUGH THE AVERAGE AND MAXIMUM MAGNETIC FIELD VALUES MEASURED AT THE WAYSIDE OF THE 60 HZ SECTION OF THE NEC AT RYE, NY	5-23
5-11 THEORETICAL ATTENUATION CURVES FITTED THROUGH THE AVERAGE AND MAXIMUM MAGNETIC FIELD VALUES MEASURED AT THE SOUTH SIDE OF THE NORTH JERSEY COAST LINE NEAR RED BANK, NJ	5-24
5-12 THEORETICAL ATTENUATION CURVES FITTED THROUGH THE AVERAGE AND MAXIMUM MAGNETIC FIELD VALUES MEASURED AT THE NORTH SIDE OF THE NORTH JERSEY COAST LINE NEAR RED BANK, NJ	5-25
5-13 CALCULATED AND MEASURED 25 HZ ELECTRIC FIELD LEVELS AT THE WAYSIDE OF THE 25 HZ SECTION OF THE NEC AT THE PRINCETON JUNCTION MEASUREMENT SITE	5-29

LIST OF FIGURES (CONT'D)

<u>Figure</u>	<u>Page</u>
5-14 CALCULATED AND MEASURED 60 HZ ELECTRIC FIELD LEVELS AT THE WAYSIDE OF THE 60 HZ SECTION OF THE NEC AT THE RYE, NY MEASUREMENT SITE	5-30
5-15 CALCULATED AND MEASURED 60 HZ ELECTRIC FIELD LEVELS AT THE WAYSIDE OF THE NORTH JERSEY COAST LINE AT THE RED BANK MEASUREMENT SITE	5-31
6-1 REPETITIVE MAGNETIC FIELD WAVEFORM MEASUREMENT LOCATIONS ON TWO NORTHEAST CORRIDOR STATION PLATFORMS	6-2
6-2 REPETITIVE MAGNETIC FIELD WAVEFORM MEASUREMENT LOCATIONS ON METRO NORTH AND NEW JERSEY TRANSIT STATION PLATFORMS	6-3
6-3 MAGNETIC FIELD LEVEL BY FREQUENCY AND TIME AT THE PRINCETON JUNCTION STATION PLATFORM (25 HZ SECTION OF THE NEC)	6-5
6-4 MAGNETIC FIELD LEVEL BY FREQUENCY AND TIME AT THE PRINCETON JUNCTION STATION PLATFORM (25 HZ SECTION OF THE NEC) WITH THE STATIC FIELD COMPONENT SUPPRESSED	6-7
6-5 MAGNETIC FIELD LEVELS BY FREQUENCY AND TIME AT THE PRINCETON JUNCTION STATION PLATFORM (25 HZ SECTION OF THE NEC) AT A POINT 6.1 M (20 FT) FURTHER ALONG THE PLATFORM FROM MEASUREMENT TAKEN IN FIGURE 6-3	6-8
6-6 RMS RECORDING OF MAGNETIC FIELD LEVELS AT WAIST HEIGHT OF A PERSON IN THE WAITING LOUNGE AT BOSTON'S SOUTH STATION	6-10
7-1 MAGNETIC FIELD MEASUREMENT LOCATIONS AT THE PRINCETON JUNCTION SUBSTATION	7-2
7-2 MAGNETIC FIELD MEASUREMENT LOCATIONS AT THE MT. VERNON SUBSTATION	7-3
7-3 MAGNETIC FIELD MEASUREMENT LOCATIONS AT THE RED BANK SUBSTATION	7-5
7-4 MAGNETIC FIELD AS A FUNCTION OF DISTANCE FROM THE STATION PLATFORM ALONG PROFILE LINE 1, 1.5 M (5 FT) OUTSIDE THE SUBSTATION FENCE AT THE MT. VERNON SUBSTATION	7-8

LIST OF FIGURES (CONT'D)

<u>Figure</u>	<u>Page</u>
7-5 MAGNETIC FIELD AS A FUNCTION OF DISTANCE FROM THE STATION PLATFORM ALONG PROFILE LINE 3, 30.5 M (100 FT) OUTSIDE THE SUBSTATION FENCE AT THE MT. VERNON SUBSTATION	7-9
7-6 MAGNETIC FIELD AS A FUNCTION OF DISTANCE FROM THE SUBSTATION FENCE ALONG PROFILE LINE 2 AT THE MT. VERNON SUBSTATION	7-10
7-7 MAGNETIC FIELD LEVEL VERSUS FREQUENCY AND TIME MEASURED 110 CM ABOVE THE SIDEWALK IN FRONT OF THE PRINCETON JUNCTION SUBSTATION ON THE 25 HZ SECTION OF THE NEC. THE STATIC FIELD IS SUPPRESSED IN THE BOTTOM FRAME TO SHOW THE TIME-VARYING FIELD COMPONENTS	7-11
7-8 MAGNETIC FIELD AS A FUNCTION OF DISTANCE ALONG THE SUBSTATION FENCE ALONG PROFILE LINE 3 BENEATH THE ENTERING TRANSMISSION LINE AT THE RED BANK SUBSTATION	7-14
7-9 MAGNETIC FIELD AS A FUNCTION OF DISTANCE AWAY FROM THE SUBSTATION FENCE ALONG PROFILE LINE 6 AT THE RED BANK SUBSTATION	7-15
7-10 MAGNETIC FIELD AS A FUNCTION OF DISTANCE FROM THE SUBSTATION FENCE ALONG PROFILE LINE 7 AT THE RED BANK SUBSTATION	7-16
7-11 RMS RECORDINGS OF THE MAGNETIC FIELD LEVELS ENCOUNTERED BY TWO RESEARCHERS WORKING OUTSIDE THE RED BANK SUBSTATION BENEATH THE INCOMING 345 KV TRANSMISSION LINE	7-18
7-12 MAGNETIC FIELD LEVEL VERSUS FREQUENCY AND TIME MEASURED 110 CM OUTSIDE THE SUBSTATION FENCE ON THE MT. VERNON STATION PLATFORM. THE STATIC FIELD IS SUPPRESSED IN THE BOTTOM FRAME TO SHOW THE TIME-VARYING FIELD COMPONENTS	7-21
8-1 REPETITIVE WAVEFORM MEASUREMENT LOCATIONS AT THE MAC MANAGER'S CENTRALIZED ELECTRIFICATION AND TRAFFIC CONTROL STATION IN THE BOSTON SOUTH STATION DISPATCH AREA	8-2
8-2 REPETITIVE WAVEFORM MEASUREMENT LOCATION IN THE UNINTERRUPTIBLE POWER SUPPLY (UPS) ROOM ADJACENT TO THE DISPATCH AREA IN BOSTON'S SOUTH STATION	8-3

LIST OF FIGURES (CONT'D)

<u>Figure</u>	<u>Page</u>
8-3	FIELD BY FREQUENCY AND TIME PLOTS OF THE MAGNETIC FIELD AT TWO DISTANCES FROM A VIDEO DISPLAY TERMINAL IN THE SOUTH STATION DISPATCH AREA 8-5
8-4	FIELD BY FREQUENCY AND TIME PLOTS OF THE MAGNETIC FIELD AT TWO HEIGHTS ABOVE THE FLOOR 60 CM (2 FT) IN FRONT OF AN UNINTERRUPTIBLE POWER SUPPLY IN THE DISPATCH AREA OF BOSTON'S SOUTH STATION 8-6
8-5	VERTICAL PROFILE OF THE STATIC MAGNETIC FIELD OVER TIME AT A POSITION 60 CM (2 FT) IN FRONT OF AN UNINTERRUPTIBLE POWER SUPPLY IN THE DISPATCH AREA OF BOSTON'S SOUTH STATION 8-8
9-1	ILLUSTRATION OF HOW THE MAGNETIC FIELD INTENSITY AT GROUND LEVEL CHANGES WITH HORIZONTAL DISTANCE FROM THREE COMMON SOURCES OF POWER-FREQUENCY MAGNETIC FIELDS. THE BANDS REPRESENT VARIATION ACROSS INDIVIDUAL SOURCES IN EACH GROUP. ADAPTED FROM NAIR, ET AL 9-9
9-2	MAGNETIC FIELD 30 CM (1 FT) FROM A SHOP VAC 9-10
9-3	ILLUSTRATION OF HOW ELECTRIC FIELD INTENSITY NEAR GROUND LEVEL WILL CHANGE WITH HORIZONTAL DISTANCE FROM THREE COMMON SOURCES OF POWER-FREQUENCY ELECTRIC FIELDS. THE BANDS REPRESENT VARIATION ACROSS INDIVIDUAL SOURCES IN EACH GROUP. ADAPTED FROM NAIR, ET AL 9-12
9-4	THE RANGE OF TOTAL TIME-VARYING MAGNETIC FIELD LEVELS IN PASSENGER COACHES COMPARED TO TYPICAL LEVELS OF POWER-FREQUENCY MAGNETIC FIELDS PRODUCED BY COMMON SOURCES 9-15
9-5	THE RANGE OF TOTAL TIME-VARYING MAGNETIC FIELD LEVELS IN THE CABS OF ELECTRIC LOCOMOTIVES COMPARED TO TYPICAL LEVELS OF POWER-FREQUENCY MAGNETIC FIELDS PRODUCED BY COMMON SOURCES 9-16

LIST OF FIGURES (CONT'D)

<u>Figure</u>	<u>Page</u>
9-6 THE RANGE OF TOTAL TIME-VARYING MAGNETIC FIELD IN THE CAB OF A DIESEL-ELECTRIC LOCOMOTIVE COMPARED TO TYPICAL LEVELS OF POWER-FREQUENCY MAGNETIC FIELDS PRODUCED BY COMMON SOURCES	9-17
9-7 THE RANGE OF TOTAL TIME-VARYING MAGNETIC FIELD ALONG THE WAYSIDE OF ELECTRIFIED RAILROADS AT VARIOUS DISTANCES FROM THE NEAREST TRACK COMPARED TO TYPICAL LEVELS OF POWER-FREQUENCY MAGNETIC FIELDS PRODUCED BY COMMON SOURCES	9-19
9-8 MAXIMUM TIME-VARYING ELECTRIC FIELD AT THE WAYSIDE OF ELECTRIFIED RAILROADS AS A FUNCTION OF DISTANCE FROM THE NEAREST TRACK COMPARED TO TYPICAL LEVELS OF POWER-FREQUENCY ELECTRIC FIELDS PRODUCED BY COMMON SOURCES	9-20
9-9 THE RANGE OF TOTAL TIME-VARYING MAGNETIC FIELD LEVELS ON STATION PLATFORMS OR IN STATION WAITING AREAS COMPARED TO TYPICAL POWER-FREQUENCY MAGNETIC FIELD LEVELS FROM COMMON SOURCES	9-21
9-10 MEASURED TOTAL TIME-VARYING ELECTRIC FIELD ON STATION PLATFORMS COMPARED TO TYPICAL POWER-FREQUENCY ELECTRIC FIELD LEVELS FROM COMMON SOURCES	9-22
9-11 THE RANGE OF TOTAL TIME-VARYING MAGNETIC FIELD LEVELS 2 M (6.6 FT) OUTSIDE THE FENCE OF THE RED BANK SUBSTATION AND LATERAL ATTENUATION PROFILES FOR THE RED BANK AND MT. VERNON SUBSTATIONS COMPARED TO TYPICAL POWER-FREQUENCY MAGNETIC FIELD LEVELS FROM COMMON SOURCES	9-24
9-12 THE RANGE OF TOTAL TIME-VARYING MAGNETIC FIELD LEVELS IN FRONT OF A DISPATCHER'S VIDEO DISPLAY TERMINAL AND AN UNINTERRUPTIBLE POWER SUPPLY COMPARED TO TYPICAL POWER-FREQUENCY MAGNETIC FIELD LEVELS FROM COMMON SOURCES	9-25

VOLUME I

LIST OF TABLES

<u>Table</u>		<u>Page</u>
2-1	INDEX OF REPETITIVE WAVEFORM DATA NORTHEAST CORRIDOR MEASUREMENTS MARCH 30 - APRIL 3, 1992	2-10
2-2	INDEX OF CONTINUOUS WAVEFORM (DAT) DATA NORTHEAST CORRIDOR MEASUREMENTS MARCH 30 - APRIL 3, 1992	2-16
2-3	SUMMARY OF PHYSICAL AND ELECTRIFICATION SYSTEM CHARACTERISTICS OF FOUR RAILROAD SECTIONS IN THIS STUDY	2-28
3-1	SUMMARY OF MAGNETIC FIELD LEVELS RECORDED IN A PASSENGER SEAT OF A COACH RECORDED WITH THE DIGITAL AUDIO TAPE RECORDER (DAT)	3-26
3-2	STATISTICAL SUMMARY OF MAGNETIC FIELDS MEASURED IN COACHES USING RMS RECORDERS	3-33
3-3	SUMMARY STATISTICS FOR DATASET NEC005 MEASURED NEAR THE SIDE BULKHEAD NEAR THE FRONT OF THE FIRST COACH ON THE 25 HZ SECTION OF THE NEC	3-35
3-4	SUMMARY STATISTICS FOR DATASET NEC006 MEASURED NEAR THE SIDE BULKHEAD NEAR THE FRONT OF THE FIRST COACH ON THE 25 HZ SECTION OF THE NEC	3-36
3-5	SUMMARY STATISTICS FOR MAGNETIC FIELD LEVELS MEASURED NEAR THE SIDE BULKHEAD NEAR THE FRONT OF THE FIRST COACH ON THE 25 HZ SECTION OF THE NEC	3-38
3-6	SUMMARY STATISTICS FOR MAGNETIC FIELD LEVELS MEASURED AT THE EDGE OF THE AISLE AT THE FRONT OF THE FIRST COACH ON THE 25 HZ SECTION OF THE NEC	3-39
3-7	SUMMARY STATISTICS FOR MAGNETIC FIELD LEVELS MEASURED AT THE EDGE OF THE AISLE AT THE MIDDLE OF THE FIRST COACH ON THE 25 HZ SECTION OF THE NEC	3-40
3-8	SUMMARY STATISTICS FOR MAGNETIC FIELD LEVELS MEASURED AT THE EDGE OF THE AISLE NEAR THE REAR OF THE FIRST COACH ON THE 25 HZ SECTION OF THE NEC	3-41

LIST OF TABLES (CONT'D)

<u>Table</u>	<u>Page</u>
3-9 SUMMARY STATISTICS FOR MAGNETIC FIELD LEVELS MEASURED NEAR THE AISLE OF THE SEVENTH COACH ON THE 25 HZ SECTION OF THE NEC	3-42
3-10 SUMMARY STATISTICS FOR MAGNETIC FIELD LEVELS MEASURED NEAR THE SIDE BULKHEAD OF THE SEVENTH COACH ON THE 25 HZ SECTION OF THE NEC	3-43
3-11 SUMMARY STATISTICS FOR MAGNETIC FIELDS MEASURED IN COACHES ON THE 25 HZ SECTION OF THE NEC	3-44
3-12 SUMMARY STATISTICS FOR MAGNETIC FIELD LEVELS MEASURED AT THE EDGE OF THE AISLE AT THE FRONT OF THE FIRST COACH ON THE 60 HZ SECTION OF THE NEC	3-46
3-13 SUMMARY STATISTICS FOR MAGNETIC FIELD LEVELS MEASURED AT THE EDGE OF THE AISLE AT THE REAR OF THE SEVENTH COACH ON THE 60 HZ SECTION OF THE NEC	3-47
3-14 SUMMARY STATISTICS FOR MAGNETIC FIELD LEVELS MEASURED NEAR THE SIDE BULKHEAD OF THE SEVENTH COACH ON THE 60 HZ SECTION OF THE NEC	3-48
3-15 SUMMARY STATISTICS FOR MAGNETIC FIELD LEVELS MEASURED IN COACHES ON THE 60 HZ SECTION OF THE NEC	3-49
3-16 SUMMARY STATISTICS FOR MAGNETIC FIELD LEVELS MEASURED AT THE EDGE OF THE AISLE AT THE FRONT OF THE FIRST COACH ON THE NON- ELECTRIFIED SECTION OF THE NEC	3-51
3-17 SUMMARY STATISTICS FOR MAGNETIC FIELDS MEASURED IN THE COACHES ON THE NON- ELECTRIFIED SECTION OF THE NEC	3-52
3-18 SUMMARY STATISTICS FOR MAGNETIC FIELD LEVELS MEASURED AT THE EDGE OF THE AISLE IN THE FIFTH COACH ON THE NON-ELECTRIFIED SECTION OF THE NEC	3-53
3-19 SUMMARY STATISTICS FOR MAGNETIC FIELD LEVELS AT THE EDGE OF THE AISLE AT THE FRONT OF THE FIRST COACH ON THE NORTH JERSEY COAST (LONG BRANCH) LINE	3-56

LIST OF TABLES (CONT'D)

<u>Table</u>	<u>Page</u>
3-20 SUMMARY STATISTICS FOR MAGNETIC FIELD LEVELS AT THE REAR OF THE LAST COACH ON THE NORTH JERSEY COAST (LONG BRANCH) LINE	3-57
3-21 SUMMARY STATISTICS FOR MAGNETIC FIELDS IN THE COACHES ON THE NORTH JERSEY COAST (LONG BRANCH) LINE	3-58
3-22 COMPARISON OF MAGNETIC FIELD LEVELS IN COACHES OPERATED ON VARIOUS SECTIONS OF THE NORTHEAST CORRIDOR AND ON THE NORTH JERSEY COAST (LONG BRANCH) LINE	3-59
3-23 SUMMARY OF ELF ELECTRIC FIELD LEVELS WITHIN THE COACHES	3-72
4-1 DISTRIBUTION OF THE SIXTEEN WAVEFORM DATASETS ACROSS MEASUREMENT LOCATIONS WITHIN THE LOCOMOTIVE CAB AND RAILROAD SECTION	4-5
4-2 SUMMARY OF MAGNETIC FIELD LEVELS RECORDED IN THE FIREMAN'S SEAT IN THE REAR CAB OF THE LOCOMOTIVE WITH THE DIGITAL AUDIO TAPE RECORDER (DAT)	4-21
4-3 STATISTICAL SUMMARY OF MAGNETIC FIELDS MEASURED IN LOCOMOTIVE CABS USING RMS RECORDERS	4-24
4-4 SUMMARY STATISTICS FOR DATASETS NEC032 AND NEC035 MEASURED AT THE LEFT OF THE ENGINEER'S SEAT IN THE REAR CAB OF A LOCOMOTIVE ON THE 25 HZ SECTION OF THE NEC	4-26
4-5 SUMMARY STATISTICS FOR DATASET NEC033 MEASURED AT THE RIGHT OF THE FIREMAN'S SEAT IN THE REAR CAB OF A LOCOMOTIVE ON THE 25 HZ SECTION OF THE NEC	4-27
4-6 SUMMARY STATISTICS FOR DATASETS NEC032, NEC033 AND NEC034 MEASURED IN THE REAR CAB OF A LOCOMOTIVE ON THE 25 HZ SECTION OF THE NEC	4-28
4-7 SUMMARY STATISTICS FOR DATASETS NEC026, NEC029 AND PART OF NEC030 MEASURED AT THE LEFT OF THE ENGINEER'S SEAT IN THE REAR CAB OF A LOCOMOTIVE ON THE 60 HZ SECTION OF THE NEC	4-29

LIST OF TABLES (CONT'D)

<u>Table</u>	<u>Page</u>
4-8 SUMMARY STATISTICS FOR DATASET NEC027 MEASURED AT THE RIGHT OF THE FIREMAN'S SEAT IN THE REAR CAB OF A LOCOMOTIVE ON THE 60 HZ SECTION OF THE NEC	4-30
4-9 SUMMARY STATISTICS FOR DATASETS NEC026, NEC027, NEC029 AND PART OF NEC030 MEASURED IN THE REAR CAB OF A LOCOMOTIVE ON THE 60 HZ SECTION OF THE NEC	4-32
4-10 SUMMARY STATISTICS FOR DATASETS NEC022 AND NEC023 MEASURED AT THE LEFT OF THE ENGINEER'S SEAT IN THE CAB OF A DIESEL- ELECTRIC LOCOMOTIVE ON THE NON-ELECTRIFIED SECTION OF THE NEC	4-34
4-11 SUMMARY STATISTICS FOR DATASET NEC025 MEASURED AT THE RIGHT OF THE FIREMAN'S SEAT IN THE CAB OF A DIESEL-ELECTRIC LOCOMOTIVE ON THE NON-ELECTRIFIED SECTION OF THE NEC	4-35
4-12 SUMMARY STATISTICS FOR DATASETS NEC022, NEC023 AND NEC025 MEASURED IN THE CAB OF A DIESEL-ELECTRIC LOCOMOTIVE ON THE NON- ELECTRIFIED SECTION OF THE NEC	4-36
4-13 SUMMARY STATISTICS FOR APPROPRIATE PARTS OF DATASETS NEC050 AND NEC051 MEASURED AT THE LEFT OF THE ENGINEER'S SEAT IN THE REAR CAB OF A LOCOMOTIVE OPERATING ON THE 60 HZ SECTION OF THE NORTH JERSEY COAST LINE	4-38
4-14 SUMMARY STATISTICS FOR PART OF DATASET NEC050 MEASURED AT THE LEFT OF THE ENGINEER'S SEAT IN THE REAR CAB OF A LOCOMOTIVE STANDING AT THE LONG BRANCH STATION ON THE 60 HZ SECTION OF THE NORTH JERSEY COAST LINE	4-40
5-1 REPETITIVE MAGNETIC FIELD WAVEFORM DATASETS MEASURED ALONG THE WAYSIDE	5-3
5-2 SUMMARY OF MAGNETIC FIELD LEVELS RECORDED AT THE WAYSIDE WITH THE DIGITAL AUDIO TAPE RECORDER (DAT)	5-9

LIST OF TABLES (CONT'D)

<u>Table</u>	<u>Page</u>
5-3 STATISTICAL SUMMARY OF MAGNETIC FIELD LEVELS MEASURED AT THE WAYSIDE OF THE NORTH JERSEY COAST LINE FOR SIX MINUTES BRACKETING THE TIME WHEN A TRAIN PASSED	5-10
5-4 SUMMARY STATISTICS FOR DATASETS NEC039 AND NEC040 MEASURED AT THE WAYSIDE OF THE 25 HZ SECTION OF THE NEC NEAR PRINCETON JUNCTION, NJ	5-11
5-5 SUMMARY STATISTICS FOR DATASET NEC041 MEASURED AT THE WAYSIDE OF THE 60 HZ SECTION OF THE NEC IN RYE, NY	5-14
5-6 SUMMARY STATISTICS FOR DATASETS NEC047 AND NEC053 MEASURED AT THE WAYSIDE OF THE NEW JERSEY TRANSIT NORTH JERSEY COAST LINE NEAR RED BANK, NJ	5-17
5-7 SUMMARY STATISTICS FOR DATASET NEC053 MEASURED AT THE WAYSIDE OF THE NEW JERSEY TRANSIT NORTH JERSEY COAST LINE NEAR RED BANK, NJ	5-19
5-8 AVERAGE AND MAXIMUM MAGNETIC FIELD LEVELS AT DISCRETE DISTANCES FROM THE NEAREST TRACK BASED ON MEASURED MAGNETIC FIELD LEVELS AT THREE LOCATIONS	5-26
5-9 DISTANCE FROM THE TRACK AT WHICH AVERAGE AND MAXIMUM MAGNETIC FIELD LEVELS WILL REACH 1.0 MG BASED ON EXTRAPOLATION OF DATA MEASURED AT THREE LOCATIONS	5-26
5-10 MEASURED ELECTRIC FIELD LEVELS AT WAYSIDE LOCATIONS	5-28
6-1 REPETITIVE MAGNETIC FIELD WAVEFORM DATASETS MEASURED ON THE STATION PLATFORMS AND IN WAITING AREAS	6-4
6-2 SUMMARY OF MAGNETIC FIELD LEVELS RECORDED ON STATION PLATFORMS WITH THE DIGITAL AUDIO TAPE RECORDER (DAT)	6-9
6-3 SUMMARY STATISTICS FOR DATASET NEC038 MEASURED ON THE PLATFORM OF THE PRINCETON JUNCTION STATION ON THE 25 HZ SECTION OF THE NEC	6-12

LIST OF TABLES (CONT'D)

<u>Table</u>	<u>Page</u>
6-4 SUMMARY STATISTICS FOR DATASETS NEC042 AND NEC043 MEASURED ON THE PLATFORM OF THE NEW ROCHELLE STATION ON THE 60 HZ SECTION OF THE NEC	6-13
6-5 SUMMARY STATISTICS FOR DATASET NEC046 MEASURED ON THE PLATFORM OF THE RED BANK STATION ON THE 60 HZ SECTION OF THE NORTH JERSEY COAST LINE	6-14
6-6 SUMMARY STATISTICS FOR DATASET NEC021 MEASURED IN THE PASSENGER WAITING AREA OF THE BOSTON SOUTH STATION ON THE NON-ELECTRIFIED PORTION OF THE NEC	6-15
6-7 SUMMARY STATISTICS FOR DATASET NEC031 MEASURED IN THE PASSENGER WAITING AREA OF THE NEW YORK PENN STATION ON THE 25 HZ SECTION OF THE NEC	6-16
6-8 COMPARISON OF AVERAGE AND MAXIMUM MAGNETIC FIELD LEVELS MEASURED AT RAILROAD PLATFORMS AND WAITING AREAS WITH THREE DIFFERENT INSTRUMENTS	6-17
7-1 REPETITIVE MAGNETIC FIELD WAVEFORM DATASETS MEASURED NEAR SUBSTATIONS	7-6
7-2 MAGNETIC FIELD PROFILE DATA MEASURED NEAR SUBSTATIONS	7-7
7-3 STATISTICAL SUMMARY OF MAGNETIC FIELDS MEASURED BENEATH THE 345 KV TRANSMISSION LINE JUST OUTSIDE THE RED BANK SUBSTATION USING RMS RECORDERS	7-17
7-4 SUMMARY STATISTICS FOR MAGNETIC FIELDS MEASURED ON THE SIDEWALK OUTSIDE THE PRINCETON JUNCTION SUBSTATION ON THE 25 HZ PORTION OF THE NEC	7-20
7-5 SUMMARY STATISTICS FOR MAGNETIC FIELDS MEASURED 1.5 M (5 FT) ABOVE THE STATION PLATFORM OUTSIDE THE MT. VERNON 60 HZ SUBSTATION	7-22
7-6 SUMMARY STATISTICS FOR MAGNETIC FIELDS MEASURED 1 M (3.3 FT) ABOVE GROUND 2 M (6.6 FT) OUTSIDE THE GATE OF THE MT. VERNON 60 HZ SUBSTATION	7-23

LIST OF TABLES (CONT'D)

<u>Table</u>	<u>Page</u>
7-7 SUMMARY STATISTICS FOR MAGNETIC FIELDS MEASURED 1 M (3.3 FT) ABOVE THE GROUND AT VARIOUS DISTANCES FROM THE GATE OF THE MT. VERNON SUBSTATION	7-24
7-8 SUMMARY STATISTICS FOR MAGNETIC FIELDS MEASURED OUTSIDE THE RED BANK SUBSTATION (60 HZ SECTION OF THE NORTH JERSEY COAST LINE) NEAR THE ENTERING 345 KV TRANSMISSION LINE	7-26
7-9 SUMMARY STATISTICS FOR 60 HZ MAGNETIC FIELD MEASUREMENTS MADE AROUND THE PERIPHERY OF THE RED BANK SUBSTATION WITH THE PROFILER	7-27
8-1 STATISTICAL SUMMARY OF MAGNETIC FIELDS MEASURED IN THE DISPATCH AREA AND UPS ROOM OF BOSTON'S SOUTH STATION USING AN RMS RECORDER	8-7
8-2 SUMMARY STATISTICS FOR DATASET NEC019 MEASURED IN FRONT OF A CETC CONSOLE IN THE DISPATCHER'S AREA OF BOSTON'S SOUTH STATION	8-9
8-3 SUMMARY STATISTICS FOR DATASET NEC020 MEASURED IN THE UNINTERRUPTIBLE POWER SUPPLY ROOM ADJACENT TO THE DISPATCHER'S AREA IN BOSTON'S SOUTH STATION	8-10

VOLUME II

TABLE OF CONTENTS

<u>Section</u>	<u>Page</u>
APPENDIX A DESCRIPTION OF APPENDED DATA	A-1
APPENDIX B DATASET NEC001 - HOME COACH AT WINDOW - 25 HZ NEC	B-1
APPENDIX C DATASET NEC002 - HOME COACH AT WINDOW - 25 HZ NEC	C-1
APPENDIX D DATASET NEC003 - HOME COACH AT AISLE - 25 HZ NEC	D-1
APPENDIX E DATASET NEC004 - HOME COACH AT AISLE - 25 HZ NEC	E-1
APPENDIX F DATASET NEC005 - FRONT OF FIRST COACH AT WINDOW - 25 HZ NEC	F-1
APPENDIX G DATASET NEC006 - FRONT OF FIRST COACH AT WINDOW - 25 HZ NEC	G-1
APPENDIX H DATASET NEC007 - FRONT OF FIRST COACH AT AISLE - 25 HZ NEC	H-1
APPENDIX I DATASET NEC008 - FRONT OF FIRST COACH AT AISLE - 25 HZ NEC	I-1
APPENDIX J DATASET NEC009 - REAR OF FIRST COACH AT AISLE - 25 HZ NEC	J-1
APPENDIX K DATASET NEC010 - FRONT OF FIRST COACH AT AISLE - 60 HZ NEC	K-1
APPENDIX L DATASET NEC011 - HOME COACH AT AISLE - 60 HZ NEC	L-1
APPENDIX M DATASET NEC012 - HOME COACH AT AISLE - 60 HZ NEC	M-1
APPENDIX N DATASET NEC013 - HOME COACH AT WINDOW, TRANSITION FROM 60 HZ TO NON-ELECTRIFIED PORTION OF NEC	N-1
APPENDIX O DATASET NEC014 - HOME COACH AT AISLE NON-ELECTRIFIED NEC	O-1
APPENDIX P DATASET NEC015 - HOME COACH AT AISLE NON-ELECTRIFIED NEC	P-1

TABLE OF CONTENTS (CONT'D)

<u>Section</u>	<u>Page</u>
APPENDIX Q DATASET NEC016 - FRONT OF FIRST COACH AT AISLE NON-ELECTRIFIED NEC	Q-1
APPENDIX R DATASET NEC017 - HOME COACH AT AISLE NON-ELECTRIFIED NEC	R-1
APPENDIX S DATASET NEC018 - VERTICAL PROFILE AT DISPATCHER'S SEAT	S-1
APPENDIX T DATASET NEC019 - HORIZONTAL PROFILE AT DISPATCHER'S SEAT	T-1
APPENDIX U DATASET NEC020 - VERTICAL PROFILE IN UNINTERRUPTABLE POWER SUPPLY ROOM	U-1
APPENDIX V DATASET NEC021 - VERTICAL PROFILE AT THE PASSENGER WAITING AREA AT THE SOUTH STATION - NON-ELECTRIFIED NEC	V-1
APPENDIX W DATASET NEC022 - VERTICAL PROFILE AT ENGINEER'S SEAT - DIESEL-ELECTRIC LOCOMOTIVE	W-1
APPENDIX X DATASET NEC023 - VERTICAL PROFILE AT THE ENGINEER'S SEAT - DIESEL-ELECTRIC LOCOMOTIVE	X-1
APPENDIX Y DATASET NEC024 - HORIZONTAL PROFILE ALONG CENTERLINE OF CAB - DIESEL-ELECTRIC LOCOMOTIVE	Y-1
APPENDIX Z DATASET NEC025 - VERTICAL PROFILE AT FIREMAN'S SEAT - DIESEL-ELECTRIC LOCOMOTIVE	Z-1
APPENDIX AA DATASET NEC026 - VERTICAL PROFILE AT THE ENGINEER'S SEAT - ELECTRIC LOCOMOTIVE, 60 HZ NEC	AA-1
APPENDIX AB DATASET NEC027 - VERTICAL PROFILE AT THE FIREMAN'S SEAT -ELECTRIC LOCOMOTIVE, 60 HZ NEC	AB-1
APPENDIX AC DATASET NEC028 - HORIZONTAL PROFILE AT THE CENTERLINE OF THE CAB - ELECTRIC LOCOMOTIVE, 60 HZ NEC	AC-1
APPENDIX AD DATASET NEC029 - VERTICAL PROFILE AT THE ENGINEER'S SEAT - ELECTRIC LOCOMOTIVE, 60 HZ NEC	AD-1

TABLE OF CONTENTS (CONT'D)

<u>Section</u>	<u>Page</u>
APPENDIX AE DATASET NEC030 - VERTICAL PROFILE AT THE ENGINEER'S SEAT OF THE ELECTRIC LOCOMOTIVE AT THE TRANSITION FROM THE 60 HZ TO 25 HZ SECTIONS OF THE NEC	AE-1
APPENDIX AF DATASET NEC031 - VERTICAL PROFILE AT THE PASSENGER WAITING AREA OF NEW YORK'S PENN STATION - 25 HZ NEC	AF-1
APPENDIX AG DATASET NEC032 - VERTICAL PROFILE AT ENGINEER'S SEAT - ELECTRIC LOCOMOTIVE, 25 HZ NEC	AG-1
APPENDIX AH DATASET NEC033 - VERTICAL PROFILE AT FIREMAN'S SEAT -ELECTRIC LOCOMOTIVE CAB, 25 HZ NEC	AH-1
APPENDIX AI DATASET NEC034 - HORIZONTAL PROFILE ALONG CENTERLINE OF CAB - ELECTRIC LOCOMOTIVE, 25 HZ NEC	AI-1
APPENDIX AJ DATASET NEC035 - VERTICAL PROFILE AT THE ENGINEER'S SEAT - ELECTRIC LOCOMOTIVE, 25 HZ NEC	AJ-1
APPENDIX AK DATASET NEC036 - FIRST COACH AT AISLE, 25 HZ NEC	AK-1
APPENDIX AL DATASET NEC037 - VERTICAL PROFILE ON SIDEWALK OUTSIDE PRINCETON JUNCTION 25 HZ SUBSTATION	AL-1
APPENDIX AM DATASET NEC038 - VERTICAL PROFILE ON STATION PLATFORM - PRINCETON JUNCTION, 25 HZ NEC	AM-1
APPENDIX AN DATASET NEC039 - VERTICAL PROFILE AT THE WAYSIDE, 25 HZ NEC	AN-1
APPENDIX AO DATASET NEC040 - VERTICAL PROFILE* AT THE WAYSIDE, 25 HZ NEC	AO-1
APPENDIX AP DATASET NEC041 - VERTICAL PROFILE AT WAYSIDE, 60 HZ NEC	AP-1
APPENDIX AQ DATASET NEC042 - VERTICAL PROFILE ON STATION PLATFORM - NEW ROCHELLE, 60 HZ NEC	AQ-1

TABLE OF CONTENTS (CONT'D)

<u>Section</u>	<u>Page</u>
APPENDIX AR DATASET NEC043 - VERTICAL PROFILE ON STATION PLATFORM - NEW ROCHELLE, 60 HZ NEC	AR-1
APPENDIX AS DATASET NEC044 - HORIZONTAL PROFILE AWAY FROM SUBSTATION FENCE - MT. VERNON STATION AND 60 HZ SUBSTATION	AS-1
APPENDIX AT DATASET NEC045 - HORIZONTAL PROFILES OUTSIDE THE GATE OF THE MT. VERNON 60 HZ SUBSTATION	AT-1
APPENDIX AU DATASET NEC046 - VERTICAL PROFILES ON STATION PLATFORM - RED BANK, NORTH JERSEY COAST LINE	AU-1
APPENDIX AV DATASET NEC047 - VERTICAL PROFILE AT THE WAYSIDE - NORTH JERSEY COAST LINE (60 HZ)	AV-1
APPENDIX AW DATASET NEC048 - COACH MEASUREMENTS - NORTH JERSEY COAST LINE (60 HZ)	AW-1
APPENDIX AX DATASET NEC049 - VERTICAL PROFILE AT THE ENGINEER'S SEAT - ELECTRIC LOCOMOTIVE, NORTH JERSEY COAST LINE	AX-1
APPENDIX AY DATASET NEC050 - VERTICAL PROFILE AT THE ENGINEER'S SEAT - ELECTRIC LOCOMOTIVE, NORTH JERSEY COAST LINE	AY-1
APPENDIX AZ DATASET NEC051 - ELECTRIC LOCOMOTIVE CAB MEASUREMENTS - NORTH JERSEY COAST LINE	AZ-1
APPENDIX BA DATASET NEC052 - VERTICAL PROFILE OUTSIDE THE RED BANK SUBSTATION - BENEATH THE ENTERING TRANSMISSION LINE	BA-1
APPENDIX BB DATASET NEC053 - VERTICAL PROFILE AT THE WAYSIDE - NORTH JERSEY COAST LINE (60 HZ)	BB-1

1. EXECUTIVE SUMMARY

This report documents the low frequency electric and magnetic fields associated with the operation of the AMTRAK and Metro North Northeast Corridor (NEC) rail system. The study and data analysis was complicated by the existence of three different rail technologies along the existing route. The section of the NEC between Washington, DC and New York City is electrically powered by a 25 Hz ("Hz" is defined as cycles per second) catenary system. The section between New York City and New Haven, CT is electrically powered by a 60 Hz catenary system. At present, the section between New Haven and Boston still operates under diesel power. A fourth technology in service on the New Jersey Transit System was measured under the assumption that it might be representative of the technology which will replace the non-electrified section in the near future. Figure 1-1 shows the general location of the routes along which the measurements were made.

1.1 BACKGROUND

Prior to conducting the measurements and analysis reported on in this document, a similar but less extensive study had been conducted on the Transrapid TR07 Maglev Vehicle operating on its test track in Emsland, Germany^{1,2}. That study utilized a recently-developed instrumentation package, the *MultiWave*[™] System, developed under sponsorship of the Electric Power Research Institute (EPRI). This system could quantify the magnetic field both spatially and temporally. The *MultiWave*[™] data from the Maglev study demonstrated that the frequency characteristics of the magnetic fields on the Maglev system were not like magnetic fields around transmission and distribution lines. To assess the difference in electric and magnetic field levels and time characteristics which the public and rail workers might experience if Maglev technology were widely utilized in the United States, it became apparent that data from other electrified rail systems would be required for comparison. The NEC is one of two rail systems which have been measured within the FRA research program to gather the desired electric and magnetic field database. Measurements were also made on two urban mass transit systems.

The *MultiWave*[™] System used for the TR07 measurements was transportable, but required a local 60 Hz power supply. For this series of studies, it was repackaged into a truly portable system with a battery pack for power. This repackaged system is hereinafter referred to as the waveform capture system. The magnetic field sensors were mounted in a staff to make rapid set-up and measurements possible. An electric field sensor was added to give a simultaneous indication of the electric field in the area of the magnetic field measurements. Two other monitoring techniques were also used to augment the data-collection process. A TEAC Model RD 130T digital audio tape (DAT) recorder and two EMDEX recorders (personal dosimeters hereinafter referred to as rms

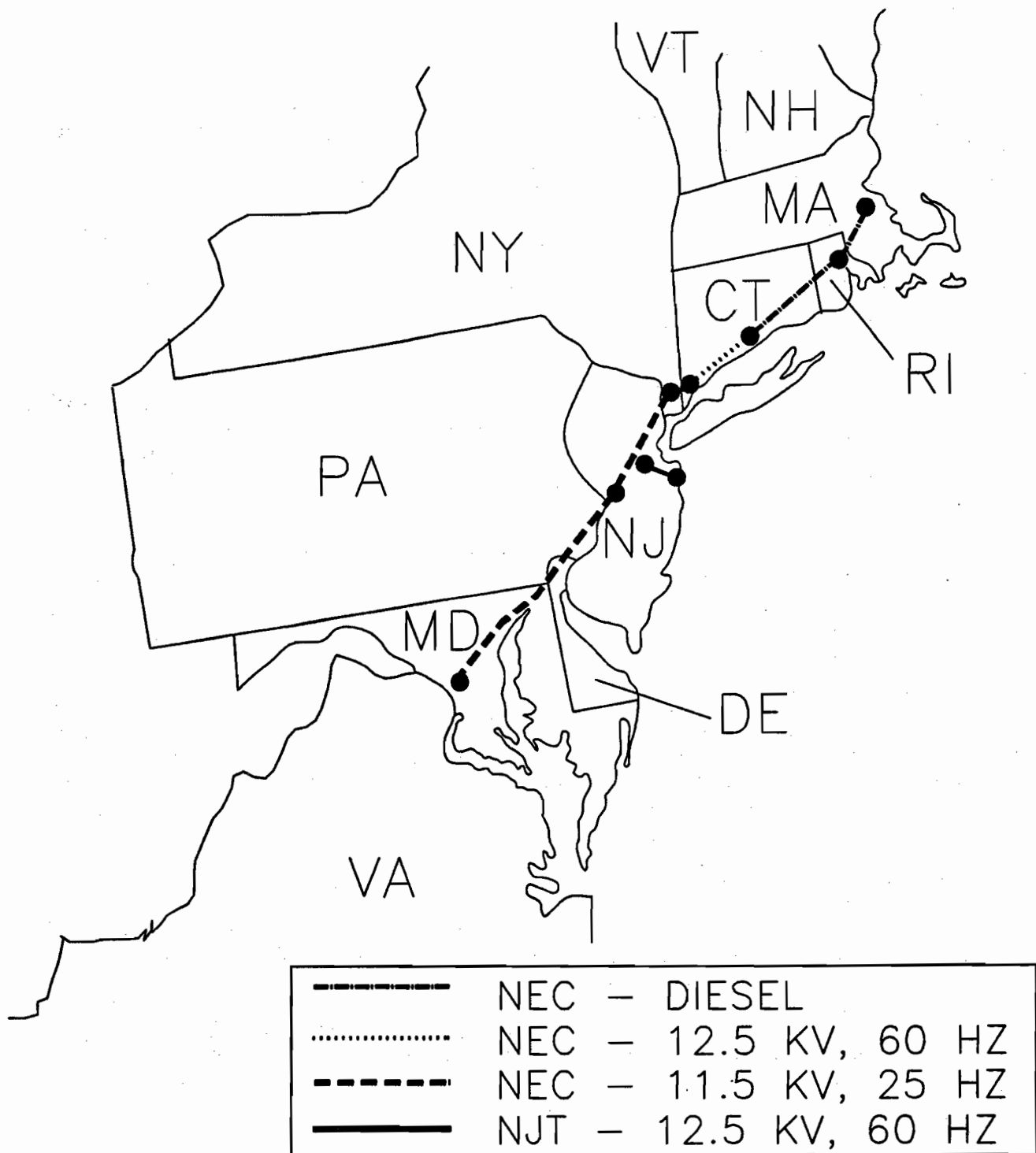

FIGURE 1-1. ROUTE OF THE AMTRAK AND METRO NORTH NORTHEAST CORRIDOR (NEC) PLUS THE NEW JERSEY TRANSIT (NJT) MATAWAN TO LONG BRANCH ROUTE

recorders) were used concurrently with most of the waveform capture measurements.

1.2 MEASUREMENT APPROACH

The magnetic field and electric field measurements associated with the study were grouped into four areas. They were onboard the trains, in the passenger stations, along the track rights-of-way, and near the substations which supply power to the rail system.

Onboard, the train measurements were made in the passenger coaches and in the engineer's cab. The field sources identified were: the traction power and control equipment on the locomotive, the catenary-track circuit, and the "Hotel Power" circuits for light, heat and air conditioning.

At the stations, electric and magnetic field measurements were taken at both ends of the platforms at points nearest the track where a person could reasonably stand. If the station layout permitted, measurements were made 3 m (9.2 ft) away from this portion perpendicular to the track to establish attenuation rates of the magnetic field.

Wayside measurements were made to quantify the field environment in areas open to the general public. "Wayside" refers to the public accesses along the system of track rights-of-way. Field measurements were made with no trains on the track and during times of passing trains.

Power substation measurements were made near the substation fences and under the connected transmission lines. If magnetic fields were sufficiently stable over time, power frequency magnetic fields were measured at incremental distances from the substation or line to quantify field attenuation rates and field distribution patterns.

1.3 SUMMARY OF ELECTRIFIED RAILROAD FIELD LEVELS

The following is a concise description of the time-varying magnetic field characteristics at each of the areas examined. Static magnetic fields from sources other than the natural field of the earth were not detected anywhere except in the diesel-electric locomotive. Similarly, electric fields are only mentioned in those situations where significant fields from sources other than routine electrical facilities like electric lights were detected.

1.3.1 Coaches

The magnetic fields in coaches operating on the electrified sections arose from current in the catenary and returning through the track circuit and averaged 134 mG, 52 mG, and 19 mG, respectively, on the 25 Hz section of the corridor, the 60 Hz section of the corridor, and the North Jersey Coast Line (Long Branch). Figure 1-2 (which is Figure 3-23 of the Onboard Coach

Comparison of Average AC Magnetic Field For the Four Technologies

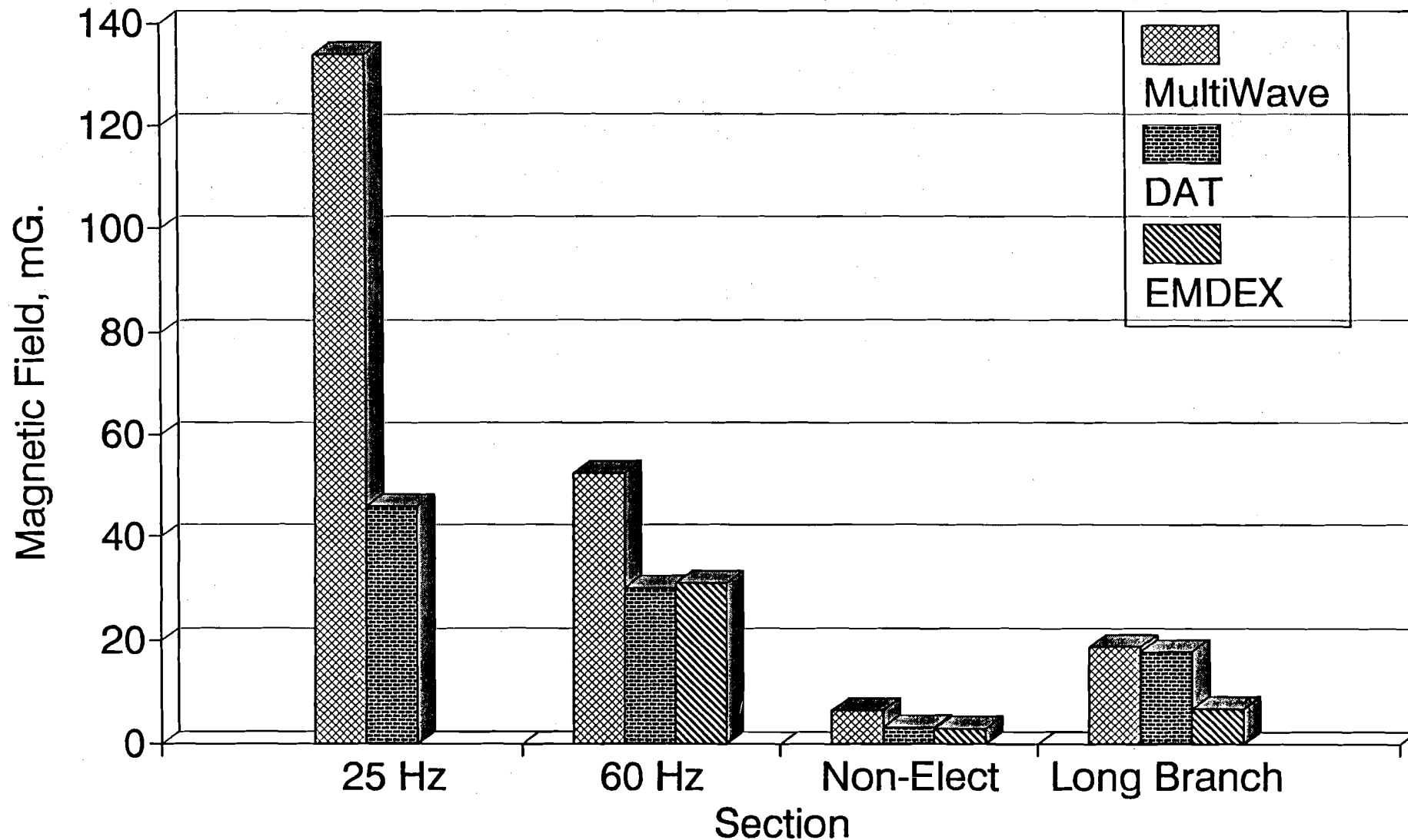

FIGURE 1-2. COMPARISON OF THE AVERAGE TIME-VARYING MAGNETIC FIELD LEVELS IN COACHES OPERATING ON VARIOUS SECTIONS OF THE NEC AND THE NORTH JERSEY COAST LINE MEASURED IN DIFFERENT WAYS

Measurements Section) depicts these values in a bar graph. Maximum field values were 628 mG, 305 mG, and 61 mG, respectively, for the three electrified railroad sections. By contrast, the average and maximum time-varying magnetic fields in the coaches on the non-electrified portion of the corridor arising from normal onboard "hotel" power and appliances were 6 mG and 13 mG, respectively. The magnetic field was relatively uniform throughout the coaches on the electrified rail sections and had frequency components consisting of the catenary current frequency and its odd harmonics.

1.3.2 Locomotive Cabs

Current in the catenary and track circuit was the principal magnetic field source throughout the locomotive cabs, but sources beneath the floor of the cab and in the machinery portion of the locomotive also contributed to the magnetic field environment. The average time-varying magnetic field measured with the waveform capture system in the cabs of the locomotives on the 25 Hz section of the NEC, the 60 Hz section of the NEC, and on the North Jersey Coast Line were 46 mG, 28 mG and 32 mG, respectively. Maximum field values for the same locomotives were 213 mG, 97 mG, and 85 mG, respectively. Average and maximum time-varying magnetic fields in the diesel-electric locomotive were 2 mG and 9 mG, respectively. The magnetic fields in the cabs of the electric locomotives had greater spatial variability and less temporal variability than those in the coaches. The contribution of 60 Hz magnetic fields from the locomotives which were highly location dependent tended to be more uniform over time than the fields from the current in the catenary and tracks. The frequency components of the electric fields in the locomotive cabs were principally 60 Hz and the odd harmonics thereof, except when the train was on the 25 Hz section of the corridor. In that case, the fields in the cab were at 25 Hz, 60 Hz, and the odd harmonics of both 25 and 60 Hz. The magnetic field in the cab of the diesel-electric locomotive was low but had a peculiar frequency spectrum producing a significant proportion of the field energy in the upper end of the ELF band (from 305 Hz to 2560 Hz).

1.3.3 Railroad Waysides

The magnetic field along the wayside of electrified railroads arises almost exclusively from current in the catenary and tracks. The magnetic fields from parallel 138 kV transmission lines along the 25 Hz portion of the NEC are very small and not easily detected in the presence of the field from the principal (catenary) source. However, once the train leaves the section of track (between substations, autotransformers, or phase breaks) where the measurements were made, the current in the track and catenary decreases to low levels and the magnetic field becomes less than 1.0 mG. Furthermore, the magnetic field at the railroad wayside attenuates rapidly as one moves away from the tracks. The average magnetic field 15.3 m (50 ft) from the nearest track was determined to be 4.6 mG, 4.2 mG and 1.5 mG, respectively, at measurement locations along the 25 Hz section of the NEC, the 60 Hz section of the NEC, and the North Jersey Coast Line. The corresponding

maximum magnetic field levels 15.3 m (50 ft) from the nearest track are 21 mG, 28 mG and 28 mG, respectively. Electric fields also exist along the wayside, produced by the voltage on the catenaries, the return wire (on the 60 Hz section of the NEC) and the transmission lines (on the 25 Hz section of the NEC). The highest electric field exists near the 25 Hz portion of the corridor (285 V/m at 12.2 m [40 ft.] away) because of the contribution of the 138 kV transmission line. On the autotransformer-fed 60 Hz section of the NEC, the electric field is lower (60 V/m at 6.7 m [22 ft.] away) due to the electric field cancellation caused by the opposite-phased 12.5 kV voltages on the catenary and return conductor. The single-fed, 12.5 kV catenary with no parallel transmission lines on the North Jersey Coast Line has electric field levels between those cited for the two sections of the NEC.

1.3.4 Station Platforms

The field environment on the open station platform is an extreme example of wayside fields because the passenger is very close to the tracks and catenary. The average magnetic field levels measured at stations on the 25 Hz section of the NEC, the 60 Hz section of the NEC, and the North Jersey Coast Line are 40 mG, 62 mG, and 29 mG, respectively. The corresponding maximum magnetic fields are 532 mG, 365 mG and 202 mG. Like the wayside magnetic fields, these fields have a large temporal variability as trains arrive and depart. Their frequency components consist of the fundamental frequency of the catenary voltage (25 Hz or 60 Hz) plus the odd harmonics of that fundamental frequency. The electric fields on the station platforms are spatially variable due to shielding by light standards, fences, station overhang, etc., but they are temporally stable due to the controlled voltage of the catenary. The largest electric fields measured at the stations on the 25 Hz section of the NEC, the 60 Hz section of the NEC, and the North Jersey Coast Line are 1.06, 1.20, and 0.69 kV/m. The electric fields on the NEC station platforms are higher than at the North Jersey Coast Line stations because they are elevated platforms.

Magnetic fields in the waiting areas at Boston's South Station (non-electrified) and New York's Penn Station (25 Hz) showed that only the usual indoor ambient magnetic fields arising from building sources and installed electrical appliances, e.g., vending machines, existed in the non-electrified station waiting area, but modest fields (6 mG average, 9 mG maximum) from the railroad electrification system were found in the waiting area at Penn Station.

1.3.5 Electric Power Substations

Only modest strength magnetic fields were found outside substation fences except in areas where entering transmission lines or exiting circuits to the catenary and track were present. In no case were the fields attributable to the substation itself measured at distances more than 15.3 m (50 ft) from the substation, and in most cases, substation fields at the substation fence were comparable to

or less than those found beneath commercial electric distribution lines in the immediate vicinity.

1.3.6 Control Facilities

Measurements in the South Station dispatch area indicated that the principal magnetic field source at a work station (dispatcher's chair) was the video display terminals. The average time-varying magnetic field 60 cm from a display unit was 1.5 mG, having the harmonic-rich frequency spectrum typical of video display units. Magnetic field levels were considerably higher in an uninterruptible power supply (UPS) room adjacent to the dispatch area. The harmonic-rich magnetic field 0.6 m (2 ft) in front of one of the electronic UPS was approximately 60 mG and had a significant portion of its energy in harmonic components above 300 Hz.

1.4 COMPARISON OF ELECTRIC AND MAGNETIC FIELDS OF DIFFERENT ELECTRO-TECHNOLOGIES

Much of the concern about ELF magnetic field levels is driven by uncertainty as to whether such fields exert an adverse effect on human health. Existing scientific knowledge provides no sound insight as to what aspects of ELF magnetic exposure, if any, are of biological concern^{7,10,11,16}. Consequently, public acceptance of magnetic field exposures is presently based more on equity and comparability to other exposures than it is to quantifiable characteristics of the field itself. Therefore, this section compares and contrasts the magnetic fields produced by electrified railroads to magnetic fields produced by other electro-technologies.

1.4.1 Static Fields

The electrified railroads showed no evidence of creating static magnetic fields. Consequently, the only static fields onboard the trains, at the wayside, at stations, or at power substations are the geomagnetic fields of the earth or static fields produced by other nearby sources unrelated to railroad electrification.

The geomagnetic field is perturbed by ferromagnetic material in the coaches and locomotives, the rails, and structural steel in the station platforms, but these effects are not related to electrification and are well within the range of static field perturbation encountered in or near automobiles, highway guardrails, most commercial buildings, etc.

1.4.2 Frequency Spectrum

The frequency characteristics of the magnetic fields onboard or near railroads electrified at 60 Hz are very similar to those near many electrical appliances in that the fundamental component of the

field is 60 Hz and there is significant energy in the odd harmonics. The magnetic fields of the 60 Hz electrified railroads are also similar to the magnetic fields near electric power transmission and distribution lines since the principal component of the field is 60 Hz. However, the magnetic fields onboard or near the electrified railroads have greater harmonic content⁸ than transmission and distribution lines.

The frequency spectrum of the magnetic field onboard and near the 25 Hz section of the NEC (Washington, DC to New York City) is composed of a principal component at 25 Hz and smaller components at the odd harmonics of 25 Hz. Twenty-five Hz magnetic fields are not routinely encountered in the usual magnetic field environment. Although the harmonics of 25 Hz fall within the general range of frequencies produced by electrical appliances, their specific frequencies are usually different.

The frequency characteristics of the magnetic fields within the coaches on the non-electrified section of the NEC arise from 60 Hz electric appliances and 60 Hz electric power distribution. Therefore, as expected, their frequency characteristics resemble those commonly found in the residential environment.

Railroad electrification does not produce any significant electric fields within the train, but at the stations and wayside along the 60 Hz railroad sections, the electric fields are similar in frequency character to those encountered near commercial electric power lines. However, the electric fields near 25 Hz catenaries are predominantly 25 Hz, a frequency of electric field not routinely found in the environment.

1.4.3 Time Characteristics

The magnetic fields onboard electrically-powered trains or near electrified railroads have pronounced temporal variability similar to the variability of magnetic fields near appliances with varying load or intermittent use. These fields have much greater variability than the magnetic fields found near most commercial electric power lines.

The magnetic field within the coaches on the non-electrified portion of the NEC have moderate temporal variability resembling that often encountered in residential or office settings.

The electric fields produced by the railroad catenaries are reasonably stable over time, nearly as stable as electric fields near commercial distribution lines.

1.4.4 Amplitude Characteristics

The measured field levels onboard and near electrified railroad facilities are compared to reported electric and magnetic field levels from various power frequency sources. The lack of electric and magnetic field data in several of the frequency bands,

especially at 25 Hz in the extreme low frequency (ELF) band, diminishes the value of this comparison, but any other approach is unworkable. The reader must be aware that the comparison of the total ELF fields of the electrified railroads, especially the 25 Hz section of the NEC, to the predominantly power frequency environmental field levels currently reported in the literature is an "apples and oranges" comparison because frequency and temporal characteristics have been ignored in this comparison.

1.4.4.1 Coaches - Figure 1-3 (Figure 9-4 in the Conclusions) shows the range of total time-varying magnetic fields measured in the coaches on the three electrified railroad sections as a function of distance from the source (track and catenary). These data are plotted over the graph of typical power line and appliance field levels as reported in the literature⁷. As the graph illustrates, the intensity of the ELF magnetic field inside the coaches is not dependent on the distance from the rails or catenary. The range of magnetic field intensities spans more than two orders of magnitude including the range of magnetic fields found under larger distribution lines through large transmission lines. However, fields of comparable or greater intensity are found close to appliances.

1.4.4.2 Locomotive Cabs - Figure 1-4 (Figure 9-4 in the Conclusions) shows the range of total time-varying magnetic fields recorded in the electric locomotive cabs as a function of distance from the floor because there was a consistently-observed source below the floor. As in the preceding figure, these data are plotted over the graph of typical power frequency magnetic field levels. In this figure, power lines of 69 kV or more are identified as "transmission lines" and power lines less than 69 kV are identified as "distribution lines." From the figure, it is evident that the magnetic field levels in locomotive cabs are within the range of field levels found beneath electric power lines or near appliances.

1.4.4.3 Wayside - The time varying-magnetic field at the wayside appears to attenuate away from the catenary and tracks at a rate very near the theoretical rate of attenuation of a long loop (field is proportional to the reciprocal of the distance to the second power). Figure 1-5 (Figure 9-7 of the Conclusions) shows that the range of magnetic field levels at the wayside at various distances from the track are in the general range of magnetic fields near power lines including distribution lines and moderate-sized transmission lines.

The projected electric field attenuation curves are superimposed on a graph of commonly-encountered electric fields to produce Figure 1-6 (Figure 9-8 in the Conclusions), which shows the upper boundary of expected electric field levels. The minimum electric field can extend to near zero at all distances if shielding objects such as trees or other tall vegetation are present. Again, the range of electric fields is seen to span the range of electric

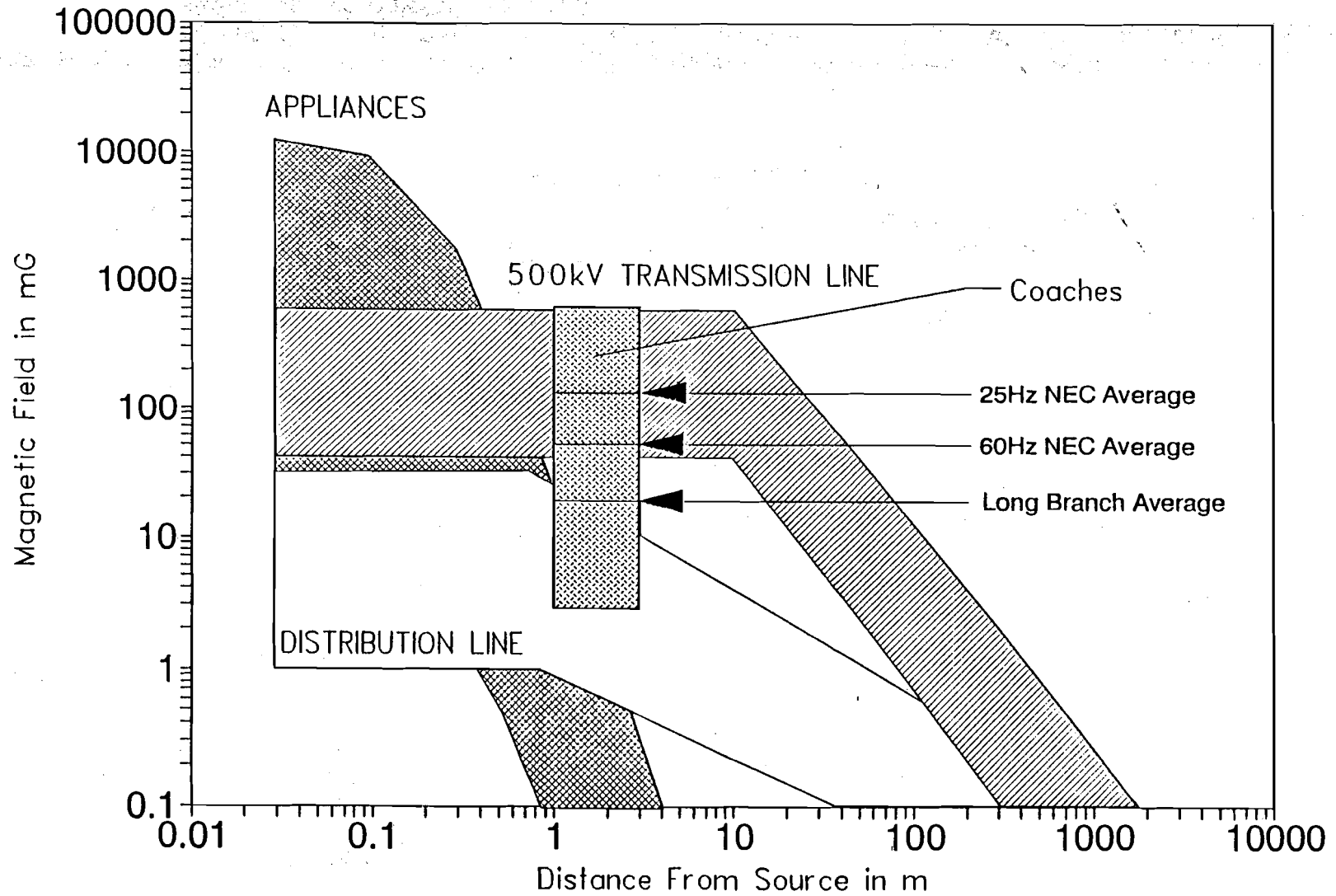

FIGURE 1-3. THE RANGE OF TOTAL TIME-VARYING MAGNETIC FIELD LEVELS IN PASSENGER COACHES COMPARED TO TYPICAL LEVELS OF POWER-FREQUENCY MAGNETIC FIELDS PRODUCED BY COMMON SOURCES

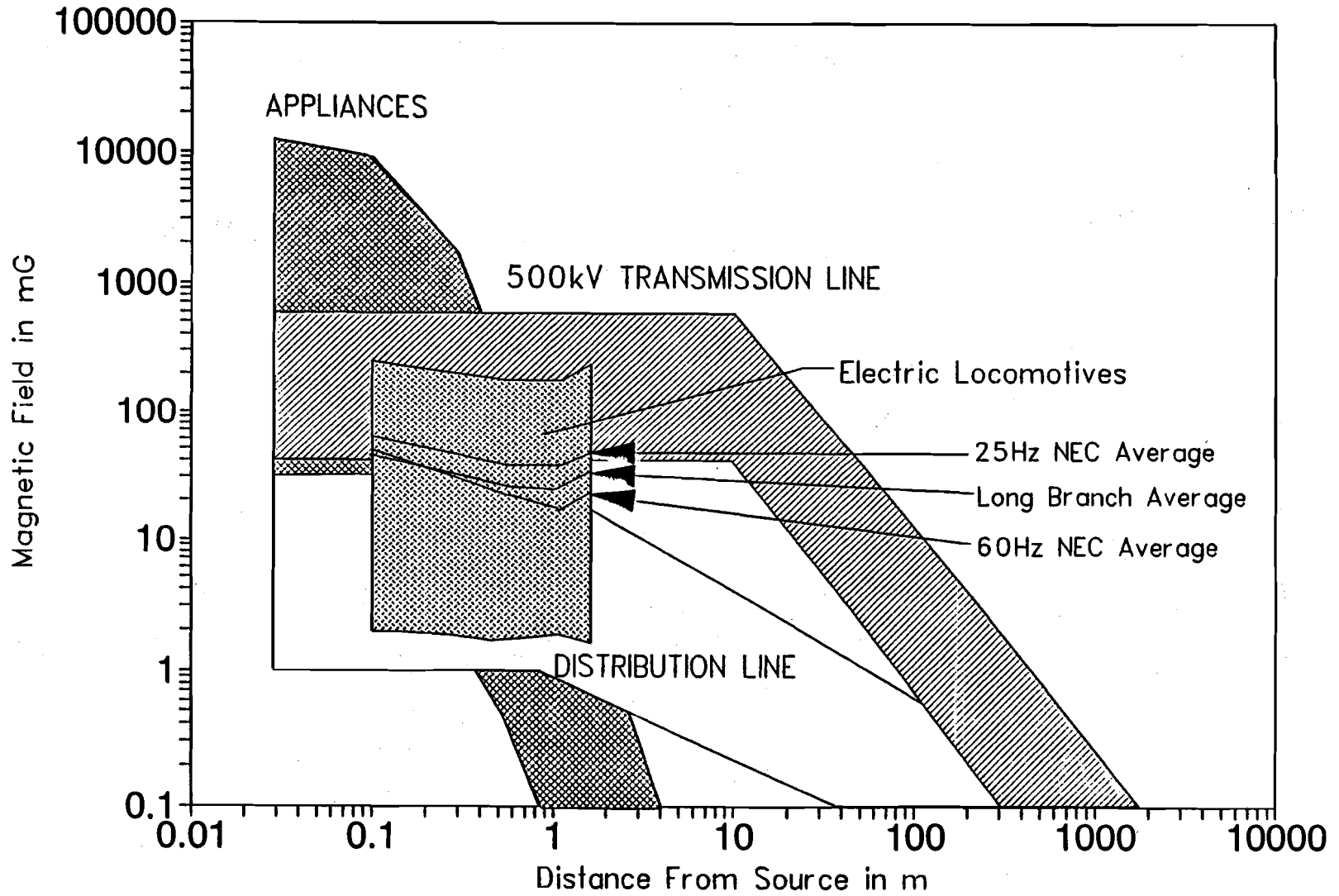

FIGURE 1-4. THE RANGE OF TOTAL TIME-VARYING MAGNETIC FIELD LEVELS IN THE CABS OF ELECTRIC LOCOMOTIVES COMPARED TO TYPICAL LEVELS OF POWER-FREQUENCY MAGNETIC FIELDS PRODUCED BY COMMON SOURCES

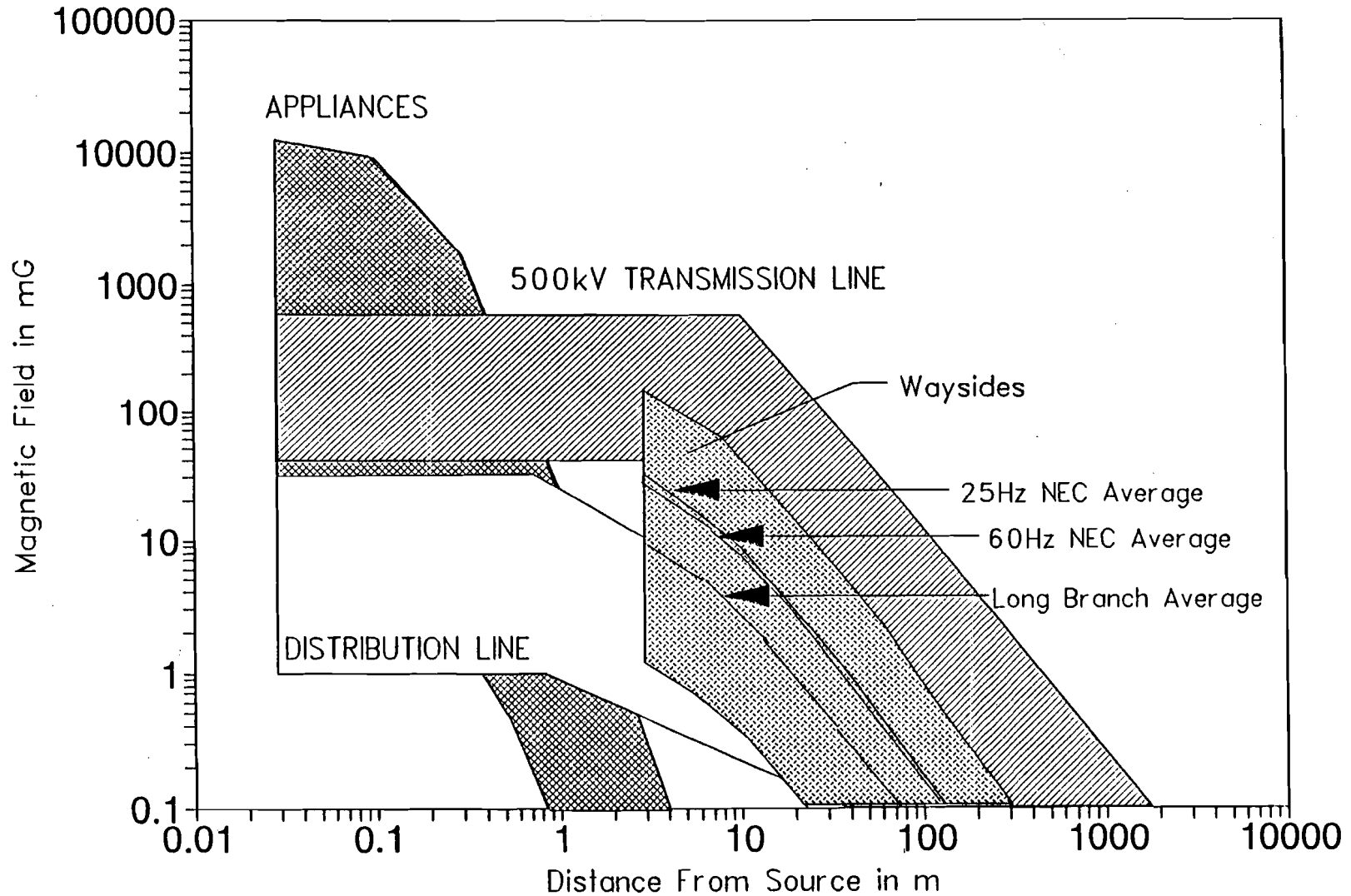

FIGURE 1-5. THE RANGE OF TOTAL TIME-VARYING MAGNETIC FIELD ALONG THE WAYSIDE OF ELECTRIFIED RAILROADS AT VARIOUS DISTANCES FROM THE NEAREST TRACK COMPARED TO TYPICAL LEVELS OF POWER-FREQUENCY MAGNETIC FIELDS PRODUCED BY COMMON SOURCES

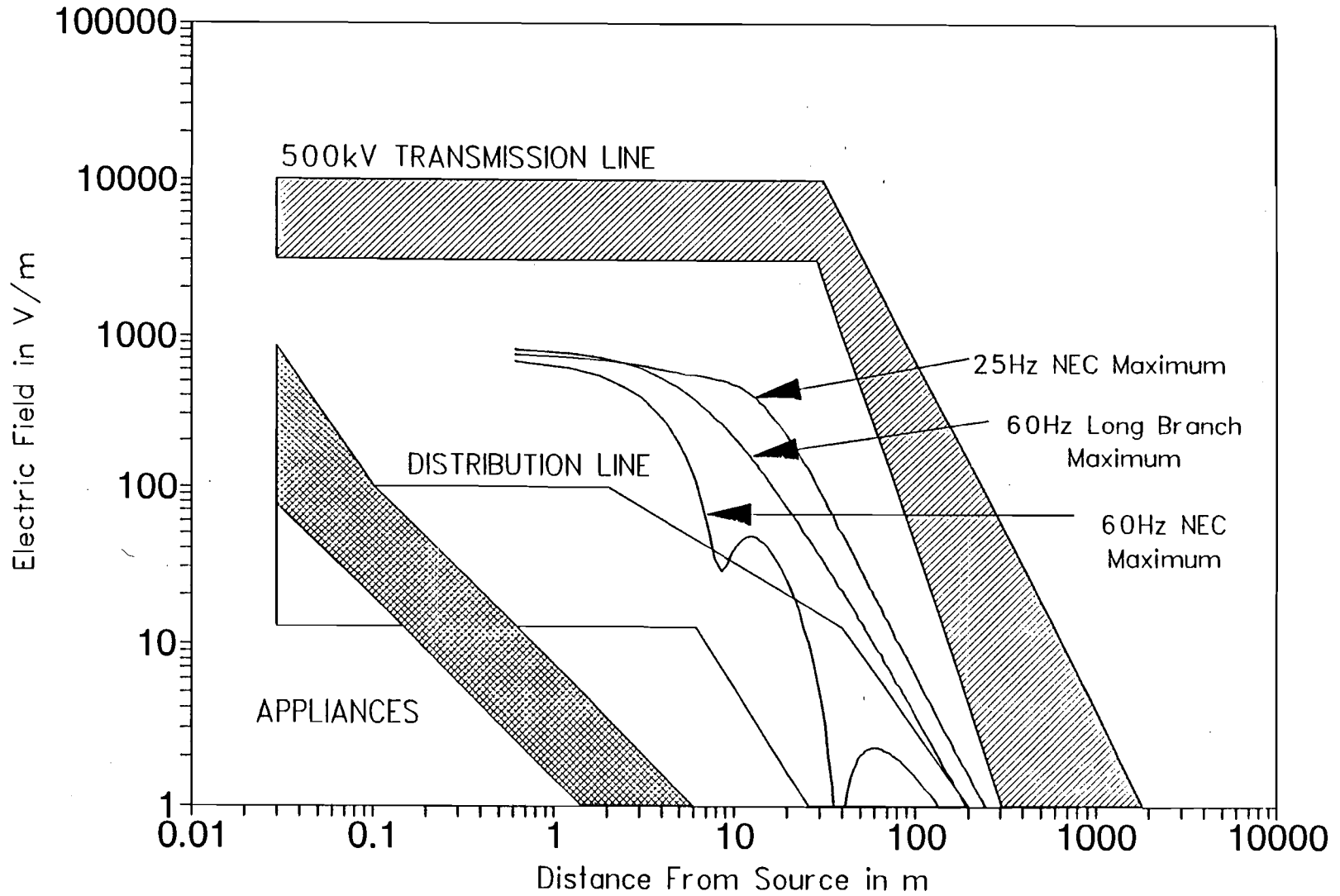

FIGURE 1-6. MAXIMUM TIME-VARYING ELECTRIC FIELD AT THE WAYSIDE OF ELECTRIFIED RAILROADS AS A FUNCTION OF DISTANCE FROM THE NEAREST TRACK COMPARED TO TYPICAL LEVELS OF POWER-FREQUENCY ELECTRIC FIELDS PRODUCED BY COMMON SOURCES

fields produced by electric distribution lines and moderate-sized transmission lines.

1.4.4.4 Passenger Stations - The range of magnetic fields encountered on station platforms is similar to that under electric power lines or within 30 cm or so of electrical appliances. The mean time-varying magnetic field levels measured on station platforms on the three electrified railroad sections are reasonably similar in comparison to the large range of magnetic fields which can be encountered at a station. The electric field levels measured on open station platforms on the three electrified railroad sections are higher than those encountered in most residential or neighborhood environments. However, they are consistent with the electric field levels encountered beneath moderate-sized electric power transmission lines. Electric field levels were lower at many other locations due to the field shielding provided by the platform overhang, by light standards, by fences, and by other tall metallic objects on or near the platform.

1.4.4.5 Substations - Data for the time-varying magnetic field levels measured near substations are typical of those found near transmission distribution lines.

Electric fields from the substations *per se* could not be measured outside the substations because electric fields from the surrounding transmission lines, distribution lines, or catenaries dominated the electric field measurements at each substation location.

2. OVERVIEW

2.1 REPORT ORGANIZATION

This report is organized into an Analysis section (Volume I) and data appendices (Volume II). The extensive appendices of Volume II detail the magnetic fields on or near the electrified railroads for the reader looking for specific details of field characteristics. The body of the report contained in Volume I focuses on the representative data which demonstrate the general characteristics of the magnetic fields on or in the vicinity of the electrified railroads. Summary statistical data, which present the "big picture" to the reader less concerned with the multitude of details in the data appendices, are also presented in Volume I.

The first section of this report is an *Executive Summary* intended for less technical readers. It describes the magnetic fields produced by the AMTRAK and Metro North Northeast Corridor and the New Jersey Transit North Jersey Coast Line (conclusions reached from these measurements are given in language which avoids engineering jargon to the greatest extent practical). In spite of its non-technical nature, it is recommended to all readers as an orientation to the report contents which will assist the technical reader in critically examining the contents of the report.

Section 2 is an overview which seeks to describe the report structure in more detail and direct the reader to other sources of relevant information not contained herein. It also provides some background information about the measurement program, describes instrumentation, explains the significance of the repetitive waveform data, the method of analysis, the format of presentation, and certain other items relevant to the report as a whole.

Sections 3 through 8 focus on the characteristics of the magnetic fields measured onboard the coaches, within the engineer's areas, along the wayside, at stations, near power supply facilities, and near control facilities, respectively.

The final section (Section 9) of the report summarizes the magnetic field characteristics of the electrified railroads and compares the characteristics of those fields to magnetic fields produced by other common sources.

2.2 BACKGROUND

The increasing public awareness of the controversy over possible health implications due to exposure to magnetic fields makes it desirable to quantify the magnetic fields associated with use or operation of all electrical apparatus. Previous measurements have characterized the magnetic fields onboard the TR07 magnetically levitated vehicle and near associated equipment^{1,2}. Similar measurements were made on board AMTRAK electrified trains and near

the facilities of the Northeast Corridor (NEC). These provide baseline magnetic field data on conventional, historically well-accepted transportation technologies against which the magnetic field environment of emerging technologies may be compared. Additional magnetic field measurements were made onboard trains and adjacent to facilities of New Jersey Transit's North Jersey Coast Line from Matawan to Long Branch. That section of the railroad is electrified using somewhat newer technology and, except for the catenary voltage, is similar to the electrification technology proposed for the NEC segment from New Haven to Boston.

To fully quantify the electromagnetic environment of conventional American electrified railroads, an exhaustive set of measurements was made onboard trains, in the engineer's areas, at stations, along the wayside, in control facilities, and near power supply facilities. These measurements were made for a variety of operating conditions. However, before the amplitude, time, and frequency characteristics of the fields are discussed, some general background information on magnetic fields must be discussed.

2.2.1 Natural Magnetic Field Characteristics

The earth's naturally-occurring geomagnetic field is generally considered to be static, i.e., not variable over time (in some literature, static fields are referred to as dc fields). The earth's field is normally steady in polarity (or dc-like, or static) at levels between 240 milligauss in Southern Brazil to 670 milligauss at the magnetic South Pole. In any region of the earth's surface, fluctuations will occur during solar magnetic disturbances. These fluctuations normally have frequencies that are less than one hundredth of a cycle per second, but may have minor oscillations as high as 1000 cycles per second. The magnitude of these fluctuations is normally largest at the lowest frequencies and in the polar regions. Mid-latitude variations of 2 to 4 milligauss are common during strong solar storms with frequencies less than one hundredth of a cycle per second. In polar regions, solar magnetic disturbances will exceed ± 20 milligauss fluctuations. Therefore, the natural environment is made up of magnetic fields with both spatial and temporal characteristics.

2.2.2 Technological Magnetic Field Perturbations

Man-made ferromagnetic structures and electro-technologies perturb these natural magnetic fields. In close proximity to building and vehicle steel, increases or decreases relative to the earth's unperturbed geomagnetic field of two-to-one are readily observed. Any electrical device that draws significant current for operation or uses magnetic material will create magnetic field intensities close to the device that are of the order of naturally occurring magnetic fields.

Most electrical devices in common usage are powered by alternating current (ac) sources. The magnetic fields produced have the frequency of the power source and weaker harmonics (sub or super) which result from the device's operating characteristics. On the North American continent, the dominant power source frequency is 60 cycles per second (the engineering and scientific communities have agreed to refer to cycles per second as hertz and to further shorten the reference by using the abbreviation Hz: e.g., in Europe most power systems are 50 Hz). Therefore, most electro-technology magnetic fields produced are primarily at these power frequencies. The magnitudes of magnetic fields at the power frequencies range from fractions of milligauss in rural residences to tens of gauss near high-current-carrying conductors found in many commercial and industrial facilities. Many commonly-used household appliances such as high speed hair dryers and handheld drills exhibit power frequency magnetic fields well above one gauss in close proximity to the appliance.

2.2.3 Electric and Magnetic Fields and Biological Effects

Since the late 1800s, electro-technologies have been perturbing the natural electromagnetic environment. In the early 1970s, the subject of electric fields surfaced as a possible health concern when electric utilities tried to gain rights-of-way for power transmission lines. Transmission lines were one of a small number of electro-technologies that produced strong power frequency electric fields where there is public access. The transmission lines at the center of the controversy were a new technology in that the operating voltage was 60% higher than previous design. The frequency characteristics were unchanged. While magnetic fields were raised as a biological issue in the 1970s because of a Navy submarine communications project, it was not until 1979 that magnetic fields appeared as a possible health concern. It was suggested that there was a weak correlation with an increased risk of childhood leukemia for populations living near distribution lines. While the first such study was considered to be technically flawed, two subsequent, improved epidemiological studies continued to find a consistent pattern when a surrogate for magnetic fields, power lines with large conductors and proximity to the cases, were documented. In 1992 Swedish researchers reported on finding a somewhat stronger association for childhood leukemia for children living in close proximity to transmission lines in Sweden¹⁶. Starting with the assertion of biological effects from electric fields, and redoubled with emergence of the magnetic field effect hypothesis, laboratory scientists have reported many electric and magnetic field effects found by *in vitro* (tissue culture preparations) and *in vivo* (whole animal studies) experiments^{7,17}.

Many of the laboratory studies and a concurrent body of clinical studies have reported effects which appear to result from exposure to fields with a wide range of magnitudes and frequencies. To explain these observations, hypotheses such as "cyclotron resonance," which links the co-existence of static and ac fields, have been offered. Because much of the controversy has been

focused on determining if transmission lines can be cited, most of the laboratory effort has been directed at the very selective power frequencies, 50 and 60 Hz. Yet many reported results have little to do with the power frequencies. Many studies report findings in the few hertz to tens of hertz frequency band. There are reports of findings when the exposure repetition rate was above the power frequencies. Some studies suggest the duration of exposure is important. Other studies suggest that both intensity (magnitude) and frequency "windows" exist, i.e., above or below a certain region no effect is observed. Some studies suggest that the transition from one field level to another is important, others debate whether magnetic fields act directly on the body or via induced currents. Few of these studies have been replicated and no accepted mechanism of interaction of environmentally relevant electric or magnetic field exists.

In the absence of an accepted mechanism, many have chosen to relegate the reported effect of electric and magnetic fields to the category of "pathological science" (a term coined by the late Irving Langmuir). However, the persistence of public concern necessitates that any serious attempt at magnetic field quantification which claims to serve as a basis for evaluating possible health effects must not be an inadvertently selective measure of magnitude at a single or narrow band of frequencies. In the extreme, if health effects are found, the continuum of electromagnetic exposure may be required to establish relative risk. Practically, it has only recently become possible to record and store all of the discrete segments of frequency bands which biological reports suggest may be important. Based on the biological studies reported to 1992, the electrified railroad measurements focused on the 0 to 3000 Hz portion of the electromagnetic spectrum.

2.3 AN APPROACH TO ORGANIZING ELECTROMAGNETIC DATA

The magnetic field environment over the desired frequency range from 0 to 3000 Hz can be efficiently recorded with excellent resolution using the repetitive field waveform recording system described in the following subsection. Unlike most systems, which merely report the total magnetic field over their frequency range, the repetitive field waveform recording system was operated during the electrified railroad tests in a manner which detects the magnetic field in very narrow frequency bands across the spectrum from 0 to 2562 Hz. Initial tests indicated that there were no significant components of the magnetic field in the frequency range from 2562 Hz to 3000 Hz on or near the electrified railroad facilities. Consequently, data were recorded over the smaller band of 0 to 2562 Hz in order to achieve a twofold increase in the amount of recordings that could be saved in the recorder. The effective frequency resolution in the NEC data is 1 Hz increments from 0 to 100 Hz and 5 Hz increments up to 2562.5 Hz. All magnetic fields having frequency less than 0.5 Hz are classified as static fields in this report even though they may change in value over longer time scales of tens of seconds or minutes.

The data collected in this manner brackets most of the frequency bandwidth implicated by the biological findings discussed briefly above. Both temporal and spatial quantification in and around the electrified railroads are available. Because each of these measurements was repeated every few seconds to gain a measure of the long term temporal characteristics of the magnetic fields, an extremely large as well as comprehensive dataset exists. The challenge of this report has been to reduce this data without losing the uniqueness of the information. Also to maximize the utility of the data, it must be presented so that it can be compared to data collected on the magnetic field characteristics of other electro-technologies.

To this end, the following aggregation was chosen for this evaluation. It was observed in a previous maglev EMF study^{1,2}, and is also being followed in an ongoing project to establish a rigorous protocol for quantifying the magnetic fields associated with appliances. Shown in pictorial form in Figure 2-1, this system allows for the grouping of data into frequency bands where effects have been reported and/or other datasets have been collected. The two large boxes depict the frequency regions defined by IEEE Std 100-1988³ as Ultra Low Frequency (ULF), which covers the frequency range from 3 Hz down to static, and Extreme Low Frequency (ELF), which covers the frequency band from 3 Hz to 3000 Hz. Other organizations and agencies sometimes define these bands differently, but the IEEE definitions will be used throughout this report. The boxes within the large boxes depict the partitioning which was chosen to present clearly but succinctly the findings of the electrified railroad measurements. Although the frequency groupings of the measurement data indicated as the smaller boxes do not correspond exactly with the ELF and ULF band limits indicated as the larger boxes, the aggregation illustrated in Figure 2-1 effectively divides the field measurement data into bands consistent with the definitions of the ULF and ELF frequency bands.

The partitioning in Figure 2-1 also allows for comparison with data collected by less sophisticated instruments. In particular, one instrument which has come into wide use in the utility industry has a bandwidth between 40 Hz and 1000 Hz⁹. Other survey meters only respond to the power frequency band.

2.4 INSTRUMENTATION

The principal instrumentation system used for magnetic field measurements on the electrified railroads was a portable version of the waveform capture system recorder. The waveform capture system was augmented with a digital audio tape recorder to obtain a continuous record of magnetic field levels at one location. RMS personal exposure monitors were also used to document the significance of personal movement throughout the train. A magnetic field profiler and electric field meter were also used for some of the tests.

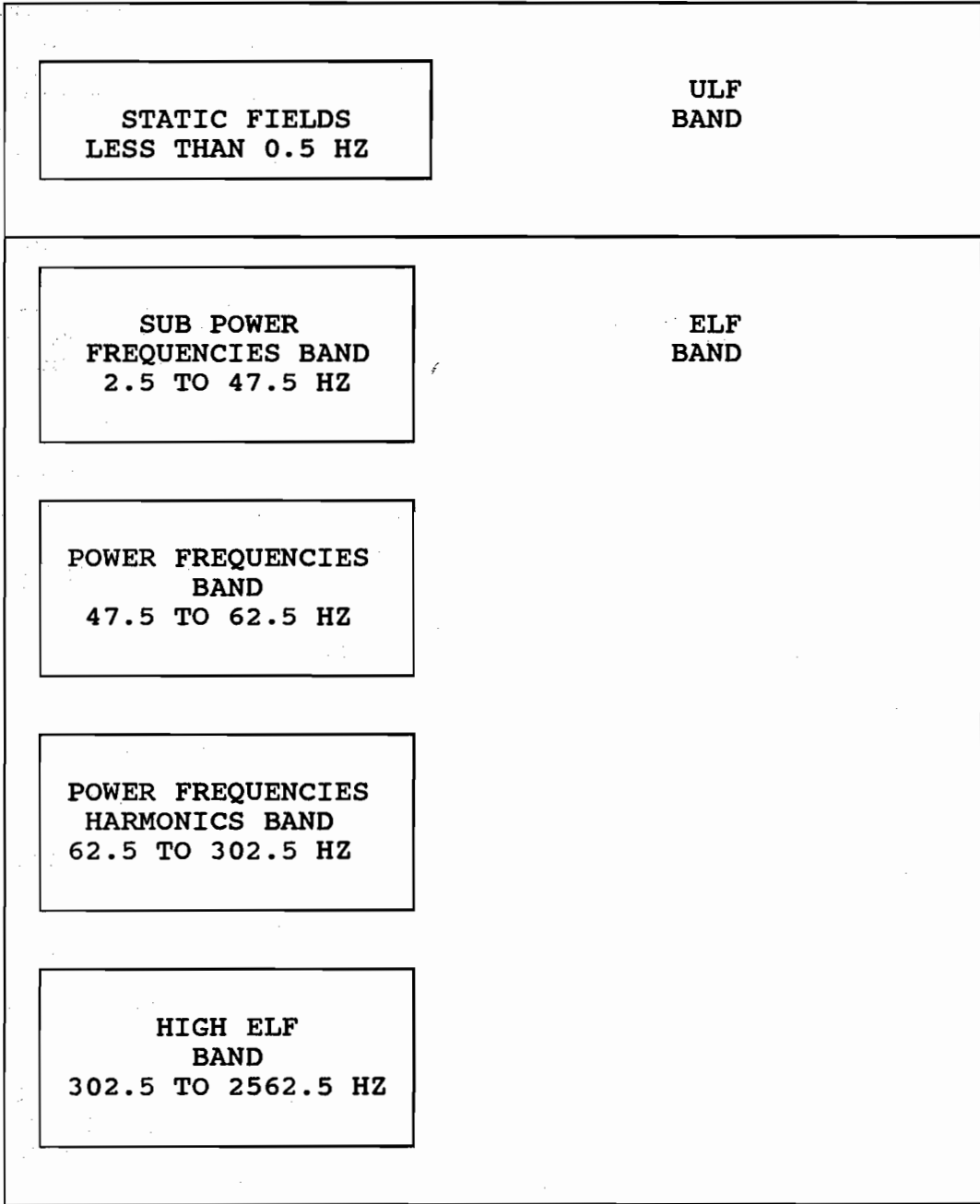

FIGURE 2-1. MAGNETIC FIELD FLUX DENSITIES GROUPED BY FREQUENCY PARTITIONS WITHIN THE ELF BAND AND ULF BAND

2.4.1 Portable Waveform Capture System

The portable repetitive field waveform recording system used in the electrified railroad tests is a version of the waveform capture system recorder used for the TRANSRAPID TR07 measurements^{1,2} but optimized for measurements on transportation systems. The magnetic field waveform recording approach utilized by the waveform capture system has already been reported^{1,8}. The portable version configured for transportation system measurements employs the same measurement philosophy and software nearly identical to the standard waveform capture system software in the following ways:

- A high performance 386-based notebook computer replaces the larger portable computer
- A battery-powered system box has been developed to house the input signal programmable amplifiers, the analog-to-digital conversion circuitry, and the bus interface to the computer.
- 32 input channels (10 3-axis signals and 2 single-axis signals) can be monitored simultaneously
- Fluxgate magnetometers with improved range (0-5 Gauss) and improved frequency response (0-3 kHz) are used as input sensors
- Miniaturized coil type sensors with improved frequency response (5 Hz to 3 kHz) used as input sensors if the total field exceeds 5 gauss
- Anti-aliasing filters included in the design
- Increased sampling rate
- Interface to a DAT recorder provided
- Four sensors incorporated into a measurement staff.

The functional significance of these changes are as follows:

- The improved waveform capture system is now truly portable
- ac power is not required for operation
- ac and dc magnetic fields are measured simultaneously at the same locations
- Measurement staff ensured rapid accurate placement of four sensors for field profile measurements.

The portable waveform capture system was operated throughout the electrified railroad tests in modes which produce data directly comparable to the data previously obtained with the EPRI-based design on the TRANSRAPID TR07 Maglev system^{1,2}. Hence the results reported for the TR07 system can be compared directly to the results reported herein for conventional electrified railroads.

2.4.2 Digital Audio Tape Recorder

The repetitive field waveform recording system is a sampling-type recording system in the sense that it records the magnetic field environment in great detail for a brief period of time (0.2 to 1.0 seconds) then pauses for a period of time (5 to 60 seconds) before

initiating another detailed sample. Hence, there is a possibility that the repetitive field waveform recording system could miss capturing brief events such as rapid field transients if they are very rare. In order to determine whether the sampling recording system was failing to capture rare short-term events, a Teac Model RD 130T digital audio tape recorder (DAT) was connected to the analog output port of the waveform capture system's reference probe. This permitted the DAT to make continuous recordings of the three-axis field (0-2500 Hz 2.5 Gauss full scale) at the reference probe. Three additional channels of the DAT made continuous recordings of the ac field (3-2500 Hz) amplified by a factor of ten to ensure enough resolution for accurate recording of the higher frequency components.

2.4.3 EMDEX-II Recorders

The Electric and Magnetic Digital Exposure (EMDEX) (hereinafter referred to as "rms") meters developed for the Electric Power Research Institute are convenient and useful instruments for monitoring personal exposure to magnetic fields from power systems. Their broadband response is nominally 40 to 800 Hz which is adequate to capture the fundamental and low order harmonic components of the magnetic fields from 50 Hz or 60 Hz power systems. Unfortunately the pass band of the rms meter is not sufficient to accurately capture the fundamental component of the 25 Hz magnetic field produced by the catenary current on the southern half of the corridor. Nevertheless, the rms recorders were used throughout the measurement programs as personal exposure monitors to determine the extent to which stationary field measurements correlate with exposure of a passenger moving throughout the train. As will be shown in the next section, instruments such as the rms recorder can give seriously misleading results when the principal field source spectrum is outside their frequency pass band.

2.4.4 Magnetic Field Profiler

A computer-based magnetic field profiler was used to facilitate magnetic field measurements around some of the electric power substations providing service to the electrified railroad. This instrument, constructed by ERM, is a three-axis magnetic field meter coupled to a distance measuring wheel. The onboard computer measures the magnitude of the three orthogonal components of the magnetic field at .3 m (1 ft) increments as the device is rolled around the substation or along radials away from the substation. Interchangeable bandpass filters allow the profiler to measure 25 Hz and 60 Hz fields separately.

2.5 REPETITIVE WAVEFORM DATA

As described in the Maglev Report², the repetitive field waveform recording system records the actual waveform of the three orthogonal components of the magnetic field at multiple measurement

locations by sampling those waveforms at a high rate and storing the values digitally on computer disk or computer tape. The three individual components can be converted to the total field by vector summation if desired later during analysis. These digital waveform recordings are saved one after another in rapid succession. Any one of these waveform recordings can be viewed individually in either the time or frequency domain to get a "snapshot view" of the waveform or frequency spectrum of the magnetic field at the particular instant in time when the waveform sample was recorded. Unfortunately, these "snapshots" when viewed individually have little statistical validity and tell little about the evolution of magnetic field characteristics over time as the train speeds up, slows down, makes use of its dynamic braking, passes the station, and so on. In order to examine these questions of statistical and temporal variability of the magnetic field, many of these "snapshots" must be played back in rapid succession to produce a "moving picture" of the magnetic field at each measurement location.

The measurement protocol applied for the electrified railroad measurements generally involved the use of five fluxgate magnetic field (B) sensors arrayed in such a way that spatial variability of the magnetic field could be characterized. Since magnetic fields onboard or near the train can arise from numerous sources, each with different temporal characteristics, the spatial pattern of the magnetic field is a dynamic characteristic which must be assessed from the "moving picture" of the magnetic field obtained from analysis of the repetitive waveform samples.

A list of the repetitive waveform datasets collected during the measurements on the electrified railroads is given in Table 2-1. The table also identifies the nature of the measurement, the measurement time, and the sample time for each of the 51 datasets.

Table 2-1 also gives numerical codes for staff and reference sensor locations which are described in more detail later in the report. The analysis method applied to these repetitive waveform datasets is described in detail in a previous report². The information contained in each of the 51 datasets has been processed using the procedure described in the following subsection and is presented in detail in Appendices B through BB in Volume II of this report.

2.6 DAT WAVEFORM DATA

Three-axis magnetic field waveforms from the waveform capture system reference sensor were recorded using the digital audio tape recorder. Two recordings were made of each orthogonal component (axis) of the field: one of the signal directly from the magnetometer; and a second of the signal with the static component filtered out and the time-varying components amplified (usually by a factor of ten) to provide better resolution of higher frequency components. Over eight hours of real-time recordings were produced for the test conditions reported in Table 2-2.

TABLE 2-1

INDEX OF REPETITIVE WAVEFORM DATA
 NORTHEAST CORRIDOR MEASUREMENTS
 MARCH 30 - APRIL 3, 1992

DATA FILE NUMBER	APPENDIX CONTAINING DATA	DATE/TIME	PROBE LOCATION			SAMPLE INTERVAL, SECONDS	NUMBER OF SAMPLES	LOCATION AND TYPE OF MEASUREMENT
			FIG.	STAFF	REF.			
		MAR 30						
NEC001	B	10:50-11:09	3-1	1	3	60	20	REAR COACH, AT WINDOW, 25 Hz SECTION
NEC002	C	11:15-11:21	3-1	1	3	5	61	SAME
NEC003	D	11:23-11:29	3-1	2	3	5	60	REAR COACH AT AISLE, 25 Hz SECTION
NEC004	E	11:32-11:41	3-1	2	3	60	10	SAME
NEC005	F	11:56-12:03	3-1	10	-	5	61	FRONT OF FIRST COACH AT WINDOW, 25 Hz SECTION
NEC006	G	12:07-12:18	3-1	10	-	60	12	SAME
NEC007	H	12:22-12:28	3-1	9	-	5	61	FRONT OF FIRST COACH AT AISLE, 25 Hz SECTION
NEC008	I	12:30-12:39	3-1	9	-	60	10	SAME
NEC009	J	12:46-12:56	3-1	7	-	5	102	REAR OF FIRST COACH AT AISLE, 25 Hz SECTION
NEC010	K	14:20-14:36	3-1	9	-	5	153	FRONT OF FIRST COACH AT AISLE, 60 Hz SECTION

TABLE 2-1

INDEX OF REPETITIVE WAVEFORM DATA
 NORTHEAST CORRIDOR MEASUREMENTS
 MARCH 30 - APRIL 3, 1992 (CONT'D)

DATA FILE NUMBER	APPENDIX CONTAINING DATA	DATE/TIME	PROBE LOCATION			SAMPLE INTERVAL, SECONDS	NUMBER OF SAMPLES	LOCATION AND TYPE OF MEASUREMENT
			FIG.	STAFF	REF.			
NEC011	L	14:56-15:04	3-1	4	3	5	71	REAR COACH AT AISLE, 60 Hz SECTION
NEC012	M	15:06-15:32	3-1	4	3	60	27	SAME
NEC013	N	15:34-16:12	3-1	5	3	60	39	REAR COACH AT WINDOW, TRANSITION FROM 60 Hz SECTION TO DIESEL SECTION
NEC014	O	16:15-16:24	3-1	4	3	60	10	REAR COACH AT AISLE, DIESEL SECTION
NEC015	P	16:27-16:33	3-1	4	3	5	61	SAME
NEC016	Q	16:46-16:55	3-1	8	-	5	76	FRONT OF FIRST COACH AT AISLE, DIESEL SECTION
NEC017	R	17:05-17:33	3-1	6	3	60	29	REAR COACH AT AISLE, DIESEL SECTION
		MAR 31						
NEC018	S	07:52-07:55	8-1	48	-	5	39	BOSTON DISPATCH AREA-CETC CONSOLE, VERTICAL PROFILE
NEC019	T	08:00-08:02	8-1	49	-	5	24	BOSTON DISPATCH AREA-CETC CONSOLE, HORIZONTAL PROFILE
NEC020	U	08:07-08:09	8-2	50	-	5	24	BOSTON DISPATCH AREA UPS ROOM

TABLE 2-1

INDEX OF REPETITIVE WAVEFORM DATA
 NORTHEAST CORRIDOR MEASUREMENTS
 MARCH 30 - APRIL 3, 1992 (CONT'D)

DATA FILE NUMBER	APPENDIX CONTAINING DATA	DATE/TIME	PROBE LOCATION			SAMPLE INTERVAL, SECONDS	NUMBER OF SAMPLES	LOCATION AND TYPE OF MEASUREMENT
			FIG.	STAFF	REF.			
NEC021	V	08:26-08:28				5	24	SOUTH STATION PASSENGER WAITING AREA
NEC022	W	09:24-09:29	4-1	20	-	5	49	DIESEL LOCOMOTIVE, VERTICAL PROFILE AT ENGINEER'S SEAT
NEC023	X	09:30-09:49	4-1	20	-	60	20	SAME
NEC024	Y	09:57-10:00	4-1	22	-	5	10	DIESEL LOCOMOTIVE, HORIZONTAL PROFILE, ALONG CENTERLINE OF CAB
NEC025	Z	10:02-10:05	4-1	23	-	5	11	DIESEL LOCOMOTIVE, VERTICAL PROFILE AT FIREMAN'S SEAT
NEC026	AA	12:29-12:34	4-1	24	25	5	56	ELECTRIC LOCOMOTIVE (60 Hz) VERTICAL PROFILE AT ENGINEER'S SEAT
NEC027	AB	12:37-12:42	4-1	26	25	5	60	ELECTRIC LOCOMOTIVE (60 Hz) VERTICAL PROFILE AT FIREMAN'S SEAT
NEC028	AC	12:45-12:48	4-1	27	25	5	28	ELECTRIC LOCOMOTIVE (60 Hz) HORIZONTAL PROFILE AT CENTERLINE OF CAB
NEC029	AD	12:49-13:23	4-1	24	25	60	34	ELECTRIC LOCOMOTIVE (60 Hz) VERTICAL PROFILE AT ENGINEER'S SEAT
NEC030	AE	13:49-13:58	4-1	24	25	5	100	ELECTRIC LOCOMOTIVE TRANSITION FROM (60-25 Hz) VERTICAL PROFILE AT ENGINEER'S SEAT

TABLE 2-1

INDEX OF REPETITIVE WAVEFORM DATA
 NORTHEAST CORRIDOR MEASUREMENTS
 MARCH 30 - APRIL 3, 1992 (CONT'D)

DATA FILE NUMBER	APPENDIX CONTAINING DATA	DATE/TIME	PROBE LOCATION			SAMPLE INTERVAL, SECONDS	NUMBER OF SAMPLES	LOCATION AND TYPE OF MEASUREMENT
			FIG.	STAFF	REF.			
NEC031	AF	15:04-15:07				5	36	PENN STATION PASSENGER WAITING AREA
NEC032	AG	15:21-15:28	4-1	24	25	5	79	ELECTRIC LOCOMOTIVE (25 Hz) VERTICAL PROFILE AT ENGINEER'S SEAT
NEC033	AH	15:29-15:33	4-1	26	25	5	38	ELECTRIC LOCOMOTIVE (25 Hz) VERTICAL PROFILE AT FIREMAN'S SEAT
NEC034	AI	15:34-15:39	4-1	27	25	5	60	ELECTRIC LOCOMOTIVE (25 Hz) HORIZONTAL PROFILE AT CENTERLINE OF CAB
NEC035	AJ	15:43-16:12	4-1	24	25	60	30	ELECTRIC LOCOMOTIVE (25 Hz) VERTICAL PROFILE ENGINEER'S SEAT
NEC036	AK	17:02-17:23	3-1	11	12	60	22	FIRST COACH AT AISLE, 25 Hz SECTION
		APR 1						
NEC037	AL	12:58-13:17	7-1	54	55	60	20	OUTSIDE 25 Hz SUBSTATION AT PRINCETON JUNCTION, NJ
NEC038	AM	13:43-14:17	6-1	37	38	5	317	STATION PLATFORM-PRINCETON JUNCTION, NJ (25 Hz SECTION)
NEC039	AN	14:38-14:41	5-1	29	30	5	29	WAYSIDE MEASUREMENT NEAR PRINCETON JUNCTION (25 Hz SECTION)

TABLE 2-1

**INDEX OF REPETITIVE WAVEFORM DATA
NORTHEAST CORRIDOR MEASUREMENTS
MARCH 30 - APRIL 3, 1992 (CONT'D)**

DATA FILE NUMBER	APPENDIX CONTAINING DATA	DATE/ TIME	PROBE LOCATION			SAMPLE INTERVAL, SECONDS	NUMBER OF SAMPLES	LOCATION AND TYPE OF MEASUREMENT
			FIG.	STAFF	REF.			
NEC040	AO	14:43- 14:52	5-1	29	30	5	44	SAME
		APR 2						
NEC041	AP	09:27- 09:44	5-1	31	32	5	196	WAYSIDE MEASUREMENT NEAR RYE, NY (60 Hz SECTION)
NEC042	AQ	10:26- 10:48	6-1	39	40	5	196	STATION PLATFORM - NEW ROCHELLE, NY (60 Hz SECTION)
NEC043	AR	11:17- 12:00	6-1	39	40	5	168	SAME
NEC044	AS	12:41- 12:42	6-2	41	-	5	12	STATION PLATFORM AND SUBSTATION AT MT. VERNON, NY (60 Hz SECTION)
NEC045	AT	12:49- 12:50	7-2	51- 52	-	5	10	OUTSIDE 60 Hz SUBSTATION AT MT. VERNON, NY
NEC046	AU	17:32- 18:00	6-2	42- 44	45- 47	5	162	STATION PLATFORM-RED BANK, NJ (JERSEY COAST LINE)
NEC047	AV	18:26- 18:42	5-1	33	34	5	105	WAYSIDE MEASUREMENT NEAR RED BANK, NJ (JERSEY COAST LINE)

TABLE 2-1

INDEX OF REPETITIVE WAVEFORM DATA
 NORTHEAST CORRIDOR MEASUREMENTS
 MARCH 30 - APRIL 3, 1992 (CONT'D)

DATA FILE NUMBER	APPENDIX CONTAINING DATA	DATE/TIME	PROBE LOCATION			SAMPLE INTERVAL, SECONDS	NUMBER OF SAMPLES	LOCATION AND TYPE OF MEASUREMENT
			FIG.	STAFF	REF.			
		APR 3						
NEC048	AW	07:05-07:25	3-2	13-18	19	5	137	VARIOUS COACH LOCATIONS, (JERSEY COAST LINE)
NEC049	AX	08:16-08:22	4-1	24	25	60	6	ELECTRIC LOCOMOTIVE (JERSEY COAST LINE) VERTICAL PROFILE AT ENGINEER'S SEAT
NEC050	AY	08:22-08:34	4-1	24	25	5	86	SAME
NEC051	AZ	08:35-08:43	4-1	24, 27, 28	25	5	60	ELECTRIC LOCOMOTIVE (JERSEY COAST LINE) VARIOUS LOCATIONS
NEC052	BA	09:52-10:14	7-3	53	-	60	23	OUTSIDE SUBSTATION (JERSEY COAST LINE) NEAR RED BANK, NJ
NEC053	BB	11:22-11:24	5-1	35	36	5	23	WAYSIDE MEASUREMENT NEAR RED BANK, NJ (JERSEY COAST LINE)

TABLE 2-2

INDEX OF CONTINUOUS WAVEFORM (DAT) DATA
NORTHEAST CORRIDOR MEASUREMENTS
MARCH 30 - APRIL 3, 1992

TAPE/ RECORD #	DATE/TIME	PROBE LOCATION		RECORD LENGTH MIN:SEC	LOCATION AND TYPE OF MEASUREMENT
		FIGURE	LOCATION		
	MAR 30				
1-1	10:30-11:44	3-1	3	73:38	COACH SEAT, NEW CARROLTON TO DELAWARE (NEC, 25 HZ)
2-2	14:55-16:34	3-1	3	98:30	COACH SEAT, SOUTH OF STAM- FORD, (MILE POST 31) TO JUST SOUTH OF OLD SAYBROOK (NEC, 60 HZ AND NON- ELECTRIFIED)
2-3	17:07-17:30	3-1	3	23:06	COACH SEAT, MAJESTIC TO NEAR KINGSTON (NEC, NON- ELECTRIFIED)
	MAR 31				
3-1	12:29-13:24	4-1	25	54:24	REAR CAB, FIREMAN'S SEAT, NEW HAVEN TO STAMFORD (NEC, 60 HZ)
3-2	13:44-13:58	4-1	25	12:59	REAR CAB, FIREMAN'S SEAT, TRANSITION FROM 60 HZ TO 25 HZ SECT. OF NEC, ADJACENT DC THIRD RAIL
4-1	15:24-16:22	4-1	25	57:08	REAR CAB, FIREMAN'S SEAT, NEW YORK TO TRENTON (NEC, 25 HZ)
4-2	17:03-17:36	3-1	12	33:30	COACH SEAT, PHILADELPHIA TO WILMINGTON (NEC, 25 HZ)

TABLE 2-2

INDEX OF CONTINUOUS WAVEFORM (DAT) DATA
NORTHEAST CORRIDOR MEASUREMENTS
MARCH 30 - APRIL 3, 1992 (CONT'D)

TAPE/ RECORD #	DATE/TIME	PROBE LOCATION		RECORD LENGTH MIN:SEC	LOCATION AND TYPE OF MEASUREMENT
		FIGURE	LOCATION		
	APR 1				
5-1	13:43-14:17	6-1	38	33:50	STATION PLATFORM AT PRINCETON JUNCTION (NEC, 25 HZ)
5-1A	14:39-14:51	5-1	30	12:26	WAYSIDE MEASUREMENT NEAR PRINCETON JUNCTION (NEC, 25 HZ)
5-2	14:52-14:53	5-1	30	1:32	WAYSIDE MEASUREMENT NEAR PRINCETON JUNCTION (NEC, 25 HZ)
	APR 2				
5-3	9:27-9:44	5-1	32	16:40	WAYSIDE MEASUREMENT NEAR RYE, NY (NEC, 60 HZ)
5-4	10:25-10:38	6-1	40	12:28	STATION PLATFORM AT NEW ROCHELLE (NEC, 60 HZ)
6-1	17:33-17:44	6-2	46	2:34	MIDDLE OF STATION PLATFORM, RED BANK (NJT, 60 HZ)
6-2	17:47-17:53	6-2	45	5:43	EAST END OF STATION PLATFORM, RED BANK (NJT, 60 HZ)
6-3	17:59-18:02	6-2	47	2:52	WEST END OF STATION PLATFORM, RED BANK (NJT, 60 HZ)

TABLE 2-2

INDEX OF CONTINUOUS WAVEFORM (DAT) DATA
 NORTHEAST CORRIDOR MEASUREMENTS
 MARCH 30 - APRIL 3, 1992 (CONT'D)

TAPE/ RECORD #	DATE/TIME	PROBE LOCATION		RECORD LENGTH MIN:SEC	LOCATION AND TYPE OF MEASUREMENT
		FIGURE	LOCATION		
	APR 2				
6-4	18:29-18:53	5-1	34	13:55	WAYSIDE MEASUREMENT NEAR RED BANK (NJT, 60 HZ)
	APR 3				
6-5	7:06-7:14	3-2	19	7:40	COACH SEAT, HAZLET TO RED BANK, (NJT, 60 HZ)
6-6	8:23-8:27	4-1	25	4:38	REAR CAB, FIREMAN'S SEAT, PARKED AT LONG BRANCH (NJT, 60 HZ)
6-7	8:28-8:44	4-1	25	16:18	REAR CAB, FIREMAN'S SEAT, LONG BRANCH TO HAZLET, (NJT, 60 HZ)
6-8	11:23-11:25	5-1	36	2:05	WAYSIDE MEASUREMENT NEAR RED BANK (NJT, 60 HZ)

The continuous recordings of magnetic field waveform were reviewed for transient magnetic field conditions which might exist as the train crosses catenary phase breaks or passes from the 25 Hz to 60 Hz section of the corridor. Rapidly changing magnetic field conditions such as those at a station platform were also examined. The final type of analysis conducted on the DAT data was to conduct plots of RMS ac magnetic field and total static field over the time of the recordings. These results were compared to the corresponding data from the portable waveform capture system to determine whether the data sampling procedure of the waveform capture system lost any significant data which is obtainable by continuous monitoring.

2.7 RMS RECORDER DATA

Two rms recorders (portable, personal EMF dosimeters) were used, at different locations, for obtaining waist-level EMF "exposure" data. Several rms recordings were made by members of the measurement crew while traveling on the electrified railroad or working at the stations, wayside, or power supply facilities where available. These data are compared and contrasted with the waveform capture system and DAT data in the following sections.

2.8 OVERVIEW OF RAILROAD FACILITIES

Electrified railroads are by their nature potential sources of exposure to electric and magnetic fields. Electrified railroads make use of either electric locomotives pulling conventional passenger coaches or self-powered coaches having propulsion equipment integrated into the passenger coach. The measurements reported herein focus on electric and magnetic fields onboard or near trains with heavy locomotives and conventional coaches although some of the wayside and station measurements included measurements of fields as self-propelled cars passed the measurement point.

The principal electrical components of an electrified railroad are the electric locomotive, the catenary and track circuit which delivers electric power to the locomotive, and the substations which feed electric power to the catenary and track circuit. All three of these components are possible sources of electric and magnetic fields.

2.8.1 Locomotives

This measurement program did not attempt to systematically examine the effect of different locomotive types on magnetic field levels. Instead, it focused on AMTRAK's standard electric locomotive, the AEM-7. This Swedish locomotive, manufactured by ASEA, operates on both the 25 Hz section of the NEC from Washington to New York and the 60 Hz section from a point just north of New York to New Haven.

The major electrical components of the AEM-7 locomotive are the roof-mounted pantograph, circuit breaker, and braking resistors;

the main power transformer, thyristor rectifier cabinets, and filter and contactor cabinet within the locomotive; and the four truck-mounted traction motors beneath the locomotive. Any of these components, as well as auxiliary devices such as compressor motors, blowers, and the head-end power inverter, are potential magnetic field sources. But, since most of these objects are compact and relatively small compared to the distances from those objects to work areas in the cabs or passenger areas in the coaches, the magnetic fields from these "point" sources of field will attenuate very rapidly at a rate proportional to the inverse distance to the third power. Because of this rapid attenuation rate, magnetic fields from equipment within the locomotives will be most accurately measured at locations very near the sources, such as in the locomotive cab.

The amount of magnetic field produced by most major electrical components of the locomotive is likely to be directly proportional to the amount of electric current within those components. Consequently, magnetic field levels produced by traction power equipment in the locomotive should vary in proportion to traction power needs. Those from auxiliary equipment in the locomotive are not expected to correlate with traction power needs.

The major electric traction power circuits can be broken into two groups: those on the primary side of the main power transformer such as the pantograph, circuit breaker, transformer and associated wiring; and those on the secondary side such as the rectifiers and traction motors. Ammeters within the locomotive cab allowed the measurement team occasionally to record the current in the traction motor armatures. Unfortunately, those data do not provide a reliable indication of the current in the primary side equipment because of the actions of the controlled rectifier bridges used at the transformer secondary. However, since it is AMTRAK policy always to run the main power transformer at the same tap setting regardless of train speed and portion of the corridor, motor ammeter readings while the train accelerates from a stop provide a reliable measure of relative current level in all major locomotive power components. Additionally, the AMTRAK AEM-7 locomotives reportedly are equipped with motor current limiters which prevent motor current from exceeding 1800 amperes per motor. Consequently, all maximum magnetic field measurements onboard or near AEM-7 locomotives accelerating from stations are subject to the same constraints on maximum motor current.

Electric locomotives and the equipment contained therein are not anticipated to be significant electric field sources because all of the major components except certain roof-mounted devices are enclosed in metal cabinets which effectively shield electric fields.

Measurements on New Jersey Transit's North Jersey Coast Line were made onboard or near trains pulled with ASEA ALP-44 locomotives. This locomotive is reportedly very similar to the AMTRAK AEM-7. However, the authors were unable to determine the specific nature of the differences between locomotive types. Nor were the authors

able to determine whether NJT operates their locomotives on a transformer tap similar to that used by AMTRAK or if motor current limiters were set at levels like those in the AEM-7s. Consequently, the AEM-7 and ALP-44 locomotives can not necessarily be considered "identical" in terms of potential for magnetic field generation. As illustrated later in Section 4 of this report, subtle differences in electric locomotive design appear insignificant compared to other sources of field variability.

The diesel-electric locomotive used to pull the train on the non-electrified portion of the NEC from New Haven to Boston is a model F-40, common throughout the AMTRAK system. Although quantifying electric and magnetic field levels in trains powered by diesel-electric locomotives was not a primary focus of this measurement program, measurements were made in both the coaches and in the locomotive of trains on this northern end of the NEC in order to identify the "background" field levels in trains from sources other than those associated with electric traction. Hence, electric and magnetic fields were measured in the cab of an F-40 locomotive.

The prime mover on the F-40 diesel-electric locomotive is a diesel engine located to the rear of the locomotive. It drives a main electric power alternator which is installed forward of the engine, just behind the engineer's cab. Six-phase 105 Hz electric power from this constant speed alternator passes through 12-pulse controlled rectifier banks where it is converted to direct current which powers four truck-mounted traction motors. An auxiliary alternator, also powered from the diesel engine, provides 60 Hz three-phase "head end" electric power for "hotel" services throughout the coaches.

2.8.2 Route

The tests reported herein were conducted on three sections of the NEC and on a section of the North Jersey Coast Line. That provided a sampling of the electric and magnetic fields associated with trains operating on tracks having three different electrification technologies as well as "baseline" data on a non-electrified section. This subsection describes the physical characteristics of the various rail sections, while the next subsection discusses electrification technologies.

The NEC, running from Union Station in Washington, DC to South Station in Boston, can be crudely divided into three sections. The southern section of some 230 miles from Union Station in Washington to the crossing of the East River just north of New York City is owned and maintained by AMTRAK. This section is electrified at 25 Hz as described below. It consists typically of three tracks south of Philadelphia and four tracks north of Philadelphia. The two mainline tracks are a high-speed line with typical maximum speeds of 177 to 201 kph (110 to 125 mph) in open areas away from urban centers.

The section of the NEC from the East River in New York to New Haven, CT is electrified at 60 Hz. This section includes

approximately 21 km (13 miles) of AMTRAK line from the East River to the junction with Metro North's line just southwest of New Rochelle, NY and 91 km (56.5 miles) of line from near New Rochelle to New Haven which is owned and maintained by Metro North Commuter Railroad. Although this section is predominantly a four-track line, the two mainline tracks are typically limited to speeds in the range of 113 to 121 kph (70 to 75 mph).

The non-electrified section of the NEC consists of approximately 251 km (156 miles) of two track line from New Haven to Boston. This section of the corridor, which is owned and maintained by AMTRAK, has typical maximum speeds of 113 to 145 kph (70 to 90 mph) between New Haven and Kingston, RI and 153 to 161 kph (95 to 100 mph) from Kingston to Boston. Speed is restricted further in urban areas such as in Providence and Boston.

Electric and magnetic field measurements were also made on trains, at stations, and at wayside locations along a short section of New Jersey Transit's North Jersey Coast Line between Matawan, NJ and Long Branch, NJ. This fifteen-mile section of two-track line is electrified at 60 Hz using technology different from that used on either electrified sections of the NEC. New Jersey Transit track charts available to these authors do not contain maximum speed listings for each section of track, but rather "timetable" speed. The timetable speed on the two-track line from Matawan to Long Branch is predominantly 97 kph (60 mph).

2.8.3 Electrification

Electric power is supplied to the locomotives via overhead catenary in all three sections of electrified railroad examined in this measurement program. Electric current flows through the energized catenary wire, down to the locomotive via the locomotive's pantograph, through various pieces of control equipment and the primary of the main power transformer within the locomotive before exiting the locomotive through its wheels to return to its source via the rails. So in a sense, the catenary and tracks make up an electric power distribution circuit which carries electric power from the supply point to the locomotive where the power is needed for traction.

Like any electric power distribution line, the energized catenary produces an electric field by virtue of the electric potential (voltage) difference between the catenary and the earth. This electric field is strongest near the catenary and becomes considerably weaker near the ground. The electric field near ground is weaker at locations where the catenary is higher above ground. Furthermore, the strength of the field is directly proportional to the catenary voltage and therefore has the same temporal characteristics (e.g., frequency, harmonic content) as the voltage.

The current flowing in the catenary and track produces magnetic fields which are directly proportional to the current magnitude and inversely proportional to the distance from the catenary or track.

The basic relationship expressed mathematically is:

$$\vec{B} = \frac{\mu_0 \vec{i} * \hat{r}}{2 \pi r}$$

where:

- \vec{B} is the magnetic flux density;
- \vec{i} is the current in the conductor;
- μ_0 is the magnetic permeability of space;
- \hat{r} is a unit vector directed radially, from the linear conductor to the measurement point; and
- r is the radial distance from the conductor.

Expressed in practical units and without regard to vector directions:

$$B = 2 \frac{i}{r} \tag{1}$$

where:

- B is magnetic flux density in mG;
- i is current in amperes; and
- r is distance from the conductor in meters.

As illustrated in the above equations, the magnetic field is directly proportional to the current. As a result, the temporal characteristics of the magnetic field (frequency, harmonic content, waveshape, etc.) are directly proportional to the temporal characteristics of the catenary and track current.

Looking closely at the vector equation (1) for the magnetic field produced by the current in the catenary or in the track, one recognizes that the direction of the magnetic field is tangential to a circle centered on the current-carrying conductor and passing through the measuring point. The polarity of the field is related to the direction of current flow by the "right hand rule." Further, recognize that in the general vicinity of the train, the supply current flowing to the locomotive in the catenary is equal

in magnitude to the return current in the tracks, but the two currents are flowing in opposite directions. At a point distant from the tracks, the magnetic field components produced by current in the catenary and current in the tracks are approximately equal in magnitude but directed in almost opposite directions. Consequently, the magnetic field components from the catenary supply current and the track return current nearly cancel one another. The residual field component which remains results from small differences in field intensity and direction brought about by the fact that the two magnetic field sources are not co-linear. Expressed mathematically, the residual field from equal supply and return currents at long distances from the source is:

$$B = 2 \frac{si}{r^2} \quad (3)$$

where:

- B is the magnetic flux density in mG;
- i is the supply and return current in amperes;
- s is the spacing between the catenary and track in meters; and
- r is the distance from the tracks to the measurement point in meters.

Comparing equations (2) and (3), one immediately recognizes that far from the tracks: 1) the total residual magnetic field is much smaller than the field from current in either the catenary or the tracks; 2) the total residual field attenuates more rapidly (inversely proportional to the distance squared) than either of the individual field components; and 3) the magnitude of the total residual magnetic field is directly proportional to the separation, s, between the catenary supply conductor and the rails which carry the return current.

Unfortunately, the relative orientations of the magnetic field components produced by the supply current in the catenary and return current in the tracks is quite different in the space between the catenary and tracks than it is at locations far from the tracks. In the area above the tracks, which is the area occupied by passengers and crew members onboard the train, the two components of the magnetic field are essentially aligned in the same direction. Therefore, they add together to produce a total magnetic field larger than either of the two components. Furthermore, the magnetic field tends to be uniform in this area because as one moves higher above the tracks to encounter less field from the return current, he is moving closer to the catenary and encounters more field from the supply current and vice versa. Consequently, the largest magnetic fields near the electrified railroad catenary and tracks occur in this area.

Since electric power delivery from the catenary supply point to the locomotive is via current in the catenary and returning in the tracks, and because all three of the electrified railroad systems use a catenary supply voltage that is regulated at approximately 12 kV to 12.5 kV, variations in locomotive traction power demand result in proportional changes in catenary and track current. Those changes in current result in corresponding changes in magnetic field levels in the vicinity of the catenary and tracks. Consequently, the strength of the magnetic fields produced by the catenary and track current depends on all of the factors which affect traction power requirement. Those include the length of the train, the load onboard, the rates of acceleration, track incline, train speed, number and horsepower capacity of locomotives, and other factors. Electric field, on the other hand, which is dependent primarily on catenary voltage and catenary height, is not strongly affected by the traction power needs of nearby trains.

The method of supplying electric power to the catenary as well as the voltage and frequency of the applied power varies among the three sections of electrified railroad examined in this measurement program. The southern section of the NEC from Union Station in Washington, DC to the vicinity of the East River crossing north of New York City has substations along the route which directly feed 25 Hz ac electric power from both ends to the section of catenary between substations. The "nominal" catenary voltage supplied by the substations on this section of the corridor is 11 kV, but the typical catenary voltage is approximately 12 kV.

The 25 Hz electric power is delivered to the wayside substations by a network of 138 kV transmission lines which are typically located immediately adjacent to the tracks. This system of supplying power to the catenary is referred to as a "direct double fed" system because substations feed power directly to the catenary from both ends. A train on this section of the corridor receives a supply current via the catenary from the substations behind and in front of the train; the proportion of current coming from each station depending on the relative distance to each. Return current from the locomotive flows into the tracks toward the substations ahead of and behind the train. However, along the route back to the substation, some of the return current leaves the rails to return through the overhead ground wires (installed above the catenary and transmission lines for lightning protection) or through the earth. Very little current flows in the catenary or track beyond the substation at either end of the block occupied by the locomotive so the only magnetic field present at those locations is that produced by current in the transmission lines.

The method of supplying 60 Hz, 12.5 kV electric power to the section of the North Jersey Coast Line where measurements were made is somewhat similar to that used on the south end of the NEC in that substations feed power directly to the catenaries. However, at a point approximately midway between substations, a section of the catenary from one substation is electrically isolated from the catenary from the other substation. This "break" in the continuity of the catenary is referred to as a "phase break." This system of

powering the catenary is referred to as a direct single fed system because power is fed to a section of catenary from only one end. The catenaries above the two tracks are typically bonded together at the substation and at the phase break between substations. As a result, a locomotive on a particular block of track between phase breaks draws power only from the one substation feeding that block. The majority of the supply current undoubtedly flows to the locomotive by the direct route of the catenary from the substation to the locomotive, but some also flows via the catenary of the other track to the bond point at the phase break between substations then back to the locomotive from the direction opposite the substation. Return current flows from the locomotive into the rails and back toward the substation by various routes including the rails of both tracks and the earth. The operation of a locomotive in one power block would not create magnetic fields in other power blocks along the railroad because each block is physically isolated by phase breaks. Power supply to the substations is from the commercial electric power grid, and transmission lines typically do not parallel the railroad.

The method of supplying power to the railroad catenaries on the 60 Hz portion of the NEC from the vicinity of the East River crossing just north of New York City to New Haven, CT is substantially different from those used on the other two sections of electrified railroad examined in this study. Substations along the wayside do not supply power directly to the catenary-track circuit. Instead, substations produce 60 Hz, 25 kV electric power which is carried to autotransformers distributed along the wayside. At the autotransformers, the 25 kV power from the substation is reduced to 12.5 kV and applied between the catenary and track. A novel feature of this approach is that the 12.5 kV catenary itself can be used as one of the two wires of the power line which carries 25 kV power from the substation to the autotransformers. A second conductor strung along the catenary support structure serves as the second wire of the balanced 25 kV powerline to the autotransformers. This autotransformer-fed scheme for supplying power to the catenary and track circuit is also sometimes called a 2 x 12.5 kV system because two conductors, each with voltage of 12.5 kV to ground (a total of 25 kV), are carried from the substation along the catenary support structures to provide primary power to the autotransformers. Power loss associated with providing electrical power to locomotives distant from the substation is less in autotransformer-fed systems than in direct-fed systems, thereby allowing the construction of fewer substations placed at greater separation along the route.

In general, when a locomotive is operating on a section of track between two autotransformers, most of the catenary supply current comes from the adjacent autotransformers and return current flows through the rails to those same autotransformers. A small percentage of the supply current may come from (and track return current return to) more distant autotransformers. As a result, the catenary supply and track return currents within the power block between autotransformers is similar to currents in the catenary and track of direct-fed systems. Hence, the generated magnetic fields

are similar. However, at locations outside the section of railroad bounded by the autotransformers bracketing the location of the operating locomotive, most of the traction power flows in the 25 kV circuit made up of the catenary and dedicated "return" wire from the autotransformers to the substation. Since the voltage of this circuit is twice that of the catenary and track circuit, the current necessary to meet the traction power needs of the operating locomotive are only half that drawn by the locomotive. This reduction in current lowers the electrical power losses and lowers the magnetic field near the railroad. Furthermore, since the two wires of the 25 kV circuit (the catenary and the autotransformer return circuit) are spaced relatively close together, the magnitude of magnetic field produced by current in those two wires is further reduced according to equation (3) above. The potential for magnetic field reduction along railroads using autotransformer-fed systems is discussed in more detail in Reference six of Section 10.

Table 2-3 summarizes the physical and electrification characteristics of the four sections of railroad examined in this measurement program.

TABLE 2-3

SUMMARY OF PHYSICAL AND ELECTRIFICATION SYSTEM
CHARACTERISTICS OF FOUR RAILROAD SECTIONS IN THIS STUDY

LINE	NEC - SOUTH	NEC - CENTRAL	NEC - NORTH	NORTH JERSEY COAST LINE
BEGIN	WASHINGTON, DC	EAST RIVER	NEW HAVEN, CT	MATAWAN, NJ
END	EAST RIVER CROSSING	NEW HAVEN, CT	BOSTON, MA	LONG BRANCH, NJ
LENGTH	369 KM (229 MI)	111 KM (69 MI)	369 KM (229 MI)	24 KM (15 MI)
# OF TRACKS	3 OR 4	4	2	2
TYPICAL MAX SPEED	177 - 201 KPH (110-125 MPH)	113 - 121 KPH (70-75 MPH)	113 - 161 KPH (70-100 MPH)	97 KPH * (60 MPH)
LOCOMOTIVE	AEM-7	AEM-7	F-40	ALP-44
TYPICAL CATENARY VOLTAGE	12 kV	12.5 kV	0	12.5 kV
POWER FREQUENCY	25 Hz	60 Hz	N/A	60 Hz
ELECTRIFICATION METHOD	DOUBLE FED DIRECT FED	DOUBLE FED WITH AUTOTRANSFORMERS	NONE	SINGLE FED DIRECT FED

* Typical Timetable Speed

3. MEASUREMENTS ONBOARD COACH

When developing the measurement plan for these tests, it was apparent that magnetic fields within the coach could arise from various sources:

- Catenary and track power circuit;
- Equipment in the locomotive;
- Hotel power beneath the coaches;
- Heating, lighting, air conditioning and other equipment on the coaches; and
- External sources

In order best to evaluate the significance of the above-mentioned sources, field measurements were made at three locations.

- 1) Front of first coach - This point nearest the locomotive maximizes the chance of detecting fields from equipment in the locomotive.
- 2) Back of first coach - This point maximizes the chance of detecting fields from hotel power cables beneath the floor of the coach because it is somewhat removed from possible effects from the locomotive, yet is above cables which provide power to the numerous coaches to the rear.
- 3) In a rear coach - This point minimizes the influence of the locomotive and hotel power cables thereby maximizing the catenary and track or other external circuits.

The magnetic field contributions from current electrification of the Northeast Corridor use two distinct technologies. This necessitated replicate measurements on the 25 Hz single feed section south of New York and the 60 Hz auto transformer feed section from New York to New Haven. A third distinct set of measurements was conducted on the non-electrified section of the corridor from New Haven to Boston. Measurements in this section provided an opportunity to look in more detail at fields from hotel power and onboard equipment without contributions to magnetic fields from the track and catenary.

Electrification of the northern portion of the corridor is proposed using a 60 Hz single feed scheme at 25 kV or perhaps an autotransformer configuration (2 x 12.5 kV) similar to the French Train a Grande Vitesse (TGV). In order to project the magnetic field characteristics of the proposed system, an additional set of measurements was made on New Jersey Transit's North Jersey Coast Line from Matawan to Long Branch. This section of railroad is electrified using technology similar to one proposed for the northern corridor segment. Although the North Jersey Coast Line operates at 12.5 kV, transformer taps are available to convert the system to 25 kV. It was initially hoped that such a conversion could be made for these tests, but upon further investigation it was found to be impractical to do so. Since the taps were internal to the transformer tank, there was not sufficient time between the

end of evening revenue service and the start of morning service to drain some oil from the transformers, open the tanks, change the taps, close the tanks, replace the oil, conduct the tests and then go through the various steps of changing taps back to the initial connections. Since the electrical circuitry and dimensions of the North Jersey Coast Line matched those proposed for electrification of the corridor north of New Haven, it was still technically valid to conduct measurements on the New Jersey system and extrapolate the results to the NEC by making appropriate scaling to the fields produced by the catenary and tracks. Since the proposed additions to the NEC will be twice the voltage of the New Jersey system, identical power will be delivered to the locomotives at half the current. Therefore, magnetic fields from catenary and track currents on the NEC should be roughly half those on the New Jersey system for similar operations. Note that power loads for long trains are generally higher than for transit consists. Electric fields on the NEC, which depend on catenary voltage, will be twice as large as those measured on the New Jersey system.

All of the trains in this series of tests were pulled (or pushed) by a single locomotive. An ASEA AEM-7 electric locomotive was used from Washington to New Haven and a F-40 Diesel-Electric locomotive from New Haven to Boston. The locomotive operating on the Long Branch line was an ASEA ALP-44 which is similar to the AMTRAK AEM-7.

3.1 MEASUREMENT LOCATIONS

Figure 3-1 depicts two AMTRAK coaches. The "home" coach was selected as the rear-most coach in which extended measurements were practical. The two following cars were a smoking car and the club car. The home coach was the seventh of nine coaches in the train as it departed Washington. However, the front two coaches were removed from the train at New Haven and routed on another destination. Hence, from New Haven to Boston, the home coach was the fifth of seven cars in the train.

The "first" coach was the coach nearest the locomotive. Although it was not physically the same coach south of New Haven as north of New Haven, it was always the coach nearest the locomotive.

Since the train was in revenue service throughout the tests, minimum interference with passengers was a critical constraint. Passengers boarded or departed the train at various stations choosing seats which pleased them. As a result, it was not always possible to make replicate measurements at identical locations within the coaches. Figure 3-1 depicts the specific locations where measurements were taken. The numbered measurement locations are keyed to datasets in Table 2-1 and to the data in Appendices B through R and AK.

The measurement locations onboard the coaches of the New Jersey Transit North Jersey Coast (Long Branch) Line are shown in Figure 3-2. These are keyed to datasets in Table 2-1 and Appendix AX. These measurements were made on an outbound train early in the

AMTRAK, Home Coach

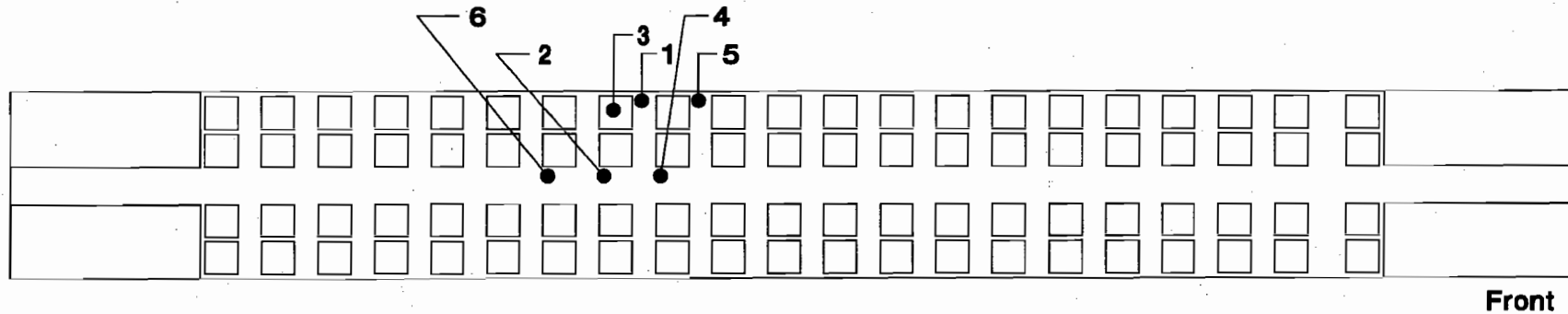

Front

3-3

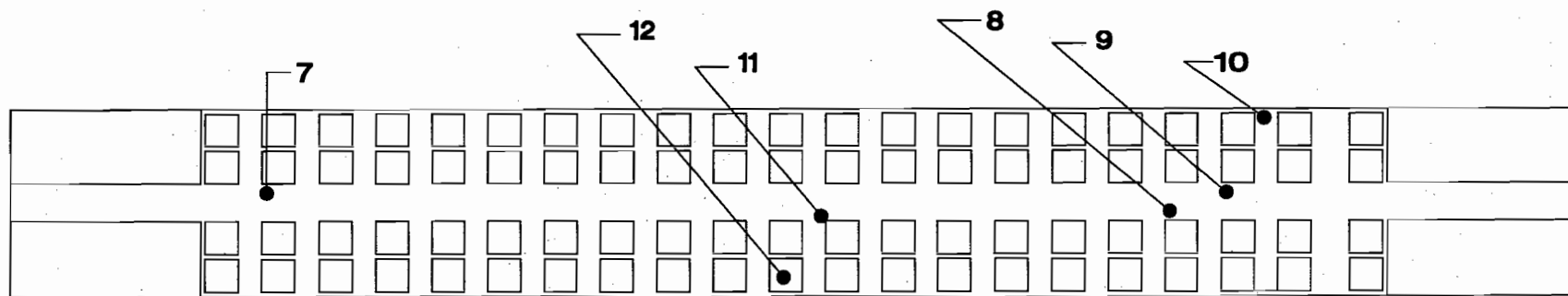

Front

AMTRAK, 1st Coach

FIGURE 3-1. REPETITIVE MAGNETIC FIELD WAVEFORM MEASUREMENT LOCATIONS IN AMTRAK COACHES

N.J. Long Branch, Last Coach

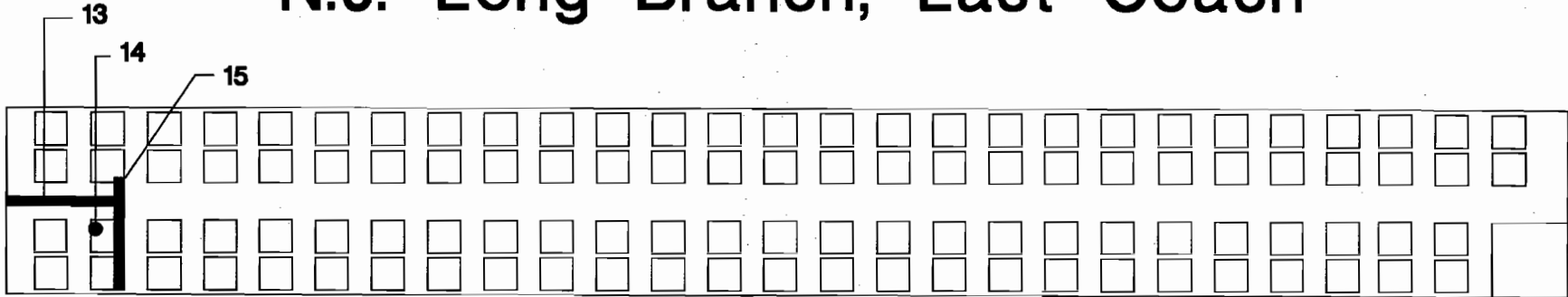

Front

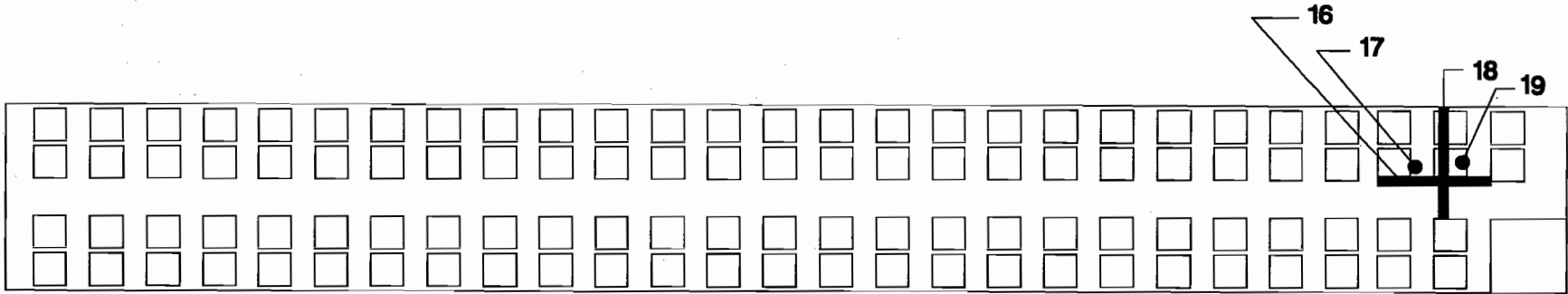

Front

N.J. Long Branch, 1st Coach

3-4

FIGURE 3-2. REPETITIVE MAGNETIC FIELD WAVEFORM MEASUREMENT LOCATIONS IN NEW JERSEY TRANSIT COACHES

morning, so passenger load was very light. Therefore, there was no problem making measurements in the very front of the first coach and very rear of the last coach. During the run from Matawan to Long Branch when the coach measurements were made, the locomotive was at the rear of the train pushing the coaches. So, for purposes of analysis sources and comparison with AMTRAK data, the last coach on the Long Branch test is analogous to the first coach on AMTRAK and the first coach on the Long Branch test is analogous to the home coach on the AMTRAK tests.

3.2 REPETITIVE WAVEFORM DATASETS

Nineteen repetitive waveform datasets quantifying magnetic field characteristics within the coaches were recorded with the waveform capture system. Table 2-1 provides pertinent information about these data. All of these datasets represent vertical profile measurements at 10 cm, 60 cm, 110 cm, and 160 cm above the coach floor. The last dataset also includes some horizontal profile measurements. Complete plots of field versus frequency over time and field versus distance above the floor over time are found in Volume II appendices, as indicated in Table 2-1. Appendices also contain notes about train operating conditions, locations and, occasionally, the presence of external field sources such as powerlines or substations.

3.3 FIELD SOURCE IDENTIFICATION

Magnetic field measurements onboard the coaches in the section of the Northeast Corridor electrified at 25 Hz provide a unique opportunity to explore the extent to which magnetic fields from various sources contribute to the total magnetic field environment. That is because the field from the catenary and track as well as from the railroad's primary electric transmission lines along the corridor have a fundamental frequency of 25 Hz while the fields from hotel power, on-coach equipment, and external non-railroad power systems have a fundamental frequency of 60 Hz. Thus, by examining the frequency of the magnetic field spectra, one can reach conclusions about the sources of various field components.

Figure 3-3 shows pseudo-three-dimensional graphs of the magnetic field versus frequency and time in the home coach near the end of the train (location 2 on Figure 3-1) for dataset NEC003 (Appendix D). This location was chosen because it has little influence from magnetic fields produced by the locomotives or the hotel power cables beneath the coach floor. Figure 3-3 demonstrates the following characteristics, all of which implicate the catenary/track circuit as the primary source:

- Field characteristics near the floor and at standing head level are similar, indicating a spatially uniform field, as would exist inside a loop.
- Frequency components of the magnetic field are 25 Hz and its odd harmonics (75 Hz, 125 Hz, 175 Hz, 225 Hz, 275 Hz, etc.) consistent with the frequency characteristics of the catenary track current.

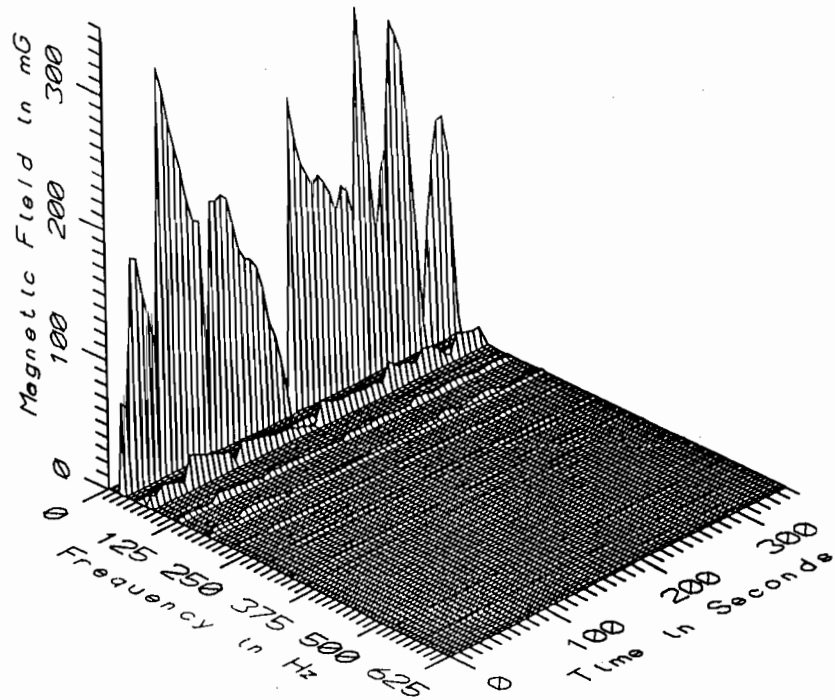

NEC003 - 10cm ABOVE FLOOR AT EDGE OF AISLE IN THE SEVENTH COACH

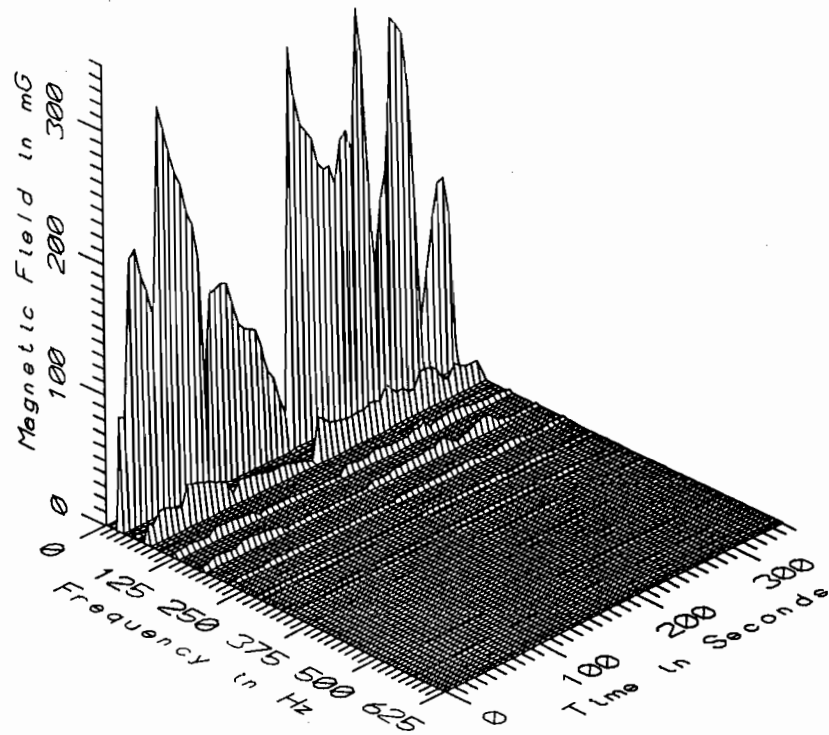

NEC003 - 160cm ABOVE FLOOR AT EDGE OF AISLE IN THE SEVENTH COACH

FIGURE 3-3. MAGNETIC FIELD LEVEL AT TWO HEIGHTS ABOVE THE FLOOR IN A REAR COACH AS A FUNCTION OF FREQUENCY AND TIME

- Field intensity is highly variable over time, consistent with fluctuating catenary/track current required to supply the locomotive's traction power needs.

Hence, there is little doubt that the principal source of magnetic fields in the rear coaches is the current in the catenary/track circuit.

Closer examination of Figure 3-3 reveals a small 60 Hz component in the magnetic field at the measurement near the floor. Such a field at that location could arise from 60 Hz current in the hotel power cables beneath the coach floor. If that is the case, the 60 Hz field should be larger nearer the front of the train where the current in the cables is larger. Figure 3-4 shows magnetic field data similar to those in Figure 3-3 except that they were measured near the front of the first coach (location 9 on Figure 3-1). These data are from dataset NEC007 found in Appendix H. In this figure, the 60 Hz component is clearly evident near the floor of the coach and is relatively uniform over time. Clearly, it does not correlate with the 25 Hz field nor the harmonics of the 25 Hz, hence it does not appear related to catenary current. The 60 Hz magnetic field is still present at 160 cm above the floor at the front of the first coach, but is smaller than the 60 Hz field value 10 cm above the floor. This spatial pattern suggests that the 60 Hz magnetic field component is coming from beneath the coach floor rather than the locomotive or some external source. The hotel power cables appear to be the most likely source.

Figure 3-4 also shows that the 25 Hz magnetic field at the front of the first coach is larger at head height (160 cm) than near the floor (10 cm). That same trend exists for the other datasets (NEC005, NEC006, and NEC008) at the front of the first coach. The non-uniformity in field at this location is apparently due to the proximity of the rear pantograph of the locomotive which was in use during these tests.

In order to look more closely at the relationship between magnetic field strength and distance from the locomotive, magnetic field data from six datasets were examined. All six datasets were measured along the center aisle of a coach operating on the 25 Hz section of the NEC. Two datasets, NEC007 and NEC008 were from the front of the first coach (location 9 of Figure 3-1). Datasets NEC036 and NEC009 were measured midway back and at the end of the first coach respectively (locations 11 and 7 of Figure 3-1). Two other datasets, NEC003 and NEC004, were measured midway back the seventh coach (location 2 of Figure 3-1). Since the six datasets were not measured simultaneously, field level comparisons between locations must be done on a statistical basis rather than by comparison of specific data samples. Figure 3-5 shows a plot of minimum, average, and maximum low-frequency (5-45 Hz) magnetic field levels at the four train locations. This band contains the magnetic field from the fundamental component of the catenary current but not 60 Hz fields from other onboard or external power system sources. For purposes of these graphs, data from four measurement heights above the floor were averaged to obtain values

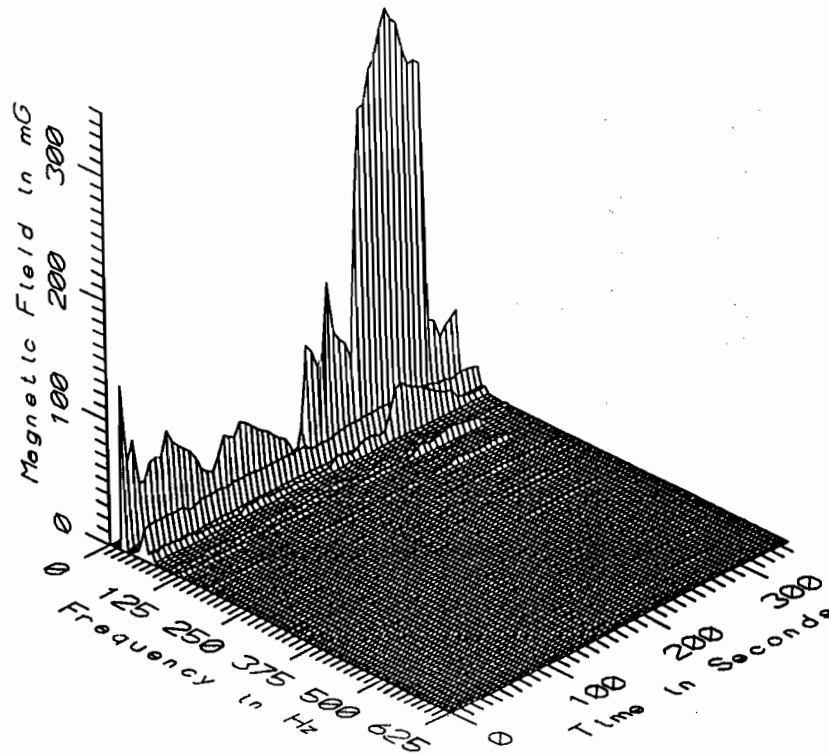

NEC007 - 10cm ABOVE FLOOR AT EDGE OF AISLE IN THE FIRST COACH

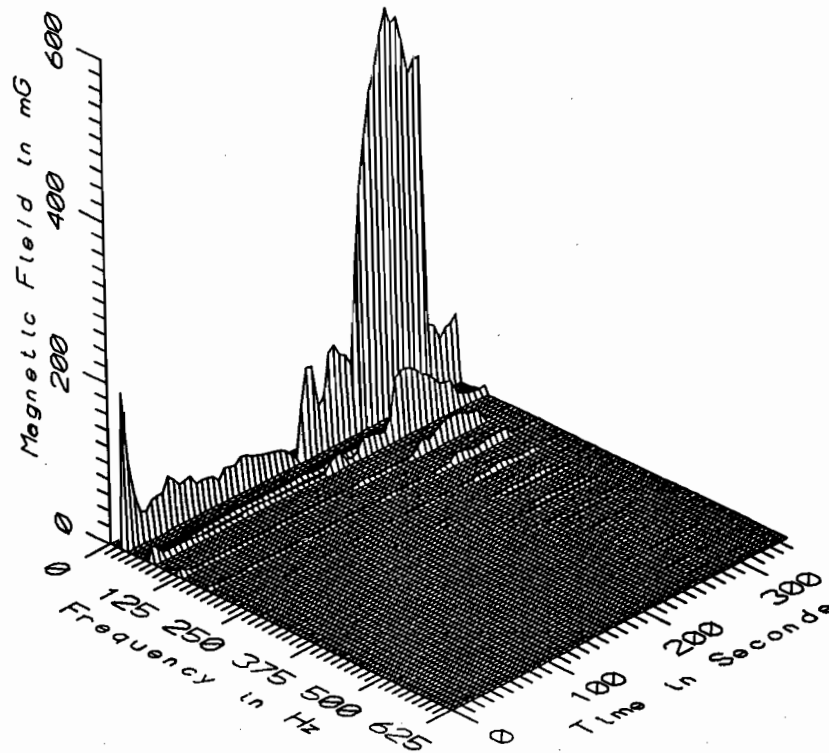

NEC007 - 160cm ABOVE FLOOR AT EDGE OF AISLE IN THE FIRST COACH

FIGURE 3-4. MAGNETIC FIELD LEVEL AT TWO HEIGHTS ABOVE THE FLOOR AT THE FRONT OF THE FIRST COACH AS A FUNCTION OF FREQUENCY AND TIME

Magnetic Field in Coaches

Low Frequency (5-45Hz) Magnetic Field

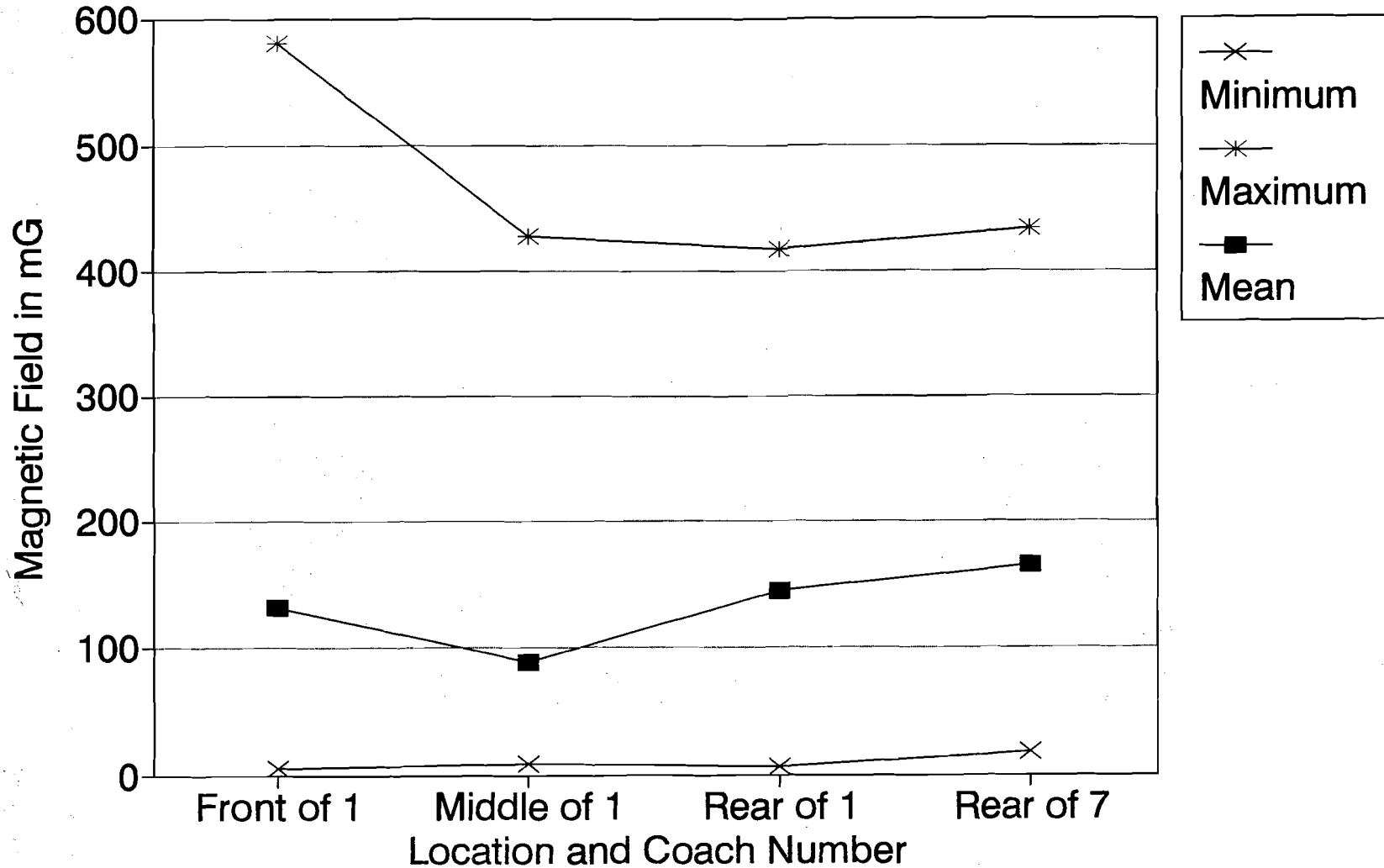

3-9

FIGURE 3-5.

LOW FREQUENCY MAGNETIC FIELD LEVELS AT VARIOUS LOCATIONS ALONG THE 25 HZ NEC SEGMENT

representative of the location relative to the locomotive. As Figure 3-5 demonstrates, the average level of the magnetic fields produced by catenary current (the predominant source of magnetic field in the low frequency band) is essentially independent of distance from the locomotive. The apparent dip in the middle of the first coach is believed to be due to less frequent and therefore lower average power demands by the locomotive during that measurement since the average maximum and average minimum field levels show no such dip. The increase in average maximum magnetic field at the front of the first coach is possibly due to proximity to the pantograph at the rear of the locomotive immediately in front of this coach.

Figure 3-6 shows the distribution of power frequency (50-60 Hz) magnetic fields at various distances from the locomotive. This figure was constructed similarly to Figure 3-5 except that only magnetic field components in the 50 to 60 Hz band are included. This grouping excludes the fields from the catenary current while allowing one to focus on the 60 Hz magnetic fields from the train's hotel power, coach electrical equipment, and external powerline sources. Figure 3-6 shows a strong gradient in 60 Hz magnetic field level throughout the first coach. The average 60 Hz field level at the end of the first coach is roughly equivalent to the average 60 Hz field in the seventh coach. This rapid attenuation along the front coach rather than a more gradual attenuation along the whole train is not completely consistent with the anticipated field pattern of a magnetic field produced by hotel power cables running the whole length of the train but having successively smaller currents in each coach. On the other hand, this 60 Hz magnetic field does not appear to originate in the locomotive. Sixty Hz magnetic field data measured at the front of the coach (location 9 of Figure 3-1) and plotted in Figure 3-7 shows a clear attenuation profile away from a source beneath the floor of the coach.

To obtain a better understanding of the magnetic fields from hotel power, electrical equipment in the coaches and from external sources, the magnetic field data from the non-electrified section of the corridor were examined. Although there is no catenary and no significant current in the rails to produce magnetic fields, the diesel-electric locomotive must be considered a potential source of magnetic fields. However, a review of the 50-60 Hz data from the non-electrified sections given in Figure 3-8 clearly show fields attenuating in intensity with increased height above the floor to a level of about 1 mG. That would suggest the presence of one source below the floor of the coach (producing the gradient field) and other more distant sources (many of which may not be associated with the railroad) producing the more homogeneous 1 mG background 60 Hz magnetic field. Furthermore, the reduction in floor level 60 Hz magnetic field from the first coach (7.1 mG) to the home coach (3.08 mG) is consistent with the hypothesis that the gradient component of the 60 Hz field comes from the hotel power cables which have dwindling current as one moves back in the train.

Magnetic Field in Coaches

Power Freq (50-60Hz) Magnetic Field

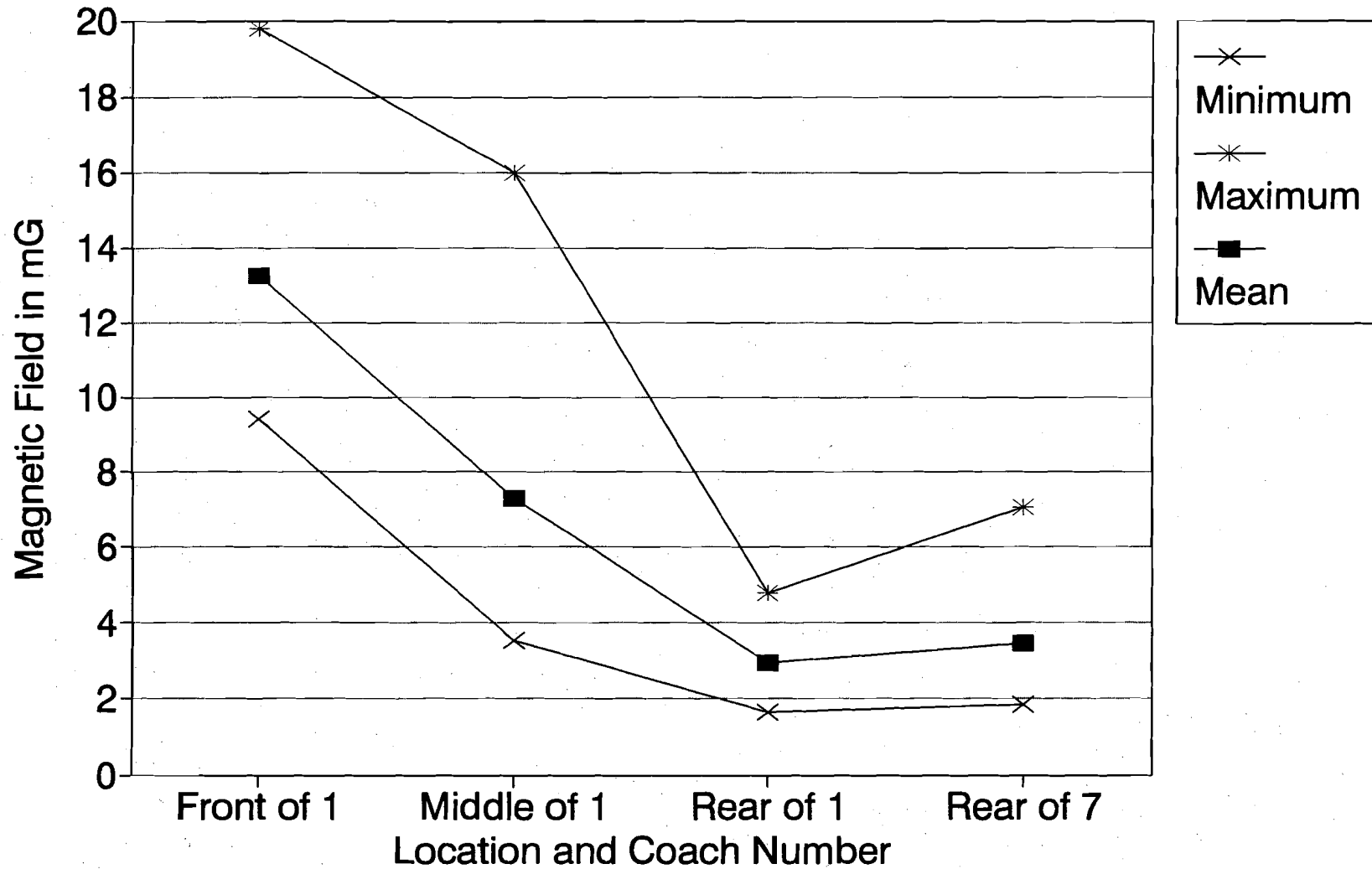

3-11

FIGURE 3-6. POWER FREQUENCY MAGNETIC FIELD LEVELS AT VARIOUS LOCATIONS ALONG THE 25 HZ NEC SEGMENT

25Hz - EDGE OF AISLE - FRONT OF COACH 1

POWER FREQUENCY (50-60 Hz)

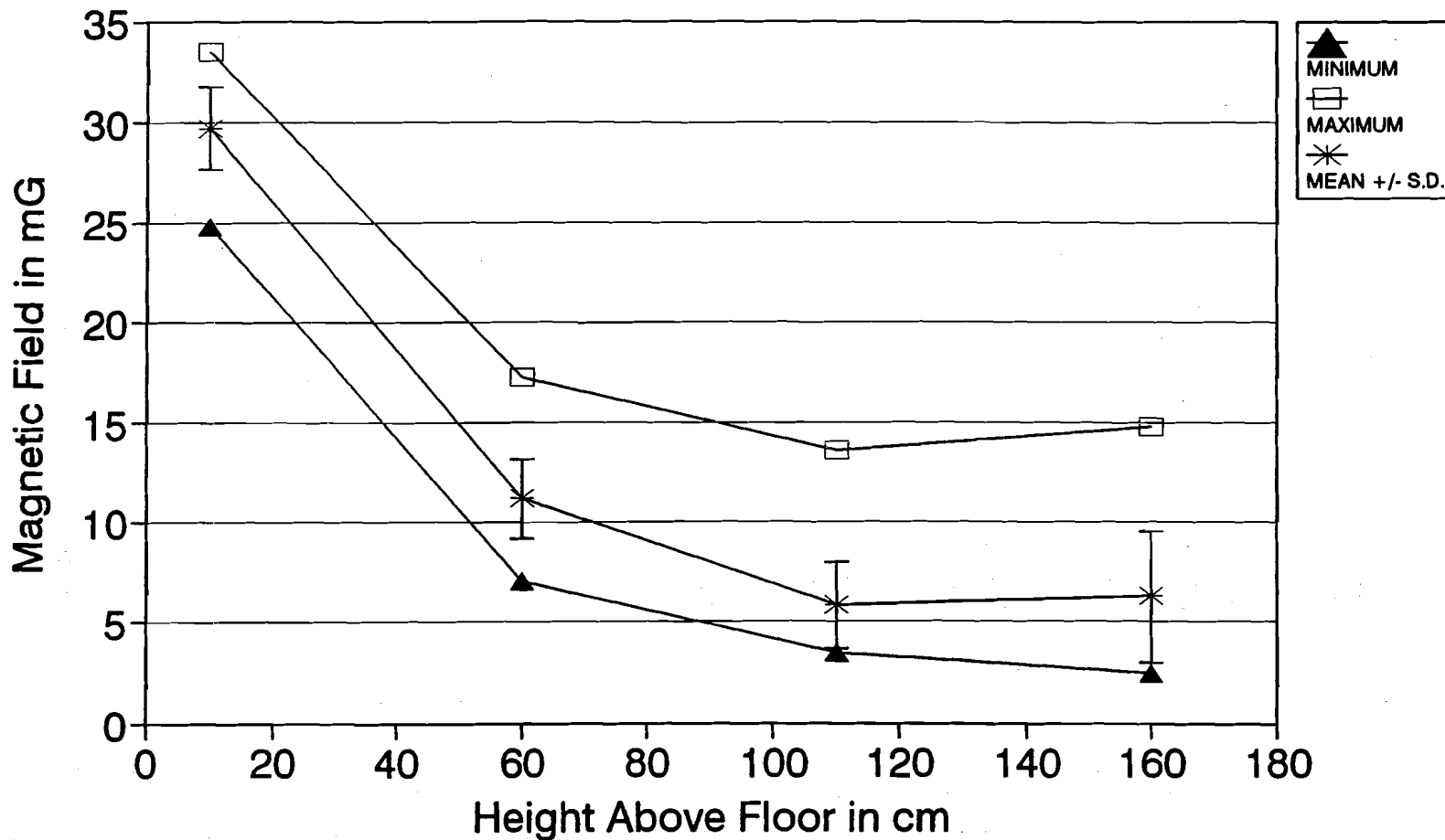

3-12

FIGURE 3-7. POWER FREQUENCY MAGNETIC FIELD LEVELS AT THE FRONT OF COACH 1 AT VARIOUS HEIGHTS ABOVE THE FLOOR FOR 25 HZ NEC SEGMENT

Power Frequency (60 Hz) Magnetic Fields Coaches on the Non-Electrified Section

3-13

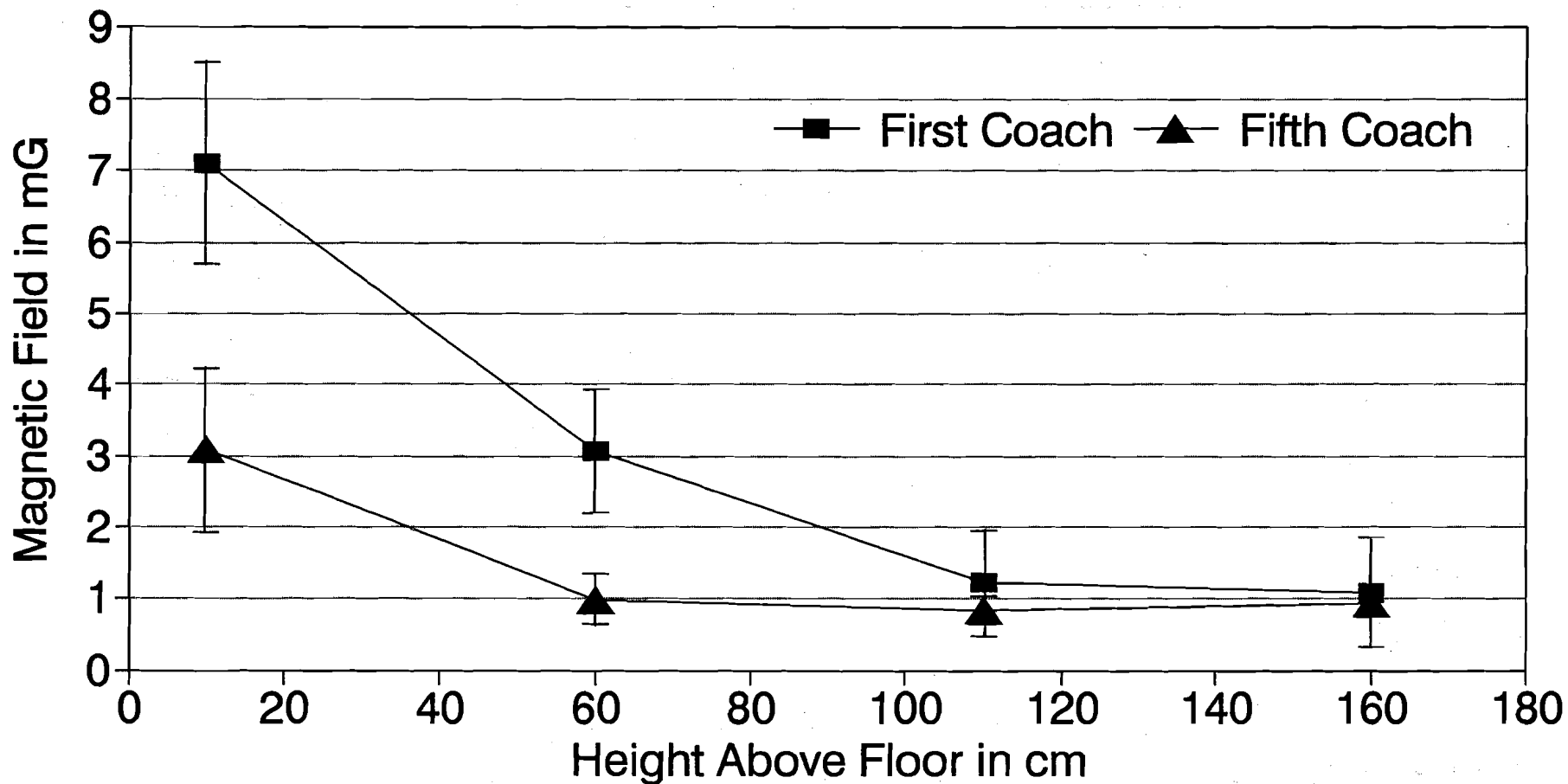

FIGURE 3-8. MEAN \pm STANDARD DEVIATION OF 60 HZ MAGNETIC FIELDS IN THE COACHES ON THE NON-ELECTRIFIED SECTION OF THE NORTHEAST CORRIDOR

Unfortunately, the 60 Hz magnetic field data from the 25 Hz section and the non-electrified section cannot be compared on a point-by-point basis because the measurement locations were not exactly the same. The front two coaches of the train from Washington to New Haven were removed from the train at New Haven. As a result, the "first coach" on the non-electrified section was the third coach on the 25 Hz section, and the "home coach," which was the seventh of nine coaches on the 25 Hz section, was the fifth of seven on the non-electrified section from New Haven to Boston. Nevertheless, the principal characteristics of the 60 Hz magnetic fields are consistent between the two measurement sets.

Time-varying magnetic field levels in the power harmonics (65-300 Hz) and the high frequency (305-2560 Hz) bands are dominated by fields produced by harmonic currents in the catenary and track circuit. The distribution of these field components throughout the train as shown in Figures 3-9 and 3-10, respectively, is very similar to the distribution of the 25 Hz catenary fields shown in Figure 3-5. Since the total field in the entire measurement frequency range is so strongly dominated by the 25 Hz component, the distribution of total time-varying magnetic field throughout the train shown in Figure 3-11 is nearly identical to the distribution of the 25 Hz field shown in Figure 3-5.

The four traction motors in the AEM-7 locomotive are direct current motors driven with high currents. Although the motors themselves are not likely to be significant sources of static magnetic fields in the coaches, some of the motor connections could be if the spacings between bus bars or cables were sufficiently large. Consequently, the static magnetic field levels in the coaches were examined in the search for evidence of magnetic fields from the dc components of the locomotive. Figure 3-12 shows the distribution of maximum, average, and minimum static magnetic field at four locations in the coaches at increasing distances from the locomotive. As with similar preceding graphs, the plotted values are the averages of the data measured at four heights above the floor of the coaches. This figure appears to indicate a static magnetic field in the coaches which becomes weaker with distance from the locomotive. However, closer examination indicates otherwise.

The geomagnetic field (natural magnetic field of the earth) along the east coast is approximately 500 mG which is more or less the average static field level throughout the coaches. Iron and steel components in the coach undercarriages and bodies obviously perturb the geomagnetic field, reducing the field level if a ferromagnetic member shunts flux around the sensor or enhancing the field if the member concentrates flux at the sensor location. Site specific field perturbations are an alternative explanation for the field profile shown in Figure 3-12.

Figure 3-13 shows plots of the static and the low frequency (5-45 Hz) magnetic fields as a function of height above the floor at the front of coach 1 (location 9 of Figure 3-1). Complete data are in Appendix H. The upper frame of Figure 3-13 shows a consistent

Magnetic Field in Coaches

Power Harm (65-300Hz) Magnetic Field

3-15

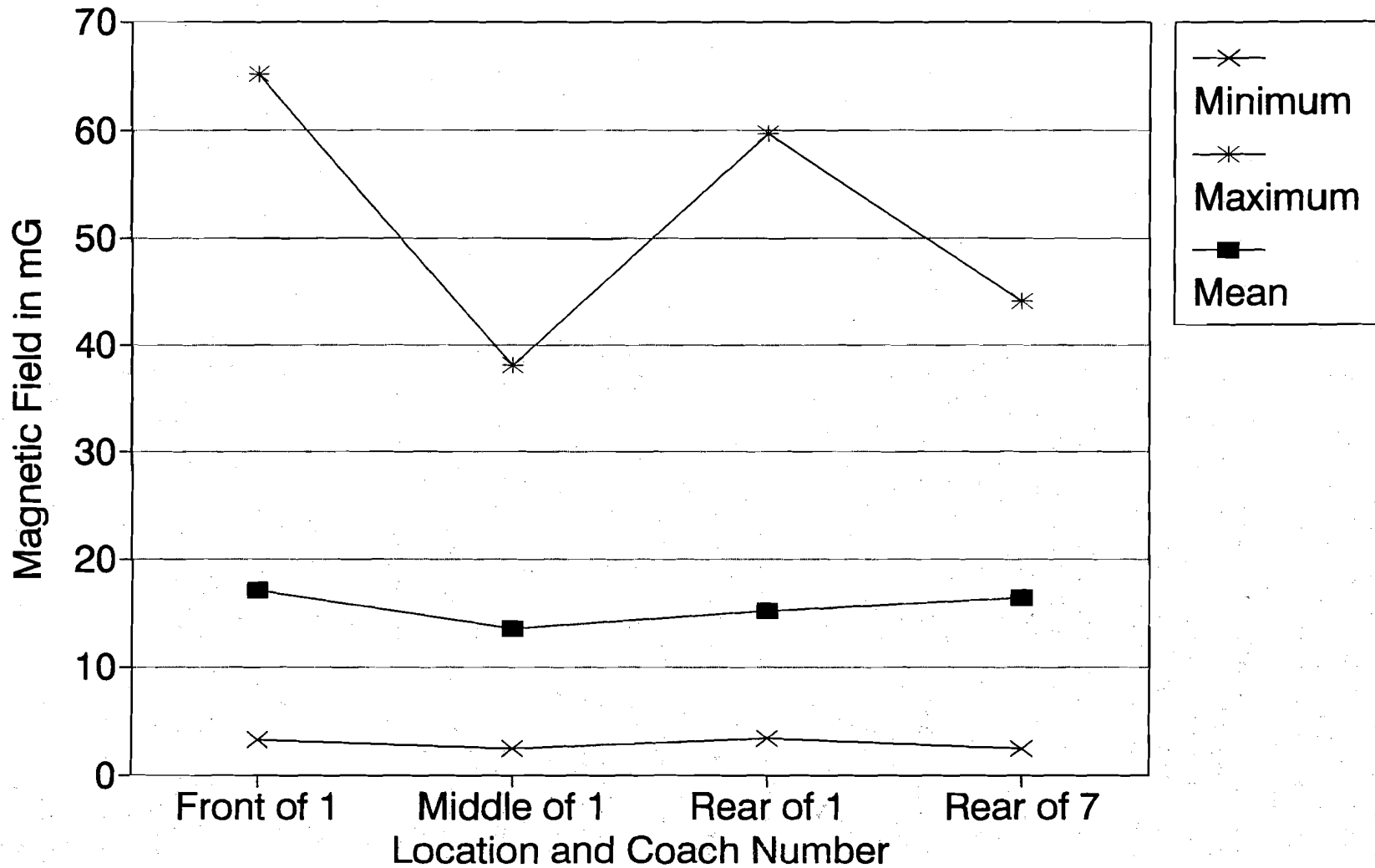
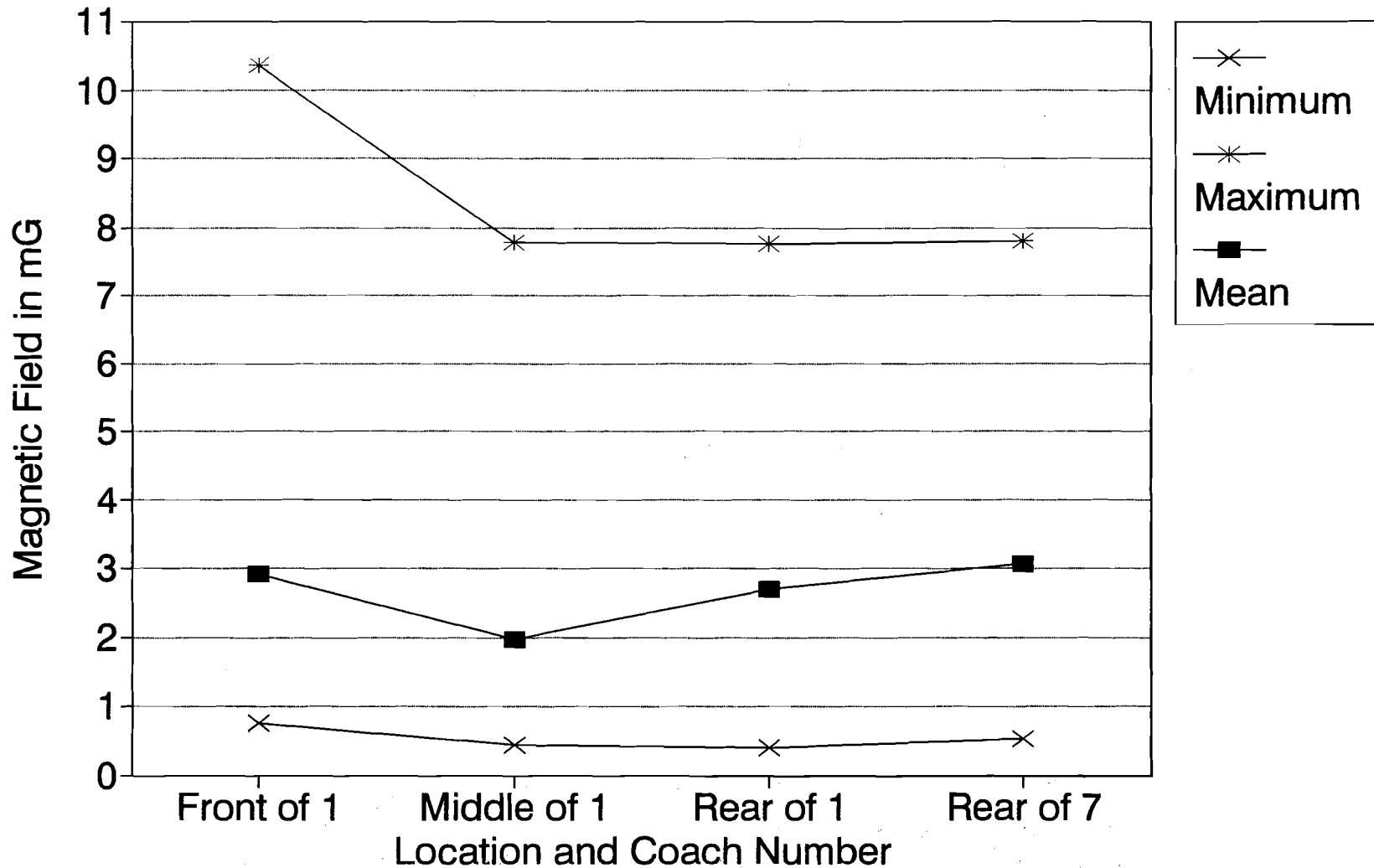

FIGURE 3-9. MAGNETIC FIELD LEVELS IN THE POWER HARMONICS BAND (65-300 HZ)

Magnetic Field in Coaches

High Freq (305-2560Hz) Magnetic Field



3-16

FIGURE 3-10. MAGNETIC FIELD LEVELS IN THE HIGH FREQUENCY BAND (305-2560 HZ)

Magnetic Field in Coaches

All Freq (5-2560Hz) Magnetic Field

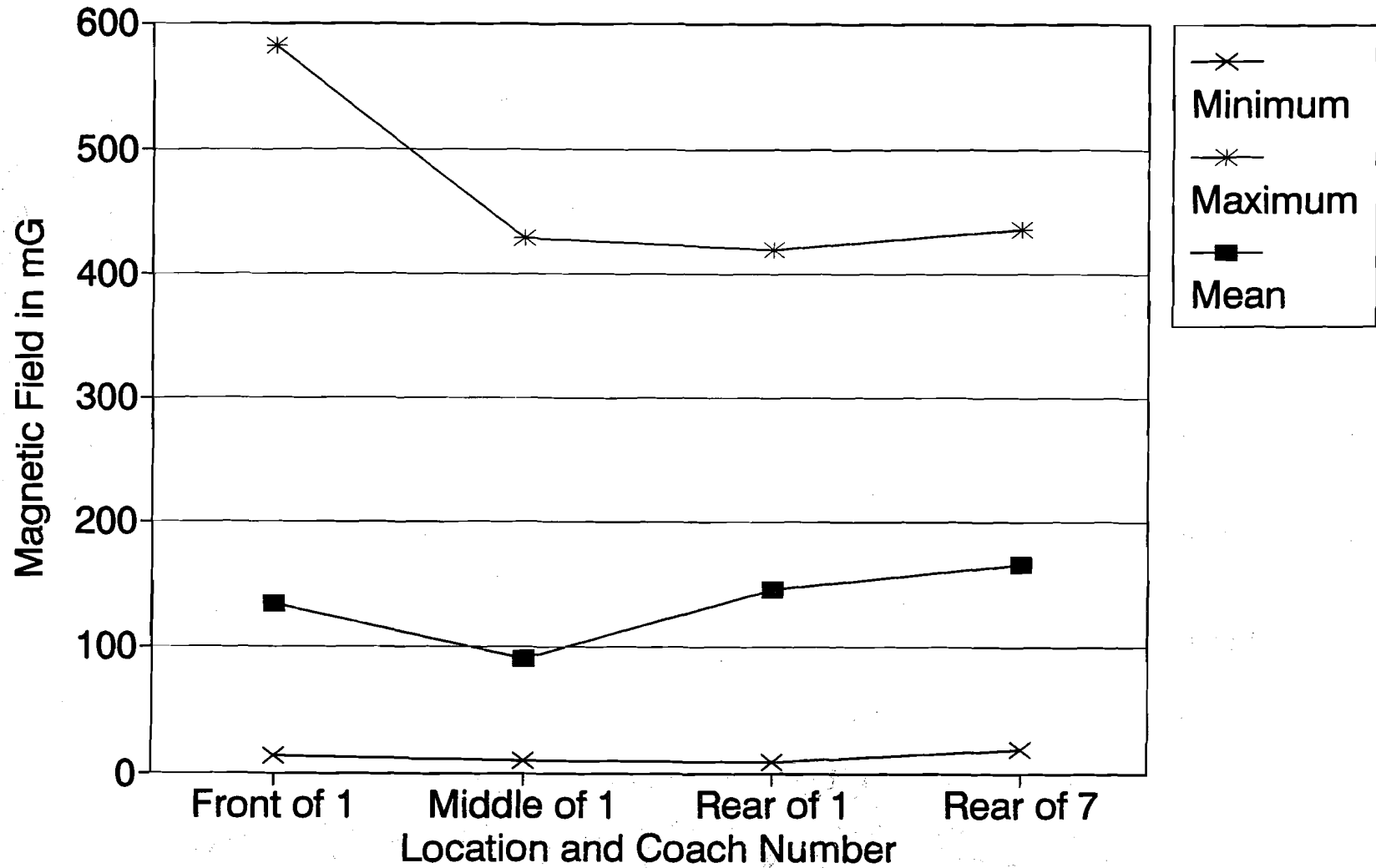

3-17

FIGURE 3-11. TOTAL TIME-VARYING MAGNETIC FIELD (5-2560 HZ) AT VARIOUS LOCATIONS

Magnetic Field in Coaches

Static Magnetic Field

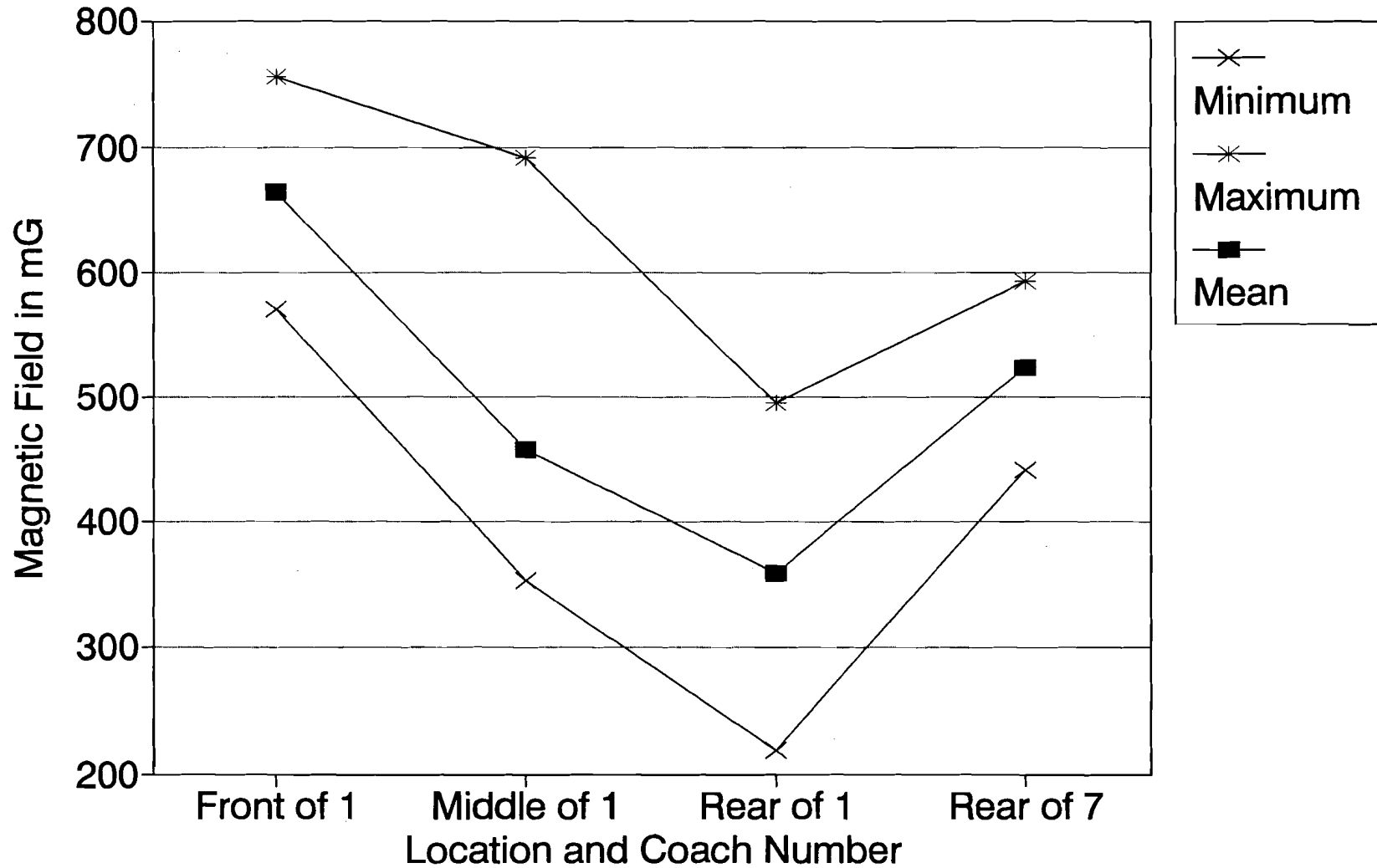

3-18

FIGURE 3-12. STATIC MAGNETIC FIELD AT VARIOUS LOCATIONS

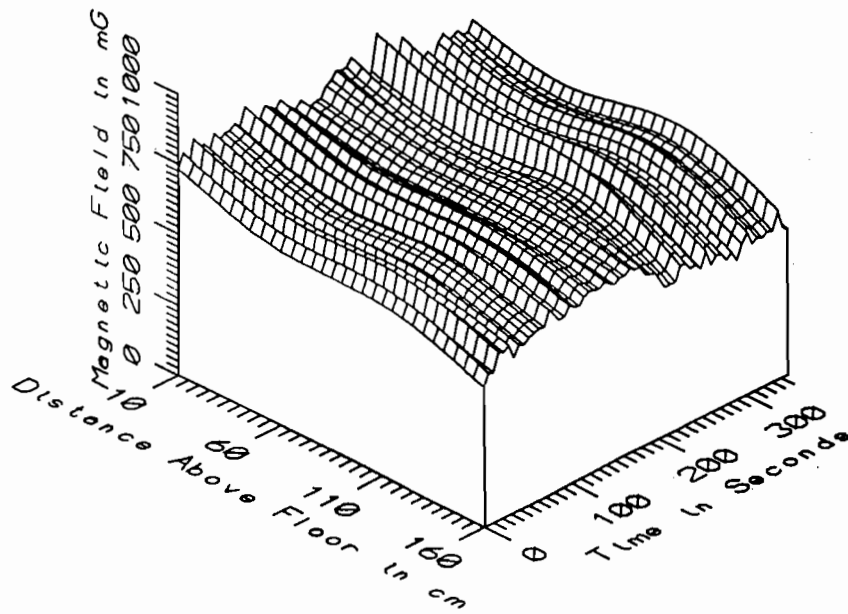

NEC007 - EDGE OF AISLE IN THE FIRST COACH - STATIC

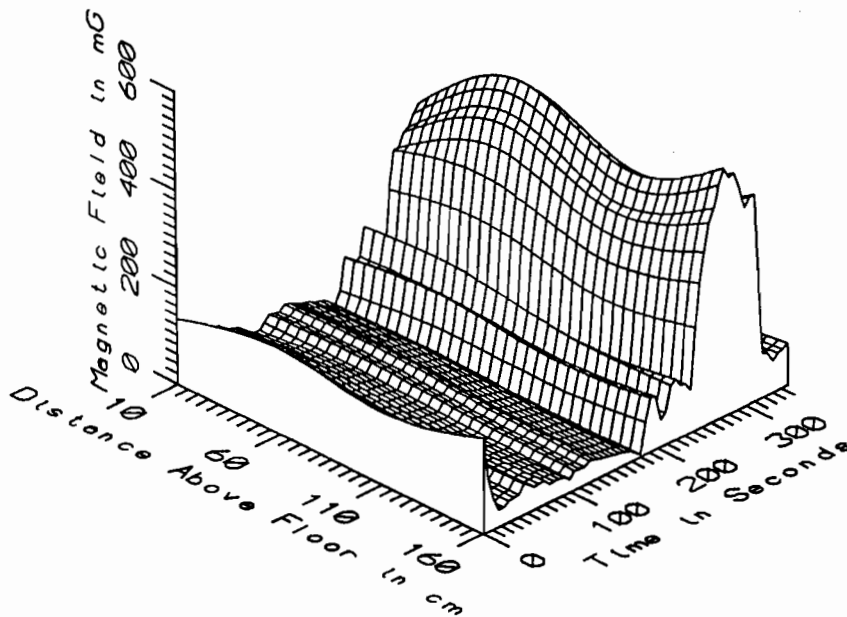

NEC007 - EDGE OF AISLE IN THE FIRST COACH - LOW FREQ, 5-45Hz

FIGURE 3-13. VERTICAL PROFILE OF STATIC AND LOW FREQUENCY (5-45 HZ) MAGNETIC FIELDS OVER TIME AT THE FRONT OF THE FIRST COACH (25 HZ SECTION OF NEC)

gradient in static magnetic field from approximately 700 mG near the floor to approximately 500 mG at head level (160 cm). There was no significant increase in static field levels or change in field spatial pattern until around 300 seconds into the test, when the locomotive increased its power as evidenced by the increased magnetic field from catenary and track current shown in the lower frame of Figure 3-13. This lack of time correlation between increased locomotive power and increased static field rules out the dc motors, cables, etc. of the locomotive as significant sources of magnetic fields and rules out the locomotive as an explanation of the static field distribution through the train shown in Figure 3-12.

Vertical profiles of static magnetic field over time at the back of coach 1 and at the middle of coach seven are shown in Figure 3-14. Significant shielding of the geomagnetic field occurs near the floor and near the ceiling at the measurement location at the rear of coach 1, causing the average static field at that location (plotted on Figure 3-12) to be below the expected 500 mG value. As at the front of the coach, this perturbation appears to be passive because it does not correlate with locomotive power. Static fields are also perturbed in the 7th coach, being slightly enhanced 60 cm above the floor and depressed 110 cm above the floor. Again, the static field perturbation is consistent over time and therefore probably entirely the result of passive effects of ferromagnetic material in the coaches.

The perturbing effects of the ferromagnetic coach members is not limited to the static fields but also affects the time-varying fields. Unfortunately, however, the degree of field enhancement or suppression caused by nearby ferromagnetic material is dependent on the orientation of the magnetic field relative to the sensor and the iron and steel coach members. Hence, one cannot "correct for these perturbing effects on the time-varying fields by applying the static field data." Nevertheless, it is interesting to note that the general field enhancement at the front of the first coach and suppression at the rear of the first coach appears to be consistent with the 60 Hz magnetic field data reported in Figure 3-6 and may account for the apparent strong gradient in 60 Hz field levels along the center aisle of the first coach. If, in fact, the 60 Hz field of Figure 3-6 was passively enhanced at the front of coach 1 and suppressed at the rear of coach 1, the data would be much more consistent with the hypothesis that the 60 Hz fields originate from the hotel power cables beneath the coach floor.

Magnetic field measurements were also made near the side bulkheads at locations 1 and 10 on Figure 3-1. The resulting data are in Appendices B, C, F, and G. These data are consistent with data measured near the aisle and with data measured with the reference probe in the window seat (location 3 of Figure 3-1) but somewhat more spatially variable. The increased variability is presumably due to more severe passive field perturbations caused by members in the coach wall. There was also a noticeable increase in the 60 Hz component of the magnetic field 160 cm above the floor against the bulkhead as indicated in the vertical profile data in Figure 3-15.

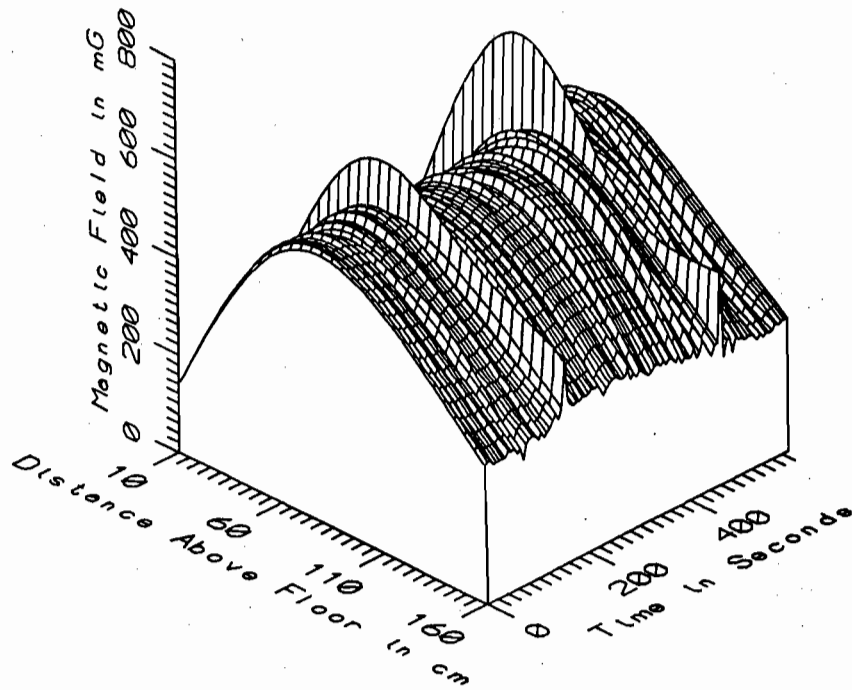

NEC009 - EDGE OF AISLE IN REAR OF 1ST COACH - STATIC

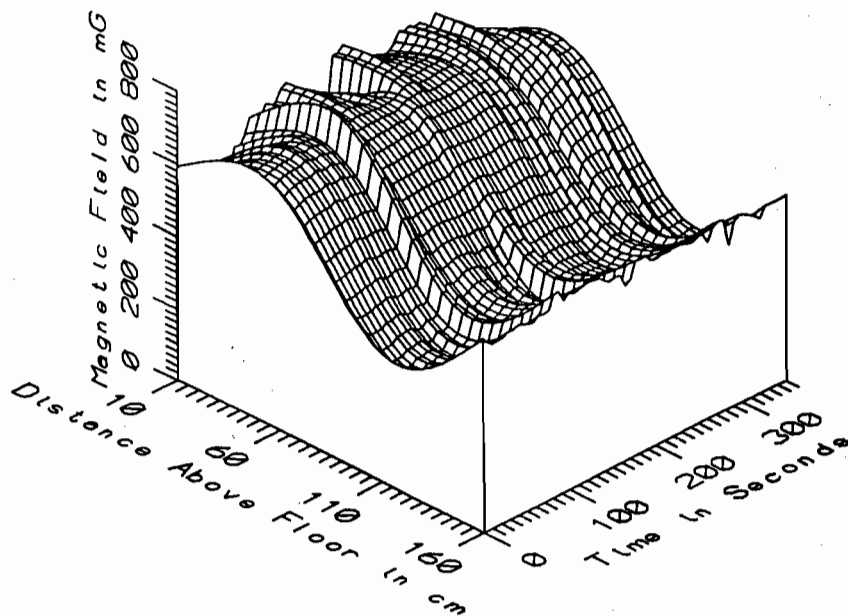

NEC003 - EDGE OF AISLE IN THE 7TH COACH - STATIC

FIGURE 3-14. VERTICAL PROFILE OF STATIC MAGNETIC FIELDS OVER TIME AT THE REAR OF COACH 1 AND MIDWAY THROUGH COACH 7

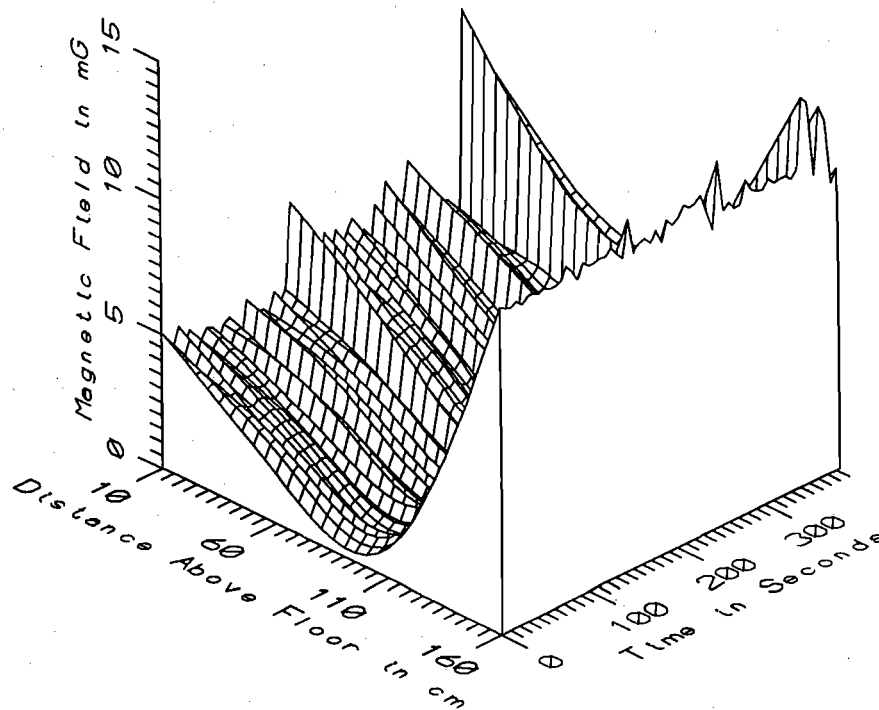

NEC005 - AGAINST SIDE BULKHEAD IN 1ST COACH - POWER FREQ, 50-60Hz

FIGURE 3-15. VERTICAL PROFILE OF MAGNETIC FIELD IN THE POWER FREQUENCY (50-60 HZ) BAND SHOWING INCREASE IN FIELD NEAR FLUORESCENT LIGHT AT THE TOP OF THE BULKHEAD

The fluorescent lights in that area are apparently the source of that localized field. The magnitude of the 60 Hz field near the lights is very small compared to the fields from the catenary and track circuit.

3.4 DAT WAVEFORM DATA

Magnetic field data from the reference probe of the waveform capture system was recorded continuously with a Digital Audio Tape Recorder as described in Section 2.6 during those occasions when magnetic fields were measured in the home coach. To minimize interference with revenue customers, the DAT was not moved throughout the coaches for recordings at other locations. Table 2-2 identifies the times and locations of DAT recordings of magnetic field levels within the AMTRAK and New Jersey Transit coaches.

All of the waveform data recorded in the coaches was scanned for significant levels of transient magnetic fields, except Record 1-1. That record was inadvertently recorded with the ac field signal amplifiers in the "autorange" mode which permitted them to switch gain from time to time. The amplifier gain switching produced "transients" in the DAT recording that were not the result of transients in the magnetic field. The scan of the remaining recordings revealed no significant departures in magnetic field waveform from the typical distorted sinewave. Consequently, the tapes were reviewed a second time with special attention on those times where the locomotive crossed a phase break in the catenary or when the locomotive passed from the 25 Hz system to the 60 Hz system. Again, no observable magnetic field transients were recorded.

The controlled rectifier system in the locomotive likely contained circuits designed to protect the rectifiers from voltage surges which could arise from rapid transients in supply current. Apparently, the commutation of inductive motor current through those circuits, together with the impedance of the catenary/track circuit, act to reduce the magnitude of current transients in the catenary, at least in the frequency range of the field measurements. Furthermore, it appears that the engineer reduces traction power prior to the phase breaks, thereby reducing the current drawn by the locomotive while crossing the phase break. It is not clear from these measurements whether that reduction in power results from intentional intervention of the engineer or judicious placement of the phase breaks.

The DAT data was also examined for rapid variations in magnetic field level which could be missed by the waveform capture system which records only 0.2 second "snapshots" of the magnetic field at selected sample intervals (typically every 5 seconds or 1 minute during these tests). Figure 3-16 compares the total ac magnetic field for the reference probe measured by the DAT (top frame) and the field measured by the waveform capture system (bottom frame). These data come from a portion of DAT Record 2-2 and repetitive waveform dataset NEC011 (Appendix L) which were recorded on the seat of the home coach (Figure 3-1, Location #3) while the train

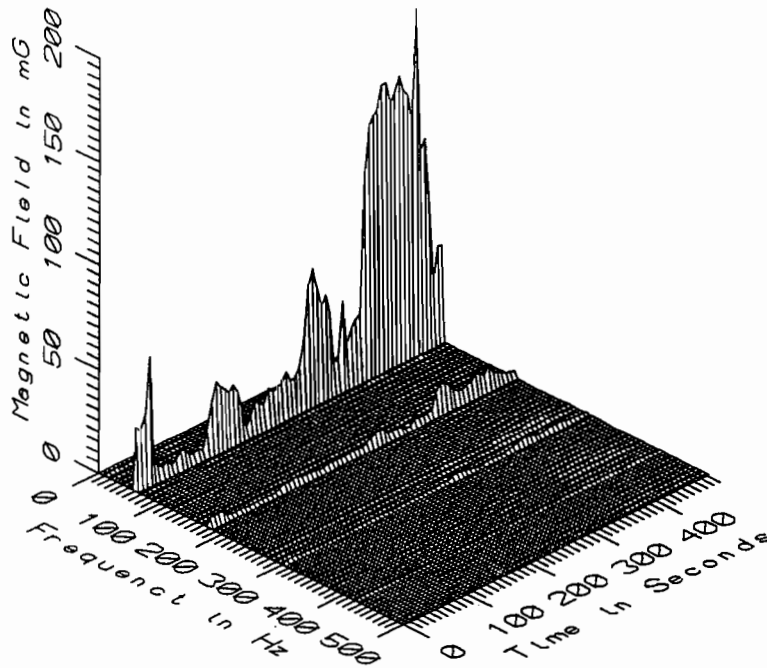
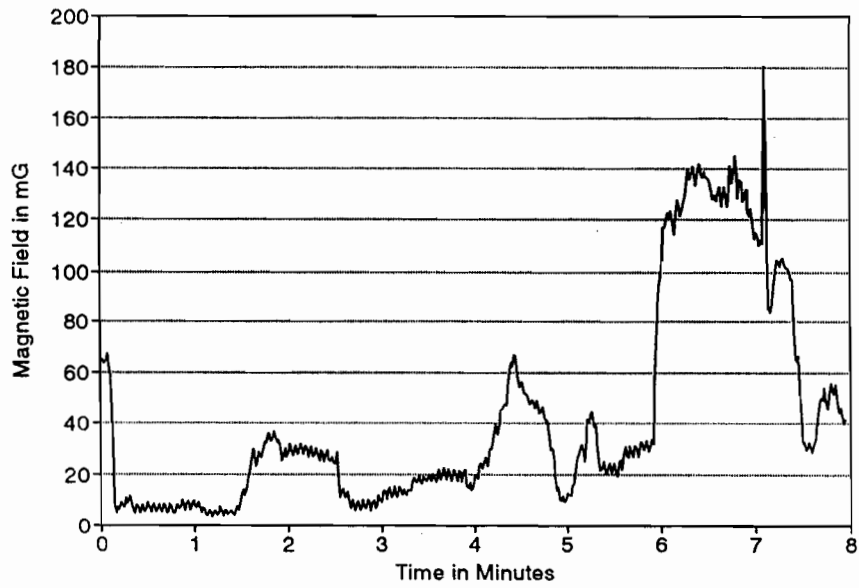

NEC011 - REFERENCE PROBE - WINDOW SEAT IN THE SEVENTH COACH

FIGURE 3-16. COMPARISON OF MAGNETIC FIELD MEASUREMENTS MADE CONTINUALLY WITH THE DIGITAL AUDIO TAPE RECORDER (TOP FRAME) AND THOSE MADE WITH THE REPETITIVE FIELD WAVEFORM RECORDING SYSTEM SAMPLING AT 5 SECOND INTERVALS (BOTTOM FRAME)

pulled into the Stamford, CT station, unloaded and loaded passengers, and departed. The consistency of the field magnitude and temporal properties is clearly evident. There is no indication in this figure or comparisons made with other datasets that significant characteristics of the field are missed using the waveform sampling approach of the repetitive field waveform recorder.

A statistical summary of rms magnetic field levels in the pass band of the DAT Recording System (5 Hz to 2.5 kHz) recorded in the coaches is presented in Table 3-1.

3.5 RMS RECORDER DATA

Magnetic field levels measured by the waveform capture system or DAT recorder provide detailed documentation of magnetic field levels at a few discrete locations within the coaches but do not factor in the possibility that passengers moving about the coaches may encounter high fields from specific localized sources. To examine the extent to which spot measurements of magnetic fields can be generalized to passenger exposure, one, and sometimes two, members of the measurement team wore rms personal magnetic field exposure monitors.

The rms monitors lack the ability to resolve the frequency characteristics of the magnetic field, recording instead the total magnetic field level within a particular frequency range. For these tests, the instruments were used in the "broadband" mode which yielded the widest frequency response (nominally 45 Hz to approximately 1000 Hz) and therefore, provided the instrument's most complete measurement of ELF magnetic fields.

During the majority of the tests in the AMTRAK coaches, one rms recorder was left in a fixed location within the home coach while the second was worn by a test team member who moved around the train from time to time but spent most of the time in the home coach. The purpose of having one rms recorder stationary and the other worn on a person was to better identify the extent to which movement of the wearer contributes to differences in field level. Simple comparison of fields measured by a mobile rms recorder and the stationary waveform capture system would not permit unambiguous comparison due to the difference in times when measurements were made during the trip.

Figure 3-17 shows a comparison of the magnetic field readings obtained from two rms recorders and from the waveform capture system. These measurements were made in the home coach while the train pulled into the New Haven Station (at 13 minutes), the electric locomotive and front two cars were replaced by a diesel and the train departed under diesel power at 28 minutes. RMS recorder 1 was worn by a test team member seated on the right side of the home coach toward the rear. Rms recorder 2 was the stationary rms recorder located near the waveform capture system recorder on the left side of the coach, just rear of center. It can be observed from the figure that the field levels recorded by

TABLE 3-1

SUMMARY OF MAGNETIC FIELD LEVELS RECORDED
 IN A PASSENGER SEAT OF A COACH RECORDED WITH
 THE DIGITAL AUDIO TAPE RECORDER (DAT)

RAILROAD SECTION (DATASETS)	MEASUREMENT LOCATION		MAGNETIC FIELD MILLIGAUSS, RMS		
	FIGURE #	LOCATION	MINIMUM	AVERAGE	MAXIMUM
25 HZ NEC (4-2)	3-1	12	1.6	45.9	217.7
60 HZ NEC (PART OF 2-2)	3-1	3	1.8	29.9	187.2
60 HZ LONG BRANCH (6-5)	3-2	19	2.5	17.9	53.8
NON- ELECTRIFIED NEC (PART OF 2-2 & 2-3)	3-1	3	0.8	3.2	26.0

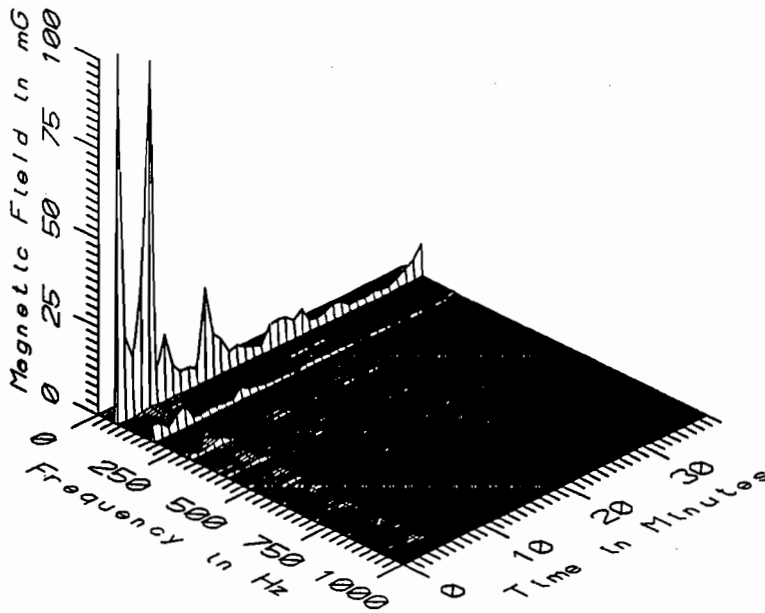
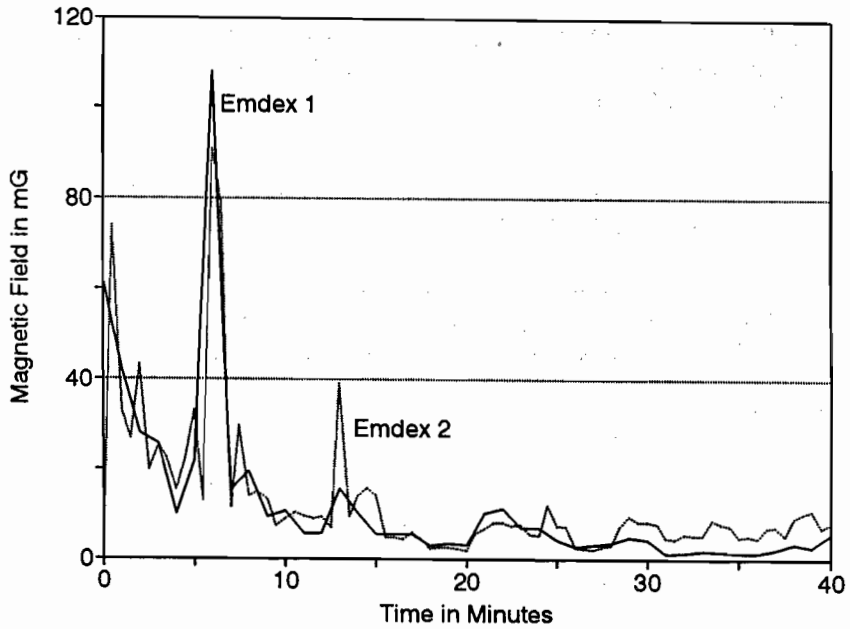

NEC013 - 60 cm ABOVE FLOOR AGAINST SIDE BULKHEAD IN THE SEVENTH COACH

FIGURE 3-17. COMPARISON OF RMS RECORDER (TOP FRAME) AND REPETITIVE FIELD WAVEFORM RECORDING SYSTEM (BOTTOM FRAME) MEASUREMENTS OF MAGNETIC FIELD LEVELS WITHIN AN AMTRAK COACH ON 60 HZ AND NON-ELECTRIFIED PORTIONS OF THE NEC

the two rms recorder units are similar in magnitude and temporal characteristic, and furthermore, that they are similar in magnitude and correlated in time with the field levels measured with the waveform capture system. The good agreement between instruments is expected for measurements on the 60 Hz section of the NEC because, as discussed earlier, current in the catenary/track circuit is the primary field source, fields arising from that source are spatially uniform throughout the coaches, and the frequency of the field (60 Hz plus low order harmonics) falls within the passband of both types of instruments.

The data on Figure 3-17, beyond the 29 minute point, represents field levels measured by the rms recorders and the repetitive field waveform recorder in the home coach after the train departed New Haven toward Boston on the non-electrified portion of the corridor. Since, in the absence of the catenary, there is no longer a single dominant field source, magnetic field levels detected by the three instruments are less well correlated. Each is responding to the weaker onboard sources in the immediate vicinity of that instrument. However, since those fields continue to be predominantly composed of 60 Hz and harmonic components, the fields are accurately recorded by both types of instruments.

Figure 3-18 depicts the results of a similar comparison of the rms and waveform capture system recorders on the NEC in Maryland where the fundamental frequency of the catenary current (and resulting magnetic field) is 25 Hz. Although the results measured by the rms recorders agree rather well, they are much smaller than the field levels recorded by the waveform capture system recorder. That is because the predominant frequency component of magnetic field produced by catenary current on the 25 Hz section of the corridor is 25 Hz and falls outside the passband of the rms recorder. Closer examination of the data in Figure 3-18 demonstrates that the field values recorded by the rms recorder units are predominantly the 75 Hz (3rd harmonic) component of the field from the catenary along with smaller contributions of 5th, 7th, 9th, and 11th harmonic components of the catenary field and 60 Hz fields from onboard "hotel" services. The failure of the rms recorder units to detect and record the fundamental component of the catenary magnetic field must be considered a fatal deficiency and invalidates the results of rms recorder measurements on the 25 Hz section of the NEC.

A critical comparison of rms and waveform capture system records was not required on the New Jersey Transit measurements on the Long Branch Line because the measurements reported in Figure 3-17 for the 60 Hz section of the NEC apply. Frequency spectra measurements for the Long Branch Line (NEC048, Appendix AW) demonstrate that the dominant components of the magnetic field fall within the passband of the rms recorders.

A plot of magnetic field level versus time as measured with an rms recorder worn by one member of the test team during the trip from Washington, DC to Boston, MA is provided in Figure 3-19. A number of "event markers" in the data identify the time at which specific

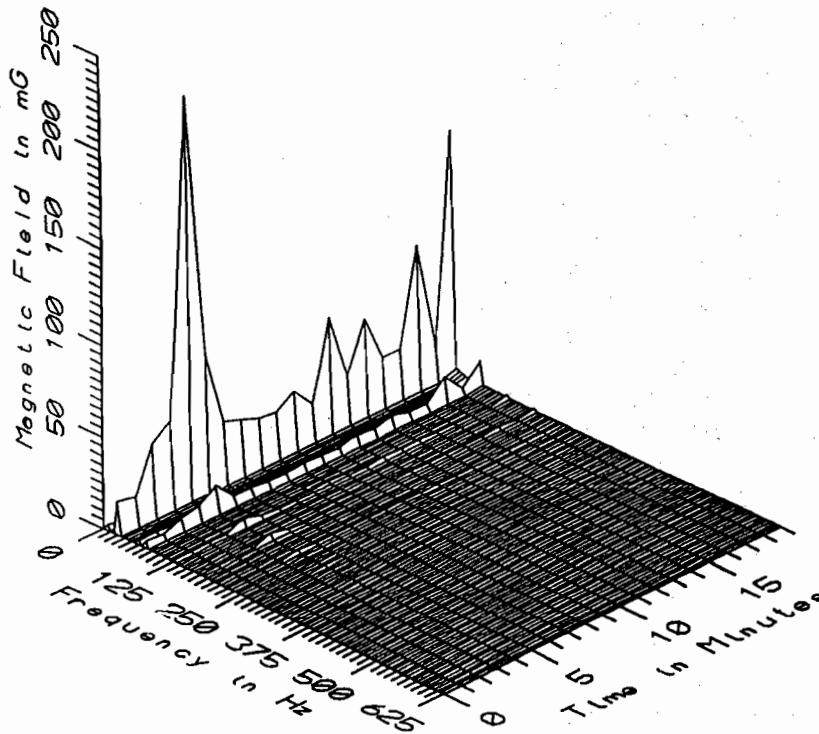
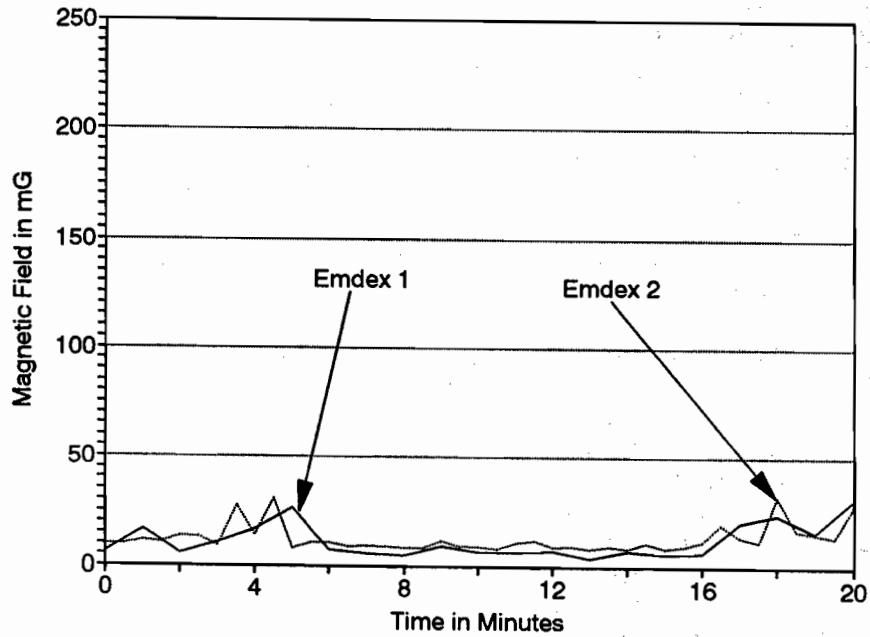

NEC001 - 60cm ABOVE FLOOR AGAINST SIDE BULKHEAD IN SEVENTH COACH

FIGURE 3-18. COMPARISON OF RMS RECORDER (TOP FRAME) AND REPETITIVE FIELD WAVEFORM RECORDING SYSTEM (BOTTOM FRAME) MEASUREMENTS OF MAGNETIC FIELD LEVELS IN AN AMTRAK COACH ON THE 25 HZ SECTION OF THE NEC

3-30

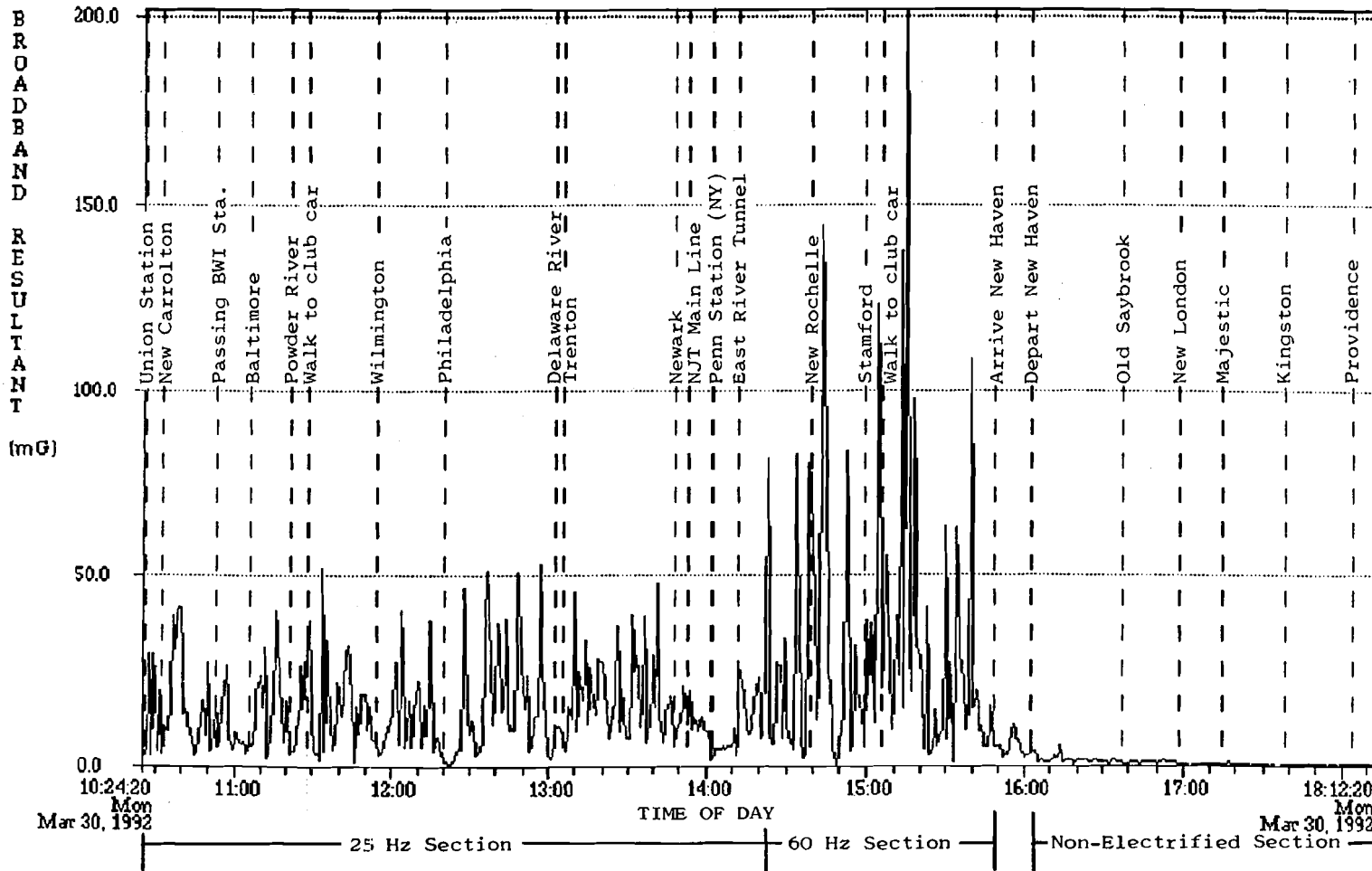

RMS recorder measurements in coaches on the 25 Hz section of the NEC are not valid because the principal time varying field component (25 Hz) is at a frequency outside the instrument's response band.

FIGURE 3-19. RMS RECORDING OF MAGNETIC FIELD LEVELS ENCOUNTERED BY A PASSENGER TRAVELING FROM WASHINGTON, DC TO BOSTON, MA. FIELD MEASUREMENTS ON THE 25 HZ SECTION OF THE TRIP ARE ERRONEOUS BECAUSE THE INSTRUMENT DOES NOT INCLUDE THE 25 HZ COMPONENT OF THE MAGNETIC FIELD

observable events occurred. Figure 3-20 shows a similar graph of the magnetic field levels measured by the second rms recorder over the identical time period. The similarity between measurements on a mobile passenger and those at a fixed location is striking on the electrified section of the corridor. That should be expected because the principal field source, current in the catenary and track circuit, generates relatively uniform fields throughout the coaches and is so much stronger than other localized sources, that it dominates the measurements. On the non-electrified portion of the corridor, however, there are noticeable differences in magnetic field levels because weaker localized field sources onboard the train are no longer obscured by stronger fields from the track and catenary current. For example, the fixed position rms recorder (Figure 3-20) was located in a seat pocket approximately above the compressor for the coach air conditioning. The air conditioning was turned off at approximately 5:20 PM (17:20) and a corresponding drop in magnetic field was observed at that location. The passenger wearing the other rms recorder was seated on the opposite side of the aisle and a few seats further back. The field record from his recorder (Figure 3-19) shows generally lower fields in his area arising from source which approximately went off at 5:00 PM (17:00).

The maximum, minimum, and average magnetic field levels measured with the rms recorders in the AMTRAK coaches on the 60 Hz portion and non-electrified portion of the NEC, as well as on the New Jersey Transit coaches on the 60 Hz section of the New Jersey Coast Line, are reported in Table 3-2. The correlation between the average fields sensed by the two recorders is good on the electrified sections of the railroad because the principal field source (the catenary/track circuit) generates uniform fields throughout the coaches. Correlation is not as good between average field levels measured with the two rms recording units on the non-electrified section of the NEC because the magnetic fields are predominantly from local sources onboard the train and therefore are spatially variable. As a result, recorders located at different locations with the coach detect different field levels.

3.6 SUMMARY AND DISCUSSION OF MAGNETIC FIELD LEVELS

As discussed in the preceding subsections, current in the track and catenary circuit is the principal source of time-varying magnetic fields within coaches operating on the electrified portion of the corridor. The magnetic field produced by this loop is generally uniform throughout the coaches. Therefore, it is appropriate to combine magnetic field measurements at various locations within the coaches in order to obtain a statistical description of the overall time-varying magnetic field level within the coaches.

Corresponding data collected on the non-electrified portion of the corridor provide a comparison to field conditions which exist from sources like onboard equipment and appliances, hotel power, and external sources not related to electrified traction. Finally, the data from the electrified North Jersey Coast Line between Matawan and Long Branch can be compared to the NEC data to evaluate

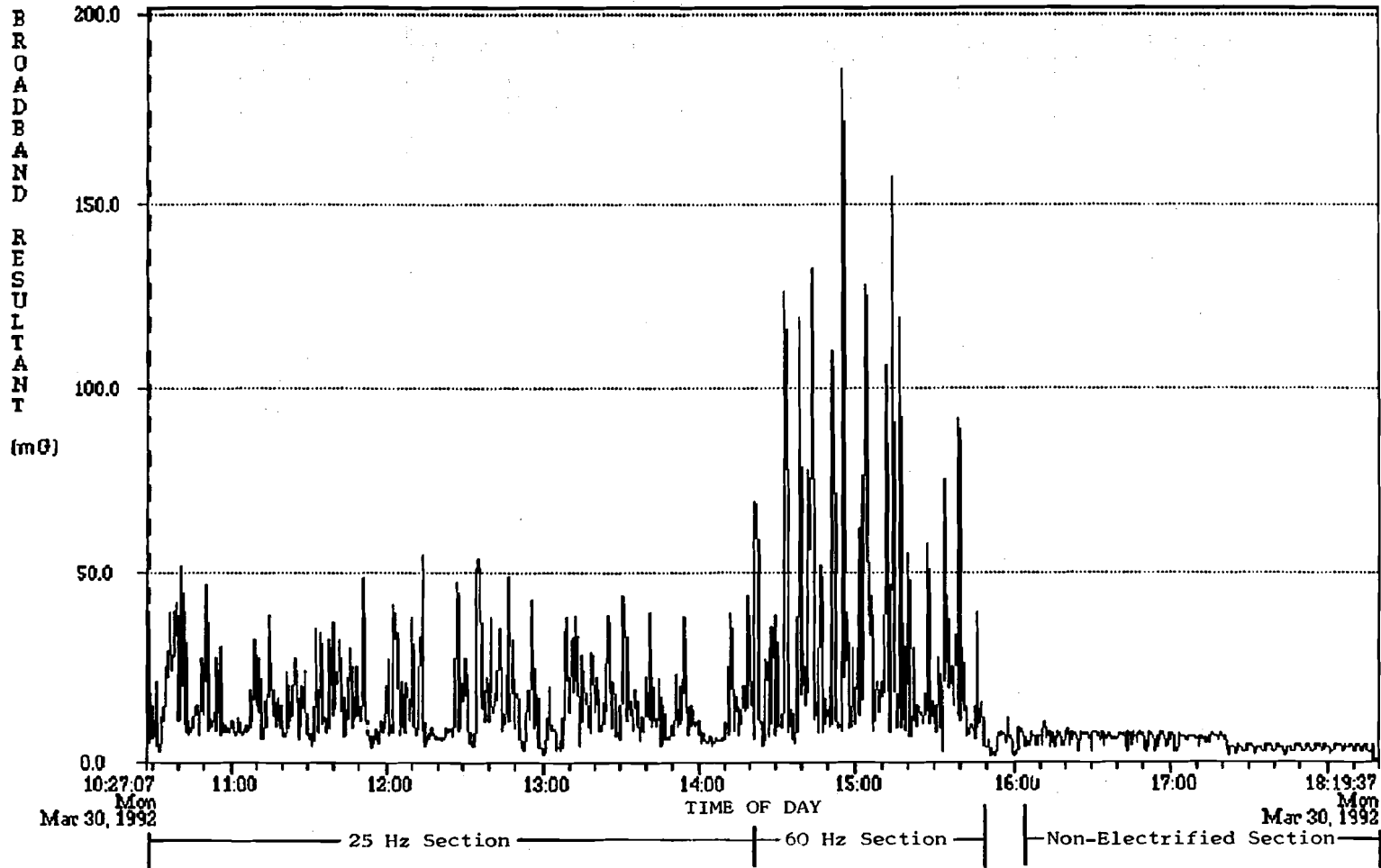

RMS recorder measurements in coaches on the 25 Hz section of the NEC are not valid because the principal time varying field component (25 Hz) is at a frequency outside the instrument's response band.

FIGURE 3-20. RMS RECORDING OF MAGNETIC FIELD LEVELS MEASURED BY A STATIONARY INSTRUMENT IN A COACH SEAT POCKET DURING A TRIP FROM WASHINGTON, DC TO BOSTON, MA. FIELD MEASUREMENTS ON THE 25 HZ SECTION OF THE TRIP ARE ERRONEOUS BECAUSE THE INSTRUMENT DOES NOT INCLUDE THE 25 HZ COMPONENT OF THE MAGNETIC FIELD

3-32

TABLE 3-2

**STATISTICAL SUMMARY OF MAGNETIC FIELDS MEASURED
IN COACHES USING RMS RECORDERS***

SYSTEM	MINIMUM	AVERAGE	MAXIMUM
NEC 60 Hz			
RMS RECORDER 1	3.3 mG	30.72 mG	183.9 mG
RMS RECORDER 2	0.9 mG	31.12 mG	199.9 mG
COMBINED	0.9 mG	30.92 mG	199.9 mG
NEC NON-ELECTRIFIED			
RMS RECORDER 1	2.2 mG	5.67 mG	10.8 mG
RMS RECORDER 2	0.6 mG	1.21 mG	5.7 mG
RMS RECORDER 2 (RETURN TRIP)	0.6 mG	1.63 mG	8.1 mG
COMBINED	0.6 mG	2.84 mG	10.8 mG
NJT LONG BRANCH 60 Hz			
RMS RECORDER 1	1.8 mG	5.79 mG	20.3 mG
RMS RECORDER 2	1.0 mG	7.38 mG	35.5 mG
COMBINED	1.0 mG	6.59 mG	35.5 mG

* RMS recorder measurements in coaches on the 25 Hz section of the NEC are not valid because the principal time varying field component (25 Hz) is at a frequency outside the instrument's response band.

possible effects of differences in electrification technology.

There was no evidence of significant static magnetic field production in the coaches by the electrification system or dc equipment in the locomotives. Therefore differences in static magnetic field levels can arise from: differences in geomagnetic field level; field shielding and perturbation by the coach bodies and understructure; or field shielding and perturbation by external structures. Since the change in geomagnetic field from location to location is very small (as demonstrated by the wayside data in Section 5), variability in average static field level is principally related to the shielding or perturbing effect of the coach.

In order to maximize the statistical validity of the data collected onboard the coaches, two successive datasets were recorded when time permitted. One set was recorded at a high sample rate (up to 12 waveform samples per minute) to identify the effects of short term variability in field conditions and a second set was recorded at a lower rate (typically one waveform sample per minute) over a long period of time to identify the full range of field conditions. Of course, the summary statistics on both samples should be in close agreement. If not, the data are flagged as suspect.

Table 3-3 presents various summary statistics (minimum field level, maximum field level, average field level, standard deviation and coefficient of variation) for the repetitive waveform data in dataset NEC005 on the 25 Hz NEC segment (Appendix F). The statistical parameters are provided for various measurement heights above the floor for static magnetic fields, low frequency magnetic fields in the range of 5-45 Hz, power frequency magnetic fields in the range from 50 to 60 Hz, power harmonic frequency magnetic fields (65-300 Hz), high frequency magnetic fields from 305 Hz to 2560 Hz and the total time-varying magnetic field in all frequency bands from 5 Hz to 2560 Hz. This dataset consists of 61 samples (as shown in the upper right corner of the figure) taken at approximately seven-second increments over a seven-minute measurement period. Table 3-4 is similar to Table 3-3 except that it summarizes dataset NEC006 (Appendix G) which was collected immediately after dataset NEC005 at the same location within the coach. The twelve measurements summarized in Table 3-4 were taken over a period of eleven minutes at one-minute intervals. Comparison of Tables 3-3 and 3-4 shows that they report approximately the same mean field levels even though they were recorded at different times, the train operating conditions were not identical, and the statistics in Table 3-4 are based on only 12 samples. Data in Table 3-3 tend to have a smaller standard deviation and coefficient of variation than do the data in Table 3-4 because they represent many samples (61) over a more limited time. Table 3-4 tends to report larger maximum fields, smaller minimum fields because it was measured over a longer period of time where the train operating conditions could produce a slightly larger range of field conditions. Datasets measured at high sample rates to reveal short-term field variability and datasets measured with lower sampling rates to quantify the field conditions over the

TABLE 3-3

SUMMARY STATISTICS FOR DATASET NEC005
 MEASURED NEAR THE SIDE BULKHEAD NEAR THE FRONT OF THE
 FIRST COACH ON THE 25 HZ SECTION OF THE NEC

25Hz - AGAINST SIDE BULKHEAD - FRONT OF COACH 1		TOTAL OF 61 SAMPLES				
FREQUENCY BAND	HEIGHT ABOVE FLOOR (cm)	MINIMUM MAGNETIC FIELD (mG)	MAXIMUM MAGNETIC FIELD (mG)	AVERAGE MAGNETIC FIELD (mG)	STANDARD DEVIATION (mG)	COEFFICIENT OF VARIATION (%)
STATIC	10	490.46	875.11	670.04	70.97	10.59
	60	385.99	659.67	527.18	61.68	11.70
	110	385.99	844.76	715.44	41.94	5.86
	160	1487.09	1733.84	1642.00	70.97	4.32
5-45Hz LOW FREQ	10	18.45	449.61	156.13	122.45	78.43
	60	11.40	396.28	126.81	106.66	84.11
	110	8.74	312.81	102.36	86.92	84.92
	160	5.26	596.28	186.33	165.27	88.70
50-60Hz PWR FREQ	10	3.21	11.41	5.10	1.53	30.02
	60	1.76	6.27	2.73	0.87	31.95
	110	0.94	6.84	2.08	1.42	68.44
	160	10.66	14.26	12.02	0.62	5.16
65-300Hz PWR HARM	10	8.96	64.77	28.12	14.94	53.13
	60	4.62	35.28	13.88	8.15	58.74
	110	4.08	27.93	11.28	6.41	56.86
	160	7.61	76.51	29.24	18.55	63.45
305-2560Hz HIGH FREQ	10	1.16	8.67	3.92	2.12	54.07
	60	0.49	7.00	2.43	1.80	74.06
	110	0.48	5.79	2.28	1.49	65.04
	160	1.24	11.42	4.60	2.82	61.25
5-2560Hz ALL FREQ	10	23.49	454.33	159.43	122.52	76.85
	60	14.54	397.91	127.84	106.72	83.48
	110	10.61	314.11	103.22	86.95	84.24
	160	18.98	601.39	190.58	164.54	86.34

TABLE 3-4

SUMMARY STATISTICS FOR DATASET NEC006
 MEASURED NEAR THE SIDE BULKHEAD NEAR THE FRONT OF THE
 FIRST COACH ON THE 25 HZ SECTION OF THE NEC

25Hz - AGAINST SIDE BULKHEAD - FRONT OF COACH 1				TOTAL OF 12 SAMPLES		
FREQUENCY BAND	HEIGHT ABOVE FLOOR (cm)	MINIMUM MAGNETIC FIELD (mG)	MAXIMUM MAGNETIC FIELD (mG)	AVERAGE MAGNETIC FIELD (mG)	STANDARD DEVIATION (mG)	COEFFICIENT OF VARIATION (%)
STATIC	10	523.23	808.26	644.20	107.00	16.61
	60	436.33	619.65	519.72	50.88	9.79
	110	436.33	757.92	696.27	45.03	6.47
	160	1327.21	1763.31	1638.25	107.00	6.53
5-45Hz LOW FREQ	10	15.37	522.88	149.49	165.63	110.79
	60	10.26	504.11	134.74	159.92	118.69
	110	7.24	406.36	110.89	131.66	118.73
	160	11.31	775.96	208.58	252.86	121.23
50-60Hz PWR FREQ	10	4.25	18.68	8.98	4.55	50.68
	60	2.44	18.06	6.92	4.27	61.63
	110	1.46	14.68	6.36	4.29	67.38
	160	10.98	41.43	17.84	8.00	44.87
65-300Hz PWR HARM	10	4.58	65.71	25.54	20.46	80.12
	60	2.08	44.43	14.62	13.42	91.78
	110	1.48	33.78	11.47	10.30	89.77
	160	4.07	95.24	31.27	29.41	94.07
305-2560Hz HIGH FREQ	10	0.73	9.81	3.45	2.96	85.79
	60	0.43	8.92	2.61	2.72	104.18
	110	0.27	7.45	2.22	2.30	103.74
	160	1.17	14.67	4.77	4.38	91.77
5-2560Hz ALL FREQ	10	16.98	527.14	152.64	166.30	108.95
	60	10.76	506.16	136.22	160.10	117.53
	110	7.54	407.84	112.12	131.75	117.51
	160	16.32	782.05	213.68	252.93	118.37

widest range of operating characteristics have surprisingly similar statistical characteristics. These were pooled to provide the maximum statistical validity of the summary field measures (average, maximum, coefficient of variation, etc.)

The pooled data from datasets NEC005 and NEC006 are summarized on Table 3-5. That table is consistent with the mean field levels of the two individual datasets, reports minimum and maximum field levels for the entire measurement period (18 minutes) and the tighter confidence of the larger sample. Throughout the statistical analysis of the NEC data and Jersey Coast Line data, datasets measured at the same location within the train were found to be consistent and were combined. Furthermore, data from various locations within coaches of the same train on the 25 Hz, 60 Hz and non-electrified sections, respectively, were also combined because the principal field sources were the earth's static field and the time-varying field from the track and catenary circuit, both of which were essentially uniform throughout the coaches.

3.6.1 Magnetic Fields on the 25 Hz Section

Magnetic fields were measured at three places along the aisle, at one place at the side bulkhead in the front coach, and at the aisle and near the side bulkhead in the fifth (home) coach. These measurement locations are identified as locations 1, 2, 7, 9, 10 and 11 in Figure 3-1. Summary statistics for the magnetic fields at those six locations are presented in Tables 3-5 to 3-10. Field levels near the side bulkheads (Tables 3-5 and 3-10) are generally comparable to field levels at the center aisle (Tables 3-6 and 3-9), but are somewhat more spatially variable. Magnetic fields near the floor at the bulkhead are somewhat higher than field levels higher in the coach or near the center aisle of the coach. This enhancement is apparently due to passive field perturbations by the coach structural members and not to active sources because it affects both the static and time-varying fields.

All of the magnetic field data obtained on AMTRAK coaches operating on the 25 Hz section of the corridor was pooled and summarized statistically in Table 3-11. Pooling all of the data for an overall summary is justified because the field levels were generally similar at all locations. The spatial variability of the field between measurement locations is considerably smaller than the temporal variation as evidenced by the fact that the coefficient of variability of the pooled data is similar to the coefficient of variability at each measurement location.

The average and maximum magnetic field levels measured with the repetitive waveform sampling shown in Table 3-11 are considerably higher than the average and maximum values recorded with the DAT and reported in Table 3-1. The DAT data were recorded at a single "reference probe" location in a bulkhead seat in the seventh (home) coach. The repetitive waveform data in Appendices B, C, D, and E consistently show lower magnetic field levels at the reference probe location than at most other measurement locations. The

TABLE 3-5

SUMMARY STATISTICS FOR MAGNETIC FIELD LEVELS
 MEASURED NEAR THE SIDE BULKHEAD NEAR THE FRONT OF THE
 FIRST COACH ON THE 25 HZ SECTION OF THE NEC

25Hz - AGAINST SIDE BULKHEAD - FRONT OF COACH 1		TOTAL OF 73 SAMPLES				
FREQUENCY BAND	HEIGHT ABOVE FLOOR (cm)	MINIMUM MAGNETIC FIELD (mG)	MAXIMUM MAGNETIC FIELD (mG)	AVERAGE MAGNETIC FIELD (mG)	STANDARD DEVIATION (mG)	COEFFICIENT OF VARIATION (%)
STATIC	10	490.46	875.11	665.79	77.13	11.58
	60	385.99	659.67	525.96	59.78	11.37
	110	385.99	844.76	712.29	42.74	6.00
	160	1327.21	1763.31	1641.38	77.13	4.70
5-45Hz LOW FREQ	10	15.37	522.88	155.04	129.20	83.33
	60	10.26	504.11	128.11	115.74	90.35
	110	7.24	406.36	103.77	94.63	91.20
	160	5.26	775.96	189.99	180.55	95.03
50-60Hz PWR FREQ	10	3.21	18.68	5.74	2.69	46.81
	60	1.76	18.06	3.42	2.42	70.87
	110	0.94	14.68	2.78	2.66	95.42
	160	10.66	41.43	12.98	3.85	29.65
65-300Hz PWR HARM	10	4.58	65.71	27.70	15.84	57.19
	60	2.08	44.43	14.00	9.11	65.06
	110	1.48	33.78	11.31	7.10	62.82
	160	4.07	95.24	29.57	20.49	69.27
305-2560Hz HIGH FREQ	10	0.73	9.81	3.84	2.26	58.84
	60	0.43	8.92	2.46	1.96	79.62
	110	0.27	7.45	2.27	1.63	71.59
	160	1.17	14.67	4.63	3.09	66.77
5-2560Hz ALL FREQ	10	16.98	527.14	158.31	129.39	81.73
	60	10.76	506.16	129.22	115.83	89.64
	110	7.54	407.84	104.68	94.68	90.44
	160	16.32	782.05	194.38	180.03	92.62

TABLE 3-6

SUMMARY STATISTICS FOR MAGNETIC FIELD LEVELS
 MEASURED AT THE EDGE OF THE AISLE AT THE FRONT OF THE
 FIRST COACH ON THE 25 HZ SECTION OF THE NEC

25Hz - EDGE OF AISLE - FRONT OF COACH 1		TOTAL OF 71 SAMPLES				
FREQUENCY BAND	HEIGHT ABOVE FLOOR (cm)	MINIMUM MAGNETIC FIELD (mG)	MAXIMUM MAGNETIC FIELD (mG)	AVERAGE MAGNETIC FIELD (mG)	STANDARD DEVIATION (mG)	COEFFICIENT OF VARIATION (%)
STATIC	10	634.55	866.12	746.76	44.92	6.01
	60	583.54	760.70	661.26	35.42	5.36
	110	583.54	750.87	681.43	28.00	4.11
	160	482.41	648.05	570.20	44.92	7.88
5-45Hz LOW FREQ	10	6.97	439.45	112.14	104.32	93.03
	60	5.56	644.41	145.43	154.05	105.93
	110	4.21	553.48	122.63	131.36	107.12
	160	4.94	683.07	146.65	164.99	112.51
50-60Hz PWR FREQ	10	24.80	33.48	29.69	2.04	6.89
	60	7.03	17.30	11.17	1.99	17.80
	110	3.43	13.61	5.81	2.13	36.63
	160	2.45	14.77	6.28	3.26	51.86
65-300Hz PWR HARM	10	5.95	45.28	14.41	9.70	67.33
	60	2.94	70.18	17.47	17.76	101.65
	110	1.69	60.10	15.06	15.84	105.23
	160	2.11	84.73	21.07	23.52	111.65
305-2560Hz HIGH FREQ	10	1.50	7.95	3.32	1.50	45.05
	60	0.90	11.35	2.96	2.70	91.17
	110	0.35	9.80	2.39	2.38	99.59
	160	0.33	12.34	2.96	3.13	105.81
5-2560Hz ALL FREQ	10	29.50	441.42	119.86	101.40	84.60
	60	11.58	646.23	147.52	154.54	104.76
	110	6.04	555.24	123.94	132.13	106.61
	160	6.70	686.03	148.62	166.44	111.99

TABLE 3-7

SUMMARY STATISTICS FOR MAGNETIC FIELD LEVELS
 MEASURED AT THE EDGE OF THE AISLE AT THE MIDDLE OF THE
 FIRST COACH ON THE 25 HZ SECTION OF THE NEC

25Hz - EDGE OF AISLE - MIDDLE OF COACH 1		TOTAL OF 22 SAMPLES				
FREQUENCY BAND	HEIGHT ABOVE FLOOR (cm)	MINIMUM MAGNETIC FIELD (mG)	MAXIMUM MAGNETIC FIELD (mG)	AVERAGE MAGNETIC FIELD (mG)	STANDARD DEVIATION (mG)	COEFFICIENT OF VARIATION (%)
STATIC	10	381.34	823.11	442.99	38.77	8.75
	60	258.14	539.07	424.85	72.00	16.95
	110	258.14	733.67	419.89	78.74	18.75
	160	514.91	671.18	544.40	38.77	7.12
5-45Hz LOW FREQ	10	8.95	364.84	79.38	97.98	123.43
	60	8.42	466.83	94.98	121.04	127.44
	110	7.27	383.88	79.01	98.08	124.14
	160	10.24	494.24	102.44	124.57	121.60
50-60Hz PWR FREQ	10	7.18	14.82	10.93	2.01	18.42
	60	3.14	13.83	5.85	3.01	51.46
	110	1.90	13.70	4.97	3.20	64.32
	160	1.98	21.61	7.43	5.30	71.28
65-300Hz PWR HARM	10	2.95	27.54	10.91	7.26	66.50
	60	1.99	36.62	12.82	9.60	74.85
	110	1.83	32.70	11.29	8.45	74.90
	160	2.87	55.35	18.80	14.25	75.79
305-2560Hz HIGH FREQ	10	0.56	6.58	1.87	1.63	87.29
	60	0.35	8.31	1.96	2.13	108.36
	110	0.33	6.90	1.67	1.75	104.53
	160	0.50	9.32	2.38	2.28	95.76
5-2560Hz ALL FREQ	10	12.50	366.18	82.04	97.28	118.57
	60	9.68	468.41	96.53	121.07	125.42
	110	8.20	385.40	80.42	98.14	122.04
	160	11.36	497.53	105.28	124.78	118.53

TABLE 3-8

SUMMARY STATISTICS FOR MAGNETIC FIELD LEVELS
 MEASURED AT THE EDGE OF THE AISLE NEAR THE REAR OF THE
 FIRST COACH ON THE 25 HZ SECTION OF THE NEC

25Hz - EDGE OF AISLE - REAR OF COACH 1		TOTAL OF 102 SAMPLES				
FREQUENCY BAND	HEIGHT ABOVE FLOOR (cm)	MINIMUM MAGNETIC FIELD (mG)	MAXIMUM MAGNETIC FIELD (mG)	AVERAGE MAGNETIC FIELD (mG)	STANDARD DEVIATION (mG)	COEFFICIENT OF VARIATION (%)
STATIC	10	91.03	268.98	137.50	27.42	19.94
	60	446.56	714.89	512.30	29.84	5.82
	110	91.03	563.79	492.67	33.01	6.70
	160	250.21	432.88	294.77	27.42	9.30
5-45Hz LOW FREQ	10	6.16	340.67	123.55	91.35	73.94
	60	5.78	434.51	146.55	114.74	78.29
	110	7.24	426.97	146.04	113.34	77.61
	160	7.66	467.55	164.47	123.98	75.38
50-60Hz PWR FREQ	10	2.62	5.72	3.75	0.75	19.93
	60	1.01	3.77	2.04	0.72	35.27
	110	1.17	4.46	2.32	0.96	41.48
	160	1.84	5.22	3.72	0.80	21.43
65-300Hz PWR HARM	10	2.65	43.58	11.19	8.21	73.34
	60	3.09	60.75	14.92	10.99	73.65
	110	3.33	59.97	15.01	10.80	71.99
	160	4.62	74.57	19.68	13.43	68.27
305-2560Hz HIGH FREQ	10	0.35	6.29	2.30	1.60	69.56
	60	0.35	7.99	2.70	2.03	75.16
	110	0.36	7.89	2.69	2.00	74.40
	160	0.51	8.87	3.13	2.23	71.19
5-2560Hz ALL FREQ	10	8.08	342.33	124.32	91.49	73.59
	60	7.72	437.00	147.50	115.09	78.02
	110	9.00	429.44	147.00	113.67	77.32
	160	10.70	471.15	165.96	124.40	74.95

TABLE 3-9

SUMMARY STATISTICS FOR MAGNETIC FIELD LEVELS
 MEASURED NEAR THE AISLE OF THE
 SEVENTH COACH ON THE 25 HZ SECTION OF THE NEC

25Hz - EDGE OF AISLE - REAR OF COACH 7		TOTAL OF 70 SAMPLES				
FREQUENCY BAND	HEIGHT ABOVE FLOOR (cm)	MINIMUM MAGNETIC FIELD (mG)	MAXIMUM MAGNETIC FIELD (mG)	AVERAGE MAGNETIC FIELD (mG)	STANDARD DEVIATION (mG)	COEFFICIENT OF VARIATION (%)
STATIC	10	480.00	702.27	601.10	17.16	2.85
	60	561.81	731.85	639.41	25.78	4.03
	110	273.72	386.77	339.31	25.05	7.38
	160	450.42	551.50	514.86	17.16	3.33
5-45Hz LOW FREQ	10	18.05	406.39	164.50	81.46	49.52
	60	19.77	455.50	173.14	92.62	53.49
	110	15.59	375.10	141.17	74.88	53.04
	160	18.87	497.58	181.34	97.37	53.69
50-60Hz PWR FREQ	10	3.50	10.00	7.00	1.15	16.45
	60	1.89	6.30	3.42	0.60	17.66
	110	1.05	4.82	1.83	0.53	28.65
	160	1.05	7.10	1.62	1.01	62.33
65-300Hz PWR HARM	10	2.70	36.30	15.10	6.81	45.09
	60	2.15	40.78	15.08	7.30	48.42
	110	1.83	36.38	13.04	6.37	48.81
	160	3.17	62.72	22.19	11.03	49.69
305-2560Hz HIGH FREQ	10	0.71	7.20	3.05	1.39	45.58
	60	0.46	8.02	3.12	1.61	51.57
	110	0.38	6.66	2.56	1.31	51.24
	160	0.59	9.34	3.51	1.80	51.20
5-2560Hz ALL FREQ	10	19.41	408.09	165.49	81.50	49.25
	60	20.44	457.27	173.92	92.80	53.36
	110	16.02	376.77	141.85	75.07	52.92
	160	19.70	501.33	182.83	97.82	53.51

TABLE 3-10

SUMMARY STATISTICS FOR MAGNETIC FIELD LEVELS
 MEASURED NEAR THE SIDE BULKHEAD OF THE
 SEVENTH COACH ON THE 25 HZ SECTION OF THE NEC

25Hz - AGAINST SIDE BULKHEAD - REAR OF COACH 7		TOTAL OF 81 SAMPLES				
FREQUENCY BAND	HEIGHT ABOVE FLOOR (cm)	MINIMUM MAGNETIC FIELD (mG)	MAXIMUM MAGNETIC FIELD (mG)	AVERAGE MAGNETIC FIELD (mG)	STANDARD DEVIATION (mG)	COEFFICIENT OF VARIATION (%)
STATIC	10	787.50	1350.41	875.83	59.34	6.78
	60	486.75	872.31	590.92	49.13	8.31
	110	391.24	767.41	524.60	51.07	9.74
	160	525.48	1000.85	908.60	59.34	6.53
5-45Hz LOW FREQ	10	13.37	291.00	98.82	76.67	77.59
	60	10.43	213.48	68.68	51.63	75.17
	110	10.63	172.01	56.66	41.45	73.16
	160	12.79	447.44	137.62	107.18	77.88
50-60Hz PWR FREQ	10	4.89	15.43	9.03	1.59	17.66
	60	1.35	4.78	2.52	0.62	24.42
	110	0.88	5.99	1.96	0.72	36.96
	160	3.82	9.44	4.93	1.37	27.82
65-300Hz PWR HARM	10	3.76	36.56	15.57	8.39	53.92
	60	2.41	17.23	6.67	3.48	52.19
	110	1.98	22.55	6.79	4.11	60.58
	160	7.73	73.61	24.59	14.30	58.15
305-2560Hz HIGH FREQ	10	0.63	5.54	2.28	1.35	59.34
	60	0.28	3.83	1.31	0.91	69.54
	110	0.30	4.03	1.22	0.86	70.47
	160	0.63	10.11	3.10	2.16	69.47
5-2560Hz ALL FREQ	10	16.81	293.11	101.13	76.27	75.41
	60	10.93	214.23	69.18	51.60	74.60
	110	11.36	173.54	57.22	41.52	72.55
	160	15.55	453.59	140.39	107.54	76.60

TABLE 3-11

SUMMARY STATISTICS FOR MAGNETIC FIELDS MEASURED
IN COACHES ON THE 25 HZ SECTION OF THE NEC

25Hz - ALL COACHES		TOTAL OF 418 SAMPLES				
FREQUENCY BAND	HEIGHT ABOVE FLOOR (cm)	MINIMUM MAGNETIC FIELD (mG)	MAXIMUM MAGNETIC FIELD (mG)	AVERAGE MAGNETIC FIELD (mG)	STANDARD DEVIATION (mG)	COEFFICIENT OF VARIATION (%)
STATIC	10	91.03	1350.41	568.40	462.58	81.38
	60	258.14	872.31	572.25	79.70	13.93
	110	91.03	844.76	539.18	135.11	25.06
	160	250.21	1763.31	744.83	462.58	62.11
5-45Hz LOW FREQ	10	6.16	522.88	126.38	100.18	79.27
	60	5.56	644.41	129.18	114.86	88.91
	110	4.21	553.48	112.59	101.48	90.13
	160	4.94	775.96	159.69	137.40	86.04
50-60Hz PWR FREQ	10	2.62	33.48	10.42	9.12	87.53
	60	1.01	18.06	4.34	3.56	81.92
	110	0.88	14.68	2.97	2.23	74.86
	160	1.05	41.43	5.84	4.45	76.13
65-300Hz PWR HARM	10	2.65	65.71	16.08	11.43	71.11
	60	1.99	70.18	13.47	11.15	82.75
	110	1.48	60.10	12.22	10.07	82.40
	160	2.11	95.24	22.91	17.03	74.33
305-2560Hz HIGH FREQ	10	0.35	9.81	2.83	1.75	61.78
	60	0.28	11.35	2.45	2.01	81.90
	110	0.27	9.80	2.20	1.79	81.53
	160	0.33	14.67	3.37	2.55	75.79
5-2560Hz ALL FREQ	10	8.08	527.14	129.20	99.53	77.03
	60	7.72	646.23	130.27	115.14	88.39
	110	6.04	555.24	113.51	101.81	89.69
	160	6.70	782.05	162.09	137.81	85.02

repetitive waveform measurements at the side bulkhead of the seventh coach were made very near the reference probe. As these data, summarized in Table 3-10, show, average and maximum magnetic field levels at the 60 cm height are comparable to those measured with the DAT at the nearby reference probe location. As mentioned in Section 3.3, it appears as though ferromagnetic structures on conductive loops, possibly carbon steel members in the seat frames, provide some magnetic field shielding down between the seats. This shielding appears to account for lower average and maximum field levels recorded with the DAT at a window seat location than those measured with the waveform capture system at a wider variety of locations in the coaches.

3.6.2 Magnetic Fields on the 60 Hz Section

Summary data for magnetic field levels at three locations (locations 4, 5 and 9 of Figure 3-1) within coaches operating on the 60 Hz section on the corridor are given in Tables 3-12 through 3-14. Only the first fourteen samples of dataset NEC013 are summarized in Table 3-14 because the train stopped at the New Haven Station at sample 14. The remaining samples in NEC013 represent field levels in the stationary train or after the train departed on the non-electrified section of the corridor and are therefore inappropriate for inclusion in the summary analysis. There is more disparity in the time-varying field levels at various locations on the 60 Hz portion of the corridor than on the 25 Hz portion. Nevertheless, similar patterns (such as field enhancement near the floor and ceiling against the bulkhead) appear in the data collected on both electrified portions of the corridor.

Pooled summary statistics for all three of the measurement locations in coaches operating on the 60 Hz section of the NEC are given in Table 3-15.

As in the data collected on the 25 Hz section of the NEC, the average and maximum magnetic field levels recorded with the DAT in a window seat location and reported in Table 3-1 are lower than the average and maximum values reported in Table 3-15 for more distributed locations throughout the coaches. The DAT data does, however, agree reasonably well with data on Table 3-14 for measurements made at the seat level near the side bulkhead, a location very near the reference sensor used for the DAT measurements.

Average and maximum field levels measured with the rms meters and reported on Table 3-2 are in good agreement with the DAT data. That correlation is presumably due to the fact that the rms recording units placed in a seat-back pocket and worn at the waist of a seated passenger experienced shielding by seat frames comparable to that present at the reference probe location.

TABLE 3-12

SUMMARY STATISTICS FOR MAGNETIC FIELD LEVELS
 MEASURED AT THE EDGE OF THE AISLE AT THE
 FRONT OF THE FIRST COACH ON THE 60 HZ SECTION OF THE NEC

EDGE OF AISLE - FRONT OF COACH 1		TOTAL OF 153 SAMPLES				
FREQUENCY BAND	HEIGHT ABOVE FLOOR (cm)	MINIMUM MAGNETIC FIELD (mG)	MAXIMUM MAGNETIC FIELD (mG)	AVERAGE MAGNETIC FIELD (mG)	STANDARD DEVIATION (mG)	COEFFICIENT OF VARIATION (%)
STATIC	10	550.98	964.04	762.17	61.45	8.06
	60	470.35	861.41	701.98	52.16	7.43
	110	431.86	839.70	681.06	55.77	8.19
	160	339.82	775.56	607.66	61.45	10.11
5-45Hz LOW FREQ	10	0.88	8.05	2.82	1.46	51.79
	60	0.47	7.79	1.70	0.95	55.72
	110	0.26	7.91	1.18	0.80	67.90
	160	0.24	12.20	1.10	1.14	103.62
50-60Hz PWR FREQ	10	17.08	77.09	32.69	10.57	32.35
	60	8.21	186.30	38.20	41.28	108.06
	110	4.84	202.37	41.67	48.17	115.62
	160	6.16	281.28	56.35	66.16	117.41
65-300Hz PWR HARM	10	1.04	7.35	2.38	1.29	54.20
	60	0.74	18.20	4.23	3.66	86.52
	110	0.91	20.22	4.99	4.34	86.82
	160	1.46	28.96	7.49	6.65	88.88
305-2560Hz HIGH FREQ	10	0.50	2.02	0.85	0.32	38.07
	60	0.26	3.99	1.01	0.90	89.02
	110	0.20	4.49	1.12	1.06	94.65
	160	0.28	6.81	1.65	1.58	95.52
5-2560Hz ALL FREQ	10	19.68	77.88	32.96	10.59	32.12
	60	8.45	187.26	38.56	41.39	107.33
	110	4.98	203.44	42.06	48.33	114.89
	160	6.36	282.38	56.97	66.45	116.64

TABLE 3-13

**SUMMARY STATISTICS FOR MAGNETIC FIELD LEVELS
MEASURED AT THE EDGE OF THE AISLE AT THE
REAR OF THE SEVENTH COACH ON THE 60 HZ SECTION OF THE NEC**

60Hz - EDGE OF AISLE - REAR OF COACH 7		TOTAL OF 98 SAMPLES				
FREQUENCY BAND	HEIGHT ABOVE FLOOR (cm)	MINIMUM MAGNETIC FIELD (mG)	MAXIMUM MAGNETIC FIELD (mG)	AVERAGE MAGNETIC FIELD (mG)	STANDARD DEVIATION (mG)	COEFFICIENT OF VARIATION (%)
STATIC	10	648.93	891.28	734.82	33.67	4.58
	60	403.03	669.64	478.69	42.85	8.95
	110	253.84	508.62	355.46	33.44	9.41
	160	392.91	661.28	533.08	33.67	6.32
5-45Hz LOW FREQ	10	0.27	5.12	1.25	0.89	71.42
	60	0.19	3.24	0.78	0.57	73.93
	110	0.12	2.13	0.58	0.42	72.68
	160	0.19	2.93	0.89	0.65	73.23
50-60Hz PWR FREQ	10	3.19	272.90	58.87	59.40	100.90
	60	5.39	298.77	62.02	69.28	111.71
	110	4.37	239.22	54.38	58.94	108.39
	160	4.25	406.98	95.36	105.97	111.13
65-300Hz PWR HARM	10	0.71	24.02	5.08	4.87	95.75
	60	0.83	21.17	5.50	5.02	91.27
	110	0.76	19.40	5.21	4.67	89.74
	160	1.30	43.85	11.45	10.71	93.57
305-2560Hz HIGH FREQ	10	0.35	6.05	1.37	1.29	94.61
	60	0.24	6.11	1.39	1.38	99.41
	110	0.17	4.97	1.26	1.21	95.95
	160	0.31	9.50	2.52	2.38	94.64
5-2560Hz ALL FREQ	10	4.20	273.51	59.16	59.57	100.69
	60	5.85	299.30	62.33	69.44	111.42
	110	4.50	239.71	54.68	59.11	108.10
	160	4.68	408.41	96.17	106.45	110.69

TABLE 3-14

SUMMARY STATISTICS FOR MAGNETIC FIELD LEVELS
 MEASURED NEAR THE SIDE BULKHEAD
 OF THE SEVENTH COACH ON THE 60 HZ SECTION OF THE NEC

60Hz - AGAINST SIDE BULKHEAD - REAR OF COACH 7				TOTAL OF 14 SAMPLES		
FREQUENCY BAND	HEIGHT ABOVE FLOOR (cm)	MINIMUM MAGNETIC FIELD (mG)	MAXIMUM MAGNETIC FIELD (mG)	AVERAGE MAGNETIC FIELD (mG)	STANDARD DEVIATION (mG)	COEFFICIENT OF VARIATION (%)
STATIC	10	834.07	918.85	883.05	33.31	3.77
	60	527.70	563.74	550.33	11.98	2.18
	110	491.04	548.89	519.90	14.16	2.72
	160	907.09	1038.73	976.76	33.31	3.41
5-45Hz LOW FREQ	10	0.31	5.69	1.28	1.36	106.18
	60	0.14	1.82	0.57	0.49	84.77
	110	0.09	1.45	0.41	0.37	89.74
	160	0.28	2.52	0.76	0.64	85.00
50-60Hz PWR FREQ	10	8.57	219.94	55.42	68.81	124.16
	60	4.44	104.09	27.27	32.62	119.60
	110	3.31	93.42	23.39	30.00	128.28
	160	12.67	376.54	92.89	122.37	131.74
65-300Hz PWR HARM	10	2.42	19.44	8.18	5.83	71.27
	60	0.64	6.79	2.61	2.03	77.76
	110	0.78	11.91	3.75	3.71	98.91
	160	3.21	43.09	14.65	13.14	89.72
305-2560Hz HIGH FREQ	10	0.58	5.50	1.85	1.60	86.60
	60	0.15	2.34	0.70	0.71	101.29
	110	0.24	4.75	1.23	1.39	113.07
	160	0.68	12.76	3.45	3.86	111.99
5-2560Hz ALL FREQ	10	9.69	220.87	56.27	68.91	122.46
	60	4.49	104.30	27.44	32.67	119.04
	110	3.41	94.31	23.78	30.22	127.08
	160	13.09	379.22	94.30	122.98	130.40

TABLE 3-15

SUMMARY STATISTICS FOR MAGNETIC FIELD LEVELS
MEASURED IN COACHES ON THE 60 HZ SECTION OF THE NEC

60Hz - ALL COACHES		TOTAL OF 265 SAMPLES				
FREQUENCY BAND	HEIGHT ABOVE FLOOR (cm)	MINIMUM MAGNETIC FIELD (mG)	MAXIMUM MAGNETIC FIELD (mG)	AVERAGE MAGNETIC FIELD (mG)	STANDARD DEVIATION (mG)	COEFFICIENT OF VARIATION (%)
STATIC	10	550.98	964.04	758.44	108.94	14.36
	60	403.03	861.41	611.40	117.21	19.17
	110	253.84	839.70	552.14	162.04	29.35
	160	339.82	1038.73	599.58	108.94	18.17
5-45Hz LOW FREQ	10	0.27	8.05	2.16	1.49	69.00
	60	0.14	7.79	1.30	0.93	71.93
	110	0.09	7.91	0.92	0.74	79.85
	160	0.19	12.20	1.00	0.97	96.55
50-60Hz PWR FREQ	10	3.19	272.90	43.57	41.91	96.19
	60	4.44	298.77	46.43	54.28	116.90
	110	3.31	239.22	45.40	52.16	114.88
	160	4.25	406.98	72.71	88.04	121.09
65-300Hz PWR HARM	10	0.71	24.02	3.69	3.76	101.87
	60	0.64	21.17	4.61	4.22	91.36
	110	0.76	20.22	5.01	4.43	88.47
	160	1.30	43.85	9.33	9.02	96.64
305-2560Hz HIGH FREQ	10	0.35	6.05	1.10	0.95	86.32
	60	0.15	6.11	1.13	1.11	97.99
	110	0.17	4.97	1.18	1.13	96.18
	160	0.28	12.76	2.07	2.13	103.00
5-2560Hz ALL FREQ	10	4.20	273.51	43.88	42.02	95.77
	60	4.49	299.30	46.76	54.40	116.33
	110	3.41	239.71	45.76	52.31	114.31
	160	4.68	408.41	73.44	88.45	120.43

3.6.3 Magnetic Fields on the Non-Electrified Section

Summaries of the magnetic field levels in coaches operating on the non-electrified portion of the NEC are provided in Tables 3-16 through 3-18. Table 3-16 shows field levels at the aisle of the front coach (Location 8 of Figure 3-1) summarized from dataset NEC016 (Appendix Q). This is not the same coach in which front coach measurements were made for the electrified sections of the corridor because the first two cars of the train were removed at New Haven and routed elsewhere. Summary data from sets NEC014, NEC015 and NEC017 are found in Table 3-17. These measurements were made at two locations (locations 4 and 6 in Figure 3-1) in the "Home Coach" which was now the fifth coach behind the diesel locomotive. All three sets of measurements could not be made at the same locations because passengers occupied different seats at different times during the tests. The third table in this group, Table 3-18 shows summary statistics from data pooled from all four datasets from NEC014 to NEC017. The principal component of the time-varying magnetic field in this section is the 60 Hz component, the characteristics of which are discussed in Section 3.3.

On the non-electrified section of the corridor, magnetic field levels recorded by the DAT (Table 3-1), by the rms recorder (Table 3-2), and by the waveform capture system (Table 3-18) are all small relative to field levels on the electrified sections of the railroad. The average values recorded by each instrumentation system are in good agreement considering the localized nature of field sources and the wide distribution of measurement locations where the different instruments were employed. The maximum field value detected by the continuous DAT recording is appreciably larger than the maximum field level recorded by the waveform capture system or rms system, which are field sampling devices. Apparently, the DAT managed to capture the magnetic field believed to have originated from an electric transmission line crossing the tracks during the brief time required for the coach to pass beneath the line. Figure 3-21 shows a plot of the rms time-varying magnetic field level recorded by the DAT during the first two and one-half minutes of the third record of tape 2 during which time the maximum field was encountered. As indicated on Table 2-2, the train was traveling toward Boston at a location just northeast of Mystic. As indicated in Figure 3-21, the magnetic field is elevated for about four seconds. The actual speed of the train is not known, but according to AMTRAK track charts, the typical passenger train speed in this area ranges from 89 to 137 kph (55 to 85 mph). Assuming a mid-range speed of 112 kph (70 mph), the train would cover approximately 122 m (400 ft) during the four-second period of elevated magnetic field. Sixty-one meters (two hundred feet) on either side of an electric transmission line is a very reasonable zone of elevated magnetic field. The other instruments, recording at 1-minute sample intervals, failed to capture the very brief event.

TABLE 3-16

SUMMARY STATISTICS FOR MAGNETIC FIELD LEVELS
 MEASURED AT THE EDGE OF THE AISLE AT THE FRONT OF THE FIRST
 COACH ON THE NON-ELECTRIFIED SECTION OF THE NEC

DIESEL ENGINE - EDGE OF AISLE - FRONT OF COACH 1			TOTAL OF 76 SAMPLES			
FREQUENCY BAND	HEIGHT ABOVE FLOOR (cm)	MINIMUM MAGNETIC FIELD (mG)	MAXIMUM MAGNETIC FIELD (mG)	AVERAGE MAGNETIC FIELD (mG)	STANDARD DEVIATION (mG)	COEFFICIENT OF VARIATION (%)
STATIC	10	438.15	648.20	564.16	15.66	2.78
	60	898.69	1033.11	969.02	26.18	2.70
	110	386.33	471.35	427.61	15.47	3.62
	160	469.56	556.50	519.27	15.66	3.02
5-45Hz LOW FREQ	10	0.77	6.65	2.35	1.00	42.57
	60	0.44	3.52	1.34	0.59	43.81
	110	0.27	2.34	0.83	0.37	44.14
	160	0.26	1.62	0.62	0.21	34.13
50-60Hz PWR FREQ	10	4.91	13.16	7.10	1.40	19.73
	60	2.10	9.01	3.06	0.88	28.71
	110	0.69	7.22	1.21	0.73	59.86
	160	0.74	7.51	1.08	0.76	69.87
65-300Hz PWR HARM	10	0.37	1.82	0.90	0.34	37.83
	60	0.20	0.83	0.44	0.15	35.42
	110	0.12	0.58	0.29	0.09	30.51
	160	0.16	0.40	0.24	0.05	20.33
305-2560Hz HIGH FREQ	10	0.14	0.71	0.32	0.12	37.12
	60	0.07	0.40	0.17	0.06	36.92
	110	0.04	0.29	0.11	0.05	43.62
	160	0.05	0.19	0.08	0.03	32.46
5-2560Hz ALL FREQ	10	5.57	13.36	7.62	1.39	18.26
	60	2.46	9.10	3.43	0.89	25.92
	110	0.96	7.26	1.55	0.73	47.46
	160	0.91	7.54	1.30	0.74	57.22

TABLE 3-17

SUMMARY STATISTICS FOR MAGNETIC FIELDS MEASURED
IN THE COACHES ON THE NON-ELECTRIFIED SECTION OF THE NEC

NON-ELECTRIFIED - EDGE OF AISLE - REAR OF COACH 5				TOTAL OF 100 SAMPLES		
FREQUENCY BAND	HEIGHT ABOVE FLOOR (cm)	MINIMUM MAGNETIC FIELD (mG)	MAXIMUM MAGNETIC FIELD (mG)	AVERAGE MAGNETIC FIELD (mG)	STANDARD DEVIATION (mG)	COEFFICIENT OF VARIATION (%)
STATIC	10	628.09	726.58	669.78	10.90	1.63
	60	411.83	715.07	558.08	63.29	11.34
	110	311.23	373.55	348.28	13.20	3.79
	160	511.57	567.44	549.42	10.90	1.98
5-45Hz LOW FREQ	10	0.31	6.33	2.52	1.16	46.04
	60	0.18	3.30	1.30	0.60	46.32
	110	0.11	2.52	0.87	0.42	48.18
	160	0.22	3.07	1.00	0.57	57.09
50-60Hz PWR FREQ	10	1.23	26.34	15.87	8.84	55.71
	60	0.44	7.57	4.60	2.50	54.44
	110	0.54	3.44	2.20	0.97	43.97
	160	0.63	2.12	1.50	0.41	27.56
65-300Hz PWR HARM	10	0.62	5.86	2.06	1.18	57.10
	60	0.33	1.92	0.69	0.32	46.22
	110	0.22	0.97	0.40	0.14	35.37
	160	0.20	0.71	0.35	0.09	26.00
305-2560Hz HIGH FREQ	10	0.13	1.85	0.60	0.34	56.16
	60	0.07	0.67	0.22	0.11	48.66
	110	0.04	0.36	0.13	0.06	47.41
	160	0.04	0.30	0.11	0.05	45.57
5-2560Hz ALL FREQ	10	1.57	26.48	16.37	8.70	53.14
	60	0.65	7.67	4.95	2.36	47.57
	110	0.68	4.08	2.47	0.90	36.25
	160	0.91	3.41	1.89	0.54	28.64

TABLE 3-18

SUMMARY STATISTICS FOR MAGNETIC FIELD LEVELS MEASURED
AT THE EDGE OF THE AISLE IN THE FIFTH COACH ON
THE NON-ELECTRIFIED SECTION OF THE NEC

NON-ELECTRIFIED - ALL COACHES		TOTAL OF 176 SAMPLES				
FREQUENCY BAND	HEIGHT ABOVE FLOOR (cm)	MINIMUM MAGNETIC FIELD (mG)	MAXIMUM MAGNETIC FIELD (mG)	AVERAGE MAGNETIC FIELD (mG)	STANDARD DEVIATION (mG)	COEFFICIENT OF VARIATION (%)
STATIC	10	438.15	726.58	624.17	19.91	3.19
	60	411.83	1033.11	735.53	210.31	28.59
	110	311.23	471.35	382.53	41.88	10.95
	160	469.56	567.44	536.40	19.91	3.71
5-45Hz LOW FREQ	10	0.31	6.65	2.45	1.09	44.71
	60	0.18	3.52	1.32	0.60	45.12
	110	0.11	2.52	0.85	0.40	46.53
	160	0.22	3.07	0.84	0.49	58.61
50-60Hz PWR FREQ	10	1.23	26.34	12.08	8.00	66.23
	60	0.44	9.01	3.93	2.11	53.68
	110	0.54	7.22	1.77	1.00	56.24
	160	0.63	7.51	1.32	0.62	47.01
65-300Hz PWR HARM	10	0.37	5.86	1.56	1.08	69.13
	60	0.20	1.92	0.58	0.29	49.69
	110	0.12	0.97	0.35	0.13	37.90
	160	0.16	0.71	0.30	0.09	31.30
305-2560Hz HIGH FREQ	10	0.13	1.85	0.48	0.30	62.50
	60	0.07	0.67	0.20	0.09	46.80
	110	0.04	0.36	0.12	0.06	47.00
	160	0.04	0.30	0.10	0.05	45.20
5-2560Hz ALL FREQ	10	1.57	26.48	12.59	7.91	62.83
	60	0.65	9.10	4.29	2.01	46.88
	110	0.68	7.26	2.07	0.95	45.70
	160	0.91	7.54	1.64	0.70	42.80

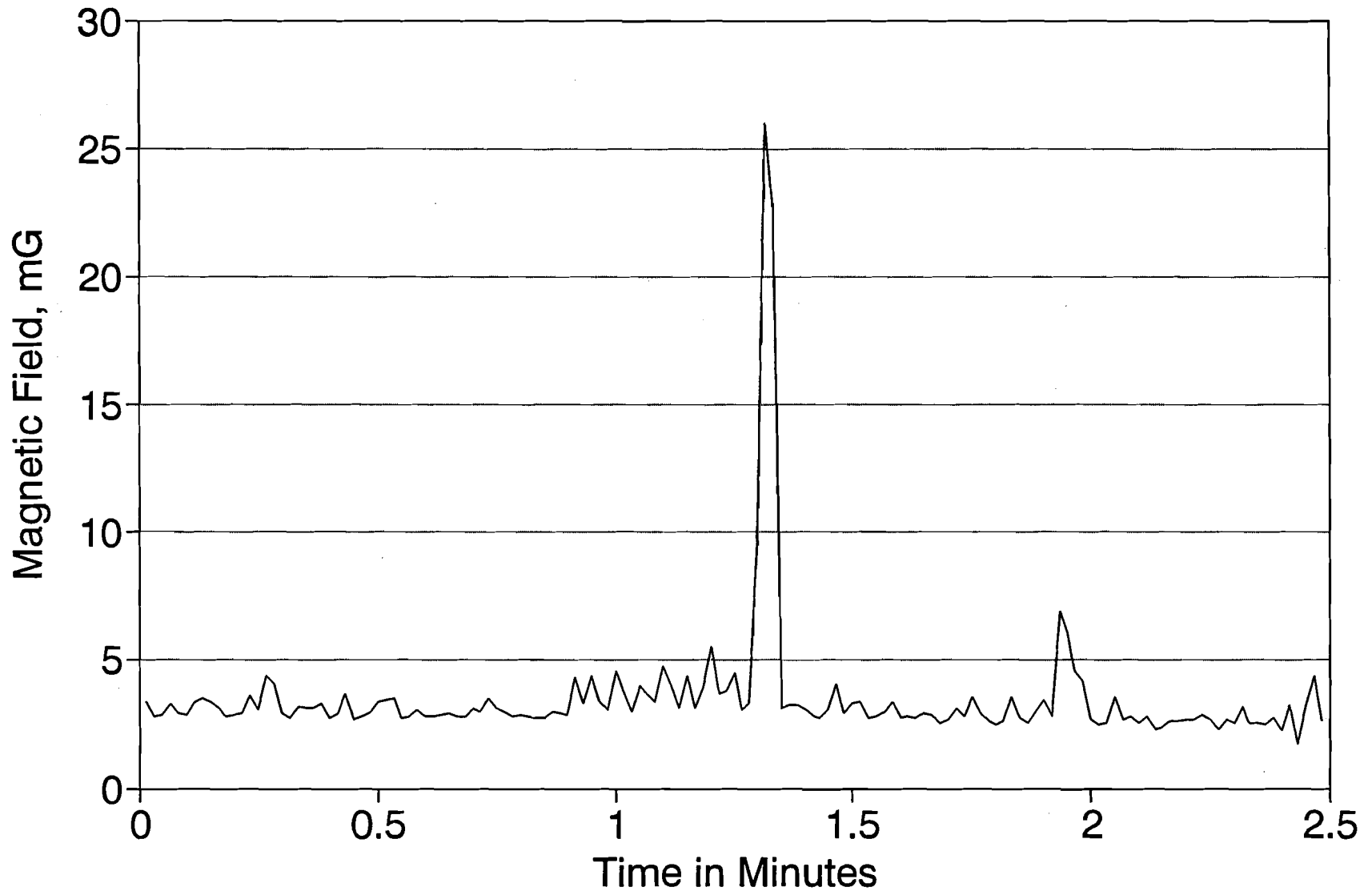

FIGURE 3-21. TOTAL RMS TIME-VARYING ELF MAGNETIC FIELD MEASURED IN A COACH SEAT ON THE NON-ELECTRIFIED PORTION OF THE NEC AS THE TRAIN PASSES AN APPARENT EXTERNAL MAGNETIC FIELD SOURCE BELIEVED TO BE AN ELECTRIC POWER TRANSMISSION LINE CROSSING THE TRACKS

3.6.4 Magnetic Fields on the North Jersey Coast Line

Dataset NEC048 (Appendix AW) contains all of the data collected in coaches operating on the North Jersey Coast Line from Matawan to Long Branch. Because of the short length of this segment, the datasets are often smaller than those on the NEC. Data from Subset 1 measured at the front of the first coach (location 17 in Figure 3-2) are summarized in Table 3-19. Table 3-20 shows a summary of data from Subset 4 which was measured at the end of the last coach (Location 14 of Figure 3-2). Table 3-21 gives summary statistics on pooled data from the two subsets. The locomotive was at the rear of the train pushing during these tests so fields from the locomotive or hotel power would be expected to be larger at the rear car measurement area.

The magnetic field levels reported in Table 3-21 are in good agreement with values measured in the New Jersey Transit coaches with the DAT (Table 3-1) and the rms Recorder (Table 3-2). The lower field levels at measurement locations between the seats seen in the AMTRAK coaches did not seem to occur in the NJT coaches, possibly due to different material in the coach seats, different seat arrangement at measurement locations, or simply a failure to detect the effect because of the limited number of measurements in these coaches.

The magnitude and distribution of magnetic fields measured on the North Jersey Coast Line are quite different from those on the NEC. Both peak and average intensities of the time-varying magnetic fields are lower in the Jersey Coast Line data and there is a very pronounced attenuation of the magnetic field with increasing height above the floor. Furthermore, a larger percentage of the 60 Hz magnetic field may be coming from hotel power cables or other onboard sources, as evidenced by the temporal uniformity of the field, especially near the floor in the last coach.

3.6.5 Effects of Electrification Technology on Electric and Magnetic Fields

Magnetic field data summarized in the four preceding subsections characterized the magnetic field environment in railroad coaches operating on the 25 Hz section, 60 Hz section and non-electrified section of the Northeast Corridor, as well as on the North Jersey Coast Line from Matawan to Long Branch. The following paragraphs compare and contrast the field environments of the three types of electrification technology and the non-electrified corridor section.

Summary data on the magnetic field levels in coaches on the 25 Hz section, 60 Hz section and non-electrified section of the Northeast Corridor have been presented in Tables 3-11, 3-15 and 3-18, respectively. Corresponding data for coaches on the Matawan to Long Branch section of the North Jersey Coast Line have been reported in Table 3-21. The data from those tables have been consolidated into Table 3-22 by computing the averages of the minimum field, maximum field and average field at the four

TABLE 3-19

SUMMARY STATISTICS FOR MAGNETIC FIELD LEVELS
 AT THE EDGE OF THE AISLE AT THE FRONT OF THE FIRST
 COACH ON THE NORTH JERSEY COAST (LONG BRANCH) LINE

LONG BRANCH - EDGE OF AISLE IN FRONT OF FIRST COACH			TOTAL OF 45 SAMPLES			
FREQUENCY BAND	HEIGHT ABOVE FLOOR (cm)	MINIMUM MAGNETIC FIELD (mG)	MAXIMUM MAGNETIC FIELD (mG)	AVERAGE MAGNETIC FIELD (mG)	STANDARD DEVIATION (mG)	COEFFICIENT OF VARIATION (%)
STATIC	10	795.19	971.21	874.11	0.64	0.07
	60	508.45	558.72	535.09	11.05	2.06
	110	508.45	802.87	775.40	10.99	1.42
5-45Hz LOW FREQ	10	0.29	13.03	3.83	2.84	74.18
	60	0.20	6.13	1.64	1.27	77.67
	110	0.14	3.26	1.07	0.82	76.74
50-60Hz PWR FREQ	10	0.48	107.07	34.32	30.10	87.69
	60	0.31	45.33	15.52	12.20	78.60
	110	0.31	27.10	9.16	6.96	75.95
65-300Hz PWR HARM	10	0.78	17.74	5.99	5.04	84.10
	60	0.39	6.75	2.34	1.90	81.09
	110	0.35	3.70	1.50	0.91	60.54
305-2560Hz HIGH FREQ	10	0.35	3.59	1.41	0.93	66.01
	60	0.17	1.37	0.57	0.35	61.12
	110	0.13	0.77	0.34	0.19	56.81
5-2560Hz ALL FREQ	10	4.44	108.79	35.46	30.22	85.22
	60	2.36	45.88	15.95	12.22	76.61
	110	1.74	27.38	9.45	6.94	73.41

TABLE 3-20

SUMMARY STATISTICS FOR MAGNETIC FIELD LEVELS
 AT THE REAR OF THE LAST COACH
 ON THE NORTH JERSEY COAST (LONG BRANCH) LINE

LONG BRANCH - EDGE OF AISLE IN END OF LAST COACH			TOTAL OF 33 SAMPLES			
FREQUENCY BAND	HEIGHT ABOVE FLOOR (cm)	MINIMUM MAGNETIC FIELD (mG)	MAXIMUM MAGNETIC FIELD (mG)	AVERAGE MAGNETIC FIELD (mG)	STANDARD DEVIATION (mG)	COEFFICIENT OF VARIATION (%)
STATIC	10	668.65	768.73	714.51	0.55	0.08
	60	507.51	563.55	538.43	9.48	1.76
	110	507.51	1016.00	973.07	25.27	2.60
5-45Hz LOW FREQ	10	1.02	2.46	1.51	0.38	25.09
	60	0.23	0.97	0.39	0.16	40.69
	110	0.13	0.57	0.30	0.12	39.36
50-60Hz PWR FREQ	10	35.43	47.90	40.99	2.61	6.38
	60	4.13	9.87	4.93	1.01	20.41
	110	1.91	8.15	2.76	1.18	42.61
65-300Hz PWR HARM	10	2.33	10.14	3.20	1.61	50.39
	60	0.29	2.53	0.54	0.48	89.04
	110	0.18	1.74	0.36	0.34	96.69
305-2560Hz HIGH FREQ	10	0.89	2.93	1.23	0.45	36.64
	60	0.12	0.64	0.18	0.11	62.14
	110	0.07	0.38	0.11	0.06	58.65
5-2560Hz ALL FREQ	10	35.54	49.09	41.19	2.70	6.55
	60	4.16	10.22	4.99	1.07	21.49
	110	1.95	8.35	2.81	1.22	43.28

TABLE 3-21

SUMMARY STATISTICS FOR MAGNETIC FIELDS
IN THE COACHES ON THE NORTH JERSEY COAST (LONG BRANCH) LINE

LONG BRANCH - ALL COACHES		TOTAL OF 78 SAMPLES				
FREQUENCY BAND	HEIGHT ABOVE FLOOR (cm)	MINIMUM MAGNETIC FIELD (mG)	MAXIMUM MAGNETIC FIELD (mG)	AVERAGE MAGNETIC FIELD (mG)	STANDARD DEVIATION (mG)	COEFFICIENT OF VARIATION (%)
STATIC	10	668.65	971.21	806.59	0.69	0.09
	60	507.51	563.55	536.50	10.48	1.95
	110	507.51	1016.00	859.03	99.98	11.64
5-45Hz LOW FREQ	10	0.29	13.03	2.85	2.45	86.11
	60	0.20	6.13	1.11	1.15	103.67
	110	0.13	3.26	0.75	0.73	98.43
50-60Hz PWR FREQ	10	0.48	107.07	37.14	23.05	62.07
	60	0.31	45.33	11.04	10.64	96.39
	110	0.31	27.10	6.45	6.20	96.01
65-300Hz PWR HARM	10	0.78	17.74	4.81	4.19	86.97
	60	0.29	6.75	1.58	1.72	109.00
	110	0.18	3.70	1.02	0.92	90.42
305-2560Hz HIGH FREQ	10	0.35	3.59	1.33	0.77	57.59
	60	0.12	1.37	0.41	0.33	82.39
	110	0.07	0.77	0.24	0.19	77.91
5-2560Hz ALL FREQ	10	4.44	108.79	37.88	23.09	60.94
	60	2.36	45.88	11.31	10.75	95.00
	110	1.74	27.38	6.64	6.25	94.08

TABLE 3-22

COMPARISON OF MAGNETIC FIELD LEVELS IN COACHES
OPERATED ON VARIOUS SECTIONS OF THE NORTHEAST CORRIDOR
AND ON THE NORTH JERSEY COAST (LONG BRANCH) LINE

FIELD FREQUENCY BAND	SECTION OF CORRIDOR	MINIMUM MAGNETIC FIELD (mG)	MAXIMUM MAGNETIC FIELD (mG)	AVERAGE MAGNETIC FIELD (mG)
0 Hz STATIC	25 Hz	172.85	1207.70	606.17
	60 Hz	386.92	925.97	630.39
	NON-ELECTRIC	407.69	699.62	531.39
	LONG BRANCH	561.22	850.25	734.04
	AVERAGE	382.17	920.89	625.50
5-45Hz LOW FREQ	25 Hz	5.22	624.18	131.96
	60 Hz	0.17	8.99	1.35
	NON-ELECTRIC	0.21	3.94	1.42
	LONG BRANCH	0.21	7.47	1.57
	AVERAGE	1.45	161.15	34.07
50-60Hz PWR FREQ	25 Hz	1.39	26.91	5.89
	60 Hz	3.80	304.45	52.03
	NON-ELECTRIC	0.71	12.52	6.04
	LONG BRANCH	0.37	59.83	18.23
	AVERAGE	1.57	100.93	20.55
65-300Hz PWR HARM	25 Hz	2.06	72.81	16.17
	60 Hz	0.85	27.32	5.66
	NON-ELECTRIC	0.21	2.37	0.88
	LONG BRANCH	0.41	9.40	2.47
	AVERAGE	0.88	27.97	6.29
305-2560Hz HIGH FREQ	25 Hz	0.31	11.41	2.71
	60 Hz	0.24	7.47	1.37
	NON-ELECTRIC	0.07	0.80	0.27
	LONG BRANCH	0.18	1.91	0.66
	AVERAGE	0.20	5.40	1.25
5-2560Hz ALL FREQ	25 Hz	7.14	627.67	133.77
	60 Hz	4.20	305.23	52.46
	NON-ELECTRIC	0.95	12.60	6.42
	LONG BRANCH	2.85	60.68	18.61
	AVERAGE	3.78	251.54	52.81

measurement heights above the floor in each frequency band to arrive at representative numbers for the interior of the coaches as a whole.

Comparisons of magnetic field levels between the 25 Hz and 60 Hz sections of the corridor are undoubtedly valid because the measurements were made in the same coaches drawn by the same locomotive with similar passenger load. The only likely confounding factor is the difference in terrain over the two sections of the corridor. The 25 Hz section tends to be hillier but straighter than the 60 Hz section, therefore permitting higher train speeds. The additional traction power required ascending grades and traveling at higher speed may tend to increase both average and maximum field levels. Comparison of those data with data on the non-electrified section of the corridor is also believed to be valid. "Front Coach" measurements could not be made in the same coach because two coaches were removed from the train at New Haven. But since all coaches were similar Amfleet coaches manufactured by Budd, coach construction is not a factor. On the non-electrified section, the shorter train (hence, less traction load on the locomotive) has no effect because the prime source of power is not electrical. The shorter train and therefore lower level of hotel power traveling through the cables in the first coach is a potential confounding effect. However, that source of field was found to be nearly insignificant compared to the current in the catenary/track circuit.

Comparisons between the NEC data and the Long Branch data are less certain. The following factors possibly confound direct comparison:

- Different electrification system design
- Different locomotive type
- Different traction load
- Different terrain
- Different coach type
- Different size of dataset (not statistically representative for Long Branch)

The dataset measured on the Long Branch Line is relatively small due to the short length of the 60 Hz electrified portion. Nevertheless, measurements were well distributed across the length of the run from Matawan to Long Branch and distributed across a full range of operating conditions (accelerating, braking, running at speed) because the train made several brief station stops throughout the measurements (recording was suspended during the time of the stops). Consequently, the observed difference does not appear to result from inadequate size of the dataset.

The purpose of measurements on the North Jersey Coast (Long Branch) Line is to identify any magnetic field differences which may be due to electrification system differences. The locomotive types are reportedly similar. Differences in traction power requirements could also arise from differences in train length, passenger load, train speed and terrain. The terrain of the northern New Jersey

area does not appear to be significantly different from that along the Connecticut coast where most of the 60 Hz NEC measurements were made. The train on the Long Branch Line was shorter than the AMTRAK train, did not achieve very high speed between frequent stops, and had a very light passenger load. However, on the return trip in the locomotive, described in the next section, motor ammeter readings were observable and during acceleration from the stations, were comparable in magnitude to those observed in the AMTRAK locomotives. Unfortunately, that observation does not confirm that catenary currents were equal because the locomotives may have been operating on different transformer tap settings.

The final possible confounding factor is differences in coach construction. The Amfleet coaches have Type 304 stainless steel bodies, stainless steel plymetal floors of unspecified alloy and high tensile strength stainless steel (unspecified alloy) sills. The New Jersey Transit Comet 3 coaches operating on the Long Branch Line had aluminum bodies, stainless steel plymetal floors and carbon steel sills. The trucks and other undercoach equipment (compressors, etc.) in both types of coaches were similarly constructed of carbon steel alloys.

The coach construction could affect field levels in two ways. First, ferromagnetic components such as steel sills, trucks, and undercoach equipment could significantly perturb the magnetic field, causing areas of both magnetic field enhancement or suppression. Judging from the average static magnetic field levels measured in the coaches and reported in Table 3-22 and Figure 3-22, there is little difference in the extent to which the geomagnetic field penetrates Amfleet and Comet 3 coaches, indicating that ferromagnetic properties of the coach bodies do not play a significant role in average internal magnetic field levels. This comment also applies to the time-varying magnetic field because ferromagnetic effects are not highly frequency dependent in the ULF and ELF frequency ranges.

The electrical conductivity of the coach bodies could affect the extent to which time-varying magnetic fields penetrate the coach because "eddy currents" induced in the coach wall could produce magnetic fields which tend to cancel the incident ac magnetic field. The extent of "shielding" resulting from this phenomenon is directly proportional to the frequency of the field, the conductivity of the metal from which the body is constructed and the thickness of the metal. The conductivity of the aluminum skin of the Comet 3 coach is considerably higher (approximately 15 times) than that of the stainless steel skin of the Amfleet coaches, so the Comet 3 coaches would provide more ac, ELF field shielding. The extent of shielding offered by the coach body is difficult to estimate because it is highly dependent on the thickness of the metal and the electrical integrity of joints between panels. Although the authors are unaware of any data on the shielding efficiency of metallic coach bodies at ELF frequencies, experience with other structures suggests that the ac shielding effectiveness will be less than 10% at 60 Hz (90% of the field penetrates the coach) for the aluminum Comet 3 coaches and

Comparison of Avg Static Magnetic Field For the Four Technologies

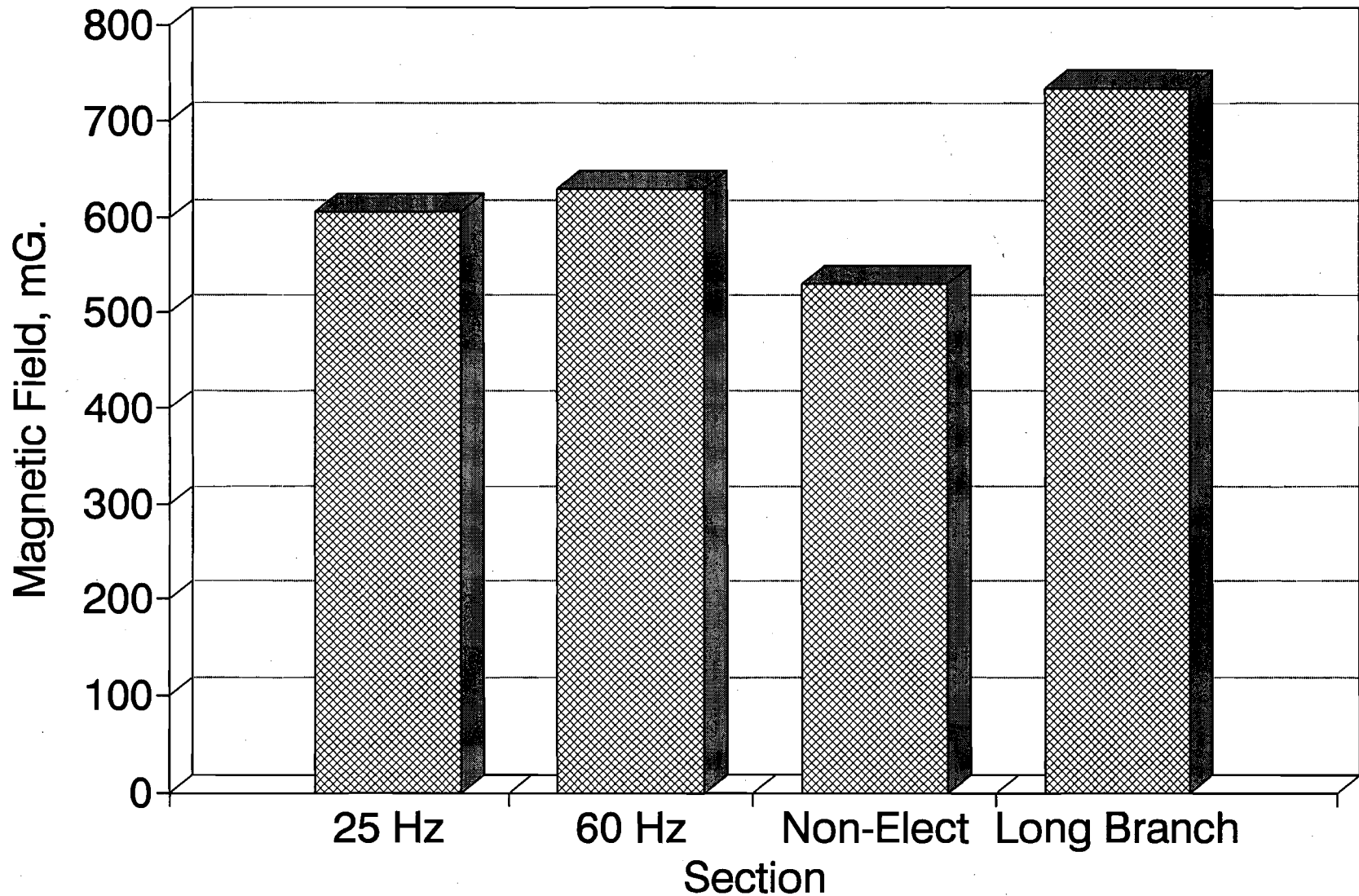

3-62

FIGURE 3-22. COMPARISON OF AVERAGE STATIC MAGNETIC FIELD LEVELS IN COACHES ON VARIOUS SECTIONS OF THE NEC AND ON THE NORTH JERSEY COAST LINE

even less for the stainless steel Amfleet coaches. Hence, it does not appear that ac magnetic field shielding could be a significant factor.

Figure 3-23 provides a comparison of the average time-varying magnetic field (without regard to frequency, i.e., broadband rms) in coaches operating on the Northeast Corridor and the Long Branch Line measured three distinctly different ways. Although there are differences between average magnetic field broadband values measured in different ways, each measurement system shows similar proportional differences in magnetic field levels of coaches operating on the four railroad sections. Note that the rms data for the 25 Hz section has not been shown, since the rms recorder does not respond at this lower frequency. Consequently, the remainder of this section focuses on repetitive waveform data because those data contain possibly important frequency information, and they also represent a more complete spatial sampling of field levels within the coaches.

Figure 3-24 shows a comparison of the average time-varying magnetic field levels in coaches operating on the NEC and the Long Branch Line. Furthermore, the shading pattern in the bars of Figure 3-24 represent the extent to which field components within various frequency bands contribute to the total RMS magnetic field. As described in earlier subsections, the principal field for the electrified sections of the corridor results from current in the track/catenary circuit. Consequently, 25 Hz magnetic fields make up most of the field energy on the 25 Hz section of the corridor, and 60 Hz fields make up most of the magnetic field energy on both the 60 Hz portion of the corridor and on the North Jersey Coast (Long Branch) Line. The difference in average magnetic field levels for various sections of railroads studied is clearly evident.

Average magnetic field levels in individual frequency bands are depicted more clearly in Figure 3-25. Note that the principal frequency components of the field on the 25 Hz section of the corridor are the catenary current frequency (25 Hz) and its harmonics (principally 75 Hz). The catenary current does not contain significant components in the 50-60 Hz power frequency band, so the only field in that frequency range comes from onboard equipment and hotel power distribution, and possibly external power frequency sources unrelated to the railroad. Since the non-electrified portion of the corridor has no significant catenary or track current to produce magnetic fields, the power frequency magnetic fields in the coaches arise from the same sources mentioned above for the 25 Hz section of the corridor. Therefore, one would expect the average fields in that frequency range to be similar for the two sections of the corridor, and Figure 3-25 shows that they in fact are. Both the 60 Hz section of the NEC and the Long Branch Line use 60 Hz catenary current so it is not possible to resolve the component of field from the catenary from other sources on an average basis. However, it is reasonable to assume that the portion of the 60 Hz field from sources other than the catenary and track current circuit are similar to those indicated for the 25 Hz and non-electrified portions of the corridor. The

Comparison of Average AC Magnetic Field For the Four Technologies

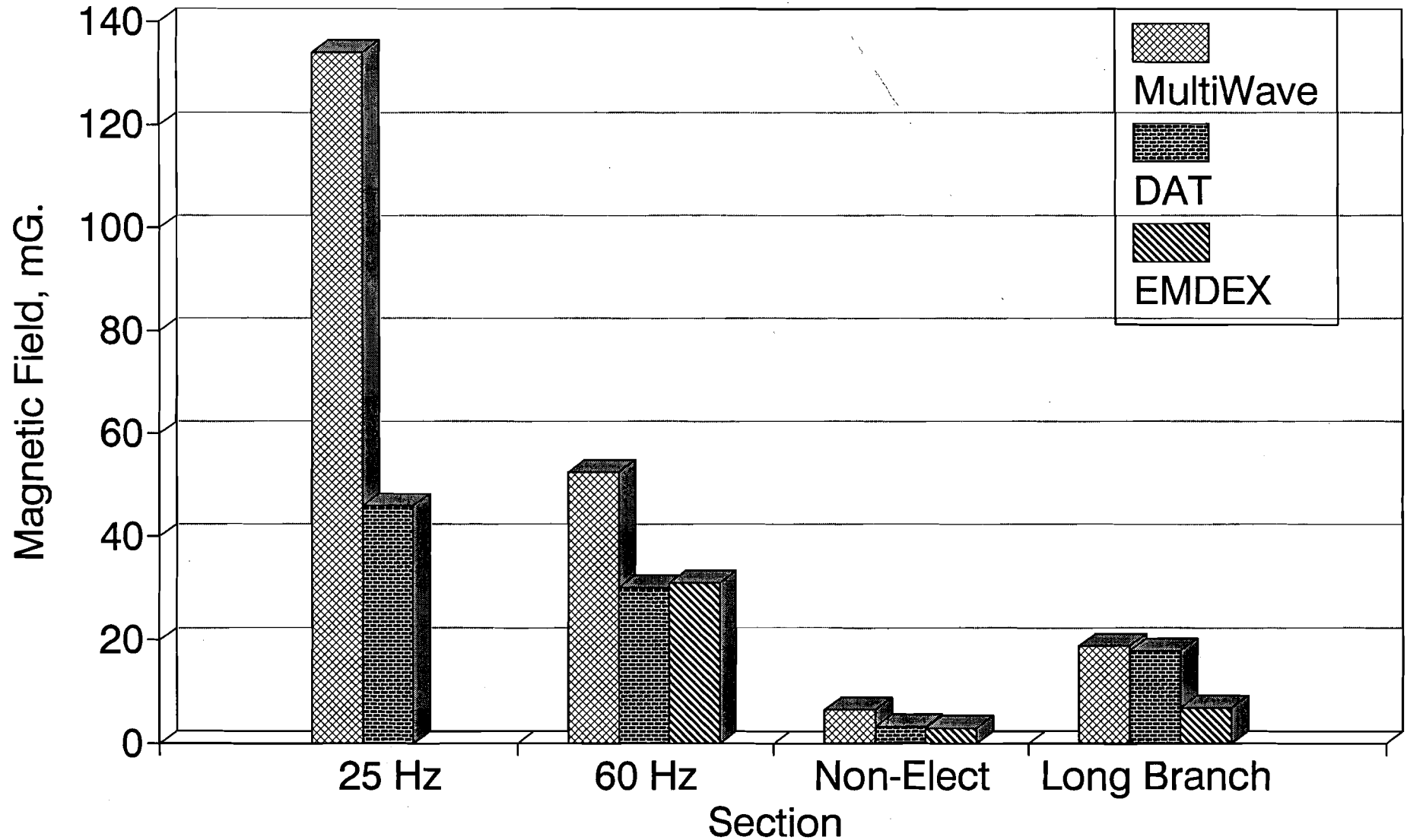

FIGURE 3-23. COMPARISON OF THE AVERAGE TIME-VARYING MAGNETIC FIELD LEVELS IN COACHES OPERATING ON VARIOUS SECTIONS OF THE NEC AND THE NORTH JERSEY COAST LINE MEASURED IN DIFFERENT WAYS

Comparison of Average AC Magnetic Field For the Four Technologies

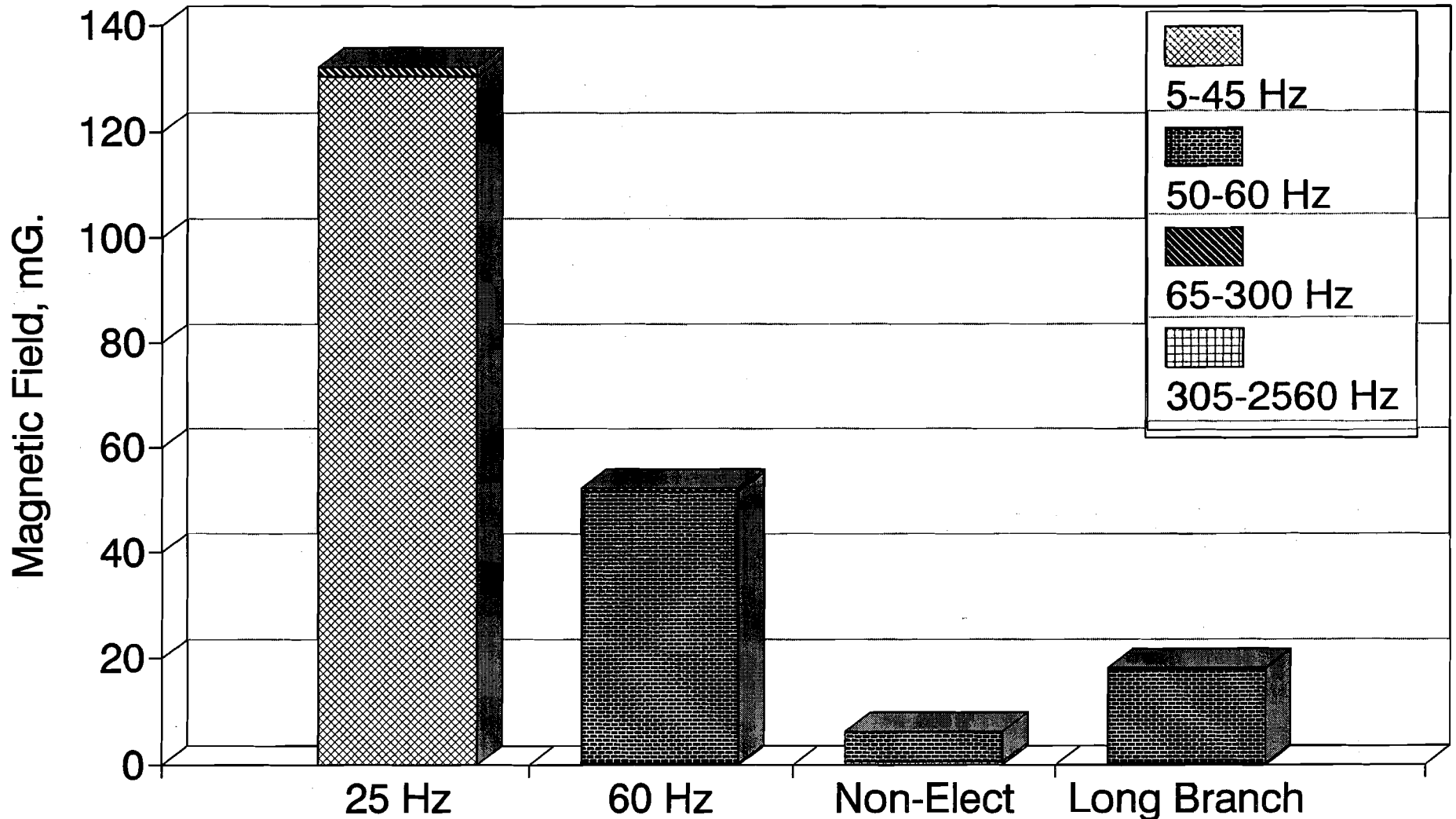
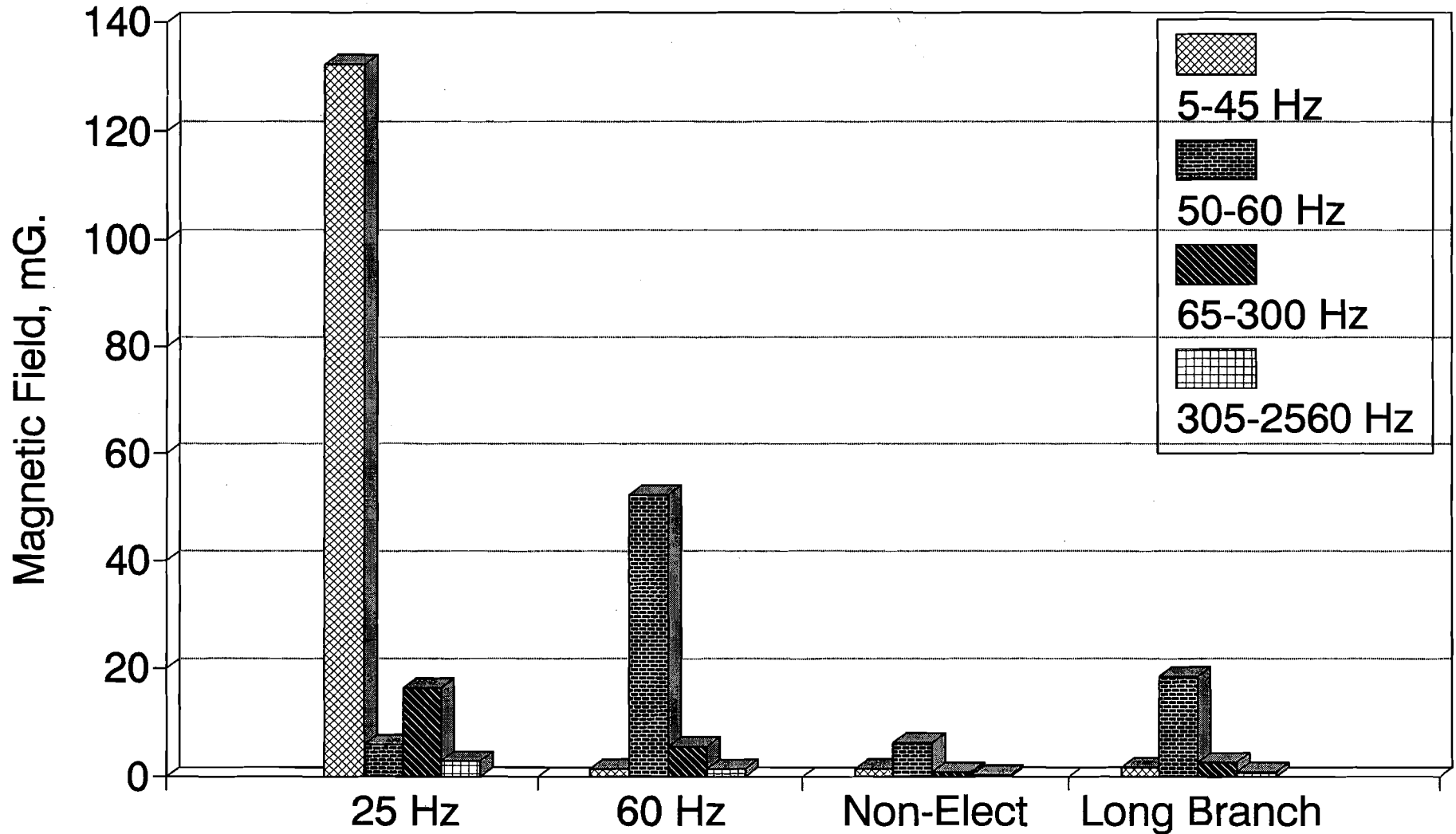

FIGURE 3-24. COMPARISON OF THE AVERAGE TIME-VARYING MAGNETIC FIELD LEVELS IN COACHES ON VARIOUS SECTIONS OF THE NEC AND ON THE NORTH JERSEY COAST LINE AND THEIR PRINCIPAL COMPONENT FREQUENCY RANGES

Comparison of Average AC Magnetic Field For the Four Technologies



3-66

FIGURE 3-25. COMPARISON OF AVERAGE TIME-VARYING MAGNETIC FIELD LEVELS IN FOUR FREQUENCY BANDS IN THE COACHES ON VARIOUS SECTIONS OF THE NEC AND ON THE NORTH JERSEY COAST LINE

excess field is then presumably due primarily to current in the catenary/track circuit.

The average magnetic field apparently due to track and catenary current on the 25 Hz section of the corridor is more than twice that on the 60 Hz section of the corridor. A small part of that difference (approximately 4%) is attributable to the lower voltage (typically 12 kV) on the catenary in the 25 Hz section of the corridor than on the 60 Hz section of the corridor (typically 12.5 kV). The lower voltage on the 25 Hz section of the system requires the locomotive to draw more current for equal motive power, but the remainder of the difference is attributable to differences in average motive power requirements (the 60 Hz section is somewhat less hilly and has more speed restrictions) and differences in electrification scheme (direct fed on the 25 Hz section versus autotransformer fed on the 60 Hz section).

During maximum acceleration, the current drawn by the locomotives is limited by outboard equipment. As a result, the maximum catenary current is similar (within 4%) on both the 60 Hz and 25 Hz sections of the NEC. Consequently, the maximum magnetic field levels due to track and catenary current during train acceleration in the 25 Hz and 60 Hz sections of the NEC are nearly the same. Figures 3-26, 3-27, and 3-28 show the differences in maximum magnetic field for the electrification technologies. While the difference between maximum fields in coaches on the 25 Hz and 60 Hz sections of the corridor are somewhat less than the relative differences for the average field levels, the difference measured with the more spatially diverse repetitive waveform measurements is still two-to-one, with the larger fields observed in the coaches on the 25 Hz section of the Northeast Corridor between Washington and New York.

The maximum magnetic field levels within the coaches appeared to occur when trains drawing considerable power passed in opposite directions. For example, six minutes into dataset NEC006 (Appendix G) and five minutes into dataset NEC008 (Appendix I), two trains passed on the 25 Hz section of the corridor producing magnetic fields of approximately 600 mG in the coaches. No comparable data for trains passing at high power were measured on the 60 Hz section of the corridor. Each pass on that section occurred with one train stopped at a station or one train coasting. If the two cases of high field measurements due to passing trains are deleted from the dataset, the maximum magnetic fields measured in the coaches on the 25 Hz section of the corridor reduces to approximately 440 mG (dataset NEC005, Appendix F). Nevertheless, that value is still approximately 40% higher than the maximum magnetic field measured in coaches on the 60 Hz section of the NEC from the New York area to New Haven. That difference appears attributable to differences in catenary voltage, terrain, and possibly differences between autotransformer-fed and direct-fed catenaries.

The cause of the significant differences in magnetic field level in Comet 3 coaches operating on the Long Branch Line compared to Amfleet coaches operating on the AMTRAK and Metro North Northeast

Comparison of Maximum AC Magnetic Field For the Four Technologies

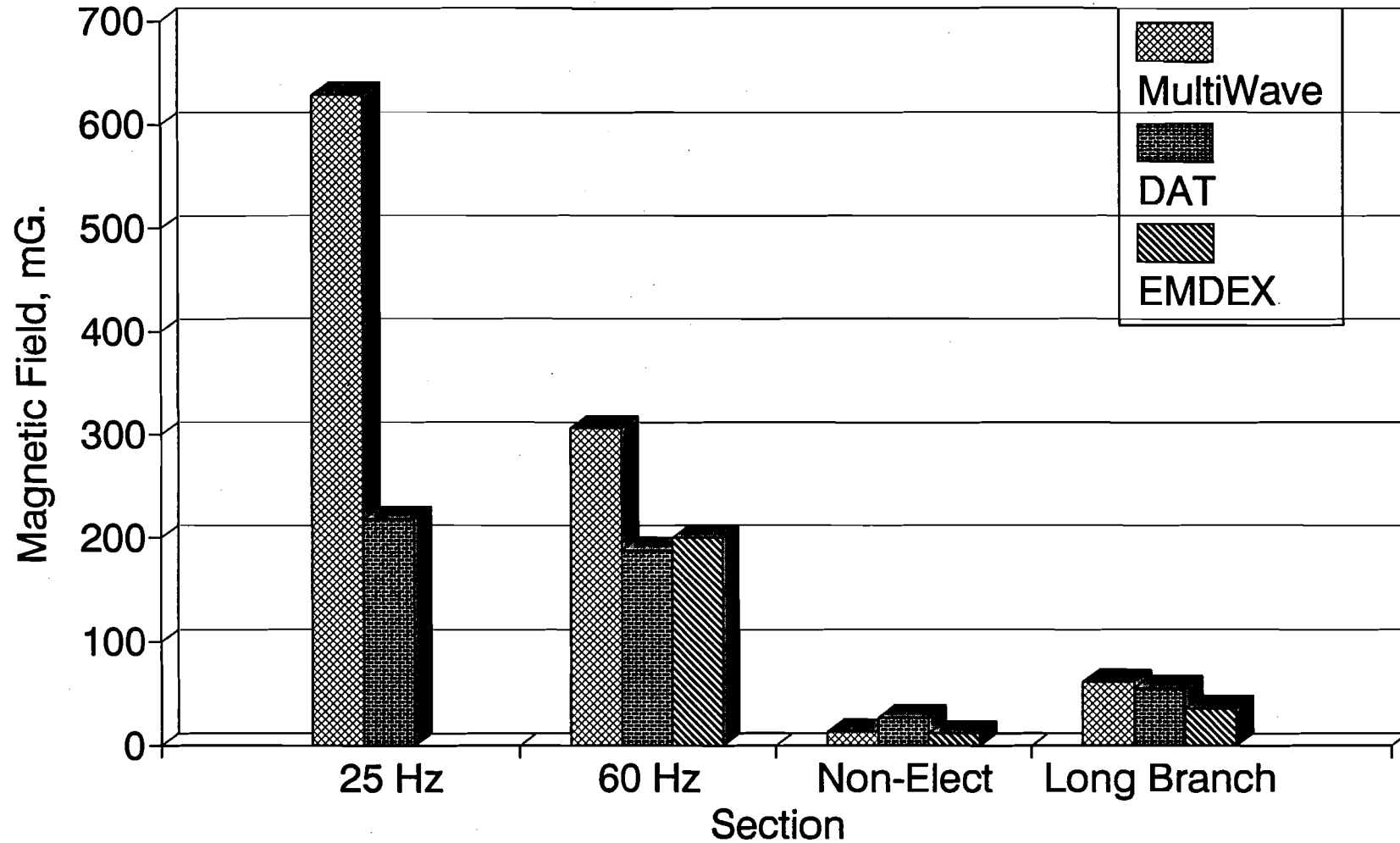

3-68

FIGURE 3-26. COMPARISON OF THE MAXIMUM TIME-VARYING MAGNETIC FIELD LEVELS IN COACHES ON VARIOUS SECTIONS OF THE NEC AND ON THE NORTH JERSEY COAST LINE MEASURED IN DIFFERENT WAYS

Comparison of Maximum AC Magnetic Field For the Four Technologies

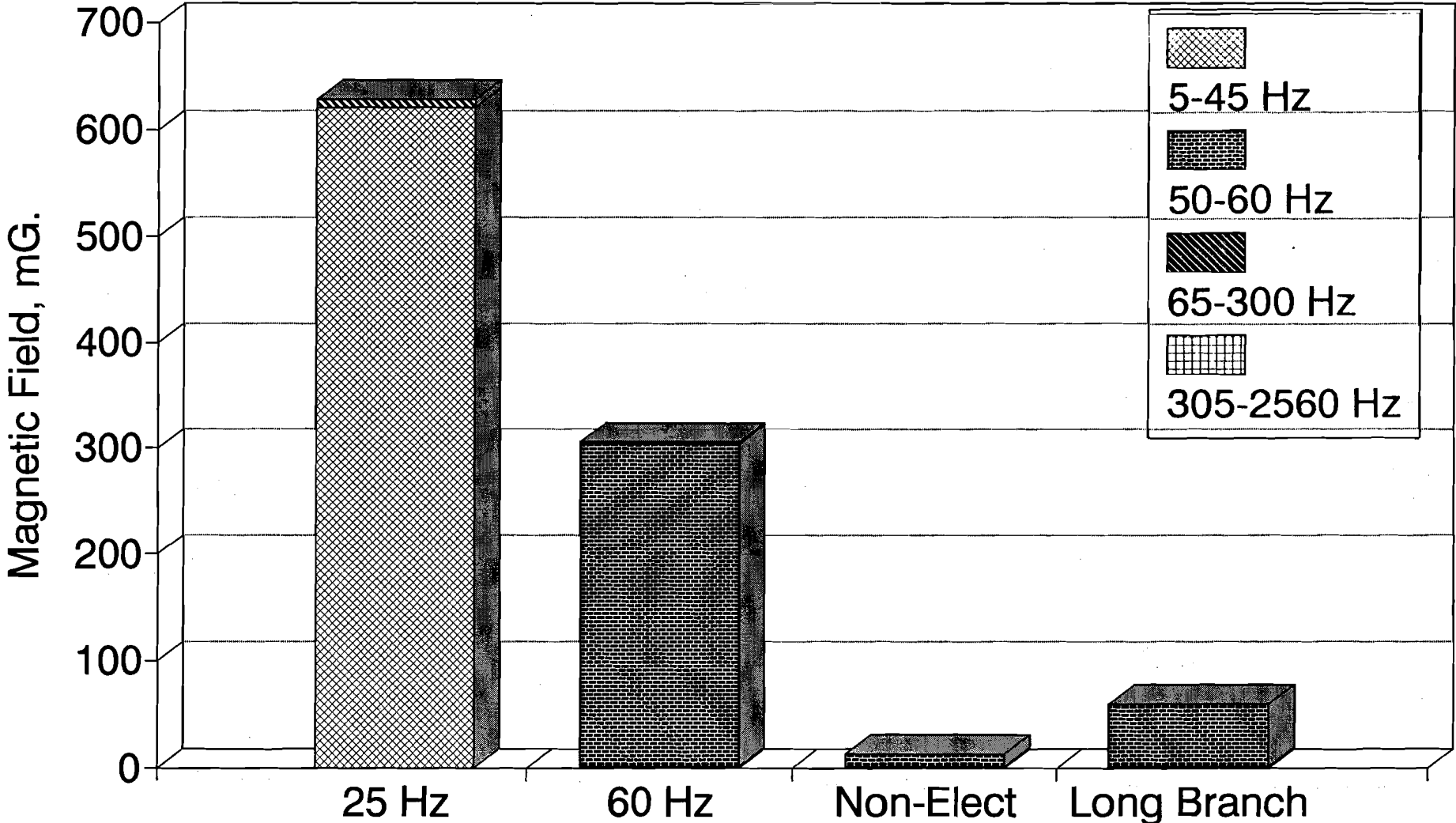

69-ε

FIGURE 3-27. COMPARISON OF THE MAXIMUM TIME-VARYING MAGNETIC FIELD LEVELS IN COACHES ON VARIOUS SECTIONS OF THE NEC AND ON THE NORTH JERSEY COAST LINE AND THEIR PRINCIPAL COMPONENT FREQUENCY RANGES

Comparison of Maximum AC Magnetic Field For the Four Technologies

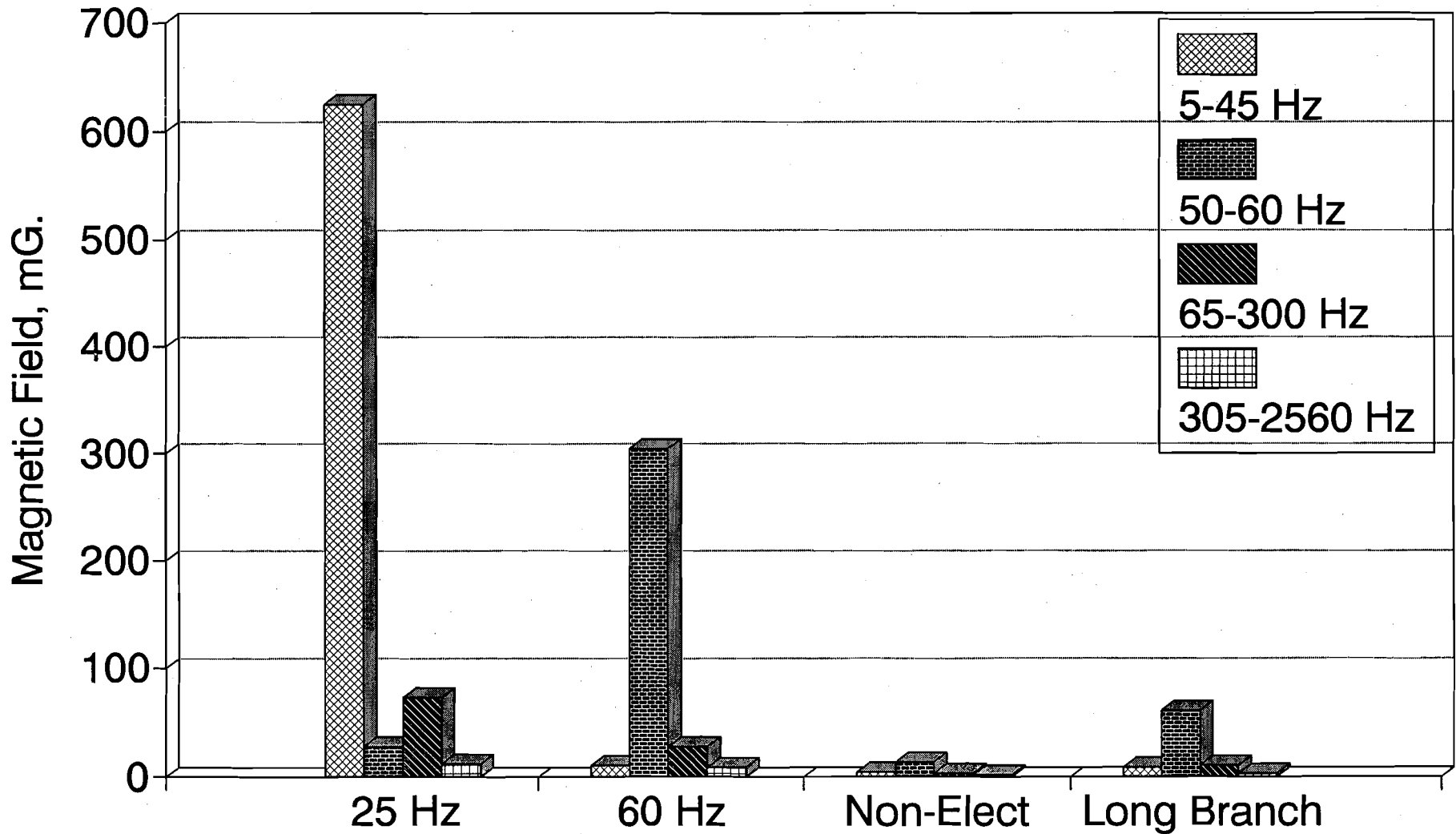

3-70

FIGURE 3-28. COMPARISON OF THE TIME-VARYING MAGNETIC FIELD LEVELS IN VARIOUS FREQUENCY BANDS DURING MAXIMUM FIELD CONDITIONS IN COACHES ON VARIOUS SECTIONS OF THE NEC AND ON THE NORTH JERSEY COAST LINE

Corridor can not be fully explained from the available data. The average and maximum magnetic field in Amfleet coaches on the 60 Hz section of the Northeast Corridor are 2.8 and 5 times higher, respectively, than corresponding magnetic field levels measured on the 60 Hz Long Branch Line. The voltage on the Long Branch Line and the New York to New Haven section of the corridor are very similar. The catenary of the Long Branch Line is fed directly from substations without the use of autotransformers; so, all other factors being equal, should have had fields no lower than the 60 Hz section AMTRAK which has autotransformers. As described above, the aluminum shell of the Comet 3 coaches might provide modest shielding, but it is unlikely that shielding can account for the rather large differences. Hence, the uncontrolled factors such as terrain, number of passengers, and/or maximum load and speed, hence lower power, appear to cause much of the observed differences in field level.

It appears inappropriate to extrapolate magnetic field measurements in coaches on the Long Branch Line in order to predict magnetic field levels which would occur in Amfleet coaches operating on a proposed future electrified portion of the NEC from New Haven to Boston because of the apparent impact of factors such as terrain, train loading, and/or train speed during the tests. Instead, a more accurate prediction would result from taking the field data from the electrified sections of the Northeast Corridor and extrapolating it to the electrification scheme ultimately selected and proposed for the New Haven to Boston electrification.

3.7 ELECTRIC FIELD SOURCES AND LEVELS

Ultra low frequency (ULF) and extreme low frequency (ELF) electric fields are effectively attenuated by conductive barriers such as the metallic bodies of rail coaches. Consequently, significant electric fields from external sources associated with the railroad or the commercial power system were not expected to be present inside the coaches.

In order to quantify the electric field within the coaches, electric field measurements were made at locations corresponding to the magnetic field measurements described earlier in this chapter. The resulting data are presented in Table 3-23. Those data confirm that the electric field is very low (2 V/m average) within the coaches on all sections of the corridor and on the North Jersey Coast Line. The similarity of electric field values for tests on electrified and non-electrified railroad sections strongly supports the conclusion that the coach bodies are effective electric field shields and the ELF electric fields within the coaches arise principally from internal sources. The largest electric fields (10-18 V/m) were found when the field sensor was placed at the bulkhead in the vicinity of the fluorescent lights, suggesting that the lights are the most significant electric field sources within the area of the coaches where measurements were made.

TABLE 3-23

SUMMARY OF ELF ELECTRIC FIELD
LEVELS WITHIN THE COACHES

RAIL SECTION AND COACH	AVERAGE ELECTRIC FIELD IN AISLE	AVERAGE ELECTRIC FIELD AT BULKHEAD
25 Hz NEC		
7th COACH	1.5 V/m	18 V/m
1st COACH	1.0 V/m	10 V/m
60 Hz NEC		
7th COACH	1.5 V/m	16 V/m
1st COACH	2.0 V/m	12 V/m
NON-ELECTRIFIED		
5th COACH	1.5 V/m	18 V/m
60 Hz LONG BRANCH		
1st COACH	3.5 V/m	10 V/m

4. ENGINEER'S COMPARTMENT MEASUREMENTS

The measurements in the engineer's compartment address the question of occupational exposure of the engineer. The electric and magnetic field environment of the locomotive cab certainly has contributions from field sources described in the preceding chapter. However, sources within the locomotive are more likely to be significant contributors to the field environment of the engineer's cab than they are to the field environment of the coaches.

As with the coach measurements, similar measurements were conducted in the cabs of locomotives operating on the 25 Hz and 60 Hz electrified section of the Northeast Corridor, the non-electrified section of the corridor, and on the 60 Hz electrified section of New Jersey Transit's North Jersey Coast Line from Matawan to Long Branch. In all cases, the tests were made on trains with a single locomotive pulling the train of six to nine coaches.

4.1 MEASUREMENT LOCATIONS

The diesel locomotive operating on the non-electrified section of the Northeast Corridor from Boston to New Haven had only one engineer's cab at the front of the locomotive. The approximate arrangement of engineer's console, the engineer's seat behind the console, and the extra "fireman's" seat at the left front of the cab are shown in the top frame of Figure 4-1. Behind the seats was a steel bulkhead which separated the cab from the machinery portion of the locomotive. Installed on that bulkhead were a number of electrical cabinets of various sizes. The electrical generator was reportedly the nearest major piece of locomotive machinery to the cab, and the diesel engine was further to the rear.

The top frame of Figure 4-1 also shows the approximate locations of the waveform capture system measurement staff where magnetic field repetitive waveform measurements were made. Four simultaneous measurements at various heights from the floor were measured at the left shoulder of the engineer, indicated as measurement Location 24 to document the vertical profile of field conditions at the side of the engineer nearest the locomotive machinery and equipment. A corresponding set of measurements was made to the right of the fireman's seat (Location 23). Another profile was measured 1.5 meters above the cab floor along the axial direction going forward from the electrical cabinet and machinery behind the bulkhead. That profile, Location 27, was intended to document the extent to which fields from locomotive machinery enter the cab and the rate at which they attenuate.

During the morning of these tests, the engineer had a second person in the cab riding in the fireman's seat for training purposes.

Diesel Locomotive

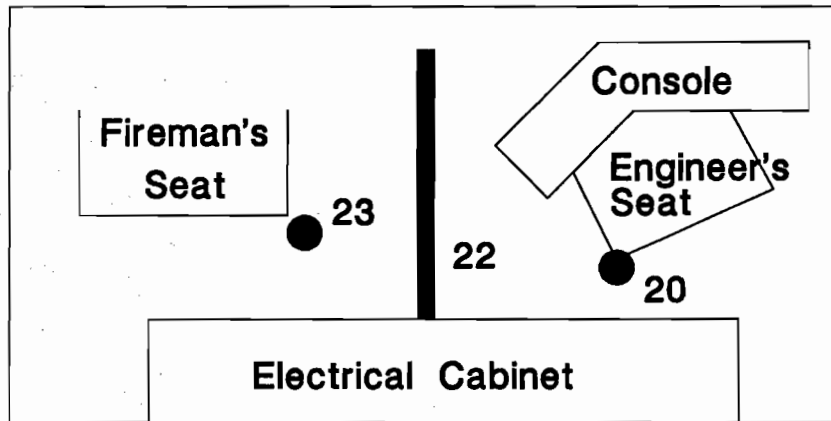

Electric Locomotive

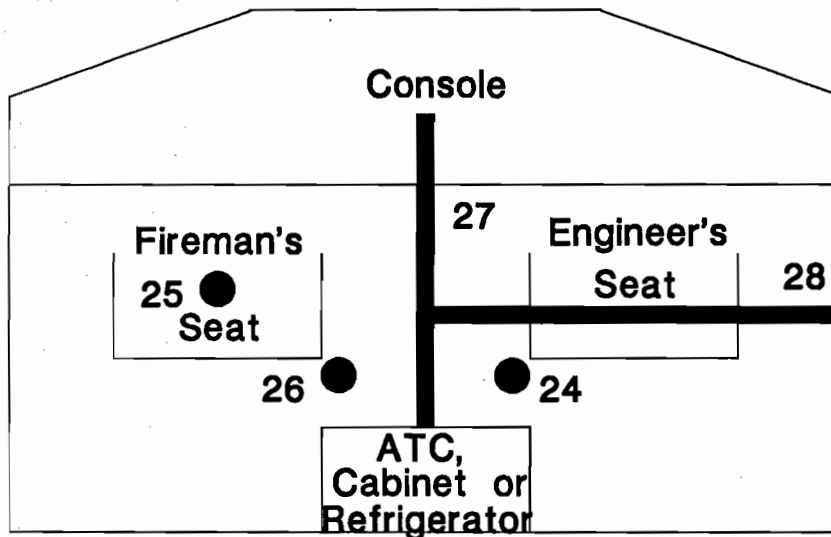

FIGURE 4-1. REPETITIVE WAVEFORM MEASUREMENT LOCATIONS IN THE FRONT CAB OF THE DIESEL ELECTRIC LOCOMOTIVE (TOP FRAME) AND THE REAR CAB OF THE ELECTRIC LOCOMOTIVE (BOTTOM FRAME)

Consequently, the cab was very crowded with only two additional persons from the measurement crew. For that reason and because of limited time to load equipment, it was judged impractical to deploy the reference probe and conduct continuous field recordings with the DAT. Furthermore, since only two members of the measurement team could ride in the locomotive cab, the other two members, along with one of the rms recorders, traveled to New Haven in the first coach behind the locomotive.

The electric locomotives (both the AMTRAK AEM-7 and the similar NJT ALP-44) had an engineer's cab at both ends of the locomotive. In order to avoid distracting the engineer and interfering with his duties, and to accomplish more comprehensive measurements, all of the tests in the electric locomotive were made in the rear cab. The choice of rear cab versus front cab undoubtedly has some impact on the magnetic field environment. For example, the rear cab is above hotel power cables to the coaches and nearer the active pantograph than is the front cab. However, since the orientation of the locomotive when attached to the train is not always consistent, the choice of the rear cab does not present a consistent bias relative to major locomotive equipment. For example, the orientation of the locomotive on the train from New Haven to New York was such that the cab with the ATC equipment was at the rear of the locomotive. But on the train from New York to Washington, the locomotive was reversed, having the cab with the ATC equipment at the front of the locomotive. Although this coincidence of locomotive orientation eliminates bias in the measurements resulting from which cab was sampled relative to locomotive machinery, it introduces another parameter in the comparison of data from 60 Hz and 25 Hz sections of the Northeast Corridor.

The lower frame of Figure 4-1 also shows the locations where repetitive waveform measurements were made. These locations generally correspond to measurement locations in the diesel-electric locomotive described above, but with three exceptions:

1. A reference probe was located on the empty fireman's seat (Location 25) for ATC tests;
2. Continuous recordings of fields detected by the reference probe were made with the DAT; and
3. A horizontal profile above the engineer's seat was measured to document lateral variability of the magnetic field in the vicinity of the engineer.

The various repetitive waveform datasets and continuous recording datasets measured in the engineer's compartments are listed in Tables 2-1 and 2-2, respectively.

4.2 REPETITIVE WAVEFORM DATASETS

Sixteen repetitive waveform datasets were collected in the engineer's compartments. These tests were distributed across a matrix of three test locations per cab by four railroad sections,

as illustrated in Table 4-1. Note that the sampling is heaviest at the test location next to the engineer's seat because that is the relevant point for assessing the engineer's most routine exposure to magnetic fields. The field-by-frequency-by-time plots and field-by-distance-by-time plots for these datasets are found in the Appendices of Volume II of this report. The appropriate appendix is identified in parentheses on Table 4-1. Comparisons across datasets allow consistent evaluation of field characteristics in each locomotive cab as well as consistent evaluation of the differences attributable to electrification type.

4.3 FIELD SOURCE IDENTIFICATION

As described in Section 3.3, the magnetic field data from the 25 Hz section of the Northeast Corridor provides an excellent opportunity for evaluation of various field sources. The fundamental frequency of the magnetic field from catenary and track current is 25 Hz, while the fields from onboard auxiliary equipment, hotel power, and external non-railroad power systems will have a fundamental frequency of 60 Hz.

Figure 4-2 shows pseudo-three-dimensional graphs of the magnetic field versus frequency and time at two different heights above the floor at the left of the engineer's seat. These data come from dataset NEC032 (Appendix AG) which was measured in locomotive 904 as it departed New York enroute to Washington on the 25 Hz section of the Northeast Corridor. The top frame of the figure shows field characteristics 160 cm above the floor. The 25 Hz component of the field is clearly the dominant component. It is similar in character to the fields measured in the coaches arising from current in the catenary and track (Figures 3-3 and 3-4). Examination of the bottom frame showing field characteristics 10 cm above the floor shows the same general characteristics for the 25 Hz magnetic field and its harmonics, but it also shows the presence of a 60 Hz magnetic field which apparently arises from a source beneath the floor. Measurements near the fireman's seat (Appendix AH, dataset NEC033) show a similar situation, however, the 60 Hz magnetic field near the floor is larger.

Data from all of the vertical profiles within the locomotive on the 25 Hz portion of the NEC have been pooled and the relationship between field strength and height above the floor plotted for the low frequency (5-45 Hz) and power frequency (50-60 Hz) components of the magnetic field. These graphs are presented in Figures 4-3 and 4-4, respectively. Figure 4-3 demonstrates that the average low frequency field, made up almost entirely of the 25 Hz field component, is relatively insensitive to height above the floor. That is consistent with a field arising from current in the catenary/track circuit as described in the last chapter for fields within the coaches. The magnetic field in the power frequency band (almost entirely 60 Hz) plotted in Figure 4-4 shows a clear attenuation at increasing height above the floor, strongly indicating that the field source or sources are beneath the floor.

TABLE 4-1

DISTRIBUTION OF THE SIXTEEN WAVEFORM
DATASETS ACROSS MEASUREMENT LOCATIONS
WITHIN THE LOCOMOTIVE CAB AND RAILROAD SECTION

RAILROAD SECTION	DATASETS (APPENDIX)			
	ENGINEER'S SEAT	FIREMAN'S SEAT	AXIAL PROFILE	LATERAL PROFILE
25 Hz SECTION NEC				
	NEC030 ¹ (AE)			
	NEC032 (AG)	NEC033 ² (AH)	NEC034 (AI)	
	NEC035 (AJ)			
60 Hz SECTION NEC				
	NEC026 (AA)	NEC027 (AB)	NEC028 (AC)	
	NEC029 (AD)			
	NEC030 ¹ (AE)			
NON- ELECTRIFIED SECTION NEC				
	NEC022 (W)	NEC025 (Z)	NEC024 (Y)	
	NEC023 (X)			
60 Hz SECTION NJT				
	NEC049 (AX)		NEC051 ³ (AZ)	NEC051 ³ (AZ)
	NEC050 (AY)			
	NEC051 ³ (AZ)			

1 NEC030 spans the transition from the 60 Hz to the 25 Hz section of the NEC.

2 NEC032 spans a section with parallel dc third rail (near NYC).

3 NEC051 contains three subsets.

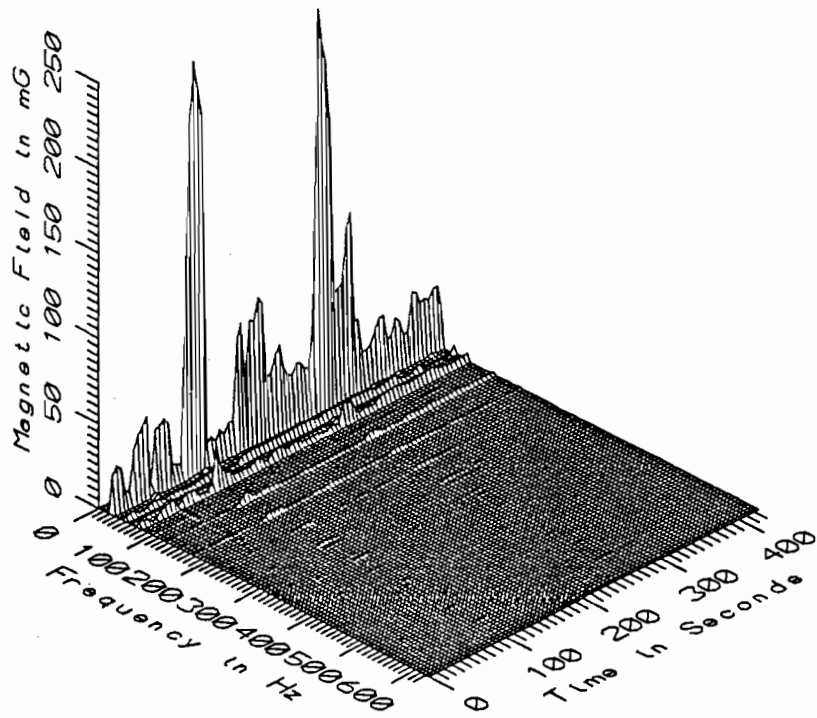

NEC032 - 160cm ABOVE FLOOR, LEFT OF ENGINEER

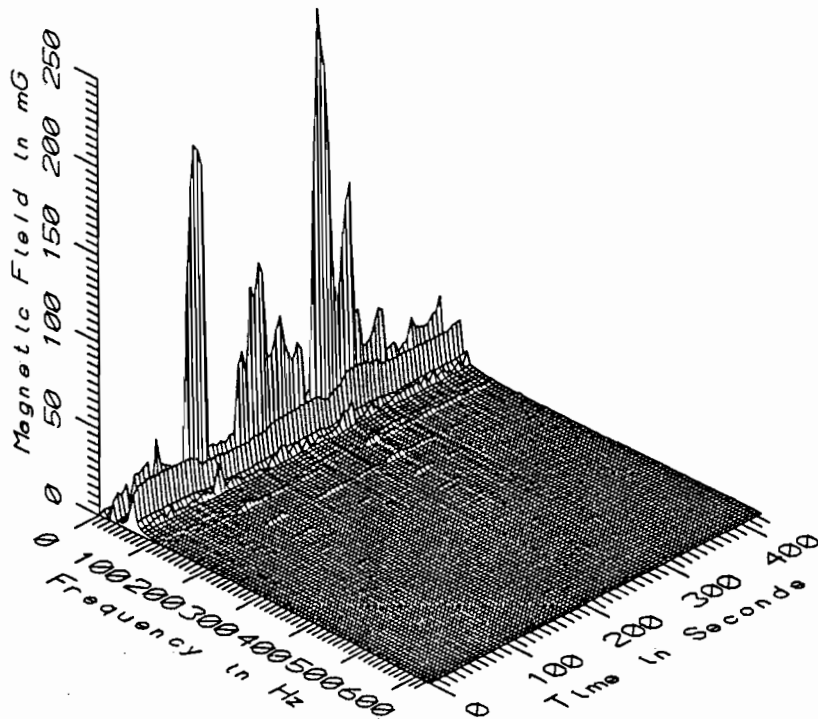

NEC032 - 10cm ABOVE FLOOR, LEFT OF ENGINEER

FIGURE 4-2. MAGNETIC FIELD LEVELS AT TWO HEIGHTS ABOVE THE FLOOR AT THE SIDE OF THE ENGINEER'S SEAT IN A LOCOMOTIVE ON THE 25 HZ SECTION OF THE NORTHEAST CORRIDOR

MAGNETIC FIELD IN LOCOMOTIVE CAB

LOW FREQUENCY (5-45 Hz)

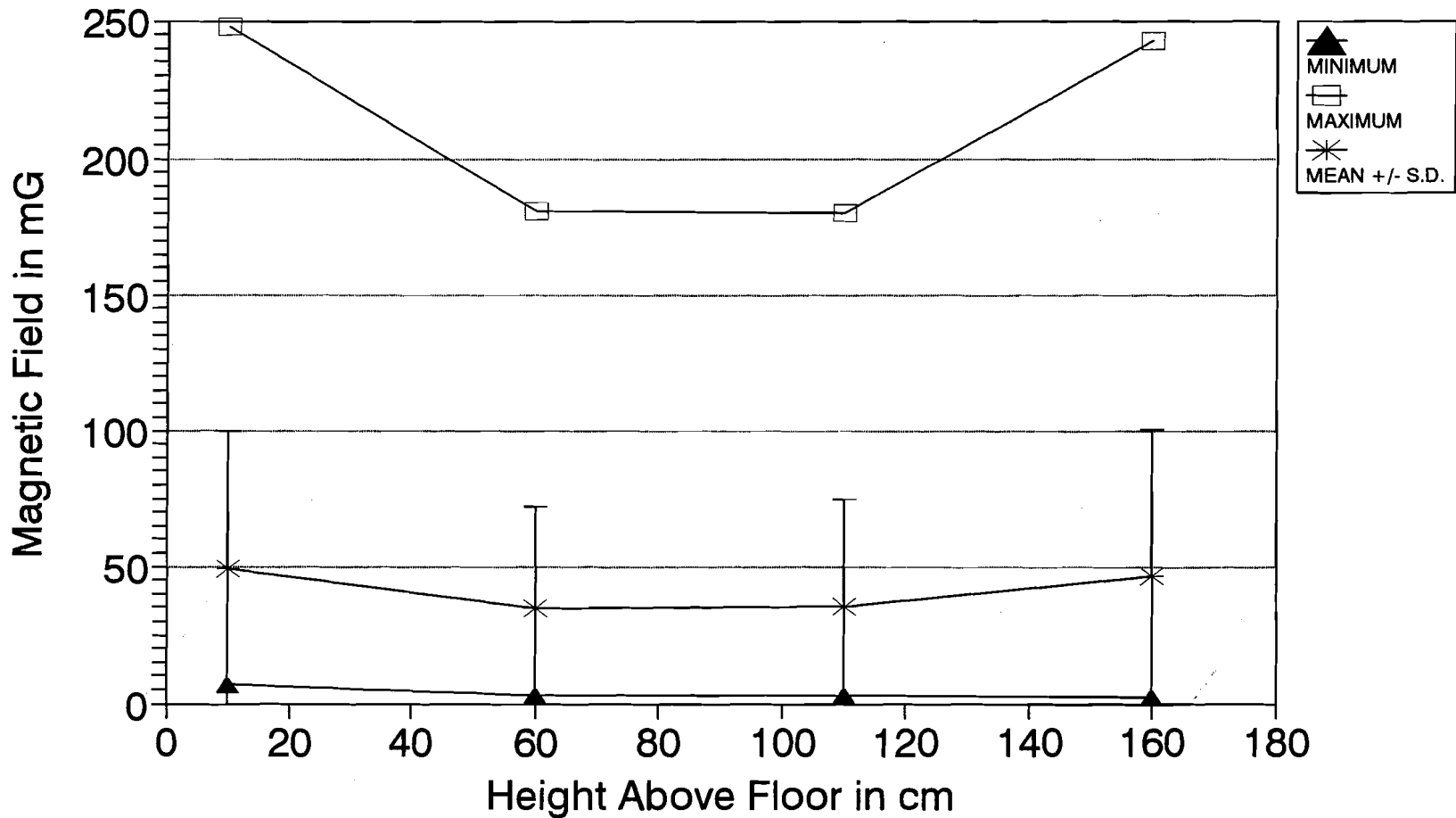
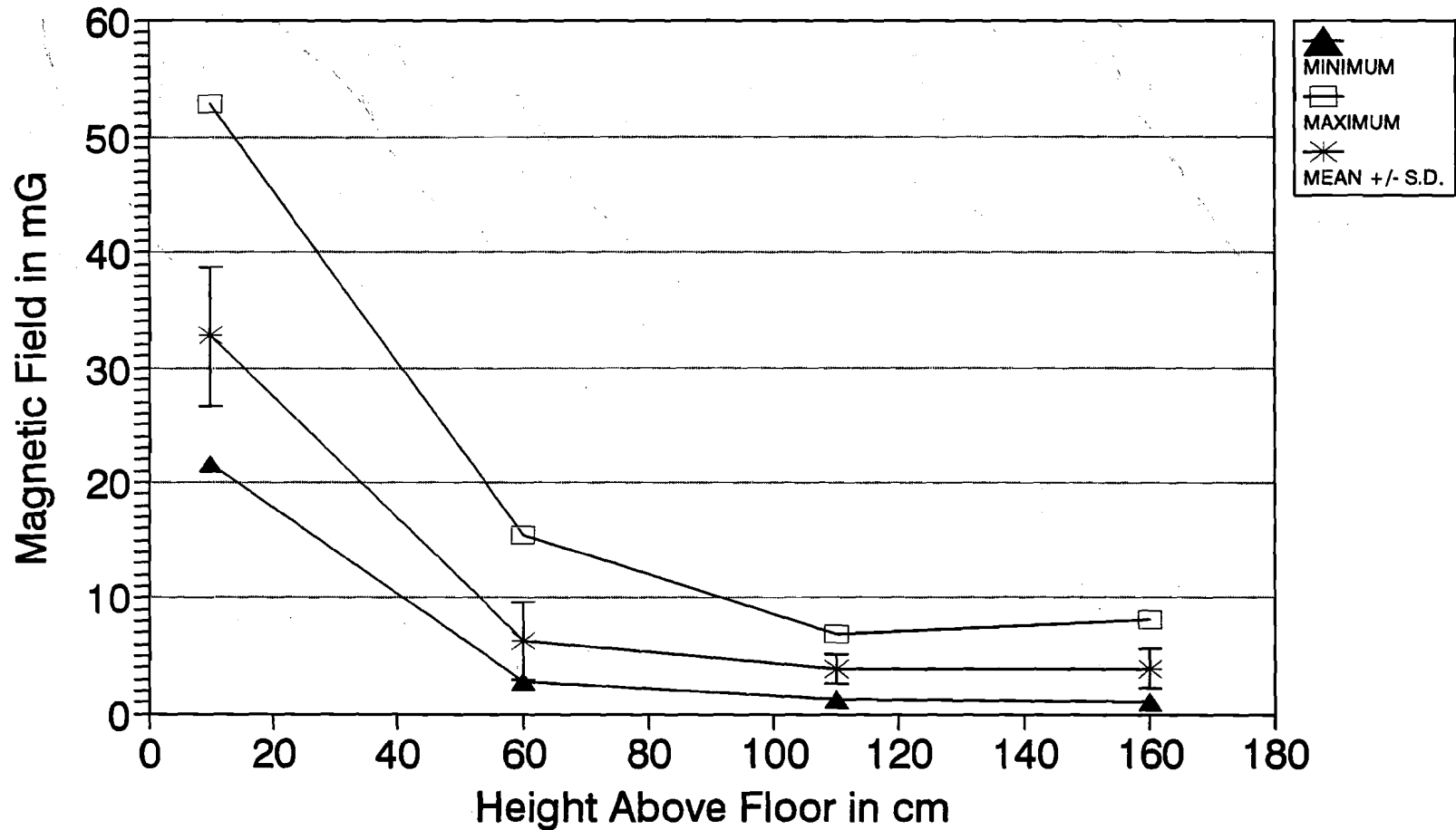

FIGURE 4-3. VERTICAL PROFILE OF LOW FREQUENCY MAGNETIC FIELD STRENGTH IN A LOCOMOTIVE CAB OPERATING ON THE 25 HZ SECTION OF THE NEC

MAGNETIC FIELD IN LOCOMOTIVE CAB

POWER FREQUENCY (50-60 Hz)



4-8

FIGURE 4-4.

VERTICAL PROFILE OF POWER FREQUENCY MAGNETIC FIELD STRENGTH IN A LOCOMOTIVE CAB OPERATING ON THE 25 HZ SECTION OF THE NEC

Other measurements were made in the cab of the electric locomotive operating on the 25 Hz portion of the NEC to document the extent to which magnetic fields produced by equipment in the locomotive itself contribute to magnetic fields within the cab. Dataset NEC034 (Appendix AI) contains data from a horizontal profile of magnetic fields measured along the axis of the locomotive at a height of 1.4 m above the floor. The magnetic field strength in the low frequency band and power frequency band have been plotted as a function of distance from the bulkhead which separates the cab from the mechanical area of the locomotive in Figures 4-5 and 4-6, respectively. Figure 4-5 shows only a modest gradient in low frequency (predominantly 25 Hz) magnetic field as one moves away from the bulkhead. If the only source of 25 Hz field was current in the catenary and track, no gradient would be expected. However, since the catenary current flows to the tracks via the pantograph, transformer, and wiring in the locomotive on the opposite side of the bulkhead, that portion of the circuit also constitutes a 25 Hz magnetic field source. It is apparently the current passing through that portion of the circuit that produces the moderate gradient seen in Figure 4-5.

Power frequency magnetic fields are seen in Figure 4-6 to have a more significant attenuation with distance as one moves away from the bulkhead. That observation suggests the presence of a source of 60 Hz fields within the machinery section of the locomotive.

Measurements in the locomotives operating on the 60 Hz section of the NEC and the 60 Hz section of the NJT Long Branch Line also show evidence of multiple field sources. However, since all of the field sources have a fundamental frequency of 60 Hz, it is more difficult to sort out the extent to which one source or another contributes to the total magnetic field environment in the cab. Figure 4-7 shows the vertical profile of the power frequency magnetic field over time next to the engineer's seat (top frame) and fireman's seat (bottom frame) for a locomotive on the 60 Hz section of the Northeast Corridor. These data come from datasets NEC026 (Appendix AA) and NEC027 (Appendix AB), respectively. The profile next to the engineer's seat shows modest fields of about 15 mg near the floor and attenuating quickly with height when the locomotive is drawing little or no power from the catenary (as at timepoint zero, for example). However, at the 130-second timepoint, the locomotive is drawing significant power and the corresponding current in the catenary and tracks provides a large and relatively uniform magnetic field which completely swamps out the weaker gradient field from the source below the engineer's seat.

The 60 Hz magnetic field source beneath the fireman's seat shown in the bottom frame of Figure 4-7 is locally very strong, producing a nearly continuous 60 Hz field of approximately 60 to 80 mG at a height of 10 cm above the floor. However, the field from the localized source attenuates rapidly and is typically only 5 to 10 mG at 60 cm above the floor. When the train's traction power needs require significant current from the catenary and track circuit, there is an additional, nearly uniform 60 Hz field produced by that

25Hz - REAR BULKHEAD, ENG. COMPARTMENT

LOW FREQUENCY (5-45 Hz)

4-10

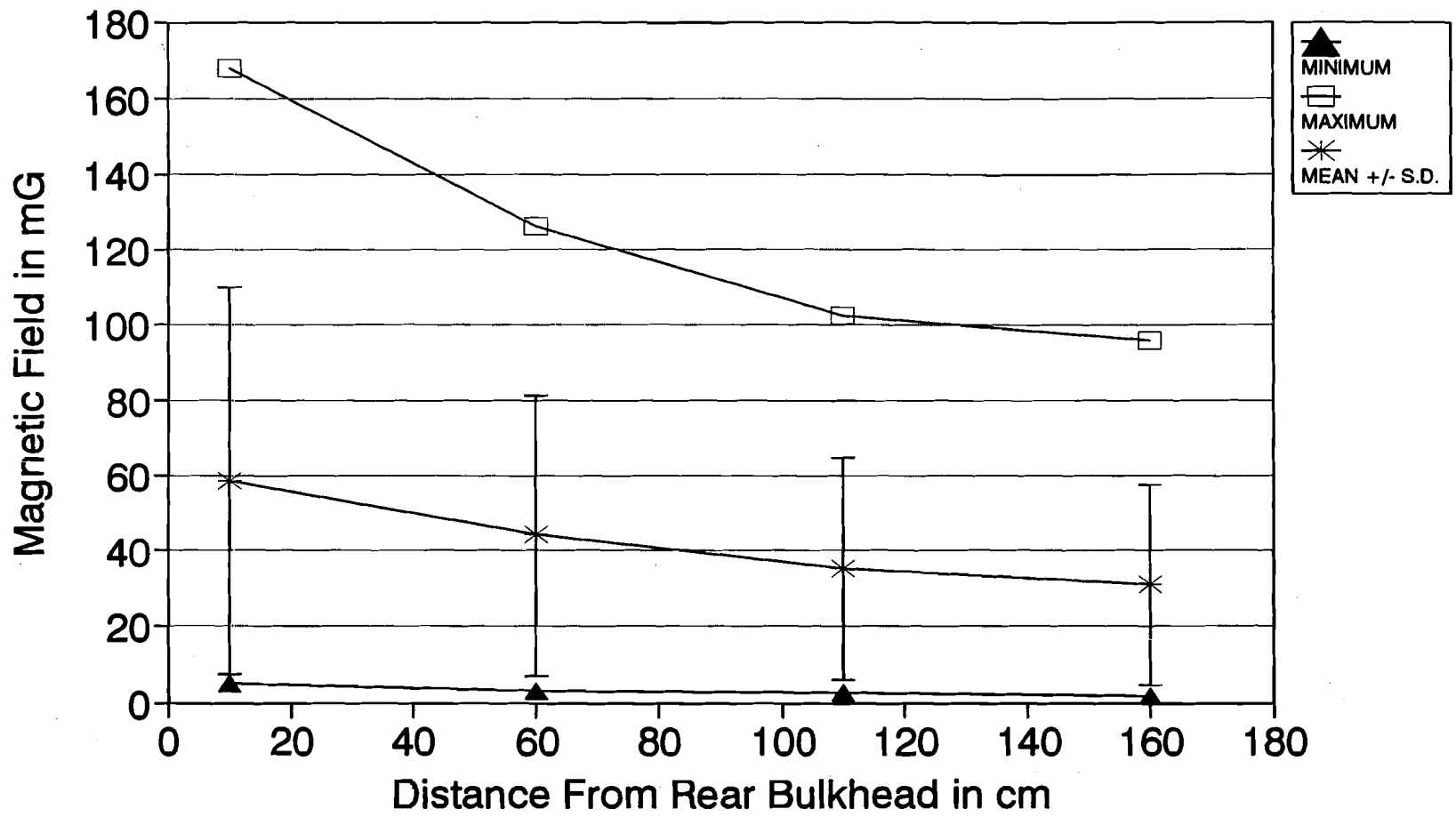
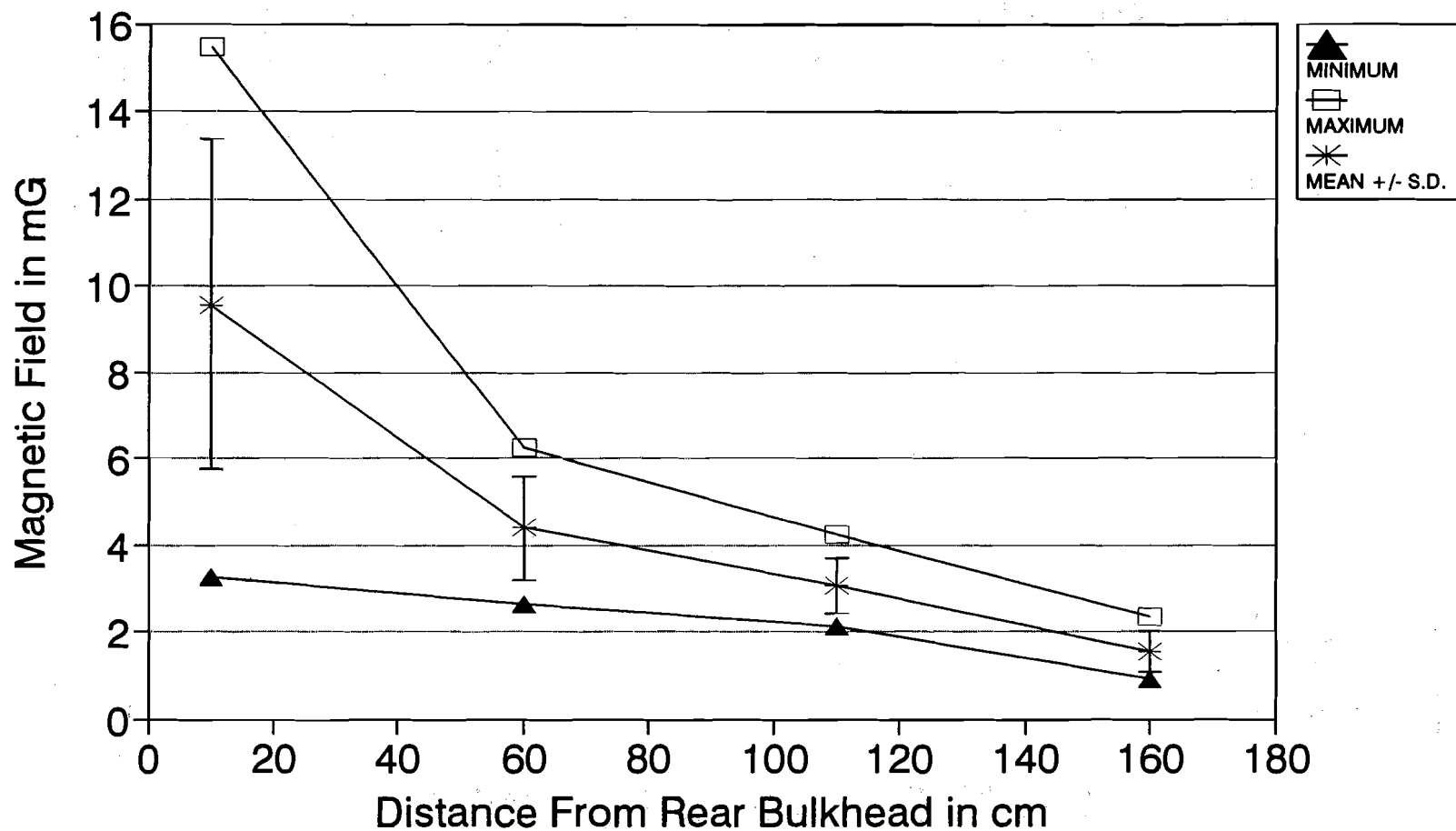

FIGURE 4-5. HORIZONTAL (AXIAL) PROFILE OF LOW FREQUENCY MAGNETIC FIELD STRENGTH 1 M (3.3 FT) ABOVE THE FLOOR OF THE CAB IN A LOCOMOTIVE OPERATING ON THE 25 HZ SECTION OF THE NEC

25Hz - REAR BULKHEAD, ENG. COMPARTMENT

POWER FREQUENCY (50-60 Hz)



4-11

FIGURE 4-6. HORIZONTAL (AXIAL) PROFILE OF POWER FREQUENCY MAGNETIC FIELD STRENGTH 1.4 M (4.6 FT) ABOVE THE FLOOR OF THE CAB IN A LOCOMOTIVE OPERATING ON THE 25 HZ SECTION OF THE NEC

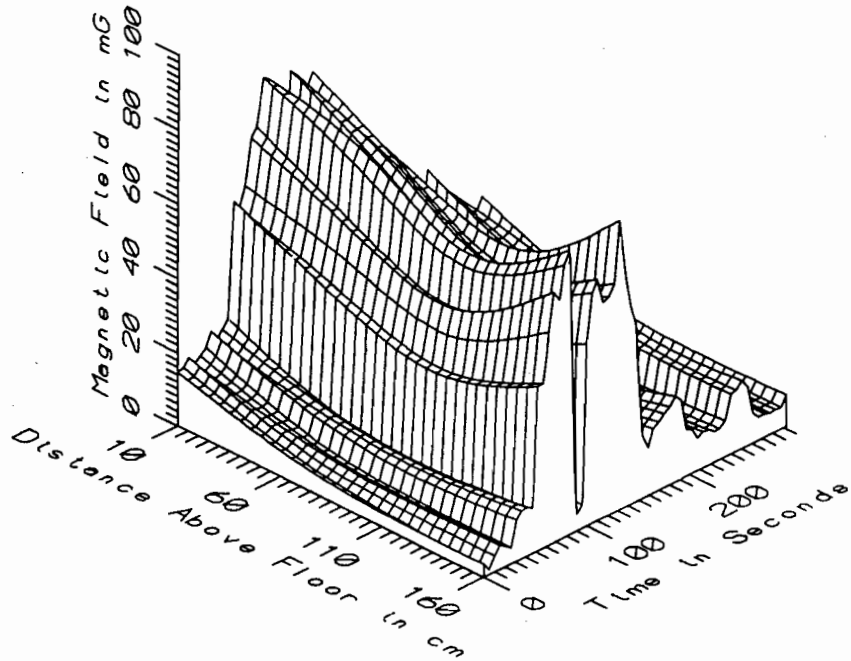

NEC026 - LEFT OF ENGINEER IN R.E.C. - POWER FREQ, 50-60Hz

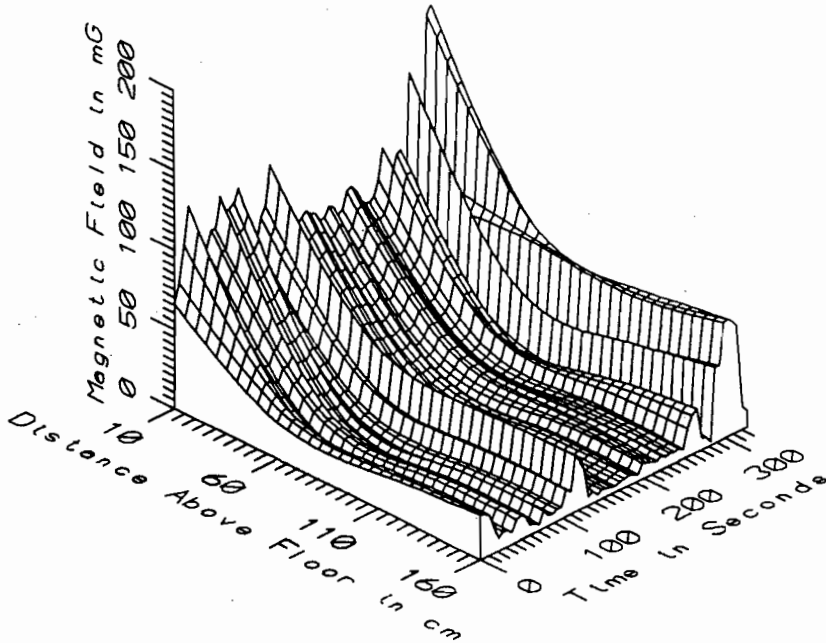

NEC027 - RIGHT OF FIREMAN IN R.E.C. - POWER FREQ, 50-60Hz

FIGURE 4-7. VERTICAL PROFILES OF POWER FREQUENCY MAGNETIC FIELD STRENGTH OVER TIME NEXT TO THE ENGINEER'S AND FIREMAN'S SEATS IN THE REAR CAB OF A LOCOMOTIVE OPERATING ON THE 60 HZ SECTION OF THE NEC

current which adds to the field from the local source beneath the fireman's seat.

Horizontal profiles of power frequency and total time-varying ELF field in the rear cab of a locomotive on the 60 Hz section of the NEC, as shown in Figure 4-8, indicate the presence of a temporally stable magnetic field source behind the bulkhead which produces a field which attenuates rapidly with distance away from the bulkhead or ATC equipment cabinet attached thereto. Superimposed on that spatially non-uniform field is a second 60 Hz field which is spatially rather uniform, but variable over time. The second field apparently arises from current in the catenary/track circuit. These data come from dataset NEC028, which is reported more completely in Appendix AC.

Dataset NEC030 records the magnetic field environment in the cab of the locomotive as the train travels from the 60 Hz section of the NEC to the 25 Hz section just north of New York City. Although all of the data are contained in Appendix AE, the field versus frequency and time plot for a measurement point 160 cm above the floor at the engineer's left shoulder is reproduced here as Figure 4-9. The top frame of the figure shows with fine detail the frequencies in the magnetic field spectrum below 100 Hz. The occurrence of a 25 Hz component in the magnetic field spectrum 280 seconds into the recording marks the crossing into the 25 Hz section of the corridor. Note that the 60 Hz component of the magnetic field does not completely disappear because other sources onboard the locomotive continue to generate some 60 Hz magnetic field. The bottom frame of Figure 4-9 has the static (zero frequency) component of the magnetic field suppressed and the time-varying fields replotted on a more sensitive scale. The low magnitude and temporal uniformity of the 60 Hz field beyond the 280-second point and the occurrence of a temporally variable 25 Hz field is more obvious. Also, notice that the transition from a significant 60 Hz field to a 25 Hz field is not abrupt. In fact, the 60 Hz field decreases markedly before the change and the 25 Hz field grows slowly over approximately 30 seconds after crossing the phase break between electrification sections. These data indicate a reduction in traction power prior to crossing the phase break as was previously observed and mentioned in the comments regarding a search for field transients (Section 3.4).

Static field measurements within the engineer's cab of the electric locomotives were carefully examined for evidence that significant static fields were produced by direct current in the traction motors, in the dynamic braking resistors, in the interconnecting circuitry, or in third rail circuits adjacent to the tracks. No such evidence was found. The static field appears to be the natural geomagnetic field but is perturbed by ferromagnetic objects within the locomotive and along the wayside.

Unfortunately, in the locomotives, data from the non-electrified portion of the Northeast Corridor does not provide a measure of "background" fields from non-traction related sources as it did in

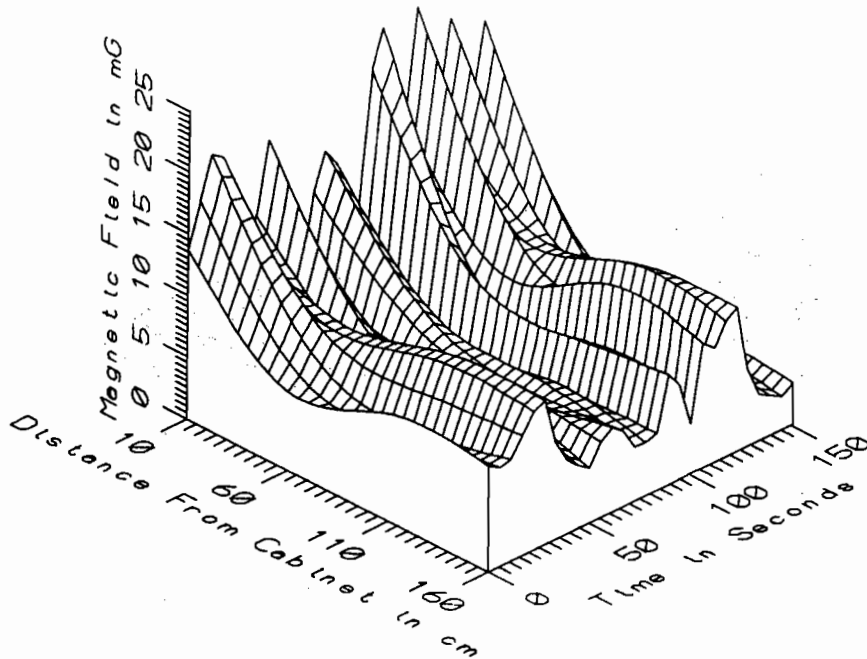

NEC028 - ATC CABINET IN R.E.C. - POWER FREQUENCY, 50-60Hz

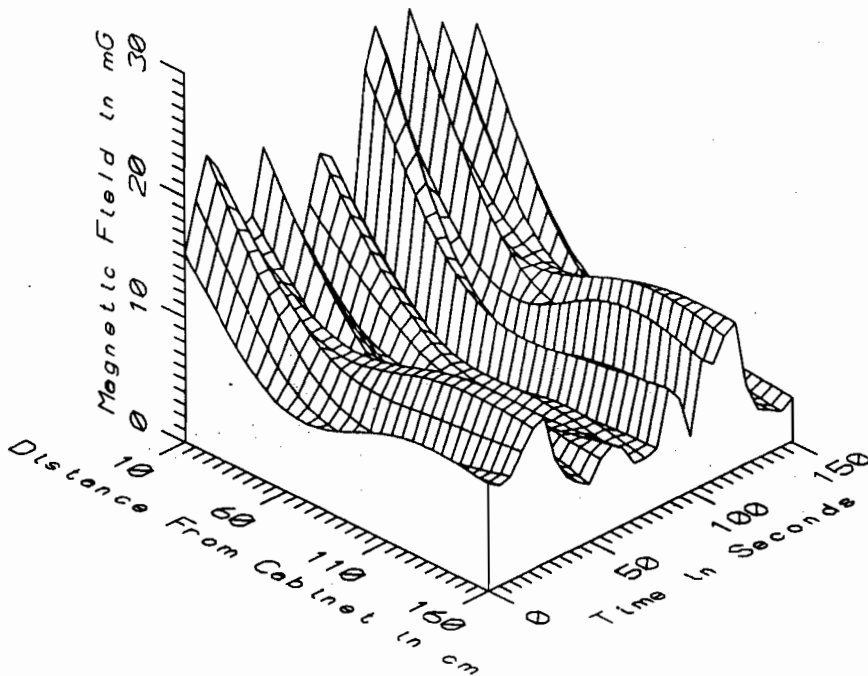

NEC028 - ATC CABINET IN R.E.C. - ALL FREQUENCIES, 5-2560Hz

FIGURE 4-8. HORIZONTAL PROFILES OF POWER FREQUENCY (TOP FRAME) AND TOTAL ELF (BOTTOM FRAME) MAGNETIC FIELDS IN THE REAR CAB OF A LOCOMOTIVE OPERATING ON A 60 HZ SECTION OF THE NEC

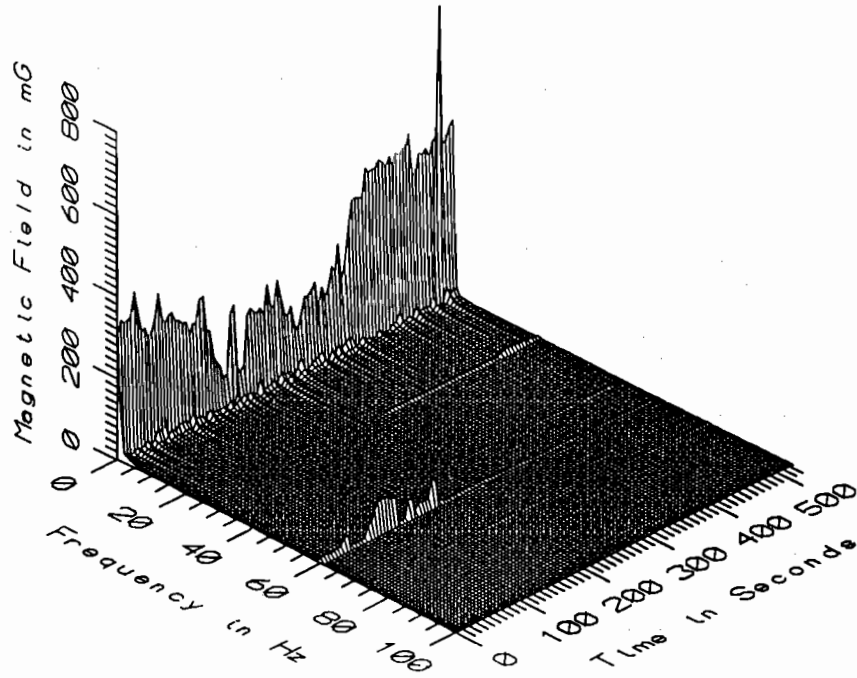

NEC030 - 160cm ABOVE FLOOR, LEFT OF ENGINEER

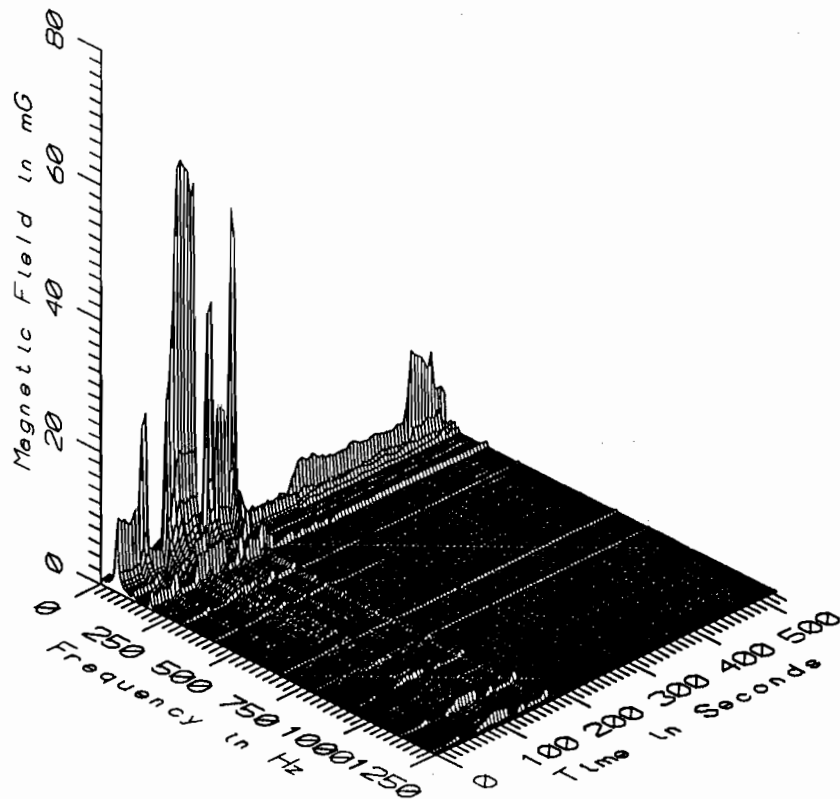

NEC030 - 160cm ABOVE FLOOR, LEFT OF ENGINEER

FIGURE 4-9. MAGNETIC FIELD FREQUENCY DISTRIBUTIONS IN THE REAR CAB OF A LOCOMOTIVE CROSSING FROM THE 60 HZ SECTION OF THE NEC ONTO THE 25 HZ SECTION

the coaches because the diesel-electric locomotive creates its own unique magnetic field environment.

Figure 4-10 shows magnetic field strength versus frequency and time at a point 60 cm above the floor at a location next to the engineer's seat in the F-40 diesel-electric locomotive. The data in this figure came from dataset NEC023 in Appendix X to the report but are typical of the magnetic field characteristics measured in the diesel-electric locomotive in other datasets as well.

One immediate observation is that the magnetic fields in the diesel-electric locomotive are generally lower than those in the electric locomotive. Secondly, these fields have a much more complex frequency spectrum than did those in the electric locomotive.

To better illustrate the frequency spectrum of these fields, the field data at the seven-minute point of Figure 4-10 (sample 8) are replotted as a two-dimensional frequency spectrum in Figure 4-11. A pattern of harmonics spaced at intervals of approximately 110 Hz is clearly evident when the train is in motion. The component at approximately 440 Hz dominates the spectrum. The main alternator on the F-40 locomotive is reportedly a six-phase, twelve-pole machine governed to operate at approximately 1050 revolutions per minute (rpm). That rotational speed would produce a fundamental frequency of 105 Hz. Hence, the main alternator, or more likely the wiring from it to the rectifier bank, appears to be the main source of ELF magnetic field in the diesel-electric locomotive. The large fourth harmonic component appears to be a rectifier ripple component.

The train stops briefly at a station between the 12-minute and 13-minute timepoints of Figure 4-10. It can be seen that most of the time-varying field disappears when the train is stopped. Figure 4-12 shows a frequency spectrum at the 12-minute point (sample 13) when the train is stopped. The remaining components are the fundamental, second, sixth, and twelfth harmonic of 60 Hz. These low fields have the frequency characteristic of fields from the normal power system (60 Hz) and of fields from a six-pole rectifier (2nd, 6th, and 12th harmonics). These fields could result from sources in the locomotive, sources in the station, or both.

The higher order frequency components which are present when the train is operating show clear attenuation patterns with increased height above the floor or increased distance from the bulkhead which separates the cab from the machinery portion of the locomotive. That suggests that they arise from multiple sources below the floor and toward the machinery section of the locomotive. However, the weaker 60 Hz and its harmonic fields which are present when the train is stopped show little variability in intensity with height above the floor, suggesting that they arise at least in part from a source in the machinery section of the locomotive.

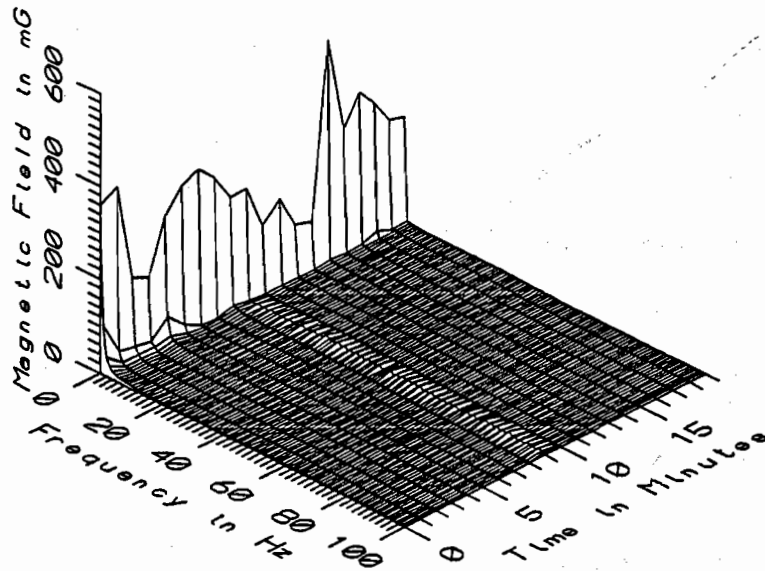

NEC023 - 60cm ABOVE FLOOR, LEFT OF ENGINEER IN D.E.C.

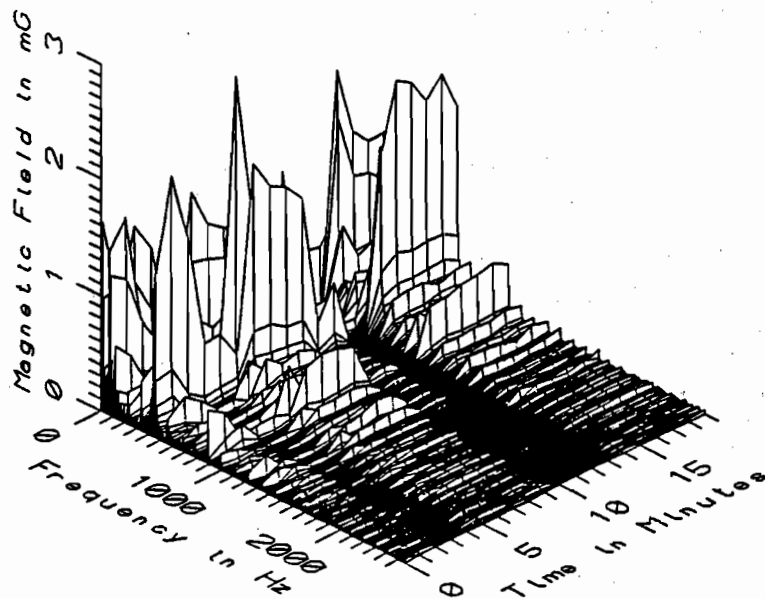

NEC023 - 60cm ABOVE FLOOR, LEFT OF ENGINEER

FIGURE 4-10. STATIC (TOP FRAME) AND TIME-VARYING (BOTTOM FRAME) MAGNETIC FIELD NEAR THE ENGINEER'S SEAT IN A DIESEL-ELECTRIC LOCOMOTIVE OPERATING ON THE NON-ELECTRIFIED PORTION OF THE NORTHEAST CORRIDOR (TRAIN STOPPED AT 12-13 MINUTES)

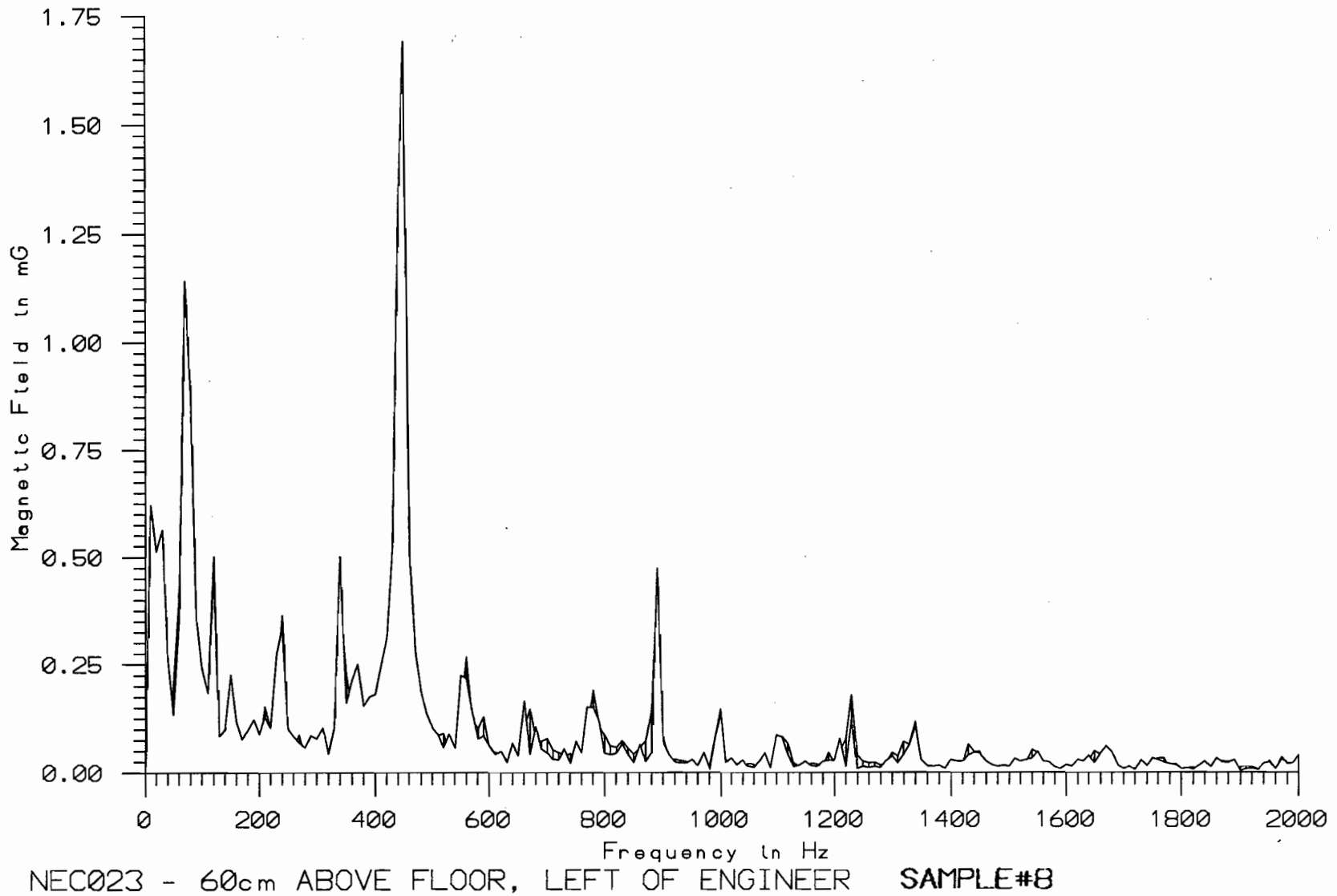

FIGURE 4-11. MAGNETIC FIELD FREQUENCY SPECTRUM NEAR THE ENGINEER'S SEAT IN A DIESEL-ELECTRIC LOCOMOTIVE OPERATING ON THE NON-ELECTRIFIED PORTION OF THE NORTHEAST CORRIDOR

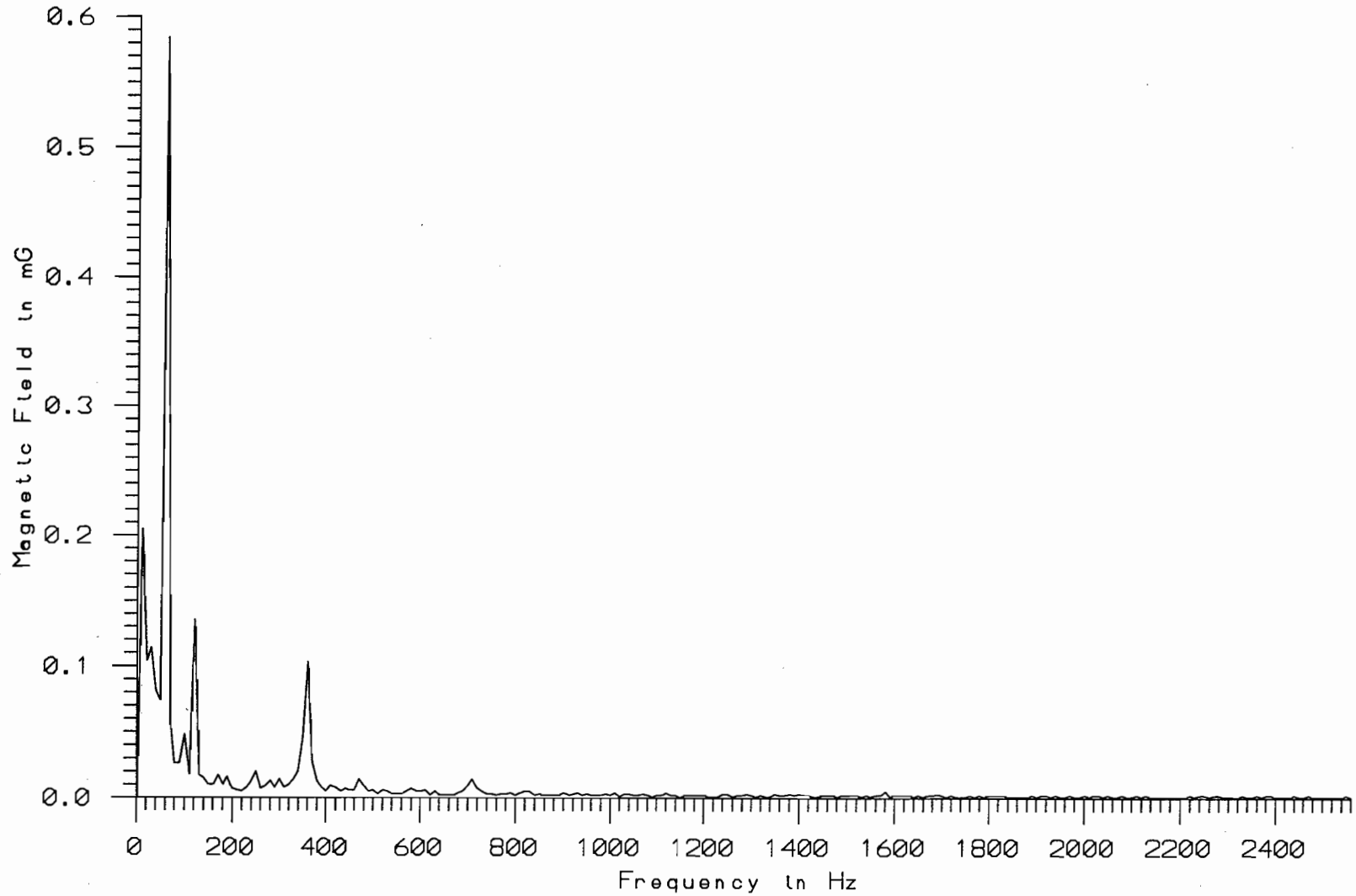

FIGURE 4-12. MAGNETIC FIELD FREQUENCY SPECTRUM NEAR THE ENGINEER'S SEAT IN A DIESEL-ELECTRIC LOCOMOTIVE STOPPED AT A STATION

The static magnetic field in the cab of the diesel locomotive is also shown in the top frame of Figure 4-10. Although the static field levels stay within the range of perturbed geomagnetic field levels which one might encounter in or near large ferromagnetic structures like a steel locomotive, there is some suggestion in Figure 4-10 that the static field intensity correlates with the time-varying field intensity. Similar correlations are seen in the data for many of the measurement points within the diesel-electric locomotive. The suggestion from these data is that the diesel-electric locomotive produces some static fields within the cab, but the magnitude of this field is lower than the natural geomagnetic field. The total static magnetic field can be either larger or smaller than the component from the geomagnetic field alone, depending on the direction of the field vectors of the components. In some locations or at some times, the field components will add, while at other times or locations, one field may partially cancel the other. The data in set NEC022 (Appendix W) illustrate this point well because the train is stopped for several samples (180 to 270 seconds), thereby providing an excellent "baseline" indication of the geomagnetic field strength within the cab.

4.4 DAT WAVEFORM DATA

Continuous recordings of the magnetic field waveforms at a sensor sitting on the fireman's seat were obtained with the digital audio tape recorder (DAT) in the rear cabs of the electric locomotives. The time and length of those recordings are provided in Table 2-2. No DAT recordings were made in the diesel. These tapes were scanned for transient fields which might result from pantograph bounce on the catenary or the crossing of phase breaks as was done for the recordings in the coaches described in Section 3.4. No significant transients were found.

The correlation between DAT recordings and waveform capture system recordings was demonstrated in Section 3.4 and is not repeated here. However, the mean, maximum, and minimum rms values of the field recorded by the DAT were determined and are presented in Table 4-2.

4.5 RMS RECORDER DATA

RMS recorders were worn by two members of the test team during trips in locomotive cabs from New Haven to New York on the 60 Hz portion of the NEC and from Long Branch to Matawan on the 60 Hz section of New Jersey Transit's North Jersey Coast Line. Only one rms recorder was worn in the cab on the non-electrified portion of the corridor from Boston to New Haven and the 25 Hz portion from New York to Philadelphia.

The frequency limitations of the rms recorder and its resulting inability to accurately measure the predominantly 25 Hz magnetic fields on the section of the corridor from New York to Philadelphia have already been discussed. The frequency spectrum of the magnetic fields in the diesel electric locomotive as shown in Figure 4-11 extends beyond the upper frequency limit of the rms

TABLE 4-2

SUMMARY OF MAGNETIC FIELD LEVELS RECORDED
 IN THE FIREMAN'S SEAT IN THE REAR CAB OF THE
 LOCOMOTIVE WITH THE DIGITAL AUDIO TAPE RECORDER (DAT)

RAILROAD SECTION (DATASETS)	MEASUREMENT LOCATION		MAGNETIC FIELD MILLIGAUSS, RMS		
	FIGURE #	LOCATION	MINIMUM	AVERAGE	MAXIMUM
25 HZ NEC (4-1)	4-1	25	4.7	31.7	160.8
60 HZ NEC (3-1 & PART OF 3-2)	4-1	25	0.4	14.9	77.9
60 HZ NJT LONG BRANCH (6-7)	4-1	25	0.3	9.9	48.6

recorder, but only a small amount of energy is in those upper harmonics. Therefore, even though the frequencies of the fields in the cab of that locomotive technically exceed the capabilities of the instrument, its readings are still useful because only a small portion of the field energy is lost.

The time course records of magnetic field measured with the rms recording units generally follow those measured with the waveform capture system and DAT and are similar in character to those previously shown in Figures 3-19 and 3-20 for measurements in the coaches. However, the correlation between the rms units or either of the rms recorders and the waveform capture system or DAT recording is not as strong in the locomotive cab as it was in the coaches. This is apparently due to field contributions from the localized sources beneath the floor or behind the bulkhead of the cab described in Section 4.3 above.

Figure 4-13 shows one of the extreme examples of variability between rms records. These data were recorded by two people in the rear cab of the locomotive during the trip from New Haven to New York. RMS recorder 2 was worn by a person seated in the engineer's seat while rms recorder 1 was worn by a person who spent the last part of the trip leaning against the bulkhead which separated the cab from the remainder of the locomotive where magnetic fields from sources within the locomotive contributed to the overall field environment.

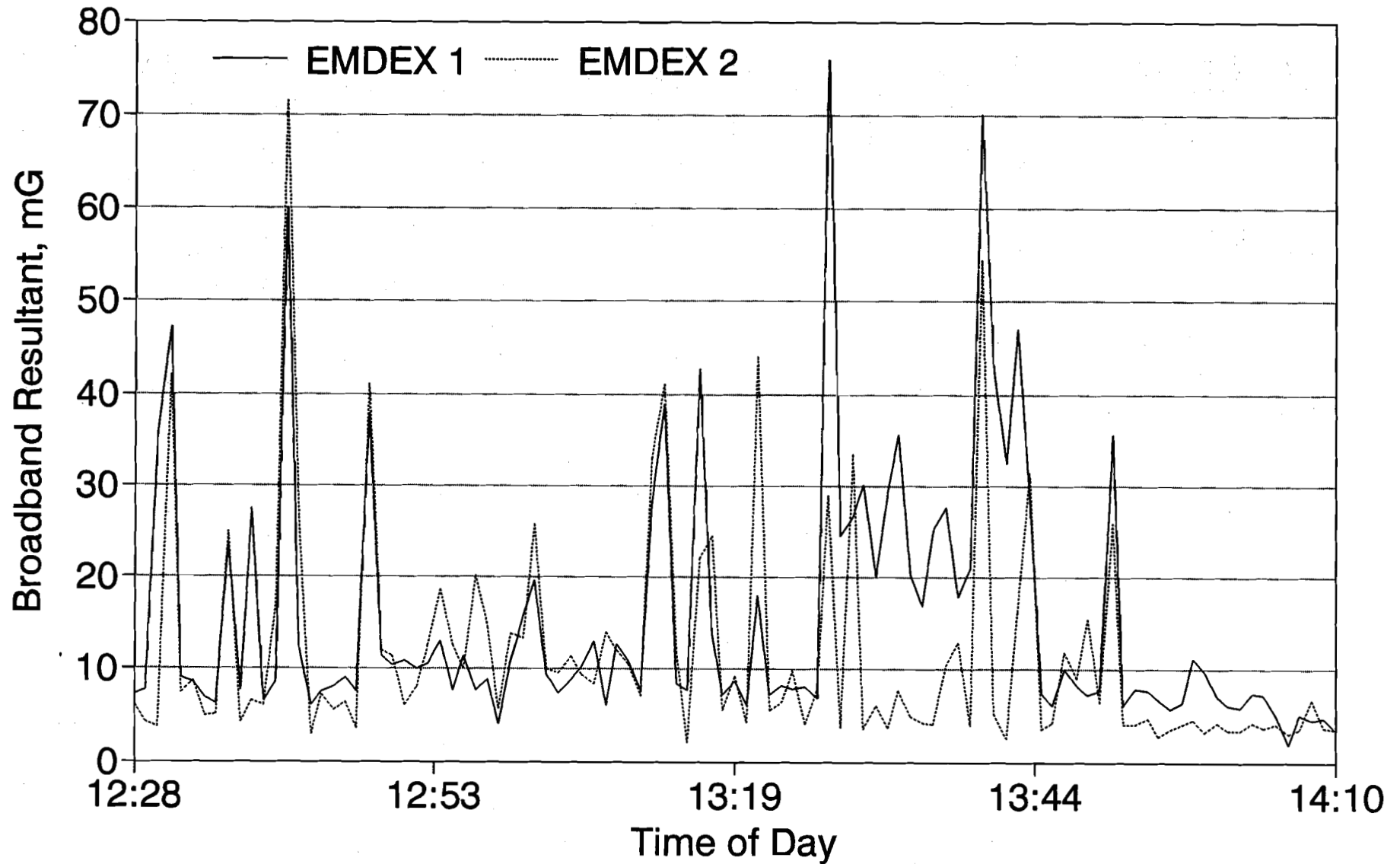

FIGURE 4-13. RMS RECORDINGS OF MAGNETIC FIELD LEVELS ENCOUNTERED BY A PERSON STANDING (RMS RECORDER 1) OR SEATED IN THE ENGINEER'S SEAT (RMS RECORDER 2) OF THE REAR CAB OF A LOCOMOTIVE ON THE 60 HZ SECTION OF THE NEC

The average, maximum, and minimum values of the magnetic fields recorded with the rms meters are reported in Table 4-3. Data are not tabulated for the 25 Hz portion of the Northeast Corridor because of errors introduced by the frequency limitations of the instrument. Small errors due to frequency limitations are also present in the data for the non-electrified portion of the corridor, but they are not significant. The difference in average field level depending on where the rms recorder wearer stood or sat is also evident in this table.

4.6 SUMMARY OF MAGNETIC FIELD LEVELS

Within the electric locomotive cabs, intermittent magnetic fields are produced by current in the catenary and track circuit. These fields tend to be large relative to fields from other sources and spatially uniform. Their frequency spectrum consists of a large fundamental component at the frequency of the catenary current and smaller harmonic components at the odd harmonics; most noticeably the third, fifth and seventh harmonics. A second harmonic component is sometimes present.

There are other sources of magnetic field in the locomotive, most noticeably beneath the floor of the cab and in the machinery section of the locomotive, which produce magnetic fields which tend to be lower in maximum amplitude than those produced by current in the catenary and track circuit. The fields produced by the locomotive are primarily 60 Hz with some harmonics of 60 Hz and tend to be relatively uniform over time but spatially non-uniform. These fields are strongest near the floor of the cab or the bulkhead which separates the cab from the machinery section of the locomotive, and become weaker at points more distant from those source locations.

Operation of the electric locomotives does not appear to produce static magnetic fields of a magnitude which can be detected above the variation of the geomagnetic field caused by the field perturbing effects of the iron and steel locomotive. Temporal variations in the static magnetic field occurs in the moving locomotive cab because of the changing orientation of the geomagnetic field relative to the locomotive and the resulting variation in perturbation. The presence of ferromagnetic structures along the route, especially large iron and steel objects like bridge members, tunnel supports or liners, and stations, also cause detectable changes in the static field within the locomotive cabs.

Magnetic field levels in the cab of the diesel locomotive are lower than those in the electric locomotive but have a much more complicated frequency spectrum. The major components are harmonics of about 110 Hz, especially the fourth harmonic at 440 Hz. There are also weaker fields at 60 Hz and some harmonics thereof within the cab of the diesel-electric locomotive. Static fields are also apparently produced by the diesel-electric locomotive but the magnitude of these fields in the cab are less than the geomagnetic field.

TABLE 4-3

STATISTICAL SUMMARY OF MAGNETIC FIELDS MEASURED
IN LOCOMOTIVE CABS USING RMS RECORDERS*

SYSTEM	MINIMUM	AVERAGE	MAXIMUM
NEC 60 Hz			
RMS RECORDER 1	4.1 mG	17.34 mG	76.1 mG
RMS RECORDER 2	2.0 mG	13.18 mG	75.5 mG
COMBINED	2.0 mG	15.26 mG	76.1 mG
NEC NON-ELECTRIFIED			
RMS RECORDER 1	0.4 mG	2.83 mG	18.9 mG
NJT LONG BRANCH 60 Hz			
RMS RECORDER 1	3.8 mG	14.85 mG	54.7 mG
RMS RECORDER 2	2.7 mG	12.29 mG	61.1 mG
COMBINED	2.7 mG	13.57 mG	61.1 mG

* RMS recorder measurements in locomotive cabs on the 25 Hz section of the NEC are not valid because the principal time varying field component (25 Hz) is at a frequency outside the instrument's response band.

Repetitive waveform data collected in the cabs of locomotives on the 60 Hz, 25 Hz, and non-electrified sections of the Northeast Corridor, as well as data for the 60 Hz section of the New Jersey Transit North Jersey Coast Line, are summarized statistically by frequency bands in the following subsections. In all cases, vertical profiles of magnetic field intensity were measured next to the engineer as indicated in Figure 4-1 as locations 20 or 24. Similar measurements were made next to the fireman's seat (locations 23 or 26 of Figure 4-1) in all cabs except on the Long Branch Line where time was limited due to the short length of the 60 Hz section of line. Statistical data for each location and pooled data for both locations (except for the Long Branch Line) are presented. Statistical data for the horizontal profiles are not included in the following discussion because measurement points include locations such as above the console where people are not normally present. Statistical summaries of those horizontal profile data can be found in Appendices Y, AC, AI, and AZ for the non-electrified, 60 Hz and 25 Hz sections of the NEC and the 60 Hz section of the Long Branch Line, respectively.

4.6.1 Magnetic Fields on the 25 Hz Section

Magnetic field levels at various heights above the floor at locations next to the engineer's and fireman's seats in the rear cab of a locomotive on the 25 Hz section of the NEC are summarized in Tables 4-4 and 4-5, respectively. Data from the last half of dataset NEC030 was not included in the summary because they are atypical, representing low speed travel into New York City. Because of the similarities in frequency distribution, spatial distribution and field intensities, the data from measurements near both seats were pooled to produce summary field values representative of the cab itself. The pooled data are found in Table 4-6. The major frequency components of the magnetic field in the cab are 25 and 60 Hz which fall within the "low frequency" and "power frequency" bands of Table 4-6. The data from those frequency bands on Table 4-6 have already been shown graphically in Figures 4-3 and 4-4.

The average and maximum magnetic field levels measured with the DAT from the reference probe in the fireman's seat (reported in Table 4-2) are ten to twelve percent less than those reported in Table 4-6 for a similar (60 cm) height above the floor. That difference is representative of the differences seen in Appendices AG through AJ for simultaneous measurements with the waveform capture system from the reference probe in the fireman's seat and measurements 60 cm above the floor at locations near the engineer's and fireman's seats. Consequently, the difference appears attributable to differences in measurement location, not differences in measurement approach.

4.6.2 Magnetic Fields on the 60 Hz Section

Tables 4-7 and 4-8 show the statistical summaries of magnetic field levels next to the engineer's seat and the fireman's seat, respectively, in the rear cab of the locomotive on the 60 Hz section

TABLE 4-4

SUMMARY STATISTICS FOR DATASETS NEC032 AND NEC035
 MEASURED AT THE LEFT OF THE ENGINEER'S SEAT IN THE
 REAR CAB OF A LOCOMOTIVE ON THE 25 HZ SECTION OF THE NEC

25Hz - LEFT OF ENGINEER		TOTAL OF 109 SAMPLES				
FREQUENCY BAND	HEIGHT ABOVE FLOOR (cm)	MINIMUM MAGNETIC FIELD (mG)	MAXIMUM MAGNETIC FIELD (mG)	AVERAGE MAGNETIC FIELD (mG)	STANDARD DEVIATION (mG)	COEFFICIENT OF VARIATION (%)
STATIC	10	416.45	1389.24	705.04	101.81	14.44
	60	552.09	1554.55	936.18	107.03	11.43
	110	416.45	1162.59	693.16	70.53	10.18
	160	610.95	1148.39	752.20	74.32	9.88
5-45Hz LOW FREQ	10	6.91	247.42	57.33	55.61	97.00
	60	2.73	180.29	41.22	40.42	98.06
	110	2.74	179.64	42.99	41.91	97.48
	160	3.23	242.33	56.65	58.13	102.60
50-60Hz PWR FREQ	10	21.52	42.99	30.35	4.23	13.95
	60	2.72	8.75	4.44	0.81	18.30
	110	1.12	6.84	3.80	1.47	38.75
	160	1.04	8.10	4.21	1.81	42.91
65-300Hz PWR HARM	10	4.15	24.93	8.80	3.55	40.40
	60	0.91	18.30	4.26	2.82	66.11
	110	0.68	18.62	4.48	2.93	65.48
	160	0.82	26.72	5.67	3.91	68.85
305-2560Hz HIGH FREQ	10	1.33	5.91	2.62	0.90	34.24
	60	0.25	3.40	0.92	0.71	77.20
	110	0.14	3.39	0.90	0.75	82.66
	160	0.13	4.42	1.11	1.00	89.42
5-2560Hz ALL FREQ	10	23.34	250.89	69.21	51.20	73.98
	60	3.97	180.88	41.94	40.26	95.99
	110	3.10	180.69	43.57	41.87	96.09
	160	3.56	242.85	57.31	58.09	101.37

TABLE 4-5

**SUMMARY STATISTICS FOR DATASET NEC033 MEASURED
AT THE RIGHT OF THE FIREMAN'S SEAT IN THE REAR CAB
OF A LOCOMOTIVE ON THE 25 HZ SECTION OF THE NEC**

25Hz - RIGHT OF FIREMAN		TOTAL OF 38 SAMPLES				
FREQUENCY BAND	HEIGHT ABOVE FLOOR (cm)	MINIMUM MAGNETIC FIELD (mG)	MAXIMUM MAGNETIC FIELD (mG)	AVERAGE MAGNETIC FIELD (mG)	STANDARD DEVIATION (mG)	COEFFICIENT OF VARIATION (%)
STATIC	10	325.84	538.27	442.35	68.53	15.49
	60	348.60	533.39	435.47	41.32	9.49
	110	325.84	555.29	424.27	46.15	10.88
	160	336.72	596.21	435.17	68.53	15.75
5-45Hz LOW FREQ	10	9.17	89.64	24.93	20.16	80.86
	60	3.62	58.08	14.81	14.60	98.54
	110	2.82	58.05	13.89	14.63	105.28
	160	2.55	81.08	17.06	19.95	116.96
50-60Hz PWR FREQ	10	35.77	52.83	39.57	5.28	13.33
	60	10.44	15.43	11.57	1.59	13.76
	110	3.34	5.61	4.13	0.68	16.48
	160	1.89	5.46	2.99	0.83	27.86
65-300Hz PWR HARM	10	6.92	17.90	10.10	2.67	26.47
	60	2.20	7.96	3.69	1.41	38.04
	110	1.11	7.83	2.45	1.67	68.31
	160	0.94	10.80	2.52	2.38	94.57
305-2560Hz HIGH FREQ	10	1.70	4.82	3.04	0.90	29.66
	60	0.53	1.70	0.98	0.30	30.80
	110	0.25	1.35	0.49	0.24	48.98
	160	0.20	1.64	0.46	0.33	71.71
5-2560Hz ALL FREQ	10	39.03	98.78	50.12	14.93	29.79
	60	11.56	59.66	20.57	12.69	61.66
	110	4.72	58.73	15.17	14.26	94.02
	160	3.94	81.88	17.77	19.87	111.86

TABLE 4-6

SUMMARY STATISTICS FOR DATASETS NEC032, NEC033 AND
NEC034 MEASURED IN THE REAR CAB OF A LOCOMOTIVE
ON THE 25 HZ SECTION OF THE NEC

25Hz - ENGINEER'S AND FIREMAN'S SEATS		TOTAL OF 147 SAMPLES				
FREQUENCY BAND	HEIGHT ABOVE FLOOR (cm)	MINIMUM MAGNETIC FIELD (mG)	MAXIMUM MAGNETIC FIELD (mG)	AVERAGE MAGNETIC FIELD (mG)	STANDARD DEVIATION (mG)	COEFFICIENT OF VARIATION (%)
STATIC	10	325.84	1389.24	637.13	146.29	22.96
	60	348.60	1554.55	806.74	239.36	29.67
	110	325.84	1162.59	623.65	134.81	21.62
	160	336.72	1148.39	670.25	157.08	23.44
5-45Hz LOW FREQ	10	6.91	247.42	48.96	50.92	104.02
	60	2.73	180.29	34.39	37.38	108.67
	110	2.74	179.64	35.47	38.95	109.80
	160	2.55	242.33	46.42	53.88	116.07
50-60Hz PWR FREQ	10	21.52	52.83	32.74	6.06	18.51
	60	2.72	15.43	6.29	3.31	52.60
	110	1.12	6.84	3.89	1.32	33.97
	160	1.04	8.10	3.90	1.70	43.57
65-300Hz PWR HARM	10	4.15	24.93	9.14	3.39	37.10
	60	0.91	18.30	4.12	2.54	61.65
	110	0.68	18.62	3.95	2.81	70.94
	160	0.82	26.72	4.86	3.83	78.78
305-2560Hz HIGH FREQ	10	1.33	5.91	2.73	0.91	33.49
	60	0.25	3.40	0.94	0.63	67.35
	110	0.14	3.39	0.80	0.68	85.03
	160	0.13	4.42	0.94	0.92	97.29
5-2560Hz ALL FREQ	10	23.34	250.89	64.28	45.46	70.72
	60	3.97	180.88	36.42	36.44	100.06
	110	3.10	180.69	36.23	38.78	107.05
	160	3.56	242.85	47.08	53.83	114.33

TABLE 4-7

SUMMARY STATISTICS FOR DATASETS NEC026, NEC029 AND PART OF NEC030 MEASURED AT THE LEFT OF THE ENGINEER'S SEAT IN THE REAR CAB OF A LOCOMOTIVE ON THE 60 HZ SECTION OF THE NEC

60Hz - LEFT OF ENGINEER		TOTAL OF 140 SAMPLES				
FREQUENCY BAND	HEIGHT ABOVE FLOOR (cm)	MINIMUM MAGNETIC FIELD (mG)	MAXIMUM MAGNETIC FIELD (mG)	AVERAGE MAGNETIC FIELD (mG)	STANDARD DEVIATION (mG)	COEFFICIENT OF VARIATION (%)
STATIC	10	215.38	512.32	367.26	59.70	16.26
	60	346.09	730.21	486.24	79.68	16.39
	110	215.38	699.82	412.06	121.71	29.54
	160	71.93	455.77	264.73	73.74	27.85
5-45Hz LOW FREQ	10	0.37	12.79	3.05	2.91	95.65
	60	0.21	10.75	1.93	2.18	112.85
	110	0.13	12.83	1.83	2.48	135.79
	160	0.20	18.95	2.22	3.60	162.00
50-60Hz PWR FREQ	10	1.18	83.02	31.94	17.50	54.79
	60	1.36	74.63	21.06	17.07	81.02
	110	1.36	61.97	18.21	16.27	89.38
	160	1.27	78.20	22.83	22.14	97.00
65-300Hz PWR HARM	10	0.46	14.03	4.76	2.80	58.82
	60	0.38	10.95	3.70	2.60	70.26
	110	0.42	13.12	3.59	2.95	82.26
	160	0.33	19.47	4.03	4.01	99.52
305-2560Hz HIGH FREQ	10	0.17	5.12	1.50	0.92	61.38
	60	0.15	3.80	1.15	0.73	62.88
	110	0.18	4.54	1.11	0.84	76.09
	160	0.14	7.12	1.19	1.24	104.14
5-2560Hz ALL FREQ	10	1.69	83.36	32.69	17.58	53.78
	60	1.64	75.12	21.66	17.22	79.51
	110	1.82	62.45	18.83	16.57	88.02
	160	1.62	81.19	23.51	22.62	96.20

TABLE 4-8

SUMMARY STATISTICS FOR DATASET NEC027 MEASURED
AT THE RIGHT OF THE FIREMAN'S SEAT IN THE REAR
CAB OF A LOCOMOTIVE ON THE 60 HZ SECTION OF THE NEC

60Hz - RIGHT OF FIREMAN		TOTAL OF 60 SAMPLES				
FREQUENCY BAND	HEIGHT ABOVE FLOOR (cm)	MINIMUM MAGNETIC FIELD (mG)	MAXIMUM MAGNETIC FIELD (mG)	AVERAGE MAGNETIC FIELD (mG)	STANDARD DEVIATION (mG)	COEFFICIENT OF VARIATION (%)
STATIC	10	449.24	688.91	556.52	61.49	11.05
	60	633.17	991.78	795.00	73.14	9.20
	110	279.01	572.58	409.95	59.92	14.62
	160	342.20	650.43	463.27	61.49	13.27
5-45Hz LOW FREQ	10	0.71	9.30	2.07	1.84	88.67
	60	0.57	11.25	1.82	2.17	119.71
	110	0.48	12.32	1.71	2.32	135.39
	160	0.36	15.44	1.64	2.70	164.58
50-60Hz PWR FREQ	10	56.02	174.27	89.61	22.94	25.60
	60	6.20	72.30	18.37	15.36	83.60
	110	2.41	61.37	13.55	14.66	108.20
	160	2.06	73.73	16.04	17.91	111.67
65-300Hz PWR HARM	10	2.63	13.42	4.89	2.56	52.27
	60	1.07	11.31	3.27	2.48	75.88
	110	0.91	9.74	2.98	2.14	71.86
	160	0.85	7.92	2.75	1.74	63.16
305-2560Hz HIGH FREQ	10	1.51	3.69	2.01	0.49	24.32
	60	0.56	2.75	0.98	0.48	49.25
	110	0.49	2.33	0.85	0.42	49.76
	160	0.48	1.91	0.78	0.37	47.54
5-2560Hz ALL FREQ	10	57.09	174.73	89.85	22.91	25.50
	60	6.66	73.20	18.99	15.45	81.34
	110	2.85	62.18	14.31	14.70	102.67
	160	2.45	74.20	16.71	17.90	107.13

of the Northeast Corridor. The pooled data from the two measurement locations are provided in Table 4-9. The 60 Hz component accounts for nearly all of the time-varying magnetic field. The variation of the 60 Hz field with height above the floor of the cab is shown in Figure 4-14. As previously discussed, the field is generally uniform through the region of the cab except near the floor and back bulkhead.

Comparison of average and maximum magnetic field levels measured using the various instruments in the rear cab of the locomotive on the 60 Hz section of the corridor yields some interesting observations. First of all, the maximum magnetic field recorded by the DAT (Table 4-2), the rms recorder (Table 4-3), and the waveform capture system at 60 cm above the floor (Table 4-9) all agree within 4%; an occurrence which is unexpected considering the differences in measurement location. Perhaps this outcome is a result of the observation reported in Section 4.3 that the largest fields within the cab appear to arise from current in the catenary and track circuit and the field component from that source tends to be relatively uniform throughout the cab.

The average magnetic field measured with both the waveform capture system and the DAT at the fireman's seat location (Table 4-2) is similar to that measured by rms recorder 2 which was worn by a test team member seated in the engineer's seat (Table 4-3). However, those average values are approximately 30% less than the average value measured 60 cm above the floor next to the seats (Table 4-9). These data suggest some reduction of field levels in the seat due to shielding by the steel frame of the seat similar to that seen in Amfleet coaches.

The other rms recorder (recorder 1) was worn at the waist of one member of the test team who stood during the measurements. The average field value recorded by that instrument (Table 4-3) is nearly identical to the average value measured by the waveform capture system at a height of 1.1 m above the floor (Table 4-9).

4.6.3 Magnetic Fields on the Non-Electrified Section

Statistical summaries of magnetic fields near the engineer's and fireman's seats in the cab of the diesel-electric locomotive on the non-electrified section of the Northeast Corridor are given in Tables 4-10 and 4-11. Data from both locations are pooled and presented in Table 4-12. In the diesel-electric locomotive, the magnetic field components are well distributed over the frequency bands examined.

The average total magnetic field in the cab of the diesel-electric locomotive found by averaging the repetitive waveform field readings at the four measurement heights indicated in Table 4-12 is 1.93 mG, which is somewhat less than the 2.83 mG reported on Table 4-3 from the rms recorder readings. This difference is not surprising because the measurement team member wearing the rms recorder stood behind the engineer and training engineer riding in the fireman's seat. The magnetic field toward the rear of the cab

TABLE 4-9

SUMMARY STATISTICS FOR DATASETS NEC026, NEC027, NEC029
AND PART OF NEC030 MEASURED IN THE REAR CAB OF A
LOCOMOTIVE ON THE 60 HZ SECTION OF THE NEC

60Hz - ENGINEER'S AND FIREMAN'S SEAT		TOTAL OF 200 SAMPLES				
FREQUENCY BAND	HEIGHT ABOVE FLOOR (cm)	MINIMUM MAGNETIC FIELD (mG)	MAXIMUM MAGNETIC FIELD (mG)	AVERAGE MAGNETIC FIELD (mG)	STANDARD DEVIATION (mG)	COEFFICIENT OF VARIATION (%)
STATIC	10	215.38	688.91	424.04	103.68	24.45
	60	346.09	991.78	578.87	161.68	27.93
	110	215.38	699.82	411.43	106.82	25.96
	160	71.93	650.43	324.29	115.06	35.48
5-45Hz LOW FREQ	10	0.37	12.79	2.76	2.67	96.95
	60	0.21	11.25	1.90	2.17	114.57
	110	0.13	12.83	1.79	2.43	135.45
	160	0.20	18.95	2.05	3.36	164.07
50-60Hz PWR FREQ	10	1.18	174.27	49.24	32.74	66.48
	60	1.36	74.63	20.26	16.58	81.85
	110	1.36	61.97	16.81	15.91	94.68
	160	1.27	78.20	20.79	21.15	101.72
65-300Hz PWR HARM	10	0.46	14.03	4.80	2.72	56.75
	60	0.38	11.31	3.57	2.57	71.86
	110	0.42	13.12	3.41	2.74	80.53
	160	0.33	19.47	3.65	3.53	96.83
305-2560Hz HIGH FREQ	10	0.17	5.12	1.66	0.85	51.25
	60	0.15	3.80	1.10	0.67	60.42
	110	0.18	4.54	1.03	0.75	72.80
	160	0.14	7.12	1.07	1.07	100.54
5-2560Hz ALL FREQ	10	1.69	174.73	49.84	32.58	65.36
	60	1.64	75.12	20.86	16.72	80.14
	110	1.82	62.45	17.48	16.13	92.31
	160	1.62	81.19	21.47	21.50	100.12

MAG. FIELD IN LOCOMOTIVE CAB - 60Hz NEC

POWER FREQUENCY (50-60 Hz)

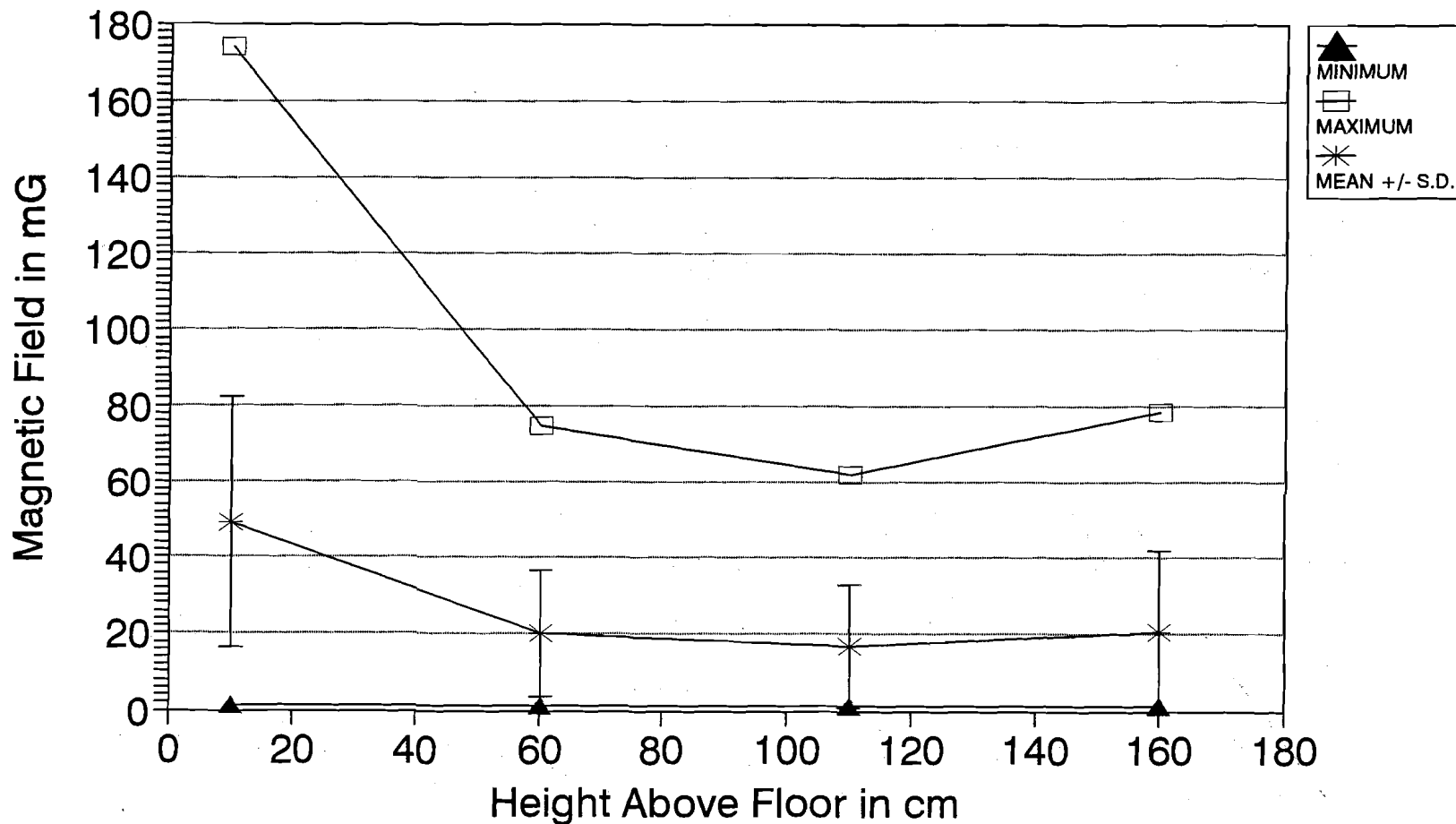

FIGURE 4-14. VERTICAL PROFILE OF POWER FREQUENCY MAGNETIC FIELD STRENGTH IN THE LOCOMOTIVE CAB OPERATING ON THE 60 HZ SECTION OF THE NEC

TABLE 4-10

SUMMARY STATISTICS FOR DATASETS NEC022 AND NEC023 MEASURED
 AT THE LEFT OF THE ENGINEER'S SEAT IN THE CAB OF A
 DIESEL-ELECTRIC LOCOMOTIVE ON THE NON-ELECTRIFIED
 SECTION OF THE NEC

DIESEL ENGINE - LEFT OF ENGINEER		TOTAL OF 69 SAMPLES				
FREQUENCY BAND	HEIGHT ABOVE FLOOR (cm)	MINIMUM MAGNETIC FIELD (mG)	MAXIMUM MAGNETIC FIELD (mG)	AVERAGE MAGNETIC FIELD (mG)	STANDARD DEVIATION (mG)	COEFFICIENT OF VARIATION (%)
STATIC	10	83.72	563.52	263.37	105.56	40.08
	60	102.61	482.63	268.24	79.12	29.50
	110	83.72	608.16	312.54	125.80	40.25
	160	284.91	767.24	456.97	105.56	23.10
5-45Hz LOW FREQ	10	0.20	3.72	1.54	0.91	59.25
	60	0.19	2.53	0.93	0.52	55.73
	110	0.30	5.87	0.91	0.78	85.26
	160	0.33	12.12	0.97	1.57	162.07
50-60Hz PWR FREQ	10	0.13	1.29	0.49	0.25	50.18
	60	0.10	1.40	0.38	0.20	52.11
	110	0.18	1.53	0.41	0.23	56.88
	160	0.10	2.20	0.35	0.31	90.62
65-300Hz PWR HARM	10	0.15	3.88	1.24	0.83	67.17
	60	0.12	2.89	0.95	0.63	66.77
	110	0.24	2.76	0.99	0.58	59.03
	160	0.26	2.90	0.81	0.50	61.48
305-2560Hz HIGH FREQ	10	0.08	5.34	1.77	1.53	86.46
	60	0.13	3.06	1.09	0.87	80.35
	110	0.18	1.68	0.65	0.46	70.07
	160	0.10	1.53	0.44	0.33	74.50
5-2560Hz ALL FREQ	10	0.34	6.87	2.82	1.79	63.63
	60	0.32	4.18	1.83	1.10	60.32
	110	0.49	6.30	1.62	0.98	60.22
	160	0.47	12.74	1.46	1.64	112.20

TABLE 4-11

SUMMARY STATISTICS FOR DATASET NEC025 MEASURED AT THE
 RIGHT OF THE FIREMAN'S SEAT IN THE CAB OF A
 DIESEL-ELECTRIC LOCOMOTIVE ON THE NON-ELECTRIFIED
 SECTION OF THE NEC

DIESEL ENGINE - RIGHT OF FIREMAN		TOTAL OF 11 SAMPLES				
FREQUENCY BAND	HEIGHT ABOVE FLOOR (cm)	MINIMUM MAGNETIC FIELD (mG)	MAXIMUM MAGNETIC FIELD (mG)	AVERAGE MAGNETIC FIELD (mG)	STANDARD DEVIATION (mG)	COEFFICIENT OF VARIATION (%)
STATIC	10	228.21	426.63	350.82	25.87	7.37
	60	427.11	516.49	468.32	29.71	6.34
	110	175.69	259.67	232.11	29.30	12.62
	160	354.40	430.42	401.25	25.87	6.45
5-45Hz LOW FREQ	10	0.34	2.20	1.02	0.47	46.43
	60	0.52	1.41	0.76	0.24	32.13
	110	0.37	1.03	0.55	0.19	34.77
	160	0.41	0.84	0.63	0.17	26.94
50-60Hz PWR FREQ	10	0.23	0.46	0.34	0.07	21.27
	60	0.15	0.54	0.34	0.11	31.19
	110	0.32	0.60	0.41	0.08	18.57
	160	0.51	0.80	0.64	0.09	13.56
65-300Hz PWR HARM	10	0.33	1.58	0.98	0.44	44.89
	60	0.30	1.23	0.83	0.34	41.04
	110	0.35	1.44	0.94	0.35	37.74
	160	0.43	1.08	0.79	0.24	29.83
305-2560Hz HIGH FREQ	10	0.56	3.87	2.08	1.07	51.42
	60	0.32	1.85	1.16	0.56	48.04
	110	0.21	1.05	0.70	0.31	44.62
	160	0.13	0.56	0.39	0.16	41.39
5-2560Hz ALL FREQ	10	0.79	4.24	2.61	1.08	41.33
	60	0.84	2.48	1.69	0.58	34.04
	110	0.69	2.00	1.39	0.43	31.24
	160	0.96	1.64	1.28	0.21	16.01

TABLE 4-12

SUMMARY STATISTICS FOR DATASETS NEC022, NEC023 AND NEC025
 MEASURED IN THE CAB OF A DIESEL-ELECTRIC LOCOMOTIVE ON
 THE NON-ELECTRIFIED SECTION OF THE NEC

DIESEL LOCOMOTIVE - ENGINEER'S AND FIREMAN'S SEATS				TOTAL OF 80 SAMPLES		
FREQUENCY BAND	HEIGHT ABOVE FLOOR (cm)	MINIMUM MAGNETIC FIELD (mG)	MAXIMUM MAGNETIC FIELD (mG)	AVERAGE MAGNETIC FIELD (mG)	STANDARD DEVIATION (mG)	COEFFICIENT OF VARIATION (%)
STATIC	10	83.72	563.52	275.40	93.62	34.00
	60	102.61	516.49	295.75	101.53	34.33
	110	83.72	608.16	301.48	120.45	39.95
	160	284.91	767.24	449.31	100.25	22.31
5-45Hz LOW FREQ	10	0.20	3.72	1.47	0.88	60.09
	60	0.19	2.53	0.91	0.49	54.33
	110	0.30	5.87	0.86	0.73	85.23
	160	0.33	12.12	0.92	1.46	158.67
50-60Hz PWR FREQ	10	0.13	1.29	0.47	0.24	50.24
	60	0.10	1.40	0.38	0.19	50.19
	110	0.18	1.53	0.41	0.22	53.09
	160	0.10	2.20	0.39	0.31	80.16
65-300Hz PWR HARM	10	0.15	3.88	1.20	0.79	65.89
	60	0.12	2.89	0.93	0.60	64.50
	110	0.24	2.76	0.98	0.55	56.63
	160	0.26	2.90	0.81	0.47	58.17
305-2560Hz HIGH FREQ	10	0.08	5.34	1.81	1.47	81.29
	60	0.13	3.06	1.10	0.83	76.08
	110	0.18	1.68	0.66	0.44	66.55
	160	0.10	1.53	0.43	0.31	71.55
5-2560Hz ALL FREQ	10	0.34	6.87	2.79	1.71	61.27
	60	0.32	4.18	1.81	1.04	57.71
	110	0.49	6.30	1.59	0.92	58.05
	160	0.47	12.74	1.43	1.52	106.05

where the rms recorder wearer stood was shown to be higher than a more forward area where the engineer is seated (see Appendix Y).

4.6.4 Magnetic Fields on the North Jersey Coast Line

Magnetic field levels measured next to the engineer's seat in the rear cab of the locomotive on the 60 Hz section of the North Jersey Coast Line are tabulated in Table 4-13. The 60 Hz component of the magnetic field is the predominant portion of the field but the harmonic components are also clearly present. The vertical profile of the 60 Hz component of the magnetic field is plotted in Figure 4-15.

Prior to the locomotive's departure from the Long Branch Station, magnetic fields were measured to the left of the engineer's seat in the rear cab of the locomotive. The data prior to and immediately after departure are contained in dataset NEC050 in Appendix AY. The data from the first 36 samples taken while the train was standing stationary at the station are summarized in Table 4-14. The effect of the 60 Hz and harmonic field source beneath the floor of the cab, which was discussed earlier in this chapter, is clearly evident. The vertical profile of the 60 Hz component of the magnetic field plotted in Figure 4-16 dramatically illustrates the temporal stability of this field source (small standard deviation and tight minimum-to-maximum range) and the rapid attenuation of the field at increasing heights above the floor. The average field level 60 cm above the floor reported in Table 4-13 for the moving locomotive is roughly twice that found with DAT (Table 4-2) and rms (Table 4-3) measurements. The discrepancy is apparently due to the fact that the majority of the waveform capture system measurements which contributed to Table 4-13 were made with the train accelerating as it left stations. As a result, the operating conditions were not representative of the more typical conditions which occurred throughout the remainder of the trip and were recorded by the DAT and rms recorders. In fact, the average magnetic field levels recorded by those devices are closer in magnitude to field levels which existed in the locomotive when it was standing at the station (Table 4-14). The maximum magnetic field levels recorded by the three instruments were more nearly equal as one would expect for reasons discussed in Section 4.6.2 above.

4.6.5 Effects of Electrification Technology

The statistical summaries of magnetic field levels in the engineer's compartments of locomotives on the NEC and the Long Branch Line presented in the four preceding subsections of the report are brought together here for comparison. To facilitate that comparison, average and maximum magnetic field levels measured at the four heights above the floor in the cabs were averaged in order to produce a single number representative of the average field throughout the cab and a second number representative of the maximum magnetic field that would be found at any typical point within the cab.

TABLE 4-13

SUMMARY STATISTICS FOR APPROPRIATE PARTS OF DATASETS NEC050
AND NEC051 MEASURED AT THE LEFT OF THE ENGINEER'S SEAT IN THE
REAR CAB OF A LOCOMOTIVE OPERATING ON THE 60 HZ
SECTION OF THE NORTH JERSEY COAST LINE

LONG BRANCH - LEFT OF ENGINEER - TRAIN IN TRANSIT		TOTAL OF 85 SAMPLES				
FREQUENCY BAND	HEIGHT ABOVE FLOOR (cm)	MINIMUM MAGNETIC FIELD (mG)	MAXIMUM MAGNETIC FIELD (mG)	AVERAGE MAGNETIC FIELD (mG)	STANDARD DEVIATION (mG)	COEFFICIENT OF VARIATION (%)
STATIC	10	136.97	268.41	210.48	31.17	14.81
	60	291.97	444.81	378.73	31.96	8.44
	110	136.97	400.27	344.34	26.19	7.61
	160	265.64	409.35	343.29	30.80	8.97
5-45Hz LOW FREQ	10	0.92	12.45	2.42	1.26	52.14
	60	0.21	7.89	1.03	0.87	84.18
	110	0.16	10.49	0.84	1.13	135.06
	160	0.15	6.17	0.76	0.74	98.20
50-60Hz PWR FREQ	10	22.83	64.77	44.83	10.66	23.77
	60	5.21	70.07	23.42	19.60	83.67
	110	2.66	81.12	23.15	23.11	99.82
	160	1.49	122.55	32.88	35.86	109.08
65-300Hz PWR HARM	10	1.56	9.95	3.64	1.76	48.31
	60	0.59	11.46	3.31	3.06	92.39
	110	0.54	12.67	3.71	3.60	96.93
	160	0.69	17.21	4.66	4.89	104.95
305-2560Hz HIGH FREQ	10	0.60	2.60	1.21	0.44	36.31
	60	0.48	2.87	1.05	0.65	62.23
	110	0.48	3.03	1.12	0.72	64.18
	160	0.44	3.77	1.22	0.92	75.29
5-2560Hz ALL FREQ	10	22.91	65.35	45.10	10.72	23.78
	60	5.34	70.96	23.76	19.79	83.26
	110	2.83	82.15	23.62	23.29	98.61
	160	1.85	123.74	33.35	36.11	108.30

LONG BRANCH - LEFT OF ENGINEER

POWER FREQUENCY (50-60 Hz)

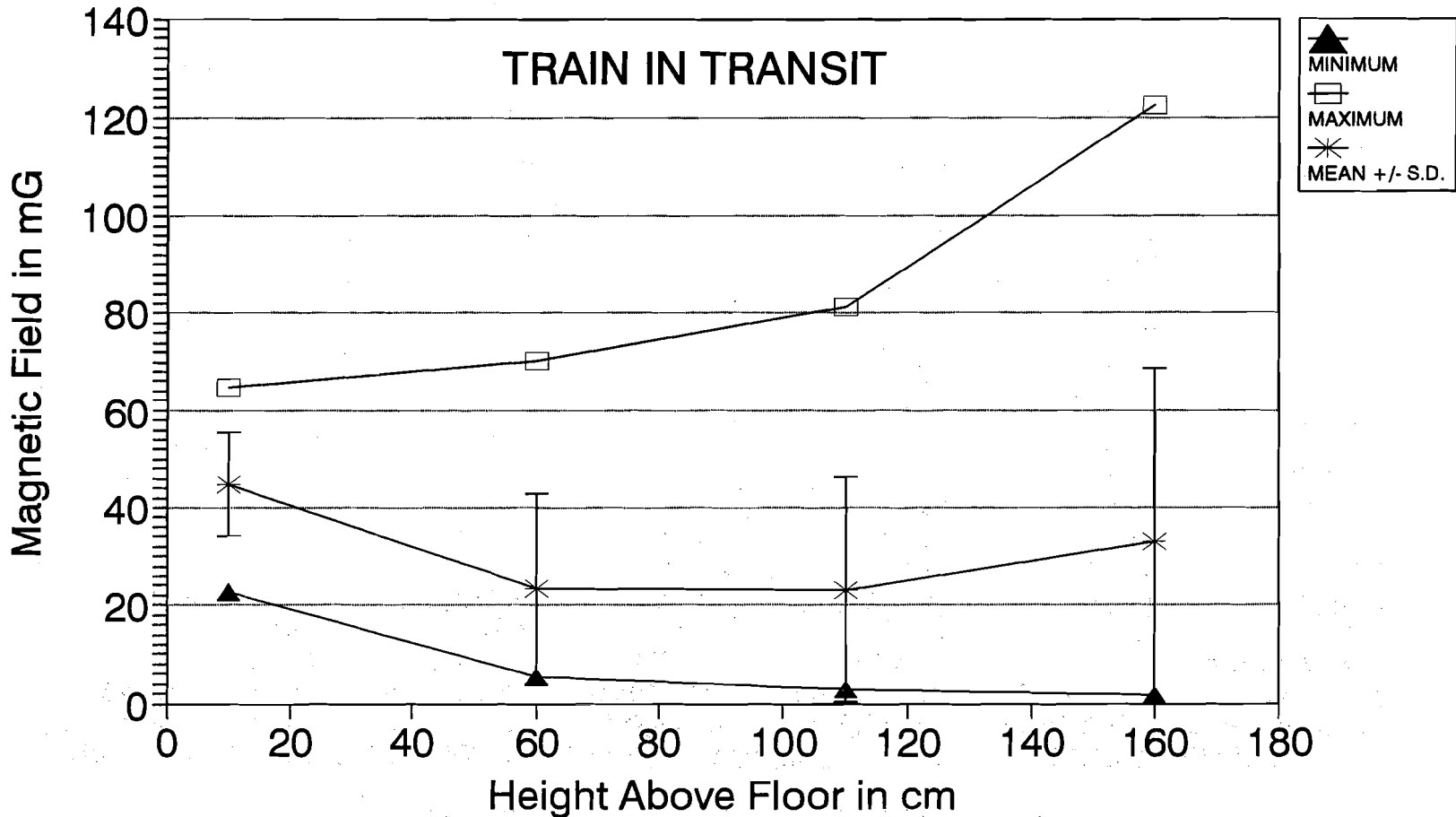

4-39

FIGURE 4-15. VERTICAL PROFILE OF THE POWER FREQUENCY MAGNETIC FIELD STRENGTH IN THE REAR CAB OF A LOCOMOTIVE OPERATING ON THE 60 HZ SECTION OF THE NORTH JERSEY COAST LINE

TABLE 4-14

SUMMARY STATISTICS FOR PART OF DATASET NEC050 MEASURED AT THE LEFT OF THE ENGINEER'S SEAT IN THE REAR CAB OF A LOCOMOTIVE STANDING AT THE LONG BRANCH STATION ON THE 60 HZ SECTION OF THE NORTH JERSEY COAST LINE

LONG BRANCH - LEFT OF ENGINEER - TRAIN @ STATION		TOTAL OF 36 SAMPLES				
FREQUENCY BAND	HEIGHT ABOVE FLOOR (cm)	MINIMUM MAGNETIC FIELD (mG)	MAXIMUM MAGNETIC FIELD (mG)	AVERAGE MAGNETIC FIELD (mG)	STANDARD DEVIATION (mG)	COEFFICIENT OF VARIATION (%)
STATIC	10	247.16	259.11	253.58	4.38	1.73
	60	299.08	317.29	310.77	4.32	1.39
	110	247.16	353.64	347.14	3.68	1.06
	160	274.38	291.39	283.32	4.54	1.60
5-45Hz LOW FREQ	10	0.97	2.19	1.51	0.38	25.20
	60	0.25	0.43	0.33	0.05	15.48
	110	0.11	0.21	0.16	0.02	14.19
	160	0.13	0.29	0.17	0.03	15.14
50-60Hz PWR FREQ	10	46.46	54.16	50.23	2.34	4.65
	60	8.75	10.89	9.93	0.67	6.70
	110	3.68	6.87	5.46	1.04	19.10
	160	2.78	5.62	4.09	0.96	23.48
65-300Hz PWR HARM	10	2.81	3.70	3.22	0.27	8.33
	60	0.90	1.61	1.27	0.23	17.80
	110	0.96	1.58	1.29	0.18	13.66
	160	0.68	1.32	1.03	0.19	18.90
305-2560Hz HIGH FREQ	10	0.99	1.20	1.10	0.07	6.25
	60	0.51	0.70	0.61	0.05	8.28
	110	0.52	0.72	0.62	0.06	9.28
	160	0.45	0.58	0.51	0.04	7.13
5-2560Hz ALL FREQ	10	46.58	54.32	50.37	2.35	4.66
	60	8.85	11.02	10.04	0.67	6.71
	110	3.96	7.07	5.65	1.02	18.12
	160	2.98	5.78	4.27	0.93	21.78

LONG BRANCH - LEFT OF ENGINEER

POWER FREQUENCY (50-60 Hz)

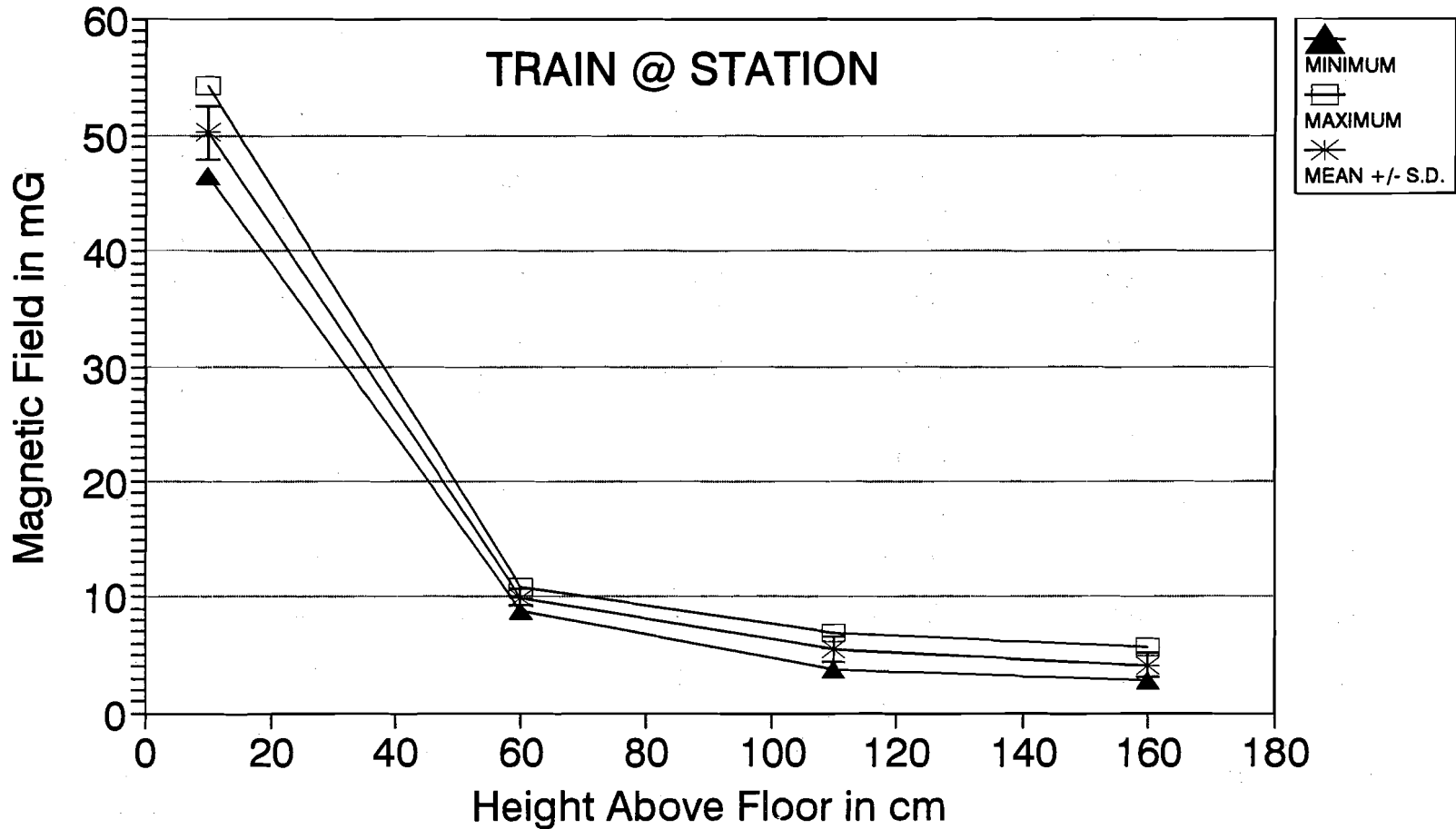
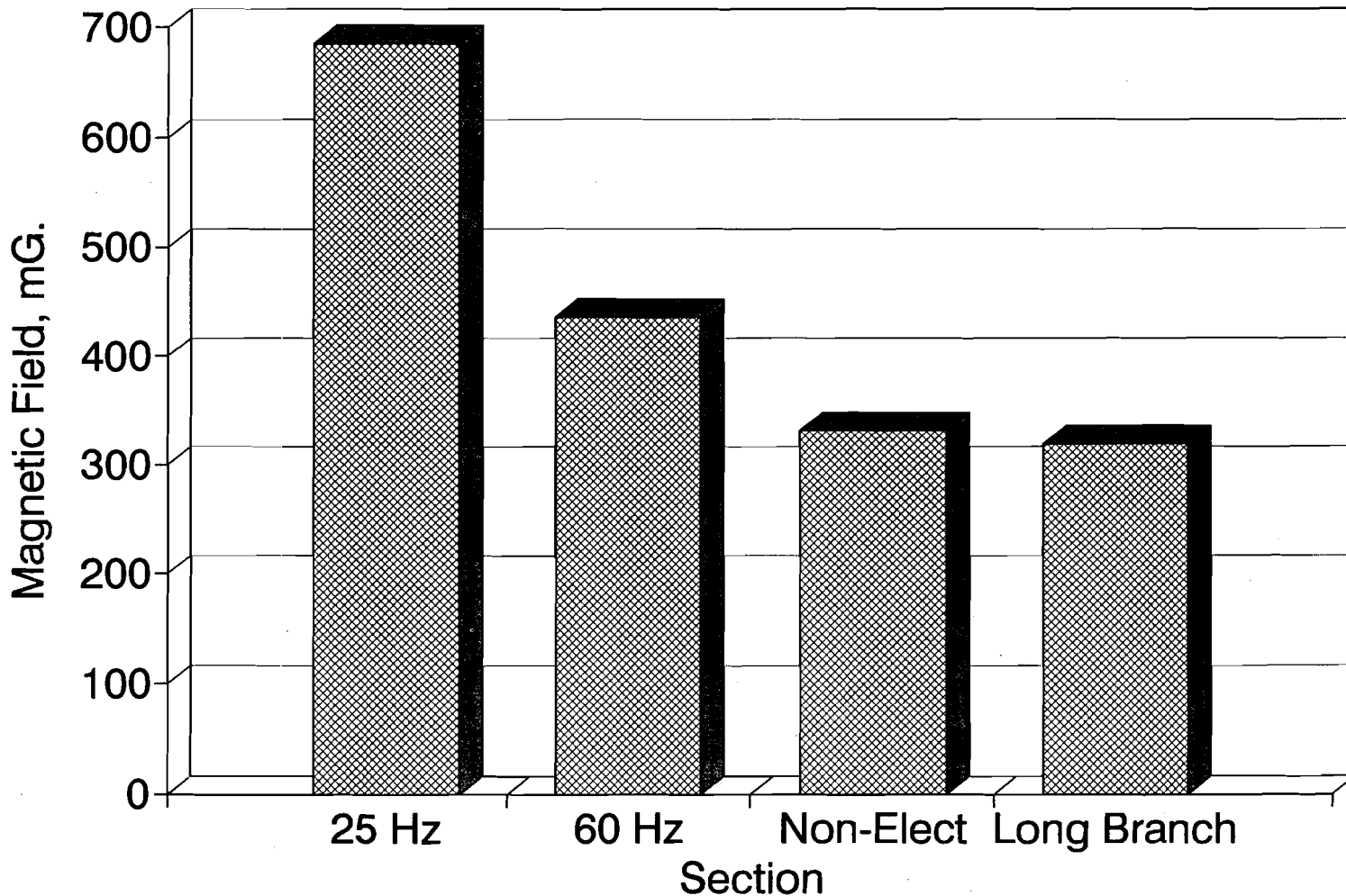

FIGURE 4-16. VERTICAL PROFILE OF THE POWER FREQUENCY MAGNETIC FIELD STRENGTH IN THE REAR CAB OF A LOCOMOTIVE STANDING AT THE LONG BRANCH STATION ON THE 60 HZ SECTION OF THE NORTH JERSEY COAST LINE

The average and maximum static magnetic fields found in the rear cabs of electric locomotives on the 25 Hz section or 60 Hz section of the NEC, or on the 60 Hz section of the North Jersey Coast Line, or in the front cab of a diesel-electric locomotive on the non-electrified portion of the Northeast Corridor are compared on Figures 4-17 and 4-18. The average static magnetic field appears elevated above the 500 mG typical value of the earth's field in the locomotive on the 25 Hz section of the Northeast Corridor and depressed to various extents within the other three locomotives. Some suppression of the geomagnetic field was expected due to the steel structure of the cab and locomotive components. The enhancement of the static field in the locomotive on the 25 Hz section of the NEC was unexpected and cannot be explained with certainty. The electrification system is 25 Hz ac and is not known to have a direct current component. Certainly, there is no intentional dc current in the catenary. Static field from dc third rail circuits in the New York area is a possible contributor, but certainly not the principal one, because the elevated static field continued throughout all of the measurements, some as far south as Trenton, NJ (Appendix AJ). The elevated static field in the rear cab of the locomotive on the 25 Hz section of the corridor does not appear related to the direct current traction power circuits in the locomotive or the dc traction motors because the field intensity does not fluctuate with traction power. Furthermore, the same dc traction equipment is operative in locomotives on the 60 Hz portions of the NEC and the North Jersey Coast Line where elevated static field levels were not observed.

The determination of the source of the elevated static field in the rear cab of the locomotive on the 25 Hz portion of the corridor and evaluation of the role of electrification technology is further complicated by the fact that since AEM-7 locomotives have cabs at both ends, they are connected to the trains randomly without concern for which end of the locomotive is forward. Because of this randomness, it turned out that measurements on the 60 Hz section of the Northeast Corridor and the small 25 Hz portion of the corridor north of New York City were made in the cab containing the ATC equipment, while the measurements on the 25 Hz section of the corridor south of New York were made in the opposite cab. Consequently, the increased static field measured on the 25 Hz section of the corridor may actually reflect the difference in which cab was evaluated rather than which kind of electrification scheme was used. Discussions with AMTRAK personnel revealed that the "head end" power inverter which supplies hotel power for the coaches is near one cab. The dc power cables to the inverter from the main rectifier are a possible source of static field which could be relevant in one cab but not the other. Furthermore, since the current in those cables reflects hotel power needs, not traction power needs, the resulting static magnetic field would be expected to have the relatively constant temporal characteristics measured. If current in these inverter power cables was the source of the elevated static field, the field would be stronger near the source but weaker at more distant points. Unfortunately, vertical and horizontal profile measurements failed to identify any consistent attenuation pattern for elevated static fields in the

Comparison of Avg Static Magnetic Field For the Four Technologies



4-43

FIGURE 4-17. COMPARISON OF THE AVERAGE STATIC MAGNETIC FIELD LEVELS IN CABS OF LOCOMOTIVES OPERATING ON VARIOUS SECTIONS OF THE NEC AND ON THE NORTH JERSEY COAST LINE

Comparison of Max Static Magnetic Field For the Four Technologies

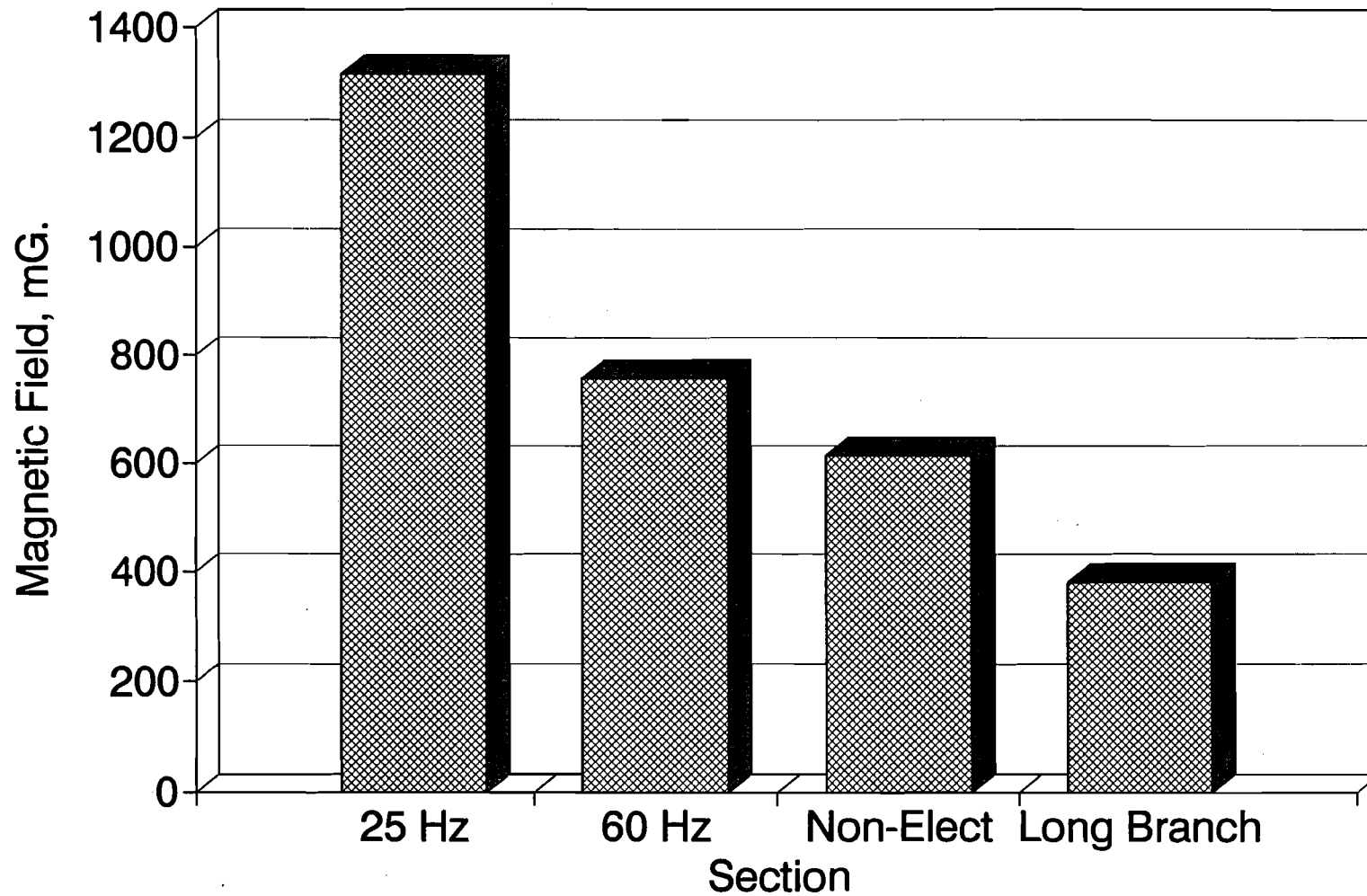

4-44

FIGURE 4-18. COMPARISON OF THE MAXIMUM STATIC MAGNETIC FIELD LEVEL TYPICAL FOR A LOCATION IN THE CABS OF LOCOMOTIVES OPERATING ON VARIOUS SECTIONS OF THE NORTHEAST CORRIDOR AND ON THE NORTH JERSEY COAST LINE

cab of the locomotive on the 25 Hz section of the corridor. Furthermore, there is an indication in dataset NEC030 of increased static field in the opposite cab (but of a different locomotive) which begins shortly after the train passes from the 60 Hz section of the corridor into the 25 Hz section of the corridor north of New York City.

Another possible explanation of the elevated static fields in one particular locomotive cab is residual magnetism in the steel components of the locomotive. Although that explanation is purely speculative, it is consistent with the wide spatial distribution of elevated static field levels and the lack of an observable attenuation pattern.

Static field levels related to locomotive function (speed, acceleration, etc.) were seen only in the cab of the diesel-electric locomotive on the non-electrified section of the corridor. But since the magnitude of the static component produced by the locomotive was considerably smaller than the geomagnetic field, and the orientation of the components were not consistent from one point in the cab to another, the average static field and the average of the maximum static field values at the various measurement locations in the cab of the diesel-electric locomotive were no different than those in electric locomotives operating on the 60 Hz sections of the NEC or North Jersey Coast Line where the only known source of static magnetic field was the earth itself.

Time-varying magnetic fields in the locomotive cabs were measured with the waveform capture system, the DAT, and the rms meters. Average field values measured in the cabs using the various instruments are shown in Figure 4-19. No rms data are given on the 25 Hz system because 25 Hz is below the frequency pass band of that instrument. Furthermore, no DAT measurements were made in the diesel-electric locomotive for the logistical reasons stated earlier in this section. The average field levels in the electric locomotives measured with the repetitive field waveform recording system are larger than the values measured with the other devices primarily because the waveform capture system measurements included measurements at various heights above the floor, some of which had consistently higher fields than were present at seat level.

Figure 4-20 shows a similar comparison of maximum field levels at a typical location in the cabs measured with the three instruments. Since magnetic field measurements with each of the three instruments rank the four railroad sections in a similar manner, most of the remainder of this section will be based on data from the repetitive field waveform recorder with its frequency-specific field values and its more comprehensive spatial coverage of the cabs.

Figures 4-21 and 4-22 show the average and typical maximum magnetic field levels measured in the locomotive cabs. Shading within the bars indicates the portion of the field on an energy basis within each of the indicated frequency bands. It is immediately obvious from the two figures that the locomotive cab on the 25 Hz system

Comparison of Average AC Magnetic Field For the Four Technologies

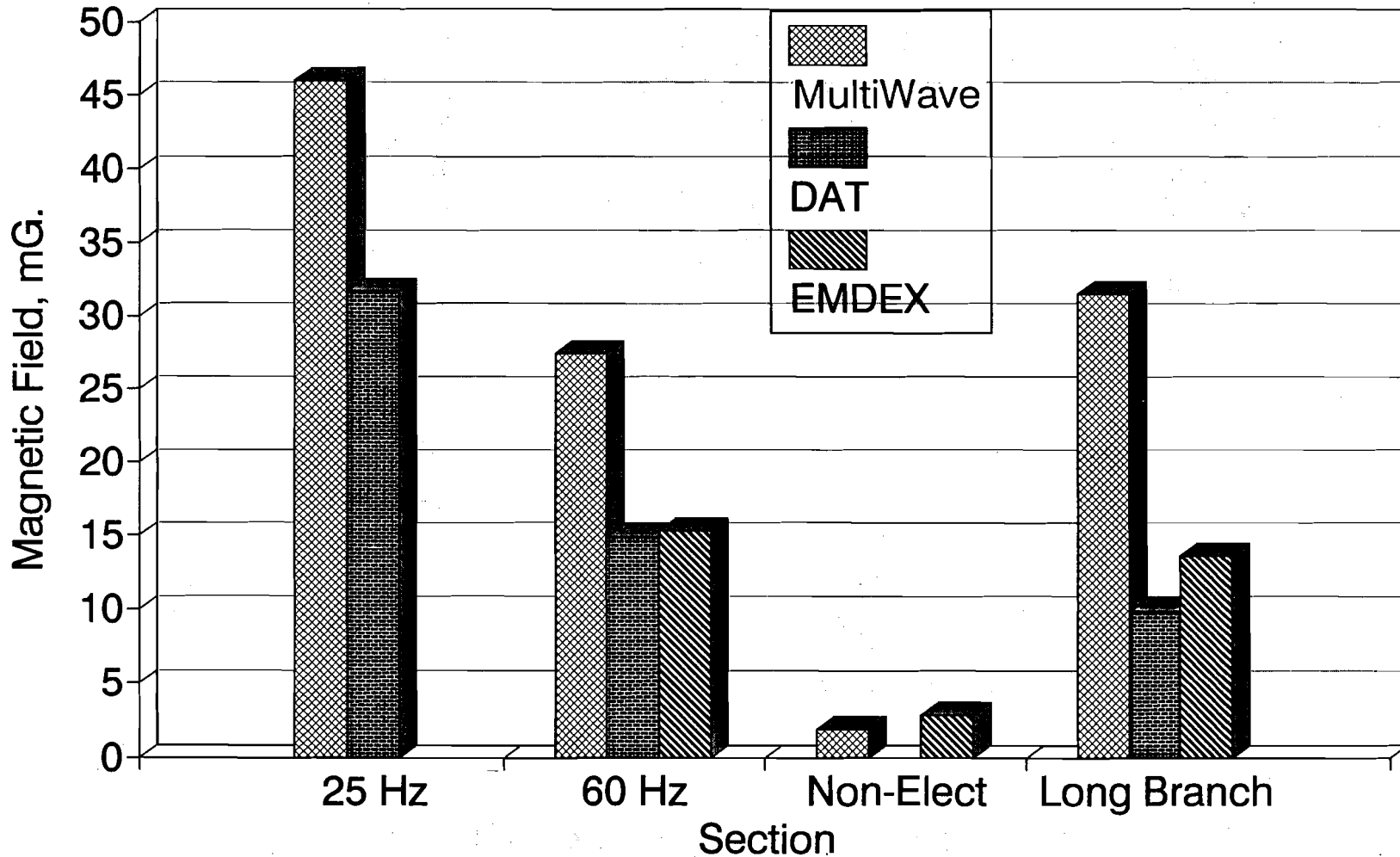

4-46

FIGURE 4-19. COMPARISON OF THE AVERAGE TIME-VARYING MAGNETIC FIELD LEVELS IN CABS OF LOCOMOTIVES OPERATING ON VARIOUS SECTIONS OF THE NEC AND ON THE NORTH JERSEY COAST LINE MEASURED IN DIFFERENT WAYS

Comparison of Maximum AC Magnetic Field For the Four Technologies

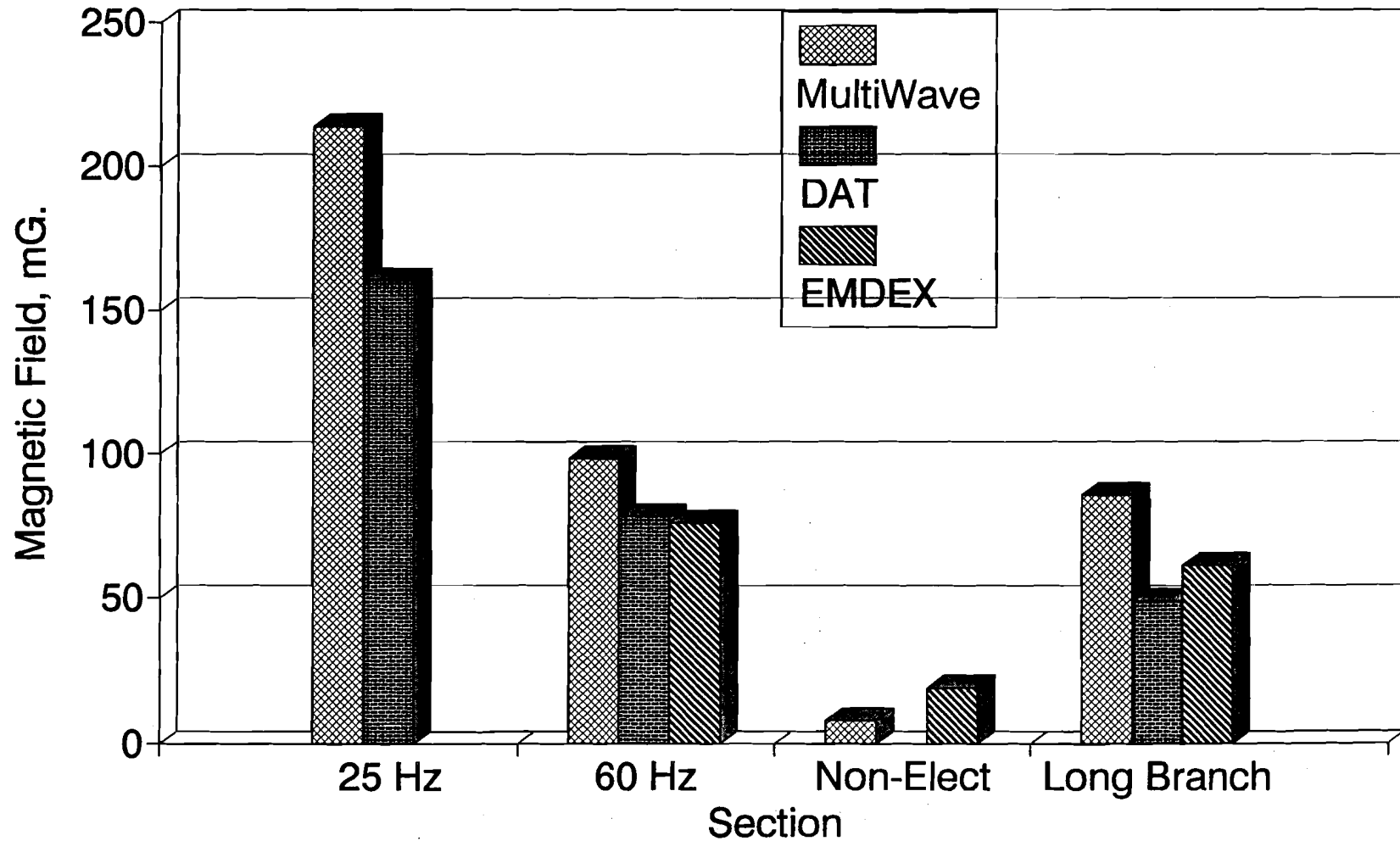

4-47

FIGURE 4-20. COMPARISON OF THE MAXIMUM TIME-VARYING MAGNETIC FIELD LEVELS AT TYPICAL LOCATIONS IN CABS OF LOCOMOTIVES OPERATING ON VARIOUS SECTIONS OF THE NEC AND THE NORTH JERSEY COAST LINE MEASURED IN DIFFERENT WAYS

Comparison of Average AC Magnetic Field For the Four Technologies

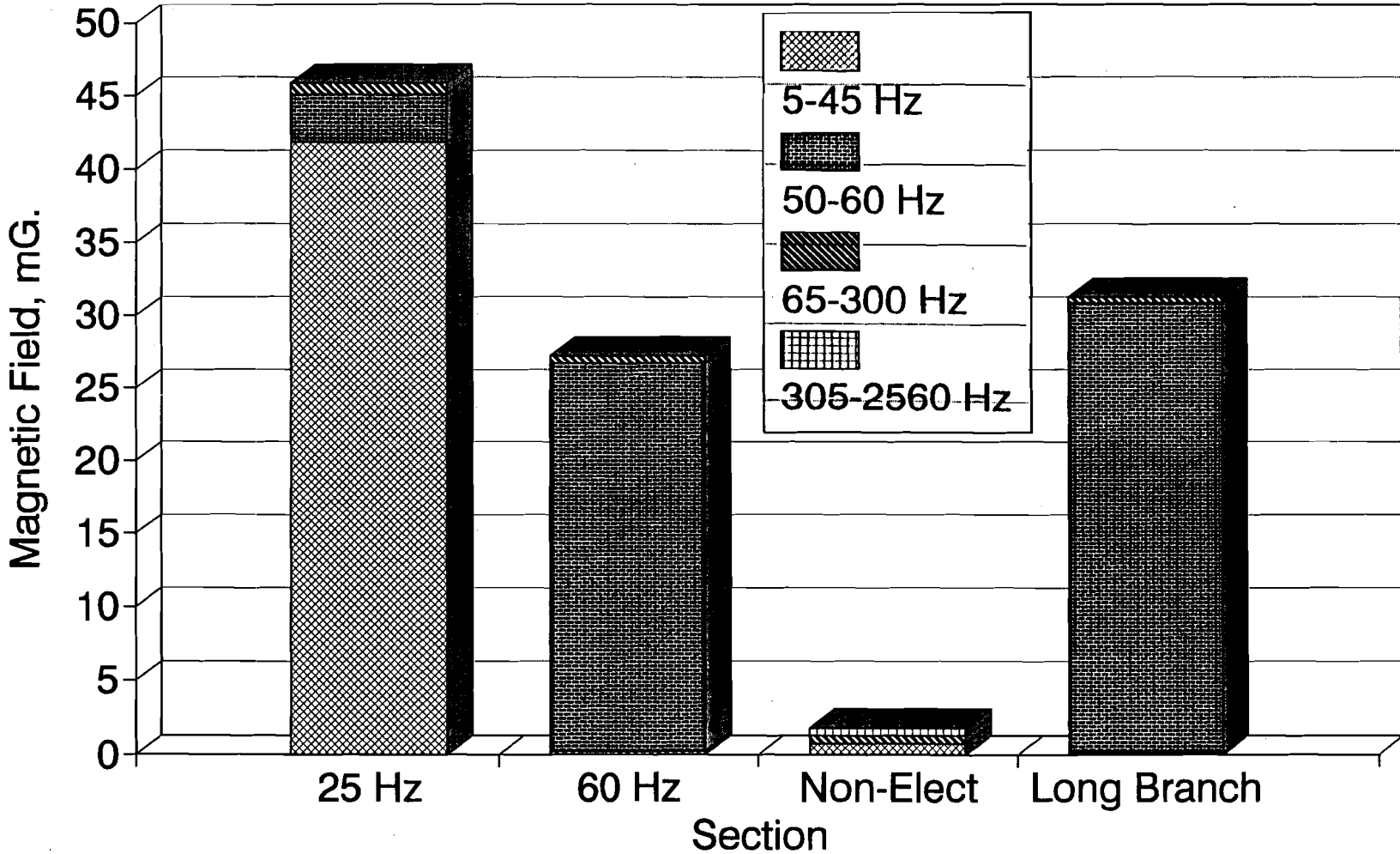

4-48

FIGURE 4-21. COMPARISON OF THE AVERAGE TIME-VARYING MAGNETIC FIELD LEVELS IN CABS OF LOCOMOTIVES OPERATING ON VARIOUS SECTIONS OF THE NEC OR THE NORTH JERSEY COAST LINE AND THE PRINCIPAL COMPONENT FREQUENCY RANGES

Comparison of Maximum AC Magnetic Field For the Four Technologies

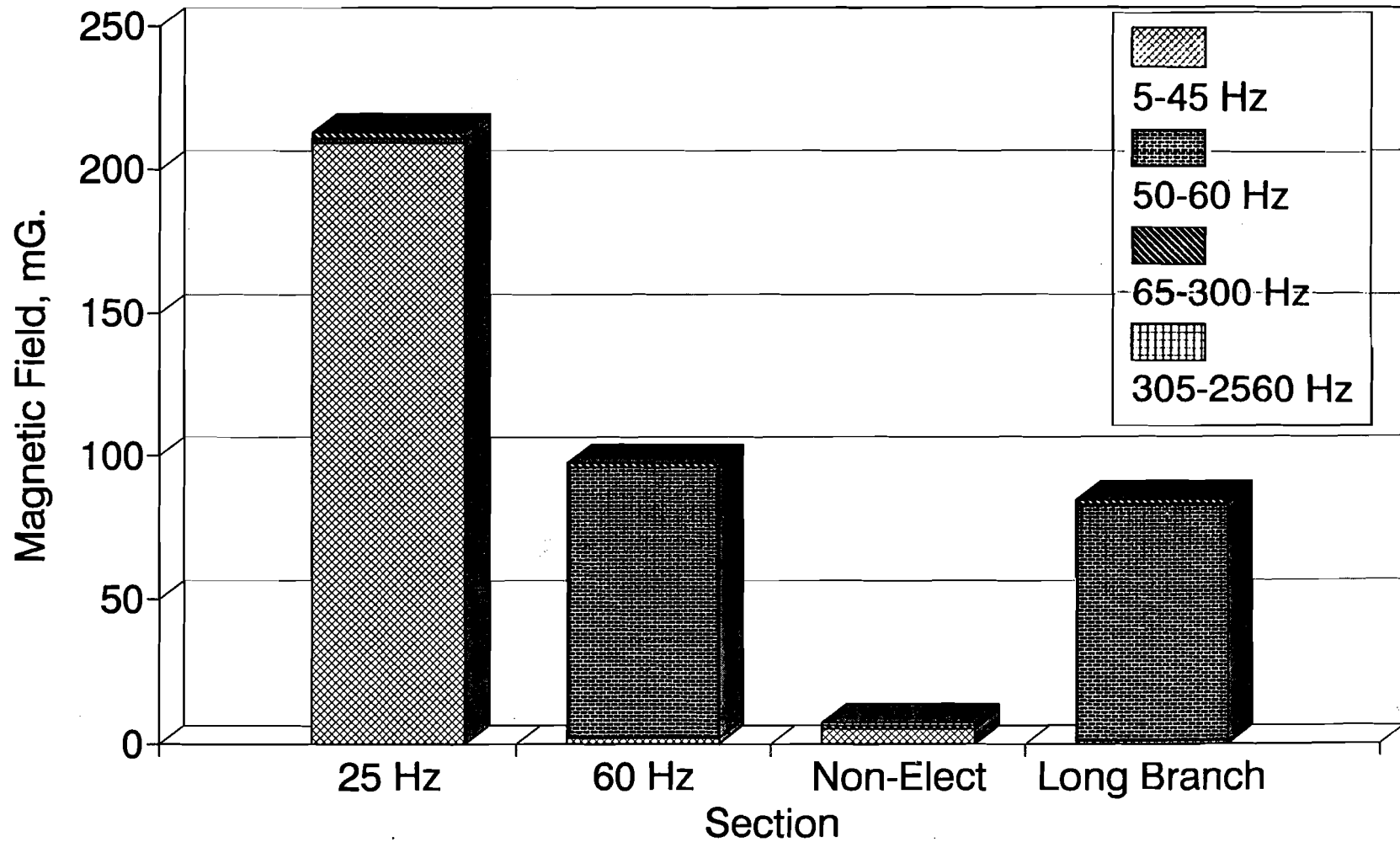

4-49

FIGURE 4-22. COMPARISON OF THE MAXIMUM TIME-VARYING MAGNETIC FIELD LEVELS IN TYPICAL LOCATIONS IN CABS OF LOCOMOTIVES OPERATING ON VARIOUS SECTIONS OF THE NEC OR THE NORTH JERSEY COAST LINE AND THE PRINCIPAL COMPONENT FREQUENCY RANGES

has the highest magnetic fields and that the frequency content of the field (primarily 25 Hz) is different from the field in the other two electric locomotives (primarily 60 Hz).

The magnetic field levels in the cabs of locomotives on the 60 Hz section of the NEC and the 60 Hz section of the North Jersey Coast Line are similar in magnitude and frequency content. The ELF magnetic field in the diesel-electric locomotive on the non-electrified portion of the Northeast Corridor is dramatically smaller than the ELF magnetic field in any of the electric locomotives and there is no single frequency component which dominates the field. That feature is shown more dramatically in Figures 4-23 and 4-24 which contain graphs of the average and maximum magnitude of the cab magnetic field in each of four frequency bands.

Both the 25 Hz section and the 60 Hz section of the NEC are double-fed systems (direct-fed and autotransformer-fed, respectively), while the North Jersey Coast Line is a single-fed system. These data fail to demonstrate a clear distinction between magnetic field levels produced by double-fed and single-fed systems because other parameters appear to have greater impact on both average and maximum field level. Similarly, the 25 Hz section of the NEC and the North Jersey Coast Line are direct fed from substation transformers, while the 60 Hz section of the NEC is fed from more closely-spaced autotransformers. Again, the magnetic field data measured in locomotives failed to demonstrate any consistent effect of catenary powering scheme. Unlike the field data in the coaches where the differences in coach construction were a possible source of variation, the construction of the AMTRAK AE-7 and the NJT ALP-33 are sufficiently similar to permit direct comparison. Furthermore, the measurements in the locomotive cab on the Long Branch Line were on an inbound train during the morning rush hour causing the train to have a substantial passenger load, perhaps similar to that on the AMTRAK trains. Unfortunately, terrain is still an uncontrolled variable in the tests and it is impossible to determine with certainty whether the differences in field levels within the cabs of the locomotives on different sections of the railroad are indicative of differences in electrification or an uncontrolled factor such as terrain.

It is interesting to note that the time-varying magnetic fields in the locomotive cabs on the electrified portions of the Northeast Corridor are substantially lower than those in the coaches. These tests did not focus on issues of vehicle shielding or source efficiency to a great enough extent to determine with certainty whether the lower time-varying magnetic field levels in the locomotive cabs were due to the shielding of the carbon steel locomotive or due to "cancellation effect" of the magnetic field components produced by currents flowing in opposite directions in the catenary (and in the track) behind the pantograph relative to those in front of the pantograph.

Comparison of Average AC Magnetic Field For the Four Technologies

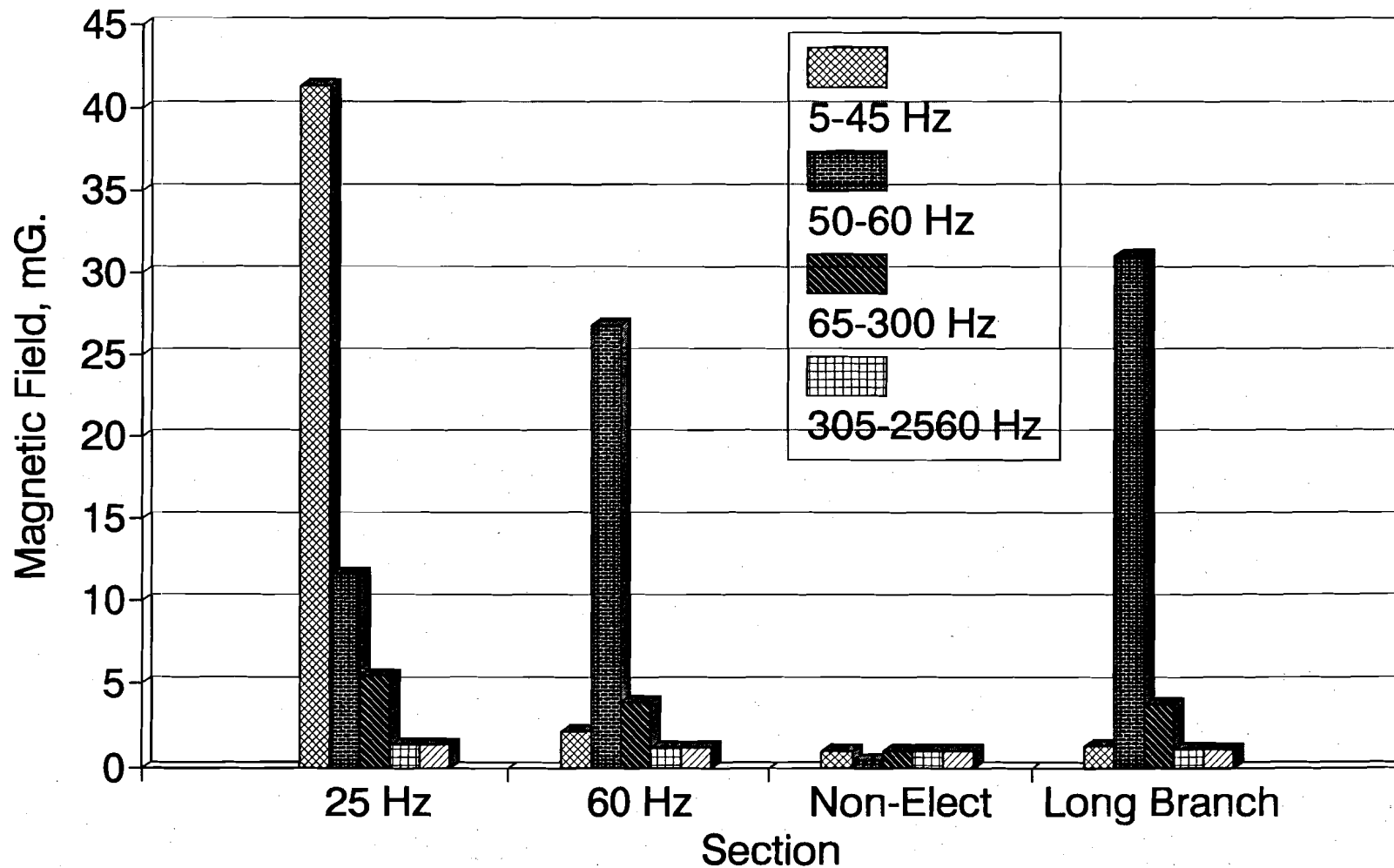

4-51

FIGURE 4-23. COMPARISON OF AVERAGE TIME-VARYING MAGNETIC FIELD LEVELS IN THE FOUR FREQUENCY BANDS IN THE CABS OF LOCOMOTIVES OPERATING ON VARIOUS SECTIONS OF THE NEC OR THE NORTH JERSEY COAST LINE

Comparison of Maximum AC Magnetic Field For the Four Technologies

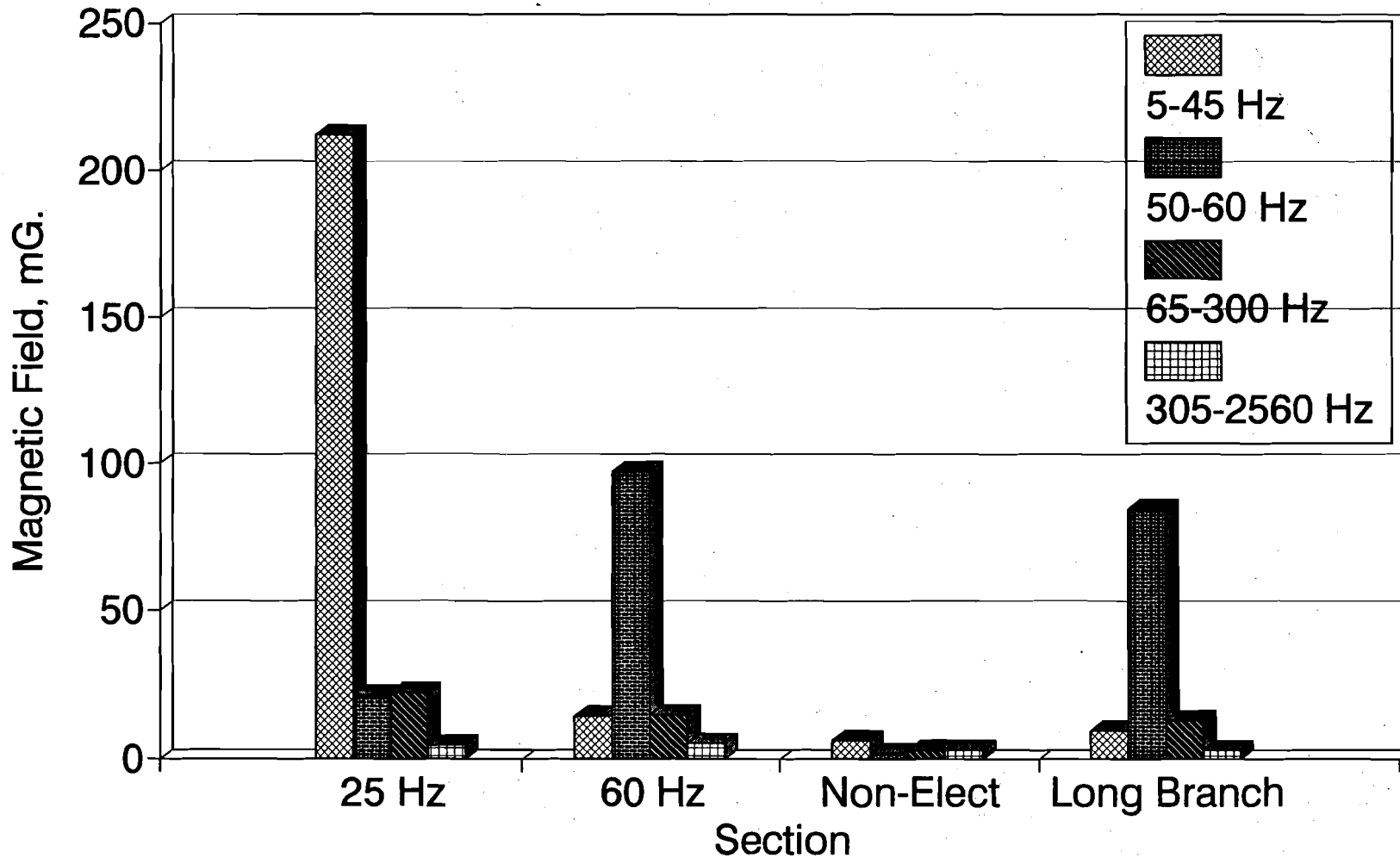

4-52

FIGURE 4-24. COMPARISON OF MAXIMUM TIME-VARYING MAGNETIC FIELD LEVELS IN FOUR FREQUENCY BANDS AT TYPICAL LOCATIONS IN CABS OF LOCOMOTIVES OPERATING ON VARIOUS SECTIONS OF THE NEC OR ON THE NORTH JERSEY COAST LINE

4.7 SUMMARY OF ELECTRIC FIELD LEVELS

Electric field levels were measured in the rear cabs of the electrified locomotives at locations similar to those depicted in Figure 4-1 for magnetic field measurements. Electric field measurements were not made in the diesel-electric locomotive in order to avoid interference with or distraction of the engineer. Since the diesel-electric locomotive operates on a non-electrified section of the corridor, the metal cab provides excellent shielding from external electric field sources, and all of the wiring inside the locomotive is within metal wireways, it was undoubtedly safe to conclude that there were no significant electric field levels within the cab of the diesel-electric locomotive.

Electric field measurements above the engineer's and fireman's seats on all three electrified railroad sections were 2 V/m or less, apparently due to the effective electric field shielding provided by the metal cab. No electric fields arising from sources within the locomotives could be detected. Penetration of electric field from the catenary through the large glass areas of the windshield and side windows appeared to account for all of the measurable electric fields within the cab.

More extensive measurements of electric field levels were made in the cab of the locomotive on the 60 Hz portion of the Northeast Corridor because the higher catenary voltage and existence of at least four parallel electrified tracks produce the highest external electric field. In these tests, the highest electric field in the cab was 55 V/m at the side window on the left of the cab. This reading probably errs on the high side due to interactions between the metal surrounding the window and the electric field meter. The electric field above the console inside the front windshield was the second highest field detected at 17 V/m. This measurement is also probably higher than the actual field level due to interactions between the meter and metal surfaces. Electric field levels greater than 5 V/m could not be detected at locations more than 30 cm from metal surfaces, a spacing necessary for accurate operation of the electric field meter.

5. ELECTRIC AND MAGNETIC FIELD MEASUREMENTS ALONG THE WAYSIDE

Electric and magnetic fields exist along the wayside of the electrified railroad originating from the voltage on the catenary wires and current in the catenary, track, and overhead shield wire, respectively. The catenary voltage on the 25 Hz section is 11.5 kV. On the 60 Hz sections, the catenary voltage is 12.5 kV. Voltage on and current in the 138 kV, 25 Hz power transmission line along most of the 25 Hz section of the NEC or voltage on and current in the return wire on the autotransformer-fed 60 Hz section of the NEC from New York City to New Haven, CT are also potential sources of electric and magnetic fields. Finally, the passing trains themselves are also sources of magnetic field for brief periods of time.

5.1 MEASUREMENT LOCATIONS

Wayside measurements were made on both the 25 Hz and 60 Hz sections of the NEC, as well as on New Jersey Transit's North Jersey Coast Line. Specific measurement sites were:

- 610 m (2000 ft) north of the Princeton Junction Station on the 25 Hz section of the NEC.
- Courtyard Hotel parking lot in Rye, New York on the 60 Hz section of the NEC.
- Oak Hill Road crossing west of Red Bank, NJ on the 60 Hz section of the North Jersey Coast Line.

Figure 5-1 shows the location of main and reference probes at each of the three sites. The four main probes were in the staff and measured the magnetic field at four different heights, 10 cm, 60 cm, 110 cm, and 160 cm. The staff was positioned at what appeared from surrounding structures or cleared vegetation to be the edge of the railroad right-of-way. Simultaneously, a reference probe measured the magnetic field at a height of 10 cm at a position approximately 6.1 m (20 ft) more distant from the tracks.

At Princeton Junction, the measurements were made on the west side of the tracks, at a location approximately 610 m (2000 ft) north of the station. The staff was placed at 12.2 m (40 ft) west of the centerline of the nearest track, and the reference probe at 18.3 m (60 ft) west of the nearest track. The measurements were taken from 14:38 to 14:52 on April 1, 1992 and recorded as datasets NEC039 and NEC040 (see Table 5-1).

At Rye, NY the measurements were made at a Courtyard Hotel parking lot, near the intersection of Peck and Midland Streets. The staff and reference probes were placed on the east side of the tracks at 11.9 m (39 ft) and 17.7 m (58 ft), respectively. The measurements were taken from 09:27 to 09:44 on April 2, 1992 and recorded as dataset NEC041.

AMTRAK Wayside, Princeton Junction, NJ

(610m (2000ft) North of Station)

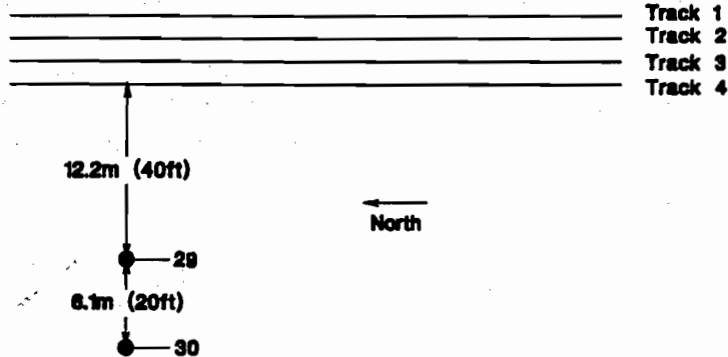

Metro North Wayside, Rye NY

Courtyard Hotel Parking Lot

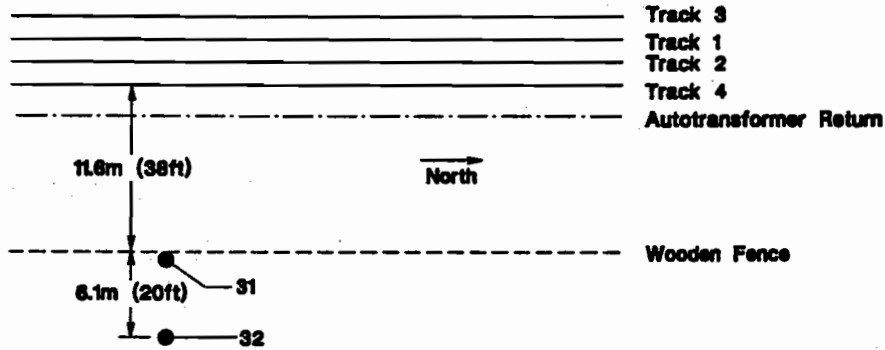

New Jersey Transit Wayside, Red Bank, NJ

(Oak Hill Road Crossing)

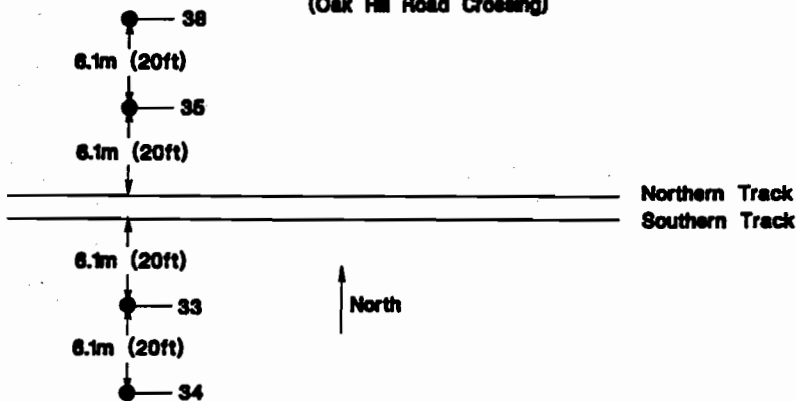

FIGURE 5-1. REPETITIVE MAGNETIC FIELD WAVEFORM MEASUREMENT LOCATIONS AT THE WAYSIDE

The Red Bank measurements were made at Oak Hill Road 2 miles west of the station. This site was at an upgrade and measurements were made on both sides of the tracks, i.e. north and south. The staff and reference probes were placed at 6.1 m (20 ft) and 12.2 m (40 ft) from the tracks, respectively. The south measurements were taken on April 2, 1992 from 18:26 to 18:42 and recorded as dataset NEC047. The measurements north of the tracks were taken on April 3, 1992 from 11:22 to 11:24 and recorded as dataset NEC053.

5.2 REPETITIVE WAVEFORM DATASETS

There are five datasets that were taken along the wayside at these three locations. The data were recorded with a waveform capture system at the dates and times shown in Table 5-1. The number of samples for each case is also shown in the table.

TABLE 5-1

REPETITIVE MAGNETIC FIELD WAVEFORM DATASETS MEASURED ALONG THE WAYSIDE

DATA FILE NUMBER	APPENDIX	DATE AND TIME	SENSOR LOCATION (SEE FIG. 5-1)		NUMBER OF SAMPLES	LOCATION AND ELECTRIFICATION
			STAFF	REF.		
NEC039	AN	APRIL 1 14:38-14:41	29	30	29	PRINCETON JTN, 25 HZ
NEC040	AO	APRIL 1 14:43-14:52	29	30	44	PRINCETON JTN, 25 HZ
NEC041	AP	APRIL 2 09:27-09:44	31	32	196	RYE, NY 60 HZ
NEC047	AV	APRIL 2 18:26-18:42	33	34	105	RED BANK 60 HZ
NEC053	BB	APRIL 3 11:22-11:24	35	36	23	RED BANK 60 HZ

5.3 FIELD SOURCE IDENTIFICATION

Possible magnetic field sources along the railroad wayside include current in the catenary-track circuit, current in the railroad 138 kV primary (power transmission line) circuits on the 25 Hz section of the NEC, or in the return wire on the autotransformer-fed 60 Hz section of the NEC, track return current flowing in the overhead shield wire, the train itself, and nearby commercial electric power transmission and distribution systems. Since the

goal of the measurement program was to quantify magnetic fields produced by railroad facilities, the wayside measurements were selected to be as far as was practical from commercial power system facilities.

The principal magnetic field source at the wayside locations was clearly catenary current drawn by locomotives within the block being fed by adjacent autotransformers or substations. Field levels were highly variable over time and correlated with trains passing the measurement point. The field levels were highest when the locomotive was a short distance from the measurement location in the direction opposite the nearest substation or autotransformer. This phenomenon was most evident at the Red Bank measurement location on the North Jersey Coast Line and the Princeton Junction measurement location on the 25 Hz section of the NEC, where measurements were made relatively near the substations, but was also plainly present at the Rye measurement location on the autotransformer-fed 60 Hz section of the NEC.

Figure 5-2 shows field by frequency and time plots without the static field suppressed (top frame) and with the static field suppressed (bottom frame) measured at Oak Hill Road approximately two miles west of the Red Bank Substation on the North Jersey Coast Line. A westbound train passes at the 35-second point. The low magnetic field which existed prior to the train's passing increased significantly as the train passed because electric current for traction power drawn by the locomotive was flowing in the catenary and tracks immediately in front of the measurement location.

It is also evident from Figure 5-2 that the principal components of the magnetic field are the 60 Hz fundamental and odd harmonics thereof at 180 Hz, 300 Hz, 420 Hz, 540 Hz, and so forth. This is the same frequency signature seen elsewhere in magnetic fields produced by catenary and track currents on 60 Hz electrified railroads.

The magnetic field magnitudes and characteristics measured with the staff at four heights above the ground at half-meter increments showed no significant variability. That again is consistent with the conclusion that the principal field source is current in the loop made up of the catenary with the track as the return.

The only evidence in Figure 5-2 for a direct magnetic field effect by the locomotive is the minor perturbation in the static field and corresponding low frequency time-varying field components as the train passes. It is not clear whether that minor observation results from the perturbation to the local geomagnetic field by the presence of a large nearby iron and steel structure or whether the observation results from slight movement of the measurement staff by the wind of the train passing only a few feet away. In either case, it appears safe to say that the train itself is not a significant source of either static or time-varying magnetic field.

Figure 5-3 shows data similar to those in Figure 5-2, except that they were simultaneously measured at a point 6.1 m (20 ft) more

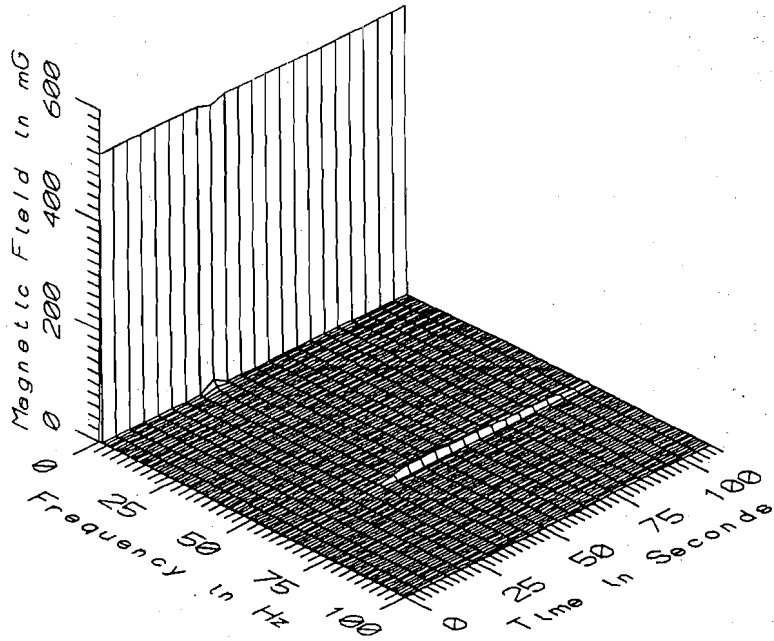

NEC053 - 10_{cm} ABOVE GROUND, 20FT FROM CENTERLINE OF TRACK

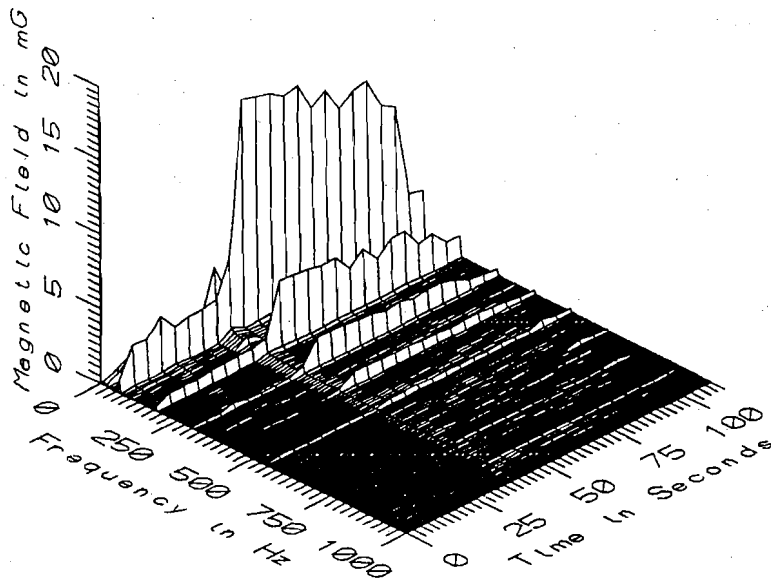

NEC053 - 10_{cm} ABOVE GROUND, 20FT FROM CENTERLINE OF TRACK

FIGURE 5-2. MAGNETIC FIELD LEVEL BY FREQUENCY AND TIME 6.1 M (20 FT) FROM CENTERLINE OF THE NEAREST TRACK ALONG THE WAYSIDE OF THE NORTH JERSEY COAST LINE 2 MILES WEST OF RED BANK. THE STATIC FIELD IS SUPPRESSED IN THE BOTTOM FRAME TO SHOW THE TIME-VARYING FIELD COMPONENTS IN MORE DETAIL

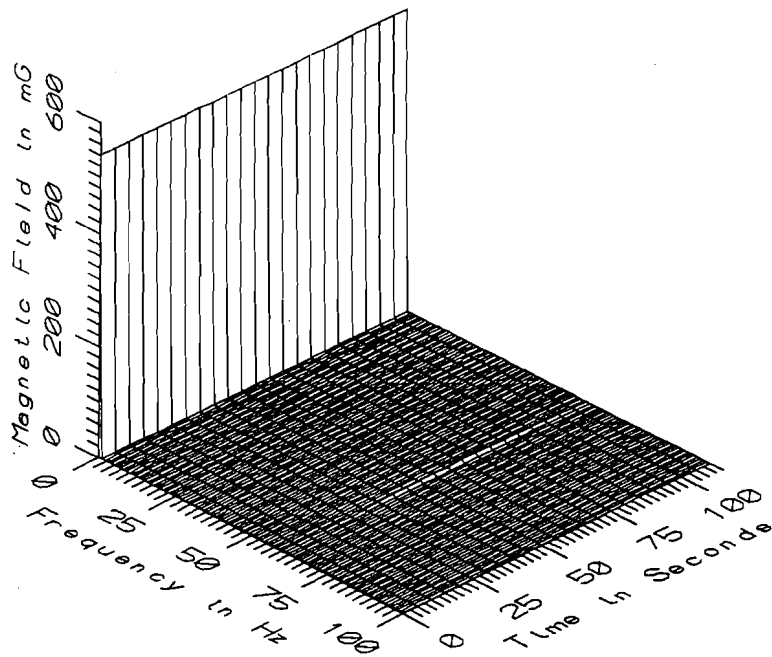

NEC053 - 10cm ABOVE GROUND, 40FT FROM CENTERLINE OF TRACK

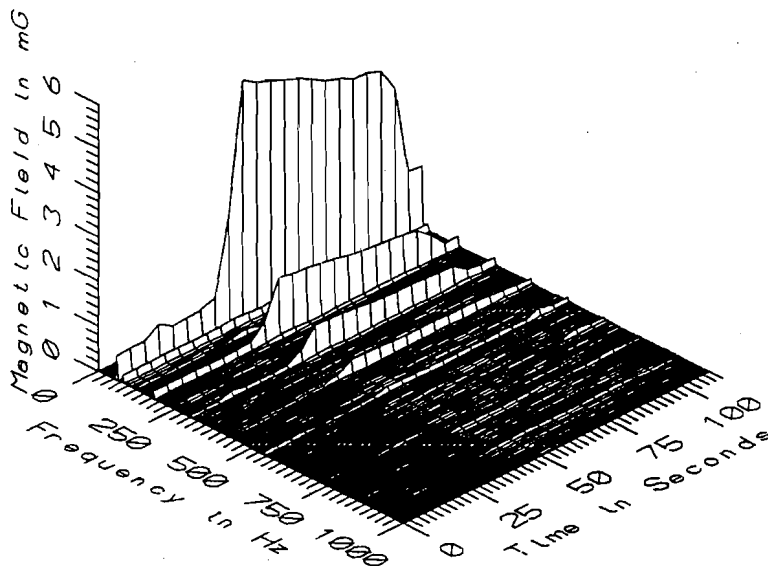

NEC053 - 10cm ABOVE GROUND, 40FT FROM CENTERLINE OF TRACK

FIGURE 5-3. MAGNETIC FIELD LEVEL BY FREQUENCY AND TIME 12.2 M (40 FT) FROM CENTERLINE OF THE NEAREST TRACK ALONG THE WAYSIDE OF THE NORTH JERSEY COAST LINE 2 MILES WEST OF RED BANK. THE STATIC FIELD IS SUPPRESSED IN THE BOTTOM FRAME TO SHOW THE TIME-VARYING FIELD COMPONENTS IN MORE DETAIL

distant from the railroad. Note that the temporal and frequency characteristics of the field are nearly identical, the effect of the passing locomotive on static and low frequency magnetic fields has disappeared, and that while static field levels are essentially identical at both locations, the magnitude of the time-varying magnetic field has decreased about 60%. The static field level remains unchanged because it is entirely the geomagnetic field of the earth. The railroad does not produce a static field of its own. The time-varying field, which is caused by current in the catenary and track, attenuates at increasing distances from the source.

The time-varying magnetic field characteristics 12.2 m (40 ft) and 18.3 m (60 ft) from centerline of the nearest track at the measurement location just north of the Princeton Junction Station and Substation are shown in Figure 5-4. The principal frequency component is again the frequency of the catenary current, 25 Hz in this case. Significant contributions to the total field are also made by the 3rd, 5th, 7th, 9th, 11th, and 13th harmonics. As previously mentioned, the intensity of these field components varies significantly with time depending on the electrical power needs of the locomotives on the section of track north of the measurement point (the opposite direction as the nearby substation). There is also a 50% reduction in field levels 18.3 m (60 ft) from the tracks relative to that 12.2 m (40 ft) from the tracks because the field attenuates at greater distances from the tracks.

A small 60 Hz magnetic field (less than 0.2 mG) can also be seen in Figure 5-4. Since the 60 Hz field is constant over time rather than correlating with train proximity or power consumption, it is in all likelihood from some nearby commercial power system source.

There is also a modest suggestion of a magnetic field component at approximately 100 Hz. That very weak field, less than 0.1 mG at a distance of 12.2 m (40 ft) from the tracks, is probably due to the railroad signal current in the tracks.

5.4 DAT WAVEFORM DATA

Continuous recordings of magnetic field waveforms were made with the DAT Recorder at the measurement sensor site more distant from the tracks in each of the wayside measurement locations depicted in Figure 5-1. The Tape/Record Numbers for these measurements are 5-1A, 5-2A, 5-3A, 6-4, and 6-8. Pertinent information such as the date and time of measurement, measurement duration, and other comments about these recordings can be found in Table 2-2.

The time-varying magnetic field data recorded on the DAT was scanned for significant field transients as described in Section 3.3, but none were found. The rms value of the time-varying field was then analyzed statistically to produce the summary data contained in Table 5-2. Because of the extreme differences in the field characteristics in the two Red Bank datasets described later in Section 5.6.3, the two sets were analyzed separately and combined.

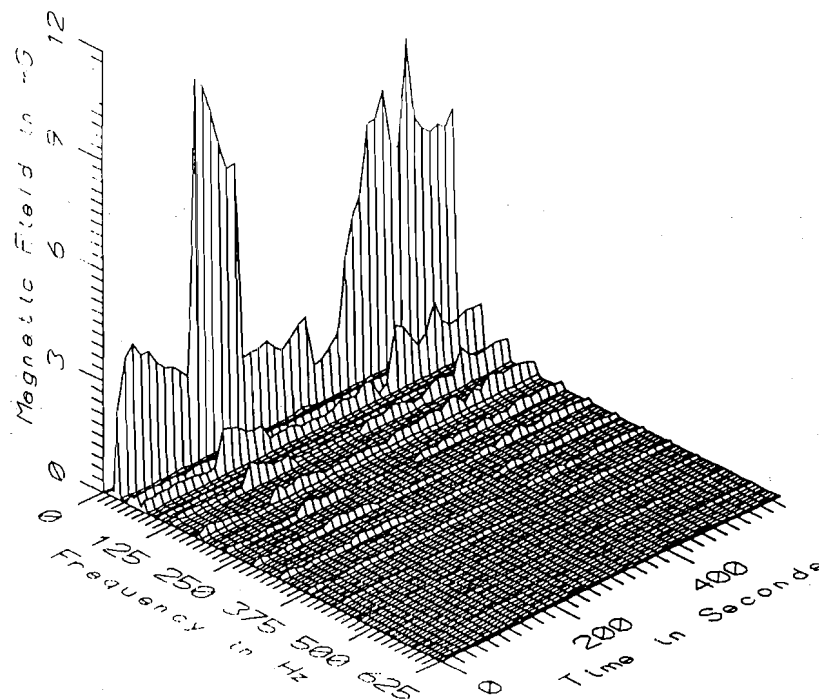

NEC040 - 10cm ABOVE GROUND, 40' WEST OF TRACK #4

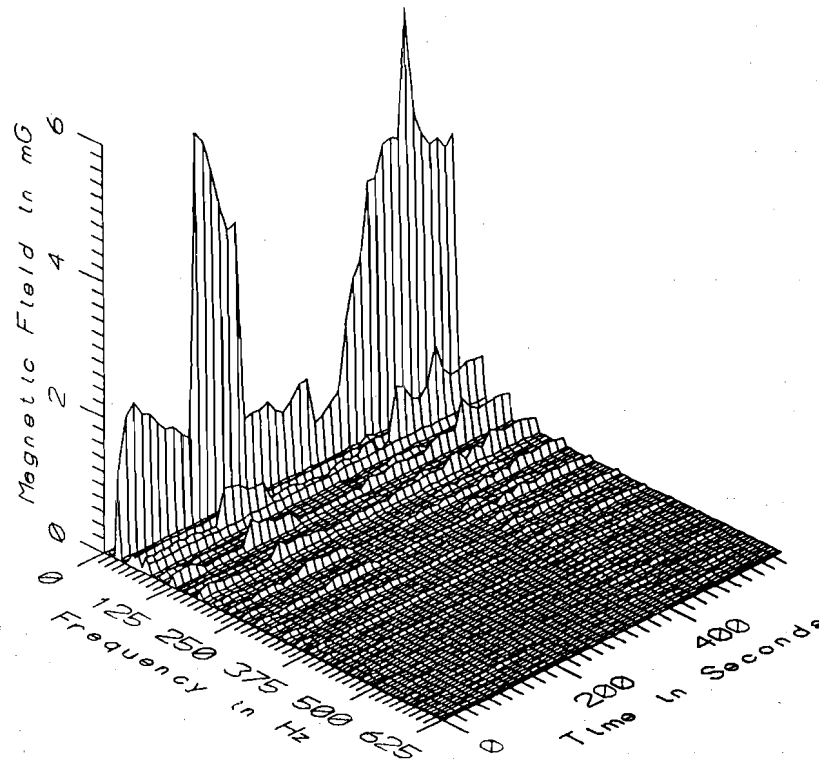

NEC040 - 10cm ABOVE GROUND, 60' WEST OF TRACK #4

FIGURE 5-4.

TIME-VARYING MAGNETIC FIELD LEVELS BY FREQUENCY AND TIME 12.2 M (40 FT) (TOP FRAME) AND 18.3 M (60 FT) (BOTTOM FRAME) FROM CENTERLINE OF THE NEAREST TRACK ALONG THE WAYSIDE OF THE 25 HZ SECTION OF THE NEC 610 M (2000 FT) NORTH OF THE PRINCETON JUNCTION STATION

TABLE 5-2

SUMMARY OF MAGNETIC FIELD LEVELS RECORDED AT THE
WAYSIDE WITH THE DIGITAL AUDIO TAPE RECORDER (DAT)

RAILROAD SECTION (DATASETS)	MEASUREMENT LOCATION		DISTANCE FROM TRACKS	MAGNETIC FIELD, MILLIGAUSS, RMS		
	FIGURE #	LOCATION		MINIMUM	AVERAGE	MAXIMUM
PRINCETON JCT. 25 HZ NEC (5-1A AND 5-2A)	5-1	30	18.3 M (60 FT)	0.2	2.6	15.3
RYE, NY 60 HZ NEC (5-3A)	5-1	32	17.7 M (58 FT)	0.0	3.0	22.5
RED BANK, NJ 60 HZ NJT (6-4)	5-1	34	12.2 M (40 FT)	0.7	1.8	39.9
RED BANK, NJ 60 HZ NJT (6-8)	5-1	36	12.2 M (40 FT)	0.3	2.4	5.2
RED BANK, NJ 60 HZ NJT (6-4 & 6-8)	5-1	34 & 36	12.2 M (40 FT)	0.3	1.9	39.9

5.5 RMS RECORDER DATA

Magnetic field measurements with the rms recorders were only made during the wayside measurements on the north side of the North Jersey Coast Line west of Red Bank. These measurements are difficult to interpret because the field intensity is highly variable with distance from the track and the recorders are worn by members of the test crew who move around through the gradient field in ways that probably have no relevance to the way a nearby resident would move about in the vicinity of the railroad tracks. Nevertheless, a six-minute segment of the rms recordings which occurred during the time when the train passed were examined and the maximum, minimum, and average field recorded by each rms recorder as well as the maximum, minimum, and average of the pooled data from the two rms recorders were calculated and are presented in Table 5-3.

TABLE 5-3

STATISTICAL SUMMARY OF MAGNETIC FIELD LEVELS MEASURED
AT THE WAYSIDE OF THE NORTH JERSEY COAST LINE FOR
SIX MINUTES BRACKETING THE TIME WHEN A TRAIN PASSED

RMS RECORDER	MINIMUM	AVERAGE	MAXIMUM
# 1	0.3 mG	2.4 mG	9.9 mG
# 2	0.6 mG	2.5 mG	5.9 mG
COMBINED	0.3 mG	2.45 mG	9.9 mG

5.6 SUMMARY OF MAGNETIC FIELD LEVELS

Repetitive waveform measurements of magnetic field were made at 5 locations. Four of the locations were at the same horizontal distance from the tracks but at incremental heights in order to determine if there was any significant variability in magnetic field level with height. None was found. The fifth measurement was made at a greater horizontal distance from the tracks than the first four in order to determine the rate at which the magnetic field from the railroad catenary and tracks attenuates with distance from the tracks. Since horizontal attenuation was the important spatial variable in these measurements, the following analysis will examine and compare the field levels measured 10 cm above the ground at the two horizontal distances. Since the vertical profile measurements established that there was no significant magnetic field variability with height above the ground up to 160 cm, the following 10 cm high data are representative at all heights relevant to human exposure.

5.6.1 Magnetic Fields on the 25 Hz Section

The data measured near the Princeton Junction Station (datasets NEC039 and NEC040 in Appendices AN and AO, respectively) characterize the magnetic field environment at the wayside of the 25 Hz section of the NEC. Summary descriptive statistics for those data are presented in Table 5-4. As previously mentioned, the static geomagnetic field of the earth is not significantly affected by railroad operations as evidenced by the consistency of static field intensity over space and time. The principal time-varying component of the magnetic field from this 25 Hz electrified railroad is 25 Hz, which falls in the "low frequency" band. A strong attenuation of low frequency fields is seen at increasing distances from the tracks. The weaker fields in the "power harmonic" and "high frequency" bands are primarily harmonics of the 25 Hz field and show spatial and temporal variability characteristics similar to those for the 25 Hz field component.

TABLE 5-4

SUMMARY STATISTICS FOR DATASETS NEC039 AND NEC040
 MEASURED AT THE WAYSIDE OF THE 25 HZ SECTION
 OF THE NEC NEAR PRINCETON JUNCTION, NJ

NEC039 AND NEC040 - PRINCETON JUNCTION - 10cm ABOVE GND					TOTAL OF 73 SAMPLES	
FREQUENCY BAND	DIST. FROM TRACK (ft)	MINIMUM MAGNETIC FIELD (mG)	MAXIMUM MAGNETIC FIELD (mG)	AVERAGE MAGNETIC FIELD (mG)	STANDARD DEVIATION (mG)	COEFFICIENT OF VARIATION (%)
STATIC	40	512.19	537.35	518.41	10.24	1.98
	60	530.48	533.79	533.07	0.54	0.10
5-45Hz LOW FREQ	40	1.04	27.55	5.99	4.85	81.04
	60	0.60	15.73	3.48	2.70	77.71
50-60Hz PWR FREQ	40	0.43	1.07	0.52	0.11	21.11
	60	0.25	0.65	0.30	0.06	19.90
65-300Hz PWR HARM	40	0.35	4.42	1.19	0.81	68.35
	60	0.29	2.53	0.72	0.43	60.39
305-2560Hz HIGH FREQ	40	0.09	0.78	0.24	0.11	47.39
	60	0.14	0.48	0.20	0.05	27.33
5-2560Hz ALL FREQ	40	1.33	27.91	6.16	4.89	79.35
	60	0.79	15.94	3.59	2.72	75.83

The weak magnetic field in the power frequency band is less variable over time as evidenced by its smaller coefficient of variation because it is produced primarily by nearby commercial power system facilities which tend to be more stable in time than is current in the track and catenary circuit.

The effect of horizontal distance from the centerline of the nearest railroad track is examined by comparing magnetic field values at the two distances from the track in Table 5-4. The attenuation data for the "all frequencies" band, which is the total ELF time-varying magnetic field, are also presented graphically in Figure 5-5.

The DAT data measured 18.3 m (60 ft) from the nearest track at the Princeton Junction location show a maximum field level similar to that listed in Table 5-4, but the average and minimum magnetic field levels identified in the DAT recordings are somewhat lower than those identified in the repetitive waveform measurements. This difference arises from differences in the recording period. The waveform capture system recordings were suspended for periods of time between train passes and therefore, focus on "worst case" conditions. The inclusion of quiescent periods between trains in the DAT recordings tends to lower the minimum and average magnetic field levels recorded.

5.6.2 Magnetic Fields on the 60 Hz Section

Magnetic field characteristics at the wayide of the 60 Hz section of the NEC were measured at Rye, NY. The repetitive waveform measurement data are dataset NEC041 and are reported in detail in Appendix AP. A statistical summary of those data is contained in Table 5-5. Although the maximum magnetic field levels measured at the wayside of the 60 Hz section of the corridor are somewhat higher than those measured at the wayside of the 25 Hz section, the average magnetic field intensity and other characteristics of the magnetic field (except the fundamental frequency, of course) are similar. The reason for the higher maximum field at the Rye measurement location could be related to motive power demands because those measurements were made during the morning rush hour when commuter trains were heavily loaded or could simply be the manifestation of capturing an unusually high field level by virtue of the very large dataset (196 records versus only 73 at Princeton Junction).

Figure 5-6 shows a graphical representation of the total time-varying ELF magnetic field measured at the Rye site. Note that with the exception of the higher maximum magnetic field at Rye, Figure 5-6 is virtually identical to Figure 5-5 which shows the wayside magnetic field data from the Princeton Junction site on the 25 Hz portion of the NEC.

The DAT measurements at this location showed field levels similar to those recorded by the waveform capture system. Although there remains a small tendency toward lower average and minimum field levels in the DAT recordings, the differences between DAT data and

NEC039 & NEC040 - PRINCETON JUNCTION

ALL FREQUENCIES (5-2560 Hz)

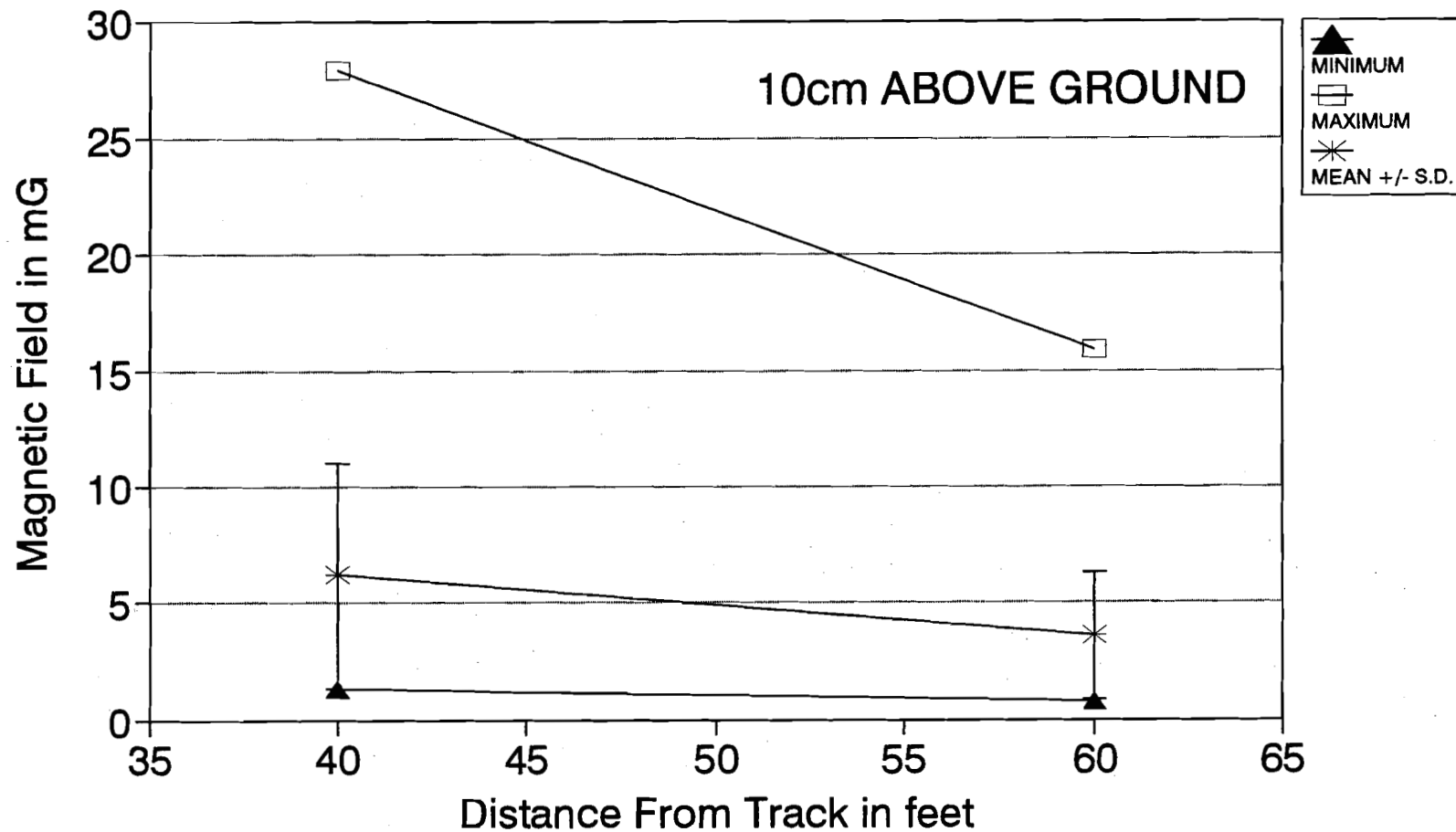

5-13

FIGURE 5-5. HORIZONTAL PROFILE TOTAL ELF MAGNETIC FIELD STRENGTH AT THE WAYSIDE OF THE 25 HZ SECTION OF THE NEC NEAR PRINCETON JUNCTION, NJ

TABLE 5-5

**SUMMARY STATISTICS FOR DATASET NEC041 MEASURED
AT THE WAYSIDE OF THE 60 HZ SECTION
OF THE NEC IN RYE, NY**

NEC041 - METRO NORTH WAYSIDE, RYE, NY - 10cm ABOVE GROUND TOTAL OF 196 SAMPLES						
FREQUENCY BAND	DIST. FROM TRACK (ft)	MINIMUM MAGNETIC FIELD (mG)	MAXIMUM MAGNETIC FIELD (mG)	AVERAGE MAGNETIC FIELD (mG)	STANDARD DEVIATION (mG)	COEFFICIENT OF VARIATION (%)
STATIC	39	524.00	532.04	529.00	2.48	0.47
	58	521.78	526.82	523.86	0.77	0.15
5-45Hz LOW FREQ	39	0.11	0.59	0.24	0.08	31.28
	58	0.02	0.21	0.04	0.03	66.19
50-60Hz PWR FREQ	39	0.20	43.59	5.73	6.66	116.35
	58	0.12	21.30	3.31	3.43	103.83
65-300Hz PWR HARM	39	0.10	8.26	1.17	1.27	108.30
	58	0.16	3.98	0.73	0.64	87.52
305-2560Hz HIGH FREQ	39	0.04	1.69	0.32	0.28	88.29
	58	0.13	0.85	0.25	0.13	49.73
5-2560Hz ALL FREQ	39	0.27	44.40	5.88	6.77	115.18
	58	0.25	21.68	3.41	3.48	101.95

NEC041 - WAYSIDE NEAR RYE, NY

ALL FREQUENCIES (5-2560 Hz)

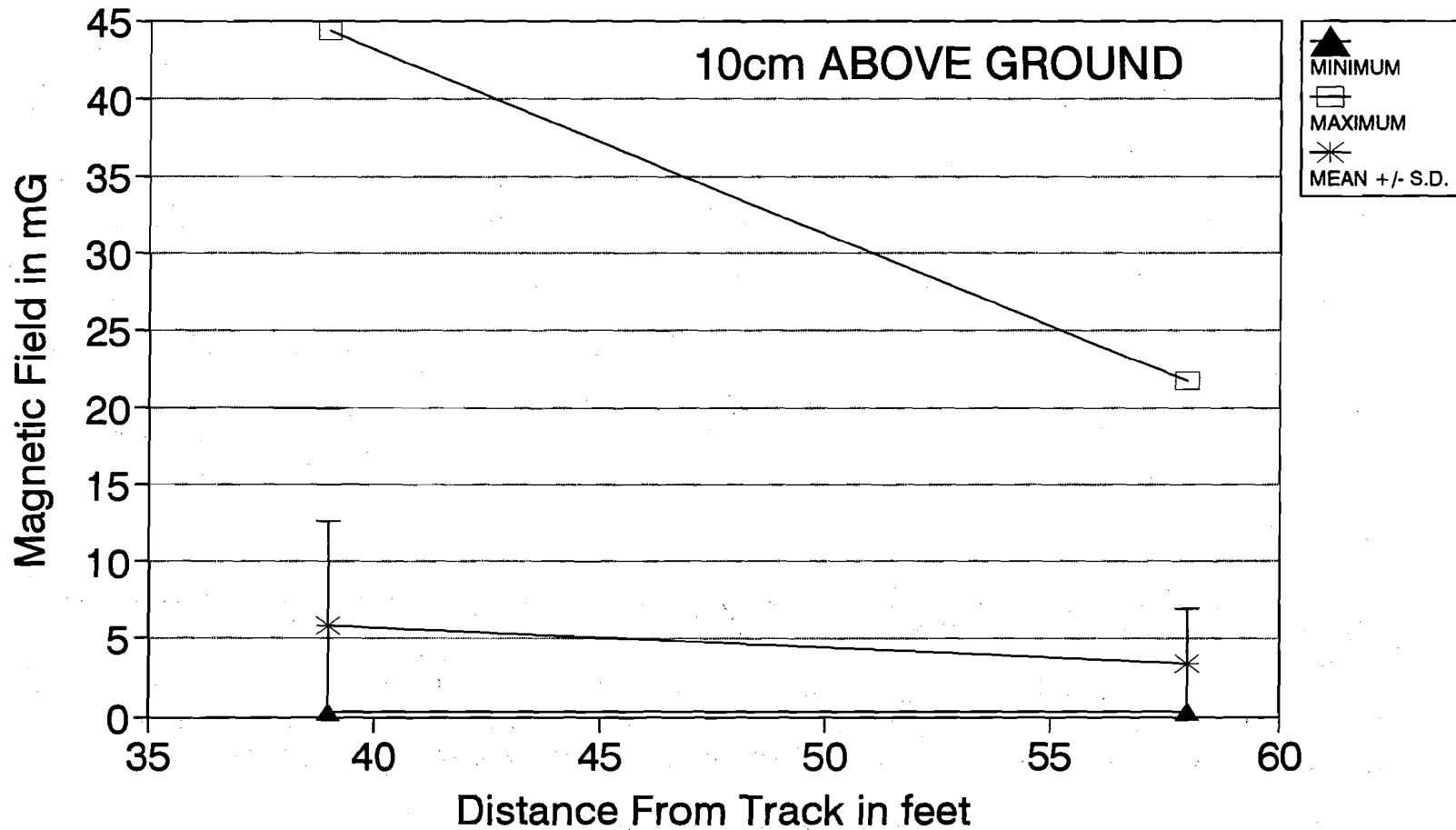

FIGURE 5-6. HORIZONTAL PROFILE OF TOTAL ELF MAGNETIC FIELD STRENGTH AT THE WAYSIDE OF THE 60 HZ SECTION OF THE NEC NEAR RYE, NEW YORK

waveform capture system data are very small, presumably due to the fact that the waveform capture system recording was much longer and contained data from quiescent periods between train passes.

5.6.3 Magnetic Fields on the North Jersey Coast Line

Two separate sets of measurements were made at the wayside of the North Jersey Coast Line at a grade crossing approximately two miles west of the town of Red Bank, NJ. The first set of measurements which produced dataset NEC047 (Appendix AV) were made late one evening. A train passed almost immediately after the test began, but then there was a long period with no more railroad traffic. Additional tests (NEC053, Appendix BB) were conducted on the opposite side of the tracks at midday on the following day. Unfortunately, the temporal and intensity characteristics of these two datasets are very different, and it is not clear that they can be legitimately pooled for statistical analysis. Consequently, the data were examined together and individually.

Summary statistics for the pooled data are given in Table 5-6 and the total time-varying field in all frequency ranges is shown graphically in Figure 5-7. These data show a larger maximum magnetic field level and much larger standard deviation and coefficient of variation than the NEC data discussed previously. Those irregularities are due to the characteristics of dataset NEC047 which, as shown in Appendix AV, consists of 15 seconds of high 60 Hz and harmonic fields, followed by 10 seconds of more modest 60 Hz and harmonic fields and finally, the remainder of the recording with no more fields due to there being no more train activity on the portion of the catenary beyond the measurement point from the substation.

If dataset NEC047 is deleted from the statistical analysis, the results presented in Table 5-7 and Figure 5-8 result. These results come from dataset NEC053 during midday when more trains are active on the portion of the catenary beyond the measurement point. During this time period, maximum magnetic field levels recorded (maximum of 16.5 mG) are much less than the previous evening (maximum of 124.4 mG) but, because of the greater number of trains, the average field is larger. The large number of samples in dataset NEC047 without railroad activity significantly diluted the average field level.

The attenuation of the magnetic field produced by current in the catenary and tracks is more obvious in Figure 5-8 than in Figure 5-7 because during the periods of railroad inactivity included in Figure 5-7, the principal field source was the distribution line on the east side of Oak Hill Road. Since it was equidistant from both sensors, the background fields were approximately equal.

The DAT data at the Red Bank wayside location shown earlier in Table 5-2 were also analyzed as two distinct datasets and as pooled data. The DAT data are consistent with the repetitive waveform data of Tables 5-6 and 5-7, except that the average magnetic field value for DAT data in dataset 4 of tape 6 (and therefore the

TABLE 5-6

SUMMARY STATISTICS FOR DATASETS NEC047 AND NEC053 MEASURED
AT THE WAYSIDE OF THE NEW JERSEY TRANSIT NORTH JERSEY
COAST LINE NEAR RED BANK, NJ

NEC047 & NEC053 - NJ TRANSIT, RED BANK, NJ - 10cm ABOVE GROUND						128 SAMPLES
FREQUENCY BAND	DIST. FROM TRACK (ft)	MINIMUM MAGNETIC FIELD (mG)	MAXIMUM MAGNETIC FIELD (mG)	AVERAGE MAGNETIC FIELD (mG)	STANDARD DEVIATION (mG)	COEFFICIENT OF VARIATION (%)
STATIC	20	454.33	521.01	468.81	5.26	1.12
	40	506.27	541.81	514.98	12.45	2.42
5-45Hz LOW FREQ	20	0.10	4.93	0.58	0.74	127.48
	40	0.02	1.35	0.07	0.15	215.61
50-60Hz PWR FREQ	20	0.87	121.76	5.39	18.01	333.95
	40	0.55	40.60	2.60	5.88	225.85
65-300Hz PWR HARM	20	0.31	25.04	1.42	3.72	262.64
	40	0.25	7.63	0.66	1.07	162.30
305-2560Hz HIGH FREQ	20	0.07	5.47	0.32	0.81	253.34
	40	0.16	1.65	0.22	0.22	98.00
5-2560Hz ALL FREQ	20	0.98	124.43	5.68	18.40	323.98
	40	0.62	41.34	2.71	5.98	220.60

NEC047 & NEC053 - NEAR RED BANK, NJ

ALL FREQUENCIES (5-2560 Hz)

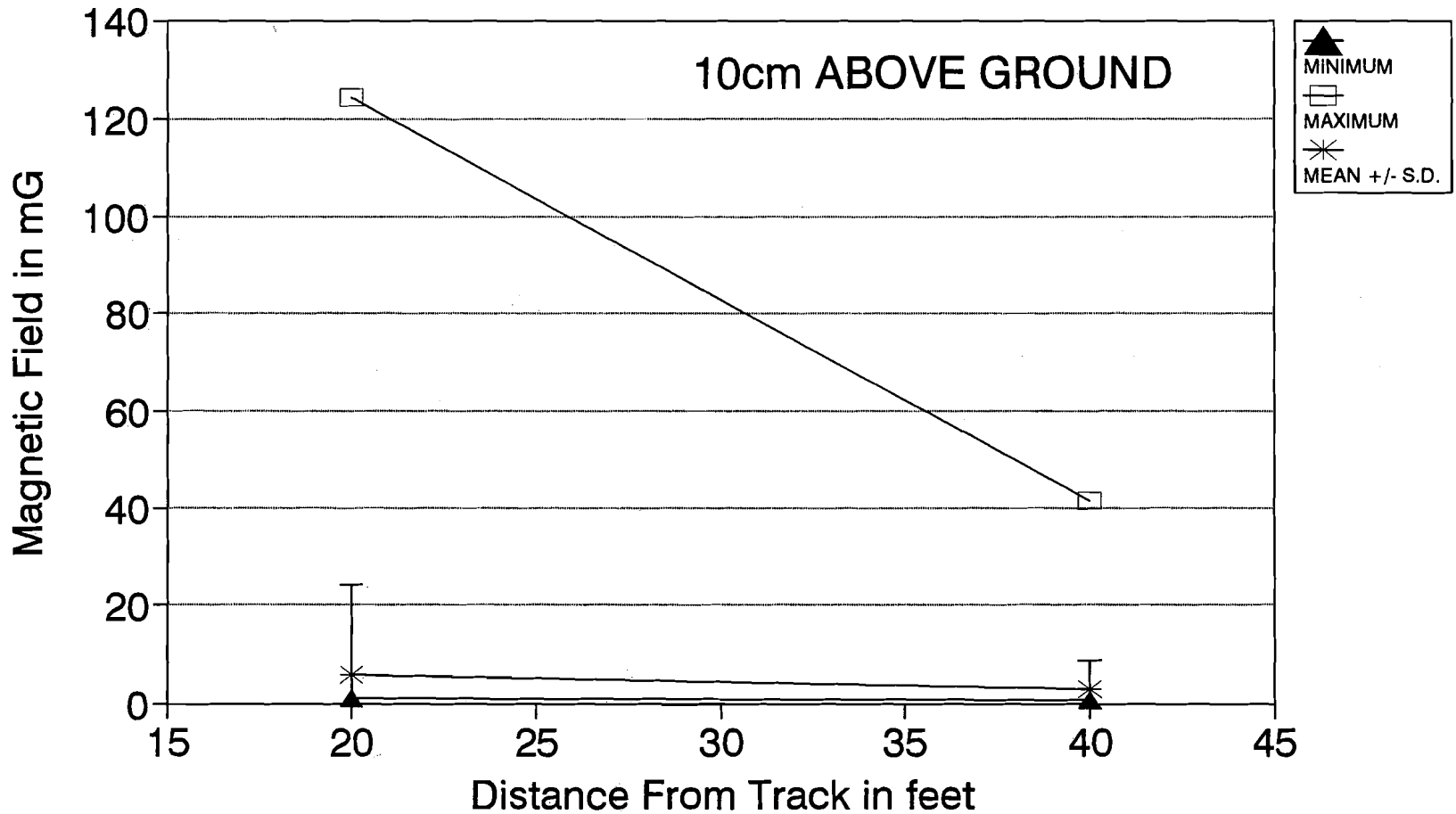

81-5

FIGURE 5-7. HORIZONTAL PROFILE OF TOTAL ELF MAGNETIC FIELD STRENGTH AT THE WAYSIDE OF THE NORTH JERSEY COAST LINE NEAR RED BANK, NJ BASED ON POOLED DATASETS

TABLE 5-7

SUMMARY STATISTICS FOR DATASET NEC053 MEASURED AT
THE WAYSIDE OF THE NEW JERSEY TRANSIT NORTH JERSEY
COAST LINE NEAR RED BANK, NJ

NEC053 - NJ TRANSIT, RED BANK, NJ - 10cm ABOVE GROUND		TOTAL OF 23 SAMPLES				
FREQUENCY BAND	DIST. FROM TRACK (ft)	MINIMUM MAGNETIC FIELD (mG)	MAXIMUM MAGNETIC FIELD (mG)	AVERAGE MAGNETIC FIELD (mG)	STANDARD DEVIATION (mG)	COEFFICIENT OF VARIATION (%)
STATIC	20	509.54	521.01	519.69	1.97	0.38
	40	539.03	541.81	541.29	0.57	0.11
5-45Hz LOW FREQ	20	0.31	4.93	1.92	0.84	43.97
	40	0.02	0.07	0.05	0.02	36.44
50-60Hz PWR FREQ	20	0.87	15.58	8.39	5.34	63.71
	40	0.55	5.35	2.81	1.92	68.20
65-300Hz PWR HARM	20	0.31	4.98	2.57	1.61	62.77
	40	0.25	1.49	0.75	0.47	62.74
305-2560Hz HIGH FREQ	20	0.08	1.14	0.61	0.35	57.61
	40	0.16	0.40	0.26	0.09	33.24
5-2560Hz ALL FREQ	20	0.98	16.53	9.13	5.43	59.48
	40	0.62	5.57	2.93	1.96	67.15

NEC053 - WAYSIDE NEAR RED BANK, NJ

ALL FREQUENCIES (5-2560 Hz)

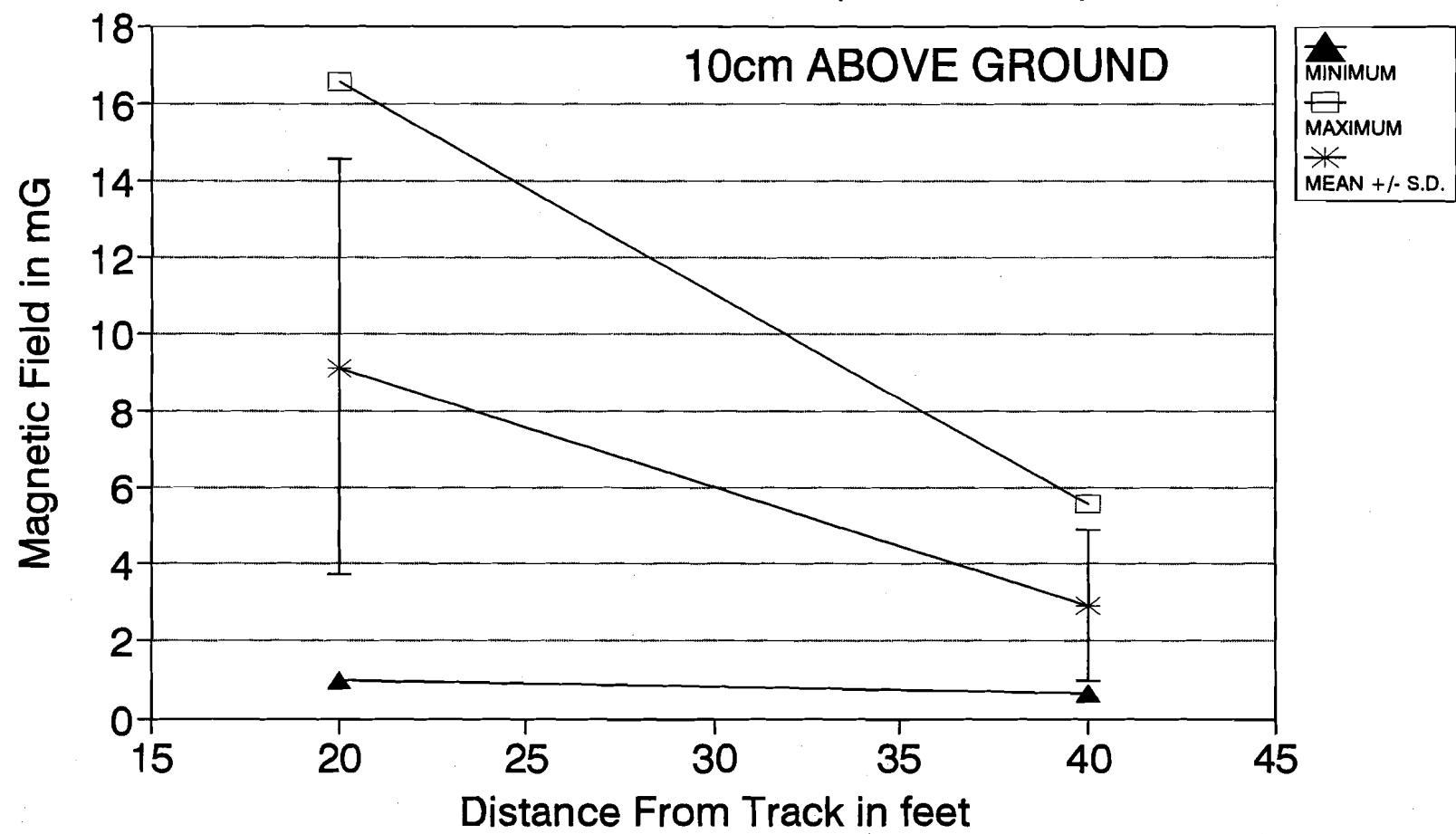

5-20

FIGURE 5-8. HORIZONTAL PROFILE OF THE TOTAL ELF MAGNETIC FIELD STRENGTH AT THE WAYSIDE OF THE NORTH JERSEY COAST LINE NEAR RED BANK, NJ BASED ON DATASET NEC053

combined field data) is more extensively diluted by a much longer (13-minute) recording period without any railroad activity. During that time, the time-varying magnetic field recorded by the DAT was not from the railroad but from a commercial electric distribution line on the opposite side of Oak Hill Road.

The rms recorder measurements (Table 5-3) were only made during the April 3rd measurements at the Red Bank wayside location while recording the waveform capture system dataset NEC053 (Table 5-7 and Appendix BB) and DAT dataset 8 of tape 6 (Table 5-2). The mean values of the rms recorder measurements are comparable to the waveform capture system and DAT measurements 12.2 m (40 ft) from the track. The maximum values vary somewhat due to the mobility of the people wearing the recorders, but are consistent with maximum field values 12.2 m (40 ft) from the tracks or a little closer.

5.6.4 Magnetic Field Attenuation

The magnetic field measurements at the wayside of the electrified railroads established that electric current in the catenary and track required for locomotive traction needs was the principal magnetic field source. The magnetic field generated by such balanced line sources theoretically attenuates at a rate inversely proportional to the distance squared ($1/d^2$). Figures 5-9 to 5-12 show the mean and maximum magnetic field levels at the three wayside measurement locations along with attenuation curves based on the theoretical rate of $1/d^2$ fitted through the data. Four graphs are included for the three measurement sites because the two Red Bank datasets north and south of the tracks differed in character and are analyzed separately. The attenuation rates plotted on graphs with logarithmic scales, such as those in Figures 5-9 through 5-12, are straight lines except near the source, where some curvature is introduced by the large dimension of the source and inconsistencies between horizontal distance from the nearest track and the effective distance to the source. Nevertheless, as the graphs demonstrate, the measured field attenuation between the two measurement sensor locations fit well to the theoretical $1/d^2$ attenuation rate.

Analytical curve fitting of the measured data to a general exponential attenuation rate ($1/d^n$) revealed a rate factor ranging very near $n=2$, confirming that the measured data well fit the theoretical attenuation rate of $1/d^2$.

Based on the field attenuation data contained in Figures 5-9 through 5-12, the maximum and average magnetic fields at two distances from the track have been determined and listed in Table 5-8.

Table 5-9 shows the point at which the value of the field attenuates to a 1 mG value. This is given as a distance from the track, in feet.

PRINCETON JUNCTION, NJ

2000' North of Station

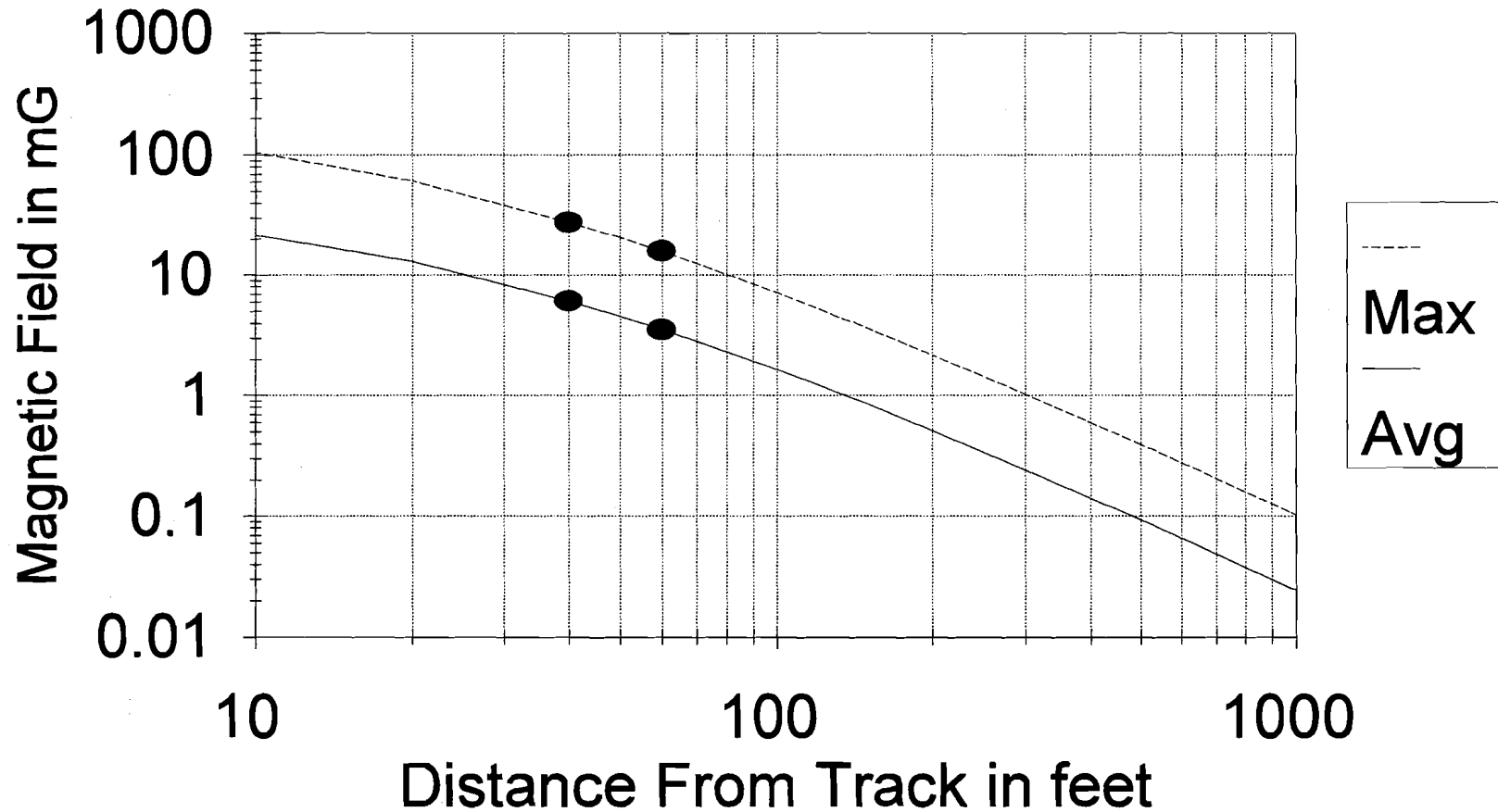

5-22

FIGURE 5-9. THEORETICAL ATTENUATION CURVES FITTED THROUGH THE AVERAGE AND MAXIMUM MAGNETIC FIELD VALUES MEASURED AT THE WAYSIDE OF THE 25 HZ SECTION OF THE NEC AT PRINCETON JUNCTION, NJ

RYE, NY

Courtyard Hotel Parking Lot

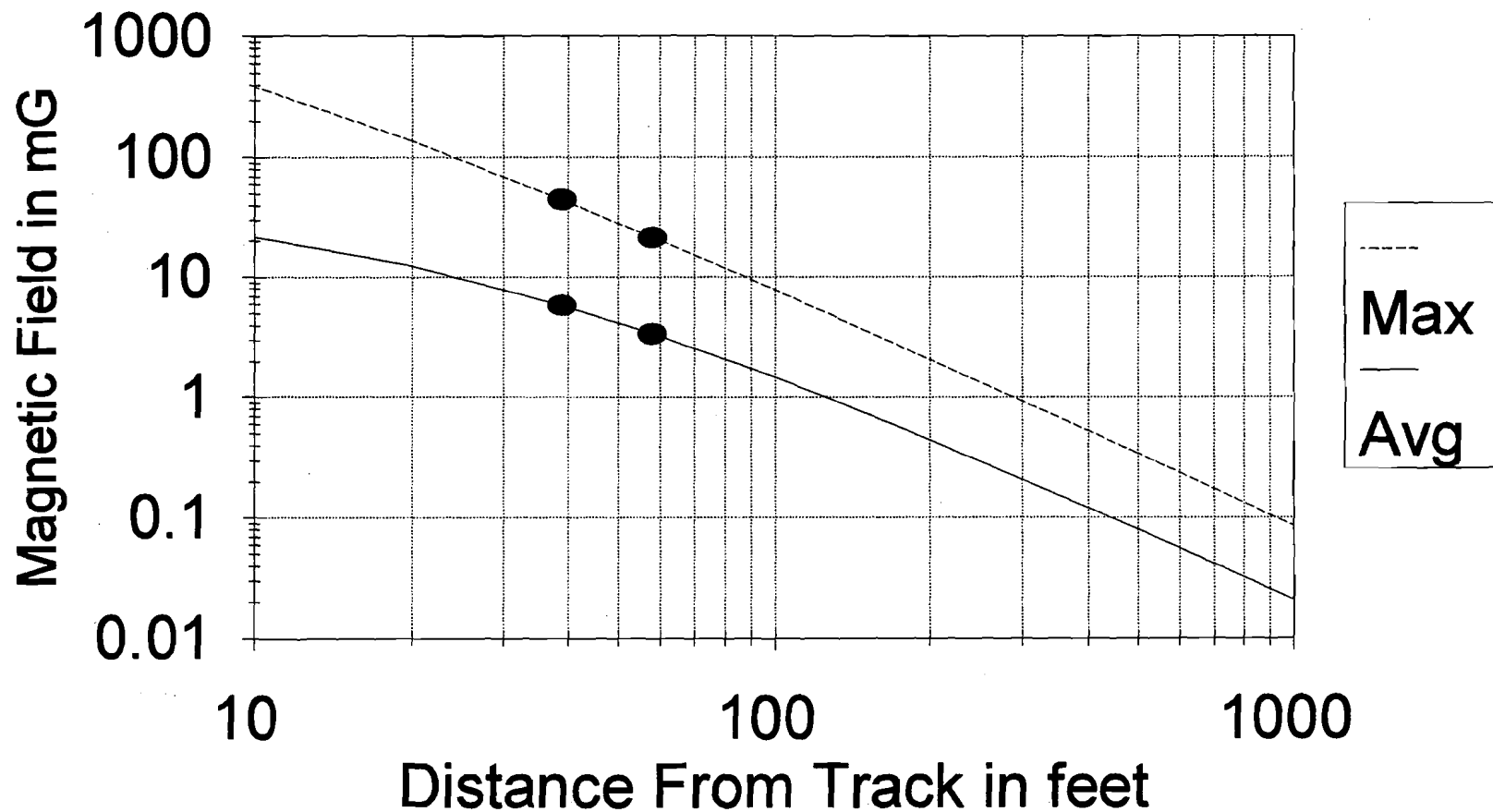
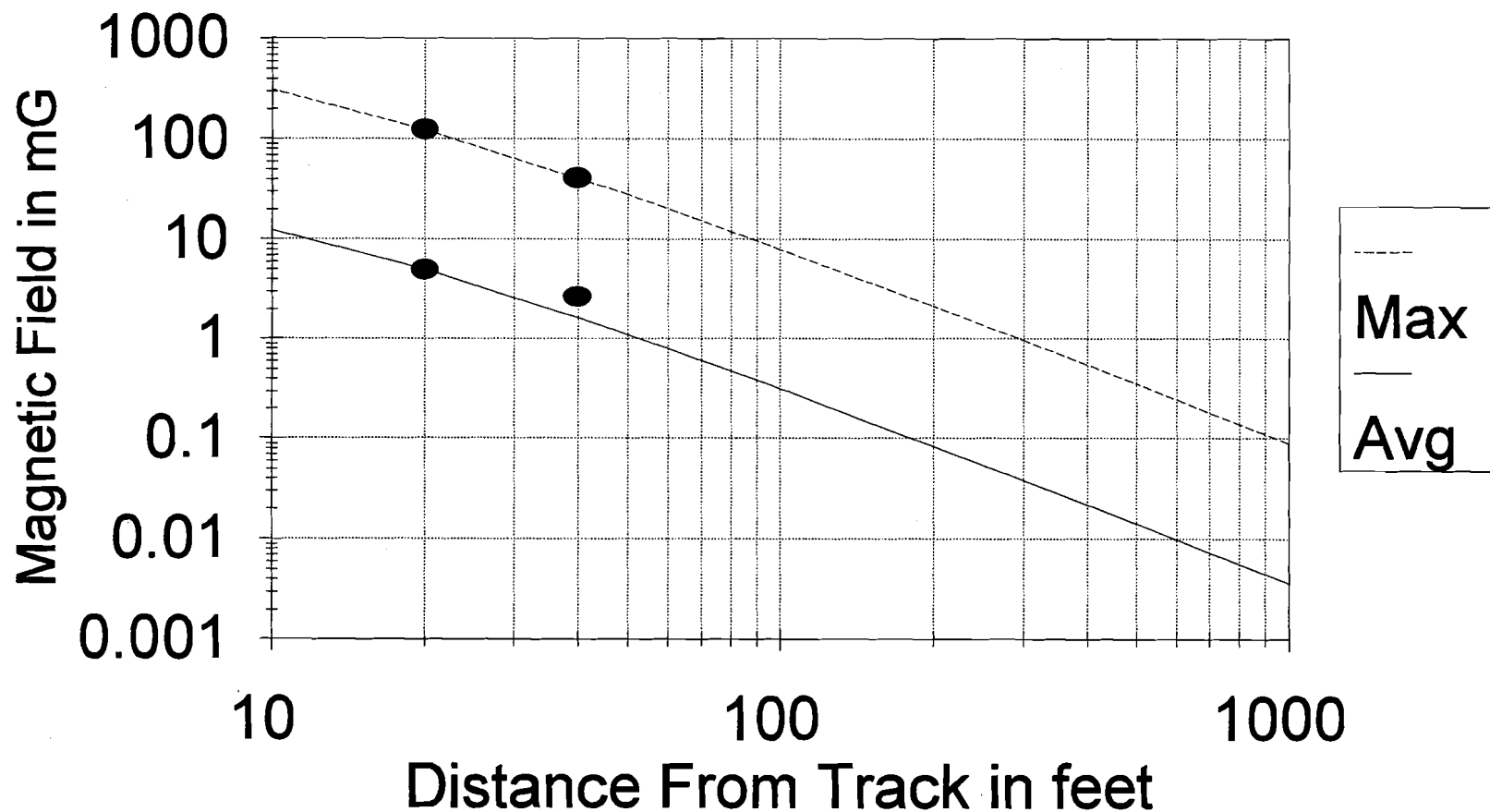

FIGURE 5-10. THEORETICAL ATTENUATION CURVES FITTED THROUGH THE AVERAGE AND MAXIMUM MAGNETIC FIELD VALUES MEASURED AT THE WAYSIDE OF THE 60 HZ SECTION OF THE NEC AT RYE, NY

RED BANK, NJ

South of Southern Track



5-24

FIGURE 5-11. THEORETICAL ATTENUATION CURVES FITTED THROUGH THE AVERAGE AND MAXIMUM MAGNETIC FIELD VALUES MEASURED AT THE SOUTH SIDE OF THE NORTH JERSEY COAST LINE NEAR RED BANK, NJ

RED BANK, NJ

North of Northern Track

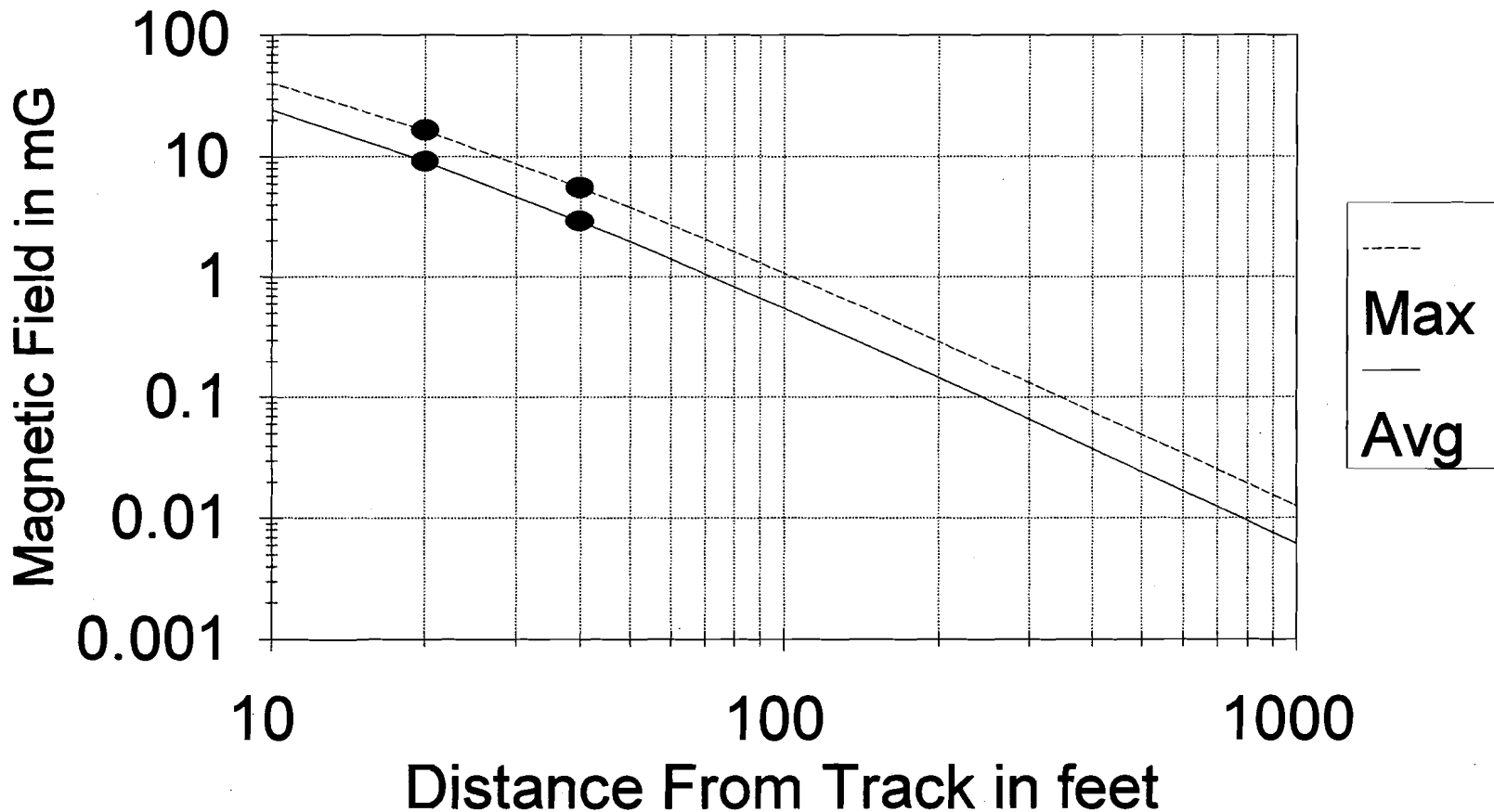

5-25

FIGURE 5-12. THEORETICAL ATTENUATION CURVES FITTED THROUGH THE AVERAGE AND MAXIMUM MAGNETIC FIELD VALUES MEASURED AT THE NORTH SIDE OF THE NORTH JERSEY COAST LINE NEAR RED BANK, NJ

TABLE 5-8

AVERAGE AND MAXIMUM MAGNETIC FIELD LEVELS AT DISCRETE DISTANCES FROM THE NEAREST TRACK BASED ON MEASURED MAGNETIC FIELD LEVELS AT THREE LOCATIONS

DISTANCE FROM TRACK	PRINCETON JUNCTION, NJ	RYE, NY	RED BANK-NORTH	RED BANK-SOUTH
MAXIMUM				
15.3 M (50 FT)	20.68	28.44	3.81	28.15
45.8 M (150 FT)	3.62	3.59	0.51	3.73
AVERAGE MAX				
15.3 M (50 FT)	4.62	4.21	1.98	1.11
45.8 M (150 FT)	0.84	0.73	0.26	0.15

TABLE 5-9

DISTANCE FROM THE TRACK AT WHICH AVERAGE AND MAXIMUM MAGNETIC FIELD LEVELS WILL REACH 1.0 MG BASED ON EXTRAPOLATION OF DATA MEASURED AT THREE LOCATIONS

	PRINCETON JUNCTION, NJ	RYE, NY	RED BANK-NORTH	RED BANK-SOUTH
MAXIMUM	93 M (305 FT)	88.1 M (289 FT)	32 M (105 FT)	90.3 M (296 FT)
AVERAGE MAX	41.5 M (136 FT)	38.1 M (125 FT)	22.3 M (73 FT)	16.2 M (53 FT)

5.6.5 Effects of Electrification Technology

The large disparity between maximum and average magnetic field levels measured at the wayside of the North Jersey Coast Line near Red Bank at two different times (Tables 5-6 and 5-7), as well as the disparity between field levels at various distances from the railroad (Tables 5-8 and 5-9) arrived at by extrapolation of those data, dramatically indicates the kind of variability in magnetic field levels which can arise from uncontrolled variables in brief measurements such as those reported here. Examination of the data in Figures 5-8 and 5-9 shows that variability in field levels at two different times (Red Bank-North and Red Bank-South) on the same railroad is larger than the variability between different railroad sections. Consequently, with the exception of field frequency, these tests are unable to detect any consistent difference in magnetic field characteristics at the wayside which can be attributed to electrification technology.

5.7 SUMMARY OF ELECTRIC FIELD LEVELS

Electric field measurements were made at each of the wayside measurement locations, but not always at the exact location of the magnetic field measurement. That is because sometimes nearby objects, such as fences, would severely affect the electric field measurement. Instead, the electric field was measured at specific sensor locations where the least amount of shielding from nearby conductive objects would distort the measurements. Because of the presence of either forested land or man-made objects at the edge of the railroad right-of-way, it was not possible to be completely free of objects which would tend to shield the electric field. Table 5-10 lists the distance from the nearest track where the electric field measurements were made, the magnitude of the field, and the presence of nearby shielding objects.

The electric field expected from the catenaries, transmission lines, and return conductors were calculated with a computer program⁴ written by the U.S. Department of Energy, Bonneville Power Authority for the calculation of electric fields near power lines. The program is suitable for the calculation of electric fields at the wayside of electrified railroads, but it fails to account for the shielding effects of nearby buildings, trees, and other conductive objects. Calculated electric field values represent an upper boundary of real world electric field levels which are usually attenuated by nearby conductive objects.

The calculated electric field from the 11 kV, 25 Hz catenary and 138 kV, 25 Hz transmission lines as a function of distance from the track at the Princeton Junction measurement location is shown in Figure 5-13, along with the actual electric field measurements. The difference between calculated and measured electric field levels is larger at the 18.3 m (60 ft) measurement location because that location was nearer the trees and the shielding was greater.

TABLE 5-10

MEASURED ELECTRIC FIELD LEVELS
AT WAYSIDE LOCATIONS

MEASUREMENT LOCATION AND RAILROAD SECTION	DISTANCE FROM TRACKS	FIELD LEVEL	NEARBY SHIELDING OBJECTS
PRINCETON JUNCTION SITE 25 HZ NEC	12.2 M (40 FT) 18.3 M (60 FT)	285 V/m 80 V/m	TALL TREES APPROXIMATELY 22.9 M (75 FT) FROM THE TRACKS
RYE, NY SITE 60 HZ NEC	6.7 M (22 FT)	60 V/m	FENCE 11.6 M (38 FT) FROM TRACKS
RED BANK SOUTH SITE	6.1 M (20 FT)	315 V/m	SIGNAL EQUIP. ENCLOSURE 4.6 M (15 FT) WEST, TALL TREES 12.2 M (40 FT) SOUTH OF TRACKS

The calculated electric field attenuation pattern near the 60 Hz section of the corridor shown in Figure 5-14 is lower and more complex than that for the wayside location at Princeton Junction because of the partial cancellation of fields from the catenary and fields from the autotransformer primary return conductor. The measured field level is in close agreement with the calculated levels because the measurement was made on the right-of-way away from major sources of electric field shielding.

Similarly, Figure 5-15 shows the calculated 60 Hz electric field from the 12.5 kV catenary on the North Jersey Coast Line near Red Bank, NJ. Again, the measured electric field is slightly less than the theoretical limit that would exist in the absence of shielding from nearby objects.

Princeton Jct. 25 Hz Section of the NEC

5-29

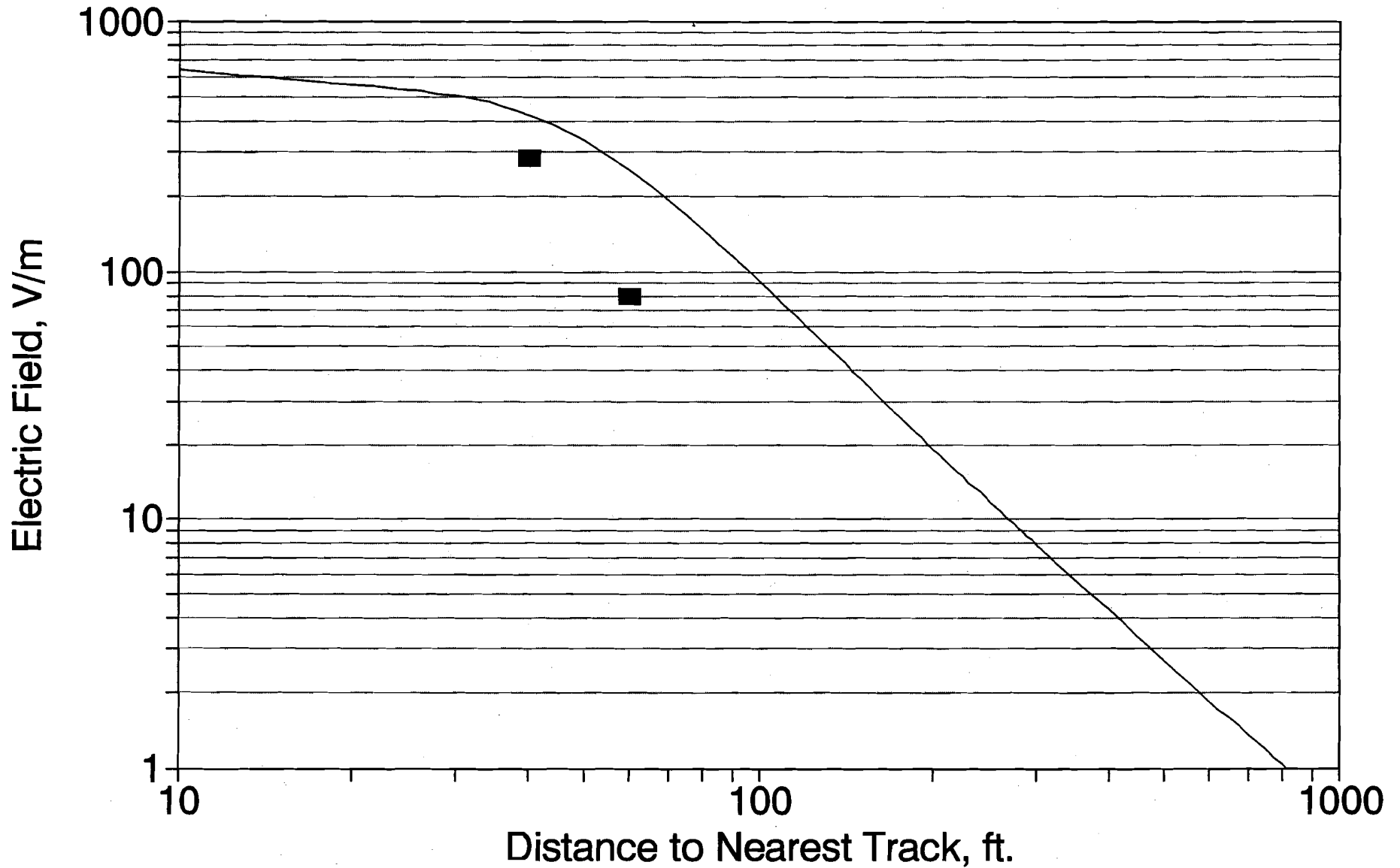

FIGURE 5-13. CALCULATED AND MEASURED 25 HZ ELECTRIC FIELD LEVELS AT THE WAYSIDE OF THE 25 HZ SECTION OF THE NEC AT THE PRINCETON JUNCTION MEASUREMENT SITE

Rye, NY 60 Hz Section of the NEC

5-30

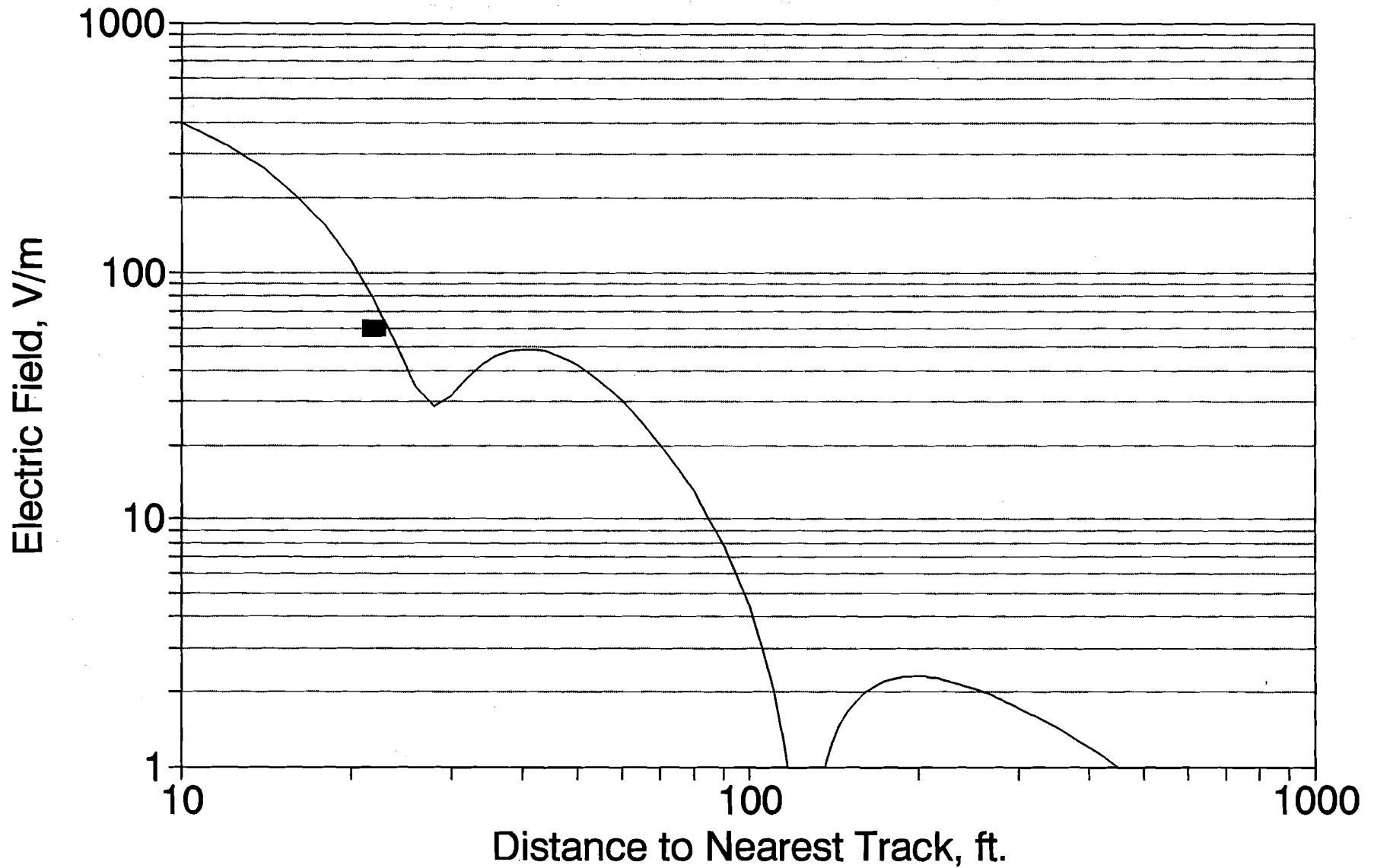
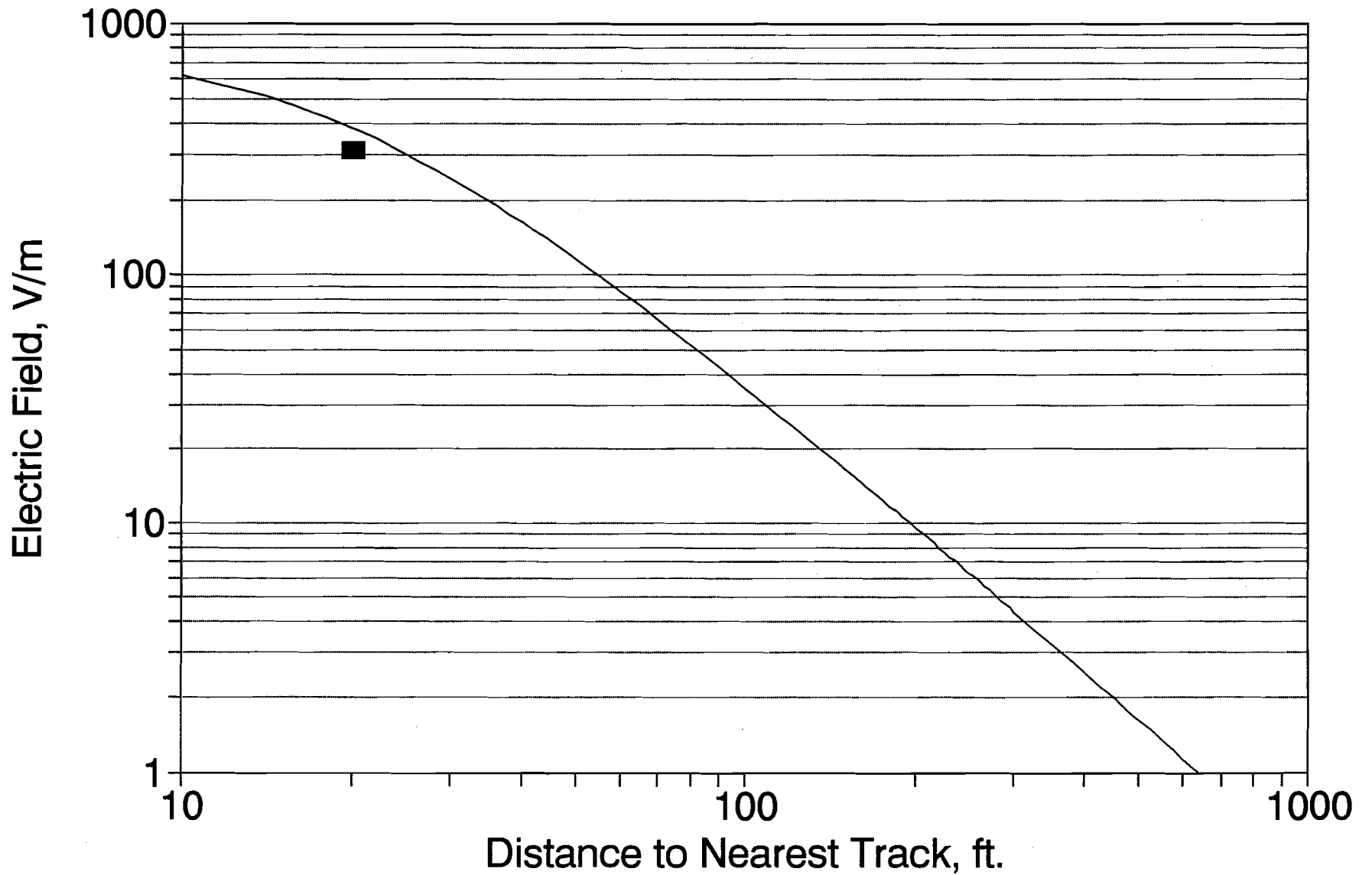

FIGURE 5-14. CALCULATED AND MEASURED 60 HZ ELECTRIC FIELD LEVELS AT THE WAYSIDE OF THE 60 HZ SECTION OF THE NEC AT THE RYE, NY MEASUREMENT SITE

Red Bank, 60 Hz Section of NJT Line



5-31/5-32

FIGURE 5-15. CALCULATED AND MEASURED 60 HZ ELECTRIC FIELD LEVELS AT THE WAYSIDE OF THE NORTH JERSEY COAST LINE AT THE RED BANK MEASUREMENT SITE

6. PASSENGER STATION ELECTRIC AND MAGNETIC FIELD MEASUREMENTS

Magnetic field measurements were made on the station platforms at three stations:

Princeton Junction, NJ - 25 Hz NEC
New Rochelle, NY - 60 Hz NEC
Red Bank, NJ - 60 Hz North Jersey Coast Line

The measurements generally consisted of repetitive waveform measurements at the yellow safety line on the platform because that was the nearest to the tracks that a person could safely stand. Measurements typically continued fifteen to thirty minutes in order to allow several trains to stop and depart the station or to pass by the station. At the Princeton Junction and the New Rochelle Stations on the NEC, the AMTRAK trains passed through without stopping. However, several self-powered commuter trains (MUs) stopped at the station. At the Red Bank Station, all trains stopped. Some were heavy electric or diesel-electric locomotives with coaches, and others were MUs.

Larger stations, such as Union Station in Washington, Penn Station in New York, and South Station in Boston prohibit passengers from waiting on the station platform. At those stations, passengers wait in a central lounge until their train arrives. Magnetic field levels were measured near the center of the waiting lounge at the South Station in Boston and Penn Station in New York because those stations represented large non-electrified and large electrified stations, respectively.

6.1 MEASUREMENT LOCATIONS

Figures 6-1 and 6-2 show the general locations where magnetic field measurements were made on the station platforms. Although magnetic field measurements were made at the Mt. Vernon (NY) Station, they were of short duration and focused on quantifying the magnetic field from the electrical substation. Since no trains passed during the time of the measurements, the data are not included in the analysis of fields at stations.

The measurements in the waiting area at the Boston South Station were at a seating area in the middle of a large lounge. The measurement point was approximately 7.6 m (25 ft) from the wall which separated the lounge area from the platform. At the Penn Station, the waiting lounge is located above the platform level. The magnetic field measurements were made in the center of a seating area judged to be above the tracks having 25 Hz catenary.

Princeton Junction Station AMTRAK 25Hz

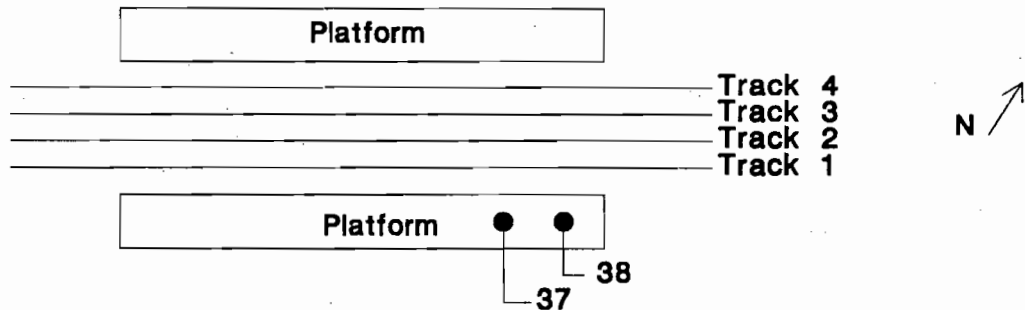

New Rochelle Station AMTRAK 60Hz

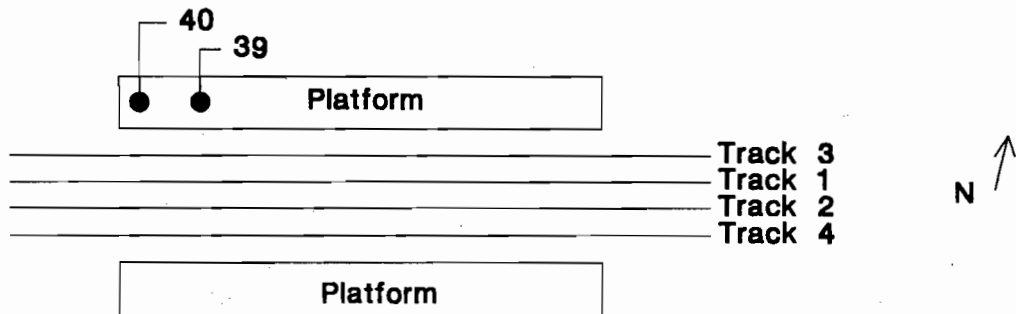
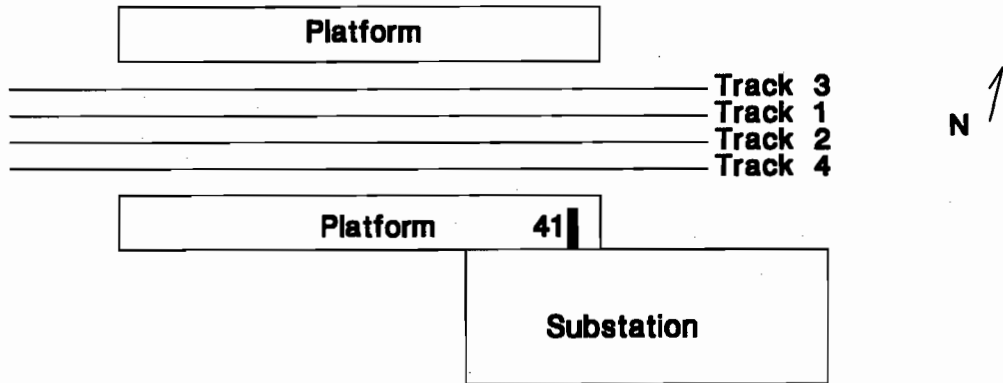

FIGURE 6-1. REPETITIVE MAGNETIC FIELD WAVEFORM MEASUREMENT LOCATIONS ON TWO NORTHEAST CORRIDOR STATION PLATFORMS

Mt. Vernon AMTRAK 60Hz



Red Bank Station Long Branch Line

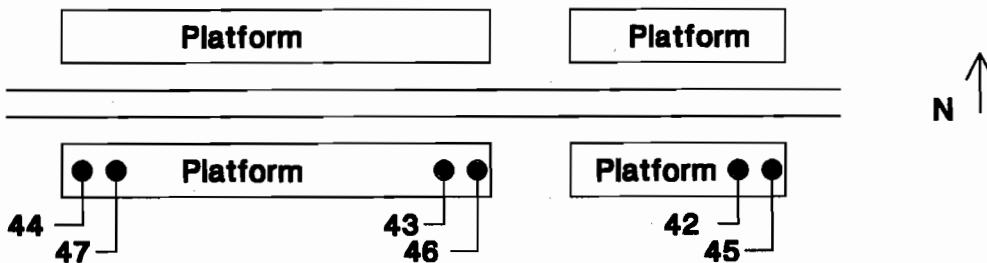

FIGURE 6-2. REPETITIVE MAGNETIC FIELD WAVEFORM MEASUREMENT LOCATIONS ON METRO NORTH AND NEW JERSEY TRANSIT STATION PLATFORMS

6.2 REPETITIVE WAVEFORM DATASETS

Table 6-1 shows the repetitive waveform datasets collected on station platforms and waiting areas as well as the appendices where the data can be found. All of the records taken on station platforms include several train passes or station stops. In some cases, recording was suspended temporarily between trains to conserve data recording capacity, concentrate the measurements on relevant time periods, or move equipment from one location to another.

TABLE 6-1

REPETITIVE MAGNETIC FIELD WAVEFORM DATASETS MEASURED ON THE STATION PLATFORMS AND IN WAITING AREAS

STATION AND LOCATION	ELECTRIFICATION	PROBE LOCATION FIGURE/KEY	DATA-SET	APPENDIX	RECORD LENGTH
<u>PLATFORMS</u>					
- PRINCETON JUNCTION, NJ (NEC)	25 HZ	6-1 / 37	NEC038	AM	26 MIN
- NEW ROCHELLE, NY (NEC)	60 HZ	6-1 / 39	NEC042 NEC043	AQ AR	16 MIN 14 MIN
- RED BANK, NJ (NJT)	60 HZ	6-2/42-44	NEC046	AU	14 MIN
<u>WAITING AREAS</u>					
- BOSTON SOUTH STATION	NON-ELECTRIC		NEC021	V	2 MIN
- NEW YORK PENN STATION	25 HZ		NEC031	AF	3 MIN

6.3 FIELD SOURCE IDENTIFICATION

The major source of magnetic fields on the station platform is current in the catenary-track circuit. The magnetic field from that source has many of the same characteristics of the magnetic field at the wayside described in the previous section of this report except that at the station platform the fields are higher because the measurements are made nearer the tracks. On some occasions, when a train is passing through the station and is immediately adjacent to the measurement location, there is a high intensity magnetic field of very short duration as shown in Figure 6-3. This example comes from dataset NEC038 (Appendix AM), which was measured at the Princeton Junction Station on the 25 Hz section of the NEC. This field, produced apparently by the electric

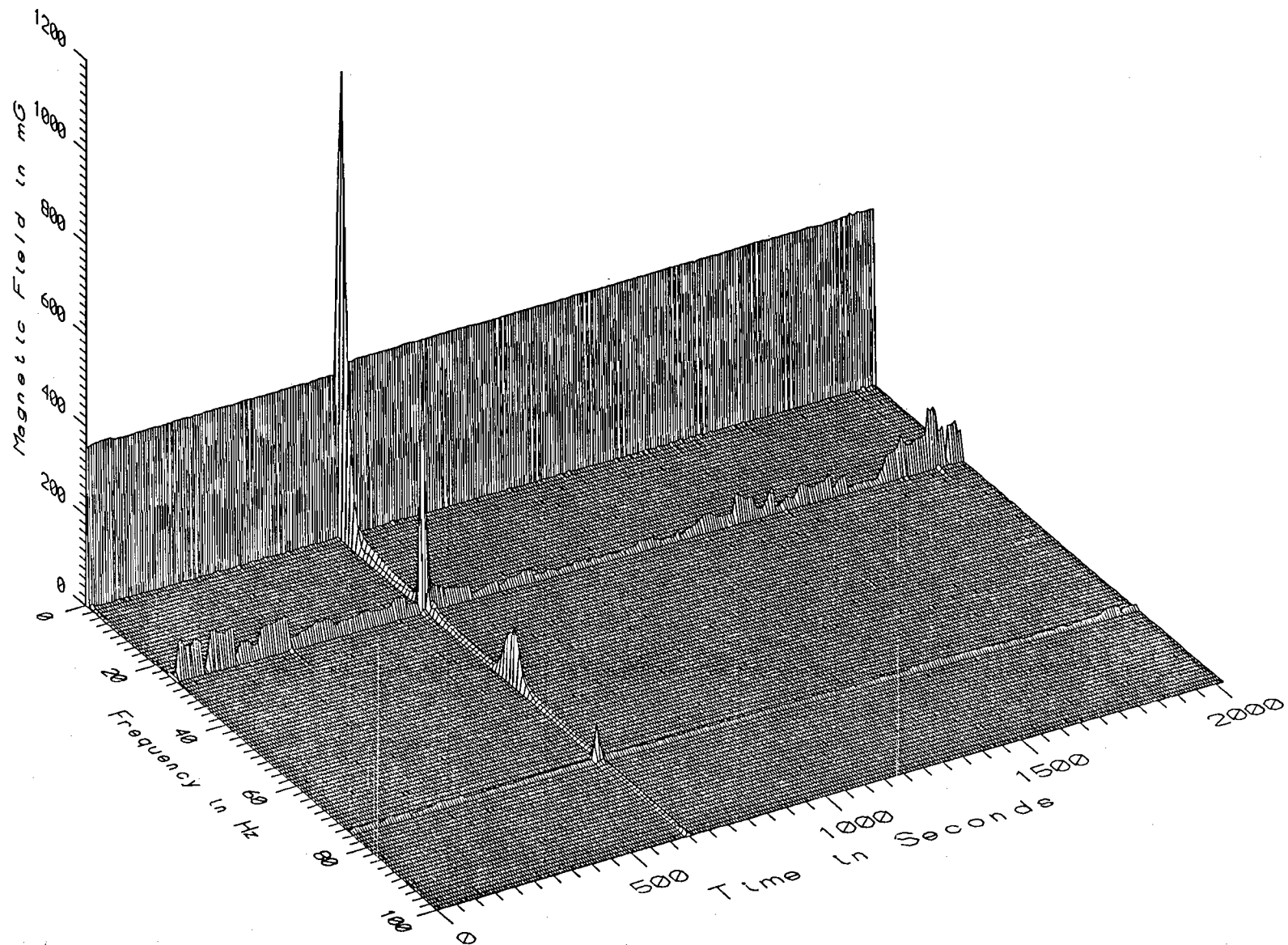

NEC038 - 10_cm ABOVE EDGE OF PRINCETON JUNCTION PLATFORM

FIGURE 6-3. MAGNETIC FIELD LEVEL BY FREQUENCY AND TIME AT THE PRINCETON JUNCTION STATION PLATFORM (25 HZ SECTION OF THE NEC)

traction equipment of the train, has both a static component shown clearly in Figure 6-3 and a time-varying component of the catenary frequency (in this case, 25 Hz) and its odd harmonics, shown in Figure 6-4. Similar events were observed on the other station platforms, as shown in Appendices AQ, AR, and AU.

The static magnetic field near the platform surface is spatially quite variable, as shown in Figures 6-3 and 6-5. These recordings were made simultaneously at two locations, both 10 cm above the Princeton Junction platform, both at the edge of the yellow safety line near the platform edge, but 6.1 m (20 ft) apart (dataset NEC038, Appendix AM). The static field is considerably different at the two locations and unrelated to rail operations. It appears that this effect is due to perturbation of the geomagnetic field by the steel structural members beneath the platform. Similar perturbations to the geomagnetic field were seen near the floor at the New Rochelle Station platform and in the waiting areas in the South Station and Penn Station.

The time-varying magnetic field levels at the South Station passenger waiting area (dataset NEC021, Appendix V) were very low and consisted primarily of 60 Hz and a smaller 180 Hz component. The field level attenuated rapidly from the 10 cm above the floor measurement location to the 60 cm high location, suggesting that the source is an electric power cable beneath the floor.

The time-varying magnetic field in the waiting area at Penn Station (dataset NEC031, Appendix AF) consisted of a predominant 25 Hz component and its odd harmonics. That and the clear field attenuation pattern with increasing height above the floor indicates that the field originates from the current in the catenaries and tracks below the waiting area.

6.4 DAT WAVEFORM DATA

Continuous recordings of the magnetic field waveforms were made 10 cm above the station platform at Princeton Junction, New Rochelle, and Red Bank. The specific sensor locations are identified as locations 38 and 40 on Figure 6-1 and Location 36 on Figure 6-2. Information about the tape number, record number, record length and measurement date and time are contained in Table 2-2. DAT recordings were not made in the South Station or Penn Station waiting areas.

Statistical analysis of the RMS magnitude of the time-varying magnetic fields recorded with the DAT are reported in Table 6-2. In some cases, the peak field exceeded the range on which the recorder was set (approximately 350 mG) and was therefore lost. In those cases, the value at which the recorder saturated is tabulated preceded by a "greater than" (>) sign.

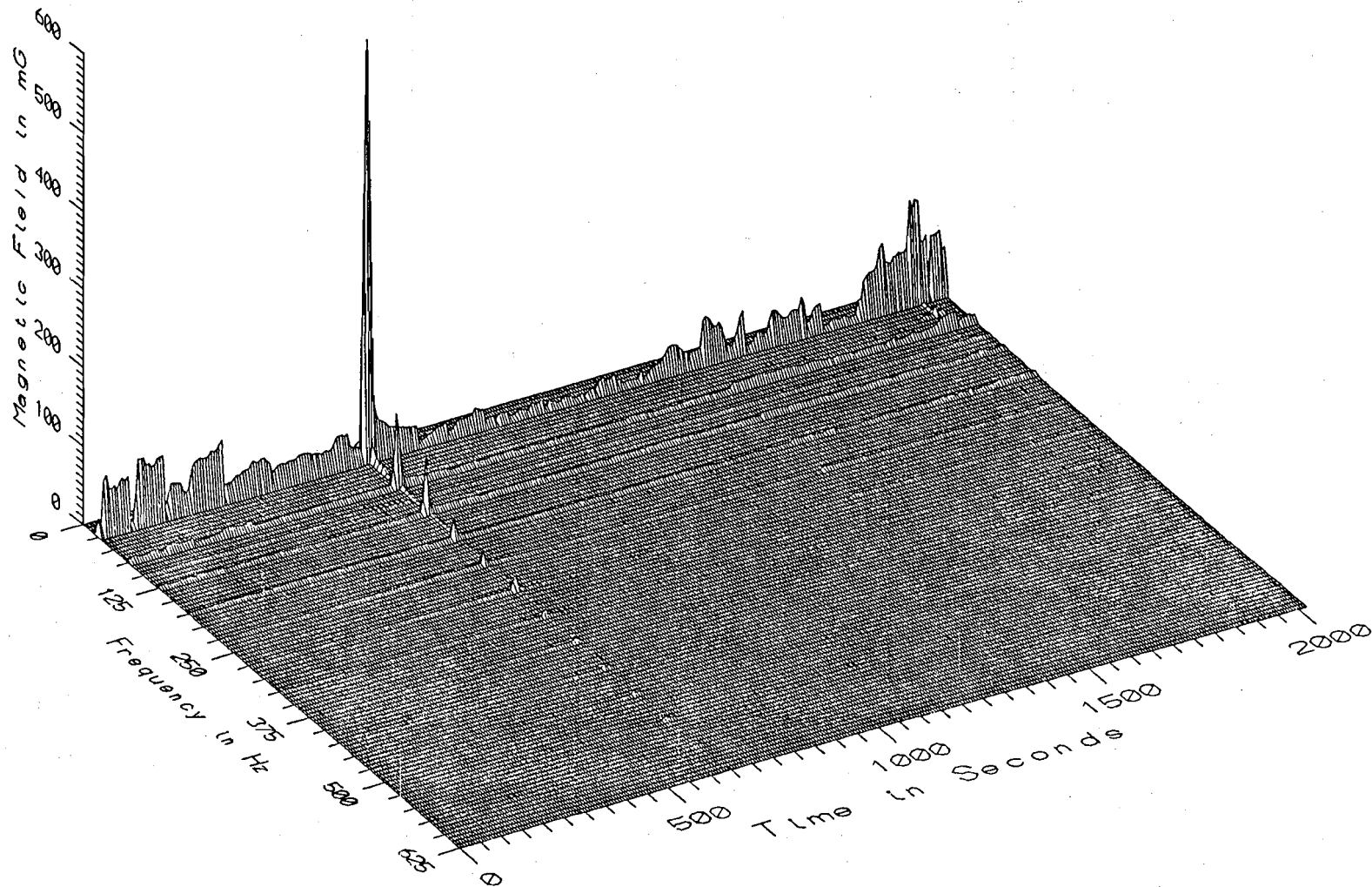

NEC038 - 10_cm ABOVE EDGE OF PRINCETON JUNCTION PLATFORM

FIGURE 6-4. MAGNETIC FIELD LEVEL BY FREQUENCY AND TIME AT THE PRINCETON JUNCTION STATION PLATFORM (25 HZ SECTION OF THE NEC) WITH THE STATIC FIELD COMPONENT SUPPRESSED

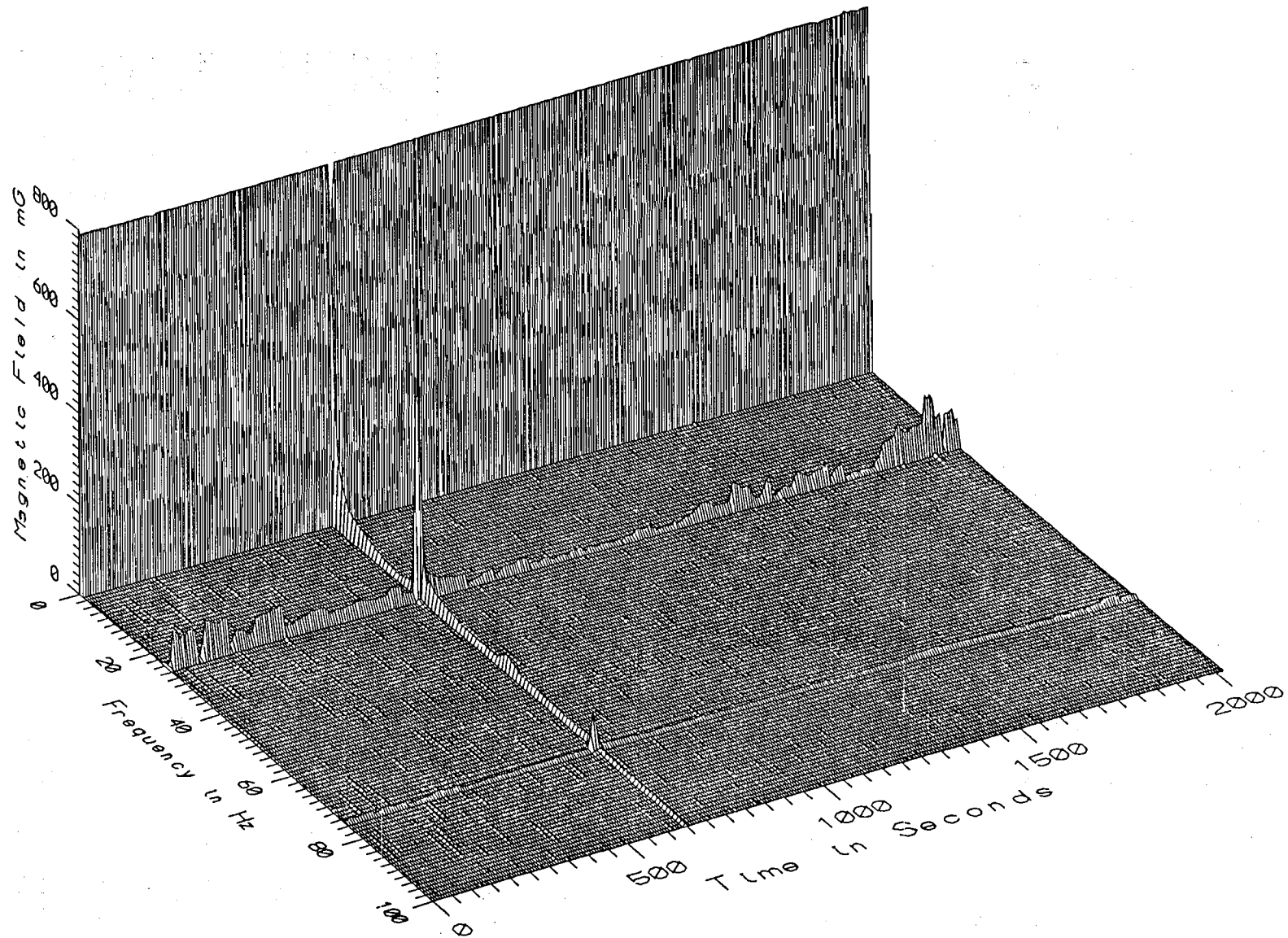

NEC038R - 10cm ABOVE EDGE OF PRINCETON JUNCTION PLATFORM

FIGURE 6-5. MAGNETIC FIELD LEVELS BY FREQUENCY AND TIME AT THE PRINCETON JUNCTION STATION PLATFORM (25 HZ SECTION OF THE NEC) AT A POINT 6.1 M (20 FT) FURTHER ALONG THE PLATFORM FROM MEASUREMENT TAKEN IN FIGURE 6-3

TABLE 6-2

SUMMARY OF MAGNETIC FIELD LEVELS RECORDED
ON STATION PLATFORMS WITH
THE DIGITAL AUDIO TAPE RECORDER (DAT)

RAILROAD SECTION (DATASETS)	MEASUREMENT LOCATION		MAGNETIC FIELD MILLIGAUSS, RMS		
	FIGURE #	LOCATION	MINIMUM	AVERAGE	MAXIMUM
PRINCETON JUNCTION 25 HZ NEC (5-1)	6-1	38	4.2	39.0	>342.6 *
NEW ROCHELE 60 HZ NEC (5-4, 5-1B, AND 5-2B)	6-1	40	0.6	52.0	>240.8 *
RED BANK 60 HZ NJT (6-1, 6-2, AND 6-3)	6-2	45, 46, & 47	1.2	31.0	158.6

* MAXIMUM FIELD LEVEL BRIEFLY EXCEEDED RECORDER RANGE

6.5 RMS RECORDER DATA

The rms recorders were worn by two members of the test team in the passenger waiting areas of Boston's South Station and New York's Penn Station. The South Station data from one rms recorder was lost due to a poor battery connection. Since the principal component of the time-varying magnetic field at the Penn Station waiting area was 25 Hz, which is outside the frequency response range of the rms recorder, the rms recorder data from Penn Station are not valid.

Figure 6-6 shows a field versus time plot of the magnetic field measured by the rms recorder. The periods of elevated field from 8:16 to 8:19 and 8:26 to 8:29 result from the rms recorder wearer's standing in front of food service counters where several electrical appliances were in use. The remainder of the time, as the wearer sat in the seating area or strolled around the room, the minimum, average, and maximum magnetic field levels recorded on the rms recorder worn in the South Station waiting area were 0.2 mG, 1.6 mG and 17.3 mG, respectively.

File: boswash2.mat

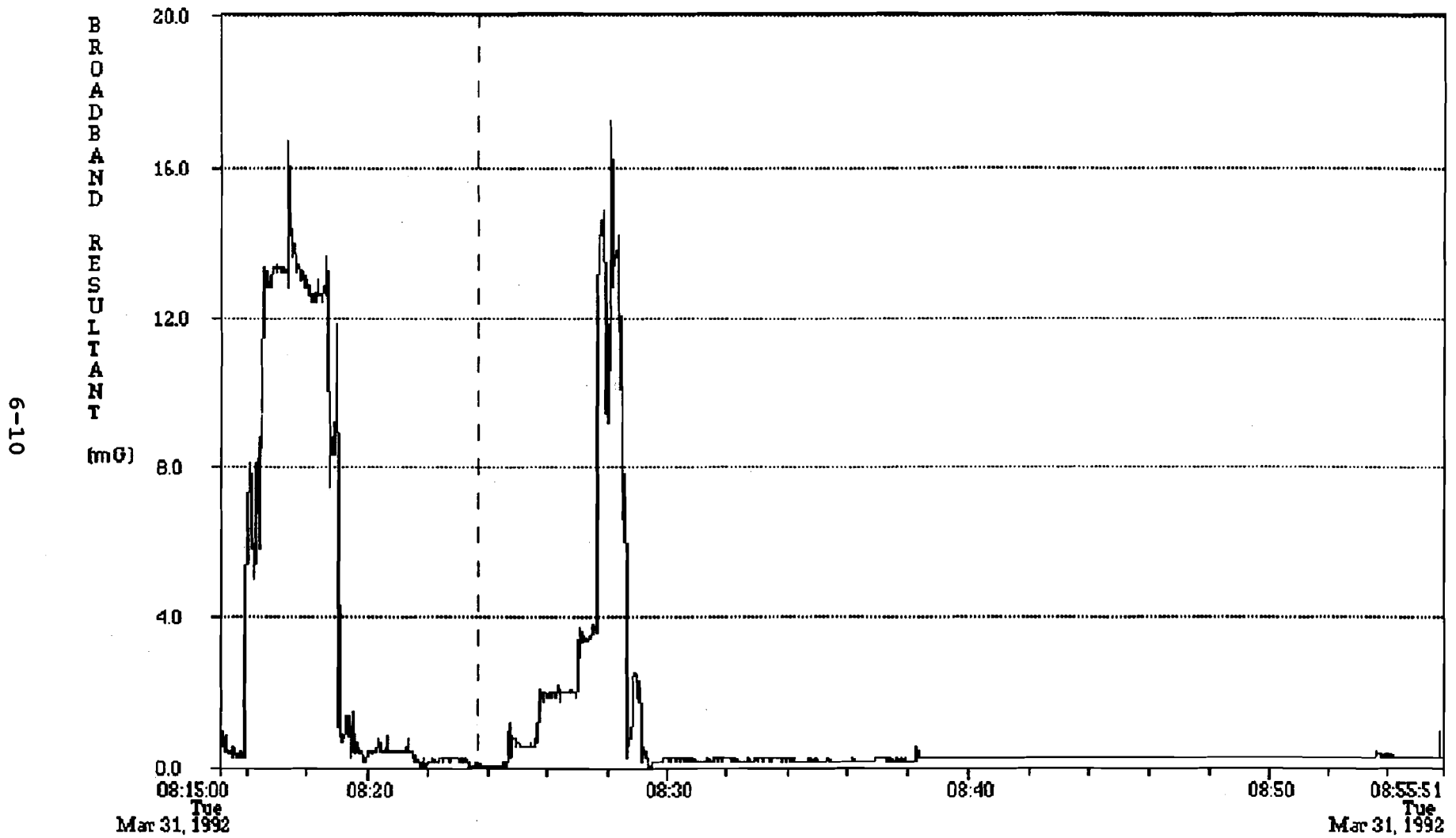

FIGURE 6-6. RMS RECORDING OF MAGNETIC FIELD LEVELS AT WAIST HEIGHT OF A PERSON IN THE WAITING LOUNGE AT BOSTON'S SOUTH STATION

6.6 SUMMARY OF MAGNETIC FIELD LEVELS

Summary statistics from the repetitive waveform data on the three station platforms are contained in Tables 6-3 through 6-5. In all cases, the principal field source is current in the catenary and track. As a result, the field is spatially uniform and has a frequency spectrum consisting of the frequency of the catenary current and its odd harmonics.

Since the catenary current is 25 Hz at the Princeton Junction Station, measurements in the power frequency band (50-60 Hz) at that station provide documentation of the magnitude of the magnetic field from the station itself and nearby field sources not related to electrification of the railroad. As indicated in Table 6-3, the 60 Hz field at Princeton Junction Station is approximately 1.2 mG from non-traction sources.

Tables 6-6 and 6-7 show summary statistics for repetitive magnetic field waveform measurements in the passenger waiting areas at Boston's South Station and New York's Penn Station, respectively. As previously mentioned, the magnetic field levels at the South Station are very low, averaging approximately 0.4 mG at waist level. That value corresponds well to field values recorded by the rms recorder when the wearer was not near one of the food service counters, as illustrated in Figure 6-5 from 8:30 to 8:55. Magnetic fields in the Penn Station passenger waiting area are primarily 25 Hz and odd harmonics thereof and apparently arise from electrification of the railroad passing through the platform area of the station beneath the waiting area.

Both the average total time-varying magnetic field and maximum time-varying magnetic field measured at the four heights above the floor on the three station platforms and in the two station waiting areas have been averaged across height and listed in Table 6-8. The average and maximum time-varying magnetic field levels measured with the DAT (from Table 6-2) and the rms recorder measurements in the South Station waiting area are also listed in Table 6-8.

Comparison of the maximum field levels recorded at each station platform ranks the three rail sections in the same order as did magnetic field measurements in the coaches. The Princeton Junction on the 25 Hz section of the NEC has the largest maximum field, followed by New Rochelle on the 60 Hz section of the NEC, and the Red Bank Station on the North Jersey Coast Line has the lowest maximum field. The average field measurements rank the Red Bank Station again with the lowest field, but reverse the order of the two stations on the NEC.

The high average and peak magnetic field at New Rochelle relative to the other two stations does not appear to be due to the number of trains passing during the test. The mean times between train passes at Princeton Junction, New Rochelle, and Red Bank were 5.93, 5.58, and 3.72 minutes of recording time, respectively. Recording was suspended when there was a long break between scheduled trains. Other factors which may affect magnetic field levels on the station

TABLE 6-3

SUMMARY STATISTICS FOR DATASET NEC038 MEASURED
ON THE PLATFORM OF THE PRINCETON JUNCTION STATION
ON THE 25 HZ SECTION OF THE NEC

NEC038 - PRINCETON JUNCTION PLATFORM		TOTAL OF 317 SAMPLES				
FREQUENCY BAND	HEIGHT ABOVE FLOOR (cm)	MINIMUM MAGNETIC FIELD (mG)	MAXIMUM MAGNETIC FIELD (mG)	AVERAGE MAGNETIC FIELD (mG)	STANDARD DEVIATION (mG)	COEFFICIENT OF VARIATION (%)
STATIC	10	352.07	796.04	373.01	26.72	7.16
	60	359.14	970.19	379.19	33.67	8.88
	110	342.28	928.34	422.72	28.91	6.84
	160	409.16	916.15	515.71	24.21	4.70
5-45Hz LOW FREQ	10	2.40	537.01	36.73	46.75	127.30
	60	2.45	519.73	37.51	46.29	123.38
	110	2.57	511.30	38.54	46.53	120.74
	160	2.61	508.72	39.75	48.12	121.05
50-60Hz PWR FREQ	10	0.74	12.50	1.16	1.02	87.71
	60	0.68	13.19	1.14	1.06	92.93
	110	0.67	13.37	1.14	1.10	96.34
	160	0.67	13.80	1.08	1.14	105.50
65-300Hz PWR HARM	10	3.27	121.24	8.57	8.23	96.13
	60	3.25	116.81	8.62	7.99	92.59
	110	3.24	114.66	8.81	7.94	90.10
	160	3.24	113.30	8.95	8.02	89.67
305-2560Hz HIGH FREQ	10	0.49	17.08	1.52	1.46	96.21
	60	0.50	16.51	1.54	1.43	92.80
	110	0.52	16.27	1.58	1.42	90.08
	160	0.53	16.13	1.62	1.44	89.15
5-2560Hz ALL FREQ	10	6.04	550.80	38.19	47.16	123.50
	60	6.04	532.95	38.96	46.66	119.77
	110	6.16	524.25	39.99	46.89	117.26
	160	6.20	521.44	41.20	48.47	117.65

TABLE 6-4

**SUMMARY STATISTICS FOR DATASETS NEC042 AND NEC043
MEASURED ON THE PLATFORM OF THE NEW ROCHELLE
STATION ON THE 60 HZ SECTION OF THE NEC**

NEC042, NEC043 - NEW ROCHELLE STATION PLATFORM		TOTAL OF 337 SAMPLES				
FREQUENCY BAND	HEIGHT ABOVE FLOOR (cm)	MINIMUM MAGNETIC FIELD (mG)	MAXIMUM MAGNETIC FIELD (mG)	AVERAGE MAGNETIC FIELD (mG)	STANDARD DEVIATION (mG)	COEFFICIENT OF VARIATION (%)
STATIC	10	354.77	1629.48	949.20	533.37	56.19
	60	354.36	1073.73	578.28	109.29	18.90
	110	354.36	714.53	526.95	34.59	6.56
	160	410.38	738.57	548.74	22.74	4.14
5-45Hz LOW FREQ	10	0.13	51.54	1.02	3.01	295.70
	60	0.12	35.20	0.89	2.11	237.07
	110	0.06	19.57	0.87	1.52	175.61
	160	0.15	20.55	0.94	1.53	162.95
50-60Hz PWR FREQ	10	0.67	302.17	53.37	54.45	102.02
	60	0.63	337.57	57.43	59.61	103.79
	110	0.65	376.40	62.00	65.08	104.97
	160	0.69	407.18	66.35	70.23	105.84
65-300Hz PWR HARM	10	1.00	78.50	14.18	12.73	89.74
	60	0.83	85.18	14.97	13.74	91.76
	110	0.72	93.28	16.05	14.93	93.05
	160	0.66	101.56	17.14	16.10	93.96
305-2560Hz HIGH FREQ	10	0.08	22.54	4.46	3.36	75.36
	60	0.07	23.75	4.69	3.60	76.84
	110	0.07	25.13	5.03	3.91	77.74
	160	0.07	26.59	5.37	4.23	78.70
5-2560Hz ALL FREQ	10	1.22	310.70	55.69	55.82	100.24
	60	1.05	346.37	59.79	61.07	102.15
	110	0.99	386.06	64.47	66.69	103.45
	160	0.97	417.58	68.97	71.97	104.35

TABLE 6-5

SUMMARY STATISTICS FOR DATASET NEC046 MEASURED
ON THE PLATFORM OF THE RED BANK STATION ON
THE 60 HZ SECTION OF THE NORTH JERSEY COAST LINE

NEC046 - RED BANK STATION PLATFORM				TOTAL OF 162 SAMPLES		
FREQUENCY BAND	HEIGHT ABOVE FLOOR (cm)	MINIMUM MAGNETIC FIELD (mG)	MAXIMUM MAGNETIC FIELD (mG)	AVERAGE MAGNETIC FIELD (mG)	STANDARD DEVIATION (mG)	COEFFICIENT OF VARIATION (%)
STATIC	10	344.18	573.82	498.21	40.41	8.11
	60	365.04	605.32	523.14	33.21	6.35
	110	234.26	564.82	506.11	24.91	4.92
	160	220.74	615.45	542.93	30.06	5.54
5-45Hz LOW FREQ	10	0.14	3.41	0.56	0.52	93.10
	60	0.14	4.46	0.56	0.68	120.00
	110	0.09	4.08	0.54	0.71	131.80
	160	0.08	4.77	0.53	0.69	129.48
50-60Hz PWR FREQ	10	1.05	186.83	27.75	37.03	133.41
	60	1.14	194.86	27.64	37.33	135.07
	110	1.24	202.62	27.22	37.33	137.17
	160	1.28	209.43	26.62	37.64	141.40
65-300Hz PWR HARM	10	0.29	50.63	8.08	8.75	108.22
	60	0.22	50.02	8.08	8.88	109.91
	110	0.20	48.81	7.96	8.89	111.76
	160	0.16	47.46	7.78	8.96	115.28
305-2560Hz HIGH FREQ	10	0.29	15.74	2.63	2.70	102.62
	60	0.22	15.73	2.66	2.78	104.56
	110	0.18	15.57	2.63	2.80	106.32
	160	0.14	15.36	2.61	2.84	108.69
5-2560Hz ALL FREQ	10	1.37	190.00	29.30	37.94	129.46
	60	1.43	198.24	29.18	38.28	131.18
	110	1.55	206.19	28.72	38.30	133.35
	160	1.65	213.18	28.09	38.64	137.54

TABLE 6-6

SUMMARY STATISTICS FOR DATASET NEC021 MEASURED
IN THE PASSENGER WAITING AREA OF THE BOSTON SOUTH
STATION ON THE NON-ELECTRIFIED PORTION OF THE NEC

NEC021 - WAITING AREA, SOUTH STATION		TOTAL OF 24 SAMPLES				
FREQUENCY BAND	HEIGHT ABOVE FLOOR (cm)	MINIMUM MAGNETIC FIELD (mG)	MAXIMUM MAGNETIC FIELD (mG)	AVERAGE MAGNETIC FIELD (mG)	STANDARD DEVIATION (mG)	COEFFICIENT OF VARIATION
STATIC	10	889.67	911.77	9 0 0 . 9 7 1		0.53
	60	371.03	389.84	379.43	5.06	1.33
	110	318.07	332.34	323.80	4.16	1.29
	160	434.09	445.06	438.37	3.24	0.74
5-45Hz LOW FREQ	10	0.11	0.73	0.32	0.16	50.90
	60	0.11	0.44	0.19	0.10	51.01
	110	0.04	0.38	0.12	0.11	87.37
	160	0.13	0.44	0.20	0.09	46.59
50-60Hz PWR FREQ	10	0.66	0.74	0.69	0.02	3.43
	60	0.30	0.42	0.35	0.04	11.20
	110	0.22	0.36	0.30	0.04	12.80
	160	0.15	0.21	0.18	0.02	10.71
65-300Hz PWR HARM	10	0.05	0.16	0.09	0.04	46.71
	60	0.06	0.16	0.09	0.02	27.10
	110	0.08	0.25	0.15	0.05	29.62
	160	0.12	0.23	0.14	0.02	15.20
305-2560Hz HIGH FREQ	10	0.02	0.08	0.04	0.02	55.10
	60	0.02	0.07	0.03	0.01	48.78
	110	0.02	0.07	0.03	0.01	47.35
	160	0.02	0.08	0.03	0.01	50.71
5-2560Hz ALL FREQ	10	0.69	1.05	0.78	0.09	12.12
	60	0.34	0.60	0.42	0.07	17.55
	110	0.25	0.54	0.37	0.07	18.14
	160	0.24	0.53	0.31	0.08	24.44

TABLE 6-7

SUMMARY STATISTICS FOR DATASET NEC031 MEASURED
 IN THE PASSENGER WAITING AREA OF THE NEW YORK PENN
 STATION ON THE 25 HZ SECTION OF THE NEC

NEC031 - WAITING AREA, PENN STATION		TOTAL OF 36 SAMPLES				
FREQUENCY BAND	HEIGHT ABOVE FLOOR (cm)	MINIMUM MAGNETIC FIELD (mG)	MAXIMUM MAGNETIC FIELD (mG)	AVERAGE MAGNETIC FIELD (mG)	STANDARD DEVIATION (mG)	COEFFICIENT OF VARIATION (%)
STATIC	10	1329.91	372.32	1357.07	9.69	0.71
	60	278.04	314.39	303.50	8.18	2.69
	110	272.68	306.50	293.81	7.12	2.42
	160	312.15	355.06	337.31	9.71	2.88
5-45Hz LOW FREQ	10	6.21	13.36	8.79	1.98	22.59
	60	4.41	8.59	5.97	1.15	19.21
	110	3.60	6.89	4.83	0.90	18.64
	160	3.32	6.69	4.52	0.92	20.44
50-60Hz PWR FREQ	10	0.34	0.94	0.57	0.13	23.70
	60	0.24	0.62	0.42	0.09	20.85
	110	0.29	0.57	0.41	0.07	16.05
	160	0.35	0.54	0.42	0.04	9.97
65-300Hz PWR HARM	10	1.14	2.22	1.46	0.28	19.31
	60	0.79	1.34	0.96	0.15	15.89
	110	0.63	1.06	0.77	0.12	15.53
	160	0.57	1.00	0.70	0.12	16.91
305-2560Hz HIGH FREQ	10	0.14	0.29	0.18	0.04	22.32
	60	0.10	0.18	0.12	0.02	18.80
	110	0.08	0.15	0.10	0.02	17.29
	160	0.07	0.14	0.10	0.02	18.51
5-2560Hz ALL FREQ	10	6.35	13.56	8.93	2.00	22.36
	60	4.51	8.70	6.07	1.15	18.96
	110	3.68	6.99	4.91	0.90	18.39
	160	3.40	6.78	4.59	0.92	20.11

TABLE 6-8

COMPARISON OF AVERAGE AND MAXIMUM MAGNETIC FIELD LEVELS
MEASURED AT RAILROAD STATION PLATFORMS AND WAITING
AREAS WITH THREE DIFFERENT INSTRUMENTS

STATION AND LOCATION	AVERAGE MAGNETIC FIELD (MAXIMUM MAGNETIC FIELD)		
	WAVEFORM CAPTURE SYSTEM	DAT	RMS RECORDER
PLATFORMS			
PRINCETON JUNCTION, NJ (NEC)	39.6 mG (532.4 mG)	39.0 mG (>342.6 mG)	
NEW ROCHELLE, NY (NEC)	62.2 mG (365.2 mG)	52.0 mG (>240.8 mG)	
RED BANK, NJ (NJT)	28.8 mG (201.9 mG)	31.0 mG (158.6 mG)	
WAITING AREAS			
BOSTON SOUTH STATION	0.5 mG (0.7 mG)		1.6 mG (17.3 mG)
NEW YORK PENN STATION	6.1 mG (9.0 mG)		

platform are design of the stations, type of electrification technology, height of the catenaries, local terrain around the station, passenger load on the trains at the time of the tests, the type of train, and the proximity of the nearest substation. The catenary wires are known to be lower at New Rochelle than at Princeton Junction because of the need to accommodate the numerous low bridges carrying roads over the tracks in the New Rochelle area. Therefore, a person standing on the platform at New Rochelle is nearer the current-carrying catenaries than at Princeton Junction. Furthermore, unlike the Princeton Junction and New Rochelle Stations, the Red Bank Station has a low platform which also results in greater distance between a person on the platform and the overhead catenaries. Considering the small number of stations sampled and the number of possible sources of variability, it would not be prudent to ascribe the differences in magnetic field levels recorded at the stations solely to electrification technology, catenary height, or platform height.

6.7 SUMMARY OF ELECTRIC FIELD LEVELS

Time-varying electric field levels were measured at several locations along the yellow safety line on each station platform. The predominant field source was clearly the catenary. Sixty Hz fields were present at the New Rochelle and Red Bank substations, where the catenary voltage was 60 Hz, and 25 Hz fields were present at the Princeton Junction Station platform. Electric field levels were highly variable along the edge of the platform, apparently as the result of shielding from the platform roof (where present), light standards, fences, poles, and adjacent buildings. The highest field intensity measured along the yellow safety line at the edge of the platform at the Princeton Junction, New Rochelle and Red Bank Stations, respectively, were 1.06 kV/m, 1.20 kV/m and 0.69 kV/m. The lower electric field at the Red Bank Station appeared due to the fewer catenaries (two rather than four at the other stations), the use of single rather than compound catenary wires, and the absence of a high level platform at Red Bank. The 138 kV, 25 Hz primary circuits above the station platform at Princeton Junction apparently did not contribute significantly to the electric field level on the platform because the field levels are slightly lower than those measured at the New Rochelle Station. The small difference between electric field levels at the two NEC stations appears to be due to the lower voltage on the 25 Hz catenary at Princeton Junction (nominally 11 kV rather than 12.5 kV), and perhaps a slightly lower catenary at New Rochelle because of minimal clearances beneath road overpasses.

7. ELECTRIC AND MAGNETIC FIELD MEASUREMENTS NEAR POWER SUBSTATIONS

7.1 MEASUREMENT LOCATIONS

Three electrical power substations for rail operations were studied, one each in the 25 Hz and 60 Hz sections of the Northeast Corridor, and the third on the North Jersey Coast Line. The three substations are:

- * Princeton Junction, NJ - 25 Hz section
- * Mt. Vernon, NY - Metro North Line, 60 Hz section
- * Red Bank, NJ - North Jersey Coast Line (Long Branch)

The object was to determine public electromagnetic field exposure at the nearest access point.

The Princeton Junction substation is located next to a passenger station. Figure 7-1 is the general layout of the electric substation showing the approximate location of the four single phase 138 kV, 25 Hz transmission lines which feed the substation and the four power transformers which convert the electric power from 138 kV to 11 kV for the railroad catenaries. The measurement staff and reference probe locations, numbered 54 and 55 respectively, are also shown on Figure 7-1. The staff is a vertical profile measurement of magnetic fields at four different heights. Measurements were taken at the center of the sidewalk just outside the substation fence at a point that gave the highest magnetic field readings. This point was also on the most accessible side of the substation perimeter, close to the road. The measurements were taken from 12:58 to 13:17 on April 1, 1992 and recorded as dataset NEC037 (See Table 2-1).

Figure 7-2 shows the Mt. Vernon substation located adjacent to the platform. It occupies an area of approximately 21.4 m (70 ft) by more than 45.8 m (150 ft) and its two main power transformers are fed by underground circuits. The tracks are on the west side of the platform (west being the top of the page) and the substation is located at the northeast side of the platform.

As shown in the figure, there were three fixed position, extended time measurements taken with the staff at position numbers 41, 51, and 52. These correspond to datasets NEC044 (position 41) and NEC045 (positions 51 & 52). All these datasets represent horizontal profile measurements. The data was collected between 12:41 and 12:50 on April 2, 1992. There were also three extended distance measurements taken with the portable Profiler. The Profiler is a computerized magnetic field meter connected to a distance-measuring wheel. This Profiler rapidly and efficiently records magnetic field strength as a function of distance as the device is rolled along. Profiles 1 and 3 run perpendicular to the

PRINCETON JUNCTION SUBSTATION (25Hz SECTION OF THE NEC)



7-2

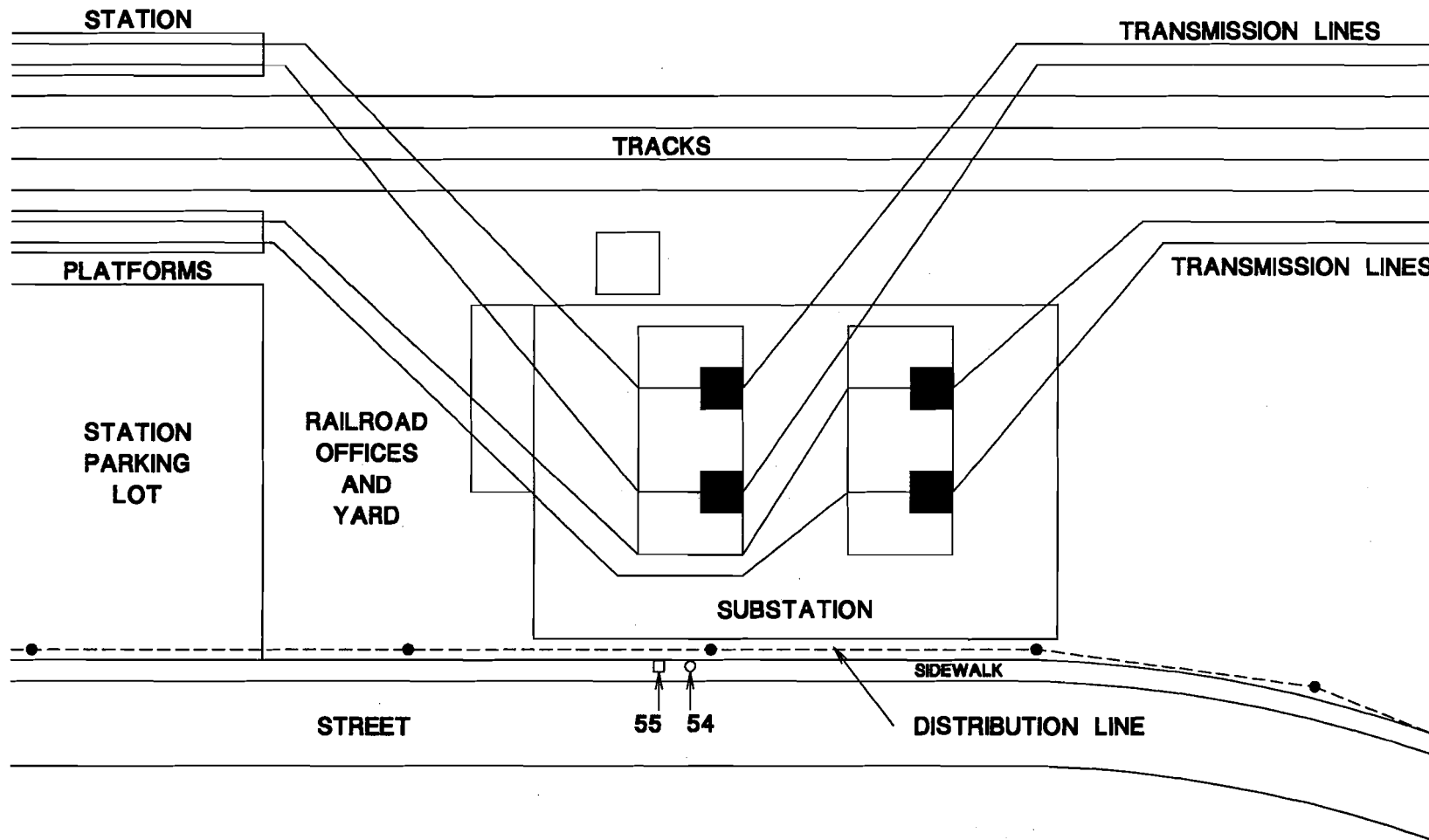
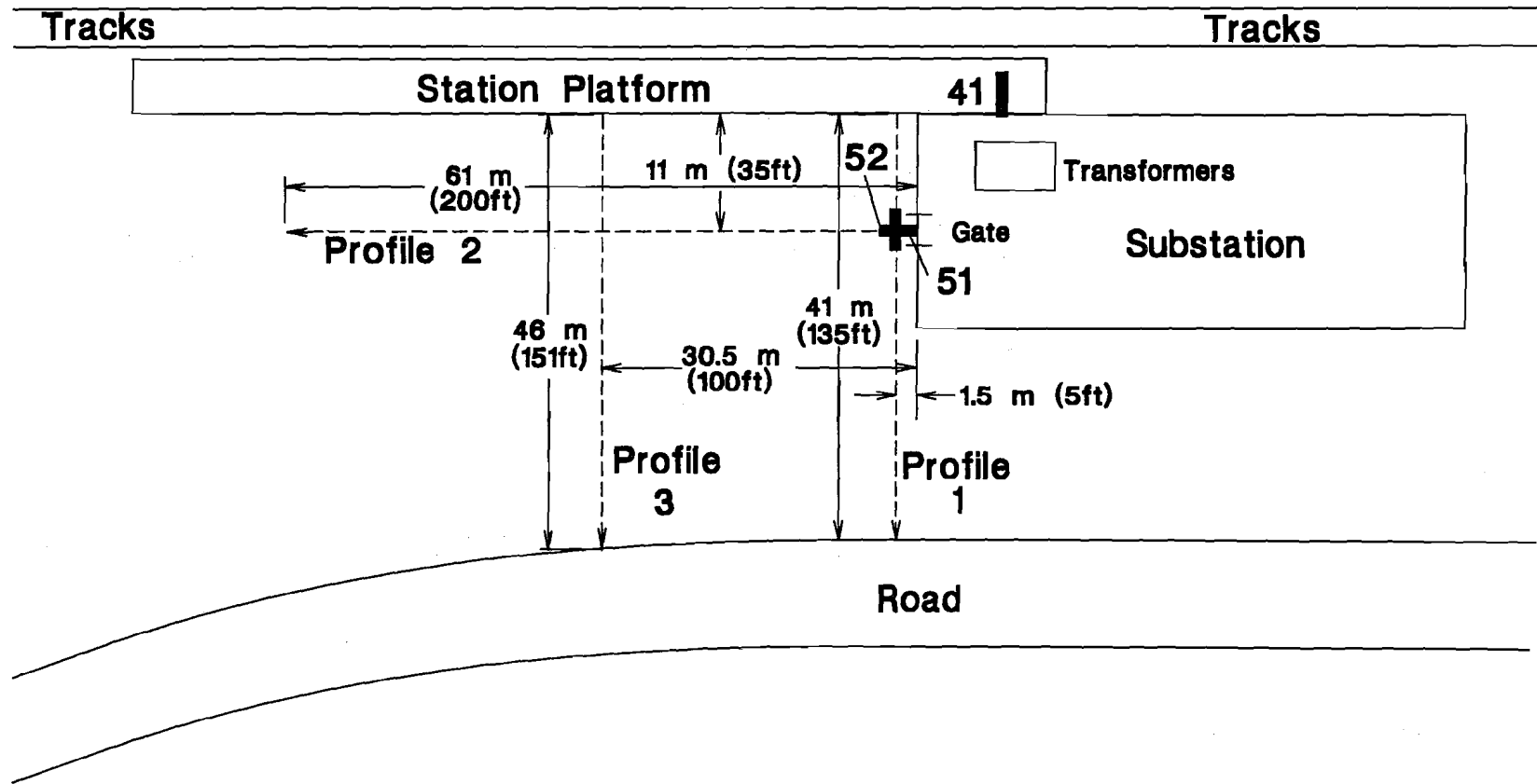

FIGURE 7-1. MAGNETIC FIELD MEASUREMENT LOCATIONS AT THE PRINCETON JUNCTION SUBSTATION

Mt. Vernon Substation (60 Hz)



7-3

FIGURE 7-2. MAGNETIC FIELD MEASUREMENT LOCATIONS AT THE MT. VERNON SUBSTATION

tracks at different distances from the substation and profile 2 parallel to the tracks, but away from the substation. These were taken between 13:20 and 13:28 on April 2, 1992.

Red Bank substation is shown in Figure 7-3. It occupies a 38.1 by 99.1 m (125 by 325 ft) area. There are two main power transformers that convert the incoming 345 kV from an overhead line to the 12.5 kV railroad electrification level. The substation also houses two smaller transformers that supply station power.

As shown in the figure, there was one fixed position, extended time measurement at staff location number 53. This represents a vertical profile measurement and corresponds to dataset NEC052. The data was collected between 9:52 and 10:14 on April 3, 1992. There were also seven extended distance measurements, taken with the portable Profiler, but within a short time span. Profiles 1 through 5 were taken at the perimeter of the substation, in a counter-clockwise direction, each profile corresponding to a straight line path. Profiles 6 and 7 radiate out from the substation boundary and are perpendicular to it. All seven profiles were taken between 09:53 and 10:14 on April 3, 1992.

Please note that there are no Digital Audio Tape (DAT) data from continuous monitoring for this segment of the study.

7.2 REPETITIVE WAVEFORM DATASETS

Four of the repetitive waveform datasets, shown in Table 2-1, are in the proximity of substations and can be used to quantify fields near them. The data was recorded with the waveform capture system. This subset of applicable datasets is summarized in Table 7-1.

Note that dataset NEC045 has data both from staff positions 51 and 52, which correspond to parallel and perpendicular positions to the fence, respectively.

Appendices AL, AS, AT and BA contain the figures of the four datasets shown in the table. These figures show three-dimensional graphs of the magnetic fields near the substations, as measured by the waveform capture system.

7.3 PORTABLE PROFILER DATA

A portable Profiler was used in addition to the fixed location probes. The Profiler consists of a computerized three-axis ac magnetic field meter that is connected electronically to a distance measuring wheel. The combination records field intensity readings at distance intervals of one foot. The data is also time stamped and then downloaded on a computer.

Red Bank Substation (New Jersey Transit)

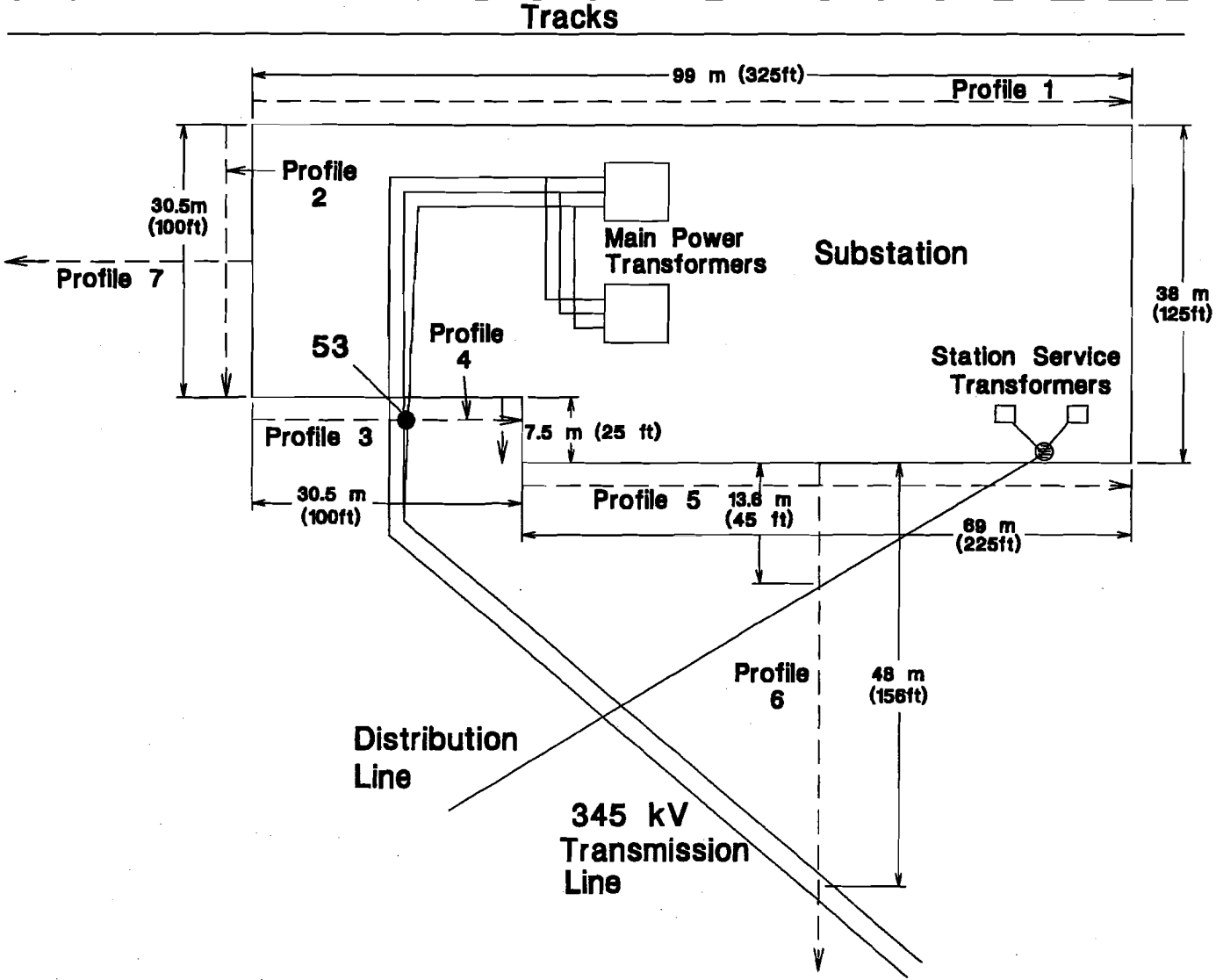

7-5

FIGURE 7-3. MAGNETIC FIELD MEASUREMENT LOCATIONS AT THE RED BANK SUBSTATION

TABLE 7-1

REPETITIVE MAGNETIC FIELD
WAVEFORM DATASETS MEASURED NEAR SUBSTATIONS

DATA FILE NUMBER	DATE/TIME	STAFF # OR PROFILE LOCATION	LOCATION FIG. #	NUMBER OF SAMPLES	REMARKS
NEC037	APR. 1 12:58-13:17	54 & 55	7-1	20	PRINCETON JUNCTN
NEC044	APR. 2 12:41-12:42	41	7-2	12	MT. VERNON
NEC045	APR. 2 12:49-12:50	51 & 52	7-2	10	MT. VERNON
NEC052	APR. 3 09:52-10:14	53	7-3	23	RED BANK

There are ten profiles, three at Mt. Vernon and seven at Red Bank, that were recorded with the portable profiler. These are summarized in Table 7-2. Some of the runs are shown as Figures 7-4 through 7-6. In each plot there are two profiler runs that correspond to two traverses of the path. The solid line is the first pass and the dotted line is the second. These two traverses of the profile paths were taken at different times, which accounts for their difference. Both times are shown in Table 7-2 along with corresponding number of sample points in each run.

7.4 FIELD SOURCE IDENTIFICATION

Substation magnetic fields arise from several sources. The most common are the incoming transmission lines, whether overhead or underground, the outgoing catenary power lines, and the transformers, equipment and bus structures inside the substation. This study is confined to the magnetic fields at the perimetry, outside the substation.

Figure 7-7 comes from the NEC037 set, 110 cm above the sidewalk outside the Princeton Junction. This location yields a unique opportunity to separate the effects of track power from the 60 Hz surroundings. These and other data show clearly the frequencies that are present during the period of measurement. These frequencies can be separated into three parts: the static component; the 25 Hz and its harmonics; and the 60 Hz and its harmonics. As can be seen from Figure 7-7 and the data at other heights in Appendix AL, the static component is constant with time, but varies with vertical distance. There are higher readings at the top than the bottom of the staff. This is probably due to the nearby steel fence.

TABLE 7-2

MAGNETIC FIELD PROFILE DATA MEASURED NEAR SUBSTATIONS

DATA FILE NUMBER	DATE/TIME	PROFILE LOCATION	LOCATION FIG. #	NUMBER OF SAMPLES	REMARKS
PRFL 1	APR. 2 13:20-13:22 13:22-13:24	PARALLEL TO FENCE AT 1.5 M (5 FT)	7-2	135 136	MT. VERNON
PRFL 2	APR. 2 13:24-13:25 13:25-13:26	PERPENDICULAR TO FENCE	7-2	200 201	MT. VERNON
PRFL 3	APR. 2 13:26-13:27 13:27-13:28	PARALLEL TO FENCE AT 30.5 M (100 FT)	7-2	151 153	MT. VERNON
PRFL 1	APR. 3 09:53-09:55 09:55-09:58	PARALLEL TO FENCE AT 1.5 M (5 FT)	7-3	326 323	RED BANK
PRFL 2	APR. 3 09:58-10:00 10:07-10:08	PARALLEL TO FENCE AT 1.5 M (5 FT)	7-3	97 95	RED BANK
PRFL 3	APR. 3 10:00-10:01 10:05-10:07	PARALLEL TO FENCE AT 1.5 M (5 FT)	7-3	100 99	RED BANK
PRFL 4	APR. 3 10:01-10:01 10:04-10:05	PARALLEL TO FENCE AT 1.5 M (5 FT)	7-3	25 24	RED BANK
PRFL 5	APR. 3 10:01-10:03 10:03-10:04	PARALLEL TO FENCE AT 1.5 M (5 FT)	7-3	225 225	RED BANK
PRFL 6	APR. 3 10:11-10:13 10:13-10:14	PERPENDICULAR TO FENCE.	7-3	186 184	RED BANK
PRFL 7	APR. 3 10:08-10:08 10:08-10:11	PERPENDICULAR TO FENCE	7-3	100 103	RED BANK

Mt. Vernon Substation

Profile 1

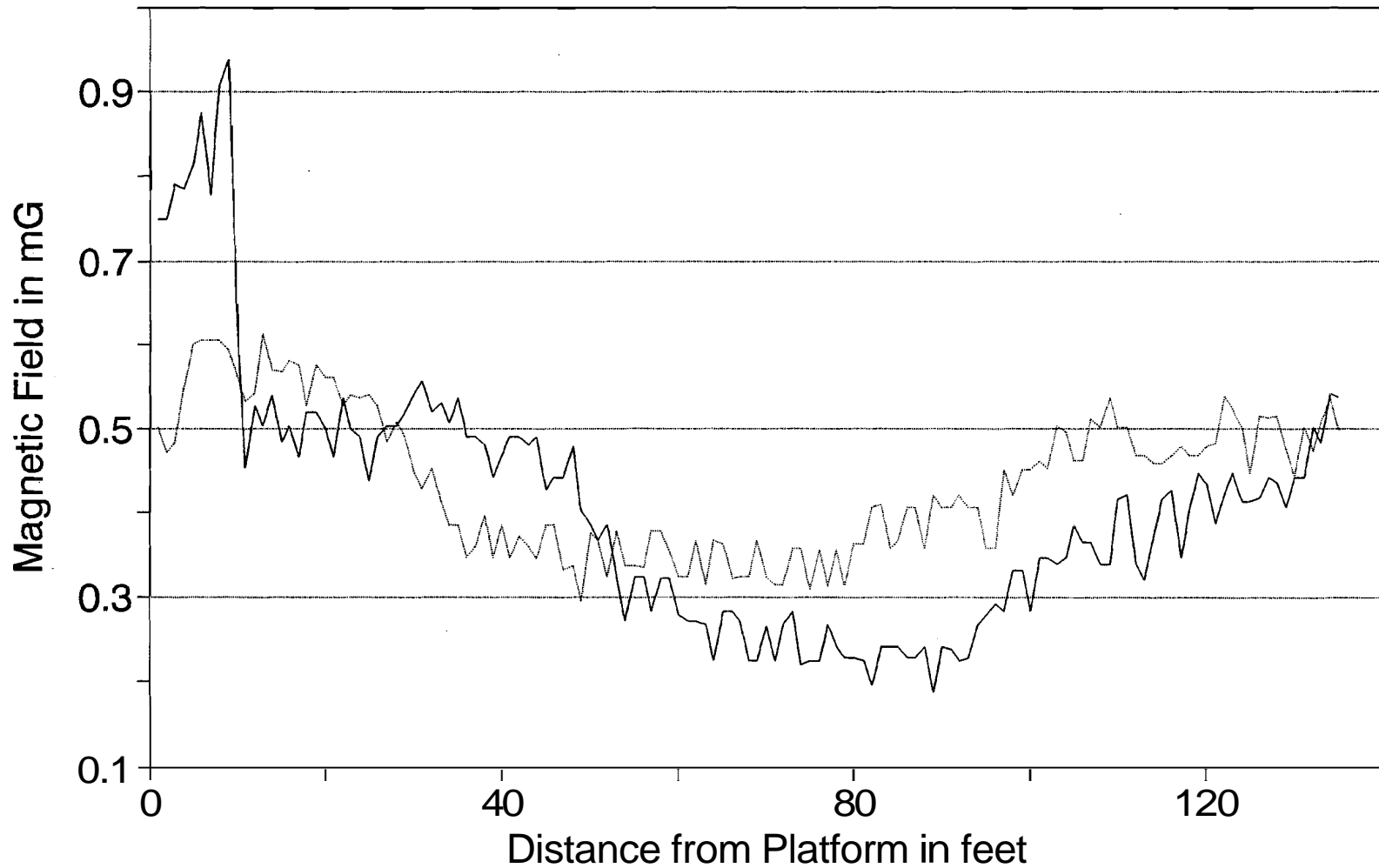

FIGURE 7-4. MAGNETIC FIELD AS A FUNCTION OF DISTANCE FROM THE STATION PLATFORM ALONG PROFILE 1, 1.5 M (5 FT) OUTSIDE THE SUBSTATION FENCE AT THE MT. VERNON SUBSTATION

Mt. Vernon Substation

Profile 3

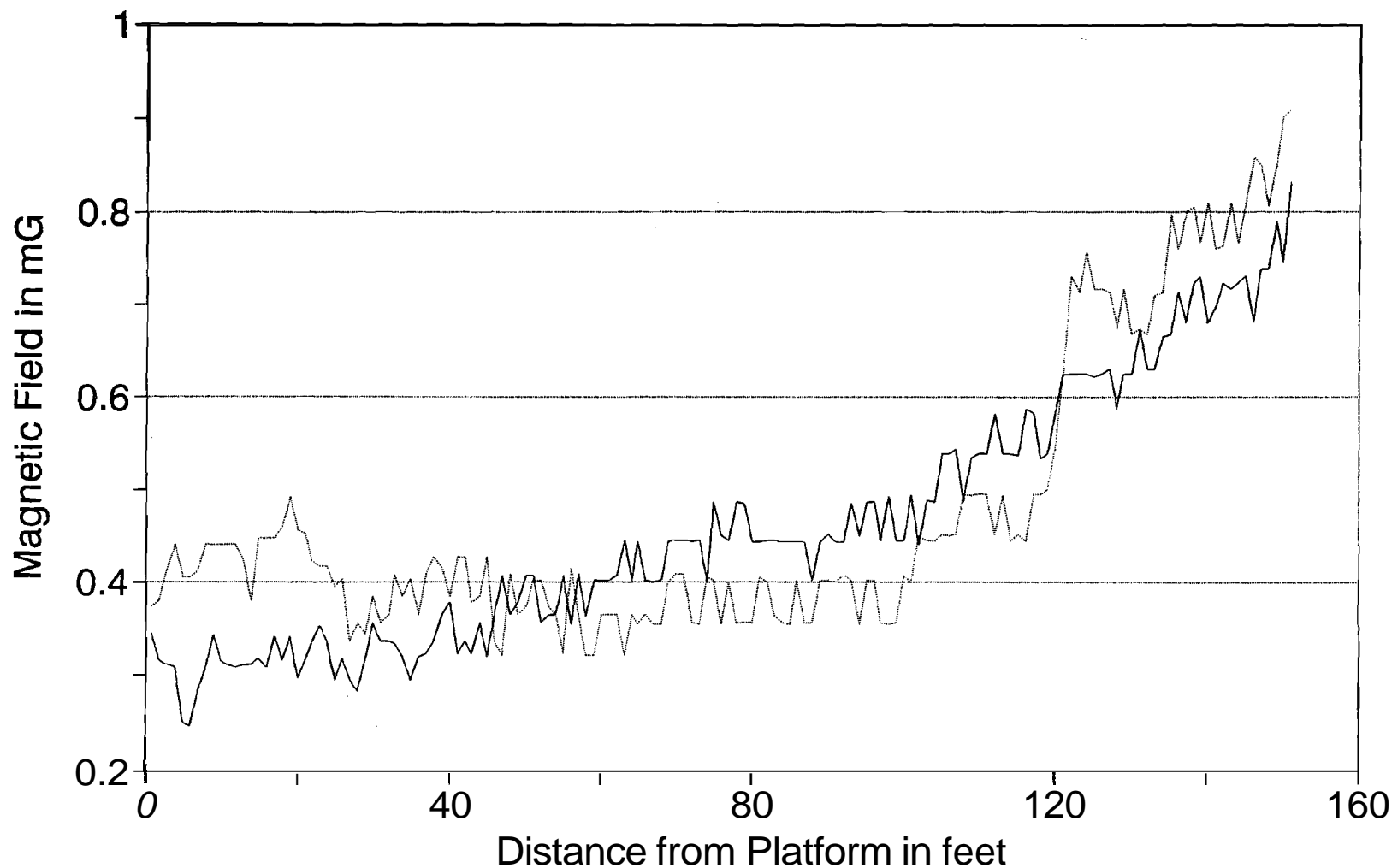

FIGURE 7-5. MAGNETIC FIELD AS A FUNCTION OF DISTANCE FROM THE STATION PLATFORM ALONG PROFILE LINE 3, 30.5 M (100 FT) OUTSIDE THE SUBSTATION FENCE AT THE MT. VERNON SUBSTATION

Mt. Vernon Substation

Profile 2

7-10

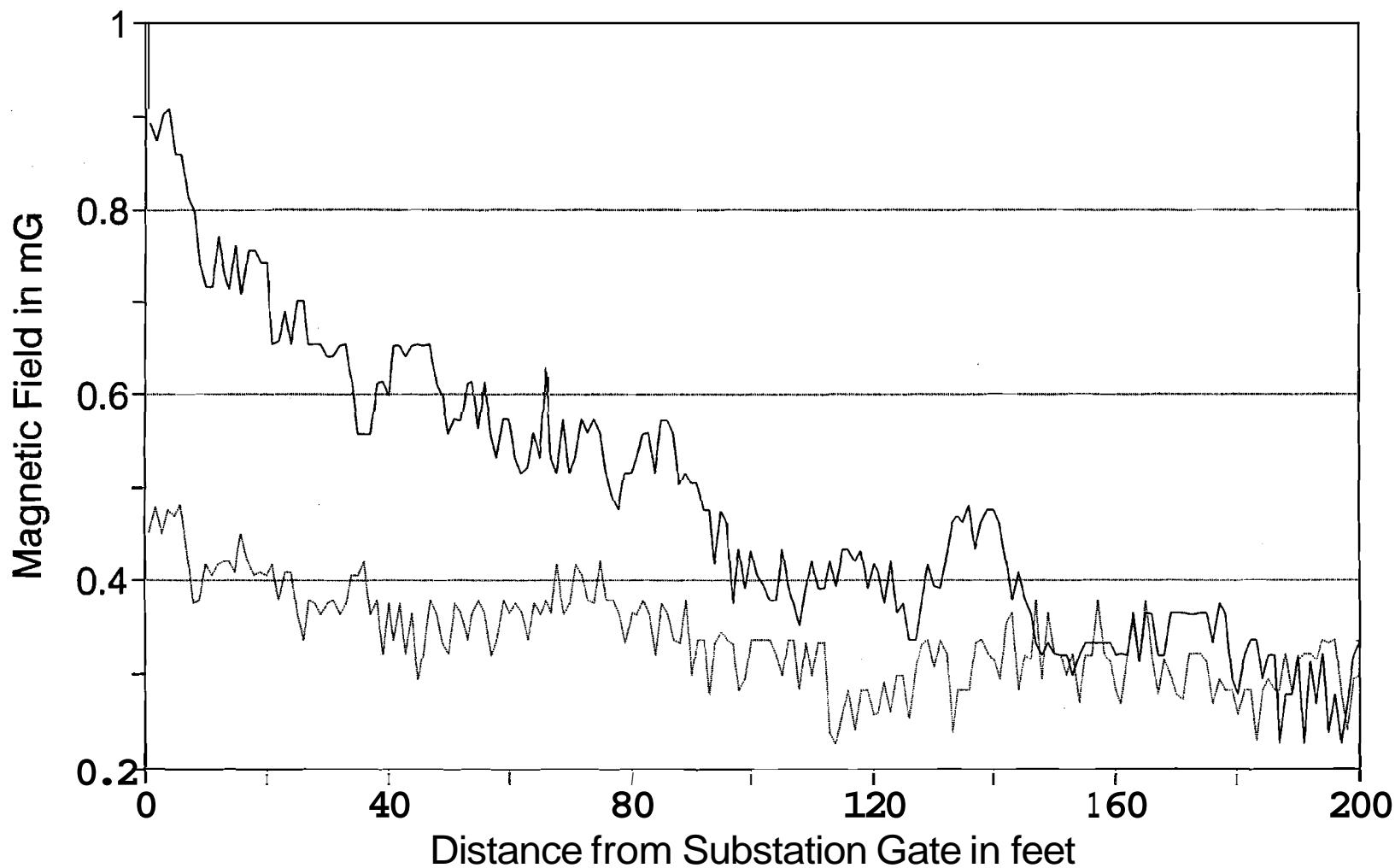
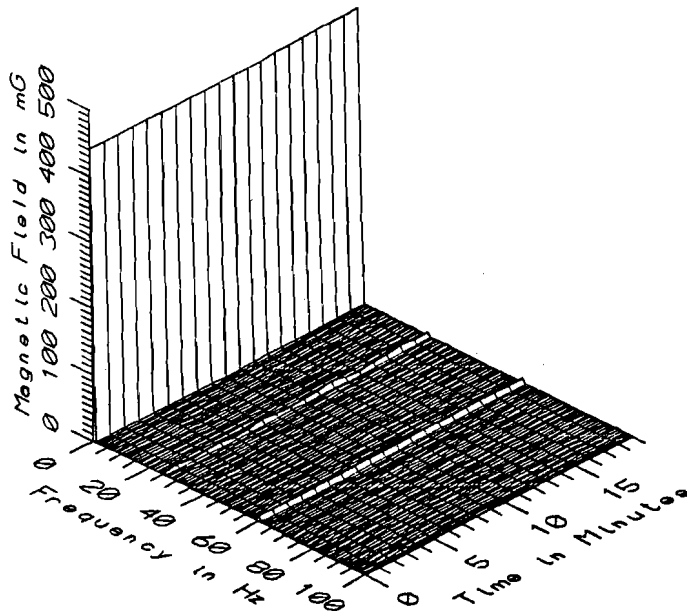
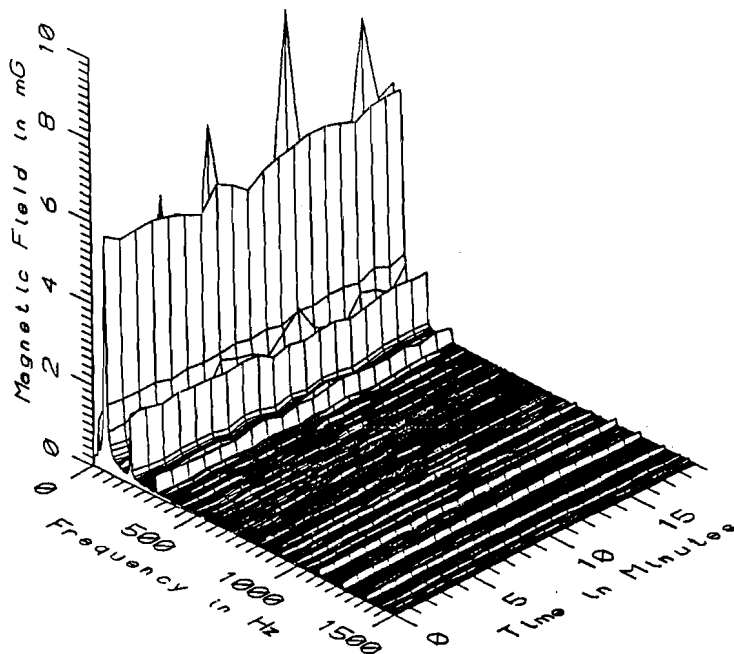

FIGURE 7-6. MAGNETIC FIELD AS A FUNCTION OF DISTANCE FROM THE SUBSTATION FENCE ALONG PROFILE LINE 2 AT THE MT. VERNON SUBSTATION



NEC037 - 110cm ABOVE GROUND IN FRONT OF PRINCETON JUNCTION SLIBSTATION



NEC037 - 110cm ABOVE GROUND IN FRONT OF PRINCETON JUNCTION SUBSTATION

FIGURE 7-7. MAGNETIC FIELD LEVEL VERSUS FREQUENCY AND TIME MEASURED 110 CM ABOVE THE SIDEWALK IN FRONT OF THE PRINCETON JUNCTION SUBSTATION ON THE 25 HZ SECTION OF THE NEC. THE STATIC FIELD IS SUPPRESSED IN THE BOTTOM FRAME TO SHOW THE TIME-VARYING FIELD COMPONENTS

The 60 Hz and its harmonics, namely the 3rd (180 Hz) and the 5th (300 Hz) can be distinguished and seen as remaining fairly constant throughout. There was a commercial distribution line overhead which accounts for this magnetic field. It is unrelated to the railroad substation. On the other hand, the 25 Hz and its harmonics, namely the 3rd (75 Hz) the 5th (125 Hz) the 9th (225 Hz) and the 11th (275 Hz) have the same temporal variability, which indicates that they all vary with the load drawn by the train or trains in that circuit. Note that the 7th harmonic (175 Hz) of the 25 Hz field is obscured by the 3rd harmonic (180 Hz) of the 60 Hz field and it is not visible. The relative strength of the 60 Hz field and its harmonics versus the 25 Hz field and its harmonics is approximately the same, which suggests that the substation contribution is of the same order of magnitude as the surrounding power lines.

The test engineer's notebook log indicates that a high speed AMTRAK train passed at the 5th and 6th minutes and another at 9th and 10th minutes. The notes also indicate that a commuter pulled out of the station starting at the 12th minute. These events coincide with the elevated 25 Hz magnetic field and its odd harmonics. Since the major variation of the 25 Hz field comes from the variation of the load in the catenary power circuits, the principal magnetic field source within the substation appears to be current in the secondary (11 kV) buswork. Figure 7-5 comes from the NEC044 set 110 cm from the substation fence at Mt. Vernon. As expected, the 60 Hz fundamental and its harmonics, corresponding to the 60 Hz electrification on this section of the railroad, are present. However, there is a 100 Hz component. This corresponds closely to the frequency of the signal current used in the rails for train detection and signal operation.

Figures 7-4 and 7-5 show two profile measurements of the magnetic field in the parking lot outside the Mt. Vernon Passenger Station and traction power substation. Both profiles are parallel to the substation fence extending from the station platform to the road. As shown in Figure 7-2, the profile in Figure 7-4 was measured along a line 1.5 m (5 ft) outside the fence while the profile in Figure 7-5 was 30.5 m (100 ft) from the substation. Figure 7-5 shows that the magnetic field 30.5 m (100 ft) from the substation is very low, but rises as the street is approached, a clear indication that the principal field source is a distribution line at the opposite side of the street. Figure 7-4, measured along the substation fence, shows that the magnetic field, while still very low, is higher in the 0-15.3 m (0-50 ft) range than in Figure 7-5, indicating that the magnetic field in the 0.3 to 0.9 mG range arises from equipment within the substation.

Figure 7-6 shows two magnetic field profiles measured along profile line 2 of Figure 7-2. The top curve shows an attenuating field pattern away from the substation which again indicates a 0.9 mG magnetic field just outside the substation fence. However, when a second profile was measured about a minute later, the substation field had dropped to the 0.4 mG range. The temporal variability in substation magnetic field is apparently in response to varying

traction power load on the station.

Magnetic field profile measurements around the periphery of the Red Bank Substation indicate that the magnetic fields are highly variable over time as evidenced by the fact that two profile measurements over the same path differ even though only minutes separate the two measurements. Magnetic field measurements along profile 3 beneath the incoming 345 kV transmission line shown in Figure 7-8 show the increased magnetic field beneath the transmission line. The differences between field intensity and pattern in the two repeated profile measurements are in response to temporal changes in load and shift in phase current balance on the incoming lines. The other area of elevated magnetic field around the station perimeter was along profile 1 where connection is made from the substation to a catenary.

Figure 7-9 shows the result of the magnetic field profile measurement away from the Red Bank Substation along profile line 6. The magnetic field is approximately 5 mG at the substation fence, but also 5 mG beneath the distribution line 13.7 m (45 ft) from the fence which provides station service power to the substation. The magnetic fields from the substation and distribution line attenuate quickly, but then increase again as the transmission line is approached. Another lateral profile was measured away from the substation along profile line 7 in Figure 7-3. The results of those measurements are given in Figure 7-10. These data again show relatively low magnetic field levels at the substation fence which attenuate with distance until the influence of an unidentified field source beyond the end of the profile is encountered.

In summary, both the repetitive waveform data and the portable profile plots indicate wide variations in the field levels as a function of the load imposed on the substation. This load, in turn, results from the actual position and running condition of the trains in that electrical vicinity. Also, there are wide variations on the side of the substation next to the tracks, depending on the current in the catenaries of the tracks. Specifically, the field is generally largest at the point along the substation perimeter that is under an incoming overhead line, an outgoing track power line and in the vicinity of equipment just inside the fence of the substation. It appears that the field contributions of the substations are at a lesser level than the fields produced by the primary circuits, the secondary circuits, the track power, and nearby commercial electric power facilities. This conclusion is consistent with the results of a **study**⁵ of magnetic field levels around commercial electric power substations.

Red Bank Station

Profile 3

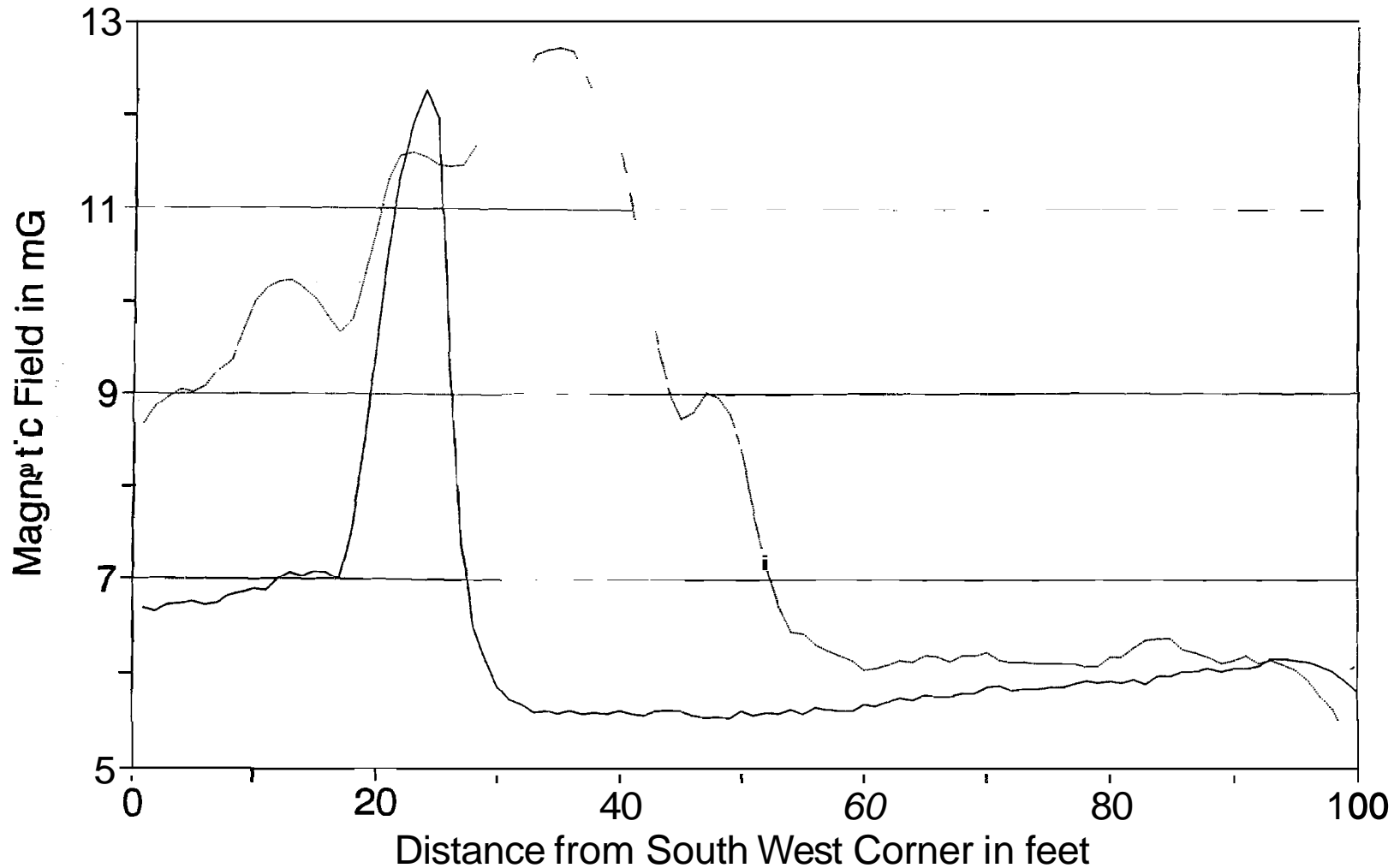
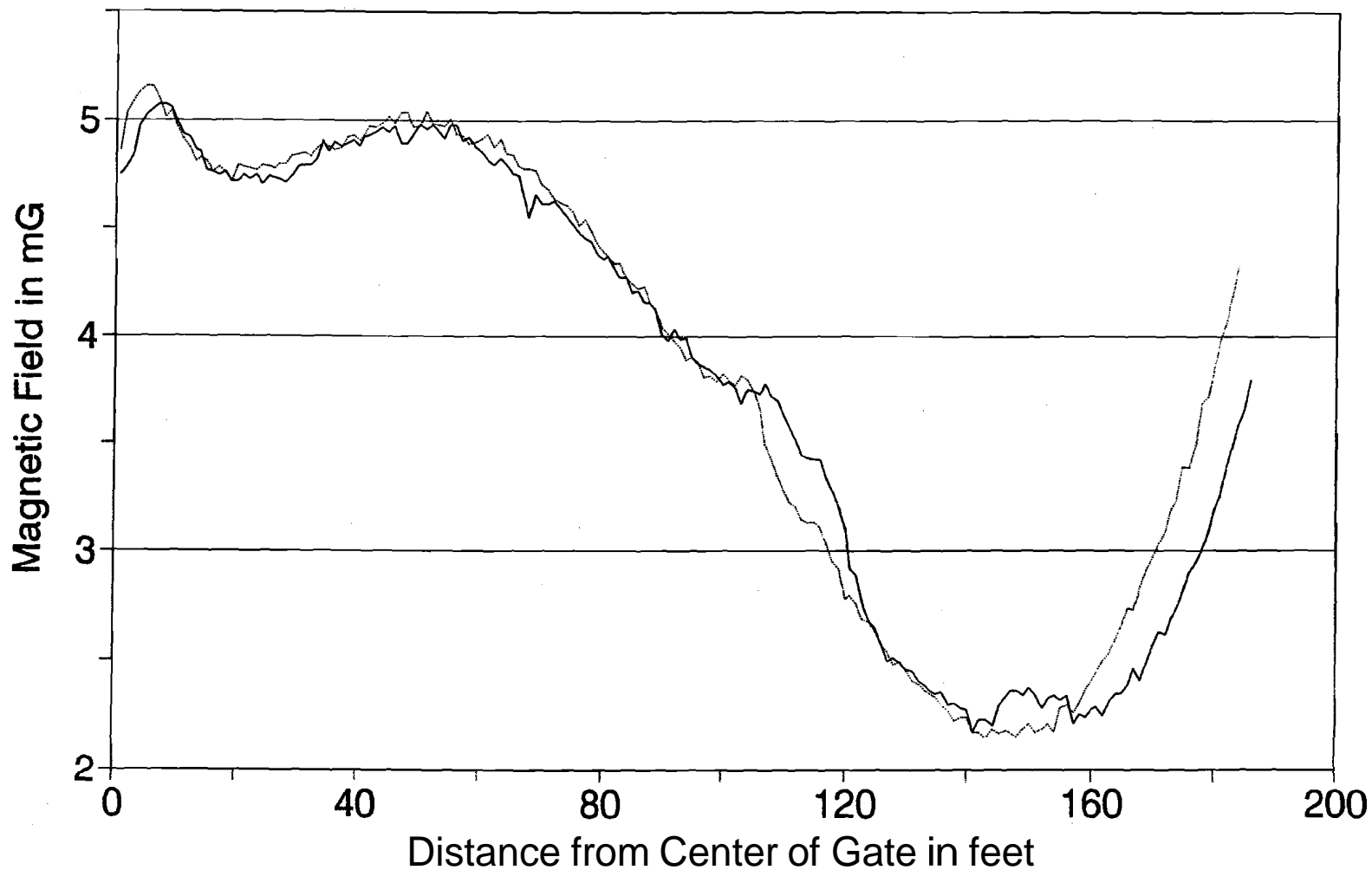

FIGURE 7-8. MAGNETIC FIELD AS A FUNCTION OF DISTANCE ALONG THE SUBSTATION FENCE ALONG PROFILE LINE 3 BENEATH THE ENTERING TRANSMISSION LINE AT THE RED BANK SUBSTATION

Red Bank Station

Profile 6



-15

FIGURE 7-9. MAGNETIC FIELD AS A FUNCTION OF DISTANCE AWAY FROM THE SUBSTATION FENCE ALONG PROFILE LINE 6 AT THE RED BANK SUBSTATION

Red Bank Station

Profile 7

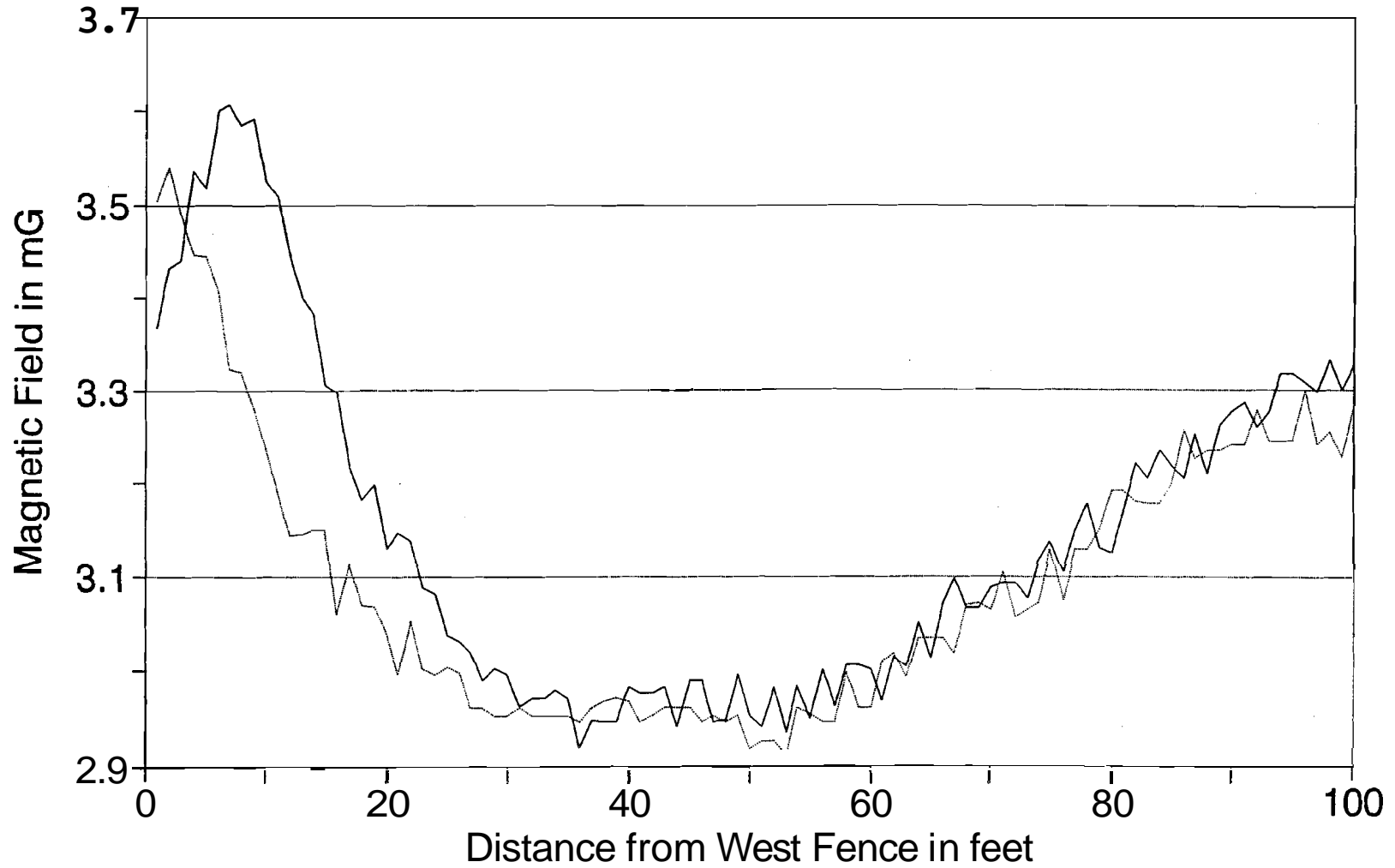

7-16

FIGURE 7-10. MAGNETIC FIELD AS A FUNCTION OF DISTANCE FROM THE SUBSTATION FENCE ALONG PROFILE LINE 7 AT THE RED BANK SUBSTATION

7.5 RMS RECORDER DATA

The rms recorders are carried on a person and, as such, they reflect the history in time and space of that person. The exposure of researchers in this study is not necessarily typical of either passengers or railroad employees. Therefore, rms recorder data may not be representative of occupational or environmental public exposures to magnetic fields.

RMS recorder data was collected by two researchers at the Red Bank substation and vicinity. Figure 7-11 shows the time sequence of the two recordings. Table 7-3 has the statistics of the two records, as well as the combination of both. It can be seen that there are differences in the detail records even though the two researchers worked near each other. On the other hand, the two averages differ by only 10%.

TABLE 7-3

STATISTICAL SUMMARY OF MAGNETIC FIELDS
MEASURED BENEATH THE 345 KV TRANSMISSION LINE
JUST OUTSIDE THE RED BANK SUBSTATION USING RMS RECORDERS

	PERSON 1	PERSON 2	BOTH
MINIMUM	0.7 mG	2.6 mG	0.7 mG
MAXIMUM	11.2 mG	7.9 mG	11.2 mG
AVERAGE	5.8 mG	5.3 mG	5.5 mG
STD. DEV.	2.0 mG	1.6 mG	1.8 mG
COEFF. OF VAR.	35.0 mG	29.7 mG	32.9 mG

7.6 SUMMARY OF MAGNETIC FIELD LEVELS

7.6.1 Princeton Junction 25 Hz Substation

The figures in Appendix AL are the plots of the magnetic field versus both frequency and time, for the four simultaneous distance measurements along the staff. The four distances are 10 cm, 60 cm, 110 cm and 160 cm above ground. There is also a plot of the reference probe, placed at 10 cm above ground. Each figure has two plots, the top includes the static component and the bottom suppresses it. Figure 7-7 is an example of this plot.

The appendix also has plots of the magnetic field versus both time and distance. Each plot is for a different frequency range, starting with the static component and ending with the total of all frequencies, without the static component. The statistics of these

Red Bank Station

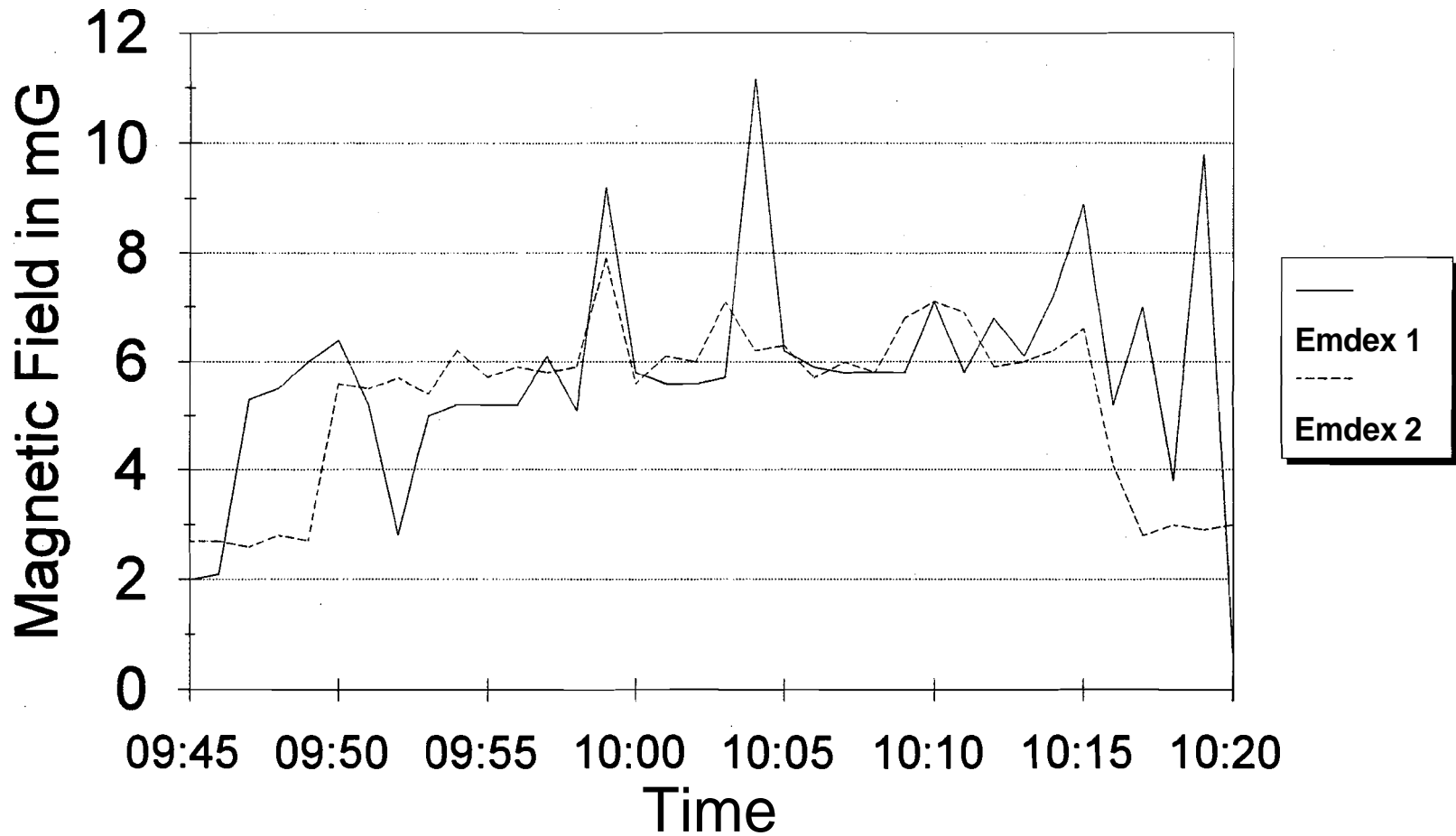

7-18

FIGURE 7-11. RMS RECORDINGS OF THE MAGNETIC FIELD LEVELS ENCOUNTERED BY TWO RESEARCHERS WORKING OUTSIDE THE RED BANK SUBSTATION BENEATH THE INCOMING 345 KV TRANSMISSION LINE

plots are summarized in Table 7-4. It can be seen that there is no appreciable variation of the field with height, in all frequency ranges. As expected, the largest value recorded, 9.19 mG, is in the low frequency range, which is the 25 Hz "power" range for this section of the railroad. The largest coefficient of variation is in the same range. However, the largest average field is the 60 Hz field from the commercial distribution line running along the street. The 60 Hz field has a low coefficient of variability because the commercial load is much more stable over time than is the field from the substation.

7.6.2 Mt. Vernon 60 Hz Substation

There are three sets of data for the Mt. Vernon substation: NEC044, NEC045-1 and NEC045-2. Appendices AS and AT contain the figures of the magnetic field plots.

As in previous sections, there are plots of the magnetic field versus both frequency and time, for the four simultaneous distance measurements along the staff. The four distances are 10 cm, 60 cm, 110 cm and 160 cm from the end. The staff was held in a horizontal position 1.5 m (5 ft) above the station platform in dataset NEC044, 1.0 m (3.3 ft) above the ground in dataset NEC045. Hence, the data at successive staff positions show attenuation of the field away from the substation or tracks. Each figure has two plots, the top includes the static component and the bottom suppresses it. Figure 7-12 is an example of one of these plots.

The appendices also contain plots of the magnetic field versus both time and distance. Each plot is for a different frequency range, starting with the static component and ending with the total of all frequencies, without the static component. The statistics of these plots are summarized in Table 7-5 for the NEC044 dataset. It can be seen that the largest field value of 0.72 mG is in the 180 Hz, 3rd harmonic, range. This component also is fairly constant which indicates that it is a harmonic probably due to transformer magnetization. The largest coefficient of variation is in the low frequency range.

Appendix AT has the NEC045-1 set of figures, arranged in the same order as the other cases. The difference is that the distance is not "height" but horizontal distance parallel to the substation fence, as measured from the gate. Table 7-6 summarizes the statistics of these data. The maximum value of 0.89 mG occurs in the power frequency range. But the largest coefficient of variability is again in the low frequency range.

Finally, the NEC045-2 set of data is also shown in Appendix AT and arranged in the same fashion. Table 7-7 summarizes the statistics of this dataset. It shows that the maximum value of 0.74 mG is in the power frequency range. The largest coefficient of variation is in the high frequency range. The three portable profiles are Figures 7-4 to 7-6. The maximum values recorded in any of the portable profiles is 0.937 mG, which is also the overall maximum.

TABLE 7-4

SUMMARY STATISTICS FOR MAGNETIC FIELDS MEASURED ON THE
 SIDEWALK OUTSIDE THE PRINCETON JUNCTION SUBSTATION
 ON THE 25 HZ PORTION OF THE NEC

NEC037 - IN FRONT OF PRINCETON JUNCTION SUBSTATION		TOTAL OF 20 SAMPLES				
FREQUENCY BAND	HEIGHT ABOVE GND (cm)	MINIMUM MAGNETIC FIELD (mG)	MAXIMUM MAGNETIC FIELD (mG)	AVERAGE MAGNETIC FIELD (mG)	STANDARD DEVIATION (mG)	COEFFICIENT OF VARIATION (%)
STATIC	10	403.36	407.85	405.98	1.28	0.32
	60	443.24	445.98	444.45	0.77	0.17
	110	441.09	443.94	442.58	0.77	0.17
	160	515.92	520.46	518.92	1.23	0.24
5-45Hz LOW FREQ	10	1.25	8.40	4.32	2.17	50.09
	60	1.33	8.70	4.33	2.16	49.92
	110	1.41	9.01	4.40	2.19	49.66
	160	1.47	9.19	4.33	2.18	50.37
50-60Hz PWR FREQ	10	5.52	6.06	5.81	0.16	2.78
	60	6.02	6.57	6.32	0.17	2.62
	110	6.69	7.34	7.03	0.18	2.61
	160	6.95	7.56	7.29	0.18	2.46
65-300Hz PWR HARM	10	1.87	2.55	2.18	0.18	8.30
	60	1.99	2.73	2.31	0.19	8.23
	110	2.14	2.91	2.48	0.20	8.14
	160	2.22	3.03	2.57	0.21	8.26
305-2560Hz HIGH FREQ	10	0.36	0.64	0.52	0.08	15.00
	60	0.39	0.68	0.56	0.09	15.38
	110	0.42	0.75	0.62	0.10	15.84
	160	0.43	0.78	0.65	0.10	15.38
5-2560Hz ALL FREQ	10	6.08	10.65	7.77	1.29	16.60
	60	6.61	11.17	8.21	1.24	15.04
	110	7.36	11.88	8.86	1.21	13.62
	160	7.57	12.24	9.06	1.20	13.28

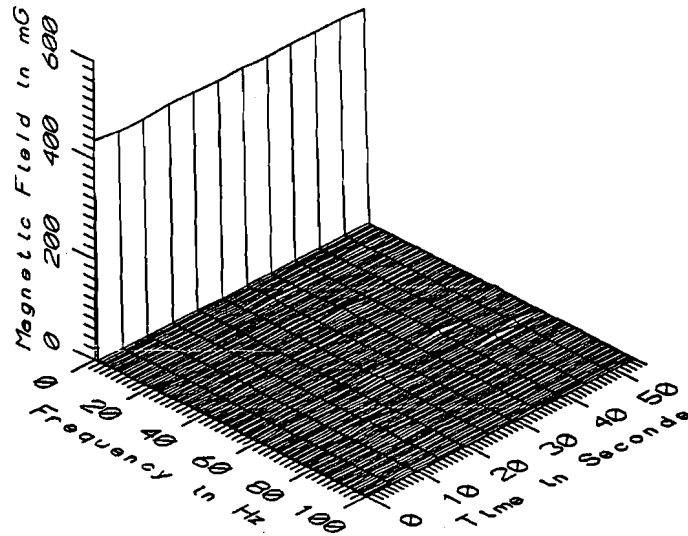

NEC044 - 110_{cm} FROM MT VERNON SUBSTATION FENCE, 1.5M ABOVE GROUND

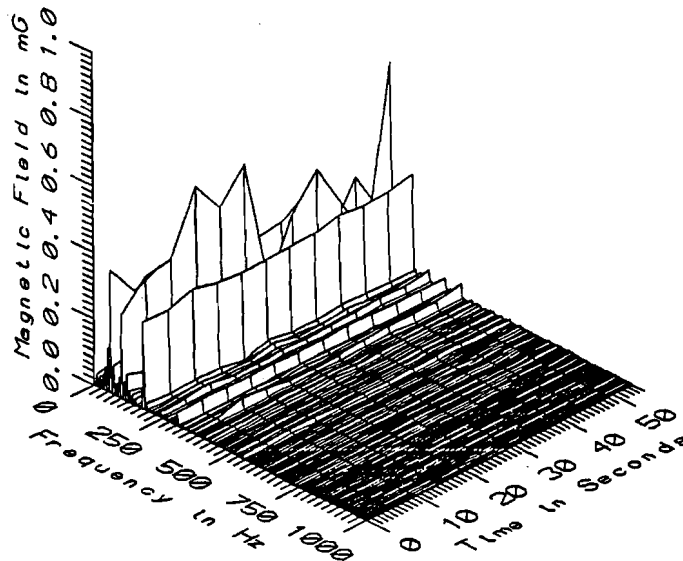

NEC044 - 110_{cm} FROM MT VERNON SUBSTATION FENCE. 1.5M ABOVE GROUND

FIGURE 7-12. MAGNETIC FIELD LEVEL VERSUS FREQUENCY AND TIME MEASURED 110 CM OUTSIDE THE SUBSTATION FENCE ON THE MT. VERNON STATION PLATFORM* THE STATIC FIELD IS SUPPRESSED IN THE BOTTOM FRAME TO SHOW THE TIME-VARYING FIELD COMPONENTS

TABLE 7-5

SUMMARY STATISTICS FOR MAGNETIC FIELDS MEASURED 1.5 M (5 FT) ABOVE
THE STATION PLATFORM OUTSIDE THE MT. VERNON 60 HZ SUBSTATION

NEC044 - MOUNT VERNON SUBSTATION FENCE, 1.5m ABOVE GND					TOTAL OF 12 SAMPLES	
FREQUENCY BAND	DIST. FROM FENCE (cm)	MINIMUM MAGNETIC FIELD (mG)	MAXIMUM MAGNETIC FIELD (mG)	AVERAGE MAGNETIC FIELD (mG)	STANDARD DEVIATION (mG)	COEFFICIENT OF VARIATION (%)
STATIC	10	448.98	455.95	452.73	2.46	0.54
	60	431.82	439.83	436.45	2.79	0.64
	110	429.79	438.93	434.72	2.78	0.64
	160	477.02	485.43	481.41	3.15	0.66
5-45Hz LOW FREQ	10	0.16	0.31	0.24	0.06	23.44
	60	0.12	0.19	0.16	0.02	12.94
	110	0.05	0.15	0.11	0.03	27.77
	160	0.16	0.21	0.18	0.02	10.51
50-60Hz PWR FREQ	10	0.14	0.25	0.20	0.03	14.75
	60	0.13	0.27	0.20	0.03	16.95
	110	0.18	0.39	0.29	0.06	21.00
	160	0.19	0.28	0.24	0.03	11.37
65-300Hz PWR HARM	10	0.28	0.59	0.42	0.10	24.00
	60	0.29	0.61	0.43	0.11	24.83
	110	0.32	0.69	0.49	0.12	24.58
	160	0.35	0.72	0.52	0.12	23.58
305-2560Hz HIGH FREQ	10	0.04	0.08	0.06	0.01	19.24
	60	0.03	0.06	0.05	0.01	15.04
	110	0.04	0.06	0.05	0.01	18.76
	160	0.03	0.06	0.05	0.01	13.92
5-2560Hz ALL FREQ	10	0.41	0.64	0.53	0.07	13.76
	60	0.37	0.65	0.50	0.09	17.55
	110	0.45	0.72	0.59	0.09	15.79
	160	0.48	0.78	0.61	0.10	16.78

TABLE 7-6

**SUMMARY STATISTICS FOR MAGNETIC FIELDS MEASURED 1 M (3.3 FT) ABOVE
GROUND 2 M (6.6 FT) OUTSIDE THE GATE OF THE MT. VERNON 60 HZ SUBSTATION**

NEC045-1 - 2m FROM MT VERNON SUBSTATION, 1m ABOVE GND		TOTAL OF 5 SAMPLES				
FREQUENCY BAND	DIST. ALONG STAFF (cm)	MINIMUM MAGNETIC FIELD (mG)	MAXIMUM MAGNETIC FIELD (mG)	AVERAGE MAGNETIC FIELD (mG)	STANDARD DEVIATION (mG)	COEFFICIENT OF VARIATION (%)
STATIC	60	466.33	468.09	461.12	0.81	0.17
	110	444.34	446.42	445.42	0.78	0.18
	160	478.18	480.80	479.74	0.98	0.21
5-45Hz LOW FREQ	60	0.13	0.16	0.14	0.01	7.78
	110	0.08	0.14	0.10	0.02	22.47
	160	0.14	0.20	0.17	0.02	13.53
50-60Hz PWR FREQ	60	0.51	0.81	0.67	0.13	19.42
	110	0.69	0.88	0.78	0.08	9.70
	160	0.52	0.89	0.72	0.13	18.77
65-300Hz PWH HARM	60	0.26	0.33	0.29	0.03	9.97
	110	0.28	0.34	0.31	0.03	8.47
	160	0.28	0.35	0.31	0.03	8.57
305-2560Hz HIGH FREQ	60	0.07	0.08	0.08	0.00	5.33
	110	0.08	0.09	0.08	0.00	5.45
	160	0.07	0.09	0.08	0.01	6.96
5-2560Hz ALL FREQ	60	0.61	0.89	0.75	0.12	16.17
	110	0.75	0.95	0.85	0.08	9.33
	160	0.63	0.97	0.81	0.12	15.23

TABLE 7-7

SUMMARY STATISTICS FOR MAGNETIC FIELDS MEASURED 1 M (3.3 FT) ABOVE
THE GROUND AT VARIOUS DISTANCES FROM THE GATE
OF THE MT. VERNON SUBSTATION

NEC045-2 - M VERNON SUBSTATION, 1m ABOVE GND			TOTAL OF 5 SAMPLES			
FREQUENCY BAND	DIST. FROM FENCE (cm)	MINIMUM MAGNETIC FIELD (mG)	MAXIMUM MAGNETIC FIELD (mG)	AVERAGE MAGNETIC FIELD (mG)	STANDARD DEVIATION (mG)	COEFFICIENT OF VARIATION (%)
STATIC	60	431.81	455.80	433.41	1.74	0.38
	110	388.27	393.55	390.06	2.30	0.59
	160	511.07	516.93	513.43	2.57	0.50
5-45Hz LOW FREQ	60	0.14	0.18	0.15	0.02	11.62
	110	0.10	0.14	0.12	0.02	13.86
	160	0.15	0.17	0.16	0.01	7.07
50-60Hz PWR FREQ	60	0.65	0.74	0.69	0.05	6.68
	110	0.61	0.74	0.68	0.05	7.14
	160	0.61	0.74	0.68	0.06	9.16
65-300Hz PWR HARM	60	0.23	0.28	0.26	0.02	7.81
	110	0.26	0.31	0.28	0.02	6.25
	160	0.25	0.30	0.28	0.02	7.43
305-2560Hz HIGH FREQ	60	0.05	0.07	0.06	0.01	12.00
	110	0.06	0.07	0.06	0.00	5.35
	160	0.05	0.07	0.06	0.01	15.64
5-2560Hz ALL FREQ	60	0.71	0.81	0.75	0.05	6.24
	110	0.69	0.80	0.75	0.04	5.70
	160	0.69	0.82	0.75	0.06	8.20

7.6.3 Red Bank 60 Hz Substation

There is one set of data for the Red Bank substation, NEC052, and seven portable **profiler** runs.

The figures of the plots are in Appendix BA. As in previous sections, the figures are the plots of the magnetic field versus both frequency and time, for the four simultaneous distance measurements along the staff. The four distances are 10 cm, 60 cm, 110 cm, and 160 cm above ground. Each figure has two plots, the top includes the static component and the bottom suppresses it.

The appendix also has figures of the plots of the magnetic field versus both time and distance. Each plot is for a different frequency range, starting with the static component and ending with the total of all frequencies, without the static component. The statistics of these plots are summarized in Table 7-8. It can be seen that the largest field value of 13.81 mG is in the power range, as expected. The largest coefficient of variation is in the low frequency range. Only one four-car train passed during the time of this data recordings.

Figures 7-8 through 7-10 are the plots of three of the seven profile curves that cover the outside of the substation. The first five profiles surround the perimeter of the station, with the maximum value of 19.153 mg occurring at the point of crossing of the outgoing lines to the tracks. This is also the overall maximum recorded at Red Bank.

Table 7-9 has the statistics of the portable profiles in the periphery of the Red Bank substation. The profiles are classified into three groups and the statistics given for each group. Profile 3 comprises the group that is associated with the incoming transmission line. Profile 1 is associated with the portion that is adjacent to the tracks. And profiles 2, 4 & 5 are associated with the general periphery of the station.

7.6.4 Effects of Electrification Technology

No conclusion can be drawn as to differences in electric and magnetic fields near power substations due to different electrification technologies (of course, the non-electrified line is omitted). It appears that the major variations in the fields are due to differences in substation design, load, terrain, starting and breaking characteristics, passenger load, number of trains on the circuit under scrutiny and operating policies. The only exception is that of the allocation of magnetic field energy by frequency spectrum. The 25 Hz Princeton Junction substation has a more pronounced field contribution in the 25 Hz range and the range of its harmonics, while the others have the predominant field components at 60 Hz and harmonics thereof.

TABLE 7-8

SUMMARY STATISTICS FOR MAGNETIC FIELDS MEASURED OUTSIDE THE RED BANK SUBSTATION (60 HZ SECTION OF THE NORTH JERSEY COAST LINE) NEAR THE ENTERING 345 KV TRANSMISSION LINE

NEC052 - OUTSIDE RED BANK SUBSTATION NEAR 345KV LINE				TOTAL OF 23 SAMPLES		
FREQUENCY BAND	HEIGHT ABOVE GND (cm)	MINIMUM MAGNETIC FIELD (mG)	MAXIMUM MAGNETIC FIELD (mG)	AVERAGE MAGNETIC FIELD (mG)	STANDARD DEVIATION (mG)	COEFFICIENT OF VARIATION (%)
STATIC	10	486.36	493.30	489.37	1.38	0.28
	60	509.33	514.61	511.80	1.72	0.34
	110	468.58	475.01	471.38	1.40	0.30
	160	529.18	535.32	532.80	1.38	0.26
5-45Hz LOW FREQ	10	1.80	3.43	2.42	0.46	18.91
	60	0.13	0.42	0.20	0.06	30.55
	110	0.09	0.56	0.17	0.10	57.35
	160	0.18	0.61	0.24	0.09	37.68
50-60Hz PWR FREQ	10	5.03	13.81	6.21	1.78	28.68
	60	5.21	13.61	6.19	1.72	27.69
	110	5.29	14.32	6.43	1.85	28.79
	160	5.35	13.48	6.31	1.69	26.76
65-300Hz PWR HARM	10	0.66	1.89	1.03	0.29	28.37
	60	0.33	1.78	0.68	0.35	51.77
	110	0.38	1.81	0.73	0.35	47.33
	160	0.34	1.71	0.67	0.33	48.93
305-2560Hz HIGH FREQ	10	0.34	0.67	0.47	0.09	19.52
	60	0.15	0.53	0.26	0.10	39.32
	110	0.14	0.54	0.27	0.11	39.56
	160	0.14	0.51	0.25	0.10	38.36
5-2560Hz ALL FREQ	10	5.55	14.11	6.79	1.73	25.46
	60	5.23	13.73	6.24	1.74	27.84
	110	5.33	14.44	6.48	1.87	28.89
	160	5.41	13.59	6.36	1.71	26.88

TABLE 7-9

SUMMARY STATISTICS FOR 60 HZ MAGNETIC FIELD MEASUREMENTS
MADE AROUND THE PERIPHERY OF THE RED BANK
SUBSTATION WITH THE PROFILER

RED BANK SUBSTATION - SUMMARY STATISTICS OF PROFILER DATA						
LOCATION	PROFILE	MINIMUM MAGNETIC FIELD (mG)	MAXIMUM MAGNETIC FIELD (mG)	AVERAGE MAGNETIC FIELD (mG)	STANDARD DEVIATION (mG)	COEFFICIENT OF VARIATION (%)
TRANS- MISSION LINE	3	5.39	12.73	7.39	2.18	29.45
199 SAMPLES						
ADJACENT TO TRACKS	1	3.40	19.15	11.99	5.76	48.04
649 SAMPLES						
GENERAL PERIPHERY	2,4,5	3.19	16.33	5.73	2.90	50.71
691 SAMPLES						

7.7 SUMMARY OF ELECTRIC FIELD LEVELS

Electric field measurements were made in the vicinity of the Princeton Junction and Mt. Vernon Substations. The number of transmission and distribution lines in the vicinity of the Red Bank Substation made it impossible to measure the electric field from that substation.

The electric field measurement at the Princeton Junction Substation was above the sidewalk at the front of the substation. This is the same location (position 54 in Figure 7-1) where the magnetic field was measured. The electric field 1 m above the sidewalk was 13 V/m and principally 60 Hz, indicating that the three phase primary distribution line overhead was the principal source. The electric field from the 138 kV, 25 Hz transmission line passing through the substation near the measurement point was apparently almost totally shielded by the substation fence and the overhead commercial primary and secondary distribution lines and the overhead telephone cable.

Electric field measurements were made at the station platform and parking lot just outside the Mt. Vernon Substation, positions 41 and 51 on Figure 7-2. The 60 Hz electric field strengths at these locations were 950 V/m and 7 V/m, respectively. At both locations, the electric field appeared to originate from the railroad catenary rather than the substation. However, since this station was fed by underground cables and had metal enclosed high voltage bus all the way to the transformers, the lack of measurable electric field from this particular substation at the accessible locations is not surprising.

8. ELECTRIC AND MAGNETIC FIELD MEASUREMENTS IN RAIL TRAFFIC CONTROL FACILITIES

Although most railroad control facilities are located sufficiently far from the electrified traction systems that magnetic fields from those facilities are of little concern, they often have electrical or electronic equipment which can produce electric and magnetic fields to which a worker may be exposed. The limited measurements reported in this section were taken in **Boston's** South Station dispatch area and are not necessarily representative of field levels in other locations. Since there were no electrified traction circuits near this facility, the field conditions reported are not specific to any one electrification technology.

8.1 MEASUREMENT LOCATIONS

The first set of measurements in the South Street Station control area was in front of a centralized electrification and traffic control (CETC) station designated as the MAC **Manager's** Console. This position consisted of a curved desktop containing six video display terminals, as illustrated in Figure 8-1. The equipment at this position was typical of equipment at other CETC stations within the **dispatcher's** area. A vertical profile of magnetic field was measured directly in front of the **worker's** chair, as indicated by position 48 in Figure 8-1. A second profile was measured horizontally from the center of the center monitor. The horizontal profile, indicated as position 49 in Figure 8-1, was approximately 1 m above the floor.

The second set of measurements were in the uninterruptible power supply (UPS) room adjacent to the dispatch area in the South Station. The principal pieces of equipment in this small room were two large UPS units occupying six equipment cabinets in the center of the room, as illustrated in Figure 8-2. A seventh cabinet in the center of the room contained switchgear to connect either the primary or secondary UPS units. Various other small cabinets on the surrounding walls contained disconnect switches, switchgear, small transformers, etc. A vertical profile of magnetic field strength was measured approximately .6 m (2 ft) from the front panel of the secondary UPS unit at a position indicated as position 50 on Figure 8-2.

8.2 REPETITIVE WAVEFORM DATASETS

Three repetitive waveform **datasets** were collected in the dispatch area of **Boston's** South Station at the positions indicated above. The first measurement was the vertical profile in front of the CETC console. Data from this set, **NEC018**, are contained in Appendix S.

Dataset NEC019 contains the data from the 24 repetitive magnetic field waveforms measured to establish the horizontal profile of field attenuation away from the central monitor on the CETC station console. These data are contained in Appendix T.

Dispatcher's Room

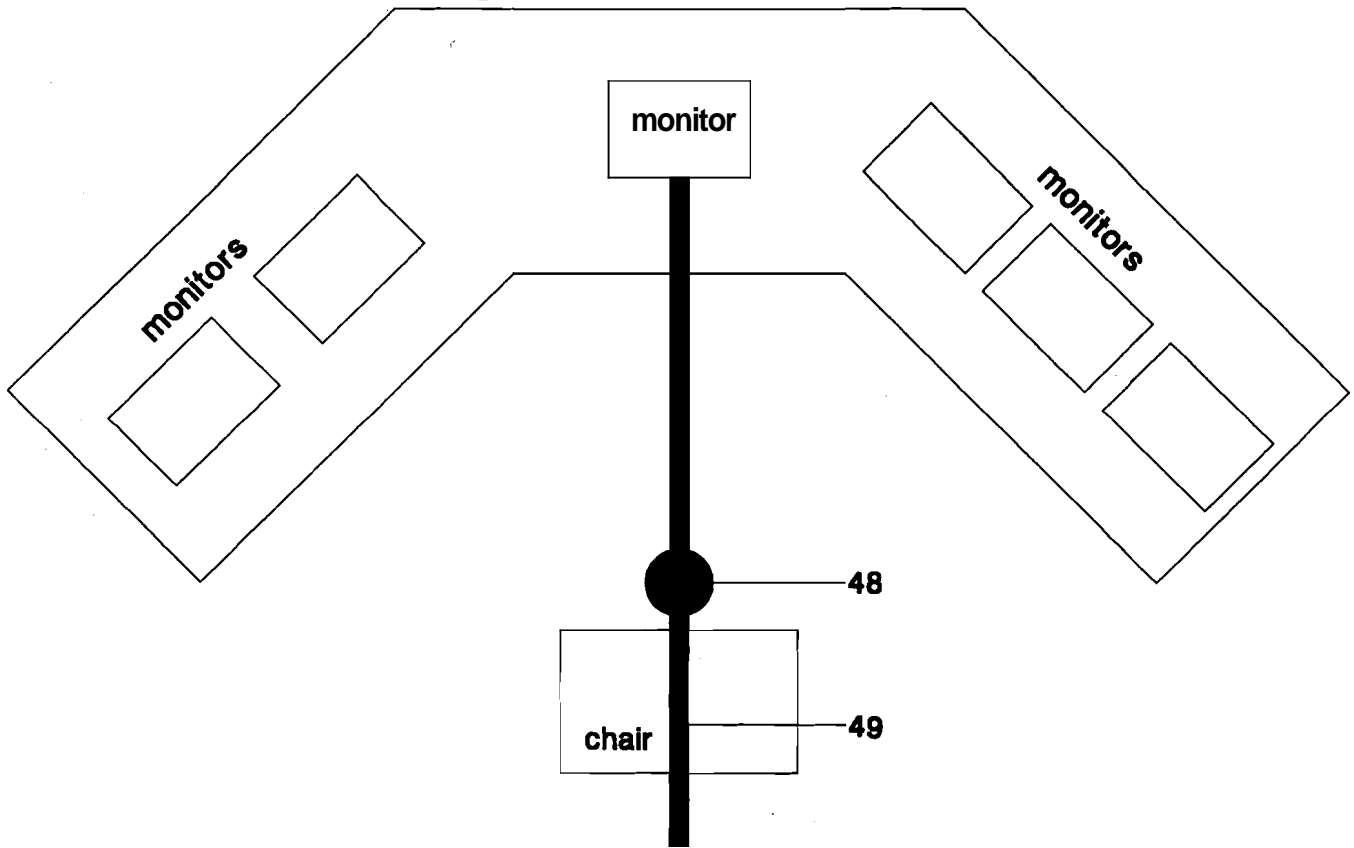

FIGURE 8-1. REPETITIVE **WAVEFORM** MEASUREMENT LOCATIONS AT THE MAC MANAGER'S CENTRALIZED ELECTRIFICATION AND TRAFFIC CONTROL STATION IN THE BOSTON SOUTH STATION DISPATCH AREA

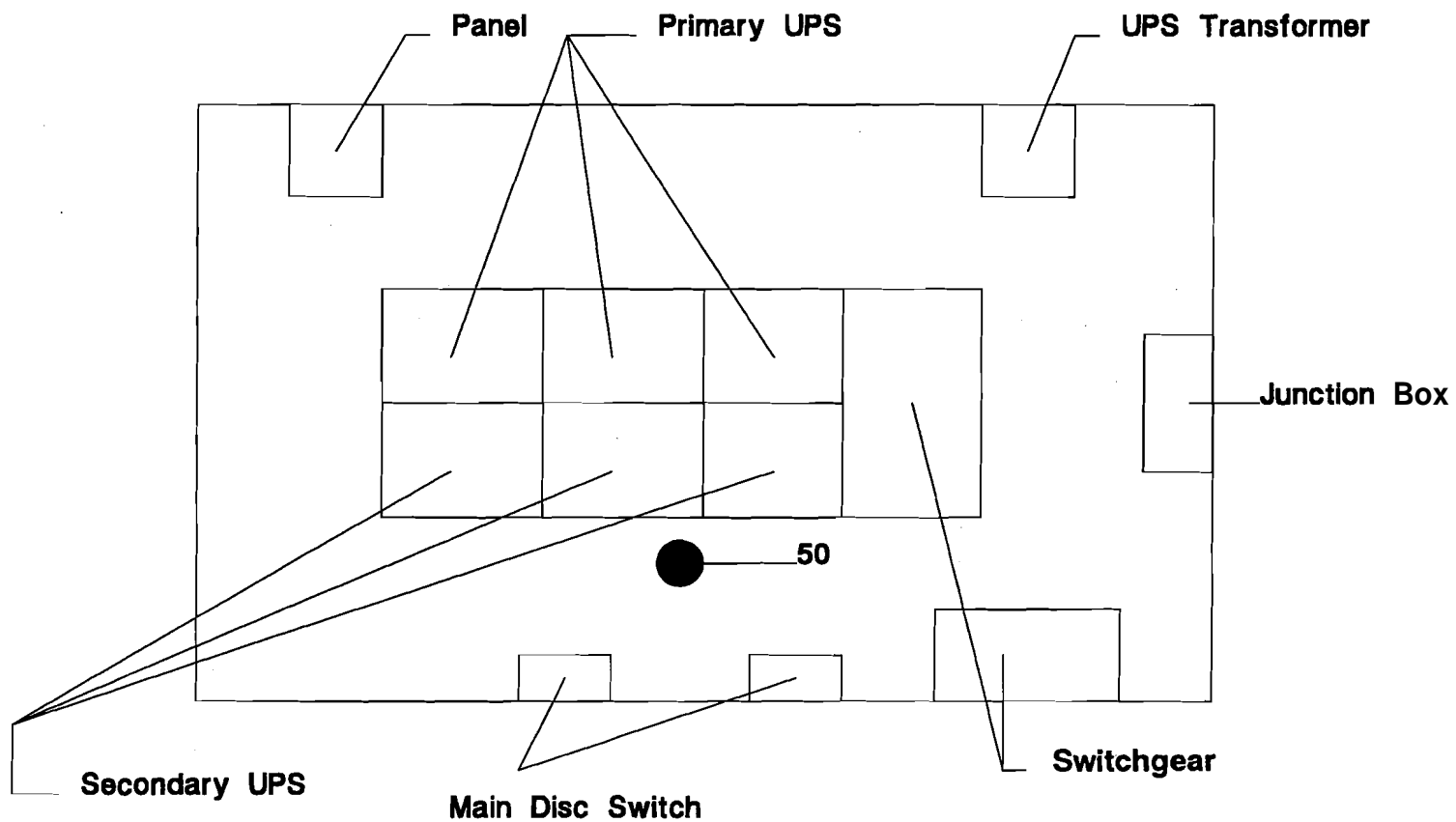

FIGURE 8-2. REPETITIVE WAVEFORM MEASUREMENT LOCATION IN THE UNINTERRUPTIBLE POWER SUPPLY (UPS) ROOM ADJACENT TO THE DISPATCH AREA IN BOSTON'S SOUTH STATION

Repetitive waveform data measured in the uninterruptible power supply room make up **dataset NEC020** and are found in Appendix **U**.

8.3 FIELD SOURCE IDENTIFICATION

The principal magnetic field source in the vicinity of the CETC station was the video display terminals on the station console. The field by frequency and time plot for the measurements 10 cm from the video display terminal is shown in the top frame of Figure 8-3. This data comes from **dataset NEC019** in Appendix T. The fundamental frequency component is approximately 60 Hz with odd and even harmonics of decreasing amplitude. That "**frequency signature**" is characteristic of the sawtooth magnetic field generated by the vertical deflection yoke of a video display terminal. The magnetic field pattern is very stable over time. A smaller field component at approximately 35 Hz is also present.

The bottom frame of Figure 8-3 shows the field by frequency by time plot for simultaneous measurements at a point 60 cm from the video display terminal. Comparison of the two frames demonstrates that while both graphs contain similar frequency components, the fields are about 6 times weaker at 60 cm from the terminal than they were 10 cm from the terminal, demonstrating the rapid rate at which the magnetic field attenuates away from the source. Furthermore, the field at the 60 cm position is much more variable over time, indicating that at the 60 cm position, the field is no longer dominated by the center video display terminal but from several other sources, and the fields from each interact causing short-term variability in the intensity of each apparent frequency component.

Examination of the vertical profile of magnetic fields at the CETC console (Appendix S) indicates that the various monitors on the console are the principal field source but an additional 60 Hz field source is indicated in the data measured 10 cm above the floor. The source of the field near the floor is most likely a power cable beneath the floor.

The magnetic fields measured in the uninterruptible power supply room (**NEC020**, Appendix **U**) appear to arise from the **UPS** unit. Figure 8-4 shows field by frequency and time plots measured 10 cm and 160 cm above the floor at a point 60 cm from the front panel of the **UPS** cabinet. The large harmonic content of the magnetic field is clearly evident, arising from the semiconductor inverter within the **UPS** unit. Although there is a gradient in the 60 Hz field component, being larger near the floor and somewhat smaller at the 160 cm height, the magnitude of the harmonic components remain approximately equal. In fact, examination of the other plots in Appendix **U** reveal that the magnitude of the harmonic components of the field are largest at a point roughly 60 cm above the floor.

The static magnetic field measurements in front of the **UPS** reveal an elevated static field near the floor but rapid return to normal geomagnetic field levels at higher locations. The source of the elevated field near the floor could be dc current in a cable from the **UPS** unit to the backup batteries or magnetization of a building

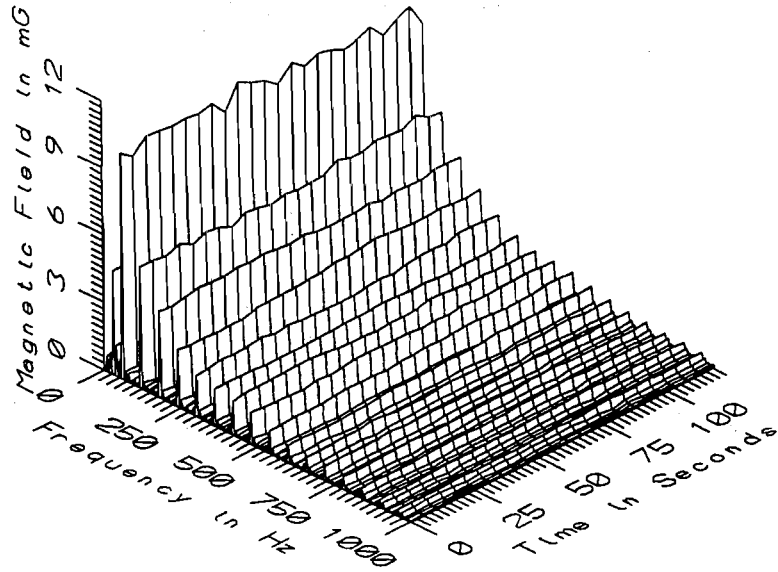

NEC019 - 10cm FROM CENTER MONITOR ON MAC MANAGER'S CONSOLE

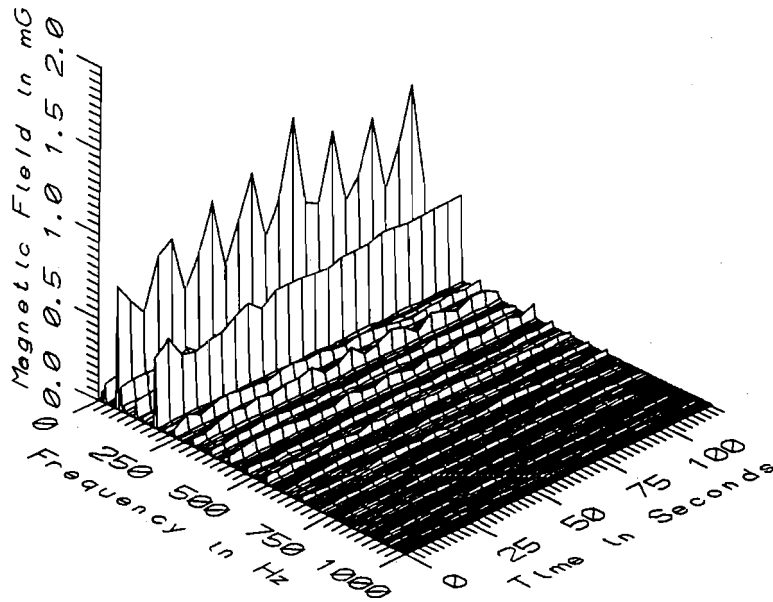

NEC019 - 160cm FROM CENTER MONITOR ON MAC MANAGER'S CONSOLE

FIGURE 8-3. FIELD BY FREQUENCY AND TIME PLOTS OF THE MAGNETIC FIELD AT TWO DISTANCES FROM A VIDEO DISPLAY TERMINAL IN THE SOUTH STATION DISPATCH AREA

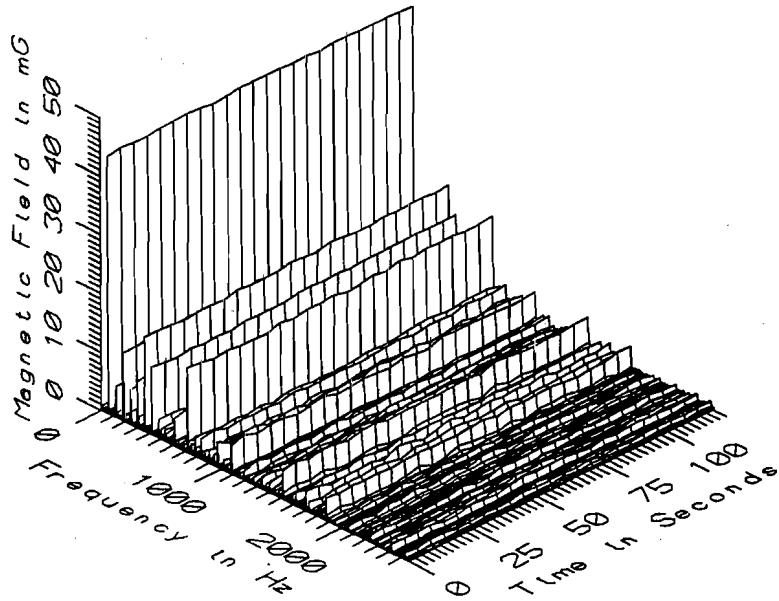

NEC020 - 10cm ABOVE FLOOR. 2' IN FRONT OF UPS UNIT

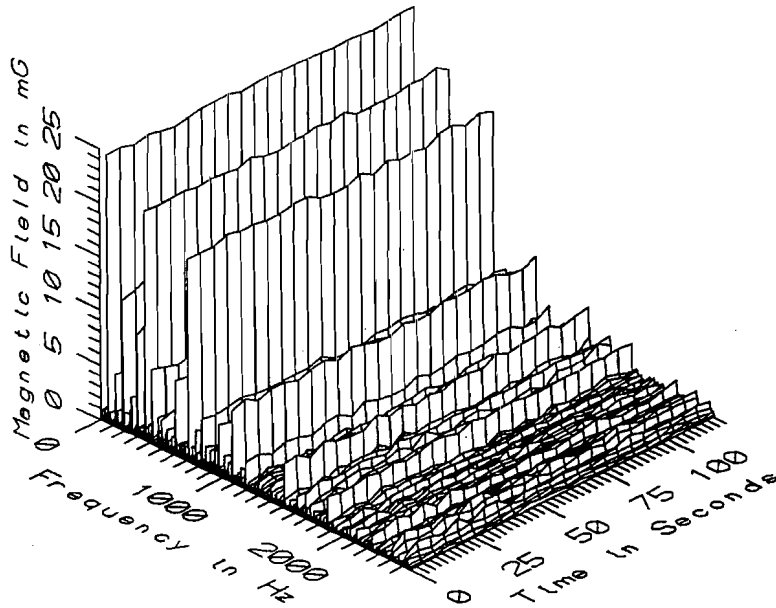

NEC020 - 160cm ABOVE FLOOR. 2' IN FRONT OF UPS UNIT

FIGURE 8-4. FIELD BY FREQUENCY AND TIME PLOTS OF THE MAGNETIC FIELD AT TWO HEIGHTS ABOVE THE FLOOR 60 CM (2 FT) IN FRONT OF AN UNINTERRUPTIBLE POWER SUPPLY IN THE DISPATCH AREA OF BOSTON'S SOUTH STATION

structural member beneath the floor. As Figure 8-5 demonstrates, there was no temporal variability in that static field over the limited time of these measurements which would help identify the source.

8.4 RMS RECORDER DATA

The rms recorder was worn by a member of the test team as she walked through the dispatchers area and the UPS room in Boston's South Station. Table 8-1 provides a summary of the magnetic field levels recorded by the rms recorder.

TABLE 8-1

STATISTICAL SUMMARY OF MAGNETIC FIELDS MEASURED
IN THE DISPATCH AREA AND UPS ROOM OF BOSTON'S
SOUTH STATION USING AN RMS RECORDER

LOCATION	MINIMUM	AVERAGE	MAXIMUM
AROUND CETC CONSOLES	0.3 mG	1.3 mG	6.9 mG
IN UPS ROOM	5.3 mG	60.0 mG	214.5 mG
IN UPS ROOM BUT AGAINST EQUIPMENT	0.9 mG	318.7 mG	446.0 mG

8.5 SUMMARY OF MAGNETIC FIELD LEVELS

Summary statistics for the repetitive magnetic field waveform measurements in front of the video display terminal at the CETC station are shown on Table 8-2. The time-varying magnetic field in all frequency bands decrease with distance from the terminal out to a distance of approximately 110 cm from the screen. Magnetic field levels at the operators position, approximately 60 cm from the terminal, average approximately 1.5 mG which is consistent with the 1.3 mG average field level recorded by the rms recorder as the wearer casually walked around the dispatcher's room. The majority of the energy of the time-varying field is in the power frequency (50-60 Hz) band but field components in the power harmonic (65-300 Hz) and high frequency (305-2560 Hz) bands are clearly present. The equipment of the CETC station does not create a static magnetic field nor does it significantly distort the ambient geomagnetic field.

Summary statistics for the repetitive waveform measurements in the UPS room (dataset NEC020, Appendix U) are given in Table 8-3. The summary data show the gradient in static field level and power frequency field level with increasing height above the floor as well as the relative uniformity of the field at other heights which

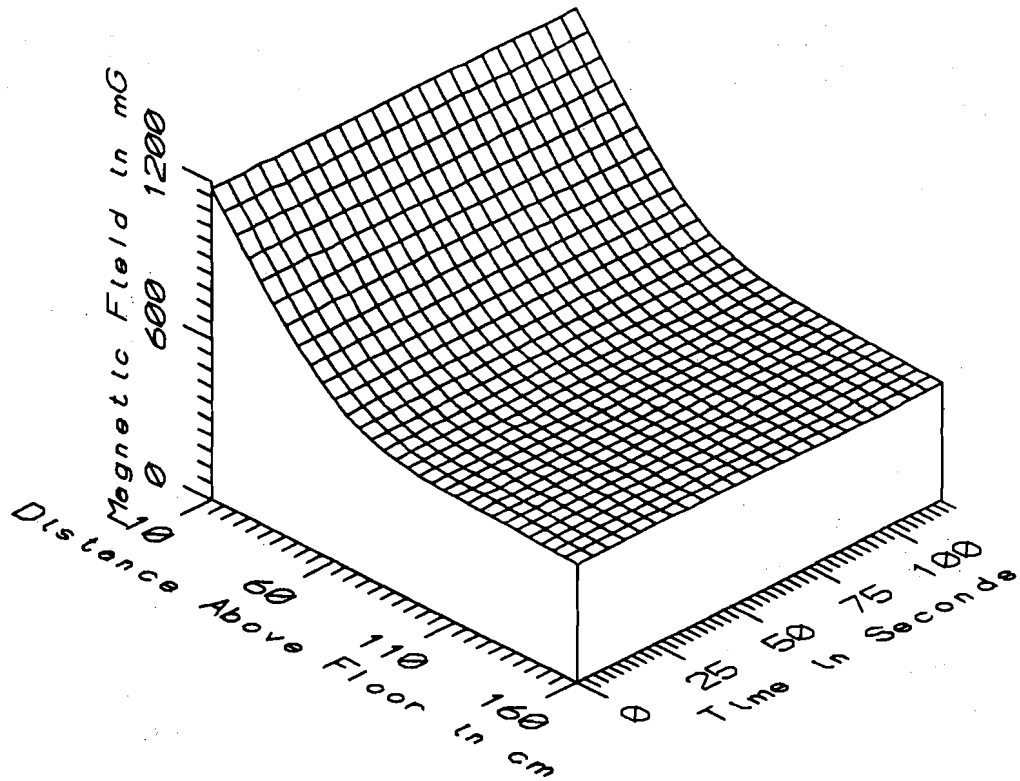

NEC020 - 2' IN FRONT OF UPS UNIT - STATIC

FIGURE 8-5. VERTICAL PROFILE OF THE STATIC MAGNETIC FIELD OVER TIME AT A POSITION 60 CM (2 FT) IN FRONT OF AN UNINTERRUPTIBLE POWER SUPPLY IN THE DISPATCH AREA OF BOSTON'S SOUTH STATION

TABLE 8-2

SUMMARY STATISTICS FOR DATASET NEC019 MEASURED
IN FRONT OF A CETC CONSOLE IN THE
DISPATCHER'S AREA OF BOSTON'S SOUTH STATION

NEC019 - CENTER MONITOR ON MAC MGR'S CONSOLE				TOTAL OF 24 SAMPLES		
FREQUENCY BAND	DIST. FROM VDT (cm)	MINIMUM MAGNETIC FIELD (mG)	MAXIMUM MAGNETIC FIELD (mG)	AVERAGE MAGNETIC FIELD (mG)	STANDARD DEVIATION (mG)	COEFFICIENT OF VARIATION (%)
STATIC	10	363.47	384.18	373.09	4.1	26
	60	326.14	347.08	337.39	4.71	1.40
	110	326.14	404.69	394.88	4.55	1.15
	160	330.89	349.82	340.59	4.24	1.24
5-45Hz LOW FREQ	10	4.38	4.97	4.61	0.14	3.05
	60	0.18	0.35	0.28	0.04	13.87
	110	0.02	0.11	0.05	0.02	34.30
	160	0.13	0.19	0.15	0.02	10.40
50-60Hz PWR FREQ	10	8.98	10.52	9.90	0.34	3.46
	60	0.86	1.69	1.25	0.23	18.00
	110	0.42	0.88	0.65	0.12	18.29
	160	0.44	1.25	0.77	0.21	27.55
65-300Hz PWR HARM	10	7.25	7.87	7.46	0.16	2.08
	60	0.50	0.82	0.71	0.09	12.49
	110	0.39	0.58	0.49	0.05	10.47
	160	0.42	0.57	0.53	0.04	8.21
305-2560Hz HIGH FREQ	10	3.33	3.64	3.46	0.08	2.27
	60	0.23	0.30	0.26	0.02	7.55
	110	0.11	0.16	0.13	0.01	9.71
	160	0.10	0.13	0.11	0.01	7.89
5-2560Hz ALL FREQ	10	13.05	14.07	13.67	0.23	1.70
	60	1.22	1.82	1.50	0.18	12.10
	110	0.62	1.03	0.83	0.11	12.91
	160	0.72	1.36	0.96	0.18	18.53

TABLE 8-3

SUMMARY STATISTICS FOR DATASET NEC020 MEASURED
IN THE UNINTERRUPTIBLE POWER SUPPLY ROOM ADJACENT TO
THE DISPATCHER'S AREA IN BOSTON'S SOUTH STATION

NEC020 - 2 FEET FROM UPS UNIT		TOTAL OF 24 SAMPLES				
FREQUENCY BAND	HEIGHT ABOVE FLOOR (cm)	MINIMUM MAGNETIC FIELD (mG)	MAXIMUM MAGNETIC FIELD (mG)	AVERAGE MAGNETIC FIELD (mG)	STANDARD DEVIATION (mG)	COEFFICIENT OF VARIATION (%)
STATIC	10	1167.88	1176.06	1172.53	2.22	0.19
	60	596.74	603.28	600.41	1.90	0.32
	110	460.33	468.21	464.58	2.13	0.46
	160	434.48	443.19	438.71	2.58	0.59
5-45Hz LOW FREQ	10	1.16	2.21	1.72	0.26	15.25
	60	1.33	2.84	2.00	0.38	18.98
	110	1.51	2.79	1.99	0.31	15.52
	160	1.24	2.09	1.70	0.23	13.41
50-60Hz PWR FREQ	10	43.78	44.37	44.10	0.15	0.34
	60	44.87	46.44	45.51	0.41	0.91
	110	35.09	36.40	35.63	0.35	0.98
	160	24.18	24.85	24.51	0.19	0.79
65-300Hz PWR HARM	10	16.14	17.75	16.96	0.39	2.28
	60	19.22	21.31	20.37	0.62	3.06
	110	17.69	19.90	18.92	0.68	3.58
	160	15.96	17.72	17.06	0.55	3.20
305-2560Hz HIGH FREQ	10	28.73	30.14	29.43	0.47	1.59
	60	41.55	43.57	42.35	0.51	1.20
	110	42.63	44.62	43.60	0.59	1.35
	160	32.79	34.29	33.59	0.48	1.44
5-2560Hz ALL FREQ	10	55.12	56.30	55.69	0.34	0.61
	60	64.21	66.38	65.46	0.56	0.86
	110	58.12	60.28	59.43	0.60	1.00
	160	43.93	45.84	44.98	0.51	1.13

were previously mentioned. The time-varying magnetic field level at the measurement location averages from approximately 45 mG to 65 mG depending on height and is very stable over time. The average field level at this location is consistent with the average field level of 60 mG (Table 8-1) measured by the rms recorder as the wearer walked around the equipment in the UPS room.

The magnetic field in the UPS room has a very complex frequency spectrum and has a considerable part of its energy in the higher frequency bands. For that reason, the magnetic field at this measurement location is quite different from most environmental ELF magnetic fields which have most of their energy at the power frequency.

8.6 SUMMARY OF ELECTRIC FIELD LEVELS

Electric field levels were not measured in the dispatcher's area or the adjacent UPS room because there were no sources of time-varying electric fields associated with neither the CETC station equipment nor the UPS room equipment. The video display terminals on the CETC consoles were likely sources of static electric field but none was available to measure static electric fields.

9. CONCLUSIONS

Sections 3 through 8 of this report present the results of the analysis of extensive measurements of magnetic and electric fields within the coaches and locomotives of trains, along the wayside, at passenger stations, near electric power substations, and near control facilities of the Northeast Rail Corridor from Washington, DC to Boston, MA. Similar data and analyses are presented in those sections for the 60 Hz portion of the North Jersey Coast Line (Long Branch Line) from Matawan to Long Branch, NJ.

As described in those sections, the time-varying magnetic fields at most locations on the trains and along the wayside of the electrified portions of the corridor and the North Jersey Coast Line arise predominantly from current in the catenary and track circuit. Consequently, those fields are highly variable over time, depending on the power needs of the locomotive, and the frequency components of those fields are at the catenary power frequency and odd harmonics thereof. In coaches and diesel-electric locomotives operating on the non-electrified portions of the corridor, time-varying magnetic field levels are substantially lower than those on the electrified portion of the railroads. The magnetic fields in these coaches are primarily 60 Hz fields arising from "hotel" power wiring and electrical devices in the coaches, but the contribution of fields from external sources such as transmission lines crossing the corridor are sometimes detected. Time-varying magnetic fields in the diesel electric locomotive are at both 60 Hz and at higher frequencies.

The static magnetic field at virtually all locations is primarily the natural geomagnetic field, perturbed in many cases by ferromagnetic material (iron and steel) in the train, station platforms, etc.

Significant electric fields were only detected near catenaries on station platforms or at the wayside and near high voltage transmission lines entering substations.

9.1 SUMMARY OF ELECTRIFIED RAILROAD FIELD LEVELS

This subsection provides a concise description of the time-varying magnetic field characteristics at each of the areas examined. Since static magnetic fields from sources other than the natural field of the earth were not detected anywhere except in the diesel-electric locomotive, they are not discussed in the following summaries except for the diesel-electric locomotive. Similarly, electric fields are only mentioned in those situations where significant fields from sources other than routine electrical facilities like electric lights were detected.

9.1.1 Coaches

The magnetic fields in coaches operating on the electrified railroads arose from current in the catenary and track circuit and averaged **134 mG**, **52 mG**, and **19 mG**, respectively, on the **25 Hz** and the **60 Hz** sections of the corridor, and the North Jersey Coast Line (Table 3-22). Maximum field values were **628 mG**, **305 mG** and **61 mG**, respectively, for these three electrified railroad sections. By contrast, the average and maximum time-varying magnetic fields in the coaches on the non-electrified portion of the corridor arising from normal **onboard "hotel"** power and appliances were **6 mG** and **13 mG**. The magnetic field tended to be relatively uniform throughout the coaches on the electrified railroads and had frequency components consisting of the catenary current frequency and its odd harmonics.

9.1.2 Locomotive Cabs

Current in the catenary and track circuit was also the principal magnetic field source throughout the locomotive cabs, but sources beneath the floor of the cab and in the machinery portion of the locomotive also contributed to the magnetic field environment. The average time-varying magnetic field measured with the waveform capture system in the locomotives on the **25 Hz** and the **60 Hz** sections of the corridor, and on the North Jersey Coast Line were **46 mG**, **28 mG** and **32 mG**, respectively (Figure 4-21). Maximum field values for the same locomotives were **213 mG**, **97 mG**, and **85 mG**, respectively. Average and maximum time-varying magnetic fields in the diesel-electric locomotive were **2 mG** and **9 mG**, respectively. The magnetic fields in the cabs of the electric locomotives had greater spatial variability and less temporal variability than those in the coaches because of the contribution of **60 Hz** magnetic fields from the locomotive which were highly location dependent, but tended to be more uniform over time than the fields from the current in the catenary and tracks. The frequency components of the electric fields in the locomotive cabs were principally **60 Hz** and the odd harmonics thereof, except when the train was on the **25 Hz** section of the corridor. In that case, the fields in the cab were at **25 Hz**, **60 Hz**, and the odd harmonics of both **25** and **60 Hz**. The magnetic field in the cab of the diesel-electric locomotive was low but had a peculiar frequency spectrum producing a significant proportion of the field energy in the "**high frequency**"ⁿ band from **305 Hz** to **2560 Hz**.

9.1.3 Railroad Waysides

The magnetic field at the wayside of electrified railroads arises almost exclusively from current in the catenary and tracks. The magnetic fields from parallel transmission lines along the **25 Hz** portion of the NEC are very small and not easily detected in the presence of the field from the principal source. The temporal and frequency of the wayside magnetic fields are the same as those just described for the fields in the coaches because both fields arise from the same source. However, once the train leaves the section of track (between substations, autotransformers, or phase breaks)

where the measurements are being made, the current in the track and catenary decreases to low levels and the magnetic field becomes **small**. Furthermore, the magnetic field at the railroad wayside rapidly attenuates as one moves away from the tracks. The average magnetic field 15.3 m (50 ft) from the nearest track was determined to be 4.6 mG, 4.2 mG and 1.5 mG, respectively, at measurement locations along the 25 Hz section of the NEC, the 60 Hz section of the NEC, and the North Jersey Coast Line (Table 5-8). The corresponding maximum magnetic field levels 15.3 m (50 ft) from the nearest track are 21 mG, 28 mG and 28 mG, respectively. Electric fields also exist along the wayside, produced by the voltage on the catenaries, the return wire (on the 60 Hz section of the NEC) and the transmission lines (on the 25 Hz section of the NEC). The highest electric field exists near the 25 Hz portion of the corridor (285 V/m at 12.2 m [40 ft] away) because of the contribution of the transmission line. On the autotransformer-fed 60 Hz section of the NEC, the electric field is lower (60 V/m at 6.7 m [22 ft] away) due to the electric field cancellation caused by the opposite-phased voltages on the catenary and return conductor. The single-fed catenary with no parallel transmission lines on the North Jersey Coast Line has electric field levels between those cited for the two sections of the NEC.

9.1.4 Station Platforms

The electric and magnetic field environment on the open station platform is an extreme example of wayside fields because the passenger is very close to the tracks and catenary. The average magnetic field levels measured at stations on the 25 Hz section of the NEC, the 60 Hz section of the NEC, and the North Jersey Coast Line are 40 mG, 62 mG, and 29 mG, respectively (Table 6-8). The corresponding maximum magnetic fields are 532 mG, 365 mG and 202 mG. Like the wayside magnetic fields, these fields have a large temporal variability. Their frequency components consist of the fundamental frequency of the catenary voltage (25 Hz or 60 Hz) plus the odd harmonics of that fundamental frequency. The electric fields on the station platforms are spatially variable due to shielding by light standards, fences, station overhang, etc., but they are temporally stable due to the controlled voltage of the catenary. The largest electric fields measured at the stations on the 25 Hz section of the NEC, the 60 Hz section of the NEC and the North Jersey Coast Line are 1.06, 1.20, and 0.69 kV/m. The electric fields on the NEC station platforms are higher than at the North Jersey Coast Line stations because they are elevated platforms.

Magnetic fields in the waiting areas at **Boston's** South Station (non-electrified) and New **York's** Penn Station (25 Hz) showed that only the usual indoor ambient magnetic fields arising from building sources and installed electrical appliances existed in the non-electrified station waiting area, but modest fields (6 mG average, 9 mG maximum, Table 6-8) from the railroad electrification system were found in the waiting area at Penn Station.

9.1.5 Electric Power Substations

Only modest strength magnetic fields were found outside substation fences except in areas where entering transmission lines or exiting circuits to the catenary and track were present. In no case were the fields attributable to the substation itself measured at distances more than 15.3 m (50 ft) from the substation, and in most cases, substation fields at the substation fence were comparable to or less than those found beneath commercial electric distribution lines in the immediate vicinity.

9.1.6 Control Facilities

Limited measurements in the South Station dispatch area showed that the principal magnetic field source at a work station was the video display terminals. The average time-varying magnetic field 60 cm from a display unit was 1.5 mG, having the harmonic-rich frequency spectrum typical of video display units. Magnetic field levels were considerably higher in an uninterruptible power supply (UPS) room adjacent to the dispatch area. The harmonic-rich magnetic field .6 m (2 ft) in front of one of the electronic UPS was approximately 60 mG and had a significant portion of its energy in harmonic components above 300 Hz.

9.2 EFFECTS OF ELECTRIFICATION TECHNOLOGY

One purpose of this study was to provide baseline information about the levels of magnetic and electric field associated with the electrified portions of the Northeast Corridor which could be extrapolated to project field levels associated with proposed electrification of the remainder of the corridor from New Haven to Boston. At the time this study was designed, the anticipated electrification scheme was to be a 25 kV, 60 Hz single-fed system. The possibility of converting the North Jersey Coast Line from **Matawan** to Long Branch from 12.5 kV single-fed to 25 kV single-fed for purposes of simulating the proposed NEC future electrification was considered, but found to be impractical. Nevertheless, measurements on the North Jersey Coast Line were incorporated into this study in order to obtain field data on a 12.5 kV, 60 Hz single-fed system that could easily be extrapolated to the anticipated 25 kV, 60 Hz single-fed **AMTRAK** design.

At the time of this writing, the authors understand that the electrification scheme now proposed for the northern end of the Northeast Corridor is a 50 kV autotransformer-fed 60 Hz system sometimes referred to as a 2 x 25 kV system because the autotransformer supply voltage (50 kV) is twice the 25 kV catenary voltage. The proposed system is similar to that in place on the corridor from just north of New York to New Haven, except that the catenary voltage on the new system will be 25 kV instead of 12.5 kV, as used on the existing 60 Hz portion. Note that the higher the line voltage, the lower the current, and hence magnetic fields produced.

Although the measurements reported herein made a systematic effort to identify any differences in magnetic field levels present **onboard** the train, at stations, or along the wayside which would result from the use of an autotransformer-fed system versus a direct-fed system or a double-fed system versus a single-fed system, none could be found of sufficient magnitude to be measurable in the presence of the other sources of field variability encountered. Since these tests were not designed to look critically at other sources of field variability, the authors cannot with certainty identify the cause of magnetic field variability between various tests (with the obvious exception of electrified versus non-electrified sections of the corridor). Nevertheless, the data, taken as a whole, indicate that currents in the catenary and track circuit are the principal field sources of significance around electrified railroads. At a given catenary voltage, the magnitude of the catenary and track current is directly related to the traction power needs of the locomotive (and other locomotives drawing power from the catenary beyond the measuring point). Therefore, traction power requirement is a critical parameter which was not controlled in these tests. In fact, the primary cause of the differences in magnetic field level measured on the **25** Hz section of the NEC, the **60** Hz section of the NEC, and the North Jersey Coast Line appears to be differences in traction power needs. The high traction power requirements of a locomotive with nine heavily-loaded coaches traveling at high speeds on the hilly **25** Hz portion of the corridor simply **isn't** simulated well by shorter trains with fewer passengers traveling at substantially lower speeds on the level North Jersey Coast Line. It is also believed that differences in catenary current resulting from the lower catenary voltage on the **25** Hz system, as well as from higher speeds and hillier terrain on that section of the NEC are the predominant causes of the higher average and maximum magnetic fields measured on the **25** Hz section of the NEC as compared to the **60** Hz section. Since the data reported herein were measured in trains of six to nine cars pulled by a single AEM-7 or ALP-44 locomotive, magnetic field values in trains with more cars, multiple locomotives, or higher power locomotives would have to be adjusted proportionally to the **train's** power requirements.

Although autotransformer-fed systems have been reported⁶ to have significant advantages for reducing magnetic fields associated with electrified railroads, one has to look critically at those advantages. The basic mechanisms for reduced magnetic fields in the autotransformer-fed system are:

1. Power delivery to the autotransformers is at twice the catenary voltage, therefore the currents in the catenary and return feeder are half the normal catenary current; and
2. The catenary and return feeder are located in relatively close proximity, thereby producing a smaller current loop for magnetic field production than does the catenary-track circuit.

While both of the above features of autotransformer-fed systems drastically reduce magnetic fields in the region between the substation and the autotransformers, they have only a small effect on the magnetic fields within the block of track between autotransformers where the locomotive is located. That is because within that block, full locomotive current must flow in the catenary/track circuit. From the point of view of the passengers and train crew, who are always in the same traction power block as the locomotive, an autotransformer-fed system provides little benefit for magnetic field reduction. The fact that traction power blocks are sometimes shorter and fed from both ends in an autotransformer-fed system provides secondary field reduction benefits because it is less likely that two trains will be operating in the same block and power flow tends to come more evenly from both directions in the catenary. But the magnetic field reduction from these secondary benefits is expected to be modest at best.

From the point of view of passengers at the station or along the wayside, the shorter traction power blocks that sometimes occur in autotransformer-fed systems mean that passing trains spend less time in the block so the magnetic field from current in the catenary and track circuit persists for a shorter period of time. While that probably does not lower maximum magnetic field levels, it does lower the average magnetic field level and time of exposure to population along the wayside.

When the train is in a traction power block other than the one directly adjacent to the station or the wayside point of concern, power to the occupied traction block flows to that block in different ways in different systems. On the 25 Hz portion of the corridor, power is delivered to the substations at both ends of the traction block via 138 kV transmission lines installed above the catenaries. Because of the higher transmission voltage, the current in the transmission lines is smaller. Furthermore, the transmission line is a "balanced" system meaning that current flows out to the substation and back from the substation in two wires located in close proximity at the top of relatively tall support structures. Consequently, the "loop" that generates magnetic fields is small and located away from people on the ground. Because of these features, the transmission lines paralleling the 25 Hz section of the corridor to carry power to other traction blocks are not significant magnetic field sources.

Along the 60 Hz section of the North Jersey Coast Line, each of the larger traction power blocks receives power from its own substation, which in turn receives power directly from the commercial power system. As a result, there are no magnetic fields produced at stations or wayside locations by power needs of trains in remote power blocks.

Finally, on the autotransformer-fed 60 Hz portion of the corridor, most of the power to remote traction power blocks is carried by the catenary and return feeder circuit. Since this is a balanced system at twice the catenary-to-track voltage, it produces

substantially smaller magnetic fields than when the train is in the traction power block at the field measurement point. However, the magnetic field produced in this arrangement is not as small as that, produced on the transmission lines of the 25 Hz system. On the autotransformer-fed system, the feed wires (catenary and return feeder) are at lower height above the ground level than the transmission lines, spaced further apart than the balanced transmission line conductors, and have a lower voltage (25 kV, rather than 138 kV) and hence higher currents.

So, in conclusion, each of the electrification schemes examined have similar theoretical magnetic field production characteristics onboard the train, or at the station, or other wayside locations while a passing train is in the same traction power block. However, in terms of average magnetic field levels at the wayside, each of the electrification schemes has both positive and negative characteristics relative to electric and magnetic field exposure to the passenger and the public.

The electric fields produced by the electrification system are not an issue from the point of view of the train passengers or crew because the metallic coaches and locomotive cab provide extremely effective electric field shielding. At wayside locations, the largest electric fields are found near the 25 Hz system because of the parallel high voltage transmission lines, and the lowest electric fields appear near the autotransformer-fed system. The electric fields for all three systems are comparable at the station (if one corrects for the absence of a high level platform at the North Jersey Coast Line Station).

9.3 OTHER ENVIRONMENTAL MAGNETIC FIELD LEVELS

The predominant source of static field in the environment is the earth's geomagnetic field. The unperturbed geomagnetic field intensity varies over the surface of the earth from roughly 240 mG to 670 mG. The geomagnetic field level of approximately 520 mG measured at the wayside locations along the NEC is typical of unperturbed mid-latitude geomagnetic field levels. The presence of iron and steel components in buildings, vehicles, and other structures perturbs the geomagnetic field in the vicinity of those objects making the geomagnetic field intensities and directions routinely encountered by people somewhat more variable. Field levels ranging from 200 mG to 1000 mG are frequently found.

Permanent magnets also represent localized sources of high intensity static magnetic fields. A child's toy magnet may have a flux density of several hundred to a few thousand gauss at its pole. Ferrite permanent magnets imbedded in seals and weatherstrips around refrigerator doors and home or office doors, and windows are frequently encountered, providing static fields of a few gauss at the portal.

The overwhelmingly predominant source of ELF magnetic fields in the environment is the 60 Hz magnetic field produced by virtually all equipment or facilities which generate, distribute, or utilize

electric power in the USA. Due to the electrification of our modern society, power frequency (60 Hz in North America, 50 Hz in Europe and many other places) ac magnetic fields are ubiquitous. Numerous authors have reported environmental levels of power frequency magnetic fields for specific situations. Nair, *et al.*⁷ provides a summary of that information as well as useful insight into the parameters which affect power frequency magnetic fields. Figure 9-1, from Reference 7, shows the range of power frequency magnetic field levels which may be found at various distances from three important sources of magnetic field.

Power frequency magnetic fields in American homes arise primarily from three sources: outdoor transmission and distribution power lines; house wiring; and household appliances. Field levels for transmission lines (69 kV or above), distribution lines (less than 69 kV), and appliances are summarized in Figure 9-1. Field levels from house wiring differ greatly from home to home. The total level of power frequency magnetic fields in homes is typically about 0.7 mG^{7,8} at the center of each room but can vary substantially from room to room or home to home. Magnetic field levels in excess of 10 mG at the center of a room are atypical but not terribly uncommon.

Power frequency magnetic field levels in the workplace are highly variable. In offices and most commercial establishments, the power frequency magnetic field environment is similar to or somewhat higher than that in homes. But in certain industrial settings, considerably higher ELF magnetic field levels above thousands of milligauss are **encountered**⁹. Unfortunately, field characterization in the workplace is limited to a small number of measurements which lack validity as indicators of "**typical**" or "**overall**" estimators of workplace magnetic field levels.

These common environmental sources of ELF magnetic field are predominantly power-frequency field sources. Magnetic fields near power line and substations may have low order harmonic components, but these are generally only a small percentage of the fundamental power frequency component⁸. The harmonic content of residential and most workplace magnetic fields is also generally quite low, but on occasion can become a significant part of the total field. High harmonic content appears most frequently in magnetic fields near appliances containing non-linear electrical load control devices.

Figure 9-2 shows a field by frequency and time plot for the magnetic field produced by a triac-controlled vacuum cleaner. Although the harmonic content is relatively large, only the lower order harmonics have significant amplitude. Essentially, no energy is present at frequencies below the power frequency. This is characteristic of the magnetic fields produced by many appliances with electric controls.

Televisions and computer video display units which make use of magnetic deflection are the most commonly encountered source of ELF magnetic fields at frequencies other than the power frequency.

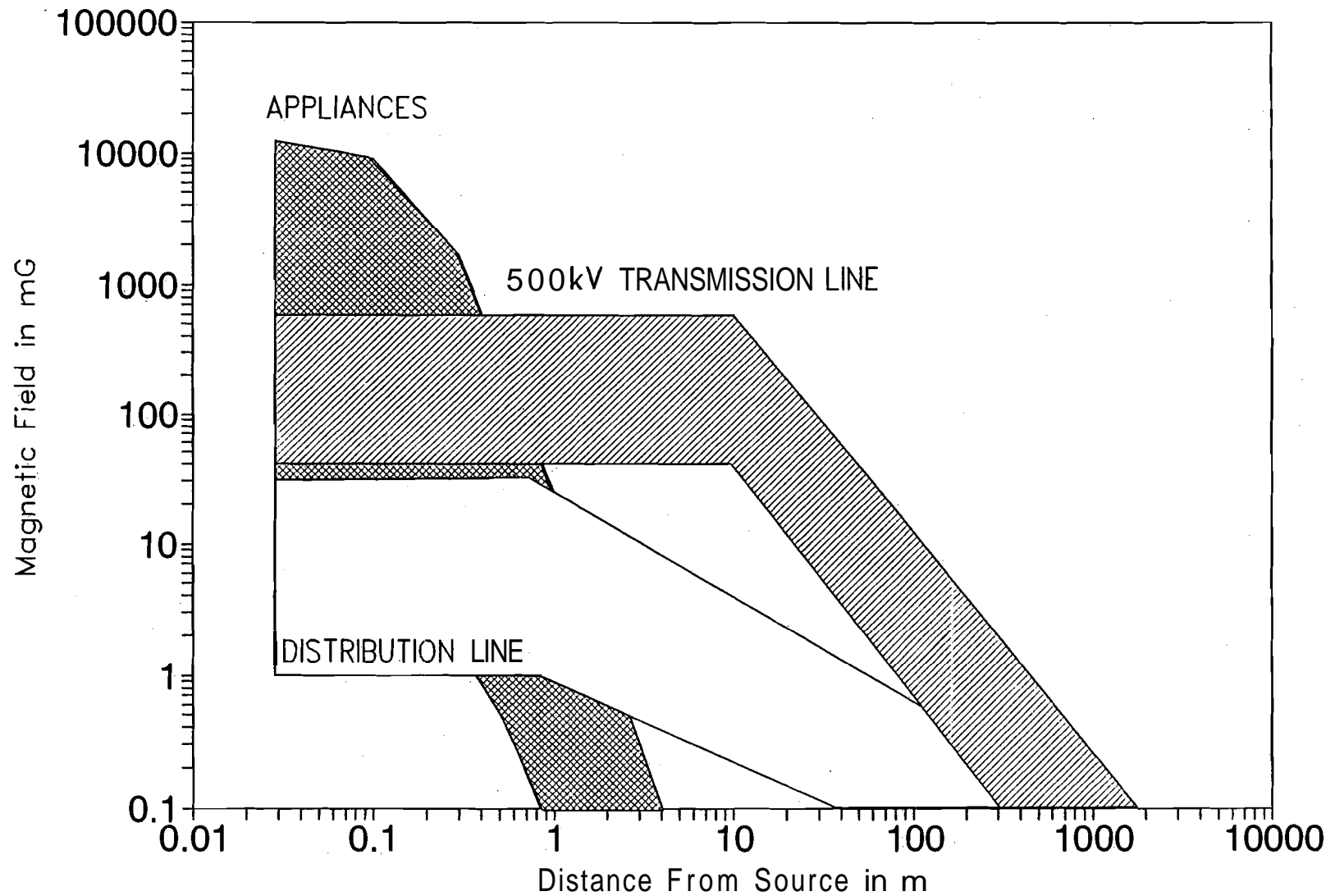

FIGURE 9-1. ILLUSTRATION OF HOW THE MAGNETIC FIELD INTENSITY AT GROUND LEVEL CHANGES WITH HORIZONTAL **DISTANCE** FROM THREE COMMON SOURCES OF POWER-FREQUENCY MAGNETIC FIELDS. THE BANDS REPRESENT VARIATION ACROSS INDIVIDUAL SOURCES IN EACH GROUP. ADAPTED FROM NAIR, ET AL⁷

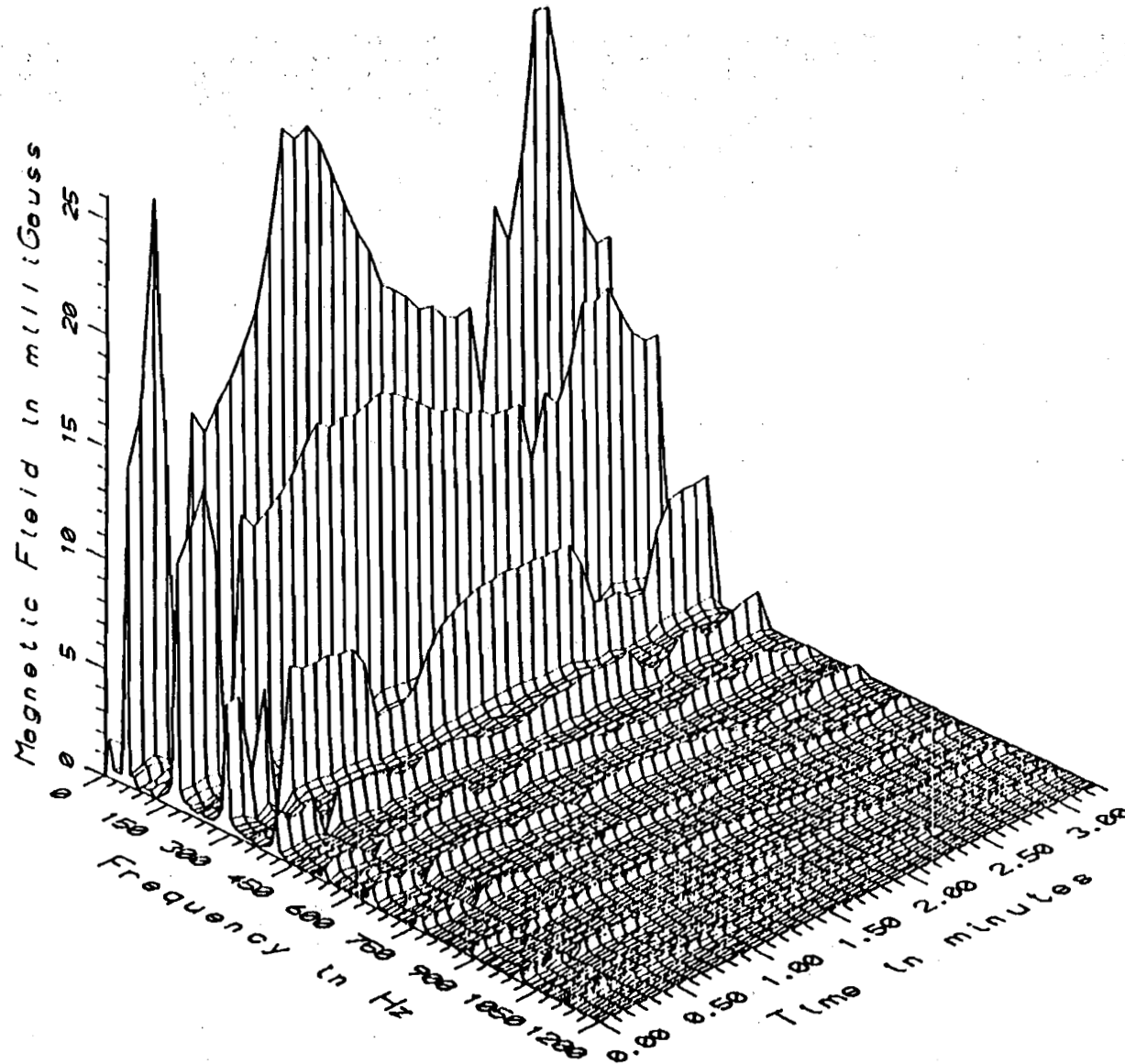

FIGURE 9-2. MAGNETIC FIELD 30 CM (1 FT) FROM A SHOP VAC

Vertical deflection frequencies for these devices are generally in the 55 to 75 Hz range; however, the magnetic fields are rich in harmonics. Horizontal deflection frequencies and their associated fields are well above the ELF range.

Other significant sources of non-power-frequency ELF magnetic fields are headphones and telephone receivers which produce relatively intense voice-frequency magnetic fields in the vicinity of the **user's** ear. However, these fields attenuate quickly with distance from the earpiece. Certain pieces of industrial and medical equipment also produce relatively large ELF magnetic fields at frequencies other than 50 or 60 Hz, but they are not frequently encountered by the general public.

ELF electric fields in the environment arise most frequently from unshielded equipment or facilities used to generate, distribute, or utilize electric power. Like ELF magnetic fields, these electric fields have the frequency of the electric power system: 60 Hz in North America and 50 Hz in Europe. Since ELF electric fields are easily shielded by materials with even modest electrical conductivity, the predominant sources encountered by the general public are overhead electric power transmission and distribution lines, home or office electrical appliances and some electric lights. Nair, *et al.*⁷ provide a discussion of environmental electric fields well summarized by Figure 9-3, which is extracted from their report.

9.4 COMPARISON OF RAILROAD FIELDS TO OTHER ENVIRONMENTAL FIELDS

Much of the concern about ELF magnetic field levels is driven by uncertainty as to whether such fields exert an adverse effect on human health. Existing scientific knowledge provides little insight into what aspects of ELF magnetic exposure, if any, are of biological concern⁷. Consequently, public acceptance of magnetic field exposures is presently based more on equity and comparability to other exposures than to quantifiable characteristics of the field itself. In this light, this section compares and contrasts the magnetic fields produced by electrified railroads to other environmental magnetic fields.

9.4.1 Static Fields

The electrified railroads showed no evidence of creating static (dc) magnetic fields. Consequently, the only static fields **onboard** the trains, at the wayside, at stations, or at power substations are the geomagnetic field of the earth or static fields produced by other nearby sources unrelated to railroad electrification.

The geomagnetic field is perturbed by ferromagnetic material in the coaches and locomotives, the rails, and structural steel in the station platforms, but these effects are not related to electrification and are well within the range of static field perturbation encountered in or near automobiles, highway guardrails, most commercial buildings, etc.

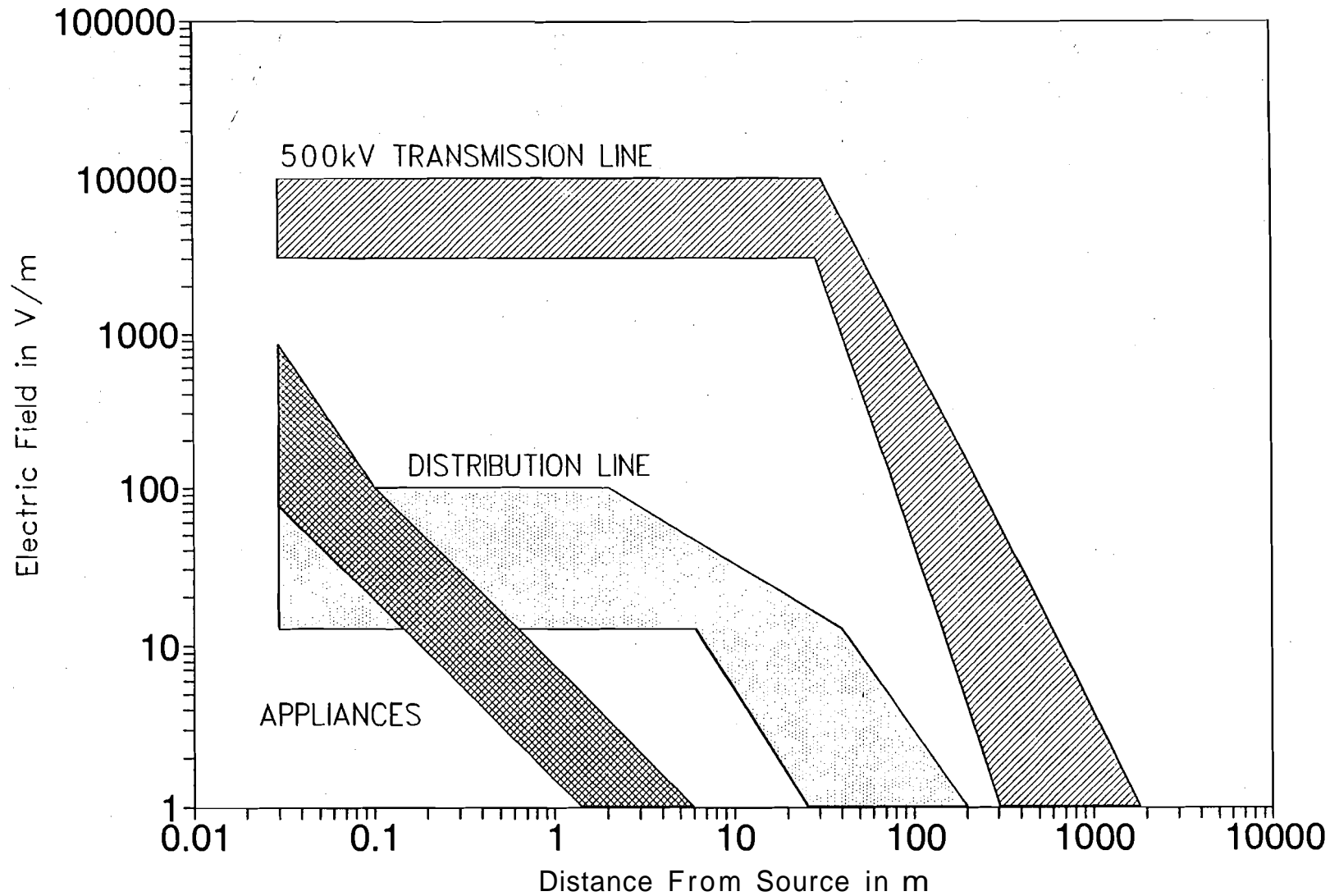

FIGURE 9-3. ILLUSTRATION OF HOW ELECTRIC FIELD INTENSITY NEAR GROUND LEVEL WILL CHANGE WITH HORIZONTAL DISTANCE FROM THREE COMMON SOURCES OF POWER-FREQUENCY ELECTRIC FIELDS. THE BANDS REPRESENT VARIATION ACROSS INDIVIDUAL SOURCES IN EACH GROUP, ADAPTED FROM NAIR, ET AL⁷

9.4.2 Frequency Spectra

The frequency characteristics of the magnetic fields onboard or near railroads electrified at 60 Hz (e.g., Figures 3-16 and 5-3) are very similar to those near many electrical appliances (e.g., Figure 9-2) in that the fundamental component of the field is 60 Hz and there is significant energy in the odd harmonics. The magnetic fields of the 60 Hz electrified railroads are also similar to the magnetic fields near electric power transmission and distribution lines in that the principal component of the field is 60 Hz. However, the magnetic fields onboard or near the electrified railroads have greater harmonic content.

The frequency spectrum of the magnetic field onboard and near the 25 Hz section of the NEC is composed of a principal component at 25 Hz and smaller components at the odd harmonics of 25 Hz. Twenty five Hz magnetic fields are not routinely encountered in the usual magnetic field environment. Although the harmonics of 25 Hz fall within the general range of frequencies produced by electrical appliances, their specific frequencies are usually different.

The frequency characteristics of the magnetic fields within the coaches on the non-electrified section of the NEC arise from 60 Hz electric appliances and 60 Hz electric power distribution. Therefore, one would expect their frequency characteristics to resemble those commonly found in the residential environment, and they do.

Railroad electrification does not produce any significant electric fields within the train. At the stations and wayside along the 60 Hz railroad sections, the electric fields are similar in frequency character to those encountered near commercial electric power lines. The electric fields near 25 Hz catenaries are predominantly 25 Hz, a frequency of electric field not routinely found in the environment.

9.4.3 Time Characteristics

The magnetic fields onboard electrically-powered trains or near electrified railroads have pronounced temporal variability similar to the variability of magnetic fields near appliances with varying load or intermittent use. These fields have much greater variability than the magnetic fields found near most commercial electric power lines.

The magnetic field within the coaches on the non-electrified portion of the NEC have moderate temporal variability resembling that often encountered in residential or office settings.

The electric fields produced by the railroad catenaries are reasonably stable over time, nearly as stable as electric fields near commercial distribution lines.

9.4.4 Amplitude Characteristics

Notwithstanding the need to compare the temporal and frequency characteristics of various ELF magnetic fields, this subsection will compare the measured field levels **onboard** and near electrified railroad facilities to other reported environmental field levels from various power frequency sources. The lack of comparable environmental field data in several of the frequency bands, especially at 25 Hz in the low frequency band, makes any other approach unworkable. The reader must be aware that the comparison of the total ELF fields of the electrified railroads, especially the 25 Hz section of the NEC, to the predominantly power frequency environmental field levels currently reported in the literature is an "apples and oranges" comparison, because frequency and temporal characteristics have been ignored in such a comparison.

9.4.4.1 Coaches - Figure 9-4 shows the range of total time-varying magnetic fields measured in the coaches on the three electrified railroad sections as a function of distance from the source (track and catenary) taken from Table 3-22 plotted over the graph of typical power line and appliance field levels⁷ reported in Figure 9-1. As the graph illustrates, the intensity of the ELF magnetic field inside the coaches is not dependent on the distance from the rails or catenary. The range of magnetic field intensities spans more than two orders of magnitude including the range of magnetic fields found under larger distribution lines through large transmission lines. However, fields of comparable or greater intensity are found close to appliances.

9.4 .4.2 Locomotive Cabs - Figure 9-5 shows the range of total **time-varying** magnetic fields recorded in the electric locomotive cabs as a function of distance from the floor because there was apparently a consistently-observed source below the floor. These data come from Tables 4-6, 4-9 and 4-13. As in the preceding figure, these data are plotted over the graph of typical power frequency magnetic field levels given in Figure 9-1. From the figure, it is evident that the magnetic field levels in locomotive cabs are within the range of field levels found beneath electric power lines or near appliances.

Similar data for the magnetic field levels in the cab of the diesel-electric locomotive (from Table 4-12) are presented in Figure 9-6 and demonstrate that the magnetic field level in the cab of that locomotive is relatively small compared to those near other common field sources.

9.4.4.3 Wayside - The time-varying magnetic field at the wayside appears to attenuate away from the catenary and tracks at a rate very near the theoretical rate of attenuation of a long loop (field is proportional to the inverse squared distance) as discussed in Section 5.6.4. From transferring the projected lateral profile curves of maximum and average field levels from Figures 5-9 through 5-12, and similar curves based on minimum magnetic field levels

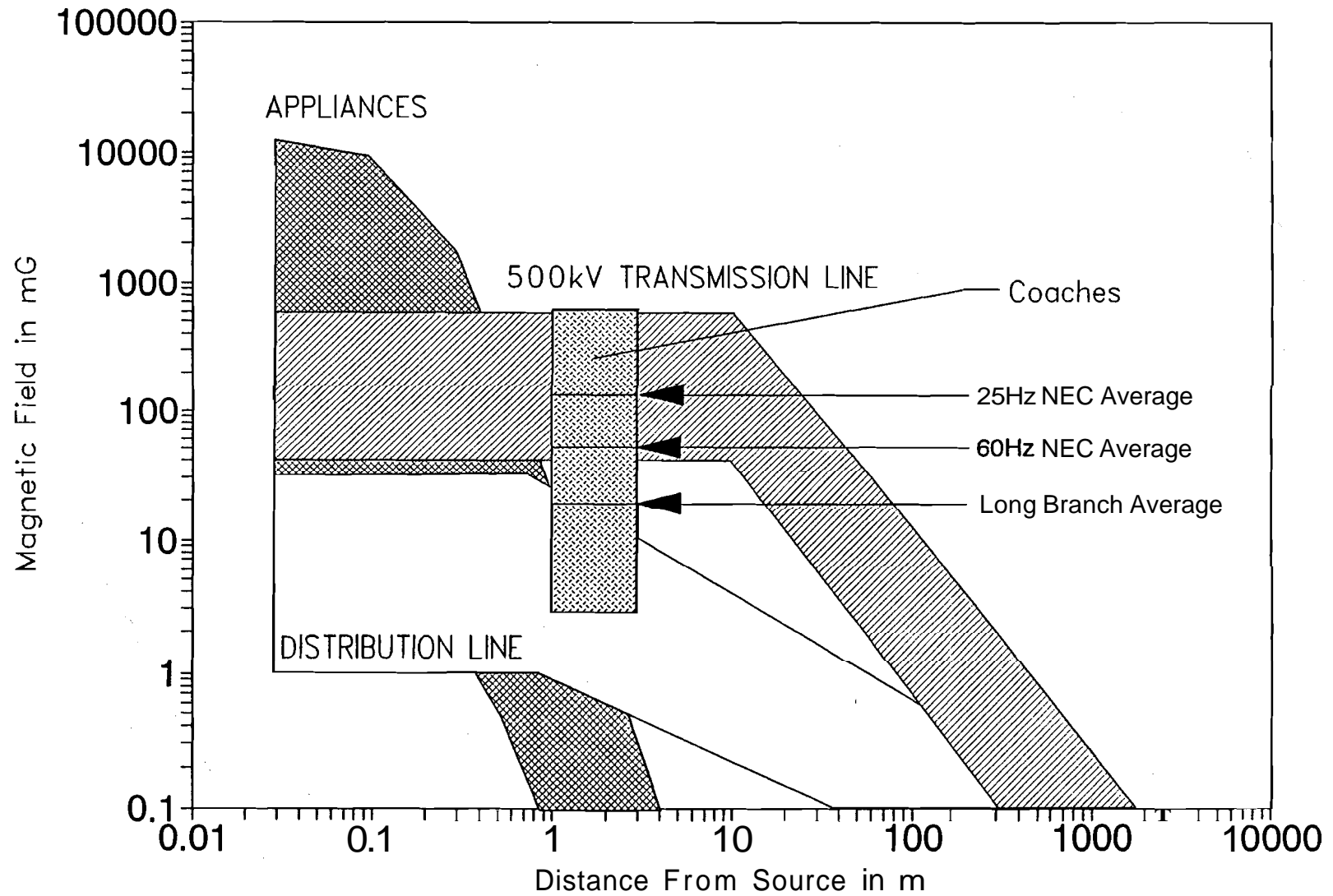

FIGURE 9-4. THE RANGE OF TOTAL TIME-VARYING MAGNETIC FIELD LEVELS IN PASSENGER COACHES COMPARED TO TYPICAL LEVELS OF POWER-FREQUENCY MAGNETIC FIELDS PRODUCED BY COMMON SOURCES

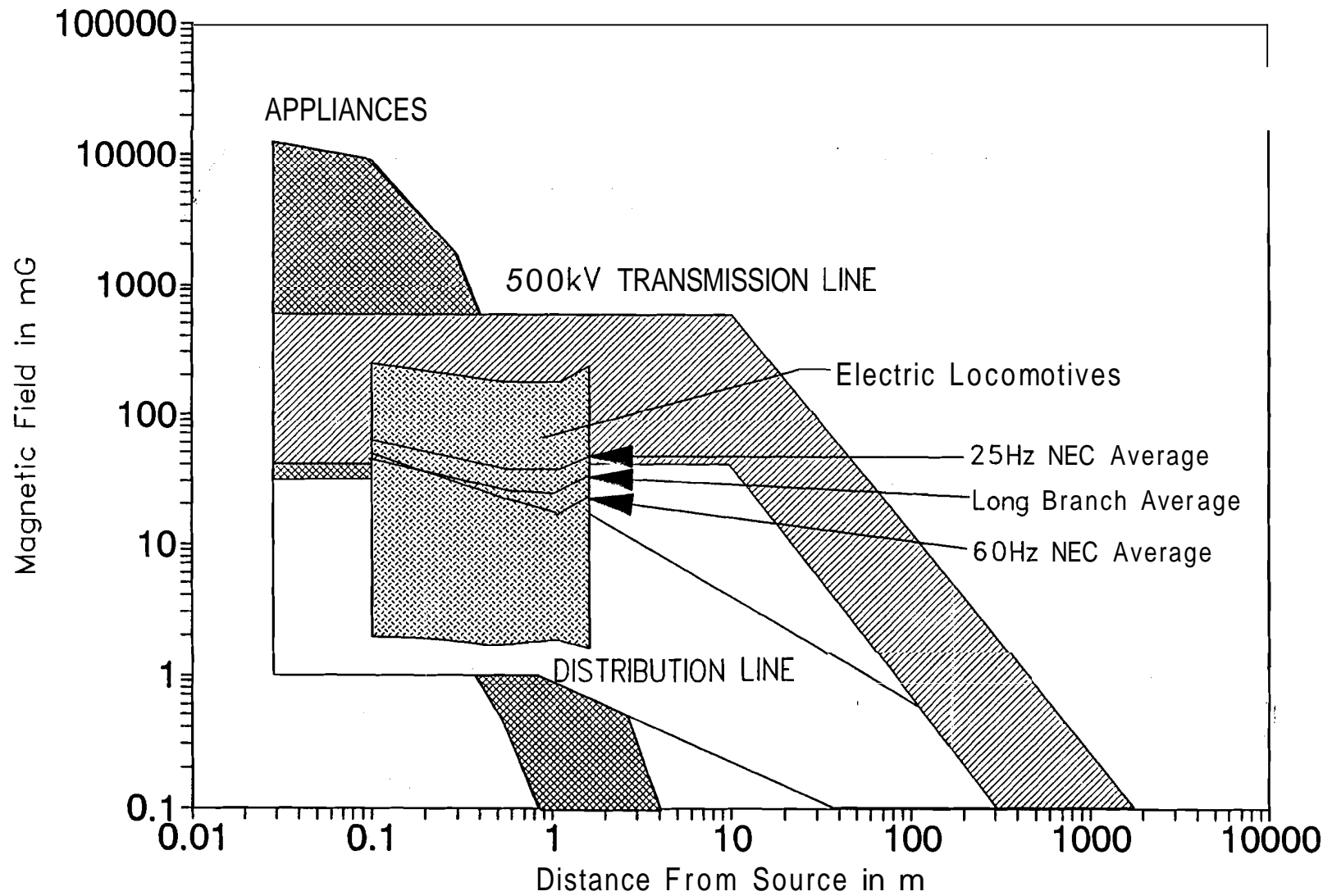

FIGURE 9-5. THE RANGE OF TOTAL TIME-VARYING MAGNETIC FIELD LEVELS IN THE CABS OF ELECTRIC LOCOMOTIVES COMPARED TO TYPICAL LEVELS OF POWER-FREQUENCY MAGNETIC FIELDS PRODUCED BY COMMON SOURCES

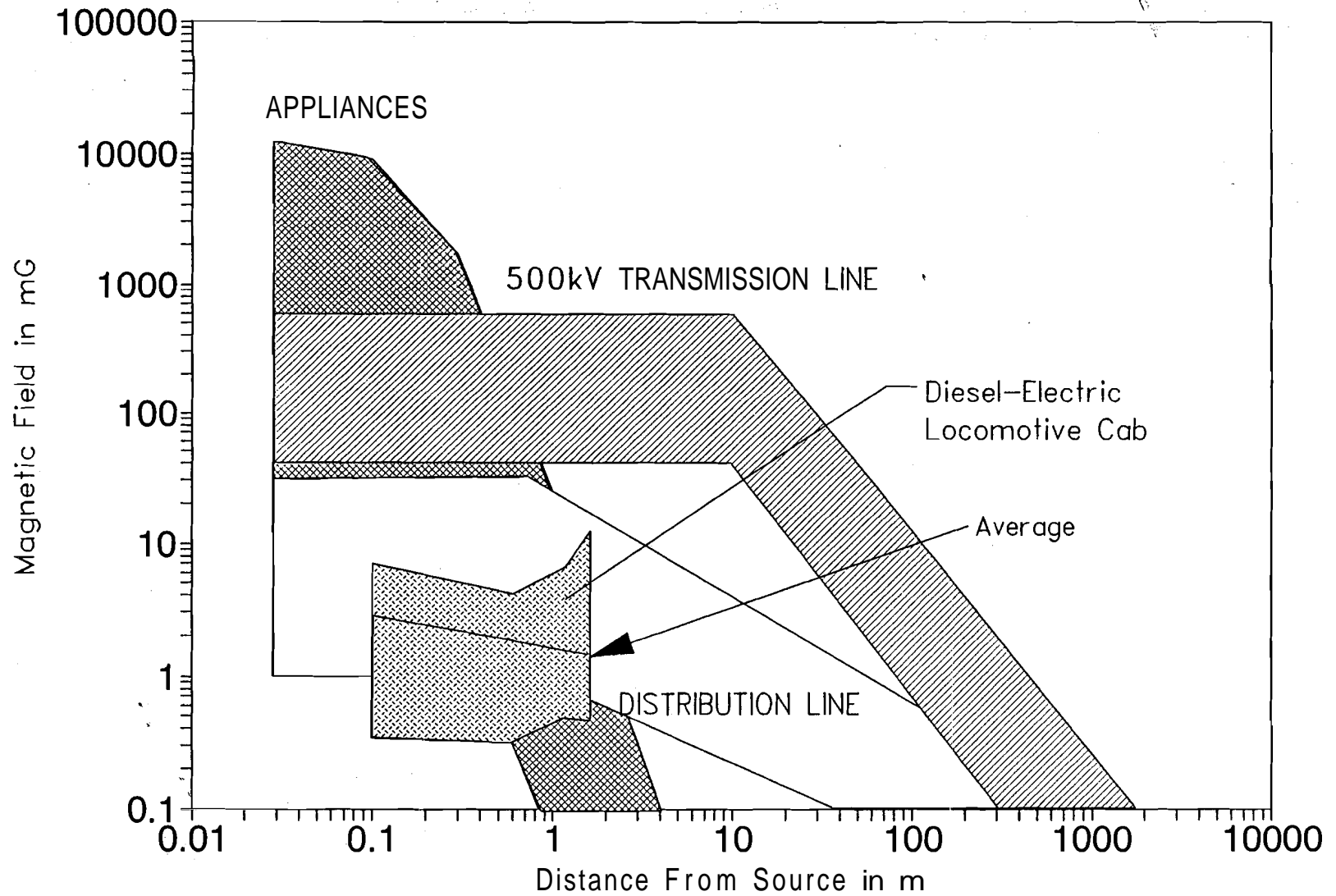

FIGURE 9-6. THE RANGE OF TOTAL TIME-VARYING MAGNETIC FIELD IN THE CAB OF A DIESEL-ELECTRIC LOCOMOTIVE COMPARED TO TYPICAL LEVELS OF POWER-FREQUENCY MAGNETIC FIELDS PRODUCED BY COMMON SOURCES

recorded in Tables 5-4 through 5-7 onto the graph of common environmental field levels shown in Figure 9-1, Figure 9-7 was produced. It shows that the range of magnetic field levels at the wayside at various distances from the track are in the general range of magnetic fields near power lines including distribution lines and moderate-sized transmission lines.

The projected electric field attenuation curves from Figures 5-13 through 5-15 are also superimposed on the graph of **commonly-**encountered electric fields (Figure 9-3) to produce Figure 9-8, which shows the upper boundary of expected electric field levels. The minimum electric field can extend to near zero at all distances if shielding objects such as trees or other tall vegetation are present. Again, the range of electric fields is seen to span the range of electric fields produced by electric distribution lines and moderate-sized transmission lines.

9.4.4.4 Passenger Stations - The ranges of time-varying magnetic fields measured on station platforms and station waiting areas (Tables 6-3 through 6-7) are shown in Figure 9-9 in relation to the power frequency magnetic fields from other sources. The range of magnetic fields encountered on station platforms is similar to that under electric power lines or within 30 cm or so of home electrical appliances. The mean time-varying magnetic field levels measured on station platforms on the three electrified railroad sections are seen to be reasonably similar in comparison to the large range of magnetic fields which can be encountered at a station.

Magnetic fields in the two station waiting areas are also depicted in Figure 9-9. At New York's Penn Station on the 25 Hz section of the NEC, the waiting area was above the platform area. The distance from the catenaries in the platform area to the floor of the waiting area is not known precisely, but is estimated as approximately 4 m (13.1 ft). Consequently, the magnetic field levels measured at incremental heights above the floor in the waiting area range from approximately 4 to 5.5 m (13.1 to 18 ft) from the source. The measured data are plotted accordingly. However, Boston's South Station is on the non-electrified section of the NEC and therefore a very long distance from any magnetic field source related to railroad traction. Although the magnetic field levels measured at the South Station waiting area are plotted at the right edge of the figure, that has been done to facilitate comparison of magnetic field intensity, and the "**distance** from the source" (horizontal axis position) has no meaning.

The electric field levels measured on the station platforms on the three electrified railroad sections are shown in Figure 9-10 relative to electric field levels produced by other common sources. While these field levels are higher than those encountered in most residential or neighborhood environments, they are consistent with the electric field levels encountered beneath high voltage electric power transmission lines. As reported in Section 6.7, the values shown on the graph are the highest electric field levels found on the platforms. Electric field levels were lower at many other locations due to the field shielding provided by the platform

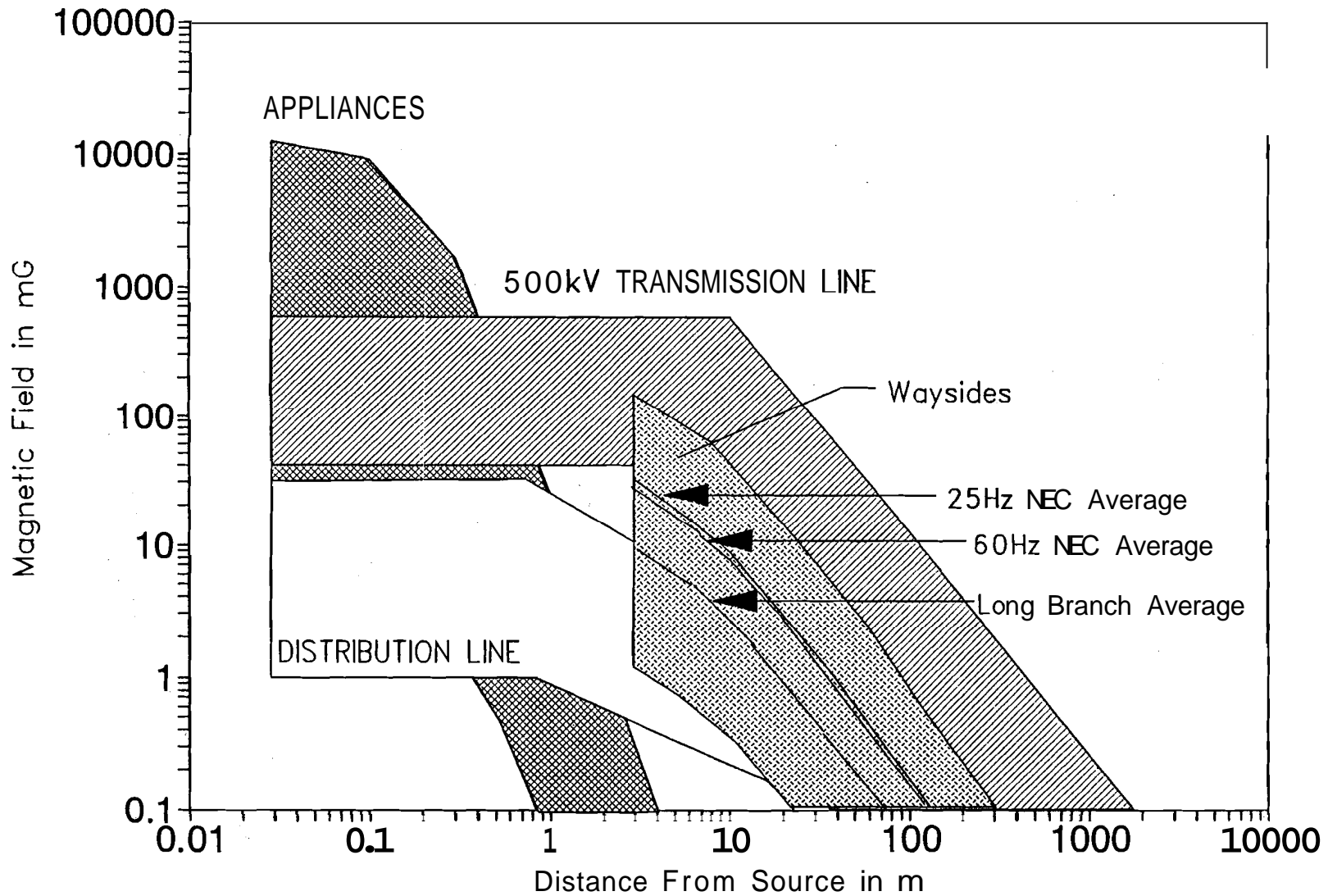

FIGURE 9-7. THE RANGE OF TOTAL TIME-VARYING MAGNETIC FIELD ALONG THE WAYSIDE OF ELECTRIFIED RAILROADS AT VARIOUS DISTANCES FROM THE NEAREST TRACK COMPARED TO TYPICAL LEVELS OF POWER-FREQUENCY MAGNETIC FIELDS PRODUCED BY COMMON SOURCES

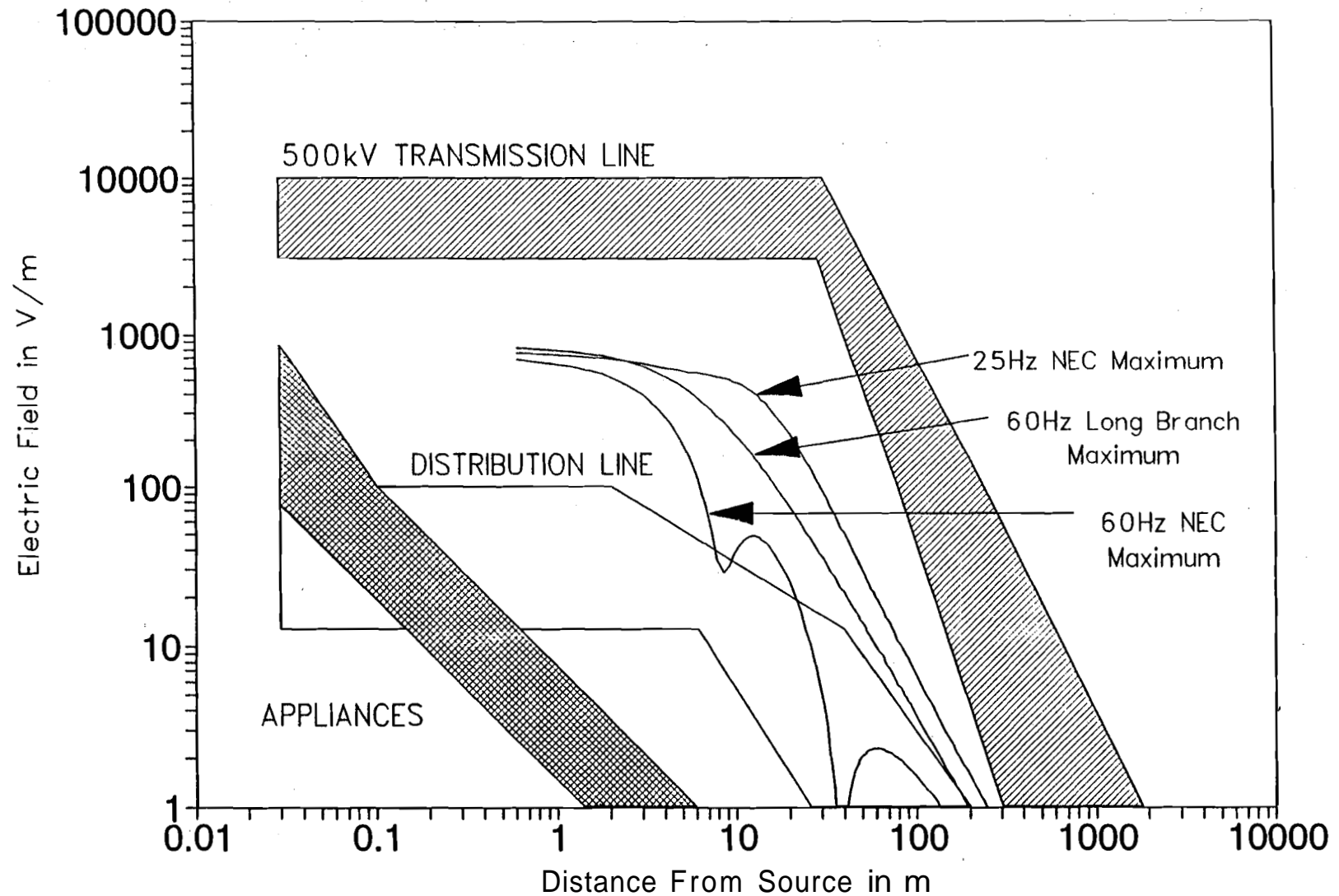

FIGURE 9-8. MAXIMUM TIME-VARYING ELECTRIC FIELD AT THE WAYSIDE OF ELECTRIFIED RAILROADS AS A FUNCTION OF DISTANCE FROM THE NEAREST TRACK COMPARED TO TYPICAL LEVELS OF POWER-FREQUENCY ELECTRIC FIELDS PRODUCED BY COMMON SOURCES

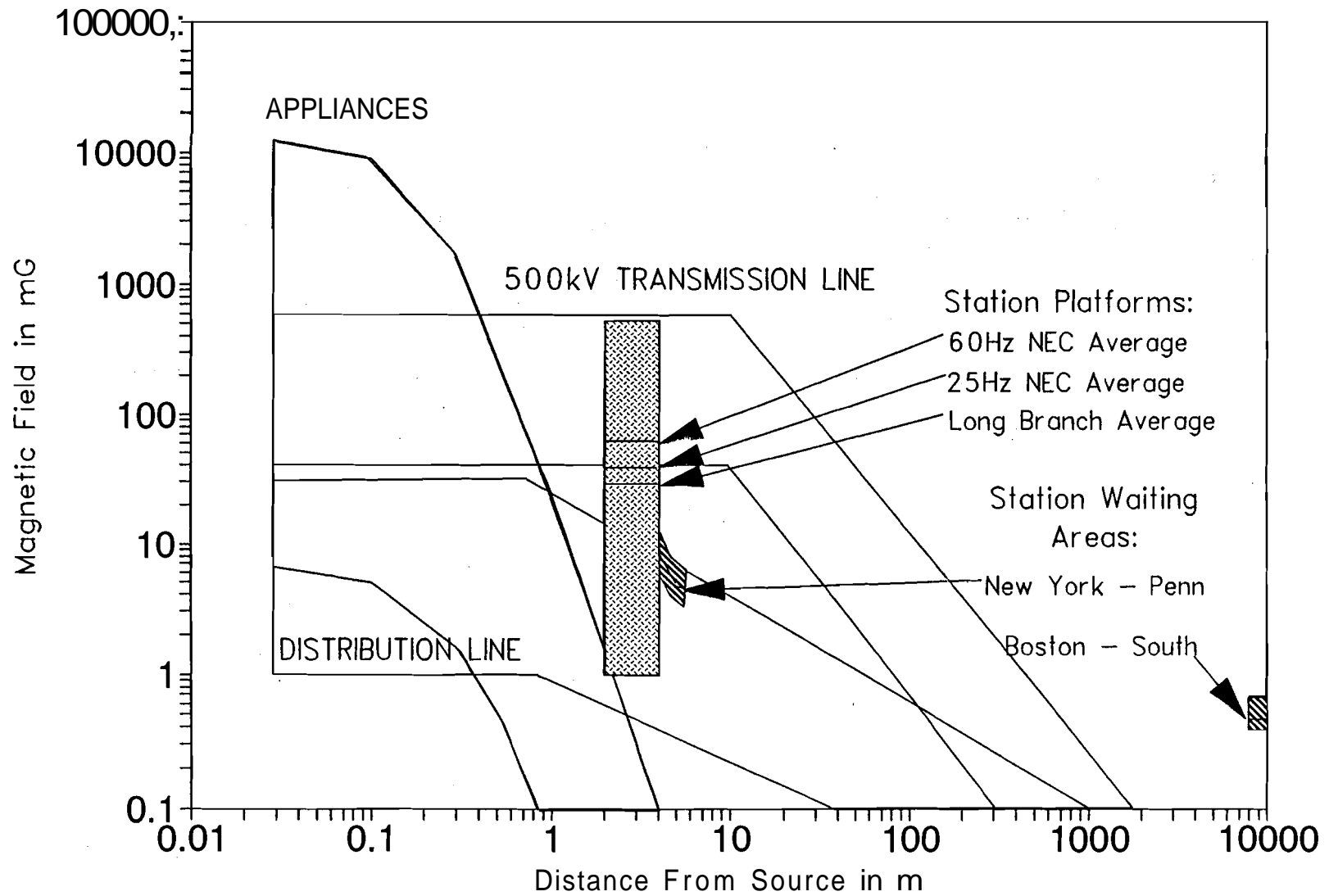

FIGURE 9-9. THE RANGE OF TOTAL TIME-VARYING MAGNETIC FIELD LEVELS ON STATION PLATFORMS OR IN STATION WAITING AREAS COMPARED TO TYPICAL POWER-FREQUENCY MAGNETIC FIELD LEVELS FROM COMMON SOURCES

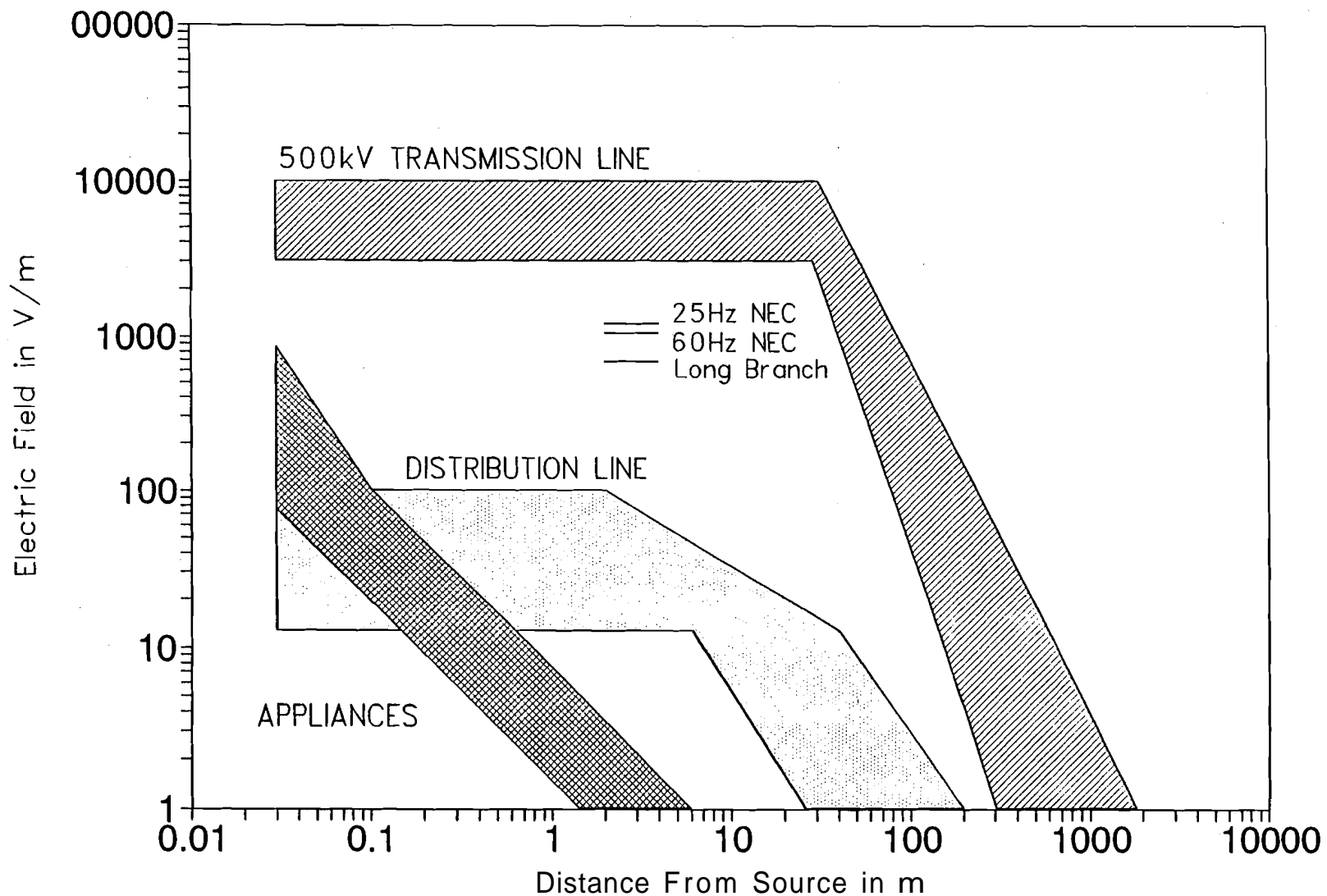

FIGURE 9-10. MEASURED TOTAL TIME-VARYING ELECTRIC FIELD ON STATION PLATFORMS COMPARED TO TYPICAL POWER-FREQUENCY ELECTRIC FIELD LEVELS FROM COMMON SOURCES

overhang, by light standards, by fence's, and by other tall metallic objects on or near the platform.

9.4.4.5 Substations - Data for the time-varying magnetic field levels measured near substations (see Section 7.6) are compared to power frequency magnetic fields from common sources in Figure 9-11. The range of field levels shown at 2 m (6.6 ft) from the substation fence were measured at the Red Bank Substation on the North Jersey Coast Line. Magnetic field levels were lower at the other stations examined. Lateral attenuation profiles of magnetic field versus distance from the substation fence are also shown for the Red Bank and Mt. Vernon Substations.

Electric fields from the substations *per se* could not be measured outside the substations because electric fields from the surrounding transmission lines, distribution lines, or catenaries dominated the electric field measurements at each substation location.

9.4.4.6 Control Areas - The magnetic field values measured at incremental distances from the video display terminal on a dispatcher's CETC console and the magnetic field values measured .6 m (2 ft) in front of an uninterruptible power supply room are compared to power frequency magnetic field levels from various common sources in Figure 9-12. The fields near each fall within the range of magnetic fields found near electrical appliances. The video display terminal is near the low end of that range, while the UPS unit is near the high end of the range.

9.5 COMPARISON OF NEC FIELDS TO EXISTING STANDARDS

The United States has no national standards which establish limits on the intensity of ELF magnetic fields. There are two guidelines established by international organizations and one established by a domestic professional trade organization. Furthermore, there are two state level standards limiting ELF magnetic fields and several others limiting ELF electric fields. However, they presently apply only to electric power lines and substations. This subsection of the report will compare the magnetic field levels **onboard** electrified railroads or near related facilities to the field levels permitted under the above-mentioned standards.

9.5.1 World Health Organization

The World Health Organization's *Environmental Health Criteria 35: Extremely Low Frequency (ELF) Fields*¹⁰ addresses both electric and magnetic fields but focuses more heavily on electric fields. Although it concludes that "adverse human health effects from exposure to ELF electric field levels normally encountered in the environment or the workplace have not been established" and recommends no numerical limits to general or occupational exposure, it recommends limiting long-term exposures to 50/60 Hz electric

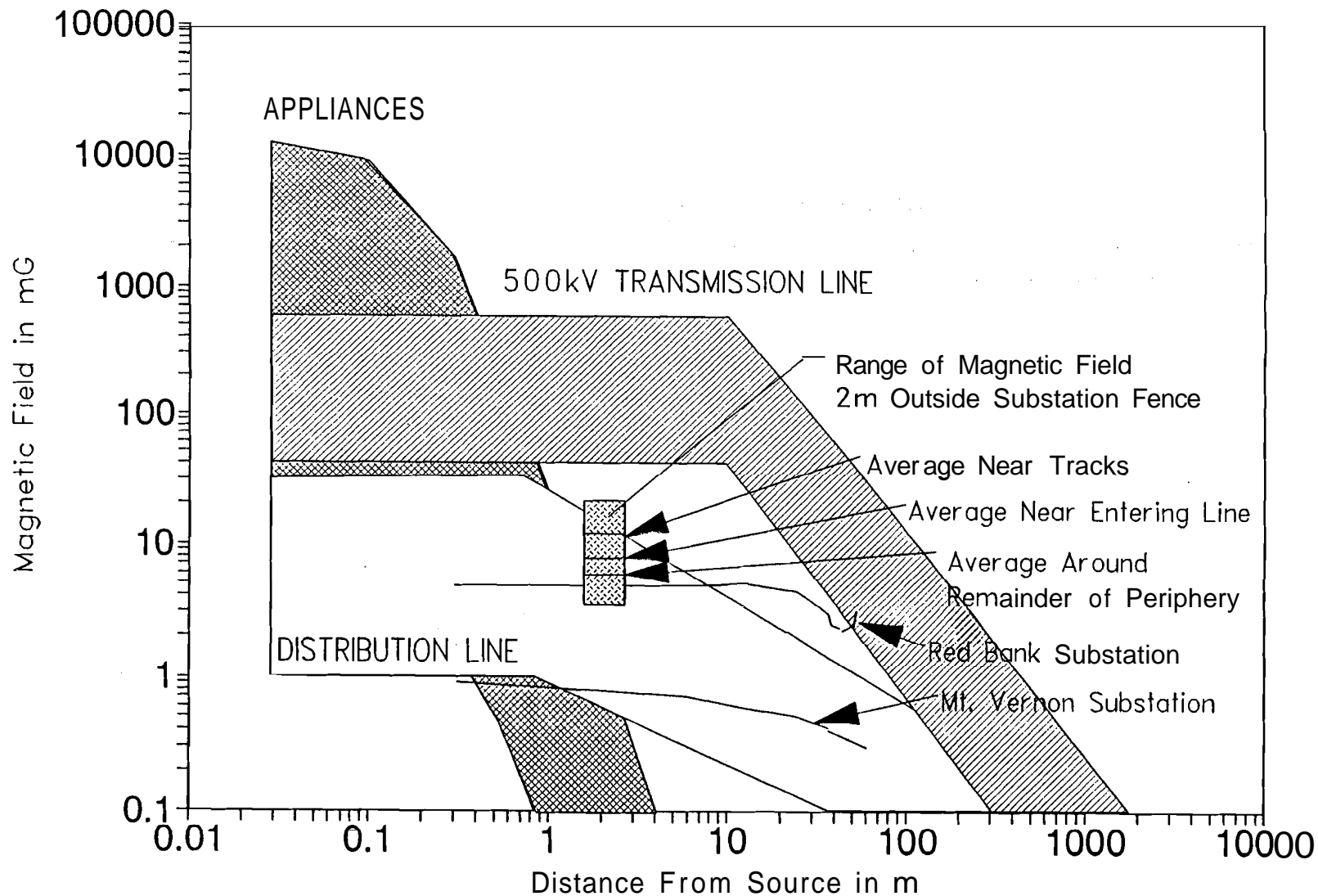

FIGURE 9-11. THE RANGE OF TOTAL TIME-VARYING MAGNETIC FIELD LEVELS 2 M (6.6 FT.) OUTSIDE THE FENCE OF THE RED BANK SUBSTATION AND LATERAL ATTENUATION PROFILES FOR THE RED BANK AND MT. VERNON SUBSTATIONS COMPARED TO TYPICAL POWER-FREQUENCY MAGNETIC FIELD LEVELS FROM COMMON SOURCES

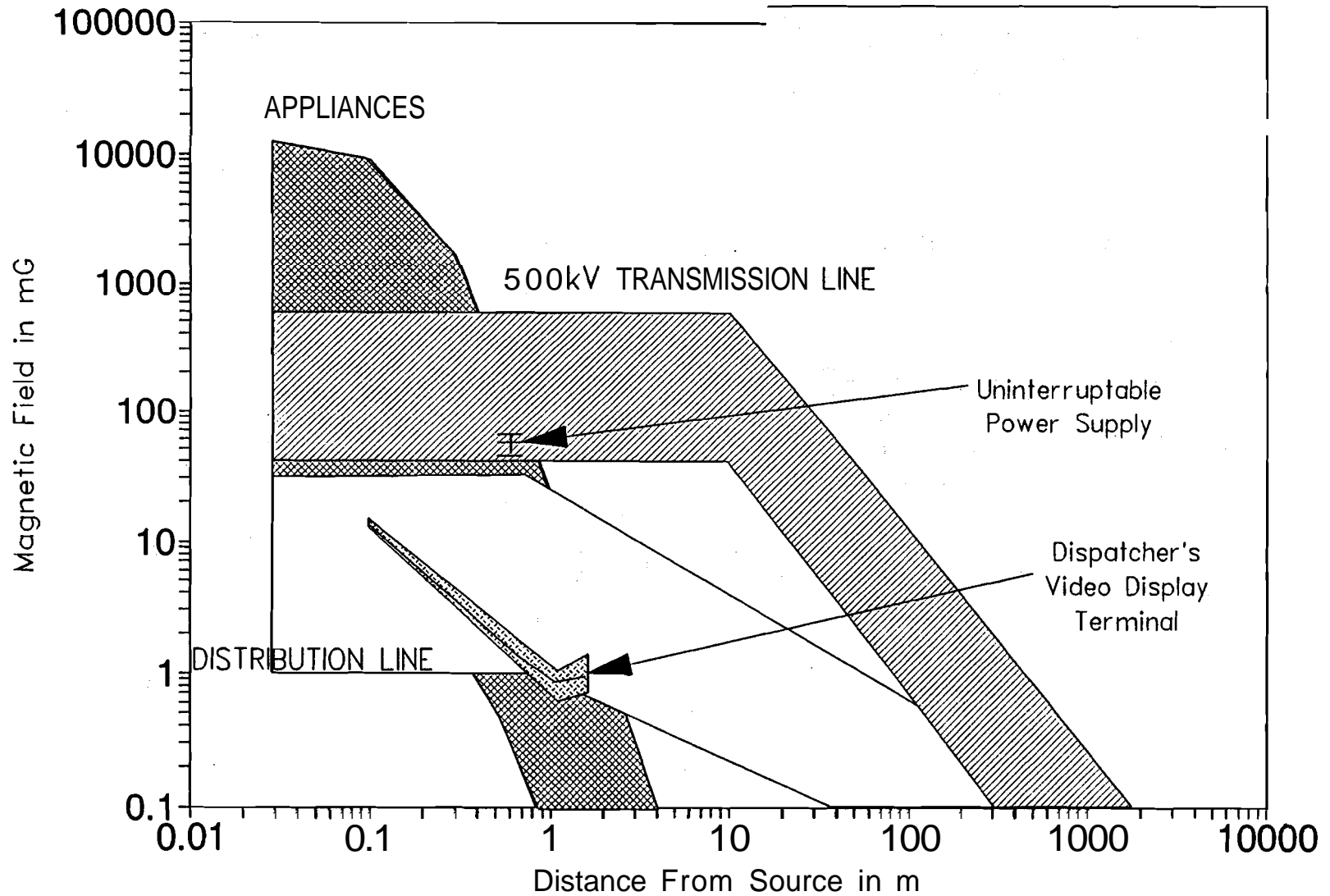

FIGURE 9-12. THE RANGE OF TOTAL TIME-VARYING MAGNETIC FIELD LEVELS IN FRONT OF A DISPATCHER'S VIDEO DISPLAY TERMINAL AND AN UNINTERRUPTIBLE POWER SUPPLY COMPARED TO TYPICAL POWER-FREQUENCY MAGNETIC FIELD LEVELS FROM COMMON SOURCES

fields between 1 and 10 kV/m to "levels as low as can be reasonably achieved." Based on electric field measurements reported above, electric fields of 1 kV/m or more were found only on station platforms where exposure occurs for only limited time periods while waiting for trains. The highest electric field levels found on station platforms were 1.2 kV/m for the 12.5 kV, 60 Hz section of the NEC and 1.06 kV/m for the 11 kV, 25 Hz section of the NEC. These field levels are at the extreme low end of the range in which the World Health Organization suggests consideration of avoiding long-term exposure and is below the thresholds cited for field detection (2 kV/m) or spark discharge sensations (3 kV/m). Station personnel will not experience long-term exposure to electric fields in excess of 1 kV/m because their duties are predominantly indoors where the station itself shields and attenuates the electric field as it does in the locomotive cab and passenger coaches. Electric field levels at the wayside are less than 1 kV/m for the existing electrified railroad sections.

The World Health Organization's *Environmental Health Criteria 69*¹¹ addresses ELF magnetic fields. The document concludes that available scientific knowledge does not permit establishment of a definitive limit for static or time-varying magnetic fields. The document indicates that adverse human health effects are unlikely at static field levels less than 2 T (20,000 gauss) or with time-varying magnetic fields which induce current densities of less than 10 mA/m² within tissue or extracellular fluids. Based on available scaling data for magnetically induced currents in the human body, the 10 mA/m² threshold is reached at power frequency field levels of approximately 10 gauss. Since the criterion is based on induced current, the permissible time-varying field level is inversely proportional to frequency. Since the electrified railroad fields are principally 60 Hz or 25 Hz depending on the electrification system, the maximum magnetic fields measured in the coaches or on the station platforms were 20 times less than the World Health Organization Criterion limit. Average time-varying magnetic field levels at those locations are less than 1% of the criterion. Even greater margins of compliance are found for static magnetic fields or time-varying magnetic fields at other locations.

9.5.2 International Radiation Protection Association

The International Non-Ionizing Radiation Committee (INIRC) of the International Radiation Protection Association (IRPA) has developed an interim **standard**¹² limiting human exposure to power frequency (50/60 Hz) electric and magnetic fields. The established magnetic field limit for 24 hours per day of the general public is 1 gauss. Short-term exposures of up to a few hours per day are permitted to 10 gauss. Permitted occupational exposure levels are five times that permitted for the general public. The 1 gauss continuous exposure limit is approximately 10 to 50 times the average time-varying magnetic field level in the passenger coaches. Average magnetic field levels in electric locomotive cabs are of the same general magnitude as the coaches. Magnetic field levels at other locations are weaker, hence have even greater margins of compliance.

The numerical field limits in the IRPA standard apply explicitly to power frequency magnetic fields. However, the text of the standard clearly demonstrates that the standard is based on induced current concerns. Hence, acceptable field limits at frequencies other than 50 or 60 Hz would be related to the 50/60 Hz threshold by the ratio of the power frequency to the frequency of the magnetic field. For the predominantly 25 Hz magnetic fields produced by the operation of the NEC electric traction system from Washington, DC to a point just north of New York, the margin of compliance with the standard would be greater if the implied frequency correction was made.

The power frequency electric field exposure limits recommended by IRPA for the general public are 5 kV/m continuous or 10 kV/m for a few hours per day. Recommended occupational exposure thresholds are two to three times higher. Maximum electric field exposure levels at stations will be no more than 1.2 kV/m or about four times less than the continuous exposure threshold. Electric field levels at other locations are significantly lower.

9.5.3 American Conference of Governmental Industrial Hygienists

The American Conference of Governmental Industrial Hygienists (ACGIH) has established a "threshold limit value" for 60 Hz magnetic fields at 10 gauss, and a TLV at 25 Hz of 24 gauss¹³ based on a 1/f functional dependence. The document recommends that routine occupational exposures should not exceed the 10 gauss at 60 Hz, or a corresponding 24 gauss at 25 Hz values, but states that the value is to be used as a guideline, not as a strict determination of safe and unsafe levels. For example, values ten times less than the above TLVs are recommended for persons with implanted pacemakers. These TLV values are comparable to the guidelines recommended by the World Health Organization and the tenfold lower level suggested for pacemaker wearers is comparable to the IRPA guideline. As discussed above, the measured magnetic fields on or near the electrified railroads meet those criteria with a comfortable margin.

The TLV for electric fields at frequencies of 100 Hz or less is 25 kV/m¹¹. The highest electric field levels found around the existing electrified railroad facilities were on the station platforms, where the highest field was less than 5% of the TLV.

9.5.4 State Power Line Limits

The states of Florida and New York have adopted standards specifically limiting the intensity of the power frequency electric and magnetic fields at the boundaries of transmission lines' rights-of-way or substation property lines to values from 1.6 to 2.0 kV/m and 150 mG to 250 mG, depending on the type of transmission line. Both standards are established on a "status quo" basis rather than a health or safety basis. Although neither applies to transportation systems, they do provide some guidance as to the levels of magnetic fields which have been judged tolerable

at the boundaries of linear electrification facilities, such as electrified railroad corridors. The maximum electric field found 6.1 m (20 ft) from the track, a typical minimum railroad right-of-way boundary, ranged from 0.11 kV/m to 0.55 kV/m depending on the electrification system.

The average magnetic field 6.1 m (20 ft) from the nearest track of the existing railroad sections ranged from approximately 5 mG to 12 mG, while maximum values ranged from 16.5 mG to 124 mG. Both average and maximum magnetic field levels for the existing railroad sections comply with even the most stringent state magnetic field limit for the edge of power line rights-of-way.

10. REFERENCES

1. Interim Report on Magnetic Field Testing of TR07 Maglev Vehicle and System Conducted August 1990, Electric Research and Management, Inc., May 1991, Revised August 1991.
2. Safety of High Speed Magnetic Levitation Transportation Systems, "Magnetic Field Testing of the TR07 Maglev Vehicle and System, Volume I - Analysis", U.S. Department of Transportation, Federal Railroad Administration, Washington, DC, DOT/FRA/ORD-92/09.I, DOT-VNTSC-FRA-92-6.1, Final Report April 1992.
3. IEEE Standard Dictionary of Electrical and Electronic Terms, ANSI/IEEE Std 100-1988 Fourth Edition, IEEE, New York, NY.
4. "Electric and Magnetic Field Concepts" In The Electrostatic and Electromagnetic Effects of AC Transmission Lines, Document 79 EH0145-3-PWR, J.R. Stewart, Institute of Electrical and Electronic Engineers, New York, NY, 1979.
5. "Magnetic Fields Remote From Substations", W.E. Feero, J. Yontz, and J.H. Dunlap, IEEE Transactions on Power Delivery, Vol PWRD-4, July 1989, pp 1862-1868.
6. "French Railroads Efforts to Reduce Traction Electromagnetic Fields", Charles G. Gourdon, Presented at the First World Congress for Electricity and Magnetism in Biology and Medicine, Lake Buena Vista, FL, June 14-19, 1992.
7. Biological Effects on Power Frequency Electric and Magnetic Fields, Indira Nair, M. Granger Morgan, H. Keith Florig, Office of Technology Assessment, OTA-BP-E-53, May 1989.
8. Measurement of Power System Magnetic Fields by Waveform Capture, EPRI TR-100061, Project RP2942-1, Final Report, February 1992.
9. The EMDEX Project: Technology Transfer and Occupational Measurements, Volume 2: Project Description and Results, EPRI EN-7048 Volume 2, Project 2966-1, Interim Report, November 1990.
10. World Health Organization, Environmental Health Criteria 35: Extreme Low Frequency (ELF) Fields, Geneva, World Health Organization, 1984.
11. World Health Organization, Environmental Health Criteria 69: Magnetic Fields, Geneva, World Health Organization, 1987.
12. International Radiation Protection Association, Interim Guidelines on Limits of Exposure to 50/60 Hz Electric and Magnetic Fields, Health Physics 58; 113-22, 1990.

REFERENCES (CONT'D)

13. 1990-1991 Threshold Limit Values for Chemical Substances and Physical Agents and Biological Exposure Indices, American Conference of Governmental Industrial Hygienists, Third Printing.
14. Electric and Magnetic Fields, Chapter 17-274, Florida Administrative Code.
15. Statement of Interim Policy on Magnetic Fields of Major Electric Transmission Facilities, State of New York Public Service Commission, September 11, 1990.
16. Magnetic Fields and Cancer in People Residing Near Swedish High Voltage Power Lines, Institutet för Miljömedicin, Karolinska Institutet, Maria Feychting, Anders Ahlbom, IMM-rapport 6/92, Stockholm 1992.
17. Health Effects of Low Frequency Electric and Magnetic Fields, Executive Summary June 1992, Prepared by An Oak Ridge Associated Universities Panel for The Committee on Interagency Radiation Research and Policy Coordination, ORAU 92/F9.