

Report No. CG-D-22-97, II  
DOT-VNTSC-CG-97-1.2

**U.S. Coast Guard  
1995 Oil Pollution Research Grants  
Publications - Part II**

U.S. Department of Transportation  
Research and Special Programs Administration  
John A. Volpe National Transportation Systems Center  
Cambridge, MA 02142-1093

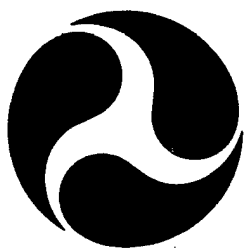

FINAL REPORT  
August 1997

This document is available to the U.S. public through the  
National Technical Information Service, Springfield, Virginia 22161

Prepared for:

U.S. Department of Transportation  
United States Coast Guard  
Marine Safety and Environmental Protection, (G-M)  
Washington, DC 20593-0001

and

U.S. Coast Guard  
Research and Development Center  
1082 Shennecossett Road  
Groton, CT 06340-6096

19971016 143

DTIC QUALITY INSPECTED 2

**NOTICE**

This document is disseminated under the sponsorship of the Department of Transportation in the interest of information exchange. The United States Government assumes no liability for its contents or use thereof.

**NOTICE**

The United States Government does not endorse products or manufacturers. Trade or manufacturers' names appear herein solely because they are considered essential to the objective of this report.

|  |  |  |  |  |           |
|--|--|--|--|--|-----------|
| 1. Report No.<br>CG-D-22-97, II  |  | 2. Government Accession No.                              |  | 3. Recipient's Catalog No.   |           |
| 4. Title and Subtitle<br><br>U.S. Coast Guard 1995 Oil Pollution Research Grants<br>Publications - Part II   |  |  |  | 5. Report Date<br>August 1997  |           |
|  |  |  |  | 6. Performing Organization Code<br>Project No: 4123  |           |
| 7. Author(s)   |  |  |  | 8. Performing Organization Report No.<br>R&DC 23/97, II  |           |
| 9. Performing Organization Name and Address<br><br>Research and Special Programs Administration<br>John A. Volpe National Transportation Systems Center<br>Cambridge, MA 02142-1093  |  |  |  | 10. Work Unit No. (TRAIS)  |           |
|  |  |  |  | 11. Contract or Grant No.<br>DTRS57-95-G-00065   |           |
| 12. Sponsoring Agency Name and Address<br><br>U.S. Department of Transportation<br>United States Coast Guard<br>Marine Safety and Environmental<br>Protection (G-M)<br>Washington, DC 20593-0001   |  |  |  | 13. Type of Report and Period Covered<br>Final Report  |           |
|  |  |  |  | 14. Sponsoring Agency Code<br>Commandant (G-MOR)<br>U.S. Coast Guard Headquarters<br>Washington, DC 20593-0001 |           |
| 15. Supplementary Notes<br><br>The R&DC point of contact is Kenneth Bitting, 860-441-2733.   |  |  |  |  |           |
| 16. Abstract<br><br>The Oil Pollution Research Grants Program was created by the Oil Pollution Act (OPA) of 1990, P.L. 101-380 (OPA 90), 33 U.S.C. 28761(c)(8) and 2761(c)(9). The OPA established a regional research program and authorized those agencies represented on the Interagency Coordinating Committee on Oil Pollution Research, including the U.S. Coast Guard (USCG), to make grants to universities and other research institutions to perform research related to regional effects of oil pollution. The USCG established such a grant program and the John A. Volpe National Transportation Systems Center (Volpe Center), a component of the Research and Special Programs Administration of the Department of Transportation (DOT), was chosen to administer this program on behalf of the USCG.<br><br>In August 1995, the Volpe Center awarded seven one-year grants. Coast Guard funds were matched by funds from the university or non-profit research institution.<br><br>This report contains the final reports for research performed under these grants. |  |  |  |  |           |
| 17. Key Words<br><br>oil pollution research<br>oil pollution grants  |  |  | 18. Distribution Statement<br><br>This document is available to the U.S. public through the National Technical Information Service, Springfield, VA 22161. |  |           |
| 19. Security Classif. (of this report)<br><br>UNCLASSIFIED   |  | 20. SECURITY CLASSIF. (of this page)<br><br>UNCLASSIFIED |  | 21. No. of Pages   | 22. Price |

[ BLANK ]

## PREFACE

### PUBLICATIONS OF THE U.S. COAST GUARD 1995 OIL POLLUTION RESEARCH GRANTS

On March 24, 1989, the EXXON VALDEZ ran aground on Bligh Reef in Prince William Sound, Alaska producing the largest oil spill in U.S. history. Following this event, the Coast Guard reexamined its mission needs and technology to formulate an R&D effort for the 1990s. Workshops were held within the Coast Guard and with other Federal agencies and private sector organizations to identify spill response needs and R&D efforts that would support those needs. One of the workshops was a U.S. Coast Guard (USCG) sponsored Interagency Planning Workshop on oil spill research and development on September 26-27, 1989. This workshop exchanged information and initiated the development of a coordinated national plan for oil spill research and development under Title VII of the Oil Pollution Act of 1990.

The Oil Pollution Research Grant Program was created by the Oil Pollution Act of 1990, P.L. 101-380 (OPA 90), 33 U.S.C. 2761 (c)(8) and 2761 (c)(9). The OPA established a regional research program and authorized those agencies represented on the Interagency Coordinating Committee on Oil Pollution Research, including the USCG, to make grants to universities and other research institutions to perform research related to regional effects of oil pollution. The USCG established such a grant program, and the John A. Volpe National Transportation Systems Center (Volpe Center), a component of the Research and Special Programs Administration of the Department of Transportation (DOT), was chosen to administer this program on behalf of the USCG.

The Volpe Center mailed Grant Applications to about 200 universities and non-profit research institutions during the first week of January 1995. The mailing list included institutions from all the Coast Guard districts. On March 13, 1995 the Volpe Center received 25 applications from six districts. These proposals were reviewed by the Volpe Center and the Coast Guard Research and Development Center and the recommendations forwarded to the Interagency Committee on Oil Pollution Research for approval. Seven one-year Grants were awarded in June 1995. Coast Guard funds were matched by funds from the university or non-profit research institution.

In August 1994, the Volpe Center awarded ten one-year Grants. Three of these Grants were extended for a second year in June 1995 to expand the research effort.

This report contains the Final Reports for research performed under these seven 1995 Grants. The results are presented in two volumes. For further information contact Kenneth Bitting at the U.S Coast Guard Research and Development Center, Groton, Connecticut (860) 441-2733.

Additional copies of this document are available through the National Technical Information Service, Springfield, Virginia 22161.

## METRIC/ENGLISH CONVERSION FACTORS

| ENGLISH TO METRIC   | METRIC TO ENGLISH   |
|---|---|
| <p style="text-align: center;"><b>LENGTH (APPROXIMATE)</b></p> <p>1 inch (in) = 2.5 centimeters (cm)<br/>                     1 foot (ft) = 30 centimeters (cm)<br/>                     1 yard (yd) = 0.9 meter (m)<br/>                     1 mile (mi) = 1.6 kilometers (km)</p>   | <p style="text-align: center;"><b>LENGTH (APPROXIMATE)</b></p> <p>1 millimeter (mm) = 0.04 inch (in)<br/>                     1 centimeter (cm) = 0.4 inch (in)<br/>                     1 meter (m) = 3.3 feet (ft)<br/>                     1 meter (m) = 1.1 yards (yd)<br/>                     1 kilometer (km) = 0.6 mile (mi)</p>  |
| <p style="text-align: center;"><b>AREA (APPROXIMATE)</b></p> <p>1 square inch (sq in, in<sup>2</sup>) = 6.5 square centimeters (cm<sup>2</sup>)<br/>                     1 square foot (sq ft, ft<sup>2</sup>) = 0.09 square meter (m<sup>2</sup>)<br/>                     1 square yard (sq yd, yd<sup>2</sup>) = 0.8 square meter (m<sup>2</sup>)<br/>                     1 square mile (sq mi, mi<sup>2</sup>) = 2.6 square kilometers (km<sup>2</sup>)<br/>                     1 acre = 0.4 hectare (ha) = 4,000 square meters (m<sup>2</sup>)</p>   | <p style="text-align: center;"><b>AREA (APPROXIMATE)</b></p> <p>1 square centimeter (cm<sup>2</sup>) = 0.16 square inch (sq in, in<sup>2</sup>)<br/>                     1 square meter (m<sup>2</sup>) = 1.2 square yards (sq yd, yd<sup>2</sup>)<br/>                     1 square kilometer (km<sup>2</sup>) = 0.4 square mile (sq mi, mi<sup>2</sup>)<br/>                     10,000 square meters (m<sup>2</sup>) = 1 hectare (ha) = 2.5 acres</p>                                  |
| <p style="text-align: center;"><b>MASS - WEIGHT (APPROXIMATE)</b></p> <p>1 ounce (oz) = 28 grams (gm)<br/>                     1 pound (lb) = .45 kilogram (kg)<br/>                     1 short ton = 2,000 pounds (lb) = 0.9 tonne (t)</p>  | <p style="text-align: center;"><b>MASS - WEIGHT (APPROXIMATE)</b></p> <p>1 gram (gm) = 0.036 ounce (oz)<br/>                     1 kilogram (kg) = 2.2 pounds (lb)<br/>                     1 tonne (t) = 1,000 kilograms (kg) = 1.1 short tons</p>   |
| <p style="text-align: center;"><b>VOLUME (APPROXIMATE)</b></p> <p>1 teaspoon (tsp) = 5 milliliters (ml)<br/>                     1 tablespoon (tbsp) = 15 milliliters (ml)<br/>                     1 fluid ounce (fl oz) = 30 milliliters (ml)<br/>                     1 cup (c) = 0.24 liter (l)<br/>                     1 pint (pt) = 0.47 liter (l)<br/>                     1 quart (qt) = 0.96 liter (l)<br/>                     1 gallon (gal) = 3.8 liters (l)<br/>                     1 cubic foot (cu ft, ft<sup>3</sup>) = 0.03 cubic meter (m<sup>3</sup>)<br/>                     1 cubic yard (cu yd, yd<sup>3</sup>) = 0.76 cubic meter (m<sup>3</sup>)</p> | <p style="text-align: center;"><b>VOLUME (APPROXIMATE)</b></p> <p>1 milliliter (ml) = 0.03 fluid ounce (fl oz)<br/>                     1 liter (l) = 2.1 pints (pt)<br/>                     1 liter (l) = 1.06 quarts (qt)<br/>                     1 liter (l) = 0.26 gallon (gal)<br/>                     1 cubic meter (m<sup>3</sup>) = 36 cubic feet (cu ft, ft<sup>3</sup>)<br/>                     1 cubic meter (m<sup>3</sup>) = 1.3 cubic yards (cu yd, yd<sup>3</sup>)</p> |
| <p style="text-align: center;"><b>TEMPERATURE (EXACT)</b></p> <p style="text-align: center;"><math>^{\circ}\text{C} = 5/9(^{\circ}\text{F} - 32)</math></p>   | <p style="text-align: center;"><b>TEMPERATURE (EXACT)</b></p> <p style="text-align: center;"><math>^{\circ}\text{F} = 9/5(^{\circ}\text{C}) + 32</math></p>   |

### QUICK INCH-CENTIMETER LENGTH CONVERSION

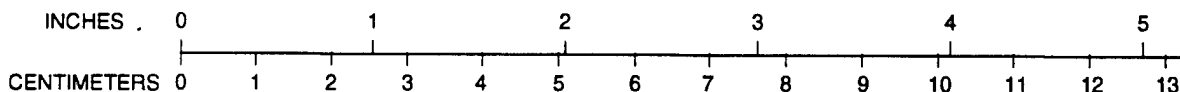

### QUICK FAHRENHEIT-CELSIUS TEMPERATURE CONVERSION

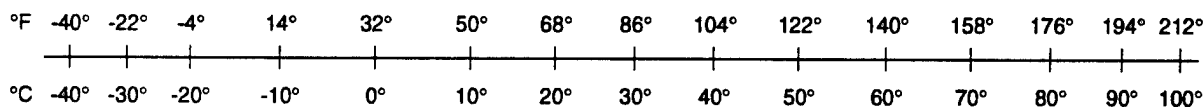

For more exact and or other conversion factors, see NIST Miscellaneous Publication 286, Units of Weights and Measures. Price \$2.50. SD Catalog No. C13 10286.

Updated 8/1/96

# TABLE OF CONTENTS

## Part I

| <u>Section</u>  | <u>Page</u> |
|---|-------------|
| <b>RUPTURE ANALYSIS OF OIL TANKERS IN A SIDE COLLISION:<br/>THEORY OF BOW CUTTING THROUGH DECKS . . . . .</b>                       | <b>1</b>    |
| B.C. Simonsen and T. Wierzbicki, Massachusetts Institute of Technology  |             |
| 1. Abstract . . . . .   | 3           |
| 2. Introduction . . . . .   | 4           |
| 3. Previous Work . . . . .  | 6           |
| 4. Comparison of Formulas for Initiation Cutting . . . . .  | 12          |
| 5. Prediction of Steady State Cutting Force . . . . .   | 13          |
| 6. Problem Statement and Basic Idea of Model . . . . .  | 15          |
| 7. Basic Equations for Plasticity, Fracture and Friction . . . . .  | 20          |
| 8. Energy Dissipation in Plasticity and Fracture . . . . .  | 24          |
| 9. Friction and Perpendicular Reaction . . . . .  | 26          |
| 10. Total Reaction and Verification . . . . .   | 29          |
| 11. Conclusion . . . . .  | 32          |
| 12. Appendix A - Model Geometry . . . . .   | 34          |
| 13. References . . . . .  | 38          |
| <br>  |             |
| <b>RUPTURE ANALYSIS OF OIL TANKERS IN A SIDE COLLISION:<br/>GLOBAL STRUCTURAL MODEL OF BOW INDENTATION INTO SHIP SIDE . . . . .</b> | <b>41</b>   |
| T. Wierzbicki and B.C. Simonsen, Massachusetts Institute of Technology  |             |
| 1. Executive Summary . . . . .  | 43          |
| 2. Plate Strip Model with Spreading Deformation . . . . .   | 45          |
| 3. Equivalence of Plate and Plate Strip Formulation . . . . .   | 66          |
| 4. Plate Indentation by a Hemispherical Bow . . . . .   | 70          |
| 5. Punch Indentation into a Deck . . . . .  | 81          |
| 6. References . . . . .   | 92          |
| <br>  |             |
| <b>RUPTURE ANALYSIS OF OIL TANKERS IN A SIDE COLLISION:<br/>HARD POINT FRACTURE OF SHELL PLATING . . . . .</b>                      | <b>93</b>   |
| F.A. McClintock and J. Atmadja, Massachusetts Institute of Technology   |             |
| 1. Introduction . . . . .   | 96          |
| 2. Finite Element Studies of Effects of Strain Hardening<br>and of Compliance at Hardpoint Supports . . . . .                       | 97          |
| 3. Lumped Parameter Estimate of Hardpoint Necking . . . . .   | 100         |
| 4. A Buckled Stiffener Mode of Hardpoint Fracture . . . . .   | 105         |
| 5. Conclusions . . . . .  | 107         |
| 6. References . . . . .   | 109         |

TABLE OF CONTENTS (cont.)

Part I

| <u>Section</u>  | <u>Page</u> |
|---|-------------|
| 7. Appendix 1 - Conditions for Necking in Transversely Plane Strain Plates of Power-Law Hardening Material with Prestrain . . . . . | 110         |
| 8. Appendix 2 - Fitting Data Using a Power-Law Stress-Strain Curve with Pre-strain . . . . .  | 111         |
| <br>NUMERICAL MODELING OF OIL CONTAINMENT BY A BOOM/BARRIER SYSTEM: PHASE II . . . . .  | <br>127     |
| S.T. Grilli, Z. Hu, M.L. Spaulding, and D. Liang, University of Rhode Island  |             |
| 1. Introduction and Project Overview . . . . .  | 131         |
| 2. Piecewise Constant Vortex Sheet (PCVS) Model and Applications . . . . .  | 139         |
| 3. Periodic Continuous Vortex Sheet (CVS) Model and Applications to KH Instability . . . . .  | 176         |
| 4. Computation of Quasi Steady-State Slick Shape . . . . .  | 190         |
| 5. Effects of Interfacial Friction on Vorticity Updating Equations . . . . .  | 201         |
| 6. Conclusions . . . . .  | 207         |
| 7. Bibliography . . . . .   | 210         |
| <br>DEVELOPMENT OF A RAPID CURRENT CONTAINMENT BOOM: PHASE II . . . . .   | <br>213     |
| M. R. Swift, B. Celikkol, P. Coyne, R. Steen, and M. Ozyalvac, University of New Hampshire  |             |
| 1. Introduction . . . . .   | 215         |
| 2. Two-Dimensional Oil Retention Results . . . . .  | 221         |
| 3. Three-Dimensional Design Development . . . . .   | 228         |
| 4. Semi-Rigid System . . . . .  | 231         |
| 5. Flexible Systems . . . . .   | 239         |
| 6. Discussion . . . . .   | 252         |
| 7. References . . . . .   | 253         |

Part II

| <u>Section</u>  | <u>Page</u> |
|---|-------------|
| FILTRATION STUDIES FOR REMOVAL OF ORIMULSION® FROM WATER IN PORTS . . . . . | 255         |
| J. Engelhardt and D. Meeroff, University of Miami                           |             |



TABLE OF CONTENTS (cont.)

Part II

| <u>Section</u>  | <u>Page</u> |
|---|-------------|
| 1. Introduction . . . . .   | 260         |
| 2. Methods . . . . .  | 280         |
| 3. Results . . . . .  | 295         |
| 4. Discussion . . . . .   | 347         |
| 5. Conclusions and Recommendations . . . . .  | 362         |
| 6. References . . . . .   | 366         |
| 7. Appendix A - Calibration Curve for Orimulsion® Concentration<br>Versus Volatile Suspended Solids Concentration . . . . .         | 374         |
| 8. Appendix B - Results of Tests of Natural Additives to Improve<br>Handling and Filterability of Orimulsion® Suspensions . . . . . | 376         |
| 9. Appendix C - Results of Burette Tests to Identify<br>Diatomite Grade . . . . .   | 383         |
| 10. Appendix D - Ultrafiltration Pilot Test Data, Including<br>Filtration of Orimulsion®/Clay Suspensions . . . . .                 | 398         |
| 11. Appendix E - Precoat Pilot Plant . . . . .  | 413         |
| 12. Appendix F - Ultrafiltration Pilot Plant . . . . .  | 418         |

**MICRO- AND MESO-SCALE METHODS FOR PREDICTING THE BEHAVIOR  
OF LOW-API GRAVITY OILS (LAPIO) SPILLED ON WATER . . . . . 423**  
S.A. Ostazeski, S.C. Macomber, L.G. Roberts, and A.D. Uhler,  
Batelle Ocean Sciences

|   |     |
|---|-----|
| 1. Introduction . . . . .   | 428 |
| 2. Methodology . . . . .  | 431 |
| 3. Results and Discussion of Results . . . . .                          | 439 |
| 4. Conclusions . . . . .  | 478 |
| 5. References . . . . .   | 480 |
| 6. Appendix A - GC/FID Chromatograms . . . . .                          | 483 |
| 7. Appendix B - Polycyclic Aromatic Hydrocarbon Distributions . . . . . | 503 |
| 8. Appendix C - Iatrosan Chromatograms . . . . .                        | 510 |

**SOURCE IDENTIFICATION OF OIL SPILLS BASED ON THE ISOTOPIC  
COMPOSITION OF INDIVIDUAL COMPONENTS IN WEATHERED OIL  
SAMPLES . . . . . 531**  
R.P. Philp, L. Mansuy, and J. Allen, University of Oklahoma

|                                     |     |
|-------------------------------------|-----|
| 1. Introduction . . . . .           | 534 |
| 2. Experimental Section . . . . .   | 536 |
| 3. Results and Discussion . . . . . | 538 |

## TABLE OF CONTENTS (cont.)

### Part II

| <u>Section</u>   | <u>Page</u> |
|--|-------------|
| HUMAN RELIABILITY AND ERROR PREVENTION IN TANKBARGE<br>TRANSFER OPERATIONS . . . . .                         | 559         |
| E. Iakovou, S.J. Czaja, C. Douligeris, J.H. Moses, University of Miami                                       |             |
| J. Sharit, State University of New York at Buffalo   |             |
| 1. Introduction . . . . .  | 561         |
| 2. Methodolgy . . . . .  | 562         |
| 3. Analysis of Accident Reports and Citations . . . . .  | 568         |
| 4. Tankerman Training and Licensing . . . . .  | 574         |
| 5. Interviews . . . . .  | 576         |
| 6. Observations . . . . .  | 583         |
| 7. Anecdotal Evidence and Near Misses . . . . .  | 584         |
| 8. Summary and Recommendations . . . . .   | 585         |
| 9. References . . . . .  | 590         |
| 10. Appendix A - An Example of Task Analysis of Tankbarge Oil<br>Transfer Operations . . . . .               | 593         |
| 11. Appendix B - A Classification of Performance Shaping Factors<br>(from Swain and Guttman, 1983) . . . . . | 598         |
| 12. Appendix C - Typical MCIR Cover Pages . . . . .  | 600         |
| 13. Appendix D - Plots Associated with MCIR Data . . . . .   | 607         |
| 14. Appendix E - Examples of Narrative Supplements Contained<br>within MCIR Reports . . . . .                | 617         |
| 15. Appendix F - An Example of an Observation Form Used<br>in This Study . . . . .                           | 629         |
| 16. Appendix G - Examples of Anecdotal Evidence . . . . .  | 631         |

**FILTRATION STUDIES FOR REMOVAL OF ORIMULSION® FROM WATER  
IN PORTS**

*J.D. Englehardt and D. Meeroff, University of Miami*

## EXECUTIVE SUMMARY

Results of bench and pilot tests to evaluate the feasibility of using ultrafiltration and diatomaceous earth precoat filtration for removal of Orimulsion<sup>®</sup> from water are presented in this report. Orimulsion<sup>®</sup> is an emulsion of 71% bitumen in water, with surfactant. At the start of the research, Florida Power & Light Company was requesting approval to import Orimulsion<sup>®</sup> as an alternative fossil fuel for use in power plants. Previous studies have found Orimulsion<sup>®</sup> to disperse in fresh water and brackish water, with subsequent flotation of some fractions. Cleanup measures have not been developed for such waters, and are under investigation for salt waters. A one year study was conducted at the University of Miami to investigate filtration as a cleanup alternative, in response to concern over potential spills. Performance characteristics, preliminary design data, and cleaning procedures developed to use non-hazardous solvents for both processes are presented in the report.

Diatomaceous earth precoat filtration was found effective for removing Orimulsion<sup>®</sup> from dilute aqueous suspensions. The flux-calcined marine diatomaceous earth filter aid grade having the trade name Celite<sup>®</sup> 545 provided optimal solids retention at flow rates of one to three gpm/ft<sup>2</sup>. Filtrate quality was good, with two logs of Orimulsion<sup>®</sup> removal found for coarse flux-calcined marine diatomite, and three logs of removal found for finer flux-calcined grades. Grades calcined without flux and grades not calcined would provide even higher removal if necessary, at a corresponding reductions in flow rate. No attempt was made to analyze filtrates for solubles. Previous research has indicated a low level of health toxicity associated with Orimulsion<sup>®</sup> (Rosenstiel School of Marine and Atmospheric Science 1995). Residuals of the precoat filtration process are a sludge comprising approximately 50% water, 25% bitumen, and 25% diatomite. The residual would be incinerable for energy recovery at electric power plants, with proper consideration of incremental air emissions, if any, and the abrasiveness of diatomite to steel equipment.

Ultrafiltration was found effective for concentrating moderate and concentrated aqueous suspensions. A tubular polyvinylidene fluoride (PVDF) membrane with negative surface charge was found to reject destabilized bitumen emulsion. Ultrafiltration permeate quality was higher than the original dilution water in terms of volatile suspended solids. Addition of 0.1 part by weight of bentonite clay to one part bitumen was found to enhance handling and cleaning characteristics, lengthen filter cycles, and increase flux substantially. Flux rates varied from 20 to 200  $gpd/ft^2$ , depending on influent concentration, whether bentonite was added, and cleaning frequency. Optimal filtration cycle length varied from two to six hours, depending on time required for cleaning and whether bentonite was added. Residuals consist of Orimulsion in water, with the possible addition of one part clay per ten parts of bitumen. Concentration of the residual depends essentially on influent concentration and recirculation rate. Residuals would be incinerable, would likely have low recoverable energy due to water content, and would not be abrasive.

Facilities and equipment needed in the case of a spill of Orimulsion<sup>®</sup> into marine and surface waters would vary considerably depending on location and circumstances. Environmental protection will depend primarily on response time. If use of Orimulsion<sup>®</sup> is approved in the U.S., offloading, onloading, and storage facilities should be equipped with retention basins and pumps for removing water from the port or nearby surface waters rapidly. If Orimulsion<sup>®</sup> is to be transported overland or by pipeline in the vicinity of surface and marine waters, portable equipment should be developed and maintained for emergency response. Either process investigated in this study could be barge or skid mounted. Required flux would be reduced if adequate detention facilities for contaminated water were available. Portable tanks from 2000 to 20,000 gallons in volume are available commercially.

In the event that Orimulsion<sup>®</sup> is considered or approved for use in electric power plants in the U.S., the following research is recommended to be based on characteristics of potential spill scenarios:

1. Conceptual design of mobile equipment and facilities to handle potential spills in port and inland locations,
2. Process selection, design, and optimization of standing equipment for use at offloading, onloading, and storage facilities,
3. Pilot tests of alternate precoat filter designs, including continuous-cycle configurations, depending on intended application and conceptual design,
4. Pilot tests of tubular and spiral wound UF cartridges for removal of Orimulsion<sup>®</sup> from water with addition of 0.1 part clay to one part bitumen, and
5. Bench tests to optimize body feed rates for diatomaceous earth precoat filtration of Orimulsion<sup>®</sup> from water.

The economics of emulsified bitumen fuels appear to represent a strong driving force for adoption at some locations in the foreseeable future. If that is the case, development of cleanup measures that can be implemented rapidly are vitally important. It is hoped that the work presented in this report will contribute to the protection of U.S. waters.

## INTRODUCTION

Orimulsion<sup>®</sup> is a Venezuelan fuel product manufactured by Bitúmenes, Orinoco, S.A. (BITOR), for use in electric power generation facilities as a cost-competitive alternative to coal and fuel oils. It was originally developed by Intevep, the research and development institute of Petróleos de Venezuela, S.A. (PDVSA), to exploit Venezuelan bitumen deposits as an alternative to coal and heavy fuel oils (Makansi 1991). At the time this study began, Orimulsion<sup>®</sup> fuel was undergoing the permitting process for use by Florida Power & Light Company (FPL) to replace fuel oil at power generation facilities, state-wide. FPL filed for a license to investigate Orimulsion<sup>®</sup> firing under the authority of the State's Power Plant Siting Act. Preliminary tests were conducted at the 1580 Megawatt Parrish Plant in Manatee County located along the southwest coast of Florida, in anticipation of conversion of the facility from fuel oil to Orimulsion<sup>®</sup>. At the time, it was projected that the product would be transported from Venezuela to Tampa Bay, where it would be unloaded via pipelines to the plant and stored in two 500,000 barrel tanks. Transportation and handling of fossil fuel products, including Orimulsion<sup>®</sup> can lead to accidental discharges, fuel tank ruptures, or spills which have the potential to cause considerable environmental stress. Although no longer under consideration for use in the State of Florida due to a cabinet ruling against its use, economics appear to represent a strong driving force for use of the product in the foreseeable future. Furthermore, it is clear that conventional oil spill technology is inadequate for dealing with spills of Orimulsion<sup>®</sup> (East 1996). Therefore, the need for development of new spill recovery technology and procedures appropriate for destabilized emulsified bitumen in open ocean, port, and inland locations near storage tank facilities is apparent. Measures are needed that are not sensitive to varying salinity, weathering, bitumen concentration, and wastewater spill volumes. The need for improved spill response strategies and treatment measures has been noted by professionals in Canada, Japan, and the United Kingdom, in which countries Orimulsion<sup>®</sup> is currently used.

## Orimulsion® Characteristics

Orimulsion® is a stabilized emulsion of bitumen in water. Specifically, Orimulsion® consists of approximately 71% natural Orinoco bitumen in water, with less than 1% nonylphenol ethoxylate surfactant and other additives. Orimulsion® is formulated with viscosity properties similar in most respects to those of heavy fuel oils. Although heating value is lower than most heavy fuel oils, this is offset by the lower cost per unit volume of Orimulsion® (Chin et al. 1995). Like residual fuel oils, Orimulsion® contains quantities of sodium, magnesium, vanadium, nickel, and other heavy metals in similar concentrations (Makansi 1991). Orimulsion® can be transported by pipeline or tanker, and burned as boiler fuel for power generation.

Orimulsion® is less expensive than other conventional fuels. It is produced in the Orinoco Belt region, an area of approximately 20,000 square miles located north of the Orinoco River in northern Venezuela. With reserves of raw bitumen estimated at over one billion barrels, the potential exists to ultimately recover over 250 billion barrels for production (Bitor America 1993 a). This is greater than the global supply of oil and natural gas, and equivalent to about 64 billion metric tons of coal, or one tenth of the world's known coal reserves (Wyman 1990).

The finished product is produced in a manufacturing process beginning with the extraction of the natural bitumen material from the subsurface reserves, located in wells from 450 to 3600 ft deep (Makansi 1991). Steam is injected into the bottom of the formation. Bitumen viscosity is thereby reduced, allowing it to flow into a well bore and pumped to the surface. At the well bore, a preliminary emulsification process is initiated to improve the characteristics of the material for handling and transport to the processing plant. At the plant, primary emulsion is destabilized, degasified, and dehydrated to remove associated brine and other contaminants. This results in the production of a raw bitumen composed of less than 2% moisture. The refined bitumen is then mixed with freshwater and emulsified with an additive mixture that includes



nonylphenol ethoxylate surfactant, to stabilize the emulsion for transport, and magnesium salts to bind vanadium during combustion. The resulting product is then subjected to dynamic and static energy mixers to reduce bitumen droplet size to approximately 10-20 microns (Bitor America 1993 a, Makansi 1991, Wyman 1990). Some physical characteristics of Orimulsion<sup>®</sup> are summarized in Table 1 (Bitor America 1993 a).

Table 1. Summary of Physical Properties of Orimulsion<sup>®</sup>.

| Orimulsion <sup>®</sup> Characteristic | Typical Value |
|--|---------------|
| Moisture Content                       | 28-30 w/w%    |
| Mean Droplet Size                      | 17-22 $\mu m$ |
| Median Droplet Size                    | 20 $\mu m$    |
| Droplets $\geq 100 \mu m$              | 1.5%          |
| Droplets $< 80 \mu m$                  | 98%           |
| Density (10 °C)                        | 1.0139 g/mL   |
| Higher Heat Content                    | 12683 Btu/lb  |
| Flashpoint                             | 130-136 °C    |
| Pourpoint                              | 0-24 °C       |

With a reported pour point of approximately 24°C, Orimulsion<sup>®</sup> would be at or near the pour point in the environment at typical Florida temperatures. Orimulsion<sup>®</sup> has a high characteristic flash point (136C) indicating that it would be difficult to ignite the spill. Orimulsion<sup>®</sup> will likely undergo little evaporation in the environment because the bitumen contains only a trace fraction of lighter aliphatics and low molecular weight aromatic hydrocarbons. Any evaporation that would occur would most likely be water (S.L. Ross Environmental Research Limited 1987).

Orimulsion<sup>®</sup> is a pseudoplastic fluid with an associated viscosity that is a function of temperature, shear rate, mean droplet size, and particle distribution, in addition to the specific composition of the emulsion. During transport, the material is generally maintained at

temperatures between 41-176 °F (30-80 °C). Temperatures above that range lead to thermal decomposition of the surfactant additive and subsequent destabilization of the emulsion (Makansi 1991). Less than 2% of Orimulsion<sup>®</sup> droplets are specified by the manufacturer to be of diameter greater than 80 microns, with an average size in the range of 10-50 microns. Droplets of Orimulsion<sup>®</sup> are to be completely coated with surfactant. Stability of properties for over one year in storage is claimed. Orimulsion<sup>®</sup> is generally not compatible with lighter fuel oil fractions. Contamination with heavier fractions of less than 2% is recommended. The emulsion can become destabilized by fine particulate matter that might accumulate during storage or transport. Contaminant particles adsorb on the droplets and allow the bitumen to agglomerate and settle out. The characteristic stability also reportedly extends to pumping and recirculation, during which the Orimulsion<sup>®</sup> resists destabilization unless subjected to conditions of large pressure fluctuation or extreme shear velocity. The elemental analysis of Orimulsion<sup>®</sup> is shown in Table 2 (Bitor America 1993 a).

Table 2. Summary of Chemical Composition Elemental Analysis.

| <b>Component</b> | <b>Concentration</b> |
|------------------|----------------------|
| Carbon           | 60 %                 |
| Hydrogen         | 7.5 %                |
| Sulfur           | 2.7 %                |
| Nitrogen         | 0.5 %                |
| Oxygen           | 0.2 %                |
| Magnesium        | 350 ppm              |
| Vanadium         | 300 ppm              |
| Nickel           | 73 ppm               |
| Sodium           | 70 ppm               |
| Ash              | 0.25 %               |

Although sulfur content in Orimulsion<sup>®</sup> is also similar to conventional fuel oils, 50% higher SO<sub>x</sub> is produced when firing Orimulsion<sup>®</sup>, and sulfur in the fly ash is greater than for fuel oil No. 6 (Wyman 1990). Therefore, air pollution abatement equipment such as flue gas scrubbers or electrostatic precipitators (ESP) with limestone injection may be required. ESP technology with the attached wet limestone scrubber has proved successful. In field trials, the residual ash and dust were collected and landfilled, after which monitoring of vanadium and magnesium leachate were required. Flue gas desulfurization is also effective for dealing with the higher levels of dust associated with the burning of Orimulsion<sup>®</sup>. Orimulsion<sup>®</sup> also contains 50% more nitrogen than conventional fuel oils, but emissions tend to be lower because of the lower combustion temperature and lower excess air required for firing Orimulsion<sup>®</sup> (Bitor America 1993 a, BP Bitor 1992). Combustion of Orimulsion<sup>®</sup> produces about 0.25% ash, slightly higher than reported for oil-fired plants and significantly lower than reported for coal-fired plants (Bitor America 1993 a). Major metallic constituents of the ash are vanadium, sulfur, and magnesium. Vanadium and sulfur are present in the bitumen deposits, and magnesium is added to minimize boiler corrosion, reduce vanadium emissions, and improve the stability of the emulsion. The composition of the Orimulsion<sup>®</sup> ash collected by electrostatic precipitators is summarized in Figure 1 (Bitor America 1993 a).

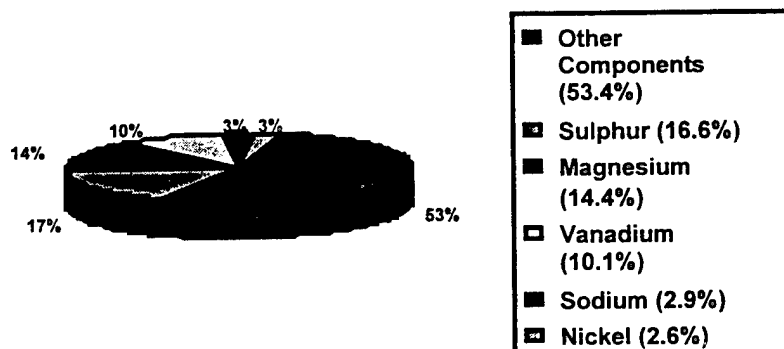

Figure 1. Summary of ash composition elemental analysis.

## Behavioral Characteristics

Orimulsion<sup>®</sup> has a dispersive, particulate nature which shows different characteristics in freshwater and sea water based on variations in salinity. In water with greater than 10 ppt salinity (e.g. open ocean), Orimulsion<sup>®</sup> tends to float to the surface after dispersal. However, if the salinity is less than 5.0 ppt like freshwater environments, it tends to sink to after initial dispersal (Brown 1995). Spilled Orimulsion<sup>®</sup> may also tend to coalesce, forming floating tarry lumps of agglomerated Orimulsion<sup>®</sup> droplets. The resurfaced bitumen is more commonly observed in sea water spills but also occurs to an extent in freshwater spills. These formations are sometimes seen as floating mats of tar referred to as surface bitumen. The process is accelerated in sea water by the presence of sunlight and low energy conditions, and is thought to be caused by alteration of the buoyancy characteristics and the presence of microbial populations that are believed to degrade the surfactant in the Orimulsion<sup>®</sup> (Brown 1995). These properties of salt water spills are being exploited in the development of air floatation technology for open ocean clean-up.

The natural tendency following a spill is for the emulsion to disperse in all directions. However, because the droplets may be buoyant, dispersion can be restricted in the vertical plane and bitumen lumps may resurface (Sommerville 1994). The tendency of Orimulsion<sup>®</sup> spills to exhibit resurfacing of bitumen is a unique property that does not occur in conventional fossil fuel spills. This formation occurs quickly within less than one hour after discharge (Sommerville 1994). The coalescence and subsequent resurfacing of bitumen droplets are processes that are affected by salinity, dilution, and turbulence. High salinity reduces the effectiveness of the surfactant, so that the droplets are allowed to come into closer contact and the likelihood of coalescence is therefore enhanced. Orimulsion<sup>®</sup> also tends to remain near the surface because of the density effect of salinity, reducing the rate of dispersion into the water column. Dilution also effects the formation of the resurfacing bitumen, through dissolution of excess surfactant. In

addition, dilution may reduce the effectiveness of the surfactant by compressing the electrostatic double layer surrounding particles. Turbulence can affect coalescence by increasing the likelihood of droplets colliding. Increased collisions allow agglomerations of sufficient size and buoyancy to resurface (Sommerville 1994).

Orinoco bitumen is less dense than sea water and will tend to float on or near the surface in the advent of a spill. However, in freshwater, the Orimulsion<sup>®</sup> is more dense allowing the bulk of material to tend to sink to the bottom. In freshwater environments, tar formations tend to remain submerged or sink to the bottom more often. The tendency of the material to sink or float is a function of both temperature and salinity (BP Bitor 1992). In tank tests in freshwater, the Orimulsion<sup>®</sup> initially gels and forms strands that tend to sink, especially in colder waters. This effect is thought to be caused by the lowering of the temperature from storage/transport temperatures (50C) to ambient environmental conditions. A thin sheen and small blobs of bitumen will tend to remain at the surface, but the addition of turbulent energy will cause the majority of the droplets to disperse throughout the water column forming a cloud. The droplets will adhere to the bottom and any other exposed surfaces at the point of initial contact and at the water level surface interface. These stains can only be removed by mechanical action and scraping in the presence of cleaning agents (S.L Ross 1987). In the event of a spill, the bitumen would likely cling to all exposed surfaces that the spill cloud came in contact with, leaving a distinct and persistent staining that would require significant manual cleaning.

In field trials, it was found that Orimulsion<sup>®</sup> disperses more rapidly in freshwater than sea water. In general, spills readily disperse (up to 90% of the total volume spilled) on initial contact with saltwater. The remaining 10% of the spill destabilizes and forms a surface sheen accompanied by resurfaced bitumen at or near the interface. These lumps are the cause of the characteristic staining of hardened Orimulsion<sup>®</sup> on marine surfaces. The dispersed fuel portion quickly gets diluted throughout the water column and becomes more susceptible to natural forces

of degradation such as photochemical breakdown, microbial degradation, and evaporation. The toxic components of dispersed Orimulsion<sup>®</sup> do, however, present a risk to certain sensitive species of shellfish and larval stages of fish (Bitor America 1993 b, BP Bitor 1992, Harwell 1995, Intevep 1993, T.A. Herbert and Associates 1990). The long term fate and transport of Orimulsion<sup>®</sup> components after initial dispersal is an issue that must be addressed when evaluating its toxicity to marine organisms and the subsequent risks to the exposed ecosystem (BP Bitor 1992, Intevep 1993).

During the tar formation and resurfacing process, a small neutrally-buoyant brown-orange suspension has been observed in controlled situations. The layer is composed of Orimulsion<sup>®</sup> droplets which can be separated using 0.45 micron filters. This suspension becomes more significant in brackish waters (less than 7.0 ppt) in which the density of the ambient water closely resembles the density of the Orimulsion<sup>®</sup>. Experiments with this bitumen-suspension indicated that with the addition of sediment particles, adhesion and sedimentation was rapid. These bitumen-sediment agglomerations were observed to form a fine layer on top of coarse bottom sand, which could then be vacuumed out of the aqueous phase (Brown et al. 1995).

### **Orimulsion<sup>®</sup> Risks**

According to the proposed plan of Florida Power and Light Company, Orimulsion<sup>®</sup> would be shipped via tanker to Port Manatee in Tampa Bay, and transported via pipeline to the power plant. An assessment of comparative ecological risks of the project was performed by researchers at the University of Miami Rosenstiel School of Marine and Atmospheric Sciences Center for Marine and Environmental Analyses. Results indicated that Orimulsion<sup>®</sup> would not pose a greater threat of ecological risks to Tampa Bay in the event of a spill than would Fuel Oil #6, a traditional fuel source for electric power generation facilities. Toxicity testing revealed that sensitive species of seagrasses and mangroves were relatively unaffected by prolonged exposures

and high concentrations of Orimulsion<sup>®</sup> indicating that long-term contamination of coastal habitat would not result in a significant deterioration of the local ecology (Rosenstiel School of Marine and Atmospheric Science 1995). It was concluded that risks associated with water column impacts would be greater than those associated with a conventional oil spill; however, these risks would be offset by the lack of impacts due to a slick, which is relatively non-existent in an Orimulsion<sup>®</sup> spill. All results assumed no preventative action taken. (Rosenstiel School of Marine and Atmospheric Science 1995).

It has been experimentally determined that toxicity is related to the relative concentration of volatile aromatic compounds (VOC) present. Compared to crude and most refined oil products, both heavy fuel oils and Orimulsion<sup>®</sup> do not contain significant levels of VOCs. Another component that could potentially affect the acute toxicity of Orimulsion<sup>®</sup> is the presence of trace metals, specifically vanadium and nickel. These metals are organically complexed in large stable porphyrin structures (Taylor and Bartlett 1990). Due to steric influences, it is believed that the decomposition of the complexes and subsequent release of metals is on a much longer time scale than dispersion and dilution, which reduces the acute risk to marine life. Questions remain as to the contribution of the surfactant to the toxicity of the dispersed bitumen (BP Bitor 1992).

Weathered crude oils and heavy fuel oils cause widespread physical contamination of shorelines and coastal structures because of their viscosity and persistence. Orimulsion<sup>®</sup> shares many of the same characteristics. For this reason, it is a priority to protect coastal areas from coming into contact with an Orimulsion<sup>®</sup> spill. Areas that are especially vulnerable include coastal power stations, desalination plants, site drainage areas, harbors, and port approaches, in addition to beaches and estuaries. Power stations require large quantities of cooling water. If floating surface bitumen were drawn into the intake system, they could contaminate condensers and necessitate temporary shutdown. Desalination plants are generally not designed to handle influent with floating or subsurface bitumen contamination, which would foul most conventional

RO treatment systems and cause potential water supply problems. Contaminated stormwater or run-off would be difficult to treat due to the stabilized emulsion and the small relative size of the bitumen droplets, and common systems are not designed to handle this type of shock load.

Estuaries are particularly sensitive areas, and the behavior of Orimulsion<sup>®</sup> is difficult to predict because of the variable salinity profile that is characteristic of estuarine systems. Spills also impact routine harbor activities by contaminating jetties, mooring lines, vessels' outer hulls and other exposed surfaces. In addition, cleanup procedures often disrupt regular operation by causing delays or rerouting of port traffic. For these reasons, preventative measures and safe operating practices would be required, and immediate containment, recovery, and treatment response would be necessary to minimize impacts to the accident site (BP Bitor 1992).

### **Clean-Up Technology**

Since the material readily disperses throughout the water column, recovery of Orimulsion<sup>®</sup> by combinations of skimmers and boom equipment would be inefficient under most spill scenario conditions. Allowing and encouraging the self-dispersion of Orimulsion<sup>®</sup> has been suggested as the most effective spill response (BP Bitor 1990). Dispersion of the resurfaced bitumen can be assisted using high-pressure hoses and outboard motors. However, this spill response strategy may not be the most environmentally acceptable approach, especially when the spill may impact protected coastal areas (BP Bitor 1990 1992, Craige 1990). In that case, containment is the preferred spill response.

Containment generally refers to encircling the spill with boom equipment that prevent further horizontal spreading at the surface. In the case of Orimulsion<sup>®</sup>, conventional boom technology does little more than collect the sticky surface bitumen, ruining the boom and having little effect on containment of the dispersal cloud. Furthermore, the behavior of a spill depends on site variables including turbulence, salinity, turbidity, temperature, and concentration. Containment



technology options are selected on the basis of ease and speed of deployment, weight, reliability, and cost. Results of tests conducted in Great Britain indicated that containment will not always be a feasible option for spills, but Modified Jackson Net Booms and Bubble Barriers have demonstrated promise. A Jackson Boom is a net that floats in a vertical plane extending below the surface. It is constructed of a double layer of knotless nylon with an inner impermeable plastic membrane. It has been demonstrated to contain both the surface bitumen and the subsurface dispersal cloud, and the boom can also be used to deflect spills in order to protect sensitive areas. Unfortunately it is bulky, and expensive to purchase and operate. Bubble barriers, on the other hand, are pre-installed tubes laid on the bottom of the water body with nozzles spaced to allow compressed air to create an impenetrable curtain of bubbles and turbulence that is an effective barrier to flow for a growing spill, especially in saltwater environments (Intevp 1991). The bubble curtain method has been proposed by John Van Lear of the University of Miami Rosenstiel School of Marine and Atmospheric Science for a port situation in order to maximize horizontal spill containment and optimize response time to reduce the volume of contaminated water that will require treatment. This particular containment set-up would be favorable for on-site filtration techniques similar to those investigated in this study for the immediate removal of Orimulsion<sup>®</sup> from water. No matter the method employed, all forms of containment will inhibit dispersion and increase the concentration of destabilized droplets, which will continue to collide and coalesce in the confined space (BP Bitor 1992). Resurfacing will be enhanced by containment, making it likely that large quantities of contained contaminated waters will have to be treated for the removal of bitumen.

After containment, clean-up and recovery of shoreline and floating bitumen should be conducted as if the spill were composed of heavy fuel oil. If contained quickly enough, the undispersed bitumen located at the air-water interface at the surface may be recoverable using standard weir-type heavy oil skimmers or vertical disc skimmers with integral screw pumps (Oil Spill Service Center 1989). The subsurface emulsion is much more difficult to handle. This

portion represents a large volume of variable quality water. Currently, evaluations are being made with respect to dockside/port spills and spills entering drainage systems (Intevep 1991).

One option for post-containment removal of Orimulsion<sup>®</sup> is the use of absorbents. Absorbent materials such as pads, oil mops, acetate discs, and special boom coatings have demonstrated to be ineffective for spills of this nature because they tend to get completely coated and stained with dried on patches of high viscosity Orimulsion<sup>®</sup> (Oil Spill Service Center 1989). Nets are also ineffective in containing the Orimulsion<sup>®</sup>, as it quickly loses its cohesiveness on immersion in water. Orimulsion<sup>®</sup> also passes through API oil/water separators with negligible hydrocarbon recovery (BP Bitor 1992).

For separating Orimulsion<sup>®</sup> contamination from water, a three stage chemical process has been suggested (BP Bitor 1992). It involves (1) Destabilization of the emulsion, (2) Flocculation of the bitumen droplets, and (3) Coagulation of the mixture to form an aqueous sludge slurry. This procedure has proven effective in laboratory scale testing because it takes advantage of the tenacious nature of the bitumen droplets and their tendency to agglomerate and form bitumen lumps that more easily settle than the individually stabilized droplets of the emulsion.

Many techniques have been tested for effectiveness in removal of Orimulsion<sup>®</sup> from stained surfaces (Oil Spill Service Center 1989, BP Bitor 1992). One such measure was steam cleaning combined with dispersants. However, this technique proved ineffective in removing fresh Orimulsion<sup>®</sup> from surfaces of equipment and vessels. Degreasing chemicals were also evaluated. Products tested included White Spirit, BP Heavy Duty Degreaser, Desolvit (Armo Product Limited), BP Quicksplit, Paraffin, Jizer Swalve S100 (Deb Chemicals Limited), and Rigidoil. Most formulations required a long time to work into the Orimulsion<sup>®</sup> and required vigorous wiping and mechanical action to remove the staining. Jizer Swalve S100 was found to be most effective, leaving clean surfaces but a waste wash that emulsified without separating. The BP

Quicksplit is a biodegradable anionic emulsifier in a hydrocarbon based solvent. It took 15 minutes to work into the stains, but the washings separated into a clear interface between the solvent/oil phase and the aqueous phase (Oil Spill Service Center 1989, BP Bitor 1992). Other solvent cleaners that could be used include natural petroleum or citrus based products such as Sokerol<sup>®</sup> or Citrikleen<sup>®</sup>, that are biodegradable.

### **Filtration Studies**

Ultrafiltration (UF) is a pressure-driven membrane treatment process that has been used to break oil-water emulsions and concentrate the emulsified product for recovery (Alcoa 1989, Caetano et al. 1995, Cheryan 1986, Enervac 1995, Fleischer 1984, Freeman 1991, Harris 1976, Ho and Sirkar 1992, Mulder 1991, Priest 1978, Schatzberg et al. 1975, Torrey 1984, Waite 1992). Hydraulic pressure is used to induce flow through a semi-permeable membrane, excluding macromolecules from the filtrate. Flow is tangential to the membrane surface, to effect self-cleaning of the membrane surface during filtration. Required pressure is low (10-100 psig) relative to other membrane separation processes because of the negligible osmotic pressures exerted by high molecular weight solutes. Membrane characteristics control which components are allowed to pass through and which components are retained. Two effluents are produced. These are the permeate, consisting of clean filtered water and small ionic salts that pass through the membrane pores, and the retentate, consisting of the stream of concentrated suspended material rejected by membrane pores. UF retains only macromolecules and particles larger than approximately 10-500 Å (0.001-0.05  $\mu$ m), or molecular weights from approximately 1000 to 1,000,000 (Cheryan 1986, Freeman 1991).

Membrane separation processes allow passage of water and some salts, to bring two solutions of differing concentrations into equilibrium with each other. Rejection is based on molecular or particulate size, shape, or charge characteristics. At ambient conditions, flow of water is from

dilute to concentrated. This flow creates an osmotic pressure, which is a function of temperature and ionic strength. Therefore, applied pressure required to overcome osmotic pressure increases with the TDS of the feed solution. Because ultrafiltration is used to separate relatively large molecules or colloidal dispersed compounds, osmotic pressures required are low. Energy costs are minimized because of the low pressures and because no change in state of the solvent is involved.

Throughput and time to cleaning for ultrafiltration depend primarily on the characteristics of the waste stream and the capacity of the treatment system. Most UF installations are designed around a one week cycle with typical runs around 700 to 1000 hours (Cheryan 1986). Industrial and commercial applications of ultrafiltration also include the removal of oils and greases from aqueous feed streams and the selective removal of turbidity from color colloids (Freeman 1991). According to Cheryan (1986), . For concentration of wastewater contaminated with 0.1-10% oils, it is reported that membranes with molecular weight cut-offs in the range of 20,000 to 50,000 or greater can be used to lower the concentration in the permeate to approximately 10-100 ppm (Cheryan 1986). An average molecular size in oil is approximately 200 Daltons, smaller than the lower limit molecular weight cutoff for ultrafiltration of around 1000 Daltons. It would appear that UF would not be effective in these circumstances. However, oil/water emulsions contain characteristic particle droplets rather than single molecules. The mean diameter of these droplet globules can be on the order of 0.05-5.0 microns, well within the range for ultrafiltration technology (Fleischer 1984).

Oil concentrates have been recovered and oily wastewaters have concentrated using UF (Caetano et al. 1995, Cheremisinoff 1992, Cheremisinoff and Cheremisinoff 1993, Cheryan 1986, Fleischer 1984; Freeman 1991; Ho and Sirkar 1992; Harris 1976; Mulder 1991; Priest 1978; Schatzberg et al. 1975; Torrey 1984; Waite 1992). Applications include separation of water soluble coolants, cutting/grinding oils, metal working lubricants, and waste oils

(Cheremisinoff 1992; Cheremisinoff and Cheremisinoff 1993; Waite 1992). Resulting retentates have been incinerated. In one application, large diameter tubular membranes were used to filter oily wastes at fluxes of 45-90 L/m<sup>2</sup>·hr (Cheryan 1986) at an automobile transmission manufacturing plant, with sedimentation and oil separation pretreatment steps.

Separation of latex emulsions is another application of ultrafiltration with similarity to the present study. Latex emulsions consist of particles in the size range of 0.05-0.3 microns which are stabilized by surfactants. UF has been successful in separating latex emulsions using tubular membranes (Cheryan 1986). Feed streams of 0.5% were concentrated to 25%. Flux was sensitive to influent concentration and flow rate. In some cases, membranes were fouled by a coherent polymer film formed by unstable latex particles. Recirculation rates were maintained at approximately 150 Lpm (40 gpm), and surfactant addition at 5% by weight was also found to increase efficiency. In addition to the use of surfactant, cleaning was supplemented by solvent washing with methyl ethyl ketone, methyl isobutyl ketone, and propanol for an hour, once per month. Such cleaning requires the use of solvent resistant membranes.

Precoat filtration of with diatomaceous earth filter aids has shown promise for breaking oil emulsions (AWWA 1985; Calvert 1930; Celite 1995; Cheremisinoff and Cheremisinoff 1993; Cheremisinoff 1992; Lange 1982). Applications include treatment of oil-water emulsions, recovery of used lubricating oils, and dehydration of petroleum products (Calvert 1930). Diatomaceous earth, or diatomite, consists of siliceous skeletal remains of diatoms, single-celled marine and freshwater organisms. Diatomite is an abrasive mineral powder characterized by an assortment of skeletal shapes. Raw diatomite is mined, milled, calcined, and air classified to produce an inert filter aid composed of amorphous and crystalline silica. Calcination at temperatures of approximately 1800 °F agglomerates the particles, producing coarser grades of filter aid. Agglomeration can be increased further through the addition of sodium fluxes to the

kiln during calcination, to lower the scintering temperature of the silica. Cristoballite content varies from near zero for natural grades to over 50% for flux-calcined grades.

As a filtration aid, diatomaceous earth is added to influent so as to deposit in a filter cake along with turbidity, on a permeable support or septum. Separation is accomplished by physical straining, without chemical coagulation. The diatomite forms a rigid, porous structure within the cake. A thin protective layer, termed the precoat layer, is deposited first by circulating a slurry of filter aid in clean water. Addition of body feed causes a fresh filtering surface to build up continuously on the precoat, increasing filter cake permeability and filter cycle length (Celite Corporation 1995; Lange 1982; Walton 1985). Depending on the stability of the emulsion, optimal body feed has been found to range from 0.1-1.0% of the total weight of the solution treated.

Surface charge modification via the addition of surface active agents has been used to enhance filtration. For example, coagulating agents carrying a positive surface charge are used to neutralize electrostatic repulsion between predominantly negatively-charged particles in water, enhancing agglomeration and filtration. Coagulants include aluminum, ferric, and calcium salts. Preliminary tests of flocculants have indicated substantial improvements in ultrafiltration membrane filtration capacity (Simpson, et.al 1995). Larger aggregates were thought to be transported away from the membrane surface by inertial lift, and subsequently excluded from prolonged contact with the surface. Thus, the fouling layer was reduced and membrane productivity was extended. The effective range of dosage was found to be narrow and dependent upon feed concentration. Cationic flocculants were most effective in treating feed streams with negatively-charged colloidal material, such as oil-in-water emulsions. Alternatively, many natural materials act as emulsifiers. Commercially available chemical emulsifiers would not be desirable for cleanup of natural water bodies. Kaolin, fuller's earth, colloidal clay, and

lampblack have been identified as emulsifiers of oil in water (Sawyer, McCarty, and Parkin 1994).

In the event of a spill of Orimulsion<sup>®</sup> in water, dilution of the surfactant can destabilize the emulsion and allow it to coalesce into bitumen lumps, resulting in difficulties in handling and filtration. Cleanup of a destabilized Orimulsion<sup>®</sup> suspension could potentially be enhanced in two ways:

1. Inactivation of the emulsifier through the use of chemical coagulating agents, or
2. Restabilization of the emulsion through addition of an emulsifying agent.

Natural emulsifying and coagulating agents that could be used as ultrafiltration pretreatment additives include alum, ferric chloride, lime, clays, and diatomaceous earth. A concern in the case of lime would be elevated pH of the effluent. Basic pH could also be detrimental to membrane life. Abrasion of membrane and circulation pump would be concerns for diatomaceous earth.

Clay would appear to be a candidate additive to improve ultrafiltration of Orimulsion<sup>®</sup> from water. Clays are complex aluminum silicates composed of silica tetrahedrons or alumina octahedrons, primarily platelet particles less than 2  $\mu\text{m}$  in size. Combinations of tetrahedral structures comprise silica sheets, and corresponding octahedral combinations are termed gibbsite sheets. Kaolinite consists of alternating layers of silica and gibbsite about 7.2  $\text{\AA}$  thick each, held together by hydrogen bonding. The layers form platelets with a lateral dimension of 1000-20,000  $\text{\AA}$ , thickness of 100 to 1000  $\text{\AA}$ , and a surface area of 15  $\text{m}^2/\text{g}$  (Das 1985). Clay particles carry a net negative surface charge due to matrix substitutions and the structural discontinuity at platelet edges. When clay is added to water, aqueous cations form a diffuse double layer around the clay particles. Dipolar water molecules are attracted to the cationic double layer. Negatively

charged colloids are attracted as well, promoting agglomeration and destabilization of the emulsion (Das 1985). Colloidal entrapment could also enhance filtration. That is, clay platelets could impact and become engulfed in the viscous bitumen droplets. The combined mass of the globules would help destabilize them, promoting continuing growth (Zeta-Meter, Inc. 1993).

In the event of a spill of Orimulsion<sup>®</sup>, removal of both suspended and resurfaced bitumen would be necessary. Use of existing conventional equipment for recovering heavy emulsified oils from the sea or beaches would be desirable. However, formation of surface bitumen residue is unique to spills of Orimulsion<sup>®</sup>, and the recovery of the tenacious material and cleaning of equipment and other surfaces will be problematic (Sommerville 1994). Previous research by Intevp has focused on development of a method of entraining air in spilled Orimulsion<sup>®</sup> via submersible pumps. The method causes the Orimulsion<sup>®</sup> to float in saltwater, for collection with conventional skimming equipment. Methods for collecting Orimulsion<sup>®</sup> in freshwater are not developed.

## **Objectives**

It was the purpose of this study to investigate two filtration methods as viable processes for removing Orimulsion<sup>®</sup> from water. Diatomaceous earth filtration (DE) and ultrafiltration (UF) were investigated for removal of Orimulsion<sup>®</sup> from water in ports, such as brackish waters, freshwaters, or inland surface waters. One application would be as a treatment alternative for freshwater or brackish water spills. In addition, the technology developed may also serve for treatment of equipment washing wastewater. In the event that both techniques were deemed feasible, then pilot test data was to be developed to determine preliminary operating and design parameters, including filtration capacity, process flow rate, recovery efficiency, energy consumption, cycle time, space requirement, potential for process automation, and potential for recovery of residuals. A corollary objective was the development of methods of cleaning and



maintaining the systems, as Orimulsion<sup>®</sup> can rapidly foul filtration equipment. Another related objective was the investigation of modification of the properties of Orimulsion<sup>®</sup> to improve filtration efficiency or viability. Finally, it was desired to collect data on the change in surface charge characteristics of Orimulsion<sup>®</sup> in water with the addition of natural filtration aids.

## Scope

Ultrafiltration pilot tests were proposed to demonstrate whether Orimulsion<sup>®</sup> could be separated and removed from water without premature, irreversible fouling of the membranes. Initial design parameters were to be developed, including process flow rates, residuals generation rates, operating pressures, equipment requirements, filtration performance, filter cycle lengths, and recommended operating and cleaning procedures. Testing was to begin with identification of a suitable membrane material that would reject Orimulsion<sup>®</sup> solids, in a configuration that could be cleaned. Alternate types of membrane materials, configurations, and manufacturers were excluded from study. In addition, it was not intended to test different operating configurations, such as multi-stage concentration systems, membrane modules in series, or multiple pass feed-and-bleed systems.

Diatomaceous earth filtration pilot tests were proposed to demonstrate the efficiency and practicality of precoat filtration for the removal of Orimulsion<sup>®</sup> from water. The method was chosen due to its potential for reducing the tenacious characteristics of Orimulsion<sup>®</sup>. Testing was to include identification of appropriate grades of diatomite and development of initial design parameters, including process flow rates, residuals generation rates, operating pressures, filtration efficiency, filter cycle lengths, and appropriate body feed rates. Filtrate quality was to be measured in terms of volatile suspended solids (VSS) or turbidity. Chemical analysis of the filtrate was beyond the scope of the project. Final disposal practices for generated residuals from both filtration processes, such as incineration or waste Orimulsion<sup>®</sup> recovery were not

investigated. The research was not intended to provide final design specifications for specific applications.

## METHODS

Experimental work included bench and pilot scale tests for development of ultrafiltration and precoat filtration processes to remove Orimulsion<sup>®</sup> from water. The first phase comprised experiments to investigate modification of surface charge, filtration, and handling characteristics of Orimulsion<sup>®</sup> dilutions in water. Bench scale diatomaceous earth filtration tests were then conducted to identify appropriate grades of filter aid for pilot tests. Pilot tests of diatomaceous earth filtration and ultrafiltration were then conducted to determine flux rates, operating parameters, and efficiency in terms of effluent volatile suspended solids (VSS). Methods for cleaning of Orimulsion<sup>®</sup> and surfaces tainted with Orimulsion<sup>®</sup> were developed simultaneously.

### Surface Charge Modification Testing

Surface charges of the Orimulsion<sup>®</sup> solids, with and without the addition of natural filtration aids, were investigated by measuring electrophoretic mobility. A Zeta Potential Meter 3.0+ comprising a Zeiss DR Microscope Module a Type GT-2 glass Teflon<sup>®</sup> electrophoresis sample cell with a platinum cathode and molybdenum anode Teflon<sup>®</sup>-based electrodes, and zeta-meter unit with incorporated statistics package, was employed. Zeta potential was calibrated using a 100 mg/L standard solution of Min-U-Sil test colloid (Zeta-Meter, Inc.), an air floated fraction of crushed sandstone. Conductivity was calibrated against a standard 100 mg/L NaCl solution. Eyepiece focal lengths and illuminating lamps were adjusted to correspond with the horizontal plane of colloid tracking, at mid-depth of the sample cell.

Test samples were prepared as a 1:1000 dilution in either tapwater or water sampled from Tropical Park, Miami, FL, and analyzed for electrophoretic mobility and specific conductance. Tracking voltage was set to the maximum allowable for the specific conductance of each sample,

to minimize premature settling and avoid thermal overturn. Colloids were tracked individually between boundaries of the grid cell, until at least 50 were tracked. Tracking grid scale was set to allow accurate particle tracking, according to colloidal speed. Sample temperature was measured and used to correct zeta potential to 25°C. Direction of travel, colloid counts, sample temperatures, travel direction, and means and standard deviations of corrected zeta potentials were recorded. Cell cleaning was effected using Citrikleen HD<sup>®</sup>, CHCl<sub>3</sub>, and distilled water.

### **Measuring Orimulsion<sup>®</sup> Concentration**

Orimulsion<sup>®</sup> concentrations in influent, effluent, permeate, and retentate samples in all pilot tests were measured by analyzing for volatile suspended solids (VSS), to a detection limit of 0.1 mg/L. A calibration curve of VSS versus Orimulsion<sup>®</sup> concentration was prepared, and is shown in Appendix A. The VSS procedure outlined in Standard Methods (1992) was used, with 4.25 cm Whatman<sup>®</sup> 934-AH glass fiber filter disks cat no. 1927-042. Filtration apparatus consisted of three glass Millipore<sup>®</sup> 47 mm diameter filter holders with stainless steel filter support screens, 300 mL ground glass seal filter funnels, and 1000 mL vacuum filtering flasks. Each filter setup was attached to a three place vacuum filtration manifold with silicone vacuum tubing. A Gast<sup>®</sup> dry-air vacuum pressure pump with a maximum applied pressure of 15 psi was used. Samples were dried in a Precision Scientific<sup>®</sup> variable temperature control economy drying oven. Samples were then ignited in a Thermolyne<sup>®</sup> Type 48000 muffle furnace. All samples were weighed by difference on a Mettler<sup>®</sup> AC 100 calibrated top loading balance.

### **Buret Tests**

Bench scale diatomaceous earth tests are typically conducted to select the appropriate diatomite grades providing sufficient clarity and maximum flow rate. Filtrate clarity was not an objective of the research, so a bench scale test was devised to indicate candidate diatomite grades that

would provide maximum flow rate while allowing less than 2 mm of penetration, representing a maximum precoat depth. The standard Buchner funnel test was modified by replacing the funnel with a 40 mL glass buret with a glass wool plug to support a filter cake. This configuration allowed visual inspection of the depth of penetration of Orimulsion<sup>®</sup> into the cake. In addition, the exposed surface area of the precoat was lowered, minimizing disruption of the filtration surface during loading. This modified vacuum filtration buret test apparatus was used to identify candidate diatomite grades.

Buret tests were conducted using a 50 mL graduated Kimax<sup>®</sup> straight bore borosilicate glass buret column with a specially-modified Kimble<sup>®</sup> PTFE vacuum stopcock attachment to a 250 mL filtering flask. Grades tested included C 560<sup>®</sup>, Kenite 5500<sup>®</sup>, C 545<sup>®</sup>, and C 503<sup>®</sup>, manufactured by World Minerals, Inc. The column was connected to a Gast<sup>®</sup> vacuum pump with a maximum applied vacuum of 15 psi. Columns were packed with sufficient glass wool to support the precoat layer, and 0.5-3.0 g of diatomite filter aid was added as a 10% slurry in distilled water. Liquid was evacuated, and the volumetric reading was recorded. Dilutions of Orimulsion<sup>®</sup> in water were prepared on a mass percent basis, from 1:1000 to 1:10 using freshwater sampled from Tropical Park Lake, Miami, FL, sea water sampled from Biscayne Bay, Miami, FL and distilled water. Diatomite was added in body feed ratios from 1:1-5:1, based on the Manufacturer's specification of 70% solids in Orimulsion<sup>®</sup>. Body feed slurry was thoroughly mixed and added to the packed column, minimizing disturbance of the precoat surface. After sample addition, the column was evacuated with applied vacuum. Depth of penetration of Orimulsion<sup>®</sup> solids into the precoat layer was measured by inspection of the cross section. Filter run length was recorded in minutes.

## Pilot Diatomaceous Earth Filtration Tests

A Starr Filter<sup>®</sup> plate and frame Unit 30 diatomaceous earth pilot filter press was used for pilot testing. The system included five removable filter plates and five filter supports. Each of the filter plates had a hexagonal surface area geometry of 0.13 ft<sup>2</sup> and depth of 1.5 inches, as shown in Figure 2. The system was modified as shown in Figure 3, to take advantage of ultrafiltration pilot plant influent delivery equipment. Valves were fitted to allow both influent and effluent to the plates from either the bottom, top, or bottom and top. This flexibility supported efforts to achieve even precoating and cake deposition and purging of air. Influent tubing and ball valves were of stainless steel. A 2.5 inch Ashcroft<sup>®</sup> glycerin filled pressure gauge on the influent was protected by a glycerin filled Plast-O-Matic<sup>®</sup> PVC gauge guard with Teflon<sup>®</sup> diaphragm. Effluent tubing and ball valves were bronze. A K71 Series King Instrument Company<sup>®</sup> water volumetric 2.0 gpm, 60 mm clear acrylic flowmeter with PVC fittings and a 316 stainless steel float was installed in the effluent line. PVC ball valves and clear vinyl tubing were used in the remainder of the system.

The delivery system was connected to a variable speed drive unit with 0.3 hp reversible motor and a single Easy Load MasterFlex<sup>®</sup> peristaltic pump head attachment (model # 7529-20). The delivery system could be set to pump between 0.1-2.0 gpm. Two separate influent tanks were used depending on dilution level tested. For dilutions of 1:100 to 1:10, a 10 gallon high density polyethylene cylindrical Nalgene<sup>®</sup> tank was used, with an attached EMI<sup>®</sup>, Inc. 1/40 hp continuous stirrer with variable 50-1700 rpm speed control and a 3/8" by 12" stainless steel shaft. For dilutions of 1:1000-1:100, a 55 gallon high density polyethylene cylindrical Nalgene<sup>®</sup> tank was used with an attached 0.5 hp, 1725 rpm General Electric<sup>®</sup> high-speed turbulent mixer. A five gallon plastic mixing tank was used for precoating. Precoat slurry was delivered to the filter using clear vinyl tubing, clamped to reach to the bottom of the mixing bucket and with the inlet end cut at an angle to avoid air entrainment.

Simulated Orimulsion<sup>®</sup> spill wastewaters of various dilutions were prepared on a mass percent basis in the appropriate influent tank, depending on the dilution rate and body feed rate. Influent concentration was measured by VSS. After diatomite filter aid was added, the slurry was rapidly mixed. The appropriate number of filter plates and frames for the run, based on the dilution rate and body feed rate, were prepared with filter septa and placed in the filter press. Cloth, 100 series disposable paper, and 200 series disposable paper septa used over the course of the research. The system was then purged of air with clean tapwater. Precoat slurry was prepared based on the amount of diatomite necessary to coat the filter septa surfaces with 0.25 inches of clean diatomaceous earth filter aid (about 10 lb/100 ft<sup>2</sup>). Precoat was mixed with water to form a 1-5% slurry, and pumped through the system to coat the septa. The slurry was mechanically or manually stirred to maintain the diatomite in suspension. Precoating was conducted with both influent valves open, and both effluent valves configured to allow minimal back pressure. Flow rate was measured volumetrically after the precoating effluent returned clear.

Filtration was initiated by opening body feed valves and closing precoating valves simultaneously, avoiding disturbance of the precoat. Beginning with the initiation of body feed, measurements of differential pressure across the filter were recorded periodically. The recycle line was then connected to the filter effluent, to discharge filtrate. Filtration proceeded until the headloss reached 30 psi, or the water level in the body feed tank dropped to a point where air would be entrained. In addition to headloss, filtrate flux was monitored at regular intervals using a graduated cylinder and a stopwatch.

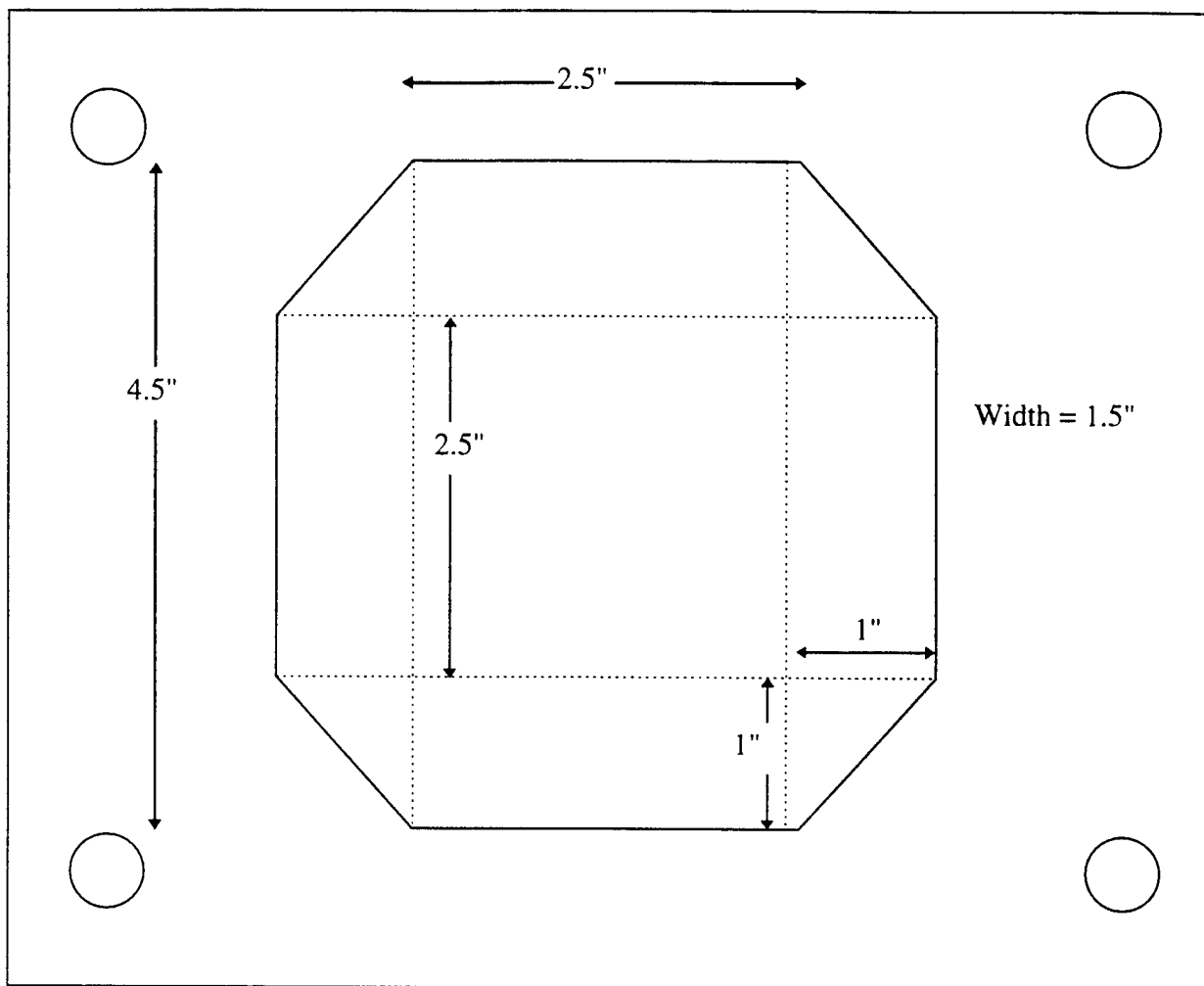

Surface Area per plate = **0.1267 ft<sup>2</sup>** (0.01177 m<sup>2</sup>)  
 Volume per plate = **0.01584 ft<sup>3</sup>** (0.0004485 m<sup>3</sup>) or (0.11849 gall)

Figure 2.  
 Diatomaceous earth plate and frame pilot filter plate dimensions (not drawn to scale)



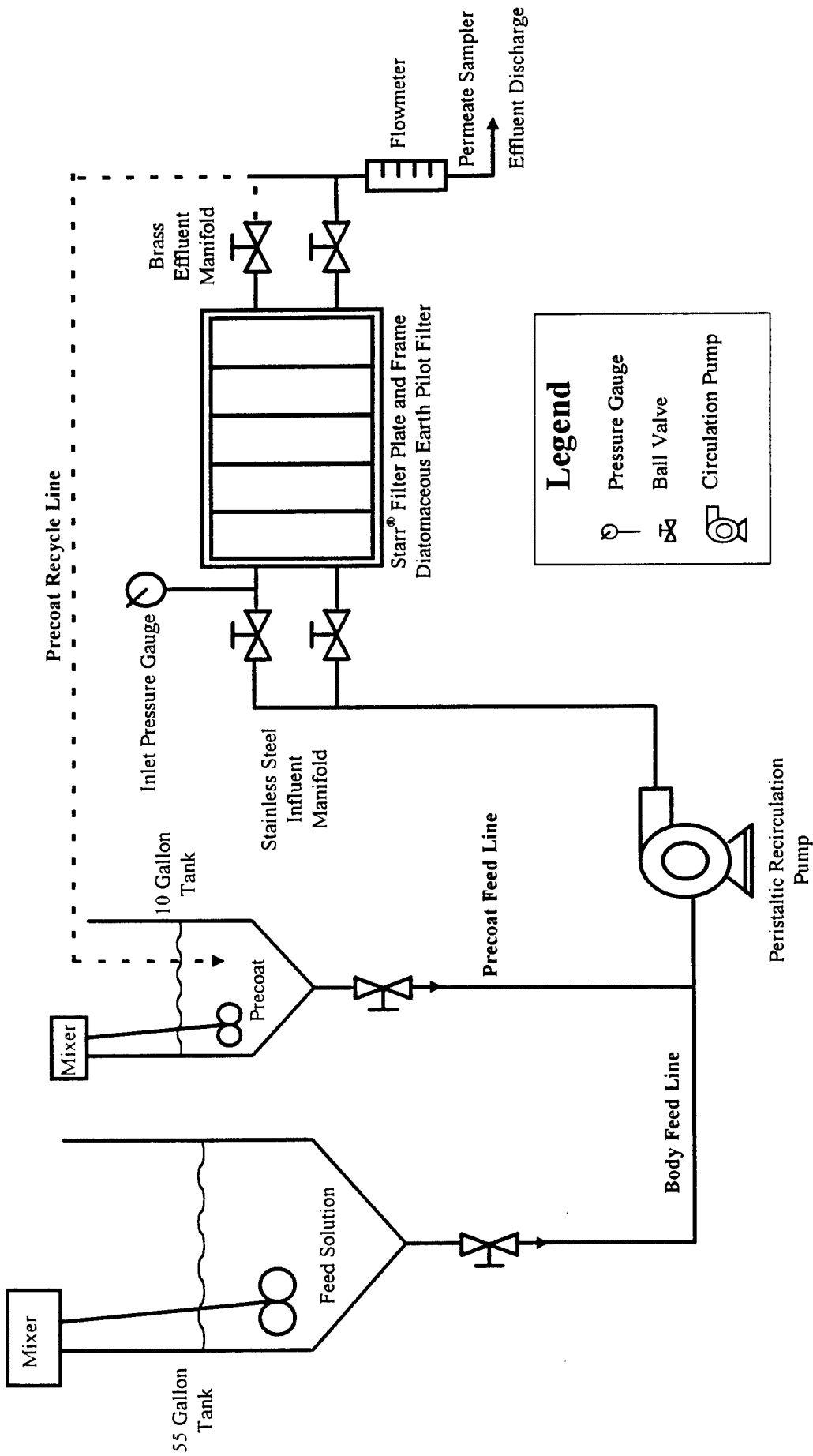
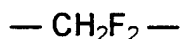

Figure 3. Schematic diagram of diatomaceous earth plate and frame pilot filter.

## Pilot Ultrafiltration Tests

The first phase of ultrafiltration research consisted of a survey of manufacturers recommendations and literature. Based on the survey, the tubular membrane configuration was selected for testing, for ease of cleaning the severe challenge posed by bitumen. Negative and neutral surface charges of the membranes were chosen based on the surface charge expected for a petroleum derivative. The Abcor<sup>®</sup> tubular ultrafiltration membrane units, manufactured by Koch Membrane Systems<sup>®</sup> had a 1 inch inside diameter, and 2.2 ft<sup>2</sup> of active membrane surface area. Each unit contained one tube per membrane cartridge. Cartridges 10-HFM-251-FNO (neutral) and 10-HFP-276-FNO (negative) were tested. The membranes of these cartridges are manufactured of polyvinylidene fluoride (PVDF) polymer, a hydrophobic polymer with the following base (Cheryan 1986):



Characteristics of the units are summarized in Table 3. PVDF was reported by the manufacturer to have a chemical resistance similar to Teflon<sup>®</sup>, and thermal stability to 49 C (Lambert 1996). Each unit was rated by the manufacturer to be operated at a flow rate of 30 gpm and a maximum pressure of 52 psi. Expected pressure drop was given as approximately 4 psi per tube, with a corresponding conservative expected average permeate flux of 30 gpd/ft<sup>2</sup>. Nominal molecular weight cutoffs correspond to apparent pore diameters on the order of 100 Å (10 nm) (Lambert 1996). Expected membrane life was reported to be five to six years with proper maintenance and cleaning (Lambert 1996).

Table 3. Summary of Ultrafiltration Membrane Characteristics.

| <b>Membrane Characteristic</b>                       | <b>10-HFM-251-FNO</b> | <b>10-HFP-276-FNO</b> |
|--|-----------------------|-----------------------|
| <b>Surface Charge</b>                                | <i>Neutral</i>        | <i>Negative</i>       |
| <b>Configuration</b>                                 | <i>Tubular</i>        | <i>Tubular</i>        |
| <b>Membrane Material</b>                             | <i>PVDF</i>           | <i>PVDF</i>           |
| <b>Length, (ft)</b>                                  | <i>10</i>             | <i>10</i>             |
| <b>Diameter, (in)</b>                                | <i>1</i>              | <i>1</i>              |
| <b>Surface Area, (ft<sup>2</sup>/tube)</b>           | <i>2.2</i>            | <i>2.2</i>            |
| <b>Molecular Weight Cut-Off (kD)</b>                 | <i>80-100</i>         | <i>100-125</i>        |
| <b>Max Operating Temperature (°C)</b>                | <i>49</i>             | <i>49</i>             |
| <b>Max Permeate Pressure (psig)</b>                  | <i>5</i>              | <i>5</i>              |
| <b>Max Operating Pressure (psig)</b>                 | <i>85</i>             | <i>85</i>             |
| <b>Initial Clean Water Flux (gpd/ft<sup>2</sup>)</b> | <i>30</i>             | <i>30</i>             |
| <b>pH Range (Short Term @49°C)</b>                   | <i>1.5-10.5</i>       | <i>1.5-10.5</i>       |
| <b>pH Range (Continuous @ 49°C)</b>                  | <i>2-10</i>           | <i>2-10</i>           |

An existing ultrafiltration pilot plant designed for separating waste oils from bilge water (Waite 1992) was modified as diagrammed in Figure 4. Pressure-resistant braided PVC tubing 0.75 inch inside diameter, was used to make connections to the 10 foot long tubular membranes used in this study. A Goulds® multi-stage convertible jet centrifugal pump model FHSJ20 with 2 hp motor was added to obtain a recirculation rate of 30 gpm per tube and a circulation velocity of 12.3 ft/s. The 55 gallon high density polyethylene Nalgene® influent tank was equipped with a 0.5 hp, 1725 rpm General Electric® high-speed turbulent mixer.

The system was operated for most tests in the constant-concentration mode. That is, influent was drawn from the bottom of the feed tank and both retentate and permeate were returned to the tank, maintaining essentially a constant influent concentration. Pressure before the membrane,  $P_1$ , pressure after the membrane,  $P_2$ , pressure in the membrane bypass line,  $P_3$ , and pump suction head,  $P_4$ , as shown on Figure 4, were recorded at each sampling time. Temperature measurements were recorded during runs, because feed temperature increased beyond the threshold recommended by the membrane manufacturer. This increase occurs in pilot tests as a result of operating in the constant-influent-concentration mode, because of high flow rates and low wastewater volumes. Heating is not expected to occur in field applications. Pilot runs were suspended for cooling of the feed water when temperature approached the manufacturer's recommended maximum temperature of 49 °C. Three feed compositions were tested using the neutral membrane after the third cleaning cycle: 1:1000 dilution of Orimulsion® in tapwater with 1:1 clay:Orimulsion® solids additive; 1:100 dilution of Orimulsion® in tapwater with 0.1:1 clay:Orimulsion® solids additive; and 1:10 dilution of Orimulsion® in tapwater with no clay. The effect of flow rate and pressure on the clean tapwater permeate flux was also tested, using the negative membrane.

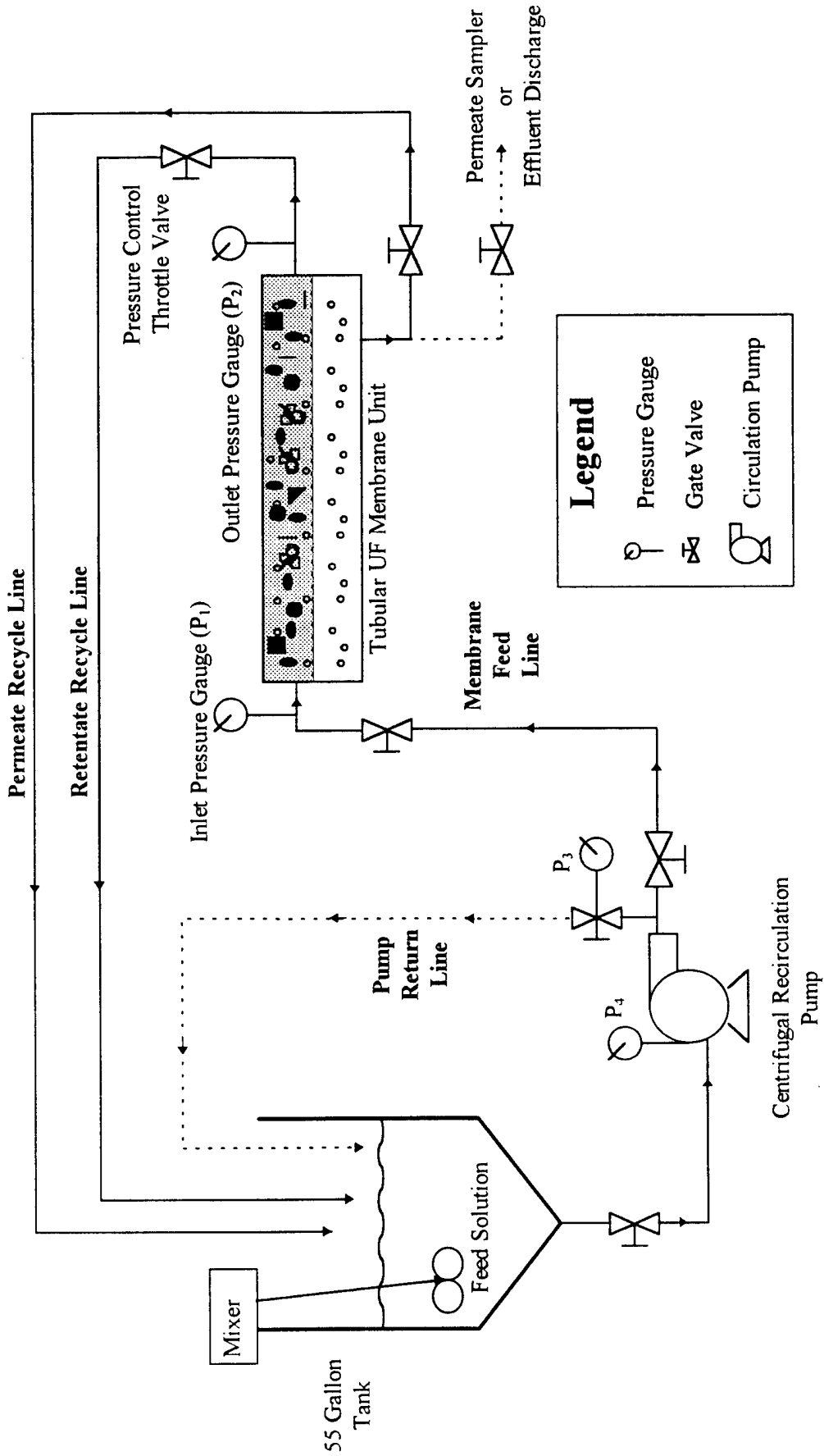

Figure 4. Schematic diagram of ultrafiltration pilot plant.

General test procedure was as follows. Samples were prepared by rapidly mixing either tapwater or Biscayne Bay sea water (approximately 35 ppt salinity) with Orimulsion<sup>®</sup> in the influent tank. Influent concentration was measured by VSS. After vigorous mixing of the influent sample, and with valves configured to bypass the membrane and return membrane bypass effluent to the influent tank, the pump was started. With the permeate valve open, feed was passed to the ultrafiltration membrane unit. After a brief pump warm-up period, the influent valve was fully opened while simultaneously restricting the bypass return line. The appropriate recirculation flow rate was set for testing. Influent and permeate were sampled periodically after establishment of full flow, for volumetric and VSS measurement. At each sampling time, one to four measurements of permeate flux were taken using a 1000 mL graduated cylinder and a stopwatch, and recorded. Each sample was saved for water quality testing based on a determination of VSS. The volume removed was replaced with an equivalent amount of sample water in order to maintain a constant volume in the feed tank. At each sampling time, permeate temperature was also recorded. When a temperature of 42°C was reached, the test was suspended to allow the feed to cool. Testing was resumed after the influent feed solution returned to room temperature. To avoid settling and cooling of bitumen in the system and consequent fouling of the membrane, sample lines were purged after pump shutoff with remaining liquid pumped back to the feed tank.

Because the bitumen proved tenacious and resistant to removal, and to improve filterability, a series of natural conditioners were tested as filtration aids. The candidates selected were clay, lime, and diatomaceous earth, all natural, inexpensive inert materials used in water treatment. Several samples of Orimulsion<sup>®</sup> in various dilutions were treated with the filtration aids at different concentrations to observe the effects on bitumen staining. As a result of this testing it was possible to identify an appropriate conditioner and concentration to use to improve filterability.

The effects of the conditioner on the surface charge distribution of the resulting colloid were also investigated using the zeta potential meter.

### **Cleaning Procedure Method Development**

Several cleaning agents were identified prior to testing as possible candidates for cleaning Orimulsion<sup>®</sup>: Citrikleen<sup>®</sup> and Citrikleen<sup>®</sup> HD (West Penetone), Koch<sup>®</sup> KLD (Koch Membrane Systems<sup>®</sup>), SAC-300 (M3 Inc.), pentane and chloroform (Baxter), Diesel Fuel, Kerosene, Unleaded Gasoline, STP<sup>®</sup> Carburetor Cleaner, Thompson's<sup>®</sup> Garage Cleaner, Chevron<sup>®</sup> Pro-Guard, and Coleman<sup>®</sup> Fuel. Overall effectiveness for removal of bitumen from glassware, filter press plates, cloth septa, and other surfaces were compared in a series of tests. Cleaning requirements were also compared with respect to the degree of mechanical scraping necessary, and ease of rinsate disposal after cleaning.

After identification of cleaning solvents, cleaning procedures for diatomaceous earth filtration were developed. Fouled filter plates were soaked in various concentrations of cleaning agent in warm water and soaked for various periods of time to determine an optimal procedure. Plates were cleaned using both mechanical action and solvent soak, to qualitatively assess the effectiveness of the procedure being tested.

Cleaning procedures for ultrafiltration were developed as follows. Membranes that required cleaning to restore permeate flux were removed from the ultrafiltration pilot plant by disconnecting the two hook-ups before and after the membrane and attaching them to the cleaning station diagrammed in Figure 5. Cleaning station solvents and tapwater rinses were circulated through the membrane using an attached Grundfos<sup>®</sup> Type UP 26-96F cast iron high head 115V 60 Hz centrifugal circulation pump model T/B2 9015. Starting from manufacturer's recommendations, cleaning cycles were tested based on the application of cleaning solvents,

strength of cleaning solution, pH of cleaning solution, contact time, flow direction, mechanical cleaning requirements, and duration of rinsing.



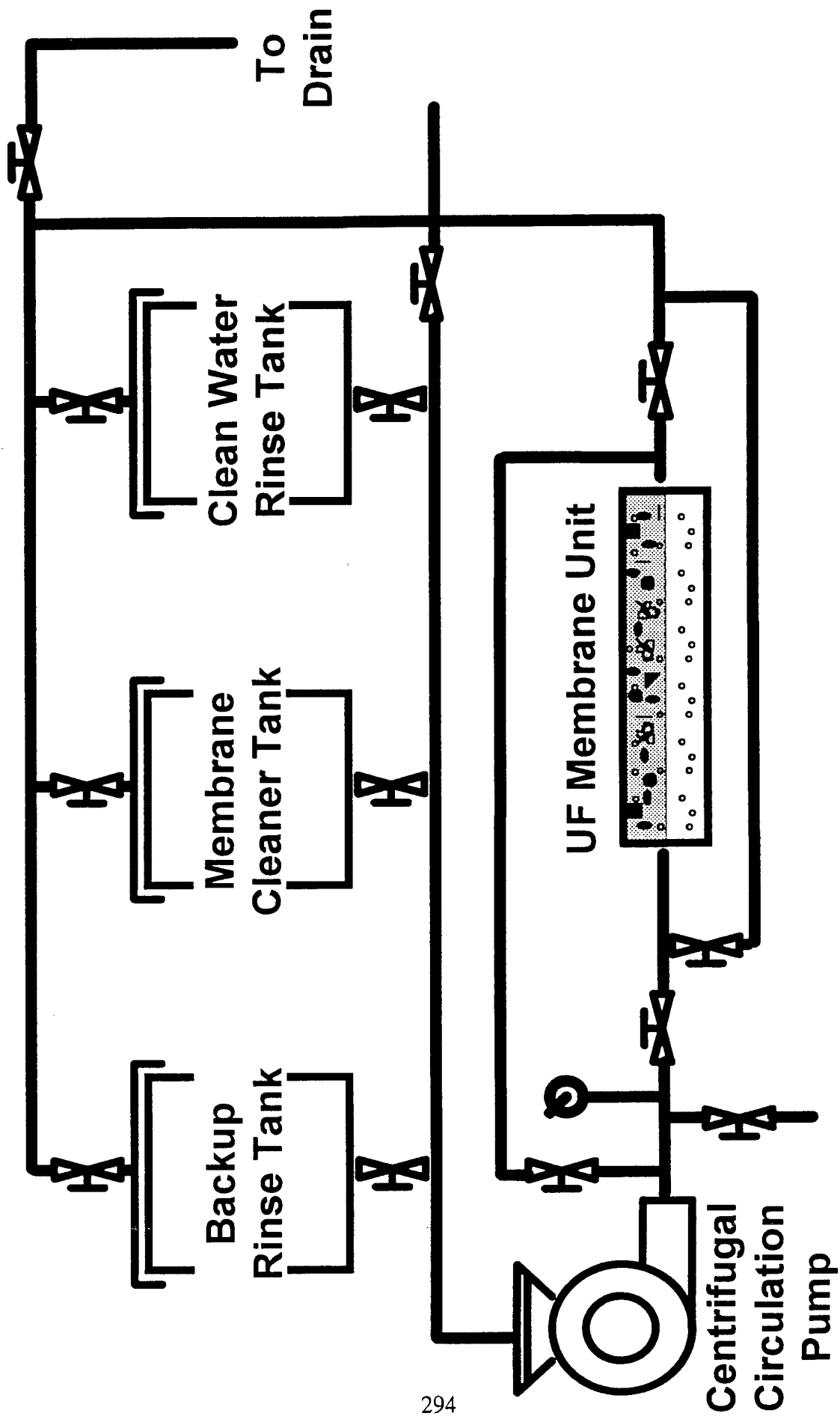

Figure 5.  
Schematic diagram of ultrafiltration membrane cleaning station.

## RESULTS

Results obtained for surface charge and pilot tests of ultrafiltration and precoat filtration are presented in this section. Results of bench tests of diatomaceous earth filtration are presented in Appendix C and discussed in this section.

### **Filtration Additives and Surface Charge Modification**

Results of electrophoretic mobility tests of Orimulsion<sup>®</sup> in water with addition of natural filtration aid candidates are found in Figure 6 and Appendix B. Clay addition rates were 0, 0.1, and 1.0 parts clay per part by weight of Orimulsion solids<sup>®</sup>. In Table B.1, the number sampled refers to the number of individual colloid particles tracked across the grid. A number less than 50 indicates premature settling of the colloids, and termination of the test. Scale setting refers to the tracking grid used. Error is reported as two standard deviations from the mean zeta potential value, corresponding to 95% confidence. All average zeta potential values recorded were negative. Zeta potential values became more positive as the concentration of conditioner was increased, particularly at the 1:1 level.

The results of preliminary tests of qualitative effects of additives on dilution handling characteristics are shown in Table B.1 of Appendix B. Diatomaceous earth was ruled out as an additive due to abrasiveness. Lime worked well as a coagulant and produced an easy to handle sludge, but was not considered due to high effluent pH. The clays improved handling characteristics at low addition rates, and prevented formation of bitumen lumps and stains.

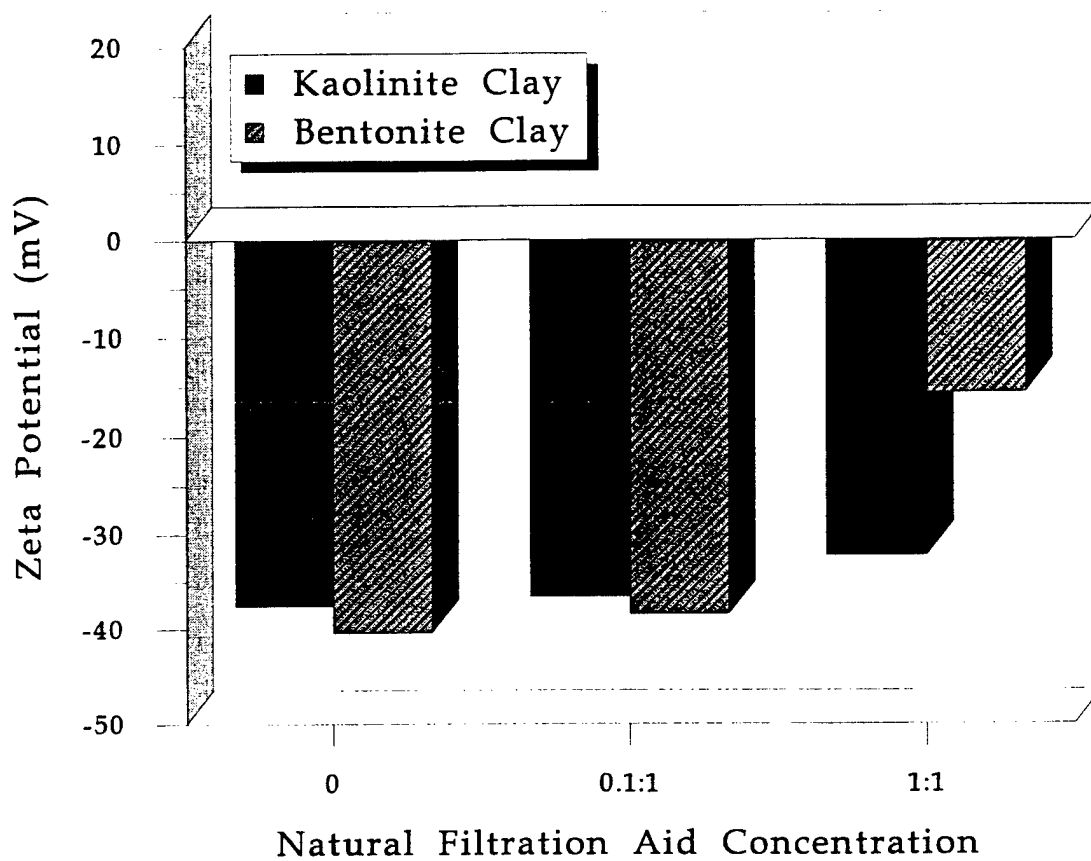

Figure 6.  
Effect of natural filtration aid conditioner concentration on zeta potential for a 1:1000 dilution of Orimulsion® in water.

## Buret Tests

Tables C.1 through C.3 and Figures C.1 through C.16 in Appendix C summarize the data recorded from buret tests. During preliminary tests, Orimulsion<sup>®</sup> behaved more like a crystalline material than a viscous fluid in terms of penetration depth, although with somewhat greater penetration. The DE:solids ratio shown is the mass ratio of diatomite to Orimulsion<sup>®</sup>, assuming 70% Orimulsion<sup>®</sup> solids. The mass of Orimulsion<sup>®</sup> solids applied in each test was held constant for each experimental run, in order to compare grades, ratios, dilutions, and water types.

In Table C.1, the three candidate grades are compared for 1:10, 1:100, and 1:1000 dilutions of Orimulsion<sup>®</sup> in distilled water. The 2:1 ratio generally showed least penetration. The 4:1 diatomite ratio for the 1:100 dilution had paste-like consistency. The large variation in penetration distances is attributed to differential settling and premature compaction of the precoat support from the relatively high applied differential pressures. Since some of the runs showed precoat compaction and differential settling, the two values listed reflect an estimate of precompaction penetration. As expected, the tightest grade of diatomite showed least penetration.

In Table C.2, two of the three previous candidate grades, Kenite<sup>®</sup> and C545<sup>®</sup>, were compared using a variety of dilutions with surface water sampled from Tropical Park, Miami, FL. All three dilutions, 1:1000, 1:100, and 1:10, were tested using the 2:1 ratio, and at the 1:100 dilution, both 1:1 and 3:1 ratios were also tested. The C545<sup>®</sup> showed less visible migration of Orimulsion<sup>®</sup> solids into the precoat. Two of the five runs using Kenite<sup>®</sup> showed uneven migration over the visible cross section. Depths in Table C.2 represent the average of minimum and maximum penetration depths. Flux values are also shown. Fluxes listed as approximate were based on times recorded to the nearest minute; other listed times were recorded to within one-hundredth of a second. Flux was slightly lower for the C545 than the Kenite. Table C.2 also includes data for

seawater sampled from Biscayne Bay, Miami, FL. Again C545<sup>®</sup> allowed less penetration, with slightly lower flux. Table C.3 shows results of bench tests using a fourth candidate grade of diatomite, C503<sup>®</sup>, having a somewhat finer particle size distribution. Tests at 1:100 dilution in seawater and freshwater were conducted using 2:1 and 3:1 body feed ratios. The C503<sup>®</sup> grade showed less penetration and lower flux.

The depth of penetration for various dilutions of Orimulsion<sup>®</sup> in distilled water is plotted against the ratio of diatomite filter aid to Orimulsion<sup>®</sup> solids in Figures C.1-C.3. The 2:1 body feed ratio appeared to minimize visible penetration using C560<sup>®</sup>, Kenite<sup>®</sup>, and C545<sup>®</sup>. Of the three, only C545<sup>®</sup> provided adequate resistance to solids migration. Tests of Kenite<sup>®</sup> and C545<sup>®</sup> at a 2:1 body feed ratio for three dilutions in Tropical Park Lake water and Biscayne Bay water are shown in Figure C.4. Celite 545<sup>®</sup> gave penetration at or below the threshold value. Results for the finer grade, C503<sup>®</sup>, are shown in Table C.3 and Figure C.8. A 2:1 body feed ratio minimized penetration.

The possibility that depth of penetration was related to total volume filtered, which was higher for the higher dilutions, by a mass action mechanism was investigated by plotting penetration versus volume filtered for the buret tests. Results are shown in Figures C.9 through C.11, for a 2:1 body feed ratio. The effect was apparent only for the distilled water tests, and not for either freshwater or saltwater. The depth of penetration was also compared to salinity of the dilution water for distilled water, Tropical Park Lake water, and Biscayne Bay water (Figures C.12 and C.13). No significant effect was evident.

Plots of filtrate flux versus diatomite ratio for freshwater and saltwater are shown in Figures C.14 and C.15. In each plot, three grades of diatomite are compared at the 1:100 dilution at ratios varying from 1:1 to 3:1. In both waters flux was maximized for the 2:1 ratio for all three grades.

## Diatomaceous Earth Filtration Pilot Testing

Operating conditions for the diatomaceous earth pilot tests are summarized in Table 4. Dilution rate was measured in mass percent of Orimulsion<sup>®</sup> solids to dilution water, verified by VSS measurement. The body feed rate in diatomite:solids ratio is also on a mass basis, calculated assuming 70% solids in the Orimulsion<sup>®</sup>. Earlier tests used cloth septa, but these showed a tendency to foul easily and were difficult to clean. Paper septa of two grades, the 200 series and the 100 series, the latter having a smaller effective pore size, were then tested. In the table, plate volume refers to the total cake space available for the run in ft<sup>3</sup>, based on the number of filter plates used. From two to four plates were used, depending on Orimulsion<sup>®</sup> and solids loading so as to empty the feed tank in the course of a run. Volume filtered was calculated from flow rate and filtration cycle length, and verified using the volumetric readings from the body feed tank. Precoat thickness was measured and recorded as the average thickness measured in three places for each plate. Precoat slurry refers to the amount of precoat used per unit surface area, in lb/100ft<sup>2</sup>. For a 1.6-2 mm precoat, slurry is from 10 to 20 lb/100ft<sup>2</sup>. For these tests, from 15.7 to 51.2 lb/100ft<sup>2</sup> were used to avoid septa fouling. Filtration flow rate was recorded as an average for the run, of multiple measurements by graduated cylinder and stopwatch. This value was verified against continuous flowmeter readings to the nearest 0.1 gpm. Effluent VSS of a of 750-1000 mL filtrate sample taken at the midpoint of the run. A value of NA indicates that no effluent filtrate samples were taken.

**Table 4.**  
**Summary of diatomaceous earth filtration pilot testing.**

| Test Water Source | Dilution Rate (Mass %) | Cellite® Diatomite Grade | Body Feed DE:Solids Ratio | Septa Type | Plate Volume (ft <sup>3</sup> ) | Volume Filtered (gal) | Precoat Thickness (mm) | Precoat Mass (g)      | Precoat Slurry (lb/100 ft <sup>2</sup> ) | Cycle Length (min) | Filtration Flow Rate (gpm) | Filtration Flux (gpm/ft <sup>2</sup> ) | Effluent VSS (mg/L) | Removal Efficiency (%) |
|-------------------|------------------------|--------------------------|---------------------------|------------|---------------------------------|-----------------------|------------------------|-----------------------|--|--------------------|----------------------------|--|---------------------|------------------------|
|                   |                        |                          |                           |            |                                 |                       |                        |                       |  |                    |                            |  |                     |                        |
| Tapwater          | 0.2%                   | C545®                    | 2:1                       | Cloth      | 0.063                           | 35.1                  | <1                     | 36.09                 | 15.7                                     | 32                 | 0.70                       | 1.38                                   | NA                  | NA                     |
| Tapwater          | 0.1%                   | C545®                    | 5:1                       | Cloth      | 0.063                           | 40.0                  | 1.6                    | 72.29                 | 31.5                                     | 25                 | 0.50                       | 0.99                                   | NA                  | NA                     |
| Tapwater          | 0.2%                   | C545®                    | 5:1                       | Cloth      | 0.063                           | 18.0                  | 3.0                    | 86.94                 | 37.8                                     | 27                 | 0.50                       | 0.99                                   | NA                  | NA                     |
| Tapwater          | 0.2%                   | C545®                    | 6.5:1                     | Cloth      | 0.063                           | 18.0                  | 3.5                    | 91.51                 | 39.8                                     | 25                 | 0.50                       | 0.99                                   | 20.0                | 97.11                  |
| Tapwater          | 0.1%                   | C545®                    | 4:1                       | Cloth      | 0.063                           | 42.0                  | 1.5                    | 72.01                 | 31.3                                     | 47                 | 0.57                       | 1.12                                   | 5.3                 | 98.74                  |
| Tapwater          | 0.1%                   | C545®                    | 3:1                       | Cloth      | 0.063                           | 52.5                  | 3.3                    | 87.61                 | 38.1                                     | 75                 | 0.70                       | 1.38                                   | 1.5                 | 99.64                  |
| Tapwater          | 0.1%                   | C545®                    | 3.5:1                     | 200        | 0.063                           | 46.0                  | 3.1                    | 88.28                 | 38.4                                     | 51                 | 0.88                       | 1.74                                   | <0.1                | >99.98                 |
| Tapwater          | 0.1%                   | C545®                    | 4:1                       | 2 Ply 200  | 0.063                           | 41.4                  | 3.1                    | 90.54                 | 39.4                                     | 40                 | 1.03                       | 2.03                                   | 6.8                 | 98.39                  |
| Tapwater          | 0.1%                   | C535®                    | 4:1                       | 200        | 0.063                           | 41.4                  | 3.0                    | 90.93                 | 39.6                                     | 45                 | 1.10                       | 2.17                                   | 14.4                | 96.59                  |
| Tapwater          | 0.1%                   | C535®                    | 4:1                       | 200        | 0.063                           | 41.4                  | 3.0                    | 90.41                 | 39.3                                     | 45                 | 0.91                       | 1.80                                   | 0.6                 | 99.86                  |
| Tapwater          | 0.1%                   | C535®                    | 5:1                       | 200        | 0.063                           | 34.5                  | 3.0                    | 90.68                 | 39.5                                     | 40                 | 1.07                       | 2.11                                   | 0.7                 | 99.84                  |
| Tapwater          | 0.1%                   | C535®                    | 3:1                       | 200        | 0.063                           | 51.8                  | 3.9                    | 92.85                 | 40.4                                     | 51                 | 1.10                       | 2.16                                   | 1.2                 | 99.71                  |
| Tapwater          | 0.2%                   | C535®                    | 5:1                       | 100        | 0.063                           | 17.3                  | 2.3                    | 85.67                 | 37.3                                     | 18                 | 1.05                       | 2.07                                   | 0.9                 | 99.87                  |
| Tapwater          | 0.2%                   | C535®                    | 5:1                       | 100        | 0.063                           | 17.3                  | 2.6                    | 91.15                 | 39.7                                     | 20                 | 1.04                       | 2.04                                   | 0.8                 | 99.88                  |
| Tapwater*         | 0.2%                   | Hyflo®                   | 5:1                       | 100        | 0.063                           | 19.8                  | 3.6                    | 98.20                 | 42.7                                     | 12                 | 1.65                       | 3.26                                   | 0.6                 | 99.90                  |
| Tapwater*         | 0.2%                   | Hyflo®                   | 5:1                       | 200        | 0.048                           | 15.2                  | 4.4                    | 93.64                 | 54.3                                     | 10                 | 1.39                       | 3.66                                   | 1.0                 | 99.84                  |
| Tapwater*         | 1.0%                   | Hyflo®                   | 0.5:1                     | 200        | 0.063                           | 0.8                   | 3.0                    | 93.66                 | 40.8                                     | 0.8                | 1.22                       | 2.41                                   | NA                  | NA                     |
| Tapwater*         | 0.1%                   | Hyflo®                   | 3:1                       | 200        | 0.063                           | 17.5                  | 3.1                    | 92.61                 | 40.3                                     | 13.8               | 1.27                       | 2.51                                   | 0.80                | 99.85                  |
| Tapwater*         | 0.1%                   | Hyflo®                   | 4:1                       | 200        | 0.063                           | 28.3                  | 3.1                    | 92.05                 | 40.1                                     | 25.5               | 1.11                       | 2.19                                   | <0.1                | >99.98                 |
| Tapwater**        | 1.3%                   | C545®                    | 1.6:1                     | 200        | 0.063                           | 7.5                   | 2.6                    | 95.61                 | 41.6                                     | 8.0                | 0.96                       | 1.89                                   | 2.0                 | 99.95                  |
| Tapwater**        | 1.3%                   | Sorbo-Cel®               | 2:1                       | 200        | 0.063                           | 5.7                   | 2.6                    | 101.67                | 44.2                                     | 5.5                | 1.04                       | 2.05                                   | 3.5                 | 99.91                  |
| Tapwater          | 1.0%                   | Sorbo-Cel®               | 2:1                       | 200        | 0.063                           | 23.0                  | 0.7 <sup>5</sup>       | 96.50                 | 42.0                                     | 27.0               | 0.85                       | 1.68                                   | 0.7                 | 99.97                  |
| Tapwater          | 1.0%                   | Sorbo-Cel®               | 1.5:1                     | 200        | 0.063                           | 10.3                  | 0.7 <sup>5</sup>       | 87.6                  | 38.1                                     | 14.0               | 0.59                       | 1.16                                   | 1.5                 | 99.95                  |
| Tapwater          | 1.0%                   | C545®                    | 2:1                       | 200        | 0.048                           | 8.4                   | 0.7 <sup>5</sup>       | 88.3                  | 51.2                                     | 7.0                | 1.20                       | 3.16                                   | NA                  | NA                     |
| Seawater          | 2.1%                   | Sorbo-Cel®               | 2:1                       | 200        | 0.048                           | 9.0                   | 2.0                    | 61.4                  | 35.6                                     | 8.0                | 1.15                       | 3.03                                   | 3.1                 | 99.95                  |
| Seawater          | 0.9%                   | Sorbo-Cel®               | 3:1                       | 200        | 0.048                           | 6.6                   | 2.0                    | 57.6                  | 33.4                                     | 5.8                | 1.15                       | 3.03                                   | 0.9                 | 99.96                  |
| Seawater          | 0.5%                   | C545®                    | 2.5:1                     | 200        | 0.048                           | 7.3                   | 1.6                    | 50.0                  | 29.0                                     | 7.2                | 1.01                       | 2.66                                   | 5.0                 | 99.64                  |
| Tapwater          | 2.1%                   | Sorbo-Cel®               | 2.25:1                    | 200        | 0.048                           | 7.5                   | 1.4                    | 50.57 <sup>5,65</sup> | 29.3                                     | 6.3                | 1.20                       | 3.16                                   | 1.5                 | 99.98                  |
| Tapwater          | 1.3%                   | C545®                    | 1:1                       | 200        | 0.032                           | 9.3                   | 1.5                    | 36.7                  | 32.0                                     | 8.8                | 1.05                       | 4.14                                   | 3.6                 | 99.90                  |
| Seawater**        | 1.2%                   | C545®                    | 1:1                       | 200        | 0.063                           | 9.4                   | 3.5                    | 73.0                  | 31.7                                     | 8.1                | 1.16                       | 2.29                                   | 0.8                 | 99.98                  |
| Seawater**        | 1.7%                   | C545®                    | 0.7:1                     | 200        | 0.063                           | 8.5                   | 2.9                    | 71.2                  | 31.0                                     | 7.2                | 1.18                       | 2.33                                   | 0.2                 | 99.99                  |
| Seawater**        | 1.8%                   | C545®                    | 0.8:1                     | 200        | 0.063                           | 9.5                   | 1.6                    | 67.3                  | 29.3                                     | 8.9                | 1.06                       | 2.09                                   | 0.3                 | 99.99                  |
| Seawater**        | 1.3%                   | C545®                    | 0.5:1                     | 200        | 0.048                           | 4.4                   | 1.4                    | 40.6                  | 23.5                                     | 3.4                | 1.31                       | 3.45                                   | 0.3                 | 99.99                  |

<sup>5</sup> Precipit was uneven due to severe air entrainment during precipitating  
<sup>6</sup> Contained bentonitic clay filtration aid at 1:1 (Clay-Orimulsin® Solids)  
<sup>65</sup> Contained bentonitic clay filtration aid at 0.1:1 (Clay-Orimulsin® Solids)

NA: Data not available  
 [ ]: Pressure data available

Results of test filtering Orimulsion® at a high dilution rate of 0.1 to 0.2% Orimulsion® in water using C545® and C535® DE grades are shown in Figures 7 and 8. Headloss is plotted versus both time and cumulative volume filtered for the runs. The horizontal line shown at 30 psi is the maximum recommended operational headloss, at which point runs were terminated. Results of filtering somewhat more concentrated Orimulsion® in water, at dilutions of 0.5 to 1.3%, are shown in Figures 9 and 10. Some runs were terminated early due to operational difficulties such as bursting of the peristaltic pump tubing.

Because of the difficulties encountered with bitumen deposits in the filter, an activated grade of diatomaceous earth filter aid, Sorbo-Cel®, was tested to investigate potential improvements in filtration. In preliminary testing, Sorbo-Cel® acted as a conditioning agent similar to bentonite clay, combining with Orimulsion® solids in agglomerations that were less sticky than the destabilized bitumen. It was desired to test whether this grade would reduce fouling problems. Sorbo-Cel® was tested at dilutions of 1:100 in combination with 0.1:1 clay:Orimulsion® solids. This combination dramatically improved the ease of cleaning the filter plates. The dry cake easily sloughed off with no messy or sticky residuals to be painstakingly removed by hand, and the plates were washed clean with a simple tapwater rinse. However, in tests that did not utilize the clay additive, the Sorbo-Cel® performed similarly to the other grades of diatomite, and no benefits were noticed in using the activated filter aid when compared to the flux-calcined grades. Results of runs using Sorbo-Cel are shown in Figures 11 and 12.

In cleanup situations, various waste streams may be contaminated with sediments and dirt, and clays or sediment may be purposely added to effect cleanup by various means. Therefore, it may be necessary to dewater waste streams containing Orimulsion® as well as particulate matter. In addition to runs just described, Orimulsion® "concentrates" remaining from the ultrafiltration runs described in the next section were also dewatered using diatomaceous earth pilot plant.



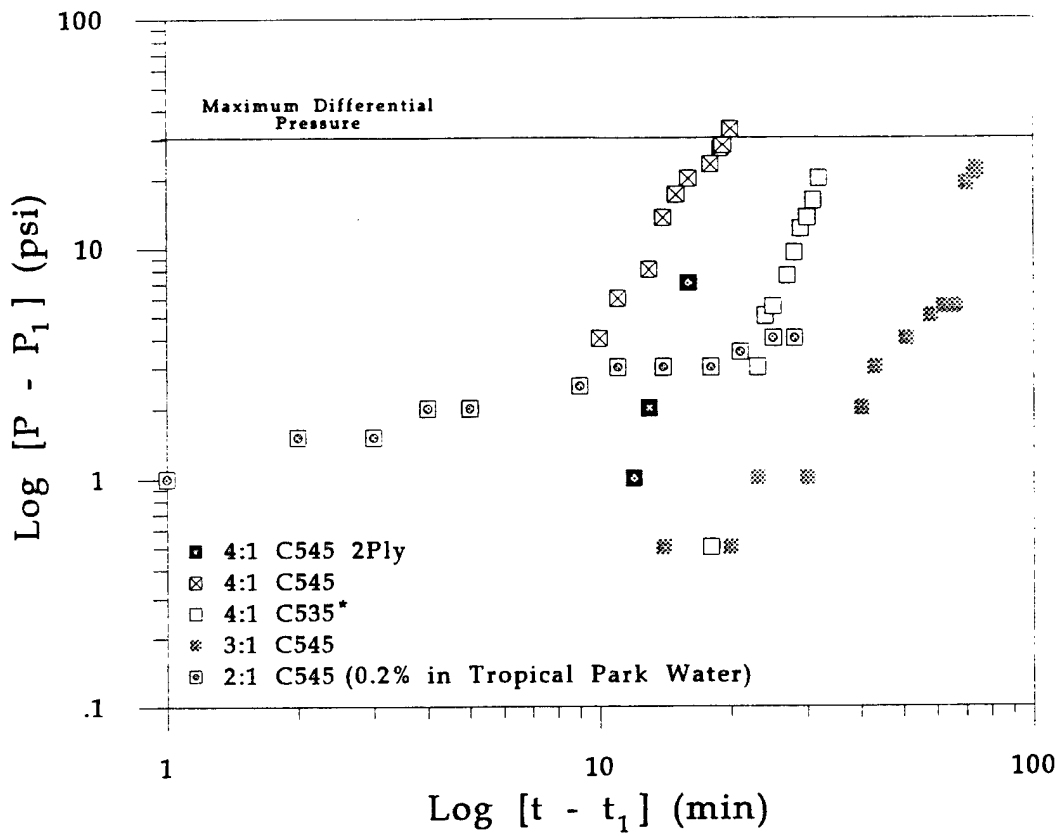

\* Indicates that 200 series paper septa was used.

2Ply Indicates that 2 sheets of 200 series paper septa were used per plate.

Unless otherwise noted, all runs used cloth septa and consisted of 0.1% Orimulsion® in tapwater.

Figure 7.  
Diatomaceous earth filtration headloss increase versus relative time for 0.1%-0.2% Orimulsion® in water.

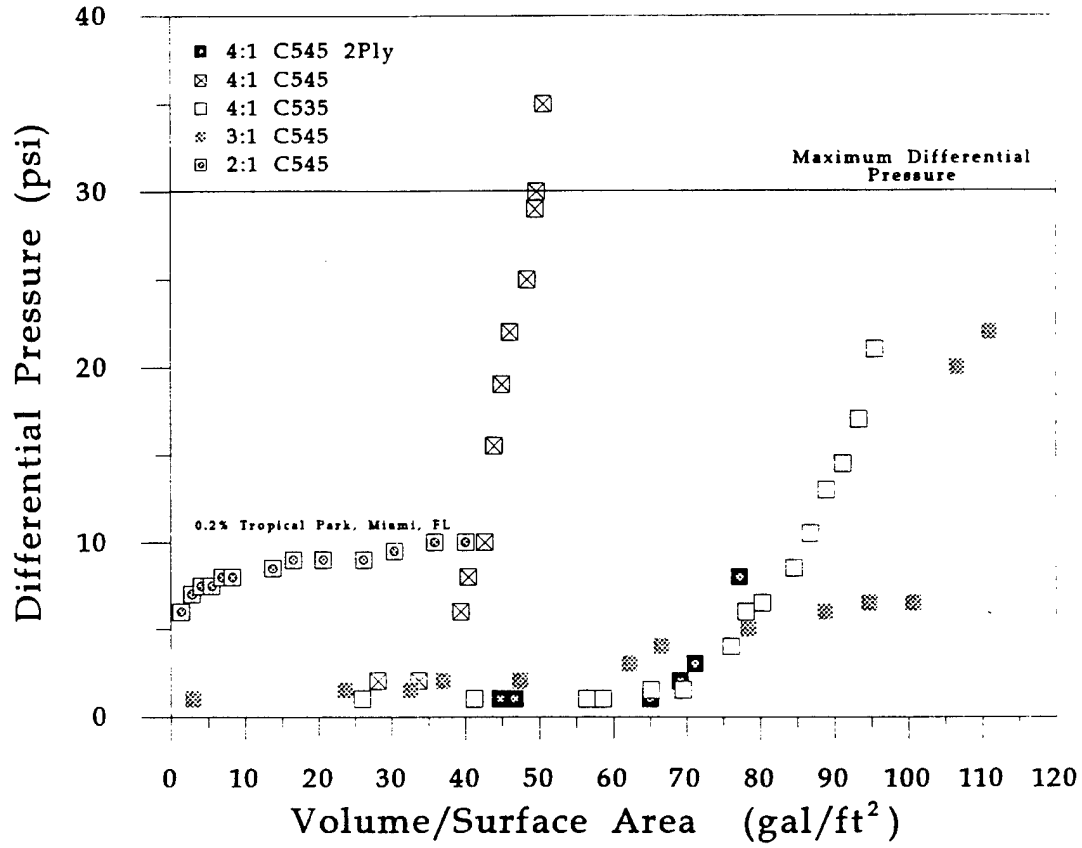

Figure 8.  
 Diatomaceous earth filtration headloss versus volume filtered per unit plate surface area for 0.1% Orimulsion® in water.

concentrates contained clay as a natural ultrafiltration aid. Eleven runs were conducted. Results are shown in Figure 13 and Appendix D.

Because bitumen is a complex, little-characterized mixture of hydrocarbons, filtrate quality and filtration efficiency were measured in terms of volatile suspended solids. The calibration curve of VSS versus percent Orimulsion<sup>®</sup> solids developed is shown in Appendix A, for dilutions in the ranges of 1:10, 1:100, and 1:1000. Filtrate quality and removal efficiency are compared for the different grades of diatomite tested in Figures 14 and 15, respectively. Error bars represent  $\pm 2$  sample standard deviations, or 95% confidence intervals about the mean over all tests shown in Table 4. Average background concentration is plotted at 1.58 mg/L for tapwater and at 7.67 mg/L for seawater.

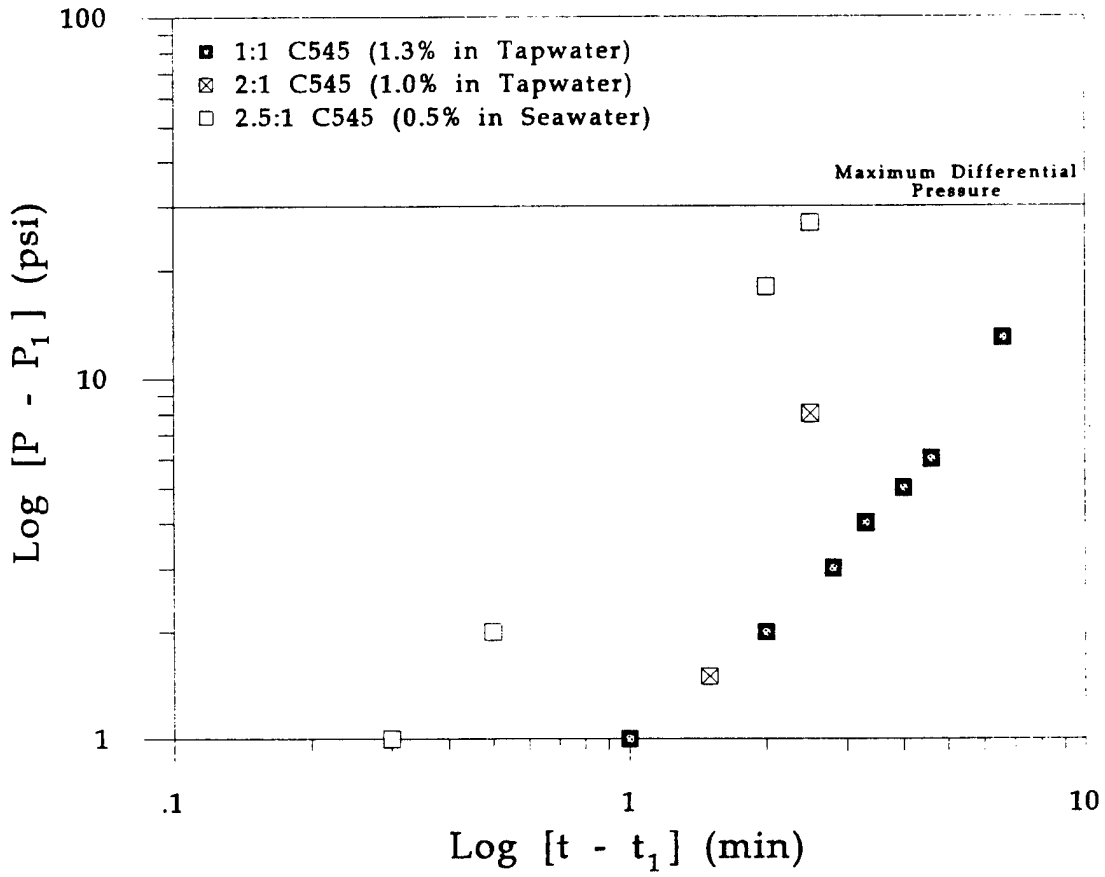

Figure 9.  
 Diatomaceous earth filtration headloss increase versus relative time for 0.5%-1.3% Orimulsion<sup>®</sup> in water.

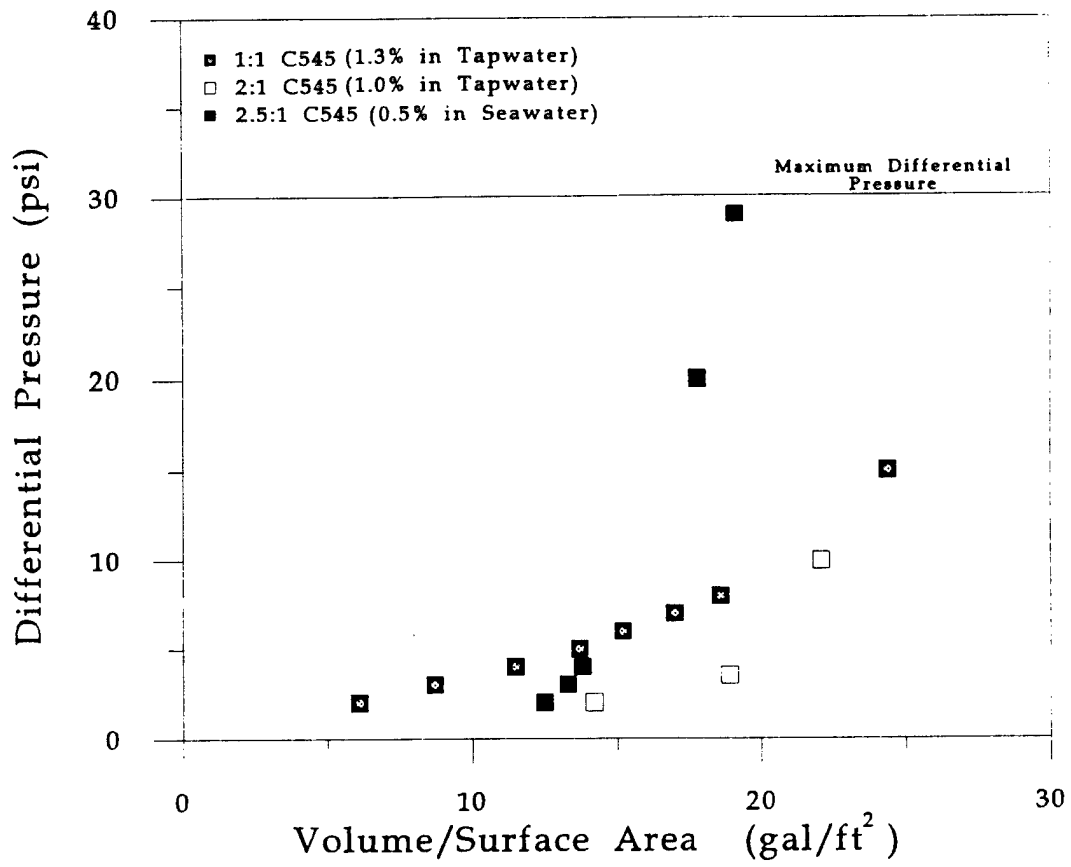

Figure 10.  
Diatomaceous earth filtration headloss versus volume filtered per unit plate surface area for 0.5%-1.3% Orimulsion<sup>®</sup> in water.

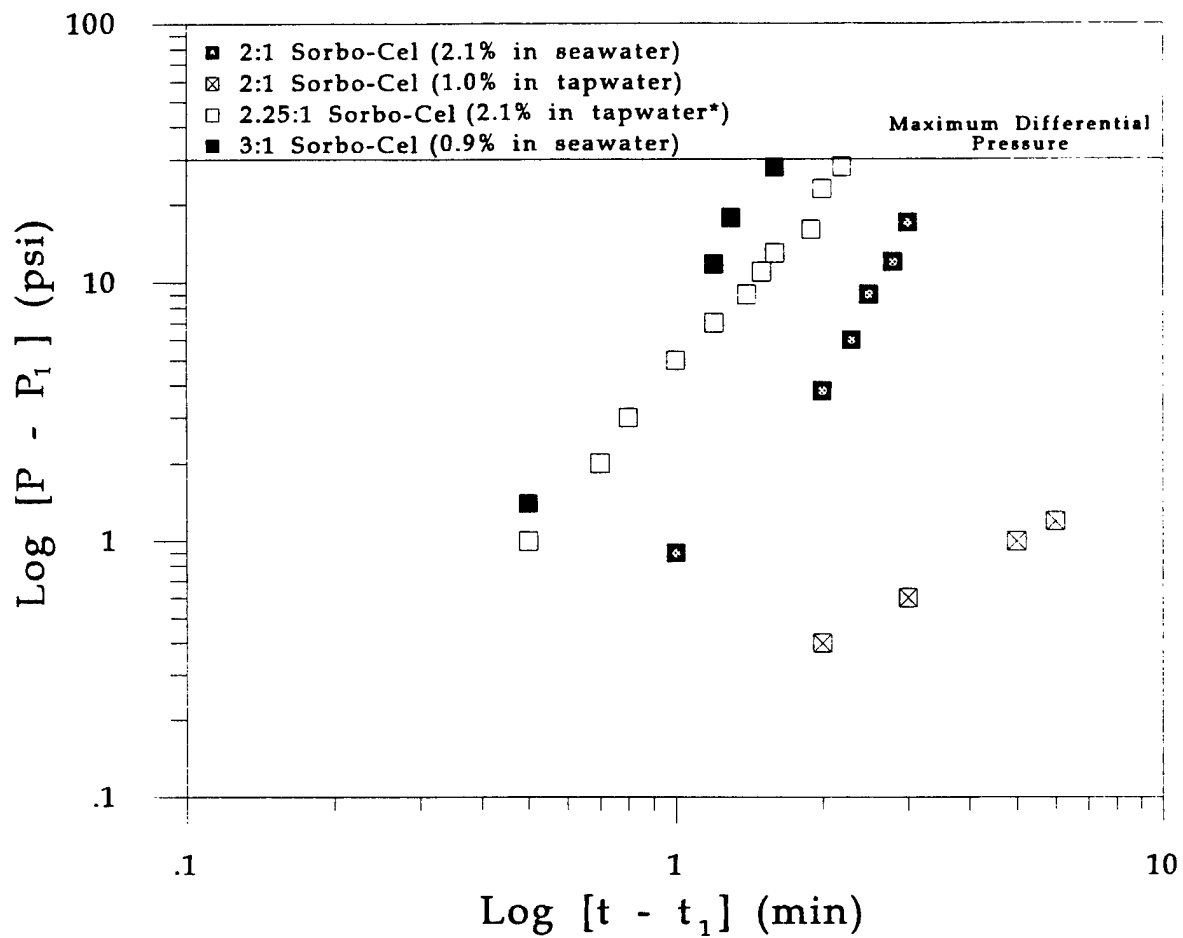
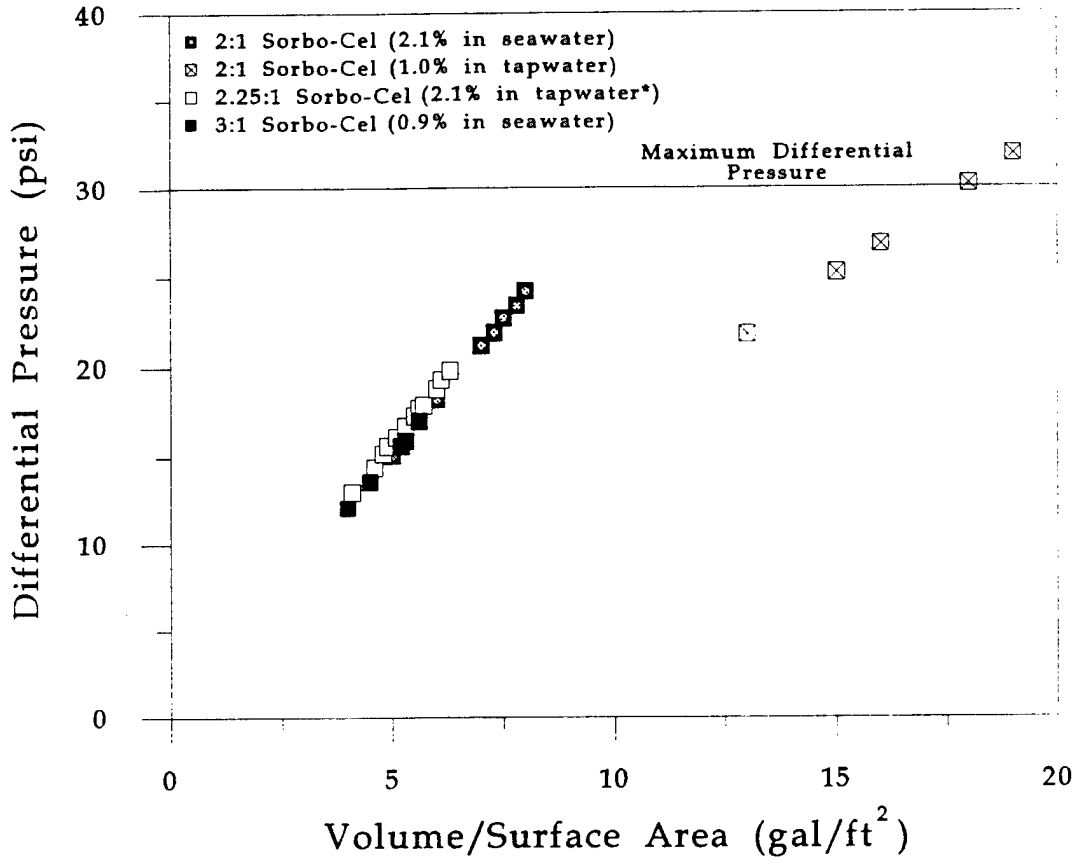

Figure 11.  
 Diatomaceous earth filtration headloss increase versus relative time for 0.9%-2.1% Orimulsion<sup>®</sup> in water.



\* Indicates that C545<sup>®</sup> was used for precoat. Unless otherwise stated, all runs used Sorbo-Cel<sup>®</sup> for precoat.

Figure 12.  
Diatomaceous earth filtration headloss versus volume filtered per unit plate surface area for 0.9%-2.1% Orimulsion<sup>®</sup> in water.

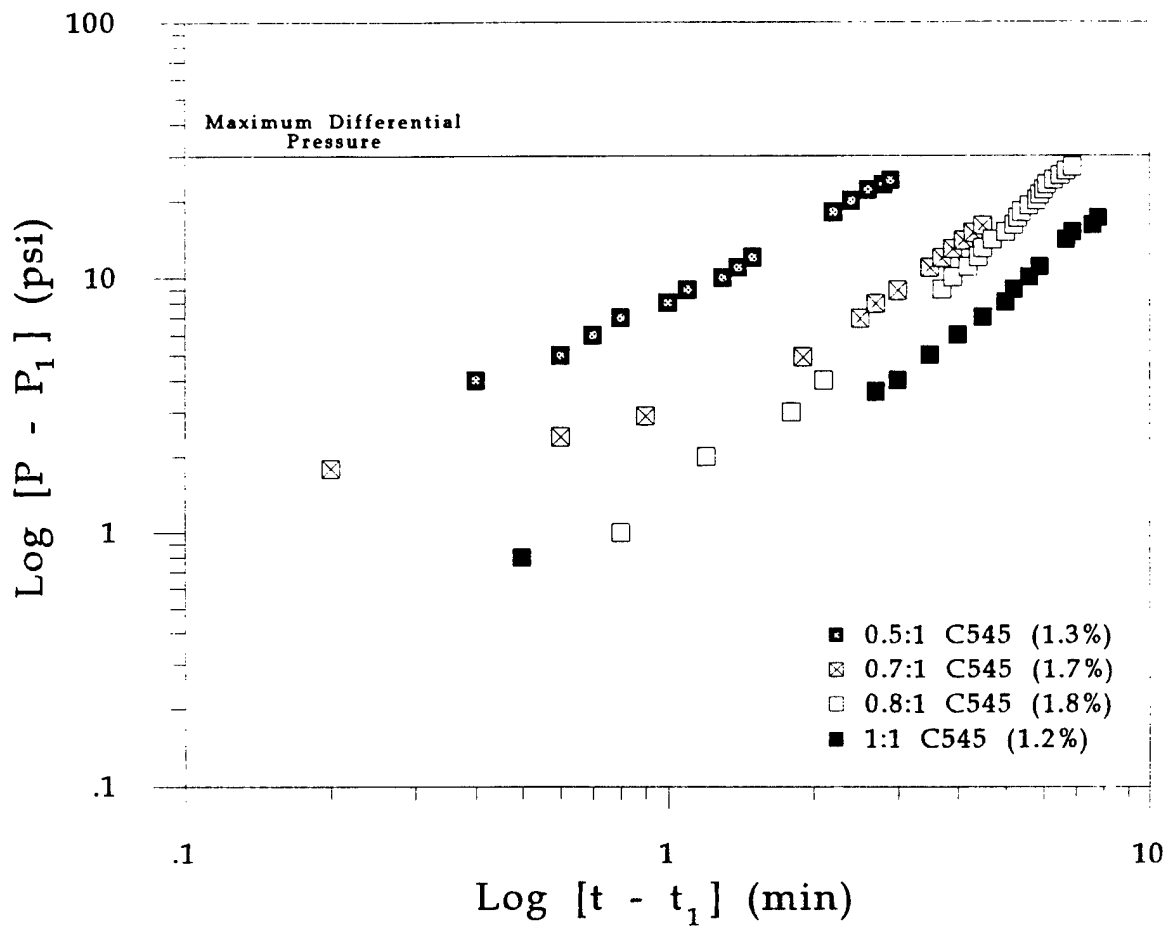

Figure 13.  
 Diatomaceous earth filtration headloss increase versus relative time for filtration of 1.2%-1.8% Orimulsion<sup>®</sup> in Biscayne Bay seawater with C545<sup>®</sup> diatomaceous earth and 0.1:1 clay:Orimulsion<sup>®</sup> solids addition.



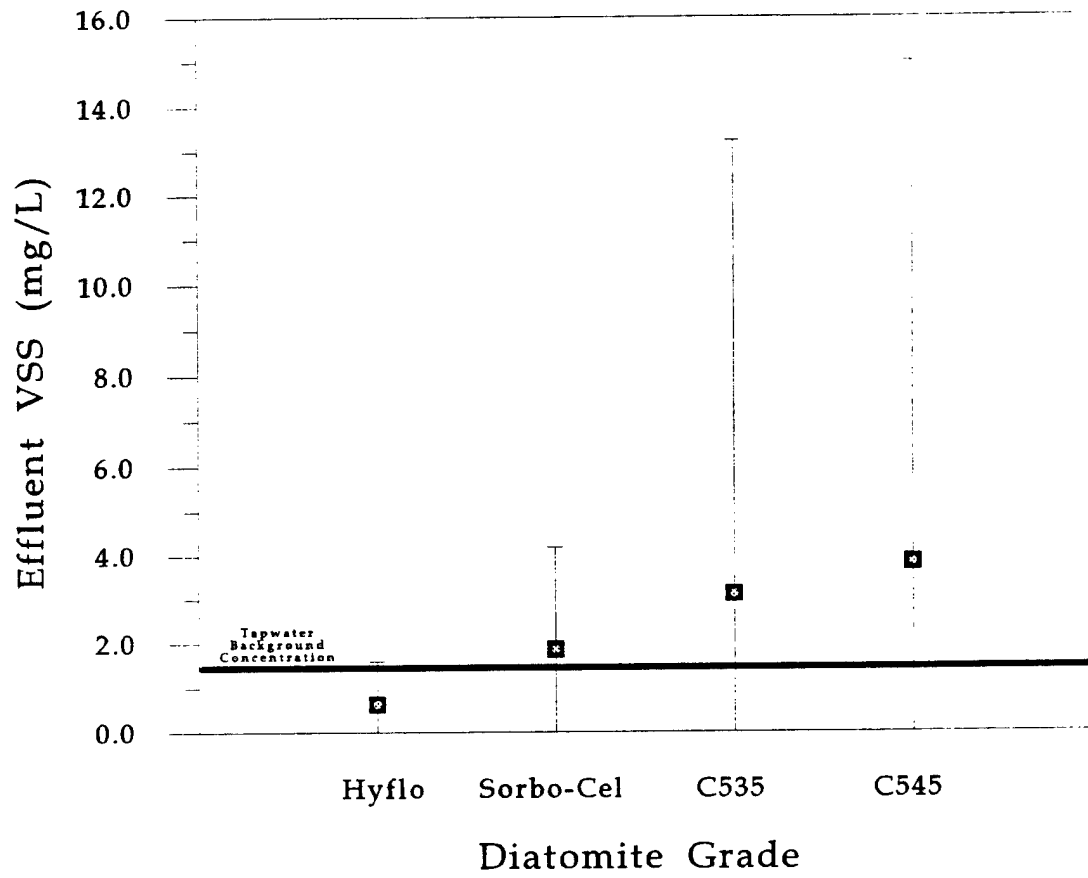

Figure 14.  
Average filtrate volatile suspended solids after filtration of Orimulsion<sup>®</sup> from freshwater for different grades of diatomaceous earth filter aid.

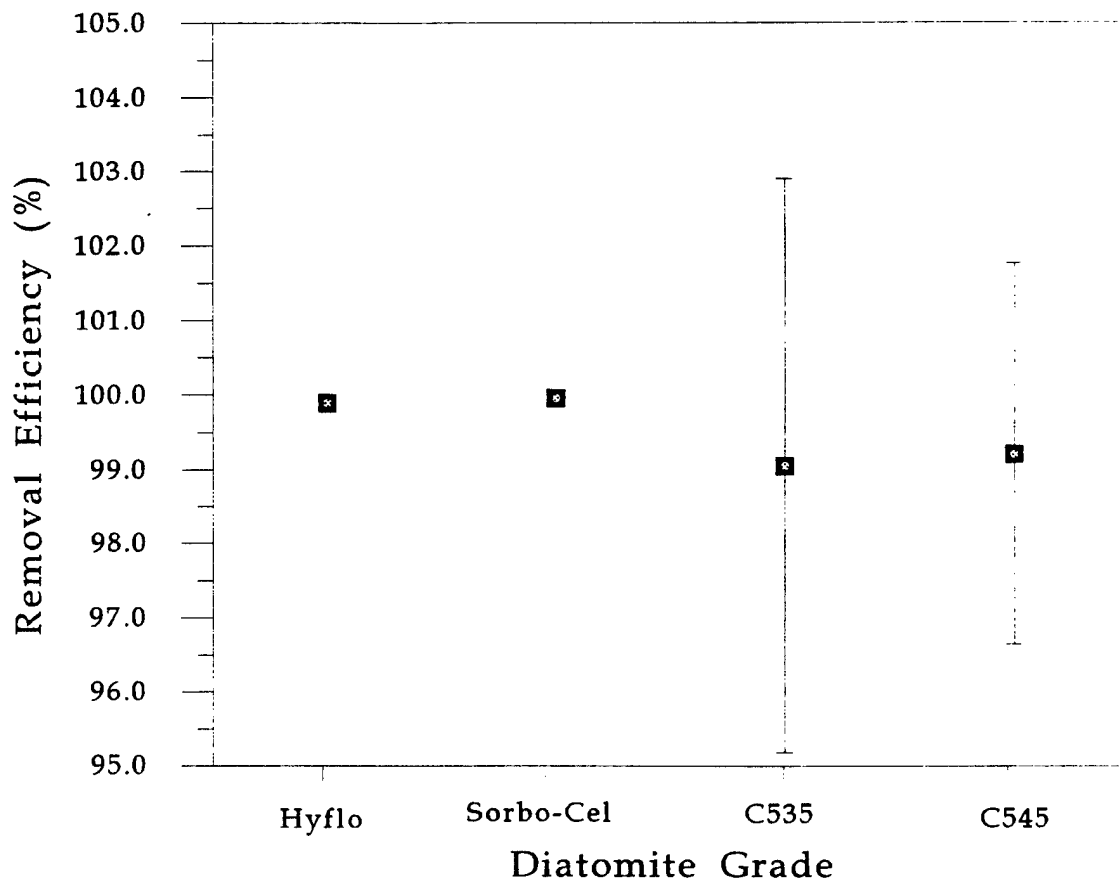

Figure 15.  
Average efficiency of removal of Orimulsion<sup>®</sup> from freshwater for different grades of diatomaceous earth filter aid.

## Cleaning Procedures

Table 5 summarizes information found in the literature and grey literature concerning the use of various solvents for removing bitumen (BP Bitor 1992, Brown, et al. 1995, Oil Spill Service Centre 1989). Table 6 summarizes the effects of solvents tested in this study. These solvents were: Citrikleen<sup>®</sup> and Citrikleen<sup>®</sup> HD (West Penetone), Koch<sup>®</sup> KLD (Koch Membrane Systems<sup>®</sup>), SAC-300 (M3 Inc.), pentane and chloroform (Baxter), Diesel Fuel, Kerosene, Unleaded Gasoline, STP<sup>®</sup> Carburetor Cleaner, Thompson's<sup>®</sup> Garage Cleaner, Chevron<sup>®</sup> Pro-Guard, and Coleman<sup>®</sup> Fuel. Chloroform (CHCl<sub>3</sub>) performed well as a solvent of the components of Orimulsion<sup>®</sup>. However, chloroform is a suspected carcinogen and its use entails generation of a hazardous waste stream for disposal. Petroleum distillates, acetone, hexanes, and various proprietary solvent formulations also proved ineffective in cleaning the bitumen staining. However, three commercially available cleaning agents were effective for removal of residual contamination when coupled with vigorous scrubbing. These were SAC-300, Citrikleen<sup>®</sup> HD, and Koch<sup>®</sup> KLD. The SAC-300 readily emulsified bitumen but had a turpentine-like odor. The other two emulsified the bitumen effectively, generating a floating contaminant fraction and a spent cleaner fraction upon settling for a short period of time. Both cleaners are biodegradable and non-toxic. Citrikleen<sup>®</sup> HD is a proprietary blend of citrus based hydrocarbon solvent degreasers, carbon removers, and concentrated surfactants, specifically formulated to emulsify and disperse tar-like substances (West Penetone 1993). Citrikleen<sup>®</sup> HD performed well when diluted to 20-50%. When permitted to stand overnight, the bitumen particles rose to the top of the spent cleaning solution and were easily separated. The Koch<sup>®</sup> KLD (Kochkleen Liquid Detergent) is a concentrated enzymatic alkaline surfactant cleaning solution, formulated for use in food, beverage, potable water, and wastewater applications. It is a biodegradable, non-hazardous, blue green liquid with a slight ammonia odor, which worked well when diluted to 0.5-1%. It is recommended by the manufacturer as compatible with the PVDF membrane, and is manufactured for that purpose.

**Table 5.**  
**Summary of solvent cleaner testing for the removal of bitumen.**

| <b>Cleaning Product</b>                        | <b>Result</b>  | <b>Reference</b>                                  |
|--|--|---|
| White Spirit                                   | Requires working into the stain with high pressure washing   | Oil Spill Service Center, 1989;<br>BP Bitor, 1992 |
| BP Heavy Duty Degreaser*                       | Takes a long time to soften the bitumen  | Oil Spill Service Center, 1989;<br>BP Bitor, 1992 |
| Desolvit*<br>(Armo Product Limited®)           | Takes a long to break down the bitumen   | Oil Spill Service Center, 1989;<br>BP Bitor, 1992 |
| BP Quicksplit*                                 | (Biodegradable anionic emulsifier in hydrocarbon solvent)<br>Brushes on and washes all bitumen staining off<br>after 15 minutes contact leaving no stains or residual<br>Emulsion separates out very quickly | Oil Spill Service Center, 1989;<br>BP Bitor, 1992 |
| Paraffin                                       | Requires working into the staining and washing off   | Oil Spill Service Center, 1989;<br>BP Bitor, 1992 |
| Jizer Swalve S100*<br>(Deb Chemicals Limited®) | (Nonionic emulsifier in an aliphatic hydrocarbon solvent)<br>Rinses easily leaving clean surfaces.<br>Washings do not separate.  | Oil Spill Service Center, 1989;<br>BP Bitor, 1992 |
| Rigidoil*                                      | Only partially gels the bitumen  | Oil Spill Service Center, 1989;<br>BP Bitor, 1992 |
| <hr/>  |  |   |
| Toluene  | Substantial dissolution  | Brown, J.W., et.al, 1995                          |
| Ethyl Acetate                                  | Little solubility  | Brown, J.W., et.al, 1995                          |
| Hexane   | Little solubility  | Brown, J.W., et.al, 1995                          |
| Isopropyl Alcohol                              | Very little solubility   | Brown, J.W., et.al, 1995                          |
| Methanol                                       | Very little solubility   | Brown, J.W., et.al, 1995                          |
| Ethanol  | Very little solubility   | Brown, J.W., et.al, 1995                          |
| Methylene Chloride                             | Complete solubility  | Brown, J.W., et.al, 1995                          |
| Chloroform                                     | Complete solubility  | Brown, J.W., et.al, 1995                          |
| Ethyl Ether                                    | Substantial dissolution  | Brown, J.W., et.al, 1995                          |
| Petroleum Ether                                | Little solubility  | Brown, J.W., et.al, 1995                          |
| Acetone  | Very little solubility   | Brown, J.W., et.al, 1995                          |

**Table 6.**  
**Summary of solvent cleaner testing experimentation for the removal of bitumen.**

| <b>Cleaning Product</b>                             | <b>Result</b>   |
|---|---|
| Pentane ( <i>Baxter</i> )                           | Requires working into the stain and wiping with high pressure washing   |
| Hydrochloric Acid ( <i>Baxter</i> )                 | No effect   |
| Diesel Fuel   | No effect   |
| Kerosene  | No effect   |
| Unleaded Gasoline                                   | No effect   |
| Coleman <sup>®</sup> Fuel                           | Minor effect on stained surfaces with vigorous scrubbing  |
| Citrikleen <sup>®</sup> HD ( <i>West Penetone</i> ) | (Heavy Duty citrus-based biodegradable hydrocarbon solvent degreaser)<br>Diluted and allowed to contact stained surfaces, dislodges bitumen with rinse.<br>Permitted to stand, the bitumen separates from the emulsion. Citrus odor.  |
| Citrikleen <sup>®</sup> ( <i>West Penetone</i> )    | (Regular strength version of Citrikleen HD) Works similar to Citrikleen HD,<br>but less concentrated and less effective.  |
| Chevron <sup>®</sup> Pro-Guard                      | (Proprietary tar stain remover) Mildly effective. Requires vigorous scrubbing<br>into stained surfaces and washing off. Washings do not separate.<br>Hydrocarbon vapors cause problems if not used in well ventilated areas.  |
| SAC 300 <sup>®</sup> ( <i>M3, Inc.</i> )            | (Specially formulated hydrocarbon microemulsion cleaning agent)<br>In concentrated form, dislodges bitumen and rinses away clean.<br>Use only in well-ventilated areas because of powerful terpentine-like odors.<br>Washings emulsified and did not separate within a reasonable time frame. |
| Thomson's <sup>®</sup> Garage Cleaner               | Minor effect on stained surfaces with vigorous scrubbing  |
| STP <sup>®</sup> Carbeurator Cleaner                | No effect   |
| Koch <sup>®</sup> KLD<br>(Koch Membrane Systems)    | (Biodegradable alkaline membrane cleaning agent surfactant)<br>Diluted, performs better than Citrikleen HD for dislodging bitumen staining.<br>However, washings took longer to separate from the emulsion.<br>No odor associated with the cleaning agent. Washings are at elevated pH.       |

Results of cleaning procedure development using equipment diagrammed in Figure 5 are reported in following paragraphs. Feed was first returned to the tank, and the system was flushed until the exit stream appeared clear. Membranes were then interchanged from the filtration plant to the cleaning station. As has been found previously (Alcoa 1987), ease of cleaning was enhanced by avoiding the opportunity for feed suspension to dry out in contact with the membrane surface.

#### Cleaning Procedure no. 1

The following procedure, recommended by the membrane manufacturer, required 2.75 hours with manual insertion of sponge balls:

1. Forward flush with warm tapwater for 30 minutes,
2. Reverse flush with warm tapwater for 30 minutes,
3. Forward rinse with warm tapwater for 15 minutes in a closed loop,
4. Reverse rinse with warm tapwater for 15 minutes in a closed loop,
5. Circulate 0.5% (by volume) Koch<sup>®</sup> KLD in warm tapwater at pH 10-10.5 (using 1M NaOH) in a closed loop in both directions for 30 minutes each,
6. Sponge balls were inserted twice during the cycle, in both directions, and
7. Forward rinse with warm tapwater for 15 minutes with the permeate valve closed.

Flush and rinse cycles moistened the membrane surface and helped transport gel layer away from the membrane surface. With bulk material and gel layer removed, the cleaning agent was able to emulsify bitumen in the membrane pores. The cleaner was effective at higher pH values and was able to dislodge bitumen material that blinded the active surface. This effect was evident in that cleaner returned black with emulsified bitumen after a short period. The tubular membrane configuration allowed mechanical cleaning with sponge balls supplied by the manufacturer.

Sponge balls were inserted twice in each direction during the cleaning cycle. Time requirement included emptying of the system and disassembly of the connecting lines each time an insertion was performed. In field applications, this part of the procedure would be automated. In this test only 10 L of cleaning solution was used, and the spent agent including the emulsified bitumen could be returned to the feed tank for processing or allowed to sit and separate in order to skim off the bitumen particles and dispose of the cleaner. As suggested by Alcoa (1987), transmembrane pressure was kept low, and rinse water and cleaning agents were circulated with permeate valves closed to protect permeate conduits from mobilized bitumen. Also, contact of the membrane with solutes containing air was minimized to prevent adsorption and clogging inside the membrane. Observed flux recovery was 76.1% of the initial value, when this procedure was used following a 7.25 hour filtration cycle of the neutrally-charged membrane filtering a 1:1000 dilution of Orimulsion<sup>®</sup> in tapwater with addition of 1:1 clay:Orimulsion<sup>®</sup> solids.

#### Cleaning Procedure no. 2

Cleaning procedure no. 2 included circulation of fresh cleaning solution with sponge balls. Time required was 2.6 hours, plus an overnight soak, as follows:

1. Forward flush with warm tapwater for 15 minutes,
2. Forward rinse with warm tapwater for 30 minutes in a closed loop,
3. Reverse rinse with warm tapwater for 5 minutes in a closed loop,
4. Forward rinse with warm tapwater for 5 minutes in a closed loop,
5. Circulate 0.5% (by volume) Koch<sup>®</sup> KLD in warm tapwater at pH 10-10.5 (using 1M NaOH) in a closed loop in the reverse direction with 2 sponge balls,
6. Forward rinse with warm tapwater for 15 minutes in a closed loop,
7. Circulate 0.5% (by volume) Koch<sup>®</sup> KLD in warm tapwater at pH 10-10.5 (using 1M NaOH) in a closed loop in the reverse direction for 10 minutes,

8. Circulate 0.5% (by volume) Koch<sup>®</sup> KLD in warm tapwater at pH 10-10.5 (using 1M NaOH) in a closed loop in the forward direction for 10 minutes,
9. Circulate 0.5% (by volume) Koch<sup>®</sup> KLD in warm tapwater at pH 10-10.5 (using 1M NaOH) in a closed loop in the forward direction for 10 minutes with the permeate valve on the membrane fully opened,
10. Forward flush with warm tapwater until detergent foam disappears and soak overnight,
11. Circulate 0.5% (by volume) Koch<sup>®</sup> KLD in warm tapwater at pH 10-10.5 (using 1M NaOH) in a closed loop in the forward direction for 10 minutes with the permeate valve on the membrane fully closed, and twice insert 2 sponge balls,
12. Circulate 0.5% (by volume) Koch<sup>®</sup> KLD in warm tapwater at pH 10-10.5 (using 1M NaOH) in a closed loop in the forward direction for 10 minutes with the permeate valve on the membrane fully opened,
13. Forward flush with warm tapwater for 1 minute,
14. Forward rinse with warm tapwater in a closed system for 30 minutes, and
15. Forward flush with warm tapwater for 1 minute.

This method was used after the neutral surface charge membrane had been in contact with a 1:1000 dilution of Orimulsion<sup>®</sup> in tapwater with 1:1 clay:Orimulsion<sup>®</sup> solids for 10 hours. The flush and rinse cycles with warm tapwater served only to displace small amounts of feed water still remaining in the system. Insertion of two sponge balls with the cleaning agent in the reverse direction greatly enhanced removal of a compacted gel layer of clay and bitumen surface deposition. Opening the permeate valve during circulation of the cleaner allowed the concentrated detergent to pass through the membrane pores at relatively high velocity, providing internal cleaning. It was found that with the permeate valve open both the detergent and clean water were passing through at a relatively high flux rate of  $183.6 \pm 18.2$  gpd/ft<sup>2</sup> (the error term corresponds to 2 sample standard deviations), or 98.8% of original flux. Cleaning agent was then



flushed from the system, and clean warm tapwater was circulated until rinsate pH was approximately neutral. Permeate flux recovery was 100.4% of the initial value.

### Cleaning Procedure no. 3

Procedure no. 3 was used after the neutral surface charge membrane had been in contact with a 1:1000 dilution of Orimulsion® in tapwater with 1:1 clay:Orimulsion® solids for 3 hours, followed by a 1:100 dilution of Orimulsion® in tapwater with 0.1:1 clay:Orimulsion® solids for 9 hours, followed by a 1:10 dilution of Orimulsion® in tapwater with no clay additive for 2 hours. After such a challenge, the membrane was completely blinded and flux was zero. The following cleaning regimen required 3.8 hours plus an overnight soak:

1. Forward flush with warm tapwater for 60 minutes,
2. Forward rinse with warm tapwater for 30 minutes in a closed loop,
3. Reverse rinse with warm tapwater for 15 minutes in a closed loop,
4. Circulate 0.5% (by volume) Koch® KLD in warm tapwater at pH 10-10.5 (using 1M NaOH) in the reverse direction for one loop with return to the feed tank,
5. Circulate 0.5% (by volume) Koch® KLD in warm tapwater at pH 10-10.5 (using 1M NaOH) in a closed loop in the reverse direction for 15 minutes, and twice insert 2 sponge balls,
6. Let soak in fresh cleaner overnight,
7. Reverse rinse with warm tapwater for 20 minutes in a closed loop,
8. Insert 2 sponge balls three times during the rinse cycle in the reverse direction,
9. Circulate 0.5% (by volume) Koch® KLD in warm tapwater at pH 10-10.5 (using 1M NaOH) in a closed loop twice in both directions for 15 minutes each way,
10. Insert 2 sponge balls twice during the circulation of cleaning solution in the forward direction,

11. Circulate 0.5% (by volume) Koch<sup>®</sup> KLD in warm tapwater at pH 10-10.5 (using 1M NaOH) in a closed loop twice in both directions for 30 minutes each way,
12. Forward flush with warm tapwater with the permeate valve fully opened for 10 minutes, and
13. Backward flush with warm tapwater with the permeate valve fully opened for 10 minutes.

The first cycle with alkaline cleaner mobilized some bitumen. Bitumen was observed through the clear vinyl tubing to move a short distance and redeposit in the system. Some of the mobilized bitumen made its way through the hydraulics to the tank containing the cleaning agent that was recycling through the system. This bitumen fouled the tank and system. This staining was cleaned, and a fresh cleaning solution was circulated in the reverse direction with the addition of the sponge balls. The sponge balls were immediately fouled and spread bitumen throughout the system for two complete cycles. After cleaning of the cleaning station, the membrane was soaked overnight in the alkaline cleanser. When this was flushed the next day, the bitumen remained emulsified and left with the cleaning agent to the drain collection. Sponge balls were inserted three more times with fresh cleaning solution until the balls returned relatively clean. Fresh cleaning solution was then circulated in both directions, to clean membrane pores. Sponge balls were inserted again, and returned with minimal staining. More cleaner was circulated until the sponge balls returned clean. Then cleaner was circulated with the permeate valve fully open. Cleaning solution flux, 117.8 gpd/ft<sup>2</sup>, indicated 63.4% recovery of the initial flux. The cleaning agent was flushed with warm tapwater forwards and backwards to neutral pH. Pilot testing indicated 95.6% flux recovery.

#### Cleaning Procedure no. 4

Procedure no. 4 was used after the negative surface charge membrane filtration of a 1:40 dilution of Orimulsion<sup>®</sup> in seawater with 0.1:1 clay:Orimulsion<sup>®</sup> solids for 3 hours, followed by a 1:1000 dilution of Orimulsion<sup>®</sup> in tapwater with no additives for 2.75 hours. The method required 2.3 hours, as follows:

1. Forward flush with warm tapwater for 10 minutes,
2. Reverse flush with warm tapwater for 10 minutes,
3. Forward rinse with warm tapwater for 5 minutes in a closed loop,
4. Reverse rinse with warm tapwater for 5 minutes in a closed loop,
5. Circulate 0.5% (by volume) Koch<sup>®</sup> KLD in warm tapwater at pH 10-10.5 (using 1M NaOH) in a closed loop in the reverse direction for 30 minutes,
6. Insert 2 sponge balls, three times during the cycle,
7. Circulate 0.5% (by volume) Koch<sup>®</sup> KLD in warm tapwater at pH 10-10.5 (using 1M NaOH) in a closed loop in the forward direction for 30 minutes,
8. Insert 2 sponge balls, three times during the cycle,
9. Forward flush with warm tapwater for 15 minutes, and
10. Backward flush with warm tapwater to neutral pH.

The permeate valve was kept closed during the procedure. Tapwater rinse and flush cycles were profitably shortened. Sponge balls returned clean after the second and third forward pass with cleaner. In the reverse direction, sponge balls were completely fouled after each pass and spread bitumen staining over small sections. In the forward direction, visible bitumen plugs were lifted off the membrane and transported to the drain basin. Pilot plant flux recovery was 88.7%. This recovery is lower than recorded for the neutral membrane, possibly because the permeate valve was not opened to pass cleaner through the membrane.

### Cleaning Procedure no. 5

Procedure no. 5 was used on the negative membrane after filtration of a 1:100 dilution of Orimulsion<sup>®</sup> in tapwater with 0.1:1 clay:Orimulsion<sup>®</sup> solids for 8.75 hours. The procedure was shortened by eliminating one forward and one reverse pass of the sponge balls, and not opening the allowing cleaner to pass through the membrane as permeate, and required 2.7 hours, as follows:

1. Forward flush with warm tapwater for 30 minutes,
2. Reverse flush with warm tapwater for 30 minutes,
3. Forward rinse with warm tapwater for 5 minutes in a closed loop,
4. Reverse rinse with warm tapwater for 5 minutes in a closed loop,
5. Circulate 0.5% (by volume) Koch<sup>®</sup> KLD in warm tapwater at pH 10-10.5 (using 1M NaOH) in a closed loop in both directions for 30 minutes each,
6. Repeat,
7. Insert sponge balls in the reverse direction two times during the circulation of the cleaning solution, and
8. Forward flush with warm tapwater for 30 minutes.

Pilot test flux recovery was 67.9%, less than for other methods.

Results using cleaning procedure no. 3 clearly demonstrated that even a membrane completely blocked with pure bitumen and with flux reduced to zero, could be completely cleaned and restored to its original flux. In this extreme case, the mechanical scraping action of the sponge balls in concert with the emulsifying alkaline cleaner supplied by the manufacturer were required. This method produced a greater volume of spent cleaner emulsion tainted with bitumen, and

sponge balls required disposal after only one pass. In practical applications, the addition of a filtration aid such as clay will be necessary to obtain realistic filtration cycles, as shown in results presented for ultrafiltration pilot tests. In such cases, cleaning may be effected using only the alkaline cleaner.

### Ultrafiltration Pilot Testing

Operating variables and selected data for ultrafiltration sessions, cycles, and runs are summarized in Table 7. A session was defined to be a period of continuous operation. Generally a session was a period of approximately of two to four hours of continuous operation, before overnight cooling of the feed was required. A cycle was used to refer to a contiguous series of sessions between membrane cleaning. A run was defined as a contiguous series of sessions in which the feed and the membrane type remained constant. Thus, the 34 ultrafiltration sessions conducted were grouped into 11 cycles and 9 runs, as shown in Table 7. Reported dilution rates are in mass percent Orimulsion® in water, determined by analysis of VSS. Clay addition rates are parts of clay to parts of bitumen solids, by mass. As shown in Figure 6,  $P_1$  refers to pressure before the membrane,  $P_2$  is pressure after the membrane,  $P_3$  is pressure at the junction between the pump return line and the membrane feed line, and  $P_4$  is pump suction head. The value  $\Delta P$  is headloss across the membrane at the membrane inlet, the difference between  $P_1$  and a small headloss in the tubing between pressure gauge 1 and the membrane inlet. Pressure loss between membrane inlet and concentrate outlet was estimated to be 4 psi. Values of  $k$  in Table 7 are the slopes of log-log plots of flux versus time for each session. Linearity of the data is indicated in the correlation  $R$  value shown. Complete results are detailed in Appendix E.

Table 7.  
Summary of ultrafiltration pilot testing.

| Run no. | Cleaning Cycle | Session no.    | Membrane Type | Dilution Rate | Clay Ratio | Water Type | Elapsed Time (hr) | Session Length (hr) | Start Flux (gpd/ft <sup>2</sup> ) | Start ΔP (psig) | Avg VSS (mg/L) | Log <sub>10</sub> k | Correlation R |
|---------|----------------|----------------|---------------|---------------|------------|------------|-------------------|---------------------|-----------------------------------|-----------------|----------------|---------------------|---------------|
| 1       | 1              | 1              | Neutral       | 1:1000        | 1:1        | Tapwater   | 2.92              | 2.92                | 185.76                            | 45.6            | 0.35           | -0.101              | -0.952        |
| 1       | 1              | 2              | Neutral       | 1:1000        | 1:1        | Tapwater   | 4.17              | 1.25                | 97.20                             | 45.6            | 1.05           | -0.117              | -0.932        |
| 1       | 1              | 3              | Neutral       | 1:1000        | 1:1        | Tapwater   | 5.42              | 1.25                | 78.55                             | 46.6            | 1.10           | -0.043              | -0.640        |
| 1       | 1              | 4              | Neutral       | 1:1000        | 1:1        | Tapwater   | 7.25              | 1.83                | 80.51                             | 46.6            | <0.10          | -0.046              | -0.755        |
| 1       | 2              | 1              | Neutral       | 1:1000        | 1:1        | Tapwater   | 2.42              | 2.42                | 141.38                            | 46.6            | NA             | -0.252              | -0.884        |
| 1       | 2              | 2              | Neutral       | 1:1000        | 1:1        | Tapwater   | 5.67              | 3.50                | 35.67                             | 45.6            | 0.35           | 0.005               | 0.575         |
| 1       | 2              | 3              | Neutral       | 1:1000        | 1:1        | Tapwater   | 9.75              | 4.08                | 32.73                             | 44.6            | <0.10          | 0.018               | 0.948         |
| 1       | 3              | 1              | Neutral       | 1:1000        | 1:1        | Tapwater   | 3.50              | 3.50                | 186.55                            | 45.6            | 0.11           | -0.088              | -0.881        |
| 2       | 3              | 1              | Neutral       | 1:100         | 0.1:1      | Tapwater   | 1.50              | 1.50                | 100.47                            | 45.6            | 0.34           | -0.012              | -0.805        |
| 2       | 3              | 2              | Neutral       | 1:100         | 0.1:1      | Tapwater   | 3.50              | 2.00                | 123.71                            | 46.6            | 1.00           | 0.056               | 0.974         |
| 2       | 3              | 3              | Neutral       | 1:100         | 0.1:1      | Tapwater   | 4.58              | 1.08                | 122.07                            | 45.6            | NA             | 0.003               | 0.368         |
| 2       | 3              | 4              | Neutral       | 1:100         | 0.1:1      | Tapwater   | 6.50              | 1.92                | 114.55                            | 46.6            | 0.12           | -0.009              | -0.758        |
| 2       | 3              | 5              | Neutral       | 1:100         | 0.1:1      | Tapwater   | 9.00              | 2.50                | 96.22                             | 46.6            | 1.34           | -0.015              | -0.904        |
| 3       | 4              | 1              | Neutral       | 1:40          | 0.1:1      | Seawater   | 3.00              | 3.00                | 430.69                            | 49.1            | 0.22           | -0.101              | -0.665        |
| 4       | 3              | 1              | Neutral       | 1:10          | None       | Tapwater   | 2.00              | 2.00                | 32.27                             | 45.6            | NA             | -0.245              | -0.926        |
| 5       | 5              | 1              | Negative      | 1:1000        | None       | Tapwater   | 2.75              | 2.75                | 709.53                            | 46.1            | 0.99           | -0.342              | -0.878        |
| 6       | 6              | 1              | Negative      | 1:100         | 0.1:1      | Tapwater   | 3.25              | 3.25                | 575.24                            | 48.1            | 0.22           | -0.122              | -0.882        |
| 6       | 6              | 2              | Negative      | 1:100         | 0.1:1      | Tapwater   | 5.75              | 2.50                | 203.14                            | 48.6            | 1.30           | -0.083              | -0.878        |
| 6       | 6              | 3              | Negative      | 1:100         | 0.1:1      | Tapwater   | 9.25              | 3.50                | 100.76                            | 48.1            | 0.12           | -0.009              | -0.441        |
| 7       | 5              | 1              | Negative      | 1:40          | 0.1:1      | Seawater   | 3.00              | 3.00                | 648.72                            | 49.1            | <0.10          | -0.194              | -0.954        |
| 8       | 7              | 1              | Negative      | 1:10          | 0.1:1      | Tapwater   | 3.00              | 3.00                | 440.44                            | 48.1            | 1.89           | -0.018              | -0.814        |
| 8       | 7              | 2              | Negative      | 1:10          | 0.1:1      | Tapwater   | 6.00              | 3.00                | 439.92                            | 48.1            | 1.33           | -0.078              | -0.820        |
| 8       | 7              | 3              | Negative      | 1:10          | 0.1:1      | Tapwater   | 9.50              | 3.50                | 239.56                            | 48.6            | 0.22           | -0.032              | -0.358        |
| 8       | 7              | 4              | Negative      | 1:10          | 0.1:1      | Tapwater   | 13.00             | 3.50                | 163.90                            | 47.6            | 0.76           | -0.012              | -0.243        |
| 8       | 7              | 5              | Negative      | 1:10          | 0.1:1      | Tapwater   | 16.50             | 3.50                | 130.91                            | 49.1            | 0.94           | -0.019              | -0.422        |
| 8       | 7              | 6              | Negative      | 1:10          | 0.1:1      | Tapwater   | 19.00             | 2.50                | 124.10                            | 48.1            | 0.59           | -0.050              | -0.630        |
| 8       | 7              | 7              | Negative      | 1:10          | 0.1:1      | Tapwater   | 21.00             | 2.00                | 77.50                             | 48.1            | <0.10          | -0.015              | -0.399        |
| 8       | 7              | 8              | Negative      | 1:10          | 0.1:1      | Tapwater   | 23.00             | 2.00                | 75.40                             | 47.6            | 0.80           | -0.033              | -0.750        |
| 8       | 7              | 9              | Negative      | 1:10          | 0.1:1      | Tapwater   | 25.50             | 2.50                | 63.10                             | 47.6            | 0.24           | -0.023              | -0.670        |
| 8       | 7              | 10             | Negative      | 1:10          | 0.1:1      | Tapwater   | 23.50             | 3.50                | 58.78                             | 48.1            | 0.69           | -0.017              | -0.712        |
| 8       | 7              | 11             | Negative      | 1:10          | 0.1:1      | Tapwater   | 32.50             | 3.50                | 55.44                             | 48.1            | 1.16           | -0.019              | -0.669        |
| 8       | 7              | 12             | Negative      | 1:10          | 0.1:1      | Tapwater   | 35.50             | 3.00                | 62.12                             | 48.1            | 0.70           | -0.008              | -0.944        |
| 9       | 7              | Devalerating 1 | Negative      | 1:10          | 0.1:1      | Tapwater   | 3.50              | 3.50                | 95.11                             | 49.1            | 1.21           | 0.015               | 0.143         |
| 9       | 7              | Devalerating 2 | Negative      | 1:10          | 0.1:1      | Tapwater   | 6.48              | 2.98                | 81.29                             | 48.1            | 1.86           | 0.035               | 0.292         |

Results of ultrafiltration runs using the neutral membrane are shown in Figures 16 through 23. For each run, flux is plotted versus time, along with temperature and membrane headloss in successive figures. Error bars representing two standard deviations, or 95% confidence, for flux measurements are shown, although measurement error was negligible and therefore most bars are not discernible in the figures. In Figures 16 and 17, results of the first run consisting of five sessions and three cycles are shown. A small increase in flux is seen with temperature. Cleaning procedures were demonstrated to achieve full flux restoration in these cycles, for dilute Orimulsion® in water with one part clay by weight added per ten parts bitumen. In Figures 18 and 19, the second run filtering a moderate concentration of Orimulsion® with added clay is plotted. Results of filtration of one part Orimulsion® in 40 parts seawater with the neutral membrane is depicted Figures 20 and 21. In Figures 22 and 23, results of ultrafiltration of a concentrated Orimulsion® suspension in tapwater are shown. No clay was added to this run. Initial flux was approximately 30 gpd/ft<sup>2</sup>, and dropped to zero within two hours. Intensive cleaning measures were required.

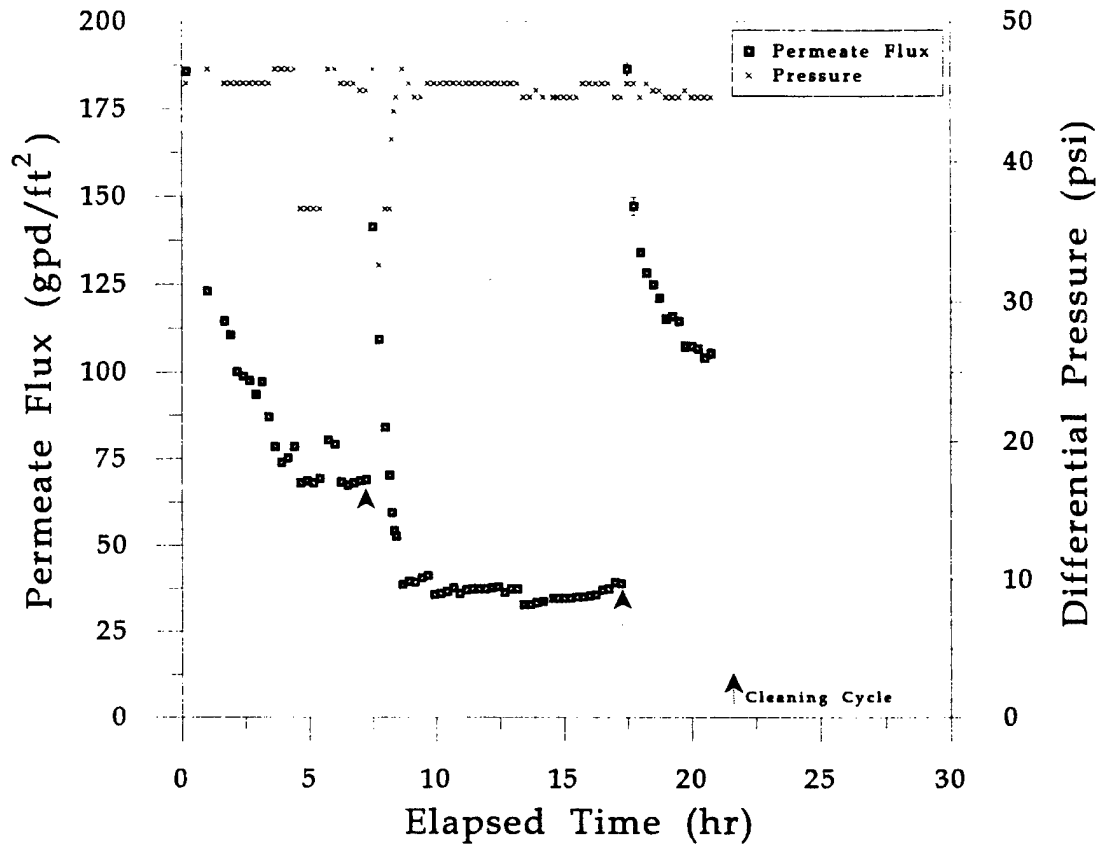

Figure 16. Flux and headloss versus time for ultrafiltration run #1 (three cleaning cycles, 0.1% Orimulsion<sup>®</sup> in tapwater with 1:1 clay:Orimulsion<sup>®</sup> solids addition using the neutral membrane).



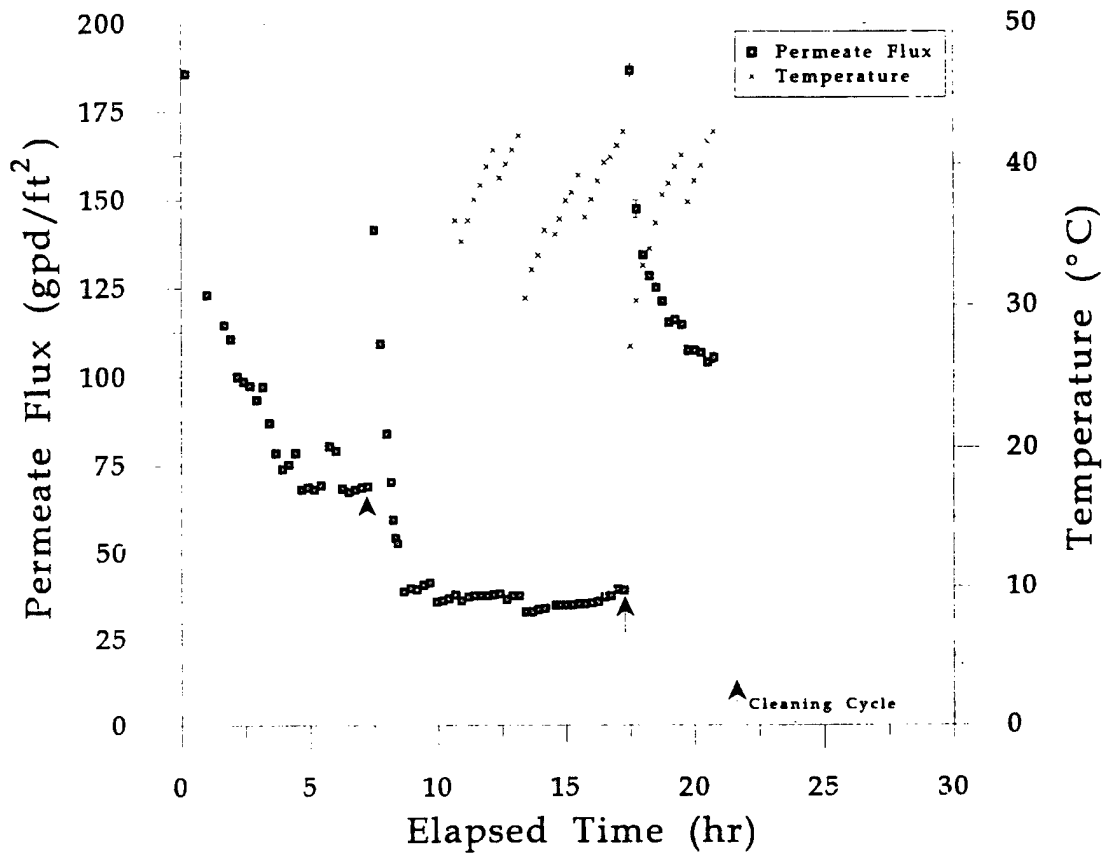

Figure 17.  
 Flux and temperature versus time for ultrafiltration run #1 (three cleaning cycles, 0.1% Orimulsion<sup>®</sup> in tapwater with 1:1 clay:Orimulsion<sup>®</sup> solids addition using the neutral membrane).

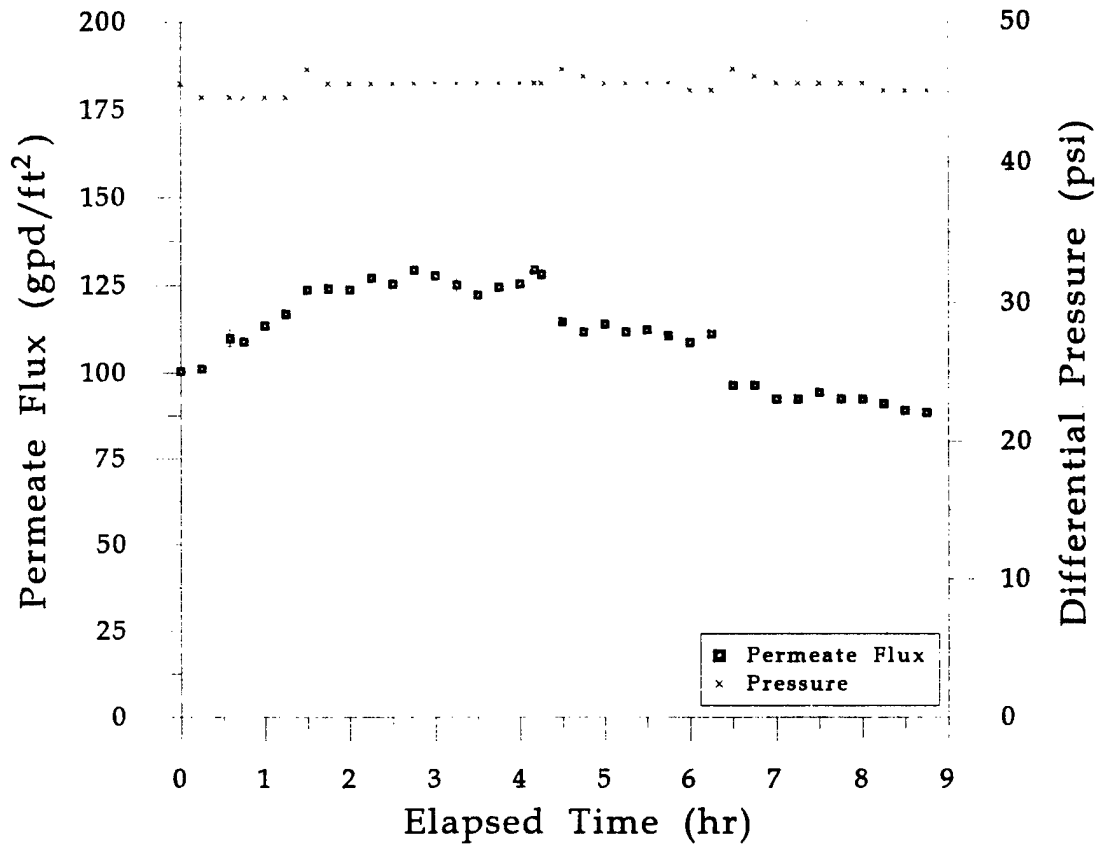

Figure 18.

Flux and headloss versus time for ultrafiltration run #2 (1.0% Orimulsion<sup>®</sup> in tapwater with 01:1 clay:Orimulsion<sup>®</sup> solids addition using the neutral membrane).

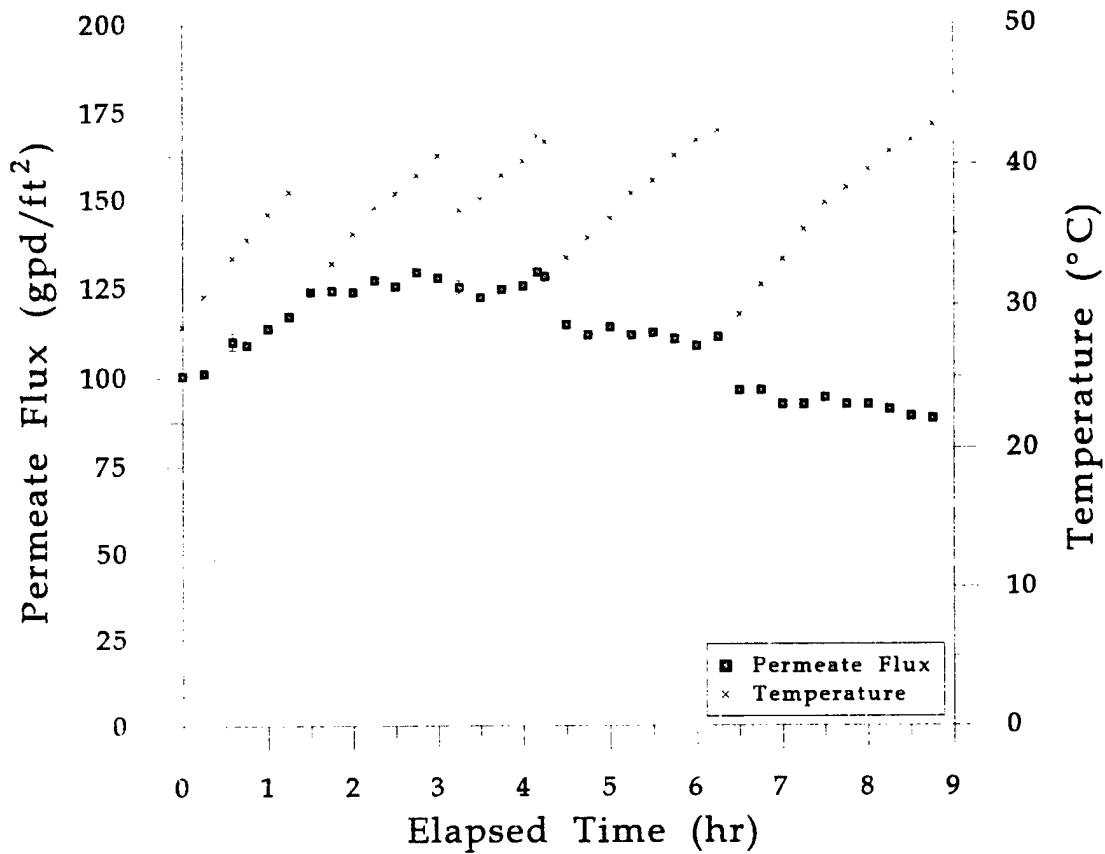

Figure 19.  
 Flux and temperature versus time for ultrafiltration run #2 (1.0% Orimulsion<sup>®</sup> in tapwater with 01:1 clay:Orimulsion<sup>®</sup> solids addition using the neutral membrane).

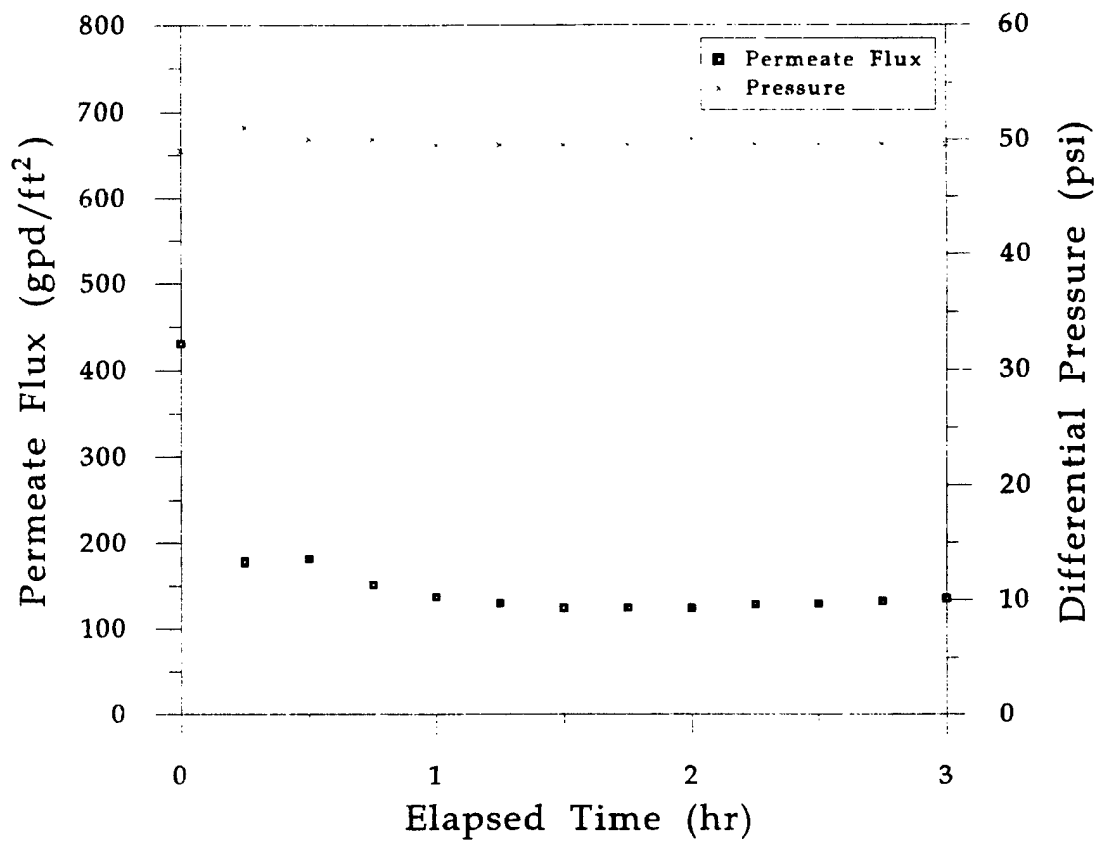

Figure 20.

Flux and headloss versus time for ultrafiltration run #3 (1:40 dilution of Orimulsion® in Biscayne Bay seawater with 01:1 clay:Orimulsion® solids addition using the neutral membrane).

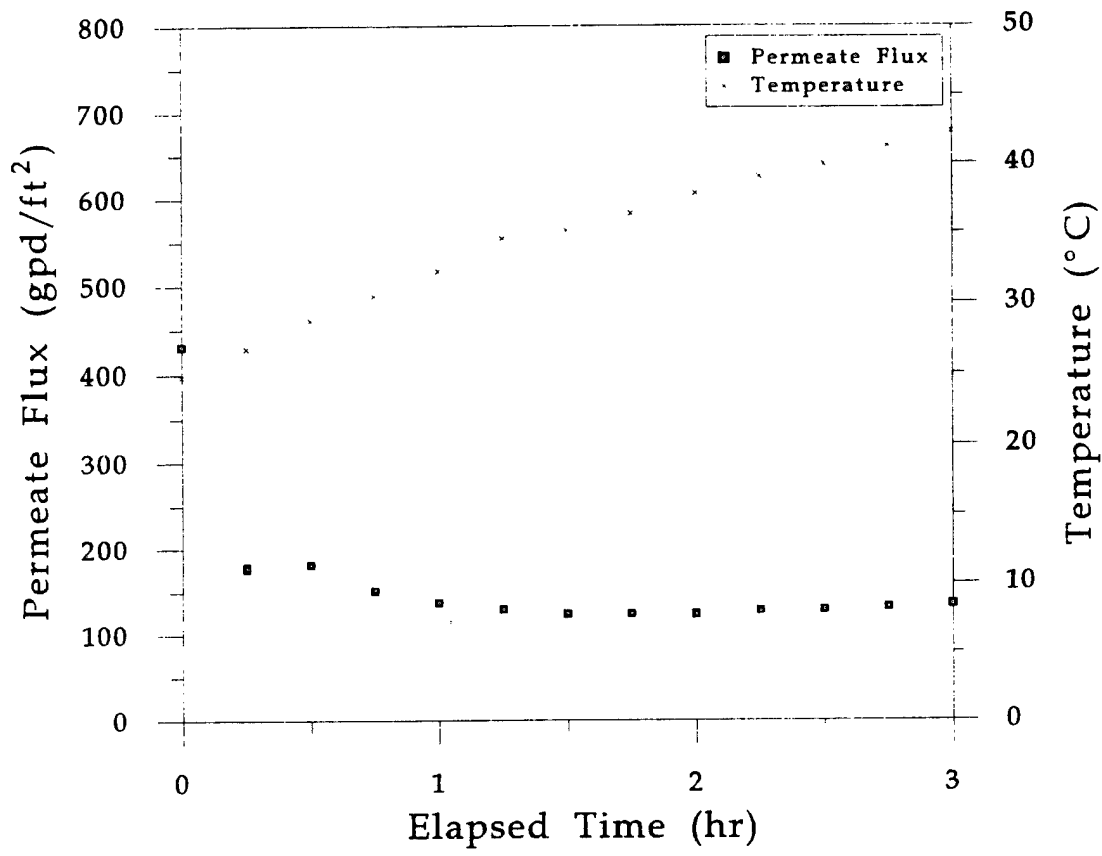

Figure 21.  
 Flux and temperature versus time for ultrafiltration run #3 (1:40 dilution of Orimulsion<sup>®</sup> in Biscayne Bay seawater with 01:1 clay:Orimulsion<sup>®</sup> solids addition using the neutral membrane).

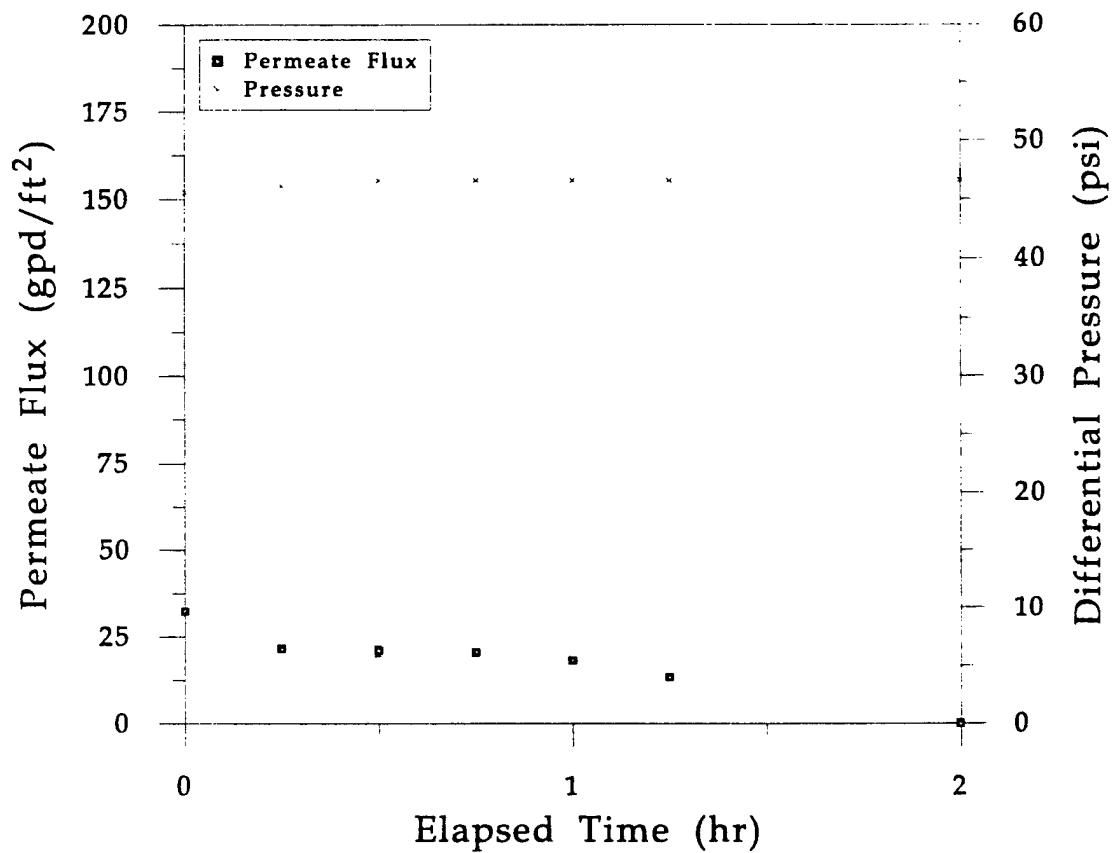

Figure 22.  
 Flux and headloss versus time for ultrafiltration run #4 (1:10 dilution of Orimulsion<sup>®</sup> in tapwater with no clay addition using the neutral membrane).

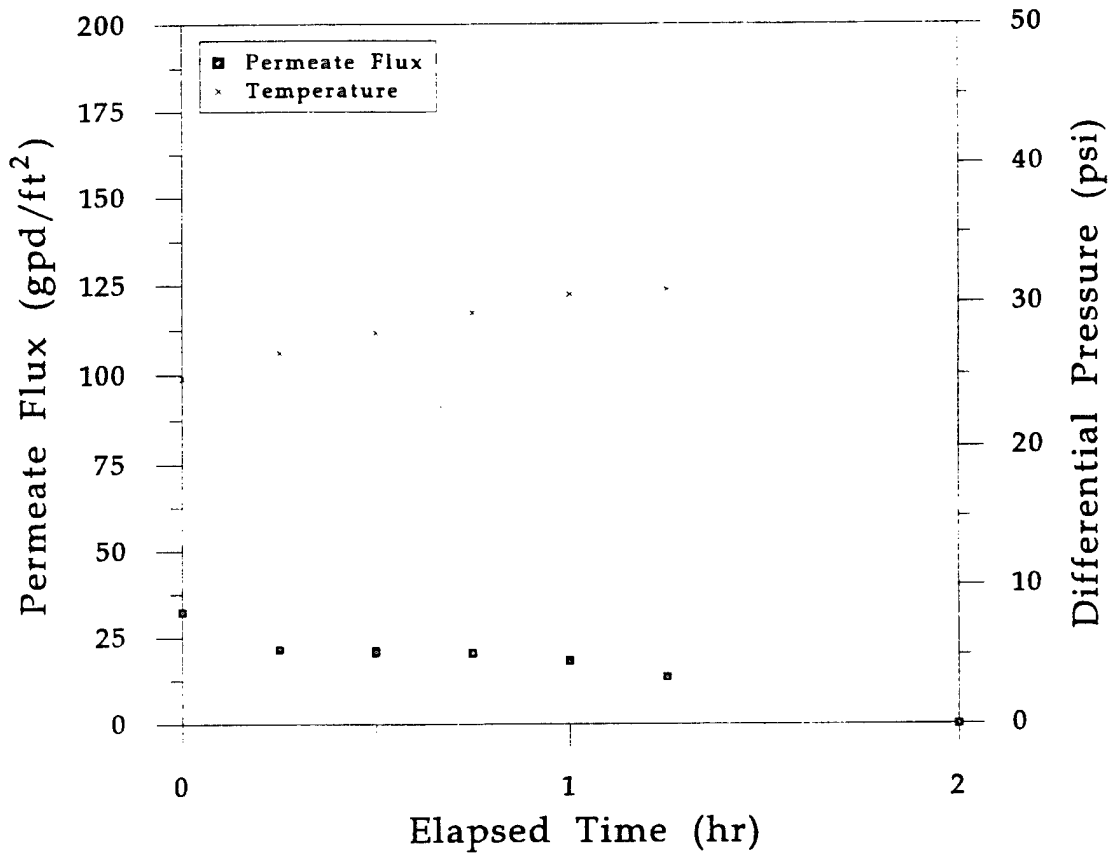

Figure 23.  
 Flux and temperature versus time for ultrafiltration run #4 (1:10 dilution of Orimulsion<sup>®</sup> in tapwater with no clay addition using the neutral membrane).

Results using the negative membrane are shown in Figures 24 through 34. Run 5, shown in Figures 24 and 25, was a second ultrafiltration experiment without addition of clay. The feed was a 1:1000 dilution of Orimulsion® in tapwater. At this higher dilution and with the negative membrane, initial flux was approximately 700 gpd/ft<sup>2</sup>, rapidly declining to approximately 150 gpd/ft<sup>2</sup> within 15 minutes and reaching 30 gpd/ft<sup>2</sup> after 165 minutes. Results of Run 6 for a 1:100 dilution of Orimulsion® in tapwater with 0.1 part added clay per part bitumen solids are shown in Figures 26 and 27. Run 7 was for a relatively concentrated suspension of Orimulsion® in seawater. Results are shown in Figures 28 and 29. Run 8 was an extended filtration of a concentrated suspension in tapwater, with added clay, as shown in Figures 30 and 31. Even at this 1:10 Orimulsion® concentration, addition of 0.1 part clay per part bitumen solids resulted in an initial flux of 450 gpm/ft<sup>2</sup>, remaining above 50 gpm/ft<sup>2</sup> after 36 hours.

Run 9 was not conducted in the constant concentration mode. Permeate was discharged to the drain for this run, allowing the feed to concentrate as in field applications. Results are shown in Figures 32 through 34. In Figure 34, flux and retentate concentrations are plotted versus time. After 6.5 hours, flux remained at 70 gpd/ft<sup>2</sup>, although the concentration of the retentate had reached a significant 47%. At this point the depth of feed in the tank was too low to proceed, or further concentration would presumably have been possible.

In almost all runs, UF permeate quality in terms of VSS was higher than that of the tapwater and seawater used to make the samples. Representative results are shown for a 1:100 dilution of Orimulsion® in tapwater and 1:40 dilution of Orimulsion® in seawater in Figures 35 and 36, respectively. Error bars represent 95% confidence intervals around the means of all samples. Qualities of the feed make-up waters are shown for comparison.



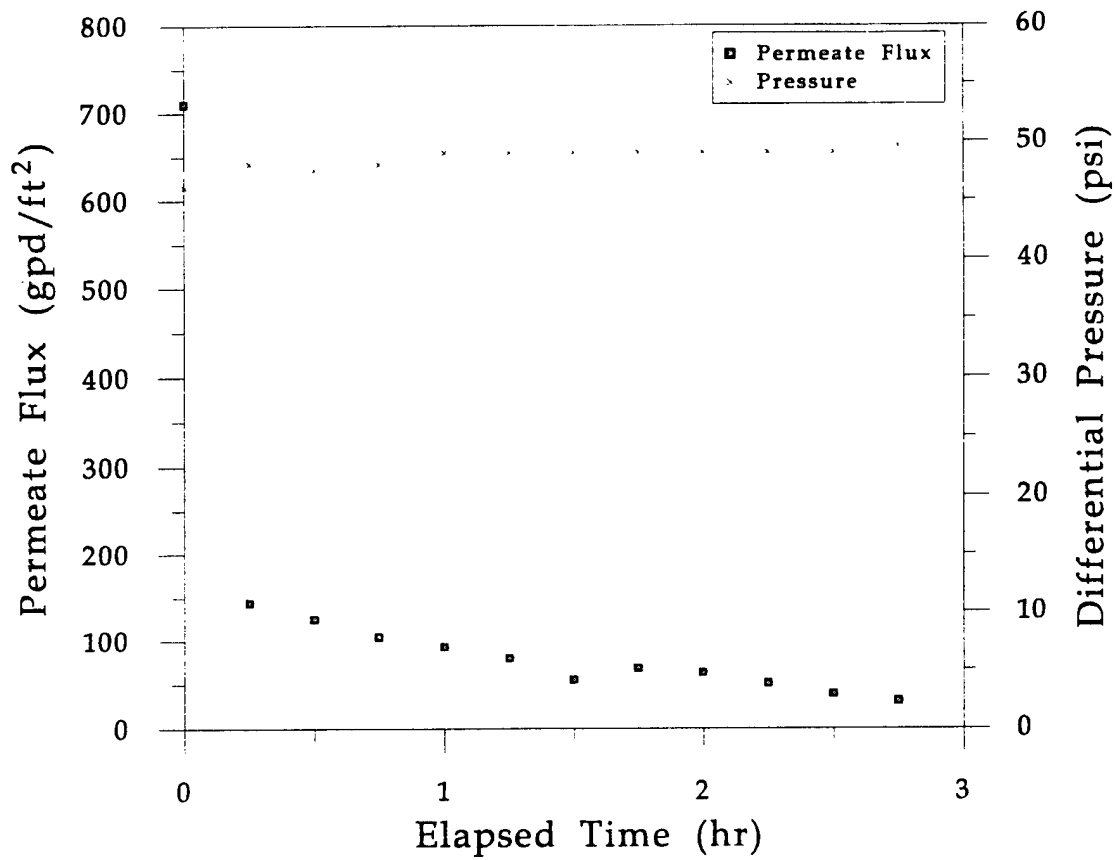

Figure 24.  
 Flux and headloss versus time for ultrafiltration run #5 (1:1000 dilution of Orimulsion<sup>®</sup> in tapwater with no clay addition using the negative membrane).

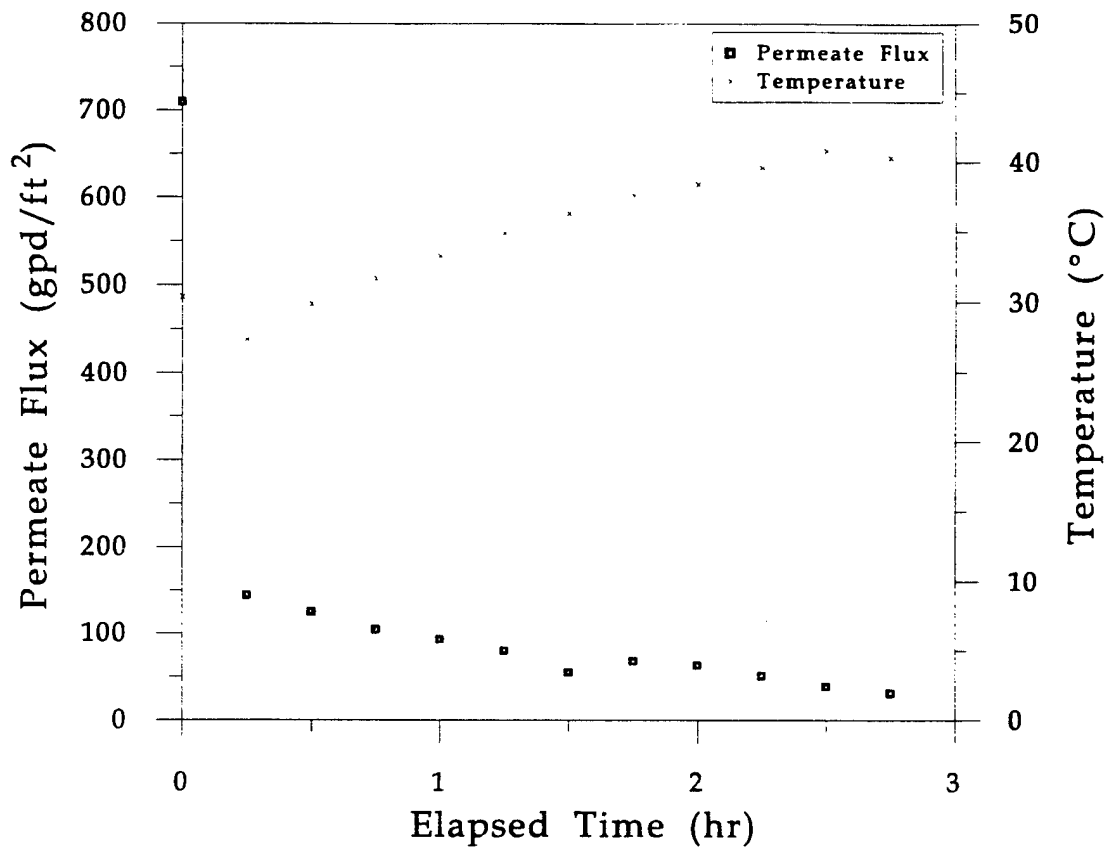

Figure 25.  
 Flux and temperature versus time for ultrafiltration run #5 (1:1000 dilution of Orimulsion<sup>®</sup> in tapwater with no clay addition using the negative membrane).

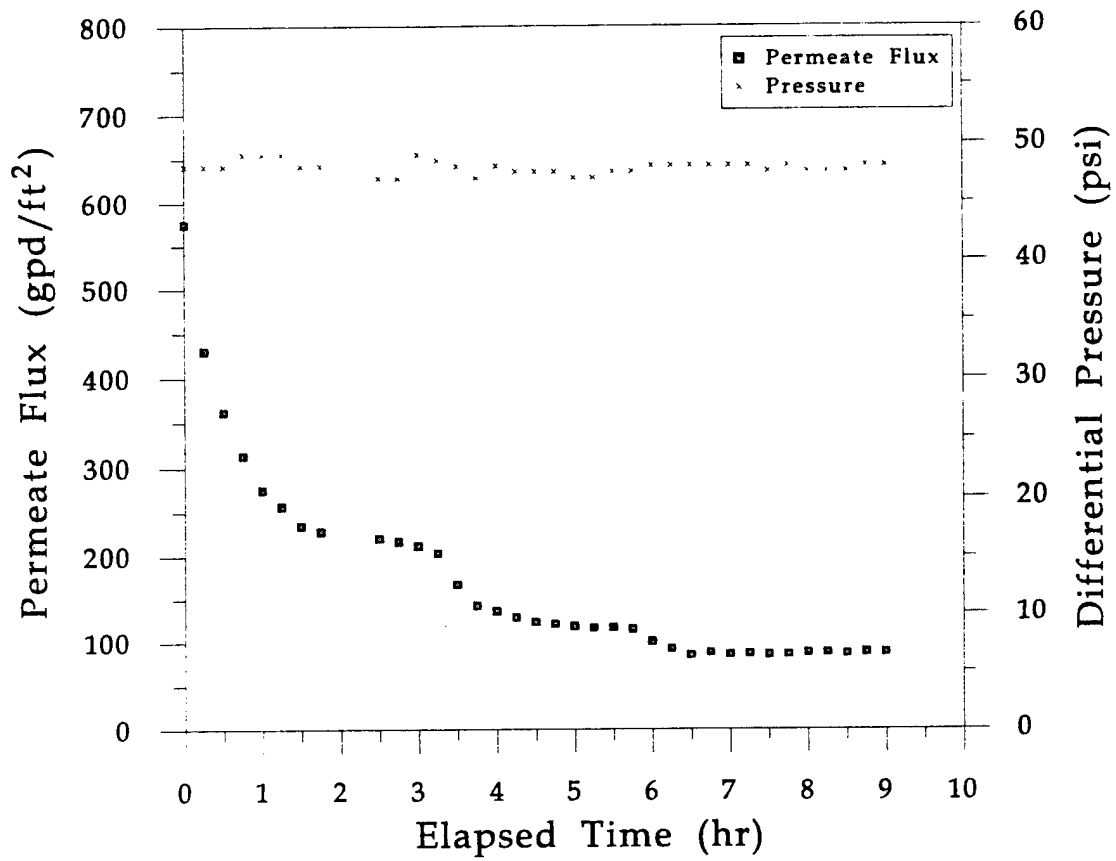

Figure 26.  
 Flux and headloss versus time for ultrafiltration run #6 (1:100 dilution of Orimulsion<sup>®</sup> in tapwater with 0.1:1 clay:Orimulsion<sup>®</sup> solids addition using the negative membrane).

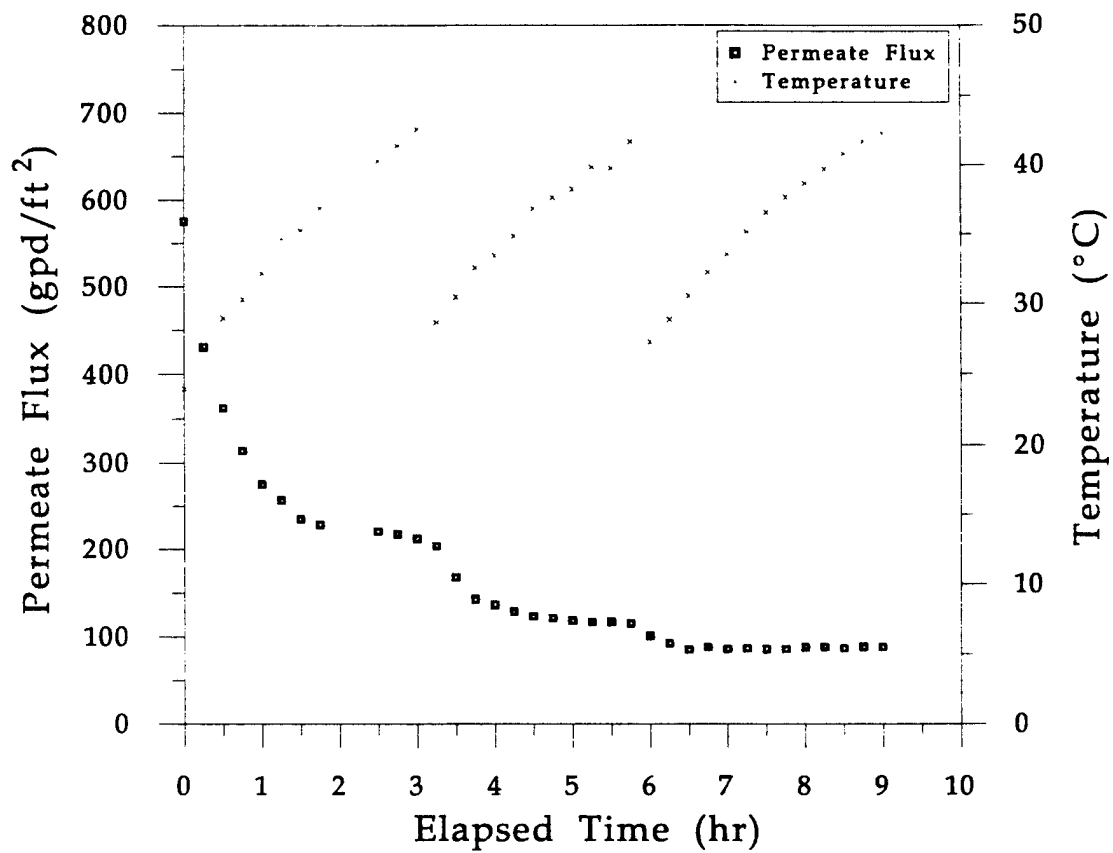

Figure 27.

Flux and temperature versus time for ultrafiltration run #6 (1:100 dilution of Orimulsion<sup>®</sup> in tapwater with 0.1:1 clay:Orimulsion<sup>®</sup> solids addition using the negative membrane).

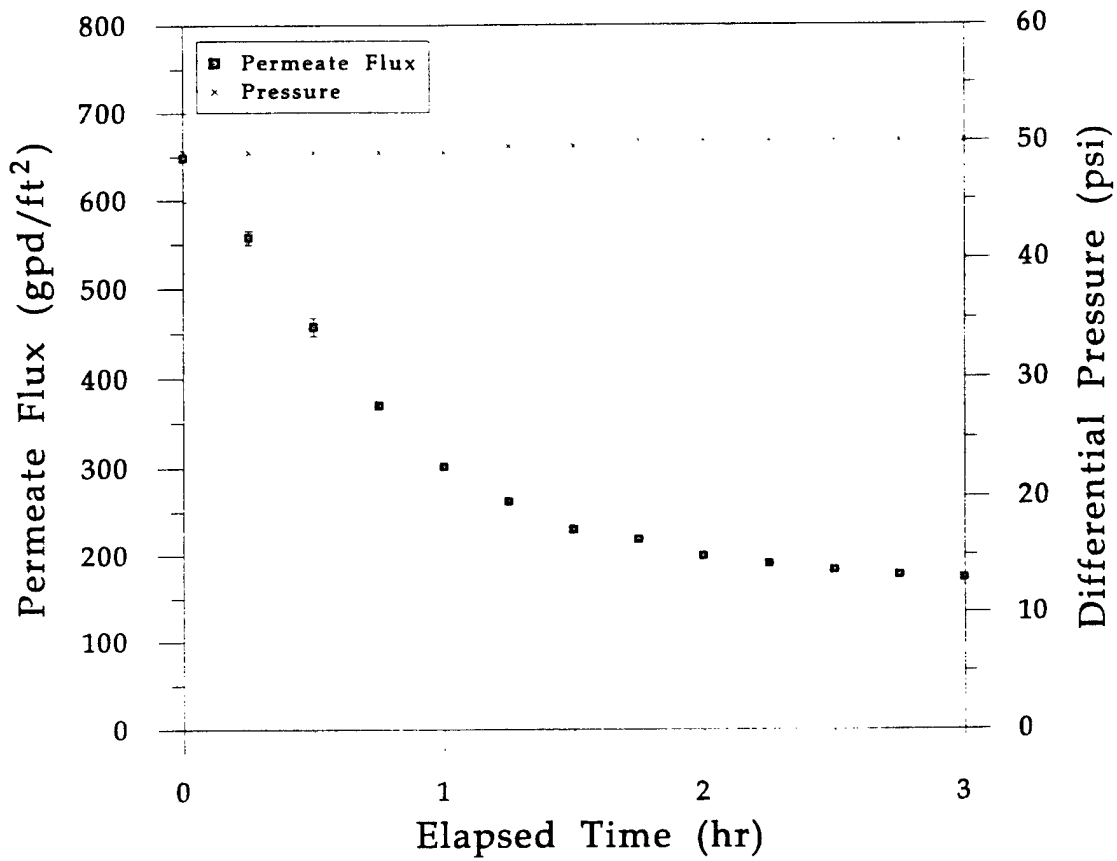

Figure 28.

Flux and headloss versus time for ultrafiltration run #7 (1:40 dilution of Orimulsion® in Biscayne Bay seawater with 0.1:1 clay:Orimulsion® solids addition using the negative membrane).

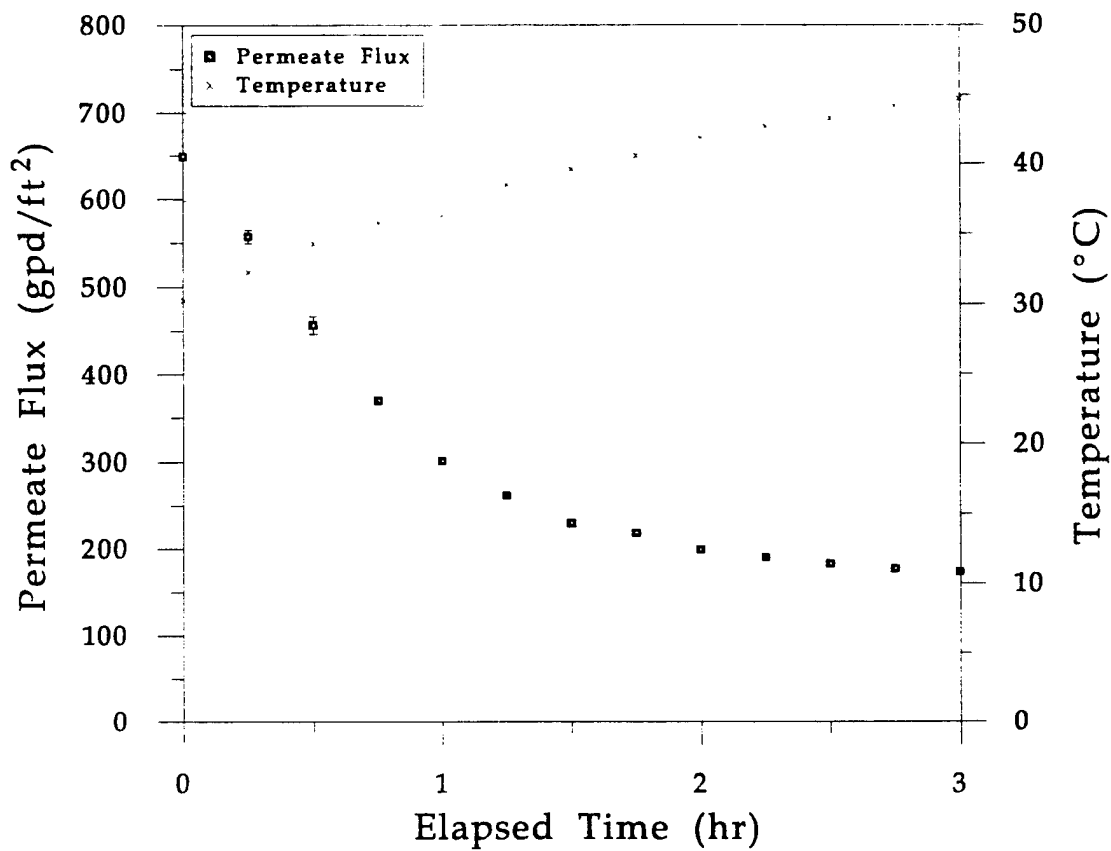

Figure 29.

Flux and temperature versus time for ultrafiltration run #7 (1:40 dilution of Orimulsion<sup>®</sup> in Biscayne Bay seawater with 0.1:1 clay:Orimulsion<sup>®</sup> solids addition using the negative membrane).

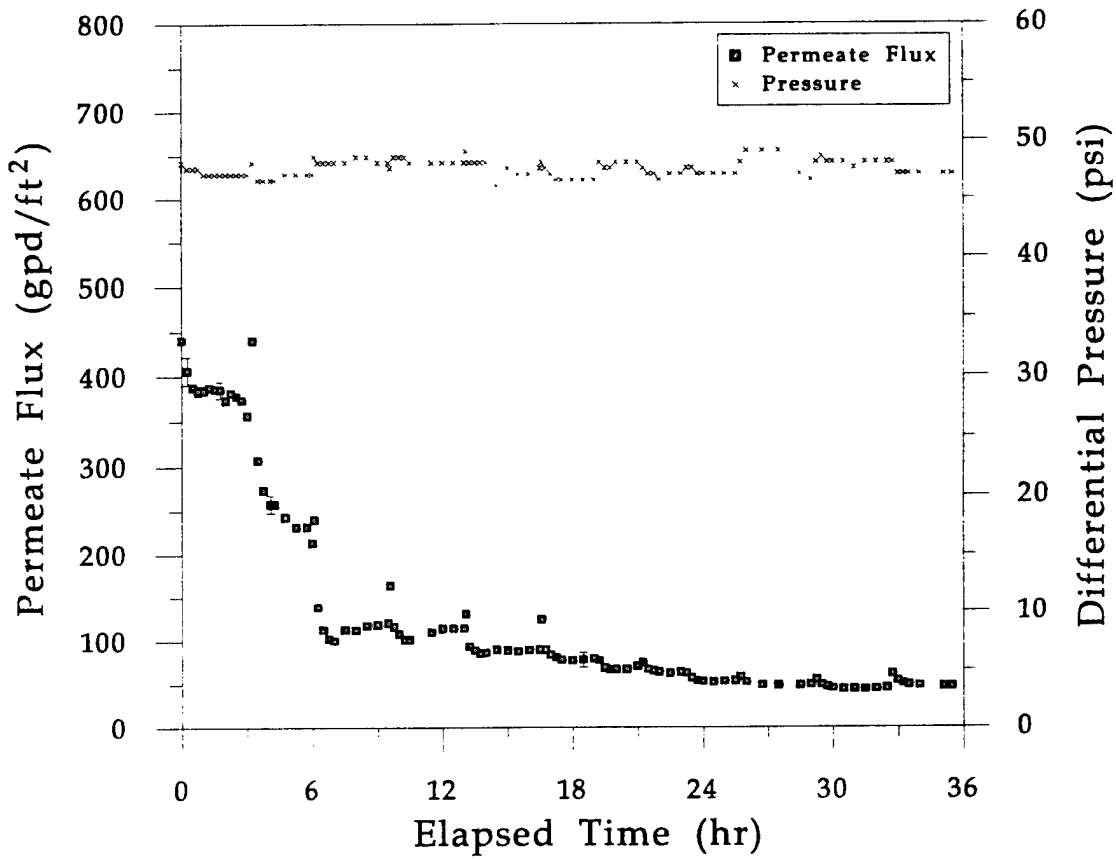

Figure 30.  
 Flux and headloss versus time for ultrafiltration run #8 (1:10 dilution of Orimulsion® in tapwater with 0.1:1 clay:Orimulsion® solids addition using the negative membrane).

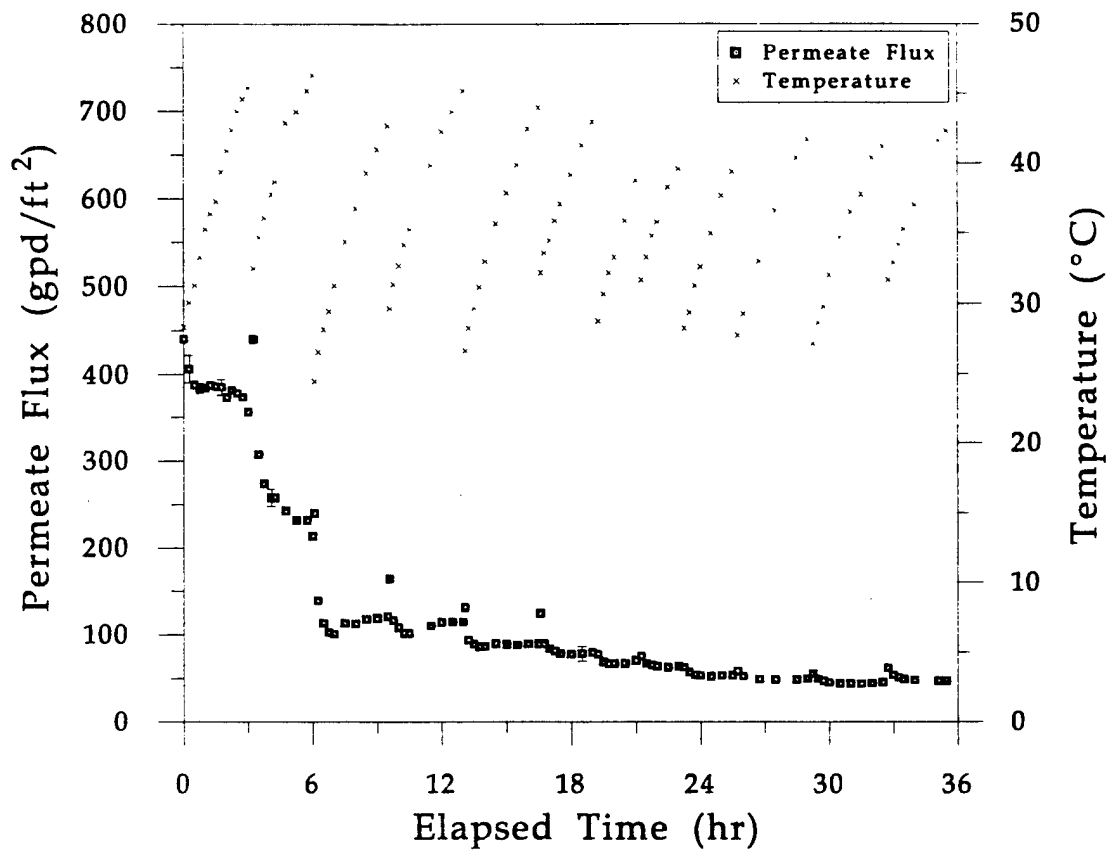

Figure 31.  
 Flux and temperature versus time for ultrafiltration run #8 (1:10 dilution of Orimulsion<sup>®</sup> in tapwater with 0.1:1 clay:Orimulsion<sup>®</sup> solids addition using the negative membrane).



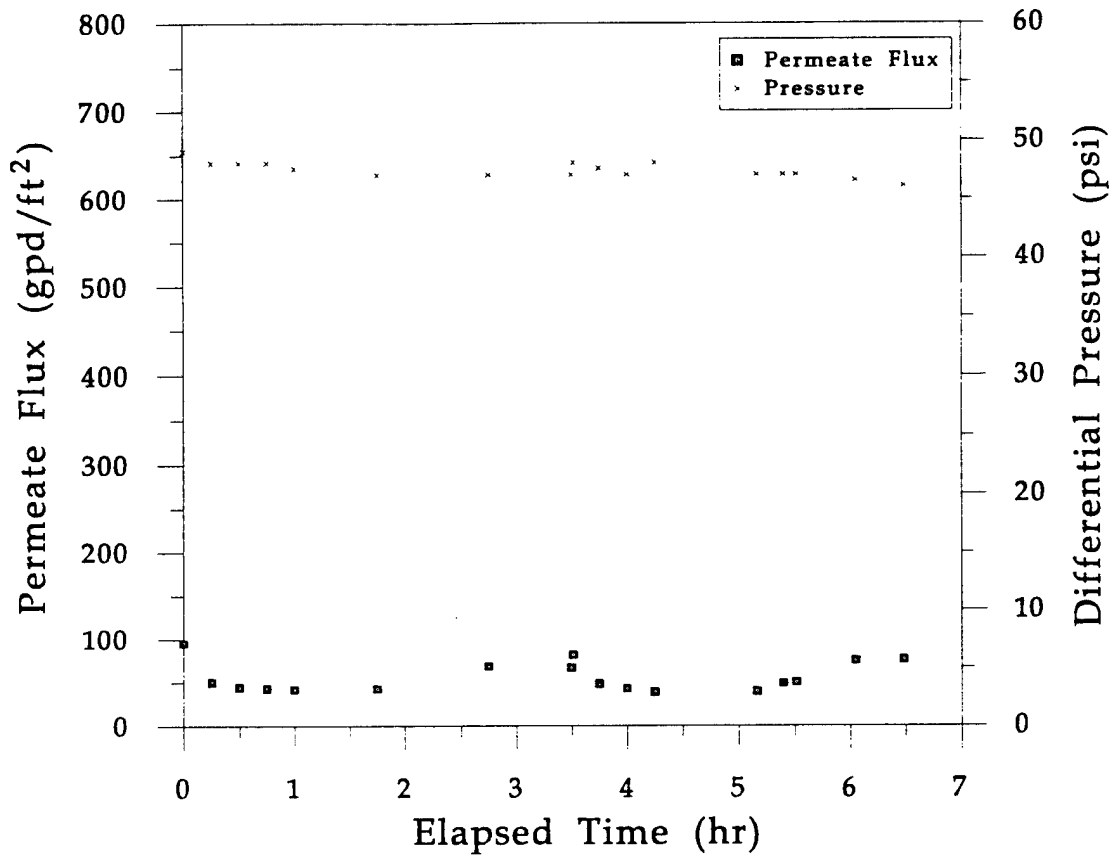

Figure 32.

Flux and headloss versus time for ultrafiltration run #9 (1:10 dilution of Orimulsion<sup>®</sup> in tapwater with 0.1:1 clay:Orimulsion<sup>®</sup> solids addition using the negative membrane in the dewatering mode).

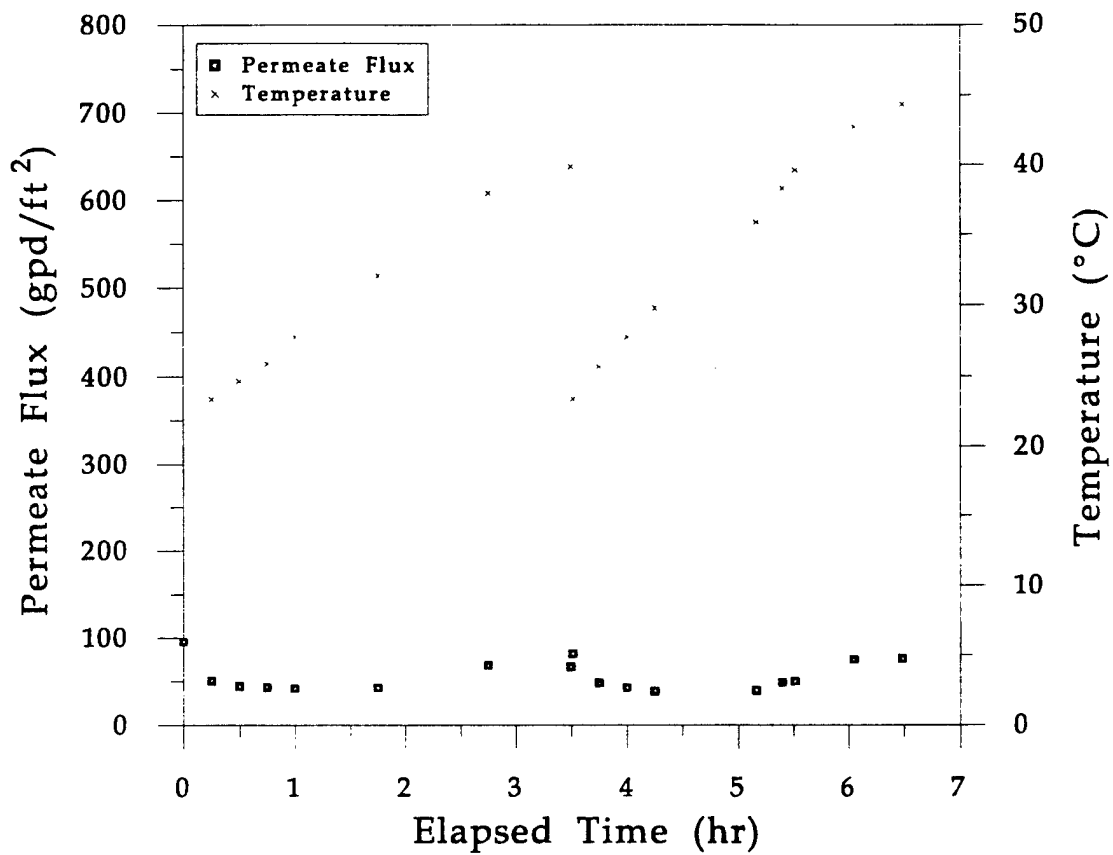

Figure 33.

Flux and temperature versus time for ultrafiltration run #9 (1:10 dilution of Orimulsion® in tapwater with 0.1:1 clay:Orimulsion® solids addition using the negative membrane in the dewatering mode).

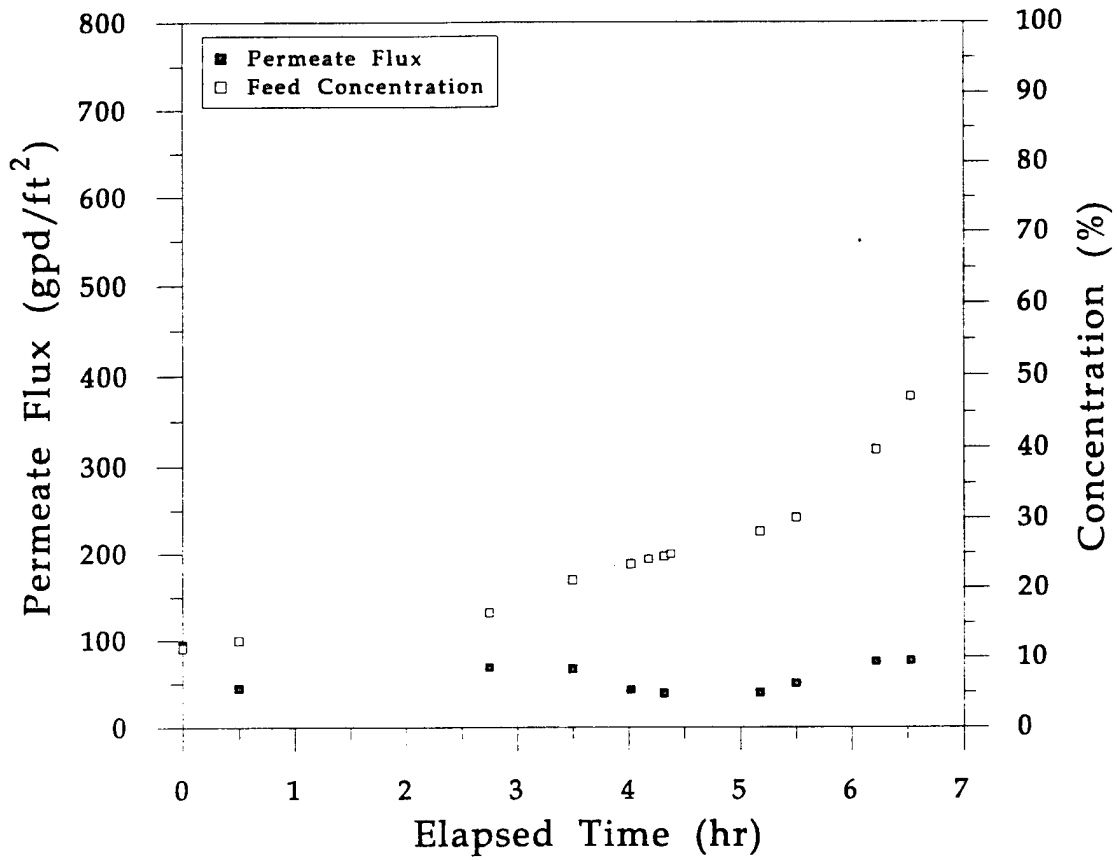

Figure 34.

Flux and retentate concentration versus time for ultrafiltration run #9 (1:10 dilution of Orimulsion® in tapwater with 0.1:1 clay:Orimulsion® solids addition using the negative membrane in the dewatering mode).

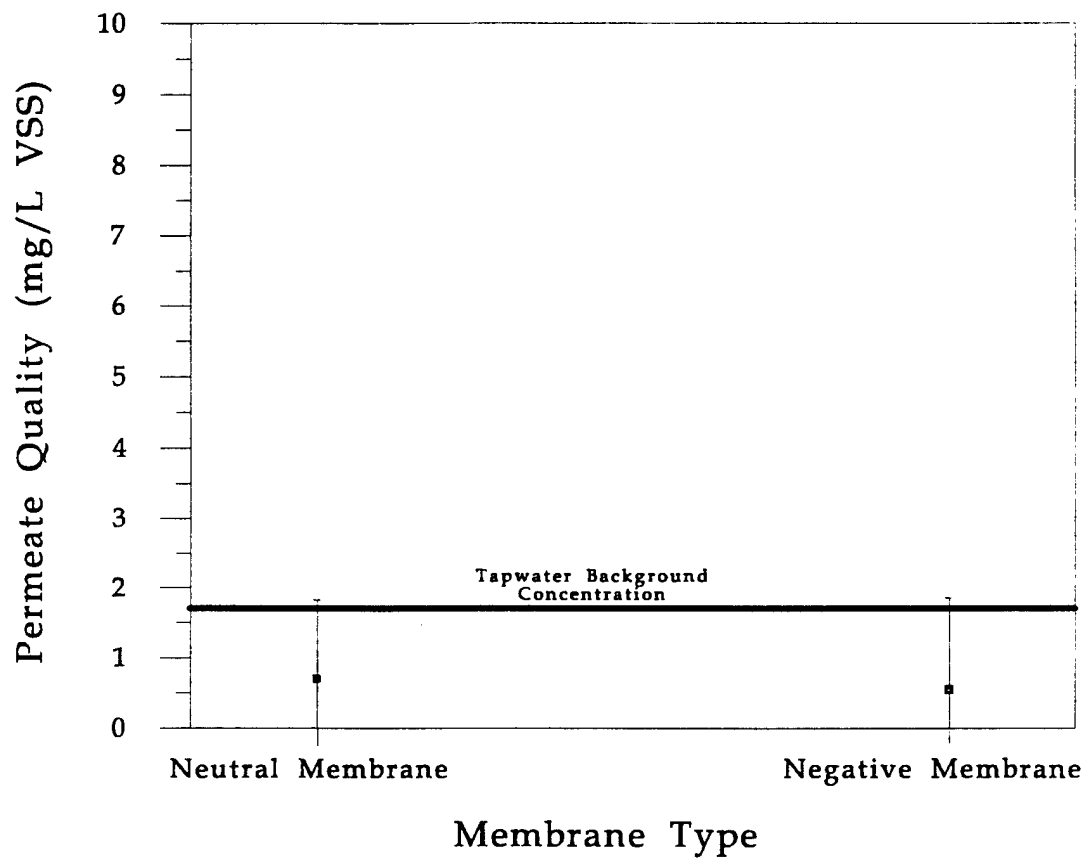

Figure 35.  
 Average permeate quality for both membranes for a 1:100 dilution of Orimulsion® in tapwater  
 with 0.1:1 clay:Orimulsion® solids addition.

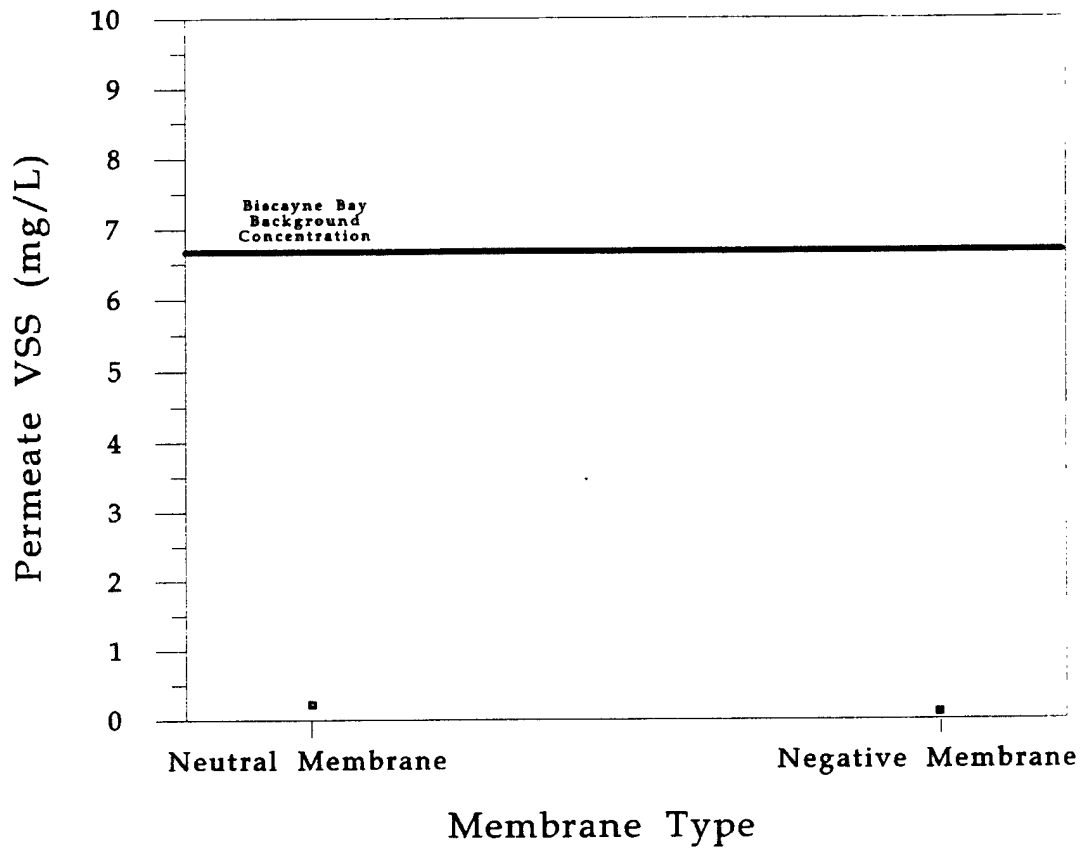

Figure 36.  
Average permeate quality for both membranes for a 1:40 dilution of Orimulsion® in Biscayne Bay seawater with 0.1:1 clay:Orimulsion® solids addition.

## DISCUSSION

Petroleum droplets and clay particles acquire negative surface charges in water by different mechanisms. Surfaces of petroleum droplets acquire negative aqueous surface charge through the adsorption of hydroxide and other anions from solution, in response to differences in electron densities of matrix surface atoms relative to atoms in the bulk matrix. Initial interface charge imbalance could result from repulsion of electrons on carbon chains into the petroleum bulk and away from strongly-held electrons of small, oxygen-dominated water molecules. In contrast, bentonite is a smectite. Smectites acquire surface charge in water primarily due to isomorphous substitution in the crystal lattice. For example,  $\text{Al}^{3+}$  may replace  $\text{Si}^{4+}$  and  $\text{Mg}^{++}$  may replace  $\text{Al}^{3+}$  in surface layers. Lattice imperfections also give rise to negative surface charge in smectites. Bentonite is reported to have a surface charge of 71 to 78 meq/100 g over the pH range 3 to 8 (Langmuir 1997). Kaolinite acquires charge by a third mechanism. Having only relatively insoluble  $\text{Al}^{3+}$  and  $\text{Si}^{4+}$  as structural cations, kaolinite acquires a relatively weak negative surface charge due primarily to broken bonds at crystal corners and edges. Kaolinite is reported to have surface charge of 1 to 5 meq/100 g over the pH range of 3 to 9 (Langmuir 1997).

Zeta potential is measured from the electrophoretic mobility of colloids in response to an electric field. According to double layer theory, a particle with surface charge in water acquires a dense layer of counterions at the surface, referred to as the Stern layer. A more less dense "diffuse layer" separates the Stern layer from the bulk solution. Particles moving in response to applied voltage move together with some ions of the diffuse layer. Accordingly, zeta potential is the potential difference between the colloid shear plane, located within the diffuse layer, and the bulk solution. The radius and corresponding voltage (zeta potential) at the shear plane depends on colloid and fluid characteristics in way that is not well understood. Therefore, zeta potential measurements are not highly reproducible (Metcalf and Eddy, Inc. 1991).

Zeta potential, in mV, was estimated from measurement of the electrophoretic mobility by the following relation (Zeta-Meter, Inc. 1992):

$$ZP = \frac{113,000EM}{D_T}, \quad (1)$$

in which ZP is zeta potential, EM is electrophoretic mobility, and  $D_T$  is the dielectric constant for the liquid (e.g., water) at the measurement temperature, T. Equation 1 is a reduction of the Smoluchowski Equation, which can be written in terms of zeta potential and electrophoretic mobility as follows:

$$ZP = \frac{4 \pi \mu_T EM}{D_T}, \quad (2)$$

in which  $\mu_T$  is the viscosity in poises at the measurement temperature, T. The Smoluchowski equation does not account for colloid size and other suspension properties.

The addition of one part bentonite and kaolinite clays to one part bitumen reduced the electrophoretic mobility and calculated zeta potential of the dilute Orimulsion<sup>®</sup> suspensions tested. Reduction may have resulted partially from increases in mass and volume of the bitumen-clay agglomerates. Addition rates of 0.1:1 clay to bitumen improved handling characteristics and filterability but did not affect zeta potential significantly. Mechanisms appear to be adhesion and sorption, in agreement with results reported for interaction of Orimulsion<sup>®</sup> with silt fractions of suspended sediment (Brown et al. 1995).

## **Diatomaceous Earth Filtration**

One problem with operation of filter plants was pressure monitoring, as the bitumen rapidly fouled pressure gauges. Proper operation is difficult without information on the pressure at filter influent and other points. The glycerin filled PVC pressure gauge protector with Teflon diaphragm cited in the description of ultrafiltration pilot test methods was found to protect pressure gauges from bitumen fouling.

A known potential operational problem with diatomaceous earth filtration is entrainment of air in the filter cake. Air pockets in the cake space destabilize the cake, allow short-circuiting, and lead to fouling of the filter septa. Throughout pilot testing, air entrainment was a problem due to the lack of air release valves in the frames of the pilot filtration unit. Despite efforts to control this effect by optimizing mixer angle and maintaining the proper volumetric level in the feed tank, air collected in the top portion of the cake space. This air space led to bitumen deposits in the filter cake near the top of the plates, resulting in resuspension of the portions of the precoat and septa fouling. This problem was thought to be associated with the pilot equipment employed. Air entrainment is expected to be controlled via air release valves in field applications.

Because the objective of the research was to ascertain feasibility of the filtration processes, pilot tests were conducted. On the basis of pilot tests, a grade of flux-calcined marine diatomite equivalent to Celite® 545 appeared to provide maximal flow rate, while retaining bitumen solids and preventing precoat bleed-through, based on burette and pilot test results. A body feed addition rate of approximately one part diatomaceous earth to one part Orimulsion® solids appeared to provide maximum cycle length before sloughing of the spent cake.



Body feed and grade are typically optimized in bench tests using a Walton filter, and this type of testing would be appropriate before design of full scale equipment. However, evidence for optimal body feed rate can be seen in Figures 7 and 9. A straight line relationship of headloss versus time to a headloss cutoff of 30 psi, on a log-log plot, was suggested by the manufacturer (Christoferson 1996) to indicate that sufficient diatomite, having a rigid, porous structure, was added to maintain a constant maximum conductivity during cake build-up, without filling the cake space prematurely. The relationship was verified as follows. Referring to Figure 37 for constant-flow precoat filtration, as for the pilot equipment used, and for a small increment of time,  $dt$ , corresponding small increments of head,  $dh$ , and filter cake depth,  $dD$ , the time derivative of Darcy's Law can be written:

$$\frac{dQ}{dt} = 0 = K A \frac{dS}{dt}, \quad (3)$$

in which  $Q$  is the flow,  $K$  is the conductivity,  $A$  is the constant cross-sectional area of flow,  $S$  is the hydraulic slope, and  $h$  is the initial hydraulic head. Then, the incremental change in hydraulic slope is:

$$dS = 0 = \frac{h + dh - h_0}{D + dD} - \frac{h - h_0}{D}. \quad (4)$$

Equation 4 integrates to the following:

$$\ln \frac{D}{D_0} = \ln(h - h_0), \quad (5)$$

For a constant flow system and constant influent composition, depth increases linearly with time. That is,  $D = kt + D_0$ , where  $k$  is the rate of increase in depth with time for given influent solids

content. Substituting for  $D$  in Equation 3 gives log of headloss linear with log time,  $t$ , with a slope of one, as follows:

$$\ln(h - h_0) = \ln t + C, \tag{6}$$

in which  $C$  is a constant. It follows that a concave relationship in Figures 7, 9, and 11 indicates that the cake space filled prematurely due to the addition of excess body feed, giving rise to a sudden increase in headloss. Too little body feed corresponds with a steep slope on the log-log plot of headloss versus time, in which the 30 psi cutoff was reached before the cake space filled.

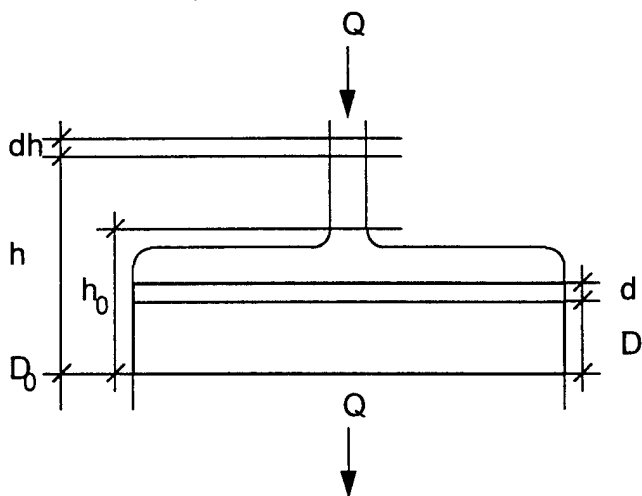

Figure 37. Definition sketch for Equation 2.

Filter septa used in the pilot plant were subject to fouling due to penetration of Orimulsion<sup>®</sup> solids where the precoat layer had been eroded near the top of the plates. Cloth septa used in early runs were found to be difficult to clean after such fouling. Subsequently, disposable paper septa were fabricated from septa paper supplied by the filter aid manufacturer. Because the 200

series paper septa allowed no detectable migration of solids, there was no need to use the tighter 100 series.

Volatile suspended solids proved a reliable indicator of Orimulsion<sup>®</sup> concentration in feeds and effluents, as can be seen in Appendix A. Solubles were not analyzed, although previous research indicated low human and ecological toxicities for Orimulsion<sup>®</sup> (Rosenstiel School of Atmospheric and Marine Sciences 1995). In general, diatomaceous earth provided two logs of removal of Orimulsion<sup>®</sup> solids for all grades. Three logs of removal were obtained with finer grades. Filtrates were observed to be slightly cloudy.

### **Ultrafiltration**

Comparison of flux for membranes having neutral and negative surface charges is shown in Figures 38 and 39 for 1:40 dilutions of Orimulsion<sup>®</sup> in tapwater and seawater, respectively, with addition of 0.1 part of clay per part of Orimulsion<sup>®</sup> solids. In general, higher initial fluxes were obtained using the negative membrane. However, after several hours of operation, flux values converged. Presumably this is due to the build-up of a bitumen surface layer on the membrane, with a permeability that dominated that of the membrane surface.

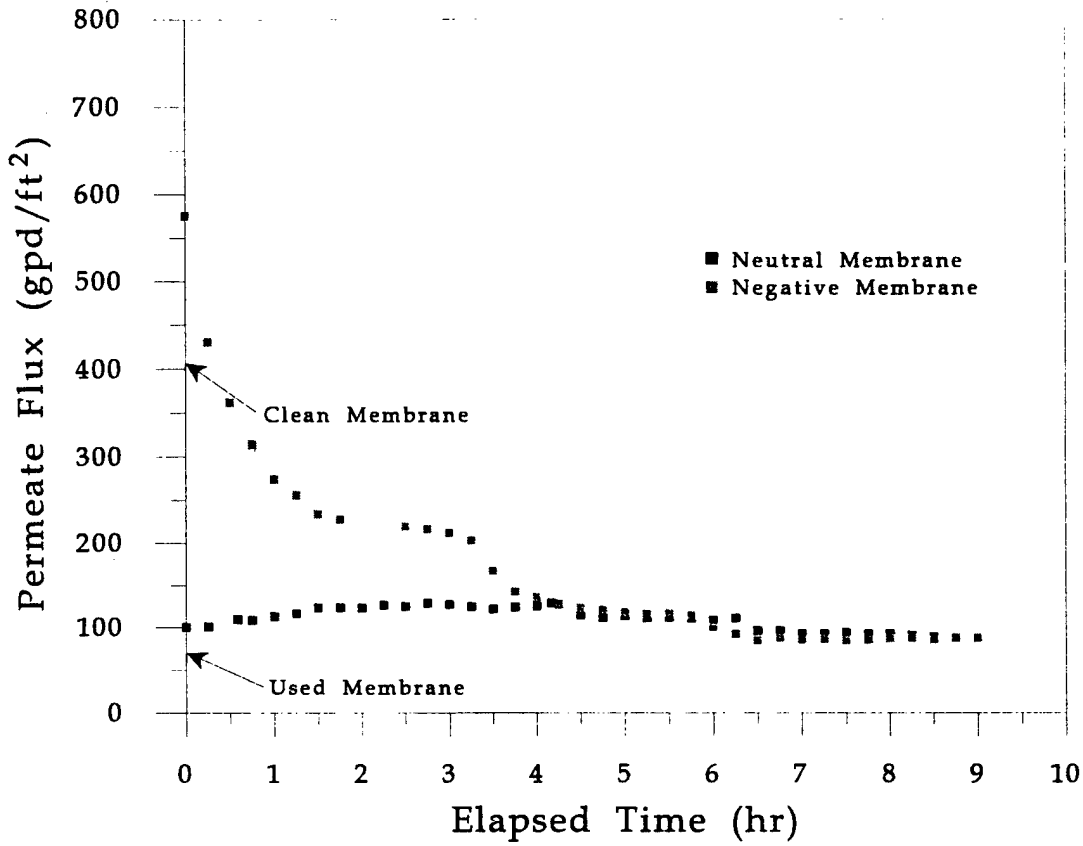

Figure 38.  
 Comparison of ultrafiltration flux for neutral and negative membranes for a 1:100 dilution of Orimulsion<sup>®</sup> in tapwater with 0.1:1 clay:Orimulsion<sup>®</sup> solids addition.

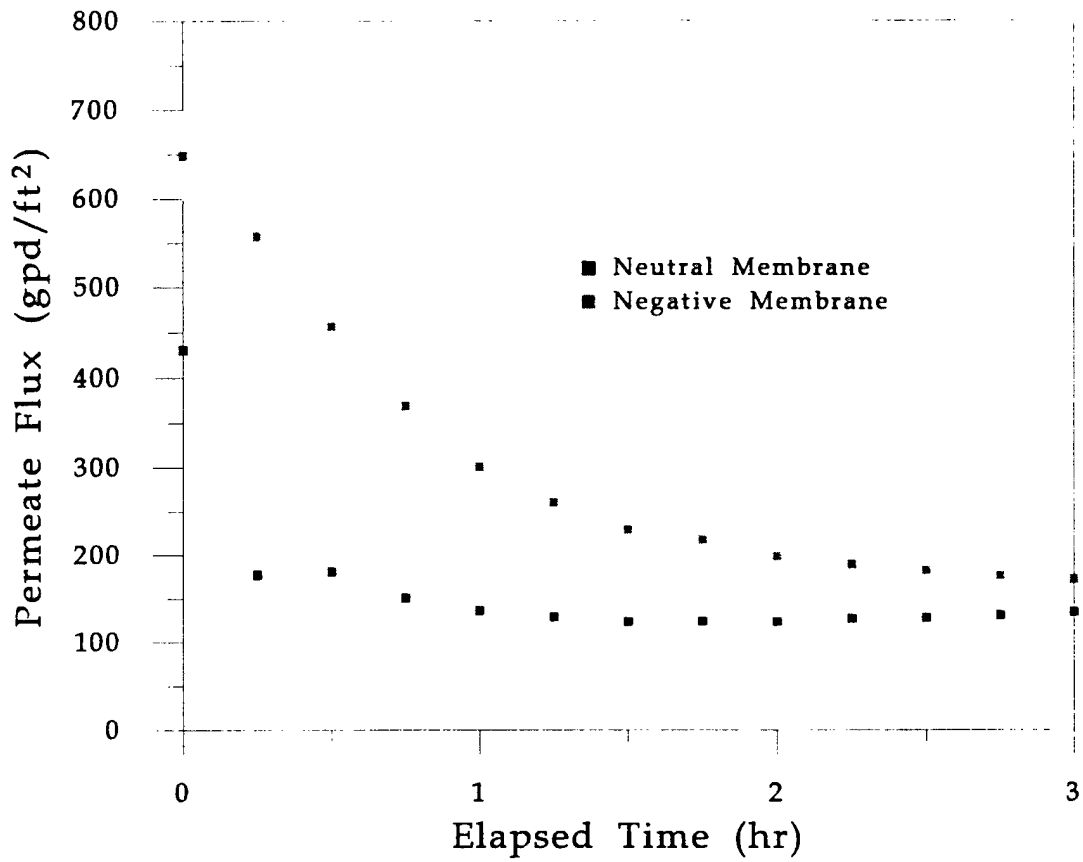

Figure 39.  
 Comparison of ultrafiltration flux for neutral and negative membranes for a 1:40 dilution of Orimulsion<sup>®</sup> in Biscayne Bay seawater with 0.1:1 clay:Orimulsion<sup>®</sup> solids addition.

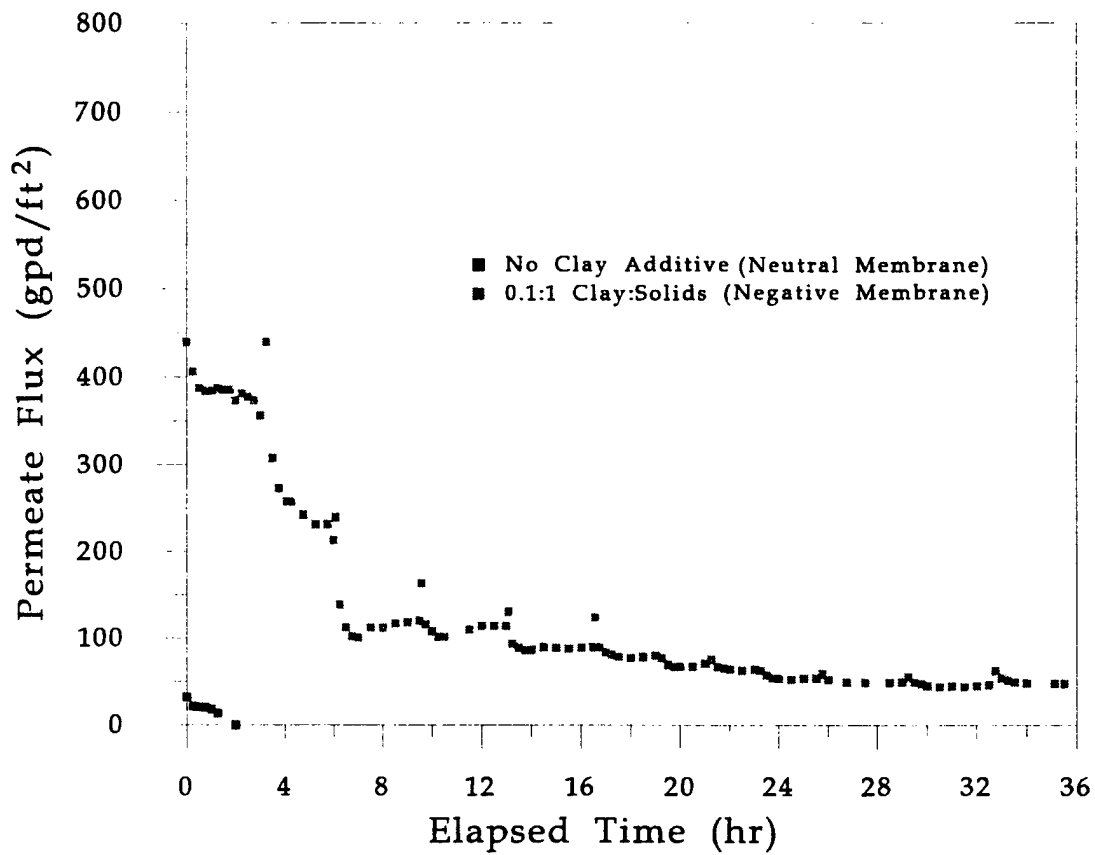

Figure 40.  
 Comparison of flux versus time for ultrafiltration with and without clay addition for a 1:10 dilution of Orimulsion<sup>®</sup> in tapwater.

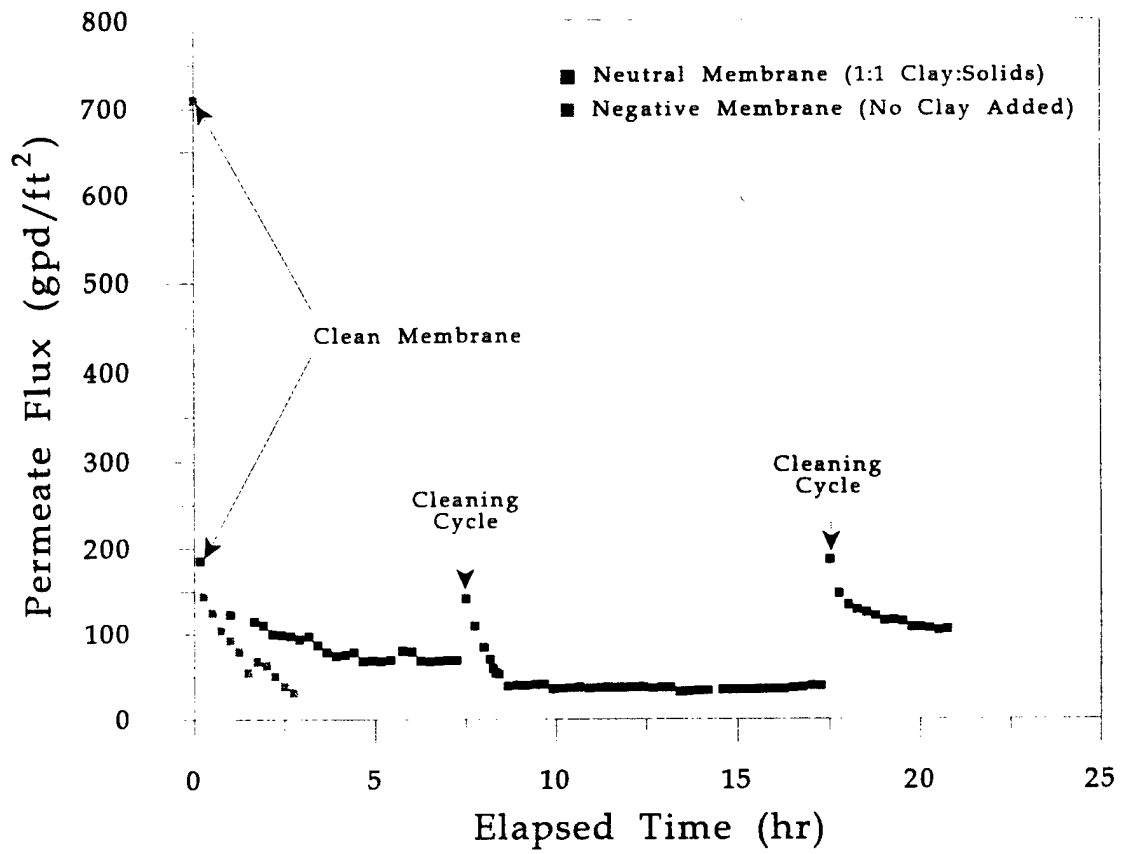

Figure 41.  
 Comparison of flux versus time for ultrafiltration with and without clay addition for a 1:1000 dilution of Orimulsion<sup>®</sup> in tapwater.

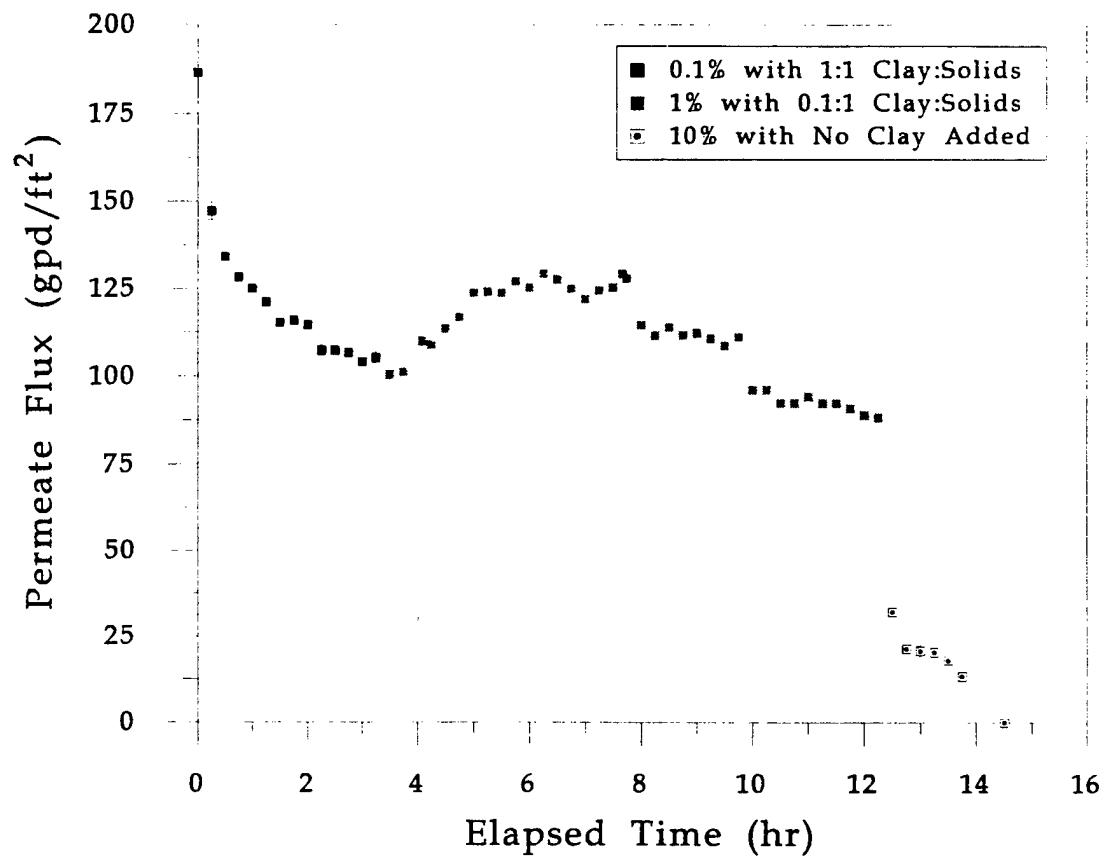

Figure 42.  
 Flux decline over various feed concentrations using the neutral membrane during cleaning cycle #3.



Results indicated that the addition of clay or other mineral filtration additive greatly improved flux, cycle length, and cleaning requirements for ultrafiltration of Orimulsion<sup>®</sup> from water. The rapid decline in flux obtained without the clay additive can be seen in Figures 40 through 42. Although comparisons shown in Figures 40 and 41 are for different membranes, it should be noted that fluxes for the two membranes were not significantly different in other tests after three to four hours. Figure 40 indicates membrane blinding after 2 hours. Rapid flux decline starting from a clean membrane without the clay additive shown in Figure 41 is more significant considering that flux for the negative membrane was otherwise high in comparison with the neutral membrane, whereas in the figures it is much lower. Destabilized Orimulsion<sup>®</sup> suspensions can most likely be removed from water via ultrafiltration without the use of mineral additives, especially from dilute suspensions. However, membrane throughput would be an order of magnitude smaller due to reduced flux and increased cleaning requirements. Cleaning would require the use of sponge balls. Throughput could be increased by replacing membranes after every cycle. The cost of membranes used in this study was approximately \$400 per square foot. At a flux of 40 gpd for three hours, the cost would be on the order of \$80/gal. of water treated if membranes were disposed. This cost would likely be three orders of magnitude higher than for diatomaceous earth filtration, not considering disposal of sludges.

Values for  $k$  given in Table 7 indicate the rate of membrane fouling. Rates were high for sessions conducted without the addition of clay. Such slopes are not generally comparable between ultrafiltration experiments, except where operating conditions are close. Cleaning history, temperature, and influent composition affect such values.

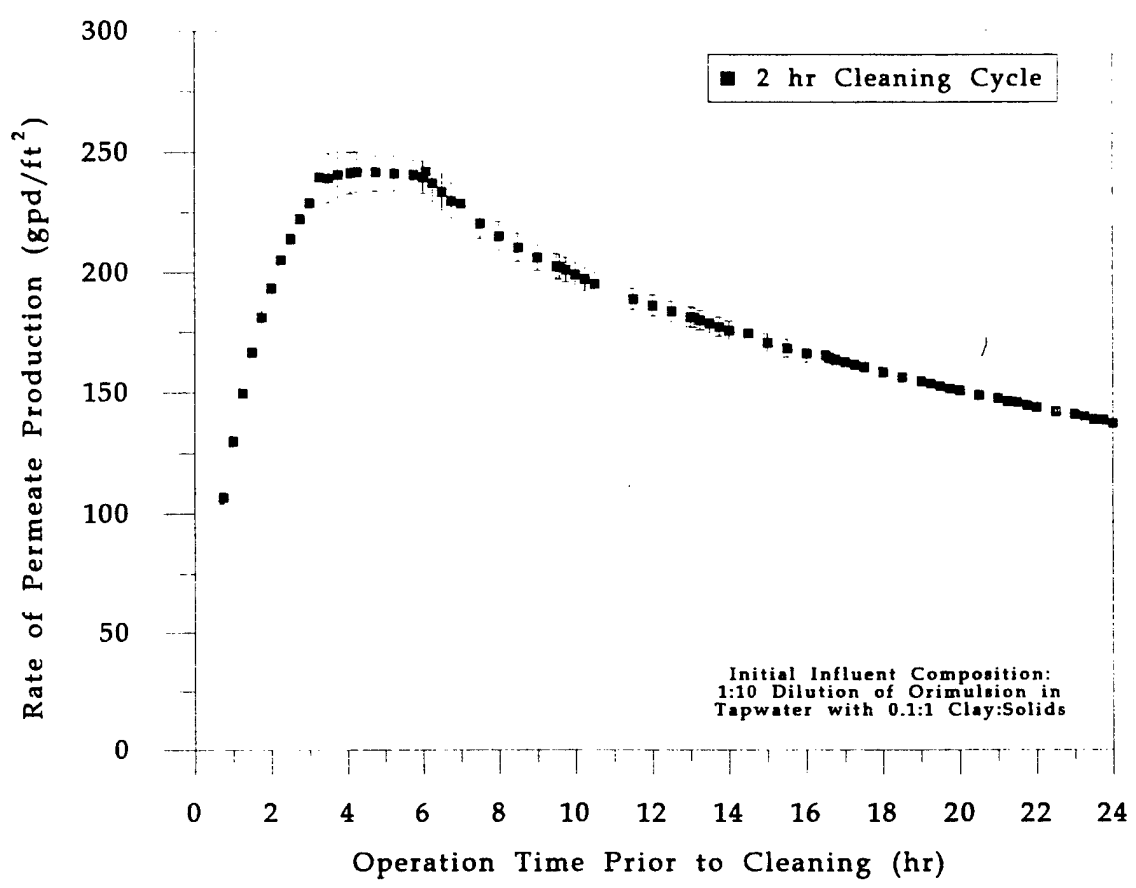

Figure 43.

Rate of permeate production versus filtration cycle length for ultrafiltration run #8 (1:10 dilution of Orimulsion<sup>®</sup> in tapwater with 0.1:1 clay:Orimulsion<sup>®</sup> solids addition using the negative membrane)

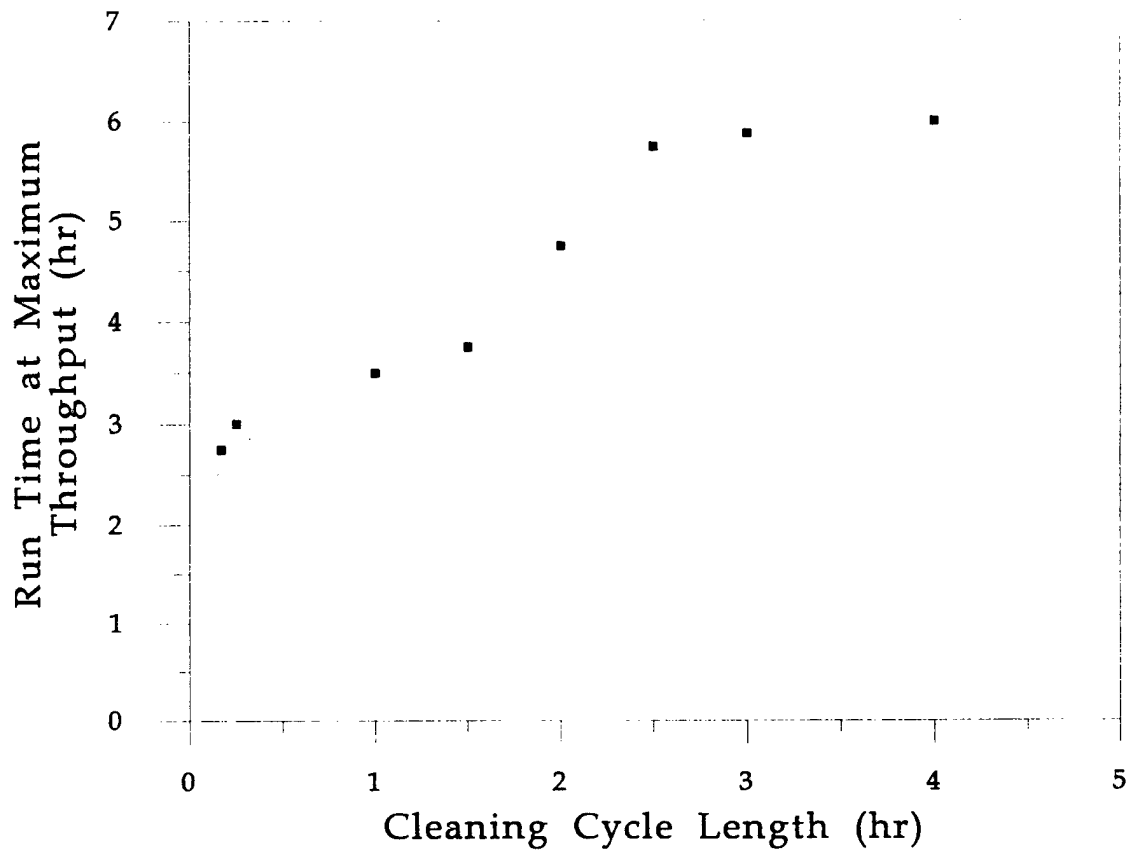

Figure 44.  
Run time at maximum throughput versus cleaning cycle length for ultrafiltration run #8 (1:10 dilution of Orimulsion® in tapwater with 0.1:1 clay:Orimulsion® solids addition using the negative membrane)

Results of a simple optimization to evaluate optimal cleaning cycle length in field applications, using long-term dewatering data of Run 9, are shown in Figures 43 and 44. The tradeoff considered so as to maximize total throughput was filtration cycle length (time to cleaning) versus clean membrane flux increase. The overall rate of permeate production considering cleaning time, for various filtration cycle lengths, was calculated using the flux versus time relationship of Figures 34 and 35, according to:

$$R = \frac{1}{t + \tau / 24} \int_0^t F dt, \quad (7)$$

in which R is the net rate of permeate production in  $\text{gpd}/\text{ft}^2$ , F is the flux ( $\text{gpd}/\text{ft}^2$ ) at time t in days, and  $\tau$  is cleaning time in hours. This rate is shown in Figure 43 as a function of time to cleaning, for a conservative two hour cleaning cycle. Error bars indicate two-sigma intervals around the means of R for the two flux measurements taken at each time. The cycle time corresponding to maximum total throughput for cleaning times from zero to four hours is plotted versus cleaning time in Figure 44. Optimal filtration cycle length varied from two to six hours for cleaning times from zero to four hours. Cleaning cycles could be automated. Other factors to consider in determining operating procedures include quantity and quality of residuals produced in the cleaning process, training and safety of operators, and labor costs, given the level of equipment automation.

## CONCLUSIONS AND RECOMMENDATIONS

Pilot tests indicated that both diatomaceous earth filtration and ultrafiltration are effective unit processes for the removal of Orimulsion<sup>®</sup> from water. With ultrafiltration, it was found beneficial to add approximately one part by weight of clay to the destabilized, diluted suspension, to enhance membrane cleaning, reduce system fouling, and reduce operating costs associated with membrane replacement and system cleaning. Ultrafiltration permeate quality was higher than the original dilution water in terms of volatile suspended solids. With adequate recirculation and addition of clay, a retentate concentration of at least 47% bitumen solids was able to be obtained. Ultrafiltration was more effective than diatomaceous earth filtration for concentrating suspensions of Orimulsion<sup>®</sup> in excess of 10%, because the diatomite slurry became too thick to reasonably handle and filter.

Diatomaceous earth precoat filtration was found to be most effective for rapid removal of small amounts of bitumen from large volumes of water. Although the addition of diatomite may approximately double the mass of sludge requiring disposal, this mass is likely to be orders of magnitude smaller than the mass of water and bitumen obtained from ultrafiltration of a 1:1000 bitumen-water suspension recovered following a spill of Orimulsion<sup>®</sup>, even in a confined water body. Two logs of Orimulsion<sup>®</sup> removal was indicated for coarse flux-calcined marine diatomite, and three logs of removal was obtained for finer flux-calcined grades. Grades calcined without flux and grades not calcined would provide even higher removal if necessary, at a corresponding reductions in flow rate. No attempt was made to analyze filtrates for solubles. However, previous research has indicated a low level of health toxicity associated with Orimulsion<sup>®</sup> (Rosenstiel School of Marine and Atmospheric Science 1995).

The use of clay as a filtration aid would potentially permit the use of membrane configurations other than the one inch diameter tubular cartridge tested. Other configurations would allow more membrane surface area in a given equipment space, making space requirements for the two filtration processes comparable for a given overall time required to filter a fixed volume.

Residuals generated by the two processes differ somewhat. Ultrafiltration is likely to generate a larger volume of more dilute bitumen, with a small amount of clay. Concentrations will depend on influent concentrations and recirculation rates. Clay is not abrasive, and the sludge would be incinerable at a power plant equipped to burn Orimulsion®. Energy recovery would not be likely, due to the potentially high water content. Diatomaceous earth filtration sludge would contain on the order of 50% solids, with approximately 50% of those solids comprising diatomaceous earth. Diatomite is abrasive to steel equipment. However, the sludge would be incinerable and would have the potential for energy recovery due to higher concentration and lower water content.

Facilities and equipment needed in the case of a spill of Orimulsion® into marine and surface waters would vary considerably depending on location and circumstances. Environmental protection will depend primarily on response time, as recovery of spilled material and of contaminated wildlife will be limited by the adhesive nature of the bitumen and dispersal of the emulsion. If Orimulsion® is approved for use at power plants, offloading, onloading, and storage facilities should be equipped with retention basins and pumps for removing water from the port or nearby surface waters rapidly. Design of filtration equipment to separate the Orimulsion® would then not have high flux as a primary constraint, and process design would be influenced by the potential for recovery and disposal of residuals. If Orimulsion® is to be transported overland or by pipeline in the vicinity of surface and marine waters, portable equipment should be developed and maintained for emergency response. Filtration equipment

would need to be skid-mounted or otherwise mobile and rapidly deployable. Either process investigated in this study could be barge or skid mounted. Required flux would be as high as possible, and automated operation would be required to allow continuous operation for the cleanup period. Design considerations could be modified where water could be pumped rapidly into barges or portable tank equipment. For example, portable tanks from 2000 to 20,000 gallons in volume are available from several manufacturers.

In the event that Orimulsion<sup>®</sup> is considered or approved for use in electric power plants in the U.S., the following research is recommended to be based on characteristics of potential spill scenarios:

1. Conceptual design of mobile equipment and facilities to handle potential spills in port and inland locations,
2. Process selection, design, and optimization of standing equipment for use at offloading, onloading, and storage facilities,
3. Pilot tests of alternate precoat filter designs, including continuous-cycle configurations, depending on intended application and conceptual design,
4. Pilot tests of tubular and spiral wound UF cartridges for removal of Orimulsion<sup>®</sup> from water with addition of 0.1 part clay to one part bitumen, and
5. Bench tests to optimize body feed rates for diatomaceous earth precoat filtration of Orimulsion<sup>®</sup> from water.

The economics of emulsified bitumen fuels appear to represent a strong driving force for adoption at some locations in the foreseeable future. If that is the case, development of cleanup measures that can be implemented rapidly are vitally important. Bitumen cleanup would be extremely difficult, and recovery of water bodies will depend primarily on response time. Significant recovery of spilled Orimulsion<sup>®</sup> in confined port environments appears more feasible

than in open water. Measures to contain the dispersal of spills are needed, and it is likely that equipment will be needed to pump large volumes of water to retention basins quickly. The filtration processes investigated in this project appear effective for use in such scenarios. It is hoped that the work presented in this report will contribute to the protection of U.S. waters.



## REFERENCES

- Alcoa Separations: Technology Division (1987). "Cleaning by chemicals." Internal Report, March 1987. pp. 1-8.
- Alcoa Separations: Technology Division (1989). "Petrolox™ separation systems." Bulletin No. APU-089, APS-089. Warrendale, PA. pp. 1-5.
- American Water Works Association (1985). "Precoat filtration: First edition." *AWWA Manual M30*. Prepared by the Precoat Filtration Subcommittee of the Coagulation and Filtration Committee: R.W. McIndoe, G.S. Logsdon, J.L. Ris, and A. Wirsig. pp. 1-37.
- American Water Works Association (1990). *Water quality and treatment: A handbook of community water supplies: Fourth edition*. McGraw-Hill, Inc.: Washington D.C. pp. 40-989.
- Bitor America (1993a). "The Orimulsion® power system." Bitor America Corporation, 5100 Town Center, Suite 450, Boca Raton, FL 33486.
- Bitor America (1993b). "Orimulsion® spill and toxicity studies." Internal publication.
- BP Bitor (1992). "Chapter Six: Spills." In *Orimulsion®: Design and operations manual*. Technical report, BP Bitor, July 1992. pp. 1-23.
- Brown, J.W. (1995). "Summary of general observations from COSAP chemical and physical fates experiments." Division of Applied Marine Physics, Rosenstiel School of Marine & Atmospheric Science, University of Miami.
- Brown, J.W., H.R. Fuentes, R. Jaffe, and V.A. Tsihrintzis (1995). "Chapter 4: Comparative evaluation of physical and chemical fate processes of orimulsion and fuel oil #6 in the Tampa Bay marine environment." Division of Applied Marine Physics, Rosenstiel School of Marine & Atmospheric Science, University of Miami and Drinking Water Research Center, Florida International University.

- Caetano, A., M.N. DePinho, E. Drioli, and H. Muntau, editors (1995). *Membrane treatment technology: Application to industrial wastewater treatment. Environmental Science and Technology Volume 1*. Kluwer Academic Publishers: Boston, MA. pp.25-62.
- Calvert, R. (1930). *Diatomaceous earth*. American Chemical Society Monograph Series. Celite Company Research Laboratory, Lompoc, CA. The Chemical Catalog Company, Inc.: New York. pp. 15-237.
- Celite Corporation (1995). *Celite filter aids for maximum clarity at lowest cost*. Lompoc, CA. pp 1-27.
- Cheremisinoff, N.P. and P.N. Cheremisinoff (1993). *Filtration equipment for wastewater treatment*. Prentice Hall: Englewood Cliffs, NJ. pp.69-237.
- Cheremisinoff, P.N. (1992). *Handbook of water and wastewater treatment technology*. Marcel Dekker, Inc.: New York. pp.116-518.
- Cheryan, M. (1986). *Ultrafiltration handbook*. Technomic Publishing: Lancaster, PA. pp.1-375.
- Chin, D.A., J.D. Wang, and J. Garimella (1995). "Fate and transport of orimulsion and fuel oil no.6 in Tampa Bay." Technical Report No. CEN-95-2. Department of Civil and Architechtrual Engineering, University of Miami, FL.
- Colbert, J.C., editor (1981). "Foam and emulsion control agents and processes: Recent developments." *Chemical Technology review No. 188*. Noyes Data Corporation: Park Ridge, NJ. pp. 1-419.
- Craige, S.F. (1990). "Orimulsion spill test at Oil Spill Service Centre, Southampton." Branch report CSB/191 Record No. 2:0 549-A. BP Sunburry Research Centre. pp. 1-5.

- Dal-Cin, M.M., C.N. Lick, T.A. Tweddle, F. McLellan, and P. Ramamurthy (1995). "Membrane performance with plug screw feeder pressate: Operating conditions and membrane interactions." National Research Council of Canada, Ottawa, Canada. In *Preprints of the 1995 Topical Conference: Recent Developments and Future Opportunities in Separations Technologies: Volume 1*. November 12-17 1995. Miami Beach, FL. American Institute of Chemical Engineers: New York. pp. 496-501.
- Das, B.M. (1985). *Principles of geotechnical engineering*. PWS Engineering Publishers: Boston, MA. pp. 7-15.
- East, J. (Perspective Editor) (1996). "Guinea pigs for Venezuelan tar." *St. Pete Times*. April 21 1996. pp. 1D-6D.
- Enervac Corporation (1995). "Mobile membrane separator." October 1995. Bulletin No. 4-42-000/4-42-001. pp. 1-4.
- Fleischer, A. (1984). "Separation of oily wastewaters: The state of the art." Presented at Annual Technical Conference of the Canadian Institute of Marine Engineers, MARI-TECH 84, Ottawa, Ontario, Canada. May 25 1984. pp. 1-11.
- Freeman, W.C. (1991). "Technical memorandum on membrane filtration processes." In *Technical Memorandums on Selected Topics in Water Treatment*. Prepared by Allen, et.al. Department of Civil Engineering, University of California, Davis, CA. pp. 91-113.
- Harris, L.R., D.F. Jackson, and P. Schatzberg (1976). "Oily bilge water treatment with a tubular ultrafiltration system." In *Transaction of the American Society of Mechanical Engineers, Journal of Engineering for Industry*. Presented at The Intersociety Conference on Environmental Systems, San Diego, CA, July 12-15 1976. Paper No. 76-ENAs-20. pp. 1-6.

- Harwell, M.A., J.S. Ault, and J.H. Gentile (1995). "Comparative ecological risk assessment volume 1: Comparison of the ecological risks to the Tampa Bay ecosystem from spills of fuel oil #6 and orimulsion." *Final Report, Center for Marine and Environmental Analyses, Rosenstiel School of Marine and Atmospheric Science, University of Miami.* pp.1-177.
- Ho, W.S.W. and K.K. Sirkar, eds. (1992). *Membrane handbook.* Van Nostrand Reinhold: New York. pp.1-936.
- Intevp, S.A. (1993). "Orimulsion<sup>®</sup> summary of environmental studies." Research and Technological Support Center Document for Bitor, S.A. pp.1-28.
- Klinkowski, P.R. (1978). "Ultrafiltration: An emerging unit operation." *Chemical Engineering.* Vol. 85, Pt. 2, No. 11. May 8 1978. pp. 165-173.
- Kuriyel, R. and K. Lachendro (1995). "Factors affecting the performance of cell lysate clarifaication by cross flow filtration." Millipore Corporation, Bedford, MA. In *Preprints of the 1995 Topical Conference: Recent Developments and Future Opportunities in Separations Technologies: Volume 1.* November 12-17 1995. Miami Beach, FL. American Institute of Chemical Engineers: New York. pp. 452-455.
- Lambert, P. (1996). Personal Communication. Technical Consultant, Koch<sup>®</sup> Membrane Systems, Inc. July 11.
- Langmuir, D. (1997) *Aqueous Environmental Geochemistry,* Prentice Hall, Inc., Upper Saddle River, NJ.
- Lange, K.P. (1982). "Laboratory exercise: Diatomaceous earth filtration for CE541: Unit processes of environmental engineering." Department of Civil Engineering. Colorado State University. March 31 1982.
- Makansi, J. (1991). "New fuel could find niche between oil, coal." *Power.* Vol. 135 No. 12. December 1991. pp. 51-56.

- McGowan, F. (1990). "The development of Orimulsion and Venezuelan oil strategy." *Energy Policy*. Vol. 18 No. 10. December 1990. pp. 913-926.
- Metcalf and Eddy, Inc. (1991) *Wastewater Engineering: Treatment, Disposal, and Reuse*, Third Edition, McGraw-Hill Publishing Company, New York, p.311.
- Moes, H. (1986). "Special report: Biotechnology/technology update: Tangential flow membrane filtration in biotechnology separations." *Chemical Processing*. February 1986.
- Mulder, M. (1991). *Basic principles of membrane technology*. Kluwer Academic Publishers: Boston, MA. pp. 1-357.
- Oil Spill Service Centre (1989). "A report on a study to determine treatment options following spillage of Orimulsion into marine and freshwater environments." OSSC, Southampton. pp. 1-12.
- Osmonics<sup>®</sup>, Inc. (1991). *Pure water handbook*. Osmonics<sup>®</sup> Corporate Librarian: Minnetonka, MN. pp.1-189.
- Priest, W. BSc (1978). "Ultrafiltration treatment of waste oil emulsions." *Wire Industry*. Vol.45, No.530. February 1978. pp. 106-107.
- Rosenstiel School of Marine and Atmospheric Science Press Release (1995). "Orimulsion<sup>®</sup> comparable to risks from fuel oil in Tampa Bay, study by marine research team shows." RSMAS Contact: Kurt Heinonen. Internet press release. July 24 1995.
- Sawyer, C.N., P.L. McCarty, and G.F. Parkin (1994). *Chemistry for environmental engineering: Fourth edition*. McGraw Hill, Inc.: New York. pp. 335-339.
- Schatzberg, P., L.R. Harris, C.M. Adema, D.F. Jackson, and C.M. Kelly (1975). "Oil-water separation with noncellulosic ultrafiltration membranes." Reprinted from *Proceedings 1975 Conference on Prevention & Control of Oil Pollution*. San Francisco, CA. March 25-27 1975. Naval Ship Research and Development Center, Annapolis, MD. pp. 443-447.

- Simpson, C., C. Winter, R. Hart, J. Kaspari, R. Fahrner, L. Kline, S. Builder, and R. van Reis (1995). "Improvement of microfiltration membrane capacity through flocculation of CHO cell debris using cationic flocculants." Department of Recovery Sciences, Genetech, Inc., South San Francisco, CA. In *Preprints of the 1995 Topical Conference: Recent Developments and Future Opportunities in Separations Technologies: Volume 1*. November 12-17 1995. Miami Beach, FL. American Institute of Chemical Engineers: New York. pp. 450-451.
- Sirkar, K.K. (1995). "Membrane separation technologies: Current development and future opportunities." New Jersey Institute of Technology, Newark, NJ. In *Preprints of the 1995 Topical Conference: Recent Developments and Future Opportunities in Separations Technologies: Volume 1*. November 12-17 1995. Miami Beach, FL. American Institute of Chemical Engineers: New York. pp. 26-32.
- S. L. Ross Environmental Research Limited (1987). "Behaviour and control of spills of orimulsion™." Ottawa, Ontario, Canada. pp. 29-67.
- Sommerville, M. (1994). "Observations of the behaviour of orimulsion released into the sea." CR 3361 (MPBM). Unpublished Internal Report from Warren Spring Laboratory BP Research Division, Hertfordshire, Great Britain. pp. 1-7.
- Stumm, W. and J.J. Morgan (1996). *Aquatic chemistry: Chemical equilibria and rates in natural waters: Third edition*. John Wiley & Sons, Inc.: New York. pp. 592-595.
- T. A. Herbert & Associates (1990). "An analysis of the environmental risks from potential spills associated with the shipment of orimulsion to Sanford, Florida on the St. Johns River: Final report." Prepared for Florida Power and Light. Resource Industry Consultants, P.O. Box 10129, Tallahassee, FL 32302. pp. 1-57.

- Taylor, P.M.H. and P.D. Bartlett (1990). "Orimulsion: Oil spill review: A report to BP Bitor LTD." Field Studies Council Research Centre, Oil Pollution Research Centre, Ft. Popton, Angle, Pembroke, Dyfed, SA71, 5AD, UK. Report No. FSC/RC/10/90. May 1990. pp. 1-21.
- Torrey, S., editor (1984). "Membrane and ultrafiltration technology: Developments since 1981." *Chemical Technology Review No. 226*. Noyes Data Corporation: Park Ridge, NJ. pp. 1-463.
- Vigneswaran, S. and R.B. Aim (1989). *Water, wastewater, and sludge filtration*. CRC Press, Inc.: Boca Raton, FL. pp. 159-171.
- Waite, T.D. and B. Kundalkar (1992). "Treatment of simulated bilgewater with ultrafiltration membranes: Toxic organics and metals rejection efficiency." Ship Materials Engineering Department. David Taylor Research Center.
- Walton, H.G. (1985). "Optimizing Celite<sup>®</sup> body feed on Rose's Lime Juice filtration for Duffy Mott Corporation, Williamson, NY." Internal research and development report (not intended for general distribution or republication). Manville Research and Development Center E. Report No. 412-8421. June 20 1985. pp. 1-10.
- West Penetone (1993). "General product information: Citrikleen HD heavy duty solvent degreaser." Penetone Corporation. 74 Hudson Avenue, Tenafly, NJ 07670. pp.1-4.
- Wyman, V. (1990). "The tar-barrel philosophers." *The Engineer*. Vol. 270 No. 6994. April 12 1990. p. 24.
- Zeta Meter, Inc. (1992). *Zeta-Meter System 3.0+: Operating Manual*. 765 Middlebrook Avenue, PO Box 3008, Staunton, VA 24402-3008. pp. 1-1 to 5-3.

Zeta Meter, Inc. (1993). *Everything you want to know about coagulation and flocculation:*

*Fourth edition.* 765 Middlebrook Avenue, PO Box 3008, Staunton, VA 24402-3008. pp.

1-37.



**APPENDIX A. CALIBRATION CURVE FOR ORIMULSION<sup>®</sup> CONCENTRATION  
VERSUS VOLATILE SUSPENDED SOLIDS CONCENTRATION**

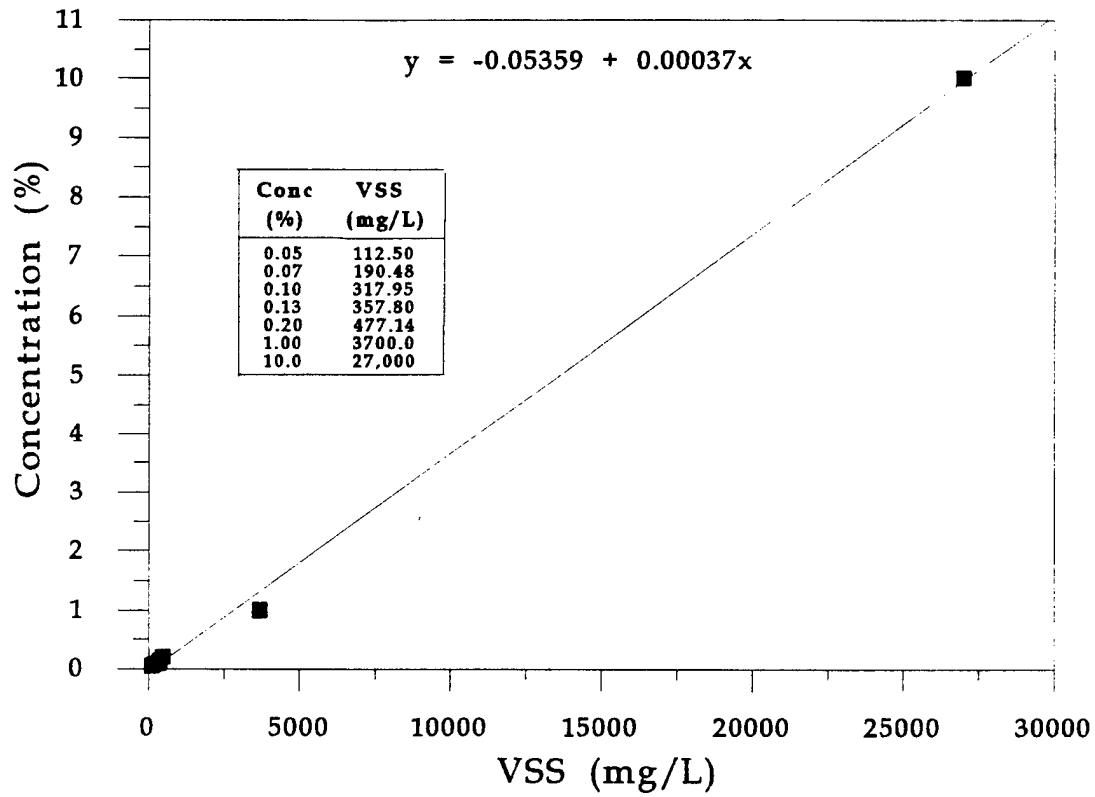

Figure A.1  
 Calibration curve for volatile suspended solids versus Orimulsion<sup>®</sup> concentration in water.

**APPENDIX B. RESULTS OF TESTS OF NATURAL ADDITIVES TO IMPROVE  
HANDLING AND FILTERABILITY OF ORIMULSION<sup>®</sup> SUSPENSIONS**

**Table B.1  
Observations of various natural filtration aid conditioners added to 1:1000 Orimulsion in water.**

| Filteration Aid Conditioner | Water Type    | FAC:Solids Ratio | Observations   |
|-----------------------------|---------------|------------------|--|
| Lime                        | Tropical Park | 5:1              | After 5 minutes rapid mix, solids settled out in less than 5 minutes. Coagulation/flocculation occurred, sweeping out all Orimulsion® solids in the process. There was a mixed sheen observed at the surface made up of lime and Orimulsion® hydrocarbons giving a slight rainbow-like appearance. Settlings were not sticky and clarified water was at elevated pH. |
| Lime                        | Tropical Park | 1:1              | Water column turned brownish with very few observed surface agglomerations of bitumen. Settled agglomerations were very fine and were sticky, neutrally buoyant fractions were not sticky, and surface agglomerations showed an affinity for the surfaces of the container and remained permanent. Elevated pH=11.60   |
| Lime                        | Tropical Park | 0.1:1            | Water column turned milky white and translucent, with only a small amount of floating surface bitumen. Some large floating agglomerations were observed to have an affinity for the surfaces of the container. Settled agglomerations appeared sticky, but floating fraction was easily removed with gentle agitation. Elevated pH=10.30                             |
| Lime                        | Biscayne Bay  | 1:1              | Surface bitumen was less sticky than the 0.2:1 concentration. Flocc particles adhered to surfaces but were easily removed with light agitation. Water column was translucent, and fine particle agglomerations settled quickly. Elevated pH=9.95   |
| Lime                        | Biscayne Bay  | 0.2:1            | Sticky surface bitumen immediately formed after dilution and combination with lime. Agglomerations formed floating irregular shaped flocc with a translucent brown water column. Both surface agglomerations and settled flocc were very sticky and extremely tenacious. Elevated pH=9.75  |
| Bentonite Clay              | Tropical Park | 2.5:1            | Clay:Orimulsion agglomerations were not sticky but showed an affinity for glass wall surfaces. Agglomerations were small with some floating, some settling, and most neutrally buoyant. After settling, the contaminated water was still very opaque with dispersed Orimulsion® solids.  |
| Bentonite Clay              | Tropical Park | 1:1              | Water column turned a gray color with very little free floating surface bitumen. After extended settling (>15 minutes), agglomerations were not sticky and the water column turned white. Bottom settled agglomerations were small to fine in size and were not sticky to any of the surfaces.   |

**Table B.1**  
**Observations of various natural filtration aid conditioners added to 1:1000 Orimulsion in water.**

| Filtration Aid Conditioner | Water Type    | FAC:Solids Ratio | Observations   |
|----------------------------|---------------|------------------|--|
| Bentonite Clay             | Tropical Park | 0.2:1            | Uncombined bitumen floated to the surface and stuck to the walls of the container (extremely tenacious). Very fine agglomerations settled quickly to the bottom, but most was neutrally buoyant with very little surface bitumen. About 75% of the surface bitumen was easily removed by slight agitation, the rest was permanently stuck. Settled agglomerations were clingy but easily removed with light agitation. |
| Bentonite Clay             | Biscayne Bay  | 1:1              | Water column turned to a grayish color with large agglomerations floating to the surface. Agglomerations showed a greater affinity for surfaces than before so that it took more vigorous agitation to remove the particles.   |
| Bentonite Clay             | Biscayne Bay  | 0.2:1            | Water column turned to a grayish color with large agglomerations floating to the surface. Agglomerations showed a greater affinity for surfaces than with the 1:1 concentration. It took even more vigorous agitation to remove clinging particles from surfaces.  |
| Bentonite Clay             | Tapwater      | 1:1              | Agglomeration were dark gray colored with dark black specks<br>Water column was completely clear after settling.<br>Thick, muddy looking agglomerations settled to the bottom and were not sticky, just slightly clingy.   |
| Bentonite Clay             | Tapwater      | 0.2:1            | Agglomerations were darker gray in color and somewhat finer than the 1:1 concentration.<br>Sandy looking particles took longer to settle than with the 1:1 concentration (almost neutrally buoyant)<br>Very little floating uncombined sticky bitumen was observed at the surface.   |
| Kaolinite Clay             | Tropical Park | 2.5:1            | Clay:Orimulsion agglomerations were very fine and showed an affinity for glass wall surfaces.<br>Agglomerations settled very well, although the water above it remained a light gray opaque color.<br>Uncombined bitumen floated and stuck to walls.   |
| Kaolinite Clay             | Tropical Park | 1:1              | Water column appeared brownish colored with thick chocolate settled agglomerations at the bottom.<br>Agglomerations were not sticky but clinged to surfaces. Clingy particles easily slid off with minimal agitation.  |
| Kaolinite Clay             | Tropical Park | 0.2:1            | Clay:Orimulsion agglomerations formed a fine, muddy looking floc.<br>After settling, the water above it remained dark black and opaque.  |
| Kaolinite Clay             | Biscayne Bay  | 1:1              | Only small amounts of floating agglomerations were observed, but they were extremely tenacious.<br>Water column turned gray-brown and the settled agglomerations were very fine and non-sticky.  |

**Table B.1  
Observations of various natural filtration aid conditioners added to 1:1000 Orimulsion in water.**

| Filtration Aid Conditioner | Water Type   | FAC:Solids Ratio | Observations  |
|----------------------------|--------------|------------------|---|
| Kaolinite Clay             | Biscayne Bay | 0.2:1            | Clear water column after extended settling (>15 minutes) with large agglomerations at the surface. Bottom flocc appeared gelatinous, did not stick but did not move with agitation. Agglomerations did not sticky, but did cling to surfaces and were easily removed with minimal agitation.  |
| Sorbo-Cel                  | Tapwater     | 5:1              | Light gray colored agglomeration settled to the bottom. Water column turned from brown to light brown to completely clear with less than 5 minutes settling. Very thick muddy bottom flocc that is not sticky and barely moves with light agitation. Bottom flocc slowly slides off surfaces.   |
| C545                       | Tapwater     | 5:1              | Uncombined bitumen formed a floating mat at the surface that stuck to the walls and became permanent. Fine gray agglomerations slowly settled becoming almost a solid sandy looking chunk at the bottom. Settling was very slow.  |
| C545 + Bentonite Clay      | Tapwater     | 4:1<br>0.1:1     | Water column turned opaque and milky white then cloudy then completely clear after 5 minutes settling. DE+Clay+Orimulsion agglomerations were easily removed with water washing. They were not sticky. Agglomerations that settled were dark gray with little black specks interspersed. Fine gray agglomerations slowly settled becoming almost a solid sandy looking chunk at the bottom. |

**Table B.2**  
**Qualitative observations of diatomaceous earth**  
**and Orimulsion® slurries at 10% Orimulsion® in water.**

| <b>Diatomite Grade</b> | <b>DE:Solids Ratio</b> | <b>Observations</b>   |
|------------------------|------------------------|---|
| <b>Kenite®</b>         | 5:1                    | DE absorbed emulsion water forming a solid with extra diatomite on top                |
|                        | 4:1                    | DE absorbed half of the emulsion water forming a solid, the remaining half was slurry |
|                        | 3:1                    | After vigorous mixing, slurry appeared pourable, but highly viscous                   |
|                        | 2:1                    | Good slurry formed  |
|                        | 1:1                    | Good slurry formed  |
| <b>C560®</b>           | 5:1                    | DE absorbed all emulsion water forming a complete solid                               |
|                        | 4:1                    | DE absorbed half of the emulsion water forming a solid, the remaining half was slurry |
|                        | 3:1                    | After vigorous mixing, slurry appearable flowable, but highly viscous                 |
|                        | 2:1                    | Solids settled out very quickly, but after slight agitation slurry returned           |
|                        | 1:1                    | Solids settled out very quickly, but after slight agitation slurry returned           |
| <b>C545®</b>           | 5:1                    | Slurry was flowable only after vigorous mixing  |
|                        | 4:1                    | Slurry was flowable only after vigorous mixing  |
|                        | 3:1                    | Slurry was flowable with only minimal agitation                                       |
|                        | 2:1                    | Good slurry formed  |
|                        | 1:1                    | Good slurry formed  |

**Table B.3**

**Summary of zeta potential electrophoretic measurements for a 1:1000 dilution of Orimulsion® in different water types.**

| Filtration Aid Condition | FAC:Solids Mass Ratio | Dilution Water Source | Specific Conductance ( $\mu\text{mhos/cm}$ ) | Voltage Setting (Volts) | Number Colloids Sampled | Field Scale Setting | Temp Reading ( $^{\circ}\text{C}$ ) | Zeta Potential Average (mV) | 95% C.I. (mV) |
|--------------------------|-----------------------|-----------------------|--|-------------------------|-------------------------|---------------------|-------------------------------------|-----------------------------|---------------|
| None                     | 0                     | Tropical Park         | 209  | 300                     | 50                      | Full                | 22.9                                | -37.6                       | 14.812        |
| Kaolinite                | 0.1:1                 | Tropical Park         | 207  | 300                     | 50                      | Full                | 22.9                                | -36.6                       | 11.186        |
| Kaolinite                | 1:1                   | Tropical Park         | 206  | 300                     | 50                      | Full                | 22.9                                | -32.3                       | 7.468         |
| Bentonite                | 1:1                   | Tapwater              | 327  | 200                     | 50                      | Quarter             | 22.3                                | -19.9                       | 6.062         |
| Bentonite                | 0.1:1                 | Tapwater              | 284  | 300                     | 21                      | Full                | 22.3                                | -39.6                       | 7.592         |
| Bentonite                | 1:1                   | Tapwater              | 317  | 200                     | 23                      | Full                | 22.4                                | -11.5                       | 4.092         |
| Bentonite                | 0.1:1                 | Tapwater              | 295  | 300                     | 24                      | Full                | 22.4                                | -37.4                       | 6.592         |
| None                     | 0                     | Tapwater              | 295  | 300                     | 50                      | Full                | 22.4                                | -38.4                       | 15.374        |
| None                     | 0                     | Tapwater              | 321  | 200                     | 50                      | Full                | 22.4                                | -42.4                       | 5.124         |



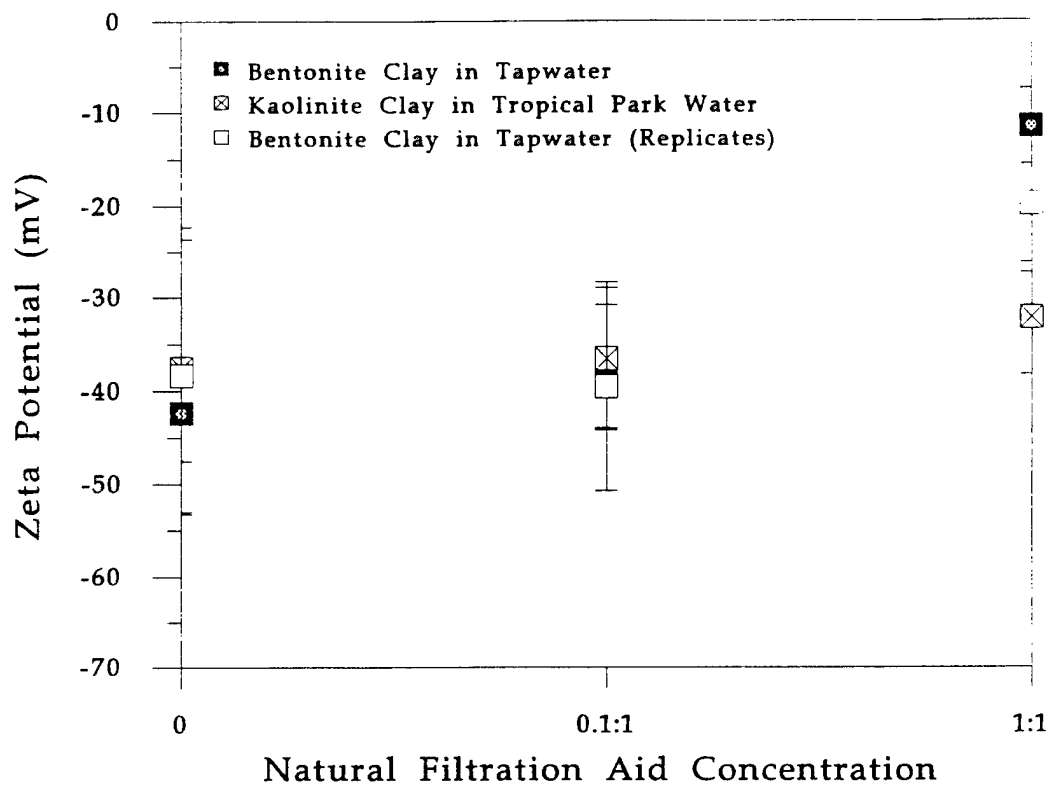

Figure B.1  
 Summary of zeta potential electrophoretic measurements for a 1:1000 dilution of Orimulsion<sup>®</sup> with different concentrations of natural filtration aid conditioners.

**APPENDIX C. RESULTS OF BURETTE TESTS TO IDENTIFY DIATOMITE GRADE**

**Table C.1**  
**Summary of buret testing results for distilled water.**

| Conc (%) | DE:Solids Ratio | Mass Applied (g) | Depth of Penetration (mm) |                     |                   |
|----------|-----------------|------------------|---------------------------|---------------------|-------------------|
|          |                 |                  | C560 <sup>®</sup>         | Kenite <sup>®</sup> | C545 <sup>®</sup> |
| 10.0     | 1:1             | 0.71             | 18.4                      | 8.2                 | 2.3               |
| 10.0     | 2:1             | 0.71             | 2.1                       | 0.8                 | 0.5               |
| 10.0     | 3:1             | 0.71             | 6.7                       | 6.6                 | 2.4               |
| 10.0     | 4:1             | 0.71             | 4.0                       | 0.2                 | 5.2               |
| 1.0      | 1:1             | 0.71             | 18.4                      | 6.0*                | 5.6 <sup>†</sup>  |
| 1.0      | 2:1             | 0.71             | 3.9*                      | 2.4*                | 2.1 <sup>†</sup>  |
| 1.0      | 3:1             | 0.71             | 16.0                      | 3.0                 | 3.6               |
| 1.0      | 4:1             | 0.71             | 13.1                      | 4.7                 | 3.1               |
| 0.1      | 2:1             | 0.71             | 10.0                      | 3.6                 | 1.7               |

\*Note: 4:1 Ratio was very concentrated resulting in difficulty in column application

\*Note: Diatomite settled out and plugged flow due to a difficulty encountered in maintaining turbulent flow

<sup>†</sup>Note: Compaction of precoat/support occurred. Value listed reflects estimate of precompaction penetration

**Table C.2**  
**Summary of buret testing results for surface water and sea water.**

| Conc (%) | Water Type    | DE:Solids Ratio | Mass Applied (g) | Penetration (mm)  |                     | Flux (gpd/ft <sup>2</sup> ) |                     |
|----------|---------------|-----------------|------------------|-------------------|---------------------|-----------------------------|---------------------|
|          |               |                 |                  | C545 <sup>®</sup> | Kenite <sup>®</sup> | C545 <sup>®</sup>           | Kenite <sup>®</sup> |
| 10.0     | Tropical Park | 2:1             | 0.71             | 1.2               | 5.6                 | ~1.32                       | NA                  |
| 1.0      | Tropical Park | 1:1             | 0.71             | 1.6               | 3.2*                | 0.72                        | 0.37                |
| 1.0      | Tropical Park | 2:1             | 0.71             | 2.7               | 10.4                | ~1.39                       | NA                  |
| 1.0      | Tropical Park | 3:1             | 0.71             | 1.2               | 3.5                 | 1.36                        | 0.94                |
| 0.1      | Tropical Park | 2:1             | 0.71             | 1.0               | 6.4*                | ~0.69                       | ~1.39               |
| 10.0     | Biscayne Ba   | 2:1             | 0.71             | 1.3*              | 1.11                | 6.0                         | 1.90                |
| 1.0      | Biscayne Ba   | 1:1             | 0.71             | 6.4               | 1.61                | 4.6*                        | 0.34                |
| 1.0      | Biscayne Ba   | 2:1             | 0.71             | 1.6               | 1.48                | 6.0                         | 2.32                |
| 1.0      | Biscayne Ba   | 3:1             | 0.71             | 1.8               | 1.25                | 3.4                         | 1.97                |
| 0.1      | Biscayne Ba   | 2:1             | 0.71             | 1.1               | 1.80                | 2.7*                        | 3.94                |

\*Note: Due to uneven contaminant migration, value listed represents average penetration rather than maximum penetration

**Table C.3**  
**Summary of buret testing results for depth of penetration using C503<sup>®</sup>.**

| Conc (%) | Water Type    | DE:Solids Ratio | Mass Applied (g) | Penetration (mm) | Flux (gpm/ft <sup>2</sup> ) | Pressure (psi) |
|----------|---------------|-----------------|------------------|------------------|-----------------------------|----------------|
| 1.0      | Tropical Park | 2:1             | 0.71             | 1.0              | 0.77                        | 13.2           |
| 1.0      | Tropical Park | 3:1             | 0.71             | 1.6              | 0.81                        | 13.2           |
| 1.0      | Biscayne Ba   | 2:1             | 0.71             | 2.0              | 0.62                        | 13.2           |
| 1.0      | Biscayne Ba   | 3:1             | 0.71             | 3.0              | 0.53                        | 13.2           |

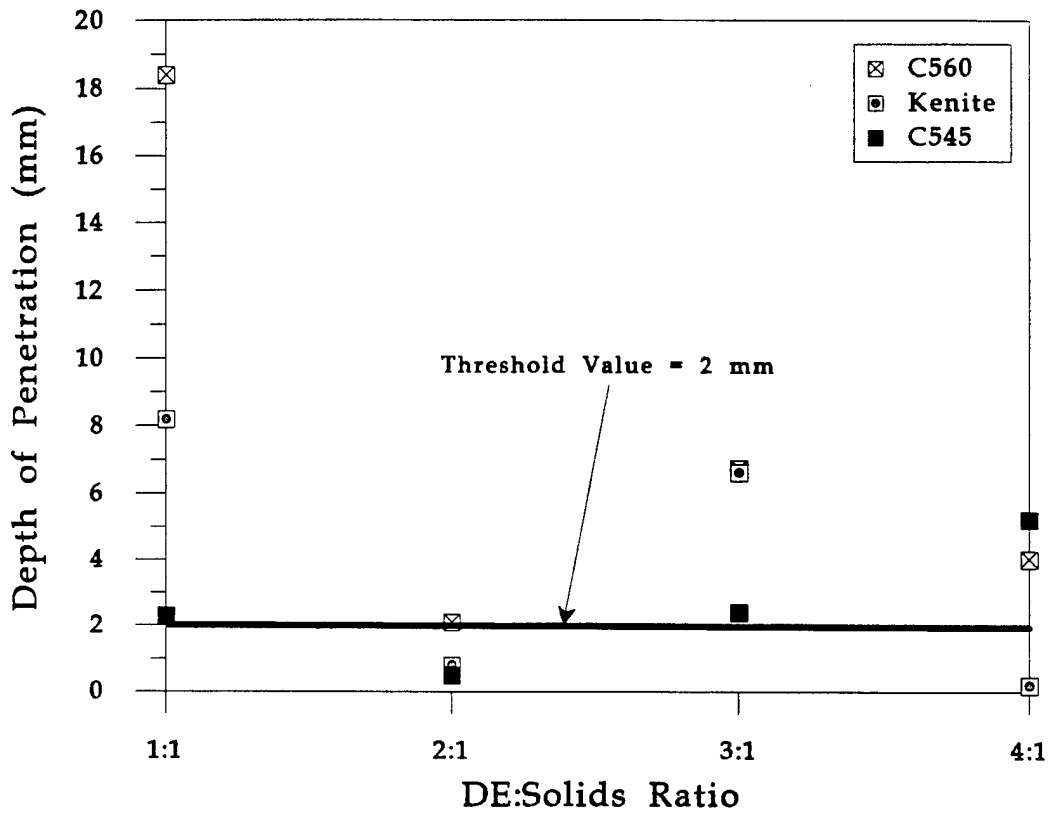

Figure C.1  
 Summary of buret testing of depth of penetration of 10% Orimulsion<sup>®</sup> in distilled water.

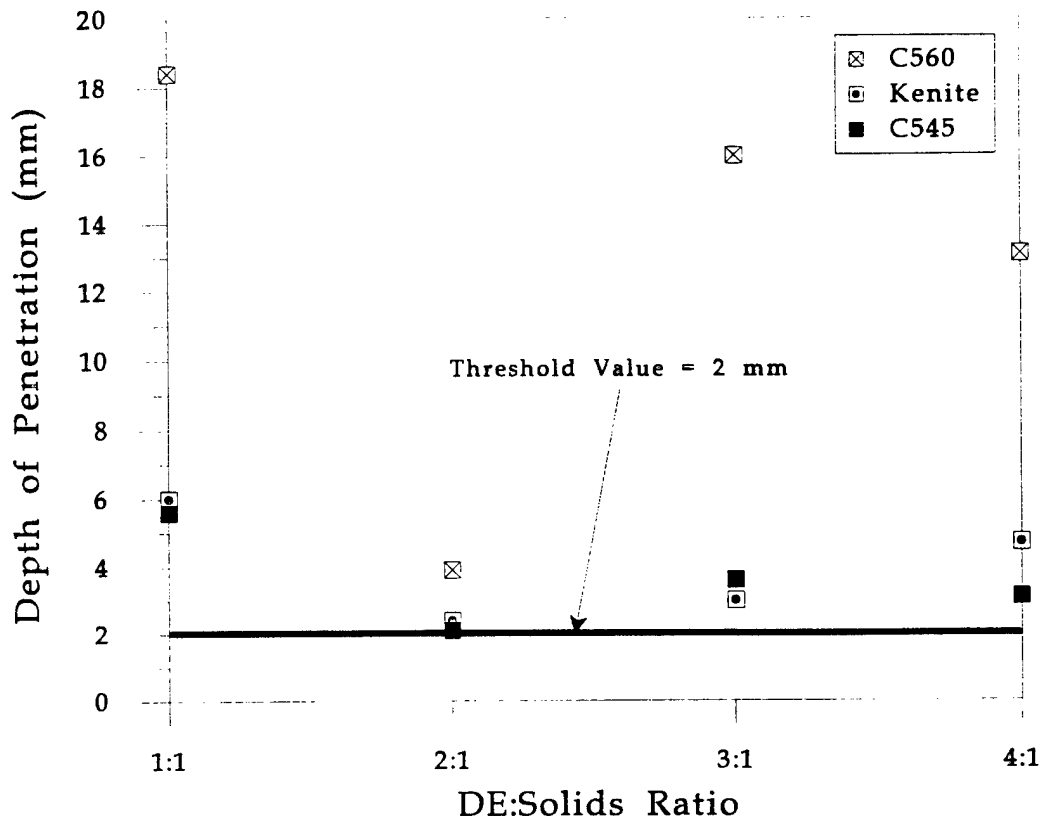

Figure C.2  
 Summary of buret testing of depth of penetration of 1% Orimulsion<sup>®</sup> in distilled water.

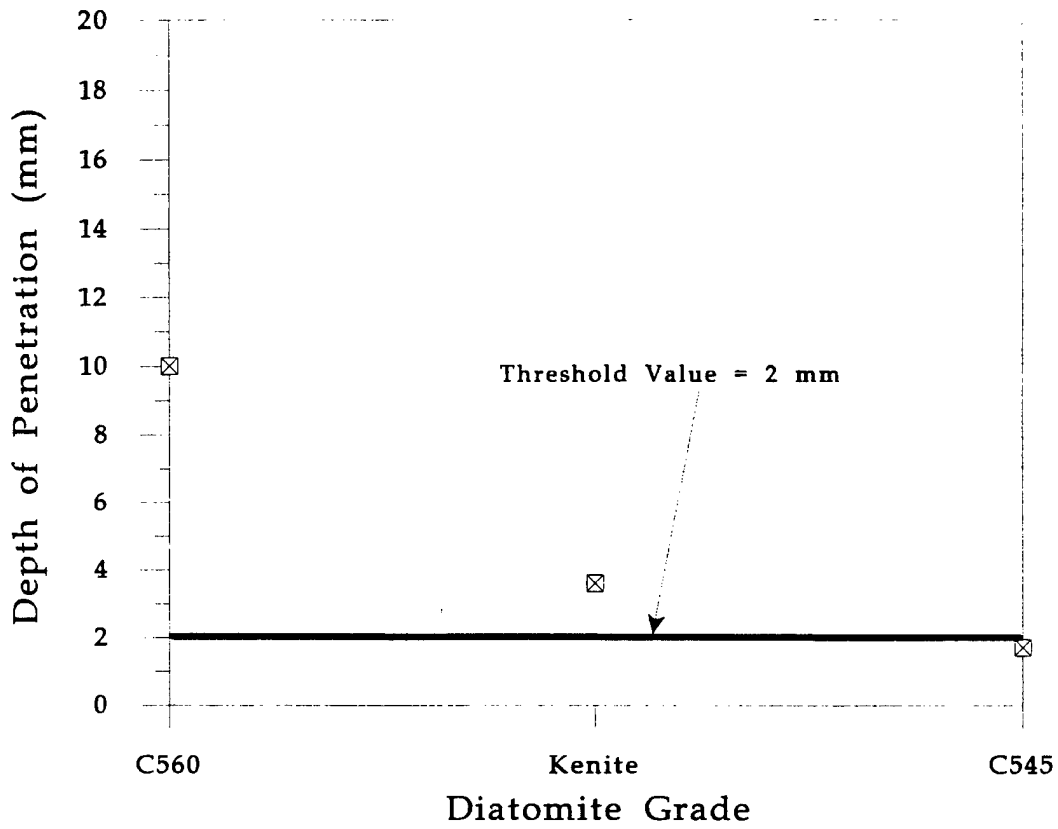

Figure C.3

Summary of buret testing of depth of penetration of 0.1% Orimulsion<sup>®</sup> in distilled water.

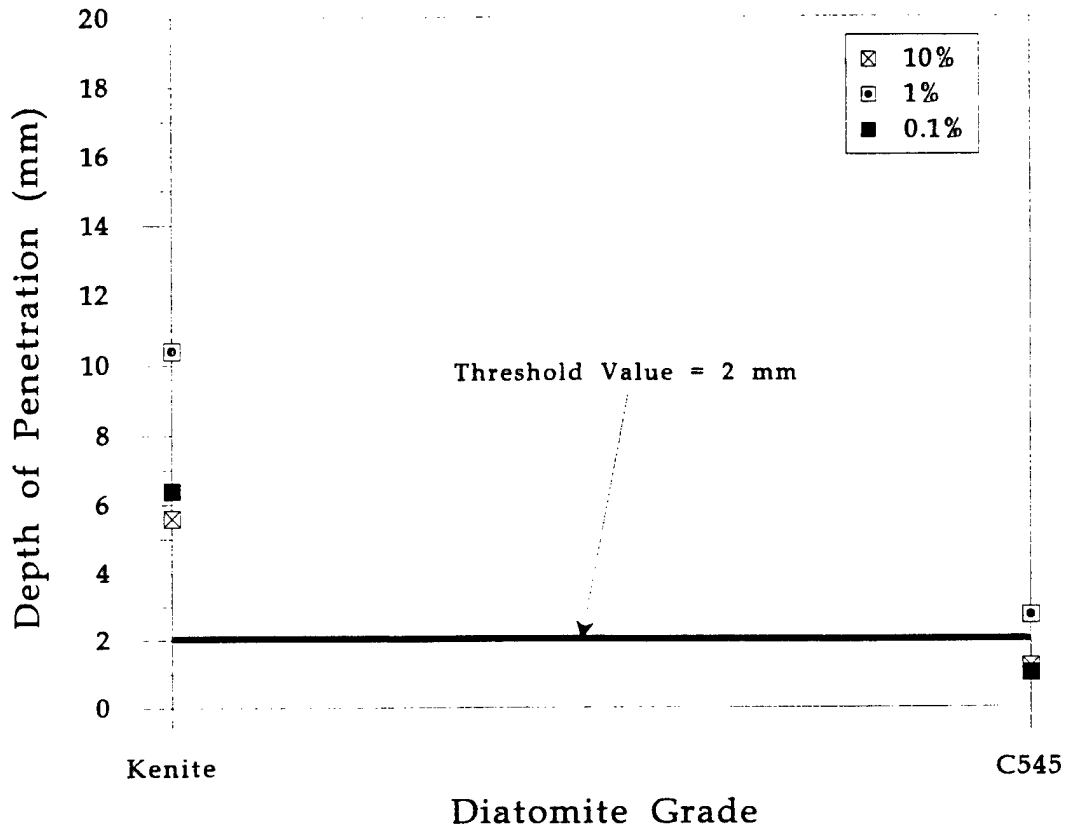

Figure C.4  
 Summary of buret testing of depth of penetration using a 2:1 DE:Orimulsion<sup>®</sup> solids ratio for dilutions using water sampled from Tropical Park, Miami, FL.

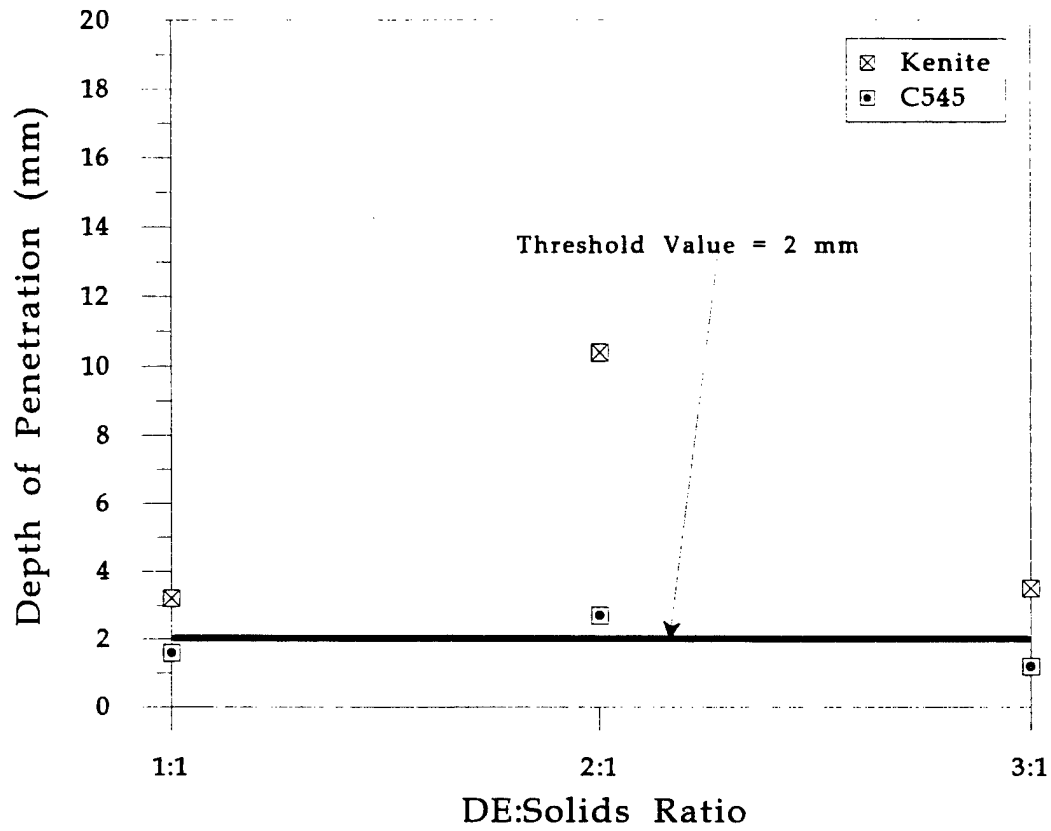

Figure C.5  
 Summary of buret testing of depth of penetration of 1% Orimulsion<sup>®</sup> in water sampled from Tropical Park, Miami, FL.



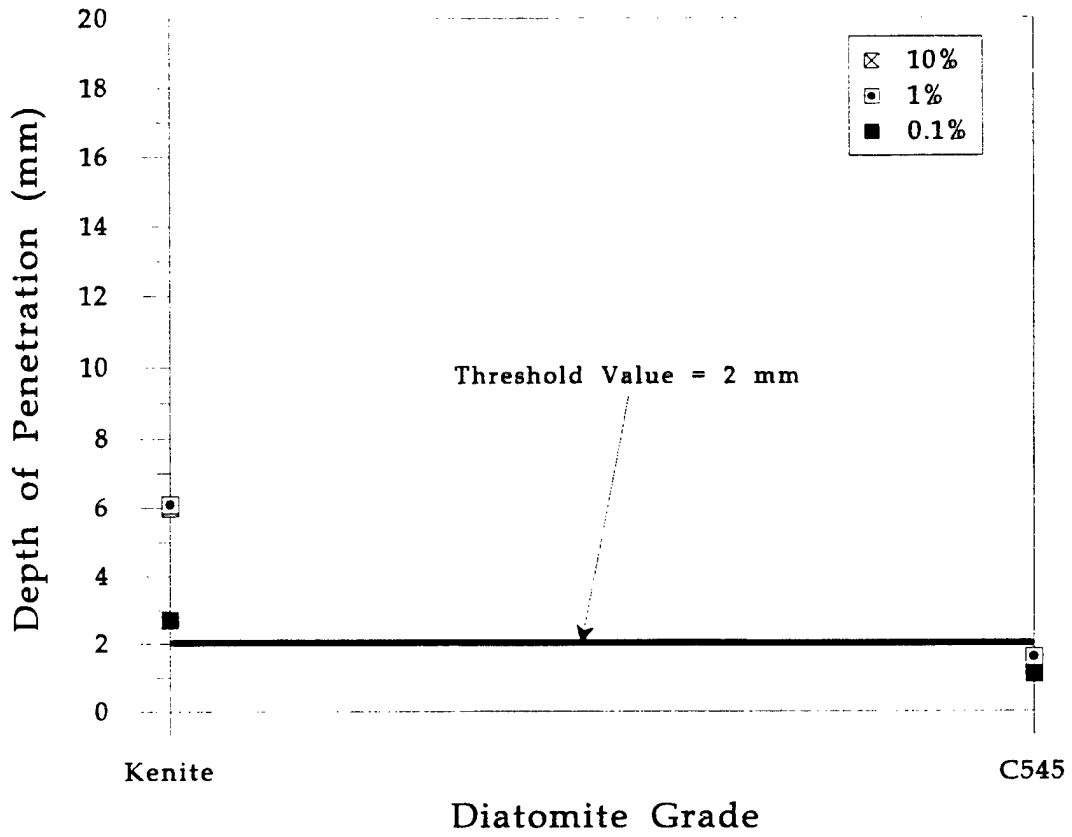

Figure C.6  
 Summary of buret testing of depth of penetration using a 2:1 DE:Orimulsion<sup>®</sup> solids ratio for dilutions using water sampled from Biscayne Bay, Miami, FL.

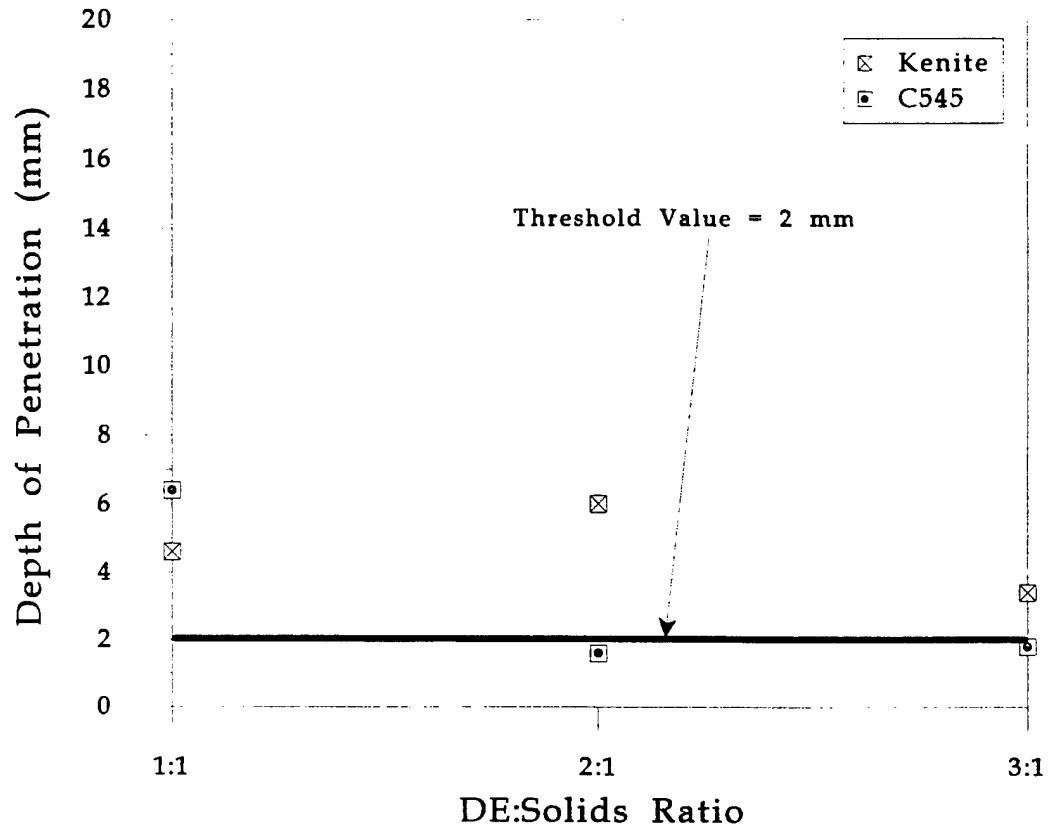

Figure C.7  
 Summary of buret testing of depth of penetration of 1% Orimulsion<sup>®</sup> in water sampled from Biscayne Bay, Miami, FL.

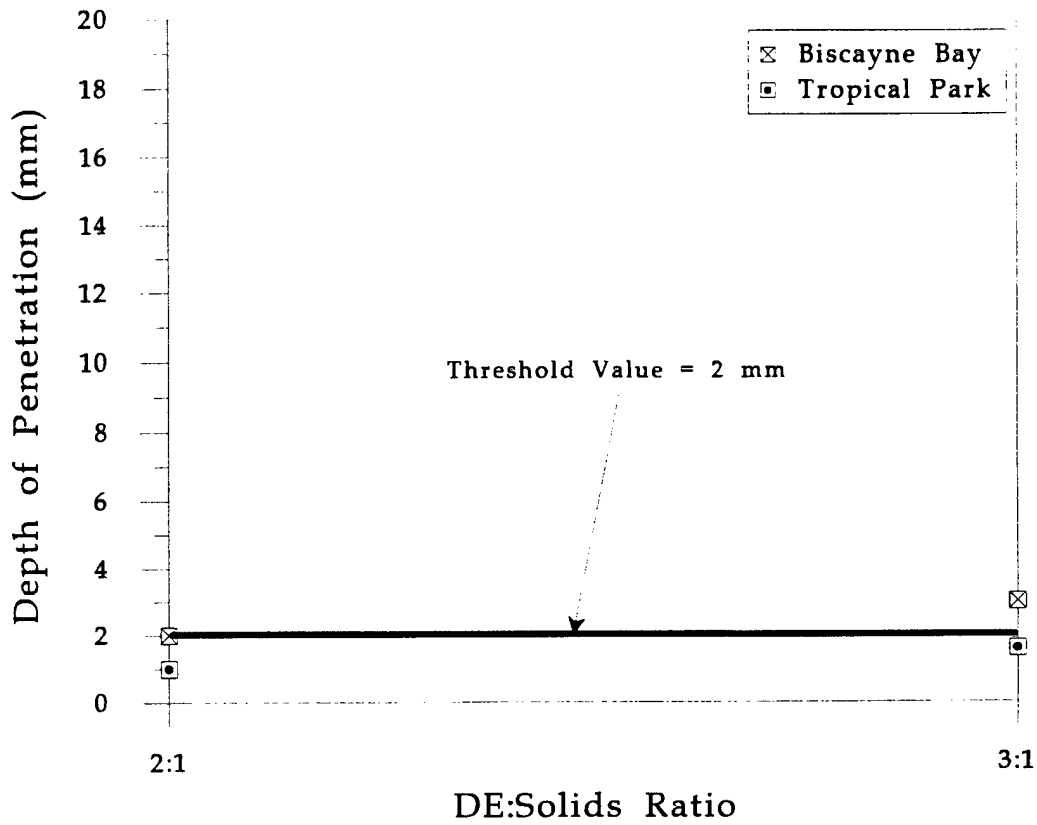

Figure C.8  
 Summary of buret testing of depth of penetration using C503<sup>®</sup> for 1% Orimulsion<sup>®</sup> two different water types.

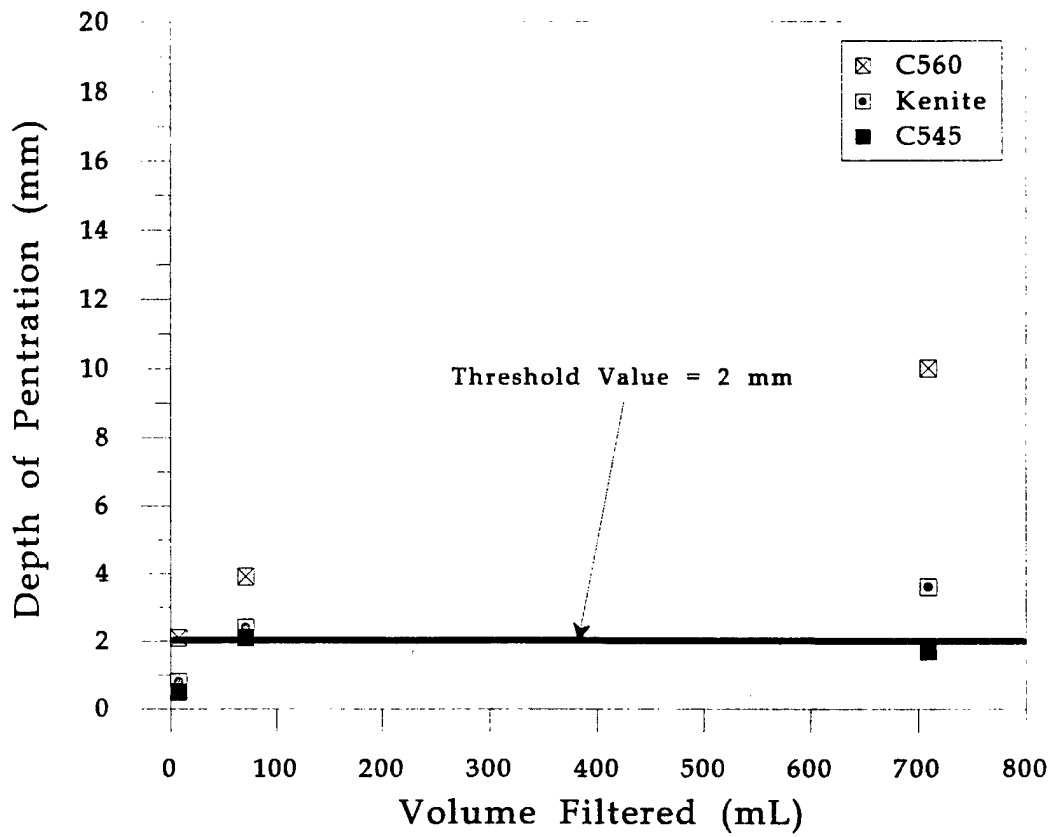

Figure C.9

Summary of buret testing of depth of penetration versus volume of distilled water filtered using a 2:1 DE:Orimulsion<sup>®</sup> solids ratio.

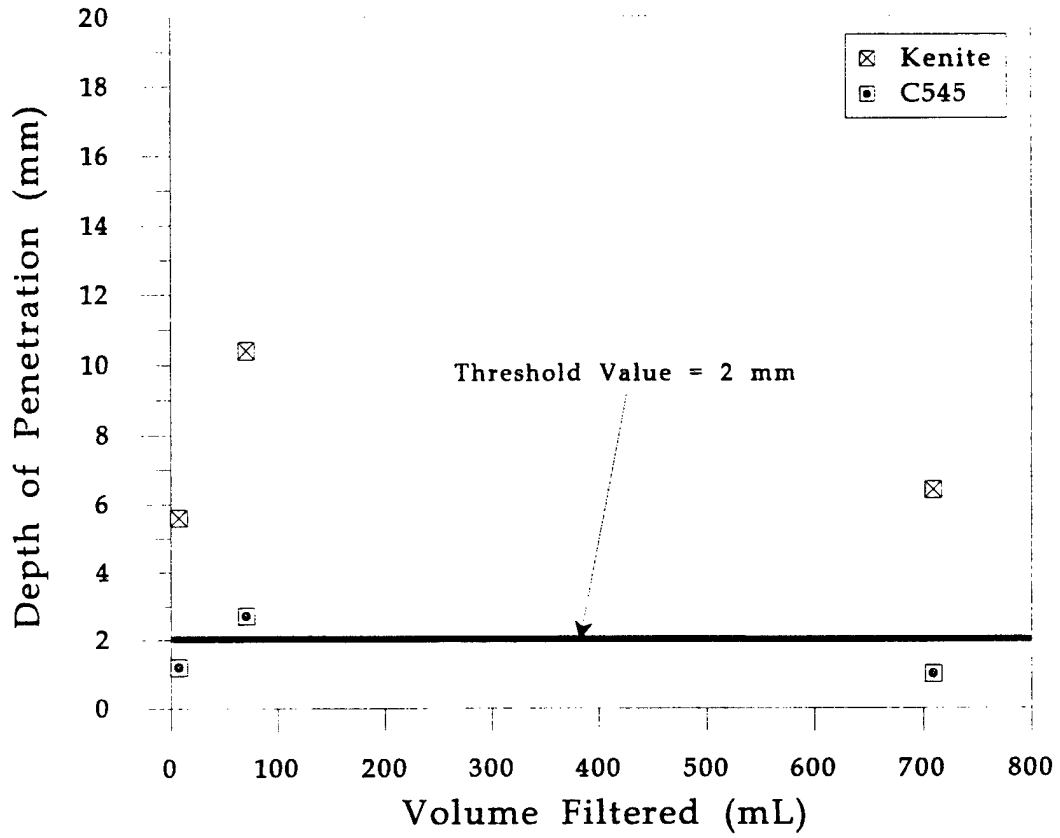

Figure C.10

Summary of buret testing of depth of penetration versus volume of water filtered using water sampled from Tropical Park, Miami, FL and using a 2:1 DE:Orimulsion<sup>®</sup> solids ratio.

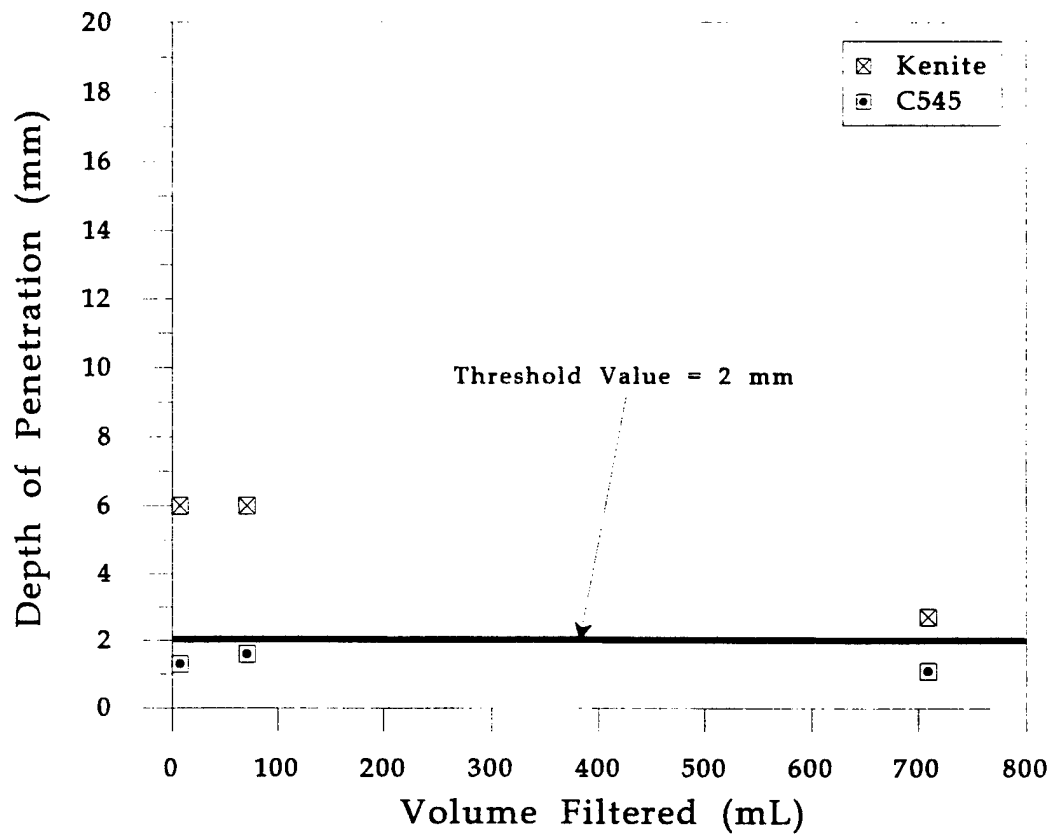

Figure C.11

Summary of buret testing of depth of penetration versus volume of water filtered using water sampled from Biscayne Bay, Miami, FL and using a 2:1 DE:Orimulsion<sup>®</sup> solids ratio.

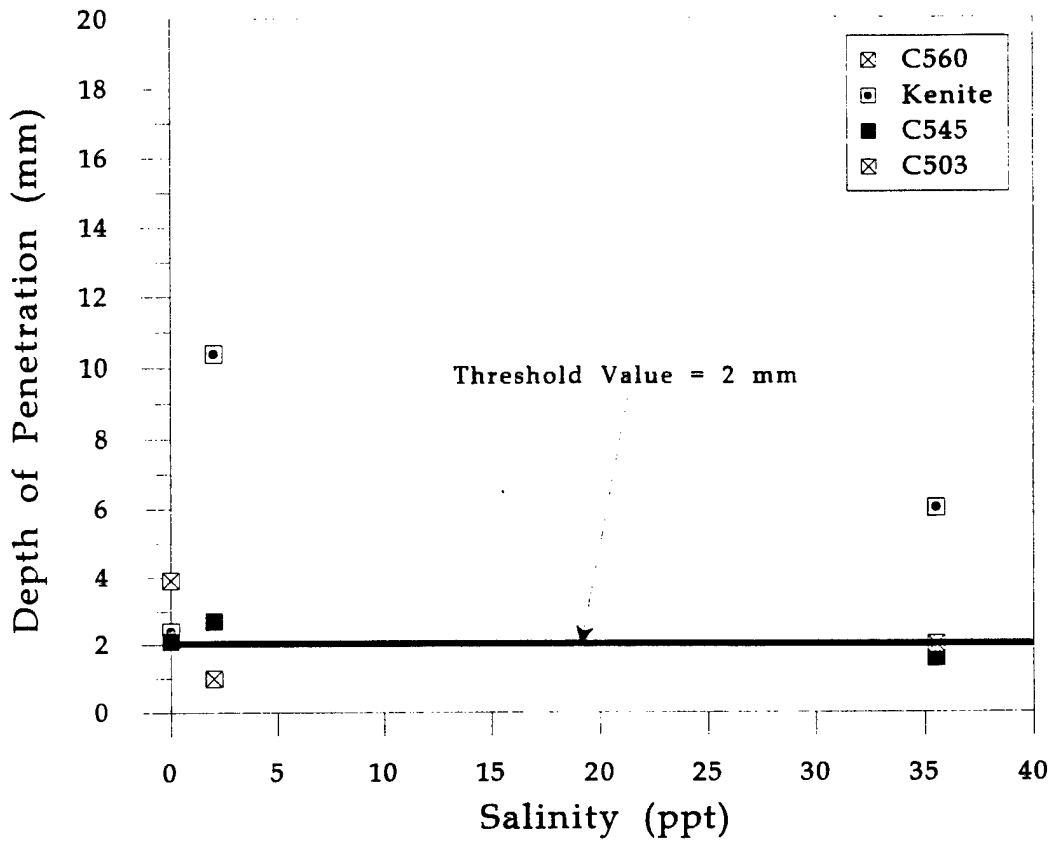

Figure C.12  
 Summary of buret testing of depth of penetration versus salinity for 1% Orimulsion<sup>®</sup> in water  
 using a 2:1 DE:Orimulsion<sup>®</sup> solids ratio.

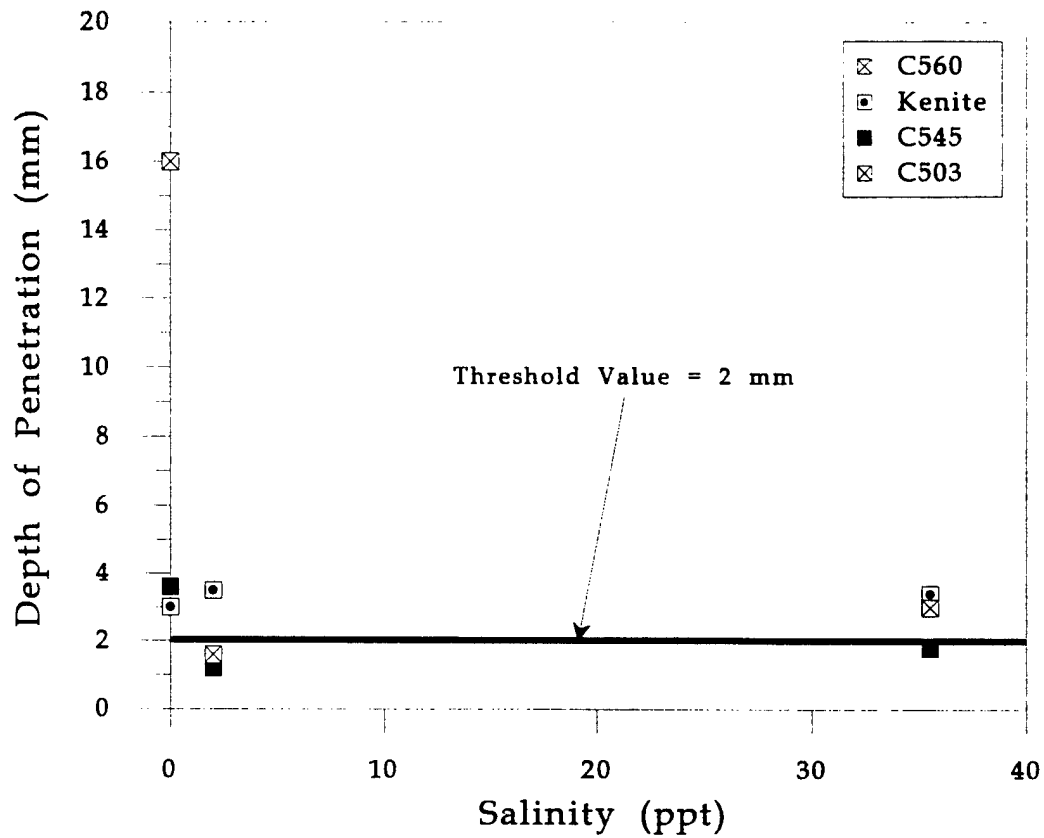

Figure C.13

Summary of buret testing of depth of penetration versus salinity for 1% Orimulsion<sup>®</sup> in water using a 3:1 DE:Orimulsion<sup>®</sup> solids ratio.



**APPENDIX D. ULTRAFILTRATION PILOT TEST DATA, INCLUDING  
FILTRATION OF ORIMULSION<sup>®</sup> /CLAY SUSPENSIONS**

Table D.1

Ultrafiltration pilot testing for Orimulsion in tapwater using the neutral membrane

| Dilution (Mass %) | Temp (°C) | VSS (mg/L) | Time (hr) | Flux (gpd/ft <sup>2</sup> ) | 95% C.I. (gpd/ft <sup>2</sup> ) | ΔP (psig) | P <sub>1</sub> (psig) | P <sub>2</sub> (psig) | P <sub>3</sub> (psig) | P <sub>4</sub> (psig)   | Notes & Observations  |      |
|-------------------|-----------|------------|-----------|-----------------------------|---------------------------------|-----------|-----------------------|-----------------------|-----------------------|---|---|------|
| 0.10%             | NA        | 0.81       | 0.17      | 185.76                      | ± 0.00                          | 45.6      | 49.0                  | 38.0                  | 64.0                  | 24.0  | Run #1, Cycle #1<br>1:1000 Dilution in Tapwater<br>With 1:1 Clay:Orimulsion® Solids<br>Neutral Membrane |      |
|                   | NA        | < 0.10     | 1.00      | 123.05                      | ± 0.00                          | 46.6      | 50.0                  | 40.0                  | 64.0                  | 24.0  |   |      |
|                   | NA        | < 0.10     | 1.67      | 114.55                      | ± 0.00                          | 45.6      | 49.0                  | 38.0                  | 64.0                  | 24.0  |   |      |
|                   | NA        | 0.40       | 1.92      | 110.62                      | ± 0.00                          | 45.6      | 49.0                  | 38.0                  | 64.0                  | 24.0  |   |      |
|                   | NA        |            | 2.17      | 100.15                      | ± 0.00                          | 45.6      | 49.0                  | 38.0                  | 64.0                  | 24.0  |   |      |
|                   | NA        |            | 2.42      | 98.84                       | ± 0.00                          | 45.6      | 49.0                  | 38.0                  | 64.0                  | 24.0  |   |      |
|                   | NA        |            | 2.67      | 97.53                       | ± 0.00                          | 45.6      | 49.0                  | 38.0                  | 64.0                  | 24.0  |   |      |
|                   | NA        |            | 2.92      | 93.60                       | ± 0.00                          | 45.6      | 49.0                  | 38.0                  | 64.0                  | 24.0  |   |      |
|                   | NA        | 1.40       | 3.17      | 97.20                       | ± 0.00                          | 45.6      | 49.0                  | 38.0                  | 64.0                  | 24.0  |   |      |
|                   | NA        |            | 3.42      | 87.05                       | ± 0.00                          | 45.6      | 49.0                  | 38.0                  | 64.0                  | 24.0  |   |      |
|                   | NA        | 0.70       | 3.67      | 78.55                       | ± 0.00                          | 46.6      | 50.0                  | 39.0                  | 64.0                  | 24.0  |   |      |
|                   | NA        |            | 3.92      | 73.96                       | ± 0.00                          | 46.6      | 50.0                  | 39.0                  | 64.0                  | 24.0  |   |      |
|                   | NA        |            | 4.17      | 75.27                       | ± 0.00                          | 46.6      | 50.0                  | 39.0                  | 64.0                  | 24.0  |   |      |
|                   | NA        |            | 4.42      | 78.55                       | ± 0.00                          | 46.6      | 50.0                  | 39.0                  | 64.0                  | 24.0  |   |      |
|                   | NA        | 1.10       | 4.67      | 68.07                       | ± 0.00                          | 36.6      | 40.0                  | 32.0                  | 64.0                  | 24.0  |   |      |
|                   | NA        |            | 4.92      | 68.73                       | ± 0.00                          | 36.6      | 40.0                  | 32.0                  | 64.0                  | 24.0  |   |      |
|                   | NA        |            | 5.17      | 68.07                       | ± 0.00                          | 36.6      | 40.0                  | 32.0                  | 64.0                  | 24.0  |   |      |
|                   | NA        |            | 5.42      | 69.38                       | ± 0.00                          | 36.6      | 40.0                  | 32.0                  | 64.0                  | 24.0  |   |      |
|                   | NA        |            | 5.75      | 80.51                       | ± 0.00                          | 46.6      | 50.0                  | 38.0                  | 64.0                  | 24.0  |   |      |
|                   | 0.24%     | NA         |           | 6.00                        | 79.20                           | ± 0.00    | 46.6                  | 50.0                  | 38.0                  | 64.0  |   | 24.0 |
| NA                |           |            | 6.25      | 68.40                       | ± 0.00                          | 45.6      | 49.0                  | 38.0                  | 64.0                  | 24.0  |   |      |
| NA                |           |            | 6.50      | 67.42                       | ± 0.00                          | 45.6      | 49.0                  | 38.0                  | 64.0                  | 24.0  |   |      |
| NA                |           |            | 6.75      | 68.07                       | ± 0.00                          | 45.6      | 49.0                  | 38.0                  | 64.0                  | 24.0  |   |      |
| NA                |           |            | 7.00      | 68.73                       | ± 0.00                          | 45.1      | 48.5                  | 38.0                  | 64.0                  | 24.0  |   |      |
| NA                |           | < 0.10     | 7.25      | 69.05                       | ± 0.00                          | 45.1      | 48.5                  | 38.0                  | 64.0                  | 24.0  |   |      |
| NA                |           |            | 7.50      | 141.38                      | ± 0.00                          | 46.6      | 50.0                  | 42.0                  | 86.0                  | 24.0  | Session #4  |      |
| NA                |           |            | 7.75      | 109.31                      | ± 0.00                          | 32.6      | 36.0                  | 37.0                  | 86.0                  | 24.0  |   |      |
| NA                |           |            | 8.00      | 84.11                       | ± 0.93                          | 36.6      | 40.0                  | 39.0                  | 86.0                  | 24.0  |   |      |
| NA                |           |            | 8.17      | 70.36                       | ± 0.93                          | 36.6      | 40.0                  | 39.0                  | 86.0                  | 24.0  |   |      |
| NA                |           |            | 8.25      | 59.56                       | ± 0.00                          | 41.6      | 45.0                  | 45.0                  | 86.0                  | 24.0  |   |      |
| NA                |           |            | 8.33      | 54.33                       | ± 0.00                          | 43.6      | 47.0                  | 46.0                  | 86.0                  | 24.0  |   |      |
| NA                |           | 8.42       | 52.69     | ± 0.83                      | 44.6                            | 48.0      | 47.0                  | 86.0                  | 24.0                  | Back Pressure Ball Valve Failed<br>Replaced with Brass Gate Valve<br>Begin First Cleaning Cycle |   |      |
| NA                |           | 8.67       | 38.62     | ± 1.02                      | 46.6                            | 50.0      | 39.0                  | 62.0                  | 24.0                  |   |   |      |
| NA                |           | 8.92       | 39.60     | ± 2.31                      | 45.6                            | 49.0      | 38.0                  | 62.0                  | 24.0                  |   |   |      |
| NA                |           | 7.50       | 141.38    | ± 0.00                      | 46.6                            | 50.0      | 42.0                  | 86.0                  | 24.0                  |   | Run #1, Cycle #2  |      |
| NA                |           | 7.75       | 109.31    | ± 0.00                      | 32.6                            | 36.0      | 37.0                  | 86.0                  | 24.0                  |   |   |      |
| NA                |           | 8.00       | 84.11     | ± 0.93                      | 36.6                            | 40.0      | 39.0                  | 86.0                  | 24.0                  |   |   |      |
| NA                |           | 8.17       | 70.36     | ± 0.93                      | 36.6                            | 40.0      | 39.0                  | 86.0                  | 24.0                  |   |   |      |
| NA                |           | 8.25       | 59.56     | ± 0.00                      | 41.6                            | 45.0      | 45.0                  | 86.0                  | 24.0                  |   |   |      |
| NA                |           | 8.33       | 54.33     | ± 0.00                      | 43.6                            | 47.0      | 46.0                  | 86.0                  | 24.0                  |   |   |      |
| NA                |           | 8.42       | 52.69     | ± 0.83                      | 44.6                            | 48.0      | 47.0                  | 86.0                  | 24.0                  | Loss of Pressure and Flowrate<br>Problem Corrected  |   |      |
| NA                |           | 8.67       | 38.62     | ± 1.02                      | 46.6                            | 50.0      | 39.0                  | 62.0                  | 24.0                  |   |   |      |
| NA                |           | 8.92       | 39.60     | ± 2.31                      | 45.6                            | 49.0      | 38.0                  | 62.0                  | 24.0                  | 24.0  |   |      |

Table D.1, Page 1

**Table D.1**  
**Ultrafiltration pilot testing for Orimulsion in tapwater using the neutral membrane**

| Dilution<br>(Mass %) | Temp<br>(°C) | VSS<br>(mg/L) | Time<br>(hr) | Flux<br>( $gpd/ft^2$ ) | 95% C.I.<br>( $gpd/ft^2$ ) | $\Delta P$<br>(psig) | P <sub>1</sub><br>(psig) | P <sub>2</sub><br>(psig) | P <sub>3</sub><br>(psig) | P <sub>4</sub><br>(psig) | Notes & Observations         |
|----------------------|--------------|---------------|--------------|------------------------|----------------------------|----------------------|--------------------------|--------------------------|--------------------------|--------------------------|------------------------------|
|                      | NA           |               | 9.17         | 39.27                  | $\pm 0.19$                 | 44.6                 | 48.0                     | 38.0                     | 62.0                     | 24.0                     |                              |
|                      | NA           |               | 9.42         | 40.58                  | $\pm 0.56$                 | 44.6                 | 48.0                     | 38.0                     | 62.0                     | 24.0                     |                              |
|                      | NA           |               | 9.67         | 41.24                  | $\pm 0.37$                 | 45.6                 | 49.0                     | 38.0                     | 62.0                     | 24.0                     |                              |
|                      | NA           |               | 9.92         | 35.67                  | $\pm 0.19$                 | 45.6                 | 49.0                     | 38.0                     | 62.0                     | 22.0                     | Session #2                   |
|                      | NA           |               | 10.17        | 36.00                  | $\pm 0.19$                 | 45.6                 | 49.0                     | 38.0                     | 62.0                     | 22.0                     |                              |
|                      | NA           |               | 10.42        | 36.65                  | $\pm 0.09$                 | 45.6                 | 49.0                     | 38.0                     | 62.0                     | 22.0                     |                              |
|                      | 36.0         |               | 10.67        | 37.64                  | $\pm 0.46$                 | 45.6                 | 49.0                     | 38.0                     | 62.0                     | 22.0                     |                              |
|                      | 34.5         |               | 10.92        | 36.00                  | $\pm 0.19$                 | 45.6                 | 49.0                     | 38.0                     | 62.0                     | 22.0                     |                              |
|                      | 36.0         |               | 11.17        | 36.98                  | $\pm 0.37$                 | 45.6                 | 49.0                     | 38.0                     | 62.0                     | 22.0                     |                              |
| 0.18%                | 37.5         | 0.60          | 11.42        | 37.31                  | $\pm 0.19$                 | 45.6                 | 49.0                     | 38.0                     | 62.0                     | 22.0                     |                              |
|                      | 38.5         |               | 11.67        | 37.31                  | $\pm 0.65$                 | 45.6                 | 49.0                     | 38.0                     | 62.0                     | 22.0                     |                              |
|                      | 39.8         |               | 11.92        | 37.31                  | $\pm 0.46$                 | 45.6                 | 49.0                     | 38.0                     | 62.0                     | 22.0                     |                              |
|                      | 41.0         |               | 12.17        | 37.64                  | $\pm 0.09$                 | 45.6                 | 49.0                     | 38.0                     | 62.0                     | 22.0                     |                              |
|                      | 39.0         |               | 12.42        | 37.96                  | $\pm 0.19$                 | 45.6                 | 49.0                     | 38.0                     | 62.0                     | 22.0                     |                              |
|                      | 40.0         |               | 12.67        | 36.33                  | $\pm 0.37$                 | 45.6                 | 49.0                     | 38.0                     | 62.0                     | 22.0                     |                              |
|                      | 41.0         | < 0.10        | 12.92        | 37.31                  | $\pm 0.09$                 | 45.6                 | 49.0                     | 38.0                     | 63.0                     | 24.0                     |                              |
|                      | 42.0         |               | 13.17        | 37.31                  | $\pm 0.37$                 | 45.6                 | 49.0                     | 38.0                     | 63.0                     | 24.0                     |                              |
| 0.11%                | 30.5         |               | 13.42        | 32.73                  | $\pm 0.56$                 | 44.6                 | 48.0                     | 38.0                     | 64.0                     | 24.0                     | Session #3                   |
|                      | 32.5         |               | 13.67        | 32.73                  | $\pm 0.46$                 | 44.6                 | 48.0                     | 38.0                     | 64.0                     | 24.0                     | Clear Vinyl Hoses Deformed   |
|                      | 33.5         |               | 13.92        | 33.38                  | $\pm 0.00$                 | 45.1                 | 48.5                     | 38.5                     | 62.0                     | 24.0                     | Under the Strees of High     |
|                      | 35.3         |               | 14.17        | 33.71                  | $\pm 0.46$                 | 44.6                 | 48.0                     | 38.0                     | 62.0                     | 24.0                     | Temperature and Pressure     |
|                      | 35.0         |               | 14.58        | 34.69                  | $\pm 0.56$                 | 44.6                 | 48.0                     | 38.0                     | 62.0                     | 24.0                     |                              |
|                      | 36.1         |               | 14.75        | 34.69                  | $\pm 0.32$                 | 44.6                 | 48.0                     | 38.0                     | 62.0                     | 24.0                     |                              |
|                      | 37.4         |               | 15.00        | 34.69                  | $\pm 0.00$                 | 44.6                 | 48.0                     | 38.0                     | 62.0                     | 24.0                     |                              |
|                      | 38.0         |               | 15.25        | 34.69                  | $\pm 0.19$                 | 44.6                 | 48.0                     | 38.0                     | 62.0                     | 24.0                     |                              |
|                      | 39.2         |               | 15.50        | 35.02                  | $\pm 0.19$                 | 44.6                 | 48.0                     | 38.0                     | 62.0                     | 24.0                     |                              |
|                      | 36.2         |               | 15.75        | 35.02                  | $\pm 0.28$                 | 45.6                 | 49.0                     | 39.0                     | 63.0                     | 24.0                     |                              |
|                      | 37.5         |               | 16.00        | 35.35                  | $\pm 0.09$                 | 45.6                 | 49.0                     | 38.0                     | 63.0                     | 24.0                     |                              |
|                      | 38.8         |               | 16.25        | 35.67                  | $\pm 0.19$                 | 45.6                 | 49.0                     | 38.0                     | 62.0                     | 24.0                     |                              |
|                      | 40.1         |               | 16.50        | 36.98                  | $\pm 0.46$                 | 45.6                 | 49.0                     | 38.0                     | 63.0                     | 24.0                     |                              |
|                      | 40.5         |               | 16.75        | 37.31                  | $\pm 0.00$                 | 45.6                 | 49.0                     | 38.0                     | 63.0                     | 24.0                     | Hoses Replaced with Pressure |
|                      | 41.3         |               | 17.00        | 39.27                  | $\pm 0.28$                 | 44.6                 | 48.0                     | 38.0                     | 63.0                     | 24.0                     | Resistant Reinforced Tubing  |
|                      | 42.3         |               | 17.25        | 38.95                  | $\pm 0.56$                 | 44.6                 | 48.0                     | 38.0                     | 62.0                     | 24.0                     | Begin Second Cleaning Cycle  |
| 0.15%                | 27.1         |               | 17.50        | 186.55                 | $\pm 3.80$                 | 45.6                 | 49.0                     | 39.0                     | 63.0                     | 24.0                     | Run #1, Cycle #3             |
|                      | 30.3         |               | 17.75        | 147.27                 | $\pm 5.09$                 | 45.6                 | 49.0                     | 39.0                     | 63.0                     | 24.0                     | Foamy Water in Recirculation |

Table D.1, Page 2

Table D.1

Ultrafiltration pilot testing for Orimulsion in tapwater using the neutral membrane

| Dilution (Mass %) | Temp (°C) | VSS (mg/L) | Time (hr) | Flux (gpd/ft <sup>2</sup> ) | 95% C.I. (gpd/ft <sup>2</sup> ) | ΔP (psig) | P <sub>1</sub> (psig) | P <sub>2</sub> (psig) | P <sub>3</sub> (psig) | P <sub>4</sub> (psig) | Notes & Observations                |
|-------------------|-----------|------------|-----------|-----------------------------|---------------------------------|-----------|-----------------------|-----------------------|-----------------------|-----------------------|-------------------------------------|
|                   | 32.8      |            | 18.00     | 134.18                      | ± 0.28                          | 44.6      | 48.0                  | 39.0                  | 62.0                  | 24.0                  | Tank                                |
|                   | 34.0      |            | 18.25     | 128.29                      | ± 0.09                          | 45.6      | 49.0                  | 39.0                  | 62.0                  | 24.0                  |                                     |
|                   | 35.8      |            | 18.50     | 125.02                      | ± 1.30                          | 45.1      | 48.5                  | 39.0                  | 62.0                  | 24.0                  |                                     |
|                   | 37.8      |            | 18.75     | 121.09                      | ± 0.74                          | 45.1      | 48.5                  | 38.5                  | 62.0                  | 24.0                  |                                     |
|                   | 38.6      |            | 19.00     | 115.20                      | ± 0.09                          | 44.6      | 48.0                  | 39.0                  | 62.0                  | 24.0                  |                                     |
|                   | 39.8      |            | 19.25     | 115.85                      | ± 1.02                          | 44.6      | 48.0                  | 38.0                  | 62.0                  | 24.0                  |                                     |
|                   | 40.6      |            | 19.50     | 114.55                      | ± 0.00                          | 44.6      | 48.0                  | 38.0                  | 62.0                  | 24.0                  |                                     |
|                   | 37.3      |            | 19.75     | 107.35                      | ± 2.87                          | 45.1      | 48.5                  | 38.0                  | 62.0                  | 24.0                  |                                     |
|                   | 38.8      |            | 20.00     | 107.35                      | ± 0.46                          | 44.6      | 48.0                  | 37.5                  | 62.0                  | 24.0                  |                                     |
|                   | 39.9      |            | 20.25     | 106.69                      | ± 0.09                          | 44.6      | 48.0                  | 37.5                  | 62.0                  | 24.0                  |                                     |
|                   | 41.6      |            | 20.50     | 104.07                      | ± 0.00                          | 44.6      | 48.0                  | 37.5                  | 62.0                  | 24.0                  |                                     |
|                   | 42.3      | 0.11       | 20.75     | 105.35                      | ± 3.24                          | 44.6      | 48.0                  | 37.5                  | 62.0                  | 24.0                  |                                     |
| 0.42%             | 28.5      |            | 21.00     | 100.47                      | ± 0.56                          | 45.6      | 49.0                  | 38.0                  | 63.0                  | 24.0                  | Run #2, Cycle #3                    |
|                   | 30.6      |            | 21.25     | 101.13                      | ± 0.83                          | 44.6      | 48.0                  | 38.0                  | 62.0                  | 24.0                  | 1:100 Dilution in Tapwater          |
|                   | 33.3      |            | 21.58     | 109.96                      | ± 4.81                          | 44.6      | 48.0                  | 38.0                  | 62.0                  | 24.0                  | With 0.1:1 Clay:Orimulsion® Solids  |
|                   | 34.6      |            | 21.75     | 108.98                      | ± 0.83                          | 44.6      | 48.0                  | 38.0                  | 62.0                  | 24.0                  | Neutral Membrane                    |
|                   | 36.4      |            | 22.00     | 113.56                      | ± 1.39                          | 44.6      | 48.0                  | 38.0                  | 62.0                  | 24.0                  |                                     |
|                   | 38.0      | 0.34       | 22.25     | 116.84                      | ± 1.11                          | 44.6      | 48.0                  | 38.0                  | 62.0                  | 24.0                  |                                     |
| 1.57%             | 30.9      |            | 22.50     | 123.71                      | ± 0.74                          | 46.6      | 50.0                  | 40.0                  | 63.0                  | 24.0                  | Session #2                          |
|                   | 32.9      |            | 22.75     | 124.04                      | ± 1.02                          | 45.6      | 49.0                  | 39.0                  | 63.0                  | 24.0                  | Sticky Chunks of Coalesced          |
|                   | 35.0      |            | 23.00     | 123.71                      | ± 1.30                          | 45.6      | 49.0                  | 39.0                  | 63.0                  | 24.0                  | Bitumen at Surface of Recirculation |
|                   | 36.9      |            | 23.25     | 126.98                      | ± 0.82                          | 45.6      | 49.0                  | 39.0                  | 63.0                  | 24.0                  | Tank                                |
|                   | 37.9      |            | 23.50     | 125.35                      | ± 0.93                          | 45.6      | 49.0                  | 39.0                  | 62.0                  | 24.0                  |                                     |
|                   | 39.2      |            | 23.75     | 129.27                      | ± 1.57                          | 45.6      | 49.0                  | 39.0                  | 62.0                  | 24.0                  |                                     |
|                   | 40.6      | 1.00       | 24.00     | 127.64                      | ± 0.09                          | 45.6      | 49.0                  | 39.0                  | 63.0                  | 24.0                  |                                     |
|                   | 36.7      |            | 24.25     | 125.02                      | ± 3.74                          | 45.6      | 49.0                  | 39.0                  | 63.0                  | 24.0                  |                                     |
|                   | 37.5      |            | 24.50     | 122.07                      | ± 0.46                          | 45.6      | 49.0                  | 39.0                  | 63.0                  | 24.0                  | Session #3                          |
|                   | 39.2      |            | 24.75     | 124.36                      | ± 0.46                          | 45.6      | 49.0                  | 39.0                  | 63.0                  | 24.0                  |                                     |
|                   | 40.2      |            | 25.00     | 125.35                      | ± 1.20                          | 45.6      | 49.0                  | 39.0                  | 63.0                  | 24.0                  |                                     |
|                   | 41.6      |            | 25.25     | 127.96                      | ± 3.24                          | 45.6      | 49.0                  | 39.0                  | 63.0                  | 24.0                  | Began Strapping Ice Packs           |
|                   | 42.0      |            | 25.33     | 129.27                      | ± 0.83                          | 45.6      | 49.0                  | 39.0                  | 63.0                  | 24.0                  | To Cool Feed Tank                   |
| 1.05%             | 33.3      |            | 25.50     | 114.55                      | ± 0.46                          | 46.6      | 50.0                  | 40.0                  | 64.0                  | 24.0                  | Session #4                          |
|                   | 34.7      |            | 25.75     | 111.60                      | ± 0.93                          | 46.1      | 49.5                  | 39.5                  | 63.0                  | 24.0                  |                                     |
|                   | 36.1      |            | 26.00     | 113.89                      | ± 0.19                          | 45.6      | 49.0                  | 39.0                  | 63.0                  | 24.0                  |                                     |
|                   | 37.9      |            | 26.25     | 111.60                      | ± 0.74                          | 45.6      | 49.0                  | 39.0                  | 63.0                  | 24.0                  |                                     |

Table D.1, Page 3

**Table D.1  
Ultrafiltration pilot testing for Orimulsion in tapwater using the neutral membrane**

| Dilution (Mass %) | Temp (°C) | VSS (mg/L) | Time (hr) | Flux (gpd/ft <sup>2</sup> ) | 95% C.I. (gpd/ft <sup>2</sup> ) | ΔP (psig) | P <sub>1</sub> (psig) | P <sub>2</sub> (psig) | P <sub>3</sub> (psig) | P <sub>4</sub> (psig) | Notes & Observations                     |
|-------------------|-----------|------------|-----------|-----------------------------|---------------------------------|-----------|-----------------------|-----------------------|-----------------------|-----------------------|--|
|                   | 38.8      |            | 26.50     | 112.25                      | ± 1.39                          | 45.6      | 49.0                  | 39.0                  | 63.0                  | 24.0                  |  |
|                   | 40.6      |            | 26.75     | 110.62                      | ± 0.37                          | 45.6      | 49.0                  | 39.0                  | 63.0                  | 24.0                  |  |
|                   | 41.7      |            | 27.00     | 108.65                      | ± 0.56                          | 45.1      | 48.5                  | 38.5                  | 62.5                  | 24.0                  |  |
|                   | 42.4      | 0.12       | 27.25     | 111.08                      | ± 1.11                          | 45.1      | 48.5                  | 38.0                  | 63.0                  | 24.0                  |  |
| 1.37%             | 29.3      |            | 27.50     | 96.22                       | ± 0.19                          | 46.6      | 50.0                  | 40.0                  | 64.0                  | 24.0                  | Session #5                               |
|                   | 31.4      |            | 27.75     | 96.22                       | ± 0.09                          | 46.1      | 49.5                  | 39.5                  | 63.0                  | 24.0                  |  |
|                   | 33.2      |            | 28.00     | 92.29                       | ± 0.56                          | 45.6      | 49.0                  | 38.0                  | 62.5                  | 24.0                  |  |
|                   | 35.3      |            | 28.25     | 92.29                       | ± 0.28                          | 45.6      | 49.0                  | 38.0                  | 63.0                  | 24.0                  |  |
|                   | 37.2      |            | 28.50     | 94.25                       | ± 0.74                          | 45.6      | 49.0                  | 38.0                  | 63.0                  | 24.0                  |  |
|                   | 38.3      |            | 28.75     | 92.29                       | ± 0.56                          | 45.6      | 49.0                  | 38.0                  | 63.0                  | 24.0                  |  |
|                   | 39.6      |            | 29.00     | 92.29                       | ± 0.65                          | 45.6      | 49.0                  | 38.0                  | 63.0                  | 24.0                  |  |
|                   | 40.9      |            | 29.25     | 90.98                       | ± 0.56                          | 45.1      | 48.5                  | 38.5                  | 62.0                  | 24.0                  |  |
|                   | 41.7      |            | 29.50     | 89.02                       | ± 0.28                          | 45.1      | 48.5                  | 38.5                  | 62.0                  | 24.0                  |  |
| 1.32%             | 42.8      | 1.34       | 29.75     | 88.36                       | ± 0.19                          | 45.1      | 48.5                  | 38.5                  | 62.0                  | 24.0                  | Begin Cleaning Cycle                     |
| 3.84%             | 24.8      |            | 0.00      | 430.69                      | ± 0.00                          | 49.1      | 52.5                  | 40.5                  | 72.0                  | 24.0                  | Run #3, Cycle #4                         |
|                   | 26.8      |            | 0.25      | 177.50                      | ± 5.90                          | 51.1      | 54.5                  | 42.0                  | 71.0                  | 24.0                  | 1:40 Dilution in Biscayne Bay Water      |
|                   | 28.8      |            | 0.50      | 181.61                      | ± 0.54                          | 50.1      | 53.5                  | 40.5                  | 69.0                  | 24.0                  | With 0.1:1 Clay:Orimulsion® Solids       |
|                   | 30.5      |            | 0.75      | 150.95                      | ± 0.34                          | 50.1      | 53.5                  | 40.5                  | 70.0                  | 23.0                  | Neutral Membrane                         |
|                   | 32.3      |            | 1.00      | 136.60                      | ± 1.27                          | 49.6      | 53.0                  | 40.5                  | 69.0                  | 23.0                  | Permeate valve leak detected             |
|                   | 34.6      |            | 1.25      | 129.28                      | ± 0.00                          | 49.6      | 53.0                  | 40.5                  | 69.0                  | 23.0                  | Leak fixed                               |
|                   | 35.2      |            | 1.50      | 123.89                      | ± 1.37                          | 49.6      | 53.0                  | 40.5                  | 69.0                  | 23.0                  |  |
|                   | 36.4      |            | 1.75      | 124.22                      | ± 1.70                          | 49.6      | 53.0                  | 40.5                  | 69.0                  | 23.0                  |  |
|                   | 37.8      |            | 2.00      | 123.75                      | ± 0.20                          | 50.1      | 53.5                  | 40.5                  | 69.0                  | 23.0                  | Recycle hose ruptured                    |
|                   | 39.0      |            | 2.25      | 127.45                      | ± 0.75                          | 49.6      | 53.0                  | 40.5                  | 69.0                  | 23.0                  | Recycle hose repaired                    |
|                   | 39.9      |            | 2.50      | 128.44                      | ± 1.31                          | 49.6      | 53.0                  | 40.5                  | 69.0                  | 23.0                  |  |
|                   | 41.2      |            | 2.75      | 131.33                      | ± 0.72                          | 49.6      | 53.0                  | 40.5                  | 69.0                  | 23.0                  | Recirculation tank contains thick mousse |
|                   | 42.3      | 0.22       | 3.00      | 135.08                      | ± 1.88                          | 49.6      | 53.0                  | 40.5                  | 69.0                  | 23.0                  |  |
| 9.94%             | 24.8      |            | 0.25      | 32.27                       | ± 1.67                          | 45.6      | 49.0                  | 38.5                  | 62.0                  | 22.0                  | Run #4, Cycle #3                         |
|                   | 26.5      |            | 0.50      | 21.47                       | ± 0.09                          | 46.1      | 49.5                  | 40.0                  | 62.0                  | 22.0                  | 1:10 Dilution in Tapwater                |
|                   | 27.9      |            | 0.75      | 20.85                       | ± 3.15                          | 46.6      | 50.0                  | 40.0                  | 62.0                  | 22.0                  | No Clay                                  |
|                   | 29.3      |            | 1.00      | 20.42                       | ± 0.19                          | 46.6      | 50.0                  | 40.0                  | 62.0                  | 22.0                  | Neutral Membrane                         |
|                   | 30.6      |            | 1.25      | 18.13                       | ± 0.19                          | 46.6      | 50.0                  | 40.0                  | 62.0                  | 22.0                  |  |
|                   | 30.9      |            | 1.50      | 13.35                       | ± 0.28                          | 46.6      | 50.0                  | 40.0                  | 62.0                  | 22.0                  |  |
| NA                |           |            | 2.25      | 0.00                        | ± 0.00                          | 46.6      | 50.0                  | 40.0                  | 62.0                  | 22.0                  |  |

Table D.1, Page 4

Table D.1

Ultrafiltration pilot testing for Orimulsion in tapwater using the neutral membrane

| Dilution (Mass %) | Temp (°C) | VSS (mg/L) | Time (hr) | Flux (gpd/ft <sup>2</sup> ) | 95% C.I. (gpd/ft <sup>2</sup> ) | ΔP (psig) | P <sub>1</sub> (psig) | P <sub>2</sub> (psig) | P <sub>3</sub> (psig) | P <sub>4</sub> (psig) | Notes & Observations   |                      |   |
|-------------------|-----------|------------|-----------|-----------------------------|---------------------------------|-----------|-----------------------|-----------------------|-----------------------|-----------------------|--|----------------------|---|
| 0.41%             | 30.4      |            | 0.00      | 709.53                      | ± 0.95                          | 46.1      | 50.0                  | 41.0                  | 63.0                  | 24.0                  | <b>Run #5, Cycle #5</b><br>1:1000 Dilution in Tapwater<br>No Clay<br>Negative Membrane |                      |   |
|                   | 27.4      |            | 0.25      | 144.13                      | ± 0.95                          | 48.1      | 52.0                  | 40.0                  | 67.0                  | 24.0                  |  |                      |   |
|                   | 29.9      |            | 0.50      | 125.14                      | ± 0.64                          | 47.6      | 51.5                  | 39.5                  | 65.0                  | 22.0                  |  |                      |   |
|                   | 31.7      |            | 0.75      | 104.57                      | ± 1.47                          | 48.1      | 52.0                  | 40.5                  | 66.5                  | 23.0                  |  |                      |   |
|                   | 33.3      |            | 1.00      | 92.78                       | ± 0.66                          | 49.1      | 53.0                  | 41.0                  | 67.0                  | 23.0                  |  |                      |   |
|                   | 34.9      |            | 1.25      | 79.77                       | ± 5.49                          | 49.1      | 53.0                  | 41.5                  | 67.0                  | 23.0                  |  |                      |   |
|                   | 36.3      |            | 1.50      | 54.79                       | ± 0.03                          | 49.1      | 53.0                  | 41.0                  | 67.0                  | 23.0                  |  |                      |   |
|                   | 37.6      |            | 1.75      | 68.00                       | ± 1.41                          | 49.1      | 53.0                  | 41.0                  | 67.0                  | 23.0                  |  |                      |   |
|                   | 38.4      |            | 2.00      | 63.17                       | ± 0.14                          | 49.1      | 53.0                  | 41.5                  | 67.0                  | 24.0                  |  |                      |   |
|                   | 39.6      |            | 2.25      | 50.79                       | ± 0.42                          | 49.1      | 53.0                  | 41.0                  | 67.0                  | 24.0                  |  |                      |   |
|                   | 40.8      |            | 2.50      | 38.90                       | ± 0.32                          | 49.1      | 53.0                  | 42.0                  | 67.0                  | 24.0                  |  |                      |   |
|                   | 40.3      | 0.99       | 2.75      | 31.04                       | ± 3.22                          | 49.6      | 53.5                  | 42.0                  | 67.0                  | 24.0                  |  | Begin Cleaning Cycle |   |
|                   | 1.54%     | 24.0       |           | 3.00                        | 575.24                          | ± 0.43    | 48.1                  | 52.0                  | 40.0                  | 67.0                  |  | 23.0                 | <b>Run #6, Cycle #6</b><br>1:100 Dilution in Tapwater<br>With 0.1:1 Clay:Orimulsion® Solids<br>Negative Membrane<br>Effluent Sample was Foamy |
|                   |           | 26.8       |           | 3.25                        | 430.64                          | ± 5.44    | 48.1                  | 52.0                  | 40.5                  | 67.0                  |  | 23.0                 |   |
|                   |           | 29.0       | 0.22      | 3.50                        | 361.74                          | ± 0.19    | 48.1                  | 52.0                  | 41.0                  | 67.0                  |  | 23.0                 |   |
| 30.3              |           |            | 3.75      | 313.50                      | ± 2.18                          | 49.1      | 53.0                  | 41.5                  | 67.0                  | 23.0                  |  |                      |   |
| 32.2              |           |            | 4.00      | 274.63                      | ± 0.13                          | 49.1      | 53.0                  | 41.5                  | 67.0                  | 23.0                  |  |                      |   |
| 34.7              |           |            | 4.25      | 256.22                      | ± 2.10                          | 49.1      | 53.0                  | 42.0                  | 67.5                  | 23.0                  |  |                      |   |
| 35.3              |           |            | 4.50      | 234.34                      | ± 4.47                          | 48.1      | 52.0                  | 40.0                  | 67.0                  | 23.0                  |  |                      |   |
| 36.9              |           |            | 4.75      | 228.02                      | ± 2.39                          | 48.1      | 52.0                  | 39.5                  | 66.0                  | 23.0                  |  |                      |   |
| 40.3              |           |            | 5.50      | 220.05                      | ± 4.09                          | 47.1      | 51.0                  | 39.5                  | 66.0                  | 23.0                  |  |                      |   |
| 41.4              |           |            | 5.75      | 216.82                      | ± 1.68                          | 47.1      | 51.0                  | 39.5                  | 66.0                  | 23.0                  |  |                      |   |
| 42.6              |           |            | 6.00      | 211.64                      | ± 6.51                          | 49.1      | 53.0                  | 41.0                  | 68.0                  | 23.0                  |  |                      |   |
| 2.13%             |           | 28.7       |           | 6.25                        | 203.14                          | ± 2.79    | 48.6                  | 52.5                  | 39.5                  | 69.0                  | 23.0   | Session #2           |   |
|                   |           | 30.5       |           | 6.50                        | 167.16                          | ± 1.31    | 48.1                  | 52.0                  | 39.0                  | 68.0                  | 23.0   |                      |   |
|                   |           | 32.6       |           | 6.75                        | 142.39                          | ± 0.43    | 47.1                  | 51.0                  | 39.0                  | 68.0                  | 22.0   |                      |   |
|                   |           | 33.5       |           | 7.00                        | 136.15                          | ± 0.44    | 48.1                  | 52.0                  | 39.0                  | 67.0                  | 22.0   |                      |   |
|                   | 34.9      |            | 7.25      | 128.56                      | ± 0.00                          | 47.6      | 51.5                  | 39.0                  | 68.0                  | 22.0                  |  |                      |   |
|                   | 36.9      |            | 7.50      | 123.12                      | ± 0.17                          | 47.6      | 51.5                  | 39.0                  | 67.0                  | 22.0                  |  |                      |   |
|                   | 37.7      |            | 7.75      | 121.00                      | ± 0.21                          | 47.6      | 51.5                  | 39.0                  | 67.0                  | 22.0                  |  |                      |   |
|                   | 38.3      |            | 8.00      | 118.26                      | ± 0.31                          | 47.1      | 51.0                  | 39.0                  | 67.5                  | 22.0                  |  |                      |   |
|                   | 39.9      |            | 8.25      | 116.48                      | ± 0.02                          | 47.1      | 51.0                  | 39.0                  | 67.0                  | 23.0                  |  |                      |   |
| 39.8              |           | 8.50       | 116.73    | ± 2.16                      | 47.6                            | 51.5      | 39.0                  | 68.0                  | 22.0                  |                       |  |                      |   |
| 41.7              | 1.30      | 8.75       | 114.79    | ± 0.19                      | 47.6                            | 51.5      | 39.0                  | 67.5                  | 23.0                  |                       |  |                      |   |

Table D.1, Page 5

**Table D.1**  
**Ultrafiltration pilot testing for Orimulsion in tapwater using the neutral membrane**

| Dilution (Mass %) | Temp (°C) | VSS (mg/L) | Time (hr) | Flux (gpd/ft <sup>2</sup> ) | 95% C.I. (gpd/ft <sup>2</sup> ) | ΔP (psig) | P <sub>1</sub> (psig) | P <sub>2</sub> (psig) | P <sub>3</sub> (psig) | P <sub>4</sub> (psig) | Notes & Observations                |
|-------------------|-----------|------------|-----------|-----------------------------|---------------------------------|-----------|-----------------------|-----------------------|-----------------------|-----------------------|-------------------------------------|
| 1.41%             | 27.3      |            | 9.00      | 100.76                      | ± 1.21                          | 48.1      | 52.0                  | 39.0                  | 69.0                  | 23.0                  | Session #3                          |
|                   | 28.9      |            | 9.25      | 92.45                       | ± 0.89                          | 48.1      | 52.0                  | 39.0                  | 68.0                  | 23.0                  |                                     |
|                   | 30.6      |            | 9.50      | 84.95                       | ± 0.98                          | 48.1      | 52.0                  | 39.0                  | 68.0                  | 23.0                  |                                     |
|                   | 32.3      |            | 9.75      | 87.81                       | ± 0.32                          | 48.1      | 52.0                  | 39.0                  | 68.0                  | 23.0                  |                                     |
|                   | 33.6      |            | 10.00     | 85.73                       | ± 0.14                          | 48.1      | 52.0                  | 39.0                  | 68.0                  | 23.0                  |                                     |
|                   | 35.2      |            | 10.25     | 86.38                       | ± 1.17                          | 48.1      | 52.0                  | 39.0                  | 68.0                  | 23.0                  |                                     |
|                   | 36.6      |            | 10.50     | 85.37                       | ± 0.27                          | 47.6      | 51.5                  | 39.0                  | 68.0                  | 23.0                  |                                     |
|                   | 37.7      |            | 10.75     | 85.79                       | ± 0.32                          | 48.1      | 52.0                  | 39.0                  | 68.0                  | 23.0                  |                                     |
|                   | 38.7      |            | 11.00     | 87.65                       | ± 1.85                          | 47.6      | 51.5                  | 39.0                  | 68.0                  | 23.0                  |                                     |
|                   | 39.7      |            | 11.25     | 87.89                       | ± 1.50                          | 47.6      | 51.5                  | 39.0                  | 68.0                  | 23.0                  |                                     |
|                   | 40.8      |            | 11.50     | 86.50                       | ± 0.06                          | 47.6      | 51.5                  | 39.0                  | 68.0                  | 23.0                  |                                     |
|                   | 41.7      | 0.12       | 11.75     | 88.40                       | ± 0.91                          | 48.1      | 52.0                  | 39.0                  | 68.0                  | 23.0                  |                                     |
|                   | 42.3      |            | 12.00     | 87.79                       | ± 0.00                          | 48.1      | 52.0                  | 39.0                  | 68.0                  | 23.0                  | Begin Cleaning Cycle                |
| 3.84%             | 30.3      |            | 0.00      | 648.72                      | ± 51.01                         | 49.1      | 53.0                  | 40.5                  | 69.0                  | 23.0                  | Run #7, Cycle #5                    |
|                   | 32.3      |            | 0.25      | 557.09                      | ± 7.66                          | 49.1      | 53.0                  | 40.5                  | 69.0                  | 23.0                  | 1:40 Dilution in Biscayne Bay Water |
|                   | 34.3      |            | 0.50      | 456.74                      | ± 10.42                         | 49.1      | 53.0                  | 41.0                  | 69.0                  | 23.0                  | With 0.1:1 Clay:Orimulsion® Solids  |
|                   | 35.8      |            | 0.75      | 369.40                      | ± 3.18                          | 49.1      | 53.0                  | 41.0                  | 69.0                  | 23.0                  | Negative Membrane                   |
|                   | 36.3      |            | 1.00      | 300.88                      | ± 1.68                          | 49.1      | 53.0                  | 41.0                  | 69.0                  | 23.0                  |                                     |
|                   | 38.5      |            | 1.25      | 261.18                      | ± 1.97                          | 49.6      | 53.5                  | 41.5                  | 69.0                  | 23.0                  |                                     |
|                   | 39.6      |            | 1.50      | 229.44                      | ± 3.13                          | 49.6      | 53.5                  | 41.5                  | 69.0                  | 23.0                  |                                     |
|                   | 40.6      |            | 1.75      | 217.90                      | ± 0.39                          | 50.1      | 54.0                  | 42.0                  | 69.0                  | 23.0                  |                                     |
|                   | 41.9      |            | 2.00      | 198.85                      | ± 0.00                          | 50.1      | 54.0                  | 41.5                  | 69.0                  | 23.0                  |                                     |
|                   | 42.7      |            | 2.25      | 190.00                      | ± 0.38                          | 50.1      | 54.0                  | 42.0                  | 69.0                  | 23.0                  |                                     |
|                   | 43.3      |            | 2.50      | 182.77                      | ± 0.32                          | 50.1      | 54.0                  | 42.0                  | 69.0                  | 23.0                  |                                     |
|                   | 44.2      |            | 2.75      | 176.86                      | ± 1.48                          | 50.1      | 54.0                  | 42.0                  | 69.0                  | 23.0                  |                                     |
|                   | 44.7      | < 0.10     | 3.00      | 173.15                      | ± 1.50                          | 50.1      | 54.0                  | 42.0                  | 69.0                  | 23.0                  | Begin Cleaning Cycle                |
| 15.49%            | 28.4      |            | 0.00      | 440.44                      | ± 1.44                          | 48.1      | 52.0                  | 40.0                  | 67.0                  | 23.0                  | Run #8, Cycle #7                    |
|                   | 30.1      |            | 0.25      | 406.41                      | ± 15.81                         | 47.6      | 51.5                  | 40.0                  | 67.0                  | 23.0                  | 1:10 Dilution in Tapwater           |
|                   | 31.3      |            | 0.50      | 387.82                      | ± 0.00                          | 47.6      | 51.5                  | 40.0                  | 67.0                  | 23.0                  | With 0.1:1 Clay:Orimulsion® Solids  |
|                   | 33.3      |            | 0.75      | 384.28                      | ± 5.90                          | 47.6      | 51.5                  | 40.0                  | 65.0                  | 23.0                  | Negative Membrane                   |
|                   | 35.3      |            | 1.00      | 384.09                      | ± 2.20                          | 47.1      | 51.0                  | 40.0                  | 65.0                  | 23.0                  | Initially Formed Mousse Which       |
|                   | 36.4      |            | 1.25      | 387.62                      | ± 1.46                          | 47.1      | 51.0                  | 40.0                  | 65.0                  | 23.0                  | Sunk and Dispersed with a Small     |
|                   | 37.3      |            | 1.50      | 385.99                      | ± 3.19                          | 47.1      | 51.0                  | 40.0                  | 65.0                  | 23.0                  | Chunk that Persisted                |
|                   | 39.4      |            | 1.75      | 385.40                      | ± 8.97                          | 47.1      | 51.0                  | 40.0                  | 65.0                  | 23.0                  |                                     |

Table D.1. Page 6

Table D.1  
Ultrafiltration pilot testing for Orimulsion in tapwater using the neutral membrane

| Dilution (Mass %) | Temp (°C) | VSS (mg/L) | Time (hr) | Flux (gpd/ft <sup>2</sup> ) | 95% C.I. (gpd/ft <sup>2</sup> ) | ΔP (psig) | P <sub>1</sub> (psig) | P <sub>2</sub> (psig) | P <sub>3</sub> (psig) | P <sub>4</sub> (psig) | Notes & Observations |
|-------------------|-----------|------------|-----------|-----------------------------|---------------------------------|-----------|-----------------------|-----------------------|-----------------------|-----------------------|----------------------|
|                   | 40.9      |            | 2.00      | 373.29                      | ± 4.07                          | 47.1      | 51.0                  | 40.0                  | 65.0                  | 23.0                  |                      |
|                   | 42.4      |            | 2.25      | 381.67                      | ± 0.00                          | 47.1      | 51.0                  | 40.0                  | 65.0                  | 23.0                  |                      |
|                   | 43.7      |            | 2.50      | 377.87                      | ± 0.46                          | 47.1      | 51.0                  | 40.0                  | 65.0                  | 23.0                  |                      |
|                   | 44.6      |            | 2.75      | 373.55                      | ± 2.27                          | 47.1      | 51.0                  | 40.0                  | 65.0                  | 23.0                  |                      |
|                   | 45.4      | 1.89       | 3.00      | 356.20                      | ± 0.99                          | 47.1      | 51.0                  | 40.0                  | 65.0                  | 23.0                  | Session #2           |
| 14.56%            | 32.5      |            | 3.25      | 439.92                      | ± 0.00                          | 48.1      | 52.0                  | 40.0                  | 66.0                  | 23.0                  |                      |
|                   | 34.7      |            | 3.50      | 306.98                      | ± 0.98                          | 46.6      | 50.5                  | 39.0                  | 65.0                  | 23.0                  |                      |
|                   | 36.1      |            | 3.75      | 273.08                      | ± 1.08                          | 46.6      | 50.5                  | 39.0                  | 65.0                  | 23.0                  |                      |
|                   | 37.8      |            | 4.08      | 257.30                      | ± 9.69                          | 46.6      | 50.5                  | 39.0                  | 65.0                  | 23.0                  |                      |
|                   | 38.7      |            | 4.25      | 257.30                      | ± 0.67                          | 46.6      | 50.5                  | 39.0                  | 65.0                  | 23.0                  |                      |
|                   | 42.9      |            | 4.75      | 242.57                      | ± 2.14                          | 47.1      | 51.0                  | 39.0                  | 65.0                  | 23.0                  |                      |
|                   | 43.7      |            | 5.25      | 231.45                      | ± 0.04                          | 47.1      | 51.0                  | 39.0                  | 65.0                  | 23.0                  |                      |
|                   | 45.2      |            | 5.75      | 231.38                      | ± 0.98                          | 47.1      | 51.0                  | 39.0                  | 65.0                  | 23.0                  |                      |
|                   | 46.3      | 1.33       | 6.00      | 213.25                      | ± 3.10                          | 47.1      | 51.0                  | 39.0                  | 65.0                  | 23.0                  |                      |
| 14.64%            | 24.5      |            | 6.08      | 239.56                      | ± 0.00                          | 48.6      | 52.5                  | 39.0                  | 69.0                  | 22.0                  | Session #3           |
|                   | 26.6      |            | 6.25      | 138.57                      | ± 0.31                          | 48.1      | 52.0                  | 39.0                  | 69.0                  | 22.0                  |                      |
|                   | 28.2      |            | 6.50      | 112.71                      | ± 0.98                          | 48.1      | 52.0                  | 39.0                  | 68.0                  | 22.0                  |                      |
|                   | 29.5      |            | 6.75      | 102.57                      | ± 0.17                          | 48.1      | 52.0                  | 39.0                  | 68.0                  | 22.0                  |                      |
|                   | 31.3      |            | 7.00      | 100.54                      | ± 0.00                          | 48.1      | 52.0                  | 39.0                  | 68.0                  | 22.0                  |                      |
|                   | 34.4      |            | 7.50      | 112.71                      | ± 0.49                          | 48.1      | 52.0                  | 39.0                  | 68.0                  | 22.0                  |                      |
|                   | 36.8      |            | 8.00      | 112.06                      | ± 0.73                          | 48.6      | 52.5                  | 40.0                  | 68.0                  | 22.0                  |                      |
|                   | 39.3      |            | 8.50      | 117.16                      | ± 0.10                          | 48.6      | 52.5                  | 40.0                  | 68.0                  | 22.0                  |                      |
|                   | 41.0      |            | 9.00      | 118.47                      | ± 2.29                          | 48.1      | 52.0                  | 40.0                  | 68.0                  | 22.0                  |                      |
|                   | 42.7      | 0.22       | 9.50      | 120.44                      | ± 0.80                          | 48.1      | 52.0                  | 39.5                  | 68.0                  | 22.0                  |                      |
| 15.29%            | 29.7      |            | 9.58      | 163.90                      | ± 1.91                          | 47.6      | 51.5                  | 40.0                  | 69.0                  | 22.0                  | Session #4           |
|                   | 31.4      |            | 9.75      | 116.25                      | ± 0.69                          | 48.6      | 52.5                  | 40.0                  | 69.0                  | 22.0                  |                      |
|                   | 32.7      |            | 10.00     | 108.33                      | ± 0.31                          | 48.6      | 52.5                  | 39.5                  | 68.0                  | 22.0                  |                      |
|                   | 34.2      |            | 10.25     | 101.59                      | ± 0.62                          | 48.6      | 52.5                  | 39.5                  | 68.5                  | 22.0                  |                      |
|                   | 35.3      |            | 10.50     | 101.39                      | ± 0.34                          | 48.1      | 52.0                  | 39.5                  | 68.0                  | 22.0                  |                      |
|                   | 39.9      |            | 11.50     | 109.90                      | ± 0.25                          | 48.1      | 52.0                  | 39.5                  | 68.0                  | 22.0                  |                      |
|                   | 42.3      |            | 12.00     | 114.02                      | ± 1.19                          | 48.1      | 52.0                  | 39.5                  | 68.0                  | 22.0                  |                      |
|                   | 43.7      |            | 12.50     | 114.28                      | ± 0.22                          | 48.1      | 52.0                  | 39.5                  | 68.0                  | 22.0                  |                      |
|                   | 45.2      | 0.76       | 13.00     | 114.35                      | ± 0.95                          | 48.1      | 52.0                  | 39.5                  | 68.0                  | 22.0                  |                      |
| 13.13%            | 26.7      |            | 13.08     | 130.91                      | ± 1.46                          | 49.1      | 53.0                  | 40.0                  | 69.0                  | 22.0                  | Session #5           |
|                   | 28.3      |            | 13.25     | 93.73                       | ± 0.87                          | 48.1      | 52.0                  | 39.5                  | 68.0                  | 22.0                  |                      |
|                   | 29.7      |            | 13.50     | 89.21                       | ± 1.72                          | 48.1      | 52.0                  | 39.5                  | 68.0                  | 22.0                  |                      |
|                   | 31.2      |            | 13.75     | 85.81                       | ± 0.42                          | 48.1      | 52.0                  | 39.0                  | 68.0                  | 22.0                  |                      |



**Table D.1**  
**Ultrafiltration pilot testing for Orimulsion in tapwater using the neutral membrane**

| Dilution (Mass %) | Temp (°C) | VSS (mg/L) | Time (hr) | Flux (gpd/ft <sup>2</sup> ) | 95% C.I. (gpd/ft <sup>2</sup> ) | ΔP (psig) | P <sub>1</sub> (psig) | P <sub>2</sub> (psig) | P <sub>3</sub> (psig) | P <sub>4</sub> (psig) | Notes & Observations |
|-------------------|-----------|------------|-----------|-----------------------------|---------------------------------|-----------|-----------------------|-----------------------|-----------------------|-----------------------|----------------------|
|                   | 33.0      |            | 14.00     | 86.27                       | ± 2.23                          | 48.1      | 52.0                  | 40.0                  | 68.0                  | 22.0                  |                      |
|                   | 35.7      |            | 14.50     | 89.80                       | ± 0.00                          | 46.1      | 50.0                  | 40.0                  | 65.0                  | 22.0                  |                      |
|                   | 37.9      |            | 15.00     | 88.89                       | ± 0.09                          | 47.6      | 51.5                  | 40.0                  | 65.0                  | 22.0                  |                      |
|                   | 39.9      |            | 15.50     | 88.10                       | ± 0.64                          | 47.1      | 51.0                  | 40.0                  | 65.0                  | 22.0                  |                      |
|                   | 42.5      |            | 16.00     | 89.28                       | ± 3.16                          | 47.1      | 51.0                  | 40.0                  | 65.0                  | 22.0                  |                      |
|                   | 44.0      | 0.94       | 16.50     | 89.61                       | ± 0.00                          | 47.6      | 51.5                  | 40.0                  | 65.0                  | 22.0                  |                      |
| 11.98%            | 32.2      |            | 16.58     | 124.10                      | ± 0.73                          | 48.1      | 52.0                  | 40.0                  | 66.0                  | 24.0                  | Session #6           |
|                   | 33.6      |            | 16.75     | 89.61                       | ± 0.78                          | 47.6      | 51.5                  | 39.5                  | 65.5                  | 24.0                  |                      |
|                   | 34.5      |            | 17.00     | 84.24                       | ± 0.02                          | 47.1      | 51.0                  | 39.5                  | 65.0                  | 24.0                  |                      |
|                   | 35.9      |            | 17.25     | 81.36                       | ± 0.25                          | 46.6      | 50.5                  | 39.0                  | 64.5                  | 23.0                  |                      |
|                   | 37.1      |            | 17.50     | 78.61                       | ± 0.93                          | 46.6      | 50.5                  | 39.5                  | 64.5                  | 23.0                  |                      |
|                   | 39.2      |            | 18.00     | 77.37                       | ± 0.09                          | 46.6      | 50.5                  | 39.0                  | 64.5                  | 23.0                  |                      |
|                   | 41.3      |            | 18.50     | 78.28                       | ± 8.32                          | 46.6      | 50.5                  | 39.0                  | 65.0                  | 23.0                  |                      |
|                   | 43.0      | 0.59       | 19.00     | 79.99                       | ± 0.06                          | 46.6      | 50.5                  | 39.5                  | 65.0                  | 23.0                  |                      |
| 12.18%            | 28.8      |            | 19.25     | 77.50                       | ± 1.15                          | 48.1      | 52.0                  | 39.5                  | 66.5                  | 24.0                  | Session #7           |
|                   | 30.7      |            | 19.50     | 69.32                       | ± 0.65                          | 47.6      | 51.5                  | 39.5                  | 66.0                  | 24.0                  |                      |
|                   | 32.2      |            | 19.75     | 66.96                       | ± 0.63                          | 47.6      | 51.5                  | 39.5                  | 66.5                  | 23.0                  |                      |
|                   | 33.3      |            | 20.00     | 67.16                       | ± 0.09                          | 48.1      | 52.0                  | 40.0                  | 66.5                  | 23.5                  |                      |
|                   | 35.9      |            | 20.50     | 67.16                       | ± 0.35                          | 48.1      | 52.0                  | 40.0                  | 66.0                  | 24.0                  |                      |
|                   | 38.8      | < 0.10     | 21.00     | 70.56                       | ± 0.00                          | 48.1      | 52.0                  | 40.0                  | 66.0                  | 24.0                  |                      |
| 11.14%            | 31.7      |            | 21.25     | 75.40                       | ± 0.27                          | 47.6      | 51.5                  | 39.5                  | 66.0                  | 24.0                  | Session #8           |
|                   | 33.3      |            | 21.50     | 67.29                       | ± 0.00                          | 47.1      | 51.0                  | 39.0                  | 65.5                  | 24.0                  |                      |
|                   | 34.8      |            | 21.75     | 65.72                       | ± 0.30                          | 47.1      | 51.0                  | 39.0                  | 65.5                  | 24.0                  |                      |
|                   | 35.8      |            | 22.00     | 64.15                       | ± 0.24                          | 46.6      | 50.5                  | 39.0                  | 65.0                  | 24.0                  |                      |
|                   | 38.3      |            | 22.50     | 62.71                       | ± 0.13                          | 47.1      | 51.0                  | 39.5                  | 65.0                  | 24.0                  |                      |
|                   | 39.6      | 0.80       | 23.00     | 64.15                       | ± 0.00                          | 47.1      | 51.0                  | 39.5                  | 65.0                  | 24.0                  |                      |
| 10.17%            | 28.3      |            | 23.25     | 63.10                       | ± 0.00                          | 47.6      | 51.5                  | 39.5                  | 66.0                  | 24.0                  | Session #9           |
|                   | 29.4      |            | 23.50     | 57.34                       | ± 0.13                          | 47.6      | 51.5                  | 39.5                  | 65.5                  | 24.0                  |                      |
|                   | 31.3      |            | 23.75     | 54.26                       | ± 0.00                          | 47.1      | 51.0                  | 39.5                  | 65.5                  | 24.0                  |                      |
|                   | 32.6      |            | 24.00     | 53.35                       | ± 0.35                          | 47.1      | 51.0                  | 39.5                  | 65.5                  | 24.0                  |                      |
|                   | 35.0      |            | 24.50     | 52.17                       | ± 0.48                          | 47.1      | 51.0                  | 39.5                  | 65.5                  | 24.0                  |                      |
|                   | 37.7      |            | 25.00     | 53.35                       | ± 0.55                          | 47.1      | 51.0                  | 39.5                  | 65.5                  | 24.0                  |                      |
|                   | 39.4      | 0.24       | 25.50     | 53.80                       | ± 0.09                          | 47.1      | 51.0                  | 39.5                  | 65.0                  | 24.0                  |                      |
| 10.77%            | 27.8      |            | 25.75     | 58.78                       | ± 0.00                          | 48.1      | 52.0                  | 39.5                  | 66.0                  | 24.0                  | Session #10          |
|                   | 29.3      |            | 26.00     | 52.49                       | ± 0.76                          | 49.1      | 53.0                  | 41.0                  | 68.0                  | 24.0                  |                      |
|                   | 33.0      |            | 26.75     | 49.03                       | ± 0.46                          | 49.1      | 53.0                  | 41.0                  | 68.0                  | 24.0                  |                      |
|                   | 36.6      |            | 27.50     | 48.83                       | ± 0.17                          | 49.1      | 53.0                  | 41.0                  | 68.0                  | 24.0                  |                      |

Table D.1, Page 8

**Table D.1  
Ultrafiltration pilot testing for Orimulsion in tapwater using the neutral membrane**

| Dilution<br>(Mass %) | Temp<br>(°C) | VSS<br>(mg/L) | Time<br>(hr) | Flux<br>(gpd/ft <sup>2</sup> ) | 95% C.I.<br>(gpd/ft <sup>2</sup> ) | ΔP<br>(psig) | P <sub>1</sub><br>(psig) | P <sub>2</sub><br>(psig) | P <sub>3</sub><br>(psig) | P <sub>4</sub><br>(psig) | Notes & Observations  |
|----------------------|--------------|---------------|--------------|--------------------------------|------------------------------------|--------------|--------------------------|--------------------------|--------------------------|--------------------------|---|
| 10.46%               | 40.4         |               | 28.50        | 48.70                          | ± 0.11                             | 47.1         | 51.0                     | 39.0                     | 66.0                     | 24.0                     | Session #11   |
|                      | 41.7         | 0.69          | 29.00        | 49.55                          | ± 0.00                             | 46.6         | 50.5                     | 39.5                     | 66.0                     | 24.0                     |   |
|                      | 27.2         |               | 29.25        | 55.44                          | ± 0.06                             | 48.1         | 52.0                     | 40.0                     | 66.0                     | 24.0                     |   |
|                      | 28.7         |               | 29.50        | 49.61                          | ± 0.28                             | 48.6         | 52.5                     | 40.5                     | 66.5                     | 24.0                     |   |
|                      | 29.8         |               | 29.75        | 47.32                          | ± 0.26                             | 48.1         | 52.0                     | 40.0                     | 67.0                     | 24.0                     |   |
|                      | 32.0         |               | 30.00        | 45.43                          | ± 0.20                             | 48.1         | 52.0                     | 40.5                     | 67.0                     | 24.0                     |   |
|                      | 34.7         |               | 30.50        | 44.12                          | ± 0.01                             | 48.1         | 52.0                     | 40.0                     | 67.0                     | 24.0                     |   |
|                      | 36.5         |               | 31.00        | 44.38                          | ± 0.04                             | 47.6         | 51.5                     | 40.0                     | 67.0                     | 24.0                     |   |
|                      | 37.8         |               | 31.50        | 43.99                          | ± 1.22                             | 48.1         | 52.0                     | 40.0                     | 67.0                     | 24.0                     |   |
|                      | 40.4         |               | 32.00        | 44.64                          | ± 0.24                             | 48.1         | 52.0                     | 40.0                     | 66.0                     | 24.0                     |   |
|                      | 41.2         | 1.16          | 32.50        | 45.56                          | ± 0.33                             | 48.1         | 52.0                     | 40.0                     | 66.5                     | 24.0                     |   |
|                      | 31.7         |               | 32.75        | 62.12                          | ± 0.20                             | 48.1         | 52.0                     | 39.5                     | 67.0                     | 24.0                     |   |
|                      | 32.9         |               | 33.00        | 54.33                          | ± 0.19                             | 47.1         | 51.0                     | 39.0                     | 66.0                     | 24.0                     |   |
|                      | 34.2         |               | 33.25        | 51.38                          | ± 0.42                             | 47.1         | 51.0                     | 39.0                     | 66.5                     | 24.0                     |   |
| 35.3                 |              | 33.50         | 49.09        | ± 0.37                         | 47.1                               | 51.0         | 39.0                     | 66.5                     | 24.0                     |                          |   |
| 37.0                 |              | 34.00         | 48.24        | ± 0.48                         | 47.1                               | 51.0         | 39.0                     | 66.0                     | 24.0                     |                          |   |
| 41.6                 |              | 35.12         | 47.32        | ± 0.00                         | 47.1                               | 51.0         | 39.0                     | 66.5                     | 24.0                     |                          |   |
| 42.3                 | 0.70         | 35.50         | 47.26        | ± 0.19                         | 47.1                               | 51.0         | 39.5                     | 67.0                     | 24.0                     |                          |   |
| 11.3                 | NA           |               | 0.00         | 95.11                          | ± 0.56                             | 49.1         | 53.0                     | 45.0                     | 68.0                     | 24.0                     | Run #9, Cycle #7<br>Dewatering Mode Test<br>Pressure Gauge (P <sub>2</sub> ) got stuck<br>on 45 psi<br>Pressure Gauge (P <sub>2</sub> ) worked<br>itself free<br>Thin, floating films were collected<br>in the permeate samples<br>Session #2 |
|                      | 23.4         |               | 0.25         | 49.94                          | ± 0.19                             | 48.1         | 52.0                     | 45.0                     | 67.0                     | 24.0                     |   |
|                      | 24.7         |               | 0.50         | 44.12                          | ± 0.00                             | 48.1         | 52.0                     | 45.0                     | 67.0                     | 24.0                     |   |
|                      | 25.9         |               | 0.75         | 42.77                          | ± 0.28                             | 48.1         | 52.0                     | 44.0                     | 66.0                     | 24.0                     |   |
|                      | 27.8         |               | 1.00         | 41.76                          | ± 0.00                             | 47.6         | 51.5                     | 44.0                     | 66.0                     | 24.0                     |   |
|                      | 32.1         |               | 1.75         | 42.22                          | ± 0.68                             | 47.1         | 51.0                     | 42.5                     | 65.0                     | 22.0                     |   |
|                      | 38.0         | 2.18          | 2.75         | 68.14                          | ± 0.00                             | 47.1         | 51.0                     | 41.0                     | 65.0                     | 22.0                     |   |
|                      | 39.9         | 0.24          | 3.50         | 66.37                          | ± 0.00                             | 47.1         | 51.0                     | 40.0                     | 66.0                     | 23.0                     |   |
|                      | 23.4         |               | 3.52         | 81.29                          | ± 1.30                             | 48.1         | 52.0                     | 40.0                     | 67.0                     | 24.0                     |   |
|                      | 25.7         |               | 3.75         | 47.78                          | ± 0.74                             | 47.6         | 51.5                     | 39.0                     | 66.0                     | 24.0                     |   |
|                      | 27.8         |               | 4.00         | 42.41                          | ± 0.00                             | 47.1         | 51.0                     | 39.0                     | 66.0                     | 24.0                     |   |
|                      | 29.8         |               | 4.25         | 38.36                          | ± 0.19                             | 48.1         | 52.0                     | 39.5                     | 66.0                     | 24.0                     |   |
|                      | 35.9         |               | 5.17         | 39.34                          | ± 0.56                             | 47.1         | 51.0                     | 39.0                     | 66.0                     | 23.0                     |   |
|                      | 38.3         |               | 5.40         | 48.17                          | ± 0.19                             | 47.1         | 51.0                     | 39.0                     | 66.0                     | 23.0                     |   |
| 39.6                 |              | 5.52          | 49.58        | ± 0.46                         | 47.1                               | 51.0         | 39.0                     | 66.0                     | 23.0                     |                          |   |
| 42.7                 |              | 6.05          | 74.62        | ± 0.00                         | 46.6                               | 50.5         | 39.0                     | 65.0                     | 22.0                     |                          |   |
| 44.3                 | 1.86         | 6.48          | 75.86        | ± 0.19                         | 46.1                               | 50.0         | 39.5                     | 64.0                     | 20.5                     |                          |   |

Table D.1, Page 9

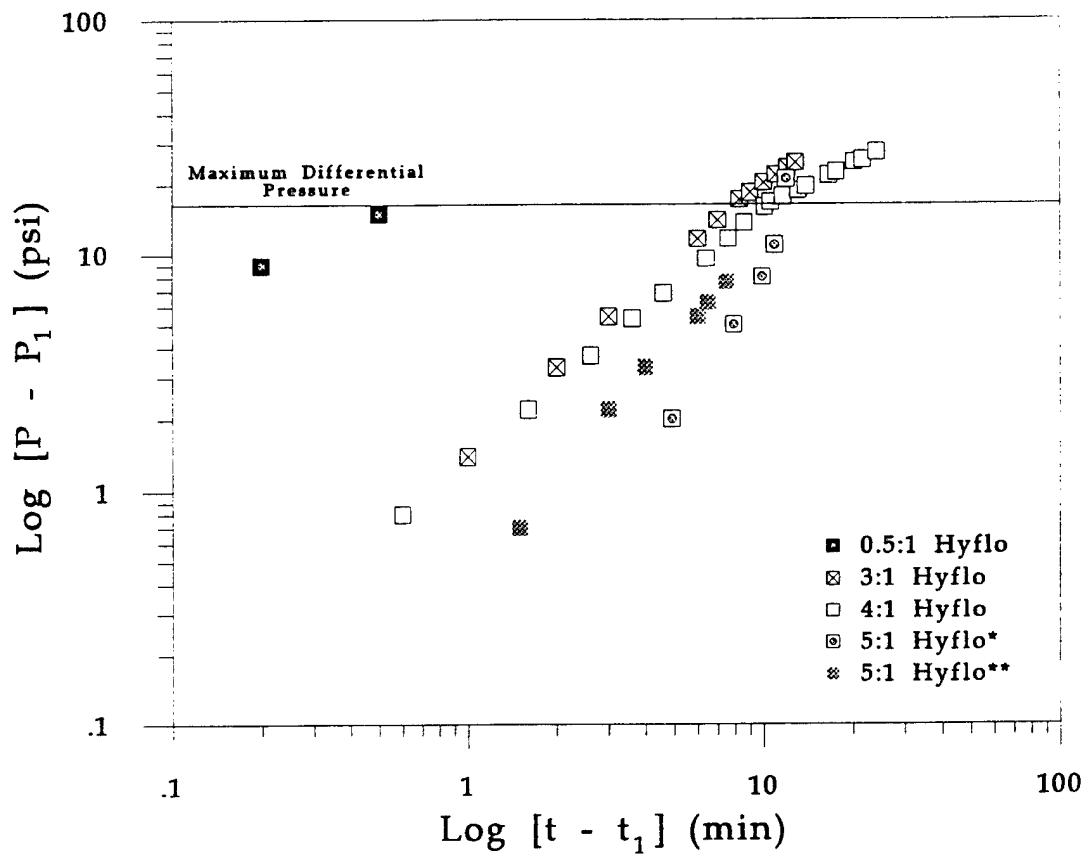

\* This run used 0.2% Orimulsion<sup>®</sup> in tapwater with 100 series paper septa and 4 filter plates  
 \*\* This run used 0.2% Orimulsion<sup>®</sup> in tapwater with 200 series paper septa and 3 filter plates  
 Note: 0.5:1 run used 1.0% Orimulsion<sup>®</sup> in tapwater. Unless otherwise stated, runs were at 0.1% Orimulsion<sup>®</sup> in tapwater

Figure D.1  
 Diatomaceous earth filtration headloss increase versus relative time for 0.1%-1.0% Orimulsion<sup>®</sup> in tapwater with Hyflo<sup>®</sup> diatomaceous earth and 1:1 clay:Orimulsion<sup>®</sup> solids addition.

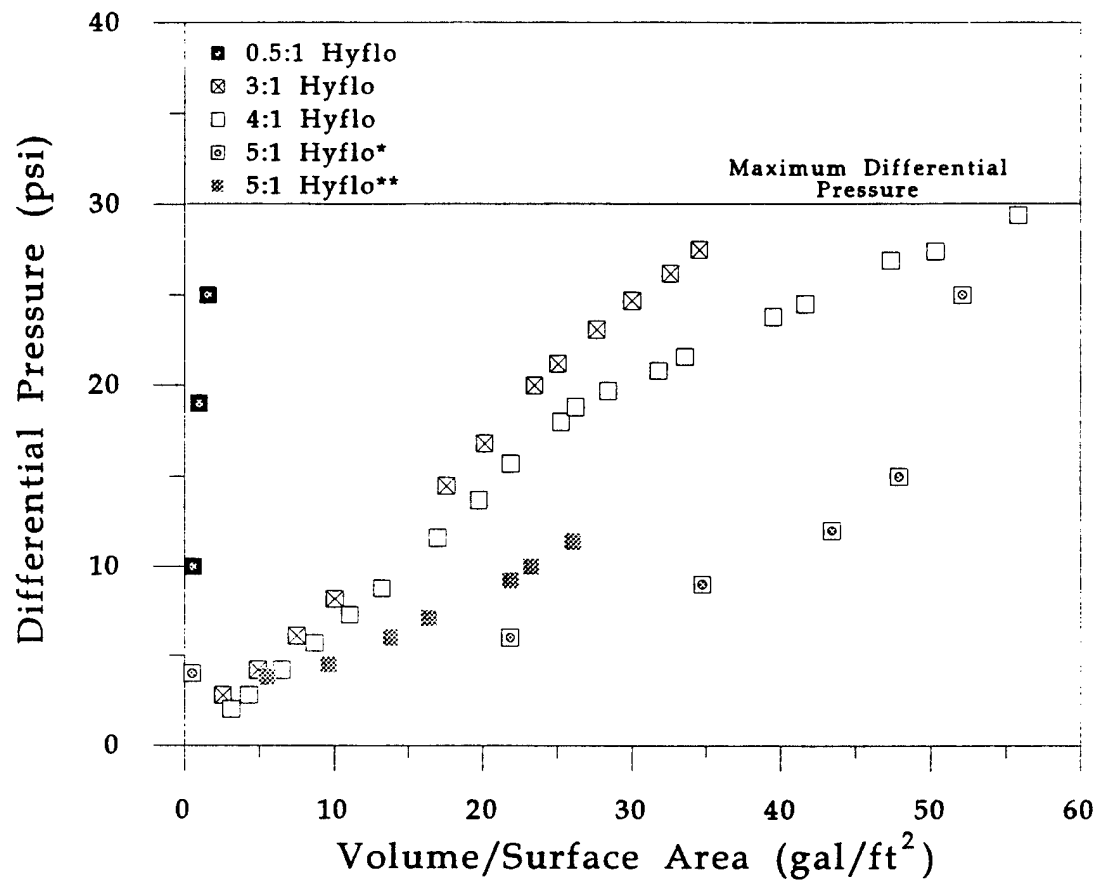

Figure D.2  
 Differential pressure versus cumulative volume filtered per unit plate surface area for filtration of 0.1%-1.0% Orimulsion<sup>®</sup> in tapwater with Hyflo<sup>®</sup> diatomaceous earth and 1:1 clay:Orimulsion<sup>®</sup> solids addition.

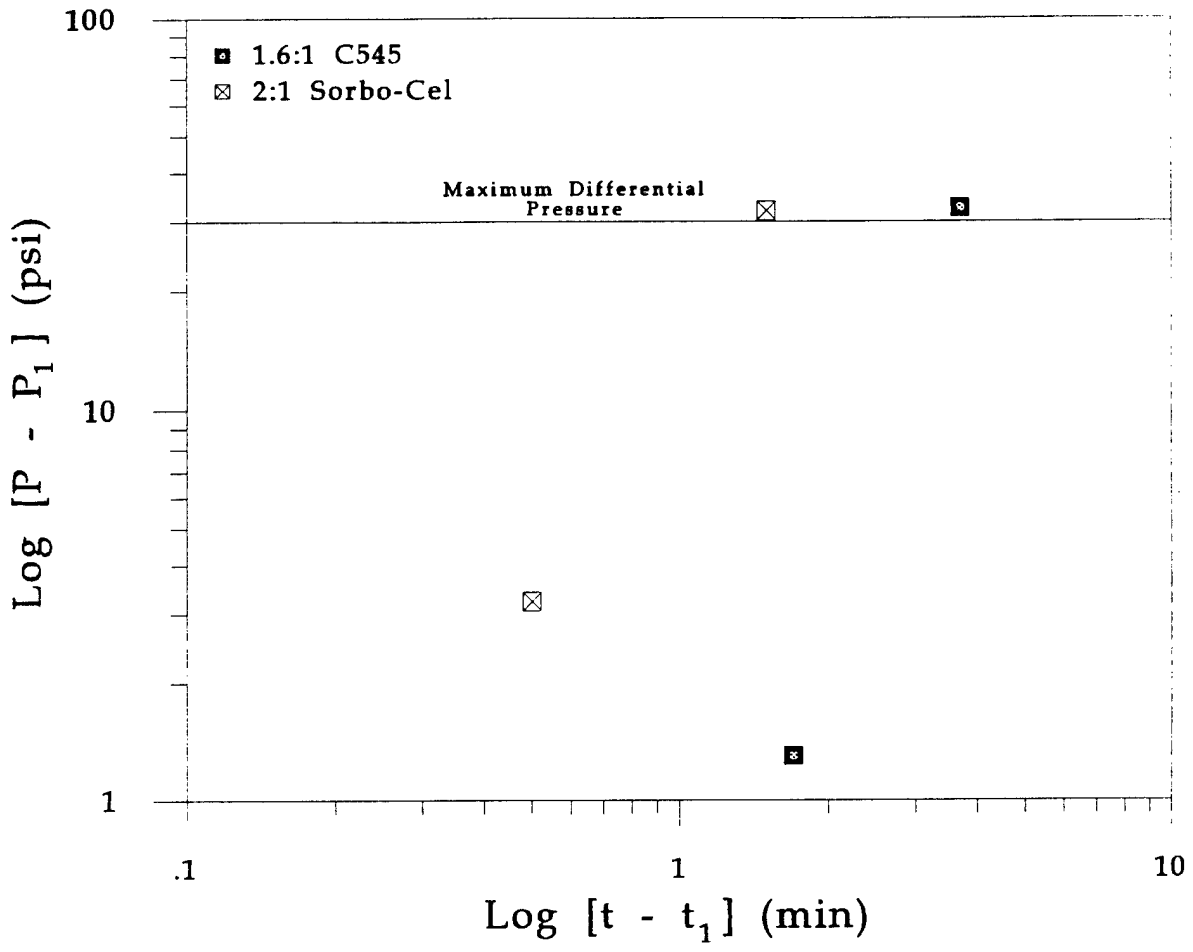

Figure D.3  
 Diatomaceous earth filtration headloss increase versus relative time for 1.3% Orimulsion<sup>®</sup> in tapwater with either Sorbo-Cel<sup>®</sup> or C545<sup>®</sup> diatomaceous earth and 0.1:1 clay:Orimulsion<sup>®</sup> solids addition.

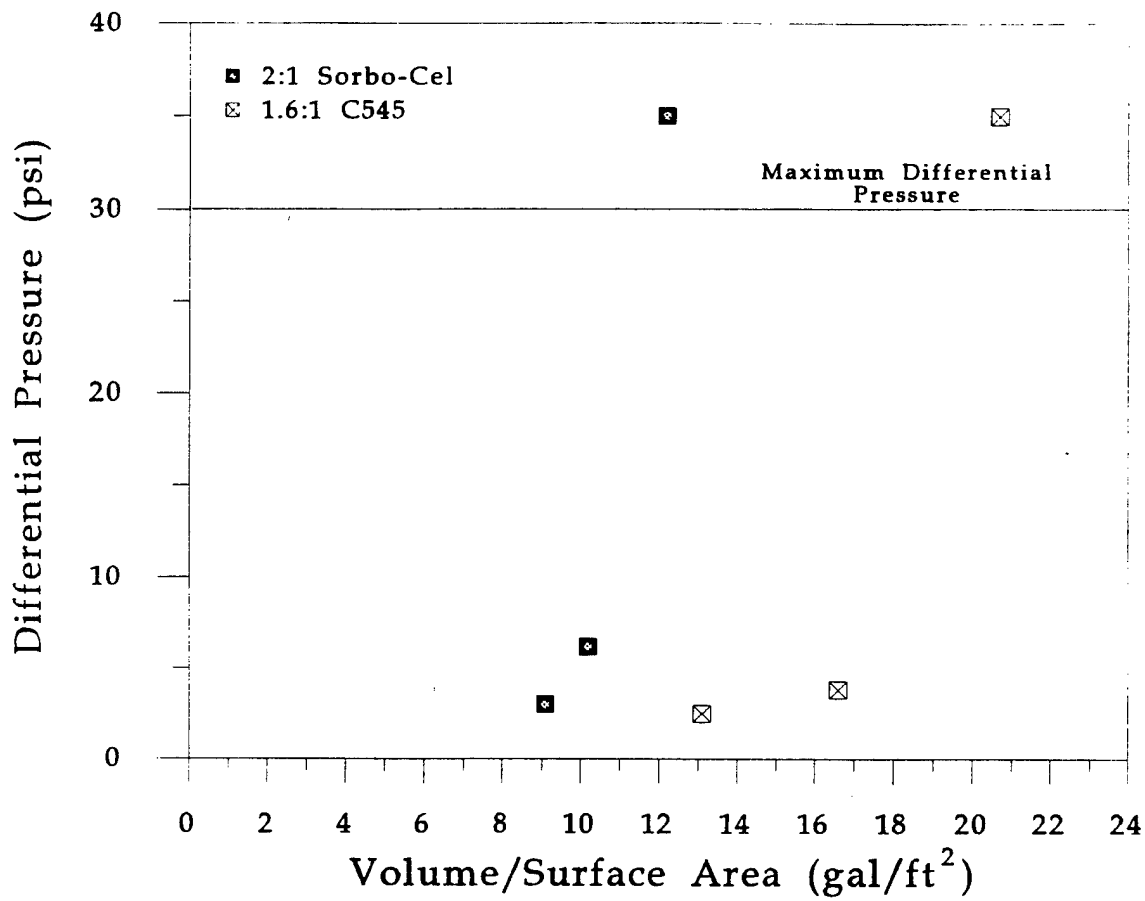

Figure D.4  
 Differential pressure versus cumulative volume filtered per unit plate surface area for filtration of 1.3% Orimulsion<sup>®</sup> in tapwater with Sorbo-Cel<sup>®</sup> or C545<sup>®</sup> diatomaceous earth and 1:1 clay:Orimulsion<sup>®</sup> solids addition.

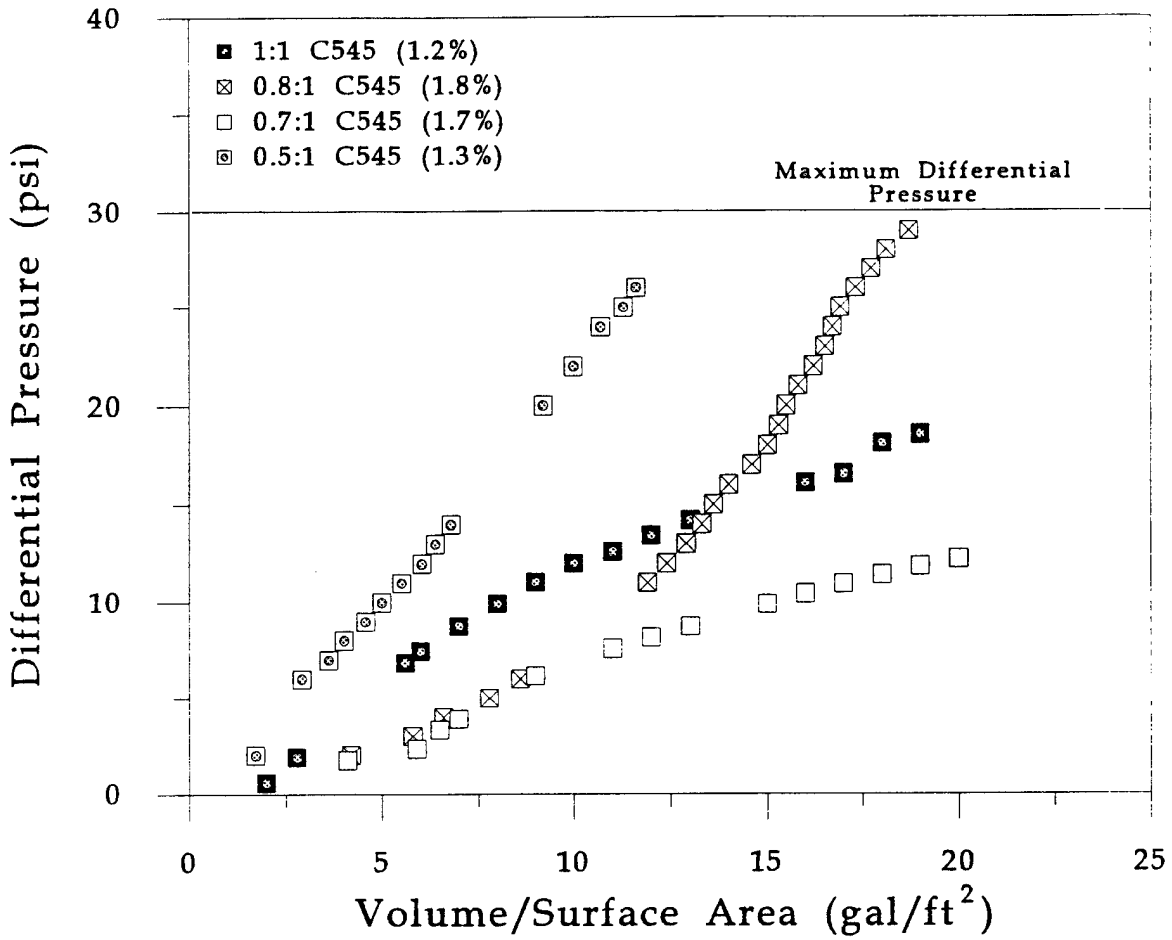
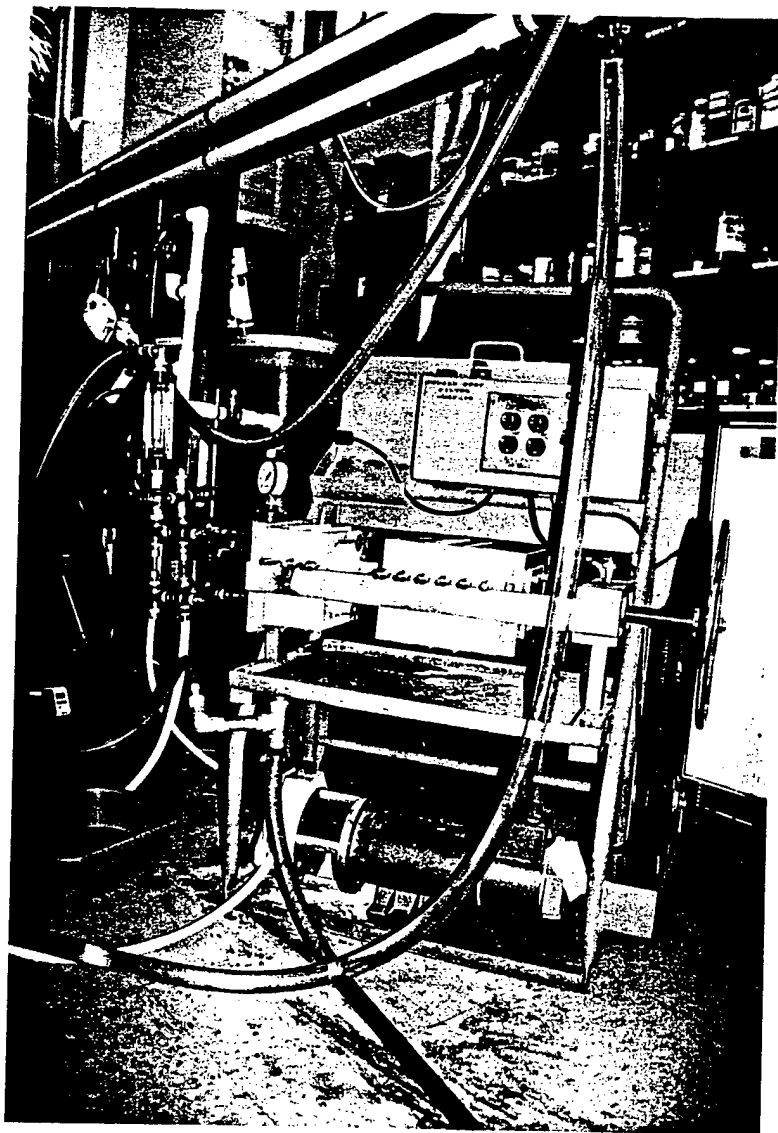

Figure D.5  
 Diatomaceous earth filtration headloss versus cumulative volume filtered per unit plate surface area for filtration of 1.2%-1.8% Orimulsion<sup>®</sup> in seawater with C545<sup>®</sup> diatomaceous earth and 0.1:1 clay:Orimulsion<sup>®</sup> solids addition.

**APPENDIX E. PRECOAT PILOT PLANT**







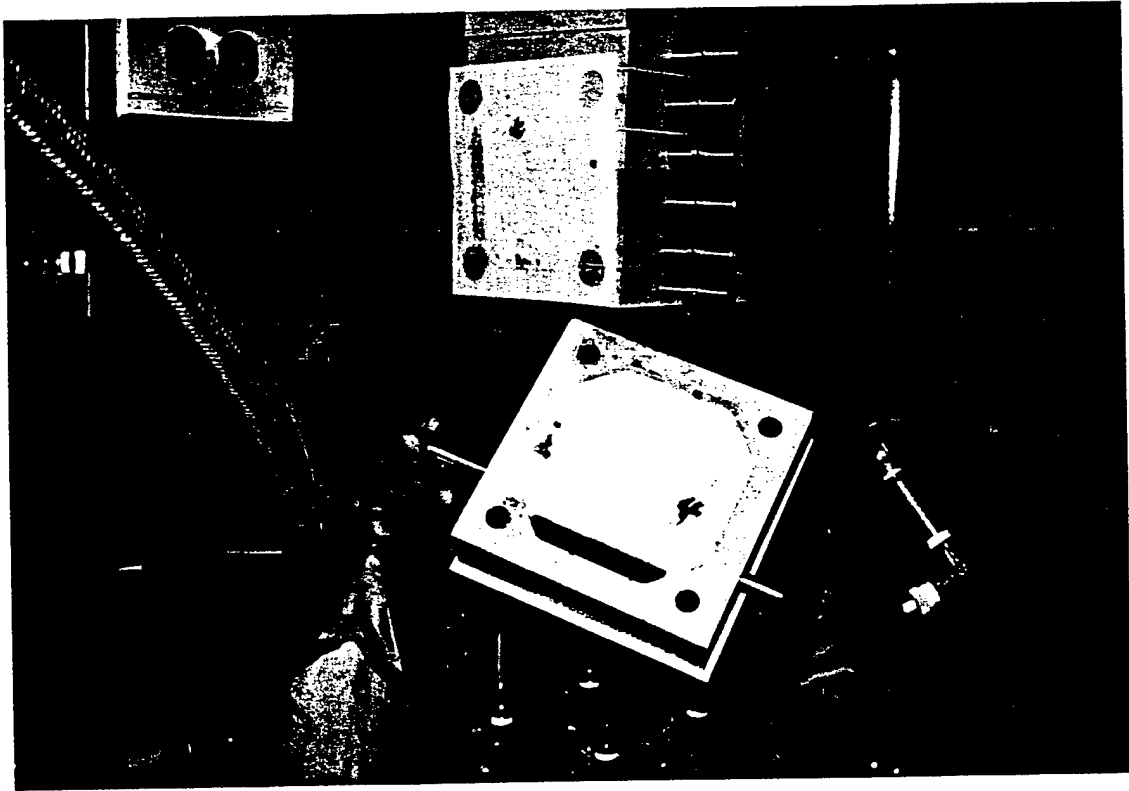



## APPENDIX F. ULTRAFILTRATION PILOT PLANT

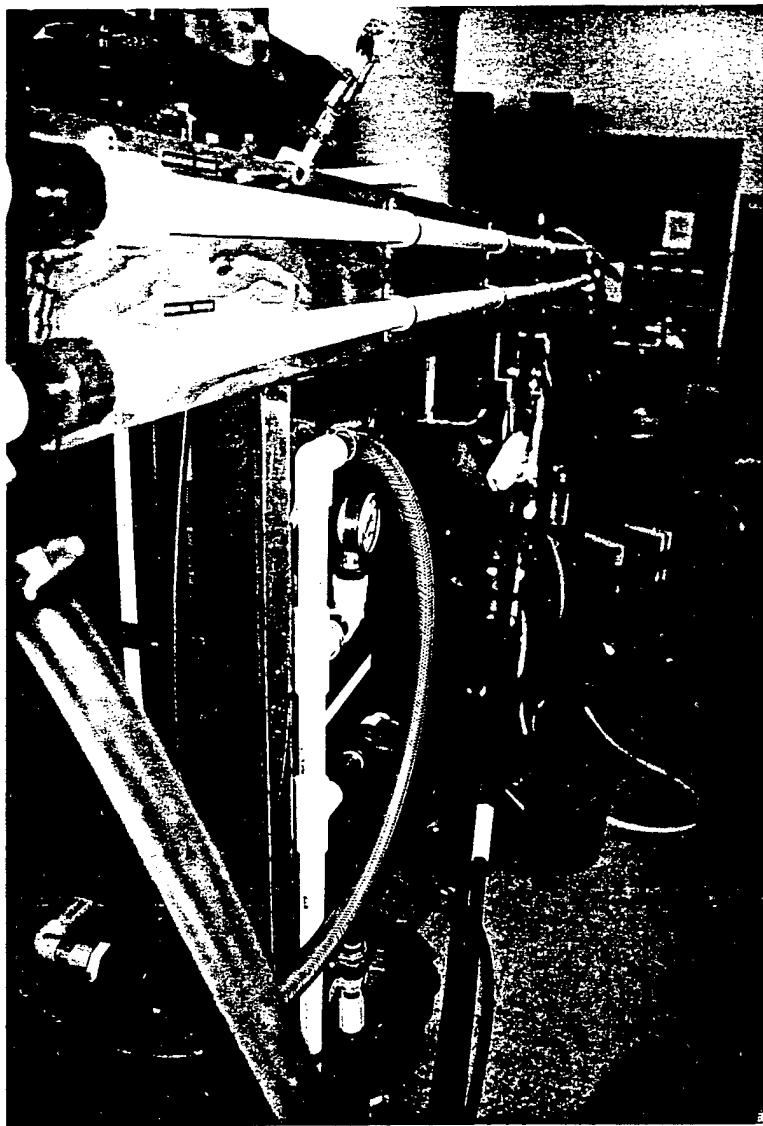

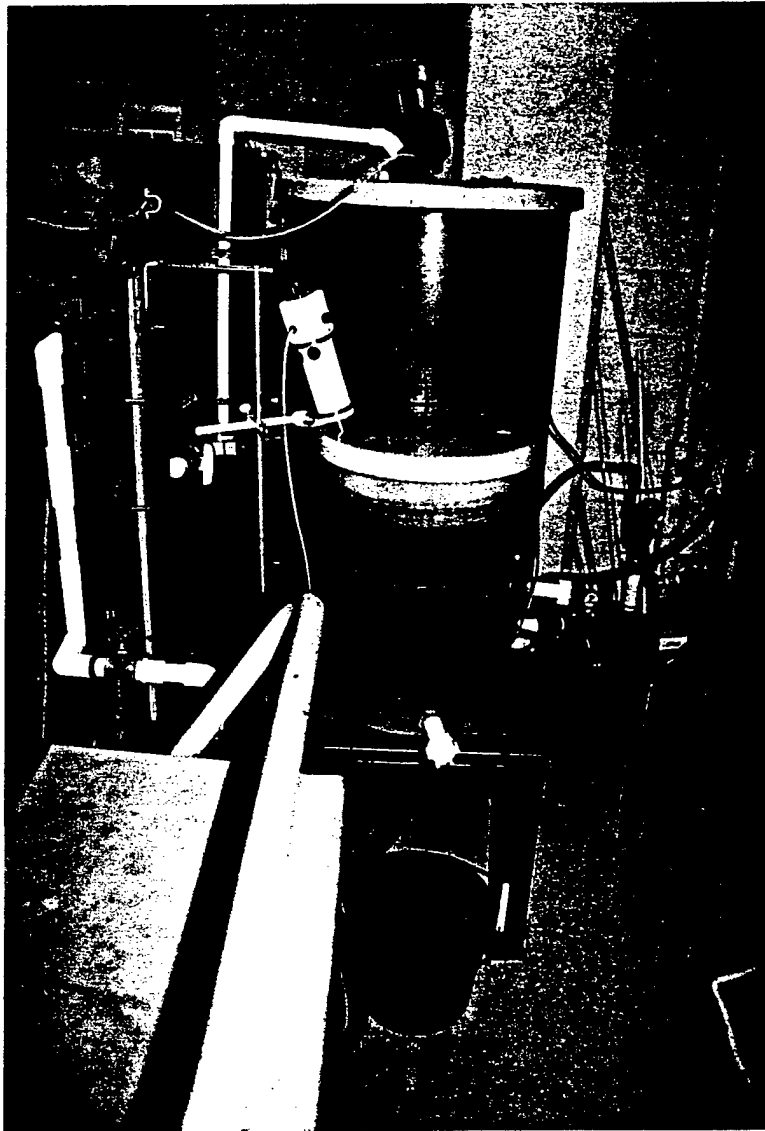

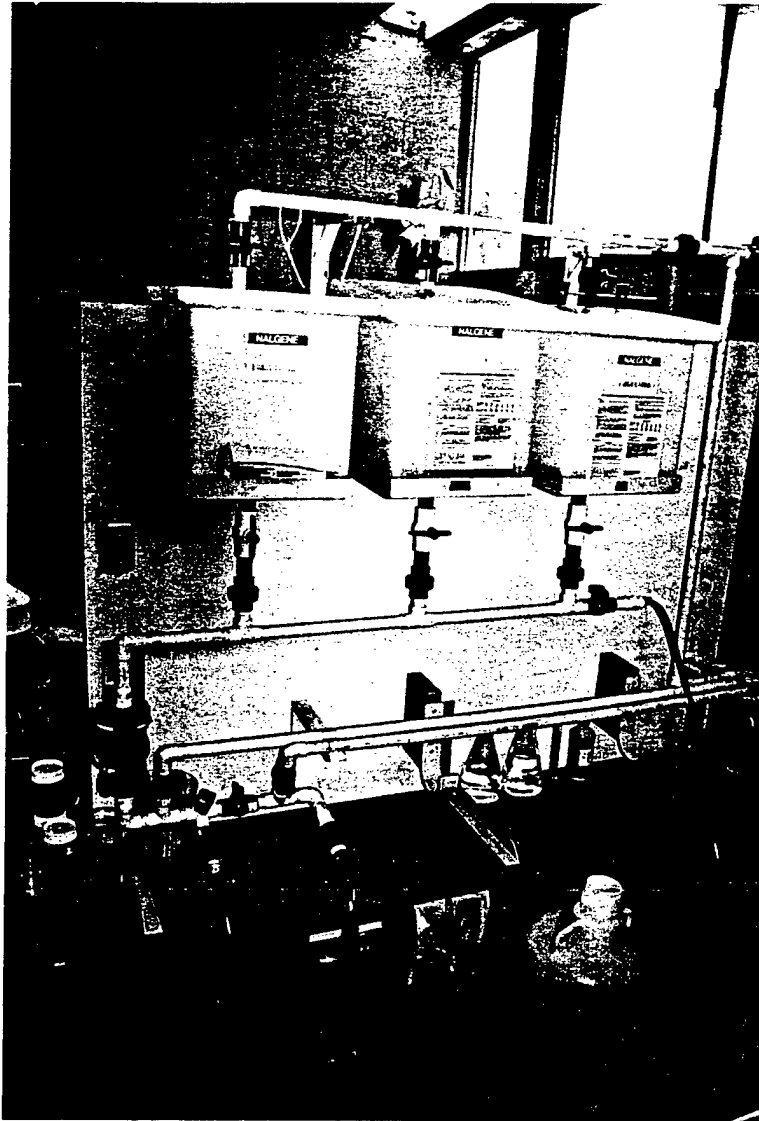





**MICRO- AND MESO-SCALE METHODS FOR PREDICTING THE BEHAVIOR OF  
LOW-API GRAVITY OILS (LAPIO) SPILLED ON WATER**

*S.A. Ostazeski, S.C. Macomber, L.G. Roberts, and A.D. Uhler, Batelle Ocean Sciences*

## **ACKNOWLEDGEMENTS**

This work has been sponsored by the United States Coast Guard, 1995 Oil Pollution Grants Program, Research & Special Programs Administration. The authors wish to acknowledge the following people for their contributions.

Mr. John Putukian of the U.S. Department of Transportation, John A. Volpe National Transportation Systems Center, served as the Contracting Officer. Mr. Kenneth R. Bitting and Dr. Bob Hiltabrand both of the U.S. Coast Guard, Research and Development Center served as the Contracting Officer's Technical Representatives for this project. Mr. Bitting and Dr. Hiltabrand provided helpful guidance and advice during all phases of this project.

Mr. Atle B. Nordvik, Research and Development, Marine Spill Response Corporation provided some matching funds in the initial phases of work. Likewise, Mr. Mark Jones of Florida Power and Light, Company provided additional funding following the dismantling of the MSRC Research and Development department.

Mr. Nelson Garcia (BITOR America Corporation), Mr. Mark Jones (Florida Power & Light Company), Mr. Paul J. MacDonald (Florida Power Corporation) and Mr. Russell Macomber (W. H. Riley and Son) provided the fuels which were selected for this work.

## EXECUTIVE SUMMARY

The majority of characterization studies using low API gravity (LAPIO) fuels have been conducted from the perspective of the utility plant operator and with ease of utility operation in mind. The focus of these studies were to determine the suitability of these fuels as feed stock for electric power generation. The results were typically directed at solving problems of fuel oil instability and incompatibility which may adversely affect fuel storage and handling. Very few characterization studies have been conducted with respect to the environmental fate and behavior of these fuels. In order to address this paucity, Battelle performed a series of detailed investigations of the weathering properties of six model low API gravity (LAPIO) fuels. The objectives of these studies were to:

- 1) determine the relative importance of key environmental parameters on the behavior of LAPIO spilled on water
- 2) develop bench- and meso-scale test protocols which can be used for predicting the environmental behavior of spilled LAPIO
- 3) begin the development of a data base of the physical and chemical characteristics of LAPIO products transported in United States waters for the purposes of modeling and predicting their behavior in the event of a spill

Six fuels were selected for study; three residual fuels (No. 6 fuels oils), a heavy crude oil and Orimulsion®. In addition to these five fuels, a No. 2 fuel oil was included in this study because often these types of light distillate fuels are used as cutter stock for heavier residual fuels.

The technical investigations included bench scale (micro-scale) and meso-scale testing. The micro-scale studies included a stepwise weathering of the oils to isolate the processes of evaporation and emulsification and allows for their independent study. The meso-scale studies investigated these weathering processes simultaneously under controlled conditions and provided a bridge between the laboratory-based studies and authentic oil spills.

Bulk property measurements were made on the fuels and the weathered residues to characterize the products and the changes in these products which occurs as a function of weathering. The characterization studies included both physical and chemical measurements. The physical characterization included the determination of density, flash-point, pour-point, viscosity and interfacial surface tension. Chemical characterization included analysis of the saturate, aromatic, resin, and polar fractions. Determination of the wax, "hard", and "soft" asphaltene content was made by chemical analysis. Studies of the influence of temperature on density and viscosity were also conducted.

In addition to the bulk property measurements, emulsification studies were conducted on the fuels and their residues. Water-in-oil emulsions were prepared and the rates of emulsification, maximum water uptake, and stability of the emulsions formed were determined as well as the effectiveness of chemical demulsifiers and commercially available dispersants.

Two fuels were selected as model fuels for meso-scale study. The first oil was a No. 6 fuel oil used by Florida Power and Light Corporation as feed stock for electric power generation. These studies were conducted in seawater. In addition to the No. 6 fuel oil, studies in full strength seawater and fresh water were conducted with Orimulsion®.

The physical and chemical measurements made on the fuels and their weathered analogues demonstrated the wide range of bulk properties which exist for fuels shipped as LAPIO fuels. The three number six fuels which were selected for study exhibited very broad ranges in such fundamental properties as density, viscosity, and interfacial surface tension. To illustrate this point, the viscosity of the fresh fuels ranged from 2.6 cP to approximately 11,400 cP. As these fuels weathered and water-in-oil emulsions were formed the viscosity increased. The range in viscosity of the water-in-oil emulsions was approximately 3 cP (No. 2 fuel) to greater than 400,000 cP. The viscosity of the fresh No. 6 fuels ranged from approximately 5,100 cP to 11,400 cP. Following emulsification and the addition of water, the viscosities observed for the water saturated No. 6 fuels ranged from approximately 41,000 cP to greater than 158,000 cP.

The ability and rates of the fuels to take up and retain water and form stable water-in-oil emulsions also varied greatly. The No. 2 fuel oil showed very little ability to take up water and did not form stable emulsions. The three No. 6 fuel oils had significant water uptake rates and formed very stable emulsions. The dispersant testing indicated that once stable emulsions were formed from these No. 6 fuels the effectiveness of commercially available dispersants was significantly reduced. However, even though dispersant effectiveness was reduced for the emulsions several of the water-in-oil emulsions responded very positively to the addition of dispersants with greater than 50% effectiveness observed in some cases. These results suggest that dispersant application to spills of LAPIO fuels is a realistic countermeasure tool and that multiple dispersant applications to a slick may be a very viable option for oil spill response.

The results of the meso-scale testing and the stepwise weathering studies were in very good agreement. The results obtained from the studies conducted with Orimulsion® indicate that bitumen particle growth and slick formation is governed by the stability of the nonylphenol surfactant used in the formulation Orimulsion®. The nonylphenol surfactant has been optimized for fresh water and in seawater significant amounts of the bitumen may reach the surface of the water column in a relatively short period of time.

The combination of bulk property measurements and the results obtained from the emulsion studies provides a framework of fundamental data required for a successful response to spills of these fuels. The greatest utility of these data would be to populate such oil weathering models as the NOAA ADIOS model and the IKU Oil Weathering model. This would allow responders and contingency planners to model the fate and behavior of these fuels released into the environment prior to a spill.

Need to discuss follow-up work

# 1. INTRODUCTION

In the event of an oil spill at sea most oils will float and rapidly begin to undergo fairly predictable modifications in their physical and chemical properties. These physical and chemical changes are collectively known as weathering. Most oil spill contingency measures that are currently available have been developed for these floating oils and emulsions. Recently, interest in studying the behavior of low-API gravity oils (LAPIO) has increased because these products may behave quite differently if spilled.

Public utilities, traditionally users of No. 6 fuel oil, have recently demonstrated an increased interest in the use of Group V fuels for generating electric power. Group V fuels are operationally defined as oils having an API gravity  $< 10^\circ$  at  $60^\circ\text{F}$ . Public utilities often refer to these Group V fuels as low-API gravity oils (LAPIO). These LAPIO fuels include No. 6 fuel oils with API gravity of  $10.0^\circ$  or less, blends of very heavy residual fuel oils cut with lighter oils, asphalt products, and very heavy crude oils (Campbell and Rahbany, 1991; Michel *et al.*, 1995).

The interest that utility companies have shown in the use of LAPIO fuels has been generated because of the lower cost and relatively higher BTU content of these fuels. Lange and Brown (1993) report that the 1992 cost of LAPIO fuels was at least \$2.25 less per barrel than alternative higher API gravity oils, while the gross BTU content of the fuel increased approximately 3.3% per  $10^\circ$  API standard gravity decrease in the fuel — clearly, LAPIOs are an attractive fuel oil alternative.

By definition, LAPIO fuels have densities  $\leq 1.0$  g/mL which implies that they may float, be neutrally buoyant, or sink when spilled on water. The ultimate behavior of any LAPIO spilled in the aqueous environment is a function of the physical and chemical properties of the specific oil as well as the temperature and composition (e.g., salinity and suspended solids content) of the water into which they are released. In the past, utility companies have avoided the use of LAPIO because of the lack of suitable spill response methods and technologies for dealing with LAPIO spills that could occur on water (Lange and Brown, 1993). The increasing use of LAPIO for electric power generation has increased the likelihood of both major and minor spills over water. It follows that there is an urgency for improved oil spill response methods and for suitable methods to predict the behavior of LAPIO spilled on water.

## 1.1 The Unique Nature of LAPIO

Traditional No. 6 fuel oils are made by blending mixtures of heavy residual oils with lighter oils in order to meet targeted specifications of viscosity, pour point and API gravity (residual oils are those components remaining after the lighter, more valuable components of a crude oil have been removed during the refining process). LAPIO fuels may also be blends of heavy residuals and light oils, but, in general, LAPIO contain more of the heavier components than do traditional No. 6 fuels (Michel *et al.*, 1995). Because LAPIO contain more of the heavy components than conventional No. 6 fuel oils they exhibit differences in their physical properties and chemical composition.

Campbell and Rahbany (1991) and Michel *et al.* (1995) report that the major sources of heavy oils that are used in the blending of fuel oils are:

- atmospheric reduced crudes - the residues remaining after crude oil is heated to boiling and the distillate collected
- vacuum bottoms - the residue produced following the vacuum distillation of residuum left from an atmospheric reduced crude

- heavy slurry oils or decanted oils - aromatic oils produced as by products of catalytic cracking.

These heavy blending stocks are known as residual fuels, as they are the residues left in the bottom of distillation towers or catalytic cracker towers following the refining process. These heavy blending stocks are then blended with a lighter cutter stock to specific viscosities, pour point, and sulfur content.

Michel *et al.* (1995), Scholz *et al.* (1994) and Campbell and Raphbany (1991) describe important but subtle differences between conventional No. 6 fuels and LAPIO fuels. It is these differences which are responsible for the unique physical and chemical properties of LAPIO. The most important ways in which LAPIO products differ from conventional No. 6 fuels are:

- Market factors have led to marketing middlemen (oil jobbers) purchasing residual oils from foreign refineries and then blending them for resale to United States utilities on the spot market. The lowest cost and most plentiful residual fuels are the vacuum bottoms. LAPIO products produced from vacuum bottoms tend to have very high aromatic contents and thus LAPIO blended from these stocks are chemically different from conventional fuel oils.
- LAPIO fuels are blended to target viscosities, pour point and sulfur content. No minimum API gravity requirement exists. The amount and source of the cutter stocks used for blending with the heavy residuals may vary. No. 2 fuel is a common cutter fuel but other light oils may also be used for blending. The cheapest LAPIO would be blended from suitable heavy oil residuals without the addition of any cutter stock. As a result of these blending differences there can exist wide variations in the chemical and physical composition of LAPIO.
- No. 6 fuels and LAPIO may show differences in their stability and compatibility. Traditional No. 6 fuels (blends of residuals and No. 2 fuel) are generally well mixed and stable during storage and transportation. As a result of the blending processes used for LAPIO production, LAPIO fuels may be unstable during transport and storage. This instability is manifested by asphaltene precipitation and/or separation during transportation and storage. LAPIO spills on water have resulted in the physical separation of the fuel into components that may float, sink, or are neutrally buoyant.

## 1.2 The Behavior of LAPIO Fuels When Spilled On Water — The Potential Problem

Because of the differences in blending of LAPIO fuels, they constitute products with distinctive physical and chemical properties that present a suite of problems from an oil spill contingency planners perspective. The most common perception is that when crude oils and petroleum products are spilled on water they will float. LAPIO spills are unpredictable and a LAPIO spilled on water may float, sink, or separate into fractions which are distributed throughout the water column as a function of the receiving waters temperature, density, and general composition (Lange and Brown, 1993; Castle *et al.*, 1995).

Michel *et al.* (1995) and Scholz *et al.* (1994) present descriptive models which describe the behavior of LAPIO spilled in coastal environments. The models described below, have as their basis a general understanding of the physical and chemical properties of LAPIO fuels.

- Model 1: oil remains liquid, majority floats.
- Model 2: oil remains liquid, majority does not float.
- Model 3: oil remains liquid, initially floats, but sinks after entraining sand/particulates.

In the case of a Model 1 LAPIO spill the LAPIO behaves as a conventional No. 6 fuel oil. At 60°F the LAPIO would have an API gravity of approximately 6.5 and would be less dense than full strength sea water. Model 1 LAPIO spills would result in a fugitive product which would float as a slick on the surface of the receiving water. Conventional spill response and cleanup technologies could be applied to Model 1 LAPIO spills.

In the case of a Model 2 LAPIO spill, the LAPIO has a density greater than the receiving water. As the oil mixes into the water column, it is expected to form small droplets. Fugitive product spilled in this case will come into contact with water-wet surfaces and it is not expected to sorb to debris or vegetation it may encounter in the water column. If the currents in the area of the spill are greater than approximately 0.1 knots the oil might be expected to remain in suspension, with the size of the oil droplets ranging from 0.5  $\mu\text{m}$  to approximately 1 mm in diameter. In areas having no currents the suspended oil would be expected to directly sink and accumulate in bottom depressions. The weathering process for the submerged fractions of the oil would be expected to be slower relative to surface slicks.

Heavy fuel spills behaving as a Model 3 LAPIO spill have been reported for sinking oil in Tampa Bay (Scholz *et al.*, 1994) and was reported to be responsible for the sinking No. 6 fuel oil associated with the *Morris J. Berman* grounding and subsequent spill in Puerto Rico (Burns *et al.*, 1995; Michel and Galt, 1995). In this case the fugitive product behaves as a conventional No. 6 fuel oil and undergoes weathering by evaporation. As the fugitive product weathers, water-in-oil emulsions are formed and the viscosity of the product increases. As the oil is transported into near-shore areas it is mixed in the water column by wave action. In areas having sandy bottoms, sand and other suspended solids are also mixed in the water column, and subsequently mixed into the product. As sand/particulates are entrained in the oil, the density of the resulting oil:water:solids emulsion increases. After approximately 2 - 3% (wt.) sand is incorporated into the emulsion the density of the emulsion is greater than the surrounding seawater and the mixture sinks. The submerged oil may eventually exist as very thick deposits that are hundreds of feet long or as small tar balls with entrained sand. Often in areas of relatively high current or wave activity the submerged oil will form long cigar shaped "rollers". These rollers become heavier, entraining more sand as well as shell fragments as they are moved about by waves and currents. In the case of the *Morris J. Berman* grounding, the submerged oil resurfaced after the sand was physically separated from the oil as a result of wave action (Burns *et al.*, 1995; Michel and Galt, 1995).

### 1.3 OBJECTIVES

The objectives of this study were to (1) determine the relative importance of key environmental parameters on the behavior of LAPIO spilled on water, (2) develop bench- and meso-scale test protocols which can be used for predicting the environmental behavior of spilled LAPIO, and (3) begin to develop a data base of the physical and chemical characteristics of LAPIO products transported in United States waters for the purposes of modeling and predicting their behavior in the event of a spill.



## 2. METHODOLOGY

The technical work has focused on gaining a thorough understanding of the fundamental behavior of LAPIO spilled on water, and determining which environmental parameters are particularly important to the behavior of the spilled product and which parameters are of minor importance. Specifically, factors that regulate whether the oil floats, sinks, or stratifies, and the emulsification characteristics of the fuels that have been studied.

The fuels which have been selected for study have been tested using both bench-top (microscale) and mesoscale laboratory testing and weathering methods.

In an effort to simulate the behavior of oil spilled in the sea the selected products have been artificially weathered by evaporative distillation (topping). The weathering endpoints that have been used represent a range of exposure at sea from a freshly released fuel to approximately one week of exposure at sea.

A battery of tests have been carried out to characterize the physical and chemical properties of the oil residues, investigate the buoyancy characteristics of the oils, investigate the emulsifying properties of the oils, and determine the chemical dispersability of the oil.

Mesoscale experiments have been carried out to more closely simulate real-world conditions of LAPIO products spilled at sea, and for calibrating microscale testing. In these studies, selected LAPIO products have been added to a circulating wave tank and allowed to weather over approximately one week, or longer, until a steady state is observed. Discrete samples of oil/emulsion and water have been taken over the course of the mesoscale experiments. The physical and chemical composition of the oil and the water was then evaluated over the duration of the experiment.

### 2.1 Selected LAPIO Fuels

Six fuels representing the range of product compositions for fuels that are shipped in United States waters were selected for this study, these are:

- No. 6 Fuel from the *Morris J. Berman* grounding in San Juan, Puerto Rico;
- No. 6 Fuel received from Florida Power and Light (FPL);
- No. 6 Fuel received from Florida Power Corporation (FPC);
- No. 2 Fuel received from W.H. Riley and Son, Taunton MA;
- Mandalay Crude oil from the Monterey Basin, received from the Marine Spill Response Corporation (MSRC);
- Orimulsion® received from BITOR America.

On January 7, 1994 the barge *Morris J. Berman* broke her tow and ran aground on a coral reef near Escambron Beach on the northern shore of Puerto Rico spilling her cargo of No. 6 fuel oil. Over an eight day period, approximately 622,000 gallons of fuel oil was released. The No. 6 cargo oil used in this study was obtained following the lightering operations subsequent to the *Morris J. Berman* grounding. Approximately 20-L of the lightered oil was supplied to Battelle Ocean Sciences (BOS) by MSRC in one gallon steel tins.

A No. 6 fuel oil which is used as feed stock by FPL for electric power generation was supplied by FPL. The fuel was shipped to BOS in 5-gal plastic pails. Approximately twenty gallons of No. 6 fuel oil was received by BOS on May 19, 1995.

A heavy No. 6 fuel oil which is used as feed stock by FPC member utilities for electric power generation was supplied by FPC. The fuel was shipped to BOS in 5-gal plastic pails. Approximately twenty gallons of No. 6 fuel oil was received by BOS on May 19, 1995.

Twenty gallons of No. 2 fuel oil was obtained locally from W. H. Riley and Son, (Taunton MA) oil was delivered to BOS on the March 8, 1995 in 5-gal steel fuel cans. The No 2 Fuel oil, though not a heavy fuel was included in this study because it is often used as cutter fuel for heavier fuels such as No. 6 fuels.

The Mandalay Crude oil is a very heavy crude oil produced from the Monterey Basin. Approximately twenty gallons of Mandalay Crude oil was obtained from UNOCAL through MSRC. The Mandalay Crude oil was received by BOS on the May 8, 1995 in 5-gal plastic pails.

Orimulsion® is the registered trade name for a synthetic fuel which has been developed by the Venezuelan oil industry (Petroleos Se Venezuela SA) for oil-fired power plants. The current formulation of Orimulsion® is a slurry of Orinoco bitumen (70%) emulsified and stabilized in a continuous phase of water (30%). Because of the unique behavior of Orimulsion® and because some electric utility companies are considering Orimulsion® as a cost effective alternative to traditional heavy fuels used as feed stock for the generation of electric power Orimulsion® was selected for these studies.

Approximately twenty gallons of Orimulsion® was obtained from BITOR America Corporation (Boca Raton, FL). The Orimulsion® was shipped in 5-gal plastic pails and received by BOS on January 25, 1996.

## 2.2 Topping Procedure for Heavy Fuel Oil

The fresh fuel oils were artificially weathered in the laboratory by evaporatively topping (distilling) the oils under controlled conditions following American Society For Testing And Materials (ASTM) Method D86-90, *Standard Test Method for Distillation of Petroleum Products*. Replicate samples of approximately 1,100 g of fresh oil were heated by stirring under an inert, flowing blanket of nitrogen in a standard distillation apparatus. The liquid and vapor phase temperatures were carefully monitored, and the volume of condensate distilled from the oil was measured as a function of vapor and liquid phase temperature. Because the continuous phase of Orimulsion® is 30% water, it was not subjected to the topping conditions described in this section.

Topping of each fraction was halted when the vapor phase reached the desired topping temperature (e.g., 150°C). Vapor-phase distillation temperatures of 150°C, 200°C, and 250°C, respectively, were used to simulate on-the-water weathering equivalents of 1-3 hrs, 0.5-1 d, and 1 week at 13°C and moderate wind conditions (Daling and Brandvik, 1992). The weight of the oil residue and the final volume of the condensate was measured. After cooling, the topped oil residue was stored under nitrogen in a sealed glass container at room temperature and used for subsequent testing of physical and chemical characteristics as well as investigations of the emulsification/demulsification and dispersion properties of the oil and its weathered residues.

## 2.3 GC/FID Analysis of the Heavy Fuel Oil Residues

Analysis of the oil residues for C<sub>8</sub> to C<sub>36</sub> *n*-alkanes, isoprenoid hydrocarbons, and total petroleum hydrocarbons (TPH) was performed on the selected fuels following modifications of EPA Method 8100. These methods and their modifications have been described by Douglas and Uhler (1993). The total gas chromatographic hydrocarbon signature of the fresh and topped residues of the fuel oils were determined using a Hewlett-Packard 5890 Series II capillary gas chromatograph with flame ionization detection

(GC/FID). A 3  $\mu\text{L}$  aliquot of a 5 mg  $\text{mL}^{-1}$  dichloromethane dilution of the oil under study was injected using splitless techniques onto a 30-m DB-5 capillary column (J&W fused silica DB-5, 30-m, 0.32-mm internal diameter, and 0.25- $\mu\text{m}$  film thickness), and the oven programmed from 35°C to 320°C at 6°C  $\text{min}^{-1}$ . Prior to sample analysis a 6-point calibration curve containing *n*-C<sub>8</sub> to *n*-C<sub>40</sub> *n*-alkanes, pristane, and phytane was analyzed to demonstrate instrument calibration and performance.

Alkane and total hydrocarbon sample analyte concentrations were quantified by the method of internal standards using the internal standard 5 alpha-androstane. Total petroleum hydrocarbons (resolved plus unresolved TPH) were quantified by the method of internal standards using the baseline corrected total area of the chromatogram and the average hydrocarbon response factor of the individual C<sub>8</sub> to C<sub>36</sub> *n*-alkanes. The target analytes are presented in Table 2-1.

## 2.4 GC/MS Analysis of the Heavy Fuel Oil Residues

The analysis of parent 2-, 3-, 4-, 5- and 6-ring PAH's, their respective C<sub>1</sub> through C<sub>4</sub> alkyl homologues, and dibenzothiophenes was performed on the oil residues prepared above using GC/MS techniques that are a modification of EPA Method 8270 (Douglas and Uhler, 1993). Prior to sample analysis, the GC/MS was tuned with perfluorotributylamine (PFTBA) and a minimum of a 5-point initial calibration consisting of parent and alkylated PAH compounds was established to demonstrate the linear range of the analysis. Quantification of individual components was performed by the method of internal standards using response factors (RRF) for individual components relative to the internal standards acenaphthene-d<sub>10</sub>, phenanthrene-d<sub>10</sub>, and benzo[*a*]pyrene-d<sub>12</sub> (RRF). PAH alkyl homologues were quantified using the straight baseline integration of each level of alkylation and the RRF of the respective parent PAH compound (Table 2-1).

Sample extracts were analyzed by GC/MS using a Hewlett-Packard 5890 gas chromatograph equipped with a 5970 mass selective detector operating in the selected ion monitoring (SIM) mode. A 2  $\mu\text{L}$  aliquot of the sample was injected into a gas chromatograph equipped with a high resolution capillary column (J&W fused silica DB-5-MS, 30-m, 0.25-mm i.d., and 0.25- $\mu\text{m}$  film thickness) operated in the splitless mode. The temperature program and capillary column specification achieve near-baseline separation of the petroleum specific PAH compounds listed in Table 2.1.

Table 2-1. GCFID and GCMS Target Analytes.

| <u>GC/MS Target Analytes</u>          | <u>GC/FID Target Analytes</u>                              |
|---------------------------------------|--|
| Naphthalene                           | <i>n</i> -C <sub>8</sub> through <i>n</i> -C <sub>36</sub> |
| C <sub>1</sub> -naphthalenes          | Pristane   |
| C <sub>2</sub> -naphthalenes          | Phytane  |
| C <sub>3</sub> -naphthalenes          | Isoprenoid 1380  |
| C <sub>4</sub> -naphthalenes          | Isoprenoid 1470  |
| Biphenyl                              | Isoprenoid 1650  |
| Acenaphthylene                        | TPH  |
| Dibenzofuran                          |  |
| Acenaphthene                          | <b>Spiking Compounds</b>                                   |
| Fluorene                              | <u>GC/MS SIS Compounds</u>                                 |
| C <sub>1</sub> -fluorenes             | Naphthalene-d <sub>8</sub>                                 |
| C <sub>2</sub> -fluorenes             | Fluorene-d <sub>10</sub>                                   |
| C <sub>3</sub> -fluorenes.            | Chrysene-d <sub>12</sub>                                   |
| Anthracene                            |  |
| Phenanthrene                          | <u>GC/FID SIS Compound</u>                                 |
| C <sub>1</sub> -                      | <i>o</i> -terphenyl  |
| C <sub>2</sub> -                      |  |
| C <sub>3</sub> -                      | <u>GC/MS RIS Compounds</u>                                 |
| C <sub>4</sub> -                      | Acenaphthene-d <sub>10</sub>                               |
| Dibenzothiophene                      | Phenanthrene-d <sub>10</sub>                               |
| C <sub>1</sub> -dibenzothiophenes     | Benzo[a]pyrene-d <sub>12</sub>                             |
| C <sub>2</sub> -dibenzothiophenes     |  |
| C <sub>3</sub> -dibenzothiophenes     |  |
| Fluoranthene                          | <b>Reporting Limits</b>                                    |
| Pyrene                                | <i>Oil/Tar</i>   |
| C <sub>1</sub> -fluoranthenes/pyrenes | PAH: 5 mg/kg   |
| C <sub>2</sub> -fluoranthenes/pyrenes | alkanes: 100 mg/kg   |
| C <sub>3</sub> -fluoranthenes/pyrenes | TPH: 100,000 mg/kg   |
| Benz[a]anthracene                     |  |
| Chrysene                              |  |
| C <sub>1</sub> -chrysenes             |  |
| C <sub>2</sub> -chrysenes             |  |
| C <sub>3</sub> -chrysenes             |  |
| C <sub>4</sub> -chrysenes             |  |
| Benzo[b]fluoranthene                  |  |
| Benzo[k]fluoranthene                  |  |
| Benzo[e]pyrene                        |  |
| Benzo[a]pyrene                        |  |
| Perylene                              |  |
| Indeno[1,2,3- <i>c,d</i> ]pyrene      |  |
| Dibenz[a,h]anthracene                 |  |
| Benzo[ <i>a,h,i</i> ]perylene         |  |

## 2.5 Physical and Chemical Characterization Test Methods

The following parameters were determined for each of the fresh oils and its weathered residues: evaporative loss, flash-point, viscosity, density, interfacial surface tension, pour-point, hard asphaltene content, soft asphaltene content, wax content, and saturated/aromatic/resin content. Brief descriptions of each test follows.

### 2.5.1 Density

The densities of the fresh oils and their respective topped residues were determined using an oscillating sample tube technique. Changes in the oscillation frequency caused by the change in mass of the tube filled with oil was proportional to the density of the liquid in the tube. The method is based on ASTM D4052-91, *Standard Test Method for Density and Relative Density of Liquids by Digital Density Meter*.

### 2.5.2 Flash-Point

The flash-point is that temperature where 75-90% of the surface area of the sample supports a flame. The flash-points of the fresh oils and the topped residues were determined in a closed cup using a Grabner Miniflash apparatus following modified ASTM D93-90, *Standard Test for Flash-Point by Pensky-Martens Closed Tester*. An oil sample was incrementally heated from ambient temperature and a spark source engaged at regular intervals.

### 2.5.3 Viscosity

The viscosities of the fresh oils, their weathered residues, as well as that of water-in-oil emulsions were determined using a rotating viscometer, operated at the lowest shear rate necessary for accurate measurement of viscosity (Daling and Almos 1988). Viscosities for fresh and weathered oils were measured at a shear rate of  $100 \text{ s}^{-1}$ . Viscosities of the emulsions were measured at a shear rate of  $5 \text{ s}^{-1}$ .

### 2.5.4 Pour-Point

The pour-point determination of the fresh oils and their weathered residues was carried out by Battelle subcontractor, Saybolt Inc. (Woburn, MA) following ASTM D97-87, *Standard Test Method for Pour-Point of Petroleum Oils*. After preliminary heating, the oil was cooled at a specific rate and examined for flow characteristics at  $3^\circ\text{C}$  intervals. The lowest temperature at which movement of the oil was observed was identified as the pour-point.

### 2.5.5 Interfacial Tension

The interfacial tension of the fresh oils and their weathered residues was determined by measuring the force necessary to detach a planar ring of platinum wire from the surface of a liquid of higher surface tension, that is, upward from the water-oil interface. This procedure is based upon ASTM D971-91, *Standard Test Method for Interfacial Tension of Oil Against Water by the Ring Method*.

### 2.5.6 Soft Asphaltene Content

The soft asphaltene content, defined as the *n*-pentane-insoluble fraction of an oil, was determined by precipitating the asphaltenes from the 250°C+ topped weathered residues with *n*-pentane, filtering the residues, and determining the soft asphaltene residue gravimetrically with a microbalance.

### 2.5.7 Hard Asphaltene Content

The hard asphaltene content, defined as the *n*-heptane insoluble fraction of oil, was determined by precipitating the asphaltenes from the 250°C+ topped weathered residues with *n*-heptane, purifying the resulting residue by soxhlet extraction, filtering the residue, and determining the hard asphaltene residue gravimetrically with a microbalance.

### 2.5.8 Wax Content

Waxes, which are defined as the 2-butanone/dichloromethane insoluble fraction of oil at temperatures at or below -10°C (Bridie, *et al.* 1982), was determined by precipitating waxes from the maltene fraction of the 250°C+ topped weathered residues in a -10°C freezer, filtering the residue, and determining the wax residue gravimetrically with a microbalance.

### 2.5.9 Saturated/Aromatic/Resin Content

The hydrocarbon composition of the fresh oils and the weathered residues were determined using a coupled thin layer chromatography/flame ionization detection system. Approximately 20 µg of oil was spotted onto a silica rod, and the saturated, aromatic, and resin fractions of the oil separated by developing the rods in a series of increasingly polar solvents (*n*-hexane, toluene, dichloromethane:methanol). The relative distribution of the saturated, aromatic, and resin fractions on each rod was determined by Iatroscan techniques, by spatially quantifying the residues using a flame ionization detector.

## 2.6 Water-in-Oil Emulsion Formation and Stability Test Methods

In order to simulate the weathering processes which an oil is subjected to at sea following a spill, water-in-oil emulsions were formed by entraining water droplets within the oil using a rotating-flask apparatus. During an actual spill this occurs as a result of mixing energy (waves and currents) on the water surface.

In order to characterize the weathering properties of the oils and its dispersability at different stages of weathering at sea, several different types of emulsion formation and characterization tests were performed. This included preparing water saturated emulsions for emulsion formation kinetics testing and the preparation of emulsions having different water content for use in dispersability testing. During the course of this study, the emulsion formation and testing work was performed at 13°C.

For each of the topped oil residues, maximum water (water saturated), 75% water, and 50% water triplicat samples of water-in-oil emulsions were prepared using the rotating flask method of Mackay and Zagorski (1982). For the water saturated emulsions, replicate 0.5 L cylindrical separatory funnels were each filled with sea water and the test oil at a ratio of 10:1 (300 mL water:30 mL oil), and rotated at 30 RPM for 24 hours to form maximum water emulsions. For the 75% and 50% water emulsions 225 mL

water:75 mL oil and 150 mL water:150 mL oil, respectively, was used. The following information was gathered during the emulsion formation experiments:

- *water-in-oil emulsion kinetics*; rate of water uptake, including determination of  $t_{1/2}$  which is defined to be the time required for emulsification to a water content of one-half of the maximum water content of the emulsion (in volume percent).
- *maximum water uptake capacity*; the maximum water content of an oil residue after 24 hours of mixing with an excess of water.
- *stability of the resulting water-in-oil emulsion*; expressed as the fractional dehydration (D) of the water-in-oil emulsion during a 24 hour settling time.

## 2.7 IFP Dispersability Test Methods

The dispersability of water-free oil and water-in-oil emulsions using Corexit 9527 was measured at 13°C using the low-energy IFP test method described by Clayton *et al.* (1993) and Brandvik *et al.* (1995). The dispersion measured in the IFP test is carried out in a cylindrical vessel containing 5-L of seawater. A known amount of oil/emulsion is added to the surface of the water in the vessel and a fixed amount of dispersant applied (a dispersant-to-oil ratio of approximately 1:25 is used). A relatively low energy system is created using a metal ring which oscillates up and down slightly below the surface of the water. There is a continuous dilution in the test system through a constant input of fresh seawater just below the water surface, at the same time as dispersed oil leaves the system and is collected through a water overflow system which removes water from the bottom of the vessel. The dispersed oil is extracted from the collected water and is quantified using UV spectrophotometry.

In order to better quantify the changes in the oil following weathering and its subsequent emulsification, the viscosity of the oils and their respective emulsions was measured. Viscosity was determined using the rotational viscometer technique described earlier. Maximum water, 75:50, and 50:50 water-in-oil emulsions were prepared and tested for the fresh oils and their topped oil to determine viscosity and the dispersability of these particular formulations.

## 2.8 Meso-Scale Studies

In the step-wise, bench-scale laboratory weathering procedure, the oils under study were evaporatively weathered by distillation (topping) and emulsified in separate procedures independently of each other. In order to better simulate the simultaneous weathering processes which an oil spilled at sea would undergo, meso-scale (flume) studies were conducted with No. 6 fuel oil supplied by FPL and with Orimulsion®. Full strength seawater (32 ppt) was used in the studies with No. 6 fuel. The Orimulsion® were conducted in both full strength seawater and fresh water.

These studies were conducted in Battelle's flume facility located in Duxbury, MA. Approximately 4000 L of seawater is circulated in a circular, temperature controlled tank. For these experiments, the flume tank was filled with 4000 L of water which had been filtered through a five micron filter. The wind conditions were maintained at approximately  $6 \text{ m s}^{-1}$ , while the wave frequency was maintained at approximately 50 breaking waves minute<sup>-1</sup>. The photo-period for the photo-oxidation lamps was ten hours on and fourteen hours off. The incident light for these experiments was measured using a Biospherical 1 RAD sensor (submersible unit) and on the bottom of the flume tank averaged  $60 \mu\text{E}$ . Circulation of the water is maintained by a turbine wind generator. A spilling wave field is imposed on the circulation pattern by a wave generator. The flume experiments were conducted at a constant

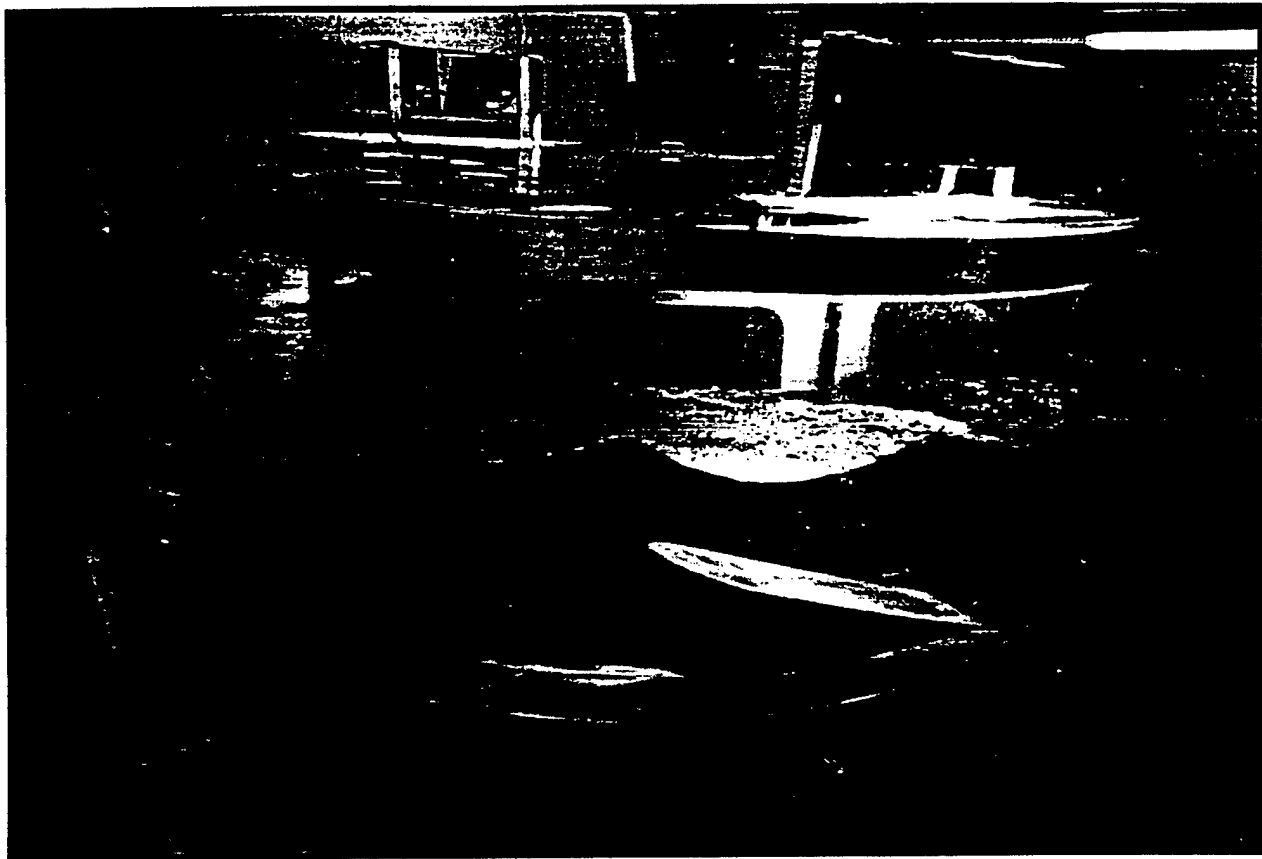

**Figure 2-1. Meso-scale wind wave basin for investigations of petroleum weathering.**

temperature of 13°C. A detailed description of the meso-scale facility and the hydrodynamic conditions imposed during testing has been discussed by Fredriksson *et al.* (1996).

Ten liters of the No. 6 fuel and approximately fourteen liters of fresh Orimulsion® was released on the surface of the water during these studies. Following the initial release of the test fuel, the fuel was allowed to weather for 120-hr (No. 6 fuel) and up to 21 days for some of the Orimulsion® experiments. Grab samples of the surface water-in-oil emulsion which formed and subsurface water samples were taken at approximately 0 minutes, 15 minutes, 30 minutes, 1 hour, 2 hours, 4 hours, 8 hours, 12 hours, and approximately every 24 hours thereafter until the test was completed.

For the studies conducted with Orimulsion® an aliquot of the subsurface water sample was filtered through a 0.3 µm filter in order to generate a dissolved phase. The subsurface water samples (filtered and unfiltered) were then serially extracted with methylene chloride and characterized for TPH, alkanes, and PAHs. These samples were also subjected to SARA analysis by Iatroscan®. Additionally, particle size analysis was conducted on aliquots of the unfiltered subsurface water sample using a Malvern Mastersizer® laser particle sizer. The surface water-in-oil emulsions were also analyzed for the following parameters; water content, viscosity, and density. The chemical dispersability of the water-in-oil emulsions was determined for selected samples using the reference dispersant Corexit 9500 and IFP methods.



### 3. RESULTS AND DISCUSSION OF RESULTS

#### 3.1 Topping of the Fuel Oils

Quadruplicate aliquots of approximately 900 to 1,100 g of the oils were used for the topping procedure and the replicate topped residues were combined. During each topping, the vapor phase and liquid phase temperatures were carefully monitored to ensure that a uniform rate of distillation was achieved. A summary of the final conditions for each of the topped fractions prepared for this study is presented in Table 3-1. The 150°C+ residue was not obtainable for the No. 2 and No. 6 fuels supplied by FPL and FPC due to the lack of the appearance of any distillate until after the 150°C vapor phase temperature had been bypassed. Orimulsion® was not subjected to the topping procedures because the continuous phase for this product is water.

#### 3.2 GC/FID Analysis of the Fuel Oil Residues

The fresh and topped oil residues were characterized by capillary gas chromatography with flame ionization detection (GC/FID) in order to obtain hydrocarbon fingerprints of the weathering of the fuels. The chromatographic results obtained from the GC/FID analysis of the fresh oils and Orimulsion® are shown in Figure 3.1. Though these chromatograms are of the fresh oils, they are representative of the type of chromatographic results which were obtained during this study. The effect of the evaporative weathering is shown (Figure 3-2) in the chromatographic results obtained for the fresh and topped residues of Mandalay Crude oil. One important aspect of the evaporative weathering process is that decreasing amounts of lower molecular weight alkanes are present with increasing degree of weathering. Chromatograms for each of the topped residues of each of these heavy fuels are presented in Appendix A.

#### 3.3 GC/MS Analysis of the Fuel Oil Residues

The fresh and topped residues of the oils were characterized by GC/MS in order to obtain concentrations of petroleum PAH in the fresh oils and the respective topped residues. The results of the GC/MS analysis of the fresh and topped residues are reported as PAH distributions in the fresh residues as mg PAH Kg oil<sup>-1</sup> (Table 3-2). Interestingly, the No. 6 fuel oil supplied by Florida Power and Light corporation had the greatest concentrations of PAHs while Orimulsion® had relatively low levels of PAH concentrations. The three No. 6 fuels were remarkable in the variability of their PAH distributions which generally varied three orders of magnitude. Not unexpectedly, the No. 2 fuel oil had relatively low levels of higher molecular weight PAHs such as the chrysenes.

The PAH distributions for the fresh and weathered residues of the Mandalay crude oil are shown in Table 3-3. Appendix B presents the PAH distribution tables for all of the fuels and their weathered residues. In general there is a trend of decreasing PAH concentrations with increasing degree of weathering. This trend is especially notable in the lower molecular weight PAH such as the naphthalene series. These results are typical of the type of results obtained when an oil is subjected to evaporative weathering.

Table 3-1. Final topping parameters for selected fuel oils. <sup>a</sup>

| Test Oil                          | Topping Level | Test Parameter                      |  |                                       |  |
|-----------------------------------|---------------|-------------------------------------|--|---------------------------------------|--|
|                                   |               | Final Temperature Residual Oil (°C) | Final Volume Percent Topped Distillate (%) | Final Weight Percent Residual Oil (%) |  |
| No. 6 Fuel Oil (MJB) <sup>b</sup> | 150°C+        | 287 ± 3.0                           | 5.4 ± 0.04                                 | 94.2 ± 0.1                            |  |
|                                   | 200°C+        | 290 ± 0                             | 5.6 ± 0.3                                  | 93.8 ± 0.4                            |  |
|                                   | 250°C+        | 325 ± 0                             | ---  | ---                                   |  |
| No. 6 Fuel Oil (FPL)              | 150°C+        | ND                                  | ND   | ND                                    |  |
|                                   | 200°C+        | 297 ± 2                             | 3.9 ± 0.8                                  | 96.2 ± 0.5                            |  |
|                                   | 250°C+        | 340 ± 2                             | 17.1 ± 0.2                                 | 84.3 ± 0.2                            |  |
| No. 6 Fuel Oil (FPC)              | 150°C+        | ND                                  | ND   | ND                                    |  |
|                                   | 200°C+        | 324 ± 1                             | 2.4 ± 0.3                                  | 97.2 ± 0.2                            |  |
|                                   | 250°C+        | 341 ± 9                             | 6.8 ± 2.0                                  | 93.1 ± 2.0                            |  |
| No. 2 Fuel Oil                    | 150°C+        | ND                                  | ND   | ND                                    |  |
|                                   | 200°C+        | 230 ± 1                             | 5.2 ± 0.9                                  | 94.8 ± 1.0                            |  |
|                                   | 250°C+        | 266 ± 1                             | 35.7 ± 1.2                                 | 64.5 ± 1.2                            |  |
| Mandalay Crude Oil                | 150°C+        | 260 ± 5                             | 14.1 ± 0.3                                 | 84.5 ± 0.5                            |  |
|                                   | 200°C+        | 305 ± 5                             | 19.7 ± 0.8                                 | 79.5 ± 0.7                            |  |
|                                   | 250°C+        | 349 ± 4                             | 28.5 ± 1.5                                 | 71.5 ± 2.1                            |  |

<sup>a</sup> average (± standard deviation) of four replicate distillations.

<sup>b</sup> average (± standard deviation) of two replicate distillations.

Table 3-2. Polycyclic aromatic hydrocarbon distributions of the fresh fuels.

| Polycyclic Aromatic Hydrocarbon | Fresh Fuel Residues |             |             |          |                    | Orimulsion® |
|---------------------------------|---------------------|-------------|-------------|----------|--------------------|-------------|
|                                 | No. 6 (MJB)         | No. 6 (FPL) | No. 6 (FPC) | No. 2    | Mandalay Crude Oil |             |
| Naphthalene                     | 751.63              | 28573.20    | 548.39      | 6956.57  | 1250.74            | 15.40       |
| C1-naphthalenes                 | 4099.89             | 32419.31    | 2521.04     | 17929.03 | 1882.96            | 43.03       |
| C2-naphthalenes                 | 7135.29             | 27015.12    | 4924.37     | 32541.29 | 2906.17            | 136.70      |
| C3-naphthalenes                 | 5508.62             | 13032.25    | 3576.52     | 28500.95 | 2661.11            | 189.37      |
| C4-naphthalenes                 | 2746.25             | 5156.22     | 1939.28     | 14685.34 | 1586.29            | 267.97      |
| Biphenyl                        | 74.43               | 12413.49    | 195.03      | 3667.26  | 57.58              | 5.00        |
| Acenaphthylene                  | 1.74                | 1660.25     | 1.43        | 0.00     | 0.00               | ND          |
| Acenaphthene                    | 219.49              | 6408.43     | 185.40      | 1337.18  | 55.42              | 10.66       |
| Dibenzofuran                    | 75.80               | 452.93      | 84.20       | 782.86   | 95.08              | 5.42        |
| Fluorene                        | 238.72              | 8913.22     | 279.77      | 3032.93  | 108.32             | 13.52       |
| C1-fluorenes                    | 658.50              | 8526.74     | 727.23      | 6330.29  | 250.68             | 57.39       |
| C2-fluorenes                    | 1144.37             | 7465.93     | 1450.45     | 12161.20 | 451.72             | 184.39      |
| C3-fluorenes                    | 1077.46             | 5815.59     | 2001.19     | 11005.45 | 488.36             | 272.13      |
| Phenanthrene                    | 743.08              | 19279.91    | 1173.28     | 5565.88  | 178.40             | 67.78       |
| Anthracene                      | 88.40               | 3556.25     | 155.62      | 486.30   | 0.00               | ND          |
| C1-phenanthrenes/anthracenes    | 2031.11             | 24451.35    | 4897.20     | 13954.98 | 443.74             | 143.84      |
| C2-phenanthrenes/anthracenes    | 2660.97             | 27382.45    | 9329.37     | 17574.53 | 668.90             | 366.41      |
| C3-phenanthrenes/anthracenes    | 1824.69             | 23753.19    | 8599.40     | 10726.14 | 620.96             | 459.43      |
| C4-phenanthrenes/anthracenes    | 929.78              | 14876.98    | 4850.42     | 3794.05  | 456.00             | 241.73      |
| Dibenzothiophene                | 345.72              | 1045.34     | 414.11      | 643.88   | 390.71             | 28.19       |
| C1-dibenzothiophenes            | 1071.96             | 3582.24     | 1704.18     | 2242.32  | 910.00             | 133.96      |
| C2-dibenzothiophenes            | 1488.85             | 6462.03     | 4022.46     | 3577.31  | 1349.16            | 345.13      |
| C3-dibenzothiophenes            | 1175.80             | 7624.38     | 5619.17     | 2879.41  | 1382.14            | 692.83      |
| Fluoranthene                    | 20.65               | 3045.99     | 151.21      | 175.57   | 0.00               | 4.03        |
| Pyrene                          | 133.73              | 7931.11     | 1081.49     | 982.98   | 0.00               | 9.59        |
| C1-fluoranthenes/pyrenes        | 463.60              | 20436.36    | 4088.18     | 2139.32  | 106.22             | 52.75       |
| C2-fluoranthenes/pyrenes        | ---                 | 23499.42    | 5853.60     | 1385.51  | 175.50             | 95.19       |
| C3-fluoranthenes/pyrenes        | ---                 | 16901.51    | 5485.40     | 581.50   | 223.00             | 141.18      |
| Benz[a]anthracene               | 72.85               | 2859.78     | 547.03      | 26.84    | 0.00               | ND          |

Table 3-2  
Continued

|  | No. 6<br>(MJB) | No. 6<br>(FPL) | No. 6<br>(FPC) | No. 2  | Mandalay<br>Crude Oil | Orimulsion® |
|--|----------------|----------------|----------------|--------|-----------------------|-------------|
| <b>Polycyclic Aromatic<br/>Hydrocarbon</b> |                |                |                |        |                       |             |
| Chrysenes                                  | 137.49         | 4694.14        | 669.06         | 86.11  | 22.15                 | 6.80        |
| C1-chrysenes                               | 618.43         | 13870.06       | 3647.38        | 126.36 | 59.48                 | 34.88       |
| C2-chrysenes                               | 740.11         | 15009.61       | 4960.26        | 92.48  | 145.06                | 74.45       |
| C3-chrysenes                               | 529.99         | 10954.29       | 3306.39        | 0.00   | 108.74                | ND          |
| C4-chrysenes                               | 294.48         | 4169.94        | 1274.92        | 0.00   | 0.00                  | ND          |
| Benzo[b]fluoranthene                       | 17.56          | 1090.63        | 195.86         | 0.00   | 0.00                  | 2.13        |
| Benzo[k]fluoranthene                       | 2.81           | 184.17         | 26.92          | 0.00   | 0.00                  | ND          |
| Benzo[e]pyrene                             | 32.11          | 1451.75        | 368.48         | 0.00   | 35.70                 | 6.36        |
| Benzo[a]pyrene                             | 40.75          | 2089.19        | 347.35         | 0.00   | 0.00                  | 3.30        |
| Perylene                                   | 15.94          | 632.26         | 132.91         | 0.00   | 167.98                | 7.78        |
| Indeno[1,2,3-c,d]pyrene                    | 3.20           | 240.46         | 22.17          | 0.00   | 0.00                  | ND          |
| Dibenz[a,h]anthracene                      | 8.69           | 375.02         | 75.98          | 0.00   | 0.00                  | ND          |
| Benzo[g,h,i]perylene                       | 9.18           | 652.60         | 170.76         | 0.00   | 0.00                  | 1.71        |

**Table 3-3. Polycyclic aromatic hydrocarbon distributions for the fresh and weathered residues of Mandalay crude oil.**

| Polycyclic Aromatic Hydrocarbon | Mandalay Crude Oil Residues |         |         |         |
|---------------------------------|-----------------------------|---------|---------|---------|
|                                 | Fresh                       | 150°C+  | 200°C+  | 250°C+  |
| Naphthalene                     | 1250.74                     | 1159.57 | 856.28  | 237.44  |
| C1-naphthalenes                 | 1882.96                     | 1897.74 | 1651.52 | 783.80  |
| C2-naphthalenes                 | 2906.17                     | 3046.43 | 2837.51 | 1724.79 |
| C3-naphthalenes                 | 2661.11                     | 2834.23 | 2725.00 | 1965.64 |
| C4-naphthalenes                 | 1586.29                     | 1947.21 | 1848.66 | 1471.08 |
| Biphenyl                        | 57.58                       | 60.85   | 52.61   | 27.32   |
| Acenaphthylene                  | 0.00                        | 0.00    | 0.00    | 0.00    |
| Acenaphthene                    | 55.42                       | 57.50   | 51.40   | 39.59   |
| Dibenzofuran                    | 95.08                       | 99.94   | 96.68   | 71.68   |
| Fluorene                        | 108.32                      | 117.21  | 116.40  | 93.87   |
| C1-fluorenes                    | 250.68                      | 270.40  | 268.71  | 243.42  |
| C2-fluorenes                    | 451.72                      | 504.12  | 511.26  | 456.60  |
| C3-fluorenes                    | 488.36                      | 472.58  | 582.29  | 558.30  |
| Phenanthrene                    | 178.40                      | 196.80  | 207.21  | 203.22  |
| Anthracene                      | 0.00                        | 0.00    | 0.00    | 0.00    |
| C1-phenanthrenes/anthracenes    | 443.74                      | 495.13  | 520.42  | 539.47  |
| C2-phenanthrenes/anthracenes    | 668.90                      | 772.88  | 794.82  | 844.06  |
| C3-phenanthrenes/anthracenes    | 620.96                      | 739.54  | 763.37  | 771.96  |
| C4-phenanthrenes/anthracenes    | 456.00                      | 543.89  | 516.11  | 636.55  |
| Dibenzothiophene                | 390.71                      | 418.10  | 430.20  | 423.37  |
| C1-dibenzothiophenes            | 910.00                      | 1024.99 | 1042.49 | 1052.21 |
| C2-dibenzothiophenes            | 1349.16                     | 1466.93 | 1499.55 | 1537.26 |
| C3-dibenzothiophenes            | 1382.14                     | 1538.79 | 1650.34 | 1755.19 |
| Fluoranthene                    | 0.00                        | 0.00    | 0.00    | 0.00    |
| Pyrene                          | 0.00                        | 0.00    | 0.00    | 0.00    |
| C1-fluoranthenes/pyrenes        | 106.22                      | 138.68  | 131.39  | 151.09  |
| C2-fluoranthenes/pyrenes        | 175.50                      | 221.37  | 212.05  | 238.79  |
| C3-fluoranthenes/pyrenes        | 223.00                      | 237.92  | 257.91  | 290.78  |
| Benz[a]anthracene               | 0.00                        | 0.00    | 0.00    | 0.00    |
| Chrysenes                       | 22.15                       | 30.08   | 25.78   | 38.17   |
| C1-chrysenes                    | 59.48                       | 74.38   | 83.11   | 82.67   |
| C2-chrysenes                    | 145.06                      | 183.61  | 188.30  | 202.69  |
| C3-chrysenes                    | 108.74                      | 137.35  | 122.70  | 153.24  |
| C4-chrysenes                    | 0.00                        | 0.00    | 0.00    | 0.00    |
| Benzo[b]fluoranthene            | 0.00                        | 0.00    | 0.00    | 0.00    |
| Benzo[k]fluoranthene            | 0.00                        | 0.00    | 0.00    | 0.00    |
| Benzo[e]pyrene                  | 35.70                       | 37.23   | 39.51   | 40.22   |
| Benzo[a]pyrene                  | 0.00                        | 0.00    | 0.00    | 0.00    |
| Perylene                        | 167.98                      | 175.87  | 181.30  | 197.02  |
| Indeno[1,2,3-c,d]pyrene         | 0.00                        | 0.00    | 0.00    | 0.00    |
| Dibenz[a,h]anthracene           | 0.00                        | 0.00    | 0.00    | 0.00    |
| Benzo[g,h,i]perylene            | 0.00                        | 0.00    | 0.00    | 0.00    |

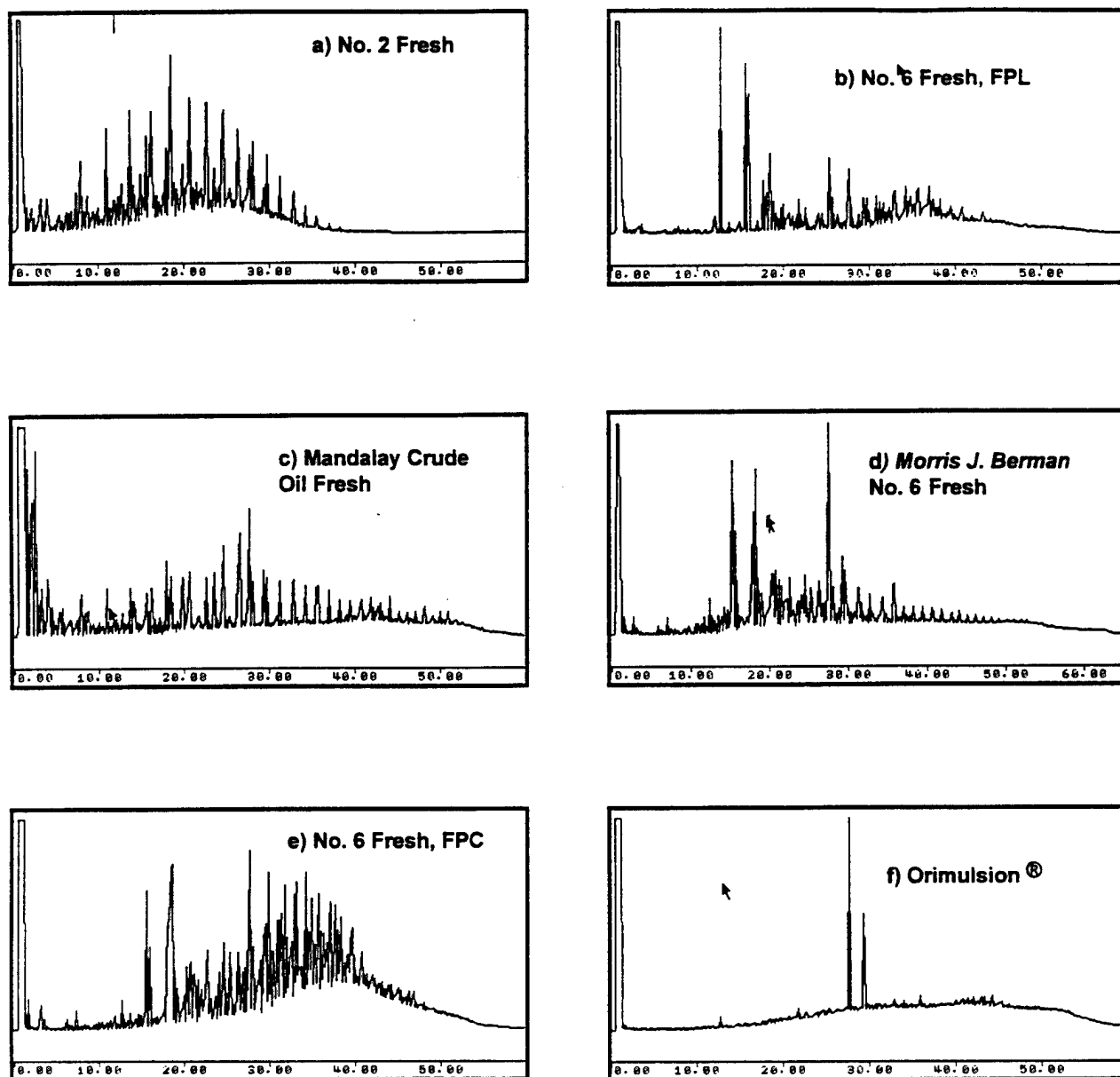
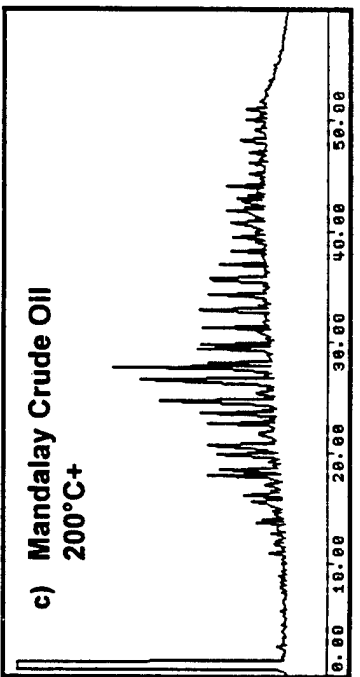
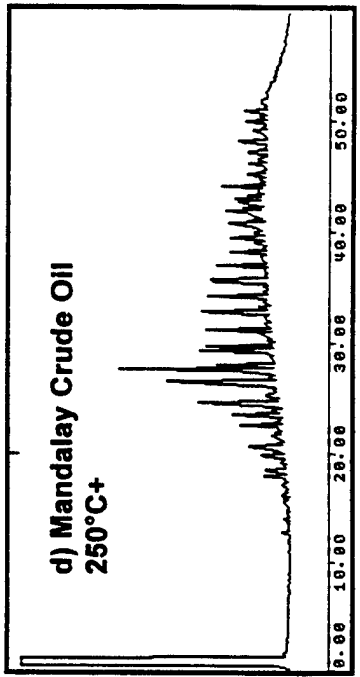
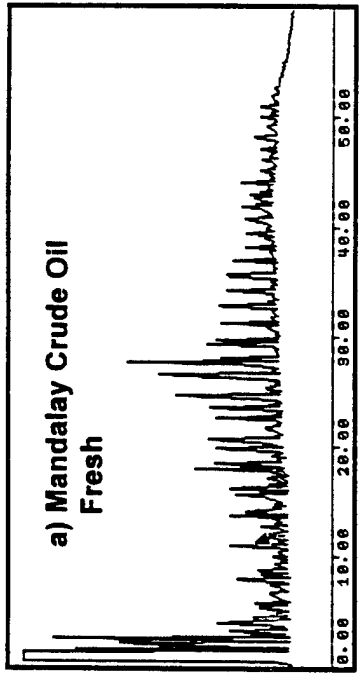
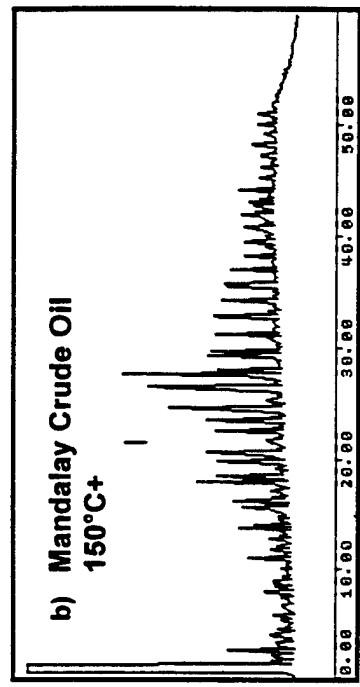

Figure 3-1. Gas chromatograms of the fresh oils a) No. 2 fuel oil, b) No. 6 fuel oil Florida Power and Light, c) Mandalay Crude Oil, d) No. 6 fuel oil Morris J. Berman, e) No. 6 fuel oil Florida Power Corporation, and f) Orimulsion®



**Figure 3-2 . Gas chromatograms of the crude oil a) fresh, b) 150°C+ , c) 200°C+ and d) 250°C+ topped residues of Mandalay Crude Oil.**

### 3.4 Physical and Chemical Properties of the Fresh and Topped Fuel Oil Residues

The fresh oils and the topped residues were analyzed for the fundamental physical (density, interfacial tension, flash-point, pour-point) and chemical parameters (saturates/aromatics/resins, hard asphaltenes, soft asphaltenes, waxes) described in Section 2. Replicate analyses were performed for these measurements to assess the degree of variability in the measurement techniques. The physical and chemical characterization of the fresh and topped residues of these fuels are summarized in Tables 3-4 and 3-5 respectively. In each of these tables, the average ( $\bar{x}$ ), and standard deviation ( $\sigma$ ) for each replicate set of measurements is presented.

#### 3.4.1 Density

Density measurements were determined at several environmentally significant temperatures ranging from 0°C to 25°C. The baseline density data is presented in Table 3-4 while the temperature dependence data for the density of these fuels has been tabulated in Table 3-6. The data presented in Tables 3-4 and 3-6 show that the density of these selected fuels increases with increasing degree of weathering. Replicate measurements of density for the fresh and topped oils all were extremely reproducible, with coefficient of variations of less than 1.0% for all of the oil residues. At 15°C the density of the fuels and their weathered residues ranged from approximately 0.86 g/mL (No. 2 fuel oil) to approximately 1.05 g/mL (No. 6 fuel oil, FPC). These data (15.0°C) are presented graphically as Figure 3-2 and are typical of the density temperature dependence of these fuels.

#### 3.4.2 Flash-Point

The lowest flash-points were observed in the fresh fuels and increased systematically for the weathered residues. These data are presented in Table 3-4 and graphically as Figure 3-3. The Mandalay crude oil had the lowest low flash-point observed (46.0°C) while the greatest value was observed for the 250°C+ residue of the *Morris J. Berman* cargo oil. The Mandalay Crude oil showed the greatest range in flash-points as a function of weathering with a low value of 46.0°C for the fresh oil which increased to 157.5°C for 250°C+ residue.

#### 3.4.3 Viscosity

The viscosity (cP) of the fuel oils and their topped residues was determined in replicate (Table 3-4) and the repeatability of these measurements was good to excellent. The temperature dependence of the viscosity of the fuels and their residues was also investigated, and these results have been presented in Table 3-7. Because of very wide range in viscosity for these materials, determinations were made at several shear rates using several different shear rates and measuring systems. Typically shear rates of 1.0, 5.0, 10.0 and 1000 s<sup>-1</sup> were reported (Table 3-4). The viscosity of the fresh fuels ranged from approximately 2.6 cP (No. 2 fuel oil) to approximately 12,000 cP (*Morris J. Berman* cargo oil).

The viscosity of the individual fuels increased with the degree of weathering. Figure 3-4 is a plot of the viscosity of the fuels as a function of weathering state (15°C). Of the fuels studied, the No. 2 fuel oil showed the smallest increase in viscosity as a function of weathering, but did increase systematically with degree of topping, from 2.64 cP to 5.96 cP. The Mandalay Crude oil showed the largest increase in



viscosity with degree of topping, increasing from 287 cP for the fresh crude to greater than 146,000 cP for the 250°C+ topped residue.

#### 3.4.4 Interfacial Tension

The interfacial surface tension (IST) of the fresh and weathered residues of the fuels was determined in duplicate (Table 3-4 and Figure 3-6). The precision achieved for these measurements was excellent with coefficients of variation ranging from 0% to 3.5%. The IST of the fresh oils ranged from approximately 8 mN/m (No. 6 fuel oil, FPL) to approximately 27 mN/m (*Morris J. Berman* cargo oil). In general the IST of the fuels increased with the degree of weathering (Figure 3-5). The No. 2 fuel oil showed the smallest amount of change in IST, but increased from 20.2 mN/m for the fresh fuel oil to 21.6 mN/m for the 200°C+ residue. The *Morris J. Berman* cargo oil showed the greatest overall increase in IST with weathering, however could not be determined accurately for the 250°C+ weathered residue. The IST values for the Mandalay crude oil increased from 13.2 (fresh) to 27.5 mN/m (250°C+ topped residue).

#### 3.4.5 Pour-Point

The pour-point temperature of the fuels was determined, however replicate measurements were not performed because of insufficient quantities of the residues. In general, the pour-point increased with the weathering state of the fuel (Table 3-4 and Figure 3-7). The three No. 6 fuel oils studied and their topped residues had similar pour-points, ranging from approximately -6°C to 9°C. In contrast, the pour-points observed for the Mandalay Crude oil ranged the greatest, with a pour-point of <-40°C observed for the fresh and 12°C for the 250°C+ weathered residue.

#### 3.4.6 "Hard" and "Soft" Asphaltenes, and Waxes

The asphaltene (hard and soft) and wax contents of the heavy fuel oils were determined in duplicate for the 250°C+ topped residues of the fuels (Table 3-5). The precision of these gravimetric methods for asphaltenes and wax determinations is considered good due to the manipulation steps involved in the procedures and the very low concentrations of asphaltene and wax materials in these residues. The asphaltene content of the fuels determined by the wet chemical precipitation method cannot be strictly compared to the results determined by Iatroscan, however there is good general agreement between the two methods.

The "hard" asphaltenes ranged from approximately 0.08 to 10%. The *Morris J. Berman* cargo oil had the highest levels while the No. 2 fuel oil was observed to have the lowest levels.

The results of the "soft" asphaltene determination were similar to those obtained for the "hard". The No. 2 fuel oil had the lowest levels (0.44%) and the *Morris J. Berman* cargo oil had the highest levels (14.4%). The Mandalay crude oil also had very high levels of "soft" asphaltenes. Orimulsion® was observed to have very high levels of both "hard" and "soft" asphaltenes.

The wax content of the fuels ranged from approximately 0.03% to 6.6%. The highest wax values were observed in the Mandalay crude oil, however the values obtained for the *Morris J. Berman* cargo oil are considered to be relatively high. Not unexpectedly the lowest wax values were observed in the No. 2 fuel oil.

### 3.4.7 Saturates/Aromatics/Resins/Asphaltenes by TLC/FID

The distribution of hydrocarbon component classes was determined for the fresh and weathered residues and is presented as weight percent (Table 3-5). Representative chromatograms of fresh fuels are shown (Figure 3-8). Iatroscan chromatograms of all of the weathered fuel oil residues included in this study are provided in Appendix C. Alaska North Slope crude (NSC) was used as a reference oil for all Iatroscans; therefore a chromatogram of NSC is included in Appendix C. Data from duplicate Iatroscan analysis of these topped residues demonstrate that the precision of this measurement is excellent. The component class data obtained for the 250°C+ weathered residues are also presented as histograms (Figure 3.9). In general, the No. 6 fuels were very similar in component class composition. The exception being the *Morris J. Berman* cargo oil which was seen to have relatively elevated levels of asphaltenes.

The saturated component of these fuels (peak #1, Figure 3-8) ranged from approximately 8.1% to approximately 51% (Table 3-5). The lowest amount of saturates was observed in the Orimulsion<sup>®</sup>, a synthetic fuel derived from a highly weathered bitumen. The fuel with the greatest percentage of saturates was the No. 2 fuel oil, a distillate.

The aromatic component of these fuels (peak #2, Figure 3-8) ranged from approximately 39% to 71%. Orimulsion<sup>®</sup> had the lowest percentage of aromatics while the No. 6 fuel oil provided by Florida Power Corporation had the highest percentage.

The resins (peak #3, Figure 3-8) and asphaltenes (peak #4, Figure 3-8) ranged from approximately 38% to less than 1%; and not detectable to 15.5% respectively. The highly weathered bitumen in Orimulsion<sup>®</sup> and the No. 2 fuel oil, respectively had the highest and lowest levels of resins and asphaltenes.

Table 3-4. Physical test parameters for selected fuels.

| TEST PARAMETER (Average $\pm$ Standard Deviation) |                |                        |                 |                               |                                      |                  |
|---|----------------|------------------------|-----------------|-------------------------------|--------------------------------------|------------------|
| Test Oil  | Topped Residue | Density (g/mL) 15.0 °C | Pour-Point (°C) | Viscosity cp <sup>1</sup>     | Interfacial Tension (mN/m) 25.0 (°C) | Flash-Point (°C) |
| No. 6 Fuel Oil (MJB) <sup>a</sup>                 | Fresh          | 0.9982 $\pm$ 0         | -6              | 11,290 $\pm$ 182 <sup>b</sup> | 26.9 $\pm$ 0.19                      | 124.5 $\pm$ 34.6 |
|   | 150°C+         | 0.9992 $\pm$ 0.0001    | 0               | 15,040 $\pm$ 205 <sup>b</sup> | 27.9 $\pm$ 0.19                      | 134.0 $\pm$ 2.8  |
|   | 200°C+         | 1.0019 $\pm$ 0.0004    | 0               | 15,860 $\pm$ 20 <sup>b</sup>  | 25.6 $\pm$ 0.25                      | 132.2 $\pm$ 2.0  |
|   | 250°C+         | 1.0089 $\pm$ 0.0023    | 9               | 84,410 $\pm$ 982 <sup>b</sup> | ---                                  | 186.7 $\pm$ 23.1 |
| No. 6 Fuel Oil (FPL)                              | Fresh          | 1.0133 $\pm$ 0.0004    | -9              | 6,861 $\pm$ 75 <sup>b</sup>   | 10.8 $\pm$ 0.3                       | 117.5 $\pm$ 2.1  |
|   | 150°C+         | ---                    | ---             | ---                           | ---                                  | ---              |
|   | 200°C+         | 1.0133 $\pm$ 0.0039    | -6              | 8,749 $\pm$ 185 <sup>b</sup>  | 13.0 $\pm$ 0.1                       | 127.5 $\pm$ 0.7  |
|   | 250°C+         | 1.0151 $\pm$ 0.0011    | 3               | 40,170 $\pm$ 650 <sup>c</sup> | 18.6 $\pm$ 1.0                       | 151.5 $\pm$ 0.7  |
| No. 6 Fuel Oil (FPC)                              | Fresh          | 1.0399 $\pm$ 0         | -6              | 5154 $\pm$ 12 <sup>b</sup>    | 16.7 $\pm$ 0.8                       | 124              |
|   | 150°C+         | ---                    | ---             | ---                           | ---                                  | ---              |
|   | 200°C+         | 1.0445 $\pm$ 0.0001    | 0               | 8454 $\pm$ 35 <sup>b</sup>    | 18.1 $\pm$ 1.8                       | 139              |
|   | 250°C+         | 1.0497 $\pm$ 0.0006    | 0               | 16,335 $\pm$ 655 <sup>b</sup> | 16.3 $\pm$ 1.5                       | 150              |
| No. 2 Fuel Oil                                    | Fresh          | 0.8642 $\pm$ 0.0001    | -21.0           | 2.64 $\pm$ 0.06 <sup>d</sup>  | 20.4 $\pm$ 0.7                       | 71.0             |
|   | 150°C+         | ---                    | ---             | ---                           | ---                                  | ---              |
|   | 200°C+         | 0.8675 $\pm$ 0.0001    | -24.0           | 2.91 $\pm$ 0.03 <sup>d</sup>  | 19.1 $\pm$ 0.7                       | 79.0             |
|   | 250°C+         | 0.8804                 | -12.0           | 5.96 $\pm$ 0.02 <sup>d</sup>  | 20.0 $\pm$ 0                         | 107.5 $\pm$ 0.7  |

Table 3-4, continued

| Test Oil           | Topped Residue | Density (g/mL) 15.0 °C | Pour-Point (°C) | Viscosity cP                  | Interfacial Tension (mN/m) 25.0 (°C) | Flash-Point (°C) |
|--------------------|----------------|------------------------|-----------------|-------------------------------|--------------------------------------|------------------|
| Mandalay Crude Oil | Fresh          | 0.9320 ± 0.001         | <-40            | 287 ± 35 <sup>b</sup>         | 13.4 ± 3.2                           | 46.0 ± 3.5       |
|                    | 150°C+         | 0.9620 ± 0.0016        | -15             | 8,591 ± 78 <sup>b</sup>       | 19.6 ± 0.4                           | 95.5 ± 0.7       |
|                    | 200°C+         | 0.9706 ± 0.0005        | 0               | 29,590 ± 862 <sup>b</sup>     | 21.9 ± 2.3                           | 126.5 ± 0.7      |
|                    | 250°C+         | 0.9804 ± 0.0051        | 12              | 146,100 ± 16,970 <sup>c</sup> | 28.5 ± 0.5                           | 157.5 ± 0.7      |
| Orimulsion ®       | Fresh          | 1.0120                 | 0               | 600 <sup>h</sup>              | ---                                  | >85              |

- a Viscosity determinations at a shear rate of 1 s<sup>-1</sup>.
- b Viscosity determinations at a shear rate of 10 s<sup>-1</sup>.
- c Viscosity determinations at a shear rate of 5 s<sup>-1</sup>.
- d Viscosity determinations at a shear rate of 1000 s<sup>-1</sup>.
- e Density determinations taken at 20°C
- f Viscosity determinations taken at 13°C
- g Viscosity determinations taken at 15°C
- h Measurement taken at 30°C at a shear rate of 100s<sup>-1</sup>.

Table 3-5. Chemical parameters for selected fuels.

| TEST PARAMETER (Average ± Standard Deviation) |                |                  |                  |               |                    |                           |                           |              |     |
|---|----------------|------------------|------------------|---------------|--------------------|---------------------------|---------------------------|--------------|-----|
| Test Oil                                      | Topped Residue | Saturates (wt %) | Aromatics (wt %) | Resins (wt %) | Asphaltenes (wt %) | "Hard" Asphaltenes (wt %) | "Soft" Asphaltenes (wt %) | Waxes (wt %) |     |
| <b>No. 6 Fuel Oil (MJB)</b>                   |                |                  |                  |               |                    |                           |                           |              |     |
|   | Fresh          | 11.3±0.1         | 54.6 ± 4.5       | 19.9±3.3      | 14.3 ± 3.3         | ---                       | ---                       | ---          | --- |
|   | 150°C+         | 12.7±1.8         | 58.3 ± 1.3       | 17.2±0.1      | 11.9 ± 0.6         | 8.9± 0.3                  | 14.1± 0.8                 | 3.4± 0.1     |     |
|   | 200°C+         | 12.1±0.1         | 57.3             | 17.0±0.2      | 13.7±0.4           | 9.5± 0.4                  | 13.8± 0.8                 | 3.3± 0.08    |     |
|   | 250°C+         | 11.5 ± 0.3       | 59.8 ± 0.3       | 15.9 ± 0.1    | 12.9 ± 0.4         | 9.8 ± 0.9                 | 12.6 ± 2.5                | 3.8 ± 0.3    |     |
| <b>No. 6 Fuel Oil (FPL)</b>                   |                |                  |                  |               |                    |                           |                           |              |     |
|   | Fresh          | 16.4 ± 0.1       | 69.3 ± 0.3       | 10.2 ± 0.4    | 4.2 ± 0.8          | ---                       | ---                       | ---          | --- |
|   | 150°C+         | ---              | ---              | ---           | ---                | ---                       | ---                       | ---          | --- |
|   | 200°C+         | 16.7             | 70.7             | 8.1           | 4.5                | ---                       | ---                       | ---          | --- |
|   | 250°C+         | 16.5             | 68.0             | 10.2          | 5.3                | 5.5 ± 0.7                 | 8.9 ± 2.0                 | 0.6 ± 0.1    |     |
| <b>No. 6 Fuel Oil (FPC)</b>                   |                |                  |                  |               |                    |                           |                           |              |     |
|   | Fresh          | 9.0 ± 0.7        | 71.3 ± 3.8       | 15.4 ± 3.3    | 4.4 ± 1.1          | ---                       | ---                       | ---          | --- |
|   | 150°C+         | ---              | ---              | ---           | ---                | ---                       | ---                       | ---          | --- |
|   | 200°C+         | 8.3 ± 0.1        | 73.0             | 14.3 ± 0.4    | 4.4 ± 0.4          | ---                       | ---                       | ---          | --- |
|   | 250°C+         | 9.2 ± 0.3        | 71.7 ± 1.3       | 14.2 ± 0.4    | 5.0 ± 2.0          | 6.1 ± 0.3                 | 9.0 ± 0.1                 | 2.3 ± 1.0    |     |
| <b>No. 2 Fuel Oil</b>                         |                |                  |                  |               |                    |                           |                           |              |     |
|   | Fresh          | 50.3 ± 0.8       | 48.8 ± 0.6       | 1.0 ± 0.1     | ND                 | ---                       | ---                       | ---          | --- |
|   | 150°C+         | ---              | ---              | ---           | ---                | ---                       | ---                       | ---          | --- |
|   | 200°C+         | 51.7             | 47.9             | 0.4           | ND                 | ---                       | ---                       | ---          | --- |
|   | 250°C+         | 51.5             | 47.9             | 0.7           | ND                 | 0.08 ± 0.01               | 0.44 ± 0.03               | 0.03 ± 0.01  |     |

Table 3-5, continued

| Test Oil           | Topped Residue | Saturates (wt %) | Aromatics (wt %) | Resins (wt %) | Asphaltenes (wt %) | "Hard" Asphaltenes (wt %) | "Soft" Asphaltenes (wt %) | Waxes (wt %) |
|--------------------|----------------|------------------|------------------|---------------|--------------------|---------------------------|---------------------------|--------------|
| Mandalay Crude Oil | Fresh          | 13.3 ± 0.4       | 49.4 ± 0.2       | 25.4 ± 0.5    | 12.1 ± 0.4         | ---                       | ---                       | ---          |
|                    | 150°C+         | 12.1             | 52.7             | 22.3          | 12.9               | ---                       | ---                       | ---          |
|                    | 200°C+         | 13.2             | 49.1             | 25.2          | 12.6               | ---                       | ---                       | ---          |
|                    | 250°C+         | 11.7             | 52.7             | 23.1          | 12.5               | 4.4                       | 14.0 ± 0.2                | 6.6          |
| Orimulsion®        | Fresh          | 8.1 ± 0.3        | 38.7 ± 4.0       | 37.8 ± 3.3    | 15.5 ± 0.6         | 8.5 ± 0.3                 | 12.0 ± 0.5                | 1.2 ± 0.07   |

**Table 3-6. Temperature dependence of density for the weathered residues of fuel oils.**

| Test Oil             | Topped Residue | Density (g mL <sup>-1</sup> ) at Temperature (°C) |        |        |        |        |        |
|----------------------|----------------|---|--------|--------|--------|--------|--------|
|                      |                | 0°  | 5°     | 10°    | 15°    | 20°    | 25°    |
| No. 6 Fuel Oil (MJB) | Fresh          | 1.0136  | 1.0071 | 1.0061 | 1.0031 | 0.9982 | 0.9949 |
|                      | 150°C+         | 1.0166  | 1.0125 | 1.0094 | 1.0060 | 1.0022 | 0.9991 |
|                      | 200°C+         | 1.0162  | 1.0132 | 1.0084 | 1.0061 | 1.0026 | 0.9979 |
|                      | 250°C+         | ND <sup>a</sup>                                   | 1.0226 | 1.0199 | 1.0153 | 1.0118 | 1.0083 |
| No. 6 Fuel Oil (FPL) | Fresh          | 1.0255  | 1.0193 | 1.0181 | 1.0143 | 1.0087 | 1.0072 |
|                      | 150°C+         | —   | —      | —      | —      | —      | —      |
|                      | 200°C+         | 1.0283  | 1.0217 | 1.0209 | 1.0166 | 1.0137 | 1.0094 |
|                      | 250°C+         | 1.0382  | 1.0335 | 1.0297 | 1.0258 | 1.0222 | 1.0191 |
| No. 6 Fuel Oil (FPC) | Fresh          | 1.0474  | 1.0456 | 1.0425 | 1.0376 | 1.0325 | 1.0303 |
|                      | 150°C+         | —   | —      | —      | —      | —      | —      |
|                      | 200°C+         | 1.0543  | 1.0510 | 1.0481 | 1.0436 | 1.0362 | 1.0369 |
|                      | 250°C+         | 1.0582  | 1.0566 | 1.0451 | 1.0491 | 1.0444 | 1.0333 |
| No. 2 Fuel Oil       | Fresh          | 0.8749  | 0.8717 | 0.8685 | 0.8647 | 0.8611 | 0.8564 |
|                      | 150°C+         | —   | —      | —      | —      | —      | —      |
|                      | 200°C+         | 0.8783  | 0.8770 | 0.8714 | 0.8679 | 0.8643 | 0.8609 |
|                      | 250°C+         | 0.8912  | 0.8879 | 0.8844 | 0.8810 | 0.8774 | 0.8729 |
| Mandalay Crude Oil   | Fresh          | 0.9464  | 0.9403 | 0.9369 | 0.9377 | 0.9329 | 0.9327 |
|                      | 150°C+         | 0.9706  | 0.9683 | 0.9683 | 0.9643 | 0.9610 | 0.9586 |
|                      | 200°C+         | 0.9857  | 0.9819 | 0.9778 | 0.9731 | 0.9712 | 0.9666 |
|                      | 250°C+         | 0.9965  | 0.9933 | 0.9884 | 0.9871 | 0.9785 | 0.9794 |
| Orimulsion ®         | Fresh          | 1.0189  | 1.0165 | 1.0141 | 1.0120 | 1.0092 | 1.0062 |

<sup>a</sup> not determined, viscosity exceeded range of instrument performance.

**Table 3-7. Temperature dependence of viscosity for the weathered residues of fuel oils.**

| Test Oil                    | Topped Residue | Viscosity (cP,) at Temperature (°C) |                        |                      |                      |                      |                     |
|-----------------------------|----------------|-------------------------------------|------------------------|----------------------|----------------------|----------------------|---------------------|
|                             |                | 0°                                  | 5°                     | 10°                  | 15°                  | 20°                  | 25°                 |
| No. 6 Fuel Oil (MJB)        | Fresh          | 202,800 <sup>b</sup>                | 92,680 <sup>b</sup>    | 40,280 <sup>b</sup>  | 19,690 <sup>c</sup>  | 11,350 <sup>c</sup>  | 6,743 <sup>c</sup>  |
|                             | 150°C+         | 413,700 <sup>a</sup>                | 209,500 <sup>b</sup>   | 91,460 <sup>b</sup>  | 40,570 <sup>c</sup>  | 19,280 <sup>c</sup>  | 10,590 <sup>c</sup> |
|                             | 200°C+         | 428,400 <sup>a</sup>                | 178,000 <sup>b</sup>   | 76,450 <sup>c</sup>  | 36,470 <sup>c</sup>  | 20,260 <sup>c</sup>  | 10,630 <sup>c</sup> |
|                             | 250°C+         | ND <sup>f</sup>                     | ND <sup>f</sup>        | 860,300 <sup>a</sup> | 306,800 <sup>a</sup> | 119,600 <sup>c</sup> | 58,460 <sup>c</sup> |
| No. 6 Fuel Oil (FPL)        | Fresh          | 53,010 <sup>b</sup>                 | 22,700 <sup>c</sup>    | 10,220 <sup>c</sup>  | 4,981 <sup>c</sup>   | 2,728 <sup>d</sup>   | 1,635 <sup>d</sup>  |
|                             | 150°C+         | —                                   | —                      | —                    | —                    | —                    | —                   |
|                             | 200°C+         | 80,760 <sup>c</sup>                 | 29,590 <sup>c</sup>    | 14,920 <sup>c</sup>  | 6,890 <sup>c</sup>   | 3,461 <sup>c</sup>   | 1,984 <sup>c</sup>  |
|                             | 250°C+         | 848,900 <sup>a</sup>                | 381,400 <sup>a</sup>   | 111,300 <sup>c</sup> | 40,220 <sup>c</sup>  | 17,080 <sup>c</sup>  | 8,544 <sup>c</sup>  |
| No. 6 Fuel Oil (FPC)        | Fresh          | 45,720 <sup>c</sup>                 | 18,970 <sup>c</sup>    | 8,199 <sup>c</sup>   | 3,903 <sup>c</sup>   | 2,109 <sup>c</sup>   | 1,150 <sup>c</sup>  |
|                             | 150°C+         | —                                   | —                      | —                    | —                    | —                    | —                   |
|                             | 200°C+         | 87,940 <sup>c</sup>                 | 44,060 <sup>c</sup>    | 17,660 <sup>c</sup>  | 6,778 <sup>c</sup>   | 3,665 <sup>c</sup>   | 1,946 <sup>c</sup>  |
|                             | 250°C+         | 231,300 <sup>b</sup>                | 75,710 <sup>c</sup>    | 35,550 <sup>c</sup>  | 13,650 <sup>c</sup>  | 6,812 <sup>c</sup>   | 3,698 <sup>c</sup>  |
| No. 2 Fuel Oil <sup>e</sup> | Fresh          | 5.4                                 | 4.3                    | 3.4                  | 2.7                  | 2.0                  | 1.7                 |
|                             | 150°C+         | —                                   | —                      | —                    | —                    | —                    | —                   |
|                             | 200°C+         | 6.5                                 | 5.2                    | 4.0                  | 3.3                  | 2.8                  | 2.3                 |
|                             | 250°C+         | 11.9                                | 9.3                    | 7.3                  | 5.8                  | 4.7                  | 3.8                 |
| Mandalay Crude Oil          | Fresh          | 2,104 <sup>c</sup>                  | 1,221 <sup>c</sup>     | 671. <sup>c</sup> 6  | 536.1 <sup>f</sup>   | 501.2 <sup>c</sup>   | 297.8 <sup>c</sup>  |
|                             | 150°C+         | 56,850 <sup>c</sup>                 | 28,260 <sup>c</sup>    | 13,420 <sup>c</sup>  | 6,857 <sup>c</sup>   | 4,132 <sup>c</sup>   | 2,759 <sup>c</sup>  |
|                             | 200°C+         | 527,900 <sup>a</sup>                | 256,200 <sup>a</sup>   | 57,070 <sup>c</sup>  | 29,210 <sup>c</sup>  | 15,560 <sup>c</sup>  | 9,024 <sup>c</sup>  |
|                             | 250°C+         | ND <sup>f</sup>                     | 1,088,000 <sup>a</sup> | 332,900 <sup>a</sup> | 126,600 <sup>b</sup> | 65,410 <sup>c</sup>  | 37,240 <sup>c</sup> |
| Orimulsion ® <sup>e</sup>   | Fresh          | 885.1                               | 487.1                  | 372.5                | 300.3                | 266.6                | 255.7               |

<sup>a</sup> shear rate = 1 s<sup>-1</sup>.

<sup>b</sup> shear rate = 5 s<sup>-1</sup>.

<sup>c</sup> shear rate = 10 s<sup>-1</sup>.

<sup>d</sup> shear rate = 100 s<sup>-1</sup>.

<sup>e</sup> shear rate = 1000 s<sup>-1</sup>.

<sup>f</sup> ND not determined, viscosity exceeded range of instrument performance



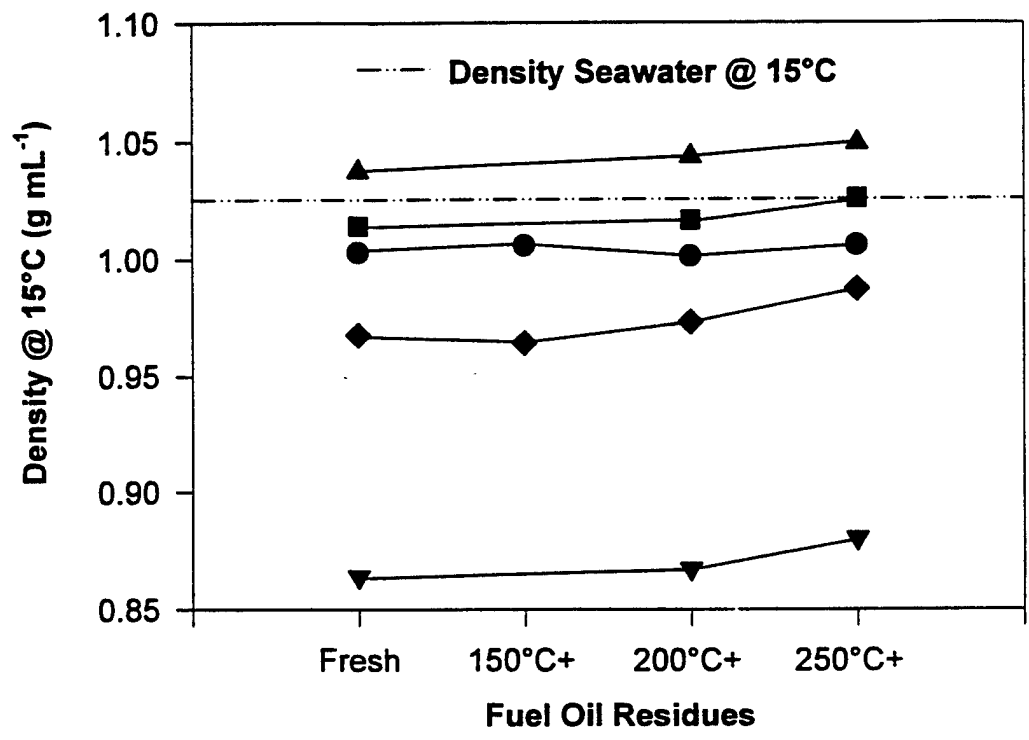

- No. 6 (MJB)
- No. 6 (FPL)
- ▲ No. 6 (FPC)
- ▼ No. 2 Fuel Oil
- ◆ Mandalay Crude Oil

Figure 3-3. Density of the fuel oil residues at 15°C.

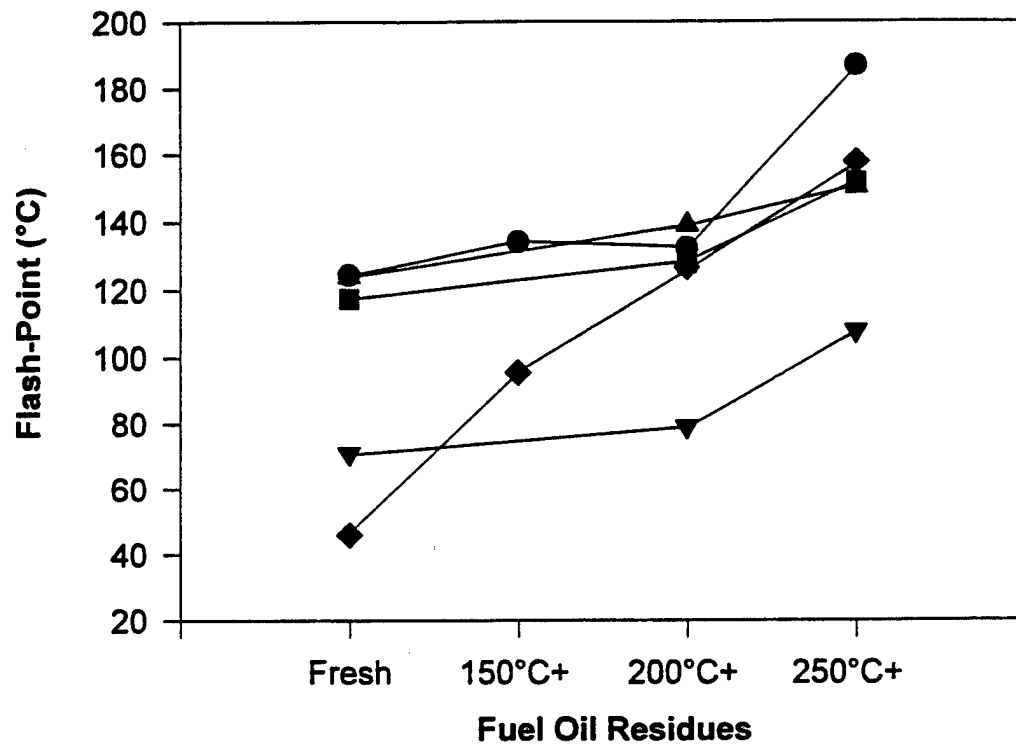

- No. 6 (MJB)
- No. 6 (FPL)
- ▲ No. 6 (FPC)
- ▼ No. 2 Fuel Oil
- ◆ Mandalay Crude Oil

Figure 3-4. Flash-point of the fuel oil residues.

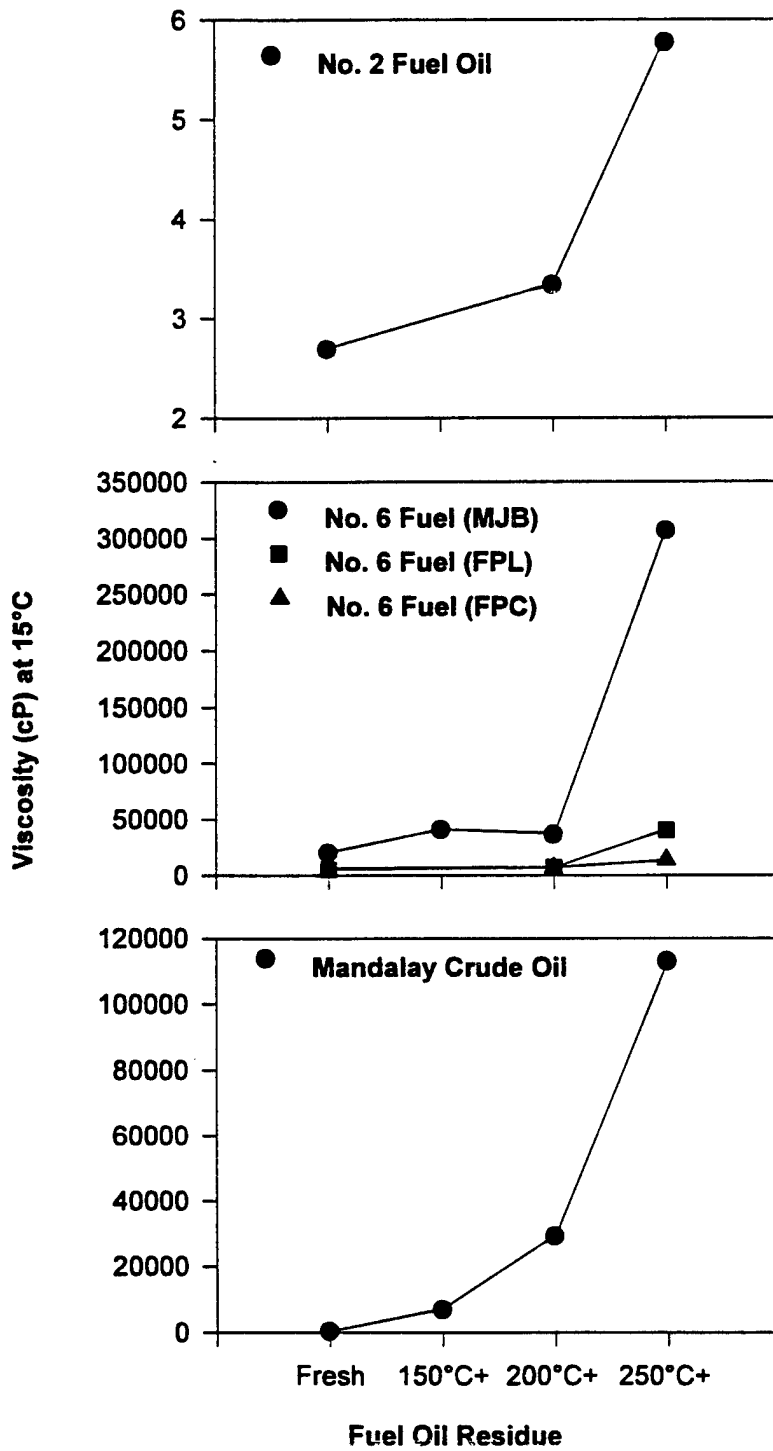

Figure 3-5. Viscosity of fuel oil residues at 15°C.

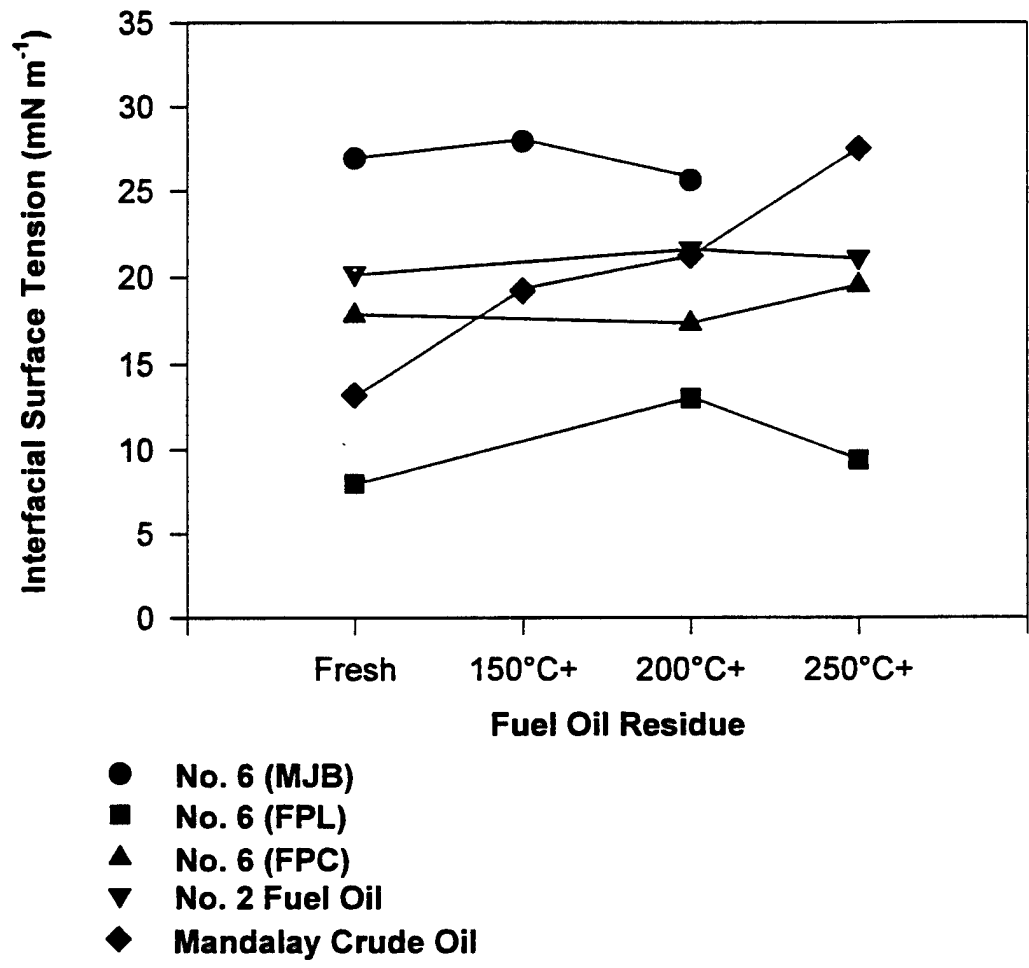
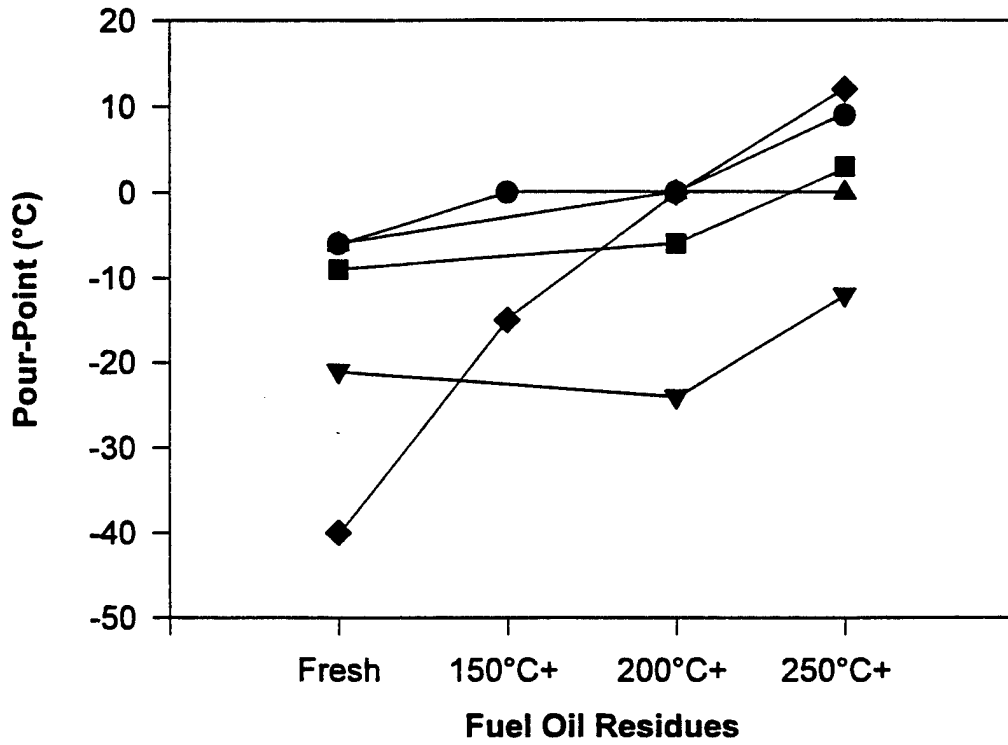

Figure 3-6. Plot of interfacial surface tension for fuel oil residues.



- No. 6 (MJB)
- No. 6 (FPL)
- ▲ No. 6 (FPC)
- ▼ No. 2 Fuel Oil
- ◆ Mandalay Crude Oil

Figure 3-7. Plot of pour-point for fuel oil residues.

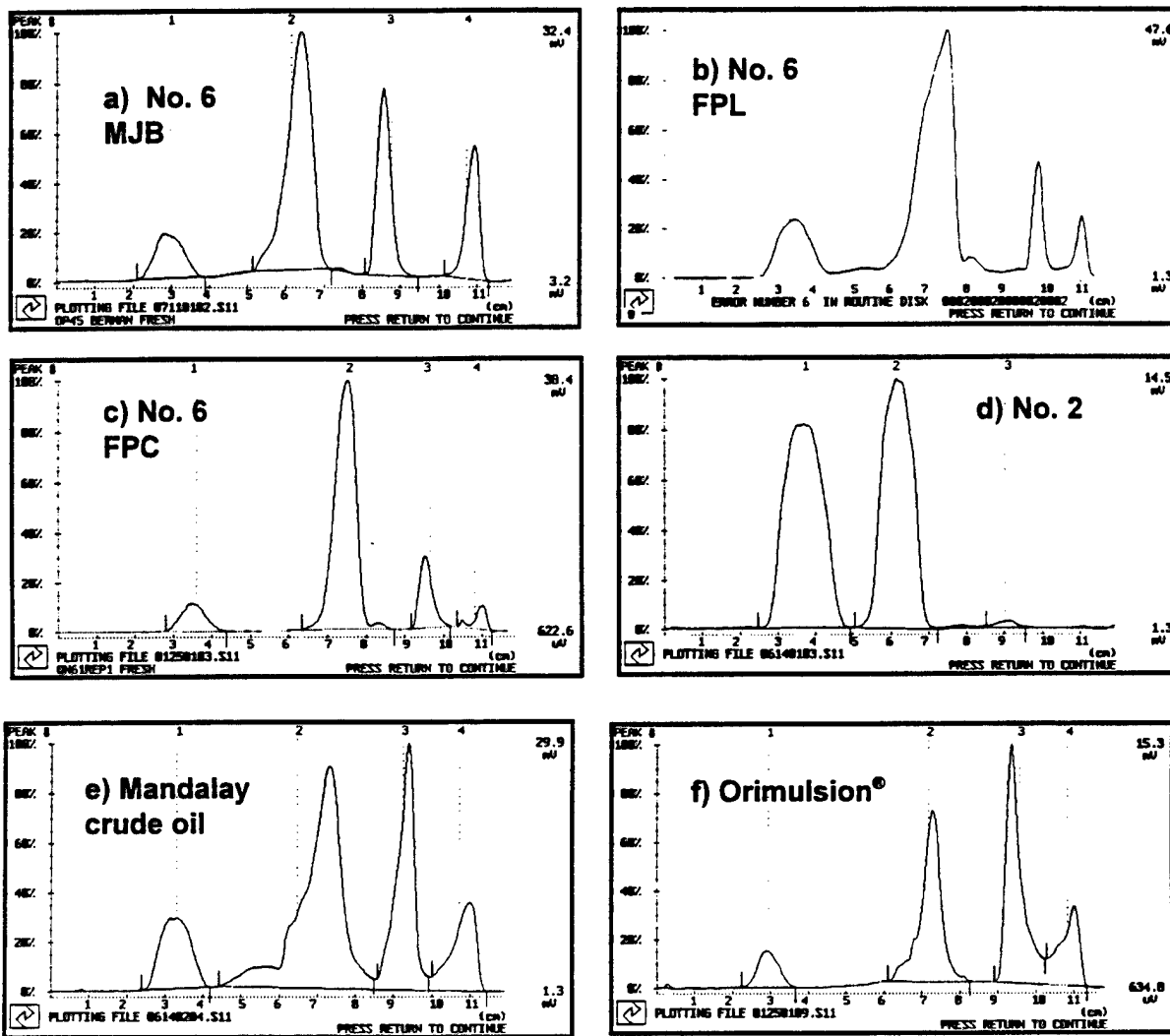

Figure 3-8. Iatroscan chromatograms of a) No. 6 fuel oil (*Morris J. Berman* cargo oil), b) No. 6 fuel oil Florida Power and Light Corporation, c) No. 6 fuel oil Florida Power Corporation, d) No. 2 fuel oil, e) Mandalay crude oil, and f) Orimulsion®.

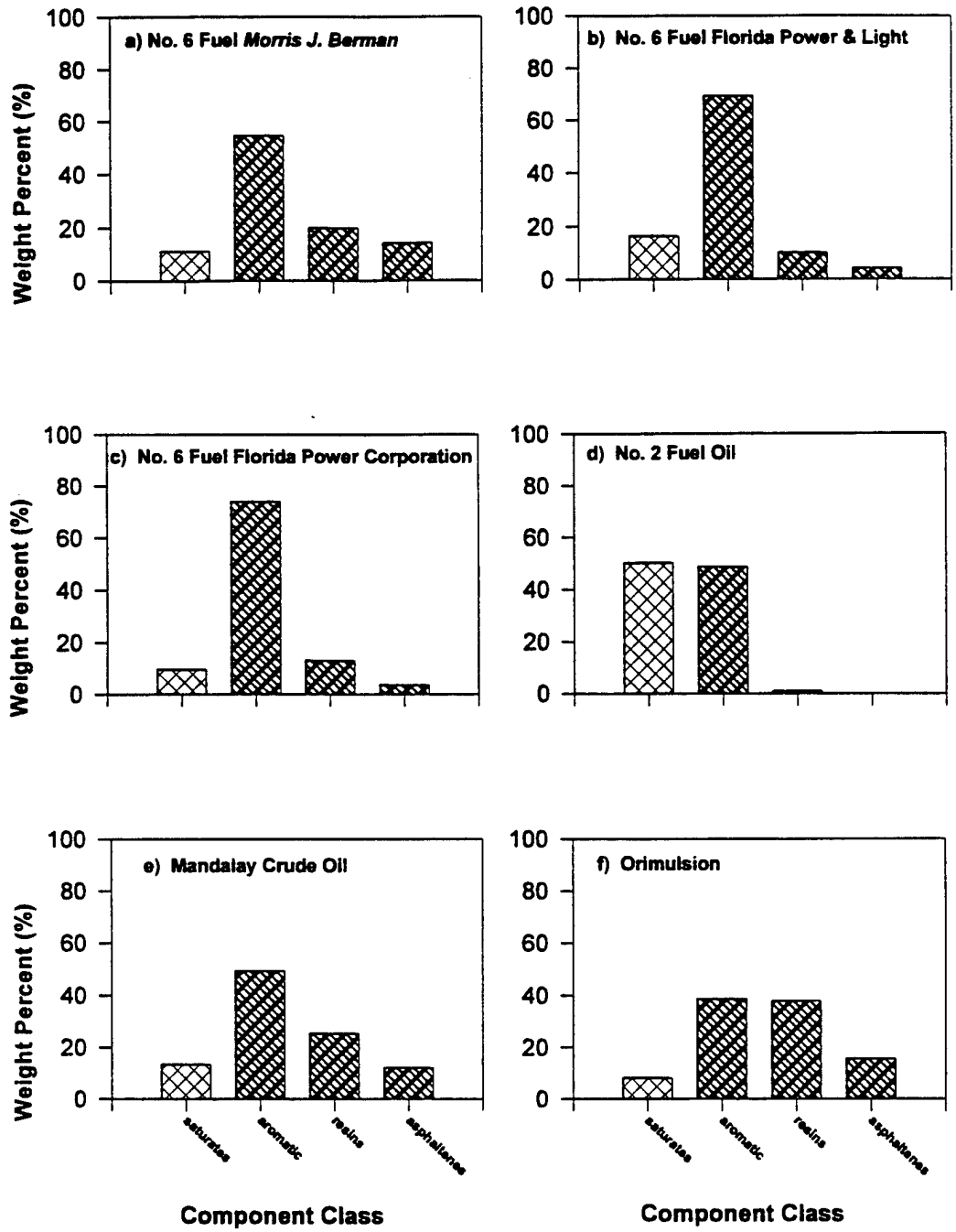

Figure 3-9. Histograms of the component class analysis for fuel oils.

### 3.5 Testing of Water-in-Oil Emulsion Properties

The water-in-oil emulsion formation kinetics, maximum water uptake, and emulsion stability were tested using the topped residues of the heavy fuel oils. In these studies with LAPIO fuels, all water content determinations were conducted by Karl Fisher titration. This is a slight modification of more standard methods in which water uptake is determined by reading gradations on a graduated flask. Additionally, the effect of Alcopol O 60% in breaking the emulsions was tested. The results of these emulsion studies are presented in this section.

#### 3.5.1 Emulsion Formation Kinetics

The rates of water-in-oil emulsification of the residues of the heavy fuels ranged from 0.08 hrs to 19.9 hrs. The most rapid water uptake was observed for the 250°C+ residue of the Mandalay crude and the slowest water uptake occurred for the 250°C+ residue of the No. 2 fuel oil. These results are summarized in Table 3-8 and depicted graphically in Figure 3-10.

#### 3.5.2 Water-In-Oil Emulsion Stability

The results obtained from the emulsion stability tests are presented in Table 3-9. The emulsions generated from the No. 2 fuel oil and the 250°C+ topped residue of the Mandalay Crude were found to be totally unstable, having fractional dehydration values ( $D_{24}$ ) values of 1.00 (obtained for the water saturated emulsions). The remaining water saturated emulsions generated were found to be very stable, having  $D_{24}$  values of 0.40 or less. Several  $D_{24}$  values were calculated to be less than zero. Though these emulsions were found to be exceptionally stable, the calculated value of  $D_{24}$  is most likely an artifact of the method used to determine the emulsion stability. The small amount of water taken up by the oils and the high viscosity of the residues did not allow accurate determination of the water uptake.

#### 3.5.3 Effectiveness of Alcopol O 60% in Breaking Emulsions

The results of the Alcopol O 60% emulsion breaking study for topped heavy fuel oils residues are reported in Table 3-9. The addition of Alcopol was found to be effective on the emulsions formed with the No. 6 fuel from the *Morris J. Berman* and in general was not found to be effective in dehydrating the maximum water emulsions. The emulsion formed with fresh and 150°C+ residues from the No. 6 fuel (FPL) were found to be partially broken by the addition of Alcopol. The No. 2 fuel oil was completely unstable with fractional dehydration values of 1.00 immediately after the addition of the demulsifier as well as 24 hours later.

All of the emulsions generated from the Mandalay Crude were extremely stable and did not immediately respond to Alcopol O 60%. However, following the 24 hour settling period the fresh and the 150°C+ topped residue of Mandalay Crude did partially dehydrate. The  $D_{24}$  values for these two emulsions were observed to be 0.60 and 0.67 for the 150°C+ and the fresh residues respectively.



**Table 3-8. Water Content and  $t_{1/2}$  values for Heavy Fuels at 13°C .**

| <b>Emulsion Water Content No. 6 Fuel Oil (Morris J. Berman cargo oil)</b> |               |               |               |               |                |               |
|---|---------------|---------------|---------------|---------------|----------------|---------------|
| <b>Mixing Time (Hours)</b>  |               | <b>WOR</b>    |               |               | <b>% Water</b> |               |
| <b>13°C</b>   | <b>150°C+</b> | <b>200°C+</b> | <b>250°C+</b> | <b>150°C+</b> | <b>200°C+</b>  | <b>250°C+</b> |
| 0   | 0             | 0             | 0             | 0             | 0              | 0             |
| 0.08 (5min)   | 0             | 0             | 0             | 0             | 0              | 0             |
| 0.17 (10min)  | 0             | 0             | 0             | 0             | 0              | 0             |
| 0.25 (15min)  | 0             | 0             | 0             | 0             | 0              | 0             |
| 0.50 (30min)  | 0.17          | 0.13          | 0             | 14            | 11             | 0             |
| 1   | 0.33          | 0.17          | 0             | 25            | 14             | 0             |
| 2   | 0.38          | 0.17          | 0             | 27            | 14             | 0             |
| 4   | 0.79          | 0.29          | 0.17          | 44            | 23             | 14            |
| 6   | 0.79          | 0.33          | 0.17          | 44            | 25             | 14            |
| 8   | 1.08          | 0.33          | 0.17          | 52            | 25             | 14            |
| 12  | 1.17          | 0.33          | 0.17          | 54            | 25             | 14            |
| 24  | 1.29          | 0.42          | 0.17          | 56            | 29             | 14            |
| <b>WOR<sub>max</sub></b>  | <b>1.29</b>   | <b>0.42</b>   | <b>0.17</b>   |               |                |               |
| <b><math>t_{1/2}</math></b>   |               |               |               | <b>1.9</b>    | <b>1.8</b>     | <b>2.5</b>    |

| <b>Emulsion Water Content No. 6 Fuel Oil (Florida Power and Light Corporation)</b> |              |               |               |              |                |               |
|--|--------------|---------------|---------------|--------------|----------------|---------------|
| <b>Mixing Time (Hours)</b>   |              | <b>WOR</b>    |               |              | <b>% Water</b> |               |
| <b>13°C</b>  | <b>Fresh</b> | <b>200°C+</b> | <b>250°C+</b> | <b>Fresh</b> | <b>200°C+</b>  | <b>250°C+</b> |
| 0  | 0.00         | 0.00          | 0.00          | 0.0          | 0.0            | 0.0           |
| 0.08 (5min)  | 0.00         | 0.00          | 0.00          | 0.0          | 0.0            | 0.0           |
| 0.17 (10min)   | 0.08         | 0.08          | 0.00          | 7.7          | 7.7            | 0.0           |
| 0.25 (15min)   | 0.29         | 0.25          | 0.17          | 22.6         | 20.0           | 14.3          |
| 0.50 (30min)   | 0.21         | 0.21          | 0.00          | 17.2         | 17.2           | 0.0           |
| 1  | 0.21         | 0.21          | 0.00          | 17.2         | 17.2           | 0.0           |
| 2.75   | 0.21         | 0.17          | 0.00          | 17.2         | 14.3           | 0.0           |
| 5  | 0.75         | 0.71          | 0.42          | 42.9         | 41.5           | 29.4          |
| 22.15  | 0.75         | 0.71          | 0.38          | 42.9         | 41.5           | 27.3          |
| 24   | <b>0.75</b>  | <b>0.71</b>   | <b>0.38</b>   | <b>42.9</b>  | <b>41.5</b>    | <b>27.3</b>   |
| <b>WOR<sub>max</sub></b>   | <b>0.75</b>  | <b>0.71</b>   | <b>0.38</b>   |              |                |               |
| <b><math>t_{1/2}</math></b>  |              |               |               | <b>3.66</b>  | <b>3.98</b>    | <b>8.58</b>   |

| <b>Emulsion Water Content No. 6 Fuel Oil (Florida Power Corporation)</b> |              |               |               |              |                |               |
|--|--------------|---------------|---------------|--------------|----------------|---------------|
| <b>Mixing Time (Hours)</b>   |              | <b>WOR</b>    |               |              | <b>% Water</b> |               |
| <b>13°C</b>  | <b>Fresh</b> | <b>200°C+</b> | <b>250°C+</b> | <b>Fresh</b> | <b>200°C+</b>  | <b>250°C+</b> |
| 0  | 0.00         | 0.00          | 0.00          | 0.00         | 0.00           | 0.00          |
| 0.08   | 0.00         | 0.00          | 0.00          | 0.00         | 0.00           | 0.00          |
| 0.17   | 0.11         | 0.08          | 0.00          | 9.33         | 4.67           | 0.00          |
| 0.25   | 0.11         | 0.08          | 0.00          | 9.33         | 4.67           | 0.00          |
| 0.5  | 0.56         | 0.42          | 0.28          | 32.67        | 21.33          | 14.00         |
| 1  | 0.67         | 0.67          | 0.56          | 40.00        | 31.33          | 30.00         |
| 2  | 0.89         | 0.83          | 0.67          | 46.67        | 34.67          | 40.00         |
| 4  | 1.17         | 1.42          | 0.67          | 53.67        | 59.33          | 40.00         |
| 24   | 2.33         | 1.92          | 0.67          | 69.67        | 65.50          | 45.00         |
| <b>WOR<sub>max</sub></b>   | <b>2.33</b>  | <b>1.92</b>   | <b>0.67</b>   |              |                |               |
| <b><math>t_{1/2}</math></b>  |              |               |               | <b>0.95</b>  | <b>0.91</b>    | <b>0.87</b>   |

**Table 3.8 continued**

| <b>Emulsion Water Content No. 2 Fuel Oil</b> |              |               |               |              |                |               |
|--|--------------|---------------|---------------|--------------|----------------|---------------|
| <b>Mixing Time (Hours)</b>                   |              | <b>WOR</b>    |               |              | <b>% Water</b> |               |
| <b>13°C</b>                                  | <b>Fresh</b> | <b>200°C+</b> | <b>250°C+</b> | <b>Fresh</b> | <b>200°C+</b>  | <b>250°C+</b> |
| 0  | 0.00         | 0.00          | 0.00          | 0.00         | 0.00           | 0.00          |
| 0.08   | 0.00         | 0.00          | 0.06          | 0.00         | 0.00           | 4.76          |
| 0.17   | 0.00         | 0.00          | 0.00          | 0.00         | 0.00           | 0.00          |
| 0.25   | 0.00         | 0.00          | 0.00          | 0.00         | 0.00           | 0.00          |
| 0.5  | 0.00         | 0.00          | 0.00          | 0.00         | 0.00           | 0.00          |
| 1  | 0.00         | —             | —             | 0.00         | —              | —             |
| 2  | 0.00         | —             | —             | 0.00         | —              | —             |
| 24   | 0.28         | 0.17          | 0.00          | 21.43        | 14.29          | 0.00          |
| <b>WOR<sub>max</sub></b>                     | <b>0.28</b>  | <b>0.17</b>   | <b>0.00</b>   |              |                |               |
| <b>t<sub>1/2</sub></b>                       |              |               |               | <b>8.00</b>  | <b>5.20</b>    | <b>19.90</b>  |

| <b>Emulsion Water Content Mandalay Crude Oil</b> |              |               |               |               |              |                |               |               |
|--|--------------|---------------|---------------|---------------|--------------|----------------|---------------|---------------|
| <b>Mixing Time (Hours)</b>                       |              | <b>WOR</b>    |               |               |              | <b>% Water</b> |               |               |
| <b>13°C</b>                                      | <b>Fresh</b> | <b>150°C+</b> | <b>200°C+</b> | <b>250°C+</b> | <b>Fresh</b> | <b>150°C+</b>  | <b>200°C+</b> | <b>250°C+</b> |
| 0  | 0.00         | 0.00          | 0.00          | 0.00          | 0.00         | 0.00           | 0.00          | 0.00          |
| 0.08   | 0.08         | 0.11          | 0.04          | 0.04          | 7.70         | 10.00          | 4.00          | 4.00          |
| 0.17   | 0.38         | 0.11          | 0.00          | 0.17          | 27.30        | 10.00          | 0.00          | 14.30         |
| 0.25   | 0.50         | 0.11          | 0.08          | 0.17          | 33.30        | 10.00          | 7.70          | 14.30         |
| 0.5  | 0.67         | 0.17          | 0.00          | 0.17          | 40.00        | 14.30          | 0.00          | 14.30         |
| 1  | 1.00         | 0.17          | 0.00          | 0.00          | 50.00        | 14.30          | 0.00          | 0.00          |
| 2  | —            | 0.33          | 0.08          | —             | —            | 25.00          | 7.70          | —             |
| 3  | 3.25         | —             | —             | 0.08          | 76.50        | —              | —             | 7.70          |
| 24   | 3.78         | 0.71          | 0.58          | 0.17          | 79.10        | 41.50          | 36.80         | 14.30         |
| <b>WOR<sub>max</sub></b>                         | <b>3.78</b>  | <b>0.71</b>   | <b>0.58</b>   | <b>0.17</b>   |              |                |               |               |
| <b>t<sub>1/2</sub></b>                           |              |               |               |               | <b>0.52</b>  | <b>1.48</b>    | <b>6.34</b>   | <b>0.08</b>   |

WOR. Water to Oil ratio of emulsion

t<sub>1/2</sub> time at which the water content (in % by volume) is half of what it is at t=24hrs

WOR<sub>max</sub> Maximum volumetric water-to-oil ratio (defined as WOR after 24hrs of mixing)

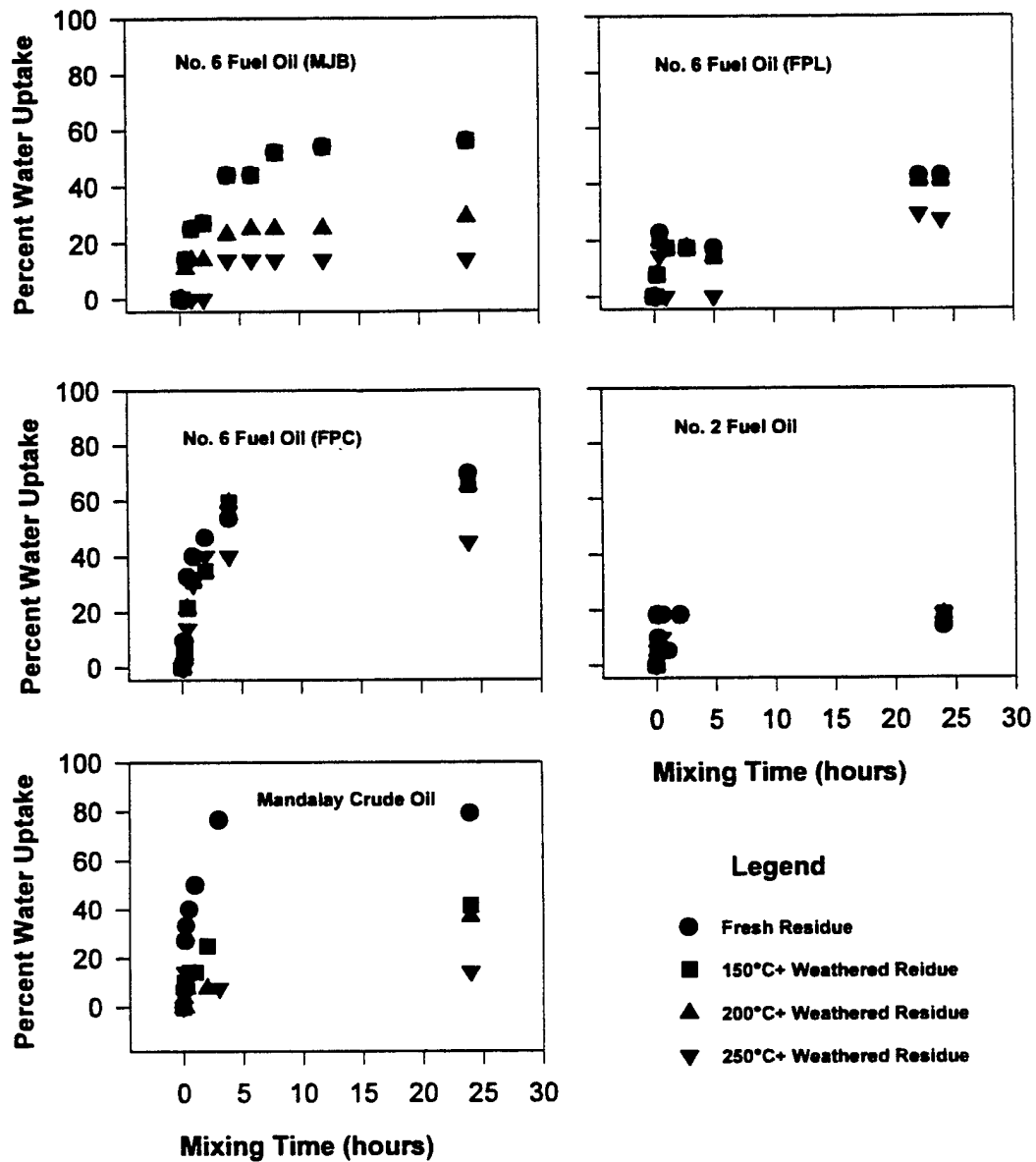

Figure 3-10. Plots of the water uptake kinetics for heavy fuels.

**Table 3-9. Emulsion Stability data for Heavy Fuels at 13°C and 20°C+ .**

| <b>Water-in-Oil Emulsion Formation and Stability testing at 20°C.</b> |           |        |        |                             |        |        |
|---|-----------|--------|--------|-----------------------------|--------|--------|
| <b>No. 6 Fuel Oil (Morris J. Berman cargo oil)</b>                    |           |        |        |                             |        |        |
| Parameter   | Stability |        |        | Treated with Alcolpol O 60% |        |        |
|   | 150 °C+   | 200°C+ | 250°C+ | 150°C+                      | 200°C+ | 250°C+ |
| WOR <sub>ref</sub>  | 1.50      | 0.17   | 0.17   | 1.50                        | 0.17   | 0.17   |
| WOR <sub>im</sub>   | —         | —      | —      | 1.33                        | 0.17   | 0.17   |
| WOR <sub>24</sub>   | 1.50      | 0.17   | 0.17   | 1.33                        | 0.17   | 0.17   |
| D <sub>im</sub>   | —         | —      | —      | 0.11                        | 0.00   | 0.00   |
| D <sub>24</sub>   | 0.00      | 0.00   | 0.00   | 0.11                        | 0.00   | 0.00   |

| <b>Water-in-Oil Emulsion Formation and Stability testing at 13°C.</b> |           |        |        |                             |        |        |
|---|-----------|--------|--------|-----------------------------|--------|--------|
| <b>No. 6 Fuel Oil (Florida Power and Light Corporation)</b>           |           |        |        |                             |        |        |
| Parameter   | Stability |        |        | Treated with Alcolpol O 60% |        |        |
|   | Fresh     | 200°C+ | 250°C+ | Fresh                       | 200°C+ | 250°C+ |
| WOR <sub>ref</sub>  | 0.83      | 0.67   | 0.17   | 0.67                        | 0.67   | 0.17   |
| WOR <sub>im</sub>   | —         | —      | —      | 0.17                        | 0.50   | 0.00   |
| WOR <sub>24</sub>   | 0.50      | 0.40   | 0.40   | 0.50                        | 0.50   | 0.30   |
| D <sub>im</sub>   | —         | —      | —      | 0.75                        | 0.25   | 1.00   |
| D <sub>24</sub>   | 0.40      | 0.40   | 1.40   | 0.25                        | 0.25   | -0.80  |

| <b>Water-in-Oil Emulsion Formation and Stability testing at 13°C.</b> |           |        |        |                             |        |        |
|---|-----------|--------|--------|-----------------------------|--------|--------|
| <b>No. 6 Fuel Oil (Florida Power Corporation)*</b>                    |           |        |        |                             |        |        |
| Parameter   | Stability |        |        | Treated with Alcolpol O 60% |        |        |
|   | Fresh     | 200°C+ | 250°C+ | Fresh                       | 200°C+ | 250°C+ |
| WOR <sub>ref</sub>  | 2.17      | 1.67   | 0.50   | 2.33                        | 2.17   | 0.67   |
| WOR <sub>im</sub>   | —         | —      | —      | 0.83                        | 0.67   | 0.33   |
| WOR <sub>24</sub>   | 2.00      | 0.17   | 0.50   | 0.17                        | 0.00   | 0.33   |
| D <sub>im</sub>   | —         | —      | —      | 0.64                        | 0.69   | 0.50   |
| D <sub>24</sub>   | 0.08      | 0.90   | 0.00   | 0.93                        | 1.00   | 0.50   |

| <b>Water-in-Oil Emulsion Formation and Stability testing at 13°C.</b> |           |        |        |                             |        |        |
|---|-----------|--------|--------|-----------------------------|--------|--------|
| <b>No. 2 Fuel Oil</b>   |           |        |        |                             |        |        |
| Parameter   | Stability |        |        | Treated with Alcolpol O 60% |        |        |
|   | Fresh     | 200°C+ | 250°C+ | Fresh                       | 200°C+ | 250°C+ |
| WOR <sub>ref</sub>  | 0.17      | 0.33   | 0.17   | 0.17                        | 0.17   | 0.17   |
| WOR <sub>im</sub>   | —         | —      | —      | 0.00                        | 0.17   | 0.17   |
| WOR <sub>24</sub>   | 0.00      | 0.00   | 0.00   | 0.00                        | 0.00   | 0.17   |
| D <sub>im</sub>   | —         | —      | —      | 1.00                        | 2.00   | 0.00   |
| D <sub>24</sub>   | 0.00      | 1.00   | 1.00   | 1.00                        | 1.00   | 0.00   |

**Table 3-9 Continued**

**Water-in-Oil Emulsion Formation and Stability testing at 13°C.  
Mandalay Crude Oil**

| Parameter          | Stability |        |        |        | Treated with Alcopol O 60% |        |        |        |
|--------------------|-----------|--------|--------|--------|----------------------------|--------|--------|--------|
|                    | Fresh     | 150°C+ | 200°C+ | 250°C+ | Fresh                      | 150°C+ | 200°C+ | 250°C+ |
| WOR <sub>ref</sub> | 3.33      | 0.67   | 0.67   | 0.17   | 3.50                       | 0.83   | 0.50   | 0.17   |
| WOR <sub>im</sub>  | —         | —      | —      | —      | 3.50                       | 0.50   | 0.67   | 0.17   |
| WOR <sub>24</sub>  | 2.00      | 0.50   | 1.00   | 0.00   | 1.17                       | 0.33   | 1.33   | 0.00   |
| D <sub>im</sub>    | —         | —      | —      | —      | 0.00                       | 0.40   | 0.33   | 0.00   |
| D <sub>24</sub>    | 0.40      | 0.25   | -0.50  | 1.00   | 0.67                       | 0.60   | 0.67   | 1.00   |

WOR<sub>ref</sub> = Volumetric Water to Oil ratio of emulsion after 24 hours of mixing.

WOR<sub>im</sub> = Volumetric Water to Oil ratio of the emulsion “immediately” after treatment with emulsion breaker.

WOR<sub>24</sub> = Volumetric Water to Oil ratio of the emulsion after 24 hours of mixing, treatment with emulsion breaker, and 24 hours of settling.

D<sub>im</sub> = Fractional dehydration obtained “immediately” after treatment with emulsion breaker.

D<sub>24</sub> = Fractional dehydration obtained during 24 hours of settling after treatment with emulsion breaker.

### 3.6 Testing of IFP Dispersability

The effectiveness of Corexit 9527 on the oil residue and its respective emulsion was measured by its ability to disperse the oil or emulsion into the water column under gentle surface agitation conditions. In addition to measuring the dispersed oil, viscosity measurements and water content determinations were performed on the test oil residues and emulsions in order to evaluate the relationship between oil viscosity, water content, and Dispersability. The results of the IFP Dispersability tests are presented in Table 3-10.

In general, the fresh and water-free residues of these fuels were well dispersed by Corexit 9527. All residues of the No. 2 fuel were well dispersed by the IFP method, however it should be noted that all of the emulsions formed with this fuel were unstable.

All of the water-free residues of the No. 6 fuel oils were well dispersed by Corexit 9527. However, the incorporation of water into the oils significantly reduced the ability of the Corexit to disperse the oil. Of these emulsions (50%-water, 75%-water, and water-saturated) the fresh No. 6 fuel was dispersed to the greatest degree and dispersability decreased as the percentage of water in the emulsion increased. Of the emulsions formed from the residues of the Mandalay crude oil, the fresh, water-free residue was the only residue or emulsion which was dispersable (56.8 %). The remaining emulsions were essentially non-dispersable.

**Table 3-10. Results from IFP Dispersability testing.**

| <b>IFP Dispersability of No. 6 Fuel Oil (Morris J. Berman cargo oil) at 20°C</b> |                 |                  |                                    |
|--|-----------------|------------------|------------------------------------|
| <b>Sample</b>  | <b>WOR</b>      | <b>Viscosity</b> | <b>Effectiveness (% Dispersed)</b> |
| Fresh  | 0               | 11,350           | 69.9                               |
| 150°C+   | 0               | 19,280           | 72.4                               |
| 200°C+   | 0               | 20,260           | 66.6                               |
| 250°C+   | 0               | 119,600          | 0.6                                |
| 150°C+ 50% Water   | 0.37            | 32,550           | 0.3                                |
| 200°C+ 50% Water   | 1.0             | 86,910           | 0.2                                |
| 250°C+ 50% Water   | NA <sup>1</sup> | NA               | NA                                 |
| 150°C+ 75% Water   | 0.33            | 33,800           | 0.4                                |
| 200°C+ 75% Water   | 0.29            | 32,280           | 0.2                                |
| 250°C+ 75% Water   | 0.36            | 158,900          | 0.0                                |
| 150°C+ Max Water   | 1.67            | 137,000          | 0.1                                |
| 200°C+ Max Water   | 1.47            | 131,200          | 0.1                                |
| 250°C+ Max Water   | 0.10            | 94,110           | 0.1                                |

<sup>1</sup> Emulsion was not prepared due to a lack of topped residue.

| <b>IFP Dispersability of No. 6 Fuel Oil (Florida Power and Light Corporation) at 13°C</b> |            |                  |                                    |
|---|------------|------------------|------------------------------------|
| <b>Sample</b>   | <b>WOR</b> | <b>Viscosity</b> | <b>Effectiveness (% Dispersed)</b> |
| Fresh   | 0          | 6,811            | 83.2                               |
| 200°C+  | 0          | 8,749            | 101.2                              |
| 250°C+  | 0          | 40,170           | 92.6                               |
| Fresh 50% Water   | 1.0        | 23,120           | 36.0                               |
| 200°C+ 50% Water  | 0.66       | 21,860           | 26.5                               |
| 250°C+ 50% Water  | 0.34       | 52,380           | 0.2                                |
| Fresh 75% Water   | 0.95       | 20,590           | 59.1                               |
| 200°C+ 75% Water  | 1.11       | 28,030           | 1.4                                |
| 250°C+ 75% Water  | 0.39       | 71,840           | 0.3                                |
| Fresh Max Water   | 0.50       | 12,870           | 28.6                               |
| 200°C+ Max Water  | 0.43       | 14,300           | 10.1                               |
| 250°C+ Max Water  | 0.33       | 56,380           | 2.5                                |

| <b>IFP Dispersability of No. 6 Fuel Oil (Florida Power Corporation) at 13°C</b> |            |                  |                                    |
|---|------------|------------------|------------------------------------|
| <b>Sample</b>   | <b>WOR</b> | <b>Viscosity</b> | <b>Effectiveness (% Dispersed)</b> |
| Fresh   | 0.0        | 5,154            | 11.9                               |
| 200°C+  | 0.0        | 8,689            | 8.3                                |
| 250°C+  | 0.0        | 16,335           | 3.1                                |
| Fresh 50% Water   | 0.97       | 22,280           | 29.3                               |
| 200°C+ 50% Water  | 0.57       | 17,970           | 5.8                                |
| 250°C+ 50% Water  | 0.40       | 26,020           | 1.8                                |
| Fresh 75% Water   | 1.33       | 18,970           | 13.2                               |
| 200°C+ 75% Water  | 0.93       | 10,120           | 12.0                               |
| 250°C+ 75% Water  | 0.80       | 21,650           | 4.1                                |
| Fresh Max Water   | 2.17       | 17,330           | 7.3                                |
| 200°C+ Max Water  | 1.67       | 16,070           | 3.5                                |

250°C+ Max Water 0.83 41,070 0.4

**Table 3-10 Continued**

| <b>IFP Dispersability of No. 2 Fuel Oil at 13°C</b> |            |                  |                                    |
|---|------------|------------------|------------------------------------|
| <b>Sample</b>                                       | <b>WOR</b> | <b>Viscosity</b> | <b>Effectiveness (% Dispersed)</b> |
| Fresh   | 0          | 2.6              | >100                               |
| 200°C+  | 0          | 5.8              | >100                               |
| 250°C+  | 0          | 6.0              | >100                               |
| Fresh 50% Water                                     | 0.8        | 2.9              | >100                               |
| 200°C+ 50% Water                                    | 0          | 3.4              | >100                               |
| 250°C+ 50% Water                                    | 0          | 6.7              | >100                               |
| Fresh 75% Water                                     | 0          | 3.2              | >100                               |
| 200°C+ 75% Water                                    | 0          | 3.5              | >100                               |
| 250°C+ 75% Water                                    | 0          | 6.6              | 35                                 |
| Fresh Max Water                                     | 0          | 3.2              | >100                               |
| 200°C+ Max Water                                    | 0          | 4.0              | >100                               |
| 250°C+ Max Water                                    | 0          | 8.7              | >100                               |

| <b>IFP Dispersability of Mandalay Crude Oil at 13°C</b> |            |                  |                                   |
|---|------------|------------------|-----------------------------------|
| <b>Sample</b>   | <b>WOR</b> | <b>Viscosity</b> | <b>Effectiveness(% Dispersed)</b> |
| Fresh   | 0.0        | 613              | 56.8                              |
| 150°C+  | 0.0        | 8,586            | 3.0                               |
| 200°C+  | 0.0        | 29,590           | 0.0                               |
| 250°C+  | 0.0        | 146,100          | 0.0                               |
| Fresh 50% Water   | 1.0        | 1,743            | 3.7                               |
| 150°C+ 50% Water  | 0.83       | 32,800           | 0.0                               |
| 200°C+ 50% Water  | 0.07       | 36,160           | 0.0                               |
| 250°C+ 50% Water  | 0.60       | 402,050          | 0.0                               |
| Fresh 75% Water   | 3.0        | 2,194            | 0.4                               |
| 150°C+ 75% Water  | 4.0        | 23,960           | 0.1                               |
| 200°C+ 75% Water  | 0.36       | 61,780           | 0.0                               |
| 250°C+ 75% Water  | 0.12       | 155,200          | 0.0                               |
| Fresh Max Water   | 4.33       | 6,991            | 0.4                               |
| 150°C+ Max Water  | 0.4        | 19,075           | 0.1                               |
| 200°C+ Max Water  | 2.53       | 47,18            | 0.1                               |
| 250°C+ Max Water  | 0.13       | ND               | 0.0                               |

WOR. Water to Oil ratio of emulsion

$t_{1/2}$  time at which the water content (in % by volume) is half of what it is at  $t=24$ hrs

WOR<sub>max</sub> Maximum volumetric water-to-oil ratio (defined as WOR after 24hrs of mixing)

## 3.7 Meso-Scale Studies

### 3.7.1 Meso-scale test conditions

During the flume experiments the flume tank was filled with 4000 L of fresh seawater (32 ppt) filtered through a five micron filter and the temperature of the flume facility was maintained at 13°C. The Orimulsion® experiments were conducted in both full strength seawater and fresh water. The initial wind turbine generator setting was at 80 rpm. Wind conditions were maintained at approximately 6 m/s. Inside the 24 inch flume track the wind velocity measurements showed the following conditions:

inside: 4.20 m/s  
middle: 5.80 m/s  
outside: 7.19 m/s

The wave measurements were made using videographic methods and demonstrated that initial wave frequency was maintained at approximately 50 breaking waves/minute resulting in a significant wave height ( $H_{1/3}$ ) of 13.2 cm at a frequency of 0.8 hertz.

### 3.7.2 Physico-chemical analyses of the flume samples

Following the initial release of the test fuel, the oil was allowed to weather. The No. 6 fuel oil (FPL) was weathered for up to 120 hours while one of the Orimulsion® studies (fresh water) was continued for 22 days. During this weathering period grab samples of both the surface water-in-oil emulsion and subsurface water were taken.

#### No. 6 Fuel Oil (FPL)

The flume tank was filled with 4000 L of 5 micron filtered seawater. After the wind and wave conditions had reached a steady state, the test oil was applied through an access port via an applicator tube constructed from 1" copper pipe. Because of the viscosity of this fuel, the time required to completely apply the test oil was approximately 20 minutes.

Following the application of the oil, the test oil was allowed to weather for 72 hours. Grab samples of the water-in-oil emulsion and from the water column were taken during this weathering period. Table 3-11 summarizes the results of the analysis of the water-in-oil emulsion samples for viscosity, density, water content, IFP dispersability, emulsion stability, and emulsion breaker effectiveness.

The subsurface water samples were extracted with methylene chloride and total petroleum hydrocarbons (TPH) content of the sample was determined for these aqueous samples. The TPH level in the flume tank was observed to increase from a background level of approximately 2.5 mg/Kg to a maximum of greater than 51,000 mg/Kg after eight hours. The TPH levels then were observed to decrease to a level of approximately 5,000 mg/Kg (72 hr).

The density and viscosity of the emulsion was monitored as a function of weathering (Table 3.-11). The density of the emulsion was seen to drop from 1.0133 g mL<sup>-1</sup> (density of starting oil) to 0.8608 g mL<sup>-1</sup> (15 min). In general, the emulsion maintained a density of approximately 0.96 to 0.97 g mL<sup>-1</sup> until 72 hr. The density of the 72 hr sampling event was 1.0718 g mL<sup>-1</sup>.



The viscosity of the water-in-oil emulsion was seen to increase with degree of weathering. These results are presented in Figure 3-11 as a plot of the observed viscosity versus exposure time (hours) in the flume. There is good agreement between the viscosity results obtained from the meso-scale weathering of this No. 6 fuel and those obtained from the laboratory based weathering study.

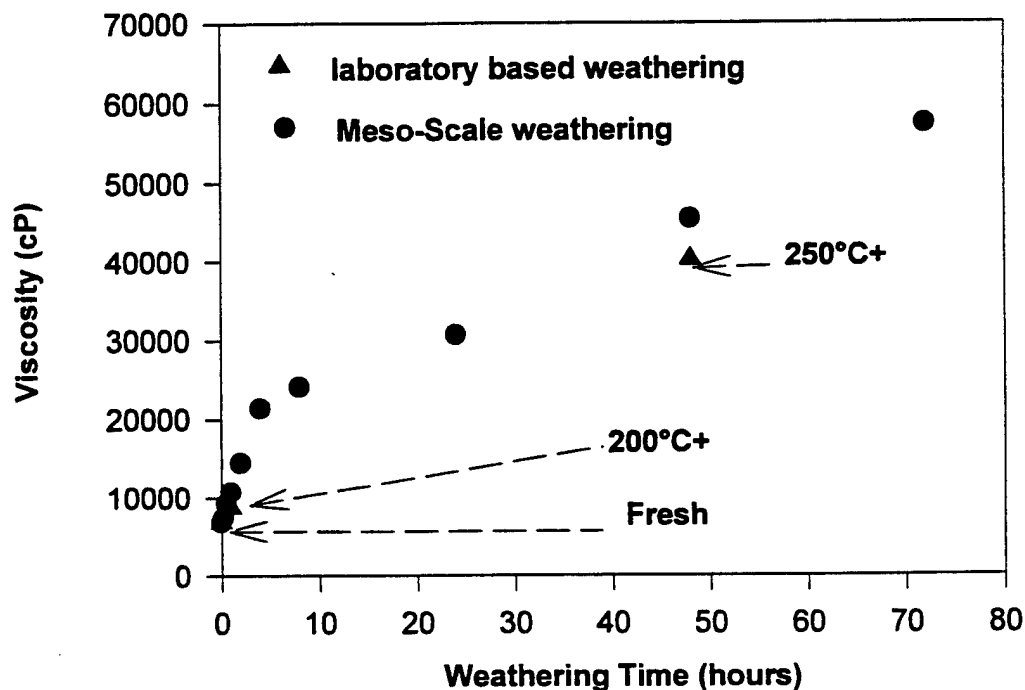

Figure 3-11. Viscosity of water-in-oil emulsions as a function of weathering state.

The water content of the emulsion was monitored by Karl-Fisher titration. As expected, the water content of the emulsion was seen to increase with degree of weathering. The maximum water content from meso-scale study was approximately 44%. These results are in excellent agreement with those obtained from the laboratory based emulsion studies (Table 3-11) and are summarized as Figure 3-12.

The stability of the water-in-oil emulsions was determined by comparing the water content observed initially with the water content observed following 24 hours of settling. The effectiveness of the emulsion breaker Alcopol O 60% on the water-in-oil emulsions was determined by comparing the water content of the observed initially with the water content observed 24 hours following the addition of emulsion breaker. The results of the emulsion stability and emulsion breaker determinations are presented as fractional dehydration (D). The chemical dispersability of the water-in-oil emulsions was determined for selected samples using the dispersant Corexit 9527 and IFP methods. The physico-chemical results are tabulated in Table 3-11.

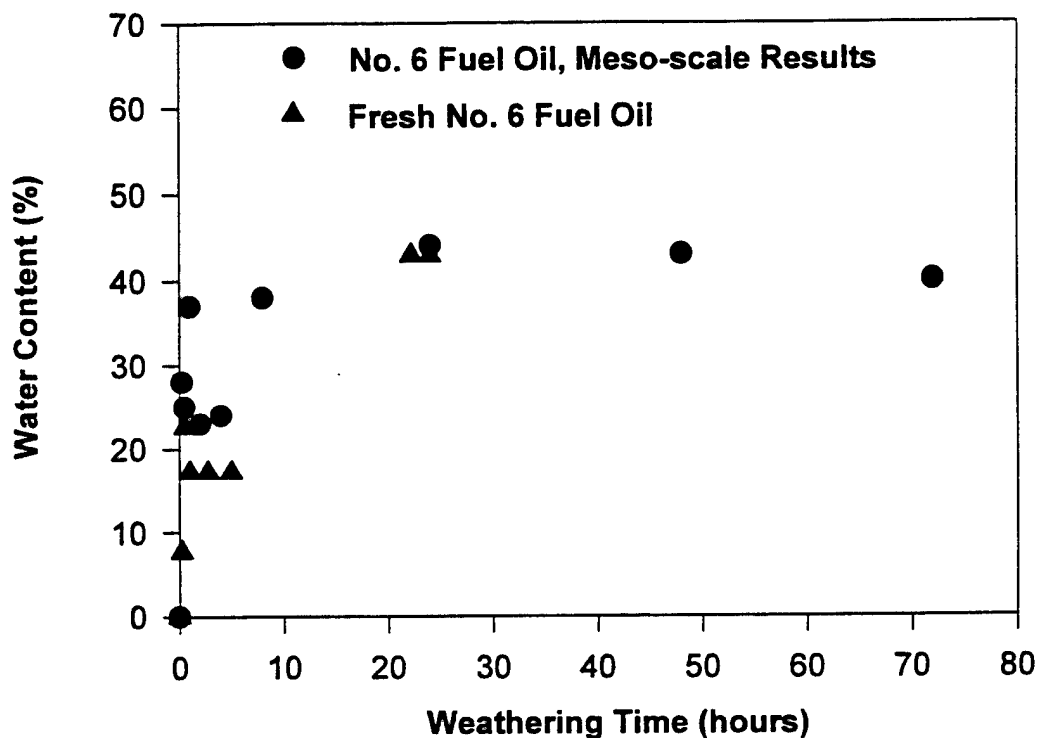

Figure 3-12. Water content of water-in-oil emulsion as a function of weathering state.

The emulsion stability and the effectiveness of the emulsion breaker Alcopol O 60% was determined for the emulsions resulting from the meso-scale experiment. The fractional dehydration ( $D_{24}$ ) values obtained (Table 3-11) summarize the emulsion stability and the emulsion breaker effectiveness data. Inspection of the  $D_{24}$ -values presented in Table 3-11 show that the emulsions increased in stability with degree of weathering. Likewise, the  $D_{24}$ -values obtained from the emulsion breaker effectiveness test indicate that Alcopol O 60% became less effective at breaking the emulsions as the weathering progressed. This was in contrast to the data generated in the laboratory based studies, but supports the discussions presented regarding difficulties in accurately determining the water content for emulsions that contain very little water, such as the ones generated in the laboratory based study.

The results of the IFP dispersability testing of the meso-scale generated emulsions are in complete agreement with those obtained from the laboratory based study (Table 3-11). The dispersability of this No. 6 fuel by Corexit 9527 is drastically reduced by the degree of weathering. The effectiveness of the dispersant was reduced from 83.2% for the fresh oil to 0% after 24 hours of weathering.

Table 3-11. Results of the physical and chemical analysis of meso-scale samples.

| Time (hours) | Oil/Emulsion |          |              |                    |                   |                 |                    |                   |                 |    | Water Content (%vol) | IFP   | TPH mg/Kg |
|--------------|--------------|----------|--------------|--------------------|-------------------|-----------------|--------------------|-------------------|-----------------|----|----------------------|-------|-----------|
|              | Viscosity    |          | Density g/mL | Emulsion Stability |                   |                 | Emulsion Breaker   |                   |                 |    |                      |       |           |
|              | D = 1/s      | D = 10/s |              | WOR <sub>ref</sub> | WOR <sub>24</sub> | D <sub>24</sub> | WOR <sub>ref</sub> | WOR <sub>24</sub> | D <sub>24</sub> |    |                      |       |           |
| 0            | 3,469        | 6,861    | 1.0133       |                    |                   |                 |                    |                   |                 |    |                      | 83.2% | 2.57      |
| 15 min       | 13,960       | 7,447    | 0.8608       | 0.39               | 0.17              | 0.6             | 0.39               | 0.0013            | 1.0             | 28 |                      |       |           |
| 30 min       | 17,190       | 9,226    | 0.9706       | 0.36               | 0.30              | 0.2             | 0.36               | 2.3E-5            | 1.0             | 25 |                      |       |           |
| 1            | 23,930       | 10,700   | 0.9573       | 0.59               | 0.59              | 0.0             | 0.59               | 0.026             | 1.0             | 37 |                      | 3.8%  | 2,106.78  |
| 2            | 40,210       | 14,430   | 0.9624       | 0.30               | 0.16              | 0.4             | 0.30               | 6.7E-5            | 1.0             | 23 |                      |       |           |
| 4            | 52,630       | 21,400   | 0.9481       | 0.32               | 0.24              | 0.2             | 0.32               | 0.12              | 0.6             | 24 |                      |       |           |
| 8            | 65,000       | 24,120   | 0.9691       | 0.61               | 0.49              | 0.2             | 0.61               | 0.37              | 0.4             | 38 |                      |       | 51,408.88 |
| 24           | 89,550       | 30,680   | 0.9882       | 0.79               | 0.78              | 0.0             | 0.79               | 0.50              | 0.4             | 44 |                      | 0.0%  | 15,025.48 |
| 48           | 99,900       | 45,410   | 0.9786       | 0.75               | 0.70              | 0.07            | 0.75               | 0.70              | 0.08            | 43 |                      |       | 26,070.20 |
| 72           | 108,000      | 57,370   | 1.0718       | 0.67               | 0.67              | 0.0             | 0.67               | 0.61              | 0.09            | 40 |                      |       | 5,370.48  |

WOR<sub>ref</sub> = Volumetric water-to-oil ratio of the emulsion

WOR<sub>24</sub> = Volumetric water-to-oil ratio of the emulsion following 24 hours of heating at 50°C

D<sub>24</sub> = Fractional dehydration obtained following 24 hours of setting (D = 0: completely stable emulsion; D = 1: completely unstable or broken emulsion)

## Meso-Scale Studies (Orimulsion®)

In these studies, the flume tank was filled with 4000 L of 5 micron filtered receiving water. The receiving waters used in these studies was full strength seawater (32 ppt) and fresh water. After the wind and wave conditions had reached steady state, the Orimulsion® was applied through an access port using an applicator tube constructed from 1" copper pipe. The time required to completely apply the 14 L of Orimulsion® was approximately 20 minutes. Following the application, the Orimulsion® was allowed to weather for 120 hours. Grab samples of the water-in-oil emulsion which formed and also from the water column were taken during this weathering period

Initially, and for both salinities, the Orimulsion® was completely dispersed into the water column as a plume of bitumen particles. The flow created by the wind and wave conditions caused the bitumen plume to move around the full circuit of the flume in approximately 2-3 minutes. In seawater, a surface slick began to form within approximately the first 15 minutes of the experiment. This surface slick was the result of bitumen particle coalescence and the subsequent rise of bitumen to the surface. In contrast, during the fresh water experiments a surface slick began to form after approximately three hours following the application. The slick which formed during the fresh water experiments resulted from large pieces of bitumen which had plated out on the side of the flume at the water/air interface. These bitumen pieces then served as "seed" areas for slick growth.

The emulsion or surface slick which developed was monitored for a number of parameters including; water content, density and viscosity. The water content of the emulsion was determined by Karl-Fisher titration and was observed to increase to a maximum value of approximately 14%. The density of the emulsion remained constant at approximately  $1.0 \text{ g mL}^{-1}$ . The viscosity of the emulsion exceeded the range of the Haake rotating viscometer which was used in these studies. However; viscosities in excess of  $6(10)^6 \text{ cP}$  have been reported for the Orinoco bitumen used in the formulation of Orimulsion® (Jokuty, *et al.*, 1995). The ability of the freshly formed emulsion to be dispersed by the reference dispersant Corexit 9500® was tested using IFP dispersant apparatus. The dispersant was found to be ineffective on the emulsion though it should be noted that these IFP results are not unexpected for materials having viscosities in the magnitude reported.

Subsurface water samples were taken for hydrocarbon analysis. An aliquot of the aqueous samples was filtered and both the filtered and unfiltered samples were extracted with methylene chloride. The sample extracts were subsequently analyzed for TPH, alkanes, PAH and SARA analysis by Iatroscan. The results obtained for the experiment conducted in seawater are presented as Figures 3-13. Similar results were obtained for fresh water experiments conducted with Orimulsion®. As expected the total TPH and PAH values in the bulk water (unfiltered) are seen to decrease in time as the surface slick was formed. In contrast, the TPH levels of the filtered water samples were observed to rapidly increase from a background level of approximately  $2.5 \mu\text{g L}^{-1}$  to a maximum value of approximately  $1,500 \mu\text{g L}^{-1}$ . These TPH values were then maintained over the course of the experiment.

The results obtained from the SARA analysis of the samples generated during these flume experiments with Orimulsion® are summarized as Table 3-12. In general, for both fresh water and seawater, the unfiltered samples demonstrated a slight decrease in the relative amounts of saturates over time. This slight decrease in saturates corresponded to significant decreases in the relative amounts of the aromatic fractions in these samples over the same time period. This loss of saturates and aromatics was contrasted by a significant increase in the relative amounts of resins present in the samples. Iatroscan® chromatograms of these samples show an absence of the saturate and aromatic peaks. Additionally, the total aromatics present in

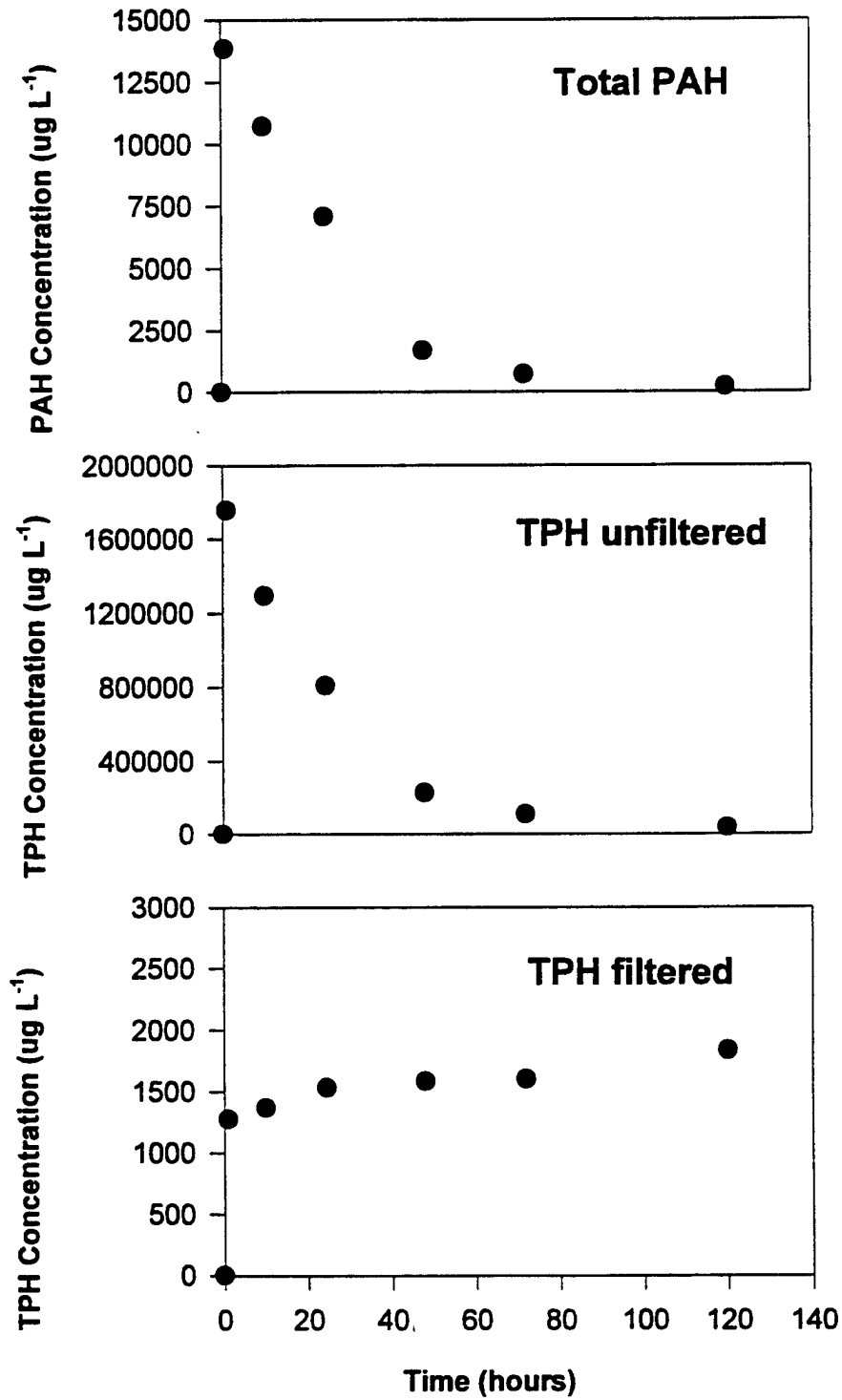

the samples obtained from the seawater and fresh water are significantly different. This "salting out" effect has important implications for Natural Resource Damage Assessment (NRDA) activities related to releases of Orimulsion®. The PAH distributions of the bitumen used in the formulation of Orimulsion® indicate a very weathered product, and it is unlikely that significant biodegradation of the bitumen could be expected in the event of a release. Additionally, acute toxicity from the bitumen would not be expected, however heavier multi-ring PAHs are associated with chronic toxicity (Neff, 1979).

**Table 3-12. Component class analysis results for filtered and unfiltered flume samples.**

| Time<br>(hours) | Seawater (32 ppt) |            |                 |            |              |            |                   |            |
|-----------------|-------------------|------------|-----------------|------------|--------------|------------|-------------------|------------|
|                 | Saturates (wt%)   |            | Aromatics (wt%) |            | Resins (wt%) |            | Asphaltenes (wt%) |            |
|                 | Filtered          | Unfiltered | Filtered        | Unfiltered | Filtered     | Unfiltered | Filtered          | Unfiltered |
| 1               | 0                 | 8.3        | 0               | 13.4       | 100          | 56.2       | —                 | 22.1       |
| 10              | 0                 | 3.6        | 0               | 10.2       | 100          | 58.9       | —                 | 24.2       |
| 24              | 0                 | 3.6        | 0               | 34.3       | 100          | 41.4       | —                 | 17.7       |
| 48              | 0                 | 6.2        | 0               | 8.2        | 100          | 63.1       | —                 | 22.7       |
| 72              | 0                 | 5.1        | 0               | 2.2        | 100          | 72.0       | —                 | 20.8       |
| 120             | 0                 | 4.5        | 0               | 4.2        | 100          | 71.3       | —                 | 24.5       |

| Time<br>(hours) | Fresh Water     |            |                 |            |              |            |                   |            |
|-----------------|-----------------|------------|-----------------|------------|--------------|------------|-------------------|------------|
|                 | Saturates (wt%) |            | Aromatics (wt%) |            | Resins (wt%) |            | Asphaltenes (wt%) |            |
|                 | Filtered        | Unfiltered | Filtered        | Unfiltered | Filtered     | Unfiltered | Filtered          | Unfiltered |
| 1               | 2.8             | 8.0        | 0               | 33.4       | 86.5         | 49.7       | 10.9              | 8.9        |
| 10              | 1.7             | 8.1        | 0               | 33.7       | 82.4         | 45.2       | 15.9              | 12.7       |
| 24              | 0               | 7.7        | 0               | 33.9       | 100          | 45.4       | —                 | 13.0       |
| 48              | 0               | 7.5        | 0               | 30.5       | 86.2         | 53.6       | 13.9              | 8.3        |
| 72              | 0               | 7.0        | 0               | 15.9       | 86.5         | 63.2       | 13.6              | 13.9       |
| 120             | 0               | 6.9        | 0               | 16.6       | 88.6         | 61.9       | 11.5              | 14.6       |

The particle size distribution of the bitumen was monitored as over the course of the experiment by the analysis of grab samples of the subsurface water (Figure 3-14). For experiments involving seawater the mean particle size diameter was observed to grow from an initial diameter of 12 microns to a maximum size of approximately 140 microns. For the fresh water experiments the particle size distribution was monitored for 22 days. The particle growth noted in experiments with seawater was not observed in the experiments involving fresh water.

The coalescence of the bitumen particles which was observed in seawater and not fresh water may be explained by the behavior of the surfactant. The polyethoxylated nonylphenol surfactant used in the formulation of Orimulsion® has been optimized for non-saline waters and becomes denatured in saline waters. Once denatured the ability of the surfactant to maintain the bitumen dispersion is significantly decreased and particle coalescence begins.

In these studies, the coalescence of the bitumen in seawater ultimately led to the formation of a surface slick. This was not the case for the studies conducted with fresh water. In fresh water, the bitumen remained dispersed but with time did settle progressively lower in the water column. These results have very significant ramifications for contingency plans to be developed for accidental releases of Orimulsion® and suggest areas for further research.

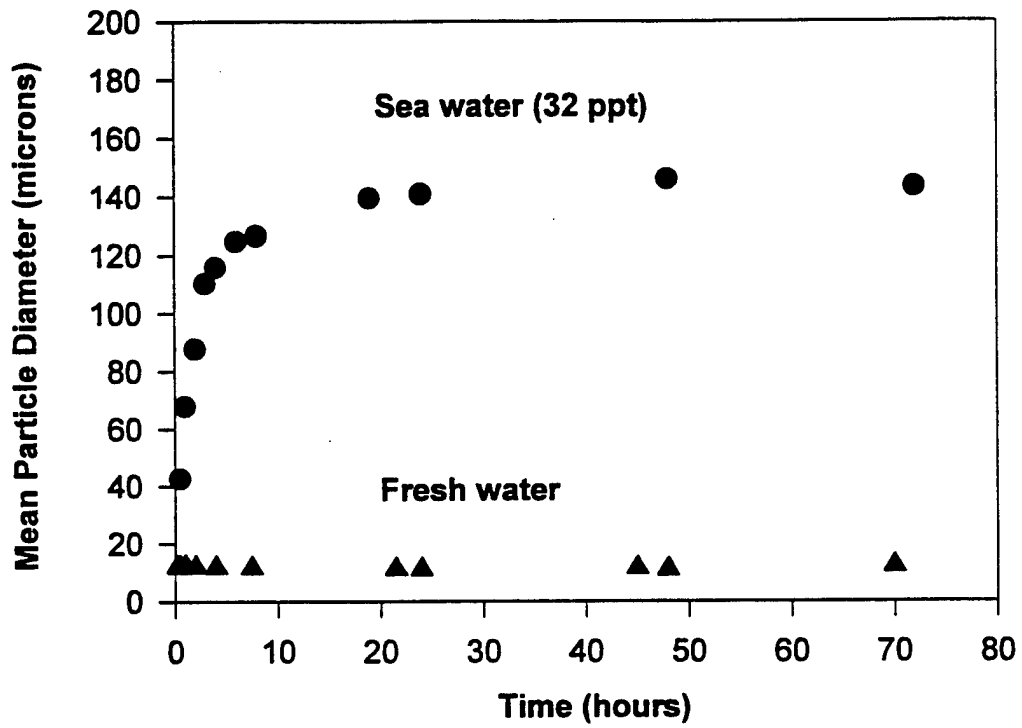

Figure 3-14. Bitumen particle size growth in seawater and fresh water.

## 4. CONCLUSIONS

This report describes a detailed oil weathering studies performed on six fuels relevant to understanding the fate and behavior of Low API Gravity Oils (LAPIO) released to water. The fuels selected were a No. 2 fuel, three residual fuels (No. 6 fuels), a heavy crude oil (Mandalay Crude) and the synthetic fuel Orimulsion®. With the exception of the Orimulsion®, source oil was obtained and artificially weathered in the laboratory. Because the continuous phase of Orimulsion® is water, this product was not subjected to bench scale weathering. The weathering process included evaporative weathering and emulsification studies. These two process were then independently studied. The evaporative weathering process typically resulted in fresh, 150°C+, 200°C+, and 250°C+ topped residues. These topped residues simulate on-the-water weathering equivalents of approximately 1-3 hrs, 0.5-1 d, and 1 week respectively.

The residues were then physically and chemically characterized. This characterization included studies of; evaporative loss, flash-point, viscosity, density, interfacial surface tension, pour-point, hard and soft asphaltene content, wax content, as well as saturated/aromatic/resin content by Iatroscan. In addition, one of the residual No. 6 fuels and Orimulsion® were selected as model fuels and subjected to meso-scale weathering in Battelle's flume facility.

Bulk property measurements which were made on the fuels and their weathered residues provide fundamental data useful for modeling the fate and behavior of these fuels at environmentally significant temperatures. The physical and chemical measurements made on the fuels and their weathered analogues demonstrated the wide range of bulk properties which exist for fuels shipped as LAPIO fuels. Additionally, the three residual fuels which were selected for study exhibited very broad ranges in such fundamental physical properties as density, viscosity, and interfacial surface tension. Surprisingly, these residual fuels also had wide ranges in their chemical composition. The asphaltene content for these residual fuels ranged from approximately 10 to 20% (wt) and the resin content ranged from approximately 4 to 14% (wt). The very high asphaltene content of these residual fuels accounts for their ability to form strong, stable emulsions.

The results of these studies show that the density, flash-points, viscosity and interfacial surface tension of these selected fuels increases with increasing degree of weathering. In general, the pour-point increased with the weathering state of the fuel. The influence of environmental temperature on these fuels and their weathered residues demonstrates that the density and viscosity decrease with increasing temperature. For released fuels having a density similar to the receiving water into which they are released, small changes in the temperature may result in sinking fuels.

The rate of emulsification and the maximum water capacity of the residues of the LAPIO fuels was investigated and found to range from very rapid (approximately 0.08 hr, Mandalay Crude oil) to relatively slow (approximately 20 hr, weathered residue of No. 2 Fuel). These studies indicate that the residual fuels, though slow to form emulsions, and that an emulsion, once formed will be stable and contain relatively little water. In contrast, the emulsions formed with the weathered residues of No. 2 Fuel were completely unstable.

The Corexit 9527 IFP dispersability of the fuels and their respective topped residues was investigated. The Mandalay Crude oil residues and all of the emulsions formed from the residues were poorly dispersed by Corexit 9527. The dispersability of the three residual fuels had a very wide range of dispersability ranging from approximately 12 to 83 % for the fresh residues. In general, all of the



weathered residues from the residual fuels showed reduced dispersability relative to their respective fresh oil. Emulsions formed from the most weathered residues of the residual fuels were essentially non-dispersed, having effectiveness values less than 1% to 0%.

In addition to the laboratory based weathering studies two fuels were selected for meso-scale study. The model fuels selected for flume studies were No. 6 fuel oil (FPL) and Orimulsion®.

The meso-scale results obtained were, in general, in excellent agreement with the results obtained from the laboratory based studies. Meso-scale studies such as these, allow an investigation of the weathering processes on a fuel under controlled conditions. These types of studies are considered to be a bridge between laboratory-based weathering studies and authentic oil spills. The results obtained from the laboratory weathering were in excellent agreement with the results obtained from the meso-scale studies.

The meso-scale studies conducted with Orimulsion® indicate that any releases of this product into an aqueous environment will result in a unique behavior. Because the continuous phase of Orimulsion® is water, a release will be followed by rapid dispersion of bitumen particles into the water column. If the release occurs in saline water the bitumen particles will begin to coalesce and rise to the surface forming a surface slick. However, Orimulsion® released into an estuary or body of fresh water may not result in particle growth and the droplets of bitumen will sink and layer at the bottom. This Orimulsion® behavior and weathering study has revealed some of the implications that may exist in monitoring and combating Orimulsion® releases in aqueous environments. To understand the environmental fate and behavior of Orimulsion® it is fundamental to understand the occurrence of bitumen particle formation. The implication of bitumen particle growth is important not only from a modeling prospective but also from the prospective of response. The surfactant which stabilizes the Orimulsion® has been optimized for fresh water and denatures in full strength sea water. Any future work should investigate the behavior of bitumen particles under a variety of environmental conditions.

In general, additional studies on Group V fuels as a class of fuels should focus on the following areas:

In light of the wide range of the physical and chemical properties of the residual fuels included in this study; the process of characterizing residual fuels should continue. Continued characterization studies of the fuels transported in the United States will a) aid in contingency planning for specific areas which transport these residual fuels b) catalogue these fuels beyond the limited subset selected for this study.

There is an important information gap regarding the interactions of these fuels with particles. Intuitively, there are two categories of research with respect to particle-fuel/oil interactions required. These types of interactions would be expected to influence the kinetics of emulsion formation. Additionally, these interactions could change the apparent density of any resulting water-in-oil emulsion resulting in a sinking fuel.

## 5. REFERENCES

- Anderson, R. P.; J.W. Reynolds. 1989: *Methods For Assessing The Stability And Compatibility Of Residual Fuel Oils. Final Report Prepared For Electric Power Research Institute, Palo Alto, California.*
- American Society For Testing And Materials (ASTM) Method D86-90, *Standard Test Method for Distillation of Petroleum Products.*
- American Society For Testing And Materials (ASTM) Method D93-90, *Standard Test for Flash-Point by Pensky-Martens Closed Tester.*
- American Society For Testing And Materials (ASTM) Method D97-87, *Standard Test Method for Pour-Point of Petroleum Oils.*
- American Society For Testing And Materials (ASTM) Method D971-91, *Standard Test Method for Interfacial Tension of Oil Against Water by the Ring Method.*
- American Society For Testing And Materials (ASTM) Method D4052-91, *Standard Test Method for Density and Relative Density of Liquids by Digital Density Meter.*
- Brandvik, J. P.; O.O. Knudsen; M.O. Moldestad.; P. S Daling. 1995. Laboratory testing of dispersants under Artic conditions. In: The Use Of Chemicals. In Oil Spill Response. P. 190-206.
- Bridie, A.L., Th. H. Wanders, W. Zegveld, and H.B. Van Der Heidje. 1982. Formation, prevention, and breaking of sea water in crude oil emulsions, "chocolate mousses". Mar. Poll. Bull. 11:343-348.
- Burns, G.H., C.A. Benson, S. Kelly, T. Eason, B.L. Benggio, J. Michel, and M. Ploen. 1995. Recovery Of Submerged Oil At San Juan, Puerto Rico 1994. *Proceedings of the 1995 Oil Spill Conference*, United States Coast Guard, American Petroleum Institute, United States Environmental Protection Agency, Washington, D.C., pp551-557.
- Campbell, K. S. and E. P. Rahbany, 1991. Guidelines for use of low-API gravity oils. Electric Power Research Institute, Washington D.C.,. 92pp.
- Castle, R.W., F. Wehrenerg, J. Bartlett, and J. Nuckols. 1995. Heavy Oil Spills: Out of Sight, Out of Mind. *Proceedings of the 1995 Oil Spill Conference*, United States Coast Guard, American Petroleum Institute, United States Environmental Protection Agency, Washington, D.C., pp565-571.
- Clayton, J. R.; J.R. Payne, and J.S. Farlow,. 1993. *Oil Spill Dispersants Mechanisms Of Action And Laboratory Tests*. CRC Press, Inc. Boca Raton, 113 pp.
- Daling, P. S. and I. Almås. 1988. Description of the laboratory methods in part 1 of the DIWO project. IKU Report No. 02.0786/2/88. IKU, Trondheim, Norway.

- Daling, P. S. and P.J. Brandvik. 1992. Characterization and Prediction of the Weathering Properties of Oils at Sea. A Manual for the Oils Investigated in the DIWO Project. IKU Report No. 02/0786.00/16/91. IKU, Trondheim, Norway
- Daling, P. S. and P.J. Brandvik. 1992. Tools for assessing the weathering processes of oil spills at sea and the effectiveness of oil spill dispersants. Scientific Seminar On The Remediation of Oil Spills, Hamburg, Germany. May 18-21.
- Douglas, G.S., R.C. Prince, E.L. Butler, and W.G. Steinhauer. 1993. The use of internal chemical indicators in petroleum and refined products to evaluate the extent of biodegradation. Presentation at the InSitu and On-Site Bioreclamation Conference, San Diego, CA April 5-8.
- Douglas, Gregory S. and A. D. Uhler. 1993. Optimizing EPA methods for petroleum-contaminated site assessments. *Env. Testing* 1993 (May/June), p. 1-6.
- Durell, G. S., S.A. Ostazeski, A.D. Uhler, and A. B. Nordvik, 1994. Transfer of Crude Oil Weathering Technology. MSRC Technical Report Series 93-027.
- Fredriksson, David. F.; C. A. Albro,.; and S. A. Ostazeski. 1996. Hydrodynamic calibration of a meso-scale, wind-wave flume basin for the study of spilled oil. In: *Proceedings of the 19th Annual (AMOP) Technical Seminar*. Environment Canada, Calgary, Canada.
- Jokuty, P.; S. Whitar, M. Fingas, Z. Wang, K. Doe, D. Kyle, P. Lambert, and B. Fieldhouse., 1995: Orimulsion: Physical Properties, Chemical Composition, Dispersibility, and Toxicity. Report No. EE-154, Environmental Technology Centre, Emergencies Science Division, Environment Canada.
- Lange, H.B. and J. P. Brown, 1993. Assessment of electric utilities' capability to utilize low API gravity fuel oils. Electric Power Research Institute and Fuel Oil Users Support Group, Washington, D.C., 58pp.
- Mackay, D. and W. Zagorski. 1982. Studies of water-in-oil emulsions. Report EE034. Environment Canada, Ottawa, Ontario.
- Michel, J., D.K. Scholz, C.B. Henry, and B.L. Benggio, 1995. Conditions Under Which Floating Slicks Can Sink In Marine Settings. Group V Fuel Oils: Source, Behavior, and Response Issues. *Proceedings of the 1995 Oil Spill Conference*, United States Coast Guard, American Petroleum Institute, United States Environmental Protection Agency, Washington, D.C., pp559-564.
- Michel, J. and J. A. Galt, 1995. Conditions Under Which Floating Slicks Can Sink In Marine Settings. *Proceedings of the 1995 Oil Spill Conference*, United States Coast Guard, American Petroleum Institute, United States Environmental Protection Agency, Washington, D.C., pp573-576.
- Neff, J.M. 1979. Polycyclic Aromatic Hydrocarbons In The Aquatic Environment. Sources, Fates, And Biological Effects. Applied Science Publishers, Barking, Essex, England. 262 pp.
- Reed, Mark; Aamo, Morton, Ole; Daling, Per S (1995): Quantitative analysis of alternate oil spill response strategies using OSCAR. *Spill Sci. Tech.* 2(1), 67-74.
- Scholz, D.K., J. Michel, C.B. Henry, and B.L. Benggio. 1994. Assessment of Risks Associated With The Shipment And Transfer Of LAPIO In The St. Johns River, Northern And Central Florida.

*HAZMAT Report 94-1*, National Oceanic and Atmospheric Administration, Seattle, Washington., 40pp.

Ostazeski, S.A., G.S. Durell, K J. McCarthy, S. C. Macomber, A. D. Uhler, and A. B. Nordvik. 1994. Oil Weathering Study of The *Morris J. Berman* No. 6 Cargo Oil. Marine Spill Response Corporation, Washington, D.C. MSRC Technical Report Series 95-024, 63 p.

Ostazeski, S.A.; G.S. Durell, S. C. Macomber, D.W. Fredriksson, A. D. Uhler, A. B. Nordvik. 1995. Weathering Characterization of Heavy Fuels. Marine Response Corporation, Washington, D.C. MSRC Technical Report Series 95-027, 50 p.

**APPENDIX A**  
**GC/FID CHROMATOGRAMS**

Alaskan North Slope Crude Oil

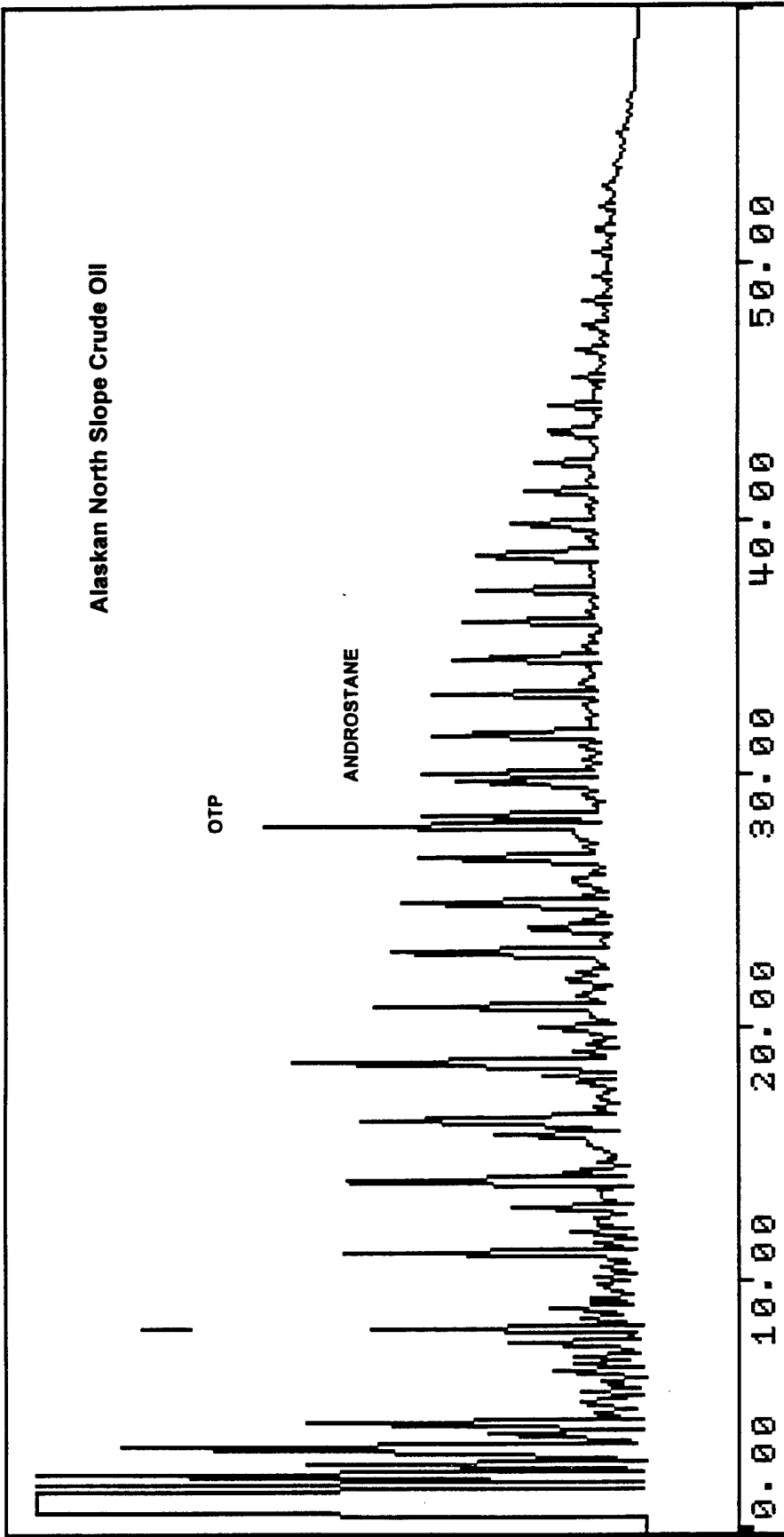

Morris J. Berman  
No. 6 Fresh

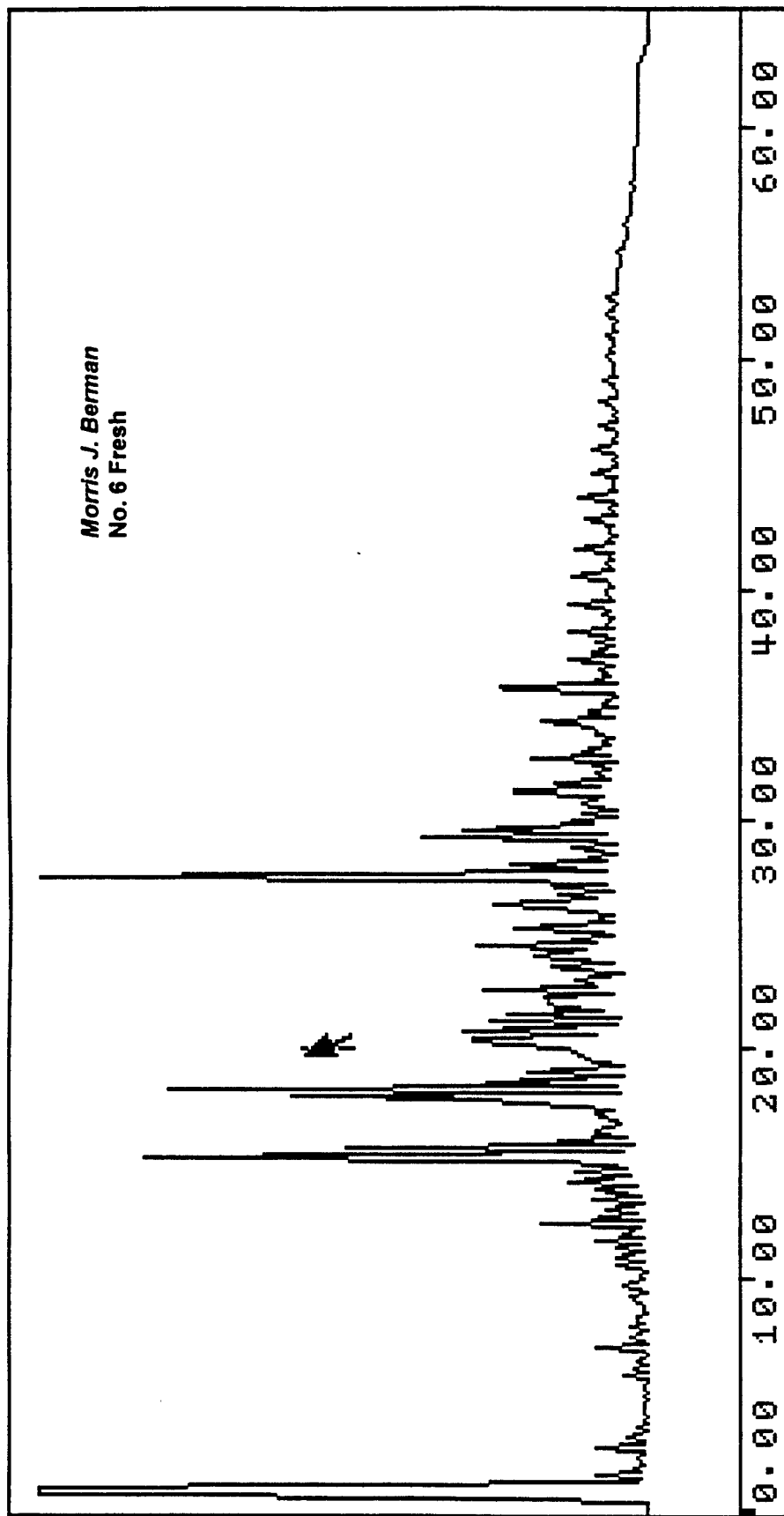

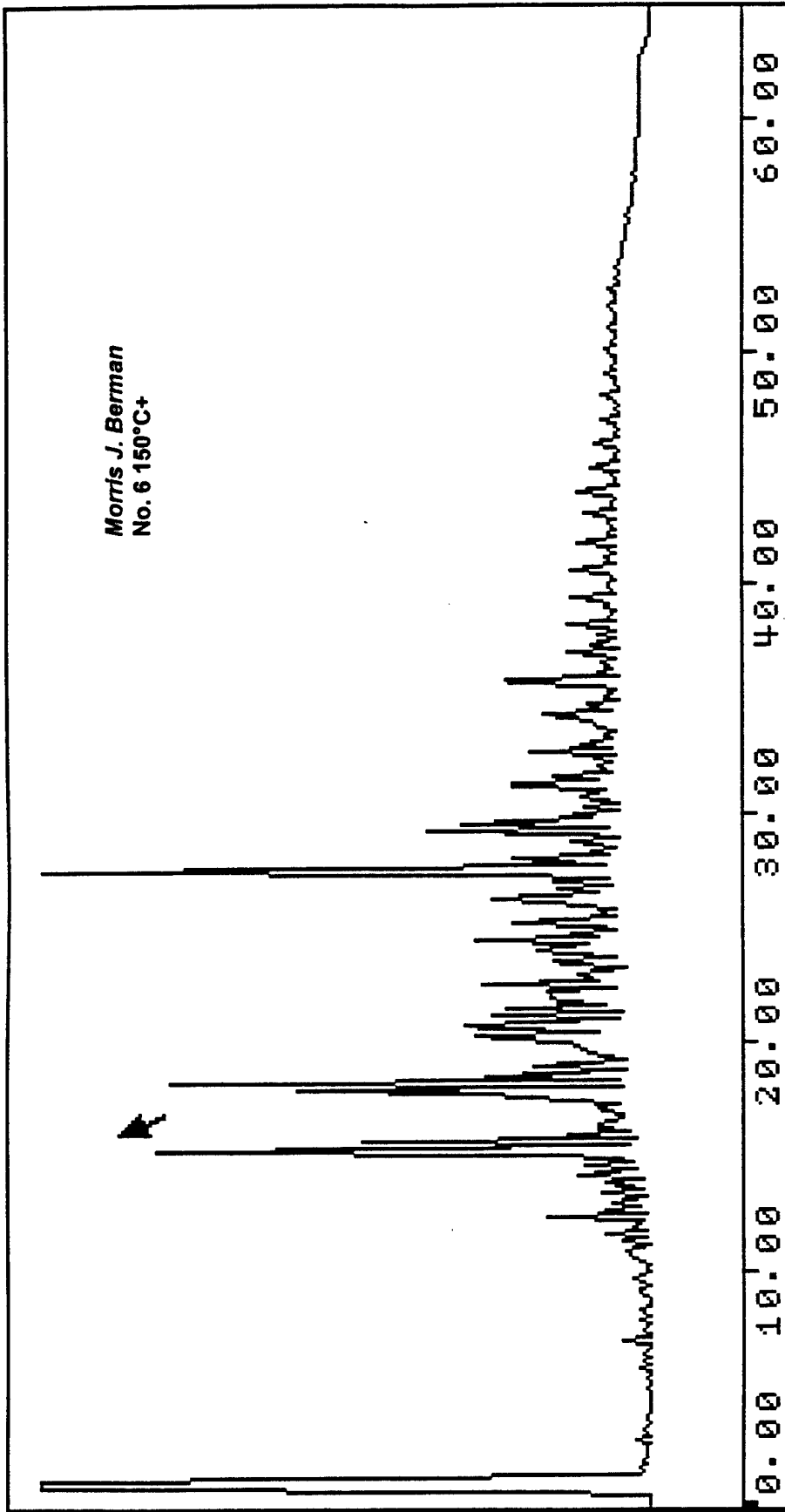



Morris J. Berman  
No. 6 200°C+

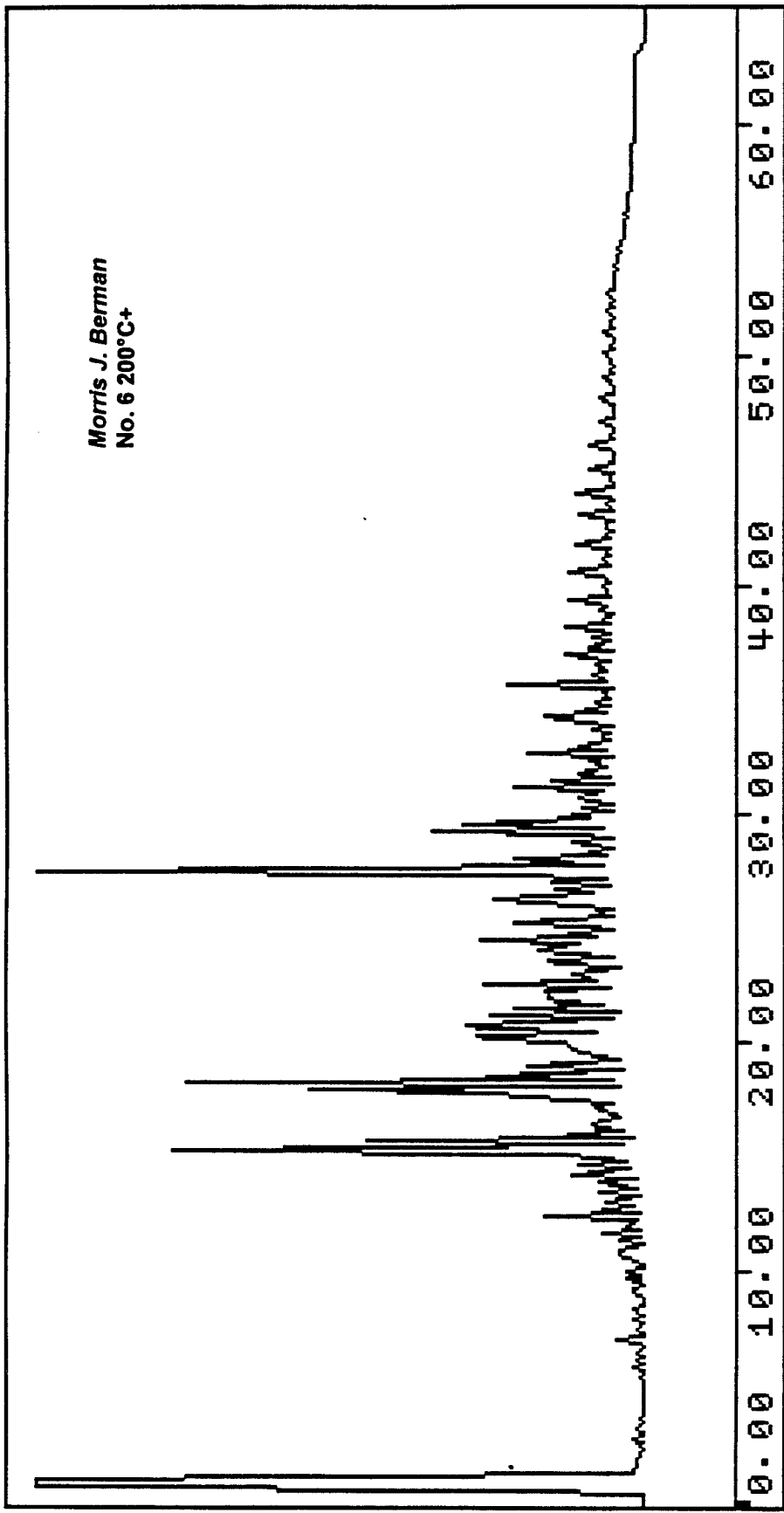

Morris J. Berman  
No. 6 250°C+

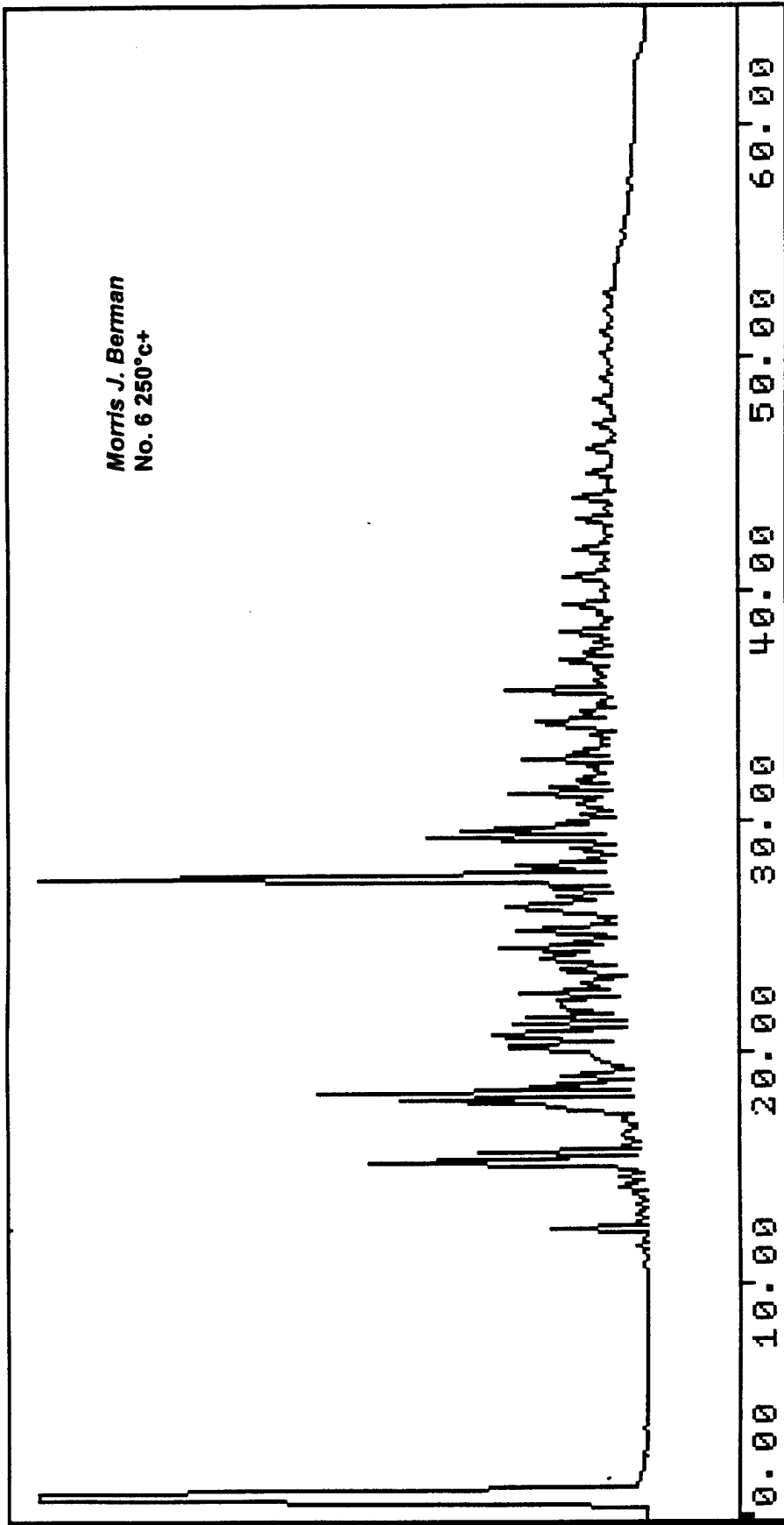

Florida Power & Light  
No. 6 Fresh

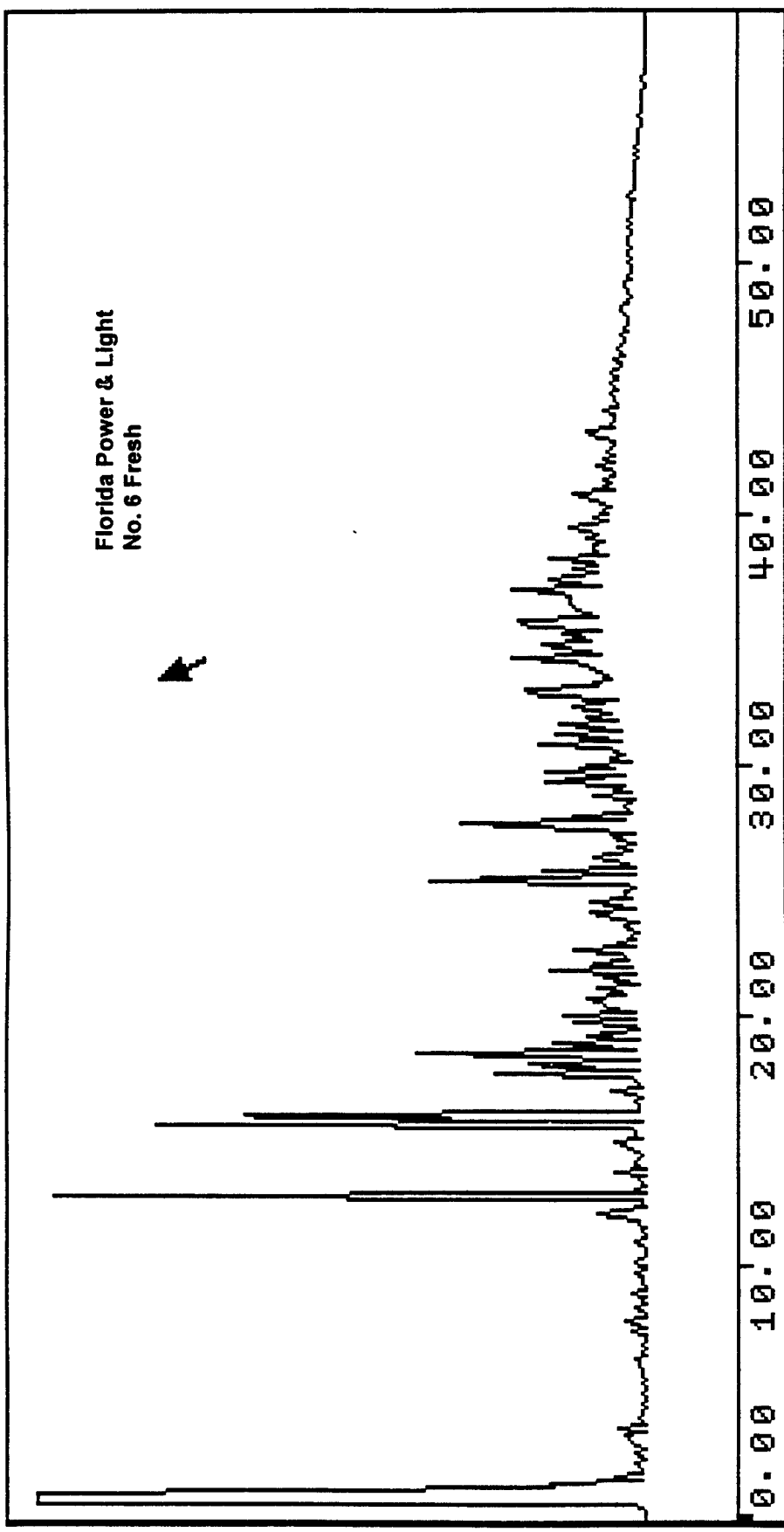

Florida Power & Light  
No. 6 200°C+

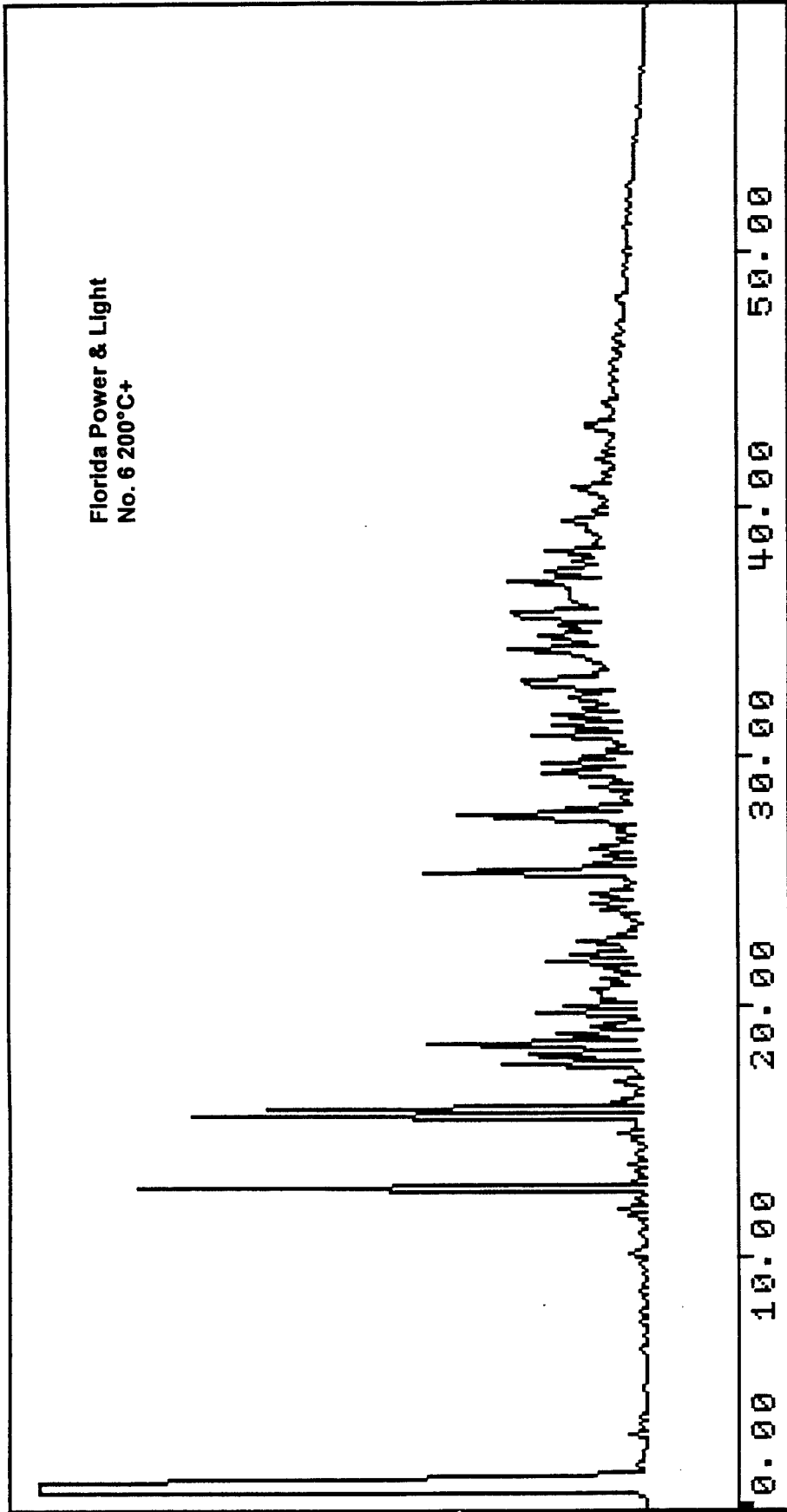

Florida Power & Light  
No. 6 250°C+

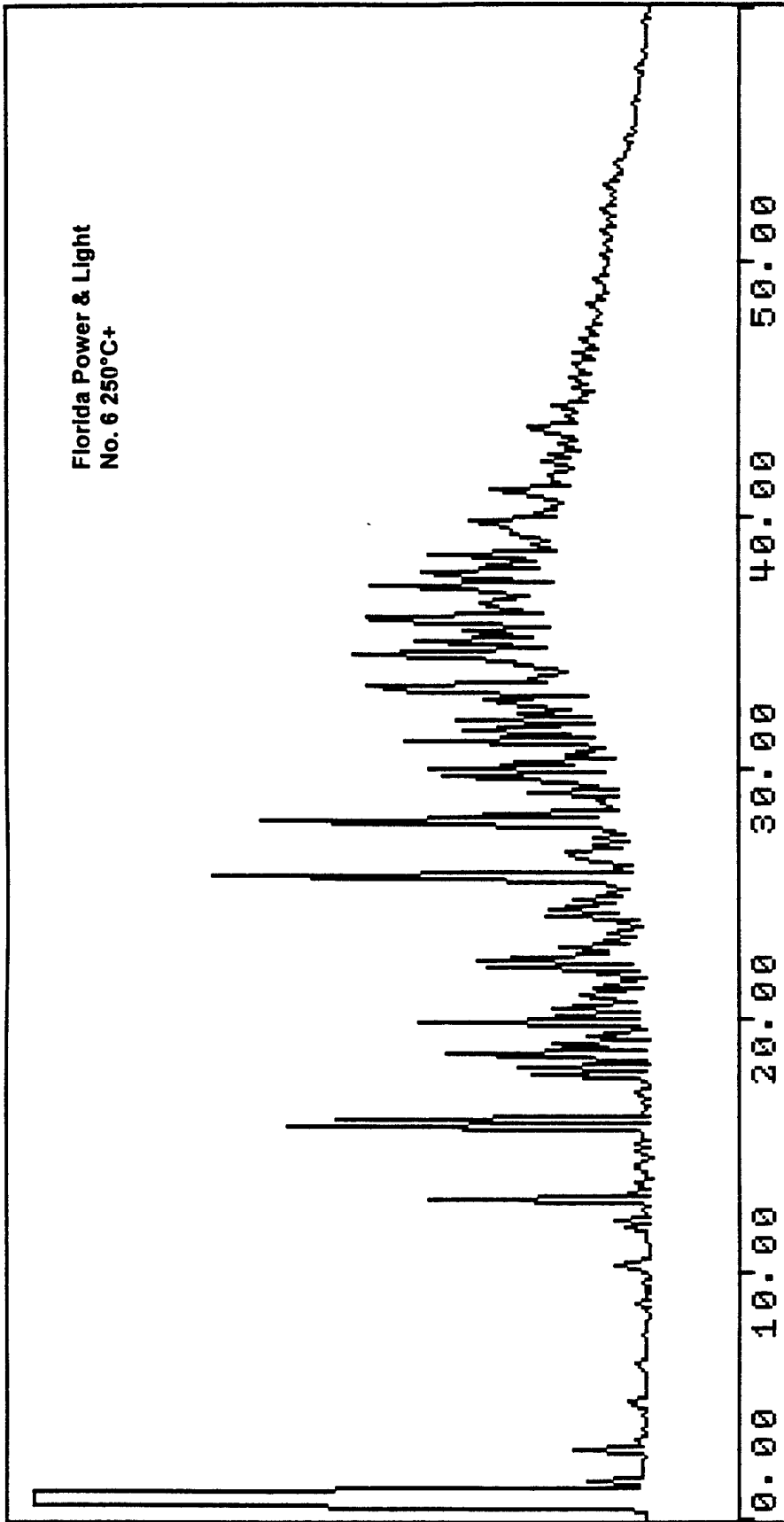

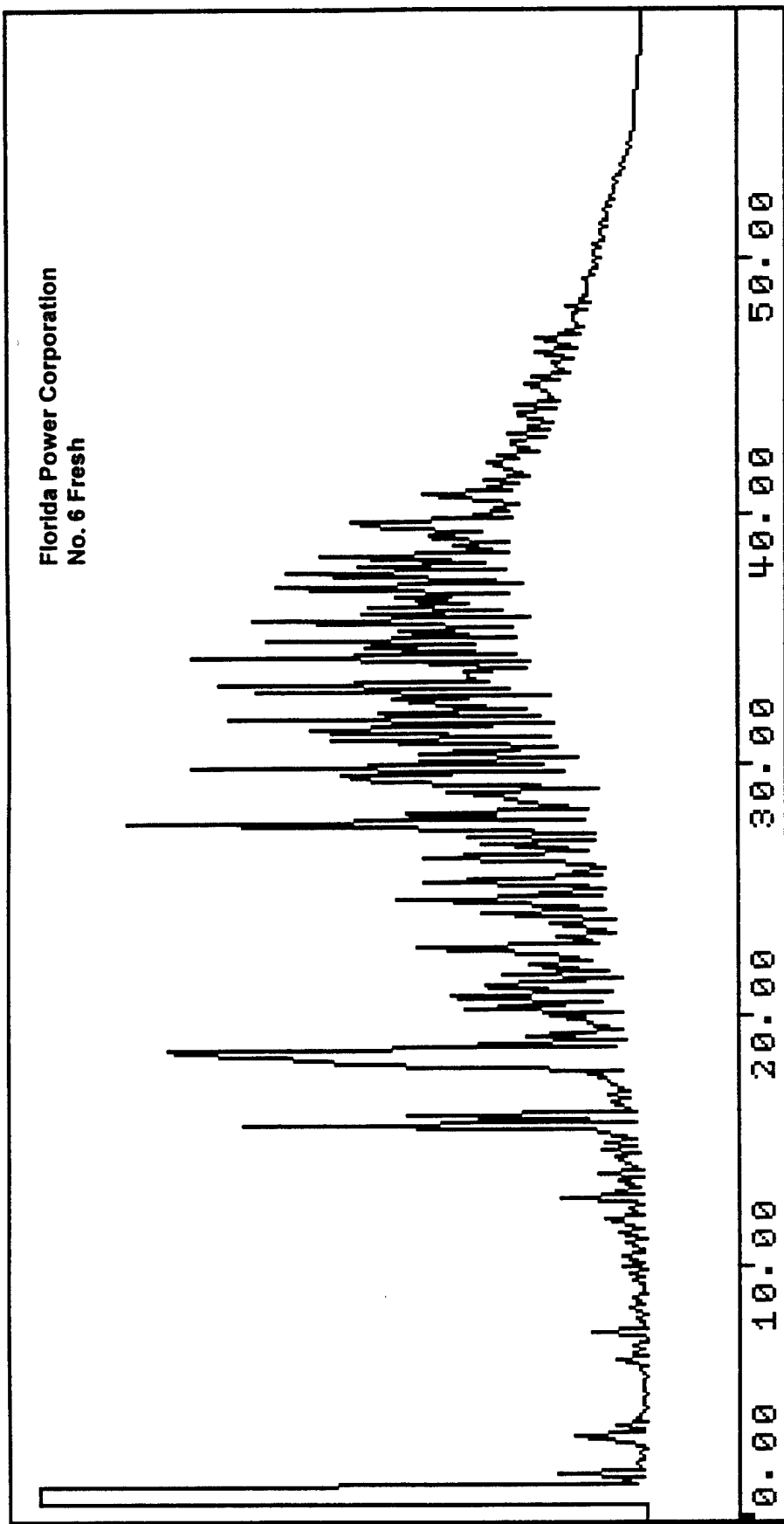

Florida Power Corporation  
No. 6 200°C+

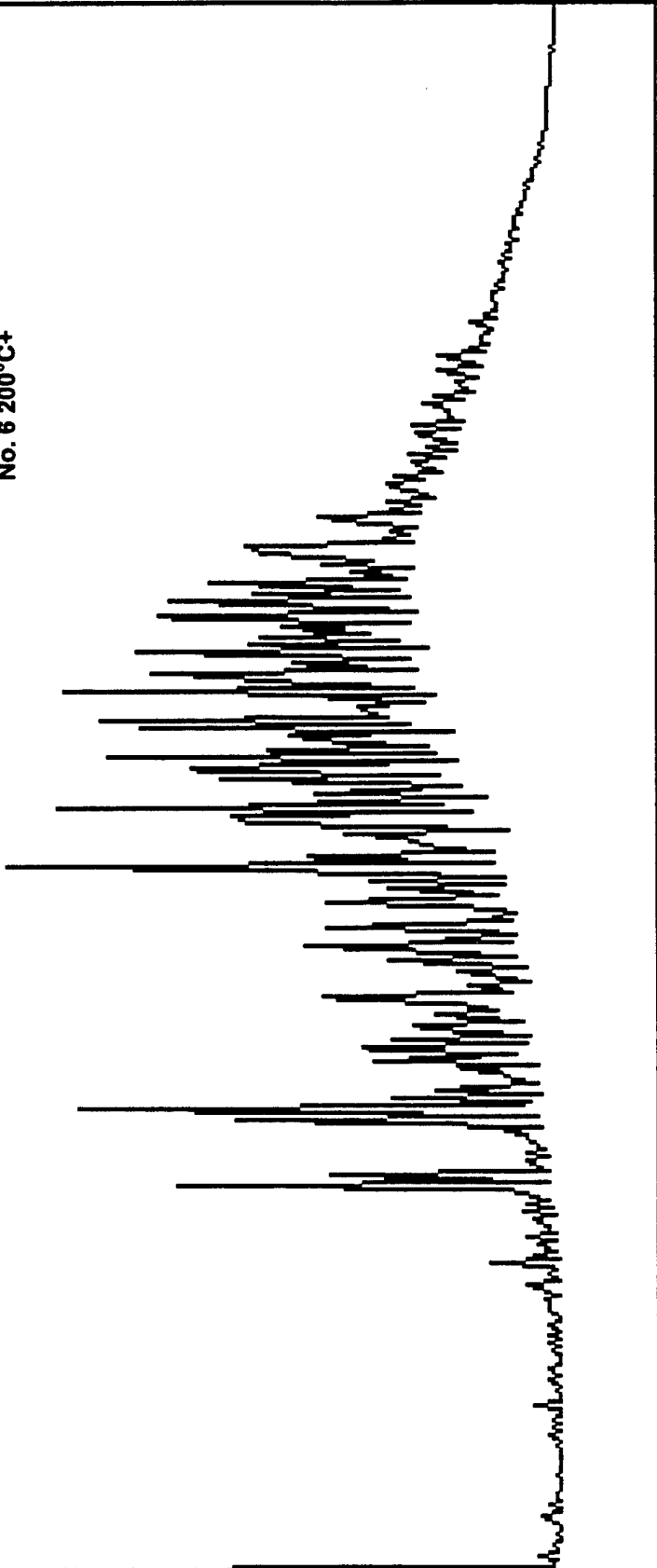

Florida Power Corporation  
No. 6 250°C+

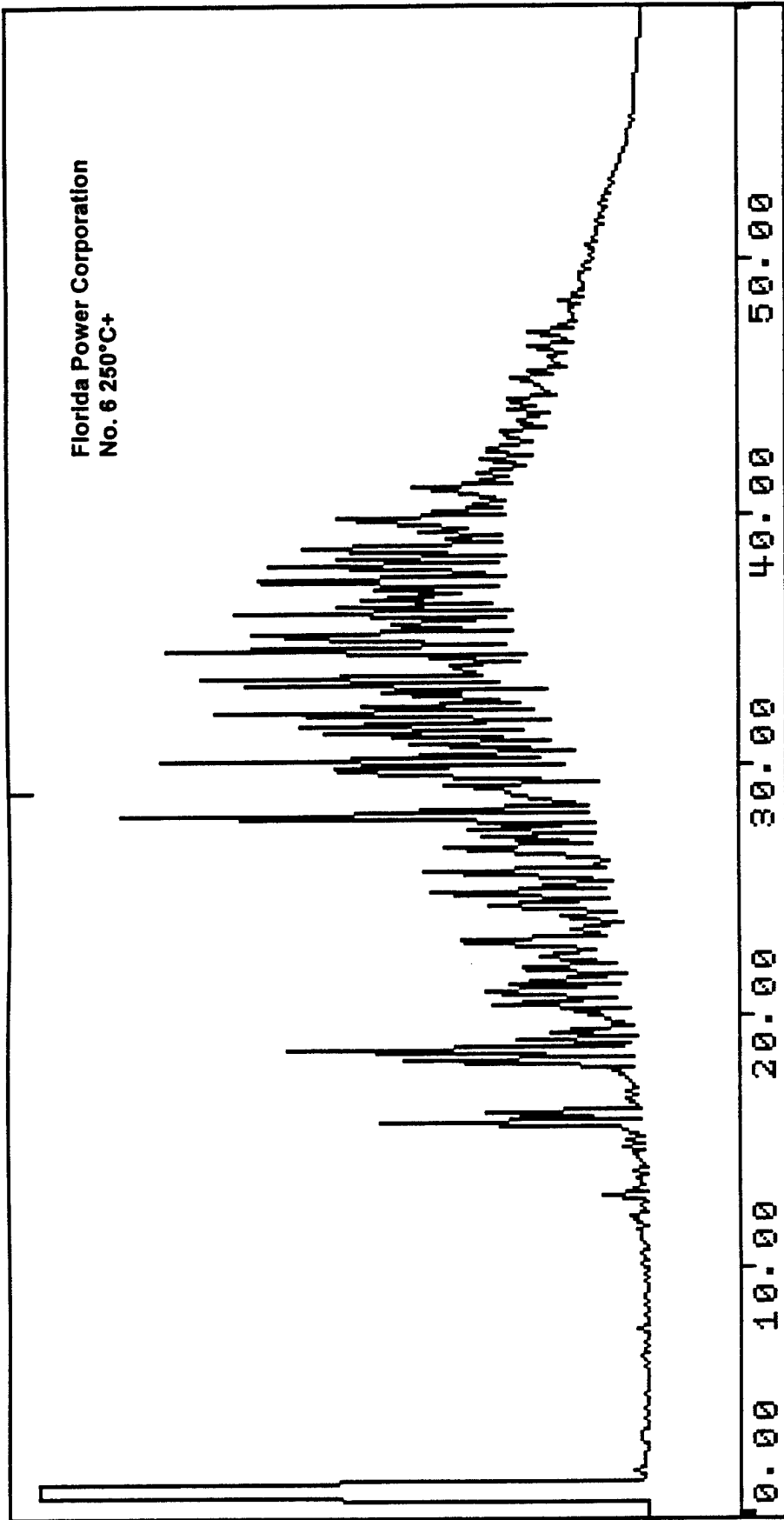



No. 2 Fuel Oil  
Fresh

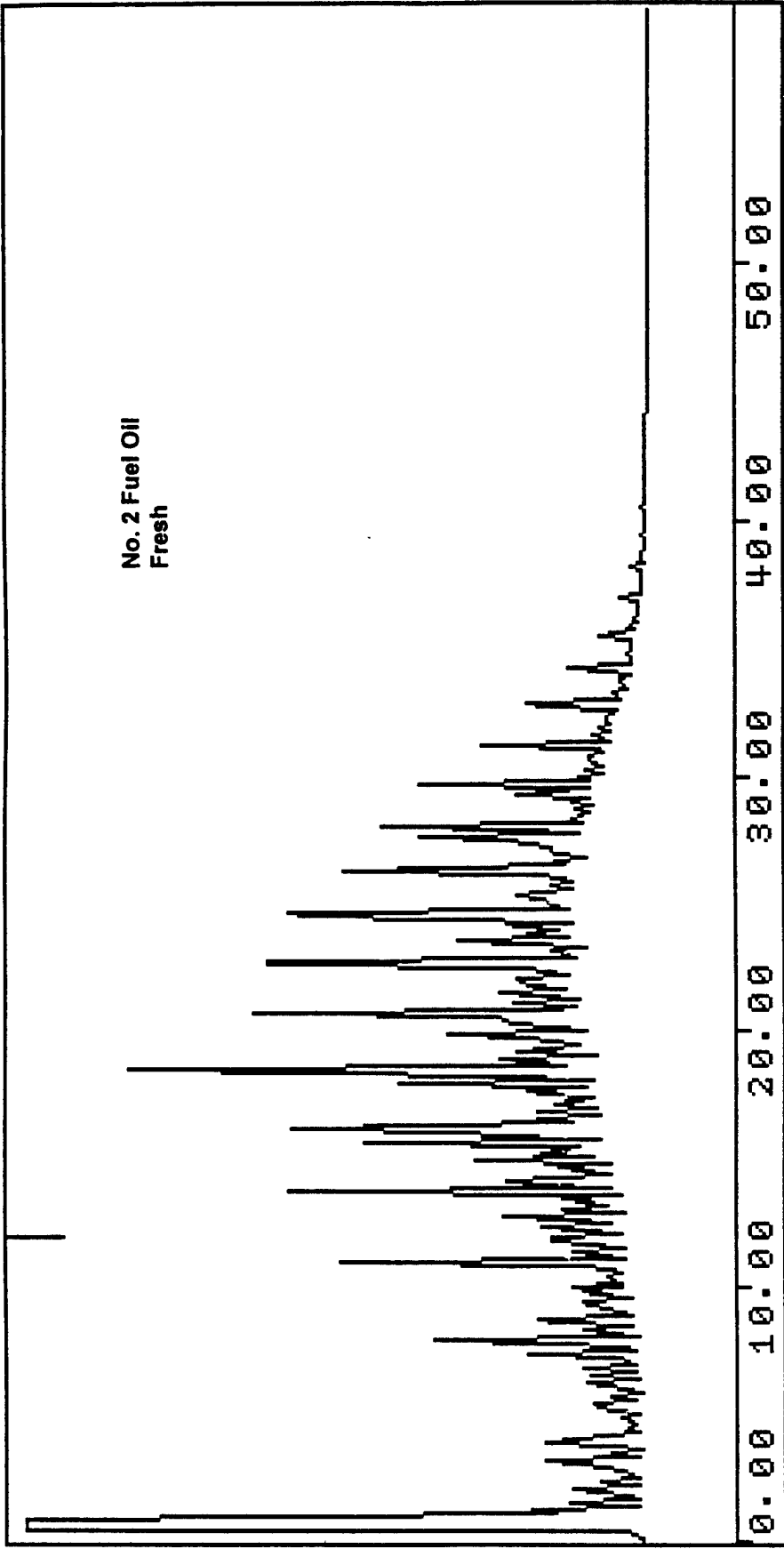

No. 2 Fuel Oil  
200°C+

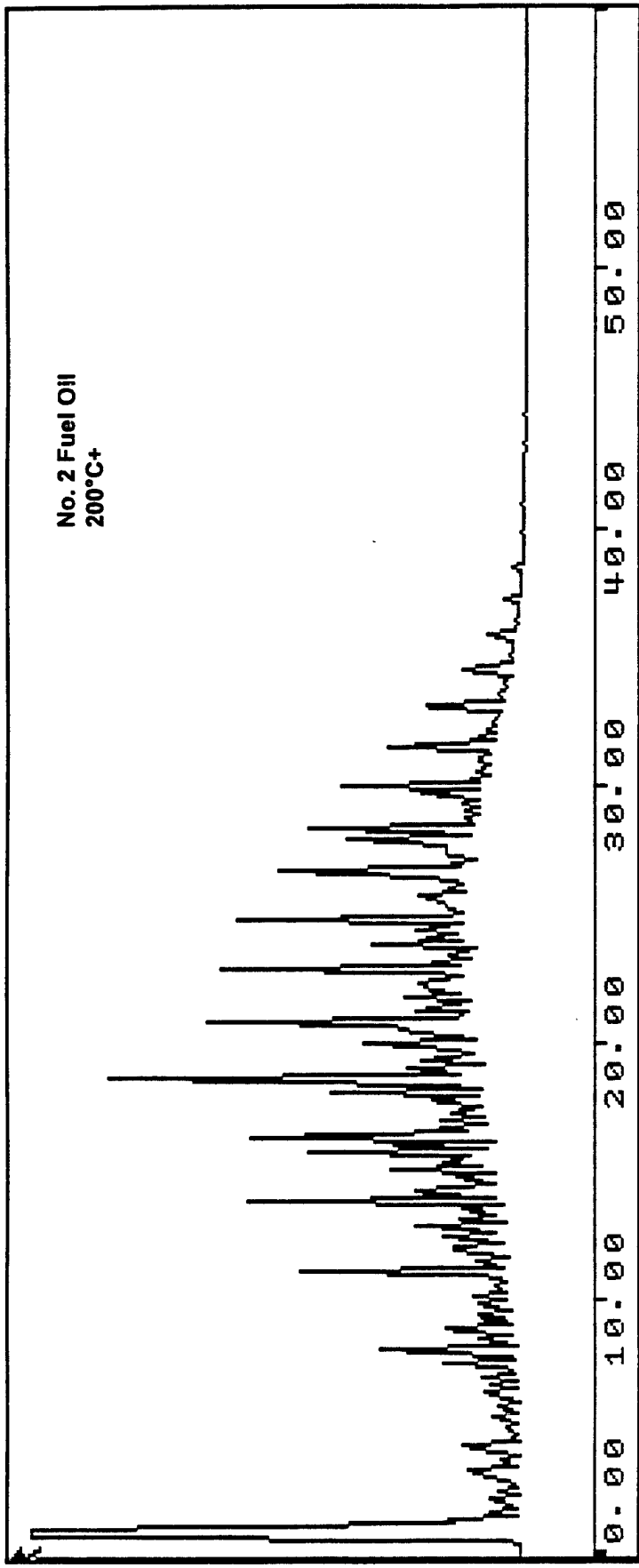

No. 2 Fuel Oil  
250°C+

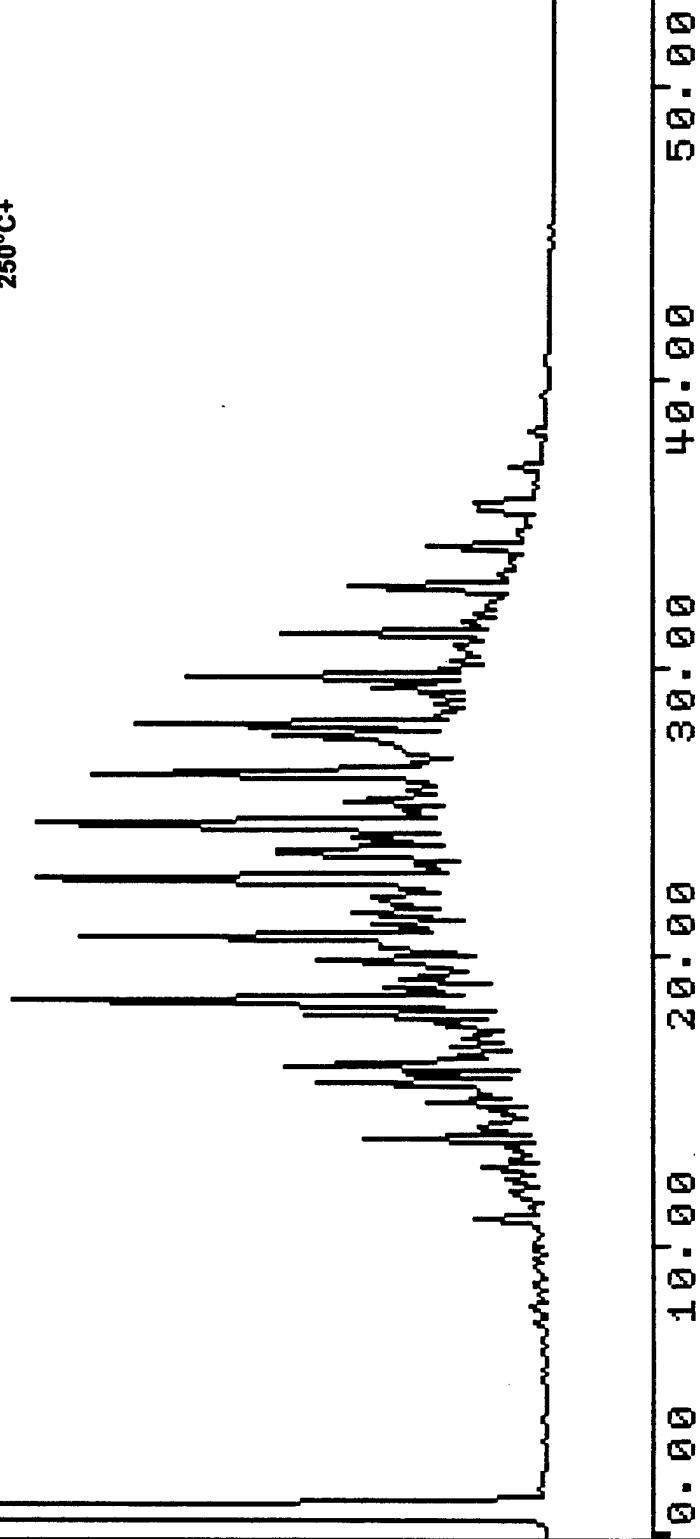

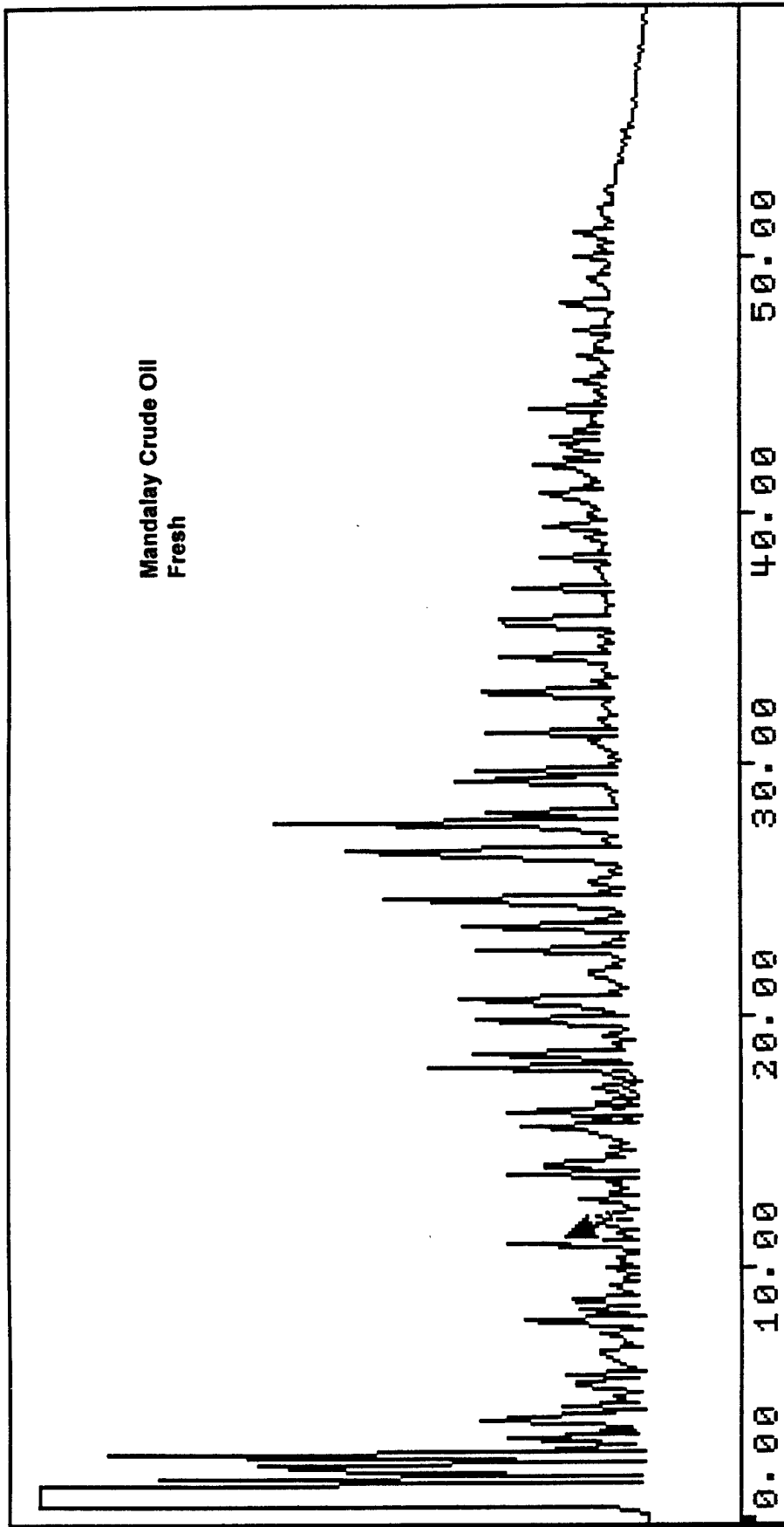

Mandalay Crude Oil  
150°C+

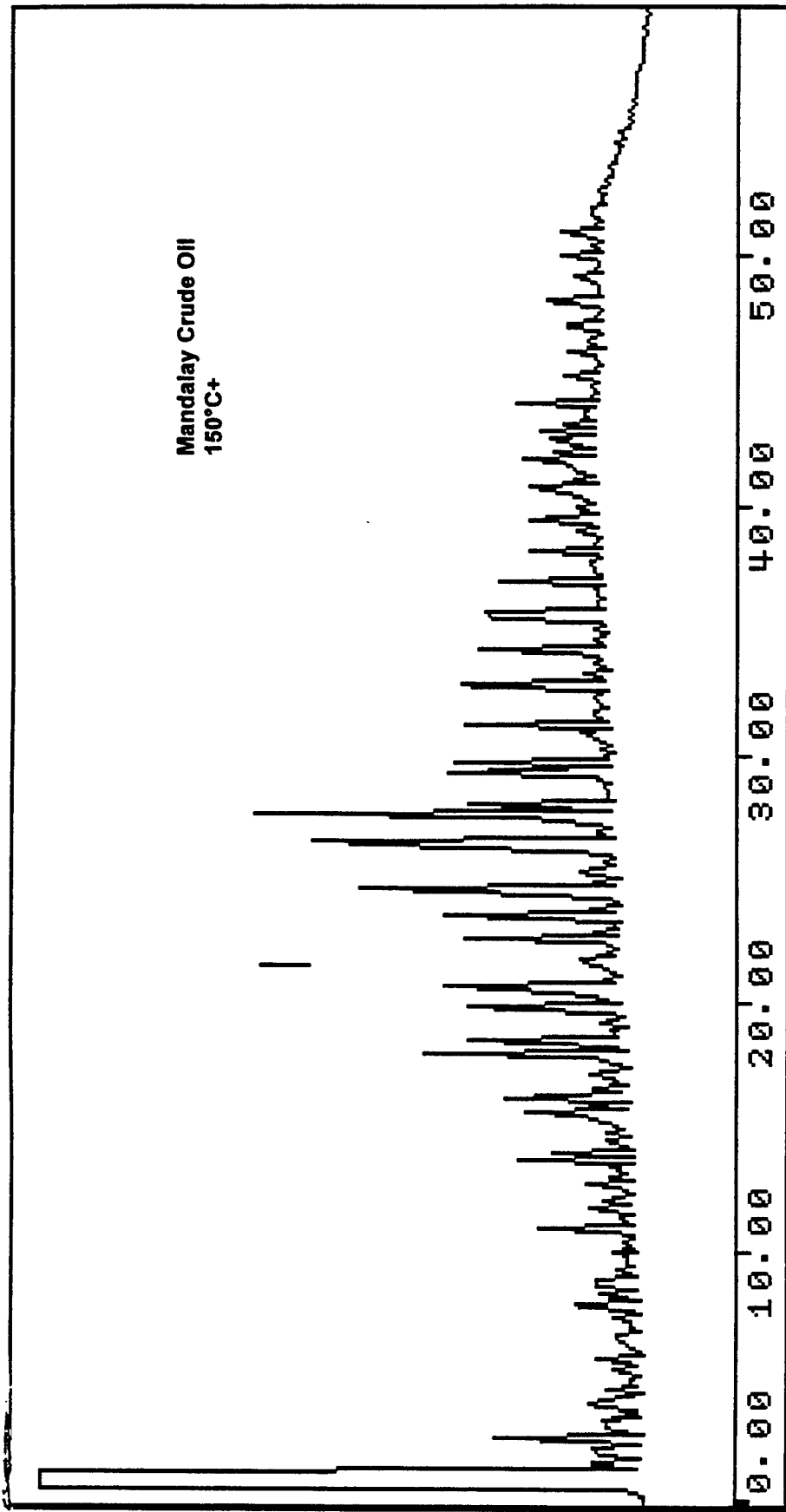

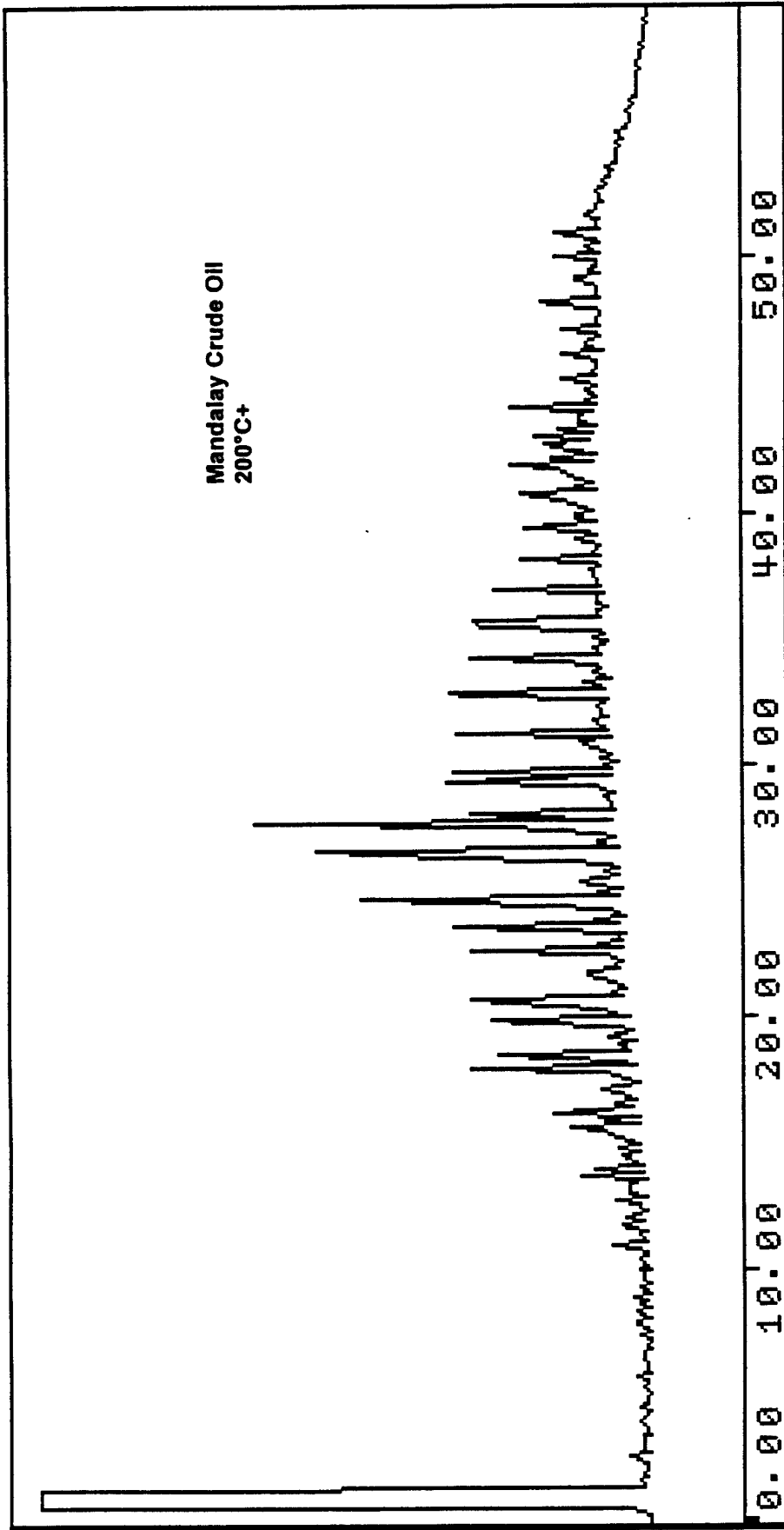

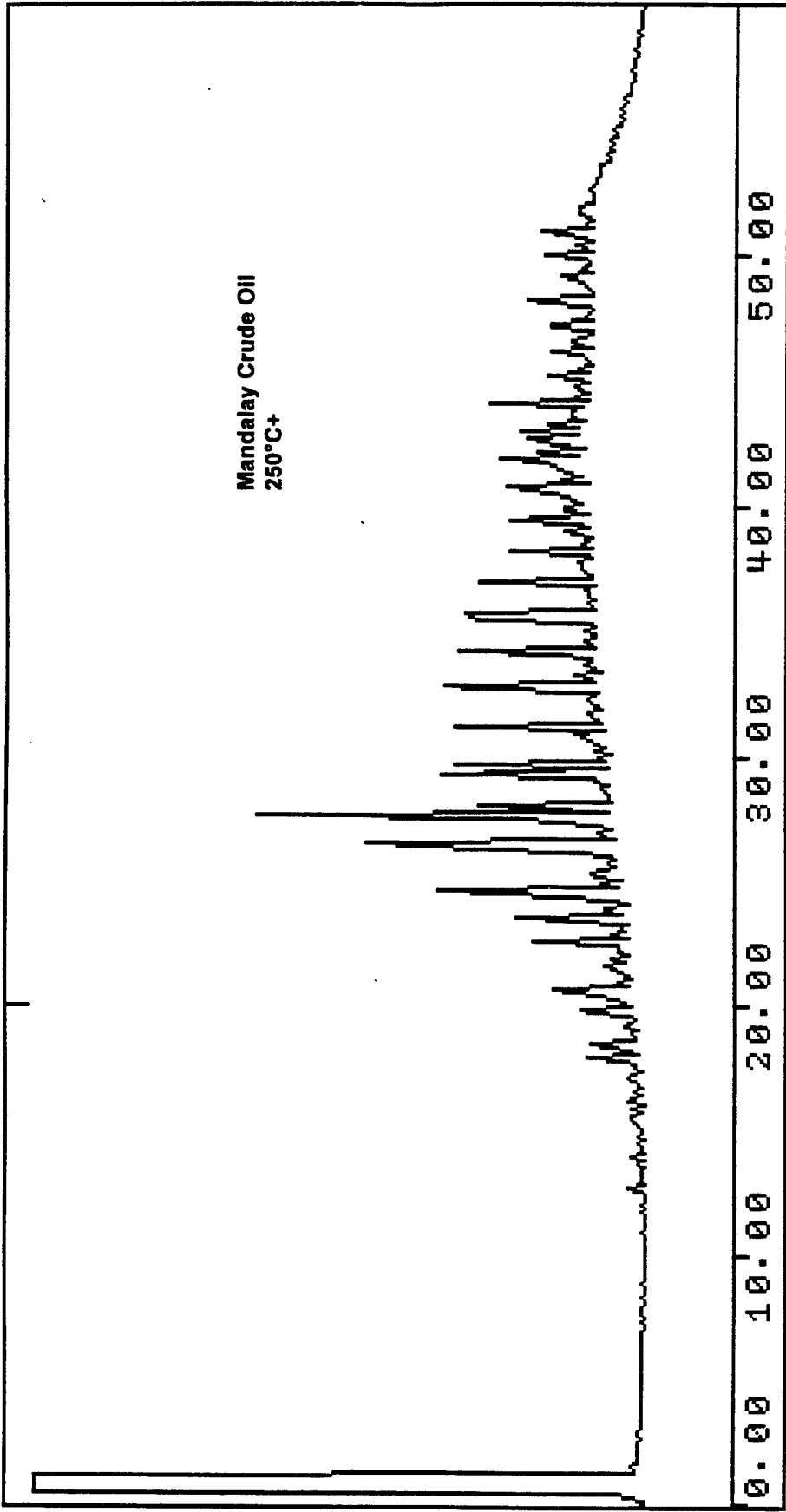

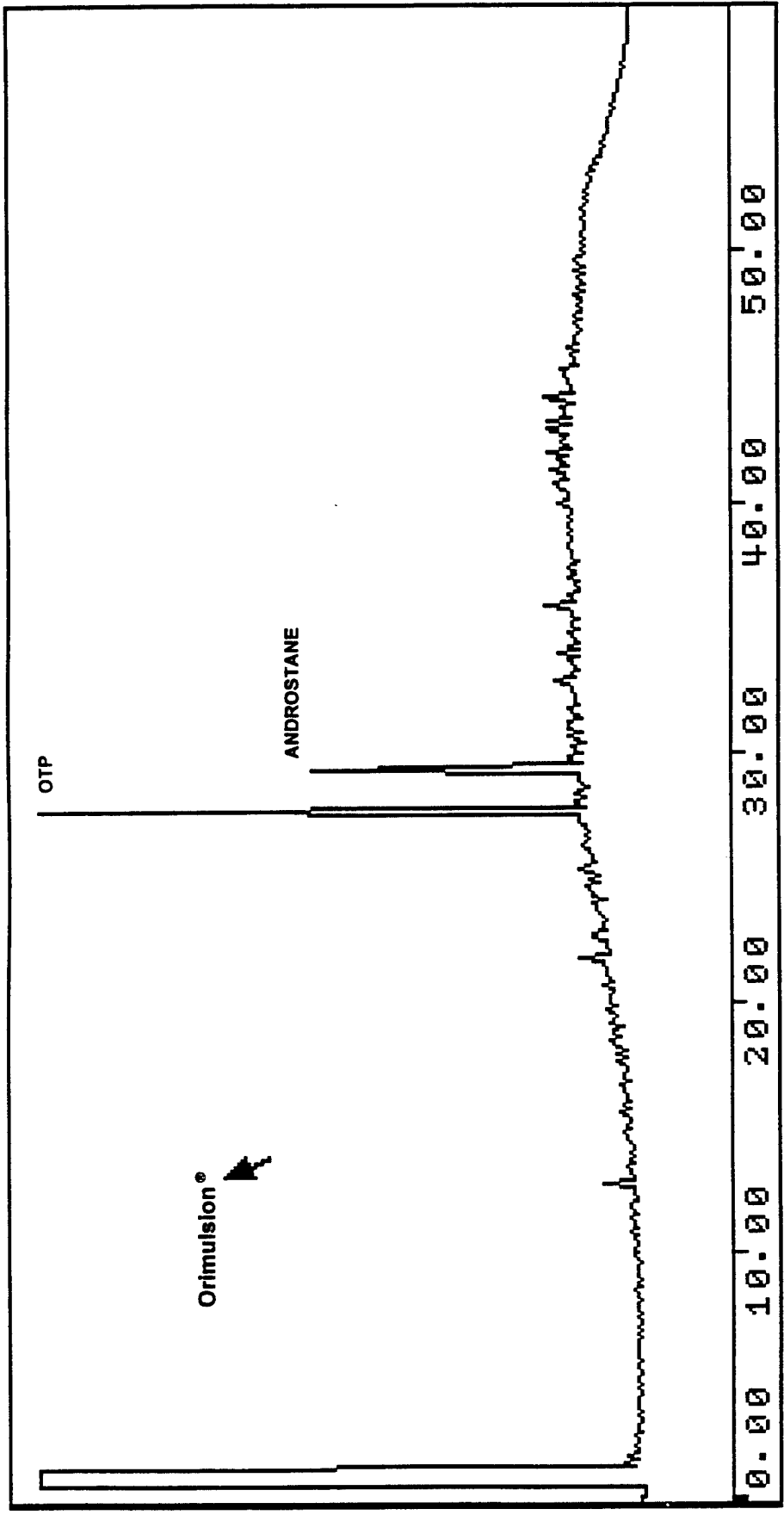



**APPENDIX B**

**POLYCYCLIC AROMATIC HYDROCARBON DISTRIBUTIONS**

| Polycyclic Aromatic Hydrocarbon | Morris J. Berman No. 6 Fuel Oil |         |         |         |
|---------------------------------|---------------------------------|---------|---------|---------|
|                                 | Fresh                           | 150°C+  | 200°C+  | 250°C+  |
| Naphthalene                     | 751.63                          | 718.87  | 694.75  | 262.52  |
| C1-naphthalenes                 | 4099.89                         | 4335.34 | 4418.63 | 2614.88 |
| C2-naphthalenes                 | 7135.29                         | 7794.15 | 7828.06 | 5648.78 |
| C3-naphthalenes                 | 5508.62                         | 6092.57 | 5971.46 | 4942.93 |
| C4-naphthalenes                 | 2746.25                         | 2919.91 | 2919.42 | 2616.79 |
| Biphenyl                        | 74.43                           | 78.02   | 75.75   | 46.59   |
| Acenaphthylene                  | 1.74                            | ND      | ND      | ND      |
| Acenaphthene                    | 219.49                          | 234.00  | 227.68  | 183.01  |
| Dibenzofuran                    | 75.80                           | 82.12   | 80.61   | 65.06   |
| Fluorene                        | 238.72                          | 263.91  | 251.79  | 220.57  |
| C1-fluorenes                    | 658.50                          | 716.57  | 700.07  | 643.59  |
| C2-fluorenes                    | 1144.37                         | 1251.08 | 1203.32 | 1141.78 |
| C3-fluorenes                    | 1077.46                         | 1212.80 | 1153.52 | 1118.05 |
| Phenanthrene                    | 743.08                          | 810.94  | 797.84  | 809.17  |
| Anthracene                      | 88.40                           | 108.41  | 106.50  | 99.82   |
| C1-phenanthrenes/anthracenes    | 2031.11                         | 2229.85 | 2156.27 | 2250.69 |
| C2-phenanthrenes/anthracenes    | 2660.97                         | 2960.79 | 2858.50 | 2908.91 |
| C3-phenanthrenes/anthracenes    | 1824.69                         | 2034.60 | 1957.01 | 2096.53 |
| C4-phenanthrenes/anthracenes    | 929.78                          | 1043.53 | 965.48  | 1035.38 |
| Dibenzothiophene                | 345.72                          | 377.11  | 366.97  | 360.62  |
| C1-dibenzothiophenes            | 1071.96                         | 1149.10 | 1082.79 | 1098.86 |
| C2-dibenzothiophenes            | 1488.85                         | 1641.32 | 1571.62 | 1621.29 |
| C3-dibenzothiophenes            | 1175.80                         | 1275.80 | 1239.19 | 1309.11 |
| Fluoranthene                    | 20.65                           | 21.95   | 21.81   | 23.02   |
| Pyrene                          | 133.73                          | 148.90  | 132.43  | 140.47  |
| C1-fluoranthenes/pyrenes        | 463.60                          | 544.05  | 503.75  | 539.47  |
| C2-fluoranthenes/pyrenes        | ND                              | ND      | ND      | ND      |
| C3-fluoranthenes/pyrenes        | ND                              | ND      | ND      | ND      |
| Benz[a]anthracene               | 72.85                           | 78.73   | 70.17   | 74.82   |
| Chrysene                        | 137.49                          | 149.87  | 148.43  | 154.31  |
| C1-chrysenes                    | 618.43                          | 654.41  | 650.00  | 674.90  |
| C2-chrysenes                    | 740.11                          | 758.42  | 816.66  | 846.38  |
| C3-chrysenes                    | 529.99                          | 586.18  | 593.70  | 636.25  |
| C4-chrysenes                    | 294.48                          | 283.15  | 283.19  | 306.58  |
| Benzo[b]fluoranthene            | 17.56                           | 20.31   | 18.76   | 21.31   |
| Benzo[k]fluoranthene            | 2.81                            | 3.27    | 2.45    | 2.81    |
| Benzo[e]pyrene                  | 32.11                           | 33.71   | 34.16   | 33.52   |
| Benzo[a]pyrene                  | 40.75                           | 42.10   | 41.71   | 43.88   |
| Perylene                        | 15.94                           | 14.45   | 15.33   | 16.68   |
| Indeno[1,2,3-c,d]pyrene         | 3.20                            | 2.71    | 2.65    | 2.58    |
| Dibenz[a,h]anthracene           | 8.69                            | 8.89    | 8.65    | 8.93    |
| Benzo[g,h,i]perylene            | 9.18                            | 9.05    | 9.61    | 8.93    |

| Polycyclic Aromatic Hydrocarbon | No. 6 Fuel Oil (Florida Power and Light ) |          |          |
|---------------------------------|---|----------|----------|
|                                 | Fresh                                     | 200°C+   | 250°C+   |
| Naphthalene                     | 28573.20                                  | 24759.41 | 8272.77  |
| C1-naphthalenes                 | 32419.31                                  | 31128.62 | 14615.29 |
| C2-naphthalenes                 | 27015.12                                  | 26528.96 | 15335.26 |
| C3-naphthalenes                 | 13032.25                                  | 13258.18 | 9143.74  |
| C4-naphthalenes                 | 5156.22                                   | 5578.28  | 4207.15  |
| Biphenyl                        | 12413.49                                  | 11810.07 | 5954.13  |
| Acenaphthylene                  | 1660.25                                   | 160.45   | 93.88    |
| Acenaphthene                    | 6408.43                                   | 9219.50  | 10046.43 |
| Dibenzofuran                    | 452.93                                    | 426.31   | 293.68   |
| Fluorene                        | 8913.22                                   | 9075.90  | 7543.13  |
| C1-fluorenes                    | 8526.74                                   | 8875.21  | 8026.80  |
| C2-fluorenes                    | 7465.93                                   | 7642.60  | 6518.36  |
| C3-fluorenes                    | 5815.59                                   | 6146.00  | 5852.16  |
| Phenanthrene                    | 19279.91                                  | 17930.15 | 16697.06 |
| Anthracene                      | 3556.25                                   | 5813.68  | 5762.89  |
| C1-phenanthrenes/anthracenes    | 24451.35                                  | 24347.36 | 23586.65 |
| C2-phenanthrenes/anthracenes    | 27382.45                                  | 26726.95 | 26331.05 |
| C3-phenanthrenes/anthracenes    | 23753.19                                  | 23599.84 | 22842.18 |
| C4-phenanthrenes/anthracenes    | 14876.98                                  | 14739.45 | 14446.36 |
| Dibenzothiophene                | 1045.34                                   | 961.89   | 853.22   |
| C1-dibenzothiophenes            | 3582.24                                   | 3278.92  | 3024.68  |
| C2-dibenzothiophenes            | 6462.03                                   | 5965.45  | 5681.22  |
| C3-dibenzothiophenes            | 7624.38                                   | 7247.65  | 6916.22  |
| Fluoranthene                    | 3045.99                                   | 2871.49  | 2811.46  |
| Pyrene                          | 7931.11                                   | 7513.29  | 7532.77  |
| C1-fluoranthenes/pyrenes        | 20436.36                                  | 19412.29 | 19489.64 |
| C2-fluoranthenes/pyrenes        | 23499.42                                  | 21684.95 | 21340.26 |
| C3-fluoranthenes/pyrenes        | 16901.51                                  | 16104.85 | 15128.99 |
| Benz[a]anthracene               | 2859.78                                   | 2737.95  | 2815.96  |
| Chrysene                        | 4694.14                                   | 4413.03  | 4475.76  |
| C1-chrysenes                    | 13870.06                                  | 13106.99 | 12810.76 |
| C2-chrysenes                    | 15009.61                                  | 16175.16 | 15102.82 |
| C3-chrysenes                    | 10954.29                                  | 10514.72 | 8873.95  |
| C4-chrysenes                    | 4169.94                                   | 4035.59  | 3869.35  |
| Benzo[b]fluoranthene            | 1090.63                                   | 984.78   | 995.73   |
| Benzo[k]fluoranthene            | 184.17                                    | 183.12   | 179.69   |
| Benzo[e]pyrene                  | 1451.75                                   | 1340.54  | 1414.37  |
| Benzo[a]pyrene                  | 2089.19                                   | 1970.83  | 1962.27  |
| Perylene                        | 632.26                                    | 575.71   | 559.04   |
| Indeno[1,2,3-c,d]pyrene         | 240.46                                    | 222.81   | 212.43   |
| Dibenz[a,h]anthracene           | 375.02                                    | 328.64   | 338.28   |
| Benzo[g,h,i]perylene            | 652.60                                    | 589.38   | 626.93   |

| Polycyclic Aromatic<br>Hydrocarbon | No. 6 Fuel Oil (Florida Power Corporation) |         |         |
|------------------------------------|--|---------|---------|
|                                    | Fresh                                      | 200°C+  | 250°C+  |
| naphthalene                        | 548.39                                     | 432.69  | 280.77  |
| C1-naphthalenes                    | 2521.04                                    | 2199.64 | 1654.12 |
| C2-naphthalenes                    | 4924.37                                    | 4610.82 | 3747.08 |
| C3-naphthalenes                    | 3576.52                                    | 3465.45 | 2990.50 |
| C4-naphthalenes                    | 1939.28                                    | 1928.71 | 1767.46 |
| biphenyl                           | 195.03                                     | 174.98  | 134.89  |
| acenaphthylene                     | 1.43                                       | ND      | ND      |
| acenaphthene                       | 185.40                                     | 174.69  | 152.13  |
| dibenzofuran                       | 84.20                                      | 80.16   | 71.49   |
| fluorene                           | 279.77                                     | 273.66  | 248.94  |
| C1-fluorenes                       | 727.23                                     | 729.38  | 693.26  |
| C2-fluorenes                       | 1450.45                                    | 1429.51 | 1405.12 |
| C3-fluorenes                       | 2001.19                                    | 2000.97 | 1997.56 |
| phenanthrene                       | 1173.28                                    | 1198.76 | 1177.06 |
| anthracene                         | 155.62                                     | 168.24  | 166.46  |
| C1-phenanthrenes/anthracenes       | 4897.20                                    | 5021.34 | 4952.18 |
| C2-phenanthrenes/anthracenes       | 9329.37                                    | 9661.96 | 9618.40 |
| C3-phenanthrenes/anthracenes       | 8599.40                                    | 8807.88 | 8860.90 |
| C4-phenanthrenes/anthracenes       | 4850.42                                    | 4799.82 | 4973.41 |
| dibenzothiophene                   | 414.11                                     | 421.17  | 405.76  |
| C1-dibenzothiophenes               | 1704.18                                    | 1707.59 | 1657.08 |
| C2-dibenzothiophenes               | 4022.46                                    | 4140.83 | 4096.03 |
| C3-dibenzothiophenes               | 5619.17                                    | 5921.77 | 5935.76 |
| fluoranthene                       | 151.21                                     | 155.83  | 155.35  |
| pyrene                             | 1081.49                                    | 1159.81 | 1149.42 |
| C1-fluoranthenes/pyrenes           | 4088.18                                    | 4215.90 | 4252.82 |
| C2-fluoranthenes/pyrenes           | 5853.60                                    | 5735.77 | 5677.10 |
| C3-fluoranthenes/pyrenes           | 5485.40                                    | 5279.38 | 5410.01 |
| benz[a]anthracene                  | 547.03                                     | 587.31  | 592.09  |
| chrysene                           | 669.06                                     | 787.49  | 818.37  |
| C1-chrysenes                       | 3647.38                                    | 3860.83 | 3864.43 |
| C2-chrysenes                       | 4960.26                                    | 4977.50 | 5171.33 |
| C3-chrysenes                       | 3306.39                                    | 3384.05 | 3477.50 |
| C4-chrysenes                       | 1274.92                                    | 1297.81 | 1342.92 |
| benzo[b]fluoranthene               | 195.86                                     | 203.33  | 206.79  |
| benzo[k]fluoranthene               | 26.92                                      | 23.60   | 25.71   |
| benzo[e]pyrene                     | 368.48                                     | 380.74  | 387.69  |
| benzo[a]pyrene                     | 347.35                                     | 366.31  | 353.73  |
| perylene                           | 132.91                                     | 132.83  | 135.08  |
| indeno[1,2,3-c,d]pyrene            | 22.17                                      | 26.47   | 23.19   |
| dibenz[a,h]anthracene              | 75.98                                      | 78.62   | 76.77   |
| benzo[g,h,i]perylene               | 170.76                                     | 176.43  | 169.91  |

| Polycyclic Aromatic Hydrocarbon | No. 2 Fuel Oil |          |          |
|---------------------------------|----------------|----------|----------|
|                                 | Fresh          | 200°C+   | 250°C+   |
| Naphthalene                     | 6956.57        | 6719.68  | 4267.14  |
| C1-naphthalenes                 | 17929.03       | 17918.74 | 15073.63 |
| C2-naphthalenes                 | 32541.29       | 32734.98 | 32728.18 |
| C3-naphthalenes                 | 28500.95       | 28051.39 | 32304.26 |
| C4-naphthalenes                 | 14685.34       | 14441.21 | 17991.42 |
| Biphenyl                        | 3667.26        | 3642.90  | 3313.63  |
| Acenaphthylene                  | 0.00           | 0.00     | 0.00     |
| Acenaphthene                    | 1337.18        | 1341.94  | 1452.51  |
| Dibenzofuran                    | 782.86         | 793.47   | 882.04   |
| Fluorene                        | 3032.93        | 3025.89  | 3566.29  |
| C1-fluorenes                    | 6330.29        | 6405.82  | 7662.51  |
| C2-fluorenes                    | 12161.20       | 12466.12 | 15933.19 |
| C3-fluorenes                    | 11005.45       | 10402.83 | 14688.60 |
| Phenanthrene                    | 5565.88        | 5671.47  | 7473.73  |
| Anthracene                      | 486.30         | 492.80   | 694.89   |
| C1-phenanthrenes/anthracenes    | 13954.98       | 14146.55 | 19059.36 |
| C2-phenanthrenes/anthracenes    | 17574.53       | 17875.39 | 24624.53 |
| C3-phenanthrenes/anthracenes    | 10726.14       | 9926.35  | 14411.51 |
| C4-phenanthrenes/anthracenes    | 3794.05        | 3699.16  | 5426.23  |
| Dibenzothiophene                | 643.88         | 661.18   | 882.75   |
| C1-dibenzothiophenes            | 2242.32        | 2253.34  | 3099.60  |
| C2-dibenzothiophenes            | 3577.31        | 3537.19  | 4973.97  |
| C3-dibenzothiophenes            | 2879.41        | 2858.05  | 4130.79  |
| Fluoranthene                    | 175.57         | 178.87   | 260.68   |
| Pyrene                          | 982.98         | 1004.39  | 1462.96  |
| C1-fluoranthenes/pyrenes        | 2139.32        | 1965.71  | 2979.33  |
| C2-fluoranthenes/pyrenes        | 1385.51        | 1364.37  | 1971.56  |
| C3-fluoranthenes/pyrenes        | 581.50         | 588.66   | 843.72   |
| Benz[a]anthracene               | 26.84          | 29.22    | 36.47    |
| Chrysene                        | 86.11          | 46.02    | 73.28    |
| C1-chrysenes                    | 126.36         | 123.21   | 186.81   |
| C2-chrysenes                    | 92.48          | 88.90    | 134.88   |
| C3-chrysenes                    | 0.00           | 0.00     | 0.00     |
| C4-chrysenes                    | 0.00           | 0.00     | 0.00     |
| Benzo[b]fluoranthene            | 0.00           | 0.00     | 0.00     |
| Benzo[k]fluoranthene            | 0.00           | 0.00     | 0.00     |
| Benzo[e]pyrene                  | 0.00           | 5.04     | 7.25     |
| Benzo[a]pyrene                  | 0.00           | 0.00     | 0.00     |
| Perylene                        | 0.00           | 0.00     | 0.00     |
| Indeno[1,2,3-c,d]pyrene         | 0.00           | 0.00     | 0.00     |
| Dibenz[a,h]anthracene           | 0.00           | 0.00     | 0.00     |
| Benzo[g,h,i]perylene            | 0.00           | 0.00     | 0.00     |

| Polycyclic Aromatic<br>Hydrocarbon | Mandalay Crude Oil Residues |         |         |         |
|------------------------------------|-----------------------------|---------|---------|---------|
|                                    | Fresh                       | 150°C+  | 200°C+  | 250°C+  |
| Naphthalene                        | 1250.74                     | 1159.57 | 856.28  | 237.44  |
| C1-naphthalenes                    | 1882.96                     | 1897.74 | 1651.52 | 783.80  |
| C2-naphthalenes                    | 2906.17                     | 3046.43 | 2837.51 | 1724.79 |
| C3-naphthalenes                    | 2661.11                     | 2834.23 | 2725.00 | 1965.64 |
| C4-naphthalenes                    | 1586.29                     | 1947.21 | 1848.66 | 1471.08 |
| Biphenyl                           | 57.58                       | 60.85   | 52.61   | 27.32   |
| Acenaphthylene                     | 0.00                        | 0.00    | 0.00    | 0.00    |
| Acenaphthene                       | 55.42                       | 57.50   | 51.40   | 39.59   |
| Dibenzofuran                       | 95.08                       | 99.94   | 96.68   | 71.68   |
| Fluorene                           | 108.32                      | 117.21  | 116.40  | 93.87   |
| C1-fluorenes                       | 250.68                      | 270.40  | 268.71  | 243.42  |
| C2-fluorenes                       | 451.72                      | 504.12  | 511.26  | 456.60  |
| C3-fluorenes                       | 488.36                      | 472.58  | 582.29  | 558.30  |
| Phenanthrene                       | 178.40                      | 196.80  | 207.21  | 203.22  |
| Anthracene                         | 0.00                        | 0.00    | 0.00    | 0.00    |
| C1-phenanthrenes/anthracenes       | 443.74                      | 495.13  | 520.42  | 539.47  |
| C2-phenanthrenes/anthracenes       | 668.90                      | 772.88  | 794.82  | 844.06  |
| C3-phenanthrenes/anthracenes       | 620.96                      | 739.54  | 763.37  | 771.96  |
| C4-phenanthrenes/anthracenes       | 456.00                      | 543.89  | 516.11  | 636.55  |
| Dibenzothiophene                   | 390.71                      | 418.10  | 430.20  | 423.37  |
| C1-dibenzothiophenes               | 910.00                      | 1024.99 | 1042.49 | 1052.21 |
| C2-dibenzothiophenes               | 1349.16                     | 1466.93 | 1499.55 | 1537.26 |
| C3-dibenzothiophenes               | 1382.14                     | 1538.79 | 1650.34 | 1755.19 |
| Fluoranthene                       | 0.00                        | 0.00    | 0.00    | 0.00    |
| Pyrene                             | 0.00                        | 0.00    | 0.00    | 0.00    |
| C1-fluoranthenes/pyrenes           | 106.22                      | 138.68  | 131.39  | 151.09  |
| C2-fluoranthenes/pyrenes           | 175.50                      | 221.37  | 212.05  | 238.79  |
| C3-fluoranthenes/pyrenes           | 223.00                      | 237.92  | 257.91  | 290.78  |
| Benz[a]anthracene                  | 0.00                        | 0.00    | 0.00    | 0.00    |
| Chrysene                           | 22.15                       | 30.08   | 25.78   | 38.17   |
| C1-chrysenes                       | 59.48                       | 74.38   | 83.11   | 82.67   |
| C2-chrysenes                       | 145.06                      | 183.61  | 188.30  | 202.69  |
| C3-chrysenes                       | 108.74                      | 137.35  | 122.70  | 153.24  |
| C4-chrysenes                       | 0.00                        | 0.00    | 0.00    | 0.00    |
| Benzo[b]fluoranthene               | 0.00                        | 0.00    | 0.00    | 0.00    |
| Benzo[k]fluoranthene               | 0.00                        | 0.00    | 0.00    | 0.00    |
| Benzo[e]pyrene                     | 35.70                       | 37.23   | 39.51   | 40.22   |
| Benzo[a]pyrene                     | 0.00                        | 0.00    | 0.00    | 0.00    |
| Perylene                           | 167.98                      | 175.87  | 181.30  | 197.02  |
| Indeno[1,2,3-c,d]pyrene            | 0.00                        | 0.00    | 0.00    | 0.00    |
| Dibenz[a,h]anthracene              | 0.00                        | 0.00    | 0.00    | 0.00    |
| Benzo[g,h,i]perylene               | 0.00                        | 0.00    | 0.00    | 0.00    |

| <b>Polycyclic Aromatic Hydrocarbon</b> | <b>ORIMULSION®</b> |
|--|--------------------|
| naphthalene                            | 15.40              |
| C1-naphthalenes                        | 43.03              |
| C2-naphthalenes                        | 136.70             |
| C3-naphthalenes                        | 189.37             |
| C4-naphthalenes                        | 267.97             |
| biphenyl                               | 5.00               |
| acenaphthylene                         | ND                 |
| acenaphthene                           | 10.66              |
| dibenzofuran                           | 5.42               |
| fluorene                               | 13.52              |
| C1-fluorenes                           | 57.39              |
| C2-fluorenes                           | 184.39             |
| C3-fluorenes                           | 272.13             |
| anthracene                             | ND                 |
| phenanthrene                           | 67.78              |
| C1-phenanthrenes/anthracenes           | 143.84             |
| C2-phenanthrenes/anthracenes           | 366.41             |
| C3-phenanthrenes/anthracenes           | 459.43             |
| C4-phenanthrenes/anthracenes           | 241.73             |
| dibenzothiophene                       | 28.19              |
| C1-dibenzothiophenes                   | 133.96             |
| C2-dibenzothiophenes                   | 345.13             |
| C3-dibenzothiophenes                   | 692.83             |
| fluoranthene                           | 4.03               |
| pyrene                                 | 9.59               |
| C1-fluoranthenes/pyrenes               | 52.75              |
| C2-fluoranthenes/pyrenes               | 95.19              |
| C3-fluoranthenes/pyrenes               | 141.18             |
| benz[a]anthracene                      | ND                 |
| chrysene                               | 6.80               |
| C1-chrysenes                           | 34.88              |
| C2-chrysenes                           | 74.45              |
| C3-chrysenes                           | ND                 |
| C4-chrysenes                           | ND                 |
| benzo[b]fluoranthene                   | 2.13               |
| benzo[k]fluoranthene                   | ND                 |
| benzo[e]pyrene                         | 6.36               |
| benzo[a]pyrene                         | 3.30               |
| perylene                               | 7.78               |
| indeno[1,2,3-c,d]pyrene                | ND                 |
| dibenz[a,h]anthracene                  | ND                 |
| benzo[g,h,i]perylene                   | 1.71               |

**APPENDIX C**  
**IATROSCAN CHROMATOGRAMS**



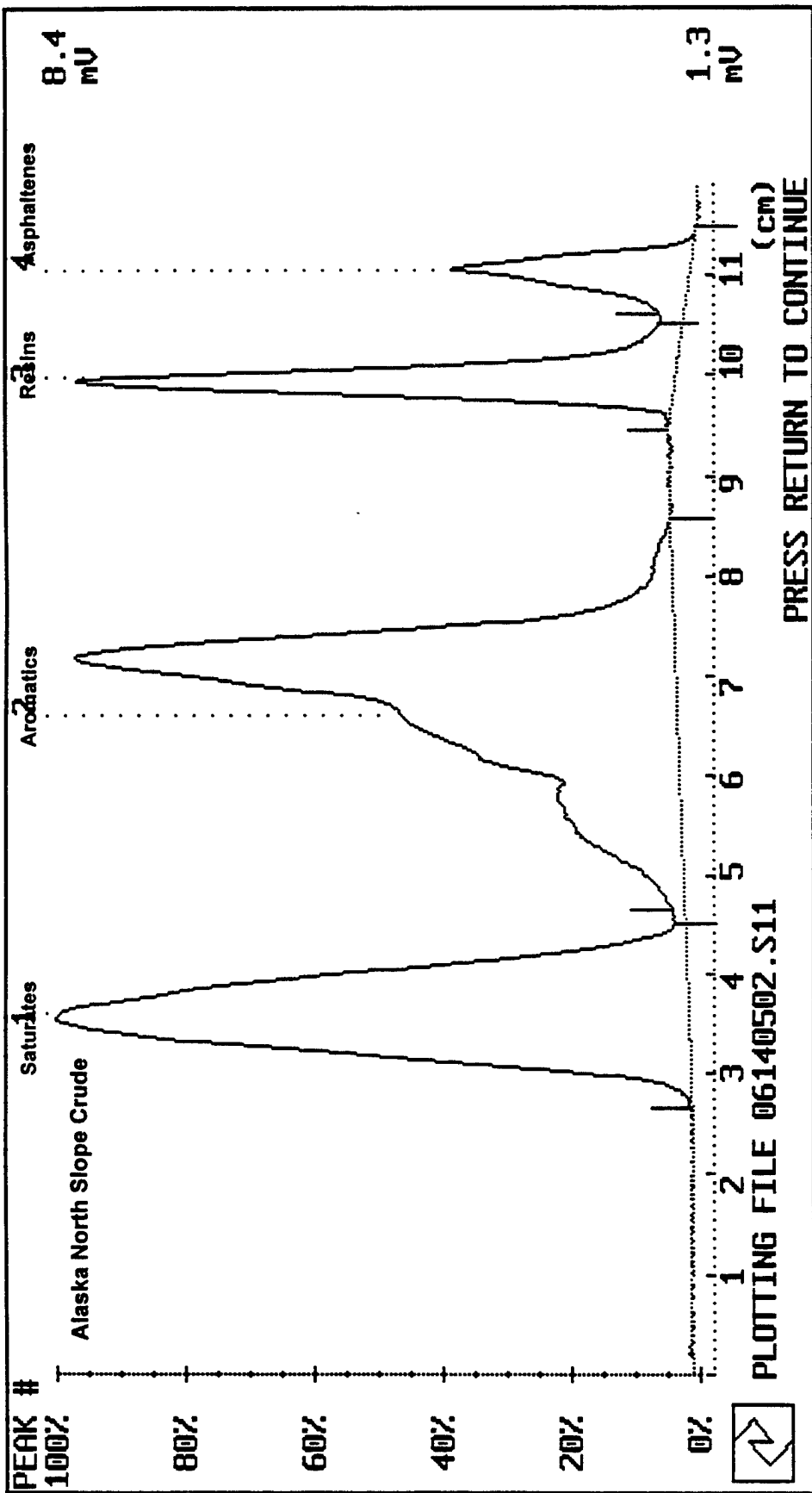

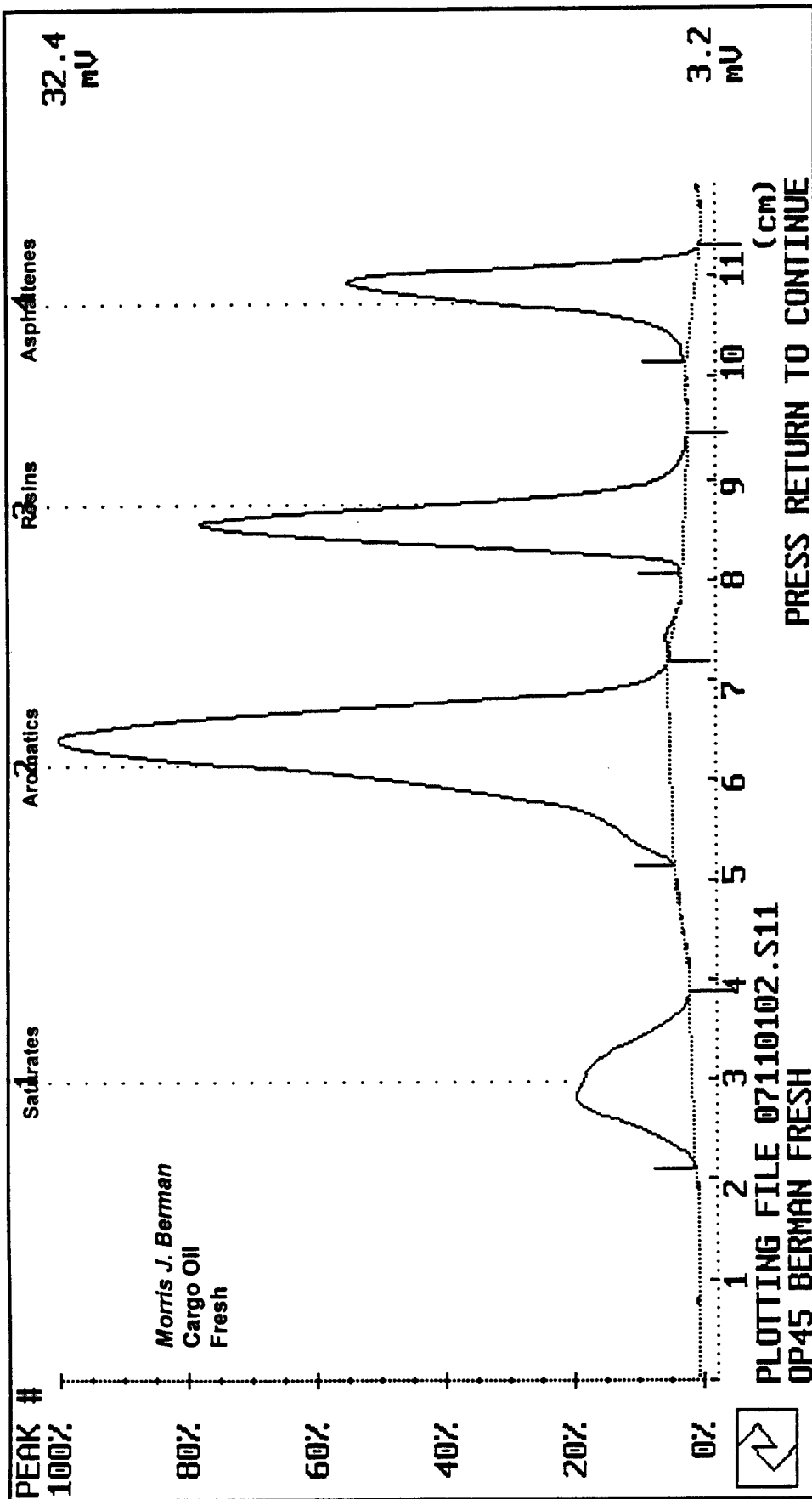

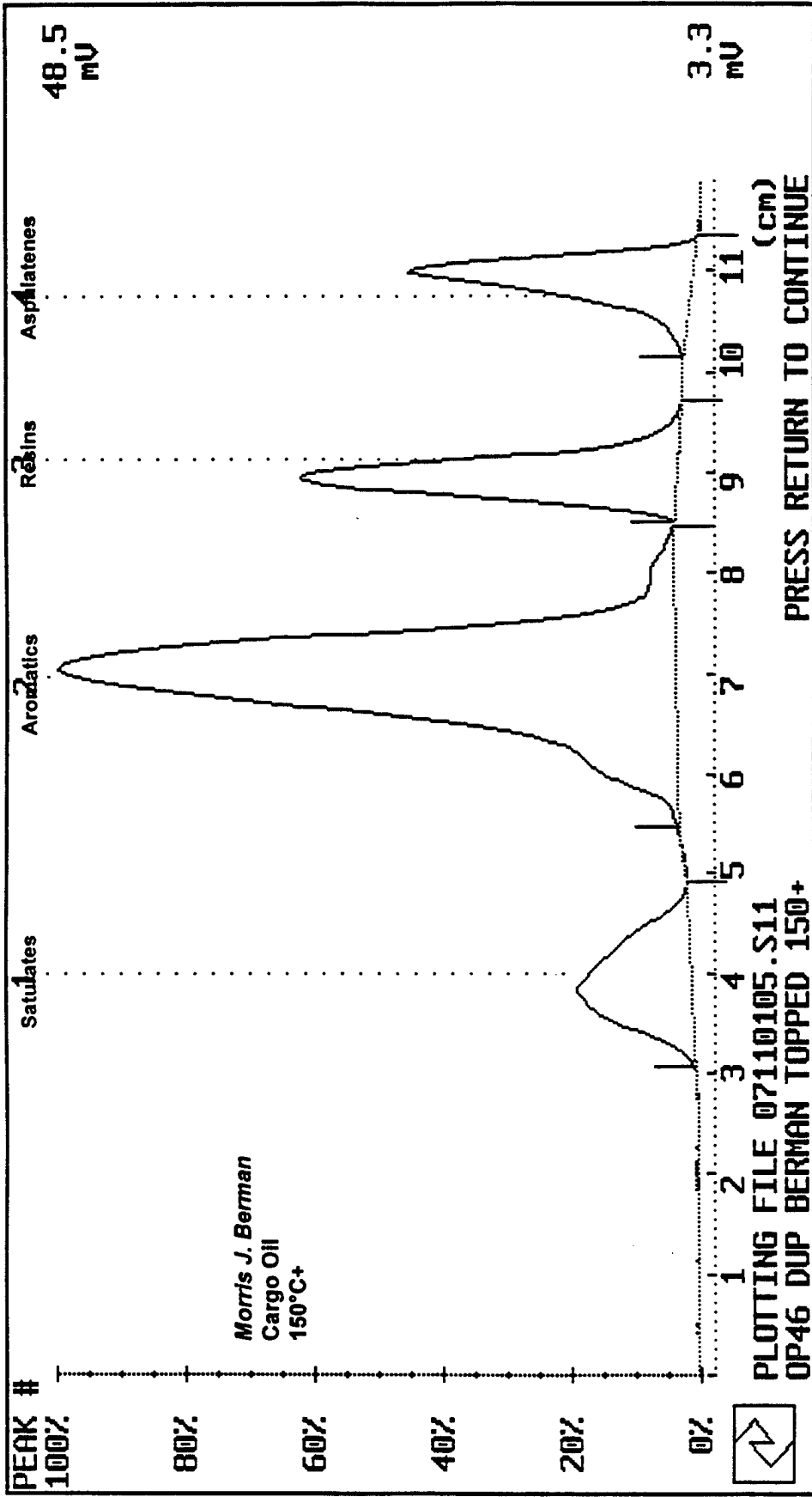

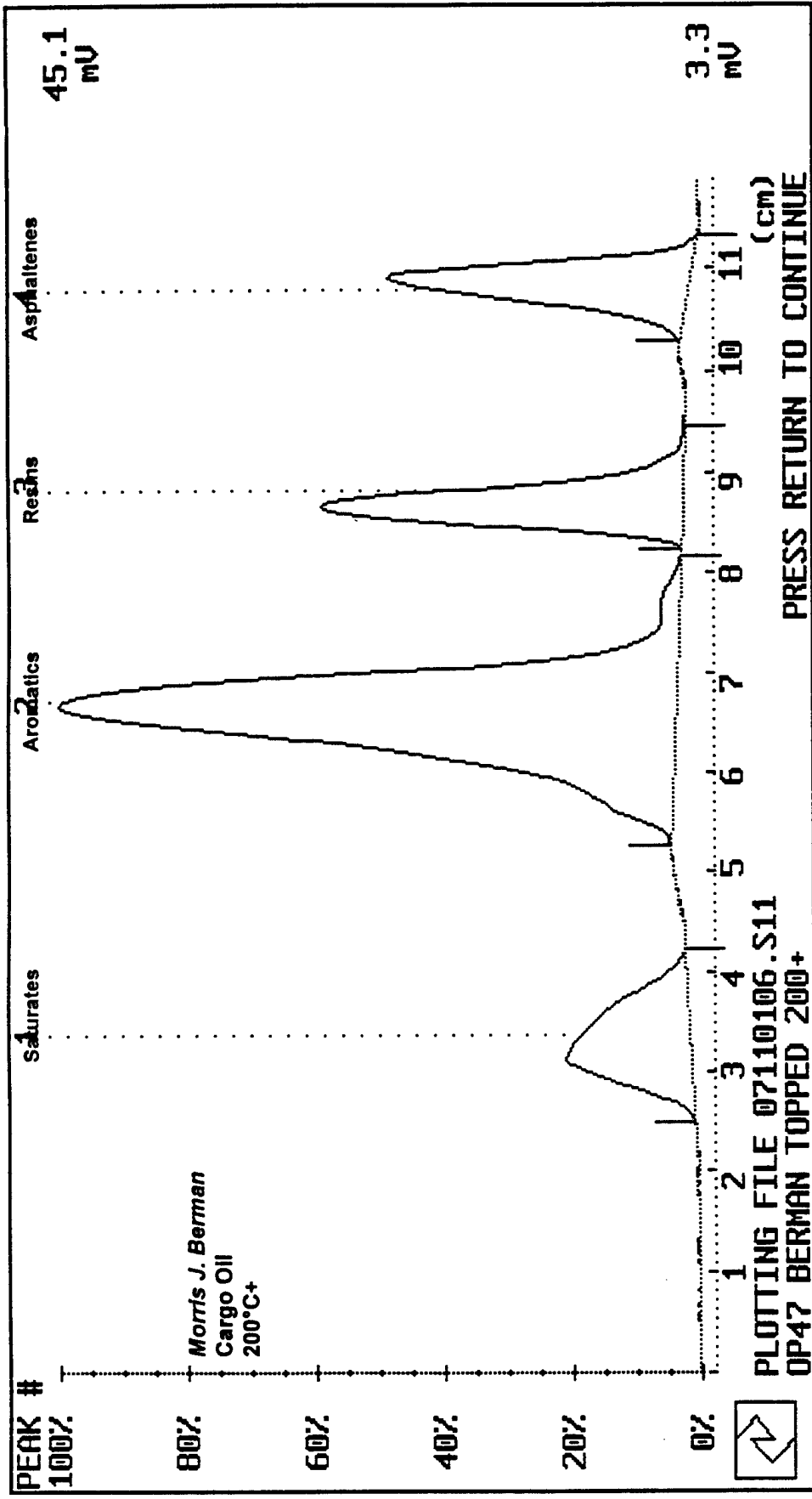

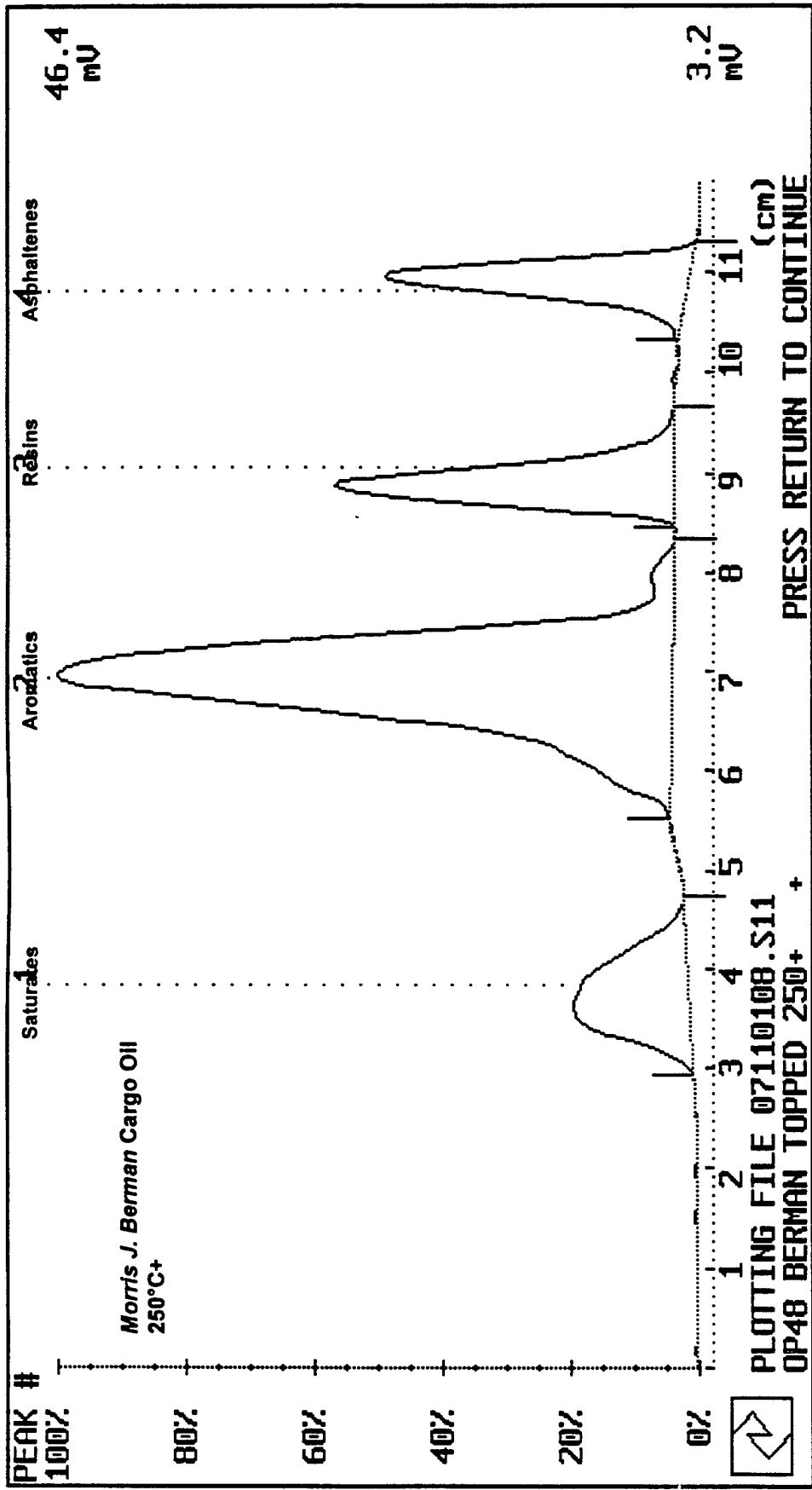

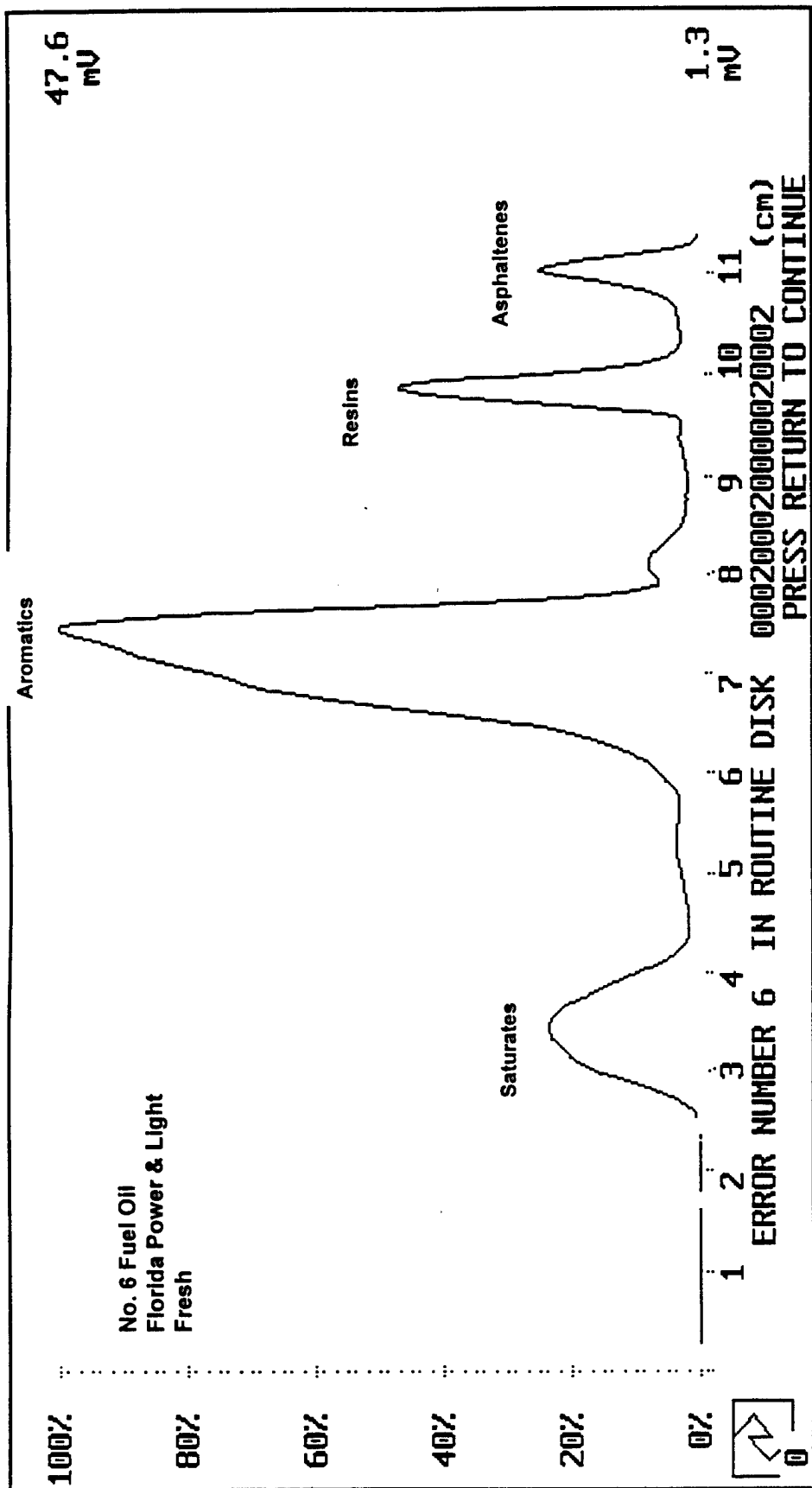

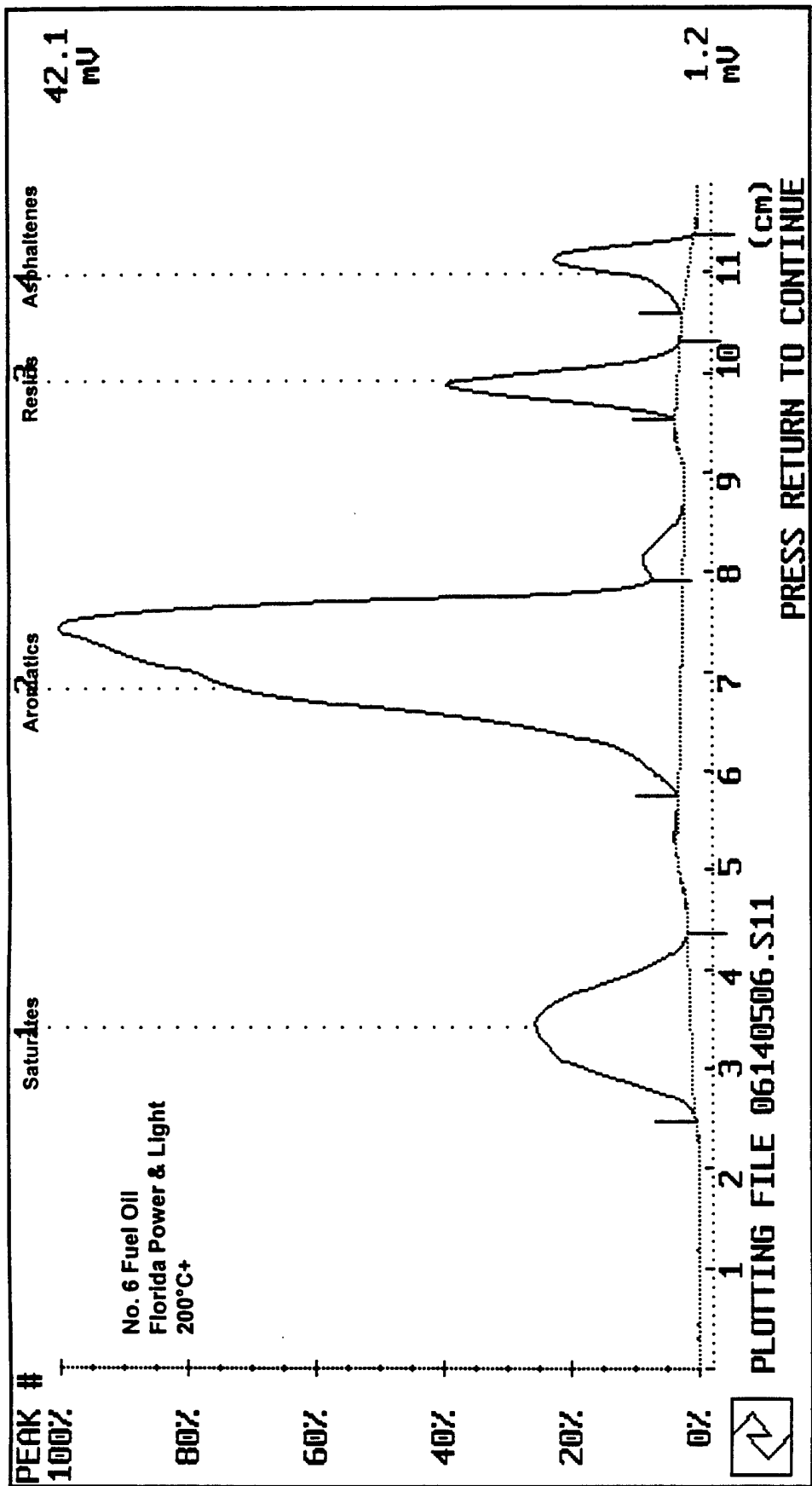

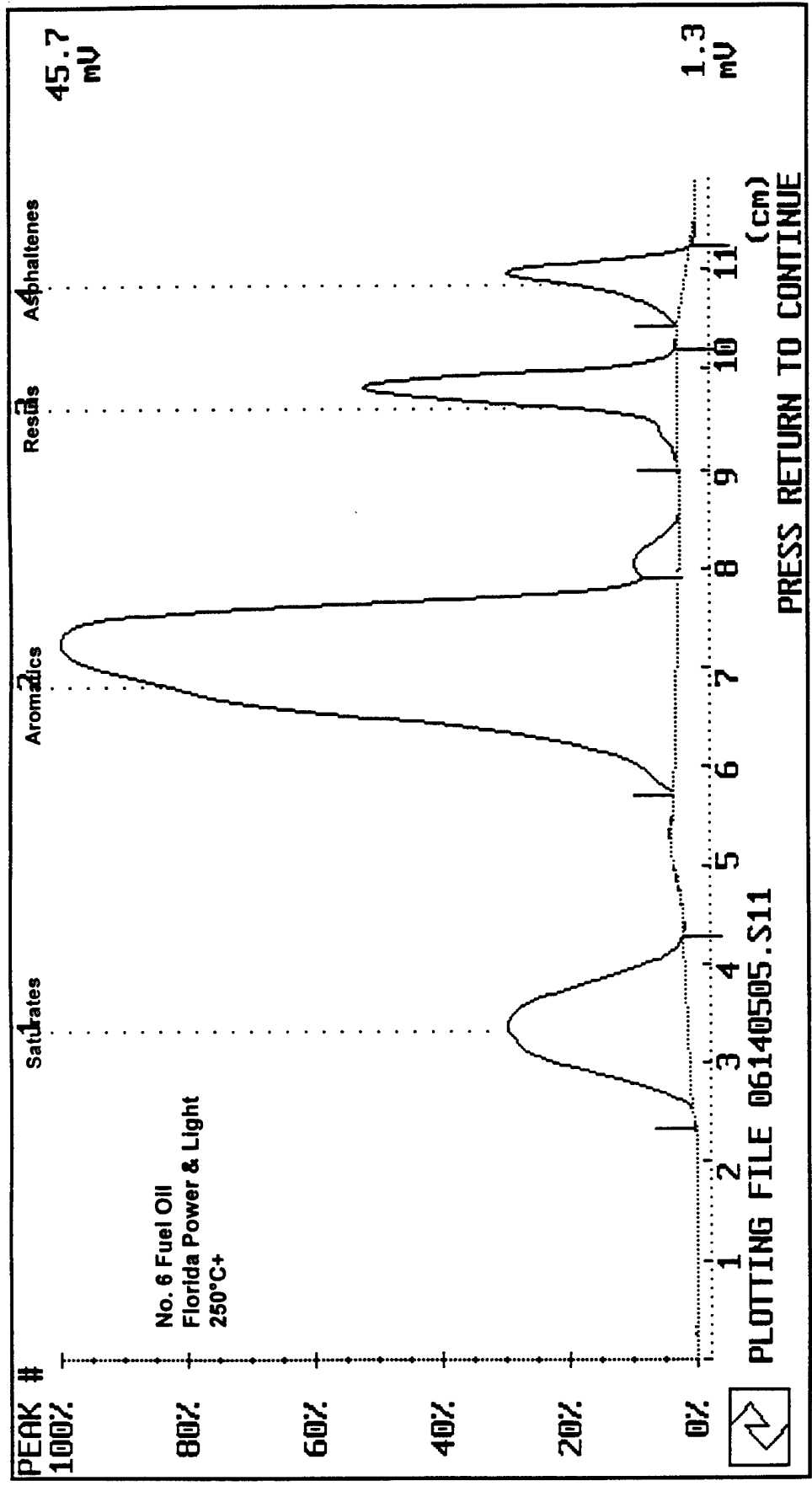



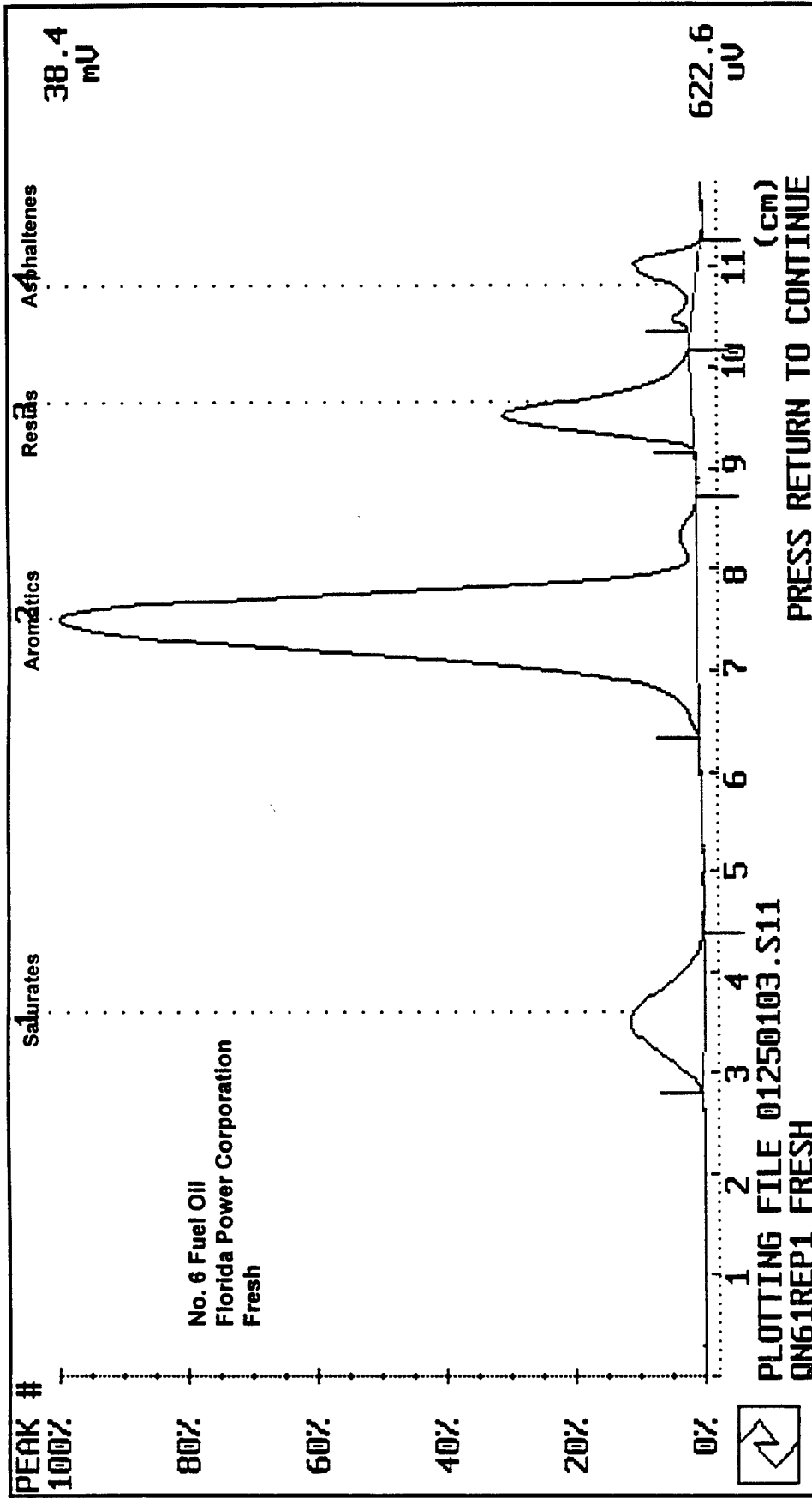

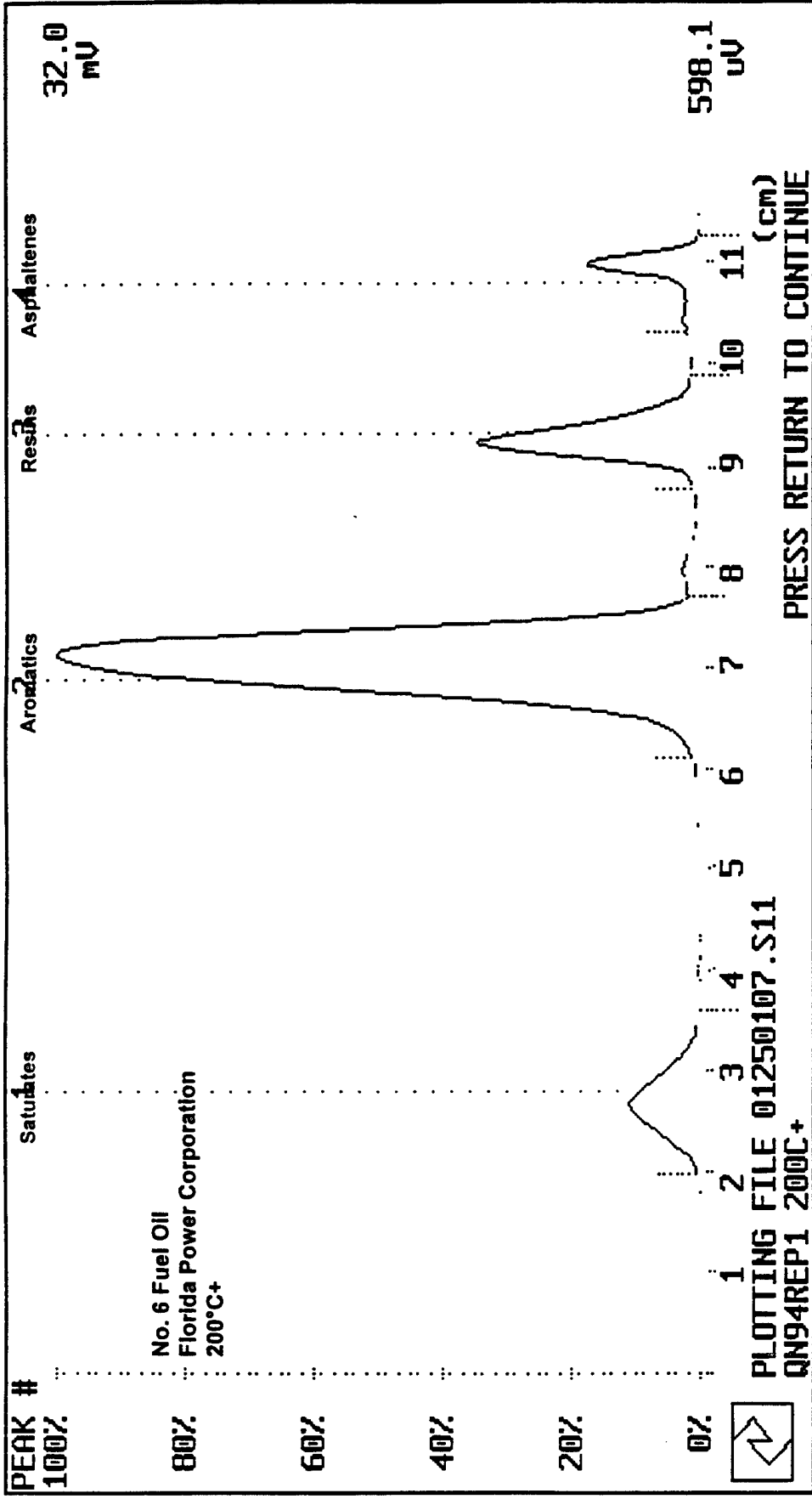

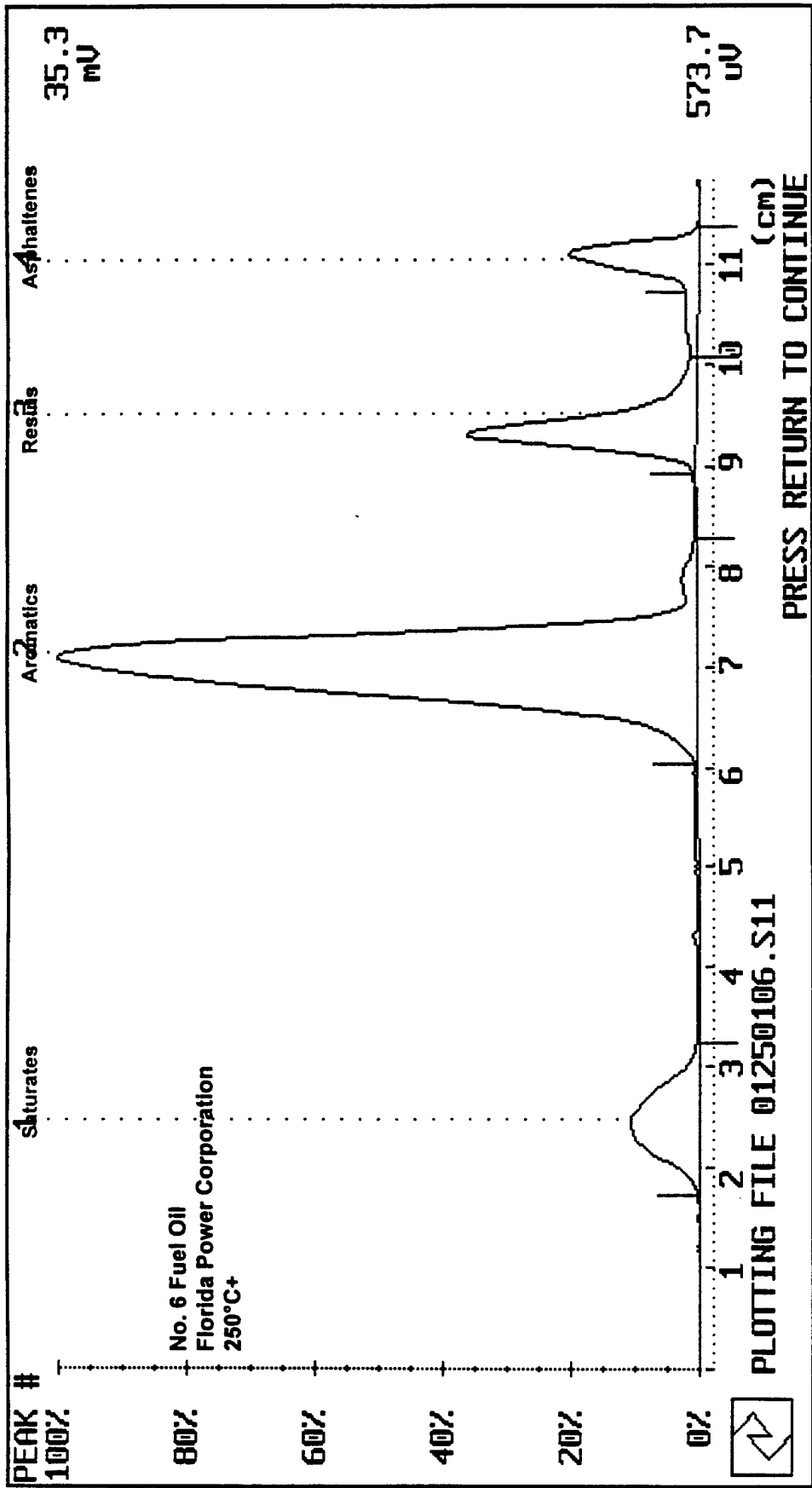

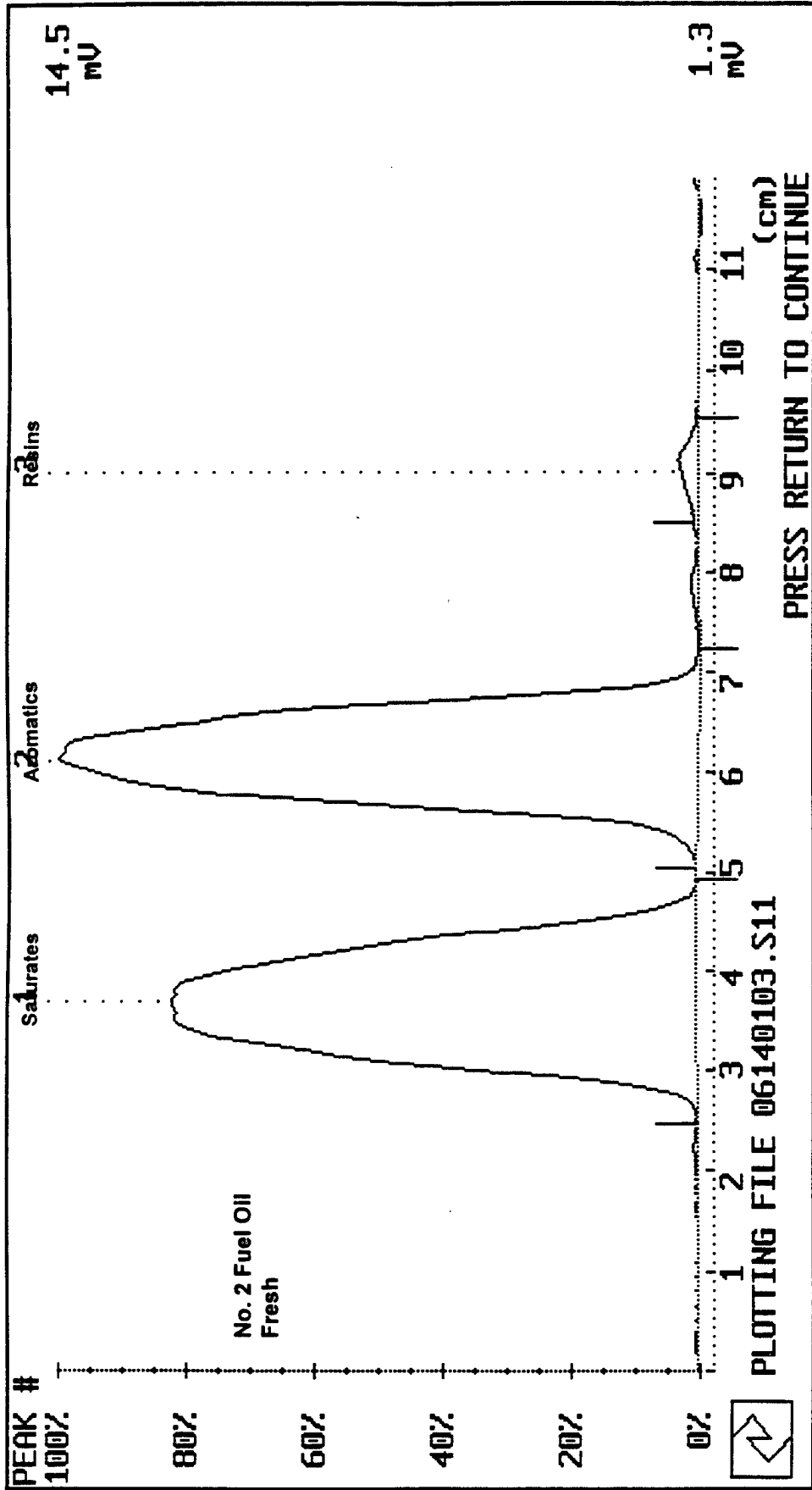

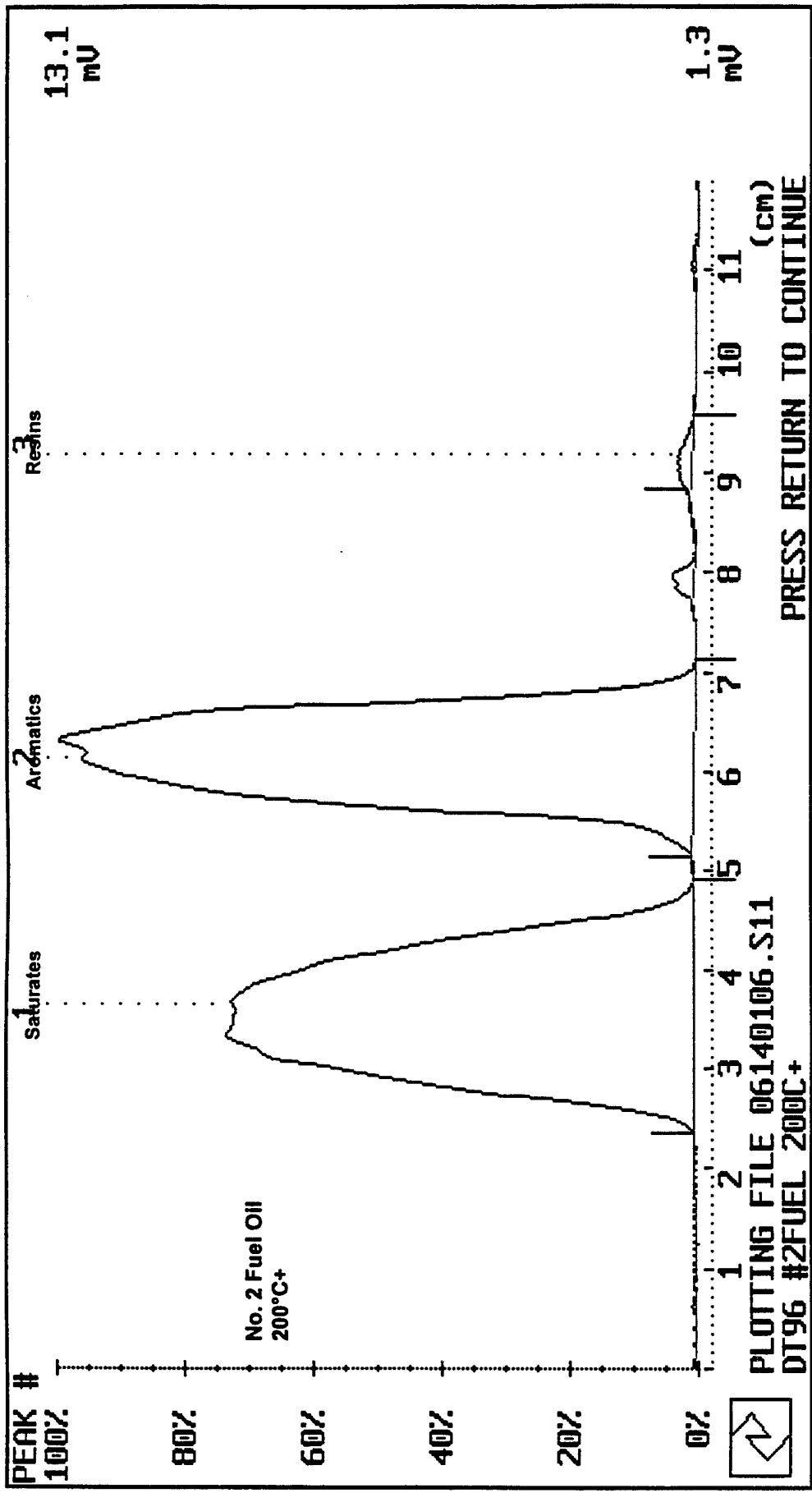

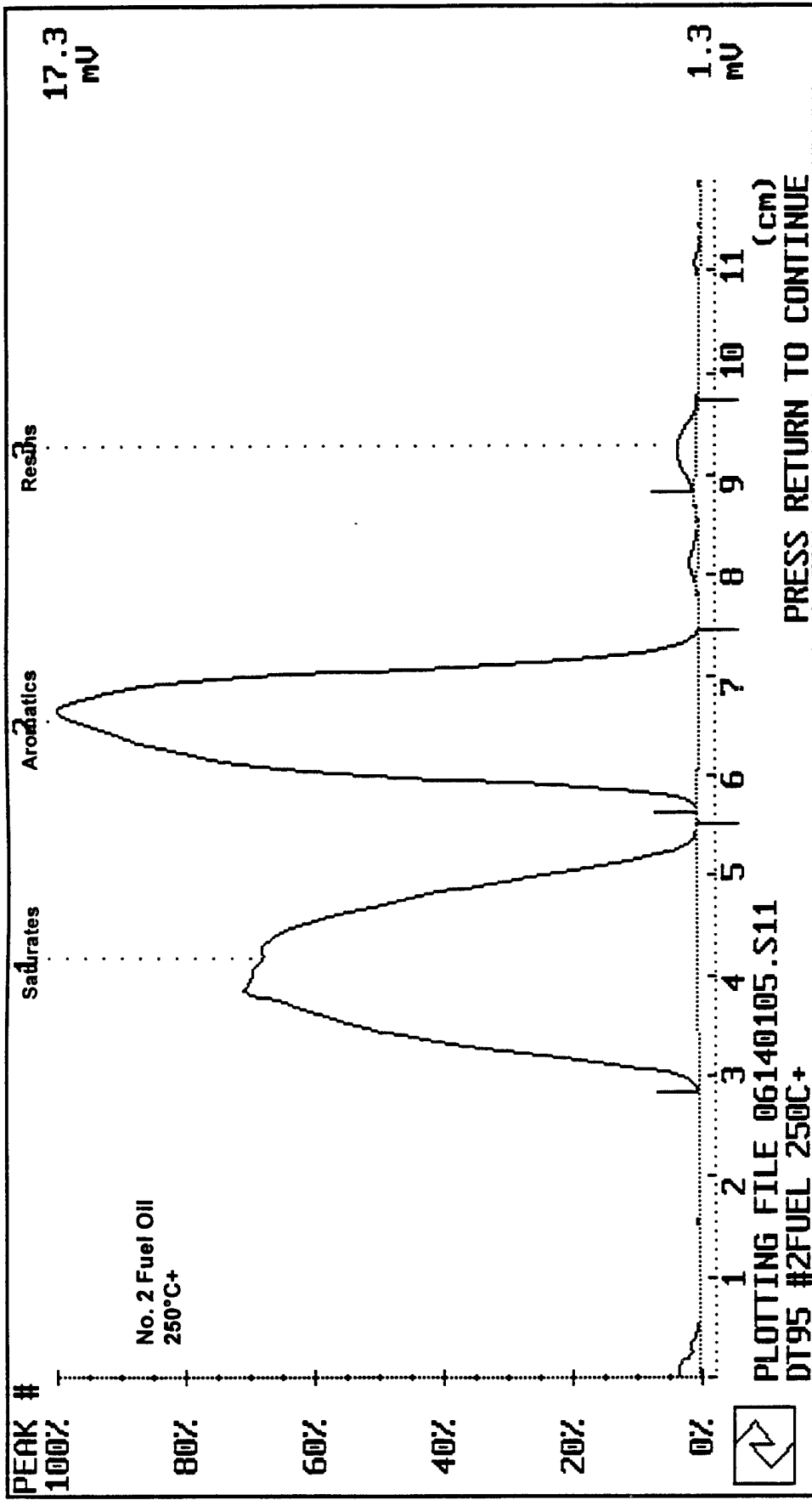

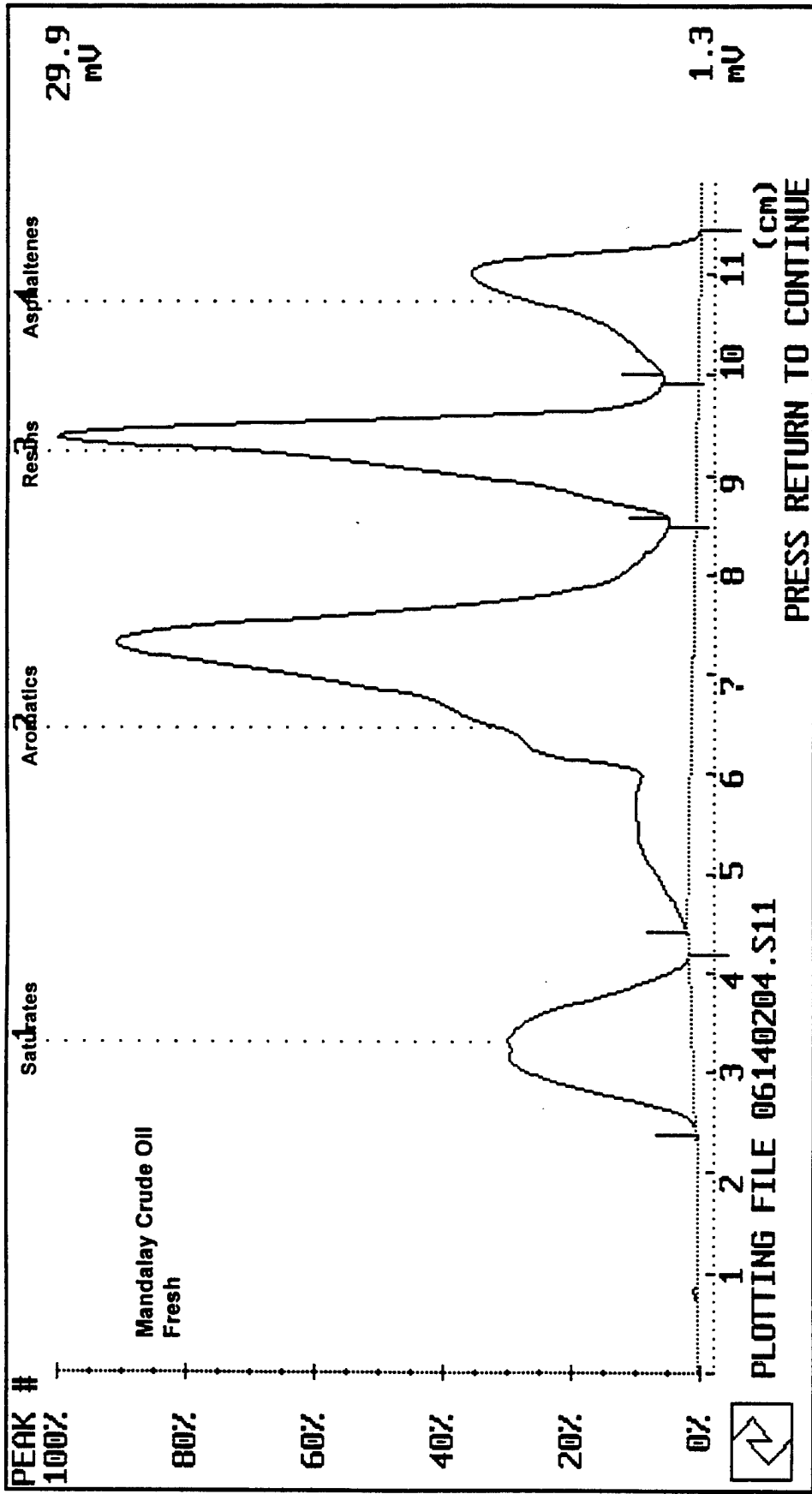

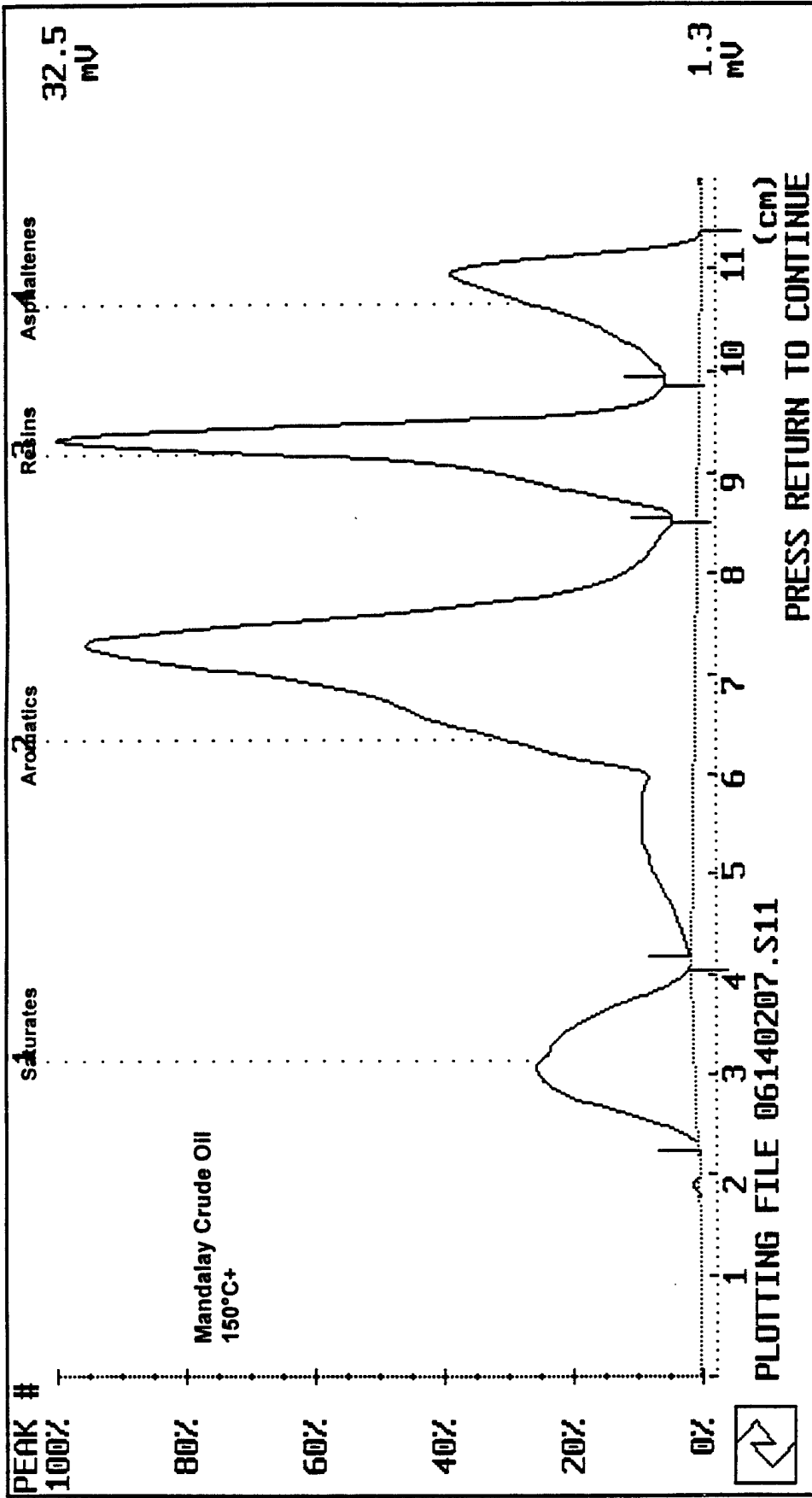



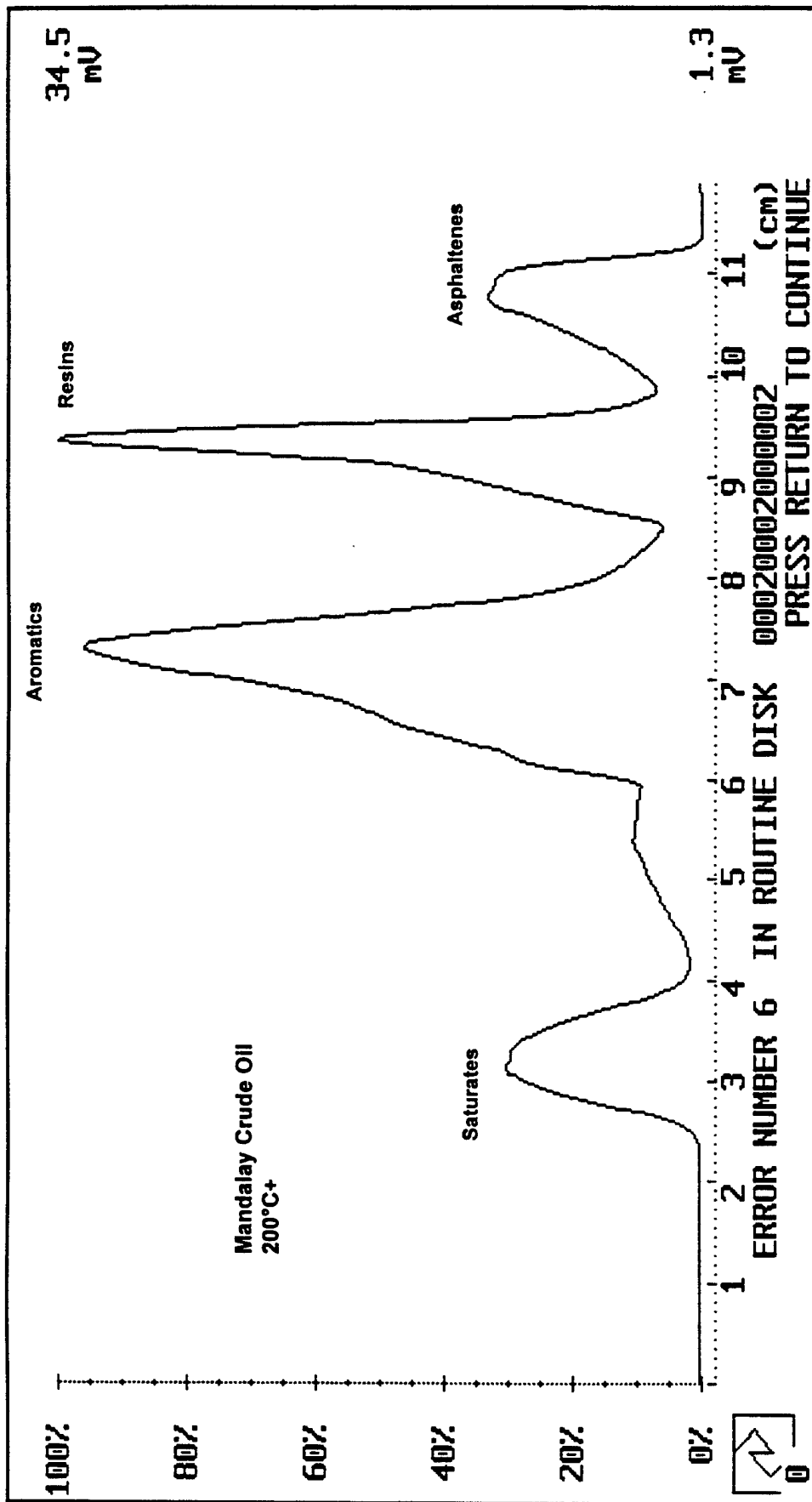

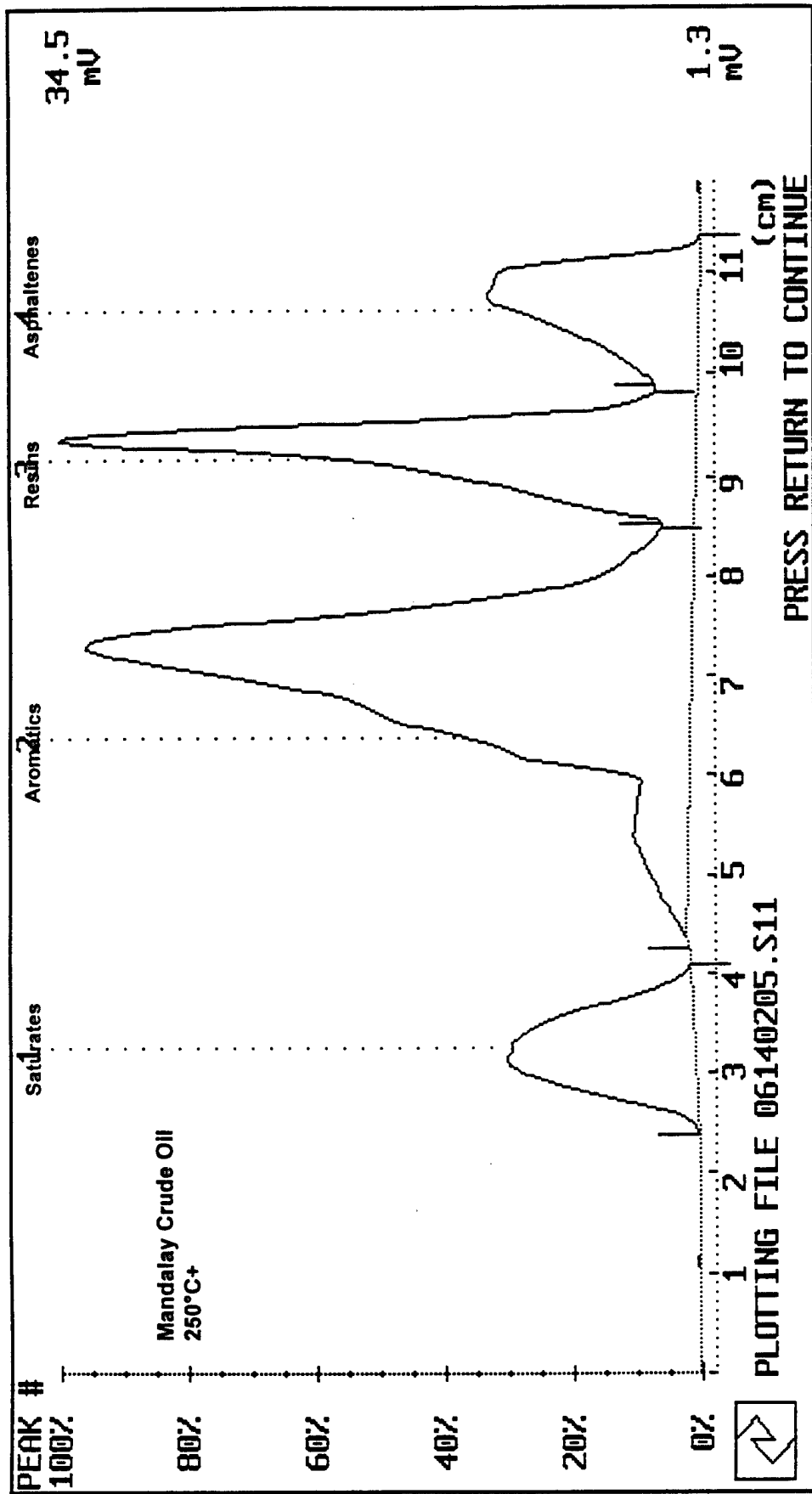

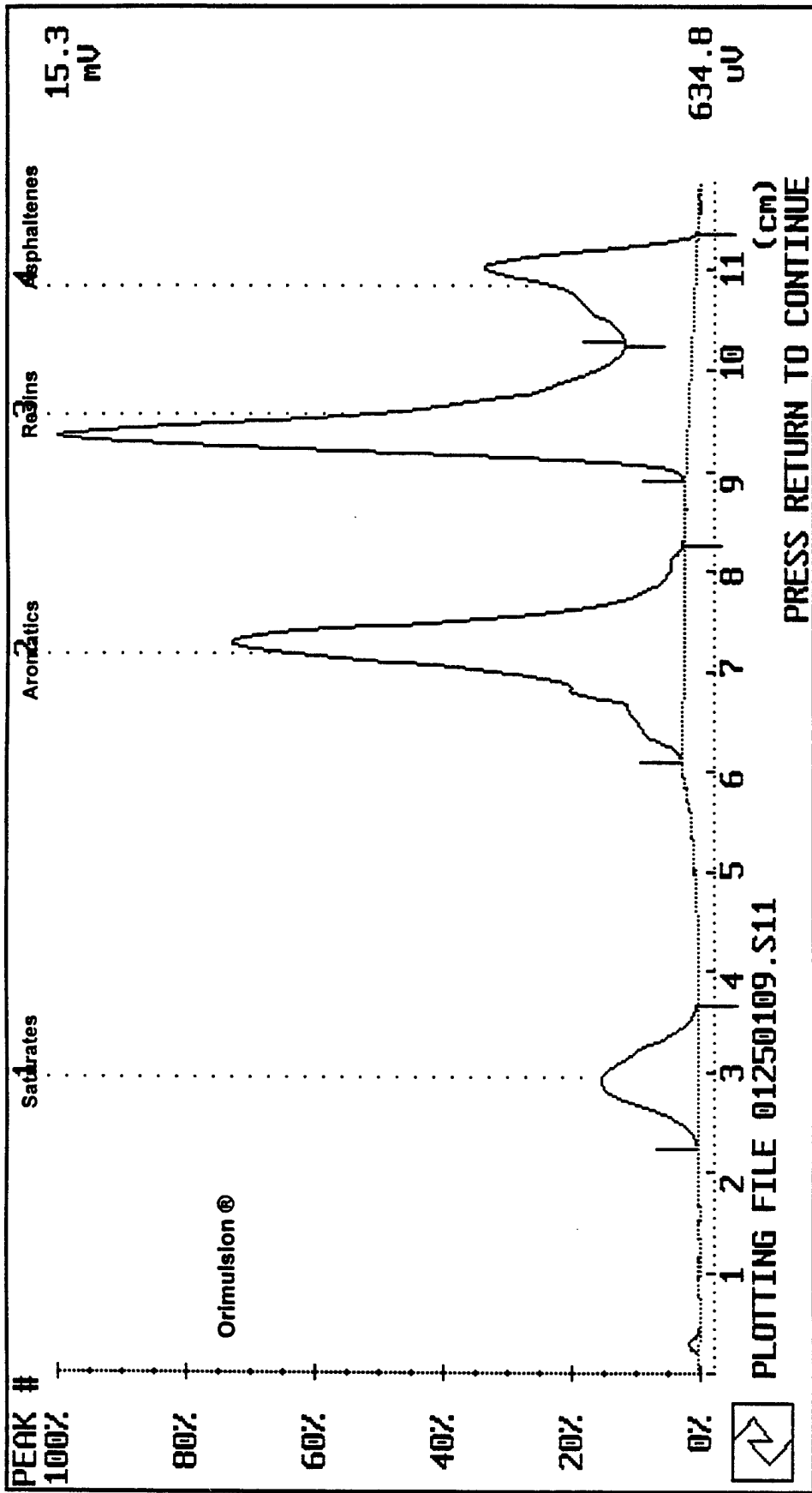

**SOURCE IDENTIFICATION OF OIL SPILLS BASED ON THE ISOTOPIC  
COMPOSITION OF INDIVIDUAL COMPONENTS IN WEATHERED OIL SAMPLES**

*R.P. Philp, L. Mansuy, and J. Allen, University of Oklahoma*

# Source identification of oil spills based on the isotopic composition of individual components in weathered oil samples.

Laurence Mansuy, R. Paul Philp, Jon Allen

School of Geology and Geophysics, The University of Oklahoma, Norman, OK 73019, USA.

## **Abstract**

Gas chromatography-mass spectrometry (GC-MS) analysis is now extensively used for the characterization of the oils spilled in the environment. The correlation between the pollutant and its suspected source is undertaken on the basis of the analysis of saturated and aromatic hydrocarbons and more specifically of biomarkers fingerprints. But this analytical approach still remains difficult and sometimes unsuccessful since an oil spilled in the environment is quickly affected by the weathering processes and loses its characteristics. The evaporation occurs in the first hours after a spill and will remove the more volatile hydrocarbons. Then water-washing occurs removing the more water-soluble hydrocarbons. At the same time, biodegradation will also severely affect the nature of the spilled oil. According to the extent of biodegradation, an oil can partially or totally lose its n-paraffins, branched paraffins and single-ring naphthenes and some biomarkers for severe biodegradation. These weathering processes can strongly modify the profiles or the parameters used to correlate an oil to its source on the basis of GC-MS analysis.

The carbon isotopic composition of individual compounds as determined by gas chromatography-isotope ratio mass spectrometry (GC-IRMS) can provide additional evidence for the correlation of a pollutant to its suspected source. This paper demonstrates that the isotopic composition of individual components of an oil is not affected by artificial as well as natural weathering processes and thus can be used as a discriminative and selective parameter. Moreover, a new approach for the correlation of severely biodegraded oils is proposed. Since pyrolysis of asphaltenes of severely biodegraded oil can regenerate an hydrocarbon fingerprint quite similar to the original, non-biodegraded sample, it is proposed to use the isotopic composition of the n-alkene/n-alkane doublets of the pyrolysis products as correlation parameters. This method has been successfully applied to severely artificially and naturally biodegraded samples.

## Introduction

There have been many studies concerned with hydrocarbon pollutants in aquatic environments (rivers, lakes, groundwaters, coastal waters...) in recent years (1-5). The sources of these contaminants are numerous: natural seepages of crude oils; ship traffic; supertankers spilling crude oils; leaking storage tanks or pipelines. Thus, identifying, quantifying and monitoring the fate of these pollutants spilled in the environment are of primary importance in providing a better response to an hydrocarbon spill.

The most common approach to the characterization of a spilled oil and the identification of its potential source relies on the gas chromatography (GC) and gas chromatography-mass spectrometry (GC-MS) analyses. The correlation between the pollutant and its suspected source is undertaken on the basis of the molecular distribution of saturate and aromatic hydrocarbons and more specifically of biomarkers fingerprints (6). However results from GC and GC-MS approaches still can be ambiguous and sometimes unsuccessful since an oil released in the environment is quickly affected by weathering processes, such evaporation, photooxidation, water washing, biodegradation (7-10). Evaporation occurs in the first few hours after a spill and removes the more volatile hydrocarbons. Water-washing also occurs rapidly and removes the more water-soluble hydrocarbons, typically hydrocarbons below C<sub>15</sub>, and some of the C<sub>15</sub>+ aromatic compounds which are more water-soluble than paraffins (9-11). At the same time, biodegradation will also start to affect the nature of the spilled oil. An oil will initially lose its low carbon number *n*-paraffins, followed by branched paraffins and single-ring naphthenes. Severe biodegradation is marked by the loss of some of the biomarkers (C<sub>27</sub>-C<sub>29</sub> steranes) and the demethylation of some others (C<sub>27</sub>-C<sub>35</sub> hopanes) (10). The combined effects of these weathering processes strongly modify the fingerprint and parameters used to correlate an oil with its source on the basis of GC-MS analysis. In the case of gasolines and other refined products, evaporation and water-washing will lead to the loss of the lower molecular weight compounds and make it extremely difficult to undertake correlations.

Correlation of a spilled oil to its suspected source requires other discriminative parameters that are relatively insensitive to weathering processes. Bulk carbon isotopic compositions of oils or fractions of these oils (aromatic, saturate, asphaltene) have been used to determine the potential source of hydrocarbon

pollutions or to discriminate different origins for these pollutants (1,2,12,13). However, carbon isotopic ratios of the different fractions of an oil can be affected by weathering processes. In a 42-day simulated oil biodegradation study, Stahl (14) demonstrated that the isotopic ratio of the saturates increased (+0.5‰) whereas the isotopic ratio of the aromatic fraction remained constant and that of the asphaltenes decreased slightly. In their study of a spilled oil in Texas, Macko *et al.* (1) observed an enrichment in  $^{13}\text{C}$  of the saturate fraction (+0.35‰) from the day of the spill and a depletion in  $^{13}\text{C}$  of the aromatic fraction (-0.54‰). Palmer (15) observed a decrease of the  $^{13}\text{C}/^{12}\text{C}$  ratio of the saturates (2‰) and very little change of the ratio of the aromatics (less than 0.5‰) with natural water washing and biodegradation of an oil in a reservoir. Sofer (16) analyzed two groups of naturally biodegraded marine oils and found that their isotopic composition was typically heavier than the non-degraded oil : +2‰ for the saturate fraction and +1‰ for the aromatic fraction. These various isotopic fractionations can be understood by the selective removal of certain classes of compounds induced by the weathering processes. Water washing preferentially removes the mono- and di-aromatics that are more enriched in  $^{13}\text{C}$  thus leaving an aromatic fraction depleted in  $^{13}\text{C}$  (16). Biodegradation removes the *n*-alkanes inducing a relative enrichment in iso- and cycloalkanes that are enriched in  $^{13}\text{C}$ . Thus, it appears that more accurate correlations between hydrocarbon pollutants and their potential source could be obtained by determining and comparing isotopic compositions on a molecular level.

It is now possible to determine the isotopic composition of individual compounds with the development in the last few years of combined gas chromatography-isotope ratio mass spectrometry (GC-IRMS) (17). This technique is widely used in petroleum exploration but has not been extensively applied to environmental problems. Borcham *et al.* (18) investigated the effects of moderate biodegradation on the isotopic composition of Australian crude oils and only observed an enrichment in  $^{13}\text{C}$  of the *n*-alkanes (+0.5‰) in the *n*C<sub>10</sub>-*n*C<sub>13</sub> range. As part of a study apportioning PAH sources, O'Malley *et al.* (19) showed that the isotopic composition of individual aromatic compounds was not affected by artificial

biodegradation and photolytic decomposition. A few studies have used this new technique to elucidate the origin of various hydrocarbon products found in the aquatic environment (20-21).

The aim of this paper is to assess the utilization of GC-IRMS for correlation of hydrocarbons spilled in an aquatic environment with its suspected source. The study focuses on two main aspects of this problem: (i) the determination of the effects of artificial as well as natural weathering processes on the isotopic composition of individual *n*-alkanes and in what way it could compromise the correlation of a weathered oil to its non-degraded counterpart; (ii) the evaluation of possibilities and limitations of GC-IRMS as a correlation tool in environmental problems. A method for the correlation of severely biodegraded oils is also proposed.

## **Experimental section**

### **Samples**

A number of different samples from various origins were analyzed in this study. A crude oil from Oklahoma was used for the artificial weathering experiments and a variety of samples were obtained from the U.S. Coast Guard including crude oils and light fuel oils (refined products). These samples were naturally weathered to different extents from slightly to moderately weathered and came with their respective unweathered counterparts. In addition, five severely weathered crude oils in the form of beach stranded tar balls were also examined as part of this study.

### **Weathering experiments**

The three main weathering processes were artificially reproduced in the laboratory using the same Oklahoman crude oil. One aliquot of the crude oil was allowed to evaporate for four years at room temperature. In the second experiment, an aliquot of the oil (100 ml) was combined with distilled water (800 ml) and stirred in a beaker for 2 months at room temperature in order to simulate water washing. Although not representative of natural conditions, distilled water was preferred to saline water and room temperature to colder water since it represents the optimal conditions for an efficient water washing (9).



Finally, an active sewage sludge was added to the crude oil in a sand and water environment. Aliquots of the biodegraded oil were taken at regular intervals so that the main stages of biodegradation could be studied.

#### **Sample preparation and analysis**

Most of the samples, except the refined products such as light fuel oils, were characterized using the same analytical protocol: (i) precipitation of the asphaltenes in pentane; (ii) fractionation of the maltene fraction into saturates, aromatics and NSOs compounds by HPLC; (iii) when necessary, isolation of the *n*-alkanes by urea adduction of the saturate fraction and recovery of the urea-adducted fraction (*n*-alkanes) by dissolution of the urea in distilled water and extraction of the *n*-alkanes using pentane.

#### **Gas Chromatography-Isotope Ratio Mass Spectrometry**

GC-IRMS analyses were performed using a Varian 3400 gas chromatograph coupled with a Finnigan MAT 252 Isotope Ratio Mass Spectrometer via a combustion furnace heated at 1050°C and a water trap. The samples were injected onto a DB-1 fused silica capillary column (60m; 0.32mm i.d.; 0.25mm film thickness) and chromatographed with the following temperature program : 40°C for 10 min to 310°C at 2°C/min with a hold of 20 min.

For some samples, the stable carbon isotope composition of the asphaltene, saturate and aromatic fractions were determined as described by Engel and Maynard (22).

#### **Reproducibility and accuracy**

The accuracy and the reproducibility obtained in the determination of the isotopic values of individual compounds are mainly affected by the chromatographic resolution (coeluting compounds) and the background defined by the column bleed as well as by the sample itself (unresolved complex mixture). The accuracy of the data provided by the instrument is monitored in several places during the analyses. Before starting the analyses of a set of standard compounds of know isotopic composition is injected in order to monitor the performance of the combustion reactor. The addition of internal standards (fully

deuterated *n*-alkanes C<sub>9</sub>, C<sub>10</sub>, C<sub>16</sub>, C<sub>19</sub>, C<sub>24</sub>, C<sub>32</sub> and C<sub>36</sub>) to the samples being analyzed allows a second control of the quality of the data. Coelutions and high background are the main problems encountered in GC-IRMS analysis and the presence of standards can help in the assessment of the data reprocessing (background subtraction). Each sample is analyzed at least two times. The data are then reprocessed by subtracting an adequate background and by redefining the start and end of the peak to be integrated when necessary. Standard deviations ( $1\sigma$ ) of the replicates are then calculated for each *n*-alkanes in order to estimate the reproducibility. The analysis of a saturate fraction gives an average reproducibility from 0.15 to 0.32‰. The reproducibility decreases with the analysis of more complex mixtures such as whole oils where the presence of aromatics increases the chance of coelution, saturate fractions of biodegraded oils where the presence of an unresolved complex mixture (UCM) can affect the measure of the isotopic composition of the *n*-alkanes. To improve the reproducibility and the accuracy of the data, the *n*-alkanes were isolated by urea adduction when it was required (i.e. moderately biodegraded oils). The accuracy of the measurements is defined by comparing the  $\delta^{13}\text{C}$  values of the deuterated compounds in the analyzed samples to the  $\delta^{13}\text{C}$  of the same compounds as determined by IRMS analysis. The isotopic values obtained from the GC-IRMS analysis are systematically heavier than the values obtained by simple IRMS analysis from 0.09 to 0.81‰ mainly because of coelutions and high background. However, as long as the reproducibility is good, this does not affect the quality of the results in this type of application where the data are being used predominantly for correlation purposes. These results are consistent with the accuracy and the reproducibility obtained in previous studies of similar samples (23,24).

### Results and discussion

The discriminative nature of the isotopic compositions of individual *n*-alkanes in crude oils is illustrated in Figure 1 and Table 1. Three oils shown here can be clearly differentiated from each other : U8-106-1 of unknown origin, a Paris Basin oil and a Middle East oil. The averaged standard deviations calculated between these three oils are higher than 0.55‰ which is out of the range of the analytical error.

The oils from Oklahoma and the Mahakam Delta show quite similar isotopic compositions. The averaged standard deviation calculated for these two samples is within the range of the analytical error (0.15 to 0.32‰) but these close values are observed in a narrow range of *n*-alkanes (C<sub>18</sub>-C<sub>30</sub>) and the isotopic compositions of the light and heavy ends are quite different. However, this illustrates the need to always combine GC-IRMS analyses with conventional analytical correlation techniques such as GC and GC-MS.

The second step of this study was to determine if weathering processes can compromise correlations between pollutants and suspected sources. The artificially weathered samples were analyzed by GC and GC-IRMS and the results compared to those of the initial oil. The initial oil shows a chromatogram largely dominated by the *n*-alkanes of low molecular weight maximizing around *n*-C<sub>12</sub> (Figure 2a). The evaporation process is marked by the depletion of *n*-alkanes with carbon numbers lower than 14 (Figure 2b) and as expected, the water-washed oil (after 38 days) is depleted in *n*-alkanes with carbon numbers < 15 (Figure 2c). The iso- and cyclo-alkanes eluting before the *n*-C<sub>15</sub> have also been partially or completely removed (Figure 2c). The aromatic fraction is more affected by the water-washing because of the higher solubility of this class of compounds in water. These experimental results are consistent with those described in the literature (9). After 1 month, the biodegraded oil is depleted in low molecular weight *n*-alkanes but the C<sub>17</sub>/pristane and C<sub>18</sub>/phytane ratios are not affected by the biodegradation (Figure 2d). After 2 months of biodegradation (Figure 2e), the *n*-alkanes are deeply affected by the process and their contribution relative to that of the unresolved compounds is severely lowered. The C<sub>17</sub>/pristane and C<sub>18</sub>/phytane ratios have increased because of the relative concentration in iso- and cyclo-alkanes. After four months, the *n*-alkanes have been completely removed and only a few iso-, cyclo-alkanes and some biomarkers can still be identified (Figure 2f).

The isotopic composition of the individual *n*-alkanes of the four artificially weathered oils were measured and compared to those of the initial oil (Figure 3). Despite the partial loss of *n*-alkanes with carbon numbers <15, the results show a good correlation between the evaporated, water-washed and unweathered oils (Figure 3ab) and the standard deviation between the isotopic values of the weathered and unweathered oils remains within the range of reproducibility except for a few peaks affected by a high

background or coelutions (deviations of 0.24‰ between the water-washed and the initial oils and 0.29‰ between the evaporated and the initial oils). The biodegraded oil after 1 month shows an isotopic composition slightly enriched in  $^{13}\text{C}$  (Figure 3c) compared to the initial oil and the standard deviation relative to the initial oil is slightly higher (0.41‰). This is attributed more to the high background resulting from the UCM induced by the biodegradation rather than an isotopic fractionation resulting from the biodegradation. In order to remove of the UCM and of most of the coelution problems, the saturate fraction of the oil biodegraded for 2 months and the initial oil were fractionated into linear and branched/cyclic alkanes and only the linear fractions were analyzed by GC-IRMS. The isotopic values of the linear fractions of the biodegraded and initial oils show a very close correlation (averaged standard deviation of 0.32‰). The lack of *n*-alkanes in the oil biodegraded for four months prevented any GC-IRMS analysis of the saturate fraction. The bulk isotopic compositions of the saturate and aromatic fractions of the weathered and unweathered oils were also determined and showed that the values remain fairly constant for evaporation and water-washing processes. However, a slight enrichment in  $^{12}\text{C}$  of the saturate fraction is observed with increasing degrees of biodegradation (Table 2). The results of these experiments demonstrate that weathering does not affect the isotopic composition of individual components of an oil that are still resolvable in the chromatogram.

Despite the increased specificity, the GC-IRMS technique still suffers from a number of problems and limitations related to the correlation of moderate to severely biodegraded oils. The approach is most effective when applied in the presence of *n*-alkanes and a reduced background. In view of these limitations and the fact that in the case of severely biodegraded oils the *n*-alkanes will have been removed, leading a significant UCM, an alternative method has been investigated for the characterization of such samples. Asphaltenes, the heavy molecular weight fraction of a crude oil, have a similar but less condensed structure than the kerogen from which they originate (25,26). Moreover, these studies have shown that the aliphatic moieties bound into the asphaltene structures are not altered by the biodegradation processes. Thus, hydrocarbons generated by pyrolysis of asphaltenes from a biodegraded oil have a fingerprint quite similar to the original oil and hence these fingerprints can be used for correlation purposes of biodegraded

and non biodegraded oils. However, the method is not specific enough to allow precise correlations in all cases and furthermore too few biomarkers are generated by the flash-pyrolysis of asphaltenes and the correlation are mainly undertaken on the only basis of the distribution of the *n*-alkene/*n*-alkane doublets. Previous studies successfully demonstrated the use of bulk isotopic composition of asphaltenes as a correlation parameter for severely weathered oils (1,13). Hartman (13) did not see any change in the isotopic composition of these compounds although Stahl (14) observed a slight <sup>12</sup>C enrichment with increasing artificial biodegradation. Considering that the pyrolysis of asphaltenes is able to regenerate individual compounds and that these components are not altered by the production, the analysis of the pyrolysis products by GC-IRMS should provide additional data particularly useful for the correlation of severely biodegraded oils.

Off-line pyrolysis of asphaltenes was performed as described elsewhere (27) and the pyrolysates collected, fractionated into saturates + unsaturates, aromatics and NSO fractions. The saturate + unsaturate fraction containing the *n*-alkene/*n*-alkane doublets, typical of the products of flash pyrolysis, was subsequently analyzed by GC-IRMS. This approach was applied initially to the asphaltenes from the oils that were artificially biodegraded for 2 and 4 months. The pyrograms of the two biodegraded oils are similar to that of the initial oil with a predominance of the light ends, maximizing at C<sub>15</sub>-C<sub>17</sub> (Figure 4). However, the two biodegraded samples show a higher contribution of *n*-alkanes around C<sub>28</sub> and C<sub>38</sub> whereas this contribution is very low in the asphaltenes of the initial oil. The correlation of these oils solely on the basis of the pyrograms of the asphaltenes would be extremely difficult. However, analyses of these fractions by GC-IRMS showed the isotopic compositions of individual *n*-alkanes of these three fractions (Figure 5) to be quite similar with standard deviations calculated between the biodegraded oils and the initial oil ranging between 0.43 and 0.48‰. These correlations are quite good considering the complexity of the analyzed mixtures. The *n*-alkene/*n*-alkane doublets and the high background (Figure 4) increase the chance of coelutions and affect the reproducibility of the analyses which ranges between 0.33 and 0.40‰. The isotopic composition of the *n*-alkanes generated by the asphaltene pyrolysis is very close to the isotopic composition of the *n*-alkanes of their respective oils and of the initial oil. These results

confirm the ability of GCIRMS and the asphaltene pyrolysates to correlate severely biodegraded oils with their unweathered counterparts with an analytical error still acceptable despite the chromatographic problems encountered during the analyses of such complex mixtures.

In order to extend the assessment of GC-IRMS as a technique for correlating degraded and non degraded oils, four sets of weathered and unweathered oils provided by the U.S. Coast Guard were analyzed by GC-IRMS. Three of them were light fuel oils and their slightly weathered counterparts and the fourth set, W8-106 and U8-106, were crude oils and with W8-106 being moderately biodegraded. The isotopic composition of the *n*-alkanes (Figure 6) along with the standard deviations calculated for each combination of oils (Table 3) easily permit correlation of the weathered oils with their unweathered counterparts with a high degree of confidence. Several significant differences were observed for the light fuel oils, U8-250/W8-250 and U8-049/W8-149, due to coelutions since these light fuel oils were not fractionated prior to the GC-IRMS analysis in order to preserve the light end of these oils. However, as can be seen in Figure 6, each oil has its own characteristic isotopic fingerprint. U8-106/W8-106 show the same irregularities related to the carbon number of the *n*-alkanes and the isotopic composition of the *n*-alkanes of the U8-113/W8-113 increase with carbon numbers.

A second set of samples also provided by the U.S. Coast Guard, involved two flocks of birds killed, and washed ashore, as a result of major oil spills. In an attempt to determine possible origins of the spilled oils, oil covered bird feathers were extracted, the extracted oils analysed by GC-IRMS, and the data compared to the corresponding suspected sources. GC and GC-MS analyses permitted several of the suspected sources to be discarded and eventually two oils were selected as the major suspects responsible for the birds death. Correlation of the two sets of oils (oils from the bird feathers and their respective suspected source) purely on the basis of GC and GC-MS were inconclusive. The first oil and bird feather extracts have the characteristics of a light fuel oil marked by the absence of biomarkers (Figure 7a and b). The oil collected from the bird feathers was weathered and light hydrocarbons had been lost by evaporation and water-washing. The oils were analyzed by GC-IRMS without any fractionation step prior to the analysis and the comparison of their isotopic values illustrated their similarity (Figure 7c). The

standard deviation calculated between the two samples (0.36‰) is close enough to the range of the reproducibility (0.21-0.26‰) to consider that these two light fuel oils are derived from the same source. In the second example, the oils have the characteristic of a weathered crude oil with a predominance of long chain *n*-alkanes (Figure 8a and b). The oil collected from the bird feathers contains organic "contaminants" tentatively identified as alcohols in lipids from the bird feathers. The significant UCM and complexity of the two samples led to their fractionation using urea adduction in order to isolate pure *n*-alkane fractions. Results from the GC-IRMS analyses (Figure 8c) showed a very good correlation between the oil extracted from the bird feathers and the suspected source with a standard deviation calculated between the two oils (0.23‰) being within the range of reproducibility (0.17-0.23‰). These results provided a high level of confidence suggesting similar origins for the oils found on the bird feathers and the suspected sources. These results illustrate that GC-IRMS approach can be particularly useful in determining the source of oils responsible for killing or injuring wildlife, particularly when used in conjunction with other techniques such as GC and GCMS.

Finally, in order to investigate the correlation potential of GCIRMS combined with asphaltenes pyrolysates, five severely biodegraded crude oils in the form of naturally occurring tar balls were studied in detail. The hydrocarbons from these tar balls have been characterized by high temperature gas chromatography and GC-MS. The saturate fractions are dominated by the long chain *n*-alkanes above C<sub>30</sub>. The tar balls 95M, 95H and 96 are severely biodegraded and most of the *n*-alkanes below C<sub>32</sub> have been removed. The two other samples (95F and 94F) are moderately biodegraded. On the basis of the biomarker fingerprints it appeared that 95H, 95M and 96 were derived from a similar source whereas, samples 95F and 94F appeared to be of a different origin. Further evidence for a relationship between samples 95H and 95M was obtained from the GCIRMS analyses of the saturate fractions of these two samples although this was somewhat ambiguous since the isotopic composition of the *n*-alkanes was defined on limited range of compounds (C<sub>32</sub> to C<sub>40</sub>) eluting in a region of the chromatogram marked by a high background. Moreover, the variations observed between the different samples were often higher than the range of the analytical error (1‰).

In an attempt to confirm the proposed correlations between these samples with a higher degree of precision, the asphaltenes of the five tar balls were isolated, pyrolyzed and the saturate fractions of the pyrolysis products analyzed by GC-IRMS. As observed previously, the reproducibility is affected by the complexity of the analyzed mixtures containing *n*-alkenes/*n*-alkanes doublets and is higher (0.16 to 0.40‰) than that obtained for the analysis of a simple saturate fraction. Dissimilarities between samples 94F and 95F can be observed in Figure 9b with 94F being isotopically lighter than the other samples by 1 to 3‰. 95F has an average isotopic composition quite similar to samples 95M, 95H and 96 (Figure 9a) but variations in the isotopic composition of *n*-alkanes and *n*-alkenes give to this sample a very characteristic fingerprint which distinguishes it from the three other samples. Furthermore it could also be distinguished by GCMS fingerprints. The standard deviations calculated for each combination of samples (Table 4) highlight possible similarities between samples 95H, 95M and 96 since the standard deviations between these range from 0.42 and 0.48‰ whereas the other values are higher than 0.6‰ demonstrating that the two other samples, 95F and 94F, are definitely different from each other and from the other group of samples.

In order to compare other correlation techniques, the bulk isotopic compositions of the asphaltenes of the five tar balls were also determined. On the basis of these only values (Table 5), the samples 95F, 95H and 96 show similar isotopic compositions ranging between -26.81 and -27.28‰ whereas the two other asphaltenes 94F and 95M have a very different isotopic composition. Thus, correlations based on only bulk isotopic compositions of the asphaltenes would have led to a very different and erroneous conclusion as to the relationship between the five tar balls. This can be explained by the fact that the bulk isotope values represent an average of all the individual components in the asphaltenes, some of which may have been affected by the weathering processes.

Although GC-IRMS analyses of the asphaltene pyrolysis products remains a complicated task and increases the analytical error because of the complexity of products, the discriminative power of this combined approach for the correlation of heavy hydrocarbon products is greater than that of a simple bulk isotopic analysis.



With the examples described in this study, an attempt has been made to demonstrate the potential of GC-IRMS as a powerful tool for the correlation of weathered and unweathered oils and refined hydrocarbon products spilled in the environment. The absence of biomarkers and the weathering that removes the light ends of the oils prevent any successful correlation of refined products using conventional techniques such as GC and GC-MS. The absence of *n*-alkanes, selective removal of some classes of compounds and possible modification of the biomarker ratios for severely biodegraded oils severely limit the ability to correlate these samples to their unweathered counterparts by using GC or GC-MS techniques. However, a combination of flash pyrolysis of asphaltenes and GC-IRMS can overcome many of these problems and allow accurate correlations. One could argue that, compared to bulk isotopic analysis, GC-IRMS provides poor reproducibility, especially when a complex mixture is analyzed. However, this limitation is largely balanced by the specificity and the quantity of information acquired from one GC-IRMS run. Whenever two oils show the same bulk carbon isotopic composition, GC-IRMS analysis of these oils may point out dissimilarities or similarities through a large range of isotopic compositions defined for each individual compound. Thus, the GC-IRMS analysis fulfills all the expected criteria for its application in the environmental field since it provides correlation parameters that are not affected by the weathering processes and that are very discriminative.

**Acknowledgments :** This work was supported in part by a grant of the US Coast Guard administrated through the U.S. Dept. of Transportation (USDOT-ID# 57-94-G-00079). The GC-IRMS system was purchased with grants from the NSF and DOE-BES University Instrumentation programs plus additional funds from the University of Oklahoma. We thank R. Maynard for his assistance with the stable carbon isotopes analyses.

#### Literature cited

- (1) Macko, S.A.; Parker, P.L.; Botello, A.V. *Environ. Poll. Bull.*, 1981, 2, 119-128.
- (2) Farran, A.; Grimalt, J.; Albaiges, J.; Botello, A.V.; Macko, S.E. *Mar. Poll. Bull.*, 1987, 18, 284-289.
- (3) Galt, J.A.; Lehr, W.J.; Payton, D.L. *Envlr. Sci. Technol.*, 1991, 25, 202-209.

- (4) Enganhouse, R.P.; Baedecker, M.J.; Cozzarelli, I.M.; Aiken, G.R.; Thorn, K.A.; Dorsey, T.F. *Appl. Geochem.*, 1993, 8, 551-567.
- (5) Oros, D.; Aboul-Kassim, T.A.; Simoneit, B.R.T.; Collier, R.C. *V Latin American Congress on organic geochemistry, Cancun, Mexico, Abstracts*, 1996, 330-332.
- (6) Wang, Z.; Fingas, M.; Sergy, G. *Envir. Sci. Technol.*, 1994, 28, 1733-1746.
- (7) Milner, C.W.D.; Rogers, M.A.; Evans, C.R. *J. Geochem. Explor.*, 1977, 7, 101-153.
- (8) Payne, J.R.; Phillips, C.R. *Environ. Sci. Technol.*, 1985, 19, 569-579.
- (9) Lafargue, E; Barker, C. *A.A.P.G. Bull.*, 1988, 72, 263-276.
- (10) Palmer, S.E. In *Organic Geochemistry*, 1993, eds M.H. Engel and S.E. Macko, Plenum Press, New-York.
- (11) Fuentes H.R., Jaffe R., Shrotiya R.V. *V Latin American Congress on organic geochemistry, Cancun, Mexico, Abstracts*, 1996, 310-312.
- (12) Macko, S.A.; Parker, P.L. *Mar. Environ. Research*, 1983, 10, 93-103.
- (13) Hartman, B.; Hammond, D. *Geochim. Cosmochim. Acta*, 1981, 45, 309-319.
- (14) Stahl, W.J. *Chem. Geol.*, 1977, 20, 121-149.
- (15) Palmer, S.E. *A.A.P.G. Bull.*, 1984, 68, 137-149.
- (16) Sofer, Z. *A.A.P.G. Bull.*, 1984, 68, 31-49.
- (17) Hayes, J.M.; Freeman, K.H., Popp, B.N.; Hoham, C.H. *Org. Geochem.*, 1990, 16, 1115-1128.
- (18) Boreham, C.J.; Dowling, L.M.; Murray, A.P. *Abstracts 17<sup>th</sup> Int. Meeting EAOG, San Sebastian, 1995* 539-541.
- (19) O'Malley, V.P.; Abrajano, T.O.; Hellou, J. *Org. Geochem.*, 1994, 21, 809-822.
- (20) Dowling, L.M.; Boreham, C.J.; Hope, J.M.; Murray, A.P.; Summons, R.E. *Org. Geochem.*, 1995, 23, 729-737.
- (21) O'Malley, V.P.; Abrajano, T.O.; Hellou, J. *Environ. Sci. Technol.*, 1996, 30, 634-639.
- (22) Engel, M.H.; Maynard, R.J. *Anal. Chem.*, 1989, 61, 1996-1998.
- (23) Bakel, A.J.; Ostrom, P.H.; Ostrom, N.E. *Org. Geochem.*, 1994, , 595-602.
- (24) O'Malley, V.P.; Abrajano, T.A.; Hellou, J. *Org. Geochem.*, 1994, 21, 809-822.
- (25) Behar, F.; Pelet, R. *J. Anal. Appl. Pyrol.*, 1984, 7, 121-135.
- (26) Bonnamy, S.; Oberlin, A.; Behar, F. *Org. Geochem.*, 1987, 11, 1-13.
- (27) Eglinton, T.I. *Org. Geochem.*, 1994, 21, 721-735.

**Table 1 : Standard deviations calculated for each combination of the five oils of different origins defined in Figure 1.**

**Table 2 : Bulk isotopic composition of the saturate and aromatic fractions of the artificially weathered oils.**

**Table 3 : Standard deviations calculated for each combination of the oils defined in Figure 6. The bold numbers highlight the best matches.**

**Table 4 : Standard deviations calculated for each combination of the tar balls. The bold numbers highlight the best matches.**

**Table 5 : Bulk isotopic composition of the asphaltenes of the five tar balls.**

Table 1

|             | U8-106-1 | Paris Basin | Middle East | Oklahoma | Mahakam |
|-------------|----------|-------------|-------------|----------|---------|
| U8-106-1    | 0        |             |             |          |         |
| Paris Basin | 3.85     | 0           |             |          |         |
| Middle East | 1.78     | 2.04        | 0           |          |         |
| Oklahoma    | 3.06     | 0.59        | 1.34        | 0        |         |
| Mahakam     | 3.41     | 0.71        | 1.34        | 0.31     | 0       |

Table 2

|                   | SATURATES | AROMATICS |
|-------------------|-----------|-----------|
| INITIAL           | -30.82    | -29.91    |
| WATER-WASHED      | -30.76    | -29.91    |
| EVAPORATED        | -30.75    | -29.82    |
| BIODEGRADED (2mo) | -30.67    | -29.90    |
| BIODEGRADED (4mo) | -30.59    | -29.93    |

Table 3

|        | U8-106 | W8-106 | U8-113 | W8-113 | U8-149 | W8-149 | U8-250 | W8-250 |
|--------|--------|--------|--------|--------|--------|--------|--------|--------|
| U8-106 | 0      |        |        |        |        |        |        |        |
| W8-106 | 0.27   | 0      |        |        |        |        |        |        |
| U8-113 | 1.23   | 1.18   | 0      |        |        |        |        |        |
| W8-113 | 1.23   | 1.15   | 0.18   | 0      |        |        |        |        |
| U8-149 | 1.03   | 0.88   | 0.61   | 0.65   | 0      |        |        |        |
| W8-149 | 1.11   | 1.08   | 0.57   | 0.63   | 0.34   | 0      |        |        |
| U8-250 | 2.28   | 2.21   | 0.42   | 0.45   | 1.72   | 1.54   | 0      |        |
| W8-250 | 2.43   | 2.40   | 0.68   | 0.73   | 1.62   | 1.51   | 0.44   | 0      |

Table 4

|     | 95F  | 95M  | 95H  | 94F  | 96 |
|-----|------|------|------|------|----|
| 95F | 0    |      |      |      |    |
| 95M | 0.69 | 0    |      |      |    |
| 95H | 0.64 | 0.42 | 0    |      |    |
| 94F | 1.65 | 1.14 | 1.28 | 0    |    |
| 96  | 0.67 | 0.45 | 0.48 | 1.29 | 0  |

Table 5

|     | $\delta^{13}\text{C}$ IRMS |
|-----|----------------------------|
| 95F | -26.97                     |
| 95M | -27.67                     |
| 95H | -26.81                     |
| 94F | -29.12                     |
| 96  | -27.28                     |

### **Captions**

**Figure 1 : Isotopic composition of the *n*-alkanes of five oils from different origins.**

**Figure 2 : Chromatograms of the saturate fraction of artificially weathered oils and the unweathered counterpart.**

**Figure 3 : Isotopic composition of the *n*-alkanes of the artificially weathered oils compared to the initial oil.**

**Figure 4 : Chromatograms of the saturate fractions of the asphaltenes pyrolyzates of the (a) initial oil and (b) the biodegraded oils after 2 months and (c) 4 months**

**Figure 5 : Isotopic composition of the *n*-alkenes/*n*-alkanes doublets of the asphaltenes pyrolyzates of the biodegraded oils compared to that of the initial oil.**

**Figure 6 : Isotopic composition of the *n*-alkanes of four pairs of weathered/unweathered oils. U = unweathered and W = weathered.**

**Figure 7 : Chromatograms of the oil collected on (a) the bird feathers and (b) its suspected source and (c) comparison of the isotopic composition of these two oils.**

**Figure 8 : Chromatograms of the oil collected from (a) the bird feathers and (b) its suspected source and (c) comparison of the isotopic composition of these two oils. The stars show the organic components identified on the bird feathers.**

**Figure 9 : Isotopic composition of the *n*-alkenes/*n*-alkanes doublets of the asphaltenes pyrolyzates of five tar balls.**

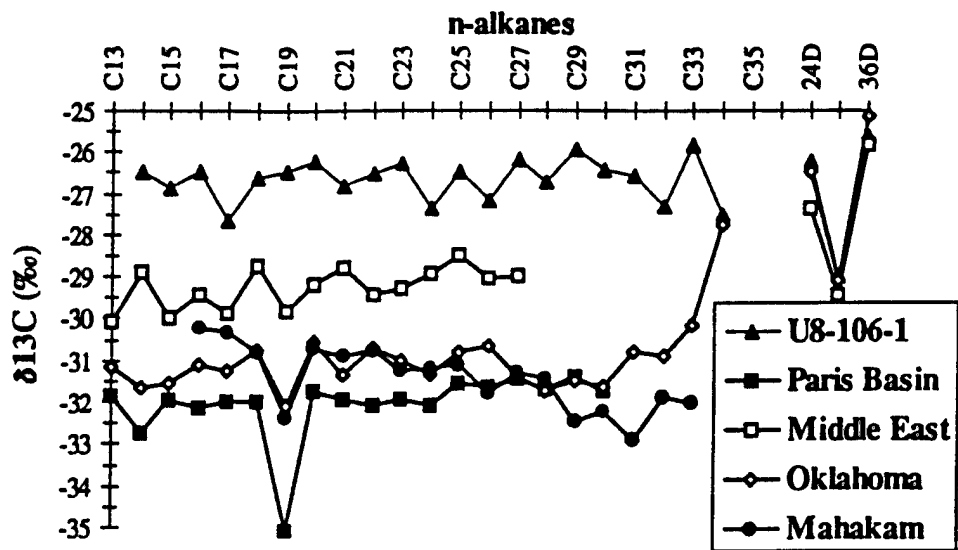

Figure 1

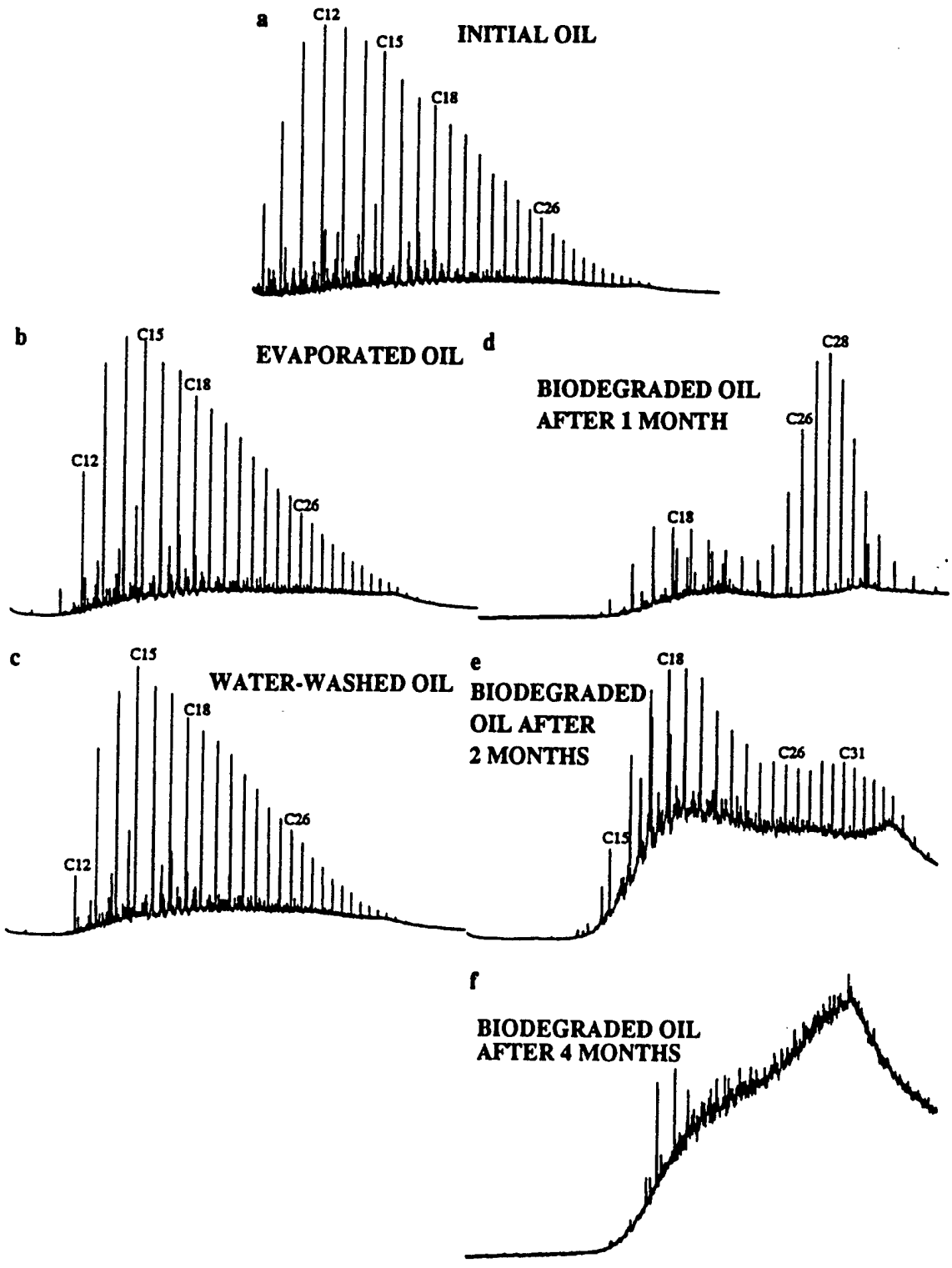

Figure 2

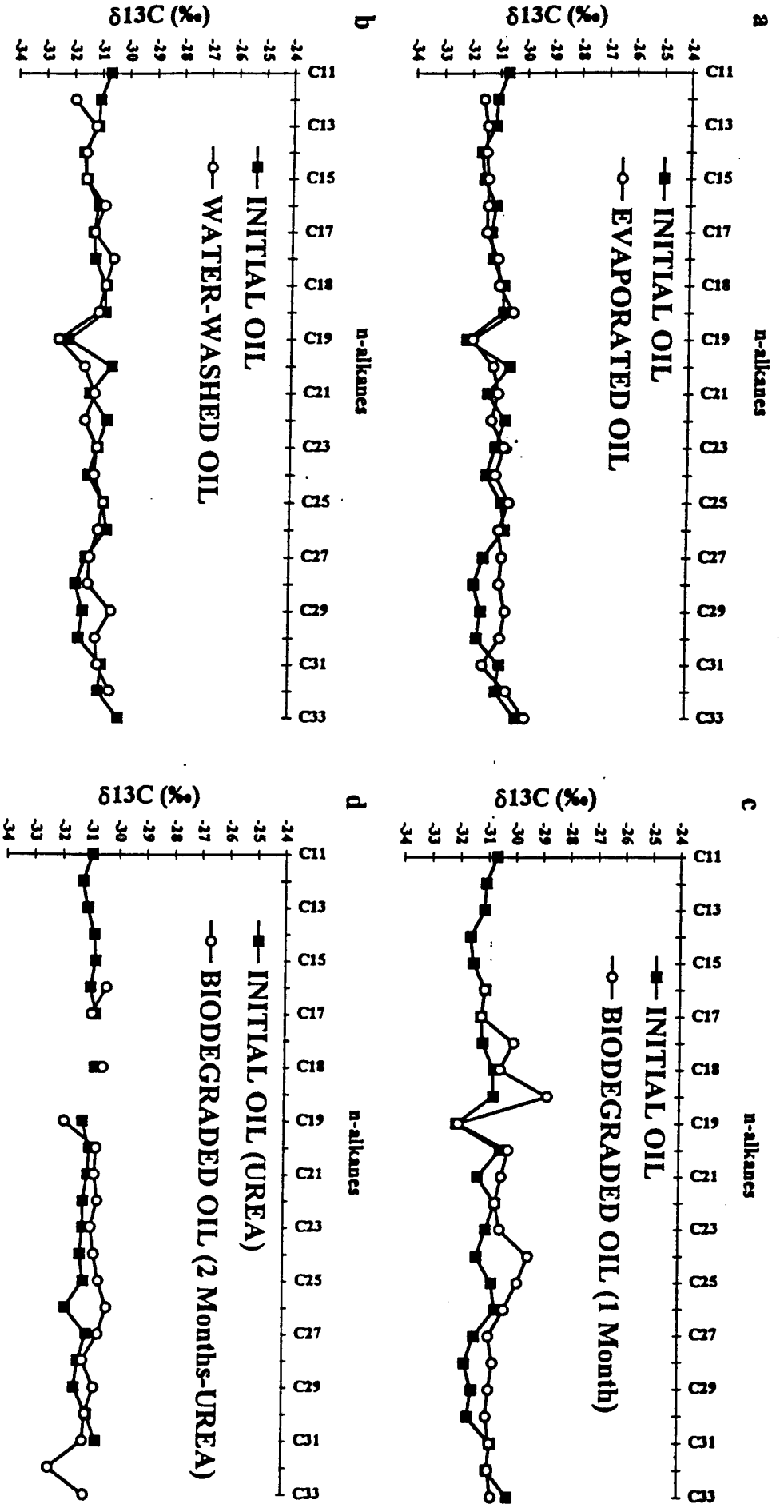

Figure 3



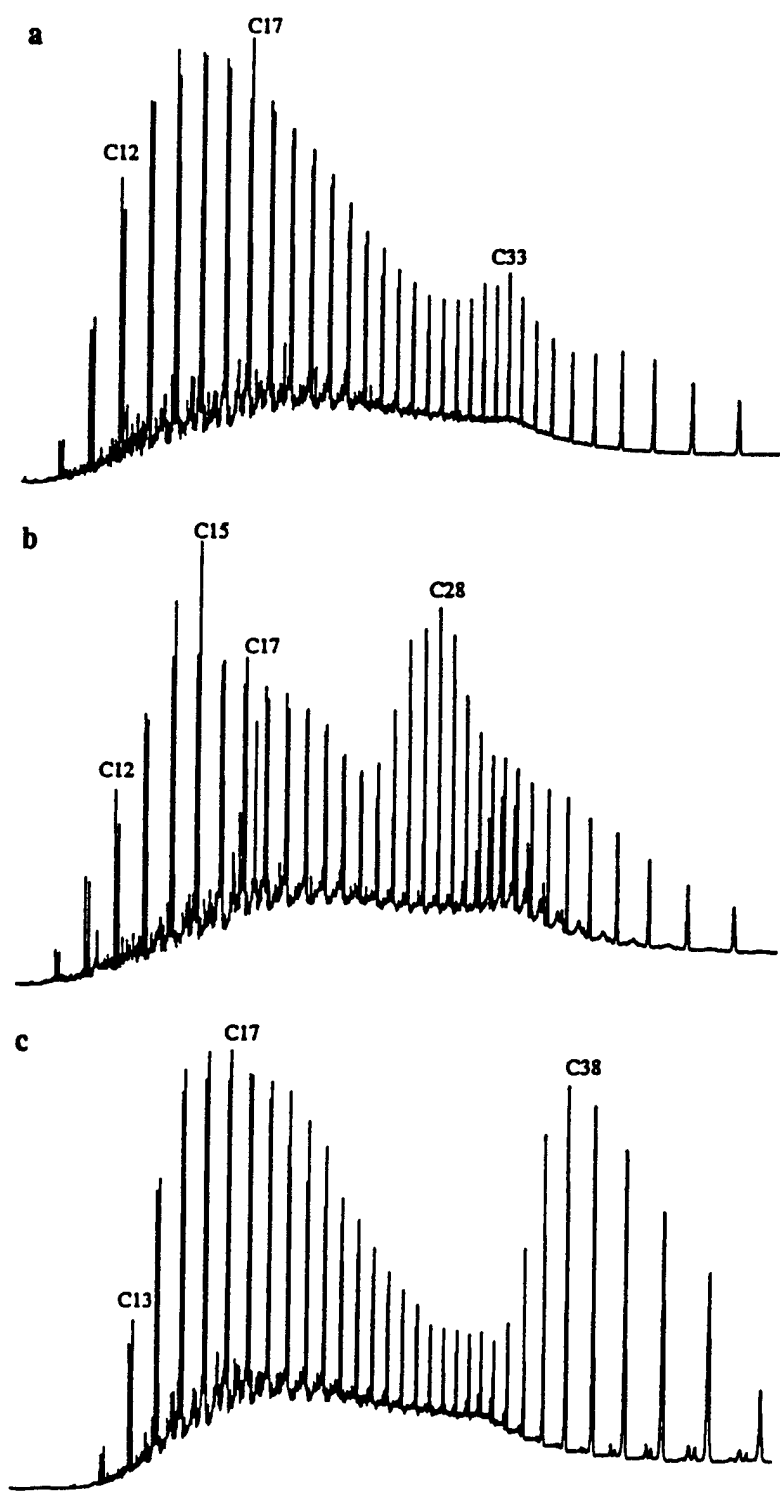

Figure 4

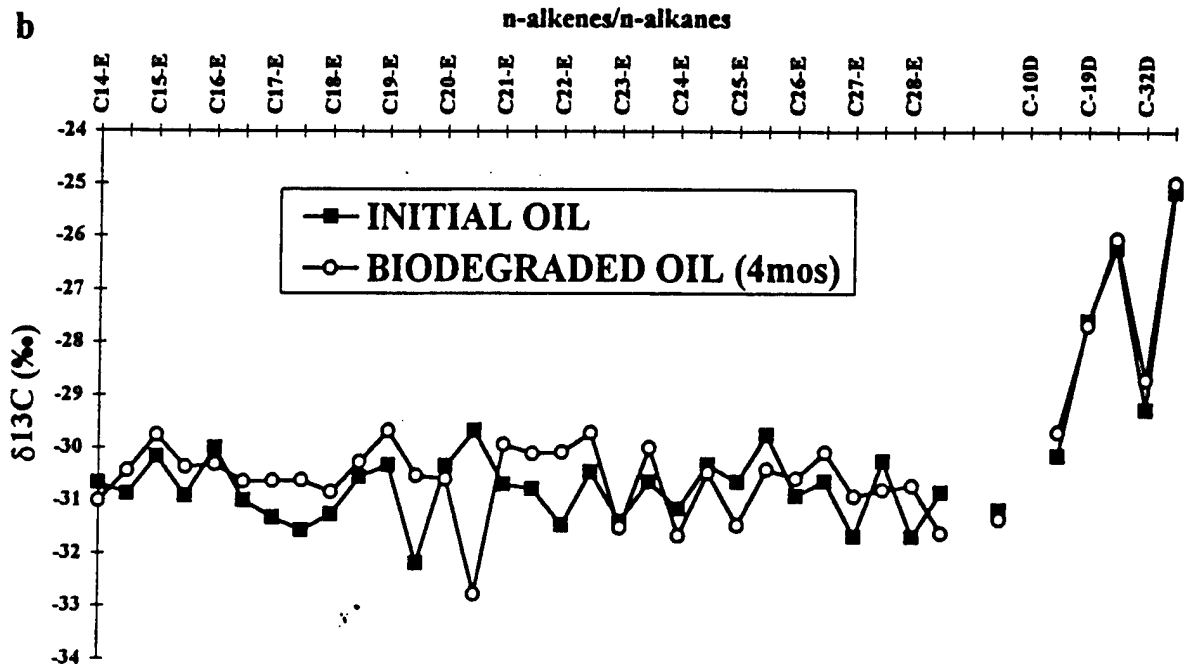
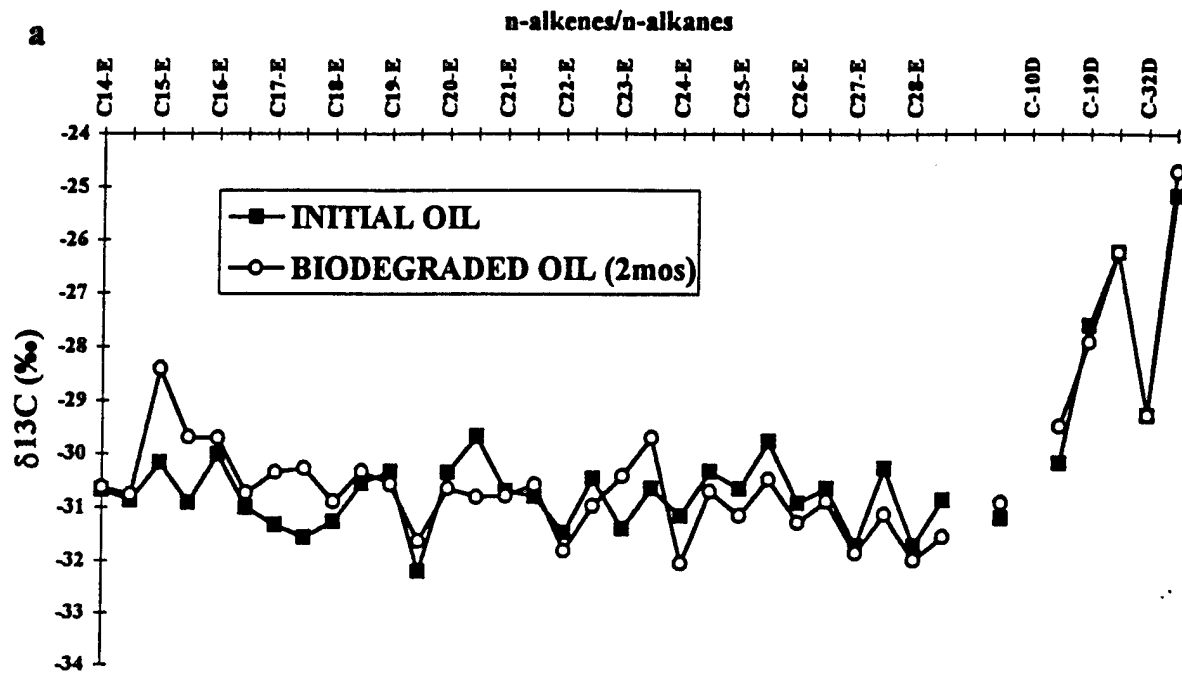

Figure 5

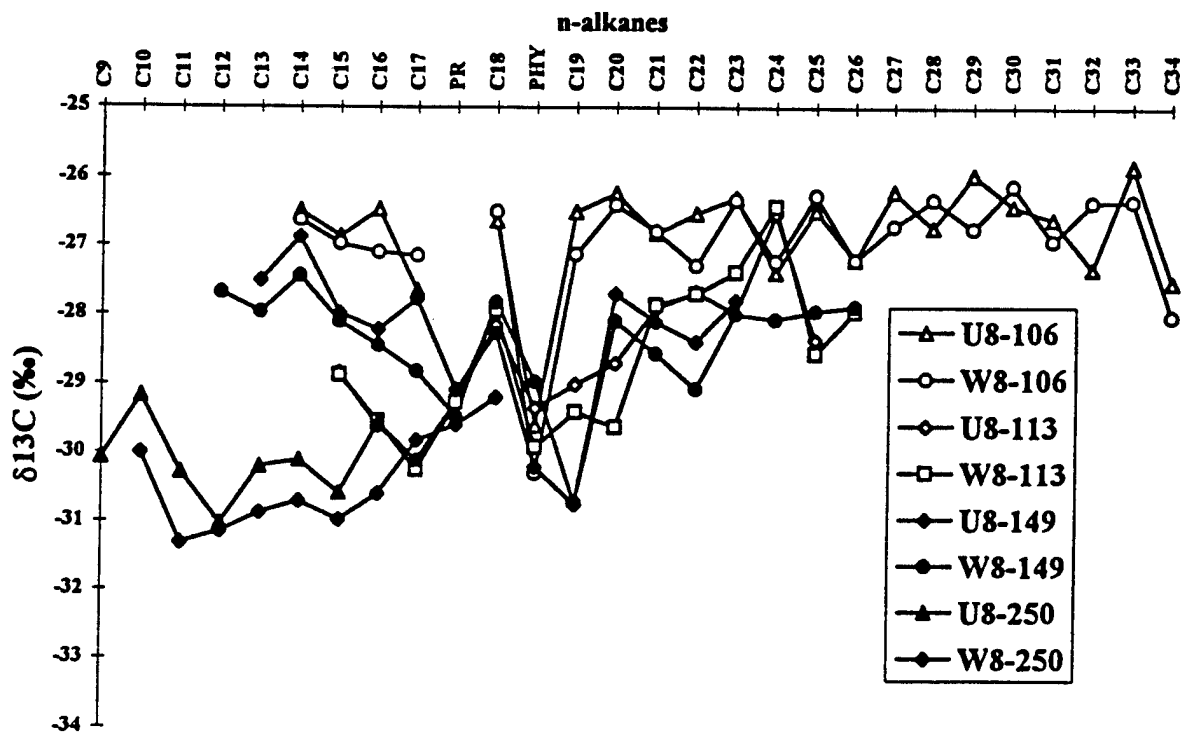
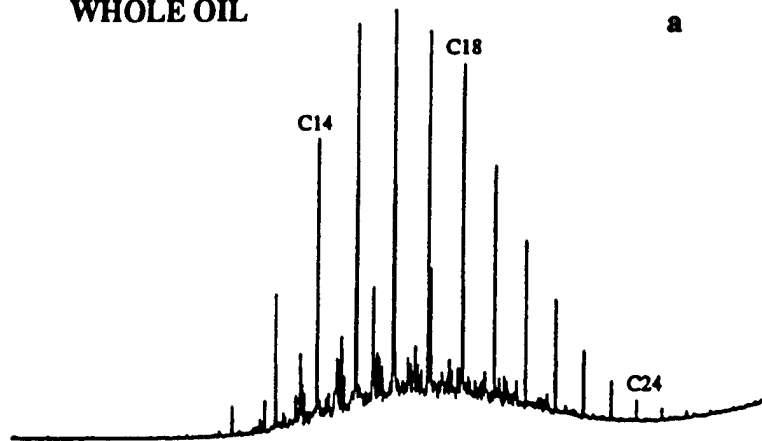

Figure 6

**OIL FROM BIRD FEATHERS  
WHOLE OIL**



**SUSPECTED SOURCE  
WHOLE OIL**

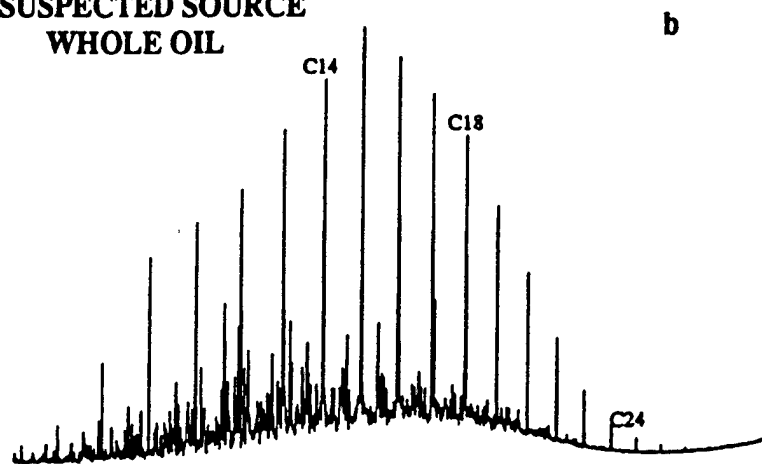

Figure 7

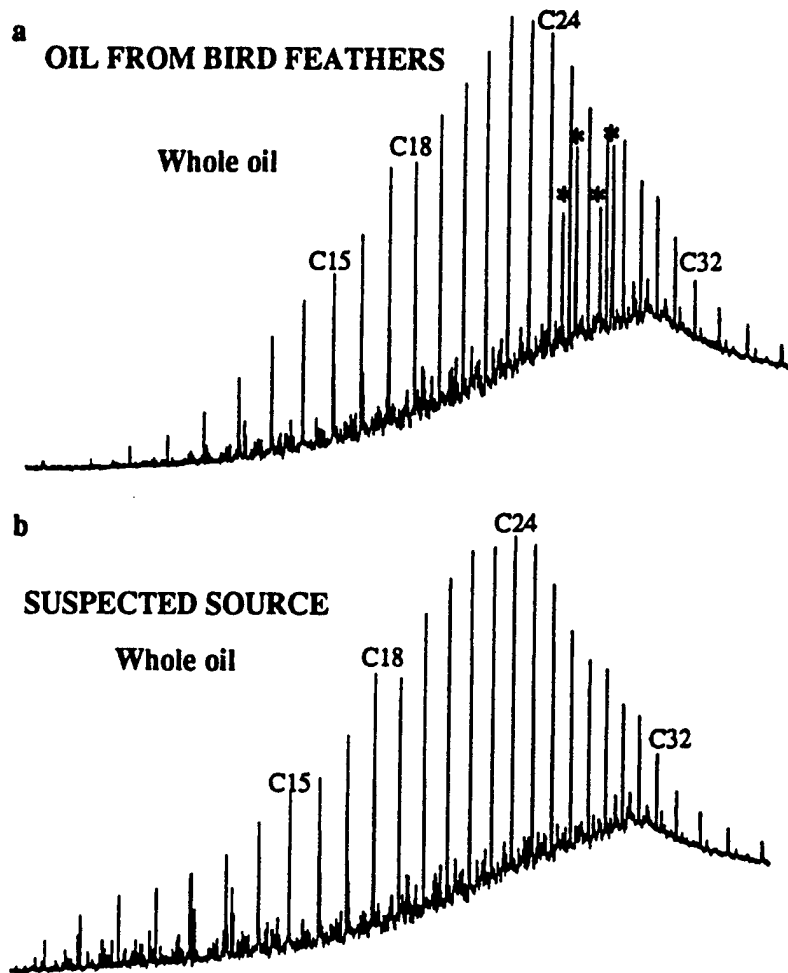

Figure 8

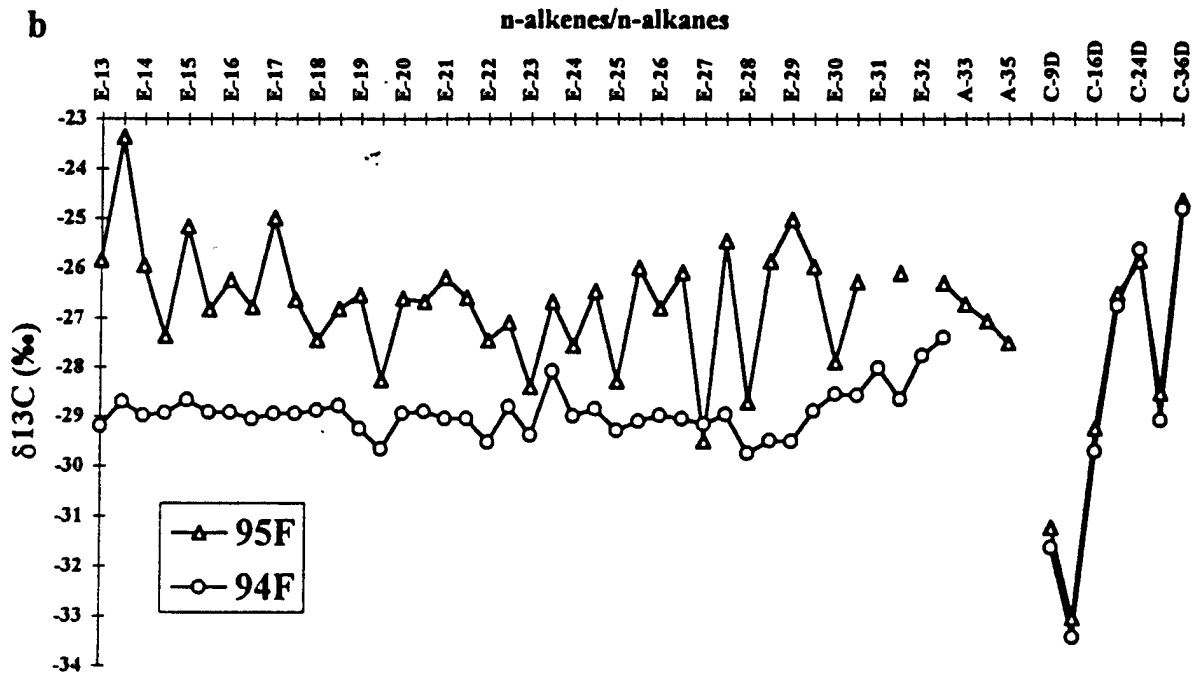
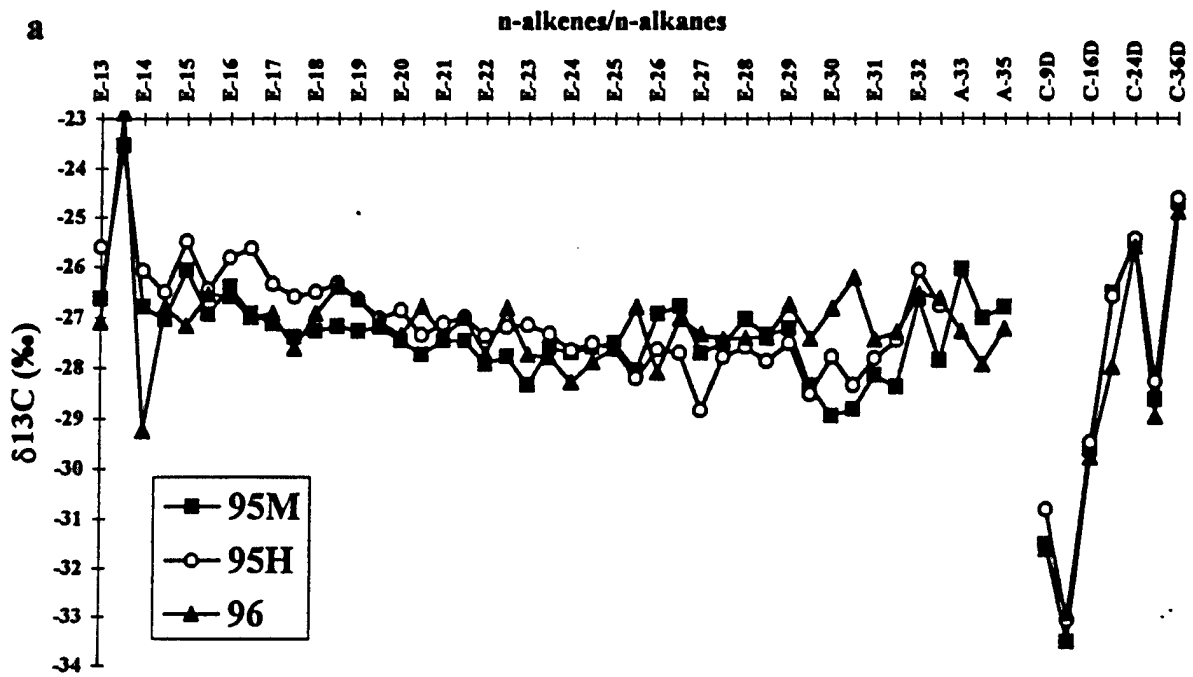

Figure 9

**HUMAN RELIABILITY AND ERROR PREVENTION IN TANKBARGE  
TRANSFER OPERATIONS**

*E. Iakovou, S.J. Czaja, C. Dougligeris, J.H. Moses, University of Miami  
J. Sharit, State University of New York at Buffalo*

## 1. Introduction

The Prevention Through People (PTP) program recently initiated by the U.S. Coast Guard represents a concerted effort towards preventing human errors in the maritime industry. The catalyst for addressing maritime accidents and oil spills was the *Exxon Valdez* grounding in Prince William Sound, Alaska, on March 24, 1989 (see NTSB, 1990) and the resultant Oil Pollution Act of 1990 (OPA 90). OPA 90 focuses on the prevention, mitigation, and penalization of oil spills while the PTP initiative primarily stresses the human element and errors in high risk areas of the maritime industry. Prior to OPA 90, oil spills were almost an accepted hazard of the waterborne transportation of chemical and petroleum products, especially when one considers that between 1986 and 1993 there were 55,998 oil spills attributable to maritime sources (DOT, 1995).

Closely paralleling OPA 90 and the PTP program has been a growing tendency in industries in which high hazard work is performed to emphasize a qualitative perspective to human reliability analysis (HRA). This perspective (Sharit, 1993, 1997; CCPS, 1994) focuses on the interplay between task and system-related factors, human information processing, and behavioral tendencies for the purposes of better defining the work contexts that are conducive to both human errors and violations. The benefits of this approach to HRA is that it provides the opportunity to better understand the causes of human errors and violations as well as to anticipate their occurrences, and therefore to suggest design interventions that could prevent or minimize the adverse consequences arising from such behaviors. Another benefit of this approach is that it naturally lends itself to the design of information systems for effectively managing and continuously improving the safety of the maritime system, in line with current total quality management (TQM) principles.

The purpose of this study was to evaluate the applicability of this HRA perspective to marine operations, and the extent to which the mechanisms and information that are needed to apply this methodology in order to derive its maximal benefits are currently in place. As Wilson (1994) has noted, human factors approaches such as HRA represent the best solution to oil spill prevention. In this study, the focus was on oil spills arising from the loading and discharging operations associated with tankbarges. Although major oil spills usually attract the most attention, they are, however, very infrequent. Meanwhile, the spills from tankbarges are usually minor but occur with greater frequency and represent a significant concern with respect to the continual impact on the environment and allocation of resources for their investigation and cleanup. This is especially relevant when one considers that 80% of U.S. petroleum products are transported by tankbarges and that most of the tankbarge spills occur during transfer operations and not from collisions or groundings (Labor, 1996). The ability to analyze and understand scenarios associated with tankbarge operations which may result in oil spills can go a long way towards helping us understand the underlying causes of human errors across many other maritime operations.



## 2. Methodology

### Overview

First, a brief summary of a current perspective to HRA will be presented. The purpose of this discussion is to illustrate the methods and concepts that comprise this approach to HRA, the types of information and expertise that is required to apply it, and the benefits—especially those that are consistent with the PTP program—that can be derived.

Next, the data collection procedures used in this study are discussed. This data included: (1) analysis of procedures, checklists, and CG data collection methods; (2) interviews with individuals from the Coast Guard, marine environmental services, tank barge corporations, and tankermen; (3) analysis of tankermen test requirements; (4) observations of oil transfer operations; (5) analysis of accident reports and citations; and (6) anecdotal evidence.

The results of this analysis will be used to evaluate the current status of information availability with respect to the feasibility of implementing an HRA program that is capable of feeding an information system as well as being fed from such a system in a dynamic order to understand the causes of accidents, predict human errors and behaviors responsible for such accidents, suggest design interventions, and raise the overall safety culture to a higher level.

### A Current Perspective to HRA

The traditional safety perspective emphasized a blame culture whereby accidents were considered the fault of the worker who either violated procedures or was not exercising proper caution. The current perspective to HRA is systems based, and recognizes the role of organizational structure and management in shaping work environments that promote human errors and violations (Reason, 1990, 1995). To understand how human errors and violations arise, the system must be analyzed in terms of systems factors, initiating and ongoing events characteristic to the system, and human error tendencies. Moreover, it is the dynamic interplay between these factors that produces the types of situations that, in the absence of appropriate barriers or safeguards, can propagate into accidents. Systems factors include sociotechnical and human factors design considerations such as communication protocols, pressure to meet production deadlines, maintenance policies, equipment layout, design of procedures, rate of information processing required, fatigue, weather, and training. Initiating and ongoing events characteristic to the system include various types of delays and interruptions that could occur, breakdowns in equipment, and sudden changes in instructions or procedures. Human error tendencies relate to understanding human capabilities and limitations in processing information as well as behavioral tendencies related to minimizing physical and cognitive effort.

The application of HRA toward analysis of work contexts involves understanding how these factors conspire to bring about conditions conducive to human error and procedural violations, and how these conditions, in turn, can propagate into accidents. Toward this

end, a host of methods, concepts, schemes, and models are generally used to provide these insights. For example, given a particular situation, information processing tendencies are likely to result in workers making certain types of errors (e.g., slips or lapses), which, depending on the work context, can result in an accident or spill.

Before briefly overviewing some of these methods and ideas, it should be noted that in the PTP Report (DOT, 1995), a lack of a standard error taxonomy or root cause investigation methods was cited as a shortfall in data analysis capabilities:

“Effective preventive measures to human error requires use of standardized terminology and investigation methods. No one uses a standard human error taxonomy...to describe the causal factors of maritime casualties. Consequently, linking human errors to causes of marine casualties becomes a problem for everyone (p. B-2).” Although this same argument can be raised for oil spill accidents, in both cases it misses an important issue. It is not so much the need for a standardized error taxonomy and root cause technique than the need to have a HRA method that is capable of constructing and analyzing the work contexts that give rise to the conditions for which errors and accidents result. Furthermore, such a method is capable of serving both retroactive, i.e., accident analysis, and proactive, i.e., predictive purposes in human and system reliability analysis. Finally, such a method provides the basis for appropriate data collection and data organization in developing an information system related to human and system reliability that can be used and updated effectively so that the human reliability program can be continuously improved.

Finally, it is also important to note that in many systems, including marine systems, adverse system outcomes such as accidents may not arise from human error per se, but rather from the complex couplings between organizational, individual, collaborative work group, and environmental factors (Sharit, Czaja, Augenstein, and Dilsen, 1996). In these cases, standardized human error taxonomies will not solve the problem. The only solution is to understand the interplay between the various factors that comprise the work context, including human behavioral tendencies under these conditions that would not generally be considered errors, but rather reasonable human behaviors in response to the conditions encountered.

### Methods Comprising the HRA Perspective

#### Task analysis, cognitive task analysis, and system analysis

A systems based HRA requires some form of organizing structure for describing human involvement with other system components in order to identify human behaviors that could potentially lead to undesirable consequences. This would also provide a basis for suggesting error reduction design interventions and for conducting follow-up assessments of these interventions. Task analysis (TA) represents the most formal approach to this problem. Many TA methods exist that differ primarily on the basis of the types of information acquired and in the ways in which this information is represented. These distinctions, in turn, depend on the types of problems the analyst is interested in. A particular type of TA technique referred to as hierarchical task analysis (HTA) can readily

organize large amounts of task-based information (Stammers and Shepherd, 1995), making it particularly suitable for HRAs involving high-risk, but relatively routine tasks. Reviews of task analysis techniques can be found in Kirwan and Ainsworth (1992), CCPS (1994), and Luczak (1997). An example of a task analysis developed in this study for oil transfer operations associated with tank barges is given in Appendix A.

While TA remains essential in almost any study of human reliability, the HRA will benefit significantly from cognitive task analysis and systems analysis. Cognitive task analysis (Rasmussen, 1986; Rasmussen, Pejtersen, and Goodstein, 1994) focuses on cognitive processes that support human planning, problem solving, and decision making and control activities that are often expressed through interactions with computer-based interfaces to the system. Cognitive task analysis often relies on 'modeling frameworks' for deriving insights concerning human performance. For example, the distinctions between skill-based, rule-based, and knowledge-based levels of performance (discussed below) can enable predictions to be made concerning the types of errors that can be expected. Cognitive task analysis would generally be preceded by a systems analysis (Rasmussen, Pejtersen, and Goodstein, 1994). In HRA, systems analysis entails describing the overall system, in terms of its various characteristics, in ways that can provide insights into work contexts that are most relevant to the problem of human and system reliability analysis. When systems analysis, as discussed below, is combined with cognitive task analysis, the tendencies for performing at either the skill-, rule-, or knowledge-based levels can be determined. In addition, analysis at the systems level can reveal tendencies for errors and violations arising due to complex 'higher-level' system factors. Cognitive task analysis and the more traditional task analysis would then provide additional layers of texture in the analysis of work contexts that could enhance predictions concerning these errors, including their types and the potential for their recovery, and also provide more detailed design recommendations for their reduction.

In performing a systems analysis, it is important that the analyst choose an appropriate system description that is consistent with the goals of the safety program. System descriptions can take many forms (cf. Sharit, 1997, pp. 303-305), and ultimately the analyst may choose to explore the degree to which different descriptions provide different insights. For example, in a large-scale trauma center, system descriptions in the form of: (1) defining relevant subsystems and the links between the different subsystems within which a trauma patient may directly or indirectly receive care; (2) the types of collaborations that exist between health care providers both within and across these subsystems; (3) the temporal constraints governing these collaborations; and (4) the communication channels between these providers, provide a basis for understanding the possibility for corruption of relevant patient-based information, and thus the occurrence of adverse system consequences. This analysis, in turn, would dictate the methods that would be adopted for analyzing human-system interactions in more detail in order to better evaluate human and system reliability.

### Prediction of human error

Prediction of human error and violations, and more generally, of adverse system outcomes, requires understanding the interplay between three factors: (1) the general error inducing environment as determined by sociotechnical, organizational, and human factors design considerations; (2) particular types of events characteristic to the system that could promote or trigger human behaviors leading to adverse system consequences; and (3) the tendencies humans have for committing errors and violations). As discussed earlier, the particular system analysis framework adopted will influence the characterization of the error-inducing environment. This analysis can be further aided by tools or methods that focus on identifying and elaborating on relevant sociotechnical factors, and by analysis of Performance Shaping Factors (PSFs). Discussion of each these concepts follows.

An example of a 'systems method' that considers sociotechnical factors is the Human Factors Analysis Methodology or HFAM (Pennycook and Embrey, 1993). This methodology is comprised of 20 groups of factors that are subdivided into three broad categories: (1) management-level factors (such as degree of worker participation, effectiveness of communications, and effectiveness of procedures development system); (2) operational-level generic factors (such as work group factors, training, process management, and job aids and procedures); and (3) operational-level job-specific factors (such as computer-based systems, control panel design, and maintenance). HFAM first invokes a screening process to identify the major areas vulnerable to human error (e.g., maintenance operations involving pumps on tankbarges); the generic and appropriate job-specific factors are then applied to these areas. The components of each factor that applies can then be evaluated at two levels of detail. The problems that are identified ultimately reflect failures at the management control level. Corresponding management-level factors would then be evaluated to identify the nature of the management-based error; these types of errors are often referred to as 'latent' errors (Reason, 1990). Management-level factors fall into various categories, including: (1) those that can be specifically linked to operational-level factors (e.g., training, procedures); (2) those that are indicators of the quality of the safety culture and therefore can affect the potential for both errors and violations; and (3) those that reflect communication of information throughout the organization, including the capability for learning lessons from operational experience based on various forms of feedback channels.

In principle, Performance Shaping Factors (PSFs), also referred to as Performance Influencing Factors (PIFs), represent any factors that can influence the potential for human error or violations. In qualitative human and system reliability assessments PSFs can serve a number of purposes. For example, their identification and assessment are an important component of human factors and ergonomics audits (CCPS, 1994) that are used for establishing which design features might be susceptible to human error. This application of PSFs can also be used by workers as part of a participative error reduction program. When used for *predicting* human error and adverse system outcomes, PSFs essentially shape the system context—their interplay with initiating and ongoing system events and with human error tendencies define contexts conducive to error and adverse outcomes.

Appendix B presents a classification structure for PSFs compiled by Swain and Guttman (1983) for application to the nuclear power industry. It is not uncommon for analysts to devise their own classification schemes based on the characteristics of the particular operating environment or organization, and this is clearly needed for maritime operations. In general, at least three broad categories of PSFs need to be considered: those related to demands (e.g., task and physical work environment factors), resources (e.g., job aids and training), and management policies. The assumption generally adopted is that when all PSFs relevant to a particular situation are optimal, error likelihood will be minimized. However, errors will still occur due to a phenomenon known as 'stochastic variability' in human performance that can derive, for instance, from movement variability or from unique intentions and biases.

While PSFs are essential for constructing a framework for error prediction, as alluded to earlier, many critical links between human behavioral tendencies and the situational context will still likely be 'underspecified.' The additional level of articulation generally required is typically provided by task and cognitive task analysis. As with systems analysis, however, it is important that the analyst choose an appropriate method of task analysis (TA) in order to expose the subtleties that best satisfy the system description. A number of taxonomies exist for classifying human performance (Fleishman and Quaintance, 1984), and many variations and hybrid schemes can be derived from these fundamental structures.

Predicting human error requires some understanding of the relationships between the various attentional processes or components comprising the human's information processing system. Even with only a very fundamental appreciation of these processes it may, for example, be possible to predict that: (1) a worker does not have enough time to input information accurately given the design of the interface; (2) the design of displays is likely to evoke control responses that are contraindicated; (3) equipment is positioned in a manner that makes it likely that a poor position will be adopted when performing some activity or that other operations will be interfered with; and (4) decision making will take place without the benefits of complete or unambiguous information.

This perspective to prediction translates the system-based and task-based information into task demands. Mismatches between these demands and the human's capabilities for meeting these demands, which are largely reflected in information processing considerations, help map out work-related areas with increased vulnerability to human error. Depending on the objectives of the human and system reliability assessment, this type of analysis may be sufficient. However, it is often incapable of predicting the *types* of errors that might occur, and in this sense it is likely to underutilize contextually rich descriptions of the error inducing environment.

#### Cognitive engineering approaches to error prediction

Perspectives that emphasize mental or cognitive processes that underlie human error can potentially reveal the causes of errors. This knowledge, in turn, provides a stronger basis for design countermeasures, and for making use of data on 'near misses'—incidents that

are precursors of more serious events—that the PTP report (p. B-2) noted the maritime industry would be well advised to develop and implement

A modeling framework that is consistent with the goal of understanding underlying causes of human error is based on distinguishing fundamentally different categories of human information processing. These categories are referred to as skill-based, rule-based, and knowledge-based levels of performance (Rasmussen, 1986). Work activities at the skill-based level are highly practiced routines that require little conscious attention. The rule-based level involves the use of rules that the worker invokes from memory, or obtains from other sources such as reference manuals or coworkers. For example, a tankerman might conclude that a certain fault is present in the equipment based on symptoms revealed by diagnostic tests. This conclusion may then trigger another rule that addresses actions that need to be taken in response to that fault. Knowledge-based performance typically occurs when workers are attempting to solve problems in relatively unfamiliar situations, and demands the greatest use of information processing resources.

The distinctions implicit to this 'SRK framework' can be used in accident analysis to trace the observed or 'external error form' to its underlying causes. For error prediction, while models of human error have been proposed that utilize this framework (e.g., Reason, 1990), the usefulness of these models is not likely to be readily apparent to analysts. Much more useful are the distinctions Reason (1990) makes between different types of errors, specifically, between skill-based slips and lapses, rule-based mistakes, and knowledge-based mistakes. In his view, the potential for error begins with 'cognitive underspecification,' implying that at some point in the processing of task-related information the specification of information is incomplete. This underspecification, which to some extent results from information processing and memory limitations, can promote one of two forms of biases: 'frequency bias' or 'similarity bias'. These biases, respectively, reflect tendencies to process information and act based on the frequency with which a behavior has been performed, or the degree to which information currently being perceived or processed appears similar to patterns of information the person is readily tuned to. The manifestation of these biases in terms of different types of errors will depend largely on the particular level of performance, the situational context, and characteristics unique to the person.

For example, assume a worker is performing a series of operations on a machine that are fairly well-practiced, requiring little attention. A modification is made to the machine that requires the operations ADB to be performed instead of ABCD. Following the modification, the worker immediately proceeded to perform operation B after performing operation A, even though the worker was aware of the new sequence and intended to perform it. This error is referred to as a "double-capture slip." More generally, this error is classified as a "skill-based slip" due to "inattention": had the worker invested more attention at the critical point where, due to the sheer frequency with which the previous routine was performed, one would expect the worker to slip into the old routine, then this error would likely have been avoided. An example of a skill-based lapse resulting from this same absence of attentional control is when a worker intends to initiate a sequence of

operations but is interrupted by an alarm. After addressing the source of the alarm the worker goes on to other activities, perhaps because initiating the intended sequence of events have not in the past been generally associated with corrective actions in response to alarms. This type of error is referred to as “an omission following an interruption.” Excessive attentional control can also lead to skill-based slips, as when a worker disrupts activities being performed in order to analyze the situation. Disruption of the ‘pre-programmed’ or automatic sequence of activities typical of skill-based work can result in the worker picking up the task at a point further along than it is (an “omission due to overattention”), or repeating steps already taken (“repetition due to overattention”).

Unlike errors at the skill-based level, errors at the rule-based and knowledge-based levels represent actions that are intentional; they just turn out to be wrong, and thus are viewed as ‘mistakes’. Examples of various types of such errors can be found in Reason (1990).

Rasmussen (1982) has provided, in flow-chart form, a guide for answering questions concerning *what*, *how*, and *why* an error occurred. Although this procedure is more easily applied to the analysis of accidents, it can also be used to predict errors if work contexts have been analyzed to sufficient detail.

### 3. Analysis of Accident Reports and Citations

#### Transfer Violation Citations

According to the CFR 33 §156.118, the Coast Guard’s Captain Of The Port (COTP) must be notified in advance of any transfer operations within the District’s operational area (the COTP stated that they attempt at least one spot inspection per day). This allows the Coast Guard not only to keep abreast of hazardous operations, but also allows for spot inspections of transfer procedures as well. If the inspection reveals any violations of the CFRs, then a citation with a possible monetary fine is imposed and kept on record, unless contested and judged not guilty.

A random sample of transfer violation citations was conducted (n =12) with the following categories being observed:

1. transfer procedures not posted
2. failure to maintain a fixed containment area
3. noncompliance with transfer procedures
4. no Person In Charge (PIC)
5. insufficient personnel for transfer operation
6. no fixed containment at fill port

Overall, the citations, which in principle could supply valuable information concerning underlying problems and “near miss” data, supplied little to no information. Although the citation documents were in some cases very detailed (especially with respect to the CFR which was violated), the citation served primarily as a penalization rather than a learning

experience. The possibility exists for using these citations, which represent an enormous amount of information regarding the vulnerabilities and breach of procedures within the oil transfer process, to gain insights into the lapses and mistakes that are occurring in the field. However, the process and documentation associated with citations would have to be extended to deeper levels in order to derive a better understanding of the problems and to link this data to other information that ultimately comprises the proposed new marine information system.

### Spill (MCIR) Database Analysis

Currently, the most critical source of information concerning oil spills is contained within the USCG's Marine Casualty Investigation Report (MCIR) system. The MCIR system is a computer based information storage and retrieval system which records not only oil spills, but a host of other Coast Guard reports such as inspections, collisions, groundings, and allisions. From the MCIR system, the Coast Guard provided a random sample of 255 spills attributed to United States flagged tankbarges which occurred during transfer operations (ship to ship, ship to shore, and shore to ship). This random sample was culled from a three year period and involved only U.S. navigable waterways (including Puerto Rico). These MCIRs consist of a cover page which contains a brief synopsis of the spill as well as an indication for any supplemental case reports such as a witness lists, human factors supplements, narratives, etc. (see Appendix C).

Initially, each MCIR oil spill report was categorized into one of two variables: equipment failure or human error. However, many of the cover page synopses contained little to no information with respect to general spill categorization (e.g., "spill occurred on the Mississippi River at Mile Marker 67"), let alone the specific causation of the spill. At this point, all the supplemental reports were retrieved from the MCIR computer in order to categorize the spills (a tedious undertaking in that one must know the case number and desired supplement and type it in manually. Even with two people using two computer terminals, it took six hours to retrieve and print 255 case supplements). Once categorized into one of two variables (human error or equipment failure), the spills were then classified as to the causation which fell into the following types:

#### Human Error

1. tank monitoring (overflow)
2. hose connection or disconnection
3. valve setup or alignment
4. loose or unblanked flange
5. maintenance
6. drip pan monitoring (overflow)
7. mooring monitoring
8. other

#### Equipment Failure

1. hull defect or penetration
2. valve or fitting failure
3. gasket failure
4. pipe or hose failure
5. packing gland or deal failure
6. pump failure
7. other



The MCIR synopses and the supplemental reports were also used to collect information on the following variables:

1. Spill amount (in gallons).
2. Cleanup effort (yes or no).
3. Oil recovered, if applicable (in gallons).
4. Time lapse from spill event to USCG notification (in minutes).
5. On-scene investigation time (in hours).
6. Administrative time (in hours).
7. Training time (in hours).
8. Travel to and from scene (in hours).
9. Spill investigation effort (on-scene investigation time + administrative time + training time).
10. Time of spill event (24 hour clock).
11. Narrative of spill event either by witnesses or investigative personnel.

### Statistical Tests and Results

#### 1. Category

A Chi-Square test was performed on the categorical data in order to reveal any significant differences between the two groups. Results: No significant difference between Tankerman error (1) and Equipment failure (2). (Chi-Square = 0.567,  $p = 0.452$ .)

\*Note the Coast Guard reports an 80% human error and 20% equipment failure ratio

#### 2. Human

No Statistical tests were performed on these categorical data. This is due to having no previous model or taxonomy to compare the results with or having any expected values for the subcategories.

#### 3. Equipment

No Statistical tests were performed on these categorical data. This is due to having no previous model or taxonomy to compare the results with or having any expected values for the subcategories.

#### 4. Cleanup

A Pearson 2 x 2 Chi-Square test (cleanup x category) was performed on these categorical data to reveal any differences between spill types. Results: There were no significant results. (Chi-Square = 0.485,  $p = 0.486$ .)

## 5. Spill amount

A. A t-test was performed between the two categories to reveal any differences between size of spill and spill type. Results: There were no significant results. (t-value = 1.23, p=0.219.)

B. An ANOVA was performed on the Tankerman error variable to reveal any significant results between the seven subcategories. Results: There were no significant results. (F=0.848, p=0.550.)

C. An ANOVA was performed on the Equipment failure variable to reveal any significant results between the seven subcategories. Results: There were no significant results. (F=0.1753, p= 0.983.)

## 6. Oil recovered

No tests were performed on these data due to the multiple influences on recovery efforts (weather, location, current, etc.)

## 7. Time of occurrence

A plot was made of the spill category vs. time of day (Appendix D).

## 8. Time lapse

A. A plot was made of the elapsed time between spill event and time to notify the C.G.

B. A t-test was performed on the mean times between Tankerman error and Equipment failure. Results: There were no significant results. (t-value = 1.06, p= 0.288.)

C. An ANOVA was performed on the equipment subcategories to reveal any significant results. Results: There were no significant results. (F=0.565, p= 0.758.)

D. An ANOVA was performed on the human subcategories to reveal any significant differences. Results: There were no significant results. (F=0.264, p= 0.953.)

## 9. On scene investigation time

A. A t-test was performed between the spill categories with respect to the amount of time spent on the scene. Results: There were no significant results. (t-value = 0.82, p= 0.411.)

B. An ANOVA was performed on the Tankerman error subcategory. Results: There were no significant results. (F= 0.682, p= 0.687.)

C. An ANOVA was also performed on the equipment subcategories Results: There were no significant results. (F= 0.410, p= 0.871.)

## 10. Administrative time

A. A t-test was performed between the spill categories with respect to the amount of administrative time. Results: There were no significant results (t-value = 0.79, p= 0.432.)

B. An ANOVA was performed on the Tankerman subcategory. Results: There were no

significant results. (F= 0.363, p= 0.922.)

C. An ANOVA was also performed on the equipment subcategories. Results: There were no significant results. (F= 1.23, p= 0.299.)

#### 11. Travel

There were no tests performed on these data due to the variable nature of traveling to and from the spill scene.

#### 12. Training

A t-test was performed between the spill categories with respect to the amount of training time spent on the scene. Results: There were no significant results. (t-value = 0.37, p= 0.713.)

B. An ANOVA was performed on the Tankerman subcategory. Results: There were no significant results. (F= 0.733, p= 0.644.)

C. An ANOVA was also performed on the equipment subcategories. Results: There were no significant results. (F= 0.979, p= 0.443.)

#### 13. Total time on case (administrative + pollution investigation + training - travel time)

A. a t-test was performed between the spill categories. Results: There were no significant results. (t-value = 0.03, p= 0.973.)

B. An ANOVA was performed on the Tankerman error subcategory to reveal any significant results. Results: There were no significant results. (F= 0.539, p= 0.804.)

C. An ANOVA was also performed on the equipment subcategories. Results: There were no significant results. (F= 0.868, p= 0.521.)

Data plots associated with these analyses can be found in Appendix D. Overall, there are three important results emerge from these analyses. First, the results counter the PTP report and other sources (Purcell, 1996) which have reported the ratio of human to equipment spill sources is 80% to 20%. However, given the inadequacies associated with the MCIR database, specifically the ambiguity and lack of details associated with many of these reports, suggests that this analysis may not reflect the actual ratios of human to equipment causes.

Second, the cover page synopsis of these reports were extremely vague and uninformative, and required piecing together various other elements, such as witness statements, human factors supplements, and pollution investigator statements, in order to derive information concerning causality of the accident. This process makes it very difficult to determine causality given reasonable resources allocated to training and analysis. This, in turn, makes it unlikely that much of the useful information pertaining to spills would be linked to other relevant information contained within the overall information system.

An interesting trend was noticed when reading the spill reports within the MCIR database and it regards the tremendous variability with respect to the quality and quantity of details regarding the spill event. Many reports had no narrative or human factor supplements and those that did were lacking in event chains and contextual details needed to arrive at a root cause analysis. In general, this variability in the skills of CG personnel in the investigation, analysis, and summary of spill events as contained in the MCIR database results in a loss of information between the investigation and input into the database system, and ultimately of the marine information system's output.

However, several narrative supplements were of reasonable quality and made an attempt at an error chain analysis (see Appendix E for a sample of narrative supplements).

Finally, and perhaps most critically, without a human and system reliability "model", there is no way to integrate the findings of these reports into an information system that can use this knowledge in a systematic way to derive deeper causes of the problem. For example, in the narrative supplement #209 (Appendix E), lack of communication appeared to be a factor in the spill:

"The receiving line at the facility is equipped with an air fitting that when utilized is designed to apply air back through the transfer line to assist in clearing the hose of residual product. This procedure was not done. The tankerman assumed that the person in charge ashore had applied air to the line. The person in charge ashore assumed that if the tankerman wanted air applied to the line he would have asked for it. Both parties have been advised to review their transfer procedures and to specific when communicating."

Was this the first time these tankermen were involved in this operation? If not, then clearly there are other work-related factors that contributed to these tankermen making these assumptions. An analysis of the work contexts, as guided by an appropriate HRA, would be necessary to reveal these contributory factors. When linked to an appropriately designed marine information system, patterns may be revealed that can point to many similar types of "faulty assumptions" that are made, ultimately leading to error reduction recommendations or design interventions that address the problem in a much more effective way than simply to state: "Both parties have been advised to review their transfer procedures and to be specific when communicating."

Danaher (1980) discusses an accident in which a commercial airliner had a controlled descent into the Everglades while on approach to Miami International Airport. Apparently the same kind of faulty assumptions were made between the air traffic controller and pilot, ultimately leading to the disaster. As a result, communication protocol was changed by the FAA. Although the magnitude of this accident obviously contributed to the much deeper analysis that was undertaken, and to a much more rigorous approach to design interventions, the marine industry needs to adopt some of the same discipline and skill in learning from accidents and spills. Having an appropriate HRA model, which could be modified as information to the marine information system is continuously updated

consistent with TQM principles, is an important start. Training personnel in conducting observations and investigations that are consistent with this knowledge, and on interacting with the information system with the purpose of understanding how to extract relevant knowledge from it as well as update it, and finally, on how to use this knowledge to derive design interventions, are all critical factors related to prevention of errors and accidents.

#### **4. Tankerman Training and Licensing**

Tankermen are required on all U.S. flagged tank vessels (ships and barges) that carry oil or hazardous chemicals in bulk. There are four (4) classifications of Tankerman as follows:

1. Tankerman PIC: May supervise transfers on tank ships and tank barges.
2. Tankerman PIC/barge :May only supervise transfers on tank barges.
3. Tankerman-Assistant: May not supervise transfers but may perform the duties associated with transfers.
4. Tankerman-Engineer: May only maintain the cargo system and related equipment.

A Merchant Mariners Document (MMD) is required by all seamen working on vessels over 100 tons. It is similar to a social security card. To obtain a Tankerman endorsement on a MMD, the following are required.:

##### General Requirements:

1. U.S.C.G. application form
2. 18 years of age
3. Pass a physical (basic)
4. Drug test
5. Completion of an approved fire fighting course
6. English language competency (§12.20-1(d) shall be able to speak and understand the English language as would be required in the rating of Tankerman and in shipboard emergencies)
7. \$95.00

##### Specific Requirements:

1. Tankerman PIC (person-in-charge)
  - a. 30 days licensed or 60 days unlicensed service on vessels certified to carry oil
  - b. 10 cargo transfers
2. Tankerman PIC (barge)
  - a. 60 days on tank vessels or 180 days of related service in the transfer of oil
  - b. 10 cargo transfers
3. Tankerman-Assistant
  - a. 90 days on tankships or attended an approved cargo course
4. Tankerman-Engineer
  - a. 90 days licensed service or 30 days and a cargo course/ or 60 days unlicensed and completion of a cargo course

Renewal Requirements:

(As of March 31, 1997 the regulations change).

Prior to March 31, 1997, the Tankerman endorsement had to be renewed every 5 years along with the Merchant Mariner Document with the following:

1. Meeting the original general requirements.
2. A letter stating participation in at least two transfers in the previous five years or completion of a cargo course.
3. 360 days (within 5 years) of sea service in the capacity of Tankerman or one of the following:
  - a. Open book exam
  - b. Refresher training course
  - c. Provide proof of employment for 1080 days in a field which is related to the operation, construction or repair of vessels .

New requirements after March 31, 1997 (the endorsement will then be permanent):

1. All the previous requirements prior to changes.
2. Mandatory completion of a U.S.C.G. liquid cargo course .
3. U.S.C.G. approved fire fighting course.

As is obvious from some of the statements made in the interviews (see section on Interviews), the requirements for licensing of tankermen is deficient in that it sets a minimal rather than a maximal standard. As a result, there is little in the way of problem solving skills or development of good knowledge bases, not to mention, mental models associated with parameters involved in transfer operations. For example, a commercial airline crew member must be able to describe pertinent flight systems and their operational parameters to a sufficient degree in order to receive and renew their commercial pilots license. The same is true for operators in the nuclear power industry.

Without adequate training, knowledge, and insight, tankermen are less likely to anticipate problems as well as deal with a variety of contingencies that may arise in transfer operations. There is a clear need to have simulator training for anomalies and mechanisms in place to ensuring that tankermen have the appropriate and current skills necessary for minimizing the occurrence of spill events and maximizing their ability to contain them.

Furthermore, the initial tankerman multiple choice written examination appears to be a token process which serves merely to flag candidates who are clearly incompetent rather than measure any skill level whatsoever.

## 5. Interviews

A series of in-depth interviews were conducted with various persons knowledgeable in the areas of marine systems safety and/or operations which are summarized below. Many of the key points from these interviews are integrated into the final summary of this report which addresses the basic conclusions and recommendations of this study. Information based on interviews with diverse yet knowledgeable personnel represents a unique opportunity to gain valuable insights, not only from the information directly obtained, but by linking the information across the interviewees in a manner consistent with the focus of the study.

### I. Interview with a Supervisor of an Environmental Service Company

This interviewee was a former CG officer with extensive experience in marine safety and marine safety engineering. The discussion revolved around the following issues:

#### Q. Issues concerning tankerman training/exam

The exam process used to be essay based. For example, an examining officer would select 10 cards from 2000, and the candidate would have to demonstrate deep knowledge of various topics. In the 1970s, marine safety moved away from professionalism in that they began hiring people without strong technical knowledge. There were less officers. Consistent with these changes, the exams began gravitating to multiple choice. In turn, the exam culture changed—candidates studied to pass exams rather than to attain thorough knowledge on relevant subject matters.

A major problem that was noted concerning the current examination process is that there is no differentiation between psychomotor and cognitive knowledge. That is, these two types of knowledge are not integrated. Instead, the focus is exclusively on 'cognitive knowledge.' For example, the candidate should be tested to demonstrate knowledge in knowing how to hook up a cam-lock fitting so that it does not open, or in knowing how to deal with water in the manifold in order to address questions concerning containment of oil. Therefore, the test needs to be designed so that it focuses on the ability to do the job rather than the ability to answer questions. There is a need to integrate knowledge with actual performance at the examination level. Along these lines, the CG needs to become more receptive to the use of simulators for exams. In areas such as bridge management (for officers), three out of four people who failed a three week simulator exam passed the more conventional exam. This indicates that similar problems would likely exist in the case of tankermen. Practical training for tankermen is done through the company system or union system. Industry would be well advised to take the lead in standardizing and controlling simulator training for tankermen.

Q. What would it take to prevent oil spills? Stated differently, what would put oil spill clean-up companies out of business?

Continued execution of OPA 90 (the Oil Pollution Act, which was implemented in response to the Exxon Valdez incident). The requirements of OPA 90 included having available vessel response plans, various procedures and policies, etc. According to the interviewee, as a result of OPA 90 "nuisance spills" (e.g., resulting from pumping 10,000 gallons into a 5,000 gallon tank) are now rare—the number of spills have been reduced by two thirds over the past three years. As a result, many emergency response companies are going out of business.

Q. So where are the spills (on tank barges) now coming from?

The interviewee did not (could not?) address this issue directly. However, he was very convinced that much of the problem stems from issues related to the MSIS (Marine Safety Information System). Essentially, persons in the CG that do not make it as captains are given assignments such as performing investigations; i.e., MSIS related assignments. Many of the MSIS people are bitter and want out. Consequently, there is a motivation problem that contributes strongly to the suboptimal use of this system. MSIS began literally "on the back of an envelope", and has evolved, with computer technology, into a massive system that collects information on all pumps (e.g., serial numbers). The current system is very elaborate and very large, but evolved without a plan. Was it designed to ask the right questions in order to understand why something went wrong? Not very likely.

Q. How is maintenance conceived by the CG?

The CG has never focused on the maintenance issue. In fact, the CG does not regulate maintenance; it's a company issue. Apparently, this is where the variance is with respect to maintenance. Although it was recognized in the discussion that maintenance was strictly a monetary issue—i.e., companies understand its importance but do not invest in maintenance due to costs—what was not clear (to me) was why tankerman could not become more active in preventive maintenance, the way the Japanese had done in their manufacturing processes. Preventive maintenance is a logical component of their jobs given that they are actively involved in initiating, executing, and monitoring operations. It also would provide feedback to management that can be used as a basis for decision making. For example, if the tankerman suggests that relatively cheap gaskets should be replaced, or whether some much more equipment could benefit from diagnostic testing, then management has more complete information that can be used for cost-benefit analyses.

In general there are three aspects to the maintenance issue: (1) the CG, who are primarily interested in safety regulations and engineering controls; (2) Class (i.e., insurance companies/industry), which also focuses on safety; and IMO, which is interested in international standards (refer to Larry's diagram). The CG has evolved in a way that is moving towards safety management, and away from inspections on maintenance.



Consequently, maintenance has fallen through the cracks. Maintenance has been addressed with the Safe Ship Code. However, these approaches are probably not what is needed to deal with the day-by-day 'nuisance' incidents, of which many appear to be related to maintenance issues. It was suggested that the CG may indeed need to apply maintenance policies, whose cost will be passed on to the customer.

Q. Can the CG currently use information on spills to determine whether certain companies have greater tendencies to have spills? (If so, then we may be able to test whether such companies spend relatively less resources on the maintenance issue and are thus, in principle, not conforming to the "Model Company" CG concept.)

The interviewee strongly suggested we talk to the Captain of the port, Miami, about maintenance, as well as to a Casualty Response Officer about what the CG is doing with the Model Company program/project. The latter person, who is a high level investigator for the CG, was told could provide valuable insights into MSIS and current needs related to data collection.

## II. Interview with a Senior Casualty Response Officer, USCG Marine Safety Office

Given the particular expertise of this officer, a good deal of this interview concerned the CG's information system and the problem of safety in marine systems. He noted that marine casualties and oil spills were alike in many ways, implying that it made sense to have a "model" capable of understanding the underlying causes that are likely to be common to both these types of occurrences.

The new information system (IS) being developed for the CG that is supposed to replace the MSIS was discussed. The "old" MSIS was hierarchical (not relational) in structure and module-based, containing components that included a pollution module, a marine inspection module, a marine investigation module, and a port safety module. It was noted that this "MINMOD" system was an attempt to capture causal factors but the software and interface was too difficult to use without extensive training and practice. For example, a grounding may be linked to situational awareness, which often was too general a relation to work with.

A previous problem related to the IS was in using information from investigations. The new system is being developed by people who are doing task analyses. However, the interviewee admitted that the new system still has not handled the problem of having an appropriate human and system reliability model so that the information comprising the database could be integrated in the most meaningful way. The new system is viewed as an improvement over the current system, but is clearly far from optimal.

When the question of discrepancies between the MCIR reports and the literature concerning the ratio of human to equipment causes of oil spills was raised, it was felt that

these discrepancies were due to user MSIS error. Specifically, the people asked to input information did not necessarily understand the implications of the data.

With respect to the causality of oil spills, it was felt that in general the oil transfer process runs smoothly but that people are overworked. It is not uncommon for them to be involved in operations for 14 hour stretches, with errors often due to falling asleep and fatigue. He was in agreement with another interviewee that since OPA 90 there has been a sharp drop in nuisance spills. [We would like to note, however, that this information is contradictory to information in the literature, including that cited in the PTP report of 1995, which notes that the nuisance spills have remained constant at about 4,000-5000 per year since OPA 90. It is the large spills that have been diminished as a result of OPA 90.] Also, he did not believe communication was a problem with respect to the CFRs, but was a problem on large tankers and foreign ships. [Actually, he was referring to language proficiency problems; clearly, the issue of communication on a more general level is still very important, as implied in discussing one of the narrative supplements to an MCIR report.]

The new/planned marine information system, which was referred to as the Marine Safety Network (MSN), presumably has multiple levels for pursuing causality: a basic level, a decision support level, and an expert system level. Although in principle close calls and near misses are to be reported, in practice they are not. According to our interviewee, this is due to the people who are inputting actual spill events into the system still struggling to catch up with that data. However, upon being questioned further about the reporting of near misses [which was a shortcoming noted in the PTP report on page B-2; in fact, this report implied that such a reporting system was currently nonexistent] he admitted that a "model" was needed for using near miss data. Along the same lines, he agreed that without the right [human and system reliability] model, the relational database [that is the basis for the new IS] may be missing crucial fields, and therefore its usefulness will be limited.

Overall, he was very supportive of the need for the IS to be model-driven and for focusing on the beneficial side effects of having users interact with an IS that is model-driven, specifically in gaining a better understanding and knowledge concerning work contexts and causes of accident, and for the need to have a system in place for reporting near misses and for incorporating this data into a model-based IS.

### III. Interview with Oil Transfer Terminal Supervisor

Q. What do you feel is the most difficult task involved with a transfer operation?

It is probably translating the unloading plan into a flow model. We may have upwards of four products flowing at one time to various tanks located throughout the tank farm. Maybe the barge or ship has five or six manifold valves but on the shore side we have 35 valves which must be sequenced accordingly to get the right product into the right tank.

Usually we get a discharge plan faxed in ahead of time but this is always subject to change at the last minute, but we'll set up the valving ahead of time in anticipation because it takes a while to get it all aligned properly. Invariably there will be a change in plans so the valving needs to be reset to some degree.

Q. Do you notice any differences among the crews that discharge here?

The American crews are the most professional compared to some of the foreign flag ones that come in here. Usually the U.S. flagged ships are ready to discharge and are basically set up upon arrival at the terminal. In addition, they have the necessary amount of people to handle the job for hooking up, monitoring, and disconnecting. Some foreign flagged crews will have only two or three seamen to do the hookup and it seems like their struggling the whole time, plus it takes them quite a bit longer.

Q. What about differences among American Tankermen?

I don't notice too many differences between the U.S. crews; they are competent and know their job, but, then again, they have probably done the job a thousand times and have been in here on numerous occasions as well. Maybe there's some difference with respect to time on the job, but it's fairly routine and with a little on-the-job training, the new hires will pick up the routine in no time.

Q. Do think the training of Tankermen is adequate?

That is probably one area which could use some improvement. Certainly transferring oil isn't extremely complicated but it does take some skills and attention to details. We hire tankermen on occasion and they require supervision until I feel comfortable leaving them alone to set up the valves. Once the vessel arrives and is ready to go I'll always check the setup and wait until the oil flows to make sure there are no leaks or problems and keep an eye on things. But, then again, that's the job of the PIC during a transfer operation.

Q. What are some common problems that you notice during transfer operations?

Probably the most common problem I see is misalignment of the setup valves. We usually sketch it out on a piece of paper, but, with numerous crossovers and sub-lines, mistakes happen. We're careful about double and triple checking everything but mistakes happen. Also, gasket leaks are common because someone will reuse a gasket even though we supply new ones for every transfer with numerous spares. I don't know if reusing a gasket is due to laziness or time pressure but there's no excuse not to use a new one, especially if the transfer has to be stopped in order to change a 30 cent gasket.

Q. Are there any regulatory problems that you notice in your position?

The most difficult regulatory problem I encounter is the lack of standard formal

procedures among the Captains Of The Port. The Captains rotate through the position with regular frequency and each one will have their own idea on how to interpret and apply the regulations. Some are hands-off and if there aren't any problems, you're left alone. On the other hand, some Captains will poke around for the most minor violation. We are a conscientious company and careful at what we do, but on occasion, spills occur; let's take it in stride and learn from it unless it's a stupid mistake or happens with regularity.

#### IV. Interview with USCG Pollution Investigators

This interview was conducted jointly with two Petty Officers (O1 and O2), each with two years of experience as Pollution Investigators (PIs).

Q. What is your primary duty in the marine safety office?

O1: It's to assure that the Code of Federal Regulations are being followed at all times during transfer operations. We do this by conducting spot checks of transfer operations with an emphasis on companies or vessels that have a history of violations. We try to conduct at least one or two spot checks a day to let the people know we're out and about enforcing the regulations.

O2: We are the eyes and ears of the Coast Guard. We go out in the field to make sure oil transfers are being conducted safely and according to the CFRs. If a spill does occur, then it is our responsibility to investigate and find the responsible party.

Q. If you find a violation, what is the procedure?

O1: If it's minor and they have no prior violations, I'll just give a verbal warning. But, if it's a major violation or a flagrant one I'll write them up for violating the appropriate regulation which will usually result in a fine. However, I'd much rather give a warning and educate the individual then slap a fine on the company.

O2: Usually, it's a judgment call. Nobody is perfect and mistakes happen, but there is no excuse for not following procedures so then I'll write up a violation. If it's something simple then I would rather educate the tankeman than fine him.

Q. What constitutes a "typical" spill?

O1: The majority of spills that I can recall are due to transferring at too high of a rate for the system setup. This is especially true when "topping-off" is taking place because there is little room for error when the tanks are almost full. Probably the second most common cause is related to people ignoring procedures or taking short cuts.

O2: Most of the spills I respond to are from private vessels like fishing boats and yachts. The boating public does not have the knowledge about prevention of oil spills and proper fueling procedures. On the other hand, most commercial spills I respond to are due to not following procedures and being complacent on the job. I would say that about half of the spills are attributable to human error and the other half to equipment failure.

Q. What are the steps for conducting an oil spill investigation?

O1: Usually we'll get a phone call from someone alerting us to a spill and we have a checklist that we follow in order to get all the necessary information. Our primary concern is for the environment and safety of the people involved; we need to know if anyone is injured and if the spill is being contained. After the relevant information is taken, we'll head out to the spill site to investigate. We use a little blue book to record the facts of the spill with emphasis on five aspects: (1) was there an oil spill?; (2) was it a navigable waterway of the U.S.?; (3) is there a responsible party?; (4) what was the cause of the spill?; and (5) was it a harmful quantity? If all five of these conditions are met, then there is a violation of the regulations and usually a fine.

O2: I try to get as much information on the phone before responding to a spill because too often details are forgotten or stories change after the spill is contained. Once on the scene, I'll take witness statements, photographs or videos, vessel documentation, and fill out the blue book which constitutes the whole spill case.

Q. How do you conduct an investigation?

O1: Our primary purpose is to find a responsible party for the spill with the secondary purpose being the causation of the spill. Usually we will conduct interviews with witnesses and tankermen or crew involved with the spill. We look for contradictions in witness statements, physical evidence, and try to analyze the chain of events that led up to the spill. In essence it's a two pronged investigation: (1) how and why; and (2) who is responsible. If necessary, we'll use a laboratory to match the spilled oil with samples taken from vessels in the vicinity. After the on-scene investigation is complete, I'll write up a formal report and enter it into the MSIS which then has the force of law behind it.

Most of the time it is fairly evident what happened: maybe there will be a trail of oil from a vent pipe across the deck and into the water; other times it may not be so easy. Usually the investigation will stop at the immediate or obvious point of causation.

O2: The primary purpose for conducting an investigation is to find the responsible party. Most of the time it's obvious where the oil came from but sometimes we can't tell and without a responsible party there can be no assessment of a fine. The blue book is primarily what guides us through an investigation and I try and get as much information as possible at the scene.

Q. Any suggestions for reducing oil spills?

O1: I think most tankermen are trained pretty well, however, an occasional refresher course would be helpful to deal with abnormal events. Also, there is an occasional communication problem when a crew member can't speak English, but I only see this on foreign flag ships. Probably the most important tool that is underutilized is education on the prevention of oil spills.

O2: Education comes to mind, especially with the public boaters. Although tankermen are well trained, they would probably benefit from the concept of situational awareness in transfer operations. Also, periodic updating of their skills would be helpful because maybe they will go years without an incident and fail to recognize the development of one that is preventable.

## 6. Observations

Initially, two unstructured observations were conducted in order to gain insight into the transfer process in order to develop a reliable method for recording data. The first observation took place in a computerized transfer simulator and provided the opportunity to ask questions and stop the transfer without jeopardizing the operation. The second observation took place in the field and was used to refine the observation form while developing the task analyses of the transfer procedure. Several other factors influenced the development of the observation form and task analysis: (1) interviews with four students taking the refresher course; (2) the instructor of the transfer simulator course; and (3) transfer descriptions in the literature (Marton 1992; International Chamber of Shipping, 1996). The observation form was designed not as a task analysis validation tool, but to provide a method for recording notes under the appropriate steps in the transfer procedure. The emphasis was to direct attention to critical steps in the procedure and to take note of factors which impact the transfer operation. However, one must keep in mind that the vast majority of direct observations result in 'normal' data and thus miss many of the unusual conditions, near miss events, and accidents associated with the domain.

Once the field observation form was complete (see Appendix F), five oil transfer operation observations were arranged within the Port of Miami and Port Everglades which are both located in Southern Florida. The observations were designed to be as unobtrusive as possible and there was no indication as to the purpose of the observations. The predominance of the observations were conducted from the shore-side terminal. However, one observation was conducted during a ship-to-ship transfer.

As a side note, there were several difficulties encountered not only securing permission to observe the transfer operations, but during the observations as well. The primary difficulty was the novelty of observing transfer operations and the hazards involved in most large port operations. All major ports are secure areas and one may need to request permission from several entities before proceeding on an observation: port authority, company

authority (may be more than one entity if multiple companies are involved), and the terminal authority. In addition, by its very nature, oil transfer operations are hazardous not only due to the cargo (explosive) but the operational environment as well (fumes, mobility hazards, etc.). These difficulties were further compounded by the novelty of "academics" observing transfer operations. Several companies refused requests for observations while others were hesitant about granting permission. As stated by one denial, "This is just going to result in more regulations of our already over-regulated operations." This is in stark contrast to other industries, notably aviation and health care, which accept and even solicit scientific observations of their work environs (e.g., see Wiener 1989; Cook and Woods, 1996). One of the minor inconveniences in organizing an observation protocol was the delay or cancellation of oil transfers; weather, equipment breakdown, rerouting, and communications played havoc with the schedule of an observation.

### Observation Summaries

As previously stated, the vast majority of field observations results in 'normal' data and rarely reveals errors or slips. This was the case with all the observations conducted in that no egregious errors were observed. However, some minor slips were noted such as valve alignment (corrected upon final setup check), verification of simultaneous multiple product flow destinations (verified upon checking system setup plans), and communication difficulties attributed to the noisy environment of diesel driven transfer pumps. Many of the tankerman interviews confirmed the observational conclusions that the transfer process is, by and large, a monotonous task with workload peaking at two points: the initial connection phase, and once again at the final 'topping-off' phase (if applicable). In addition, several factors external to the transfer process were noted that may impact the process such as being in transit for several days prior to transfer operations, night operations with minimal lighting, long and monotonous shifts (10 hours with nothing to do), and the extended length of some operations (up to 20 hours in one instance). These all have ramifications with respect to fatigue, boredom and especially complacency due to repeated uneventful transfers.

### **7. Anecdotal Evidence and Near Misses**

One useful tool used by many safety analysts is the collection of anecdotal and near miss evidence which is currently lacking in the marine field. Primarily, anecdotal evidence serves the objective to gain insight into small or near failures which were caught prior to escalating into an accident or spill event. In addition, anecdotal evidence may be used to arrive at reliable statistical evidence that give indications as to events that are contributing, but not necessarily causing, problems in the field. Finally, the collection of anecdotal evidence serves the important function of providing safety alerts to unsafe conditions, procedures, and operations within an organization or the field as a whole. In addition, the collection of anecdotal evidence may serve a positive role in the design and improvement of procedures.

Furthermore, anecdotal and near miss data would help direct Coast Guard inspections during the most critical phases and types of the transfer operations and thus increase the likelihood of observing behavioral slips and mistakes at its most critical period instead of the current approach of arriving at the scene and more than likely, just observe the routine 'normal' behavior which occurs at the vast majority of transfers. This would allow for better allocation of Coast Guard resources.

Finally, it should be noted that this type of evidence typically allows the analyst to consider contextual information. In this sense, anecdotal evidence need not be large in numbers but rather thorough in its details, and soliciting and maintaining a database of such evidence would likely result in tremendous payoffs, although the startup and implementation costs would be high.

In contrast to the detailed contextual information generally provided by anecdotal evidence, near miss data is much less detailed. However, this information is, in principle much easier to collect given that a description of the background context is not necessary. It is when large numbers of this data is collected that analysts can extract relevant trends that may lead to important insights concerning human error and system design deficiencies. An excellent example of a near miss reporting system is the ASRS (Aviation Safety Reporting System) sponsored by NASA for the commercial aviation industry. It is a self reporting system which grants immunity (within a given time frame) to pilots from the FAA for infractions, unsafe procedures, etc. In order to facilitate data collection, ASRS reports may even be filed and accessed via the internet

In light of the new marine information system that is being developed, it would be highly beneficial to incorporate a similar reporting system, either currently or in the near future. Ideally, the decisions as to what near-miss data to collect, how to integrate this data with other marine safety related information such as spill report and casualty data, and how to use this information for error reduction and design recommendations should be based on a human and system reliability model that is consistent with marine operations.

Several examples of anecdotal evidence collected during the study are presented in Appendix G. These are examples of incidents that did not involve spills and are highly revealing to analysis of human and system reliability, but are currently not captured by the data collection system.

## **8. Summary and Recommendations**

1. In Appendix B of the Prevention Through People (PTP) Report (DOT, 1995), three shortfalls in current data analysis capabilities were noted: (a) inadequate human error causal data; (b) no standard human error taxonomy or root cause investigation method; (c) study of near-miss events. As emphasized repeatedly in this report, even with the planned new marine information system, namely MSN (Marine Safety Network), without the development and implementation of an appropriate human reliability analysis (HRA)



model, major shortfalls in the capability to anticipate conditions conducive to human error and to understanding how accidents occur will remain.

Contrary to what is implied in the PTP Report, the solution is not in identifying a standard human error taxonomy or root cause investigation method. This approach will simply serve to substitute the current problem with another similar problem. The key is to tailor current perspectives in qualitative HRA to the marine system contexts. As discussed in this report, this perspective requires an understanding of a variety of concepts and methods such as: system analysis; task and cognitive task analysis; human information processing considerations; sociotechnical and human factors design considerations including the influence of performance shaping factors; models and schemes related to tendencies for errors and procedural violations; and, more generally, how these factors conspire to produce the work contexts, many of which are subtle, that can be linked to the deeper causal factors that result in casualty and oil spill events.

There are many advantages to implementing such a program. Most importantly, it provides the best insight into how and why adverse events occur. Moreover, through its deeper analysis of work contexts, it can be used both proactively, to predict human errors, as well as retroactively, as the basis to an accident analysis program, although one must keep in mind that determining causes to accidents is necessarily a more exact process than error prediction. With respect to its ability to analyze work contexts at a deeper and more intuitive level and thereby identify possible conditions conducive to human error, this approach has the advantage of being able to anticipate problems in situations that are seemingly innocuous, such as the routine daily actions of tankermen. Another advantage of this approach is that it is capable of analyzing the basis for procedural violations, which in many high-risk work environments have become an even more serious problem than human error. By considering human error and behavioral tendencies within a task and systems context, this approach is well-suited to predicting and analyzing procedural violations.

Another advantage to adopting this perspective to human and system reliability analysis is that it provides a stronger basis for error reduction recommendations and, more generally, design interventions. In addressing the shortfalls in current data analysis capabilities, the PTP Report states: "Effective preventive measures to human error requires use of standardized terminology and investigation methods." This is far from being necessarily true. Effective preventive measures requires understanding the interrelationships between the factors comprising the work context, such as sociotechnical and human factors design considerations and initiating and ongoing events characteristic to the work situation that together comprise the error-inducing environment, and information processing considerations that form the basis for human error tendencies. Without this knowledge, error preventive measures may solve certain problems but make other problems worse, by virtue of not considering the solution within the context of other factors. Along the same lines, while standardized terminology and investigative methods often focus on human errors, it should be emphasized that many adverse outcomes do not necessarily result from errors. Various human actions which would be considered normal behaviors under the

circumstances could, depending on the particular work context, propagate into adverse outcomes. The ability to gain insight into these occurrences is another reason why a current qualitative HRA perspective tailored to marine operations is necessary.

Finally, adopting such an approach for prevention of casualties and oil spills is necessary in order to optimize the benefits from the use of the planned MSN. Having such a HRA "model" in place will allow for much better utilization of near miss and anecdotal evidence data (discussed below). Without an appropriate HRA model guiding data collection and analysis, much of the available information in the information system will be underutilized. Furthermore, through training and experience in using this model, the users of the information system will become much more highly skilled in both recognizing problems and in determining solutions. Also, this type of HRA model is inherently adaptable, and is intended to be continuously fine-tuned as data becomes available. For example, different types of initiating (such as an interruption) or ongoing events characteristic to work operations, or facts related to tankerman training, may need to be considered. Or it may be the case that the data is complete but the interrelationships between the various factors, in terms of producing contexts conducive to errors, may need to be modeled differently. Consequently, this HRA perspective is more suited to implementing a Total Quality Management (TQM) type of program that not only would lead to improved safety but, due to the feedback channels incorporated within such a program, would also likely lead to an improved work culture as well.

2. Consistent with the need stated above, there is a need for collecting more useful data in support of such a HRA program and its incorporation into the marine information system. By virtue of its greater detail, anecdotal evidence would support the contextual modeling effort that underlies a systems based HRA. A system needs to be put in place that would allow a sample of such evidence to be collected, either in written or verbal form. Workers with good written and/or verbal skills would obviously be capable of providing much more useful anecdotal evidence, and therefore represent better candidates for providing this data.

Near miss data is generally symptomatic of work-related problems, and typically it is a question of subtle differences in the work context that determines whether a near miss would have transpired into an accident or spill. A contextually based HRA model would therefore be needed to understand the implications of this data, and to suggest design interventions that would serve as barriers to their occurrence. Near misses thus represent a rich source of data and the CG would be remiss not to implement a program for supporting the collection of this data. As noted in this report, the commercial aviation industry has a very successful near miss reporting system (Aviation Safety Reporting System) in place, and many of the mechanisms associated with this system could be adapted depending on the particular constraints and needs associated with the marine field. Obviously, analysts responsible for maintaining and using the marine information system would need to be trained on how to best utilize this data. As with anecdotal evidence, near miss data compliments an overall HRA marine system model for casualties and spill events. However, by virtue of its frequency it does so by intensifying focus on

particular aspects of the work context rather than on tying various contextual considerations together. Moreover, as with anecdotal evidence, given that this data is available on an ongoing basis, this data serves to continuously update the model and therefore contributes significantly to maintaining a continuous improvement marine safety system.

3. One of the most important components of the entire marine information system concerns data collection methods. The needs addressed above clearly depend on having meaningful data that could support the HRA effort. Currently, there are serious shortcomings in the type, variability, and quality of data collected concerning spills. These deficiencies encompass several critical areas, including: (a) the training of pollution investigators (PIs); (b) the actual incident collection workbooks (bluebook); and (c) the translation of this data into the information system. Ideally, as implied above, if the training is consistent with an overall human and system reliability model, the tools for collecting data and the procedures for integrating this data into the information system would compliment themselves as well as the data collection system.

Adopting a HRA perspective and the training and tools that support this perspective would also serve to shift the mentality of accident investigations from an individual blame culture, which is clearly evident in a majority of the marine casualty investigation reports (MCIRs) as well as in the interviews with pollution investigators, to a system perspective to human error that focuses on problems at all levels in the system that are responsible for or contribute to conditions that promote errors and accidents.

It is also important that CG investigative personnel become more familiar with actual oil transfer operations over and beyond their role in responding to incidents and conducting spot checks. This knowledge would also support the HRA model in terms of better understanding work contexts, and contribute to the ability for these investigators to better utilize this model when collecting data and interacting with the information system. Obtaining this knowledge requires developing a protocol for conducting observations. As noted in this report, on any particular observation it is not likely that overt errors and accidents will be observed. However, there are many work-related factors that represent very meaningful information, especially when guided by an underlying systems based HRA model. In these cases, for example, an investigator may determine that if the conditions were slightly altered, the seemingly normal actions and behaviors could result in conditions that could initiate a chain of events that lead to an accident.

In general, the investigator needs to identify information and actions that, when evaluated across a broad spectrum of contexts, can potentially contribute to a condition conducive to error or to a chain of events leading to an accident. This entails having a model or understanding of the various phases of the overall oil transfer operation. For example, certain phases of the operation are more vulnerable to distractions or interruptions that could occur, given the omissions and incorrect actions (e.g., slips, lapses) that these events induce. Other types of knowledge that would support the investigator's model of the process include: (a) assumptions operators are making (e.g., do tendencies exist for

operators to rationalize events based on previous experience or to use confirmation biases by seeking out what they know); (b) the degree to which operators have "maintenance situation awareness" (MSA) leading to better understanding, anticipation, and reaction to equipment-related issues, in light of the evidence indicating that equipment failures contribute to many accidents; (c) the recognition of ambiguous situations and situations where information is incomplete such as that resulting from faulty assumptions in communications between workers, orders that are given, changes in work shift, or information deriving from new equipment or work procedures; and (d) particular features of the work situation such as weather conditions, lighting, noise, the extent to which workers appear fatigued or restless, status of the housekeeping, and the point in the work shift. In compiling such observations, the investigators need to rise above the apparent situation. To do this, they need to ask workers many "what-if" questions and maintain an inquisitive and global perspective.

Maintenance situation awareness refers to the tendency for an operator to: (a) have knowledge concerning the weak links in the system; and (b) use spare attentional capacity efficiently so that the status of these vulnerable links (e.g., attending to leaks or abnormal parameters in an operation) can be explored or at least noted. Ultimately, this observational knowledge can be used to train workers to achieve heightened MSA. This is in line with deficiencies that have been noted in this report concerning the knowledge and skills of tankermen and discussed below.

4. A consistent theme in the interviews was the deficiencies in knowledge and skills of tankermen associated with the entire oil transfer process. There is a need for more thorough training that addresses various contingencies that could arise, the concept of MSA as discussed above, and communication during collaborative work. The regulations, training, and testing of tankermen need to address the acquisition of a more global knowledge base of all aspects of oil transfer operations, and also acknowledge the need for updating this knowledge and skills base in line with changes in equipment, procedures, and regulations.

### **Concluding Remark**

Given the PTP initiative and the overall emphasis by the U.S. Coast Guard in developing a new marine information system (MSN), we feel that it is critical that the CG consider and integrate the current perspective to human and system reliability analysis and its implications for training, data collection, and analysis into the MSN, as well as into the overall administrative and managerial cultures as they pertain to all marine safety-related issues.

## References

- Center for Chemical Process Safety (CCPS) (1994). *Guidelines for Preventing Human Error in Process Safety*. New York: American Institute of Chemical Engineers.
- Cook, R.I., & Woods, D.D. (1996). Adapting new technology in the operating room. *Human Factors*, 38 (4), 593-613.
- Danaher, J.W. (1980). Human error in ATC system operations. *Human Factors*, 22, 535-546.
- DOT (1995). Prevention Through People. *Department of Transportation, Quality Action Team Report*, July, 1995.
- Fleishman, E.A., and Quaintance, M.K. (1984). *Taxonomies of Human Performance: The Description of Human Tasks*. New York: Academic Press.
- International Chamber of Shipping. (1996). *International safety guide for oil tankers & terminals* (4th ed.). London: Witherby & Co, Ltd.
- Kirwan, B. and Ainsworth, L.K. (1992). *Guide to Task Analysis*. London: Taylor & Francis.
- Labar, I. (June/July 1996). At the end of a string. *Professional Mariner*, 19, 30-35
- Luczak, H. (1997). Task analysis. In G. Salvendy (ed.) *Handbook of Human Factors and Ergonomics, Second Edition*. New York: John Wiley & Sons.
- Marton, G.S. (1992). *Tanker operations: A handbook for the ship's officer*. Centerville, MD: Cornell Maritime Press.
- NTSB. (1990). Marine accident report: Grounding of the U.S. Tankship Exxon Valdez on Bligh Reef, Prince William Sound, near Valdez, Alaska, March 24, 1989. (Report No. NTSB/MAR-91/01). Washington, DC: Author.
- Office of the Federal Registrar. (1995). *Code of Federal regulations: Navigation and navigable waters (33) parts 125 to 199*. Washington DC: National Archives and Records Administration.
- Office of the Federal Registrar. (1995). *Code of Federal regulations: Shipping (46) parts 1 to 40*. Washington DC: National Archives and Records Administration.
- Office of the Federal Registrar. (1995). *Code of Federal regulations: Shipping (46) parts 140 to 155*. Washington DC: National Archives and Records Administration.
- Pennycook, W.A., and Embrey, D.E. (1993). An operating approach to error analysis. In *Proceedings of the First Biennial Canadian Conference on Process Safety and Loss*

*Management*. Edmonton, Alberta, Canada. Waterloo, Ontario, Canada: Institute for Risk Research, University of Waterloo.

Purcell, Denise. (August 1996). Barge business bouncing back. *Marine Log*, 100, 17-20.

Rasmussen, J. (1982). Human Errors. A Taxonomy for Describing Human Malfunction in Industrial Installations, *Journal of Occupational Accidents*, vol. 4, pp. 311-333.

Rasmussen, J., (1986). *Information Processing and Human-Machine Interaction*. Amsterdam: Roland, H.E. and Moriarty, B. (1983). *System Safety Engineering and Management*. New York: John Wiley & Sons.

Rasmussen, J., Pejtersen, A.M., and Goodstein, L.P. (1994). *Cognitive Systems Engineering*. New York: John Wiley & Sons.

Reason, J. (1990). *Human Error*. Cambridge: Cambridge University Press.

Reason, J. (1995). A systems approach to organizational error. *Ergonomics*, 38, 1708-1721

Sharit, J. (1993). Human reliability modeling. In K.B. Misra (ed.) *New Trends in System Reliability Evaluation*. Amsterdam: Elsevier, 369-410.

Sharit, J., Czaja, S.J., Augenstein, J., and Dilsen, K. (1996). A systems analysis of a trauma center: a methodology for predicting human error. In A.F. Ozok and G. Salvendy (eds.) *Advances in Applied Ergonomics*, 996-1101. Indiana: USA Publishing Corporation.

Sharit, J. (1997). Human and system reliability analysis. In W. Karwowski and W. Marras (eds.) *Handbook of Industrial Ergonomics*. Boca Raton: CRC Press (in press).

Stammers, R.B. and Shephard, A. (1995). Task analysis. In J.R. Wilson and E. N. Cortlett (eds.) *Evaluation of Human Work, Second Edition*. London: Taylor & Francis, 144-168.

Swain, A. D., and Guttman, H. E. (1983). *Handbook of Human Reliability Analysis with Emphasis on Nuclear Power Plant Applications*. NUREG/CR-1278, U.S. Nuclear Regulatory Commission, Washington, DC.

Wiener, E.L. (1989). The human factors of cockpit automation: A field study of flight crew transition. (Contractor Report 177333). Moffett Field, CA: NASA Ames Research Center.

Wilson, M. (1994). The significance of human factors in the prevention of oil spills. From *Prevention, Response, and Oversight Five Years After the Exxon Valdez Oil Spill, Proceedings of an International Conference*, March 23-25, Anchorage, Alaska.

## APPENDICES

32

592

## **APPENDIX A**

### **An Example of Task Analysis of Tankbarge Oil Transfer Operations**



## Oil Transfer Task Analysis

### I. Load Planning

#### A. Cargo orders (instructions specifying what product is to be carried)

1. Necessary tank cleaning to meet with cargo contamination limits
2. Limitations and special requirements for specific cargo to be carried

#### B. Cargo layout

1. Tankage volumes
2. Distribution of cargo to meet with trim requirements
3. Consideration for expansion of cargo
  - a. Traversing temperature extremes (cold to hot)
4. Loading sequence if carrying more than one product
  - a. Load high grade first then lesser grades in order (ex, aviation fuel first, then diesel fuel, then asphalt, etc.)
5. Ullage stops (calculating when to stop cargo influx)

#### C. Load plan

1. What systems are to be used
  - a. piping
  - b. pumps
  - c. valves
2. Sequencing of cargo and rates of flow
3. Topping off of tanks (*Most critical*)
4. Spill planning
5. Stress on tanks and ship in general (sequencing of tank filling to minimize stress on the vessel)
6. Calculate final list and trim of the vessel
7. If conducting single point mooring operations
  - a. Awareness of where the underwater hose is located
  - b. Minimize the pumping of air to avoid floating the hose
  - c. Attention to leakage

#### D. Mooring plan

1. What lines to use to dock the vessel
2. Attention to weather and tidal flow
3. Placement of appropriate fenders

## E. Communications review

1. Vessel personnel
  - a. who is involved with the operations
  - b. shutdown procedures
  - c. shift changes
  - d. communication procedures
2. Terminal personnel
  - a. who is involved
  - b. shutdown procedures
  - c. communications procedures

## F. Custodial procedures

1. Cargo ownership
2. Gauging and sampling of cargo
  - a. protests
    - (1) time to load
    - (2) quantities
3. Tank and system inspection
  - a. Degree of tank cleanliness

## II. Load preparations

- A. Actual tank cleaning
- B. Tank atmosphere (necessary O<sub>2</sub> content for personnel entry and lack of a combustible environment)
- C. Set-up of system and required cleaning if any
  1. Piping
  2. Valves
  3. Pumps
- D. Verification of valving for appropriate flow patterns
- E. Sequencing of de-ballasting while cargo flows onboard
- F. Procedure for venting of product fumes
- G. Inert gas system on stand-by if available or required
- H. All deck personnel are aware of the mooring plan
- I. Vessel- environment interface is appropriately attended to
  1. Oil booms are out
  2. Scuppers are plugged

3. Drains are closed
4. Unnecessary pipes and valves are blanked off
- J. Fire protection system is in order and ready for operation
  1. Fire watch is posted
  2. Fire system is tested
  3. Hoses are out and accessible
- K. Schedule for personnel changes with consideration for fatigue
- L. Final system check (conducted by 2 persons for cross-checking)

### III. Loading operations

- A. Pre-cargo flow
  1. Vessel is moored adequately
  2. Ship - shore conference is completed
    - a. Agreement to procedures for flow of cargo
    - b. Any peculiarities of cargo or procedures are noted
    - c. Emergency shutdown procedure
  3. Ship - shore safety checklist is completed
  4. Hose and boom arm connections are inspected
    - a. connections are double gasketed
    - b. Flanges are inspected for defects
  5. Communications test
    - a. Spare batteries for radios are available
    - b. Radios are actually working
  6. Initial gauging of tanks
  7. Emergency shutdown procedure is tested or checked
  8. Spill prevention check
    - a. Scuppers are plugged
    - b. Drains are closed
    - c. Oil booms are in place
  9. Tugs and other vessels in close proximity to operations are checked for ignition sources
- B. Starting cargo flow
  1. Begin flow slowly at first
    - a. Flush lines with product to slop tank
  2. Verification of flow to tank
    - a. Gauge filling tank
    - b. Check other tanks for seepage

3. Meet static electricity accumulation requirements
    - a. go slow to cushion the tank until product does not splash
  4. Check vessel - environment interface for leaks
    - a. Deck of vessel
    - b. Dock of terminal
    - c. Water
  5. Increase flow to full rate upon satisfaction of above requirements
- C. Topping off (most critical stage)
1. Have ullage stops available
  2. reduce rates upon approaching ullage stops
  3. Bleed off pressure in cargo hoses after shore stops pumping
  4. Do not shut down against shore pressure (will cause safety valves to open and possible stress on cargo lines and hoses)
  5. Continually check for creepage in tanks not being filled
  6. Upon final tank filling, allow for shore shutdown and proceed in 30 - 20 - 10 - 5 - 1 minute increments with appropriate flow rates

#### IV. Ancillary Notes

- A. Cargo loading requires a group effort with continual cross-checking
  1. Cross-checking is intended to locate error chains and not to find blame or trip someone up
- B. Situational awareness
  1. A good mental model of vessel systems, cargo flows and sequencing is very important to a smooth operation
- C. Attention must be continuous with respect to the vessel - environmental interface
  1. Constantly check vessel and mooring lines
    - a. Tidal influences
    - b. Weather influences
    - c. Ballasting, loading and trim influences
  2. Constantly check for indications of a spill
    - a. Dock
    - b. Vessel
    - c. Water
- D. Communications and intentions must be clear and timely

## **APPENDIX B**

### **A Classification of Performance Shaping Factors (from Swain and Guttman, 1983)**

| EXTERNAL PSFs   |  | INTERNAL PSFs  | STRESSOR PSFs  | INTERNAL PSFs   |
|---|--|--|--|---|
| <p><b>SITUATIONAL CHARACTERISTICS</b></p> <p>THOSE PSFs GENERAL TO ONE OR MORE JOBS IN A WORK SITUATION</p> <p>ARCHITECTURAL FEATURES<br/>QUALITY OF ENVIRONMENT:<br/>TEMPERATURE, HUMIDITY,<br/>AIR QUALITY, AND RADIATION<br/>LIGHTING<br/>NOISE AND VIBRATION<br/>DEGREE OF GENERAL CLEANLINESS<br/>WORK HOURS/WORK BREAKS<br/>SHIFT ROTATION<br/>AVAILABILITY/ADEQUACY OF SPECIAL EQUIPMENT, TOOLS, AND SUPPLIES<br/>MANNING PARAMETERS<br/>ORGANIZATIONAL STRUCTURE<br/>(e.g., AUTHORITY, RESPONSIBILITY, COMMUNICATION CHANNELS)<br/>ACTIONS BY SUPERVISORS, CO-WORKERS, UNION REPRESENTATIVES, AND REGULATORY PERSONNEL<br/>REWARDS, RECOGNITION, BENEFITS</p> | <p><b>TASK AND EQUIPMENT CHARACTERISTICS:</b></p> <p>THOSE PSFs SPECIFIC TO TASKS IN A JOB</p> <p>PERCEPTUAL REQUIREMENTS<br/>MOTOR REQUIREMENTS (SPEED, STRENGTH, PRECISION)<br/>CONTROL-DISPLAY RELATIONSHIPS<br/>ANTICIPATORY REQUIREMENTS<br/>INTERPRETATION<br/>DECISION-MAKING<br/>COMPLEXITY (INFORMATION LOAD)<br/>NARROWNESS OF TASK<br/>FREQUENCY AND REPETITIVENESS<br/>TASK CRITICALITY<br/>LONG- AND SHORT-TERM MEMORY<br/>CALCULATIONAL REQUIREMENTS<br/>FEEDBACK (KNOWLEDGE OF RESULTS)<br/>DYNAMIC VS. STEP-BY-STEP ACTIVITIES<br/>TEAM STRUCTURE AND COMMUNICATION<br/>MAN-MACHINE INTERFACE FACTORS:<br/>DESIGN OF PRIME EQUIPMENT,<br/>TEST EQUIPMENT, MANUFACTURING EQUIPMENT, JOB AIDS, TOOLS, FIXTURES</p> | <p><b>PSFs WHICH DIRECTLY AFFECT MENTAL STRESS</b></p> <p>SUDDENNESS OF ONSET<br/>DURATION OF STRESS<br/>TASK SPEED<br/>HIGH JEOPARDY RISK<br/>THREATS (OF FAILURE, LOSS OF JOB)<br/>MONOTONOUS, DEGRADING, OR MEANINGLESS WORK<br/>LONG, UNEVENTFUL VIGILANCE PERIODS<br/>CONFLICTS OF MOTIVES ABOUT JOB PERFORMANCE<br/>REINFORCEMENT ABSENT OR NEGATIVE<br/>SENSORY DEPRIVATION<br/>DISTRACTIONS (NOISE, GLARE, MOVEMENT, FLICKER, COLOR)<br/>INCONSISTENT CUEING</p> | <p><b>PSFs WHICH DIRECTLY AFFECT PHYSICAL STRESS</b></p> <p>DURATION OF STRESS<br/>FATIGUE<br/>PAIN OR DISCOMFORT<br/>HUNGER OR THIRST<br/>TEMPERATURE EXTREMES<br/>RADIATION<br/>G-FORCE EXTREMES<br/>ATMOSPHERIC PRESSURE EXTREMES<br/>OXYGEN INSUFFICIENCY<br/>VIBRATION<br/>MOVEMENT CONSTRICTION<br/>LACK OF PHYSICAL EXERCISE<br/>DISRUPTION OF CIRCADIAN RHYTHM</p> | <p><b>ORGANISMIC FACTORS:</b></p> <p>CHARACTERISTICS OF PEOPLE RESULTING FROM INTERNAL &amp; EXTERNAL INFLUENCES</p> <p>PREVIOUS TRAINING/EXPERIENCE<br/>STATE OF CURRENT PRACTICE OR SKILL<br/>PERSONALITY AND INTELLIGENCE VARIABLES<br/>MOTIVATION AND ATTITUDES<br/>EMOTIONAL STATE<br/>STRESS (MENTAL OR BODILY TENSION)<br/>KNOWLEDGE OF REQUIRED PERFORMANCE STANDARDS<br/>SEX DIFFERENCES<br/>PHYSICAL CONDITION<br/>ATTITUDES BASED ON INFLUENCE OF FAMILY AND OTHER OUTSIDE PERSONS OR AGENCIES<br/>GROUP IDENTIFICATIONS</p> |
| <p><b>JOB AND TASK INSTRUCTIONS:</b></p> <p>SINGLE MOST IMPORTANT TOOL FOR MOST TASKS</p> <p>PROCEDURES REQUIRED<br/>(WRITTEN OR NOT WRITTEN)<br/>CAUTIONS AND WARNINGS<br/>WORK METHODS<br/>PLANT POLICIES (SHOP PRACTICES)</p>  |  |  |  |   |

**APPENDIX C**

**Typical MCIR Cover Pages**

CASE NUMBER../ MC93011865 INV INIT/ DJT PORT/ HOUMS LAST UPDATE/ 20JUL93  
CASUALTY TYPE: VESSEL/ PERSONNEL/ X FACILITY/ POLLUTION/ X MARPOL/  
INCIDENT DATE/ 04JUL93 TIME/ 1958 KNOWN/ X ESTIMATED/ REF CASE/  
NOTIFY DATE../ 04JUL93 TIME/ 2020 REPORTER TYPE/ COMM. SOURCE  
SUBJECT...../ BUFFALO BARGE 102 LOCAL FILE REFERENCE/  
LOCATION...../ HOUSTON FUEL OIL, NO.4 DOCK LOCAL CODE/ PCN-151  
INCIDENT STATUS: VERIFIED/ X NOT VERIFIED/ VERIFIED, NOT REPORTABLE/  
NOTIFY/ ACTION: CTF/ RETURN/ (TO IAPR)

--- VALIDATION AND ENDORSEMENT ---

|               |   |         |                  |        |
|---------------|---|---------|------------------|--------|
| INVESTIGATOR: | X | POLLVAL | POLLUTION BRANCH | DATE   |
| UNIT COMMAND: | X | POLLVAL | POLLUTION BRANCH | 20JUL9 |
| POST REQ?     | : |         |                  | 20JUL9 |
| PRE REQ?      | : |         |                  |        |

--- GENERAL INFORMATION ---

TYPE/ HOUSTON ST/ TX WATERBODY/ HOUSTON SHIP CHANNEL  
OVER MILE/ LATITUDE/ N 29-45.0 LONGITUDE/ W 95- 6.0  
SUMMARY: TYPE/ POLLUTION CLASS/ NONE  
POSSIBLE DRUG INVOLVEMENT?/ N PUBLIC VESSEL/ BOATING/  
DEATHS/ MISSING/ INJURED/ TOTAL DAMAGE/  
IMPACT: MODE/ WATER SEVERITY CATEGORY/ MINOR MATERIAL CATEGORY/ OIL/OIL  
OSC/ USCG EPA REGION/ 6 CLEANUP REQ?/ Y  
RESPONSE BY NSF?/ N NSF TIME TO RESPOND/ HOURS  
NOTIFICATION FROM NRC?../ Y NRC CASE../ 184354  
NOTIFICATION FROM APHIS?/ APHIS PORT/

--- INCIDENT BRIEF ---

TANK BARGE BUFFALO 102, OVERFILLED ITS NO. 4 STARBOARD TANK AT HOUSTON FUEL DOCK TERMINAL, DUE TO TANKERMAN INATTENTION DURING LOADING PROCEDURE.

--- ACTIONS REPORTED ---

|     |                                |     |                                  |
|-----|--------------------------------|-----|----------------------------------|
| SEL | CASE SUPPLEMENTS               | SEL | EVENT SUPPLEMENTS                |
| 1   | WITNESS LIST.....(IAWL)/ X     | 14  | COLLISION OR GROUNDING.(MCCG)/ 0 |
| 2   | COMDT RECOMMENDATION.(MCCR)/   | 15  | EQUIP FAILURE.....(MCDR)/ 0      |
| 3   | CASUALTY DETAILS.....(MCDD)/ X | 16  | FLOOD,CAPSIZE,SINKING..(MCFC)/ 0 |
| 4   | NARRATIVE SUPPLEMENT.(MCNS)/   | 17  | FIRE,EXPLOSION.....(MCFE)/ 0     |
| 5   | PERS ACTION RECOMMEND(MCPA)/ 1 | 18  | HUMAN FACTORS SUPP.....(MCHF)/ 0 |
| 6   | POLLUTANT DETAILS....(MCPD)/ 1 | 19  | HAZ MAT INVOLVEMENT....(MCHM)/ 0 |
| 7   | MARPOL DETAIL SUP....(MCMD)/ 0 | 20  | LIFESAVING SUPPLEMENT..(MCLS)/ 0 |
| 8   | OPERATIONAL CONTROLS (PSOC)/ 0 | 21  | PERSONNEL CASUALTY.....(MCPC)/ 0 |
| 9   | PERSONNEL INVOLVEMENT(MCPI)/ 0 | 22  | STRUCTURAL FAILURE.....(MCSF)/ 0 |
| 10  | SMI SUPPLEMENT.....(MCSI)/ 0   |     |                                  |
| 11  | TOWING SUPPLEMENT....(MCTS)/ 0 |     |                                  |
| 12  | SUBJECT SUPPLEMENT... (MCSS)/  |     |                                  |
| 13  | WEATHER FACTORS.....(MCWX)/    |     |                                  |

-SUPPLEMENTS-

|                     |             |                  |                 |   |   |   |   |         |
|---------------------|-------------|------------------|-----------------|---|---|---|---|---------|
| VESSELS INVOLVED/ 1 |             |                  |                 |   |   |   |   |         |
| VIN                 | NAME        | FLAG             | SERVICE         | D | D | R | A | I       |
| 28990               | BUFFALO 102 | US               | TANK BARGE "OD" | X | X |   |   |         |
| ACTIONS:            | REQ LOU/    | REQ SURETY BOND/ | NONE/           |   |   |   |   | REF DMG |
|                     |             |                  |                 |   |   |   |   | NONE    |

ENTER HERE IF ASSOCIATED WITH AN MC CASE, OTHERWISE RECORD IN PSAR)



CASE NUMBER../ MC93006589 INV INIT/ DLK PORT/ HOUMS LAST UPDATE/ 05MAY93  
 CASUALTY TYPE: VESSEL/ PERSONNEL/ FACILITY/ POLLUTION/ X MARPOL/  
 INCIDENT DATE/ 14APR93 TIME/ 0320 KNOWN/ X ESTIMATED/ REF CASE/  
 NOTIFY DATE../ 14APR93 TIME/ 0343 REPORTER TYPE/ RESP PARTY  
 SUBJECT...../ TANK BARGE GW 701 LOCAL FILE REFERENCE/ PCN 085  
 LOCATION...../ HOUSTON FUEL OIL BARGE DOCK #4 LOCAL CODE/  
 INCIDENT STATUS: VERIFIED/ X NOT VERIFIED/ VERIFIED, NOT REPORTABLE/  
 NOTIFY/ ACTION: CTF/ RETURN/ (TO IAPI)

--- VALIDATION AND ENDORSEMENT ---

|                 |         |        |         |                  |      |
|-----------------|---------|--------|---------|------------------|------|
| END/FWD         | END/CLS | RETURN | USER-ID | NAME             | DATE |
| INVESTIGATOR: X |         |        | POLLVAL | POLLUTION BRANCH | 05M  |
| UNIT COMMAND:   | X       |        | POLLVAL | POLLUTION BRANCH | 05M  |
| DIST REQ? :     |         |        |         |                  |      |
| HQ REQ? :       |         |        |         |                  |      |

--- GENERAL INFORMATION ---

CITY/ CHANNELVIEW ST/ WATERBODY/ HOUSTON SHIP CHANNEL  
 RIVER MILE/ . LATITUDE/ N 29-45.0 LONGITUDE/ W 95- 6.0  
 CAS SUMMARY:TYPE/ POLLUTION CLASS/ NONE  
 POSSIBLE DRUG INVOLVEMENT?/ N PUBLIC VESSEL/ BOATING/  
 DEATHS/ MISSING/ INJURED/ TOTAL DAMAGE/  
 ENV IMPACT: MODE/ WATER SEVERITY CATEGORY/ MINOR MATERIAL CATEGORY/ OIL/  
 OSC/ USCG EPA REGION/ 6 CLEANUP REQ?/ Y  
 RESPONSE BY NSF?/ N NSF TIME TO RESPOND/ HOURS  
 NOTIFICATION FROM NRC?../ Y NRC CASE../ 167355  
 NOTIFICATION FROM APHIS?/ APHIS PORT/

--- INCIDENT BRIEF ---

WHILE TOPPING OFF TANK BARGE GW 701 THE #6 FUEL OIL BEGAN TO OVERFLOW FROM #2 PORT TANK. THIS ALLOWED APROXIMATELY 10-15 GALLONS OF #6 FUEL OIL TO DISCHARGE INTO THE HOUSTON SHIP CHANNEL.

--- ACTIONS REPORTED ---

|     |                                |     |                                  |
|-----|--------------------------------|-----|----------------------------------|
| SEL | CASE SUPPLEMENTS               | SEL | EVENT SUPPLEMENTS                |
| 1   | WITNESS LIST.....(IAWL)/ X     | 14  | COLLISION OR GROUNDING.(MCCG)/ ( |
| 2   | COMDT RECOMMENDATION.(MCCR)/   | 15  | EQUIP FAILURE.....(MCDR)/ (      |
| 3   | CASUALTY DETAILS.....(MCDD)/ X | 16  | FLOOD,CAPSIZE,SINKING..(MCFC)/ ( |
| 4   | NARRATIVE SUPPLEMENT.(MCNS)/   | 17  | FIRE,EXPLOSION.....(MCFE)/ (     |
| 5   | PERS ACTION RECOMMEND(MCPA)/ 0 | 18  | HUMAN FACTORS SUPP.....(MCHF)/ ( |
| 6   | POLLUTANT DETAILS....(MCPD)/ 1 | 19  | HAZ MAT INVOLVEMENT....(MCHM)/ ( |
| 7   | MARPOL DETAIL SUP....(MCMD)/ 0 | 20  | LIFESAVING SUPPLEMENT..(MCLS)/ ( |
| 8   | OPERATIONAL CONTROLS (PSOC)/ 0 | 21  | PERSONNEL CASUALTY.....(MCPC)/ ( |
| 9   | PERSONNEL INVOLVEMENT(MCPI)/ 0 | 22  | STRUCTURAL FAILURE.....(MCSF)/ ( |
| 10  | SMI SUPPLEMENT.....(MCSI)/ 0   |     |                                  |
| 11  | TOWING SUPPLEMENT....(MCTS)/ 0 |     |                                  |
| 12  | SUBJECT SUPPLEMENT... (MCSS)/  |     |                                  |
| 13  | WEATHER FACTORS.....(MCWX)/    |     |                                  |

-SUPPLEMENTS-

|  |                  |       |            |                    |
|--|------------------|-------|------------|--------------------|
| VESSELS INVOLVED/ 1  |                  |       |            | P M F P P S TOW    |
| VIN  | NAME             | FLAG  | SERVICE    | D D R A I I REF DM |
| D292618  | GW 701           | US    | TANK BARGE | X NON              |
| ENF ACTIONS: REQ LOU/  | REQ SURETY BOND/ | NONE/ |            |                    |
| (ENTER HERE IF ASSOCIATED WITH AN MC CASE, OTHERWISE RECORD IN PSAR) |                  |       |            |                    |

CASE NUMBER../ MC93022465 INV INIT/ JWB PORT/ SJPMS LAST UPDATE/ 08MAR95  
 CASUALTY TYPE: VESSEL/ PERSONNEL/ FACILITY/ POLLUTION/ X MARPOL/  
 INCIDENT DATE/ 12DEC93 TIME/ 1230 KNOWN/ ESTIMATED/ X REF CASE/  
 NOTIFY DATE../ 12DEC93 TIME/ 1350 REPORTER TYPE/ RESP PARTY  
 SUBJECT...../ BGI TRADER 195-93 LOCAL FILE REFERENCE/ 195-93  
 LOCATION...../ CARIBBEAN GULF REFINERY LOCAL CODE/  
 INCIDENT STATUS: VERIFIED/ X NOT VERIFIED/ VERIFIED, NOT REPORTABLE/  
 NOTIFY/ ACTION: CTF/ RETURN/ (TO IAPR)

--- VALIDATION AND ENDORSEMENT ---

| END/FWD         | END/CLS | RETURN | USER-ID | NAME           | DATE   |
|-----------------|---------|--------|---------|----------------|--------|
| INVESTIGATOR: X |         |        | MSTCS   | MSTCS HAGGERTY | 07MAR9 |
| INIT COMMAND:   | X       |        | MSTCS   | MSTCS HAGGERTY | 08MAR9 |
| IST REQ? :      |         |        |         |                |        |
| Q REQ? :        |         |        |         |                |        |

--- GENERAL INFORMATION ---

ITY/ SAN JUAN ST/ PR WATERBODY/ SAN JUAN HBR(BAHIA DE SN JN)  
 RIVER MILE/ LATITUDE/ N 18-25.8 LONGITUDE/ W 66- 6.7  
 AS SUMMARY:TYPE/ POLLUTION CLASS/ NONE  
 POSSIBLE DRUG INVOLVEMENT?/ N PUBLIC VESSEL/ BOATING/  
 DEATHS/ MISSING/ INJURED/ TOTAL DAMAGE/  
 ENV IMPACT: MODE/ WATER SEVERITY CATEGORY/ MINOR MATERIAL CATEGORY/ OIL/OIL  
 OSC/ USCG EPA REGION/ 2 CLEANUP REQ?/  
 RESPONSE BY NSF?/ Y NSF TIME TO RESPOND/ 48 HOURS  
 NOTIFICATION FROM NRC?../ N NRC CASE../  
 NOTIFICATION FROM APHIS?/ APHIS PORT/

--- INCIDENT BRIEF ---

On 12Dec94 at approx. 1415 MST3 J.J. Mason and I, DC3 J.W. Butler, arrived at the Gulf Oil Dock (Barge BGI Trader) to investigate a spill that was reported by the OpsCen. Stavros Emmamual Vasiliou, the tankerman, stated that during transfer operations, the #3p tank was overfilled causing a 20 gallon spill. We ultimately discovered a large (8000 gallon) spill. When asked, the RP admitted to the spill. Bunker Group (the RP) cleaned the spill (a 14 day operation).

--- ACTIONS REPORTED ---

| SEL | CASE SUPPLEMENTS               | SEL | EVENT SUPPLEMENTS                  |
|-----|--------------------------------|-----|------------------------------------|
| 1   | WITNESS LIST.....(IAWL)/ X     | 14  | COLLISION OR GROUNDING.(MCCG)/ 0   |
| 2   | COMDT RECOMMENDATION.(MCCR)/   | 15  | EQUIP FAILURE.....(MCDR)/ 0        |
| 3   | CASUALTY DETAILS.....(MCDD)/ X | 16  | FLOOD,CAPSIZING,SINKING..(MCFC)/ 0 |
| 4   | NARRATIVE SUPPLEMENT.(MCNS)/   | 17  | FIRE,EXPLOSION.....(MCFE)/ 0       |
| 5   | PERS ACTION RECOMMEND(MCPA)/ 1 | 18  | HUMAN FACTORS SUPP.....(MCHF)/ 0   |
| 6   | POLLUTANT DETAILS....(MCPD)/ 1 | 19  | HAZ MAT INVOLVEMENT....(MCHM)/ 0   |
| 7   | MARPOL DETAIL SUP....(MCMD)/ 0 | 20  | LIFESAVING SUPPLEMENT..(MCLS)/ 0   |
| 8   | OPERATIONAL CONTROLS (PSOC)/ 0 | 21  | PERSONNEL CASUALTY.....(MCPC)/ 0   |
| 9   | PERSONNEL INVOLVEMENT(MCPI)/ 0 | 22  | STRUCTURAL FAILURE.....(MCSF)/ 0   |
| 10  | SMI SUPPLEMENT.....(MCSI)/ 0   |     |                                    |
| 11  | TOWING SUPPLEMENT....(MCTS)/ 0 |     |                                    |
| 12  | SUBJECT SUPPLEMENT...(MCSS)/   |     |                                    |
| 13  | WEATHER FACTORS.....(MCWX)/    |     |                                    |

-SUPPLEMENTS-

| VESSELS INVOLVED/ | 1          | FLAG             | SERVICE | P | M | F | P | P | S | TOW     |
|-------------------|------------|------------------|---------|---|---|---|---|---|---|---------|
| VIN               | NAME       | US TANK          | BARGE   | D | D | R | A | I | I | REF DMG |
| 293348            | BGI TRADER |                  |         | X |   | X |   |   |   | NONE    |
| INF ACTIONS:      | REQ LOU/   | REQ SURETY BOND/ | NONE/   |   |   |   |   |   |   |         |

ENTER HERE IF ASSOCIATED WITH AN MC CASE, OTHERWISE RECORD IN PSAR)

FACILITIES INVOLVED/ 1  
 FIN NAME CATEGORY

CASE NUMBER../ MC94018201 INV INIT/ POL PORT/ MOBMS LAST UPDATE/ 16NOV94  
 CASUALTY TYPE: VESSEL/ PERSONNEL/ FACILITY/ POLLUTION/ X MARPOL/  
 INCIDENT DATE/ 28AUG94 TIME/ 1533 KNOWN/ X ESTIMATED/ REF CASE/  
 NOTIFY DATE../ 28AUG94 TIME/ 1533 REPORTER TYPE/ COMM. SOURCE  
 SUBJECT...../ T/B CHEM 39; POLLUTION LOCAL FILE REFERENCE/  
 LOCATION...../ CHEVRON PASCAGOULA REFINERY LOCAL CODE/  
 INCIDENT STATUS: VERIFIED/ X NOT VERIFIED/ VERIFIED, NOT REPORTABLE/  
 NOTIFY/ ACTION: CTF/ RETURN/ (TO IAPF)

--- VALIDATION AND ENDORSEMENT ---

| END/FWD       | END/CLS | RETURN | USER-ID | NAME                   | DATE |
|---------------|---------|--------|---------|------------------------|------|
| INVESTIGATOR: | X       |        | DANIEL  | MST2 CHRISTINE JACKSON | 16NC |
| UNIT COMMAND: |         | X      | DANIEL  | MST2 CHRISTINE JACKSON | 16NC |
| DIST REQ?     | :       |        |         |                        |      |
| HQ REQ?       | :       |        |         |                        |      |

--- GENERAL INFORMATION ---

CITY/ PASACAGOULA ST/ MS WATERBODY/ NAVIGABLE WATERS NEC  
 RIVER MILE/ . LATITUDE/ N 30-20.0 LONGITUDE/ W 88-30.5  
 CAS SUMMARY:TYPE/ POLLUTION CLASS/ NONE  
 POSSIBLE DRUG INVOLVEMENT?/ N PUBLIC VESSEL/ BOATING/  
 DEATHS/ MISSING/ INJURED/ TOTAL DAMAGE/  
 ENV IMPACT: MODE/ WATER SEVERITY CATEGORY/ MINOR MATERIAL CATEGORY/ OIL/O  
 OSC/ USCG EPA REGION/ 4 CLEANUP REQ?/ N  
 RESPONSE BY NSF?/ N NSF TIME TO RESPOND/ HOURS  
 NOTIFICATION FROM NRC?../ Y NRC CASE../ 257680  
 NOTIFICATION FROM APHIS?/ APHIS PORT/

--- INCIDENT BRIEF ---

THE TANKERMAN OVERFILLED THE NUMBER #3 CARGO TANK ON THE T/B CHEM 39.

--- ACTIONS REPORTED ---

| SEL | CASE SUPPLEMENTS               | SEL | EVENT SUPPLEMENTS                |
|-----|--------------------------------|-----|----------------------------------|
| 1   | WITNESS LIST.....(IAWL)/ X     | 14  | COLLISION OR GROUNDING.(MCCG)/ 0 |
| 2   | COMDT RECOMMENDATION.(MCCR)/   | 15  | EQUIP FAILURE.....(MCDR)/ 0      |
| 3   | CASUALTY DETAILS.....(MCDD)/ X | 16  | FLOOD,CAPSIZE,SINKING..(MCFC)/ 0 |
| 4   | NARRATIVE SUPPLEMENT.(MCNS)/   | 17  | FIRE,EXPLOSION.....(MCFE)/ 0     |
| 5   | PERS ACTION RECOMMEND(MCPA)/ 0 | 18  | HUMAN FACTORS SUPP.....(MCHF)/ 0 |
| 6   | POLLUTANT DETAILS....(MCPD)/ 1 | 19  | HAZ MAT INVOLVEMENT....(MCHM)/ 0 |
| 7   | MARPOL DETAIL SUP....(MCMD)/ 0 | 20  | LIFESAVING SUPPLEMENT..(MCLS)/ 0 |
| 8   | OPERATIONAL CONTROLS (PSOC)/ 0 | 21  | PERSONNEL CASUALTY.....(MCPC)/ 0 |
| 9   | PERSONNEL INVOLVEMENT(MCPI)/ 0 | 22  | STRUCTURAL FAILURE.....(MCSF)/ 0 |
| 10  | SMI SUPPLEMENT.....(MCSI)/ 0   |     |                                  |
| 11  | TOWING SUPPLEMENT....(MCTS)/ 0 |     |                                  |
| 12  | SUBJECT SUPPLEMENT...(MCSS)/   |     |                                  |
| 13  | WEATHER FACTORS.....(MCWX)/    |     |                                  |

-SUPPLEMENTS-

| VESSLS INVOLVED/ | 1        | NAME             | FLAG  | SERVICE    | P | M | F | P | P | S | TOW |
|------------------|----------|------------------|-------|------------|---|---|---|---|---|---|-----|
| D295705          | CHEM 39  |                  | US    | TANK BARGE |   |   |   |   |   |   |     |
| ENF ACTIONS:     | REQ LOU/ | REQ SURETY BOND/ | NONE/ |            |   |   |   |   |   |   |     |

(ENTER HERE IF ASSOCIATED WITH AN MC CASE, OTHERWISE RECORD IN PSAR)

FACILITIES INVOLVED/ 1  
 FIN NAME

604  
 CATEGORY

CASE NUMBER../ MC94024248 INV INIT/ JAH PORT/ HOUMS LAST UPDATE/ 27DEC94  
 CASUALTY TYPE: VESSEL/ PERSONNEL/ X FACILITY/ POLLUTION/ X MARPOL/  
 INCIDENT DATE/ 20NOV94 TIME/ 1120 KNOWN/ X ESTIMATED/ REF CASE/  
 NOTIFY DATE../ 20NOV94 TIME/ 2131 REPORTER TYPE/ COMM. SOURCE  
 SUBJECT...../ BUFFALO 300 LOCAL FILE REFERENCE/ PCN-348  
 LOCATION...../ DEER PARK (ITC) LOCAL CODE/  
 INCIDENT STATUS: VERIFIED/ X NOT VERIFIED/ VERIFIED, NOT REPORTABLE/  
 NOTIFY/ ACTION: CTF/ RETURN/ (TO IAPR)

--- VALIDATION AND ENDORSEMENT ---

| END/FWD       | END/CLS | RETURN | USER-ID  | NAME             | DATE   |
|---------------|---------|--------|----------|------------------|--------|
| INVESTIGATOR: | X       |        | RJOHNSON | MST1 RAY JOHNSON | 27DEC9 |
| INIT COMMAND: |         | X      | RJOHNSON | MST1 RAY JOHNSON | 27DEC9 |
| LIST REQ?     | :       |        |          |                  |        |
| REQ?          | :       |        |          |                  |        |

--- GENERAL INFORMATION ---

CITY/ DEER PARK ST/ TX WATERBODY/ HOUSTON SHIP CHANNEL  
 RIVER MILE/ LATITUDE/ N 29-45.0 LONGITUDE/ W 95-17.0  
 AS SUMMARY: TYPE/ POLLUTION CLASS/ NONE  
 POSSIBLE DRUG INVOLVEMENT?/ N PUBLIC VESSEL/ BOATING/  
 DEATHS/ 0 MISSING/ 0 INJURED/ 0 TOTAL DAMAGE/  
 ENV IMPACT: MODE/ WATER SEVERITY CATEGORY/ MINOR MATERIAL CATEGORY/ OIL/OIL  
 OSC/ USCG EPA REGION/ 6 CLEANUP REQ?/ Y  
 RESPONSE BY NSF?/ N NSF TIME TO RESPOND/ HOURS  
 NOTIFICATION FROM NRC?../ Y NRC CASE../ 270349  
 NOTIFICATION FROM APHIS?/ APHIS PORT/

--- INCIDENT BRIEF ---

20NOV94 POLLUTION INVESTIGATORS RESPONDED TO A POLLUTION INCIDENT ON THE T/ BUFFALO 300 DOCKED AT I.T.C., DEER PARK, TX. INVESTIGATORS OBSERVED #6 OIL IN THE WATER AND ALONG SIDE OF THE VESSEL COVERING AN AREA APPROXIMATELY 10' X 20' ESTIMATED TO BE 5 GALLONS OF #6 OIL. APPROXIMATELY 30 GALLONS WAS OBSERVED ON THE DECK. GARNER ENVIRONMENTAL WAS CALLED TO PERFORM THE CLEANUP. TANKERMAN CHARGED WITH NEGLIGENCE; S & R PROCEEDING INITIATED (REF PA94002401).

--- ACTIONS REPORTED ---

| SEL | CASE SUPPLEMENTS               | SEL | EVENT SUPPLEMENTS                |
|-----|--------------------------------|-----|----------------------------------|
| 1   | WITNESS LIST.....(IAWL)/ X     | 14  | COLLISION OR GROUNDING.(MCCG)/ 0 |
| 2   | COMDT RECOMMENDATION.(MCCR)/   | 15  | EQUIP FAILURE.....(MCDR)/ 1      |
| 3   | CASUALTY DETAILS.....(MCDD)/ X | 16  | FLOOD,CAPSIZE,SINKING..(MCFC)/ 0 |
| 4   | NARRATIVE SUPPLEMENT.(MCNS)/   | 17  | FIRE,EXPLOSION.....(MCFE)/ 0     |
| 5   | PERS ACTION RECOMMEND(MCPA)/ 0 | 18  | HUMAN FACTORS SUPP.....(MCHF)/ 0 |
| 6   | POLLUTANT DETAILS....(MCPD)/ 1 | 19  | HAZ MAT INVOLVEMENT....(MCHM)/ 0 |
| 7   | MARPOL DETAIL SUP....(MCMD)/ 0 | 20  | LIFESAVING SUPPLEMENT..(MCLS)/ 0 |
| 8   | OPERATIONAL CONTROLS (PSOC)/ 0 | 21  | PERSONNEL CASUALTY.....(MCPC)/ 0 |
| 9   | PERSONNEL INVOLVEMENT(MCPI)/ 1 | 22  | STRUCTURAL FAILURE.....(MCSF)/ 0 |
| 10  | SMI SUPPLEMENT.....(MCSI)/ 0   |     |                                  |
| 11  | TOWING SUPPLEMENT....(MCTS)/ 0 |     |                                  |
| 12  | SUBJECT SUPPLEMENT...(MCSS)/   |     |                                  |
| 13  | WEATHER FACTORS.....(MCWX)/    |     |                                  |

-SUPPLEMENTS-

| VESSELS INVOLVED/ | 1           |                  |            |   |   |   |   |   |      |
|-------------------|-------------|------------------|------------|---|---|---|---|---|------|
| VIN               | NAME        | FLAG             | SERVICE    | P | M | F | P | P | S    |
|                   |             |                  |            | D | D | R | A | I | I    |
| 84915             | BUFFALO 300 | US               | TANK BARGE | X |   |   |   |   |      |
| ACTIONS:          | REQ LOU/    | REQ SURETY BOND/ | NONE/      |   |   |   |   |   |      |
|                   |             |                  |            |   |   |   |   |   | NONE |

ENTER HERE IF ASSOCIATED WITH AN MC CASE, OTHERWISE RECORD IN PSAR)

FACILITIES INVOLVED/ 1  
 VIN NAME

605  
 CATEGORY

CASE NUMBER../ MC94013176 INV INIT/ WJC PORT/ HMRMS LAST UPDATE/ 14FEB95  
 CASUALTY TYPE: VESSEL/ PERSONNEL/ FACILITY/ POLLUTION/ X MARPOL/  
 INCIDENT DATE/ 28JUN94 TIME/ 1735 KNOWN/ ESTIMATED/ X REF CASE/ PS94063/  
 NOTIFY DATE../ 28JUN94 TIME/ 2256 REPORTER TYPE/ COMM. SOURCE  
 SUBJECT...../ HM 100 BARGE SPILL LOCAL FILE REFERENCE/  
 LOCATION...../ ELIZABETH RIVER LOCAL CODE/ MER-94-4/  
 INCIDENT STATUS: VERIFIED/ X NOT VERIFIED/ VERIFIED, NOT REPORTABLE/  
 NOTIFY/ ACTION: CTF/ RETURN/ (TO IAPR)

--- VALIDATION AND ENDORSEMENT ---

| END/FWD         | END/CLS | RETURN | USER-ID   | NAME          | DATE  |
|-----------------|---------|--------|-----------|---------------|-------|
| INVESTIGATOR: X |         |        | LTJGBROSS | LTJG BROSSMAN | 14FEB |
| UNIT COMMAND:   | X       |        | LTJGBROSS | LTJG BROSSMAN | 14FEB |
| DIST REQ? :     |         |        |           |               |       |
| HQ REQ? :       |         |        |           |               |       |

--- GENERAL INFORMATION ---

CITY/ PORTSMOUTH ST/ VA WATERBODY/ ELIZABETH RIVER  
 RIVER MILE/ . LATITUDE/ N 36-53.2 LONGITUDE/ W 76-20.4  
 CAS SUMMARY:TYPE/ POLLUTION CLASS/ NONE  
 POSSIBLE DRUG INVOLVEMENT?/ N PUBLIC VESSEL/ BOATING/  
 DEATHS/ MISSING/ INJURED/ TOTAL DAMAGE/  
 ENV IMPACT: MODE/ WATER SEVERITY CATEGORY/ MINOR MATERIAL CATEGORY/ OIL/O1  
 OSC/ USCG EPA REGION/ 3 CLEANUP REQ?/ Y  
 RESPONSE BY NSF?/ N NSF TIME TO RESPOND/ HOURS  
 NOTIFICATION FROM NRC?../ Y NRC CASE../ 246485  
 NOTIFICATION FROM APHIS?/ APHIS PORT/

--- INCIDENT BRIEF ---

MISO RCVD RPT FM WILLIAM REESE (EASTERN CARRIERS INC.) OF 5 GALLON JP-5 SPILL  
 THE ELIZABETH RIVER, VICINITY OF CRANEY ISLAND FUEL DEPOT. INVESTIGATION BY  
 MISO REVEALED THAT THE TANKERMAN WAS IN THE FINAL STAGES OF TOPPING OFF HIS  
 TANKS. THE PRODUCT WAS DISCHARGING FROM #4 PORT. THE TANKERMAN AND THE  
 DOCKMASTER SECURED THE FUEL AND PERFORMED CLEANUP. ROV

--- ACTIONS REPORTED ---

| SEL | CASE SUPPLEMENTS               | SEL | EVENT SUPPLEMENTS                |
|-----|--------------------------------|-----|----------------------------------|
| 1   | WITNESS LIST.....(IAWL)/ X     | 14  | COLLISION OR GROUNDING.(MCCG)/ 0 |
| 2   | COMDT RECOMMENDATION.(MCCR)/   | 15  | EQUIP FAILURE.....(MCDR)/ 0      |
| 3   | CASUALTY DETAILS.....(MCDD)/ X | 16  | FLOOD,CAPSIZE,SINKING..(MCFC)/ 0 |
| 4   | NARRATIVE SUPPLEMENT.(MCNS)/ X | 17  | FIRE,EXPLOSION.....(MCFE)/ 0     |
| 5   | PERS ACTION RECOMMEND(MCPA)/ 0 | 18  | HUMAN FACTORS SUPP.....(MCHF)/ 0 |
| 6   | POLLUTANT DETAILS....(MCPD)/ 1 | 19  | HAZ MAT INVOLVEMENT....(MCHM)/ 0 |
| 7   | MARPOL DETAIL SUP....(MCMD)/ 0 | 20  | LIFESAVING SUPPLEMENT..(MCLS)/ 0 |
| 8   | OPERATIONAL CONTROLS (PSOC)/ 0 | 21  | PERSONNEL CASUALTY.....(MCPC)/ 0 |
| 9   | PERSONNEL INVOLVEMENT(MCPI)/ 0 | 22  | STRUCTURAL FAILURE.....(MCSF)/ 0 |
| 10  | SMI SUPPLEMENT.....(MCSI)/ 0   |     |                                  |
| 11  | TOWING SUPPLEMENT....(MCTS)/ 0 |     |                                  |
| 12  | SUBJECT SUPPLEMENT...(MCSS)/   |     |                                  |
| 13  | WEATHER FACTORS.....(MCWX)/    |     |                                  |

-SUPPLEMENTS-

| VESSELS INVOLVED/ | 1        | FLAG             | SERVICE    | P | M | F | P | P | S | TOW     |
|-------------------|----------|------------------|------------|---|---|---|---|---|---|---------|
| VIN               | NAME     |                  |            | D | D | R | A | I | I | REF DMG |
| D629670           | HM-100   | US               | TANK BARGE | X |   |   |   |   |   | NONE    |
| ENF ACTIONS:      | REQ LOU/ | REQ SURETY BOND/ | NONE/      |   |   |   |   |   |   |         |

(ENTER HERE IF ASSOCIATED WITH AN MC CASE, OTHERWISE RECORD IN PSAR)

FACILITIES INVOLVED/ 1  
 FIN NAME CATEGORY

## **APPENDIX D**

### **Plots Associated with the MCIR Data**

# Spills by Human Error Category

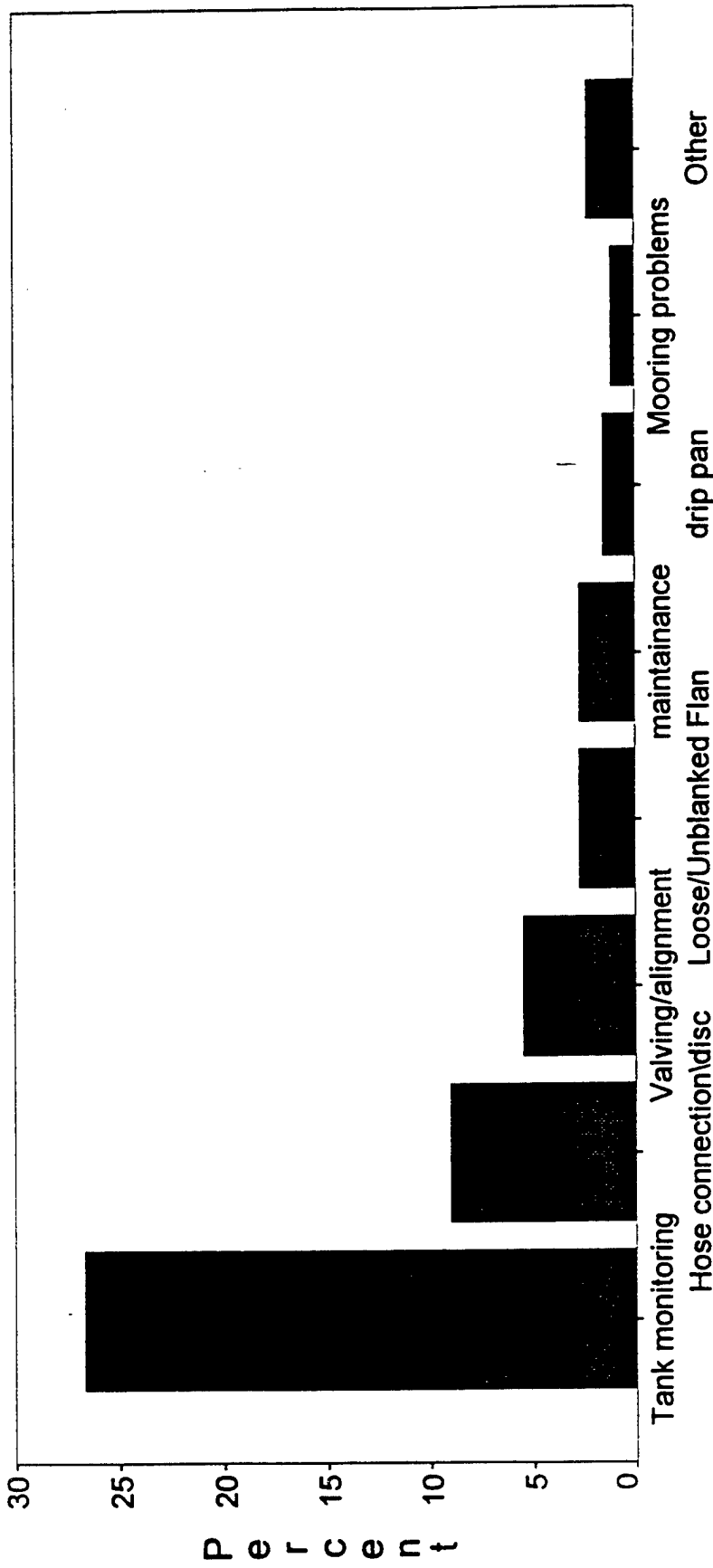

# Spills by Equipment Category

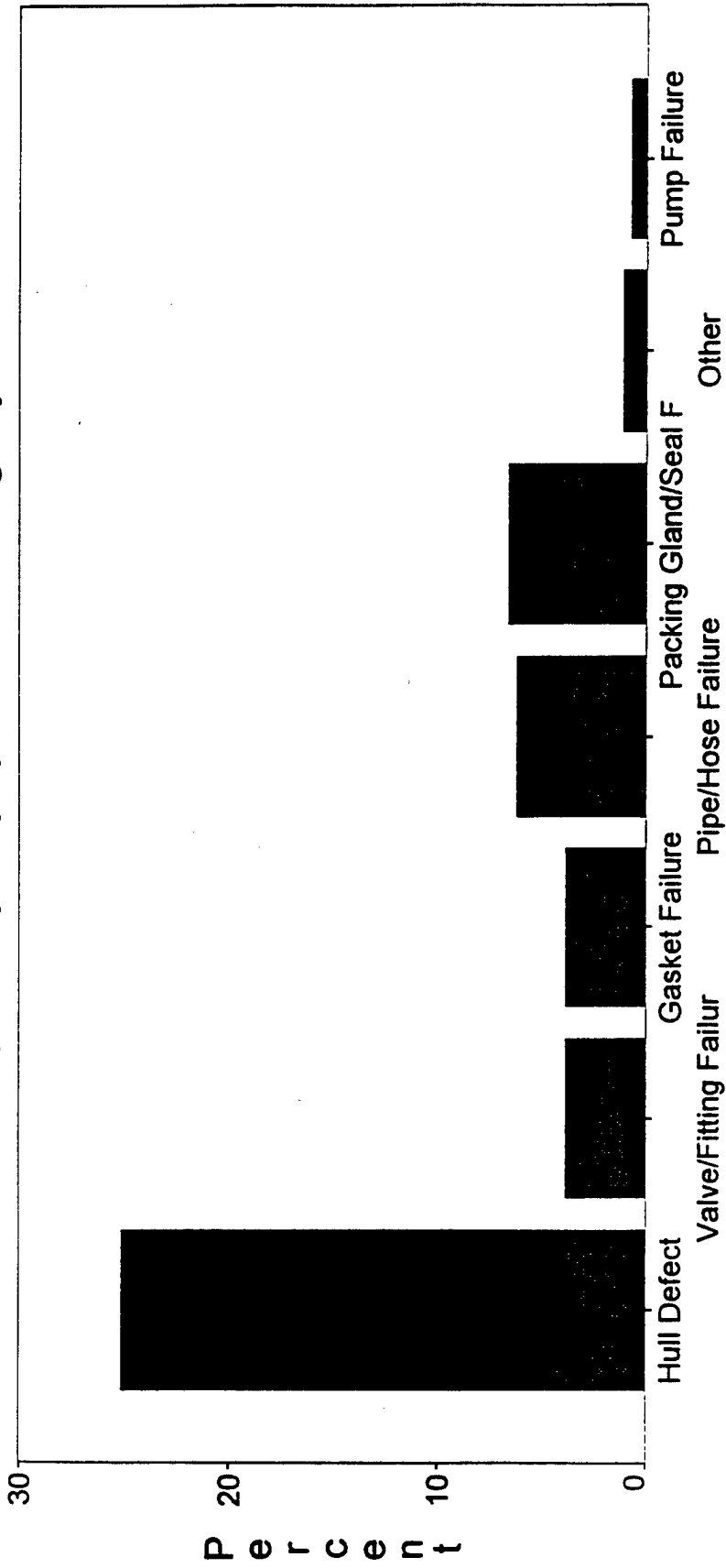



# Time of Spill (by 24 hour clock)

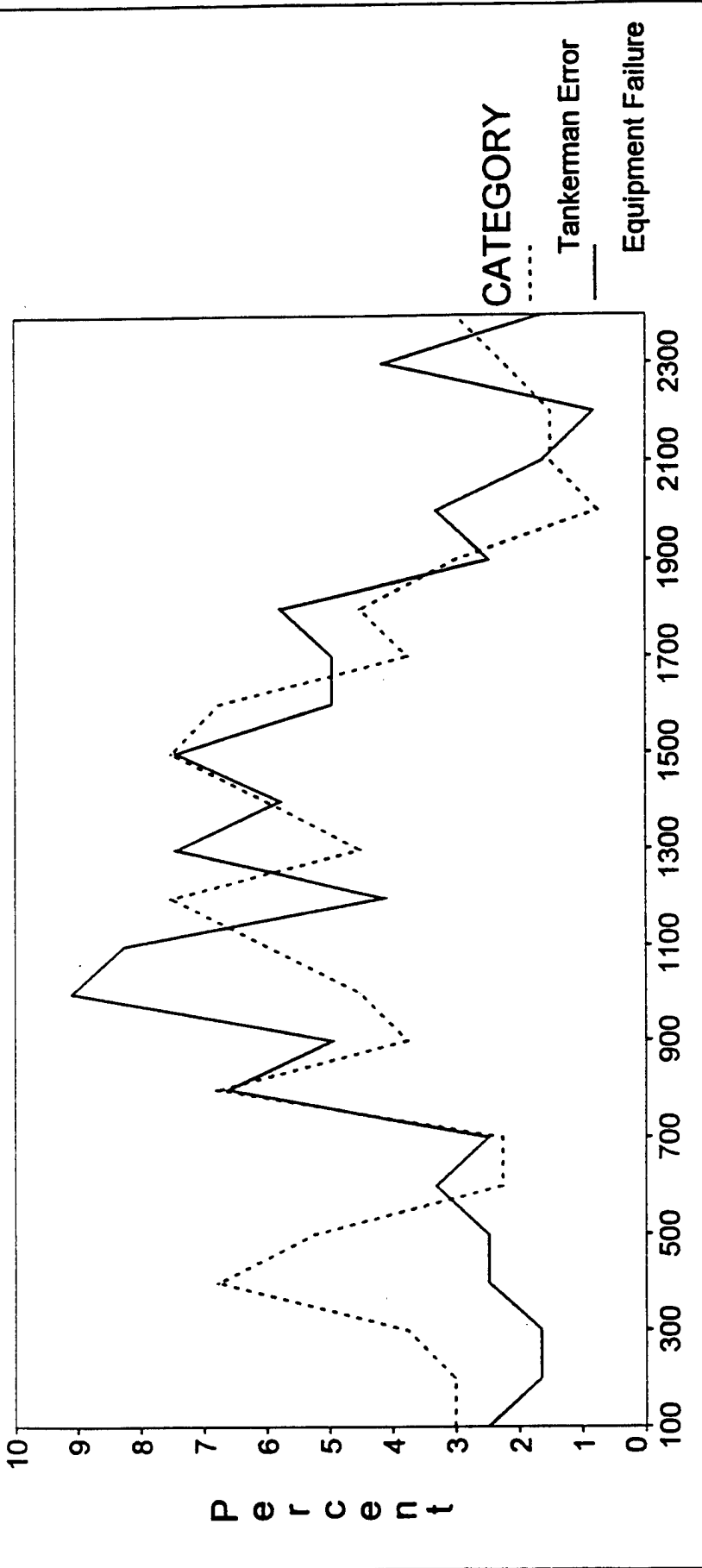

# Time to Notify U.S.C.G. (in minutes)

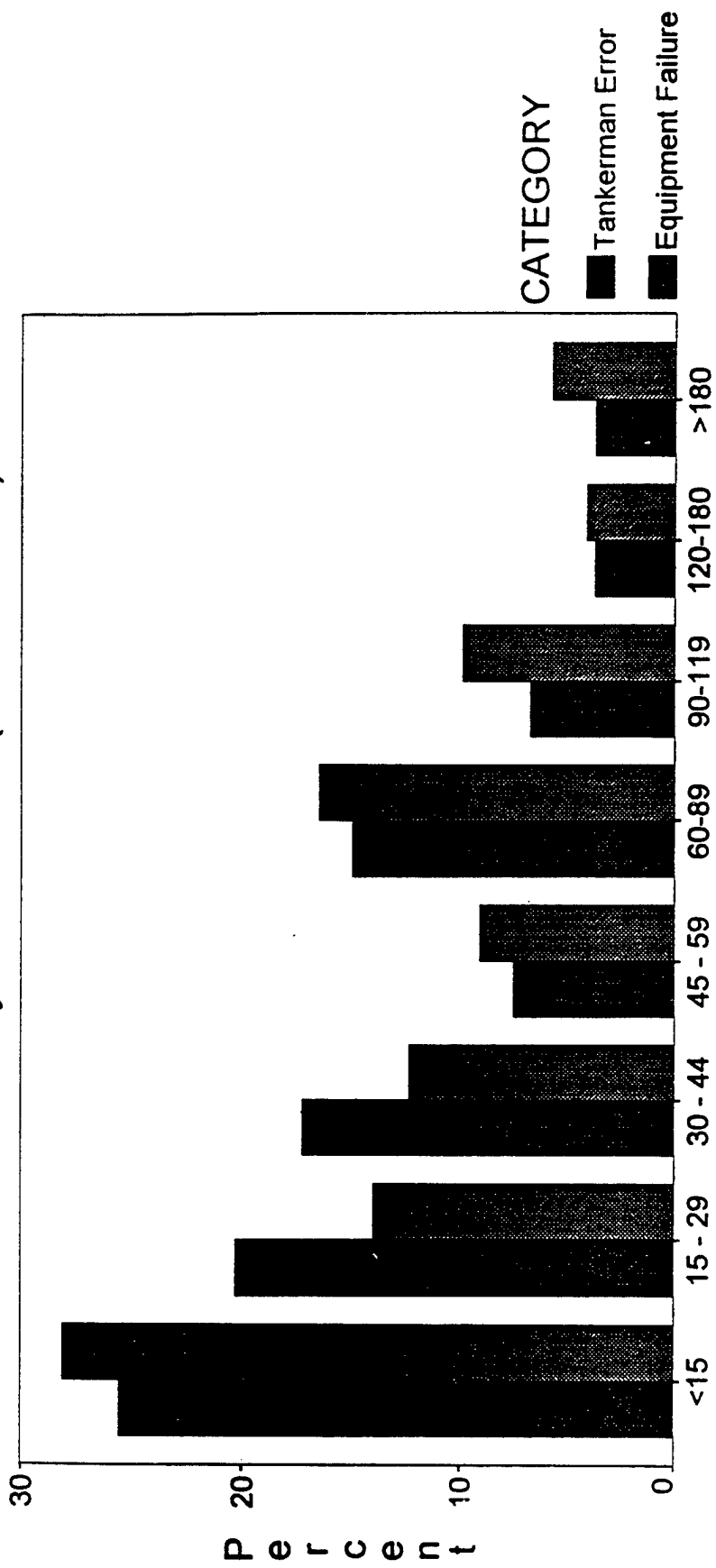

# Total Investigation Time (in hours)

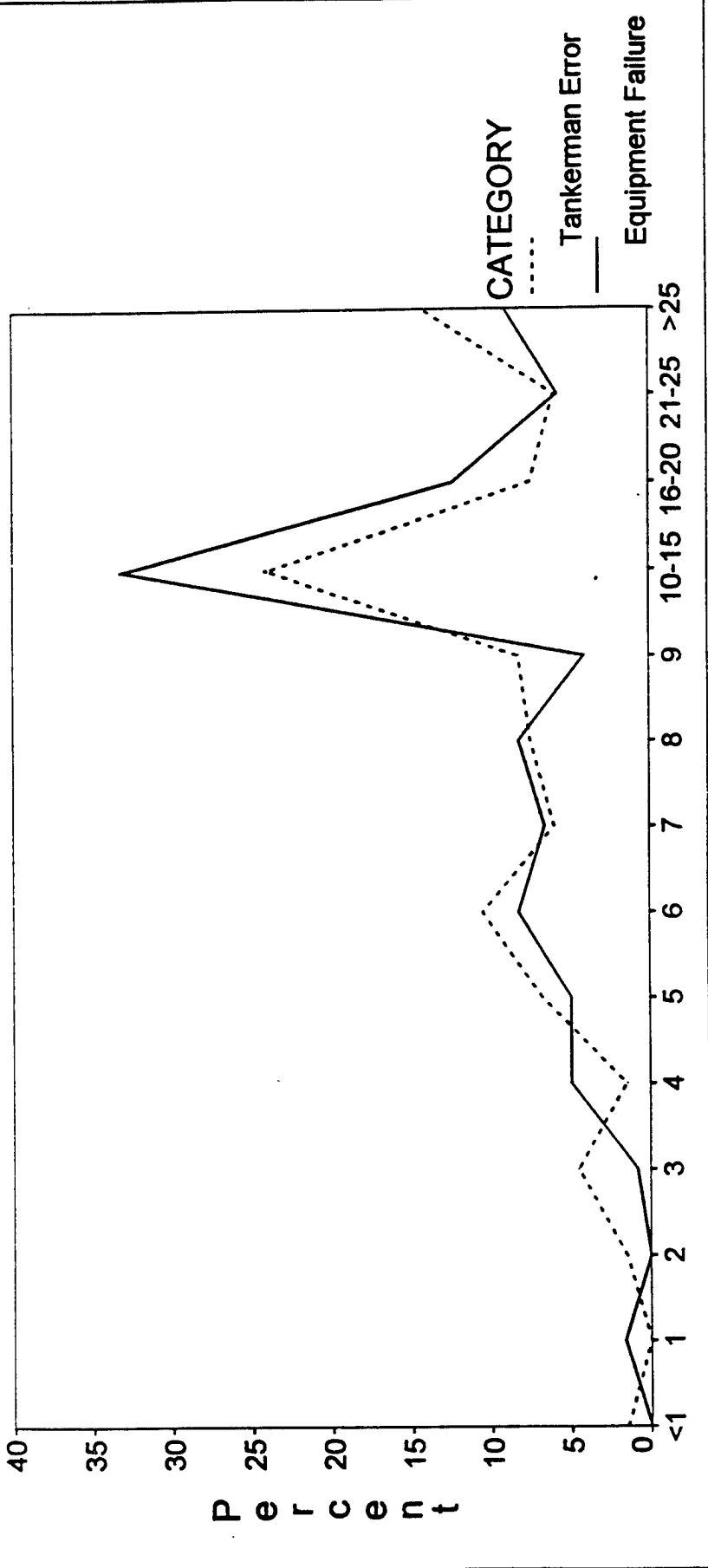

# Training (in hours)

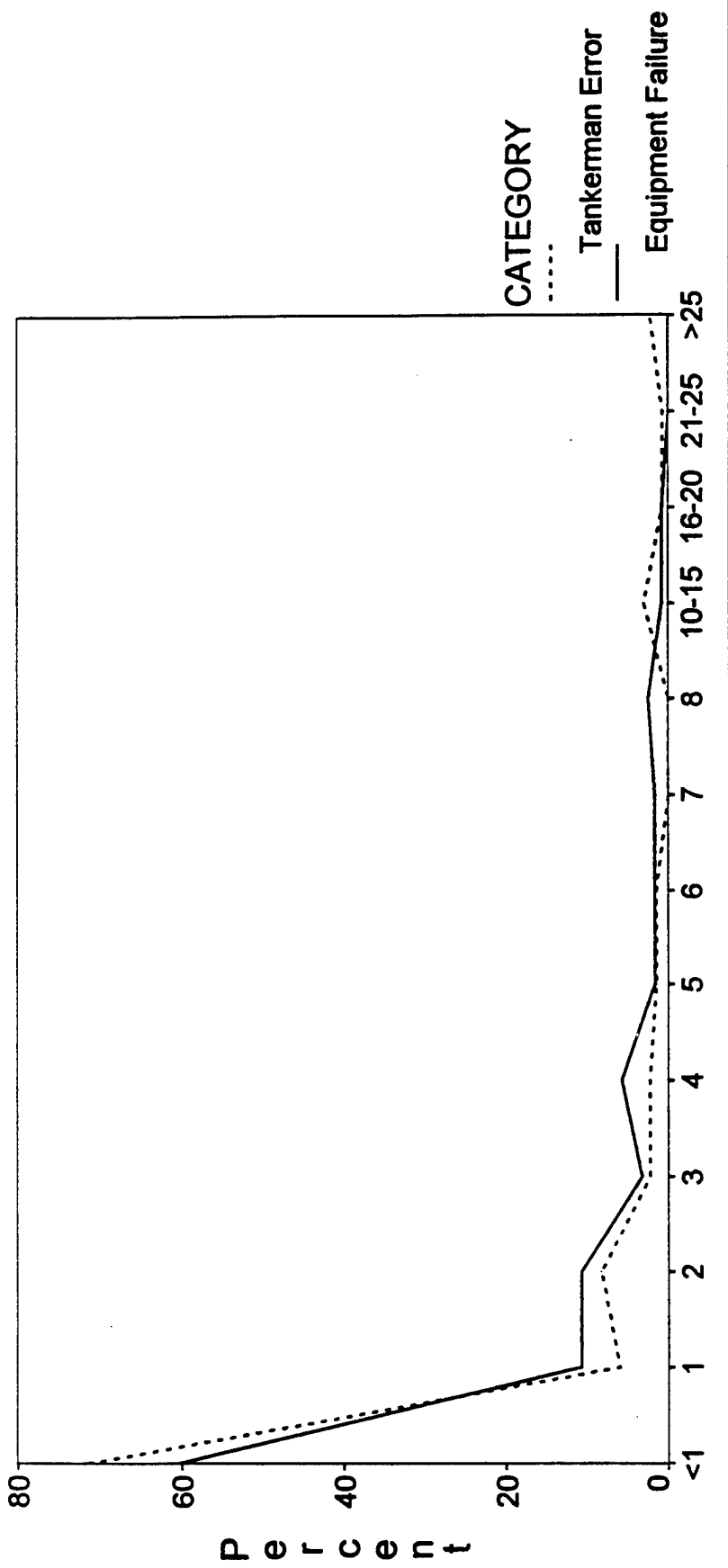

# Administration Time (in hours)

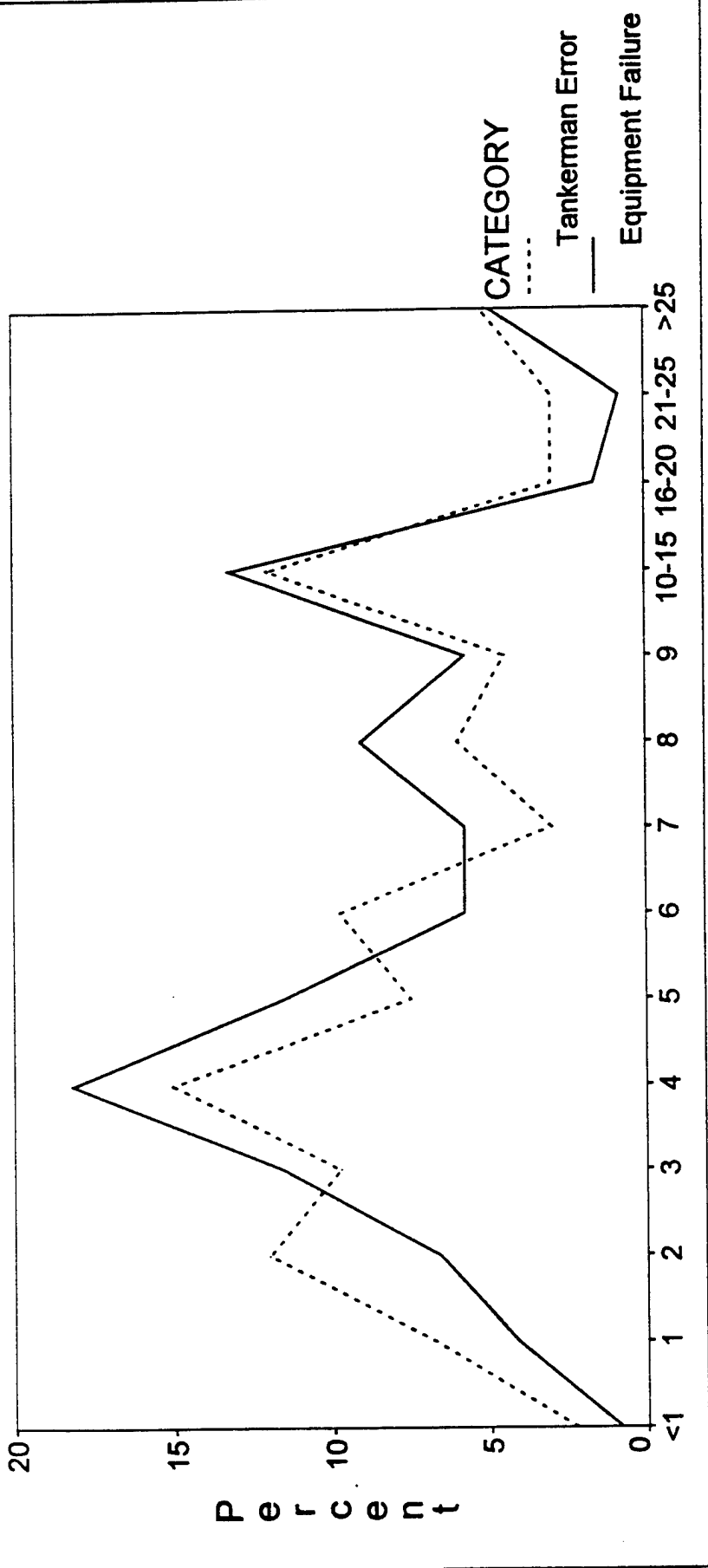

# Pollution Investigation (in hours)

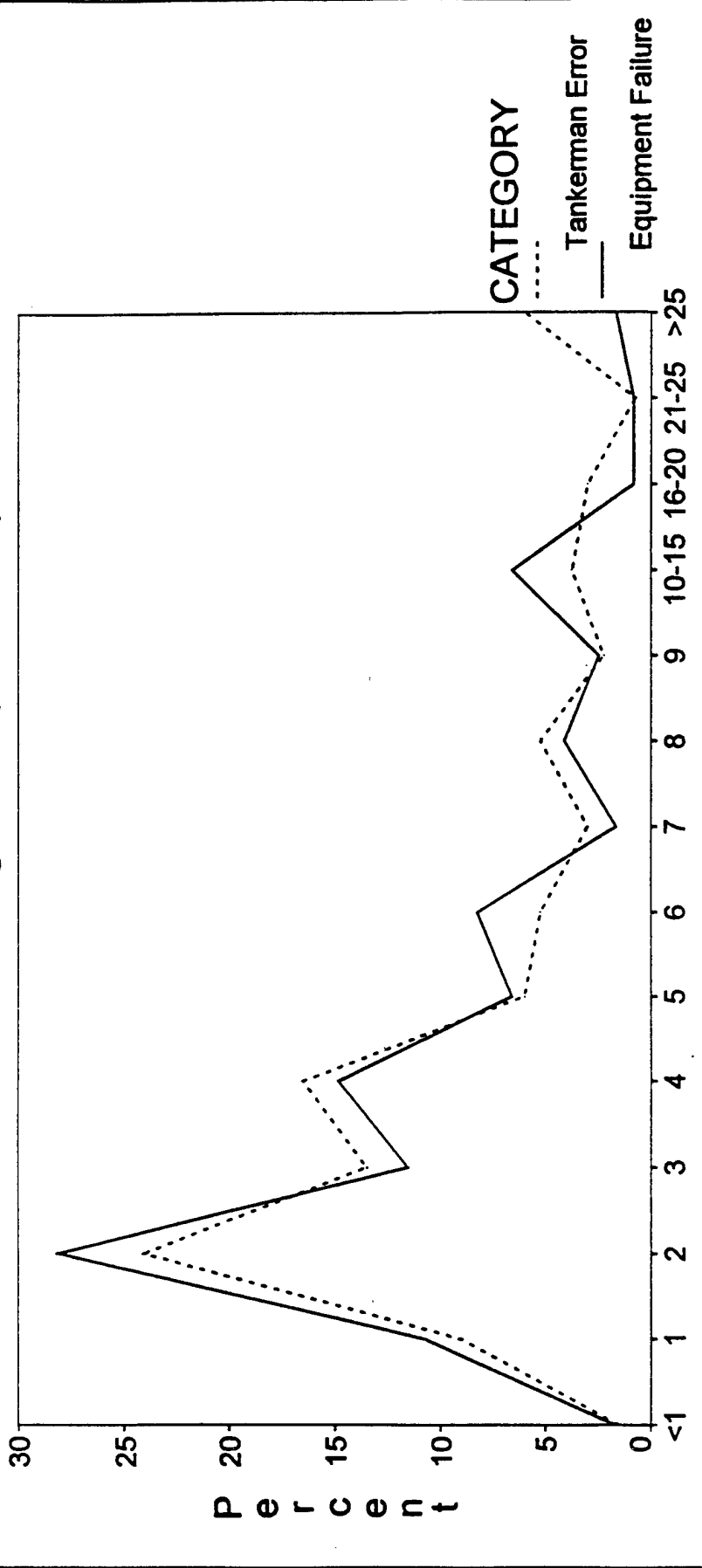

# Spill Amounts by Coast Guard Classification

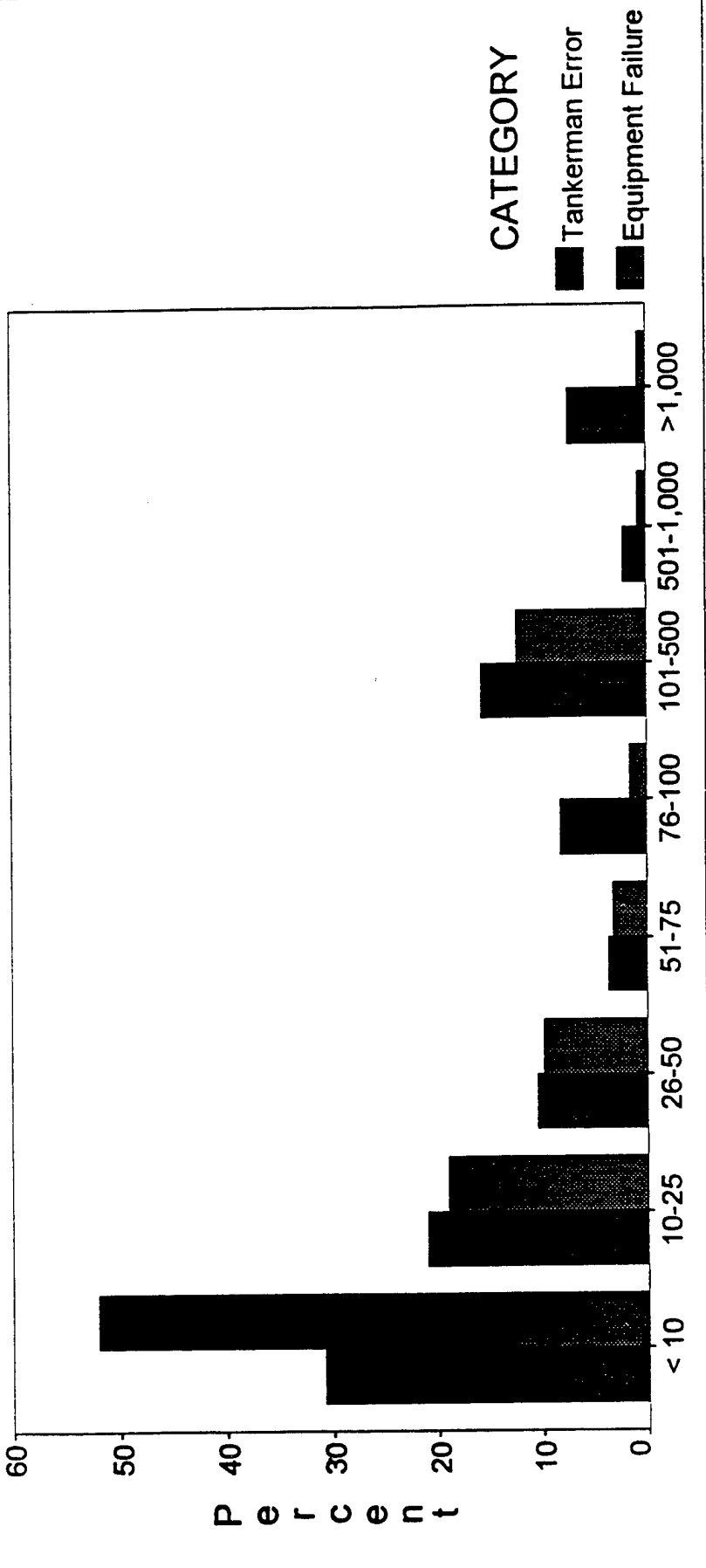

**APPENDIX E**

**Examples of Narrative Supplements  
Contained within MCIR Reports**



# 17

S

MARINE CASUALTY NARRATIVE SUPPLEMENT

03OCT96

E/ MC95003838 PORT/ TAMMS SUBJECT/ V PM T/B COASTAL #32 20G R DATE/ 07MAR95

--- COMMENTS ---

I RESPONDED TO THE INCIDENT INVOLVING THE T/B COASTAL 32 (D274649) ON MAR 95 AT 1350. UPON ARRIVING ON SCENE, I OBSERVED A SHEEN ON THE WATER'S SURFACE OF PORT MANATEE ON THE STARBOARD SIDE OF T/B COASTAL 32, A NAVIGABLE WATERWAY OF THE UNITED STATES. I ALSO OBSERVED BLACK OILY RESIDUE ON THE DECK OF THE BARGE UNDERNEATH THE AFT STARBOARD DISCHARGE MANIFOLD OPENING AND OVER THE DECK COAMING AND GUNWALE. CLEANUP OPERATIONS WERE ONGOING BY FACILITY EMPLOYEES AND TUG AND BARGE CREWMEMBERS USING SORBENT BOOM AND

DURING MY ON SCENE INVESTIGATION, I SPOKE WITH EDWARD WAYNE GEORGE, TANKERMAN, WHO STATED TO ME THAT AFTER HE AND THE DOCKMAN SIGNED THE D.O.I., HE COMMENCED TRANSFER OPERATIONS (LOADING) OF #6 OIL. TO PREPARE FOR A SECOND, SIMULTANEOUS TRANSFER OF #2 DIESEL, MR. GEORGE REMOVED AN 8" TO 6" REDUCER (TYPICALLY USED FOR THE SECOND TRANSFER OPERATION) AND AN 8" BLANKING FLANGE FROM THE TUG'S AFT 6" DISCHARGE LINE. HE DID NOT BLANK OFF THE OPEN 6" DISCHARGE LINE AFTER REMOVAL. AFTER PLACING THE REDUCER ON THE 8" LINE AND CONNECTING THE TUG'S 6" LINE FOR LOADING, HE THEN COMMENCED LOADING OF #2 DIESEL. MR. GEORGE STATED TO ME THAT HE WAS TRYING TO SAVE TIME BY UTILIZING THE DISCHARGE LINE'S REDUCER RATHER THAN OBTAINING ONE FROM ELSEWHERE. 45 MINUTES AFTER REMOVING THE FLANGE, #6 OIL HAD RECIRCULATED THROUGH THE PIPING BYPASSING THE CHECK VALVE IN THE AREA OF THE TRANSFER PUMP AND BEGAN DISCHARGING FROM THE TUG'S DISCHARGE LINE. CAPT. STEPHEN ZAWADSKI, MASTER OF THE TUG COASTAL FORT WORTH, STATED THAT HE WAS WALKING ACROSS THE PIER WHEN HE NOTICED THE DISCHARGE OCCURRING. HE YELLED FOR THE TANKERMAN AND DOCKMAN TO SECURE THE TRANSFER, AND IMMEDIATELY INITIATED CLEANUP USING THE FACILITY'S AND BARGE'S RESPONSE EQUIPMENT. AFTER CLEANUP OPERATIONS WERE UNDERWAY, CAPT. ZAWADSKI ADVISED THE N.R.C. OF THE INCIDENT. CLEANUP TOOK APPROXIMATELY 3 HOURS. DEBRIS COLLECTED FROM WATER AND MATERIALS USED FOR CLEANUP WERE TAKEN TO CLARK COUNTY WASTE TREATMENT PLANT FOR DISPOSAL.

UPON COMPLETION OF MY INVESTIGATION, I DETERMINED THAT THE DISCHARGE WAS A RESULT OF THE TANKERMAN, EDWARD WAYNE GEORGE, REMOVING A FLANGE FROM THE TUG'S DISCHARGE LINE WHILE TRANSFERRING #6 OIL FROM THE DOCK TO THE T/B. AS A RESULT, APPROXIMATELY 20 GALLONS OF #6 OIL WERE DISCHARGED THROUGH THE DISCHARGE LINE OF THE T/B COASTAL 32, CREATING A VISIBLE SHEEN AND EMULSION ON THE WATERS OF PORT MANATEE, A NAVIGABLE WATERWAY OF THE UNITED STATES. IN ADDITION, MR GEORGE FAILED TO ENSURE THAT EACH PART OF THE TRANSFER SYSTEM NOT NECESSARY FOR THE #6 OIL AND #2 FUEL WERE SECURELY BLANKED. I RECOMMEND A SUBSTANTIAL CIVIL PENALTY BE ASSESSED AGAINST COASTAL TUG AND BARGE, CAPTAIN/OPERATOR OF THE T/B COASTAL 32.

MARINE CASUALTY NARRATIVE SUPPLEMENT

03OCT9

MC... PORT/ HMRMS SUBJECT/ BARGE NO. 27, HESS OIL CHES DATE/ 18JAN9

--- COMMENTS ---

MR. MELVIN BROWN OF CHESAPEAKE FOREST PRODUCTS (CHES CORP) WEST POINT, VIRGINIA NOTIFIED MSO HAMPTON ROADS VIA MARINE RADIO AT 2330, 18 JANUARY, 1995, THAT APPROXIMATELY 1 GALLON OF NO. 6 OIL HAD SPILLED INTO THE ELIZABETH RIVER FROM THE BARGE NO. 27 WHILE RECEIVING CARGO AT HESS OIL IN CHESAPEAKE, VIRGINIA. SGT. DENNIS MAULDING AND MK3 JOHNNY G. HALL, POLLUTION INVESTIGATORS FROM MSO HAMPTON ROADS, ARRIVED ON SCENE AT 0003, 19 JANUARY, 1995. THE INVESTIGATORS OBSERVED APPROXIMATELY 1/2 GALLON OF NO. 6 OIL UNDERNEATH THE PIER AT HESS OIL. THE INVESTIGATORS WENT ONBOARD THE BARGE NO. 27 WHERE THEY OBSERVED APPROXIMATELY 5 GALLONS OF NO. 6 OIL ON THE DECK OF THE VESSEL. THE OIL RAN FROM THE PUMP SHAFT COVERING / PACKING GLAND HOUSING TO THE DECK OF THE BARGE ACROSS THE DECK TO THE EDGE OF THE VESSEL WHERE IT RAN DOWN TO THE ELIZABETH RIVER. BARGE PERSONNEL USED OIL DRY (DI-TENACIOUS EARTH) TO ABSORB THE OIL FROM THE DECK OF THE BARGE AND MITIGATE FURTHER SPILLAGE. THE INVESTIGATORS ISSUED A NOTICE OF FEDERAL INTEREST TO THE TANKERMAN FOR BARGE NO. 27, MR. MELVIN BROWN, AND INTERVIEWED HIM. THE INVESTIGATORS THEN PROCEEDED TO INTERVIEW MR. MYRON WATERFIELD, THE DOCKMAN FOR HESS OIL. BASED ON THE INTERVIEWS AND THE INVESTIGATORS FINDINGS, IT WAS DETERMINED THAT WHILE LOADING A CARGO OF NO. 6 OIL, THE TRANSFER PUMP ONBOARD THE BARGE NO. 27, THOUGH NOT IN OPERATION, FILLED WITH PRODUCT AND LEAKED BY THE PUMP'S ALREADY WORN SHAFT PACKING GLAND, ALLOWING THE PRODUCT TO SPILL ONTO THE DECK OF THE BARGE NO. 27 WHERE IT RAN ACROSS THE DECK AND INTO THE ELIZABETH RIVER. THE INVESTIGATORS WERE LEAVING THE SCENE AT APPROXIMATELY 0130, THEY SHONED THEIR SPOTLIGHTS INTO THE WATER WHERE THEY OBSERVED A SLICK OF NO. 6 OIL 100 FEET LONG X 3 FEET WIDE. THE INVESTIGATORS NOTIFIED MR. BROWN, THE TANKERMAN FOR BARGE NO. 27, WHO NOTIFIED MR. STILLWAGON OF CHESAPEAKE FOREST PRODUCTS (CHES CORP). MR. STILLWAGON THEN INSTRUCTED INDUSTRIAL MARINE SERVICES TO ARRIVE ON SCENE AND PERFORM A CLEANUP OF THE BARGE AND THE SURROUNDING AREA. THE INVESTIGATORS STAYED ON SCENE UNTIL IMS ARRIVED WHICH WAS AT 0300, 19 JANUARY,

MC94000664 PORT/ HMRMS SUBJECT/ MARPOL BARGE - ATLANTIC 28 DATE/ 02JA

## --- COMMENTS ---

MR. EARL EDWARDS OF MARPOL INC, NORFOLK, VA, NOTIFIED MSO HAMPTON ROADS A 35, 02JAN94, OF AN OIL SPILL OF APPROX 1 GAL OF NO. 6 FUEL OIL INTO THE JAWLIVER ON 02JAN94 AT APPROX 1220.

SENIOR CHIEF PETTY OFFICER JENNINGS, PETTY OFFICERS NEWLON AND LEWIS, POLLUTION INVESTIGATORS FROM USCG MSO HAMPTON ROADS, ARRIVED ON-SCENE AT PIE 15, CSX, NEWPORT NEWS, ON 02JAN93, AT APPROX 1405. DUE TO THE ELAPSED TIME BETWEEN THE TIME OF NOTIFICATION AND TIME THAT THE POLLUTION INVESTIGATORS ARRIVED ON-SCENE, THE PRODUCT HAD BEEN RECOVERED AND THERE WAS NO SHEEN OBSERVED.

PETTY OFFICER NEWLON PROCEEDED WITH THE INVESTIGATION BY ISSUING A NOTICE FEDERAL INTEREST TO THE TANKERMAN IN CHARGE OF THE ATLANTIC 28, MACK LYONS, 1415. PETTY OFFICER NEWLON THEN INTERVIEWED MR. LYONS. MR. LYONS STATED THAT WHILE DISCHARGING BUNKER FUEL TO THE U.S.N.S. CAPE HORN, HE NOTICED A SHEEN (THE STARBOARD SIDE OF THE ATLANTIC 28 AT APPROX 1230. UPON DISCOVERING THE SHEEN, MR. LYONS INVESTIGATED AND FOUND THAT THE NO.2 STARBOARD CARGO TANK HAD A "WEEPY SEAM" THAT WAS LEAKING APPROX 4 INCHES BELOW THE DECK. MR LYONS DEPLOYED A SORBENT BOOM AND THEN NOTIFIED HIS OFFICE. HE CONTINUED TO PUMP OIL FROM THE NO.2 STARBOARD CARGO TANK UNTIL THE OIL LEVEL WAS BELOW THE "WEEPY SEAM". AT 1250, HE WAS NOTIFIED BY HIS OFFICE TO STOP TRANSFER AND CONTINUE CLEANING UP.

PETTY OFFICER NEWLON THEN INTERVIEWED JACK S. MENENDEZ, THE NIGHT MATE ON THE U.S.N.S. CAPE HORN. MR. MENENDEZ STATED THAT WHILE MAKING A ROUND OF THE VESSEL, HE LOOKED OVER THE PORT BRIDGE WING TO CHECK ON THE FUEL BARGE. HE NOTICED A SHEEN COMING FROM THE OFFSHORE SIDE OF THE ATLANTIC 28. WHEN HE WAS NOTIFYING THE CHIEF MATE, THE CREW OF THE BARGE NOTICED THE SHEEN AND TOOK STEPS TO STOP THE LEAK AND RECOVER THE LEAKED PRODUCT.

U.S. COAST GUARD INSPECTORS ARRIVED ON-SCENE TO ASSESS THE DAMAGE ON THE ATLANTIC 28. THE INSPECTORS DEEMED IT FIT ENOUGH TO FINISH THE TRANSFER AND PROCEED TO IT'S FACILITY, MARPOL INC. INSPECTORS ISSUED A CG835 REQUIRING IT HAVE REPAIRS COMPLETED PRIOR TO ANY FUTURE OPERATIONS. REFER TO MARINE INSPECTION CASE MI94000411 FOR ADDITIONAL INFO REGARDING REPAIRS.

MK3 JOHNNY G. HALL  
POLLUTION INVESTIGATOR

4114

MARINE CASUALTY NARRATIVE SUPPLEMENT

03OCT96

MC94002818 PORT/ NYCFI SUBJECT/ T/B ERIE\EQUIP FAILURE

DATE/ 10FEB94

--- COMMENTS ---

On Feb 1994 the T/B ERIE D292345 reported spilling 100 gallons of #2 fuel at the Amerada Hess terminal in New Jersey. The suspected cause of the spill was a malfunctioning valve in the #1 starboard cargo tank. As the vessel was topping off the number 4 tanks the number 1 starboard tank started overflowing from the ullage opening. The spill was boomed off and clean up barges were brought in to pick up the oil. An CG-835 was issued to the vessel to ensure the proper operation of the valve to the satisfaction of the attending inspector prior to loading cargo again. The cargo was offloaded and the valve cycled several times and the vessel was loaded again without incident. The CG-835 was cleared with a phone call and no inspector was present to witness the operation of the valve we have no way of knowing what the actual cause was. It is very likely that the original problem was debris in the tank jamming itself in the valve causing it not to close completely. This particular vessel isn't the newest or the best maintained vessel in the barge fleet.

137

# 149

MS

MARINE CASUALTY NARRATIVE SUPPLEMENT

03OCT96

SE/ MC94003563 PORT/ COND SUBJECT/ BARGE MILLICOMA

DATE/ 20FEB94

--- COMMENTS ---

According to tug master of the HONCHO (O.N. 565026) Capt. B. Shipps, Lic. 16746, on 19FEB94, while towing the T/B MILLICOMA (O.N. 686720) alongside in Richmond Inner harbor, high wind speeds caused the barge to hit a dock. Initial investigation by tug crew revealed a minor inset in the area of the No. 5 starboard cargo tank and some paint was removed from the hull.

According to Sause Bros barge & tankerman logs of 19FEB94 and 20FEB94 being dictated by Mr. Harry Mollier and Gary Hall, Person in Charge (PIC) of the oil transfer, that at 201840UFEB94 the No. 5 starboard cargo tank was topped off. At 201905UFEB94, something was noticed in the water on the starboard side of the barge and cargo operations were secured. Diesel fuel was leaking around the No. 5 starboard cargo tank causing a sheen upon the surface waters of San Pablo Bay. PIC's reported to their office (Mr. John Lemos) that a sheen 3ft x 75ft on the surface waters and that the source of the sheen was from a 3 inch x 4 inch fracture 4 feet from the deck on the starboard side shell of the No. 5 starboard cargo tank. The time from when the No. 5 starboard cargo tank is topped off till the leak was stopped is approx. 50 minutes. Amount thought to have been discharge is approx. 50 gallons. The diesel fuel in the No. 5 starboard cargo tank was transferred to other tanks within the barge. No. 5 tank was entered and a temporary patch placed over the hole (Z-Spar) on the inside and outside of the hull.

At 201915UFEB94, crew of the Tug Honcho and T/B Millicoma start placing clean up pads and sorbent boom around barge.

At 201928UFEB94, Mr. John Lemos, acting on behalf of the responsible party, SAUSE BROS OCEAN TOWING CO INC., reported the incident to the National Response Center, Incident report # 222560. Mr. Lemos reports that an incident occurred at Pacific Refining facility at Hercules, CA., in which diesel fuel leaked from the No. 5 starboard tank of the T/B MILLICOMA, causing a sheen 3ft x 75ft.

On 20FEB94 AT 1905U THE BARGE MILLICOMA (O.N. 686720) DISCHARGED A HARMFUL QUANTITY OF 50 GALLONS OF DIESEL FUEL, UPON SAN PABLO BAY A NAVIGABLE WATERWAY IN THE UNITED STATES, WHICH CREATED A 3 FT X 75 FT SHEEN ON THE SURFACE WATERS. THE BARGE MILLICOMA IS OPERATED BY SAUSE BROS OCEAN TOWING CO INC. CLEAN UP WAS ACCOMPLISHED BY THE CREW OF THE BARGE AND TUG HONCHO (O.N. 565026) AND MINOR DISAPPOINTMENT DUE TO HEAVY SEAS AND WINDS.

Notice of Federal Interest mailed to Sause Bros Ocean Towing Co Inc. on 20FEB94.

MARINE CASUALTY NARRATIVE SUPPLEMENT

MC94008845 PORT/ HOUMS SUBJECT/ T/B SSC 80

PCN 101

030

DATE/ 23A.

--- COMMENTS ---

23 APRIL 1994, AT APPROX. 1515, POLLUTION INVESTIGATORS RESPONDED TO A POLLUTION INCIDENT AT RHONE POULENC BASIC CHEMICALS, HOUSTON TX. INVESTIGATORS OBSERVED THE MANIFOLD OF T/B SCC 80 HAD BROKE OFF OF THE CARGO PIPING SYSTEM AND WAS LAYING ON THE DECK AND WAS STILL CONNECTED TO THE FACILITY LOADING AND THREE PARTED MOORING LINES WERE ON DECK AND FACILITY PERSONNEL PERFORMED CLEANUP OPERATIONS ON THE DECK OF T/B SCC 80. TIMOTHY RISER (DOCKMAN) AND DAVID ELIZARRAS (TANKERMAN) STATED THEY WERE TRANSFERING SULFURIC ACID TO THE T/B SCC 80 WHEN THEY OBSERVED THE M/V ZNAMAY OKTYABRA (O.N. L7645500) UNDERWAY IN THE HOUSTON SHIP CHANNEL AT A HIGH RATE OF SPEED. THEY ATTEMPTED TO ADJUST THE MOORING LINES BUT, WERE UNABLE TO MAKE THE ADJUSTMENTS BEFORE THE WAKE OF THE VESSEL HIT THE BARGE CAUSING THE MOORING LINES TO PART. AN EMERGENCY SHUTDOWN WAS PERFORMED JUST AS THREE MOORING LINES PARTED AND THE MANIFOLD BROKE FROM THE T/B SCC 80. CLEANUP WAS PERFORMED BY RHONE POULENC PERSONNEL. INVESTIGATIONS DEPT. IS CONDUCTING AN INVESTIGATION ON THE M/V ZNAMAY OKTYABRA WHICH CAUSED THE DAMAGE AND SPILL. 50 GALLONS OF SULFURIC ACID IS BELOW THE FLOOR OF 1000 POUNDS.

M2/E-5 DARRIN L. KERSCHNER  
POLLUTION INVESTIGATOR  
650 HOUSTON TX  
(713) 671-5100

2187

H 205

MARINE CASUALTY NARRATIVE SUPPLEMENT

03OCT96

MC94012169 PORT/ SAVMS SUBJECT/ COLONIAL-BARGE,OIL,MINOR DATE/ 16JUN94

--- COMMENTS ---

Upon arrival at SEPCO, the mso team was met by Mr. Dwayne Washington. He explained that approximately one quart of #6 diesel fuel spilled out of the transfer hose, then splashed off of the containment onto the dock, while barge B's hose was being disconnected from SEPCO's manifold. A portion of which dropped into the Savannah river, a navigable water of the United States. Because of the river current, recovery of the oil in the water was not possible. SEPCO employees accomplished clean-up of the dock. Letters of General Interest were issued to SEPCO and Barge B-18.

GM1 HANS C. PITTMAN

Interviewed parties listed on IAWL from both the responsible party and the reside facility. Lack of communication appears to be a contributing factor. Tankerman handling the disconnect asked the person in charge shoreside if everything was OK, the "PIC" replied yes. As the tankerman loosened a few of connecting bolts, residual oil remaining in the hose began to run down the side of the hose missing the containment area and running on to the hands of tankerman.

A relieving line at the facility is equipped with an air fitting that when utilized is designed to apply air back through the transfer line to assist in clearing the hose of residual product. This procedure was not done. The tankerman assumed that the person in charge ashore had applied air to the line. The person in charge ashore assumed that if the tankerman wanted air applied to the line he would have asked for it. Both parties have been advised to review their transfer procedures and to be specific when communicating.

BM1 P. M. WEBBER

MARINE CASUALTY NARRATIVE SUPPLEMENT

03OCT96

94013583 PORT/ HOUMS SUBJECT/ DM 958 BENZENE SPILL PCN- DATE/ 06JUL94

--- COMMENTS ---

CONNECTED REDUCER BETWEEN 6 AND 8 INCH HOSE FROM BARGE TO FACILITY. REPORTEDLY CONDUCTED VISUAL INSPECTION. BENZENE RELEASED FROM REDUCER DURING START-UP OF TRANSFER. TANKERMAN CORRECTLY DESCRIBED METHOD OF SECURING BOLTS. GASKET IN GOOD CONDITION. TANKERMAN HAS NO PRIOR RECORD. IMPROPER CONNECTION IS SPECULATED CAUSE BUT NOT DETERMINABLE.

PERSONAL DATA:

NAME: KEHLMEIER  
ADDRESS: 94 8199  
CITY: HOUSTON, TX 77587  
PHONE: 0490

4217



## MARINE CASUALTY NARRATIVE SUPPLEMENT

03OCT

94014737 PORT/ HMRMS SUBJECT/ T/B M-40 OILY WATER (DIESEL DATE/ 02JUL

## --- COMMENTS ---

Mr. Robert Doran of Earl Industries, Portsmouth, Virginia, notified MSO at Hampton Roads at 0847, 02JUL94, of approximately 20 gallons of OILY WATER spilling into the Elizabeth River. Mr. Doran further advised that the spill occurred while conducting a transfer from the M/V Saipan, through the T/B Duke (being used as a pipeline) to the T/B M-40, a high transfer rate caused a surging action at the start of the transfer and caused the quick release cam lock ears (on the T/B M-40) to open, and the hose disconnected. The hose 'backed off' and discharged approx 20 gals of Oily Water into the Elizabeth River.

PS1 Raymond Newlon, and PS3 Larry Harris, pollution investigators from MSO at Hampton Roads (RU Norfolk), arrived on scene at Norfolk Naval Shipyard at 0910 02JUL94. They observed a sheen on the waters of the Elizabeth River, a navigable water of the United States. The sheen consisted of approximately 20 gallons of Oily Water (Diesel) and was of sufficient amount to constitute a harmful quantity. They additionally observed a containment boom in place around the spill. Earl Industries personnel were conducting cleanup with small boats and absorbent pads.

They interviewed and obtained statements from Robert J. Doran Jr., Program Manager, Earl Industries, Inc., and Paul G. West Jr., Tankerman T/B Duke. Based upon their statements and the investigator's findings, it was determined that while conducting a transfer from the M/V Saipan, through the T/B Duke (being used as a pipeline) to the T/B M-40, a high transfer rate caused a surging action at the start of the transfer and caused the quick release cam lock ears (on the T/B M-40) to open, and the hose disconnected. The hose 'backed off' and discharged approx 20 gals of Oily Water into the Elizabeth River.

PENALTY RECOMMENDED IS BASED ON:

COMDINST 16200.3A, ENCL (1) PG.9. CATEGORY (C)

Category C: Discharge from any source where issues of gravity or culpability are important, for example: the volume or location of the spill; the relative hazard posed by the substance spilled; evidence of negligence, inattention, failure to perform, or a lapse of professional standards; evidence of a failure to reasonably anticipate the cause, or a failure to observe other applicable law or code, causing or contributing to the discharge.

RECOMMEND \$1,000

#228

/ MC94018266 PORT/ ANCMS SUBJECT/ T/B ANNAHOOTZ, POLLUTION DATE/ 01SEP9

## --- COMMENTS ---

## SUMMARY:

1. The U.S. tank barge ANNAHOOTZ, while moored at the Port of Anchorage, P.O.L. terminal #2 on or about 0715 September 1, 1994, had an overflow of the port tank, discharging approximately 400 gallons of #2 diesel fuel into the waters of Cook Inlet, a navigable waterway of the United States. This discharge created a visible sheen on the surface of the water.
2. Vessel Specifics: Tank barge ANNAHOOTZ - D655941, 2638 GT, 240.0 ft in length, 70.0 ft in breadth, 18.1 ft depth.
3. Weather: Visibility 8-10 miles, winds 10-15 kts, seas calm, overcast, 1000 ft ceiling(Enclosure 1).

## FINDINGS OF FACT:

1. While moored to the P.O.L. terminal #2 at the Port of Anchorage, the tank barge ANNAHOOTZ started receiving #2 diesel fuel from the shoreside facility on or about midnight 31 August 1994. The tankermen intended to unload the barge, keeping it as level and trim as possible(Enclosure 2).
2. After commencing the onload, Michael Kearns went to sleep and later awoke Mark Napier on or about 0330, 01 September 1994. Mr. Napier was back on duty on or about 0600, 01 September 1994. At that time, both tankermen continued to monitor the tank barge levels, with Mr. Kearns monitoring the starboard tanks and Mr. Napier monitoring the port tanks(Enclosure 3).
3. The #3 tanks were the initial tanks to receive fuel. The #4 and #5 tanks were topped off to the 95 percent level. The #1 and #2 tanks were being fueled at the time of the spill(Enclosure 3).
4. The #1 port and starboard and #2 port and starboard tanks were being fueled with the #1 tanks at a slightly reduced flow rate. The lines and hoses at the dock were reported to be loose and not hung up. The last reported reading of the #1 port tank prior to the spill indicated that the level was about 12-1/2 feet(approximately 78,000 gallons). The 95 percent level for this tank is approximately 17 feet or 106,000 gallons(Enclosure 3).
5. Mr. Napier stated that after checking the level of the #1 port tank, he went back aft to check the levels of the #3 and #4 tanks to insure no fuel was entering these tanks. While checking these tanks, he looked forward and observed fuel coming out of the access cover and sounding tube for the #1 port tank and pouring onto the deck of the barge, and into the water. Mr. Napier and Mr. Kearns stated that they immediately contacted the dock side person in charge to secure the fuel flow to the barge. The flow of fuel from the shoreside facility was reported to have been immediately stopped. All valves on the tanks on the barge were also secured(Enclosure 3).
6. After the fueling operation was secured, the tankermen commenced containment and cleanup procedures using on board response gear(Enclosures 1 and 3). VRCA Environmental Services was later contracted by the owners to continue the cleanup response(Enclosure 1). On September 2, 1994 the MSO representative determined no further active cleanup was necessary(Enclosure 4).
7. COTP order 21-94 issued on vessel movement restrictions. To prevent further pollution from the residual diesel fuel on the barge deck, the COTP representative directed the removal of all wood deck planking, as necessary, and remove the residual diesel fuel from the deck(Enclosure 5). On September 3, 1994, the planking removal and deck cleanup was completed and the COTP order was terminated(Enclosure 4).

## MARINE CASUALTY NARRATIVE SUPPLEMENT

03007

MC94018266 PORT/ ANCMS SUBJECT/ T/B ANNAHOOTZ, POLLUTION DATE/ 01SEP

## --- COMMENTS ---

8. The two tankermen involved in the monitoring of the product onload provided post incident drug test specimens for testing.

## D. CONCLUSIONS:

1. A discharge of #2 diesel fuel from the #1 port fuel tank on the tank barge ANNAHOOTZ did occur on the waters of Cook Inlet, Anchorage Alaska, on or about 0715, September 1, 1994.
2. Upon discovery of the discharge, the fueling operation was immediately stopped and efforts to contain and cleanup the discharge were initiated by the tankermen using the response gear on board the ANNAHOOTZ.
3. The tankermen on board the ANNAHOOTZ at the time of the product discharge into Cook Inlet, failed to adequately monitor the tank soundings while unloading #2 diesel fuel from the shoreside facility.
4. Fatigue may have been a contributing causal factor in the inadequate monitoring of the tank soundings on the ANNAHOOTZ.
5. Negative results of the post incident chemical testing indicate that dangerous drugs were not a factor in the discharge of petroleum products from the ANNAHOOTZ (Enclosures 6 and 7).

## E. ENCLOSURES:

- (1) COGARD MSO ANCHORAGE message date time group R 012224Z AUG 94.
- (2) Record of conversation, Michael B. Kearns, and CWO Schweizer, Investigating Officer, 1300, 01SEP94.
- (3) Record of conversation, Michael B. Kearns and Mark W. Napier, and CWO Schweizer, Investigating Officer, 1800, 01SEP94.
- (4) COGARD MSO ANCHORAGE message date time group R 072158Z SEP 94.
- (5) Captain of the Port order, 21-94 Vessel Movement restrictions, T/B ANNAHOOTZ O.N. D655941, dated September 1, 1994.
- (6) Record of conversation, Al Snelling, and CWO Schweizer, Investigating Officer, 1510, 23FEB95.
- (7) National Medical Review Offices, Inc., Urine test for drugs of abuse results, date of test Sep 1 94.

## **Appendix F**

**An Example of an Observation Form Used in this Study**

## Tankbarge Transfer Observations

Date: \_\_\_\_\_ Time: \_\_\_\_\_ Location: \_\_\_\_\_ Observer \_\_\_\_\_

Weather details: Cloudy / Sunny \_\_\_\_\_ Temp \_\_\_\_\_

Wind \_\_\_\_\_ Sea Conditions \_\_\_\_\_

Other: \_\_\_\_\_

Type of transfer: Bunkering Unloading Loading Other \_\_\_\_\_

Type of product \_\_\_\_\_

\*Note any special circumstances to the operation

Details of Tankbarge(s) involved (size, condition, equip. details ,etc.):

Number of individuals involved and details: (use Tankerman interview sheet)

1. Title: \_\_\_\_\_ (M / F) Age \_\_\_\_\_ Experience (Yrs) \_\_\_\_\_

Function in transfer \_\_\_\_\_ Hours on Shift \_\_\_\_\_

2. Title: \_\_\_\_\_ (M / F) Age \_\_\_\_\_ Experience (Yrs) \_\_\_\_\_

Function in transfer \_\_\_\_\_ Hours on Shift \_\_\_\_\_

3. Title: \_\_\_\_\_ (M / F) Age \_\_\_\_\_ Experience (Yrs) \_\_\_\_\_

Function in transfer \_\_\_\_\_ Hours on Shift \_\_\_\_\_

4. Title: \_\_\_\_\_ (M / F) Age \_\_\_\_\_ Experience (Yrs) \_\_\_\_\_

Function in transfer \_\_\_\_\_ Hours on Shift \_\_\_\_\_

### General notes regarding all phases

1. Take note of distractions and inattention to detail
2. Record apparent assumptions taken by each party involved regarding others involved
3. Maintaining Situational Awareness is critical to consistently safe operations. Record how individuals support MSA whether through cognitive aids, routine checks, anticipatory behavior and etc.
4. Record opportunities for ambiguity due to incomplete information or misleading information
5. Record as many salient features as possible during each phase.

## **Phases**

Note key events and interactions

### **1. Arrival and mooring operations**

Keep in mind level of preparedness, distractions, incorrect actions, and especially note the following:

- A. All necessary mooring equipment is available and ready for use
- B. Integrity of tanks (i.e. are tank hatches open or closed?)
- C. Consideration of emergency release procedures
- D. Firefighting and spill response equipment
- E. General state of the tankbarge and personnel
- F. Ease of personnel access to and from the barge
- G. Lighting and environmental factors

## **2. Hookup/ Connections and transfer conference**

Keep in mind preparedness, distractions, and attention to detail. Especially take note of the following:

- A. Inspection of cargo hoses
- B. Precautions regarding flanges and connections (pressurized or not?, full of oil or not?)
- C. Double checking of hose and valve alignments with appropriate product type
- D. Agreed upon loading/unloading plan
  - 1. Cargo flow and pressure rates
  - 3. Types and distribution of cargo
- E. Transfer conference
  - 1. Type and meaning of signals (slow, increase, decrease, stop, emergency stop)
  - 2. Communications parameters and cross-check
  - 3. Emergency stop procedures and sequence
  - 4. Deceleration of inspection
  - 5. Pertinent factors (expected weather, wind, unusual tides, etc.)
  - 6. Person In Charge (PIC) with respect to each participating party
  - 7. Discuss topping off procedures (if required)
- F. Final deck check before commencement of flow

### **3. Commencement of product flow**

Keep in mind preparedness, distractions, incorrect actions and especially take note of Maintaining Situational Awareness (MSA) and assumptions made. Also, note attention to detail and level of thoroughness (i.e., proactive or reactive stance) and the following:

1. Joint agreement to begin flow
2. Slow initial rate with incremental increases as flow and distribution is cross-checked (including closed tanks)
3. Inspection of connections, pump seals, valves and hoses for leaks



#### **4. Continuation of transfer**

Keep in mind levels of attention to situation (MSA), level of boredom, ancillary activities and the following:

1. Maintaining situational awareness of cargo rates and distribution
2. Continual attention to possible leak sources (connections, flanges, hoses, and etc.)
3. Communication checks to insure radio effectiveness
4. Notification of participating parties when a tank and/or valving switch will occur
5. Attention to mooring lines as tankbarge draft increases/decreases or due to tidal flow

## **5. Cessation of product flow**

Pay special attention to the topping-off procedure (If applicable) and the level of coordination between the involved parties. Especially note the following:

1. Slowing of flow rate to ensure adequate time for topping off
2. Time lag necessary to halt flow
3. Final tank gauging
4. Topping off needs to be restricted to the minimum number of tanks required (usually 1)

## **6. Disengagement of connections**

Pay attention to spill prevention and the following:

1. All requisite valves are closed and secured
2. All hoses and pipe work are drained of excess oil prior to opening connections
3. All tank openings are closed and secured
4. Open flanges are covered and secured with appropriate bolts

## **APPENDIX G**

### **Examples of Anecdotal Evidence**

## Anecdotal Evidence

The following three pieces of anecdotal evidence were solicited from licensed crewmembers and are responses to the following question: do you recall a near spill event? and if so, what did you learn from it?

1. A #2 fuel oil transfer was underway and expected to take an hour, so it was decided to do some routine maintenance on the transfer pump (check fluid levels, grease some fittings, etc.). Some difficulties were encountered and attention previously focused on the transfer was now focused on resolving the maintenance problem. This resulted in losing track of time, but, fortunately, fuel was noticed gurgling out of the vent pipes into the containment area and the transfer was immediately stopped with the tank being virtually full.

Lesson learned: pay attention to the transfer process and don't get distracted by other duties.

2. It was wintertime and we just arrived after a long transit when we began setting up the valves for taking on two types of product simultaneously. The two products began to flow onboard when it was noticed that one tank was filling which was not supposed to. The transfer process was stopped and the valving alignment rechecked with one valve being set improperly. The valve was reset and the transfer process was restarted with no more difficulties.

Lesson learned: the valve setup was not double-checked prior to product flow (I was tired and cold). So, it's best to have someone else verify the setup if possible, especially when tired; at least make a sketch before hand in order to have a reference.

3. We were connecting a hose for taking on diesel fuel but the connection did not seem to be right. The connection began to leak shortly after starting the flow, but did not appear to be too much of a problem because the drips were falling into the drip pan on the deck. During a switch in tanks, a butterfly valve was closed too quickly which caused a pressure surge to blow the hose seal. At this point the operation had to be stopped and the hose connection redone with another gasket.

Lesson learned: take time in the beginning to do it right. We were in a hurry and didn't think about the consequences of a leaky connection if an emergency shutdown had to be performed.

