



U.S. Department
of Transportation
**Federal Railroad
Administration**

Single Passenger Rail Car Impact Test Volume I: Overview and Selected Results

PB2000-107448



Office of Research
and Development
Washington, DC 20590

Rail Passenger Equipment Collision Tests

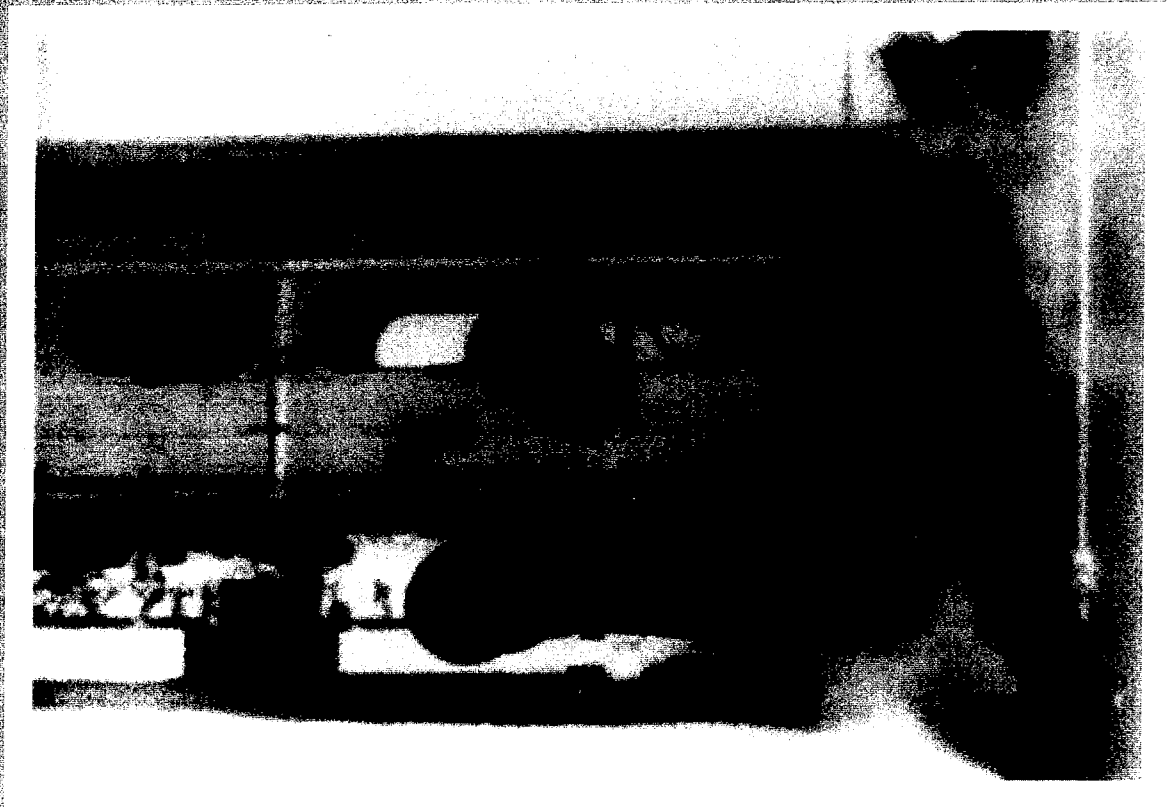

REPRODUCED BY: **NTIS**
U.S. Department of Commerce
National Technical Information Service
Springfield, Virginia 22161

DOT/FRA/ORD-00/02.1
DOT-VNTSC-FRA-00-01

Final Report
March 2000

This document is available to the
public through the National Technical
Information Service, Springfield, VA 22161
This document is also available on the FRA
web site at www.fra.dot.gov

NOTICE

This document is disseminated under the sponsorship of the Department of Transportation in the interest of information exchange. The United States Government assumes no liability for its contents or use thereof.

NOTICE

The United States Government does not endorse products or manufacturers. Trade or manufacturers' names appear herein solely because they are considered essential to the objective of this report.

REPORT DOCUMENTATION PAGEForm Approved
OMB No. 0704-0188

Public reporting burden for this collection of information is estimated to average 1 hour per response, including the time for reviewing instructions, searching existing data sources, gathering and maintaining the data needed, and completing and reviewing the collection of information. Send comments regarding this burden estimate or any other aspect of this collection of information, including suggestions for reducing this burden, to Washington Headquarters Services, Directorate for Information Operations and Reports, 1215 Jefferson Davis Highway, Suite 1204, Arlington, VA 22202-4302, and to the Office of Management and Budget, Paperwork Reduction Project (0704-0188), Washington, DC 20503.

1. AGENCY USE ONLY (Leave blank)		2. REPORT DATE March 2000		3. REPORT TYPE AND DATES COVERED Final Report November 1999 – December 1999	
4. TITLE AND SUBTITLE Single Passenger Rail Car Impact Test Volume I: Overview and Selected Results				5. FUNDING NUMBERS RR028/R0122	
6. AUTHOR(S) David Tyrell, Kristine Severson, A. Benjamin Perlman					
7. PERFORMING ORGANIZATION NAME(S) AND ADDRESS(ES) U.S. Department of Transportation Research and Special Programs Administration John A. Volpe National Transportation Systems Center 55 Broadway Cambridge, MA 02142-0193				8. PERFORMING ORGANIZATION REPORT NUMBER DOT-VNTSC-FRA-00-01	
9. SPONSORING/MONITORING AGENCY NAME(S) AND ADDRESS(ES) U.S. Department of Transportation Federal Railroad Administration Office of Research and Development 1120 Vermont Avenue, NW - Mail Stop 20 Washington, DC 20590				10. SPONSORING/MONITORING AGENCY REPORT NUMBER DOT/FRA/ORD-00/02.1	
11. SUPPLEMENTARY NOTES					
12a. DISTRIBUTION/AVAILABILITY STATEMENT This document is available to the U.S. public through the National Technical Information Service, Springfield VA 22161 This document is also available on the FRA web site at www.fra.dot.gov .				12b. DISTRIBUTION CODE	
13. ABSTRACT (Maximum 200 words) On November 16, 1999, at the Transportation Technology Center in Pueblo, Colorado, a test was conducted of a single rail passenger car colliding with a fixed wall at 35 mph. The car was instrumented to measure (1) the deformations of critical structural elements, (2) the vertical, lateral, and longitudinal deceleration of the carbody and trucks, and (3) displacements of suspension systems. The car was equipped with anthropomorphic test devices (test dummies) in three interior arrangements: 1. Forward-facing unrestrained occupants seated in rows, compartmentalized by the forward seat in order to limit the motions of the occupants. 2. Forward-facing restrained occupants with lap and shoulder belts. 3. Rear-facing unrestrained occupants. The purpose of the test was to validate and calibrate computer models for analyzing crashworthiness of rail passenger vehicles. Prior to the test, computer models were used to simulate the car's response during the test, and to develop the information required to determine the placement and type of instrumentation, as well as bounding the range of the interior decelerations likely to be experienced by the test dummies. Qualitatively, the results of the test and pre-test analyses are in reasonable agreement. Quantitatively, the results are in reasonable agreement for many of the key measures of the response of the equipment.					
14. SUBJECT TERMS Transportation, safety, crashworthiness, occupant protection, rail vehicles				15. NUMBER OF PAGES 32	
				16. PRICE CODE	
17. SECURITY CLASSIFICATION OF REPORT Unclassified	18. SECURITY CLASSIFICATION OF THIS PAGE Unclassified	19. SECURITY CLASSIFICATION OF ABSTRACT Unclassified	20. LIMITATION OF ABSTRACT		

PREFACE

This work was performed as part of the Equipment Safety Research Program sponsored by the Office of Research and Development of the Federal Railroad Administration. The authors would like to thank Dr. Tom Tsai, Program Manager, and Claire Orth, Division Chief, Equipment and Operating Practices Research Division, Office of Research and Development, Federal Railroad Administration, for their support.

Gunars Spons, Federal Railroad Administration Resident Engineer at the Transportation Technology Center, directed and coordinated the activities of all the parties involved in the test. Dr. Barrie Brickle, Senior Engineer, Transportation Technology Center, Inc., implemented the equipment-related portions of the test. Caroline Van Ingen-Dunn, Senior Engineer, Simula Technologies, Inc., implemented the occupant protection tests.

The authors would like to thank Edward Murphy, Chief Mechanical Officer, Southeastern Pennsylvania Transportation Authority, for arranging the donation of the cars in the test effort, Doug Karan of Amtrak for arranging the donation of the intercity passenger seats, and Gordon Campbell, Senior Engineer, LDK Engineering, Inc., for securing a copy of the Pioneer car structural drawings from Bombardier, Inc. Thomas Peacock of the American Public Transportation Association was exceptionally effective in his efforts to coordinate the test with members of the passenger rail transportation industry.

The authors would also like to thank Roy Allen, President, Transportation Technology Center, Inc., and his staff for hosting the guests who came to view the test, for arranging for a tour of the facilities at the Transportation Technology Center for those guests, and for their support in working with the media.

The authors would like to acknowledge the assistance of the US DOT's National Highway Transportation Safety Administration, which provided six test dummies, the US DOT's Federal Aviation Administration, which provided four load cells, and the US Navy, which provided two test dummies.

METRIC/ENGLISH CONVERSION FACTORS

ENGLISH TO METRIC

METRIC TO ENGLISH

<p>LENGTH (APPROXIMATE)</p> <p>1 inch (in) = 2.5 centimeters (cm) 1 foot (ft) = 30 centimeters (cm) 1 yard (yd) = 0.9 meter (m) 1 mile (mi) = 1.6 kilometers (km)</p>	<p>LENGTH (APPROXIMATE)</p> <p>1 millimeter (mm) = 0.04 inch (in) 1 centimeter (cm) = 0.4 inch (in) 1 meter (m) = 3.3 feet (ft) 1 meter (m) = 1.1 yards (yd) 1 kilometer (km) = 0.6 mile (mi)</p>
<p>AREA (APPROXIMATE)</p> <p>1 square inch (sq in, in²) = 6.5 square centimeters (cm²) 1 square foot (sq ft, ft²) = 0.09 square meter (m²) 1 square yard (sq yd, yd²) = 0.8 square meter (m²) 1 square mile (sq mi, mi²) = 2.6 square kilometers (km²) 1 acre = 0.4 hectare (he) = 4,000 square meters (m²)</p>	<p>AREA (APPROXIMATE)</p> <p>1 square centimeter (cm²) = 0.16 square inch (sq in, in²) 1 square meter (m²) = 1.2 square yards (sq yd, yd²) 1 square kilometer (km²) = 0.4 square mile (sq mi, mi²) 10,000 square meters (m²) = 1 hectare (ha) = 2.5 acres</p>
<p>MASS - WEIGHT (APPROXIMATE)</p> <p>1 ounce (oz) = 28 grams (gm) 1 pound (lb) = 0.45 kilogram (kg) 1 short ton = 2,000 pounds (lb) = 0.9 tonne (t)</p>	<p>MASS - WEIGHT (APPROXIMATE)</p> <p>1 gram (gm) = 0.036 ounce (oz) 1 kilogram (kg) = 2.2 pounds (lb) 1 tonne (t) = 1,000 kilograms (kg) = 1.1 short tons</p>
<p>VOLUME (APPROXIMATE)</p> <p>1 teaspoon (tsp) = 5 milliliters (ml) 1 tablespoon (tbsp) = 15 milliliters (ml) 1 fluid ounce (fl oz) = 30 milliliters (ml) 1 cup (c) = 0.24 liter (l) 1 pint (pt) = 0.47 liter (l) 1 quart (qt) = 0.96 liter (l) 1 gallon (gal) = 3.8 liters (l) 1 cubic foot (cu ft, ft³) = 0.03 cubic meter (m³) 1 cubic yard (cu yd, yd³) = 0.76 cubic meter (m³)</p>	<p>VOLUME (APPROXIMATE)</p> <p>1 milliliter (ml) = 0.03 fluid ounce (fl oz) 1 liter (l) = 2.1 pints (pt) 1 liter (l) = 1.06 quarts (qt) 1 liter (l) = 0.26 gallon (gal) 1 cubic meter (m³) = 36 cubic feet (cu ft, ft³) 1 cubic meter (m³) = 1.3 cubic yards (cu yd, yd³)</p>
<p>TEMPERATURE (EXACT)</p> <p>$[(x-32)(5/9)] \text{ } ^\circ\text{F} = y \text{ } ^\circ\text{C}$</p>	<p>TEMPERATURE (EXACT)</p> <p>$[(9/5)y + 32] \text{ } ^\circ\text{C} = x \text{ } ^\circ\text{F}$</p>

QUICK INCH - CENTIMETER LENGTH CONVERSION



QUICK FAHRENHEIT - CELSIUS TEMPERATURE CONVERSION

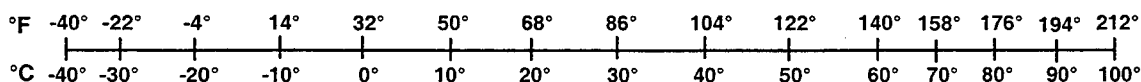

For more exact and or other conversion factors, see NIST Miscellaneous Publication 286, Units of Weights and Measures. Price \$2.50 SD Catalog No. C13 10286

Updated 6/17/98

TABLE OF CONTENTS

<u>Section</u>	<u>Page</u>
1. INTRODUCTION.....	1
1.1 Background	1
1.2 Technical Issues	2
1.3 Test Planning.....	2
1.4 Summary of Comparison of Test Data and Pre-Test Simulation Results.....	3
2. OVERVIEW OF TESTING.....	5
2.1 Single-Car Test Description.....	5
2.2 Two-Car Test Description (Future Test).....	6
2.3 Occupant Protection Tests.....	6
3. COMPARISON OF SINGLE-CAR TEST DATA AND PRE-TEST ANALYSES	9
3.1 Car Crush.....	11
3.2 Car Gross Motions	14
3.3 Occupant Response	16
4. CONCLUSIONS.....	21
REFERENCES.....	23

LIST OF FIGURES

<u>Figure</u>	<u>Page</u>
1. Schematic of In-Line Collision Scenario	5
2. Schematic of Single-Car Test.....	6
3. Schematic of Two-Car Test.....	6
4. Occupant Protection Configurations Tested During Single-Car and Two-Car Tests	7
5. Placement in the Car of Occupant Protection Configurations for the Single-Car Test.....	7
6. Car Crush Finite Element Model	9
7. Collision Dynamics Model.....	10
8. Occupant Response Model.....	10
9. Pre-Test and Post-Test Photos of the Single-Car Test	12
10. Initial and Final Crush, Collision Dynamics Model with Coupler	12
11. Car Force/Crush Characteristic, Reduced from Test Data and from Simulation Results	13
12. Car at Maximum Vertical Displacement During Test	14
13. Occupant Volume Deceleration Time History, Measured and Pre-Test Simulation Results	15
14. Photographs of Interior Occupant Protection Configurations Tested During Single-Car Test.....	16
15. Unrestrained Forward-Facing Occupant Velocity as a Function of Occupant Travel Relative to Car Interior.....	18

EXECUTIVE SUMMARY

On November 16, 1999, at the Transportation Technology Center in Pueblo, Colorado, a test was conducted of a single rail passenger car colliding with a fixed wall at 35 mph. The car was instrumented to measure the deformations of critical structural elements; the vertical, lateral, and longitudinal deceleration of the carbody and trucks; and the suspension displacements. The car was equipped with instrumented anthropomorphic test devices (test dummies) in three interior arrangements:

1. Forward-facing unrestrained occupants seated in rows, compartmentalized by the forward seat in order to limit the motions of the occupants.
2. Forward-facing restrained occupants with lap and shoulder belts.
3. Rear-facing unrestrained occupants.

The purpose of the test was to obtain data to validate and calibrate computer models for analyzing crashworthiness of rail passenger vehicles.

Three-position production seats of commuter passenger cars were used in both the first and third arrangements. Modified intercity coach seats were used in the second arrangement. This seat design is a proof-of-concept design.

The car was permanently crushed by approximately 5 feet during the test. The permanent deformations of the car structure were limited to a zone approximately 7 feet in length at the impacting end of the car. The impacting end of the car rose by approximately 6 inches, as a result of the mode of deformation of the car structure.

During the test, the seat attachments of the commuter car seat failed for the rear-facing seats and the forward-facing seats impacted by the unrestrained test dummies. All the mounting failures were essentially failures of the attachments of the seats. The floor and wall mounting rails of the car remained essentially intact. The modified intercity passenger seats remained attached during and after the test. One of the unrestrained occupants did catapult over the seat ahead, eventually coming to rest on top of one of the restrained dummies. Upon initial review of the high-speed film taken of this test, this motion appears to be due substantially to the deformation of the seat back, rather than to the vertical motion of the car.

Prior to the test, computer models were used to simulate the car's response during the test and to develop the information required to determine the placement and type of instrumentation, as well as bounding the range of the interior decelerations likely to be experienced by the instrumented test dummies. Comparisons have been made of selected test measurements and model predictions.

Qualitatively, the results of the test and pre-test analyses are in reasonable agreement. Quantitatively, the results are in reasonable agreement for many of the key measures of the response of the equipment. However, there are aspects of the car response for which the test and

pre-test analyses results differ. While the models did capture the fundamental response of the equipment during the test, there is a need to further refine the models in order to be able to predict the car response with greater fidelity.

1. INTRODUCTION

1.1 BACKGROUND

The Federal Railroad Administration's (FRA) Office of Research and Development, with the support of the Volpe National Transportation Systems Center (Volpe Center), has been conducting research into rail equipment crashworthiness. The approach taken in conducting this research has been to review relevant accidents, identify options for design modifications to improve occupant survivability, and to apply analytic tools and testing techniques for evaluating the effectiveness of these strategies.

As part of this research, computer models have been developed and applied to determine the response of rail equipment in a range of collision scenarios [1, 2, 3]. In-line and oblique train-to-train collisions, as well as grade crossing collisions and rollover events subsequent to derailment have been modeled. The responses of locomotives, cab cars, and coach cars in a range of collision scenarios have been simulated.

To assess the validity of the models, results of these analyses have been compared with accident data, and component and subscale test results. While providing useful information and a level of assurance in the validity of the models, accident data and component and subscale testing all have limitations. There is uncertainty about the initial conditions of any accident — the precise speeds and locations of the two colliding objects are never accurately known. In addition, there is no information on the trajectories of the objects involved in the collision which lead to their resting places; this information must be inferred from the results of the accidents. The support and loading conditions in component tests can only approximate the actual conditions these components experience during a collision. Competing modes of crush (e.g., bending, bulk crushing, and material failure) cannot be consistently scaled for subscale testing [4]. Either one mode of crush must be chosen as the dominant mode and the other modes ignored, or the simulation must be assumed to accurately scale the competing modes.

Full-scale tests are currently being carried out to develop data to verify the validity of current analytic models for the prediction of passenger car and occupant response during collisions. A test of a single passenger car, colliding into a fixed barrier at 35 mph, was carried out on November 16, 1999, at the Transportation Technology Center (TTC) in Pueblo, Colorado. The TTC is operated for the FRA by the Transportation Technology Center, Inc., a subsidiary of the Association of American Railroads. A second test of two coupled cars, colliding into a fixed barrier at 25 mph, is planned for the spring of 2000.

As indicated by the title, this report gives an overview of selected results from a single-car test. For a complete set of test data from this test, including the interior seat/occupant data, refer to References 5 and 6.

1.2 TECHNICAL ISSUES

There are three areas that require full-scale crash test data to further the understanding of train collisions and to provide the information to refine the simulation models of rail equipment collisions:

- Car-to-Car Interactions
- Large Crush Distances
- Secondary Collision Environment

During train collisions, one car can override another car or the trainset can buckle laterally. Override occurs when the relatively strong underframe of one car rides up and over the underframe of an adjacent car, causing extensive crush of the relatively weak superstructure of the adjacent car. Lateral buckling occurs when the cars in the train end up in a zig-zag pattern. Lateral buckling can lead to encroachment of adjacent track, side-to-side impacts between cars, and impacts with wayside structures. Both override and lateral buckling are consequences of the gross motions of the cars (e.g., the bouncing and pitching of the car on its suspension), the initial geometry of the coupling system and the cars, and the dynamic collapse of the car structures during the collision.

In a train collision, relatively large portions of the cars can crush. Significant parts of the carbody structure also can be separated from the car. The modeling of material failure and structural crush much greater than 3 feet have not been as extensively validated as other aspects of the dynamic collapse of structures. Analyses associated with material failure and large crush distances are difficult technical issues [7].

To date, modeling and testing of occupant interactions with the interior of cars during train collisions have been limited to longitudinal motion. Analysis of occupant dynamics during train collisions has been limited to one-dimensional modeling of train-to-train collisions. Only the longitudinal motion of the train has been considered in studies of occupant protection to date – the influence of the pitch and yaw motions of the car on occupant response have been neglected. However, the pitch motions of the car may significantly influence the response of the occupant – large vertical accelerations can arise when the car bottoms out on its suspension, as it may do during a collision. The influence of the vertical and lateral car accelerations on occupant response and the effectiveness of occupant protection in such a better-defined secondary collision environment need to be determined.

1.3 TEST PLANNING

Prior to the first test, car crush and collision dynamics models were used to simulate the car's response during the test, to develop the information required to determine the placement and type of instrumentation for the full-scale testing, and to bound the range of the interior decelerations likely to be experienced by the instrumented test dummies. The predictions were based on the integration of two kinds of models. A car crush model was adapted from a detailed finite

element model of an Amfleet coach car, with modifications, to approximate the Budd Pioneer car used in the single-car test. This crush model was used to bound the ranges of the force imparted to the wall by the car as it crushes and to estimate the changes in geometry that the car structure undergoes as it crushes. A collision dynamics model incorporated the non-linear force/crush characteristic developed with the crush model. This simple model was used to bound the ranges for the gross motion of the car and to estimate the environment that the instrumented test dummies would experience during the test.

1.4 SUMMARY OF COMPARISON OF TEST DATA AND PRE-TEST SIMULATION RESULTS

Prior to the test, at the October 28, 1999, meeting of the Passenger Rail Equipment Safety Standards Committee of the American Public Transportation Association, a presentation was made on the pre-test simulation results. Preliminary comparison of these results and the test results show reasonable agreement between predicted and measured longitudinal decelerations and force/crush characteristics. However, there is a difference between the assumed and observed mode of crush of the draft sill – the principal longitudinal structure at the ends of the car. Immediate comparisons of calculated and measured vertical and pitch motions of the car are difficult because the vertical accelerometer measurements include the motions caused by the elastic vibrations and the accelerometer mountings. While the high-speed film recorded during the test shows carbody vertical motions consistent with the results of simulations carried out prior to the test, direct comparisons of the simulation and accelerometer data have not yet been possible. Detailed analysis is ongoing to analyze the accelerometer data for appropriate comparison with the pre-test simulation results and to determine if these vibrations significantly influence the gross motions of the car.



2. OVERVIEW OF TESTING

The collision scenario addressed by the single-car impacting a fixed, rigid wall test performed on November 16, 1999, and the two-car test planned for the spring of 2000, is a locomotive-led passenger train colliding with a cab-car-led passenger train on tangent track. Figure 1 shows a schematic representation of such a collision.

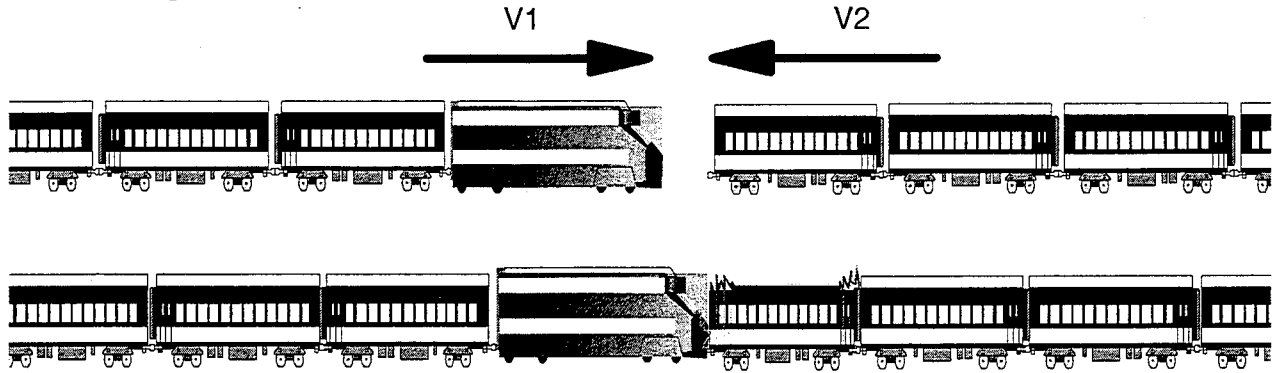

Figure 1. Schematic of In-Line Collision Scenario

The objectives of these tests are to determine the forces that develop as the structures collapse, the failure modes of major structural components, the gross motions of the cars, and to evaluate occupant protection options. During the single-car test, high elongation strain gages were used to measure the deformations of the principal longitudinal structural members -- the draft sill, the side sills, and the cant rails. String potentiometers were used to measure the displacement across the secondary suspension (i.e., the air bags). Accelerometers were placed throughout the car to measure the lateral, vertical, and longitudinal accelerations of the car. Instrumented and uninstrumented dummies were seated in modified Amtrak intercity and production M-Style commuter car passenger seats during the test to approximate the response of occupants during a collision. High-speed cameras were placed at each side of the fixed wall, on the top of the wall, and in a pit below the wall, and used to film the response of the car. Such cameras also were used inside the car to film the response of the dummies during the test. Similar instrumentation is planned for the next test.

Budd Pioneer cars were used in the single-car test and are to be used in the two-car test [8]. These cars include a stainless-steel body shell with a high-strength low-alloy steel underframe. These were designed to the Association of American Railroads Passenger Equipment Standards and Recommended Practices [9], including the 800,000-pound buff-strength requirement. The underframe design of the car is similar to the underframe design of most single-level passenger coach and cab cars used in North America, including the Amtrak Amfleet cars.

2.1 SINGLE-CAR TEST DESCRIPTION

The car was run at 35 mph into a fixed wall, with instrumented and uninstrumented dummies seated unrestrained and restrained in forward-facing seats, and unrestrained in rear-facing seats.

This collision speed was chosen in order to crush the car extensively – a reduction in car length of at least 3 feet – because of increased computational uncertainties in the finite element analysis employed for large plastic deformations. Figure 2 shows a schematic of the single-car dynamic test, immediately prior to the car striking the wall.

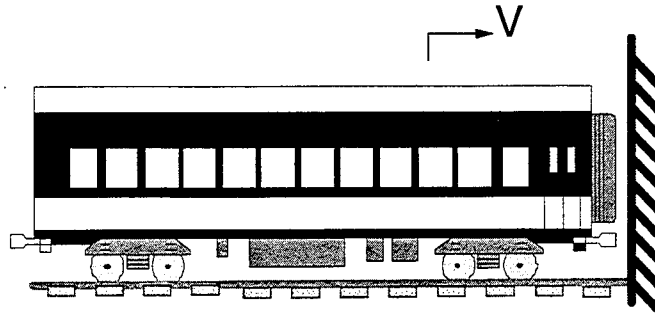

Figure 2. Schematic of Single-Car Test

2.2 TWO-CAR TEST DESCRIPTION (FUTURE TEST)

The approach to be used in dynamic testing of two coupled cars is to run the cars at approximately 25 mph into a fixed wall, with instrumented and uninstrumented dummies seated unrestrained and restrained in forward-facing seats, and unrestrained in rear-facing seats. The collision speed is being chosen such that the lead car will crush by at least 3 feet. A total of four interior occupant tests will be conducted simultaneously. The lead car will have all three interior configurations used in the single-car test while the trailing car will have forward-facing unrestrained dummies. The test will be conducted on level, tangent track. The two-car test is illustrated in Figure 3.

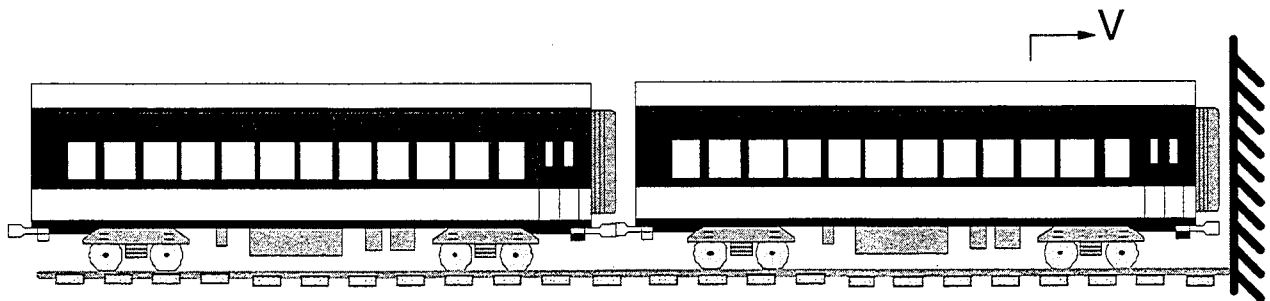

Figure 3. Schematic of Two-Car Test

2.3 OCCUPANT PROTECTION TESTS

The three occupant protection configurations being tested are:

1. Forward-facing unrestrained occupants seated in rows, compartmentalized by the forward seat in order to limit the motions of the occupants.

2. Occupants restrained with lap and shoulder belts.
3. Rear-facing occupants.

These occupant protection configurations are illustrated in Figure 4.

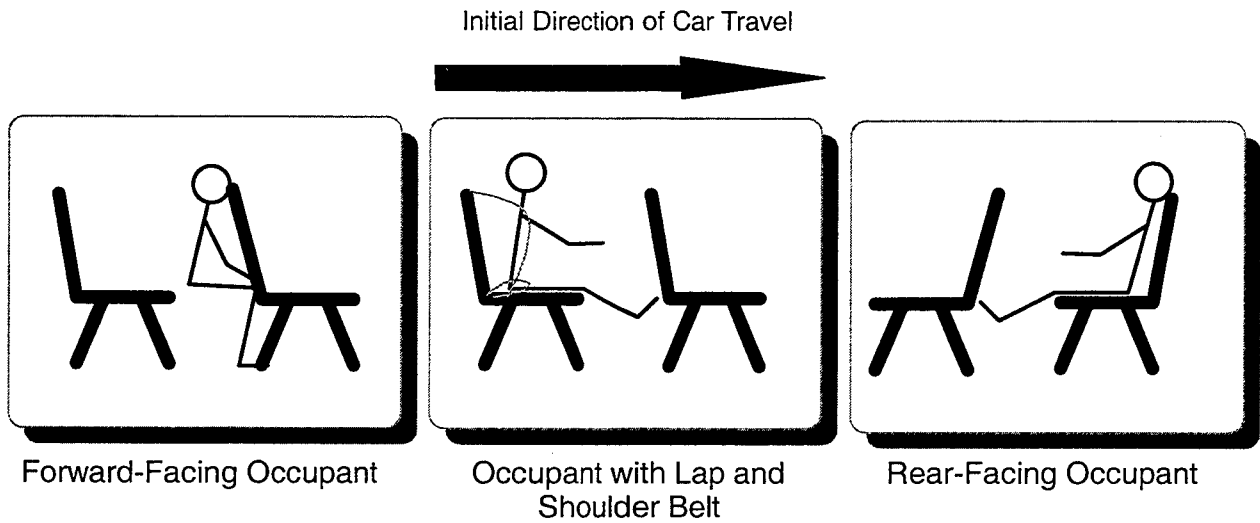

Figure 4. Occupant Protection Configurations Tested During Single-Car and Two-Car Tests

All three occupant protection configurations were tested during the single-car test. Occupant configuration in the car is illustrated in Figure 5. For the two-car test, as mentioned above, it is planned that all three configurations will be tested in the lead car, with the same placement as for the single-car test; the forward-facing unrestrained occupant protection configuration with the commuter car seat will be tested in the trailing car.

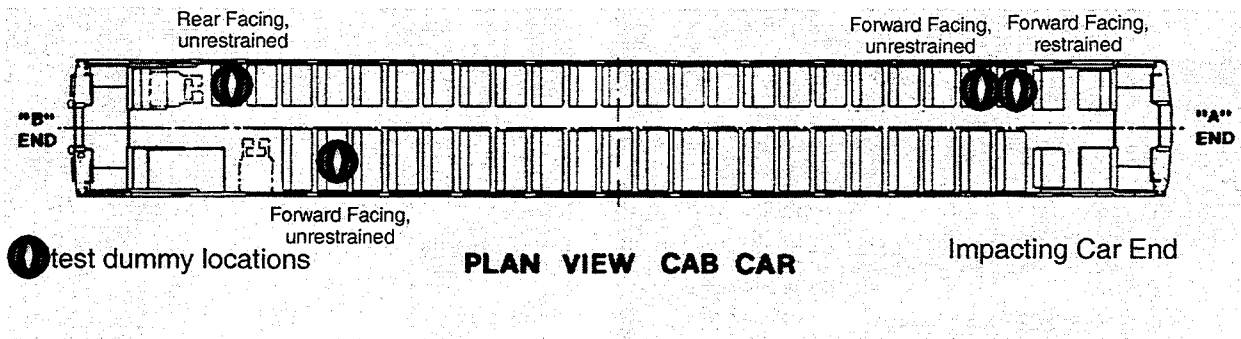

Figure 5. Placement in the Car of Occupant Protection Configurations for the Single-Car Test



3. COMPARISON OF SINGLE-CAR TEST DATA AND PRE-TEST ANALYSES

Prior to the single-car test, the response of the car and occupants were simulated. Car crush, the gross motions of the car, and the occupant response were simulated with three different models. These models were used to bound the range of potential responses of the car and the dummies inside the car. The results were used for the sizing and the placement of instruments, and the location of dummies for the occupant protection tests.

Car crush was analyzed with a previously developed finite element model of an Amfleet car [10], implemented using the LS-DYNA 3D computer program [11]. The car tested was a Budd Pioneer car [8]. Both cars were designed and built by the Budd Company. While there are differences in the shape of the body shell, the overall car construction is similar for the two cars. Both cars have stainless steel body shells and both cars include many underframe components made from high-strength, low-alloy steel. In particular, the draft sills of the two cars are similar. Modifications to the model included adding a coupler and allowing vertical motion of the trucks. The model is illustrated in Figure 6. This model was used principally to calculate the force/crush characteristic of the car and to estimate the mode of collapse.

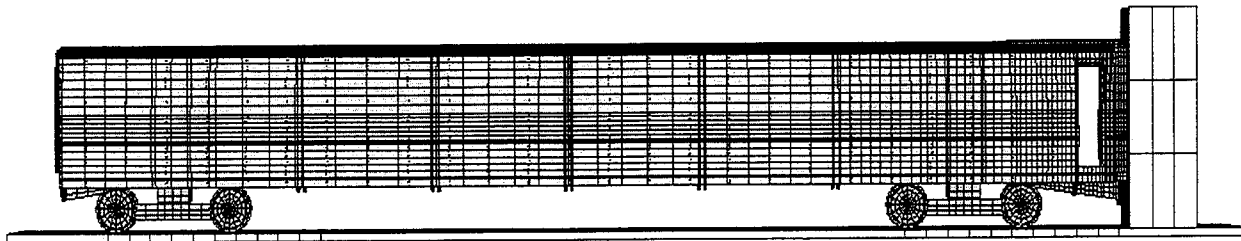

Figure 6. Car Crush Finite Element Model

A lumped-parameter collision dynamics model of the test car was developed in order to determine the gross motions of the car. The gross motions include the bounce and pitch of the carbody. The model is illustrated in Figure 7. The force/crush characteristic developed with the crush model was used as input data for the collision dynamics model. This model was used to estimate the secondary collision environment expected for the test dummies. The secondary collision environment includes the vertical, lateral, and longitudinal acceleration of the occupant volume.

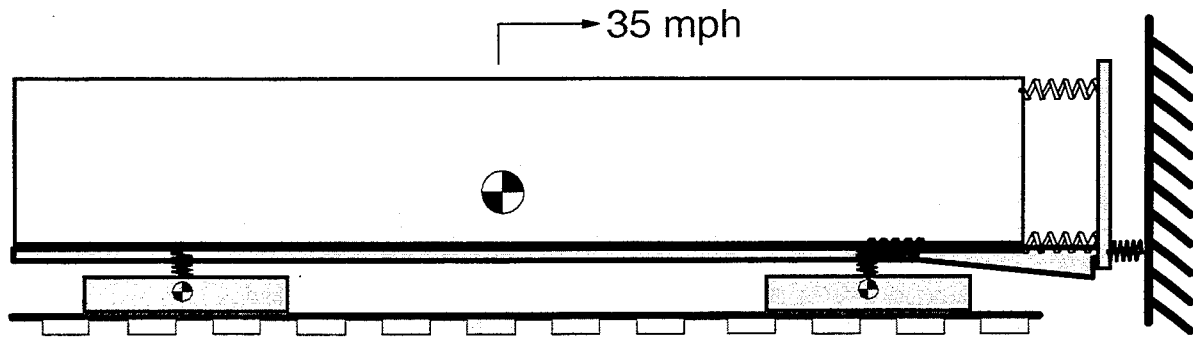

Figure 7. Collision Dynamics Model

A lumped-parameter occupant response model was developed and implemented in the MADYMO computer program [12] to determine the response of the test dummies during the test. The secondary collision environment from the collision dynamics model was used as input to this model. The occupant response model was used principally to determine the potential influence of the vertical accelerations on compartmentalization for the forward-facing occupants. There was a concern that the vertical acceleration could potentially cause the test dummies to catapult over the seatback ahead, rather than being contained by the seatback ahead. See Figure 8.

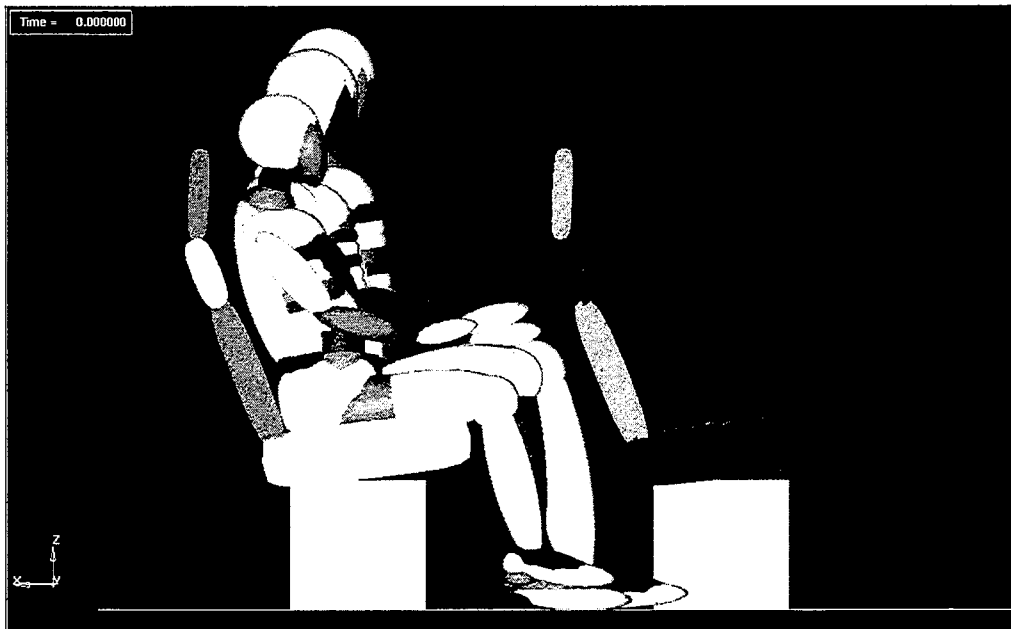

Figure 8. Occupant Response Model

While exercising the models, it became apparent that relatively modest changes in the initial conditions could have a significant influence on some aspects of the response of the car and occupants. The mode of crush (i.e., the series of geometric changes the car structure undergoes as it crashes) of the structure was found to be sensitive to the presence or absence of the coupler.

However, the force/crush characteristic (i.e., the force that the car structure develops as it crashes) was not sensitive to the presence or absence of the coupler; in other words, the force/crush characteristic was found not to be sensitive to the mode of crush. Due to the car structure not being designed to collapse in a controlled manner, there are a number of different modes of crush that can potentially occur.

The models were used to bound the range of potential responses of crush, car gross motions, and occupant response. There was uncertainty as to the precise mode of crush of the car structure, and the mode of crush influences the gross motions of the car. In turn, the gross motions of the car consequently influence the response of the dummies.

The car used in the single-car test was weighed about two weeks prior to the test. At that time the car was found to be significantly lighter than the weight used in the simulations that had been conducted earlier. The simulations were run again prior to the test, using the lighter car weight. The simulation results for the heavier car weight have been presented to the industry, while the simulation results for the lighter car were only disseminated to organizations involved in implementing the tests. In the following sections, for those simulation results that are influenced by car weight, results are described for both the heavier car and the lighter car.

The initial estimate of the car weight was 105 kips - the weight of the car in ready-to-run condition, with a full load of passengers. A substantial amount of equipment was removed prior to the test, including the traction motors from the trucks, and the transformer from under the carbody. All the original seats and many interior fixtures also were removed prior to the test. As tested, the car weighed approximately 75 kips.

At a weight of 105 kips, the test speed was planned to be 30 mph, with an initial kinetic energy of approximately 3.16×10^6 ft-lbs. With a weight of 75 kips, the planned test speed was revised to 35 mph, with an initial kinetic energy of 3.07×10^6 ft-lbs. The change in car weight did influence the predicted longitudinal deceleration of the car; however, it did not affect the predicted force/crush characteristics. Since the weight of the car was reduced, while the force expected to be acting on the car remained the same, the longitudinal deceleration of the car was expected to be increased.

3.1 CAR CRUSH

The photographs in Figure 9 show the car prior to the test and subsequent to the test. The car impacted the wall at 35.1 mph. The car crushed approximately 5 feet during the test, including the crush of the coupler. The modes of failure of the draft sill observed after the test were axial crushing and fracture, with little or no vertical buckling. The coupler was pushed straight back into the draft sill.

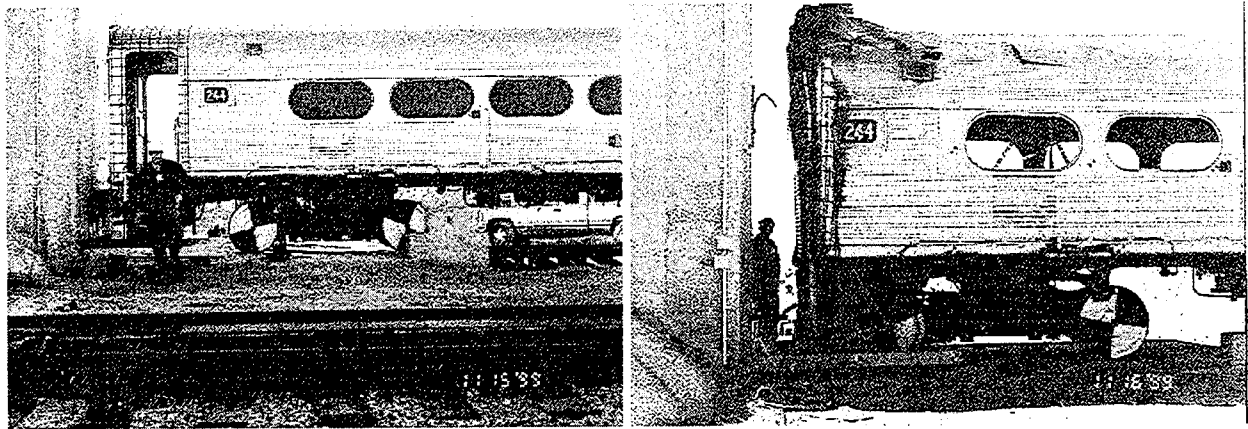

Figure 9. Pre-Test and Post-Test Photos of the Single-Car Test

Prior to the test, the car crush model was used to simulate the response of the car with and without a coupler. In addition, the draft sill and body bolster were extracted from the model, and four cases were analyzed with the substructure: with coupler, without coupler, without coupler or end plate, and without coupler or end plate and no friction between the wall and the draft sill. Conclusions from these analyses were that the draft sill would absorb about 75 percent of the impact energy and that several different modes of crush of the draft sill are possible. Although several different modes of crush were seen in the simulations, the force/crush characteristic remained essentially the same. Figure 10 shows the initial and final crushed state from the collision dynamics model with the coupler. The deformed shape of the draft sill in the figure shows a plastic hinge forming at the connection with the body bolster, as well as crushing of the draft sill where it impacts the wall. While the amount and geometry of the draft sill crush near the wall and near the body bolster varied for the different cases run, all the simulations indicated visible deformation near the body bolster.

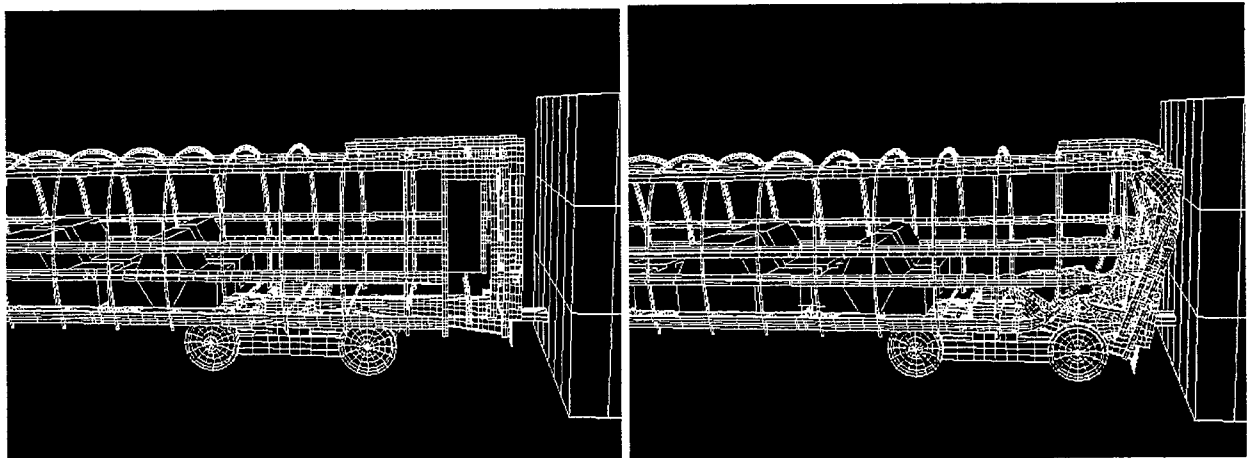

Figure 10. Initial and Final Crush, Collision Dynamics Model with Coupler

The mode of failure observed from the test was axial crushing of the draft sill, localized at the impacting end of the draft sill. During the test, material failed near the longitudinal welds of the fabricated draft sill, and to some extent, the sides and top of the draft sill folded back as individual plates. The pre-test simulations indicated that, in addition to crushing of the draft sill at the impacting end, a plastic hinge would form at the connection of the draft sill and body bolster. The principal cause for the difference in the calculated mode of crush and the observed mode is that the crush model does not include some of the structural details that influenced the mode of collapse during the test, such as the longitudinal welds. The principal reason that the model does not include these details is that the mode of crush observed in the test has not been observed in many accidents. Accident results have been observed in which the mode of failure of the draft sill is the formation of a plastic hinge near the body bolster [13].

Figure 11 shows the force/crush characteristic, derived from the accelerometer measurements and calculated with the car crush model. Although overall agreement is reasonable, there are a number of differences between the force derived from the test data and the pre-test analysis. The peak force estimated prior to the test was about 1.8 million pounds, while the peak force derived from the test data was just over 1 million pounds. The average force derived from the test data is 600 kips, while the average force from the simulation is 700 kips. The total crush calculated prior to the test was about 3.8 feet, and the total crush measured during the test was about 5 feet.

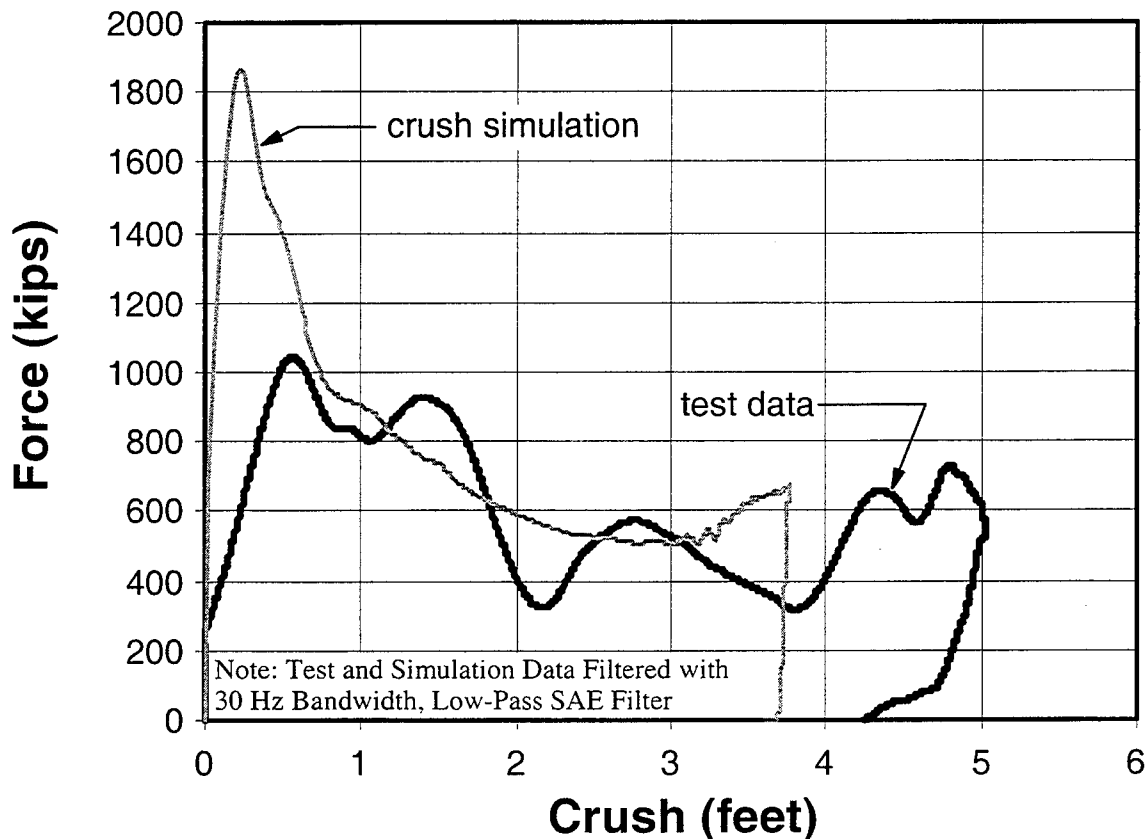

Figure 11. Car Force/Crush Characteristic, Reduced from Test Data and from Simulation Results

It has been shown that the variation in the peak force derived from test measurements can be as much as 140 percent for ostensibly identical structures crushed under similar test conditions; it also has been shown that the variations in average force computed from test data can be approximately 20 percent [14]. The variation in the peak force predicted prior to the test and derived from the single-car test data is 75 percent, and the variation in the average force is 17 percent. These variations are close to the variations that would be expected if the test were to be repeated with another ostensibly identical car; i.e., the analysis predictions are within the likely range of repeatability of the test. The specimens tested in Reference 14 and the structure of the car tested in the single-car test did not include any cutouts, dimples, or any other perturbations intended to limit the peak force. It is expected that there would be substantially less variation in the peak forces derived from test data and determined from analysis for structures with perturbations than for structures without perturbations.

3.2 CAR GROSS MOTIONS

The photograph in Figure 12 shows the car at its greatest vertical displacement during the test. The impacting end of the car was raised to a maximum of approximately 6 inches during the test. This elevation was achieved fairly late during the impact.



Figure 12. Car at Maximum Vertical Displacement During Test

The collision dynamics model was used prior to the test to simulate the bounce and pitch motions of the car. One of the conclusions drawn from the car crush analyses was that a range of vertical motions of the car was possible, depending upon the mode of collapse of the draft sill. At one extreme, the structure of the car simply crushes and the maximum vertical displacement of the

car is several inches. At the other extreme, the crushing of the car acts like a linkage, causing the impacting end to rise by 2 ½ feet. The collision dynamics model was used to estimate the vertical accelerations of the car for this range of vertical displacement, as well as the longitudinal deceleration of the car. The pitching and vertical displacements of the car observed during the test are within the range calculated prior to the test. However, immediate comparisons of the measured and calculated vertical accelerations of the car have been difficult, because, as mentioned previously, in addition to the rigid body motion of the car, the accelerometers also measured the elastic vibrations of the carbody and the accelerometer mountings. Thus, the measured vertical accelerations included this vibratory component. This component effectively masks the accelerations associated with the rigid body mode. Efforts are in progress to isolate the rigid-body motion of the carbody.

Figure 13 shows the time history of the longitudinal deceleration of the occupant volume (crash pulse), as measured during the test and as simulated prior to the test. Two lines are shown for the pre-test simulations: one for a car with a total weight of 105 kips and the other for a car with a total weight of 75 kips. The measured and calculated crash pulses are in reasonable agreement. The peak deceleration measured is somewhat lower than estimated; however, this number is extremely sensitive to filtering, and by itself has no direct influence on the occupant response.

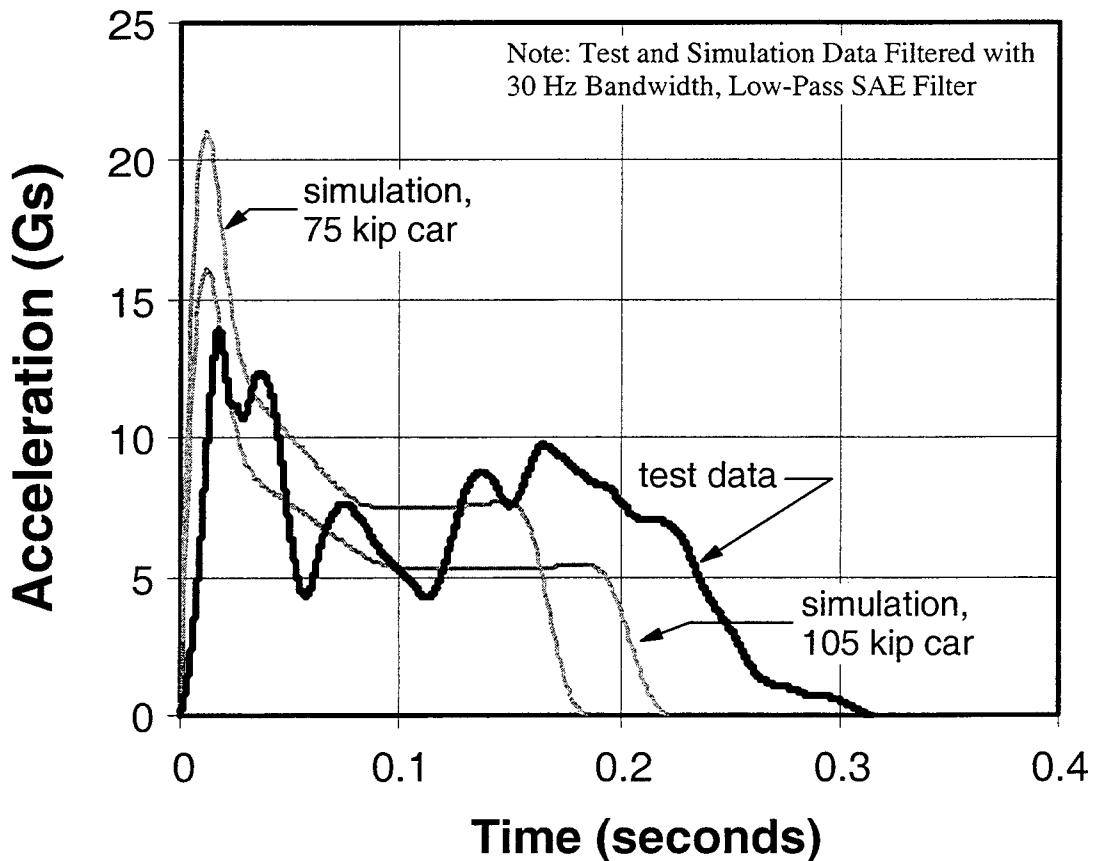

Figure 13. Occupant Volume Deceleration Time History, Measured and Pre-Test Simulation Results

The average deceleration, which is more closely related to occupant response, is approximately 8 Gs for the measured data, about 7 Gs for the 105 kip car simulation, and 9 Gs for the 75 kip car simulation. The duration of the measured crash pulse is somewhat longer than those from the simulations. This is due in part to the average force being somewhat lower than estimated and to the car's rebound velocity off the wall being higher than predicted before the test.

3.3 OCCUPANT RESPONSE

Figure 14 shows photographs of the three interior configurations tested during the single-car test:

1. Forward-facing unrestrained occupants seated in rows, compartmentalized by the forward seat in order to limit the motions of the occupants.
2. Forward-facing restrained occupants with lap and shoulder belts.
3. Rear-facing unrestrained occupants.

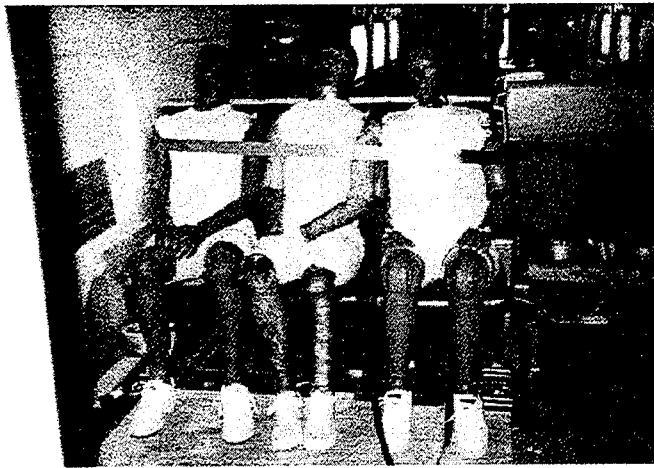

Rear-Facing Unrestrained

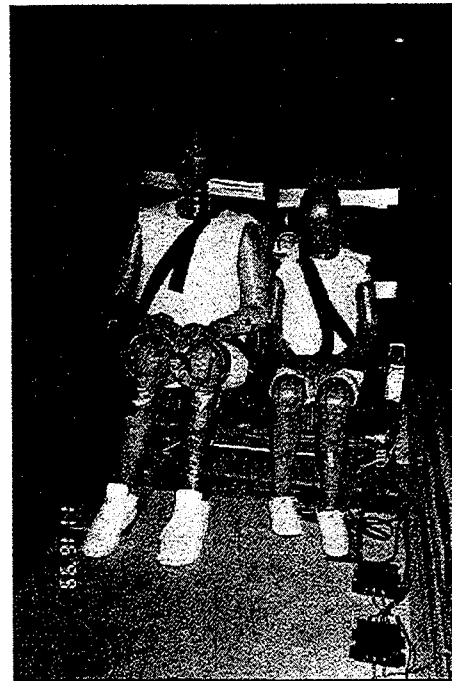

Forward-Facing Restrained



Forward-Facing Unrestrained

Figure 14. Photographs of Interior Occupant Protection Configurations Tested During Single-Car Test

M-Style, three-position commuter car passenger seats were used in both the test of the forward-facing unrestrained occupants seated in rows and in the test of the rear-facing unrestrained occupants. These seats are used by a number of commuter rail authorities. They are production seats, which were not designed to the FRA's recently published Passenger Equipment Safety Standards [15].

The test dummies restrained with lap and shoulder belts were placed in modified Amtrak traditional intercity coach seats. This seat design is a proof-of-concept or engineering model design, intended to demonstrate that a production model design incorporating lap and shoulder belts could be developed. The seat pan was modified from the original: the attachment to the seat back was strengthened, lap belt anchors were added, and energy absorbing elements replaced the recline mechanisms. The seatback is a completely different design from the original, and is significantly stronger to support the combined loads from the belted occupants, through the lap and shoulder belts, and unrestrained rear-occupants impacting the seatback. The seat pedestals were fastened to steel plates in the floor of the car. This seat-to-car attachment is similar to the attachment used in some recently refurbished Southeastern Pennsylvania Transportation Authority commuter cars.

In order to maximize the load imparted to the seat, three 95th-percentile male test dummies were placed in the rear-facing M-Style seat. In order to provide a basis for comparison with previous sled testing [16,17], three unrestrained 50th-percentile male test dummies were placed in the forward-facing M-Style seat. In order to evaluate the influence of occupant size on potential injury, a 95th-percentile male dummy and a 5th-percentile female dummy were placed in the forward-facing seat with lap and shoulder belts. In order to maximize the load imparted to the seat with lap and shoulder belts, two 95th-percentile male dummies, unrestrained, were placed in the seat behind the seat with the restrained test dummies.

Because of the results available from previous analyses and sled testing efforts [16,17,18], only a small number of simulations of the occupant response to the expected secondary collision environment were carried out prior to the test. Instrumentation requirements for the occupant protection tests were based on the requirements developed for prior sled testing. The principal issue addressed with the pre-test occupant response simulations was the potential for the unrestrained, forward-facing test dummies to catapult over the seats ahead. It was concluded that the likelihood of the unrestrained test dummies catapulting over the seat ahead depended upon the vertical pitch and bounce motions of the car, location of the dummies in the car (i.e., the front, middle, or rear), and the extent of deformation of the seatback. Since the car was expected to potentially pitch up significantly, the vertical accelerations vary along the length of the car. The vertical acceleration was expected to be greatest upward near the front of the car and greatest downward near the rear. The center of pitch rotation was expected to be at the center of percussion of the car, near the rear body bolster. If the vertical motions of the car were to be small and the deformation of the seatback limited, then it was expected that the dummies would not be catapulted over the seat ahead. If, however, there were significant vertical motion during the test and the seatback ahead deformed significantly, then it was expected that the unrestrained forward-facing occupants would indeed be catapulted over the seats ahead.

Figure 15 shows the velocity of an unrestrained occupant as a function of distance traveled inside the car, as reduced from the test data and as calculated with the collision dynamics model. The force imparted to the occupant when he strikes the interior is related to the relative speed at which the occupant strikes the interior. The plot of the test data shows that if the pedestals for the M-Style seat had not failed, the heads of the forward-facing unrestrained dummies would have traveled approximately 2 feet before striking the back of the seat ahead, at a speed of approximately 20 mph. The heads of the forward-facing unrestrained dummies seated in the Amtrak traditional coach seat traveled approximately 2.5 feet before striking the back of the seat with lap and shoulder belts, at a speed of approximately 22 mph. The plot from the simulation of the 105 kip car nearly overlays the test data. The car as tested actually weighed about 75 kips, and the force to crush it was somewhat less than estimated prior to the test with the crush model. The values estimated for the 75-kip car are approximately 15 percent higher than the measured values, which is reasonable agreement.

Also shown on the plot in Figure 15, for comparison, is the relative velocity of an unrestrained occupant associated with the 8 G triangular pulse used in previous sled testing of passenger seats [16]. For a relative displacement of 2 feet, the relative velocity of the dummy would be approximately 19 mph and, for 2 ½ feet, the velocity would be approximately 21 mph. In the range of 2 to 2 ½ feet, the test values and values associated with the 8 G triangular pulse are within 15 percent of each other. The collision environment during the full-scale test resulted in secondary impact velocities about 10 percent greater than during previous sled testing.

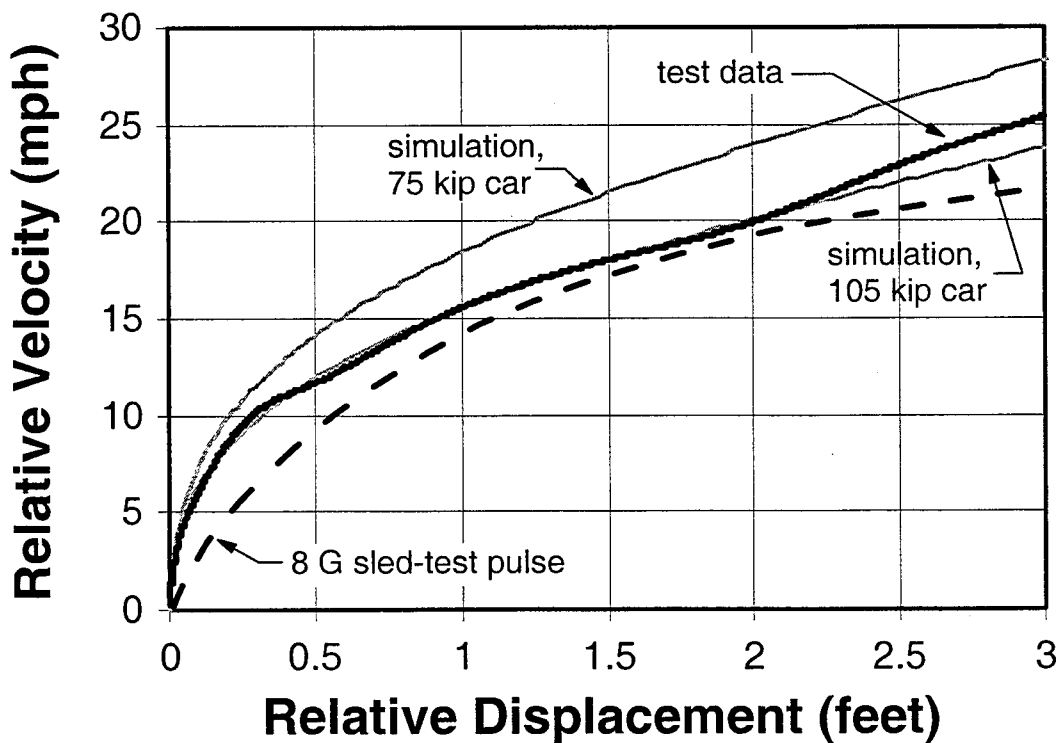

Figure 15. Unrestrained Forward-Facing Occupant Velocity as a Function of Occupant Travel Relative to Car Interior

During the test, the seat pedestals failed for both the rear-facing and forward-facing M-Style seats with unrestrained test dummies. The floor pedestal for the rear-facing seat tore away from its load cell mountings. The wall mounts to that seat failed in a similar manner, apparently subsequent to the failure of the floor mount. The floor pedestal for the forward-facing seat was substantially crushed, and the wall mounts failed in a manner that allowed substantial forward pitching of the seat. The dummies went over this seat, as it formed a ramp during the test. The seat originally holding the forward-facing dummies experienced significant deformation, even though the load acting on it was only due to its own mass. All the seat failures were essentially failures of the seat pedestals, rather than the seat-to-floor mounting. The floor and wall mounting rails of the car remained essentially intact.

Because the production M-Style seat pedestals failed, they were ineffective in protecting the dummies from conditions that could lead to injuries and fatalities for occupants. These seats may have been effective in limiting the forces and decelerations to humanly survivable levels if the seat pedestal had not failed and the seats had remained attached to the car. Since these seats were mounted on load cells, the load environment that caused the mountings to fail was measured. The maximum load that the mountings should be able to support is greater than the load that caused the mountings to fail during the test.

The modified intercity passenger seats remained attached during and after the test. One of the unrestrained occupants did catapult over the seat ahead, eventually coming to rest on top of one of the restrained dummies. Upon initial review of the high-speed film taken of this test, this motion appears to be substantially owing to the deformation of the seat back, rather than owing to the vertical motion of the car. More detailed analysis of the test data is required in order to verify this preliminary assessment.



4. CONCLUSIONS

Qualitatively, the results of the test and pre-test analyses are in reasonable agreement. Quantitatively, the results are in reasonable agreement for many of the key measures of the response of the equipment. However, there are aspects of the car response for which the test and pre-test analyses results differ. While the models did capture the fundamental response of the equipment during the test, there is a need to further refine the models in order to be able to predict the car response with greater fidelity.

The test data and the analysis results are in reasonable agreement for the force/crush characteristic, longitudinal deceleration of the carbody, and the relative velocity of unrestrained occupants. There are differences between the mode of crush observed from the testing and that calculated with the car crush model. The vertical displacement of the carbody observed during the test is within the range estimated prior to the test. Efforts are currently underway to refine the analysis models using the test data, including more detailed geometry of the draft sill, in order to capture the mode of failure observed during the test.

The final details of the two-car test are currently being planned. In order to evaluate the effectiveness of compartmentalization as an occupant protection strategy for both forward- and rear-facing occupants, the M-Style seat pedestals will be modified to support a greater load without failure. A collision dynamics model has been developed to determine the interactions between the coupled cars during the test. Instrumentation of the couplers between the cars is currently being developed from analyses with this model.



REFERENCES

1. Tyrell, D.C., K.J. Severson, and B.P. Marquis, *Crashworthiness of Passenger Trains*, U.S. Department of Transportation, DOT/FRA/ORD-97/10, 1998.
2. Tyrell, D.C., K.J. Severson, R.A. Mayville, R.G. Stringfellow, S. Berry, and A.B. Perlman, "Evaluation of Cab Car Crashworthiness Design Modifications," *Proceedings of the 1997 IEEE/ASME Joint Railroad Conference*, IEEE Catalog Number 97CH36047, 1997.
3. Tyrell, D., K. Severson, B. Marquis, E. Martinez, R. Mayville, Rancatore, R., Stringfellow, R., Hammand, and A.B. Perlman, "Locomotive Crashworthiness Design Modifications Study," *Proceedings of the 1999 IEEE/ASME Joint Railroad Conference*, April 13-15, 1999, IEEE Catalog Number 99CH36340, ASME RTD Volume 16, 1999.
4. Holmes, B.S. and J.D. Colton, "Application of Scale Modeling Techniques to Crashworthiness Research," Kenneth J. Saczalski, et al. Editors, *Aircraft Crashworthiness*, Charlottesville, VA: University Press of Virginia, 1975.
5. Brickle, B., "Single Car Dynamic Impact Test at Transportation Technology Center November 16, 1999," Draft Report, U.S. Department of Transportation, Federal Railroad Administration, 2000.
6. VanIngen-Dunn, C., "Single Passenger Rail Car Impact Test Volume II: Summary of Occupant Protection Program," U.S. Department of Transportation, DOT/FRA/ORD-00/02.2, March 2000.
7. Wierzbicki, T., "Body Shell and Beam Interaction," Draft Final Report, U.S. Department of Transportation, Cambridge, MA, 1999.
8. White, J.H., Jr., "The American Railroad Passenger Car," The Johns Hopkins University Press, 1978.
9. Association of American Railroads, "Manual of Standards and Recommended Practices, Section A, Part III: Passenger Car Requirements," Washington, D.C., 1980 (Revised 1983 and 1984).
10. Kirkpatrick, S.W. and J.W. Simons, "High-Speed Rail Collision Safety," *Rail Vehicle Crashworthiness Symposium*, June 1996, DOT/FRA/ORD-97/08, 1998.
11. LS-DYNA 3D Version 940, Livermore Software Technology Corporation, Livermore, CA.
12. MADYMO 3D, Release 5.3, TNO Road-Vehicles Research Institute, Delft, The Netherlands.

13. National Transportation Safety Board, "Railroad Accident Report: Head-On Collision of Boston and Maine Corporation Extra 1731 East and Massachusetts Bay Transportation Authority Train No. 570 on Former Boston and Maine Corporation Tracks, Beverly, Massachusetts, August 11, 1981," PB82-916301, NTSB-RAR-82-1, 1982.
14. Hanefi, E.H., and T. Wierzbicki, "Calibration of Impact Rigs for Dynamic Crash Testing," Joint Research Center, European Commission Institute for Safety Technology, Report EUR 16347 EN, 1995.
15. U.S. Department of Transportation, Federal Railroad Administration, "49 CFR Part 216 et al., Passenger Equipment Safety Standards; Final Rule," Federal Register, May 12, 1999.
16. Tyrell, D., and K.J. Severson, "Crashworthiness Testing of Amtrak's Traditional Coach Seat," DOT/FRA/ORD-96/08, October 1996.
17. VanIngen-Dunn, C., and J. Manning, "Baseline Testing of Commuter Passenger Rail Seats," Draft Final Report, U.S. Department of Transportation, Cambridge, MA, 1999.
18. Tyrell, D.C., K.J. Severson, and B.P. Marquis, "Analysis of Occupant Protection Strategies in Train Collisions," ASME International Mechanical Engineering Congress and Exposition, AMD-Vol. 210, BED-Vol. 30, pp. 539-557, 1995.



U.S. Department
of Transportation
**Federal Railroad
Administration**

Single Passenger Rail Car Impact Test Volume II: Summary of Occupant Protection Program

PB2000-107448



Office of Research
and Development
Washington, DC 20590

Rail Passenger Equipment Collision Tests

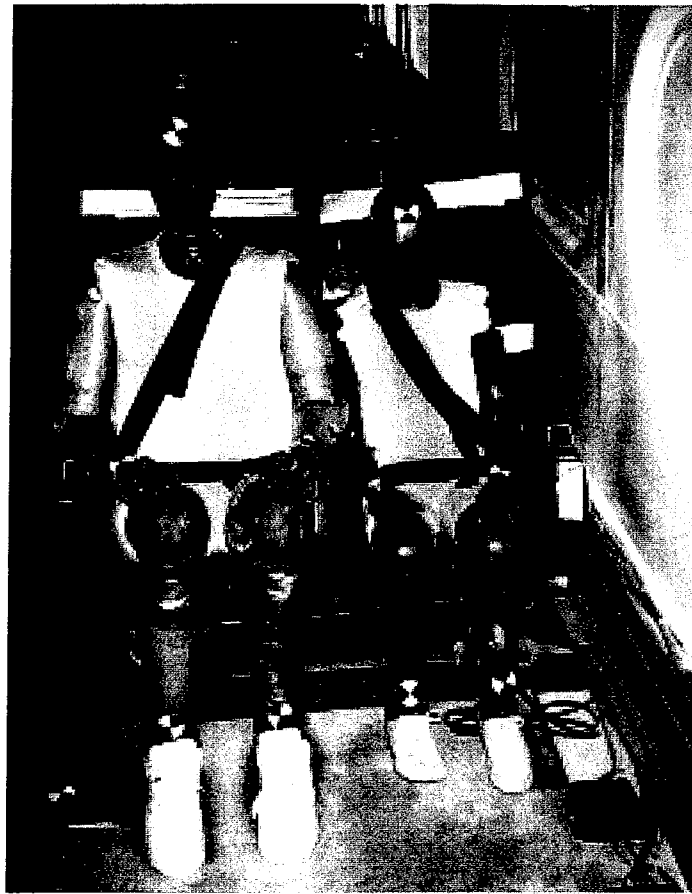

REPRODUCED BY: **NTIS**
U.S. Department of Commerce
National Technical Information Service
Springfield, Virginia 22161

DOT/FRA/ORD-00/02
DOT-VNTSC-FRA-00-02

Final Report
March 2000

This document is available to the
public through the National Technical
Information Service, Springfield, VA 22161
This document is also available on the FRA
web site at www.fra.dot.gov

NOTICE

This document is disseminated under the sponsorship of the Department of Transportation in the interest of information exchange. The United States Government assumes no liability for its contents or use thereof.

NOTICE

The United States Government does not endorse products or manufacturers. Trade or manufacturers' names appear herein solely because they are considered essential to the objective of this report.

REPORT DOCUMENTATION PAGE

Form Approved
OMB No. 0704-0188

Public reporting burden for this collection of information is estimated to average 1 hour per response, including the time for reviewing instructions, searching existing data sources, gathering and maintaining the data needed, and completing and reviewing the collection of information. Send comments regarding this burden estimate or any other aspect of this collection of information, including suggestions for reducing this burden, to Washington Headquarters Services, Directorate for Information Operations and Reports, 1215 Jefferson Davis Highway, Suite 1204, Arlington, VA 22202-4302, and to the Office of Management and Budget, Paperwork Reduction Project (0704-0188), Washington, DC 20503.

1. AGENCY USE ONLY (Leave blank)		2. REPORT DATE March 2000		3. REPORT TYPE AND DATES COVERED Final Report November 1999 – December 1999	
4. TITLE AND SUBTITLE Single Passenger Rail Car Impact Test Volume II: Summary of Occupant Protection Program				5. FUNDING NUMBERS RR028/R0122	
6. AUTHOR(S) Caroline VanIngen-Dunn*					
7. PERFORMING ORGANIZATION NAME(S) AND ADDRESS(ES) Simula Technologies, Inc.* 10016 S. 51 st Street Phoenix, AZ 85044				8. PERFORMING ORGANIZATION REPORT NUMBER DOT-VNTSC-FRA-00-02	
9. SPONSORING/MONITORING AGENCY NAME(S) AND ADDRESS(ES) U.S. Department of Transportation Federal Railroad Administration Office of Research and Development 1120 Vermont Avenue NW – Mail Stop 20 Washington, DC 20590				10. SPONSORING/MONITORING AGENCY REPORT NUMBER DOT/FRA/ORD-00/02.2	
11. SUPPLEMENTARY NOTES *Under contract to: U.S. Department of Transportation Research and Special Programs Administration John A. Volpe National Transportation Systems Center 55 Broadway Cambridge, MA 02142-0193					
12a. DISTRIBUTION/AVAILABILITY STATEMENT This document is available to the U.S. public through the National Technical Information Service, Springfield VA 22161 This document is also available on the FRA web site at www.fra.dot.gov .				12b. DISTRIBUTION CODE	
13. ABSTRACT (Maximum 200 words) A test in which a single rail passenger car was crashed into a fixed wall at 35 mph was conducted at the Transportation Technology Center on November 16, 1999. The car was instrumented to measure (1) the deformations of critical structural elements, (2) the vertical, lateral, and longitudinal deceleration of the carbody and trucks, and (3) displacements of suspension systems. The objective of the interior tests was to determine the corresponding level of occupant safety for that impact scenario. Several interior configurations were tested with the appropriate data acquisition technology and quantified occupant injury parameters and seat strength characteristics. The car was equipped with anthropomorphic test devices (ATDs) in the following three arrangements: <ol style="list-style-type: none"> 1. Forward-facing unrestrained occupants seated in rows, compartmentalized by the forward seat in order to limit the motions of the occupants. 2. Forward-facing restrained occupants with lap and shoulder belts. 3. Rear-facing unrestrained occupants. <p>The principal goal of this full-scale rail car impact test and the overall test program was to obtain scientific data that define a realistic rail car crash pulse, structural response, and corresponding level of occupant safety.</p>					
14. SUBJECT TERMS Transportation, safety, crashworthiness, occupant protection, passenger rail vehicles				15. NUMBER OF PAGES 32	
				16. PRICE CODE	
17. SECURITY CLASSIFICATION OF REPORT Unclassified	18. SECURITY CLASSIFICATION OF THIS PAGE Unclassified	19. SECURITY CLASSIFICATION OF ABSTRACT Unclassified	20. LIMITATION OF ABSTRACT		



PREFACE

The work described in this report was performed as part of the Equipment Safety Research Program at the Volpe National Transportation Systems Center (Volpe Center), sponsored by the Federal Railroad Administration. Dr. Tom Tsai, Program Manager, and Claire Orth, Division Chief, Equipment and Operating Practices Research Division, Office of Research and Development, Federal Railroad Administration direct this program. David Tyrell, Senior Engineer, Volpe Center, developed the test requirements and initiated and monitored this work.

Gunars Spons, FRA Resident Engineering Manager at the Transportation Technology Center, directed and coordinated the activities of all the parties involved in the test. Dr. Barrie Brickle, Senior Engineer, Transportation Technology Center, Inc., implemented the equipment-related portions of the test.

METRIC/ENGLISH CONVERSION FACTORS

ENGLISH TO METRIC

METRIC TO ENGLISH

<p>LENGTH (APPROXIMATE)</p> <p>1 inch (in) = 2.5 centimeters (cm)</p> <p>1 foot (ft) = 30 centimeters (cm)</p> <p>1 yard (yd) = 0.9 meter (m)</p> <p>1 mile (mi) = 1.6 kilometers (km)</p>	<p>LENGTH (APPROXIMATE)</p> <p>1 millimeter (mm) = 0.04 inch (in)</p> <p>1 centimeter (cm) = 0.4 inch (in)</p> <p>1 meter (m) = 3.3 feet (ft)</p> <p>1 meter (m) = 1.1 yards (yd)</p> <p>1 kilometer (km) = 0.6 mile (mi)</p>
<p>AREA (APPROXIMATE)</p> <p>1 square inch (sq in, in²) = 6.5 square centimeters (cm²)</p> <p>1 square foot (sq ft, ft²) = 0.09 square meter (m²)</p> <p>1 square yard (sq yd, yd²) = 0.8 square meter (m²)</p> <p>1 square mile (sq mi, mi²) = 2.6 square kilometers (km²)</p> <p>1 acre = 0.4 hectare (he) = 4,000 square meters (m²)</p>	<p>AREA (APPROXIMATE)</p> <p>1 square centimeter (cm²) = 0.16 square inch (sq in, in²)</p> <p>1 square meter (m²) = 1.2 square yards (sq yd, yd²)</p> <p>1 square kilometer (km²) = 0.4 square mile (sq mi, mi²)</p> <p>10,000 square meters (m²) = 1 hectare (ha) = 2.5 acres</p>
<p>MASS - WEIGHT (APPROXIMATE)</p> <p>1 ounce (oz) = 28 grams (gm)</p> <p>1 pound (lb) = 0.45 kilogram (kg)</p> <p>1 short ton = 2,000 pounds (lb) = 0.9 tonne (t)</p>	<p>MASS - WEIGHT (APPROXIMATE)</p> <p>1 gram (gm) = 0.036 ounce (oz)</p> <p>1 kilogram (kg) = 2.2 pounds (lb)</p> <p>1 tonne (t) = 1,000 kilograms (kg) = 1.1 short tons</p>
<p>VOLUME (APPROXIMATE)</p> <p>1 teaspoon (tsp) = 5 milliliters (ml)</p> <p>1 tablespoon (tbsp) = 15 milliliters (ml)</p> <p>1 fluid ounce (fl oz) = 30 milliliters (ml)</p> <p>1 cup (c) = 0.24 liter (l)</p> <p>1 pint (pt) = 0.47 liter (l)</p> <p>1 quart (qt) = 0.96 liter (l)</p> <p>1 gallon (gal) = 3.8 liters (l)</p> <p>1 cubic foot (cu ft, ft³) = 0.03 cubic meter (m³)</p> <p>1 cubic yard (cu yd, yd³) = 0.76 cubic meter (m³)</p>	<p>VOLUME (APPROXIMATE)</p> <p>1 milliliter (ml) = 0.03 fluid ounce (fl oz)</p> <p>1 liter (l) = 2.1 pints (pt)</p> <p>1 liter (l) = 1.06 quarts (qt)</p> <p>1 liter (l) = 0.26 gallon (gal)</p> <p>1 cubic meter (m³) = 36 cubic feet (cu ft, ft³)</p> <p>1 cubic meter (m³) = 1.3 cubic yards (cu yd, yd³)</p>
<p>TEMPERATURE (EXACT)</p> <p>$[(x-32)(5/9)]^{\circ}\text{F} = y^{\circ}\text{C}$</p>	<p>TEMPERATURE (EXACT)</p> <p>$[(9/5)y + 32]^{\circ}\text{C} = x^{\circ}\text{F}$</p>

QUICK INCH - CENTIMETER LENGTH CONVERSION

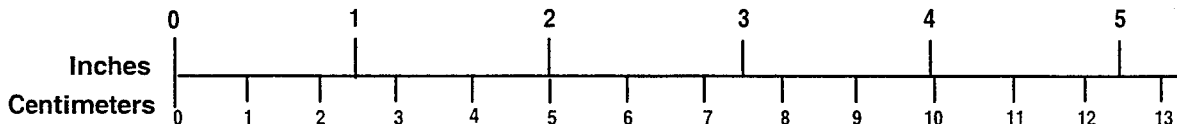

QUICK FAHRENHEIT - CELSIUS TEMPERATURE CONVERSION

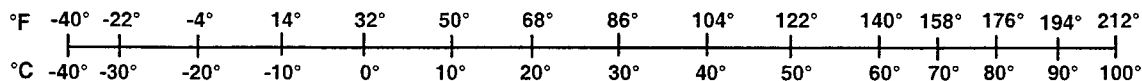

For more exact and or other conversion factors, see NIST Miscellaneous Publication 286, Units of Weights and Measures. Price \$2.50 SD Catalog No. C13 10286

Updated 6/17/98

TABLE OF CONTENTS

<u>Section</u>	<u>Page</u>
1. INTRODUCTION.....	1
2. SEAT/OCCUPANT EXPERIMENTS.....	3
2.1 Experiment No. 1 – Row-to-Row Commuter Seats.....	3
2.2 Experiment No. 2 – Row-to-Row Amtrak Seats with Restraints.....	5
2.3 Experiment No. 3 – Rear-Facing Commuter Seat.....	5
2.4 Experiment Layout in Rail Car	5
3. TEST RESULTS AND OBSERVATIONS.....	9
3.1 Experiment No. 1, Row-to-Row Commuter Seats.....	9
3.1.1 Seat Result.....	10
3.1.2 ATD.....	12
3.2 Experiment No. 2, Row-to-Row Intercity Seats with Restraints	12
3.2.1 Seat Result.....	12
3.2.2 ATD.....	14
3.3 Experiment No. 3, Rear-Facing Commuter Seat.....	14
3.3.1 Seat Result.....	15
3.3.2 ATD.....	17
4. CONCLUSIONS AND RECOMMENDATIONS	19
4.1 Conclusions	19
4.2 Recommendations	19
APPENDIX - SEAT ATTACHMENT LOADS	A-1
REFERENCES.....	R-1

LIST OF FIGURES

<u>Figure</u>	<u>Page</u>
1. Commuter Rail Seats Tested.....	4
2. Pre-Test Photo of Experiment No. 1 – Row-to-Row Commuter Seats.....	4
3. Pre-Test Photo of Experiment No. 2 – Row-to-Row Amtrak Seats with Restraints	6
4. Pre-Test Photo of Experiment No. 3 – Rear-Facing Commuter Seat	6
5. Rail Car Seat Experiment Layout for Test No. 1.	7
6. Experiment No. 1 – Loss of Passenger Compartmentalization.....	10
7. Experiment No. 1 – Front-Row Seat Pedestal Collapse and Seat Deformation	11
8. Experiment No. 1 – Front-Row Seat Frame Deformation and Weld Seam Failure	11
9. Experiment No. 2 – ATD Not Compartmentalized.....	13
10. Experiment No. 2 – ATD Knee Markings on the Deformed Seat Back	13
11. Experiment No. 2 – Metal Floor Attachment Bar Deformed Under Load	14
12. Experiment No. 3 – Seat Pedestal Sheared Near the Floor Attachment	16
13. Experiment No. 3 – Failed Weld Seams at the Side Wall Mounts	16

LIST OF TABLES

<u>Table</u>	<u>Page</u>
1. Injury Criteria.....	9
2. Experiment No. 1 – Row-to-Row Commuter Seats - Occupant Injury Loads.....	12
3. Experiment No. 2 – Row-to-Row Intercity Seats with Restraints - Occupant Injury Loads	15
4. Experiment No. 3 – Rear-Facing Commuter Seats - Occupant Injury Loads.....	17

EXECUTIVE SUMMARY

On November 16, 1999, at the Transportation Technology Center in Pueblo, Colorado, a test was conducted of a single rail passenger car colliding with a fixed wall at 35 mph. The car was equipped with instrumented anthropomorphic test devices (test dummies) in three interior arrangements:

1. Forward-facing unrestrained occupants seated in rows, compartmentalized by the forward seat in order to limit the motions of the occupants.
2. Forward-facing restrained occupants with lap and shoulder belts.
3. Rear-facing unrestrained occupants.

The purpose of the test was to obtain data to validate and calibrate computer models for analyzing crashworthiness of rail passenger vehicles.

Three-position production seats of commuter rail passenger cars were used in both the first and third arrangements. Modified intercity coach seats were used in the second arrangement. This seat design is a proof-of-concept design. This report summarizes a preliminary analysis of the data – a more in-depth analysis of the test results is ongoing.

Both the rear- and forward-facing commuter seats failed under the impact loads of the severe test condition. Points of failure include the pedestal, the side wall attachment on the frame, and the elbow juncture at the seat back/pan hinge point on the frame. Generally, the attachment bolts remained intact at the floor and side wall mounts. The unrestrained test dummies were not compartmentalized.

The modified intercity seat with lap and shoulder belts performed well under the impact loads. The restrained occupants remained seated, although the neck moment in the 5th-percentile female exceeded the injury criterion. This finding was consistent with previous predictions made through modeling and analysis efforts. One of the unrestrained occupants did catapult over the seat ahead, eventually coming to rest on top of one of the restrained dummies.

•

•

•

•

•

•

•

•

•

•

•

1. INTRODUCTION

Two full-scale impact tests of rail cars fitted with seat/occupant experiments have been scheduled; the first test was conducted at the Transportation Technology Center, Pueblo, Colorado, on November 16, 1999. This report describes that test which involved a single rail car impacting a rigid barrier at approximately 35 mph. The second test, scheduled to occur in the spring, will involve two rail cars coupled together impacting a rigid barrier at approximately 25 mph.

The principal goal of this full-scale rail car impact test and the overall test program was to obtain scientific data that define a realistic rail car crash pulse, structural response, and corresponding level of occupant safety. The objective of the interior tests was to determine the corresponding level of occupant safety for that impact scenario. Several interior configurations were tested with the appropriate data acquisition technology and quantified occupant injury parameters and seat strength characteristics.

Three seat/occupant experiments were on board the first full-scale rail impact:

1. Two row-to-row commuter seats with three unrestrained 50th-percentile anthropomorphic test devices (ATDs) in the rear seat.
2. Two row-to-row intercity seats with two unrestrained 95th-percentile ATDs in the rear seat and two restrained ATDs (one 5th- and one 95th-percentile) in the front-row seat that had been modified with lap and shoulder belts.
3. One rear-facing commuter seat with three unrestrained 95th-percentile ATDs.

The instrumentation, lights, cameras, power sources, and fixtures required to fully document and evaluate the experiments also were on board the rail car.

The results of the three seat/occupant experiments from Impact Test No. 1 are provided in this Test Summary Report along with a description of the experiments (Section 2), the test results and observations (Section 3), and conclusions and recommendations (Section 4).



2. SEAT/OCCUPANT EXPERIMENTS

The seat/occupant experiments that were incorporated into the full-scale rail car impact test represent typical commuter and intercity seat configurations with typical-size occupants. The current-production commuter rail passenger seats were not designed to meet the recently published FRA dynamic standards [1]. One of the objectives of the test was to determine the potential impact tolerance of the existing commuter seats. These experiments were designed to be compared to baseline data produced previously from dynamic sled tests [2], as well as to provide new information about seat/occupant responses in more realistic environments (compared to the controlled test environment provided by sled tests). The intercity seat/occupant experiment was designed to provide information about restraint systems in rail seats. This experiment involved an intercity seat modified with restraints – there is no seat like this in service today - and used 95th-percentile male ATDs and one 5th-percentile female ATD. These large and small ATDs were used rather than average-size ATDs to represent a more severe environment – both for the 5th-percentile ATD and the seat.

The commuter rail seats used on this test were M-style seats manufactured by Coach and Car Equipment Corporation (CCEC). The intercity seats tested were provided by Amtrak.

Three seat/occupant experiments were conducted and are described in the following sections.

2.1 EXPERIMENT NO. 1 – ROW-TO-ROW COMMUTER SEATS

Experiment No. 1 consisted of two row-to-row three-place passenger commuter seats – specifically the M-style seat manufactured for transit authorities such as Metro North, Long Island Railroad, Southeast Pennsylvania Transit Authority (SEPTA), Northern Indiana, New Jersey Transit, and the Maryland Area Rail Commuter System. A schematic of the seat is shown in Figure 1. The seat pitch between the seats was 32 in., and the rear seat was occupied by three 50th-percentile male ATDs. This experiment was installed aft in the rail car, in front of the rear body bolster, on the right side (orientations are made with respect to a forward-facing occupant, facing the impacting end of the rail car).

The seats were bolted onto retrofitted steel bars (2.00 in. x 0.75 in.) that replaced the original wooden floor. These steel bars represented the retrofit floor design in SEPTA's Silverliner 3 rail car. Two floor load cells were installed between the seat pedestal and the steel floor bar. At the wall mounting points, two load cells were installed between the seat attachment and the heater guard – a lip that extends horizontally from the wall of the car. The rear-row seat was similarly installed, but instead of load cells, spacer blocks of equivalent height were used.

The focus of this experiment was on the head/neck forces experienced by the front-facing occupants, and the reaction load at the seat attachment points. A pre-test photo of Experiment 1 is shown in Figure 2.

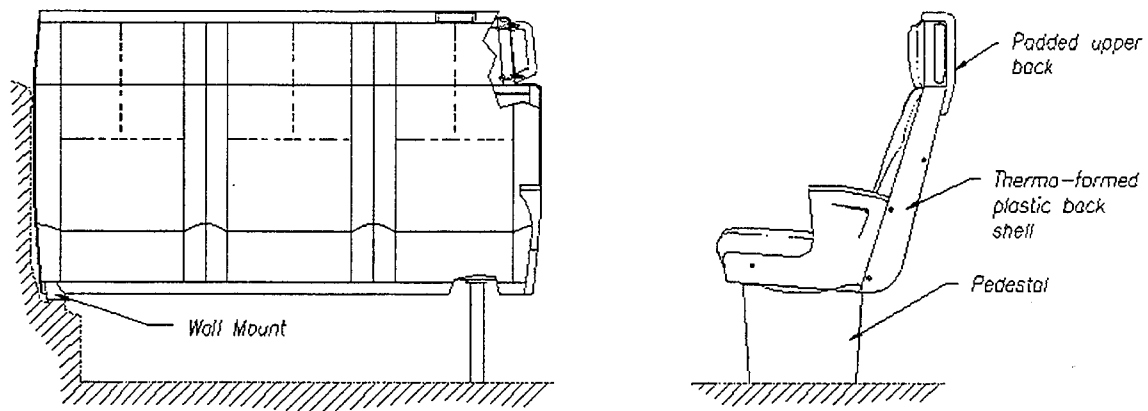

3 Passenger M-Style Seat

Figure 1. Commuter Rail Seats Tested

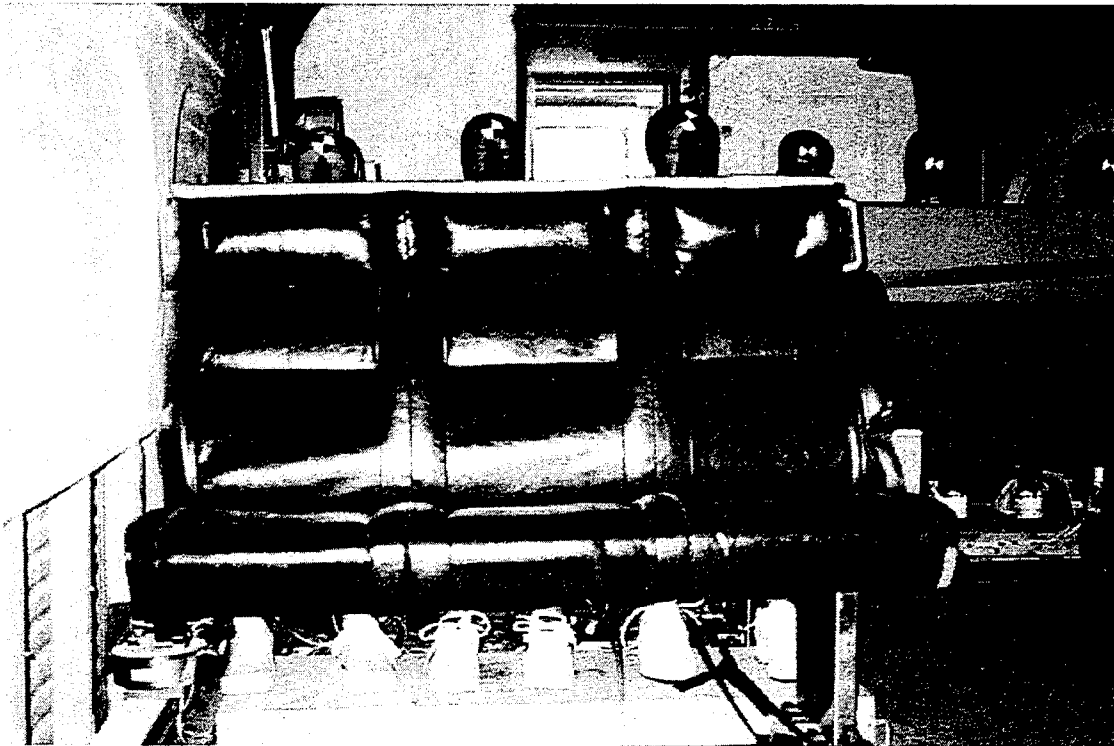

Figure 2. Pre-Test Photo of Experiment No. 1 – Row-to-Row Commuter Seats

2.2 EXPERIMENT NO. 2 – ROW-TO-ROW AMTRAK SEATS WITH RESTRAINTS

Experiment No. 2 consisted of two row-to-row two-place passenger intercity seats provided by Amtrak. These intercity seats were manufactured by AMI of Colorado Springs, Colorado, and the front-row seats were modified with lap and shoulder belts. The seat back panel and hinge-point between the seat pan and the seat back were both strengthened to bear the load of the lap and shoulder belts, as well as the load of unrestrained occupants impacting the seat from behind. Energy-absorbing devices were also incorporated into the modified seat to bear some of the impact load. The two original seat pedestals were replaced with higher strength pedestals. The rear seat was occupied by two unrestrained 95th-percentile ATDs, and the front seat was occupied by two restrained ATDs (a 5th-percentile in the window seat and a 95th-percentile in the aisle seat).

The Amtrak seats were floor mounted and bolted onto steel bars (2.00 in. x 0.75 in.) that replaced the original wooden floor. Two floor load cells were installed between each seat pedestal and the steel bars to which they were attached. The rear row seat was similarly installed, but instead of load cells, spacer blocks of equivalent height were used.

The focus of this experiment was on the rear-seat occupants impacting the front-row seat occupied with restrained ATDs, and observing the reaction of the front-row seat, the restrained occupants in this seat, and the unrestrained ATDs impacting the seat from behind. A pre-test photo of Experiment 2 is shown in Figure 3.

2.3 EXPERIMENT NO. 3 – REAR-FACING COMMUTER SEAT

Experiment No. 3 consisted of a single, rear-facing M-style commuter seat. This rear-facing seat was occupied by unrestrained ATDs – one Hybrid III 95th-percentile male ATD in the aisle seat and two 95th-percentile ATDs, manufactured by GARD, in the middle and window seats. It was later determined that while these GARD ATDs represented the 95th-percentile male population in size, they only represented the 50th-percentile male population by weight (172 lb).

This seat was installed exactly like the front-row seat of Experiment No. 1. Two floor load cells were installed between the seat pedestal and the steel floor beam. At the wall mount, two load cells were installed between the seat attachment and the heater guard.

The focus of this experiment was the crash pulse and the applied force of the seated occupants and the reaction of the seat. The head/neck reaction of the occupants also was observed. A pre-test photo of Experiment 3 is shown in Figure 4.

2.4 EXPERIMENT LAYOUT IN RAIL CAR

A modeling analysis effort, performed at the Volpe Center on a single car, predicted the acceleration pulse and structural response of the car during impact. The results suggested that a vertical (upward) pitch would occur to both the front and aft ends of the car. This information helped determine the preferred location for each seat/occupant experiment inside the car. The experiments were all installed between the trucks of the car (to allow the ends of the car to crush without damaging any interior experiments).

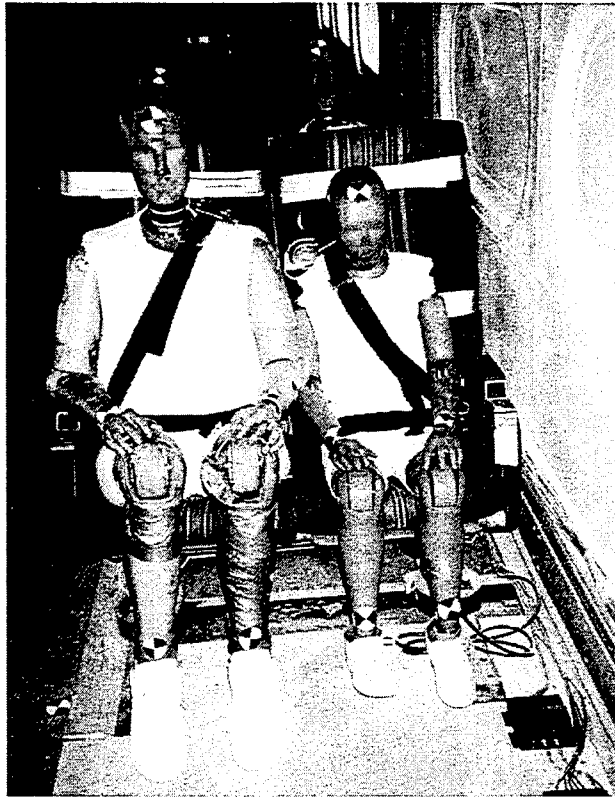

Figure 3. Pre-Test Photo of Experiment No. 2 – Row-to-Row Amtrak Seats with Restraints

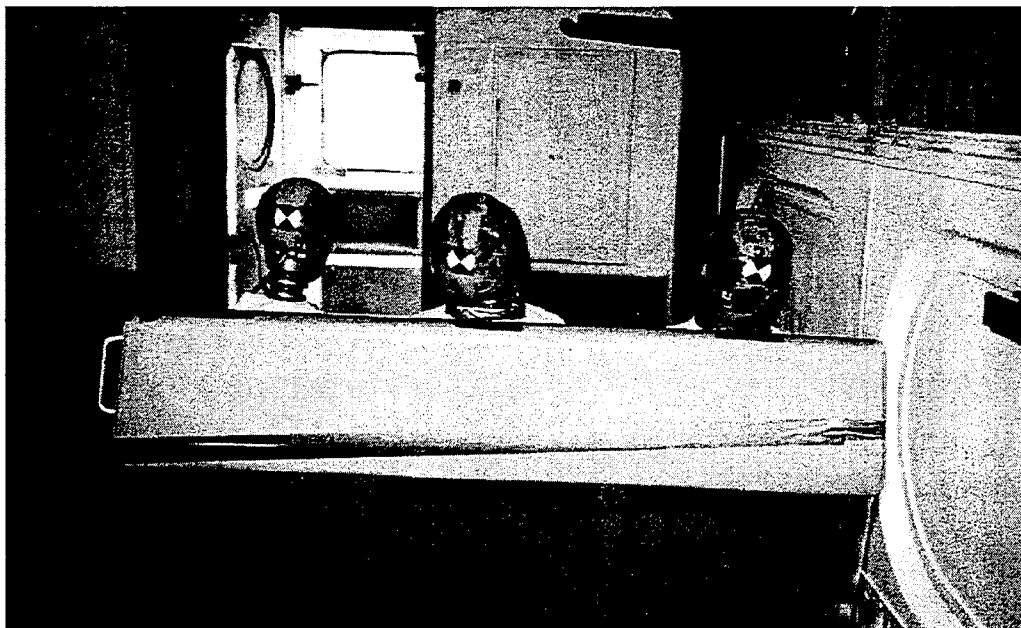

Figure 4. Pre-Test Photo of Experiment No. 3 – Rear-Facing Commuter Seat

Experiment No. 1 was installed approximately 36 in. forward of the rear-facing seat (Experiment No. 3) which was installed 24 in. from the rear body bolster. The seats in Experiment No. 1 were installed 32 in. apart. Experiment No. 2 was installed toward the front of the car, approximately 40 in. from the front body bolster with a 41-in. seat pitch. Figure 5 is a layout of the seat experiments in the rail car.

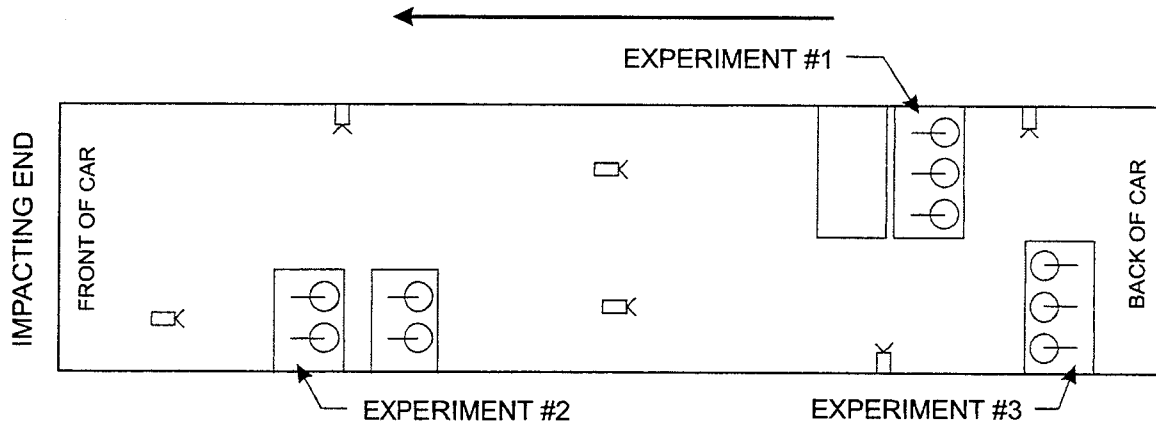

Figure 5. Rail Car Seat Experiment Layout for Test No. 1



3. TEST RESULTS AND OBSERVATIONS

The impact of the single car into a rigid barrier produced an acceleration pulse that compares favorably to the pulse predicted in the simulations. This acceleration pulse is more severe than would be anticipated in an accident that consists of a train of coupled rail cars. However, it provides useful information that can, in turn, be extrapolated out of data from future tests that involve more than one rail car. Future tests will provide data that could be used to confirm the preliminary observations made about this test.

Preliminary results of the seat and ATD responses in each experiment are provided in the following sections. Seat attachment loads and the key ATD injury loads are presented in tables with corresponding injury criteria. The injury criteria used are shown in Table 1.

Table 1. Injury Criteria*

	5th (F)	50th (M)	95th (M)
HIC	1,000 ⁽²⁾	1,000 ⁽¹⁾⁽³⁾	1,000
Neck Fx (lb)	+/- 438 ⁽²⁾	+/- 697 ⁽²⁾	+/-856
Neck Fz (lb)	+468 / -567 ⁽²⁾	+742 / -900 ⁽²⁾	+910/-1,104
Neck My (ft-lb)	+70 / -21 ⁽²⁾	+140/-42 ⁽²⁾	+190/-58
Chest (G)	60	60 ⁽¹⁾	60
Femur (lb)	-1,530 ⁽²⁾	-2,250 ⁽¹⁾⁽³⁾	-2,594

*Melvin, J.W., Nahum, A.M., Eds. *Accidental Injury: Biomechanics and Prevention*, Springer-Verlag, 1993.

⁽¹⁾FMVSS 208 Requirement

⁽²⁾FMVSS Proposed Rule

⁽³⁾FAA Requirement

3.1 EXPERIMENT NO. 1, ROW-TO-ROW COMMUTER SEATS

Gross failure of the seat pedestal in Experiment No. 1 allowed the seat to be pushed out of the way, resulting in a complete loss of occupant compartmentalization (see Figure 6). Overall, the measured occupant injuries were low because the seat offered little or no restraint value and the ATDs were tethered. There were no further obstacles for the occupant to impact before landing on the floor. The Hybrid III 50th-percentile ATD in the rear window seat was instrumented, and recorded a lower neck extension moment that exceeded the injury criterion.



Figure 6. Experiment No. 1 – Loss of Passenger Compartmentalization

3.1.1 Seat Result

The aft-row seat pedestal deformed under inertial loads. There was little to no deformation in the wall bracket attachment and the seat and floor attachments stayed relatively intact. The aft-row seat cushions all detached.

The front-row seat pedestal deformed completely forward, causing the seat to rotate forward until the front edge of the seat pan contacted the floor (Figure 7). The seat deformation was severe, occurring in the frame at the seat/pan hinge (Figure 8). The floor attachments to the pedestal remained intact. The side wall attachment brackets on the side frame of the seat separated at the weld seam, leaving the attachment on the side wall intact (Figure 8). The front-row seat cushions detached.

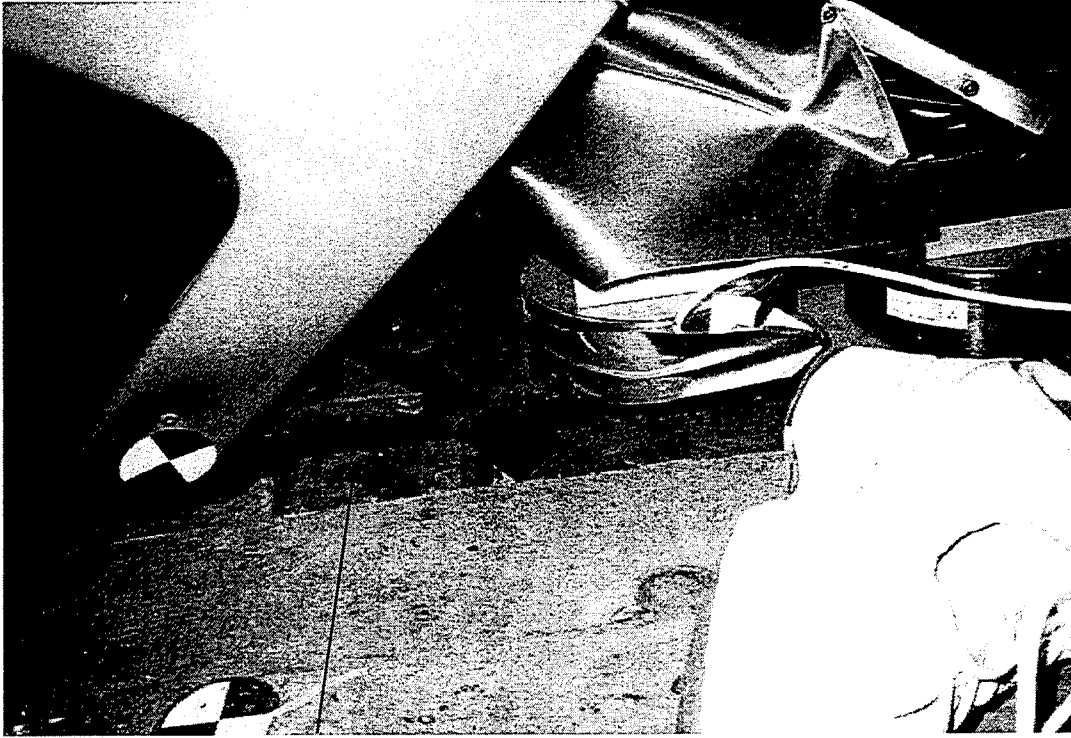

Figure 7. Experiment No. 1 – Front-Row Seat Pedestal Collapse and Seat Deformation

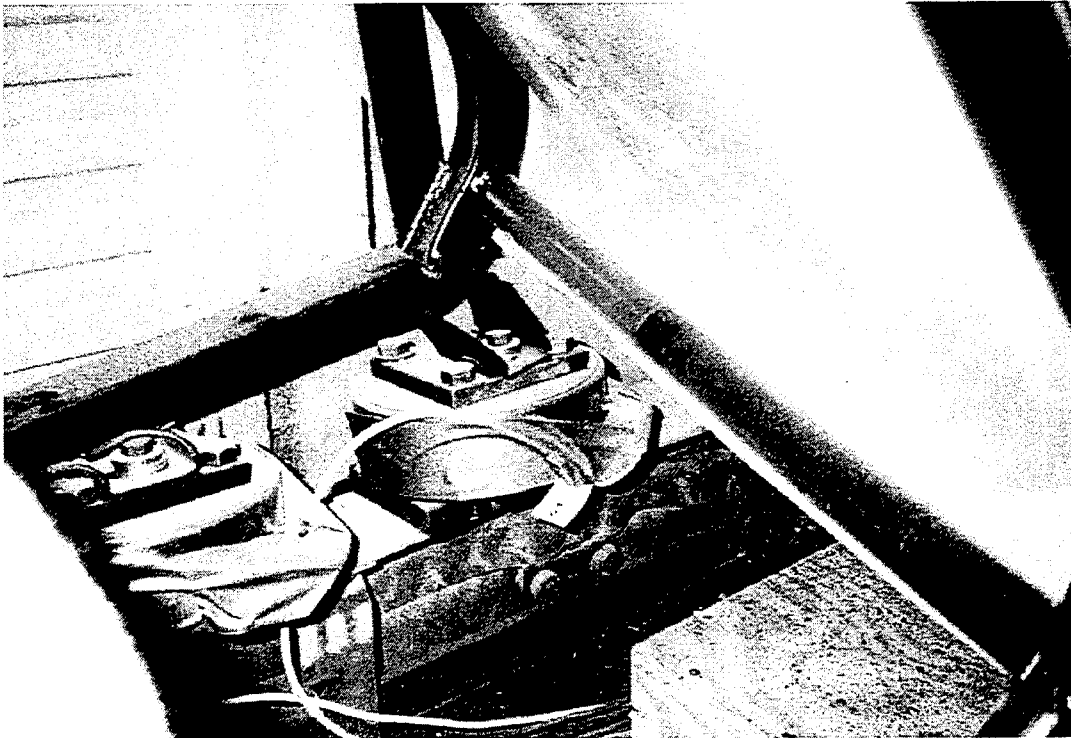

Figure 8. Experiment No. 1 – Front-Row Seat Frame Deformation and Weld Seam Failure

3.1.2 ATD

All injury load measurements were made from instrumentation installed in the Hybrid III 50th-percentile ATD seated in the aft row, window seat. The knees of this ATD impacted the seat back ahead of it, which contributed significantly to the deformation of the front-row seat. The knees impacted the seat back at approximately 57 msec, and the head impacted at approximately 150 msec, deforming the seat severely and allowing the ATD to continue traveling forward. While the overall injury measurements were low, the lower neck extension measured in the instrumented ATD exceeded the injury criterion (See Table 2).

Table 2. Experiment No. 1, Row-to-Row Commuter Seats - Occupant Injury Loads

	Hybrid III 50 th , Window Seat Occupant	
	Criteria	Recorded Loads
HIC	1,000	202
Neck Fx (lb)	+/-697	+242/-45
Neck Fz (lb)	+742/-900	326/-45
Upper Neck My (ft-lb)	+140/-42	37/-17
Lower Neck My (ft-lb)	+140/-42	33/-94
Chest (G)	60	14
Left Femur (lb)	-2,250	-670
Right Femur (lb)	-2,250	-806

3.2 EXPERIMENT NO. 2, ROW-TO-ROW INTERCITY SEATS WITH RESTRAINTS

The increased strength of the modified Amtrak seats resisted the loads imposed by the impact accelerations, prevented secondary impact of the occupants, and absorbed the loads produced by the restraints. The restrained ATDs hardly moved — the seat provided excellent restraint value. Compartmentalization for the unrestrained rear-seat ATDs was somewhat effective because the seat backs withstood the loads of the impacting ATDs. However, had the rear-seat ATDs not been tethered to the floor behind the seat, it appears that they would have projected farther over the seats toward the front of the rail car (Figure 9). Seat pitch may be a significant factor in the success of compartmentalization.

3.2.1 Seat Result

The forward motion of the front-seat back panel was somewhat controlled by the energy-absorbers at the seat back/pan hinge. The front-seat back panel appeared to deform under the impact load of the rear occupant's knees (Figure 10). The longitudinal metal bars to which the seat was attached were both severely deformed as a result of the load transferred to them from the seat (Figure 11). The modified seat performed exceptionally well under the circumstances. The seat frame and pedestals did not deform, so the seat can be easily refurbished with new seat backs for use in future testing.

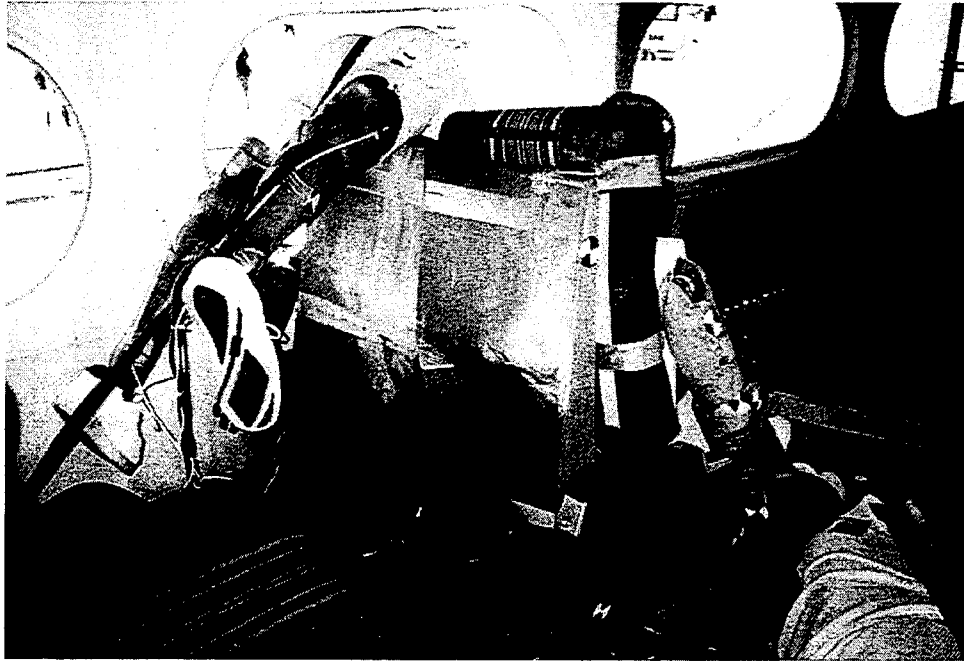

Figure 9. Experiment No. 2 – ATD Not Compartmentalized

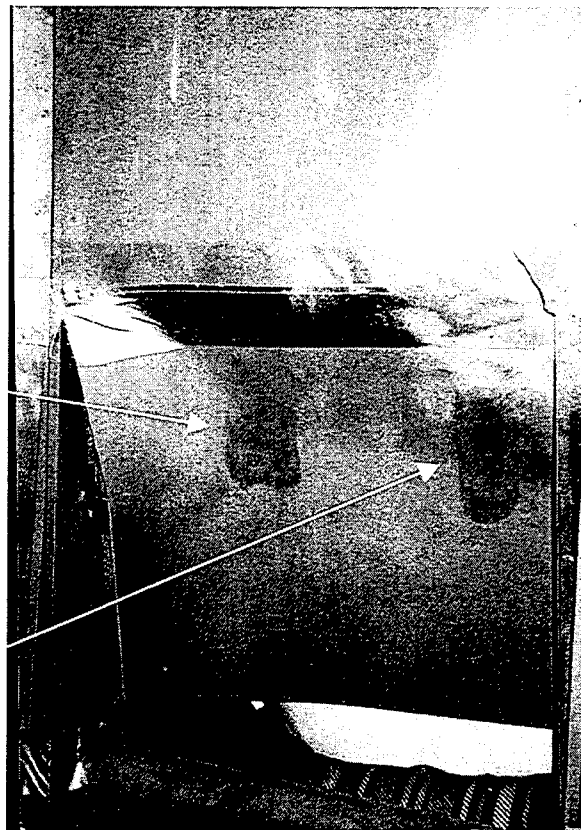

Figure 10. Experiment No. 2 – ATD Knee Markings on the Deformed Seat Back

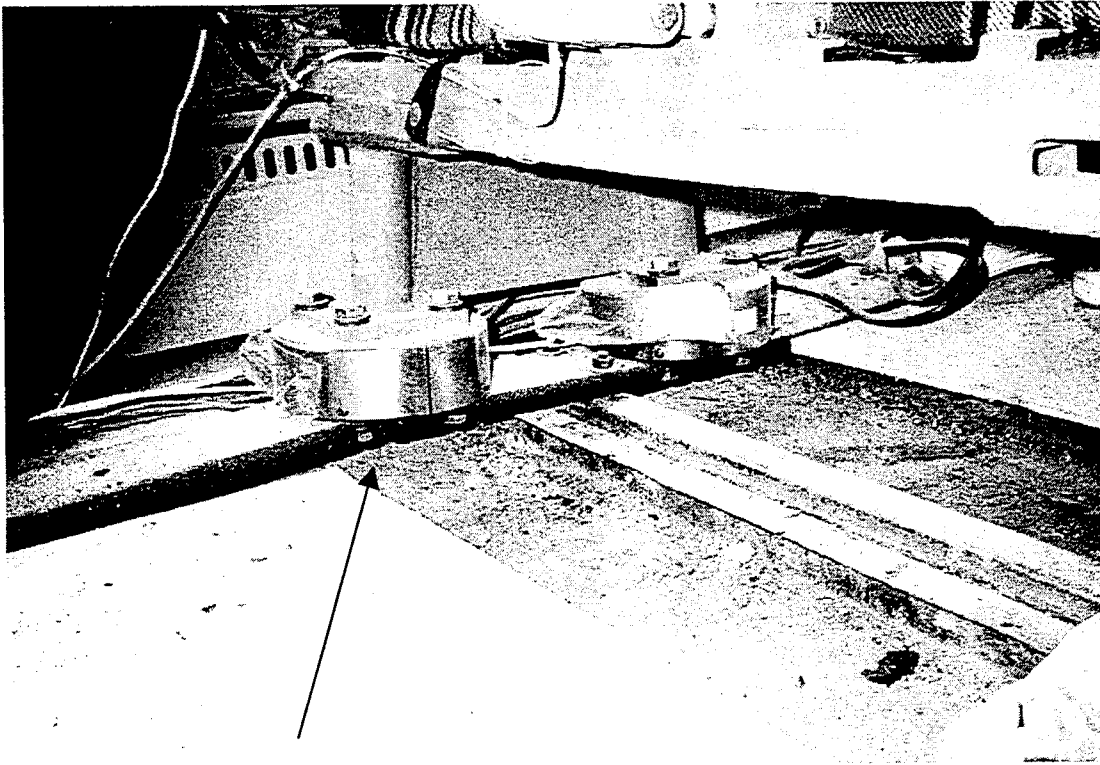

Figure 11. Experiment No. 2 – Metal Floor Attachment Bar Deformed Under Load

3.2.2 ATD

The head, chest, and femurs of the rear-seat occupants impacted the front-row seat backs, causing seat-back deformation. The ATD's knees impacted the seat back at approximately 127 msec, and the head impacted the seat after the knees did at about 184 msec. The 95th-percentile ATD in the rear window seat was instrumented, and recorded a right femur load that exceeded the injury criterion. This ATD also experienced neck flexion and shear loads that exceeded the corresponding injury criteria. The head injury criterion was just below the injury criteria (Table 3). While the modified Amtrak seat absorbed some of the impact energy through its energy-absorbing tubes, the stiffness of the modified seat back contributed to these excess injury loads. Placing padding on the seat back and using a longer range for the energy-absorber to stroke would likely improve these injury loads. The restrained occupants in the front row remained seated, although the neck moment in the 5th-percentile female exceeded the injury criterion.

3.3 EXPERIMENT NO. 3, REAR-FACING COMMUTER SEAT

Gross failure of the seat pedestal and the attachment fittings allowed the seat to rotate backward (toward the impact direction), resulting in a loss of occupant compartmentalization. The 95th-percentile ATD in the aisle seat was instrumented and recorded a shear neck load that exceeded the injury criterion. It is likely that the 95th-percentile ATD in the aisle seat created a high moment about the pedestal and side wall attachment, causing increased rotation about these

attachments. Replacing the existing pedestal with a stronger pedestal and improving the weld at the side wall attachment should improve the seat's attachment to the rail car.

Table 3. Experiment No. 2 – Row-to-Row Intercity Seats with Restraints - Occupant Injury Loads

	Hybrid III 5th-, Window Seat, Front-Row Occupant		Hybrid III 95th-, Window Seat, Back-Row Occupant	
	Criteria	Recorded Loads	Criteria	Recorded Loads
HIC	1,000	(not measured)	1,000	854
Neck Fx (lb)	+/- 438	+15/-126	+/-856	+1,510/-99
Neck Fy (lb)	+/- 438	+17/-13	+/-856	+30/-461
Neck Fz (lb)	+468 / -567	+251/-28	+910/-1,104	+539/-709
Neck Mx (ft-lb)		+3/-4		+89/-46
Neck My (ft-lb)	+70 / -21	+22/-23	+190/-58	+305/-44
Neck Mz (ft-lb)		+1/-0		+19/-41
Chest (G)	60	(not measured)	60	27
Left Femur (lb)	-1,530	(not measured)	-2,594	-1,959
Right Femur (lb)	-1,530	(not measured)	-2,594	-3,116

3.3.1 Seat Result

The seat offered minimal resistance to the inertial loads; i.e., the pedestal was sheared off near the floor attachment at the aft end (Figure 12), while the bolts attaching the pedestal to the load cell mount remained intact. The pedestal failure caused the seat to rotate backward and failed the weld seams on the side wall mounts (Figure 13).

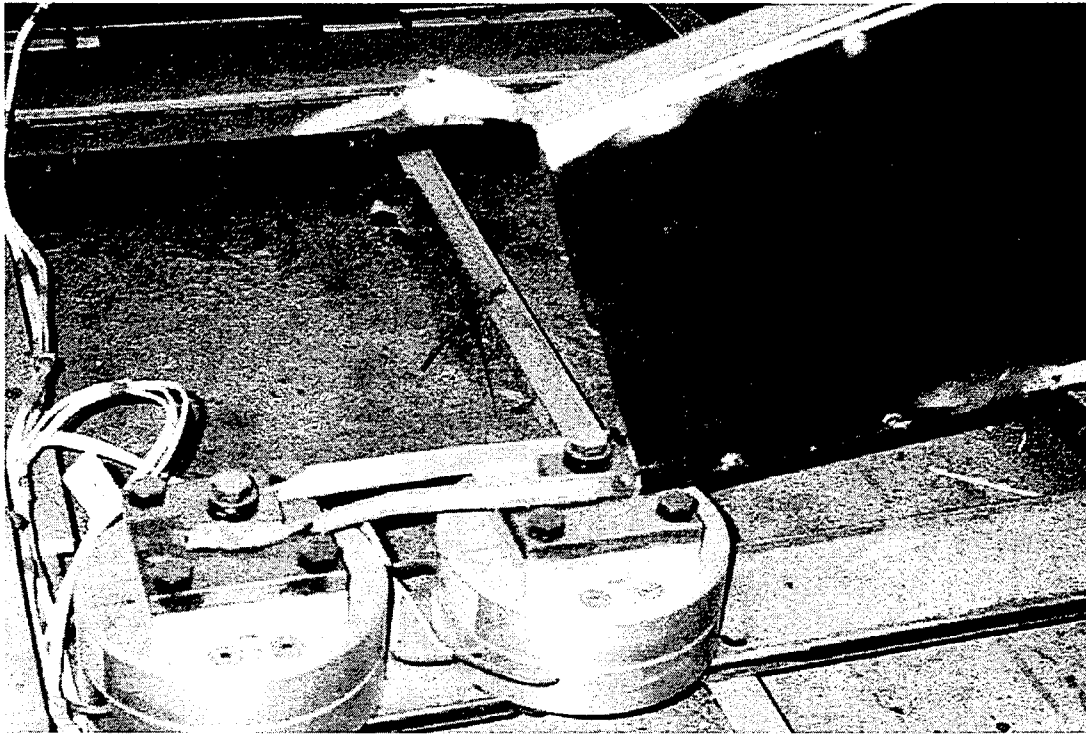

Figure 12. Experiment No. 3 – Seat Pedestal Sheared Near the Floor Attachment



Figure 13. Experiment No. 3 – Failed Weld Seams at the Side Wall Mounts

3.3.2 ATD

The 95th-percentile ATD in the aisle seat was instrumented with an upper neck load cell that recorded shear loads in excess of the injury criterion (Table 4).

Table 4. Experiment No. 3 – Rear-Facing Commuter Seats - Occupant Injury Loads

	Hybrid III 95th-, Aisle Seat Occupant	
	Criteria	Recorded Loads
Neck Fx (lb)	+/-856	+1,835/-277
Neck Fz (lb)	+910/-1,104	+226/-62
Neck My (ft-lb)	+190/-58	+28/-47



4. CONCLUSIONS AND RECOMMENDATIONS

4.1 CONCLUSIONS

The commuter seats collapsed under the impact loads of the severe test condition. Areas of failure occurred in the pedestal, side wall attachment on the frame, and at the elbow juncture at the seat back/pan hinge point on the frame. Generally, the attachment bolts remained intact at the floor and side wall mounts. The unrestrained ATDs were not compartmentalized.

The modified intercity seat with restraints performed well under the impact loads. The restrained occupants remained seated, although the neck moment in the 5th-percentile female exceeded the injury criterion. This finding was consistent with previous predictions made through modeling and analysis efforts. The unrestrained rear-seat occupants were compartmentalized; however, injury loads measured in the knees, head, and neck exceeded or nearly exceeded injury criteria.

Relative to human survivability, the dynamic environment generated in this single-car test was considered very severe. The neck and knees appear to be the predominant body areas where measured injury loads exceeded the injury criteria.

4.2 RECOMMENDATIONS

The following recommendations will be incorporated into Test No. 2:

- Reproduce all the seat/occupant experiments in the lead car of Test No. 2 to compare the responses in this dynamic environment (a single car impacting a barrier) to those observed in Test No. 2 (two coupled cars impacting a barrier).
- Modify a similar commuter seat for Test No. 2 with a stronger pedestal and weld seams on the seat frame and compare the test outcomes to Test No. 1.
- Refurbish the intercity seat with new seat back panels and reuse it in Test No. 2.
- Tether all the ATDs to prevent them from traveling toward the front end of the rail car and to prevent significant damage to the ATDs.
- Conduct the rear-facing seat experiment with the same weight ATDs to reduce the torsion effect about the pedestal and wall mount.
- Consider placing all the instrumented ATDs in aisle seats where they may be better viewed by the cameras.



**APPENDIX
SEAT ATTACHMENT LOADS**



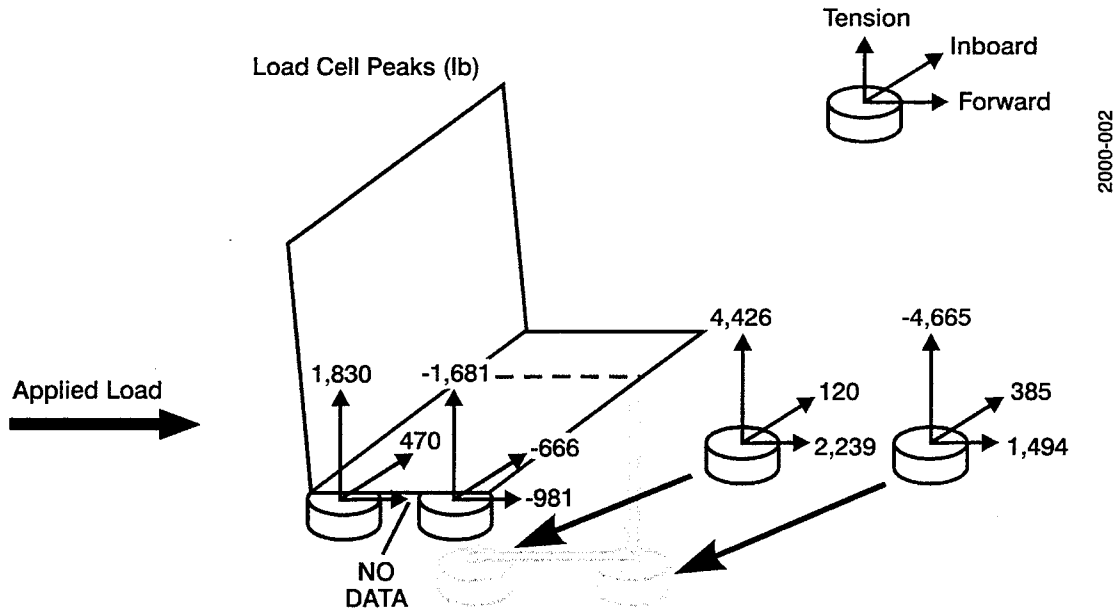

Figure A-1. Experiment No. 1 – Row-to-Row Commuter Seats – Front-Row Seat Attachment Loads (Maximums)

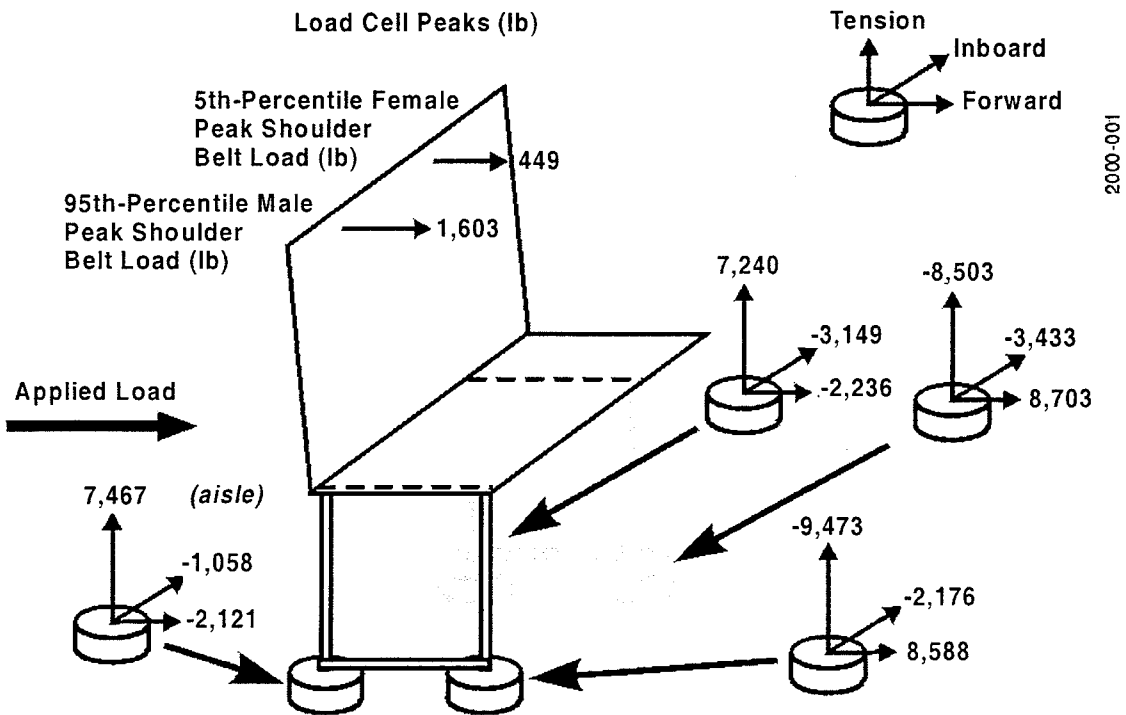
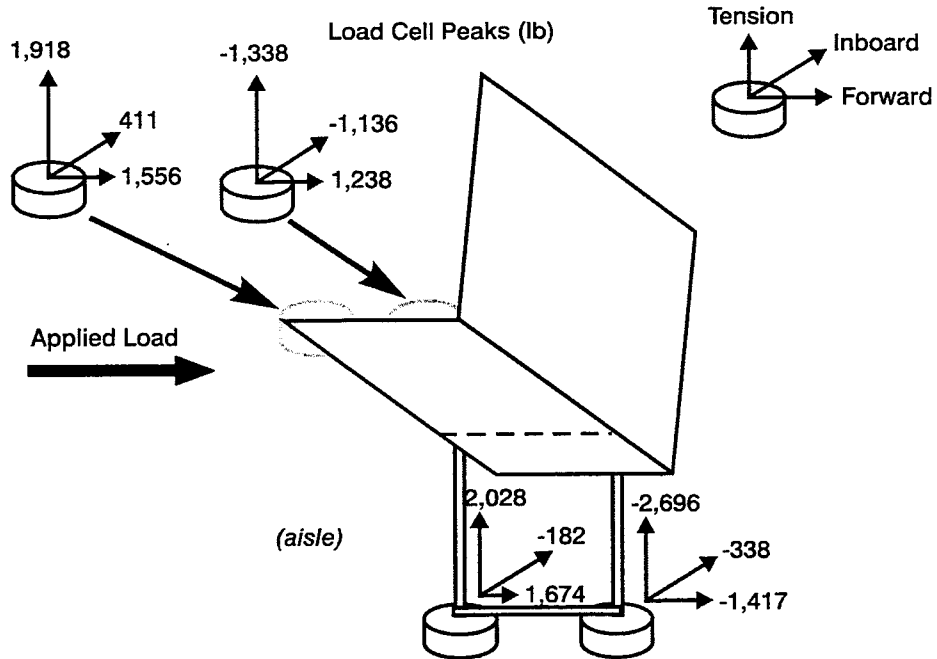

Figure A-2. Experiment No. 2 – Row-to-Row Intercity Seats – Front-Row Seat Attachment Loads (Maximums)



2000-003

Figure A-3. Experiment No. 3 – Rear-Facing Commuter Seat - Seat Attachment Loads (Maximums)

REFERENCES

1. U.S. Department of Transportation, Federal Rail Administration, "49 CFR Part 216 et al., Passenger Equipment Safety Standards; Final Rule," Federal Register, Wednesday, May 12, 1999.
2. Tyrell, D., and K.J. Severson, "Crashworthiness Testing of Amtrak's Traditional Coach Seat," U.S. Department of Transportation, DOT/FRA/ORD-96/08, October 1996.

