

"MAILBOX BRACKET CRASH TESTS"

an

INTERIM REPORT

RESEARCH STUDY 7-1945

by

Hayes E. Ross, Jr., P.E.
Study Supervisor
Texas Transportation Institute

April 1993

Preface

As requested in a letter, Underwood to Bridges, dated March 30, 1993, this is an interim report, summarizing the nine crash tests conducted to date on the subject study. It is noted that additional tests may be conducted prior to completion of the study August 31, 1993. A comprehensive final report will be prepared at the conclusion of the study to include a description of all tests conducted within the study. All information contained herein should be considered preliminary in nature, subject to review and final edit.

General:

A total of nine full-scale crash tests have been conducted to date. Each test was conducted and evaluated in accordance with nationally recognized guidelines as contained in NCHRP Report 230. In each test a car weighing approximately 1,800 lb impacted the test article at approximately 60 mph. Initial impact point of the test article on the vehicle was approximately 15 inches to the left or right of the centerline of the vehicle on the front bumper. A 50th percentile anthropometric dummy, weighing approximately 160 lb, was placed in the driver's position and restrained with lap and shoulder belts.

According to Report 230, test results are to be evaluated in terms of three criteria, namely, "Structural Adequacy," "Occupant Risk," and "Vehicle Trajectory." Details of these criteria are given in Attachment A to this report. In all nine tests, results met the recommended criteria for occupant risk and vehicle trajectory. However, as discussed subsequently, in some tests there were questions as to whether item D of the criteria (see Attachment A) was met. It is noted that an absolute evaluation of the item D criteria is not always possible, and judgement must therefore be used in assessing results.

The purpose of the first eight tests was to determine the adequacy of a new bracket, developed by TxDOT to attach the mailbox to the support post, when the mailbox installation was subjected to recommended crash tests. Tests were conducted with one and two mailboxes mounted on a single support, and multiple mailboxes mounted on the Foresight Tubular Support. The ninth test was conducted with multiple mailboxes mounted on a modified version of the Foresight Tubular Support. The modified installation consisted of a "replacement footing" to facilitate use of salvaged parts from damaged supports, and to minimize cost of replacement following a vehicular impact. Drawings of the test articles, including the new bracket, for each of the nine tests are shown in Attachment B.

Given in Attachment C are draft copies of the nine test reports prepared by support staff at the crash test facilities. Following is an abbreviated description of each test article and test results.

Test 1945-1

A size no. 1 mailbox was mounted on a single 2 lb/ft steel winged channel support. The mailbox was attached to the bracket (no extensions) with four 3/16 inch stove bolts. Other details of the installation are given in Attachment B.

The test met all evaluation criteria.

Test 1945-2

A size no. 2 mailbox was mounted on a single 2 lb/ft steel winged channel support. The mailbox was attached to the bracket extensions, with four 3/16 inch stove bolts. Other details of the installation are given in Attachment B.

The mailbox separated from the bracket extensions and the bracket separated from the angles upon impact, then struck and dished the windshield, although it did not penetrate the windshield. Examination of the test article showed that separation occurred for two reasons: (1) the bolts connecting the angle to the mailbox bracket pulled out of the slot in the bracket, and (2) the bolts connecting the mailbox to the bracket extensions sheared through the mailbox sheet metal. It was decided that these problems could and should be corrected.

Test 1945-3

The installation was the same as test 1945-2 with three exceptions: (1) two flat washers (one between the head and angle, and one between the bracket and the lock washer) were added to each of the two bolts attaching the angles to the bracket, (2) two flat washers (one between the head and angle, and one between the angle and the lock washer) were added to each of the two bolts attaching the angles to the support, and (3) six 3/16 inch stove bolts were used to attach the mailbox to the bracket extensions.

Behavior of the mailbox was similar to that in test 1945-2. However, a partial solution of the problems seen in test 1945-2 was achieved since the bracket and extensions remained with the angles and the support. Separation of the mailbox occurred when the six bolts connecting the box to the extensions sheared through the mailbox sheet metal. As before, it was concluded that this problem could and should be corrected.

Test 1945-4

The installation was the same as test 1945-3 with one exception: the size of the stove bolts connecting the mailbox to the bracket extensions was increased to 1/4 inch.

Although the mailbox again separated from the bracket extensions, the larger stove bolts kept the box attached for a sufficient duration of time to allow the box to obtain a velocity approximately equal to that of the vehicle. Consequently, the box did not hit the windshield, and the test met all evaluation criteria.

Test 1945-5

Two size no. 1½ mailboxes were mounted on a single 2 lb/ft steel winged channel support. Each mailbox was attached to the bracket and one bracket extension with six 1/4 inch stove bolts. An adapter plate was used to attach the two brackets to the angles. Other details of the installation are given in Attachment B.

In this test, the boxes remained attached to the support. The test met all evaluation criteria.

Test 1945-6

One size no. 2 mailbox was mounted on a single 2.375 inch O.D. x 0.095 inch thin-wall steel tube. The tube was mounted in a base socket. Attachment of the mailbox to the bracket extensions, attachment of the bracket to the angles, and attachment of the angles to the support (with the exception of bolt length) were the same as test 1945-4. Other details of the installation are given in Attachment B.

In this test the box and bracket separated from the angles, but only after the vehicle had knocked the installation to the ground and was riding over the installation. The test met all evaluation criteria.

Test 1945-7

Five size no. 1 mailboxes were mounted on a Foresight Tubular Support. Hardware used to attach each mailbox to the bracket, and to attach the bracket to the angles were the same as that used in test 1945-4. Note that in this installation the 2-inch leg of the 2 inch x 3 inch angles was attached to the horizontal member of the Foresight Tubular Support with one 3/8 inch bolt. Other details of the installation are given in Attachment B.

Upon impact all mailboxes remained attached as the support was pulled from the ground socket and projected up and over the car without any windshield contact. The test met all evaluation criteria.

Test 1945-8

Three size no. 2 mailboxes were mounted on a Foresight Tubular Support. Hardware used to attach each mailbox to the bracket, and to attach the bracket to the angles were the same as that used in test 1945-4. Note that in this installation the 2-inch leg of the 2 inch x 3 inch angles was attached to the horizontal member of the Foresight Tubular Support with one 3/8 inch bolt. Other details of the installation are given in Attachment B.

Upon impact all mailboxes remained attached as the support was pulled from the ground socket and projected up and over the car without any windshield contact. The test met all evaluation criteria.

Test 1945-9

A modified version of the Foresight Tubular Support was evaluated in this test. The modification consisted of a "replacement footing," attached to the support structure by two 5/16 inch bolts at the normal splice, and a 3/8 inch bolt at the uppermost splice. The lower portion of the replacement footing was inserted in the ground socket. It is noted that TxDOT standards drawings call for 3/8 inch bolts at the normal splice; however, it was learned after the test that the support assembly, as provided by TxDOT, for this test as well as those used in tests 1945-7 and -8, contained 5/16 inch bolts. Fortunately, none of the splices in tests 1945-7, -8, and -9 failed. Nonetheless, it is recommended that 3/8 inch bolts be used for both splices to insure structural adequacy. The installation was oriented such that the uppermost splice would be subjected to its most critical loading. Other details of the installation are given in Attachment B.

Upon impact, the support structure deformed, was pulled from the ground socket, and subsequently the upstream mailbox on the support impacted and dished the windshield. Penetration of the windshield did not occur. Two items were identified as probable causes of the differences in behavior of the installation in this test with the two previous tests. First, and likely the dominate reason, the replacement footing in test 1945-9 was inserted approximately 11 inches into the ground socket, whereas the support in tests 1945-7 and -8 were inserted approximately 9 inches. In all three tests the insertion depth was controlled by the 42 inch dimension from the top of the horizontal member of the support structure to the ground. It is believed that the added insertion depth of the replacement footing in test 1945-9 increased the force needed to pull the footing from the socket, which resulted in further deformation of the support structure by the vehicle, and hence contact of the mailbox with the windshield. Secondly, the horizontal distance from the front bumper to the lower edge of the windshield of the vehicle used in test 1945-9 was approximately 2 inches less than the vehicles used in tests 1945-7 and -8.

It is noted that the primary purpose of this test was to verify the structural adequacy of the modified support structure, primarily the uppermost splice. The test did in fact verify the adequacy of the modified support. It is the researchers' opinion that had the insertion depth of the replacement footing been approximately 9 inches, or less, the impact behavior of the modified installation would have been essentially the same as that observed in test 1945-8. Thus, it is concluded that the modified design will meet all impact performance evaluation criteria when the replacement footing is inserted 9 inches or less into the ground socket.

Results of test 1945-9 underscore the critical effect that seemingly minor design and installation details can have on the impact behavior of a safety feature. In this case it points to the need to limit the insertion depth, whether it be the standard design or the modified design, to 9 inches or less.

Summary

Tests described herein verify that the new TxDOT mailbox bracket with extensions meets national impact performance guidelines when used with various support structures, provided proper attachment hardware (number and sizes of bolts, nuts, and washers) as described herein is used. Acceptable impact performance has been demonstrated for use of the bracket with (a) a 2 lb/ft steel winged channel single support with a size no. 1 mailbox, (b) a 2 lb/ft steel winged channel single support with a size no. 2 mailbox, (c) a 2 lb/ft steel winged channel single support with two size no. 1½ mailboxes, (d) a 2 inch O.D. thin wall steel tube single support with a size no. 2 mailbox, (e) a standard Foresight Tubular Support with five size no. 1 mailboxes, (f) a standard Foresight Tubular Support with three size no. 2 mailboxes, and (g) a modified Foresight Tubular Support with three size no. 2 mailboxes.

Based on test results reported herein, insertion into the ground socket of the vertical support member of the standard or modified Foresight Tubular Support system should be limited to a maximum of 9 inches. Impact performance will be enhanced with smaller insertion depths.

ATTACHMENT A

NCHRP REPORT 230 EVALUATION CRITERIA

TABLE 6. SAFETY EVALUATION GUIDELINES

Evaluation Factors	Evaluation Criteria	Applicable to Minimum Matrix Test Conditions (see Table 3)
Structural Adequacy	A. Test article shall smoothly redirect the vehicle; the vehicle shall not penetrate or go over the installation although controlled lateral deflection of the test article is acceptable.	10, 11, 12, 30, 40
	B. The test article shall readily activate in a predictable manner by breaking away or yielding.	60, 61, 62, 63
	C. Acceptable test article performance may be by redirection, controlled penetration, or controlled stopping of the vehicle	41, 42, 43, 44, 45, 50, 51, 52, 53, 54
	D. Detached elements, fragments or other debris from the test article shall not penetrate or show potential for penetrating the passenger compartment or present undue hazard to other traffic.	All
Occupant Risk	E. The vehicle shall remain upright during and after collision although moderate roll, pitching and yawing are acceptable. Integrity of the passenger compartment must be maintained with essentially no deformation or intrusion.	All
	F. Impact velocity of hypothetical front seat passenger against vehicle interior, calculated from vehicle accelerations and 24 in. (0.61m) forward and 12 in. (0.30m) lateral displacements, shall be less than: $\frac{\text{Occupant Impact Velocity-fps}}{\begin{array}{cc} \text{Longitudinal} & \text{Lateral} \\ 40/F_1 & 30/F_2 \end{array}}$ and vehicle highest 10 ms average accelerations subsequent to instant of hypothetical passenger impact should be less than: $\frac{\text{Occupant Ridedown Accelerations—g's}}{\begin{array}{cc} \text{Longitudinal} & \text{Lateral} \\ 20/F_3 & 20/F_4 \end{array}}$ where F_1 , F_2 , F_3 , and F_4 are appropriate acceptance factors (see Table 8, Chapter 4 for suggested values).	11, 12, 41, 42, 43, 44, 45, 50, 51, 52, 54, 60, 61, 62, 63
	G. (Supplementary) Anthropometric dummy responses should be less than those specified by FMVSS 208, i.e., resultant chest acceleration of 60g, Head Injury Criteria of 1000, and femur force of 2250 lb (10 kN) and by FMVSS 214, i.e., resultant chest acceleration of 60 g, Head Injury Criteria of 1000 and occupant lateral impact velocity of 30 fps (9.1 m/s).	11, 12, 41, 42, 43, 44, 45, 50, 51, 52, 54, 60, 61, 62, 63
Vehicle Trajectory	H. After collision, the vehicle trajectory and final stopping position shall intrude a minimum distance, if at all, into adjacent traffic lanes.	All
	I. In test where the vehicle is judged to be redirected into or stopped while in adjacent traffic lanes, vehicle speed change during test article collision should be less than 15 mph and the exit angle from the test article should be less than 60 percent of test impact angle, both measured at time of vehicle loss of contact with test device.	10, 11, 12, 30, 40, 42, 44, 53
	J. Vehicle trajectory behind the test article is acceptable.	41, 42, 43, 44, 45, 50, 51, 53, 54, 60, 61, 62, 63

ATTACHMENT B

TEST ARTICLE DRAWINGS

TEST MATRIX OF PROJECT 1945

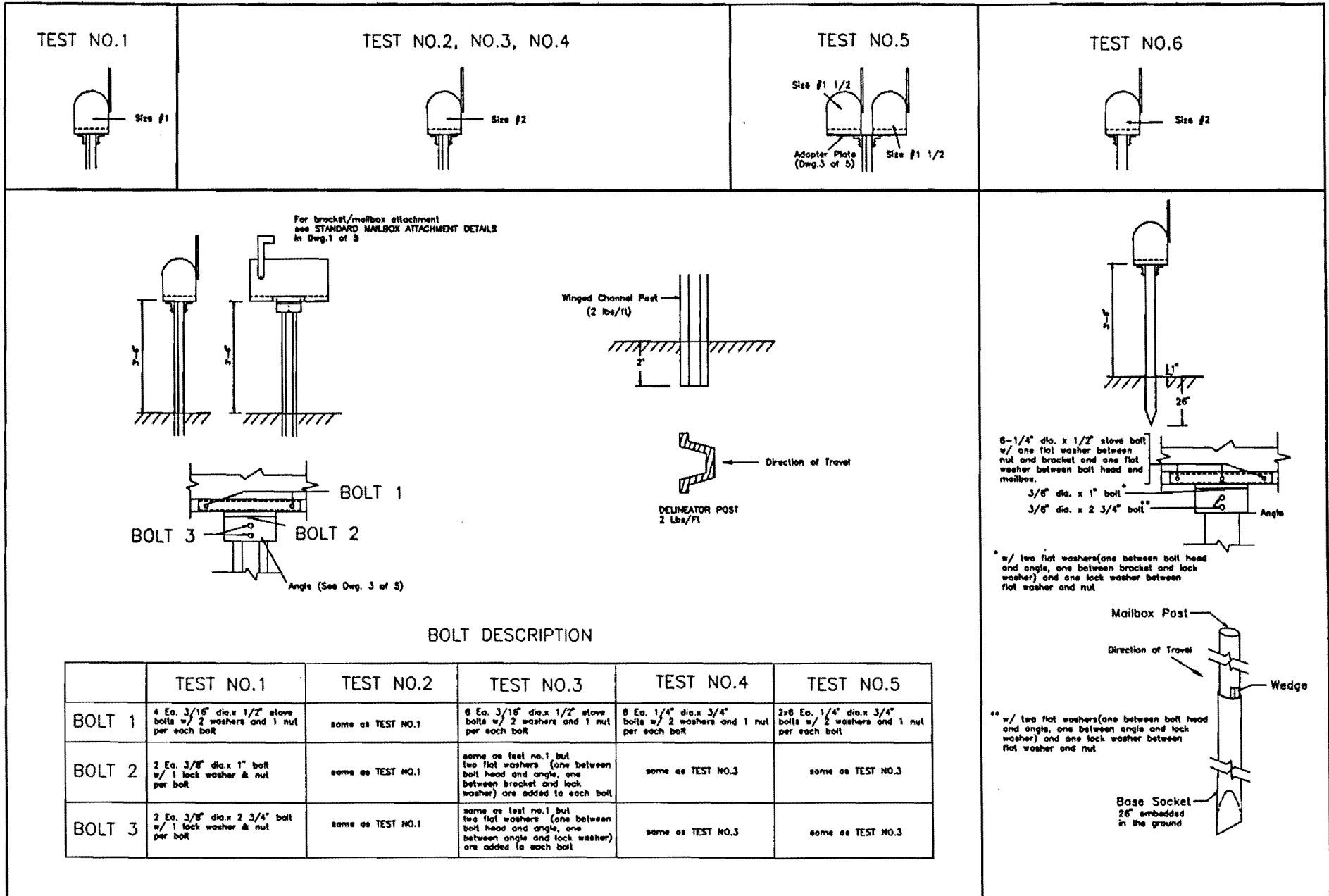

TEST MATRIX OF PROJECT 1945

TEST NO.7

FIVE #1 MAILBOXES

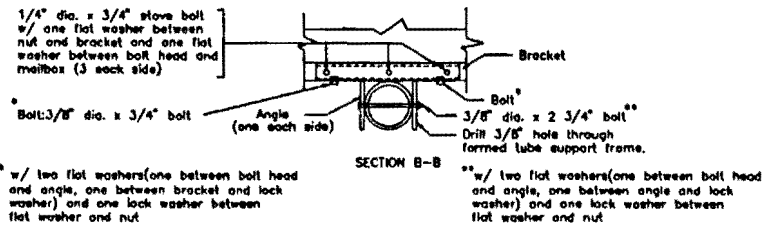
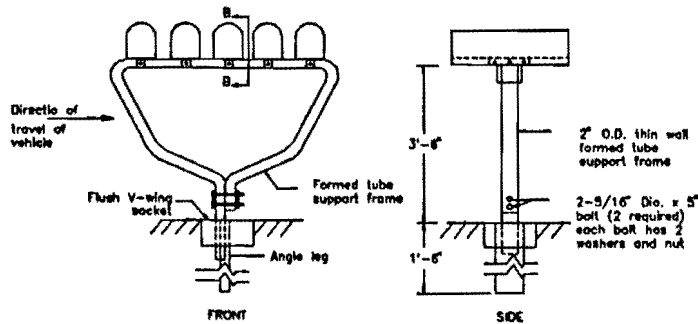
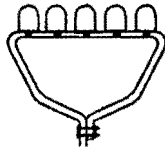

TEST NO.8

THREE #2 MAILBOXES

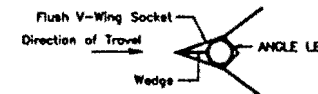
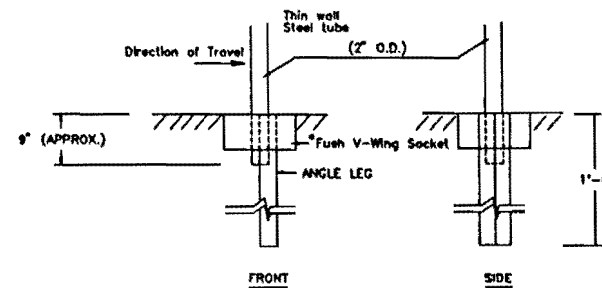
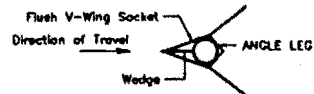
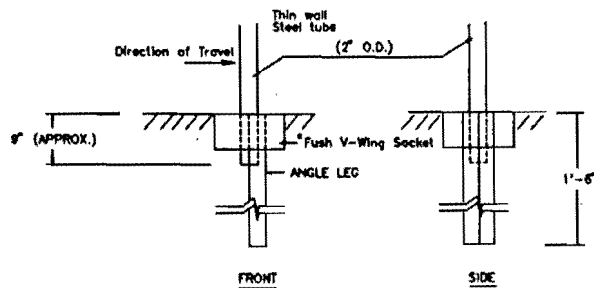
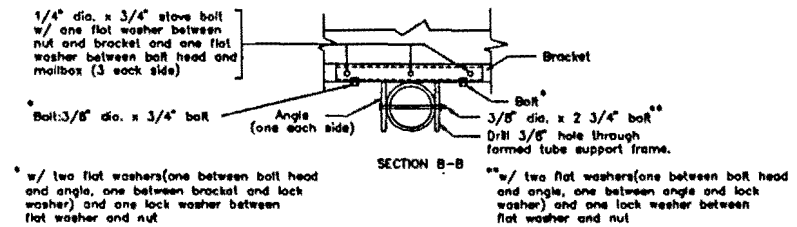
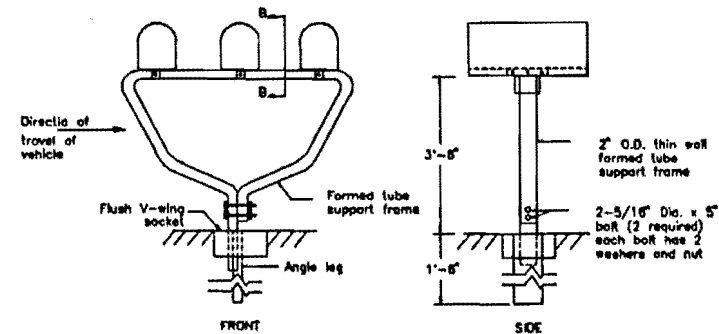
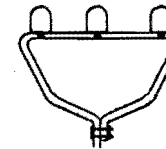

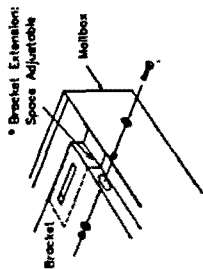

* Use two bracket extensions for size 2 mailboxes

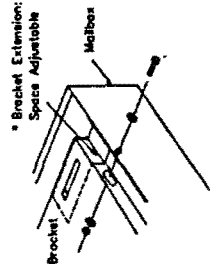

* Use only one bracket extension for size 1 1/2 mailboxes

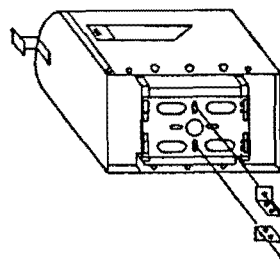

SIZE NO. 2 MAILBOX

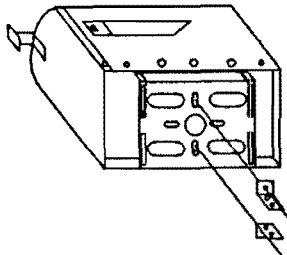

SIZE NO. 1 1/2 MAILBOX

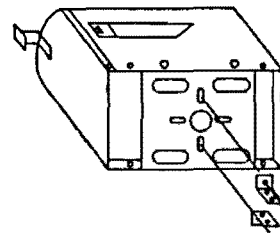
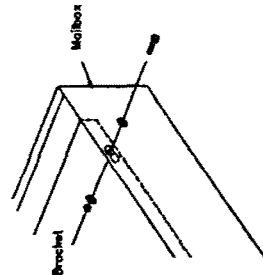

SIZE NO. 1 MAILBOX

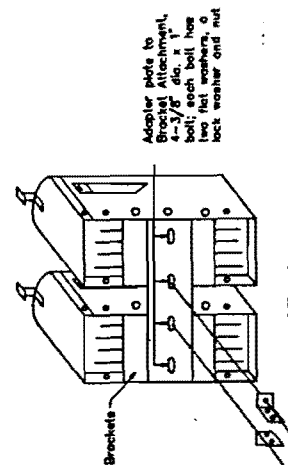

Adapter plate to Bracket Attachment, 4-3/8" dia. x 1" bolt; each bolt has two flat washers, a lock washer and nut

DETAIL B
DOUBLE MAILBOX MOUNT
(Not permitted for No. 2 Mailboxes)

BRACKET

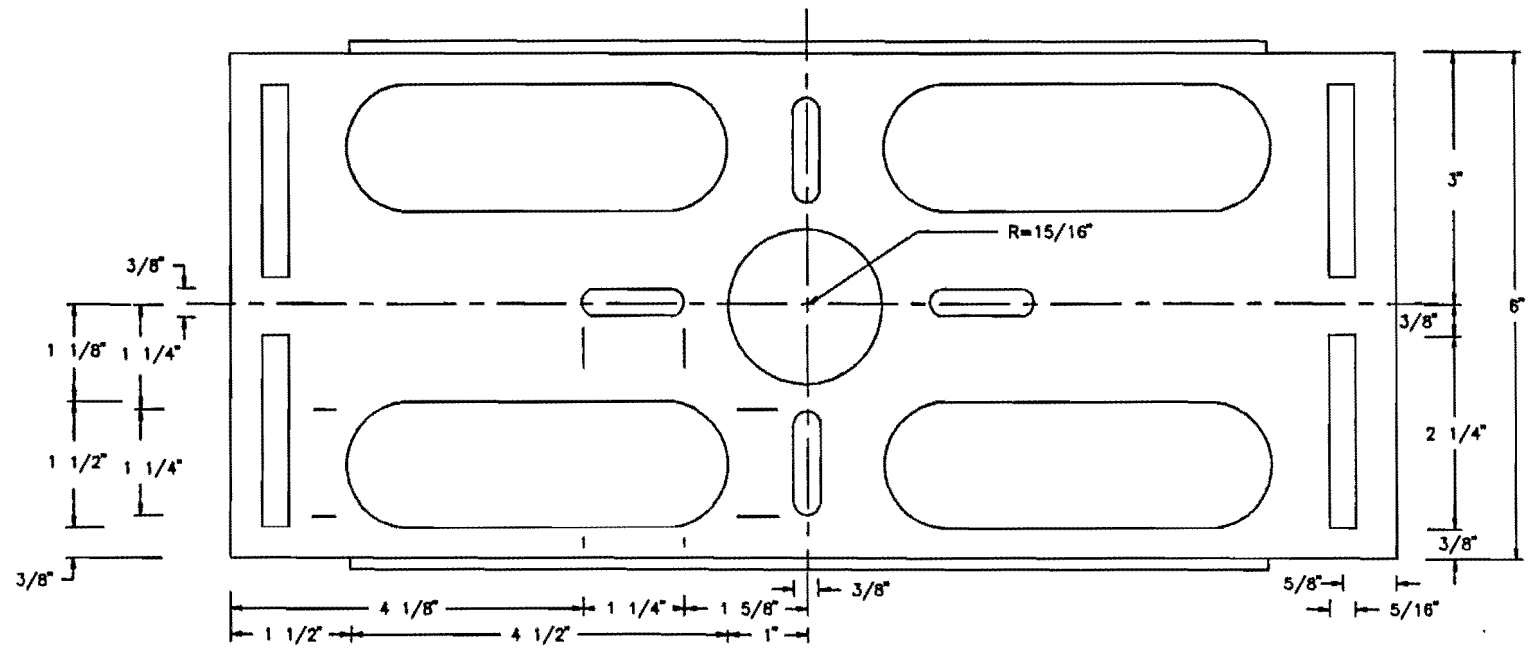

PLAN-VIEW

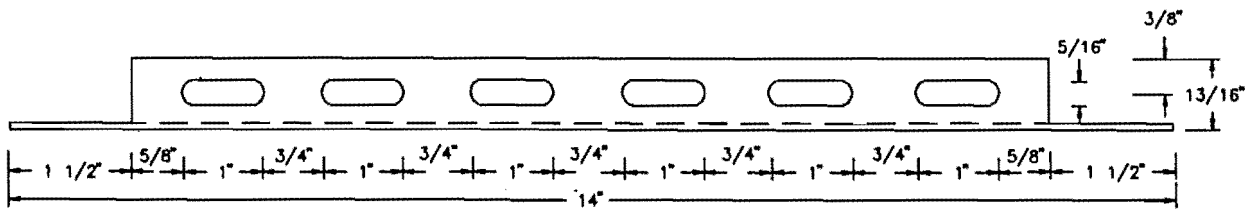

SIDE-VIEW

To be constructed of 14 gage galvanized steel sheet.

The Texas A&M University System					
TEXAS TRANSPORTATION INSTITUTE COLLEGE STATION, TEXAS 77843					
Revisions		Project No.	Date	Drawn By	Scale
No.	Date	By			at 1/8" = 1"
1.					
2.					
3.					
4.					
5.					
Title				Sheet No.	
				4 of 5	

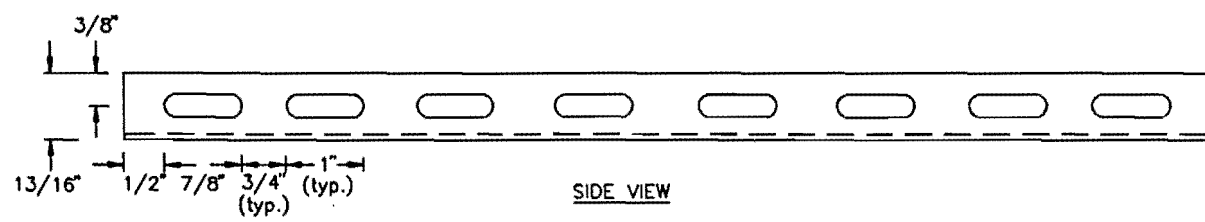
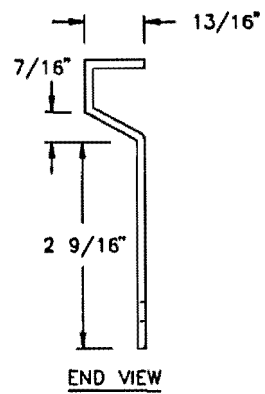
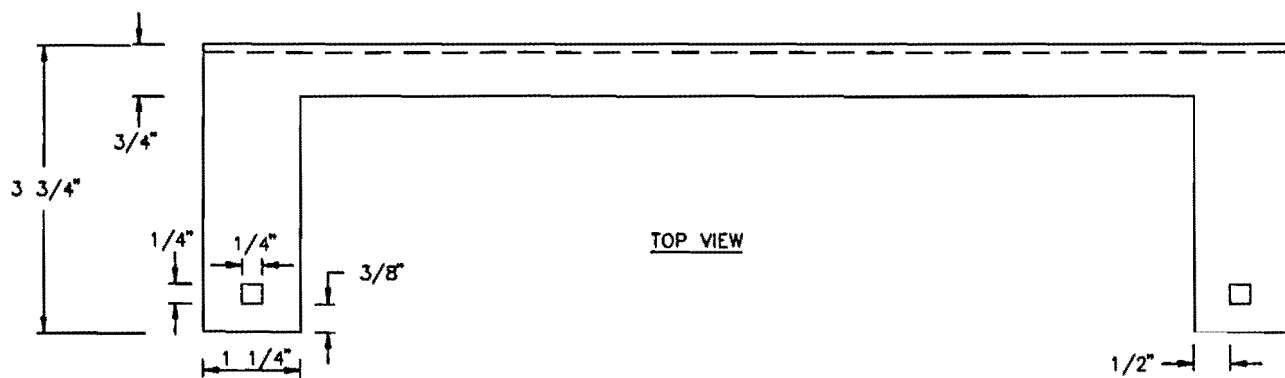

BRACKET EXTENSION

To be constructed of 14 gage galvanized steel sheet.

The Texas A&M University System				
Revisions			TEXAS TRANSPORTATION INSTITUTE COLLEGE STATION, TEXAS 77843	
No.	Date	By	Project No.	Date
1.				
2.				
3.				
4.				
5.				

Drawn By	Scale
TUE	as shown
Sheet No.	5 of 5

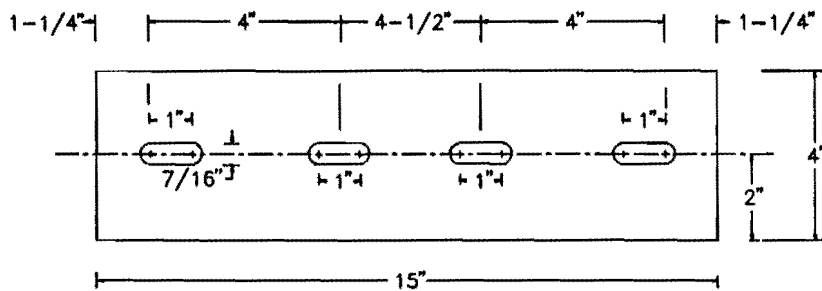

HOLES SHALL HAVE A DIAMETER OF 7/16"

ADAPTER PLATE

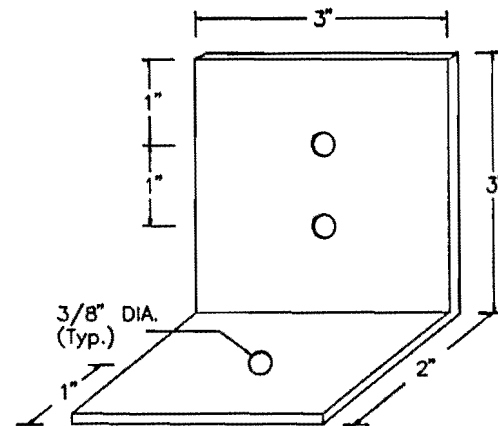

ANGLE

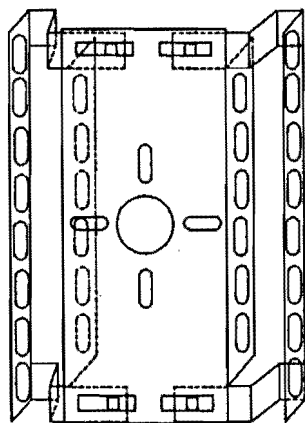

BRACKET / BRACKET EXTENSION

Note: Use 4-1/4"x3/4" Carriage Bolts w/ flat washer and lock washer to attach extension wings to bracket. For dimensions refer to Dwg.4 of 5 and Dwg.5 of 5

Hardware for mounting mailboxes to support/foundation furnished by Foresight Industries or equivalent may be used when approved by the Engineer

The bracket is to be constructed of 14 gage galvanized steel sheet. The angle is to be constructed of 14 gage galvanized steel sheet. The adapter is to be constructed of 12 gage steel sheet. The angle and adapter may be galvanized before or after fabrication in accordance with ASTM A568. The angle must be formed into the 90 degree bend without damaging to the galvanizing coating. The base metal of the angle and adapter plate must have sufficient ductility to be bent flat upon itself without breaking. Items with wet storage stains (white rust) will not be accepted.

The Texas A&M University System				
Revisions			TEXAS TRANSPORTATION INSTITUTE COLLEGE STATION, TEXAS 77843	
No.	Date	By	Project No.	Date
1.			Drawn By	Scale
2.				as shown
3.			Title	
4.			Sheet No.	
5.			3 of 5	

MULTIPLE MAIL BOX SUPPORT REPAIR

TEST NO. 9
 (TEST ARTICLE SAME AS TEST NO. 8 EXCEPT AS SHOWN BELOW)

(ALL DIMENSIONS ARE APPROXIMATE)

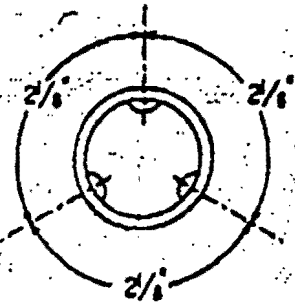
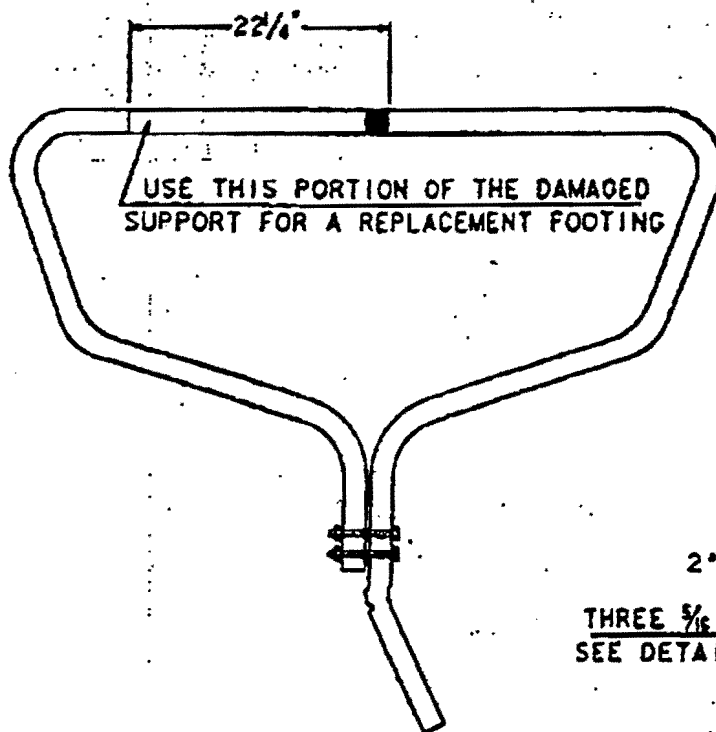
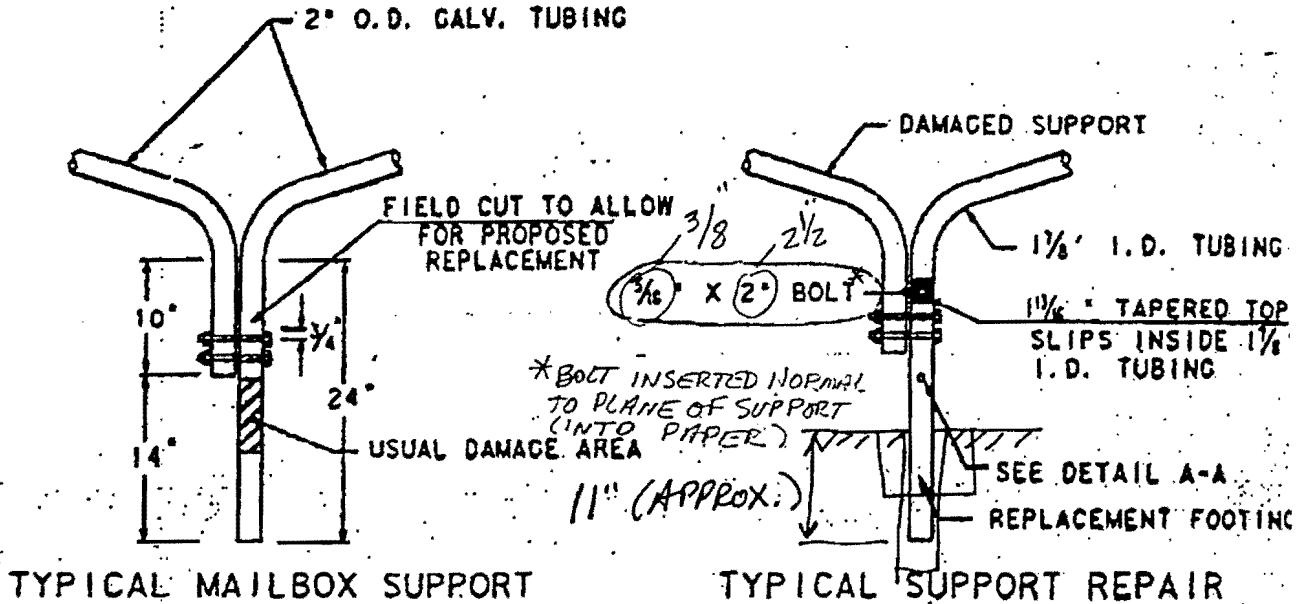

THREE 5/16" HOLES DRILLED & COUNTERSUNK 2/8" APART

DETAIL A-A

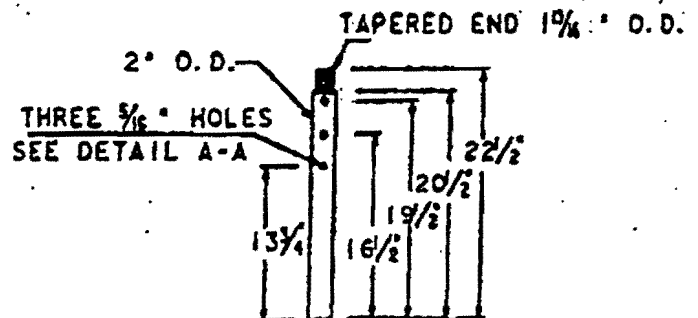

DAMAGED SUPPORT

ATTACHMENT C

DRAFT TEST REPORTS

CRASH TEST RESULTS

Test 19452-1

A 1988 Yugo GV (shown in Figures *** & ***) impacted a single mount type 1 mailbox installation. The impact was conducted at 58.7 miles per hour (94.4 km/h) using a cable reverse tow and guidance system. The point of impact was the front left quarter point of the vehicle bumper with the mailbox installation. Test inertia mass of the vehicle was 1,800 lb (816 kg) and its gross static mass was 1,968 lb (893 kg). The height from roadway surface to the lower edge of the vehicle bumper was 14.8 inches (37.5 cm) and 20.3 inches (51.4 cm) to the top of the bumper. Other dimensions and information on the vehicle are given in Figure ***.

The vehicle was free wheeling and unrestrained just prior to impact. Upon impact, the support began to yield and pocket around the front of the vehicle. By approximately 0.025 second, the support had yielded sufficiently enough to allow the mailbox to strike the hood of the vehicle. At 0.054 second, the mailbox still attached to the support, struck the roadway. Shortly thereafter, the mailbox was pulled off of the support and was dragged in front of the vehicle. The vehicle passed over the support, the brakes were applied and the vehicle came to rest 320 feet (97.6 m) from the point of impact. Sequential photographs of the test are shown in Figure ***.

The installation yielded to the vehicle. The support was displaced over at ground level. The mailbox attachment bracket remained attached to the support. The mailbox components came to rest approximately 72.5 feet (22.1 m) from the point of impact. The vehicle sustained only minor damage to the bumper and hood as shown in Figure ***.

A summary of the test results and other information pertinent to this test are given in Figure ***. The maximum 0.050 second average acceleration experienced by the vehicle was -1.3 g in the longitudinal direction and 0.4 g in the lateral direction. No occupant contact occurred in the longitudinal or lateral direction. Vehicle angular displacements are plotted in Figure *** and vehicle accelerometer traces are displayed in Figures *** through ***. Change in vehicle velocity was 1.4 mi/h (2.3 km/h) and change in momentum was 125.5 lb-s.

In summary, the mailbox installation safely yielded to the vehicle. The vehicle

sustained minor damage and did not present undue hazard to other traffic. There was no deformation or penetration into the occupant compartment. There was no occupant contact in the longitudinal or lateral directions. This installation in "strong soil" is acceptable according to the evaluation criteria recommended in NCHRP Report 230.

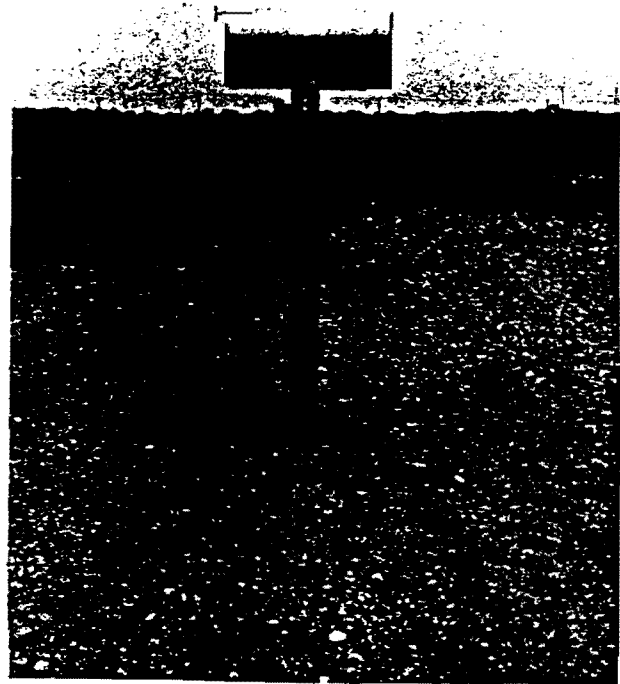
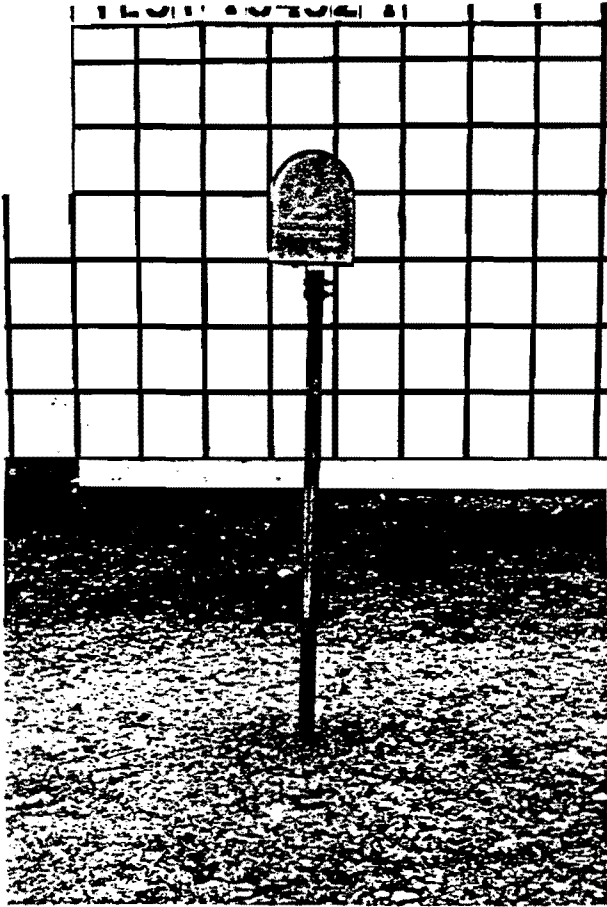

Figure . Mailbox installation for test 19452-1.

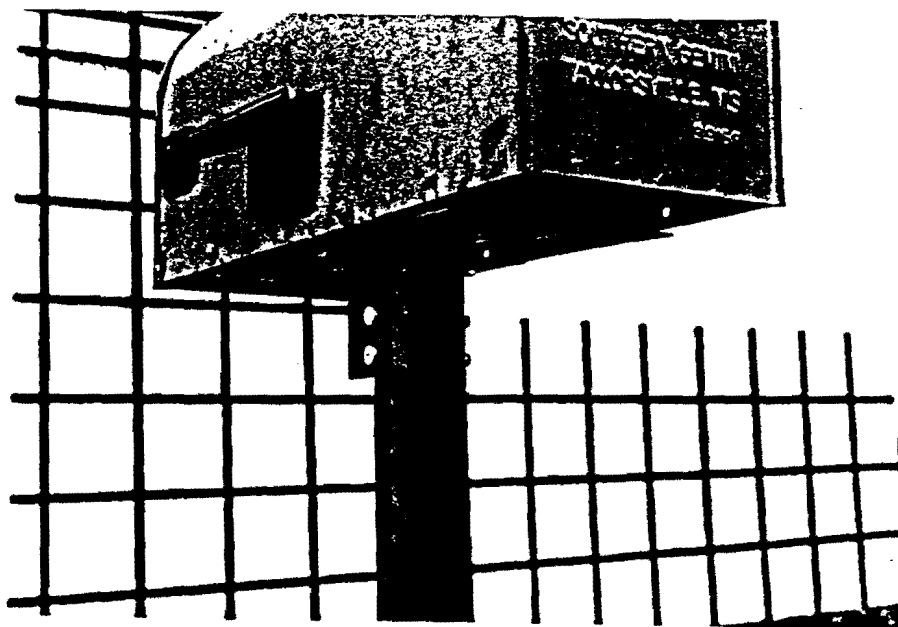
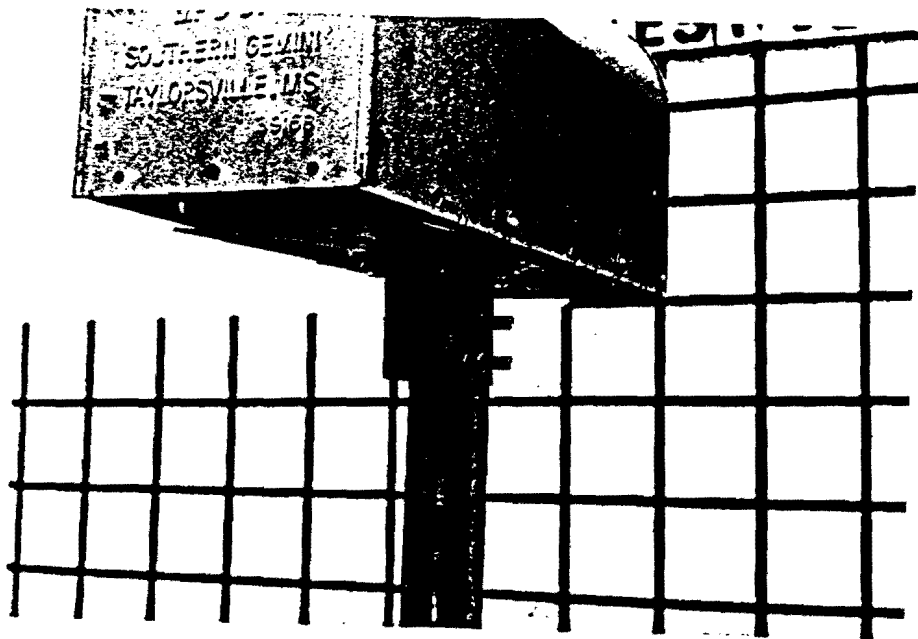

Figure . Mailbox/support connection for installation used in test 19452-1.

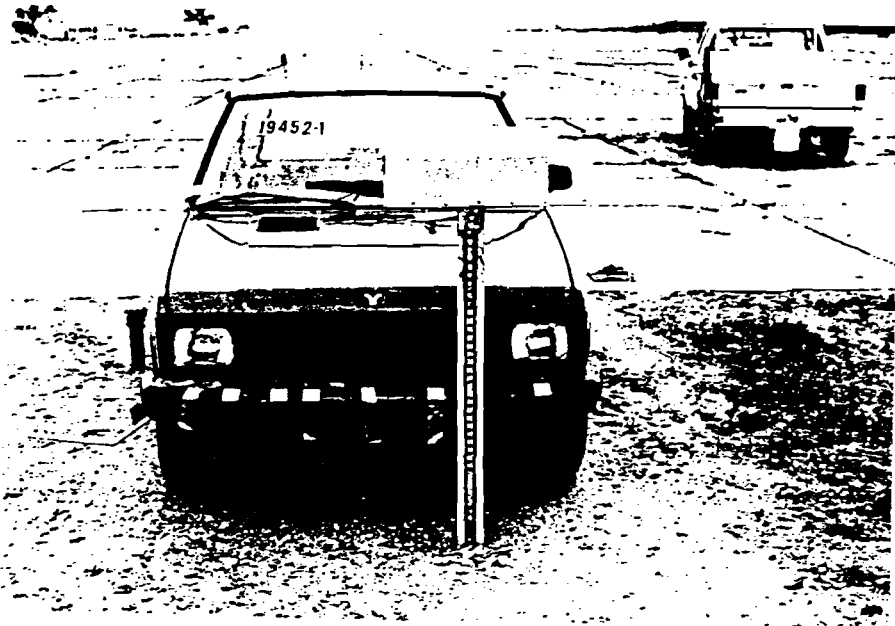

Figure . Vehicle/mailbox geometrics for test 19452-1.

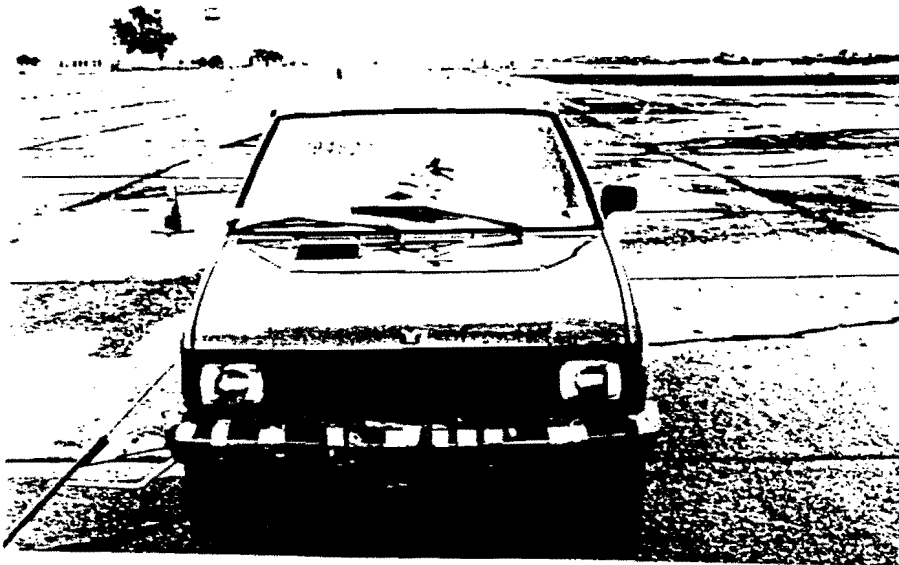
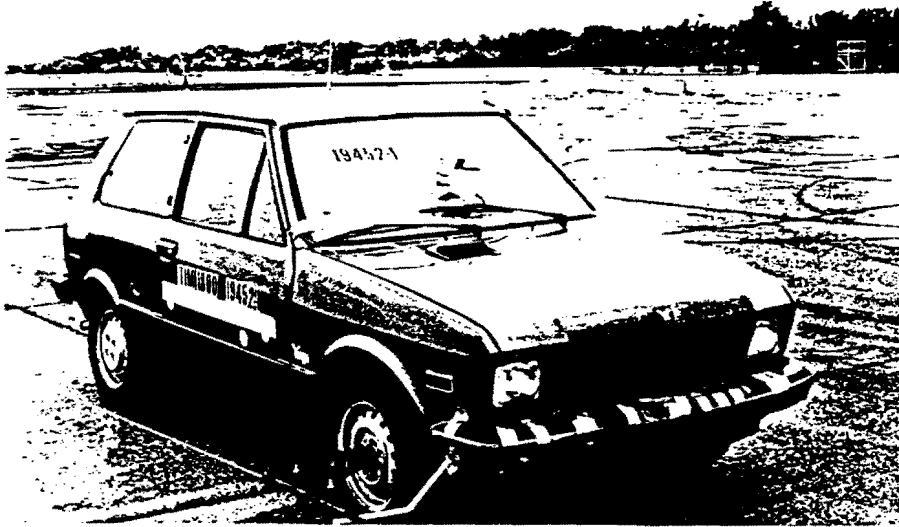

Figure . Vehicle prior to test 19452-1.

Date: 7-22-92 Test No.: 19452-1,2,5&6 VIN: VX1BA1216JK404378

Make: YUGO Model: GV Year: 1988 Odometer: 48466

Tire Size: 145R13 Ply Rating: _____ Bias Ply: _____ Belted: _____ Radial: X

Tire Condition: good X
 fair _____
 badly worn _____

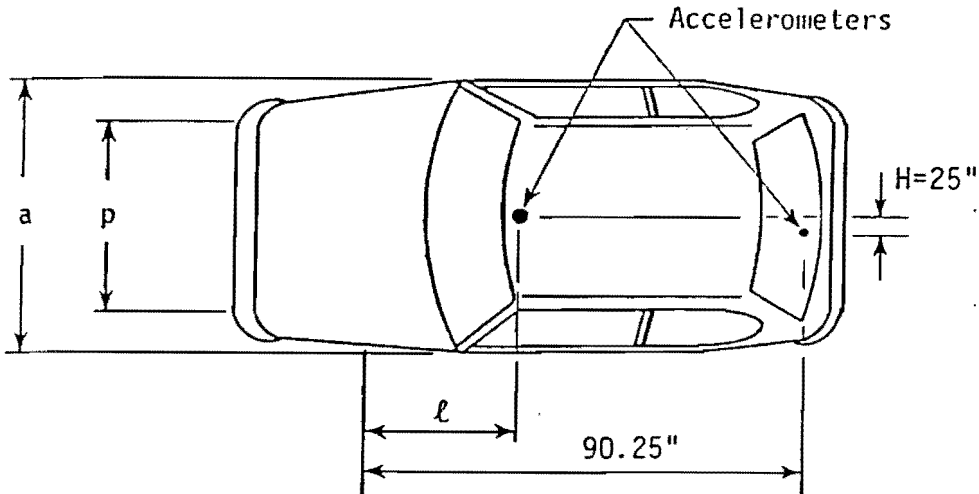

Vehicle Geometry - inches

a	<u>59.75"</u>	b	<u>27.5"</u>
c	<u>85.25"</u>	d*	<u>56.5"</u>
e	<u>24"</u>	f	<u>136.75"</u>
g	_____	h	<u>32.8"</u>
i	_____	j	<u>31"</u>
k	<u>15.5"</u>	l	<u>32"</u>
m	<u>20.25"</u>	n	<u>2.75"</u>
o	<u>14.75"</u>	p	<u>50.5"</u>
r	<u>22.75"</u>	s	<u>14.25"</u>

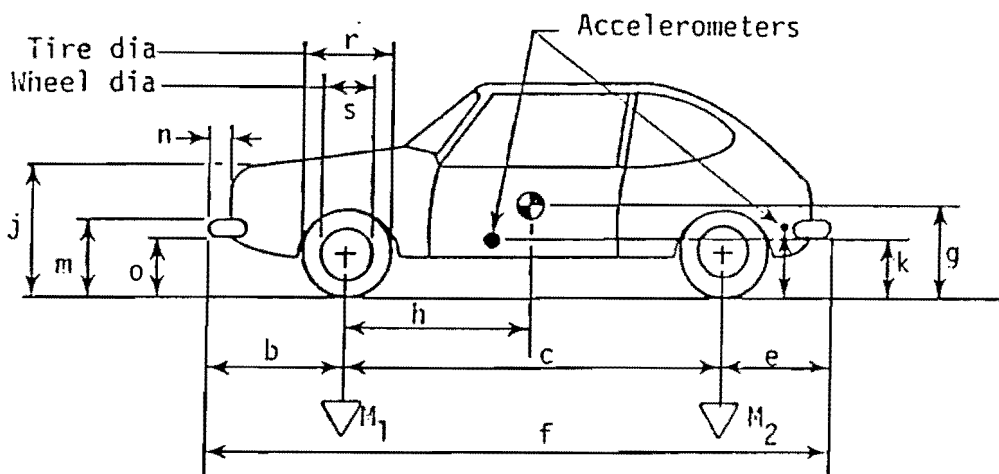

Engine Type: V4 Gas
 Engine CID: 1.1 L

Transmission Type:
 Automatic or Manual
 FWD XXXXXX

Body Type: 3Door

Steering Column Collapse Mechanism:
 ___ Behind wheel units
 ___ Convoluted tube
 ___ Cylindrical mesh units
 ___ Embedded ball
 ___ NOT collapsible
 ___ Other energy absorption
 ___ Unknown

4-wheel weight for c.g. det. lf 551 rf 556 lr 344 rr 349

Mass - pounds	Curb	Test Inertial	Gross Static
M ₁	<u>1182</u>	<u>1107</u>	<u>1192</u>
M ₂	<u>627</u>	<u>693</u>	<u>776</u>
M _T	<u>1809</u>	<u>1800</u>	<u>1968</u>

Note any damage to vehicle prior to test:

Brakes:
 Front: disc X drum _____
 Rear: disc _____ drum X

*d = overall height of vehicle

Figure . Test vehicle properties (19452-1,2,5&6).

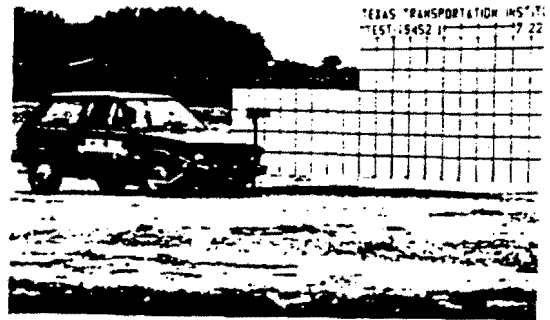
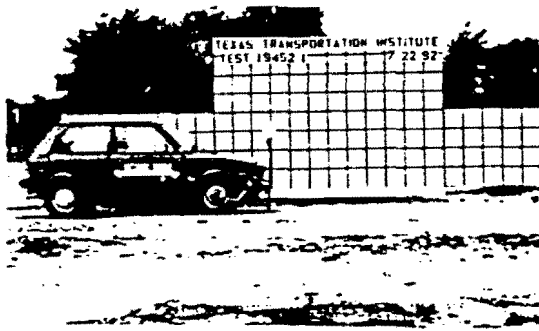

0.000 s

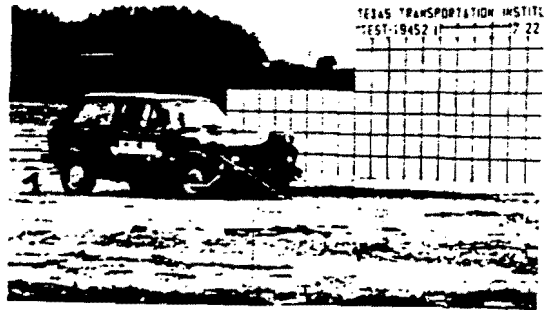
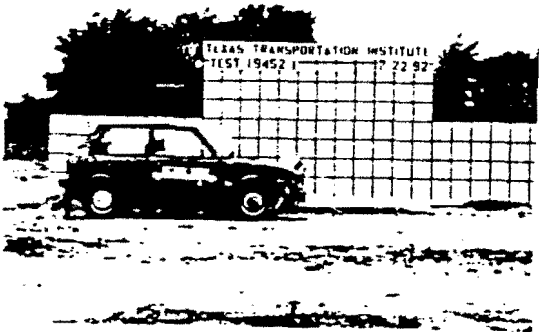

0.027 s

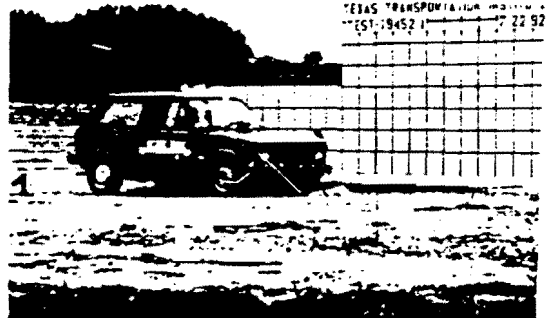

0.054 s



0.082 s

Figure . Sequential photographs for test 19452-1.
(perpendicular and side views)

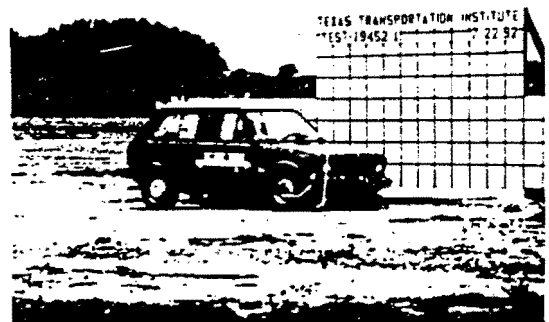

0.109 s

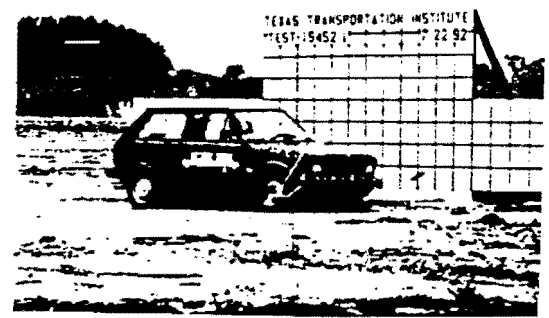

0.136 s

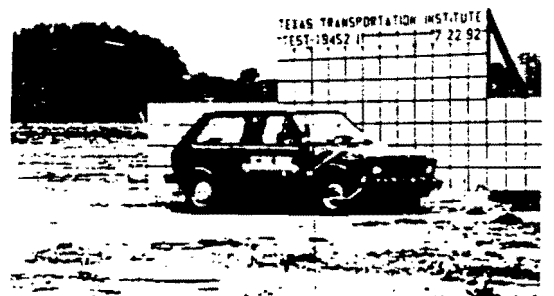
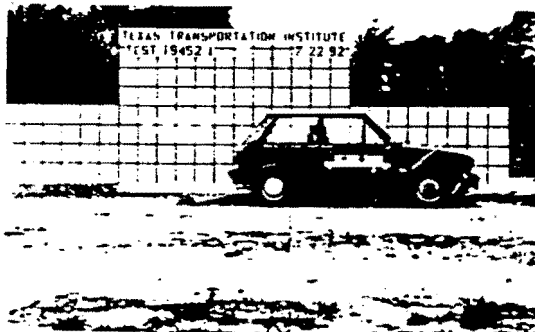

0.163 s



0.191 s

Figure . Sequential photographs for test 19452-1.
(perpendicular and side views) cont.

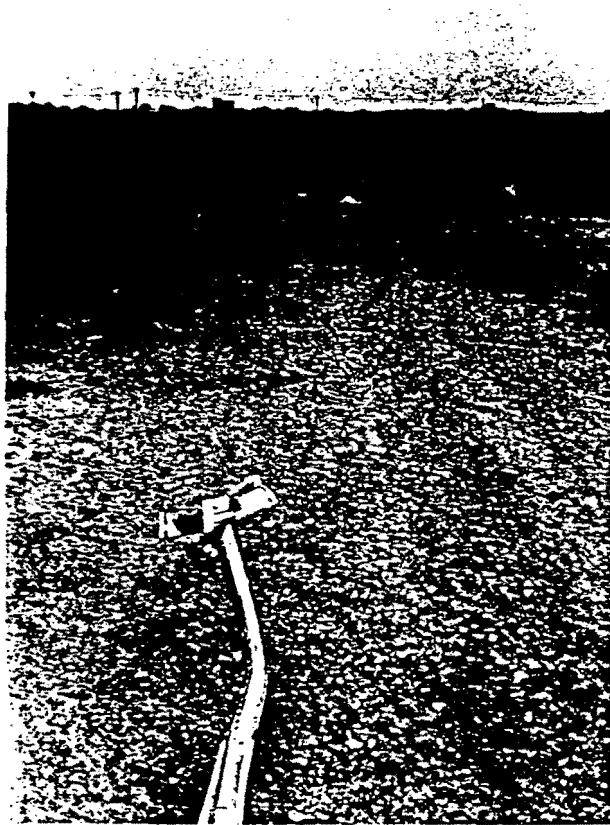
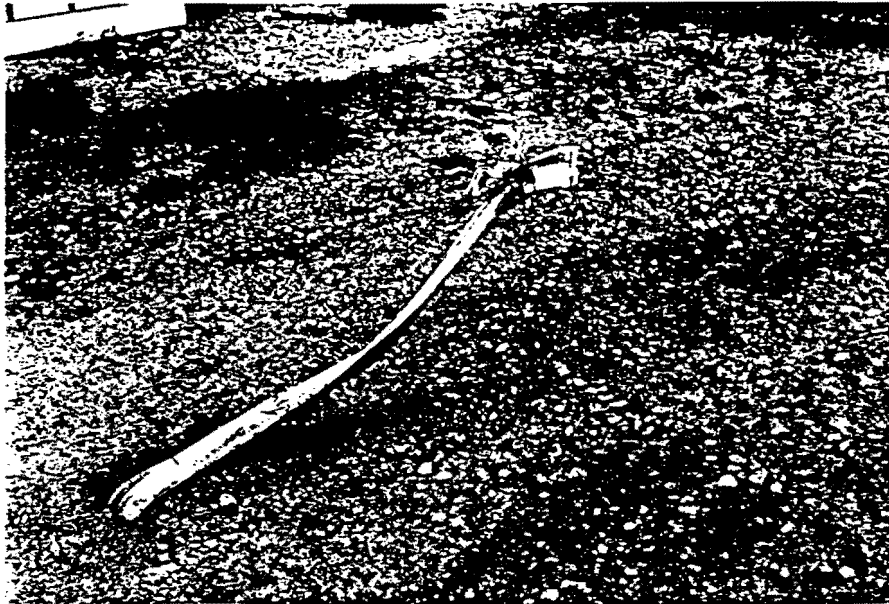

Figure . Test site after test 19452-1.

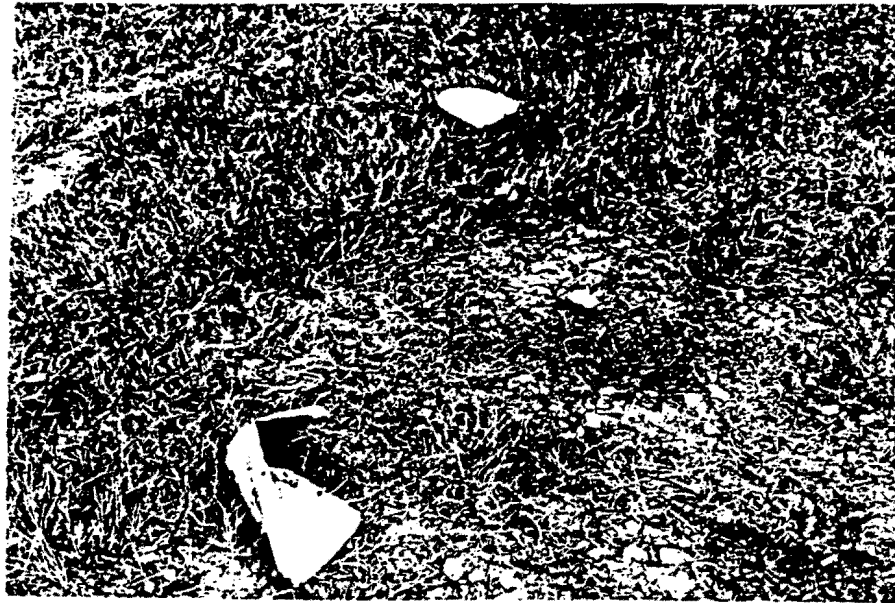
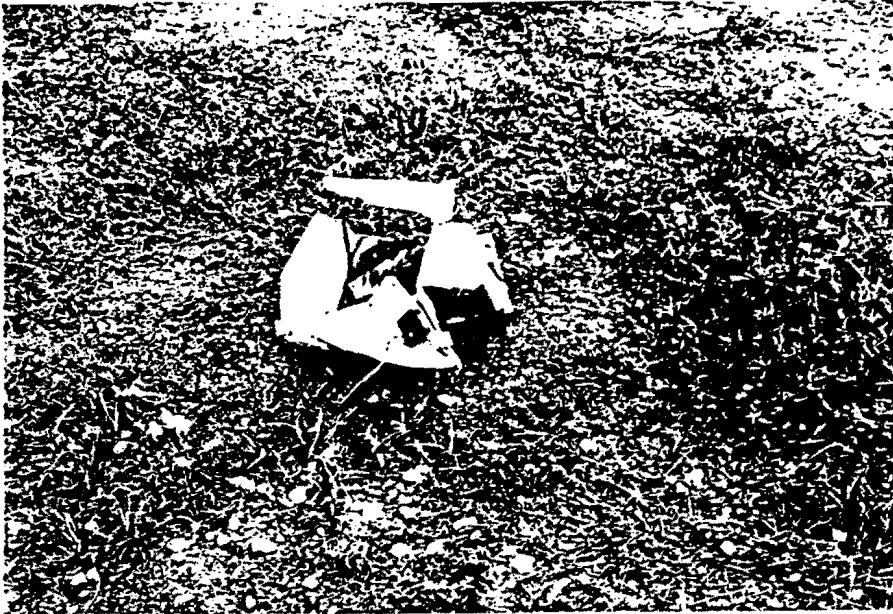

Figure . Damage to mailbox, test 19452-1.

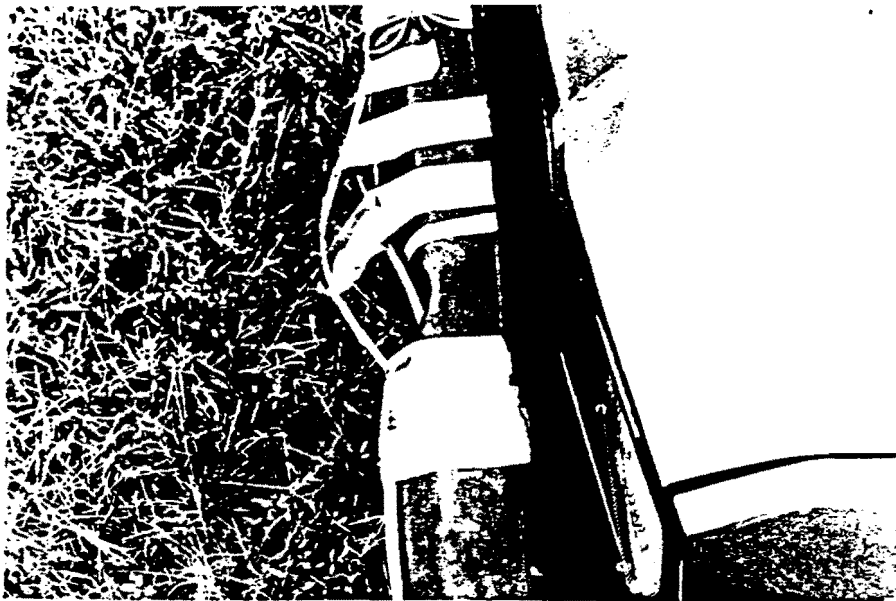
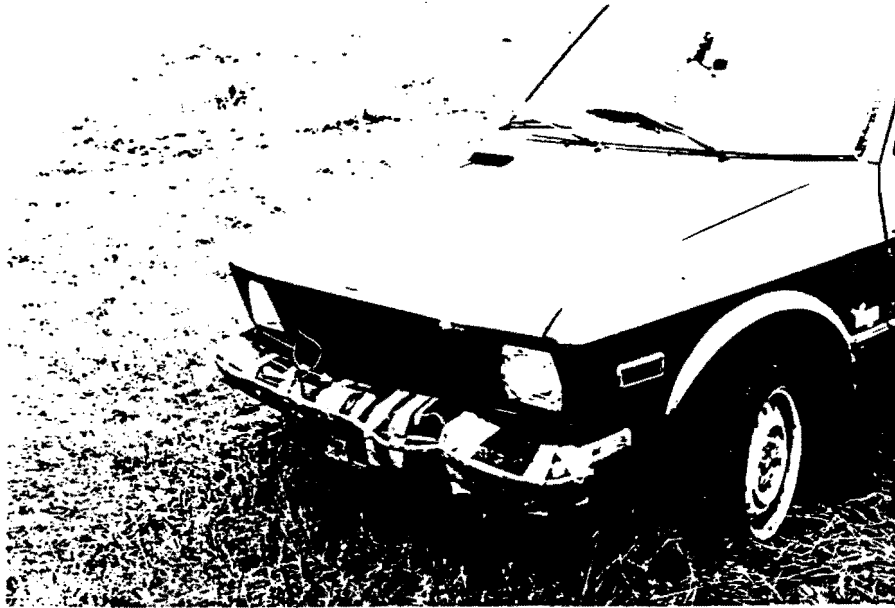
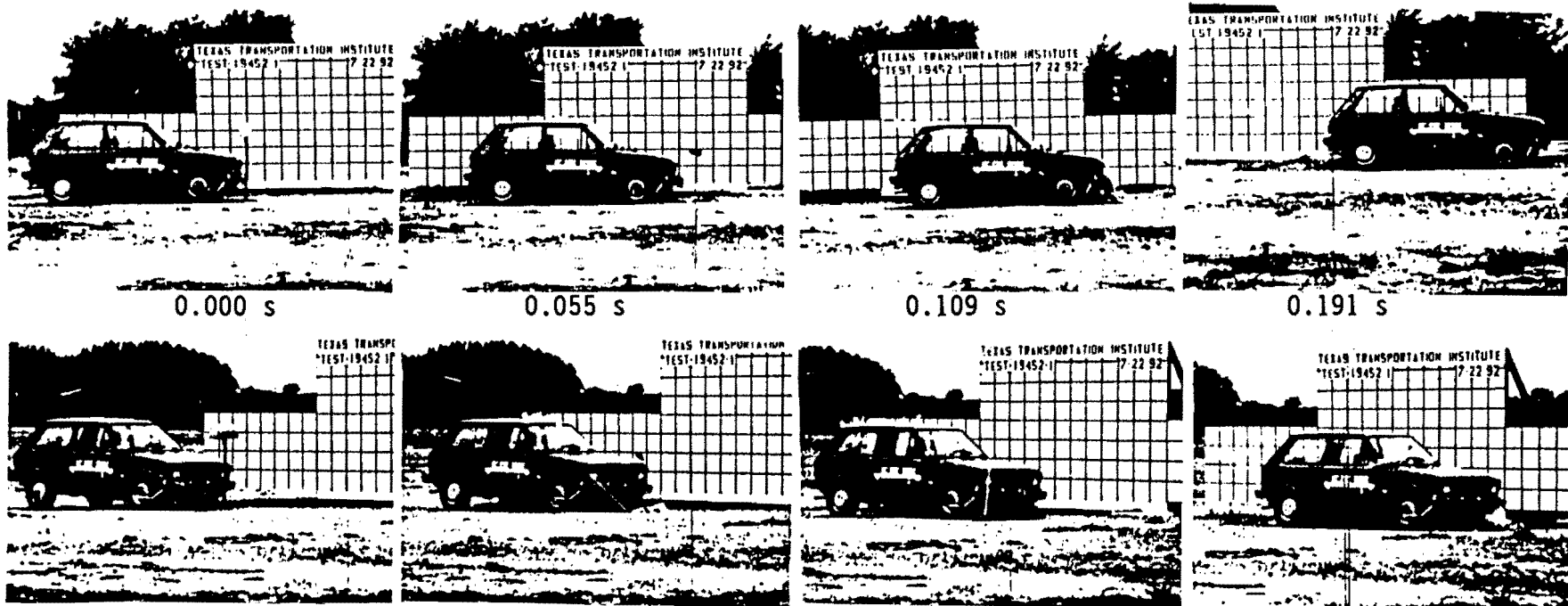

Figure . Vehicle after test 19452-1.



Figure . Anthropometric dummy before and after test 19452-1.



Test No	19452-1.	Impact Speed	58.7 mi/h (94.4 km/h)
Date	07/22/92.	Change in Velocity . . .	1.4 mi/h (2.3 km/h)
Test Article	Single mount, Type 1 Mailbox Installation.	Change in Momentum . . .	114.8 lb-s
Support	Type 4 (2 lb/ft winged channel post)	Vehicle Accelerations (Max. 0.050-sec Avg)	
Embedment	2'-0" driven(strong soil)	Longitudinal . . .	-1.3 g
Vehicle	1988 Yugo GV	Lateral	0.4 g
Vehicle Weight		Occupant Impact Velocity	
Test Inertia	1800 lb (816 kg)	Longitudinal . . .	N/A
Gross Static	1968 lb (893 kg)	Lateral	N/A
Vehicle Damage Classification		Occupant Ridedown Accelerations	
TAD	12-FL-1	Longitudinal . . .	No contact
SAE	12FLEN1	Lateral	No contact

Figure . Summary of results for test 19452-1.

19452-1

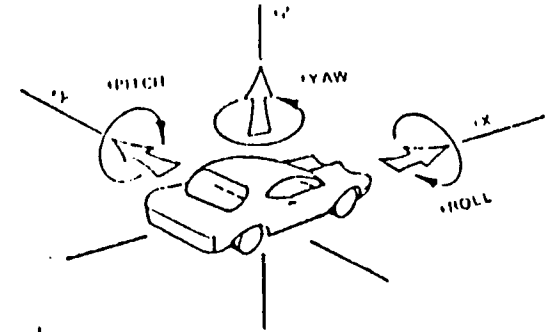
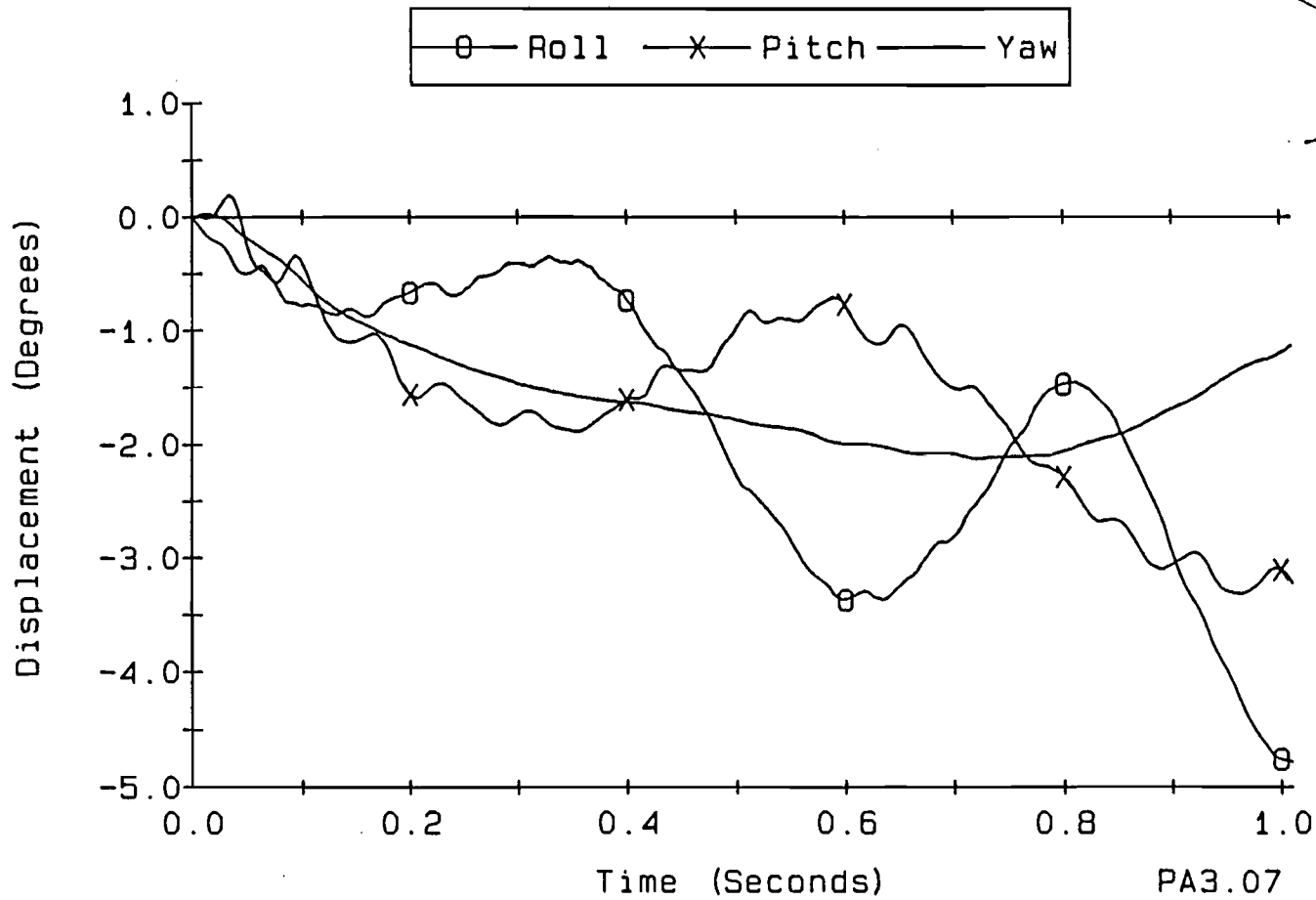

Axes are vehicle fixed.
Sequence for determining orientation is:

1. Yaw
2. Pitch
3. Roll

Figure . Vehicle angular displacements for test 19452-1.

PA3.07

CRASH TEST 19452-1

Class 180 Filter

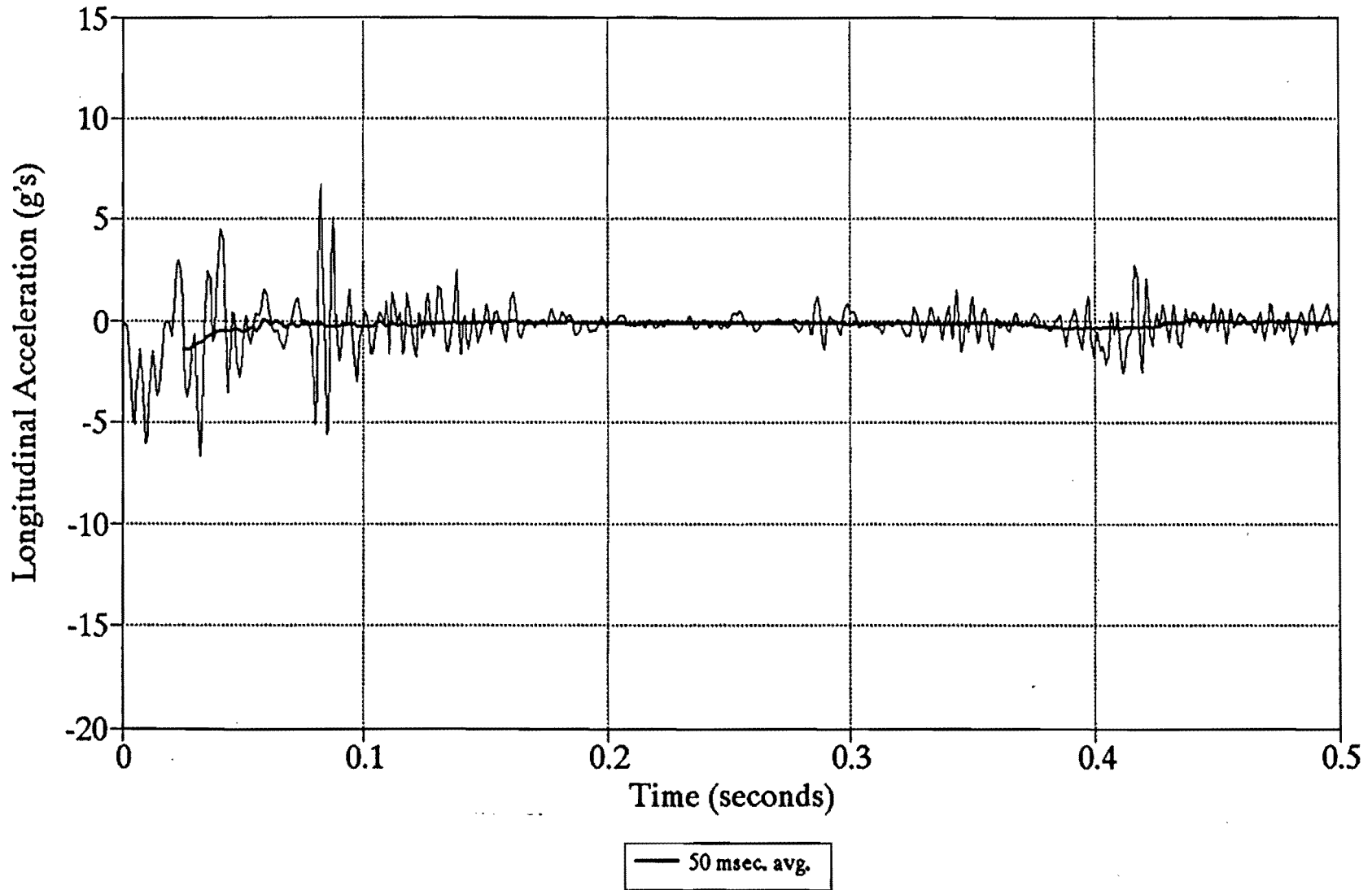

Figure . Longitudinal accelerometer trace of test 19452-1.

CRASH TEST 19452-1

Class 180 Filter

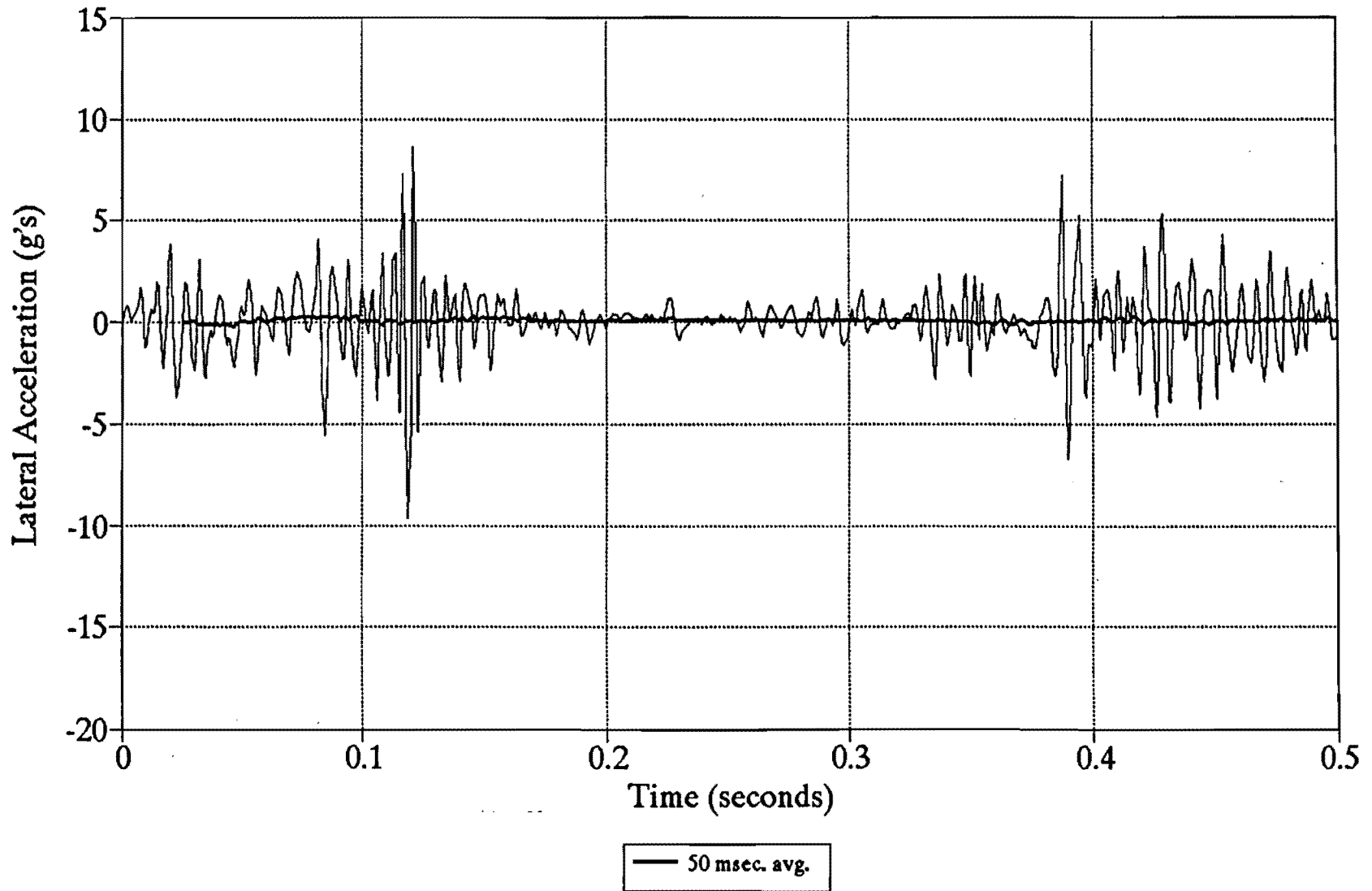

Figure . Lateral accelerometer trace of test 19452-1.

CRASH TEST 19452-1

Class 180 Filter

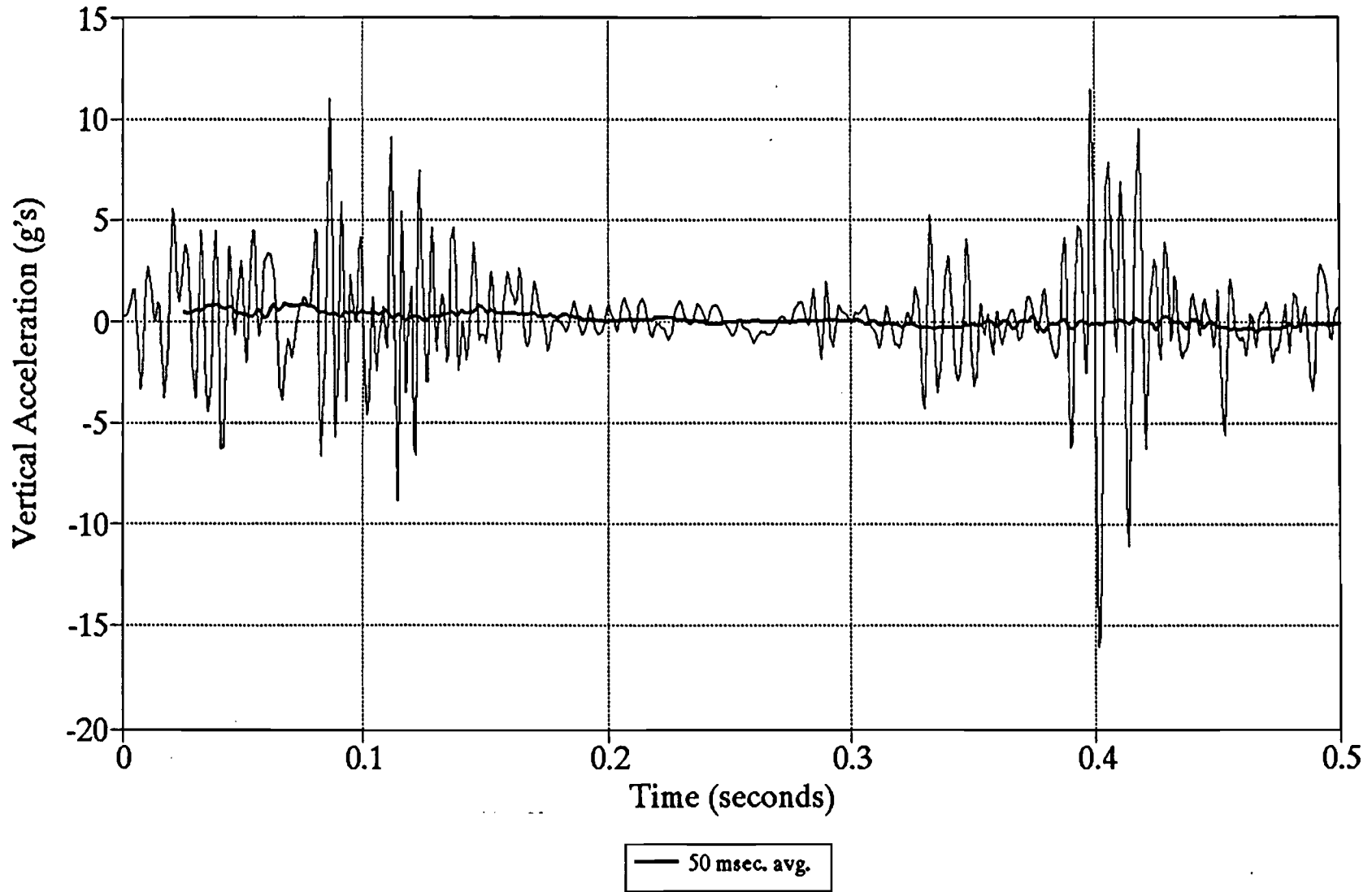

Figure . Vertical accelerometer trace of test 19452-1.

Test 19452-2

The same 1988 Yugo GV used in test 1 impacted a single mount type 2 mailbox installation. The impact was conducted at 61.3 miles per hour (98.6 km/h) using a cable reverse tow and guidance system. The point of impact was the front right quarter point of the vehicle bumper with the mailbox installation. Test inertia mass of the vehicle was 1,800 lb (816 kg) and its gross static mass was 1,968 lb (893 kg).

The vehicle was free wheeling and unrestrained just prior to impact. Upon impact, the support began to yield and by 0.017 second, the mailbox had detached from the support. At approximately 0.037 second, the mailbox struck the hood of the vehicle, then the windshield, sliding up, over and off the right upper A-pillar. The vehicle lost contact with the installation at approximately 0.184 second, the brakes were applied and the vehicle came to rest 315 feet (96.0 m) from the point of impact. Sequential photographs of the test are shown in Figure ***.

The installation yielded to the vehicle. The support was displaced over at ground level. The mailbox attachment bracket detached from the support and came to rest approximately 153.0 feet (46.6 m) from the point of impact. In addition, the mailbox components came to rest approximately 101.3 feet (30.9 m) from the point of impact. The vehicle sustained only minor damage to the bumper, hood and windshield as shown in Figure ***.

A summary of the test results and other information pertinent to this test are given in Figure ***. The maximum 0.050 second average acceleration experienced by the vehicle was -1.3 g in the longitudinal direction and -0.3 g in the lateral direction. No occupant contact occurred in the longitudinal or lateral direction. Vehicle angular displacements are plotted in Figure *** and vehicle accelerometer traces are displayed in Figures *** through 18. Change in vehicle velocity was 4.6 mi/h (7.4 km/h) and change in momentum was 412.3 lb-s.

In summary, the mailbox installation safely yielded to the vehicle. The vehicle sustained minor damage and did not present undue hazard to other traffic. There was no deformation and minimal penetration into the occupant compartment. There was no occupant contact in the longitudinal or lateral directions. This installation in "strong soil" is acceptable according to the evaluation criteria recommended in NCHRP Report 230.

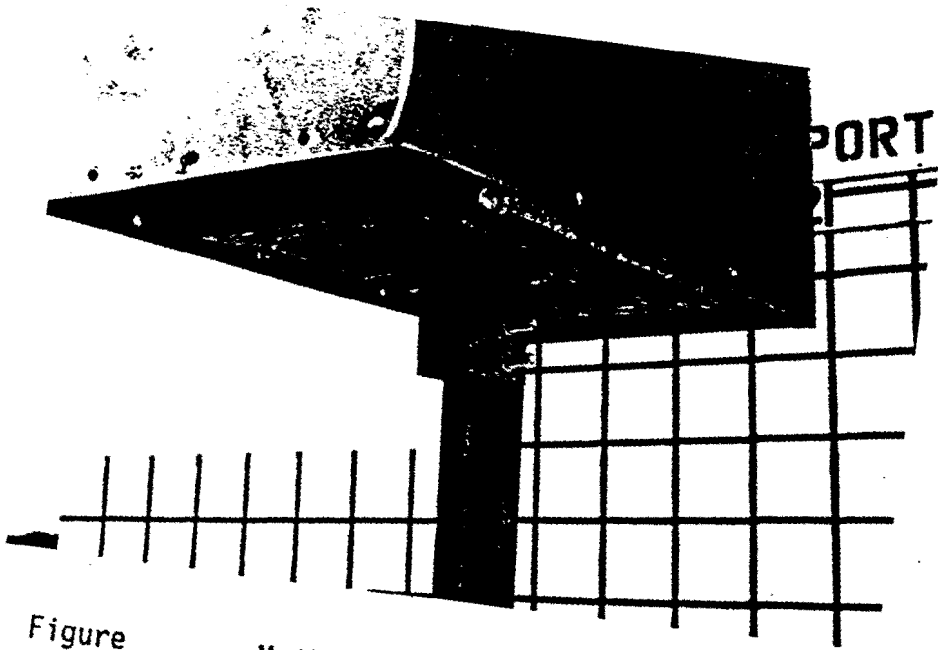
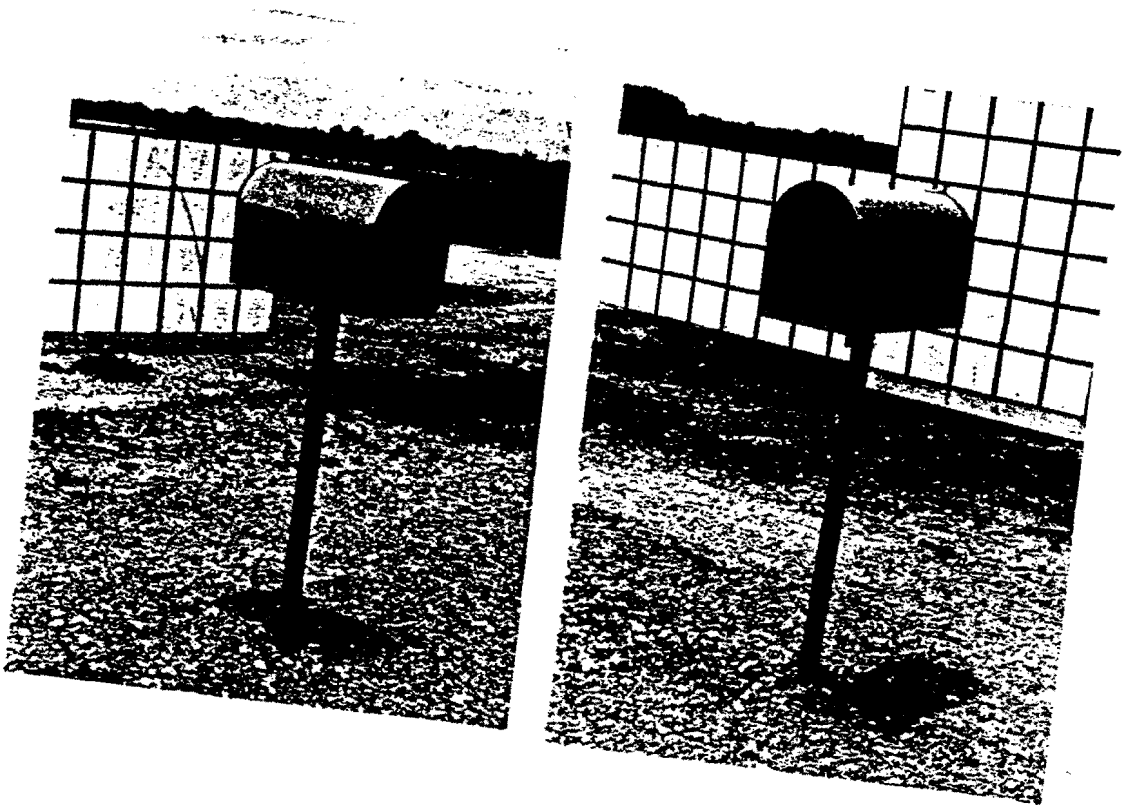

Figure . Mailbox installation for test 19452-2.



Figure . Vehicle/mailbox geometrics for test 19452-2.

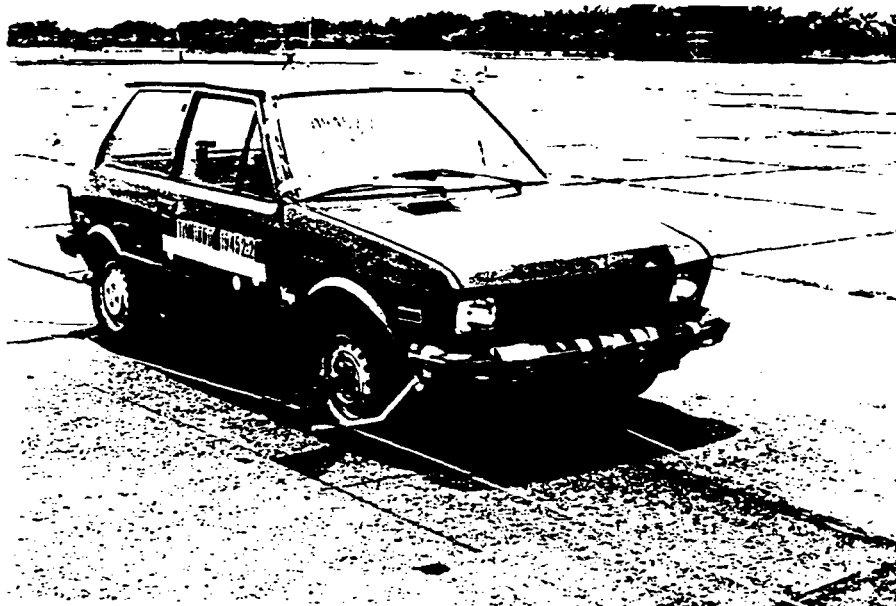
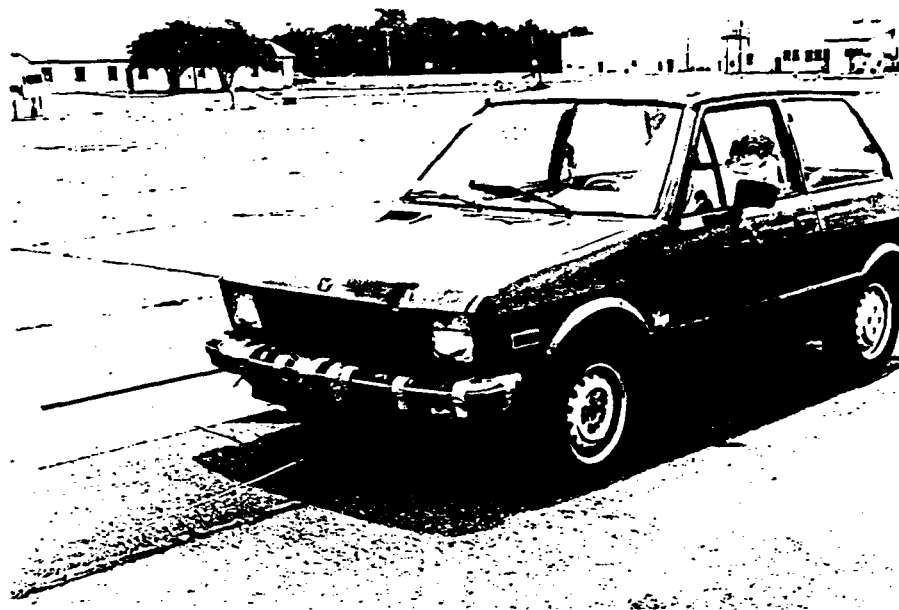

Figure . Vehicle prior to test 19452-2.

Date: 7-22-92 Test No.: 19452-1,2,5&6 VIN: VX1BA1216JK404378

Make: YUGO Model: GV Year: 1988 Odometer: 48466

e Size: 145R13 Ply Rating: _____ Bias Ply: _____ Belted: _____ Radial: X

Tire Condition: good X
 fair _____
 badly worn _____

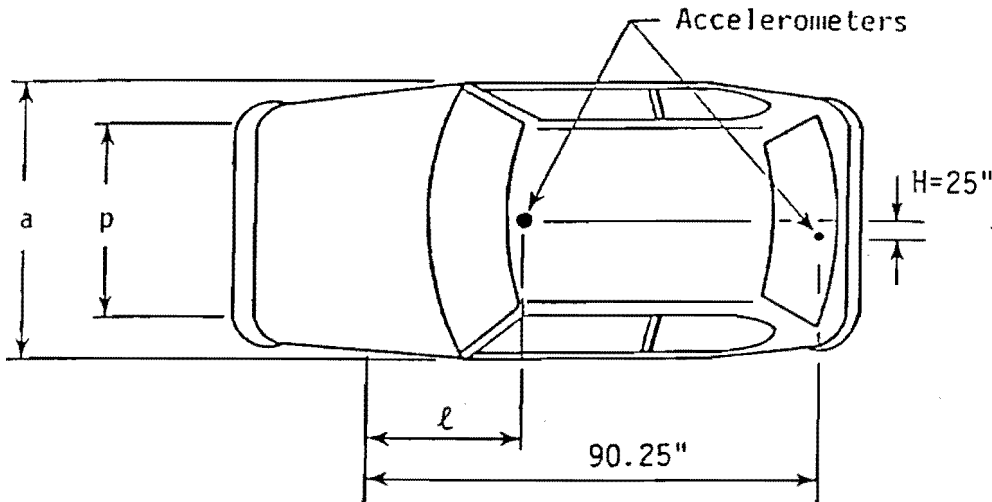

Vehicle Geometry - inches

a 59.75" b 27.5"
 c 85.25" d* 56.5"
 e 24" f 136.75"
 g _____ h 32.8"
 i _____ j 31"
 k 15.5" l 32"
 m 20.25" n 2.75"
 o 14.75" p 50.5"
 r 22.75" s 14.25"

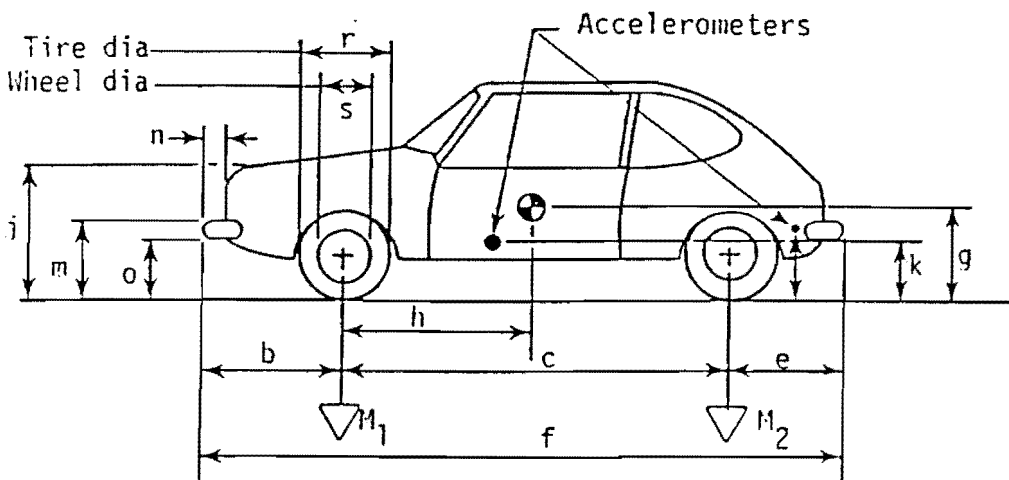

Engine Type: V4 Gas
 Engine CID: 1.1 L

Transmission Type:
 Automatic or Manual
 FWD ~~XXXXXXXXXXXX~~

Body Type: 3 Door

Steering Column Collapse Mechanism:

- Behind wheel units
- Convoluted tube
- Cylindrical mesh units
- Embedded ball
- NOT collapsible
- Other energy absorption
- Unknown

4-wheel weight for c.g. det. lf 551 rf 556 lr 344 rr 349

Mass - pounds	Curb	Test Inertial	Gross Static
M_1	<u>1182</u>	<u>1107</u>	<u>1192</u>
M_2	<u>627</u>	<u>693</u>	<u>776</u>
M_T	<u>1809</u>	<u>1800</u>	<u>1968</u>

Note any damage to vehicle prior to test:

Brakes:

Front: disc X drum _____

Rear: disc _____ drum X

*d = overall height of vehicle

Figure . Test vehicle properties (19452-1,2,5&6).

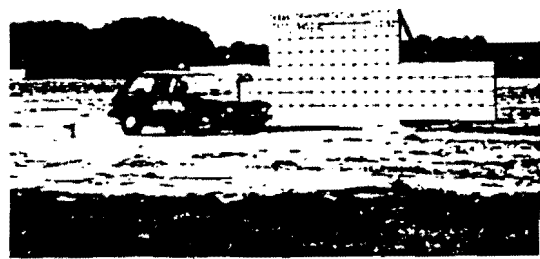
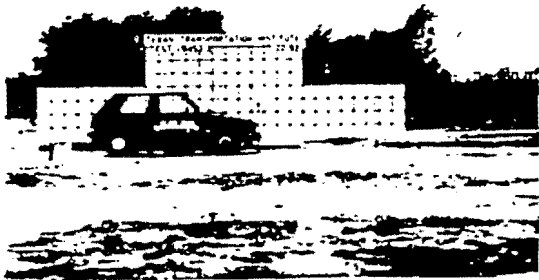

0.000 s

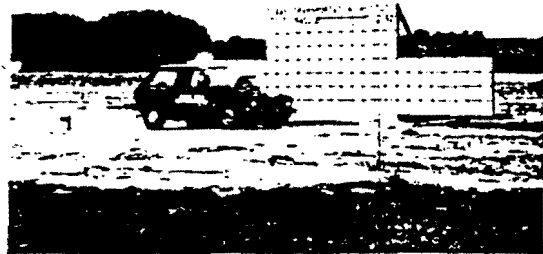

0.027 s



0.055 s



0.082 s

Figure . Sequential photographs for test 19452-2.
(perpendicular and side views)



0.109 s

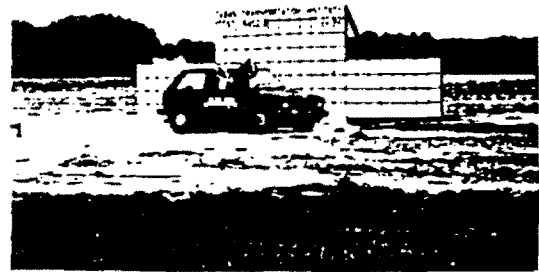

0.137 s

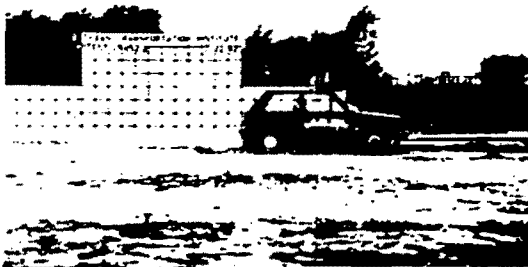
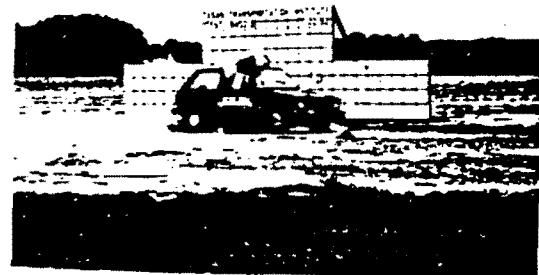

0.164 s

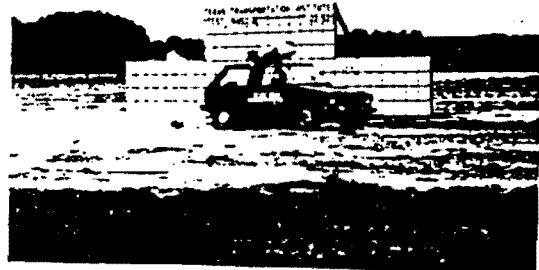

0.191 s

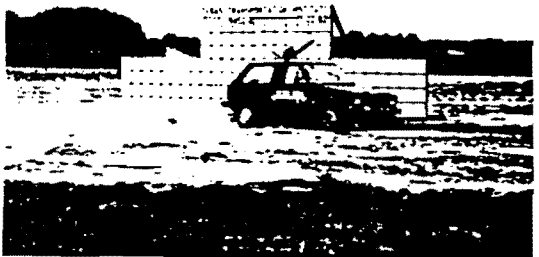

Figure . Sequential photographs for test 19452-2.
(perpendicular and side views) cont.

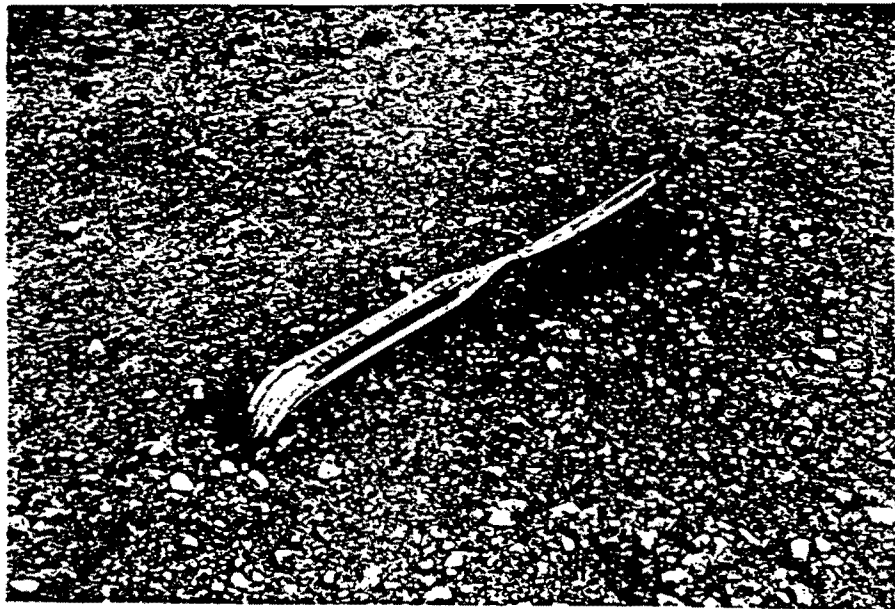

Figure . Test site after test 19452-2.

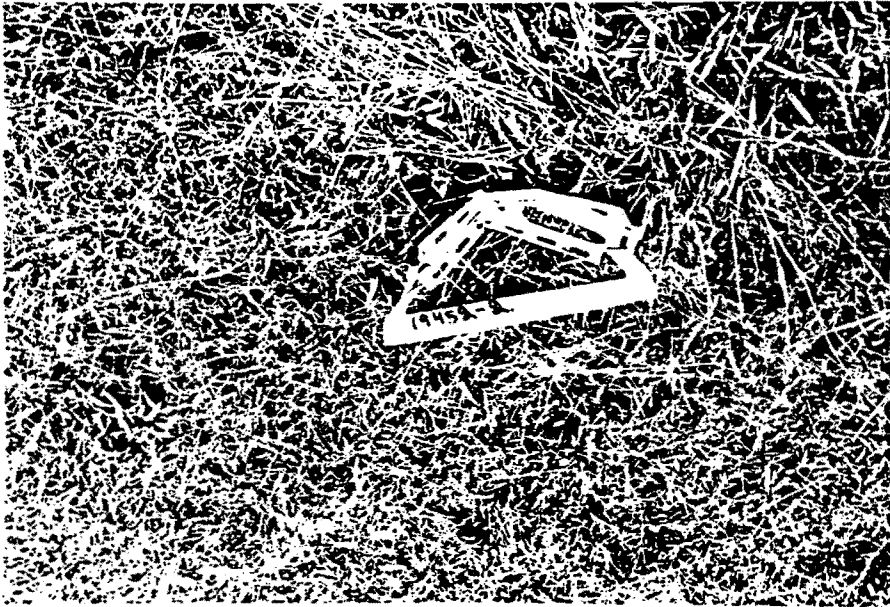
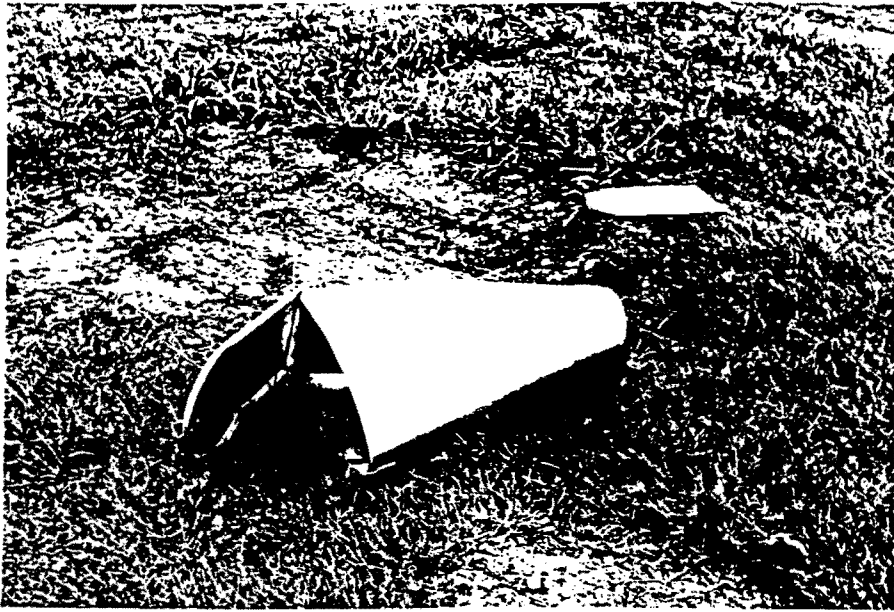

Figure . Damage to mailbox and brackett, test 19452-2.

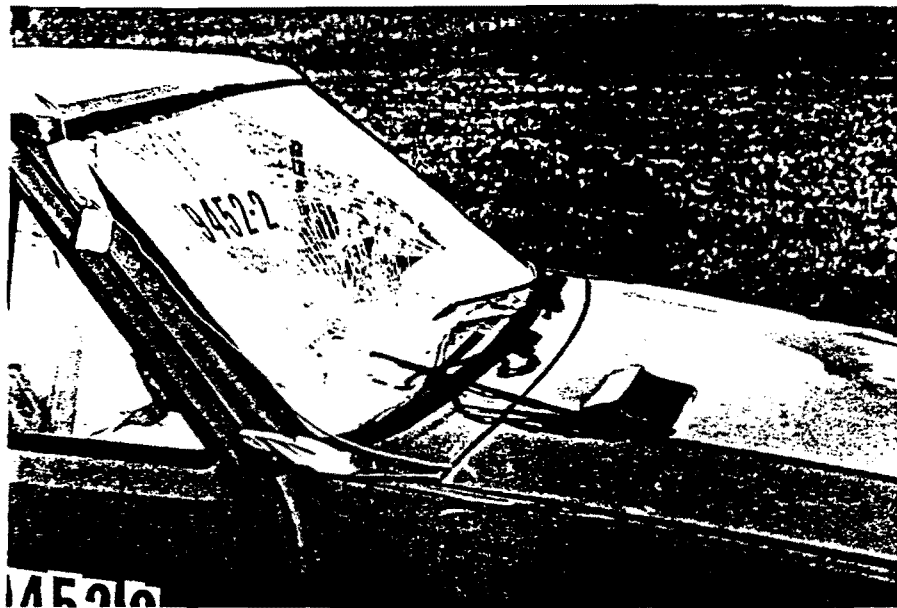
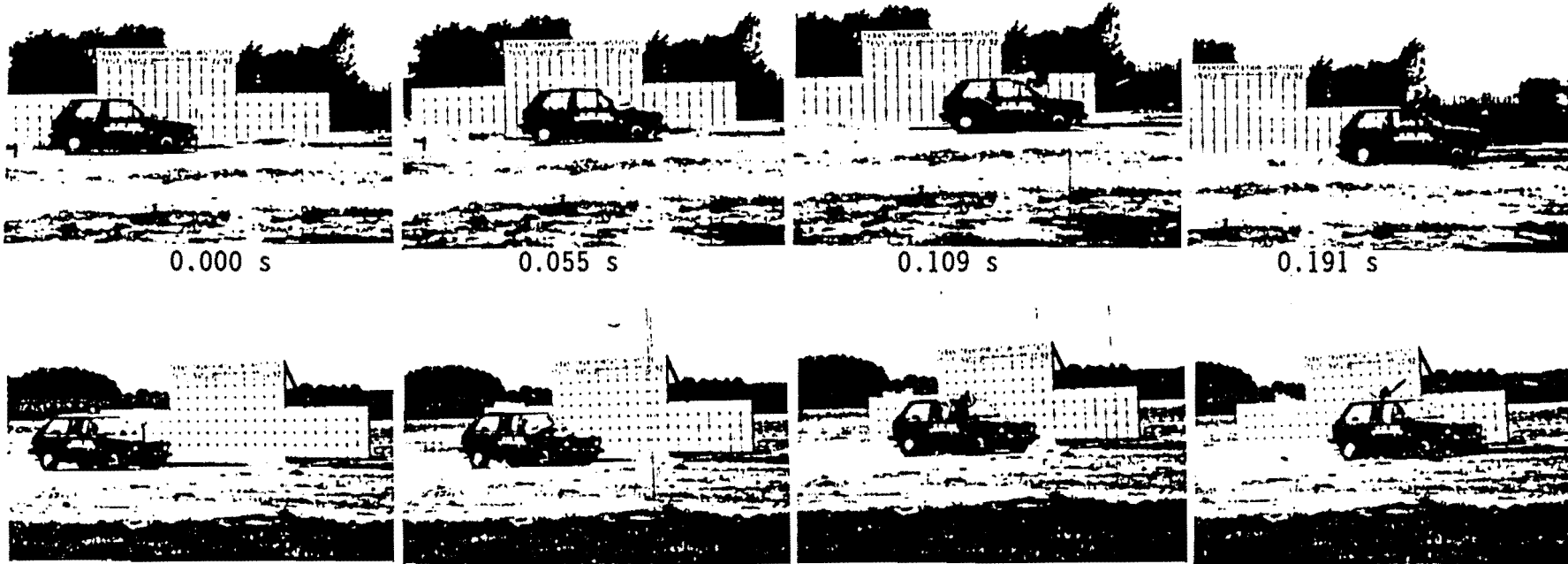

Figure . Vehicle after test 19452-2.



Figure . Anthropometric dummy before and after test 19452-2.



Test No19452-2.	Impact Speed.	61.3 mi/h (98.6 km/h)
Date	07/22/92.	Change in Velocity. . .	4.6 mi/h (7.4 km/h)
Test Article	Single mount, Type 2 Mailbox Installation.	Change in Momentum. . .	377.1 lb-s
Support	Type 4 (2 lb/ft winged channel post)	Vehicle Accelerations (Max. 0.050-sec Avg)	
Embedment.	2'-0" driven(strong soil)	Longitudinal. . .	-1.3 g
Vehicle	1988 Yugo GV	Lateral	-0.3 g
Vehicle Weight		Occupant Impact Velocity	
Test Inertia	1800 lb (816 kg)	Longitudinal. . .	N/A
Gross Static	1968 lb (893 kg)	Lateral	N/A
Vehicle Damage Classification		Occupant Ridedown Accelerations	
TAD	12-FR-1	Longitudinal. . .	No contact
SAE	12FRAN1	Lateral	No contact

Figure . Summary of results for test 19452-2.

19452-2

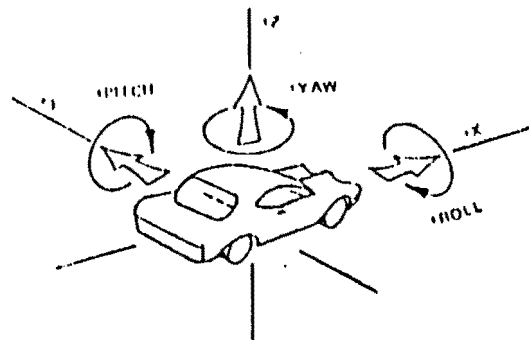
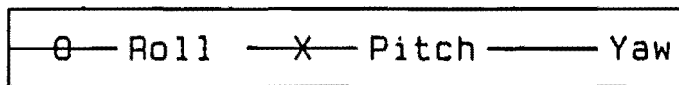

Axes are vehicle fixed.
Sequence for determining
orientation is:

1. Yaw
2. Pitch
3. Roll

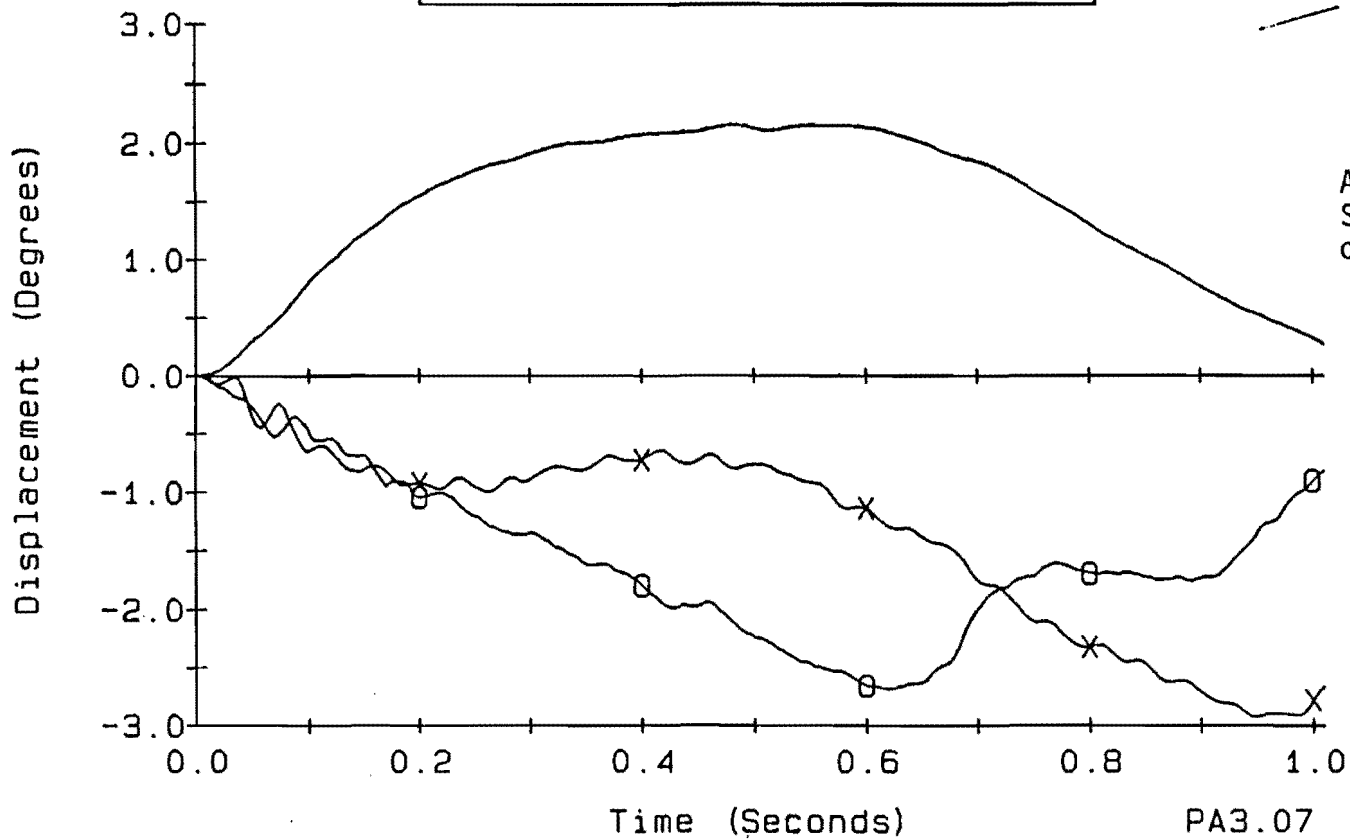

Figure . Vehicle angular displacements for test 19452-2.

CRASH TEST 19452-2

Class 180 Filter

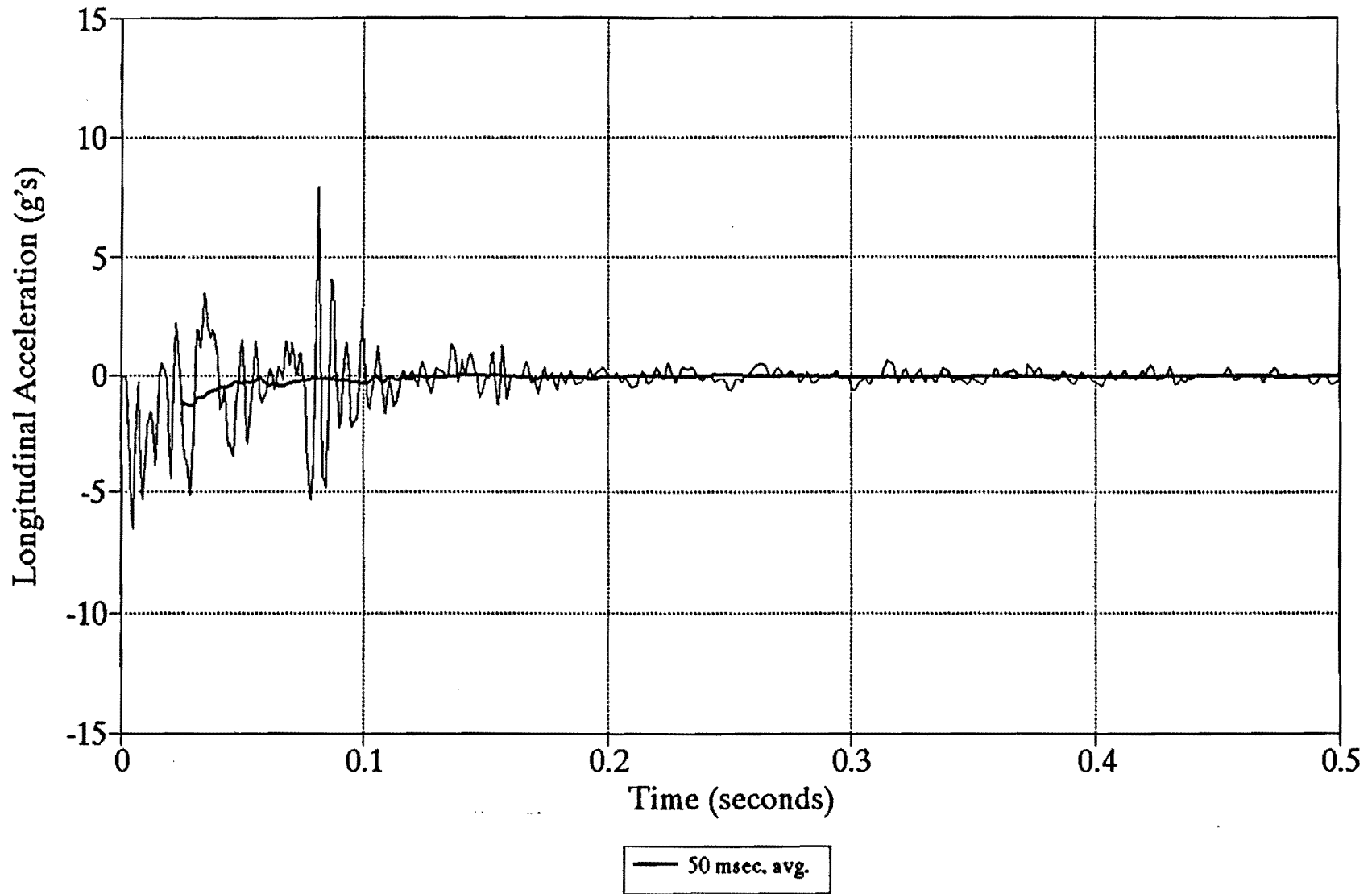

Figure . Longitudinal accelerometer trace of test 19452-2.

CRASH TEST 19452-2

Class 180 Filter

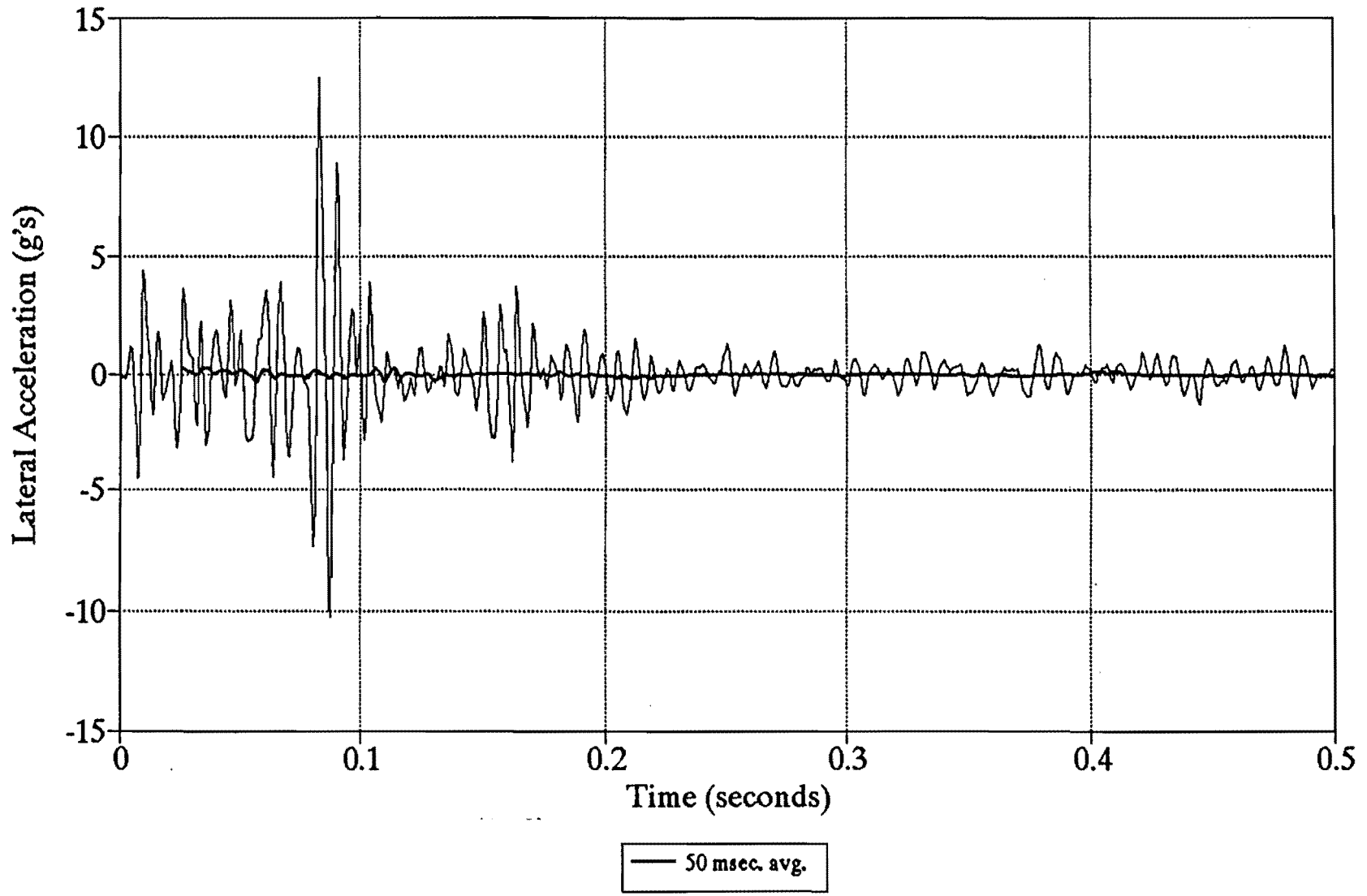

Figure . Lateral accelerometer trace of test 19452-2.

CRASH TEST 19452-2

Class 180 Filter

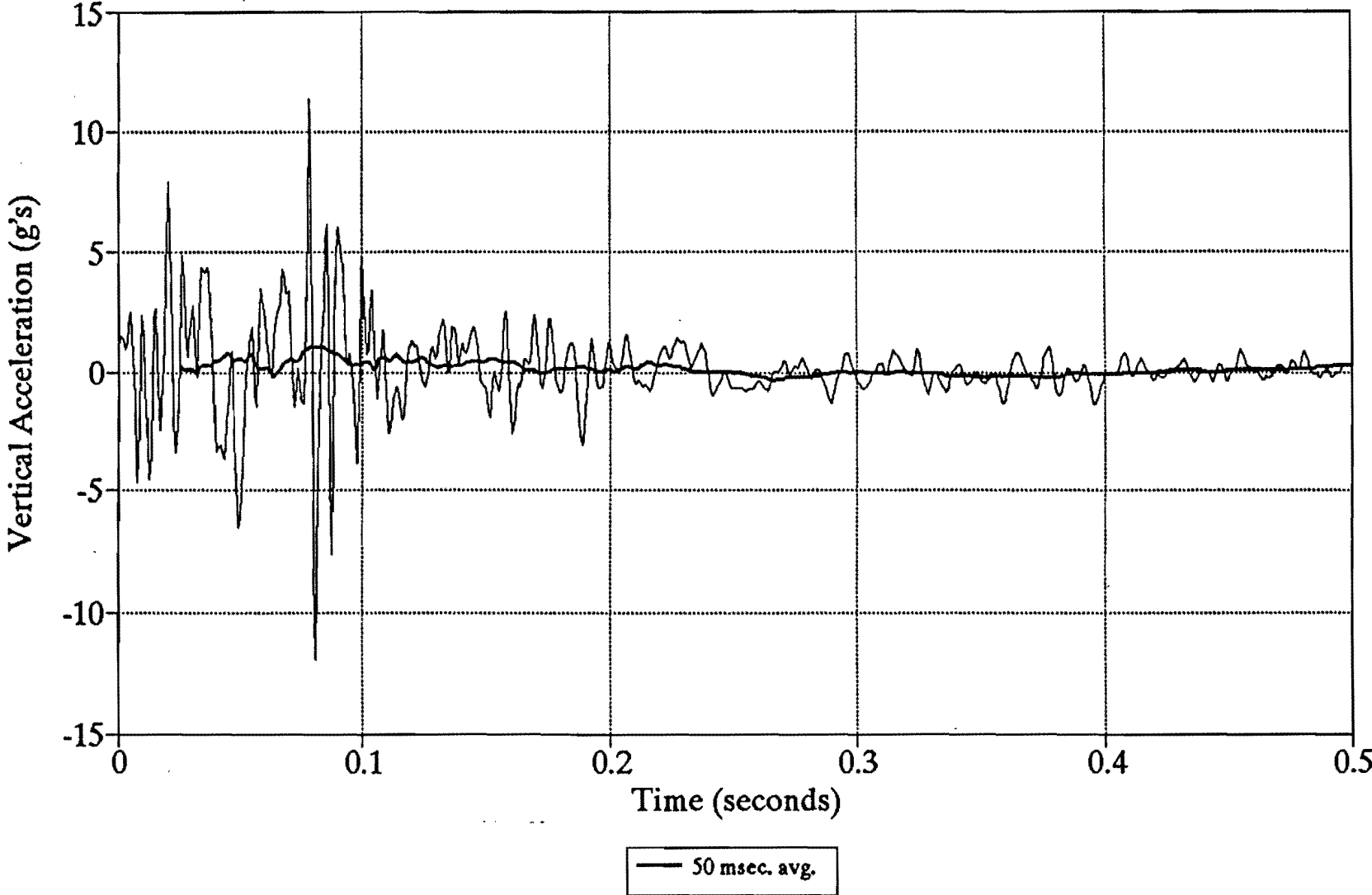

Figure . Vertical accelerometer trace of test 19452-2.

Test 19452-3

A 1987 Yugo GV (shown in Figures *** & ***) impacted a single mount type 2 mailbox installation. The impact was conducted at 61.2 miles per hour (98.5 km/h) using a cable reverse tow and guidance system. The point of impact was the front right quarter point of the vehicle bumper with the mailbox installation. Test inertia mass of the vehicle was 1,800 lb (816 kg) and its gross static mass was 1,968 lb (893 kg). The height from roadway surface to the lower edge of the vehicle bumper was 11.5 inches (29.2 cm) and 19.0 inches (48.3 cm) to the top of the bumper. Other dimensions and information on the vehicle are given in Figure ***.

The vehicle was free wheeling and unrestrained just prior to impact. Upon impact, the support began to yield and by 0.017 second, the mailbox had detached from the support. At approximately 0.035 second, the mailbox struck the hood of the vehicle, then the windshield, sliding up, over and off the right upper A-pillar. The vehicle lost contact with the installation at approximately 0.174 second, the brakes were applied and the vehicle came to rest 345 feet (105.2 m) from the point of impact. Sequential photographs of the test are shown in Figure ***.

The installation yielded to the vehicle. The support was displaced over at ground level. The mailbox attachment bracket remained attached to the support. The mailbox components came to rest approximately 96.3 feet (29.3 m) from the point of impact. The vehicle sustained only minor damage to the bumper, hood and windshield as shown in Figure ***.

A summary of the test results and other information pertinent to this test are given in Figure ***. The maximum 0.050 second average acceleration experienced by the vehicle was -1.2 g in the longitudinal direction and -0.3 g in the lateral direction. No occupant contact occurred in the longitudinal or lateral direction. Vehicle angular displacements are plotted in Figure *** and vehicle accelerometer traces are displayed in Figures *** through ***. Change in vehicle velocity was 1.3 mi/h (2.1 km/h) and change in momentum was 106.6 lb-s.

In summary, the mailbox installation safely yielded to the vehicle. The vehicle sustained minor damage and did not present undue hazard to other traffic. There was no deformation and minimal penetration into the occupant compartment. There was no

occupant contact in the longitudinal or lateral directions. This installation in "strong soil" is acceptable according to the evaluation criteria recommended in NCHRP Report 230.

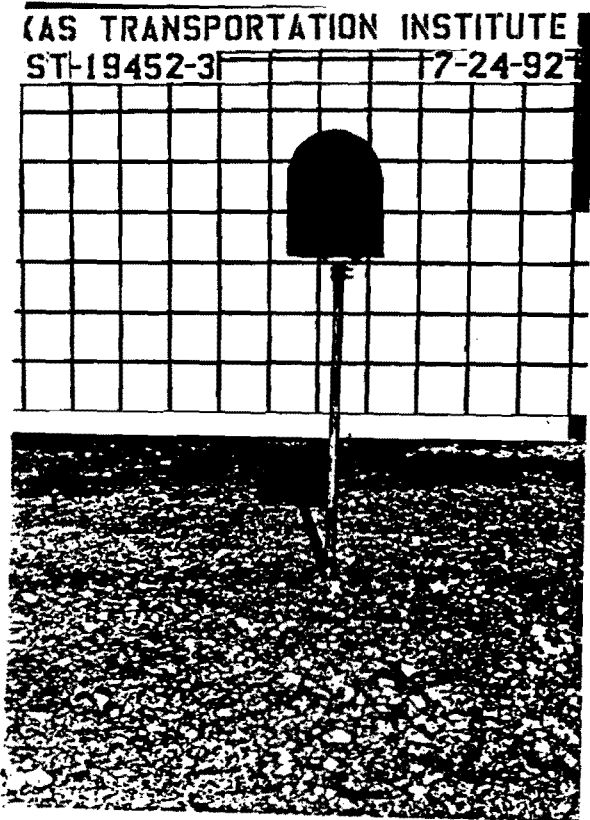

Figure . Mailbox installation before test 19452-3.

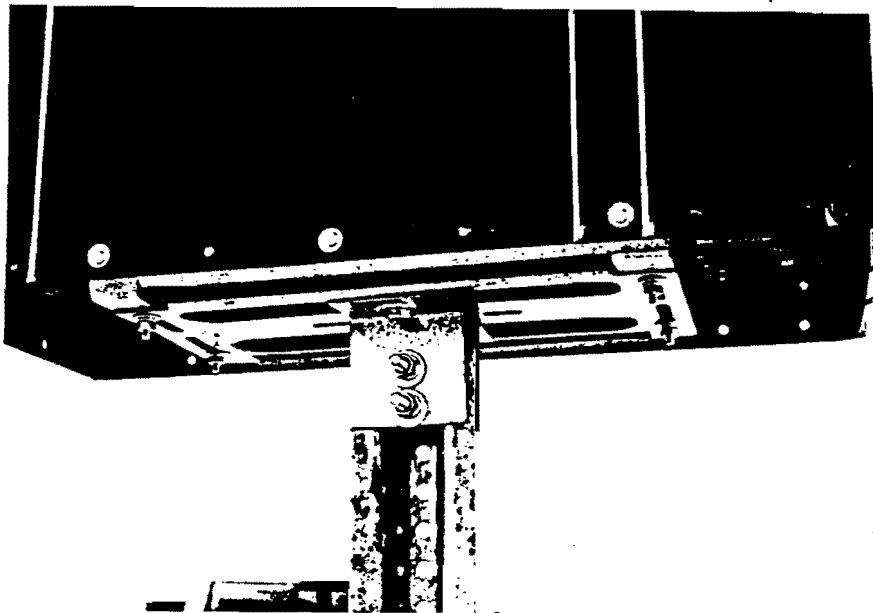
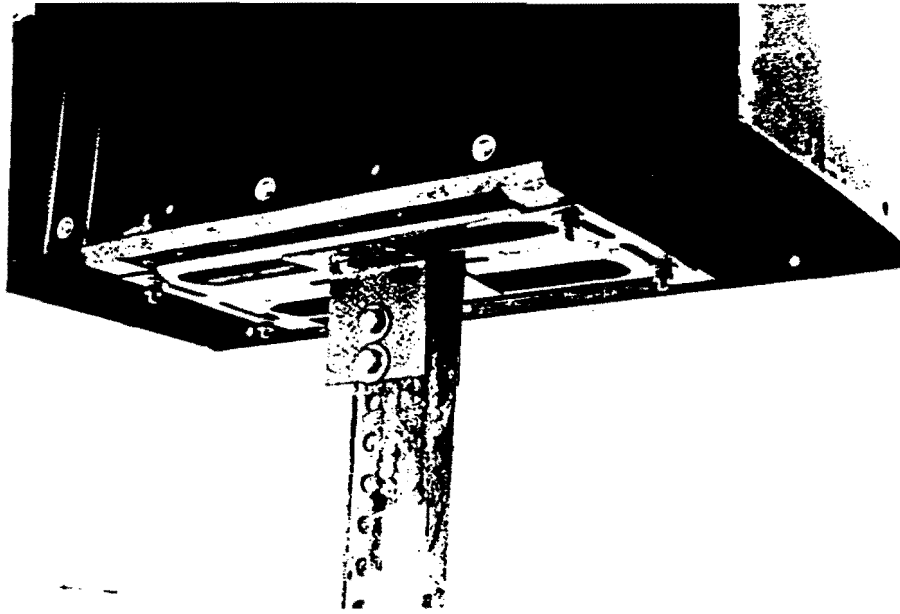

Figure . Mailbox/support connection for installation used in test 19452-3.

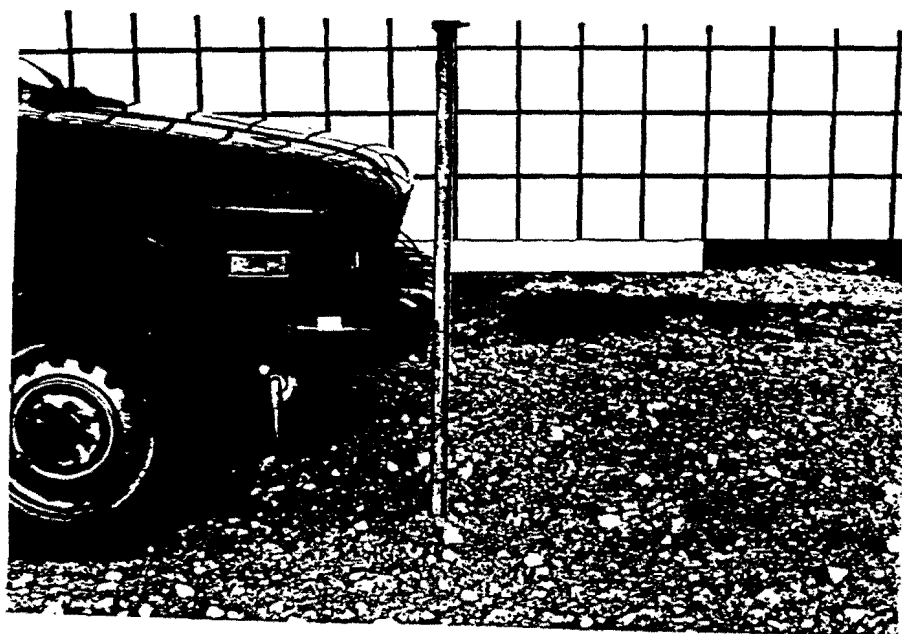
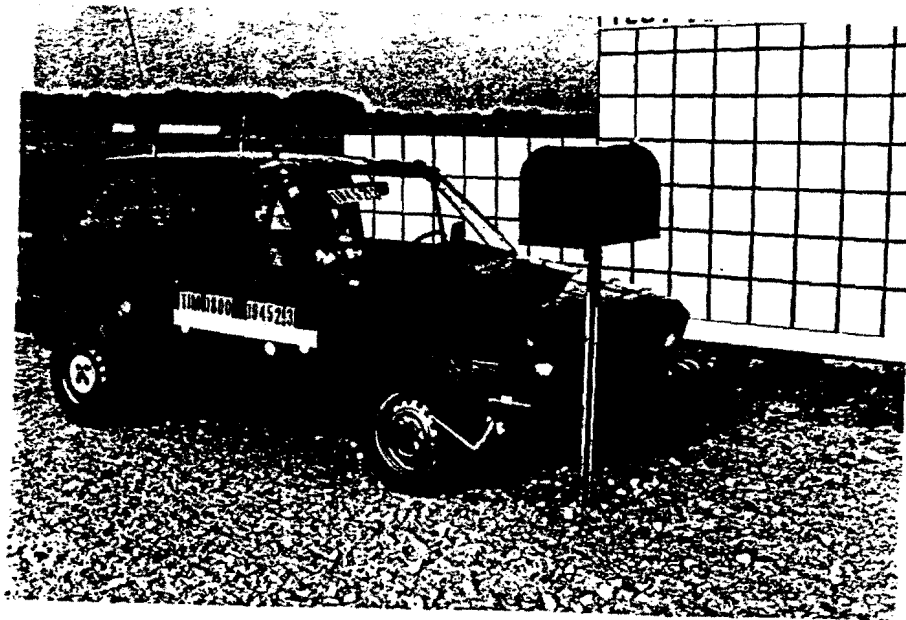

Figure . Vehicle/mailbox geometrics before test 19452-3.

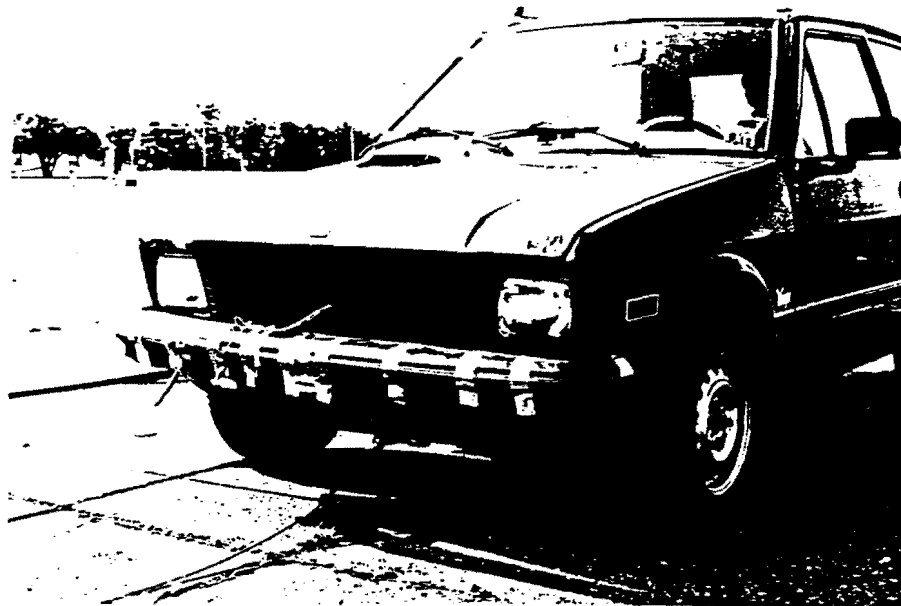
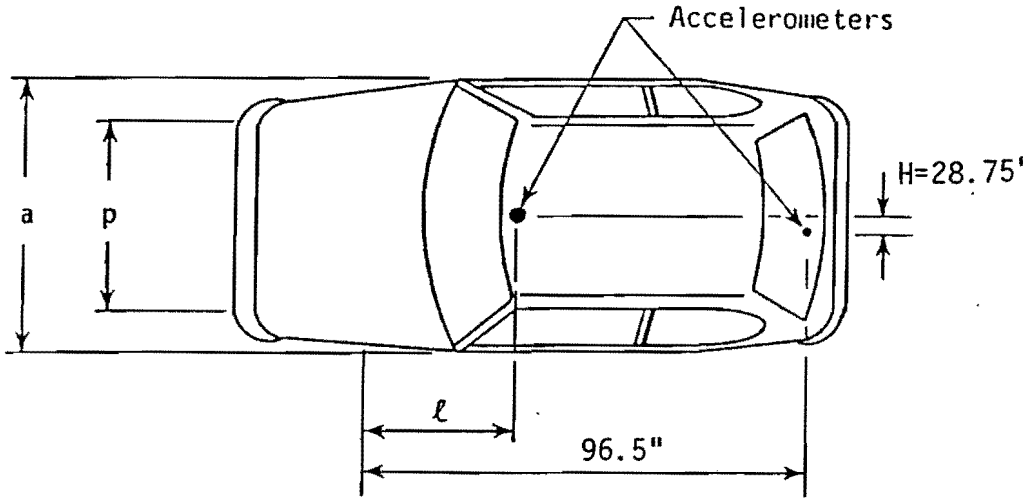

Figure . Vehicle before test 19452-3.

Date: 7-24-92 Test No.: 19452-3&4 VIN: VX1BA1215H12353059
 Make: YUGO Model: GV Year: 1987 Odometer: 51069
 Tire Size: 145R13 Ply Rating: _____ Bias Ply: _____ Belted: _____ Radial: X

Tire Condition: good _____
 fair X
 badly worn _____



Vehicle Geometry - inches

- a 60.5" b 27.5"
- c 84.25" d* 55.5"
- e 25" f 136.75"
- g _____ h 30.6"
- i _____ j 30.25"
- k 15" l 32"
- m 19" n 2.5"
- o 11.5" p 52.25"
- r 22" s 14.5"

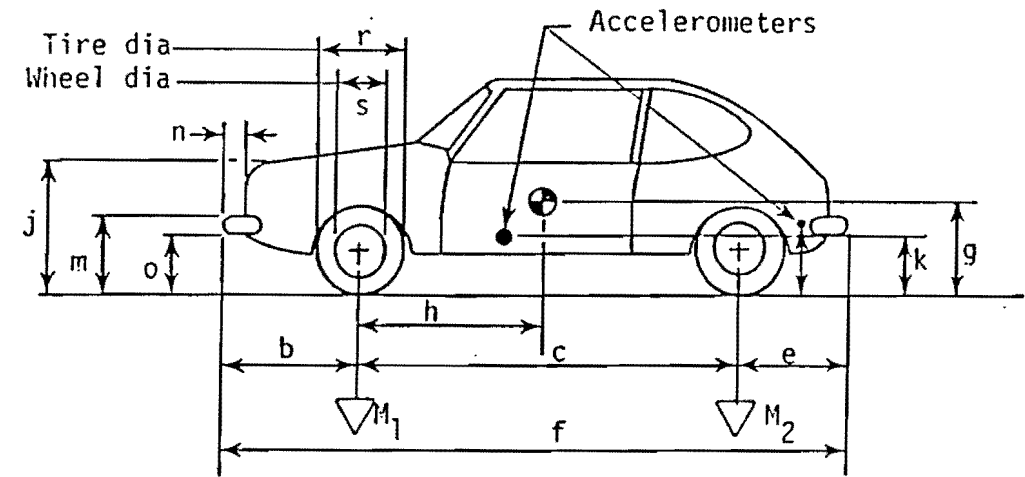

Engine Type: V4 Gas
 Engine CID: 28A.064

Transmission Type:
 Automatic or Manual
 FWD ~~XXXXXXX~~ ~~XXXXXXX~~ ~~XXXXXXX~~

Body Type: 3 Door

Steering Column Collapse Mechanism:

- Behind wheel units
- Convoluted tube
- Cylindrical mesh units
- Embedded ball
- NOT collapsible
- Other energy absorption
- Unknown

4-wheel weight for c.g. det. lf 552 rf 594 lr 323 rr 331

Mass - pounds	Curb	Test Inertial	Gross Static
M_1	<u>1167</u>	<u>1146</u>	<u>1226</u>
M_2	<u>639</u>	<u>654</u>	<u>742</u>
M_T	<u>1806</u>	<u>1800</u>	<u>1968</u>

Note any damage to vehicle prior to test:

Brakes:
 Front: disc X drum _____
 Rear: disc _____ drum X

*d = overall height of vehicle

Figure . Test vehicle properties (19452-3&4).

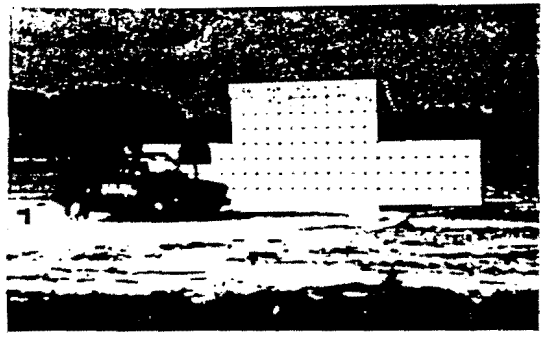

0.000 s

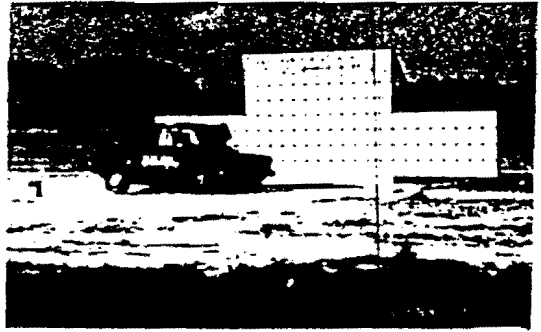

0.027 s

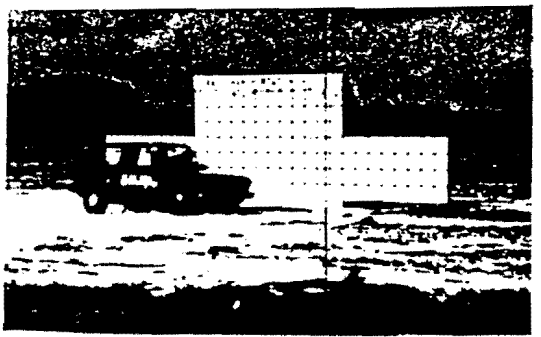

0.055 s

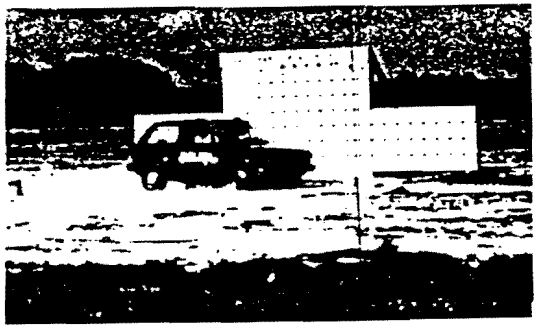

0.082 s

Figure . Sequential photographs for test 19452-3.
(perpendicular and side views)

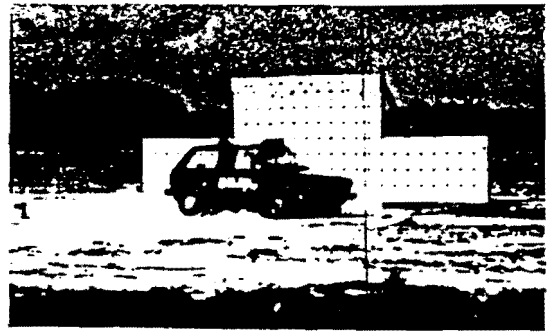

0.109 s

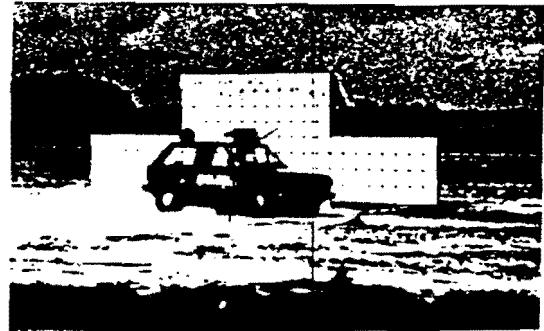

0.136 s



0.164 s



0.191 s

Figure . Sequential photographs for test 19452-3.
(perpendicular and side views) cont.

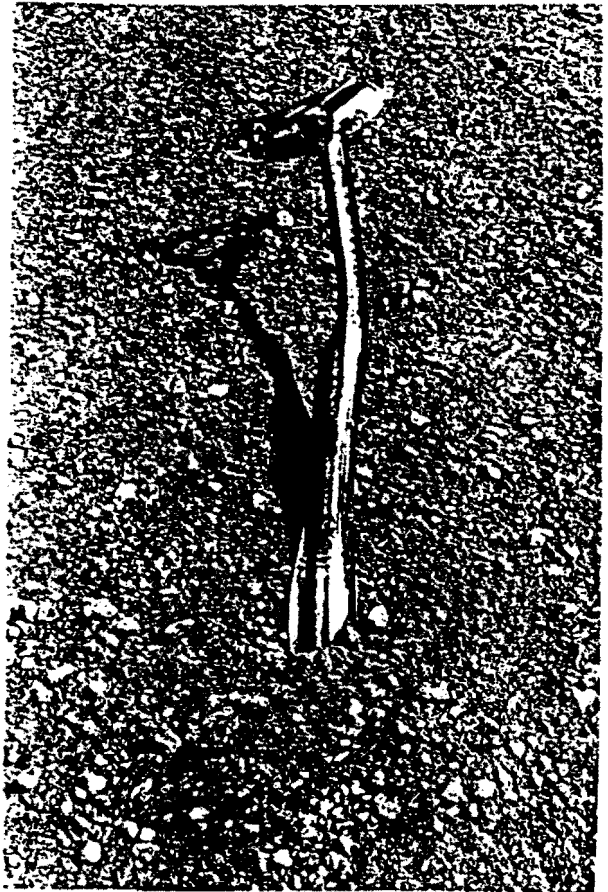

Figure . Test site after test 19452-3.

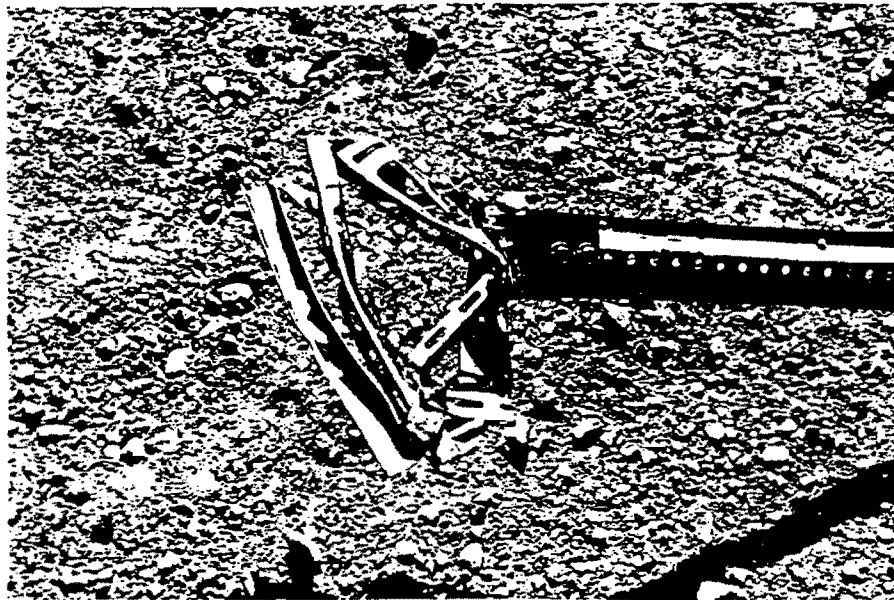
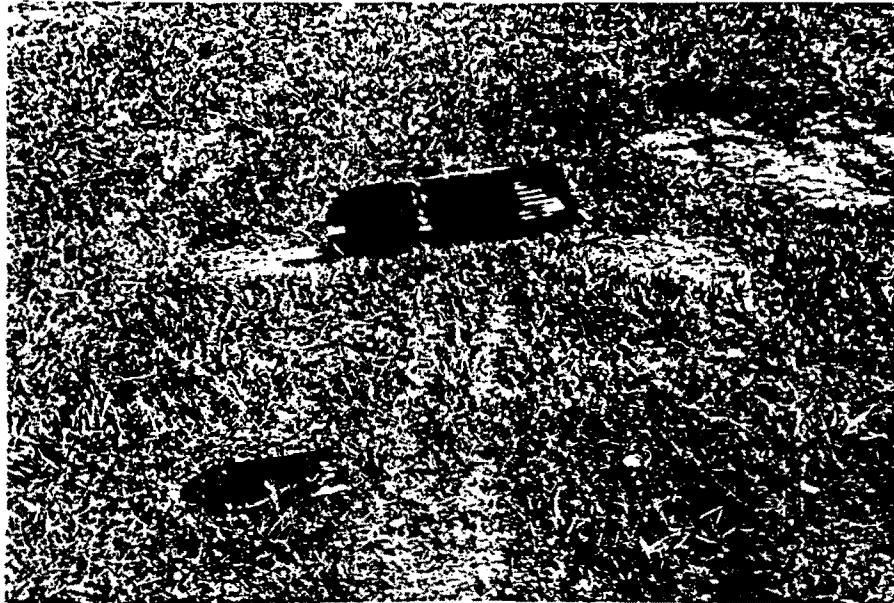

Figure . Damage to mailbox and brackett after test 19452-3.

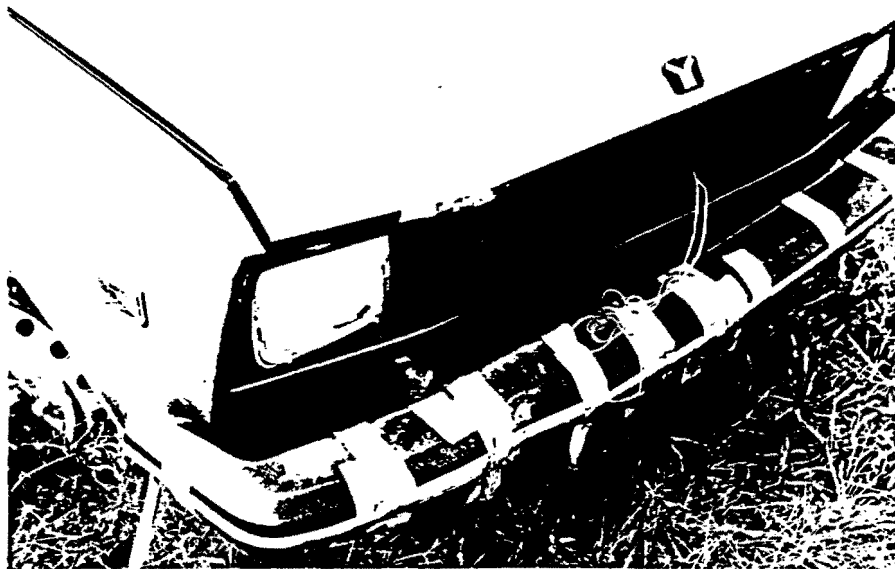
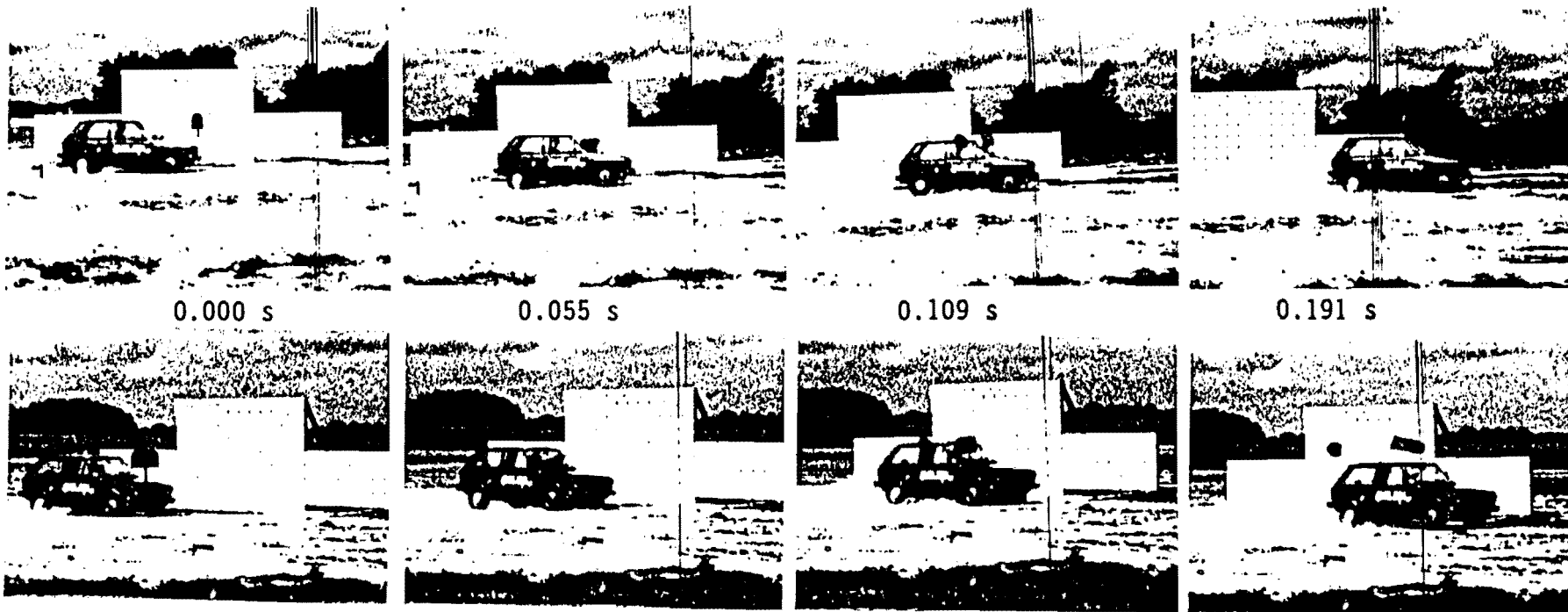

Figure . Vehicle after test 19452-3.



Test No	19452-3.	Impact Speed.	61.2 mi/h (98.4 km/h)
Date	07/24/92.	Change in Velocity. . .	1.3 mi/h (2.1 km/h)
Test Article	Single mount, Type 2 Mailbox Installation.	Change in Momentum. . .	106.6 lb-s
Support	Type 4 (2 lb/ft winged channel post)	Vehicle Accelerations (Max. 0.050-sec Avg)	
Embedment.	2'-0" driven(strong soil)	Longitudinal. . .	-1.2 g
Vehicle	1987 Yugo GV	Lateral	-0.3 g
Vehicle Weight		Occupant Impact Velocity	
Test Inertia	1800 lb (816 kg)	Longitudinal. . .	N/A
Gross Static	1968 lb (893 kg)	Lateral	N/A
Vehicle Damage Classification		Occupant Ridedown Accelerations	
TAD	12-FR-1	Longitudinal. . .	No contact
SAE	12FRAN1	Lateral	No contact

Figure . Summary of results for test 19452-3.

19452-3

○ Roll — X — Pitch — Yaw

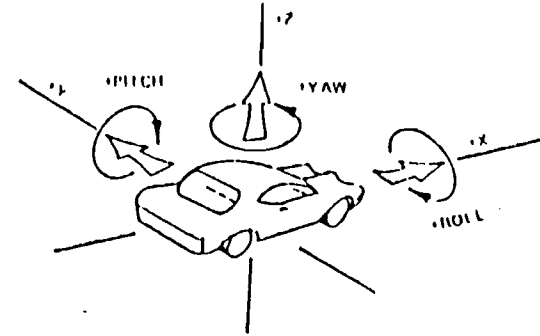

Axes are vehicle fixed.
Sequence for determining
orientation is:

1. Yaw
2. Pitch
3. Roll

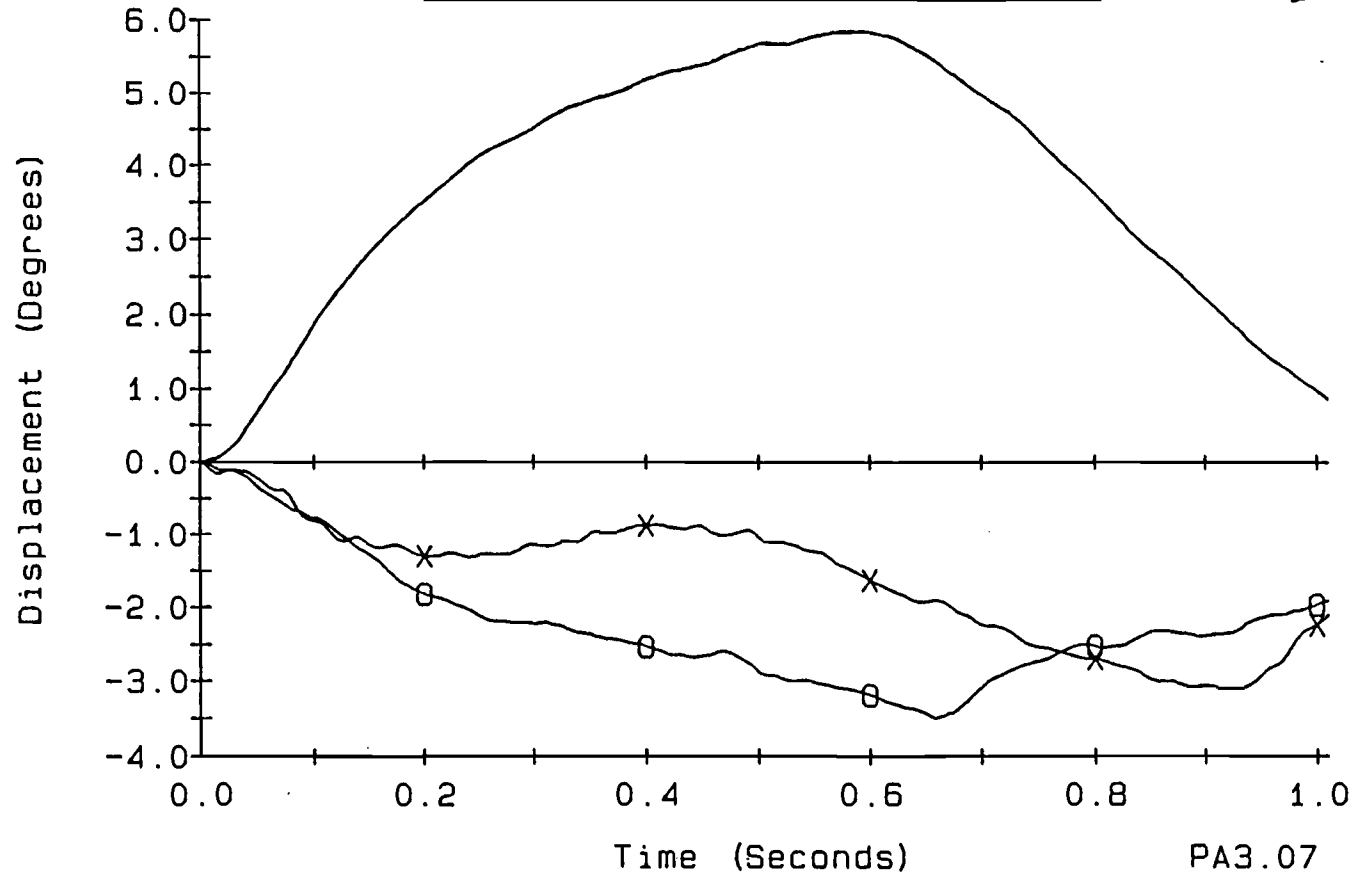

Figure . Vehicle angular displacements for test 19452-3.

PA3.07

CRASH TEST 19452-3

Class 180 Filter

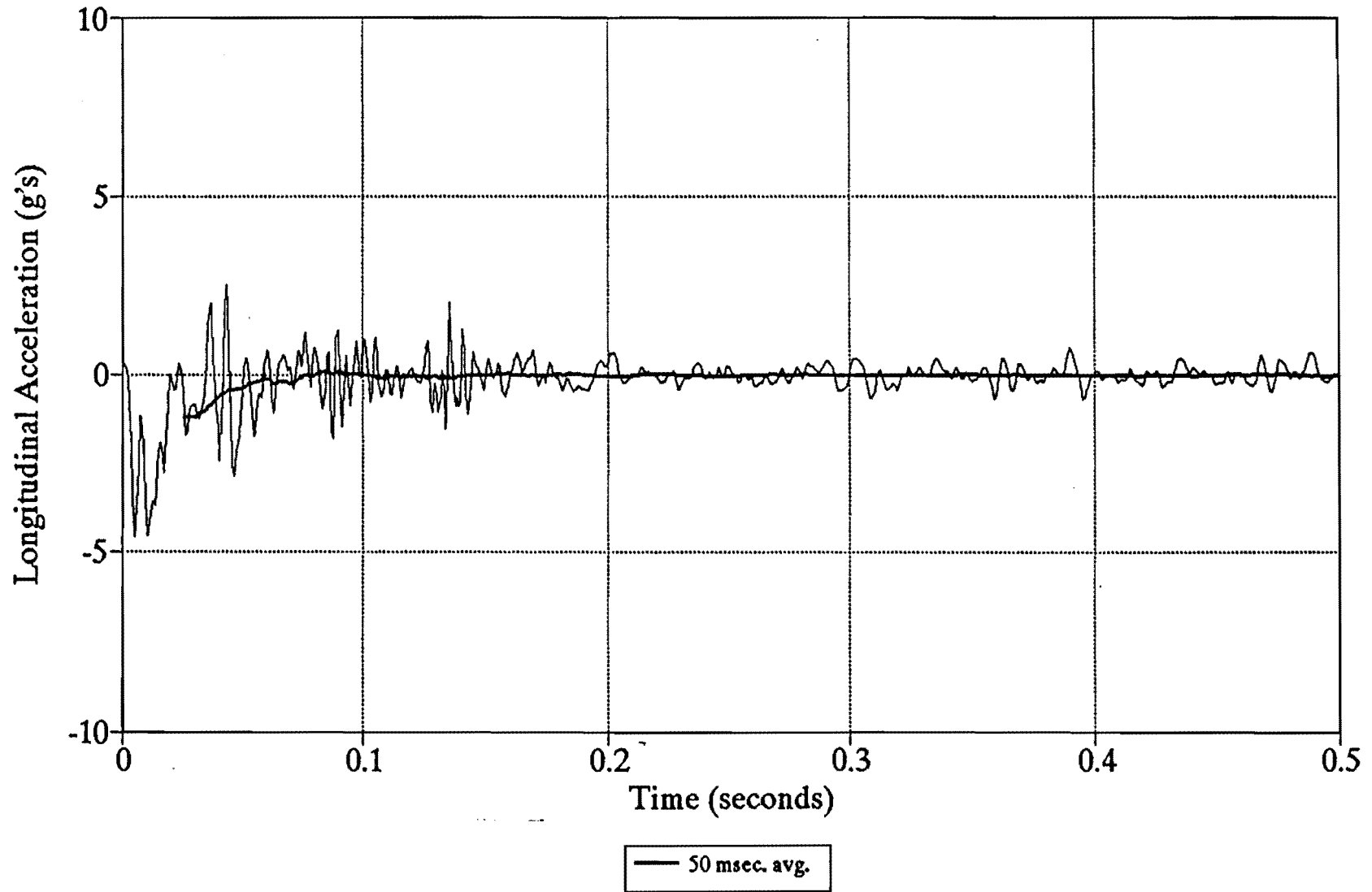

Figure . Longitudinal accelerometer trace of test 19452-3.

CRASH TEST 19452-3

Class 180 Filter

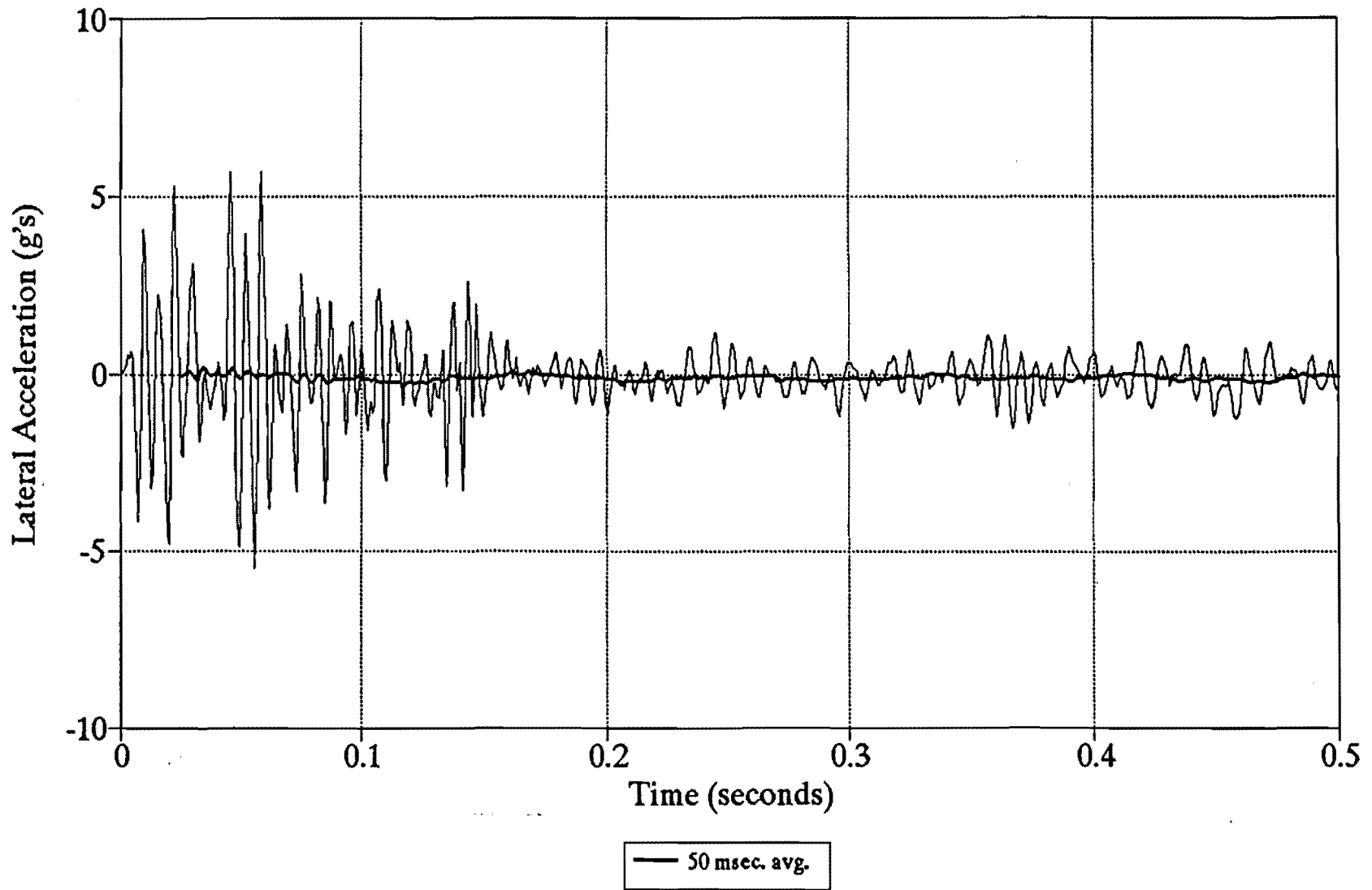

Figure . Lateral accelerometer trace of test 19452-3.

CRASH TEST 19452-3

Class 180 Filter

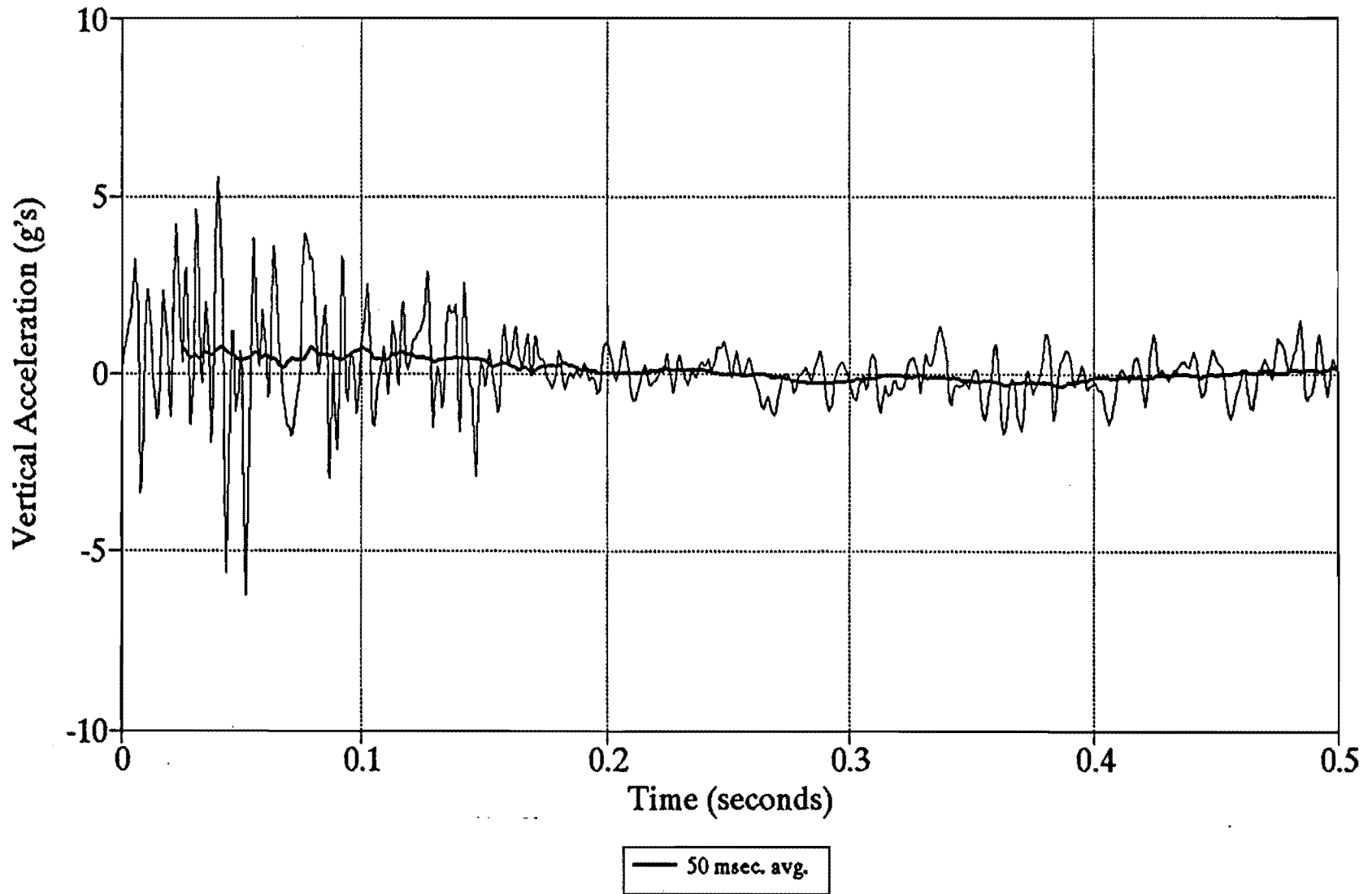

Figure . Vertical accelerometer trace of test 19452-3.

Test 19452-4

The same 1987 Yugo GV used in test 3 impacted a double mount type 1-1/2 mailbox installation. The impact was conducted at 61.2 miles per hour (98.4 km/h) using a cable reverse tow and guidance system. The point of impact was the front left quarter point of the vehicle bumper with the mailbox installation. Test inertia mass of the vehicle was 1,800 lb (816 kg) and its gross static mass was 1,968 lb (893 kg).

The vehicle was free wheeling and unrestrained just prior to impact. Upon impact, the support began to yield and by 0.025 second, the mailbox had detached from the support. At approximately 0.035 second, the mailbox struck the hood of the vehicle, bounced off, and the vehicle passed beneath. The vehicle lost contact with the installation at approximately 0.174 second, the brakes were applied and the vehicle came to rest 300 feet (91.5 m) from the point of impact. Sequential photographs of the test are shown in Figure ***.

The installation yielded to the vehicle. The support was displaced over at ground level. The mailbox body came to rest approximately 90.0 feet (27.4 m) from the point of impact. The vehicle sustained only minor damage to the bumper and hood as shown in Figure ***.

A summary of the test results and other information pertinent to this test are given in Figure ***. The maximum 0.050 second average acceleration experienced by the vehicle was -1.5 g in the longitudinal direction and 0.4 g in the lateral direction. No occupant contact occurred in the longitudinal or lateral direction. Vehicle angular displacements are plotted in Figure *** and vehicle accelerometer traces are displayed in Figures *** through ***. Change in vehicle velocity was 1.5 mi/h (2.3 km/h) and change in momentum was 123.0 lb-s.

In summary, the mailbox installation safely yielded to the vehicle. The vehicle sustained minor damage and did not present undue hazard to other traffic. There was no deformation and no penetration into the occupant compartment. There was no occupant contact in the longitudinal or lateral directions. This installation in "strong soil" is acceptable according to the evaluation criteria recommended in NCHRP Report 230.

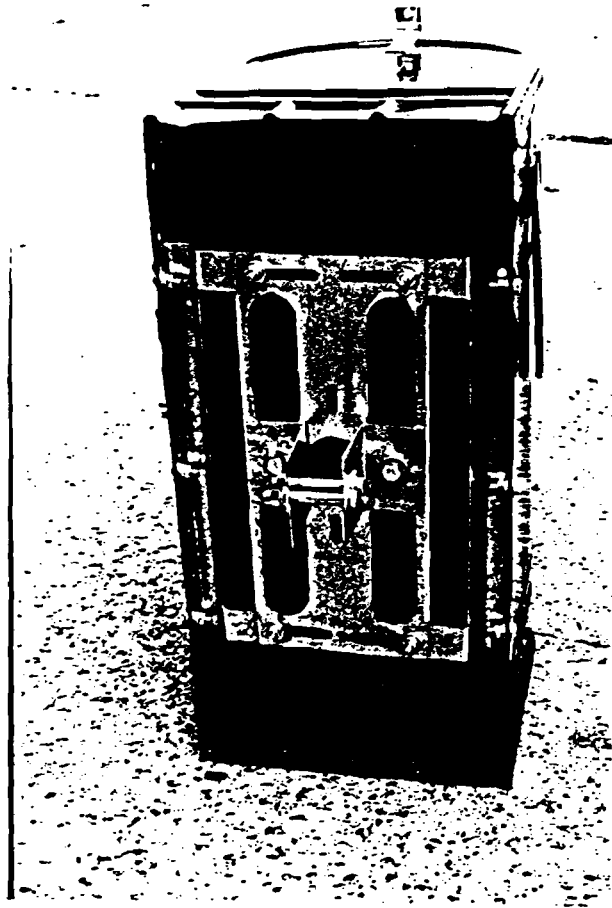

Figure . Mailbox installation before test 19452-4.

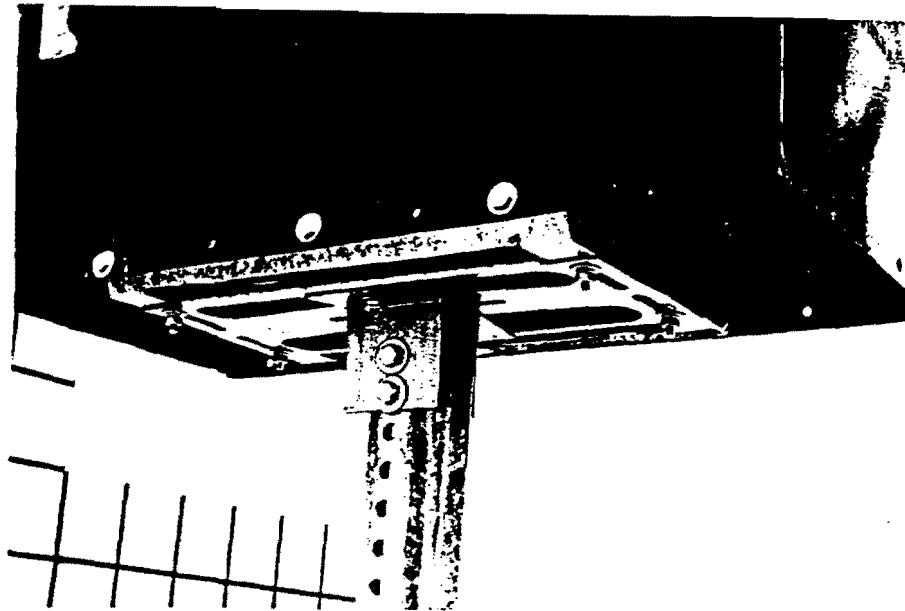
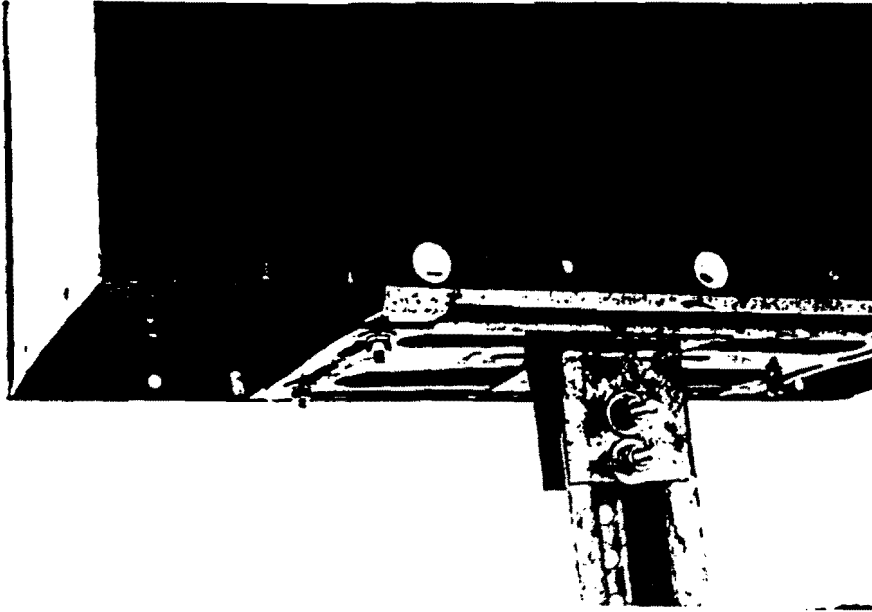

Figure . Mailbox installation before test 19452-4.
cont.

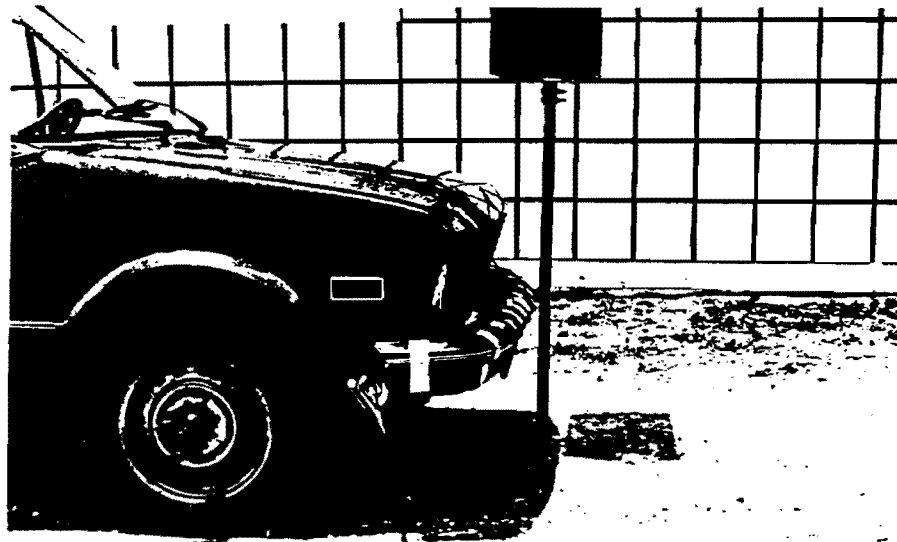
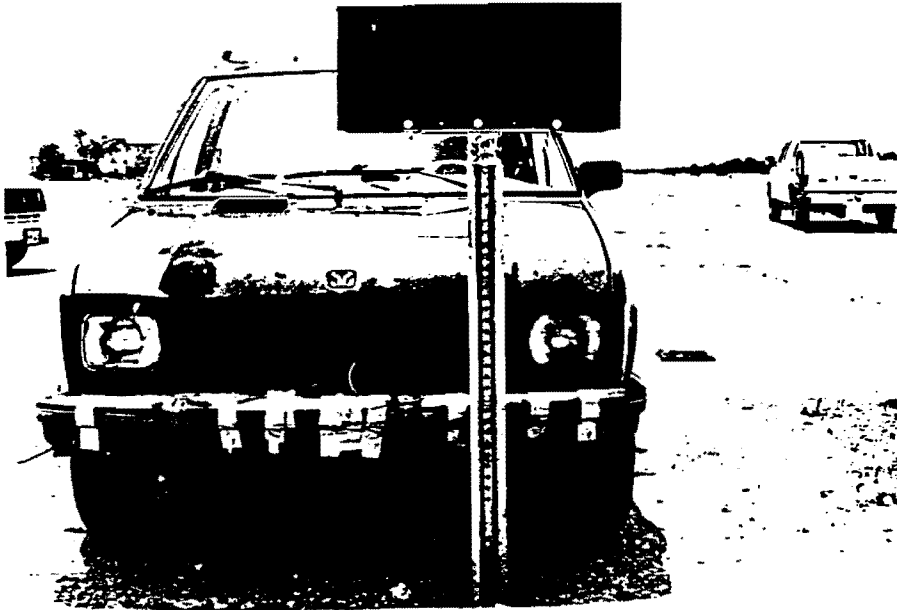

Figure . Vehicle/mailbox geometrics before test 19452-4.

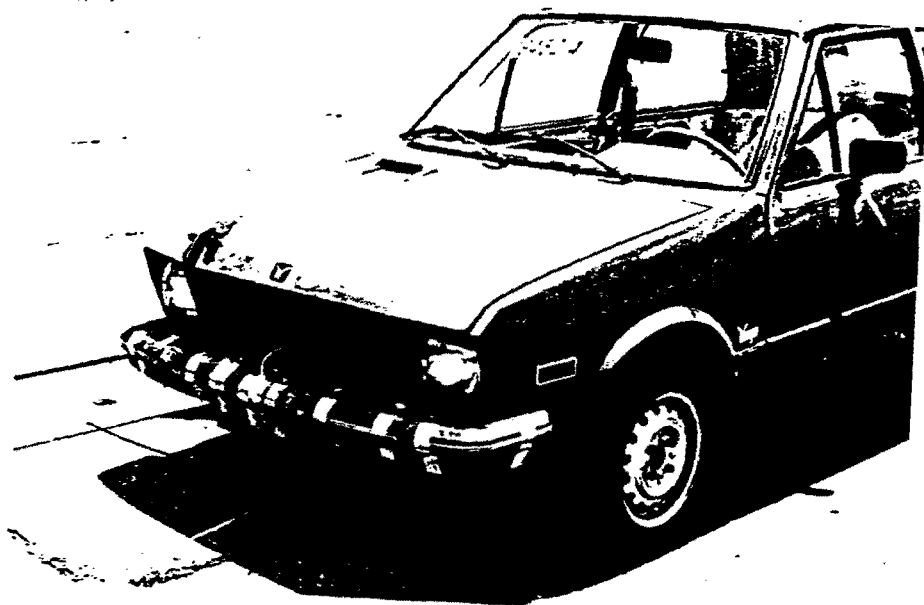

Figure . Vehicle before test 19452-4.

Date: 7-24-92 Test No.: 19452-3&4 VIN: VX1BA1215H12353059

Make: YUGO Model: GV Year: 1987 Odometer: 51069

Tire Size: 145R13 Ply Rating: _____ Bias Ply: _____ Belted: _____ Radial: x

Tire Condition: good _____
 fair X
 badly worn _____

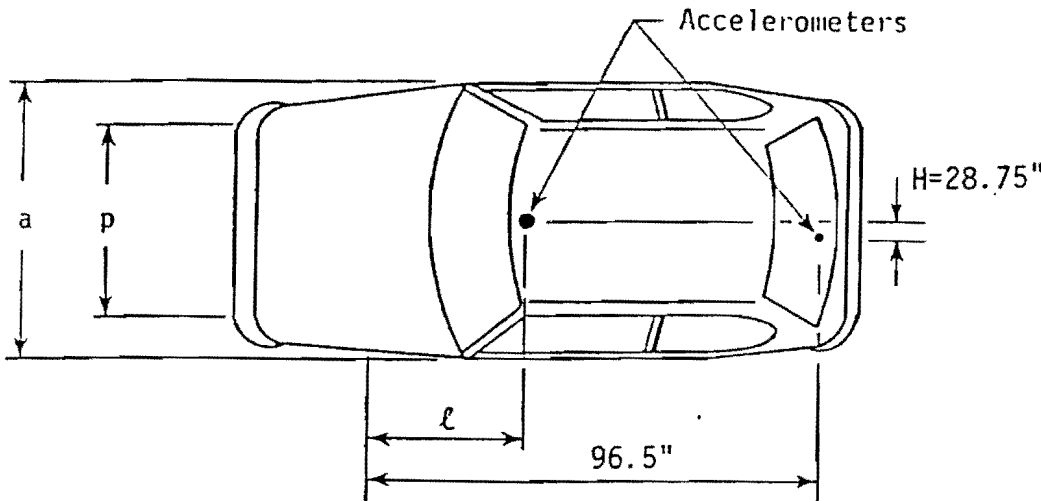

Vehicle Geometry - inches

- a 60.5" b 27.5"
- c 84.25" d* 55.5"
- e 25" f 136.75"
- g _____ h 30.6"
- i _____ j 30.25"
- k 15" l 32"
- m 19" n 2.5"
- o 11.5" p 52.25"
- r 22" s 14.5"

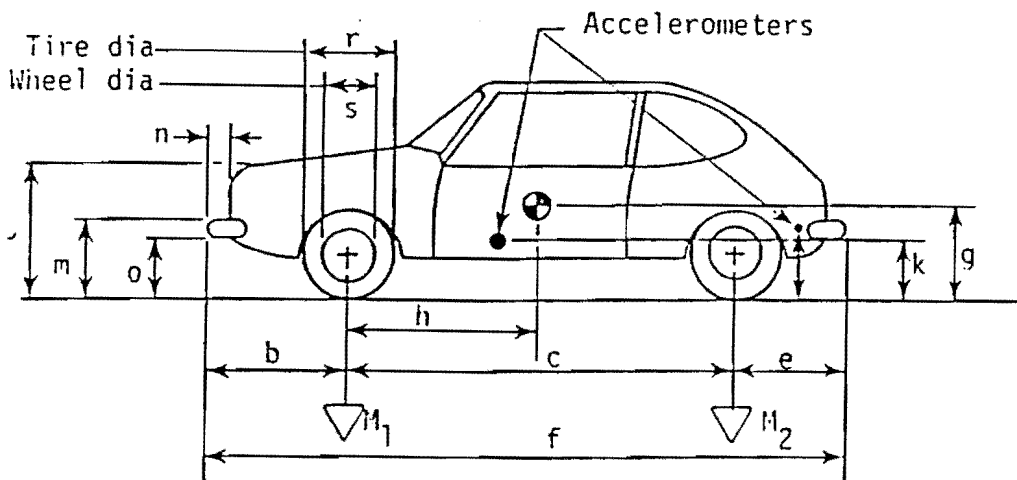

Engine Type: V4 Gas

Engine CID: 28A.064

Transmission Type:

Automatic or Manual

FWD ~~XXXXXXXXXXXX~~

Body Type: 3 Door

Steering Column Collapse Mechanism:

- Behind wheel units
- Convoluted tube
- Cylindrical mesh units
- Embedded ball
- NOT collapsible
- Other energy absorption
- Unknown

4-wheel weight for c.g. det. lf 552 rf 594 lr 323 rr 331

Mass - pounds	Curb	Test Inertial	Gross Static
M_1	<u>1167</u>	<u>1146</u>	<u>1226</u>
M_2	<u>639</u>	<u>654</u>	<u>742</u>
M_T	<u>1806</u>	<u>1800</u>	<u>1968</u>

Note any damage to vehicle prior to test:

Brakes:

Front: disc X drum _____

Rear: disc _____ drum X

*d = overall height of vehicle

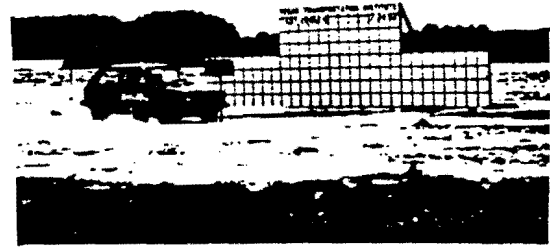
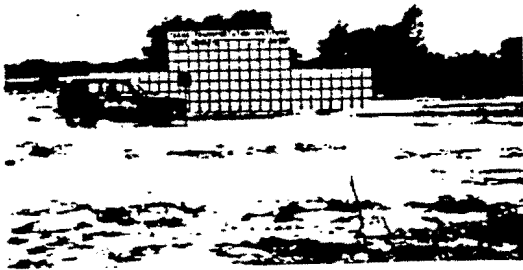

0.000 s

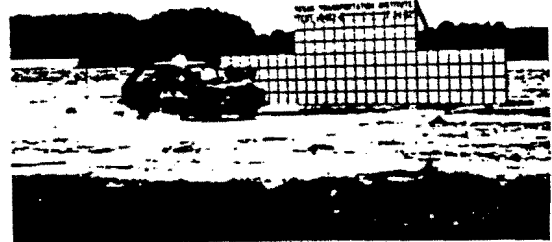
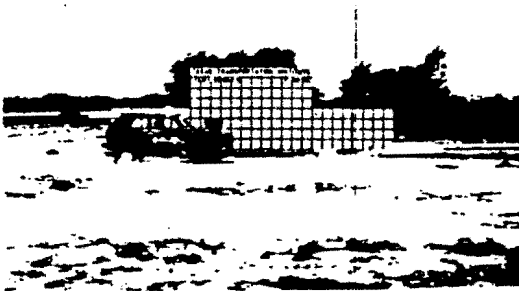

0.027 s



0.055 s

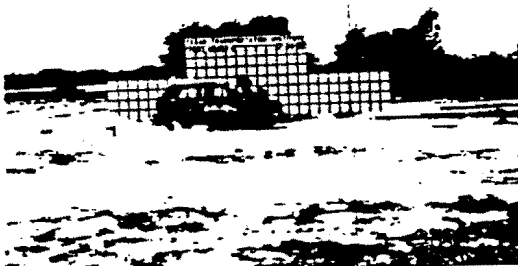

0.082 s

Figure . Sequential photographs for test 19452-4.
(perpendicular and side views)



0.109 s

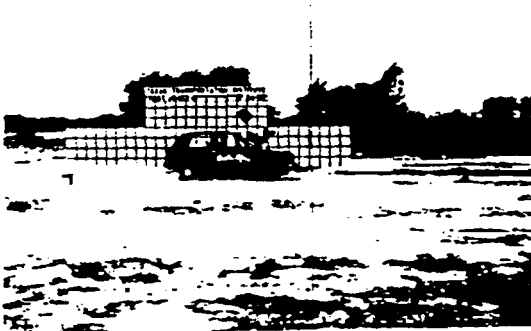
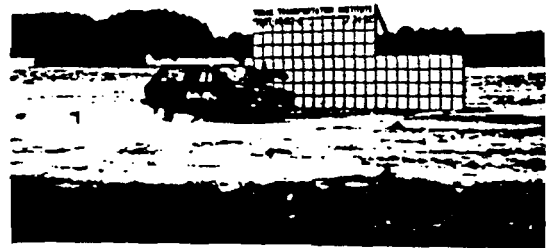

0.137 s



0.164 s



0.191 s

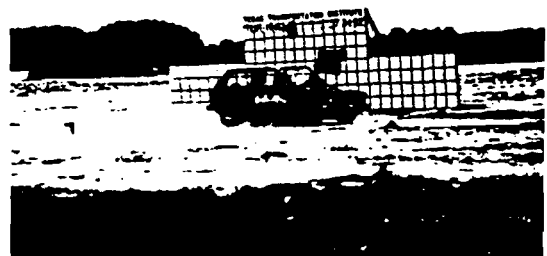

Figure . Sequential photographs for test 19452-4.
(perpendicular and side views) cont.

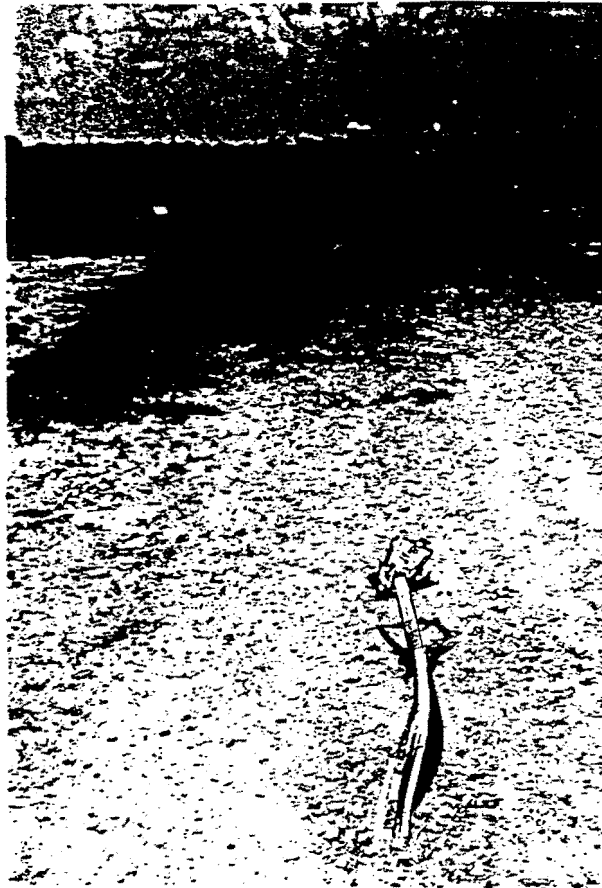

Figure . Test site after test 19452-4.

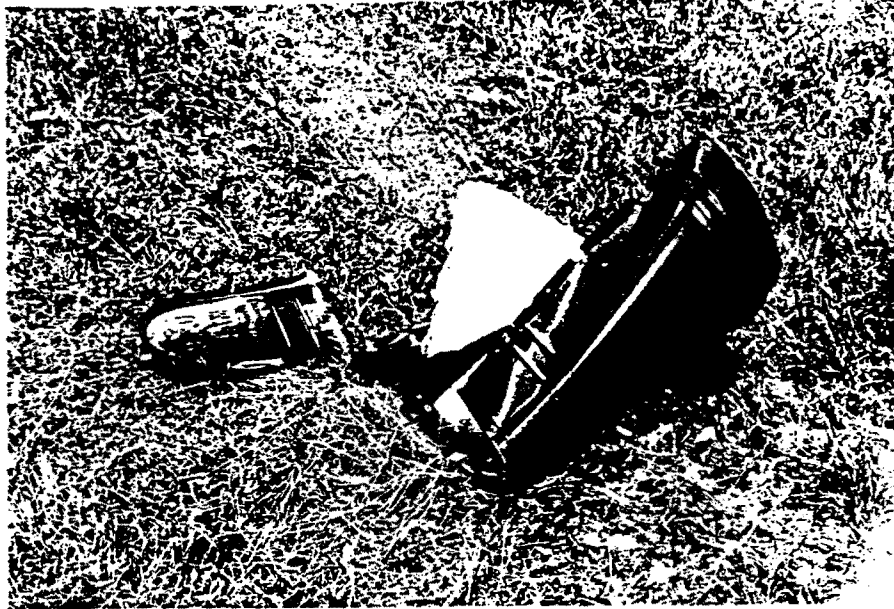

Figure . Damage to mailbox and brackett after test 19452-4.

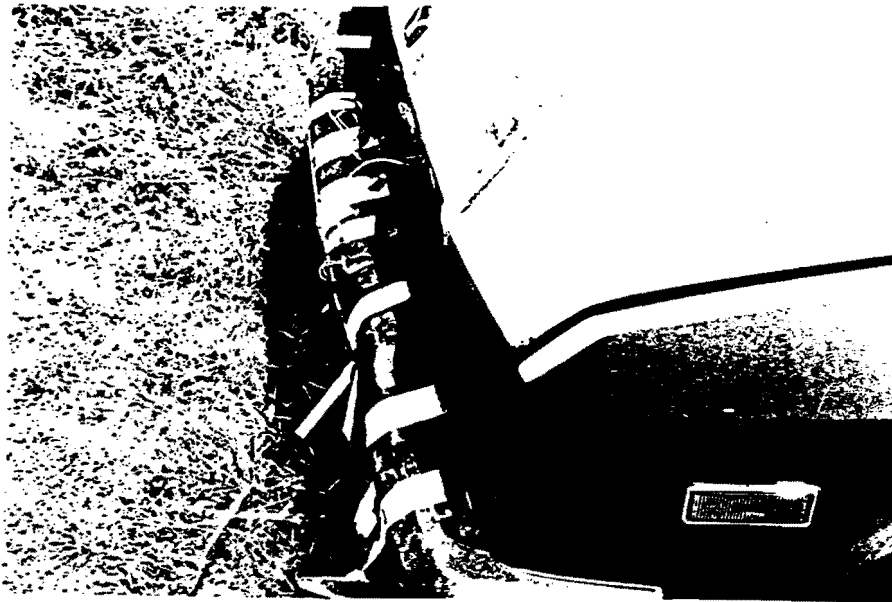
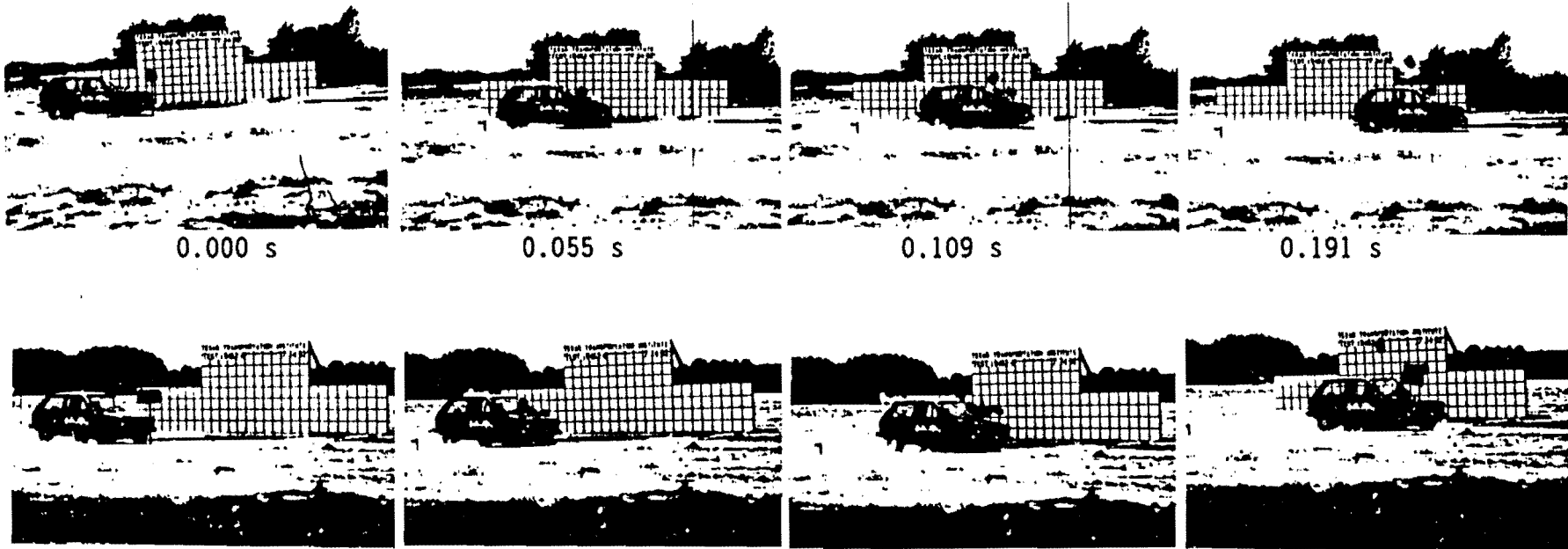

Figure . Vehicle after test 19452-4.



Test No	19452-4.	Impact Speed	61.2 mi/h (98.4 km/h)
Date	07/24/92.	Change in Velocity . . .	1.5 mi/h (2.3 km/h)
Test Article	Double mount, Type 1 1/2	Change in Momentum . . .	123.0 lb-s
	Mailbox Installation.		
Support	Type 4 (2 lb/ft winged	Vehicle Accelerations	
	channel post)	(Max. 0.050-sec Avg)	
Embedment	2'-0" driven(strong soil)	Longitudinal . . .	-1.5 g
Vehicle	1987 Yugo GV	Lateral	0.4 g
Vehicle Weight		Occupant Impact Velocity	
Test Inertia	1800 lb (816 kg)	Longitudinal . . .	N/A
Gross Static	1968 lb (893 kg)	Lateral	N/A
Vehicle Damage Classification		Occupant Ridedown Accelerations	
TAD	12-FL-1	Longitudinal . . .	No contact
SAE	12FLENI	Lateral	No contact

Figure . Summary of results for test 19452-4.

19452-4

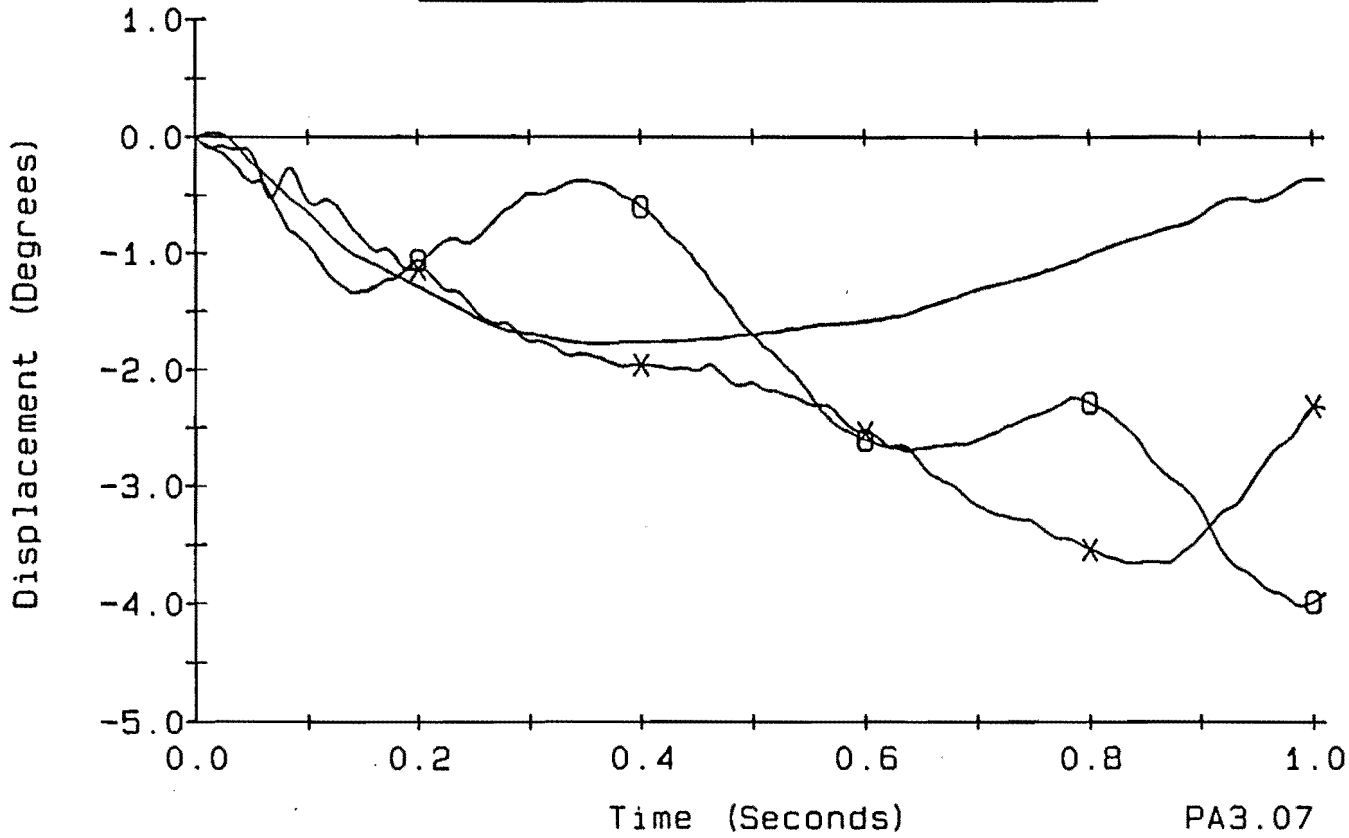
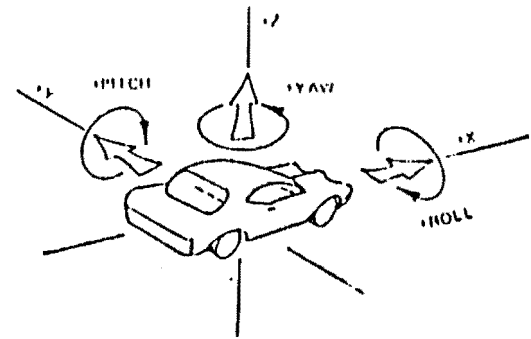
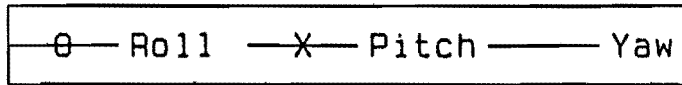

Axes are vehicle fixed.
Sequence for determining orientation is:

1. Yaw
2. Pitch
3. Roll

Figure . Vehicle angular displacements for test 19452-4.

PA3.07

CRASH TEST 19452-4

Class 180 Filter

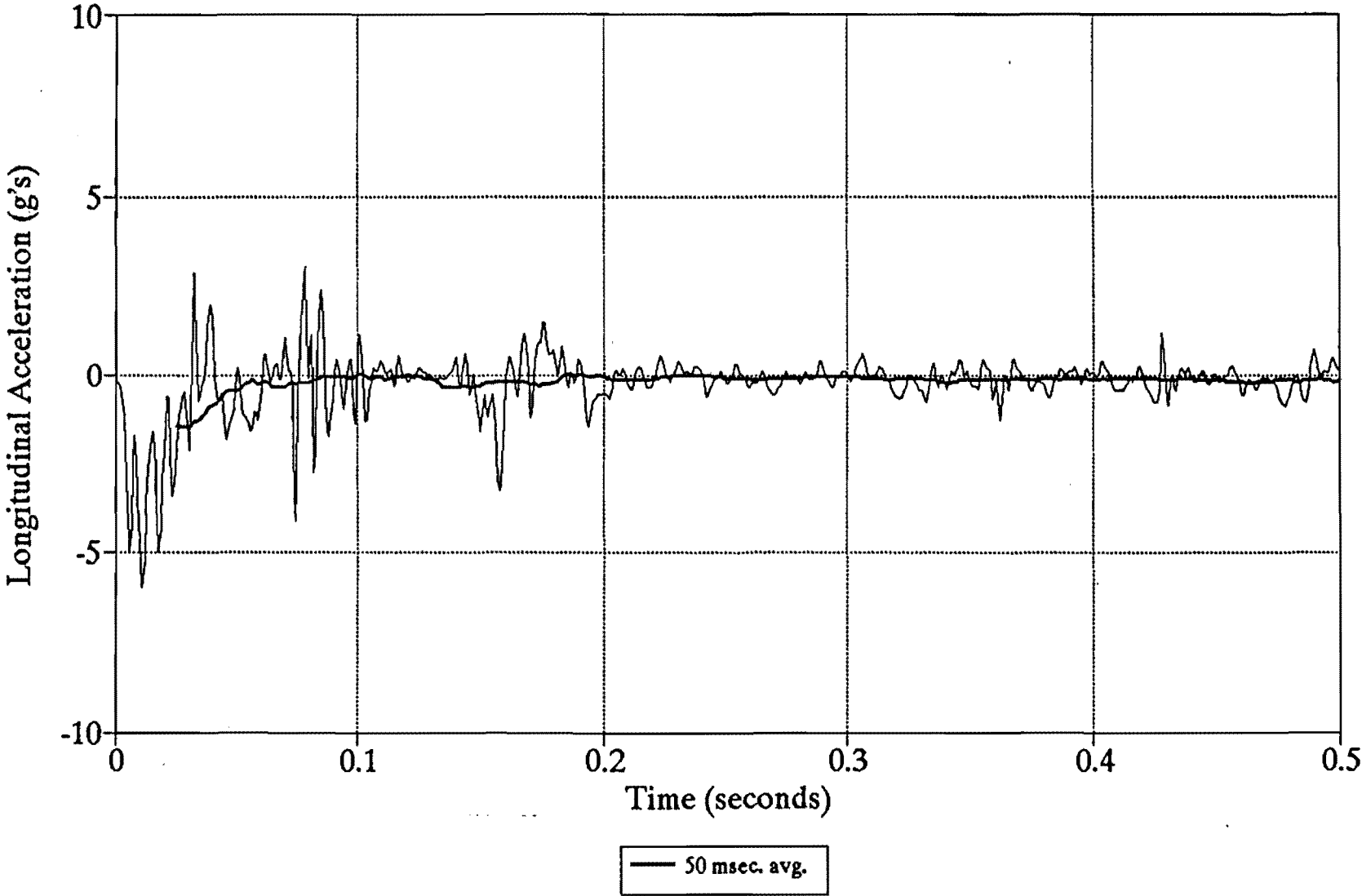

Figure . Longitudinal accelerometer trace of test 19452-4.

CRASH TEST 19452-4

Class 180 Filter

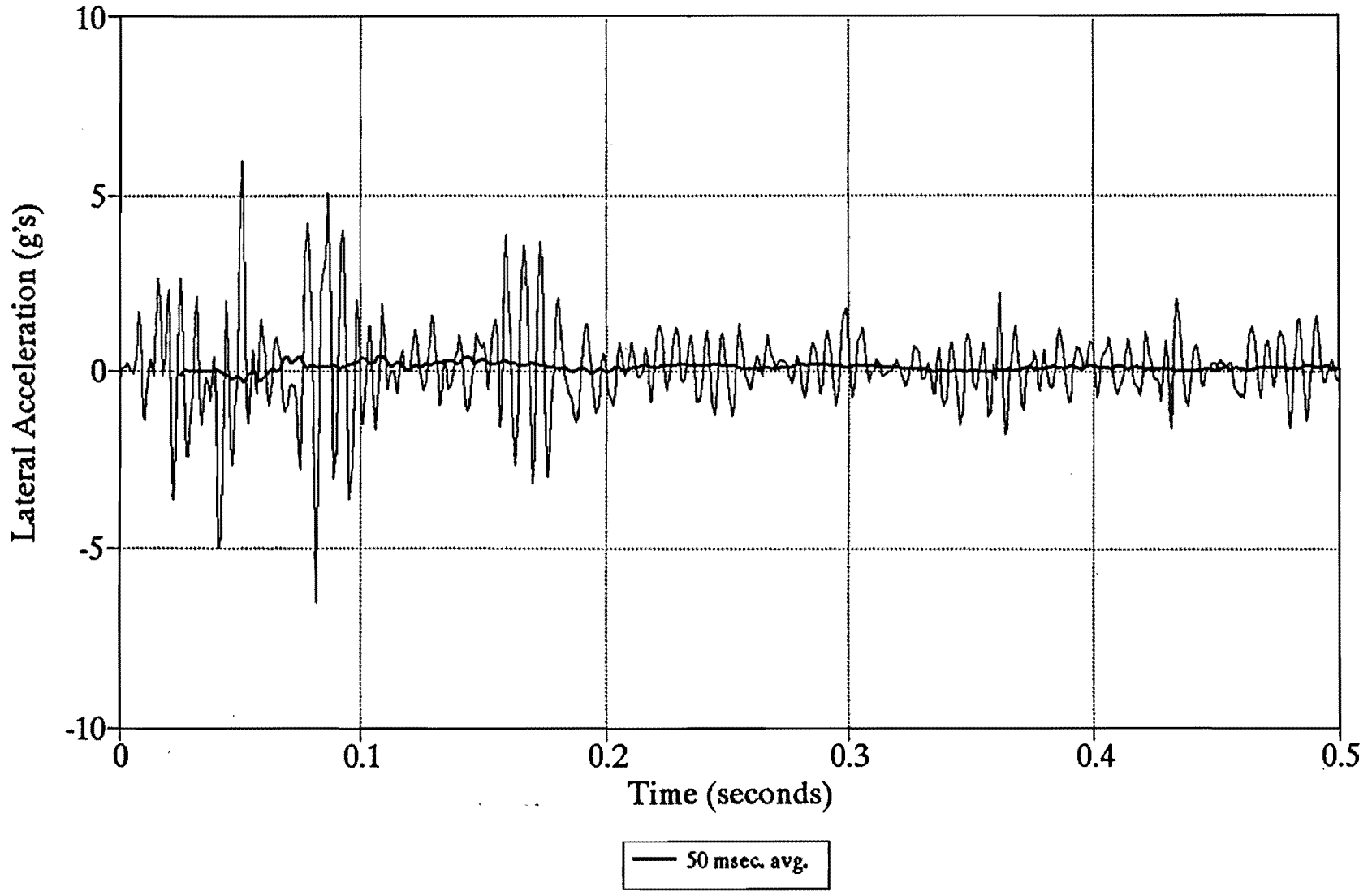

Figure . Lateral accelerometer trace of test 19452-4.

CRASH TEST 19452-4

Class 180 Filter

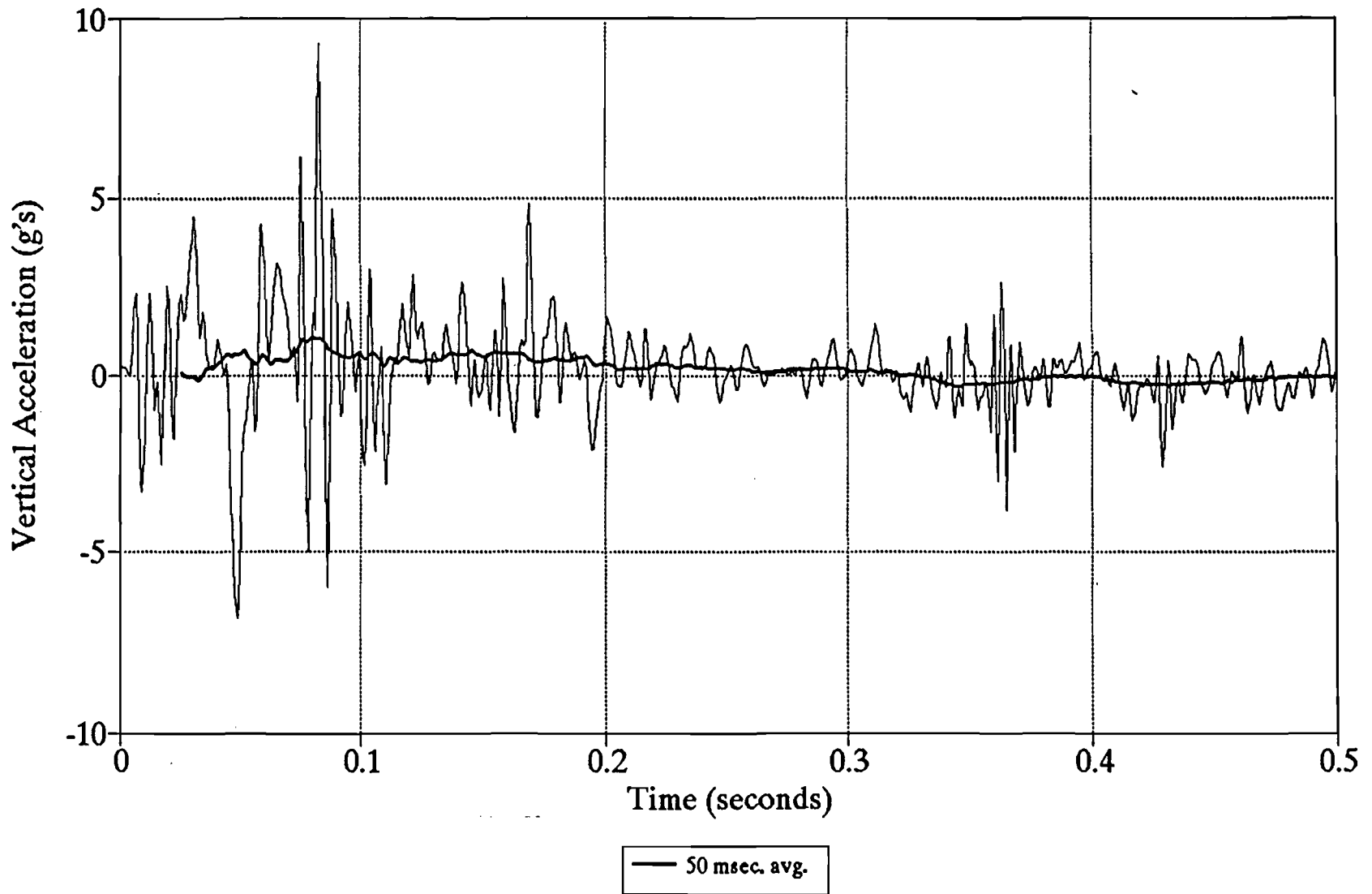

Figure . Vertical accelerometer trace of test 19452-4.

Test 19452-5

The same vehicle ('88 Yugo GV) used in tests 1 and 2 was reused for this test (shown in Figures *** & ***). The vehicle impacted a double mount type 1-1/2 mailbox installation. The impact was conducted at 62.4 miles per hour (100.4 km/h) using a cable reverse tow and guidance system. The point of impact was the front left quarter point of the vehicle bumper with the mailbox installation. Test inertia mass of the vehicle was 1,800 lb (816 kg) and its gross static mass was 1,968 lb (893 kg). The height from roadway surface to the lower edge of the vehicle bumper was 11.5 inches (29.2 cm) and 19.0 inches (48.3 cm) to the top of the bumper. Other dimensions and information on the vehicle are given in Figure ***.

The vehicle was free wheeling and unrestrained just prior to impact. Upon impact, the support began to yield and pocket around the front of the vehicle. By approximately 0.022 second, the support had yielded sufficiently enough to allow the mailboxes to strike the hood of the vehicle. Shortly thereafter, the vehicle exited with the installation pocketed around the front of the vehicle. The brakes were applied and the vehicle came to rest 275 feet (83.8 m) from the point of impact. Sequential photographs of the test are shown in Figure ***.

The installation yielded to the vehicle. The support was pulled from the ground. The mailbox installation remained essentially intact. The mailbox and support came to rest approximately 85.0 feet (25.9 m) from the point of impact. The doors and backs of the mailboxes were detached and distributed along the exit path of the vehicle. The vehicle sustained only minor damage to the bumper and hood as shown in Figure ***.

A summary of the test results and other information pertinent to this test are given in Figure ***. The maximum 0.050 second average acceleration experienced by the vehicle was -2.7 g in the longitudinal direction and 0.7 g in the lateral direction. No occupant contact occurred in the longitudinal or lateral direction. Vehicle angular displacements are plotted in Figure *** and vehicle accelerometer traces are displayed in Figures *** through ***. Change in vehicle velocity was 4.7 mi/h (7.6 km/h) and change in momentum was 385.3 lb-s.

In summary, the mailbox installation safely yielded to the vehicle. The vehicle sustained minor damage and did not present undue hazard to other traffic. There was no

deformation and no penetration into the occupant compartment. There was no occupant contact in the longitudinal or lateral directions. This installation in "strong soil" is acceptable according to the evaluation criteria recommended in NCHRP Report 230.

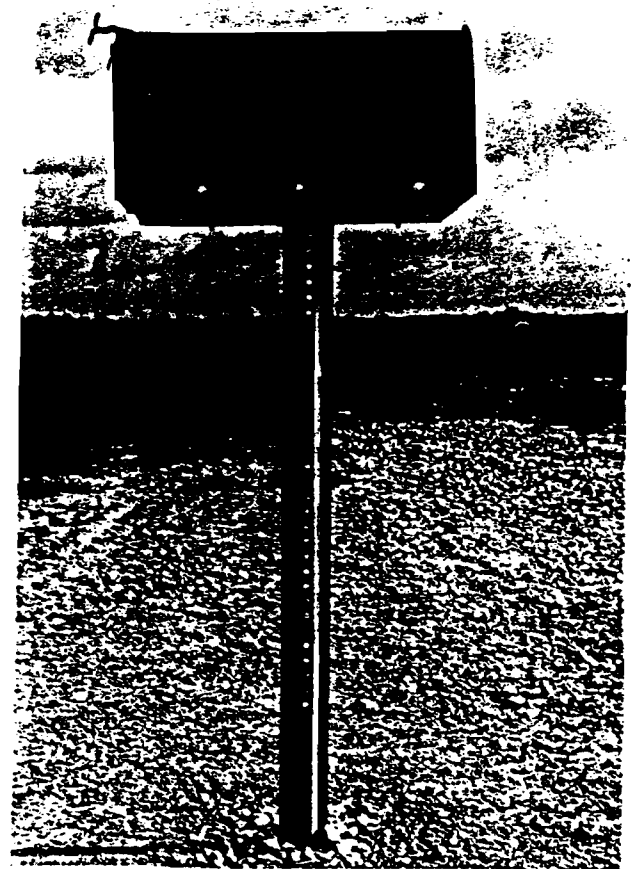
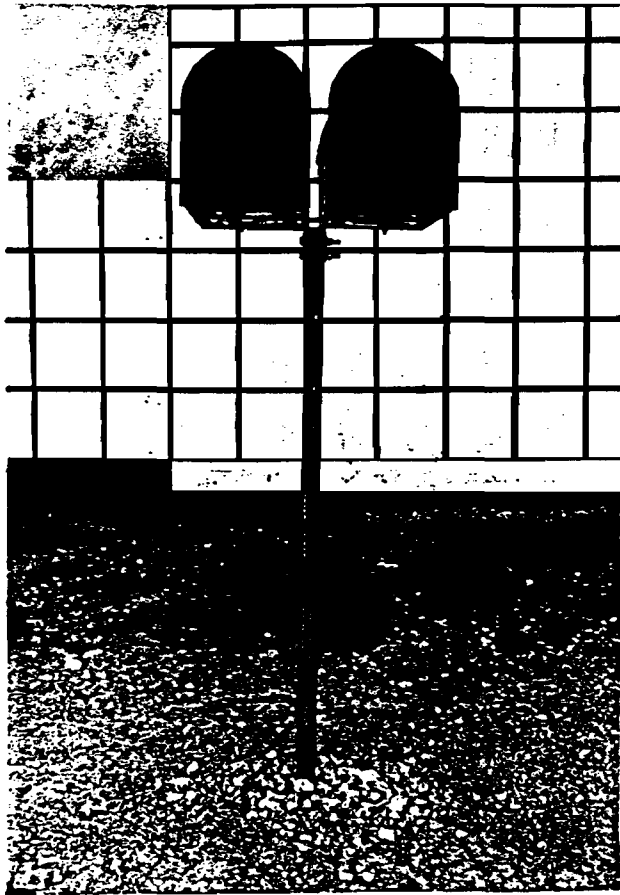

Figure . Mailbox installation before test 19452-5.

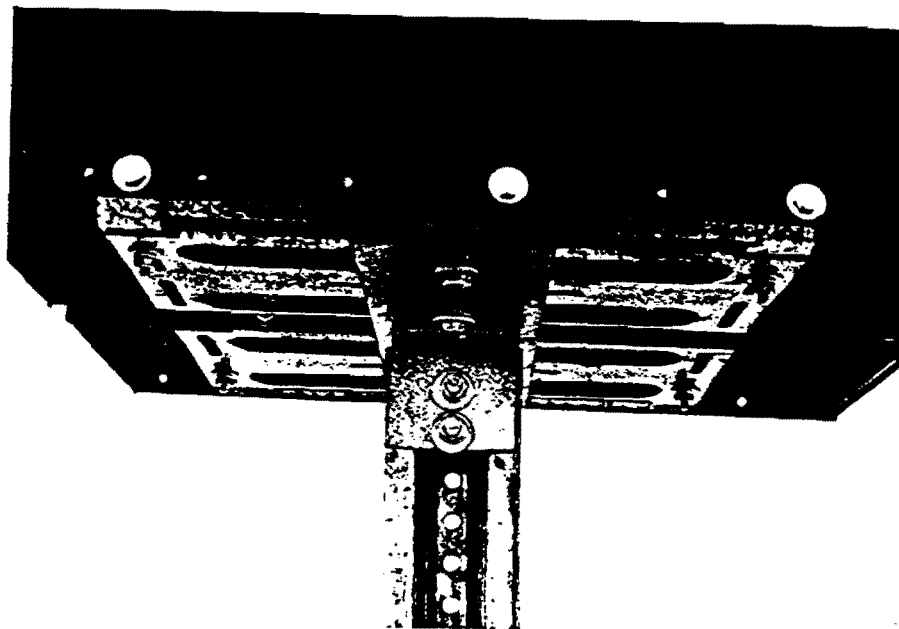

Figure . Mailbox/support Connection for installation used in test 19452-5.

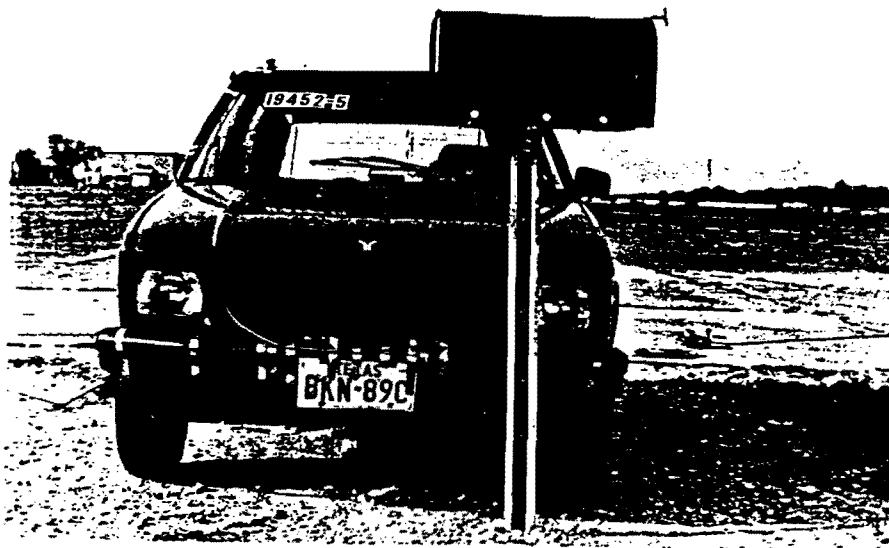
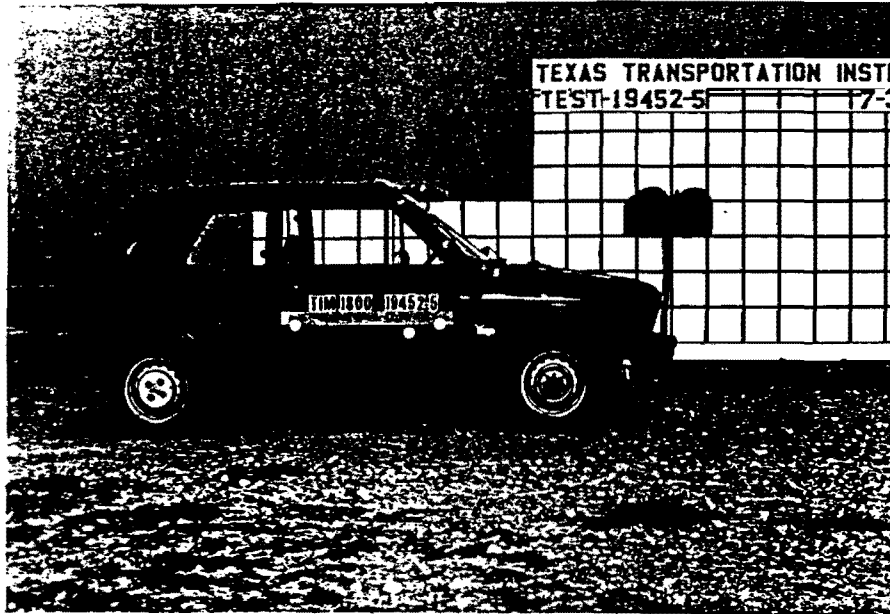

Figure . Vehicle/mailbox geometrics for test 19452-5.

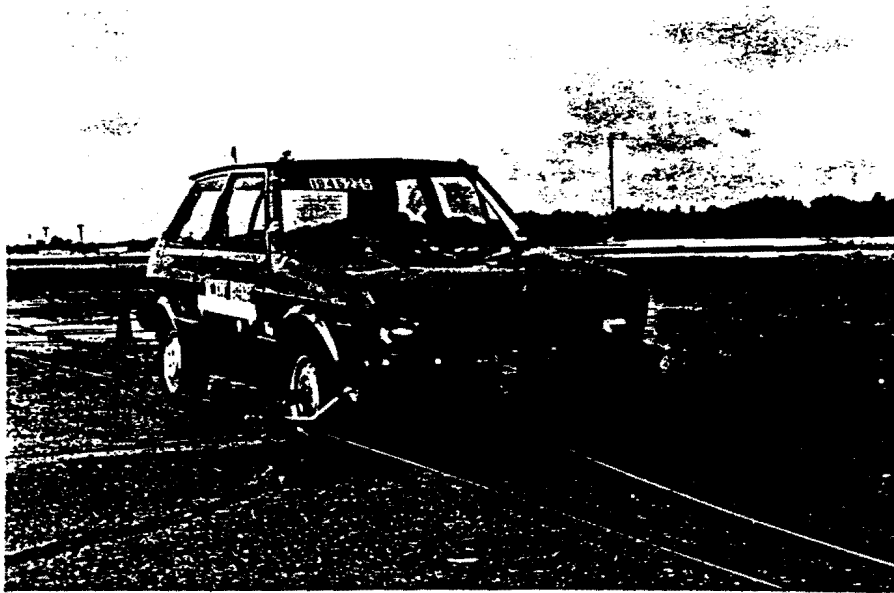
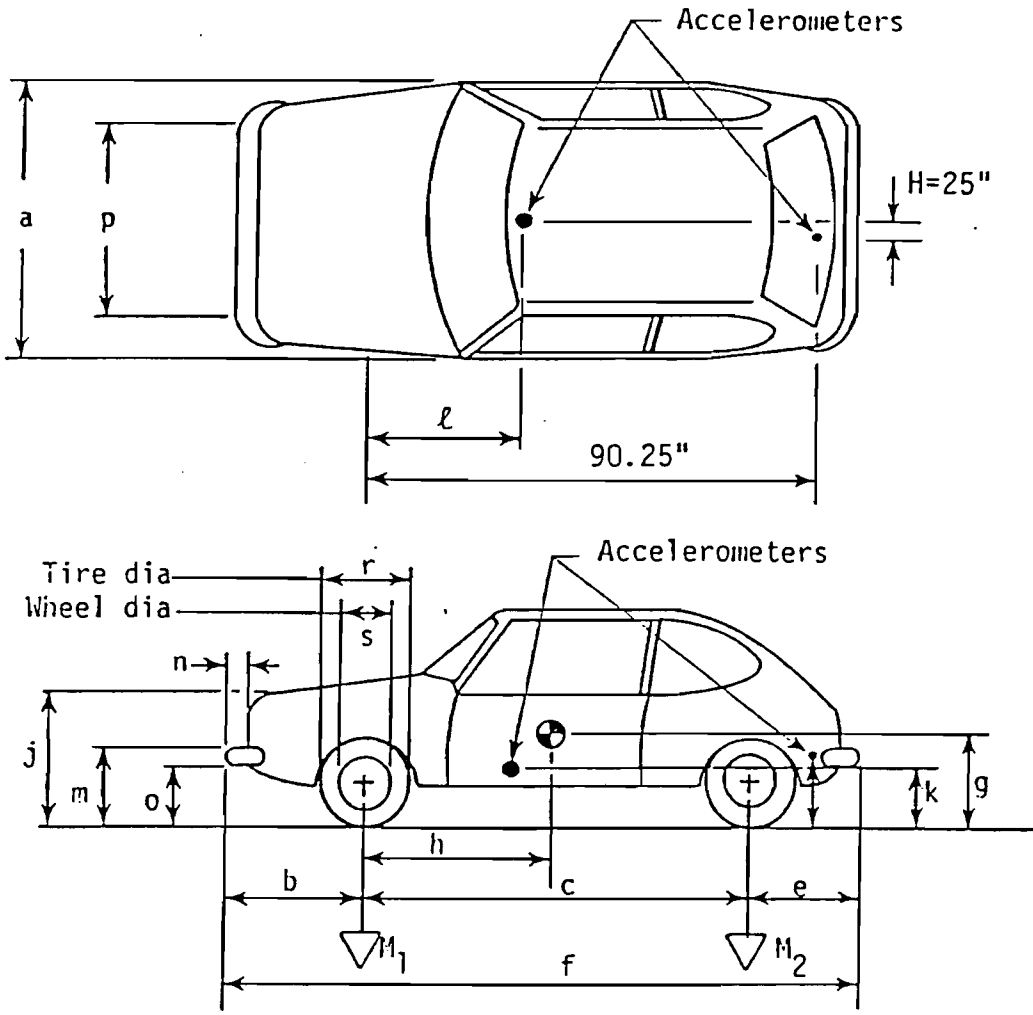

Figure . Vehicle prior to test 19452-5.

Date: 7-22-92 Test No.: 19452-1,2,5&6 VIN: VX1BA1216JK404378
 Make: YUGO Model: GV Year: 1988 Odometer: 48466
 Tire Size: 145R13 Ply Rating: _____ Bias Ply: _____ Belted: _____ Radial: X

Tire Condition: good X
 fair _____
 badly worn _____



Vehicle Geometry - inches

a	<u>59.75"</u>	b	<u>27.5"</u>
c	<u>85.25"</u>	d*	<u>56.5"</u>
e	<u>24"</u>	f	<u>136.75"</u>
g	_____	h	<u>32.8"</u>
i	_____	j	<u>31"</u>
k	<u>15.5"</u>	l	<u>32"</u>
m	<u>20.25"</u>	n	<u>2.75"</u>
o	<u>14.75"</u>	p	<u>50.5"</u>
r	<u>22.75"</u>	s	<u>14.25"</u>

4-wheel weight for c.g. det. lf 551 rf 556 lr 344 rr 349

Mass - pounds	Curb	Test Inertial	Gross Static
M ₁	<u>1182</u>	<u>1107</u>	<u>1192</u>
M ₂	<u>627</u>	<u>693</u>	<u>776</u>
M _T	<u>1809</u>	<u>1800</u>	<u>1968</u>

Note any damage to vehicle prior to test:

Engine Type: V4 Gas
 Engine CID: 1.1 L
 Transmission Type:

Automatic or Manual
 FWD ~~XXXXXXXXXXXX~~
 Body Type: 3 Door

Steering Column Collapse Mechanism:
 ___ Behind wheel units
 ___ Convoluted tube
 ___ Cylindrical mesh units
 ___ Embedded ball
 ___ NOT collapsible
 ___ (Other energy absorption
 ___ Unknown

Brakes:
 Front: disc X drum _____
 Rear: disc _____ drum X

*d = overall height of vehicle

Figure . Test vehicle properties (19452-1,2,5&6).

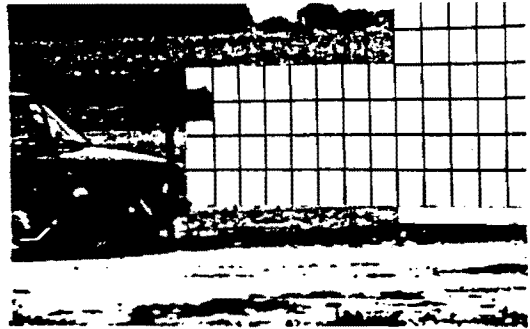
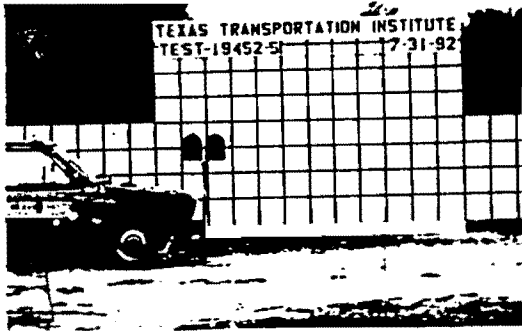

0.000 s

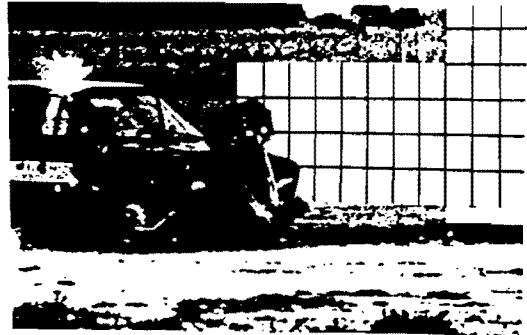
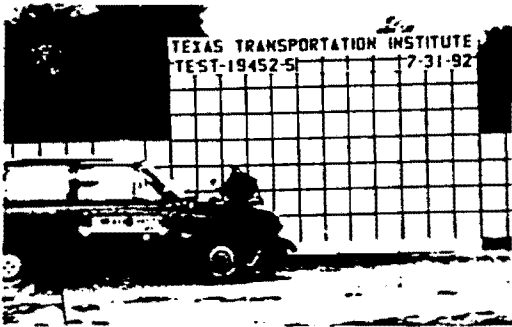

0.027 s

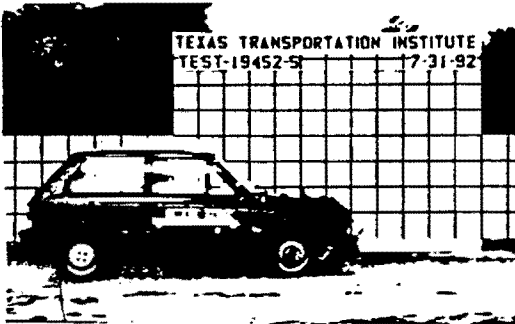

0.055 s

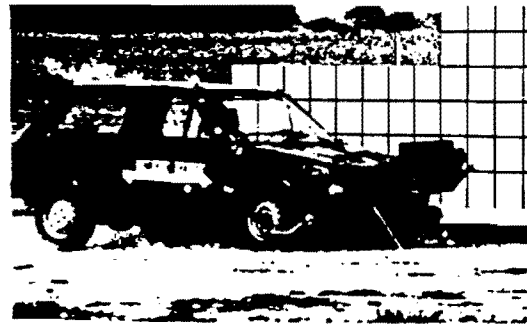
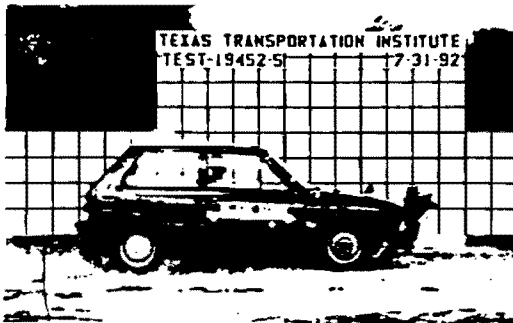

0.082 s

Figure . Sequential photographs for test 19542-5.
(perpendicular and side views)

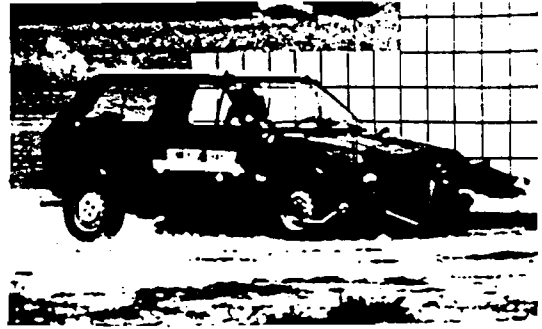
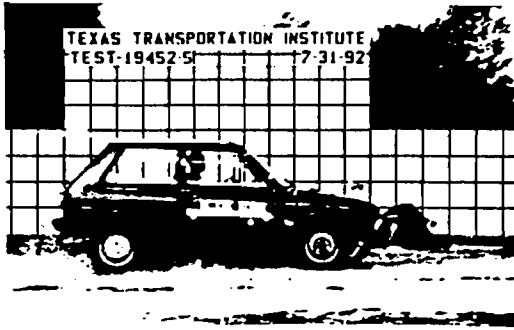

0.109 s

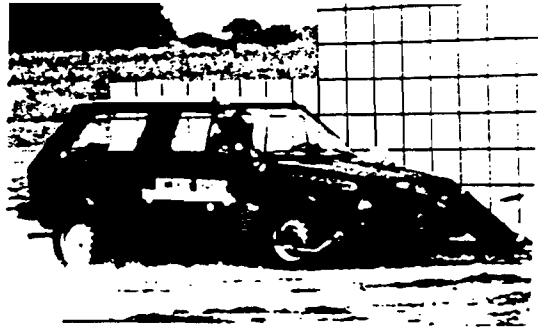
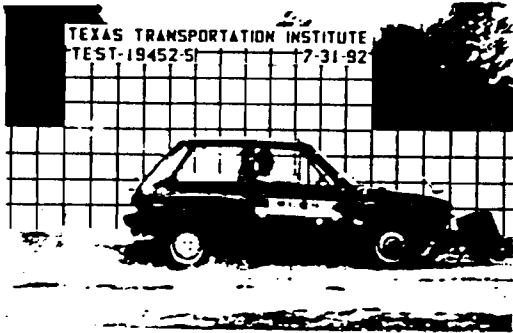

0.136 s

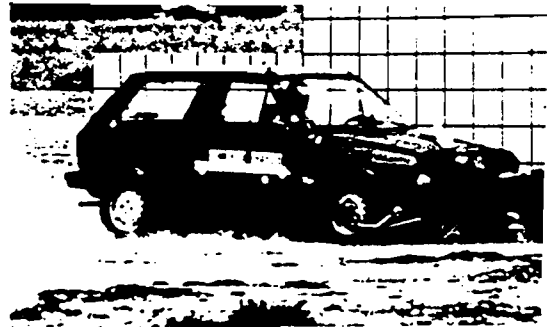
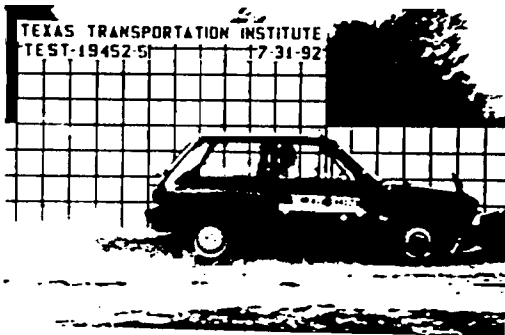

0.164 s

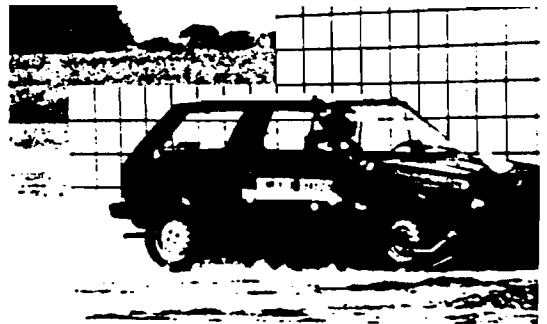
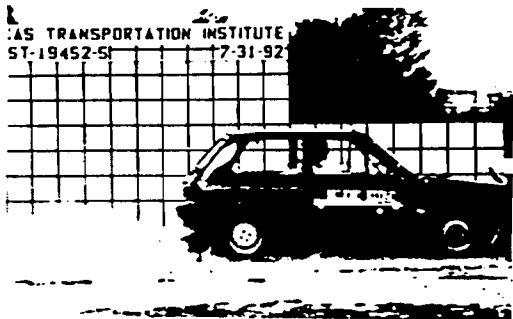

0.191 s

Figure . Sequential photographs for test 19542-5.
(perpendicular and side views) cont.



Figure . Test installation after test 19452-5.

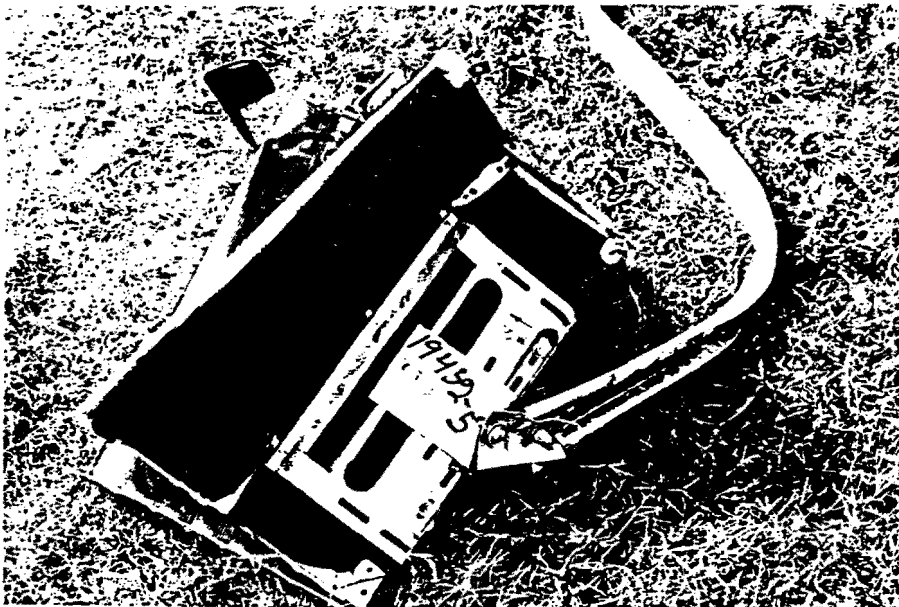
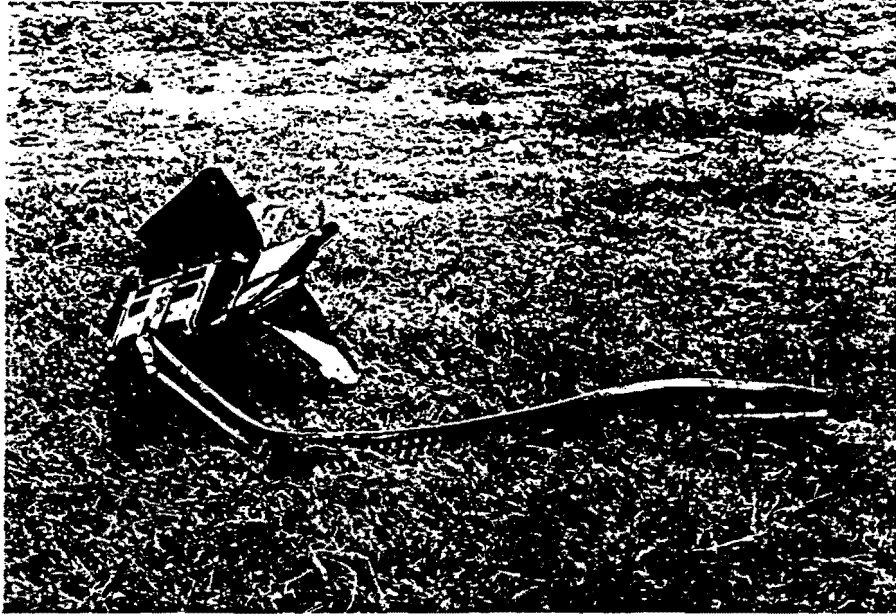

Figure . Damage to installation after test 19452-5.

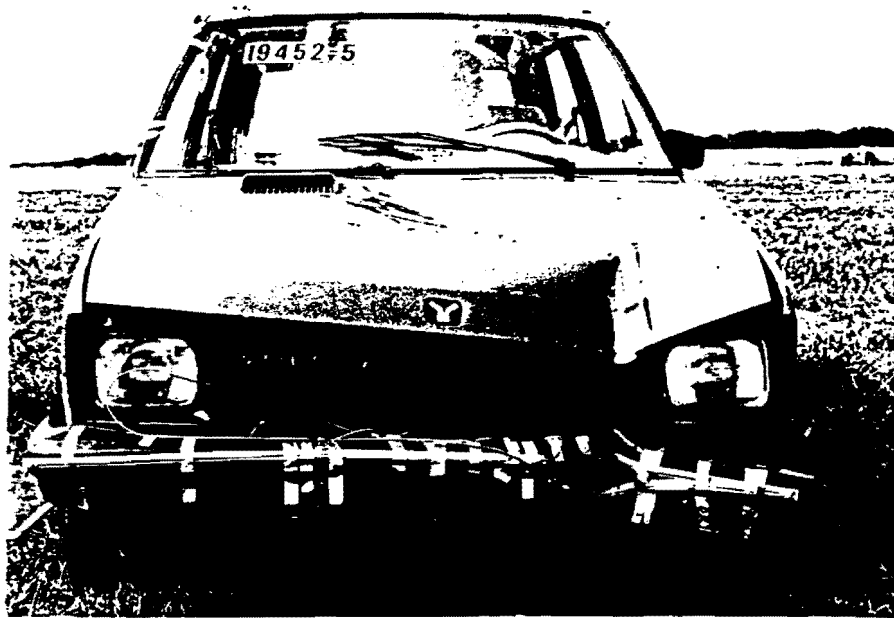
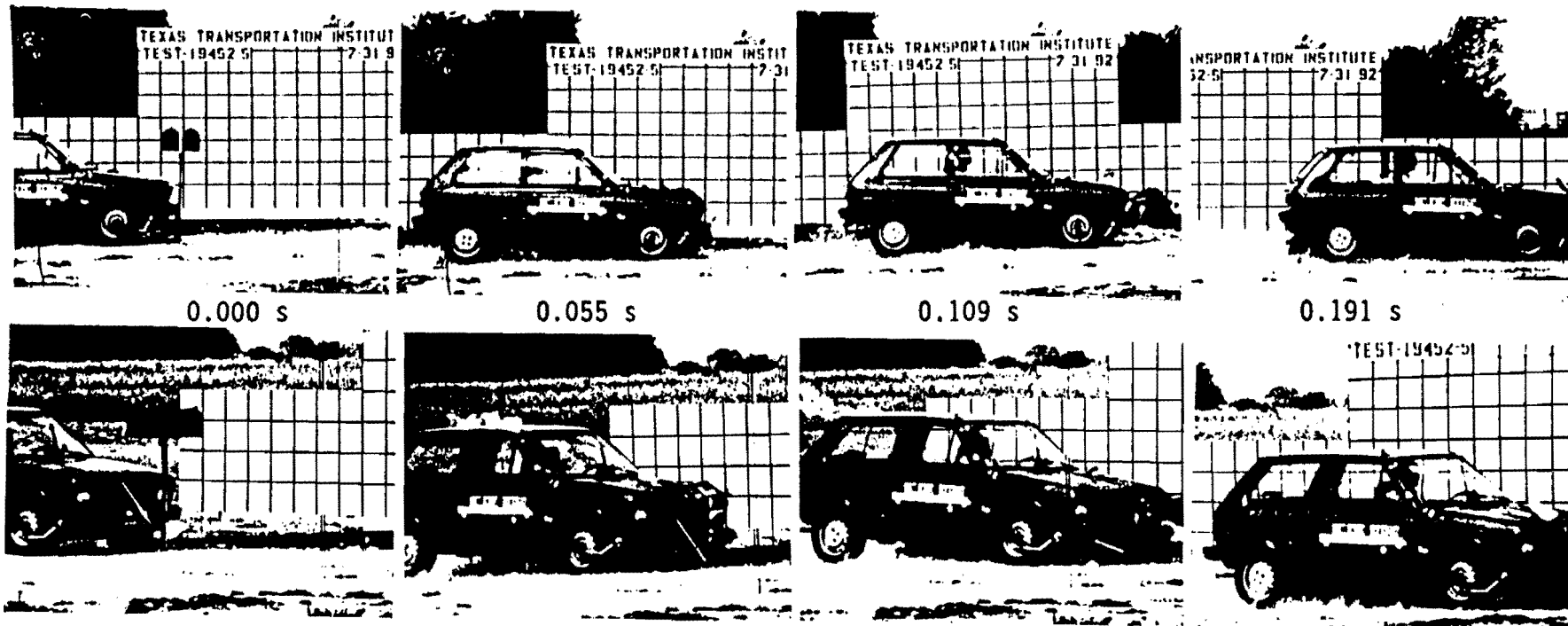

Figure . . . Vehicle after test 19452-5.



Figure . Anthropometric dummy before and after test 19452-5.



Test No19452-5.	Impact Speed.	62.4 mi/h (100.4 km/h)
Date07/31/92.	Change in Velocity. . .	4.7 mi/h (7.6 km/h)
Test Article	Double mount, Type 1 1/2 Mailbox Installation.	Change in Momentum. . .	385.3 lb-s
Support	Type 4 (2 lb/ft winged channel post)	Vehicle Accelerations (Max. 0.050-sec Avg)	
Embedment.	2'-0" driven(strong soil)	Longitudinal. . .	-2.7 g
Vehicle	1988 Yugo GV	Lateral	0.7 g
Vehicle Weight		Occupant Impact Velocity	
Test Inertia	1800 lb (816 kg)	Longitudinal. . .	N/A
Gross Static	1968 lb (893 kg)	Lateral	N/A
Vehicle Damage Classification		Occupant Ridedown Accelerations	
TAD	12-FL-1	Longitudinal. . .	No contact
SAE	12FLEN1	Lateral	No contact

Figure . Summary of results for test 19452-5.

CRASH TEST 19452-8

Class 180 Filter

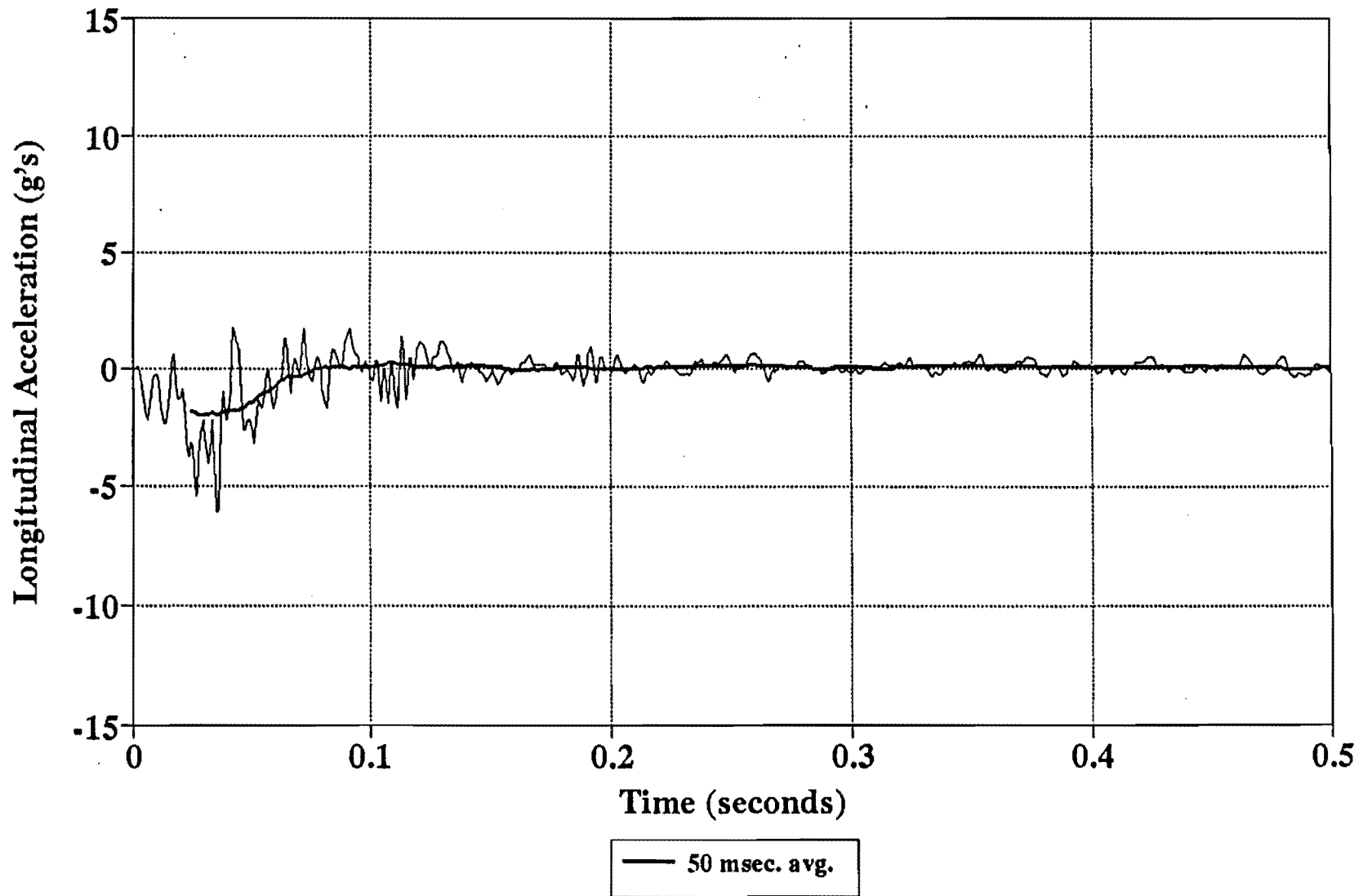

Figure . Longitudinal accelerometer trace for test 19452-8.

CRASH TEST 19452-8

Class 180 Filter

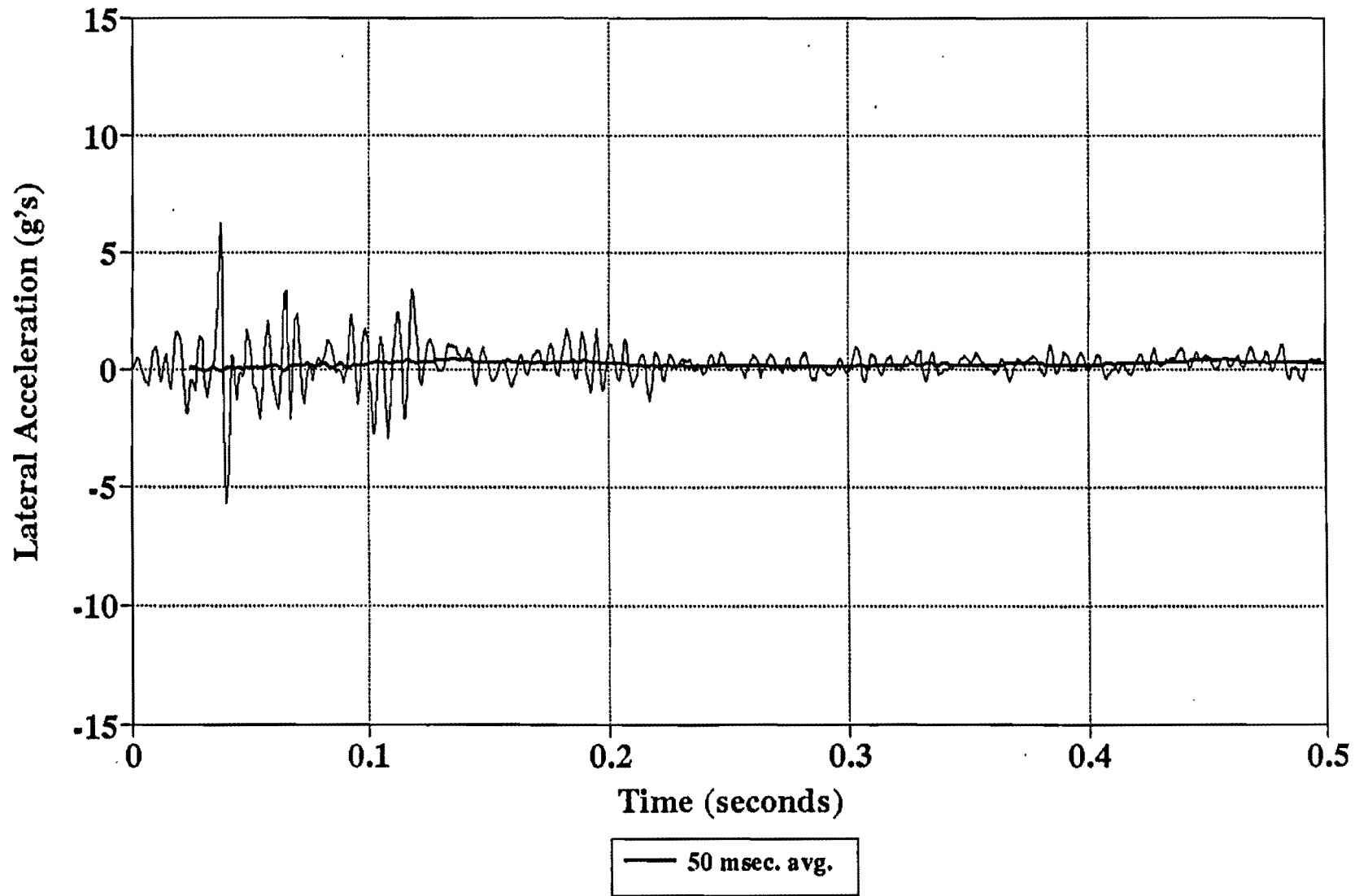
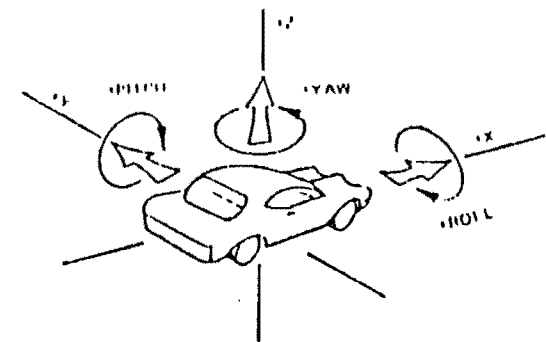
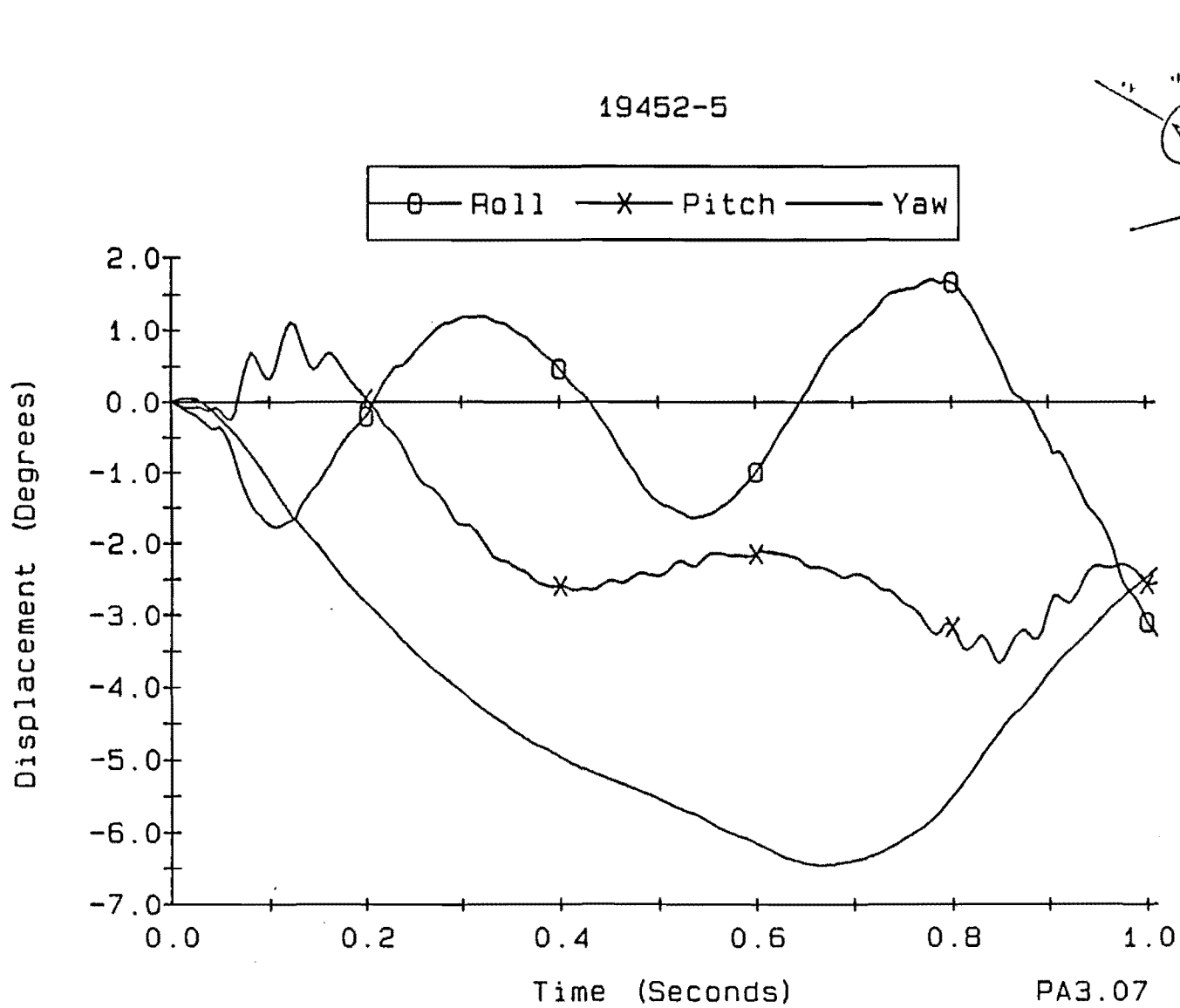

Figure . Lateral accelerometer trace for test 19452-8.



Axes are vehicle fixed.
Sequence for determining orientation is:

1. Yaw
2. Pitch
3. Roll

Figure . Vehicle angular displacements for test 19452-5.

CRASH TEST 19452-5

Class 180 Filter

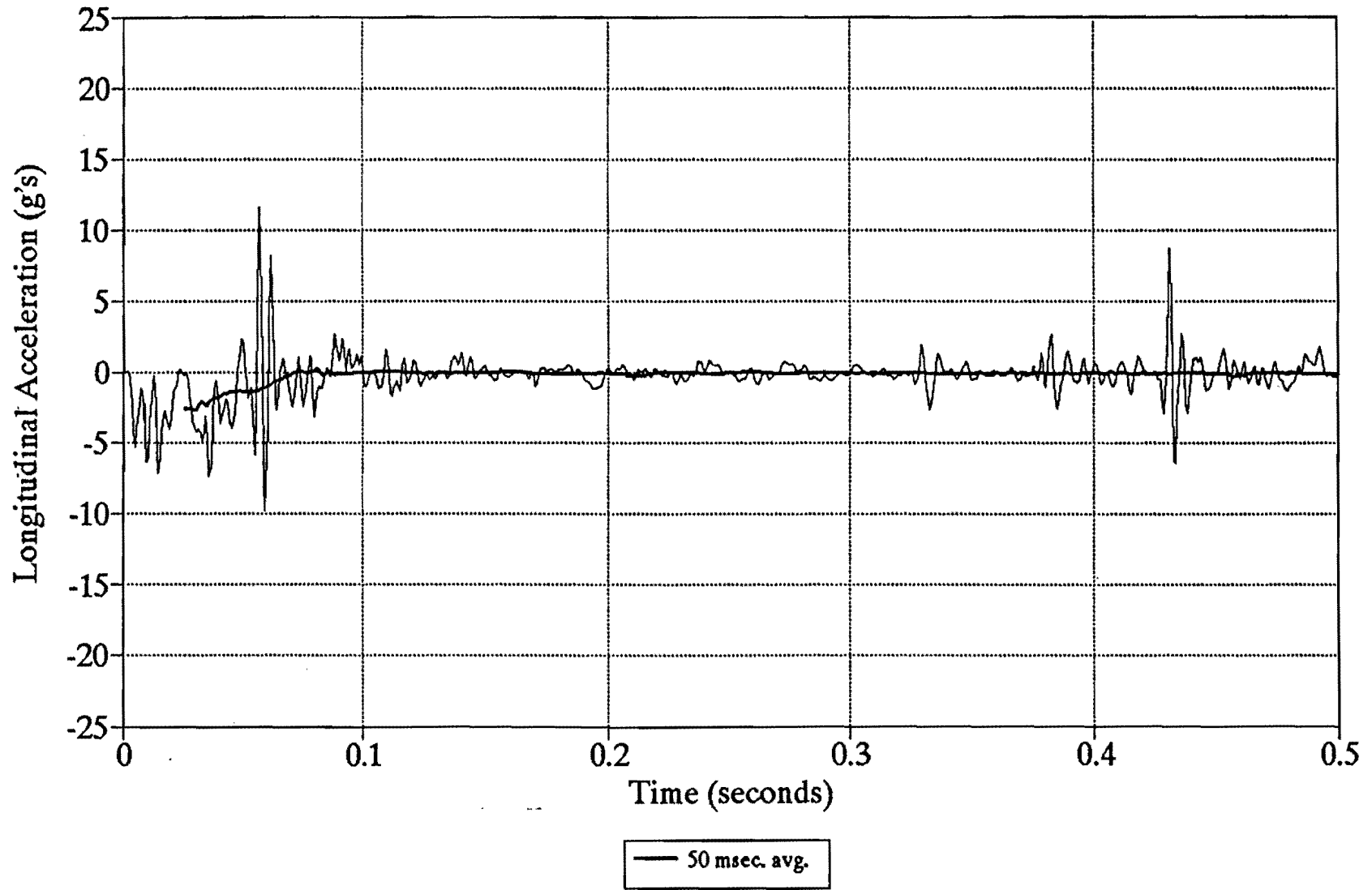

Figure . Longitudinal accelerometer trace of test 19452-5.

CRASH TEST 19452-5

Class 180 Filter

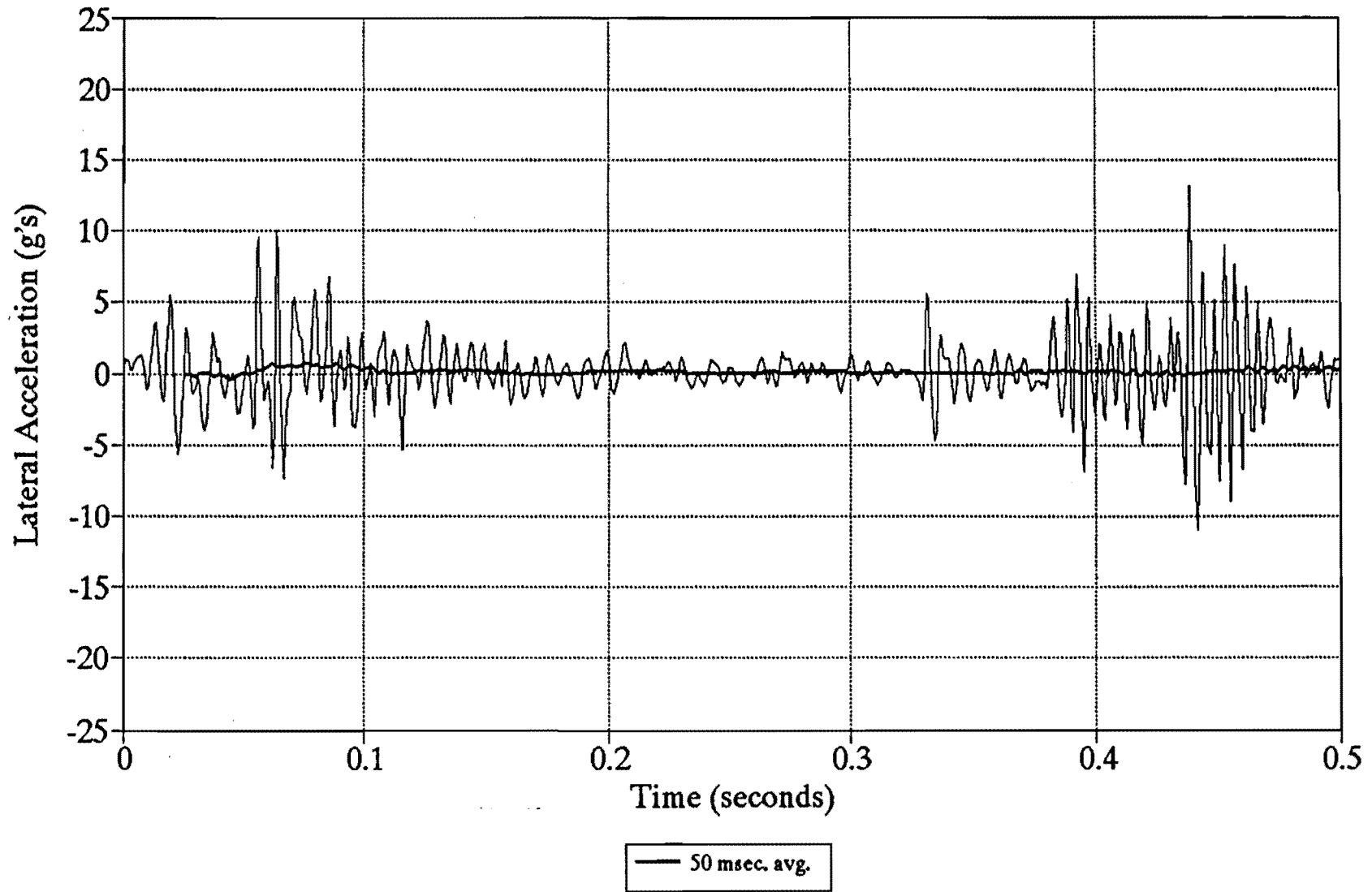

Figure . Lateral accelerometer trace of test 19452-5.

CRASH TEST 19452-5

Class 180 Filter

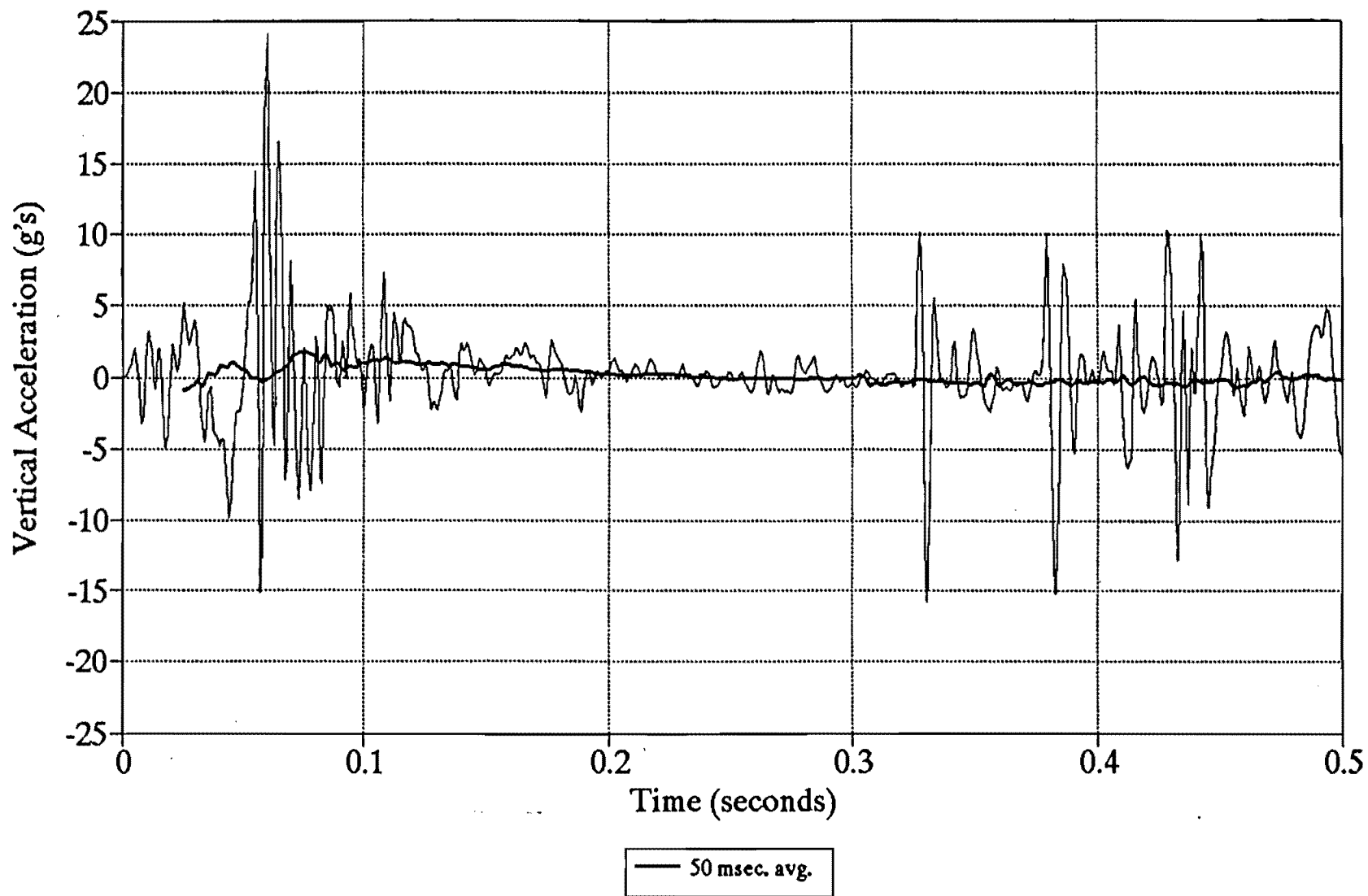

Figure . Vertical accelerometer trace of test 19452-5.

Test 19452-6

The same 1987 Yugo GV used in test 5 impacted a single mount type 2 mailbox installation. The impact was conducted at 60.9 miles per hour (98.0 km/h) using a cable reverse tow and guidance system. The point of impact was the front left quarter point of the vehicle bumper with the mailbox installation. Test inertia mass of the vehicle was 1,800 lb (816 kg) and its gross static mass was 1,968 lb (893 kg).

The vehicle was free wheeling and unrestrained just prior to impact. Upon impact, the support began to yield and by 0.020 second, the mailbox had detached from the support. At approximately 0.040 second, the mailbox struck the hood of the vehicle, thereafter slid up the windshield and up and over the upper A-pillar. As the vehicle lost contact with the installation, the brakes were applied and the vehicle came to rest 295 feet (89.9 m) from the point of impact. Sequential photographs of the test are shown in Figure ***.

The installation yielded to the vehicle. The support was pulled from the ground and came to rest 20 feet (6.1 m) from the point of impact. In addition, the mailbox came to rest approximately 108.0 feet (32.9 m) from the point of impact. The vehicle sustained only minor damage to the bumper and hood as shown in Figure ***.

A summary of the test results and other information pertinent to this test are given in Figure ***. The maximum 0.050 second average acceleration experienced by the vehicle was -1.9 g in the longitudinal direction and 0.6 g in the lateral direction. No occupant contact occurred in the longitudinal or lateral direction. Vehicle angular displacements are plotted in Figure *** and vehicle accelerometer traces are displayed in Figures *** through ***. Change in vehicle velocity was 2.3 mi/h (3.7 km/h) and change in momentum was 190.2 lb-s.

In summary, the mailbox installation safely yielded to the vehicle. The vehicle sustained minor damage and did not present undue hazard to other traffic. There was no deformation and no penetration into the occupant compartment. There was no occupant contact in the longitudinal or lateral directions. This installation in "strong soil" is acceptable according to the evaluation criteria recommended in NCHRP Report 230.

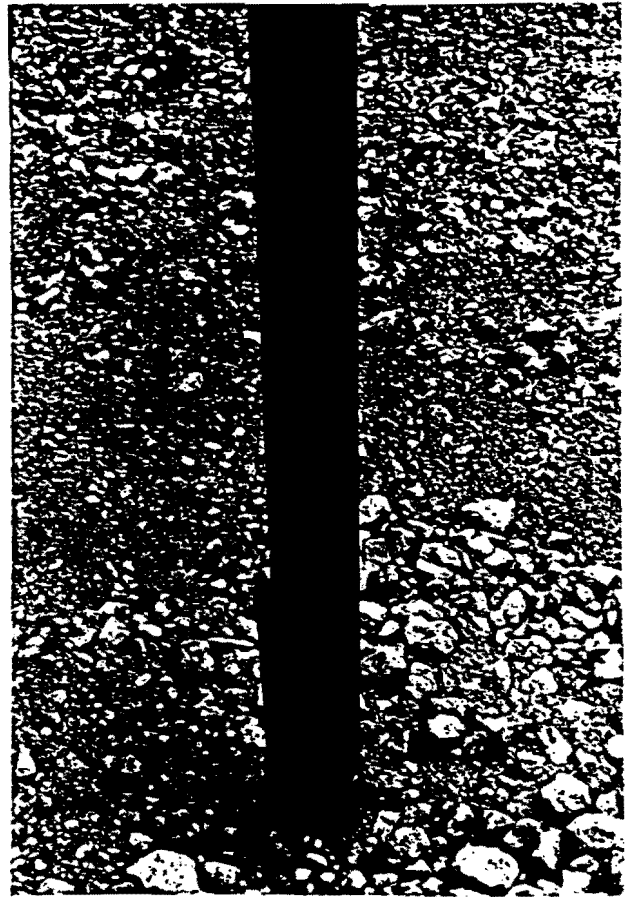
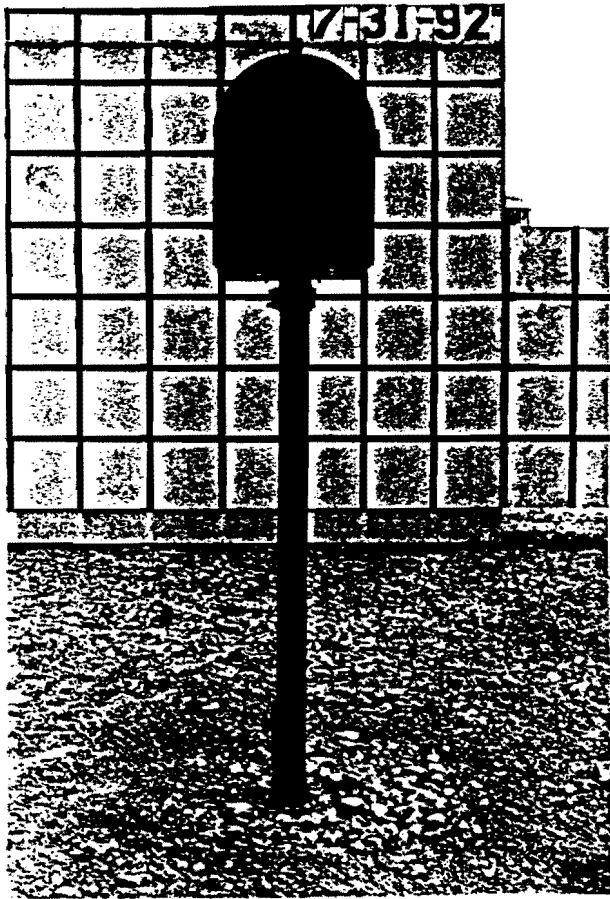
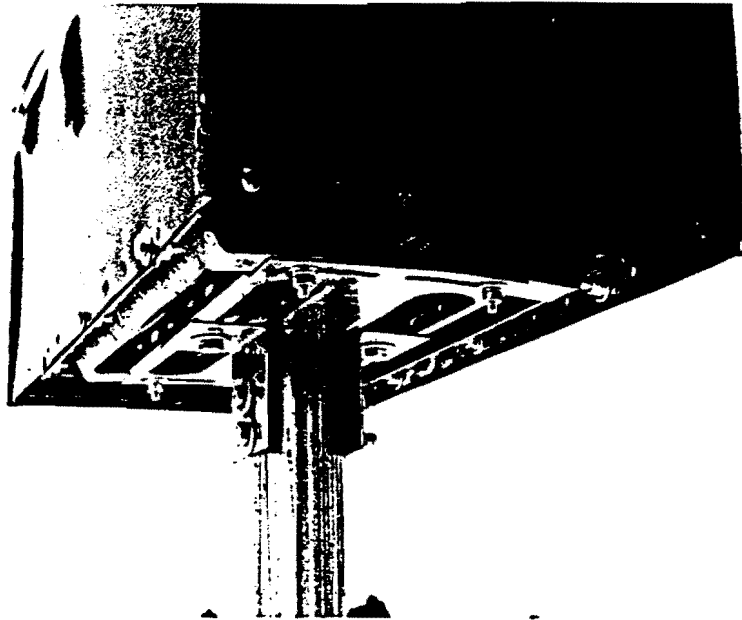

Figure . Mailbox installation before test 19452-6.



NSI
2-6

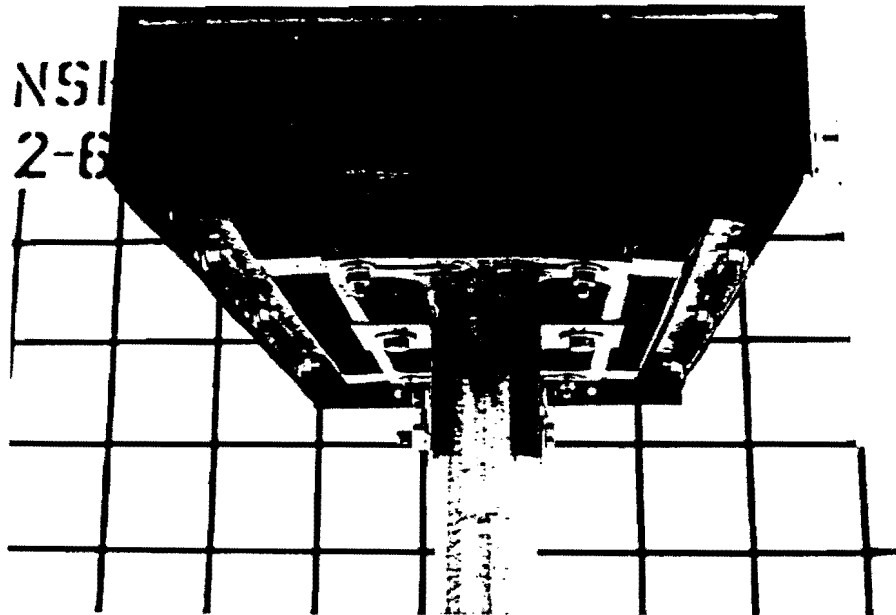

Figure . Mailbox/support Connection for installation used in test 19452-6.

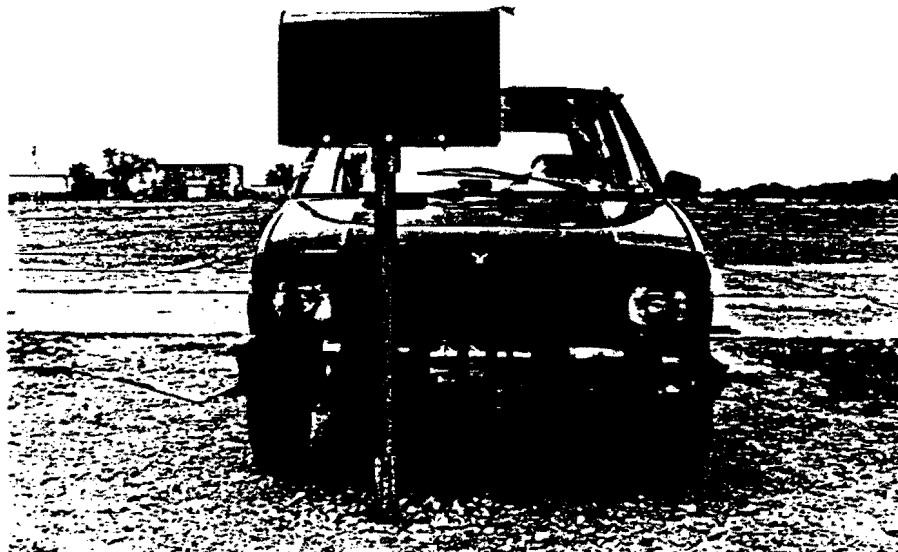

Figure . Vehicle/mailbox geometrics for test 19452-6.

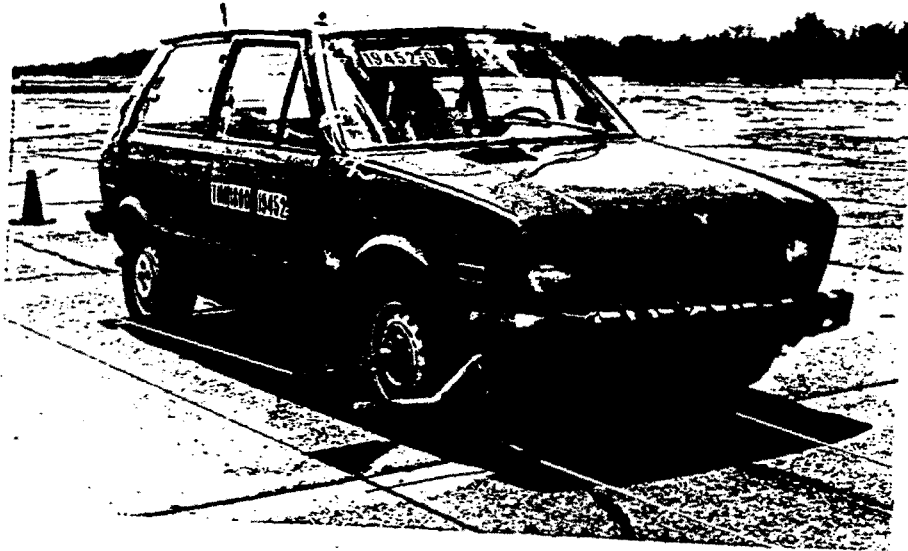
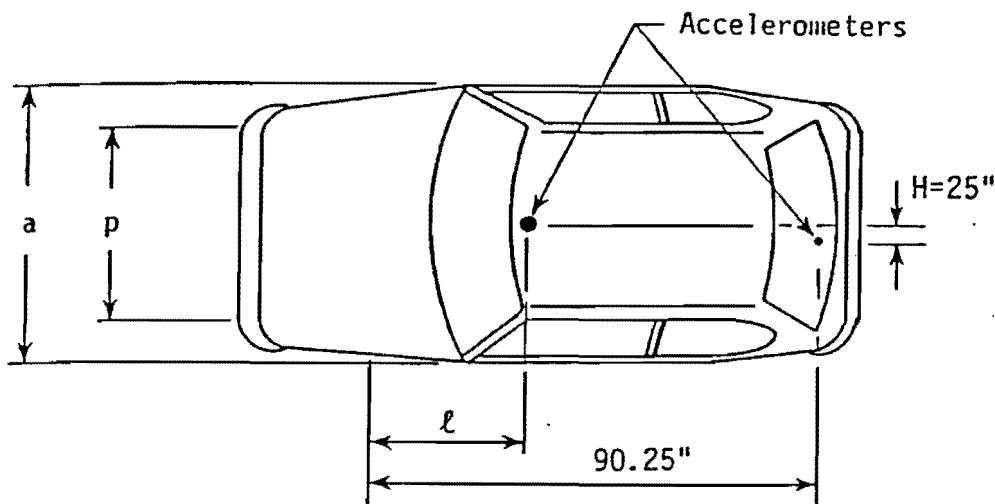

Figure . Vehicle prior to test 19452-6.

Date: 7-22-92 Test No.: 19452-1,2,5&6 VIN: VX1BA1216JK404378
 Make: YUGO Model: GV Year: 1988 Odometer: 48466
 Tire Size: 145R13 Ply Rating: _____ Bias Ply: _____ Belted: _____ Radial: X

Tire Condition: good X
 fair _____
 badly worn _____



Vehicle Geometry - inches

a	<u>59.75"</u>	b	<u>27.5"</u>
c	<u>85.25"</u>	d*	<u>56.5"</u>
e	<u>24"</u>	f	<u>136.75"</u>
g	_____	h	<u>32.8"</u>
i	_____	j	<u>31"</u>
k	<u>15.5"</u>	l	<u>32"</u>
m	<u>20.25"</u>	n	<u>2.75"</u>
o	<u>14.75"</u>	p	<u>50.5"</u>
r	<u>22.75"</u>	s	<u>14.25"</u>

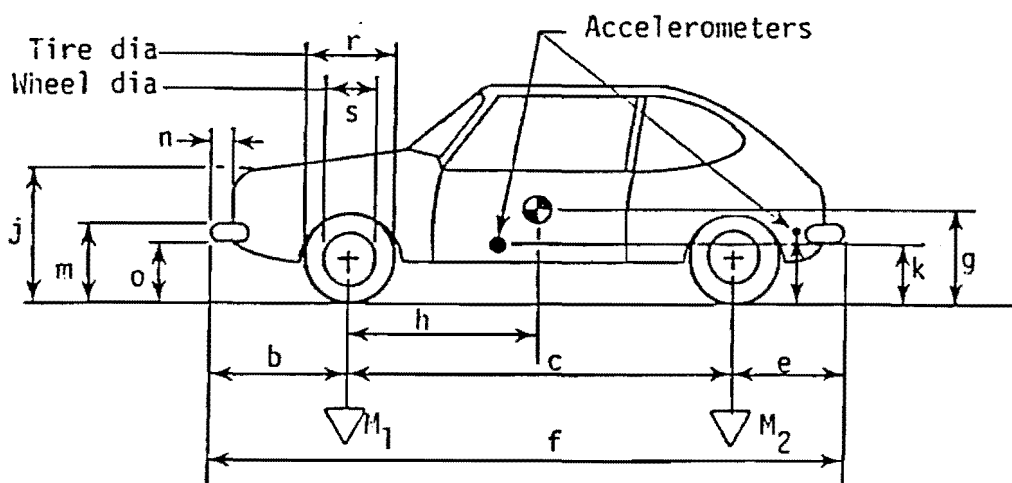

Engine Type: V4 Gas
 Engine CID: 1.1 L

Transmission Type:
 Automatic or Manual
 FWD ~~XXXXXX~~

Body Type: 3 Door

Steering Column Collapse Mechanism:

- Behind wheel units
- Convoluted tube
- Cylindrical mesh units
- Embedded ball
- NOT collapsible
- Other energy absorption
- Unknown

4-wheel weight for c.g. det. lf 551 rf 556 lr 344 rr 349

Mass - pounds	Curb	Test Inertial	Gross Static
M ₁	<u>1182</u>	<u>1107</u>	<u>1192</u>
M ₂	<u>627</u>	<u>693</u>	<u>776</u>
M _T	<u>1809</u>	<u>1800</u>	<u>1968</u>

Note any damage to vehicle prior to test:

Brakes:
 Front: disc X drum _____
 Rear: disc _____ drum X

*d = overall height of vehicle

Figure . Test vehicle properties (19452-1,2,5&6).

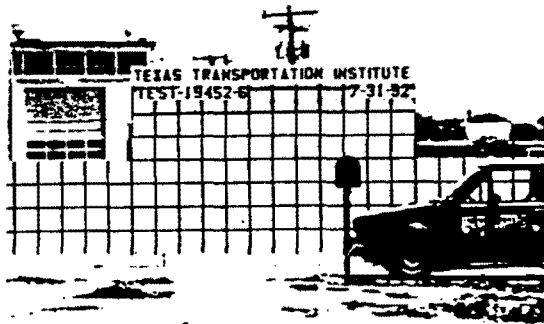

0.000 s

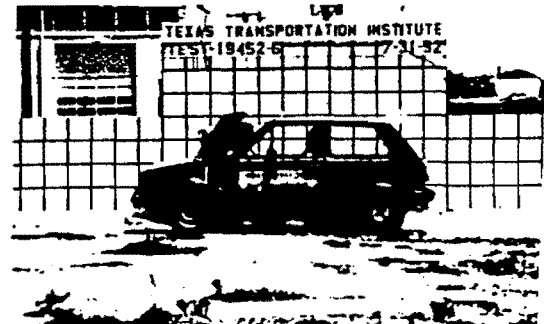

0.109 s

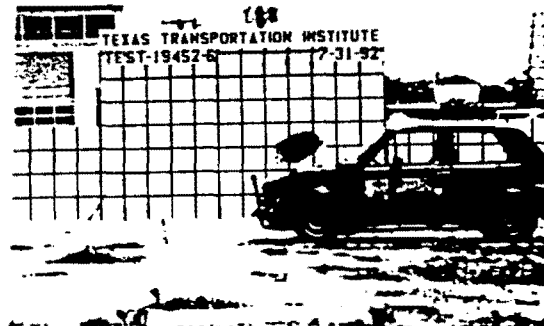

0.027 s

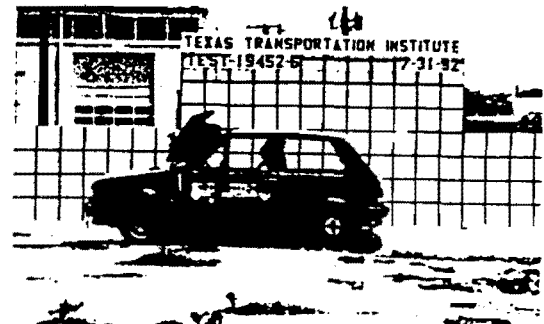

0.137 s

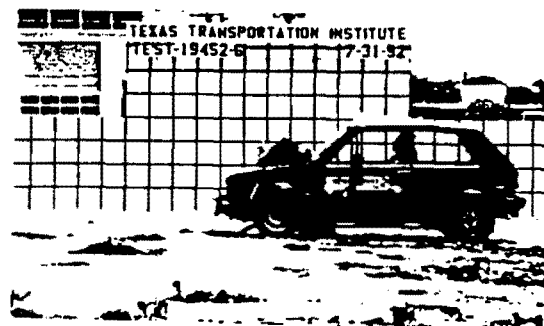

0.055 s

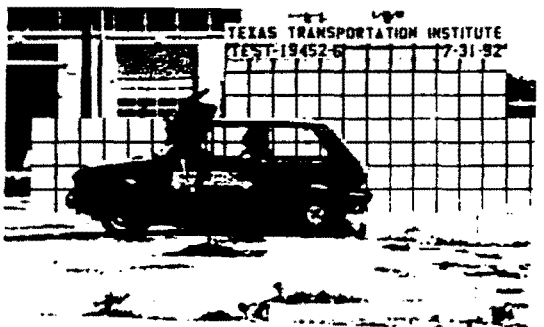

0.164 s



0.082 s



0.191 s

Figure . Sequential photographs for test 19452-6.
(perpendicular view).

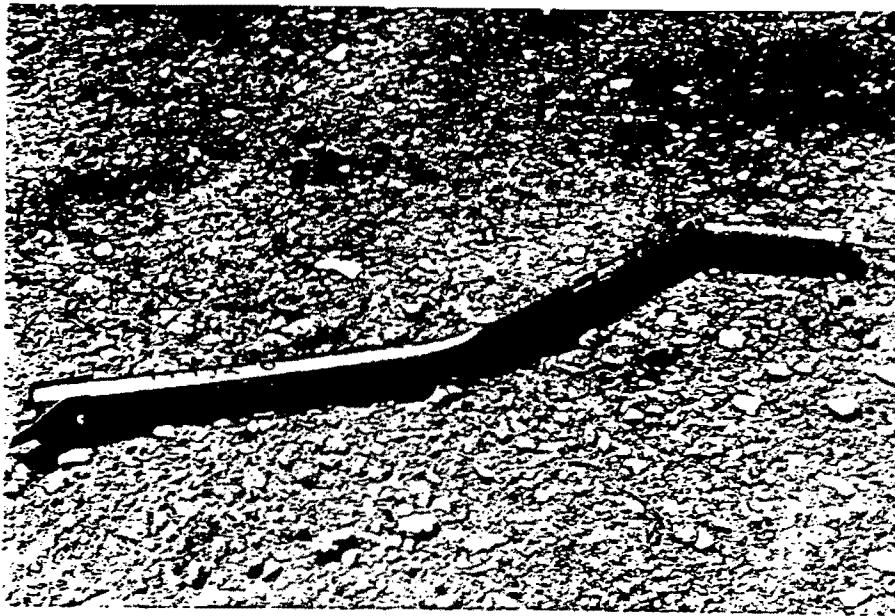

Figure . Damage to support after test 19452-6.

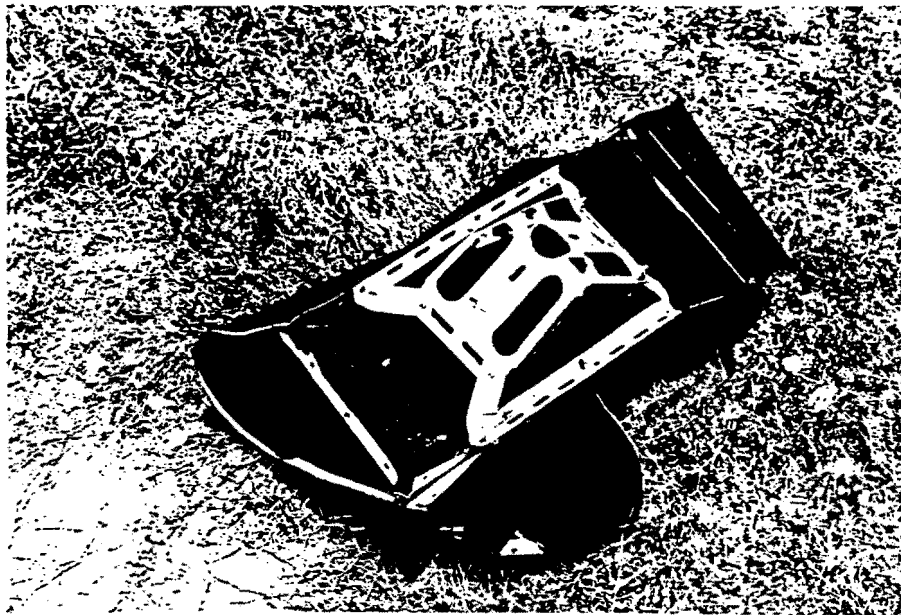
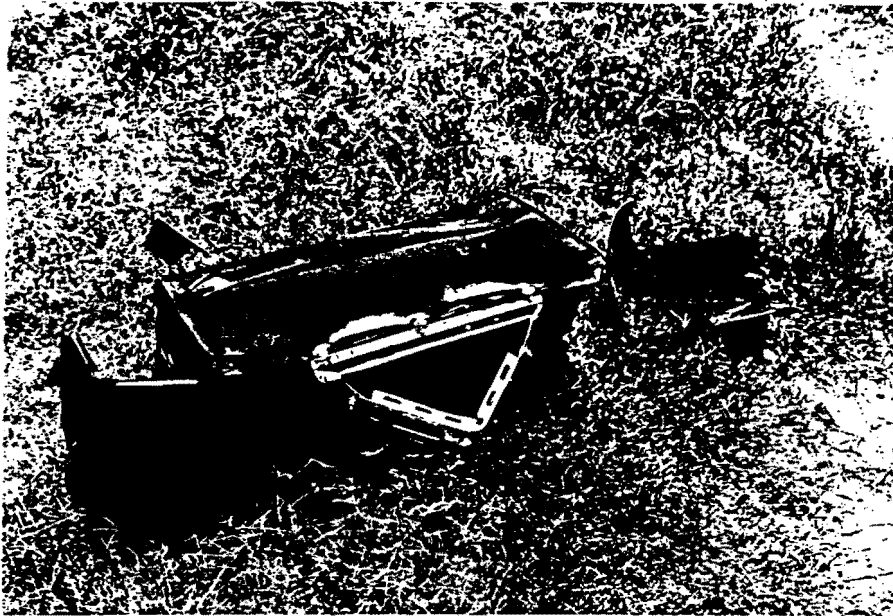

Figure . Damage to mailbox and brackett, test 19452-6.



Figure . Damage to base after test 19452-6.

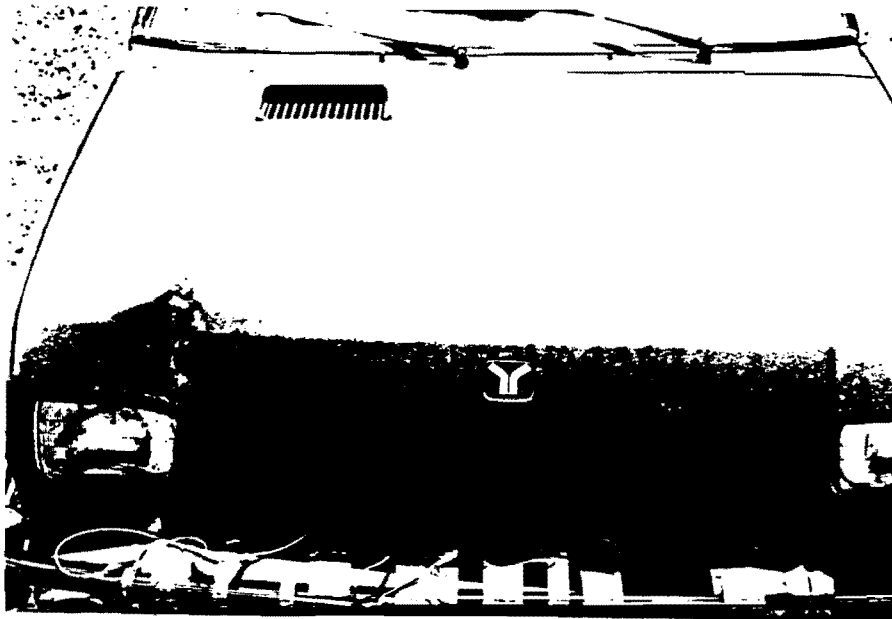
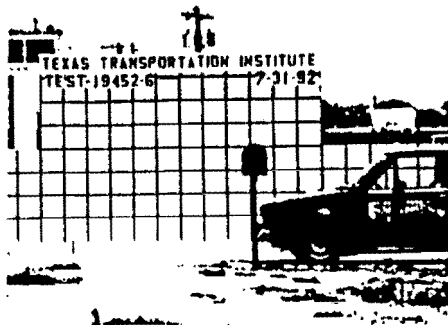

Figure . Vehicle after test 19452-6.



Figure 1 : Anthropometric dummy before and after test 19452-6.



0.000 s

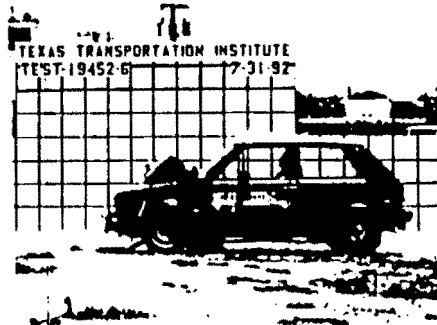

0.055 s



0.109 s

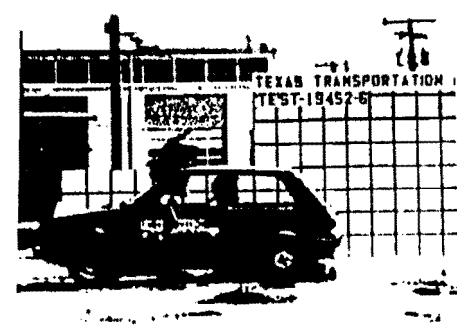

0.191 s

Test No19452-6.	Impact Speed	60.9 mi/h (98.0 km/h)
Date	07/31/92.	Change in Velocity . . .	2.3 mi/h (3.7 km/h)
Test Article	Single mount, Type 2 Mailbox Installation.	Change in Momentum . . .	190.2 lb-s
Support	Type 2 (2 3/8" thin wall steel tube)	Vehicle Accelerations (Max. 0.050-sec Avg)	
Embedment.	26" driven (strong soil)	Longitudinal . . .	-1.9 g
Vehicle	1988 Yugo GV	Lateral	0.6 g
Vehicle Weight		Occupant Impact Velocity	
Test Inertia	1800 lb (816 kg)	Longitudinal . . .	N/A
Gross Static	1968 lb (893 kg)	Lateral	N/A
Vehicle Damage Classification		Occupant Ridedown Accelerations	
TAD	12-FR-1	Longitudinal . . .	No contact
SAE	12FREN1	Lateral	No contact

Figure . Summary of results for test 19452-6.

19452-6

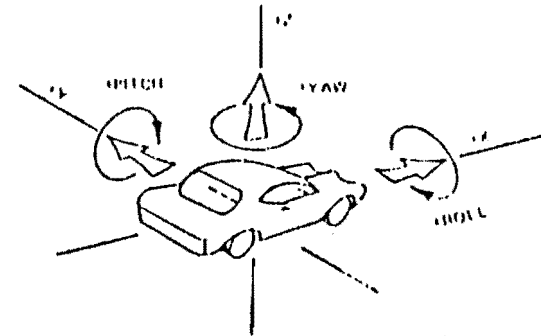
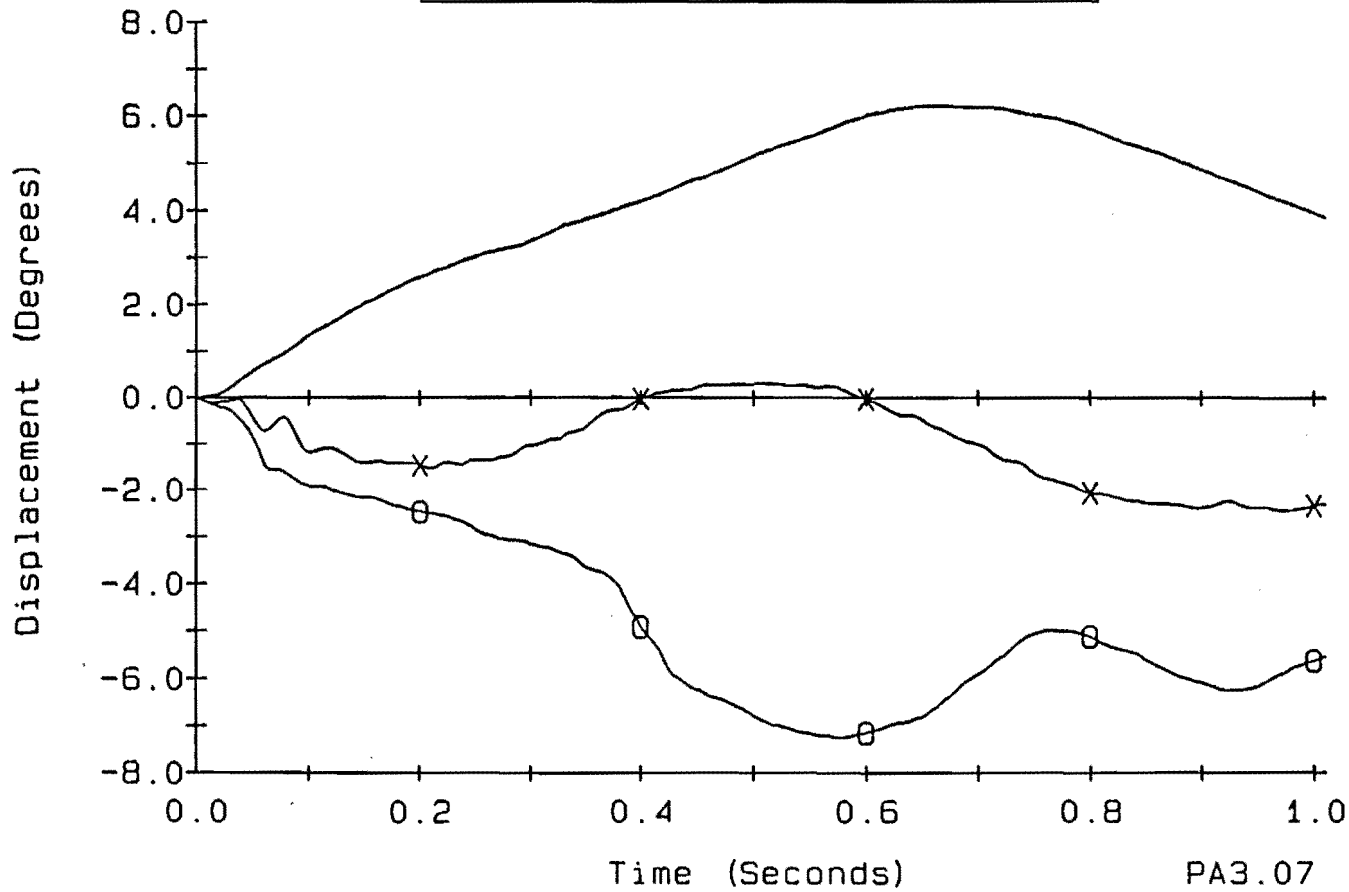
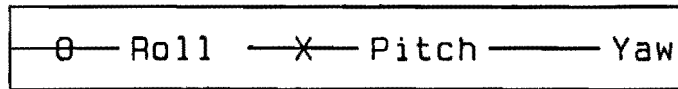

Axes are vehicle fixed.
Sequence for determining orientation is:

1. Yaw
2. Pitch
3. Roll

Figure . Vehicle angular displacements for test 19452-6.

PA3.07

CRASH TEST 19452-6

Class 180 Filter

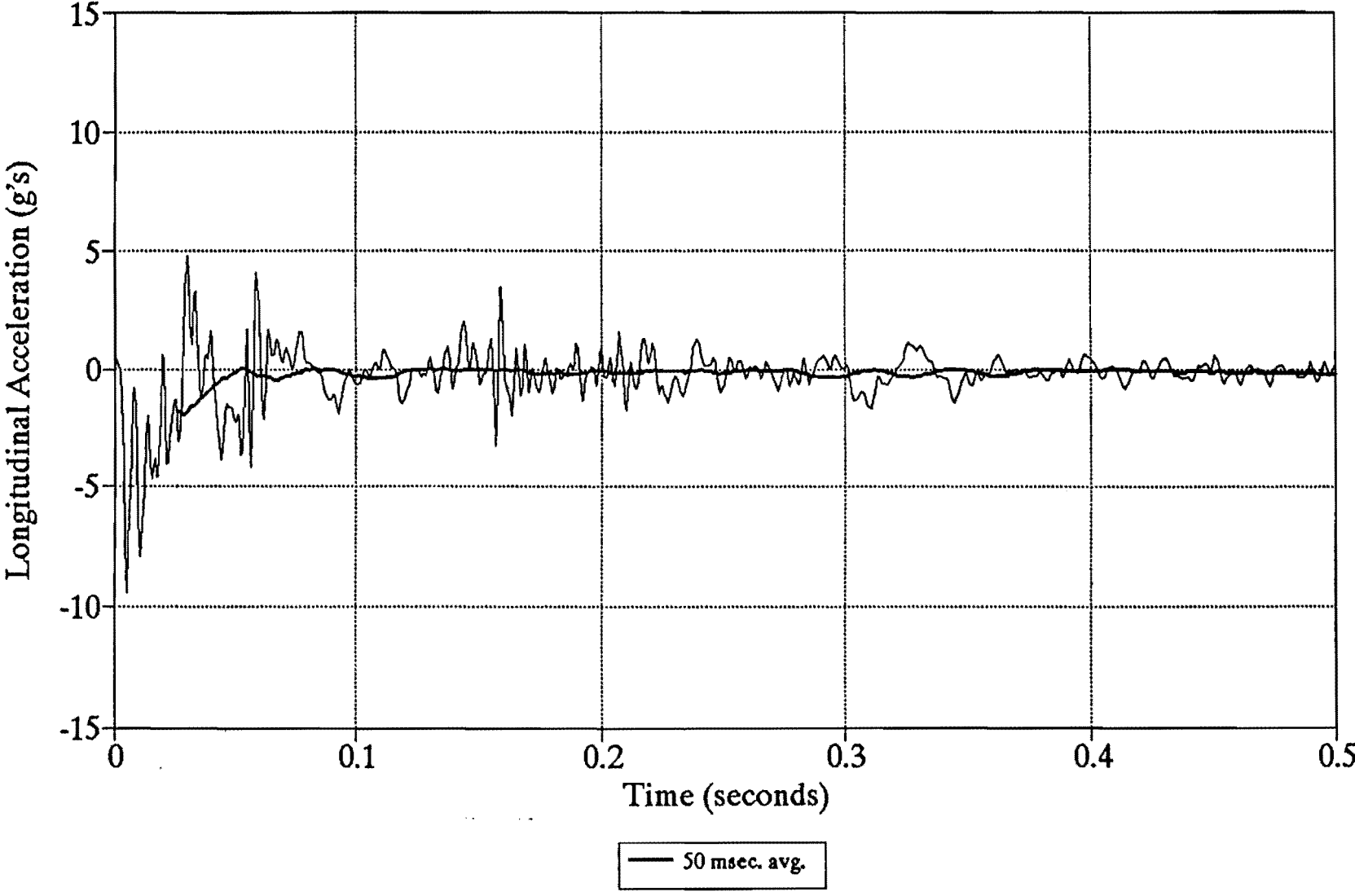

Figure . Longitudinal accelerometer trace of test 19452-6.

CRASH TEST 19452-6

Class 180 Filter

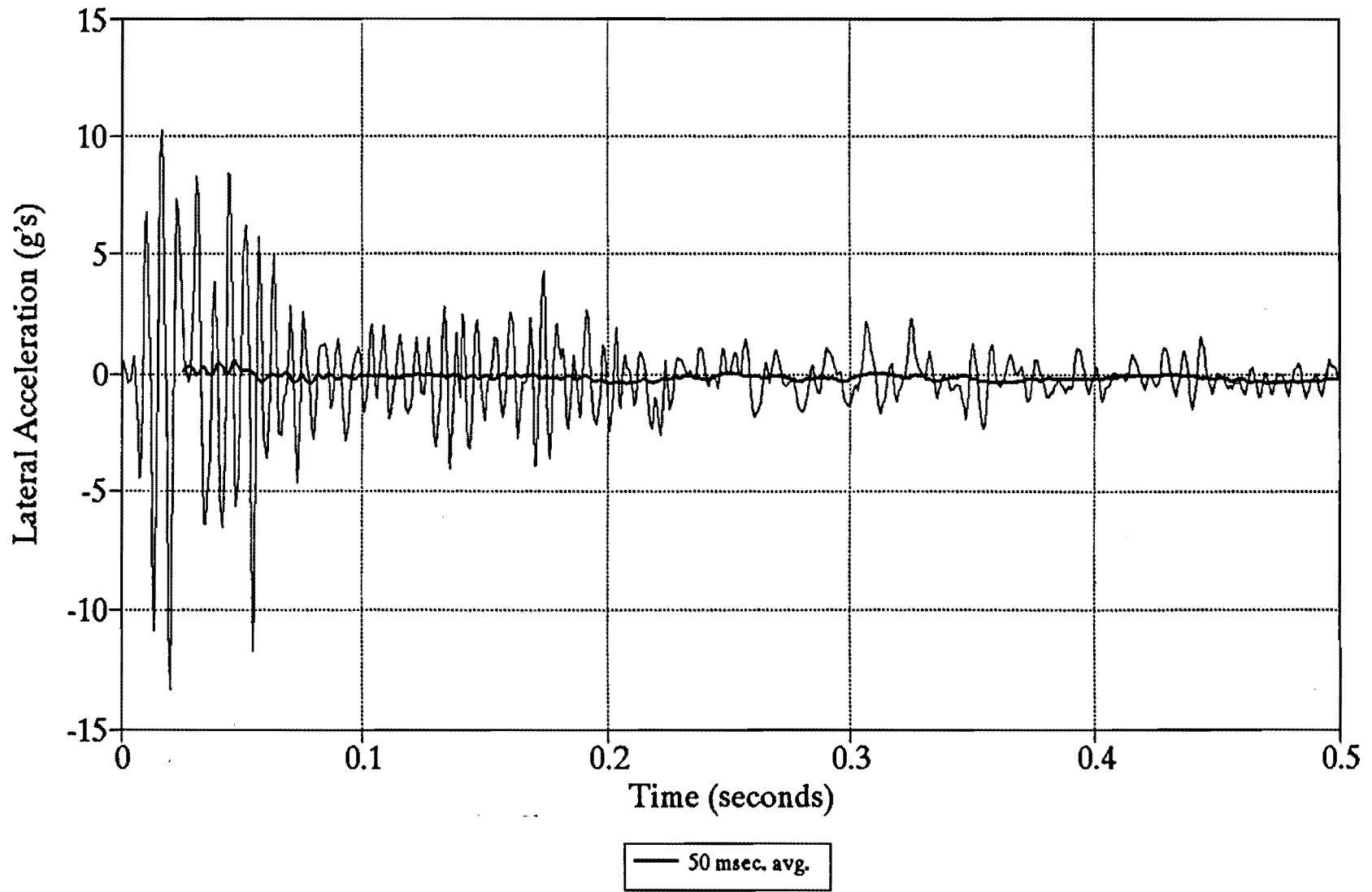

Figure . Lateral accelerometer trace of test 19452-6.

CRASH TEST 19452-6

Class 180 Filter

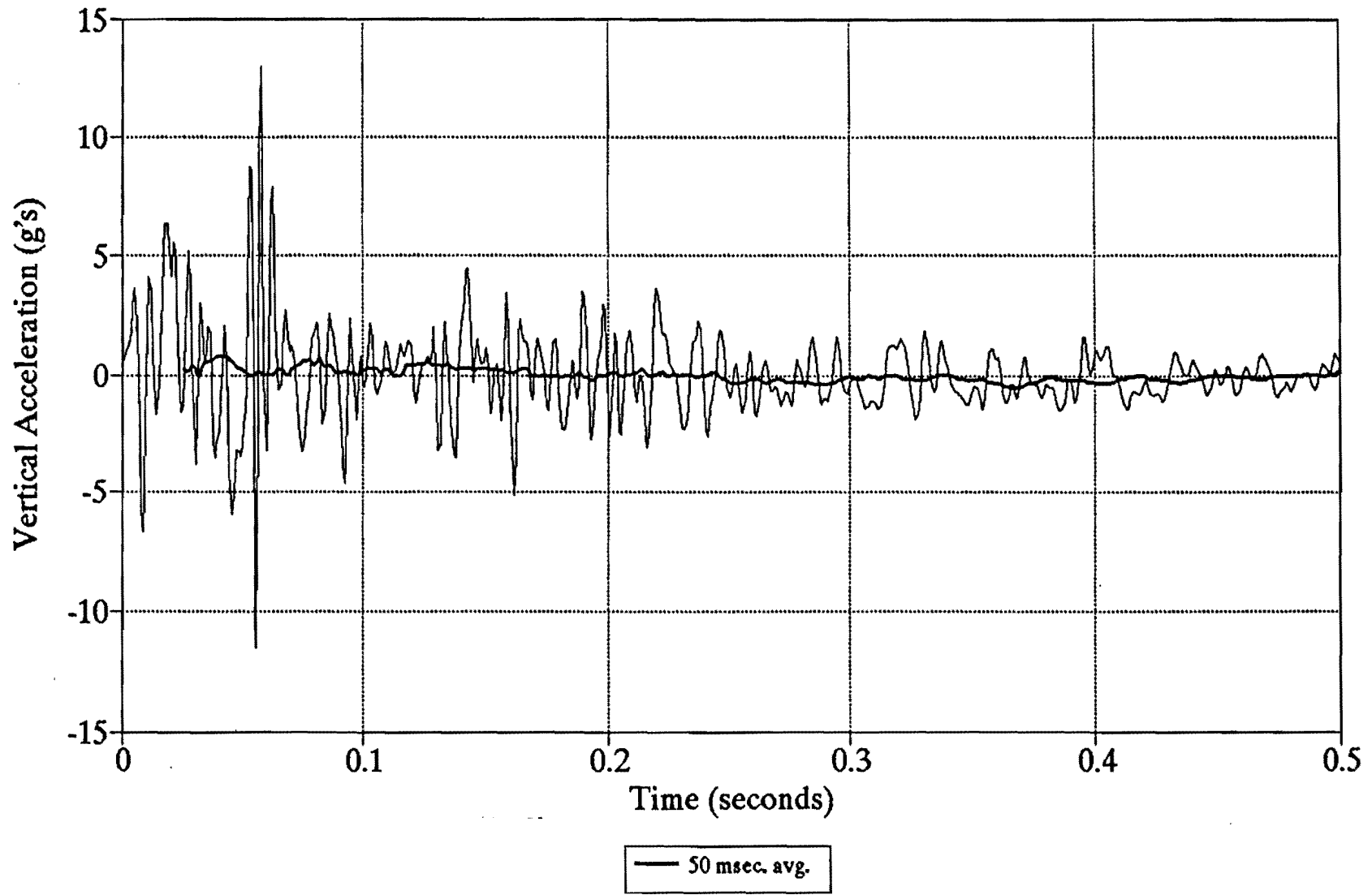

Figure . Vertical accelerometer trace of test 19452-6.

Test 19452-7

A 1987 Yugo GV (shown in Figures X & Y) impacted a formed tube support frame with 5 type 1 mailboxes installed. The impact was conducted at 63.4 miles per hour (102.0 km/h) using a cable reverse tow and guidance system. The point of impact was the front left quarter point of the vehicle bumper with the centerline of the mailbox installation. Test inertia mass of the vehicle was 1,808 lb (820 kg) and its gross static mass was 1,967 lb (892 kg). The height

from roadway surface to the lower edge of the vehicle bumper was 14.6 inches (37.0 cm) and 19.7 inches (50.0 cm) to the top of the bumper. Other dimensions and information on the vehicle are given in Figure XX.

The vehicle was free wheeling and unrestrained just prior to impact. Upon impact, the support began to yield and by 0.029 second, the support began to separate from the ground sleeve(Flush V-Wing socket). At approximately 0.056 second, the upper section of the support struck the hood of the vehicle. The vehicle lost contact with the installation at approximately 0.115 second and the entire assembly went over the top of the vehicle with no subsequent contacts. The brakes were applied at 1.0 second and the vehicle came to rest 339.0 feet (103.3 m) from the point of impact. Sequential photographs of the test are shown in Figure XX.

The installation yielded to the vehicle. The support separated from the ground sleeve and the support and mailboxes came to rest approximately 132.0 feet (40.2 m) from the point of impact. All mailboxes remained attached to the support. The vehicle sustained only minor damage to the bumper and hood as shown in Figure XX.

A summary of the test results and other information pertinent to this test are given in Figure XX. The maximum 0.050 second average acceleration experienced by the vehicle was -1.8 g in the longitudinal direction and -0.6 g in the lateral direction. In the longitudinal direction the occupant contact velocity was 4.9 ft/s (1.5 m/s) at .546 second and 3.5 ft/s (1.1 m/s) at .655 second in the lateral direction. Vehicle angular displacements are plotted in Figure XX and vehicle accelerometer traces are displayed in Figures XX through XX. Change in vehicle velocity was 4.8 mi/h (7.7 km/h) and change in momentum was 396.2 lb-s.

In summary, the mailbox installation safely yielded to the vehicle. The vehicle sustained minor damage and did not present undue hazard to other traffic. There was no deformation of or penetration into the occupant compartment. The occupant contact velocities in the longitudinal and lateral directions were within acceptable limits. This installation in "strong soil" is acceptable according to the evaluation criteria recommended in NCHRP Report 230.

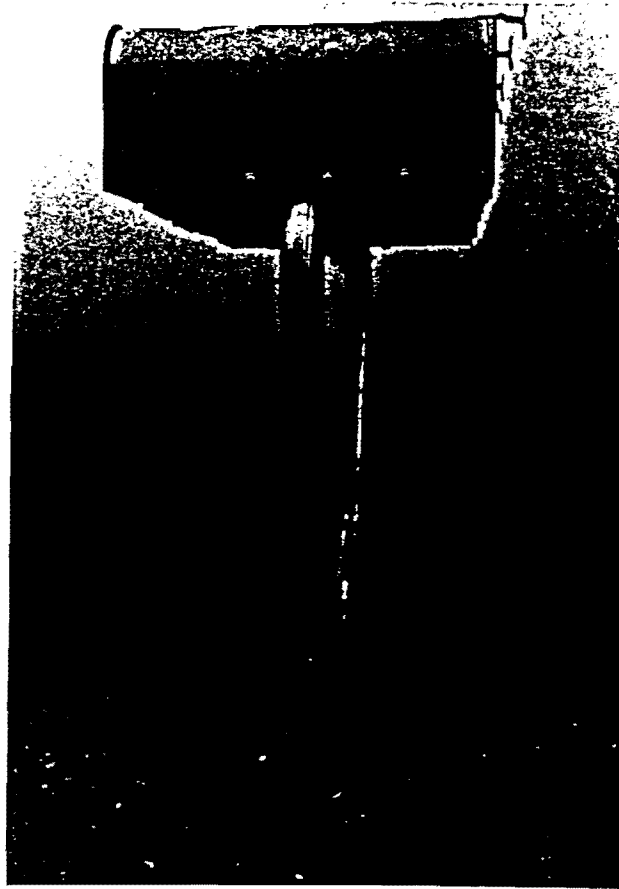

Figure . Mailbox/support connection for installation used in test 19452-7.

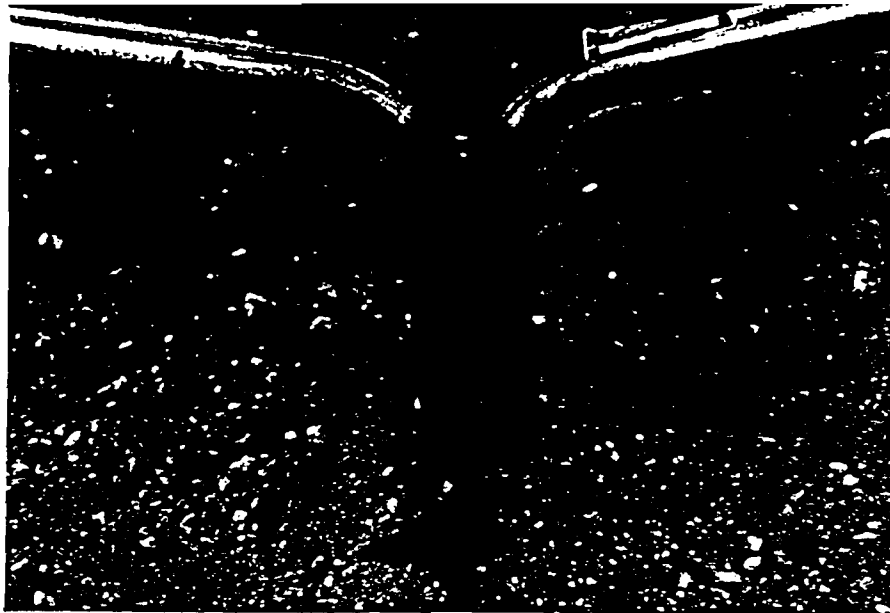
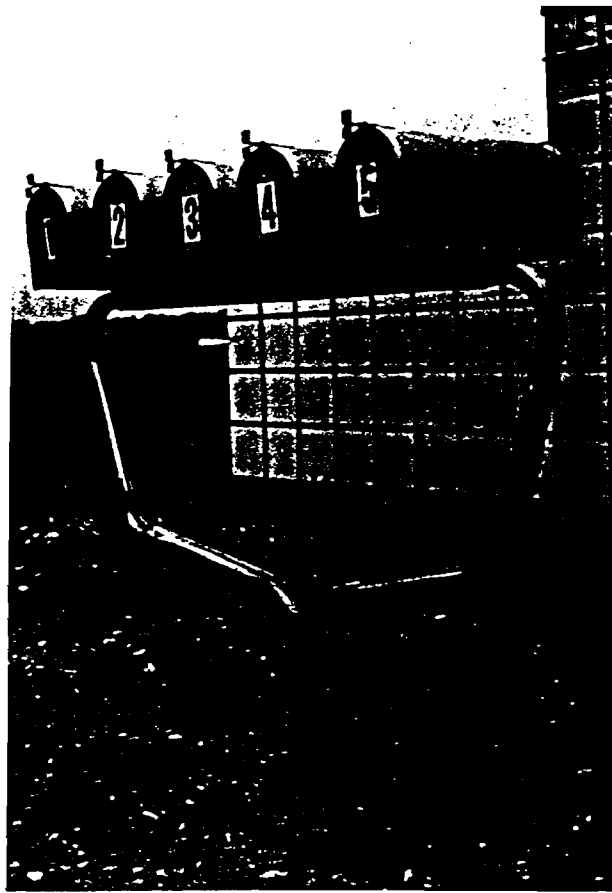

Figure . Mailbox installation before test 19452-7.

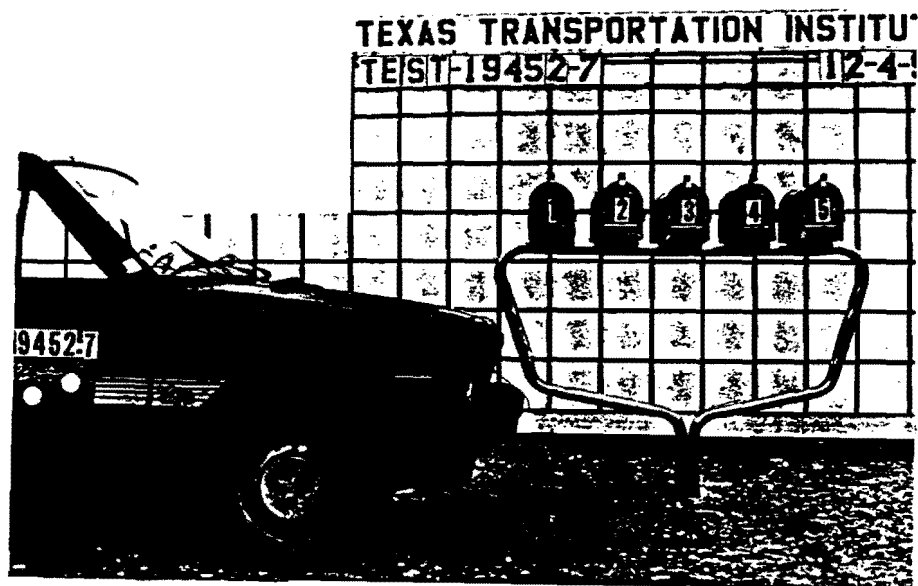

Figure . Vehicle/mailbox support geometrics for test 19452-7.

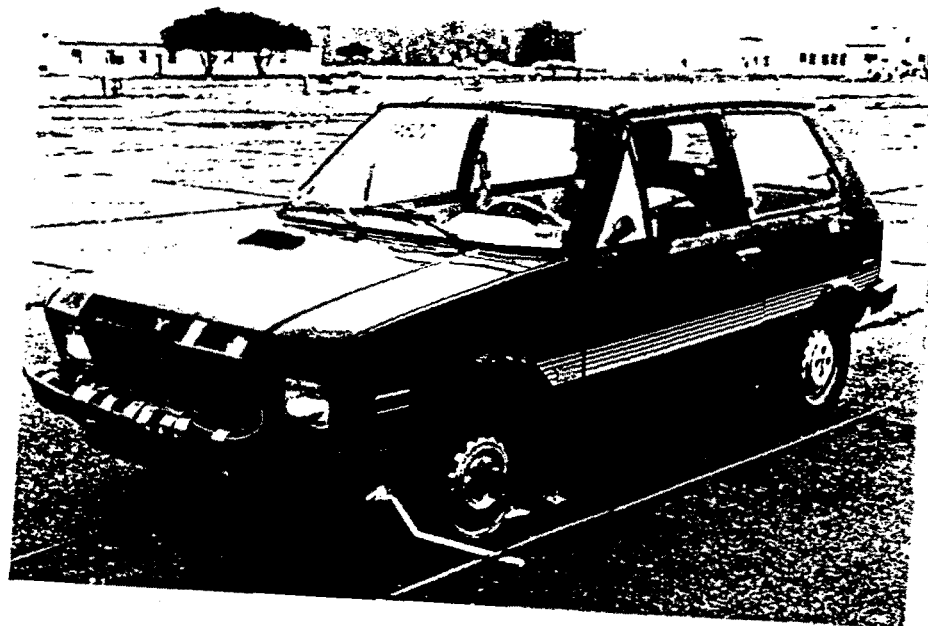

Figure . Vehicle prior to test 19452-7.

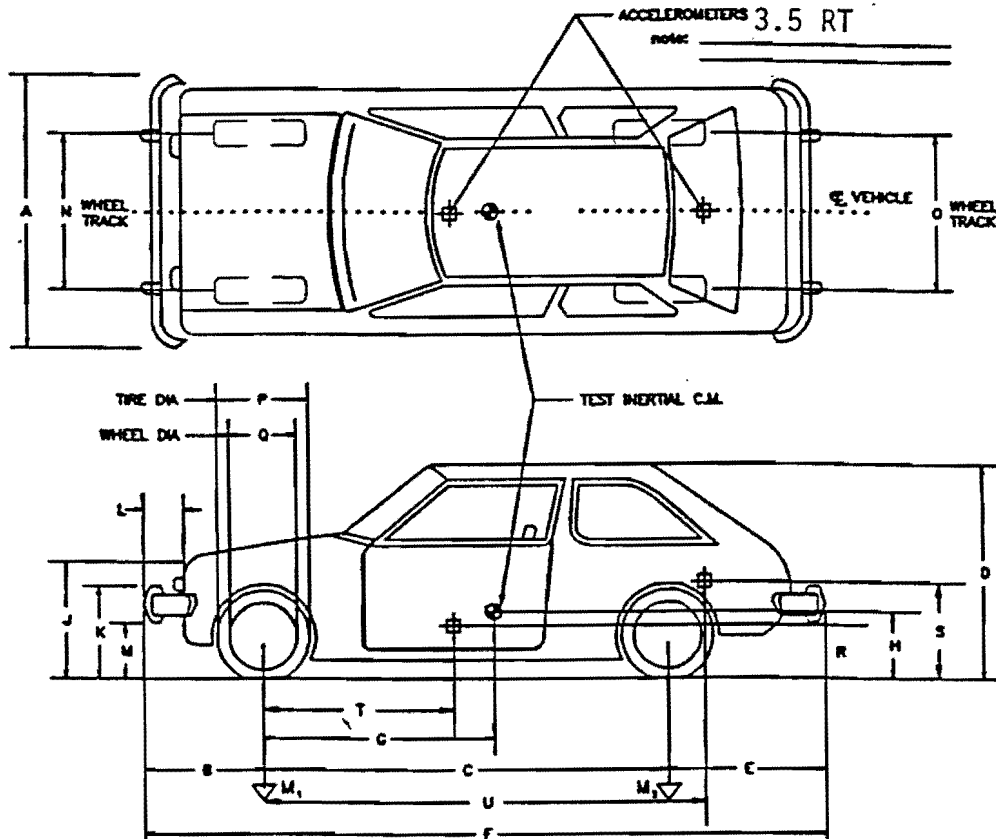

Figure . Anthropomorphic dummy prior to test 19452-7.

DATE: 12-4-92 TEST NO.: 19452-7. VIN NO.: VX1BA1216JK389865 MAKE: Yugo
 MODEL: GV YEAR: 1987 ODOMETER: 42729 TIRE SIZE: P155/80R13
 TIRE INFLATION PRESSURE: 32P51

MASS DISTRIBUTION (kg) LF 258 RF 267 LR 148 RR 147

DESCRIBE ANY DAMAGE TO VEHICLE PRIOR TO TEST:



ENGINE TYPE: 4 cyl
 ENGINE CID: 1100 CC
 TRANSMISSION TYPE:

AUTO
 MANUAL

OPTIONAL EQUIPMENT:

DUMMY DATA:
 TYPE: _____
 MASS: _____
 SEAT POSITION: _____

GEOMETRY - (cm)

A	<u>153</u>	E	<u>61</u>	J	<u>80</u>	N	<u>132</u>	R	<u>38</u>
B	<u>67</u>	F	<u>344.5</u>	K	<u>50</u>	O	<u>127</u>	S	<u>70</u>
C	<u>216.5</u>	G	<u>77.9</u>	L	<u>6.5</u>	P	<u>57.5</u>	T	<u>79</u>
D	<u>140</u>	H	_____	M	<u>37</u>	Q	<u>36.5</u>	U	<u>249</u>

<u>MASS - (kg)</u>	<u>CURB</u>	<u>TEST INERTIAL</u>	<u>GROSS STATIC</u>
M ₁	<u>551</u>	<u>525</u>	<u>558</u>
M ₂	<u>276</u>	<u>295</u>	<u>334</u>
M _T	<u>827</u>	<u>820</u>	<u>892</u>

Vehicle properties

Figure . Vehicle properties for test 19452-7.

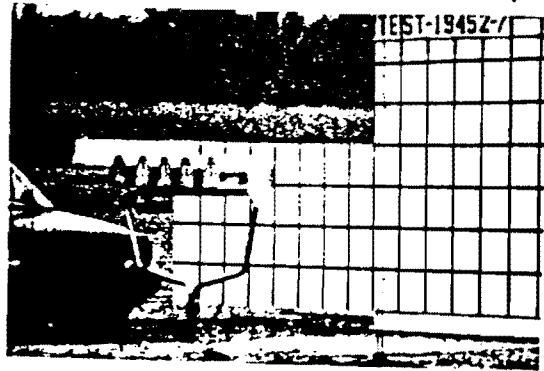
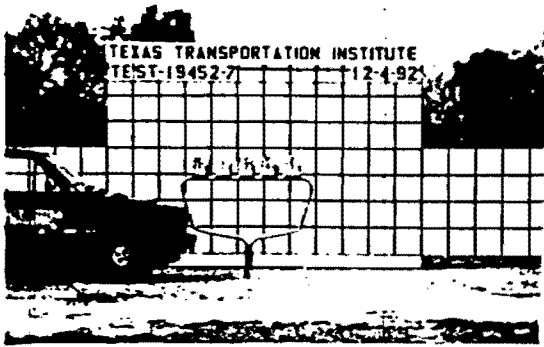

0.000 s

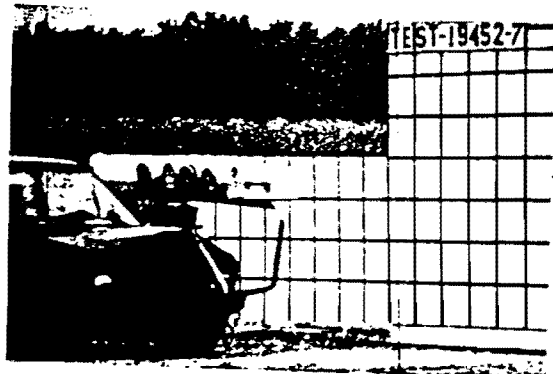
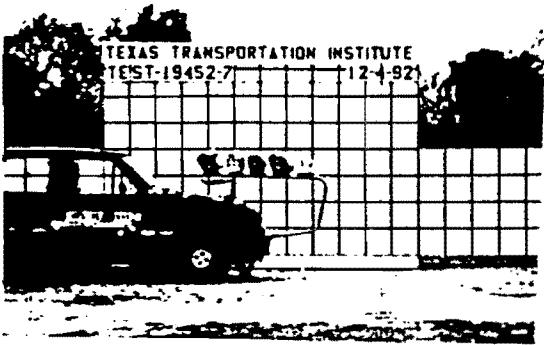

0.029 s

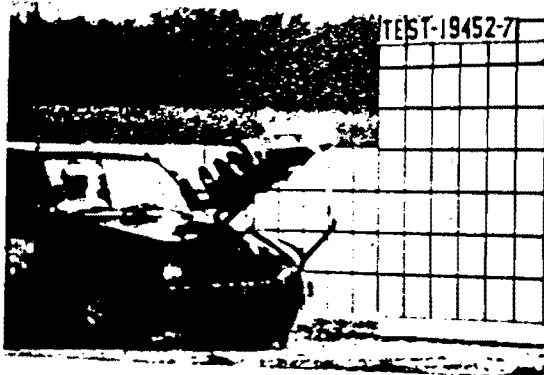
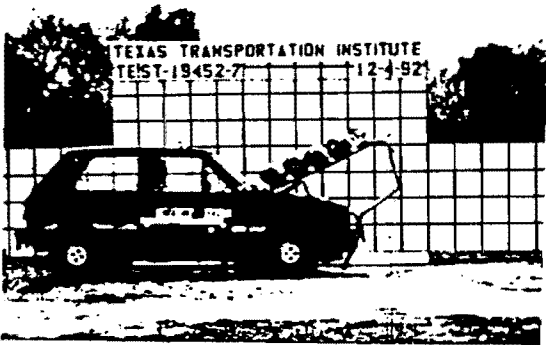

0.059 s

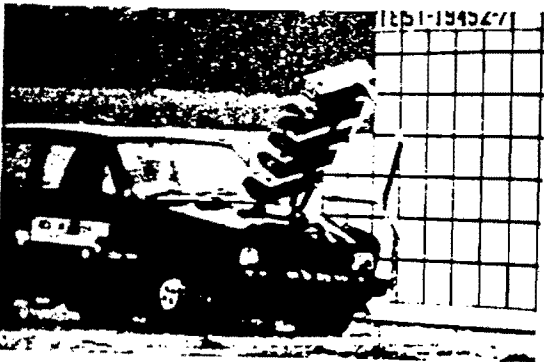
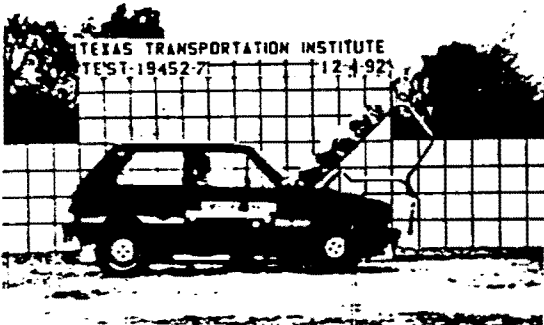

0.088 s

Figure . Sequential photographs for test 19452-7.
(perpendicular and side views)

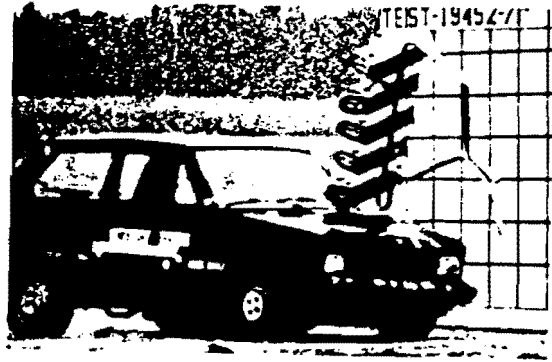
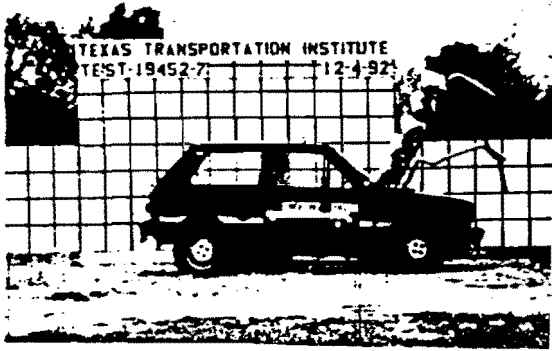

0.117 s

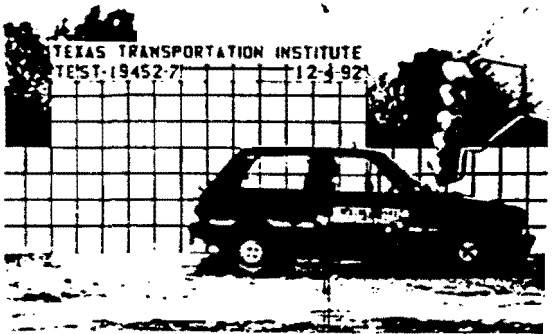

0.147 s

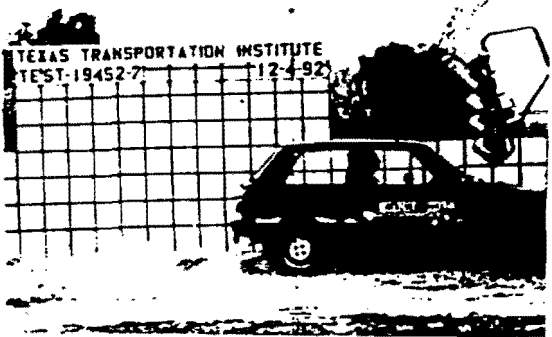

0.176 s

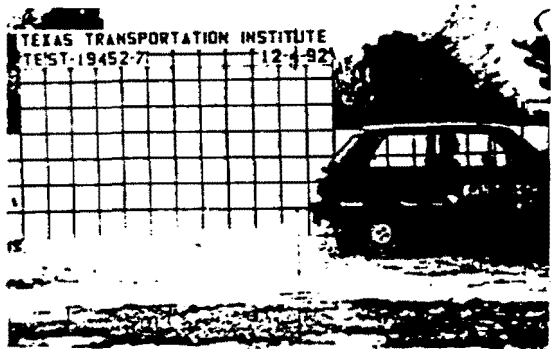

0.205 s

Figure . Sequential photographs for test 19452-7.
(perpendicular and side views) cont.

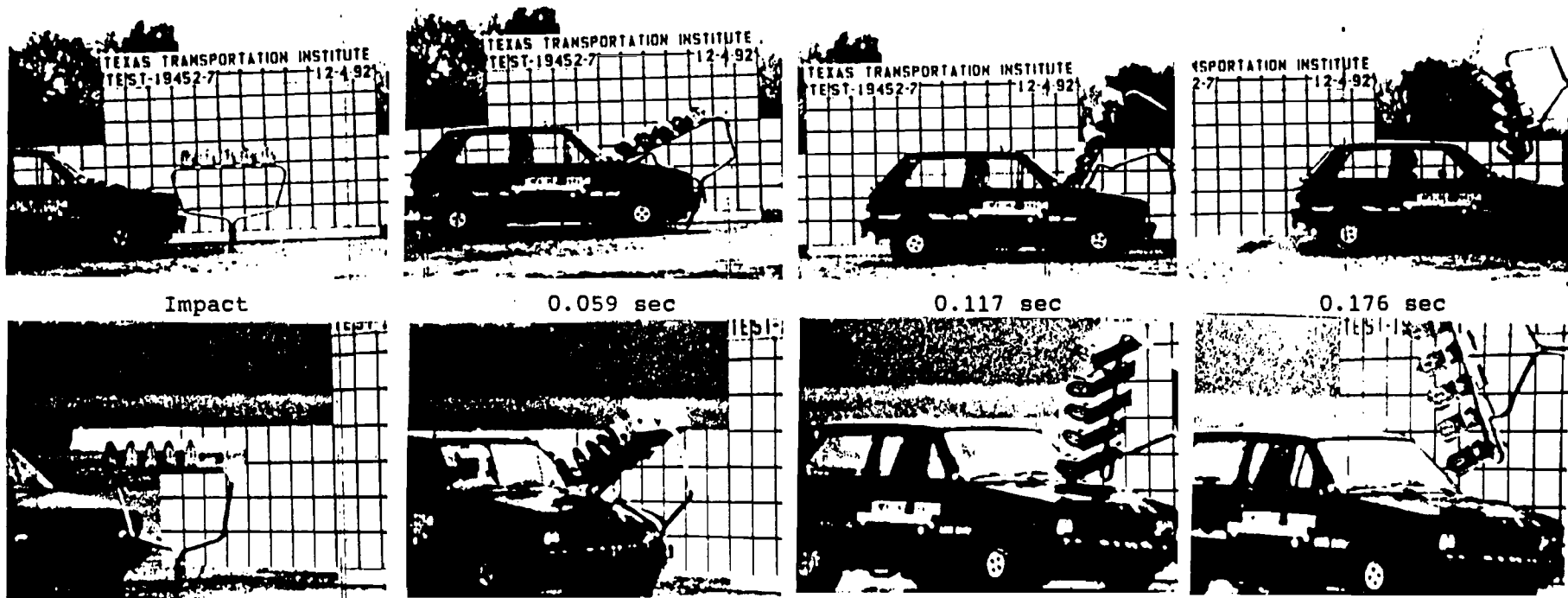

Test No. 19452-7
 Date 12/04/92
 Test Installation . . . Mailbox

 Installation Length . . N/A
 Max. Dynamic Movement . N/A
 Max. Perm. Movement . . 132 ft (40.2 m)
 Test Vehicle 1987 Yugo
 Vehicle Weight
 Test Inertia 1,808 lb (820 kg)
 Gross Static 1,967 lb (892 kg)
 Vehicle Damage Classification
 TAD 12FL1
 CDC 12FLEN1
 Maximum Vehicle Crush. . 2.0 in (5.0 cm)

Impact Speed. 63.4 mi/h (102.0 km/h)
 Impact Angle. 0.0 deg
 Speed at Parallel . . N/A
 Exit Speed 58.8 mi/h (94.6 km/h)
 Exit Trajectory . . . N/A
 Vehicle Accelerations at center-of-gravity
 (Max. 0.050-sec Average)
 Longitudinal. -1.8 g
 Lateral -0.6 g
 Occupant Impact Velocity at true c.g.
 Longitudinal. 4.9 ft/s (1.5 m/s)
 Lateral 3.5 ft/s (1.1 m/s)
 Occupant Ridedown Accelerations
 Longitudinal -0.64 g
 Lateral 0.64 g

Figure . Summary of results for test 19452-7.

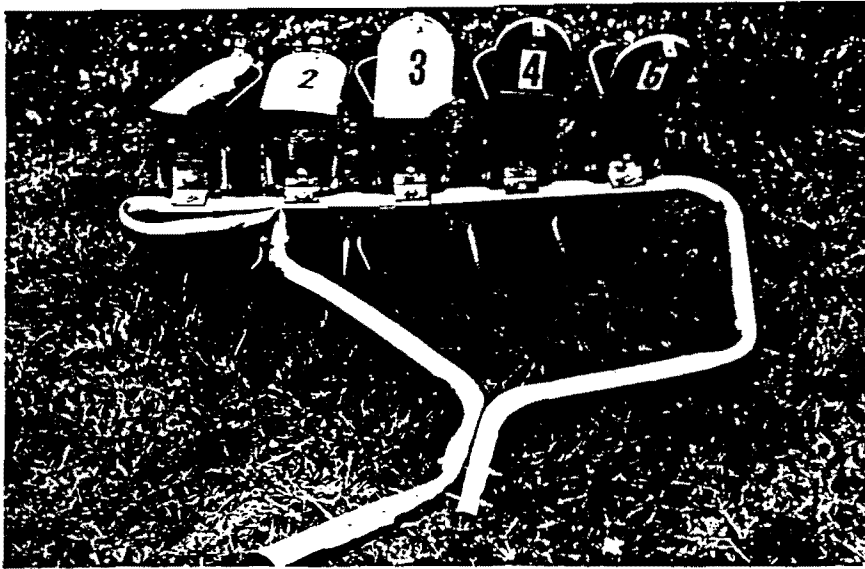

Figure . Mailbox/support and base after test 19452-7.

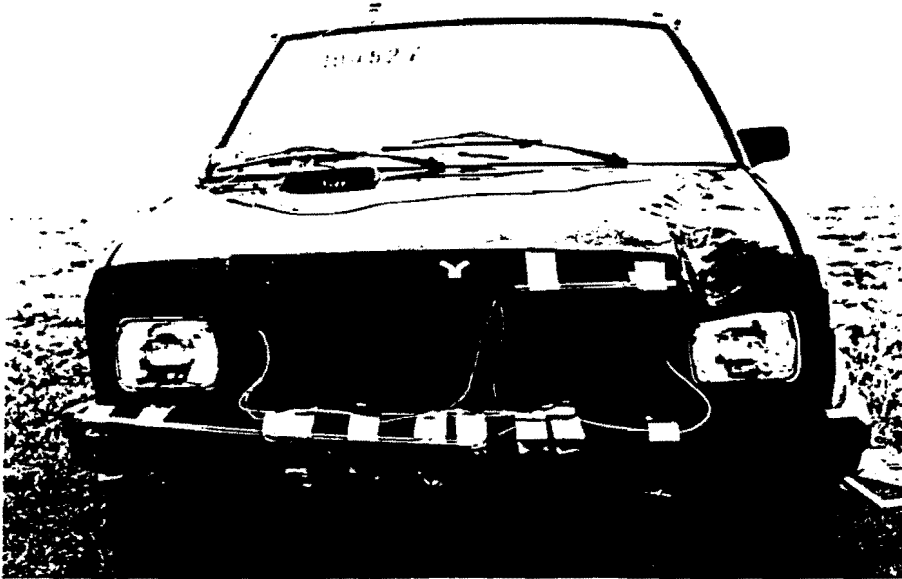
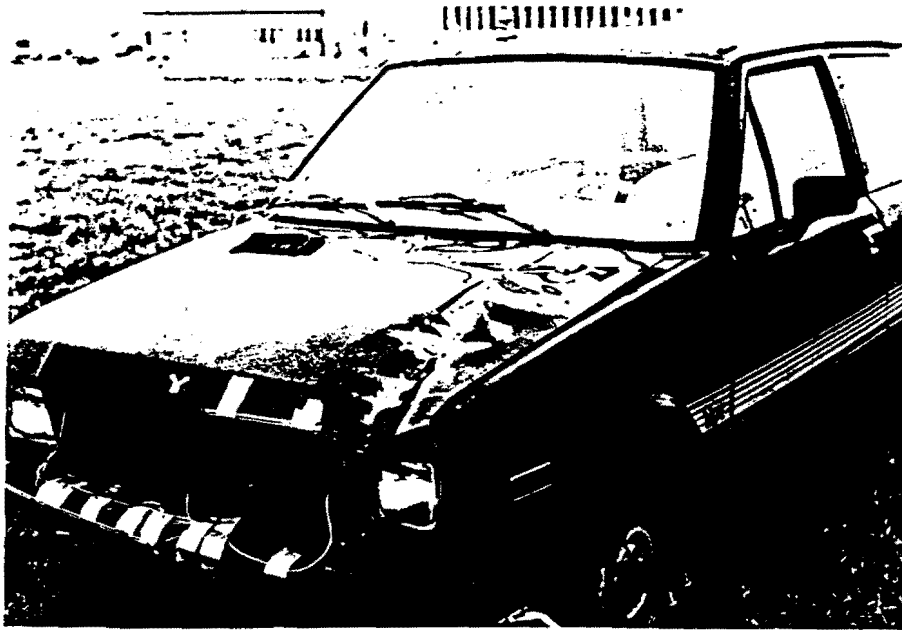

Figure . Vehicle after test 19452-7.

CRASH TEST 19452-7

Class 180 Filter

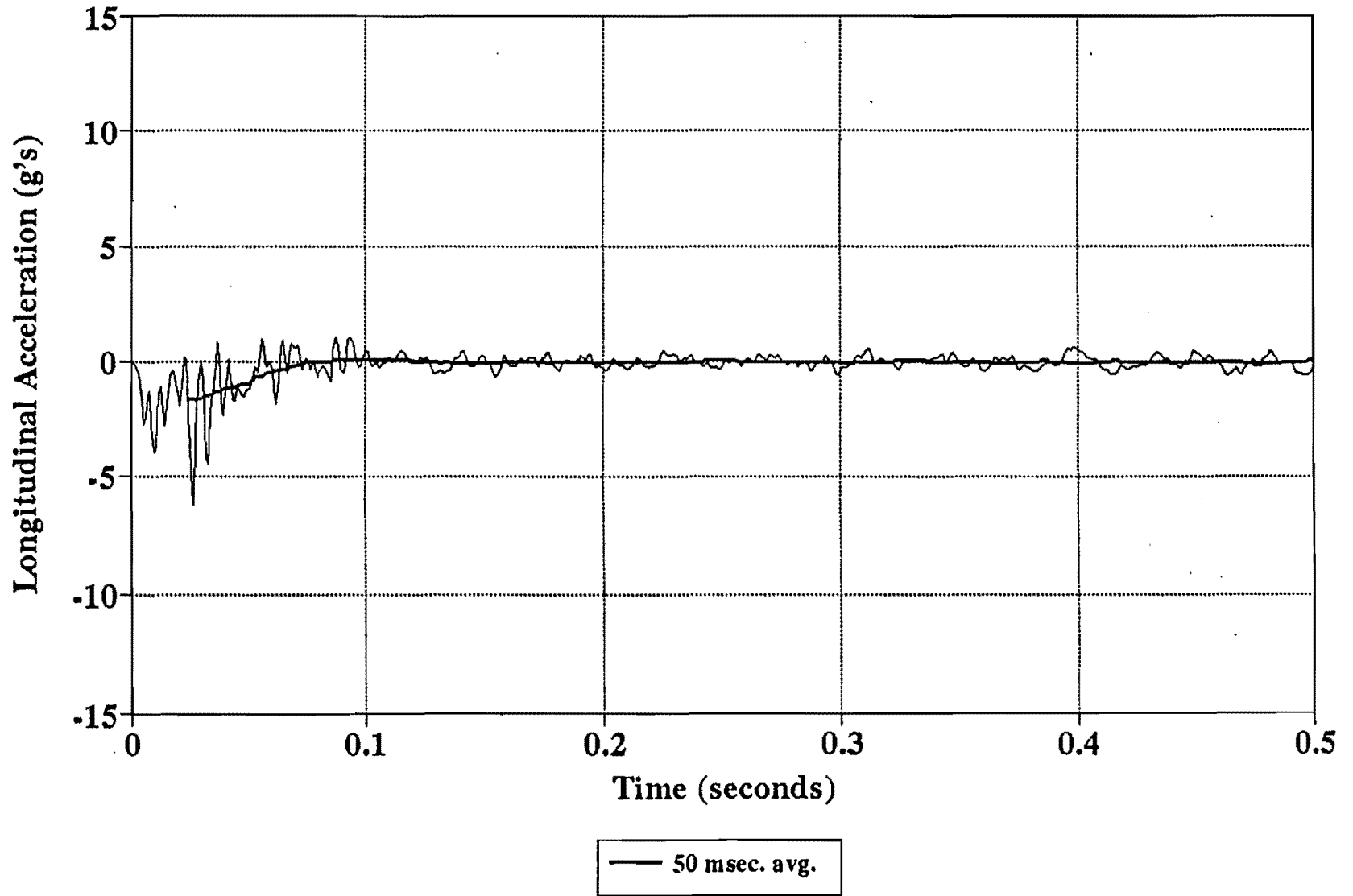

Figure . Longitudinal accelerometer trace for test 19452-7.

CRASH TEST 19452-7
Class 180 Filter

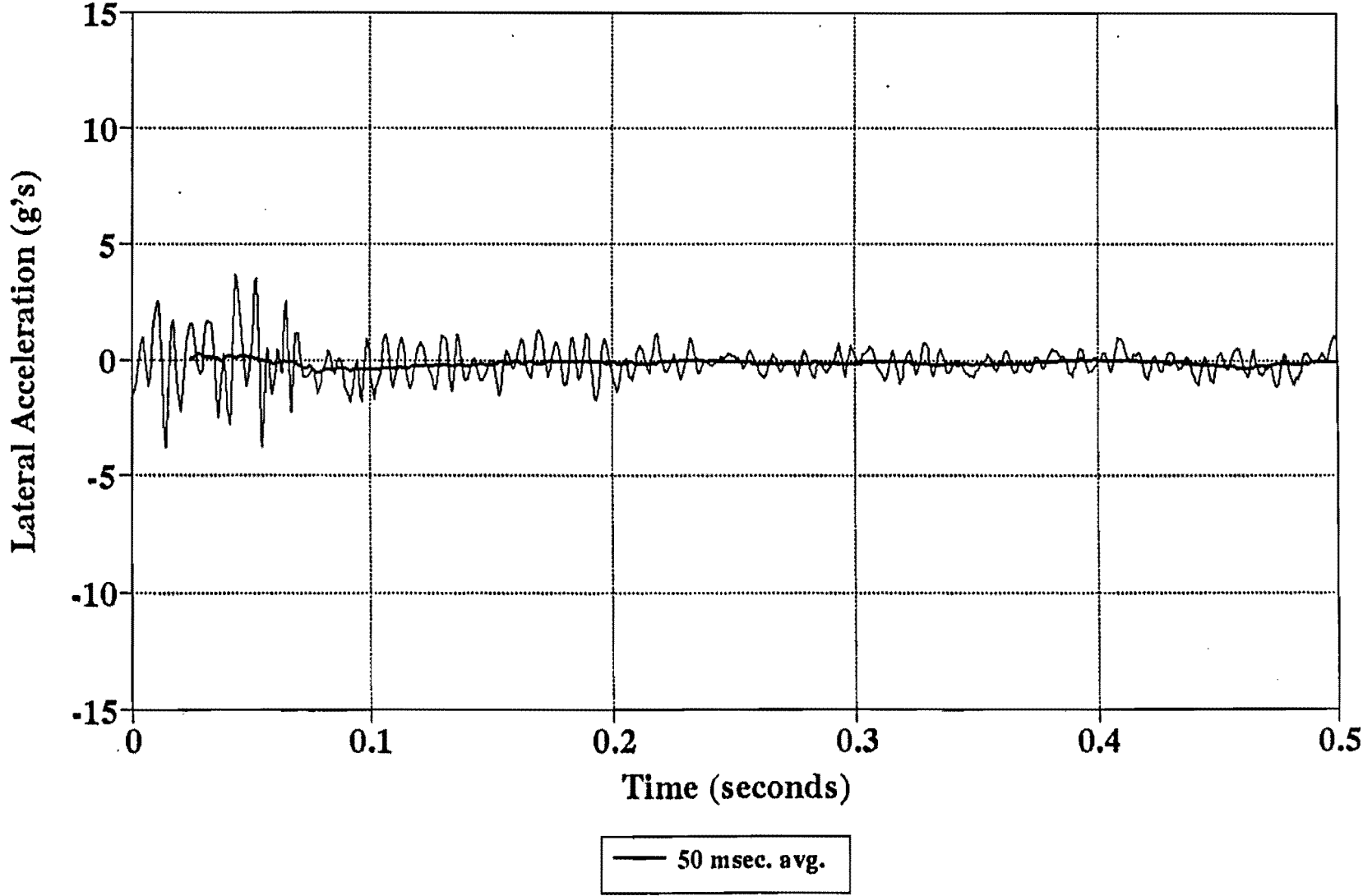

Figure . Lateral accelerometer trace for test 19452-7.

CRASH TEST 19452-7
Class 180 Filter

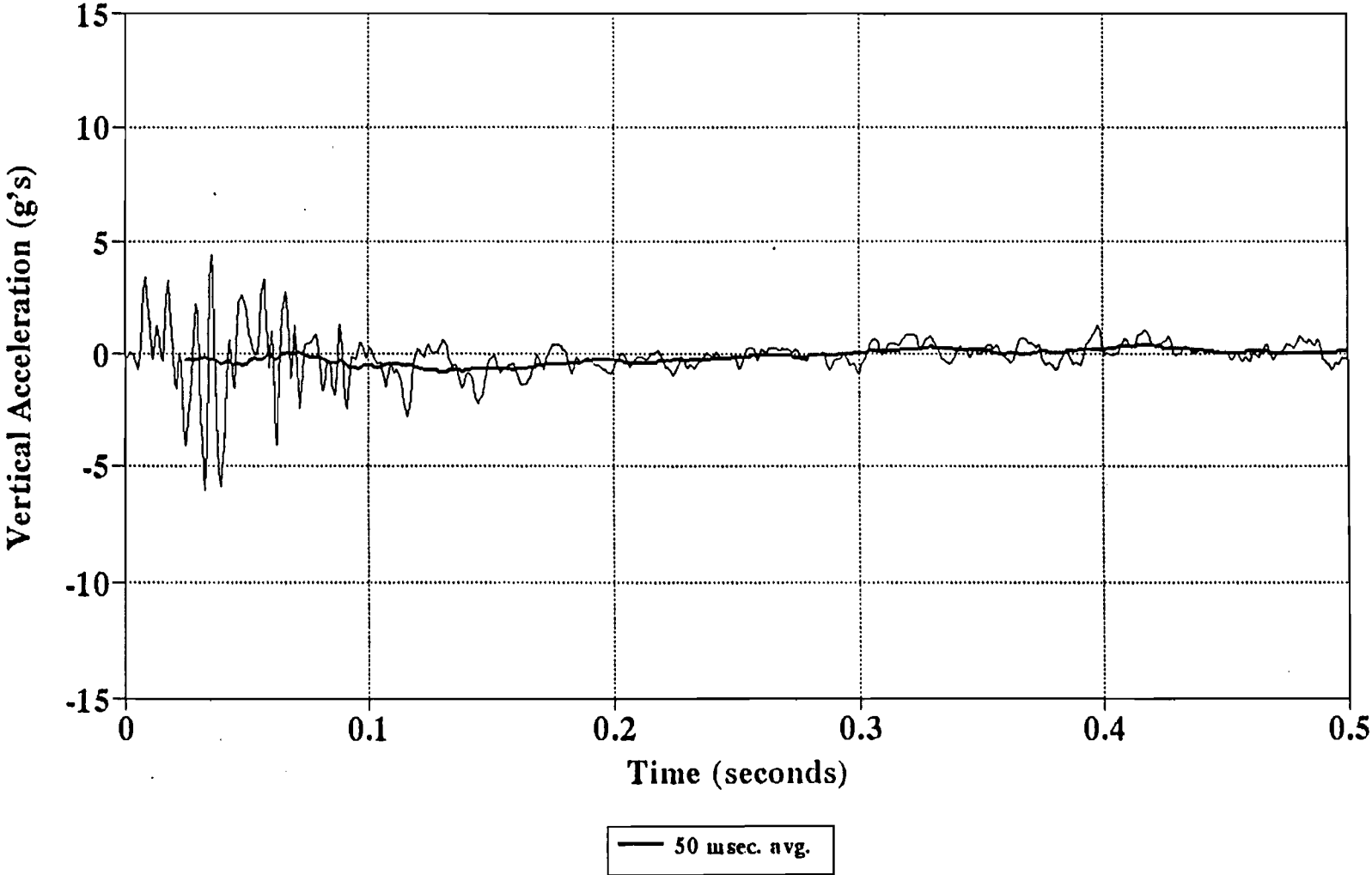

Figure . Vertical accelerometer trace for test 19452-7.

Test 19452-8

The same 1987 Yugo GV used in test 7 impacted a formed tube support frame with 3 type 2 mailboxes installed. The impact was conducted at 61.2 miles per hour (98.5 km/h) using a cable reverse tow and guidance system. The point of impact was the front right quarter point

of the vehicle bumper with the centerline of the mailbox installation. Test inertia mass of the vehicle was 1,808 lb (820 kg) and its gross static mass was 1,967 lb (892 kg). The height from roadway surface to the lower edge of the vehicle bumper was 14.6 inches (37.0 cm) and 19.7 inches (50.0 cm) to the top of the bumper. Other dimensions and information on the vehicle are given in Figure XX.

The vehicle was free wheeling and unrestrained just prior to impact. Upon impact, the support began to yield and by 0.027 second, the support began to separate from the ground sleeve (Flush V-Wing socket). At approximately 0.034 second, the upper section of the support struck the hood of the vehicle. Contact with the windshield occurred at 0.063 second. The vehicle lost contact with the installation at approximately 0.121 second and the entire assembly went over the top of the vehicle with no subsequent contacts. The brakes were applied at 1.2 second and the vehicle came to rest 312.0 feet (95.1 m) from the point of impact. Sequential photographs of the test are shown in Figure XX.

The installation yielded to the vehicle. The support separated from the ground sleeve and the support and mailboxes came to rest approximately 102.0 feet (31.1 m) from the point of impact. All mailboxes remained attached to the support. The vehicle sustained only minor damage to the bumper and hood as shown in Figure XX.

A summary of the test results and other information pertinent to this test are given in Figure XX. The maximum 0.050 second average acceleration experienced by the vehicle was -2.0 g in the longitudinal direction and 0.4 g in the lateral direction. In the longitudinal direction the occupant contact velocity was 2.6 ft/s (0.8 m/s) at .694 second and -4.1 ft/s (1.2 m/s) at .599 second in the lateral direction. Vehicle angular displacements are plotted in Figure XX and vehicle accelerometer traces are displayed in Figures XX through XX. Change in vehicle velocity was 4.4 mi/h (7.1 km/h) and change in momentum was 362.3 lb-s.

In summary, the mailbox installation safely yielded to the vehicle. The vehicle sustained minor damage and did not present undue hazard to other traffic. There was no deformation and minor penetration into the occupant compartment. The occupant contact velocities in the longitudinal and lateral directions were within acceptable limits. This installation in "strong soil" is acceptable according to the evaluation criteria recommended in NCHRP Report 230.

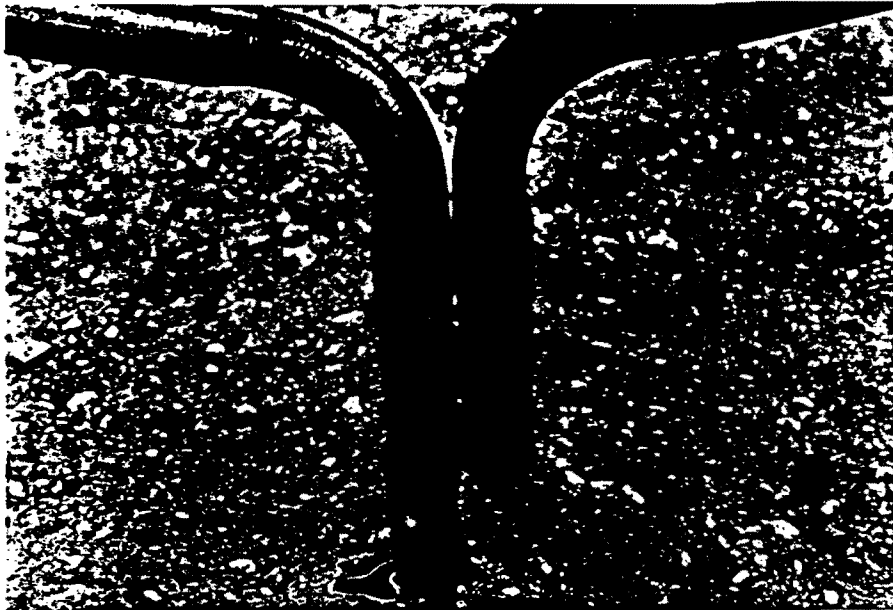
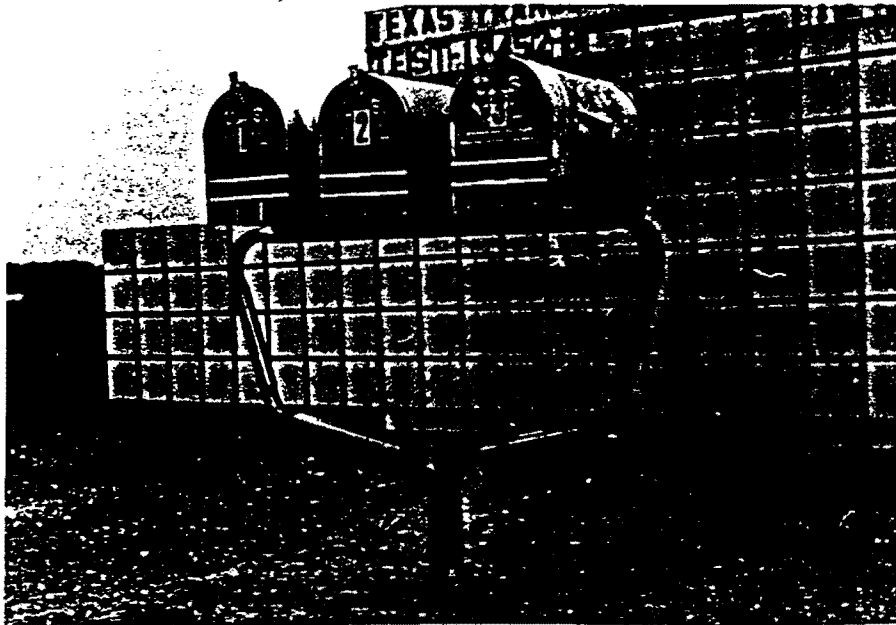

Figure . Mailbox installation before test 19452-8.

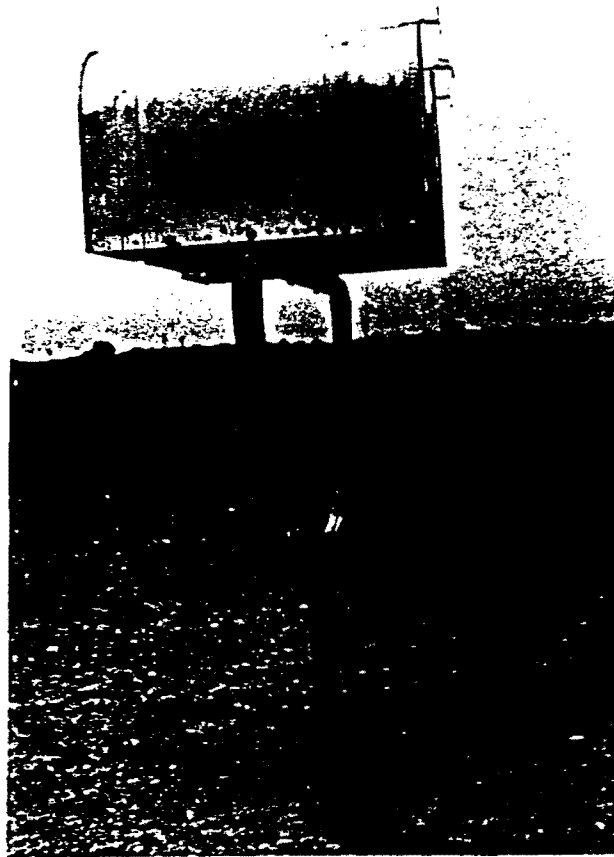

Figure . Mailbox/support connections for test 19452-8.



Figure . Vehicle before test 19452-8.

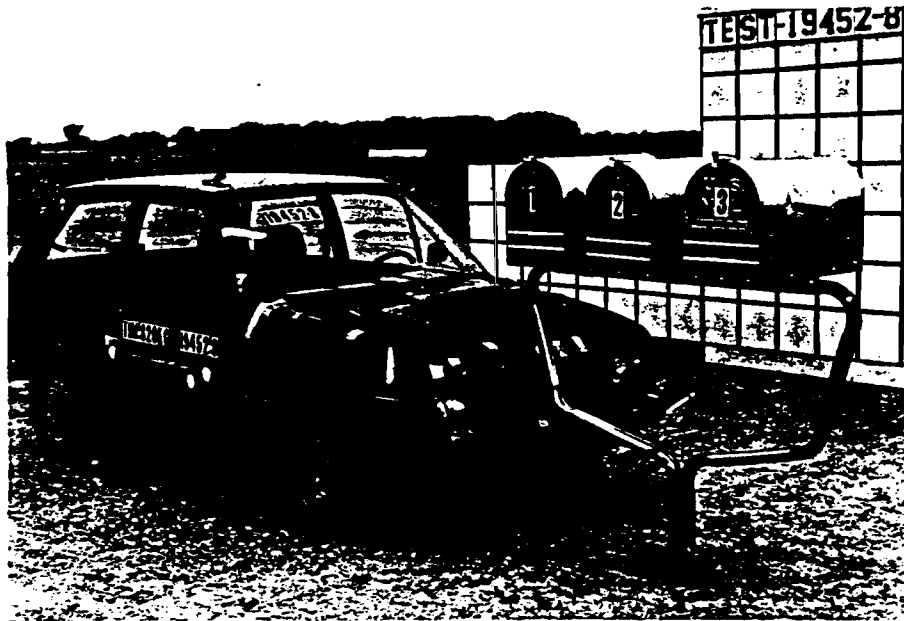

Figure . Vehicle/mailbox geometrics for test 19452-8.

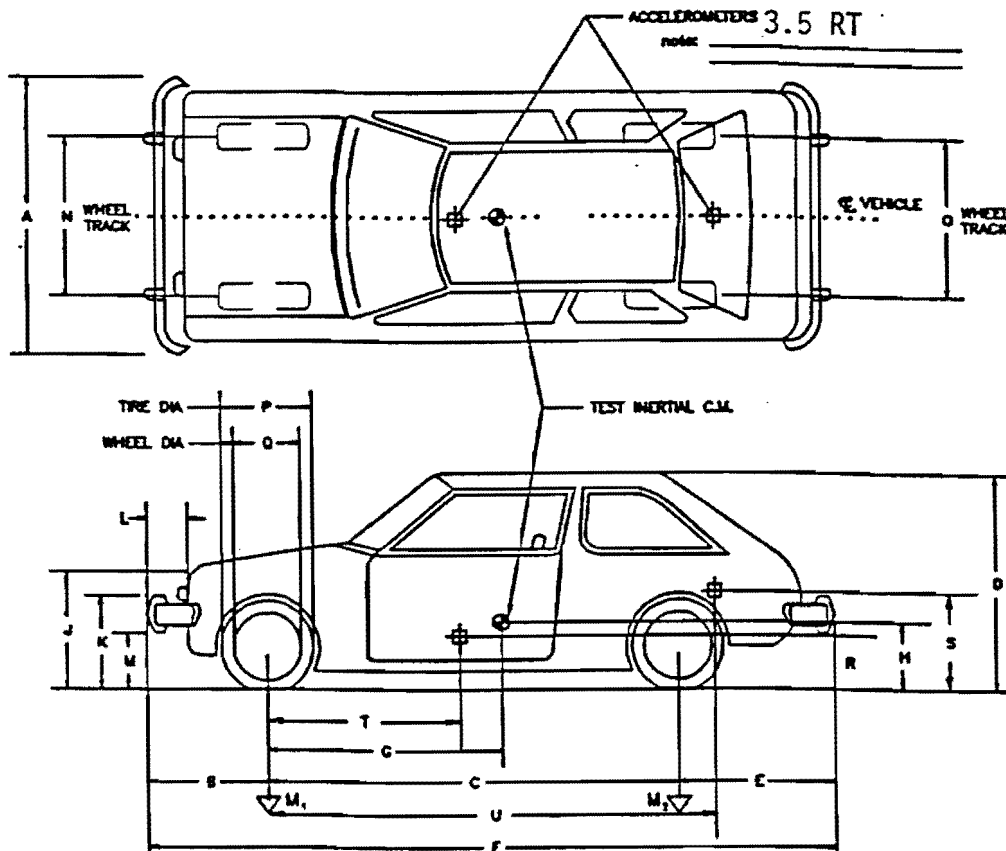

Figure . Anthropomorphic dummy prior to test 19452-8.

DATE: 12-4-92 TEST NO.: 19452-8 VIN NO.: VX1BA1216JK389865 MAKE: Yugo
 MODEL: GV YEAR: 1987 ODOMETER: 42729 TIRE SIZE: P155/80R13
 TIRE INFLATION PRESSURE: 32P51

MASS DISTRIBUTION (kg) LF 258 RF 267 LR 148 RR 147

DESCRIBE ANY DAMAGE TO VEHICLE PRIOR TO TEST:



ENGINE TYPE: 4 cyl

ENGINE CID: 1100 cc

TRANSMISSION TYPE:

AUTO
 MANUAL

OPTIONAL EQUIPMENT:

DUMMY DATA:

TYPE: _____

MASS: _____

SEAT POSITION: _____

GEOMETRY - (cm)

A	153	E	61	J	80	N	132	R	38
B	67	F	344.5	K	50	O	127	S	70
C	216.5	G	77.9	L	6.5	P	57.5	T	79
D	140	H		M	37	Q	36.5	U	249

<u>MASS - (kg)</u>	<u>CURB</u>	<u>TEST INERTIAL</u>	<u>GROSS STATIC</u>
M ₁	551	525	558
M ₂	276	295	334
M _T	827	820	892

Vehicle properties

Figure . Vehicle properties for test 19452-8.

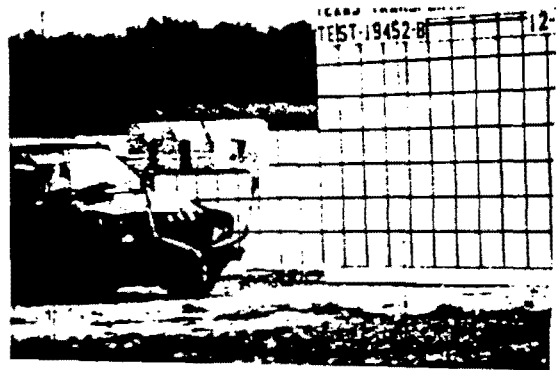
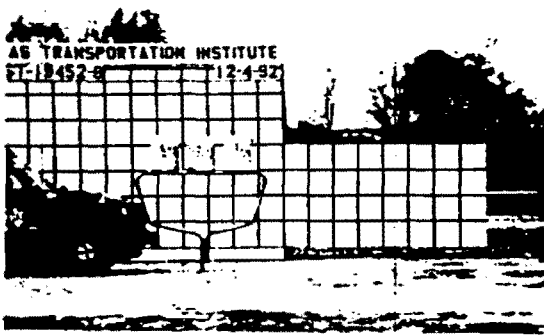

0.000 s

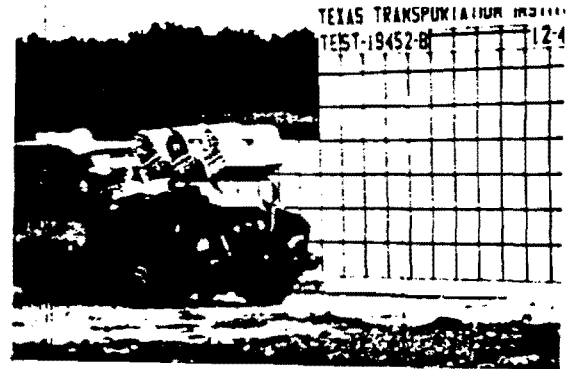
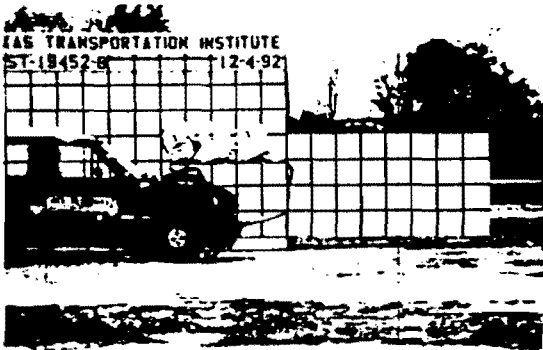

0.034 s

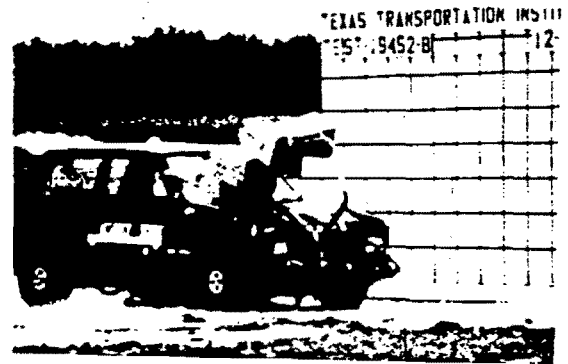

0.068 s

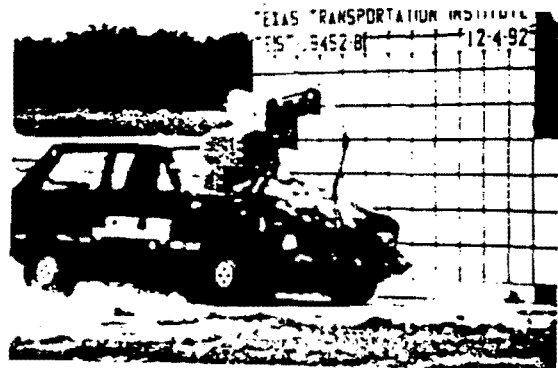

0.102 s

Figure . Sequential photographs for test 19452-8.
(perpendicular and side views)

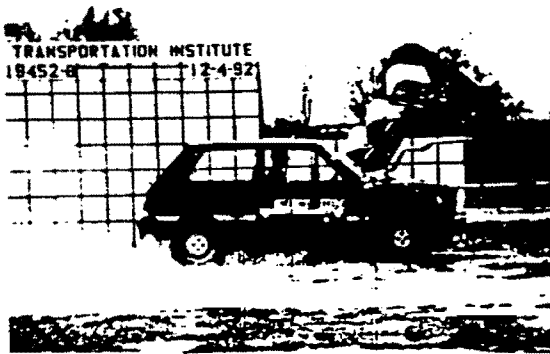

0.136 s

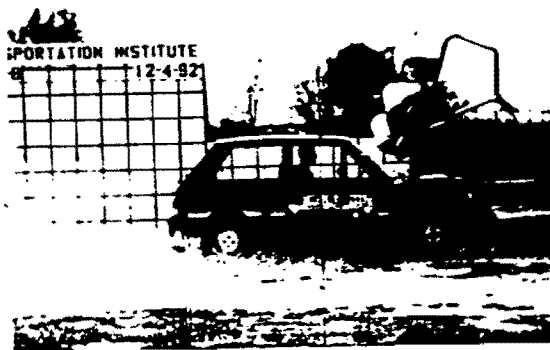
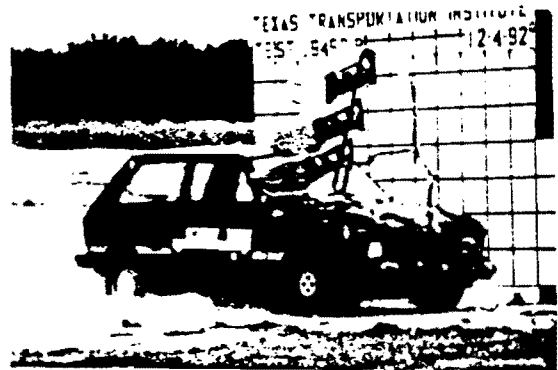

0.170 s

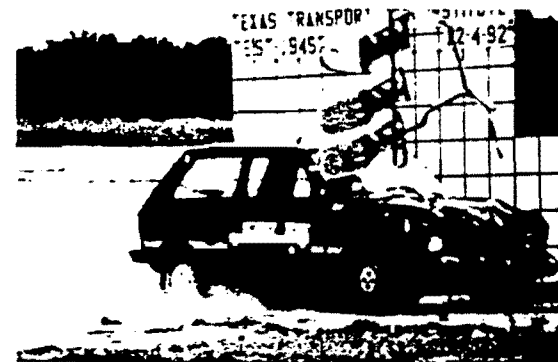

0.204 s

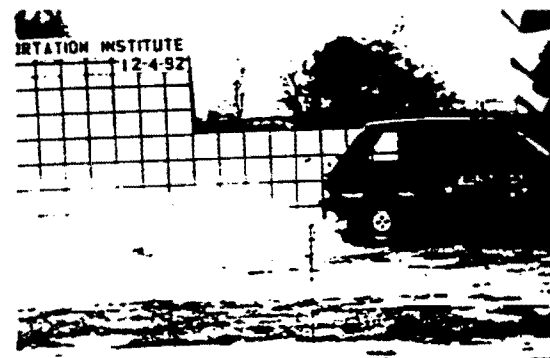
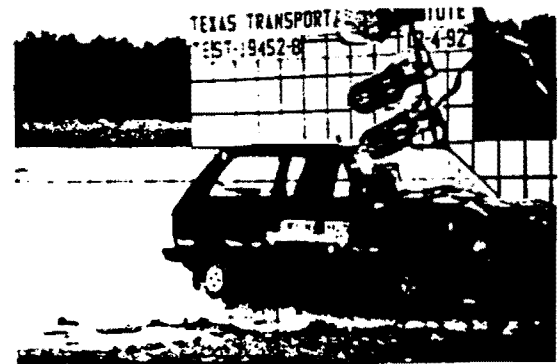

0.238 s

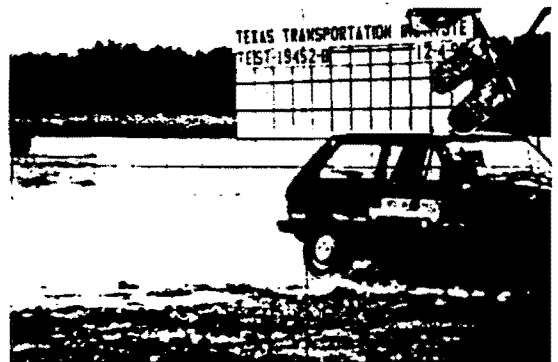

Figure . Sequential photographs for test 19452-8.
(perpendicular and side views) cont.

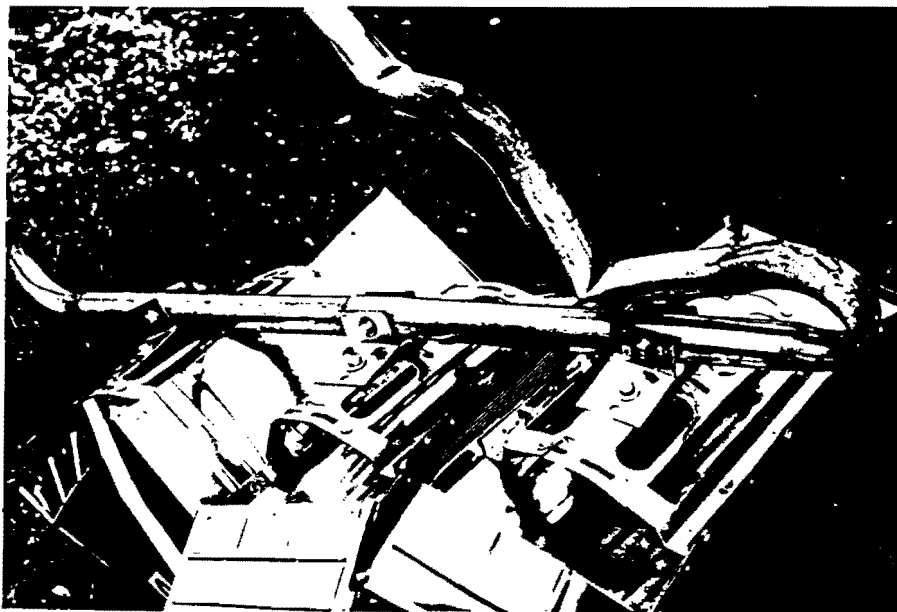

Figure . Mailbox/support after test 19452-8.

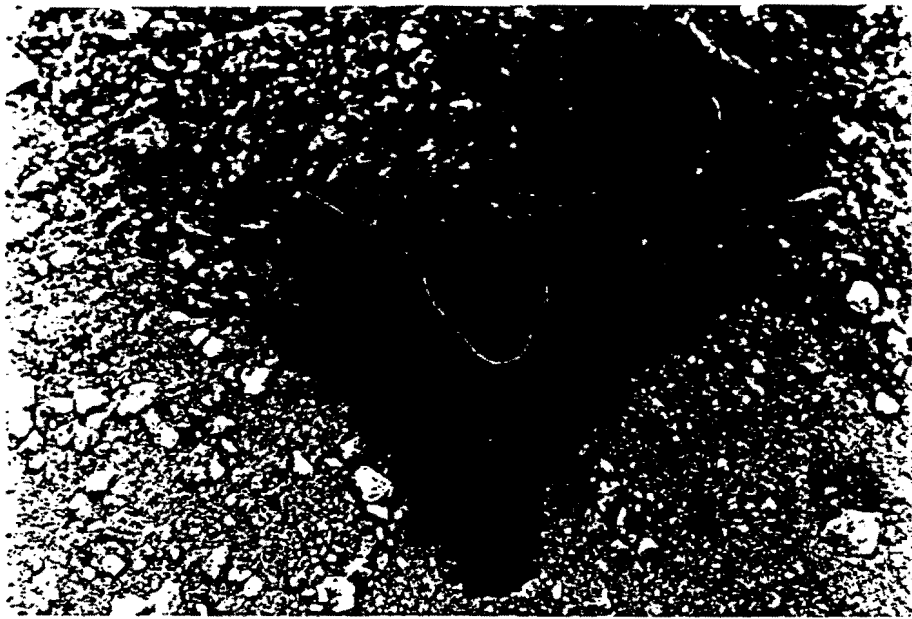

Figure . Support base after test 19452-8.

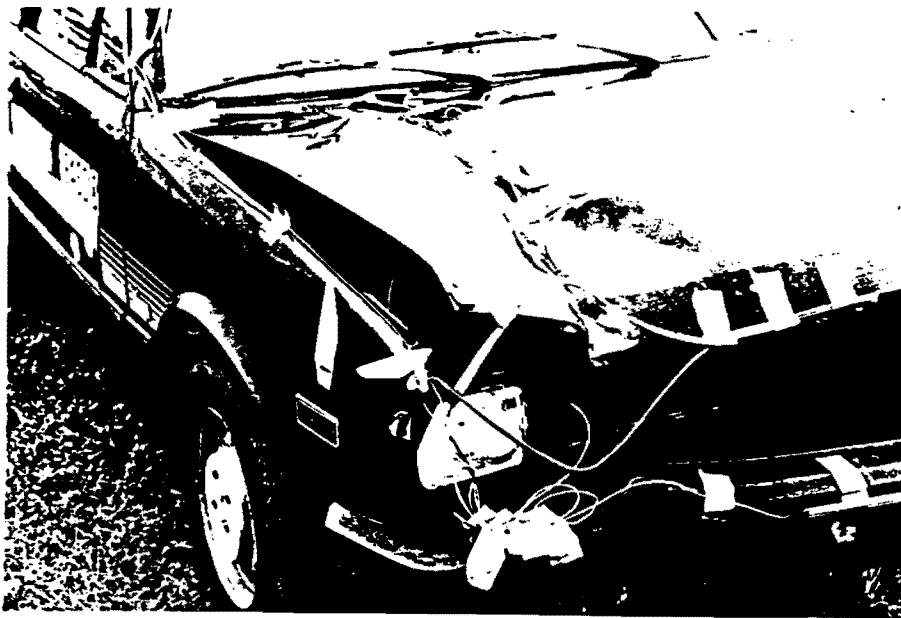
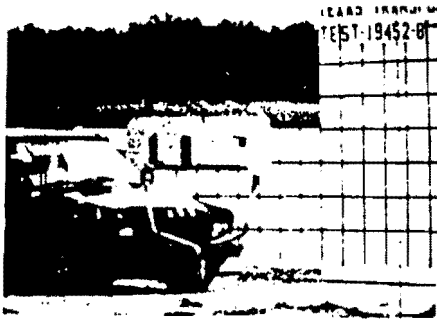

Figure . Vehicle after test 19452-8.



Impact



0.068 sec

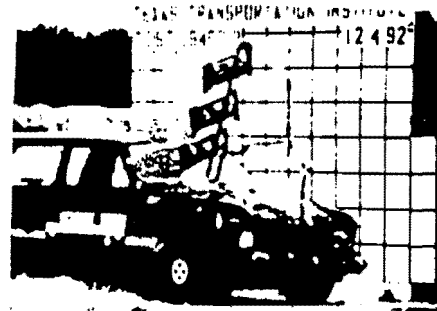

0.136 sec

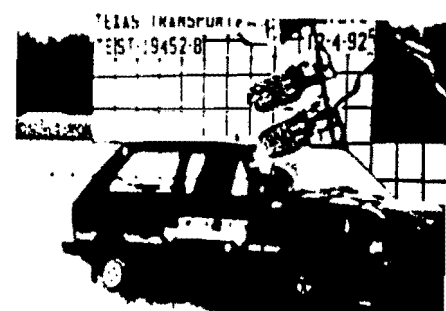

0.204 sec

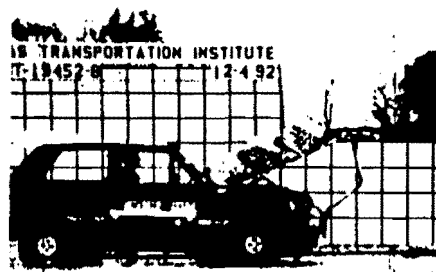
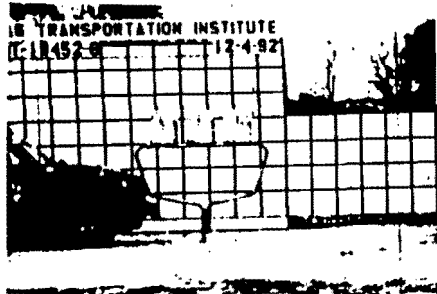

Test No. 19452-8
 Date 12/04/92
 Test Installation . . . Mailbox

 Installation Length . . N/A
 Max. Dynamic Movement . N/A
 Max. Perm. Movement . . 102 ft (31.1 m)
 Test Vehicle 1987 Yugo
 Vehicle Weight
 Test Inertia 1,808 lb (820 kg)
 Gross Static 1,967 lb (892 kg)
 Vehicle Damage Classification
 TAD 12FR1
 CDC 12FREN1
 Maximum Vehicle Crush. . 5.0 in (12.7 cm)

Impact Speed. 61.2 mi/h (98.5 km/h)
 Impact Angle. 0.0 deg
 Speed at Parallel . . . N/A
 Exit Speed 55.7 mi/h (89.6 km/h)
 Exit Trajectory N/A
 Vehicle Accelerations at center-of-gravity
 (Max. 0.050-sec Average)
 Longitudinal. -2.0 g
 Lateral -0.4 g
 Occupant Impact Velocity at true c.g.
 Longitudinal. 2.6 ft/s (0.8 m/s)
 Lateral -4.1 ft/s (1.2 m/s)
 Occupant Ridedown Accelerations
 Longitudinal 0.31 g
 Lateral 0.78 g

Figure . Summary of results for test 19452-8.

19452-8

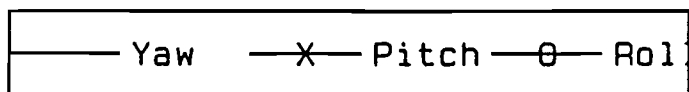
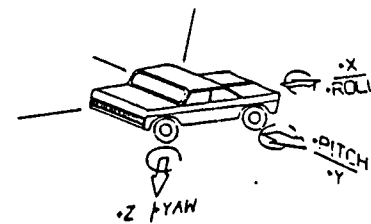

Axes are vehicle fixed.
Sequence for determining orientation is:

1. Yaw
2. Pitch
3. Roll

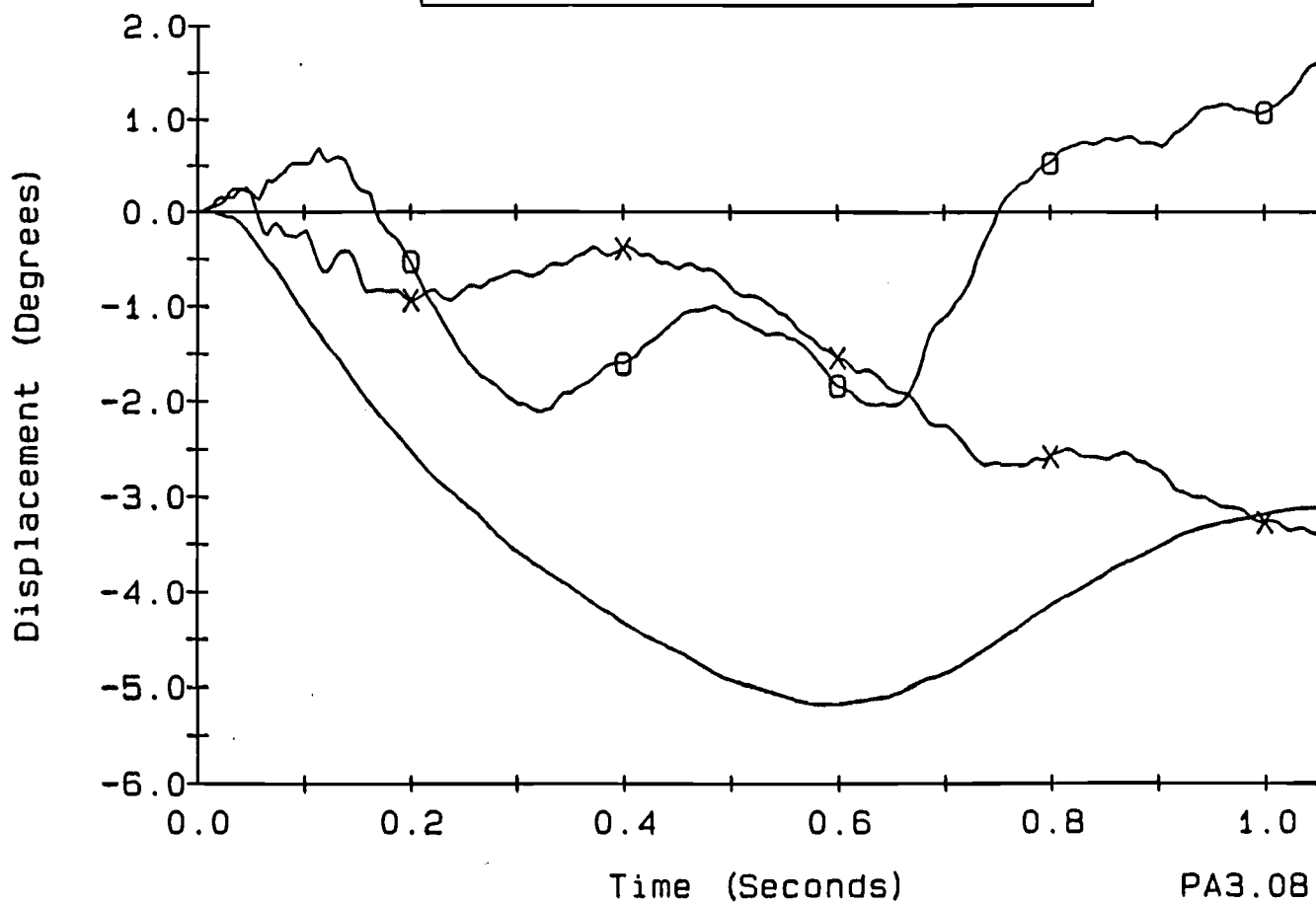

Figure . Vehicle angular displacements for test 19452-8.

CRASH TEST 19452-8

Class 180 Filter

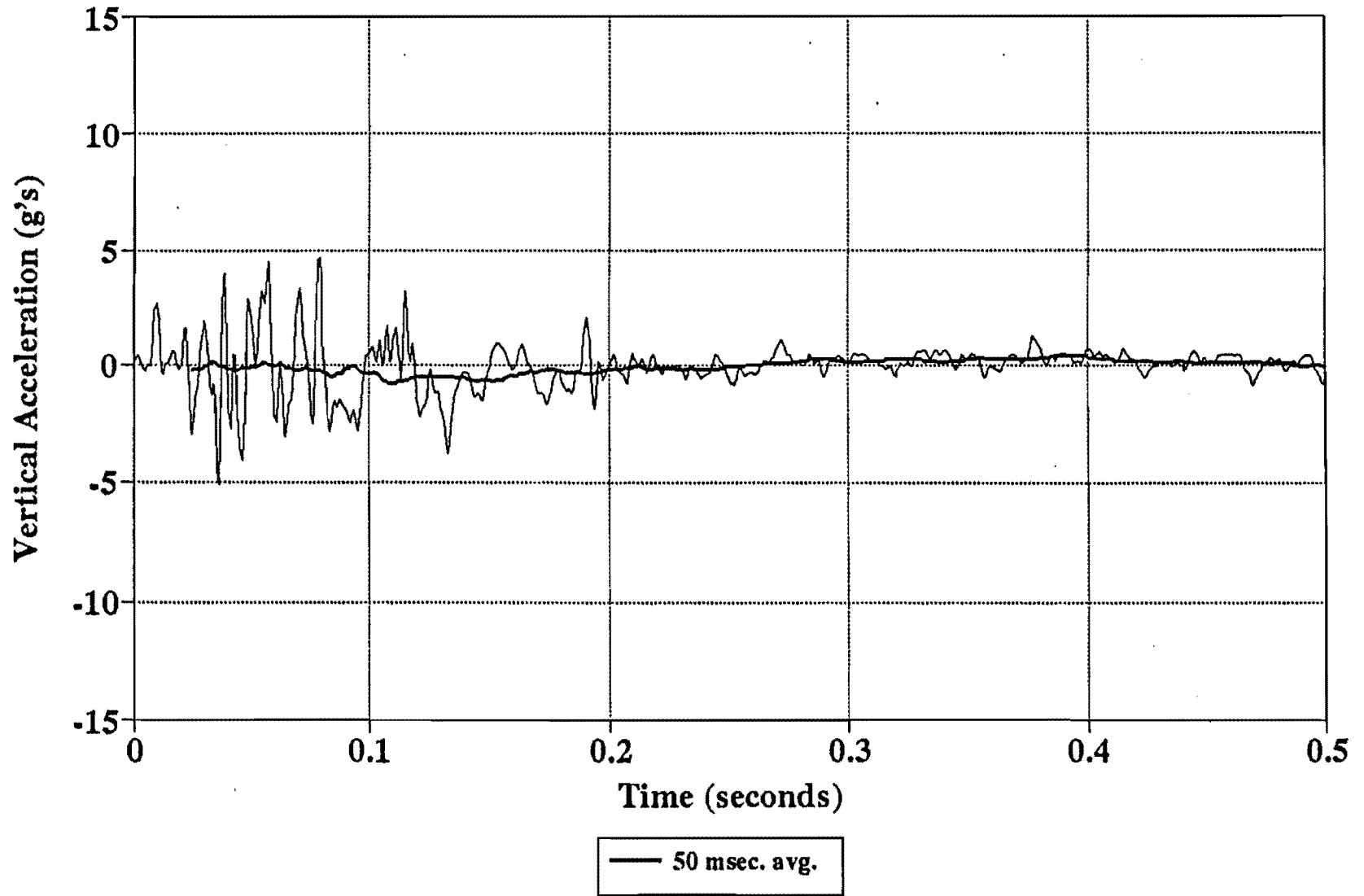

Figure . Vertical accelerometer trace for test 19452-8.

Test 19452-9

A 1989 Ford Festiva (shown in Figures X & Y) impacted a formed tube support frame with 3 type 2 mailboxes installed. The impact was conducted at 62.9 miles per hour (101.2 km/h) using a cable reverse tow and guidance system. The point of impact was the front left quarter point of the vehicle bumper with the centerline of the mailbox installation. Test inertia mass of the vehicle was 1,808 lb (820 kg) and its gross static mass was 1,967 lb (893 kg). The height from roadway surface to the lower edge of the vehicle bumper was 15.0 inches (38.0 cm) and 21.1 inches (53.5 cm) to the top of the bumper. Other dimensions and information on the vehicle are given in Figure XX.

The vehicle was free wheeling and unrestrained just prior to impact. Upon impact, the support began to yield and by 0.034 second, the support began to separate from the ground sleeve (Flush V-Wing socket). At approximately 0.066 second, the first mailbox struck the windshield of the vehicle. The vehicle lost contact with the installation at approximately 0.166 second and the entire assembly went over the top of the vehicle with no subsequent contacts. The brakes were applied at 1.1 second and the vehicle came to rest 282.0 feet (85.0 m) from the point of impact. Sequential photographs of the test are shown in Figure XX.

The installation yielded to the vehicle. The support separated from the ground sleeve and the support and mailboxes came to rest approximately 132.0 feet (40.2 m) from the point of impact. All mailboxes remained attached to the support. The vehicle sustained damage to the bumper, hood, grill, and windshield as shown in Figure XX. The fan and radiator also sustained damage.

A summary of the test results and other information pertinent to this test are given in Figure XX. The maximum 0.050 second average acceleration experienced by the vehicle was -2.6 g in the longitudinal direction and -0.6 g in the lateral direction. In the longitudinal direction the occupant contact velocity was 4.7 ft/s (1.4 m/s) at .470 second and there was no contact in the lateral direction. Vehicle angular displacements are plotted in Figure XX and vehicle accelerometer traces are displayed in Figures XX through XX. Change in vehicle velocity was 3.9 mi/h (6.3 km/h) and change in momentum was 321.2 lb-s.

In summary, the mailbox installation safely yielded to the vehicle. The vehicle sustained minor damage and did not present undue hazard to other traffic. There was no deformation or penetration into the occupant compartment. The occupant contact velocities in the

longitudinal and lateral directions were within acceptable limits. This installation in "strong soil" is acceptable according to the evaluation criteria recommended in NCHRP Report 230.

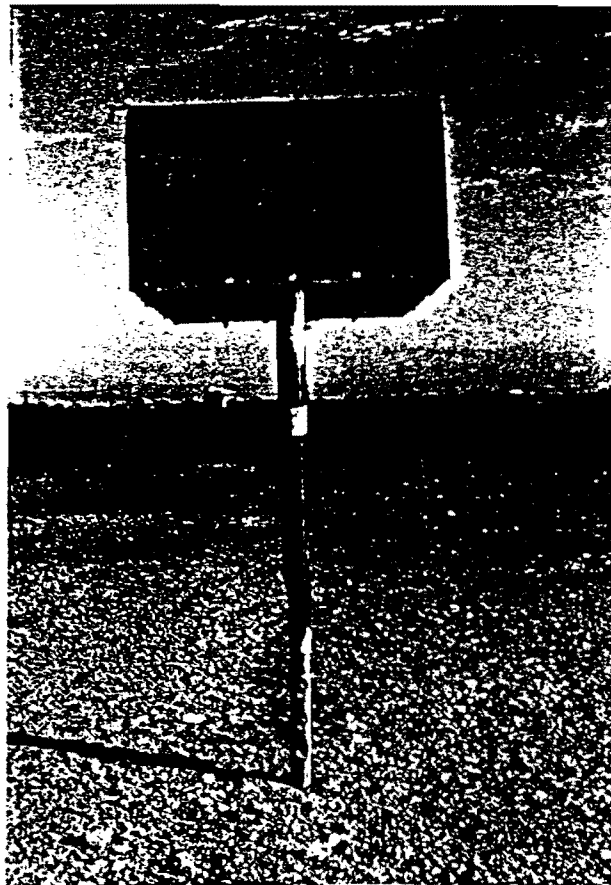
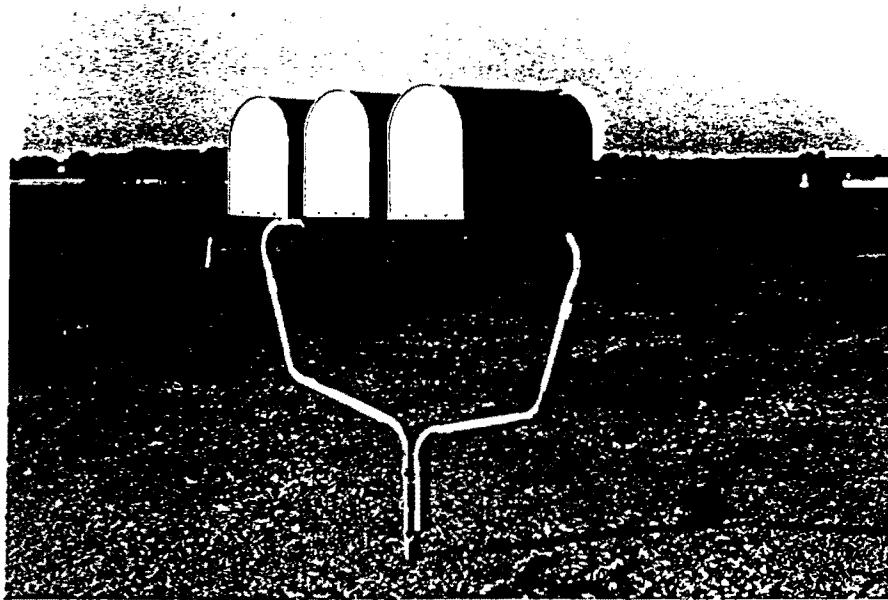

Figure . Mailbox installation for test 19453-9.

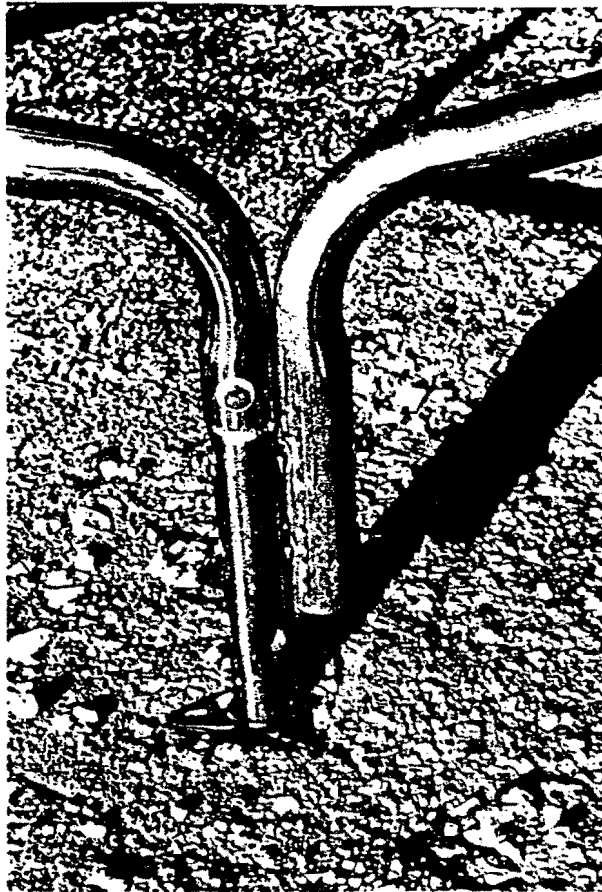
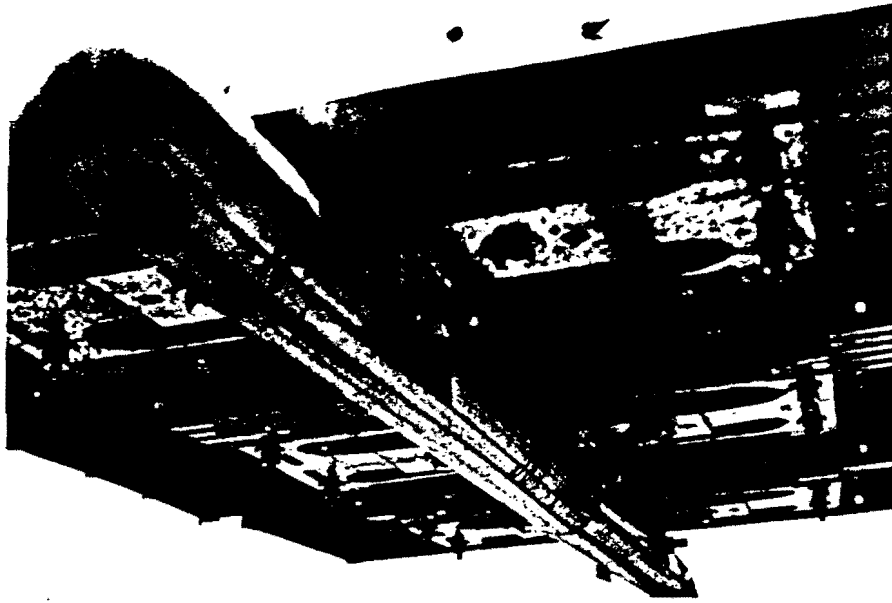

Figure . Support connections for test 19453-9.



Figure . Vehicle prior to test 19453-9.

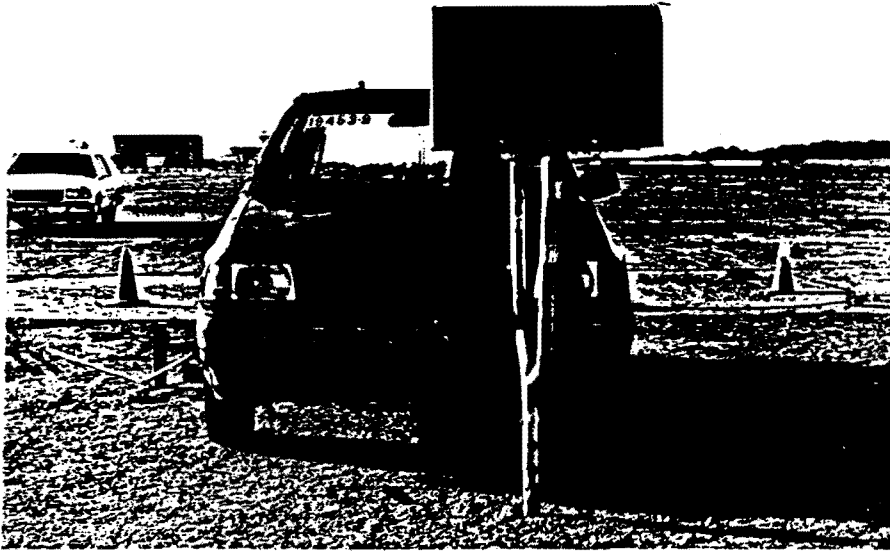
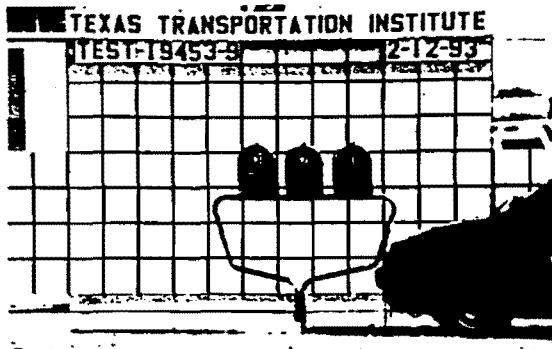
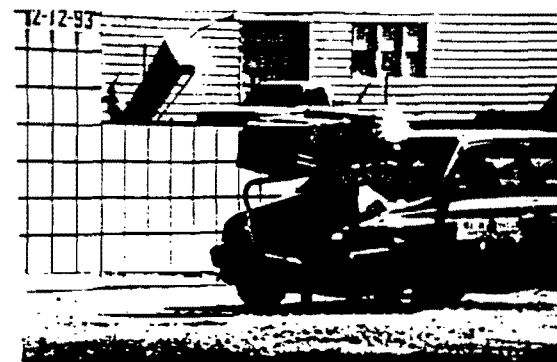
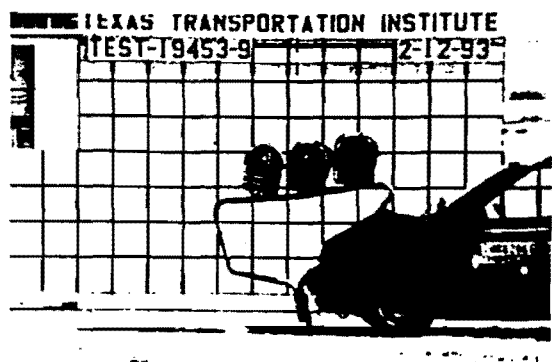

Figure . Mailbox/vehicle geometrics for test 19453-9.



0.000 s



0.022 s

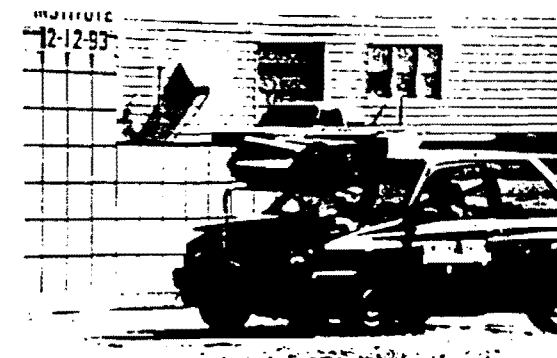
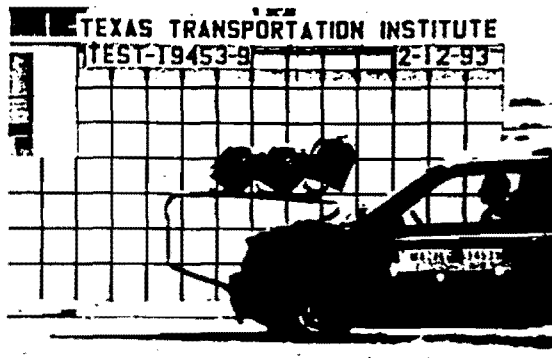

0.044 s

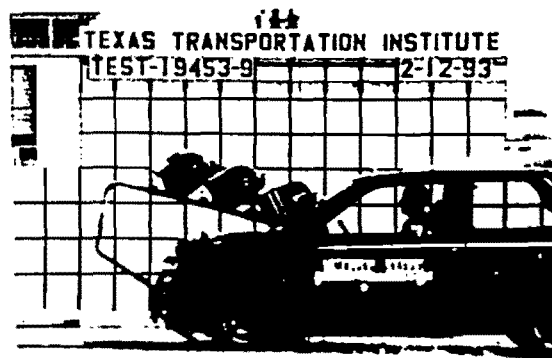

0.066 s

Figure . Sequential photographs for test 19453-9.
(perpendicular and side views)

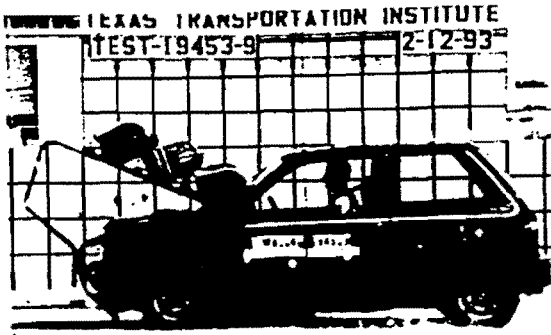

0.088 s

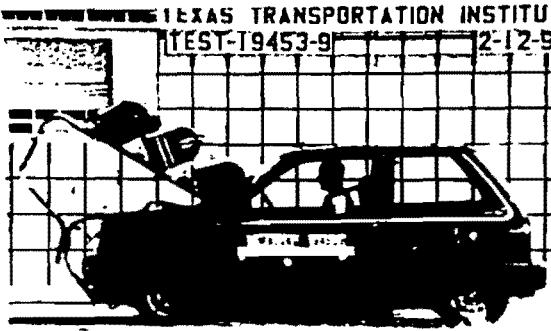

0.110 s



0.132 s

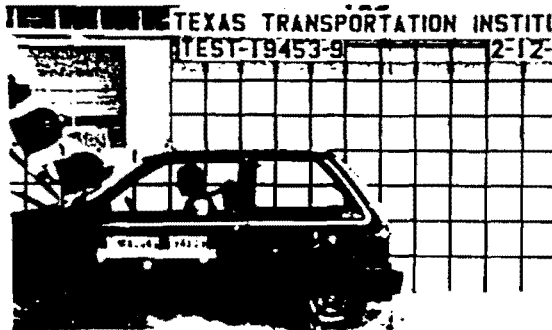

0.154 s

Figure . Sequential photographs for test 19453-9.
(perpendicular and side views) cont.

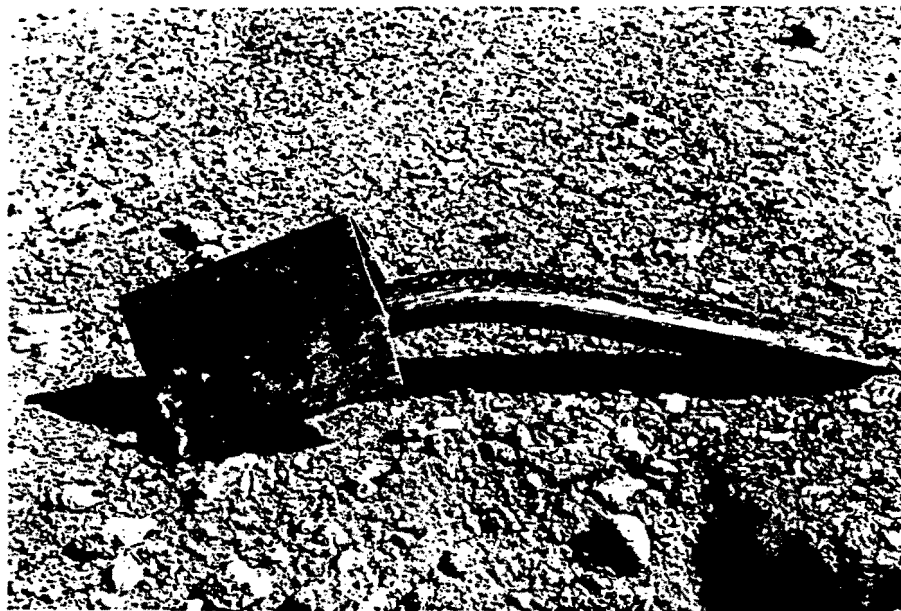

Figure . Flush V-Wing socket after test 19453-9.

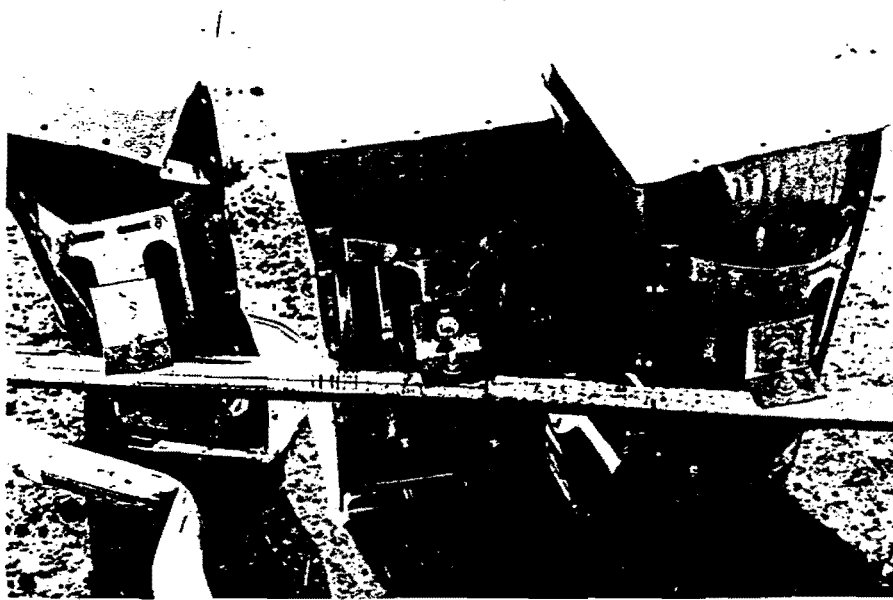
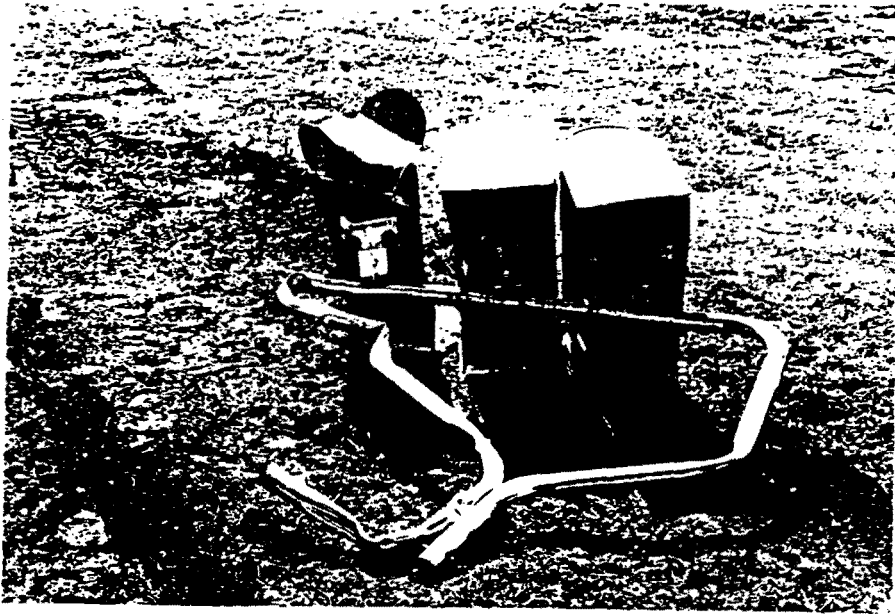
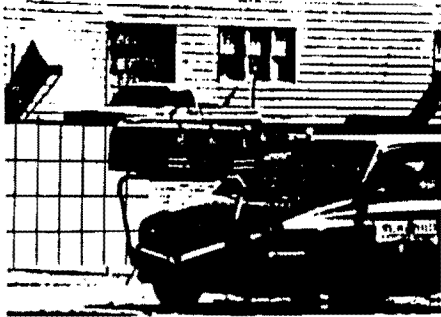

Figure . Mailbox/support after test 19453-9.



Figure . Vehicle after test 19453-9.



Impact



0.044 sec



0.088 sec

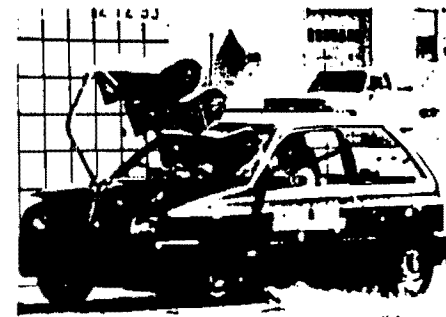

0.132 sec

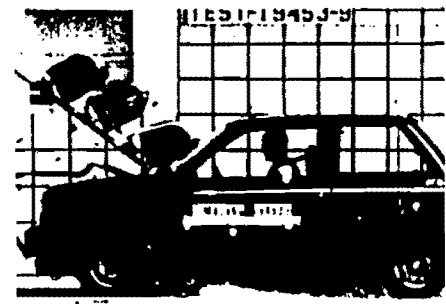
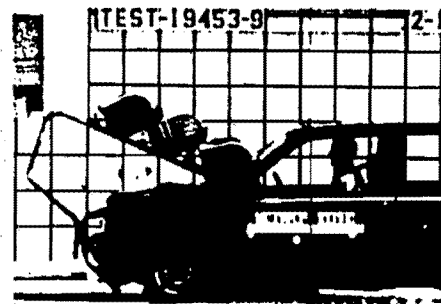
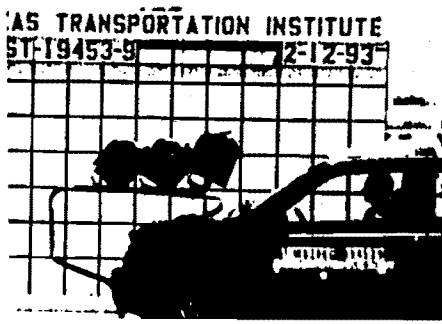
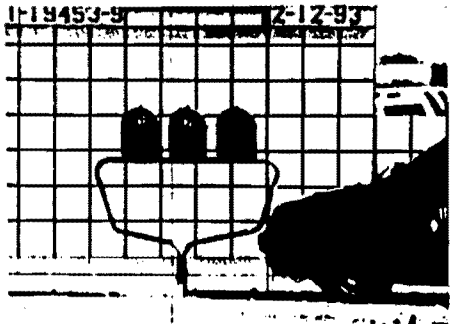

Test No. 19453-9
 Date 2/12/93
 Test Installation . . . Mailbox

 Installation Length . . N/A
 Max. Dynamic Movement . N/A
 Max. Perm. Movement . . 115 ft (35.1 m)
 Test Vehicle 1989 Ford Festiva
 Vehicle Weight
 Test Inertia 1,808 lb (820 kg)
 Gross Static 1,969 lb (893 kg)
 Vehicle Damage Classification
 TAD 12F11
 CDC 12F1EN1
 Maximum Vehicle Crush. . 3.9 in (10.0 cm)

Impact Speed. 62.9 mi/h (101.2 km/h)
 Impact Angle. 0.0 deg
 Speed at Parallel . . . N/A
 Exit Speed 59.0 mi/h (94.5 km/h)
 Exit Trajectory N/A
 Vehicle Accelerations at center-of-gravity
 (Max. 0.050-sec Average)
 Longitudinal. -2.6 g
 Lateral -0.6 g
 Occupant Impact Velocity at true c.g.
 Longitudinal. 4.7 ft/s (1.4 m/s)
 Lateral N/A
 Occupant Ridedown Accelerations
 Longitudinal -0.24 g
 Lateral N/A

Figure . Summary of results for test 19453-9.