

1. Report No. FHWA/TX-92/1232-6		2. Government Accession No.		3. Recipient's Catalog No.	
4. Title and Subtitle Development of Fiberoptic Sign Displays for Dynamic Lane Assignment				5. Report Date March 1992	
				6. Performing Organization Code	
7. Author(s) Wayne L. Gisler and Neilon J. Rowan				8. Performing Organization Report No. Research Report 1232-6	
9. Performing Organization Name and Address Texas Transportation Institute The Texas A&M University System College Station, Texas 77843-3135				10. Work Unit No.	
				11. Contract or Grant No. Study No. 2-18-90/4-1232	
12. Sponsoring Agency Name and Address Texas Department of Transportation Transportation Planning Division P.O. Box 5051 Austin, Texas 78763				13. Type of Report and Period Covered Interim-September 1989 December 1991	
				14. Sponsoring Agency Code	
15. Supplementary Notes Research performed in cooperation with the U.S. Department of Transportation and Federal Highway Administration. Research Study Title: Development of Fiberoptic Sign Displays for Dynamic Lane Assignment					
16. Abstract This report presents the findings of the research conducted during the first year of the Highway Planning and Research (HPR) Project 1232-Task 5.1, titled "Development of Fiberoptic Sign Displays for Dynamic Lane Assignment," sponsored by the Texas Department of Transportation (formerly known as the Texas State Department of Highways and Public Transportation). This report presents the concepts of various types of signing technology. The feasibility of the fiberoptic technology as an appropriate means of implementing the concept of dynamic lane assignment has been presented. The crucial parameters involved in determining the optimum operating conditions at nighttime were identified. The adopted data collection methods to collect data in a testing environment are documented. The results of the analysis of the collected data have also been discussed. The results indicated that there is an inverse relationship between legibility and target value with variation in voltage. A voltage of 35 to 65 volts was found to provide optimum legibility and target value. The arrow shafts were visible from a distance of 800 feet. However, the word messages were visible from 200 feet only. The necessity to consider the presence and the operation of the traffic signals in the vicinity of the fiberoptic sign was also identified.					
17. Key Words Glance Legibility, Target Value, Fiberoptic Signs, Lane Use Control Signs, Dynamic Lane Assignment, Time Management, Space Management			18. Distribution Statement No restrictions. This document is available to the public through the National Technical Information Service 5285 Port Royal Road Springfield, Virginia 22161		
19. Security Classif. (of this report) Unclassified		20. Security Classif. (of this page) Unclassified		21. No. of Pages 94	22. Price

**DEVELOPMENT OF FIBEROPTIC SIGN DISPLAYS
FOR DYNAMIC LANE ASSIGNMENT**

Wayne L. Gisler
Engineering Research Associate

and

Neilon J. Rowan
Research Engineer

Research Report 1232-5

Research Study Number 2-18-90/4-1232

Sponsored By

Texas Department of Transportation
in cooperation with the
U.S. Department of Transportation
U.S. Federal Highway Administration

Texas Transportation Institute
The Texas A&M University System
College Station, Texas 77843-3135

March 1992

METRIC (SI*) CONVERSION FACTORS

APPROXIMATE CONVERSIONS TO SI UNITS

Symbol	When You Know	Multiply By	To Find	Symbol
LENGTH				
in	inches	2.54	centimetres	cm
ft	feet	0.3048	metres	m
yd	yards	0.914	metres	m
mi	miles	1.61	kilometres	km

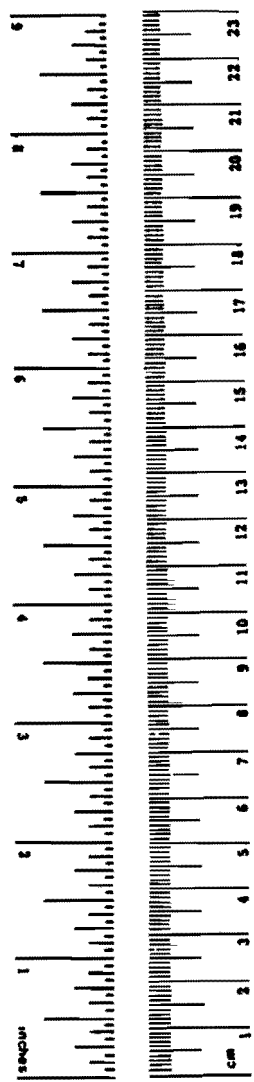

AREA				
in ²	square inches	645.2	centimetres squared	cm ²
ft ²	square feet	0.0929	metres squared	m ²
yd ²	square yards	0.836	metres squared	m ²
mi ²	square miles	2.59	kilometres squared	km ²
ac	acres	0.395	hectares	ha

MASS (weight)				
oz	ounces	28.35	grams	g
lb	pounds	0.454	kilograms	kg
T	short tons (2000 lb)	0.907	megagrams	Mg

VOLUME				
fl oz	fluid ounces	29.57	millilitres	mL
gal	gallons	3.785	litres	L
ft ³	cubic feet	0.0328	metres cubed	m ³
yd ³	cubic yards	0.0765	metres cubed	m ³

NOTE: Volumes greater than 1000 L shall be shown in m³.

TEMPERATURE (exact)				
°F	Fahrenheit temperature	5/9 (after subtracting 32)	Celsius temperature	°C

APPROXIMATE CONVERSIONS TO SI UNITS

Symbol	When You Know	Multiply By	To Find	Symbol
LENGTH				
mm	millimetres	0.039	inches	in
m	metres	3.28	feet	ft
m	metres	1.09	yards	yd
km	kilometres	0.621	miles	mi

AREA				
mm ²	millimetres squared	0.0016	square inches	in ²
m ²	metres squared	10.764	square feet	ft ²
km ²	kilometres squared	0.39	square miles	mi ²
ha	hectares (10 000 m ²)	2.53	acres	ac

MASS (weight)				
g	grams	0.0353	ounces	oz
kg	kilograms	2.205	pounds	lb
Mg	megagrams (1 000 kg)	1.103	short tons	T

VOLUME				
mL	millilitres	0.034	fluid ounces	fl oz
L	litres	0.264	gallons	gal
m ³	metres cubed	35.315	cubic feet	ft ³
m ³	metres cubed	1.308	cubic yards	yd ³

TEMPERATURE (exact)

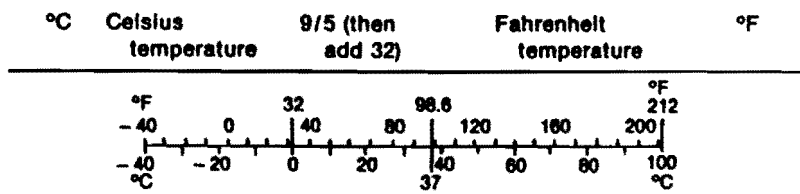

These factors conform to the requirement of FHWA Order 5190.1A.

* SI is the symbol for the International System of Measurements

EXECUTIVE SUMMARY

INTRODUCTION

A strong case is frequently made that congestion is the direct result of ever-increasing travel demands, particularly in urban areas. Also, there is merit in the claims that variability in turning movement volumes exacerbate the perennial problem of congestion. These problems prompt traffic engineers to continually search for better ways to manage traffic, particularly on urban systems. We have developed and refined "time management" methods, ie, traffic responsive signal phasing and timing techniques, to a high level of efficiency. This research deals with a complementary concept - "space management". Space management utilizes dynamic lane assignment, ie, changing specific lane use assignments in response to changes in the turning movement demand volumes at major intersections. This report describes the activities and results of the research conducted during the first year of the Highway Planning and Research (HPR) Project 1232-Task 5.1 Dynamic Lane Assignment Systems.

THE STUDY

This report presents a review of the current signing technology and a brief evaluation of the various signing technologies that can be used to design changeable message signs. The advantages of using fiberoptics technology are highlighted. A prototype fiberoptics sign was developed to facilitate displays that would convey the same messages as Lane-Use Control Signs R3-5 and R3-6 as illustrated in the Manual on Uniform Traffic Control Devices (see Figure S1 and S2), and an additional display that would provide for an exclusive through movement. This sign satisfied the "dynamic lane assignment " designation because it could be controlled electronically to select turn arrow displays for exclusive left turns, exclusive through movements, or combined left turns and

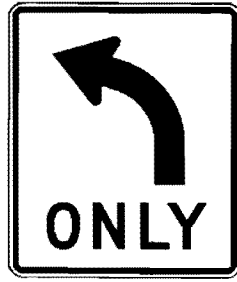

R3-5
30" x 36"

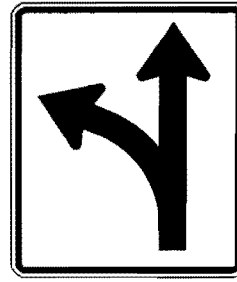

R3-6
30" x 36"

Figure S1 - Lane-Use Control Signs as Illustrated in the Manual on Uniform Traffic Control Devices.

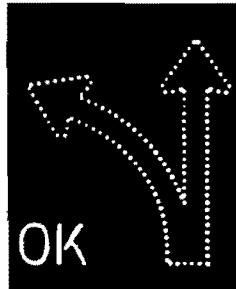

Figure S2 - An Illustration of Some of the Displays that were Possible Using the Prototype Fiber-optics Sign.

through movements from the same lane. The prototype sign was subjected to a thorough evaluation at the Texas A&M Riverside Campus Sign Test Laboratory. This evaluation included studies of legibility, visibility, target value and other human factors measures as they are affected by sign design features such as stroke width, letter height, symbol shape, pixel spacing, redundancy and others. Operational issues included in the evaluation were sign brightness, light output, operating voltage, sign placement relative to traffic signals, and the presence of fixed source lighting as they relate to the human factors measures.

FINDINGS OF THE RESEARCH

The results showed that the symbols (the turn arrows) were clearly legible from a distance of 800 feet, but the supplemental text "ONLY" and "OK" were legible at 200 feet or less. An inverse relationship between legibility and target value was found. As expected, light output of the sign was proportional to the applied voltage; then it was observed that an increase in voltage resulted in an increase in target value but it also resulted in a corresponding decrease in legibility. The optimum voltage for acceptable levels of legibility and target value was found to be between 35 and 65 volts. While the best legibility was found to exist when sign voltage was 35 volts, the best target value was found at 65 volts. However, legibility and target value were found to be acceptable at all points within the range of 35 to 65 volt settings. It should be noted that the studies were performed in a field laboratory which is essentially devoid of extraneous light. For field applications, it is important that signs have features that permit voltage adjustments to compensate for the effects of ambient light conditions.

This research has demonstrated a very high potential for fiberoptics signs to effectively communicate to the driver the requirements for dynamic lane assignment. The knowledge gained in this research has been used to design the

second generation signs that will be used at the Sign Test Laboratory at the Texas A&M Riverside Campus to develop sign/signal control strategies and ultimately will be installed for field evaluation under actual traffic conditions.

The second generation signs will have single row pixels to form all symbols and letters used. These pixels will be spaced at 0.7 inches, and every other pixel in a line will be connected to an alternate light source. This arrangement provides the redundancy that is essential for an acceptable display when one light bulb is burned out. Six-inch letters will be used to improve the legibility distance for the word messages.

SUMMARY

In summary, fiberoptic signs used in dynamic lane assignment applications have the potential to improve the capabilities of the traffic engineer to accommodate variations in traffic demand caused by both recurrent and non-recurrent congestion. Dynamic lane assignment can be defined as "space management". When it is used in conjunction with "time management" strategies, it can be a cost-effective alternative to the re-design of major intersections.

The problems associated with non-recurrent congestion provide a great opportunity for the application of dynamic lane assignment techniques. Currently, freeway incident management strategies may require the use of frontage roads to move large volumes of through traffic. Static lane assignments are frequently a deterrent to this strategy. With dynamic lane assignment techniques, the lane use as well as the signal timing can be modified to accommodate the diverted freeway traffic.

ABSTRACT

This report describes the activities and results of the first year of the Highway Planning and Research (HPR) Project 1232-Task 5.1, Dynamic Lane Assignment Systems. A prototype fiberoptics sign was developed to facilitate displays that would convey the same messages as Lane Use Control Signs R3-5 and R3-6 as illustrated in the Manual on Traffic Control Devices, and an additional display that would provide for an exclusive through movement. Dynamic lane assignment could be accomplished by electronically selecting one of the three lane use assignment displays. The sign was subjected to thorough studies of legibility, visibility, target value and other human factors measures as they are affected by sign design features such as stroke width, letter height, symbol shape, pixel spacing, and operational parameters such as sign brightness, light output, operating voltage, and sign placement relative to traffic signals.

The results of the study showed that the symbols were legible from a distance of 800 feet, but the supplemental text "ONLY" and "OK" were legible from 200 feet. Also, it was found that target value of the sign was directly proportional to brightness of the sign, but legibility was inversely proportional. For nighttime operations, it was determined that a dimming device was desirable so that the sign operating voltage could be reduced to about 35 to 65 volts to control the brightness level of the sign.

It was concluded that fiberoptic signs used in dynamic lane assignment applications have the potential to improve the capabilities of the traffic engineer to accommodate variations in traffic demand caused by both recurrent and non-recurrent congestion. Dynamic lane assignment can be defined as "space management". When it is used in conjunction with "time management" strategies

(the use of demand responsive signal control), it can be a cost-effective alternative to re-design of major intersections.

ACKNOWLEDGEMENT

The authors wish to acknowledge the contributions of Jim Livingston and others of The National Sign and Signal Company, in Battle Creek, Michigan, and Cindy Hood of C. J. Hood Company of Stamford, Connecticut, for their assistance in the design and procurement of the experimental fiberoptic sign. The authors also express appreciation to representatives of TTI and TxDOT for their advice and counsel and for their participation in various phases of the study.

The authors also wish to acknowledge that Dr. Carroll J. Messer served as the Task Leader for this research effort and proposed the original concept for DALAS. A related application has been installed by the city of Richmond Hills at a diamond interchange at IH 820 and Rufe Snow Road in Ft. Worth, Texas.

A special acknowledgment is due District 12 of TxDOT for its enthusiastic participation in this phase of the research and its cooperative spirit in arranging for the installation of the signs for field studies.

DISCLAIMER

The contents of this report reflect the views of the authors who are responsible for the opinions, findings, and conclusions presented herein. The contents do not necessarily reflect the views or policies of the Federal Highway Administration or the Texas Department of Transportation. This report does not constitute a standard, specification, or regulation. This report is not intended for construction, bidding or permit purposes.

TABLE OF CONTENTS

EXECUTIVE SUMMARY	iii
ABSTRACT	vii
LIST OF FIGURES	xi
LIST OF TABLES	xii
GLOSSARY	xiii
INTRODUCTION	1
PROBLEM STATEMENT	3
OBJECTIVES AND BACKGROUND	5
Types of Signing	8
Fiberoptic Technology	9
Review of Signing Terminology	11
STUDY DESIGN	13
Design Characteristics of the Fiberoptic Sign	13
Initial Design of Laboratory	17
First Subjective Analysis	17
Analytic Measurement of Luminous Output	19
Pilot Study	21
Second Subjective Analysis	23
Quantitative Evaluation of Glance Legibility	23
RESULTS	25
Results from First Subjective Observations	25
Evaluation of the Fiberoptic Sign	25
Laboratory Improvements	26
Analysis of Analytic Measurements of Luminous Output	28
Pilot Study Results	33
Voltage Distribution for the Traffic Signals	33
Voltage Distribution for Fiberoptic Signing	34
Intensity Distribution for Fiberoptic Signing	38
Results from Second Subjective Analysis	42
Evaluation of Traffic Signal Settings	43
Evaluation of Fiberoptic Sign Voltage Settings	43

Selection of Voltage Settings for Legibility Studies	44
Analysis of Glance Legibility Studies	45
Age Distribution of Study Participants	45
Results from Legibility Studies	46
FINDINGS AND RECOMMENDATIONS	54
Future Applications	57
REFERENCES	60
APPENDIX A	62
APPENDIX B	73

LIST OF FIGURES

Figure S1-	Lane Use Control Signs as Illustrated in the Manual of Uniform Traffic Control Devices	iv
Figure S2-	An Illustration of Some of the Displays that were Possible Using the Prototype Fiberoptics Sign	iv
Figure 1 -	Displays Tested	5
Figure 2 -	Dimensioned Layout of the Fiberoptic Sign Box ¹⁴	
Figure 3 -	Detailed Layout of the Fiberoptic Sign Face	16
Figure 4 -	Laboratory Layout Used for Legibility Studies	18
Figure 5 -	Luminance Curves for Single-Row Through-and-Left Displays	29
Figure 6 -	Luminance Curves for Single-Row Through Only and Single-Row Left- Turn Only Displays	30
Figure 7 -	Luminance Curves for Bold Through-and Left Displays . . .	31
Figure 8 -	Luminance Curves for Bold Through Only and Bold Left-Turn Only Displays	32
Figure 9 -	Frequency Distribution for Threshold Intensity Voltage for the Traffic Signals	35
Figure 10 -	Frequency Distribution of Fiberoptic Display Voltages	37
Figure 11 -	Cumulative Frequency Distribution for Fiberoptic Display Voltages	39
Figure 12 -	Frequency Distribution for Fiberoptic Display Intensities . .	40
Figure 13 -	Cumulative Frequency Distribution of Fiberoptic Display Intensities	41
Figure 14 -	Grouping of Study Participants	47
Figure 15 -	Glance Legibility for General Format of Sign	49
Figure 16 -	Glance Legibility Distance for "OK" Word Message	50
Figure 17 -	Glance Legibility Distance for "ONLY" Word Message . . .	51
Figure 18 -	Glance Legibility Distance for Shaft Design	53
Figure 19 -	AM and PM Peak Hour Rates at IH-10 and Voss/Bingle Rd	58

LIST OF TABLES

Table 1 -	Age Distribution of Texas Drivers	7
Table 2 -	Typical Fiberoptic Pixel Sizes	10
Table 3 -	Age Distribution of Study Participants	46

GLOSSARY

Actual Brightness - the brightness of the sign at the face of the sign.

Arm - group of fiberoptic strands of which one end is grouped to form an individual pixel while the other end is grouped with other arms into which light can be shown.

Attention Value - a subjective measure of the ability of a sign to attract the attention of a driver. Attention value can be broken down into terms of target value and priority value.

Brightness - a measure of luminous energy being reflected or emitted from an reflective object or a light source.

Central Vision - vision associated with the fovea of the eye. Central vision corresponds to the portion of the visual field within approximately 2 degrees of the line of sight (11). Color distinctions and sharp images are associated with central vision as a result of the concentration of cones within the fovea.

Contrast - (1) the ratio of the difference between the object being viewed and the background surroundings or (2) the ratio of the difference between the legend of a sign and the sign background.

Flux - lines that are typically used to quantitatively represent the magnitude of energy being emitted from a source.

Gaussian Surface - an imaginary closed surface used to determine the luminous intensity of a light source (12).

Glance Legibility - a measure of a person's ability to discern a legend in a very limited amount of time.

Glare - sensation caused by the light intensity within the visual field being greater than that to which the light is adapted to cause annoyance, discomfort, or loss of visual performance and visibility (11, 13).

Intensity - the light output of a source. Intensity can be theoretically represented as vectors of light being emitted from a source. Intensity is typically expressed in terms of candelas.

Internally-lighted Signing - signing that produces its own light to form displays.

Legibility - a measure of a person's ability to read and/or discern the actual appearance of an object under good viewing conditions.

Line - group of fiberoptic arms that make up an single element of a display.

Luminance - the luminous intensity of any surface in a given direction per unit of projected area of the surface as viewed from that direction (7, 11). It is typically expressed in foot-lamberts or candelas per unit area.

Luminous Flux - vectors used to conceptually represent the magnitude of light exiting a source and passing through an area "A". Units are typically expressed in lumens or candelas.

Luminous Intensity - the luminous flux per unit solid angle in a specific direction. Hence, it is the luminous flux on a small surface normal to that direction divided by the solid angle in steradians (12).

Negative Contrast - contrast associated with a black legend on a white background.

Perceived Brightness - the brightness of the sign that is perceived by the driver.

Positive Contrast - contrast associated with a white legend on a black background.

Priority Value - a subjective measure of a sign's ability to be seen first out of a group of signs. It is related to reading habits of the driver and the relative position of the signing (14).

Pure Legibility - refers to the condition where a person has unlimited time to view the sign.

Reflective Signing - signing that utilizes reflective materials to redirect light produced by external sources, e.g., headlights, street lighting, sunlight, etc., to provide sign visibility under low levels of illumination.

Solid Angle - the ratio of the area on the surface of a sphere to the square of the radius of the sphere, normally expressed in steradians. When the distance between the eye and the light source is greater than three times the largest dimension of the projected area, this ratio is approximately equal to the ratio of the projected area on the surface of a sphere divided by the square of the distance from the eye to the light source (7).

Target Value - a subjective value that corresponds to ability of a sign to compete with its surroundings for attention. Target value is dependent on contrast, relative size, placement, and the type of signing (14).

Conversion Factors

1 Foot-lambert	=	452 Candelas/in ²
1 Foot-lambert	=	3.142 Candelas/ft ²
1 Lumen	=	12.57 Candelas
1 Foot-candle	=	3.14 Foot-lamberts
1 Foot-candle	=	1 Lumen/ft ²
1 Foot-candle	=	12.57 Candelas/ft ²

INTRODUCTION

The research reported herein was conducted as Task 5.1 (1), the (first year activity) within Area 5 of the HP&R Project 1232 -- TRAFFIC CONTROL SYSTEMS.

The initial definition of Task 5.1 (1) was stated as follows:

Task 5.1 (1): Dynamic Lane Assignment. Turning movements at diamond interchanges vary by time of day, yet traditional traffic signing for lane use is static. The result is inefficient use of available capacity, particularly along one-way frontage roads which must serve not only temporal surges of traffic but also traffic diversion from the freeway due to incidents and pavement maintenance activities. This task will consist of several related steps. Preliminary functional specifications will be developed initially for DynAmic Lane Assignment Signs (DALAS) operating within a SC&C system together with preliminary real-time operations strategies and control logic. Human factors issues will be identified including visibility, understandability, signal transitions, and driver response. These human factors issues will be examined and addressed through a carefully designed series of laboratory experiments based on high-resolution VCR color video techniques. Plans for field testing the signs will be formulated.

It was decided that the human factors laboratory experiment could be effectively integrated into full-scale field laboratory experiments to be conducted at the TTI Sign Laboratory located at the Texas A&M Riverside Campus. To facilitate these full-scale field laboratory experiments, a fiberoptic sign providing dynamic lane assignment capability was designed, procured and installed at the TTI sign laboratory. Traffic signals and roadway illumination devices were installed to create a realistic sign test environment.

The principal objective of this phase of the research was to identify the design requirements for a second generation of fiberoptic DALAS signs which would be installed at a selected diamond interchange for evaluation under real-world traffic conditions. Thus, the first generation sign was designed in such a manner that it would completely encompass the probable range of design and performance requirements for the real-world application. In other words, the flexibility designed into the sign provided for the selection of displays that were far more than adequate for visual performances on one extreme and then less than adequate on the other extreme of performance levels. This flexibility was achieved by providing for variation of stroke width, pixel spacing, and voltage/light output of the sign.

The results of this phase of the research have been reported in a thesis by Wayne Gisler, a graduate student in the Transportation and Public Works Area of Civil Engineering at Texas A&M University. The thesis is entitled "Dynamic Lane Assignment Using Fiberoptic Signing".

PROBLEM STATEMENT

Maintaining uncongested traffic conditions at intersections that exhibit wide variations in turning movement volumes is a challenging problem for transportation agencies in many Texas metropolitan areas. Lane use information at intersections is presently conveyed to drivers via pavement markings and overhead reflective signing. Problems occur at intersections that use these traffic control devices for lane use assignments when wide variations in turning movement volumes exist. The static nature of these devices does not allow lane usage to be optimized based on the traffic demand. The use of changeable message signing would provide a more efficient means of responding to cyclical variations in turning movement volumes.

Static signs and changeable message signs have basically the same performance requirements: they must first attract the attention of the driver, then provide a display that is easily discernable. Furthermore, a display must be discerned and understood sufficiently in advance of the point where the information is needed to allow a reasonable and prudent driver to act accordingly (1). The ability of a sign to function in this manner is dependent on the *legibility** and *target value* of the sign. Legibility and target value of signs vary with the contrast between the sign legend and background as well as the contrast between the sign and its surroundings. The characteristics that contribute to a sign's effectiveness are external illumination, whether the sign reflects or emits light, and the size of the sign and its legend (2). While design procedures for reflective signs have been documented throughout transportation and human factors engineering journals, the design and operation of internally lighted displays depend on basic "rules-of-thumb" and experience. Design procedures for

*Italicized words denote Glossary terms.

changeable message signs are not yet well established, due largely to the rapid development of changeable message signs (1). Design procedures and requirements must be developed that take into account the limitations of driver visibility in both daytime and nighttime driving conditions. Liability issues further mandate that changeable message signing conform as closely as possible to the requirements of the Manual on Uniform Traffic Control Devices (MUTCD) for signing (1).

Fiberoptic technology provides a viable alternative to many other types of changeable message signing. Fiberoptic displays are typically associated with the provision of higher levels of resolution, very uniform light output between individual pixels, and lower costs than are associated with other types of internally illuminated signing (3). A large amount of work has been done by European companies to quantify the light output of this type of signing and to develop design procedures that limit the number of pixels used to form a display based on the average pixel output (3). Procedures that provide engineers with the ability to design displays such that they can be discerned at specific distances must be developed. The development of national standards for the design of fiberoptic displays is essential to ensure that future transportation systems continue to provide information to drivers in a safe, effective, and uniform manner.

OBJECTIVES AND BACKGROUND

The primary objective of this research was to evaluate target value and legibility distance of a changeable message sign developed by the Texas Transportation Institute and the National Sign and Signal Company. This sign is capable of producing several different displays (see Figure 1). In order to accomplish the objective of this research, the specific procedures adopted were to:

- Conduct a survey of professionals in the Transportation and Industrial Engineering fields to evaluate sign characteristics for:
 - Various illumination conditions,
 - Various pixel spacings, and
 - Different distances from the sign.
- Conduct a pilot study to refine testing procedures

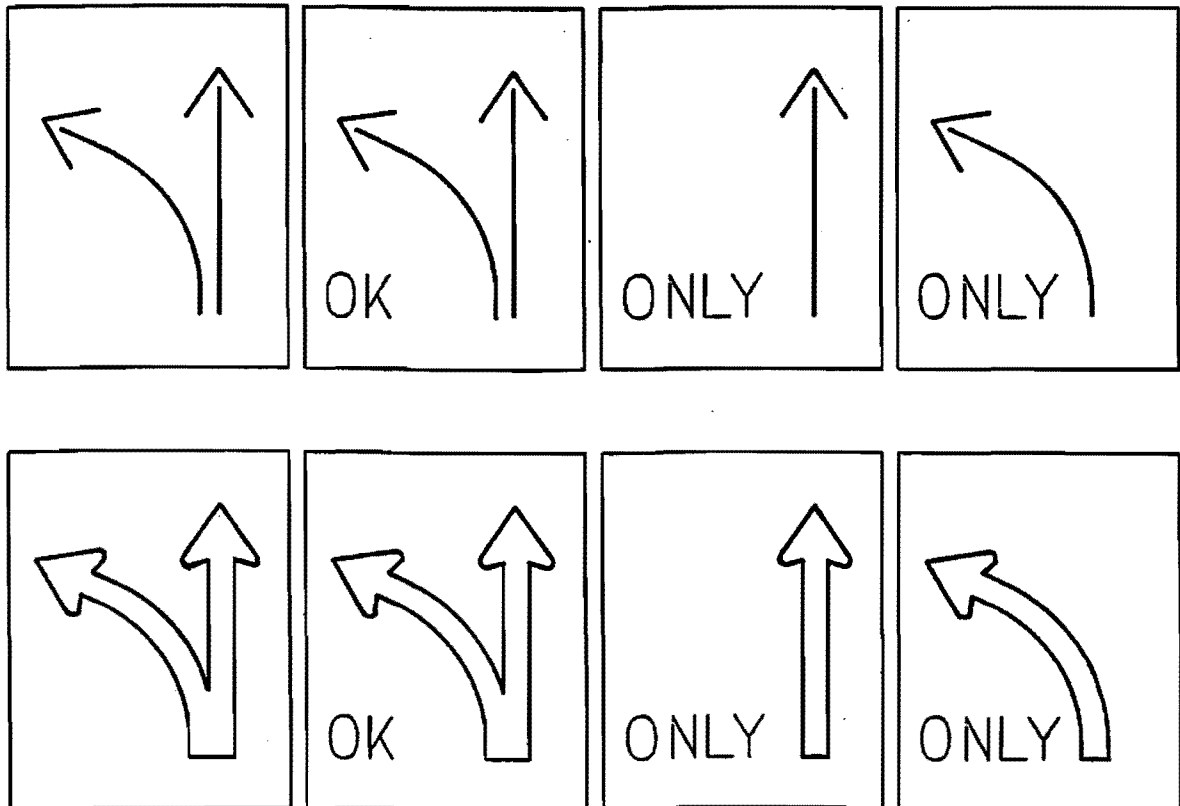

Figure 1 - Displays Tested

Figure 1 - Displays Tested

- Utilize the results from the pilot study to:
 - Identify limitations of the study design, and
 - Identify the range of study variables needed to obtain a manageable study size.
- Conduct a second subjective survey to:
 - Evaluate the final laboratory design,
 - Establish ranges to be used for study variables, and
 - Evaluate target value, legibility, and the interaction of the sign with the traffic signals at the installation.
- Develop and conduct a driver study to evaluate legibility distance associated with various fiberoptic displays.

Secondary objectives of this research were to evaluate various characteristics of the fiberoptic sign and to identify areas for future fiberoptic sign research. Characteristics that were examined included:

- Differences in pixel spacings,
- The minimum visual angle of the light output for the study settings, and
- The effect that light intensity produced by the sign has on the legibility of different displays.

The ability of a sign to attract the attention of a driver and provide a legible display is largely dependent on illumination conditions surrounding the sign. Studies have identified large differences in visual capabilities between day- and nighttime conditions (4). This is due to the steady-state condition of the eye during these different viewing conditions. Day- and nighttime operations, therefore, will require that different operational considerations be made with

respect to light output. The scope of this research was limited to nighttime observations.

A minimum sample of 50 drivers was specified for the studies that evaluated glance legibility distance associated with the fiberoptic sign. Based on the preliminary study design, this number was expected to provide a statistically balanced study for the evaluation of the legibility of the displays at different levels of light output.

The selection of participants used in the legibility study was based solely on the age distribution for Texas drivers (see Table 1). Gender has not been shown to affect legibility in previous studies (4) and was not considered in the selection of study participants. The level of education of the participants was not considered since the study dealt strictly with the evaluation of the glance legibility for the fiberoptic displays.

Table 1 - Age Distribution of Texas Drivers

AGE GROUP	1988 ESTIMATES OF TEXAS DRIVER POPULATION BY AGE¹	MINIMUM NUMBER OF DRIVERS FOR EACH AGE GROUP²
< 25	21.7%	11
25 - 54	53.8%	27
55+	24.5%	12

¹Obtained from the Texas State Data Center, Department of Rural Sociology, Texas A&M University.

²The number of study subjects required in the required age groups.

Types of Signing

The process for selecting or designing a sign display for dynamic lane assignment narrowed the field of candidates to that of changeable message sign technology. Many different technologies are used in the design of changeable message displays. These include rotating drum displays, lamp matrix displays, blank-out displays, and fiberoptic displays. Rotating drum signs use reflective sheeting placed on each side of a triangular drum. Each drum that makes up a display rotates about its centroid to exhibit different patterns, depending on the desired display. A variety of symbols and displays can be produced using this type of signing. It is limited, however, because of its size and the number of displays that can be presented with a single sign. The large number of mechanical parts results in high maintenance costs. It is, however, an effective means of utilizing reflective sheeting for changeable message signs.

Lamp matrix displays have also been used in the design of changeable message displays. These displays utilize light bulbs arranged in a series of columns and rows. This type of signing is capable of producing a wide variety of displays and/or symbols. The size of the bulbs used, however, requires a large sign face in order to obtain an acceptable level of resolution. The intensity of the light typically does not provide a uniform appearance because of variances in the length of life for individual bulbs.

The blank-out or shutter display is another type of changeable message sign. This type of signing utilizes a mechanical shutter system to "black out" parts of the sign face that are not needed to form a display. Blank-out displays have many of the same advantages and disadvantages that bulb matrix signs have. The physical makeup of this type of signing limits the size and complexity of the symbols which can be produced.

Fiberoptic Technology

The use of fiberoptic technology for providing information to drivers has gained popularity in recent years. Fiberoptic signing provides advantages over other types of internally lighted signing. Words and symbols are formed using individual bundles of fiberoptics known as *arms*. One end of each arm is clamped together with other arms to form a larger bundle of fibers. The end of this large bundle is then polished and clamped to a fixture that holds a lamp aimed directly at this end. On the other end of this arm, the fibers are divided into individual pixels which are strategically placed to form a desired display. Thus, when the lamp is energized, the light is transmitted to the pixels and the display is formed.

Table 2 shows the range of pixel sizes that are typically used as well as the purpose for which they are used. The largest pixels shown in Table 2 are typically smaller than the lighting elements used in other types of internally lighted signing. Smaller pixel sizes allow symbols and words to be formed with greater resolution so that a more continuous appearance is obtained. The application of a single light source to the common end of a bundle of arms produces highly uniform light output for individual pixels. The high light output and intensity associated with these pixels eliminates the "phantom effect" exhibited by other types of internally illuminated signing.

Several tradeoffs must be identified and addressed when considering the use of internally lighted fiberoptic signing versus conventional reflective signing. The ability of fiberoptic signing to produce light can be both an advantage and a disadvantage. While fiberoptic signs provide more target value than do reflective signs, the amount of light produced by fiberoptic signs must be adjusted to insure that the sign is legible sufficiently in advance of the point where the

information is needed. A variety of information can be presented using fiberoptic displays, whereas conventional reflective signing provides only one message.

Several disadvantages associated with internally illuminated signing also exist. These disadvantages make the decision to utilize this type of signing highly dependent on the benefits that can be gained at the facility. These include higher capital, maintenance, and operating costs for the sign itself. Backup systems that provide redundancy must be designed to assure that, in the event of a mechanical breakdown or bulb failure, the sign will still be capable of providing a message. Internally lighted signs are also heavier than conventional reflective signs and require the development of special, more substantial supports and mast arms to accommodate the increased weight.

Table 2 - Typical Fiberoptic Pixel Sizes

PIXEL DIAMETER ¹	TYPICAL USE/APPLICATION
0.055"	Pedestrian Signals
0.068"	Lane Assignment/Regulatory Signing
0.090"	
0.125"	Lane Control Signing
0.177"	Word Message Signing
0.238"	Used for turn angles that need wide angle of dispersion

¹Obtained from the National Sign and Signal Company

Review of Signing Terminology

The effectiveness of signing in providing information to the driver is dependent on the driver first being able to see the sign. The information must then be evaluated with respect to how it relates to the condition of the roadway and the desired action of the driver. The *attention value* associated with a sign refers to the ability of a sign to attract the attention of the driver. Attention value is affected by many factors, including the size of the object and the amount of light produced or emitted. The overall contrast between the display and its surroundings and the contrast between the legend and the sign background also contributes to the attention value of a sign. Two different types of contrast exist and the attention values associated with them are very different. *Positive contrast* is the contrast associated with a white legend on a black background. *Negative contrast* associates a black legend with a white background, such as that which is used for regulatory signs.

Attention value can be broken down into two components, target value and *priority value*. Target value refers to the ability of a sign to compete with its visual surroundings. Priority value corresponds to the ability of a given display to attract the attention of the driver "first and best" (5). Forbes (5) described the difference between target value and priority value as shown below.

Target value is applied to the characteristic which makes a sign stand out as different from other objects and other signs. For instance, in one state, extremely large 'SLOW' signs are used near construction projects in order to make these signs stand out from all other signs and objects. Priority value is used to designate the qualities which result in one of the signs of a group being read first, even when all signs are of the same type and therefore have the same target value. On approaching a group of destination signs at a crossroad, which one will the driver read first? The sign which is consistently read first by a

large number of drivers may be said to have greatest priority value (pp. 669).

Legibility can be defined as the ability to discern elements which make up a display. The legibility of word messages and symbols is dependant on the height, stroke-width, light output and contrast. The legibility of word messages is also dependant on the word and letter spacing used (2). Legibility is often evaluated in terms of the distance from a visual stimulus at which this stimulus is legible. Forbes indicated that legibility can be broken down into two sub-classes, *pure legibility* and *glance legibility* (5). Pure legibility corresponds to the condition in which the driver has unlimited time to view a sign (5). Glance legibility corresponds to the condition in which the amount of time the driver has to view the sign is limited (5). The latter condition is similar to what might be expected in heavy traffic conditions (5).

Contrast, legibility and attention value are all affected by the brightness of the display. Brightness is defined as a measure of luminous energy radiating from a light source (2). When developing traffic signing, a distinction must be made between the *actual brightness* of a display and the *perceived brightness* viewed by the driver. The relationship between the actual and perceived brightness of a sign is important in determining whether or not information is provided to the driver in a safe and effective manner (5).

STUDY DESIGN

The first task of this study was to design and procure a prototype sign that would facilitate an evaluation of the various aspects of the dynamic lane assignment concept. After considering the various changeable message signs previously discussed, it was decided that a fiberoptics sign was the best choice. This decision was based on the characteristics of color choice, contrast, flexibility in design, and compatibility in control techniques with accompanying signalization. The prototype sign design was a joint effort of the project staff and representatives of the National Sign and Signal Company. The project staff prepared the preliminary functional layout and specifications. The manufacturer provided valuable assistance in the physical design and layout of the sign.

Design Characteristics of the Fiberoptic Sign

The sign used in this research was procured for the purpose of evaluating (1) the light output characteristics of fiberoptics, (2) the legibility distance associated with the sign displays, (3) the target value associated with each display, and (4) the general applicability of DALAS to predictable variations in traffic movement volumes at intersections. Also, consideration of DALAS applications in the overall Traffic Operations Management are important. Figure 2 shows a dimensioned layout of three different views of the sign box used to house the circuitry and fiberoptics. The face of the sign is hinged on the left side of the box and functions as a door to allow access to the circuitry and lamps which power the sign. A numerical aperture monofilament glass face plate was used to protect the pixels from adverse weather conditions. A hood was utilized to eliminate problems associated with glare and adverse weather conditions. With the exception of the glass face plate, the entire exterior of the sign was painted black so that contrast and target value were maximized.

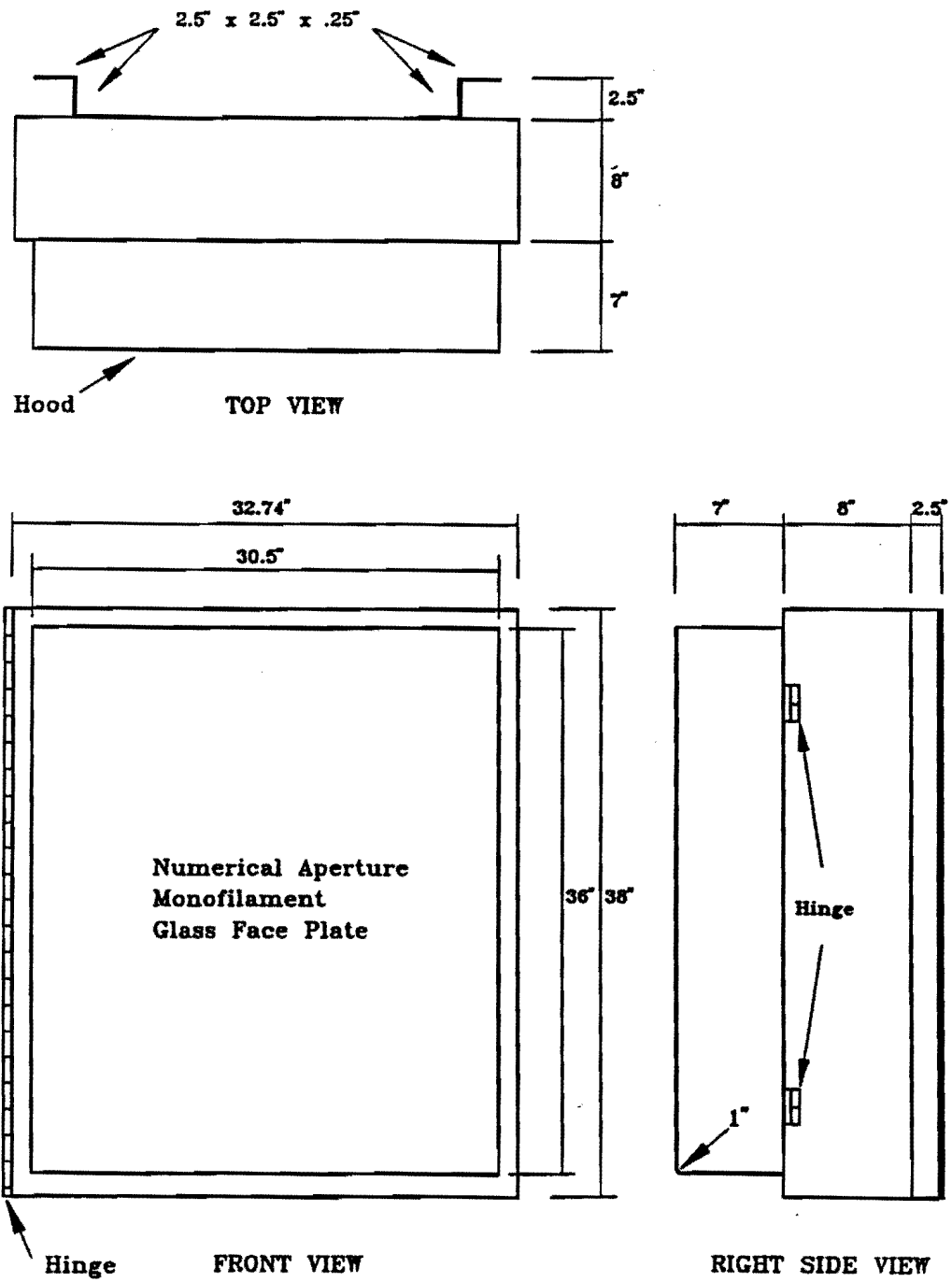

Figure 2 - Dimensioned Layout of the Fiberoptic Sign Box

The sign was used to produce the eight different displays shown previously in Figure 1. Figure 3 shows a detailed layout of the face of the fiberoptic sign. Each pixel is part of a *line*, or group of fiberoptic pixels that make up a single element of a sign display. A total of 14 lamps and transformers were used to power the individual lines used to form various displays. Lines were grouped as necessary to form specific displays. Two overlapping lines were used to form an arrow shaft. Pixels were arranged such that pixels from each line that formed a shaft alternated on 1/2 inch centers. This allowed both 1/2- and 1-inch pixel spacings to be evaluated. Actual field applications will utilize a similar arrangement to provide redundancy in displays as a backup measure to protect against mechanical and lamp failure. This concept was not used in the design of word messages for this sign. Each word message was made up of two lines arranged such that different stroke-widths could be evaluated.

The pixel layout allows both a single-row and a bold or outline arrow shaft to be produced. The height and stroke-width associated with bold arrow displays were designed to parallel that of arrow shaft designs used in reflective signing. The radius of the left-turn arrow is slightly larger than that of a standard R3-6L retroreflective sign. This radius was increased so that the light output would be spread over a wider expanse of the sign. This reduced the concentration of light across the sign face and provided a more legible display with higher target value than would have otherwise been obtained.

Two different stroke-widths for word messages were also evaluated. The letters were 5 inches tall and conformed to letter design and spacing for standard Series-E lettering (6). The height of the lettering was selected after the design of the arrow shafts had been determined. The major concern with the design of the lettering was that the word messages not interfere with arrow shafts as they are intended to supplement the information conveyed by the arrow shafts.

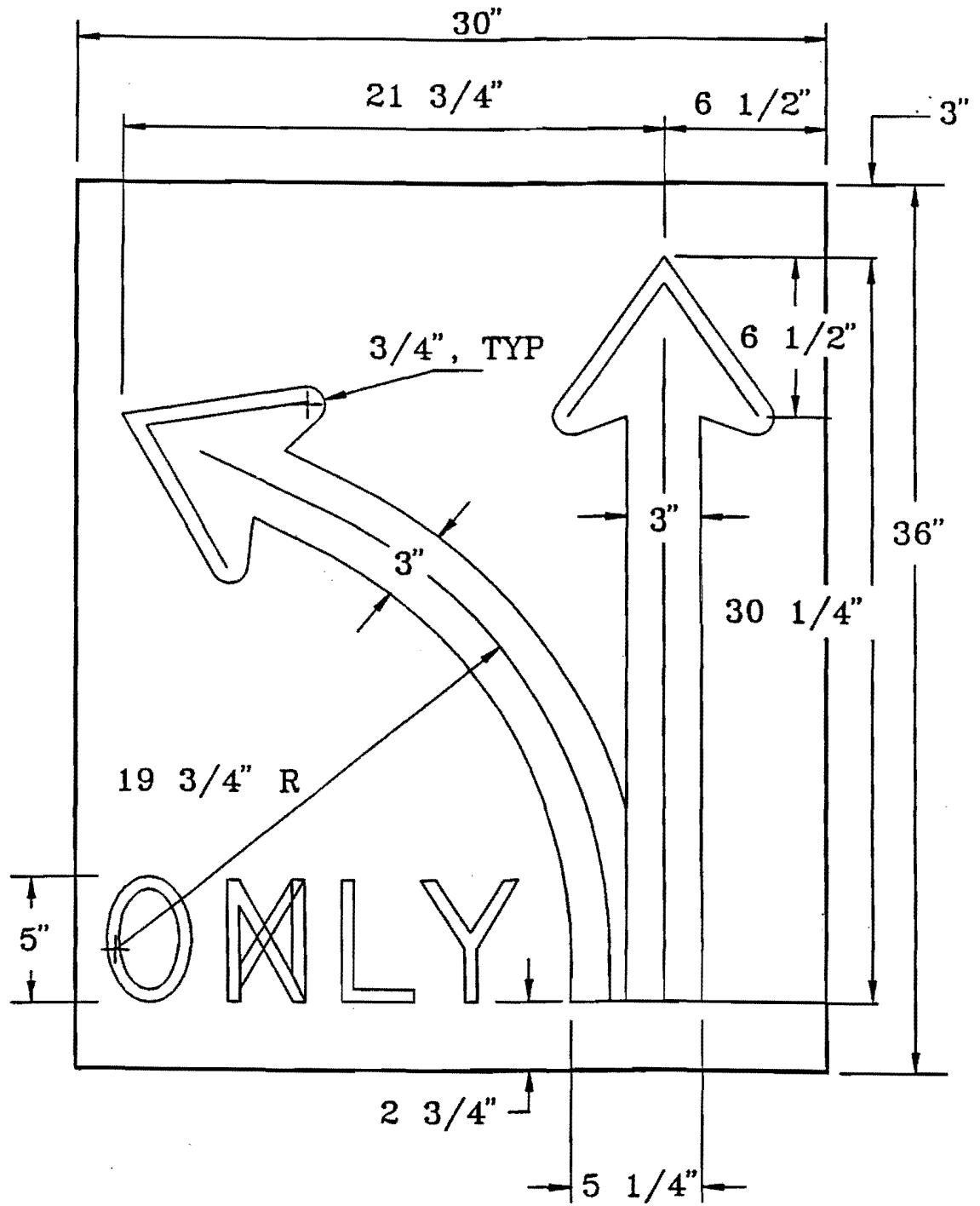

Figure 3 - Detailed Layout of the Fiberoptic Sign Face

Initial Design of Laboratory

The major objective of the initial laboratory design was to provide realistic conditions for the study of legibility and target value of the sign. The initial laboratory design was evaluated through a series of subjective observations. A number of changes were made to this setup as a result of these observations.

The laboratory layout shown in Figure 4 illustrates the final laboratory design used for evaluating legibility and target value for the fiberoptic sign. The sign tower was used to support two 3-lens traffic signal heads with 12-inch lenses, two overhead high-intensity grade retroreflective signs, and the overhead fiberoptic changeable message sign. The distance between the right edge of the signals and the sign to the left of the signals is 3 feet.

Longitudinal pavement joints were used to simulate three traffic lanes. The fiberoptic sign and its associated signal were centered over the middle lane of the installation. External illumination was provided by placing Type II, 250 watt high pressure sodium luminaires 120 feet in front of and behind the sign tower. Power used to operate the fiberoptic sign and the luminaires was produced by a 120 volt portable generator.

First Subjective Analysis

A group of professionals from the fields of Transportation and Industrial Engineering were used to evaluate the preliminary layout of the laboratory. Several informal observations were also held to provide input to the design of laboratory conditions and parameters. In this manner, conditions that are considered more characteristic of signalized intersections were established at the

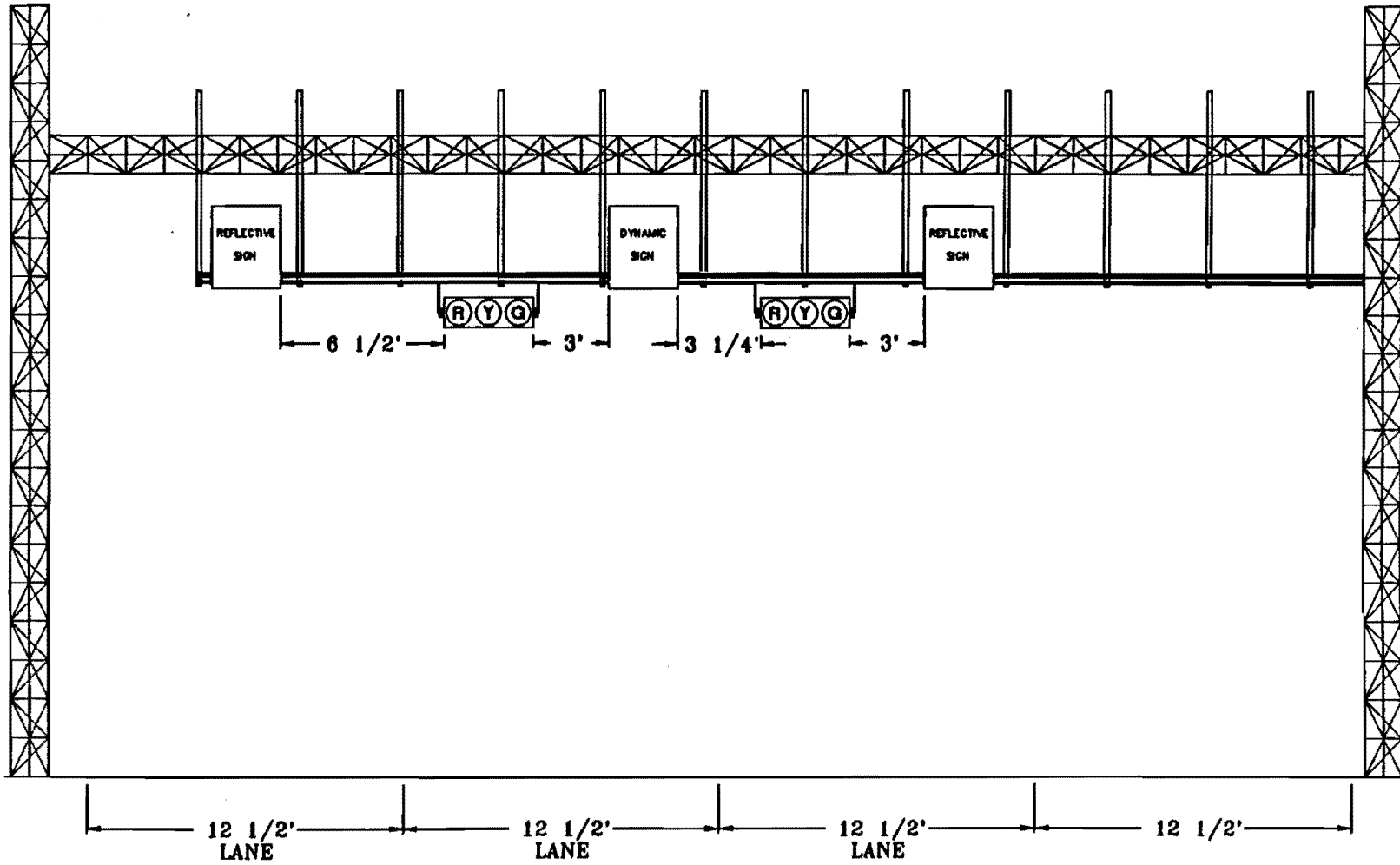

Figure 4 - Laboratory Layout Used for Legibility Studies

laboratory. Subjective evaluations of the attention value and legibility of the fiberoptic sign were obtained. Individuals were asked to compare the fiberoptic and reflective signing with respect to legibility and target value.

Participants in the first group of professionals were asked to fill out the questionnaire presented in Appendix A. This questionnaire evaluated the layout of the laboratory and provided information concerning a number of variables that affected the safe and efficient operation of the traffic control devices that made up the facility. The variables identified prior to this survey were evaluated by posing specific questions to the group concerning their effect on legibility and target value. These variables included:

- The effects of pixel spacing,
- Differences in the formation of arrow shafts,
- The effectiveness of the sign at different levels of light output,
- The effectiveness of the word messages, and
- The effectiveness of the fiberoptic changeable message sign as compared to the retroreflective signing.

Analytic Measurement of Luminous Output

Two parameters were used in the selection of operational settings for the fiberoptic displays. These parameters were voltage across a display and the light output of the display. Voltage was selected as a parameter because of the ease with which this variable can be measured and because of its relationship to the light output. Because each display uses a different number of lamps, it was questionable as to whether a single voltage setting would accommodate all displays. Luminance of each display was measured so that a second means of selecting operational settings for voltage would be available. A relationship

between intensity and voltage was developed for each display so that the distribution of the intensity associated with irradiation could be evaluated.

The light output of each display was measured using a J6523 1-degree Narrow Angle Luminance Probe. Luminance measurements of the displays were taken at 10- volt increments over a range of voltage levels between 20 and 100 volts. These measurements were taken from approximately 172 feet from the face of the sign such that the entire sign face was encompassed by the field of view for the 1-degree instrument. These measurements were used to develop predictive equations that related overall light intensity for each display to the voltage across the display.

Intensity is a measure of the power produced when electrical current, I_e , crosses some resistance, R . Utilizing electrical relationships between voltage, resistance, and current, the power across a given resistance can be related to the voltage drop across that resistance as follows:

$$P = \frac{V^2}{R} \qquad \text{Equation 1}$$

where: P = power dissipated across a resistance,
 V = voltage drop across the resistance, and
 R = amount of resistance.

Light intensity is the result of electrical power being transformed to light energy. Light output, therefore, should be directly related to the power consumed by the lamps. There should be a direct relationship between the light output of a display and the power dissipated within the circuitry. The general form of the equation that should represent the relationship between light output and voltage for the various displays is shown below:

$$I = m * V^2 \qquad \text{Equation 2}$$

where: I = intensity at the sign face (candelas),
 m = constant for each display that includes (1) conversion between power and intensity and (2) the resistance associated with the display, and
 V = voltage measured across the fiberoptic display (volts).

Analysis of the data included an evaluation of how precisely the general form for Equation 2 represented the measured data. The data was also used to determine the level of intensity at the sign which accommodated all but 15% of the observations.

Pilot Study

The pilot study was designed to relate the limitations of the human eye to light output levels for the light-emitting components at the laboratory. The effect of glare from the traffic signals and the point at which irradiation occurred in the fiberoptic displays was analyzed with respect to the overall quality of target value and legibility of the signing. The effectiveness of the data collection procedure was also evaluated. The two-part study required each participant to view various displays produced by the sign from distances of 800, 600, 400, and 200 feet. The first part of the study involved the evaluation of threshold intensity for the traffic signals and the point of irradiation for the fiberoptic displays. Threshold intensity corresponds to the light output of the signals that caused disability glare with respect to a person's ability to view the fiberoptic display. The point of irradiation for fiberoptic displays corresponded to the initial voltage level that produced irradiation for a given display.

The process used to evaluate these parameters was termed *focusing*. Both the traffic signals and fiberoptic displays were presented to the participants at the maximum possible light output level. Each participant was then instructed to observe the traffic signal as its light output was reduced. They were told to identify the point at which glare from the signals ceased to affect their ability to view the fiberoptic display. The voltage across the signals was measured and recorded. Light output of the signals was then reduced to zero. Study participants were instructed to indicate when glare from the signals began to inhibit their ability to discern the fiberoptic display as the voltage was increased. The voltage across the signals was again measured and recorded.

This process was repeated in order to determine the point of irradiation for the fiberoptic displays. The average voltages obtained for the signals were statistically analyzed to determine the applicability of a mathematical distribution of the threshold intensity. Similar analysis of the voltages and light output levels that corresponded to the point of irradiation for the fiberoptic displays were also performed. These analyses were expected to provide information concerning operational settings for the signals and the fiberoptic displays such that the light output of the total installation was below the threshold of glare for a majority of the drivers tested.

Four additional displays were then presented in a random order to the participants at each distance. Each person was asked to draw the displays presented to them exactly as the sign appeared. The data obtained from this portion of the study was analyzed to determine the usefulness of the test procedure in evaluating legibility distance of the fiberoptic displays. Restructuring of the instructions was completed as necessary to eliminate unclear statements and instructions.

Second Subjective Analysis

A second group of professionals was utilized in evaluating laboratory conditions selected for analysis of legibility of the fiberoptic displays. The purpose for these observations was to evaluate the pixel spacing, arrow design, and the light output associated with various voltage settings. These parameters were evaluated in order to limit the number of variables so that the results of the glance legibility study would provide statistically significant results.

Comparisons between the fiberoptic displays and the reflective signing at the installation were also evaluated. Comparisons with respect to legibility and target value were made between the two types of signing by means of specific questions posed in the questionnaire and through general comments provided by the participants. Information was also obtained concerning problems associated with mixing sign types for an approach to an intersection.

Quantitative Evaluation of Glance Legibility

The purpose of this portion of the study was to evaluate the legibility associated with different elements of the fiberoptic sign. Glance legibility was evaluated in an attempt to provide results that would more closely represent actual driving conditions (5). The displays shown in Figure 1 were presented to study participants at distances from the sign of 800, 600, 400, and 200 feet. Specific settings for the displays during the legibility studies were selected based on results from subjective observations. These settings included:

- One-half inch pixel spacings,
- No adverse weather conditions,
- Fifty volts across the traffic signals, and
- A constant level of external illumination.

Each participant was provided with a walkie-talkie, a data form, and a pencil. They were then instructed to travel to a distance of 800 feet from the face of the sign and park the test vehicle in the lane which lined up with the fiberoptic sign. Each participant was then informed that eight different displays would be presented on the sign and remain visible for a total of three seconds. Each participant was instructed to view the sign long enough to identify the visual image, then look away and begin drawing the display exactly as it appeared to them. The remaining displays were presented to the subject in the same manner. The participant was then instructed to proceed to 600 feet where this procedure was repeated. Displays were presented in a random order to insure that each display was given proper consideration by each participant.

Analysis of the data involved grading the drawings from each study participant to determine the glance legibility distance associated with specific elements that make up the different displays. An evaluation of when drivers perceived the difference between single row and bold shaft arrows was made to evaluate the effects of light output on the visual acuity of the study participants. Data from the pilot study provided additional questions pertaining to how different elements were perceived by the participants at specific distances from the sign.

RESULTS

Results from First Subjective Observations

Evaluation of the Fiberoptic Sign

Several factors associated with the design of the fiberoptic sign were subjectively evaluated during this part of the study. These factors were evaluated using a questionnaire survey. Information obtained from these evaluations was used to prioritize the variables so as to limit the scope of the driver studies. The factors that were evaluated included:

- The effect of luminous output on legibility and target value,
- The type of arrow design, and
- The design of word messages.

Evaluation of the legibility and target value of the sign at different voltage levels illustrated the relationship of these variables to light output. Legibility of the displays was found to decrease as the light output increased. Target value, however, was found to increase with increasing light output. The relationships between legibility, target value and voltage indicate the existence of an inverse relationship between target value and legibility. This relationship should be considered in selecting operational settings for fiberoptic displays.

Subjective evaluations were made by professional observers from a distance of 300 feet. The consensus of these observers indicated a preference of the single-row arrow design over the bold arrow design. Discussions indicated that the single-row displays were more simple and easier to discern than the bold arrow displays. The difference in target value for the two types of arrow shaft

designs was not felt to provide a significant advantage for the bold arrow indications over the more legible single-row alternative.

Two different word messages ("ONLY" and "OK") were also viewed by the study participants. Each word message was displayed using two different stroke-widths. Different stroke-widths were formed using one row (single-stroke) and two rows (double-stroke) of pixels. Double-stroke word messages could not be discerned by the group. Some letters of the single-stroke word messages were partially legible at the 300 foot viewing distance. The group did not, however, feel that they would be discernible if the effects of dynamic visual acuity were taken into account. The consensus of the group was that the word messages should be enlarged and possibly repositioned to improve their legibility. The group preferred the single-stroke letters to the double-stroke letters. The double-stroke letters were subsequently eliminated from further observations.

Laboratory Improvements

One purpose of the first subjective observations was to identify needed improvements to the laboratory so that conditions would more closely simulate those of a typical signalized urban intersection. Analysis of the information obtained from this portion of the study identified the need for the following improvements:

- The provision of external illumination in the form of standard roadway lighting,
- The rearrangement of the initial sign and signal layout,
- The need to vary the light output of the signals and the fiberoptic sign independently, and
- The need to design the study to simulate dynamic visual acuity.

The need to provide fixed source lighting was identified by consensus of the professionals that participated in the study. Although the target value of the displays was believed to be acceptable, increases in the voltage across the sign caused irradiation to occur in the displays. This level of irradiation was reduced when headlights were used to illuminate the laboratory area. The provision of fixed source lighting was expected to reduce the effect of irradiation on the legibility of the fiberoptic displays. The addition of fixed source lighting was also expected to provide viewing conditions more typical of signalized urban intersections.

One important consideration identified during the initial design of the laboratory was the need to enable drivers to associate a traffic signal and changeable message sign with a given lane. The initial laboratory layout called for the placement of a traffic signal one foot to the right of each lane use sign. Evaluation of this spacing indicated that this distance was not sufficient to prevent light from the signals from interfering with the fiberoptic sign. The vertical position of the traffic signals relative to the signing appeared to create a band of glare that surrounded the base of the signing and the traffic signals. It was felt that this problem could be remedied by placing the signals below the base of the sign.

The need to vary the voltage across the traffic signals and the fiberoptic sign independently was also identified. The original wiring design utilized a common neutral wire for the traffic signals and fiberoptic sign. Consensus among the participants was that operational needs for light output of the fiberoptic sign and the traffic signals would be very different. Varying the fiberoptic sign and signal voltages would allow various conditions to be evaluated. Final modifications to the wiring at the laboratory were made.

Analysis of Analytic Measurements of Luminous Output

Analytic measurements were made to obtain the luminous output for each display. As previously stated, the luminous output of the displays was expected to be represented by the general form of Equation 2. Preliminary analysis of the data indicated that Equation 2 consistently overestimated the luminous output at low voltage levels and underestimated luminous output at high voltage levels. The recurrence of these discrepancies indicated the possible presence of power losses within the system. Consequently, regression analysis was performed using the model shown in Equation 3.

$$I = m * V^2 + n * V \qquad \text{Equation 3}$$

where n = a constant that corresponds to energy that is either not converted to light or is otherwise lost.

The regression analysis resulted in equations that were used to develop Figures 5, 6, 7, and 8 shown on the following pages. The coefficients of regression for all equations were equal to one at three significant figures. Visual analysis of the data indicates that this model slightly overestimates the luminous output at lower voltage levels. The magnitude of these discrepancies, however, does not have any practical significance. The differences between the actual and calculated values were attributed to fluctuations in voltage delivered by the electric generator. Consequently, the model was believed to provide an acceptable means of estimating the luminous output of each display across the range of voltage settings used in the remainder of the study.

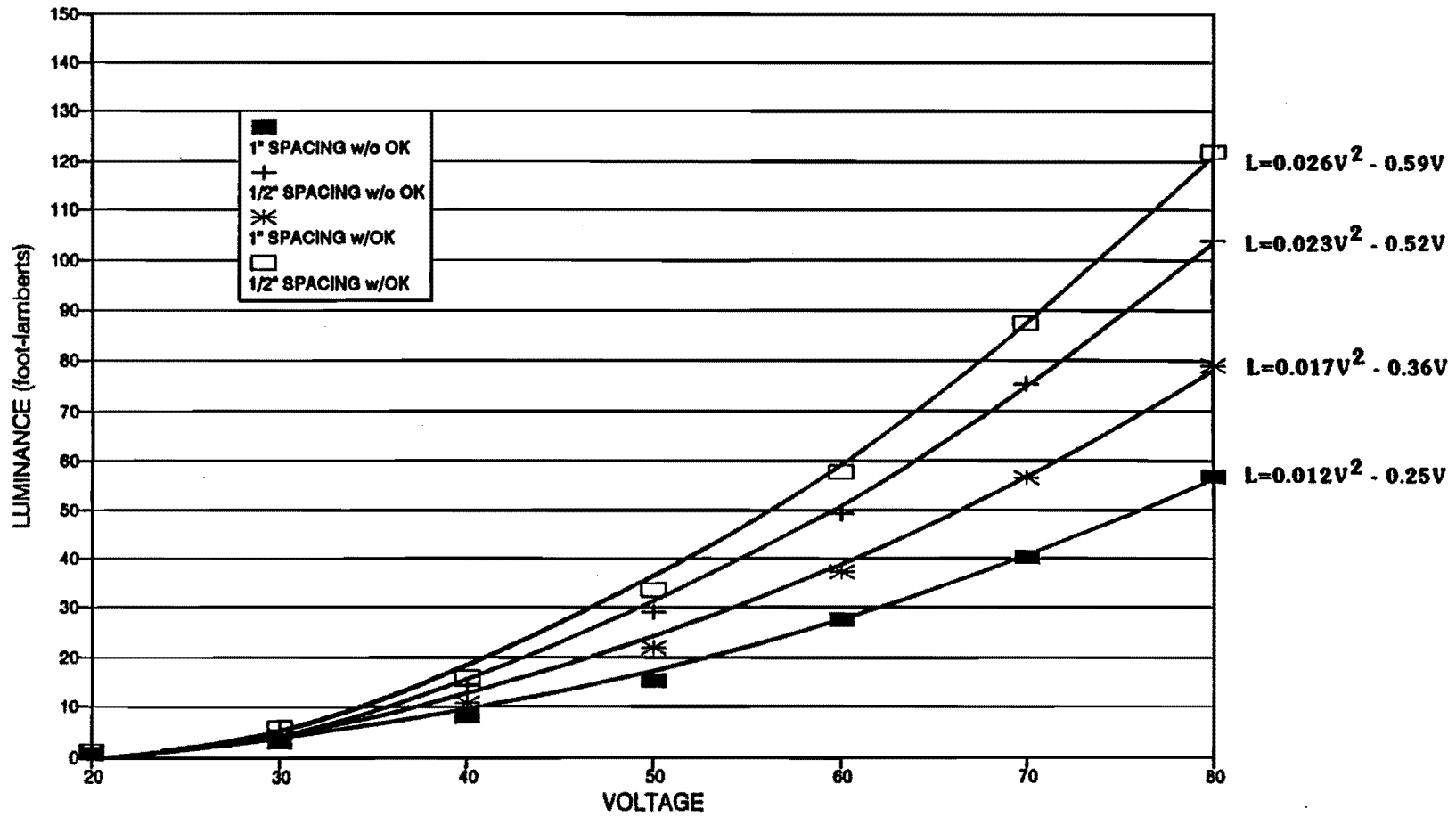

Figure 5 - Luminance Curves for Single-Row Through-and-Left Displays

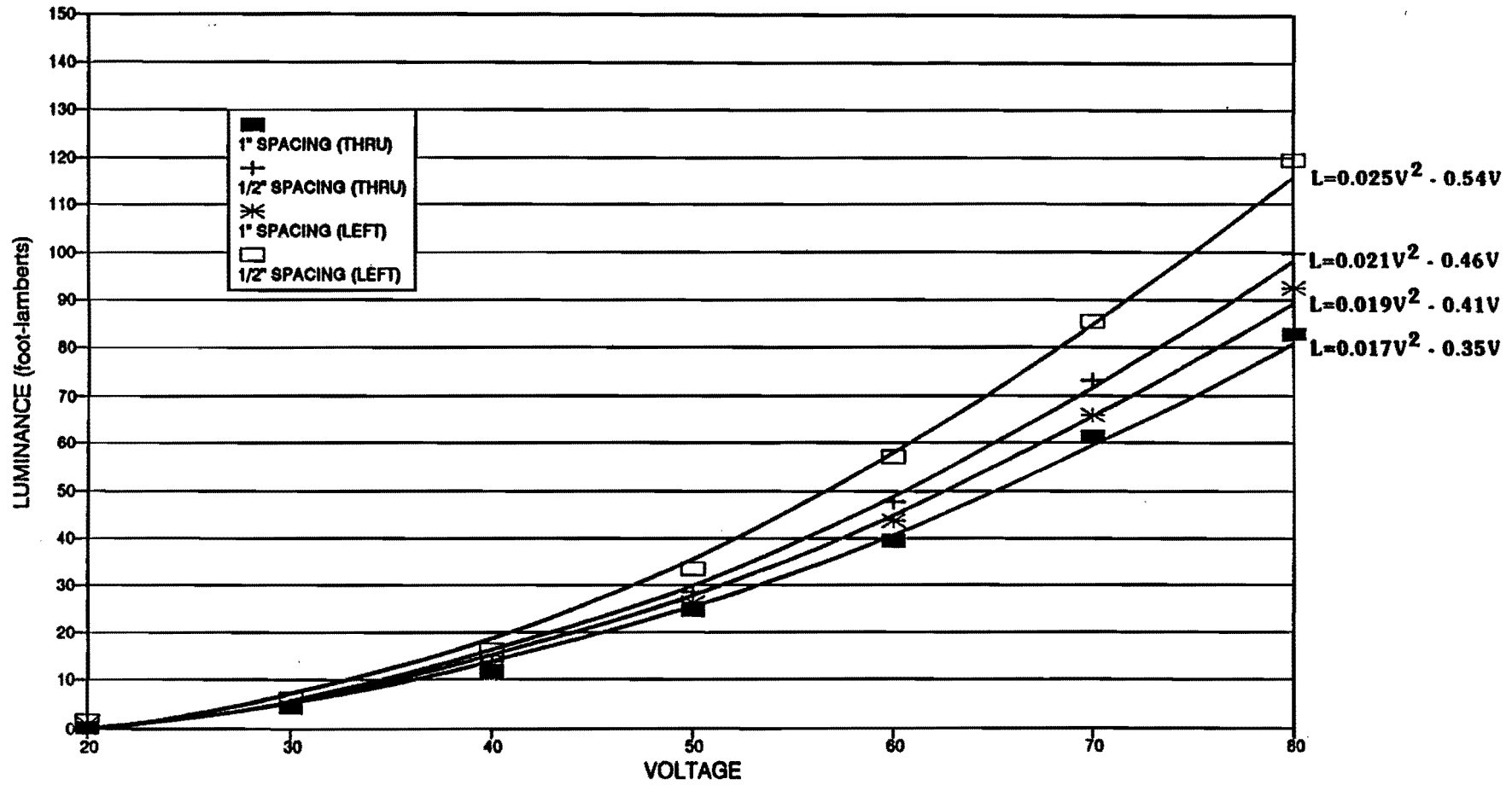

Figure 6 - Luminance Curves for Single-Row Through Only and Single-Row Left-Turn Only Displays

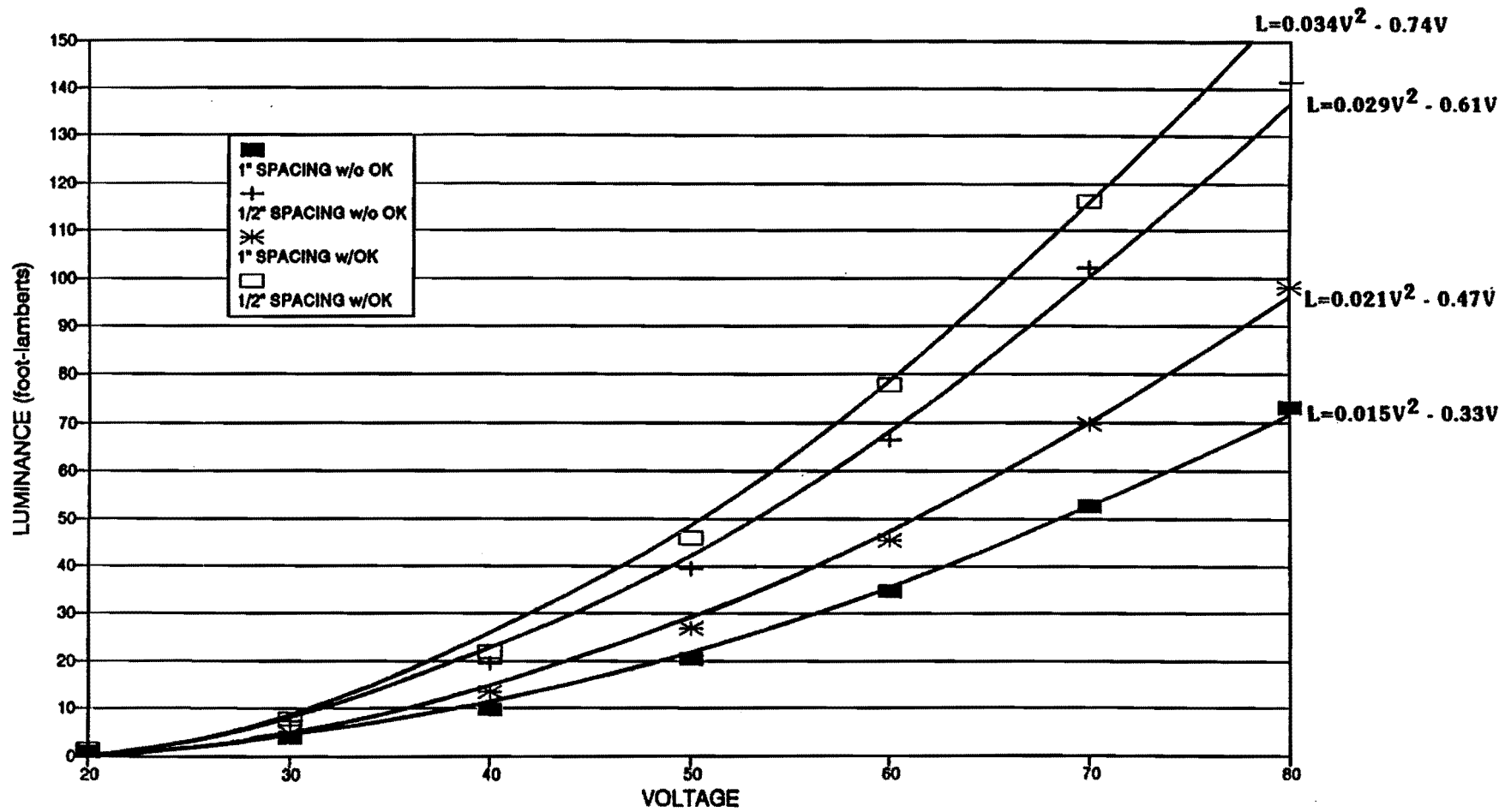

Figure 7 - Luminance Curves for Bold Through-and Left Displays

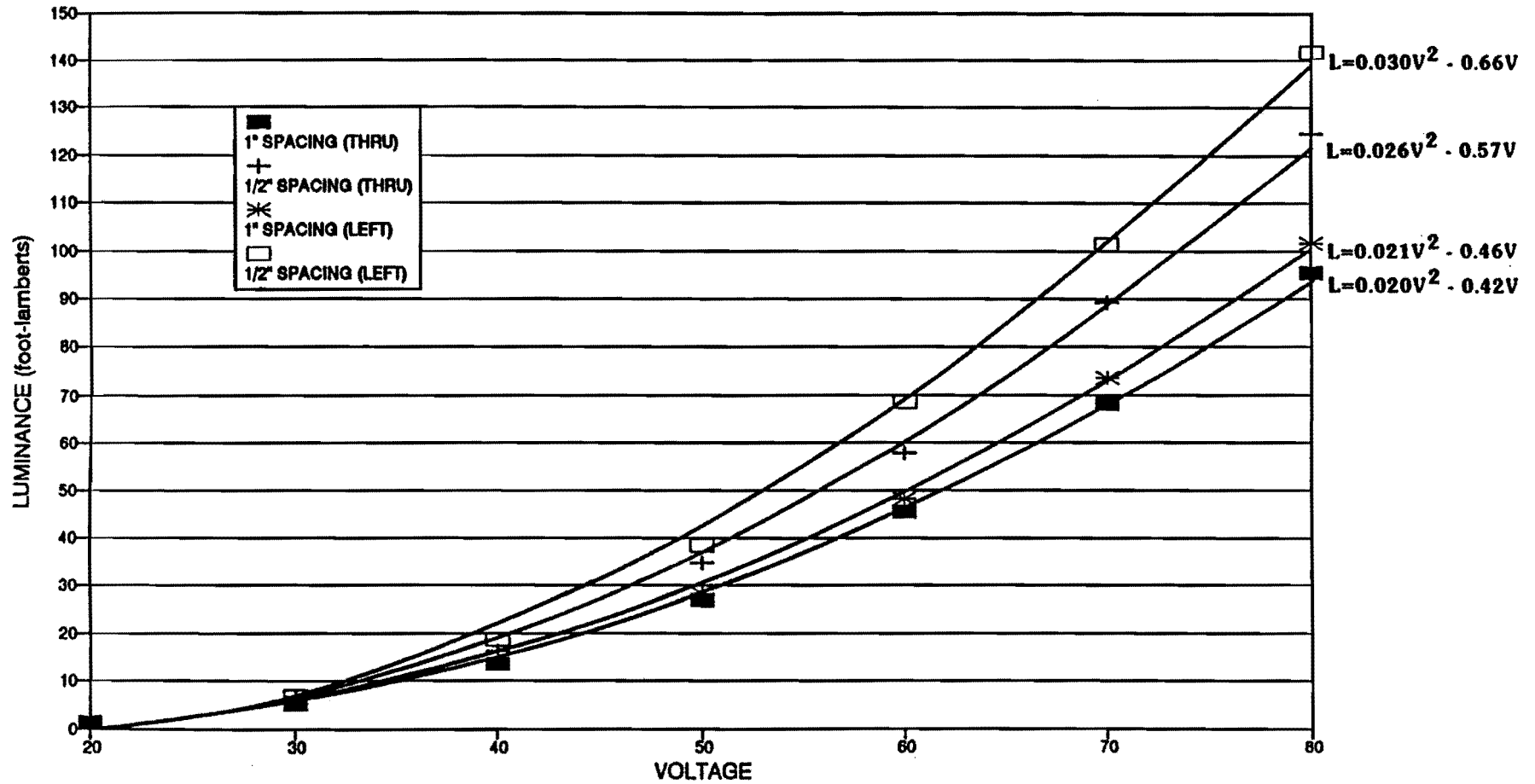

Figure 8 - Luminance Curves for Bold Through Only and Bold Left-Turn Only Displays

Pilot Study Results

The purpose of the pilot study was to develop a relationship between the capabilities of the human eye and the voltage and light output of the traffic signals and the fiberoptic sign. These relationships were utilized to determine voltage settings for the signals and fiberoptic signs, such that:

- The voltage settings minimized disability glare and still provided adequate target value to allow the signals to compete with the fiberoptic display for the attention of the driver, and
- The relationship between legibility and target value for the fiberoptic displays was optimized.

A total of 19 individuals participated in this portion of the study. Analysis of data obtained from the first six participants, however, required that modifications be made to the study design. A total of 42 observations from the remaining thirteen subjects were utilized in defining the voltage distribution for the traffic signals. A total of 52 observations were made by the last 13 subjects to establish the voltage distribution for the fiberoptic displays.

Voltage Distribution for the Traffic Signals

The light output associated with the voltages identified by the participants of this study corresponded to the threshold intensity for individuals to the glare produced by the signals. These voltages were evaluated in an attempt to establish voltage settings below which glare did not interfere with a specific percentage of the participants' ability to view the fiberoptic displays. The green indication was used for each participant, since this color has been shown to be more critical at low levels of illumination than red or amber (7). Maximum voltage was utilized for the fiberoptic display so that the total light intensity emitted from the installation was maximized. Since the total amount of light that enters the eye

contributes to the glare observed, glare produced by the traffic signals at these voltage settings was not expected to hinder the legibility of the fiberoptic displays when these displays were viewed at lower light output levels.

The histogram in Figure 9 shows a breakdown of the voltages associated with the threshold intensity of the signals. The distribution of these voltages was expected to be normal. The histogram indicates, however, that a bimodal distribution of the voltages was obtained. One possible reason for the non-normal distribution is the small study size used in this portion of the pilot study. The inability to identify a normal distribution of voltages at the threshold intensity for glare warranted a subjective evaluation of a range of voltages for the traffic signals prior to the evaluation of glance legibility for the fiberoptic displays.

Voltage Distribution for Fiberoptic Signing

The focussing process described previously was used to evaluate the voltage distribution associated with the point of irradiation for each display. The average voltage obtained from each participant corresponded to the point at which the light output from the sign caused irradiation to occur. These average voltages were statistically analyzed to determine whether or not they could be grouped to obtain a single voltage distribution that represented the point of irradiation for all displays. Initial groupings compared all single-row displays with 1-inch pixel spacings to single-row displays with 1/2-inch pixel spacings. Bold-arrow displays were grouped in the same manner. F-tests that compared the variance of these groups were performed using a 95% confidence level. Based on these results, pooled estimates of the standard deviation for the combined group were obtained so that statistical t-tests could be performed to evaluate whether or not the means were statistically equal.

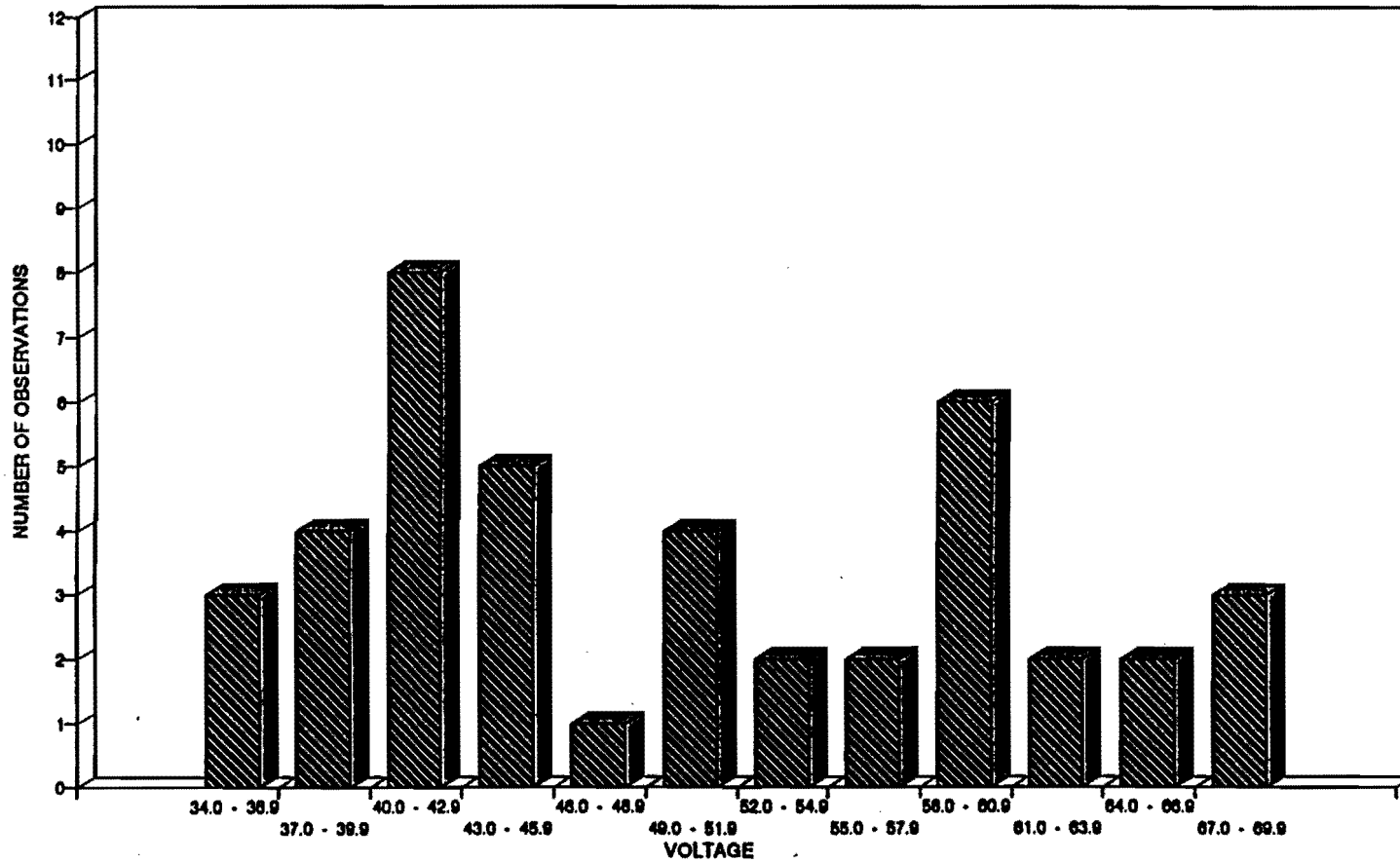

Figure 9 - Frequency Distribution for Threshold Intensity Voltage for the Traffic Signals

The results of this analysis showed that the mean and standard deviation for the average voltages for each subgroup were the same. All single-row displays and bold displays were then grouped together and compared. Similar analyses indicated that the means and variances of these groups were also the same. This finding enabled all voltage measurements obtained from the pilot study to be grouped together to provide a single voltage distribution that could represent all displays that were tested. This finding was unexpected. Prior to the evaluation of the pilot study results, it was felt that the difference in the number of pixels used to form a display would cause individuals to select lower voltages for signs made up of greater numbers of pixels. The voltages obtained, however, appeared to be relatively consistent for each individual regardless of the display viewed or the viewing distance. Two possible reasons are:

- (1) A significant difference in the point of irradiation was not caused by the difference between 1/2- and 1-inch pixel spacings. All but two of the voltages identified by the pilot study participants during the focussing process for the traffic signals were below 80 volts. Furthermore, 85% of the average voltages were below 65 volts. Results from the first subjective analysis indicated that virtually no practical difference in light output existed for 1/2- and 1-inch pixel spacings below approximately 60 volts.
- (2) The displays associated with higher numbers of pixels utilized more of the sign face. Although the number of pixels increased, it is possible that the distribution of these pixels over a larger area of the sign face offset the effects of the increased light output.

The histogram shown in Figure 10 illustrates the distribution of voltages that corresponded to the point identified by individuals where irradiation began

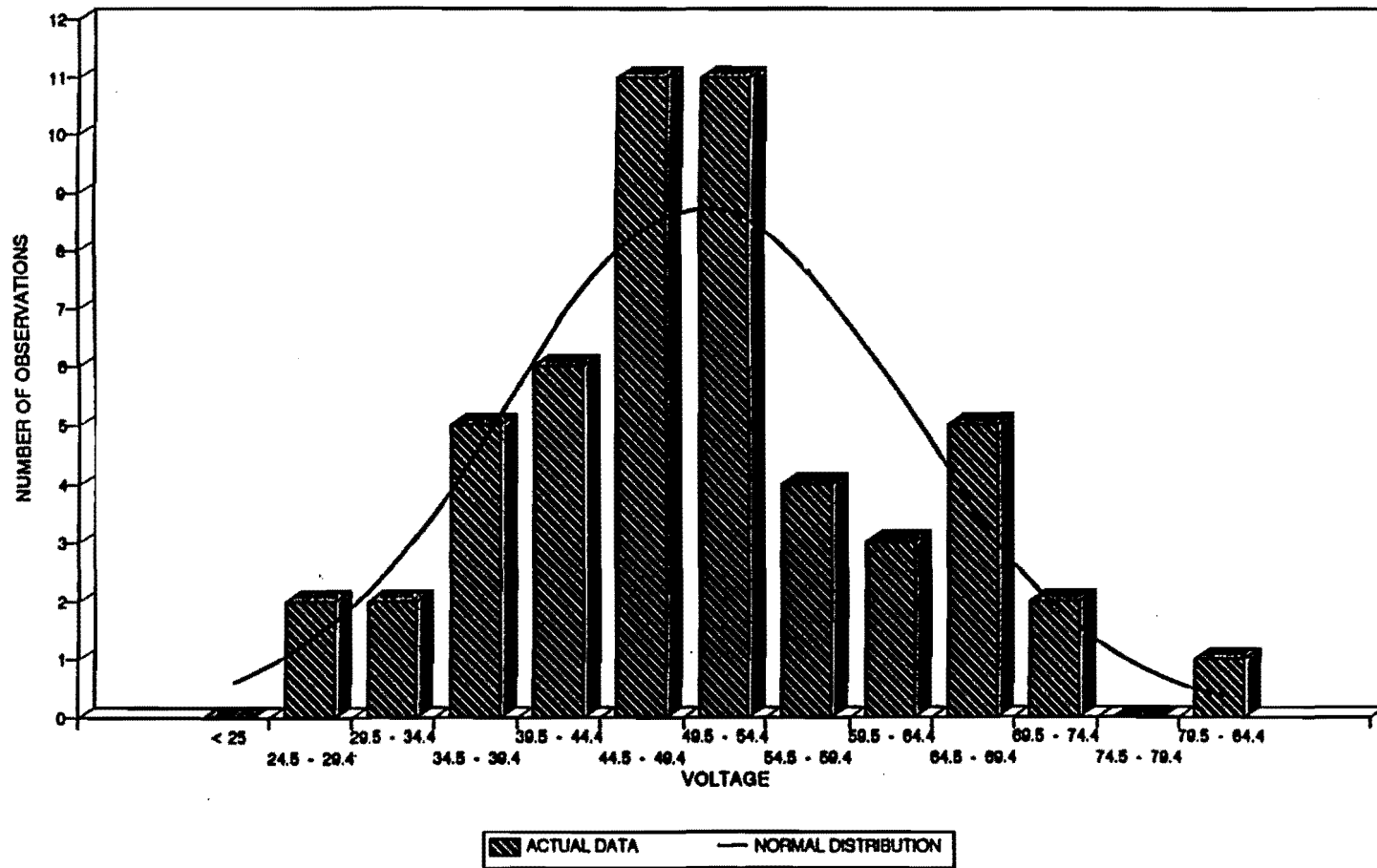

Figure 10 - Frequency Distribution of Fiberoptic Display Voltages

to occur. This histogram represents a total of 42 observations made by study participants. A Chi-Square analysis performed for this data indicated that the distribution of the data was normal at a 95% confidence level with 52 degrees of freedom. The shape of the cumulative frequency distribution shown in Figure 11 further supports the fit of the data to a normal curve. This figure indicates that the 15th, 50th, and 85th percentile values for the voltage distribution were 38.7, 51.0, and 63.2 volts, respectively. These voltages were presented to a second group of professional observers to be evaluated subjectively with respect to target value and legibility.

Intensity Distribution for Fiberoptic Signing

Figure 12 shows a plot of the distribution of observations for intensity which corresponded to the voltages selected by study participants. Luminous output of the displays was obtained for the range of voltages as previously described. This data was then fit to the general form of Equation 2 to obtain predictive equations for luminance at a given voltage. Radiation physics and geometry were utilized to convert luminance values to estimates of the light output for the sign.

A Chi-Square goodness of fit analysis performed at a 95% confidence level with 52 degrees of freedom indicated that the data fit a normal distribution. Figure 12, however, shows that the actual distribution of the data is skewed to the left. Figure 13 supports this conclusion, since the lower portion of the actual curve does not contain the "knee" normally associated with unskewed distributions. The fact that this distribution is not normal is explained by examining the mathematical relationship between intensity and voltage denoted by the general form of Equation 2. The distribution of voltages selected during

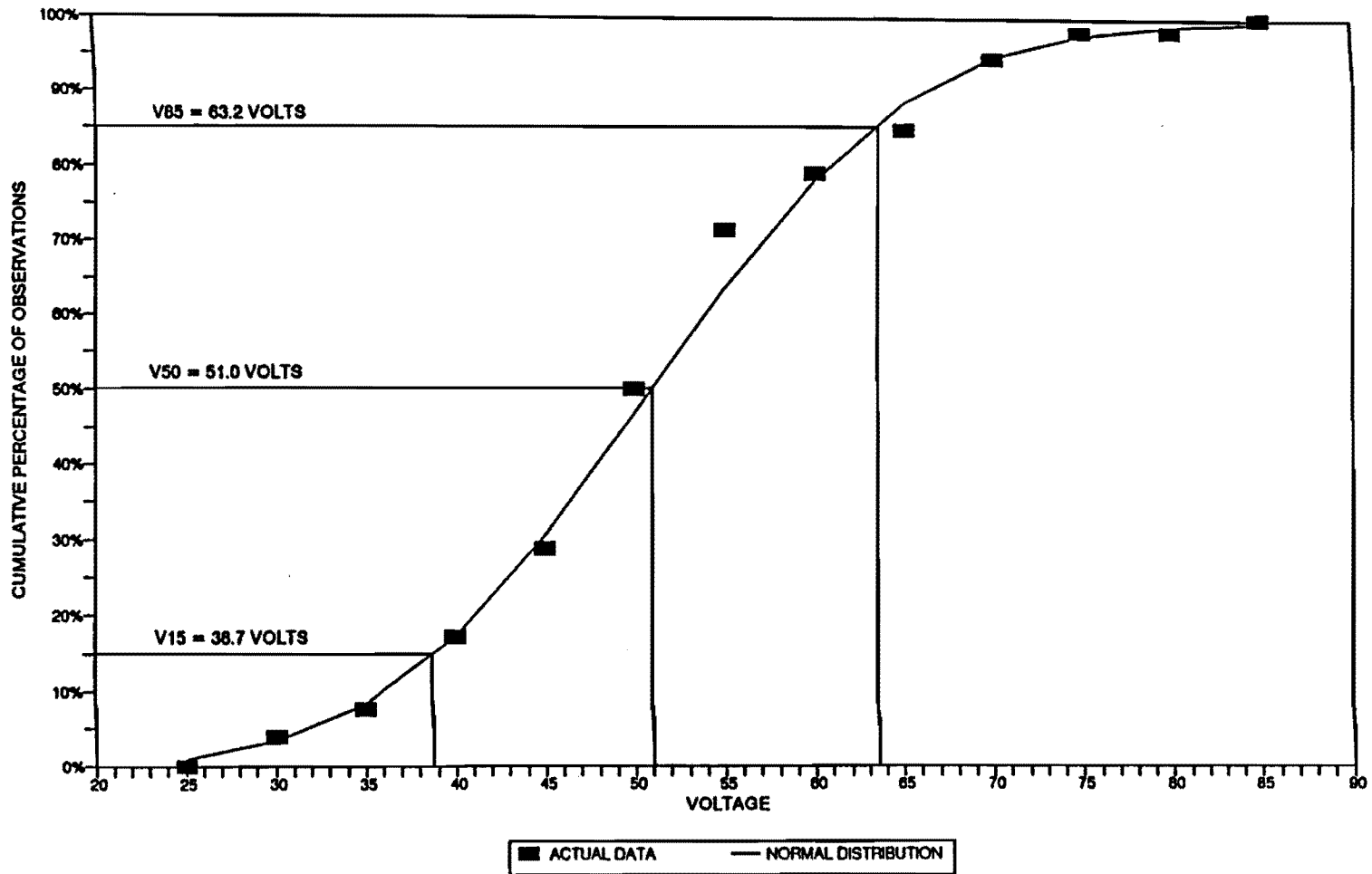

Figure 11 - Cumulative Frequency Distribution for Fiberoptic Display Voltages

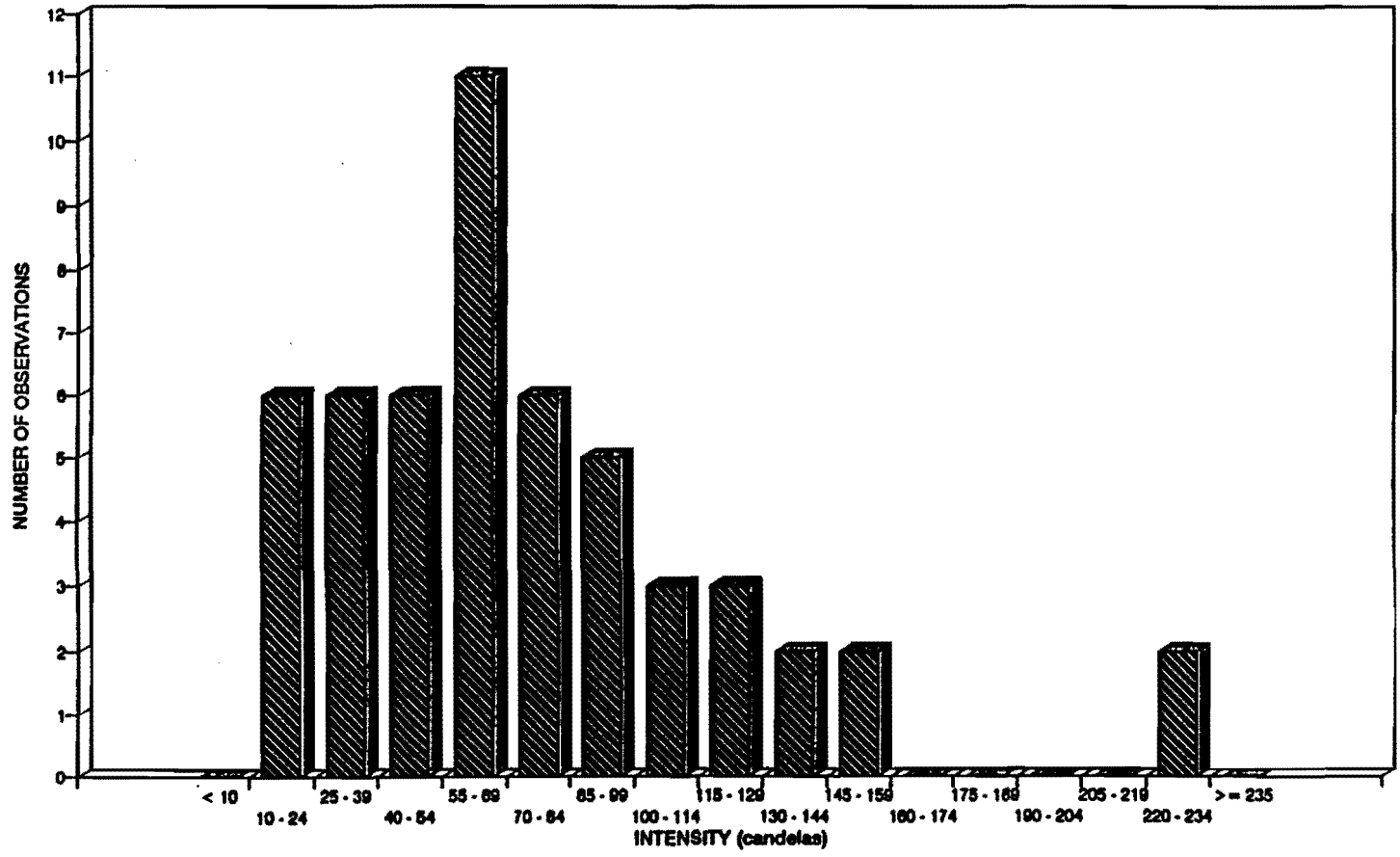

Figure 12 - Frequency Distribution for Fiberoptic Display Intensities

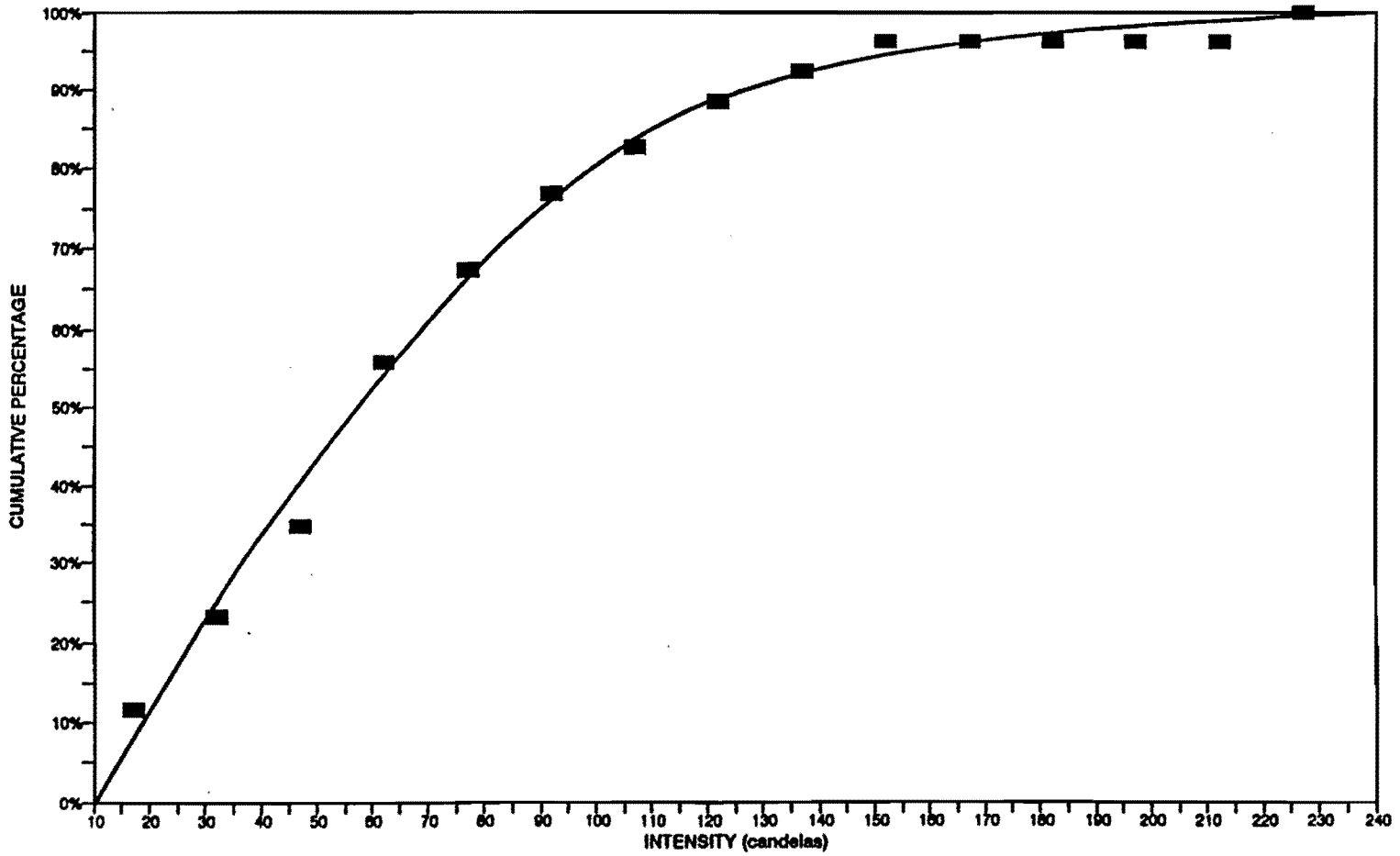

Figure 13 - Cumulative Frequency Distribution of Fiberoptic Display Intensities

the study was shown to be normal. According to statistical theory, the square of values that define a standard normal curve should produce a skewed distribution (8). The development of design criteria for fiberoptic displays should examine the relationship between intensity and voltage. This would provide an efficient means of setting light output levels in the field.

Results from Second Subjective Analysis

This portion of the study was used to evaluate the legibility and target value of the fiberoptic sign as well as the target value and glare associated with the traffic signals at the voltage levels identified by the pilot study results. The format used to obtain data during this portion of the study was similar to that used in the first subjective analysis. A questionnaire survey was utilized to obtain specific information concerning:

- The magnitude of the glare produced by the traffic signals at two different voltage settings,
- The target value associated with each voltage setting for the traffic signals,
- The legibility and target value for single-row and bold displays at the 15th, 50th, and 85th percentile voltage settings (35, 50, and 65 volts) determined from the pilot study, and
- The use of different pixel spacings at the 15th, 50th, and 85th percentile voltages (35, 50, and 65 volts) determined for the fiberoptic display.

Participants were allowed to inspect the installation from various distances prior to group discussions and completion of the survey. Following these preliminary observations, the group was assembled at a distance of 300 feet from the sign for evaluation of the signal and sign settings. General comments were

obtained as to the comparison between the fiberoptic displays and the reflective signing. Problems associated with mixing the fiberoptic and reflective signing on an approach were also discussed.

Evaluation of Traffic Signal Settings

The magnitude of the glare caused by the traffic signals was evaluated for voltage levels of 50 and 65 volts. Glare was rated on a five-point rating system (see Appendix B). The green indication was used for the evaluation of glare since, as has been previously stated, it provides the limiting condition under low levels of illumination.

The glare caused by the signals at the 50 volt setting was found by the study participants to be less than discomfort glare. Glare associated with 65 volts across the signal was found to be greater than the threshold level for discomfort glare. None of the participants, however, felt that either of these settings produced disability glare. The target value associated with both voltage settings was found to be acceptable for the conditions at the laboratory.

Evaluation of Fiberoptic Sign Voltage Settings

The single-row and bold through-and-left arrow indications were selected for an evaluation of the different voltage settings for the fiberoptic sign. These settings were selected so that the light output for each type of arrow shaft design was maximized. These displays were presented to the participants at voltage levels of 35, 50, and 65 volts. The selection of these voltages corresponded approximately to estimates of the 15th, 50th, and 85th percentile voltages as determined in the pilot study. Evaluation of the displays at these voltage levels showed that the legibility and target value for the displays were, at worst,

acceptable. Analysis of the surveys further supported the existence of an inverse relationship between target value and legibility.

The group was asked to rank order the reflective signing and the bold and single-row indications with respect to target value and legibility. Evaluation of this data indicated a preference for the single-row arrow indications over the bold arrow indications and the reflective signing. Discussion indicated that the majority of the group felt that the difference in target value between the single-row and bold fiberoptic indications was not sufficient to offset the more readable legend associated with the single-row indications. The group also indicated that mixing of the reflective and fiberoptic signing was not desirable because of the difference in contrast and light intensity of the two types of signing. The group further indicated that if these types are mixed, then external illumination should be provided above the reflective signing so that differences in target value could be reduced as much as possible.

Selection of Voltage Settings for Legibility Studies

Analysis of the information obtained from this portion of the study was utilized to select the voltage settings for the traffic signals and fiberoptic displays. These settings were used in the evaluation of legibility distance associated with the fiberoptic displays. The voltage selected for the traffic signals was 50 volts. Glare associated with this setting provided a more comfortable viewing condition without significantly reducing the target value as compared to the 65 volt setting. Voltage levels of 35 and 50 volts were selected for evaluation of glance legibility for the fiberoptic displays. Two settings were selected so that (1) an estimate of the glance legibility for the displays at each setting could be obtained and (2) the significance of the difference in light output at these voltages could be evaluated.

Analysis of Glance Legibility Studies

Studies were conducted to evaluate the glance legibility distance associated with specific elements which make up individual fiberoptic displays. These studies required participants to view eight displays at 800, 600, 400, and 200 feet. After viewing these displays, participants were required to draw the display exactly as it had appeared to them. These drawings were evaluated to determine when the participants were able to distinguish:

- The distance at which the general format of the sign was identified,
- The distance at which the word messages were discerned, and
- The distance at which the difference between single-row and bold arrow shafts could be detected.

This information provided an estimate of the overall effectiveness of the sign with respect to glance legibility. Analysis of individual elements also allowed statements to be made concerning the effectiveness of the design of these elements.

Age Distribution of Study Participants

The primary concern in the selection of participants for this study was to provide an age distribution of participants which corresponded to the general age distribution of drivers identified in Table 1. Fifty-three subjects participated in this study. Table 3 shows the age breakdown of the participants used in the study.

Table 3 - Age Distribution of Study Participants

AGE GROUPS	NUMBER OF DRIVERS IN EACH AGE GROUPS	PERCENT DISTRIBUTION OF PARTICIPANTS ACROSS AGE GROUPS
< 25	18	33.3%
25 - 54	24	44.4%
55+	12	22.3%

Figure 14 shows that the number of participants from each age group that viewed each of the light output levels was approximately equal.

Results from Legibility Studies

Drivers were asked to view the sign at 200 foot intervals between distances of 200 and 800 feet, inclusive. Prior to this study, it was determined that the participants would be divided into two groups. One group would view the sign at a 35 volt setting, while the other group would view it at a 50 volt setting. The use of 200-foot intervals was selected in order to insure that the distribution of the driver observations was large enough to make an inference about the glance legibility of specific elements.

Glance legibility distance for the general format of the fiberoptic displays was evaluated. The ability to discern the general format of the sign refers to when word messages and arrows could be identified as separate elements. Identification of this point is important since, prior to this point, word messages were typically perceived as a second or third arrow by the majority of the study participants at both voltage levels tested. At the point where participants realized

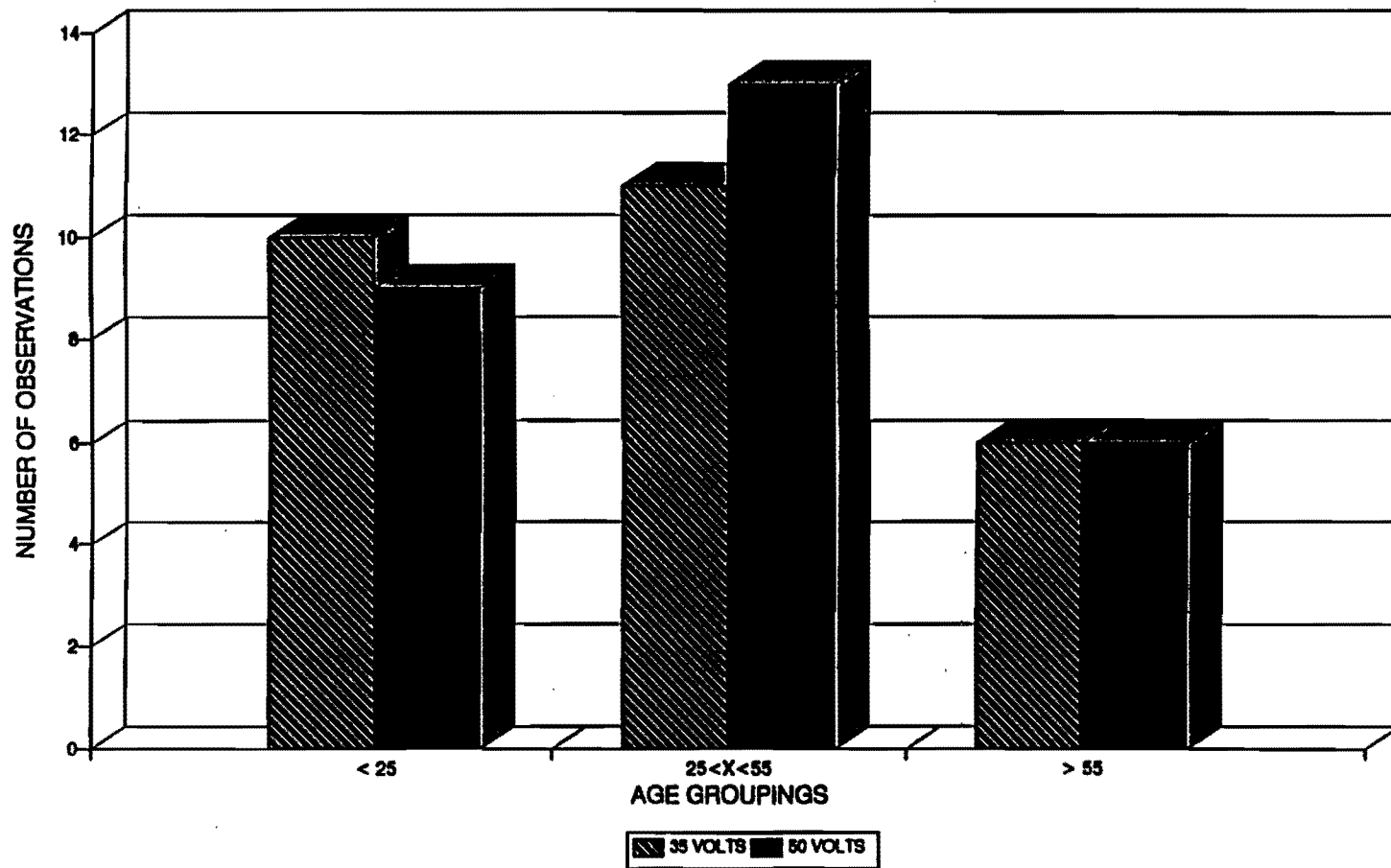

Figure 14 - Grouping of Study Participants

the word message was a separate element, they were able to recognize that it was not an arrow. Subsequently, the message was represented as a blur until it was correctly identified.

Figure 15 illustrates where participants identified the separation between the word message and the arrow shaft(s). Approximately 85% of the participants who viewed the displays were able to discern this separation at a distance of 400 feet from the face of the sign for both voltage levels. The use of smaller distance intervals would have provided a more uniform distribution for the observations. It is believed that voltage setting had very little effect on the ability of the participants to discern this separation.

Glance legibility distance was also evaluated for the "OK" and "ONLY" word messages. The size and spacing of the word messages corresponds to standard Series E lettering used for reflective signing. The arrows are considered the primary information element while the word messages are supplemental information. Figure 16 illustrates the distribution of glance legibility observations for the "OK". This figure shows that approximately 10% of the participants were able to discern this message at distances greater than 200 feet. Figure 17 shows that approximately 50% of the participants were able to read the "ONLY" at a greater distance than 200 feet. No difference in legibility is believed to have existed at the two different voltages for the "OK". The 35 volt setting appeared to provide slightly more legibility for the "ONLY" word message than did the 50 volt setting.

The reason for the difference in legibility between the "OK" and "ONLY" is believed to be in the length of the word and the legibility of the "O" and the "Y" letters in "ONLY". The legibility of the "O" in both word messages and the "Y" was much better than that of the "K", "N", and "L". They had better legibility

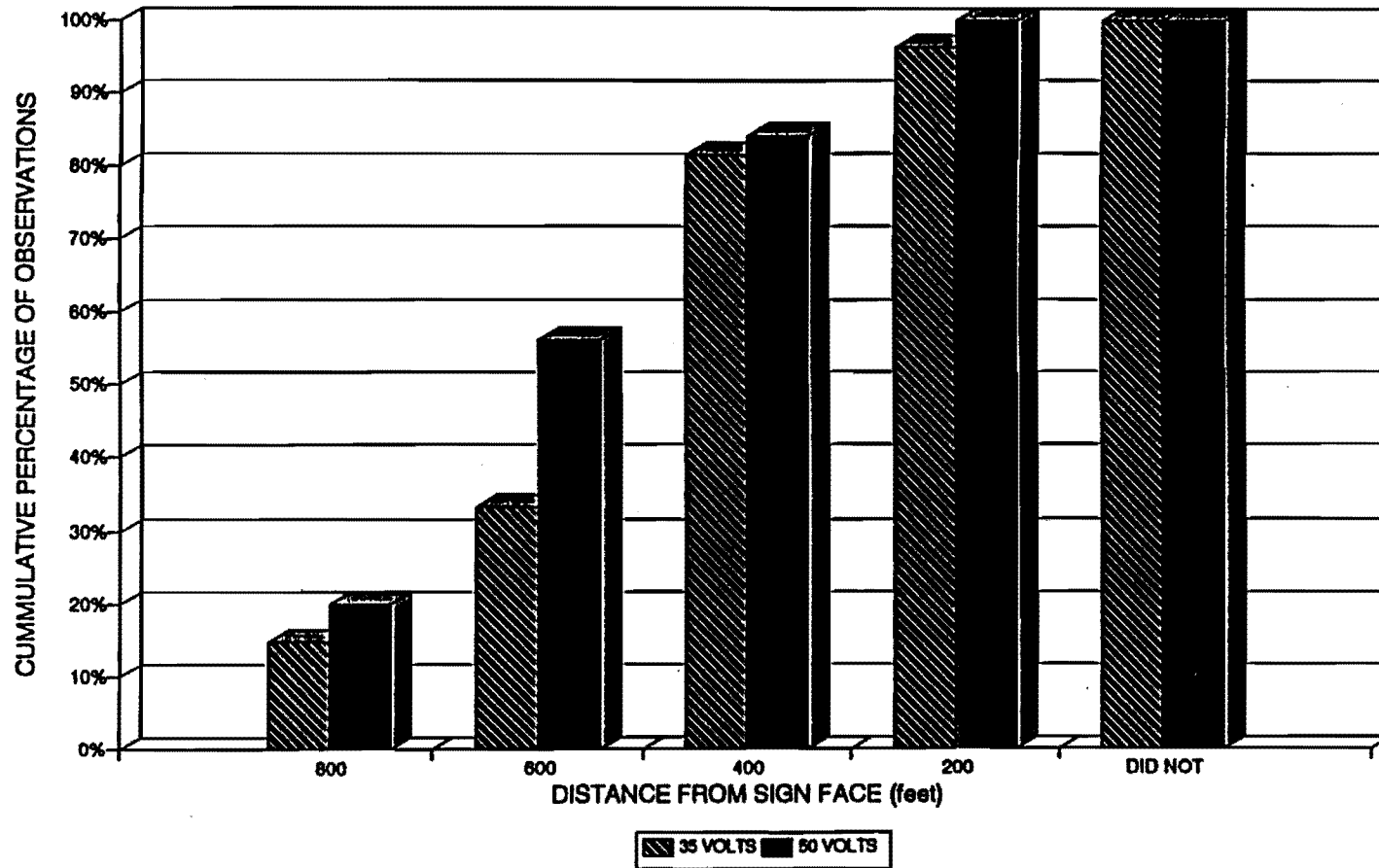

Figure 15 - Glance Legibility for General Format of Sign

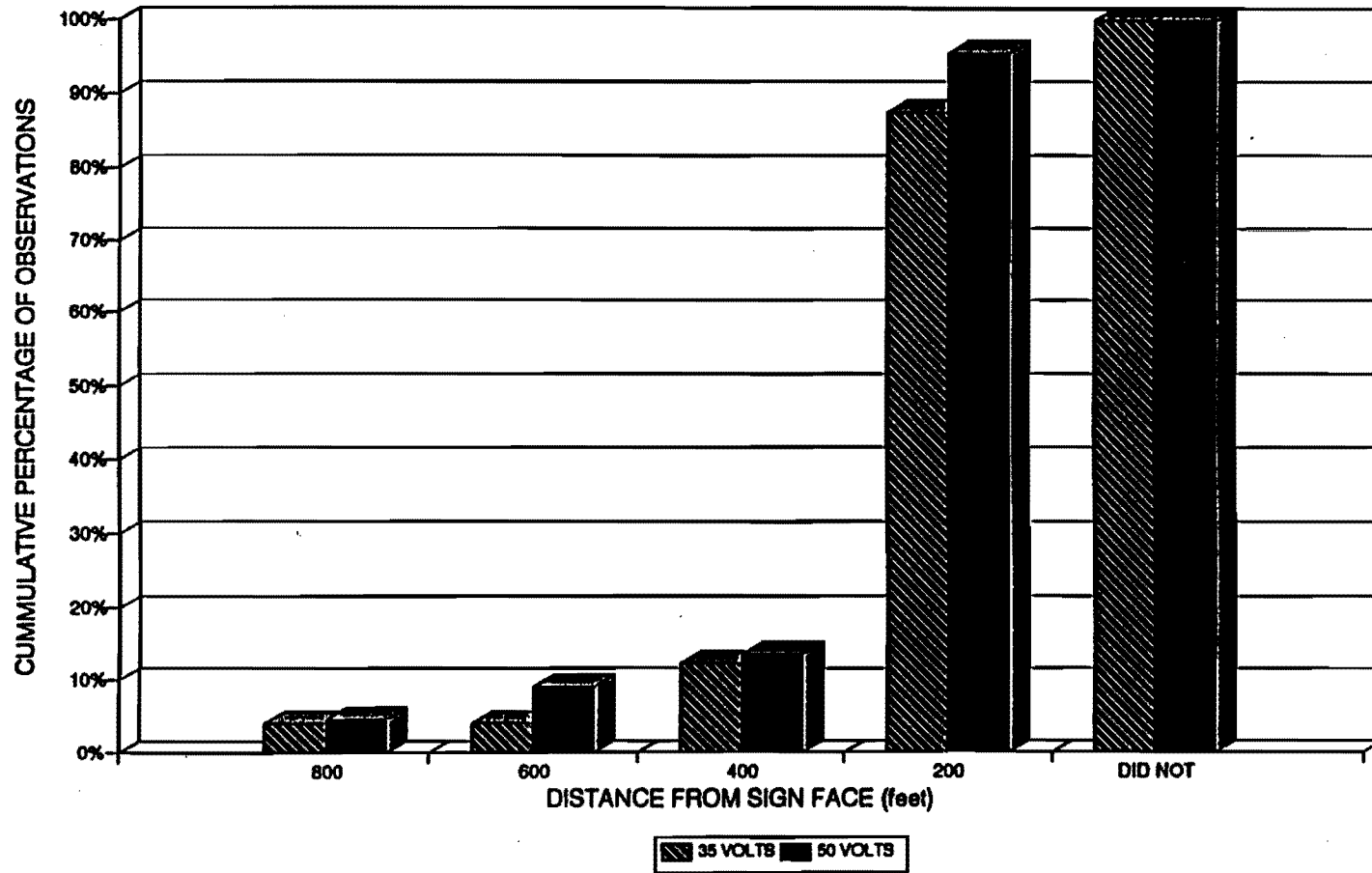

Figure 16 - Glance Legibility Distance for "OK" Word Message

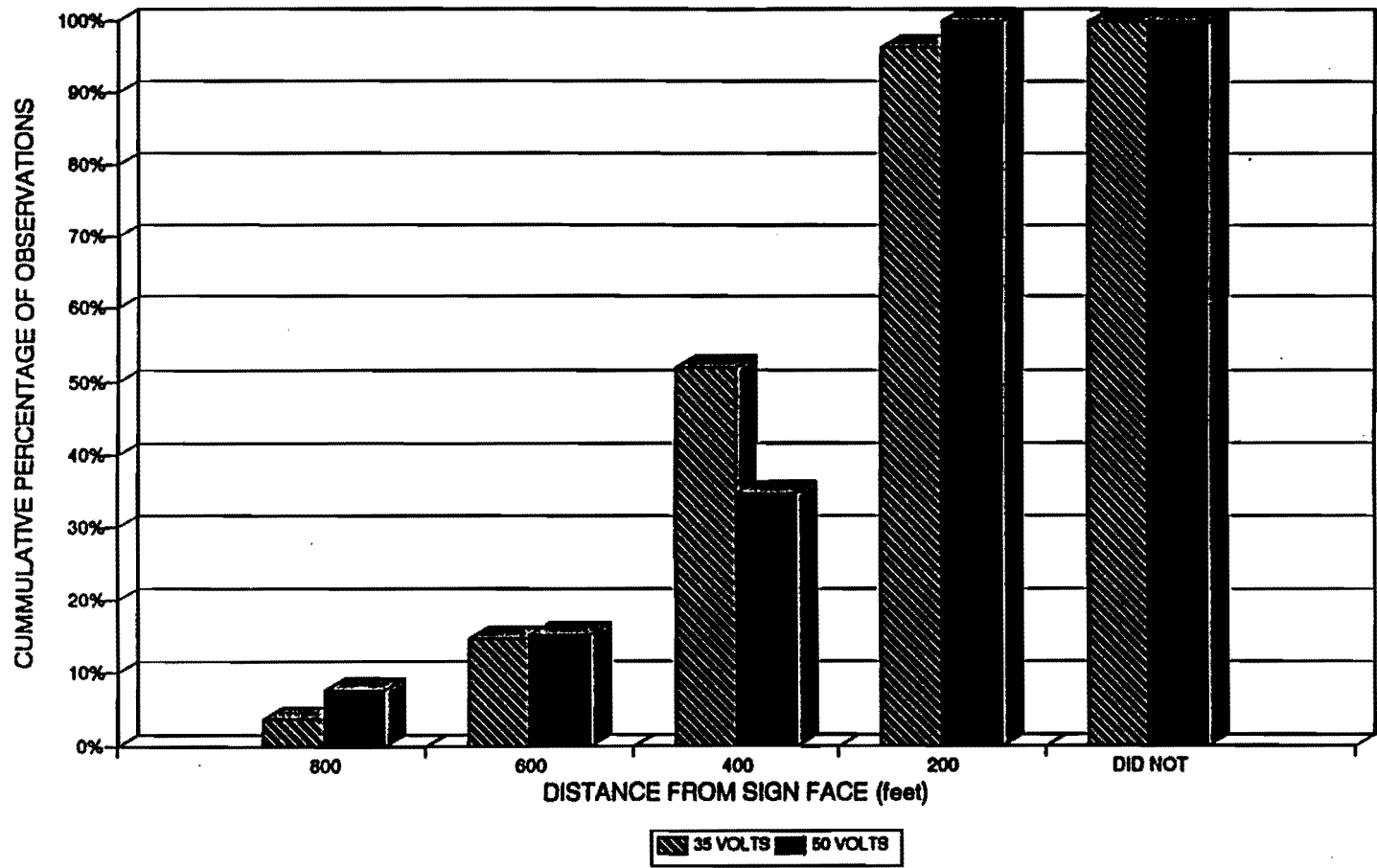

Figure 17 - Glance Legibility Distance for "ONLY" Word Message

because of their width, outside position in the message, and because of their simplistic shape, especially at the 35 volt setting. Once participants were able to distinguish the "O" and "Y" in the "ONLY" indication, it is believed that they inferred the remaining letters within this message based on prior experience. Because the "OK" word message was only two letters long and because of the complexity of the design of the letter "K", participants were believed to have had more difficulty in making these inferences. Several participants identified the word messages as saying "ON" and "OFF" at greater distances than where they were actually able to discern their meaning. These findings indicate that the spacing of word messages is very important in the design of fiberoptic displays.

The distance at which participants were able to detect the difference between single-row and bold arrow shaft design was also analyzed. The ability to discern this difference was originally intended for evaluating the minimum visual acuity of the participants. Figure 18 indicates that the ability of the participants to discern this level of detail was not consistent for either voltage. While no single distance could be identified as the point at which this detail became evident, virtually all participants identified a difference in shaft design at or before 200 feet. These results indicate, therefore, that the ability to identify fine details in symbol designs is highly dependent on the capabilities of an individual's eye to deal with the light emitted by the sign.

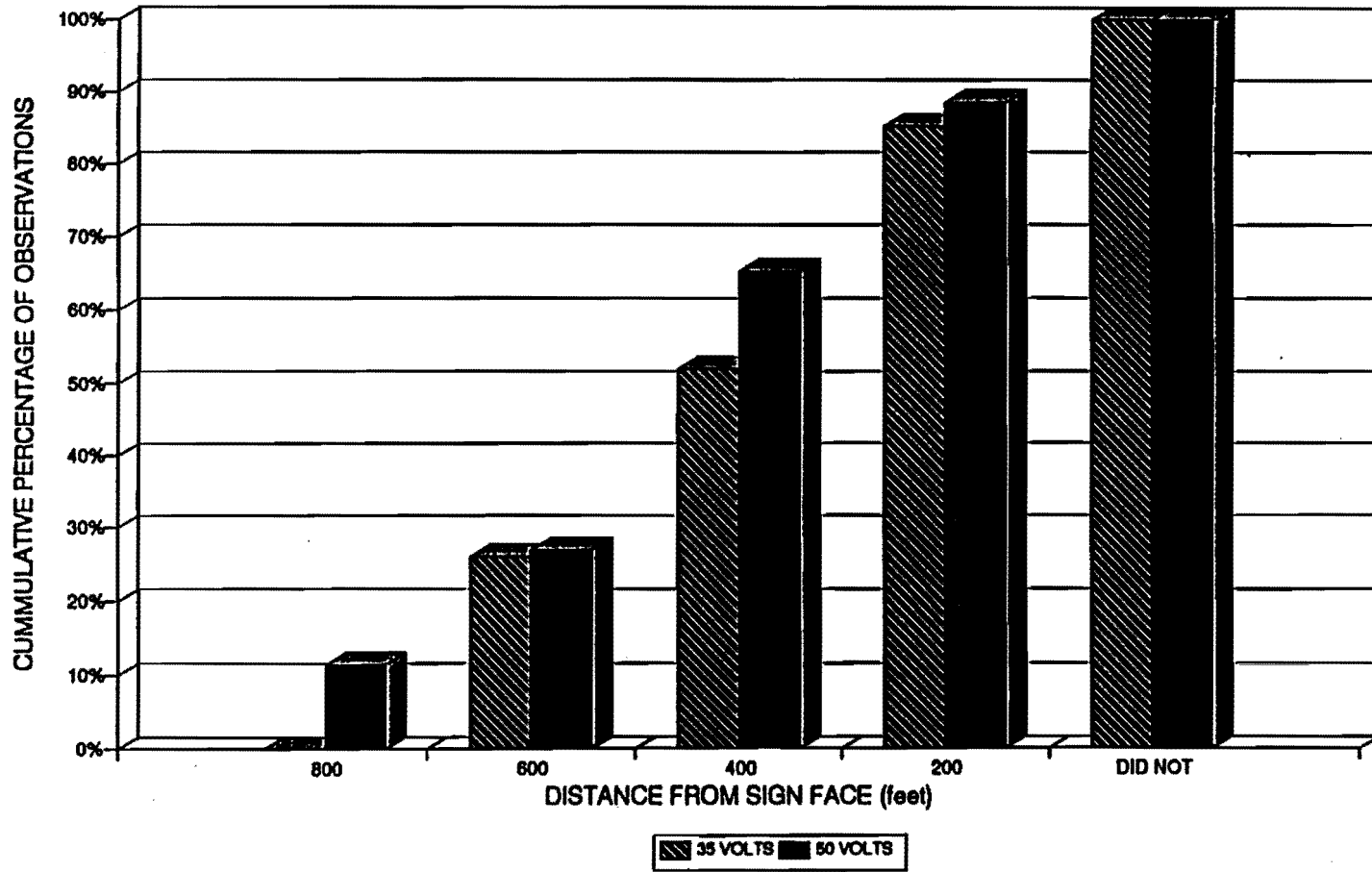

Figure 18 - Glance Legibility Distance for Shaft Design

FINDINGS AND RECOMMENDATIONS

This research has shown that fiberoptic signs are equally or more effective than conventional static signs in conveying the messages of lane assignment at intersections, when compared on the basis of target value and legibility. Further, the changeable aspects of the fiberoptics sign provides the added dimension of achieving dynamic lane assignment (i.e., altering the lane assignment display to fit the desired operational pattern with time).

This research indicated that sign brightness, light output, target value and legibility of the fiberoptics sign are all related. Sign brightness is proportional to light output, and light output is proportional to voltage across the lamps of the sign. Target value was found to increase, but sign legibility decreased as sign brightness increased. The selection of voltage settings for operating the fiberoptics signs, therefore, should involve optimizing the relationship between these variables with respect to surrounding or ambient illumination conditions.

For the relatively dark environment of the experimental test facility, it was found that the best viewing conditions for night operation were achieved when the fiberoptic sign was operated between 35 and 65 volts, based on a nominal 120 volt supply. Thirty five volts provided the best legibility, but 65 volts provided the best target value. The principal importance of this finding is that all fiberoptic sign circuits should contain a variable voltage supply so that the voltage level can be adjusted to fit the ambient light conditions.

The placement of the traffic signals relative to the fiberoptic signing was found to be critical to the proper operation of both components. The interaction of the signals and fiberoptic sign was dependent on the operational settings for

and the visual separation between each piece of equipment. These devices provide equally important but very different types of information. Operational settings and the amount of visual separation should, therefore, provide adequate target value for both the traffic signals and the fiberoptic signing without hindering the legibility of the fiberoptic sign.

The findings of the glance legibility studies indicate a strong dichotomy in the legibility of the symbols versus the words. In general, the subjects could discern the shape of the arrows at 800 feet, but the word messages remained a blur until they were in the range 200 feet from the sign. For the word messages to have a desirable effect, there is a need to increase their legibility. Letter size and spacing are key factors, and need to be explored further, in conjunction with light output in lieu of stroke width.

These findings raise the question of whether the word messages contribute to or detract from the effectiveness of the sign in transmitting information to the driver sufficiently in advance of the intersection. Past studies have shown that signs which use symbols exclusively are more efficient in providing information to the driver than are signs that mix words and symbols or signs that use words exclusively (9, 10). This statement is supported by the increased use of symbols in traffic signing over the last 30 years. Consequently, it is believed that the lane use information presented by the displays would be conveyed in a more safe and effective manner through the use of arrows exclusively.

Research is needed to develop design procedures for fiberoptic displays that relate light output and visual acuity to legibility distance. The difference in legibility between the letters of the word messages examined in this research was attributed to their proximity to other letters in the word and to the complexity of their shape. This indicates that minimum visual acuity of an object is related to

the total light output per unit area within the object. The procedures used in this research to identify the point of irradiation for the fiberoptic displays could be used to relate minimum visual acuity, light output per unit area, and the overall dimensions of letters and symbols. This information could be used to develop a standard letter series for use with fiberoptic signing.

The number of rows of pixels, either one or two, used to form the arrows does not have any appreciable effect on legibility. Neither does pixel spacing; however, the closer pixel spacing provides an aesthetic quality in smoothness of the symbol. From the standpoint of continuity of service, pixel spacing should be maintained closer than needed and every other pixel should connect to and alternate light source. In this manner, two lamps will be used to form an arrow or line of a symbol. When one of the lamps expires, then the symbol is maintained even with half the pixels operational.

It is recommended that the fiberoptic lane assignment displays be evaluated under actual traffic operating conditions. A location for such a study has been selected and the signs have been designed and procured. The results of this research were used in developing the design of the new signs. Single row pixels for the symbols, 0.70 inch spacing of pixels, and six-inch letters with single row pixels were specified.

The research to be performed in the field study includes integrating and coordinating the dynamic lane assignment display with the signal timing and phasing plan. Transition patterns from one lane assignment configuration to another constitutes a major concern. These various aspects of the project will be studied at the TTI sign laboratory at the Texas A&M Riverside Campus prior to installation at the study location.

Ultimately, the dynamic lane assignment concept will be integrated with the overall plan for transportation management.

Future Applications

Fiberoptic dynamic lane assignment techniques have the potential to improve the capabilities of the traffic engineer to accommodate variations in traffic demand caused by both recurrent and non-recurrent congestion. Dynamic lane assignment can be defined as "space management". When it is used in conjunction with "time management" (the use of demand responsive signal control), it can be a cost-effective alternative to re-design of major intersections. A typical example is presented.

Figure 19 shows peak flow rates for the morning and afternoon peaks on the eastbound frontage road approach to the diamond interchange at Bingle Road and Interstate 10 in Houston, Texas. The cross section for the approach shown consists of three lanes. According to the existing lane use configuration, the left lane is a shared left turn and through lane, the middle lane is an exclusive through lane, and the right lane is a shared through and right turn lane. This configuration is sufficient to accommodate the heavy morning through movement. During the afternoon peak, however, recurrent congestion occurs as a result of the ineffective use of the approach geometry. The ability to change between the morning lane configuration and a configuration that would provide additional capacity for the heavy left-turn movement during the afternoon peak could provide a significant reduction in delay at the intersection without the need to provide geometric improvements.

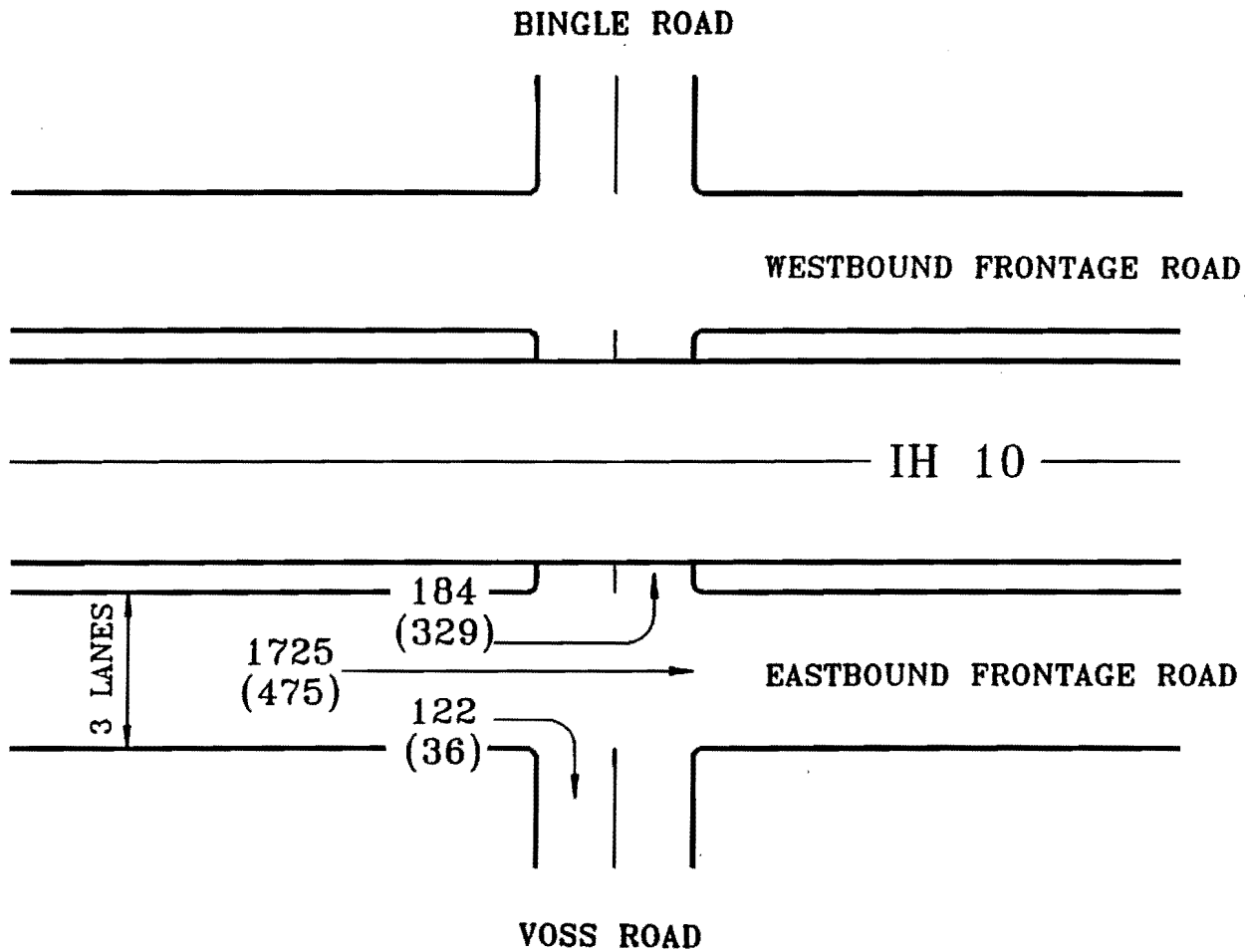

XXX - AM PEAK HOUR
(XXX) - PM PEAK HOUR

Figure 19 - AM and PM Peak Hour Rates at IH-10 and Voss/Bingle Rd

This type of signing also has applicability at interfaces between various transportation facilities. Transportation facilities that are in operation only during specific times of the day provide a good area for the application of this type of signing. One such site exists in Houston, Texas, at the Katy Transitway entrance near the intersection of Old Katy Road and Post Oak Road. The westbound approach to Post Oak Road on Old Katy Road is a one-way, three lane roadway with a single left-turn bay at the intersection. The lane adjacent to the left-turn bay is designated as a through lane and is used to enter the Katy Transitway during the evening hours of operation for the facility. A heavy left-turn movement from Old Katy Road onto Post Oak Road exists, however, during the morning peak period. A fiberoptic changeable message sign could be designed to provide a shared through-and-left turn movement from this lane onto Post Oak Road during the morning peak period. The evening display could designate the lane as an exclusive through-lane to accommodate transitway patrons.

One area where dynamic signing would provide a significant advantage over conventional static lane assignment techniques is in freeway incident management. By adjusting signal timing patterns to work with lane use assignments during freeway incidents and/or special events, the congested conditions that typically occur on the frontage road adjacent to the freeway could possibly be served in a more efficient manner.

The development of the ability of engineers to exercise centralized control of metropolitan transportation systems presents a number of possible applications for fiberoptic lane use signing. The advantages that fiberoptic signing has over other types of internally-lighted signing should produce continued growth in the application of this technology. The need to maintain a high degree of uniformity and flexibility associated with today's transportation facilities should reinforce the need for continued research into the design and operation of this ty

REFERENCES

1. Manual on Uniform Traffic Control Devices, 1988 Edition, Federal Highway Administration, Washington DC, 1988.
2. Dudek, C. L. et al. Design Guide, Vol. 1 of "Human Factors Requirements for Real-Time Motorist Information Displays," Federal Highway Administration, FHWA-RD-78-5, September 1978.
3. *Changeable Message Signs from SCHOTT*, SCHOTT America, Glass & Scientific Products, Inc., Yonkers NY, February 1990.
4. Lauer, A. R. "Relation Between Scotopic Vision as Measured by the Night Sight Meter, Daylight Vision and Age," Highway Research Board Bulletin 191, Washington DC, 1958.
5. Forbes, T. W. "Method for Analysis of the Effectiveness of Highway Signs," *Journal of Applied Psychology*, Vol. 22, No. 6, pp. 669-684, 1939.
6. *Standard Highway Sign Designs for Texas*, Texas State Department of Highways and Public Transportation, Austin, Texas, 1980.
7. *IES Lighting Handbook, 5th Edition*, Illuminating Engineering Society, New York, 1972.
8. Devore, J. L. *Probability and Statistics for Engineering and the Sciences, 2nd Edition*, Brooks/Cole Publishing Company, Monterrey, California., 1987.
9. Janda, H. F. and Volk, W. N. "Effectiveness of Various Highway Signs", HRB Proceedings, Vol. 14, 1934, pp. 442-447.
10. Ellis, J. G. and Dewar, R. E. "Rapid Comprehension of Verbal and Symbolic Traffic Sign Messages," *Human Factors*, Vol. 21, No. 2, 1979.
11. *Roadway Lighting Handbook*, Federal Highway Administration, Washington DC, December 1978.
12. Bueche, F. J. *Introduction to Physics for Scientists and Engineers, Third Edition*, McGraw-Hill, New York, 1980.
13. *Outdoor Lighting Photometric Data and Sample Calculations*, General Electric, Outdoor Lighting Department, Hendersonville, N. C., 1966.

14. Forbes, T. W. "Factors in Highway Sign Visibility," *Traffic Engineering*, Vol. 39, No. 12, September 1969.

APPENDIX A

SURVEY FOR FIRST SUBJECTIVE ANALYSIS

DEFINITIONS

- LEGIBILITY - The ability to read and/or discern the actual appearance of the sign face.
- TARGET VALUE - The ability of a sign to compete with its surroundings for the attention of the driver.
- UNDERSTANDABILITY - The ability of the driver to understand the message being conveyed.

1/2 INTENSITY

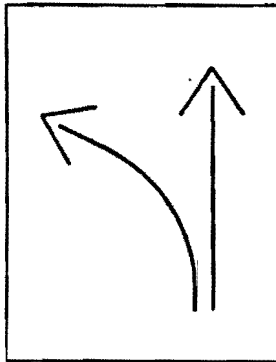

	E X C E L L E N T		A C C E P T A B L E		U N A C C E P T A B L E
Legibility	1	2	3	4	5
Target Value	1	2	3	4	5
Understandability	1	2	3	4	5

FULL INTENSITY

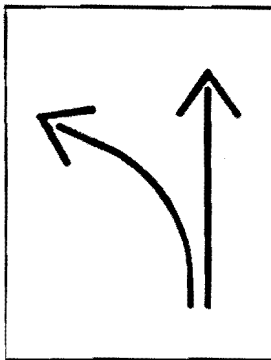

	E X C E L L E N T		A C C E P T A B L E		U N A C C E P T A B L E
Legibility	1	2	3	4	5
Target Value	1	2	3	4	5
Understandability	1	2	3	4	5

1/2 INTENSITY

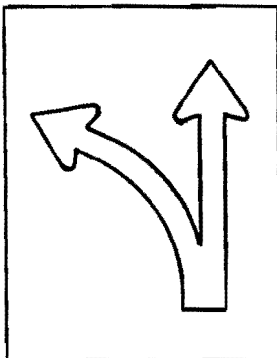

	E X C E L L E N T		A C C E P T A B L E		U N A C C E P T A B L E
Legibility	1	2	3	4	5
Target Value	1	2	3	4	5
Understandability	1	2	3	4	5

FULL INTENSITY

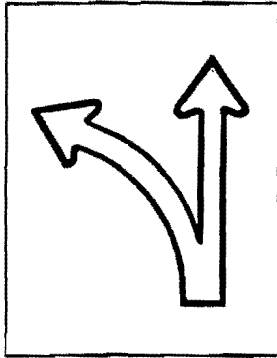

Legibility
Target Value
Understandability

	E X C E L L E N T		A C C E P T A B L E		U N A C C E P T A B L E
Legibility	1	2	3	4	5
Target Value	1	2	3	4	5
Understandability	1	2	3	4	5

1/2 INTENSITY w/ SINGLE-ROW OK

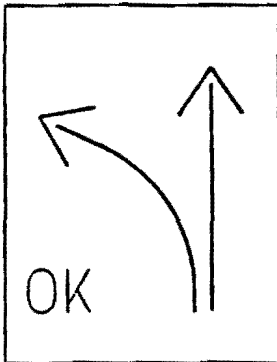

Legibility
Target Value
Understandability

	E X C E L L E N T		A C C E P T A B L E		U N A C C E P T A B L E
Legibility	1	2	3	4	5
Target Value	1	2	3	4	5
Understandability	1	2	3	4	5

FULL INTENSITY w/ SINGLE-ROW OK

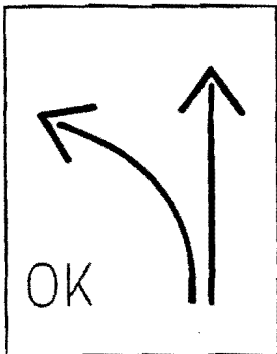

Legibility
Target Value
Understandability

	E X C E L L E N T		A C C E P T A B L E		U N A C C E P T A B L E
Legibility	1	2	3	4	5
Target Value	1	2	3	4	5
Understandability	1	2	3	4	5

1/2 INTENSITY w/ BOLD OK

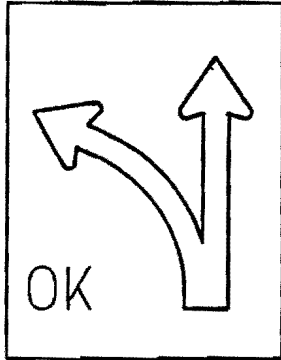

	E X C E L L E N T	2	A C C E P T A B L E	4	U N A C C E P T A B L E
Legibility	1	2	3	4	5
Target Value	1	2	3	4	5
Understandability	1	2	3	4	5

FULL INTENSITY w/ BOLD OK

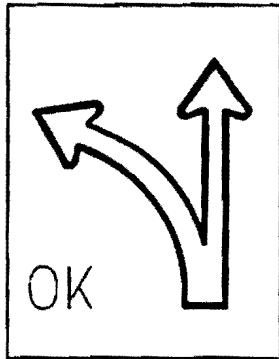

	E X C E L L E N T	2	A C C E P T A B L E	4	U N A C C E P T A B L E
Legibility	1	2	3	4	5
Target Value	1	2	3	4	5
Understandability	1	2	3	4	5

1/2 INTENSITY w/ SINGLE-ROW ONLY

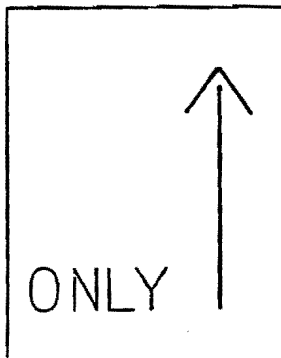

	E X C E L L E N T	2	A C C E P T A B L E	4	U N A C C E P T A B L E
Legibility	1	2	3	4	5
Target Value	1	2	3	4	5
Understandability	1	2	3	4	5

FULL INTENSITY w/ SINGLE-ROW ONLY

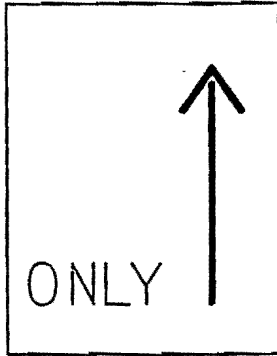

	E X C E L L E N T	A C C E P T A B L E	U N A C C E P T A B L E		
Legibility	1	2	3	4	5
Target Value	1	2	3	4	5
Understandability	1	2	3	4	5

1/2 INTENSITY w/ BOLD ONLY

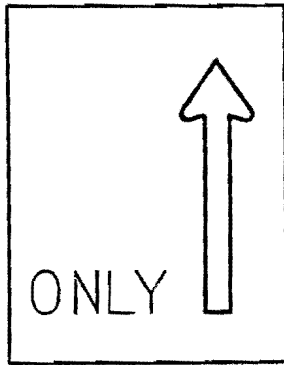

	E X C E L L E N T	A C C E P T A B L E	U N A C C E P T A B L E		
Legibility	1	2	3	4	5
Target Value	1	2	3	4	5
Understandability	1	2	3	4	5

FULL INTENSITY w/ BOLD ONLY

	E X C E L L E N T	A C C E P T A B L E	U N A C C E P T A B L E		
Legibility	1	2	3	4	5
Target Value	1	2	3	4	5
Understandability	1	2	3	4	5

1. We have considered two ways of forming the combination through-and-left turn arrow; (1) from a single shaft branching into two and (2) using two single-row shafts beginning in close proximity to each other. The latter is much easier to construct, but may be a source of confusion.

(A) Did you notice separate shafts for the single-row, combination left and through indication at half intensity? Yes_____ No_____

If you answered "NO" to question (A), proceed to question #2.

(B) If you did notice individual shafts, were they discernable under all conditions? Yes_____ No_____

(C) If "YES", identify specific conditions under which you were able to identify the individual shafts.

(D) Was the appearance of separate shafts a source of confusion?
Yes_____ No_____

If "YES", what was confusing?

2. (A) While you were observing the various displays, did any single display seem to overpower the traffic signal or the static display sign. Yes _____ No _____

(B) If "YES", identify which display(s) appeared to be overpowering?

(C) Do you think these displays are more or less effective when the luminous output is reduced?

3. There is some question as to how a black background affects driver perception of the position of the sign relative to that of the traffic signal.

(A) Did you feel there was any confusion generated as to the relative position of the sign with respect to the traffic signal? Yes _____ No _____

(B) If "YES", explain.

4. We examined several different alternative arrow combinations and indications, both with and without word messages.

(A) Do you think the word messages are effective in reinforcing the arrow indications associated with them? Yes_____ No_____

(B) If "YES", could they be improved? How?

(C) If "NO", do you feel that the word messages could be improved, or should they be removed?

IMPROVED _____

REMOVED _____

(D) If you think the word messages could be improved, how?

5. This sign is capable of displaying two different classes of indications, i.e., single-row and outline displays. Each class of sign requires a different arrowhead design.

(A) Of the two arrowhead designs, do you feel that one was more effective than the other in terms of providing a more readable display?

Yes_____ No_____

(B) If "YES", which design provided a more readable alternative?

Why?

6. (A) In comparing the dynamic display sign with the static display sign, was either of the two signs more effective in providing a more legible message than the other?

Yes _____ No _____

- (B) If YES, which provides a more legible display? Why?

7. Please provide any general comments you have concerning the dynamic display sign.

8. Please provide any comments concerning the content of this questionnaire. Comments and constructive criticisms will be greatly appreciated.

APPENDIX B

SURVEY FOR SECOND SUBJECTIVE ANALYSIS

DEFINITIONS

- LEGIBILITY - The ability to read and/or discern the actual appearance of the sign face.
- TARGET VALUE - The ability of a sign to compete with its surroundings for the attention of the driver.
- UNDERSTANDABILITY - The ability of the driver to understand the message being conveyed. This will not be evaluated as a part of this study.
- DISABILITY GLARE - Glare that is so severe that it adversely affects a driver's ability to safely operate a vehicle.
- DISCOMFORT GLARE - Glare that does not hinder the driver's ability to safely operate a vehicle, but is nevertheless uncomfortable.

SINGLE ROW DISPLAY @ 50%-tile VOLTAGE

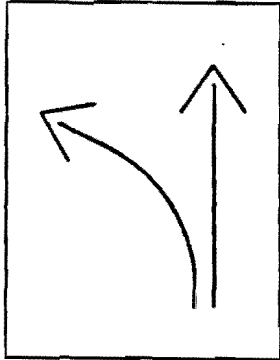

Legibility
Target Value

	E X C E L L E N T		A C C E P T A B L E		U N A C C E P T A B L E
	1	2	3	4	5
Legibility	1	2	3	4	5
Target Value	1	2	3	4	5

SINGLE ROW DISPLAY @ 85%-tile VOLTAGE

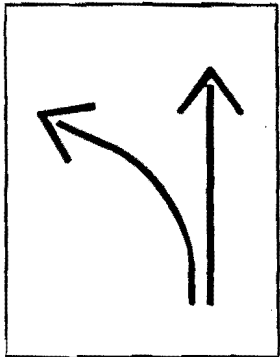

Legibility
Target Value

	E X C E L L E N T		A C C E P T A B L E		U N A C C E P T A B L E
	1	2	3	4	5
Legibility	1	2	3	4	5
Target Value	1	2	3	4	5

BOLD DISPLAY @ 50%-tile VOLTAGE

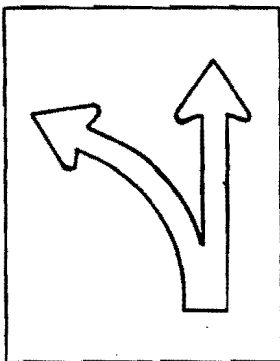

Legibility
Target Value

	E X C E L L E N T		A C C E P T A B L E		U N A C C E P T A B L E
	1	2	3	4	5
Legibility	1	2	3	4	5
Target Value	1	2	3	4	5

BOLD DISPLAY @ 85%-tile VOLTAGE

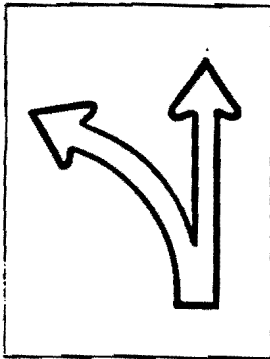

	E X C E L L E N T		A C C E P T A B L E		U N A C C E P T B L E
Legibility	1	2	3	4	5
Target Value	1	2	3	4	5

RANK ORDER THE FOLLOWING TYPES OF DISPLAYS w/r TO:

	S I N G L E	R E F L E C T I V E	B O L D
TARGET VALUE			
LEGIBILITY			

1. We have considered two ways of forming the combination through-and-left turn arrow; (1) from a single shaft branching into two and (2) using two single-row shafts beginning in close proximity to each other. The latter is much easier to construct, but may be a source of confusion.

(A) Did you notice separate shafts for the single-row, combination left and through indication at half intensity? Yes_____ No_____

If you answered "NO" to question (A), proceed to question #2.

(B) At what voltage level was this level of detail discernable?

50%-tile 85%-tile Both

(C) Was the appearance of separate shafts a source of confusion?

Yes_____ No_____

2. We examined several different alternative arrow combinations and indications, both with and without word messages.

(A) Do you think the word messages are effective in reinforcing the arrow indications associated with them? Yes_____ No_____

(B) If "NO", do you feel that the word messages could be improved, or should they be removed?

3. Did you feel that the use of 1" pixel spacing adversely affected:

(A) Target Value Yes_____ No_____

(B) Legibility Yes_____ No_____

4. Evaluate the glare caused by the traffic signals based on the scale below (refer to the first page of this handout for definitions) w/r to how they affect your ability to discern the sign legend:

	DISABILITY GLARE		DISCOMFORT GLARE		NO GLARE
50%-tile	1	2	3	4	5
85%-tile	1	2	3	4	5

5. Evaluate the target value at each of the signal settings:

	EXCELLENT		ACCEPTABLE		UNACCEPTABLE
50%-tile	1	2	3	4	5
85%-tile	1	2	3	4	5

6. Please provide any comments concerning the content of this questionnaire. Comments and constructive criticisms will be greatly appreciated.
