



11 March 2010

TransportationResearch.gov: An Overview of RITA's New Collaboration Site for the Transportation Research and Information Community

Amanda J. Wilson, National Transportation Library

TR.gov and National Transportation Library

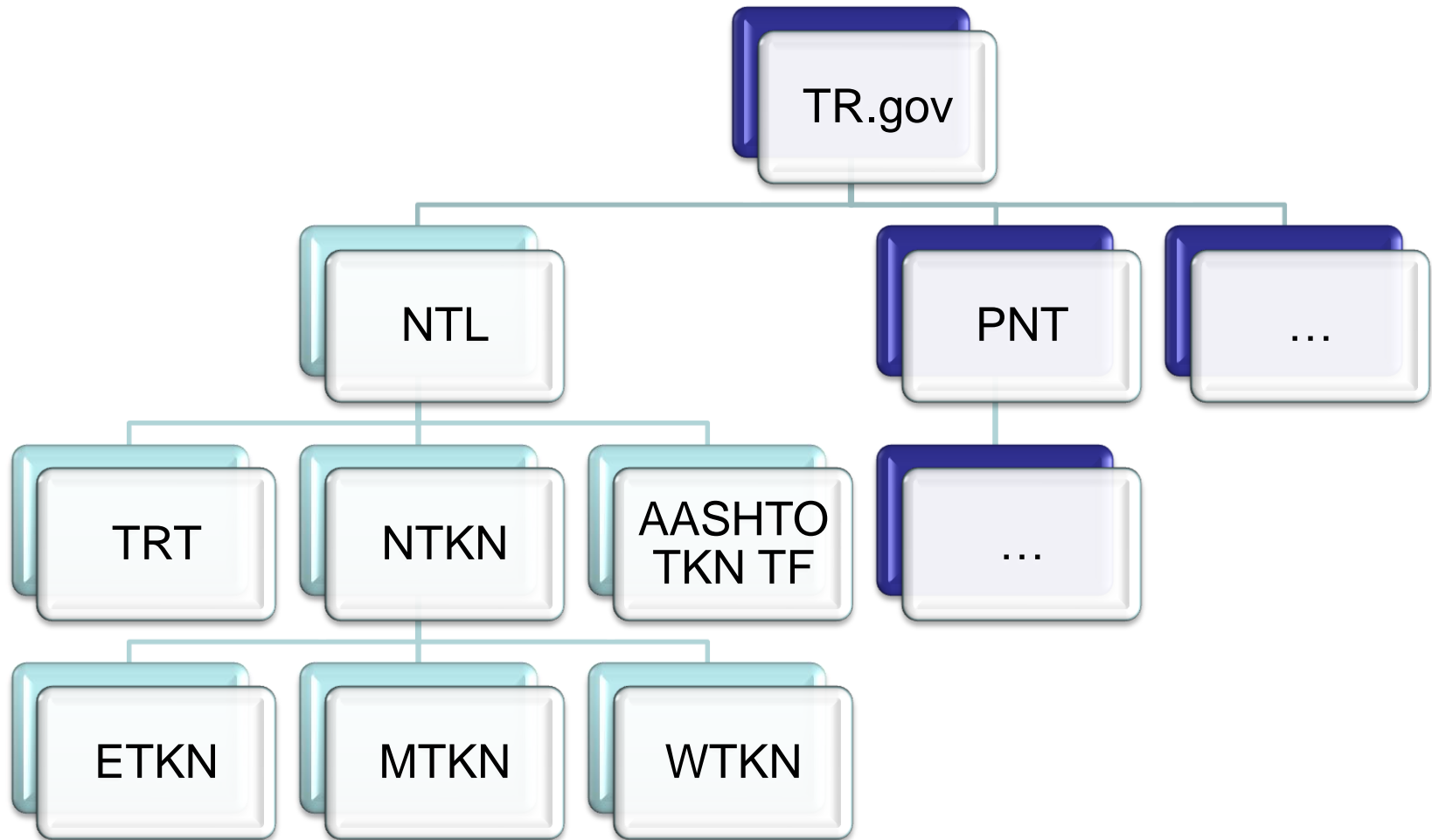

How To Get Started on TR.gov

One step and you're done!

- Step 1: send an email request to amanda.wilson@dot.gov
- Within five (5) business days, we'll send you an email with your TR.gov credentials
- You can get started with TR.gov

Participation – Using Sharepoint Lists



U.S. Department of Transportation
Research and Innovative Technology Administration

Transportation Research Collaboration

Documents

Lists

Discussions

Sites

People and Groups

Transportation Research > National Transportation Library > NTKN > TKN ILL Metrics

Resource Sharing Metrics - Charts

Year

Month

Load

Update Your Metrics

ILL requests from TKN libraries



ILL received from TKN libraries



Fill rate from TKN libraries

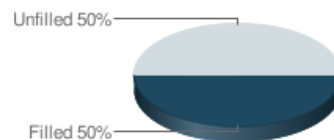

Lost to TKN libraries

TKN ILL Metrics FAQs

1. How to see all the metrics in full
2. How to create a new Metrics
3. How to Delete a Metrics
4. How to see different Views for Library Metrics

Announcements

There are currently no active announcements. To add a new announcement, click "Add new announcement" below.

Add new announcement

Links

There are currently no favorite links to display. To add a new link, click "Add new link" below.

Add new link

Calendar

There are currently no upcoming events. To add a new event, click "Add new event" below.

Add new event

Participation – Using Sharepoint Lists cont'd

U.S. Department of Transportation
Research and Innovative Technology Administration

Transportation Research Collaboration

- Documents
- Lists
- Discussions
- Sites
- People and Groups

Transportation Research > National Transportation Library > NTKN

Resource Sharing Metrics

Monthly statistics on borrowing and lending for each participating library

New
Actions
Settings

View: **All**

	Rec_Total	Lent_Total	Lent_TKN	Unfilled_Total	Received_TKN	
<div style="display: flex; justify-content: space-between; align-items: center; margin-bottom: 5px;"> <div style="border: 1px solid #ccc; border-radius: 5px; padding: 2px 5px; background-color: #fff; display: flex; align-items: center; gap: 5px;"> New Actions Settings </div> <div style="border: 1px solid #ccc; border-radius: 5px; padding: 2px 5px; background-color: #fff; display: flex; align-items: center; gap: 5px;"> View: All </div> </div> <div style="display: flex; justify-content: space-between; align-items: center; margin-bottom: 5px;"> <div style="border: 1px solid #ccc; border-radius: 5px; padding: 2px 5px; background-color: #fff; display: flex; align-items: center; gap: 5px;"> New Actions Settings </div> <div style="border: 1px solid #ccc; border-radius: 5px; padding: 2px 5px; background-color: #fff; display: flex; align-items: center; gap: 5px;"> View: All </div> </div>						
Library : ETKN-FHA (16)						
Library : ETKN-TDG (17)						
Library : MTKN-APS (15)						
Library : MTKN-EEV (10)						
Library : MTKN-IZA (16)						
Library : MTKN-JCR (10)						
2009 June MTKN-JCR	4	3	140	10	56	0
2009 July MTKN-JCR	0	0	168	12	58	0
2009 August MTKN-JCR	3	2	107	9	40	1
2009 January MTKN-JCR	3	2	127	11	60	0
2008 December MTKN-JCR	0	0	116	8	35	0
2008 November MTKN-JCR	1	1	138	6	36	1
2008 October MTKN-JCR	4	4	149	6	49	0
2008 September MTKN-JCR	0	0	161	16	26	0
2009 October MTKN-JCR	3	3	136	16	58	0
2009 November MTKN-JCR	2	2	122	19	43	0
Library : MTKN-JDC (14)						

Add new data for Resource Sharing Metrics

Different Views

Participation – Input option for using Sharepoint Lists

 **RITA** U.S. Department of Transportation
Research and Innovative Technology Administration

Transportation Research Collaboration

Account **GO**

Transportation Research > National Transportation Library > NTKN

Resource Sharing Metrics: New Item

| * indicates a required field

Year *	<input type="text" value="2010"/>
Month *	<input type="text" value="January"/>
Library *	<input type="text" value="ETKN-FHATR"/>
Req_Total *	<input type="text" value="0"/>
Rec_Total *	<input type="text" value="0"/>
Requested_TKN *	<input type="text" value="0"/>
Received_TKN *	<input type="text" value="0"/>
Lent_Total *	<input type="text" value="0"/>
Lent_ETKN *	<input type="text" value="0"/>
Lent_MTKN *	<input type="text" value="0"/>
Lent_WTKN *	<input type="text" value="0"/>
Lent_Mail *	<input type="text" value="0"/>
Unfilled_Bindery *	<input type="text" value="0"/>

Participation – Using Sharepoint Wikis



- Documents
- Lists
- Discussions
- Sites
- People and Groups
- Recent Changes
- May 2009 (Q2) TRT Preferred Terms for Discussion PRB
- February 2010 (Q1) TRT Non-Preferred Terms to Discuss
- February 2010 (Q1) TRT Preferred Terms to Discuss
- February 2010 (Q1) TRT Parked Terms to Discuss
- February 2010 (Q1) TRT Declined Terms to Discuss

[View All Pages](#)

Transportation Research > National Transportation Library > TRT

May 2009 (Q2) TRT Preferred Terms for Discussion PRB

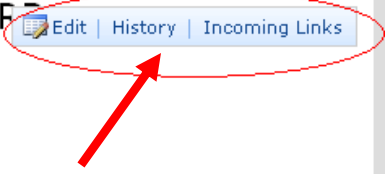

1.
New Preferred Term: Active safety systems
Notation: Dcmvgb
Facet: D: Communication and control
BT: Automated vehicle control for ground vehicles

Discussion:
Agree - Barbara Post
ST: Agree
SP: Agree
AE: Agree

2.
New Preferred Term: Air ambulance services
Notation:Hpef
Facet: H: Safety and security
BT: Emergency medical services

Discussion:
PRB This term comes from the periodical "Air Beat" that we've (Northwestern) begun to contribute to TRIS. There should be little usage in TRIS so far, but many hundreds of records to come.
Usage:
---Alberta's air-ambulance service saves lives when minutes matter most.
---SOS Air Rescue Africa / Morné Booij-Liewes. Subtitle: Morné Booij-Liewes reports on the round-the-clock air ambulance service which is setting new standards.

Participation – Capturing knowledge using Sharepoint Wikis

Transportation Research | National Transportation Library | Positioning, Navigation, and Timing | Sites

Transportation Research > National Transportation Library > TRT > TRT Terms Wiki > May 2009 (Q2) TRT Preferred Terms for Discussion PRB > Page History

May 2009 (Q2) TRT Preferred Terms for Discussion PRB

Edit Item | Delete Item | Manage Permissions | Check Out | Version History | Alert Me

This page does not show changes in Web Parts, images, or HTML formatting. Deleted Added

Modified at 3/10/2010 4:28 PM by Elizabeth Weldekidan

Wiki Content

35.0 3/10/2010 4:28 PM

34.0 3/10/2010 4:26 PM

33.0 3/10/2010 3:21 PM

32.0 3/8/2010 1:36 PM

31.0 3/8/2010 7:51 AM

30.0 3/8/2010 7:41 AM

29.0 2/8/2010 9:34 AM

28.0 11/18/2009 11:00 AM

27.0 8/3/2009 4:59 PM

26.0 6/1/2009 1:29 PM

25.0 6/1/2009 1:16 PM

24.0 6/1/2009 1:10 PM

23.0 6/1/2009 1:08 PM

22.0 6/1/2009 12:10 PM

21.0 5/27/2009 8:03 AM

20.0 5/21/2009 4:27 PM

19.0 5/19/2009 5:51 PM

18.0 5/19/2009 4:42 PM

17.0 5/19/2009 4:34 PM

16.0 5/19/2009 4:33 PM

15.0 5/14/2009 1:51 PM

14.0 5/14/2009 1:51 PM

13.0 5/14/2009 1:48 PM

12.0 5/14/2009 1:48 PM

11.0 5/14/2009 12:29 PM

10.0 5/14/2009 11:45 AM

9.0 5/14/2009 9:37 AM

8.0 5/12/2009 1:34 PM

Wiki Content

NTL is part of RITA

1.
New Preferred Term: Active safety systems
Notation: Dcmvgb
Facet: D: Communication and control
BT: Automated vehicle control for ground vehicles

Discussion:
Agree - Barbara Post

ST: Agree
SP: Agree
AE: Agree
2.
New Preferred Term: Air ambulance services
Notation: Hpef
Facet: H: Safety and security
BT: Emergency medical services

Discussion:
PRB This term comes from the periodical "Air Beat" that we've (Northwestern) begun to contribute to TRIS. There should be little usage in TRIS s many hundreds of records to come

Participation – Managing Documents with Sharepoint



U.S. Department of Transportation
Research and Innovative Technology Administration

Transportation Research Collaboration

Documents

Lists

Discussions

Sites

People and Groups

Transportation Research > National Transportation Library > ETKN

ETKN Announcements

There are currently no active announcements. To add a new announcement, click "Add new announcement" below.

Add new announcement

ETKN Research Wiki

New | Actions | Settings

Name	Modified
Home	12/12/2009 4:29 PM
How To Use This Wiki Library	12/12/2009 4:29 PM

ETKN Shared Documents

New | Upload | Actions | Settings

Type	Name
	Eastern Transportation Knowledge Network
	ETKN Library Asset Needs
	ETKN Meeting 20071109
	ETKN Membership Directory
	ETKN Membership Overview
	ETKN Minutes - 26 March 2009
	ETKN Minutes - 28 May 2009
	ETKN Minutes - Organizing Meeting
	ETKN Organizing Meeting Minutes
	ETKN Resolution
	ETKN_Invitation
	ETKNpurpose
	ETKNresolution
	Ken's Thoughts on Purpose

- View Properties
- Edit Properties
- Manage Permissions
- Edit in Microsoft Office Word
- Delete
- Send To
- Check Out**
- Workflows
- Alert Me

ETKN Calendar

There are currently no upcoming events. To add a new event, click "Add new event" below.

Add new event

ETKN Links

There are currently no favorite links to display. To add a new link, click "Add new link" below.

Add new link



Participation – Managing Documents cont'd



U.S. Department of Transportation
Research and Innovative Technology Administration

Transportation Research Collaboration

Documents

Lists

Discussions

Sites

People and Groups

Transportation Research > National Transportation Library > ETKN

ETKN Announcements















There are currently no active announcements. To add a new announcement, click "Add new announcement" below.

Add new announcement

ETKN Research Wiki

Name	Modified
Home	12/12/2009 4:29 PM
How To Use This Wiki Library	12/12/2009 4:29 PM

ETKN Shared Documents

Type	Name	
	Eastern Transportation Knowledge Network	
	ETKN Library Asset Needs	View Properties
	ETKN Meeting 20071109	Edit Properties
	ETKN Membership Directory	Manage Permissions
	ETKN Membership Overview	Edit in Microsoft Office Word
	ETKN Minutes - 26 March 2009	Delete
	ETKN Minutes - 28 May 2009	Send To
	ETKN Minutes - Organizing Meeting	Check In
	ETKN Organizing Meeting Minutes	Discard Check Out
	ETKN Resolution	Workflows
	ETKN_Invitation	Alert Me
	ETKNpurpose	
	ETKNresolution	
	Ken's Thoughts on Purpose	
	webconference_instructions	

ETKN Calendar

There are currently no upcoming events. To add a new event, click "Add new event" below.

Add new event

ETKN Links

There are currently no favorite links to display. To add a new link, click "Add new link" below.

Add new link



Communications – Calendar option

 **RITA** U.S. Department of Transportation
Research and Innovative Technology Administration

Transportation Research Collaboration

Transportation Research > National Transportation Library > TRT

TRT Calendar

Use the Calendar list to keep informed of upcoming meetings, deadlines, and other important events.

View: **Calendar**

Expand All Collapse All | Day Week **Month**

Today is Thursday, March 11, 2010

Documents
Lists
Discussions
Sites
People and Groups

New Item
Add a new item to this list.

Sunday	Monday	Tuesday	Wednesday	Thursday	Friday	Saturday
31	1 NTL notifies TRB of new terms TRB Subcommittee reviews/comments on proposed terms	2	3	4 8:00 AM Subcommittee Consensus Pre-Vote	5 8:00 AM Committee Pre-vote for Consensus	6
7	8	9	10	11	12	13
14	15	16	17	18	19	20
21	22	23	24	25	26	27

Communications – Alerts and RSS feeds option

RITA U.S. Department of Transportation
Research and Innovative Technology Administration

Research Collaboration

Transportation Research > National Transportation Library > WTKN

WTKN Shared Documents

Share a document with the team by adding it to this document library.

New | Upload | **Actions** | Settings

Type	Name	Modified	Modified By
	wtkn-bylaws-FI	3/10/2010 4:38 PM	Elizabeth Weldekidan
	wtkn-guiding-p	3/2/2010 11:30 AM	Elizabeth Weldekidan

Edit in Datasheet
Bulk edit items using a datasheet format.

Open with Windows Explorer
Drag and drop files into this library.

Export to Spreadsheet
Analyze items with a spreadsheet application.

View RSS Feed
Syndicate items with an RSS reader.

Alert Me
Receive e-mail notifications when items change.

Administrative Features – FAQs



U.S. Department of Transportation
Research and Innovative Technology Administration

Transportation Research Collaboration

Transportation Research > National Transportation Library > NTKN

Directory FAQs

Frequently Asked Questions on Using the NTKN SharePoint Site

Documents

Lists

Discussions

Sites

People and Groups

*Collapse
or
Expand*

1. To access the site
2. Searching for a Library/Information Center
3. Filtering Directory Entries
4. Viewing Details for a Library/Information Center,
5. Adding a Library or Information center to the Directory

This function requires login access. You can add a resource in the temporary or permanent site. If you add it to the temporary site, you will need to follow the instructions given in "**7. Moving a Resource from the Temporary Site to the Permanent Site.**" The answer given here is for entries to the permanent site.

- Select **Library and Information Center Directory** from the menu on the left side of your screen.
- Using the **New** button located above the resource names, select **LibraryDirectory** -Create a new Library Directory from the drop down menu. A blank resource form appears.
- Fill in the appropriate information for the resource using the text fields and dropdown boxes. Make sure to enter an **Organization Type**
TIP: The system requires a name for the library or information center you are entering. If the resource does not have a name, use the parent organization name.
TIP: If a dotted red box appears around the date box when you enter a date of **last updated** filed, check your spelling or enter the date in a different format (e.g. January 1, 2009).
- Save your changes using the save button located at the top left corner of the resources form (you will need to scroll down to see it).
- Select **Close**. The system will prompt you if you have forgotten to save your changes.

6. Modifying Information for An Existing Resource

7. Moving a Resource from the Temporary Site to the Permanent Site

Upcoming Developments

The screenshot shows the RITA website interface. At the top right, there are links for 'Sign In', 'Manage My Account', and 'Logout'. A red arrow points to 'Sign In', and another red arrow points to 'Manage My Account'. Below these links is a search bar with a 'GO' button. A red circle highlights the search bar area, and a red arrow points to a 'Search' button in a box on the right side of the page.

The main content area is titled 'Transportation Research > National Transportation Library > TRT'. It features a 'Manage Your Account' button. The content is organized into sections: 'Documents', 'Lists', and 'Discussions'. The 'Discussions' section contains several updates to TRT terms, each with a date and time. Below this is a 'TRT Terms Wiki' table listing various terms and their modifiers.

On the right side, there are sections for 'TRT Recent Links' (including 'The Thesaurus: Review, Renaissance and Revision' and 'Instructions for TRB TRT Subcommittee Comment and Discussion') and 'TRT Calendar' (listing events from 5/3/2010 to 8/5/2010).

Maximizing TR.gov for TKN use

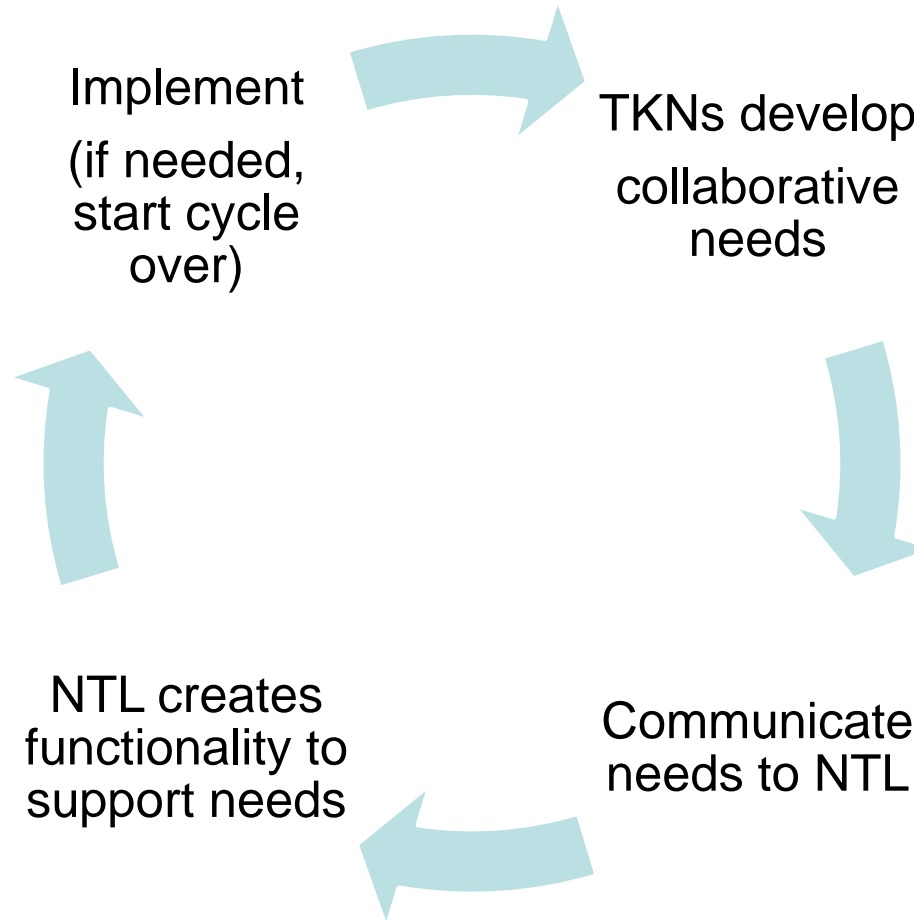

Features and Functionalities of <http://www.transportationresearch.gov> NTL's External SharePoint site

No	General Public Privileges	Registered User Privileges
1	Open/View documents (Shared Documents, Announcement)	Add/edit documents (Shared Documents, Announcement)
2	View SharePoint List	Create SharePoint List
3	View Wiki	Edit Wiki
4	View Calendar	Add/Edit Calendar events
5	Reply / View / Edit Discussion board	Reply / View / Edit Discussion board
6	View FAQs	Edit FAQs
7	View different Views of the SharePoint lists	Add/Edit different SharePoint lists Views
8	View different SharePoint lists Views	Change different views of the SharePoint lists
9	View RSS Feeds	Set Up the RSS Feeds criteria
10	View Alerts	Set up Alerts
11	View Versioning/History	Set Up Versioning/History options
12	N/A	Checking in/Checking out documents
13	N/A	Manage Your Account (Not implemented yet)
14	Search (Not implemented yet)	Search (Not implemented yet)



Contacts

- For General Questions:
 - Amanda J. Wilson
NTL Director
amanda.wilson@dot.gov
202-366-2480

