

Smart Robot Design and Implementation to Assist Pedestrian Road Crossing

Hovannes Kulhandjian, PhD



MINETA TRANSPORTATION INSTITUTE

Founded in 1991, the Mineta Transportation Institute (MTI), an organized research and training unit in partnership with the Lucas College and Graduate School of Business at San José State University (SJSU), increases mobility for all by improving the safety, efficiency, accessibility, and convenience of our nation's transportation system. Through research, education, workforce development, and technology transfer, we help create a connected world. MTI leads the [Mineta Consortium for Transportation Mobility \(MCTM\)](#) and the [Mineta Consortium for Equitable, Efficient, and Sustainable Transportation \(MCEEST\)](#) funded by the U.S. Department of Transportation, the [California State University Transportation Consortium \(CSUTC\)](#) funded by the State of California through Senate Bill I and the Climate Change and Extreme Events Training and Research (CCEETR) Program funded by the Federal Railroad Administration. MTI focuses on three primary responsibilities:

Research

MTI conducts multi-disciplinary research focused on surface transportation that contributes to effective decision making. Research areas include: active transportation; planning and policy; security and counterterrorism; sustainable transportation and land use; transit and passenger rail; transportation engineering; transportation finance; transportation technology; and workforce and labor. MTI research publications undergo expert peer review to ensure the quality of the research.

Education and Workforce Development

To ensure the efficient movement of people and products, we must prepare a new cohort of transportation professionals who are ready to lead a more diverse, inclusive, and equitable transportation industry. To help achieve this, MTI sponsors a suite of workforce development and education opportunities. The Institute supports educational programs offered by the Lucas Graduate School of Business: a Master of Science in Transportation Management, plus graduate certificates that include High-Speed and Intercity Rail Management and Transportation Security Management. These flexible programs offer live online classes so that working transportation professionals can pursue an advanced degree regardless of their location.

Information and Technology Transfer

MTI utilizes a diverse array of dissemination methods and media to ensure research results reach those responsible for managing change. These methods include publication, seminars, workshops, websites, social media, webinars, and other technology transfer mechanisms. Additionally, MTI promotes the availability of completed research to professional organizations and works to integrate the research findings into the graduate education program. MTI's extensive collection of transportation-related publications is integrated into San José State University's world-class Martin Luther King, Jr. Library.

Disclaimer

The contents of this report reflect the views of the authors, who are responsible for the facts and accuracy of the information presented herein. This document is disseminated in the interest of information exchange. MTI's research is funded, partially or entirely, by grants from the U.S. Department of Transportation, the U.S. Department of Homeland Security, the California Department of Transportation, and the California State University Office of the Chancellor, whom assume no liability for the contents or use thereof. This report does not constitute a standard specification, design standard, or regulation.

Report 24-10

Smart Robot Design and Implementation to Assist Pedestrian Road Crossing

Hovannes Kulhandjian, PhD

June 2024

A publication of the
Mineta Transportation Institute
Created by Congress in 1991

College of Business
San José State University
San José, CA 95192-0219

TECHNICAL REPORT DOCUMENTATION PAGE

1. Report No. 24-10	2. Government Accession No.	3. Recipient's Catalog No.	
4. Title and Subtitle Smart Robot Design and Implementation to Assist Pedestrian Road Crossing		5. Report Date June 2024	
		6. Performing Organization Code	
7. Authors Hovannes Kulhandjian, PhD		8. Performing Organization Report CA-MTI-2353	
9. Performing Organization Name and Address Mineta Transportation Institute College of Business San José State University San José, CA 95192-0219		10. Work Unit No.	
		11. Contract or Grant No. ZSB12017-SJAUX	
12. Sponsoring Agency Name and Address State of California SB1 2017/2018 Trustees of the California State University Sponsored Programs Administration 401 Golden Shore, 5 th Floor Long Beach, CA 90802		13. Type of Report and Period Covered	
		14. Sponsoring Agency Code	
15. Supplemental Notes 10.31979/mti.2024.2353			
16. Abstract <p>This research focuses on designing and developing a smart robot to assist pedestrians with road crossings. Pedestrian safety is a major concern, as highlighted by the high annual rates of fatalities and injuries. In 2020, the United States recorded 6,516 pedestrian fatalities and approximately 55,000 injuries, with children under 16 being especially vulnerable. This project aims to address this need by offering an innovative solution that prioritizes real-time detection and intelligent decision-making at intersections. Unlike existing studies that rely on traffic light infrastructure, our approach accurately identifies both vehicles and pedestrians at intersections, creating a comprehensive safety system. Our strategy involves implementing advanced Machine Learning (ML) algorithms for real-time detection of vehicles, pedestrians, and cyclists. These algorithms, executed in Python, leverage data from LiDAR and video cameras to assess road conditions and guide pedestrians and cyclists safely through intersections. The smart robot, powered by ML insights, will make intelligent decisions to ensure a safer and more secure road-crossing experience for pedestrians and cyclists. This project is a pioneering effort in holistic pedestrian safety, ensuring robust detection capabilities and intelligent decision-making.</p>			
17. Key Words Smart robot Pedestrian detection Smart traffic light Safe road crossing Vehicle detection		18. Distribution Statement No restrictions. This document is available to the public through The National Technical Information Service, Springfield, VA 22161.	
19. Security Classif. (of this report) Unclassified	20. Security Classif. (of this page) Unclassified	21. No. of Pages 42	22. Price

Copyright © 2024

by **Mineta Transportation Institute**

All rights reserved.

DOI: 10.31979/mti.2024.2353

Mineta Transportation Institute
College of Business
San José State University
San José, CA 95192-0219

Tel: (408) 924-7560

Fax: (408) 924-7565

Email: mineta-institute@sjsu.edu

transweb.sjsu.edu/research/2353

ACKNOWLEDGMENTS

This study received support from the CSU Transportation Consortium and the Fresno State Transportation Institute. Any opinions, findings, conclusions, and recommendations expressed in this material are those of the author and do not necessarily reflect the views of these institutes. The author would like to thank his student assistants, Oludayo Iredele and Nicholas Amely, undergraduate students from the Electrical and Computer Engineering (ECE) department at California State University, Fresno, for working on this interesting research project and implementing and testing the final proposed prototype. The author would also like to thank Editing Press for editorial services, as well as MTI staff, including Executive Director Karen Philbrick, Ph.D.; Deputy Executive Director Hilary Nixon, Ph.D.; Graphic Designer Alverina Eka Weinardy; and Executive Administrative Assistant Jill Carter.

CONTENTS

Acknowledgments.....	vi
List of Figures.....	ix
Executive Summary	1
1. Introduction	2
2. System Overview.....	4
3. Machine Learning for Object Detection.....	5
3.1 You Only Look Once (YOLO) Machine Learning Algorithm	5
3.2 YOLO Algorithm Implementation.....	7
3.3 Bounding Boxes, Object Labeling, and Frame-by-Frame Analysis	7
3.4 Curb Detection Implementation	8
4. Traffic Light Chassis Design Methodology.....	10
4.1 Designing for Functionality.....	10
4.2 Traffic Light Design.....	10
4.3 Raspberry Pi and Jetson Orin Mount Design.....	12
5. Software System Architecture	15
5.1 Software System Architecture Overview	15
5.2 ROS 2 Integration for Control Software	15
5.3 Control Software Design and ROS 2 Integration	16
5.4 ROS Node Architecture for Traffic Control System.....	17
6. Robot Framework Implementation.....	18
6.1 360 LiDAR Sensor, Velodyne LiDAR PUCK.....	18

6.2 Central Processing Unit, NVIDIA Jetson AGX Orin Developer Kit.....	19
6.3 Micro-Computer, Raspberry Pi 5.....	20
6.4 Mobile Robot, Pioneer 3-AT Robot.....	20
6.5 Power Delivery and Distribution Strategy.....	21
7. Prototype Experimentations	23
8. Conclusion	27
Abbreviations and Acronyms	28
Bibliography.....	29
About the Author	31

LIST OF FIGURES

Figure 1. (a) School Personnel Helping Students Cross the Street, (b) Proposed Smart Robot Assisting Pedestrians Crossing the Street	3
Figure 2. Traffic Control Flow Chart	4
Figure 3. YOLO Algorithm Implementation.....	5
Figure 4. YOLO Algorithm Architecture.....	6
Figure 5. Pedestrian Detection Algorithm in Action for Person Detection Crossing the Street; Bounding Box and Percentage Accuracy Displayed.....	8
Figure 6. Pedestrian Detection Algorithm in Action for Person Detection Crossing the Street, Detects the Pedestrian has Stepped on the Street.....	9
Figure 7. Led Matrix Case CAD Model Design.	10
Figure 8. 3D Printed Case for LED Matrix Panels.....	11
Figure 9. CAD Model Design for LED Matrix and LiDAR Integration.....	12
Figure 10. Tray Mount for Raspberry PI and Jetson Orin.....	12
Figure 11. Raspberry PI and NVIDIA Jetson Orin Mounted on 3D Printed Tray	13
Figure 12. Smart Traffic Light Robot 3D CAD Model.....	14
Figure 13. ROS2 Node Publisher and Subscriber Architecture.....	15
Figure 14. Block Diagram of the ROS2 Node Architecture.....	16
Figure 15. Velodyne LiDAR PUCK VLP-16 Sensor.	19
Figure 16. NVIDIA Jetson AGX Orin Developer Kit.	19
Figure 17. Raspberry Pi 5.....	20
Figure 18. Pioneer 3-AT Mobile Robot.	21
Figure 19. P3AT Mobile Robot Interior Hardware with the Intel Processor.....	21

Figure 20. P3AT Mobile Robot Power Distribution Board.22

Figure 21. P3AT Mobile Robot with Jetson Orin and Rasbery Pi 522

Figure 22. Experiments on Smart Traffic Light Carried Out on Fresno State Roads.23

Figure 23. The Fully Built and Functional Smart Traffic Light Experiments at Fresno State School and Streets24

Figure 24. Training Results of the Classification Deep Neural Network for Optical Images of Pedestrians and Cyclists Detection25

Figure 25. Training Results of the Classification Deep Neural Network for Vehicles and Cyclist Detection.....25

Figure 26. Live Caption of the LiDAR Sensor Point Cloud with the Machine Learning Model Predicting the Pedestrians in the Crosswalk.....26

Figure 27. Live Caption of the LiDAR Sensor Point Cloud with the Machine Learning Model Identifying a Car and a Pedestrian on the Street.26

Executive Summary

Pedestrian safety remains a critical concern, with a high number of fatalities and injuries reported annually. The vulnerability of children under 16 is particularly high, especially during road crossings. This project addresses the need for an innovative solution to enhance pedestrian safety, focusing on real-time detection and intelligent decision-making at crossroads. Unlike previous studies relying on existing traffic-light infrastructure, our approach aims to accurately detect both vehicles on the road and pedestrians at crossroads, ensuring a comprehensive safety system. The use of advanced Machine Learning (ML) algorithms for real-time vehicle, pedestrian, and cyclist detection is at the core of our strategy. Large datasets from diverse sensors will be gathered and utilized to train sophisticated ML models. These algorithms, implemented in Python on a minicomputer, will harness information from LiDAR and video cameras, providing an integrated and accurate assessment of road conditions. The proposed smart robot, leveraging ML insights, will make intelligent decisions on when to guide pedestrians and cyclists safely through crossroad intersections. This project pioneers a holistic approach to pedestrian safety, ensuring robust detection capabilities and intelligent decision-making, ultimately contributing to a safer and more secure road-crossing experience for pedestrians and cyclists alike.

1. Introduction

Given that almost everyone is a pedestrian at some point each day, persistently high rates of pedestrian fatalities should be of universal concern. In 2020 alone, vehicle collisions killed 6,516 pedestrians and injured an estimated 55,000 pedestrians nationwide (NHSTA 2020). The most vulnerable pedestrians are children under 16 using crosswalks in school zones, according to the National Highway Traffic Safety Administration ("School Zone and School Crosswalk Safety Tips," 2018, NCSA 2023). In California alone, six million students attend 10,453 public schools on any given school day. Of these students, more than 3.1 million are of elementary school age. A recent study conducted by the California Department of Education reveals that Los Angeles, Oakland, and San Francisco areas are among the top three most vulnerable school districts (CBSLA News, 2017, "PSBR Law," n.d.). Jardin de la Infancia School in LA had the highest incidence of traffic accidents with 271 car accidents, 72 pedestrian accidents, and 54 bicycle accidents. To promote safe crossings at school crosswalks, school personnel are often deployed to help students cross the street shortly before the bell rings, when the inflow of pedestrian traffic is heaviest. These personnel are often schoolteachers or teacher assistants who must return to their classrooms after the bell rings, leaving vulnerable students to cross the street unassisted, often in locations with no traffic lights or stop signs. Schoolchildren are not able accurately to judge when it is safe to cross the street, resulting in potentially fatal accidents (Wann et al, 2011). There has been only a handful of studies (Pau et al, 2018 and Saad et al, 2020) on developing systems for pedestrian safety, most of which aim to add new frameworks to the existing traffic-light infrastructure. In this study, we propose instead to replicate the work of the human crossing guard by developing a digital twin/ smart robot that helps pedestrians and cyclists safely cross the street. The smart robot would use a combination of sensors and artificial intelligence to detect both the presence of a pedestrian or cyclist and the flow of traffic before safely entering the street along with the pedestrian. The smart robot would also be capable of detecting danger during the crossing operation and sounding an alarm to alert the driver and the pedestrians/cyclists. Smart robot technology can also assist other vulnerable populations, including the elderly, to cross the street safely at crossroads without traffic lights. The proposed system is functional both during the day and at night using the combination of a LiDAR and video cameras.



Figure 1. (a) School Personnel Helping Students Cross the Street,
 (b) Proposed Smart Robot Assisting Pedestrians Crossing the Street.
 The robot is mounted with several sensors and a traffic signal

The proposed system is built on top of an old nonfunctioning P3-AT Mobile Robot, which has an obsolete computer system and inaccessible software. We have revived the robot by replacing its computer system with a modern NVIDIA Jetson AGX Orin computer. The robot is mounted with a traffic light on top of a post, which displays a walking-man light on two opposite sides to signal to pedestrians and cyclists that it is safe to cross the street. The traffic light also displays a stop sign on the other two opposite sides to signal traffic coming from both directions to stop while pedestrians are crossing. Additionally, we have added a LiDAR system on top of the traffic signals and four visible light cameras to monitor the flow of cars and the presence of pedestrians on both sides of the street crosswalk. Two of the video cameras are used to monitor the pedestrians and cyclists on each side of the road and make a smart decision to let the robot cross the street. To detect pedestrians, we utilize some of the groundwork we have developed for pedestrian detection and avoidance of cars, as described in references (Kulhandjian 2022, Kulhandjian 2023). The current proposed system is more elaborate and contains other types of sensors and detection mechanisms that we have not previously explored, namely the LiDAR sensor to detect the inflow of cars and visible light cameras to detect vehicles. Previously, we have only conducted experiments for pedestrian detection, as opposed to vehicle detection. In this project, it is crucial to detect both vehicles in the street and pedestrians at the crossroads accurately to make an intelligent decision. We utilize advanced machine learning algorithms to conduct vehicle, pedestrian, and cyclist detection in real time. To achieve this, we will gather large data sets to train the advanced machine learning models to allow the sensors to detect pedestrians and cars. The machine learning algorithms will be programmed using Python running on a minicomputer. By combining the information from the LiDAR and video cameras, and by integrating the data to create an efficient and accurate assessment of the road conditions, the robot will make an intelligent decision as to when it is safe to walk the pedestrians/cyclists through the crossroad intersection. If during the crossing, the robot detects that a vehicle may endanger the pedestrian, it will sound an alarm to warn the driver and the pedestrian.

2. System Overview

The smart robot design and its implementation to assist pedestrian road crossing uses advanced software, machine learning neural networks, and hardware subsystems that all work together to perform the intended task.

The traffic control system flowchart, depicted in Figure 2, operates in a continuous manner to manage pedestrian and road traffic. Upon detecting pedestrians waiting to cross the street at either side of the crosswalk, the system scans for incoming road traffic at the crossing. If there are no approaching vehicles, the system initiates a red light for inbound and outbound traffic, positions itself in the middle of the street, and, once deemed safe, activates a walking light for pedestrians to cross. The system monitors continuously to ensure that all pedestrians safely cross the street. After confirming that no more pedestrians need to cross, the system signals a red light to prevent further crossings, relocates the robot to its initial position on the pavement, and signals a green light for inbound and outbound traffic.

Upon reaching the side of the pavement, the system permits any waiting traffic to proceed. The system then reverts to a monitoring state, actively observing pedestrian presence and traffic flow. In scenarios where pedestrians and traffic coexist, the system assesses traffic speed. If it determines that it is unsafe for incoming traffic to stop, it allows vehicles to proceed. Conversely, if a safe stopping distance exists, the system signals a red light, prompting the vehicles to halt at the smart traffic light.

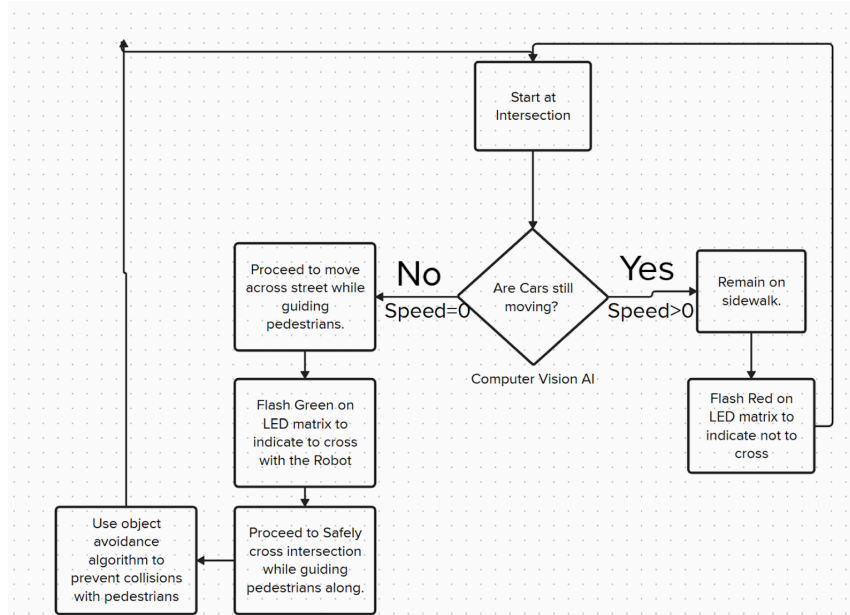

Figure 2. Traffic Control Flow Chart.

3. Machine Learning for Object Detection

3.1 You Only Look Once (YOLO) Machine Learning Algorithm

The development of a robust detection algorithm is a pivotal element for our smart robot development, enabling the robot to adapt dynamically to its environment in real time. This necessitates the deployment of advanced computer vision algorithms, leveraging machine learning techniques for the classification and tracking of objects in images and videos. After careful consideration of alternatives, we have opted to implement the YOLO (You Only Look Once) algorithm, recognizing its superior efficiency in real-time applications, heightened accuracy, and reduced false positives.

The YOLO algorithm represents a cutting-edge solution in the domain of object detection, harnessing the capabilities of deep learning via a convolutional neural network (CNN). This approach allows YOLO to predict bounding box coordinates and class probabilities for multiple object categories in a single pass over the image, constituting an end-to-end architecture that excels in accuracy and adaptability. Widely embraced for applications ranging from autonomous vehicles to image captioning, YOLO's efficacy stems from its adeptness at handling intricate detection scenarios, even in instances of overlapping objects, thereby enabling efficient detection and classification of multiple objects within a given image.

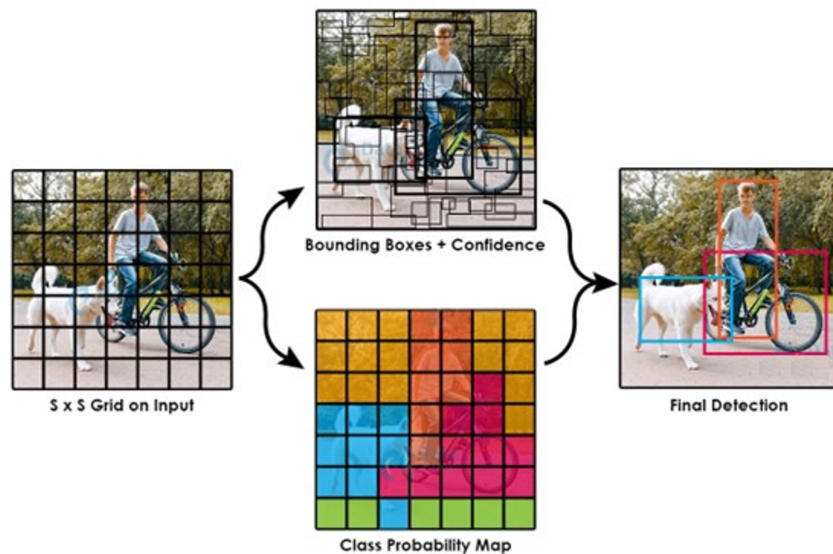

Figure 3. YOLO Algorithm Implementation.

The YOLO algorithm operates by dividing the input image into an $S \times S$ grid as shown in Figure 3, where S is the number of grid cells along each dimension. For each grid cell, the algorithm predicts bounding boxes along with associated confidence scores and generates a class probability map.

The input image is divided into a grid of $S \times S$ cells. This grid structure forms the basis for the subsequent detection process, allowing the algorithm to scan the entire image efficiently.

For each grid cell, YOLO predicts bounding boxes that enclose objects present in that cell. These bounding boxes are represented by coordinates, typically including the x and y coordinates of the box's center, width, and height. Additionally, the algorithm assigns a confidence score to each predicted bounding box, indicating the algorithm's confidence in the accuracy of the prediction.

Alongside bounding boxes, YOLO generates a class probability map for each grid cell. This map assigns probabilities to different object classes, indicating the likelihood of an object belonging to a specific category. The algorithm uses these probabilities to classify objects present within the bounding boxes.

The final step involves consolidating the predictions from all grid cells and selecting the most confident detections. The algorithm filters out redundant or less confident predictions, resulting in a set of final detections that include bounding boxes, associated confidence scores, and the predicted class labels. These final detections represent the algorithm's output, providing a comprehensive understanding of the objects present in the input image.

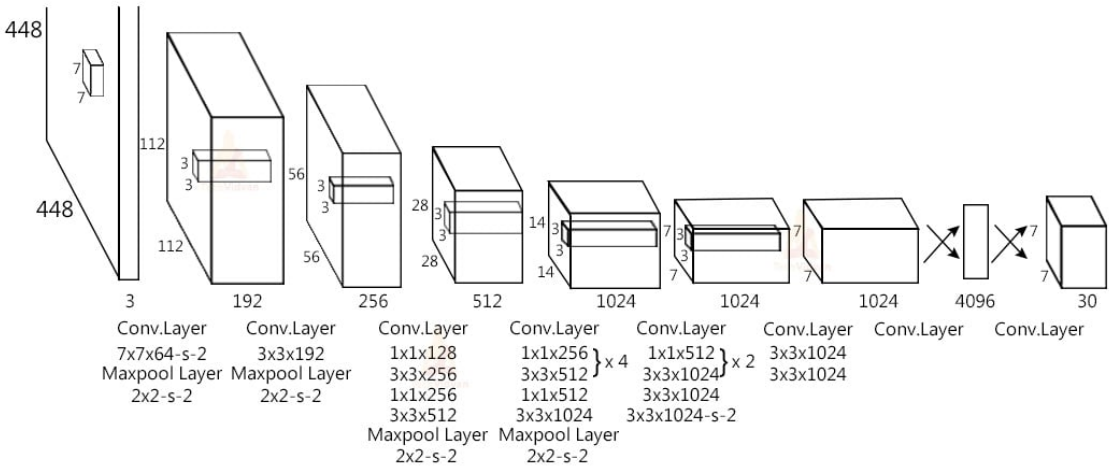

Figure 4. YOLO Algorithm Architecture.

The YOLO algorithm architecture, shown in Figure 4, operates in the following manner. First, the input image is resized to 448x448 before passing through the convolutional network. Initially, a 1x1 convolution is applied to decrease the number of channels, followed by a 3x3 convolution to produce a cuboidal output. ReLU is employed as the activation function throughout the network, except for the final layer, which utilizes a linear activation function. Additional techniques such as batch normalization and dropout are incorporated to regularize the model and mitigate overfitting.

3.2 YOLO Algorithm Implementation

Leveraging Python's OpenCV2 library facilitates the seamless implementation of multiple YOLO machine learning models dedicated to vehicle and pedestrian detection within a video feed. OpenCV2 provides an extensive toolkit along with pre-trained YOLO classifiers specifically tailored for diverse objects, including vehicles and pedestrians, streamlining the implementation process. The integration of these classifiers into each frame of a video feed is achieved with minimal lines of code, enabling practical real-time detection. Furthermore, OpenCV2 incorporates built-in functions designed for the precise delineation of bounding boxes around detected objects, offering a straightforward means to visualize and analyze results. Through the synergistic utilization of OpenCV2's capabilities and YOLO models, one can expediently develop robust solutions for vehicle and pedestrian detection in video streams. These solutions find applicability across a spectrum of domains, including but not limited to traffic monitoring and surveillance.

3.3 Bounding Boxes, Object Labeling, and Frame-by-Frame Analysis

In the context of employing a YOLO model for car and pedestrian detection, the crucial steps involve the generation of bounding boxes, labeling, and conducting frame-by-frame analyses to identify objects precisely within an image. The procedure encompasses preprocessing the image, segmenting it into smaller regions through a sliding window mechanism, applying YOLO to each region, and establishing a threshold for positive detections. Subsequently, bounding boxes are constructed around the identified objects, and a non-maximum suppression step is executed to eliminate redundant or overlapping boxes. The final step involves rendering the retained bounding boxes onto the original image, providing a visual representation of the detected pedestrians. This meticulous process is integral for the comprehensive analysis and effective utilization of detection outcomes across diverse applications, notably in tracking scenarios.

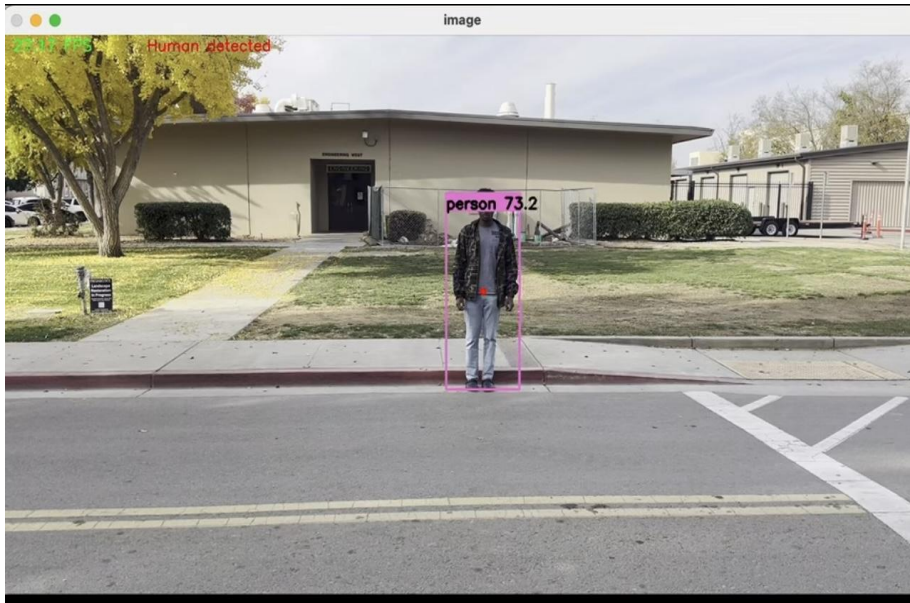

Figure 5. Pedestrian Detection Algorithm in Action for Person Detection Crossing the Street; Bounding Box and Percentage Accuracy Displayed.

3.4 Curb Detection Implementation

The integration of curb detection monitors the successful crossing of pedestrians onto the sidewalk and tracks those still in the process of crossing.

The implementation outline is as follows: utilizing OpenCV, the AI model executes pedestrian detection and applies bounding boxes to identify targets. Employing edge detection techniques, the algorithm discerns the edges of the sidewalk and delineates a line along this edge. In the event of a pedestrian intersecting with this defined line, the system accurately registers the crossing event, providing valuable insights into pedestrian movement dynamics, as shown in Figure 6. This approach enhances the overall functionality of the system, particularly in scenarios where precise monitoring of pedestrian traffic is crucial.

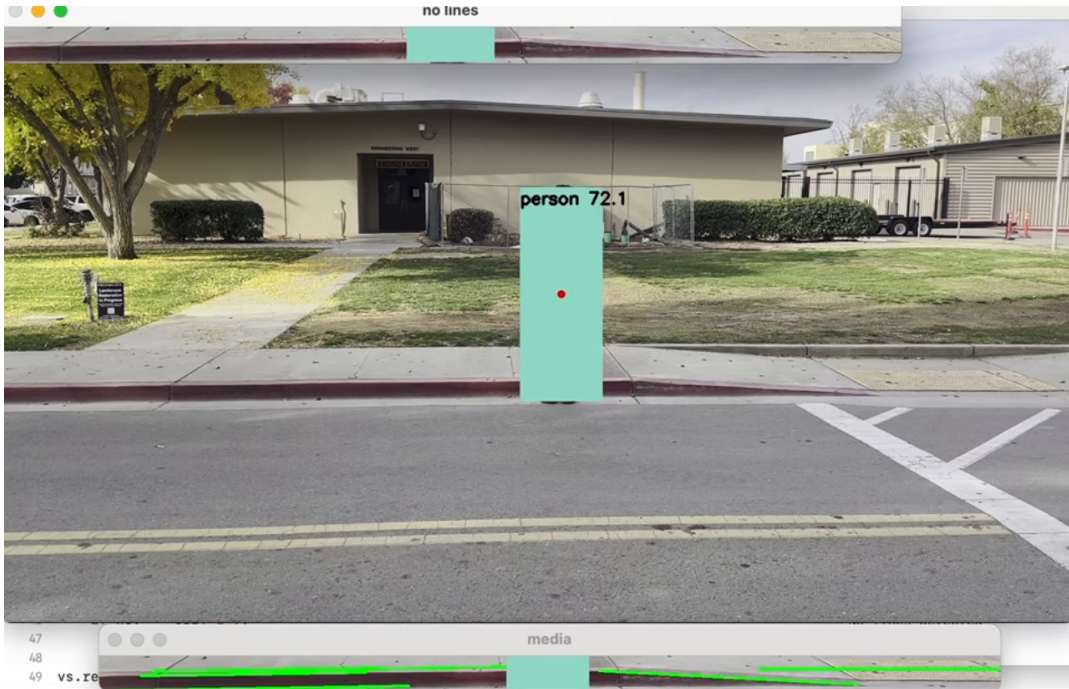

Figure 6. Pedestrian Detection Algorithm in Action for Person Detection Crossing the Street, Detects the Pedestrian has Stepped on the Street.

4. Traffic Light Chassis Design Methodology

The detailed CAD model design process required significant engineering to integrate the light emitting diode (LED) matrix and LiDAR components seamlessly. This design exploration encompasses the intricacies of creating a cohesive and functional assembly, ensuring optimal placement, structural integrity, and streamlined integration of these critical elements. The CAD model intricacies are tailored to facilitate the seamless incorporation of the LED matrix and LiDAR, aligning with the specific requirements of the overall robotic system.

4.1 Designing for Functionality

When shaping the ultimate appearance of the robot, the primary focus is on creating a design that revolves around the robot's core functionality. Employing this criterion, decisions such as sensor placement, LED matrix configuration, and overall build size gained clarity.

4.2 Traffic Light Design

To ensure the robot imparts clear and consistent directions to pedestrians, a deliberate decision was made to arrange the four LED matrix panels in a box-like formation. This configuration situates two sides facing pedestrians and the other two sides facing vehicles for the inbound and outbound traffic. The design of the LED enclosure meticulously accommodates this arrangement, as depicted in Figure 7.

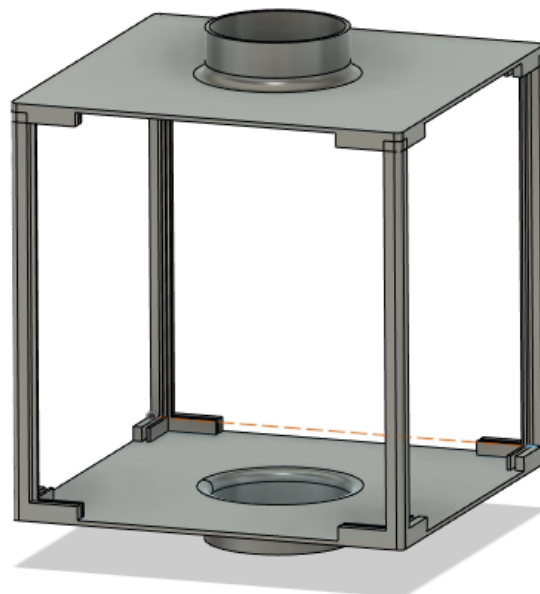

Figure 7. Led Matrix Case CAD Model Design.

The design features four columns strategically positioned to support the acrylic glass covering, acting as a protective shield for the LED matrix and internal wires against external elements. These columns, along with the base, incorporate intentional gaps to facilitate the easy insertion of the glass protection and the LED matrix into their designated positions.

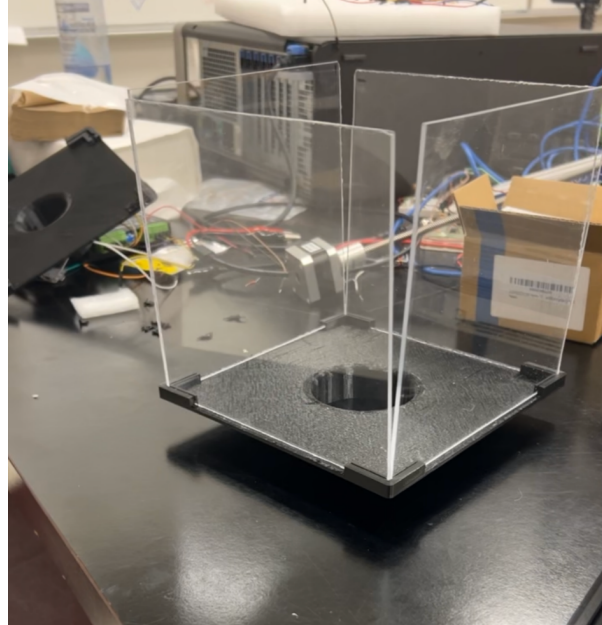

Figure 8. 3D Printed Case for LED Matrix Panels.

Additionally, an extrusion at the bottom is designed to secure the connecting polyvinyl chloride (PVC) pipe, elevating the LED enclosure. This pipe serves a dual purpose by providing a secure mount for the LiDAR.

The wires for the LED matrix, 3D LiDAR, and cameras travel down the hollow PVC pipe, emerging at the surface of the rover. This surface serves as the focal point for all power connections and interfaces with the Raspberry Pi and Jetson Orin.

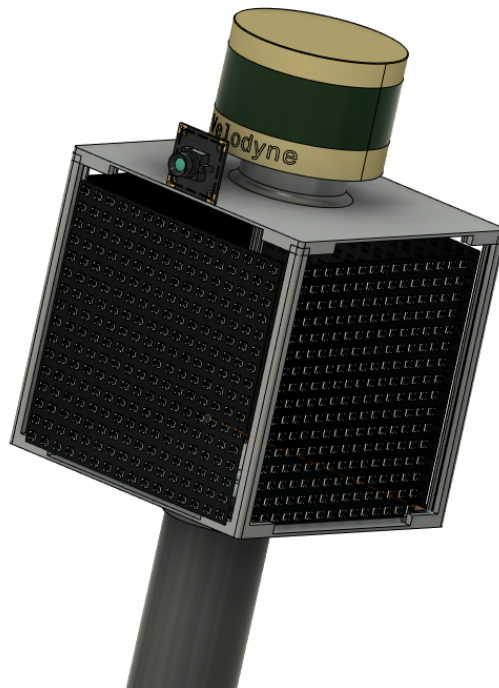

Figure 9. CAD Model Design for LED Matrix and LiDAR Integration.

4.3 Raspberry Pi and Jetson Orin Mount Design

For securing the onboard computers responsible for computations and controls, a low-profile tray was devised. This tray houses all the computers and is mounted on the rover's surface, as illustrated in the figure below.

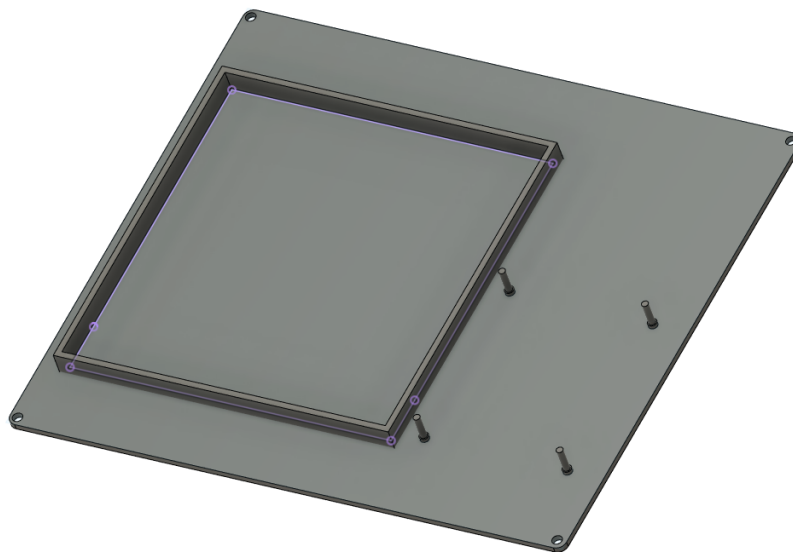

Figure 10. Tray Mount for Raspberry PI and Jetson Orin.

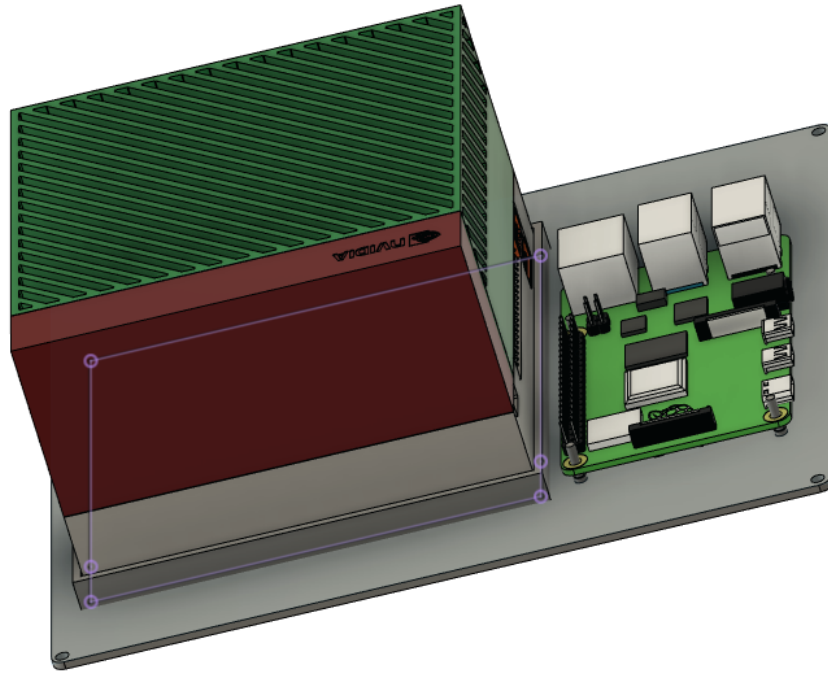

Figure 11. Raspberry PI and NVIDIA Jetson Orin Mounted on 3D Printed Tray.

Upon completion of 3D printing and assembly of all designs, the final robot design was established. Standing at a height of approximately 6 feet 1 inch, the robot met the required specifications effectively.



Figure 12. Smart Traffic Light Robot 3D CAD Model.

5. Software System Architecture

5.1 Software System Architecture Overview

The foundational structure of our system is grounded in the Robot Operating System 2 (ROS2) architecture, renowned as an industry standard for building sophisticated robot applications. ROS2 comprises a set of cutting-edge software libraries and tools that embody best practices in the field. The architecture is structured around the publisher-subscriber model, manifested as nodes and topics, as depicted in Figure 13.

ROS2's implementation of the publisher-subscriber model, utilizing nodes and topics, offers a streamlined approach for data dissemination. Notably, the system facilitates multiple nodes to access and utilize the disseminated data concurrently without necessitating the intricate implementation of multi-threading; this functionality is seamlessly managed by ROS2 in the backend. The modular nature of ROS2 allows the formation of a network of nodes and topics, creating a scalable and efficient infrastructure for complex systems. This design principle facilitates continuous growth and expedites the development process by focusing on the construction of specific nodes, thus enhancing the system's adaptability and ease of deployment.

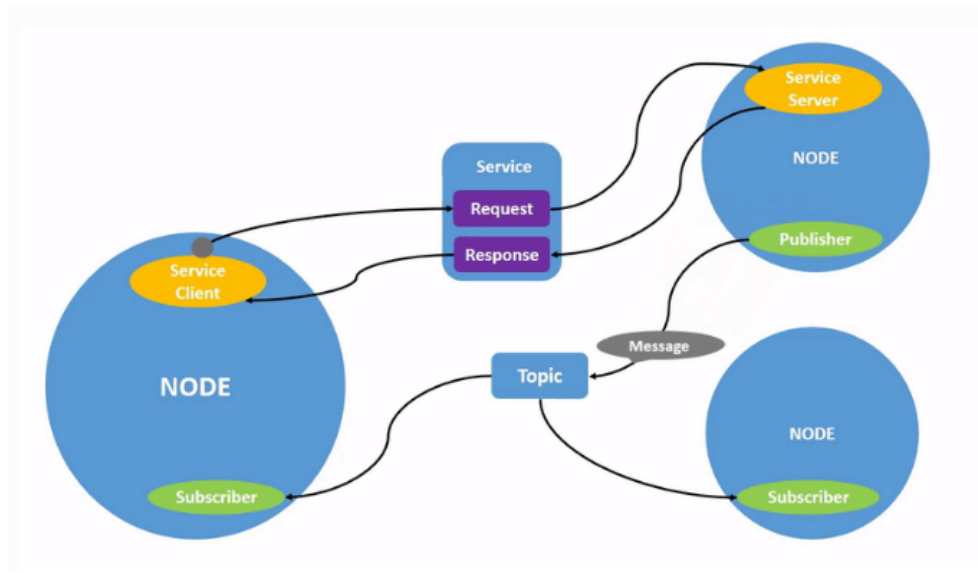

Figure 13. ROS2 Node Publisher and Subscriber Architecture.

5.2 Control Software Design and ROS 2 Integration

In the context of our project, the intricacies of the control software design significantly influence the successful integration of diverse components. Our chosen framework for this critical aspect is ROS 2 (Robot Operating System 2) Humble: a sophisticated middleware tailored for the development of intricate robotic systems. The selection of ROS 2 Humble, representing an evolutionary leap from its predecessor ROS, stems from its advanced features and heightened

scalability, aligning seamlessly with the intricate control architecture of our project (ROS 2 Control. (n.d.), ROS 2 Documentation. (n.d.)).

Operating on a distributed architecture, ROS 2 Humble adopts a publisher-subscriber model, establishing fluid communication channels between distinct nodes within the system. This decentralized approach amplifies modularity and flexibility, enabling the segregation of functionalities into discrete nodes. Communication between these nodes occurs through topics—a pivotal communication mechanism in ROS 2—facilitating the efficient exchange of data. This architectural choice ensures a cohesive and adaptable control software design, aligning with the dynamic and interconnected nature of our electrical engineering project.

5.3 ROS 2 Integration for Control Software

Our control software capitalizes on the capabilities of various ROS 2 packages to streamline and fortify the development process. Notably, the implementation harnesses the ROS 2 control package, which proves instrumental in establishing resilient navigation controls. This empowers our electrical system autonomously to navigate its environment or be manually controlled using diverse inputs such as a keyboard, joysticks, and more. In conjunction, the integration of Sensor Integration packages assumes significance, including the Velodyne package for 3D LiDAR and the camera package for the USB camera. This section places a primary emphasis on the control nodes dedicated to managing the LED matrix and motor commands. The subsequent figure provides a comprehensive visualization of the ROS node architecture flow chart, elucidating the intricate orchestration and interaction among these crucial components within our control software framework.

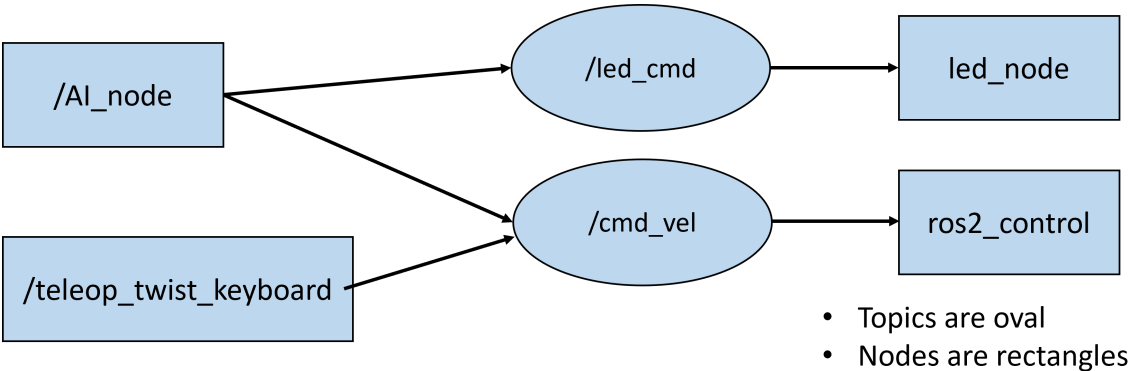

Figure 14. Block Diagram of the ROS2 Node Architecture.

5.4 ROS Node Architecture for Traffic Control System

Commencing from the left, as shown in Figure 14, the architecture comprises two pivotal nodes: `"/AI_node"` and `"/teleop_twist_keyboard."` Both nodes independently publish to the common `"/cmd_vel"` topic. The `"/AI_node"` is a script intricately designed to handle artificial intelligence logic for pedestrian detection. It outputs velocity commands to the `"/cmd_vel"` topic when determining the need to assume traffic control. Simultaneously, the `"/teleop_twist_keyboard"` node serves as a manual control interface, enabling robot movement control via a keyboard. This node also publishes velocity commands to the `"/cmd_vel"` topic when activated.

The `"/ros2_control"` node is integral to the system, subscribing to the `"/cmd_vel"` topic and processing any incoming commands. This script functions as the intermediary for hardware interface management between the motor driver and input commands, whether originating from the keyboard or the AI logic.

Moreover, the `"/AI_node"` extends its responsibilities to include the logic governing traffic light signals. Upon determining the appropriate traffic signal, the AI script dispatches commands to the `"/led_cmd"` topic. This communication is then intercepted by the `"/led_node,"` which interfaces with the LED matrix hardware, effectively translating AI-driven traffic signal decisions into actionable displays. This intricate interplay among nodes illustrates the cohesive orchestration of the system's intelligence, control, and hardware interaction within the ROS framework.

6. Robot Framework Implementation

6.1 360 LiDAR Sensor, Velodyne LiDAR PUCK

We have employed Velodyne's cutting-edge VLP-16 sensor, the latest and smallest addition to Velodyne's 3D LiDAR product lineup, shown in Figure 17. This sensor stands out as the pinnacle of innovation, combining advanced features with cost-effectiveness, making it a standout choice among sensors in its price range. Engineered for mass production, the VLP-16 upholds Velodyne's hallmark advancements in LiDAR technology, offering real-time, 360°, and 3D distance measurements, coupled with calibrated reflectivity readings.

The VLP-16 boasts a remarkable range of 100m and stands out for its exceptional attributes, including low power consumption (~8W), lightweight design (830 grams), compact dimensions (~Ø103mm x 72mm), and dual return capability. These features render it particularly well-suited for Unmanned Aerial Vehicles (UAVs) and various mobile applications. With 16 channels, delivering approximately 300,000 points per second, a 360° horizontal field of view, and a 30° vertical field of view (with +/- 15° up and down), Velodyne's LiDAR Puck offers versatile and comprehensive scanning capabilities.

Notably, the LiDAR Puck is distinguished by its absence of visible rotating parts, ensuring robust performance even in challenging environments, earning it an IP67 rating. Having been integrated into diverse applications across various industries, from lightweight implementations in drones and robotics to facilitating autonomous navigation for vehicles, the VLP-16 stands out as a versatile and reliable solution.

Another one of its key advantages lies in providing users with access to a higher density of usable points within the scanning field. This capability enhances precision during navigation and mapping processes, preventing the smoothing out or oversight of critical features around the sensor. This is particularly beneficial for projects demanding a high level of accuracy.

Moreover, the VLP-16 addresses common challenges by allowing users to determine distances from surfaces with greater accuracy. It offers flexibility through various modes of identification, enabling users to enhance visualization by adjusting colors or values associated with color changes. This adaptability not only benefits the user but also optimizes the performance of accompanying packages utilized alongside the VLP-16.

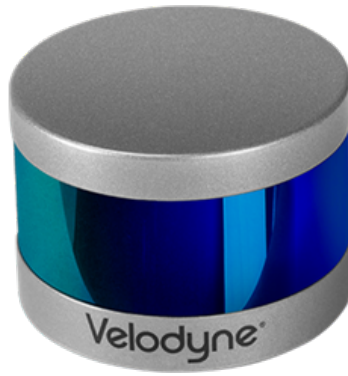

Figure 15. Velodyne LiDAR PUCK VLP-16 Sensor.

6.2 Central Processing Unit, NVIDIA Jetson AGX Orin Developer Kit

We have incorporated the NVIDIA Jetson AGX Orin Developer Kit, shown in Figure 16, as the central processing unit for our smart robot. This kit serves as the primary hub responsible for collecting data from LiDAR and cameras, facilitating machine learning training, and overseeing implementations.

The NVIDIA Jetson AGX modules feature advanced GPU architectures specifically crafted for AI and deep learning applications, complemented by Tensor Cores that enhance deep learning performance significantly. Furthermore, the kit offers versatile connectivity options, including high-speed interfaces such as PCIe and USB. It also boasts extensive support for well-known AI frameworks like TensorFlow and PyTorch, making it a robust and adaptable solution for our smart robot's operations.



Figure 16. NVIDIA Jetson AGX Orin Developer Kit.

6.3 Micro-Computer, Raspberry Pi 5

To control the four LED panels of the traffic light, we have employed a Raspberry Pi 5, as illustrated in Figure 17. The Raspberry Pi 5 stands out as a robust and versatile computer suitable for a diverse range of applications. Boasting an upgraded processor compared to its predecessor, the Raspberry Pi 5 delivers enhanced performance, particularly in tasks such as video playback and gaming, supporting dual 4Kp60 display output. With added connectivity options for expanding functionality and utilizing a microSD card for storage, the Raspberry Pi 5 provides flexibility. It features multiple USB ports for connecting devices, supports wired internet access, and incorporates the latest wireless capabilities, including Wi-Fi and Bluetooth.

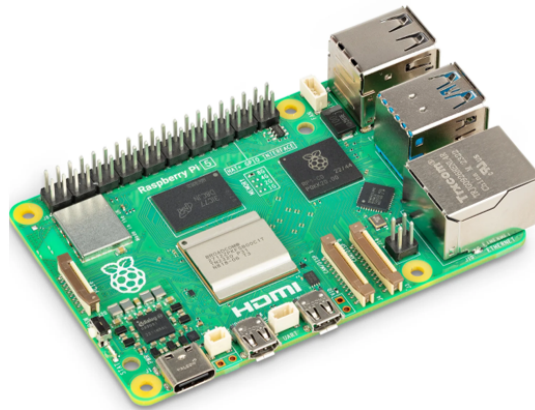

Figure 17. Raspberry Pi 5.

6.4 Mobile Robot, Pioneer 3-AT Robot

The central component of our smart robot development is the incorporation of a foundational robot, namely the Pioneer 3-AT robot depicted in Figure 18. This versatile outdoor base serves a multitude of purposes, ranging from research to prototyping applications encompassing mapping, navigation, monitoring, reconnaissance, and other behavioral functionalities. Regrettably, the company responsible for its production has been defunct for over two decades, rendering the robot obsolete. Notably, the hardware, including the computer system and software, has become outdated and is no longer accessible for operational use. Figure 21 provides a glimpse of the internal hardware system of the robot, featuring an aged Intel processor.



Figure 18. Pioneer 3-AT Mobile Robot.

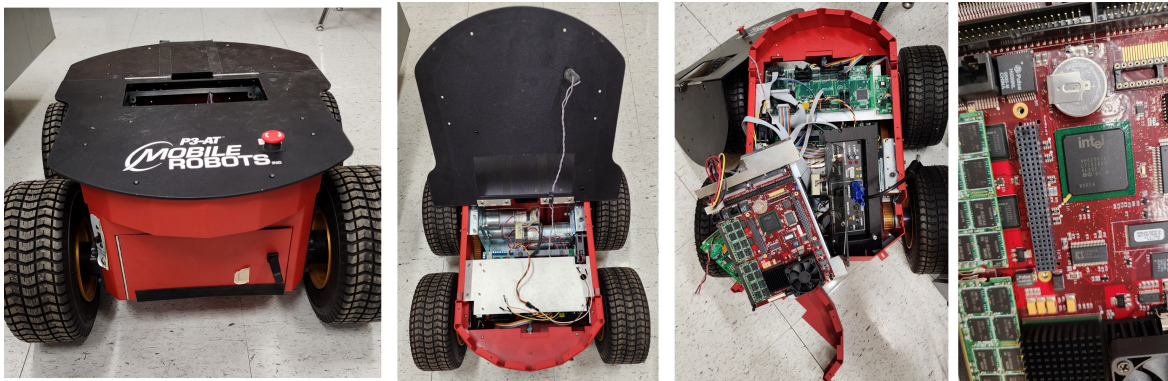

Figure 19. P3AT Mobile Robot Interior Hardware with the Intel Processor.

6.5 Power Delivery and Distribution Strategy

In our pursuit of efficiency in the system electronics design, the effective distribution of power stands as a cornerstone for ensuring the seamless operation of the diverse peripheral electronics integrated into our system. To address this pivotal requirement, we have strategically incorporated the P3AT Mobile Robot Power Distribution Board as a central element in our comprehensive power management strategy.

The inherent power distribution board contains multiple output ports, each meticulously configured to deliver precise voltage and current levels, tailored to meet the specific power demands of varied subsystems. This modular design streamlines the connection of peripherals, including sensors, actuators, and communication modules, fostering a systematic and well-organized power distribution architecture.

For this project's design, the selected ports are the 12 V and 5 V supply ports. These ports play a crucial role in distributing power to the 3D LiDAR and the Raspberry Pi computers respectively.

Figure 20 provides a visual representation of the distribution board, illustrating its pivotal role in our robust power delivery framework.

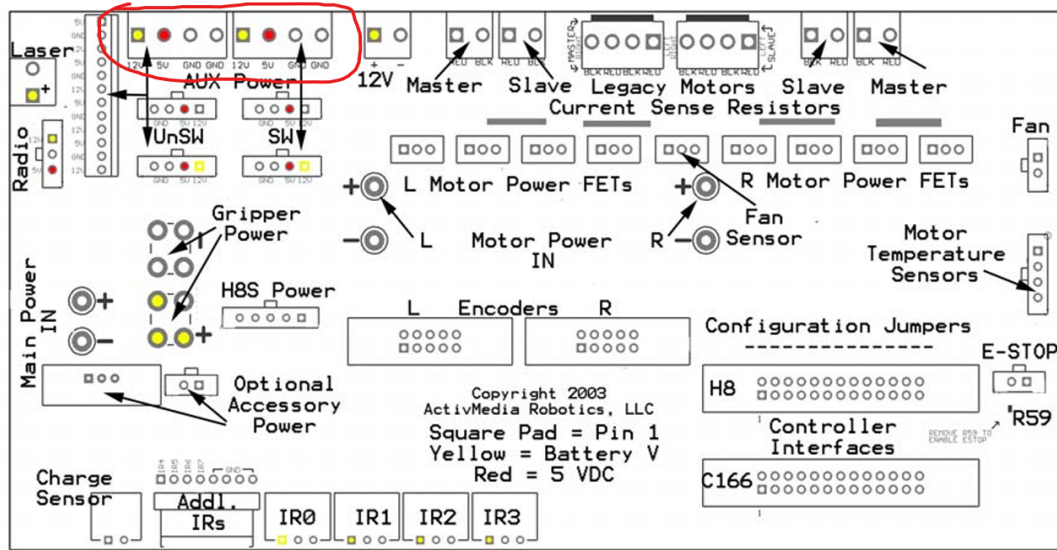

Figure 20. P3AT Mobile Robot Power Distribution Board Diagram.

The final prototype of the smart robot is shown in Figure 21, which incorporates the NVIDIA Jetson Orin computer as well as the Rasbery Pi 5.

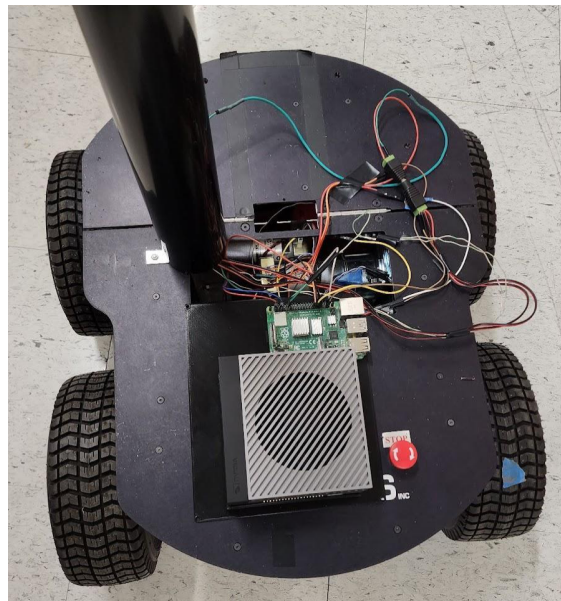

Figure 21. P3AT Mobile Robot with Jetson Orin and Rasbery Pi 5.

7. Prototype Experimentation

The development of the smart robot designed to assist pedestrians crossing the street has been completed successfully. The Velodyne LiDAR and cameras have been installed on the smart traffic light robot, and software has been implemented to ensure autonomous control and functionality. Moreover, the machine learning component has achieved success in constructing multiple classification deep neural networks, and the YOLO algorithms have been effectively implemented. These models exhibit a high degree of accuracy, as evidenced by the results obtained from the training dataset, as detailed in the machine learning experimental section below.

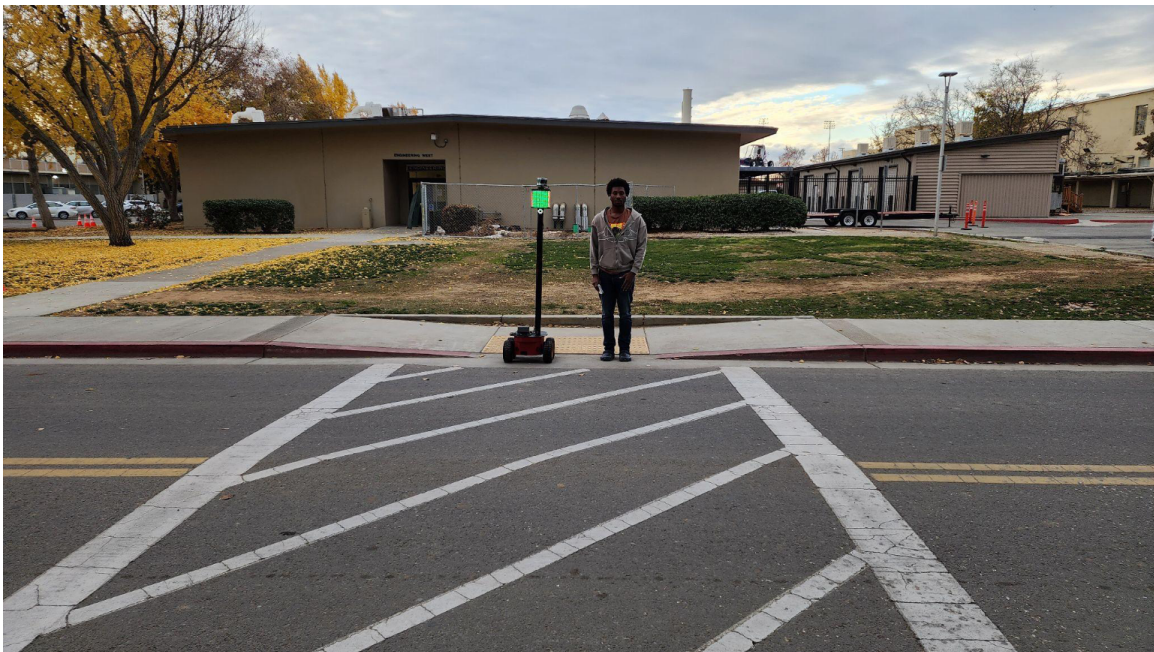

Figure 22. Experiments on Smart Traffic Light Carried Out on Fresno State Roads

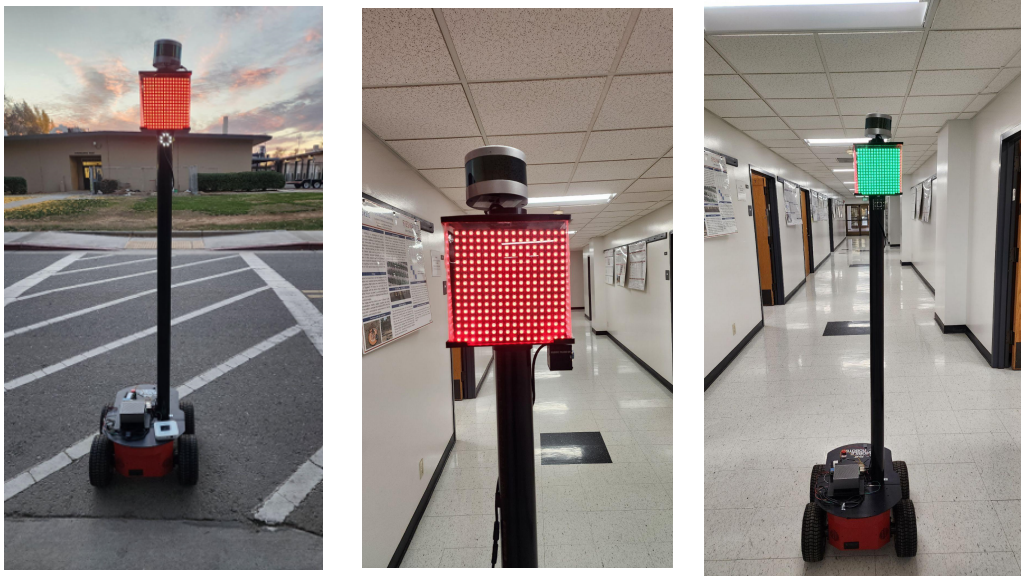

Figure 23. The Fully Built and Functional Smart Traffic Light Experiments in Fresno State School and Streets

All models constructed for this project exhibit a high level of accuracy. The deep neural networks achieved an average validation accuracy of 90.48% for pedestrian and cyclist detection, and an average validation accuracy of 90.1% for vehicle and road cyclist detection, as illustrated in Figures 24 and 25.

The figures below depict the training and validation results for all trained data. Figures 26 and 27 offer real-time captioning and visualization of points from the LiDAR sensor, with the machine learning model identifying the presence of a car or pedestrian, accompanied by corresponding percentage predictions.

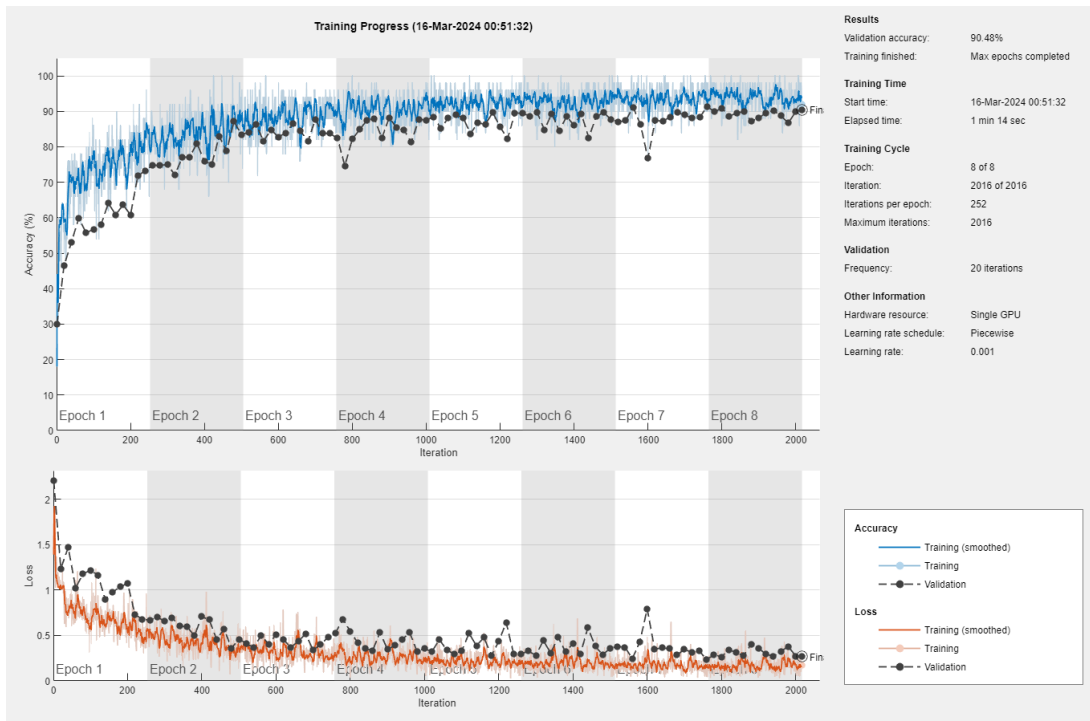

Figure 24. Training Results of the Classification Deep Neural Network for Optical Images of Pedestrians and Cyclists Detection

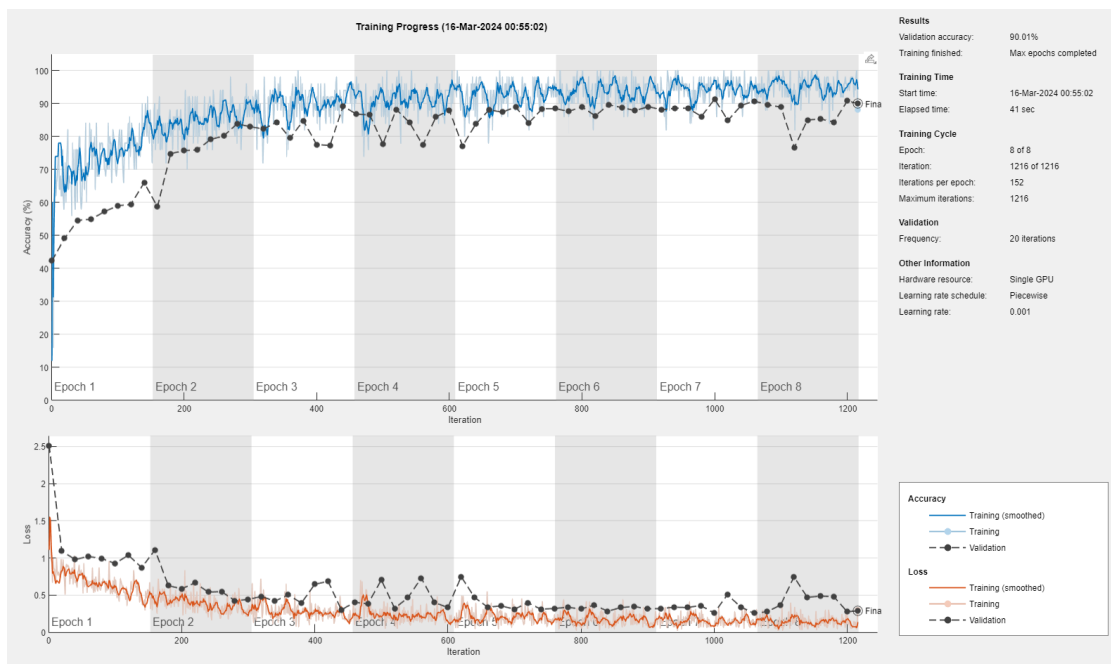

Figure 25. Training Results of the Classification Deep Neural Network for Vehicles and Cyclist Detection

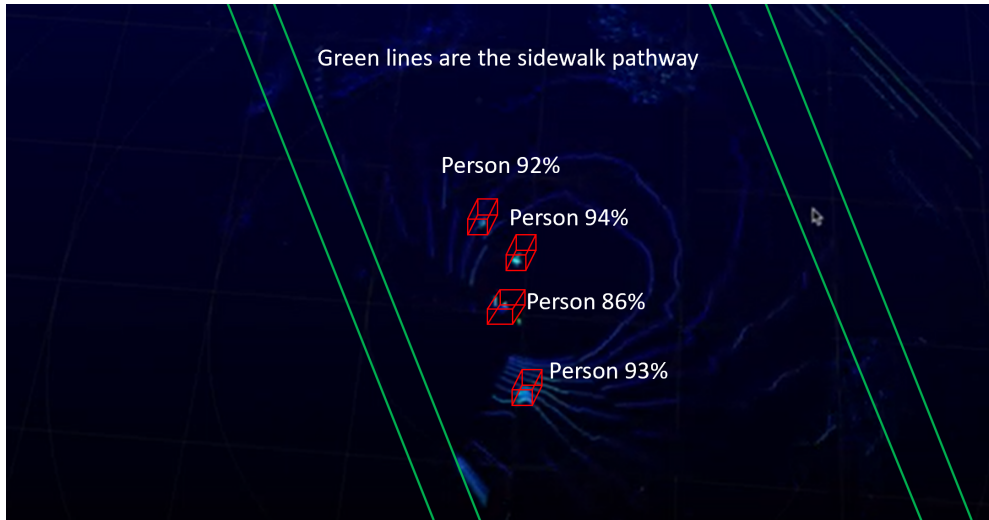

Figure 26. Live Caption of the LiDAR Sensor Point Cloud with the Machine Learning Model Predicting the Pedestrians in the Crosswalk.

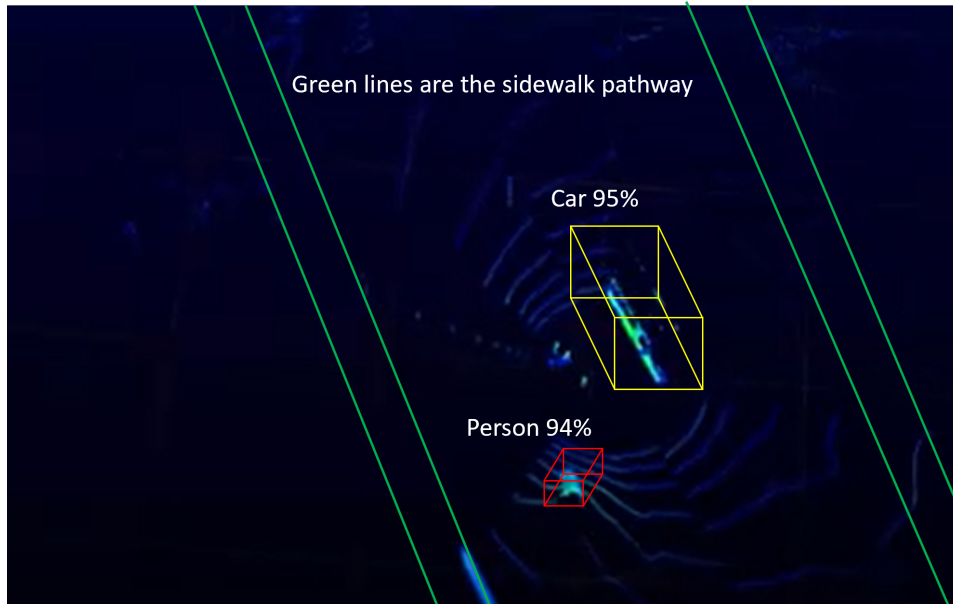

Figure 27. Live Caption of the LiDAR Sensor Point Cloud with the Machine Learning Model Identifying a Car and a Pedestrian on the Street.

8. Conclusion

In conclusion, this project stands as a crucial step forward in addressing the persistent and pressing issue of pedestrian safety. The alarming statistics of pedestrian fatalities and injuries underscore the urgent need for innovative solutions. By focusing on real-time detection and intelligent decision-making at crossroads, our approach distinguishes itself from existing studies by offering a comprehensive safety system. The project's commitment to accurate detection of both vehicles and pedestrians during road crossings is paramount, especially considering the vulnerability of children.

Central to our strategy is the integration of advanced Machine Learning (ML) algorithms for real-time detection of vehicles, pedestrians, and cyclists. The utilization of extensive datasets from diverse sensors ensure the robust training of ML models, which will be implemented in Python on a minicomputer. This integrated approach, incorporating information from LiDAR and video cameras, promises a sophisticated and accurate assessment of road conditions.

The envisioned smart robot, empowered by ML insights, represents an innovative initiative. Its intelligent decision-making capabilities, guided by real-time detection, are designed to ensure the safe passage of pedestrians and cyclists through crossroad intersections. This holistic approach, marrying robust detection capabilities with intelligent decision-making, marks a significant contribution to pedestrian safety. Ultimately, the project aspires to reshape the road-crossing experience, fostering a safer and more secure environment for pedestrians and cyclists alike.

Abbreviations and Acronyms

ML	Machine Learning
YOLO	You Only Look Once
ECE	Electrical and Computer Engineering
AI	Artificial Intelligence
CNN	Convolutional Neural Network
LED	Light Emitting Diode
PVC	Polyvinyl Chloride
ROS2	Robot Operating System 2
UAVs	Unmanned Aerial Vehicles

Bibliography

- Aggarwal, C. C. (2018). *Neural Networks and Deep Learning: A Textbook* (1st ed.). Springer Publishing Company, Incorporated.
- Bengio, Y., Goodfellow, I., & Courville, A. (2017). *Deep Learning*. MIT Press.
- CBSLA News, Many Los Angeles Elementary Schools Surrounded by Dangerous Streets, February 13, 2017. <https://www.cbsnews.com/losangeles/news/many-los-angeles-elementary-schools-surrounded-by-dangerous-streets/>
- Diwan, T., Anirudh, G., & Tembhurne, J. V. (2023). Object detection using YOLO: challenges, architectural successors, datasets and applications. *Multimed Tools Appl*, 82(11), 9243-9275. DOI: 10.1007/s11042-022-13644-y
- H. Kulhandjian, "AI-based Pedestrian Detection and Avoidance at Night using an IR Camera, Radar, and a Video Camera," in California State Transportation Consortium, Project No. 2127, pp. 1-42, March, 2022.
- H. Kulhandjian, J. Barron, M. Tamiyasu, M. Thompson, M. Kulhandjian, "Pedestrian Detection and Avoidance at Night Using Multiple Sensors and Machine Learning," in Proc. of IEEE International Conference on Computing, Networking and Communications (ICNC), Honolulu, Hawaii, Feb. 2023.
- Iredele/scrap_ws GitHub Repository. (n.d.). Project github. https://github.com/Iredele/scrap_ws.git
- National Highway Safety Traffic Administration (NHSTA), "nhtsa.gov," December 2020. [Online]. Available: <https://crashstats.nhtsa.dot.gov/Api/Public/ViewPublication/813053>
- NCSA. (2023c, June). Pedestrians: 2021 data (Traffic Safety Facts. Report No. DOT HS 813 458). National Highway Traffic Safety Administration.
- Wann, J. P., Poulter, D. R., & Purcell, C. (2011). Reduced Sensitivity to Visual Looming Inflates the Risk Posed by Speeding Vehicles When Children Try to Cross the Road. *Psychological Science*, 22(4), 429-434. <https://doi.org/10.1177/0956797611400917>
- Pau G, Campisi T, Canale A, Severino A, Collotta M, Tesoriere G. Smart pedestrian crossing management at traffic light junctions through a fuzzy-based approach. *Future Internet*. 2018 Feb;10(2):15.

PSBR Law. (n.d.). The Most Dangerous Elementary School Zones in California. Retrieved from <https://www.psbr.law/dangerous-school-zones.html>

ROS 2 Control. (n.d.). Welcome to the ros2_control documentation! — ROS2_Control: Rolling Nov 2023 documentation. Control.ros.org.
<https://control.ros.org/master/index.html>

ROS 2 Documentation. (n.d.). ROS 2 Documentation: Humble documentation. Docs.ros.org.
<https://docs.ros.org/en/humble/index.html>

Saad WK, Hashim Y, Jabbar WA. Design and implementation of portable smart wireless pedestrian crossing control system. IEEE Access. 2020 Jun 4;8:106109-20.

School Zone and School Crosswalk Safety Tips. (2018, October 28). [Online]. Available: <https://jsh-law.com/2018/10/28/school-zone-and-crosswalk-safety-tips/>

About the Author

Hovannes Kulhandjian

Dr. Hovannes Kulhandjian is an Associate Professor in the Department of Electrical and Computer Engineering at California State University, Fresno (Fresno State). He joined Fresno State in Fall 2015 as a tenure-track faculty member. Prior to this position, he was an Associate Research Engineer in the Department of Electrical and Computer Engineering at Northeastern University. He received his B.S. degree in Electronics Engineering with high honors from the American University in Cairo (AUC) in 2008, and his M.S. and Ph.D. degrees in Electrical Engineering from the State University of New York at Buffalo in 2010 and 2014, respectively. His current research interests are in applied machine learning, autonomous vehicle navigation, wireless communications, and networking, with applications to underwater and visible light communications and networking geared towards Intelligent Transportation Systems (ITS).

Dr. Kulhandjian has received six research grants from the Fresno State Transportation Institute (FSTI). He is a recipient of the Claude C. Laval III Award for Commercialization of Research, Innovation and Creativity 2021 as well as the Claude C. Laval Award for Innovative Technology and Research 2020 at Fresno State. In April 2021 as a PI, he received a grant from the Department of Defense (DOD) Research and Education Program for Historically Black Colleges and Universities and Minority-Serving Institutions (HBCU/MI) Equipment/Instrumentation, to establish a "Secure Communications and Embedded Systems Laboratory at California State University, Fresno".

Dr. Kulhandjian is an active member of the Association for Computing Machinery (ACM) and the Institute of Electrical and Electronics Engineers (IEEE). He is a Senior Member of IEEE. He currently serves as a guest editor for the special issue "Advances in Wireless Sensor Networks and Communication Technology." He has also served as a Guest Editor for IEEE Access Special Section Journal and for MDPI Special Issue on "Advances in Intelligent Transportation Systems (ITS)", Session Co-Chair for IEEE UComms'20 Conference, Session Chair for ACM WUWNet'19 Conference, Publicity Co-Chair for IEEE BlackSeaCom Conference. He is a member of the Technical Program Committee (TCP) for ACM and IEEE Conferences, such as GLOBECOM 2024, WTS 2024, WD 2021, ICC 2018, WUWNet 2024, and WiMob2019. Dr. Kulhandjian is a recipient of the Outstanding Reviewer Award from ELSEVIER Ad Hoc Networks and ELSEVIER Computer Networks.

MTI FOUNDER

Hon. Norman Y. Mineta

MTI BOARD OF TRUSTEES

Founder, Honorable Norman Mineta***
Secretary (ret.),
US Department of Transportation

Chair, Jeff Morales
Managing Principal
InfraStrategies, LLC

Vice Chair, Donna DeMartino
Retired Transportation Executive

Executive Director, Karen Philbrick, PhD*
Mineta Transportation Institute
San José State University

Rashidi Barnes
CEO
Tri Delta Transit

David Castagnetti
Partner
Dentons Global Advisors

Maria Cino
Vice President
America & U.S. Government
Relations Hewlett-Packard Enterprise

Grace Crunican**
Owner
Crunican LLC

John Flaherty
Senior Fellow
Silicon Valley American
Leadership Form

Stephen J. Gardner*
President & CEO
Amtrak

Ian Jefferies*
President & CEO
Association of American Railroads

Diane Woodend Jones
Principal & Chair of Board
Lea + Elliott, Inc.

Priya Kannan, PhD*
Dean
Lucas College and
Graduate School of Business
San José State University

Will Kempton**
Retired Transportation Executive

David S. Kim
Senior Vice President
Principal, National Transportation
Policy and Multimodal Strategy
WSP

Therese McMillan
Retired Executive Director
Metropolitan Transportation
Commission (MTC)

Abbas Mohaddes
CEO
Econolite Group Inc.

Stephen Morrissey
Vice President – Regulatory and
Policy
United Airlines

Toks Omishakin*
Secretary
California State Transportation
Agency (CALSTA)

April Rai
President & CEO
Conference of Minority
Transportation Officials (COMTO)

Greg Regan*
President
Transportation Trades Department,
AFL-CIO

Rodney Slater
Partner
Squire Patton Boggs

Paul Skoutelas*
President & CEO
American Public Transportation
Association (APTA)

Kimberly Slaughter
CEO
Systra USA

Tony Tavares*
Director
California Department of
Transportation (Caltrans)

Jim Tymon*
Executive Director
American Association of
State Highway and Transportation
Officials (AASHTO)

Josue Vaglienty
Senior Program Manager
Orange County Transportation
Authority (OCTA)

* = Ex-Officio
** = Past Chair, Board of Trustees
*** = Deceased

Directors

Karen Philbrick, PhD
Executive Director

Hilary Nixon, PhD
Deputy Executive Director

Asha Weinstein Agrawal, PhD
Education Director
National Transportation Finance
Center Director

Brian Michael Jenkins
National Transportation Security
Center Director

