

TE
662
.A3
no.
FHWA-
RD-
78-199

Report No. FHWA-RD-78-199

QUALITY OF FLOW IN URBAN ARTERIALS — PHASE I

Vol. I. Final Report and Appendix A



December 1978
Final Report

Document is available to the public through
the National Technical Information Service,
Springfield, Virginia 22161

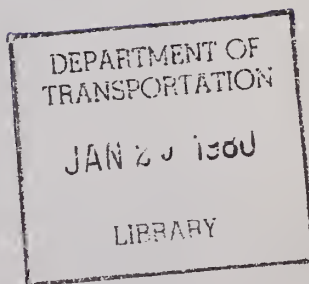

Prepared for
FEDERAL HIGHWAY ADMINISTRATION
Offices of Research & Development
Washington, D. C. 20590

FOREWORD

This report presents basic concepts, the framework and an experimental design for the development of better methods to evaluate the quality of flow on urban arterials and estimate their traffic capacities. It also contains, as Appendix A, a manual describing procedures for inventorying urban arterial street segments. It is intended primarily for research and development audiences.

A companion volume "Quality of Flow in Urban Arterials, Phase I, Volume II: Appendixes B and C," Report FHWA-RD-78-200, presents a state-of-the-art review of quality of flow on urban arterials and a description of 15 data sources related to this type of flow.

These two volumes constitute the Final Report of Phase I of the two-phase study "Quality of Flow in Urban Arterials." Phase II of this study consists of the actual development of new methods for computing arterial quality of flow and capacity.

Both volumes are being distributed by FHWA memorandum to interested researchers. A limited number of copies of these reports are available for official use from the Traffic Systems Division (HRS-31), Office of Research, Federal Highway Administration, Washington, D.C. 20590. Additional copies for the public can be obtained from the National Technical Information Service (NTIS), U.S. Department of Commerce, 5285 Port Royal Road, Springfield, Virginia 22161. A small charge is imposed for copies provided by NTIS.

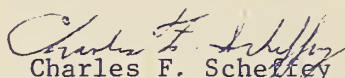

Charles F. Scheffey
Director, Office of Research
Federal Highway Administration

NOTICE

This document is disseminated under the sponsorship of the Department of Transportation in the interest of information exchange. The United States Government assumes no liability for its contents or use thereof.

The contents of this report reflect the views of Alan M. Voorhees & Associates, Inc. (AMV). AMV is responsible for the facts and the accuracy of the data presented herein. The contents do not necessarily reflect the official views or policy of the Department of Transportation. This report does not constitute a standard, specification, or regulation.

662
 AB
 no.
 FHWA-
 RD-
 78-199

1. Report No. FHWA-RD-78-199		2. Government Accession No.		3. Recipient's Catalog No.	
4. Title and Subtitle ✓ QUALITY OF FLOW IN URBAN ARTERIALS -- PHASE I. Vol. I. Final Report and Appendix A				5. Report Date December 1978	
7. Author(s) David W. Schoppert, Wayne Kittelson, Steven Shapiro				6. Performing Organization Code	
9. Performing Organization Name and Address Alan M. Voorhees & Associates, Inc. 7798 Old Springhouse Road McLean, Virginia 22102				8. Performing Organization Report No.	
12. Sponsoring Agency Name and Address U.S. Department of Transportation Federal Highway Administration Washington, D.C. 20590				10. Work Unit No. (TRAIS) FCP 32MI-013	
				11. Contract or Grant No. DOT-FH-11-9338	
				13. Type of Report and Period Covered Final Report September 1977 to December 1978	
				14. Sponsoring Agency Code T-0320	
15. Supplementary Notes FHWA Contract Manager: Dr. Guido Radelat (HRS-31)					
16. Abstract The report identifies measures of effectiveness (MOE's) for quality of flow in urban arterial streets and describes a series of studies which will lead to the development of models which will predict values of the MOE's from roadway, traffic, and environmental characteristics. The specific measures of effectiveness are: travel time, intersection stops, intersection delays, travel time variance, and service volume. Studies include a so-called "basic" study which will use a carefully controlled sample of urban arterial segments drawn from 22 urban areas of varying sizes. An additional sample of intersections will be drawn from eight small urban areas. Supplementary special studies address the influence of heavy vehicles and grades, parking, left turns through oncoming vehicles and pedestrians and weaving maneuvers near interchanges. Appendix A describes the data collection methods to be used in the basic study. Volume II contains a state-of-the-art review and a detailed description of existing data sources from previous and ongoing studies.					
17. Key Words Capacity, quality of flow, experimental design, measures of effectiveness, urban arterials, data collection methods			18. Distribution Statement Report is available from the National Technical Information Service, Springfield, Virginia 22161.		
19. Security Classif. (of this report) Unclassified		20. Security Classif. (of this page) Unclassified		21. No. of Pages 185	22. Price

DEPARTMENT OF
 TRANSPORTATION
 JAN 25 1980
 LIBRARY

TABLE OF CONTENTS

List of Figures	iii
List of Tables	v

<u>Chapter</u>	<u>Page</u>
SUMMARY	1
I INTRODUCTION	12
Research Requirements	13
Issues Addressed by the Phase II Studies	14
II CAPACITY AND QUALITY OF FLOW	19
Definition of Arterial Capacity	19
Definition of Quality of Flow	25
Formulation of Capacity and Quality of Flow in Terms of Measures of Effectiveness	25
Estimation of Arterial Capacity and Quality of Flow as Functions of the Measures of Effectiveness	31
III INDEPENDENT CHARACTERISTICS	33
Pre-Measure for Regression	33
Dynamic Measures for Regression	37
Surrogates	40
Characteristics for Calibration	41
Characteristics for Reference/Analysis	41
Independent Characteristics for the Segments.	42
IV SAMPLE DESIGN: BASIC STUDY	44
Stratified Multistage Design	44
Estimated Precision	50
Site Selection Procedure	58
V DATA COLLECTION: BASIC STUDY	73
Data Collection Methods	76
Data Collection Schedule	82
VI ANALYSIS PLAN	86
Development of Factors from Independent Variables	86
Development of Composite MOE	87
Development of Regression Models	88
VII SPECIAL STUDIES AND SIMULATION	91
Effect of Grades and Trucks on Maximum Intersection Discharge Volume Rates	91
Effect of Parking on Maximum Intersection Discharge Volume Rates	98

Table of Contents (continued)

<u>Chapter</u>		<u>Page</u>
	Effects of Opposing Traffic and Pedestrian Conflicts on Maximum Discharge Volume Rates of Lanes with Left Turns	104
	Data Collection Methodology	112
	Weaving Near Freeway Interchanges	112
	Simulation	117
VIII	COST ESTIMATE	130
	Cost Estimates	130
 <u>Appendix</u>		
A	URBAN ARTERIAL STREET SEGMENT DATA COLLECTION MANUAL	139
	Introduction	139
	Intersection Field Surveys	144
	Intersection Characteristics	146
	Intersection Traffic Signal Characteristics	149
	Segment Characteristics	151
	Recording Dynamic Measures	153
	Stops and Delays	156
	Traffic Signal Timing	158
	Bus Volumes and Dwell Times	161
	Parking Turnover Rate	163
	Lane Blockage	166
	Segment Demand	168
	Progression	170
	Travel Time	172
	Data Reduction	176

LIST OF FIGURES

<u>Figure</u>		<u>Page</u>
1	Arterial segment	6
2	Segment capacity profile	21
3	Segment volume profile	23

List of Figures (continued)

<u>Figure</u>		<u>Page</u>
4	Arterial capacity profile	23
5	Levels of service for urban and suburban arterial streets . .	26
6	Process for selecting measures of effectiveness	28
7	Classification of lane types.	36
8	Distribution of urbanized population groups.	46
9	Miles of "other freeway expressway" and "other principal arterial" with no access and partial access control.	47
10	Allocation of sample design strata -- large urban areas . .	49
11	Definition of six impedance factors from independent variables.	51
12	Relationship between error and sample size.	59
13	Segment rating sheet	64
14	Reverse segment rating sheet.	65
15	Matrix for selection of sites	67
16	Matrix showing number of candidate sites for each cell. . .	67
17	Matrix with one sample unit in each cell for which there are samples available	68
18	Matrix with fifty sample units assigned	68
19	Matrix with all zeros and ones	70
20	Matrix sample units in rows and columns with totals below or near desired total	70
21	Sample of 100 units	71
22	One-way street	74
23	Two-way street	75
24	Tabulation of saturation flow headway and lost time data as a function of grade and trucks	97

List of Figures (continued)

<u>Figure</u>		<u>Page</u>
25	Types of intersection situations under study	101
26	Example regression diagram	103
27	Diagram of alternative regression approach.	105
28	Lane types under study	107
29	Example chart of pedestrian volume level 1.	111
30	Study site diagram	114
31	Example of lane changes analysis	118
32	Example of ramp volume analysis	118
33a	Evaluation of traffic generation distributions	123
33b	Distributions of inter-vehicle headways by detector location	124

LIST OF TABLES

<u>Table</u>		<u>Page</u>
1	Independent characteristics -- intersection MOE's	4
2	Independent characteristics -- segment MOE's	5
3	Allocation of sample design strata -- large urban areas. . .	9
4	Independent characteristics	30
5	Independent characteristics -- intersection MOE's	34
6	Independent characteristics -- segment MOE's	43
7	Estimated precision levels corresponding to three design alternatives	57
8	Comparison of film formats	79

List of Tables (continued)

<u>Table</u>		<u>Page</u>
9	Schedule times for six major data collection activities . . .	84
10	Number of lane changes for each origin-destination pair . .	115
11	Lane changes as a function of ramp volume and number of lanes	116
12	Relationship of characteristics to the experimental design .	129
13	Estimated cost of data collection and reduction	132
14	Summary of cost (large urban areas)	134
15	Summary of costs (small urban areas)	135
16	Cost estimate for special study of effect of grades and of trucks.	136
17	Cost estimate for special study of effects of parking. . . .	137
18	Cost estimate for special study of effects of weaving near interchanges	138

QUALITY OF FLOW IN URBAN ARTERIALS SUMMARY

In the 1965 Highway Capacity Manual, considerations of levels of service and service volumes on streets and highways without access control are described in Chapter 10. Approximately ten pages of that chapter are devoted to urban and suburban arterials and the discussion leans heavily on intersection capacities.

The purpose of this research was to design a study to develop information which would be useful in the revision of portions of Chapters X "Streets and Highways Without Access Control" and VI "At Grade Intersections." Accordingly, this study was entitled "Phase I" and the specific tasks were to:

1. Review the state of the art
2. Define arterial capacity and quality of flow
3. Select measures of effectiveness for urban arterial capacity and quality of flow
4. Identify the independent roadway, traffic and environmental characteristics that could be related to the measures of effectiveness in Phase II.
5. Prepare a data collection plan
6. Prepare and test detailed data collection procedures

STATE-OF-THE-ART REVIEW

Available data sources and knowledge on vehicular/roadway/environmental interactions were analyzed for their completeness and accuracy. From this analysis the nature and strength of the interactions was developed and needed research to better define these interactions was identified.

Literature sources were identified at a number of private and public technical libraries. All literature which was identified as being relevant to this investigation was abstracted and summarized. The abstracted references are presented in Appendix A of this report.

DEFINITION OF ARTERIAL CAPACITY

The research in Phase II is intended to improve the understanding of the quality of flow and capacity along an arterial. Accordingly, a definition of arterial capacity was derived. That definition uses the same concepts and terms as the definition of capacity found on page 5 of the 1965 Highway Capacity Manual, but it is modified to apply to a linear section. The proposed definition is:

Arterial Capacity is the maximum number of vehicle miles of travel which can reasonably be expected to be accommodated by a given arterial segment per unit time and length under prevailing roadway and traffic conditions.

MEASURES OF EFFECTIVENESS

Four measures of effectiveness (MOE's) were selected for the quality of flow along an arterial. These measures were selected from a long list of candidate measures gleaned from the state-of-the-art review. The first measure selected was travel time. This measure is widely used and readily understood. It can be used in economic analysis and has been a major factor in planning and analysis for many years.

The second measure is intersection delay. Although intersection delay is one component of travel time, it represents a special concern to motorists. Also analysts would find it useful in any given situation to know how much of total travel time is due to intersection delay because that knowledge would help them to direct their efforts in cases where their objective is to reduce total travel time.

The third measure is intersection stops. There is a definite cost associated with stopping, both in pure economic terms as well as in fuel consumption, emissions, and noise—three increasingly important considerations in design and traffic control. There is also substantial evidence that motor vehicle accidents are related to the number of stops. Taken together, these reasons were compelling arguments for the selection of this measure.

The fourth measure is travel time variance. This was included to provide some measure which expressed the degree of turbulence within the traffic stream,

since it was recognized that accelerations and decelerations have a significant impact on the overall quality of flow. Certainly stops and starts can be viewed as simply the highly visible extremes of accelerations and decelerations. After consideration of the methods of measurement and definition associated with this MOE, travel time variance was selected as the appropriate turbulence measure.

A fifth MOE is service volume. This term applies to the volume associated with a given level of service, or any of the measures of effectiveness.

INDEPENDENT CHARACTERISTICS

There are many individual traffic, physical, operational, and environmental characteristics which determine the capacity and quality of flow on an urban arterial. A review of the literature and discussions with interested engineers and planners resulted in a list of nearly 100 such characteristics. These were examined carefully for the strength of their relationship to each of the MOE's, for redundancy and for methods of measurement. The list was finally reduced to those shown in Tables 1 and 2.

The two lists, titled Segment and Intersection, require some explanation. An arterial segment is a portion of an urban arterial segment between two capacity controlling features. For purpose of analysis, each direction of travel on a two-way arterial constitutes a segment. The concept is illustrated in Figure 1, using two signalized intersections as the capacity controlling features. Thus, the independent characteristics listed in Table 1 refer to conditions at the downstream intersection, while those listed in Table 2 refer to conditions along the arterial.

DATA COLLECTION

The objective of this study was to design a more comprehensive effort to define the relationships between the independent characteristics and the MOE's discussed earlier. Because data collection is costly, the next step in the design was to examine existing data sources to determine the extent to which they could be used. The 17 sources which were reviewed are listed below. All were found to be seriously deficient.

Table 1. Independent characteristics intersection MOE's.

Characteristics

- | | |
|---------------------------|--------------------------------------|
| 1. Width | 16. Discharge Headways |
| 2. Number of Lanes | 17. Gap Acceptance |
| 3. Lane Control | 18. Lane Width |
| 4. Median Type | 19. Load Factor |
| 5. Type of Bus Stop | 20. Parking Turnover |
| 6. RTOR | 21. Distance to First Parked Vehicle |
| 7. Type of Signal Control | 22. Progression |
| 8. Parking Condition | 23. Total Green Per Approach |
| 9. One/Two Way | 24. Number of Times Green |
| 10. Type of Land Use | 25. Volume Per Movement |
| 11. Intensity of Land Use | 26. Truck Volume |
| 12. Location Within City | 27. Local Buses |
| 13. SMSA Population | 28. Bus Dwell Time |
| 14. Urban Population | 29. Lane Blockage |
| 15. City Population | 30. Pedestrian Levels |

Measures of Effectiveness

Intersection Stops

Intersection Delay

Service Volume

Table 2. Independent characteristics segment MOE's.

Characteristics

- | | |
|--------------------------|----------------------|
| 1. Width | 11. SMSA Population |
| 2. Number of Lanes | 12. Urban Population |
| 3. Median Type | 13. City Population |
| 4. Length | 14. Lane Width |
| 5. Bus Stop Type | 15. Parking Turnover |
| 6. Parking Condition | 16. Segment Demand |
| 7. One/Two Way | 17. Truck Volume |
| 8. Type of Land Use | 18. Local Buses |
| 9. Intensity of Land Use | 19. Bus Dwell Time |
| 10. Location Within City | |

Measures of Effectiveness

Travel Time
Speed Variability
Service Volume

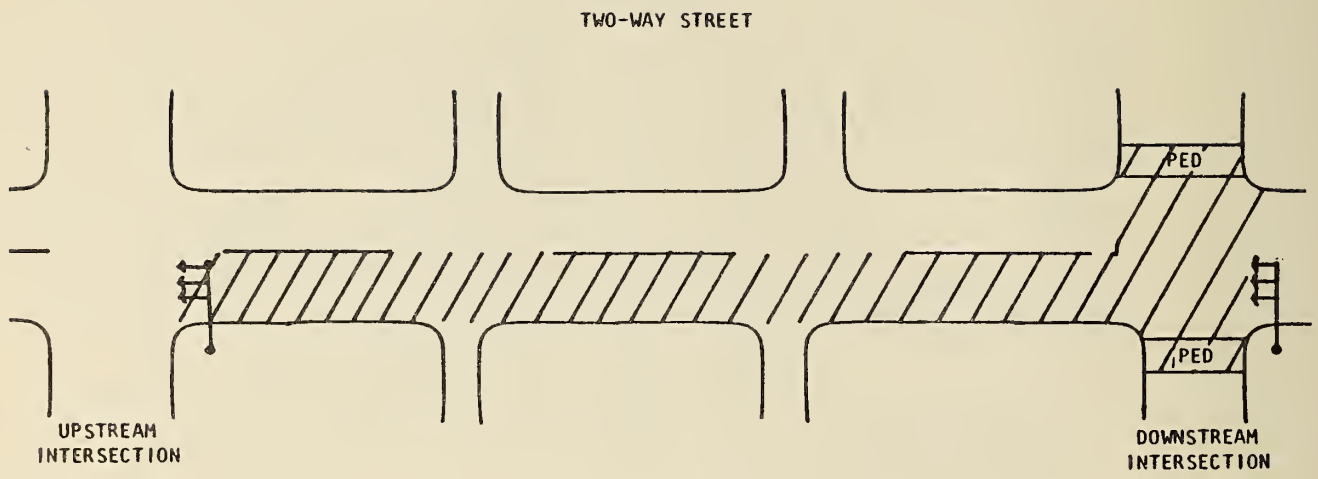

Figure 1. Arterial segment.

1

- CAPE-10 VOS
- General Motors Chase Car
- California Air Resources Board (ARB)
- City of Los Angeles
- FHWA/St. Louis Speed Study
- Toronto
- San Jose, California
- Washington, D.C.
- New Orleans
- JHK Delay Study
- Greensboro, North Carolina
- Raleigh, North Carolina
- Phoenix, Arizona
- Tucson, Arizona
- Sacramento, California

It was concluded that none of the sources included measures of all of the characteristics which were needed, although in certain cases some of the missing physical characteristics could be obtained from field surveys and historical records. Even so, there were many significant gaps remaining in the data. While they are not suitable for the principal part of the study, some of the existing sources are rich in data which can be used to validate the models to be developed in Phase II, and others included information which was useful in determining ranges of values, variances, and other statistics which were helpful in the study design.

In the absence of available data, it was necessary to include a sizeable data collection component in the Phase II study design. The design embraces four major study elements, which will be described below:

- A Basic Study
- The use of existing data
- Special Studies
- Simulation

The basic study includes the collection of information on 400 urban arterial segments (as illustrated in Figure 1 earlier). Data on the fixed physical, traffic

control and environmental characteristics (listed under pre-measure in Tables 1 and 2) will be obtained by means of a field inventory prior to collection of traffic characteristics (listed under Dynamic Measures in Tables 1 and 2). The so-called "Dynamic Measures" will be collected simultaneously for a period of 15 minutes at each site.

The sites will be drawn from 22 U.S. cities in five population ranges as shown in Table 3. In this table the entries in the first four columns give the following information:

1. The upper left number in each cell is the number of miles of that type of arterial in urban areas of the population range indicated.
2. The upper right number in each cell gives the proportion that the mileage is of all such arterials in all urban areas.
3. The lower left number in each cell is the number of sites of that type of arterial that will be included in the sample.

The remaining columns need no explanation.

The headings of the first five columns were selected to represent the types of urban streets for which the relationships between the independent characteristics and the MOE's would be modeled. In other words, it is expected that the relationship between certain characteristics and the MOE's would be different for each of these cases.

The sample of sites will be selected by a process that is briefly summarized as follows:

1. The 22 urban areas will be drawn at random from the U.S. urban areas in each of the five population classes.
2. Each urban area will be divided into many subareas, each containing about the same number of miles of urban arterials.
3. A sample of subareas in each area will be selected at random. This sample will be large enough to provide 100 or more candidate sites. These sites will form the sample frame.

Table 3. Allocation of sample design strata large urban areas.

Urbanized Area Population	Two-Way				One-Way	Number of Sample Cities	Total Number of Cities	Total Number of Sample Sites	Average Number of Sample Sites Per City
	Multi-Lane		Two-Lane						
	Divided	Undivided							
100,000-200,000	1,244, .120 30	646, .088 10	1,292, .135 10	149, .156 20	4	73	70	17.5	
200,000-500,000	1,692, .163 20	1,350, .183 20	1,811, .189 10	251, .263 20	4	57	70	17.5	
500,000-1,000,000	1,245, .120 35	1,063, .144 15	1,165, .121 10	97, .101 10	4	22	70	17.5	
1,000,000-2,000,000	1,913, .185 20	1,177, .160 20	1,858, .194 10	149, .156 20	4	16	70	17.5	
Over 2,000,000	3,251, .314 45	2,492, .339 35	2,035, .212 10	173, .181 30	6	9	120	20.0	
TOTAL	10,362, 1.00 150	7,358, 1.00 100	9,597, 1.00 50	956, 1.00 100	22	177	400	18.2	

4. The sites in the sample frame will be rated by inspection on six major factors, called impedances. Each site will be subjectively judged as having either a high or low rating on each of the following:
 1. Intersection Impedance
 2. Traffic Signal Impedance
 3. Traffic Volume Impedance
 4. Bus Impedance
 5. Heavy Vehicle Impedance
 6. Mid-Link Impedance

5. A sample of sites for each type of urban arterial will be specified such that adequate variation is assured for each of the six impedance variables. The sites to be included in the study will be limited to streets which are essentially straight and level. The geometrics of the segment will be uniform throughout, although this will not eliminate the possibility of additional lanes or widening on the downstream intersection approach. The upstream and downstream intersections will be signalized, and the intersections will be four-way with the streets intersecting at approximately right angles.

In addition, a sample of 80 intersections will be selected from eight urban areas of less than 100,000 population. Data for the independent characteristics and the intersection MOE's will be collected on all approaches to these intersections. Models for intersection capacity and quality of flow in smaller urban areas will be developed from these data.

Because the conditions imposed on the sample sites eliminate some characteristics which are of interest (e.g., grades), and because the sites are not expected to represent the full range of values of some characteristics (e.g., parking, bus activity), four special studies are proposed to supplement the basic study. They are:

1. A study of effects of heavy vehicles and grades
2. A study of the effects of on-coming traffic and pedestrians on left turns
3. A study of the effects of parking
4. A study of the effects of weaving near freeway interchanges

In each case, these special studies will be supplemented with simulation to develop a full range of values for the situations they are studying.

Simulation will also be used to supplement the findings of the basic study and to provide a basis for interpolating between data points established in the field.

DATA COLLECTION PROCEDURES

The data collection requirements of Phase II are uniquely demanding in the breadth of field surveys and coordination. At the same time the project offers an unusual opportunity to assemble a body of information which could be immensely valuable for future studies of urban traffic. For that reason, several techniques were evaluated. The two principal methods are, (1) time-lapse photography and, (2) manual observation and recording. Each has its advantages and its drawbacks. Two methods of obtaining time-lapse photographs were tested. The first involved the use of cameras mounted on buildings or high vantage points; the second involved the use of a helicopter as a platform for the cameras. The data collection plan permits the use of all three types at locales which best suit their use. Thus, manual methods will be used where traffic volumes are light, where there is little or no activity such as parking and turning into and out of driveways along the segment, and where pedestrian volumes are low.

Ground-mounted, time-lapse photography will be used where segments are short, vehicle and pedestrian activity is high, and locations for camera mounting are available.

Aerial time-lapse photography will be used where activity is high, and ground mounting is not feasible.

CHAPTER I INTRODUCTION

Intersection and roadway capacity has been a subject of continuing interest within the traffic engineering community during the past 50 years. The need for a in-depth understanding of this subject arises from the need to determine the operational effectiveness of existing facilities, predict the results of operational changes made to these facilities, and evaluate the impact of changes in traffic demand.

In 1950, the first Highway Capacity Manual assembled the large amounts of data that were available at that time. This manual was a result of the joint activities of Committee TO-4 of the Highway Research Board, the Bureau of Public Roads, and numerous state and city traffic engineering organizations, universities, and consultants. The widespread need for such a document is described by May, who reports that more than 26,000 copies of this original manual were distributed.(1)

In 1965 a revised version of the Highway Capacity Manual was published as Highway Research Board Special Report 87. This manual, like its predecessor, was intended to serve as a practical guide to determining the level of service that would be provided by a new facility or an existing highway under a given set of conditions. The manual was again prepared under the leadership of Highway Research Board Committee TO-4 on Highway Capacity. This manual has again received widespread distribution. Twenty-seven thousand copies of the manual have been distributed and it has been translated into German, Italian, and Spanish.¹

Since the publication of the Highway Capacity Manual in 1965, researchers throughout the world have studied various aspects of the relationships between vehicle flow and roadway characteristics. In the area of urban arterials alone, which is the subject of this report, over 100 references have already been identified and reviewed. Those references are listed in Appendix B.

¹May, Adolf D. "Intersection Capacity 1974: An Overview," TRB Special Report 153, 1975.

Although the Manual is widely used, the current approach to the calculation of urban highway capacity and level of service has several weaknesses. Some of those weaknesses include:

- The Manual focuses on intersection characteristics and does not adequately consider midblock frictional factors such as double parking, truck loading and unloading, midblock origins and destinations, jaywalking, etc.
- The data on which the current Highway Capacity Manual is based was developed during the 1950's. There is a need to update this data to reflect changes in vehicle characteristics and driver behavior.
- The interrelationships between various roadway and traffic flow characteristics are treated independently. In addition, the accuracy of these relationships is not high enough to ensure the validity of the capacity calculations over the range of its possible applications.
- Relationships are not defined for various types of signal control.
- There is not a unique relationship between load factor (a measure of the number of signal-green phases that are fully utilized) and the actual quality of service provided to the motorist.

It was the intent of this research for studying the "Quality of Traffic Flow In Urban Arterials" to attack these problems through the use of a methodology that began with a definition of the problem based upon a review of the state-of-the-art, and continued through the definition of the measures to be used and an experimental design. The Phase I experimental design includes consideration of data collection methodology, a data gathering plan, and a definition of data collection procedures. Phase II of this project, which will be the subject of one or more separate contracts, will include the data collection and analysis activities.

RESEARCH REQUIREMENTS

The overall objective of Phase I was to establish the basis for the Phase II activity of developing an improved methodology for evaluating the quality of flow and capacity of existing urban arterial streets and highways. The specific objectives of the Phase I activities were:

- Define the existing state-of-the-art relative to the evaluation of quality of flow and capacity of urban arterials
- Select specific measures to be used for representing quality of flow and capacity
- Determine additional data required to relate the measures to the roadway and traffic characteristics, and identify the data collection procedures required to develop these relationships
- Determine the accuracy required for the relationships that have been developed, and identify potential sources of error that will limit this accuracy
- Develop a data collection plan that includes consideration of available data, and collection of new data as required
- Define data collection procedures required to satisfy the requirements of the data collection plan

The study was sponsored by the Federal Highway Administration and is part of a series of coordinated but independent studies by FHWA and by the National Cooperative Highway Research Program to improve the understanding of and methods for using highway capacity analysis.

ISSUES ADDRESSED BY THE PHASE II STUDIES

Over the last decade, the users of the Highway Capacity Manual have identified a number of issues which should be addressed by further research. Some of those issues are quite broad, encompassing a variety of subjects; others address a very specific area of concern. One of the broad and basic issues is that of level of service. As now defined, it does not provide a basis for evaluating alternatives in precise terms which can be translated into economic units or other measures of effectiveness. The measures of effectiveness which have been selected in this study should greatly improve the ability of analysts to define the quality of service.

Another broad area of concern has been a method of portraying the capacity of an urban arterial since capacity until now has been a spot measure. The method developed in Phase I responds to that issue with a simple, straightforward method. In fact, Phase II should greatly advance the understanding of travel on urban arterials.

It will certainly put into perspective the relative roles of intersections and the connecting links and their associated design and operational characteristics.

Apart from these broad concerns, there are a number of specific concerns which are to be addressed in whole or in part by the Phase II studies. They are described and discussed below.

Number of Lanes and Approach Width

This issue arises from conflicting research regarding the use of "number of lanes" in lieu of "approach width" to calculate capacities. It is also of interest in connection with the use of "critical lane" methods of capacity calculation. Phase II studies are designed to address this issue. Both approach width and number of lanes will be measured and analyzed in connection with capacity and quality of flow.

Multi-Phase and Traffic-Actuated Signals

Present methods of capacity calculation require an assumption regarding cycle length or the ratio of green time to cycle length. Also, level of service is based to some extent on cycles. New methods and measures should be independent of the type of signal control used or, more precisely, should be usable with any type of signal control. The data collection sites in Phase II will include all types of signal control, presumably in proportion to their occurrence in the general population of signal types. Thus, Phase II will provide information about the effects of signal type on quality of flow and capacity. Additionally, simulation can be used to extend or interpolate the findings in this regard.

Urban Bus Impedance and Bus Stop Types

The influence of urban bus operations on the capacity and quality of flow in urban arterials is a subject of concern to many transportation analysts. This concern has been heightened by the increase in the volume of buses which has occurred in the past decade in most U.S. cities. Phase II will explicitly address this issue by including bus stop types, number of buses, and bus dwell times as independent characteristics. In the event that the sample does not include a full range of bus operating

conditions, additional information regarding the effects of buses blocking lanes could be developed through simulation.

Mid-Block Events Such as Parking, Driveway Activity, Etc.

Phase II will include the examination of about 700 street segments specifically to determine the effects of mid-block events.

It is clear, though, that mid-block events can occur in an almost unlimited number of combinations of values of the independent characteristics. Thus, it would be naive to expect that the sample of segments in Phase II will cover the full range of possibilities. What is more likely is that Phase II will provide enough information to develop models and concepts which can then be used beyond Phase II for more precise determination of mid-block effects.

Influence of Opposing Volume on Left Turns from Through Lanes

Phase II addresses this issue in both the basic study and a special study. It was felt that the basic study might not adequately address this issue for the detailed analysis which it deserves. This is particularly true if the new capacity procedure relies heavily on discharge headways and critical lane analysis methods. Therefore, a special study which addresses this issue in microscopic detail and which could provide input for simulation models was made a part of Phase II.

Pedestrian Interference

Data on pedestrian volumes will be included in the basic study and in the special study on left turns. It is expected that a fairly wide range of pedestrian volumes will be encountered. Related to this are the findings with respect to right-turn-on-red from prior research.¹

¹ Alan M. Voorhees & Associates, Inc. Right-Turn-on-Red, Volume I, Final Report. Prepared for Federal Highway Administration, May 1976.

Lane Utilization, Turning, and Other Auxiliary Lanes Including the Length of "No Parking" Zones at Intersection Approaches

Data on all of the characteristics mentioned in this issue will be collected and analyzed in Phase II. The data collection plan includes a lane classification plan which will permit evaluation of different lane types.

Weaving Maneuvers on Arterials Created by the Presence of Freeway Interchanges

This issue is not addressed in the basic study and therefore a special study has been designed for inclusion in Phase II. There is some evidence that weaving does increase travel time, particularly, but there has been no definitive finding of the effect which would allow an estimate of the relationship. The special study should produce the facts needed.

Grades

There is substantial evidence that grades tend to influence capacity, with upgrades reducing throughput and down-grades increasing it. There is also evidence that the influence of grade varies with the proportion of heavy vehicles in the traffic stream. Accordingly, it was felt to be important that the two characteristics be studied. A special study was developed which should provide the capability to calculate the effects for a wide range of values of the two characteristics.

Delineation, Including Medians

It appears that delineation is most important with respect to travel time along the segment. This results from the difference in the impedance offered by left-turning vehicles in mid-block, either by virtue of their prohibition in the case of raised medians, or by providing a refuge out of the through lanes in the case of wide flush medians or continuous left-turn lanes. The sample of segments in the basic study includes approximately 300 segments of divided arterials. This group of segments will be analyzed separate from 200 of the undivided segments.

Time of Day and Day of Week

The literature did not reveal any definitive information regarding the effects of time of day and day of week on capacity or quality of flow. Many traffic engineers have expressed the belief that differences do exist and that they are attributable to different driver behavior in relation to trip familiarity and trip purpose. The most common example used to support this hypothesis is the relatively higher observed flows during peak hours when most drivers are making work trips. Those driver are generally very familiar with their route and seem to accept shorter headways and shorter gaps.

Phase II data collection will include peak and off-peak hours, but it is unlikely that the data will produce definitive answers to the questions which make up this general issue. However, it should provide enough insight to permit the development of a cost-effective study design for a future study of the issue.

CHAPTER II

CAPACITY AND QUALITY OF FLOW

DEFINITION OF ARTERIAL CAPACITY

The definition of arterial capacity which has been selected is consistent with the definitions employed in the Highway Capacity Manual. In that manual, capacity is defined as follows:

Capacity is the maximum number of vehicles which has a reasonable expectation of passing over a given section of a lane or a roadway in one direction (or in both directions for a two-lane or a three-lane highway) during a given time period under prevailing roadway and traffic conditions. The term capacity as used in this manual is synonymous with the term "possible capacity" as used in certain other publications. In the absence of a time modifier, capacity is an hourly volume. The capacity would not normally be exceeded without changing one or more of the conditions that prevail. In expressing capacity, it is essential to state the prevailing roadway and traffic conditions under which the capacity is applicable.

The definition applies to a specific point on an arterial and is not really suited to the description of capacity on a segment of an arterial street. In developing the proposed definition for arterial capacity, there were several important considerations which were taken into account.

Because the definition of capacity is so widely accepted and understood, it was regarded as essential that the definition retain the specific elements of the definition of intersection capacity. These included the following phrases:

- "during a given time period", and
- "under prevailing roadway and traffic conditions", and
- "the maximum number"

The major change in the definition needed was to include the effects of length. This was accomplished by changing the term "vehicles" to vehicle miles; thus the definition reads:

Arterial capacity is the maximum number of vehicles miles of travel which can reasonably be expected to be accommodated by a given arterial segment

per unit time and length under prevailing roadway and traffic conditions. This capacity can be expressed in either one-way or two-way flows. In the absence of time and distance modifiers it would be expressed in vehicle miles of travel per hour per mile.

Method of Measurement

The method of measurement described below begins with the calculation of point capacity and, as will be seen, expands the individual point calculations to an expression of arterial capacity.

It is probably the case that the point capacity along an arterial street section is a continuously-varying function of location; thus, in a given block the point capacity at midblock may be higher or lower than at the upstream or downstream intersection and the capacities of the intersections may also be different from each other. However, if point capacity calculations were to be made every 10 feet or 100 feet along the length of a link, the results would be almost meaningless. The essential issue is to develop an understanding of the "limiting" point capacities of major segments, as well as a methodology for establishing the magnitude of these limiting values.

The first problem to be addressed, then, is to determine what constitutes a major road segment. Intuitively, it seems that an arterial street should be divisible into a series of segments, each of whose maximum throughput is limited by one or more specific point capacity-controlling features. Further, it should be clear that the length of each segment is equivalent to the zone of influence for its respective capacity-controlling feature. Thus, for example, the zone of influence for a specific intersection may extend through the upstream intersection if the capacity of the upstream intersection is calculated to be greater than the capacity of the intersection being investigated. However, this should not be interpreted to mean that the capacity of an arterial is limited by the most restrictive capacity-controlling feature, and that the excess capacity upstream of this limiting feature cannot be utilized. In fact, whether or not this excess capacity can be utilized is dependent to a large degree upon the particular traffic flow patterns that are being experienced: heavy turning movements off an arterial just upstream of the capacity-controlling feature may allow greater utilization of available upstream

capacity than would have been calculated using the definition just given. In light of this observation, then, it seems obvious that a modified definition for the zone of influence of a capacity-controlling feature should be adopted. The definition that is proposed is as follows:

The zone of influence of a capacity-controlling feature is the distance between the feature being investigated and the capacity-controlling feature immediately upstream. In this regard, a capacity-controlling feature is an intersection or a mid-block location either of which has a point capacity that is less than the capacity of the downstream capacity-controlling feature.

An example of this concept is presented in Figure 2. The solid line represents the segment-by-segment capacity of a section of arterial. It can be seen that while most capacity-controlling features are intersections, some are also identified at midblock locations. Examples of midblock capacity restrictions include the loss of a lane, the presence of heavy midblock turning movements, or a high level of parking and unparking activity.

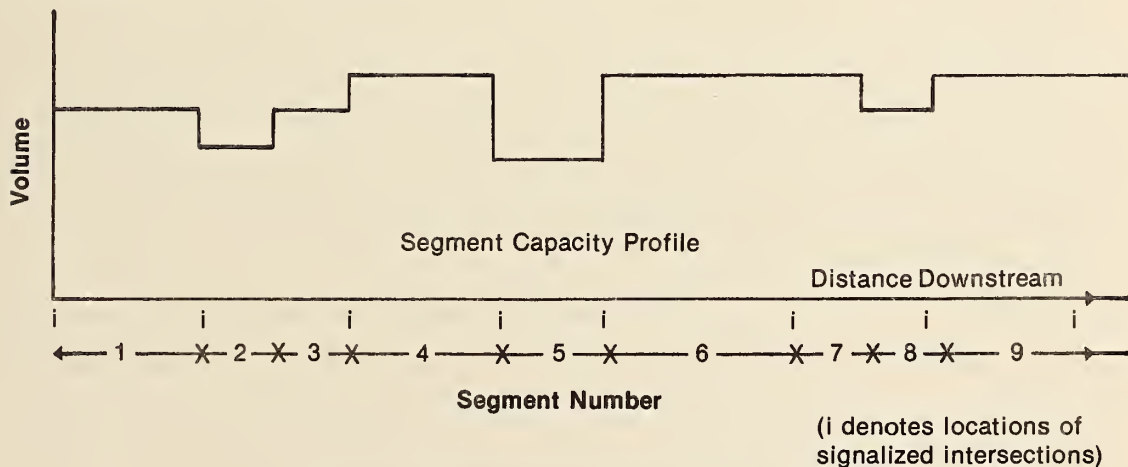

Figure 2. Segment capacity profile.

Utilizing the definition of a major road segment that has just been presented, it is possible to develop a definition for arterial capacity which is not solely dependent upon the point capacity of the most restrictive feature on the facility. Instead, this new definition is dependent upon the relationship between two parameters:

(1) the controlling capacity of each road segment; and (2) the arterial volume profiles (by road segment) for the facility being investigated. This relationship is described in detail within the following paragraphs.

If the capacity of a series of segments along an arterial were determined and plotted on a volume vs. distance graph, a segment capacity profile (C_s) would be produced which would be similar to the example shown in Figure 3. The capacity-controlling features defining the limits of segments 1, 4, 5, 6, and 9 are signalized intersections. Midblock capacity constraints have been used to determine one of the boundaries for segments 2, 3, 7, and 8.

The segment capacity, in vehicle miles, of the individual segments C_{s_i} is equivalent to the maximum segment volume multiplied by the length of the segment. This is represented by the area under the segment capacity profile. The sum of the individual segment capacities is the segment capacity of the entire arterial, i.e.,

$$C_s = \sum_i C_{s_i}.$$

The segment capacity profile represents the maximum potential throughput on the arterial. Since this value can only be achieved if there is an exact match of the observed volumes and the segment capacity of each segment, this value should be viewed as an upper bound which is not likely to be reached.

As indicated previously, the segment capacity profile is based on the computation of the individual segment capacities. It is, therefore, a function of signalization, traffic stream and arterial characteristics, and does not have a single fixed value. It is a dynamic variable that responds to changes in the traffic and in the operation of the arterial.

In Figure 3 a volume profile is shown superimposed on the segment capacity profile. This volume profile is based on the observed traffic volumes during a particular traffic flow period, i.e., a.m. peak. It could be obtained by taking volume counts at short intervals along the arterial, but it is probably sufficient to conduct these counts at points where the volume changes significantly. The result is a profile identifying the current utilization of the segment capacity in each segment.

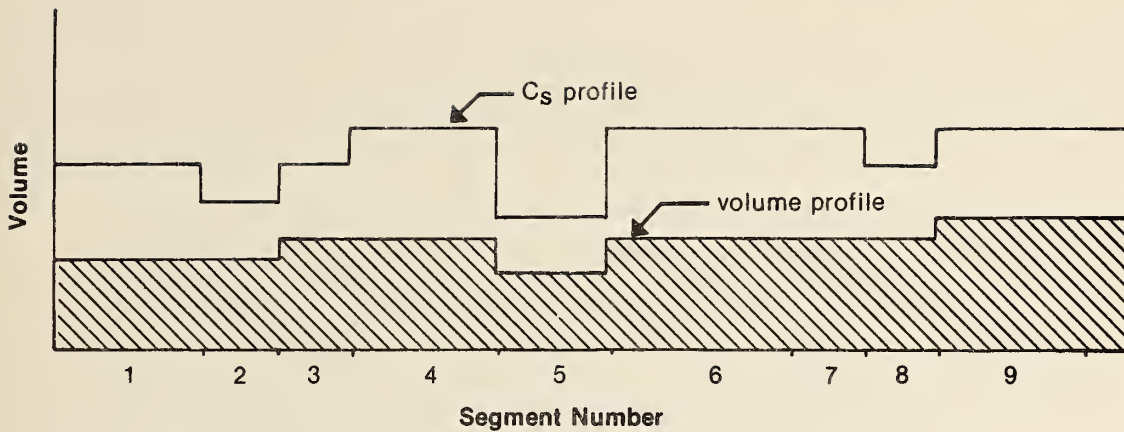

Figure 3. Segment volume profile.

It can be seen from this figure that current volumes do not equal the segment capacity at any point along the arterial being analyzed. The arterial is, therefore, not operating at capacity.

In order to determine what the arterial capacity is, it is necessary to raise the volume profile to a level where at least one segment of the arterial is observed to be operating at the segment capacity. This is the critical segment. In the absence of additional information, the volume level for each road segment could be raised by the same percentage that is required to reach the critical segment capacity. The resultant shaded area, shown in Figure 4, represents the arterial capacity, C_a , of the arterial being investigated.

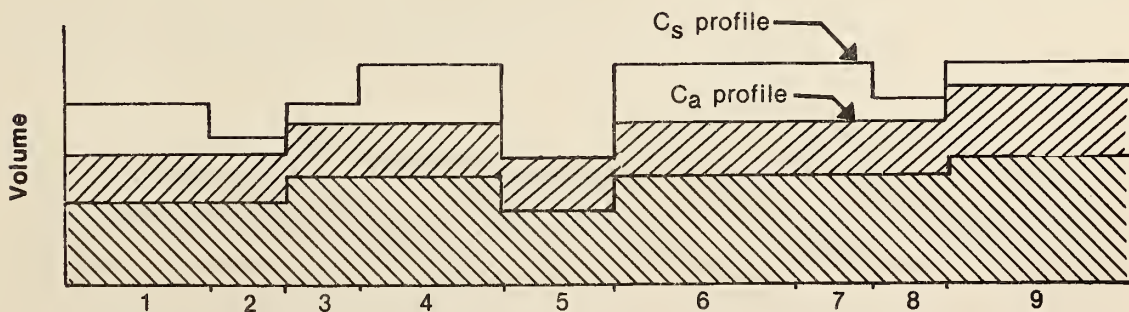

Figure 4. Arterial capacity profile.

This capacity profile was obtained in the following manner. The individual volume to segment capacity ratios (V_i/Cs_i) were calculated for each segment. The maximum value of this ratio was found in Segment 5. This became the controlling segment. The volumes in all segments were expanded by a common factor which causes the new V_{s_5}/Cs_5 ratio to have a value of one.

Three utilization ratios are available to describe the relationship between the segment capacity, arterial capacity and volume profiles. The volume to segment capacity ratio (V_i/Cs_i) is an indicator of the utilization of a segment capacity under prevailing traffic conditions. This is a measure of how fully the total segment capacity is utilized. On an individual segment basis, it is the traditional V/C ratio.

The ratio of the area under the arterial capacity profile to the area under the segment capacity profile Ca/Cs is an indicator of the usability of the segment capacity. A Ca/Cs value far below 1.0 indicates that there is excess capacity on some segments of the arterial. An efficiently operated arterial will have a Ca/Cs value close to one. This measure may be useful in evaluating improvements to the arterial. For example, for an arterial where the Ca/Cs ratios for a series of segments was 0.7, 0.8, 0.95, 0.7 it would not be cost effective to improve the segment capacity of the third segment so that the Ca_3/Cs_3 ratio was 0.6. A more reasonable approach would be to improve the Ca/Cs ratios to a value of 0.7 at both the second and third segments.

The ratio of the volume profile to the arterial capacity (V/Ca) is an indicator of the utilization of the arterial capacity. As the V/Ca ratio approaches one, congestion increases in the critical segment.

In summary, a procedure has been developed for determining the capacity of an arterial, and three measures which indicate the utilization of the facility have been identified. The method proposed for measuring arterial capacity is independent of the technique used to determine the intersection or segment capacity, and is consistent with the practice of expressing capacity in terms of "prevailing roadway and traffic conditions." The procedure may be used to evaluate arterial improvements, gain insight to the impact of new developments, and locate segments where flows, other than the peak movements, may be improved.

DEFINITION OF QUALITY OF FLOW

Traditionally, quality of flow has been defined as the "level of service." The Highway Capacity Manual describes level of service as:¹

Level of service is a term which, broadly interpreted, denotes any one of an infinite number of differing combinations of operating conditions that may occur on a given lane or roadway when it is accommodating various traffic volumes. Level of service is a qualitative measure of the effect of a number of factors, which include speed and travel time, traffic interruptions, freedom to maneuver, safety, driving comfort and convenience, and operating costs. In practice, selected specific levels are defined in terms of particular limiting values of certain of these factors.

With respect to urban and suburban arterials, the Manual provides a tabulation of levels of service in relation to average overall speed, load factor, likely peak-hour factor, and the ratio of service volume to capacity. This tabulation is reproduced in Figure 5.

The levels of service are designated A, B, C, D, E, and F. These designations have gained considerable acceptance within the profession and it would be highly desirable to retain them.

FORMULATION OF CAPACITY AND QUALITY OF FLOW IN TERMS OF MEASURES OF EFFECTIVENESS

It is hoped that level of service can be more explicitly stated in terms of measures of effectiveness (MOE's) such as those recited in the definition earlier (travel time, interruptions, freedom to maneuver, operating cost, etc.). To that end, an evaluation of possible MOE's was undertaken.

Over the years a great many possible measures of capacity and quality have been proposed and used. Some of these measures were developed for special studies dealing with specific facilities; others have been used in traffic simulation, safety evaluations, and road systems analysis. It was necessary to select a set of effectiveness measures for capacity and quality of flow on urban arterial streets which could be measured in Phase II.

¹Highway Research Board. Highway Capacity Manual, HRB Special Report 87, 1965.

LEVEL OF SERVICE	TRAFFIC FLOW CONDITIONS (TYPICAL APPROXIMATIONS, NOT RIGID CRITERIA)				SERVICE VOLUME/ CAPACITY RATIO ^{a,c}
	DESCRIPTION	AVERAGE ^a OVERALL TRAVEL SPEED (MPH)	LOAD ^a FACTOR	LIKELY PEAK-HOUR FACTOR ^b	
A	Free flow (relatively)	≥30	0.0	≤0.70	≤0.60 (0.80)
B	Stable flow (slight delay)	≥25	≤0.1	≤0.80	≤0.70 (0.85)
C	Stable flow (acceptable delay)	≥20	≤0.3	≤0.85	≤0.80 (0.90)
D	Approaching unstable flow (tolerable delay)	≥15	≤0.7	≤0.90	≤0.90 (0.95)
E ^e	Unstable flow (congestion; intolerable delay)	Approx. 15	≤1.0 (0.85 typical) ^d	≤0.95	≤1.00
F	Forced flow (jammed)	<15	(Not meaningful)	(Not meaningful)	(Not meaningful) ^f

^a Operating speed and v/c ratio are independent measures of level of service; both limits should be satisfied in any determination of levels, with due consideration given to the fact that they are largely rationalizations. Load factor, a measure of individual intersection level of service, can be used as a supplemental criterion where necessary.

^b This is the peak-hour factor commonly associated with the specified conditions; in practice, considerable variation is possible.

^c Values in parenthesis refer to near-perfect progression.

^d Load factor of 1.0 is infrequently found, even under capacity operation, due to inherent fluctuations in traffic flow.

^e Capacity.

^f Demand volume/capacity ratio may well exceed 1.00, indicating overloading.

Source: *Highway Capacity Manual HRB Special Report 87*, 1965.

Figure 5. Levels of service for urban and suburban arterial streets.

This was done through an evaluation which consisted of nine steps which are shown in graphic form in Figure 6. In brief, the process consisted of compiling a comprehensive list of measures, then screening the list to eliminate the weakest or least likely measures and obtain a reduced list of candidates. These candidates were then evaluated for sensitivity, usability, and likely cost. Based on the ratings each candidate received in the sensitivity and usability evaluations, it was given an importance rating and then arranged in a matrix with importance as one index and cost, or level of effort, as the other. The final selection was made from this matrix.

The ratings were made in several iterations following a modified Delphi format in an attempt to reduce individual bias and also to assure that uniform definitions of the measures and of the rating were employed. As a further guarantee of uniformity of definition, each candidate measure was defined and described in a standard format. Additionally, recent experience with the measures on the part of other researchers was taken into account.

The measures of effectiveness which were selected are service volume, travel time per mile, intersection stops, intersection delays, and travel time variance. The final selection of the measures of effectiveness was based on the desire to obtain a set of measures that reflect throughput, delay, and flow quality and which would describe conditions at the intersections and on an arterial between intersections.

Service volume is a measure related to capacity. It was selected to represent throughput at a point or along the arterial. Alone, it would be expressed as vehicles per hour or vehicles per hour per lane. In conjunction with the length of the arterial, it could be written as vehicle miles per hour. Expressed in this form, the units of service volume reflect the linear characteristic of arterials, and permit service volumes from segments of the arterial which are different to be combined so that an overall service volume can be determined for the arterial.

Travel time per mile, intersection delays, intersection stops, and travel time variance were the measures of effectiveness chosen to reflect the quality of flow.

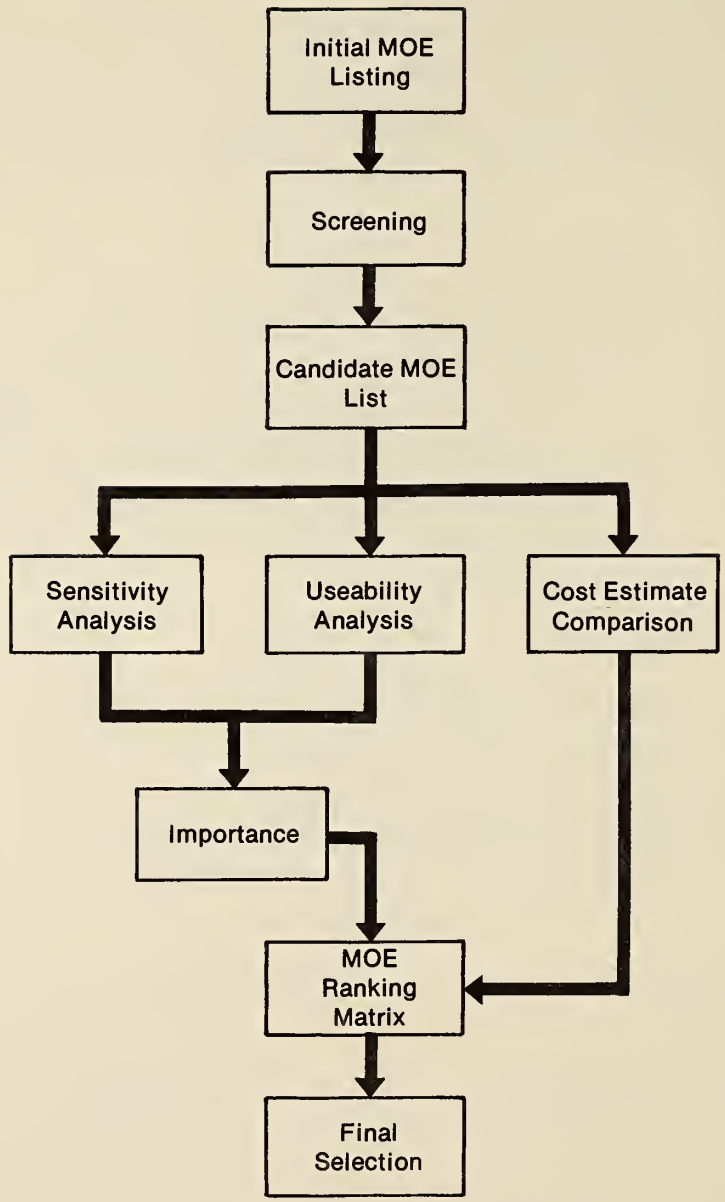

Figure 6. Process for selecting measures of effectiveness.

It was necessary to use two measures of effectiveness to describe delays which occur on the arterial between and at the intersections. Travel time/mile is the time spent on the arterial reflecting the overall conditions. It becomes directly descriptive of arterial delay when combined with the free flow speed on the arterial. Intersection delay is a measure of the activity at both the main street and side street approaches to the intersection. Subtracting the main street intersection delay from the arterial delay yields information regarding the delay on the arterial between intersections.

Intersection stops and travel time variance will be used to describe the smoothness characteristic of the quality of flow.

ESTIMATION OF THE MEASURES OF EFFECTIVENESS AS FUNCTIONS OF INDEPENDENT CHARACTERISTICS

The above measures of effectiveness can be estimated by determining the relationships between them and known or predictable physical, traffic, and environmental characteristics on an urban arterial. The number of characteristics which are influential in determining the actual values of each of the MOE's is very large. A review of the literature (reported in Appendix B) was undertaken to determine the strength and nature of the relationships between a candidate list of characteristics and the MOE's. The candidate list was examined for those few which would account for most of the variability and for practicality of measurement. After much study, a selected list of independent characteristics was compiled. It contains all of the characteristics employed in other countries, and those for which relationships have been demonstrated or for which a strong case could be made as being influential in determining either capacity or quality of flow.

Some very important characteristics were identified for special study and studies were designed specifically to determine their relationship to capacity and quality of flow. The remainder were included in the list to be studied in the Phase II basic studies. They are shown in Table 4 and are described in detail in Chapter III.

Table 4. Independent characteristics.

- | | |
|-------------------------------------|---------------------------|
| 1. Approach or Segment Width | 17. Lane Blockage |
| 2. Number of Lanes | 18. Pedestrian Levels |
| 3. Lane Control | 19. Segment Demand |
| 4. Median Type | 20. Parking Condition |
| 5. Type of Bus Stop | 21. One/Two Way |
| 6. RTOR | 22. Type of Land Use |
| 7. Type of Signal Control | 23. Intensity of Land Use |
| 8. Parking Turnover | 24. Location Within City |
| 9. Distance to First Parked Vehicle | 25. SMSA Population |
| 10. Progression | 26. Urban Population |
| 11. Total Green Per Approach | 27. City Population |
| 12. Number of Times Green | 28. Discharge Headways |
| 13. Volume Per Movement | 29. Gap Acceptance |
| 14. Truck Volume | 30. Lane Width |
| 15. Local Buses | 31. Load Factor |
| 16. Bus Dwell Time | |

ESTIMATION OF ARTERIAL CAPACITY AND QUALITY OF FLOW AS FUNCTIONS OF THE MEASURES OF EFFECTIVENESS

The capacity and quality of flow along an arterial are defined by the measures of effectiveness described above. In brief, they are:

- Travel Time
- Intersection Stops
- Intersection Delay
- Travel Time Variance
- Service Volume

The first four measures together give a good measure of the quality of flow or the service provided by the physical and operating characteristics of the street. The volume which is related to a certain level of service is defined as the service volume. The maximum service volume at a point is the point capacity at this location. Using this volume it is possible to estimate the point capacity of the capacity controlling features of an arterial and then to expand the individual point capacities to an expression of arterial capacity as described above.

The individual measures of effectiveness for the quality of flow could be combined into a single measure of service or they could be dealt with individually. The problem with a combination of the four measures is essentially one of value. That is, the relative weights to be given to the different measures when they are combined. Travel time and intersection delay can be fairly easily combined since they are both expressed in terms of users time. However, intersection stops and travel time variance are difficult to handle because they have no common units.

Converting all of the MOE's to user cost is one possibility. Costs of stops and travel time variance can be calculated but the latter will have to be based on the controversial value of time. For all these reasons, no effort has been made in Phase I of this study to develop an expression for a single measure of the quality of flow. But eventually, the quality of flow MOE's will have to be used to define an overall level of service. A panel approach is proposed for defining a single level of service MOE from the set of separate MOE's.

It must also be recognized that a simple combination could result in the situation where different combinations of individual MOE's would yield the same total. Or, stated in other words that a given total value could be made up of very different individual values.

CHAPTER III INDEPENDENT CHARACTERISTICS

In Phase II, models will be developed which can be used to predict the capacity and quality of flow from a series of independent characteristics. The independent characteristics were enumerated in Chapter II. Some characteristics are influential in determining MOE's related to intersection performance; others are specifically related to the performance of an arterial segment. Additionally it is anticipated that models of varying levels of detail and precision would be developed to meet the needs of different users such as planners, designers, and traffic operations analysts. For that reason, characteristics likely to be measurable or easily estimated have been included in the list.

The characteristics for intersections are shown in Table 5. Each characteristic is described below. Details on methods of measurement are given in Appendix A.

PRE-MEASURE FOR REGRESSION

The first group of characteristics titled "Pre-Measure for Regression" are those characteristics which can be measured prior to the collection of traffic data; essentially by survey techniques.

Approach Width, Lane Width, Number of Lanes

These three characteristics are known to be highly related to capacity. In the analysis only approach width and number of lanes will be tested to see which gives better results. The range of values expected are:

Number of lanes	1 to 7
Lane width	8 ft. to 16 ft. (2.45m to 4.90m)
Approach width	12 ft. to 80 ft. (3.65m to 24.40m)

The number of lanes and the width on the approach to the downstream intersection and along the segment may be different. Thus both will be recorded. Lane width will be recorded for purpose of analysis or calibration.

**Table 5. Independent characteristics
Intersection MOE's.**

PRE-MEASURE

For Regression

1. Approach Width
2. Number of Lanes
3. Lane Control
4. Median Type
5. Type of Bus Stop
6. RTOR
7. Parking Condition
8. One/Two Way

Surrogates

Type of Signal Control
 Type of Land Use
 Intensity of Land Use
 Location Within City
 SMSA Population
 Urban Population
 City Population

For Calibration

Discharge Headways
 Gap Acceptance

For Reference Analysis

Lane Width
 Load Factor

DYNAMIC MEASURE

For Regression

9. Parking Turnover
10. Distance to First Parked Vehicle
11. Progression
12. Total Green Per Approach
13. Number of Times Green
14. Volume per Movement
15. Truck Volume
16. Local Buses
17. Bus Dwell Time
18. Lane Blockage
19. Pedestrian Levels
- B. Intersection Stops
- C. Intersection Delay
- E. Service Volume

Lane Control

This characteristic describes the traffic controls and regulation governing the movements which can be made from a lane and also describes the conditions under which the movement can be made. The classification scheme shown in Figure 7 will be used. It is the scheme used in the Swedish capacity manual.

Median Type

The type of median affects left turns along the segment and the impact of turning on other traffic. Types of medians are:

- Painted
- Continuous left-turn lane
- Raised
- Flush

Also included in this characteristic will be the width of median so that the description of the median will include both type and width.

Type of Bus Stop

Where bus volumes are heavy and boarding/alighting volumes result in long bus dwell times, the type of bus stop can be a significant factor in the effects of buses on the MOE's. In the field data collection, the bus stops will be classified into two types: those which are so located that a stopped bus blocks a lane and those which are so located that a stopped bus is clear of the traveled lanes.

Right-Turn-On-Red (RTOR)

A study of right-turn-on-red effects showed increases in throughput and reductions in delay where RTOR is permitted. Accordingly, it is planned to record for each study site whether right turns are permitted on red. In the analysis, this variable will be combined with pedestrian volumes.









Type	Description	Illustration
A	Only through traffic	
B	Some turning traffic without conflict	
C	Only turning traffic without conflict	
D	Some turning traffic in conflict with pedestrians	
E	Only turning traffic in conflict with pedestrians	
F	Some turning traffic in conflict with opposing traffic	
G	Only turning traffic in conflict with opposing traffic	
D/F	Some turning traffic in conflict with opposing traffic and pedestrians	
E/G	Only turning traffic in conflict with opposing traffic and pedestrians	

Figure 7. Classification of lane types.

Parking Condition

The presence or absence of parking has a significant effect on the capacity and quality of flow. This characteristic is defined as simply whether or not parking is permitted. Additional information on parking (whether legal or illegal) will be collected as dynamic characteristics. On the basis of field observations it is expected that few arterials allow parking during peak hours, and many of the study sites will have no parking throughout the day. However, parking will be present, either legally or illegally on many of the study segments, and the number of parked vehicles, the turnover, and location characteristics will be measured.

One-Two Way Traffic

This characteristic is importantly related to capacity and quality of flow. Data for one-way streets will be analyzed separately from that for two-way streets.

DYNAMIC MEASURES FOR REGRESSION

The dynamically measured characteristics to be used in the regression analysis are the following.

Parking Turnover

The number of parking and un-parking maneuvers influences traffic moving in the lane adjacent to the parking lane on segments where parking occurs. Accordingly where parking occurs, the turnover rate will be measured. A special study, together with simulation, will be performed to develop the impacts of parking on the MOE's.

Distance to First Parked Vehicle

This is the distance from the "Stop" line to the first parked vehicle. It will be measured to the nearest foot and will be recorded at the time data collection begins.

Progression

The quality of the progression provided by the signals is an important determinant of the number of intersection stops. This has been demonstrated by many studies and by simulation. Therefore, this characteristic was included in the list of variables to be included in the regression analysis. Several methods of measurement were considered including synchronized timing of the signals at the upstream and downstream intersections. The method finally selected was to count the vehicles arriving or joining a queue at the downstream intersection during the green interval. The percentage of the total approach volume which those vehicles represent will be used as an indication of the quality of the progression.

Total Green Per Approach

Clearly the proportion of green time on an approach is directly related to its capacity. This will be measured manually in the field.

Number of Times Green

Start-up delay at the onset of green has been well studied and the discharge headways of the first four vehicles in a queue have been shown to be substantially longer than those for other vehicles in a queue. Accordingly the total green time must be modified to reflect the number of green intervals which comprised the total.

Volume per Movement

This is a count of the vehicles turning left and right and moving through the intersection. The counts will be made on a cycle-by-cycle basis and then summed for the 15-minute period. This will yield service volume or service rate which is listed at item E.

Truck Volume

All studies have shown that trucks materially affect capacity. Accordingly the traffic movement counts will include a classification of heavy vehicles which includes trucks and intercity buses. This will be expressed as a percentage of the total volume.

Number of Local Buses

The Highway Capacity Manual includes an adjustment factor for bus volume, and other studies have shown that buses reduce vehicular capacity. Thus the number of local buses using each study segment will be recorded.

Bus Dwell Time

The effects of buses stopping in traffic lanes is not well-defined but logic would indicate that it has an important effect which increases with vehicle and bus volumes. Accordingly the dwell times (duration of stop) will be recorded at all bus stops at the downstream intersection or along the segment. It will be expressed as the total time accumulated over the 15-minute study period.

Lane Blockage

This characteristic is included to reflect the effects of events (other than those measured by other characteristics) which block a lane. Lane blockage is, therefore, defined as the occupancy of a lane by double parking, disabled vehicles, queues from side streets across the arterial, and queues from parking facilities. Not included are lane blockage by a bus in a bus stop, queues from left and right turns, and lane blockage by curb parking. These exceptions are measured by other characteristics.

Pedestrian Levels

The interference posed by pedestrians at intersections can be substantial. Pedestrian activity varies over a wide-range of values from virtually zero to several thousand pedestrians per hour. The data to be collected will measure only the pedestrian activity on a scale of four levels.

Other Dynamic Measures

The measures of effectiveness related to the intersections will also be measured when the data on independent characteristics are being collected. Specifically, these include intersection stops and intersection delay. Service volume will be determined from the turning movement counts.

SURROGATES

The fourth set of characteristics are headed "Surrogates." They are characteristics of a more general nature which will be suitable for use in general models for planning studies or for preliminary analysis of urban arterial systems.

Type of Signal Control

Precise measures of traffic signal performance will be collected under the "Dynamic" measures. Therefore, the type of traffic signal control is not required for the regression analysis. However, the control type will be recorded and may be used as a surrogate. Traffic signal control types are:

- Fixed time uncoordinated
- Fixed time coordinated
- Semi-actuated uncoordinated
- Semi-actuated coordinated
- Fully actuated uncoordinated
- Fully actuated coordinated
- Areawide real time

Type and Intensity of Lane Use

The type and density of land use has been shown to affect the quality of flow on urban arterials. It is thought that the effect is indirect in that land use is related to parking, pedestrian volumes, and more importantly to the volumes of vehicles using driveways and side streets along the arterial. The design for Phase II includes direct measurement of this latter characteristic (see Segment Demand), but it is recognized that many planners and designers would not have detailed estimates of demand along the segment. The types and densities of land use range from undeveloped land

to very high density commercial uses. The units of measurement and the codes given the inventory manual relate to the trip generation characteristics of the uses and types encountered.

Location Within The City

The definition of location is the same as that used in the Highway Capacity Manual. It is thought that this characteristic reflects differences in pedestrian activity, bus volumes, and marginal friction and may be a useful surrogate.

Population

There are three candidate population figures. One is the population of the standard metropolitan statistical area; another is the population within the urbanized area; and the third is the population of the city in which the street is located. It is expected that one of these will be chosen as a surrogate for other measures.

CHARACTERISTICS FOR CALIBRATION

The fifth set of characteristics are those which can be used for calibration of future models. There are two such characteristics which are basic to operations at intersections and which might be found to vary with certain conditions. These are discharge headways and gap acceptance. They will be obtained and analyzed separately.

CHARACTERISTICS FOR REFERENCE/ANALYSIS

The last group of characteristics are for reference and for use in special analyses. As mentioned earlier, lane width will be measured when the intersection approaches are surveyed. Thus the width of each lane will be known, as will the average lane width.

The loaded cycles will be recorded when traffic is counted, and load factor will be expressed as the percentage of total cycles which were loaded.

INDEPENDENT CHARACTERISTICS FOR THE SEGMENTS

The independent characteristics for the segments are listed in Table 6. These are, in most cases, the same as those for the intersections except that the characteristic is measured along the segment. There are, however some characteristics which were not described in the preceding section.

Median Type

Median type will be recorded for divided multi-lane streets. Both the width of median and the type are included.

Segment Demand

Segment Demand is defined as the total number of vehicles entering, leaving and crossing the segment at all points other than upstream and downstream intersections.

Lane Blockage

The number and duration of lane blockages from events other than parking turnover and bus dwell time are also measured at all points along the segment. Lane blockage is defined as interruption of flow in a lane due to events such as breakdown, double parking, and queues from driveways.

Other Dynamic Measures

The MOE's of travel time and travel time variance will be measured at the same time that other dynamic measures are made. Service volume will be taken as the service volume at the downstream intersection.

Table 6. Independent characteristics segment MOE's.

PRE-MEASURE

For Regression

1. Width
2. Number of Lanes
3. Median Type
4. Length
5. Bus Stop Type
6. Parking Condition
7. One/Two Way

Surrogates

Type of Land Use
Intensity of Land Use
Location Within City
SMSA Population
Urban Population
City Population

For Reference/Analysis

Lane Width

DYNAMIC MEASURE

For Regression

8. Parking Turnover
9. Segment Demand
10. Truck Volume
11. Local Buses
12. Bus Dwell Time
13. Lane Blockage
- A. Travel Time
- D. Travel Time Variance
- E. Service Volume

CHAPTER IV

SAMPLE DESIGN: BASIC STUDY

This chapter describes the experimental design and the sample selection process for the Basic Study. The Basic Study includes the development of models for estimating capacity and quality of flow from known values of the independent variables. It uses two separate samples: one for large urban areas (urban areas with populations of 100,000 or more) and another sample from smaller urban areas (population of 25,000 to 100,000). The latter sample will involve only intersections while the sample from the larger urban areas involves the use of arterial segments. The sampling methods are similar as are the data collection methods. In this chapter, the methods of selection for the larger urban areas are discussed first.

STRATIFIED MULTISTAGE DESIGN

The sample design proposed for the basic study is a stratified multistage sampling plan. This design is described in the several subsections of this chapter.

Sampling Units

The recommended design is a two-stage sample design, in which a (first stage) sample of urban areas is selected, and a (second stage) sample of links is selected from each sampled city.

Sample Frame and Sample Selection Procedures—Large Urbanized Areas

There are two sample selection procedures that must be specified to complete the design specification—one for the first-stage sample of urban areas, the other for the second-stage sample of sites.

The urban areas should be selected from within the population groups without replacement and with equal probabilities.

Stratification Variables

The proposed variables of stratification are the categories defined as:

- Two-way Multilane Divided
- Two-way Multilane Undivided
- Two-way Two Lane
- One Way
- Urban Area Population

The first four stratification variables are specified because of the likely need to develop a separate model for each of the four arterial types, with the attendant need to control the sample size for these four groups. The last variable of stratification is added because it is anticipated that the urban areas within various size groups may be somewhat homogeneous with respect to the relationships under study. Stratification by population size will enable an improvement in precision of the estimates.

Figure 8 shows the number of urban areas in each of five population groups. Also shown are the vehicle miles of travel and the number of miles of arterials. Figure 9 shows the mileage of urban arterials according to the stratifications listed above.

Sample Sizes and Allocation of Sample to Strata for Large Urban Areas

The determination of sample size rests on two factors—the precision levels desired for the estimates, and the total funds available for the survey. In order for the estimates of relationships to be of meaningful precision, a sample size of about 200-400 sample units is desired for each regression model to be developed. This sample size will permit the development of regression estimates of adequate precision, and will enable the development of tables (cross-tabulations) with two or three variables each at two or three levels.

In order to improve the precision/cost ratio for the survey, it is recommended that each sample site (link) be studied for a 15-minute interval, and in both directions except on one-way streets. This produces a total of two sample units per site

Description of Groups		Population (1975)		Daily Veh. Miles of Travel		1 Miles of Arterials	
Size	Number of Areas	Sum of Group	Percent of Total	Sum of Group	Percent of Total	Sum of Group	Percent of Total
1. 100,000-200,000	73	10,933,00	8.7	50,614	10.9	3,331	11.4
2. 200,000-500,000	57	18,738,000	14.9	77,353	16.7	5,104	18.1
3. 500,000-1,000,000	22	16,091,000	12.8	57,499	12.4	3,574	12.6
4. 1,000,000-2,000,000	16	22,655,000	18.0	79,935	17.2	5,097	18.0
5. Over 2,000,000	9	49,485,000	39.4	162,053	34.9	7,954	28.1

¹“Other Freeway and Expressway” plus “Other Principal Arterials” with “No” and “Partial” Access Control.

Source: 1976 National Highway Inventory and Performance Study: FHWA 1977.

Figure 8. Distribution of urbanized population groups.

1 veh. mile = 1.609 veh./km
1 mile = 1.609km

Population Group (City Size)	Two-Way				One-Way
	Multi-Lane		Two-Lane		
	Divided	Undivided			
100,000-200,000	1,244 (4.4)*	646 (2.3)	1,292 (4.6)	149 (0.5)	
200,000-500,000	1,692 (6.0)	1,350 (4.8)	1,811 (6.4)	251 (0.9)	
500,000-1,000,000	1,245 (4.4)	1,063 (3.8)	1,165 (4.1)	97 (0.3)	
1,000,000-2,000,000	1,913 (6.8)	1,177 (4.2)	1,858 (6.6)	149 (0.5)	
Over 2,000,000	3,251 (11.5)	2,492 (8.8)	2,035 (7.2)	173 (0.6)	

*(Percentage of Total in Parentheses)

Source: 1976 National Highway and Performance Study: FHWA 1977.

Figure 9. Miles of "other freeway and expressway" and "other principal arterial" with no access and partial access control.

1 mile = 1.609km

for two-way traffic. Unfortunately, although substantial cost savings are realized through this sampling approach, there is a corresponding loss in precision, because of the fact that there is a correlation between the observed characteristics of the same link in its two directions. The magnitude of the loss in precision depends on the intracluster correlation coefficient, which is not known, but this coefficient is not expected to be very large.

Preliminary information on the total funds that are likely to be available for data collection, on the cost to sample a site (i.e., to collect four sample units), and to process the data indicates that a total of 400 sites (700 sample units) may be selected. In order to achieve comparable accuracy for estimates in the four arterial type categories, comparable portions of the sample should be allocated to the four categories. Because of the greater variety of conditions encountered on two-way multilane divided and undivided arterials, however, a larger portion of the sample will be allocated to these strata. The suggested allocation of the 400 sites to the four arterial-type strata is shown below:

Allocation of Sample to Strata

	<u>Sites</u>	<u>Samples</u>
Two-way Divided	150	300
Two-way Undivided	100	200
Two-way Two Lane	50	100
One-way	<u>100</u>	<u>100</u>
	400 Sites	700 Samples

Figure 10 illustrates the proposed allocation of the sample sites to the various city size categories. The proposed allocation is obtained by allocating the sample in each column approximately proportional to the number of miles of arterials in each of the city size categories.

In Figure 9 the entries in the first four columns give the following information:

1. The upper left number in each cell is the number of miles of that type of arterial in urban areas of the population range indicated.
2. The upper right number in each cell gives the proportion that the mileage is of all such arterials in all urban areas.

Urbanized Area Population	Two-Way						One-Way	Number of Sample Cities	Total Number of Cities	Total Number of Sample Sites	Average Number of Sample Sites Per City
	Multi-Lane			Two-Lane							
	Divided	Undivided		Divided	Undivided						
100,000-200,000	1,244, .120 30	646, .088 10	1,292, .135 10	149, .156 20	4	73	70	17.5			
200,000-500,000	1,692, .163 20	1,350, .183 20	1,811, .189 10	251, .263 20	4	57	70	17.5			
500,000-1,000,000	1,245, .120 35	1,063, .144 15	1,165, .121 10	97, .101 10	4	22	70	17.5			
1,000,000-2,000,000	1,913, .185 20	1,177, .160 20	1,858, .194 10	149, .156 20	4	16	70	17.5			
Over 2,000,000	3,251, .314 45	2,492, .339 35	2,035, .212 10	173, .181 30	6	9	120	20.0			
TOTAL	10,362, 1.00 150	7,358, 1.00 100	9,597, 1.00 50	956, 1.00 100	22	177	400	18.2			

Figure 10. Allocation of sample design strata large urban areas.

3. Two low left number in each cell is the number of sites of that type of arterial that will be included in the sample.

The remaining columns need no explanation.

Impedance Factors

In addition to the stratifications by arterial type and urban area population it is desired that the sample will have a range of values for the independent characteristics. Because there are very many possible combinations of values of the independent characteristics, a matrix showing all possible combinations would be very large and it would not be possible to have one sample for each cell. Additionally, it is desirable to identify those independent variables that are correlated with each other, and stratify according to other variables (factors) that represent groups of correlated variables. Figure 11 represents a tentative collapsing of the independent variables into six factors: traffic signal impedance, intersection impedance, traffic volume impedance, mid-link impedance, bus impedance, and heavy vehicle impedance. It is these factors that will be used in the controlled selection of links from sample cities.

The procedure for site selection, including an example of the method for developing and selecting sample units, is presented later in this chapter.

ESTIMATED PRECISION

It is difficult to derive accurate estimates of the precision that will result from alternative sample designs for the proposed survey. This difficulty arises because the precision will depend very heavily on the strength of the relationships between the measures of effectiveness (MOE's) and the independent characteristics and those relationships can only be roughly estimated. Nevertheless, it is possible, by making various assumptions, to obtain rough estimates of the magnitude of the precision that corresponds to alternative designs.

Estimates of the precision of an estimated regression coefficient, and of the precision of a predicted value (i.e., a MOE value predicted by substituting in an esti-

Traffic Signal Impedance	Mid-Link Impedance
Spacing	Parking Condition
Type	Turnover Rate
Progression	Median Treatment
Green Time	Access Points Per Mile
Number of Greens	Mid-Block Demand
	Lane Blockage
Intersection Impedance	Bus Impedance
App.Width	Local Buses/Hour
Lane Width	Bus Stop Location
Number Lanes	Bus Stop Type
Park Condition	Bus Dwell Time
Turnover Rate	
Distance to First Parked Vehicle	Heavy Vehicle Impedance
Lane Control	Approach Grade
Number Pedestrians	Percent Trucks
R.T.O.R.	Local Buses/Hour
Traffic Volume Impedance	
Demand by Movement	
Side Street Demand	

Figure 11. Definition of six impedance factors from independent variables.

mated regression equation) can be derived as follows. For simplicity, consider only the case of predicted values obtained by substituting mean values for all the explanatory values.

The regression model is, in matrix notation:

$$\underline{y} = X'\underline{p} + \underline{e}$$

where:

\underline{y} = dependent variable (measure of effectiveness)

\underline{p} = parameters (regression coefficients)

X' = design matrix (dependent variables)

\underline{e} = model error term

Assume that each observation is sampled independently and with equal probability, and has the same distribution. The least-squares estimate of the regression coefficients is:

$$\underline{p} = (XX')^{-1}X\underline{y}$$

the variance of \underline{p} is

$$S = \text{var } \underline{p} = (XX')^{-1}Se^2$$

where

Se^2 = estimated residual variance

$$= \underline{yy}' - \underline{p}'X\underline{y}$$

$$= (1 - R^2) Sy^2$$

where

R^2 = coefficient of determination

and

Sy^2 = (unconditional) variance of y .

the variance of p_i is hence

$$Se^2 C_{ii}$$

where

C_{ii} = i -th diagonal element of the inverse of the covariance matrix XX' .

Assume further that the independent variables are not highly correlated (which will be the case if we develop a model for impedances), then the matrix XX' is diagonal, and

$$C_{ii} = \frac{1}{(N-k)S_{xi}^2}$$

where

k = number of estimated parameters
= number of regression coefficients + 1

and

S_{xi}^2 = variance of x_i (the i -th independent variable).

If the variable x_i is a 0-1 dummy variable (i.e., $x_i = 0$ corresponds to the low level of the i -th independent variable, and $x_i = 1$ corresponds to the high level), then

$$\begin{aligned} S_{xi}^2 &= E x_i^2 - (E x_i)^2 \\ &= P_i - P_i^2 \\ &= P_i (1 - P_i) \end{aligned}$$

where

P_i = proportion of the sample at the high level ($x_i = 1$)

The variance of an estimated value (ordinate on the regression line), given the value X_1 for the independent variables, is

$$y = X_1' p,$$

is

$$\text{var } y = X_1' S X_1.$$

If the matrix X is comprised of elements set equal to the means, this reduces to

$$\text{Var } y = S e^2 n$$

where

n = sample size.

The variance of a predicted value (individual value) of y , given X_1 , is

$$\begin{aligned} \text{var } y &= \text{var } E(y | X_1) + E \text{ var } (Y | X_1) \\ &= S e^2 (1/n + 1). \end{aligned}$$

For an independent variable that is well balanced over the sample, $p_1 = .5$,

$$S_{x_1}^2 = .25$$

or

$$S_{x_1} = .5$$

For an independent variable that is moderately balanced, say $p_1 = .25$,

$$S_{x_1}^2 = .1875$$

or

$$S_{x_1} = .433.$$

For an independent variable that is not at all well balanced, say $p_1 = .1$,

$$S_{x_1}^2 = .09$$

or

$$S_{x_1} = .3.$$

(Through use of a properly constructed design, based on controlled selection, it should be possible to achieve fairly high balance on all of the independent variables. The possibility of achieving good balance, however, is because the sample will be a relatively large proportion of the sample frame.)

To compute the above standard errors (of estimated regression coefficients, of estimated ordinates and of predicted values), it is necessary to specify values for n and R^2 . Since the observations are not selected independently and identically distributed, n should be replaced by the "effective" sample size, defined by

$$n_{\text{eff}} = n \text{ design effect,}$$

where the "design effect" is the ratio of the variance of an estimate that would result from a simple random sample, to the variance that will result from a sample collected in accordance with the proposed design. The design effect is increased above 1.0 because of the intracity correlation coefficient, and the intra-area correlation coefficient, and variations in the selection probabilities caused by the controlled selection procedure. For one-way streets the design effect can be estimated to be 2.0, and for two-way streets, it can be estimated to be 3.0. (The design effect is greater for two-way streets because two observations are collected per site—one in each direction—and there will be some correlation between these observations, conditional on all of the explanatory variables.)

The quantity R^2 , shown below was taken from the best available models that have been developed to date.¹

<u>MOE (y)</u>	<u>Units</u>	<u>Mean</u>	<u>R²</u>	<u>Se²</u>	<u>Var (y)</u>
Travel time	minutes/mile ²	.75	.271	.206	
Stops	% of total vehicles stopping	NA			1.0 ³
Average Delay	minutes/vehicle	.50	.178	.209	
Speed Variance	variance of travel time	NA			
Volume	vehicles/hour	NA ⁴			

¹Peat, Marwick, Mitchell and Co. and General Applied Science Laboratories. Network Flow Simulation for Urban Traffic Control System, Report No. FH-11-7462-2. Prepared for the Federal Highway Administration (undated) p. 163.

²1 minute mile = 1.609 minute km

³The report provides figures for volume, but in this study this quantity was essentially specified, rather than observed.

⁴Estimated from New Orleans experience.

Based on all of the above assumptions, Table 7 can be constructed to show the enacted precision that results from three sample size design alternatives, corresponding to different sample sizes. The formulas used to compute the table entries are, in summary:

Estimated Precision of Regression Coefficient:

$$SD(p) = \frac{S_e}{S_{x_i}} \sqrt{\frac{D}{n}}$$

Estimated Precision of Estimated Ordinate:

$$SD_1(y) = S_e \sqrt{\frac{D}{n}}$$

Estimated Precision of Predicted Value:

$$SD_2(y) = S_e \sqrt{\frac{D}{n} + 1}$$

where D = design effect.

Several conclusions may be inferred from Table 7. First, the precision of predicted values is poor, regardless of which design (sample size) is used. This simply reflects the fact that the relationships are not very strong (i.e., R^2 is low). Second, there is very little precision increase in the two-way street estimates, if all of the one-way sites are eliminated and the number of two-way sites is correspondingly increased. Third, if the sample size can be increased, the largest payoff in terms of precision accrues to the one-way street stratum. For example, if the number of "A" sites is increased from 200 to 300, the precision changes from .079 to .064 for the "good balance" estimates; whereas if the number of "D" (one-way) sites is increased from 50 to 100, the precision changes from .183 to .129.

It should be noted that there is a substantial loss in precision of estimated coefficients as the balance of the sample changes from good to moderate to poor. This implies that it is very important to attempt to achieve good balance through proper design of the sample.

Finally, the precision associated with estimated ordinates (which are the estimates of primary concern in this study) is about .06, for samples of size 100 or more. This implies that a 95 percent confidence interval would be about $\pm .12$. For Average Delay, the mean was about .5, so that the relative error of the estimated mean

Table 7. Estimated precision levels corresponding to three design alternatives.

Design	Sample Size (n)	Design Effect (D)	MOE(y)	S ² y	R ²	S ² _e	Good Balance			Moderate Balance			Poor Balance					
							S ₁	S ₂	S ₃	S ₁	S ₂	S ₃	S ₁	S ₂	S ₃			
Design 1:																		
A	200	3.0	Delay	1.174	.178	.209	.25	.079	.040	.459	.1875	.091	.040	.459	.09	.132	.040	.459
B	100	3.0	Delay	1.174	.178	.209	.25	.112	.056	.461	.1875	.129	.056	.461	.09	.185	.056	.461
C	100	3.0	Delay	1.174	.178	.209	.25	.112	.056	.461	.1875	.129	.056	.461	.09	.185	.056	.461
D	50	2.0	Delay	1.174	.178	.209	.25	.183	.092	.466	.1375	.211	.092	.466	.09	.305	.092	.466
Design 2:																		
A	200	3.0	Delay	1.174	.178	.209	.25	.079	.040	.459	.1875	.091	.040	.459	.09	.132	.040	.459
B	125	3.0	Delay	1.174	.178	.209	.25	.100	.050	.460	.1875	.116	.050	.460	.09	.168	.050	.460
C	125	3.0	Delay	1.174	.178	.209	.25	.100	.050	.460	.1875	.116	.050	.460	.09	.168	.050	.460
D	0	2.0	Delay	1.174	.178	.209	.25	-	-	-	.1875	-	-	-	.09	-	-	-
Design 3:																		
A	300	3.0	Delay	1.174	.178	.209	.25	.064	.032	.458	.1875	.074	.032	.458	.09	.108	.032	.458
B	100	3.0	Delay	1.174	.178	.209	.25	.112	.056	.461	.1875	.129	.056	.461	.09	.185	.056	.461
C	100	3.0	Delay	1.174	.178	.209	.25	.112	.056	.461	.1875	.129	.056	.461	.09	.185	.056	.461
D	100	2.0	Delay	1.174	.178	.209	.25	.129	.065	.462	.1875	.149	.065	.464	.09	.215	.065	.464

A: Two-way, multilane, divided
 B: Two-way, multilane, undivided
 C: Two-way, two-lane
 D: One way

S₁ = SD(p) = standard error of estimated regression coefficient
 S₂ = SD₁(y) = standard error of estimated ordinate
 S₃ = SD₂(y) = standard error of predicted value

The tabled value is the site sample size. The number of observations for cases A, B, and C is twice the number of sites (i.e., one observation in each direction at the site).

is about 24 percent. For Travel Time, the mean was about .75, so that the relative error of the estimated mean is about 16 percent. (Note, however, that for samples of size 50, these numbers increase to 37 percent and 12 percent, respectively.) These levels of precision are not very high, suggesting that the total sample size could well be increased beyond that considered feasible given the currently assumed budget levels. The levels of precision corresponding to larger sample sizes may be computed by multiplying the precision estimates in Table 7 by the factor

$$\sqrt{\frac{n \text{ old}}{n \text{ new}}}$$

where

n new = new sample size

n old = sample size used in Table 7 (Column 2).

If the sample sizes were doubled for example, the relative errors of 24 percent and 16 percent would decrease to $1/\sqrt{2}$ times these values, or 17 percent and 12 percent, respectively.

The effect of sample size on precision is illustrated in Figure 12 where it can be seen that the sample sizes proposed should yield errors in the general range of 15 percent. Increasing the sample size brings smaller and smaller increments of accuracy.

SITE SELECTION PROCEDURE

The selection of sites will be performed in several steps. The initial survey of each city will be for the purpose of identifying a number of candidate sites from which the final set of sites will be chosen. The candidates will then be screened to assure a representative set of sites for the study.

Local Agency Contact

The identification of candidate sites will begin with a visit to the traffic or transportation department in each city. The responsible local officials will be briefed

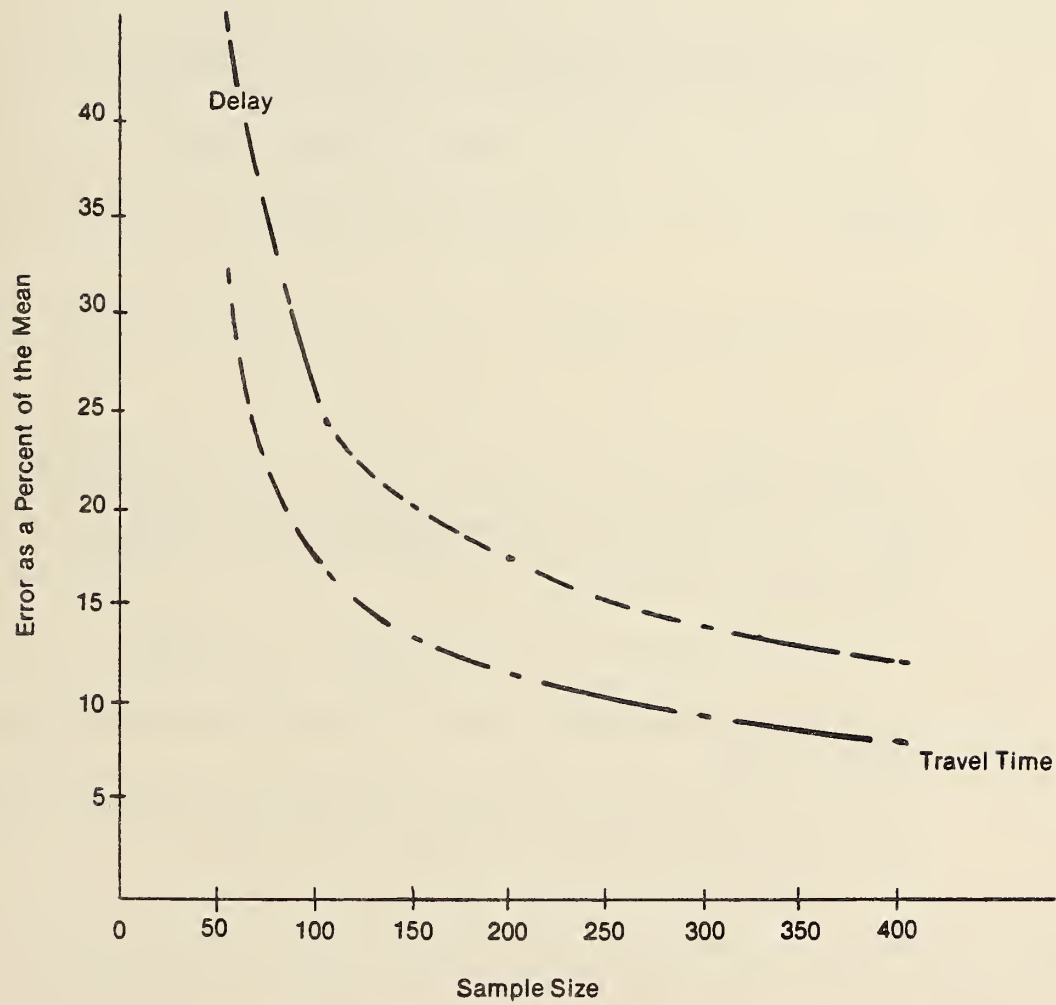

Figure 12. Relationship between error and sample size.

on the nature of the project and their cooperation and support will be solicited. In the larger metropolitan areas, contact will be made with the metropolitan planning organization (MPO) and with state, county and municipal organizations through the MPO and Federal Highway Administration staff.

The following items of information will be obtained if they are available.

1. A map of the arterial street system showing the number of lanes and the type of divider, if any, and the one-way streets
2. A map or tabulation of the average daily traffic volumes
3. A map or tabulation of the parking conditions on the arterial street system
4. A map showing bus routes and the approximate number of buses in the peak and mid-day periods
5. A map showing the land use in the metropolitan area
6. A map showing the location of traffic signals and a description of the types of traffic signals commonly employed, the extent of interconnection, and information on the requirements for opening the traffic signal control box for the purpose of observing and recording the traffic signal indications
7. A map showing the general extent of rolling and hilly areas
8. The approximate beginning and ending times of the morning and afternoon peak hours
9. Locations where lanes are reversed, turns prohibited and other operational measures are instituted during the peak hours

Additionally, during the initial visit to each city, representatives of the Federal Aviation Agency will be visited. During that visit the areas where photographing flights would be prohibited will be identified on a map of the metropolitan area. Any high crime areas where field survey crews might be exposed to personal danger or harassment will also be identified as will those streets which are expected to be under construction or major repair at the time of data collection. Thus areas to be excluded by reason of terrain, hazard and inability to fly photographic will be identified and excluded from the potential sites.

Select Sample of Subareas

Using the information obtained in the preceding steps, a map of urban area will be prepared showing those areas from which candidate sites can be selected. Because only 10 to 15 sites will be selected in any city, and because the number of potential sites is very large, it will be necessary to select a limited number of sites as candidates. This will be done by laying a numbered grid over the metropolitan area and selecting at random enough areas to provide approximately 100 arterial segments. Because the arterial segment will normally have closer spacing near the center of the area, the grid should be of variable size to assure that each area has roughly the same number of arterial segments. The next step is to rate the segments in the selected areas as described below.

Rating Segments for Sample Selection

The purpose of the ratings is to assure a reasonable coverage of possible conditions by the sample. The ratings will not be used in the correlation since actual dimensions for independent characteristics will then be known. Thus, the ratings are characterizations of the segments based on observation and judgement. Each segment will be rated for three time periods, morning and afternoon peak and midday. The definitions of what constitutes "high" or "low" are necessarily general and the rater will occasionally have trouble deciding which rating should be given to a particular segment. Clearly, some segments will fall between high or low since there is no clear unequivocal definition for the point which divides the two ratings.

Therefore, definitions have been written for both high and low; and the procedure to be followed where a segment falls between high and low is to alternately assign first to low then to high. With experience, the number of such cases should be very small.

Traffic Signal Impedance

- High —
- Spacing: Signals are spaced less than 1,000 feet (300m) apart.

- Coordination: Signals are not interconnected or are timed to provide progression in the opposite direction so that the particular segment is not likely to have good progression.
- Type: Signals are fixed time.
- Low —
 - Spacing: Spacing is adequate to permit progression.
 - Coordination: Signals are timed for progression or are part of an areawide system.
 - Type: Signals are actuated or part of an areawide real-time controlled system.

Intersection Impedance

- High — At least two of the following features are present:
 - Lanes and Width: Downstream intersection has narrow lanes 10 feet or less or no turning lanes, short radius curb returns or driveways near the stop line.
 - Pedestrians: Pedestrian activity is very heavy with the crosswalks full for all or most of each phase.
 - Parking: Parking is permitted on the intersection approach and the spaces in the approach are generally in use.
 - Turning Lane Control: Left and right turns are permitted.
- Low —
 - Lanes and Width: Lanes are wide, left-turn lanes are provided.
 - Parking: Parking is set back 100 feet (30m) or more from the stop line.
 - Pedestrians: Pedestrian volumes are light or moderate.
 - Turning Lane Control: Left turns are prohibited or are made from a left-turn lane. Right turns are light or are made from a right turn lane.

Traffic Volume Impedance

- High — Either of the following:
 - Volume: Flows average more than 400 vehicles per lane per hour during the time the intersection will be observed.

- Turning Movements: Turning movements are heavy, loaded cycles occur at least one-half the time.
- Low —
 - Volume: Flows average less than 400 vehicles per lane per hour.
 - Turning Movements: Turning movements are light to moderate with few loaded cycles.

Mid Link Impedance

- High — Either of the following:
 - Segment Demand: Frequent driveways or unsignalized intersections with moderate to heavy usage.
 - Parking: Parking permitted along the segment with high turnover.
- Low —
 - Segment Demand: Few driveways with light usage.
 - Parking: No parking

Bus Impedance

- High —
 - Number of Buses Stopping: More than 50 buses per hour if buses stop outside the travel lane. More than 20 buses per hour if buses block a lane while at bus stops.
- Low —
 - Number of Buses: Less than 50 or 20 buses as described above, or segments with no bus stops.

Heavy Vehicle Impedance

- High —
 - Truck Volume: More than 10 percent of total traffic is made up of trucks and buses. Trucks are defined as multi-unit or single units with dual-rear wheels.
- Low —
 - Truck Volume: Less than 10 percent of total traffic is heavy trucks and buses.

SEGMENT RATING SHEET

Metropolitan Area _____

City _____

Upstream Intersection _____

Downstream Intersection _____

One-Two Way _____ (Rate Reverse Section on Two-Way Streets)

Number of Lanes _____

Divided? _____

Parking Legal? Yes No

AM Peak
PM Peak
Mid-Day

Impedance	Rating					
	AM		MID		PM	
	High	Low	High	Low	High	Low
Traffic Sig. Imp.						
Intersection						
Traffic Volume						
Mid Link						
Bus						
Heavy Vehicle						

Figure 13. Segment rating sheet.

REVERSE SECTION RATING

Metropolitan Area _____

City _____

Upstream Intersection _____

Downstream Intersection _____

Number of Lanes _____

Divided? _____

Parking Legal? Yes No

AM Peak
PM Peak
Mid-Day

Impedance	Rating					
	AM		MID		PM	
	High	Low	High	Low	High	Low
Traffic Sign. Imp.						
Intersection						
Traffic Volume						
Mid Link						
Bus						
Heavy Vehicle						

Figure 14. Reverse segment rating sheet.

Selecting the Sample from the Candidate Sites

The candidate segments will be assigned to a matrix as shown in Figure 15. There will be one such matrix for each arterial type. A sample of the desired number of sites will be drawn from the candidates in accordance with the following general rules. First, the sample will contain at least one sample unit for every cell for which there is a candidate site. There are 64 cells in the matrix and the smallest sample is 50. If there are candidates in more than 50 cells, then the sample should be increased to include one sample from each cell.

Second, the total of all sample units in each row and each column should be as near the average as possible. With these two criteria in mind two examples of sample selection have been developed to illustrate the process.

Figure 16 shows a matrix with 500 candidate sites. It can be seen that the sample units in each cell vary widely with no candidates in 22 cells and as many as 60 in one cell. In the following sections two examples are given: one for a sample of 50, the other for a sample of 100. These are arbitrary numbers.

To select a sample of 50 out of 500 candidate sites, the process begins by assigning one sample unit to each cell in the matrix for which there is at least one candidate. This results in assignment of a total of 42 of the desired total of 500 units. The matrix is shown in Figure 17. Individual row and column totals range from three to eight. The number of samples available for the cells is indicated on their right hand corner when this number is between one and five. The next step is to assign the remaining eight sample units so that the difference between individual row totals and the differences among column totals is minimized. Figure 18 shows the matrix with all 50 sample units assigned and with differences between individual row and column totals minimized.

Drawing a sample of 100 from the same 500 candidates requires a similar approach. The same general principles of drawing at least one sample unit from every cell for which there are candidates and achieving a balance in the row and column totals is pursued.

Mid-Link Impedance		Bus Impedance		Heavy Vehicle Impedance		Traffic Signal Impedance													
						High				Low									
						Intersection Impedance				Traffic Volume Impedance									
						High	Low	High	Low	High	Low	High	Low						
High	Low	High	Low	H	L	H	L	H	L	H	L								
High	Low	High	Low	High	Low	L													
High	Low	High	Low	High	Low	H													
High	Low	High	Low	High	Low	L													
High	Low	High	Low	High	Low	H													
High	Low	High	Low	High	Low	L													
High	Low	High	Low	High	Low	H													
High	Low	High	Low	High	Low	L													
High	Low	High	Low	High	Low	H													

00 Number of candidate sites.

Figure 15. Matrix for selection of sites.

Mid-Link Impedance		Bus Impedance		Heavy Vehicle Impedance		Traffic Signal Impedance									
						High				Low					
						Intersection Impedance				Traffic Volume Impedance					
						High	Low	High	Low	High	Low	High	Low		
High	Low	High	Low	H	L	H	L	H	L	H	L				
High	Low	High	Low	High	Low	L	1	0	0	0	2	0	8	3	14
High	Low	High	Low	High	Low	H	50	5	10	3	40	1	10	10	129
High	Low	High	Low	High	Low	L	60	2	30	0	30	4	20	2	148
High	Low	High	Low	High	Low	H	20	0	20	1	40	8	20	0	109
High	Low	High	Low	High	Low	L	0	1	0	0	5	0	4	0	10
High	Low	High	Low	High	Low	H	0	9	8	0	10	0	5	5	37
High	Low	High	Low	High	Low	L	0	7	0	0	13	11	0	0	31
High	Low	High	Low	High	Low	H	3	0	5	7	2	4	0	1	22
							134	24	73	11	142	28	67	21	

00 Number of candidate sites.

Figure 16. Matrix showing number of candidate sites for each cell total candidate equals 500.

Mid-Link Impedance		Bus Impedance		Heavy Vehicle Impedance		Traffic Signal Impedance								
						High				Low				
						Intersection Impedance				Traffic Volume Impedance				
						High	Low	High	Low	High	Low	High	Low	
H	L	H	L	H	L	H	L	H	L					
Low	High	Low	High	L	H	1	0	0	0	2	0	1	3	4
						1	0	0	0	1	0	1	1	4
High	Low	High	Low	L	H	5	1	1	3	1	1	1	1	8
						1	1	1	1	1	1	1	1	8
High	High	Low	High	L	H	2	1	0	1	4	1	2	1	7
						1	1	1	0	1	1	1	1	7
Low	High	Low	High	L	H	1	0	1	1	1	1	1	0	6
						1	0	1	1	1	1	1	0	6
High	Low	High	Low	L	H	1	1	0	0	5	0	4	0	3
						0	1	0	0	1	0	1	0	3
Low	High	Low	High	L	H	0	1	1	0	1	0	5	5	5
						0	1	1	0	1	0	1	1	5
High	Low	High	Low	L	H	0	1	0	0	1	1	0	0	3
						0	1	0	0	1	1	0	0	3
Low	High	Low	High	L	H	3	0	1	1	2	4	1	1	6
						1	0	1	1	1	1	0	1	6
						5	5	5	3	8	5	6	5	

00 Number of candidate sites assigned.

0 Number of candidates available in cells with few candidates.

Figure 17. Matrix with one sample unit in each cell for which there are samples available.

Mid-Link Impedance		Bus Impedance		Heavy Vehicle Impedance		Traffic Signal Impedance								
						High				Low				
						Intersection Impedance				Traffic Volume Impedance				
						High	Low	High	Low	High	Low	High	Low	
H	L	H	L	H	L	H	L	H	L					
Low	High	Low	High	L	H	1	0	0	0	1	0	1	2	5
						1	1	1	1	1	1	1	1	8
High	Low	High	Low	L	H	1	1	1	0	1	1	1	1	7
						1	0	1	1	1	1	1	0	6
Low	High	Low	High	L	H	0	1	0	0	1	0	3	0	5
						0	1	2	0	1	0	1	1	6
High	Low	High	Low	L	H	0	3	0	0	1	1	0	0	5
						1	0	1	3	1	1	0	1	8
						5	7	6	5	8	5	8	6	

00 Number of candidate sites.

00 Number of candidate sites assigned.

0 Number of candidates available in cells with few candidates.

Figure 18 Matrix with fifty sample units assigned.

First, one sample unit is assigned to each cell where there is only one candidate. Figure 19 shows the matrix with all zeros and ones. The desired individual row and column total is 12.5 ($50 \div 8$) in this case. Then, the next step is to identify those rows and columns in the candidate site matrix (Figure 16) whose totals are below or near the desired total. The samples in those rows and columns are then made equal to the number of candidates and fixed. These fixed rows and columns plus the fixed zeros and ones are shown in Figure 20. Then the rest of the candidate sites are assigned so as to minimize the differences between the individual row and column totals. This is shown in Figure 21.

Smaller Urban Areas

A sample of intersections will be selected in smaller urban areas for the purpose of collecting data which can be used in the analysis of capacity and quality of flow at intersections in these urban areas. Data collection in the smaller cities will be limited to intersections for the following reasons. First, it is expected that sites suitable for data collection by photography from high level fixed cameras would be difficult to locate. Second, the availability of helicopters in the smaller cities is doubtful. Third, most of the stops and delays will occur at intersections.

Additionally, it seems possible that conditions on arterials in smaller cities are distinctly different from those in larger cities. If this is the case then a sample of segments equal in size to the large city sample would be required to provide reasonable accuracy for the small cities. By eliminating data collection on segments and concentrating data collection at intersections, a sample of reasonable size can be obtained which will permit the development of models for quality of flow through intersections in smaller cities. This will be a significant increase in knowledge about such intersections.

The population ranges involved are 25,000 to 50,000 and 50,000 to 100,000. Four cities in each population range will be selected at random and the intersections will be selected by a modification of the procedure used to select the sample of segments in the larger urban areas. The modification is required because only intersection counts are to be obtained. Accordingly, there will not be a segment

		Mid-Link Impedance		Bus Impedance		Heavy Vehicle Impedance		Traffic Signal Impedance			
								High		Low	
								Intersection Impedance			
								High	Low	High	Low
High		Low		High		Low		Traffic Volume Impedance			
								H	L	H	L
Low	High	L	1	0	0	0		0			
		H						1			
		L				0					
		H		0		1					0
	Low	L	0	1	0	0		0		0	
		H	0			0		0			
		L	0		0	0				0	0
		H		0						0	1

- 00 Number of candidate sites.
- 00 Number of candidate sites assigned.
- 0 Number of candidates available in cells with few candidates.

Figure 19. Matrix with all zeros and ones.

		Mid-Link Impedance		Bus Impedance		Heavy Vehicle Impedance		Traffic Signal Impedance			
								High		Low	
								Intersection Impedance			
								High	Low	High	Low
High		Low		High		Low		Traffic Volume Impedance			
								H	L	H	L
Low	High	L	1	0	0	0	2	0	8	3	14
		H		5		3		1			4
		L		2		0		4		2	0
		H		0		1				0	1
	Low	L	0	1	0	0	5	0	4	0	10
		H	0			0		0	5	5	0
		L	0		0	0			0	0	0
		H	3	0	5	7	2	4	0	1	8
			1	1	0	11	7	1	12	4	

- 00 Number of candidate sites assigned.
- 0 Number of candidates available in cells with few candidates.

Figure 20. Matrix sample units in rows and columns with totals below or near desired total.

Mid-Link Impedance		Bus Impedance		Heavy Vehicle Impedance		Traffic Signal Impedance									
						High				Low					
High		Low		High		Low		Intersection Impedance							
								High		Low		High		Low	
Low		High		Low		High		Low		Traffic Volume Impedance					
										H	L	H	L	H	L
High	Low	High	Low	High	Low	J	1	0	0	0	2	0	6	3	12
						H	2	2	1	3	1	1	1	2	13
Low	High	High	Low	High	Low	J	3	1	3	0	1	2	1	2	13
						H	4	0	1	1	1	4	1	0	12
Low	High	High	Low	High	Low	J	0	1	0	0	5	0	4	0	10
						H	0	3	5	0	1	0	1	4	5
Low	High	High	Low	High	Low	L	0	7	0	0	1	4	0	0	12
						H	3	2	0	2	5	7	1	1	4

- 00 Number of candidate sites assigned.
- 0 Number of candidates available in cells with few candidates.

Figure 21. Sample of 100 units.

to identify as in the case of the larger urban areas. Additionally, it is desired to have the sample include intersection approaches of the four types of arterials:

- Divided multi-lane, two way
- Undivided multi-lane, two way
- Two lane, two way
- One way

At the same time, it is desired to limit the cost of data collection by counting all approaches at any intersection which is included in the sample. Finally, it is desirable to have at least one fourth of the sample of the approaches operating under peak-hour conditions.

With these objectives in mind, the procedure involves selecting intersections with at least one approach being of the desired arterial type and to collect data on all approaches during the peak hour for that approach.

The site selection process will involve selecting subareas from each of eight small urban areas, then selecting a candidate list of 20 intersection approaches of each type and drawing a sample of ten for each arterial type at random from the candidate list for each of the cities.

This will yield a total of 80 intersections and approximately 300 approaches for data collection.

CHAPTER V
DATA COLLECTION: BASIC STUDY

There are two units for which measurements will be obtained. One is a segment of an arterial street, the other is an intersection approach. For data collection purposes, a segment is defined as the one-way portion of a street between two signalized intersections with no intervening traffic signals. It includes the downstream intersection, but does not include the upstream one. Figure 22 shows how a segment is defined on a typical two-way street, while Figure 23 shows a segment for a typical one-way street. Characteristics of the segments to be included in the sample are.

1. Both the upstream and downstream intersections will be simple four-legged intersections crossing no more than 10 degrees off right angles.
2. The segment will be essentially level and essentially straight with no more than 1 percent grade and curvature shall be such that a driver can clearly see the downstream intersection from the upstream intersection.
3. The roadway surface will be reasonably smooth and free of any construction or maintenance activity.
4. The segment will be of reasonably uniform width throughout except that the downstream intersection may be wider than the segment due to channelization or added lanes.
5. The median treatment will be uniform throughout the segment except that the treatment may be modified at the downstream intersection.

These segments will be located in 22 large urbanized areas selected at random from United States urban areas in five population ranges. There will be an average of about 18 sites in each urban area yielding 400 sites. Because 300 of the sites will be on two-way streets, and because each direction represents one segment there will be a total of 700 segments for which complete information will be obtained. An additional sample of intersections from urban areas with populations less than 100,000 will be selected for intersection analysis only.

The information to be obtained covers over 30 items describing independent characteristics which are importantly related to one or more of the MOE's. These

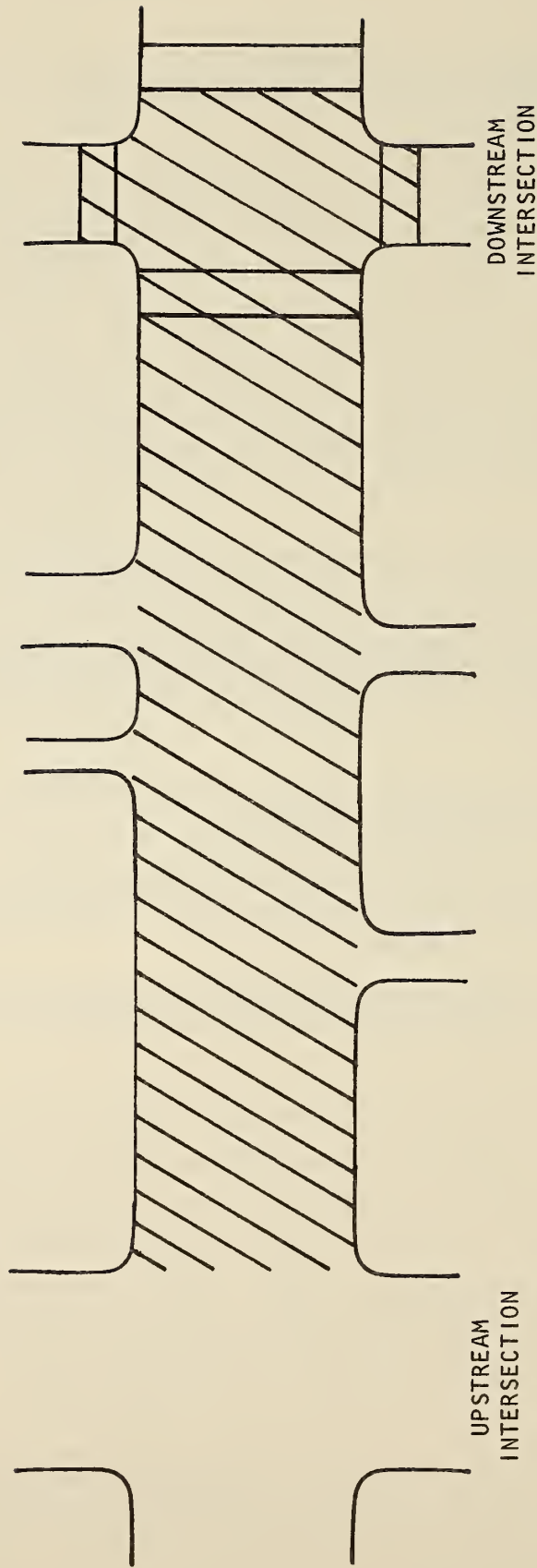

Figure 22. One-way street.

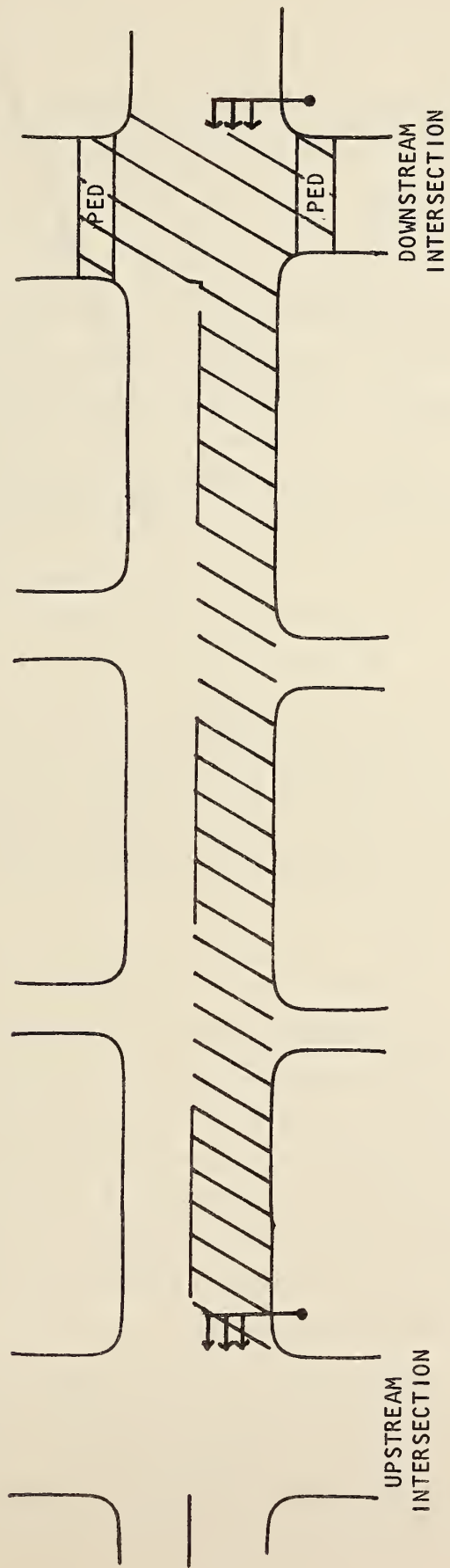

Figure 23. Two-way street.

characteristics and the MOEs are listed in Tables 2 and 3 for the downstream intersection and the segment, respectively in Chapter III.

DATA COLLECTION METHODS

Collection of data in the field will take one of two forms. Data will either be collected by time-lapse photography or by manual methods. There are two alternatives for time-lapse photography. In the first, the camera will be mounted in a helicopter and aerial photography will be used. In the second case, cameras will be mounted on high level vantage points (buildings, utility poles, street light standards, etc.). Each of these three methods are available for use where they are effective.

Aerial Photography

Positioning the helicopter above the site depends on a number of factors including length of the segment, the arrangement of surrounding buildings, and the ability of the cameraman to keep the entire segment in view. A high oblique angle is preferred because it allows the pilot greater freedom in position-holding than does a vertical shot.

The precise angle of the camera will vary with the height, with position of the helicopter relative to the end of the segment, and with the length of the segment being photographed. Desirable elevations are between 1,500 and 2,000 feet.¹ With such elevations, the angle will fall between 30 and 45 degrees from vertical. The preferred angle is about 30 degrees which allows the cameraman about 15 degrees of tilt to compensate for movement of the helicopter and also would not result in masking of the intersection from buildings, other than very tall buildings. Since the method is best suited to locations with low buildings set back from the street, this is not regarded as a serious shortcoming.

The cameraman should select the best position and elevation which will permit him to keep the segment in view by panning and tilting the camera with some rotation, and lateral and elevation changes of the aircraft position.

¹450 and 600m

As soon as the position has been selected, the ground crew should be alerted to stand by for a time of beginning of the filming. Observation of the signal timing can be commenced well before the filming begins and should continue for several minutes after the filming is completed. Coordination of the film with the signal observations can be achieved with electronic watches and time-of-day entries. If the pilot is unable to hold position long enough to complete the 15 minutes of filming, the ground crew supervisor should be advised to stand by for a second time coordination when the aircraft is back in position for a second filming run.

Camera mounting in the helicopter with the high oblique position can be achieved in a variety of ways. The simplest would be a tripod mounted to a false floor panel which can be attached to the permanent floor of the aircraft. With the door removed and the camera positioned in the door frame, the cameraman can keep the camera aimed at the segment through a fairly large range of positions and modest rotation of the craft. The cameraman and pilot are in voice communication and thus can jointly select their position and define the limits of the position from which the segment can be kept in view. Mounting the camera outside the aircraft would provide a greater tilting angle for the camera but may introduce a requirement for Federal Aviation Administration inspection prior to flight and introduces a possible hazard for both the camera and the cameraman. It also makes in-flight adjustments, including changing lenses or film, somewhat less convenient.

Film Rate — The number of frames per second, or exposure rate, is essentially a function of the speed of vehicles on the segment and film cost. For any given exposure rate the speed of the vehicles will determine how far a vehicle will move between successive frames and this impinges on the accuracy and on the comfort of the data reduction staff. Most of the data to be taken from the film does not require a frame-by-frame analysis. However, it does require determining where a vehicle came from or went to and whether it is moving or stopped. Thus a film rate which is so slow that a turning vehicle could disappear between frames would be unsatisfactory for counting turning movements and movements into, and out of, driveways.

Film costs, including processing, are about \$0.80 per foot (\$2.60 per meter) for 35mm film. Thus high rates of exposure introduce cost considerations which need to

be taken into account and the slowest rate which will result in acceptable accuracy and ease of data reduction is the rate which should be used.

Assuming an exposure rate of one frame per second, a vehicle moving at 25 to 30 mph would travel about 40 feet between frames. That amount of movement is not great enough to cause errors in data reduction. However at vehicle speeds of 40 to 45 mph, the distance traveled would be about 60 feet and at that point some confusion could be introduced, particularly where a vehicle could turn or continue straight, about the maneuver which was actually made. As a practical matter then, a film rate of one frame per second should be used where speeds are less than 40 mph, and a rate of two frames per second should be used where speeds are likely to be more than 40 mph.¹

Comparative Film Cost — The photography costs associated with recording events at a site were compared for 16mm and 35mm motion picture formats and 35mm slide format. This cost is a function of the cost of purchasing and developing the film, and the amount of film that is required.

Since a permanent record of the events at each site is desired, the costs used are associated with an original and one print. This has been done because the repeated use of film in a projector and the frequent reversal of film direction (which is required when tracing the paths of a series of vehicles) will put scratches on the film and tear the film sprocket holes. Using prints in the projector and saving the original will ensure that a picture of high quality is always available.

Calls to several film development laboratories in the Washington, D.C. area and price lists published by the Eastman Kodak Company produced estimates of film purchase and development costs that averaged 40 cents per foot for 16mm film and 80 cents per foot for 35mm film. This estimate includes the cost of the original film, the development of the original, and the costs of producing one copy.

The second factor required to determine the film cost is the number of feet of film that are required. This is a function of the size of the individual frames of film and the number of frames that are required. The number of frames per foot of film in 16mm and 35mm motion picture format and 35mm slide format are 40,

¹
1 mph = 1.609 km/h
1 foot = 0.3048m

16, and 8 respectively. Thus, to record as many frames as contained in 1 foot of 16mm film requires 2 1/2 feet of 35mm film in the motion picture format and 5 feet of film in the 35mm slide format.¹

Combining the frame and cost data in terms of the ratios of frames per foot and cost per foot, as shown in Table 5, is illuminating. The 35mm motion picture format requires 2 1/2 times as much film and is twice as expensive on a per foot basis as the 16mm motion picture format. Although the 35mm slide format is, again, twice as expensive per foot, it requires 5 times as much film as the 16mm motion picture format. Overall, assuming the 16 mm costs as a base cost, the 35mm motion pictures are five times this base cost, and the 35mm slide format is ten times the base costs.

Table 8. Comparison of film formats.

<u>Film Format</u>	<u>Frames Per Foot¹</u>	<u>Ratio Frames/Ft.¹</u>	<u>Cost Factor</u>	<u>Total Cost Per Site Factor</u>
16mm (motion picture)	40	1	1	1
35mm (motion picture)	16	2.5	2	5
35mm slide	8	5	2	10

Using a film rate of one frame per second and a 15-minute data collection period, the cost of 16mm film would be about \$9.00 per site while the cost of a 35mm motion picture format would be \$45.00. Assuming that there are 400 sites to be photographed and that had filming runs, unusable film fragments and other problems would result in the use of 50 percent more film than the net amount needed the total cost for 16mm would be about \$5,400 and for the 35mm would be about \$27,000.

The difference of about \$21,000 has to be weighed against the greater potential quality of the larger frame size. Considering that the film will be a valuable resource for detailed studies well beyond Phase II, it is recommended that a 35mm motion picture format be used for the aerial photography. The figure of \$27,000 has been used in the cost estimate for Phase II data collection. The 35mm camera has also been specified in the functional requirements which follow.

¹ 1 foot = 0.3048m

Functional Requirements for the Aerial Time-Lapse Camera System — The time-lapse system used for aerial photography in Phase II of the "Quality of Traffic Flow in Urban Arterials" should meet or exceed the following characteristics:

1. Exposure frequency — 1 frame per second
2. Film size — 35mm
3. Shutter speed — 1/450 second
4. Light meter — automatic
5. Film capacity acceptance — 250' (76.2m)
6. Film packaging — metal spool for "daylight loading"
7. Film triggering — remote via intervalometer
8. Intervalometer accuracy — 0.125%
9. Film type — color
10. Power source — batteries or compatability with standard helicopter voltages

High Level Photography

The first step in this method is the selection of locations to mount the cameras. The locations should be such that traffic counts can be obtained for all intersection approaches. Also, one or more cameras must be positioned to cover the entire length of the segment so that mid-segment activities can be observed on the film. Finally, a single camera must be positioned so that the vehicles entering the segment from the upstream intersection can be observed for the purpose of recording travel times.

Smaller cameras can be employed for this purpose. Super-8 cameras with accurate intervalometers are required. Timing coordination can be maintained for the beginning and end of recording by means of digital watches.

Manual Methods

All of the required data can be collected by manual methods using data collection forms and simple equipment, such as stop watches and mechanical counters on clipboards. The instructions for this type of data collection are described in Appendix A.

With manual methods, the size of the ground crew will vary with conditions. A minimum of seven and probable maximum of 16 would be required to man each site.

Considerations for the Use of Each Method

Because of the large number of measurements required, manual methods can require a very large number of personnel in some situations. This is particularly true on long segments with frequent intersections and driveways. Thus, manual methods could best be employed for data collection in the smaller urban areas.

High level photography will usually require three cameras for data collection on segments and suitable location for mounting the cameras may be difficult if not impossible to find. On the other hand, this method is relatively low in cost and has the advantage over manual methods of creating a permanent record from which data can be reduced in relatively controlled conditions.

Aerial photography is the most expensive method but it has several advantages. First, it requires a small, though highly skilled ground crew. Second, it does not require extensive searching for camera mounting locations. Third, like high level photography, it captures all activities on a single permanent record from which data can be reduced under controlled conditions.

On the other hand, the method requires that the helicopter remain reasonably stationary for 15 minutes and it is occasionally necessary to abort a filming run. Also inclement weather can cause delays and repeated filming runs. These features are part of the higher cost, although even with no lost time the method is the most expensive.

As might be expected, crew size is different for each method. With aerial photography, a cameraman and one man on the ground are required. The data to be collected on the ground consists of the traffic signal timing and observation of the pedestrian activity.

With high level photography, a three-man crew is required to monitor and mount cameras.

Field Testing Data Collection Methods

The methods described in this chapter and in Appendix A should be tested and revised as necessary at the conclusion of data collection in the first urban area.

The methods were tested in Phase I to the point of observing conditions and recording observations. It is expected that they can be improved upon with field experience.

DATA COLLECTION SCHEDULE

Data collection for the basic study consists of the five major activities enumerated earlier:

1. Mobilize and plan
2. Select candidate sites
3. Select specific sample of sites for data collection
4. Field data collection
5. Field data reduction

Mobilize and Plan

This activity consists of selecting the sample cities and training and scheduling the crews to compile the list of candidate sites. The total time for selecting the cities and scheduling the crews is estimated to require one calendar month.

Select Candidate Sites

It is further estimated that one week per city would be required to compile the list of candidate sites. This, however, is net time assuming that the field staff would go directly from city to city. Since such intensive travel is not usually possible and because it would not permit review and quality control, the net time has been expanded by 50 percent to allow two weeks of travel, then a one-week break.

Such a cycle is reasonable and results in a total block of time of 30 plus 15, or 45 weeks. This total amount of time can be collapsed by the assignment of more than one field crew.

Select Specific Sample of Sites for Data Collection

This activity cannot be performed until the complete list of candidate sites has been compiled for a given group of cities. If the schedule of the preceding tasks can be arranged so that all cities in each population range can be completed, the preceding activity can be overlapped with this activity.

Because the schedule for compiling the list of candidates will logically attempt to optimize travel time, the schedule should not be based on the assumption that any overlap can be achieved.

It is estimated that the sample selection will require one calendar month and that this time cannot be reduced by increasing the staff or by overlap.

Field Data Collection

It is estimated that field data collection in each of the 30 urban areas will require one week. Delays due to inclement weather and any number of unforeseeable occurrences, plus allowance for travel breaks, will increase the total time appreciably. To estimate the amount of that increase it was assumed that a three-week cycle (two in the field, one in the office), as in the case of the candidate site activity, would be practical and would allow the time to monitor the work of the data collection supervisors and correction of tendencies to depart from quality standards.

The additional time lost due to weather and contingencies is harder to estimate. If scheduling is done in light of long-range weather forecasts and if the alternate cities are scheduled, this time might be controllable. Even so, some time must be allowed and it has been assumed that one week of data collection would be lost for each four which are scheduled.

Thus the total time, assuming one field crew, would be 30 plus 15 plus 8 for a total of 53 weeks.

Field Data Reduction

This activity not only can, but should, be overlapped with data collection. This would allow the editing of field forms and prompt action to correct any tendencies to improperly record the data. Data reduction requires less time than data collection but the total calendar time is the same as that for data collection plus one additional week with a one-week offset.

Summary of Gross Schedule

The gross times allocated for the five major activities are summarized in Table 6. Also shown are the estimated times assuming different numbers of field crews and the overlapping of data collection and data reduction. Field crew sizes vary with the activity being performed and the data collection method. Crew sizes are shown in Table 9 for aerial photography. As many as 16 people might be required at some sites and as few as 7 at others with manual methods.

Table 9. Schedule times for six major data collection activities.

	Crew Size	Time in Weeks			
		One Crew	Two Crews	Three Crews	Four Crews
Mobilize and Plan		4	4	4	4
Select Candidate Sites	2	45	22	19	10
Select Sample Sites		4	4	4	4
Collect Data	2	53	26	19	12
Reduce Data*	3	<u>54</u>	<u>27</u>	<u>20</u>	<u>13</u>
Total With Overlaps**		108	58	48	32

* Begins one week after data collection; ends two weeks after data collection

** Assumes aerial photography, sizes vary with method used

These times do not include any allowance for review of the work by FHWA.

The use of several crews is obviously called for to complete the work within a reasonable time span. The most critical time involved is the selection of the candidate sites which requires 10 weeks with four crews, each responsible for seven or eight cities.

The 19 week data collection period with three crews seems appropriate in light of the desire to complete that work during a season of the year when good weather can be expected. The 50 percent contingency time has been distributed evenly over the four crews and that may be unreasonable in light of variation in weather between the different regions of the country. Thus, crews operating in the northern regions may experience more than average delay. For these reasons, the project should be extended to allow for such a contingency.

Another factor in crew size determination is the number of cameras which can be employed and their cost.

CHAPTER VI ANALYSIS PLAN

This section summarizes the major aspects of the plan for analysis of the collected data.

The principal features of the analysis plan are the following:

- Development of factors (composite variables) from the 40 independent variables
- Development of a composite MOE from the four individual MOE's of Travel Time, Travel Time Variance, Intersection Stops, and Intersection Delay
- Development of regression models to describe the relationship of the MOE's to the independent variables and factors
- Development of tables to represent the most important features of the regression models
- Inclusion of results of the special studies in the models
- Supplementing analysis based on field data with analysis based on simulation models to investigate relationships not covered by the field survey
- Development of techniques for presentation of standard errors of estimates

Each of the preceding is described in brief detail in the paragraphs that follow.

DEVELOPMENT OF FACTORS FROM INDEPENDENT VARIABLES

It is clear from a review of the independent variables that they are intercorrelated, i.e., many of them reflect similar aspects of arterial performance. In the development of parametric models from data involving many variables, it is usually very helpful to reduce a large set of correlated variables to a smaller set of composite variables or factors.

There are basically two procedures for developing a set of factor variables from a larger set--experienced judgment based on knowledge of the physical process under study, and the statistical technique of factor analysis (combined with judgment). Both procedures represent attempts to replace a large set of redundant variables by a smaller set which is closer in number to the "dimensionality" of the process under study.

In the sample design stage of Phase I, there is little data available to use statistical procedures such as factor analysis to reduce the variables to factors, so the latter route (judgment) was adopted to define a set of six "impedances" which reflect much of the dimensionality of the original set of variables.

The use of composite variables often makes the presentation of results much easier (since fewer variables are required to present the results), and so they will likely be used in the display of the results of Phase II. To this end, the definition of the composite variables must be reexamined when the data become available to determine whether a better set is available (a "better" set is less intercorrelated or spans the vector space defined by the original variables to a greater extent).

DEVELOPMENT OF COMPOSITE MOE

The four quality of flow MOE's (Travel Time, Travel Time Variance, Intersection Stops, Stops and Intersection Delay) appear to reflect most of the dimensionality of the "performance space" of an urban arterial. It may be, however, that some users will want to deal with a single MOE that reflects the overall arterial level of service (LOS) rather than with four MOE's.

It is proposed to use a panel approach to define a single LOS MOE from the four separate MOE's. This procedure can be implemented virtually independent of the nature of the sample design and data collection. No problems arise with regard to the problem of determining the LOS MOE as a function of the independent variables as long as the LOS MOE can be quantified in terms of the other MOE's (for which data are collected in the field). Analysis of the data from other studies show that the four MOE's are highly interrelated. Thus it might be possible to reduce the number of MOE's or to use one MOE for most cases since it would approximate any composite values.

DEVELOPMENT OF REGRESSION MODELS

The statistical technique of multiple regression analysis will be used for most of the data analysis to determine the relationship of the MOE's to the independent variables or factors. It is well-known that the inexperienced application of regression analysis to data sets having large numbers of variables can easily produce nonsense results. To avoid these problems, it is emphasized that the analysis must be accomplished by technical staff with heavy experience in both the technique of regression analysis and traffic system analysis.

Most difficulties in regression analysis occur because of intercorrelations between the independent variables. If composite factors which are must less intercorrelated can be found, these problems will be largely avoided.

Another difficulty that often arises with the application of regression analysis to develop a model of a complex process is that, unless the technique is skillfully applied, the models become very cumbersome, with many "interaction" terms. These difficulties are avoided by the specification of separate regression models for situations (levels of certain variables) that are substantially different with respect to the relativity between the MOE and the explanatory variables. The sample design has been structured to allow the development of separate models for the most salient such situations.

When empirical models are being developed, there is a substantial danger that biased estimates of relationships may result if the probabilities of selection of the study population are not taken into account. (This may happen because the theoretical model is misspecified, and the model "error terms" may be correlated with the probability of selection.) It will be possible to avoid these bias problems through the use of "weighted" regression analysis, where the weights are the reciprocals of the sample unit selection probabilities.

It is noted that proposed survey design--based on cluster sampling, stratification, and controlled selection--is very complex. The formulas for computing good estimates of various parameters of interest will be complicated. In order to compute

estimates of variance, the use of pseudoreplication techniques would be the best procedure to use from a theoretical viewpoint.

In view of the large amount of data analysis to be conducted, it is recommended, however, that (at least initially) a standard regression analysis computer program be used to determine the relationships between the MOE's and the explanatory variables. A program that allows for the incorporation of the sample weights into the analysis should be used. To account for the impact of the intracluster correlation coefficient on variances of estimates, either pseudoreplication or very conservative "effective" sample sizes should be used in testing the significance of regression coefficients (such as the city sample size or the number of geographically distant sample sites, rather than the total number of sample sites).

It is recommended that theoretically meaningful models be specified rather than use a "stepwise" regression program to "find" a model and the regression program used to estimate the parameters of those models.

There are several relationships which need to be refined through special studies and simulation. These include the effects of grade and of parking setbacks from special studies and the effects of parking along a segment and of bus impedance from simulation. These need to be combined with the results of the regression analysis.

The number of models to be developed is very large. First, there are four sets of information which are:

- For large urban areas
 - Arterial segments
 - Downstream intersections
 - Side street approaches to the downstream intersections

- For smaller urban areas
 - Intersection approaches

Second, there are four basic urban arterial types and models which must be developed for each type. Third, there are five MOE's plus capacity and separate models will be required for each MOE for each arterial type.

Following are the basic steps to be followed in the analysis:

1. Develop models for intersection stops and delay for each of the four arterial types using the data from the downstream intersections.
2. Develop models for travel time and travel time variance for the segments for each of the four arterial types.
3. Develop models for intersection stops and delays for each of the four arterial types using data from "side-street" approaches of the downstream intersections.
4. Combine the data used in 1 and 3 above and develop models.
5. Develop models for intersection stops and delay for each of the four arterial types using data from the "smaller urban areas."
6. Compare models developed in 4 and 5 above, and determine whether the data should be combined for a single set of models for all urban area sizes.
7. Develop tables and/or curves for use in predicting MOE's from known values for the independent variables.
8. Identify the areas in the tables or on the curves where the reliability of results is questionable and determine whether simulation can be used to improve the reliability of the estimate. Specify the simulation to be performed.
9. Develop models for predicting point capacity from the independent characteristics beginning with the intersection data from the larger areas. Two alternative methods will be employed for the capacity analysis. One will use regression analysis to develop capacity from the independent variables. The other will use the critical lane analysis. For this, the discharge headways and gap acceptance characteristics will be analyzed.
10. Modify models to incorporate the effects of grades and heavy vehicles from the special studies.
11. Modify models to reflect the effects of parking.

CHAPTER VII
SPECIAL STUDIES AND SIMULATION

EFFECT OF GRADES AND TRUCKS ON MAXIMUM INTERSECTION DISCHARGE
VOLUME RATES

Research Objectives

Determine the combined effects of intersection approach grade and proportion of heavy vehicles (trucks and through buses) on maximum intersection discharge volume rates. Determine these effects for intersection approach lanes which are for through traffic only as lanes which serve through and turning traffic but are not subject to conflict with opposing traffic or pedestrians.

The desired product is a set of tables of adjustment factors for maximum discharge time headways (saturation headways) and start of green lost times, given varying values of truck percent and percent grade. The user can in turn use adjusted values of maximum discharge headways and lost times to compute maximum discharge volumes per hour.

Separate tables of adjustment factors will be determined for lane types A, B, and C to determine whether the grade and truck effects differ for the three different lane types.

The user may also utilize the results to determine the effects on total intersection stops and delays if the volume and pattern of traffic arrivals on the intersection approach lanes and signal timing are known.

Hypotheses

1. Maximum intersection discharge volume rates are dependent on truck percentage. Higher truck percentages cause lower discharge rates.
2. Maximum intersection discharge rates are dependent on intersection approach grades. Upgrades will cause lower discharge rates and downgrades will cause higher discharge rates.
3. There is an interaction between the effects of trucks and grades on intersection discharge rates. On upgrades, in particular, trucks discharge headways are more strongly affected by grade than are automobile discharge headways.

4. The effect of trucks and grades may be greater on lanes with turning traffic, because of speed change and tracking maneuvers necessary during turning than on lanes with through traffic only

Definitions

Maximum intersection discharge volume rates (or minimum saturation flow headways) are generally reached after the first four vehicles in a single lane queue have been discharged after the onset of the green signal. The saturation flow headways can be determined by averaging the headways of the fifth and succeeding vehicles which are discharged while there is a sustained demand for service (i.e., until the queue is dissipated).

Lost time is the extra time required for discharging the initial vehicles in the queue (over and above the time required if these vehicles discharged at maximum rates, i.e., at saturation flow headways), due to driver perception and reaction time and the startup acceleration wave. Lost time, L , can be computed as:

$$L = t_4 - 4\bar{h}$$

where:

t_4 = the time from onset of green until the 4th vehicle crosses the intersection discharge boundary, sec.

\bar{h} = the average saturation flow headway for the lane, sec., i.e., the saturated headways for the 5th and succeeding vehicles

Measurement and Analysis Approach

The percent of trucks cannot be controlled in the field studies. Therefore, a microscopic approach is proposed for measuring truck effects which form the bases for synthesizing any desired level of truck percent and computing the resultant effects on saturation flow headways and lost times.

Measurements will be made at selected intersection sites having a variety of grades, and regression relationships will be determined between headways and percent grade so that the effects for any selected grade within the domain of the regression data can be estimated.

Sites will be selected with varying grades. For each data set, measure the following:

t = time from green onset to passage of 4th vehicle

For each measurement of t , record the number of trucks that were included in the first four vehicles. Classify the data into three sets:

t_0 , no trucks in the first 4 vehicles

t_1 , one truck in the first 4 vehicles

t_{2+} , two or more trucks in the first 4 vehicles

Note that measurements with 2, 3, or 4 heavy trucks are grouped into one class because the occurrence of three or more such vehicles in the first group of four vehicles is very infrequent. For example, with 20 percent trucks in the lane, the probability of 3 or more trucks among the first 4 vehicles is only 0.03 (i.e., less than 3 percent of the time). In this case, the probability of exactly 2 trucks is 0.15. Even with 30 percent trucks in the lane, the probability of 3 or more trucks among the first 4 vehicles is 0.08, while the probability of exactly 2 trucks is 0.26.

Also measure:

h = time headway of individual vehicles beginning with the fifth vehicle of discharge after green onset and continuing until the queue is dissipated

For each individual headway record, the composition by vehicle type of the lead vehicle/subject vehicle sequence. Classify the data into 4 sets:

h_{aa} , lead vehicle auto, subject vehicle auto

h_{at} , lead vehicle auto, subject vehicle truck

h_{ta} , lead vehicle truck, subject vehicle auto

h_{tt} , lead vehicle truck, subject vehicle truck

From the total sample of observations, compute the mean values of the 7 variables measured, namely:

- \bar{t}_0
- \bar{t}_1

- \bar{t}_{2+}
- \bar{h}_{aa}
- \bar{h}_{at}
- \bar{h}_{ta}
- \bar{h}_{tt}

Combine data from different intersection approaches with varying grades to perform regression analyses to estimate each of the 7 variables as a function of grade. For example, in the case of linear regression:

$$\begin{aligned} \hat{t}_0 &= a_0 + b_0g \\ \hat{t}_1 &= a_1 + b_0g \\ \hat{t}_{2+} &= a_{2+} + b_{2+}g \\ \hat{h}_{aa} &= a_{aa} + b_{aa}g \\ \hat{h}_{at} &= a_{at} + b_{at}g \\ \hat{h}_{ta} &= a_{ta} + b_{ta}g \\ \hat{h}_{tt} &= a_{tt} + b_{tt}g \end{aligned}$$

where:

- g = percent grade (up+, down-)
- a = the estimate of the variable for $g = 0$
- b = the regression coefficient, i.e., the slope of the regression line

It may well be that relationships appear to be non-linear. If so, curvilinear regression analyses should be performed to estimate the form of (for example):

$$\hat{t}_0 = a_0 + b_{00}g + c_{00}g^2$$

and tests made to determine whether the second order coefficient, c_{00} , is statistically significant.

Once the regression equations for the 7 variables are determined, it is then possible to estimate the mean value of each variable for any selected value of grade. Make these regression estimate calculations at increments of 2 percent grade throughout the range of data; for example, compute the values for:

$$g = -12, -10, -8, -6, -4, -2, +2, +4, +6, +8, +10, +12$$

$$| \quad | \quad | \quad , \quad | \quad | \quad |$$

The next step is to synthesize estimates of saturation flow and lost time for any desired percent of trucks.

First, considering the first four vehicles to discharge, if we specify proportion of trucks, P_T , we can make direct calculations using binomial equations of the probabilities that zero, one, or two or more trucks are included, as follows:

$$P_0 = (1-P_T)^4$$

$$P_1 = 4(P_T)(1-P_T)^3$$

$$P_{2+} = 1-P_1-P_0$$

Then the estimated mean value of the t for a given truck percent is computed by:

$$\hat{t}_{PT} = P_0 \hat{t}_0 + P_1 \hat{t}_1 + P_{2+} \hat{t}_{2+}$$

We also can compute probabilities of occurrence of each of the four types of headway sequences, auto-auto, auto-truck, truck-auto, and truck-truck, for any specified proportion of trucks:

$$P_{aa} = (1-P_T)^2$$

$$P_{at} = P_T(1-P_T)$$

$$P_{ta} = P_T(1-P_T)$$

$$P_{tt} = P_T^2$$

and then the mean value of saturation flow headway for the specified P_T is:

$$\hat{h}_{PT} = P_{aa}\hat{h}_{aa} + P_{at}\hat{h}_{at} + P_{ta}\hat{h}_{ta} + P_{tt}\hat{h}_{tt}$$

Start of green lost time for the specified P_T is:

$$l_{PT} = \hat{t}_{PT} - 4\hat{h}_{PT}$$

The values of \hat{t}_{PT} , \hat{h}_{PT} , and l_{PT} should be computed for truck proportions at increments of 0.05. In other words, for:

$$P_T = 0, .05, .10, .15, .20, .25, .30$$

This would be done for each previously selected values of grade in increments of 2 percent.

The results of the above computations would be entered in two tables (one for t_{PT} , and one for l_{PT}), as illustrated in Figure 24. These data can then be translated into adjustment factors for grades and trucks, A_{gt} :

- Set $A_{gt} = 1.00$ for grade = 0% and trucks = 0%
- Calculate A_{gt} for each cell in the table by dividing the data entry for that cell by the data entry for the cell with 0% grade and 0% trucks

The final products will be two tables of adjustment factors, one for saturation flow headways and one for lost times. Separate pairs of tables will be developed for lane types A, B, and C to determine whether truck and grade effects differ for the three types.

It is estimated that six sites on each arterial having significantly different grades ranging from about -8 percent to +8 percent will be adequate. A total of 200 observations and at least 50 cycles will be needed to yield an accuracy of +10 percent.

Site Selection

Select two different arterials, each having variable grades on individual intersection approaches, but otherwise having consistent geometric design and traffic control features. Perform the above analysis separately for each arterial.

		PERCENT HEAVY VEHICLES							
		0	5	10	15	20	25	30	35
GRADE	+8								
	+6								
	+4								
	+2								
	0	1.00							
	-2								
	-4								
	-6								
	-8								

Figure 24. Tabulation of saturation flow headway and lost time data as a function of grade and trucks.

Calculate adjustment factors for trucks and grades for each. Determine if significant differences exist between arterials. If not, compute average values of adjustment factors.

Data Collection Methodology

It is proposed that data collection be performed manually using an event recorder which can record two events, a heavy truck or a light vehicle passing a predetermined point.

Strictly manual methods of data collection (e.g., using stopwatches) could feasibly be employed to collect the type of raw data needed, but in comparison to the use of an event recorder, much longer field times would be necessary to obtain equal sample sizes and less control could be exerted over measurement errors.

Because we are attempting to discern small effects of grades and trucks, it is believed that sample sizes should be large enough to compute the estimates of saturation flow headway and lost time within close tolerances. Pilot data are needed to determine the variances of these estimates before the design of sample sizes can be finalized.

EFFECT OF PARKING ON MAXIMUM INTERSECTION DISCHARGE VOLUME RATES

Research Objectives

Determine the effects on maximum intersection discharge volume rates of parked vehicles on the approach of the intersection. The effects are to be determined as a function of the distance of the parked vehicle either upstream or downstream of the intersection approach stop line. Perform the study for through lanes and for lanes with through and right turns but which are not subject to conflicts with opposing traffic or pedestrians. Determine the relationships between the effects on maximum discharge rates and the proportion of right turns in the affected lanes.

The desired product is a set of adjustment factors for maximum discharge rates (saturation flow rates) for different combinations of parked vehicle position and proportion of right turns.

Start of green lost times are presumed to be unaffected by parked vehicles; hence, standard lost time values for the no-parking situation are assumed to prevail for all test conditions which can be subtracted from green times to obtain effective green times for use in saturation flow calculations. The results can be used to compute the effects on maximum discharge volume per hour.

The user may also utilize the results to compute the effects of parked vehicles on intersection stops and delays if signal timing and traffic arrival patterns are known.

Hypotheses

1. Maximum intersection discharge rates are degraded by vehicles parked on the approach leg of the intersection. The closer the vehicle is parked to the stop line, the greater the effect.
2. Maximum discharge rates both in the curb (right) lane and in the adjacent lane are degraded by vehicles parked on the approach leg.
3. There is an interaction between proportion of right turns and position of the parked vehicle on the approach leg, i.e., for a given parked vehicle position, the effect on maximum discharge rates will vary depending on the proportion of right turns.

Definitions

For the purposes of this special study, maximum discharge (saturation flow) rate is defined as the number of vehicles discharged in one lane per second of effective green time when there is a sustained demand for service. Observations will be made only during the portion of green time when the queue in the adjacent lane is still dissipating. This includes periods when approaching traffic cannot reach the curb lane because of queue spillback in the adjacent lane. Saturation flow, S , observed during one fully loaded portion of the cycle in one lane is given by:

$$S = \frac{N}{G-L}, \text{ veh. per sec.}$$

where:

- N = number of vehicles discharged during the saturated portion of the green plus amber period.
- G = green time, sec. during which adjacent lane is saturated. In the case of fully loaded cycles, G = green + amber.
- L = start of green lost time, sec., determined when no parked vehicles are obstructing traffic flow.

Two generic types of traffic situations will be studied. These are defined by the schematic diagrams in Figure 25 which include designations of type of lane (I or II).

Measurement and Analysis Approach

Perform measurements only during fully green periods at pretimed signals. During each cycle count the following:

- For Type I Intersections

- N_A = number of vehicles discharged in Lane A
- N_{B_R} = Number of right-turn vehicles discharged in Lane B
- N_{B_T} = number of through vehicles discharged in Lane B

- For Type II Intersections

- N_A = as defined
- N_C = number of vehicles discharged in Lane C

Also time the duration of the associated green period. Aggregate the data into sets of 5 consecutive signal cycles, and for each type of lane for each 5-cycle set, compute:

$$S_A = \frac{\sum_1^5 N_A}{\sum_1^5 (G-1)}$$

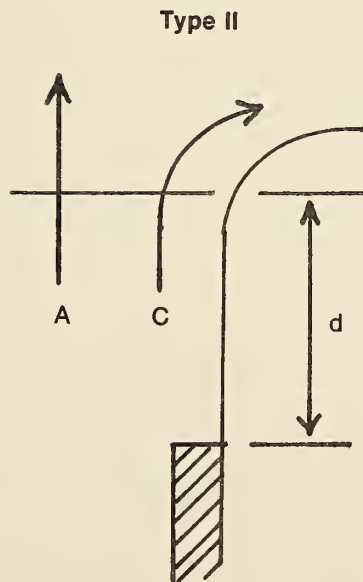
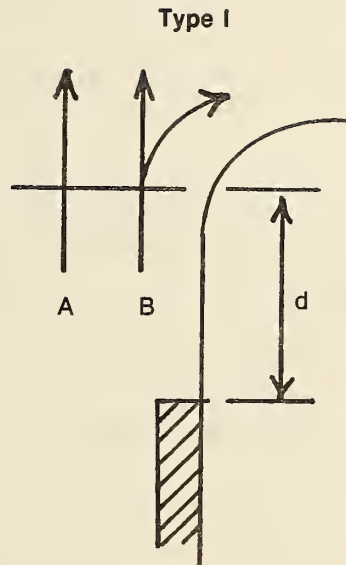

Figure 25. Types of intersection situations under study.

$$S_B = \frac{\sum_1^5 N_B}{\sum_1^5 (G-1)}$$

$$S_C = \frac{\sum_1^5 N_C}{\sum_1^5 (G-1)}$$

Also compute the proportion of right turns (P_R), i.e., the proportion that right turns are of total discharges in the two lanes during the 5-cycle data set.

- Type I and Type III

$$P_R = \frac{\sum_1^5 N_{B_R}}{\sum_1^5 N_A + N_{B_R} + N_{B_T}}$$

- Type II

$$P_R = \frac{\sum_1^5 N_C}{\sum_1^5 N_A + N_C}$$

A survey of arterial streets conducted in Phase I showed that parking is usually (almost invariably) prohibited during peak hours in the major flow direction but is often permitted in the reverse direction. Therefore, it is expected that the data collected in Phase II will include many intersection approaches which have parking. The sample of sites for this special study will be drawn from the Phase II sites and will include a range of parking setbacks. It is expected that 10 sites with setbacks ranging up to 200 feet (60m) will be available for this special study. Such a sample should be possible from the nearly 1,000 intersection approaches for which data will be collected in Phase II.

The result of these experiments will be a series of regression lines for saturation flows in lane types A, B, and C as a function of right-turn proportion for each of the staged positions. An example is shown in Figure 26.

$S_A, S_B, \text{ or } S_C$

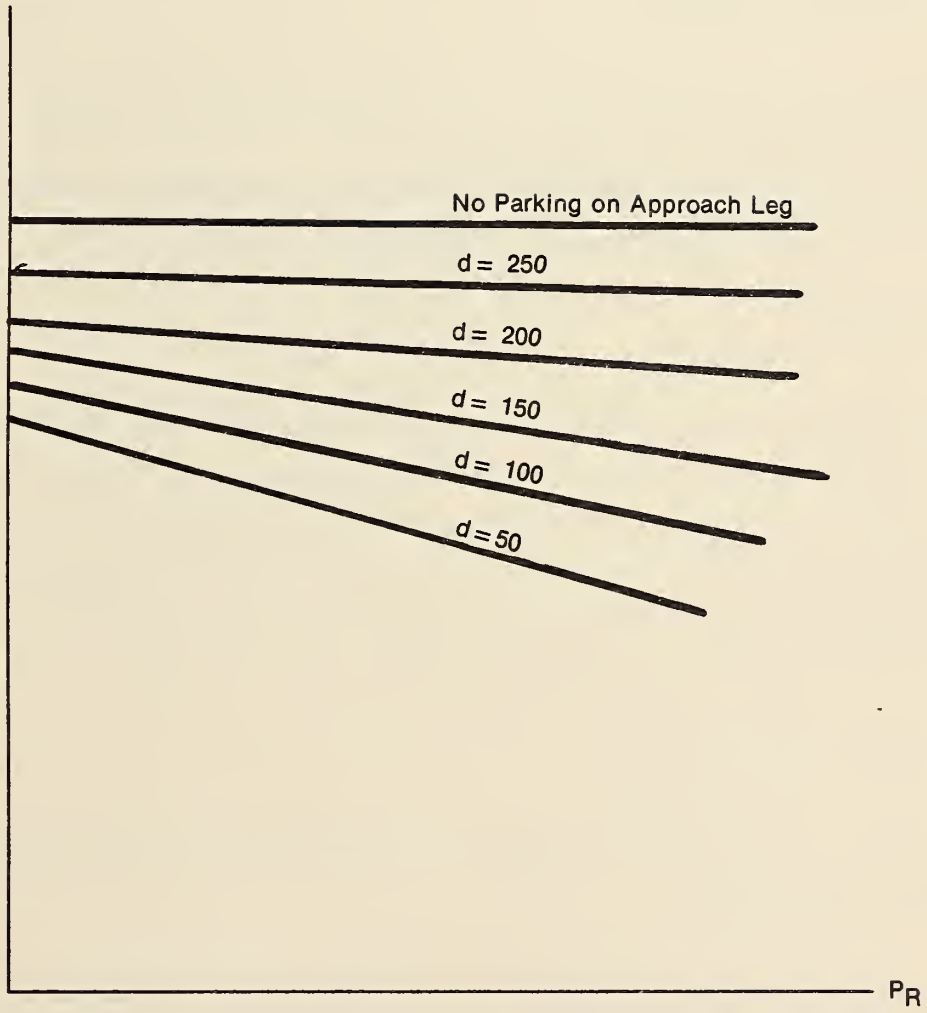

Figure 26. Example regression diagram.

An alternative analysis approach is to group the data into right-turn proportion classes, for example,

$$P_R = 0-.05, .05-.10, .10-.15, .15-.20, \dots$$

and then for each P_R class, perform a regression of S against the parked vehicle position. An example of this is shown in Figure 27. This alternative is probably a superior analysis approach.

The regression charts can then be used to determine adjustment factors of saturation flow values for the three lane types as a function of parked vehicle position and right-turn percent. The adjustment factor would be computed by dividing the S values for the test conditions by the S values for the no-parking case.

Site Selection

Several different intersections should be selected for Type I and Type II experiments. These should all have straight and level approach and exit legs and standard lane widths. The sites selected should have varying average right-turn percentages during peak hours in order to obtain a wide range of 5 cycle P_R data points. All sites should have moderate truck percentages (e.g., approximately 10 percent) and minimal bus traffic to avoid extraneous effects due to bus stops.

Data Collection Methodology

The method to be used will be to reduce the data from the photographs obtained for the basic Phase II study.

EFFECTS OF OPPOSING TRAFFIC AND PEDESTRIAN CONFLICTS ON MAXIMUM DISCHARGE VOLUME RATES OF LANES WITH LEFT TURNS

Research Objectives

The objective of this special study is to determine the combined effects on single lane maximum discharge rates (saturation flow) of conflicts with opposing traffic flows and with pedestrians crossing the left-turn exit leg of the intersection. Included in the study will be approach lane types D/F and E/F (as per the Swedish

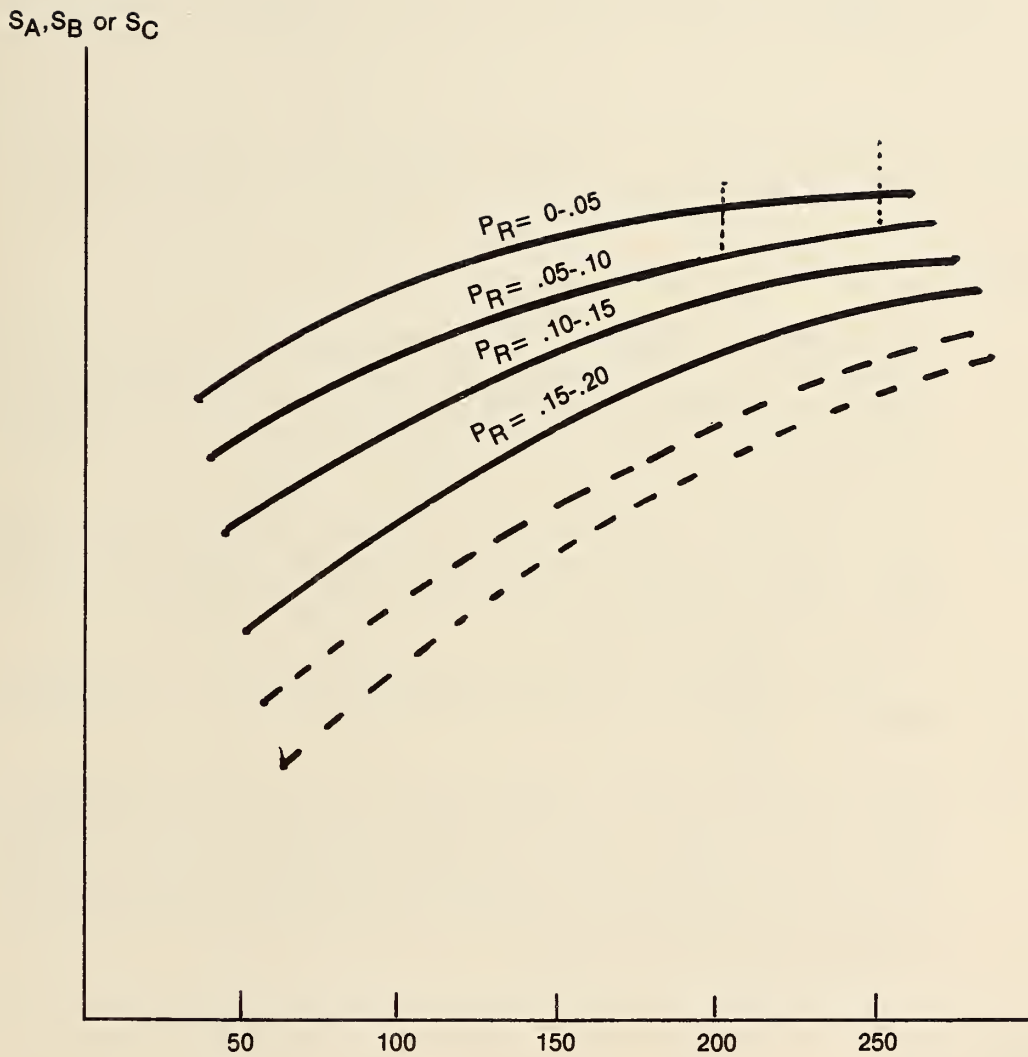

d, distance to parked vehicle on approach leg.

Figure 27. Diagram of alternative regression approach.

definition) as illustrated in Figure 28. Also included as special cases are lane types D and E for which pedestrian conflicts exist but opposing traffic conflicts are absent, and lane types F and G for which opposing traffic conflicts exist but pedestrian conflicts are absent or negligible.

Also to be determined are the effects of the proportion of left turns in lane types D/F, D, or F for different levels of opposing traffic volumes and pedestrian volumes.

The effects on maximum discharge rates will be determined under conditions (portions of the cycle) in which there is a sustained demand for service in the lane.

Hypotheses

1. The maximum discharge rates of lanes with some or all left-turn traffic depend on the magnitude of traffic flows in the opposite direction which left turners must cross. The higher the opposing flow, the greater the reduction of maximum discharge rates since acceptable left-turn gaps will occur less frequently.
2. The maximum discharge rates of such lanes will depend on the magnitude of pedestrian flows on the conflicting exit leg which left turners must cross. The higher the pedestrian volumes, the greater the reduction of discharge rates.
3. Pedestrian conflicts and opposing traffic conflicts have an interactive effect on discharge rates.
4. The combined effects of pedestrian conflicts and opposing traffic conflict (both of which relate to left-turn vehicles and not to through vehicles in the same lane) will differ depending on the proportion of left turns in the lane. The higher the proportion of left turns, the greater the reduction of discharge rates for given levels of pedestrian and opposing traffic conflicts.

Definitions

Maximum discharge rate (saturation flow) is defined as the number of vehicles discharged in one lane per unit of effective green time when there is a sustained demand for traffic service in the lane. Saturation flow is observed each cycle as defined by:

$$S = \frac{N}{G-L}, \text{ veh. per sec.}$$

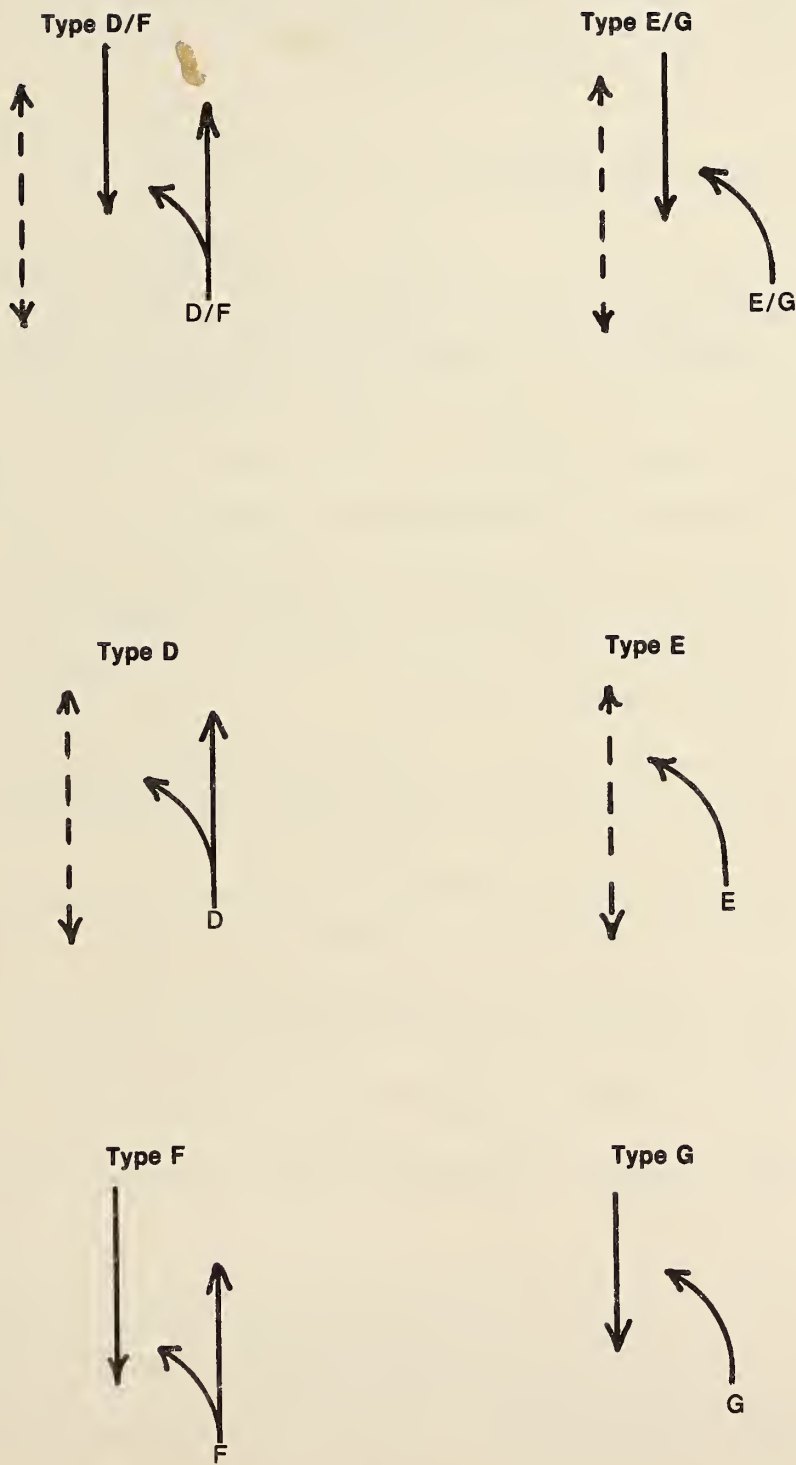

Figure 28. Lane types under study.

where

- G = green time, sec., during which the lane has sustained demand
N = number of vehicles discharged during period G
L = start of green lost time, sec.

Measurement and Analysis Approach

The Swedish Transport Research Commission developed a very useful approach to analyzing and displaying the effects of opposing flow and left turn percent on saturation flow. They pursued their analysis using probability theory formulation in which there was crucial reliance on left turn gap acceptance phenomena. The proposed approach will display final results in a very similar manner, but the measurement and analysis approach differs in three key respects.

1. It is a more macroscopic, cycle-based approach instead of being directly based on individual vehicle gap acceptance behavior.
2. It employs strict empirical methods supported by statistical analyses, instead of relying on theory.
3. It extends the analysis to incorporate pedestrian conflict effects in addition to opposing flow and left turn proportion effects.

During each signal cycle, during that period from the onset of green until the queue in the lane is dissipated, the following measurements are made:

N_L = number of left turn vehicles discharged

N_T = number of through vehicles discharged

N_O = number of vehicles discharged from the opposing intersection approach

N_P = number of pedestrians crossing the left-turn exit leg (This is measured for the entire signal cycle rather than just during the fully loaded portion of the traffic lane, and converted into hourly pedestrian volume rate.)

$V_P = \frac{3600N_P}{C}$, where

C is cycle length in seconds

Then compute

$$P_L = \text{the left turn proportion for the lane in question}$$
$$= \frac{N_L}{N_L + N_T}$$

$$V_O = \text{opposing approach volume during period G}$$
$$= \frac{3600 N_o}{G}$$

$$\frac{V_O}{S_O} = \text{the degree of saturation of the opposing approach during period C}$$

where

$$S_O = \text{the estimated saturation flow rate in vph for the opposing approach}$$

Group the raw data into four major subsets according to the following tentative pedestrian volume levels:

$$V_P = 0 \text{ or negligible}$$

$$V_P = 100 \text{ per hour}$$

$$V_P = 100 \text{ to } 300 \text{ per hour}$$

$$V_P = 300 \text{ per hour}$$

Next, for each of the above subsets, group the individual cycle data into subsets according to opposing degree of saturation, $\frac{V_O}{S_O}$, tentatively increments of 0.05.

Finally divide the resulting subsets according to left-turn proportions, tentatively in increments of 0.10.

The result of the above classification steps will be a series of subsets which are unique combinations of pedestrian volume, V_P , opposing flow degree of saturation,

$\frac{V_O}{S_O}$, and left-turn proportions. There will be several individual cycle saturation flow data points, S , for each unique subset.

Now for each of the four levels of V_P , perform regressions analyses of S as a function of V_O for each of the classes of P_L . The result will be four charts, one for each V_P level, as illustrated by one example chart in Figure 29. With the exception of using $\frac{V_O}{S_O}$ instead of V_O in the abscissa, this chart is basically the same form as one contained in the Swedish Highway Capacity Manual. These four charts encompass all of the lane types D, E, F, G, D/F, and E/G.

The charts for $V_P = 0$, represent lane types F and G (i.e., no pedestrian interference). Lane type G is represented by the single regression line for which $P_L = 1.0$ (i.e., only left turns). The rest of the regression lines represent lane type F (i.e., left and through movements).

The three other charts (for three different pedestrian levels) represent the other lane types. The $\frac{V_O}{S_O}$ intercept of the regression lines represent lane types D or E (i.e., no opposing traffic). The single regression line for $P_L = 1.0$ represents lane type E/G (i.e., only left turns). The remaining regression lines represent lane type D/F (i.e., opposing traffic, pedestrian conflict, through and left movements).

Site Selection

A minimum of 14 intersection approach sites need to be selected

- 3 of lane type D/F, selected on the basis of substantially different pedestrian volume leads
- 3 of lane type E/G, also selected on the basis of differing pedestrian volumes.
- 3 of lane type D (this will probably have to be a one-way approach) with varying pedestrian volumes.
- 3 of lane type E (also a one-way approach) with varying pedestrian volumes
- 1 lane type F (with negligible pedestrian volumes)
- 1 lane type G (with negligible pedestrian volumes)

Saturation
Flow, S

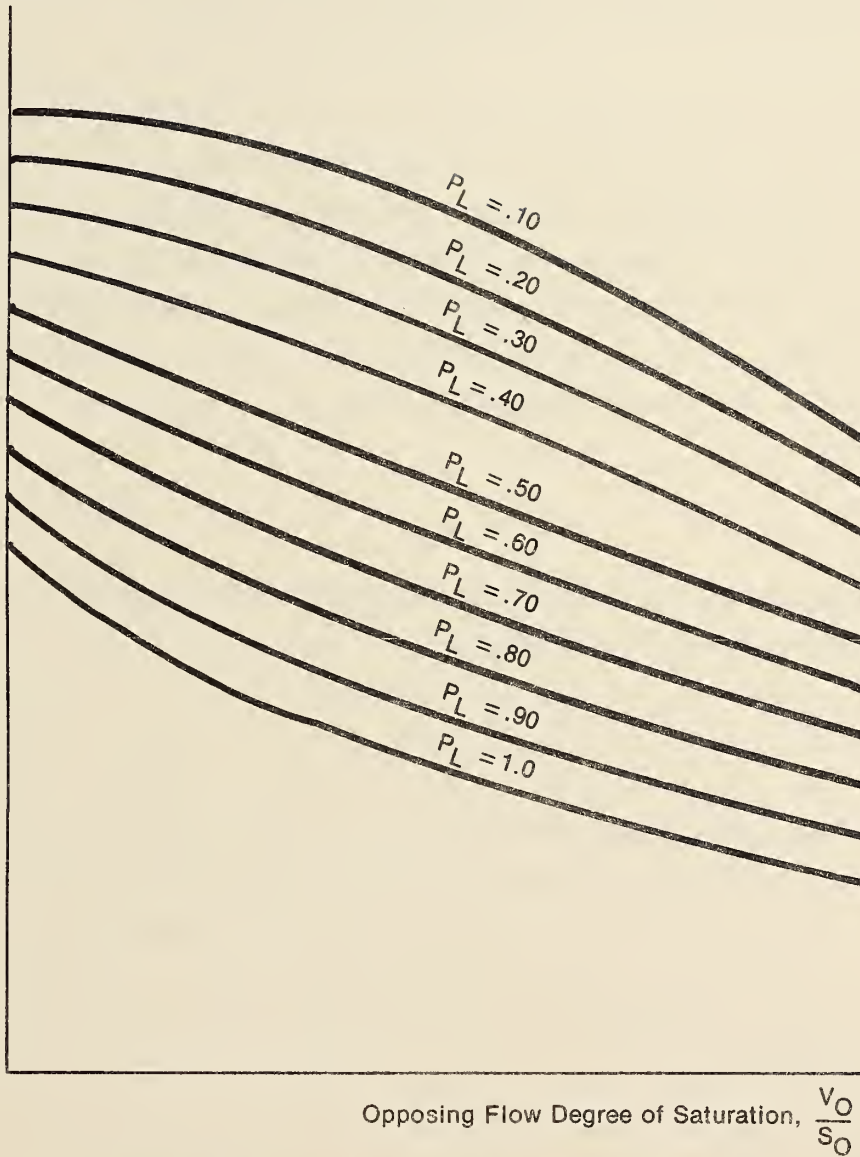

Figure 29. Example chart pedestrian volume level 1.

All of the sites should be straight and level multilane approaches with standard lane widths and moderate truck percentages.

DATA COLLECTION METHODOLOGY

It is highly likely that multiple examples of all these types of intersection approaches will be found in the data base for the basic study.

The sites selected for the special study are the ones for which elevated, fixed-position photographic data are collected. All of the data needed in the analysis can be extracted directly from the film records. Instead of relying on only 14 intersection approaches, a larger sample should be analyzed, as resources permit, to fill the maximum number of the special classification subsets needed for this analysis.

WEAVING NEAR FREEWAY INTERCHANGES

Objective

To determine the impact of weaving near freeway interchanges on the capacity and quality of flow of urban arterial streets.

Hypothesis

Travel times and travel time variability increase with increasing volumes of weaving traffic. The number of lane changes required will be a function of the total volume, the ramp volumes and the number of lanes on the urban arterial. The relationship between volume and travel time is non-linear increasing more rapidly as volumes approach capacity. Weaving related to freeway interchanges is significant only at cloverleaf interchanges.

Definitions

Weaving is measured as the number of lane changes per 100 vehicles within the area of influence of the interchange. It excludes the lane changes between acceleration and deceleration lanes and the through lanes on the urban arterial.

Measurement and Analysis Approach

Weaving volumes cannot be controlled in field studies. Therefore a microscopic approach is proposed for measuring the effects of lane changes which will make it possible to synthesize different levels of weaving traffic. A series of sites will be selected to provide a range of volumes and arterial widths (number of through lanes). Sites with variation in volumes throughout the day will be selected to control logistic costs. Observations at different times of day will yield multiple data points from a single site.

Sites which are essentially level and straight with standard geometrics will be selected to control influences due to grade, curvature and geometrics. Sites with nearby major intersections will not be included in the sample. The sample of sites will include arterials with two, three, and four through lanes. Travel times will be measured only for through vehicles on the arterial.

Vehicles on Arterial

The method of measurement will be license plate recording. The plate numbers will be recorded at 8 to 12 points as shown in Figure 30. The license plate numbers will then be matched to provide an origin-destination matrix of the vehicles which passed through the study section. From this matrix the number of lane changes can be determined as can the total through volumes and the ramp volumes. Table 10 shows the number of lane changes for each origin-destination pair. The matrix can be divided into two parts to give the number of lane changes made by vehicles using the ramps and those made by vehicles continuing through the section.

The number of lane changes is expected to be directly related to the ramp volumes and it should, therefore, be possible to construct a table similar to the one shown in Table 11. If this proves to be the case the number of lane changes can be related to travel time as shown in Figure 31. In that figure, a family of curves using through volume is shown although the parameter might be total, rather than through, volume.

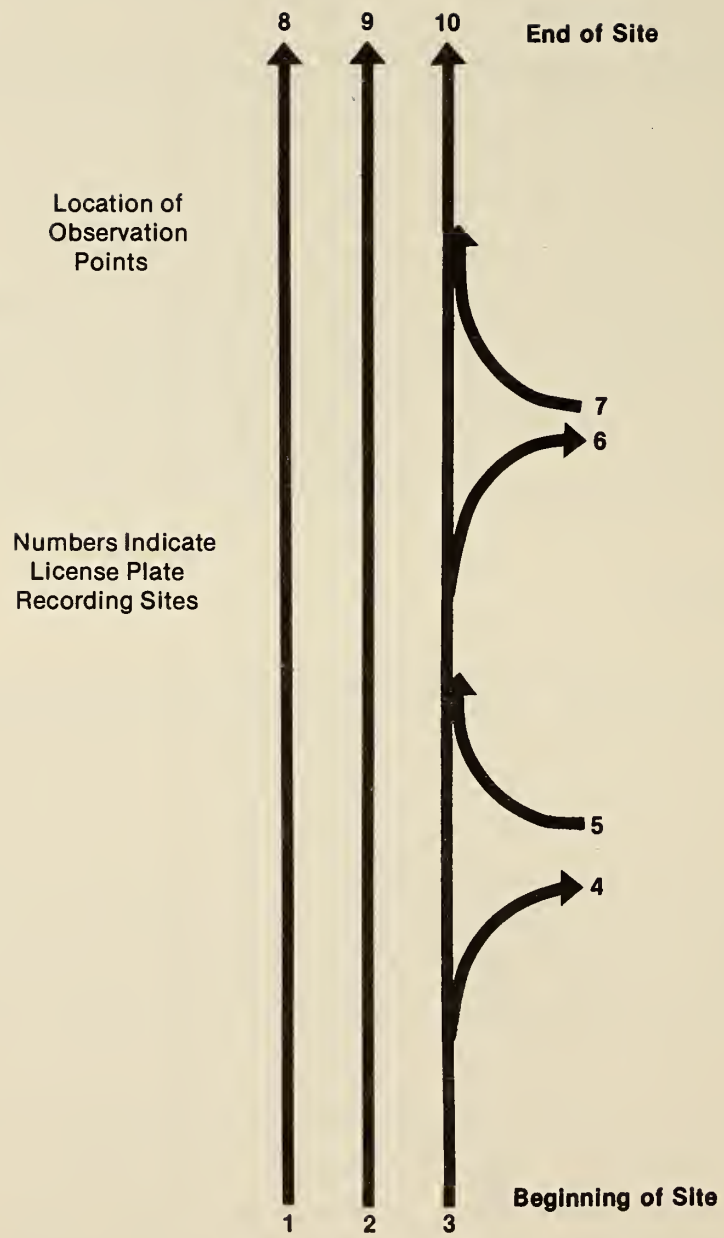

Figure 30. Study site diagram.

Table 10. Number of lane changes for each orgln-destination pair.

Lane of Origin	Lane of Destination				
	10	9	8	6	4
1	2	1	0	2	2
2	1	0	1	1	1
3	0	1	2	0	0
5	0	1	2	0	
7	0	1	2		

Table 11. Lane changes as a function of ramp volume and number of lanes.

Number of Lanes	Total Ramp Volume							
	Less Than 400	400 to 600	600 to 800	800 to 1,000	1,000 to 1,200	1,200 to 1,500	1,500 to 2,000	2,000 to 3,000
2								
3								
4								

Alternatively, regressions using travel time against through volume and ramp volume as a percent of through volume might yield acceptable results, in which case the relationship between travel time and the two volume measures could be portrayed as shown in Figure 32.

However, the relationship between travel time (and travel time variance) and number of lane changes would be more satisfying because one could then develop the number of lane changes associated with different volumes and travel patterns and, from that, develop the travel times and travel time variances.

Because travel time is likely to be on the order of one minute in the study section, the times must be recorded with an accuracy which is quite precise. For that reason, the measurement of travel times on the arterials will be made from time-lapse photography using an exposure rate of four frames per second. Photographs will be obtained at the entry to the section and at the exit from the section. This will allow precise measurement of speeds for a sample of the vehicles. Travel times for the vehicles using the ramps will not be measured. Thus the two measures of effectiveness, Travel Time and Travel Time Variance, will be only for vehicles which pass through the study section on the arterial street.

Stops and intersection delay will be measured at the downstream intersection using the method described in Appendix A.

The illustration shown earlier used Travel Time as the dependent variable or the MOE for illustrative purpose only. Relationships for the other MOE's: Travel Time Variance, Intersection Stops and Intersection Delays, will also be developed.

SIMULATION

The first step in the definition of a role for simulation in the analysis of urban arterials is the selection of the simulation programs to be used as the basis for this analysis. A review of current simulation practice would suggest the NETSIM model for this operation. The selection of NETSIM is based upon the following observations:

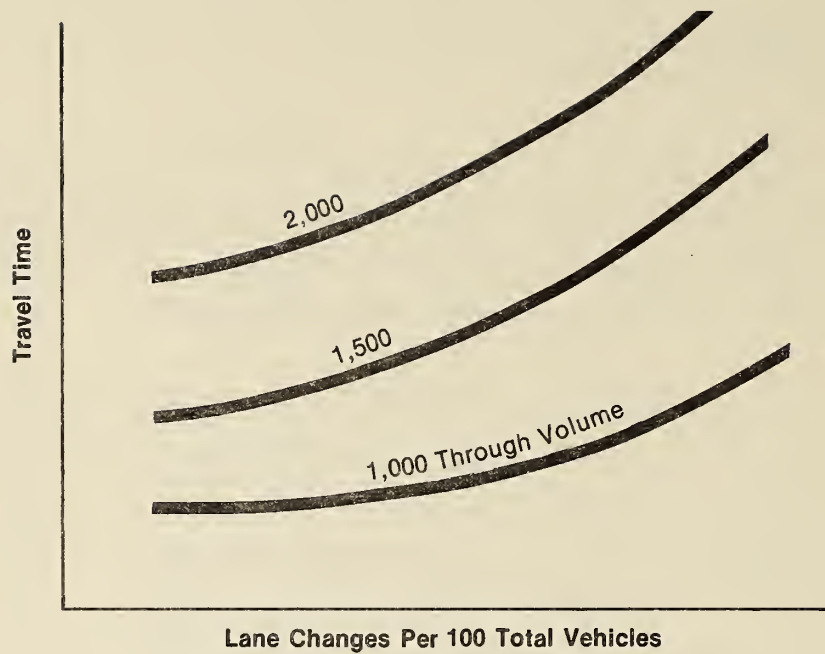

Figure 31. Example of lane changes analysis.

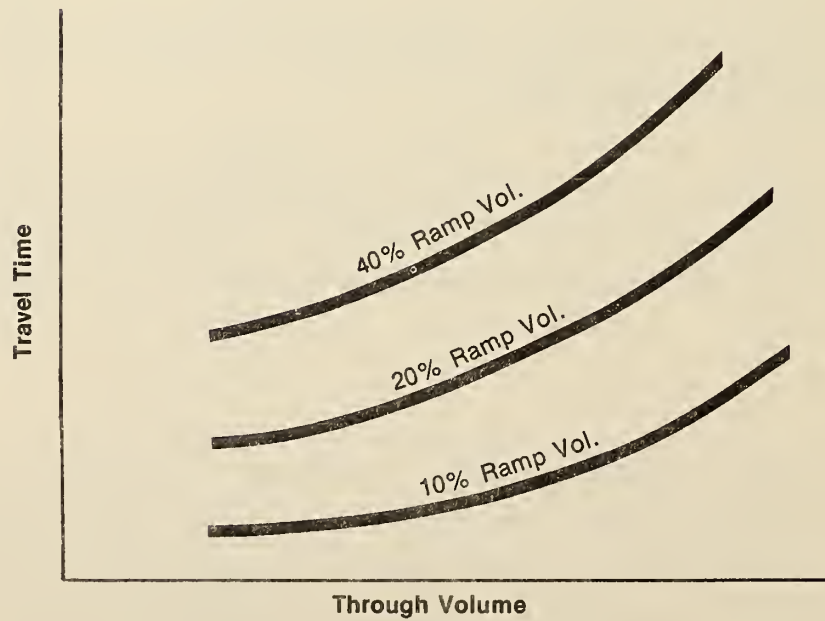

Figure 32. Example of ramp volume analysis.

- It has undergone a more rigorous validation under a wide range of traffic conditions than any other program currently in existence.
- It has been applied to the analysis of numerous traffic flow situations. This experience has led to model refinements and improved program reliability that has further improved the effectiveness of the simulation as an analysis tool.
- The simulation models a wider variety of roadway traffic, signal control, and analysis features than is available with any other simulation currently available.

In considering the application of NETSIM to the analysis of urban arterials, it is necessary to review both the capabilities of the model and the reliability with which they represent actual traffic conditions indicated by the validation results. Finally, it is necessary to identify modifications that must be made either to the model or to its internal data in order for it to be used as an effective tool for the analysis of urban arterials.

Model Capabilities

The NETSIM model was developed for the purpose of modeling traffic flow in urban street networks. The overall objective of this development was to provide a tool for the evaluation of alternative network control strategies. The model incorporates the following major features as summarized in Reference 1.

- Stochastic simulation of individual vehicles by type, utilizing a simplified car-following model, time-scanning methods, and one-second updates.
- Representation of a network of about 40 intersections (the limiting factor is computer capacity), together with associated input and output links, and the ability to simulate the full range of geometric configurations found in the central areas of U.S. cities of 50,000 population or more.
- Provision for a flexible mix of both input and output options, including provision for necessary link-specific and networkwide output to evaluate alternative traffic control schemes. Standard output measures include:
 - Link Volume
 - Average Link Speed

- Average Link Travel Time
- Total Vehicle Miles of Travel
- Traffic Density/Vehicle Content
- Vehicle Delay
- Queue Length
- Number of Stops

These measures may be accumulated by cycle or any larger time period for both individual intersections/links, groups of links, and for the network as a whole.

- Detailed treatment of both intersection and intra-link behavior, including queue discharge and turning behavior, intersection "spillback", pedestrian/vehicular traffic interaction, intra-link acceleration and deceleration, and traffic response to non-signalized controls and exclusive channelization, (e.g., "Stop" and "Yield" signs, free/forced merge, exclusive bus lanes, etc.).
- Detailed treatment of bus traffic, including specification of bus routes, bus-stop dwell times, and bus/vehicular traffic interaction.
- Treatment of intra-link friction, including both legal and illegal parking, parking garage flows, and intra-link rare events--e.g., cab pickups, stops by delivery vehicles, and temporary lane closure (although some refinement is required in the model).
- Simulation of alternative surveillance systems including location and type of detector (e.g., presence detector, counter and spot speed detector), detector signals and detector reliability (up to 3 detectors may be utilized per lane and up to 12 per link).
- Replication of traffic performance under all forms of network traffic control, including dynamic control systems based on the areawide surveillance of such traffic parameters as traffic volume, average speed, traffic density/vehicle content and smoothness of flow.
- Provision for minimum essential input data to simulate a given set of field conditions, including allowance for both location specific and phenomeno-logical (i.e., networkwide) data inputs, and provision for a comprehensive set of default options/values.
- Description of the traffic network at varying levels of detail and specificity.

In reviewing the basis for the development of the component models of the simulation, it is necessary to realize that all data employed in this development was collected in a test network located in Washington, D.C. This network is characterized by a 16-square block street network with typical intersection spacings of

approximately 450 feet (140m). Vehicle speeds in the network were between 15 and 25 mph (25 and 40 km/h), and signal control was exclusively fixed time. The remaining features are typical of those found within the CBD of a major city.

Thus, in order to apply NETSIM to the wider variety of conditions, it is necessary to verify that the components of this model are representative of these conditions.

Components that will be particularly sensitive to variations include:

- Gap acceptance models for stop signs and turning vehicles are represented as probability distributions as a function of gap length. These distributions are considered to be independent of vehicle speeds. The NETSIM (previously UTCS-1) communication indicates that "No significant differences were found in the set of separate distributions generated for individual intersection approaches due primarily to the extremely limited range of intersection conditions..."
- Intra-link target speeds are the desired speeds assigned to vehicles traversing the link. This distribution of target speeds is presented as a distribution of vehicle speeds about the mean "free flow" speed on the link. The stability of this distribution as a function of free flow speed should also be examined.

The selection of these model components as candidates for further validation under the conditions prevalent on urban arterials is based upon their potential sensitivity to higher vehicle speeds and longer intersection spacing. Features not sensitive to these factors were not considered. For example, it is generally true that startup delay at an intersection is based solely on motorist reaction times and is independent of roadway and signal control characteristics.

Modifications Required

As previously indicated, NETSIM's ability to model an impressive range of traffic and roadway conditions makes it an attractive candidate for use in the analysis of traffic flow on urban arterials. However, in spite of its range of capabilities, two additional features are required in order for it to be applied to this analysis.

The first of these features is the enhancement of entry link characteristics and capabilities. An arterial is usually composed of a linear series of interconnected

links with side streets whose traffic characteristics are only of interest insofar as they affect the operation of the arterial. Thus, each side street is considered in effect a traffic generator that is producing vehicular flow that affects the operation of the arterial. The distribution of headways of the vehicles on the side streets are dependent upon the type of traffic control on the side street and its distance from the street's intersection with the arterial. For example, light to moderate traffic with no traffic control might exhibit a shifted negative exponential distribution, while heavy traffic could be characterized by an Erlang distribution. Traffic that is flowing from an upstream signalized intersection might have a bimodal distribution. The side street arrival distributions are important because of their impact on the operation of actuated signals on the arterial. They might also have an impact at uncontrolled or stop-sign controlled entry points, since they will influence the time varying demand of turning vehicles entering the arterial traffic flow from these locations.

NETSIM currently generates vehicles at entry links with a constant vehicle headway that is inversely proportional to the entry link volume specified by the user. The decision to use a non-statistical model of entry link traffic flow was based upon a comparison of headway distributions using a uniform arrival distribution produced by the shifted exponential arrival distribution as a function of the distance from the entry link. These comparisons, which are reproduced in Figure 33, indicate that close agreement between the two distributions exists. No significant statistical differences could be detected between the equivalent curves plotted for the second and third detectors (B and C).

While this analysis might be valid for the case of coordinated fixed time signals, it is not applicable to side street arrivals produced at an entry link with no signal control. Therefore, it is necessary for a series of statistical headway distributions to be introduced into the model that is selectable by the user as a function of the entry link characteristics.

The second modification to the model that is required for it to be applicable to the evaluation of traffic flow on urban arterials is the capability to compute an additional measure of effectiveness corresponding to speed variance exclusive of intersection stops and delays. This MOE has been identified during this project as being

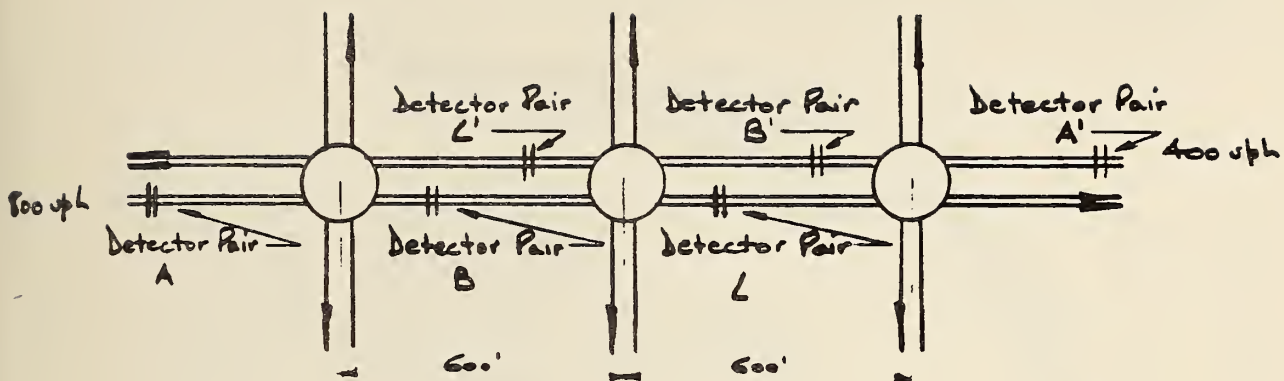

- INPUTS:
- . Flow Levels: High = 800 vph
Low = 400 vph
 - . Signal Settings (all signals): 80 sec. cycles, 50%/50% phase split, 40 sec. offset
 - . Turning Movements: 3% left and right off main roadway at all intersections; 20 vph left and 20 vph right from side roads at all intersections
 - . Target Speed (all links): 35 feet/second
 - . Traffic Generating Distributions:
 - . Shifted Negative Exponential
 - . Uniform
 - . Vehicle Types: Automobiles only
- OUTPUTS:
- . Standard UTCS-I Output by link
 - . Headway distributions by detector location
- TESTS:
- . Comparison of headway distributions by detector location for Shifted Negative Exponential inputs
 - . Comparison of headway distributions by detector location for Uniform inputs

Figure 33a. Evaluation of traffic generation distributions.

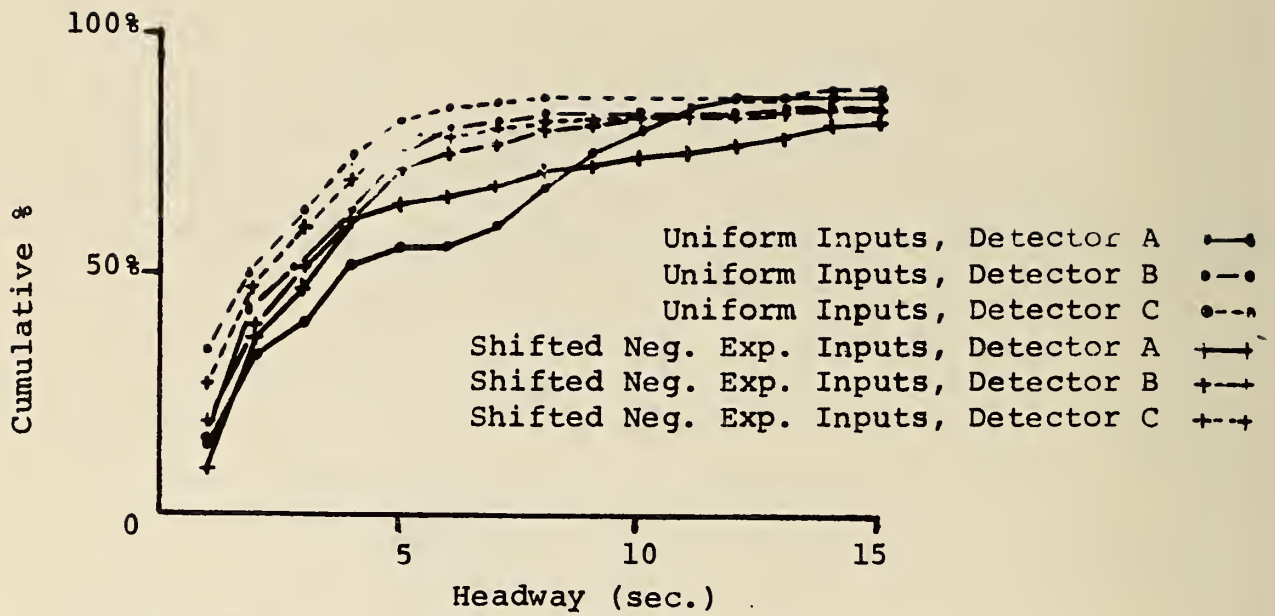

(a) LOW VOLUME CONDITION

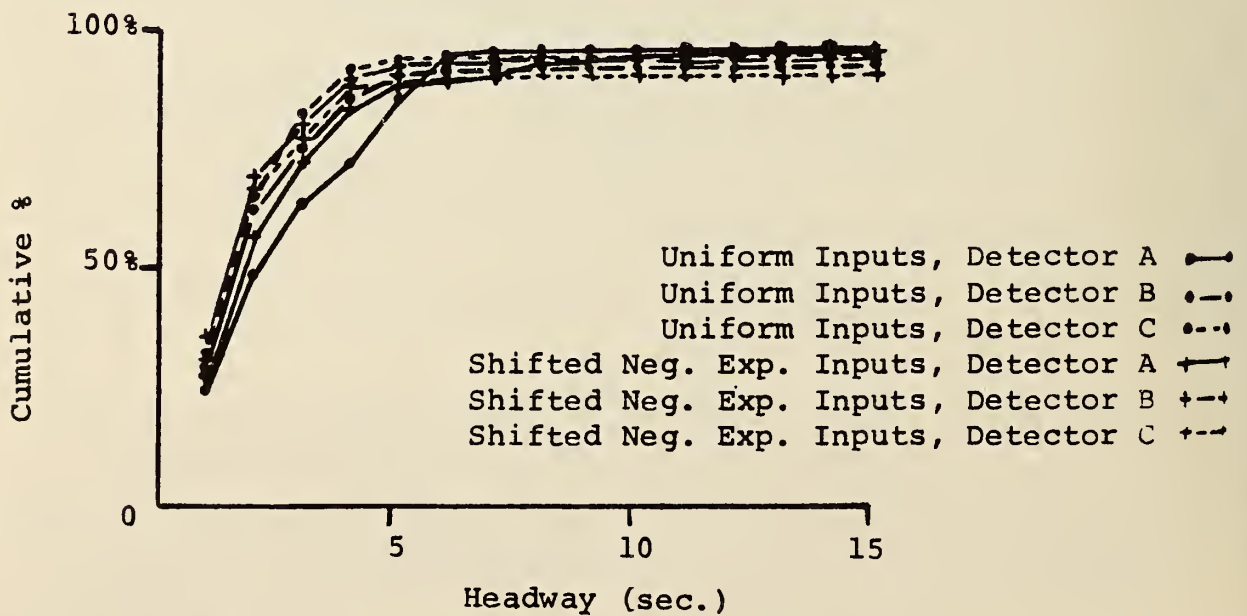

(b) HIGH VOLUME CONDITION

Figure 33b. Distributions of inter-vehicle headways by detector location.

an indicator of the overall quality of traffic flow on urban arterial segments. The equation for this MOE is:

$$SV = \text{Var} \frac{LL - QL}{TT - ID}$$

where:

SV	=	Speed variance
LL	=	Link length
QL	=	Queue length
TT	=	Travel time
ID	=	Intersection delay

Each of these terms, except for link length, is evaluated for each vehicle. The variance of these terms is the speed variability. The equivalent of this calculation is not currently performed in NETSIM. As a result, it will be necessary to add this feature.

The level of effort required to add these features is considered minimal. In every case, the required modifications are localized to a single subroutine and require no supplementary data collection to support their development. Another modification needed is refinement of the rare event logic (lane blockage).

Review of NETSIM Validation Results

In order to determine the type of studies for which NETSIM is applicable, it is necessary to review the overall model capabilities as exhibited by the results of its validation. The validation process produced several overall conclusions:

- Data produced for individual links was significantly less representative of traffic conditions measured in the field than were the network-wide statistics.
- Estimates of network content (number of vehicles), travel time and vehicle miles of travel were significantly more accurate than estimates of stop and delay.

- A bias exists in NETSIM that causes it to overestimate the number of vehicles that flow through the network.
- Peak-period conditions can be modeled significantly more accurately than off-peak conditions.
- The nature of the stochastic elements embedded in the model results in the need for a lengthy simulation running time. These requirements are expected to be consistent with the time periods required for field data collection based upon the statistics of the traffic data being collected.

The relative accuracy of modeling peak- and off-peak conditions, and the model bias are both related to the model's ability to represent the occurrence of "rare events" and traffic turbulence. These events include the presence of double-parked vehicles, accidents, and other temporary impedances to the traffic stream that are extremely difficult to predict. They are also difficult to model since they are usually not anticipated by the motorist and, therefore, can produce an unpredictable change in his performance. Fortunately, rare events and traffic turbulence are more common in the congested environment of an urban CBD than on an urban arterial. However, they can be found on certain types of urban arterials. The model's inability to reliably treat these conditions leads to the conclusion that it should not be used for cases where they might exist unless the logic that handles lane blockage is refined.

The fact that data produced for individual links were not as accurate as network-wide statistics is a result of the fact that every detailed condition existing on these links cannot be practically incorporated into the simulation. However, on a networkwide basis, the impact of these modeling inaccuracies tend to balance out. This effect is common to all traffic simulations and demonstrates the importance of using the model to evaluate overall traffic flow on all arterial segments rather than a microscopic section of roadway.

While not directly transferable to the analysis of urban arterials, the relative accuracy of the measures of effectiveness compared in the validation provide an indication of the practical achievable levels of delay measurement accuracy from the use of the simulation. Table 9 summarizes the results of this validation. From this table, it can be seen that a practical limit of delay is approximately 15 percent

while speed will be predicted within an accuracy of 11 percent. It is anticipated that a careful validation of internal models will produce at least this level of accuracy since the effects of rare events and turbulence on arterial flow will be less severe than they would be in a CBD.

As a result of this review of validation results, it has been concluded that, if properly validated and selectively applied, the simulation has the potential for providing a valuable supplement to the field data collected during the second phase of this project.

Application of the Simulation

The primary advantage of applying simulation to the analysis of traffic flow on urban arterials is that it provides the opportunity to economically evaluate the desired relationships under carefully controlled conditions. Desired combinations of variables can be easily selected without extensive, nationwide searches for the appropriate combination of field conditions. Measures of effectiveness can be easily collected without requiring large investments in labor and equipment.

However, as discussed in the previous section, the assumptions and simplifications inherent in the modeling process limit the potential accuracy and applicability of the simulation. As a result, it cannot be used to the exclusion of all field data collection for the development of the desired relationships. On the basis of conclusions developed in previous sections, the applications of the simulation must be restricted to analyses which:

- Require consideration of traffic flow along more than one link.
- Do not include the presence of rare events or excessive turbulence in the traffic stream until the logic has been refined.
- Permits an evaluation of comparative effects. These comparative effects can be used for the development of adjustment factors that are applied to the primary relationship developed from the field data. For example, the simulation might be used to determine the incremental degradation in vehicle delay produced by the presence of local bus operations as a function of bus headways and average dwell times. However, it should not be used for the estimation of total delay on an

arterial given its geometrics, traffic flow, signalization and bus operations. This approach is significant in that it will eliminate possible model biases and incompatibilities with field data.

On the basis of these restrictions, the set of independent variables has been reviewed to identify the relationships that could be effectively analyzed using NETSIM. These variables are summarized in Table 12. From this table it can be seen that the simulation experiments can play a significant role in the overall data collection process. This table indicates that approximately one-half of the relationships can be developed using the simulation.

The number of runs required and the associated computer time has been estimated assuming that each run performed will represent 15 minutes of real time traffic flow. It has been further assumed that where possible, rank 1 variables will require 3-4 data points per run, rank 2 and 3 variables will require 2 data points per run, and rank 4 through 5 variables will not be considered. Considering the number of possible combinations of data to be analyzed, subtracting 20 percent for unlikely combinations of variables and adding 50 percent to the remainder for validation runs and aborted tests, leads to the conclusion that nearly 700 runs will be required, and that 58 hours of computer time will be used, assuming a ratio of real time to computer time of 3:1.

This is a significant amount of computer time and cost. However, the equivalent field data collection requirements would be far in excess of this amount.

Table 12. Relationship of characteristics to the experimental design.

Rank		Relationship to MOE's to be Determined Through		
		Field Studies	Simulation	Analytically
1	Approach Width	Yes		
	Lane Width			
	Number of Lanes			
	Lane Control		Yes	
	Signal Spacing	Yes	Yes	
	Progression	Yes	Yes	
	Total Green/Approach Demand (Vol./Prof.)	Yes	Yes	
	Demand by Movement	Yes		
	2	Parking Condition	Yes	Yes
Turnover Rate				
Distance to First Parked Vehicle				
Intersections/Mile		Yes		
Driveways/Mile				
Approach Grade		Yes		
Side Street Demand		Yes		
Midblock Demand		Yes		
Discharge Headways			Yes	
Gap Acceptance Characteristics			Yes	
Percent Trucks		Yes		
Local Buses/Hour				
Lane Blockage			Yes	Yes
3	Type of Signal Control			Yes
	Number of Times Recorded Green			Yes
	Number of Pedestrians	Yes		
	Right Turn on Red			Yes
4	Median Treatment	Yes		
	Horizontal/Vertical Curve	Yes	Yes	
	Type of Land Use	Yes		
	Density of Land Use	Yes		
	Type of Bus Stop	Yes	Yes	
5	Posted Speed Limit	Yes		
	Location Within City	Yes		
	SMSA Population	Yes		
	Urban Population			
	City Population			
	Bus Stop Location	Yes	Yes	
Bus Dwell Time	Yes	Yes		

CHAPTER VIII
COST ESTIMATE

COST ESTIMATES

The estimates of cost are based on the following general assumptions which prevail throughout all parts of the estimates.

1. All labor costs are based on assumed reasonable salaries for the categories of professional and technical personnel. Those costs are then multiplied by a factor of 2.5 which represents an average overhead for the employer including salary related benefits and allowable overhead costs as those costs are normally defined in government contracts for professional and technical services.
2. A fee of 10 percent of the total costs is added to the total costs. This fee is slightly higher than the fees associated with CPFF contracts but is in line with fees or profits associated with lump sum contracts. The Federal Highway Administration may wish to reduce the estimate slightly to reflect either lower overheads or lower fees. However, the amounts used are reasonable and are within the level of accuracy of the other estimates.
3. Average salary rates for various classes of people are as follows:

<u>Position</u>	<u>Salary Without Overhead</u>
Principal-in-Charge	annual \$40,000 weekly \$770 hourly \$19
Senior Analyst Assistant Principal-in-Charge	annual \$35,000 weekly \$670 hourly \$17
Data Collection Manager Analyst	annual \$25,000 weekly \$480 hourly \$12
Field Crew Supervisor Camera Operator Data Reduction Manager	annual \$15,000 weekly \$290 hourly \$7.20
Field Crew Member Data Reduction Crew Member	annual \$8,300 weekly \$160 hourly \$4.00

4. Costs of Helicopter Service was assumed to average \$300 per hour. This cost can be as low as \$250 or as high as \$400, depending on the type of aircraft. It is assumed that helicopters in the \$250 to \$300 range will generally be available and therefore the average of \$300 is reasonable for cost estimating purposes.

It was further assumed that five hours of flight time would produce photography of six sites. This allows some margin for pilot training, the first day of data collection in each urban area and also for aborts due to emergency events.

5. Costs for travel and per diem are estimated as follows: The average air fare or auto allowance for a round trip to a city for one person is \$200.00. The per diem allowance for one person is \$35.00 per day or \$175 per week. The average cost of car rental for one week is \$100. These costs are necessarily averages, particularly the air fare. The average round trip air fare (coach class) from Chicago to 22 major cities is \$180. Thus a \$200 average seems reasonable since the contractor for Phase II might be located in a city which is not as centrally situated as Chicago.

Using these figures, the cost of a one-person-week trip to a sample city is \$475. This has been rounded to \$500 to cover incidental costs and surface transportation to and from the home-base airport.

6. Data Collection (small urban areas) -- There are eight sample urban areas with an average of 10 sites per area. Data collection is modest and involves a crew chief and an average of seven data collectors. Data will be collected at each site for one hour and with allowance for travel, four sites can be surveyed each day. No photography is planned for sites in the smaller urban area. Therefore, the estimate for each urban area includes the cost of a data collection supervisor for a week and a data collection crew for three days to allow time for possible aborts due to weather or other unforeseeable events.
7. Data Reduction -- The reduction of data from the aerial photographs includes a series of observations of the films for each site. These operations are expected to require approximately three hours per site, with two data reduction clerks performing the operation. Thus, with 700 segments the data reduction would require 4,200 hours or 105 person-weeks for the reduction of the data. The cost of a full-time data reduction manager during the 20-week period of data reduction is also included.

With these basic assumptions the cost of six major elements of the data collection plan is shown in Table 13. Summaries for large and small urban areas are shown in Tables 14 and 15.

Table 13. Estimated cost of data collection and reduction.

<u>Person Weeks</u>	<u>Weekly Labor Cost</u>	<u>Total Labor Cost</u>	<u>Travel/Per Diem</u>
<u>1. Mobilize and Plan</u>			
3	770	2,310	
4	480	1,920	
<u>3</u>	670	<u>2,010</u>	
10		6,240	
<u>2. Select Candidate Sites (large urban areas)</u>			
22	480	10,560	22,000
22	290	6,380	0
<u>6</u>	770	<u>4,620</u>	<u>0</u>
50		21,560	22,000
<u>3. Select Sample</u>			
4	770	3,080	
6	670	4,020	
<u>3</u>	290	<u>870</u>	
13		7,970	
<u>4. Plan For and Collect Data (large urban areas)</u>			
22	290	6,380	11,000
8	770	6,160	0
<u>22</u>	160	<u>3,520</u>	<u>99,000*</u>
52		16,060	110,000
<u>5. Data Reduction (large urban areas)</u>			
8	770	6,160	
20	290	5,800	
<u>40</u>	160	<u>6,400</u>	
68		18,360	
<u>6. Analysis (large urban areas)</u>			
16	770	12,320	
16	670	10,720	
16	670	10,720	
16	290	4,640	
<u>32</u>	160	<u>5,120</u>	
96		43,520	

Table 13. (continued)

<u>Person Weeks</u>	<u>Weekly Labor Cost</u>	<u>Total Labor Cost</u>	<u>Travel/Per Diem</u>
<u>7. Data Collection (small urban areas)</u>			
8	290	2,320	4,000
<u>34</u>	160	<u>5,440</u>	<u>0</u>
42		7,780	4,000
<u>8. Data Reduction (small urban areas)</u>			
1	770	770	
4	290	1,160	
<u>8</u>	160	<u>1,280</u>	
13		3,210	
<u>9. Analysis (small urban areas)</u>			
2	770	1,540	
4	670	2,680	
4	670	2,680	
4	290	1,160	
<u>8</u>	160	<u>1,280</u>	
22		9,340	

*Helicopter rental

Table 14. Summary of cost (large urban areas).

	<u>Labor</u>	<u>Other</u>
Mobilize and Plan	6,240	
Select Candidate Sites	21,560	22,000
Select Sample	7,970	
Collect Data	16,060	110,000
Data Reduction	18,360	
Analysis	<u>43,520</u>	
Total	113,710	132,000
With Overhead	284,275	132,000
With Overhead and Fee		457,900
Cameras, Projectors		20,000
Film and Processing		27,000
Computer Time		<u>20,000</u>
Total		524,900

Table 15. Summary of costs (small urban areas).

	<u>Labor</u>	<u>Other</u>
Data Collection	7,780	4,000
Data Reduction	3,210	0
Analysis	<u>9,340</u>	<u>0</u>
Total	20,330	4,000
With Overhead	50,825	4,000
With Overhead and Fee	55,910	4,400
Grand Total		60,310

Table 16. Cost estimate for special study of effect of grades and of trucks.

SITE SELECTION:		<u>Labor</u>	<u>Other</u>
3 @ 670	=	2,010	1,500
3 @ 480	=	<u>1,440</u>	<u>1,500</u>
		1,450	3,000
DATA COLLECTION:			
6 @ 670	=	4,020	3,000
6 @ 290	=	3,540	3,000
6 @ 160	=	<u>960</u>	<u>--</u>
		8,520	6,000
ANALYSIS:			
6 @ 670	=	4,020	
6 @ 290	=	3,540	
6 @ 160	=	<u>960</u>	
		8,520	
TOTAL		18,490	9,000
WITH OVERHEAD		46,225	9,000
WITH OVERHEAD AND FEE		50,850	9,900
GRAND TOTAL		60,750	

Table 17. Cost estimate for special study of effects of parking.

SITE SELECTION:		<u>Labor</u>	<u>Other</u>
1 @ 670	=	<u>670</u>	
		670	0
DATA REDUCTION:			
2 @ 290	=	580	
2 @ 160	=	<u>320</u>	
		900	0
ANALYSIS:			
3 @ 670	=	2,010	
3 @ 290	=	<u>870</u>	
		2,880	0
TOTAL		4,450	0
WITH OVERHEAD		11,125	0
WITH OVERHEAD AND FEE		12,240	0

Table 18. Cost estimate for special study of effects of weaving near interchanges.

SITE SELECTION:		<u>Labor</u>	<u>Other</u>
3 @ 670	=	2,010	1,500
3 @ 480	=	<u>1,440</u>	<u>1,500</u>
		3,450	3,000
DATA COLLECTION:			
2 @ 670	=	1,340	--
6 @ 480	=	2,880	6,000
6 @ 290	=	1,740	--
24 @ 160	=	<u>3,840</u>	<u>--</u>
		9,800	6,000
DATA REDUCTION:			
2 @ 670	=	1,340	
6 @ 290	=	1,740	
12 @ 160	=	<u>1,920</u>	
		5,000	
TOTAL		18,250	9,000
WITH OVERHEAD		45,625	9,000
WITH OVERHEAD AND FEE		50,200	9,900
GRAND TOTAL		60,100	

APPENDIX A
URBAN ARTERIAL STREET
SEGMENT DATA COLLECTION MANUAL

INTRODUCTION

The purpose of this manual is to describe the procedures for inventorying urban arterial street segments. The inventory is an essential part of a national study of the quality of flow and capacity of urban arterials. The inventory phase is for the purpose of collecting measurements of the study segments and intersections.

Definitions

An urban arterial segment is a one-way section of street between two signalized intersections. Two-way street sections are divided into two segments, one for each direction of travel.

The intersections at each end of a segment are designated as the upstream and downstream intersection in relation to the direction of flow on the segment. Thus on a two-way street, an intersection is the upstream intersection for one segment and the downstream intersection for another segment.

All lane and width dimensions may be measured with a tape or measuring wheel and are to be recorded to the nearest one-tenth of a foot (305mm).

All data is to be recorded on the forms which begin on page 7 according to the following definitions and instructions.

Length -- Record the length of the segment to the nearest 1/100 of a mile (16.09m). Measure the length with a measuring wheel or scale it from an accurate map. The measurement should be from the far side crosswalk of the upstream intersection to the far side crosswalk of the downstream intersection.

One-Way or Two-Way — Enter a 1 for one-way travel, a 2 for two-way travel on the street.

Lane Width Along Segment — Measure the width of each lane at a mid-block location. On two-way streets, lane 1 is the lane nearest the right hand curb. Enter only those lanes for the direction of travel shown on the identification sheet. Enter the width to the nearest one-tenth foot (305mm). Enter the width of all lanes including parking lanes.

Type and Width of Median — Enter the type, the width (and height for raised medians) in the appropriate space. The width of median should be measured from the face of curb to face of curb if it is raised. If the median is not raised the width should be measured from edge of lane to edge of lane.

Number of Access Points — On one-way, undivided two-way, and divided streets where left turns are permitted across the median, count the total number of intersections and major driveways on both sides of the street between the upstream and downstream intersections. On divided streets, count only the driveways on the right side of the street.

Major driveways are all driveways to parking lots, service stations, shopping centers, apartment houses with 10 units or more, or, in general, to all land uses except low density residential uses. Low-density residential uses are defined as single-family housing and small apartment or townhouse housing with less than 10 residential units per driveway.

Each approach at intersections of streets (other than the upstream and downstream intersections) with the arterial segment are to be counted as an access point. That is, a four-way or crossing intersection will be counted as two approaches while three-way intersections would be counted as one.

On two-way streets where the median is of a type where left turns from the arterial are either impossible or illegal, only those major driveways on the right side of the street are to be counted. Intersection approaches and major driveways on the left side where there is an opening in the median are to be counted.

Number and Type of Bus Stop — The two types of bus stops are:

- Type 1 — A stop outside the traveled lane. Such stops would be in the parking lane, if parking is permitted, or in a specifically constructed pull-out area beside the traveled lane.
- Type 2 — A stop which is in a traveled lane. That is, a stopped bus will block a traveled lane.

Count the number of stops on the right-hand side of the segment beginning at the center of the upstream intersection and proceeding to the downstream intersection. Do not count any bus stop which is within the downstream approach. Such stops are to be recorded in the downstream intersection data.

Type and Intensity of Land Use — Check the box which best describes the land use along the segment. On one-way streets and undivided streets where the type and intensity of land use on opposite sides of the segment is very different record the data for the most highly developed side.

Business, Retail, Offices — Check this type if all or nearly all of the buildings along the segment are stores, offices, car dealerships, drive-in restaurants, motels, and the like. Check low density if the businesses are small with all or nearly all being one- or two-story buildings.

Check medium density if the businesses tend to be regional shopping centers with sizeable parking areas or if the buildings tend to be more than three or four stories in height.

Check high density if the buildings tend to be more than four stories in height and parking tends to be in multi-story garages.

Mixed Residential and Business — Check this type of land use where residential and business land uses are mixed. Use the appropriate density code as described above.

Residential — Check this type of land use where all or nearly all of the land along the segment is developed for residential use.

Check low density where the predominant housing is single-family or townhouses.

Check medium density where the residential buildings are apartments or condominiums generally less than four (4) stories in height.

Check high density where the buildings are generally more than four (4) stories in height.

Institutional — Check this land use type where the predominant development consists of hospitals, schools (including colleges) and check the appropriate density in each case.

Parks, Open Land, Reservation — Check this category when the abutting land is either undeveloped or is used for cemeteries, parks, fenced military reservations, and similar uses. Always check low density.

Warehousing, Manufacturing, Utilities — Check this category where most of the buildings are used for factories, warehouses, terminals, public utility storage yards, generating plants, railroad yards, docks, or other similar purposes.

Check low density where buildings are low in height with rather large parking or unused space between them.

Check medium density where the buildings average two or three stories and are not closely spaced.

Check high density where buildings average three or more stories and are closely spaced with all of the land used for parking or for trucking, etc.

Location Within City

Source: "Highway Capacity Manual," Page 19

	<u>Code</u>
Central Business District	4
Fringe Area	3
Outlying Business Area	2
Residential Area	1

Location Within City Definitions

1. Central Business District — That portion of a municipality in which the dominant land use is for intense business activity. This district is characterized by large numbers of pedestrians, commercial vehicle loadings of goods and people, a heavy demand for parking space, and high parking turnover.
2. Fringe Area — That portion of a municipality immediately outside the central business district in which there is a wide range in type of business activity, generally including small business, light industry, warehousing, automobile service activities, and intermediate strip development, as well as some concentrated residential areas. Most of the traffic in this area involves trips that do not have an origin or a destination within the area. This area is characterized by moderate pedestrian traffic and a lower parking turnover than is found in the central business district, but it may include large parking areas serving the district.
3. Outlying Business District — That portion of a municipality or an area within the influence of a municipality, normally separated geographically by some distance from the central business district and its fringe area, in which the principal land use is for business activity. This district has its own local traffic circulation superimposed on through movements to and from the central business district, a relatively high parking demand and turnover, and moderate pedestrian traffic. Compact off-street shopping developments entirely on one side of the street are not included in the scope of this definition.
4. Residential Area — That portion of a municipality, or an area within the influence of a municipality, in which the dominant land use is residential development, but where small business areas may be included. This area is characterized by few pedestrians and a low parking turnover.

INTERSECTION FIELD SURVEYS

The field survey party will prepare a detailed survey of the downstream intersection. This survey will cover all approaches. Data will be recorded directly on a sketch of the intersection

The intersection will be given a unique identification number which will consist of seven digits. The first two digits will identify the urbanized area. The third and fourth digits will identify the city or suburb within which the intersection is located. The fifth and sixth digits will be assigned to the particular intersection.

In the case of larger urban areas, the intersection is associated with a segment and the seventh digit will be an A, B, C, or D. The letter "D" will be assigned to the downstream approach. In keeping with this manner of designation the segment will be assigned the six digit code of the downstream intersection plus the letter "S". The letters A, B, and C are to be assigned to the remaining three approaches of the downstream intersection in this order; A to the approach on the left, B to the oncoming approach, and C to the approach on the right of the downstream approach.

In the case of the smaller cities, the intersection is not associated with a segment and the last digit will be a 1, 2, 3, or 4. These may be assigned in any order.

The forms for recording the intersection and segment follow. A total of four forms are required. Form 1 is for recording general characteristics such as population, location, land use and intensity. Form 2 is for recording the physical characteristics of intersections. Form 3 is for recording the traffic signal characteristics. Form 4 is for recording the physical characteristics of a segment.

INTERSECTION CHARACTERISTICS (FORM 2)

This form is to be completed for each intersection. Lane lengths are to be shown only for those lanes which exist only at the intersection. Each approach is to be either numbered or assigned a letter as described on page 6. Space is provided for 6 lanes plus two parking lanes. If there are more than that number of lanes the information should be entered on the back of the form. If there are fewer than four through lanes or if there is no parking, zeros must be entered in those lanes. Lane types are shown on page 10.

All dimensions—lane width, median width, etc.—are to be recorded in feet to the nearest one-tenth foot (1 ft. = 0.3048m).

The beginning and end of any parking prohibition is to be measured from the extension of the curb on the cross street and is to be recorded to the nearest foot.

The intersection identification is to be entered in the six digit box provided. The alpha or numeric code for the approaches are to be entered in the boxes provided on the intersection sketch.

Bus stops within 100 feet (30m) of the stop line must be recorded. Stops which are outside the 100 foot (30m) measure are to be recorded on Form 4.

INTERSECTION CHARACTERISTICS

IDENTIFICATION

CITY _____

INTERSECTION IDENTIFICATION

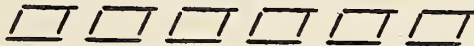

MEDIAN TYPE _____ WIDTH _____

PARKING PROHIBITION BEGIN _____
END _____

BUS STOP TYPE _____

BEGIN _____ END _____

LANES WIDTH TYPE LENGTH

Pkg _____

1 _____

2 _____

3 _____

4 _____

Pkg _____



MEDIAN TYPE _____ WIDTH _____

PARKING PROHIBITION BEGIN _____
END _____

BUS STOP TYPE _____

BEGIN _____ END _____

LANES WIDTH TYPE LENGTH

Pkg _____

1 _____

2 _____

3 _____

4 _____

Pkg _____



MEDIAN TYPE _____ WIDTH _____

PARKING PROHIBITION BEGIN _____
END _____

BUS STOP TYPE _____

BEGIN _____ END _____

LANES WIDTH TYPE LENGTH

Pkg _____

1 _____

2 _____

3 _____

4 _____

Pkg _____



MEDIAN TYPE _____ WIDTH _____

PARKING PROHIBITION BEGIN _____
END _____

BUS STOP TYPE _____

BEGIN _____ END _____

LANES WIDTH TYPE LENGTH

Pkg _____

1 _____

2 _____









3 _____

4 _____

Pkg _____

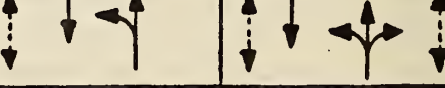

CLASSIFICATION OF LANE TYPES

Type	Description	Illustration
A	Only through traffic	
B	Some turning traffic without conflict	
C	Only turning traffic without conflict	
D	Some turning traffic in conflict with pedestrians	
E	Only turning traffic in conflict with pedestrians	
F	Some turning traffic in conflict with opposing traffic	
G	Only turning traffic in conflict with opposing traffic	
D/F	Some turning traffic in conflict with opposing traffic and pedestrians	
E/G	Only turning traffic in conflict with opposing traffic and pedestrians	

INTERSECTION TRAFFIC SIGNAL CHARACTERISTICS (FORM 3)

Enter the code for the type of signal controller. Check the appropriate boxes for the possible indications on each approach. Be sure to check all possible combinations. For example if a turn indication may appear either with or without the through indication, both such possibilities should be checked.

FORM 3

INTERSECTION TRAFFIC SIGNAL CHARACTERISTICS

IDENTIFICATION CODE

SIGNAL CONTROL TYPE

FIXED TIME UNCOORDINATED

COORDINATED

SEMI-ACTUATED UNCOORDINATED

COORDINATED

FULL ACTUATED UNCOORDINATED

COORDINATED

AREAWIDE, REAL TIME

OTHER DESCRIBE _____

POSSIBLE INDICATIONS

APPROACH

	A or 1	B or 2	C or 3	D or 4
THROUGH ONLY				
LEFT ONLY				
RIGHT ONLY				
THROUGH PLUS LEFT				
THROUGH PLUS RIGHT				
RIGHT PLUS LEFT				
ALL MOVEMENTS				

Check Appropriate Boxes

SEGMENT CHARACTERISTICS (FORM 4)

All data regarding the segment must be recorded on Form 4. The form is self explanatory.

SEGMENT CHARACTERISTICS

Length in Miles (Nearest 0.01) (1 mile = 1.609km)

 / . / / /

Lanes and Width

Lanes are numbered from left side of approach.

<u>Lane</u>	<u>Lane Width</u>
Parking	<u> </u> . <u> </u> / <u> </u> /
Lane 1	<u> </u> . <u> </u> / <u> </u> /
Lane 2	<u> </u> . <u> </u> / <u> </u> /
Lane 3	<u> </u> . <u> </u> / <u> </u> /
Lane 4	<u> </u> . <u> </u> / <u> </u> /
Lane 5	<u> </u> . <u> </u> / <u> </u> /
Lane 6	<u> </u> . <u> </u> / <u> </u> /
Parking	<u> </u> . <u> </u> / <u> </u> /

Total Width With Parking / / . / / ft. (1 ft.=0.3048m)

Total Width Without Parking / / . / / ft.

Total Lanes Without Parking /

Average Lane Width Without Parking / . / ft.

Parking

Permitted (1) /

Not Permitted (2)

Median Type and Width

<u>Type</u>	<u>Width</u>	<u>Code</u>
None	0	0
Paint	--	
Less than 8 feet (2.50m)		1
Wider than 8 feet (2.50m)		2
Two-Way Left Turn Lane		3
Flush Unpaved under 8 feet (2.50m)		4
Raised over 8 feet (2.50m)	--	5
Under 8 feet (2.50m)		6
Over 8 feet (2.50m)		7

Number of Bus Stops By Type

Bus Stops Out of Travelled Lanes (1) /

Bus Stops in Travelled Lanes (2) /

Do not include bus stops within 100 feet (30m) of stop line of downstream intersection. They will be inventoried with the intersection characteristics.

Access Points

Total Number of:

- Intersections (not counting the upstream and downstream intersections)
- Major Driveways (includes commercial, parking lot and garage, residential to 10 or more dwelling units)

On divided roadways, count only those on right side plus those with median openings. (See instructions for details)

Total Access Points / /

(Office Entry)

Total Access Points = Points Per Mile (1 mile - 1.609km) / . / /
Length

RECORDING DYNAMIC MEASURES (FORM 5)

Following are the instructions and typical field forms for collecting the dynamic measures by manual methods. Similar methods are to be used for recording the data from time-lapse photographs, but where appropriate separate forms are provided.

Coordination of Ground Crew Data Collection and Time Lapse Photography

When time-lapse photography is used, a field crew will be collecting data on signal timing and on pedestrian flows. The coordination of the time during the collection period is vital to the accuracy of the data. The cameraman and crew chief will be in communication by radio and timing will be maintained on digital electronic watches. The cameraman will signal the crew chief a few minutes prior to the beginning so that the ground crew can begin recording. When filming begins, the cameraman will give the ground crew a "Mark". The cameraman will also give "Mark" at the conclusion of filming. Both parties will record their "begin" and "end" times.

All of the forms employed provide space for about one hour of data collection. This permits the different recorders to begin and end at different times and the common 15 minutes will be selected for analysis.

Turning Movements

The turning movements on all approaches at the downstream intersection are to be collected for the 15-minute study period. Standard turning movement counting methods are to be used and totals are to be recorded every cycle. The form for recording this data is Form 5. Local buses and trucks are to be separately tabulated. Additionally, the number of fully loaded cycles on the downstream approach of the segment are to be recorded.

The recorder may tally the vehicles in the appropriate boxes. The column headed "Loaded" is to be checked when the green period for that approach was fully utilized.

Pedestrian Volumes

These counts are to be taken in the crosswalks at the downstream intersection and are to be recorded only in four general classes of volumes as follows:

<u>Level</u>	<u>Approximate Volume</u>
0	Less than 100 pedestrians per hour
1	100 to 250 pedestrians per hour
2	250 to 500 pedestrians per hour
3	More than 500 pedestrians per hour

To determine the appropriate level, the observer should determine immediately before the beginning of the 15-minute study period what the typical signal cycle is. The following table shows the approximate number of pedestrians that would use a crosswalk per cycle. By observing the number of pedestrians in the crosswalks, the observer can readily assign an appropriate level after a few cycles.

NUMBER OF PEDESTRIANS PER CYCLE

<u>Level</u>	<u>Average Cycle Length (Seconds)</u>			
	<u>40-45</u>	<u>50-70</u>	<u>80-90</u>	<u>100</u>
0	1	2	2	3
1	2	4	6	7
2	5	8	12	13
3	7	10	14	14

The recorder will enter the appropriate level for each crosswalk in the space provided on form 5.

FORM 5
TURNING MOVEMENT COUNTS

CITY _____

STREET _____

IDENTIFICATION / / / / / / / /

TIME OF DAY STARTED _____ ^{AM}/_{PM} TIME OF DAY ENDED _____ ^{AM}/_{PM}

PEDESTRIAN LEVEL ACROSS APPROACH _____

CYCLE	LEFT			THROUGH			RIGHT			LOADED
	PASS.	TRUCK	Local BUS	PASS.	TRUCK	Local BUS	PASS.	TRUCK	Local BUS	
1										
2										
3										
4										
5										
6										
7										
8										
9										
10										
11										
12										
13										
14										
15										
16										
17										
18										
19										
20										
TOTAL										

STOPS AND DELAYS (FORM 6)

An analysis of the various ways that delay can be measured is presented in Reilly and Gardner's "Technique for Measurement of Delay at Intersections." They "recommend that the point sample, stopped delay study be used for field measurement of delay."

This method is outlined by Box and Oppenlander in their Manual of Traffic Engineering Studies. It is based on a periodic sample of the number of stopped vehicles on the intersection approach—a series of instantaneous samples having an interval of time between each sample.

The number of vehicles actually stopped in the approach at the start of the sampling time is recorded. At each consecutive 15- or 30-second interval, the number of vehicles stopped in queue is recorded in the proper columns of the data sheet. At the same time, a count is being made of the total approach volume in two separately tabulated categories—the number of approach vehicles stopping and the number of approach vehicles not stopping. Thirteen-second intervals are used for fixed-time signals, while either 13- or 15-second intervals may be used for actuated signals.

It is useful and time-saving to have a tape recorder that gives the data collector a cue at each 13-second interval, so that the collector's full attention may be focused on counting vehicles. It is possible to have two people sharing the recorder and each counting an approach provided they have good visual access to the respective approaches.

The following information may be calculated from the data:

1. Total delay (vehicles/sec.)
2. Average delay per stopped vehicle (seconds)
3. Average delay per approach vehicle (seconds)
4. Percentage of vehicles stopped (percent)

The data will be recorded on form 6 which is set up to take any interval length. The recorder simply enters the chosen interval.

In many cases, two approaches will have exactly the same indications and timing. In such cases, the recorder will enter both approach letters or digits. Space is provided for recording different clearance intervals if a uniform interval is not used. In such cases, the recorder should enter the approach designations and clearance interval. If the interval is uniform, the recorder should enter "All" and the time. The clearance interval is equal to the yellow interval plus any all red interval, if one exists.

Timing may begin in advance of other data acquisition and extend beyond the 15-minute period. The time of day when timing begins must be entered.

If an observer fails to note the beginning or end of an indication, a dash will be put in that space and recording will continue.

BUS VOLUMES AND DWELL TIMES (FORM 8)

The data to be collected on Form 8 is:

1. The time of day when each bus reaches a bus stop.
2. The bus dwell time at the stop. (Dwell time is defined as the time from locked wheel to unlocked wheel.)

One person can easily collect data for two bus stops provided the stations have capacities for one or two buses only. It is necessary for the data collector to have a stopwatch with provisions for making two timings simultaneously in the case where both bus stops are being serviced during the same time period. It will be necessary to have one person do each bus stop if the stops are situated so that one checker would not have full view of both.

The same form will be used for collecting data from time-lapse photography except that a single observer can collect the data for all bus stops in the segment.

FORM 8
BUS DWELL TIME

IDENTIFICATION NUMBER



TIME OF DAY STARTED _____ AM
PM

TIME ENDED _____ AM
PM

TIME	STOP #1	STOP #2	STOP #3	STOP #4
ARRIVED				
DEPARTED				
ARRIVED				
DEPARTED				
ARRIVED				
DEPARTED				
ARRIVED				
DEPARTED				
ARRIVED				
DEPARTED				
ARRIVED				
DEPARTED				
ARRIVED				
DEPARTED				
ARRIVED				
DEPARTED				
ARRIVED				
DEPARTED				
ARRIVED				
DEPARTED				
ARRIVED				
DEPARTED				

PARKING TURNOVER RATE (FORMS 9 AND 9P)

The License Plate Checks method of determining parking turnover rate will be used. Parking turnover rate is defined as the number of parking maneuvers during the study period in each space of a given block face. The license plate check method provides a viable sampling technique for detailed observation of curbside parking. The manpower requirement is dependent upon the parking turnover rate and the length of the study segment.

Because the survey period is only 15 minutes, the recorder should begin the first round before the 15-minute period begins so that the vehicles parked at the beginning are known. The recorder should then begin recording and traverse the segment recording new license numbers as they appear. Form 9 provides for five circuits of the area. At a rate of one every three minutes this would allow nearly 30 minutes of recording which should be more than adequate.

Illegal parking which occurs in a traveled lane and double parking should be recorded as lane blockages and not as parking. Illegal parking in such curbside areas as loading zones and driveways but which does not block a lane should be recorded as parking maneuvers.

The result should be recorded as: Number of vehicles which performed a parking maneuver during the 15-minute study period, divided by the length of segment to give maneuvers per mile.

Time-Lapse Photography Method

The method of recording is much different when time-lapse is used. Form 9P will be used. The recorder enters the number of cars parked when recording began and then tallies the number of parking and unparking maneuvers.

LANE BLOCKAGE (FORM 10)

Lane blockage is defined as the occupancy of a lane which should be available to moving traffic by double parking, disabled vehicles, queues from side streets and driveways. Not included are lane blockage by buses in bus stops, queues from left and right turns at the downstream intersection and from curb parking. Form number 10 is to be used to record the beginning and ending times and the lane in which the blockage took place.

SEGMENT DEMAND (FORM 11)

Segment demand is a measure of those vehicles that enter or exit the mainstream flow via side streets or sources and sinks such as driveways, parking lots, and gas stations. The procedure for positioning and instructing the data collectors for segment demand counts are similar to those for turning movement counts. Turning movement volumes, legal and illegal including U-turns, for heavy-volume driveways and all side streets are to be recorded.

The recorder should list the streets and driveways which he can observe and for which he is to obtain counts in the left-most column. He may then tally the in-and-out in second and third columns. The total movements for each location can then be entered in the fourth column and these can be totaled to obtain the total for the segment.

PROGRESSION (FORM 12)

This characteristic is to express the goodness of progression and is to be collected on the intersection approach. The characteristic is defined as the percentage of total vehicles arriving at the approach while the through green indication is on. The data is to be recorded on Form 12.

FORM 12
PROGRESSION

CITY _____

STREET _____

IDENTIFICATION NUMBER / / / / / / / /

TIME OF DAY STARTED _____ AM _____ PM TIME OF DAY ENDED _____ AM _____ PM

CYCLE	ARRIVED DURING GREEN	ARRIVED ON RED	TOTAL
1			
2			
3			
4			
5			
6			
7			
8			
9			
10			
11			
12			
13			
14			
15			
16			
17			
18			
19			
20			
TOTAL			

TRAVEL TIME (FORMS 13, 13PH, AND 13PA)

Travel Time, when measured manually, will be done by the license plate recording technique. When measured from time-lapse photographs, vehicles will be "tracked" from the beginning to the end of the segment. This process will also yield the variance in travel time.

Because the segments will be not more than one-half mile in length, the average travel time will range from one minute to three minutes. Therefore it will be necessary to code times to the nearest second. Therefore the observer will be required to select individual vehicles for which the license number and precise time of passing can be recorded.

To reduce the number of mis-matches, both the upstream and downstream recorders can pre-select certain types of vehicles for recording. Thus, they would attempt to record all automobiles of a certain color, all vans, and all trucks of a certain color. Thus, even with some missed recording, the number of matches would be relatively high.

With high level time-lapse photography, the method requires the use of two cameras and two projectors. The recorder synchronizes the two projectors and finds a vehicle which can be uniquely identified in the upstream film. The downstream camera is then advanced until the vehicle is located and the frame number for each projector is recorded. (Not all vehicles can be matched due to parking, side street, and driveway turns.) The process is repeated until a total of 50 matches has been achieved. Form 13PH is for the recording where high level photography is used.

When recording travel time from time-lapse photographs taken from an aircraft, the method involves tracking vehicles as the film is advanced through the segment and recording the frame numbers when the vehicle crossed the upstream reference point and the downstream reference point. Form 13PA is for this recording. Care must be exercised to select vehicles throughout the 15-minute time period.

TRAVEL TIME AND TRAVEL TIME VARIANCE FROM HIGH LEVEL TIME-LAPSE PHOTOGRAPHY

IDENTIFICATION NUMBER



FRAME INTERVAL EQUALS _____ PER SECOND

FRAME NUMBER _____ UPSTREAM EQUALS

FRAME NUMBER _____ DOWNSTREAM EQUALS

VEHICLE NUMBER	FRAME NUMBER		FRAME NUMBER		FRAME NUMBER	
	UPSTREAM	DOWNSTREAM	UPSTREAM	DOWNSTREAM	UPSTREAM	DOWNSTREAM
1						
2						
3						
4						
5						
6						
7						
8						
9						
10						
11						
12						
13						
14						
15						
16						
17						
18						
19						
20						

FORM 13PA

TRAVEL TIME AND TRAVEL TIME VARIANCE FROM AERIAL TIME LAPSE PHOTOGRAPHY

IDENTIFICATION NUMBER

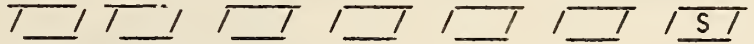

FRAME INTERVAL EQUALS _____ PER SECOND

VEHICLE NUMBER	FRAME NUMBER		FRAME NUMBER		FRAME NUMBER	
	BEGIN	END	BEGIN	END	BEGIN	END
1						
2						
3						
4						
5						
6						
7						
8						
9						
10						
11						
12						
13						
14						
15						
16						
17						
18						
19						
20						

DATA REDUCTION

The data from the field surveys must be reduced to totals and organized into a single set of data for each intersection approach and for each segment. The data will be collected in a disaggregate form and it should be filed in that form to permit future analyses. The following pages list the items to be included in the file. During the analysis items can be extracted from the master file to form analysis files and save computer processing time.

DATA FILE FOR AN INTERSECTION APPROACH

<u>Data Name</u>	<u>Dimension</u>
Identification Number	Seven Digits
Approach Width	In Feet - 3 digits
Number of Lanes	Number - 1 digit
Lane Control One entry each lane	Type of Lane By Code - 1 digit
Median Type	Coded Median Type - 1 digit
Type of Bus Stop	1 digit code
Right Turn on Red	1 digit code
Parking Condition	1 digit code
One-Way Two Way	1 digit code
Parking Turnover	Number of Parking Maneuvers
Distance to First Parked Vehicle	In feet, 3 digits
Progression	2 digit percent of total volume arriving during green
Number of Times Green	2 digit number of green indications ● through ● left (three entries) ● right
Volume by Movement	six entries - 3 digits each <u>entries</u> ● through ● left ● right ● total (service volume) ● percent left ● percent right
Truck Volume	seven entries - 3 digits each <u>entries</u> ● trucks through ● trucks left ● trucks right ● percent through ● percent left ● percent right ● percent total

DATA FILE FOR AN INTERSECTION APPROACH (Continued)

<u>Data Name</u>	<u>Dimension</u>
Local Buses	five entries - 3 digits each <u>entries</u> <ul style="list-style-type: none">● buses through● buses left● buses right● total● percent of total
Bus Dwell Time	Total minutes and tenths that buses spent in bus stop
Lane Blockage	Total minutes a lane was blocked
Pedestrian Levels	1 digit code for each of the four crosswalks
Type of Signal Control	<ul style="list-style-type: none">● one digit code for type● one digit code for number of phases per cycle
Intensity of Land Use	2 digit code
Location Within City	1 digit code
SMSA Population	4 digits - population in thousands
Urban Population	4 digits - population in thousands
City Population	4 digits - population in thousands
Lane Width	2 digits each lane - up to six entries
Average Lane Width	2 digits
Load Factor	2 digits - percent of cycles loaded

DATA FILE FOR A SEGMENT

<u>Data Name</u>	<u>Dimension</u>
Identification Number	Seven Digits
Approach Width	In feet - 3 digits
Number of Lanes	Number 1 digit
Lane Control	Type of Lane by Code - 1 digit
One Entry Each Lane	
Median Type	Coded Median Type - 1 digit
Length	In Tenths of miles - 2 digits
Type of Bus Stop	One digit code
Parking Condition	1 digit code
One-Way Two Way	1 digit code
Parking Turnover	Number of parking movements per mile 3 digits
Number of Parked Vehicles	2 digits
Service Volume	Total vehicles - 4 digits
Truck Volume	Seven entries - 3 digits each <u>entries</u> <ul style="list-style-type: none">● trucks through● trucks left● trucks right● percent through● percent left● percent right● percent total
Local Buses	Five entries - 3 digits each <u>entries</u> <ul style="list-style-type: none">● buses through● buses left● buses right● total● percent of total
Bus Dwell Time	● total time in minutes and tenths that buses spent in bus stops - 3 digits
Lane Blockage	● total minutes any lane was b-ocked 2 digits
Intensity of Lane Use	2 digit code
Location Within City	1 digit code
SMSA Population	4 digits - population in thousands
Urban Population	4 digits - population in thousands
City Population	4 digits - population in thousands
Lane Width	2 digits each lane - up to six entries
Average Lane Width	2 digits









FEDERALLY COORDINATED PROGRAM OF HIGHWAY RESEARCH AND DEVELOPMENT (FCP)

The Offices of Research and Development of the Federal Highway Administration are responsible for a broad program of research with resources including its own staff, contract programs, and a Federal-Aid program which is conducted by or through the State highway departments and which also finances the National Cooperative Highway Research Program managed by the Transportation Research Board. The Federally Coordinated Program of Highway Research and Development (FCP) is a carefully selected group of projects aimed at urgent, national problems, which concentrates these resources on these problems to obtain timely solutions. Virtually all of the available funds and staff resources are a part of the FCP, together with as much of the Federal-aid research funds of the States and the NCHRP resources as the States agree to devote to these projects.*

FCP Category Descriptions

1. Improved Highway Design and Operation for Safety

Safety R&D addresses problems connected with the responsibilities of the Federal Highway Administration under the Highway Safety Act and includes investigation of appropriate design standards, roadside hardware, signing, and physical and scientific data for the formulation of improved safety regulations.

2. Reduction of Traffic Congestion and Improved Operational Efficiency

Traffic R&D is concerned with increasing the operational efficiency of existing highways by advancing technology, by improving designs for existing as well as new facilities, and by keeping the demand-capacity relationship in better balance through traffic management techniques such as bus and carpool preferential treatment, motorist information, and rerouting of traffic.

3. Environmental Considerations in Highway Design, Location, Construction, and Operation

Environmental R&D is directed toward identifying and evaluating highway elements which affect the quality of the human environment. The ultimate goals are reduction of adverse highway and traffic impacts, and protection and enhancement of the environment.

4. Improved Materials Utilization and Durability

Materials R&D is concerned with expanding the knowledge of materials properties and technology to fully utilize available naturally occurring materials, to develop extender or substitute materials for materials in short supply, and to devise procedures for converting industrial and other wastes into useful highway products. These activities are all directed toward the common goals of lowering the cost of highway construction and extending the period of maintenance-free operation.

5. Improved Design to Reduce Costs, Extend Life Expectancy, and Insure Structural Safety

Structural R&D is concerned with furthering the latest technological advances in structural designs, fabrication processes, and construction techniques, to provide safe, efficient highways at reasonable cost.

6. Prototype Development and Implementation of Research

This category is concerned with developing and transferring research and technology into practice, or, as it has been commonly identified, "technology transfer."

7. Improved Technology for Highway Maintenance

Maintenance R&D objectives include the development and application of new technology to improve management, to augment the utilization of resources, and to increase operational efficiency and safety in the maintenance of highway facilities.

* The complete 7-volume official statement of the FCP is available from the National Technical Information Service (NTIS), Springfield, Virginia 22161 (Order No. PB 242057, price \$45 postpaid). Single copies of the introductory volume are obtainable without charge from Program Analysis (HRD-2), Offices of Research and Development, Federal Highway Administration, Washington, D.C. 20590.

DOT LIBRARY



00056196

