



U.S. Department
of Transportation
**National Highway
Traffic Safety
Administration**



DOT HS 812 575

August 2018

Functional Safety Assessment Of a Generic Electric Power Steering System With Active Steering and Four-Wheel Steering Features

Disclaimer

This publication is distributed by the U.S. Department of Transportation, National Highway Traffic Safety Administration, in the interest of information exchange. The opinions, findings, and conclusions expressed in this publication are those of the authors and not necessarily those of the Department of Transportation or the National Highway Traffic Safety Administration. The United States Government assumes no liability for its contents or use thereof. If trade or manufacturers' names or products are mentioned, it is because they are considered essential to the object of the publication and should not be construed as an endorsement. The United States Government does not endorse products or manufacturers.

Suggested APA Format Citation:

Becker, C., Nasser, A., Attioui, F., Arthur, D., Moy, A., & Brewer, J., (2018, August). *Functional safety assessment of a generic electric power steering system with active steering and four-wheel steering features* (Report No. DOT HS 812 575). Washington, DC: National Highway Traffic Safety Administration.

REPORT DOCUMENTATION PAGE			Form Approved OMB No.0704-0188	
Public reporting burden for this collection of information is estimated to average 1 hour per response, including the time for reviewing instructions, searching existing data sources, gathering and maintaining the data needed, and completing and reviewing the collection of information. Send comments regarding this burden estimate or any other aspect of this collection of information, including suggestions for reducing this burden, to Washington Headquarters Services, Directorate for Information Operations and Reports, 1215 Jefferson Davis Highway, Suite 1204, Arlington, VA 22202-4302, and to the Office of Management and Budget, Paperwork Reduction Project (0704-0188), Washington, DC 20503.				
1. AGENCY USE ONLY (Leave blank)		2. REPORT DATE August 2018		3. REPORT TYPE AND DATES COVERED July 2014 – November 2015
4. TITLE AND SUBTITLE Functional Safety Assessment of a Generic Electric Power Steering System With Active Steering and Four-Wheel Steering Features			5. FUNDING NUMBERS Intra-Agency Agreement DTNH22-14-V-00136 51HS6CA100	
6. AUTHORS Christopher Becker, Ahmad Nasser, Fouad Attioui, David Arthur, Andy Moy, and John Brewer				
7. PERFORMING ORGANIZATION NAME AND ADDRESS John A. Volpe National Transportation Systems Center 55 Broadway Cambridge, MA 02142			8. PERFORMING ORGANIZATION REPORT NUMBER DOT-VNTSC-NHTSA-16-02	
9. SPONSORING/MONITORING AGENCY NAME(S) AND ADDRESS(ES) National Highway Traffic Safety Administration 1200 New Jersey Avenue SE Washington, DC 20590			10. SPONSORING/MONITORING AGENCY REPORT NUMBER DOT HS 812 575	
11. SUPPLEMENTARY NOTES Paul Rau was Contracting Officer Representative for this project.				
12a. DISTRIBUTION/AVAILABILITY STATEMENT This document is available to the public through the National Technical Information Service, www.ntis.gov.			12b. DISTRIBUTION CODE	
13. ABSTRACT This report describes the research effort to assess the functional safety of electric power steering (EPS) systems. This study also considers the additional active steering and four-wheel steering features, which are incorporated into some EPS systems. This study follows the Concept Phase process in the ISO 26262 standard and applies hazard and operability study, functional failure modes and effects analysis, and systems theoretic process analysis methods. In total, this study identifies four vehicle-level safety goals and 125 EPS system safety requirements (an output of the ISO 26262 process). This study uses the results of the analysis to develop potential test scenarios and identify possible areas for diagnostic trouble code coverage.				
14. SUBJECT TERMS Electric power steering, active steering, four-wheel steering, hazard and operability study, failure modes and effects analysis, systems theoretic process analysis, ISO 26262, hazard analysis, risk assessment, and safety requirements.			15. NUMBER OF PAGES 454	
			16. PRICE CODE	
17. SECURITY CLASSIFICATION OF REPORT Unclassified	18. SECURITY CLASSIFICATION OF THIS PAGE Unclassified	19. SECURITY CLASSIFICATION OF ABSTRACT Unclassified	20. LIMITATION OF ABSTRACT	

Foreword

NHTSA's Automotive Electronics Reliability Research Program

The mission of the National Highway Traffic Safety Administration is to save lives, prevent injuries, and reduce economic costs due to motor vehicle crashes. As part of this mission, NHTSA researches methods to ensure the safety and reliability of emerging safety-critical electronic control systems in motor vehicles. The electronics reliability research area focuses on the body of methodologies, processes, best practices, and industry standards that are applied to ensure the safe operation and resilience of vehicular systems. More specifically, this research area studies the mitigation and safe management of electronic control system failures and making operator response errors less likely.

NHTSA has established five research goals for the electronics reliability research program to ensure the safe operation of motor vehicles equipped with advanced electronic control systems. This program covers various safety-critical applications deployed on current generation vehicles, as well as those envisioned on future vehicles that may feature more advanced forms of automation and connectivity. These goals are:

1. Expand the knowledge base to establish comprehensive research plans for automotive electronics reliability and develop enabling tools for applied research in this area;
2. Strengthen and facilitate the implementation of safety-effective voluntary industry-based standards for automotive electronics reliability;
3. Foster the development of new system solutions for ensuring and improving automotive electronics reliability;
4. Research the feasibility of developing potential minimum vehicle safety requirements pertaining to the safe operation of automotive electronic control systems; and
5. Gather foundational research data and facts to inform potential future NHTSA policy and regulatory decision activities.

This Report

This publication is part of a series of reports that describe NHTSA's initial work in the automotive electronics reliability program. This research specifically supports the first, second, fourth, and fifth goals of NHTSA's electronics reliability research program by gaining understanding on both the technical safety requirements for automated lane centering (ALC) control systems and related foundational systems, and how the industry standard may enhance safety.

Specifically, this report describes the research effort to assess the functional safety and derive safety requirements related to a generic electric power steering system that includes features such as active steering and four-wheel steering. This supports the overall project objective of assessing the functional safety of ALC systems, and the foundational steering and braking

control systems upon which these ALC systems are based. The analysis described in this report follows the Concept Phase of the ISO 26262 standard.

TABLE OF CONTENTS

EXECUTIVE SUMMARY	xi
1 INTRODUCTION.....	1
1.1 Research Objectives	1
1.2 Electric Power Steering.....	2
1.3 Report Outline	3
2 ANALYSIS APPROACH.....	4
2.1 Analysis Steps	6
2.2 Hazard and Safety Analysis Methods	7
2.2.1 Hazard and Operability Study.....	7
2.2.2 Functional Failure Mode Effects Analysis	8
2.2.3 Systems-Theoretic Process Analysis	9
3 SYSTEM DEFINITION.....	12
3.1 System Analysis Scope	12
3.2 Analysis Assumptions	14
3.3 System Block Diagram.....	16
3.4 System Description	18
3.4.1 Driver-Operated Control and Steering Requests From Other Vehicle Systems.....	18
3.4.2 Mechanical Transmission of Steering Forces.....	18
3.4.3 Power-Assist Motor Control.....	19
3.4.4 Active Steering Feature.....	20
3.4.5 Four-Wheel Steering Feature.....	20
3.4.6 Fault Detection.....	21
3.4.7 Related Systems: Yaw Rate Stabilization Coordination.....	21
3.4.8 Related Systems: Ignition System	21
4 VEHICLE-LEVEL HAZARD ANALYSIS	23
4.1 Vehicle-Level Hazards.....	23
4.2 Hazard and Operability Study	26
4.2.1 System Description.....	26
4.2.2 System Functions.....	26

4.2.3	System Malfunctions and Hazards.....	27
4.3	System-Theoretic Process Analysis: Step 1	30
4.3.1	Detailed Control Structure Diagram	30
4.3.2	Vehicle-Level Loss and Initial Hazards.....	32
4.3.3	Control Actions and Context Variables	32
4.3.4	Unsafe Control Actions.....	35
5	RISK ASSESSMENT	40
5.1	Automotive Safety Integrity Level Assessment Steps	40
5.1.1	Vehicle Operational Situations	40
5.1.2	Automotive Safety Integrity Level Assessment	41
5.2	Automotive Safety Integrity Level Assignment for Each Hazard	45
6	VEHICLE-LEVEL SAFETY GOALS	46
7	SAFETY ANALYSIS	48
7.1	Functional Failure Modes and Effects Analysis	48
7.2	Systems-Theoretic Process Analysis: Step 2	50
8	FUNCTIONAL SAFETY CONCEPT	56
8.1	Safety Strategies.....	56
8.2	Example Safe States	57
8.3	Example Driver Warning Strategies.....	58
9	APPLICATION OF THE FUNCTIONAL SAFETY CONCEPT.....	59
9.1	Vehicle-Level Safety Requirements (Safety Goals)	59
9.2	EPS Functional Safety Requirements	60
9.2.1	General EPS System	62
9.2.2	Driver Steering Input Sensor Functional Safety Requirements.....	65
9.2.3	Functional Safety Requirements for the EPS Control Module.....	68
9.2.4	Functional Safety Requirements for the Power-Assist Motor	74
9.2.5	Functional Safety Requirements for the Rear-Wheel Assembly	77
9.2.6	Functional Safety Requirements for the Mechanical Steering Assembly	79
9.2.7	Functional Safety Requirements for the Communication System.....	81
9.2.8	Functional Safety Requirements for Interfacing Systems	83

10	DIAGNOSTICS AND PROGNOSTICS	85
10.1	Metrics for Diagnostics	85
10.2	Common Diagnostic Trouble Codes for the EPS System.....	86
10.2.1	Assessment of Selected Generic Diagnostic Trouble Codes	86
10.2.2	Potential Additional Generic Diagnostic Trouble Code Needs	87
11	PERFORMANCE PARAMETERS AND TEST SCENARIOS.....	89
11.1	Potential Test Scenarios for SG 1	90
11.2	Potential Test Scenarios for SG 2	93
11.3	Potential Test Scenarios for SG 3	99
11.4	Potential Test Scenarios for SG 4	102
12	CONCLUSIONS.....	104
Appendix A:	Current Safety Issues for the EPS System	A-1
Appendix B:	STPA causal factor guidewords and guidewords subcategories.....	B-1
Appendix C:	HAZOP Study Results	C-1
Appendix D:	Unsafe Control Action (UCA) Assessment Tables.....	D-1
Appendix E:	STPA Step 1: UCAs and MAPPING to Hazards.....	E-1
Appendix F:	OPERational Situations.....	F-1
Appendix G:	ASIL Assessment	G-1
Appendix H:	FMEA.....	H-1
Appendix I:	STPA Step 2: Causal Factors	I-1
Appendix J:	Detailed Functional Safety Requirements.....	J-1
Appendix K:	Three-Level Monitoring Strategy.....	K-1
Appendix L:	Diagnostic Trouble Codes RElevant to the EPS System	L-1

LIST OF FIGURES

Figure 1. Diagram of a Generic Column-Assist EPS System.....	2
Figure 2. Safety Analysis and Requirements Development Process	5
Figure 3. HAZOP Study Process	7
Figure 4. STPA Process	9
Figure 5. Guidewords for UCAs.....	10
Figure 6. Block Diagram of a Generic EPS System With Active Steering and 4WS Features....	17
Figure 7. Example Wheel Positions.....	19
Figure 8. Diagram of In-Phase and Reverse-Phase Rear-Wheel Positions	21
Figure 9. Detailed Control Structure Diagram for a Generic EPS System With Active Steering and 4WS Features.....	31
Figure 10. Traceability in STPA Results	51
Figure 11. Functional Safety Concept Process	56
Figure 12. Relevant Components and Interfaces for Deriving Functional Safety Requirements for the Driver Steering Input Sensor.....	65
Figure 13. Relevant Components and Interfaces for Deriving Functional Safety Requirements for the EPS Control Module	68
Figure 14. Relevant Components and Interfaces for Deriving Functional Safety Requirements for the Power-Assist Motor.....	74
Figure 15. Components and Interfaces for Deriving Functional Safety Requirements for the Rear-Wheel Assembly	77
Figure 16. Relevant Components and Interfaces for Deriving Functional Safety Requirements for the Mechanical Steering Assembly.....	79

LIST OF TABLES

Table 1. Synthesized List of Potential Vehicle-Level Hazards	24
Table 2. Derivation of Malfunctions and Hazards Using HAZOP Study (Example).....	28
Table 3. Number of Identified Malfunctions for Each HAZOP Function.....	29
Table 4. STPA Context Variables for Commanding Torque From the Power-Assist Motor.....	33
Table 5. STPA Context Variables for Commanding In-Phase Rear-Wheel Heading	34
Table 6. STPA Context Variables for Commanding Reverse-Phase Rear-Wheel Heading.....	34
Table 7. STPA Context Variables for Commanding Toe-In Rear-Wheel Heading	34
Table 8. STPA Context Variable for the Driver Issuing a Steering Command.....	35
Table 9. UCA Assessment Table (Example)	36
Table 10. Number of Identified UCAs for Each STPA Control Action.....	38
Table 11. Example UCA Statement for Commanding Torque From the Power-Assist Motor	38
Table 12. Example UCA Statement for Commanding a Change in the Rear-Wheel Position.....	39
Table 13. Variables and States for Description of Vehicle Operational Situations.....	41
Table 14. Exposure Assessment	42

Table 15. Severity Assessment	42
Table 16. Example Method for Assessing Severity	42
Table 17. Controllability Assessment	43
Table 18. ASIL Assessment.....	43
Table 19: Example ASIL Assessment for Hazard H1	44
Table 20: Example ASIL Assessment for Hazard H2	44
Table 21. Vehicle-Level Hazards and Corresponding ASIL	45
Table 22. Safety Goals for the EPS System.....	46
Table 23. Breakdown of Identified Failure Modes and Potential Faults	48
Table 24. Portion of the Functional FMEA for H1: Potential Unintended Vehicle Lateral Motion/Unintended Yaw	49
Table 25. Number of Identified Causal Factors by Causal Factor Category	52
Table 26. Examples of Causal Factors for a UCA Related to Controlling the Power- Assist Motor.....	53
Table 27. Examples of Causal Factors for a UCA Related to Controlling the Rear- Wheel Position	54
Table 28. Examples of Causal Factors for a UCA Related to the Driver’s Steering Input	55
Table 29. Examples of Safety Requirements for the EPS Control Module.....	61
Table 30. General Functional Safety Requirements for the EPS System.....	63
Table 31. Functional Safety Requirements for the Driver Steering Input Sensor	66
Table 32. Functional Safety Requirements for the EPS Control Module.....	69
Table 33. Functional Safety Requirements for the Power-Assist Motor	75
Table 34. Functional Safety Requirements for the Rear-Wheel Assembly	78
Table 35. Functional Safety Requirements for the Mechanical Steering Assembly	80
Table 36. Functional Safety Requirements for the Communication System.....	82
Table 37. Functional Safety Requirements for Interfacing Systems	84
Table 38. Breakdown of Identified DTCs by EPS System Component or Connection	87
Table 39. Breakdown of Identified EPS-Relevant DTCs by Interfacing System or Subsystem ..	87
Table 40. Possible Areas for Additional DTC Coverage in the EPS System.....	88
Table 41. Example Driving Scenarios for SG 1	90
Table 42. Examples of Simulated Faults to Test SG 1 Under Driving Scenario 1	91
Table 43. Examples of Simulated Faults to Test SG 1 Under Driving Scenario 2.....	92
Table 44. Example Driving Scenarios for SG 2	93
Table 45. Examples of Simulated Faults to Test SG 2 Under Driving Scenario 1	95
Table 46. Examples of Simulated Faults to Test SG 2 Under Driving Scenario 2.....	97
Table 47. Examples of Simulated Faults to Test SG 2 Under Driving Scenario 3.....	98
Table 48. Example Driving Scenario for SG 3	99
Table 49. Examples of Simulated Faults to Test SG 3 Under Driving Scenario 1	101
Table 50. Example Driving Scenario for SG 4	102
Table 51. Examples of Simulated Faults to Test SG 4 UUnder Driving Scenario 1	103

LIST OF ACRONYMS

4WS	four-wheel steering
A/D	analog/digital
ALC	automated lane centering
ASIL	automotive safety integrity level
CAN	controller area network
CF	causal factor
CPU	central processing unit
DTC	diagnostic trouble code
DVI	driver-vehicle interface
EEPROM	electronically erasable programmable read-only memory
EMC	electromagnetic compatibility
EMI	electromagnetic interference
ESD	electrostatic discharge
EPS	electric power steering
FARS	Fatality Analysis Reporting System
FMEA	failure mode effects analysis ¹
FMVSS	Federal Motor Vehicle Safety Standard
FTTI	fault tolerant time interval
GES	General Estimates System
HAZOP	hazard and operability study
I/O	input/output
IC	integrated circuit
IEC	International Electrotechnical Commission
ISO	International Organization for Standardization
QM	quality management
RAM	random access memory
ROM	read-only memory
SAE	SAE International, formerly the Society of Automotive Engineers
SG	safety goal
STPA	system-theoretic process analysis
TBD	to be determined

¹ Editor's Note: The term "Failure Mode Effects Analysis," FMEA, was coined by the Department of Defense in 1949 in a military standard called MIL-P-1629, which later morphed into MIL-STD-1629 and its amended forms, cited in this report. Over the years, the term itself has changed, sometimes using "Modes," plural, instead of "Mode," and sometimes inserting the word "and," to Failure Mode *and* Effects Analysis. It is clear in the original that the term means the effects of a failure mode, not a failure mode or modes AND effects thereof. As such, the term must remain unitary as "failure mode effects," and the totality as an analysis of those effects. Thus, NHTSA prefers to use "failure mode effects analysis" as its preferred term in respect to father and son, MIL-P-1629 and MIL-STD-1629, without necessarily asserting that other forms of the term are "wrong." Variant terms are left as they are when quoting or citing a source, but is changed or "corrected" as well as lowercased (because it is a generic form of analysis) in text.

UCA	unsafe control action
UNECE	United Nations Economic Commission for Europe
VOQ	vehicle owner questionnaire

EXECUTIVE SUMMARY

The National Highway Traffic Safety Administration established the electronics reliability research area to study the mitigation and safe management of electronic control system failures and operator response errors. This project supports NHTSA's electronics reliability research area by:

- Expanding the knowledge base for automated lane centering systems and the foundational steering and braking systems upon which ALC relies.
- Providing an example for implementing a portion of the voluntary, industry-based functional safety standard, International Organization for Standardization's ISO 26262.
- Deriving example functional safety requirements.
- Providing research to inform potential future NHTSA policy and regulatory decision activities.

As advanced driver assistance systems and other automated technologies are introduced into the nation's fleet, the safety of these systems will depend in part on the safety of the underlying foundational vehicle systems. While emerging technologies may be designed in accordance with the ISO 26262 functional safety standard, many foundational systems currently deployed are legacy systems that predate ISO 26262 [4].

This report describes research by the Volpe National Transportation Systems Center, in conjunction with NHTSA, to derive functional safety requirements related to one such foundational system — the electric power steering system. Foundational steering systems, together with foundational brake systems, form the basis for automated lateral control technologies, such as ALC.

The primary purpose of this work is to study and analyze the potential hazards that could result from cases of electrical or electronic failures impacting the functions of vehicular control systems. The study follows the ISO 26262 process to identify the integrity requirements of these functions at the concept level, independent of implementation variations. This study also considers potential causes that could lead to such functional failures and documents the technical requirements the ISO 26262 process suggests with respect to the identified automotive safety integrity level of the item under consideration. While this study does not go into implementation strategies to achieve these ASILs, the ISO 26262 process provides a flexible framework and explicit guidance for manufacturers to pursue different methods and approaches to do so. Manufacturers employ a variety of techniques, such as ASIL decompositions, driver warnings, fault detection mechanisms, plausibility checks, redundancies, etc. to achieve the necessary ASILs that effectively mitigate the underlying safety risks.

In order to assess the EPS system, this study applies a method for developing a functional safety concept by following the Concept Phase (Part 3) of the ISO 26262 standard.² The following outlines the analysis approach used in this study along with key findings:

1. Defines the scope and functions of a generic EPS system. The EPS system considered in this study includes additional features, including active steering and four-wheel steering. In addition to executing the driver's steering command, the EPS system is also capable of implementing steering requests from other vehicle systems, such as ALC.
2. Performs a vehicle-level hazard analysis using both the hazard and operability study and the systems-theoretic process analysis method. By integrating the hazards identified in both the HAZOP study and STPA, the process establishes four vehicle-level hazards.
3. Applies the ASIL assessment³ approach in the ISO 26262 standard to evaluate the risks associated with each of the identified hazards. The vehicle-level hazards identified for the EPS system ranged from ASIL A to ASIL D; ASIL D is the most severe ASIL.
4. Performs safety analysis using both the functional failure mode effects analysis and the STPA method.
5. Derives 125 functional safety requirements for the EPS system and components by combining the results of the two safety analyses⁴ (functional FMEA and STPA) and following the Concept Phase in the ISO 26262 standard.⁵
6. Identifies 140 generic diagnostic trouble codes listed in the SAE International's SAE J2012 standard⁶ that are relevant to the EPS system.
7. Develops seven example test scenarios that could be used to validate the safety goals and functional safety requirements.

² The Concept Phase of the ISO 26262 standard is the initial stage of the development process and can be implemented before the specifics of the system design are known.

³ The ASIL is established by performing a risk analysis of a potential hazard that looks at the severity, exposure, and controllability of the vehicle operational situation.

⁴ The HAZOP study is not used directly in deriving the functional safety requirements. The HAZOP study is used to identify the relevant vehicle-level hazards, which are then assigned ASILs that cascade down to the functional safety requirements.

⁵ All requirements presented in this report are intended to illustrate a set of requirements that could be derived from the safety analysis results. These safety requirements are not intended to represent NHTSA's official position or requirements on the EPS system.

⁶ The SAE J2012 standard defines the standardized DTCs that on-board diagnostic systems in vehicles are required to report when malfunctions are detected.

The results of this report may be used to:

- Demonstrate how the Concept Phase of ISO 26262 may be implemented, including integration of multiple analysis methods.
- Establish a baseline functional safety concept for future development of EPS systems.
- Provide research data for future NHTSA activities with respect to EPS systems.
- Illustrate how the analysis results may be used to develop potential test scenarios to validate the safety goals and functional safety requirements.

1 INTRODUCTION

1.1 Research Objectives

In conjunction with NHTSA, Volpe is conducting a research project to assess the functional safety of automated lane centering systems in light vehicles.⁷ These ALC systems are largely implemented through foundational braking and/or steering control systems. Therefore, the reliability of the ALC technology depends in part on the reliability of these foundational braking and steering systems. The foundational braking and steering systems are shared resources that may also be used to implement commands from other longitudinal and lateral control systems such as adaptive cruise control, forward collision avoidance, and emergency steer assist.

This project is part of NHTSA's electronics reliability research program for ensuring the safe operation of motor vehicles equipped with advanced electronic control systems. The objectives of this project are:

1. Identify and describe various ALC, foundational braking, and foundational steering system implementations, including system variations related to the five levels of automation defined in the SAE J3016 standard⁸ [1].
2. Determine the hazards and their severity levels pertaining to the functional safety of ALC controls and related foundational systems, and identify safety requirements and constraints.
3. Assess diagnostic and prognostic needs.
4. Identify performance parameters and recommend functional safety test scenarios.
5. Review human factors considerations, including driver-vehicle interface requirements and the need for driver awareness and training resources.

⁷ Light vehicles include passenger cars, vans, minivans, SUVs, and pickup trucks with gross vehicle weight ratings of 10,000 pounds or less.

⁸ The five levels of automated driving systems include:

- Level 1 automation where the vehicle is controlled by the driver, but some driving assist features may be included in the vehicle that can assist the human driver with either steering or braking/accelerating, but not both simultaneously.
- Level 2 automation where the vehicle has combined automated functions, like speed control and steering simultaneously, but the driver must remain engaged with the driving task and monitor the environment at all times.
- Level 3 automation where an automated driving system on the vehicle can itself perform all aspects of the driving task under some circumstances. The driver is still a necessity, but is not required to monitor the environment when the system is engaged. The driver is expected to be takeover-ready to take control of the vehicle at all times with notice.
- Level 4 automation where the vehicle can perform all driving functions under certain conditions. A user may have the option to control the vehicle.
- Level 5 automation where the vehicle can perform all driving functions under all conditions. The human occupants never need to be involved in the driving task.

In addition to assessing the functional safety of ALC systems, this research project will also study the functional safety of two foundational steering system variants —EPS and steer-by-wire — and a conventional hydraulic brake system with electronic stability control and anti-lock brakes.

1.2 Electric Power Steering

This report covers the study of the EPS system. The market share for EPS systems is expected to increase over the next decade. Some estimates predict EPS systems could be installed by 2021 in over 70 percent of North American vehicles [2] [3].

The EPS system is a power-assisted steering system that combines the torque input from the driver with torque from the power-assist motor. The combined steering forces are mechanically transmitted to the road wheels. Depending on the EPS system architecture, the power-assist motor may be located at the steering column or at the rack and pinion. This report is based on the column assist EPS system architecture, which connects the power-assist motor to the steering column through a gear set, such as a planetary gear. The layout of a generic EPS system is shown in Figure 1.

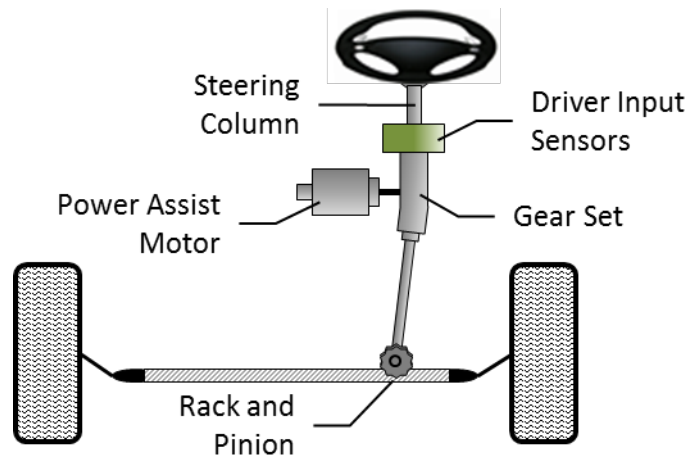

Figure A-1. Diagram of a Generic Column-Assist EPS System

In addition to providing power-assist to the driver's steering input, the generic EPS system considered in this study includes two additional features: active steering and four-wheel steering (4WS). These additional features may not be included in all EPS systems. The active steering feature enables the EPS to adjust the steering ratio as a function of vehicle speed and to provide steering independent of the driver's input. The 4WS feature operates the rear-wheel heading based on the driver's steering input and vehicle speed. These features are described in more detail in Section 3.4 of this report.

This study reviewed some of the current safety issues related to EPS systems. This study included a review of crash data in the General Estimates System and Fatality Analysis Reporting System to understand the crash types at least partially attributable to steering system related failures. NHTSA's recall and vehicle owner questionnaire databases were also reviewed to identify potential failure modes related to EPS systems. The findings from the review of current safety issues are included in Appendix A.

1.3 Report Outline

This report documents the approach and the findings of the analysis of the EPS system. In addition to this Introduction, the report contains the following sections:

- **Section 2:** details the analysis approaches, including descriptions of the hazard and safety analysis methods used in this study.
- **Section 3:** provides the description of a generic EPS system that includes features such as Active Steering and 4WS. It also defines the analysis scope and assumptions used in this study.
- **Section 4:** details the vehicle-level hazard analysis approaches and results.
- **Section 5:** documents the risk assessment of the identified vehicle-level hazards.
- **Section 6:** summarizes the vehicle-level safety goals derived from the hazard analysis and risk assessment.
- **Section 7:** details the safety analysis that supports the functional safety concept and the safety requirements.
- **Section 8:** describes the functional safety concept.
- **Section 9:** lists the functional safety requirements.
- **Section 10:** identifies common diagnostic trouble codes covering the EPS system and discusses the need for additional diagnostics for the EPS system.
- **Section 11:** provides recommendations for functional safety test scenarios.

2 ANALYSIS APPROACH

The primary purpose of this work is to study and analyze the potential hazards that could result from cases of electrical or electronic failures impacting the functions of vehicular control systems. The study follows the International Organization for Standardization (ISO) 26262 process to identify the integrity requirements of these functions at the concept level, independent of implementation variations. ISO 26262 is a functional safety process adapted from the International Electrotechnical Commission's IEC 61508 standard, and is intended for application to electrical and electronic systems in motor vehicles (Introduction in Part 1 of ISO 26262 [4]). Part 3 of ISO 26262 describes the steps for applying the industry standard during the concept phase of the system engineering process.

This study also considers potential causes that could lead to such functional failures and documents the technical requirements the ISO 26262 process suggests with respect to the identified automotive safety integrity level (ASIL) of the item under consideration. While this study does not go into implementation strategies to achieve these ASILs, the ISO 26262 process provides a flexible framework and explicit guidance for manufacturers to pursue different methods and approaches to do so. Manufacturers employ a variety of techniques, such as ASIL decompositions, driver warnings, fault detection mechanisms, plausibility checks, redundancies, etc., to achieve the necessary ASILs that effectively mitigate the underlying safety risks.

Figure 2 illustrates the safety analysis and safety requirements development process in this project, which is adopted from the Concept Phase (Part 3) of ISO 26262.

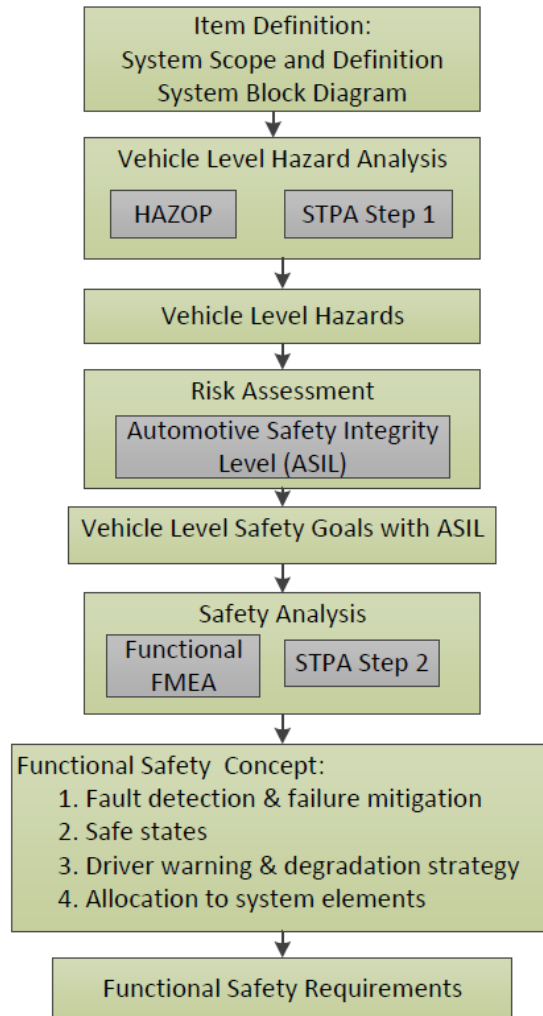

- HAZOP:** Hazard and Operability study
STPA: Systems-Theoretic Process Analysis
- **STPA Step 1:** Identify Unsafe Control Actions
 - **STPA Step 2:** Identify Causal Factors
- FMEA:** Failure Modes and Effects Analysis

Note: ISO 26262 does not recommend or endorse a particular method for hazard and safety analyses. Other comparable and valid hazard and safety analysis methods may be used at the discretion of the analyst/engineer.

Figure A-1. Safety Analysis and Requirements Development Process

2.1 Analysis Steps

As depicted in Figure 2, this project involves the following steps:

1. Define the system:
 - a. Identify the system boundary. Clearly state what components and interactions are within the system boundary, and how the system interacts with other components and systems outside of the system boundary.
 - b. Understand and document how the system functions.
 - c. Develop system block diagrams to illustrate the above understandings and to assist the analysts in the rest of the process.
 - d. Record any assumptions about the system operation or configuration made when defining the system.
2. Carry out the hazard analysis using both the HAZOP study [5] and the STPA method [6]. The output of the hazard analysis step is a list of vehicle-level hazards. If the methods do not use a common list of hazards at the outset, an additional step may be necessary to synthesize the hazards identified in the HAZOP study and STPA.
3. Apply the ISO 26262 risk assessment approach to the identified vehicle-level hazards, and assign an ASIL to each hazard as defined in ISO 26262.
4. Generate vehicle-level safety goals, which are vehicle-level safety requirements based on the identified vehicle-level hazards. The ASIL associated with each hazard is also transferred directly to the corresponding vehicle-level safety goal. If a safety goal satisfies more than one vehicle-level hazard, the more stringent ASIL is applied to the safety goal [4].
5. Perform safety analyses on the relevant system components and interactions as defined in the first step of this process. This project uses both a functional FMEA [7] and STPA to complete the safety analysis. Note that only single-point faults were considered when performing the safety analysis.
6. Follow the ISO 26262 process to develop a functional safety concept and functional safety requirements at the system and component levels, based on results from the functional FMEA and STPA, ISO 26262 guidelines, and industry practice experiences.

Once the functional safety concept and functional safety requirements are derived, these are used along with the safety analysis results to develop potential test scenarios and performance parameters.

This report describes how the HAZOP study, functional FMEA, and STPA methods were applied to a generic EPS system that includes active steering and 4WS features.

2.2 Hazard and Safety Analysis Methods

This project uses multiple analysis methods to generate a list of hazard and safety analysis results.⁹ These methods are described in this section.¹⁰

2.2.1 Hazard and Operability Study

This study uses the HAZOP study as one of the methods for identifying vehicle-level hazards. Figure 3 illustrates the analytical steps of the HAZOP study.

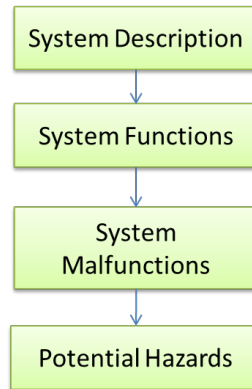

Figure A-1. HAZOP Study Process

This study performs the HAZOP study steps in Figure 3 as follows:

1. Define the system of study and the scope of the analysis. Draw a block diagram to illustrate the system components, system boundary, and interfaces. This step is accomplished in the first step of the overall project (Figure 2).
2. List all of the functions that the system components are designed to perform. This step is also accomplished in the first step of the overall project (Figure 2).
3. For each of the identified functions, apply a set of guidewords that describe the various ways in which the function may deviate from its design intent. IEC 61882¹¹ lists 11 suggested guidewords, but notes that the guidewords can be tailored to the particular system being analyzed [5]. The HAZOP study implemented in this project uses the following seven malfunction guidewords.

⁹ ISO 26262 does not recommend or endorse specific methods for hazard or safety analysis. Comparable and valid hazard and safety analysis methods may be used at the discretion of the analyst/engineer.

¹⁰ This report provides more details on the STPA than other methods because the application of the STPA method to automotive electronic control systems is relatively new. Unlike HAZOP and Functional FMEA, a standard approach has not been defined and published for STPA. Therefore, this report provides more descriptions in order to better explain how the analysis is performed.

¹¹ IEC 61882:2001, *Hazard and operability studies (HAZOP studies) - Application guide*, provides a guide for HAZOP studies of systems utilizing the specific set of guide words defined in this industry standard; and also gives guidance on application of the technique and on the HAZOP study procedure, including definition, preparation, examination sessions, and resulting documentation.

- Loss of function
- More than intended
- Less than intended
- Intermittent
- Incorrect direction
- Not requested
- Locked function

The combination of a system function and guideword may have more than one interpretation. In these situations, the analyst may identify more than one malfunction.

4. Assess the effect of these functional deviations at the vehicle level. If a deviation from an intended function could potentially result in a vehicle-level hazard, the hazard is then documented.

2.2.2 Functional Failure Mode Effects Analysis

The FMEA is a bottom-up reliability analysis method that relies on brainstorming to identify failure modes and determine their effects on higher levels of the system. There are several types of FMEAs, such as system or functional FMEAs, design FMEAs, and process FMEAs. This study uses a functional FMEA in the safety analysis to identify failure modes at the function level that could lead to the vehicle-level hazards. The failure modes identified by the functional FMEA are used to derive the safety requirements.

Standard J1739 by SAE provides guidance on applying the functional FMEA method [7]. The analysis includes the following steps:

1. List each function of the item on an FMEA worksheet.
2. Identify potential failure modes for each item and item function.
3. Describe potential effects of each specific failure mode and assign a severity to each effect.
4. Identify potential failure causes or mechanisms.
5. Assign a likelihood of occurrence to each failure cause or mechanism.
6. Identify current design controls that detect or prevent the cause, mechanism, or mode of the failure.
7. Assign a likelihood of failure detection to the design control.

This study applies the first four steps listed above for the functional FMEA. Since this study is implemented at the concept phase and is not based on a specific design, the FMEA does not assume controls or mitigation measures are present; there is no data to support Steps 5 through 7. The completed functional FMEA worksheet is intended to be a living document that is continually updated throughout the development process.

2.2.3 Systems-Theoretic Process Analysis

The STPA is a top-down systems engineering approach to system safety [6]. In STPA, the system is modelled as a dynamic control problem, where proper controls and communications in the system ensure the desired outcome for emergent properties such as safety. In the STPA framework, a system will not enter a hazardous state unless an unsafe control action is issued by a controller, or a control action needed to maintain safety is not issued. Figure 4 shows a process flow diagram for the STPA method.

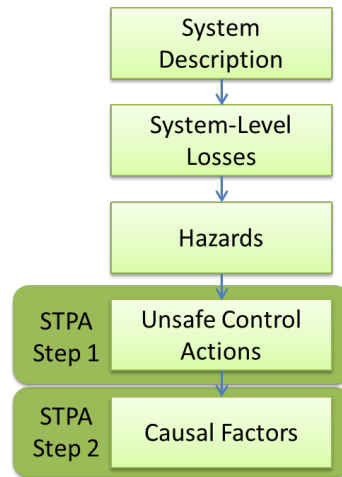

Figure A-1. STPA Process

This project performs STPA following these steps:

1. Define the system of study and the scope of the analysis:
 - a. Draw a hierarchical control structure of the system that captures the feedback control loops (controller, sensors, actuators, controlled process, and communications links). This control structure is a generic representation of the system, based on common implementation strategies.
 - b. Identify the system boundary and interfaces with other vehicle systems and the external environment.

This step is accomplished in the first step of the overall project (Figure 2).

2. Define the loss or losses at the system level that should be mitigated. STPA defines system-level losses as undesired and unplanned events that result in the loss of human life or injury, property damage, environmental pollution, etc. [6]. For this project, one loss was considered: occurrence of a vehicle crash.
3. Identify a preliminary list of vehicle-level hazards. STPA defines a hazard as a system state or set of conditions that, together with a particular set of worst-case environmental conditions, will lead to a system-level loss [6]. In this project, a preliminary hazard list is

generated based on engineering experience and a literature search. This list is refined during STPA Steps 1 and 2.

4. **STPA Step 1:** Identify potential UCAs issued by each of the system controllers that could lead to hazardous states for the system. Four sub-steps are involved:
 - a. For each controller in the scope of the system, list all of the relevant control actions it can issue.
 - b. For each control action, develop a set of context variables.¹² Context variables and their states describe the relevant external control inputs to the control system and the external environment that the control system operates in, which may have an impact on the safety of the control action of interest. Enumerating the combinations of context variable states creates an exhaustive list of possible states. This approach is based on a recent enhancement to the STPA method [8] that enumerates the process variable states during STPA Step 1. Process variables refer to variables that the control algorithm uses to model the physical system it controls. However, this study is not based on a specific design and a detailed process model algorithm is not available. Therefore, this study modifies this approach to focus on context variables instead of process variables.
 - c. Apply the UCA guidewords to each control action. The original STPA literature includes four such guidewords [6]. This study uses a set of six guidewords for the identification of UCAs as illustrated in Figure 5.

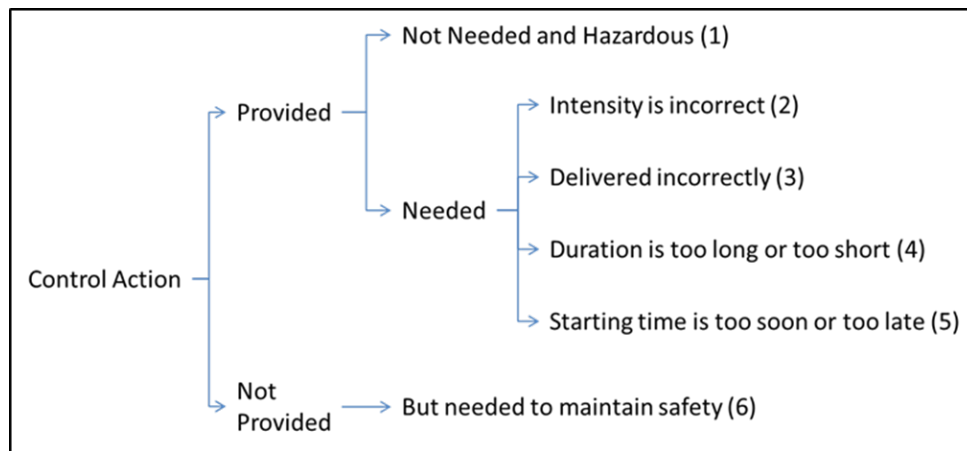

Figure A-2. Guidewords for UCAs

¹² The context variables describe the context in which a controller issues a control action. For example, the control command “provide torque in the Θ direction” may operate in the context of the driver’s steering command; steering commands from other vehicle systems; and whether the vehicle speed is in a range where the EPS’s active steering feature adds or subtracts torque from the driver’s input.

For each control action, assess each of the six guidewords against each of the context variable combinations to determine if it could lead to any of the preliminary vehicle-level hazards. If this step identifies new hazards, add them to the vehicle-level hazard list initiated in the previous step.

- d. Apply logical reduction to the resulting UCA matrix using the Quine-McCluskey minimization algorithm [9] in order to reduce the number of UCA statements.

STPA Step 1 produces a list of UCAs that can be used to derive safety requirements for software control logic and initiate the STPA Step 2 analysis.

5. **STPA Step 2:** Determine CFs for each UCA identified in STPA Step 1.

Analyze each component and interaction in the control structure representation of the system to determine if the component or the interaction may contribute to one of the UCAs identified in STPA Step 1. STPA literature provides 17 guidewords to assist the analyst in identifying CFs [6]. This project uses an expanded list of 26 guidewords for identifying CFs. Appendix B provides the list of CF guidewords and detailed causes under each guideword that are used in this project.

As discussed above, there are two main analysis steps in STPA (Figure 4). This project applies STPA Step 1 in the hazard analysis stage of the study and STPA Step 2 as part of the safety analysis stage (Figure 2).

3 SYSTEM DEFINITION

3.1 System Analysis Scope

NHTSA has established two Federal Motor Vehicle Safety Standards— FMVSS 203 and FMVSS 204 — establishing crashworthiness parameters to minimize injury to vehicle occupants from steering system components in the event of a crash. However, there is no FMVSS that specifies minimum performance parameters for steering systems.

The United Nations Economic Commission for Europe does establish the *Uniform Provisions Concerning the Approval of Vehicles with Regard to Steering Equipment* [10]. The UNECE regulation defines the “main steering system” as:

“the steering equipment of a vehicle which is mainly responsible for determining the direction of travel.”

According to the UNECE regulation, steering equipment may consist of:

- The *steering control*, which is the “part of the steering equipment which controls its operation.” This includes the driver-operated control, such as a steering wheel, but may also include steering equipment that is not operated with direct intervention by the driver.
- The *steering transmission*, which includes “all components which form a functional link between the steering control and the road wheels.” This includes both the control transmission (e.g., control signals transmitted to steering equipment) and energy transmission (e.g., transmission of necessary power to adjust the road wheels).
- The *steered wheels*, which are the wheels that “may be altered directly or indirectly in relation to the longitudinal axis of the vehicle in order to determine the direction of movement of the vehicle.” For the generic EPS system described in this report, the term “front-wheels” refers to the front road wheels of the vehicle. The term “rear-wheels” refers to the rear road wheels of the vehicle, which may be steered in vehicles equipped with the 4WS feature.
- The *energy supply*, which are the “parts of the steering equipment which provide it with energy, regulate that energy and where appropriate, process and store it.” For the EPS, this includes the power supply, wiring, etc.

The scope of this analysis generally conforms to the UNECE definition, and includes all components involved in transmission of forces from both the driver-operated control and electronic control system to the road wheels. However, the scope of this study terminates at the transmission of steering forces to the road wheels; transfer of forces from the road wheels to the road surface is out-of-scope for this study. This includes tire wear, wheel alignment, or other mechanical failures that may prevent the road wheels from transferring the appropriate lateral forces to the road surface.

This analysis also considers incoming steering requests from other vehicle systems that may be implemented through the EPS. However, this analysis assumes that these other vehicle systems are operating correctly; failures in other vehicle systems that could result in incorrect steering requests are out of scope for this study.

The following list identifies specific elements considered to be in-scope for this study.

1. All mechanical components leading from the driver-operated control to the road wheels, including the following:
 - Steering wheel
 - Steering column
 - Rack and pinion
2. All components in the electronic control system providing power-assist, including the following:
 - EPS control unit
 - Power-assist motor
 - Gear set that combines the torque from the power-assist motor and the driver's steering torque
 - Steering wheel angle sensor
 - Steering wheel torque sensor
3. All components necessary to control the rear-wheel steering angle for 4WS (if equipped), including the following:
 - Rear-wheel motors
 - Rear-wheel position sensor
4. All connections between the components listed above, including:
 - Wired connections
 - Communication over the vehicle bus (e.g., controller area network)
5. Active Steering function algorithms in the EPS control unit
6. Incoming steering requests from other vehicle systems
7. Interfacing sensor signals, including:
 - Vehicle speed and individual wheel speed data
 - Yaw rate/lateral acceleration data
8. Interface with the human operator of the vehicle

The following list identifies specific failures and hazards considered to be out-of-scope for this study.

- Multiple-point failures
- Failures in the road wheels (low tire pressure, tread wear, etc.) that affect transfer of lateral forces to the road or affect feedback to the driver
- Hazards not directly caused by malfunctioning behavior specific to the electronic control system, such as fire hazards

- Failures in other vehicle systems (e.g., brake/vehicle stability system) that may lead to lateral motion related hazards
- Failures in other vehicle systems (such as ALC, automated park assist, or other vehicle systems that command steering) that may result in incorrect steering requests
- Failures in the instrument panel display (considered as an interfacing system) that prevent driver notifications from illuminating
- Failures in ancillary functions which, in some designs, may be performed by the EPS control module but are not related to steering, such as validating vehicle speed with the engine rotational speed
- Failures due to improper maintenance over the lifetime of the vehicle (e.g., incorrect parts, failure to conduct scheduled inspections)

3.2 Analysis Assumptions

In addition to the system scope defined in Section 3.1, this analysis includes several assumptions regarding the operation of the EPS system. The following list identifies the key assumptions made in this study. Each assumption is addressed by explaining how the findings from this study may apply to cases where the assumption is no longer valid, or whether additional analysis is needed.

- The generic EPS system modelled in this report includes two features, Active Steering and 4WS, which may not be standard equipment on all EPS systems. In addition, this analysis does not assume any design limitations on the steering authority of these features, such as limits on the allowable steering angle for the rear-wheels.
 - *Findings in this report relating to the Active Steering and 4WS (e.g., malfunctions, UCAs, faults, CFs, and safety requirements) may not apply to EPS systems that do not include these features.*
- The 4WS function is located in the EPS control module. Some designs may include a separate control module for this function.
 - *Findings in this report related to the 4WS function (e.g., malfunctions, UCAs, faults, CFs, and safety requirements) would apply to whichever physical component houses this feature. If the 4WS function is located in a separate controller from the EPS control module, additional analysis of the communication between the two modules would be necessary.*
- The vehicle speed is provided to the EPS control module by the brake/vehicle stability¹³ control module. Some system architectures may obtain the vehicle speed from other components or may rely on individual wheel speeds instead of the computed vehicle speed.

¹³ The vehicle stability control may include, but is not limited to, the following functions: antilock braking, electronic stability control, traction control, etc.

- *Requirements related to vehicle speed would apply to whichever component is responsible for providing this information to the EPS control module. If individual wheel speeds are used, the vehicle speed related requirements should be modified to apply to the individual wheel speeds.*
- The power-assist motor torque is combined with the driver's torque input at the steering column ("column assist"). Other EPS system architectures include "rack assist," where the power-assist motor torque is combined with the driver's torque at the rack and pinion.
 - *This would affect the layout of the system block diagram. However, the functional safety requirements would still apply regardless of whether the EPS system has a column assist or rack assist architecture.*
- The driver's steering input is measured using a steering wheel torque sensor. Other system designs may use other types of sensors to measure the driver's steering input, such as steering wheel angle sensors.
 - *Additional analysis may be required to identify safety requirements relevant to other types of steering input sensors.*
- The EPS assist torque is provided directly to the steering column from the output shaft of the power-assist motor.
 - *A separate analysis would be required for other steering architectures where the electric motor is used to operate another energy source (e.g., hydraulic pressure) that's used to provide steering-assist.*
- The front-wheels are connected with each other through the steering rack and tie rods, which limit the possible front-wheel steering angle configurations (i.e., the front-wheels turn in the same direction).
 - *Additional analysis would be required for vehicles with independent front-wheel steering.*
- The tires are capable of transmitting the appropriate lateral forces to the roadway. This analysis does not assess faults that may affect the ability of the tires to transmit forces (e.g., worn treads, low pressure).
 - *Additional analysis would be required to assess faults related to the tires.*
- The driver is physically capable of operating the vehicle (e.g., the driver is not impaired, distracted). The scope of this study is limited to how the DVI may lead the driver to issue an unsafe steering command.
 - *A separate human factors study would be required to evaluate driver-centric failures that affect their ability to operate the vehicle.*
- Vehicle automation systems are not considered in the analysis of the foundational EPS system. This includes potential mode confusion which may affect the driver's steering inputs.
 - *A later stage of this project will analyze the ALC system and will include DVI considerations related to mode confusion. The findings from the ALC system analysis will be published as a separate report.*

- Safety strategies, such as redundant sensors, are not considered in the hazard analysis or safety analysis stages. They are only considered as part of the functional safety concept and are reflected in the safety requirements.
 - *Once specific design strategies have been adopted, additional hazard and safety analyses should be performed to determine if the safety measures are adequate and do not introduce additional hazards into the system.*

3.3 System Block Diagram

The EPS system is a power-assisted steering system that combines the torque input from the driver with torque from the power-assist motor, and mechanically transmits the steering forces to the road wheels. This report is based on the column-assist EPS system architecture, which connects the power-assist motor to the steering column.

The driver's steering input is transmitted through a mechanical pathway that directly connects the driver-operated control (e.g., steering wheel) with the front-wheels. The power-assist motor and rear-wheel motors are part of the electronic control subsystem, which also includes relevant sensors and the EPS control module. Together, these electronic and mechanical subsystems comprise the EPS system.

Figure 6 shows a block diagram representation of the EPS system considered in this study. The dashed line delineates the EPS system boundary. Interfacing vehicle systems are shown in gray and are treated as black boxes with respect to the EPS system. As discussed in Section 3.1, this analysis assumes that these interfacing vehicle systems are functioning properly. Key interfaces between these systems and the EPS system are shown as lines that cross the dashed line.

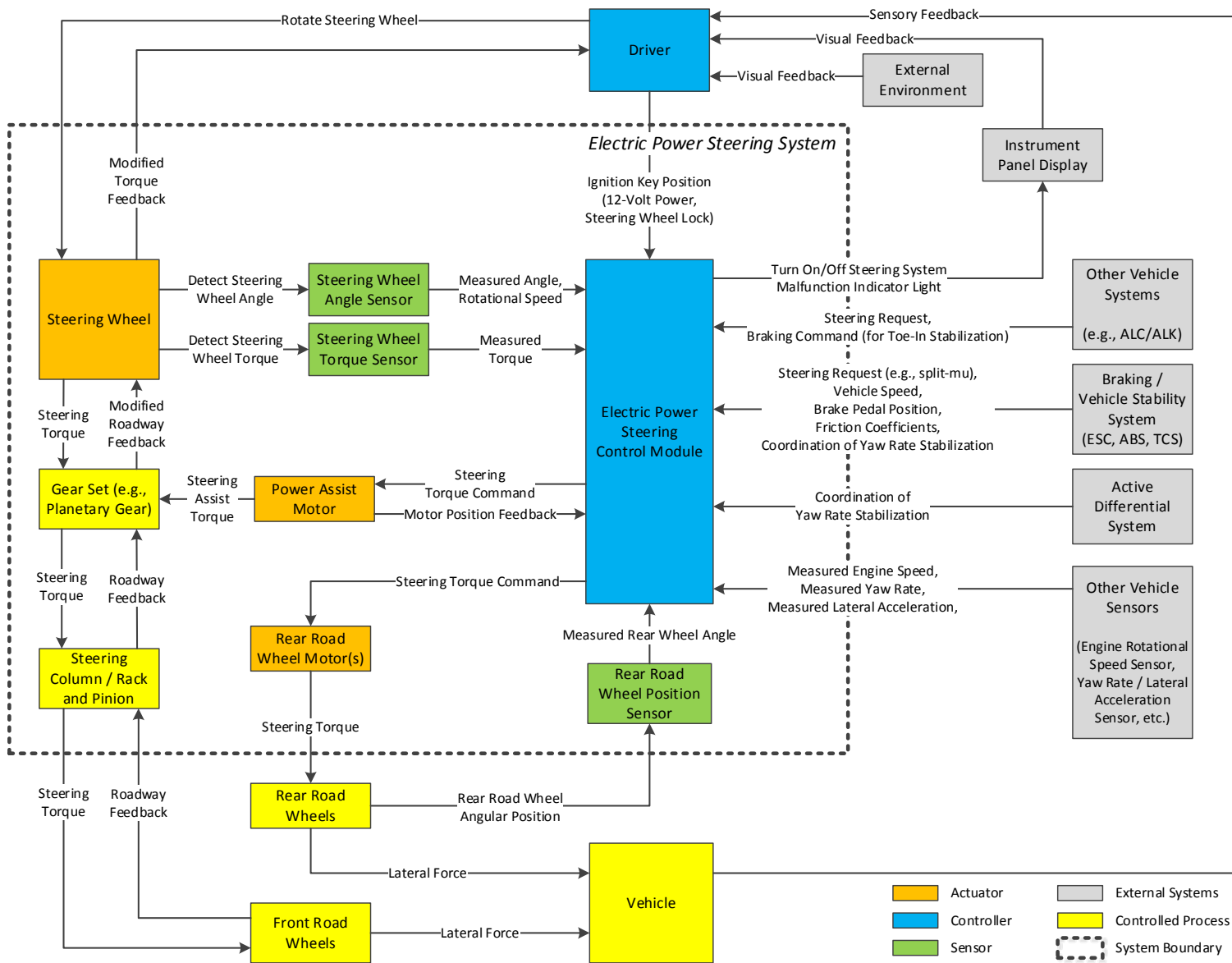

Figure A-1. Block Diagram of a Generic EPS System With Active Steering and 4WS Features

3.4 System Description

The following description outlines the functions of a column-assist EPS system [11] [12] [13] [14] [15] [16] [17] [18] [19] [20] [21].

3.4.1 Driver-Operated Control and Steering Requests From Other Vehicle Systems

The steering wheel is the driver's primary interface with the EPS system. By rotating the steering wheel, the driver commands a change in the steering angle of the road wheels. This action causes the vehicle to turn. The driver's command via the steering wheel affects the steering system in two ways:

- The driver's torque input is mechanically transmitted directly to the rack and pinion via the steering column.
- The steering wheel angle sensor and torque sensor measure the amount the steering wheel is rotated and the force of the driver's steering input. These measurements are transmitted to the EPS control module, which determines the amount of assistance the EPS system should provide to the driver.

In addition to responding to the driver's steering input, the EPS control module also receives and implements steering requests from other vehicle systems, such as the ALC system. These steering requests may be independent of the driver's control input.

3.4.2 Mechanical Transmission of Steering Forces

The mechanical portion of the steering system transmits steering torque to the road wheels via the steering column. The rack and pinion converts the rotational motion of the steering column to linear motion that changes the steering angle of the front-wheels. The steering geometry of the front-wheels is important for maximizing the lateral forces as well as minimizing wear and tear of the tires. For example:

- Steering geometries typically conform to the Ackerman angle¹⁴ to minimize tire slip when turning.
- The wheel toe setting can affect the stability of the vehicle. For example, a toe-in position can provide greater stability for the vehicle when traveling straight ahead. Figure 7 illustrates the concept of the wheel toe position.

¹⁴ Ackerman angle is used in the concept of Ackerman steering. While going around a corner, all the tires turn along a circle with a common center point. The intention of Ackerman geometry is to minimize the need for tires to slip sideways when following the path around a curve.

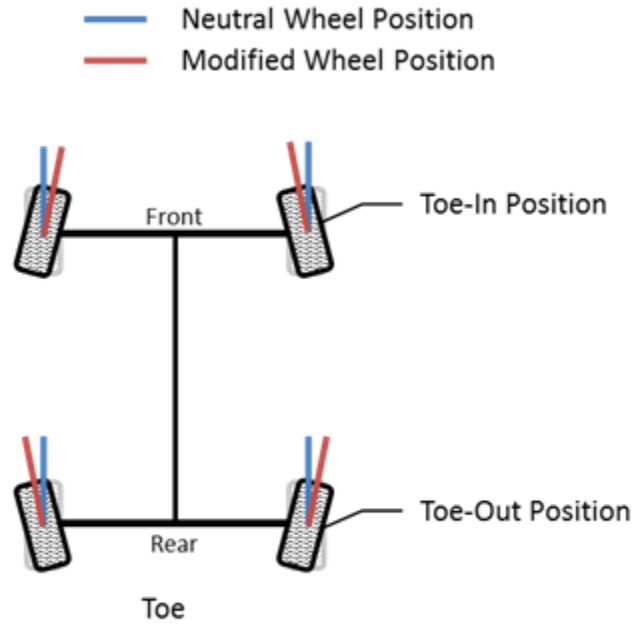

Figure A-1. Example Wheel Positions

In the EPS system, the mechanical portion of the steering system is also responsible for providing feedback to the driver. For example:

- The road surface and roughness may induce vibrations that are transmitted via the steering column to the steering wheel.
- Mechanical failures in the steering system may cause changes in the steering feel.
- The steering wheel may stop rotating when the front-wheels reach their maximum steering angle.

3.4.3 Power-Assist Motor Control

The EPS control module receives the angular position and rotational speed measurements from the steering wheel angle sensor, and the torque measurement from the steering wheel torque sensor. The EPS control module uses these measurements to calculate the amount of assistance that the EPS system should provide to the driver.

To provide steering-assist for the driver, the EPS control module commands torque from the power-assist motor, which is connected to a gear set (e.g., a planetary gear) located in the steering column. The driver's torque input from the steering wheel and the power-assist motor provide inputs to the gear set. The steering column is the single output for the gear set and is

connected to the rack and pinion. The power-assist motor provides position feedback to the EPS control module.

The EPS control module also uses the power-assist motor to implement steering adjustment requests from other vehicle systems, such as the brake/vehicle stability system or ALC system. The EPS control module arbitrates these steering requests with the driver's steering request and determines an appropriate road wheel heading based on the vehicle's current operating state. These steering adjustments may be made independent of steering inputs from the driver.

3.4.4 Active Steering Feature

EPS systems may incorporate an Active Steering feature, which enables the EPS control module to modify the steering ratio based on the vehicle's operating conditions (e.g., vehicle speed). For instance, with the Active Steering feature, the EPS control module may increase the level of torque added to the driver's input at low vehicle speeds to make the vehicle more responsive to the driver's steering command. At higher vehicle speeds, the EPS control module may subtract torque from the driver's steering input by operating the power-assist motor in the opposite direction of the driver's steering command. This can enhance the driver's precision and provide increased stability. At low vehicle speeds, the EPS control module may rely on individual wheel speed data (rather than the aggregated vehicle speed) for greater resolution of speed data. Examples of vehicle speed thresholds used in current design implementations include approximately 62 mph for Bosch [18] and approximately 75 mph for BMW [22].

In addition to adjusting the steering ratio, the Active Steering feature is also capable of adjusting the steering angle of the road wheels independent of the driver. The EPS control module receives input from the vehicle dynamics sensors, such as yaw rate and lateral acceleration. This additional sensor data helps the EPS adjust the steering based on changes in the vehicle's dynamics and to reject disturbances. For example, the Active Steering feature may adjust the steering angle to compensate for road pull or drift (e.g., due to crosswinds), eliminating the need for the driver to continuously counter-steer. Depending on the system design, these steering angle adjustments may or may not be transmitted back to the driver via the steering wheel. This feature enables the EPS to isolate the driver from certain types of road disturbances.

3.4.5 Four-Wheel Steering Feature

Traditionally, vehicles only adjust the steering angle of the front-wheels in response to steering inputs. However, vehicles with the 4WS feature can adjust both the front and rear-wheels to steer the vehicle. This can allow for greater responsiveness and improved stability.

The orientation of the rear-wheels of the vehicle may be operated by individual motors located at each wheel or a single motor at the rear axle. The rear-wheels can turn in the same direction as the front-wheels ("in-phase") to provide more stable maneuvering at high speeds. The rear-wheels can also turn in the opposite direction from the front-wheels ("reverse-phase") at low

vehicle speeds to improve turning. Figure 8 depicts the in-phase and reverse-phase rear-wheel positions.

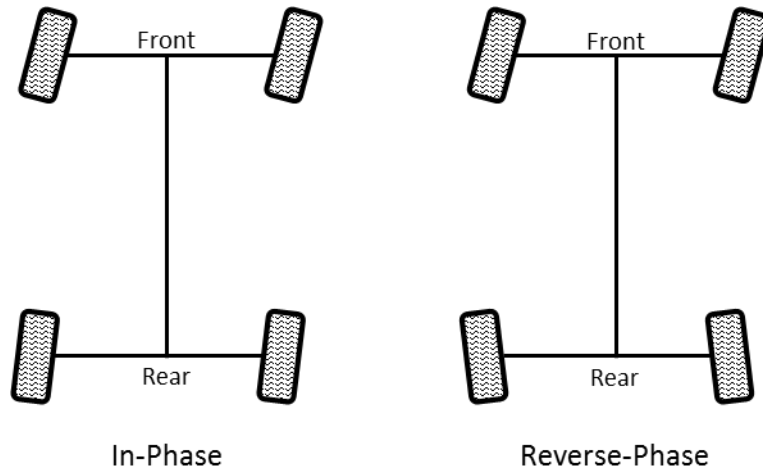

Figure A-1. Diagram of In-Phase and Reverse-Phase Rear-Wheel Positions

Finally, the rear-wheels may “toe-in” during heavy braking to improve stability. Figure 7 illustrates the concept of “toe-in.” Depending on the implementation of the rear-wheel actuator, the available rear-wheel configurations may be limited (e.g., a single motor may not be capable of providing the “toe-in” position).

3.4.6 Fault Detection

In the event the EPS control module detects a fault in the system, the system may revert to a standard mechanical steering system with no power-assistance. For example, the EPS system might lock the gear set so that the direct mechanical connection between the steering wheel and rack and pinion is the only way torque is transmitted to the wheels.

3.4.7 Related Systems: Yaw Rate Stabilization Coordination

Through the Active Steering feature, the EPS system may be capable of implementing yaw rate stabilization (e.g., correcting for oversteer or understeer conditions). Other vehicle systems, such as the brake/vehicle stability system and active differential system, are also capable of performing yaw rate stabilization. The EPS system and these other vehicle systems would need to coordinate their yaw rate stabilization efforts to ensure their net action results in the correct vehicle dynamics.

3.4.8 Related Systems: Ignition System

Some steering systems may lock the steering wheel when the vehicle is turned off as an anti-theft measure. The steering wheel lock prevents the steering wheel from rotating. This is typically accomplished through mechanical means, such as a solenoid or spring-loaded latch. When the

ignition key (or other security device) is turned to the “on” position, the lock mechanism disengages allowing the driver to rotate the steering wheel.

4 VEHICLE-LEVEL HAZARD ANALYSIS

This study performed two types of hazard analysis — HAZOP study and STPA. Section 4.1 presents the synthesized vehicle-level hazards from both analyses. Sections 4.2 and 4.3 provide additional details about the HAZOP study and STPA.

4.1 Vehicle-Level Hazards

The HAZOP study identified six vehicle-level hazards and STPA identified seven vehicle-level hazards. In addition, SAE J2980¹⁵ provides an example high-level HAZOP for the steering system which identifies three vehicle-level hazards [23]. The majority of these hazards describe similar vehicle-level behaviors. Key differences between the hazard lists include the resolution at which hazards are defined and how specific failure modes are considered. For example, STPA identified a potential hazard “Driver’s Command Overrides an Active Safety System” arising from conflicting inputs to the EPS control module from the driver and other vehicle systems. The analysts determined that this potential hazard could also be considered as a potential failure mode manifesting as the hazards “Unintended Vehicle Lateral Motion/Unintended Yaw” or “Insufficient Vehicle Lateral Motion/Insufficient Yaw,,” rather than a separate hazard.

In order to synthesize the results of the hazard analysis, the vehicle-level hazards identified in the HAZOP study and STPA, as well as SAE J2980, were combined to produce the list of four hazards in Table 1. As part of this process, some of the hazard terminology was refined to provide more clarity of the hazardous vehicle state.

¹⁵ SAE J2980, “Considerations for ISO26262 ASIL Hazard Classification,,” presents a method and example results for determining the ASIL for automotive electrical and electronic systems.

Table 1. Synthesized List of Potential Vehicle-Level Hazards

ID	Potential Hazard (Synthesized Term)	Potential Hazard Description	Analysis Source	Potential Hazard (Original Term)
H1	Unintended Vehicle Lateral Motion/Unintended Yaw	The vehicle moves laterally more than, at a faster rate than, or in the opposite direction of what is commanded by the driver or another vehicle system controller.	STPA Step 1	Unintended Vehicle Lateral Motion
			STPA Step 1	Unintended Vehicle Rotational Motion (Yaw)
			STPA Step 1	Vehicle Roll Resulting From Too Large of a Yaw Velocity
			STPA Step 1	Driver's Command Overrides an Active Safety System
			SAE J2980	Unintended Loss of Vehicle Lateral Motion Control
			HAZOP	Unintended Vehicle Direction
			HAZOP	Unintended Vehicle Direction With Unrecoverable Steering
H2	Insufficient Vehicle Lateral Motion/Insufficient Yaw	The vehicle moves laterally, but less than or at a slower rate than what is commanded by the driver or another vehicle system controller.	STPA Step 1	Insufficient Vehicle Lateral Motion
			STPA Step 1	Insufficient Vehicle Rotational Motion (Yaw)
			STPA Step 1	Driver's Command Overrides an Active Safety System
			HAZOP	Unintended Vehicle Direction
			HAZOP	Vehicle Yaw Rate Is Lower Than Intended

ID	Potential Hazard (Synthesized Term)	Potential Hazard Description	Analysis Source	Potential Hazard (Original Term)
H3	Unintended Loss of Steering-Assist ⁱ	The Electric Power-assist system becomes unavailable in an uncontrolled manner (e.g., the loss of assist is sudden and the driver is not notified). However, mechanical steering is still available.	SAE J2980	Increased Manual Effort to Steer
H4	Reduced Responsiveness to the Driver's Commands Due to Increased Rear-Wheel Drag ⁱⁱ	The rear-wheel position causes an increased drag effect, slowing the vehicle but not at a level that results in significant vehicle deceleration. This drag effect may also affect the vehicle response if the driver is trying to steer.	HAZOP	Unintended vehicle braking

ⁱ Unintended in this context is used to differentiate from intentional disabling of the EPS system as a potential safe state for the system. In particular, the unintended loss of steering-assist is not controlled and the driver is not notified that steering-assist is not available.

ⁱⁱ Rear-wheel drag indicates a rear-wheel position (i.e., toe-in) that slows the vehicle when the brakes are not being applied. However, the amount of drag may not be sufficient for characterization as deceleration.

4.2 Hazard and Operability Study

4.2.1 System Description

The HAZOP study uses the block diagram provided in Figure 6 to visually represent the EPS system, and identifies the EPS system functions based on the description provided in Section 3.4.

4.2.2 System Functions

The HAZOP study identifies 27 system functions for the EPS system. These functions are organized based on the system description presented in Section 3.4:

Driver-Operated Control and Steering Requests From Other Vehicle Systems

1. Mechanically transmits the driver's torque from the steering wheel to the steering column to induce lateral vehicle force.
2. Senses the torque applied to the steering wheel.
3. Senses the steering wheel angle and steering column angle.
4. Communicates with internal subsystems and other vehicle systems, including receiving steering inputs from other vehicle systems.

Mechanical Transmission of Steering Forces

5. Turns road wheels such that available/surplus lateral force is sufficient to achieve the desired vehicle path, including at low speeds and consistent with Ackerman angle practice.
6. Turns vehicle at highest steering wheel input angle to a to-be-determined (TBD) turning circle/radius for sufficient maneuverability.
7. Turns road wheels such that tire wear and tear is minimized.
8. Absorbs environmental sounds from the tire patch and the mechanical steering system to minimize cabin noise.
9. Provides feedback to the driver via steering wheel when turning limit is reached by disallowing more rotation of the steering wheel.
10. Transmits road surface roughness from the tire patch to the driver through the steering wheel.
11. Transmits lateral road friction from the tire patch to the driver through steering wheel.
12. Absorbs road shocks from the tire patch to prevent full transmission to the driver's hands.
13. Transmits mechanical failures from within steering system to the driver through an easily perceivable change in steering effort.
14. Adjusts steering wheel to a proper height and angle for a comfortable driving position.¹⁶

¹⁶ This is not a standard feature in all vehicles and is included to assess the potential impact of malfunctions on the safety of the EPS system.

Power-Assist Motor Control (including the active steering feature)

15. Adds torque to or subtracts torque from the driver's steering wheel input to ease or impede lateral force induction based on vehicle speed.
16. Modulates torque to create an on-center, straight steer by default.
17. Disables all energy sources to steering equipment When the Ignition Is off or once the EPS system enters a maintenance/repair mode.
18. Stores relevant data.

Four-Wheel Steering Feature

19. Turns the 4WS mode from on to off (or vice-versa) in 4WS-equipped vehicles.
20. Turns rear-wheels in-phase smoothly and without alarming driver when at or above the in-phase vehicle speed threshold in 4WS-equipped vehicles.
21. Turns rear-wheels in reverse-phase smoothly and without alarming driver when below the reverse-phase vehicle speed threshold in 4WS-equipped vehicles.
22. Turns the rear-wheels inward (toe-in) to enhance stability in 4WS-equipped vehicles.

Fault Detection

23. Provides diagnostics and fault detection.
24. Provides mitigation for system faults.
25. Electronically transmits steering system failures to the driver using all or some of the dashboard indicators, chimes, or similar alerts.

Interfacing Vehicle Systems (ignition system)

26. Locks the steering wheel when vehicle is off such that any steering inputs (torque or angle) are not transmitted to the road wheels.
27. Unlocks the steering wheel for normal functions after the vehicle is accessed with the appropriate security device (key, biometrics, etc.).

Functions 23 and 24 are shown here for completeness, but are not considered part of the scope for the hazard analysis. Functions 23 and 24 are part of the design to mitigate hazards resulting from other malfunctions.

4.2.3 System Malfunctions and Hazards

The seven HAZOP study guidewords presented in Section 2.2.1 were applied to each of the 27 EPS functions listed above. This process generated a list of 150 malfunctions.¹⁷ Each of these

¹⁷ This does not represent an exhaustive list of all possible EPS malfunctions. Identification of malfunctions is dependent on the item definition (e.g., system functions), the interpretation of the guidewords, and the judgment of the analyst.

malfunctions was then assessed to determine if they may lead to one of the vehicle-level hazards; 91 of the 150 malfunctions lead to one or more of the vehicle-level hazards.

Table 2 provides an example of how malfunctions are derived from one of the EPS functions and are assigned vehicle-level hazards. Table 3 shows the number of malfunctions identified for each of the EPS functions. Appendix C provides the complete results of the HAZOP study.

Table 2. Derivation of Malfunctions and Hazards Using HAZOP Study (Example)

<i>HAZOP Guideword</i>	<i>Malfunction</i>	<i>Potential Vehicle Level Hazard</i>
Loss of function	Torque cannot be sensed from steering wheel	H1: Unintended Vehicle Lateral Motion/Yaw
		H2: Insufficient Vehicle Lateral Motion/Yaw
		H3: Loss of Steering-assist
More than intended	Senses more torque than the actual torque	H1: Unintended Vehicle Lateral Motion/Yaw
	Senses torque with greater frequency than needed	Not Hazardous
Less than intended	Senses less torque than the actual torque	H2: Insufficient Vehicle Lateral Motion/Yaw
	Senses torque with less frequency than needed	H1: Unintended Vehicle Lateral Motion/Yaw H2: Insufficient Vehicle Lateral Motion/Yaw
Intermittent	Senses torque intermittently	H1: Unintended Vehicle Lateral Motion/Yaw
Incorrect direction	Senses torque in the opposite direction	H1: Unintended Vehicle Lateral Motion/Yaw
Not requested	Senses torque when there is no steering input	H1: Unintended Vehicle Lateral Motion/Yaw
Locked function	Senses a constant torque regardless of steering input	H1: Unintended Vehicle Lateral Motion/Yaw
		H2: Insufficient Vehicle Lateral Motion/Yaw

Table 3. Number of Identified Malfunctions for Each HAZOP Function

HAZOP Function	Number of Malfunctions	Malfunctions Leading to Hazards
Mechanically transmits the driver's torque from the steering wheel to the steering column to induce lateral vehicle force.	8	8
Senses the torque applied to the steering wheel.	9	8
Senses the steering wheel angle and steering column angle.	9	8
Communicates with internal subsystems and other vehicle systems, including receiving steering inputs from other vehicle systems.	5	3
Turns road wheels such that available/surplus lateral force is sufficient to achieve the desired vehicle path, including at low speeds and consistent with Ackerman angle practice.	4	4
Turns vehicle at highest steering wheel input angle to a TBD turning circle/radius for sufficient maneuverability.	3	3
Turns road wheels such that tire wear and tear is minimized.	2	0
Absorbs environmental sounds from the tire patch and the mechanical steering system to minimize cabin noise.	3	0
Provides feedback to the driver via steering wheel when turning limit is reached by disallowing more rotation of the steering wheel.	3	3
Transmits road surface roughness from the tire patch to the driver through the steering wheel.	6	4
Transmits lateral road friction from the tire patch to the driver through steering wheel.	6	4
Absorbs road shocks from the tire patch to prevent full transmission to driver's hands.	5	5
Transmits mechanical failures from within steering system to the driver through an easily perceivable change in steering effort.	6	0
Adjusts steering wheel to a proper height and angle for a comfortable driving position. ⁱ	2	0
Adds torque to or subtracts torque from the driver's steering wheel input to ease or impede lateral force induction based on vehicle speed.	9	9
Modulates torque to create an on-center, straight steer by default.	5	5

HAZOP Function	Number of Mal-functions	Mal-functions Leading to Hazards
Disables all energy sources to steering equipment When the Ignition Is off or once the EPS system enters a maintenance/repair mode.	5	2
Stores relevant data.	5	0
Turns the 4WS mode from on to off (or vice-versa) in 4WS-equipped vehicles.	5	3
Turns rear-wheels in-phase smoothly and without alarming driver when at or above the in-phase vehicle speed threshold in 4WS-equipped vehicles.	9	7
Turns rear-wheels in reverse-phase smoothly and without alarming driver when below the reverse-phase vehicle speed threshold in 4WS-equipped vehicles.	9	7
Turns the rear-wheels inward (toe-in) to enhance stability in 4WS-equipped vehicles.	7	5
Provides diagnostics and fault detection. ⁱ	6	0
Provides mitigation for system faults. ⁱ	5	0
Electronically transmits steering system failures to the driver using all or some of the dashboard indicators, chimes, or similar alerts.	6	0
Locks the steering wheel when vehicle is off such that any steering inputs (torque or angle) are not transmitted to the road wheels.	4	1
Unlocks the steering wheel for normal functions after the vehicle is accessed with the appropriate security device (e.g., key, biometrics).	4	2

ⁱ This function is only included for completeness and the identified malfunctions were not associated with potential vehicle level hazards.

4.3 System-Theoretic Process Analysis: Step 1

4.3.1 Detailed Control Structure Diagram

Figure 9 illustrates the detailed control structure diagram used in the STPA method to represent a generic EPS system (in the dashed line) and its interfacing systems and components. The low voltage (e.g., 12-volt) power supply is only shown on this diagram as an effect of the driver's action on the ignition key. However, the impact of the low voltage power supply on the operation of the system electronics is considered in detail as part of STPA Step 2.

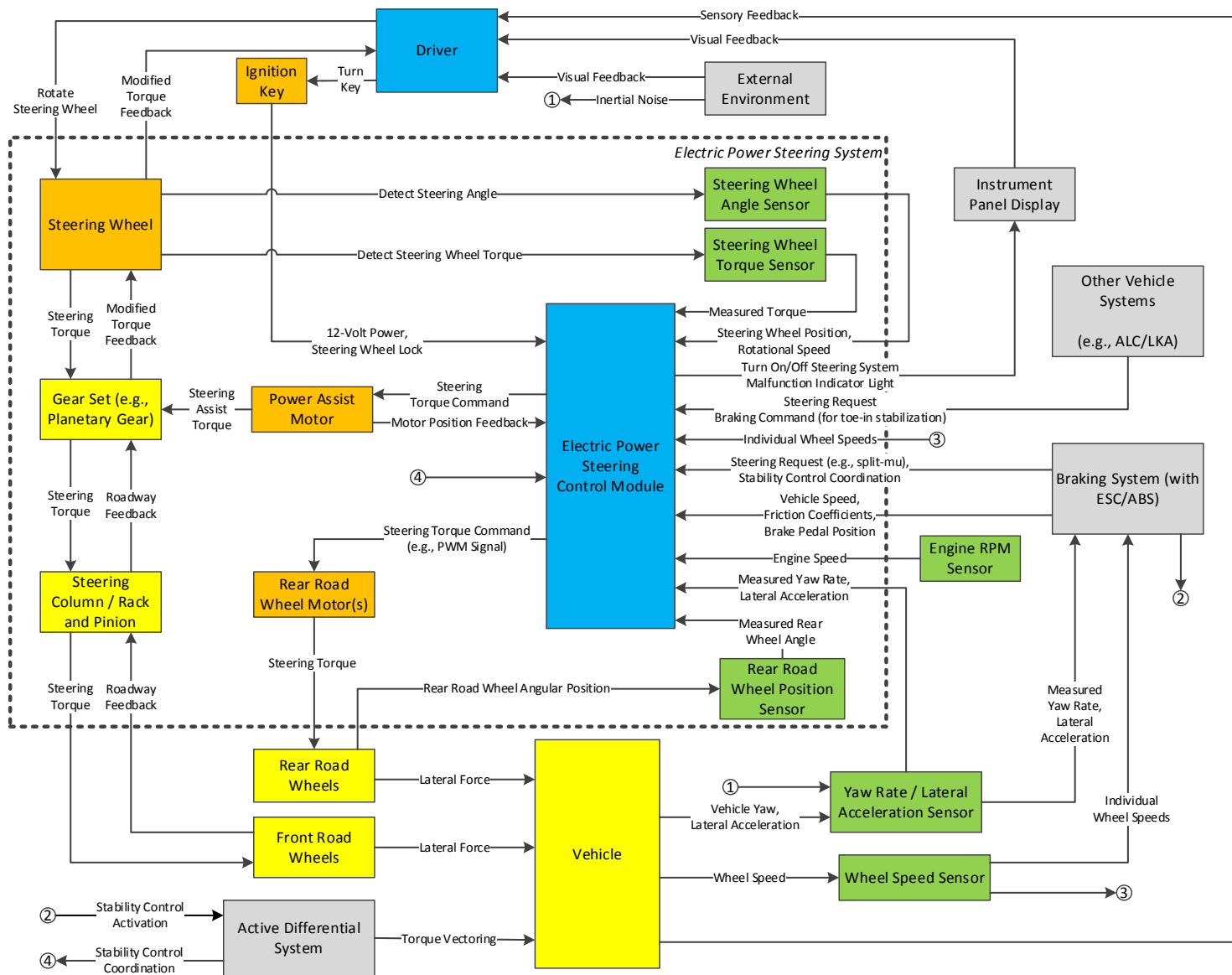

Figure A-1. Detailed Control Structure Diagram for a Generic EPS System With Active Steering and 4WS Features

4.3.2 Vehicle-Level Loss and Initial Hazards

STPA begins by identifying specific losses that the study is trying to prevent. In the STPA method, these losses result from a combination of a hazardous state along with a worst-case set of environmental conditions [6]. The vehicle-level loss relevant to this study is a vehicle crash.

An initial list of vehicle-level hazards is generated based on a literature search and engineering experiences. As the analyst identifies UCAs as part of STPA Step 1, the initial hazard list may be refined. Section 4.3.3 and Section 4.3.4 provide the details of this process. Then, the hazards generated from both the HAZOP study and STPA are synthesized to produce the hazard list shown in Table 1.

4.3.3 Control Actions and Context Variables

STPA Step 1 studies ways in which control actions in the system may become unsafe, leading to vehicle-level hazards. This study identifies four control actions issued by the EPS control module related to the EPS system function:

- One control action is related to commanding torque from the power-assist motor.
 - **Command Torque From the Power-Assist Motor to Change the Front-Wheel Heading by Θ degrees** – The EPS control module issues this command to add or subtract torque from the driver’s steering command. The EPS control module also issues this command to implement steering requests from other vehicle systems.

Table 4 lists three context variable states used for the analysis of the control action to command torque from the power-assist motor. The vehicle speed threshold of Active Steering is determined as part of the system design. Therefore, a specific vehicle speed is not presented in Table 4. Examples of vehicle speed thresholds used in current design implementations include approximately 62 mph for Bosch [18] and approximately 75 mph for BMW [22].

For this control action, the symbol “ Θ ,” theta, is used to convey whether the actions of the driver and steering requests from other vehicle systems are in the same direction (i.e., in the Θ direction) or in the opposite direction (i.e., in the $-\Theta$ direction) of the torque output from the power-assist motor. An alternative approach could be to consider separate control actions for clockwise and counterclockwise torque commands. However, this would result in redundant analyses since the only difference in the UCAs for the clockwise and counterclockwise cases would be the direction.

Table 4. STPA Context Variables for Commanding Torque From the Power-Assist Motor

Context Variable	Context Variable States
Driver's Steering Command	No steering
	Steering in the Θ direction
	Steering in the $-\Theta$ direction
Steering Requests from Other Vehicle Systems	No steering request
	Steering requested in the Θ direction
	Steering requested in the $-\Theta$ direction
Vehicle Speed	Steering requested in both the Θ and $-\Theta$ directions.
	Below the speed threshold for Active Steering (the EPS adds torque)
	Above the speed threshold for Active Steering (the EPS subtracts torque)
	At the speed threshold for Active Steering

- Three control actions relate to commanding torque from the rear-wheel motor if the vehicle is equipped with 4WS. The EPS control module issues these commands to adjust the rear-wheel steering angle in response to the vehicle speed and the driver's steering input.
 - **Command an In-Phase Rear-Wheel Heading** – the EPS control module issues this command to turn the rear-wheels in the same direction as the front-wheels to enhance vehicle stability at high vehicle speeds.
 - **Command a Reverse-Phase Rear-Wheel Heading** – the EPS control module issues this command to turn the rear-wheels in the opposite direction as the front-wheels to provide improved turning at low vehicle speeds.
 - **Command the Rear-Wheels to Toe-In** – the EPS control module issues this command to turn the rear-wheels inward to provide greater stability during braking.

The context variables used to consider the three control actions differ slightly, and are presented in Table 5, Table 6, and Table 7. Similar to active steering, the vehicle speed thresholds for activating in-phase steering and reverse-phase steering are determined as part of the system design. The vehicle speed values for activating in-phase and reverse-phase steering are not necessarily the same.

Table 5. STPA Context Variables for Commanding In-Phase Rear-Wheel Heading

Context Variable	Context Variable States
Steering Torque Commanded by Driver or Other Vehicle Systems	Yes
	No
Vehicle Speed	Above Threshold Value for Activating In-Phase Steering
	Below Threshold Value for Activating In-Phase Steering
	At Threshold Value for Activating In-Phase Steering

Table 6. STPA Context Variables for Commanding Reverse-Phase Rear-Wheel Heading

Context Variable	Context Variable States
Steering Torque Commanded by Driver or Other Vehicle Systems	Yes
	No
Vehicle Speed	Above Threshold Value for Activating Reverse-Phase Steering
	Below Threshold Value for Activating Reverse-Phase Steering
	At Threshold Value for Activating Reverse-Phase Steering

Table 7. STPA Context Variables for Commanding Toe-In Rear-Wheel Heading

Context Variable	Context Variable States
Steering Torque Commanded by Driver or Other Vehicle Systems	Yes
	No
Brakes Applied	Yes
	No

In addition to the control actions of the EPS control module described above, this study models the driver as a high-level controller that can also issue control actions to the steering system.

- One control action is related to the driver’s steering command.
 - **Command Steering** – the driver issues this command by rotating the steering wheel. This command is transmitted directly to the front-wheels through the mechanical portion of the EPS system and also serves as an input to the EPS control module for determining the amount of power-assist to provide.

Table 8 shows one context variable considered in assessing this control action. There are numerous conditions that could influence why the driver may issue a steering command, and it is not practical for this study to consider all possible combinations of these conditions. Therefore, this study assumes a competent driver and considers only whether the driver perceives the need for steering; this study does not analyze why the driver may arrive at that conclusion.

Table 8. STPA Context Variable for the Driver Issuing a Steering Command

Context Variable	Context Variable States
Is a Steering Adjustment Needed	Yes No

4.3.4 Unsafe Control Actions

The six UCA guidewords (Figure 5) were applied to each combination of context variable states for the five control actions listed in the previous section. The analysts then assessed whether the control action would result in a vehicle-level hazard under that particular scenario. Table 9 shows how this is done for one of the control actions – “Command a Reverse-Phase Rear-Wheel Heading.” Appendix D contains all of the UCA assessment tables for the five control actions.

Table 9. UCA Assessment Table (Example)

Control Action: Command a Reverse-Phase Rear-Wheel Heading

Context Variables		Guidewords for Assessing Whether the Control Action May Be Unsafe								
Steering Torque Commanded (by Driver or Other Vehicle Systems)	Vehicle Speed (Threshold for Reverse-Phase Steering) ⁱ	Not Provided in This Context	Provided in This Context	Provided, But Duration Is Too Long	Provided, But Duration Is Too Short	Provided, But the Intensity Is Incorrect (Too Much)	Provided, But the Intensity is Incorrect (Too Little)	Provided, But Executed Incorrectly	Provided, But the Starting Time Is Too Soon	Provided, But the Starting Time Is Too Late
Yes	Above Threshold Value	Not hazardous	H1	Hazardous if provided	Hazardous if provided	Hazardous if provided	Hazardous if provided	Hazardous if provided	Hazardous if provided	Hazardous if provided
Yes	At or Below Threshold Value	Not hazardous	Not hazardous	H1	Not hazardous	H1	Not hazardous	H1, H2	Not applicable ⁱⁱ	H1
No	Above Threshold Value	Not hazardous	H1	Hazardous if provided	Hazardous if provided	Hazardous if provided	Hazardous if provided	Hazardous if provided	Hazardous if provided	Hazardous if provided
No	At or Below Threshold Value	Not hazardous	H1	Hazardous if provided	Hazardous if provided	Hazardous if provided	Hazardous if provided	Hazardous if provided	Hazardous if provided	Hazardous if provided

ⁱ The vehicle speed threshold is established by each manufacturer as part of the design.

ⁱⁱ Since the context variables assume that the vehicle is already below the threshold vehicle speed, the “provided, but the starting time is too soon” UCA guideword is not applicable. Adopting the reverse-phase rear-wheel heading before the vehicle speed transitions below the threshold value is considered as part of the “provided in this context” guideword for the context variable “above threshold value..”

Vehicle-Level Hazards:

H1: Potential unintended vehicle lateral motion/unintended yaw

H2: Potential insufficient vehicle lateral motion/insufficient yaw

Each cell in Table 9 represents a UCA. For example, application of the guideword “provided in this context” to the first row of context variables in Table 9 results in the following UCA statement:

The EPS control module commands the rear-wheels to turn in reverse-phase when:

- *steering is commanded by the driver or other vehicle systems, and*
- *the vehicle speed is above the threshold speed value for activating reverse-phase steering.*

This may result in unintended vehicle lateral motion/unintended yaw.

However, writing each cell of the table into a UCA statement would create a very long list of UCAs and many of these UCAs would have overlapping logical states. Therefore, this study uses the Quine-McCluskey minimization algorithm [9] to consolidate and reduce the overall number of UCA statements.

STPA Step 1 identifies a total of 50 UCAs for the generic EPS system. All 50 UCAs lead to one or more vehicle-level hazard. Table 10 provides the breakdown of these UCAs by control action.

Table 10. Number of Identified UCAs for Each STPA Control Action

STPA Control Action	Number of UCAs
EPS Control Module	
Command Torque From the Power-Assist Motor to Change the Front-Wheel Heading by Θ Degrees	29
Command an In-Phase Rear-Wheel Heading	6
Command a Reverse-Phase Rear-Wheel Heading	6
Command the Rear-Wheels to Toe-In	2
Driver/Vehicle Operator	
Command Steering	7

Appendix E presents a complete list of the UCAs identified in STPA Step 1. Table 11 and Table 12 show examples of UCAs and their associated vehicle-level hazards.

Table 11. Example UCA Statement for Commanding Torque from the Power-Assist Motor

Hazard	Potential unintended vehicle lateral motion/unintended yaw
UCA (Example)	<p>The EPS control module commands torque from the power-assist motor to change the front-wheel heading by Θ degrees when:</p> <ul style="list-style-type: none"> • the driver is steering in the Θ direction, and • the vehicle speed is in the range where the EPS subtracts torque from the driver’s input or does not modify the driver’s input.

This UCA describes a situation where the EPS control module should either subtract torque from the driver’s input (as part of the active steering feature) or not modify the driver’s steering input. Instead the EPS control module adds torque in the same direction as the driver’s steering command resulting in the front-wheel steering angle changing by more than expected. This could potentially result in unintended vehicle lateral motion and unintended yaw.

Table 12. Example UCA Statement for Commanding a Change in the Rear-Wheel Position

Hazard	Potential Insufficient Vehicle Lateral Motion/Insufficient Yaw
UCA (Example)	<p>The EPS control module commands the rear-wheels to turn in-phase when:</p> <ul style="list-style-type: none"> • steering is commanded by the driver or other vehicle systems, and • the vehicle speed is below the threshold for activating in-phase steering.

This UCA describes a situation where the EPS commands the rear-wheels to the wrong position, based on the vehicle speed. An example of this situation may be where the driver is trying to make a turn at an intersection. If the rear-wheels turn in-phase, this would increase the turning radius of the vehicle, which may prevent the vehicle from executing the turn maneuver. This could potentially result in insufficient vehicle lateral motion and insufficient yaw.

5 RISK ASSESSMENT

This study follows the risk assessment approach in ISO 26262. The assessment derives the ASIL for each of the four identified vehicle-level hazards.

5.1 Automotive Safety Integrity Level Assessment Steps

The ASIL assessment contains the following steps.

1. Identify vehicle operational situations
2. For each identified vehicle-level hazard, apply the ISO 26262 risk assessment framework:
 - a. Assess the probability of exposure to the operational situation.
 - b. Identify the potential crash scenario.
 - c. Assess the severity of the harm to the people involved if the crash occurred.
 - d. Assess the controllability of the situation and the vehicle in the potential crash scenario.
 - e. Look up the ASIL per ISO 26262 based on the exposure, severity, and controllability.
3. Assign the worst-case ASIL to the hazard.

5.1.1 Vehicle Operational Situations

Operational situations are scenarios that can occur during a vehicle's life (Part 1 Clause 1.83 in ISO 26262 [4]). This study generates 26 vehicle operational situations that are provided in Appendix F. Below are two examples:

- Driving at high speeds ($100 \text{ kph} \leq V < 130 \text{ kph}$), heavy traffic,¹⁸ good visibility, and good road conditions.
- Driving at medium speed ($40 \text{ kph} \leq V < 100 \text{ kph}$), exiting or entering a ramp, independent of traffic, visibility or road conditions.

These 26 scenarios cover 7 variables and their states as shown in Table 13. These variables and their states were identified following current industry practices.

¹⁸ Heavy traffic is used in this context to indicate conditions with more vehicles on the road. Heavy traffic is not related to Level of Service.

Table 13. Variables and States for Description of Vehicle Operational Situations

Vehicle Speed	Very high speed ($130 \text{ kph} \leq V$)	Roadway Type	Parking lot or driveway
	High speed ($100 \text{ kph} \leq V < 130 \text{ kph}$)		City road
	Medium speed ($40 \text{ kph} \leq V < 100 \text{ kph}$)		Country road
	Low speed ($V < 40 \text{ kph}$)	Road Condition¹⁹	Slippery
	Stopped ($V = 0 \text{ kph}$)		Good
Traffic	Heavy	Driving Maneuver	Going straight (no special driving maneuvers or stopped)
	Light		
Visibility	Low/bad		Starting to move
	Good		Driving in reverse
Pedestrian Presence	Negligible		Stop-and-go driving
	Present/low		Exiting/entering an on-ramp/off-ramp
	Heavy		

5.1.2 Automotive Safety Integrity Level Assessment

ISO 26262 assesses the ASIL of identified hazards according to the severity, exposure, and controllability (Part 3 in ISO 26262).

Exposure is defined as the state of being in an operational situation that can be hazardous if coincident with the failure mode under analysis (Part 1 Clause 1.37 in ISO 26262). Table 14 is directly copied from ISO 26262 Part 3 Table 2.

¹⁹ Road geometry (e.g., curvature) was considered in the ASIL assessment based on the vehicle-level hazard. For example, the hazard “Potential Unintended Vehicle Lateral Motion/Yaw” applies regardless of whether or not the driver is steering and the road geometry does not require special consideration. If the road geometry were considered as a separate factor for this hazard, it would likely result in a reduced exposure value. The hazards “Potential Insufficient Vehicle Lateral Motion/Yaw” and “Potential Unintended Loss of Steering-Assist” are relevant only in instances where the driver is steering. These hazards would apply on road curves, when turning, executing lane-change or evasive maneuvers, and other situations that involve the driver steering. For these hazards, the severity may be impacted in some specific scenarios where the loss of steering may cause road departure; however, the exposure in these scenarios would also likely be reduced. For the remaining two hazards, road geometry is not a significant factor.

Table 14. Exposure Assessment

	Class				
	E0	E1	E2	E3	E4
Description	Incredible	Very low probability	Low probability	Medium probability	High probability
E = Exposure					

Severity is defined as the estimate of the extent of harm to one or more individuals that can occur in a potentially hazardous situation (Part 1 Clause 1.120 in ISO 26262). Table 15 is directly quoted from ISO 26262 Part 3 Table 1.

Table 15. Severity Assessment

	Class			
	S0	S1	S2	S3
Description	No injuries	Light and moderate injuries	Severe and life-threatening injuries (survival probable)	Life-threatening injuries (survival uncertain), fatal injuries
S = Severity				

Table 16 is one method for assessing severity that is provided in ISO 26262 (Part 3 Clause 7.4.3.2 and Annex B Table B.1).

Table 16. Example Method for Assessing Severity

	Class of Severity			
	S0	S1	S2	S3
Reference for single injuries (from AIS scale)	<ul style="list-style-type: none"> • AIS 0 and less than 10% probability of AIS 1-6 • Damage that cannot be classified safety-related 	More than 10% probability AIS 1- 6 (and not S2 or S3)	More than 10% probability of AIS 3-6 (and not S3)	More than 10% probability of AIS 5-6

ISO 26262 defines controllability as the “ability to avoid a specified harm or damage through the timely reactions of the persons²⁰ involved, possibly with support from external measures” (Part 1 Clause 1.19 in ISO 26262). Table 17 is ISO 26262’s approach to assessing controllability (Table

²⁰ Persons involved can include the driver, passengers, or persons in the vicinity of the vehicle's exterior.

3 in Part 3 in ISO 26262). Table 18 shows how ASIL is assessed based on exposure, severity, and controllability (Table 4 in Part 3 of ISO 26262).

Table 17. Controllability Assessment

Description	Class			
	C0	C1	C2	C3
	Controllable in general	Simply controllable	Normally controllable	Difficult to control or uncontrollable

C = Controllability

Table 18. ASIL Assessment

Severity Class	Probability Class (Exposure)	Controllability Class		
		C1	C2	C3
S1	E1	QM	QM	QM
	E2	QM	QM	QM
	E3	QM	QM	A
	E4	QM	A	B
S2	E1	QM	QM	QM
	E2	QM	QM	A
	E3	QM	A	B
	E4	A	B	C
S3	E1	QM	QM	A
	E2	QM	A	B
	E3	A	B	C
	E4	B	C	D
QM: Quality Management E: Exposure S: Severity C: Controllability				

Table 19 and Table 20 provide two examples of how this study assesses the ASIL for each hazard under identified operational situations.

Table 19: Example ASIL Assessment for Hazard H1

Vehicle-Level Hazard	Potential Unintended Vehicle Lateral Motion/Unintended Yaw		
Operational Situation	Driving at high speed ($100 \text{ kph} \leq V < 130 \text{ kph}$), with heavy traffic, good visibility, and good road conditions.		
Potential Crash Scenario	Vehicle runs into another vehicle or barrier. ⁱ		
ASIL Assessment	Severity	S3	Side or frontal impact with another vehicle, or roll over with intrusion into the passenger compartment. More than 10% probability of AIS 5-6.
	Exposure	E4	This scenario occurs often (> 10% of average driving time).
	Controllability	C3	This situation is very difficult to control, especially if there is a complete loss of steering.
Assigned ASIL Value	D		

ⁱThis hazard also considers untripped roll-over resulting from too large of a yaw rate as a special case.

Table 20: Example ASIL Assessment for Hazard H2

Vehicle-Level Hazard	Potential Insufficient Vehicle Lateral Motion/Insufficient Yaw		
Operational Situation	Driving at medium speed ($40 \text{ kph} \leq V < 100 \text{ kph}$) on a country road, with heavy traffic, good visibility, and good road conditions.		
Potential Crash Scenario	The vehicle runs into another vehicle or an object on the roadway.		
ASIL Assessment	Severity	S3	Side or frontal impact with another vehicle with intrusion into the passenger compartment. More than 10% probability of AIS 5-6.
	Exposure	E4	This scenario occurs often (> 10% of average driving time).
	Controllability	C2	This situation is somewhat controllable due to the moderate speed of the vehicle and the availability of steering to a certain extent.
Assigned ASIL Value	C		

Appendix G contains the full ASIL assessment.

5.2 Automotive Safety Integrity Level Assignment for Each Hazard

The ASIL assessment for each operational situation forms the basis for the ASIL assignment to each of the four vehicle-level hazards. ISO 26262 requires the most severe ASIL be chosen for each hazard. Table 21 shows the resulting ASIL values for each hazard.

Table 21. Vehicle-Level Hazards and Corresponding ASIL

	Hazard	ASIL
H1	Potential unintended vehicle lateral motion/unintended yaw ⁱ	D
H2	Potential insufficient vehicle lateral motion/insufficient yaw	C
H3	Potential loss of steering-assist	B ⁱⁱ
H4	Potential reduced responsiveness to the driver's commands due to increased rear-wheel drag	A

ⁱ A subset of this hazard, where some degree of steering remains available to the driver, has an ASIL C classification. However, the ASIL D classification represents the worst-case ASIL.

ⁱⁱ In evaluating this hazard, the ASIL assessment assumed the manual steering is not affected by the failure and provides the driver with sufficient steering.

6 VEHICLE-LEVEL SAFETY GOALS

Based on the hazard analysis and risk assessment, the safety goals (i.e., vehicle-level safety requirements) are established as listed in Table 22. The safety goals correspond to the potential hazards in Table 21.

Table 22. Safety Goals for the EPS System

ID	Safety Goals	ASIL
SG 1	The EPS system is to prevent unintended self-steering in any direction under all vehicle operating conditions.	D
SG 2	The EPS system is to provide the correct level of steering-assist under all vehicle operating conditions.	C
SG 3	The EPS system is to prevent the unintended ⁱ loss of steering-assist under all vehicle operating conditions.	B
SG 4	The EPS system is to prevent rear-wheel drag under all vehicle operating conditions. ⁱⁱ	A

ⁱ Unintended in this context is used to differentiate from intentional disabling of the EPS system as a potential safe state for the system. Specifically, the unintended loss of steering-assist is not controlled and the driver is not notified that steering-assist is not available.

ⁱⁱ Rear-wheel drag indicates a rear-wheel position (i.e., toe-in) that affects the vehicle dynamics or slows the vehicle when the brakes are not being applied. However, the drag effect may not reach the level of “deceleration.”

When developing the safety goals in Table 22, the potential vehicle-level hazard “unintended vehicle lateral motion/unintended yaw” (H1) was decomposed into three categories:

- The subset of cases where the EPS system provides steering without an input from either the driver or other vehicle systems.
- The subset of cases where the EPS system provides steering in the opposite direction of the driver’s input.
- The subset of cases where the EPS system provides too much steering-assist in response to the input from either the driver or other vehicle systems.

Safety Goal 1 covers the first two categories. In these cases, the driver may not expect steering or may not be able to properly control the EPS system output (e.g., the EPS system provides torque in the opposite direction of the driver’s steering input). The driver’s ability to control the vehicle may be reduced in these situations and this reduced controllability contributes to ASIL D classification.

The third category is covered by SG 2, along with the hazard “insufficient vehicle lateral motion/insufficient yaw” (H2). In both of these cases, the EPS system provides the wrong magnitude response to the driver’s steering command. However, since the driver initiates steering and the steering system still responds to the driver’s input to some degree, greater

controllability is assumed to be available in these situations. The assumption of greater controllability contributes to ASIL C classification, rather than ASIL D.

Safety goals SG 3 and SG 4 correspond to hazards H3 and H4, respectively.

7 SAFETY ANALYSIS

This study uses the functional FMEA and STPA to complete the safety analysis.

7.1 Functional Failure Modes and Effects Analysis

This study carried out a functional FMEA for all of the potential vehicle-level hazards identified in Table 1. Overall, the functional FMEA covers nine EPS subsystems and components, and 11 interfacing systems or subsystems. The functional FMEA identifies 94 failure modes and 607 potential faults. Table 23 shows a breakdown of failure modes and potential faults by the systems, subsystems, and components.

Table 23. Breakdown of Identified Failure Modes and Potential Faults

System/Subsystem/Component	Number of Failure Modes	Number of Potential Faults
EPS Subsystems and Components		
EPS Control Module	32	163
Gear Set (e.g., Planetary Gear)	1	1
Power-Assist Motor	9	56
Rear-Wheel Motors	8	43
Rear-Wheel Position Sensor	5	60
Steering Column/Rack and Pinion	1	1
Steering Wheel	1	1
Steering Wheel Angle Sensor	6	80
Steering Wheel Torque Sensor	7	82
Interfacing Systems or Subsystems		
Active Differential System	2	2
Brake/Vehicle Stability System	7	7
Front-wheels	1	1
Ignition Key	3	24
Instrument Panel Display	1	1
Other Vehicle Systems (e.g., ALC)	3	3
Rear-wheels	1	1
Wheel Speed Sensor	3	41
Yaw Rate/Lateral Acceleration Sensor	3	40

Note: Some faults may result in one or more failure modes.

Table 24 shows a few examples of the functional FMEA. Appendix H provides the complete functional FMEA results.

Table 24. Portion of the Functional FMEA for H1: Potential Unintended Vehicle Lateral Motion/Unintended Yaw

System/Subsystem	Potential Failure Mode	Potential Causes or Mechanisms of Failure	Current Process Controls		
			Safety Mechanism	Diagnostics	Diagnostic Trouble Code
EPS Control Module	(includes commanding torque when not needed or commanding a constant torque value)	Hardware fault (sensors, ICs, circuit components, circuit boards...)		Hardware diagnostics	
		Internal connection fault (short or open)		Hardware diagnostics	
		Break in EPS input/output (I/O) connections	Critical messages/data transfer qualification	Stuck open/short	I/O Fault
		Commands too much torque from power-assist motor	Critical messages/data transfer qualification	Stuck open/short	I/O Fault
		Short in EPS I/O connections to ground or voltage			
		Short in EPS I/O connections to another connection		Stuck open/short	
		Signal connector connection failure		Hardware diagnostics	
		Power connector connection failure		Hardware diagnostics	
	Power-assist motor torque command calculation algorithm fault	Three-level monitoring	Software diagnostics	System fault	
	Firmware crash/failure (software parameters corrupted)		Periodic checks		
	Arbitration logic fault	Three-level monitoring		System fault	

7.2 Systems-Theoretic Process Analysis: Step 2

STPA Step 1 identified 50 UCAs and 7 vehicle-level hazards. The analysts integrated these seven vehicle-level hazards with the HAZOP results to yield the 4 vehicle-level hazards described in Section 4. The goal of STPA Step 2 is to identify CFs that may lead to the UCAs, which then may result in one or more of the 4 synthesized vehicle-level hazards. Each of the 26 CF guidewords and the detailed causes (Appendix B) are applied to the components and interactions depicted in the STPA control structure diagram (Figure 9). Specifically, the STPA Step 2 analysis includes the following components and interactions:

- Components within the EPS system – defined as any component within the EPS scope boundary shown in Figure 6.
- Interactions within the EPS system – defined as any interaction between components entirely within the EPS scope boundary. Types of interactions include wired or communication bus connections used to transmit data, or physical connections (e.g., to transmit torque).
- Interactions with interfacing components and systems – defined as any interaction which involves a component within the EPS system boundary and a component external to the EPS system. Types of interactions include wired or communication bus connections used to transmit data, or physical connections.

The choices of these components and interactions enable the analysis to focus on the defined scope of this study while still considering critical interfaces between the EPS system and other vehicle systems. For example, the vehicle speed signal may be provided by the brake/vehicle stability control system. This analysis will consider faults in the transmission of the vehicle speed data to the EPS (e.g., over the CAN bus). However, failures within the brake/vehicle stability control module or other parts of the brake/vehicle stability system that may lead to an incorrect vehicle speed are not considered in the analysis of the EPS system.

Each identified CF relates to one or more of the UCAs identified in STPA Step 1, providing a traceable pathway from CFs up to vehicle-level hazards (Figure 10).

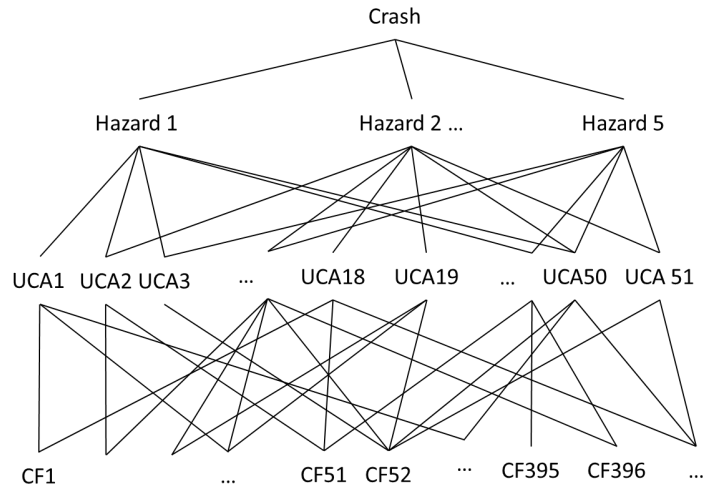

Figure A-1. Traceability in STPA Results

The STPA Step 2 analysis identifies 798 unique CFs. Below is a breakdown of CFs by the type of UCAs they affect.

- 509 CFs may lead to UCAs related to EPS control of the power-assist motor
- 294 CFs may lead to UCAs related to EPS control of the rear-wheel position
- 265 CFs may lead to UCAs related to the driver’s steering input

As shown in Figure 10, a CF may lead to more than one UCA. Therefore, the totals listed above exceed the number of unique CFs identified in this study.

Table 25 shows a breakdown of the identified CFs by the 26 CF guidewords applied in this study. Appendix I provides the complete list of CFs identified in this study.

Table 25. Number of Identified Causal Factors by Causal Factor Category

Causal Factor Category	Number of Causal Factors
Actuation delivered incorrectly or inadequately: Actuation delayed	5
Actuation delivered incorrectly or inadequately: Hardware faulty	5
Actuation delivered incorrectly or inadequately: Incorrect connection	5
Actuator inadequate operation, change over time	18
Conflicting control action	3
Controlled component failure, change over time	4
Controller hardware faulty, change over time	24
Controller to actuator signal ineffective, missing, or delayed: Communication bus error	12
Controller to actuator signal ineffective, missing, or delayed: Hardware open, short, missing, intermittent faulty	18
Controller to actuator signal ineffective, missing, or delayed: Incorrect connection	6
External control input or information wrong or missing	12
External disturbances	250
Hazardous interaction with other components in the rest of the vehicle	216
Output of controlled process contributes to system hazard	3
Power supply faulty (high, low, disturbance)	24
Process model or calibration incomplete or incorrect	26
Sensor inadequate operation, change over time	23
Sensor measurement delay	6
Sensor measurement inaccurate	4
Sensor measurement incorrect or missing	6
Sensor to controller signal inadequate, missing, or delayed: Communication bus error	30
Sensor to controller signal inadequate, missing, or delayed: Hardware open, short, missing, intermittent faulty	47
Sensor to controller signal inadequate, missing, or delayed: Incorrect connection	14
Software error (inadequate control algorithm, flaws in creation, modification, or adaptation)	37

Table 26 shows three examples of CFs that may result in a UCA related to controlling the power-assist motor. In this UCA, the EPS control module commands torque from the power-assist motor that supplements the driver's steering input. However, the vehicle speed is in a range where the EPS control module should not add torque to the driver's steering input (i.e., the EPS should either subtract torque from the driver's input or provide no assist torque).

Table 26. Examples of Causal Factors for a UCA Related to Controlling the Power-Assist Motor

Hazard	Potential unintended vehicle lateral motion/unintended yaw	
UCA (Example)	<p>The EPS control module commands torque to change the front-wheel heading by Θ degrees when:</p> <ul style="list-style-type: none"> the driver is steering in the Θ direction, and the vehicle speed is in a range where the EPS subtracts torque from the driver's steering input or does not modify the driver's steering input. 	
Potential Causal Factors (Example)	Component	Potential Causal Factors
	EPS Control Module	The EPS control module may incorrectly consider the vehicle speed when determining whether to add or subtract torque from the driver's input.
	Brake/Stability System to EPS Control Module	A bus overload or bus error might affect communication between the brake/stability system and EPS control module, including vehicle speed, road friction, or brake pedal position signals.
	Steering Wheel Torque Sensor	An internal hardware failure might affect the steering wheel torque sensor and cause it to output an incorrect steering wheel torque measurement to the EPS control module.

1. The first example CF in Table 26 describes a flaw in the EPS control module software that affects how vehicle speed is considered by the active steering feature. This may include faulty parameters, corrupted vehicle speed to power-assist motor torque maps, or errors in the control algorithm.
2. The second example CF in Table 26 describes how a problem with the communication bus, such as a bus overload or error, may prevent critical data from reaching the EPS control module. For example, if the EPS control module does not receive updated vehicle speed data, the active steering feature may continue to operate in the regime where it adds torque to the driver's steering input.
3. The third example CF in Table 26 describes an internal hardware failure in the steering wheel torque sensor that could affect the torque measurement transmitted to the EPS control module. An incorrect torque measurement may cause the EPS control module to command the wrong amount of steering-assist.

Table 27 provides CF examples that may lead to a UCA related to controlling the rear-wheel position. In this UCA, the EPS control module commands a change in the rear-wheel heading when there is no steering input from the driver or other vehicle systems.

Table 27. Examples of Causal Factors for a UCA Related to Controlling the Rear-Wheel Position

Hazard	Potential unintended vehicle lateral motion/unintended yaw	
UCA (Example)	The EPS control module commands the rear-wheels to turn in-phase when: <ul style="list-style-type: none"> steering is not commanded by the driver or other vehicle systems. 	
Potential Causal Factors (Example)	Component	Potential Causal Factors
	EPS Control Module	A programming error or flaw in software logic may cause the EPS control module to command the rear-wheels to move to an in-phase or reverse-phase position when not needed (e.g., no steering input).
	Rear-Wheel Position Sensor	An internal hardware failure might affect the rear-wheel position sensor and cause it to output an incorrect rear-wheel steering angle measurement to the EPS control module.
	Rear-Wheel Position Sensor to EPS Control Module	Electromagnetic interference (EMI) or electrostatic discharge (ESD) from components within the vehicle might affect the signal from the rear-wheel position sensor to the electric power steering control module.

- The first CF in Table 27 describes a flaw in the EPS control module software program (e.g., a flawed control algorithm, incorrect parameters, etc.) that causes the EPS control module to command a change in the rear-wheel position when there's no steering input.
- The second CF in Table 27 describes a hardware failure in the rear-wheel position sensor (e.g., an internal short). If the rear-wheel position sensor provides incorrect data to the EPS control module, the EPS control module may think it's centering the rear-wheels when it's actually moving them away from the center position.
- The third CF in Table 27 describes an interaction where EMI or ESD from other vehicle components affects the connection from the rear-wheel position sensor to the EPS control module. If this affects the rear-wheel position measurement, the EPS may incorrectly control the position of the rear-wheels.

Table 28 shows some example CFs for UCAs related to the driver's steering command. In this UCA, the driver issues a necessary steering command, but the driver steers with too little force.

Table 28. Examples of Causal Factors for a UCA Related to the Driver’s Steering Input

Hazard	Potential insufficient vehicle lateral motion/insufficient yaw	
UCA (Example)	The driver commands steering when: <ul style="list-style-type: none"> • a steering adjustment is needed, but too little steering is commanded. 	
Potential Causal Factors (Examples)	Component	Potential Causal Factor
	Driver to Steering Wheel	Physical interference with components within the vehicle (e.g., the seat belt locking mechanism) might affect the driver's ability to operate the steering wheel.
	EPS Control Module to Instrument Panel Display	A signal priority that is too low might delay or prevent communication between the EPS Control Module and instrument panel display.

- The first CF in Table 28 describes physical interference with the driver’s range of motion by other components in the vehicle. For example, activation of the seatbelt pre-tensioner may limit how much the driver can rotate the steering wheel.
- The second CF in Table 28 describes a case where the communication bus priority for the driver notification from the EPS control module to the instrument panel display is too low. For example, if the EPS is disabled but the notification is not provided to the driver, the driver may not know that additional steering effort is required.

8 FUNCTIONAL SAFETY CONCEPT

The objective of the functional safety concept is to derive a set of functional safety requirements from the safety goals, and to allocate them to the preliminary architectural elements of the system, or to external measures (Part 3 Clause 8.1 in ISO 26262). Figure 11 illustrates how the functional safety concept takes into consideration the results from the safety analysis; applies safety strategies, industry practices, and engineering experiences; and derives a set of safety requirements following the established process in ISO 26262.

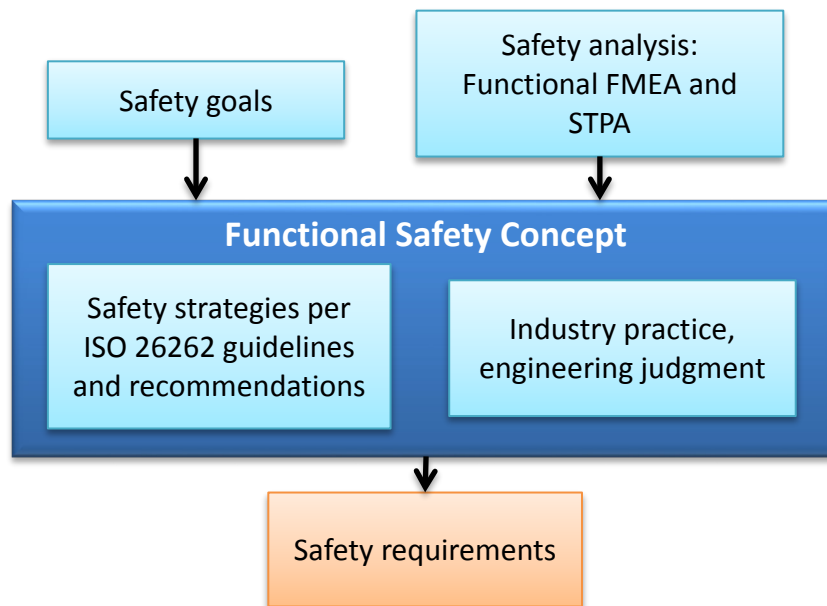

Figure A-1. Functional Safety Concept Process

8.1 Safety Strategies

As stated in ISO 26262 Part 3 Clause 8.2, “*the functional safety concept addresses:*”

- *Fault detection and failure mitigation;*
- *Transitioning to a safe state;*
- *Fault tolerance mechanisms, where a fault does not lead directly to the violation of the safety goals and which maintains the item in a safe state (with or without degradation)*
- *Fault detection and driver warning in order to reduce the risk exposure time to an acceptable interval (e.g. engine malfunction indicator lamp, anti-lock brake fault warning lamp);*
- *Arbitration logic to select the most appropriate control request from multiple requests generated simultaneously by different functions.”*

Typical safety strategy elements may include the following:

1. Ensure that the system elements are functioning correctly.
2. Ensure that the critical sensors' inputs to the main controller are valid and correct (redundant measurements paths).
3. Validate²¹ the health of the main controller (using an auxiliary processor).
4. Ensure the validity and correctness²² of critical parameters (mitigate latent faults through periodic checks).
5. Ensure the validity and correctness of the critical communication signals internal and external to the EPS system (Quality factors²³).
6. Ensure that the correct steering torque in terms of magnitude and direction is delivered to the road wheels at the correct time when requested.
7. Ensure that low-voltage power is available until the safe state is reached under all safety hazards conditions.
8. Mitigate the safety hazards when an unsafe condition is detected.
9. Ensure that the safe state is reached on time when a hazard is detected.
10. Ensure driver warnings are delivered when an unsafe condition is detected.
11. Ensure the correctness and timeliness of the arbitration strategy.

8.2 Example Safe States

ISO 26262 defines a safe state as an operating mode of the item without an unreasonable risk. A safe state may be the intended operating mode, a degraded operating mode, or a switched off mode (Part 1 Clause 1.102 of ISO 26262). The developer of the functional safety concept attempts to maximize the availability of the item while ensuring the safety of the vehicle operation. Therefore, a careful consideration is given to selecting the safe states in relation to the potential failure modes.

The safe states for the EPS system may include full operation (full steering-assist availability), degraded operation (certain steering-assist modes are disabled), or switched off mode (no steering-assist available). Possible safe states for the EPS system may include, but are not limited to:

- Safe State 1: Steering-assist is available at low speeds, but is disabled at high speeds.
- Safe State 2: Rear-wheels returned to the straight-ahead position and rear-wheel steering-assist is disabled.

²¹ “Validate” means to ensure that the value of a parameter or the state of an element falls within a valid set of values or states.

²² “Correctness” means that the value of a parameter is the correct one from the valid set.

²³ Quality factors refer to techniques for error detection in data transfer and communication including checksums, parity bits, cyclic redundancy checks, error correcting codes, etc.

- Safe State 3: All steering-assist is disabled.

Safe State 3 and the potential hazard “Unintended Loss of Steering-assist” (H3) both describe a similar vehicle behavior — where the EPS system does not provide steering-assist to the driver. However, there are key differences between the safe state and potential hazard:

- When entering Safe State 3, the steering-assist is disabled in a controlled manner. For example, the steering-assist may be gradually reduced to prevent an abrupt change in the vehicle’s response to the driver’s steering input.
- When entering Safe State 3, the driver is informed that the vehicle is in a degraded operating state (e.g., through a driver warning light) and can take appropriate action. The driver may not be notified of the degraded operating state when the potential hazard “Unintended Loss of Steering-assist” manifests.

8.3 Example Driver Warning Strategies

The following is an example of driver warning strategies commonly seen in the automotive industry:

- Amber Light: Potential violation of a safety goal is detected, but the probability of violating a safety goal is moderate (e.g., failures associated with Safe States 1 and 2).
- Red Light:
 - Potential violation of a safety goal is detected and the probability of violating a safety goal is high (e.g., failures associated with Safe State 3), or
 - Violation of a safety goal is detected
- Chime: Audible notification of the driver is implemented whenever the conditions for the red light driver warning are identified. The chime may continue until the fault is removed.
- Messages: Messages are displayed to the driver at least with the red light driver warning. The messages include instructions to the driver in case exiting or staying away from the vehicle is required.
- Haptic warning: Haptic warning may be an additional driver warning strategy. Dashboard lights and audible chimes are commonly used in conjunction with haptic warning. It may be beneficial to assess driver reactions to a haptic warning issued at the same time the system is attempting to reach safe state and degraded operation.

9 APPLICATION OF THE FUNCTIONAL SAFETY CONCEPT

This study identifies four vehicle-level safety requirements (Safety Goals) and derives 125 EPS system and component functional safety requirements by following the Concept Phase (Part 3) in the ISO 26262 standard. Sections 9.1 and 9.2 present these requirements.²⁴

9.1 Vehicle-Level Safety Requirements (Safety Goals)

Vehicle-level safety requirements for the EPS system correspond to the safety goals presented in Table 22. They are summarized below, along with the recommended safety strategies.

SG 1: The EPS system is to prevent unintended self-steering in any direction under all vehicle operating conditions in accordance with ASIL D classification.

- Unintended self-steering is defined as any steering that was not initiated by the driver or other vehicle systems (which are assumed to be operating correctly) due to failures that lead to:
 - Unintended initiation of steering.
 - Electrical steering stuck at a non-zero torque output.
 - Steering in the wrong direction (e.g., torque sensor).

SG 2: The EPS system is to provide the correct level of steering-assist under all vehicle operating conditions in accordance with ASIL C classification.

- An incorrect level of steering-assist is defined as any steering-assist that deviates from the *requested* steering angle, including:
 - Any amount of lateral motion that deviates from the driver's *intended* lateral motion or yaw.
 - Any rate of change of lateral motion that exceeds the driver's intended yaw rate.

SG 3: The EPS system is to prevent the unintended loss of steering-assist under all vehicle operating conditions in accordance with ASIL B classification.

- Loss of steering-assist is defined as the absence of electrical steering-assist without affecting any available mechanical steering mechanisms.
- In case of a loss of steering-assist, the added steering effort caused by the presence of the EPS system components (the motor, controller, and reduction gear) is not to increase the steering effort required to operate the mechanical back-up system to an effort level that exceeds TBD N·m to achieve a turning radius of TBD m.

SG 4: The EPS system is to prevent rear-wheel drag under all vehicle operating conditions in accordance with ASIL A classification.

²⁴ All requirements presented in this report are intended to illustrate a set of requirements that could be derived from the safety analysis results. These safety requirements are not intended to represent NHTSA's official position or requirements on the EPS system.

In addition to any specific safety strategies listed for the safety goals above, the following general safety strategies are to be followed for each of the safety goals:

- The EPS system is to prevent or detect faults and failures that could lead to the vehicle-level hazards.
- In case of the detection of any failure that could lead to vehicle-level hazards, the EPS system is to transition into a safe state within the fault tolerant time interval (FTTI).
 - The FTTI is to be set based on established empirical data.
 - In the absence of data, the safe state is to be reached as fast as the technology used can diagnose the fault and trigger the system actions.
 - The safe state is to correspond to the failure.
- In case of the detection of any failure that could lead to vehicle-level hazards, a warning is to be sent to the driver, and when necessary, the actions required by the driver are to be communicated to them.

9.2 EPS Functional Safety Requirements

Following the Concept Phase (Part 3) in the ISO 26262 standard, this study identifies 125 functional safety requirements for the EPS system and its components. The distribution of these requirements is as follows.

1. General EPS System – 20 requirements
2. Driver Steering Input Sensor – 18 requirements
3. EPS Control Module – 41 requirements
4. Power-Assist Motor – 10 requirements
5. Rear-Wheel Assembly – 12 requirements
6. Mechanical Steering Assembly – 8 requirements
7. Communication System – 6 requirements
8. Interfacing System – 10 requirements

Table 29 shows examples of safety requirements associated with the EPS control module, the safety analysis results from which the requirements are derived, and how the vehicle-level safety goal (SG 1) is allocated to one of the components in the system. The safety analysis identifies many failure modes and CFs for the EPS control module which could potentially lead to the violation of SG 1. Table 29 shows two EPS control module failures as examples that illustrate the development process of the safety requirements.

Table 29. Examples of Safety Requirements for the EPS Control Module

Safety Goal	SG 1: The EPS system is to prevent unintended self-steering in any direction under all vehicle operating conditions in accordance with ASIL D classification.
ASIL	D
Component	EPS control module
Safety Analysis (Examples)	<ul style="list-style-type: none"> • Hardware fault (sensors, ICs, etc.) • Power-assist motor torque command calculation algorithm fault
Safety Strategy	Potential Safety Requirements (Examples)
Detection	<p>The steering-assist control algorithm is to be checked periodically based on the correct FTTI in order to prevent violation of a safety goal.</p> <ul style="list-style-type: none"> • A fault tolerant strategy is to be applied for the steering-assist control; the fault tolerant techniques may include redundancy, voting logic, or other techniques.
Fault Tolerance	<ul style="list-style-type: none"> • A control flow monitoring strategy²⁵ is to be applied for the steering-assist control. • Hardware and software watchdogs with a 300 ms timer to monitor the EPS control algorithm execution sequence are considered by some manufacturers for similar safety goals.
Safe State	In case of a fault in the steering-assist control algorithm that hinders the EPS control module’s ability to control the steering-assist, the EPS system is to transition into Safe State 3 (all steering-assist is disabled) within a time threshold, and the red light driver warning is to be issued.
Warning	<ul style="list-style-type: none"> • 100 ms is considered by some manufacturers for similar safety goals. • DTCs are to be set.

The first safety requirement presented in Table 29 provides an example of detection and fault tolerance safety strategies. This requirement specifies periodic checks of the steering-assist control algorithm as well as possible fault tolerant strategies. In the event of a fault in the steering-assist control, the second requirement specifies a possible system response – transitioning into a safe state and alerting the driver.

The rest of this section lists the 125 EPS functional safety requirements derived through this process. A functional safety requirement may have more than one ASIL associated with it, because the same requirement may cover more than one safety goal and these safety goals may

²⁵ Control flow monitoring is one mechanism for error detection recommended for ASIL B, C, and D in ISO 26262 Part 6 (Table 4) [1]. Control flow monitoring determines if the correct software program execution sequence is being followed [35].

have various levels of ASILs. The requirement may be implemented using different ASIL classification if independence among the implementation solutions can be demonstrated (Part 9 Clause 5.2 of ISO 26262).

9.2.1 General EPS System

There are 20 general system-level functional safety requirements derived for the generic EPS system examined in this study. These requirements may cover the whole EPS system or may apply to all components within the EPS system.

Each of the general EPS system functional safety requirements is listed in Table 30 along with the safety goals supported by the requirement and the associated ASIL levels. Additional details on the functional safety requirements listed in Table 30 are provided in Appendix J.

Table 30. General Functional Safety Requirements for the EPS System

Safety Req. ID	Safety Goal	ASIL	Safety Requirement
1.1	1, 2, 3	B, C, D	The EPS system is to perform Power On tests, periodic tests or continuous monitoring tests to ensure the correctness of safety-critical parameters and the integrity of critical system elements and safety-critical signals.
1.2	1, 2	C, D	In case of any failure in the EPS system that violates a safety goal with ASIL D or C, the EPS system is to send a vehicle instability message to the vehicle stability controller for potential corrective action.
1.3	1, 2, 3	B, C, D	The EPS system is to deliver the steering-assist required to the vehicle wheels at the correct level under all vehicle operating conditions.
1.4	1, 2, 3	B, C, D	The EPS system is to deliver the steering-assist required to the vehicle wheels in the correct direction under all vehicle operating conditions.
1.5	1, 2, 3	B, C, D	The EPS system is to deliver the steering-assist required to the vehicle wheels at the correct time under all vehicle operating conditions.
1.6	1, 2, 3	B, C, D	The EPS system steering-assist is to be controlled and updated within the correct time duration. The time duration required to update the steering-assist level is not to result in the violation of safety goals (e.g., failure mode in software execution, execution time, motor inertia).
1.7	2	C	The EPS system is to provide more assistance at low vehicle speeds (< TBD kph) and less assistance at higher vehicle speeds (> TBD kph) to avoid oversteering.
1.8	1, 2, 3	B, C, D	The steering wheel is to be stabilized in an on-center position at high speeds (> TBD kph).
1.9	1, 2, 3	B, C, D	The EPS system is to have a redundant low voltage power supply.
1.10	4	A	If equipped with the 4WS architecture, the EPS system is to rotate the rear-wheels in the correct direction and at the correct time.
1.11	1, 2, 3	QM, A, B	Diagnostics of all safety-critical components functions are to be conducted. If a fault is detected, the system is to take mitigation action to prevent failures that could lead to a violation of a safety goal.
1.12	1, 2, 3	QM	DTCs are to be set every time a safety goal is violated.

Safety Req. ID	Safety Goal	ASIL	Safety Requirement
1.13	1, 2, 3, 4	A, B, C, D	To recover from a safe state, the EPS system is to reset and pass a self-test to ensure all system components (including software functions) are operating correctly.
1.14	1, 2, 3, 4	No ASIL	The hardware architectural Single Point Fault and Latent Fault metrics targets per ISO 26262 are to be demonstrated for each safety goal.
1.15	1, 2	C, D	If redundant elements are used, they are to be verified against common cause failures.
1.16	1, 2	C, D	If redundant elements are used and one element fails, the EPS system is to transition into Safe State 1 within the FTTI and an amber light driver warning is to be issued.
1.17	1, 2	C, D	If redundant elements are used and both elements fail, or if only one element is used and it fails, then the EPS system is to transition to Safe State 3 within the FTTI and a red light driver warning is to be issued.
1.18	1, 2, 3, 4	No ASIL	Diagnostics mechanisms are to adhere to ASIL B classification for ASIL D related elements and ASIL A classification for ASIL C related elements, and QM for ASIL B and A related requirements.
1.19	1, 2, 3, 4	No ASIL	Diagnostics covering the safety related functionality of the steering wheel torque sensor, steering wheel angle sensor, EPS motor position sensor, EPS motor, EPS motor current sensors, rear-wheel position sensor, rear-wheel actuator, harnesses, and connectors/controllers are to be instituted with a level of coverage corresponding to the ASIL of the safety goal that is affected. Diagnostics are to adhere to ISO 26262 diagnostics coverage guidelines for low, medium, and high coverage levels.
1.20	1, 2, 3, 4	No ASIL	<p>Diagnostics covering the following failure modes are to be implemented for safety-critical EPS components and connections:</p> <ul style="list-style-type: none"> • Integrated circuit faults • Open/short I/Os • Stuck on the same reading • Out of range • Offset • State of health • Electromagnetic circuit faults • Open/short circuits

9.2.2 Driver Steering Input Sensor Functional Safety Requirements

There are 18 functional safety requirements related to the driver's steering input sensor. The driver's steering input sensors measures the driver's steering command. Figure 12 shows the relevant portions of the block diagram in Figure 6 considered when deriving these requirements.

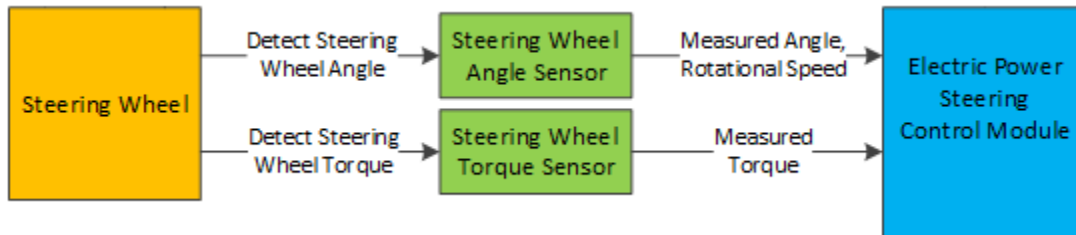

Figure A-1. Relevant Components and Interfaces for Deriving Functional Safety Requirements for the Driver Steering Input Sensor

The functional safety requirements described in this report assume that the steering wheel torque sensor measures the driver's steering input for the EPS system. Other designs may use different sensors for determining the driver's input, such as the steering wheel angle sensor [18]. In deriving the functional safety requirements in this section, the steering wheel angle sensor input is not considered as the primary sensor for measuring the driver's steering input. Instead, the steering wheel angle sensor is considered as a safety mechanism in the functional safety concept.²⁶ The functional safety requirements for the steering wheel angle sensor are derived only from this point of view.

Each of the functional safety requirements for the driver steering input sensor is listed in Table 31 along with the safety goals supported by the requirement and the associated ASIL levels. Additional details on the functional safety requirements listed in Table 31 are provided in Appendix J.

²⁶ The steering wheel angle sensor is also a primary input to the brake / vehicle stability control system. The ASIL assessment described in Section 5 did not consider the presence of a vehicle stability control system when assigning controllability values. Therefore, since credit for controllability was not taken for the vehicle stability control system during the ASIL assessment, the steering wheel angle sensor can be considered as a safety mechanism in the EPS system functional safety concept.

Table 31. Functional Safety Requirements for the Driver Steering Input Sensor

Safety Req. ID	Safety Goal	ASIL	Safety Requirement
2.1	1, 2, 3, 4	No ASIL	The steering wheel torque resulting from the driver's input is to generate a consistent twist in the torsion bar under all vehicle operating conditions over the usable life of the vehicle. (This requirement is not covered by ISO 26262, but compliance with it is to be part of the review of complying with ISO 26262.)
2.2	1, 2, 3	B, C, D	The steering wheel torque sensor is to measure the torsion bar twist resulting from the steering wheel input, and the value is to be qualified for validity and correctness.
2.3	1, 2, 3	B, C, D	The torque sensor's method for converting torsion bar twist to an electrical signal is to be validated.
2.4	1, 2, 3, 4	A, B, C, D	The torque sensor input voltage is to be monitored for over and under voltage whenever the EPS system is on. In case of a failure in the input voltage, the EPS is to transition into Safe State 3 within TBD ms.
2.5	1, 2, 3, 4	A, B, C, D	The torque measurement by the torque sensor is to be communicated to the EPS control module and is to be qualified for validity, correctness, and rationality. ²⁷
2.6	1, 2, 3, 4	A, B, C, D	The torque sensor data are to be monitored continuously and the EPS system is to only provide power-assist to the driver when the torque sensor data are correctly received by the EPS control module per Safety Requirement 2.7.
2.8	1, 2, 3, 4	A, B, C, D	The torque sensor output is to be analyzed by a torque sensor data analysis unit in the monitoring circuit.
2.9	1, 2	C, D	The health and sanity of the torque sensor are to be monitored and confirmed under all operating vehicle conditions.
2.10	1, 2, 3, 4	A, B, C, D	In case of a fault that violates a safety goal, the torque sensor is to communicate the fault to the EPS control module.
2.11	1, 2, 3	QM, A, B	The torque sensor is to have diagnostics for safety relevant failures caused by electromagnetic compatibility (EMC)/EMI, ESD, contamination, single event effects, and other environmental conditions.
2.12	1, 2, 3, 4	No ASIL	All single point torque sensor hardware faults that lead to violation of a safety goal are to be detected within the fault detection interval and mitigated within the FTTI. In case of a failure, the system is to transition to the corresponding safe state.

²⁷ Rationality means that the signal does not contradict previous or other related signals or messages.

Safety Req. ID	Safety Goal	ASIL	Safety Requirement
2.13	2	A	The steering wheel angle sensor is to measure/detect the steering wheel angle resulting from the steering wheel input and the value is to be qualified.
2.14	2	A	The steering wheel angle to electrical conversion method is to be validated.
2.15	2	A	The angle measurement by the steering wheel angle sensor is to be communicated to the EPS control module.
2.16	2	A	The angle sensor data are to be checked at regular intervals in order to mitigate latent faults that may result in the violation of SG 2.
2.17	2	A	In case of a fault that violates SG 2, the steering wheel angle sensor is to communicate the fault to the EPS control module.
2.18	2	A	The angle sensor is to have diagnostics for safety relevant failures caused by EMC/EMI, ESD, contamination, single event effects, and other environmental conditions.
2.19	2	A	All single point steering wheel angle sensor hardware faults that lead to violation of SG 2 are to be detected within the fault detection interval and mitigated within the FTTI. In case of a failure, the system is to issue an amber light driver warning.

9.2.3 Functional Safety Requirements for the EPS Control Module

This analysis derived 41 functional safety requirements for the EPS control module. Figure 13 shows the relevant components and interfaces considered when deriving the functional safety requirements for the EPS control module.

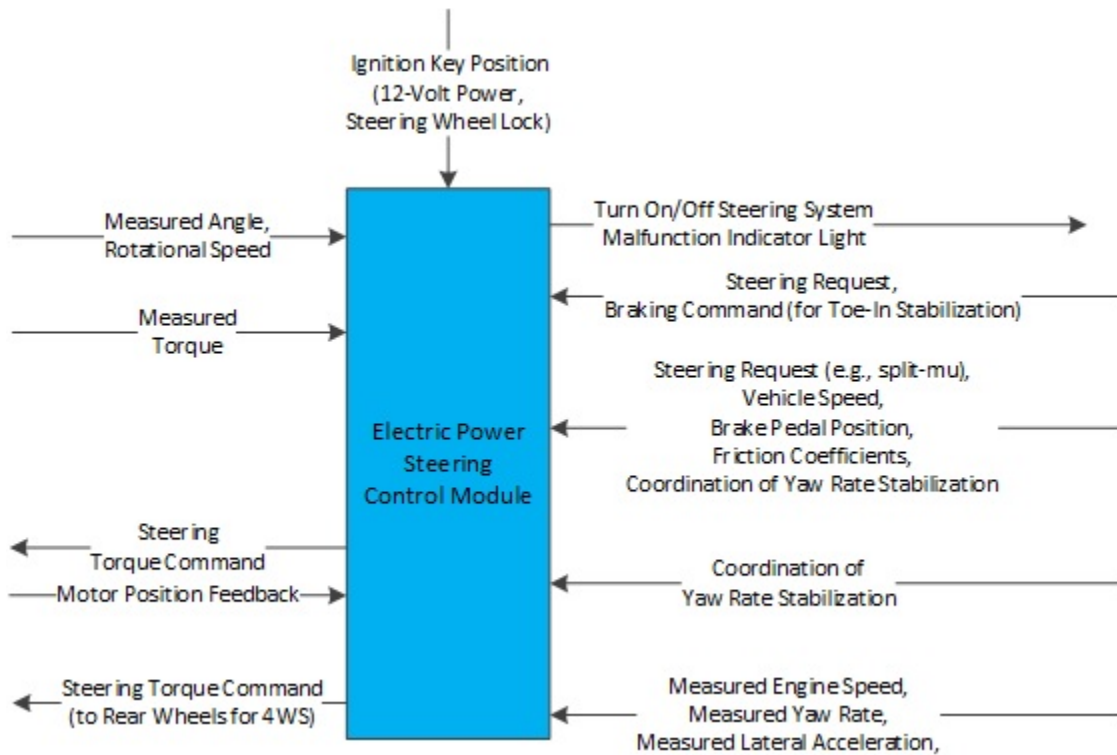

Figure A-1. Relevant Components and Interfaces for Deriving Functional Safety Requirements for the EPS Control Module

Each of the functional safety requirements for the EPS control module is listed in Table 32 along with the safety goals supported by the requirement and the associated ASIL levels. Additional details on the functional safety requirements listed in Table 32 are provided in Appendix J.

Table 32. Functional Safety Requirements for the EPS Control Module

Safety Req. ID	Safety Goal	ASIL	Safety Requirement
3.1	1, 2	C, D	The health and sanity of the EPS control module are to be ensured. This includes power-on self-tests, interrupt and exception tests, EEPROM checksum tests, and device tests.
3.2	1, 2, 3, 4	A, B, C, D	The EPS control module's I/O pins are to be monitored for shorts to system voltages or ground.
3.3	1, 2, 3, 4	A, B, C, D	The EPS control module is to be protected against the back electromotive force of the EPS motor to prevent any damage to its hardware components.
3.4	1, 2, 3, 4	A, B, C, D	The EPS control module is to have diagnostics for safety relevant failures caused by EMC/EMI, ESD, contaminations, single event effects, and other environmental conditions.
3.5	1, 2, 3, 4	No ASIL	All single point EPS control module hardware faults that lead to violation of a safety goal are to be detected within the fault detection interval and mitigated within the FTTI. In case of a failure, the system is to transition to the corresponding safe state.
3.6	1, 2, 3, 4	A, B, C, D	The EPS control module is to calculate the steering-assist based on the driver's steering input (e.g., torque input) and the vehicle speed.
3.7	1, 2, 3, 4	A, B, C, D	The EPS control module is to have an arbitration strategy for steering-assist requests from the driver and other vehicle systems.
3.8	1, 2, 3, 4	A, B, C, D	The steering-assist command and control communication channels with the EPS motor controls are to be validated at start up. Steering-assist commands are not to be issued until the validation of the communication channels is successful.
3.9	1, 2, 3, 4	A, B, C, D	All electrical hardware and software elements associated with the delivery of the steering-assist function are to comply with ASIL D classification for SG 1, ASIL C classification for SG 2, ASIL B classification for SG 3, and ASIL A classification for SG 4 unless otherwise specified.
3.10	1, 2, 3	B, C, D	The EPS control module is to qualify the steering wheel sensor inputs (e.g., torque input) for validity and correctness.
3.11	1, 2, 3	B, C, D	The EPS control module is to qualify the steering requests from other vehicle systems for validity and correctness.

Safety Req. ID	Safety Goal	ASIL	Safety Requirement
3.12	1, 2, 3, 4	A, B, C, D	Communication and data transfer between the EPS control module and the steering wheel sensors are to be qualified for validity and correctness.
3.13	1, 2, 3, 4	A, B, C, D	The controller algorithm or method for calculating the steering-assist is to be validated.
3.14	1, 2, 3, 4	A, B, C, D	The steering-assist corresponding to the driver's steering input (e.g., torque input) or the requests from other vehicle systems is to be calculated correctly and the results are to be qualified for validity and correctness under all vehicle operating conditions.
3.15	1, 2, 3, 4	A, B, C, D	The steering-assist command is to be controlled and updated in the correct direction within the correct time duration.
3.16	1, 2, 3, 4	A, B, C, D	The time duration required to update the steering-assist command is not to result in violation of a safety goal.
3.17	1, 2	C, D	The steering-assist control algorithm is to be checked periodically based on the correct FTTI in order to prevent violation of a safety goal.
3.18	1, 2, 3, 4	A, B, C, D	In case of a fault in the steering-assist control algorithm that leads the controller to be unable to control the steering-assist, the EPS system is to transition into Safe State 3 within the TBD ms time, and the red light driver warning is to be issued.
3.19	1, 2, 3	A, B, C	The EPS control module is to have power-assist motor torque current calculations and torque control algorithms for all motor speeds.
3.20	1, 2, 3	B, C, D	The EPS control module is to command motor torque current to drive the power-assist motor in both the clockwise and counterclockwise directions.
3.21	1, 2, 3	B, C, D	The EPS control module is to deliver the motor torque current at the correct value, in the correct direction, and at the correct time to the power-assist motor.
3.22	1, 2, 3	B, C, D	All other critical parameters used by the power-assist motor torque current calculation algorithm that may lead to a violation of a safety goal when not correct are to be checked periodically based on the FTTI.

Safety Req. ID	Safety Goal	ASIL	Safety Requirement
3.23	1, 2, 3	B, C, D	All electrical hardware and software elements associated with the delivery of the power-assist motor torque current to the power-assist motor are to comply with ASIL D classification for SG 1, ASIL C classification for SG 2, and ASIL B classification for SG 3 unless otherwise specified.
3.24	1, 2, 3	B, C, D	The EPS control module is to control the power-assist motor torque current such that the motor's torque output remains within a pre-established tolerance band based on the vehicle operating scenario. The allowable deviation within the tolerance band is not to result in a violation of a safety goal.
3.25	1, 2, 3	B, C, D	The power-assist motor torque current value and direction are to be qualified for validity and correctness.
3.26	1, 2, 3	B, C, D	If look up tables are used to determine the value of the power-assist motor current, the contents of the tables are to be checked for correctness every time the EPS system is activated.
3.27	1, 2, 3	B, C, D	The power-assist motor position feedback to the EPS control module is to be checked for validity and correctness.
3.28	1, 2, 3	B, C, D	The power-assist motor current sensor inputs are to be checked for validity and correctness.
3.29	1, 2, 3	No ASIL	All faults that result in a failure to determine the power-assist motor torque current are to be detected and mitigated within the FTTI.
3.30	1, 2	C, D	The health and sanity of the power-assist motor torque current calculation algorithm are to be checked periodically based on the correct FTTI in order to prevent violations of the safety goals (for example, via an auxiliary processor or equivalent means).
3.31	1, 2, 3, 4	No ASIL	Critical communications and data transfer between the EPS control module and other vehicle systems/components are to be qualified for validity and correctness (plausibility and rationality) including the brake pedal sensor (ASIL A), vehicle speed sensor (ASIL D), yaw rate sensor (ASIL D), and all other inputs that are used by the steering-assist control.
3.32	1, 2, 3, 4	A, B, C, D	All other critical parameters used to control steering-assist are to be checked periodically based on the FTTI requirements.

Safety Req. ID	Safety Goal	ASIL	Safety Requirement
3.33	1, 2, 3	B, C, D	The EPS control module is to have a mechanism to prevent unauthorized access to the steering-assist algorithms, stored maps, calculations, and command paths.
3.34	1, 2, 3	B, C, D	All single point faults that result in a failure to prevent unauthorized access to the EPS control module are to be detected and mitigated.
3.35	1, 2, 3, 4	A, B, C, D	The EPS control module is to arbitrate between multiple requests for steering-assist from interfacing vehicle systems and the driver and the controller arbitration logic strategy and algorithm are to be checked for health and sanity periodically based on the FTTL.
3.36	1, 2, 3, 4	A, B, C, D	The output of the EPS control module arbitration logic is to be qualified for validity and correctness.
3.37	1, 2, 3, 4	A, B, C, D	The arbitration strategy is to clearly define the action of the EPS system when the driver's steering request conflicts with the requests or inputs of safety relevant systems.
3.38	1, 2, 3, 4	No ASIL	Diagnostics covering the safety related functionality of the EPS control module are to be instituted with a level of coverage corresponding to the ASIL of the safety goal that is affected. ISO 26262 diagnostics coverage guidelines for low, medium, and high coverage levels are to be adhered to in order to comply with the hardware architectural metrics targets.
3.39	1, 2, 3, 4	No ASIL	A software failure management routine is to initiate controlled shutdown of the EPS system immediately after a diagnostic detects a failure.

Safety Req. ID	Safety Goal	ASIL	Safety Requirement
3.40	1, 2, 3, 4	No ASIL	<p>Diagnostics covering the failures for the following parts of the EPS control module are to be implemented:</p> <ul style="list-style-type: none"> • Execution logic (wrong coding, wrong or no execution, execution out of order, execution too fast or too slow, stack overflow or underflow). • On-chip communication and bus arbitration • The main and auxiliary controller: <ul style="list-style-type: none"> ○ CPU ○ Controller processor memory ○ Arithmetic logic unit ○ Registers ○ Analogue to digital converter ○ Signal conditioning and conversion ○ Software program execution ○ Connections (I/O) faults (short/open/drift/oscillation) ○ Power supply • The wiring harnesses and connectors for open and short circuits • Critical CAN messages • Critical messages
3.41	1, 2, 3, 4	QM	<p>The EPS control module is to log and save the following data every time a transition to a safe state is executed due to a violation of a safety goal:</p> <ul style="list-style-type: none"> • The diagnostics information of the faults including the time at which the fault was detected and the nature of the fault. • The time interval from the detection of the fault to reaching a safe state. • The time the system degradation strategy started, including the start and end of each phase if applicable and the values of the system metrics for each phase (i.e., torque output level). • The time the driver warning strategy started, including the start and end of each phase if applicable and the values of the system metrics for each phase.

9.2.4 Functional Safety Requirements for the Power-Assist Motor

This analysis derived 10 functional safety requirements for the power-assist motor. The power-assist motor provides torque to change the front-wheel heading. Figure 14 shows the relevant components and interfaces considered in deriving these functional safety requirements.

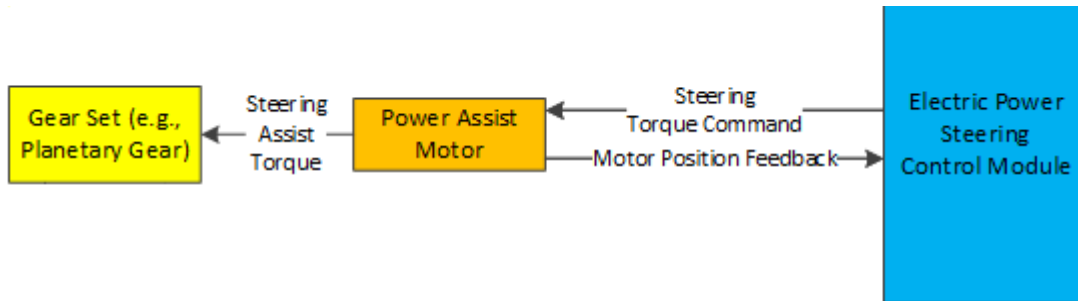

Figure A-1. Relevant Components and Interfaces for Deriving Functional Safety Requirements for the Power-Assist Motor

Each of the functional safety requirements for the power-assist motor is listed in Table 33 along with the safety goals supported by the requirement and the associated ASIL levels. Additional details on the functional safety requirements listed in Table 33 are provided in Appendix J.

Table 33. Functional Safety Requirements for the Power-Assist Motor

Safety Req. ID	Safety Goal	ASIL	Safety Requirement
4.1	1, 2, 3	B, C, D	The EPS motor is to provide the required steering-assist torque commanded by the EPS control module under all EPS system operating conditions
4.2	2	C	The EPS motor torque is to adhere to the level of quality (e.g., ripple ²⁸) that does not lead to a violation of SG 2.
4.3	1, 2, 3	B, C, D	The EPS motor is to have a transient response that will not lead to violation of a safety goal.
4.4	1, 2, 3	B, C, D	The maximum value of the EPS motor's back electromotive force is not to result in the failure of any EPS component, critical interface input, or critical communication signal under all EPS operating scenarios.
4.5	1, 2, 3	B, C, D	The EPS motor is to prevent changes in the torque versus current characteristics under all EPS operating scenarios.
4.6	1, 2, 3	B, C, D	The EPS motor is to prevent locked rotor failures under all EPS operating scenarios.
4.7	1, 2	C, D	The EPS motor rotor position is to be measured, and the rotor position is to be qualified for validity and correctness.
4.8	1, 2, 3	B, C, D	The EPS motor rotor position is to be communicated to the EPS control module.
4.9	1, 2, 3	B, C, D	In case of a fault in the EPS motor that leads to violation of a safety goal, the EPS motor is to communicate the fault to the EPS control module.

²⁸ Torque ripple is a general term to describe periodic fluctuation in the motor torque output as the motor shaft rotates. It may affect the smoothness of the torque output or cause unwanted vibrations.

Safety Req. ID	Safety Goal	ASIL	Safety Requirement
4.10	1, 2, 3	B, C, D	All single point EPS motor faults that lead to violations of a safety goal are to be detected within the fault detection interval and mitigated within the FTTI. In case of a failure, the system is to transition to the corresponding safe state.

9.2.5 Functional Safety Requirements for the Rear-Wheel Assembly

This analysis derived 12 functional safety requirements related to the rear-wheel assembly. These requirements are applicable to vehicles with the 4WS feature. The rear-wheel assembly includes the actuators and sensors required to implement 4WS. Figure 15 shows the relevant components and interfaces considered in deriving these functional safety requirements.

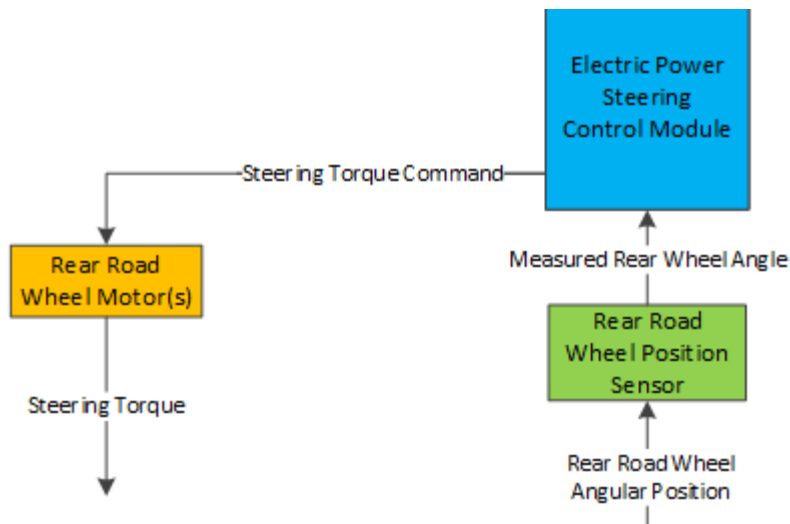

Figure A-1. Components and Interfaces for Deriving Functional Safety Requirements for the Rear-Wheel Assembly

Each of the functional safety requirements for the rear-wheel assembly is listed in Table 34 along with the safety goals supported by the requirement and the associated ASIL levels. Additional details on the functional safety requirements listed in Table 34 are provided in Appendix J.

Table 34. Functional Safety Requirements for the Rear-Wheel Assembly

Safety Req. ID	Safety Goal	ASIL	Safety Requirement
5.1	1, 2, 4	A, C, D	The rear-wheel position sensor is to measure/detect the rear-wheel position under all vehicle operating conditions. The measured rear-wheel position is to be qualified for validity and correctness.
5.2	1, 2	C, D	The rear-wheel orientation is not to result in a violation of SG 1 or SG 2.
5.3	1, 2, 4	A, C, D	The rear-wheel position to electrical conversion method is to be validated.
5.4	1, 2, 4	A, C, D	The rear-wheel position is to be communicated to the EPS control module and the rear-wheel actuator.
5.5	1, 2, 4	A, C, D	The EPS control module is to check the validity and correctness of the rear-wheel position.
5.6	1, 2, 4	A, C, D	In case of a fault that violates a safety goal, the rear-wheel position sensor is to communicate the fault to the EPS control module. The EPS system is to transition to Safe State 2 within TBD ms and an amber light driver warning is to be issued.
5.7	1, 2, 4	A, C, D	The rear-wheel position sensor is to have diagnostics for safety relevant failures caused by EMC/EMI, ESD, contamination, single event effects, and other environmental conditions.
5.8	1, 2, 4	A, C, D	All single point rear-wheel position sensor hardware faults that lead to violations of a safety goal are to be detected within the fault detection interval and mitigated within the FTTI.
5.9	1, 2, 4	A, C, D	The rear-wheel actuator is to provide the required torque commanded by the EPS control module under all vehicle operating conditions.
5.10	1, 2, 4	A, C, D	The rear-wheel actuator is to prevent locked rotor failures under all vehicle operating conditions.
5.11	1, 2, 4	A, C, D	In case of a fault in the rear-wheel actuator that leads to a violation of a safety goal, the actuator is to communicate the fault to the EPS control module.
5.12	1, 2, 4	A, C, D	All single point faults of the rear-wheel actuator that lead to violations of a safety goal are to be detected within the fault detection interval and mitigated within the FTTI. In case of a failure, EPS system is to transition to Safe State 2 within TBD ms.

9.2.6 Functional Safety Requirements for the Mechanical Steering Assembly

This analysis derived eight requirements related to the mechanical steering assembly. The mechanical steering assembly includes the series of components responsible for transmitting the driver's torque to the front-wheels. Figure 16 shows the relevant portion of Figure 6 used for deriving the functional safety requirements for the mechanical steering assembly.

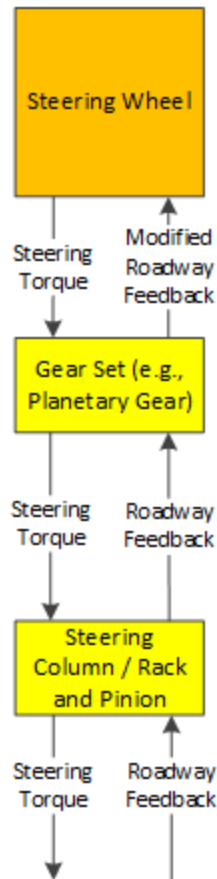

Figure A-1. Relevant Components and Interfaces for Deriving Functional Safety Requirements for the Mechanical Steering Assembly

The requirements presented in this section are not covered by ISO 26262. However, these requirements are part of the safety assessment required by ISO 26262. These requirements may be captured by other industry processes. Each of the functional safety requirements for the mechanical steering assembly is listed in Table 35 along with the safety goals supported by the requirement. Since these requirements are not part of the ISO 26262 scope, no ASILs were assigned. Additional details on the functional safety requirements listed in Table 35 are provided in Appendix J.

Table 35. Functional Safety Requirements for the Mechanical Steering Assembly

Safety Req. ID	Safety Goal	ASIL	Safety Requirement
6.1	1, 2, 3	No ASIL	Reduction gear is to prevent locked gear conditions.
6.2	1, 2, 3	No ASIL	Reduction gear is to prevent conditions that may lead to gear damage.
6.3	1, 2, 3	No ASIL	Rack and pinion is to prevent any failure that leads to violation of a safety goal.
6.4	1, 2, 3	No ASIL	Steering column is to support a maximum torque value of TBD N·m. Failures of the EPS system are not to result in delivery of torque to the steering column that exceeds TBD N·m.
6.5	1, 2, 3	No ASIL	Mechanical steering system is to provide vehicle steering when the electric power steering-assist is not available.
6.6	1, 2, 3	No ASIL	Mechanical steering system is to meet the intended steering profile versus driver input force at all times and under all vehicle operating scenarios.
6.7	1, 2, 3	No ASIL	All single point faults that lead to failures in the mechanical steering system's primary function (i.e., provide vehicle steering) are to be prevented.
6.8	1, 2, 3	No ASIL	Mechanical steering system is to provide indication to the driver in case of any failures that affect the primary function (i.e., provide vehicle steering).

9.2.7 Functional Safety Requirements for the Communication System

This analysis derived six requirements related to the communications for the EPS system. These communications may include wired connections or relevant data transfer over the communication bus (e.g., CAN bus). All of the connections between components shown in Figure 6 were considered when deriving these functional safety requirements.

Critical communications in the EPS system include:

- Steering wheel input sensor (e.g., torque sensor) signals from the sensor to the EPS controller
- Steering wheel input sensor (e.g., torque sensor) fault diagnostics signal to the EPS controller
- Brake pedal position sensor signal to the EPS control module (for systems with 4WS)
- Communication channel “secure” signals within the EPS control module
- Communication channel “secure” signals between EPS control module and systems that can request modification to the steering torque
- Commands or requests for steering torque modifications from interfacing systems to the EPS system
- Vehicle speed or wheel speed signal
- Yaw rate sensor signal
- Rear-wheel position sensor signal to EPS control module (for systems with 4WS)
- Rear-wheel position sensor fault diagnostics signal to EPS control module (for systems with 4WS)
- Rear-wheel motor fault diagnostics signal to EPS control module (for systems with 4WS)
- EPS fault diagnostics signals to the vehicle systems controller
- Power-assist motor position sensor signal to EPS control module
- Driver warning signals
- Low voltage power system faults signals to EPS control module
- Communication bus failure signal from the communication bus to the EPS control module

Each of the functional safety requirements for the communication system is listed in Table 36 along with the safety goals supported by the requirement and associated ASIL. Additional details on the functional safety requirements listed in Table 36 are provided in Appendix J.

Table 36. Functional Safety Requirements for the Communication System

Safety Req. ID	Safety Goal	ASIL	Safety Requirement
7.1	1, 2, 3, 4	A, B, C, D	All critical communication signals are to be qualified for validity and correctness (plausibility and rationality). The ASIL classifications for the signals are to correspond to the safety goal they are associated with. If a signal is associated with more than one safety goal, then it is to adhere to the higher ASIL classification.
7.2	1, 2, 3, 4	A, B, C, D	Communication bus is to support the communication of the EPS system with other vehicle systems in order to support the safe operation of the EPS system.
7.3	1, 2, 3, 4	A, B, C, D	Communication bus is to support the qualification of all critical communication signals between the EPS system and interfacing vehicle systems.
7.4	1, 2, 3, 4	A, B, C, D	Communication bus is to prevent the corruption of the critical communication bus signals during transmission between the EPS system and interfacing vehicle systems.
7.5	1, 2, 3, 4	A, B, C, D	In case of malfunction of the communication bus or communication bus module, the communication bus system is to inform the EPS control module of the fault.
7.6	1, 2, 3, 4	A, B, C, D	Communication bus is to detect an unauthorized access and inform the EPS control module.

9.2.8 Functional Safety Requirements for Interfacing Systems

This analysis derived 10 functional safety requirements related to interfacing systems that include the low voltage power supply system and other vehicle systems capable of requesting steering torque modifications, such as ALC. As described in Section 3.1, this study assumes that the interfacing vehicle systems capable of requesting steering torque modifications are operating correctly.

Each of the functional safety requirements for the interfacing systems is listed in Table 37 along with the safety goals supported by the requirement and associated ASIL. Additional details on the functional safety requirements listed in Table 37 are provided in Appendix J.

Table 37. Functional Safety Requirements for Interfacing Systems

Safety Req. ID	Safety Goal	ASIL	Safety Requirement
8.1	1, 2, 3, 4	A, B, C, D	Low voltage power supply is to provide the EPS system with the required low voltage (e.g., 12 volt) power supply for operation.
8.2	1, 2, 3, 4	No ASIL	Supply voltage and current are to meet the quality parameters (levels (min, max), ripple, transient, and overshoot) as set by the EPS system components. The ASIL classification of this requirement is to be based on the safety analysis and the safety goal impacted.
8.3	1, 2, 3, 4	A, B, C, D	EPS system is to be notified of any malfunction or disruption in the low voltage (e.g., 12 volt) power supply system operation.
8.4	1, 2, 3, 4	A, B, C, D	All communications and data transfer sent by the low voltage power system to the EPS system are to be qualified for validity and correctness. This includes the low voltage power system diagnostics.
8.5	1, 2, 3, 4	A, B, C, D	In case of a malfunction, the low voltage power supply is to maintain the low voltage (e.g., 12 volt) power supply to the EPS system for a time that is longer than the longest FTTI of the EPS system.
8.6	1, 2, 3, 4	A, B, C, D	All single point failure modes that cause the loss of low voltage power are to be prevented or mitigated.
8.7	1, 2, 3, 4	A, B, C, D	All requests or commands for steering torque from interfacing vehicle systems are to be sent to the EPS controller.
8.8	1, 2, 3, 4	A, B, C, D	All communications and data transfer regarding requests or commands for steering torque sent by interfacing vehicle systems to the EPS are to be qualified for validity and correctness (plausibility and rationality) by the sending systems.
8.9	1, 2, 3, 4	A, B, C, D	All interfacing systems are to inform the EPS system in case of any failure that may cause the system to transition into a degraded mode of operation.
8.10	1, 2, 3, 4	A, B, C, D	In case of a fault in the transmitted information to the EPS system from the interfacing system, the correct failure mode effect mitigation strategy is to be applied.

10 DIAGNOSTICS AND PROGNOSTICS

10.1 Metrics for Diagnostics

The diagnostics presented in this section are limited to the sensing and evaluation elements of the EPS system and critical interfaces, as described in Section 3.1. While failures in other vehicle systems may be amenable to diagnostic evaluation, this report focuses on methodologies for identifying existing and potential problems with the EPS system and critical interfaces.

Many diagnostic functions are characterized by detecting when a key parameter strays out of its normal operating range. In any electronic system, short-term anomalies are possible in both the electronic components and the communications network. The safety analysis for a system should identify FTTIs over which a fault has to be identified and mitigated. For many serious malfunctions, these FTTIs are significantly less than one second. Therefore, the EPS system is to continually recheck abnormal readings to verify diagnostic system integrity. The EPS system might also use three-level monitoring, as described in Appendix K.

Diagnostics covering the safety-related functionality of the EPS system are to be instituted with a level of coverage corresponding to the ASIL of the safety goal that is affected. The EPS system design is to adhere to ISO 26262 diagnostics coverage guidelines. Diagnostics coverage levels are associated with the number of failure modes detected by the specific technique. For example, a low diagnostics coverage level for a sensor might only detect out-of-range and stuck-in-range conditions. A medium diagnostics coverage level for a sensor might also detect offsets, in addition to out-of-range and stuck-in-range conditions. A high diagnostics coverage level might detect oscillations in addition to offsets, out-of-range, and stuck-in-range conditions.

Diagnostics coverage supports several metrics required by ISO 26262, including the hardware architectural metrics and the evaluation of safety goal violations due to random hardware failures. ISO 26262 specifies how to implement diagnostic coverage for the safety-related functionality of critical EPS sensors, harnesses, and connectors based on the ASIL of the safety goal that is affected.

Diagnostics covering the following failure modes may be implemented for the following.

- Main and auxiliary controllers
 - CPU
 - Processor memory
 - Arithmetic logic unit
 - Registers
 - A/D converter
 - Software program execution

- Connections (I/O) faults (short or open circuits)
- Power supply
- Critical communication bus messages
- Harnesses and connectors (short or open circuits)

10.2 Common Diagnostic Trouble Codes for the EPS System

10.2.1 Assessment of Selected Generic Diagnostic Trouble Codes

DTCs are part of a safety system that senses, diagnoses, and controls situations, using driver warnings when appropriate. Some EPS system-related DTCs are identified in the SAE J2012.

SAE J2012 uses a five-digit format for DTCs. Powertrain codes always start with the letter “P,” whereas network codes start with “U,” chassis codes start with “C,” and body system codes start with “B.” The second digit is numeric – typically 0, 1, 2, or 3. Predefined SAE (i.e., “controlled” non-OEM-specific) powertrain codes have a 0 or 2 as the second digit. Manufacturer-defined powertrain codes have a 1 or 3 in the second digit. For instance, P0XXX and P2XXX are SAE-controlled powertrain codes while P1XXX and P3XXX are unique to the manufacturer.

Predefined SAE network codes, chassis codes, and body system codes have a 0 as the second digit whereas manufacturer-specific network codes, chassis codes, and body system codes have a 1 or 2 as the second digit. Thus, the first two digits can generally be used to determine whether the EPS system DTCs are SAE-controlled codes.

The codes are characterized by the phenomenon they represent. Some DTCs indicate an existing or emerging hazardous state, while others indicate a situation that requires attention to prevent the system from moving toward an unsafe state. System responses to DTCs, such as issuing a driver warning transitioning to a safe state is determined by the manufacturer.

Review of SAE J2012 identified 21 DTCs that cover EPS-related components and interfaces. SAE J2012 also includes 134 DTCs that cover critical EPS system interfaces. Table 38 and

Table 39 provide a breakdown of these DTCs by the EPS system component or connection, and interfacing system or subsystem. Appendix L summarizes the DTCs relevant to the EPS system.

Table 38. Breakdown of Identified DTCs by EPS System Component or Connection

EPS System Component or Connection	Number of DTCs
Variable Effort Steering	1
EPS Communications	3
Steering Wheel Angle Sensor	8
Steering Wheel Torque Sensor	2
EPS Control Module	3
Steering Wheel Lock	4

Table 39. Breakdown of Identified EPS-Relevant DTCs by Interfacing System or Subsystem

EPS System Component or Connection	Number of DTCs
Wheel Speed Sensor	15
Brake Pedal Switch/Position Sensor	4
Brake Pressure Sensor	3
Brake/Stability Control System	7
Vehicle Speed Sensor	11
Instrument Panel System	5
Communication Bus	72
Yaw Rate/Lateral Acceleration Sensor	4
Differential Control Module	4
Ignition/Start System	8
Vehicle Battery	1

10.2.2 Potential Additional Generic Diagnostic Trouble Code Needs

SAE J2012 does not include DTC coverage of the entire EPS system. Many of the DTCs provided in Appendix L are included in SAE J2012 because of their relevance to the brake/vehicle stability system. The EPS system requirements in Section 9 suggest additional DTCs for the EPS system, which could be incorporated into SAE J2012 as part of the generic DTC coverage. These possible DTC coverage areas are listed in Table 40. The DTCs in Table 40 are based on similar DTC types listed in SAE J2012.

Table 40. Possible Areas for Additional DTC Coverage in the EPS System

Phenomenon	System or Component
Internal EPS Control Module Memory Check Sum Error	EPS Control Module
EPS Control Module Programming Error	EPS Control Module
Internal EPS Control Module KAM Error	EPS Control Module
Internal EPS Control Module RAM Error	EPS Control Module
Internal EPS Control Module ROM Error	EPS Control Module
EPS Control Module Processor	EPS Control Module
EPS Control Module Performance	EPS Control Module
Internal EPS Control Module Monitoring Processor Performance	EPS Control Module
Internal EPS Control Module A/D Processing Performance	EPS Control Module
Internal EPS Control Module Main Processor Performance	EPS Control Module
EPS Control Module Vehicle Options Error	EPS Control Module
EPS Motor Failure	Power-Assist Motor Rear-Wheel Motor
EPS Motor Relay Circuit	Power-Assist Motor Rear-Wheel Motor
EPS Rear-Wheel Position Sensor Circuit	Rear-Wheel Position Sensor
EPS Rear-Wheel Position Sensor Circuit Range/Performance	Rear-Wheel Position Sensor
EPS Rear-Wheel Position Sensor Circuit Low	Rear-Wheel Position Sensor
EPS Rear-Wheel Position Sensor Circuit High	Rear-Wheel Position Sensor
EPS Rear-Wheel Position Sensor Circuit Intermittent	Rear-Wheel Position Sensor
EPS Steering Wheel Angle Sensor Circuit	Steering Wheel Angle Sensor
EPS Steering Wheel Angle Sensor Circuit Range/Performance	Steering Wheel Angle Sensor
EPS Steering Wheel Angle Sensor Circuit Low	Steering Wheel Angle Sensor
EPS Steering Wheel Angle Sensor Circuit High	Steering Wheel Angle Sensor
EPS Steering Wheel Angle Sensor Circuit Intermittent	Steering Wheel Angle Sensor
EPS Steering Wheel Torque Sensor Circuit	Steering Wheel Torque Sensor
EPS Steering Wheel Torque Sensor Circuit Range/Performance	Steering Wheel Torque Sensor
EPS Steering Wheel Torque Sensor Circuit Low	Steering Wheel Torque Sensor
EPS Steering Wheel Torque Sensor Circuit High	Steering Wheel Torque Sensor
EPS Steering Wheel Torque Sensor Circuit Intermittent	Steering Wheel Torque Sensor
Torque Sensor Zero Point Adjustment is Not Initialized	Steering Wheel Torque Sensor
Torque Sensor Zero Point Adjustment Incomplete	Steering Wheel Torque Sensor
Sensor Reference Voltage Circuit/Open	All EPS Sensors
Sensor Reference Voltage Circuit Low	All EPS Sensors
Sensor Reference Voltage Circuit High	All EPS Sensors

11 PERFORMANCE PARAMETERS AND TEST SCENARIOS

This section describes potential test scenarios based on the each of identified vehicle-level hazards and results of the hazard and safety analyses. These test scenarios may be used to verify that the functional safety requirements are achieved. Each test scenario includes the following:

- **Test Goals:** Each of the safety goals identified in this study serves as the testing goal for a test scenario. The test objective is to ensure that the safety goal is not violated.
- **Driving Scenarios:** The driving scenario is developed using a combination of the vehicle’s operating scenario and key inputs to the system. Together, this represents the situation under which the system should avoid entering a hazardous state when a fault is injected. The two components of the driving scenario are described below.
 - The operational scenarios are generated as part of the ASIL assessment and describe the operating environment of the vehicle. The operational scenarios considered in these test scenarios are based on the variables listed in Table 13. In particular, the ASIL operating scenarios that lead to the highest ASIL value for a hazard may represent worst-case driving situations under which the system should avoid entering a hazardous state. Note that test procedures may deviate from the “worst case” driving situation in the ASIL assessment for the purposes of testing safety. For example, test procedures may be developed that implement lower vehicle speeds if it can be shown that failure modes are independent of speed or if the protocol implements incremental speed increases.
 - The context variables used for deriving the UCAs represent key inputs to the system. Certain system behaviors are expected based on the combinations of these context variables to avoid entering a hazardous state.
- **Fault Injection:** The CFs identified in STPA, and failure modes and faults identified in the functional FMEA may be used as the basis for determining faults to inject at the component and connection levels. Examples of potential faults that could be introduced to the system include inducing hardware failures in system components, transmitting erroneous measurements from sensors, or issuing incorrect controller commands (e.g., to simulate a flaw in the software algorithm).
- **Expected Safe Behavior:** The test scenarios can be evaluated by monitoring for expected safe behaviors. The following are examples of possible safe behaviors:
 - The system may transition into one of the identified safe states within the FTTL. As described in Section 8.2, safe states are operating modes of the system that do not present an unreasonable risk.
 - The system’s controller may still be capable of issuing the correct command when a fault is injected. For example, if the EPS control module may be capable of using other sensor data to determine the correct amount of steering-assist when there’s a disruption in the voltage supply to one of the EPS sensors.

Although the role of the driver was considered in the hazard and safety analyses, the test scenarios presented in this section focus on the behavior of the electronic control system. Evaluation of driver behavior when certain faults are injected into the vehicle would require a human factors study.

11.1 Potential Test Scenarios for SG 1

Safety Goal 1 states that the EPS system prevent unintended self-steering in any direction under all vehicle operating conditions. Table 41 describes two possible driving scenarios to test this safety goal. Both driving scenarios are based on the same operational scenario, identified as the worst-case scenario from the ASIL assessment. The driving scenarios differ based on the system input:

Table 41. Example Driving Scenarios for SG 1

Test Goal		The EPS system is to prevent unintended self-steering in any direction under all vehicle operating conditions.
ASIL		D
Driving Scenarios	Operational Scenario	Driving at high speeds ($100 \text{ kph} \leq V < 130 \text{ kph}$), ²⁹ light or heavy traffic, good visibility, and good road conditions
	System Input #1	<ul style="list-style-type: none"> • Driver is not issuing a steering command. • Other vehicle systems are not issuing a steering command.
	System Input #2	Driver issues a steering command.

- *Driving Scenario 1:* Neither the driver nor other vehicle systems issue a steering command while driving at high speeds in light or heavy traffic, under good visibility, and with good road conditions. This test scenario is intended to determine if an induced fault may cause the EPS system to issue a steering command when there is no request for steering.
- *Driving Scenario 2:* The driver issues a steering command while driving at high speeds in light or heavy traffic, under good visibility, and with good road conditions. This test scenario is intended to determine if an induced fault may cause the EPS system to issue a steering command in the opposite direction of the driver’s steering request.

For each of the two test scenarios listed in Table 41, potential faults could be simulated in the EPS system to determine if these faults result in violation of the safety goal. The induced faults presented in Table 42 and Table 43 are examples of potential faults that can be derived from the STPA and functional FMEA results. The lists of potential faults in Table 42 and Table 43 are not

²⁹ High speed is the “worst case” or most critical condition. Test procedures may be developed that implement lower vehicle speeds for the purposes of testing safety if it can be shown that failure modes are independent of speed or if the protocol implements incremental speed increases.

intended to be exhaustive. The full STPA and functional FMEA results in Appendix H and Appendix I can be used to identify additional faults to include in the test scenarios.

Table 42. Examples of Simulated Faults to Test SG 1 UUnder Driving Scenario 1

Test Goal		The EPS system is to prevent unintended self-steering in any direction under all vehicle operating conditions.
ASIL		D
Driving Scenarios	Operational Scenario	Driving at high speeds ($100 \text{ kph} \leq V < 130 \text{ kph}$) ³⁰ , light or heavy traffic, good visibility, and good road conditions
	System Input	<ul style="list-style-type: none"> • Driver is not issuing a steering command. • Other vehicle systems are not issuing a steering command. • Subject the EPS control module to a range of EMI and ESD disturbances. (CF #251)
	EPS Control Module	<ul style="list-style-type: none"> • Simulate short circuits in the EPS control module. (CF #287) • Issue a steering request from the EPS control module to the power-assist motor (e.g., simulated software fault). (CF #853, 1187) • Disrupt the power supply to the steering wheel angle sensor. (CF #701)
	Steering Wheel Angle Sensor	<ul style="list-style-type: none"> • Transmit a non-zero steering wheel angle measurement to the EPS control module. (CF #686, 688)
Injected Fault (Examples)	Incoming Connection from Other Vehicle Systems	Issue an errant signal on the communication bus that mimics a steering request. (CF #255, 256)
	Incoming Connection from Yaw Rate Sensor	Transmit a non-zero yaw rate measurement to the EPS control module. (CF #553, 554, 557, 563, 565, 573)
	Power-Assist Motor	Simulate a short circuit to battery voltage. (CF #1139, 1140)
	Rear-Wheel Position Sensor	<ul style="list-style-type: none"> • Transmit a non-zero rear-wheel measurement to the EPS control module. (CF #894, 896, 906) • Subject the connection from the rear-wheel position sensor to the EPS control module to a range of EMI and ESD disturbances. (CF #898, 911)
Expected Safety Strategies		<ul style="list-style-type: none"> • Detects fault and does not provide steering. • Transitions to Safe State 1 or Safe State 3

³⁰ High speed is the “worst case” or most critical condition. Test procedures may be developed that implement lower vehicle speeds for the purposes of testing safety if it can be shown that failure modes are independent of speed or if the protocol implements incremental speed increases.

Table 43. Examples of Simulated Faults to Test SG 1 Under Driving Scenario 2

Test Goal		The EPS system is to prevent unintended self-steering in any direction under all vehicle operating conditions.
ASIL		D
Driving Scenarios	Operational Scenario	Driving at high speeds ($100 \text{ kph} \leq V < 130 \text{ kph}$) ³¹ , light or heavy traffic, good visibility, and good road conditions
	System Input	Driver is issuing a steering command.
Injected Fault (Examples)	EPS Control Module	<ul style="list-style-type: none"> • Subject the EPS control module to a range of EMI and ESD disturbances. (CF #251) • Simulate short circuits in the EPS control module. (CF #287) • Issue a steering request from the EPS control module to the power-assist motor in the wrong direction (e.g., simulate a software fault). (CF #301, 1167)
	Steering Wheel Angle Sensor	<ul style="list-style-type: none"> • Disrupt the power supply to the steering wheel angle sensor. (CF #701) • Transmit the reversed steering wheel angle measurement to the EPS control module (e.g., Θ° clockwise instead of counterclockwise). (CF #583, 590, 591, 686, 688)
	Incoming Connection From Other Vehicle Systems	Issue steering requests from another vehicle system that conflict with the direction of the driver's steering input. Issue the requests with varying levels of priority (i.e., test the EPS system's arbitration logic). (CF #1167, 1168)
	Incoming Connection From Yaw Rate Sensor	Transmit a yaw rate measurement to the EPS control module in the opposite direction of the driver's steering command. (CF #1182)
	Power-Assist Motor	Simulate reversed polarity from the vehicle power supply to the motor. (CF #1139, 1140, 1151)
Expected Safety Strategies		<ul style="list-style-type: none"> • EPS system detects the fault and provides steering-assist in the correct direction based on the driver's steering input. • Transitions to Safe State 1 or Safe State 3

11.2 Potential Test Scenarios for SG 2

Safety Goal 2 states that the EPS system provide the correct amount of steering-assist under all vehicle operating conditions. Table 44 describes three possible driving scenarios to test this safety goal. The operational scenario shown in Table 44 includes a vehicle speed range covering several operating scenarios in the ASIL assessment that all result in ASIL C. The driving scenarios differ based on the system input.

Table 44. Example Driving Scenarios for SG 2

Test Goal	The EPS system is to provide the correct amount of steering-assist under all vehicle operating conditions.	
ASIL	C	
	Operational Scenario	Driving at medium to very high speeds ($40 \text{ kph} \leq V$) ³² , light or heavy traffic, good visibility, and good road conditions.
	System Input #1	<ul style="list-style-type: none"> • Driver issues a steering command. • Vehicle speed is constant.
Driving Scenarios	System Input #2	<ul style="list-style-type: none"> • Driver issues a steering command. • Vehicle speed transitions across the threshold for reverse-phase/in-phase rear-wheel steering.
	System Input #3	<ul style="list-style-type: none"> • Driver issues a steering command. • Vehicle speed transitions across the threshold for active steering (EPS changes from adding torque to subtracting torque).

- *Driving Scenario 1:* The vehicle speed is steady, so the test scenario is not influenced by changes in the steering mode as a function of vehicle speed. This test scenario is intended to determine if an induced fault may cause the EPS system to provide the incorrect amount of steering-assist.
- *Driving Scenario 2:* The driver issues a steering command as the vehicle crosses the speed threshold for operating the rear-wheels in the reverse-phase and in-phase positions. This test scenario is intended to determine if an induced fault may affect transition of the rear-wheel positions, resulting in unexpected vehicle dynamics.

³² The medium to very high speed range is the “worst case” or most critical condition. Test procedures may be developed that implement lower vehicle speeds for the purposes of testing safety if it can be shown that failure modes are independent of speed or if the protocol implements incremental speed increases.

- *Driving Scenario 3*: The vehicle crosses the active steering threshold speed for adding or subtracting torque from the driver's input. This test scenario is intended to determine if an induced fault may affect how the EPS system simulates a variable steering ratio.

For each of the three test scenarios listed in Table 44, potential faults could be simulated in the EPS system to determine if these faults result in violation of the safety goal. The induced faults presented in Table 45, Table 46, and Table 47 are examples of potential faults that can be derived from the STPA and functional FMEA results. The lists of potential faults in Table 45, Table 46, and Table 47 are not intended to be exhaustive. The full STPA and functional FMEA results in Appendix H and Appendix I can be used to identify additional faults to include in the test scenarios.

Table 45. Examples of Simulated Faults to Test SG 2 Under Driving Scenario 1

Test Goal		The EPS system is to provide the correct amount of steering-assist under all vehicle operating conditions.
ASIL		C
Driving Scenarios	Operational Scenario	Driving at medium to very high speeds ($40 \text{ kph} \leq V$) ³³ , light or heavy traffic, good visibility, and good road conditions.
	System Input	<ul style="list-style-type: none"> • Driver issues a steering command. • Vehicle speed is constant.
Injected Fault (Examples)	EPS Control Module	<ul style="list-style-type: none"> • Subject the EPS control module to a range of EMI and ESD disturbances. (CF #251) • Simulate short circuits in the EPS control module. (CF #287) • Issue a steering request from the EPS control module to the power-assist motor with the wrong torque magnitude (simulated software fault). (CF #850) • Store the incorrect vehicle speed to power-assist motor torque maps in the EPS control module. (CF #302)
	Steering Wheel Angle Sensor	<ul style="list-style-type: none"> • Disrupt the power supply to the steering wheel angle sensor. (CF #701) • Transmit a steering wheel angle measurement to the EPS control module that is higher than the actual steering wheel position. (CF #516, 686, 688, 698, 831) • Simulate a hardware fault that limits the steering wheel angle sensor measurement to a single 360° rotation. (CF #1191)
	Incoming Connection from Other Vehicle Systems	Issue steering requests from another vehicle system in the same direction as the driver’s steering input. Issue the requests with varying levels of priority (i.e., test the EPS system’s arbitration logic). (CF #1166)

³³ The medium to very high speed range is the “worst case” or most critical condition. Test procedures may be developed that implement lower vehicle speeds for the purposes of testing safety if it can be shown that failure modes are independent of speed or if the protocol implements incremental speed increases.

Incoming
Connection
from Vehicle
Speed Sensor

- Simulate a loss of vehicle speed data. (CF #1314, 1315, 1320, 1322)
- Transmit the incorrect vehicle speed data to the EPS control module. (CF #1315, 1318, 1323)

Power-Assist
Motor

- Introduce a delay in the power-assist motor position feedback to the EPS control module. (CF #771, 1139, 1140)
- Disrupt the power supply to the power-assist motor. (CF #1151)

Expected Safety Strategies

- EPS system detects the fault and provides the correct amount of steering-assist based on the driver's steering input.
- Transitions to Safe State 1 or Safe State 3

Table 46. Examples of Simulated Faults to Test SG 2 Under Driving Scenario 2

Test Goal		The EPS system is to provide the correct amount of steering-assist under all vehicle operating conditions.
ASIL		C
Driving Scenarios	Operational Scenario	Driving at medium to very high speeds ($40 \text{ kph} \leq V$) ³³ , light or heavy traffic, good visibility, and good road conditions.
	System Input	<ul style="list-style-type: none"> • Driver issues a steering command. • Vehicle speed transitions across the threshold for reverse-phase/in-phase rear-wheel steering.
	EPS Control Module	<ul style="list-style-type: none"> • Subject the EPS control module to a range of EMI and ESD disturbances. (CF #251) • Simulate short circuits in the EPS control module. (CF #287) • Issue a steering request from the EPS control module to turn the rear-wheels reverse-phase above the vehicle speed threshold (e.g., simulate a software fault). (CF #1044)
Injected Fault (Examples)	Incoming Connection from Vehicle Speed Sensor	Delay providing the EPS control module with updates to the vehicle speed data. (CF #1320, 1321, 1322)
	Rear-Wheel Position Sensor	<ul style="list-style-type: none"> • Store the wrong calibration data for the rear-wheel position sensor. (CF #1000) • Simulate a loss of power supply to the rear-wheel position sensor. (CF #907) • Simulate short circuits in the connection between the rear-wheel position sensor and EPS control module. (CF #1004, 1005, 1008)
	Rear-Wheel Motor	Simulate an over-temperature condition in the rear-wheel motor while the rear-wheels are in either the in-phase or reverse-phase position. (CF #1118, 1120)
Expected Safety Strategies		<ul style="list-style-type: none"> • EPS system detects the fault and provides the correct amount of steering-assist based on the driver's steering input. • Transitions to Safe State 2

Table 47. Examples of Simulated Faults to Test SG 2 Under Driving Scenario 3

Test Goal		The EPS system is to provide the correct amount of steering-assist under all vehicle operating conditions.
ASIL		C
	Operational Scenario	Driving at medium to very high speeds ($40 \text{ kph} \leq V$) ³⁴ , light or heavy traffic, good visibility, and good road conditions.
Driving Scenarios	System Input	<ul style="list-style-type: none"> • Driver issues a steering command. • Vehicle speed transitions across the threshold for active steering (EPS changes from adding torque to subtracting torque).
	EPS Control Module	<ul style="list-style-type: none"> • Subject the EPS control module to a range of EMI and ESD disturbances. (CF #251) • Simulate short circuits in the EPS control module. (CF #287) • Issue a steering request from the EPS control module to add torque to the driver’s steering input when above the vehicle speed threshold (e.g., simulate a software fault). (CF #859) • Store the incorrect vehicle speed to power-assist motor torque maps in the EPS control module. (CF #302)
Injected Fault (Examples)	Steering Wheel Angle Sensor	Simulate short circuits in the connection between the steering wheel angle sensor and the EPS control module. (CF #580)
	Incoming Connection from Other Vehicle Systems	Issue steering requests from another vehicle system that conflict with the direction of the driver’s steering input. Issue the requests with varying levels of priority (i.e., test the EPS system’s arbitration logic). (CF #1167, 1168)
	Incoming Connection from Vehicle Speed Sensor	Delay providing the EPS control module with updates to the vehicle speed data. (CF #1320, 1321, 1322)

Power-Assist Motor Provide a constant power supply to the motor. (CF #1151)

Expected Safety Strategies

- EPS system detects the fault and provides the correct amount of steering-assist based on the driver’s steering input.
- Transitions to Safe State 1 or Safe State 3

11.3 Potential Test Scenarios for SG 3

Safety Goal 3 states that the EPS system prevent the unintended loss of steering-assist under all vehicle operating conditions. This study derives a possible driving scenario to test this safety goal. The operational scenario shown in Table 48 includes a vehicle speed range covering several operating scenarios in the ASIL assessment that all result in ASIL B.

Table 48. Example Driving Scenario for SG 3

Test Goal		The EPS system is to prevent the unintended loss of steering-assist under all vehicle operating conditions.
ASIL		B
Driving Scenarios	Operational Scenario	Driving at medium to high speed ($40 \text{ kph} \leq V < 130 \text{ kph}$) ³⁵ with light or heavy traffic, good visibility, and good road conditions.
	System Input	Driver issues a steering command.

- *Driving Scenario 1:* The driver is in the middle of a steering maneuver at medium to high vehicle speeds in light or heavy traffic, under good visibility, and with good road conditions. This test scenario is intended to determine if an induced fault may cause an unintended loss of power steering. For this test goal, “unintended” implies that the system

³⁴ The medium to very high speed range is the “worst case” or most critical condition. Test procedures may be developed that implement lower vehicle speeds for the purposes of testing safety if it can be shown that failure modes are independent of speed or if the protocol implements incremental speed increases.

³⁵ The medium to high speed range is the “worst case” or most critical condition. Test procedures may be developed that implement lower vehicle speeds for the purposes of testing safety if it can be shown that failure modes are independent of speed or if the protocol implements incremental speed increases.

does not safely transition into Safe State 3 and that the driver is not alerted about the loss of steering-assist.

The induced faults presented in Table 49 are examples of potential faults that can be derived from the STPA and functional FMEA results. The lists of potential faults in Table 49 are not intended to be exhaustive. The full STPA and functional FMEA results in Appendix H and Appendix I can be used to identify additional faults to include in the test scenario.

Table 49. Examples of Simulated Faults to Test SG 3 Under Driving Scenario 1

Test Goal		The EPS system is to prevent the unintended loss of steering-assist under all vehicle operating conditions.
ASIL		B
Driving Scenarios	Operational Scenario	Driving at medium to high speed ($40 \text{ kph} \leq V < 130 \text{ kph}$) ³⁶ with light or heavy traffic, good visibility, and good road conditions.
	System Input	<ul style="list-style-type: none"> • Driver issues a steering command.
Injected Fault (Examples)	EPS Control Module	<ul style="list-style-type: none"> • Subject the EPS control module to a range of EMI and ESD disturbances. (CF #251) • Simulate short circuits in the EPS control module. (CF #287) • Simulate a loss of power to the EPS control module. (CF #264) • Simulate an over-temperature condition in the EPS control module CPU. (CF #65, 66)
	Steering Wheel Angle Sensor	<ul style="list-style-type: none"> • Transmit a steering wheel angle measurement that is outside the calibration range. (CF #517) • Simulate a loss of power to the steering wheel angle sensor. (CF #669) • Prevent transmission of the steering wheel angle measurement to the EPS control module. (CF #580, 587, 590, 591, 598, 602, 686, 688)
	Incoming Connection from Vehicle Speed Sensor	Simulate a loss of vehicle speed data. (CF #1314, 1315, 1320, 1322)
	Power-Assist Motor	<ul style="list-style-type: none"> • Simulate a loss of power supply to the power-assist motor. (CF #1150) • Simulate open circuits in the connections to the power-assist motor. (CF #1139)
Expected Safety Strategies		<ul style="list-style-type: none"> • EPS system detects the fault and ensures the operability of steering-assist. • Transitions to Safe State 3

11.4 Potential Test Scenarios for SG 4

Safety Goal 4 states that the EPS system prevent rear-wheel drag under all vehicle operating conditions. This study derived a possible driving scenario to test this safety goal, which is shown in Table 50.

Table 50. Example Driving Scenario for SG 4

Test Goal		The EPS is to prevent rear-wheel drag under all vehicle operating conditions.
ASIL		A
Driving Scenarios	Operational Scenario	Driving at high speed ($100 \text{ kph} \leq V < 130 \text{ kph}$) ³⁷ with heavy traffic, good visibility, and good road conditions.
	System Input	<ul style="list-style-type: none"> • Driver issues a steering command. • Brake pedal is in the at-rest (i.e., undepressed) position.

- *Driving Scenario 1*: The driver issues a steering command and is not applying the brakes, while the vehicle is travelling at high speeds in heavy traffic, under good visibility, and with good road conditions. This test scenario is intended to determine if an induced fault could cause the rear-wheels to toe-in by an amount that reduces the vehicle’s speed or otherwise affects the vehicle dynamics.

The induced faults presented in Table 51 are examples of potential faults that can be derived from the STPA and functional FMEA results. The lists of potential faults in Table 51 are not intended to be exhaustive. The full STPA and functional FMEA results in Appendix H and Appendix I can be used to identify additional faults to include in the test scenarios.

³⁶ The medium to high speed range is the “worst case” or most critical condition. Test procedures may be developed that implement lower vehicle speeds for the purposes of testing safety if it can be shown that failure modes are independent of speed or if the protocol implements incremental speed increases.

³⁷ High speed is the “worst case” or most critical condition. Test procedures may be developed that implement lower vehicle speeds for the purposes of testing safety if it can be shown that failure modes are independent of speed or if the protocol implements incremental speed increases.

Table 51. Examples of Simulated Faults to Test SG 4 UUnder Driving Scenario 1

Test Goal		The EPS is to prevent rear-wheel drag under all vehicle operating conditions.
ASIL		A
Driving Scenarios	Operational Scenario	Driving at high speed ($100 \text{ kph} \leq V < 130 \text{ kph}$) ³⁸ with heavy traffic, good visibility, and good road conditions.
	System Input	<ul style="list-style-type: none"> • The driver issues a steering command. • The brake pedal is in the at-rest (i.e., undepressed) position.
	EPS Control Module	<ul style="list-style-type: none"> • Subject the EPS control module to a range of EMI and ESD disturbances. (CF #251) • Simulate short circuits in the EPS control module. (CF #287) • Issue a command to the rear-wheel motor to toe-in to the maximum degree (e.g., simulate a software fault). (CF #999)
Injected Fault (Examples)	Incoming Connection from Other Vehicle Systems	Issue a signal to the EPS control module that mimics a braking command from another vehicle system. (CF #45, 972, 973)
	Rear-Wheel Position Sensor	Simulate short circuits in the connection between the rear road wheel position sensor and EPS control module. (CF #1004, 1005, 1008)
	Rear-Wheel Motor	Simulate a short circuit to battery voltage. (CF #1131)
Expected Safety Strategies		<ul style="list-style-type: none"> • EPS system detects the fault and prevents the rear-wheels from causing a drag effect. • Transitions to Safe State 2

³⁸ High speed is the “worst case” or most critical condition. Test procedures may be developed that implement lower vehicle speeds for the purposes of testing safety if it can be shown that failure modes are independent of speed or if the protocol implements incremental speed increases.

12 CONCLUSIONS

This study followed the Concept Phase process (Part 3) in ISO 26262 standard to derive a list of potential safety requirements for the EPS system. Specifically, this research:

1. Identified four vehicle-level safety goals and assessed their ASIL:

ID	Safety Goals	ASIL
SG 1	The EPS system is to prevent unintended self-steering in any direction under all vehicle operating conditions.	D
SG 2	The EPS system is to provide the correct level of steering-assist under all vehicle operating conditions.	C
SG 3	The EPS system is to prevent the unintended ⁱ loss of steering-assist under all vehicle operating conditions.	B
SG 4	The EPS system is to prevent rear-wheel drag under all vehicle operating conditions. ⁱⁱ	A

ⁱ Unintended in this context is used to differentiate from intentional disabling of the EPS system as a potential safe state for the system. Specifically, the unintended loss of steering-assist is not controlled and the driver is not notified that steering-assist is not available.

ⁱⁱ Rear-wheel drag indicates a rear-wheel position (i.e., toe-in) that affects the vehicle dynamics or slows the vehicle when the brakes are not being applied. However, the drag effect may not reach the level of “deceleration.”

2. Developed the functional safety concept and identified 125 functional safety requirements by following the Concept Phase in the ISO 26262 standard, combining the results of the two safety analyses (functional FMEA and STPA), and leveraging industry practice experiences. The breakdown of the number of requirements is as follows.
 - General EPS System – 20 requirements
 - Driver Steering Input Sensor – 18 requirements
 - EPS Control Module – 41 requirements
 - Power-Assist Motor – 10 requirements
 - Rear-Wheel Assembly – 12 requirements
 - Mechanical Steering Assembly – 8 requirement
 - Communication System – 6 requirement
 - Interfacing System – 10 requirements
3. Identified 16 generic DTCs included in SAE J2012 that provide coverage of the EPS system and 124 DTCs that provide coverage for safety-critical interfacing components and communication systems. In addition, this study identified 33 potential DTCs that could provide additional coverage of the EPS system.

4. Developed seven example test scenarios which could be used to validate the safety goals and functional safety requirements. The results from this study could also be used to develop a more comprehensive set of test scenarios.

REFERENCES

- [1] SAE International. (2014). *Taxonomy and Definitions for Terms Related to On-Road Motor Vehicle Automated Driving Systems* (SAE J3016). Warrendale, PA: SAE International, 2014.
- [2] Frost & Sullivan. (2015, December 14). Active Safety and Fuel Economy Features Push the Use of Electric Power Steering in North American Cars (PowerPoint presentation by business consulting firm). Alexandria, VA: Author. Available at http://images.discover.frost.com/Web/FrostSullivan/NA_PR_JCarson_NEA5-18_15Dec14.pdf
- [3] Greimel, H. (2014, August 4). NSK: Electric power steering saves fuel (Web page). Detroit: Automotive News Available at www.autonews.com/article/20140804/OEM10/308049987/nsk:-electric-power-steering-saves-fuel
- [4] International Organization for Standardization. (2011). Road vehicles - functional safety(Final Draft). (ISO 26262). Geneva: Author.
- [5] International Electrotechnical Commission. (2001). Hazard and operability studies (HAZOP Studies) - Application guide, Edition 1.0. (IEC 61882-2001). Geneva: Author.
- [6] Leveson, N. (2012). *Engineering a safer world*, Cambridge, MA: MIT Press
- [7] Society of Automotive Engineers. (1994). Potential failure mode and effects analysis in design and potential failure mode and effects analysis in manufacturing and assembly processes. (SAE J1739). Warrendale, PA: Author. [Editor's note: In 2006 the Society of Automotive Engineers changed its name to SAE International.]
- [8] Thomas, J. (2013). Extending and Automating a Systems-Theoretic Hazard Analysis for Requirements Generation and Analysis (Ph.D. dissertation). Cambridge, MA: Massachusetts Institute of Technology.
- [9] Coudert, O. (1994). Two-level logic minimization: An overview, *Integration, the VLSI Journal*, 17(2), pp. 97-140.
- [10] United Nations Economic Commission for Europe. (1988, December 1). *Regulation No. 79: Uniform Provisions Concerning the Approval of Vehicles with Regard to Steering Equipment* (Multilateral Treaty, Chapter XI, Transport and Communications, [Section] B. Road Traffic). Available at

https://treaties.un.org/Pages/ViewDetails.aspx?src=TREATY&mtdsg_no=XI-B-16-79&chapter=11&clang=_en

- [11] Kade, A., Bartz, D., Hudas, G., & D. G. Mikulski, D. G. (2014, October 28). *Tank Automotive Research, Development and Engineering Center Subject Matter Expert Interview on Automated Lane Centering*. [Interview].
- [12] Miller, J., Seewald, A., Heitzer, H.-D., Wegner, M., Kristofik, J., & Standtke, P. (2014, October 29). Interviewees, TRW Automotive Subject Matter Expert Interview on Automated Lane Centering. [Interview].
- [13] K. Reif, Ed.(2014). *Brakes, brake control and driver assistance systems: Function, regulation and components* (Bosch Professional Automotive Information), Heidelberg, Germany: Springer Vieweg.
- [14] Stanyer, T., & Chutorash, R. (2014, October 27). Interviewees, *ESG Automotive Subject Matter Expert Interview on Automated Lane Centering*. [Interview].
- [15] Toyota Motor Corporation. (n.a.) Toyota Technical Training - Section 7, Electric Power Steering. [No other information available]. Retrieved from www.autoshop101.com/forms/Hybrid17.pdf
- [16] Badawy, A., Zuraski, J., Bolourchi, F., & Chandy, A. (1999). Modeling and Analysis of an Electric Power Steering System. (SAE Technical Paper 1999-01-0399). International Congress and Exposition, Detroit, March 1-4, 1999. doi.org/10.4271/1999-01-0399. Also in: Electronic Steering and Suspension Systems-PT-77, Steering and Suspension Technology Symposium 1999-SP-1438
- [17] Honda North America. (2014, August 4). 2015 Acura TLX: Chassis (Web page).. Torrance, CA: Honda News. Available at www.hondanews.com/channels/tlx-press-kit/releases/2015-acura-tlx-chassis
- [18] ZF Lenksysteme. (n.a.). ZF Active Steering in the Steering Column for Mid-Size and Luxury Cars. Retrieved from www.bosch-automotive-steering.com/fileadmin/_migrated/content_uploads/Aktivlenkung_Lenksaeule_0911_E.pdf [Editor's Note: ZF Lenksysteme was formerly a joint venture of AF Friedrichshafen AG and NA Robert Bosche SV, but is now wholly owned by now called Robert Bosch Automotive Steering GmbH.]

- [19] General Motors Corporation. (2002). ASE 4 - Suspension and Steering: Module 3 - Rear Wheel Steering. Retrieved from www.hvcc.edu/deptweb-ats/asep/A4_SuspSteer_StudentWorkBooks/SWB_a4_m03_Final.pdf
- [20] Markel, G. (2015). Electric Power Steering Diagnostics. Retrieved from the Brake & Front End web page at www.brakeandfrontend.com/electric-power-steering-diagnostics/
- [21] AUTOSAR, *Software Component Steer (Steering System)*, Release 4.2.1 ed.
- [22] BMW. (n.a.). BMW Technology Guide: Active Steering. BMW Technology Guide, retrieved from www.bmw.com/com/en/insights/technology/technology_guide/articles/mm_active_steering.html
- [23] SAE International. (2015) *Considerations for ISO 26262 ASIL Hazard Classification* (SAE J2980). Warrendale, PA: Author.
- [24] Furtado, P., & Madeira, H. (1996). Fault Injection Evaluation of Assigned Signatures in a RISC Processor. In *Second European Dependable Computing Conference*, Taormina, Italy, October 2 - 4, 1996.

APPENDIX A: CURRENT SAFETY ISSUES FOR THE EPS SYSTEM

This appendix summarizes the findings from this study's review of current safety issues related to the EPS system. This study examined crash databases and NHTSA's vehicle recall and VOQ databases to identify potential safety concerns related to the EPS system.

General Estimates System and Fatality Analysis Reporting System

In 2012 there were an estimated 5.6 million police-reported crashes involving vehicles of all types in the GES database³⁹ and 30,800 fatal crashes in the FARS database.⁴⁰ Although they represent two distinct databases, and as a result of an effort to standardize the FARS and GES databases in 2010, these two databases now include similar data. The data contained in FARS are actual counts and the data in GES represent a nationally weighted sample of crashes.

Volpe analyzed the 2012 GES and FARS crash databases to identify crashes at least partially attributable to steering system issues. The GES and FARS crash databases, however, do not differentiate between different types of steering systems (e.g., EPS versus steer-by-wire) and do not identify specific failure modes that may have contributed to the crash. The steering system entry in these databases broadly covers tie rod ends, kingpins, power steering components, ball joints, and other steering components.

The data element "ACC_TYPE" was used to determine the crash category that best describes the type of crash that the vehicle was involved in based on the pre-crash circumstances. To determine if the vehicle had a pre-existing steering issue that may have contributed to the crash, the data element "MFACTOR" was used. More information on the coding can be found in the user's manuals of these databases.

Review of the GES database identified 9,497 crashes (0.17%) at least partially attributable to steering issues. The FARS database identified 20 crashes (0.06%) at least partially attributable to steering issues. The most common steering-related crash types identified in both databases are right roadside departures. The second most common steering-related crash types are left roadside departures.

³⁹ The GES database contains crash statistics on police-reported crashes across the United States involving all types of vehicles. The information comes from samples of police reports for over 5 million crashes that occur annually. The database is weighted to characterize a nationally representative sample. Each crash must involve at least one motor vehicle travelling on a roadway that results in property damage, injury, or death, and it must be obtained from a police report. [3]

⁴⁰ The FARS database contains information on all crashes in the United States involving at least one fatality resulting from the crash. The fatality can be either an occupant of the vehicle or a non-motorist, such as a pedestrian, and it must have occurred within 30 days of the crash. The crash must have occurred on a public roadway. [4]

NHTSA Motor Vehicle Recall Campaigns

This study reviewed 41 motor vehicle recall campaigns⁴¹ for model year 2002 to 2015 light vehicles related to EPS systems. The review covered recalls through October 8, 2014. Each recall campaign was assessed based on publically available information to determine how the EPS system may have become unsafe, contributing to a vehicle-level hazard.

The results are categorized based on the STPA UCA guide phrases described in Section 2.2.3 of this report. Figure 1 shows the results of this analysis.

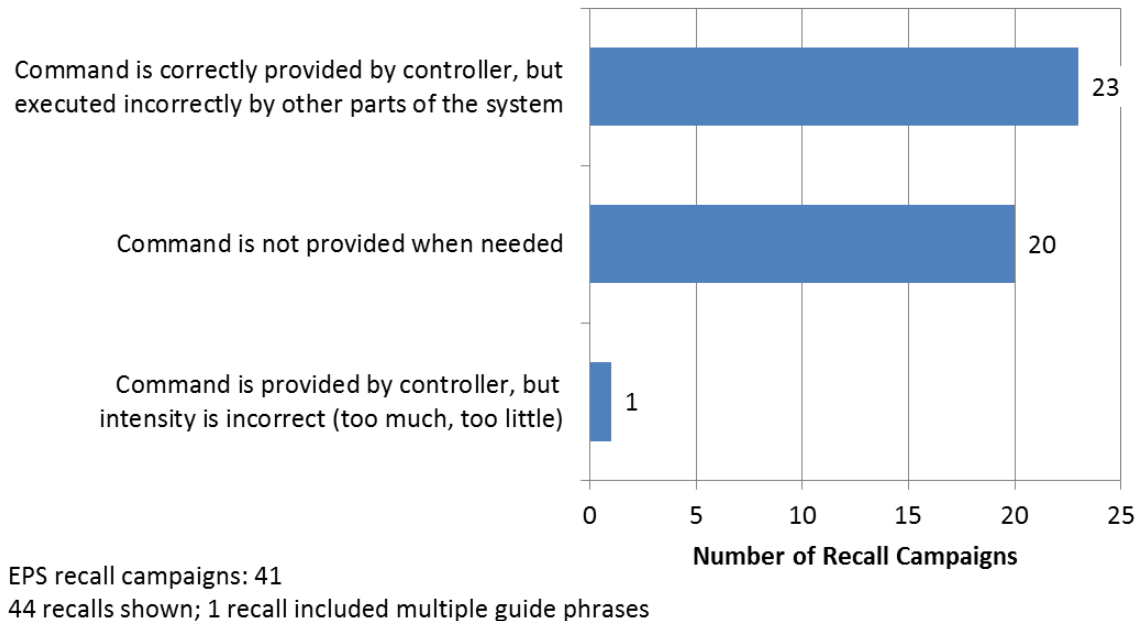

Figure A-1: Unsafe Control Action Breakdown of EPS Recalls

The largest category of EPS-related recalls describe situations where the EPS control module's steering command is not delivered to the road wheels. For example, these recalls include failure of the power assist motor or damage to the mechanical steering components. The second largest category of EPS-related recalls describe situations where the EPS control module does not issue an assist command. This category includes situations where the driver expects steering assist, but the system is not available.

⁴¹ Either NHTSA or the manufacturers may issue recalls due to vehicle or equipment defects once it is determined that a safety defect exists in a motor vehicle or items of motor vehicle equipment that poses a risk to safety [5]. CFR 49 Volume 7 Part 573.6 [6] requires the manufacturer to furnish a report to NHTSA for each defect once a recall is warranted.

Each recall was further categorized based on the potential CFs contributing to the recall. The CF categories used for the analysis are presented in Appendix B. Figure 2 provides a breakdown of the EPS-related CFs.

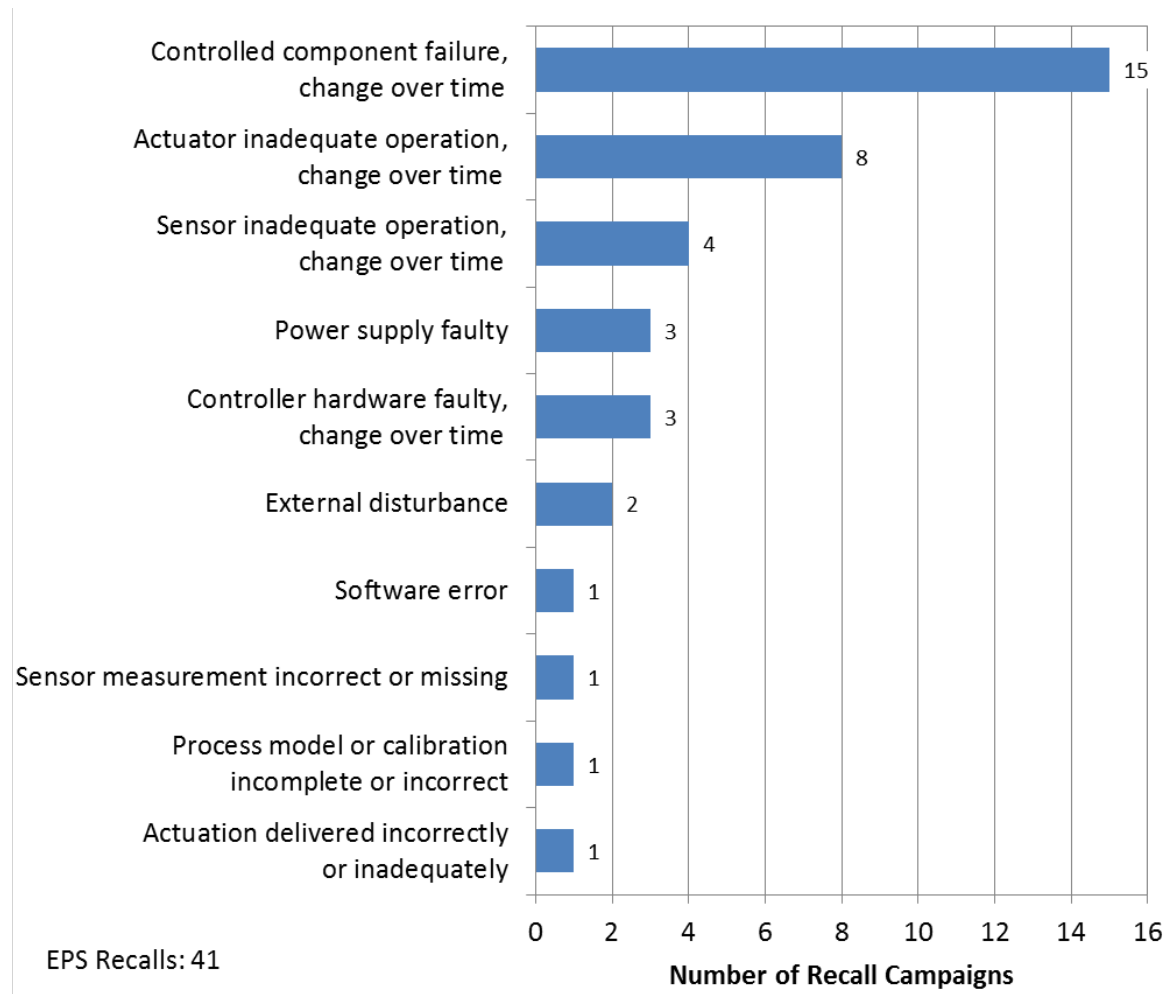

Figure A-2: Causal Factor Breakdown of EPS Recalls

The largest percentage of recall campaigns related to the EPS cited failure of controlled components, such as tie rods, the steering column, and other mechanical parts associated with adjusting the wheel position. The second highest percentage of recall campaigns cited failures with the actuator, such as the power assist motor.

NHTSA Vehicle Owner Questionnaires

Vehicle owners can express their safety concerns to NHTSA via the vehicle owner questionnaire mechanism. NHTSA’s Defects Assessment Division screens more than 30,000 VOQs annually to inform their decisions on issues requiring further investigation [5].

Volpe reviewed 573 VOQs related to the EPS system. These are only a subset of the available EPS-related VOQs and were identified by searching the VOQ database for the terms “electric power steering” and “EPS.” The VOQ search was also limited to manufacturers with greater than one percent market share for light vehicles [6] [7].

The data obtained from the VOQs were categorized in a similar manner as the recalls. Figure 3 shows the breakdown of the VOQs by UCA category. Figure 4 shows the breakdown of VOQs by CF category.

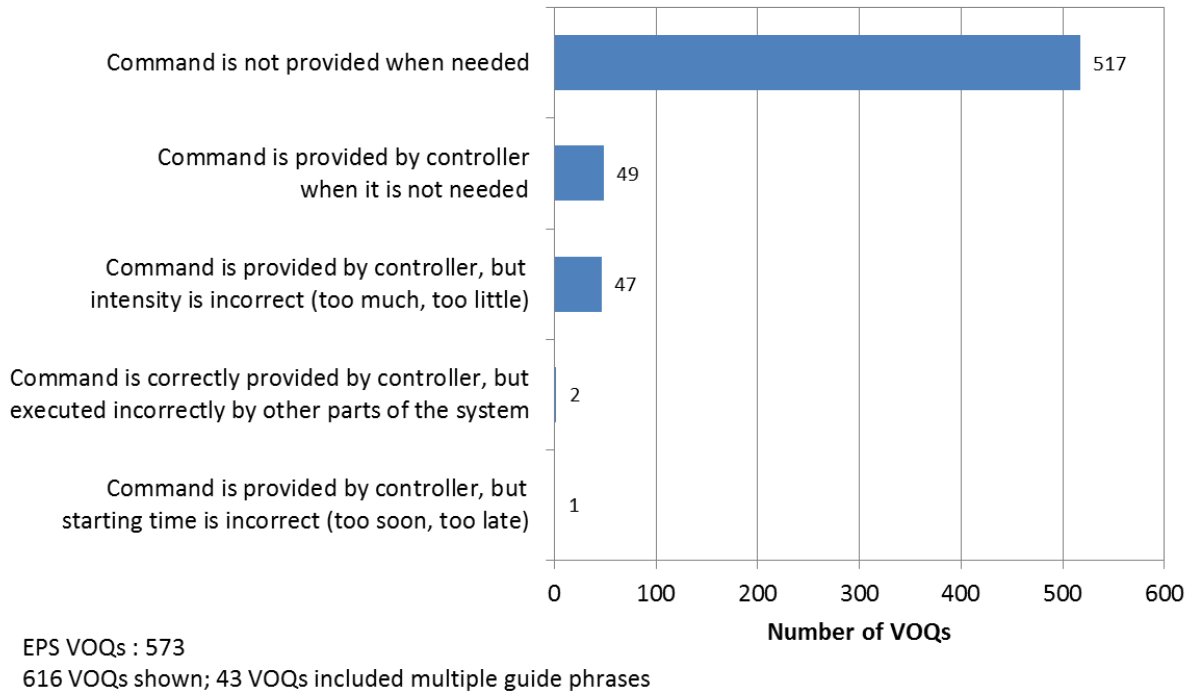
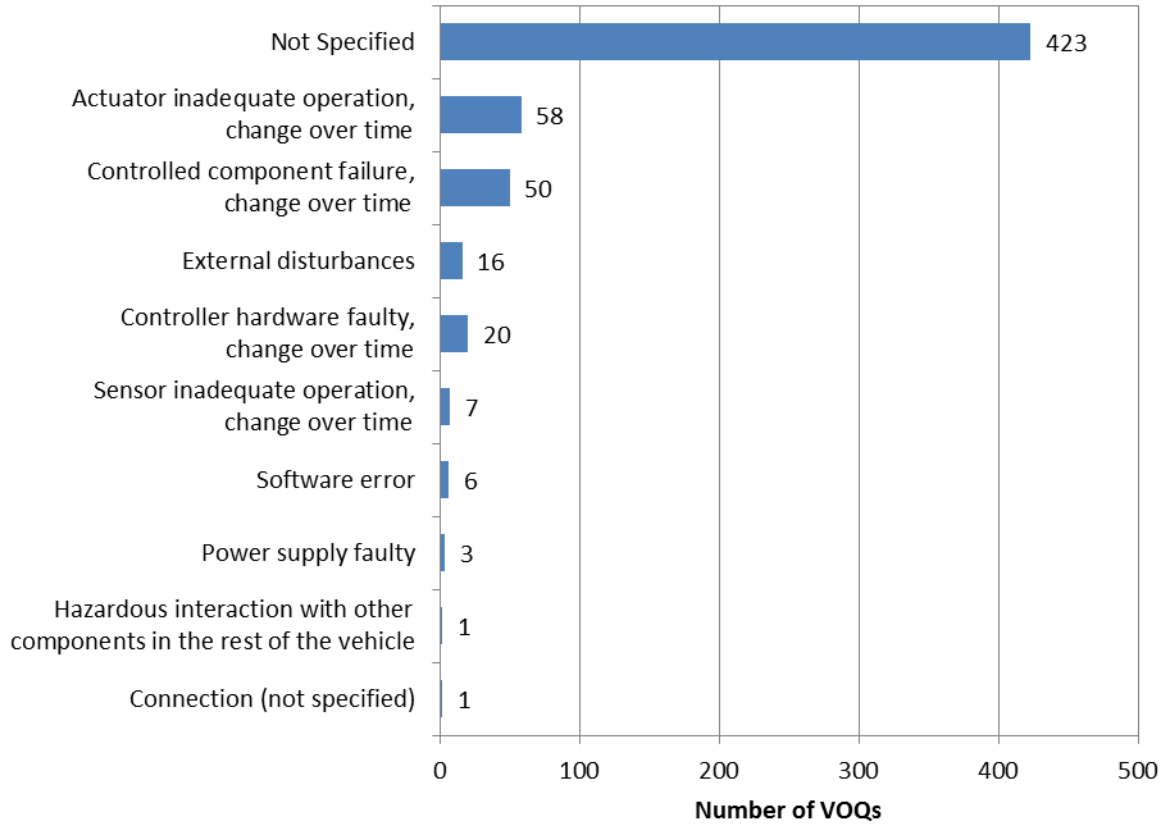

Figure A-3: Unsafe Control Action Breakdown of EPS VOQs

Similar to the EPS-related recalls, which mostly consisted of failures in implementing the EPS steering command or loss of power assist, the majority of VOQs described situations where the EPS system did not provide steering assist when expected by the driver.

As shown in Figure 5, most of the EPS-related VOQs did not have a specified or even speculative cause of the failure. Of the VOQs that provided a cause, hardware failures in actuators in the system (e.g., power steering motor) were the most frequently reported cause of malfunctions of the EPS system. Note that VOQs are often submitted by vehicle owners based on perceived vehicle behavior and the vehicle owners submitting VOQs may not have technical expertise on how the system operates.



EPS VOQs : 573

585 VOQs shown; 12 VOQs included multiple guide phrases

Figure A-4: Causal Factor Breakdown of EPS VOQs

**APPENDIX B: STPA CAUSAL FACTOR GUIDEWORDS AND GUIDEWORDS
SUBCATEGORIES**

Figure B-1. Causal Factor Categories for Automotive Electronic Control Systems B-2
Table B-1. Causal Factor Sub-categories for Automotive Electronic Control Systems..... B-3

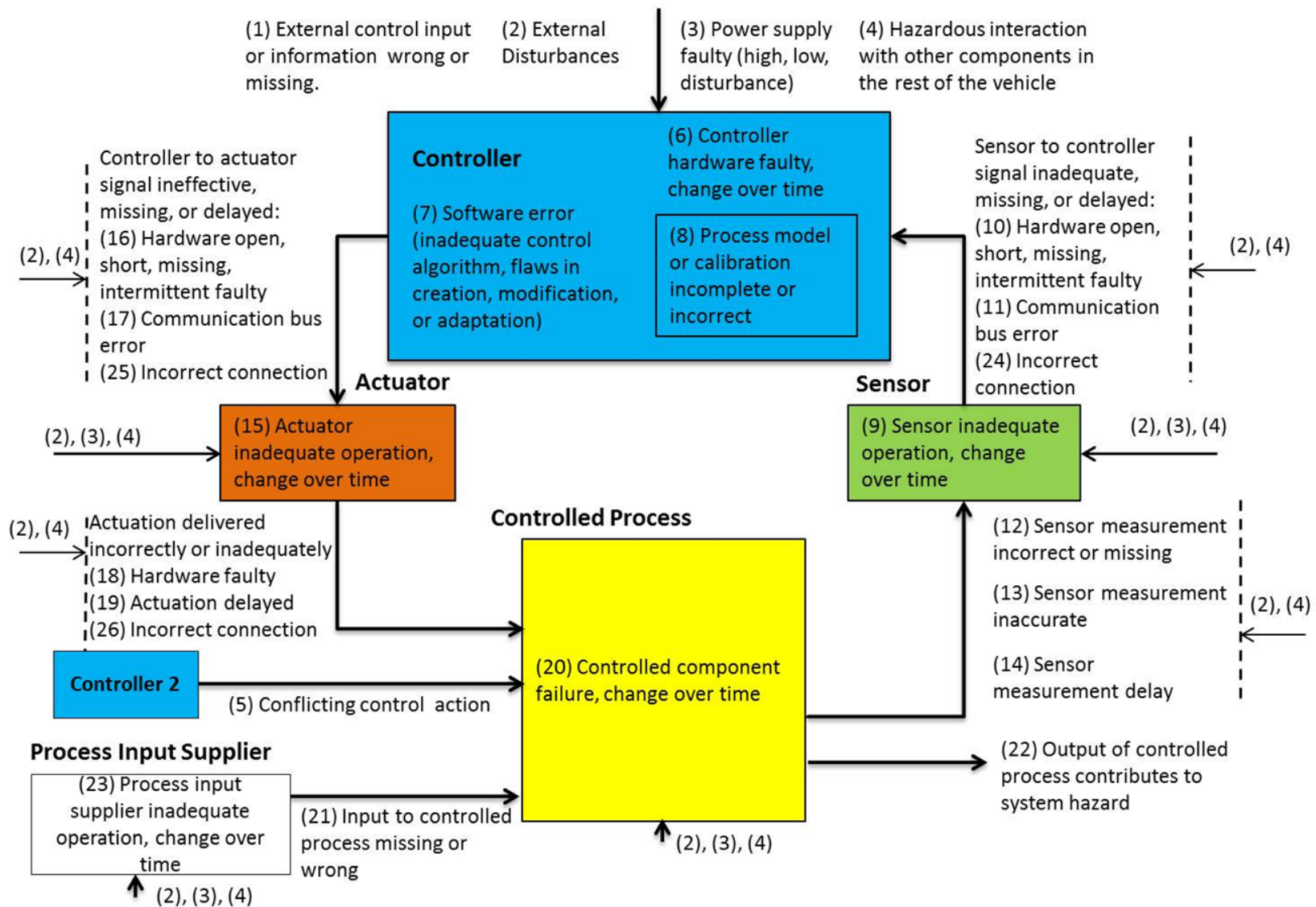

Figure B-1. Causal Factor Categories for Automotive Electronic Control Systems

Table B-1. Causal Factor Sub-categories for Automotive Electronic Control Systems
 The numbering in the table below corresponds to those in Figure B-1.

Components	
Controller	(6) Controller hardware faulty, change over time <ul style="list-style-type: none"> • Internal hardware failure • Overheating due to increased resistance in a subcomponent or internal shorting • Over temperature due to faulty cooling system • Degradation over time • Faulty memory storage or retrieval • Faulty internal timing clock • Faulty signal conditioning or converting (e.g., analog-to-digital converter, signal filters) • Unused circuits in the controller
	(7) Software error (inadequate control algorithm, flaws in creation, modification, or adaptation) <ul style="list-style-type: none"> • Inadequate control algorithm • Flaws in software code creation
	(8) Process model or calibration incomplete or incorrect <ul style="list-style-type: none"> • Sensor or actuator calibration, including degradation characteristics • Model of the controlled process, including its degradation characteristics
	(2) External control input or information wrong or missing <ul style="list-style-type: none"> • Timing-related input is incorrect or missing • Spurious input due to shorting or other electrical fault • Corrupted signal • Malicious intruder
	(3) Power supply faulty (high, low, disturbance) <ul style="list-style-type: none"> • Loss of 12-volt power • Power supply faulty (high, low, disturbance)
	(2) External disturbances <ul style="list-style-type: none"> • EMI or ESD • Single event effects (e.g., cosmic rays, protons) • Vibration or shock impact • Manufacturing defects and assembly problems • Extreme external temperature or thermal cycling • Moisture, corrosion, or contamination • Organic growth • Physical interference (e.g., chafing)

Sensor

(4) Hazardous interaction with other components in the rest of the vehicle

- EMI or ESD
- Vibration or shock impact
- Physical interference (e.g., chafing)
- Moisture, corrosion, or contamination
- Excessive heat from other components
- Electrical arcing from neighboring components or exposed terminals
- Corona effects from high voltage components

(9) Sensor inadequate operation, change over time

- Internal hardware failure
- Overheating due to increased resistance in a subcomponent or internal shorting
- Degradation over time
- Over temperature due to faulty cooling system
- Reporting frequency too low

(3) Power supply faulty (high, low, disturbance)

- Loss of 12-volt power
- Reference voltage incorrect (e.g., too low, too high)
- Power supply faulty (high, low, disturbance)

(2) External disturbances

- EMI or ESD
- Single event effects (e.g., cosmic rays, protons)
- Vibration or shock impact
- Manufacturing defects and assembly problems
- Extreme external temperature or thermal cycling
- Moisture, corrosion, or contamination
- Organic growth
- Physical interference (e.g., chafing)
- Magnetic interference

(4) Hazardous interaction with other components in the rest of the vehicle

- EMI or ESD
- Vibration or shock impact
- Physical interference (e.g., chafing)
- Moisture, corrosion, or contamination
- Excessive heat from other components
- Magnetic interference
- Electrical arcing from neighboring components or exposed terminals
- Corona effects from high voltage components

Actuator	(15) Actuator inadequate operation, change over time
	<ul style="list-style-type: none"> • Internal hardware failure • Degradation over time • Over temperature due to faulty cooling system • Incorrectly sized actuator • Relay failure modes, including: 1) does not energize, 2) does not de-energize, and 3) welded contacts • Overheating due to increased resistance in a subcomponent or internal shorting
	(3) Power supply faulty (high, low, disturbance)
	<ul style="list-style-type: none"> • Loss of 12-volt power • Power supply faulty (high, low, disturbance)
	(2) External disturbances
<ul style="list-style-type: none"> • EMI or ESD • Single event effects (e.g., cosmic rays, protons) • Vibration or shock impact • Manufacturing defects and assembly problems • Extreme external temperature or thermal cycling • Moisture, corrosion, or contamination • Organic growth • Physical interference (e.g., chafing) • Magnetic interference 	
	(4) Hazardous interaction with other components in the rest of the vehicle
	<ul style="list-style-type: none"> • EMI or ESD • Vibration or shock impact • Physical interference (e.g., chafing) • Moisture, corrosion, or contamination • Excessive heat from other components • Magnetic interference • Electrical arcing from neighboring components or exposed terminals • Corona effects from high voltage components • Unable to meet demands from multiple components (e.g., inadequate torque)
Controlled Process	(20) Controlled component failure, change over time
	<ul style="list-style-type: none"> • Internal hardware failure • Degradation over time
	(3) Power supply faulty (high, low, disturbance)
	<ul style="list-style-type: none"> • Loss of 12-volt power • Power supply faulty (high, low, disturbance)

Controlled Process	<p>(2) External disturbances</p> <ul style="list-style-type: none"> • EMI or ESD • Single event effects (e.g., cosmic rays, protons) • Vibration or shock impact • Manufacturing defects and assembly problems • Extreme external temperature or thermal cycling • Moisture, corrosion, or contamination • Organic growth • Physical interference (e.g., chafing) • Magnetic interference
	<p>(4) Hazardous interaction with other components in the rest of the vehicle</p> <ul style="list-style-type: none"> • EMI or ESD • Vibration or shock impact • Physical interference (e.g., chafing) • Moisture, corrosion, or contamination • Excessive heat from other components • Magnetic interference • Electrical arcing from neighboring components or exposed terminals • Corona effects from high voltage components • Unable to meet demands from multiple components (e.g., inadequate torque)
	<p>(22) Output of controlled process contributing to system hazard</p>
Process Input Supplier to Controlled Process	<p>(23) Process input supplier inadequate operation, change over time</p> <ul style="list-style-type: none"> • Process input supplier inadequate operation, change over time • Electrical noise other than EMI or ESD
	<p>(3) Power supply faulty (high, low, disturbance)</p> <ul style="list-style-type: none"> • Loss of 12-volt power • Power supply faulty (high, low, disturbance)
	<p>(2) External disturbances</p> <ul style="list-style-type: none"> • EMI or ESD • Single event effects (e.g., cosmic rays, protons) • Vibration or shock impact • Manufacturing defects and assembly problems • Extreme external temperature or thermal cycling • Moisture, corrosion, or contamination • Organic growth • Physical interference (e.g., chafing) • Magnetic interference

	(4) Hazardous interaction with other components in the rest of the vehicle
	<ul style="list-style-type: none"> • EMI or ESD • Vibration or shock impact • Physical interference (e.g., chafing) • Moisture, corrosion, or contamination • Excessive heat from other components • Magnetic interference • Electrical arcing from neighboring components or exposed terminals • Corona effects from high voltage components • Unable to meet demands from multiple components (e.g., inadequate torque)
Connections	
Sensor to Controller, Controller to Actuator	(10) and (16) Hardware open, short, missing, intermittent faulty
	<ul style="list-style-type: none"> • Connection is intermittent • Connection is open, short to ground, short to battery, or short to other wires in harness • Electrical noise other than EMI or ESD • Connector contact resistance is too high • Connector shorting between neighboring pins • Connector resistive drift between neighboring pins
	(11) and (17) Communication bus error <ul style="list-style-type: none"> • Bus overload or bus error • Signal priority too low • Failure of the message generator, transmitter, or receiver • Malicious intruder
	(24) and (25) Incorrect connection
	<ul style="list-style-type: none"> • Incorrect wiring connection • Incorrect pin assignment
	(2) External disturbances
	<ul style="list-style-type: none"> • EMI or ESD • Single event effects (e.g., cosmic rays, protons) • Vibration or shock impact • Manufacturing defects and assembly problems • Extreme external temperature or thermal cycling • Unused connection terminals affected by moisture, corrosion, or contamination • Organic growth

	<ul style="list-style-type: none"> • Physical interference (e.g., chafing) • Active connection terminals affected by moisture, corrosion, or contamination
	(4) Hazardous interaction with other components in the rest of the vehicle
	<ul style="list-style-type: none"> • EMI or ESD • Vibration or shock impact • Physical interference (e.g., chafing) • Unused connection terminals affected by moisture, corrosion, or contamination • Excessive heat from other components • Electrical arcing from neighboring components or exposed terminals • Corona effects from high voltage components • Active connection terminals affected by moisture, corrosion, or contamination • Mechanical connections affected by moisture, corrosion, or contamination
Actuator to Controlled Process	(18) Actuation delivered incorrectly or inadequately: Hardware faulty
	(19) Actuation delayed
	(20) Actuator to controlled process incorrect connection
	(2) External disturbances <ul style="list-style-type: none"> • EMI or ESD • Single event effects (e.g., cosmic rays, protons) • Vibration or shock impact • Manufacturing defects and assembly problems • Extreme external temperature or thermal cycling • Unused connection terminals affected by moisture, corrosion, or contamination • Organic growth • Physical interference (e.g., chafing) • Active connection terminals affected by moisture, corrosion, or contamination • Mechanical connections affected by moisture, corrosion, or contamination
	(4) Hazardous interaction with other components in the rest of the vehicle <ul style="list-style-type: none"> • EMI or ESD • Vibration or shock impact • Physical interference (e.g., chafing) • Unused connection terminals affected by moisture, corrosion, or contamination • Excessive heat from other components • Electrical arcing from neighboring components or exposed terminals • Corona effects from high voltage components

	<ul style="list-style-type: none"> • Active connection terminals affected by moisture, corrosion, or contamination • Mechanical connections affected by moisture, corrosion, or contamination
Controlled Process to Sensor	(12) Sensor measurement incorrect or missing Sensor incorrectly aligned/positioned
	(13) Sensor measurement inaccurate Sensor incorrectly aligned/positioned
	(14) Sensor measurement delay Sensor incorrectly aligned/positioned
	(2) External disturbances <ul style="list-style-type: none"> • EMI or ESD • Single event effects (e.g., cosmic rays, protons) • Vibration or shock impact • Manufacturing defects and assembly problems • Extreme external temperature or thermal cycling • Unused connection terminals affected by moisture, corrosion, or contamination • Organic growth • Physical interference (e.g., chafing) • Active connection terminals affected by moisture, corrosion, or contamination • Mechanical connections affected by moisture, corrosion, or contamination
	(4) Hazardous interaction with other components in the rest of the vehicle <ul style="list-style-type: none"> • EMI or ESD • Vibration or shock impact • Physical interference (e.g., chafing) • Unused connection terminals affected by moisture, corrosion, or contamination • Excessive heat from other components • Electrical arcing from neighboring components or exposed terminals • Corona effects from high voltage components • Active connection terminals affected by moisture, corrosion, or contamination • Mechanical connections affected by moisture, corrosion, or contamination
Other Controller to Controlled Process	(5) Conflicting control action
Process Input Supplier to Controlled Process	(21) Input to controlled process missing or wrong

APPENDIX C: HAZOP STUDY RESULTS

Table C- 1. Function 1: Mechanically transmits the driver’s torque from the steering wheel to the steering column to induce lateral vehicle force.	C-3
Table C-2. Function 2: Senses the torque applied to the steering wheel.	C-4
Table C-3. Function 3: Senses the steering wheel angle and steering column angle.	C-5
Table C-4. Function 4: Communicate with internal subsystems and other vehicle systems (including receiving steering inputs from other vehicle systems)	C-6
Table C-5. Function 5: Turns wheels such that available/surplus lateral force is sufficient to achieve desired vehicle path, including at low speeds consistent with Ackerman angle practice	C-7
Table C-6. Function 6: Turns vehicle at highest input angle to a maximum TBD turning circle/radius for sufficient maneuverability	C-7
Table C-7. Function 7: Turns wheels such that tire wear and tear is minimized.....	C-7
Table C-8. Function 8: Absorbs environmental sounds from tire patch and mechanical steering system to minimize cabin noise	C-8
Table C-9. Function 9: Provides feedback to driver via steering wheel when turning limit is reached by disallowing more steering wheel turning.	C-8
Table C-10. Function 10: Transmits road surface roughness from the tire patch to the driver through the steering wheel.	C-9
Table C-11. Function 11: Transmits lateral road friction from tire patch to driver's hands through steering wheel	C-10
Table C-12. Function 12: Absorbs road shocks from tire patch to prevent full transmission to driver's hands	C-11
Table C-13. Function 13: Transmits mechanical failures from within steering system to the driver through an easily perceivable change in steering effort.....	C-12
Table C- 14. Function 14: Adjusts steering wheel to a proper height and angle for a comfortable driving position	C-12
Table C-15. Function 15: Adds or subtracts torque with driver's steering wheel input to ease or impede lateral force induction based on vehicle speed.....	C-13
Table C-16. Function 16: Modulates torque to create an on-center, straight steer by default..	C-14
Table C-17. Function 17: Disables all energy sources to steering equipment When the Ignition Is off or once the EPS system enters a maintenance/repair mode	C-14
Table C-18. Function 18: Store relevant data	C-15
Table C-19. Function 19: Turns four-wheel steering (4WS) mode from on to off (or vice versa)	C-15
Table C-20. Function 20: Turn rear wheels in-phase smoothly and without alarming driver when at or above the in-phase speed threshold in 4WS-equipped vehicles	C-16
Table C-21. Function 21: Turn rear wheels in reverse-phase smoothly and without alarming driver when below the reverse-phase speed threshold in 4WS-equipped vehicles	C-17

Table C-22. Function 22: Turns the rear wheels inward (toe-in) to supplement braking force and enhance stability in 4WS-equipped vehicles.	C-18
Table C-23. Function 23: Provide diagnostics/fault detection.....	C-19
Table C-24. Function 24: Provide mitigation	C-19
Table C-25. Function 25: Electronically transmits steering system failures to driver using all or some of dashboard indicator, chimes, or similar (alerts)	C-20
Table C-26. Function 26: Locks the steering wheel when vehicle is off such that any steering inputs (torque or angle) are not transmitted to the road wheels.....	C-21
Table C-27. Function 27: Unlocks the steering wheel for normal functions after the vehicle is accessed with the appropriate security device (e.g., key, biometrics)	C-21

Table C- 1. Function 1: Mechanically transmits the driver’s torque from the steering wheel to the steering column to induce lateral vehicle force.

<i>I.D.</i>	<i>Malfunction</i>	<i>Potential Vehicle Level Hazard</i>
F1-1	Does not transmit torque from steering wheel indefinitely	Unintended Vehicle Lateral Motion / Unintended Yaw Insufficient Vehicle Lateral Motion / Insufficient Yaw
F1-2	Does not transmit torque from steering wheel in a timely manner	Unintended Vehicle Lateral Motion / Unintended Yaw Insufficient Vehicle Lateral Motion / Insufficient Yaw
F1-3	Transmits more torque to steering column	Unintended Vehicle Lateral Motion / Unintended Yaw
F1-4	Transmits less torque than intended	Insufficient Vehicle Lateral Motion / Insufficient Yaw
F1-5	Does not smoothly transmit torque	Unintended Vehicle Lateral Motion / Unintended Yaw Insufficient Vehicle Lateral Motion / Insufficient Yaw
F1-6	Driver's torque input is transmitted in opposite direction	Unintended Vehicle Lateral Motion / Unintended Yaw
F1-7	Torque is transmitted when steering wheel is not adjusted. (Torque is transmitted without any motion of steering wheel)	Unintended Vehicle Lateral Motion / Unintended Yaw
F1-8	Constant torque is applied regardless of steering wheel angle.	Unintended Vehicle Lateral Motion / Unintended Yaw

Table C-2. Function 2: Senses the torque applied to the steering wheel.

<i>I.D.</i>	<i>Malfunction</i>	<i>Potential Vehicle Level Hazard</i>
F2-1	Does not sense steering wheel angle	Unintended Vehicle Lateral Motion / Unintended Yaw Insufficient Vehicle Lateral Motion / Insufficient Yaw Loss of Steering Assist
F2-2	Senses large angle while only small angle desired	Unintended Vehicle Lateral Motion / Unintended Yaw
F2-3	Senses the steering angle with more frequency than needed	No hazard
F2-4	Senses a small angle while large angle desired	Unintended Vehicle Lateral Motion / Unintended Yaw
F2-5	Senses the steering angle with less frequency than needed	Unintended Vehicle Lateral Motion / Unintended Yaw Insufficient Vehicle Lateral Motion / Insufficient Yaw
F2-6	Intermittently sensing the steering wheel angle	Unintended Vehicle Lateral Motion / Unintended Yaw
F2-7	Angle changes positively as opposed to negatively and vice versa	Unintended Vehicle Lateral Motion / Unintended Yaw
F2-8	Measures a change in steering angle in either direction when there is no change in the actual steering wheel angle	Unintended Vehicle Lateral Motion / Unintended Yaw
F2-9	Senses a constant steering wheel angle regardless of steering input	Unintended Vehicle Lateral Motion / Unintended Yaw Insufficient Vehicle Lateral Motion / Insufficient Yaw

Table C-3. Function 3: Senses the steering wheel angle and steering column angle.

<i>I.D.</i>	<i>Malfunction</i>	<i>Potential Vehicle Level Hazard</i>
F3-1	Driver's steering wheel does not vibrate according to surface roughness; or road surface roughness is not transmitted	Unintended Vehicle Lateral Motion / Unintended Yaw Insufficient Vehicle Lateral Motion / Insufficient Yaw
F3-2	Steering wheel vibrates more than desired for a specific surface roughness	No Hazard
F3-3	Steering wheel vibrates less than intended for a specific surface	Unintended Vehicle Lateral Motion / Unintended Yaw Insufficient Vehicle Lateral Motion / Insufficient Yaw
F3-4	Transmits actual road roughness part of the time	Unintended Vehicle Lateral Motion / Unintended Yaw Insufficient Vehicle Lateral Motion / Insufficient Yaw
F3-5	Steering wheel vibrates erroneously when road is smooth	No Hazard
F3-6	Steering wheel vibrates indefinitely	Unintended Vehicle Lateral Motion / Unintended Yaw Insufficient Vehicle Lateral Motion / Insufficient Yaw

Table C-4. Function 4: Communicate with internal subsystems and other vehicle systems
(including receiving steering inputs from other vehicle systems)

<i>I.D.</i>	<i>Malfunction</i>	<i>Potential Vehicle Level Hazard</i>
F4-1	Does not communicate with subsystems	Unintended Vehicle Lateral Motion / Unintended Yaw Insufficient Vehicle Lateral Motion / Insufficient Yaw
F4-2	Communication of extraneous information to other vehicle systems	No Hazard
F4-3	Some information omitted in communication between internal subsystems and other vehicle systems	Unintended Vehicle Lateral Motion / Unintended Yaw Insufficient Vehicle Lateral Motion / Insufficient Yaw
F4-4	Intermittently communicates with subsystems	Unintended Vehicle Lateral Motion / Unintended Yaw Insufficient Vehicle Lateral Motion / Insufficient Yaw
F4-5	Communicates with internal subsystems needlessly, receives steering inputs for other vehicle systems when not requested	No Hazard

Table C-5. Function 5: Turns wheels such that available/surplus lateral force is sufficient to achieve desired vehicle path, including at low speeds consistent with Ackerman angle practice

<i>I.D.</i>	<i>Malfunction</i>	<i>Potential Vehicle Level Hazard</i>
F5-1	Does not provide any lateral force	Insufficient Vehicle Lateral Motion / Insufficient Yaw
F5-2	Lateral force is not sufficient	Insufficient Vehicle Lateral Motion / Insufficient Yaw
F5-3	Wheels turn in opposite direction (at least one wheel turns in opposite direction other than intended)	Unintended Vehicle Lateral Motion / Unintended Yaw
F5-4	Wheels induce more lateral force than required	Unintended Vehicle Lateral Motion / Unintended Yaw

Table C-6. Function 6: Turns vehicle at highest input angle to a maximum TBD turning circle/radius for sufficient maneuverability

<i>I.D.</i>	<i>Malfunction</i>	<i>Potential Vehicle Level Hazard</i>
F6-1	Does not turn vehicle at highest input angle	Insufficient Vehicle Lateral Motion / Insufficient Yaw
F6-2	Input angle is locked at particular angle	Unintended Vehicle Lateral Motion / Unintended Yaw Insufficient Vehicle Lateral Motion / Insufficient Yaw
F6-3	Turn vehicle at an input angle that is less than maximum	Insufficient Vehicle Lateral Motion / Insufficient Yaw

Table C-7. Function 7: Turns wheels such that tire wear and tear is minimized

<i>I.D.</i>	<i>Malfunction</i>	<i>Potential Vehicle Level Hazard</i>
F7-1	Wheel turns is not optimized for tire wear	No Hazard
F7-2	Wheels are turned more than intended	No Hazard

Table C-8. Function 8: Absorbs environmental sounds from tire patch and mechanical steering system to minimize cabin noise

<i>I.D.</i>	<i>Malfunction</i>	<i>Potential Vehicle Level Hazard</i>
F8-1	Does not absorb environmental sounds from tire patch	No Hazard
F8-2	Environmental sounds not fully absorbed	No Hazard
F8-3	Environmental sounds absorbed at random times	No Hazard

Table C-9. Function 9: Provides feedback to driver via steering wheel when turning limit is reached by disallowing more steering wheel turning.

<i>I.D.</i>	<i>Malfunction</i>	<i>Potential Vehicle Level Hazard</i>
F9-1	Does not provide any feedback to driver at turning limit	Insufficient Vehicle Lateral Motion / Insufficient Yaw
F9-2	Provides feedback when not needed	Insufficient Vehicle Lateral Motion / Insufficient Yaw
F9-3	Stuck at always providing the same feedback level	Insufficient Vehicle Lateral Motion / Insufficient Yaw

Table C-10. Function 10: Transmits road surface roughness from the tire patch to the driver through the steering wheel.

F10-1	Driver's steering wheel does not vibrate according to surface roughness; or road surface roughness is not transmitted	Unintended Vehicle Lateral Motion / Unintended Yaw Insufficient Vehicle Lateral Motion / Insufficient Yaw
F10-2	Steering wheel vibrates more than desired for a specific surface roughness	No Hazard
F10-3	Steering wheel vibrates less than intended for a specific surface	Unintended Vehicle Lateral Motion / Unintended Yaw Insufficient Vehicle Lateral Motion / Insufficient Yaw
F10-4	Transmits actual road roughness part of the time	Unintended Vehicle Lateral Motion / Unintended Yaw Insufficient Vehicle Lateral Motion / Insufficient Yaw
F10-5	Steering wheel vibrates erroneously when road is smooth	No Hazard
F10-6	Steering wheel vibrates indefinitely, regardless of road surface roughness	Unintended Vehicle Lateral Motion / Unintended Yaw Insufficient Vehicle Lateral Motion / Insufficient Yaw

Table C-11. Function 11: Transmits lateral road friction from tire patch to driver's hands through steering wheel

<i>I.D.</i>	<i>Malfunction</i>	<i>Potential Vehicle Level Hazard</i>
F11-1	Lateral road friction from tire patch not transmitted	Unintended Vehicle Lateral Motion / Unintended Yaw Insufficient Vehicle Lateral Motion / Insufficient Yaw
F11-2	Transmits more road friction than actual road friction	No Hazard
F11-3	Transmits less road friction than actual road friction	Unintended Vehicle Lateral Motion / Unintended Yaw Insufficient Vehicle Lateral Motion / Insufficient Yaw
F11-4	Road friction is transmitted intermittently	Unintended Vehicle Lateral Motion / Unintended Yaw Insufficient Vehicle Lateral Motion / Insufficient Yaw
F11-5	Road friction is transmitted when not present	No Hazard
F11-6	Continuously transmits road friction from tire patch regardless of road condition	Unintended Vehicle Lateral Motion / Unintended Yaw Insufficient Vehicle Lateral Motion / Insufficient Yaw

Table C-12. Function 12: Absorbs road shocks from tire patch to prevent full transmission to driver's hands

<i>I.D.</i>	<i>Malfunction</i>	<i>Potential Vehicle Level Hazard</i>
F12-1	Does not absorb road shocks from tire patch, full transmission delivered to driver's hands	Unintended Vehicle Lateral Motion / Unintended Yaw Insufficient Vehicle Lateral Motion / Insufficient Yaw
F12-2	Absorbs more road shocks from tire patch	Unintended Vehicle Lateral Motion / Unintended Yaw Insufficient Vehicle Lateral Motion / Insufficient Yaw
F12-3	Road shocks not fully absorbed	Unintended Vehicle Lateral Motion / Unintended Yaw Insufficient Vehicle Lateral Motion / Insufficient Yaw
F12-4	Absorbs road shocks when not needed	Unintended Vehicle Lateral Motion / Unintended Yaw Insufficient Vehicle Lateral Motion / Insufficient Yaw
F12-5	Road shocks absorbed at random times	Unintended Vehicle Lateral Motion / Unintended Yaw Insufficient Vehicle Lateral Motion / Insufficient Yaw

Table C-13. Function 13: Transmits mechanical failures from within steering system to the driver through an easily perceivable change in steering effort.

<i>I.D.</i>	<i>Malfunction</i>	<i>Potential Vehicle Level Hazard</i>
F13-1	No driver feedback is generated following a mechanical failure	No Hazard (Failure of the driver warning strategy)
F13-2	Change in steering effort indicates more severe mechanical failures than are actually present	No Hazard (Failure of the driver warning strategy)
F13-3	Some mechanical failures not transmitted to driver	No Hazard (Failure of the driver warning strategy)
F13-4	Mechanical failures are transmitted to driver intermittently	No Hazard (Failure of the driver warning strategy)
F13-5	Mechanical failures are transmitted when there are no failures in the steering system	No Hazard (Failure of the driver warning strategy)
F13-6	Feedback is stuck at a specific level (e.g., the level of feedback is not related to the types of mechanical failures)	No Hazard (Failure of the driver warning strategy)

Table C- 14. Function 14: Adjusts steering wheel to a proper height and angle for a comfortable driving position

<i>I.D.</i>	<i>Malfunction</i>	<i>Potential Vehicle Level Hazard</i>
F14-1	Steering wheel does not adjust to proper height	No Hazard
F14-2	Steering wheel automatically adjusts its height while driver is driving	No Hazard

Table C-15. Function 15: Adds or subtracts torque with driver's steering wheel input to ease or impede lateral force induction based on vehicle speed

<i>I.D.</i>	<i>Malfunction</i>	<i>Potential Vehicle Level Hazard</i>
F15-1	Does not smoothly add or subtract torque	Loss of Steering Assist
F15-2	Adds more torque than intended	Unintended Vehicle Lateral Motion / Unintended Yaw
F15-3	Subtracts more torque than intended	Unintended Vehicle Lateral Motion / Unintended Yaw Insufficient Vehicle Lateral Motion / Insufficient Yaw
F15-4	Adds less torque than intended	Insufficient Vehicle Lateral Motion / Insufficient Yaw
F15-5	Subtracts less torque than intended	Unintended Vehicle Lateral Motion / Unintended Yaw
F15-6	Adds or subtracts torque intermittently	Unintended Vehicle Lateral Motion / Unintended Yaw
F15-7	Adds or subtracts torque when it should subtract or add torque respectively	Unintended Vehicle Lateral Motion / Unintended Yaw
F15-8	Adds or subtracts torque when it shouldn't	Unintended Vehicle Lateral Motion / Unintended Yaw
F15-9	Continually adds or subtracts torque	Unintended Vehicle Lateral Motion / Unintended Yaw

Table C-16. Function 16: Modulates torque to create an on-center, straight steer by default

<i>I.D.</i>	<i>Malfunction</i>	<i>Potential Vehicle Level Hazard</i>
F16-1	Does not modulate torque	Unintended Vehicle Lateral Motion / Unintended Yaw
F16-2	Torque is modulated too much	Insufficient Vehicle Lateral Motion / Insufficient Yaw
F16-3	Torque is modulated less than desired	Unintended Vehicle Lateral Motion / Unintended Yaw
F16-4	Modulates torque intermittently	Unintended Vehicle Lateral Motion / Unintended Yaw
F16-5	Modulates torque when vehicle is turning	Insufficient Vehicle Lateral Motion / Insufficient Yaw

Table C-17. Function 17: Disables all energy sources to steering equipment When the Ignition Is off or once the EPS system enters a maintenance/repair mode

<i>I.D.</i>	<i>Malfunction</i>	<i>Potential Vehicle Level Hazard</i>
F17-1	Steering wheel equipment still powered while in maintenance mode	Exposure to Moving Vehicle Components When the Ignition Is in the Off Position
F17-2	Disables some energy sources to steering wheel while leaving some powered	Exposure to Moving Vehicle Components When the Ignition Is in the Off Position
F17-3	Disables all energy sources intermittently	Exposure to Moving Vehicle Components When the Ignition Is in the Off Position
F17-4	Disables all energy sources to steering wheel equipment when not in maintenance/repair mode	Loss of Steering Assist
F17-5	Energy sources cannot be re-enabled after maintenance/repair mode is exited	Loss of Steering Assist

Table C-18. Function 18: Store relevant data

<i>I.D.</i>	<i>Malfunction</i>	<i>Potential Vehicle Level Hazard</i>
F18-1	Does not store relevant data	No Hazard
F18-2	Stores more relevant data	No Hazard
F18-3	Does not store enough relevant data	No Hazard
F18-4	Stores some data and does not store other data	No Hazard
F18-5	Erases relevant data	No Hazard

Table C-19. Function 19: Turns four-wheel steering (4WS) mode from on to off (or vice versa)

<i>I.D.</i>	<i>Malfunction</i>	<i>Potential Vehicle Level Hazard</i>
F19-1	Does not turn four-wheel steering mode on	No Hazard
F19-2	Does not turn four-wheel steering mode off	No Hazard
F19-3	Turns four-wheel steering on and off intermittently	Unintended Vehicle Lateral Motion / Unintended Yaw Insufficient Vehicle Lateral Motion / Insufficient Yaw
F19-6	Turns on four-wheel steering when not requested by driver or steering control module	No Hazard
F19-7	Turns off four-wheel steering when not requested by driver or steering control module	Unintended Vehicle Lateral Motion / Unintended Yaw

Table C-20. Function 20: Turn rear wheels in-phase smoothly and without alarming driver when at or above the in-phase speed threshold in 4WS-equipped vehicles

<i>I.D.</i>	<i>Malfunction</i>	<i>Potential Vehicle Level Hazard</i>
F20-1	Does not turn rear wheels in-phase smoothly (such as lurching and/or step response)	Unintended Vehicle Lateral Motion / Unintended Yaw Insufficient Vehicle Lateral Motion / Insufficient Yaw
F20-2	Does not turn rear wheels in-phase (remains in nominal position)	No Hazard
F20-3	Turns rear wheels in-phase intermittently (intermittent switching between different in-phase angles or between in-phase and straight ahead)	Unintended Vehicle Lateral Motion / Unintended Yaw
F20-4	Rear wheels turn out-of-phase	Unintended Vehicle Lateral Motion / Unintended Yaw
F20-5	Turns rear wheels in-phase below speed threshold	Unintended Vehicle Lateral Motion / Unintended Yaw
F20-6	Turns rear wheels in-phase with a large angle (for example, rear wheel angle > front wheel angle)	Unintended Vehicle Lateral Motion / Unintended Yaw
F20-7	Rear wheels stuck at a particular steering angle	Unintended Vehicle Lateral Motion / Unintended Yaw
F20-8	Rear wheels control stuck in in-phase mode as vehicle crosses the speed threshold	Unintended Vehicle Lateral Motion / Unintended Yaw
F20-9	Turns rear wheel in-phase slightly (too little)	No Hazard

Table C-21. Function 21: Turn rear wheels in reverse-phase smoothly and without alarming driver when below the reverse-phase speed threshold in 4WS-equipped vehicles

<i>I.D.</i>	<i>Malfunction</i>	<i>Potential Vehicle Level Hazard</i>
F21-1	Does not turn rear wheels reverse-phase	No Hazard
F21-2	Does not smoothly turn rear wheels reverse-phase	Unintended Vehicle Lateral Motion / Unintended Yaw Insufficient Vehicle Lateral Motion / Insufficient Yaw
F21-3	Turn rear wheels reverse-phase intermittently; (intermittent switching between different reverse-phase angles or between reverse-phase and straight ahead)	Unintended Vehicle Lateral Motion / Unintended Yaw
F21-4	Turn rear wheels in reverse-phase at too high of an angle	Unintended Vehicle Lateral Motion / Unintended Yaw
F21-5	Rear wheels turn in-phase	Insufficient Vehicle Lateral Motion / Insufficient Yaw
F21-6	Turns rear wheels reverse-phase above speed threshold	Unintended Vehicle Lateral Motion / Unintended Yaw
F21-7	Rear wheels stuck at a particular steering angle	Unintended Vehicle Lateral Motion / Unintended Yaw
F21-8	Rear wheels control stuck in reverse-phase mode as vehicle crosses the speed threshold	Unintended Vehicle Lateral Motion / Unintended Yaw
F21-9	Turns rear wheels in reverse-phase slightly (too little)	No Hazard

Table C-22. Function 22: Turns the rear wheels inward (toe-in) to supplement braking force and enhance stability in 4WS-equipped vehicles.

<i>I.D.</i>	<i>Malfunction</i>	<i>Potential Vehicle Level Hazard</i>
F22-1	Toe-in not actuated to supplement braking force	No Hazard
F22-2	Toe-in actuated more than intended	Increased Rear-Wheel Drag
F22-3	Toe-in actuated less than intended	No Hazard
F22-4	Wheels intermittently change from toe-in to straight ahead	Unintended Vehicle Lateral Motion / Unintended Yaw Insufficient Vehicle Lateral Motion / Insufficient Yaw Increased Rear-Wheel Drag
F22-5	Toe-in actuated in wrong direction (toe-out) OR asymmetric toe-in	Unintended Vehicle Lateral Motion / Unintended Yaw
F22-6	Toe-in actuated when not in braking mode	Unintended Vehicle Lateral Motion / Unintended Yaw Insufficient Vehicle Lateral Motion / Insufficient Yaw Increased Rear-Wheel Drag
F22-7	Rear wheels stuck at some toe-in angle or position	Unintended Vehicle Lateral Motion / Unintended Yaw Insufficient Vehicle Lateral Motion / Insufficient Yaw Increased Rear-Wheel Drag

Table C-23. Function 23: Provide diagnostics/fault detection

<i>I.D.</i>	<i>Malfunction</i>	<i>Potential Vehicle Level Hazard</i>
F23-1	Does not provide diagnostics, no faults detected when fault exists	No Hazard (Part of the safety mechanism to address other malfunctions)
F23-2	DTC is issued with too high of a frequency	No Hazard (Part of the safety mechanism to address other malfunctions)
F23-3	DTC is issued with too low of a frequency	No Hazard (Part of the safety mechanism to address other malfunctions)
F23-4	Provides diagnostics and detects faults intermittently	No Hazard (Part of the safety mechanism to address other malfunctions)
F23-5	Fault detected when no fault exists	No Hazard (Part of the safety mechanism to address other malfunctions)
F23-6	Vehicle stuck in diagnostic mode	No Hazard (Part of the safety mechanism to address other malfunctions)

Table C-24. Function 24: Provide mitigation

<i>I.D.</i>	<i>Malfunction</i>	<i>Potential Vehicle Level Hazard</i>
F24-1	Does not mitigate failures at all	No Hazard (Part of the safety mechanism to address other malfunctions)
F24-2	Some faults are detected and mitigated, but not all	No Hazard (Part of the safety mechanism to address other malfunctions)
F24-3	Faults are intermittently detected, and mitigated on and off	No Hazard (Part of the safety mechanism to address other malfunctions)
F24-4	Fault is falsely detected, followed by a mitigation for a non-existent fault	No Hazard (Part of the safety mechanism to address other malfunctions)
F24-5	Mitigation is continuously provided, regardless of fault presence	No Hazard (Part of the safety mechanism to address other malfunctions)

Table C-25. Function 25: Electronically transmits steering system failures to driver using all or some of dashboard indicator, chimes, or similar (alerts)

<i>I.D.</i>	<i>Malfunction</i>	<i>Potential Vehicle Level Hazard</i>
F25-1	Failures not electronically transmitted	No Hazard (Failure of the driver warning strategy)
F25-2	More indicators are activated than intended	No Hazard (Failure of the driver warning strategy)
F25-3	Some steering system failures are not electronically transmitted	No Hazard (Failure of the driver warning strategy)
F25-4	Failures are transmitted intermittently	No Hazard (Failure of the driver warning strategy)
F25-5	Mechanical failures are transmitted when there are none in the steering system	No Hazard (Failure of the driver warning strategy)
F25-6	Warnings are continuously issued	No Hazard (Failure of the driver warning strategy)

Table C-26. Function 26: Locks the steering wheel when vehicle is off such that any steering inputs (torque or angle) are not transmitted to the road wheels

<i>I.D.</i>	<i>Malfunction</i>	<i>Potential Vehicle Level Hazard</i>
F26-1	Steering wheel is not locked when vehicle is off, steering wheel input is communicated to wheels	No Hazard
F26-2	Locks and unlocks the steering wheel while vehicle is off when it should lock only	No Hazard
F26-3	Unlocks steering wheel when vehicle is off	No Hazard
F26-4	Locks steering wheel when vehicle is not off	Unintended Vehicle Lateral Motion / Unintended Yaw Insufficient Vehicle Lateral Motion / Insufficient Yaw

Table C-27. Function 27: Unlocks the steering wheel for normal functions after the vehicle is accessed with the appropriate security device (e.g., key, biometrics)

<i>I.D.</i>	<i>Malfunction</i>	<i>Potential Vehicle Level Hazard</i>
F27-1	Steering wheel remains locked when accessed with security device.	Unintended Vehicle Lateral Motion / Unintended Yaw Insufficient Vehicle Lateral Motion / Insufficient Yaw
F27-2	Intermittently issues unlock command	No Hazard
F27-3	Locks steering wheel when accessed with security device	Unintended Vehicle Lateral Motion / Unintended Yaw Insufficient Vehicle Lateral Motion / Insufficient Yaw
F27-4	Steering wheel unlocks even when not accessed with security device	No Hazard

APPENDIX D: UNSAFE CONTROL ACTION (UCA) ASSESSMENT TABLES

Table D-1: UCA Assessment for the “Command Torque to Change Front Road Wheel Heading by Θ Degrees” Control Action D-2

Table D-2: UCA Assessment for the “Command the Rear Wheels to Turn In-Phase” Control Action D-9

Table D-3: UCA Assessment for the “Command Rear Wheels to Turn in Reverse-Phase” Control Action D-10

Table D-4: UCA Assessment for the “Command the Rear Wheels to Toe-In” Control Action..... D-11

Table D-5: UCA Assessment for the “Command Steering” Driver Control Action D-12

Table D-1: UCA Assessment for the “Command Torque to Change Front Road Wheel Heading by Θ Degrees” Control Action

Context Variables (Command Torque to Change Front Road Wheel Heading by Θ Degrees)			Guidewords for Assessing Whether the Control Action May Be Unsafe									
Driver's Steering Command	Other Vehicle Systems' Steering Command	Vehicle Speed	Not provided in this context	Provided in this context	Provided, but duration is too long	Provided, but duration is too short	Provided, but the intensity is incorrect (too much)	Provided, but the intensity is incorrect (too little)	Provided, but executed incorrectly	Provided, but the starting time is too soon	Provided, but the starting time is too late	
None	None	Below the speed threshold for Active Steering (the EPS adds torque)	No Hazard	H1, H3	Hazardous if provided	Hazardous if provided	Hazardous if provided	Hazardous if provided	Hazardous if provided	Hazardous if provided	Hazardous if provided	
None	In Θ Direction	Below the speed threshold for Active Steering (the EPS adds torque)	H2	No Hazard	H1, H3	H2	H1, H3	H2	H1, H2, H3	N/A*	H2	
None	In $-\Theta$ Direction	Below the speed threshold for Active Steering (the EPS adds torque)	No Hazard	H1, H3	Hazardous if provided	Hazardous if provided	Hazardous if provided	Hazardous if provided	Hazardous if provided	Hazardous if provided	Hazardous if provided	
None	In Both the Θ and $-\Theta$ Directions	Below the speed threshold for Active Steering (the EPS adds torque)	H2	H1, H3	Hazardous if provided	Hazardous if provided	Hazardous if provided	Hazardous if provided	Hazardous if provided	Hazardous if provided	Hazardous if provided	

Context Variables (Command Torque to Change Front Road Wheel Heading by Θ Degrees)			Guidewords for Assessing Whether the Control Action May Be Unsafe								
Driver's Steering Command	Other Vehicle Systems' Steering Command	Vehicle Speed	Not provided in this context	Provided in this context	Provided, but duration is too long	Provided, but duration is too short	Provided, but the intensity is incorrect (too much)	Provided, but the intensity is incorrect (too little)	Provided, but executed incorrectly	Provided, but the starting time is too soon	Provided, but the starting time is too late
In Θ Direction	None	Below the speed threshold for Active Steering (the EPS adds torque)	H2	No Hazard	H1, H3	H2	H1, H3	H2	H1, H2, H3	N/A*	H2
In Θ Direction	In Θ Direction	Below the speed threshold for Active Steering (the EPS adds torque)	H2	No Hazard	H1, H3	H2	H1, H3	H2	H1, H2, H3	N/A*	H2
In Θ Direction	In $-\Theta$ Direction	Below the speed threshold for Active Steering (the EPS adds torque)	H2	No Hazard	Hazardous if provided	Hazardous if provided	Hazardous if provided	Hazardous if provided	Hazardous if provided	Hazardous if provided	Hazardous if provided
In Θ Direction	In Both the Θ and $-\Theta$ Directions	Below the speed threshold for Active Steering (the EPS adds torque)	H2	H1, H2	Hazardous if provided	Hazardous if provided	Hazardous if provided	Hazardous if provided	Hazardous if provided	Hazardous if provided	Hazardous if provided
In $-\Theta$ Direction	None	Below the speed threshold for Active Steering (the EPS adds torque)	No Hazard	H1, H2, H3	Hazardous if provided	Hazardous if provided	Hazardous if provided	Hazardous if provided	Hazardous if provided	Hazardous if provided	Hazardous if provided

Context Variables (Command Torque to Change Front Road Wheel Heading by Θ Degrees)			Guidewords for Assessing Whether the Control Action May Be Unsafe								
Driver's Steering Command	Other Vehicle Systems' Steering Command	Vehicle Speed	Not provided in this context	Provided in this context	Provided, but duration is too long	Provided, but duration is too short	Provided, but the intensity is incorrect (too much)	Provided, but the intensity is incorrect (too little)	Provided, but executed incorrectly	Provided, but the starting time is too soon	Provided, but the starting time is too late
In $-\Theta$ Direction	In Θ Direction	Below the speed threshold for Active Steering (the EPS adds torque)	No Hazard	H1, H2, H3	Hazardous if provided	Hazardous if provided	Hazardous if provided	Hazardous if provided	Hazardous if provided	Hazardous if provided	Hazardous if provided
In $-\Theta$ Direction	In $-\Theta$ Direction	Below the speed threshold for Active Steering (the EPS adds torque)	No Hazard	H1, H2, H3	Hazardous if provided	Hazardous if provided	Hazardous if provided	Hazardous if provided	Hazardous if provided	Hazardous if provided	Hazardous if provided
In $-\Theta$ Direction	In Both the Θ and $-\Theta$ Directions	Below the speed threshold for Active Steering (the EPS adds torque)	H1, H2	H1, H2, H3	Hazardous if provided	Hazardous if provided	Hazardous if provided	Hazardous if provided	Hazardous if provided	Hazardous if provided	Hazardous if provided
None	None	Above the speed threshold for Active Steering (the EPS subtracts torque)	No Hazard	H1, H3	Hazardous if provided	Hazardous if provided	Hazardous if provided	Hazardous if provided	Hazardous if provided	Hazardous if provided	Hazardous if provided
None	In Θ Direction	Above the speed threshold for Active Steering (the EPS subtracts torque)	H2	No Hazard	H1, H3	H2	H1, H3	H2	H1, H2, H3	N/A*	H2

Context Variables (Command Torque to Change Front Road Wheel Heading by Θ Degrees)			Guidewords for Assessing Whether the Control Action May Be Unsafe								
Driver's Steering Command	Other Vehicle Systems' Steering Command	Vehicle Speed	Not provided in this context	Provided in this context	Provided, but duration is too long	Provided, but duration is too short	Provided, but the intensity is incorrect (too much)	Provided, but the intensity is incorrect (too little)	Provided, but executed incorrectly	Provided, but the starting time is too soon	Provided, but the starting time is too late
None	In $-\Theta$ Direction	Above the speed threshold for Active Steering (the EPS subtracts torque)	No Hazard	H1, H3	Hazardous if provided	Hazardous if provided	Hazardous if provided	Hazardous if provided	Hazardous if provided	Hazardous if provided	Hazardous if provided
None	In Both the Θ and $-\Theta$ Directions	Above the speed threshold for Active Steering (the EPS subtracts torque)	H2	H1, H3	Hazardous if provided	Hazardous if provided	Hazardous if provided	Hazardous if provided	Hazardous if provided	Hazardous if provided	Hazardous if provided
In Θ Direction	None	Above the speed threshold for Active Steering (the EPS subtracts torque)	No Hazard	H1, H3	Hazardous if provided	Hazardous if provided	Hazardous if provided	Hazardous if provided	Hazardous if provided	Hazardous if provided	Hazardous if provided
In Θ Direction	In Θ Direction	Above the speed threshold for Active Steering (the EPS subtracts torque)	H2	H1, H3	Hazardous if provided	Hazardous if provided	Hazardous if provided	Hazardous if provided	Hazardous if provided	Hazardous if provided	Hazardous if provided
In Θ Direction	In $-\Theta$ Direction	Above the speed threshold for Active Steering (the EPS subtracts torque)	No Hazard	H1, H3	Hazardous if provided	Hazardous if provided	Hazardous if provided	Hazardous if provided	Hazardous if provided	Hazardous if provided	Hazardous if provided

Context Variables (Command Torque to Change Front Road Wheel Heading by Θ Degrees)			Guidewords for Assessing Whether the Control Action May Be Unsafe								
Driver's Steering Command	Other Vehicle Systems' Steering Command	Vehicle Speed	Not provided in this context	Provided in this context	Provided, but duration is too long	Provided, but duration is too short	Provided, but the intensity is incorrect (too much)	Provided, but the intensity is incorrect (too little)	Provided, but executed incorrectly	Provided, but the starting time is too soon	Provided, but the starting time is too late
In Θ Direction	In Both the Θ and $-\Theta$ Directions	Above the speed threshold for Active Steering (the EPS subtracts torque)	H2	H1, H3	Hazardous if provided	Hazardous if provided	Hazardous if provided	Hazardous if provided	Hazardous if provided	Hazardous if provided	Hazardous if provided
In $-\Theta$ Direction	None	Above the speed threshold for Active Steering (the EPS subtracts torque)	H1, H3	No Hazard	H1, H3	H1, H3	H1, H2, H3	H1, H3	H1, H2, H3	N/A*	H1, H3
In $-\Theta$ Direction	In Θ Direction	Above the speed threshold for Active Steering (the EPS subtracts torque)	H1, H2, H3	H1, H3	Hazardous if provided	Hazardous if provided	Hazardous if provided	Hazardous if provided	Hazardous if provided	Hazardous if provided	Hazardous if provided
In $-\Theta$ Direction	In $-\Theta$ Direction	Above the speed threshold for Active Steering (the EPS subtracts torque)	H1, H3	H1, H3	Hazardous if provided	Hazardous if provided	Hazardous if provided	Hazardous if provided	Hazardous if provided	Hazardous if provided	Hazardous if provided
In $-\Theta$ Direction	In Both the Θ and $-\Theta$ Directions	Above the speed threshold for Active Steering (the EPS subtracts torque)	H1, H2, H3	H1, H2, H3	Hazardous if provided	Hazardous if provided	Hazardous if provided	Hazardous if provided	Hazardous if provided	Hazardous if provided	Hazardous if provided

Context Variables (Command Torque to Change Front Road Wheel Heading by Θ Degrees)			Guidewords for Assessing Whether the Control Action May Be Unsafe								
Driver's Steering Command	Other Vehicle Systems' Steering Command	Vehicle Speed	Not provided in this context	Provided in this context	Provided, but duration is too long	Provided, but duration is too short	Provided, but the intensity is incorrect (too much)	Provided, but the intensity is incorrect (too little)	Provided, but executed incorrectly	Provided, but the starting time is too soon	Provided, but the starting time is too late
None	None	At the speed threshold for Active Steering	No Hazard	H1, H3	Hazardous if provided	Hazardous if provided	Hazardous if provided	Hazardous if provided	Hazardous if provided	Hazardous if provided	Hazardous if provided
None	In Θ Direction	At the speed threshold for Active Steering	H2	No Hazard	H1, H3	H2	H1, H3	H2	H1, H2, H3	N/A*	H2
None	In $-\Theta$ Direction	At the speed threshold for Active Steering	No Hazard	H1, H3	Hazardous if provided	Hazardous if provided	Hazardous if provided	Hazardous if provided	Hazardous if provided	Hazardous if provided	Hazardous if provided
None	In Both the Θ and $-\Theta$ Directions	At the speed threshold for Active Steering	H2	H1, H3	Hazardous if provided	Hazardous if provided	Hazardous if provided	Hazardous if provided	Hazardous if provided	Hazardous if provided	Hazardous if provided
In Θ Direction	None	At the speed threshold for Active Steering	No Hazard	H1, H3	Hazardous if provided	Hazardous if provided	Hazardous if provided	Hazardous if provided	Hazardous if provided	Hazardous if provided	Hazardous if provided
In Θ Direction	In Θ Direction	At the speed threshold for Active Steering	H2	H1, H3	Hazardous if provided	Hazardous if provided	Hazardous if provided	Hazardous if provided	Hazardous if provided	Hazardous if provided	Hazardous if provided
In Θ Direction	In $-\Theta$ Direction	At the speed threshold for Active Steering	No Hazard	H1, H3	Hazardous if provided	Hazardous if provided	Hazardous if provided	Hazardous if provided	Hazardous if provided	Hazardous if provided	Hazardous if provided
In Θ Direction	In Both the Θ and $-\Theta$ Directions	At the speed threshold for Active Steering	H2	H1, H3	Hazardous if provided	Hazardous if provided	Hazardous if provided	Hazardous if provided	Hazardous if provided	Hazardous if provided	Hazardous if provided
In $-\Theta$ Direction	None	At the speed threshold for Active Steering	No Hazard	H1, H2, H3	Hazardous if provided	Hazardous if provided	Hazardous if provided	Hazardous if provided	Hazardous if provided	Hazardous if provided	Hazardous if provided

Context Variables (Command Torque to Change Front Road Wheel Heading by Θ Degrees)			Guidewords for Assessing Whether the Control Action May Be Unsafe								
Driver's Steering Command	Other Vehicle Systems' Steering Command	Vehicle Speed	Not provided in this context	Provided in this context	Provided, but duration is too long	Provided, but duration is too short	Provided, but the intensity is incorrect (too much)	Provided, but the intensity is incorrect (too little)	Provided, but executed incorrectly	Provided, but the starting time is too soon	Provided, but the starting time is too late
In $-\Theta$ Direction	In Θ Direction	At the speed threshold for Active Steering	No Hazard	H1, H2, H3	Hazardous if provided	Hazardous if provided	Hazardous if provided	Hazardous if provided	Hazardous if provided	Hazardous if provided	Hazardous if provided
In $-\Theta$ Direction	In $-\Theta$ Direction	At the speed threshold for Active Steering	No Hazard	H1, H2, H3	Hazardous if provided	Hazardous if provided	Hazardous if provided	Hazardous if provided	Hazardous if provided	Hazardous if provided	Hazardous if provided
In $-\Theta$ Direction	In Both the Θ and $-\Theta$ Directions	At the speed threshold for Active Steering	H1, H2	H1, H2, H3	Hazardous if provided	Hazardous if provided	Hazardous if provided	Hazardous if provided	Hazardous if provided	Hazardous if provided	Hazardous if provided
Vehicle Level Hazards: <ul style="list-style-type: none"> • H1: Unintended Vehicle Lateral Motion/Unintended Yaw • H2: Insufficient Vehicle Lateral Motion / Insufficient Yaw • H3: Loss of Steering Assist 											
*The steering system controller can't issue a command too soon (i.e., before the other vehicle system issues its request).											

Table D-2: UCA Assessment for the “Command the Rear Wheels to Turn In-Phase” Control Action

Context Variables (Command the Rear Wheels to Turn In-Phase)		Guidewords for Assessing Whether the Control Action May be Unsafe								
Steering Torque Commanded (from Driver or Other Vehicle Systems)	Vehicle Speed	Not provided in this context	Provided in this context	Provided, but duration is too long	Provided, but duration is too short	Provided, but the intensity is incorrect (too much)	Provided, but the intensity is incorrect (too little)	Provided, but executed incorrectly	Provided, but the starting time is too soon	Provided, but the starting time is too late
Yes	At or Above Threshold Value for Activating In-Phase Steering	No Hazard	No Hazard	H1, H3	No Hazard	H1, H3	No Hazard	H1, H3	H1, H3	No Hazard
Yes	Below Threshold Value for Activating In-Phase Steering	No Hazard	H2	Hazardous if provided	Hazardous if provided	Hazardous if provided	Hazardous if provided	Hazardous if provided	Hazardous if provided	Hazardous if provided
No	At or Above Threshold Value for Activating In-Phase Steering	No Hazard	H1, H3	Hazardous if provided	Hazardous if provided	Hazardous if provided	Hazardous if provided	Hazardous if provided	Hazardous if provided	Hazardous if provided
No	Below Threshold Value for Activating In-Phase Steering	No Hazard	H1, H3	Hazardous if provided	Hazardous if provided	Hazardous if provided	Hazardous if provided	Hazardous if provided	Hazardous if provided	Hazardous if provided

Vehicle Level Hazards:

- H1: Unintended Vehicle Lateral Motion/Unintended Yaw
- H2: Insufficient Vehicle Lateral Motion / Insufficient Yaw
- H3: Loss of Steering Assist

Table D-3: UCA Assessment for the “Command Rear Wheels to Turn in Reverse-Phase” Control Action

Context Variables (Command Rear Wheels to Turn in Reverse-Phase)		Guidewords for Assessing Whether the Control Action May be Unsafe								
Steering Torque Commanded (from Driver or Other Vehicle Systems)	Vehicle Speed	Not provided in this context	Provided in this context	Provided, but duration is too long	Provided, but duration is too short	Provided, but the intensity is incorrect (too much)	Provided, but the intensity is incorrect (too little)	Provided, but executed incorrectly	Provided, but the starting time is too soon	Provided, but the starting time is too late
Yes	Above Maximum Threshold Value for Activating Reverse-Phase Steering	No Hazard	H1, H3	Hazardous if provided	Hazardous if provided	Hazardous if provided	Hazardous if provided	Hazardous if provided	Hazardous if provided	Hazardous if provided
Yes	At or Below Maximum Threshold Value for Activating Reverse-Phase Steering	No Hazard	No Hazard	H1, H3	No Hazard	H1, H3	No Hazard	H1, H2, H3	No Hazard	H1, H3
No	Above Maximum Threshold Value for Activating Reverse-Phase Steering	No Hazard	H1, H3	Hazardous if provided	Hazardous if provided	Hazardous if provided	Hazardous if provided	Hazardous if provided	Hazardous if provided	Hazardous if provided
No	At or Below Maximum Threshold Value for Activating	No Hazard	H1, H3	Hazardous if provided	Hazardous if provided	Hazardous if provided	Hazardous if provided	Hazardous if provided	Hazardous if provided	Hazardous if provided

	Reverse-Phase Steering									
Vehicle Level Hazards: H1: Unintended Vehicle Lateral Motion/Unintended Yaw H2: Insufficient Vehicle Lateral Motion / Insufficient Yaw H3: Loss of Steering Assist										

Table D-4: UCA Assessment for the “Command the Rear Wheels to Toe-In” Control Action

Context Variables (Command the Rear Wheels to Toe-In)		Guidewords for Assessing Whether the Control Action May be Unsafe								
Steering Torque Commanded (from Driver or Other Vehicle Systems)	Brakes Applied	Not provided in this context	Provided in this context	Provided, but duration is too long	Provided, but duration is too short	Provided, but the intensity is incorrect (too much)	Provided, but the intensity is incorrect (too little)	Provided, but executed incorrectly	Provided, but the starting time is too soon	Provided, but the starting time is too late
Yes	Yes	No Hazard	H2	Hazardous if provided	Hazardous if provided	Hazardous if provided	Hazardous if provided	Hazardous if provided	Hazardous if provided	Hazardous if provided
Yes	No	No Hazard	H2	Hazardous if provided	Hazardous if provided	Hazardous if provided	Hazardous if provided	Hazardous if provided	Hazardous if provided	Hazardous if provided
No	Yes	No Hazard	No Hazard	No Hazard	No Hazard	No Hazard	No Hazard	H1, H2, H3	N/A	No Hazard
No	No	No Hazard	No Hazard	No Hazard	No Hazard	No Hazard	No Hazard	H1, H2, H3	N/A	No Hazard
Vehicle Level Hazards: H1: Unintended Vehicle Lateral Motion/Unintended Yaw H2: Insufficient Vehicle Lateral Motion / Insufficient Yaw H3: Loss of Steering Assist										

Table D-5: UCA Assessment for the “Command Steering” Driver Control Action

Context Variables (Command Steering)	Guidewords for Assessing Whether the Control Action May be Unsafe								
Is Steering Needed	Not provided in this context	Provided in this context	Provided, but duration is too long	Provided, but duration is too short	Provided, but the intensity is incorrect (too much)	Provided, but the intensity is incorrect (too little)	Provided, but executed incorrectly	Provided, but the starting time is too soon	Provided, but the starting time is too late
Yes	N/A ⁱ	No Hazard	H1	H2	H1	H2	H1, H2	N/A	H2
No	No Hazard	H1	Hazardous if provided	Hazardous if provided	Hazardous if provided	Hazardous if provided	Hazardous if provided	Hazardous if provided	Hazardous if provided
<p>ⁱ This analysis assumes a competent driver. It is expected that the driver will provide the required steering based on available cues.</p> <p>Vehicle Level Hazards: H1: Unintended Vehicle Lateral Motion/Unintended Yaw H2: Insufficient Vehicle Lateral Motion/Insufficient Yaw</p>									

APPENDIX E: STPA STEP 1: UCAS AND MAPPING TO HAZARDS

Table E-1: Unsafe Control Actions for the “Command Torque From the Power Assist Motor to Change the Front-Wheel Heading by Θ Degrees” Control Action.....E-2

Table E-2: Unsafe Control Actions for the “Command Torque From the Rear-Wheel Motors to Turn the Rear Wheels In-Phase” Control ActionE-9

Table E-3: Unsafe Control Actions for the “Command Torque From the Rear-Wheel Motors to Turn the Rear Wheels in Reverse-Phase” Control Action.....E-10

Table E-4: Unsafe Control Actions for the “Command Torque From the Rear-Wheel Motors to Toe-In the Rear Wheels” Control ActionE-11

Table E-5: Unsafe Control Actions for the “Rotate Steering Wheel” Control ActionE-12

1. Electric Power Steering Control Module UCAs

Table E- 1: Unsafe Control Actions for the “Command Torque From the Power Assist Motor to Change the Front-Wheel Heading by Θ Degrees” Control Action

Vehicle Level Hazard	Unsafe Control Actions (Command Torque From the Power Assist Motor to Change the Front-Wheel Heading by Θ Degrees)
H2	<p>The steering system control module does not command torque to change the front-wheel heading by Θ degrees when:</p> <ul style="list-style-type: none"> • the driver is not steering or is steering in the direction of Θ, and • other vehicle systems are requesting steering in the Θ direction or in both the Θ and $-\Theta$ direction.
H2	<p>The steering system control module does not command torque to change the front-wheel heading by Θ degrees when:</p> <ul style="list-style-type: none"> • the driver is steering in the direction of Θ, and • the vehicle speed is in the range where the EPS adds torque to the driver's input (e.g., enhanced response at low vehicle speeds).
H2	<p>The steering system control module does not command torque to change the front-wheel heading by Θ degrees when:</p> <ul style="list-style-type: none"> • the driver is steering in the $-\Theta$ direction, • other vehicle systems are requesting steering in the Θ direction or in both the Θ and $-\Theta$ direction, and • the vehicle speed is in the range where the EPS subtracts torque from the driver's input (e.g., stability at high vehicle speeds).
H1	<p>The steering system control module does not command torque to change the front-wheel heading by Θ degrees when:</p> <ul style="list-style-type: none"> • the driver is steering in the $-\Theta$ direction, and • the vehicle speed is in the range where the EPS subtracts torque from the driver's input (e.g., stability at high vehicle speeds).

**Vehicle
Level
Hazard**

Unsafe Control Actions

(Command Torque From the Power Assist Motor to Change the Front-Wheel Heading by Θ Degrees)

- H1, H2 The steering system control module does not command torque to change the front-wheel heading by Θ degrees when:
- the driver is steering is in the $-\Theta$ direction,
 - the other vehicle systems request steering in either the Θ direction or in both the Θ and $-\Theta$ directions, and
 - the vehicle speed is in the range where the EPS either adds torque to the driver's input (e.g., for enhanced turning at low speeds) or does not provide any adjustment to the driver's input (e.g., at the threshold speed).
- H2 The steering system control module commands torque to change the front-wheel heading by Θ degrees when:
- the driver's steering command is in the $-\Theta$ direction, and
 - the vehicle speed is in the range where the EPS either adds torque to the driver's input (e.g., enhanced turning at low speeds) or does not modify the driver's input (e.g., at the vehicle speed threshold).
- H1 The steering system control module commands torque to change the front-wheel heading by Θ degrees when:
- the driver is steering in the $-\Theta$ direction, and
 - other vehicle systems request steering in the Θ direction or in both the Θ and $-\Theta$ directions.
- H1 The steering system control module commands torque to change the front-wheel heading by Θ degrees when:
- the driver is steering in the $-\Theta$ direction, and
 - other vehicle systems are requesting steering in the $-\Theta$ direction or both the Θ and $-\Theta$ direction.
- H1 The steering system control module commands torque to change the front-wheel heading by Θ degrees when:
- the driver is not steering,
 - other vehicle systems are not requesting steering, are requesting steering in the $-\Theta$ direction, or are requesting steering in both the Θ and $-\Theta$ directions.

Vehicle Level Hazard	Unsafe Control Actions
	(Command Torque From the Power Assist Motor to Change the Front-Wheel Heading by Θ Degrees)

- | | |
|--------|--|
| H1 | <p>The steering system control module commands torque to change the front-wheel heading by Θ degrees when:</p> <ul style="list-style-type: none"> • the driver is steering in the Θ direction, and • the vehicle speed is in the range where the EPS subtracts torque or does nothing to the driver's input. |
| H1 | <p>The steering system control module commands torque to change the front-wheel heading by Θ degrees when:</p> <ul style="list-style-type: none"> • the driver is steering in the $-\Theta$ direction • other vehicle systems are not requesting steering, and • the vehicle speed is in the range where the EPS adds torque or does nothing to the driver's input. |
| H1, H2 | <p>The steering system control module commands torque to change the front-wheel heading by Θ degrees when:</p> <ul style="list-style-type: none"> • the driver's steering command is in the $-\Theta$ direction, • the other vehicle systems request steering in the Θ direction or request steering in both the Θ and $-\Theta$ directions, and • the vehicle speed is in the range where the EPS subtracts torque to the driver's input (e.g., stability at high speeds). |
| H1, H2 | <p>The steering system control module commands torque to change the front-wheel heading by Θ degrees when:</p> <ul style="list-style-type: none"> • the driver's steering command is in the Θ direction, • the other vehicle systems request steering in the $-\Theta$ direction or request steering in both the Θ and $-\Theta$ directions, and • the vehicle speed is in the range where the EPS adds torque to the driver's input (e.g., improved handling at low speeds). |
| H1 | <p>The steering system control module commands torque to change the front-wheel heading by Θ degrees when:</p> <ul style="list-style-type: none"> • the driver is not issuing a steering command, and • other vehicle systems request steering in the Θ direction, <p>but the steering heading is adjusted for too long (i.e., the heading changes by more than Θ degrees).</p> |

**Vehicle
Level
Hazard**

Unsafe Control Actions

(Command Torque From the Power Assist Motor to Change the Front-Wheel Heading by Θ Degrees)

- H1 The steering system control module commands torque to change the front-wheel heading by Θ degrees when:
- the driver is steering in the $-\Theta$ direction,
 - other vehicle systems are not requesting a steering adjustment, and
 - the vehicle speed is in the range where the EPS subtracts torque from the driver's input (e.g., stability at high speeds),
- but the steering heading is adjusted for too long (i.e., the heading changes by more than Θ degrees).
- H1 The steering system control module commands torque to change the front-wheel heading by Θ degrees when:
- the driver is steering in the Θ direction,
 - other vehicle systems are not requesting a steering adjustment or are requesting a steering adjustment in the Θ direction, and
 - the vehicle speed is in the range where the EPS adds torque from the driver's input (e.g., improved handling at low speeds),
- but the steering heading is adjusted for too long (i.e., the heading changes by more than Θ degrees).
- H2 The steering system control module commands torque to change the front-wheel heading by Θ degrees when:
- the driver is not issuing a steering command, and
 - other vehicle systems request steering in the Θ direction,
- but the steering heading is adjusted for too short (i.e., the active steering stops subtracting torque from the driver's input).
- H2 The steering system control module commands torque to change the front-wheel heading by Θ degrees when:
- the driver is steering in the Θ direction,
 - other vehicle systems are not requesting a steering adjustment or are requesting a steering adjustment in the Θ direction, and
 - the vehicle speed is in the range where the EPS adds torque from the driver's input (e.g., improved handling at low speeds),
- but the steering heading is adjusted for too short (i.e., the active steering stops subtracting torque from the driver's input).
- H1 The steering system control module commands torque to change the front-wheel heading by Θ degrees when:
- the driver is steering in the $-\Theta$ direction,
 - other vehicle systems are not requesting a steering adjustment, and
 - the vehicle speed is in the range where the EPS subtracts torque from the driver's input (e.g., stability at high speeds),
- but the steering heading is adjusted for too short (i.e., the active steering stops subtracting torque from the driver's input).

**Vehicle
Level
Hazard**

Unsafe Control Actions

**(Command Torque From the Power Assist Motor to Change the Front-Wheel
Heading by Θ Degrees)**

- H1 The steering system control module commands torque to change the front-wheel heading by Θ degrees when:
- the driver is steering in the $-\Theta$ direction,
 - other vehicle systems are not requesting a steering adjustment, and
 - the vehicle speed is in the range where the EPS subtracts torque from the driver's input (e.g., stability at high speeds),
- but the steering heading is adjusted by too much (e.g., the steering system subtracts more torque than the driver's steering input).
- H1 The steering system control module commands torque to change the front-wheel heading by Θ degrees when:
- the driver is not issuing a steering command, and
 - other vehicle systems request steering in the Θ direction,
- but the steering heading is adjusted by too much (e.g., the heading changes too fast or by more than Θ degrees).
- H1 The steering system control module commands torque to change the front-wheel heading by Θ degrees when:
- the driver is steering in the Θ direction,
 - other vehicle systems are not requesting a steering adjustment or are requesting a steering adjustment in the Θ direction, and
 - the vehicle speed is in the range where the EPS adds torque from the driver's input (e.g., improved handling at low speeds),
- but the steering heading is adjusted by too much (e.g., the heading changes too fast or by more than Θ degrees).
- H2 The steering system control module commands torque to change the front-wheel heading by Θ degrees when:
- the driver is steering in the $-\Theta$ direction,
 - other vehicle systems are not requesting a steering adjustment, and
 - the vehicle speed is in the range where the EPS subtracts torque from the driver's input (e.g., stability at high speeds),
- but the steering heading is adjusted by too much (e.g., the steering system subtracts too much torque, but the vehicle still moves in the direction commanded by the driver).

**Vehicle
Level
Hazard**

Unsafe Control Actions

**(Command Torque From the Power Assist Motor to Change the Front-Wheel
Heading by Θ Degrees)**

- H2 The steering system control module commands torque to change the front-wheel heading by Θ degrees when:
- the driver is not issuing a steering command, and
 - other vehicle systems request steering in the Θ direction,
- but the steering heading is adjusted by too little (e.g., the heading changes at too slow a rate or by less than Θ degrees).
- H2 The steering system control module commands torque to change the front-wheel heading by Θ degrees when:
- the driver is steering in the Θ direction,
 - other vehicle systems are not requesting a steering adjustment or are requesting a steering adjustment in the Θ direction, and
 - the vehicle speed is in the range where the EPS adds torque from the driver's input (e.g., improved handling at low speeds),
- but the steering heading is adjusted by too little (e.g., the heading changes at too slow a rate or by less than Θ degrees).
- H1 The steering system control module commands torque to change the front-wheel heading by Θ degrees when:
- the driver is steering in the $-\Theta$ direction,
 - other vehicle systems are not requesting a steering adjustment, and
 - the vehicle speed is in the range where the EPS subtracts torque from the driver's input (e.g., stability at high speeds),
- but the steering heading is adjusted by too little (e.g., too little torque is subtracted from the driver's input).
- H1, H2, The steering system control module correctly issues the command for torque to change the front-wheel heading by Θ degrees, but the command is executed incorrectly.
- H2 The steering system control module commands torque to change the front-wheel heading by Θ degrees when:
- the driver is not issuing a steering command, and
 - other vehicle systems request steering in the Θ direction,
- but the steering heading is adjusted too late.

Vehicle Level Hazard **Unsafe Control Actions**
(Command Torque From the Power Assist Motor to Change the Front-Wheel Heading by Θ Degrees)

- H2 The steering system control module commands torque to change the front-wheel heading by Θ degrees when:
- the driver is steering in the Θ direction,
 - other vehicle systems are not requesting a steering adjustment or are requesting a steering adjustment in the Θ direction, and
 - the vehicle speed is in the range where the EPS adds torque from the driver's input (e.g., improved handling at low speeds),
- but the steering heading is adjusted too late.
- H1 The steering system control module commands torque to change the front-wheel heading by Θ degrees when:
- the driver is steering in the $-\Theta$ direction,
 - other vehicle systems are not requesting a steering adjustment, and
 - the vehicle speed is in the range where the EPS subtracts torque from the driver's input (e.g., stability at high speeds),
- but the steering heading is adjusted too late.

H1: Unintended Vehicle Lateral Motion / Unintended Yaw

H2: Insufficient Vehicle Lateral Motion / Insufficient Yaw

(In some designs, the EPS may either add or subtract torque from the driver's input as a function of vehicle speed)

Table E-2: Unsafe Control Actions for the “Command Torque From the Rear-Wheel Motors to Turn the Rear Wheels In-Phase” Control Action

Vehicle Level Hazard	Unsafe Control Actions (Command Torque From the Rear-Wheel Motors to Turn the Rear Wheels In-Phase)
H2	<p>The steering system control module commands the rear wheels to turn in-phase when:</p> <ul style="list-style-type: none"> • steering is commanded by the driver or other vehicle systems, and • the vehicle speed is below the threshold for activating in-phase steering.
H1	<p>The steering system control module commands the rear wheels to turn in-phase when:</p> <ul style="list-style-type: none"> • steering is not commanded by the driver or other vehicle systems.
H1	<p>The steering system control module commands the rear wheels to turn in-phase when:</p> <ul style="list-style-type: none"> • steering is commanded by the driver or other vehicle systems, and • the vehicle speed is at or above the threshold for activating in-phase steering, <p>but the rear wheels heading is adjusted for too long a period (e.g., after the driver has stopped turning).</p>
H1	<p>The steering system control module commands the rear wheels to turn in-phase when:</p> <ul style="list-style-type: none"> • steering is commanded by the driver or other vehicle systems, and • the vehicle speed is at or above the threshold for activating in-phase steering, <p>but the rear wheels heading is changed by too much.</p>
H1	<p>The steering system control module correctly commands the rear wheels to turn in-phase, but the command is executed incorrectly.</p>
H1	<p>The steering system control module commands the rear wheels to turn in-phase when:</p> <ul style="list-style-type: none"> • steering is commanded by the driver or other vehicle systems, and • the vehicle speed is at or above the threshold for activating in-phase steering, <p>but the command is provided too soon.</p>

H1: Unintended Vehicle Lateral Motion / Unintended Yaw

H2: Insufficient Vehicle Lateral Motion / Insufficient Yaw

Table E-3: Unsafe Control Actions for the “Command Torque From the Rear-Wheel Motors to Turn the Rear Wheels in Reverse-Phase” Control Action

Vehicle Level Hazard	Unsafe Control Actions (Command Torque From the Rear-Wheel Motors to Turn the Rear Wheels in Reverse-Phase)
H1	<p>The steering system control module commands the rear wheels to turn in reverse-phase when:</p> <ul style="list-style-type: none"> • steering is commanded by the driver or other vehicle systems, and • the vehicle speed is above the maximum speed value for activating reverse-phase steering.
H1	<p>The steering system control module commands the rear wheels to turn in reverse-phase when:</p> <ul style="list-style-type: none"> • steering is not commanded by the driver or other vehicle systems.
H1	<p>The steering system control module commands the rear wheels to turn in reverse-phase when:</p> <ul style="list-style-type: none"> • steering is commanded by the driver or other vehicle systems, and • the vehicle speed is at or below the maximum speed value for activating reverse-phase steering, <p>but the rear wheel heading is adjusted for too long of a period (e.g., the wheels remain turned after the steering command stops).</p>
H1	<p>The steering system control module commands the rear wheels to turn in reverse-phase when:</p> <ul style="list-style-type: none"> • steering is commanded by the driver or other vehicle systems, and • the vehicle speed is at or below the maximum speed value for activating reverse-phase steering, <p>but the rear wheel heading is adjusted by too much.</p>
H1, H2	<p>The steering system control module correctly commands the rear wheels to turn in reverse-phase, but the command is executed incorrectly.</p>

Vehicle Level Hazard	Unsafe Control Actions
	(Command Torque From the Rear-Wheel Motors to Turn the Rear Wheels in Reverse-Phase)

H1 The steering system control module commands the rear wheels to turn in reverse-phase when:

- steering is commanded by the driver or other vehicle systems, and
- the vehicle speed is at or below the maximum speed value for activating reverse-phase steering,

but the command is issued too late (e.g., the rear wheels turn after the steering command stops).

H1: Unintended Vehicle Lateral Motion / Unintended Yaw

H2: Insufficient Vehicle Lateral Motion / Insufficient Yaw

Table E- 4: Unsafe Control Actions for the “Command Torque From the Rear-Wheel Motors to Toe-In the Rear Wheels” Control Action

Vehicle Level Hazard	Unsafe Control Actions
	(Command Torque From the Rear-Wheel Motors to Toe-In the Rear Wheels)

H2 The steering system control module commands the rear wheels to toe-in when:

- the steering is commanded by the driver or other vehicle systems.

H1, H2 The steering system control module correctly commands the rear wheels to toe-in, but the command is executed incorrectly.

H1: Unintended Vehicle Lateral Motion / Unintended Yaw

H2: Insufficient Vehicle Lateral Motion / Insufficient Yaw

2. Driver UCAs

Table E- 5: Unsafe Control Actions for the “Rotate Steering Wheel” Control Action

	Vehicle Level Hazard	Unsafe Control Actions (Rotate Steering Wheel)
H1	The driver commands steering when: <ul style="list-style-type: none">• a steering adjustment is not needed.	
H1	The driver commands steering when: <ul style="list-style-type: none">• a steering adjustment is needed, but too much steering is commanded.	
H2	The driver commands steering when: <ul style="list-style-type: none">• a steering adjustment is needed, but too little steering is commanded.	
H1, H2	The driver correctly commands steering, but the command is executed incorrectly.	
H1	The driver commands steering when: <ul style="list-style-type: none">• a steering adjustment is needed, but the duration is too long.	
H2	The driver commands steering when: <ul style="list-style-type: none">• a steering adjustment is needed, but the duration is too short.	
H2	The driver commands steering when: <ul style="list-style-type: none">• the lateral automation system is disabled, and• a steering adjustment is needed, but the steering command is provided too late.	

H1: Unintended Vehicle Lateral Motion / Unintended Yaw

H2: Insufficient Vehicle Lateral Motion / Insufficient Yaw

APPENDIX F: OPERATIONAL SITUATIONS

1. Vehicle in a parking lot or drive way and starting to move; good visibility with light pedestrian traffic.
2. Vehicle in a parking lot or drive way and starting to move; low visibility with light pedestrian traffic.
3. Vehicle in a parking lot or drive way and starting to move; good visibility with high pedestrian traffic (mall, supermarket).
4. Vehicle in a parking lot or drive way and starting to move; low visibility with high pedestrian traffic (mall, supermarket).
5. Vehicle going in reverse from a stopped condition at (relatively) low speed; low/good visibility; other vehicles present (stopped or moving at low speed); slippery/good road conditions; pedestrians present.
6. Driving inside the city with light/heavy traffic and pedestrians presence, stop and go driving, good visibility, good road conditions.
7. Driving inside the city with light/ heavy traffic and pedestrians presence, stop and go driving, low visibility, slippery road conditions.
8. Driving inside the city with light/heavy traffic and negligible pedestrian presence, stop and go driving, good visibility, and good road conditions.
9. Driving inside the city with light/ heavy traffic and negligible pedestrian presence, stop and go driving, bad visibility, and slippery road conditions.
10. Driving inside (≤ 40 kph) the city with heavy traffic and negligible pedestrian presence, good visibility, and good road conditions.
11. Driving inside the city (≤ 40 kph) with heavy traffic and negligible pedestrian presence, bad visibility, and slippery road conditions.
12. Driving at medium speed ($40 \text{ kph} \leq V < 100 \text{ kph}$), country road, heavy traffic, good visibility, and good road conditions.
13. Driving at medium speed ($40 \text{ kph} \leq V < 100 \text{ kph}$), country road, light traffic, good visibility, and good road conditions.
14. Driving at medium speed ($40 \text{ kph} \leq V < 100 \text{ kph}$), country road, heavy traffic, low visibility, and slippery road conditions.
15. Driving at medium speed ($40 \text{ kph} \leq V < 100 \text{ kph}$), country road, light traffic, low visibility, and slippery road conditions.
16. Driving at medium speed ($40 \text{ kph} \leq V < 100 \text{ kph}$), exiting or entering a ramp, light/heavy traffic, good/low visibility, and good/slippery road conditions.
17. Driving at high speed ($100 \text{ kph} \leq V < 130 \text{ kph}$), heavy traffic, good visibility, and good road conditions.
18. Driving at high speed ($100 \text{ kph} \leq V < 130 \text{ kph}$), light traffic, good visibility, and good road conditions.

19. Driving at high speed ($100 \text{ kph} \leq V < 130 \text{ kph}$), heavy traffic, low visibility, and slippery road conditions.
20. Driving at high speed ($100 \text{ kph} \leq V < 130 \text{ kph}$), country road, light traffic, low visibility, and slippery road conditions.
21. Driving at very high speed ($V \geq 130 \text{ kph}$), heavy traffic, good visibility, and good road conditions.
22. Driving at very high speed ($V \geq 130 \text{ kph}$), light traffic, good visibility, and good road conditions.
23. Driving at very high speed ($V \geq 130 \text{ kph}$), heavy traffic, low visibility, and slippery road conditions.
24. Driving at very high speed ($V \geq 130 \text{ kph}$), light traffic, low visibility, and slippery road conditions.
25. Vehicle in a parking lot or drive way and starting to move; good visibility with light/heavy pedestrian traffic.
26. Vehicle is disabled; a person is attempting to replace a tire or is partially under the vehicle.

APPENDIX G: ASIL ASSESSMENT

Table G-1: Unintended Vehicle Lateral Motion / Unintended Yaw..... G-2
Table G-2: Insufficient Vehicle Lateral Motion / Insufficient Yaw G-7
Table G-3: Loss of Steering Assist..... G-11
Table G-4: Reduced Responsiveness to the Driver’s Commands Due to Increased Rear
Wheel Drag G-15
Table G-5: Potential Exposure of a Person Performing Vehicle Maintenance to Moving EPS
Components When the Ignition Is in the Off Position..... G-20

Table G-1: Unintended Vehicle Lateral Motion / Unintended Yaw

Assumptions	Operating Scenario Description	Potential Crash Scenario	ASIL Assessment (Unintended Vehicle Lateral Motion / Unintended Yaw)			ASIL
			Exposure	Severity	Controllability	
The vehicle moves laterally more than, at a faster rate than, or in the opposite direction of what is commanded; potential loss of steering.	Vehicle in a parking lot or drive way and starting to move; good visibility with light pedestrian traffic.	The vehicle runs into a pedestrian at low speed.	E4	S2	C1	A
	Vehicle in a parking lot or drive way and starting to move; low visibility with light pedestrian traffic.	The vehicle runs into a pedestrian at low speed.	E3	S2	C1	QM
	Vehicle in a parking lot or drive way and starting to move; good visibility with high pedestrian traffic (mall, supermarket)	The vehicle runs into a pedestrian; potential for running over the pedestrian also exists.	E3	S3	C1	A
	Vehicle in a parking lot or drive way and starting to move; low visibility with high pedestrian traffic (mall, supermarket)	The vehicle runs into a pedestrian; potential for running over the pedestrian also exists.	E2	S3	C1	QM
	Vehicle going in reverse from a stopped condition at (relatively) low speed; low/good visibility; other vehicles present (stopped	The vehicle runs into a pedestrian; potential for running over the	E2	S3	C1	QM

	or moving at low speed); slippery/good road conditions; pedestrians present.	pedestrian also exists.				
	Driving inside the city with light/heavy traffic and pedestrians presence, stop and go driving, good visibility, good road conditions.	The vehicle runs into another vehicle or a pedestrian; potential for running over the pedestrian also exists.	E3	S3	C2	B
	Driving inside the city with light/ heavy traffic and pedestrians presence, stop and go driving, low visibility, slippery road conditions.	The vehicle runs into another vehicle or a pedestrian; potential for running over the pedestrian also exists.	E2	S3	C2	A
	Driving inside the city with light/heavy traffic and negligible pedestrian presence, stop and go driving, good visibility, and good road conditions.	The vehicle runs into another vehicle.	E4	S1	C2	A
	Driving inside the city with light/ heavy traffic and negligible pedestrian presence, stop and go driving, bad visibility, and slippery road conditions.	The vehicle runs into another vehicle.	E3	S1	C2	QM
	Driving inside (< 40 kph) the city with heavy traffic and negligible pedestrian presence,	The vehicle runs into another vehicle or barrier.	E4	S1	C2	A

	good visibility, and good road conditions.					
	Driving inside the city (< 40 kph) with heavy traffic and negligible pedestrian presence, bad visibility, and slippery road conditions.	The vehicle runs into another vehicle or barrier.	E3	S1	C2	QM
	Driving at medium speed (40 kph < V < 100 kph), country road, heavy traffic, good visibility, and good road conditions.	The vehicle runs into another vehicle or barrier.	E4	S3	C2	C
	Driving at medium speed (40 kph < V < 100 kph), country road, light traffic, good visibility, and good road conditions.	The vehicle runs into another vehicle or barrier.	E4	S3	C2	C
	Driving at medium speed (40 kph < V < 100 kph), country road, heavy traffic, low visibility, and slippery road conditions.	The vehicle runs into another vehicle or barrier.	E3	S3	C2	B
	Driving at medium speed (40 kph < V < 100 kph), country road, light traffic, low visibility, and slippery road conditions.	The vehicle runs into another vehicle or barrier.	E3	S3	C2	B
	Driving at medium speed (40 kph < V < 100 kph), exiting or entering a ramp, light/heavy traffic, good/low visibility, and good/slippery road conditions.	The vehicle runs into another vehicle or barrier.	E2	S3	C3	B

	Driving at high speed (100 kph < V < 130 kph), heavy traffic, good visibility, and good road conditions.	Vehicle rollover resulting from too large of a yaw rate, particularly during evasive maneuvers is a special case of this hazard.	E4	S3	C3	D
	Driving at high speed (100 kph < V < 130 kph), light traffic, good visibility, and good road conditions.	Vehicle rollover resulting from too large of a yaw rate, particularly during evasive maneuvers is a special case of this hazard.	E4	S3	C3	D
	Driving at high speed (100 kph < V < 130 kph), heavy traffic, low visibility, and slippery road conditions.	Vehicle rollover resulting from too large of a yaw rate, particularly during evasive maneuvers is a special case of this hazard.	E3	S3	C3	C
	Driving at high speed (100 kph < V < 130 kph), country road, light traffic, low visibility, and slippery road conditions.	Vehicle rollover resulting from too large of a yaw rate, particularly during evasive maneuvers is a special case of this hazard.	E3	S3	C3	C
	Driving at very high speed (V > 130 kph), heavy traffic, good visibility, and good road conditions.	Vehicle rollover resulting from too large of a yaw rate, particularly during evasive maneuvers	E3	S3	C3	C

		is a special case of this hazard.				
	Driving at very high speed ($V > 130$ kph), light traffic, good visibility, and good road conditions.	Vehicle rollover resulting from too large of a yaw rate, particularly during evasive maneuvers is a special case of this hazard.	E3	S3	C3	C
	Driving at very high speed ($V > 130$ kph), heavy traffic, low visibility, and slippery road conditions.	Vehicle rollover resulting from too large of a yaw rate, particularly during evasive maneuvers is a special case of this hazard.	E2	S3	C3	B
	Driving at very high speed ($V > 130$ kph), light traffic, low visibility, and slippery road conditions.	Vehicle rollover resulting from too large of a yaw rate, particularly during evasive maneuvers is a special case of this hazard.	E2	S3	C3	B

Table G-2: Insufficient Vehicle Lateral Motion / Insufficient Yaw

Assumptions	Operating Scenario Description	Potential Accident Scenario	ASIL Assessment (Insufficient Vehicle Lateral Motion / Insufficient Yaw)			ASIL
			Exposure	Severity	Controllability	
The vehicle moves laterally, but less than or at a slower rate than what is commanded by the driver	Vehicle in a parking lot or drive way and starting to move; good visibility with light/heavy pedestrian traffic.	The vehicle runs into a pedestrian at low speed.	E3	S3	C1	A
	Vehicle in a parking lot or drive way and starting to move; low visibility with light pedestrian traffic.	The vehicle runs into a pedestrian at low speed.	E3	S2	C1	QM
	Vehicle in a parking lot or drive way and starting to move; good visibility with high pedestrian traffic (mall, supermarket)	The vehicle runs into a pedestrian; potential for running over the pedestrian also exists.	E3	S3	C1	A
	Vehicle in a parking lot or drive way and starting to move; low visibility with high pedestrian traffic (mall, supermarket)	The vehicle runs into a pedestrian; potential for running over the pedestrian also exists.	E2	S3	C1	QM
	Vehicle going in reverse from a stopped condition at (relatively) low speed; low/good visibility; other vehicles present (stopped or moving at low speed); slippery/good road conditions; pedestrians present.	The vehicle runs into a pedestrian; potential for running over the pedestrian also exists.	E2	S3	C1	QM

Assumptions	Operating Scenario Description	Potential Accident Scenario	ASIL Assessment (Insufficient Vehicle Lateral Motion / Insufficient Yaw)			ASIL
			Exposure	Severity	Controllability	
	Driving inside the city with light/heavy traffic and pedestrians presence, stop and go driving, good visibility, good road conditions.	The vehicle runs into another vehicle or a pedestrian; potential for running over the pedestrian also exists.	E3	S3	C2	B
	Driving inside the city with light/ heavy traffic and pedestrian presence, stop and go driving, low visibility, slippery road conditions.	The vehicle runs into another vehicle or a pedestrian; potential for running over the pedestrian also exists.	E2	S3	C2	A
	Driving inside the city with light/heavy traffic and negligible pedestrian presence, stop and go driving, good visibility, and good road conditions.	The vehicle runs into another vehicle.	E4	S1	C2	A
	Driving inside the city with light/ heavy traffic and negligible pedestrian presence, stop and go driving, bad visibility, and slippery road conditions.	The vehicle runs into another vehicle.	E3	S1	C2	QM

Assumptions	Operating Scenario Description	Potential Accident Scenario	ASIL Assessment (Insufficient Vehicle Lateral Motion / Insufficient Yaw)			ASIL
			Exposure	Severity	Controllability	
	Driving at medium speed (40 kph < V < 100 kph), country road, heavy traffic, good visibility, and good road conditions.	The vehicle runs into another vehicle or an object on the roadway.	E4	S3	C2	C
	Driving at medium speed (40 kph < V < 100 kph), country road, light traffic, good visibility, and good road conditions.	The vehicle runs into another vehicle or an object on the roadway.	E4	S3	C2	C
	Driving at medium speed (40 kph < V < 100 kph), country road, heavy traffic, low visibility, and slippery road conditions.	The vehicle runs into another vehicle or an object on the roadway.	E3	S3	C2	B
	Driving at medium speed (40 kph < V < 100 kph), country road, light traffic, low visibility, and slippery road conditions.	The vehicle runs into another vehicle or an object on the roadway.	E3	S3	C2	B
	Driving at medium speed (40 kph < V < 100 kph), exiting or entering a ramp, light/heavy traffic, good/low visibility, and good/slippery road conditions.	The vehicle runs into another vehicle or an object on the roadway.	E2	S3	C3	B
	Driving at high speed (100 kph < V < 130 kph), heavy traffic, good visibility, and good road conditions.	The vehicle runs into another vehicle or an object on the roadway.	E4	S3	C2	C

Assumptions	Operating Scenario Description	Potential Accident Scenario	ASIL Assessment (Insufficient Vehicle Lateral Motion / Insufficient Yaw)			ASIL
			Exposure	Severity	Controllability	
	Driving at high speed (100 kph < V < 130 kph), light traffic, good visibility, and good road conditions.	The vehicle runs into another vehicle or an object on the roadway.	E4	S3	C2	C
	Driving at high speed (100 kph < V < 130 kph), heavy traffic, low visibility, and slippery road conditions.	The vehicle runs into another vehicle or an object on the roadway.	E3	S3	C2	B
	Driving at high speed (100 kph < V < 130 kph), country road, light traffic, low visibility, and slippery road conditions.	The vehicle runs into another vehicle or an object on the roadway.	E3	S3	C2	B
	Driving at very high speed (V > 130 kph), heavy traffic, good visibility, and good road conditions.	The vehicle runs into another vehicle or an object on the roadway.	E3	S3	C3	C
	Driving at very high speed (V > 130 kph), light traffic, good visibility, and good road conditions.	The vehicle runs into another vehicle or an object on the roadway.	E3	S3	C3	C
	Driving at very high speed (V > 130 kph), heavy traffic, low visibility, and slippery road conditions.	The vehicle runs into another vehicle or an object on the roadway.	E2	S3	C3	B
	Driving at very high speed (V > 130 kph), light traffic, low visibility, and slippery road conditions.	The vehicle runs into another vehicle or an object on the roadway.	E2	S3	C3	B

Table G-3: Loss of Steering Assist

Assumptions	Operating Scenario Description	Potential Accident Scenario	ASIL Assessment (Loss of Steering Assist)			ASIL
			Exposure	Severity	Controllability	
The Electric Power Assist system becomes unavailable. However, mechanical steering is still available.	Vehicle in a parking lot or drive way and starting to move; good visibility with light pedestrian traffic.	The vehicle runs into a pedestrian at low speed; potential for running over the pedestrian also exists.	E4	S2	C1	A
	Vehicle in a parking lot or drive way and starting to move; low visibility with light pedestrian traffic.	The vehicle runs into a pedestrian at low speed; potential for running over the pedestrian also exists.	E3	S2	C1	QM
	Vehicle in a parking lot or drive way and starting to move; good visibility with high pedestrian traffic (mall, supermarket)	The vehicle runs into a pedestrian; potential for running over the pedestrian also exists.	E3	S3	C1	A
	Vehicle in a parking lot or drive way and starting to move; low visibility with high pedestrian traffic (mall, supermarket)	The vehicle runs into a pedestrian; potential for running over the pedestrian also exists.	E2	S3	C1	QM

Assumptions	Operating Scenario Description	Potential Accident Scenario	ASIL Assessment (Loss of Steering Assist)			ASIL
			Exposure	Severity	Controllability	
	Vehicle going in reverse from a stopped condition at (relatively) low speed; low/good visibility; other vehicles present (stopped or moving at low speed); slippery/good road conditions; pedestrians present.	The vehicle runs into a pedestrian; potential for running over the pedestrian also exists.	E2	S3	C1	QM
	Driving inside the city with light/heavy traffic and pedestrian presence, stop and go driving, good visibility, and good road conditions.	The vehicle runs into another vehicle or pedestrian; potential for running over the pedestrian also exists.	E3	S3	C1	A
	Driving inside the city with light/ heavy traffic and pedestrian presence, stop and go driving, low visibility, slippery road conditions.	The vehicle runs into another vehicle or pedestrian; potential for running over the pedestrian also exists.	E2	S3	C2	QM
	Driving inside the city with light/heavy traffic and negligible pedestrian presence, stop and go driving, good visibility, and good road conditions.	The vehicle runs into another vehicle or barrier.	E4	S1	C1	QM

Assumptions	Operating Scenario Description	Potential Accident Scenario	ASIL Assessment (Loss of Steering Assist)			ASIL
			Exposure	Severity	Controllability	
	Driving inside the city with light/ heavy traffic and negligible pedestrian presence, stop and go driving, bad visibility, and slippery road conditions.	The vehicle runs into another vehicle or barrier.	E3	S1	C1	QM
	Driving at medium speed (40 kph < V < 100 kph), country road, heavy traffic, good visibility, and good road conditions.	The vehicle runs into another vehicle or barrier.	E4	S3	C1	B
	Driving at medium speed (40 kph < V < 100 kph), country road, light traffic, good visibility, and good road conditions.	The vehicle runs into another vehicle or barrier.	E4	S3	C1	B
	Driving at medium speed (40 kph < V < 100 kph), country road, heavy traffic, low visibility, and slippery road conditions.	The vehicle runs into another vehicle or barrier.	E3	S3	C1	A
	Driving at medium speed (40 kph < V < 100 kph), country road, light traffic, low visibility, and slippery road conditions.	The vehicle runs into another vehicle or barrier.	E3	S3	C1	A

Assumptions	Operating Scenario Description	Potential Accident Scenario	ASIL Assessment (Loss of Steering Assist)			ASIL
			Exposure	Severity	Controllability	
	Driving at medium speed (40 kph < V < 100 kph), exiting or entering a ramp, light/heavy traffic, good/low visibility, and good/slippery road conditions.	The vehicle runs into another vehicle or barrier.	E2	S3	C2	A
	Driving at high speed (100 kph < V < 130 kph), heavy traffic, good visibility, and good road conditions.	The vehicle runs into another vehicle or barrier.	E4	S3	C1	B
	Driving at high speed (100 kph < V < 130 kph), light traffic, good visibility, and good road conditions.	The vehicle runs into another vehicle or barrier.	E4	S3	C1	B
	Driving at high speed (100 kph < V < 130 kph), heavy traffic, low visibility, and slippery road conditions.	The vehicle runs into another vehicle or barrier.	E3	S3	C1	A
	Driving at high speed (100 kph < V < 130 kph), country road, light traffic, low visibility, and slippery road conditions.	The vehicle runs into another vehicle or barrier.	E3	S3	C1	A
	Driving at very high speed (V > 130 kph), heavy traffic, good visibility, and good road conditions.	The vehicle runs into another vehicle or barrier.	E3	S3	C1	A
	Driving at very high speed (V > 130 kph), light traffic, good visibility, and good road conditions.	The vehicle runs into another vehicle or barrier.	E3	S3	C1	A

Assumptions	Operating Scenario Description	Potential Accident Scenario	ASIL Assessment (Loss of Steering Assist)			ASIL
			Exposure	Severity	Controllability	
	Driving at very high speed ($V > 130$ kph), heavy traffic, low visibility, and slippery road conditions.	The vehicle runs into another vehicle or barrier.	E2	S3	C1	A
	Driving at very high speed ($V > 130$ kph), light traffic, low visibility, and slippery road conditions.	The vehicle runs into another vehicle or barrier.	E2	S3	C2	QM

Table G-4: Reduced responsiveness to the driver's commands due to increased rear wheel drag

Assumptions	Operating Scenario Description	Potential Accident Scenario	ASIL Assessment (Reduced responsiveness to the driver's commands due to increased rear wheel drag)			ASIL
			Exposure	Severity	Controllability	
The vehicle decelerates when braking is not commanded, but at a rate that does not meet the TBD threshold for unintended vehicle deceleration. For example, if the rear wheels toe-in, this may cause sufficient friction force to decelerate the vehicle.	Vehicle in a parking lot or drive way and starting to move; good visibility with light pedestrian traffic.	None	E4	S0		N/A

Assumptions	Operating Scenario Description	Potential Accident Scenario	ASIL Assessment (Reduced responsiveness to the driver's commands due to increased rear wheel drag)			ASIL
			Exposure	Severity	Controllability	
	Vehicle in a parking lot or drive way and starting to move; low visibility with light pedestrian traffic.	None	E3	S0		N/A
	Vehicle in a parking lot or drive way and starting to move; good visibility with high pedestrian traffic (mall, supermarket)	None	E3	S0		N/A
	Vehicle in a parking lot or drive way and starting to move; low visibility with high pedestrian traffic (mall, supermarket)	None	E2	S0		N/A
	Vehicle going in reverse from a stopped condition at (relatively) low speed; low/good visibility; other vehicles present (stopped or moving at low speed); slippery/good road conditions; pedestrians present.	None	E2	S0		N/A
	Driving inside the city with light/heavy traffic and pedestrian presence, stop and go driving, good visibility, and good road conditions.	Rear collision with another vehicle	E4	S1	C1	QM

Assumptions	Operating Scenario Description	Potential Accident Scenario	ASIL Assessment (Reduced responsiveness to the driver's commands due to increased rear wheel drag)			ASIL
			Exposure	Severity	Controllability	
	Driving inside the city with light/ heavy traffic and pedestrian presence, stop and go driving, low visibility, slippery road conditions.	Rear collision with another vehicle	E3	S1	C1	QM
	Driving inside the city with light/heavy traffic and negligible pedestrian presence, stop and go driving, good visibility, and good road conditions.	Rear collision with another vehicle	E4	S1	C1	QM
	Driving inside the city with light/ heavy traffic and negligible pedestrian presence, stop and go driving, bad visibility, and slippery road conditions.	Rear collision with another vehicle	E3	S1	C1	QM
	Driving at medium speed (40 kph < V < 100 kph), country road, heavy traffic, good visibility, and good road conditions.	Rear collision with another vehicle	E4	S1	C1	QM
	Driving at medium speed (40 kph < V < 100 kph), country road, light traffic, good visibility, and good road conditions.	Rear collision with another vehicle	E4	S1	C1	QM

Assumptions	Operating Scenario Description	Potential Accident Scenario	ASIL Assessment (Reduced responsiveness to the driver's commands due to increased rear wheel drag)			ASIL
			Exposure	Severity	Controllability	
	Driving at medium speed (40 kph < V < 100 kph), country road, heavy traffic, low visibility, and slippery road conditions.	Rear collision with another vehicle	E3	S1	C1	QM
	Driving at medium speed (40 kph < V < 100 kph), country road, light traffic, low visibility, and slippery road conditions.	Rear collision with another vehicle	E3	S1	C1	QM
	Driving at medium speed (40 kph < V < 100 kph), exiting or entering a ramp, light/heavy traffic, good/low visibility, and good/slippery road conditions.	Rear collision with another vehicle	E2	S2	C2	QM
	Driving at high speed (100 kph < V < 130 kph), heavy traffic, good visibility, and good road conditions.	Rear collision with another vehicle	E4	S1	C2	A
	Driving at high speed (100 kph < V < 130 kph), light traffic, good visibility, and good road conditions.	Rear collision with another vehicle	E4	S1	C1	QM
	Driving at high speed (100 kph < V < 130 kph), heavy traffic, low visibility, and slippery road conditions.	Rear collision with another vehicle	E3	S1	C2	QM

Assumptions	Operating Scenario Description	Potential Accident Scenario	ASIL Assessment (Reduced responsiveness to the driver's commands due to increased rear wheel drag)			ASIL
			Exposure	Severity	Controllability	
	Driving at high speed (100 kph < V < 130 kph), country road, light traffic, low visibility, and slippery road conditions.	Rear collision with another vehicle	E3	S1	C1	QM
	Driving at very high speed (V > 130 kph), heavy traffic, good visibility, and good road conditions.	Rear collision with another vehicle	E3	S1	C2	QM
	Driving at very high speed (V > 130 kph), light traffic, good visibility, and good road conditions.	Rear collision with another vehicle	E3	S3	C2	QM
	Driving at very high speed (V > 130 kph), heavy traffic, low visibility, and slippery road conditions.	Rear collision with another vehicle	E2	S1	C2	QM
	Driving at very high speed (V > 130 kph), light traffic, low visibility, and slippery road conditions.	Rear collision with another vehicle	E2	S1	C2	QM

Table G-5: Potential Exposure of a Person Performing Vehicle Maintenance to Moving EPS Components When the Ignition Is in the Off Position

Assumptions	Operating Scenario Description	Potential Accident Scenario	ASIL Assessment (Exposure of a person performing vehicle maintenance to moving EPS components When the Ignition Is in the off position*)			ASIL
			Exposure	Severity	Controllability	
An operator of the vehicle is harmed by inadvertent operation of the system when the vehicle is off. For example, residual charge in a capacitor may cause the assist motor to operate unexpectedly when the operator is changing a tire.	Vehicle is disabled; a person is attempting to replace a tire or is partially under the vehicle.	The system causes the tires to move and hit the person.	E1	S0		N/A
	Vehicle is disabled; a person is attempting to replace a tire or is partially under the vehicle.	The system causes the tires to move and causes the vehicle to fall off a "jack" on the person.	E1	S1	C3	QM

*This does not include maintenance performed by professional mechanics, which are excluded from the scope of ISO 26262. This hazard is intended to cover maintenance by non-professionals, such as the vehicle owner.

APPENDIX H: FMEA

Table H-1. FMEA for H1: Unintended Vehicle Lateral Motion/Unintended Yaw H-2
Table H-2. FMEA for H1: Unintended Vehicle Lateral Motion/Unintended Yaw H-16
Table H-3. FMEA for H2: Insufficient Vehicle Lateral Motion/Insufficient Yaw H-24
Table H-4. FMEA for H3: Loss of Steering Assist H-36
Table H-5. FMEA for H4: Reduced Responsiveness to the Driver’s Commands Due to Increased Rear-Wheel Drag H-44
Table H-6. FMEA for H5: Exposure of a Person Performing Vehicle Maintenance to Moving EPS Components When the Ignition Is in the Off Position* H-49

Table H-1. FMEA for H1: Unintended Vehicle Lateral Motion/Unintended Yaw
(Malfunction: Induces More Lateral Force than Needed)

System /Subsystem	Potential Failure Mode (Unintended Vehicle Lateral Motion/Unintended Yaw)	Potential Causes/Mechanisms of Failure	Current Process Controls		
			Safety Mechanism	Diagnosics	Diagnostic Trouble Code
EPS Control Module	Commands too much torque from power assist motor (includes commanding torque when not needed or commanding a constant torque value)	Hardware fault (sensors, ICs, circuit components, circuit boards...)			
		Internal connection fault (short or open)			
		Break in control module I/Os connections			
		Short in control module I/Os connections to ground or voltage			
		Short in control module I/Os connections to another connection			
		Signal connector connection failure			
		Power connector connection failure			
		Power assist motor torque command calculation algorithm fault			
		Arbitration logic fault			
		Firmware crash/failure (SW parameters corrupted)			
		Supply power out of range			
		Supply power quality failure			
		EMI/EMC fault			
		Contamination/corrosion			
		NVH fault			

System /Subsystem	Potential Failure Mode (Unintended Vehicle Lateral Motion/Unintended Yaw)	Potential Causes/Mechanisms of Failure	Current Process Controls		
			Safety Mechanism	Diagnostics	Diagnostic Trouble Code
		Environmental temperature exposure failure			
		Aging (durability)			
		Manufacturing defect			
		Manufacturing variability			
		Service/maintenance			
	Subtracts too little torque from driver's request at high vehicle speeds (includes subtracting torque when not needed or subtracting a constant torque value)	HW or SW Fault (covered above)			
	Improperly resolves conflicting steering request between driver and other vehicle systems	HW or SW Fault (covered above)			
	Incorrectly resolves multiple steering requests from other vehicle systems	HW or SW Fault (covered above)			
	Incorrectly resolves steering requests from other vehicle systems with steering commands from internal active steering function	HW or SW Fault (covered above)			
	Misinterprets steering wheel angle or torque input	HW or SW fault (covered above)			
	Steering wheel angle or torque to power assist motor torque map corrupted (e.g., active steering)	HW fault (covered above)			
		Corrupted parameters (vehicle and/or environment)			

System /Subsystem	Potential Failure Mode (Unintended Vehicle Lateral Motion/Unintended Yaw)	Potential Causes/Mechanisms of Failure	Current Process Controls		
			Safety Mechanism	Diagnos tics	Diagnos tic Trouble Code
	Incorrectly establishes "on-center" position	HW fault (covered above)			
		Corrupted parameters (vehicle and/or environment)			
	Locks steering wheel while vehicle is moving (if lock is electronically controlled)	HW or SW Fault (covered above)			
	Incorrectly enables or disables four-wheel steering	HW or SW Fault (covered above) - except power assist motor algorithm fault			
	Does not disable four-wheel steering when front wheel power assist is not available	HW or SW Fault (covered above) - except power assist motor algorithm fault			
	Commands incorrect rear wheel position	HW or SW Fault (covered above) - except power assist motor algorithm fault			
		Rear road wheel motors torque command calculation algorithm fault			
	Does not smoothly control rear wheel steering adjustments	HW or SW Fault (covered above) - except power assist motor algorithm fault			
		Rear road wheel motors torque command calculation algorithm fault			
	Miscommunicates with internal sub-systems	From: Steering wheel angle sensor			
		From: Steering wheel torque sensor			
		From: Rear road wheel position sensor			

System /Subsystem	Potential Failure Mode (Unintended Vehicle Lateral Motion/Unintended Yaw)	Potential Causes/Mechanisms of Failure	Current Process Controls			
			Safety Mechanism	Diagnostics	Diagnostic Trouble Code	
		From: Power assist motor position feedback				
		To: Power assist motor				
		To: Rear road wheel motors				
	Miscommunicates with external systems	From: Brake/vehicle stability system				
		From: Active Differential System				
		From: Lateral motion control systems (e.g., ALK/ALC)				
	Diagnostic fault	Considered only in mitigation of multiple point failure analysis (FTA)				
Power Assist Motor	Adds too much torque to driver's steering input	Internal connection fault (short or open)				
		Signal connector connection failure				
		Power connector connection failure				
		Supply power out of range				
		Supply power quality failure				
		HW fault in stator				
		HW fault in rotor				
		HW fault in insulation and windings				
		Over or under current				
		Manufacturing variability				
		Manufacturing defect				
		Subtracts too little torque from driver's steering input (at high speeds)	HW fault (covered above)			
		Electromagnetic interference with other EPS components	Over-emission of EMF			

System /Subsystem	Potential Failure Mode (Unintended Vehicle Lateral Motion/Unintended Yaw)	Potential Causes/Mechanisms of Failure	Current Process Controls		
			Safety Mechanism	Diagnostics	Diagnostic Trouble Code
		Inadequate shielding			
	Mechanical failure	Out of scope			
Steering Wheel Angle Sensor	Steering wheel angle measured value higher than actual	Hardware fault (sensors, ICs, circuit components, circuit boards...)			
		Internal connection fault (short or open)			
		Break in steering wheel angle sensor I/Os connections			
		Short in steering wheel angle sensor I/Os connections to ground or voltage			
		Short in steering wheel angle sensor I/Os connections to another connection			
		Signal connector connection failure			
		Power connector connection failure			
		Steering wheel angle calculation algorithm fault			
		SW parameters corrupted			
		Supply power out of range			
		Supply power quality failure			
		EMC/EMI fault			
		Contamination/corrosion			
		NVH fault			
		Environmental temperature exposure failure			
	Aging (durability)				
	Manufacturing defect				

System /Subsystem	Potential Failure Mode (Unintended Vehicle Lateral Motion/Unintended Yaw)	Potential Causes/Mechanisms of Failure	Current Process Controls		
			Safety Mechanism	Diagnos tics	Diagnos tic Trouble Code
		Manufacturing variability			
		Service/maintenance			
	Steering wheel angle measured value lower than actual (applies when subtracting torque at high speeds)	HW or SW fault (covered above)			
	Steering wheel angle not measured	HW or SW fault (covered above)			
	Steering wheel angle sensor communicates with EPS control module incorrectly	HW or SW fault (covered above)			
		Communication bus fault			
Steering Wheel Torque Sensor	Steering wheel torque measured value higher than actual	Hardware fault (sensors, ICs, circuit components, circuit boards...)			
		Internal connection fault (short or open)			
		Break in steering wheel torque sensor I/Os connections			
		Short in steering wheel torque sensor I/Os connections to ground or voltage			
		Short in steering wheel torque sensor I/Os connections to another connection			
		Signal connector connection failure			
		Power connector connection failure			
		Steering wheel torque calculation algorithm fault			

System /Subsystem	Potential Failure Mode (Unintended Vehicle Lateral Motion/Unintended Yaw)	Potential Causes/Mechanisms of Failure	Current Process Controls			
			Safety Mechanism	Diagnostics	Diagnostic Trouble Code	
		SW parameters corrupted				
		Supply power out of range				
		Supply power quality failure				
		EMC/EMI fault				
		Contamination/corrosion				
		NVH fault				
		Environmental temperature exposure failure				
		Aging (durability)				
		Manufacturing defect				
		Manufacturing variability				
		Service/maintenance				
		Steering wheel torque measured value lower than actual (applies when subtracting torque at high speeds)	HW or SW fault (covered above)			
		Steering wheel torque not measured	HW or SW fault (covered above)			
		Steering wheel torque sensor communicates with EPS control module incorrectly	HW or SW fault (covered above)			
		Communication bus fault				
Steering Wheel	Mechanical failure	Out of scope				
Gear Set (e.g. Planetary Gear)	Mechanical failure	Out of scope				

System /Subsystem	Potential Failure Mode (Unintended Vehicle Lateral Motion/Unintended Yaw)	Potential Causes/Mechanisms of Failure	Current Process Controls			
			Safety Mechanism	Diagnostics	Diagnostic Trouble Code	
Steering Column / Rack and Pinion	Mechanical failure	Out of scope				
Front Road Wheels	Mechanical failure	Out of scope				
Rear Road Wheel Motors	Provides too much steering torque to adjust rear road wheel steering angle	Internal connection fault (short or open)				
		Signal connector connection failure				
		Power connector connection failure				
		HW fault in stator				
		HW fault in rotor				
		HW fault in insulation and windings				
		Over or under current				
		Manufacturing defect				
		Manufacturing variability				
		Supply power out of range				
		Supply power quality failure				
		Motor torque output in wrong direction	HW fault (covered above)			
		Motor torque output is not smooth	HW fault (covered above)			
		Electromagnetic interference with other EPS components	Over-emission of EMF			
			Inadequate shielding			
	Mechanical failure	Out of scope				

System /Subsystem	Potential Failure Mode (Unintended Vehicle Lateral Motion/Unintended Yaw)	Potential Causes/Mechanisms of Failure	Current Process Controls		
			Safety Mechanism	Diagnostics	Diagnostic Trouble Code
Rear Road Wheels	Mechanical failure	Out of scope			
Rear Road Wheel Position Sensor	Rear road wheel position sensor measured value lower than actual	Hardware fault (sensors, ICs, circuit components, circuit boards...)			
		Internal connection fault (short or open)			
		Break in rear road wheel position sensor I/Os connections			
		Short in rear road wheel position sensor I/Os connections to ground or voltage			
		Short in rear road wheel position sensor I/Os connections to another connection			
		Signal connector connection failure			
		Power connector connection failure			
		Rear road wheel position sensor calculation algorithm fault			
		SW parameters corrupted			
		Supply power out of range			
		Supply power quality failure			
		EMC/EMI fault			
		Contamination/corrosion			
		NVH (noise vibration harshness) fault			
	Environmental temperature exposure failure				

System /Subsystem	Potential Failure Mode (Unintended Vehicle Lateral Motion/Unintended Yaw)	Potential Causes/Mechanisms of Failure	Current Process Controls		
			Safety Mechanism	Diagnos tics	Diagnos tic Trouble Code
		Aging (durability)			
		Manufacturing defect			
		Manufacturing variability			
		Service/maintenance			
	Rear road wheel position measurements made at too low a frequency (may affect smoothness of rear-wheel control)	HW or SW fault (covered above)			
	Rear road wheel position sensor communicates with EPS control module incorrectly	HW or SW fault (covered above)			
		Communication bus fault			
Yaw Rate / Lateral Acceleration Sensor	Yaw rate/lateral acceleration sensor measured value incorrect (e.g., active steering increases steering angle to correct for perceived yaw/steering wheel position mismatch)	Hardware fault (sensors, ICs, circuit components, circuit boards...)			
		Internal connection fault (short or open)			
		Break in yaw rate/lateral acceleration sensor I/Os connections			
		Short in yaw rate/lateral acceleration sensor I/Os connections to ground or voltage			
		Short in yaw rate/lateral acceleration sensor I/Os connections to another connection			
		Signal connector connection failure			

System /Subsystem	Potential Failure Mode (Unintended Vehicle Lateral Motion/Unintended Yaw)	Potential Causes/Mechanisms of Failure	Current Process Controls			
			Safety Mechanism	Diagnostics	Diagnostic Trouble Code	
		Power connector connection failure				
		Yaw rate/lateral acceleration sensor calculation algorithm fault				
		SW parameters corrupted				
		Supply power out of range				
		Supply power quality failure				
		EMC/EMI fault				
		Contamination/corrosion				
		NVH fault				
		Environmental temperature exposure failure				
		Aging (durability)				
		Manufacturing defect				
		Manufacturing variability				
		Service/maintenance				
		Yaw rate/lateral acceleration sensor communicates with EPS control module incorrectly	HW or SW fault (covered above)			
			Communication bus fault			
Wheel Speed Sensor	Wheel speed sensor measured value higher or lower than actual	Hardware fault (sensors, ICs, circuit components, circuit boards...)				
		Internal connection fault (short or open)				
		Break in wheel speed sensor I/Os connections				
		Short in wheel speed sensor I/Os connections to ground or voltage				

System /Subsystem	Potential Failure Mode (Unintended Vehicle Lateral Motion/Unintended Yaw)	Potential Causes/Mechanisms of Failure	Current Process Controls		
			Safety Mechanism	Diagnos tics	Diagnos tic Trouble Code
		Short in wheel speed sensor I/Os connections to another connection			
		Signal connector connection failure			
		Power connector connection failure			
		Wheel speed calculation algorithm fault			
		SW parameters corrupted			
		Supply power out of range			
		Supply power quality failure			
		EMC/EMI fault			
		Contamination/corrosion			
		NVH fault			
		Environmental temperature exposure failure			
		Aging (durability)			
		Manufacturing defect			
		Manufacturing variability			
		Service/maintenance			
		Wheel speed sensor communicates with EPS control module incorrectly	HW or SW fault (covered above)		
		Communication bus fault			
Braking System with (ESC/ABS)	Request for steering adjustment is incorrect when received by the EPS control module	Communication fault to EPS control module			
	Road friction measurement is incorrect when received by the EPS control module	Communication fault to EPS control module			

System /Subsystem	Potential Failure Mode (Unintended Vehicle Lateral Motion/Unintended Yaw)	Potential Causes/Mechanisms of Failure	Current Process Controls		
			Safety Mechanism	Diagnos tics	Diagnos tic Trouble Code
	Vehicle speed measurement is incorrect when received by the EPS control module	Communication fault to EPS control module			
	Does not coordinate yaw rate stabilization with EPS control module (applies if EPS also implements yaw rate stabilization)	Communication fault to EPS control module			
	Failures within braking system	Out of scope			
Active Differential System	Does not coordinate yaw rate stabilization with EPS control module (applies if EPS also implements yaw rate stabilization)	Communication fault to EPS control module			
	Failures within active differential system	Out of scope			
Instrument Panel Display	Failures within instrument panel display, including incorrectly displaying warnings	Out of scope			
Engine RPM Sensor	Safety mechanism to validate vehicle speed	Out of scope			
Driver	Outside of ISO 26262 scope	Out of scope			
Ignition Key	Does not detect ignition key presence (applies to wireless keys, start/stop button ignition, etc.)	Hardware fault (sensors, ICs, circuit components, circuit boards...)			
		Internal connection fault (short or open)			
		Break in ignition module I/Os connections			
		Short in ignition module I/Os connections to ground or voltage			

System /Subsystem	Potential Failure Mode (Unintended Vehicle Lateral Motion/Unintended Yaw)	Potential Causes/Mechanisms of Failure	Current Process Controls		
			Safety Mechanism	Diagnostics	Diagnostic Trouble Code
		Short in ignition module I/Os connections to another connection			
		Signal connector connection failure			
		Power connector connection failure			
		SW parameters corrupted			
		Wireless key transmitter fault			
		Wireless transmission frequency interference			
		Supply power out of range			
		Supply power quality failure			
		Supply power loss			
		EMC/EMI fault			
		Contamination/corrosion			
		NVH (noise vibration harshness) fault			
		Environmental temperature exposure failure			
		Aging (durability)			
		Manufacturing defect			
		Manufacturing variability			
		Service/maintenance			
	Does not communicate with EPS control module	Communication fault			
		Supply power disruption			
	Mechanical failure (applies to physical ignition switches)	Out of scope			
Other Vehicle	Request for steering adjustment is incorrect	Communication Fault to EPS control module			

System /Subsystem	Potential Failure Mode (Unintended Vehicle Lateral Motion/Unintended Yaw)	Potential Causes/Mechanisms of Failure	Current Process Controls		
			Safety Mechanism	Diagnos tics	Diagnos tic Trouble Code
System s (e.g., ALC/L KA)	when received by the EPS control module				
	Failures within Other Vehicle Systems	Out of scope			

Table H-2. FMEA for H1: Unintended Vehicle Lateral Motion/Unintended Yaw
(Malfunction: Provides steering in the wrong direction)

System /Subsystem	Potential Failure Mode (Unintended Vehicle Lateral Motion/Unintended Yaw)	Potential Causes/Mechanisms of Failure	Current Process Controls		
			Safety Mechanism	Diagnos tics	Diagnos tic Trouble Code
EPS Control Module	Net torque to front road wheels is opposite of the driver's steering command (includes subtracting too much torque)	Hardware fault (sensors, ICs, circuit components, circuit boards...)			
		Internal connection fault (short or open)			
		Break in control module I/Os connections			
		Short in control module I/Os connections to ground or voltage			
		Short in control module I/Os connections to another connection			
		Signal connector connection failure			
		Power connector connection failure			
		Power assist motor torque command calculation algorithm fault			
		Arbitration logic fault			

System /Subsystem	Potential Failure Mode (Unintended Vehicle Lateral Motion/Unintended Yaw)	Potential Causes/Mechanisms of Failure	Current Process Controls		
			Safety Mechanism	Diagnos tics	Diagnos tic Trouble Code
		Firmware crash/failure (SW parameters corrupted)			
		Supply power out of range			
		Supply power quality failure			
		EMI/EMC fault			
		Contamination/corrosion			
		NVH fault			
		Environmental temperature exposure failure			
		Aging (durability)			
		Manufacturing defect			
		Manufacturing variability			
		Service/maintenance			
	Improperly resolves conflicting steering request between driver and other vehicle systems	HW or SW Fault (covered above)			
	Incorrectly resolves multiple steering requests from other vehicle systems	HW or SW Fault (covered above)			
	Incorrectly resolves steering requests from other vehicle systems with steering commands from internal active steering function	HW or SW Fault (covered above)			
	Misinterprets steering wheel angle or torque input	HW or SW fault (covered above)			
	Steering wheel angle or torque to power assist motor torque map corrupted (e.g., active steering)	HW fault (covered above)			

System /Subsystem	Potential Failure Mode (Unintended Vehicle Lateral Motion/Unintended Yaw)	Potential Causes/Mechanisms of Failure	Current Process Controls		
			Safety Mechanism	Diagnos tics	Diagnos tic Trouble Code
		Corrupted parameters (vehicle and/or environment)			
	Miscommunicates with internal sub-systems	From: Steering wheel angle sensor			
		From: Steering wheel torque sensor			
		From: Rear road wheel position sensor			
		From: Power assist motor position feedback			
		To: Power assist motor			
		To: Rear road wheel motors			
	Miscommunicates with external systems	From: Brake/vehicle stability system			
		From: Active Differential System			
		From: Lateral motion control systems (e.g., ALK/ALC)			
	Diagnostic fault	Considered only in mitigation of multiple point failure analysis (FTA)			
Power Assist Motor	Provides torque in wrong direction	Internal connection fault (short or open)			
		Signal connector connection failure			
		Power connector connection failure			
		Supply power out of range			
		Supply power quality failure			
		HW fault in stator			
		HW fault in rotor			
		HW fault in insulation and windings			
	Over or under current				

System /Subsystem	Potential Failure Mode (Unintended Vehicle Lateral Motion/Unintended Yaw)	Potential Causes/Mechanisms of Failure	Current Process Controls		
			Safety Mechanism	Diagnos tics	Diagnos tic Trouble Code
Steering Wheel Angle Sensor		Manufacturing variability			
		Manufacturing defect			
	Mechanical failure	Out of scope			
	Steering wheel angle measured in opposite direction	Hardware fault (sensors, ICs, circuit components, circuit boards...)			
		Internal connection fault (short or open)			
		Break in steering wheel angle sensor I/Os connections			
		Short in steering wheel angle sensor I/Os connections to ground or voltage			
		Short in steering wheel angle sensor I/Os connections to another connection			
		Signal connector connection failure			
		Power connector connection failure			
		Steering wheel angle calculation algorithm fault			
		SW parameters corrupted			
		Supply power out of range			
		Supply power quality failure			
		EMC/EMI fault			
	Contamination/corrosion				
	NVH fault				
	Environmental temperature exposure failure				
	Aging (durability)				
	Manufacturing defect				

System /Subsystem	Potential Failure Mode (Unintended Vehicle Lateral Motion/Unintended Yaw)	Potential Causes/Mechanisms of Failure	Current Process Controls		
			Safety Mechanism	Diagnos tics	Diagnos tic Trouble Code
Steerin g Wheel Torque Sensor		Manufacturing variability			
		Service/maintenance			
	Steering wheel angle sensor communicates with EPS control module incorrectly	HW or SW fault (covered above)			
		Communication bus fault			
	Steering wheel torque measured in opposite direction	Hardware fault (sensors, ICs, circuit components, circuit boards...)			
		Internal connection fault (short or open)			
		Break in steering wheel torque sensor I/Os connections			
		Short in steering wheel torque sensor I/Os connections to ground or voltage			
		Short in steering wheel torque sensor I/Os connections to another connection			
		Signal connector connection failure			
		Power connector connection failure			
		Steering wheel torque calculation algorithm fault			
		SW parameters corrupted			
		Supply power out of range			
	Supply power quality failure				
	EMC/EMI fault				
	Contamination/corrosion				
	NVH fault				

System /Subsystem	Potential Failure Mode (Unintended Vehicle Lateral Motion/Unintended Yaw)	Potential Causes/Mechanisms of Failure	Current Process Controls		
			Safety Mechanism	Diagnostics	Diagnostic Trouble Code
		Environmental temperature exposure failure			
		Aging (durability)			
		Manufacturing defect			
		Manufacturing variability			
		Service/maintenance			
	Steering wheel torque sensor communicates with EPS control module incorrectly	HW or SW fault (covered above)			
		Communication bus fault			
Steering Wheel	Mechanical failure	Out of scope			
Gear Set (e.g. Planetary Gear)	Mechanical failure	Out of scope			
Steering Column / Rack and Pinion	Mechanical failure	Out of scope			
Front Road Wheels	Mechanical failure	Out of scope			
Rear Road Wheel Motors	Not relevant to this malfunction				
Rear Road Wheels	Not relevant to this malfunction				

System /Subsystem	Potential Failure Mode (Unintended Vehicle Lateral Motion/Unintended Yaw)	Potential Causes/Mechanisms of Failure	Current Process Controls		
			Safety Mechanism	Diagnos tics	Diagnos tic Trouble Code
Rear Road Wheel Position Sensor	Not relevant to this malfunction	Hardware fault (sensors, ICs, circuit components, circuit boards...)			
Yaw Rate / Lateral Acceleration Sensor	Yaw rate/lateral acceleration sensor measured value in opposite direction	Hardware fault (sensors, ICs, circuit components, circuit boards...)			
		Internal connection fault (short or open)			
		Break in yaw rate/lateral acceleration sensor I/Os connections			
		Short in yaw rate/lateral acceleration sensor I/Os connections to ground or voltage			
		Short in yaw rate/lateral acceleration sensor I/Os connections to another connection			
		Signal connector connection failure			
		Power connector connection failure			
		Yaw rate/lateral acceleration sensor calculation algorithm fault			
		SW parameters corrupted			
		Supply power out of range			
		Supply power quality failure			
		EMC/EMI fault			
		Contamination/corrosion			
		NVH fault			

System /Subsystem	Potential Failure Mode (Unintended Vehicle Lateral Motion/Unintended Yaw)	Potential Causes/Mechanisms of Failure	Current Process Controls		
			Safety Mechanism	Diagnostics	Diagnostic Trouble Code
		Environmental temperature exposure failure			
		Aging (durability)			
		Manufacturing defect			
		Manufacturing variability			
		Service/maintenance			
	Yaw rate/lateral acceleration sensor communicates with EPS control module incorrectly	HW or SW fault (covered above)			
	Communication bus fault				
Wheel Speed Sensor	Not relevant to this malfunction				
Braking System with (ESC/ABS)	Request for steering adjustment is incorrect when received by the EPS control module	Communication fault to EPS control module			
	Failures within braking system	Out of scope			
Active Differential System	Not relevant to this malfunction	Communication fault to EPS control module			
Instrument Panel Display	Failures within instrument panel display, including incorrectly displaying warnings	Out of scope			
Engine RPM Sensor	Safety mechanism to validate vehicle speed	Out of scope			
Driver	Outside of ISO 26262 scope	Out of scope			
Ignition Key	Not relevant to this malfunction				
Other Vehicle	Request for steering adjustment is incorrect	Communication Fault to EPS control module			

System /Subsystem	Potential Failure Mode (Unintended Vehicle Lateral Motion/Unintended Yaw)	Potential Causes/Mechanisms of Failure	Current Process Controls		
			Safety Mechanism	Diagnos tics	Diagnos tic Trouble Code
Systems (e.g., ALC/LKA)	when received by the EPS control module				
	Failures within Other Vehicle Systems	Out of scope			

Table H-3. FMEA for H2: Insufficient Vehicle Lateral Motion/Insufficient Yaw
(Malfunction: Induces less lateral force than needed)

System /Subsystem	Potential Failure Mode (Insufficient Vehicle Lateral Motion / Insufficient Yaw)	Potential Causes/Mechanisms of Failure	Current Process Controls		
			Safety Mechanism	Diagnos tics	Diagnos tic Trouble Code
EPS Control Module	Commands too little torque from power assist motor	Hardware fault (sensors, ICs, circuit components, circuit boards...)			
		Internal connection fault (short or open)			
		Break in control module I/Os connections			
		Short in control module I/Os connections to ground or voltage			
		Short in control module I/Os connections to another connection			
		Signal connector connection failure			
		Power connector connection failure			
		Power assist motor torque command calculation algorithm fault			
		Arbitration logic fault			
		Firmware crash/failure (SW parameters corrupted)			
		Supply power out of range			

System /Subsystem	Potential Failure Mode (Insufficient Vehicle Lateral Motion / Insufficient Yaw)	Potential Causes/Mechanisms of Failure	Current Process Controls		
			Safety Mechanism	Diagnostics	Diagnostic Trouble Code
		Supply power quality failure			
		EMI/EMC fault			
		Contamination/corrosion			
		NVH fault			
		Environmental temperature exposure failure			
		Aging (durability)			
		Manufacturing defect			
		Manufacturing variability			
		Service/maintenance			
	Subtracts too much torque from driver's request, but net torque remains in the direction of the driver's steering input	HW or SW Fault (covered above)			
	Misinterprets steering wheel angle or torque input	HW or SW fault (covered above)			
	Improperly resolves conflicting steering request between driver and other vehicle systems	HW or SW Fault (covered above)			
	Incorrectly resolves multiple steering requests from other vehicle systems	HW or SW Fault (covered above)			
	Incorrectly resolves steering requests from other vehicle systems with steering commands from internal active steering function	HW or SW Fault (covered above)			
	Steering wheel angle or torque to power assist motor torque map corrupted	HW fault (covered above)			
		Corrupted parameters (vehicle and/or environment)			

System /Subsystem	Potential Failure Mode (Insufficient Vehicle Lateral Motion / Insufficient Yaw)	Potential Causes/Mechanisms of Failure	Current Process Controls		
			Safety Mechanism	Diagnostics	Diagnostic Trouble Code
	Incorrectly establishes "on-center" position (steering wheel centering resists driver's steering input)	HW fault (covered above)			
		Corrupted parameters (vehicle and/or environment)			
	Incorrectly enables or disables four-wheel steering	HW or SW fault (covered above)			
	Commands incorrect rear wheel position	HW or SW Fault (covered above) - except power assist motor algorithm fault			
		Rear road wheel motors torque command calculation algorithm fault			
	Does not smoothly control rear wheel steering adjustments	HW or SW Fault (covered above) - except power assist motor algorithm fault			
		Rear road wheel motors torque command calculation algorithm fault			
	Miscommunicates with internal subsystems	From: Steering wheel angle sensor			
		From: Steering wheel torque sensor			
		From: Rear road wheel position sensor			
		From: Power assist motor position feedback			
		To: Power assist motor			
		To: Rear road wheel motors			
	Miscommunicates with external systems	From: Brake/vehicle stability system			

System /Subsystem	Potential Failure Mode (Insufficient Vehicle Lateral Motion / Insufficient Yaw)	Potential Causes/Mechanisms of Failure	Current Process Controls			
			Safety Mechanism	Diagnos tics	Diagnos tic Trouble Code	
		From: active differential system				
		From: Lateral motion control systems (e.g., ALK/ALC)				
	Diagnostic fault	Considered only in mitigation of multiple point failure analysis (FTA)				
Power Assist Motor	Adds too little torque to driver's steering input	Internal connection fault (short or open)				
		Signal connector connection failure				
		Power connector connection failure				
		Supply power out of range				
		Supply power quality failure				
		HW fault in stator				
		HW fault in rotor				
		HW fault in insulation and windings				
		Over or under current				
		Manufacturing defect				
		Manufacturing variability				
		Subtracts too much torque from driver's steering input, but net torque to the road wheels in the direction of the driver's steering input	HW fault (covered above)			
		Electromagnetic interference with other EPS components	Over-emission of EMF			
			Inadequate shielding			
	Mechanical failure	Out of scope				
Steering Wheel	Steering wheel angle measured value lower than actual	Hardware fault (sensors, ICs, circuit components, circuit boards...)				

System /Subsystem	Potential Failure Mode (Insufficient Vehicle Lateral Motion / Insufficient Yaw)	Potential Causes/Mechanisms of Failure	Current Process Controls		
			Safety Mechanism	Diagnos tics	Diagnos tic Trouble Code
Angle Sensor		Internal connection fault (short or open)			
		Break in steering wheel angle sensor I/Os connections			
		Short in steering wheel angle sensor I/Os connections to ground or voltage			
		Short in steering wheel angle sensor I/Os connections to another connection			
		Signal connector connection failure			
		Power connector connection failure			
		Steering wheel angle calculation algorithm fault			
		SW parameters corrupted			
		Supply power out of range			
		Supply power quality failure			
		EMC/EMI fault			
		Contamination/corrosion			
		NVH fault			
		Environmental temperature exposure failure			
		Aging (durability)			
		Manufacturing defect			
		Manufacturing variability			
		Service/maintenance			
		Steering wheel angle measured value higher than actual (when	HW or SW fault (covered above)		

System /Subsystem	Potential Failure Mode (Insufficient Vehicle Lateral Motion / Insufficient Yaw)	Potential Causes/Mechanisms of Failure	Current Process Controls		
			Safety Mechanism	Diagnos tics	Diagnos tic Trouble Code
	subtracting torque at high vehicle speeds)				
	Steering wheel angle not measured	HW or SW fault (covered above)			
	Steering wheel angle sensor communicates with EPS control module incorrectly	HW or SW fault (covered above)			
		Communication bus fault			
Steering Wheel Torque Sensor	Steering wheel torque measured value lower than actual	Hardware fault (sensors, ICs, circuit components, circuit boards...)			
		Internal connection fault (short or open)			
		Break in steering wheel torque sensor I/Os connections			
		Short in steering wheel torque sensor I/Os connections to ground or voltage			
		Short in steering wheel torque sensor I/Os connections to another connection			
		Signal connector connection failure			
		Power connector connection failure			
		Steering wheel torque calculation algorithm fault			
		SW parameters corrupted			
		Supply power out of range			
		Supply power quality failure			
		EMC/EMI fault			
	Contamination/corrosion				

System /Subsystem	Potential Failure Mode (Insufficient Vehicle Lateral Motion / Insufficient Yaw)	Potential Causes/Mechanisms of Failure	Current Process Controls		
			Safety Mechanism	Diagnos tics	Diagnos tic Trouble Code
		NVH fault			
		Environmental temperature exposure failure			
		Aging (durability)			
		Manufacturing defect			
		Manufacturing variability			
		Service/maintenance			
	Steering wheel torque measured value higher than actual (when subtracting torque at high vehicle speeds)	HW or SW fault (covered above)			
	Steering wheel torque not measured	HW or SW fault (covered above)			
	Torque sensor communicates with EPS control module incorrectly	HW or SW fault (covered above)			
		Communication bus fault			
Steering Wheel	Mechanical failure	Out of scope			
Gear Set (e.g. Planetary Gear)	Mechanical failure	Out of scope			
Steering Column / Rack and Pinion	Mechanical failure	Out of scope			
Front Road Wheels	Mechanical failure	Out of scope			

System /Subsystem	Potential Failure Mode (Insufficient Vehicle Lateral Motion / Insufficient Yaw)	Potential Causes/Mechanisms of Failure	Current Process Controls		
			Safety Mechanism	Diagnos tics	Diagnos tic Trouble Code
Rear Road Wheel Motors	Provides steering torque in wrong direction at low vehicle speeds (i.e., rear wheels turned in-phase at low speeds)	Internal connection fault (short or open)			
		Signal connector connection failure			
		Power connector connection failure			
		Supply power out of range			
		Supply power quality failure			
		HW fault in stator			
		HW fault in rotor			
		HW fault in insulation and windings			
		Over or under current			
		Manufacturing defect			
		Manufacturing variability			
	Motor torque output is not smooth	HW fault (covered above)			
	Electromagnetic interference with other EPS components	Over-emission of EMF			
		Inadequate shielding			
Mechanical failure	Out of scope				
Rear Road Wheels	Mechanical failure	Out of scope			
Rear Road Wheel Position Sensor	Rear road wheel position sensor measured value incorrect (e.g., opposite direction)	Hardware fault (sensors, ICs, circuit components, circuit boards...)			
		Internal connection fault (short or open)			
		Break in rear road wheel position sensor I/Os connections			

System /Subsystem	Potential Failure Mode (Insufficient Vehicle Lateral Motion / Insufficient Yaw)	Potential Causes/Mechanisms of Failure	Current Process Controls		
			Safety Mechanism	Diagnos tics	Diagnos tic Trouble Code
		Short in rear road wheel position sensor I/Os connections to ground or voltage			
		Short in rear road wheel position sensor I/Os connections to another connection			
		Signal connector connection failure			
		Power connector connection failure			
		Rear road wheel position sensor calculation algorithm fault			
		SW parameters corrupted			
		Supply power out of range			
		Supply power quality failure			
		EMC/EMI fault			
		Contamination/corrosion			
		NVH (noise vibration harshness) fault			
		Environmental temperature exposure failure			
		Aging (durability)			
		Manufacturing defect			
		Manufacturing variability			
		Service/maintenance			
	Rear road wheel position measurements at too low a frequency (may affect smoothness of rear-wheel control)	HW or SW fault (covered above)			
	Rear road wheel position sensor communicates with	HW or SW fault (covered above)			

System /Subsystem	Potential Failure Mode (Insufficient Vehicle Lateral Motion / Insufficient Yaw)	Potential Causes/Mechanisms of Failure	Current Process Controls		
			Safety Mechanism	Diagnostics	Diagnostic Trouble Code
	EPS control module incorrectly				
		Communication bus fault			
Yaw Rate / Lateral Acceleration Sensor	Yaw rate/lateral acceleration sensor measured value incorrect (e.g., active steering reduces steering angle to correct for perceived yaw/steering wheel position mismatch)	Hardware fault (sensors, ICs, circuit components, circuit boards...)			
		Internal connection fault (short or open)			
		Break in yaw rate/lateral acceleration sensor I/Os connections			
		Short in yaw rate/lateral acceleration sensor I/Os connections to ground or voltage			
		Short in yaw rate/lateral acceleration sensor I/Os connections to another connection			
		Signal connector connection failure			
		Power connector connection failure			
		Yaw rate/lateral acceleration sensor calculation algorithm fault			
		SW parameters corrupted			
		Supply power out of range			
		Supply power quality failure			
		EMC/EMI fault			
		Contamination/corrosion			

System /Subsystem	Potential Failure Mode (Insufficient Vehicle Lateral Motion / Insufficient Yaw)	Potential Causes/Mechanisms of Failure	Current Process Controls		
			Safety Mechanism	Diagnos tics	Diagnos tic Trouble Code
		NVH fault			
		Environmental temperature exposure failure			
		Aging (durability)			
		Manufacturing defect			
		Manufacturing variability			
		Service/maintenance			
	Yaw rate/lateral acceleration sensor communicates with EPS control module incorrectly	HW or SW fault (covered above)			
	Communication bus fault				
Wheel Speed Sensor	Wheel speed sensor measured value higher or lower than actual	Hardware fault (sensors, ICs, circuit components, circuit boards...)			
		Internal connection fault (short or open)			
		Break in wheel speed sensor I/Os connections			
		Short in wheel speed sensor I/Os connections to ground or voltage			
		Short in wheel speed sensor I/Os connections to another connection			
		Signal connector connection failure			
		Power connector connection failure			
		Wheel speed calculation algorithm fault			
		SW parameters corrupted			
		Supply power out of range			
		Supply power quality failure			
		EMC/EMI fault			

System /Subsystem	Potential Failure Mode (Insufficient Vehicle Lateral Motion / Insufficient Yaw)	Potential Causes/Mechanisms of Failure	Current Process Controls		
			Safety Mechanism	Diagnos tics	Diagnos tic Trouble Code
		Contamination/corrosion			
		NVH fault			
		Environmental temperature exposure failure			
		Aging (durability)			
		Manufacturing defect			
		Manufacturing variability			
		Service/maintenance			
	Wheel speed sensor communicates with EPS control module incorrectly	HW or SW fault (covered above)			
		Communication bus fault			
Braking System with (ESC/ ABS)	Request for steering adjustment is incorrect when received by the EPS control module	Communication fault to EPS control module			
	Road friction measurement is incorrect when received by the EPS control module	Communication fault to EPS control module			
	Vehicle speed measurement is incorrect when received by the EPS control module	Communication fault to EPS control module			
	Does not coordinate yaw rate stabilization with EPS (applies if EPS also implements yaw rate stabilization)	Communication fault to EPS control module			
	Failures within braking system	Out of scope			
Active Differential System	Does not coordinate yaw rate stabilization with EPS (applies if EPS also implements yaw rate stabilization)	Communication fault to EPS control module			
	Failures within active differential system	Out of scope			

System /Subsystem	Potential Failure Mode (Insufficient Vehicle Lateral Motion / Insufficient Yaw)	Potential Causes/Mechanisms of Failure	Current Process Controls		
			Safety Mechanism	Diagnos tics	Diagnos tic Trouble Code
Instrument Panel Display	Failures within Instrument Panel Display, including incorrectly displayed warnings	Out of scope			
Engine RPM Sensor	Safety mechanism to validate vehicle speed	Out of scope			
Driver	Outside of ISO 26262 scope	Not relevant to this hazard			
Ignition Key	Not relevant to this hazard	Not relevant to this hazard			
Other Vehicle Systems (e.g., ALC/LKA)	Request for steering adjustment is incorrect when received by the EPS control module	Communication Fault to EPS control module			
	Other failures	Out of scope			

Table H-4. FMEA for H3: Loss of Steering Assist

(Malfunction: EPS does not provide power assist to driver’s steering input [add or subtract torque].)

System /Subsystem	Potential Failure Mode (Loss of Steering Assist)	Potential Causes/Mechanisms of Failure	Current Process Controls		
			Safety Mechanism	Diagnos tics	Diagnos tic Trouble Code
EPS Control Module	Does not provide steering assist	Hardware fault (sensors, ICs, circuit components, circuit boards...)			
		Internal connection fault (short or open)			
		Break in control module I/Os connections			
		Short in control module I/Os connections to ground or voltage			
		Short in control module I/Os connections to another connection			

System /Subsystem	Potential Failure Mode (Loss of Steering Assist)	Potential Causes/Mechanisms of Failure	Current Process Controls		
			Safety Mechanism	Diagnosics	Diagnostic Trouble Code
		Signal connector connection failure			
		Power connector connection failure			
		Power assist motor torque command calculation algorithm fault			
		Arbitration logic fault			
		Firmware crash/failure (SW parameters corrupted)			
		Supply power out of range			
		Supply power quality failure			
		Supply power loss			
		EMI/EMC fault			
		Contamination/corrosion			
		NVH fault			
		Environmental temperature exposure failure			
		Aging (durability)			
		Manufacturing defect			
		Manufacturing variability			
		Service/maintenance			
	Disables all energy sources while vehicle is not in maintenance/repair mode (e.g., while vehicle is in motion)	HW or SW fault (covered above)			
	Does not re-enable energy sources when exiting maintenance/repair mode	HW or SW fault (covered above)			
	Steering wheel angle or torque to power assist motor torque map corrupted (e.g., zero output for all inputs)	HW fault (covered above)			

System /Subsystem	Potential Failure Mode (Loss of Steering Assist)	Potential Causes/Mechanisms of Failure	Current Process Controls		
			Safety Mechanism	Diagnosics	Diagnostic Trouble Code
		Corrupted parameters (vehicle and/or environment)			
	Miscommunicates with internal subsystems	From: Steering wheel angle sensor			
		From: Steering wheel torque sensor			
		From: Rear road wheel position sensor			
		From: Power assist motor position feedback			
		To: Power assist motor			
		To: Rear road wheel motors			
	Diagnostic fault	Considered only in mitigation of multiple point failure analysis (FTA)			
Power Assist Motor	No torque output from assist motor	Internal connection fault (short or open)			
		Signal connector connection failure			
		Power connector connection failure			
		Supply power out of range			
		Supply power quality failure			
		Supply power loss			
		HW fault in stator			
		HW fault in rotor			
		HW fault in insulation and windings			
		Over or under current			
		Manufacturing defect			
		Manufacturing variability			
	HW fault (covered above)				

System /Subsystem	Potential Failure Mode (Loss of Steering Assist)	Potential Causes/Mechanisms of Failure	Current Process Controls		
			Safety Mechanism	Diagnosics	Diagnostic Trouble Code
	Electromagnetic interference with other EPS components	Over-emission of EMF			
		Inadequate shielding			
	Mechanical failure	Out of scope			
Steering Wheel Angle Sensor	Steering wheel angle not measured	Hardware fault (sensors, ICs, circuit components, circuit boards...)			
		Internal connection fault (short or open)			
		Break in steering wheel angle sensor I/Os connections			
		Short in steering wheel angle sensor I/Os connections to ground or voltage			
		Short in steering wheel angle sensor I/Os connections to another connection			
		Signal connector connection failure			
		Power connector connection failure			
		Steering wheel angle calculation algorithm fault			
		SW parameters corrupted			
		Supply power out of range			
		Supply power quality failure			
		Supply power loss			
		EMC/EMI fault			
		Contamination/corrosion			
		NVH fault			
	Environmental temperature exposure failure				

System /Subsystem	Potential Failure Mode (Loss of Steering Assist)	Potential Causes/Mechanisms of Failure	Current Process Controls		
			Safety Mechanism	Diagnosics	Diagnostic Trouble Code
		Aging (durability)			
		Manufacturing defect			
		Manufacturing variability			
		Service/maintenance			
	Steering wheel angle sensor communicates with EPS control module incorrectly	HW or SW fault (covered above)			
		Communication bus fault			
Steering Wheel Torque Sensor	Steering wheel torque not measured	Hardware fault (sensors, ICs, circuit components, circuit boards...)			
		Internal connection fault (short or open)			
		Break in steering wheel torque sensor I/Os connections			
		Short in steering wheel torque sensor I/Os connections to ground or voltage			
		Short in steering wheel torque sensor I/Os connections to another connection			
		Signal connector connection failure			
		Power connector connection failure			
		Steering wheel torque calculation algorithm fault			
		SW parameters corrupted			
		Supply power out of range			
		Supply power quality failure			
		Supply power loss			

System /Subsystem	Potential Failure Mode (Loss of Steering Assist)	Potential Causes/Mechanisms of Failure	Current Process Controls			
			Safety Mechanism	Diagnosics	Diagnostic Trouble Code	
		EMC/EMI fault				
		Contamination/corrosion				
		NVH fault				
		Environmental temperature exposure failure				
		Aging (durability)				
		Manufacturing defect				
		Manufacturing variability				
		Service/maintenance				
		Steering wheel torque sensor communicates with EPS control module incorrectly	HW or SW fault (covered above)			
			Communication bus fault			
Gear Set (e.g. Planetary Gear)	Mechanical failure	Out of scope				
Steering Column / Rack and Pinion	Not relevant to this hazard	N/A				
Front Road Wheels	Not relevant to this hazard	N/A				
Rear Road Wheel Motors	Not relevant to this hazard	N/A				
Rear Road Wheels	Not relevant to this hazard	N/A				

System /Subsystem	Potential Failure Mode (Loss of Steering Assist)	Potential Causes/Mechanisms of Failure	Current Process Controls		
			Safety Mechanism	Diagnostics	Diagnostic Trouble Code
Rear Road Wheel Position Sensor	Not relevant to this hazard	N/A			
Yaw Rate / Lateral Acceleration Sensor	Not relevant to this hazard	N/A			
Wheel Speed Sensor	Wheel speed not measured	Hardware fault (sensors, ICs, circuit components, circuit boards...)			
		Internal connection fault (short or open)			
		Break in wheel speed sensor I/Os connections			
		Short in wheel speed sensor I/Os connections to ground or voltage			
		Short in wheel speed sensor I/Os connections to another connection			
		Signal connector connection failure			
		Power connector connection failure			
		Wheel speed calculation algorithm fault			
		SW parameters corrupted			
		Supply power out of range			
		Supply power quality failure			
		Supply power loss			
		EMC/EMI fault			
		Contamination/corrosion			
	NVH fault				

System /Subsystem	Potential Failure Mode (Loss of Steering Assist)	Potential Causes/Mechanisms of Failure	Current Process Controls		
			Safety Mechanism	Diagnostics	Diagnostic Trouble Code
		Environmental temperature exposure failure			
		Aging (durability)			
		Manufacturing defect			
		Manufacturing variability			
		Service/maintenance			
	Wheel speed sensor communicates with EPS control module Incorrectly	HW or SW fault (covered above)			
		Communication bus fault			
Braking System with (ESC/ABS)	EPS control module does not receive vehicle speed measurement	Communication fault to EPS control module			
	Failures within braking system	Out of scope			
Active Differential System	Not relevant to this hazard	N/A			
Instrument Panel Display	Failures within Instrument Panel Display, including incorrectly displayed warnings	Out of scope			
Engine RPM Sensor	Safety mechanism to validate vehicle speed	Out of scope			
Driver	Outside ISO 26262 scope	Out of scope			
Ignition Key	Not relevant to this hazard	N/A			
Other Vehicle Systems (e.g., ALC/LKA)	Not relevant to this hazard	N/A			

Table H-5. FMEA for H4: Reduced Responsiveness to the Driver’s Commands Due to Increased Rear-Wheel Drag

(Malfunction: Rear wheels toe-in when it is not needed)

System /Subsystem	Potential Failure Mode (Reduced Responsiveness to the Driver’s Commands Due to Increased Rear-Wheel Drag)	Potential Causes/Mechanisms of Failure	Current Process Controls		
			Safety Mechanism	Diagnosics	Diagnostic Trouble Code
EPS Control Module	Commands rear wheels to toe-in when brakes are not applied	Hardware fault (sensors, ICs, circuit components, circuit boards...)			
		Internal connection fault (short or open)			
		Break in control module I/Os connections			
		Short in control module I/Os connections to ground or voltage			
		Short in control module I/Os connections to another connection			
		Signal connector connection failure			
		Power connector connection failure			
		Rear wheel motor torque command calculation algorithm fault			
		Arbitration logic fault			
		Firmware crash/failure (SW parameters corrupted)			
		Supply power out of range			
		Supply power quality failure			
		EMI/EMC fault			
		Contamination/corrosion			
		NVH fault			
	Environmental temperature exposure failure				
	Aging (durability)				

System /Subsystem	Potential Failure Mode (Reduced Responsiveness to the Driver's Commands Due to Increased Rear-Wheel Drag)	Potential Causes/Mechanisms of Failure	Current Process Controls		
			Safety Mechanism	Diagnostics	Diagnostic Trouble Code
		Manufacturing defect			
		Manufacturing variability			
		Service/maintenance			
	Misinterprets brake pedal position	HW or SW fault (covered above)			
	Miscommunicates with internal subsystems	From: Rear road wheel position sensor			
		To: Rear road wheel motors			
	Miscommunicates with external systems	From: Brake/vehicle stability system			
		From: Longitudinal motion control systems (e.g., ACC)			
	Diagnostic fault	Considered only in mitigation of multiple point failure analysis (FTA)			
Power Assist Motor	Not relevant to this hazard	N/A			
Steering Wheel Angle Sensor	Not relevant to this hazard	N/A			
Steering Wheel Torque Sensor	Not relevant to this hazard	N/A			
Steering Wheel	Not relevant to this hazard	N/A			
Gear Set (e.g. Planeta	Not relevant to this hazard	N/A			

System /Subsystem	Potential Failure Mode (Reduced Responsiveness to the Driver's Commands Due to Increased Rear-Wheel Drag)	Potential Causes/Mechanisms of Failure	Current Process Controls			
			Safety Mechanism	Diagnosics	Diagnostic Trouble Code	
ry Gear)						
Steering Column / Rack and Pinion	Not relevant to this hazard	N/A				
Front Road Wheels	Not relevant to this hazard	N/A				
Rear Road Wheel Motors	Incorrectly provides steering torque that causes the rear road wheels to toe-in	Internal connection fault (short or open)				
		Signal connector connection failure				
		Power connector connection failure				
		Supply power out of range				
		Supply power quality failure				
		HW fault in stator				
		HW fault in rotor				
		HW fault in insulation and windings				
		Over or under current				
		Manufacturing defect				
		Manufacturing variability				
		Electromagnetic interference with other EPS components	Over-emission of EMF			
			Inadequate shielding			
	Mechanical failure	Out of scope				
Rear Road Wheels	Mechanical failure	Out of scope				

System /Subsystem	Potential Failure Mode (Reduced Responsiveness to the Driver's Commands Due to Increased Rear-Wheel Drag)	Potential Causes/Mechanisms of Failure	Current Process Controls		
			Safety Mechanism	Diagnosics	Diagnostic Trouble Code
Rear Road Wheel Position Sensor	Rear road wheel position sensor measurement incorrect	Hardware fault (sensors, ICs, circuit components, circuit boards...)			
		Internal connection fault (short or open)			
		Break in rear road wheel position sensor I/Os connections			
		Short in rear road wheel position sensor I/Os connections to ground or voltage			
		Short in rear road wheel position sensor I/Os connections to another connection			
		Signal connector connection failure			
		Power connector connection failure			
		Rear road wheel position sensor calculation algorithm fault			
		SW parameters corrupted			
		Supply power out of range			
		Supply power quality failure			
		EMC/EMI fault			
		Contamination/corrosion			
		NVH (noise vibration harshness) fault			
		Environmental temperature exposure failure			
		Aging (durability)			
	Manufacturing defect				

System /Subsystem	Potential Failure Mode (Reduced Responsiveness to the Driver's Commands Due to Increased Rear-Wheel Drag)	Potential Causes/Mechanisms of Failure	Current Process Controls		
			Safety Mechanism	Diagnostics	Diagnostic Trouble Code
		Manufacturing variability			
		Service/maintenance			
	Rear road wheel position sensor communicates with EPS control module incorrectly	HW or SW fault (covered above)			
		Communication bus fault			
Braking System with (ESC/ABS)	Brake pedal position signal incorrect	Communication fault to EPS control module			
	Failures within braking system	Out of scope			
Active Differential System	Not relevant to this hazard	N/A			
Instrument Panel Display	Failures within instrument panel display, including incorrectly displayed warnings	Out of scope			
Engine RPM Sensor	Safety mechanism to validate vehicle speed	Out of scope			
Driver	Outside ISO 26262 scope	Out of scope			
Ignition Key	Not relevant to this hazard	Not relevant to this hazard			
Other Vehicle Systems (e.g., ALC/LKA)	Braking command from other vehicle systems (e.g., ACC) incorrect when received by EPS control module	Communication fault to EPS control module			
	Failures within other vehicle systems	Out of scope			

Table H-6. FMEA for H5: Exposure of a Person Performing Vehicle Maintenance to Moving EPS Components When the Ignition Is in the Off Position*

(Malfunction: Stored energy is present in the EPS system when ignition is in the off position)

System /Subsystem	Potential Failure Mode (Exposure of a Person Performing Vehicle Maintenance to Moving EPS Components When the Ignition Is in the Off Position*)	Potential Causes/Mechanisms of Failure	Current Process Controls		
			Safety Mechanism	Diagnos tics	Diagnos tic Trouble Code
EPS Control Module	Does not discharge energy sources	Hardware fault (sensors, ICs, circuit components, circuit boards...)			
		Internal connection fault (short or open)			
		Break in control module I/Os connections			
		Short in control module I/Os connections to ground or voltage			
		Short in control module I/Os connections to another connection			
		Signal connector connection failure			
		Power connector connection failure			
		Firmware crash/failure (SW parameters corrupted)			
		Supply power out of range			
		Supply power quality failure			
		EMI/EMC fault			
		Contamination/corrosion			
		NVH fault			
		Environmental temperature exposure failure			
		Aging (durability)			
		Manufacturing defect			
		Manufacturing variability			
	Service/maintenance				

System /Subsystem	Potential Failure Mode (Exposure of a Person Performing Vehicle Maintenance to Moving EPS Components When the Ignition Is in the Off Position*)	Potential Causes/Mechanisms of Failure	Current Process Controls		
			Safety Mechanism	Diagnos tics	Diagnos tic Trouble Code
	Intermittently discharges energy sources	HW or SW fault (covered above)			
	Does not fully discharge energy sources	HW or SW fault (covered above)			
	Diagnostic fault	Considered only in mitigation of multiple point failure analysis (FTA)			
Power Assist Motor	Motor capacitor retains charge	Internal connection fault (short or open)			
		Signal connector connection failure			
		Power connector connection failure			
		Manufacturing defect			
		Manufacturing variability			
Steering Wheel Angle Sensor	Not relevant to this hazard	N/A			
Steering Wheel Torque Sensor	Not relevant to this hazard	N/A			
Steering Wheel	Not relevant to this hazard	N/A			
Gear Set (e.g. Planetary Gear)	Not relevant to this hazard	N/A			
Steering Colum	Not relevant to this hazard	N/A			

System /Subsystem	Potential Failure Mode (Exposure of a Person Performing Vehicle Maintenance to Moving EPS Components When the Ignition Is in the Off Position*)	Potential Causes/Mechanisms of Failure	Current Process Controls		
			Safety Mechanism	Diagnostics	Diagnostic Trouble Code
n / Rack and Pinion					
Front Road Wheels	Not relevant to this hazard	N/A			
Active Differential System	Not relevant to this hazard	N/A			
Rear Road Wheel Motors	Motor capacitor retains charge	Internal connection fault (short or open)			
		Signal connector connection failure			
		Power connector connection failure			
		Manufacturing defect			
		Manufacturing variability			
Rear Road Wheels	Not relevant to this hazard	N/A			
Rear Road Wheel Position Sensor	Not relevant to this hazard	N/A			
Yaw Rate / Lateral Acceleration Sensor	Not relevant to this hazard	N/A			
Wheel Speed Sensor	Not relevant to this hazard	N/A			

System /Subsystem	Potential Failure Mode (Exposure of a Person Performing Vehicle Maintenance to Moving EPS Components When the Ignition Is in the Off Position*)	Potential Causes/Mechanisms of Failure	Current Process Controls		
			Safety Mechanism	Diagnostics	Diagnostic Trouble Code
Braking System with (ESC/ABS)	Not relevant to this hazard	N/A			
Instrument Panel Display	Not relevant to this hazard	N/A			
Engine RPM Sensor	Safety mechanism to validate vehicle speed	Out of scope			
Driver	Outside ISO 26262 Scope	Out of scope			
Ignition Key	Does not detect ignition key presence (applies to wireless keys, start/stop button ignition, etc.)	Hardware fault (sensors, ICs, circuit components, circuit boards...)			
		Internal connection fault (short or open)			
		Break in ignition module I/Os connections			
		Short in ignition module I/Os connections to ground or voltage			
		Short in ignition module I/Os connections to another connection			
		Signal connector connection failure			
		Power connector connection failure			
		SW parameters corrupted			
		Wireless key transmitter fault			
		Wireless transmission frequency interference			

System /Subsystem	Potential Failure Mode (Exposure of a Person Performing Vehicle Maintenance to Moving EPS Components When the Ignition Is in the Off Position*)	Potential Causes/Mechanisms of Failure	Current Process Controls		
			Safety Mechanism	Diagnos tics	Diagnos tic Trouble Code
		Supply power out of range			
		Supply power quality failure			
		Supply power loss			
		EMC/EMI fault			
		Contamination/corrosion			
		NVH (noise vibration harshness) fault			
		Environmental temperature exposure failure			
		Aging (durability)			
		Manufacturing defect			
		Manufacturing variability			
		Service/maintenance			
	Does not communicate with EPS control module	Communication fault			
		Supply power disruption			
	Mechanical failure (applies to physical ignition switches)	Out of scope			
Other Vehicle Systems (ALC/LKA)	Not relevant to this hazard	N/A			

* This does not include maintenance performed by professional mechanics, which are excluded from the scope of ISO 26262. This hazard is intended to cover maintenance by non-professionals, such as the vehicle owner.

APPENDIX I: STPA STEP 2: CAUSAL FACTORS

Table I- 1: Driver I-2

Table I- 2: Electric Power Steering Control Module I-3

Table I- 3: Gear Set..... I-32

Table I- 4: Power Assist Motor..... I-36

Table I- 5: Rear Road Wheel Motors..... I-43

Table I- 6: Rear Road Wheel Position Sensor I-46

Table I- 7: Steering Column/Rack and Pinion..... I-50

Table I- 8: Steering Wheel..... I-54

Table I- 9: Steering Wheel Angle Sensor I-57

Table I- 10: Steering Wheel Torque Sensor I-62

Table I- 11: Wheel Speed Sensor..... I-66

Table I- 12: Yaw Rate/Lateral Acceleration Sensor I-69

Table I- 13: Active Differential System to Electric Power Steering Control Module..... I-73

Table I- 14: Brake System (With ESC/ABS) to Electric Power Steering Control Module..... I-78

Table I- 15: Driver to Steering Wheel I-83

Table I- 16: Electric Power Steering Control Module to Instrument Panel Display I-84

Table I- 17: Electric Power Steering Control Module to Power Assist Motor I-91

Table I- 18: Electric Power Steering Control Module to Rear Road Wheel Motors..... I-96

Table I- 19: Front Road Wheels to Steering Column/Rack and Pinion..... I-101

Table I- 20: Gear Set to Steering Column/Rack and Pinion..... I-103

Table I- 21: Gear Set to Steering Wheel..... I-106

Table I- 22: Ignition Key to Electric Power Steering Control Module..... I-108

Table I- 23: Instrument Panel Display to Driver I-110

Table I- 24: Power Assist Motor to Gear Set..... I-112

Table I- 25: Rear Road Wheel Motors to Rear Road Wheels..... I-116

Table I- 26: Rear Road Wheel Position Sensor to Electric Power Steering Control Module .. I-118

Table I- 27: Rear Road Wheels to Rear Road Wheel Position Sensor I-124

Table I- 28: Steering Column/Rack and Pinion to Front Road Wheels..... I-126

Table I- 29: Steering Column/Rack and Pinion to Gear Set..... I-131

Table I- 30: Steering Wheel to Driver I-133

Table I- 31: Steering Wheel to Gear Set..... I-134

Table I- 32: Steering Wheel to Steering Wheel Angle Sensor I-136

Table I- 33: Steering Wheel to Steering Wheel Torque Sensor..... I-139

Table I- 34: Steering Wheel Angle Sensor to Electric Power Steering Control Module I-142

Table I- 35: Steering Wheel Torque Sensor to Electric Power Steering Control Module..... I-148

Table I- 36: Wheel Speed Sensor to Electric Power Steering Control Module..... I-153

Table I- 37: Yaw Rate/Lateral Acceleration Sensor to Electric Power Steering Control Module..... I-158

Table I- 1: Driver

Causal Factor ID Number	Causal Factor Guide Phrase	Causal Factor Subcategory	Causal Factor (Driver)
8	Process model or calibration incomplete or incorrect	Other	The driver might get confused due to warnings from another vehicle system having the same sound, visual icon, and/or haptic feel as the steering system warnings. This might cause the driver to change their steering behavior. This can lead the driver to issue an incorrect steering command or not issue a steering command when needed.
122	Hazardous interaction with other components in the rest of the vehicle	Other	The driver might panic if inundated with vehicle system alerts (e.g., too many vehicle system warning lights activate due to a short in the dashboard circuit). This might cause the driver to change their steering behavior. This can lead the driver to issue an incorrect steering command or not issue a steering command when needed.
135	Process model or calibration incomplete or incorrect	Other	The driver might not know how a certain EPS features works. For example, the drift compensation feature might make the steering wheel stiff at high speeds and the driver might not be able to make micro adjustments, the driver might panic and issue an incorrect steering command.

Table I- 2: Electric Power Steering Control Module

Causal Factor ID Number	Causal Factor Guide Phrase	Causal Factor Subcategory	Causal Factor (Electric Power Steering Control Module)
44	External control input or information wrong or missing	Timing related input is incorrect or missing	A timing related input that is incorrect or missing might affect the electric power steering control module when issuing a command. This could cause a delay or affect coordination when adjusting the feedback to the driver or adjusting the front and/or rear road wheel steering angle.
45	External control input or information wrong or missing	Spurious input due to shorting or other electrical fault	Spurious input due to shorting or other electrical fault might affect the electric power steering control module when issuing a command. This could cause a delay or affect coordination when adjusting the feedback to the driver or adjusting the front and/or rear road wheel steering angle.
46	External control input or information wrong or missing	Corrupted input signal	A corrupted input signal from another vehicle system might cause the electric power steering control module to incorrectly adjust the front and/or rear road wheel steering angle.
47	External control input or information wrong or missing	Malicious intruder	A malicious intruder might cause the electric power steering control module to incorrectly change the front and/or rear road wheel steering angle (e.g., issue a command that mimics a steering request).
48	External disturbances	EMI or ESD	EMI or ESD from external environment might affect the electric power steering control module. This could affect adjustments in feedback to the driver, direction or amount of steering angle change in the front road wheels, or the direction or amount of steering angle change in the rear road wheels. <ul style="list-style-type: none"> • Affecting the feedback to the driver may cause the driver to incorrectly issue a steering adjustment. • Not adjusting the front road wheels, or adjusting the front road wheels by the wrong amount or in the wrong direction may cause the steering system to respond differently than expected. • Adjusting the rear road wheels in the wrong direction or by the wrong amount may cause unexpected vehicle dynamics.

Causal Factor ID Number	Causal Factor Guide Phrase	Causal Factor Subcategory	Causal Factor (Electric Power Steering Control Module)
49	External disturbances	Single event effects (e.g., cosmic rays, protons)	<p>Single event effects (e.g., cosmic rays, protons) from external environment might affect the electric power steering control module. This could affect adjustments in feedback to the driver, direction or amount of steering angle change in the front road wheels, or the direction or amount of steering angle change in the rear road wheels.</p> <ul style="list-style-type: none"> • Affecting the feedback to the driver may cause the driver to incorrectly issue a steering adjustment. • Not adjusting the front road wheels, or adjusting the front road wheels by the wrong amount or in the wrong direction may cause the steering system to respond differently than expected. • Adjusting the rear road wheels in the wrong direction or by the wrong amount may cause unexpected vehicle dynamics.
50	External disturbances	Vibration or shock impact	<p>Vibration or shock impact from external environment might affect the electric power steering control module. This could affect adjustments in feedback to the driver, direction or amount of steering angle change in the front road wheels, or the direction or amount of steering angle change in the rear road wheels.</p> <ul style="list-style-type: none"> • Affecting the feedback to the driver may cause the driver to incorrectly issue a steering adjustment. • Not adjusting the front road wheels, or adjusting the front road wheels by the wrong amount or in the wrong direction may cause the steering system to respond differently than expected. • Adjusting the rear road wheels in the wrong direction or by the wrong amount may cause unexpected vehicle dynamics.

Causal Factor ID Number	Causal Factor Guide Phrase	Causal Factor Subcategory	Causal Factor (Electric Power Steering Control Module)
51	External disturbances	Manufacturing defects and assembly problems	<p>Manufacturing defects and assembly problems from external environment might affect the electric power steering control module. This could affect adjustments in feedback to the driver, direction or amount of steering angle change in the front road wheels, or the direction or amount of steering angle change in the rear road wheels.</p> <ul style="list-style-type: none"> • Affecting the feedback to the driver may cause the driver to incorrectly issue a steering adjustment. • Not adjusting the front road wheels, or adjusting the front road wheels by the wrong amount or in the wrong direction may cause the steering system to respond differently than expected. • Adjusting the rear road wheels in the wrong direction or by the wrong amount may cause unexpected vehicle dynamics.
52	External disturbances	Extreme external temperature or thermal cycling	<p>Extreme external temperature or thermal cycling from external environment might affect the electric power steering control module. This could affect adjustments in feedback to the driver, direction or amount of steering angle change in the front road wheels, or the direction or amount of steering angle change in the rear road wheels.</p> <ul style="list-style-type: none"> • Affecting the feedback to the driver may cause the driver to incorrectly issue a steering adjustment. • Not adjusting the front road wheels, or adjusting the front road wheels by the wrong amount or in the wrong direction may cause the steering system to respond differently than expected. • Adjusting the rear road wheels in the wrong direction or by the wrong amount may cause unexpected vehicle dynamics.

Causal Factor ID Number	Causal Factor Guide Phrase	Causal Factor Subcategory	Causal Factor (Electric Power Steering Control Module)
53	External disturbances	Moisture, corrosion, or contamination	<p>Moisture, corrosion, or contamination from external environment might affect the electric power steering control module. This could affect adjustments in feedback to the driver, direction or amount of steering angle change in the front road wheels, or the direction or amount of steering angle change in the rear road wheels.</p> <ul style="list-style-type: none"> • Affecting the feedback to the driver may cause the driver to incorrectly issue a steering adjustment. • Not adjusting the front road wheels, or adjusting the front road wheels by the wrong amount or in the wrong direction may cause the steering system to respond differently than expected. • Adjusting the rear road wheels in the wrong direction or by the wrong amount may cause unexpected vehicle dynamics.
54	External disturbances	Organic growth	<p>Organic growth from external environment might affect the electric power steering control module. This could affect adjustments in feedback to the driver, direction or amount of steering angle change in the front road wheels, or the direction or amount of steering angle change in the rear road wheels.</p> <ul style="list-style-type: none"> • Affecting the feedback to the driver may cause the driver to incorrectly issue a steering adjustment. • Not adjusting the front road wheels, or adjusting the front road wheels by the wrong amount or in the wrong direction may cause the steering system to respond differently than expected. • Adjusting the rear road wheels in the wrong direction or by the wrong amount may cause unexpected vehicle dynamics.

Causal Factor ID Number	Causal Factor Guide Phrase	Causal Factor Subcategory	Causal Factor (Electric Power Steering Control Module)
55	External disturbances	Physical interference (e.g., chafing)	<p>Physical interference from external environment might affect the electric power steering control module. This could affect the adjustments in feedback to the driver, and affect the transmission of torque from driver or from power assist motor direction or amount of steering angle change in the front road wheels, or the direction or steering angle of steering angle change in the rear road wheels.</p> <ul style="list-style-type: none"> • Affecting the feedback to the driver may cause the driver to incorrectly issue a steering adjustment. • Not adjusting the front road wheels, or adjusting the front road wheels by the wrong amount or in the wrong direction may cause the steering system to respond differently than expected. • Adjusting the rear road wheels in the wrong direction or by the wrong amount may cause unexpected vehicle dynamics.
56	Power supply faulty (high, low, disturbance)	Loss of 12-volt power	<p>Loss of 12-volt power might affect the electric power steering control module. This could affect adjustments in feedback to the driver, the direction or amount of steering angle change in the front road wheels, or the direction or amount of steering angle change in the rear road wheels.</p> <ul style="list-style-type: none"> • Affecting the feedback to the driver may cause the driver to incorrectly issue a steering adjustment. • Not adjusting the front road wheels, or adjusting the front road wheels by the wrong amount or in the wrong direction may cause the steering system to respond differently than expected. • Adjusting the rear road wheels in the wrong direction or by the wrong amount may cause unexpected vehicle dynamics.

Causal Factor ID Number	Causal Factor Guide Phrase	Causal Factor Subcategory	Causal Factor (Electric Power Steering Control Module)
57	Power supply faulty (high, low, disturbance)	Power supply faulty (high, low, disturbance)	<p>A power supply that is faulty (high, low, disturbance) might affect the electric power steering control module. This could affect adjustments in feedback to the driver, direction or amount of steering angle change in the front road wheels, or the direction or amount of steering angle change in the rear road wheels.</p> <ul style="list-style-type: none"> • Affecting the feedback to the driver may cause the driver to incorrectly issue a steering adjustment. • Not adjusting the front road wheels, or adjusting the front road wheels by the wrong amount or in the wrong direction may cause the steering system to respond differently than expected. • Adjusting the rear road wheels in the wrong direction or by the wrong amount may cause unexpected vehicle dynamics.
58	Hazardous interaction with other components in the rest of the vehicle	EMI or ESD	<p>EMI or ESD from other components within the vehicle might affect the electric power steering control module. This could affect adjustments in feedback to the driver, direction or amount of steering angle change in the front road wheels, or the direction or amount of steering angle change in the rear road wheels.</p> <ul style="list-style-type: none"> • Affecting the feedback to the driver may cause the driver to incorrectly issue a steering adjustment. • Not adjusting the front road wheels, or adjusting the front road wheels by the wrong amount or in the wrong direction may cause the steering system to respond differently than expected. • Adjusting the rear road wheels in the wrong direction or by the wrong amount may cause unexpected vehicle dynamics.

Causal Factor ID Number	Causal Factor Guide Phrase	Causal Factor Subcategory	Causal Factor (Electric Power Steering Control Module)
59	Hazardous interaction with other components in the rest of the vehicle	Vibration or shock impact	<p>Vibration or shock impact from other components within the vehicle might affect the electric power steering control module. This could affect adjustments in feedback to the driver, direction or amount of steering angle change in the front road wheels, or the direction or amount of steering angle change in the rear road wheels.</p> <ul style="list-style-type: none"> • Affecting the feedback to the driver may cause the driver to incorrectly issue a steering adjustment. • Not adjusting the front road wheels, or adjusting the front road wheels by the wrong amount or in the wrong direction may cause the steering system to respond differently than expected. • Adjusting the rear road wheels in the wrong direction or by the wrong amount may cause unexpected vehicle dynamics.
60	Hazardous interaction with other components in the rest of the vehicle	Physical interference (e.g., chafing)	<p>Physical interference with other components within the vehicle might affect the electric power steering control module. This could affect adjustments in feedback to the driver, direction or amount of steering angle change in the front road wheels, or the direction or amount of steering angle change in the rear road wheels.</p> <ul style="list-style-type: none"> • Affecting the feedback to the driver may cause the driver to incorrectly issue a steering adjustment. • Not adjusting the front road wheels, or adjusting the front road wheels by the wrong amount or in the wrong direction may cause the steering system to respond differently than expected. • Adjusting the rear road wheels in the wrong direction or by the wrong amount may cause unexpected vehicle dynamics.

Causal Factor ID Number	Causal Factor Guide Phrase	Causal Factor Subcategory	Causal Factor (Electric Power Steering Control Module)
61	Hazardous interaction with other components in the rest of the vehicle	Moisture, corrosion, or contamination	<p>Moisture, corrosion, or contamination from other components within the vehicle might affect the electric power steering control module. This could affect adjustments in feedback to the driver, direction or amount of steering angle change in the front road wheels, or the direction or amount of steering angle change in the rear road wheels.</p> <ul style="list-style-type: none"> • Affecting the feedback to the driver may cause the driver to incorrectly issue a steering adjustment. • Not adjusting the front road wheels, or adjusting the front road wheels by the wrong amount or in the wrong direction may cause the steering system to respond differently than expected. • Adjusting the rear road wheels in the wrong direction or by the wrong amount may cause unexpected vehicle dynamics.
62	Hazardous interaction with other components in the rest of the vehicle	Electrical arcing from neighboring components or exposed terminals	<p>Electrical arcing from neighboring components or exposed terminals might affect the electric power steering control module. This could affect adjustments in feedback to the driver, direction or amount of steering angle change in the front road wheels, or the direction or amount of steering angle change in the rear road wheels.</p> <ul style="list-style-type: none"> • Affecting the feedback to the driver may cause the driver to incorrectly issue a steering adjustment. • Not adjusting the front road wheels, or adjusting the front road wheels by the wrong amount or in the wrong direction may cause the steering system to respond differently than expected. • Adjusting the rear road wheels in the wrong direction or by the wrong amount may cause unexpected vehicle dynamics.

Causal Factor ID Number	Causal Factor Guide Phrase	Causal Factor Subcategory	Causal Factor (Electric Power Steering Control Module)
63	Hazardous interaction with other components in the rest of the vehicle	Corona effects from high voltage components	<p>If the vehicle has high voltage components (e.g., electric or hybrid electric powertrain), corona effects might affect the electric power steering control module. This could affect adjustments in feedback to the driver, direction or amount of steering angle change in the front road wheels, or the direction or amount of steering angle change in the rear road wheels.</p> <ul style="list-style-type: none"> • Affecting the feedback to the driver may cause the driver to incorrectly issue a steering adjustment. • Not adjusting the front road wheels, or adjusting the front road wheels by the wrong amount or in the wrong direction may cause the steering system to respond differently than expected. • Adjusting the rear road wheels in the wrong direction or by the wrong amount may cause unexpected vehicle dynamics.
64	Controller hardware faulty, change over time	Internal hardware failure	<p>An internal hardware failure might affect the electric power steering control module. This could affect adjustments in feedback to the driver, direction or amount of steering angle change in the front road wheels, or the direction or amount of steering angle change in the rear road wheels.</p> <ul style="list-style-type: none"> • Affecting the feedback to the driver may cause the driver to incorrectly issue a steering adjustment. • Not adjusting the front road wheels, or adjusting the front road wheels by the wrong amount or in the wrong direction may cause the steering system to respond differently than expected. • Adjusting the rear road wheels in the wrong direction or by the wrong amount may cause unexpected vehicle dynamics.

Causal Factor ID Number	Causal Factor Guide Phrase	Causal Factor Subcategory	Causal Factor (Electric Power Steering Control Module)
65	Controller hardware faulty, change over time	Overheating due to increased resistance in a subcomponent or internal shorting	<p>Overheating due to increased resistance in a subcomponent or internal shorting might affect the electric power steering control module. This could affect adjustments in feedback to the driver, direction or amount of steering angle change in the front road wheels, or the direction or amount of steering angle change in the rear road wheels.</p> <ul style="list-style-type: none"> • Affecting the feedback to the driver may cause the driver to incorrectly issue a steering adjustment. • Not adjusting the front road wheels, or adjusting the front road wheels by the wrong amount or in the wrong direction may cause the steering system to respond differently than expected. • Adjusting the rear road wheels in the wrong direction or by the wrong amount may cause unexpected vehicle dynamics.
66	Controller hardware faulty, change over time	Over temperature due to faulty cooling system	<p>Over temperature due to faulty cooling system might affect the electric power steering control module. This could affect adjustments in feedback to the driver, direction or amount of steering angle change in the front road wheels, or the direction or amount of steering angle change in the rear road wheels.</p> <ul style="list-style-type: none"> • Affecting the feedback to the driver may cause the driver to incorrectly issue a steering adjustment. • Not adjusting the front road wheels, or adjusting the front road wheels by the wrong amount or in the wrong direction may cause the steering system to respond differently than expected. • Adjusting the rear road wheels in the wrong direction or by the wrong amount may cause unexpected vehicle dynamics.

Causal Factor ID Number	Causal Factor Guide Phrase	Causal Factor Subcategory	Causal Factor (Electric Power Steering Control Module)
67	Controller hardware faulty, change over time	Degradation over time	<p>Degradation over time might affect the electric power steering control module. This could affect adjustments in feedback to the driver, direction or amount of steering angle change in the front road wheels, or the direction or amount of steering angle change in the rear road wheels.</p> <ul style="list-style-type: none"> • Affecting the feedback to the driver may cause the driver to incorrectly issue a steering adjustment. • Not adjusting the front road wheels, or adjusting the front road wheels by the wrong amount or in the wrong direction may cause the steering system to respond differently than expected. • Adjusting the rear road wheels in the wrong direction or by the wrong amount may cause unexpected vehicle dynamics.
68	Controller hardware faulty, change over time	Faulty memory storage or retrieval	<p>Faulty memory storage or retrieval might affect the electric power steering control module. This could affect adjustments in feedback to the driver, direction or amount of steering angle change in the front road wheels, or the direction or amount of steering angle change in the rear road wheels.</p> <ul style="list-style-type: none"> • Affecting the feedback to the driver may cause the driver to incorrectly issue a steering adjustment. • Not adjusting the front road wheels, or adjusting the front road wheels by the wrong amount or in the wrong direction may cause the steering system to respond differently than expected. • Adjusting the rear road wheels in the wrong direction or by the wrong amount may cause unexpected vehicle dynamics.
69	Controller hardware faulty, change over time	Faulty internal timing clock	<p>A faulty internal timing clock might affect the electric power steering control module. This could affect timing for adjustments in feedback to the driver, changing the front road wheel steering angle, or changing the rear road wheel steering angle.</p>

Causal Factor ID Number	Causal Factor Guide Phrase	Causal Factor Subcategory	Causal Factor (Electric Power Steering Control Module)
70	Controller hardware faulty, change over time	Faulty signal conditioning or converting (e.g., analog-to-digital converter, signal filters)	<p>Faulty signal conditioning or converting (e.g., analog-to-digital converter, signal filters) might affect the electric power steering control module. This could affect adjustments in feedback to the driver, direction or amount of steering angle change in the front road wheels, or the direction or amount of steering angle change in the rear road wheels.</p> <ul style="list-style-type: none"> • Affecting the feedback to the driver may cause the driver to incorrectly issue a steering adjustment. • Not adjusting the front road wheels, or adjusting the front road wheels by the wrong amount or in the wrong direction may cause the steering system to respond differently than expected. • Adjusting the rear road wheels in the wrong direction or by the wrong amount may cause unexpected vehicle dynamics.
71	Controller hardware faulty, change over time	Unused circuits in the controller	<p>Unused circuits might affect the electric power steering control module. This could affect adjustments in feedback to the driver, direction or amount of steering angle change in the front road wheels, or the direction or amount of steering angle change in the rear road wheels.</p> <ul style="list-style-type: none"> • Affecting the feedback to the driver may cause the driver to incorrectly issue a steering adjustment. • Not adjusting the front road wheels, or adjusting the front road wheels by the wrong amount or in the wrong direction may cause the steering system to respond differently than expected. • Adjusting the rear road wheels in the wrong direction or by the wrong amount may cause unexpected vehicle dynamics.

Causal Factor ID Number	Causal Factor Guide Phrase	Causal Factor Subcategory	Causal Factor (Electric Power Steering Control Module)
72	Software error (inadequate control algorithm, flaws in creation, modification, or adaptation)	Flaws in software code creation	Flaws in software code creation (e.g., automatic code generation) might affect the electric power steering control module.
73	Software error (inadequate control algorithm, flaws in creation, modification, or adaptation)	Inadequate control algorithm	A programming error or flaw in software logic may cause the EPS control module to delay adjusting the feedback to the driver.
74	Process model or calibration incomplete or incorrect	Sensor or actuator calibration, including degradation characteristics	Sensor or actuator calibration, including degradation characteristics, in the electric power steering control module may be incorrect. This could affect how the EPS control module adjusts feedback to the driver and affect the direction or amount by which the front and/or rear road wheel steering angle is adjusted.
75	Process model or calibration incomplete or incorrect	Model of the controlled process, including degradation characteristics	Model of the controlled process, including degradation characteristics, in the electric power steering control module may be incorrect. This could affect how the EPS control module adjusts feedback to the driver and affect the direction or amount by which the front and/or rear road wheel steering angle is adjusted.
76	Process model or calibration incomplete or incorrect	Errors in stored maps	Stored calibration maps in the electric power steering control module may be incorrect. This could affect how the EPS control module adjusts feedback to the driver and affect the direction or amount by which the front and/or rear road wheel steering angle is adjusted.

Causal Factor ID Number	Causal Factor Guide Phrase	Causal Factor Subcategory	Causal Factor (Electric Power Steering Control Module)
238	Software error (inadequate control algorithm, flaws in creation, modification, or adaptation)	Inadequate control algorithm	All UCAs related to the EPS control module apply
241	Software error (inadequate control algorithm, flaws in creation, modification, or adaptation)	Inadequate control algorithm	A programming error or flaw in software logic may prevent the EPS control module from adjusting feedback to the driver when needed (e.g., a pull on the steering wheel may cause the driver to incorrectly countersteer).
243	Software error (inadequate control algorithm, flaws in creation, modification, or adaptation)	Inadequate control algorithm	A programming error or flaw in software logic may cause the EPS control module to adjust feedback to the driver at the wrong rate (e.g., adjusting the feedback too slowly/too fast may cause the driver to steer for too long/too short).
244	Software error (inadequate control algorithm, flaws in creation, modification, or adaptation)	Inadequate control algorithm	A programming error or flaw in software logic may cause the EPS control module to adjust feedback to the driver by the wrong amount (e.g., too much or too little).

Causal Factor ID Number	Causal Factor Guide Phrase	Causal Factor Subcategory	Causal Factor (Electric Power Steering Control Module)
301	Process model or calibration incomplete or incorrect	Model of the controlled process, including degradation characteristics	Model of the controlled process, including degradation characteristics, in the electric power steering control module may be incorrect. This could affect how the EPS control module adjusts feedback to the driver and affect the direction or amount by which the front and/or rear road wheel steering angle is adjusted.
302	Process model or calibration incomplete or incorrect	Errors in stored maps	Stored calibration maps in the electric power steering control module may be incorrect. This could affect how the EPS control module adjusts feedback to the driver and affect the direction or amount by which the front and/or rear road wheel steering angle is adjusted.
425	Power supply faulty (high, low, disturbance)	Power supply faulty (high, low, disturbance)	<p>A power supply that is faulty (high, low, disturbance) might affect the electric power steering control module. This could affect adjustments in feedback to the driver, direction or amount of steering angle change in the front road wheels, or the direction or amount of steering angle change in the rear road wheels.</p> <ul style="list-style-type: none"> • Affecting the feedback to the driver may cause the driver to incorrectly issue a steering adjustment. • Not adjusting the front road wheels, or adjusting the front road wheels by the wrong amount or in the wrong direction may cause the steering system to respond differently than expected. • Adjusting the rear road wheels in the wrong direction or by the wrong amount may cause unexpected vehicle dynamics.
726	Process model or calibration incomplete or incorrect	Sensor or actuator calibration, including degradation characteristics	Sensor or actuator calibration, including degradation characteristics, in the electric power steering control module may be incorrect. This could affect how the EPS control module adjusts feedback to the driver and affect the direction or amount by which the front and/or rear road wheel steering angle is adjusted.

Causal Factor ID Number	Causal Factor Guide Phrase	Causal Factor Subcategory	Causal Factor (Electric Power Steering Control Module)
849	Software error (inadequate control algorithm, flaws in creation, modification, or adaptation)	Inadequate control algorithm	A programming error or flaw in software logic may cause the EPS control module to command torque from the power assist motor for the wrong duration (e.g., too short, too long).
850	Software error (inadequate control algorithm, flaws in creation, modification, or adaptation)	Inadequate control algorithm	A programming error or flaw in software logic may cause the EPS control module to command torque from the power assist motor at the wrong rate (e.g., a magnitude of torque that is too low or too high).
851	Software error (inadequate control algorithm, flaws in creation, modification, or adaptation)	Inadequate control algorithm	Inadequate control algorithms might affect the EPS control module. This might cause the EPS control module to command from the power assist motor a magnitude of torque that is too high.
852	Software error (inadequate control algorithm, flaws in creation, modification, or adaptation)	Inadequate control algorithm	A programming error or flaw in software logic may prevent the EPS control module from commanding torque from the power assist motor when the driver requires steering assist or when other vehicle systems request a steering adjustment.

Causal Factor ID Number	Causal Factor Guide Phrase	Causal Factor Subcategory	Causal Factor (Electric Power Steering Control Module)
853	Software error (inadequate control algorithm, flaws in creation, modification, or adaptation)	Inadequate control algorithm	A programming error or flaw in software logic may cause the EPS control module to command torque from the power assist motor when the driver does not require steering assist and other vehicle systems are not requesting a steering adjustment.
855	Software error (inadequate control algorithm, flaws in creation, modification, or adaptation)	Inadequate control algorithm	A programming error or flaw in software logic may cause the EPS control module to command torque from the power assist motor for the wrong duration (e.g., too short, too long).
856	Software error (inadequate control algorithm, flaws in creation, modification, or adaptation)	Inadequate control algorithm	A programming error or flaw in software logic may cause a delay in commanding torque from the power assist motor.
857	Software error (inadequate control algorithm, flaws in creation, modification, or adaptation)	Inadequate control algorithm	A programming error or flaw in software logic may cause the EPS control module to subtract torque from the driver's steering input while below the speed threshold.

Causal Factor ID Number	Causal Factor Guide Phrase	Causal Factor Subcategory	Causal Factor (Electric Power Steering Control Module)
858	Software error (inadequate control algorithm, flaws in creation, modification, or adaptation)	Inadequate control algorithm	A programming error or flaw in software logic may cause the EPS control module to command torque from the power assist motor in the opposite direction from another vehicle system's request.
859	Software error (inadequate control algorithm, flaws in creation, modification, or adaptation)	Inadequate control algorithm	A programming error or flaw in software logic may cause the EPS control module to subtract or add torque from the driver's steering input while below or above the speed threshold respectively or command torque from the power assist motor when the driver does not require steering assist.
860	Software error (inadequate control algorithm, flaws in creation, modification, or adaptation)	Inadequate control algorithm	A programming error or flaw in software logic may cause the EPS control module to add torque to the driver's steering input while above the speed threshold.
972	External control input or information wrong or missing	Spurious input due to shorting or other electrical fault	Spurious input due to shorting or other electrical fault might affect the EPS control module torque command to the rear road wheel motors.
973	External control input or information wrong or missing	Corrupted input signal	Corrupted input signal might affect the EPS control module torque command to the rear road wheel motors.

Causal Factor ID Number	Causal Factor Guide Phrase	Causal Factor Subcategory	Causal Factor (Electric Power Steering Control Module)
974	External control input or information wrong or missing	Malicious intruder	Malicious intruder (e.g. virus) might affect the EPS control module torque command to the rear road wheel motors.
975	External disturbances	EMI or ESD	EMI or ESD might affect the EPS control module torque command to the rear road wheel motors.
976	External disturbances	Single event effects (e.g., cosmic rays, protons)	Single event effects (e.g., cosmic rays, protons) might affect the EPS control module torque command to the rear road wheel motors.
977	External disturbances	Vibration or shock impact	Vibration or shock impact might affect the EPS control module torque command to the rear road wheel motors.
978	External disturbances	Manufacturing defects and assembly problems	Manufacturing defects and assembly problems might affect the EPS control module torque command to the rear road wheel motors.
979	External disturbances	Extreme external temperature or thermal cycling	Extreme external temperature or thermal cycling might affect the EPS control module torque command to the rear road wheel motors.
980	External disturbances	Moisture, corrosion, or contamination	Moisture, corrosion, or contamination might affect the EPS control module torque command to the rear road wheel motors.
981	External disturbances	Organic growth	Organic growth (e.g., mold) might affect the EPS control module circuitry and might create a fault that can affect the torque command to the rear road wheel motors.
982	External disturbances	Physical interference (e.g., chafing)	Physical interference (e.g., chafing) might affect the EPS control module torque command to the rear road wheel motors.
983	Power supply faulty (high, low, disturbance)	Loss of 12-volt power	Loss of 12-volt power might affect the EPS control module torque command to the rear road wheel motors.
984	Power supply faulty (high, low, disturbance)	Power supply faulty (high, low, disturbance)	Power supply faulty (high, low, disturbance) might affect the EPS control module torque command to the rear road wheel motors.

Causal Factor ID Number	Causal Factor Guide Phrase	Causal Factor Subcategory	Causal Factor (Electric Power Steering Control Module)
985	Hazardous interaction with other components in the rest of the vehicle	EMI or ESD	EMI or ESD from components within the vehicle might affect the EPS control module torque command to the rear road wheel motors.
986	Hazardous interaction with other components in the rest of the vehicle	Vibration or shock impact	Vibration or shock impact from components within the vehicle might affect the EPS control module torque command to the rear road wheel motors.
987	Hazardous interaction with other components in the rest of the vehicle	Physical interference (e.g., chafing)	Physical interference (e.g., chafing) with components within the vehicle might affect the EPS control module torque command to the rear road wheel motors.
988	Hazardous interaction with other components in the rest of the vehicle	Moisture, corrosion, or contamination	Moisture, corrosion, or contamination from components within the vehicle might affect the EPS control module torque command to the rear road wheel motors.
989	Hazardous interaction with other components in the rest of the vehicle	Electrical arcing from neighboring components or exposed terminals	Electrical arcing from neighboring components or exposed terminals might affect the EPS control module torque command to the rear road wheel motors.
990	Hazardous interaction with other components in the rest of the vehicle	Corona effects from high voltage components	Corona effects from high voltage components might affect the EPS control module torque command to the rear road wheel motors.
991	Controller hardware faulty, change over time	Internal hardware failure	Internal hardware failure might affect the EPS control module torque command to the rear road wheel motors.

Causal Factor ID Number	Causal Factor Guide Phrase	Causal Factor Subcategory	Causal Factor (Electric Power Steering Control Module)
992	Controller hardware faulty, change over time	Overheating due to increased resistance in a subcomponent or internal shorting	Overheating due to increased resistance in a subcomponent or internal shorting might affect the EPS control module torque command to the rear road wheel motors.
993	Controller hardware faulty, change over time	Over temperature due to faulty cooling system	Over temperature due to faulty cooling system might affect the EPS control module torque command to the rear road wheel motors.
994	Controller hardware faulty, change over time	Degradation over time	Degradation over time might affect the EPS control module torque command to the rear road wheel motors.
995	Controller hardware faulty, change over time	Faulty memory storage or retrieval	Faulty memory storage or retrieval might affect the EPS control module torque command to the rear road wheel motors.
996	Controller hardware faulty, change over time	Faulty internal timing clock	Faulty internal timing clock might affect the EPS control module torque command to the rear road wheel motors.
997	Controller hardware faulty, change over time	Faulty signal conditioning or converting (e.g., analog-to-digital converter, signal filters)	Faulty signal conditioning or converting (e.g., analog-to-digital converter, signal filters) might affect the EPS control module torque command to the rear road wheel motors.

Causal Factor ID Number	Causal Factor Guide Phrase	Causal Factor Subcategory	Causal Factor (Electric Power Steering Control Module)
998	Software error (inadequate control algorithm, flaws in creation, modification, or adaptation)	Flaws in software code creation	Flaws in software code creation might affect the EPS control module torque command to the rear road wheel motors.
999	Software error (inadequate control algorithm, flaws in creation, modification, or adaptation)	Inadequate control algorithm	A programming error or flaw in software logic may cause the EPS control module to command the rear wheels to toe-in when not needed (e.g., while the driver is steering or while the brakes are not applied).
1000	Process model or calibration incomplete or incorrect	Sensor or actuator calibration, including degradation characteristics	Sensor or actuator calibration, including degradation characteristics might affect the EPS control module torque command to the rear road wheel motors.
1002	Process model or calibration incomplete or incorrect	Model of the controlled process, including degradation characteristics	Model of the controlled process, including degradation characteristics might affect the EPS control module torque command to the rear road wheel motors.
1003	Process model or calibration incomplete or incorrect	Errors in stored maps	Errors in stored maps might affect the EPS control module torque command to the rear road wheel motors.

Causal Factor ID Number	Causal Factor Guide Phrase	Causal Factor Subcategory	Causal Factor (Electric Power Steering Control Module)
1039	External control input or information wrong or missing	Timing related input is incorrect or missing	Timing related input that is incorrect or missing (e.g., input from brake pressure sensor or pedal position sensor or steering wheel angle sensor) might affect the EPS control module torque command to the rear road wheel motors.
1040	Software error (inadequate control algorithm, flaws in creation, modification, or adaptation)	Inadequate control algorithm	A programming error or flaw in software logic may cause the EPS control module to command the rear wheels to move to an in-phase or reverse-phase position when not needed (e.g., no steering input).
1041	Software error (inadequate control algorithm, flaws in creation, modification, or adaptation)	Inadequate control algorithm	A programming error or flaw in software logic may cause the EPS control module to change the rear road wheel steering angle by the wrong magnitude (e.g., rear road wheel steering angle is too large).
1042	Software error (inadequate control algorithm, flaws in creation, modification, or adaptation)	Inadequate control algorithm	A programming error or flaw in software logic may cause the EPS control module to adjust the a rear wheel steering angle for the wrong duration (e.g., the rear wheels have a non-zero steering angle after the driver returns the steering wheel to the center position).

Causal Factor ID Number	Causal Factor Guide Phrase	Causal Factor Subcategory	Causal Factor (Electric Power Steering Control Module)
1044	Software error (inadequate control algorithm, flaws in creation, modification, or adaptation)	Inadequate control algorithm	A programming error or flaw in software logic may cause the EPS control module to command the rear wheels to turn to the reverse-phase position when the vehicle speed is above the maximum speed value for activating reverse-phase steering.
1045	Software error (inadequate control algorithm, flaws in creation, modification, or adaptation)	Inadequate control algorithm	A programming error or flaw in software logic may cause the EPS control module to adjust the rear wheel steering angle with the wrong timing (e.g., the transition from in-phase to reverse-phase is not smooth).
1047	Software error (inadequate control algorithm, flaws in creation, modification, or adaptation)	Inadequate control algorithm	A programming error or flaw in software logic may cause the EPS control module to command the rear wheels to turn to the in-phase position when the vehicle speed is below the minimum speed value for activating in-phase steering.
1051	Software error (inadequate control algorithm, flaws in creation, modification, or adaptation)	Inadequate control algorithm	A programming error or flaw in software logic may cause the EPS control module to change the rear road wheel steering angle by the wrong magnitude (e.g., rear road wheel steering angle is too large).

Causal Factor ID Number	Causal Factor Guide Phrase	Causal Factor Subcategory	Causal Factor (Electric Power Steering Control Module)
1162	Hazardous interaction with other components in the rest of the vehicle	Excessive heat from other components	<p>Excessive heat from other vehicle components may affect the electric power steering control module. This could affect adjustments in feedback to the driver, the direction or amount of steering angle change in the front road wheels, or the direction or amount of steering angle change in the rear road wheels.</p> <ul style="list-style-type: none"> • Affecting the feedback to the driver may cause the driver to incorrectly issue a steering adjustment. • Not adjusting the front road wheels, or adjusting the front road wheels by the wrong amount or in the wrong direction may cause the steering system to respond differently than expected. • Adjusting the rear road wheels in the wrong direction or by the wrong amount may cause unexpected vehicle dynamics.
1163	Software error (inadequate control algorithm, flaws in creation, modification, or adaptation)	Inadequate control algorithm	A programming error or flaw in software logic may cause the EPS control module to adjust the rear wheel steering angle at the wrong rate (e.g., an abrupt change in vehicle handling).
1164	Software error (inadequate control algorithm, flaws in creation, modification, or adaptation)	Inadequate control algorithm	A programming error or flaw in software logic may cause the EPS control module to amplify, rather than reduce, feedback to the driver (or vice versa).

Causal Factor ID Number	Causal Factor Guide Phrase	Causal Factor Subcategory	Causal Factor (Electric Power Steering Control Module)
1165	Software error (inadequate control algorithm, flaws in creation, modification, or adaptation)	Inadequate control algorithm	A programming error or flaw in software logic may cause the EPS control module to adjust the front or rear road wheel steering angle by the wrong amount (e.g., the steering angle changes more than requested by another vehicle system).
1168	Software error (inadequate control algorithm, flaws in creation, modification, or adaptation)	Inadequate control algorithm	A programming error or flaw in software logic may cause the EPS control module to incorrectly prioritize between the driver and an active safety system.
1169	Process model or calibration incomplete or incorrect	Model of the controlled process, including degradation characteristics	The EPS control module may incorrectly consider the vehicle speed when determining whether to add or subtract torque from the driver's input.
1170	Process model or calibration incomplete or incorrect	Model of the controlled process, including degradation characteristics	The EPS control module may incorrectly consider the vehicle speed when determining whether to turn the rear road wheel's to the in-phase or reverse-phase position.
1171	Process model or calibration incomplete or incorrect	Model of the controlled process, including degradation characteristics	The EPS control module understanding of the vehicle yaw rate and lateral acceleration may be different from the actual vehicle yaw rate and lateral acceleration.

Causal Factor ID Number	Causal Factor Guide Phrase	Causal Factor Subcategory	Causal Factor (Electric Power Steering Control Module)
1172	Process model or calibration incomplete or incorrect	Model of the controlled process, including degradation characteristics	The EPS control module's model of the vehicle dynamics may be incorrect (e.g., incorrect parameters, calibration for wrong vehicle type, etc.).
1173	Process model or calibration incomplete or incorrect	Model of the controlled process, including degradation characteristics	The EPS control module may have an incorrect understanding of which other vehicle systems are capable of requesting steering adjustments. For example, if the EPS control module thinks the ALK/ALC system is disabled, it may not respond to steering requests from the ALK/ALC system.
1174	Process model or calibration incomplete or incorrect	Model of the controlled process, including degradation characteristics	The EPS control module may have an incorrect understanding of the health of the steering system (e.g., whether faults are present). This may prevent the EPS control module from entering a degraded operating state or issuing a warning notification to the driver.
1175	Process model or calibration incomplete or incorrect	Model of the controlled process, including degradation characteristics	The EPS control module may have an incorrect understanding of the ignition key state (e.g., a disruption in the power supply causes the EPS to think the key is in the "off" position). If the EPS incorrectly thinks the driver has turned the vehicle "off," it may engage the steering wheel locking mechanism.
1176	Process model or calibration incomplete or incorrect	Model of the controlled process, including degradation characteristics	The EPS may not know what yaw rate corrective actions other vehicle systems are taking (e.g., active differential or brake/stability control systems). The EPS may implement yaw stability control at the same time another vehicle system is making the same adjustments.
1177	Process model or calibration incomplete or incorrect	Model of the controlled process, including degradation characteristics	If the EPS may not compare the driver's steering input with the vehicle's yaw rate when computing the adjustment needed for drift compensation (e.g., crosswind compensation). This may cause the EPS to misinterpret a steady steering input from the driver as a countersteer effort.

Causal Factor ID Number	Causal Factor Guide Phrase	Causal Factor Subcategory	Causal Factor (Electric Power Steering Control Module)
1180	Process model or calibration incomplete or incorrect	Model of the controlled process, including degradation characteristics	The EPS may not know what yaw rate corrective actions other vehicle systems are taking (e.g., active differential or brake/stability control systems). The EPS may implement yaw stability control at the same time another vehicle system is making the same adjustments.
1181	Process model or calibration incomplete or incorrect	Model of the controlled process, including degradation characteristics	The EPS control module may have an incorrect understanding of the health of the steering system (e.g., whether faults are present). This may prevent the EPS control module from entering a degraded operating state or issuing a warning notification to the driver.
1182	Process model or calibration incomplete or incorrect	Model of the controlled process, including degradation characteristics	The EPS may not compare the driver's steering input with the vehicle's yaw rate when computing the adjustment needed for drift compensation (e.g., crosswind compensation). This may cause the EPS to misinterpret a steady steering input from the driver as a countersteer effort.
1184	Process model or calibration incomplete or incorrect	Model of the controlled process, including degradation characteristics	The EPS control module may have an incorrect understanding of the ignition key state (e.g., a disruption in the power supply causes the EPS to think the key is in the "off" position). If the EPS incorrectly thinks the driver has turned the vehicle "off," it may engage the steering wheel locking mechanism.
1185	Controller hardware faulty, change over time	Other	If the rear wheel steering control module is housed separately from the EPS control module, faults along the communication channel between the EPS and rear wheel steering control module (communication bus faults, wiring faults, connector faults, etc.) may affect the rear wheel steering command.
1186	Controller hardware faulty, change over time	Unused circuits in the controller	Unused circuits might affect the electric power steering control module. This could affect adjustments in feedback to the driver, direction or amount of steering angle change in the front road wheels, or the direction or amount of steering angle change in the rear road wheels.

Causal Factor ID Number	Causal Factor Guide Phrase	Causal Factor Subcategory	Causal Factor (Electric Power Steering Control Module)
1187	Software error (inadequate control algorithm, flaws in creation, modification, or adaptation)	Inadequate control algorithm	The Active Steering feature incorrectly determining that compensation was needed (e.g., interprets a steady non-zero input from the driver as the driver compensating for crosswinds).
1188	Software error (inadequate control algorithm, flaws in creation, modification, or adaptation)	Inadequate control algorithm	The Active Steering feature incorrectly determining that compensation was needed (e.g., interprets a steady non-zero input from the driver as the driver compensating for crosswinds).
1251	Process model or calibration incomplete or incorrect	Other	The EPS control module adjusts the rear road wheel steering angle when power assist to the front wheels is not available (e.g., power assist motor fault).
1252	Process model or calibration incomplete or incorrect	Model of the controlled process, including degradation characteristics	If the rear wheel steering control module is housed separately from the EPS control module, faults along the communication channel between the EPS and rear wheel steering control module (communication bus faults, wiring faults, connector faults, etc.) may affect the rear wheel steering command.
1256	Software error (inadequate control algorithm, flaws in creation, modification, or adaptation)	Flaws in software code creation	The EPS system might deactivate itself without giving the driver enough time to react or assess the roadway conditions. This might cause the driver to issue an incorrect steering command.

Causal Factor ID Number	Causal Factor Guide Phrase	Causal Factor Subcategory	Causal Factor (Electric Power Steering Control Module)
1258	Software error (inadequate control algorithm, flaws in creation, modification, or adaptation)	Flaws in software code creation	EPS control module might not be programmed to issue a warning to the driver for some situations. For example, when the rear wheels lock but the driver does not know since there was no warning from the EPS control module.
1373	Process model or calibration incomplete or incorrect	Other	An incorrect software mode might affect the EPS control module torque command. For example, the vehicle might produce an incorrect torque output if the EPS control module is still set to the supplier's factory operating mode.

Table I- 3: Gear Set

Causal Factor ID Number	Causal Factor Guide Phrase	Causal Factor Subcategory	Causal Factor (Gear Set)
1071	Actuator inadequate operation, change over time	Degradation over time	<p>Degradation over time might affect the gear set. This could affect the feedback to the driver or the EPS control module and affect the transmission of torque from the driver or from the power assist motor.</p> <p>Affecting the feedback to the driver may cause the driver to incorrectly issue a steering adjustment. Incorrectly transmitting the driver's torque or the power assist motor torque may cause the vehicle to respond differently than expected.</p>

Causal Factor ID Number	Causal Factor Guide Phrase	Causal Factor Subcategory	Causal Factor (Gear Set)
1072	Actuator inadequate operation, change over time	Internal hardware failure	<p>An internal hardware failure might affect the gear set. This could affect the feedback to the driver or the EPS control module and affect the transmission of torque from the driver or from the power assist motor.</p> <p>Affecting the feedback to the driver may cause the driver to incorrectly issue a steering adjustment. Incorrectly transmitting the driver's torque or the power assist motor torque may cause the vehicle to respond differently than expected.</p>
1073	Actuator inadequate operation, change over time	Incorrectly sized actuator	<p>An incorrectly sized gear set (e.g., wrong gear ratio) might affect the feedback to the driver or the EPS control module and affect the transmission of torque from the driver or from the power assist motor.</p> <p>Affecting the feedback to the driver may cause the driver to incorrectly issue a steering adjustment. Incorrectly transmitting the driver's torque or the power assist motor torque may cause the vehicle to respond differently than expected.</p>
1074	External disturbances	Vibration or shock impact	<p>Vibration or shock impact might affect the gear set (e.g., fretting). This could affect the feedback to the driver or the EPS control module and affect the transmission of torque from the driver or from the power assist motor.</p> <p>Affecting the feedback to the driver may cause the driver to incorrectly issue a steering adjustment. Incorrectly transmitting the driver's torque or the power assist motor torque may cause the vehicle to respond differently than expected.</p>

Causal Factor ID Number	Causal Factor Guide Phrase	Causal Factor Subcategory	Causal Factor (Gear Set)
1075	External disturbances	Manufacturing defects and assembly problems	<p>Manufacturing defects and assembly problems might affect the gear set. This could affect the feedback to the driver or the EPS control module and affect the transmission of torque from the driver or from the power assist motor.</p> <p>Affecting the feedback to the driver may cause the driver to incorrectly issue a steering adjustment. Incorrectly transmitting the driver's torque or power assist motor torque may cause the vehicle to respond differently than expected.</p>
1076	External disturbances	Moisture, corrosion, or contamination	<p>Moisture, corrosion, or contamination might affect the gear set. This could affect the feedback to the driver or the EPS control module and affect the transmission of torque from the driver or from the power assist motor.</p> <p>Affecting the feedback to the driver may cause the driver to incorrectly issue a steering adjustment. Incorrectly transmitting the driver's torque or power assist motor torque may cause the vehicle to respond differently than expected.</p>
1077	External disturbances	Physical interference (e.g., chafing)	<p>Physical interference might affect the gear set. This could affect the feedback to the driver or the EPS control module and affect the transmission of torque from the driver or from the power assist motor.</p> <p>Affecting the feedback to the driver may cause the driver to incorrectly issue a steering adjustment. Incorrectly transmitting the driver's torque or power assist motor torque may cause the vehicle to respond differently than expected.</p>

Causal Factor ID Number	Causal Factor Guide Phrase	Causal Factor Subcategory	Causal Factor (Gear Set)
1078	Hazardous interaction with other components in the rest of the vehicle	Vibration or shock impact	<p>Vibration or shock impact from components within the vehicle might affect the gear set. This could affect the feedback to the driver or the EPS control module and affect the transmission of torque from the driver or from the power assist motor.</p> <p>Affecting the feedback to the driver may cause the driver to incorrectly issue a steering adjustment. Incorrectly transmitting the driver's torque or power assist motor torque may cause the vehicle to respond differently than expected.</p>
1079	Hazardous interaction with other components in the rest of the vehicle	Physical interference (e.g., chafing)	<p>Physical interference from components within the vehicle might affect the gear set. This could affect the feedback to the driver or the EPS control module and affect the transmission of torque from the driver or from the power assist motor.</p> <p>Affecting the feedback to the driver may cause the driver to incorrectly issue a steering adjustment. Incorrectly transmitting the driver's torque or power assist motor torque may cause the vehicle to respond differently than expected.</p>
1080	Hazardous interaction with other components in the rest of the vehicle	Moisture, corrosion, or contamination	<p>Moisture, corrosion, or contamination from components within the vehicle might affect the gear set. This could affect the feedback to the driver or the EPS control module and affect the transmission of torque from the driver or from the power assist motor.</p> <p>Affecting the feedback to the driver may cause the driver to incorrectly issue a steering adjustment. Incorrectly transmitting the driver's torque or power assist motor torque may cause the vehicle to respond differently than expected.</p>

Causal Factor ID Number	Causal Factor Guide Phrase	Causal Factor Subcategory	Causal Factor (Gear Set)
1081	External disturbances	Extreme external temperature or thermal cycling	<p>Extreme external temperature or thermal cycling could affect the gear set (e.g., thermal expansion causing binding). This could affect the feedback to the driver or to the EPS control module and affect the transmission of torque from the driver or from the power assist motor.</p> <p>Affecting the feedback to the driver may cause the driver to incorrectly issue a steering adjustment. Incorrectly transmitting the driver's torque or power assist motor torque may cause the vehicle to respond differently than expected.</p>
1082	Hazardous interaction with other components in the rest of the vehicle	Excessive heat from other components	<p>Excessive heat from other vehicle components could affect the gear set (e.g., thermal expansion causing binding). This could affect the feedback to the driver or the EPS control module and affect the transmission of torque from the driver or from the power assist motor.</p> <p>Affecting the feedback to the driver may cause the driver to incorrectly issue a steering adjustment. Incorrectly transmitting the driver's torque or power assist motor torque may cause the vehicle to respond differently than expected.</p>

Table I- 4: Power Assist Motor

Causal Factor ID Number	Causal Factor Guide Phrase	Causal Factor Subcategory	Causal Factor (Power Assist Motor)
651	External disturbances	Organic growth	<p>Organic growth might affect the power assist motor operation (e.g., mold might grow on the motor contacts and create a short). This could affect the feedback to the driver and the EPS control module and affect the torque delivered to the road wheels.</p> <p>Affecting the feedback to the driver may cause the driver to incorrectly issue a steering adjustment. An incorrect power assist motor torque may cause the system to respond differently than expected.</p>

Causal Factor ID Number	Causal Factor Guide Phrase	Causal Factor Subcategory	Causal Factor (Power Assist Motor)
1139	Actuator inadequate operation, change over time	Internal hardware failure	<p>An internal hardware failure might affect the power assist motor. This could affect the feedback to the driver and the EPS control module and affect torque delivered to the road wheels.</p> <p>Affecting the feedback to the driver may cause the driver to incorrectly issue a steering adjustment. An incorrect power assist motor torque may cause the system to respond differently than expected.</p>
1140	Actuator inadequate operation, change over time	Degradation over time	<p>Degradation over time might affect the power assist motor. This could affect the feedback to the driver and the EPS control module and affect the torque delivered to the road wheels.</p> <p>Affecting the feedback to the driver may cause the driver to incorrectly issue a steering adjustment. An incorrect power assist motor torque may cause the system to respond differently than expected.</p>
1141	Actuator inadequate operation, change over time	Incorrectly sized actuator	<p>Incorrectly sized power assist motor might deliver the incorrect amount of torque. This could affect the feedback to the driver and the EPS control module and affect torque delivered to the road wheels.</p> <p>Affecting the feedback to the driver may cause the driver to incorrectly issue a steering adjustment. An incorrect power assist motor torque may cause the system to respond differently than expected.</p>
1142	Actuator inadequate operation, change over time	Overheating due to increased resistance in a subcomponent or internal shorting	<p>Overheating due to increased resistance or internal shorting in the traction motor might affect the torque delivered to the road wheels.</p> <p>Affecting the feedback to the driver may cause the driver to incorrectly issue a steering adjustment. An incorrect power assist motor torque may cause the system to respond differently than expected.</p>

Causal Factor ID Number	Causal Factor Guide Phrase	Causal Factor Subcategory	Causal Factor (Power Assist Motor)
1143	External disturbances	EMI or ESD	<p>EMI or ESD might affect the power assist motor. This could affect the feedback to the driver and the EPS control module and affect the torque delivered to the road wheels.</p> <p>Affecting the feedback to the driver may cause the driver to incorrectly issue a steering adjustment. An incorrect power assist motor torque may cause the system to respond differently than expected.</p>
1144	External disturbances	Vibration or shock impact	<p>Vibration or shock impact might affect the power assist motor. This could affect the feedback to the driver and the EPS control module and affect the torque delivered to the road wheels.</p> <p>Affecting the feedback to the driver may cause the driver to incorrectly issue a steering adjustment. An incorrect power assist motor torque may cause the system to respond differently than expected.</p>
1145	External disturbances	Manufacturing defects and assembly problems	<p>Manufacturing defects and assembly problems might affect the power assist motor. This could affect the feedback to the driver and the EPS control module and affect the torque delivered to the road wheels.</p> <p>Affecting the feedback to the driver may cause the driver to incorrectly issue a steering adjustment. An incorrect power assist motor torque may cause the system to respond differently than expected.</p>
1146	External disturbances	Extreme external temperature or thermal cycling	<p>Extreme external temperature or thermal cycling might affect the power assist motor. This could affect the feedback to the driver and the EPS control module and affect the torque delivered to the road wheels.</p> <p>Affecting the feedback to the driver may cause the driver to incorrectly issue a steering adjustment. An incorrect power assist motor torque may cause the system to respond differently than expected.</p>
1147	External disturbances	Moisture, corrosion, or contamination	<p>Moisture, corrosion, or contamination might affect the power assist motor. This could affect the feedback to the driver and the EPS control module and affect the torque delivered to the road wheels.</p>

Causal Factor ID Number	Causal Factor Guide Phrase	Causal Factor Subcategory	Causal Factor (Power Assist Motor)
1148	External disturbances	Physical interference (e.g., chafing)	<p>Physical interference (e.g., chafing) might affect the power assist motor. This could affect the feedback to the driver and the EPS control module and affect the torque delivered to the road wheels.</p> <p>Affecting the feedback to the driver may cause the driver to incorrectly issue a steering adjustment. An incorrect power assist motor torque may cause the system to respond differently than expected.</p>
1149	External disturbances	Magnetic interference	<p>Magnetic interference might affect the power assist motor. This could affect the feedback to the driver and affect the torque delivered to the road wheels.</p> <p>Affecting the feedback to the driver may cause the driver to incorrectly issue a steering adjustment. An incorrect power assist motor torque may cause the system to respond differently than expected.</p>
1150	Power supply faulty (high, low, disturbance)	Loss of 12-volt power	<p>Loss of 12-volt power might affect the power assist motor. This could affect the feedback to the driver and the EPS control module and affect the torque delivered to the road wheels.</p> <p>Affecting the feedback to the driver may cause the driver to incorrectly issue a steering adjustment. An incorrect power assist motor torque may cause the system to respond differently than expected.</p>
1151	Power supply faulty (high, low, disturbance)	Power supply faulty (high, low, disturbance)	<p>Power supply that is faulty (high, low, disturbance) might affect the power assist motor. This could affect the feedback to the driver and the EPS control module and affect the torque delivered to the road wheels.</p> <p>Affecting the feedback to the driver may cause the driver to incorrectly issue a steering adjustment. An incorrect power assist motor torque may cause the system to respond differently than expected.</p>

Causal Factor ID Number	Causal Factor Guide Phrase	Causal Factor Subcategory	Causal Factor (Power Assist Motor)
1152	Hazardous interaction with other components in the rest of the vehicle	EMI or ESD	<p>EMI or ESD from components within the vehicle might affect the power assist motor. This could affect the feedback to the driver and the EPS control module and affect the torque delivered to the road wheels.</p> <p>Affecting the feedback to the driver may cause the driver to incorrectly issue a steering adjustment. An incorrect power assist motor torque may cause the system to respond differently than expected.</p>
1153	Hazardous interaction with other components in the rest of the vehicle	Vibration or shock impact	<p>Vibration or shock impact from components within the vehicle might affect the power assist motor. This could affect the feedback to the driver and the EPS control module and affect the torque delivered to the road wheels.</p> <p>Affecting the feedback to the driver may cause the driver to incorrectly issue a steering adjustment. An incorrect power assist motor torque may cause the system to respond differently than expected.</p>
1154	Hazardous interaction with other components in the rest of the vehicle	Physical interference (e.g., chafing)	<p>Physical interference with components within the vehicle might affect the power assist motor. This could affect the feedback to the driver and the EPS control module and affect the torque delivered to the road wheels.</p> <p>Affecting the feedback to the driver may cause the driver to incorrectly issue a steering adjustment. An incorrect power assist motor torque may cause the system to respond differently than expected.</p>
1155	Hazardous interaction with other components in the rest of the vehicle	Moisture, corrosion, or contamination	<p>Moisture, corrosion, or contamination from components within the vehicle might affect the power assist motor. This could affect the feedback to the driver and the EPS control module and affect the torque delivered to the road wheels.</p> <p>Affecting the feedback to the driver may cause the driver to incorrectly issue a steering adjustment. An incorrect power assist motor torque may cause the system to respond differently than expected.</p>

Causal Factor ID Number	Causal Factor Guide Phrase	Causal Factor Subcategory	Causal Factor (Power Assist Motor)
1156	Hazardous interaction with other components in the rest of the vehicle	Electrical arcing from neighboring components or exposed terminals	<p>Electrical arcing from neighboring components or exposed terminals within the vehicle might affect the power assist motor. This could affect the feedback to the driver and the EPS control module and affect the torque delivered to the road wheels.</p> <p>Affecting the feedback to the driver may cause the driver to incorrectly issue a steering adjustment. An incorrect power assist motor torque may cause the system to respond differently than expected.</p>
1157	Hazardous interaction with other components in the rest of the vehicle	Corona effects from high voltage components	<p>Corona effects from high voltage components within the vehicle might affect the power assist motor. This could affect the feedback to the driver and the EPS control module and affect the torque delivered to the road wheels.</p> <p>Affecting the feedback to the driver may cause the driver to incorrectly issue a steering adjustment. An incorrect power assist motor torque may cause the system to respond differently than expected.</p>
1158	Actuator inadequate operation, change over time	Over temperature due to faulty cooling system	<p>Faulty or inadequate cooling system might affect the power assist motor. This could affect the feedback to the driver and the EPS control module and affect the torque delivered to the road wheels.</p> <p>Affecting the feedback to the driver may cause the driver to incorrectly issue a steering adjustment. An incorrect power assist motor torque may cause the system to respond differently than expected.</p>
1159	External disturbances	Organic growth	<p>Organic growth might affect the power assist motor operation (e.g., mold might grow on the motor contacts and create a short). This could affect the feedback to the driver and the EPS control module and affect the torque delivered to the road wheels.</p> <p>Affecting the feedback to the driver may cause the driver to incorrectly issue a steering adjustment. An incorrect power assist motor torque may cause the system to respond differently than expected.</p>

Causal Factor ID Number	Causal Factor Guide Phrase	Causal Factor Subcategory	Causal Factor (Power Assist Motor)
1160	Hazardous interaction with other components in the rest of the vehicle	Magnetic interference	<p>Magnetic interference with components within the vehicle might affect the power assist motor. This could affect the feedback to the driver and affect the torque delivered to the road wheels.</p> <p>Affecting the feedback to the driver may cause the driver to incorrectly issue a steering adjustment. An incorrect power assist motor torque may cause the system to respond differently than expected.</p>

Table I- 5: Rear Road Wheel Motors

Causal Factor ID Number	Causal Factor Guide Phrase	Causal Factor Subcategory	Causal Factor (Rear Road Wheel Motors)
1116	Actuator inadequate operation, change over time	Internal hardware failure	An internal hardware failure might affect the rear road wheel motors and cause the motors to incorrectly position the rear road wheels.
1117	Actuator inadequate operation, change over time	Degradation over time	Degradation over time might affect the rear road wheel motors and cause the motors to incorrectly position the rear road wheels.
1118	Actuator inadequate operation, change over time	Over temperature due to faulty cooling system	Over temperature due to faulty cooling system might affect the rear road wheel motors and cause the motors to incorrectly position the rear road wheels.
1119	Actuator inadequate operation, change over time	Incorrectly sized actuator	Incorrectly sized rear road wheel motors might cause the rear wheel position to change by the wrong amount.
1120	Actuator inadequate operation, change over time	Overheating due to increased resistance in a subcomponent or internal shorting	Overheating due to increased resistance in a subcomponent or internal shorting might affect the rear road wheel motors and cause the motors to incorrectly position the rear road wheels.
1121	External disturbances	EMI or ESD	EMI or ESD might affect the rear road wheel motors and cause it to incorrectly change the rear road wheel position.
1122	External disturbances	Vibration or shock impact	Vibration or shock impact might affect the rear road wheel motors and cause it to incorrectly change the rear road wheel position.
1123	External disturbances	Manufacturing defects and assembly problems	Manufacturing defects and assembly problems might affect the rear road wheel motors and cause it to incorrectly change the rear road wheel position.

Causal Factor ID Number	Causal Factor Guide Phrase	Causal Factor Subcategory	Causal Factor (Rear Road Wheel Motors)
1124	External disturbances	Extreme external temperature or thermal cycling	Extreme external temperature or thermal cycling might affect the rear road wheel motors and cause it to incorrectly change the rear road wheel position.
1125	External disturbances	Moisture, corrosion, or contamination	Moisture, corrosion, or contamination might affect the rear road wheel motors and cause it to incorrectly change the rear road wheel position.
1126	External disturbances	Organic growth	Organic growth (e.g., mold) might affect the rear road wheel motors and cause it to incorrectly change the rear road wheel position.
1127	External disturbances	Physical interference (e.g., chafing)	Physical interference might affect the rear road wheel motors and cause it to incorrectly change the rear road wheel position.
1128	External disturbances	Magnetic interference	Magnetic interference might affect the rear road wheel motors and cause it to incorrectly change the rear road wheel position.
1129	Power supply faulty (high, low, disturbance)	Loss of 12-volt power	Loss of 12-volt power might affect the rear road wheel motors. This may prevent the motor from adjusting the rear wheel position.
1130	Hazardous interaction with other components in the rest of the vehicle	EMI or ESD	EMI or ESD from components within the vehicle might affect the rear road wheel motors and cause the motors to incorrectly position the rear road wheels.
1131	Power supply faulty (high, low, disturbance)	Power supply faulty (high, low, disturbance)	A power supply that is faulty (high, low, disturbance) might affect the rear road wheel motors. This may cause the motor to incorrectly adjust the rear wheel position.
1132	Hazardous interaction with other components in the rest of the vehicle	Vibration or shock impact	Vibration or shock impact from components within the vehicle might affect the rear road wheel motors and cause the motors to incorrectly position the rear road wheels.

Causal Factor ID Number	Causal Factor Guide Phrase	Causal Factor Subcategory	Causal Factor (Rear Road Wheel Motors)
1133	Hazardous interaction with other components in the rest of the vehicle	Physical interference (e.g., chafing)	Physical interference with components within the vehicle might affect the rear road wheel motors and cause the motors to incorrectly position the rear road wheels.
1134	Hazardous interaction with other components in the rest of the vehicle	Moisture, corrosion, or contamination	Moisture, corrosion, or contamination from components within the vehicle might affect the rear road wheel motors and cause the motors to incorrectly position the rear road wheels.
1135	Hazardous interaction with other components in the rest of the vehicle	Magnetic interference	Magnetic interference from components within the vehicle might affect the rear road wheel motors and cause the motors to incorrectly position the rear road wheels.
1136	Hazardous interaction with other components in the rest of the vehicle	Electrical arcing from neighboring components or exposed terminals	Electrical arcing from neighboring components or exposed terminals might affect the rear road wheel motors and cause the motors to incorrectly position the rear road wheels.
1137	Hazardous interaction with other components in the rest of the vehicle	Excessive heat from other components	Excessive heat from other vehicle components could affect the rear road wheel motors and cause the motors to incorrectly position the rear road wheels.
1138	Hazardous interaction with other components in the rest of the vehicle	Corona effects from high voltage components	If the vehicle contains a high voltage power system, corona effects from high voltage components may affect the rear road wheel motors. This may cause the motors to incorrectly position the rear road wheels.

Table I- 6: Rear Road Wheel Position Sensor

Causal Factor ID Number	Causal Factor Guide Phrase	Causal Factor Subcategory	Causal Factor (Rear Road Wheel Position Sensor)
894	Sensor inadequate operation, change over time	Internal hardware failure	An internal hardware failure might affect the rear road wheel position sensor and cause it to output an incorrect rear road wheel steering angle measurement to the EPS control module. This might affect the EPS control module's adjustment of the rear road wheel steering angle.
895	Sensor inadequate operation, change over time	Overheating due to increased resistance in a subcomponent or internal shorting	Overheating due to increased resistance in a subcomponent or internal shorting might affect the rear road wheel position sensor and cause it to output an incorrect rear road wheel steering angle measurement to the EPS control module. This might affect the EPS control module's adjustment of the rear road wheel steering angle.
896	Sensor inadequate operation, change over time	Degradation over time	Degradation over time might affect the rear road wheel position sensor and cause it to output an incorrect rear road wheel steering angle measurement to the EPS control module. This might affect the EPS control module's adjustment of the rear road wheel steering angle.
897	Sensor inadequate operation, change over time	Reporting frequency too low	A reporting frequency that is too low might affect the rear road wheel position sensor and cause a delay in reporting the rear road wheel steering angle to the EPS control module. This might delay the EPS control module's adjustment of the rear road wheel steering angle.
898	External disturbances	EMI or ESD	EMI or ESD might affect the rear road wheel position sensor and cause it to output an incorrect rear road wheel steering angle measurement to the EPS control module. This might affect the EPS control module's adjustment of the rear road wheel steering angle.
899	External disturbances	Single event effects (e.g., cosmic rays, protons)	Single event effects (e.g., cosmic rays, protons) might affect the rear road wheel position sensor and cause it to output an incorrect rear road wheel steering angle measurement to the EPS control module. This might affect the EPS control module's adjustment of the rear road wheel steering angle.

Causal Factor ID Number	Causal Factor Guide Phrase	Causal Factor Subcategory	Causal Factor (Rear Road Wheel Position Sensor)
900	External disturbances	Vibration or shock impact	Vibration or shock impact might affect the rear road wheel position sensor and cause it to output an incorrect rear road wheel steering angle measurement to the EPS control module. This might affect the EPS control module's adjustment of the rear road wheel steering angle.
901	External disturbances	Manufacturing defects and assembly problems	Manufacturing defects and assembly problems might affect the rear road wheel position sensor and cause it to output an incorrect rear road wheel steering angle measurement to the EPS control module. This might affect the EPS control module's adjustment of the rear road wheel steering angle.
902	External disturbances	Extreme external temperature or thermal cycling	Extreme external temperature or thermal cycling might affect the rear road wheel position sensor and cause it to output an incorrect rear road wheel steering angle measurement to the EPS control module. This might affect the EPS control module's adjustment of the rear road wheel steering angle.
903	External disturbances	Moisture, corrosion, or contamination	Moisture, corrosion, or contamination might affect the rear road wheel position sensor and cause it to output an incorrect rear road wheel steering angle measurement to the EPS control module. This might affect the EPS control module's adjustment of the rear road wheel steering angle.
904	External disturbances	Organic growth	Organic growth (e.g., mold) might affect the rear road wheel position sensor and cause it to output an incorrect rear road wheel steering angle measurement to the EPS control module. This might affect the EPS control module's adjustment of the rear road wheel steering angle.
905	External disturbances	Physical interference (e.g., chafing)	Physical interference from the external environment (e.g., road debris) might affect the rear road wheel position sensor and cause it to output an incorrect rear road wheel steering angle measurement to the EPS control module. This might affect the EPS control module's adjustment of the rear road wheel steering angle.

Causal Factor ID Number	Causal Factor Guide Phrase	Causal Factor Subcategory	Causal Factor (Rear Road Wheel Position Sensor)
906	External disturbances	Magnetic interference	Magnetic interference might affect the rear road wheel position sensor and cause it to output an incorrect rear road wheel steering angle measurement to the EPS control module. This might affect the EPS control module's adjustment of the rear road wheel steering angle.
907	Power supply faulty (high, low, disturbance)	Loss of 12-volt power	Loss of 12-volt power might affect the rear road wheel position sensor and cause it to output an incorrect rear road wheel position to the EPS control module. This might affect control of the rear road wheel position.
908	Power supply faulty (high, low, disturbance)	Reference voltage incorrect (e.g., too low, too high)	Reference voltage that is incorrect (e.g., too low, too high) might affect the rear road wheel position sensor and cause it to output an incorrect rear road wheel position to the EPS control module. This might affect control of the rear road wheel position.
910	Power supply faulty (high, low, disturbance)	Power supply faulty (high, low, disturbance)	Power supply that is faulty (high, low, disturbance) might affect the rear road wheel position sensor and cause it to output an incorrect rear road wheel position to the EPS control module. This might affect control of the rear road wheel position.
911	Hazardous interaction with other components in the rest of the vehicle	EMI or ESD	EMI or ESD from components within the vehicle might affect the rear road wheel position sensor and cause it to output an incorrect rear road wheel steering angle measurement to the EPS control module. This might affect the EPS control module's adjustment of the rear road wheel steering angle.
912	Hazardous interaction with other components in the rest of the vehicle	Vibration or shock impact	Vibration or shock impact from components within the vehicle might affect the rear road wheel position sensor and cause it to output an incorrect rear road wheel steering angle measurement to the EPS control module. This might affect the EPS control module's adjustment of the rear road wheel steering angle.
913	Hazardous interaction with other components in the rest of the vehicle	Physical interference (e.g., chafing)	Physical interference with components within the vehicle might affect the rear road wheel position sensor and cause it to output an incorrect rear road wheel steering angle measurement to the EPS control module. This might affect the EPS control module's adjustment of the rear road wheel steering angle.

Causal Factor ID Number	Causal Factor Guide Phrase	Causal Factor Subcategory	Causal Factor (Rear Road Wheel Position Sensor)
914	Hazardous interaction with other components in the rest of the vehicle	Moisture, corrosion, or contamination	Moisture, corrosion, or contamination from components within the vehicle might affect the rear road wheel position sensor and cause it to output an incorrect rear road wheel steering angle measurement to the EPS control module. This might affect the EPS control module's adjustment of the rear road wheel steering angle.
915	Hazardous interaction with other components in the rest of the vehicle	Magnetic interference	Magnetic interference from components within the vehicle might affect the rear road wheel position sensor and cause it to output an incorrect rear road wheel steering angle measurement to the EPS control module. This might affect the EPS control module's adjustment of the rear road wheel steering angle.
916	Hazardous interaction with other components in the rest of the vehicle	Electrical arcing from neighboring components or exposed terminals	Electrical arcing from neighboring components or exposed terminals might affect the rear road wheel position sensor and cause it to output an incorrect rear road wheel steering angle measurement to the EPS control module. This might affect the EPS control module's adjustment of the rear road wheel steering angle.
1189	Hazardous interaction with other components in the rest of the vehicle	Corona effects from high voltage components	If the vehicle contains a high voltage power system, corona effects from high voltage components may affect the rear road wheel position sensors. This may cause the rear road wheel position sensors to output an incorrect rear road wheel steering angle measurement to the EPS control module. This might affect the EPS control module's adjustment of the rear road wheel steering angle.

Table I- 7: Steering Column/Rack and Pinion

Causal Factor ID Number	Causal Factor Guide Phrase	Causal Factor Subcategory	Causal Factor (Steering Column/Rack and Pinion)
1058	Actuator inadequate operation, change over time	Internal hardware failure	<p>An internal hardware failure might affect the steering column/rack and pinion. This could affect the feedback to the driver or the EPS control module and affect the transmission of torque from the driver or from the power assist motor.</p> <p>Affecting the feedback to the driver may cause the driver to incorrectly issue a steering adjustment. Incorrectly transmitting the driver's torque may cause the system to respond differently from the driver's intent.</p>
1059	Actuator inadequate operation, change over time	Degradation over time	<p>Degradation over time might affect the steering column/rack and pinion. This could affect the feedback to the driver or the EPS control module and affect the transmission of torque from the driver or from the power assist motor.</p> <p>Affecting the feedback to the driver may cause the driver to incorrectly issue a steering adjustment. Incorrectly transmitting the driver's torque may cause the system to respond differently from the driver's intent.</p>
1060	Actuator inadequate operation, change over time	Incorrectly sized actuator	<p>An incorrectly sized steering column/rack and pinion (e.g., incorrect torsion bar diameter) might affect the feedback to the driver or to the EPS control module and affect the transmission of torque from the driver or from the power assist motor.</p> <p>Affecting the feedback to the driver may cause the driver to incorrectly issue a steering adjustment. Incorrectly transmitting the driver's torque may cause the system to respond differently from the driver's intent.</p>

Causal Factor ID Number	Causal Factor Guide Phrase	Causal Factor Subcategory	Causal Factor (Steering Column/Rack and Pinion)
1061	External disturbances	Vibration or shock impact	<p>Vibration or shock impact might affect the steering column/rack and pinion. This could affect the feedback to the driver or the EPS control module and affect the transmission of torque from the driver or from the power assist motor.</p> <p>Affecting the feedback to the driver may cause the driver to incorrectly issue a steering adjustment. Incorrectly transmitting the driver's torque may cause the system to respond differently from the driver's intent.</p>
1062	External disturbances	Manufacturing defects and assembly problems	<p>Manufacturing defects and assembly problems might affect the steering column/rack and pinion. This could affect the feedback to the driver and the EPS control module and affect the transmission of torque from the driver or from the power assist motor. Affecting the feedback to the driver may cause the driver to incorrectly issue a steering adjustment. Incorrectly transmitting the driver's torque may cause the system to respond differently from the driver's intent.</p>
1063	External disturbances	Moisture, corrosion, or contamination	<p>Moisture, corrosion, or contamination might affect the steering column/rack and pinion. This could affect the feedback to the driver and the EPS control module and affect the transmission of torque from the driver or from the power assist motor. Affecting the feedback to the driver may cause the driver to incorrectly issue a steering adjustment. Incorrectly transmitting the driver's torque may cause the system to respond differently from the driver's intent.</p>
1064	External disturbances	Physical interference (e.g., chafing)	<p>Physical interference might affect the steering column/rack and pinion. This could affect the feedback to the driver or the EPS control module and affect the transmission of torque from the driver or from the power assist motor. Affecting the feedback to the driver may cause the driver to incorrectly issue a steering adjustment. Incorrectly transmitting the driver's torque may cause the system to respond differently from the driver's intent.</p>

Causal Factor ID Number	Causal Factor Guide Phrase	Causal Factor Subcategory	Causal Factor (Steering Column/Rack and Pinion)
1066	Hazardous interaction with other components in the rest of the vehicle	Physical interference (e.g., chafing)	Physical interference with components within the vehicle might affect the steering column/rack and pinion. This could affect the feedback to the driver and the EPS control module and affect the transmission of torque from the driver or from the power assist motor. Affecting the feedback to the driver may cause the driver to incorrectly issue a steering adjustment. Incorrectly transmitting the driver's torque may cause the system to respond differently from the driver's intent.
1067	Hazardous interaction with other components in the rest of the vehicle	Vibration or shock impact	Vibration or shock impact from components within the vehicle might affect the steering column/rack and pinion. This could affect the feedback to the driver and the EPS control module and affect the transmission of torque from the driver or from the power assist motor. Affecting the feedback to the driver may cause the driver to incorrectly issue a steering adjustment. Incorrectly transmitting the driver's torque may cause the system to respond differently from the driver's intent.
1068	Hazardous interaction with other components in the rest of the vehicle	Moisture, corrosion, or contamination	Moisture, corrosion, or contamination from components within the vehicle might affect the steering column/rack pinion. This could affect the feedback to the driver and the EPS control module and affect the transmission of torque from the driver or from the power assist motor. Affecting the feedback to the driver may cause the driver to incorrectly issue a steering adjustment. Incorrectly transmitting the driver's torque may cause the system to respond differently from the driver's intent.

Causal Factor ID Number	Causal Factor Guide Phrase	Causal Factor Subcategory	Causal Factor (Steering Column/Rack and Pinion)
1069	Hazardous interaction with other components in the rest of the vehicle	Excessive heat from other components	<p>Excessive heat from other vehicle components could affect the steering column / rack and pinion (e.g., thermal expansion causing binding). This could affect the feedback to the driver and the EPS control module and affect the transmission of torque from the driver or from the power assist motor.</p> <p>Affecting the feedback to the driver may cause the driver to incorrectly issue a steering adjustment. Incorrectly transmitting the driver's torque or the power assist motor torque may cause the vehicle to respond differently than expected.</p>
1083	Hazardous interaction with other components in the rest of the vehicle	Excessive heat from other components	<p>Excessive heat from other vehicle components could affect the steering column / rack and pinion (e.g., thermal expansion causing binding). This could affect the feedback to the driver and the EPS control module and affect the transmission of torque from the driver or from the power assist motor.</p> <p>Affecting the feedback to the driver may cause the driver to incorrectly issue a steering adjustment. Incorrectly transmitting the driver's torque or the power assist motor torque may cause the vehicle to respond differently than expected.</p>

Table I- 8: Steering Wheel

Causal Factor ID Number	Causal Factor Guide Phrase	Causal Factor Subcategory	Causal Factor (Steering Wheel)
12	Actuator inadequate operation, change over time	Degradation over time	<p>Degradation over time can affect the motion of the steering wheel. This could affect the feedback to the driver and affect the transmission of torque from driver (both mechanical and electronic transmission).</p> <p>Affecting the feedback to the driver may cause the driver to incorrectly issue a steering adjustment. Incorrectly transmitting the driver's torque may cause the vehicle to respond differently from the driver's intent.</p>
14	External disturbances	Vibration or shock impact	<p>Vibration or shock impact might affect the steering wheel. This could affect the feedback to the driver and affect the transmission of torque from the driver (both mechanical and electronic transmission).</p> <p>Affecting the feedback to the driver may cause the driver to incorrectly issue a steering adjustment. Incorrectly transmitting the driver's torque may cause the vehicle to respond differently from the driver's intent.</p>
15	External disturbances	Manufacturing defects and assembly problems	<p>Manufacturing defects and assembly problems might affect the motion of the steering wheel. This could affect the feedback to the driver and affect the transmission of torque from the driver (both mechanical and electronic transmission).</p> <p>Affecting the feedback to the driver may cause the driver to incorrectly issue a steering adjustment. Incorrectly transmitting the driver's torque may cause the vehicle to respond differently from the driver's intent.</p>
16	External disturbances	Moisture, corrosion, or contamination	<p>Moisture, corrosion, or contamination might affect the motion of the steering wheel. This could affect the feedback to the driver and affect the transmission of torque from driver (both mechanical and electronic transmission).</p> <p>Affecting the feedback to the driver may cause the driver to incorrectly issue a steering adjustment.</p>

Causal Factor ID Number	Causal Factor Guide Phrase	Causal Factor Subcategory	Causal Factor (Steering Wheel)
			Incorrectly transmitting the driver's torque may cause the vehicle to respond differently from the driver's intent.
17	External disturbances	Physical interference (e.g., chafing)	<p>Physical interference from everyday objects in the vehicle cabin might affect the motion of the steering wheel. This could affect the feedback to the driver and affect the transmission of torque from driver (both mechanical and electronic transmission).</p> <p>Affecting the feedback to the driver may cause the driver to incorrectly issue a steering adjustment. Incorrectly transmitting the driver's torque may cause the vehicle to respond differently from the driver's intent.</p>
18	Hazardous interaction with other components in the rest of the vehicle	Vibration or shock impact	<p>Vibration or shock impact from components within the vehicle might affect the motion of the steering wheel. This could affect the feedback to the driver and affect the transmission of torque from driver (both mechanical and electronic transmission).</p> <p>Affecting the feedback to the driver may cause the driver to incorrectly issue a steering adjustment. Incorrectly transmitting the driver's torque may cause the vehicle to respond differently from the driver's intent.</p>
19	Hazardous interaction with other components in the rest of the vehicle	Physical interference (e.g., chafing)	<p>Physical interference with components within the vehicle might affect the motion of the steering wheel. This could affect the feedback to the driver and affect the transmission of torque from driver (both mechanical and electronic transmission).</p> <p>Affecting the feedback to the driver may cause the driver to incorrectly issue a steering adjustment. Incorrectly transmitting the driver's torque may cause the vehicle to respond differently from the driver's intent.</p>

Causal Factor ID Number	Causal Factor Guide Phrase	Causal Factor Subcategory	Causal Factor (Steering Wheel)
20	Hazardous interaction with other components in the rest of the vehicle	Moisture, corrosion, or contamination	<p>Moisture, corrosion, or contamination from components within the vehicle might affect the motion of the steering wheel. This could affect the feedback to the driver and affect the transmission of torque from driver (both mechanical and electronic transmission).</p> <p>Affecting the feedback to the driver may cause the driver to incorrectly issue a steering adjustment. Incorrectly transmitting the driver's torque may cause the vehicle to respond differently from the driver's intent.</p>
630	Actuator inadequate operation, change over time	Internal hardware failure	<p>An internal hardware failure might affect the motion of the steering wheel. This could affect the feedback to the driver and affect the transmission of torque from driver (both mechanical and electronic transmission).</p> <p>Affecting the feedback to the driver may cause the driver to incorrectly issue a steering adjustment. Incorrectly transmitting the driver's torque may cause the vehicle to respond differently from the driver's intent.</p>
633	External disturbances	Vibration or shock impact	<p>Vibration or shock impact might affect the steering wheel and cause it to output an incorrect feedback to the EPS control module. This might affect the EPS control module torque command.</p>
1054	External disturbances	Extreme external temperature or thermal cycling	<p>Excessive heat in the vehicle cabin may affect the motion of the steering wheel (e.g., thermal expansion causing binding or increased friction). This could affect the feedback to the driver and affect the transmission of torque from the driver (both mechanical and electronic transmission).</p> <p>Affecting the feedback to the driver may cause the driver to incorrectly issue a steering adjustment. Incorrectly transmitting the driver's torque may cause the vehicle to respond differently from the driver's intent.</p>

Table I- 9: Steering Wheel Angle Sensor

Causal Factor ID Number	Causal Factor Guide Phrase	Causal Factor Subcategory	Causal Factor (Steering Wheel Angle Sensor)
686	Sensor inadequate operation, change over time	Internal hardware failure	An internal hardware failure might affect the steering wheel angle sensor and cause it to output an incorrect steering wheel angle measurement to the EPS control module. This might affect how the EPS control module determines the direction and level of steering assist required.
687	Sensor inadequate operation, change over time	Overheating due to increased resistance in a subcomponent or internal shorting	Overheating due to increased resistance in a subcomponent or internal shorting might affect the steering wheel angle sensor and cause it to output an incorrect steering wheel angle measurement to the EPS control module. This might affect how the EPS control module determines the direction and level of steering assist required.
688	Sensor inadequate operation, change over time	Degradation over time	Degradation over time might affect the steering wheel angle sensor and cause it to output an incorrect steering wheel angle measurement to the EPS control module. This might affect how the EPS control module determines the direction and level of steering assist required.
689	Sensor inadequate operation, change over time	Reporting frequency too low	A reporting frequency that is too low might affect the steering wheel angle sensor and prevent or delay reporting the steering wheel angle measurement to the EPS control module. This might affect the EPS control module's timing for providing steering assist.
690	External disturbances	EMI or ESD	EMI or ESD might affect the steering wheel angle sensor and cause it to output an incorrect steering angle measurement to the EPS control module. This might affect how the EPS control module determines the direction or level of steering assist required.
691	External disturbances	Single event effects (e.g., cosmic rays, protons)	Single event effects (e.g., cosmic rays, protons) might affect the steering wheel angle sensor and cause it to output an incorrect steering angle measurement to the EPS control module. This might affect how the EPS control module determines the direction or level of steering assist required.

Causal Factor ID Number	Causal Factor Guide Phrase	Causal Factor Subcategory	Causal Factor (Steering Wheel Angle Sensor)
692	External disturbances	Vibration or shock impact	Vibration or shock impact might affect the steering wheel angle sensor and cause it to output an incorrect steering angle measurement to the EPS control module. This might affect how the EPS control module determines the direction or level of steering assist required.
693	External disturbances	Manufacturing defects and assembly problems	Manufacturing defects and assembly problems might affect the steering wheel angle sensor and cause it to output an incorrect steering angle measurement to the EPS control module. This might affect how the EPS control module determines the direction or level of steering assist required.
694	External disturbances	Extreme external temperature or thermal cycling	Extreme external temperature might affect the steering wheel angle sensor and cause it to output an incorrect steering angle measurement to the EPS control module. This might affect how the EPS control module determines the direction or level of steering assist required.
695	External disturbances	Moisture, corrosion, or contamination	Moisture, corrosion, or contamination might affect the steering wheel angle sensor and cause it to output an incorrect steering angle measurement to the EPS control module. This might affect how the EPS control module determines the direction or level of steering assist required.
696	External disturbances	Organic growth	Organic growth might affect the steering wheel angle sensor and cause it to output an incorrect steering angle measurement to the EPS control module. This might affect how the EPS control module determines the direction or level of steering assist required.
697	External disturbances	Physical interference (e.g., chafing)	Physical interference might affect the steering wheel angle sensor and cause it to output an incorrect steering angle measurement to the EPS control module. This might affect how the EPS control module determines the direction or level of steering assist required.

Causal Factor ID Number	Causal Factor Guide Phrase	Causal Factor Subcategory	Causal Factor (Steering Wheel Angle Sensor)
698	External disturbances	Magnetic interference	Magnetic interference might affect the steering wheel angle sensor and cause it to output an incorrect steering angle measurement to the EPS control module. This might affect how the EPS control module determines the direction or level of steering assist required.
699	Power supply faulty (high, low, disturbance)	Loss of 12-volt power	Loss of 12-volt power might affect the steering wheel angle sensor and cause it not to output a steering angle measurement to the EPS control module. This might affect how the EPS control module determines the level of steering assist required.
700	Power supply faulty (high, low, disturbance)	Reference voltage incorrect (e.g., too low, too high)	A reference voltage that is incorrect (e.g., too low, too high) might affect the steering wheel angle sensor and cause it to output an incorrect steering angle measurement to the EPS control module. This might affect how the EPS control module determines the level of steering assist required.
701	Power supply faulty (high, low, disturbance)	Power supply faulty (high, low, disturbance)	Power supply that is faulty (high, low, disturbance) might affect the steering wheel angle sensor and cause it to output an incorrect steering angle measurement to the EPS control module. This might affect how the EPS control module determines the direction and level of steering assist required.
827	Hazardous interaction with other components in the rest of the vehicle	EMI or ESD	EMI or ESD from components within the vehicle might affect the steering wheel angle sensor and cause it to output an incorrect steering angle measurement to the EPS control module. This might affect how the EPS control module determines the direction and level of steering assist required.
828	Hazardous interaction with other components in the rest of the vehicle	Vibration or shock impact	Vibration or shock impact from components within the vehicle might affect the steering wheel angle sensor and cause it to output an incorrect steering angle measurement to the EPS control module. This might affect how the EPS control module determines the direction and level of steering assist required.

Causal Factor ID Number	Causal Factor Guide Phrase	Causal Factor Subcategory	Causal Factor (Steering Wheel Angle Sensor)
829	Hazardous interaction with other components in the rest of the vehicle	Physical interference (e.g., chafing)	Physical interference with components within the vehicle might affect the steering wheel angle sensor and cause it to output an incorrect steering angle measurement to the EPS control module. This might affect how the EPS control module determines the direction and level of steering assist required.
830	Hazardous interaction with other components in the rest of the vehicle	Moisture, corrosion, or contamination	Moisture, corrosion, or contamination from components within the vehicle might affect the steering wheel angle sensor and cause it to output an incorrect steering angle measurement to the EPS control module. This might affect how the EPS control module determines the direction and level of steering assist required.
831	Hazardous interaction with other components in the rest of the vehicle	Magnetic interference	Magnetic interference from components within the vehicle might affect the steering wheel angle sensor and cause it to output an incorrect steering angle measurement to the EPS control module. This might affect how the EPS control module determines the direction and level of steering assist required.
832	Hazardous interaction with other components in the rest of the vehicle	Electrical arcing from neighboring components or exposed terminals	Electrical arcing from neighboring components or exposed terminals might affect the steering wheel angle sensor and cause it to output an incorrect steering angle measurement to the EPS control module. This might affect how the EPS control module determines the direction and level of steering assist required.
833	Hazardous interaction with other components in the rest of the vehicle	Corona effects from high voltage components	If the vehicle has high voltage components (e.g., electric or hybrid electric powertrain), corona effects might affect the steering wheel angle sensor and cause it to output an incorrect steering angle measurement to the EPS control module. This might affect how the EPS control module determines the direction and level of steering assist required.

Causal Factor ID Number	Causal Factor Guide Phrase	Causal Factor Subcategory	Causal Factor (Steering Wheel Angle Sensor)
1190	Hazardous interaction with other components in the rest of the vehicle	Excessive heat from other components	Excessive heat from other vehicle components might affect the steering wheel angle sensor and cause it to output an incorrect steering angle measurement to the EPS control module. This might affect how the EPS control module determines the direction and level of steering assist required.
1191	Sensor inadequate operation, change over time	Other	The steering wheel angle sensor may not correctly measure steering inputs greater than 360 degrees (e.g., the steering wheel may be able to rotate 720 degrees, but the steering wheel angle sensor may only detect rotation up to 360 degrees). This might affect how the EPS control module determines the direction and level of steering assist required.

Table I- 10: Steering Wheel Torque Sensor

Causal Factor ID Number	Causal Factor Guide Phrase	Causal Factor Subcategory	Causal Factor (Steering Wheel Torque Sensor)
702	Sensor inadequate operation, change over time	Internal hardware failure	An internal hardware failure might affect the steering wheel torque sensor and cause it to output an incorrect steering wheel torque measurement to the EPS control module. This might affect how the EPS control module determines the level of steering assist required.
703	Sensor inadequate operation, change over time	Overheating due to increased resistance in a subcomponent or internal shorting	Overheating due to increased resistance in a subcomponent or internal shorting might affect the steering wheel torque sensor and cause it to output an incorrect steering wheel torque measurement to the EPS control module. This might affect how the EPS control module determines the level of steering assist required.
704	Sensor inadequate operation, change over time	Degradation over time	Degradation over time might affect the steering wheel torque sensor and cause it to output an incorrect steering wheel torque measurement to the EPS control module. This might affect how the EPS control module determines the level of steering assist required.
705	Sensor inadequate operation, change over time	Reporting frequency too low	A reporting frequency that is too low might affect the steering wheel torque sensor and delay or prevent it from reporting the steering wheel torque measurement to the EPS control module. This might affect how the EPS control module determines the level of steering assist required.
706	External disturbances	EMI or ESD	EMI or ESD might affect the steering wheel torque sensor and cause it to output an incorrect steering wheel torque measurement to the EPS control module. This might affect how the EPS control module determines the level of steering assist required.
707	External disturbances	Single event effects (e.g., cosmic rays, protons)	Single event effects (e.g., cosmic rays, protons) might affect the steering wheel torque sensor and cause it to output an incorrect steering wheel torque measurement to the EPS control module. This might affect how the EPS control module determines the level of steering assist required.

Causal Factor ID Number	Causal Factor Guide Phrase	Causal Factor Subcategory	Causal Factor (Steering Wheel Torque Sensor)
708	External disturbances	Vibration or shock impact	Vibration or shock impact might affect the steering wheel torque sensor and cause it to output an incorrect steering wheel torque measurement to the EPS control module. This might affect how the EPS control module determines the level of steering assist required.
709	External disturbances	Manufacturing defects and assembly problems	Manufacturing defects and assembly problems might affect the steering wheel torque sensor and cause it to output an incorrect steering wheel torque measurement to the EPS control module. This might affect how the EPS control module determines the level of steering assist required.
710	External disturbances	Extreme external temperature or thermal cycling	Extreme external temperature might affect the steering wheel torque sensor and cause it to output an incorrect steering wheel torque measurement to the EPS control module. This might affect how the EPS control module determines the level of steering assist required.
711	External disturbances	Moisture, corrosion, or contamination	Moisture, corrosion, or contamination might affect the steering wheel torque sensor and cause it to output an incorrect steering wheel torque measurement to the EPS control module. This might affect how the EPS control module determines the level of steering assist required.
712	External disturbances	Organic growth	Organic growth might affect the steering wheel torque sensor and cause it to output an incorrect steering wheel torque measurement to the EPS control module. This might affect how the EPS control module determines the level of steering assist required.
713	External disturbances	Physical interference (e.g., chafing)	Physical interference might affect the steering wheel torque sensor and cause it to output an incorrect steering wheel torque measurement to the EPS control module. This might affect how the EPS control module determines the level of steering assist required.
714	External disturbances	Magnetic interference	Magnetic interference might affect the steering wheel torque sensor and cause it to output an incorrect steering wheel torque measurement to the EPS control module. This might how affect how the EPS control module determines the level of steering assist required.

Causal Factor ID Number	Causal Factor Guide Phrase	Causal Factor Subcategory	Causal Factor (Steering Wheel Torque Sensor)
715	Power supply faulty (high, low, disturbance)	Loss of 12-volt power	Loss of 12-volt power might affect the steering wheel torque sensor and cause it not to output a steering wheel torque measurement to the EPS control module. This might affect how the EPS control module determines the level of steering assist required.
716	Power supply faulty (high, low, disturbance)	Reference voltage incorrect (e.g., too low, too high)	A reference voltage that is incorrect (e.g., too low, too high) might affect the steering wheel torque sensor and cause it to output an incorrect steering wheel torque measurement to the EPS control module. This might affect how the EPS control module determines the level of steering assist required.
717	Power supply faulty (high, low, disturbance)	Power supply faulty (high, low, disturbance)	Power supply that is faulty (high, low, disturbance) might affect the steering wheel torque sensor and cause it to output an incorrect steering wheel torque measurement to the EPS control module. This might affect how the EPS control module determines the level of steering assist required.
718	Hazardous interaction with other components in the rest of the vehicle	EMI or ESD	EMI or ESD from components within the vehicle might affect the steering wheel torque sensor and cause it to output an incorrect steering wheel torque measurement to the EPS control module. This might affect how the EPS control module determines the level of steering assist required.
719	Hazardous interaction with other components in the rest of the vehicle	Vibration or shock impact	Vibration or shock impact from components within the vehicle might affect the steering wheel torque sensor and cause it to output an incorrect steering wheel torque measurement to the EPS control module. This might affect how the EPS control module determines the level of steering assist required.
720	Hazardous interaction with other components in the rest of the vehicle	Physical interference (e.g., chafing)	Physical interference with components within the vehicle might affect the steering wheel torque sensor and cause it to output an incorrect steering wheel torque measurement to the EPS control module. This might affect how the EPS control module determines the level of steering assist required.

Causal Factor ID Number	Causal Factor Guide Phrase	Causal Factor Subcategory	Causal Factor (Steering Wheel Torque Sensor)
721	Hazardous interaction with other components in the rest of the vehicle	Moisture, corrosion, or contamination	Moisture, corrosion, or contamination from components within the vehicle might affect the steering wheel torque sensor and cause it to output an incorrect steering wheel torque measurement to the EPS control module. This might affect how the EPS control module determines the level of steering assist required.
722	Hazardous interaction with other components in the rest of the vehicle	Magnetic interference	Magnetic interference from components within the vehicle might affect the steering wheel torque sensor and cause it to output an incorrect steering wheel torque measurement to the EPS control module. This might affect how the EPS control module determines the level of steering assist required.
723	Hazardous interaction with other components in the rest of the vehicle	Electrical arcing from neighboring components or exposed terminals	Electrical arcing from neighboring components or exposed terminals might affect the steering wheel torque sensor and cause it to output an incorrect steering wheel torque measurement to the EPS control module. This might affect how the EPS control module determines the level of steering assist required.
724	Hazardous interaction with other components in the rest of the vehicle	Corona effects from high voltage components	If the vehicle has high voltage components (e.g., electric or hybrid electric powertrain), corona effects might affect the steering wheel torque sensor and cause it to output an incorrect steering torque measurement to the EPS control module. This might affect how the EPS control module determines the level of steering assist required.
1192	Hazardous interaction with other components in the rest of the vehicle	Excessive heat from other components	Excessive heat from other vehicle components might affect the steering wheel torque sensor and cause it to output an incorrect steering torque measurement to the EPS control module. This might affect how the EPS control module determines the level of steering assist required.

Table I- 11: Wheel Speed Sensor

Causal Factor ID Number	Causal Factor Guide Phrase	Causal Factor Subcategory	Causal Factor (Wheel Speed Sensor)
1351	Sensor inadequate operation, change over time	Internal hardware failure	Internal hardware failure might affect wheel speed sensor operation and send incorrect data to the EPS control module. This might affect the EPS control module torque command.
1352	Sensor inadequate operation, change over time	Overheating due to increased resistance in a subcomponent or internal shorting	Overheating due to increased resistance in a subcomponent or internal shorting might affect wheel speed sensor operation and send incorrect data to the EPS control module. This might affect the EPS control module torque command.
1353	Sensor inadequate operation, change over time	Degradation over time	Degradation of the wheel speed sensor might affect its operation and send incorrect data to the EPS control module. This might affect the EPS control module torque command.
1354	Sensor inadequate operation, change over time	Reporting frequency too low	Reporting frequency that is too low from the wheel speed sensor might affects its operation and send incorrect data to the EPS control module. This might affect the EPS control module torque command.
1355	External disturbances	EMI or ESD	EMI or ESD might affect the wheel speed sensor and cause it to send incorrect data to the EPS control module. This might affect the EPS control module torque command.
1356	External disturbances	Vibration or shock impact	Vibration or shock impact might affect the wheel speed sensor and cause it to send incorrect data to the EPS control module. This might affect the EPS control module torque command.
1357	External disturbances	Manufacturing defects and assembly problems	Manufacturing defects and assembly problems might affect the wheel speed sensor and cause it to send incorrect data to the EPS control module. This might affect the EPS control module torque command.
1358	External disturbances	Extreme external temperature or thermal cycling	Extreme external temperature or thermal cycling might affect the wheel speed sensor and cause it to send incorrect data to the EPS control module. This might affect the EPS control module torque command.

Causal Factor ID Number	Causal Factor Guide Phrase	Causal Factor Subcategory	Causal Factor (Wheel Speed Sensor)
1359	External disturbances	Moisture, corrosion, or contamination	Moisture, corrosion, or contamination might affect the wheel speed sensor and cause it to send incorrect data to the EPS control module. This might affect the EPS control module torque command.
1360	External disturbances	Organic growth	Organic growth might affect the wheel speed sensor and cause it to send incorrect data to the EPS control module. This might affect the EPS control module torque command.
1361	External disturbances	Physical interference (e.g., chafing)	Physical interference (e.g., chafing) might affect the wheel speed sensor and cause it to send incorrect data to the EPS control module. This might affect the EPS control module torque command.
1362	Power supply faulty (high, low, disturbance)	Loss of 12-volt power	Loss of 12-volt power might affect the wheel speed sensor and cause it to send incorrect data to the EPS control module. This might affect the EPS control module torque command.
1363	Power supply faulty (high, low, disturbance)	Power supply faulty (high, low, disturbance)	Power supply that is faulty (high, low, disturbance) might affect the wheel speed sensor and cause it to send incorrect data to the EPS control module. This might affect the EPS control module torque command.
1364	Hazardous interaction with other components in the rest of the vehicle	EMI or ESD	EMI or ESD from components within the vehicle might affect the wheel speed sensor and cause it to send incorrect data to the EPS control module. This might affect the EPS control module torque command.
1365	Hazardous interaction with other components in the rest of the vehicle	Vibration or shock impact	Vibration or shock impact from components within the vehicle might affect the wheel speed sensor and cause it to send incorrect data to the EPS control module. This might affect the EPS control module torque command.

Causal Factor ID Number	Causal Factor Guide Phrase	Causal Factor Subcategory	Causal Factor (Wheel Speed Sensor)
1366	Hazardous interaction with other components in the rest of the vehicle	Physical interference (e.g., chafing)	Physical interference (e.g., chafing) with components within the vehicle might affect the wheel speed sensor and cause it to send incorrect data to the EPS control module. This might affect the EPS control module torque command.
1367	Hazardous interaction with other components in the rest of the vehicle	Moisture, corrosion, or contamination	Moisture, corrosion, or contamination from components within the vehicle might affect the wheel speed sensor and cause it to send incorrect data to the EPS control module. This might affect the EPS control module torque command.
1368	Hazardous interaction with other components in the rest of the vehicle	Corona effects from high voltage components	High voltage components within the vehicle (e.g., electric or hybrid electric powertrain) might affect the wheel speed sensor and cause it to send incorrect data to the EPS control module. This might affect the EPS control module torque command.
1369	Hazardous interaction with other components in the rest of the vehicle	Electrical arcing from neighboring components or exposed terminals	Electrical arcing from neighboring components or exposed terminals might affect the wheel speed sensor and cause it to send incorrect data to the EPS control module. This might affect the EPS control module torque command.

Table I- 12: Yaw Rate/Lateral Acceleration Sensor

Causal Factor ID Number	Causal Factor Guide Phrase	Causal Factor Subcategory	Causal Factor (Yaw Rate/Lateral Acceleration Sensor)
663	Sensor inadequate operation, change over time	Internal hardware failure	An internal hardware failure might affect the yaw rate/lateral acceleration sensor and cause it to output an incorrect yaw rate or lateral acceleration measurement to the EPS control module. This might affect the EPS yaw rate stabilization or adjustments to driver feedback.
664	Sensor inadequate operation, change over time	Overheating due to increased resistance in a subcomponent or internal shorting	Overheating due to increased resistance in a subcomponent or internal shorting might affect the yaw rate/lateral acceleration sensor and cause it to output an incorrect yaw rate or lateral acceleration measurement to the EPS control module. This might affect the EPS yaw rate stabilization or adjustments to driver feedback.
665	Sensor inadequate operation, change over time	Degradation over time	Degradation over time might affect the yaw rate/lateral acceleration sensor and cause it to output an incorrect yaw rate or lateral acceleration measurement to the EPS control module. This might affect the EPS yaw rate stabilization or adjustments to driver feedback.
666	Sensor inadequate operation, change over time	Reporting frequency too low	Reporting frequency that is too low might affect the yaw rate/lateral acceleration sensor and cause it to output an incorrect yaw rate or lateral acceleration measurement to the EPS control module. This might affect the EPS yaw rate stabilization or adjustments to driver feedback.
667	External disturbances	EMI or ESD	EMI or ESD might affect the yaw rate/lateral acceleration sensor and cause it to output an incorrect yaw rate or lateral acceleration measurement to the EPS control module. This might affect the EPS yaw rate stabilization or adjustments to driver feedback.
668	External disturbances	Single event effects (e.g., cosmic rays, protons)	Single event effects (e.g., cosmic rays, protons) might affect the yaw rate/lateral acceleration sensor and cause it to output an incorrect yaw rate or lateral acceleration measurement to the EPS control module. This might affect the EPS yaw rate stabilization or adjustments to driver feedback.

Causal Factor ID Number	Causal Factor Guide Phrase	Causal Factor Subcategory	Causal Factor (Yaw Rate/Lateral Acceleration Sensor)
669	External disturbances	Vibration or shock impact	Vibration or shock impact might affect the yaw rate/lateral acceleration sensor and cause it to output an incorrect yaw rate or lateral acceleration measurement to the EPS control module. This might affect the EPS yaw rate stabilization or adjustments to driver feedback.
670	External disturbances	Manufacturing defects and assembly problems	Manufacturing defects and assembly problems might affect the yaw rate/lateral acceleration sensor and cause it to output an incorrect yaw rate or lateral acceleration measurement to the EPS control module. This might affect the EPS yaw rate stabilization or adjustments to driver feedback.
671	External disturbances	Extreme external temperature or thermal cycling	Extreme external temperature or thermal cycling might affect the yaw rate/lateral acceleration sensor and cause it to output an incorrect yaw rate or lateral acceleration measurement to the EPS control module. This might affect the EPS yaw rate stabilization or adjustments to driver feedback.
672	External disturbances	Moisture, corrosion, or contamination	Moisture, corrosion, or contamination might affect the yaw rate/lateral acceleration sensor and cause it to output an incorrect yaw rate or lateral acceleration measurement to the EPS control module. This might affect the EPS yaw rate stabilization or adjustments to driver feedback.
673	External disturbances	Organic growth	Organic growth might affect the yaw rate/lateral acceleration sensor and cause it to output an incorrect yaw rate or lateral acceleration measurement to the EPS control module. This might affect the EPS yaw rate stabilization or adjustments to driver feedback.
674	External disturbances	Physical interference (e.g., chafing)	Physical interference might affect the yaw rate/lateral acceleration sensor and cause it to output an incorrect yaw rate or lateral acceleration to the EPS control module. This might affect the EPS yaw rate stabilization or adjustments to driver feedback.
676	Power supply faulty (high, low, disturbance)	Loss of 12-volt power	Loss of 12-volt power might affect the yaw rate/lateral acceleration sensor and cause it to output an incorrect yaw rate or lateral acceleration to the EPS control module. This might affect the EPS yaw rate stabilization or adjustments to driver feedback.

Causal Factor ID Number	Causal Factor Guide Phrase	Causal Factor Subcategory	Causal Factor (Yaw Rate/Lateral Acceleration Sensor)
677	Power supply faulty (high, low, disturbance)	Reference voltage incorrect (e.g., too low, too high)	Reference voltage that is incorrect (e.g., too low, too high) might affect the yaw rate/lateral acceleration sensor and cause it to output an incorrect yaw rate or lateral acceleration to the EPS control module. This might affect the EPS yaw rate stabilization or adjustments to driver feedback.
678	Power supply faulty (high, low, disturbance)	Power supply faulty (high, low, disturbance)	Power supply that is faulty (high, low, disturbance) might affect the yaw rate/lateral acceleration sensor and cause it to output an incorrect yaw rate or lateral acceleration to the EPS control module. This might affect the EPS yaw rate stabilization or adjustments to driver feedback.
679	Hazardous interaction with other components in the rest of the vehicle	EMI or ESD	EMI or ESD from components within the vehicle might affect the yaw rate/lateral acceleration sensor and cause it to output an incorrect yaw rate or lateral acceleration measurement to the EPS control module. This might affect the EPS yaw rate stabilization or adjustments to driver feedback.
680	Hazardous interaction with other components in the rest of the vehicle	Vibration or shock impact	Vibration or shock impact from components within the vehicle might affect the yaw rate/lateral acceleration sensor and cause it to output an incorrect yaw rate or lateral acceleration measurement to the EPS control module. This might affect the EPS yaw rate stabilization or adjustments to driver feedback.
681	Hazardous interaction with other components in the rest of the vehicle	Physical interference (e.g., chafing)	Physical interference with components within the vehicle might affect the yaw rate/lateral acceleration sensor and cause it to output an incorrect yaw rate or lateral acceleration measurement to the EPS control module. This might affect the EPS yaw rate stabilization or adjustments to driver feedback.
682	Hazardous interaction with other components in the rest of the vehicle	Moisture, corrosion, or contamination	Moisture, corrosion, or contamination from components within the vehicle might affect the yaw rate/lateral acceleration sensor and cause it to output an incorrect yaw rate or lateral acceleration measurement to the EPS control module. This might affect the EPS yaw rate stabilization or adjustments to driver feedback.

Causal Factor ID Number	Causal Factor Guide Phrase	Causal Factor Subcategory	Causal Factor (Yaw Rate/Lateral Acceleration Sensor)
684	Hazardous interaction with other components in the rest of the vehicle	Electrical arcing from neighboring components or exposed terminals	Electrical arcing from neighboring components or exposed terminals might affect the yaw rate/lateral acceleration sensor and cause it to output an incorrect yaw rate or lateral acceleration measurement to the EPS control module. This might affect the EPS yaw rate stabilization or adjustments to driver feedback.
685	Hazardous interaction with other components in the rest of the vehicle	Corona effects from high voltage components	If the vehicle has high voltage components (e.g., electric or hybrid electric powertrain), corona effects might affect the yaw rate/lateral acceleration sensor and cause it to output an incorrect yaw rate or lateral acceleration measurement to the EPS yaw rate stabilization or adjustments to driver feedback.
1161	Hazardous interaction with other components in the rest of the vehicle	Excessive heat from other components	Excessive heat from components within the vehicle might affect the yaw rate/lateral acceleration sensor and cause it to output an incorrect yaw rate or lateral acceleration measurement to the EPS control module. This might affect the EPS yaw rate stabilization or adjustments to the driver feedback.
1249	Sensor inadequate operation, change over time	Other	Yaw rate sensor has faulty signal conditioning or converting (e.g., signal filters, signal amplification).
1250	Sensor inadequate operation, change over time	Other	Steering wheel angle sensor incorrectly indexes rotations above 360 degrees. This may cause the steering wheel angle sensor to report too small of a steering angle or develop an offset from the actual steering wheel position.

Table I- 13: Active Differential System to Electric Power Steering Control Module

Causal Factor ID Number	Causal Factor Guide Phrase	Causal Factor Subcategory	Causal Factor (Active Differential System to Electric Power Steering Control Module)
1265	Sensor to controller signal inadequate, missing, or delayed: Hardware open, short, missing, intermittent faulty	Connection is intermittent	Intermittent connection between the active differential system and EPS control module might affect the stability control coordination feedback to the EPS control module.
1266	Sensor to controller signal inadequate, missing, or delayed: Hardware open, short, missing, intermittent faulty	Connection is open, short to ground, short to battery, or short to other wires in harness	Connection that is open, short to ground, short to battery, or short to other wires in harness between the active differential system and EPS control module might affect the stability control coordination feedback to the EPS control module.
1267	Sensor to controller signal inadequate, missing, or delayed: Hardware open, short, missing, intermittent faulty	Electrical noise other than EMI or ESD	Electrical noise other than EMI or ESD between the active differential system and EPS control module might affect the stability control coordination feedback to the EPS control module.
1268	Sensor to controller signal inadequate, missing, or delayed: Hardware open, short, missing, intermittent faulty	Connector contact resistance is too high	Contact resistance that is too high between the active differential system and EPS control module might affect the stability control coordination feedback to the EPS control module.

Causal Factor ID Number	Causal Factor Guide Phrase	Causal Factor Subcategory	Causal Factor (Active Differential System to Electric Power Steering Control Module)
1269	Sensor to controller signal inadequate, missing, or delayed: Hardware open, short, missing, intermittent faulty	Connector shorting between neighboring pins	Short circuit on the connector neighboring pins between the active differential system and EPS control module might affect the stability control coordination feedback to the EPS control module.
1270	Sensor to controller signal inadequate, missing, or delayed: Hardware open, short, missing, intermittent faulty	Connector resistive drift between neighboring pins	Resistive drift on the connector neighboring pins between the active differential system and EPS control module might affect the stability control coordination feedback to the EPS control module.
1271	Sensor to controller signal inadequate, missing, or delayed: Communication bus error	Bus overload or bus error	Bus overload or bus error between the active differential system and EPS control module might affect the stability control coordination feedback to the EPS control module.
1272	Sensor to controller signal inadequate, missing, or delayed: Communication bus error	Signal priority too low	Signal priority that is too low between the active differential system and EPS control module might affect the stability control coordination feedback to the EPS control module.

Causal Factor ID Number	Causal Factor Guide Phrase	Causal Factor Subcategory	Causal Factor (Active Differential System to Electric Power Steering Control Module)
1273	Sensor to controller signal inadequate, missing, or delayed: Communication bus error	Failure of the message generator, transmitter, or receiver	Failure of the message generator, transmitter, or receiver between the active differential system and EPS control module might affect the stability control coordination feedback to the EPS control module.
1274	Sensor to controller signal inadequate, missing, or delayed: Communication bus error	Malicious intruder	Malicious intruder on the active differential system and EPS control module connection might affect the stability control coordination feedback to the EPS control module.
1275	Sensor to controller signal inadequate, missing, or delayed: Incorrect connection	Incorrect wiring connection	Incorrect active differential system and EPS control module wiring connection might affect the stability control coordination feedback to the EPS control module.
1276	Sensor to controller signal inadequate, missing, or delayed: Incorrect connection	Incorrect pin assignment	Incorrect pin assignment on the active differential system and EPS control module connection might affect the stability control coordination feedback to the EPS control module.
1277	External disturbances	EMI or ESD	EMI or ESD on the active differential system and EPS control module connection might affect the stability control coordination feedback to the EPS control module.
1278	External disturbances	Vibration or shock impact	Vibration or shock impact disrupting the active differential system and EPS control module connection might affect the stability control coordination feedback to the EPS control module.

Causal Factor ID Number	Causal Factor Guide Phrase	Causal Factor Subcategory	Causal Factor (Active Differential System to Electric Power Steering Control Module)
1279	External disturbances	Manufacturing defects and assembly problems	Manufacturing defects and assembly problems of the active differential system and EPS control module connection might affect the stability control coordination feedback to the EPS control module.
1281	External disturbances	Organic growth	Organic growth on the active differential system and EPS control module connection might affect the stability control coordination feedback to the EPS control module.
1282	External disturbances	Physical interference (e.g., chafing)	External physical interference (e.g., shafting with dry snow or extreme rain) with active differential system and EPS control module connection might affect the stability control coordination feedback to the EPS control module.
1283	External disturbances	Active connection terminals affected by moisture, corrosion, or contamination	Active connection terminals affected by moisture, corrosion, or contamination on the active differential system and EPS control module connection might affect the stability control coordination feedback to the EPS control module.
1284	Hazardous interaction with other components in the rest of the vehicle	EMI or ESD	EMI or ESD from components within the vehicle dispersed on the active differential system and EPS control module connection might affect the stability control coordination feedback to the EPS control module.
1285	Hazardous interaction with other components in the rest of the vehicle	Vibration or shock impact	Vibration or shock impact from components within the vehicle disrupting the active differential system and EPS control module connection might affect the stability control coordination feedback to the EPS control module.
1286	Hazardous interaction with other components in the rest of the vehicle	Physical interference (e.g., chafing)	Physical interference (e.g., chafing) with components within the vehicle and the active differential system and EPS control module connection might affect the stability control coordination feedback to the EPS control module.

Causal Factor ID Number	Causal Factor Guide Phrase	Causal Factor Subcategory	Causal Factor (Active Differential System to Electric Power Steering Control Module)
1287	Hazardous interaction with other components in the rest of the vehicle	Electrical arcing from neighboring components or exposed terminals	Electrical arcing from neighboring components or exposed terminals could affect the active differential system and EPS control module connection and might affect the stability control coordination feedback to the EPS control module.
1288	Hazardous interaction with other components in the rest of the vehicle	Corona effects from high voltage components	If the vehicle has high voltage components (e.g., electric or hybrid electric powertrain), corona effects from high voltage components could affect the active differential system and EPS control module connection and might affect the stability control coordination feedback to the EPS control module.
1289	Hazardous interaction with other components in the rest of the vehicle	Active connection terminals affected by moisture, corrosion, or contamination	Active connection terminals of the active differential system or EPS control module may be affected by moisture, corrosion, or contamination from components within the vehicle and might affect the stability control coordination feedback to the EPS control module.
1370	External disturbances	Extreme external temperature or thermal cycling	Extreme external temperature or thermal cycling may affect the connection between the active differential system and EPS control module. This might affect the stability control coordination between the active differential system and EPS.

Table I- 14: Brake System (With ESC/ABS) to Electric Power Steering Control Module

Causal Factor ID Number	Causal Factor Guide Phrase	Causal Factor Subcategory	Causal Factor (Brake System (With ESC/ABS) to Electric Power Steering Control Module)
1314	Sensor to controller signal inadequate, missing, or delayed: Hardware open, short, missing, intermittent faulty	Connection is intermittent	Intermittent connection between the brake system and EPS control module might affect the vehicle speed and/or friction coefficient and/or brake pedal position feedback to the EPS control module.
1315	Sensor to controller signal inadequate, missing, or delayed: Hardware open, short, missing, intermittent faulty	Connection is open, short to ground, short to battery, or short to other wires in harness	Connection that is open, short to ground, short to battery, or short to other wires in harness between the brake system and EPS control module might affect the vehicle speed and/or friction coefficient and/or brake pedal position feedback to the EPS control module.
1316	Sensor to controller signal inadequate, missing, or delayed: Hardware open, short, missing, intermittent faulty	Electrical noise other than EMI or ESD	Electrical noise other than EMI or ESD between the brake system and EPS control module might affect the vehicle speed and/or friction coefficient and/or brake pedal position feedback to the EPS control module.
1317	Sensor to controller signal inadequate, missing, or delayed: Hardware open, short, missing, intermittent faulty	Connector contact resistance is too high	Contact resistance that is too high between the brake system and EPSEPS control module might affect the vehicle speed and/or friction coefficient and/or brake pedal position feedback to the EPS control module.

Causal Factor ID Number	Causal Factor Guide Phrase	Causal Factor Subcategory	Causal Factor (Brake System (With ESC/ABS) to Electric Power Steering Control Module)
1318	Sensor to controller signal inadequate, missing, or delayed: Hardware open, short, missing, intermittent faulty	Connector shorting between neighboring pins	Short circuit on the connector neighboring pins between the brake system and EPSEPS control module might affect the vehicle speed and/or friction coefficient and/or brake pedal position feedback to the EPS control module.
1319	Sensor to controller signal inadequate, missing, or delayed: Hardware open, short, missing, intermittent faulty	Connector resistive drift between neighboring pins	Resistive drift on the connector neighboring pins between the brake system and EPSEPS control module might affect the vehicle speed and/or friction coefficient and/or brake pedal position feedback to the EPS control module.
1320	Sensor to controller signal inadequate, missing, or delayed: Communication bus error	Bus overload or bus error	Bus overload or bus error between the brake system and EPSEPS control module might affect the vehicle speed and/or friction coefficient and/or brake pedal position feedback to the EPS control module.
1321	Sensor to controller signal inadequate, missing, or delayed: Communication bus error	Signal priority too low	Signal priority that is too low between the brake system and EPSEPS control module might affect the vehicle speed and/or friction coefficient and/or brake pedal position feedback to the EPS control module.

Causal Factor ID Number	Causal Factor Guide Phrase	Causal Factor Subcategory	Causal Factor (Brake System (With ESC/ABS) to Electric Power Steering Control Module)
1322	Sensor to controller signal inadequate, missing, or delayed: Communication bus error	Failure of the message generator, transmitter, or receiver	Failure of the message generator, transmitter, or receiver between the brake system and EPSEPS control module might affect the vehicle speed and/or friction coefficient and/or brake pedal position feedback to the EPS control module.
1323	Sensor to controller signal inadequate, missing, or delayed: Communication bus error	Malicious intruder	Malicious intruder on the brake system and EPSEPS control module connection might affect the vehicle speed and/or friction coefficient and/or brake pedal position feedback to the EPS control module.
1324	Sensor to controller signal inadequate, missing, or delayed: Incorrect connection	Incorrect wiring connection	Incorrect brake system and EPSEPS control module wiring connection might affect the vehicle speed and/or friction coefficient and/or brake pedal position feedback to the EPS control module.
1325	Sensor to controller signal inadequate, missing, or delayed: Incorrect connection	Incorrect pin assignment	Incorrect pin assignment on the brake system and EPSEPS control module connection might affect the vehicle speed and/or friction coefficient and/or brake pedal position feedback to the EPS control module.
1326	External disturbances	EMI or ESD	EMI or ESD on the brake system and EPSEPS control module connection might affect the vehicle speed and/or friction coefficient and/or brake pedal position feedback to the EPS control module.
1327	External disturbances	Vibration or shock impact	Vibration or shock impact disrupting the brake system and EPSEPS control module connection might affect the vehicle speed and/or friction coefficient and/or brake pedal position feedback to the EPS control module.

Causal Factor ID Number	Causal Factor Guide Phrase	Causal Factor Subcategory	Causal Factor (Brake System (With ESC/ABS) to Electric Power Steering Control Module)
1328	External disturbances	Manufacturing defects and assembly problems	Manufacturing defects and assembly problems of the brake system and EPSEPS control module connection might affect the vehicle speed and/or friction coefficient and/or brake pedal position feedback to the EPS control module.
1329	External disturbances	Extreme external temperature or thermal cycling	Extreme external temperature or thermal cycling affecting the brake system and EPS control module connection might affect the vehicle speed and/or friction coefficient and/or brake pedal position feedback to the EPS control module.
1330	External disturbances	Organic growth	Organic growth on the brake system and EPS control module connection might affect the vehicle speed and/or friction coefficient and/or brake pedal position feedback to the EPS control module.
1331	External disturbances	Physical interference (e.g., chafing)	External physical interference (e.g., shafting) with brake system and EPS control module connection might affect the vehicle speed and/or friction coefficient and/or brake pedal position feedback to the EPS control module.
1332	External disturbances	Active connection terminals affected by moisture, corrosion, or contamination	Active connection terminals affected by moisture, corrosion, or contamination on the brake system and EPS control module connection might affect the vehicle speed and/or friction coefficient and/or brake pedal position feedback to the EPS control module.
1333	Hazardous interaction with other components in the rest of the vehicle	EMI or ESD	EMI or ESD from components within the vehicle dispersed on the brake system and EPS control module connection might affect the vehicle speed and/or friction coefficient and/or brake pedal position feedback to the EPS control module.
1334	Hazardous interaction with other components in the rest of the vehicle	Vibration or shock impact	Vibration or shock impact from components within the vehicle disrupting the brake system and EPS control module connection might affect the vehicle speed and/or friction coefficient and/or brake pedal position feedback to the EPS control module.

Causal Factor ID Number	Causal Factor Guide Phrase	Causal Factor Subcategory	Causal Factor (Brake System (With ESC/ABS) to Electric Power Steering Control Module)
1335	Hazardous interaction with other components in the rest of the vehicle	Physical interference (e.g., chafing)	Physical interference (e.g., chafing) with components within the vehicle and the brake system and EPS control module connection might affect the vehicle speed and/or friction coefficient and/or brake pedal position feedback to the EPS control module.
1336	Hazardous interaction with other components in the rest of the vehicle	Electrical arcing from neighboring components or exposed terminals	Electrical arcing from neighboring components or exposed terminals could affect the brake system and EPS control module connection and might affect the vehicle speed and/or friction coefficient and/or brake pedal position feedback to the EPS control module.
1337	Hazardous interaction with other components in the rest of the vehicle	Corona effects from high voltage components	If the vehicle has high voltage components (e.g., electric or hybrid electric powertrain), corona effects from high voltage components could affect the brake system and EPS control module connection and might affect the vehicle speed and/or friction coefficient and/or brake pedal position feedback to the EPS control module.
1338	Hazardous interaction with other components in the rest of the vehicle	Active connection terminals affected by moisture, corrosion, or contamination	Active connection terminals of the Brake System or EPS control module may be affected by moisture, corrosion, or contamination from components within the vehicle and might affect the vehicle speed and/or friction coefficient and/or brake pedal position feedback to the EPS control module.

Table I- 15: Driver to Steering Wheel

Causal Factor ID Number	Causal Factor Guide Phrase	Causal Factor Subcategory	Causal Factor (Driver to Steering Wheel)
224	External disturbances	Extreme external temperature or thermal cycling	Extreme temperatures in the vehicle cabin might affect the driver's ability to operate the steering wheel (e.g., the driver might maintain a light grip on the steering wheel).
230	External disturbances	Vibration or shock impact	Vibration or shock impact (e.g., excessive vibrations due to poor road conditions) might affect the driver's handling of the steering wheel.
232	Hazardous interaction with other components in the rest of the vehicle	Vibration or shock impact	Vibration or shock impact from components within the vehicle (e.g., a deflated tire on one side of the vehicle causing extreme vibrations) might affect the driver's ability to operate the steering wheel.
233	Hazardous interaction with other components in the rest of the vehicle	Physical interference (e.g., chafing)	Physical interference with components within the vehicle (e.g., the seat belt locking mechanism) might affect the driver's ability to operate the steering wheel.
1193	Hazardous interaction with other components in the rest of the vehicle	Mechanical connections affected by moisture, corrosion, or contamination	If the steering wheel has a steering wheel cover, moisture, corrosion, or contamination from other vehicle components may cause deterioration or degradation of the steering wheel cover, affecting the driver's ability to operate the steering wheel.
1194	External disturbances	Other	If the steering wheel has a steering wheel cover, moisture, corrosion, or contamination may cause deterioration or degradation of the steering wheel cover, affecting the driver's ability to operate the steering wheel.

Table I- 16: Electric Power Steering Control Module to Instrument Panel Display

Causal Factor ID Number	Causal Factor Guide Phrase	Causal Factor Subcategory	Causal Factor (Electric Power Steering Control Module to Instrument Panel Display)
188	Controller to actuator signal ineffective, missing, or delayed: Hardware open, short, missing, intermittent faulty	Connection is intermittent	The connection between the EPS control module and instrument panel display may become intermittent. This might cause the steering system malfunction indicator light to turn on or off regardless of the actual command from the EPS control module. This could affect the driver's understanding of the status of the steering system (e.g., whether or not power assist is available).
189	Controller to actuator signal ineffective, missing, or delayed: Hardware open, short, missing, intermittent faulty	Connection is open, short to ground, short to battery, or short to other wires in harness	Connection that is open, short to ground, short to battery, or short to other wires in harness might disrupt the EPS control module and instrument panel display connection. This might cause the steering system malfunction indicator light to turn on or off regardless of the actual command from the EPS control module. This could affect the driver's understanding of the status of the steering system (e.g., whether or not power assist is available).
190	Controller to actuator signal ineffective, missing, or delayed: Hardware open, short, missing, intermittent faulty	Electrical noise other than EMI or ESD	Electrical noise other than EMI or ESD might disrupt the EPS control module and instrument panel display connection. This might cause the steering system malfunction indicator light to turn on or off regardless of the actual command from the EPS control module. This could affect the driver's understanding of the status of the steering system (e.g., whether or not power assist is available).
191	Controller to actuator signal ineffective, missing, or delayed: Hardware open, short, missing, intermittent faulty	Connector contact resistance is too high	Contact resistance in the connectors of the EPS control module and instrument panel display may be too high. This might cause the steering system malfunction indicator light to turn on or off regardless of the actual command from the EPS control module. This could affect the driver's understanding of the status of the steering system (e.g., whether or not power assist is available).

Causal Factor ID Number	Causal Factor Guide Phrase	Causal Factor Subcategory	Causal Factor (Electric Power Steering Control Module to Instrument Panel Display)
192	Controller to actuator signal ineffective, missing, or delayed: Hardware open, short, missing, intermittent faulty	Connector shorting between neighboring pins	Shorting between neighboring pins in the connectors might disrupt the EPS control module and instrument panel display connection. This might cause the steering system malfunction indicator light to turn on or off regardless of the actual command from the EPS control module. This could affect the driver's understanding of the status of the steering system (e.g., whether or not power assist is available).
193	Controller to actuator signal ineffective, missing, or delayed: Hardware open, short, missing, intermittent faulty	Connector resistive drift between neighboring pins	Connector resistive drift between neighboring pins might affect the EPS control module and instrument panel display connection. This might cause the steering system malfunction indicator light to turn on or off regardless of the actual command from the EPS control module. This could affect the driver's understanding of the status of the steering system (e.g., whether or not power assist is available).
194	Controller to actuator signal ineffective, missing, or delayed: Communication bus error	Bus overload or bus error	A bus overload or bus error might disrupt communication between the EPS control module and instrument panel display. This might cause the steering system malfunction indicator light to turn on or off regardless of the actual command from the EPS control module. This could affect the driver's understanding of the status of the steering system (e.g., whether or not power assist is available).
195	Controller to actuator signal ineffective, missing, or delayed: Communication bus error	Signal priority too low	A signal priority that is too low might delay or prevent communication between the EPS control module and instrument panel display. This might cause the steering system malfunction indicator light to turn on or off regardless of the actual command from the EPS control module. This could affect the driver's understanding of the status of the steering system (e.g., whether or not power assist is available).

Causal Factor ID Number	Causal Factor Guide Phrase	Causal Factor Subcategory	Causal Factor (Electric Power Steering Control Module to Instrument Panel Display)
196	Controller to actuator signal ineffective, missing, or delayed: Communication bus error	Failure of the message generator, transmitter, or receiver	Failure of the message generator, transmitter, or receiver might affect the EPS control module and instrument panel display connection. This might cause the steering system malfunction indicator light to turn on or off regardless of the actual command from the EPS control module. This could affect the driver's understanding of the status of the steering system (e.g., whether or not power assist is available).
197	Controller to actuator signal ineffective, missing, or delayed: Communication bus error	Malicious intruder	A malicious intruder or aftermarket component might disrupt communication between the EPS control module and instrument panel display. This might cause the steering system malfunction indicator light to turn on or off regardless of the actual command from the EPS control module. This could affect the driver's understanding of the status of the steering system (e.g., whether or not power assist is available).
198	Controller to actuator signal ineffective, missing, or delayed: Incorrect connection	Incorrect wiring connection	Incorrect wiring might affect the EPS control module and instrument panel display connection. This might cause the steering system malfunction indicator light to turn on or off regardless of the actual command from the EPS control module. This could affect the driver's understanding of the status of the steering system (e.g., whether or not power assist is available).
199	Controller to actuator signal ineffective, missing, or delayed: Incorrect connection	Incorrect pin assignment	An incorrect pin assignment might disrupt the EPS control module and instrument panel display connection. This might cause the steering system malfunction indicator light to turn on or off regardless of the actual command from the EPS control module. This could affect the driver's understanding of the status of the steering system (e.g., whether or not power assist is available).

Causal Factor ID Number	Causal Factor Guide Phrase	Causal Factor Subcategory	Causal Factor (Electric Power Steering Control Module to Instrument Panel Display)
200	External disturbances	EMI or ESD	EMI or ESD might disrupt the EPS control module and instrument panel display connection. This might cause the steering system malfunction indicator light to turn on or off regardless of the actual command from the EPS control module. This could affect the driver's understanding of the status of the steering system (e.g., whether or not power assist is available).
202	External disturbances	Vibration or shock impact	Vibration or shock impact might affect the EPS control module and instrument panel display connection. This might cause the steering system malfunction indicator light to turn on or off regardless of the actual command from the EPS control module. This could affect the driver's understanding of the status of the steering system (e.g., whether or not power assist is available).
203	External disturbances	Manufacturing defects and assembly problems	Manufacturing defects and assembly problems might affect the EPS control module and instrument panel display connection. This might cause the steering system malfunction indicator light to turn on or off regardless of the actual command from the EPS control module. This could affect the driver's understanding of the status of the steering system (e.g., whether or not power assist is available).
204	External disturbances	Extreme external temperature or thermal cycling	Extreme external temperature or thermal cycling might affect the EPS control module and instrument panel display connection. This might cause the steering system malfunction indicator light to turn on or off regardless of the actual command from the EPS control module. This could affect the driver's understanding of the status of the steering system (e.g., whether or not power assist is available).

Causal Factor ID Number	Causal Factor Guide Phrase	Causal Factor Subcategory	Causal Factor (Electric Power Steering Control Module to Instrument Panel Display)
206	External disturbances	Organic growth	Organic growth (e.g. mold on a printed circuit board) might affect the EPS control module and instrument panel display connection. This might cause the steering system malfunction indicator light to turn on or off regardless of the actual command from the EPS control module. This could affect the driver's understanding of the status of the steering system (e.g., whether or not power assist is available).
207	External disturbances	Physical interference (e.g., chafing)	Physical interference (e.g., chafing) might affect the EPS control module and instrument panel display connection. This might cause the steering system malfunction indicator light to turn on or off regardless of the actual command from the EPS control module. This could affect the driver's understanding of the status of the steering system (e.g., whether or not power assist is available).
209	Hazardous interaction with other components in the rest of the vehicle	EMI or ESD	EMI or ESD from components within the vehicle might affect the EPS control module and instrument panel display connection. This might cause the steering system malfunction indicator light to turn on or off regardless of the actual command from the EPS control module. This could affect the driver's understanding of the status of the steering system (e.g., whether or not power assist is available).
210	Hazardous interaction with other components in the rest of the vehicle	Vibration or shock impact	Vibration or shock impact from components within the vehicle might affect the EPS control module and instrument panel display connection. This might cause the steering system malfunction indicator light to turn on or off regardless of the actual command from the EPS control module. This could affect the driver's understanding of the status of the steering system (e.g., whether or not power assist is available).

Causal Factor ID Number	Causal Factor Guide Phrase	Causal Factor Subcategory	Causal Factor (Electric Power Steering Control Module to Instrument Panel Display)
211	Hazardous interaction with other components in the rest of the vehicle	Physical interference (e.g., chafing)	Physical interference (e.g., chafing) with components within the vehicle might affect the EPS control module and instrument panel display connection. This might cause the steering system malfunction indicator light to turn on or off regardless of the actual command from the EPS control module. This could affect the driver's understanding of the status of the steering system (e.g., whether or not power assist is available).
212	Hazardous interaction with other components in the rest of the vehicle	Excessive heat from other components	Excessive heat from other components might affect the EPS control module and instrument panel display connection. This might cause the steering system malfunction indicator light to turn on or off regardless of the actual command from the EPS control module. This could affect the driver's understanding of the status of the steering system (e.g., whether or not power assist is available).
213	Hazardous interaction with other components in the rest of the vehicle	Electrical arcing from neighboring components or exposed terminals	Electrical arcing from neighboring components or exposed terminals might affect the EPS control module and instrument panel display connection. This might cause the steering system malfunction indicator light to turn on or off regardless of the actual command from the EPS control module. This could affect the driver's understanding of the status of the steering system (e.g., whether or not power assist is available).
214	Hazardous interaction with other components in the rest of the vehicle	Corona effects from high voltage components	If the vehicle has high voltage components (e.g., electric or hybrid electric powertrain), corona effects from high voltage components might affect the EPS control module and instrument panel display connection. This might cause the steering system malfunction indicator light to turn on or off regardless of the actual command from the EPS control module. This could affect the driver's understanding of the status of the steering system (e.g., whether or not power assist is available).

Causal Factor ID Number	Causal Factor Guide Phrase	Causal Factor Subcategory	Causal Factor (Electric Power Steering Control Module to Instrument Panel Display)
1261	External disturbances	Active connection terminals affected by moisture, corrosion, or contamination	Active connection terminals of the EPS control module or instrument panel display may be affected by moisture, corrosion, or contamination. This might cause the steering system malfunction indicator light to turn on or off regardless of the actual command from the EPS control module. This could affect the driver's understanding of the status of the steering system (e.g., whether or not power assist is available).
1262	Hazardous interaction with other components in the rest of the vehicle	Active connection terminals affected by moisture, corrosion, or contamination	Active connection terminals of the EPS control module or instrument panel display may be affected by moisture, corrosion, or contamination from other components within the vehicle. This might cause the steering system malfunction indicator light to turn on or off regardless of the actual command from the EPS control module. This could affect the driver's understanding of the status of the steering system (e.g., whether or not power assist is available).
1263	External disturbances	Unused connection terminals affected by moisture, corrosion, or contamination	Unused connection terminals in the wiring harness connecting the EPS control module and instrument panel display may be affected by moisture, corrosion, or contamination. This might cause the steering system malfunction indicator light to turn on or off regardless of the actual command from the EPS control module. This could affect the driver's understanding of the status of the steering system (e.g., whether or not power assist is available).
1264	Hazardous interaction with other components in the rest of the vehicle	Unused connection terminals affected by moisture, corrosion, or contamination	Unused connection terminals in the wiring harness connecting the EPS control module and instrument panel display may be affected by moisture, corrosion, or contamination from components within the vehicle. This might cause the steering system malfunction indicator light to turn on or off regardless of the actual command from the EPS control module. This could affect the driver's understanding of the status of the steering system (e.g., whether or not power assist is available).

Table I- 17: Electric Power Steering Control Module to Power Assist Motor

Causal Factor ID Number	Causal Factor Guide Phrase	Causal Factor Subcategory	Causal Factor (Electric Power Steering Control Module to Power Assist Motor)
763	Controller to actuator signal ineffective, missing, or delayed: Hardware open, short, missing, intermittent faulty	Connection is intermittent	An intermittent connection between the EPS control module and power assist motor may affect the power assist motor position feedback to the EPS control module or the EPS control module torque command to the power assist motor.
764	Controller to actuator signal ineffective, missing, or delayed: Hardware open, short, missing, intermittent faulty	Connection is open, short to ground, short to battery, or short to other wires in harness	A connection that is open, short to ground, short to battery, or short to other wires in harness might affect the connection between the EPS control module and power assist motor. This could affect the power assist motor position feedback to the EPS control module or the EPS control module torque command to the power assist motor.
765	Controller to actuator signal ineffective, missing, or delayed: Hardware open, short, missing, intermittent faulty	Electrical noise other than EMI or ESD	Electrical noise other than EMI or ESD might affect the connection between the EPS control module and power assist motor. This could affect the power assist motor position feedback to the EPS control module or the EPS control module torque command to the power assist motor.
766	Controller to actuator signal ineffective, missing, or delayed: Hardware open, short, missing, intermittent faulty	Connector shorting between neighboring pins	Shorting between neighboring pins in the connector might affect the EPS control module and power assist motor connection. This could affect the power assist motor position feedback to the EPS control module or the EPS control module torque command to the power assist motor.

Causal Factor ID Number	Causal Factor Guide Phrase	Causal Factor Subcategory	Causal Factor (Electric Power Steering Control Module to Power Assist Motor)
767	Controller to actuator signal ineffective, missing, or delayed: Hardware open, short, missing, intermittent faulty	Connector contact resistance is too high	Connector contact resistance that is too high might affect the EPS control module and power assist motor connection. This may affect the power assist motor position feedback to the EPS control module or the EPS control module torque command to the power assist motor.
768	Controller to actuator signal ineffective, missing, or delayed: Hardware open, short, missing, intermittent faulty	Connector resistive drift between neighboring pins	Connector resistive drift between neighboring pins might affect the EPS control module and power assist motor connection. This may affect the power assist motor position feedback to the EPS control module or the EPS control module torque command to the power assist motor.
769	Controller to actuator signal ineffective, missing, or delayed: Communication bus error	Bus overload or bus error	A bus overload or bus error might affect the EPS control module and power assist motor connection. This may affect the power assist motor position feedback to the EPS control module or the EPS control module torque command to the power assist motor.
771	Controller to actuator signal ineffective, missing, or delayed: Communication bus error	Signal priority too low	A signal priority that is too low might affect the EPS control module and power assist motor connection. This may affect the power assist motor position feedback to the EPS control module or the EPS control module torque command to the power assist motor.
772	Controller to actuator signal ineffective, missing, or delayed: Communication bus error	Failure of the message generator, transmitter, or receiver	A failure of the message generator, transmitter, or receiver might affect the EPS control module and power assist motor connection. This may affect the power assist motor position feedback to the EPS control module or the EPS control module torque command to the power assist motor.

Causal Factor ID Number	Causal Factor Guide Phrase	Causal Factor Subcategory	Causal Factor (Electric Power Steering Control Module to Power Assist Motor)
773	Controller to actuator signal ineffective, missing, or delayed: Communication bus error	Malicious intruder	A malicious intruder (e.g., a computer virus) might affect the EPS control module and power assist motor connection. This could affect the power assist motor feedback to the EPS control module or the EPS control module torque command to the power assist motor.
774	Controller to actuator signal ineffective, missing, or delayed: Incorrect connection	Incorrect wiring connection	An incorrect wiring connection might affect the EPS control module and power assist motor connection. This may affect the power assist motor position feedback to the EPS control module or the EPS control module torque command to the power assist motor.
775	Controller to actuator signal ineffective, missing, or delayed: Incorrect connection	Incorrect pin assignment	An incorrect pin assignment might affect the EPS control module and power assist motor connection. This may affect the power assist motor position feedback to the EPS control module or the EPS control module torque command to the power assist motor.
776	External disturbances	EMI or ESD	EMI or ESD might affect the EPS control module and power assist motor connection. This could affect the power assist motor position feedback to the EPS control module or the EPS control module torque command to the power assist motor.
777	External disturbances	Single event effects (e.g., cosmic rays, protons)	Single event effects (e.g., cosmic rays, protons) might affect the EPS control module and power assist motor connection. This could affect the power assist motor position feedback to the EPS control module or the EPS control module torque command to the power assist motor.
780	External disturbances	Extreme external temperature or thermal cycling	Extreme external temperatures or thermal cycling might affect the EPS control module and power assist motor connection. This could affect the power assist motor position feedback to the EPS control module or the EPS control module torque command to the power assist motor.

Causal Factor ID Number	Causal Factor Guide Phrase	Causal Factor Subcategory	Causal Factor (Electric Power Steering Control Module to Power Assist Motor)
781	External disturbances	Unused connection terminals affected by moisture, corrosion, or contamination	Unused connection terminals in the wiring harness connecting the EPS control module and power assist motor may be affected by moisture, corrosion, or contamination. This may cause a short in the wiring harness which could affect the power assist motor position feedback to the EPS control module or the EPS control module torque command to the power assist motor.
782	External disturbances	Organic growth	Organic growth might affect the EPS control module and power assist motor connection. This could affect the power assist motor position feedback to the EPS control module or the EPS control module torque command to the power assist motor.
785	Hazardous interaction with other components in the rest of the vehicle	EMI or ESD	EMI or ESD from components within the vehicle might affect the EPS control module and power assist motor connection. This could affect the power assist motor position feedback to the EPS control module or the EPS control module torque command to the power assist motor.
788	Hazardous interaction with other components in the rest of the vehicle	Electrical arcing from neighboring components or exposed terminals	Electrical arcing from neighboring components or exposed terminals might affect the EPS control module and power assist motor connection. This could affect the power assist motor position feedback to the EPS control module or the EPS control module torque command to the power assist motor.
789	Hazardous interaction with other components in the rest of the vehicle	Corona effects from high voltage components	If the vehicle has high voltage components (e.g., an electric or hybrid electric powertrain), corona effects from high voltage components might affect the EPS control module and power assist motor connection. This may affect the power assist motor position feedback to the EPS control module or the EPS control module torque command to the power assist motor.

Causal Factor ID Number	Causal Factor Guide Phrase	Causal Factor Subcategory	Causal Factor (Electric Power Steering Control Module to Power Assist Motor)
1195	Hazardous interaction with other components in the rest of the vehicle	Excessive heat from other components	Excessive heat from other vehicle components may affect the EPS control module and power assist motor connection (e.g., melt the wiring). This may affect the power assist motor feedback to the EPS control module or the EPS control module torque command to the power assist motor.
1196	Hazardous interaction with other components in the rest of the vehicle	Unused connection terminals affected by moisture, corrosion, or contamination	Unused connection terminals in the wiring harness connecting the EPS control module and power assist motor may be affected by moisture, corrosion, or contamination from other vehicle components. This may affect the power assist motor feedback to the EPS control module or the EPS control module torque command to the power assist motor.
1253	External disturbances	Active connection terminals affected by moisture, corrosion, or contamination	Active connection terminals affected by moisture, corrosion, or contamination might affect the EPS control module and power assist motor connection. This could affect the power assist motor position feedback to the EPS control module or the EPS control module torque command to the power assist motor.
1254	Hazardous interaction with other components in the rest of the vehicle	Active connection terminals affected by moisture, corrosion, or contamination	Active connection terminals affected by moisture, corrosion, or contamination from other components within the vehicle might affect the EPS control module and power assist motor connection. This could affect the power assist motor position feedback to the EPS control module or the EPS control module torque command to the power assist motor.
1371	External disturbances	Manufacturing defects and assembly problems	Manufacturing defects and assembly problems might affect the connection between EPS control module and the power assist motor. This might affect adjustment of the feedback to the driver and affect the transmission of torque from driver or from power assist motor to the road wheels.

Table I- 18: Electric Power Steering Control Module to Rear Road Wheel Motors

Causal Factor ID Number	Causal Factor Guide Phrase	Causal Factor Subcategory	Causal Factor (Electric Power Steering Control Module to Rear Road Wheel Motors)
917	Controller to actuator signal ineffective, missing, or delayed: Hardware open, short, missing, intermittent faulty	Connection is intermittent	An intermittent connection between the EPS control module and rear road wheel motors might affect the EPS control module's adjustment of the rear road wheel steering angle.
918	Controller to actuator signal ineffective, missing, or delayed: Hardware open, short, missing, intermittent faulty	Connection is open, short to ground, short to battery, or short to other wires in harness	Connection that is open, short to ground, short to battery, or short to other wires in harness between the EPS control module and rear road wheel motors might affect the EPS control module's adjustment of the rear road wheel steering angle.
919	Controller to actuator signal ineffective, missing, or delayed: Hardware open, short, missing, intermittent faulty	Electrical noise other than EMI or ESD	Electrical noise other than EMI or ESD might affect the connection between the EPS control module and rear road wheel motors. This might affect the EPS control module's adjustment of the rear road wheel steering angle.
920	Controller to actuator signal ineffective, missing, or delayed: Hardware open, short, missing, intermittent faulty	Connector contact resistance is too high	Contact resistance that is too high in the connector of the EPS control module or the rear road wheel motors might affect the EPS control module's adjustment of the rear road wheel steering angle.

Causal Factor ID Number	Causal Factor Guide Phrase	Causal Factor Subcategory	Causal Factor (Electric Power Steering Control Module to Rear Road Wheel Motors)
921	Controller to actuator signal ineffective, missing, or delayed: Hardware open, short, missing, intermittent faulty	Connector shorting between neighboring pins	Connector shorting between neighboring pins on the EPS control module and rear road wheel motors might affect the EPS control module's adjustment of the rear road wheel steering angle.
925	Controller to actuator signal ineffective, missing, or delayed: Communication bus error	Failure of the message generator, transmitter, or receiver	A failure of the message generator, transmitter, or receiver can affect the EPS control module and rear road wheel motors connection. This might affect the EPS control module's adjustment of the rear road wheel steering angle.
926	Controller to actuator signal ineffective, missing, or delayed: Communication bus error	Malicious intruder	A malicious intruder or aftermarket component might issue a command to the communication bus that affects communication between the EPS control module and the rear road wheel motors. This might affect the EPS control module's adjustment of the rear road wheel steering angle.
927	Controller to actuator signal ineffective, missing, or delayed: Communication bus error	Signal priority too low	A signal priority that is too low might delay or prevent communication between the EPS control module and rear road wheel motors. This might affect the EPS control module's adjustment of the rear road wheel steering angle.
928	Controller to actuator signal ineffective, missing, or delayed: Communication bus error	Bus overload or bus error	A bus overload or bus error can affect the EPS control module and rear road wheel motors connection. This might affect the EPS control module's adjustment of the rear road wheel steering angle.

Causal Factor ID Number	Causal Factor Guide Phrase	Causal Factor Subcategory	Causal Factor (Electric Power Steering Control Module to Rear Road Wheel Motors)
929	Controller to actuator signal ineffective, missing, or delayed: Hardware open, short, missing, intermittent faulty	Connector resistive drift between neighboring pins	Connector resistive drift between neighboring pins on the EPS control module and rear road wheel motors might affect the EPS control module's adjustment of the rear road wheel steering angle.
930	Controller to actuator signal ineffective, missing, or delayed: Incorrect connection	Incorrect wiring connection	An incorrect wiring connection between the EPS control module and rear road wheel motors might affect the EPS control module's adjustment of the rear road wheel steering angle.
931	Controller to actuator signal ineffective, missing, or delayed: Incorrect connection	Incorrect pin assignment	An incorrect pin assignment between the EPS control module and rear road wheel motors connection might affect the EPS control module's adjustment of the rear road wheel steering angle.
932	External disturbances	EMI or ESD	EMI or ESD might affect the EPS control module and rear road wheel motors connection. This might affect the EPS control module's adjustment of the rear road wheel steering angle.
934	External disturbances	Vibration or shock impact	Vibration or shock impact might affect the EPS control module and rear road wheel motors connection. This might affect the EPS control module's adjustment of the rear road wheel steering angle.
935	External disturbances	Manufacturing defects and assembly problems	Manufacturing defects and assembly problems might affect the EPS control module and rear road wheel motors connection. This might affect the EPS control module's adjustment of the rear road wheel steering angle.

Causal Factor ID Number	Causal Factor Guide Phrase	Causal Factor Subcategory	Causal Factor (Electric Power Steering Control Module to Rear Road Wheel Motors)
936	External disturbances	Organic growth	Organic growth (e.g., mold) might create a short circuit in the connection between the EPS control module and rear road wheel motors. This might affect the EPS control module's adjustment of the rear road wheel steering angle.
937	External disturbances	Physical interference (e.g., chafing)	Physical interference (e.g., chafing) might affect the EPS control module and rear road wheel motors connection. This might affect the EPS control module's adjustment of the rear road wheel steering angle.
938	Hazardous interaction with other components in the rest of the vehicle	Active connection terminals affected by moisture, corrosion, or contamination	Active connection terminals of the EPS control module or the rear road wheel motors might be affected by moisture, corrosion, or contamination from other vehicle components (e.g., shorting). This might affect the EPS control module's adjustment of the rear road wheel steering angle.
939	Hazardous interaction with other components in the rest of the vehicle	EMI or ESD	EMI or ESD from components within the vehicle might affect the EPS control module and rear road wheel motors connection. This might affect the EPS control module's adjustment of the rear road wheel steering angle.
940	Hazardous interaction with other components in the rest of the vehicle	Vibration or shock impact	Vibration or shock impact from components within the vehicle might affect the EPS control module and rear road wheel motors connection. This might affect the EPS control module's adjustment of the rear road wheel steering angle.
941	Hazardous interaction with other components in the rest of the vehicle	Physical interference (e.g., chafing)	Physical interference (e.g., chafing) with components within the vehicle might affect the EPS control module and rear road wheel motors connection. This might affect the EPS control module's adjustment of the rear road wheel steering angle.
942	Hazardous interaction with other components in the rest of the vehicle	Electrical arcing from neighboring components or exposed terminals	Electrical arcing from neighboring components or exposed terminals might affect the EPS control module and rear road wheel motors connection. This might affect the EPS control module's adjustment of the rear road wheel steering angle.

Causal Factor ID Number	Causal Factor Guide Phrase	Causal Factor Subcategory	Causal Factor (Electric Power Steering Control Module to Rear Road Wheel Motors)
943	Hazardous interaction with other components in the rest of the vehicle	Corona effects from high voltage components	If the vehicle has high voltage components (e.g., electric or hybrid electric powertrain), corona effects from high voltage components might affect the EPS control module and rear road wheel motors connection. This might affect the EPS control module's adjustment of the rear road wheel steering angle.
1197	External disturbances	Extreme external temperature or thermal cycling	Extreme ambient temperatures or thermal cycling may affect the connection between the EPS control module and the rear road wheel motors. This might affect the EPS control module's adjustment of the rear road wheel steering angle.
1198	External disturbances	Unused connection terminals affected by moisture, corrosion, or contamination	Unused connection terminals in the wiring harness connecting the EPS control module and the rear road wheel motors might be affected by moisture, corrosion, or contamination from the external environment. This might affect the EPS control module's adjustment of the rear road wheel steering angle.
1199	Hazardous interaction with other components in the rest of the vehicle	Excessive heat from other components	Excessive heat from other vehicle components might affect the connection between the EPS control module and the rear road wheel motors. This might affect the EPS control module's adjustment of the rear road wheel steering angle.
1200	Hazardous interaction with other components in the rest of the vehicle	Unused connection terminals affected by moisture, corrosion, or contamination	Unused connection terminals in the wiring harness connecting the EPS control module and the rear road wheel motors might be affected by moisture, corrosion, or contamination from other vehicle components. This might affect the EPS control module's adjustment of the rear road wheel steering angle.
1372	External disturbances	Active connection terminals affected by moisture, corrosion, or contamination	Active connection terminals of the EPS control module or the rear road wheel motors might be affected by moisture, corrosion, or contamination from the external environment (e.g., shorting). This might affect the EPS control module's adjustment of the rear road wheel steering angle.

Table I- 19: Front Road Wheels to Steering Column/Rack and Pinion

Causal Factor ID Number	Causal Factor Guide Phrase	Causal Factor Subcategory	Causal Factor (Front Road Wheels to Steering Column/Rack and Pinion)
170	Sensor measurement incorrect or missing	Other	If the feedback from the front road wheels to the steering column/rack and pinion is incorrect or missing, this might affect the feedback to the driver about road conditions. For example, a loose mechanical joint/planetary gear that results in an intermittent connection.
172	Sensor measurement delay	Other	If the feedback from the front road wheels to the steering column/rack and pinion is delayed, this might delay feedback to the driver about changes in the road conditions.
173	External disturbances	Vibration or shock impact	Vibration or shock impact could affect the connection between the front road wheels and steering column/rack and pinion. This might affect the feedback to the driver about the road conditions.
174	External disturbances	Manufacturing defects and assembly problems	Manufacturing defects and assembly problems could affect the connection between the front road wheels and steering column/rack and pinion. This might affect the feedback to the driver about the road conditions.
175	External disturbances	Mechanical connections affected by moisture, corrosion, or contamination	Moisture, corrosion, or contamination could affect the connection between the front road wheels and steering column/rack and pinion. This might affect the feedback to the driver about the road conditions.
176	Hazardous interaction with other components in the rest of the vehicle	Physical interference (e.g., chafing)	Physical interference (e.g., chafing) with components within the vehicle might affect the front road wheels and steering column/rack and pinion connection. This might affect the feedback to the driver about the road surface.
177	Hazardous interaction with other components in the rest of the vehicle	Mechanical connections affected by moisture, corrosion, or contamination	Moisture, corrosion, or contamination from components within the vehicle might affect the front road wheels and steering column/rack and pinion connection. This might affect the feedback to the driver about the road surface.

Causal Factor ID Number	Causal Factor Guide Phrase	Causal Factor Subcategory	Causal Factor (Front Road Wheels to Steering Column/Rack and Pinion)
1052	Sensor measurement inaccurate	Other	Inaccurate sensor measurement from front road wheels to steering column/rack and pinion connection might cause the driver to issue an incorrect steering adjustment or no steering adjustment or correct steering adjustment that is executed incorrectly.
1053	External disturbances	Physical interference (e.g., chafing)	Physical interference from external objects might affect the roadway feedback to the driver. This might cause the driver to issue an incorrect steering adjustment or no steering adjustment or correct steering adjustment that is executed incorrectly. For example, a crow bar is left after fixing the front road wheels - steering column/rack and pinion connection; this might send false roadway feedback to the driver.
1209	Hazardous interaction with other components in the rest of the vehicle	Vibration or shock impact	Vibration or shock impact from components within the vehicle might affect the front road wheels and steering column/rack and pinion connection. This might affect the feedback to the driver about the road surface.
1210	Hazardous interaction with other components in the rest of the vehicle	Excessive heat from other components	Excessive heat from other vehicle components may affect the connection between the front road wheels and steering column/rack and pinion. This might affect the feedback to the driver about the road surface.
1211	External disturbances	Extreme external temperature or thermal cycling	Extreme external temperatures or thermal cycling may affect the connection between the front road wheels and steering column/rack and pinion (e.g., premature wear). This might affect the feedback to the driver about the road conditions.

Table I- 20: Gear Set to Steering Column/Rack and Pinion

Causal Factor ID Number	Causal Factor Guide Phrase	Causal Factor Subcategory	Causal Factor (Gear Set to Steering Column/Rack and Pinion)
143	Actuation delivered incorrectly or inadequately: Hardware faulty	Actuation delivered incorrectly or inadequately: Hardware faulty	A faulty hardware connection between the gear set and steering column/rack and pinion might affect the transmission of torque from the driver or from the power assist motor to the front road wheels. Incorrectly transmitting the driver's torque or the power assist motor torque may cause the vehicle to respond differently than expected.
144	Actuation delivered incorrectly or inadequately: Actuation delayed	Actuation delivered incorrectly or inadequately: Actuation delayed	Delayed transmission of torque between the gear set and the steering column/rack and pinion might affect the transmission of torque from the driver or from the power assist motor to the road wheels. Incorrectly transmitting the driver's torque or the power assist motor torque may cause the vehicle to respond differently than expected.
145	Actuation delivered incorrectly or inadequately: Incorrect connection	Actuation delivered incorrectly or inadequately: Incorrect connection	Incorrect connection between the gear set (e.g., planetary gear) and steering column/rack and pinion might affect the transmission of torque from the driver or from the power assist motor to the front road wheels. Incorrectly transmitting the driver's torque or the power assist motor torque may cause the vehicle to respond differently than expected.
146	External disturbances	Vibration or shock impact	Vibration or shock impact between gear set (e.g., planetary gear) and steering column/rack and pinion might affect the feedback to the driver and affect the transmission of torque from driver or from power assist motor. This might lead to the driver making an incorrect steering adjustment or no steering adjustment or correct steering adjustment that is executed incorrectly.
147	External disturbances	Manufacturing defects and assembly problems	Manufacturing defects and assembly problems may affect torque transmission between the gear set (e.g., planetary gear) and steering column/rack and pinion, which might affect the feedback to the driver and affect the transmission of torque from the driver or from the power assist motor to the road wheels. Incorrectly transmitting the driver's torque or the power assist motor torque may cause the vehicle to respond differently than expected.

Causal Factor ID Number	Causal Factor Guide Phrase	Causal Factor Subcategory	Causal Factor (Gear Set to Steering Column/Rack and Pinion)
148	External disturbances	Physical interference (e.g., chafing)	Physical interference may affect torque transmission between the gear set and steering column/rack and pinion connection, which might affect the transmission of torque from the driver or from the power assist motor to the road wheels. Incorrectly transmitting the driver's torque or the power assist motor torque may cause the vehicle to respond differently than expected.
149	External disturbances	Mechanical connections affected by moisture, corrosion, or contamination	Moisture, corrosion, or contamination may affect torque transmission between the gear set and steering column/rack and pinion, which might affect the transmission of torque from the driver or from the power assist motor to the road wheels. Incorrectly transmitting the driver's torque or the power assist motor torque may cause the vehicle to respond differently than expected.
150	Hazardous interaction with other components in the rest of the vehicle	Vibration or shock impact	Vibration or shock impact from other components may affect the transmission of torque between the gear set and steering column/rack and pinion, which might affect the transmission of torque from the driver or from the power assist motor to the road wheels. Incorrectly transmitting the driver's torque or the power assist motor torque may cause the vehicle to respond differently than expected.
151	Hazardous interaction with other components in the rest of the vehicle	Physical interference (e.g., chafing)	Physical interference with components within the vehicle might affect the transmission of torque between the gear set and steering column/rack and pinion, which might affect the transmission of torque from the driver or from the power assist motor to the road wheels. Incorrectly transmitting the driver's torque or the power assist motor torque may cause the vehicle to respond differently than expected.
152	Hazardous interaction with other components in the rest of the vehicle	Mechanical connections affected by moisture, corrosion, or contamination	Moisture, corrosion, or contamination from components within the vehicle might affect the transmission of torque between the gear set and steering column/rack and pinion, which might affect the transmission of torque from the driver or from the power assist motor to the road wheels. Incorrectly transmitting the driver's torque or the power assist motor torque may cause the vehicle to respond differently than expected.

Causal Factor ID Number	Causal Factor Guide Phrase	Causal Factor Subcategory	Causal Factor (Gear Set to Steering Column/Rack and Pinion)
1201	External disturbances	Extreme external temperature or thermal cycling	Extreme external temperature or thermal cycling could affect the torque transmission between the gear set and the steering column / rack and pinion, which could affect the transmission of torque from the driver or power assist motor to the road wheels. Incorrectly transmitting the driver's torque or the power assist motor torque may cause the vehicle to respond differently than expected.
1202	Hazardous interaction with other components in the rest of the vehicle	Excessive heat from other components	Excessive heat from other vehicle components may affect the torque transmission between the gear set and steering column / rack and pinion, which may affect the transmission of torque from the driver or power steering motor to the road wheels. Incorrectly transmitting the driver's torque or the power assist motor torque may cause the vehicle to respond differently than expected.

Table I- 21: Gear Set to Steering Wheel

Causal Factor ID Number	Causal Factor Guide Phrase	Causal Factor Subcategory	Causal Factor (Gear Set to Steering Wheel)
134	Sensor measurement incorrect or missing	Other	The feedback from the gear set to the steering wheel might be incorrect or missing. This could affect the feedback to the driver about changes in the road conditions or transmit unwanted feedback to the driver when implementing active feedback features (e.g., crosswind compensation).
136	Sensor measurement delay	Other	The feedback from the gear set to the steering wheel might be delayed. This could delay the feedback to the driver about changes in the road conditions.
137	External disturbances	Vibration or shock impact	Vibration or shock impact might affect the steering wheel and gear set connection. This might affect the feedback to the driver about changes in the road conditions or transmit unwanted feedback to the driver when implementing active feedback features (e.g., crosswind compensation).
138	External disturbances	Manufacturing defects and assembly problems	Manufacturing defects and assembly problems might affect the steering wheel and gear set (e.g., planetary gear) connection. This might affect the feedback to the driver about changes in the road conditions or transmit unwanted feedback to the driver when implementing active feedback features (e.g., crosswind compensation).
139	External disturbances	Mechanical connections affected by moisture, corrosion, or contamination	Mechanical connections affected by moisture, corrosion, or contamination might affect the steering wheel and gear set (e.g., planetary gear) connection. This might affect the feedback to the driver about changes in the road conditions or transmit unwanted feedback to the driver when implementing active feedback features (e.g., crosswind compensation).
140	Hazardous interaction with other components in the rest of the vehicle	Vibration or shock impact	Vibration or shock impact from other components within the vehicle might affect the steering wheel and gear set connection. This might affect the feedback to the driver about changes in the road conditions or transmit unwanted feedback to the driver when implementing active feedback features (e.g., crosswind compensation).

Causal Factor ID Number	Causal Factor Guide Phrase	Causal Factor Subcategory	Causal Factor (Gear Set to Steering Wheel)
141	Hazardous interaction with other components in the rest of the vehicle	Physical interference (e.g., chafing)	Physical interference (e.g., chafing) with other components within the vehicle might affect the steering wheel and gear set connection. This might affect the feedback to the driver about changes in the road conditions or transmit unwanted feedback to the driver when implementing active feedback features (e.g., crosswind compensation).
142	Hazardous interaction with other components in the rest of the vehicle	Mechanical connections affected by moisture, corrosion, or contamination	Moisture, corrosion, or contamination from other components within the vehicle might affect the steering wheel and gear set connection. This might affect the feedback to the driver about changes in the road conditions or transmit unwanted feedback to the driver when implementing active feedback features (e.g., crosswind compensation).
1203	External disturbances	Extreme external temperature or thermal cycling	Extreme external temperatures or thermal cycling might affect the steering wheel and gear set connection. This might affect the feedback to the driver about changes in the road conditions or transmit unwanted feedback to the driver when implementing active feedback features (e.g., crosswind compensation).

Table I- 22: Ignition Key to Electric Power Steering Control Module

Causal Factor ID Number	Causal Factor Guide Phrase	Causal Factor Subcategory	Causal Factor (Ignition Key to Electric Power Steering Control Module)
1339	Sensor to controller signal inadequate, missing, or delayed: Hardware open, short, missing, intermittent faulty	Connection is intermittent	Intermittent connection between the ignition key and EPS control module might affect the steering adjustment of the driver. A prox key with a push button for engine start might fail (e.g., RFID tag might stop working) causing the steering wheel to lock.
1341	Sensor to controller signal inadequate, missing, or delayed: Hardware open, short, missing, intermittent faulty	Connection is open, short to ground, short to battery, or short to other wires in harness	Connection that is open, short to ground, short to battery, or short to other wires in harness between the ignition key and EPS control module might affect the steering adjustment of the driver. This might cause the steering wheel to lock. This will most likely be possible with vehicles that use transponder keys.
1342	Sensor to controller signal inadequate, missing, or delayed: Hardware open, short, missing, intermittent faulty	Electrical noise other than EMI or ESD	Electrical noise other than EMI or ESD between the ignition key and EPS control module might affect the steering adjustment of the driver (e.g., electrical noise affecting the RFID tag possibly causing the engine to turn off). This might cause the steering wheel to lock.
1343	Sensor to controller signal inadequate, missing, or delayed: Communication bus error	Failure of the message generator, transmitter, or receiver	Failure of the message generator, transmitter, or receiver between the ignition key and EPS control module might affect the steering adjustment of the driver (e.g., RFID tag and the vehicle communicating an incorrect message and possibly causing the engine to turn off). This might cause the steering wheel to lock.

Causal Factor ID Number	Causal Factor Guide Phrase	Causal Factor Subcategory	Causal Factor (Ignition Key to Electric Power Steering Control Module)
1344	Sensor to controller signal inadequate, missing, or delayed: Communication bus error	Malicious intruder	Malicious intruder might disrupt the communication between the RFID keyless ignition and the vehicle communicating an incorrect message and possibly causing the engine to turn off. This might cause the steering wheel to lock.
1345	External disturbances	EMI or ESD	EMI or ESD might disrupt the communication between the RFID keyless ignition and the vehicle communicating an incorrect message and possibly causing the engine to turn off. This might cause the steering wheel to lock.
1346	External disturbances	Manufacturing defects and assembly problems	Manufacturing defects and assembly problems of the ignition key and EPS control module might affect the steering adjustment of the driver. This might cause the steering wheel to lock.
1347	External disturbances	Extreme external temperature or thermal cycling	Extreme external temperature or thermal cycling might affect the ignition key and EPS control module connection. This might cause the steering wheel to lock and affect the driver steering.
1348	External disturbances	Physical interference (e.g., chafing)	Physical interference (e.g., chafing) might affect the ignition key and EPS control module connection. This might cause the steering wheel to lock and affect the driver steering. This might apply to transponder keys only.
1349	Hazardous interaction with other components in the rest of the vehicle	EMI or ESD	EMI or ESD from components within the vehicle might disrupt the communication between the RFID keyless ignition and the vehicle communicating an incorrect message and possibly causing the engine to turn off. This might cause the steering wheel to lock.
1350	Hazardous interaction with other components in the rest of the vehicle	Physical interference (e.g., chafing)	Physical interference (e.g., chafing) within the vehicle might affect the ignition key and EPS control module connection. This might cause the steering wheel to lock and affect the driver steering. This might apply to transponder keys only.

Table I- 23: Instrument Panel Display to Driver

Causal Factor ID Number	Causal Factor Guide Phrase	Causal Factor Subcategory	Causal Factor (Instrument Panel Display to Driver)
217	Hazardous interaction with other components in the rest of the vehicle	Other	A confusing telematics interface that makes it hard to differentiate warnings from other things might cause the driver to make incorrect steering adjustment or no steering adjustment when needed.
234	External disturbances	Other	External factors might affect the visual feedback from instrument panel display to the driver. For example, the display may not have a non-glare coating. If there's glare, the driver may not see the notification in the first place. This might cause the driver to make incorrect steering adjustment or no steering adjustment when needed.
1204	Hazardous interaction with other components in the rest of the vehicle	Other	Interaction with components within the vehicle might affect the visual feedback from instrument panel display to the driver. Visually obscured notifications (e.g., steering wheel design might limit what the driver can see on the dashboard) might cause the driver to make incorrect steering adjustment or no steering adjustment when needed.
1205	Hazardous interaction with other components in the rest of the vehicle	Mechanical connections affected by moisture, corrosion, or contamination	Environmental conditions in the vehicle cabin (e.g., moisture/humidity or icing) may affect the visibility of critical steering notifications on the instrument panel display (e.g., EPS availability or lateral automation system status).
1259	Sensor to controller signal inadequate, missing, or delayed: Hardware open, short, missing, intermittent faulty	Other	Warning notifications do not provide enough information to the driver to take appropriate action. For example, the driver may see a notification without an explanation of what it means (some vehicles have an LCD on the side to explain what the warning means).

Causal Factor ID Number	Causal Factor Guide Phrase	Causal Factor Subcategory	Causal Factor (Instrument Panel Display to Driver)
1260	Sensor to controller signal inadequate, missing, or delayed: Hardware open, short, missing, intermittent faulty	Other	A single LCD screen might be used to show multiple system failures. If two failures occur at the same time or in rapid succession, the LCD screen might not show all system failures or might not display a system failure long enough for the driver to notice. This might cause the driver to issue an incorrect steering command.

Table I- 24: Power Assist Motor to Gear Set

Causal Factor ID Number	Causal Factor Guide Phrase	Causal Factor Subcategory	Causal Factor (Power Assist Motor to Gear Set)
178	Actuation delivered incorrectly or inadequately: Hardware faulty	Actuation delivered incorrectly or inadequately: Hardware faulty	<p>A faulty hardware connection between the power assist motor and gear set might affect the feedback to the driver and affect the transmission of torque from the power assist motor to the road wheels.</p> <p>Affecting the feedback to the driver may cause the driver to incorrectly issue a steering adjustment. Incorrectly transmitting the power assist motor torque may cause the system to respond differently than expected to a steering command.</p>
179	Actuation delivered incorrectly or inadequately: Actuation delayed	Actuation delivered incorrectly or inadequately: Actuation delayed	<p>A delayed torque delivery from the power assist motor and gear set might delay the feedback to the driver and delay the transmission of torque from the power assist motor to the road wheels.</p> <p>Affecting the feedback to the driver may cause the driver to incorrectly issue a steering adjustment. Incorrectly transmitting the power assist motor torque may cause the system to respond differently than expected to a steering command.</p>
180	Actuation delivered incorrectly or inadequately: Incorrect connection	Actuation delivered incorrectly or inadequately: Incorrect connection	<p>An incorrect connection between the power assist motor and gear set might affect the feedback to the driver and affect the transmission of torque from the power assist motor to the road wheels.</p> <p>Affecting the feedback to the driver may cause the driver to incorrectly issue a steering adjustment. Incorrectly transmitting the power assist motor torque may cause the system to respond differently than expected to a steering command.</p>
181	External disturbances	Vibration or shock impact	<p>Vibration or shock impact might affect the connection between the power assist motor and gear set. This might affect adjustments to the feedback to the driver and transmission of torque from the power assist motor to the road wheels.</p> <p>Affecting the feedback to the driver may cause the driver to incorrectly issue a steering adjustment. Incorrectly transmitting the power assist motor torque may cause the system to respond differently than expected to a steering command.</p>

Causal Factor ID Number	Causal Factor Guide Phrase	Causal Factor Subcategory	Causal Factor (Power Assist Motor to Gear Set)
182	External disturbances	Manufacturing defects and assembly problems	<p>Manufacturing defects and assembly problems might affect the connection between the power assist motor and gear set. This might affect adjustment to the feedback to the driver and affect the transmission of torque from driver or from power assist motor to the road wheels.</p> <p>Affecting the feedback to the driver may cause the driver to incorrectly issue a steering adjustment. Incorrectly transmitting the power assist motor torque may cause the system to respond differently than expected to a steering command.</p>
183	External disturbances	Physical interference (e.g., chafing)	<p>Physical interference (e.g., chafing) might affect the connection between the power assist motor and gear set. This might affect adjustment to the feedback to the driver and affect the transmission of torque from driver or from power assist motor to the road wheels.</p> <p>Affecting the feedback to the driver may cause the driver to incorrectly issue a steering adjustment. Incorrectly transmitting the power assist motor torque may cause the system to respond differently than expected to a steering command.</p>
184	External disturbances	Mechanical connections affected by moisture, corrosion, or contamination	<p>Moisture, corrosion, or contamination might affect the connection between the power assist motor and gear set. This might affect adjustment to the feedback to the driver and affect the transmission of torque from driver or from power assist motor to the road wheels.</p> <p>Affecting the feedback to the driver may cause the driver to incorrectly issue a steering adjustment. Incorrectly transmitting the power assist motor torque may cause the system to respond differently than expected to a steering command.</p>

Causal Factor ID Number	Causal Factor Guide Phrase	Causal Factor Subcategory	Causal Factor (Power Assist Motor to Gear Set)
185	Hazardous interaction with other components in the rest of the vehicle	Vibration or shock impact	<p>Vibration or shock impact from other components might affect the torque transmission from the power assist motor to the gear set. This might affect the feedback to the driver and affect the transmission of torque from the power assist motor to the road wheels.</p> <p>Affecting the feedback to the driver may cause the driver to incorrectly issue a steering adjustment. Incorrectly transmitting the power assist motor torque may cause the system to respond differently than expected to a steering command.</p>
186	Hazardous interaction with other components in the rest of the vehicle	Physical interference (e.g., chafing)	<p>Physical interference (e.g., chafing) with other components might affect the torque transmission from the power assist motor to the gear set. This might affect the feedback to the driver and affect the transmission of torque from the power assist motor to the road wheels.</p> <p>Affecting the feedback to the driver may cause the driver to incorrectly issue a steering adjustment. Incorrectly transmitting the power assist motor torque may cause the system to respond differently than expected to a steering command.</p>
187	Hazardous interaction with other components in the rest of the vehicle	Mechanical connections affected by moisture, corrosion, or contamination	<p>Moisture, corrosion, or contamination from components might affect the torque transmission from the power assist motor to the gear set. This might affect the feedback to the driver and affect the transmission of torque from the power assist motor to the road wheels.</p> <p>Affecting the feedback to the driver may cause the driver to incorrectly issue a steering adjustment. Incorrectly transmitting the power assist motor torque may cause the system to respond differently than expected to a steering command.</p>

Causal Factor ID Number	Causal Factor Guide Phrase	Causal Factor Subcategory	Causal Factor (Power Assist Motor to Gear Set)
779	External disturbances	Manufacturing defects and assembly problems	<p>Manufacturing defects and assembly problems might affect the connection between the power assist motor and gear set. This might affect adjustment to the feedback to the driver and affect the transmission of torque from driver or from power assist motor to the road wheels.</p> <p>Affecting the feedback to the driver may cause the driver to incorrectly issue a steering adjustment. Incorrectly transmitting the power assist motor torque may cause the system to respond differently than expected to a steering command.</p>
1207	External disturbances	Extreme external temperature or thermal cycling	<p>An extreme ambient temperature or thermal cycling may affect the connection between the power assist motor and gear set (e.g., thermal expansion). This might affect adjustments to the feedback to the driver or transmission of torque from the power assist motor to the road wheels.</p> <p>Affecting the feedback to the driver may cause the driver to incorrectly issue a steering adjustment. Incorrectly transmitting the power assist motor torque may cause the system to respond differently than expected to a steering command.</p>
1208	Hazardous interaction with other components in the rest of the vehicle	Excessive heat from other components	<p>Excessive heat from other vehicle components may affect the torque transmission from the power assist motor to the gear set. This might affect the feedback to the driver and affect the transmission of torque from the power assist motor to the road wheels.</p> <p>Affecting the feedback to the driver may cause the driver to incorrectly issue a steering adjustment. Incorrectly transmitting the power assist motor torque may cause the system to respond differently than expected to a steering command.</p>

Table I- 25: Rear Road Wheel Motors to Rear Road Wheels

Causal Factor ID Number	Causal Factor Guide Phrase	Causal Factor Subcategory	Causal Factor (Rear Road Wheel Motors to Rear Road Wheels)
945	Actuation delivered incorrectly or inadequately: Hardware faulty	Actuation delivered incorrectly or inadequately: Hardware faulty	Faulty hardware in the connection between rear road wheel motors and rear road wheels might affect the transmission of torque to adjust the rear road wheel steering angle.
946	Actuation delivered incorrectly or inadequately: Actuation delayed	Actuation delivered incorrectly or inadequately: Actuation delayed	The connection between rear road wheel motors and rear road wheels might cause a delay when transmitting torque to adjust the rear road wheel steering angle.
947	Actuation delivered incorrectly or inadequately: Incorrect connection	Actuation delivered incorrectly or inadequately: Incorrect connection	The rear road wheel motors might be incorrectly connected to the rear road wheels, affecting the transmission of torque to adjust the rear road wheel steering angle.
948	External disturbances	Vibration or shock impact	Vibration or shock impact might affect the rear road wheel motors and rear road wheels connection. This might affect the transmission of torque to change the rear road wheel steering angle.
949	External disturbances	Manufacturing defects and assembly problems	Manufacturing defects and assembly problems might affect the rear road wheel motors and rear road wheels connection. This might affect the feedback transmission of torque to change the rear road wheel steering angle.
950	External disturbances	Mechanical connections affected by moisture, corrosion, or contamination	Moisture, corrosion, or contamination might affect the rear road wheel motors and rear road wheels connection. This might affect the transmission of torque to change the rear road wheel steering angle.

Causal Factor ID Number	Causal Factor Guide Phrase	Causal Factor Subcategory	Causal Factor (Rear Road Wheel Motors to Rear Road Wheels)
952	Hazardous interaction with other components in the rest of the vehicle	Vibration or shock impact	Vibration or shock impact from components within the vehicle might affect the rear road wheel motors and rear road wheels connection. This might affect the transmission of torque to change the rear road wheel steering angle.
953	Hazardous interaction with other components in the rest of the vehicle	Physical interference (e.g., chafing)	Physical interference (e.g., chafing) with components within the vehicle might affect the rear road wheel motors and rear road wheels connection. This might affect the transmission of torque to change the rear road wheel steering angle.
954	Hazardous interaction with other components in the rest of the vehicle	Mechanical connections affected by moisture, corrosion, or contamination	Moisture, corrosion, or contamination from components within the vehicle might affect the rear road wheel motors and rear road wheels connection. This might affect the transmission of torque to change the rear road wheel steering angle.
1212	External disturbances	Physical interference (e.g., chafing)	Physical interference from the external environment (e.g., road debris) may affect the connection between the rear road wheel motors and rear road wheels. This might affect the transmission of torque to change the rear road wheel steering angle.
1213	External disturbances	Extreme external temperature or thermal cycling	Extreme ambient temperatures or thermal cycling might affect the connection between the rear road wheel motors and rear road wheels (e.g., premature wear of seals). This might affect the transmission of torque to change the rear road wheel steering angle.
1214	Hazardous interaction with other components in the rest of the vehicle	Excessive heat from other components	Excessive heat from other vehicle components might affect the connection between the rear road wheel motors and rear road wheels. This might affect the transmission of torque to change the rear road wheel steering angle.

Table I- 26: Rear Road Wheel Position Sensor to Electric Power Steering Control Module

Causal Factor ID Number	Causal Factor Guide Phrase	Causal Factor Subcategory	Causal Factor (Rear Road Wheel Position Sensor to Electric Power Steering Control Module)
1004	Sensor to controller signal inadequate, missing, or delayed: Hardware open, short, missing, intermittent faulty	Connection is intermittent	An intermittent connection between the rear road wheel position sensor and electric power steering control module might affect the EPS control module's ability to control the rear road wheel steering angle.
1005	Sensor to controller signal inadequate, missing, or delayed: Hardware open, short, missing, intermittent faulty	Connection is open, short to ground, short to battery, or short to other wires in harness	The connection between the rear road wheel position sensor and EPS control module might be open, short to ground, short to battery, or short to other wires in harness. This might affect the rear road wheel position measurement received by the EPS control module.
1006	Sensor to controller signal inadequate, missing, or delayed: Hardware open, short, missing, intermittent faulty	Electrical noise other than EMI or ESD	Electrical noise other than EMI or ESD might affect the connection between the rear road wheel position sensor and electric power steering control module. This might affect the rear road wheel position measurement received by the EPS control module.
1007	Sensor to controller signal inadequate, missing, or delayed: Hardware open, short, missing, intermittent faulty	Connector contact resistance is too high	Contact resistance that is too high in the connection terminals of the the rear road wheel position sensor or electric power steering control module might affect the rear road wheel position measurement received by the EPS control module.

Causal Factor ID Number	Causal Factor Guide Phrase	Causal Factor Subcategory	Causal Factor (Rear Road Wheel Position Sensor to Electric Power Steering Control Module)
1008	Sensor to controller signal inadequate, missing, or delayed: Hardware open, short, missing, intermittent faulty	Connector shorting between neighboring pins	Connector shorting between neighboring pins in the connection terminals of the the rear road wheel position sensor or electric power steering control module might affect the rear road wheel position measurement received by the EPS control module.
1009	Sensor to controller signal inadequate, missing, or delayed: Hardware open, short, missing, intermittent faulty	Connector resistive drift between neighboring pins	Connector resistive drift between neighboring pins in the connection terminals of the the rear road wheel position sensor or electric power steering control module might affect the rear road wheel position measurement received by the EPS control module.
1014	Sensor to controller signal inadequate, missing, or delayed: Communication bus error	Bus overload or bus error	A bus overload or bus error might affect the rear road wheel position sensor and electric power steering control module connection (e.g., prevent data transmission). This might affect the EPS control module's ability to control the rear road wheel steering angle.
1017	Sensor to controller signal inadequate, missing, or delayed: Communication bus error	Malicious intruder	A malicious intruder or aftermarket component might disrupt or corrupt data transmission from the rear road wheel position sensor to the electric power steering control module. This might affect the EPS control module's ability to control the rear road wheel steering angle.

Causal Factor ID Number	Causal Factor Guide Phrase	Causal Factor Subcategory	Causal Factor (Rear Road Wheel Position Sensor to Electric Power Steering Control Module)
1018	Sensor to controller signal inadequate, missing, or delayed: Communication bus error	Failure of the message generator, transmitter, or receiver	A failure of the message generator, transmitter, or receiver might affect the rear road wheel position sensor and electric power steering control module connection (e.g., prevent data transmission). This might affect the EPS control module's ability to control the rear road wheel steering angle.
1019	Sensor to controller signal inadequate, missing, or delayed: Communication bus error	Signal priority too low	A signal priority that is too low might delay transmission of or disrupt the rear road wheel position measurement to the electric power steering control module. This might affect the EPS control module's ability to control the rear wheel position.
1020	Sensor to controller signal inadequate, missing, or delayed: Incorrect connection	Incorrect wiring connection	Incorrect wiring in the connection between the rear road wheel position sensor and electric power steering control module might affect the rear road wheel position measurement received by the EPS control module.
1021	Sensor to controller signal inadequate, missing, or delayed: Incorrect connection	Incorrect pin assignment	An incorrect pin assignment for the connection between the rear road wheel position sensor and electric power steering control module might affect the rear road wheel position measurement received by the EPS control module.
1024	External disturbances	Vibration or shock impact	Vibration or shock impact might affect the rear road wheel position sensor and electric power steering control module connection. This might affect the rear road wheel position measurement received by the EPS control module.

Causal Factor ID Number	Causal Factor Guide Phrase	Causal Factor Subcategory	Causal Factor (Rear Road Wheel Position Sensor to Electric Power Steering Control Module)
1026	External disturbances	Manufacturing defects and assembly problems	Manufacturing defects and assembly problems might affect the rear road wheel position sensor and electric power steering control module connection. This might affect the rear road wheel position measurement received by the EPS control module.
1027	External disturbances	Extreme external temperature or thermal cycling	Extreme external temperature or thermal cycling might affect the rear road wheel position sensor and electric power steering control module connection. This might affect the rear road wheel position measurement received by the EPS control module.
1028	External disturbances	Organic growth	Organic growth (e.g., mold) in the connection terminals of the rear road wheel position sensor or EPS control module might affect the rear road wheel position sensor and electric power steering control module connection (e.g., causing shorting). This might affect the rear road wheel position measurement received by the EPS control module.
1029	External disturbances	Physical interference (e.g., chafing)	Physical interference (e.g., chafing) might affect the rear road wheel position sensor and electric power steering control module connection. This might affect the rear road wheel position measurement received by the EPS control module.
1030	External disturbances	Active connection terminals affected by moisture, corrosion, or contamination	Moisture, corrosion, or contamination in the connection terminals of the rear road wheel position sensor or EPS control module might affect the rear road wheel position sensor and electric power steering control module connection (e.g., causing shorting). This might affect the rear road wheel position measurement received by the EPS control module.
1032	External disturbances	EMI or ESD	EMI or ESD might affect the rear road wheel position sensor and electric power steering control module connection. This might affect the rear road wheel position measurement received by the EPS control module.

Causal Factor ID Number	Causal Factor Guide Phrase	Causal Factor Subcategory	Causal Factor (Rear Road Wheel Position Sensor to Electric Power Steering Control Module)
1033	Hazardous interaction with other components in the rest of the vehicle	EMI or ESD	EMI or ESD from components within the vehicle might affect the rear road wheel position sensor and electric power steering control module connection. This could affect the rear road wheel position measurement received by the EPS control module.
1034	Hazardous interaction with other components in the rest of the vehicle	Vibration or shock impact	Vibration or shock impact from components within the vehicle might affect the rear road wheel position sensor and electric power steering control module connection. This could affect the rear road wheel position measurement received by the EPS control module.
1035	Hazardous interaction with other components in the rest of the vehicle	Physical interference (e.g., chafing)	Physical interference (e.g., chafing) with components within the vehicle might affect the rear road wheel position sensor and electric power steering control module connection. This could affect the rear road wheel position measurement received by the EPS control module.
1036	Hazardous interaction with other components in the rest of the vehicle	Electrical arcing from neighboring components or exposed terminals	Electrical arcing from neighboring components or exposed terminals might affect the rear road wheel position sensor and electric power steering control module connection. This could affect the rear road wheel position measurement received by the EPS control module.
1037	Hazardous interaction with other components in the rest of the vehicle	Corona effects from high voltage components	If the vehicle has high voltage components (e.g., electric or hybrid electric powertrains), corona effects from high voltage components might affect the rear road wheel position sensor and electric power steering control module connection. This could affect the rear road wheel position measurement received by the EPS control module.
1038	Hazardous interaction with other components in the rest of the vehicle	Active connection terminals affected by moisture, corrosion, or contamination	Active connection terminals of the rear road wheel position sensor or EPS control module might be affected by moisture, corrosion, or contamination from other vehicle components. This could affect the rear road wheel position measurement received by the EPS control module.

Causal Factor ID Number	Causal Factor Guide Phrase	Causal Factor Subcategory	Causal Factor (Rear Road Wheel Position Sensor to Electric Power Steering Control Module)
1215	External disturbances	Unused connection terminals affected by moisture, corrosion, or contamination	Moisture, corrosion, or contamination might affect unused connection terminals in the wiring harness connecting the rear road wheel position sensor and the EPS control module. This may affect the rear road wheel position measurement received by the EPS control module.
1216	Hazardous interaction with other components in the rest of the vehicle	Unused connection terminals affected by moisture, corrosion, or contamination	Unused connection terminals in the wiring harness connecting the rear road wheel position sensor and EPS control module might be affected by moisture, corrosion, or contamination from other vehicle components. This could affect the rear road wheel position measurement received by the EPS control module.
1217	Hazardous interaction with other components in the rest of the vehicle	Excessive heat from other components	Excessive heat from other vehicle components might affect the connection between the rear road wheel position sensor and EPS control module (e.g., melting the wiring). This could affect the rear road wheel position measurement received by the EPS control module.

Table I- 27: Rear Road Wheels to Rear Road Wheel Position Sensor

Causal Factor ID Number	Causal Factor Guide Phrase	Causal Factor Subcategory	Causal Factor (Rear Road Wheels to Rear Road Wheel Position Sensor)
955	Sensor measurement incorrect or missing	Sensor incorrectly aligned or positioned	If the connection between the rear road wheels and rear road wheel position sensor is missing (e.g., the sensor is incorrectly positioned), the EPS control module may not receive a rear road wheel position measurement.
956	Sensor measurement inaccurate	Sensor incorrectly aligned or positioned	If the connection between the rear road wheels and rear road wheel position sensor is inaccurate (e.g., the sensor is incorrectly aligned), the EPS control module may receive an incorrect rear road wheel position measurement.
960	External disturbances	Vibration or shock impact	Vibration or shock impact might affect the rear road wheels and rear road wheel position sensor connection. This might affect the measurement of the rear road wheel position.
961	External disturbances	Manufacturing defects and assembly problems	Manufacturing defects and assembly problems might affect the rear road wheels and rear road wheel position sensor connection. This might affect the measurement of the rear road wheel position.
962	External disturbances	Extreme external temperature or thermal cycling	Extreme external temperature might affect the rear road wheels and rear road wheel position sensor connection. This might affect the measurement of the rear road wheel position.
963	External disturbances	Physical interference (e.g., chafing)	Physical interference (e.g., chafing) might affect the rear road wheels and rear road wheel position sensor connection. This might affect the measurement of the rear road wheel position.
964	External disturbances	Mechanical connections affected by moisture, corrosion, or contamination	Moisture, corrosion, or contamination might affect the rear road wheels and rear road wheel position sensor connection. This might affect the measurement of the rear road wheel position.
965	Hazardous interaction with other components in the rest of the vehicle	EMI or ESD	EMI or ESD from components within the vehicle might affect the rear road wheels and rear road wheel position sensor connection. This might affect the measurement of the rear road wheel position.

Causal Factor ID Number	Causal Factor Guide Phrase	Causal Factor Subcategory	Causal Factor (Rear Road Wheels to Rear Road Wheel Position Sensor)
966	Hazardous interaction with other components in the rest of the vehicle	Vibration or shock impact	Vibration or shock impact from components within the vehicle might affect the rear road wheels and rear road wheel position sensor connection. This might affect the measurement of the rear road wheel position.
967	Hazardous interaction with other components in the rest of the vehicle	Physical interference (e.g., chafing)	Physical interference (e.g., chafing) with components within the vehicle might affect the rear road wheels and rear road wheel position sensor connection. This might affect the measurement of the rear road wheel position.
968	Hazardous interaction with other components in the rest of the vehicle	Mechanical connections affected by moisture, corrosion, or contamination	Moisture, corrosion, or contamination from components within the vehicle might affect the rear road wheels and rear road wheel position sensor connection. This might affect the measurement of the rear road wheel position.
969	Sensor measurement delay	Sensor incorrectly aligned or positioned	If the rear road wheel position sensor is incorrectly aligned or positioned relative to the rear road wheels, this may delay the measurement of the rear road wheel position.
1218	External disturbances	EMI or ESD	EMI or ESD might affect the rear road wheels and rear road wheel position sensor connection. This might affect the measurement of the rear road wheel position.
1219	Hazardous interaction with other components in the rest of the vehicle	Excessive heat from other components	Excessive heat from other vehicle components could affect the connection between the rear road wheels and rear road wheel position sensor. This might affect the measurement of the rear road wheel position.

Table I- 28: Steering Column/Rack and Pinion to Front Road Wheels

Causal Factor ID Number	Causal Factor Guide Phrase	Causal Factor Subcategory	Causal Factor (Steering Column/Rack and Pinion to Front Road Wheels)
153	Sensor measurement incorrect or missing	Other	The feedback from the steering column/rack and pinion to the gear set might be incorrect or missing. This might affect the feedback to the driver about changes in the road conditions.
154	Sensor measurement delay	Other	The feedback from the steering column/rack and pinion to the gear set might be delayed. This might delay the feedback to the driver about changes in the road conditions.
155	External disturbances	Vibration or shock impact	Vibration or shock impact could affect transmission of feedback from the steering column/rack and pinion to the gear set. This might affect the feedback to the driver about changes in the road conditions.
156	External disturbances	Manufacturing defects and assembly problems	Manufacturing defects and assembly problems could affect transmission of feedback from the steering column/rack and pinion to the gear set. This might affect the feedback to the driver about changes in the road conditions.
157	External disturbances	Mechanical connections affected by moisture, corrosion, or contamination	Moisture, corrosion, or contamination could affect transmission of feedback from the steering column/rack and pinion to the gear set. This might affect the feedback to the driver about changes in the road conditions.
158	Hazardous interaction with other components in the rest of the vehicle	Vibration or shock impact	Vibration or shock impact from components within the vehicle might affect the steering column/rack and pinion and gear set connection. This might affect the feedback to the driver about changes in the road conditions.
159	Hazardous interaction with other components in the rest of the vehicle	Physical interference (e.g., chafing)	Physical interference (e.g., chafing) with components within the vehicle might affect the steering column/rack and pinion and gear set connection. This might affect the feedback to the driver about changes in the road conditions.

Causal Factor ID Number	Causal Factor Guide Phrase	Causal Factor Subcategory	Causal Factor (Steering Column/Rack and Pinion to Front Road Wheels)
160	Hazardous interaction with other components in the rest of the vehicle	Mechanical connections affected by moisture, corrosion, or contamination	Moisture, corrosion, or contamination from components within the vehicle might affect the steering column/rack and pinion and gear set connection. This might affect the feedback to the driver about changes in the road conditions.
161	Actuation delivered incorrectly or inadequately: Hardware faulty	Actuation delivered incorrectly or inadequately: Hardware faulty	Faulty hardware might affect torque transmission from the steering column/rack and pinion to the front road wheels. This could affect the transmission of torque from the driver or from the power assist motor to the road wheels. Incorrectly transmitting the driver's torque or the power assist motor torque may cause the system to respond differently than expected.
162	Actuation delivered incorrectly or inadequately: Actuation delayed	Actuation delivered incorrectly or inadequately: Actuation delayed	A delayed torque transmission from the steering column/rack and pinion to the front road wheels might delay transmission of torque from the driver or from the power assist motor to the road wheels. Incorrectly transmitting the driver's torque or the power assist motor torque may cause the system to respond differently than expected.
163	Actuation delivered incorrectly or inadequately: Incorrect connection	Actuation delivered incorrectly or inadequately: Incorrect connection	An incorrect connection between the steering column/rack and pinion and front road wheels might affect the transmission of torque from driver or from power assist motor to the road wheels. Incorrectly transmitting the driver's torque or the power assist motor torque may cause the system to respond differently than expected.
164	External disturbances	Vibration or shock impact	Vibration or shock impact might affect the transmission of steering torque from the steering column/rack and pinion to the front road wheels. This could affect the transmission of torque from the driver or from the power assist motor to the road wheels. Incorrectly transmitting the driver's torque or the power assist motor torque may cause the system to respond differently than expected.

Causal Factor ID Number	Causal Factor Guide Phrase	Causal Factor Subcategory	Causal Factor (Steering Column/Rack and Pinion to Front Road Wheels)
165	External disturbances	Manufacturing defects and assembly problems	Manufacturing defects and assembly problems might affect the transmission of steering torque from the steering column/rack and pinion to the front road wheels. This could affect the transmission of torque from the driver or from the power assist motor to the road wheels. Incorrectly transmitting the driver's torque or the power assist motor torque may cause the system to respond differently than expected.
166	External disturbances	Mechanical connections affected by moisture, corrosion, or contamination	Moisture, corrosion, or contamination might affect the transmission of steering torque from the steering column/rack and pinion to the front road wheels. This could affect the transmission of torque from the driver or from the power assist motor to the road wheels. Incorrectly transmitting the driver's torque or the power assist motor torque may cause the system to respond differently than expected.
167	Hazardous interaction with other components in the rest of the vehicle	Vibration or shock impact	Vibration or shock impact from other components within the vehicle might affect the transmission of steering torque from the steering column/rack and pinion to the front road wheels. This could affect the transmission of torque from the driver or from the power assist motor. Incorrectly transmitting the driver's torque or the power assist motor torque may cause the system to respond differently than expected.
168	Hazardous interaction with other components in the rest of the vehicle	Physical interference (e.g., chafing)	Physical interference with other components within the vehicle might affect the transmission of steering torque from the steering column/rack and pinion to the front road wheels. This could affect the transmission of torque from the driver or from the power assist motor to the road wheels. Incorrectly transmitting the driver's torque or the power assist motor torque may cause the system to respond differently than expected.

Causal Factor ID Number	Causal Factor Guide Phrase	Causal Factor Subcategory	Causal Factor (Steering Column/Rack and Pinion to Front Road Wheels)
169	Hazardous interaction with other components in the rest of the vehicle	Mechanical connections affected by moisture, corrosion, or contamination	Moisture, corrosion, or contamination from components within the vehicle might affect the transmission of steering torque from the steering column/rack and pinion to the front road wheels. This could affect the transmission of torque from the driver or from the power assist motor. Incorrectly transmitting the driver's torque or the power assist motor torque may cause the system to respond differently than expected.
1220	External disturbances	Extreme external temperature or thermal cycling	Extreme ambient temperatures or thermal cycling may affect the transmission of steering torque from the steering column / rack and pinion to the front road wheels. This could affect transmission of torque from the driver or power assist motor to the road wheels. Incorrectly transmitting the driver's torque or the power assist motor torque may cause the system to respond differently than expected.
1221	External disturbances	Physical interference (e.g., chafing)	Physical interference from foreign objects may affect the transmission of steering torque from the steering column / rack and pinion to the front road wheels. This could affect transmission of torque from the driver or power assist motor to the road wheels. Incorrectly transmitting the driver's torque or the power assist motor torque may cause the system to respond differently than expected.
1222	Hazardous interaction with other components in the rest of the vehicle	Vibration or shock impact	Excessive heat from other vehicle components might affect the transmission of steering torque from the steering column/rack and pinion to the front road wheels. This could affect the transmission of torque from the driver or from the power assist motor to the road wheels. Incorrectly transmitting the driver's torque or the power assist motor torque may cause the system to respond differently than expected.
1223	External disturbances	Extreme external temperature or thermal cycling	Extreme external temperatures or thermal cycling could affect transmission of feedback from the steering column/rack and pinion to the gear set. This might affect the feedback to the driver about changes in the road conditions.

Causal Factor ID Number	Causal Factor Guide Phrase	Causal Factor Subcategory	Causal Factor (Steering Column/Rack and Pinion to Front Road Wheels)
1224	Hazardous interaction with other components in the rest of the vehicle	Excessive heat from other components	Excessive heat from other components within the vehicle might affect the steering column/rack and pinion and gear set connection. This might affect the feedback to the driver about changes in the road conditions.

Table I- 29: Steering Column/Rack and Pinion to Gear Set

Causal Factor ID Number	Causal Factor Guide Phrase	Causal Factor Subcategory	Causal Factor (Steering Column/Rack and Pinion to Gear Set)
153	Sensor measurement incorrect or missing	Other	The feedback from the steering column/rack and pinion to the gear set might be incorrect or missing. This might affect the feedback to the driver about changes in the road conditions.
154	Sensor measurement delay	Other	The feedback from the steering column/rack and pinion to the gear set might be delayed. This might delay the feedback to the driver about changes in the road conditions.
155	External disturbances	Vibration or shock impact	Vibration or shock impact could affect transmission of feedback from the steering column/rack and pinion to the gear set. This might affect the feedback to the driver about changes in the road conditions.
156	External disturbances	Manufacturing defects and assembly problems	Manufacturing defects and assembly problems could affect transmission of feedback from the steering column/rack and pinion to the gear set. This might affect the feedback to the driver about changes in the road conditions.
157	External disturbances	Mechanical connections affected by moisture, corrosion, or contamination	Moisture, corrosion, or contamination could affect transmission of feedback from the steering column/rack and pinion to the gear set. This might affect the feedback to the driver about changes in the road conditions.
158	Hazardous interaction with other components in the rest of the vehicle	Vibration or shock impact	Vibration or shock impact from components within the vehicle might affect the steering column/rack and pinion and gear set connection. This might affect the feedback to the driver about changes in the road conditions.
159	Hazardous interaction with other components in the rest of the vehicle	Physical interference (e.g., chafing)	Physical interference (e.g., chafing) with components within the vehicle might affect the steering column/rack and pinion and gear set connection. This might affect the feedback to the driver about changes in the road conditions.

Causal Factor ID Number	Causal Factor Guide Phrase	Causal Factor Subcategory	Causal Factor (Steering Column/Rack and Pinion to Gear Set)
160	Hazardous interaction with other components in the rest of the vehicle	Mechanical connections affected by moisture, corrosion, or contamination	Moisture, corrosion, or contamination from components within the vehicle might affect the steering column/rack and pinion and gear set connection. This might affect the feedback to the driver about changes in the road conditions.
1223	External disturbances	Extreme external temperature or thermal cycling	Extreme external temperatures or thermal cycling could affect transmission of feedback from the steering column/rack and pinion to the gear set. This might affect the feedback to the driver about changes in the road conditions.
1224	Hazardous interaction with other components in the rest of the vehicle	Excessive heat from other components	Excessive heat from other components within the vehicle might affect the steering column/rack and pinion and gear set connection. This might affect the feedback to the driver about changes in the road conditions.

Table I- 30: Steering Wheel to Driver

Causal Factor ID Number	Causal Factor Guide Phrase	Causal Factor Subcategory	Causal Factor (Steering Wheel to Driver)
222	External disturbances	Vibration or shock impact	Vibration or shock impact from the external environment (e.g., vibrations due to poor road conditions) might mask the feedback from the steering wheel to the driver. This might affect the torque feedback to the driver and can affect the driver's steering command.
227	Hazardous interaction with other components in the rest of the vehicle	Vibration or shock impact	Vibration or shock impact from components within the vehicle might mask the feedback from the steering wheel to the driver. For example, deflated tire on one side of the vehicle causing vibrations might affect the steering wheel torque feedback to the driver.
1227	External disturbances	Extreme external temperature or thermal cycling	An extreme temperature in the vehicle cabin may cause the driver to grip the steering wheel lightly (e.g., steering wheel is too hot). The driver's reduced grip may limit the amount of feedback that can be transmitted to the driver.
1228	External disturbances	Mechanical connections affected by moisture, corrosion, or contamination	If the steering wheel has a steering wheel cover, moisture, corrosion, or contamination from the external environment may cause deterioration or degradation of the steering wheel cover. If the cover becomes loose, this may affect the feedback transmitted from the steering wheel to the driver.
1229	Hazardous interaction with other components in the rest of the vehicle	Mechanical connections affected by moisture, corrosion, or contamination	If the steering wheel has a steering wheel cover, moisture, corrosion, or contamination from other vehicle components may cause deterioration or degradation of the steering wheel cover. If the cover becomes loose, this may affect the feedback transmitted from the steering wheel to the driver.

Table I- 31: Steering Wheel to Gear Set

Causal Factor ID Number	Causal Factor Guide Phrase	Causal Factor Subcategory	Causal Factor (Steering Wheel to Gear Set)
124	Actuation delivered incorrectly or inadequately: Hardware faulty	Actuation delivered incorrectly or inadequately: Hardware faulty	Faulty hardware might affect the torque transmission from the steering wheel to the gear set. This might affect the transmission of torque from the driver to the road wheels.
125	Actuation delivered incorrectly or inadequately: Actuation delayed	Actuation delivered incorrectly or inadequately: Actuation delayed	The transmission of torque from the steering wheel to the gear set may be delayed. This could affect the transmission of torque from the driver to the road wheels.
126	Actuation delivered incorrectly or inadequately: Incorrect connection	Actuation delivered incorrectly or inadequately: Incorrect connection	An incorrect connection between the steering wheel and gear set might result in incorrectly transmitting torque from driver to the road wheels.
127	External disturbances	Vibration or shock impact	Vibration or shock impact might affect the transmission of torque from the steering wheel to the gear set. This could affect the transmission of torque from driver to the road wheels.
128	External disturbances	Manufacturing defects and assembly problems	Manufacturing defects and assembly problems between steering wheel and gear set (e.g., planetary gear) might affect the transmission of torque from the steering wheel to the gear set. This could affect the transmission of torque from driver to the road wheels.
129	External disturbances	Physical interference (e.g., chafing)	Physical interference might affect the transmission of torque from the steering wheel to the gear set. This could affect the transmission of torque from driver to the road wheels.
130	External disturbances	Mechanical connections affected by moisture, corrosion, or contamination	Moisture, corrosion, or contamination between steering wheel and gear set (e.g., planetary gear) might affect the transmission of torque from the steering wheel to the gear set. This could affect the transmission of torque from driver to the road wheels.

Causal Factor ID Number	Causal Factor Guide Phrase	Causal Factor Subcategory	Causal Factor (Steering Wheel to Gear Set)
131	Hazardous interaction with other components in the rest of the vehicle	Vibration or shock impact	Vibration or shock impact from other components might affect the transmission of torque from the steering wheel to the gear set. This could affect the transmission of torque from the driver to the road wheels.
132	Hazardous interaction with other components in the rest of the vehicle	Physical interference (e.g., chafing)	Physical interference with other components within the vehicle might affect the transmission of torque from the steering wheel to the gear set. This could affect the transmission of torque from driver to the road wheels.
133	Hazardous interaction with other components in the rest of the vehicle	Mechanical connections affected by moisture, corrosion, or contamination	Moisture, corrosion, or contamination from components in the vehicle might affect the transmission of torque from the steering wheel to the gear set. This could affect the transmission of torque from the driver to the road wheels.
1225	External disturbances	Extreme external temperature or thermal cycling	An extreme ambient temperature or thermal cycling may affect the transmission of torque from the steering wheel to the gear set (e.g., thermal expansion causing binding).
1226	Hazardous interaction with other components in the rest of the vehicle	Excessive heat from other components	Excessive heat from other vehicle components may affect the transmission of torque from the steering wheel to the gear set (e.g., high temperatures causing binding). This could affect the transmission of torque from the driver to the road wheels.

Table I- 32: Steering Wheel to Steering Wheel Angle Sensor

Causal Factor ID Number	Causal Factor Guide Phrase	Causal Factor Subcategory	Causal Factor (Steering Wheel to Steering Wheel Angle Sensor)
516	Sensor measurement inaccurate	Sensor incorrectly aligned or positioned	If the steering wheel and steering wheel angle sensor are incorrectly aligned or positioned (e.g., offset), the steering wheel angle measurement may be inaccurate (e.g., wrong value but within range). This might affect the steering wheel angle measurement, which could affect the amount of steering assist provided by the EPS control module or adjustment of the rear road wheel steering angle.
517	Sensor measurement incorrect or missing	Sensor incorrectly aligned or positioned	If the steering wheel and steering wheel angle sensor are incorrectly aligned or positioned (e.g., offset), the steering wheel angle measurement may be incorrect or missing (e.g., no value or value outside of range). This might affect the steering wheel angle measurement, which could affect the amount of steering assist provided by the EPS control module or adjustment of the rear road wheel steering angle.
518	Sensor measurement delay	Sensor incorrectly aligned or positioned	If the steering wheel and steering wheel angle sensor are incorrectly aligned or positioned, the steering wheel angle measurement may be delayed. This could delay the steering assist provided by the EPS control module or delay adjustment of the rear road wheel steering angle.
813	External disturbances	Vibration or shock impact	Vibration or shock impact might affect the steering wheel and steering wheel angle sensor connection. This might affect the measurement of the driver's steering input, which could affect the amount of steering assist provided by the EPS control module or adjustment of the rear road wheel steering angle.
814	External disturbances	Manufacturing defects and assembly problems	Manufacturing defects and assembly problems might affect the steering wheel and steering wheel angle sensor connection and might affect the feedback to the EPS control module. This might affect the EPS control module torque command.
815	External disturbances	Extreme external temperature or thermal cycling	Extreme external temperature might affect the steering wheel and steering wheel angle sensor connection and might affect the feedback to the EPS control module. This might affect the EPS control module torque command.

Causal Factor ID Number	Causal Factor Guide Phrase	Causal Factor Subcategory	Causal Factor (Steering Wheel to Steering Wheel Angle Sensor)
817	External disturbances	Physical interference (e.g., chafing)	Physical interference (e.g., chafing) might affect the steering wheel and steering wheel angle sensor connection. This might affect the measurement of the driver's steering input, which could affect the amount of steering assist provided by the EPS control module or adjustment of the rear road wheel steering angle.
818	External disturbances	Mechanical connections affected by moisture, corrosion, or contamination	Moisture, corrosion, or contamination may affect the connection between the steering wheel and steering wheel angle sensor. This might affect the measurement of the driver's steering input, which could affect the amount of steering assist provided by the EPS control module or adjustment of the rear road wheel steering angle.
820	Hazardous interaction with other components in the rest of the vehicle	Vibration or shock impact	Vibration or shock impact from components within the vehicle might affect the steering wheel and steering wheel angle sensor connection. This might affect the measurement of the driver's steering input, which could affect the amount of steering assist provided by the EPS control module or adjustment of the rear road wheel steering angle.
821	Hazardous interaction with other components in the rest of the vehicle	Physical interference (e.g., chafing)	Physical interference (e.g., chafing) with components within the vehicle might affect the steering wheel and steering wheel angle sensor connection. This might affect the measurement of the driver's steering input, which could affect the amount of steering assist provided by the EPS control module or adjustment of the rear road wheel steering angle.
1230	Hazardous interaction with other components in the rest of the vehicle	Mechanical connections affected by moisture, corrosion, or contamination	Moisture, corrosion, or contamination from other vehicle components may affect the connection between the steering wheel and steering wheel angle sensor. This might affect the measurement of the driver's steering input, which could affect the amount of steering assist provided by the EPS control module or adjustment of the rear road wheel steering angle.

Causal Factor ID Number	Causal Factor Guide Phrase	Causal Factor Subcategory	Causal Factor (Steering Wheel to Steering Wheel Angle Sensor)
1231	Hazardous interaction with other components in the rest of the vehicle	Excessive heat from other components	Excessive heat from other vehicle components might affect the connection between the steering wheel and steering wheel angle sensor. This might affect the measurement of the driver's steering input, which could affect the amount of steering assist provided by the EPS control module or adjustment of the rear road wheel steering angle.

Table I- 33: Steering Wheel to Steering Wheel Torque Sensor

Causal Factor ID Number	Causal Factor Guide Phrase	Causal Factor Subcategory	Causal Factor (Steering Wheel to Steering Wheel Torque Sensor)
534	Sensor measurement inaccurate	Sensor incorrectly aligned or positioned	The steering wheel torque sensor may be incorrectly aligned or positioned relative to the steering wheel, resulting in an inaccurate measurement (e.g., within range, but incorrect value). This might affect the measurement of the driver's steering input, which could affect amount of power assist provided by the EPS control module or adjustment of the rear road wheel steering angle.
535	Sensor measurement delay	Sensor incorrectly aligned or positioned	The steering wheel torque sensor may be incorrectly aligned or positioned relative to the steering wheel, resulting in a delayed measurement (e.g., within range, but incorrect value). This might affect the measurement of the driver's steering input, which could affect amount of power assist provided by the EPS control module or adjustment of the rear road wheel steering angle.
536	Sensor measurement incorrect or missing	Sensor incorrectly aligned or positioned	The steering wheel torque sensor may be incorrectly aligned or positioned relative to the steering wheel, resulting in an incorrect measurement (e.g., out of range or missing). This might affect the measurement of the driver's steering input, which could affect amount of power assist provided by the EPS control module or adjustment of the rear road wheel steering angle.
539	External disturbances	Vibration or shock impact	Vibration or shock impact might affect the steering wheel and steering wheel torque sensor connection. This might affect the measurement of the driver's steering input, which could affect amount of power assist provided by the EPS control module or adjustment of the rear road wheel steering angle.
540	External disturbances	Manufacturing defects and assembly problems	Manufacturing defects and assembly problems might affect the steering wheel and steering wheel torque sensor connection. This might affect the measurement of the driver's steering input, which could affect amount of power assist provided by the EPS control module or adjustment of the rear road wheel steering angle.

Causal Factor ID Number	Causal Factor Guide Phrase	Causal Factor Subcategory	Causal Factor (Steering Wheel to Steering Wheel Torque Sensor)
542	External disturbances	Physical interference (e.g., chafing)	Physical interference (e.g., chafing) might affect the steering wheel and steering wheel torque sensor connection. This might affect the EPS control module torque command.
548	Hazardous interaction with other components in the rest of the vehicle	Physical interference (e.g., chafing)	Physical interference (e.g., chafing) with components within the vehicle might affect the steering wheel and steering wheel torque sensor connection. This might affect the measurement of the driver's steering input, which could affect the amount of power assist provided by the EPS control module or adjustment of the rear road wheel steering angle.
549	Hazardous interaction with other components in the rest of the vehicle	Vibration or shock impact	Vibration or shock impact from components within the vehicle might affect the steering wheel and steering wheel torque sensor connection. This might affect the measurement of the driver's steering input, which could affect the amount of power assist provided by the EPS control module or adjustment of the rear road wheel steering angle.
1232	External disturbances	Mechanical connections affected by moisture, corrosion, or contamination	Moisture, corrosion, or contamination might affect the steering wheel and steering wheel torque sensor connection. This might affect the measurement of the driver's steering input, which could affect the amount of power assist provided by the EPS control module or adjustment of the rear road wheel steering angle.
1233	Hazardous interaction with other components in the rest of the vehicle	Mechanical connections affected by moisture, corrosion, or contamination	Moisture, corrosion, or contamination from components within the vehicle might affect the steering wheel and steering wheel torque sensor connection. This might affect the measurement of the driver's steering input, which could affect the amount of power assist provided by the EPS control module or adjustment of the rear road wheel steering angle.

Causal Factor ID Number	Causal Factor Guide Phrase	Causal Factor Subcategory	Causal Factor (Steering Wheel to Steering Wheel Torque Sensor)
1234	External disturbances	Extreme external temperature or thermal cycling	Extreme ambient temperatures or thermal cycling may affect the connection between the steering wheel and steering wheel torque sensor. This might affect the measurement of the driver's steering input, which could affect the amount of power assist provided by the EPS control module or adjustment of the rear road wheel steering angle.
1235	Hazardous interaction with other components in the rest of the vehicle	Excessive heat from other components	Excessive heat from other vehicle components may affect the connection between the steering wheel and steering wheel torque sensor. This might affect the measurement of the driver's steering input, which could affect the amount of power assist provided by the EPS control module or adjustment of the rear road wheel steering angle.

Table I- 34: Steering Wheel Angle Sensor to Electric Power Steering Control Module

Causal Factor ID Number	Causal Factor Guide Phrase	Causal Factor Subcategory	Causal Factor (Steering Wheel Angle Sensor to Electric Power Steering Control Module)
579	Sensor to controller signal inadequate, missing, or delayed: Hardware open, short, missing, intermittent faulty	Connection is intermittent	An intermittent connection between the steering wheel angle sensor and EPS control module could affect the measurement of the driver's steering input received by the EPS control module.
580	Sensor to controller signal inadequate, missing, or delayed: Hardware open, short, missing, intermittent faulty	Connection is open, short to ground, short to battery, or short to other wires in harness	The connection between the steering wheel angle sensor and EPS control module could become open, short to ground, short to battery, or short to other wires in harness. This could affect the measurement of the driver's steering input received by the EPS control module.
581	Sensor to controller signal inadequate, missing, or delayed: Hardware open, short, missing, intermittent faulty	Electrical noise other than EMI or ESD	Electrical noise other than EMI or ESD could affect the connection between the steering wheel angle sensor and EPS control module. This could affect the measurement of the driver's steering input received by the EPS control module.
582	Sensor to controller signal inadequate, missing, or delayed: Hardware open, short, missing, intermittent faulty	Connector contact resistance is too high	The contact resistance in the connection terminal of the steering wheel angle sensor or EPS control module may be too high. This could affect the measurement of the driver's steering input received by the EPS control module.

Causal Factor ID Number	Causal Factor Guide Phrase	Causal Factor Subcategory	Causal Factor (Steering Wheel Angle Sensor to Electric Power Steering Control Module)
583	Sensor to controller signal inadequate, missing, or delayed: Hardware open, short, missing, intermittent faulty	Connector shorting between neighboring pins	The connector shorting between neighboring pins in the connection terminal of the steering wheel angle sensor or EPS control module may affect the measurement of the driver's steering input received by the EPS control module.
584	Sensor to controller signal inadequate, missing, or delayed: Hardware open, short, missing, intermittent faulty	Connector resistive drift between neighboring pins	Connector resistive drift between neighboring pins in the connection terminal of the steering wheel angle sensor or EPS control module may affect the measurement of the driver's steering input received by the EPS control module.
585	Sensor to controller signal inadequate, missing, or delayed: Communication bus error	Bus overload or bus error	A bus overload or bus error could affect the steering wheel angle sensor and EPS control module connection (e.g., prevent transmission of the steering angle). This could affect the measurement of the driver's steering input received by the EPS control module.
586	Sensor to controller signal inadequate, missing, or delayed: Communication bus error	Signal priority too low	Signal priority that is too low could affect the steering wheel angle sensor and EPS control module connection (e.g., prevent transmission of the steering angle). This could affect the measurement of the driver's steering input received by the EPS control module.

Causal Factor ID Number	Causal Factor Guide Phrase	Causal Factor Subcategory	Causal Factor (Steering Wheel Angle Sensor to Electric Power Steering Control Module)
587	Sensor to controller signal inadequate, missing, or delayed: Communication bus error	Failure of the message generator, transmitter, or receiver	Failure of the message generator, transmitter, or receiver could affect the steering wheel angle sensor and EPS control module connection (e.g., prevent transmission of the steering angle). This could affect the measurement of the driver's steering input received by the EPS control module.
588	Sensor to controller signal inadequate, missing, or delayed: Communication bus error	Malicious intruder	A malicious intruder or aftermarket component could affect the steering wheel angle sensor and EPS control module connection (e.g., transmit incorrect information). This could affect the measurement of the driver's steering input received by the EPS control module.
590	Sensor to controller signal inadequate, missing, or delayed: Incorrect connection	Incorrect wiring connection	Incorrect wiring of the steering wheel angle sensor and EPS control module connection could affect the measurement of the driver's steering input received by the EPS control module.
591	Sensor to controller signal inadequate, missing, or delayed: Incorrect connection	Incorrect pin assignment	An incorrect pin assignment in the steering wheel angle sensor or EPS control module could affect the measurement of the driver's steering input received by the EPS control module.
592	External disturbances	EMI or ESD	EMI or ESD might affect the steering wheel angle sensor and EPS control module connection. This could affect the measurement of the driver's steering input received by the EPS control module.

Causal Factor ID Number	Causal Factor Guide Phrase	Causal Factor Subcategory	Causal Factor (Steering Wheel Angle Sensor to Electric Power Steering Control Module)
594	External disturbances	Vibration or shock impact	Vibration or shock impact could result in disturbances to the steering wheel angle sensor and EPS control module connection (e.g., fretting at the connection terminals). This could affect the measurement of the driver's steering input received by the EPS control module.
595	External disturbances	Manufacturing defects and assembly problems	Manufacturing defects and assembly problems could affect the steering wheel angle sensor and EPS control module connection. This might affect the measurement of the driver's steering input received by the EPS control module.
596	External disturbances	Extreme external temperature or thermal cycling	Extreme external temperature or thermal cycling could affect the steering wheel angle sensor and EPS control module connection. This might affect the measurement of the driver's steering input received by the EPS control module.
597	External disturbances	Organic growth	Organic growth could affect the steering wheel angle sensor and EPS control module connection. This might affect the measurement of the driver's steering input received by the EPS control module.
598	External disturbances	Physical interference (e.g., chafing)	Physical interference (e.g., chafing) could affect the steering wheel angle sensor and EPS control module connection. This might affect the measurement of the driver's steering input received by the EPS control module.
600	Hazardous interaction with other components in the rest of the vehicle	EMI or ESD	EMI or ESD from components within the vehicle could affect the steering wheel angle sensor and EPS control module connection. This might affect the measurement of the driver's steering input received by the EPS control module.
601	Hazardous interaction with other components in the rest of the vehicle	Vibration or shock impact	Vibration or shock impact from components within the vehicle could affect the steering wheel angle sensor and EPS control module connection. This might affect the measurement of the driver's steering input received by the EPS control module.

Causal Factor ID Number	Causal Factor Guide Phrase	Causal Factor Subcategory	Causal Factor (Steering Wheel Angle Sensor to Electric Power Steering Control Module)
602	Hazardous interaction with other components in the rest of the vehicle	Physical interference (e.g., chafing)	Physical interference (e.g., chafing) with components within the vehicle could affect the steering wheel angle sensor and EPS control module connection. This might affect the measurement of the driver's steering input received by the EPS control module.
603	Hazardous interaction with other components in the rest of the vehicle	Electrical arcing from neighboring components or exposed terminals	Electrical arcing from neighboring components or exposed terminals could affect the steering wheel angle sensor and EPS control module connection. This might affect the measurement of the driver's steering input received by the EPS control module.
604	Hazardous interaction with other components in the rest of the vehicle	Corona effects from high voltage components	If the vehicle has high voltage components (e.g., electric or hybrid electric powertrain), corona effects from high voltage components could affect the steering wheel angle sensor and EPS control module connection. This might affect the measurement of the driver's steering input received by the EPS control module.
1236	External disturbances	Active connection terminals affected by moisture, corrosion, or contamination	Active connection terminals in the steering wheel angle sensor and EPS control module connection may be affected by moisture, corrosion, or contamination. This might affect the measurement of the driver's steering input received by the EPS control module.
1237	Hazardous interaction with other components in the rest of the vehicle	Active connection terminals affected by moisture, corrosion, or contamination	Active connection terminals of the steering wheel angle sensor and EPS control module may be affected by moisture, corrosion, or contamination. This might affect the measurement of the driver's steering input received by the EPS control module.
1238	External disturbances	Unused connection terminals affected by moisture, corrosion, or contamination	Unused connection terminals in the wiring harness connecting the steering wheel angle sensor and EPS control module may be affected by moisture, corrosion, or contamination. This might affect the measurement of the driver's steering input received by the EPS control module.

Causal Factor ID Number	Causal Factor Guide Phrase	Causal Factor Subcategory	Causal Factor (Steering Wheel Angle Sensor to Electric Power Steering Control Module)
1239	Hazardous interaction with other components in the rest of the vehicle	Excessive heat from other components	Excessive heat from other vehicle components could affect the connection between the steering wheel angle sensor and EPS control module (e.g., melting the wiring). This might affect the measurement of the driver's steering input received by the EPS control module.
1240	Hazardous interaction with other components in the rest of the vehicle	Unused connection terminals affected by moisture, corrosion, or contamination	Unused connection terminals in the wiring harness connecting the steering wheel angle sensor and EPS control module may be affected by moisture, corrosion, or contamination from other vehicle components. This might affect the measurement of the driver's steering input received by the EPS control module.

Table I- 35: Steering Wheel Torque Sensor to Electric Power Steering Control Module

Causal Factor ID Number	Causal Factor Guide Phrase	Causal Factor Subcategory	Causal Factor (Steering Wheel Torque Sensor to Electric Power Steering Control Module)
605	Sensor to controller signal inadequate, missing, or delayed: Hardware open, short, missing, intermittent faulty	Connection is intermittent	An intermittent connection between the steering wheel torque sensor and EPS control module could affect the measurement of the driver's steering input received by the EPS control module.
606	Sensor to controller signal inadequate, missing, or delayed: Hardware open, short, missing, intermittent faulty	Connection is open, short to ground, short to battery, or short to other wires in harness	The connection between the steering wheel torque sensor and EPS control module could become open, short to ground, short to battery, or short to other wires in harness. This could affect the measurement of the driver's steering input received by the EPS control module.
607	Sensor to controller signal inadequate, missing, or delayed: Hardware open, short, missing, intermittent faulty	Electrical noise other than EMI or ESD	Electrical noise other than EMI or ESD could affect the connection between the steering wheel torque sensor and EPS control module. This could affect the measurement of the driver's steering input received by the EPS control module.
608	Sensor to controller signal inadequate, missing, or delayed: Hardware open, short, missing, intermittent faulty	Connector contact resistance is too high	The contact resistance in the connection terminal of the steering wheel torque sensor or EPS control module may be too high. This could affect the measurement of the driver's steering input received by the EPS control module.

Causal Factor ID Number	Causal Factor Guide Phrase	Causal Factor Subcategory	Causal Factor (Steering Wheel Torque Sensor to Electric Power Steering Control Module)
609	Sensor to controller signal inadequate, missing, or delayed: Hardware open, short, missing, intermittent faulty	Connector shorting between neighboring pins	The connector shorting between neighboring pins in the connection terminal of the steering wheel torque sensor or EPS control module may affect the measurement of the driver's steering input received by the EPS control module.
610	Sensor to controller signal inadequate, missing, or delayed: Hardware open, short, missing, intermittent faulty	Connector resistive drift between neighboring pins	Connector resistive drift between neighboring pins in the connection terminal of the steering wheel torque sensor or EPS control module may affect the measurement of the driver's steering input received by the EPS control module.
611	Sensor to controller signal inadequate, missing, or delayed: Communication bus error	Bus overload or bus error	A bus overload or bus error could affect the steering wheel torque sensor and EPS control module connection (e.g., prevent transmission of the steering angle). This could affect the measurement of the driver's steering input received by the EPS control module.
612	Sensor to controller signal inadequate, missing, or delayed: Communication bus error	Signal priority too low	Signal priority that is too low could affect the steering wheel torque sensor and EPS control module connection (e.g., prevent transmission of the steering angle). This could affect the measurement of the driver's steering input received by the EPS control module.

Causal Factor ID Number	Causal Factor Guide Phrase	Causal Factor Subcategory	Causal Factor (Steering Wheel Torque Sensor to Electric Power Steering Control Module)
613	Sensor to controller signal inadequate, missing, or delayed: Communication bus error	Failure of the message generator, transmitter, or receiver	Failure of the message generator, transmitter, or receiver could affect the steering wheel torque sensor and EPS control module connection (e.g., prevent transmission of the steering angle). This could affect the measurement of the driver's steering input received by the EPS control module.
614	Sensor to controller signal inadequate, missing, or delayed: Communication bus error	Malicious intruder	A malicious intruder or aftermarket component could affect the steering wheel torque sensor and EPS control module connection (e.g., transmit incorrect information). This could affect the measurement of the driver's steering input received by the EPS control module.
615	Sensor to controller signal inadequate, missing, or delayed: Incorrect connection	Incorrect wiring connection	Incorrect wiring of the steering wheel torque sensor and EPS control module connection could affect the measurement of the driver's steering input received by the EPS control module.
616	Sensor to controller signal inadequate, missing, or delayed: Incorrect connection	Incorrect pin assignment	An incorrect pin assignment in the steering wheel torque sensor or EPS control module could affect the measurement of the driver's steering input received by the EPS control module.
617	External disturbances	EMI or ESD	EMI or ESD might affect the steering wheel torque sensor and EPS control module connection. This could affect the measurement of the driver's steering input received by the EPS control module.

Causal Factor ID Number	Causal Factor Guide Phrase	Causal Factor Subcategory	Causal Factor (Steering Wheel Torque Sensor to Electric Power Steering Control Module)
619	External disturbances	Vibration or shock impact	Vibration or shock impact could result in disturbances to the steering wheel torque sensor and EPS control module connection (e.g., fretting at the connection terminals). This could affect the measurement of the driver's steering input received by the EPS control module.
620	External disturbances	Manufacturing defects and assembly problems	Manufacturing defects and assembly problems could affect the steering wheel torque sensor and EPS control module connection. This might affect the measurement of the driver's steering input received by the EPS control module.
621	External disturbances	Extreme external temperature or thermal cycling	Extreme external temperature or thermal cycling could affect the steering wheel torque sensor and EPS control module connection. This might affect the measurement of the driver's steering input received by the EPS control module.
622	External disturbances	Organic growth	Organic growth could affect the steering wheel torque sensor and EPS control module connection. This might affect the measurement of the driver's steering input received by the EPS control module.
623	External disturbances	Physical interference (e.g., chafing)	Physical interference (e.g., chafing) could affect the steering wheel torque sensor and EPS control module connection. This might affect the measurement of the driver's steering input received by the EPS control module.
625	Hazardous interaction with other components in the rest of the vehicle	EMI or ESD	EMI or ESD from components within the vehicle could affect the steering wheel torque sensor and EPS control module connection. This might affect the measurement of the driver's steering input received by the EPS control module.
626	Hazardous interaction with other components in the rest of the vehicle	Vibration or shock impact	Vibration or shock impact from components within the vehicle could affect the steering wheel torque sensor and EPS control module connection. This might affect the measurement of the driver's steering input received by the EPS control module.

Causal Factor ID Number	Causal Factor Guide Phrase	Causal Factor Subcategory	Causal Factor (Steering Wheel Torque Sensor to Electric Power Steering Control Module)
627	Hazardous interaction with other components in the rest of the vehicle	Physical interference (e.g., chafing)	Physical interference (e.g., chafing) with components within the vehicle could affect the steering wheel torque sensor and EPS control module connection. This might affect the measurement of the driver's steering input received by the EPS control module.
628	Hazardous interaction with other components in the rest of the vehicle	Electrical arcing from neighboring components or exposed terminals	Electrical arcing from neighboring components or exposed terminals could affect the steering wheel torque sensor and EPS control module connection. This might affect the measurement of the driver's steering input received by the EPS control module.
629	Hazardous interaction with other components in the rest of the vehicle	Corona effects from high voltage components	If the vehicle has high voltage components (e.g., electric or hybrid electric powertrain), corona effects from high voltage components could affect the steering wheel torque sensor and EPS control module connection. This might affect the measurement of the driver's steering input received by the EPS control module.
1241	External disturbances	Active connection terminals affected by moisture, corrosion, or contamination	Active connection terminals in the steering wheel torque sensor and EPS control module connection may be affected by moisture, corrosion, or contamination. This might affect the measurement of the driver's steering input received by the EPS control module.
1242	Hazardous interaction with other components in the rest of the vehicle	Active connection terminals affected by moisture, corrosion, or contamination	Active connection terminals of the steering wheel torque sensor and EPS control module may be affected by moisture, corrosion, or contamination. This might affect the measurement of the driver's steering input received by the EPS control module.
1243	External disturbances	Unused connection terminals affected by moisture, corrosion, or contamination	Unused connection terminals in the wiring harness connecting the steering wheel torque sensor and EPS control module may be affected by moisture, corrosion, or contamination. This might affect the measurement of the driver's steering input received by the EPS control module.

Table I- 36: Wheel Speed Sensor to Electric Power Steering Control Module

Causal Factor ID Number	Causal Factor Guide Phrase	Causal Factor Subcategory	Causal Factor (Wheel Speed Sensor to Electric Power Steering Control Module)
1280	External disturbances	Extreme external temperature or thermal cycling	Extreme external temperature or thermal cycling affecting the wheel speed sensor and EPS control module connection might affect the individual wheel speed feedback to the EPS control module.
1290	Sensor to controller signal inadequate, missing, or delayed: Hardware open, short, missing, intermittent faulty	Connection is intermittent	Intermittent connection between the wheel speed sensor and EPS control module might affect the individual wheel speed feedback to the EPS control module.
1291	Sensor to controller signal inadequate, missing, or delayed: Hardware open, short, missing, intermittent faulty	Connection is open, short to ground, short to battery, or short to other wires in harness	Connection that is open, short to ground, short to battery, or short to other wires in harness between the wheel speed sensor and EPS control module might affect the individual wheel speed feedback to the EPS control module.
1292	Sensor to controller signal inadequate, missing, or delayed: Hardware open, short, missing, intermittent faulty	Electrical noise other than EMI or ESD	Electrical noise other than EMI or ESD between the wheel speed sensor and EPS control module might affect the individual wheel speed feedback to the EPS control module.

Causal Factor ID Number	Causal Factor Guide Phrase	Causal Factor Subcategory	Causal Factor (Wheel Speed Sensor to Electric Power Steering Control Module)
1293	Sensor to controller signal inadequate, missing, or delayed: Hardware open, short, missing, intermittent faulty	Connector contact resistance is too high	Contact resistance that is too high between the wheel speed sensor and EPS control module might affect the individual wheel speed feedback to the EPS control module.
1294	Sensor to controller signal inadequate, missing, or delayed: Hardware open, short, missing, intermittent faulty	Connector shorting between neighboring pins	Short circuit on the connector neighboring pins between the wheel speed sensor and EPS control module might affect the individual wheel speed feedback to the EPS control module.
1295	Sensor to controller signal inadequate, missing, or delayed: Hardware open, short, missing, intermittent faulty	Connector resistive drift between neighboring pins	Resistive drift on the connector neighboring pins between the wheel speed sensor and EPS control module might affect the individual wheel speed feedback to the EPS control module.
1296	Sensor to controller signal inadequate, missing, or delayed: Communication bus error	Bus overload or bus error	Bus overload or bus error between the wheel speed sensor and EPS control module might affect the individual wheel speed feedback to the EPS control module.

Causal Factor ID Number	Causal Factor Guide Phrase	Causal Factor Subcategory	Causal Factor (Wheel Speed Sensor to Electric Power Steering Control Module)
1297	Sensor to controller signal inadequate, missing, or delayed: Communication bus error	Signal priority too low	Signal priority that is too low between the wheel speed sensor and EPS control module might affect the individual wheel speed feedback to the EPS control module.
1298	Sensor to controller signal inadequate, missing, or delayed: Communication bus error	Failure of the message generator, transmitter, or receiver	Failure of the message generator, transmitter, or receiver between the wheel speed sensor and EPS control module might affect the individual wheel speed feedback to the EPS control module.
1299	Sensor to controller signal inadequate, missing, or delayed: Communication bus error	Malicious intruder	Malicious intruder on the wheel speed sensor and EPS control module connection might affect the individual wheel speed feedback to the EPS control module.
1300	Sensor to controller signal inadequate, missing, or delayed: Incorrect connection	Incorrect wiring connection	Incorrect wheel speed sensor and EPS control module wiring connection might affect the individual wheel speed feedback to the EPS control module.
1301	Sensor to controller signal inadequate, missing, or delayed: Incorrect connection	Incorrect pin assignment	Incorrect pin assignment on the wheel speed sensor and EPS control module connection might affect the individual wheel speed feedback to the EPS control module.

Causal Factor ID Number	Causal Factor Guide Phrase	Causal Factor Subcategory	Causal Factor (Wheel Speed Sensor to Electric Power Steering Control Module)
1302	External disturbances	EMI or ESD	EMI or ESD on the wheel speed sensor and EPS control module connection might affect the individual wheel speed feedback to the EPS control module.
1303	External disturbances	Vibration or shock impact	Vibration or shock impact disrupting the wheel speed sensor and EPS control module connection might affect the individual wheel speed feedback to the EPS control module.
1304	External disturbances	Manufacturing defects and assembly problems	Manufacturing defects and assembly problems of the wheel speed sensor and EPS control module connection might affect the individual wheel speed feedback to the EPS control module.
1305	External disturbances	Organic growth	Organic growth on the wheel speed sensor and EPS control module connection might affect the individual wheel speed feedback to the EPS control module.
1306	External disturbances	Physical interference (e.g., chafing)	External physical interference (e.g., shafting with dry snow or extreme rain) with wheel speed sensor and EPS control module connection might affect the individual wheel speed feedback to the EPS control module.
1307	External disturbances	Active connection terminals affected by moisture, corrosion, or contamination	Active connection terminals affected by moisture, corrosion, or contamination on the wheel speed sensor and EPS control module connection might affect the individual wheel speed feedback to the EPS control module.
1308	Hazardous interaction with other components in the rest of the vehicle	EMI or ESD	EMI or ESD from components within the vehicle dispersed on the wheel speed sensor and EPS control module connection might affect the individual wheel speed feedback to the EPS control module.
1309	Hazardous interaction with other components in the rest of the vehicle	Vibration or shock impact	Vibration or shock impact from components within the vehicle disrupting the wheel speed sensor and EPS control module connection might affect the individual wheel speed feedback to the EPS control module.

Causal Factor ID Number	Causal Factor Guide Phrase	Causal Factor Subcategory	Causal Factor (Wheel Speed Sensor to Electric Power Steering Control Module)
1310	Hazardous interaction with other components in the rest of the vehicle	Physical interference (e.g., chafing)	Physical interference (e.g., chafing) with components within the vehicle and the wheel speed sensor and EPS control module connection might affect the individual wheel speed feedback to the EPS control module.
1311	Hazardous interaction with other components in the rest of the vehicle	Electrical arcing from neighboring components or exposed terminals	Electrical arcing from neighboring components or exposed terminals could affect the wheel speed sensor and EPS control module connection and might affect the individual wheel speed feedback to the EPS control module.
1312	Hazardous interaction with other components in the rest of the vehicle	Corona effects from high voltage components	If the vehicle has high voltage components (e.g., electric or hybrid electric powertrain), corona effects from high voltage components could affect the wheel speed sensor and EPS control module connection and might affect the individual wheel speed feedback to the EPS control module.
1313	Hazardous interaction with other components in the rest of the vehicle	Active connection terminals affected by moisture, corrosion, or contamination	Active connection terminals of the wheel speed sensor or EPS control module may be affected by moisture, corrosion, or contamination from components within the vehicle and might affect the individual wheel speed feedback to the EPS control module.

Table I- 37: Yaw Rate/Lateral Acceleration Sensor to Electric Power Steering Control Module

Causal Factor ID Number	Causal Factor Guide Phrase	Causal Factor Subcategory	Causal Factor (Yaw Rate/Lateral Acceleration Sensor to Electric Power Steering Control Module)
552	Sensor to controller signal inadequate, missing, or delayed: Hardware open, short, missing, intermittent faulty	Connection is intermittent	The connection between the yaw rate/lateral acceleration sensor and EPS control module could become intermittent. If the yaw rate/lateral acceleration sensor is used by the EPS control module for yaw rate stabilization or to compensate for pull or drift independent of the driver's input, this might affect implementation of these active feedback features.
553	Sensor to controller signal inadequate, missing, or delayed: Hardware open, short, missing, intermittent faulty	Connection is open, short to ground, short to battery, or short to other wires in harness	The connection between the yaw rate/lateral acceleration sensor and EPS control module could become open, short to ground, short to battery, or short to other wires harness. If the yaw rate/lateral acceleration sensor is used by the EPS control module for yaw rate stabilization or to compensate for pull or drift independent of the driver's input, this might affect implementation of these active feedback features.
554	Sensor to controller signal inadequate, missing, or delayed: Hardware open, short, missing, intermittent faulty	Electrical noise other than EMI or ESD	Electrical noise other than EMI or ESD could affect the connection between the yaw rate/lateral acceleration sensor and EPS control module. If the yaw rate/lateral acceleration sensor is used by the EPS control module for yaw rate stabilization or to compensate for pull or drift independent of the driver's input, this might affect implementation of these active feedback features.
555	Sensor to controller signal inadequate, missing, or delayed: Hardware open, short, missing, intermittent faulty	Connector contact resistance is too high	Contact resistance in the connectors for the yaw rate/lateral acceleration sensor or EPS control module could be too high. If the yaw rate/lateral acceleration sensor is used by the EPS control module for yaw rate stabilization or to compensate for pull or drift independent of the driver's input, this might affect implementation of these active feedback features.

Causal Factor ID Number	Causal Factor Guide Phrase	Causal Factor Subcategory	Causal Factor (Yaw Rate/Lateral Acceleration Sensor to Electric Power Steering Control Module)
557	Sensor to controller signal inadequate, missing, or delayed: Hardware open, short, missing, intermittent faulty	Connector shorting between neighboring pins	Connector shorting between neighboring pins on the yaw rate/lateral acceleration sensor and EPS control module connection could affect the feedback to the EPS control module torque command. If the yaw rate/lateral acceleration sensor is used by the EPS control module for yaw rate stabilization or to compensate for pull or drift independent of the driver's input, this might affect implementation of these active feedback features.
558	Sensor to controller signal inadequate, missing, or delayed: Hardware open, short, missing, intermittent faulty	Connector resistive drift between neighboring pins	Connector resistive drift between neighboring pins on the yaw rate/lateral acceleration sensor and EPS control module connection could affect the EPS control module torque command. If the yaw rate/lateral acceleration sensor is used by the EPS control module for yaw rate stabilization or to compensate for pull or drift independent of the driver's input, this might affect implementation of these active feedback features.
559	Sensor to controller signal inadequate, missing, or delayed: Communication bus error	Bus overload or bus error	A bus overload or bus error could affect the yaw rate/lateral acceleration sensor and EPS control module connection. If the yaw rate/lateral acceleration sensor is used by the EPS control module for yaw rate stabilization or to compensate for pull or drift independent of the driver's input, this might affect implementation of these active feedback features.
560	Sensor to controller signal inadequate, missing, or delayed: Communication bus error	Signal priority too low	A signal priority that is too low could affect the yaw rate/lateral acceleration sensor and EPS control module connection. If the yaw rate/lateral acceleration sensor is used by the EPS control module for yaw rate stabilization or to compensate for pull or drift independent of the driver's input, this might cause a delay when implementing these active feedback features.

Causal Factor ID Number	Causal Factor Guide Phrase	Causal Factor Subcategory	Causal Factor (Yaw Rate/Lateral Acceleration Sensor to Electric Power Steering Control Module)
561	Sensor to controller signal inadequate, missing, or delayed: Communication bus error	Failure of the message generator, transmitter, or receiver	A failure of the message generator, transmitter, or receiver could affect the yaw rate/lateral acceleration sensor and EPS control module connection. If the yaw rate/lateral acceleration sensor is used by the EPS control module for yaw rate stabilization or to compensate for pull or drift independent of the driver's input, this might affect implementation of these active feedback features.
563	Sensor to controller signal inadequate, missing, or delayed: Incorrect connection	Incorrect wiring connection	The connection between the yaw rate/lateral acceleration sensor and EPS control module might be incorrectly wired. If the yaw rate/lateral acceleration sensor is used by the EPS control module for yaw rate stabilization or to compensate for pull or drift independent of the driver's input, this might affect implementation of these active feedback features.
564	Sensor to controller signal inadequate, missing, or delayed: Incorrect connection	Incorrect pin assignment	The pin assignment for the yaw rate/lateral acceleration sensor or EPS control module might be incorrect. If the yaw rate/lateral acceleration sensor is used by the EPS control module for yaw rate stabilization or to compensate for pull or drift independent of the driver's input, this might affect implementation of these active feedback features.
565	External disturbances	EMI or ESD	EMI or ESD could affect the yaw rate/lateral acceleration sensor and EPS control module connection. If the yaw rate/lateral acceleration sensor is used by the EPS control module for yaw rate stabilization or to compensate for pull or drift independent of the driver's input, this might affect implementation of these active feedback features.
567	External disturbances	Vibration or shock impact	Vibration or shock impact could affect the yaw rate/lateral acceleration sensor and EPS control module connection. If the yaw rate/lateral acceleration sensor is used by the EPS control module for yaw rate stabilization or to compensate for pull or drift independent of the driver's input, this might affect implementation of these active feedback features.

Causal Factor ID Number	Causal Factor Guide Phrase	Causal Factor Subcategory	Causal Factor (Yaw Rate/Lateral Acceleration Sensor to Electric Power Steering Control Module)
568	External disturbances	Manufacturing defects and assembly problems	Manufacturing defects and assembly problems could affect the yaw rate/lateral acceleration sensor and EPS control module connection. If the yaw rate/lateral acceleration sensor is used by the EPS control module for yaw rate stabilization or to compensate for pull or drift independent of the driver's input, this might affect implementation of these active feedback features.
569	External disturbances	Extreme external temperature or thermal cycling	Extreme external temperature or thermal cycling could affect the yaw rate/lateral acceleration sensor and EPS control module connection. If the yaw rate/lateral acceleration sensor is used by the EPS control module for yaw rate stabilization or to compensate for pull or drift independent of the driver's input, this might affect implementation of these active feedback features.
570	External disturbances	Organic growth	Organic growth could affect the yaw rate/lateral acceleration sensor and EPS control module connection. If the yaw rate/lateral acceleration sensor is used by the EPS control module for yaw rate stabilization or to compensate for pull or drift independent of the driver's input, this might affect implementation of these active feedback features.
571	External disturbances	Physical interference (e.g., chafing)	Physical interference (e.g., chafing) could affect the yaw rate/lateral acceleration sensor and EPS control module connection. If the yaw rate/lateral acceleration sensor is used by the EPS control module for yaw rate stabilization or to compensate for pull or drift independent of the driver's input, this might affect implementation of these active feedback features.

Causal Factor ID Number	Causal Factor Guide Phrase	Causal Factor Subcategory	Causal Factor (Yaw Rate/Lateral Acceleration Sensor to Electric Power Steering Control Module)
573	Hazardous interaction with other components in the rest of the vehicle	EMI or ESD	EMI or ESD from components within the vehicle could affect the yaw rate/lateral acceleration sensor and EPS control module connection. If the yaw rate/lateral acceleration sensor is used by the EPS control module for yaw rate stabilization or to compensate for pull or drift independent of the driver's input, this might affect implementation of these active feedback features.
574	Hazardous interaction with other components in the rest of the vehicle	Vibration or shock impact	Vibration or shock impact from components within the vehicle could affect the yaw rate/lateral acceleration sensor and EPS control module connection. If the yaw rate/lateral acceleration sensor is used by the EPS control module for yaw rate stabilization or to compensate for pull or drift independent of the driver's input, this might affect implementation of these active feedback features.
576	Hazardous interaction with other components in the rest of the vehicle	Physical interference (e.g., chafing)	Physical interference (e.g., chafing) with components within the vehicle could affect the yaw rate/lateral acceleration sensor and EPS control module connection. If the yaw rate/lateral acceleration sensor is used by the EPS control module for yaw rate stabilization or to compensate for pull or drift independent of the driver's input, this might affect implementation of these active feedback features.
577	Hazardous interaction with other components in the rest of the vehicle	Electrical arcing from neighboring components or exposed terminals	Electrical arcing from neighboring components or exposed terminals could affect the yaw rate/lateral acceleration sensor and EPS control module connection. If the yaw rate/lateral acceleration sensor is used by the EPS control module for yaw rate stabilization or to compensate for pull or drift independent of the driver's input, this might affect implementation of these active feedback features.

Causal Factor ID Number	Causal Factor Guide Phrase	Causal Factor Subcategory	Causal Factor (Yaw Rate/Lateral Acceleration Sensor to Electric Power Steering Control Module)
578	Hazardous interaction with other components in the rest of the vehicle	Corona effects from high voltage components	If the vehicle has high voltage components (e.g., electric or hybrid electric powertrain), corona effects from high voltage components could affect the yaw rate/lateral acceleration sensor and EPS control module connection. If the yaw rate/lateral acceleration sensor is used by the EPS control module for yaw rate stabilization or to compensate for pull or drift independent of the driver's input, this might affect implementation of these active feedback features.
589	Sensor to controller signal inadequate, missing, or delayed: Communication bus error	Malicious intruder	A malicious intruder or aftermarket component could affect the yaw rate/lateral acceleration sensor and EPS control module connection. If the yaw rate/lateral acceleration sensor is used by the EPS control module for yaw rate stabilization or to compensate for pull or drift independent of the driver's input, this might affect implementation of these active feedback features.
1244	External disturbances	Active connection terminals affected by moisture, corrosion, or contamination	Active connection terminals of the yaw rate/lateral acceleration sensor or EPS control module might be affected by moisture, corrosion, or contamination. If the yaw rate/lateral acceleration sensor is used by the EPS control module for yaw rate stabilization or to compensate for pull or drift independent of the driver's input, this might affect implementation of these active feedback features.
1245	Hazardous interaction with other components in the rest of the vehicle	Active connection terminals affected by moisture, corrosion, or contamination	Active connection terminals of the yaw rate/lateral acceleration sensor or EPS control module may be affected by moisture, corrosion, or contamination from components within the vehicle. If the yaw rate/lateral acceleration sensor is used by the EPS control module for yaw rate stabilization or to compensate for pull or drift independent of the driver's input, this might affect implementation of these active feedback features.

Causal Factor ID Number	Causal Factor Guide Phrase	Causal Factor Subcategory	Causal Factor (Yaw Rate/Lateral Acceleration Sensor to Electric Power Steering Control Module)
1246	External disturbances	Unused connection terminals affected by moisture, corrosion, or contamination	Unused connection terminals in the wiring harness connecting the yaw rate/lateral acceleration sensor and EPS control module might be affected by moisture, corrosion, or contamination. If the yaw rate/lateral acceleration sensor is used by the EPS control module for yaw rate stabilization or to compensate for pull or drift independent of the driver's input, this might affect implementation of these active feedback features.
1247	Hazardous interaction with other components in the rest of the vehicle	Excessive heat from other components	Excessive heat from other vehicle components could affect the yaw rate/lateral acceleration sensor and EPS control module connection. If the yaw rate/lateral acceleration sensor is used by the EPS control module for yaw rate stabilization or to compensate for pull or drift independent of the driver's input, this might affect implementation of these active feedback features.
1248	Hazardous interaction with other components in the rest of the vehicle	Unused connection terminals affected by moisture, corrosion, or contamination	Unused connection terminals in the wiring harness connecting the yaw rate/lateral acceleration sensor and the EPS control module may be affected by moisture, corrosion, or contamination from other components in the vehicle. If the yaw rate/lateral acceleration sensor is used by the EPS control module for yaw rate stabilization or to compensate for pull or drift independent of the driver's input, this might affect implementation of these active feedback features.

APPENDIX J: DETAILED FUNCTIONAL SAFETY REQUIREMENTS

Table J-1. General Functional Safety Requirements for the EPS System J-2
Table J-2. Functional Safety Requirements for the Driver Steering Input Sensor J-7
Table J-3. Functional Safety Requirements for the EPS Control Module J-10
Table J-4. Functional Safety Requirements for the Power-Assist Motor J-18
Table J-5. Functional Safety Requirements for the Rear-Wheel Assembly J-20
Table J-6. Functional Safety Requirements for the Mechanical Steering Assembly J-22
Table J-7. Communication System Functional Safety Requirements J-23
Table J-8. Functional Safety Requirements for Interfacing Systems J-24

Table J-1. General Functional Safety Requirements for the EPS System

Safety Req. ID	Safety Goal	ASIL	Safety Requirement
1.11	1, 2, 3	B, C, D	<p>The EPS system is to perform Power On tests, periodic tests or continuous monitoring tests to ensure the correctness of safety-critical parameters and the integrity of critical system elements and safety-critical signals.</p> <ul style="list-style-type: none"> • Critical parameters are those used to calculate EPS system torque value and direction (steering-assist control algorithm), the vehicle speed, vehicle yaw rate, and the low voltage power supply. • Other critical parameters may include calculation and comparison results that confirm the proper operation of the system including motor back electromotive force. • The steering wheel torque angle versus vehicle speed maps are to be checked. • The proper operation of the followings critical system elements is to be checked before any steering-assist is provided by the EPS system: <ul style="list-style-type: none"> ○ Steering wheel torque sensor ○ EPS motor ○ EPS motor position sensor ○ EPS motor current sensors ○ Communications channels between the steering wheel torque sensor and the EPS control module, and between the brake controller and the EPS control module. • A confirmation of the health and sanity of the EPS control module is to be confirmed via an acceptable strategy before any steering-assist command is issued by the EPS system: <ul style="list-style-type: none"> ○ State of health checks may include: <ul style="list-style-type: none"> ▪ RAM/ ROM/ EEPROM tests ▪ Analog/digital converter test ▪ Shut-down test ○ Sanity checks may include: <ul style="list-style-type: none"> ▪ Quizzer or Seed & Key strategies • The frequency of the periodic tests is to be selected based on the FTTI, the fault detection time interval, and the fault reaction time interval. <ul style="list-style-type: none"> ○ For example, an EPS system may run periodic tests every 30 ms, based on the results of a safety analysis and available technology. ○ In case of failure in the periodic self-tests, the EPS system is to transition to safe state within TBD ms. (Some manufacturers consider 100 ms as a FTTI for the EPS system.)

Safety Req. ID	Safety Goal	ASIL	Safety Requirement
1.12	1, 2	C, D	In case of any failure in the EPS system that violates a safety goal with ASIL D or C, the EPS system is to send a vehicle instability message to the vehicle stability controller for potential corrective action.
1.13	1, 2, 3	B, C, D	<p>The EPS system is to deliver the steering-assist required to the vehicle wheels at the correct level under all vehicle operating conditions.</p> <ul style="list-style-type: none"> • The EPS system is to deliver the correct level of steering-assist to within a tolerance of TBD Newton-meter (N•m).
1.14	1, 2, 3	B, C, D	<p>The EPS system is to deliver the steering-assist required to the vehicle wheels in the correct direction under all vehicle operating conditions.</p> <ul style="list-style-type: none"> • The EPS system is to deliver the steering-assist to achieve the desired yaw to within TBD degrees and yaw rate to within TBD degrees/s.
1.15	1, 2, 3	B, C, D	<p>The EPS system is to deliver the steering-assist required to the vehicle wheels at the correct time under all vehicle operating conditions.</p> <ul style="list-style-type: none"> • The EPS system is to deliver the steering-assist within TBD ms.
1.16	1, 2, 3	B, C, D	The EPS system steering-assist is to be controlled and updated within the correct time duration. The time duration required to update the steering-assist level is not to result in the violation of safety goals (e.g., failure mode in software execution, execution time, motor inertia).
1.17	2	C	<p>The EPS system is to provide more assistance at low vehicle speeds (< TBD kph) and less assistance at higher vehicle speeds (> TBD kph).</p> <ul style="list-style-type: none"> • At high speeds (> TBD kph) the steering torque assist is to avoid oversteering. <ul style="list-style-type: none"> ○ 100 kph is considered by some manufacturers for similar safety goals. ○ Examples of approaches for avoiding oversteer include providing zero assist at high speed and subtracting torque from the driver's input at high speeds.
1.18	1, 2, 3	B, C, D	The steering wheel is to be stabilized in an on-center position at high speeds (> TBD kph).

Safety Req. ID	Safety Goal	ASIL	Safety Requirement
1.19	1, 2, 3	B, C, D	The EPS system is to have a redundant low voltage power supply. In case of a fault in the vehicle's low voltage power supply system, the redundant EPS power supply is to activate within TBD ms (some manufacturers consider 100 ms for similar safety goals) and, at a minimum, sustain the power to the EPS system for a duration equal to the longest FTTI.
1.20	4	A	If equipped with the 4WS architecture, the EPS system is to rotate the rear wheels in the correct direction and at the correct time.
1.21	1, 2, 3	QM, A, B	<p>Diagnostics of all safety-critical components functions are to be conducted.</p> <ul style="list-style-type: none"> • In case of detected faults: <ul style="list-style-type: none"> ○ The system is to take mitigation action to prevent failures that could lead to a violation of a safety goal. ○ Appropriate DTCs are to be set. • The diagnostics are to cover: <ul style="list-style-type: none"> ○ Hardware, including: steering wheel torque sensor, EPS control module, EPS motor, EPS steering wheel angle, and communications hardware. ○ Software functions including: steering torque calculations, steering-assist command determination, motor torque calculations, and steering-assist control.
1.22	1, 2, 3	QM	DTCs are to be set every time a safety goal is violated.
1.23	1, 2, 3, 4	A, B, C, D	To recover from a safe state, the EPS system is to reset and pass a self-test to ensure all system components (including software functions) are operating correctly.
1.24	1, 2, 3, 4	No ASIL	The hardware architectural single-point fault and latent fault metrics targets per ISO 26262 are to be demonstrated for each safety goal.
1.25	1, 2	C, D	<p>If redundant elements are used, they are to be verified against common cause failures.</p> <ul style="list-style-type: none"> • Failure in the electric power supply of one element is not to affect the power supply of the other element. • Failure in the communication path of one element is not to affect the communication path of the other element.

Safety Req. ID	Safety Goal	ASIL	Safety Requirement
1.26	1, 2	C, D	If redundant elements are used and one element fails, the EPS system is to transition into Safe State 1 within the FTTI and an amber light driver warning is to be issued.
1.27	1, 2	C, D	If redundant elements are used and both elements fail, or if only one element is used and it fails, then the EPS system is to transition to Safe State 3 within the FTTI and a red light driver warning is to be issued.
1.28	1, 2, 3, 4	No ASIL	Diagnostics mechanisms are to adhere to ASIL B classification for ASIL D related elements and ASIL A classification for ASIL C related elements, and QM for ASIL B and A related requirements.
1.29	1, 2, 3, 4	No ASIL	Diagnostics covering the safety related functionality of the steering wheel torque sensor, steering wheel angle sensor, EPS motor position sensor, EPS motor, EPS motor current sensors, rear-wheel position sensor, rear-wheel actuator, harnesses, and connectors/controllers are to be instituted with a level of coverage corresponding to the ASIL of the safety goal that is affected. Diagnostics are to adhere to ISO 26262 diagnostics coverage guidelines for low, medium, and high coverage levels.

Safety Req. ID	Safety Goal	ASIL	Safety Requirement
1.30	1, 2, 3, 4	No ASIL	<p>Diagnostics covering the following failure modes are to be implemented:</p> <ul style="list-style-type: none"> • Steering wheel torque sensor: <ul style="list-style-type: none"> ○ Integrated circuit faults ○ Open/short I/Os ○ Stuck on the same reading ○ Out of range ○ Offset ○ State of health • Steering wheel angle sensor: <ul style="list-style-type: none"> ○ Integrated circuit faults ○ Open/short I/Os ○ Stuck on the same reading ○ Out of range • EPS motor position sensor: <ul style="list-style-type: none"> ○ Integrated circuit faults ○ Open/short I/Os ○ Stuck on the same reading ○ Out of range ○ Offset ○ State of health • Rear-wheel road position sensor: <ul style="list-style-type: none"> ○ Integrated circuit faults ○ Open/short I/Os ○ Stuck on the same reading ○ Out of range • Power-assist motor: <ul style="list-style-type: none"> ○ Electromagnetic circuit faults • Rear-wheel road actuator: <ul style="list-style-type: none"> ○ Electromagnetic circuit faults ○ Integrated circuit faults ○ Open/short I/Os • Harnesses and connectors: <ul style="list-style-type: none"> ○ Open/short circuits

Table J-2. Functional Safety Requirements for the Driver Steering Input Sensor

Safety Req. ID	Safety Goal	ASIL	Safety Requirement
2.1	1, 2, 3, 4	No ASIL	The steering wheel torque resulting from the driver's input is to generate a consistent twist in the torsion bar under all vehicle operating conditions over the usable life of the vehicle. (This requirement is not covered by ISO 26262, but compliance with it is to be part of the review of complying with ISO 26262.)
2.2	1, 2, 3	B, C, D	The steering wheel torque sensor is to measure the torsion bar twist resulting from the steering wheel input, and the value is to be qualified for validity and correctness.
2.3	1, 2, 3	B, C, D	The torque sensor's method for converting torsion bar twist to an electrical signal is to be validated.
2.4	1, 2, 3, 4	A, B, C, D	<p>The torque sensor input voltage is to be monitored for over and under voltage whenever the EPS system is on. In case of a failure in the input voltage, the EPS is to transition into Safe State 3 within TBD ms.</p> <ul style="list-style-type: none"> • 100 ms is considered by some manufacturers for similar safety goals. • Monitoring circuit of the torque sensor supply voltage functionality is to be checked as part of periodic tests.
2.5	1, 2, 3, 4	A, B, C, D	<p>The torque measurement by the torque sensor is to be communicated to the EPS control module.</p> <ul style="list-style-type: none"> • Communication message or data transfer is to be qualified for: <ul style="list-style-type: none"> ○ Validity (sent and received signals are the same) ○ Correctness (within range) ○ Rationality (does not contradict with previous or other related signals/messages) • Updated value of the torque sensor is to be received by TBD seconds. This time is to be specified to support the timely update of the steering-assist in order to prevent the violation of a safety goal.

Safety Req. ID	Safety Goal	ASIL	Safety Requirement
2.6	1, 2, 3, 4	A, B, C, D	<p>The torque sensor data are to be monitored continuously and the EPS system is to only provide power-assist to the driver when the torque sensor data are correctly received by the EPS control module per Safety Requirement 2.7.</p> <ul style="list-style-type: none"> • This requirement addresses the driver's input. The EPS system may provide assist when requested by other vehicle systems without involving the torque sensor.
2.8	1, 2, 3, 4	A, B, C, D	The torque sensor output is to be analyzed by a torque sensor data analysis unit in the monitoring circuit.
2.9	1, 2	C, D	The health and sanity of the torque sensor are to be monitored and confirmed under all operating vehicle conditions.
2.10	1, 2, 3, 4	A, B, C, D	In case of a fault that violates a safety goal, the torque sensor is to communicate the fault to the EPS control module.
2.11	1, 2, 3	QM, A, B	The torque sensor is to have diagnostics for safety relevant failures caused by electromagnetic compatibility/EMI, ESD, contamination, single event effects, and other environmental conditions.
2.12	1, 2, 3, 4	No ASIL	<p>All single point torque sensor hardware faults that lead to violation of a safety goal are to be detected within the fault detection interval and mitigated within the FTTI. In case of a failure, the system is to transition to the corresponding safe state.</p> <ul style="list-style-type: none"> • Hardware faults include those occurring in the IC, circuit components, printed circuit board, I/O pins, signal connectors, and power connectors.
2.13	2	A	The steering wheel angle sensor is to measure/detect the steering wheel angle resulting from the steering wheel input and the value is to be qualified.
2.14	2	A	The steering wheel angle to electrical conversion method is to be validated.

Safety Req. ID	Safety Goal	ASIL	Safety Requirement
2.15	2	A	<p>The angle measurement by the steering wheel angle sensor is to be communicated to the EPS control module.</p> <ul style="list-style-type: none"> • The updated value of the angle sensor is to be received by TBD seconds. This time is to be specified to support the timely update of the EPS algorithms requiring this input.
2.16	2	A	<p>The angle sensor data are to be checked at regular intervals in order to mitigate latent faults that may result in the violation of SG 2.</p>
2.17	2	A	<p>In case of a fault that violates SG 2, the steering wheel angle sensor is to communicate the fault to the EPS control module.</p>
2.18	2	A	<p>The angle sensor is to have diagnostics for safety relevant failures caused by EMC/EMI, ESD, contamination, single event effects, and other environmental conditions.</p>
2.19	2	A	<p>All single point steering wheel angle sensor hardware faults that lead to violation of SG 2 are to be detected within the fault detection interval and mitigated within the FTTI. In case of a failure, the system is to issue an amber light driver warning.</p> <ul style="list-style-type: none"> • Hardware faults include those occurring in the IC, circuit components, printed circuit board, I/O pins, signal connectors, and power connectors.

Table J-3. Functional Safety Requirements for the EPS Control Module

Safety Req. ID	Safety Goal	ASIL	Safety Requirement
3.1	1, 2	C, D	<p>The health and sanity of the EPS control module are to be ensured. This includes:</p> <ul style="list-style-type: none"> • Power-On Self-Tests – to check the health of EPS control module. This may include CPU and register tests to check the internal working of the CPU. All CPU registers associated with steering-assist functions are to be checked during this test. • Interrupt and Exception Test – to check the interrupt and exception processing of the processor. • EEPROM Checksum Test – to check the EEPROM health. • Device Tests – to check the peripheral devices connected to the microcontroller used on a board.
3.2	1, 2, 3, 4	A, B, C, D	The EPS control module’s I/O pins are to be monitored for shorts to system voltages or ground.
3.3	1, 2, 3, 4	A, B, C, D	The EPS control module is to be protected against the back electromotive force of the EPS motor to prevent any damage to its hardware components.
3.4	1, 2, 3, 4	A, B, C, D	The EPS control module is to have diagnostics for safety relevant failures caused by EMC/EMI, ESD, contaminations, single event effects, and other environmental conditions.
3.5	1, 2, 3, 4	No ASIL	<p>All single point EPS control module hardware faults that lead to violation of a safety goal are to be detected within the fault detection interval and mitigated within the FTTI. In case of a failure, the system is to transition to the corresponding safe state.</p> <ul style="list-style-type: none"> • Hardware faults include those occurring in the ICs, circuit components, printed circuit boards, I/O pins, signal connectors, and power connectors.
3.6	1, 2, 3, 4	A, B, C, D	The EPS control module is to calculate the steering-assist based on the driver’s steering input (e.g., torque input) and the vehicle speed.
3.7	1, 2, 3, 4	A, B, C, D	The EPS control module is to have an arbitration strategy for steering-assist requests from the driver and other vehicle systems.

Safety Req. ID	Safety Goal	ASIL	Safety Requirement
3.8	1, 2, 3, 4	A, B, C, D	<p>The steering-assist command and control communication channels with the EPS motor controls are to be validated at start up.</p> <ul style="list-style-type: none"> • Steering-assist commands are not to be issued until the validation of the communication channels is successful. • In case of validation failure, the EPS is to transition into Safe State 3 within a FTTI of TBD seconds and a red light driver warning is to be issued.
3.9	1, 2, 3, 4	A, B, C, D	<p>All electrical hardware and software elements associated with the delivery of the steering-assist function are to comply with ASIL D classification for SG 1, ASIL C classification for SG 2, ASIL B classification for SG 3, and ASIL A classification for SG 4 unless otherwise specified.</p> <ul style="list-style-type: none"> • If independence of the elements (per ISO 26262) cannot be demonstrated, then the higher ASIL classification is to be adopted. • If torque maps or look up tables are used, their content is to be checked for validity and correctness at the correct frequency based on the FTTI for the corresponding fault.
3.10	1, 2, 3	B, C, D	The EPS control module is to qualify the steering wheel sensor inputs (e.g., torque input) for validity and correctness (plausibility and rationality).
3.11	1, 2, 3	B, C, D	The EPS control module is to qualify the steering requests from other vehicle systems for validity and correctness.
3.12	1, 2, 3, 4	A, B, C, D	Communication and data transfer between the EPS control module and the steering wheel sensors are to be qualified for validity and correctness (plausibility and rationality). In case of a fault, the correct failure mode effect mitigation strategy is to be applied. The critical communications may include the steering wheel torque input and the diagnostics of the steering wheel torque sensor.
3.13	1, 2, 3, 4	A, B, C, D	The controller algorithm or method for calculating the steering-assist is to be validated.
3.14	1, 2, 3, 4	A, B, C, D	The steering-assist corresponding to the driver's steering input (e.g., torque input) or the requests from other vehicle systems is to be calculated correctly and the results are to be qualified for validity and correctness under all vehicle operating conditions.

Safety Req. ID	Safety Goal	ASIL	Safety Requirement
3.15	1, 2, 3, 4	A, B, C, D	The steering-assist command is to be controlled and updated in the correct direction within the correct time duration.
3.16	1, 2, 3, 4	A, B, C, D	<p>The time duration required to update the steering-assist command is not to result in violation of a safety goal.</p> <ul style="list-style-type: none"> • The time duration is to be reflected in the relevant software function's execution time, and the transient response of the motor. • This time duration is dependent on the software architecture. An EPS software execution time of 10 ms is considered by some manufacturers for safety relevant requirements.
3.17	1, 2	C, D	<p>The steering-assist control algorithm is to be checked periodically based on the correct FTTI in order to prevent violation of a safety goal.</p> <ul style="list-style-type: none"> • A fault tolerant strategy is to be applied for the steering-assist control; the fault tolerant techniques may include redundancy, voting logic, or other techniques. • A control flow monitoring strategy is to be applied for the steering-assist control: • Hardware and software watchdogs with a 300 ms timer to monitor the EPS control algorithm execution sequence are considered by some manufacturers for similar safety goals.
3.18	1, 2, 3, 4	A, B, C, D	<p>In case of a fault in the steering-assist control algorithm that leads the controller to be unable to control the steering-assist, the EPS system is to transition into Safe State 3 within the TBD ms time, and the red light driver warning is to be issued.</p> <ul style="list-style-type: none"> • 100 ms is considered by some manufacturers for similar safety goals. • DTCs are to be set.
3.19	1, 2, 3	A, B, C	The EPS control module is to have power-assist motor torque current calculations and torque control algorithms for all motor speeds.
3.20	1, 2, 3	B, C, D	The EPS control module is to command motor torque current to drive the power-assist motor in both the clockwise and counterclockwise directions.

Safety Req. ID	Safety Goal	ASIL	Safety Requirement
3.21	1, 2, 3	B, C, D	<p>The EPS control module is to deliver the motor torque current at the correct value, in the correct direction, and at the correct time to the power-assist motor.</p> <ul style="list-style-type: none"> • The motor torque current direction is defined in terms of the intended direction of the motor's torque output. This means that if a 3-phase current is used, the motor's rotor position may have to be considered when establishing the current direction. • The transient response of the EPS motor is to be established to prevent a violation of any safety goal.
3.22	1, 2, 3	B, C, D	<p>All other critical parameters used by the power-assist motor torque current calculation algorithm that may lead to a violation of a safety goal when not correct are to be checked periodically based on the FTTL.</p>
3.23	1, 2, 3	B, C, D	<p>All electrical hardware and software elements associated with the delivery of the power-assist motor torque current to the power-assist motor are to comply with ASIL D classification for SG 1, ASIL C classification for SG 2, and ASIL B classification for SG 3 unless otherwise specified.</p> <ul style="list-style-type: none"> • If independence of the elements (per ISO 26262) cannot be demonstrated, the higher ASIL classification is to be adopted.
3.24	1, 2, 3	B, C, D	<p>The EPS control module is to control the power-assist motor torque current such that the motor's torque output remains within a pre-established tolerance band based on the vehicle operating scenario. The allowable deviation within the tolerance band is not to result in a violation of a safety goal.</p>
3.25	1, 2, 3	B, C, D	<p>The power-assist motor torque current value and direction are to be qualified for validity and correctness.</p>
3.26	1, 2, 3	B, C, D	<p>If look up tables are used to determine the value of the power-assist motor current, the contents of the tables are to be checked for correctness every time the EPS system is activated.</p>
3.27	1, 2, 3	B, C, D	<p>The power-assist motor position feedback to the EPS control module is to be checked for validity and correctness.</p>
3.28	1, 2, 3	B, C, D	<p>The power-assist motor current sensor inputs are to be checked for validity and correctness.</p>

Safety Req. ID	Safety Goal	ASIL	Safety Requirement
3.29	1, 2, 3	No ASIL	<p>All faults that result in a failure to determine the power-assist motor torque current are to be detected and mitigated within the FTTI.</p> <ul style="list-style-type: none"> • In case of a failure in establishing the validity and correctness of the motor torque current, the EPS system is to transition into Safe State 3 and a red light driver warning is to be issued. • DTCs are to be set.
3.30	1, 2	C, D	<p>The health and sanity of the power-assist motor torque current calculation algorithm are to be checked periodically based on the correct FTTI in order to prevent violations of the safety goals (for example, via an auxiliary processor or equivalent means).</p> <ul style="list-style-type: none"> • A fault tolerant strategy is to be applied; the fault tolerant techniques may include redundancy, voting logic, or other techniques. • A control flow monitoring strategy is to be applied.
3.31	1, 2, 3, 4	No ASIL	<p>Critical communications and data transfer between the EPS control module and other vehicle systems/components are to be qualified for validity and correctness (plausibility and rationality) including the brake pedal sensor (ASIL A), vehicle speed sensor (ASIL D), yaw rate sensor (ASIL D), and all other inputs that are used by the steering-assist control.</p> <ul style="list-style-type: none"> • The ASIL classification may be applied based on a selected ASIL decomposition strategy. For example, vehicle speed and engine rotational speed may be used redundantly.
3.32	1, 2, 3, 4	A, B, C, D	<p>All other critical parameters used to control steering-assist are to be checked periodically based on the FTTI requirements.</p>
3.33	1, 2, 3	B, C, D	<p>The EPS control module is to have a mechanism to prevent unauthorized access to the steering-assist algorithms, stored maps, calculations, and command paths.</p>
3.34	1, 2, 3	B, C, D	<p>All single point faults that result in a failure to prevent unauthorized access to the EPS control module are to be detected and mitigated.</p> <ul style="list-style-type: none"> • In case of unauthorized access of the EPS control module, the EPS system is to transition to Safe State 3 within TBD ms, and a red light driver warning is to be issued. • A DTC is to be set.

Safety Req. ID	Safety Goal	ASIL	Safety Requirement
3.35	1, 2, 3, 4	A, B, C, D	<p>The EPS control module is to arbitrate between multiple requests for steering-assist from interfacing vehicle systems and the driver.</p> <ul style="list-style-type: none"> • The controller arbitration logic strategy and algorithm are to be checked for health and sanity periodically based on the FTTL.
3.36	1, 2, 3, 4	A, B, C, D	The output of the EPS control module arbitration logic is to be qualified for validity and correctness.
3.37	1, 2, 3, 4	A, B, C, D	The arbitration strategy is to clearly define the action of the EPS system when the driver's steering request conflicts with the requests or inputs of safety relevant systems.
3.38	1, 2, 3, 4	No ASIL	Diagnostics covering the safety related functionality of the EPS control module are to be instituted with a level of coverage corresponding to the ASIL of the safety goal that is affected. ISO 26262 diagnostics coverage guidelines for low, medium, and high coverage levels are to be adhered to in order to comply with the hardware architectural metrics targets.
3.39	1, 2, 3, 4	No ASIL	<p>A software failure management routine is to initiate controlled shutdown of the EPS system immediately after a diagnostic detects a failure.</p> <ul style="list-style-type: none"> • The EPS system is to transition into a safe state that corresponds to the failure within TBD ms. <ul style="list-style-type: none"> ○ 200 ms is considered by some manufacturers for similar safety goals.

Safety Req. ID	Safety Goal	ASIL	Safety Requirement
3.40	1, 2, 3, 4	No ASIL	<p>Diagnostics covering the failures for the following parts of the EPS control module are to be implemented:</p> <ul style="list-style-type: none"> • Execution logic (wrong coding, wrong or no execution, execution out of order, execution too fast or too slow, stack overflow or underflow). • On-chip communication and bus arbitration • The main controller: <ul style="list-style-type: none"> ○ CPU ○ Controller processor memory ○ Arithmetic logic unit ○ Registers ○ Analogue to digital converter ○ Signal conditioning and conversion ○ Software program execution ○ Connections (I/O) faults (short/open/drift/oscillation) ○ Power supply • If an auxiliary processor is used, the auxiliary controller: <ul style="list-style-type: none"> ○ CPU ○ Processor memory (if auxiliary processor is used) ○ Arithmetic logic unit ○ Registers ○ Analogue to digital converter ○ Signal conditioning and conversion ○ Software program execution ○ Connections (I/O) faults (short/open/drift/oscillation) ○ Power supply • The wiring harnesses and connectors for open and short circuits • Critical CAN messages • Critical messages

Safety Req. ID	Safety Goal	ASIL	Safety Requirement
3.41	1, 2, 3, 4	QM	<p>The EPS control module is to log and save the following data every time a transition to a safe state is executed due to a violation of a safety goal:</p> <ul style="list-style-type: none"> • The diagnostics information of the faults including the time at which the fault was detected and the nature of the fault. • The time interval from the detection of the fault to reaching a safe state. • The time the system degradation strategy started, including the start and end of each phase if applicable and the values of the system metrics for each phase (i.e., torque output level). • The time the driver warning strategy started, including the start and end of each phase if applicable and the values of the system metrics for each phase. • The data are to be retained until they are accessed by authorized personnel.

Table J-4. Functional Safety Requirements for the Power-Assist Motor

Safety Req. ID	Safety Goal	ASIL	Safety Requirement
4.1	1, 2, 3	B, C, D	The EPS motor is to provide the required steering-assist torque commanded by the EPS control module under all EPS system operating conditions
4.2	2	C	The EPS motor torque is to adhere to the level of quality (e.g., ripple ⁴²) that does not lead to a violation of SG 2.
4.3	1, 2, 3	B, C, D	The EPS motor is to have a transient response that will not lead to violation of a safety goal.
4.4	1, 2, 3	B, C, D	The maximum value of the EPS motor's back electromotive force is not to result in the failure of any EPS component, critical interface input, or critical communication signal under all EPS operating scenarios.
4.5	1, 2, 3	B, C, D	<p>The EPS motor is to prevent changes in the torque versus current characteristics under all EPS operating scenarios.</p> <ul style="list-style-type: none"> • The EPS system is to detect motor winding short circuits and magnet demagnetization faults. • In case of a change in the torque vs current characteristics, the EPS system is to transition to Safe State 1 within TBD ms, and an amber light driver warning is to be issued (200 ms is considered by some manufacturers for similar safety goals).
4.6	1, 2, 3	B, C, D	<p>The EPS motor is to prevent locked rotor failures under all EPS operating scenarios.</p> <ul style="list-style-type: none"> • In case a locked rotor failure occurs, the EPS system is to transition to Safe State 3 within TBD ms, and a red light driver warning is to be issued (200 ms is considered by some manufacturers for similar safety goals). • A DTC is to be set
4.7	1, 2	C, D	The EPS motor rotor position is to be measured, and the rotor position is to be qualified for validity and correctness.

⁴² Torque ripple is a general term to describe periodic fluctuation in the motor torque output as the motor shaft rotates. It may affect the smoothness of the torque output or cause unwanted vibrations.

Safety Req. ID	Safety Goal	ASIL	Safety Requirement
4.8	1, 2, 3	B, C, D	The EPS motor rotor position is to be communicated to the EPS control module.
4.9	1, 2, 3	B, C, D	In case of a fault in the EPS motor that leads to violation of a safety goal, the EPS motor is to communicate the fault to the EPS control module.
4.10	1, 2, 3	B, C, D	<p>All single point EPS motor faults that lead to violations of a safety goal are to be detected within the fault detection interval and mitigated within the FTTI. In case of a failure, the system is to transition to the corresponding safe state.</p> <ul style="list-style-type: none"> • Hardware faults include those occurring in the motor electromagnetic circuit and the rotor position measuring mechanism (e.g., sensor), I/O pins, signal connectors, and power connectors.

Table J-5. Functional Safety Requirements for the Rear-Wheel Assembly

Safety Req. ID	Safety Goal	ASIL	Safety Requirement
5.1	1, 2, 4	A, C, D	The rear-wheel position sensor is to measure/detect the rear-wheel position under all vehicle operating conditions. The measured rear-wheel position is to be qualified for validity and correctness.
5.2	1, 2	C, D	The rear wheel orientation is not to result in a violation of SG 1 or SG 2.
5.3	1, 2, 4	A, C, D	The rear-wheel position to electrical conversion method is to be validated.
5.4	1, 2, 4	A, C, D	The rear-wheel position is to be communicated to the EPS control module and the rear-wheel actuator.
5.5	1, 2, 4	A, C, D	The EPS control module is to check the validity and correctness of the rear-wheel position.
5.6	1, 2, 4	A, C, D	In case of a fault that violates a safety goal, the rear-wheel position sensor is to communicate the fault to the EPS control module. The EPS system is to transition to Safe State 2 within TBD ms and an amber light driver warning is to be issued.
5.7	1, 2, 4	A, C, D	The rear-wheel position sensor is to have diagnostics for safety relevant failures caused by EMC/EMI, ESD, contamination, single event effects, and other environmental conditions.
5.8	1, 2, 4	A, C, D	All single point rear-wheel position sensor hardware faults that lead to violations of a safety goal are to be detected within the fault detection interval and mitigated within the FTTL. <ul style="list-style-type: none"> • Hardware faults include those occurring in the IC, circuit components, printed circuit board, I/O pins, signal connectors, and power connectors.
5.9	1, 2, 4	A, C, D	The rear-wheel actuator is to provide the required torque commanded by the EPS control module under all vehicle operating conditions.

Safety Req. ID	Safety Goal	ASIL	Safety Requirement
5.10	1, 2, 4	A, C, D	<p>The rear-wheel actuator is to prevent locked rotor failures under all vehicle operating conditions.</p> <ul style="list-style-type: none"> • In case a locked rotor failure occurs, the EPS system is to transition to Safe State 2 within TBD ms and a red light driver warning is to be issued. • A DTC is to be set
5.11	1, 2, 4	A, C, D	<p>In case of a fault in the rear-wheel actuator that leads to a violation of a safety goal, the actuator is to communicate the fault to the EPS control module.</p>
5.12	1, 2, 4	A, C, D	<p>All single point faults of the rear-wheel actuator that lead to violations of a safety goal are to be detected within the fault detection interval and mitigated within the FTTI. In case of a failure, EPS system is to transition to Safe State 2 within TBD ms.</p> <ul style="list-style-type: none"> • Hardware faults include those occurring in the actuator electromagnetic circuit and the rotor position measuring mechanism (e.g., sensor), ICs, circuit components, printed circuit boards, I/O pins, signal connectors, and power connectors.

Table J-6. Functional Safety Requirements for the Mechanical Steering Assembly

Safety Req. ID	Safety Goal	ASIL	Safety Requirement
6.1	1, 2, 3	No ASIL	Reduction gear is to prevent locked gear conditions.
6.2	1, 2, 3	No ASIL	Reduction gear is to prevent conditions that may lead to gear damage.
6.3	1, 2, 3	No ASIL	Rack and pinion is to prevent any failure that leads to violation of a safety goal.
6.4	1, 2, 3	No ASIL	Steering column is to support a maximum torque value of TBD N•m. Failures of the EPS system are not to result in delivery of torque to the steering column that exceeds TBD N•m.
6.5	1, 2, 3	No ASIL	Mechanical steering system is to provide vehicle steering when the electric power steering-assist is not available.
6.6	1, 2, 3	No ASIL	Mechanical steering system is to meet the intended steering profile versus driver input force at all times and under all vehicle operating scenarios.
6.7	1, 2, 3	No ASIL	All single point faults that lead to failures in the mechanical steering system's primary function (i.e., provide vehicle steering) are to be prevented.
6.8	1, 2, 3	No ASIL	Mechanical steering system is to provide indication to the driver in case of any failures that affect the primary function (i.e., provide vehicle steering). <ul style="list-style-type: none"> • Indication to the driver may be described in the owner's manual.

Table J-7. Communication System Functional Safety Requirements

Safety Req. ID	Safety Goal	ASIL	Safety Requirement
7.1	1, 2, 3, 4	A, B, C, D	<p>All critical communication signals are to be qualified for validity and correctness (plausibility and rationality). The ASIL classifications for the signals are to correspond to the safety goal they are associated with. If a signal is associated with more than one safety goal, then it is to adhere to the higher ASIL classification. In case of a fault in any critical signal, the system detecting the fault is to:</p> <ul style="list-style-type: none"> • Inform the EPS control module of the fault • Invoke the correct failure mode effect mitigation strategy
7.2	1, 2, 3, 4	A, B, C, D	Communication bus is to support the communication of the EPS system with other vehicle systems in order to support the safe operation of the EPS system.
7.3	1, 2, 3, 4	A, B, C, D	Communication bus is to support the qualification of all critical communication signals between the EPS system and interfacing vehicle systems.
7.4	1, 2, 3, 4	A, B, C, D	Communication bus is to prevent the corruption of the critical communication bus signals during transmission between the EPS system and interfacing vehicle systems.
7.5	1, 2, 3, 4	A, B, C, D	In case of malfunction of the communication bus or communication bus module, the communication bus system is to inform the EPS control module of the fault.
7.6	1, 2, 3, 4	A, B, C, D	Communication bus is to detect an unauthorized access and inform the EPS control module.

Table J-8. Functional Safety Requirements for Interfacing Systems

Safety Req. ID	Safety Goal	ASIL	Safety Requirement
8.1	1, 2, 3, 4	A, B, C, D	Low voltage power supply is to provide the EPS system with the required low voltage (e.g., 12 volt) power supply for operation.
8.2	1, 2, 3, 4	No ASIL	Supply voltage and current are to meet the quality parameters (levels (min, max), ripple, transient, and overshoot) as set by the EPS system components. The ASIL classification of this requirement is to be based on the safety analysis and the safety goal impacted.
8.3	1, 2, 3, 4	A, B, C, D	EPS system is to be notified of any malfunction or disruption in the low voltage (e.g., 12 volt) power supply system operation.
8.4	1, 2, 3, 4	A, B, C, D	All communications and data transfer sent by the low voltage power system to the EPS system are to be qualified for validity and correctness (plausibility and rationality). This includes the low voltage power system diagnostics.
8.5	1, 2, 3, 4	A, B, C, D	In case of a malfunction, the low voltage power supply is to maintain the low voltage (e.g., 12 volt) power supply to the EPS system for a time that is longer than the longest FTTI of the EPS system.
8.6	1, 2, 3, 4	A, B, C, D	All single point failure modes that cause the loss of low voltage power are to be prevented or mitigated. <ul style="list-style-type: none"> The EPS system is to transition to Safe State 3 in case of the loss or malfunction of the vehicle's low voltage power system and a red light driver warning is to be issued to the driver.

Safety Req. ID	Safety Goal	ASIL	Safety Requirement
8.7	1, 2, 3, 4	A, B, C, D	<p>All requests or commands for steering torque from interfacing vehicle systems are to be sent to the EPS controller. This may include requests for:</p> <ul style="list-style-type: none"> • Steering torque increases from the ALC/ALK system • Torque modification from the brake/vehicle stability control system • Steering torque from the collision avoidance system
8.8	1, 2, 3, 4	A, B, C, D	All communications and data transfer regarding requests or commands for steering torque sent by interfacing vehicle systems to the EPS are to be qualified for validity and correctness (plausibility and rationality) by the sending systems.
8.9	1, 2, 3, 4	A, B, C, D	All interfacing systems are to inform the EPS system in case of any failure that may cause the system to transition into a degraded mode of operation.
8.10	1, 2, 3, 4	A, B, C, D	In case of a fault in the transmitted information to the EPS system from the interfacing system, the correct failure mode effect mitigation strategy is to be applied.

APPENDIX K: THREE-LEVEL MONITORING STRATEGY

The three-level monitoring strategy is a redundant design strategy that is employed to meet requirements for components that address high ASIL (C or D) hazards. When this design approach is applied to the EPS system, the EPS system will include two micro controllers: a main controller and an auxiliary controller.

The main controller is the one that runs the system. It receives the inputs, runs the algorithms, makes the decisions, and sends out the output. It is also the one that communicates with the rest of the vehicle systems, and takes the vehicle to a safe state in the case of a sufficiently severe hazard.

The sole purpose of the auxiliary controller is to ensure the health and “sanity” of the main controller. It cannot run any system controls. However, it is capable of shutting down the main controller and taking the vehicle into a safe state.

The three levels of the strategy can be described as follows:

Level 1: The main controller runs its calculations or algorithms. It re-runs them again using different calculation methods or algorithms. If the two results don't match, a fault is set, and a fault mitigation strategy is enacted.

Level 2: The auxiliary controller collects the inputs independently, and runs the calculations or algorithms that the main controller ran, although it uses different methods and algorithms. The auxiliary controller then compares its results to those of the main controller. If the results don't match, a fault is set, and a fault mitigation strategy is enacted.

Level 3: This level has different names in industry: “Seed & Key,” “Quizzer,” “Questions & Answers,” etc. It employs a set of scenarios or questions with pre-determined answers. The auxiliary controller poses these questions or scenarios to the main controller randomly. If the main controller does not respond correctly, then a fault is set, and a fault mitigation strategy is enacted.

**APPENDIX L: DIAGNOSTIC TROUBLE CODES RELEVANT TO THE EPS
SYSTEM**

Table L-1 Identification of Selected SAE J2012 DTCs for the EPS SystemL-2

Table L-2 Identification of Selected SAE J2012 DTCs for Critical EPS System InterfacesL-3

Table L-1. Identification of Selected SAE J2012 DTCs for the EPS System

SAE J2012 Code	Phenomenon	System or Component
C0051	Steering Wheel Position Sensor (Subfault)	Steering Wheel Angle Sensor
C0052	Steering Wheel Position Sensor "Signal A" (Subfault)	Steering Wheel Angle Sensor
C0053	Steering Wheel Position Sensor "Signal B" (Subfault)	Steering Wheel Angle Sensor
C0054	Steering Wheel Position Sensor "Signal C" (Subfault)	Steering Wheel Angle Sensor
C0055	Steering Wheel Position Sensor "Signal D" (Subfault)	Steering Wheel Angle Sensor
C0079	Variable Effort Steering (Subfault)	Variable Effort Steering
P0635	Power Steering Control Circuit	EPS Communications
P0636	Power Steering Control Circuit Low	EPS Communications
P0637	Power Steering Control Circuit High	EPS Communications
U0126	Lost Communication With Steering Angle Sensor Module	Steering Wheel Angle Sensor
U0130	Lost Communication With Steering Effort Control Module	Steering Wheel Torque Sensor
U0131	Lost Communication With Power Steering Control Module	EPS Control Module
U0134	Lost Communication With Power Steering Control Module	EPS Control Module
U0212	Lost Communication With Steering Column Control Module	Steering Wheel Lock Module
U0236	Lost Communication With Column Lock Module	Steering Wheel Lock Module
U0319	Software Incompatibility With Steering Effort Control Module	Steering Wheel Torque Sensor

Table L-2. Identification of Selected SAE J2012 DTCs for Critical EPS System Interfaces

SAE J2012 Code	Phenomenon	System or Component
C0030	Left Front Tone Wheel (Subfault)	Wheel Speed Sensor
C0031	Left Front-Wheel Speed Sensor (Subfault)	Wheel Speed Sensor
C0032	Left Front-Wheel Speed Sensor Supply (Subfault)	Wheel Speed Sensor
C0033	Right Front Tone Wheel (Subfault)	Wheel Speed Sensor
C0034	Right Front-Wheel Speed Sensor (Subfault)	Wheel Speed Sensor
C0035	Right Front-Wheel Speed Sensor Supply (Subfault)	Wheel Speed Sensor
C0036	Left Rear Tone Wheel (Subfault)	Wheel Speed Sensor
C0037	Left Rear-Wheel Speed Sensor (Subfault)	Wheel Speed Sensor
C0038	Left Rear-Wheel Speed Sensor Supply (Subfault)	Wheel Speed Sensor
C0039	Right Rear Tone Wheel (Subfault)	Wheel Speed Sensor
C003A	Right Rear-Wheel Speed Sensor (Subfault)	Wheel Speed Sensor
C003B	Right Rear-Wheel Speed Sensor Supply (Subfault)	Wheel Speed Sensor
C003C	Rear Tone Wheel (Subfault)	Wheel Speed Sensor
C003D	Rear-Wheel Speed Sensor (Subfault)	Wheel Speed Sensor
C003E	Rear-Wheel Speed Sensor Supply (Subfault)	Wheel Speed Sensor
C0040	Brake Pedal Switch "A" (Subfault)	Brake Pedal Switch
C0041	Brake Pedal Switch "B" (Subfault)	Brake Pedal Switch
C0042	Brake Pedal Position Sensor "Circuit A" (Subfault)	Brake Pedal Position Sensor
C0043	Brake Pedal Position Sensor "Circuit B" (Subfault)	Brake Pedal Position Sensor
C0044	Brake Pressure Sensor "A" (Subfault)	Brake Pressure Sensor
C0045	Brake Pressure Sensor "B" (Subfault)	Brake Pressure Sensor
C0046	Brake Pressure Sensor "A"/"B" (Subfault)	Brake Pressure Sensor
C0086	Vehicle Dynamics Indicator (Subfault)	Brake/Stability Control System
P0500	Vehicle Speed Sensor "A"	Vehicle Speed Sensor
P0501	Vehicle Speed Sensor "A" Range/Performance	Vehicle Speed Sensor
P0502	Vehicle Speed Sensor "A" Circuit Low	Vehicle Speed Sensor
P0503	Vehicle Speed Sensor "A" Intermittent/Erratic/High	Vehicle Speed Sensor
P0644	Driver Display Serial Communication Circuit	Instrument Panel System
P0650	Malfunction Indicator Lamp (MIL) Control Circuit	Instrument Panel System
P2158	Vehicle Speed Sensor "B"	Vehicle Speed Sensor
P2159	Vehicle Speed Sensor "B" Range/Performance	Vehicle Speed Sensor
P215A	Vehicle Speed - Wheel Speed Correlation	Vehicle Speed Sensor
P215B	Vehicle Speed - Output Shaft Speed Correlation	Vehicle Speed Sensor
P2160	Vehicle Speed Sensor "B" Circuit Low	Vehicle Speed Sensor
P2161	Vehicle Speed Sensor "B" Intermittent/Erratic/High	Vehicle Speed Sensor

SAE J2012 Code	Phenomenon	System or Component
P2162	Vehicle Speed Sensor "A"/"B" Correlation	Vehicle Speed Sensor
U0010	Medium Speed CAN Communication Bus	Communication Bus
U0011	Medium Speed CAN Communication Bus Performance	Communication Bus
U0012	Medium Speed CAN Communication Bus (+) Open	Communication Bus
U0013	Medium Speed CAN Communication Bus (+) Low	Communication Bus
U0014	Medium Speed CAN Communication Bus (+) High	Communication Bus
U0015	Medium Speed CAN Communication Bus (-) Open	Communication Bus
U0016	Medium Speed CAN Communication Bus (-) Low	Communication Bus
U0017	Medium Speed CAN Communication Bus (-) High	Communication Bus
U0018	Medium Speed CAN Communication Bus (-) shorted to Bus (+)	Communication Bus
U0019	Low Speed CAN Communication Bus	Communication Bus
U0020	Low Speed CAN Communication Bus Performance	Communication Bus
U0021	Low Speed CAN Communication Bus (+) Open	Communication Bus
U0022	Low Speed CAN Communication Bus (+) Low	Communication Bus
U0023	Low Speed CAN Communication Bus (+) High	Communication Bus
U0024	Low Speed CAN Communication Bus (-) Open	Communication Bus
U0025	Low Speed CAN Communication Bus (-) Low	Communication Bus
U0026	Low Speed CAN Communication Bus (-) High	Communication Bus
U0027	Low Speed CAN Communication Bus (-) shorted to Bus (+)	Communication Bus
U0028	Vehicle Communication Bus A	Communication Bus
U0029	Vehicle Communication Bus A Performance	Communication Bus
U0030	Vehicle Communication Bus A (+) Open	Communication Bus
U0031	Vehicle Communication Bus A (+) Low	Communication Bus
U0032	Vehicle Communication Bus A (+) High	Communication Bus
U0033	Vehicle Communication Bus A (-) Open	Communication Bus
U0034	Vehicle Communication Bus A (-) Low	Communication Bus
U0035	Vehicle Communication Bus A (-) High	Communication Bus
U0036	Vehicle Communication Bus A (-) shorted to Bus A (+)	Communication Bus
U0037	Vehicle Communication Bus B	Communication Bus
U0038	Vehicle Communication Bus B Performance	Communication Bus
U0039	Vehicle Communication Bus B (+) Open	Communication Bus
U0040	Vehicle Communication Bus B (+) Low	Communication Bus
U0041	Vehicle Communication Bus B (+) High	Communication Bus
U0042	Vehicle Communication Bus B (-) Open	Communication Bus
U0043	Vehicle Communication Bus B (-) Low	Communication Bus

SAE J2012 Code	Phenomenon	System or Component
U0044	Vehicle Communication Bus B (-) High	Communication Bus
U0045	Vehicle Communication Bus B (-) shorted to Bus B (+)	Communication Bus
U0046	Vehicle Communication Bus C	Communication Bus
U0047	Vehicle Communication Bus C Performance	Communication Bus
U0048	Vehicle Communication Bus C (+) Open	Communication Bus
U0049	Vehicle Communication Bus C (+) Low	Communication Bus
U0050	Vehicle Communication Bus C (+) High	Communication Bus
U0051	Vehicle Communication Bus C (-) Open	Communication Bus
U0052	Vehicle Communication Bus C (-) Low	Communication Bus
U0053	Vehicle Communication Bus C (-) High	Communication Bus
U0054	Vehicle Communication Bus C (-) shorted to Bus C (+)	Communication Bus
U0055	Vehicle Communication Bus D	Communication Bus
U0056	Vehicle Communication Bus D Performance	Communication Bus
U0057	Vehicle Communication Bus D (+) Open	Communication Bus
U0058	Vehicle Communication Bus D (+) Low	Communication Bus
U0059	Vehicle Communication Bus D (+) High	Communication Bus
U0060	Vehicle Communication Bus D (-) Open	Communication Bus
U0061	Vehicle Communication Bus D (-) Low	Communication Bus
U0062	Vehicle Communication Bus D (-) High	Communication Bus
U0063	Vehicle Communication Bus D (-) shorted to Bus D (+)	Communication Bus
U0064	Vehicle Communication Bus E	Communication Bus
U0065	Vehicle Communication Bus E Performance	Communication Bus
U0066	Vehicle Communication Bus E (+) Open	Communication Bus
U0067	Vehicle Communication Bus E (+) Low	Communication Bus
U0068	Vehicle Communication Bus E (+) High	Communication Bus
U0069	Vehicle Communication Bus E (-) Open	Communication Bus
U0070	Vehicle Communication Bus E (-) Low	Communication Bus
U0071	Vehicle Communication Bus E (-) High	Communication Bus
U0072	Vehicle Communication Bus E (-) shorted to Bus E (+)	Communication Bus
U0122	Lost Communication With Vehicle Dynamics Control Module	Brake/Stability Control System
U0123	Lost Communication With Yaw Rate Sensor Module	Yaw Rate Sensor
U0124	Lost Communication With Lateral Acceleration Sensor Module	Lateral Acceleration Sensor
U0129	Lost Communication With Brake System Control Module	Brake/Stability Control System

SAE J2012 Code	Phenomenon	System or Component
U0135	Lost Communication With Differential Control Module	Differential Control Module
U0136	Lost Communication With Differential Control Module	Differential Control Module
U0155	Lost Communication With Instrument Panel Cluster (IPC) Control Module	Instrument Panel System
U0316	Software Incompatibility With Vehicle Dynamics Control Module	Brake/Stability Control System
U0323	Software Incompatibility With Instrument Panel Control Module	Instrument Panel System
U0416	Invalid Data Received From Vehicle Dynamics Control Module	Brake/Stability Control System
U0423	Invalid Data Received From Instrument Panel Cluster Control	Instrument Panel System
U0436	Invalid Data Received From Differential Control Module	Differential Control Module
U0437	Invalid Data Received From Differential Control Module	Differential Control Module
U0513	Invalid Data Received From Yaw Rate Sensor Module	Yaw Rate Sensor
U0536	Invalid Data Received From Lateral Acceleration Sensor Module	Lateral Acceleration Sensor
U0555	Invalid Data Received From Remote Start Module	Remote Start Module
U3003	Battery Voltage	Battery
U300A	Ignition Switch	Ignition Switch
U300B	Ignition Input Accessory/On/Start	Ignition Switch
U300C	Ignition Input Off/On/Start	Ignition Switch
U300D	Ignition Input On/Start	Ignition Switch
U300E	Ignition Input On	Ignition Switch
U300F	Ignition Input Accessory	Ignition Switch
U3010	Ignition Input Start	Ignition Switch
U3011	Ignition Input Off	Ignition Switch

DOT HS 812 575
August 2018



U.S. Department
of Transportation
**National Highway
Traffic Safety
Administration**

