



U.S. Department
of Transportation

**Federal Highway
Administration**

Publication No. FHWA-TS-80-224

August 1980

(Reprinted July 1990)

Highway Subdrainage Design

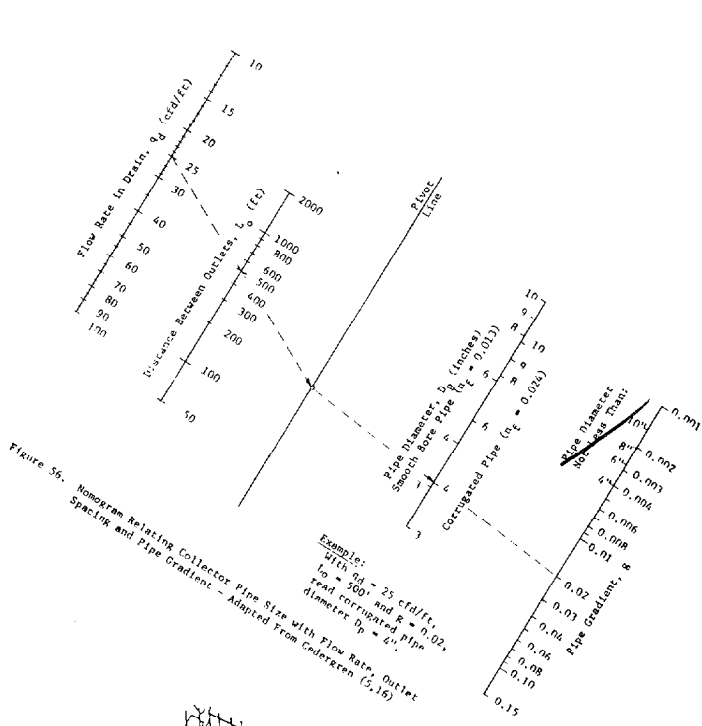

Figure 35. Nomogram relating collector pipe size with flow rate, outlet spacing, and pipe gradient - Adapted From Underkren (5,16)

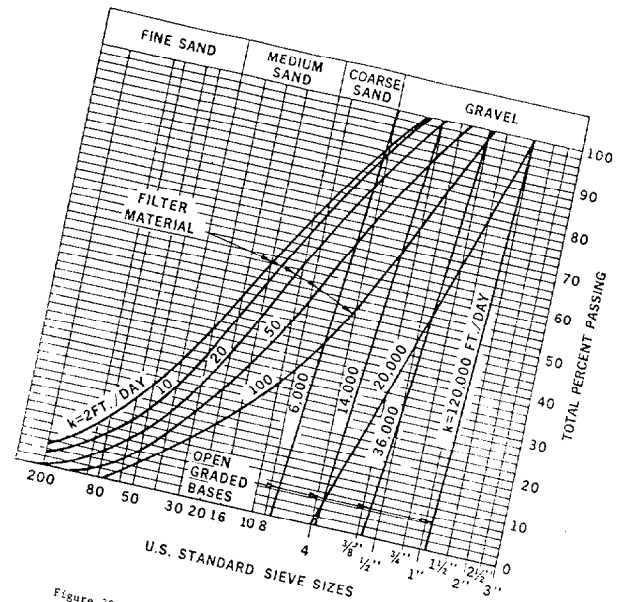

Figure 29. Typical Gradations and Permeabilities of Open Graded Bases and Filter Materials (5,16)

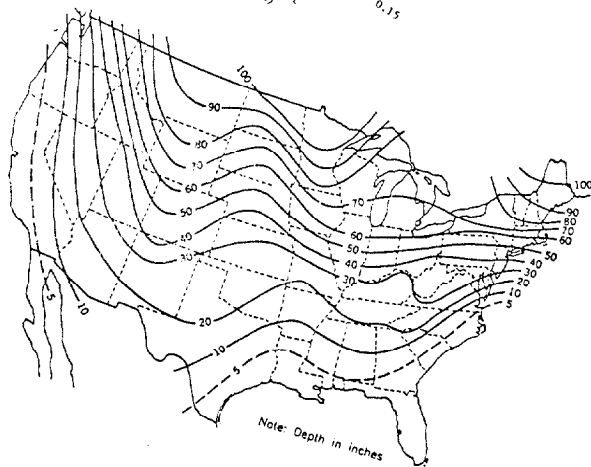

Figure 33. Maximum Depth of Frost Penetration In The United States (69)

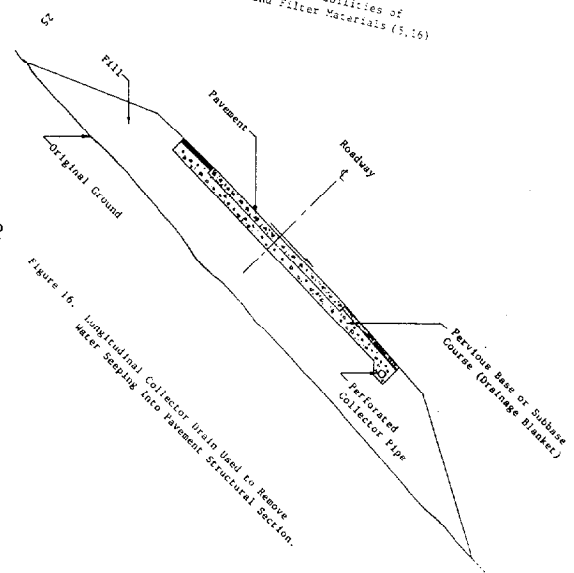

Figure 15. Longitudinal collector drain used to remove water seeping into pavement structural section.

PREFACE

The author wishes to express his sincere appreciation to the Federal Highway Administration and the many individuals and agencies that provided assistance during the preparation of this Manual. In particular, the author wishes to thank Mr. Edwin Granley of the Implementation Division of the Office of Development of FHWA, who served as project manager throughout the project. His patience and understanding will long be remembered.

The successful completion of this Manual would not have been possible without the wholehearted cooperation and technical assistance of Mr. George W. Ring of the Pavement Systems Group of the Structures and Applied Mechanics Division of the FHWA Office of Research. His continued support and encouragement are very much appreciated.

The author is very grateful to the members of the Transportation Research Board Committee A2K06 on Subsurface Drainage for their support of this project, for their review of the manuscript and their valuable suggestions. The contribution of the many other reviewers of the manuscript is also gratefully acknowledged.

Finally, the author wishes to express his appreciation to Mrs. Linda Sutherland for her untiring efforts in the preparation of the manuscript of the Manual.

NOTICE

This document is disseminated under the sponsorship of the Department of Transportation in the interest of information exchange. The United States Government assumes no liability for its contents or use thereof.

The contents of this report reflect the views of the Office of Development of the Federal Highway Administration, which is responsible for the facts and the accuracy of the data presented herein. The contents do not necessarily reflect the official views or policy of the Department of Transportation.

This report does not constitute a standard, specification, or regulation.

The United States Government does not endorse products or manufacturers. Trade or manufacturers' names appear herein only because they are considered essential to the object of this document.

Report No. FHWA-TS-80-224

HIGHWAY SUBDRAINAGE DESIGN

by

Lyle K. Moulton, Ph.D., P.E.
Professor of Civil Engineering
West Virginia University

and

Principal Engineer
TRIAD Engineering Consultants, Inc.
Morgantown, West Virginia

Sponsored by

Federal Highway Administration
Offices of Research and Development
Washington, D.C. 20590

August 1980

SUMMARY

Chapter I - General Considerations

This Chapter is devoted to a general discussion of the adverse effects of subsurface water, the types and sources of subsurface water and its movements, and the types of subsurface drainage installations that can be used either singly or in combination, to control this water. (Pages 1-40)

Chapter II - Data Required for Analysis and Design

Lists the data requirements for analysis and design and presents recommended procedures for assembling these data. (Pages 41-58)

Chapter III - Pavement Drainage

Presents methods and recommended criteria for the control of groundwater and infiltration in pavement structural sections. (Pages 60-113)

Chapter IV - Control of Groundwater

Deals with the more general control of groundwater away from the pavement. (Pages 114-140)

Chapter V - Construction and Maintenance

Presents a discussion of the construction and maintenance aspects of subdrainage systems. Recommendations are presented for construction techniques designed to insure that the subsurface drainage systems will actually function in the manner in which they were designed to function. Chapter V also presents recommendations for maintenance procedures designed to insure that subsurface drainage systems continue to perform satisfactorily for the life of the facility. In addition, the utilization of subsurface drainage for remedial purposes or in connection with pavement rehabilitation is discussed. (Pages 141-153)

TABLE OF CONTENTS

	Page
List of Tables	vi
List of Figures	vii
Chapter I - GENERAL CONSIDERATIONS	1
1.1 - Introduction	1
1.2 - Adverse Effects of Subsurface Water	2
1.2.1 <u>Stability of Slopes</u>	3
1.2.2 <u>Pavement Performance</u>	3
1.2.3 <u>Economic Considerations</u>	13
1.3 - Occurrence and Movement of Subsurface Water	13
1.3.1 <u>Types of Subsurface Water</u>	13
1.3.2 <u>Sources of Subsurface Moisture</u>	13
1.3.3 <u>Seepage (Movement) of Subsurface Moisture</u>	18
1.4 - Type and Uses of Highway Subdrainage	21
1.4.1 <u>Classifications of Highway Subdrainage</u>	21
1.4.2 <u>Longitudinal Drains</u>	26
1.4.3 <u>Transverse Drains</u>	26
1.4.4 <u>Drainage Blankets</u>	30
1.4.5 <u>Well Systems</u>	35
1.4.6 <u>Miscellaneous Drainage</u>	40
Chapter II - DATA REQUIRED FOR ANALYSIS AND DESIGN	41
2.1 - General	41
2.2 - Geometry of Flow Domain	41
2.2.1 <u>Highway Geometry</u>	41
2.2.2 <u>Subsurface Geometry</u>	44
2.3 - Properties of Materials	45
2.3.1 <u>Index Properties</u>	45
2.3.2 <u>Performance Characteristics</u>	45

Table of Contents (continued)

	Page
2.4 - Climatological Data	55
2.4.1 <u>Precipitation</u>	55
2.4.2 <u>Depth of Frost Penetration</u>	55
2.5 - Miscellaneous Considerations	58
Chapter III - PAVEMENT DRAINAGE	60
3.1 -- General	61
3.2 - Quantity of Water to be Removed	61
3.2.1 <u>Infiltration</u>	61
3.2.2 <u>Groundwater</u>	63
3.2.3 <u>Melt Water From Ice Lenses</u>	68
3.2.4 <u>Vertical Outflow</u>	73
3.2.5 <u>Net Inflow</u>	84
3.3 - Analysis and Design of Drainage Layers	87
3.3.1 <u>Thickness and Permeability</u>	87
3.3.2 <u>Filter Requirements</u>	98
3.3.3 <u>Special Considerations</u>	101
3.4 - Analysis and Design of Collection Systems	103
3.4.1 <u>General Considerations</u>	103
3.4.2 <u>Longitudinal Collectors</u>	104
3.4.3 <u>Transverse Collectors</u>	110
3.4.4 <u>Outlets</u>	111
Chapter IV - CONTROL OF GROUNDWATER	114
4.1 - General	114
4.2 - Longitudinal Interceptor Drains	114
4.3 - Multiple Interceptor Drains	123
4.4 - Symmetrical Drawdown Drains	124
4.5 - Miscellaneous Groundwater Control Measures	134
4.6 - Filter Protection in Groundwater Control	137

Table of Contents (continued)

	Page
Chapter V - CONSTRUCTION AND MAINTENANCE	141
5.1 - General	141
5.2 - Construction Operations	141
5.2.1 <u>General Precautions</u>	141
5.2.2 <u>Sequence of Construction Operations and</u> <u>Inspection</u>	143
5.3 - General Maintenance	144
5.3.1 <u>Cleaning of Collector Pipes</u>	144
5.3.2 <u>Maintenance of Outlets</u>	144
5.3.3 <u>Miscellaneous Maintenance and Other</u> <u>Considerations</u>	146
5.4 - Subsurface Drainage and Pavement Rehabilitation	146
REFERENCES	154

LIST OF TABLES

	Page
1. Typical values of soil permeability	47
2. Approximate correlation between permeability and Unified Soil Classification (59)	48
3. Average values of soil permeabilities (50)	49
4. Guidelines for selection of heave rate or frost susceptibility classification for use in Figure 38	72
5. Guidelines for using Equations (12) through (16) to compute net inflow, q_n , for design of pavement drainage	86
6. Summary of recommended inspection activities associated with subsurface drainage system installation	145
7. Description of drainage problems in pavement re- habilitation and their possible solution (adapted from Ring (25))	151

LIST OF FIGURES

	Page
1. Potentially Unstable Cut Slope Resulting From Uncontrolled Groundwater Flow	4
2. Typical Cut Slope Failure - Secondary Route 6339, Moore County, Tennessee (Photo Courtesy of William D. Trolinger, Tennessee Department of Transportation) . .	5
3. Potentially Unstable Fill Slope Resulting From the Damming of Wet Weather Groundwater Flow	6
4. Typical Slope Failure in Sidehill Fill - State Route 30, Rhea County, Tennessee (Photo Courtesy of William D. Trolinger, Tennessee Department of Transportation) .	7
5. Action of Free Water in A. C. Pavement Structural Sections Under Dynamic Loading	8
6. Pumping Phenomena Under Portland Cement Concrete Pavements	9
7. Capillary Moisture Migrating Toward Freezing Front To Feed The Growth of Ice Lenses	11
8. Seepage of Meltwater From Ice Lenses Into Pavement Structural Section	12
9. Capillary Moisture as a Function of The History of Watertable Position (28)	14
10. Schematic Illustration of the Occurrence of Groundwater in a Gravity-Flow System	16
11. Schematic Illustration of the Occurrence of Groundwater in an Artesian System	17
12. Points of Entrance of Water Into Highway Pavement Structural Sections	19
13. Paths of Flow of Surface and Subsurface Water in Portland Cement Concrete Pavement Structural Sections	22
14. Longitudinal Interceptor Drain Used to Cut Off Seepage and Lower the Groundwater Table	23

List of Figures (continued)

	Page
15. Symmetrical Longitudinal Drains Used to Lower the Water Table	24
16. Longitudinal Collector Drain Used to Remove Water Seeping Into Pavement Structural Section	25
17. Multiple, Multipurpose, Longitudinal Drain Installations	27
18. Multiple Longitudinal Drawdown Drain Installation	28
19. Transverse Drains on Superelevated Curve	29
20. Transverse Interceptor Drain Installation in Roadway Cut With Alignment Perpendicular to Existing Contours	31
21a. Plan Showing Drainage Details and Boring Locations at Towle Slide (35)	32
21b. Profile and Typical Section of Drainage Trench at Towle Slide (35)	33
22. Applications of Horizontal Drainage Blankets	35
23. Drainage Blanket (Wedge) on Cut Slope Drained by Longitudinal Collector Drain	36
24. Drainage Blanket Beneath Sidehill Fill Outletted by Collector Drain	37
25. Well System Used for Draining Unstable Slope (36)	38
26. Typical Sand Drainage Well Installation	40
27. Path of Subsurface Water in Drainage Layer	43
28. Chart For Estimating Coefficient of Permeability of Granular Drainage and Filter Materials	51
29. Typical Gradations and Permeabilities of Open Graded Bases and Filter Materials (5,16)	52
30. Chart For Determining Yield Capacity (Effective Porosity)	53
31. Summary of Results of All Standard Laboratory Freezing Tests Performed by the Corps of Engineers Between 1950 and 1970 (64)	64

List of Figures (continued)

	Page
32. The 1 Hour/1 Year Frequency Precipitation Rates for the United States (66)	56
33. Maximum Depth of Frost Penetration in the United States (69)	57
34. Rigid Pavement Section In Cut-Dimensions and Details for Examples 1, 3, 11, 13, 14 and 17	64
35. Flexible Pavement Section In Fill - Dimensions and Details for Examples 2, 12 and 15.	65
36. Chart for Determining Flow Rate in Horizontal Drainage Blanket	67
37. Artesian Flow of Groundwater Into a Pavement Drainage Layer - Dimensions and Details for Example 4	69
38. Chart for Estimating Design Inflow Rate of Melt Water From Ice Lenses	71
39. Vertical Outflow Toward An Underlying Watertable	74
40. Vertical Outflow Toward an Underlying Layer of Very High Permeability	75
41. Vertical and Lateral Outflow Through Embankment and its Foundation	76
42. Transient Flow Net for the Case of Vertical Outflow Toward an Existing Horizontal Watertable - Dimensions and Details for Example 6	78
43. Chart for Estimating Vertical Outflow From Pavement Structural Section Through Subgrade Soil to a Sloping Underlying Watertable	80
44. Chart for Estimating Vertical Outflow From a Pavement Structural Section Through the Subgrade to an Under- lying High Permeability Layer	82
45. Chart for Estimating Vertical Outflow From a Pavement Structural Section Through Embankment and Foundation Soil	83

List of Figures (continued)

	Page
46. Chart for Estimating Maximum Depth of Flow Caused by Steady Inflow (12)	88
47. Time Dependent Drainage of Saturated Layer (27, 79)	89
48. Plan and Profile of Proposed Roadway - Dimensions and Details for Example 16	93
49. Proposed Subsurface Drainage System for Flexible Pavement on Fill-Dimensions and Details for Example 16	94
50. Gradation Bands for Subbase, Drainage Layer, and Embankment Material - Examples 16 and 18	95
51. Layout of Proposed Drainage System Showing Direction of Flow in Drainage Layer - Details and Dimensions for Example 16	97
52. Gradation Bands for Subbase, Filter Layer and Subgrade Material - Example 17	100
53. Gradation Bands For Filter Layer and Embankment Material - Example 18	102
54. Typical Location of Shallow Longitudinal Collector Pipes	105
55. Typical Location of Deep Longitudinal Collector Pipes	106
56. Nomogram Relating Collector Pipe Size with Flow Rate, Outlet Spacing and Pipe Gradient - Adapted From Cedergren (5,16)	108
57. Recommended Detail for Outlet Pipe and Marker (16)	113
58. Multiple Interceptor Drain Installation	115
59. Flow Toward a Single Interceptor Drain	116
60. Flow Toward a Single Interceptor Drain When the Drawdown Can be Considered to be Insignificant at a Finite Distance, L_i , from the Drain	118

List of Figures (continued)

	Page
61. Chart for Determining Flow Rate in Interceptor Drains . . .	120
62. Chart for Determining Drawdown Curves for Interceptor Drains	121
63. Example No. 21 - Flow Net, Dimensions and Details	122
64. Example No. 22 - Dimensions and Details Required for the use of Figures 61 and 62.	125
65. Example No. 22 - Flow Net, Dimensions and Details	126
66. Division of a Symmetrical Drawdown Drain Problem Into Two Equivalent Fragments	128
67. Free Water Surfaces Based on Gilboy Modification of Dupuit Theory	129
68. Chart for Determining Flow Rate in Symmetrical Underdrains	131
69. Chart for Determining the Maximum Height of Free Water Surface Between Symmetrical Underdrains	132
70. Example No. 23 - Flow Net, Dimensions, and Details	133
71. Localized Surface Drains. (a) Cross-Section of Fill. (b) Draining a Single Spring. (c) Draining a Group of Springs. After Cedergren (11)	136
72. Typical Filter System for Interceptor Drain Using Only Filter Aggregates	138
73. Typical Filter System for Interceptor Drain Using Coarse Filter Aggregate and Filter Fabric	138
74. Typical Components of Prefabricated Fin Drains (96)	140
75. Installation of Prefabricated Fin Drain in Trench (96). . .	140
76. Drains at Cracks and Joints (25)	149
77. Combined Edge and Joint Drains (25)	149

List of Figures (continued)

	Page
78. Utilizing New Edge and Lateral Drains With Existing Drain Pipe (25)	150
79. Providing New Drainage Capabilities Through the Shoulder (25)	150

METRIC CONVERSION FACTORS

Approximate Conversions to Metric Measures		Approximate Conversions from Metric Measures		
Symbol	When You Know	Multiply by	To Find	Symbol
LENGTH				
in	inches	2.5	centimeters	cm
ft	feet	30	centimeters	cm
yd	yards	0.9	meters	m
mi	miles	1.6	kilometers	km
AREA				
in ²	square inches	6.5	square centimeters	cm ²
ft ²	square feet	0.09	square meters	m ²
yd ²	square yards	0.8	square meters	m ²
mi ²	square miles	2.6	square kilometers	km ²
	acres	0.4	hectares	ha
MASS (weight)				
oz	ounces	28	grams	g
lb	pounds	0.45	kilograms	kg
	short tons	0.9	tonnes	t
	(2000 lb)			
VOLUME				
teaspoon	teaspoons	5	milliliters	ml
Tablespoon	tablespoons	15	milliliters	ml
fl oz	fluid ounces	30	milliliters	ml
c	cups	0.24	liters	l
pt	pints	0.47	liters	l
qt	quarts	0.96	liters	l
gal	gallons	3.8	liters	l
ft ³	cubic feet	0.03	cubic meters	m ³
yd ³	cubic yards	0.76	cubic meters	m ³
TEMPERATURE (exact)				
°F	Fahrenheit temperature	5/9 (after subtracting 32)	Celsius temperature	°C
TEMPERATURE (exact)				
°C	Celsius temperature	9/5 (then add 32)	Fahrenheit temperature	°F

*1 in. = 2.54 (exactly). For other exact conversions and more detailed tables, see NBS Misc. Publ. 286, Units of Weights and Measures, Price \$2.25, SD Catalog No. C13.1U-286.

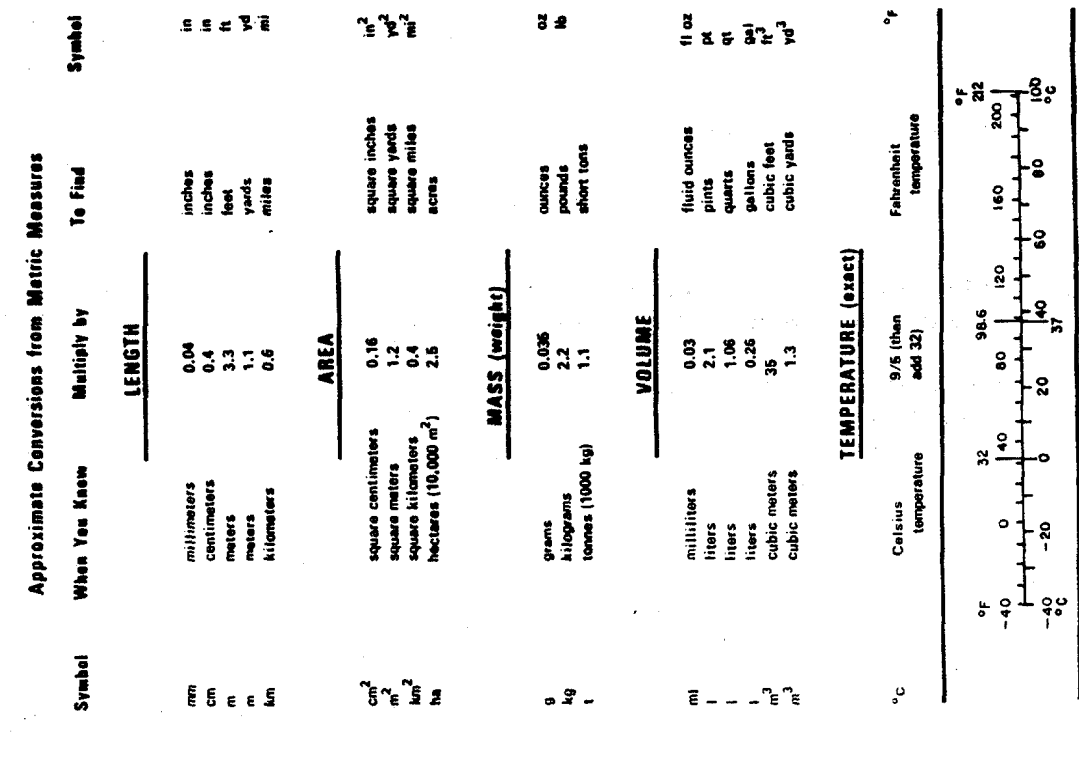
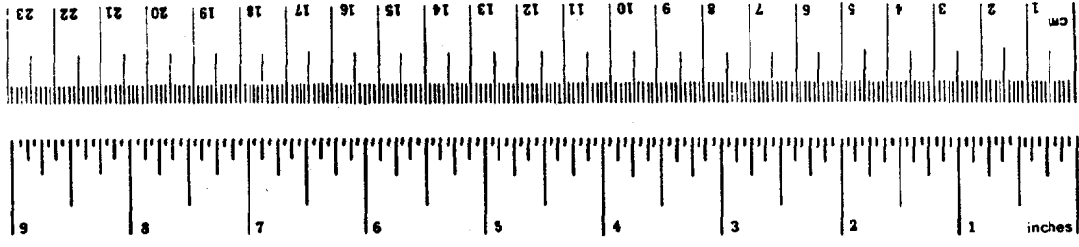

DISCLAIMER

- ❖ This document has been reproduced from the best copy furnished by the sponsoring agency. It is being released in the interest of making available as much information as possible.

Chapter I - GENERAL CONSIDERATIONS

1.1 - Introduction

It would be difficult, if not impossible, to select the date when the early road builders first became aware of the need for adequate subsurface drainage. However, there is some evidence that this need was recognized almost as soon as formal road building began (1,2)¹. Certainly, by the middle of the 18th Century, it was understood that appropriate subsurface drainage was absolutely necessary for the satisfactory long term performance of roadways. The subsequent introduction of "french drains" and the pavement systems of Tresaguet and MacAdam shows not only an understanding of the problem, but an attempt to incorporate into the roadway design formal measures for the satisfactory removal of water from the pavement structure and subgrade (2,3). In the years that have followed these early beginnings, the number of published accounts of research dealing with highway subsurface drainage has undergone a substantial growth (4,5). In addition, there has been a steady growth in the knowledge and availability of solutions to problems of fluid flow through porous media (6,7,8,9,10,11,12). Consequently, we now recognize and understand many of the problems that can be created by excessive subsurface moisture, and we have the means available to provide for the satisfactory control of this moisture. It is the purpose of this manual to provide the designer with the tools to analyze subdrainage problems and to design subsurface drainage facilities to adequately solve these problems.

It is difficult to separate the design of subsurface drainage from the design of other elements of a highway. In fact, it cannot, in the final analysis, be eliminated from consideration with respect to the stability of slopes, design of pavements, etc. However, as far as the assembly of data on highway geometry and material properties is concerned, we do need a starting point. Thus, it is recommended that the normal highway and pavement design practice be followed to develop general cross-sections, whether this involves individual detailed analysis and design or the utilization of design standards. This will yield a highway geometry and material properties that can then be subjected to analysis and design for subsurface drainage. This procedure may result in some changes in the design in order to provide adequate drainage as recommended in this manual, but it is felt that this approach tends to be less confusing than attempting to incorporate detailed consideration of subsurface drainage into the design from the outset. It will also permit the use of specialized personnel for the analysis and design of subsurface drainage, if this is considered to be desirable.

¹Numbers in parenthesis refer to the reference list, which begins on page 154.

The remainder of Chapter I is devoted to a general discussion of the adverse effects of subsurface water, the types and sources of subsurface water and its movements, and the types of subsurface drainage installations that can be used either singly or in combination, to control this water. Chapter II lists the data requirements for analysis and design and presents recommended procedures for assembling these data. Chapter III presents methods and recommended criteria for the control of groundwater and infiltration in pavement structural sections. Chapter IV deals with the more general control of groundwater away from the pavement, and Chapter V presents a discussion of the construction and maintenance aspects of subdrainage systems. Recommendations are presented for construction techniques designed to insure that the subsurface drainage system will actually function in the manner in which it was designed to function. Chapter V also presents recommendations for maintenance procedures designed to insure that subsurface drainage systems continue to perform satisfactorily for the life of the facility. In addition, the utilization of subsurface drainage for remedial purposes or in connection with pavement rehabilitation is discussed.

Many of the techniques for the analysis and design of subdrainage systems have been simplified for inclusion in this manual, and considerable use is made of solutions in chart form. Examples are presented to illustrate the recommended analysis and design procedures and the use of the various charts.

Although it is felt that the treatment of highway subsurface drainage in this publication is a comprehensive one, the infinite variety of seepage and drainage problems that can occur in nature is such that absolute coverage is impossible. The methods of analysis and design presented here are considered to be tools to aid in solving subsurface drainage problems - there are no standard solutions. The subdrainage problems encountered on each highway, or section of highway, will commonly be different and will require individual consideration and treatment. This manual can help in this regard, but it cannot substitute for the efforts of a well trained and experienced designer working with reliable field and laboratory data and exercising good engineering judgment.

1.2 - Adverse Effects of Subsurface Water

Excessive and uncontrolled subsurface water is known or suspected to have been responsible for a very large amount of unsatisfactory highway performance and many outright failures (5). In general, these adverse effects of subsurface water can be placed in two general categories: (a) slope instability, including the sloughing and sliding of cut slopes and sidehill fills; and (b) unsatisfactory pavement perfor-

mance as manifested in premature rutting, cracking, faulting, increasing roughness, and a relatively rapid decrease in the level of serviceability.

1.2.1 Stability of Slopes. Slope instability results when the applied shear stresses exceed the strength of the soil or rock mass along a potential sliding surface. Subsurface water can contribute to this instability by increasing the stress level and decreasing the shear strength. Seepage forces, resulting from the viscous drag that is created by the flow of water through a porous medium, can add substantially to the level of the stresses that must be resisted. At the same time, the porewater pressures within the slope reduce the level of effective normal stresses, thus reducing the effective shear strength (11,13). The result could be minor slope sloughing or a complete slope failure. Figure 1 shows schematically the development of one type of subsurface flow that can lead to cut slope instability. Figure 2 shows a typical cut slope failure for which the uncontrolled flow of groundwater was, at least partially, responsible. The manner in which a sidehill fill can function to dam the natural flow of groundwater is illustrated in Figure 3. This trapping of the groundwater can result in a loss of strength of the natural soil and/or the fill and lead to its ultimate collapse, as shown in Figure 4.

1.2.2 Pavement Performance. Excessive moisture in the pavement structure (surface, base and subbase) and the underlying subgrade can cause a wide variety of problems, leading to early pavement distress and ultimately to complete destruction of the pavement, if remedial measures are not undertaken.

If the pavement structural section and subgrade can become saturated, by groundwater, and/or infiltration, its ability to transmit the dynamic loading imposed by traffic can be greatly impaired (5,14, 15,16).

In asphaltic concrete pavement systems, this impairment is primarily the result of the temporary development of very high pore water pressures and the consequent loss of strength in unbound base, subbase and subgrade under dynamic loading (5,16). This action is illustrated schematically in Figure 5. In some instances, the pressures induced in the free water may be sufficient to cause it to be ejected through cracks in the pavement surface along with suspended fines (5). A similar ejection of water and fines, or pumping, can occur at the joints or edges of Portland cement concrete pavements, although the mechanism is different.

Shortly after a Portland cement concrete pavement has been completed, it is possible that small spaces can exist under the joints because of the thermally induced upward curl of the pavement slabs (see Figure 6a). These spaces can become enlarged under the action

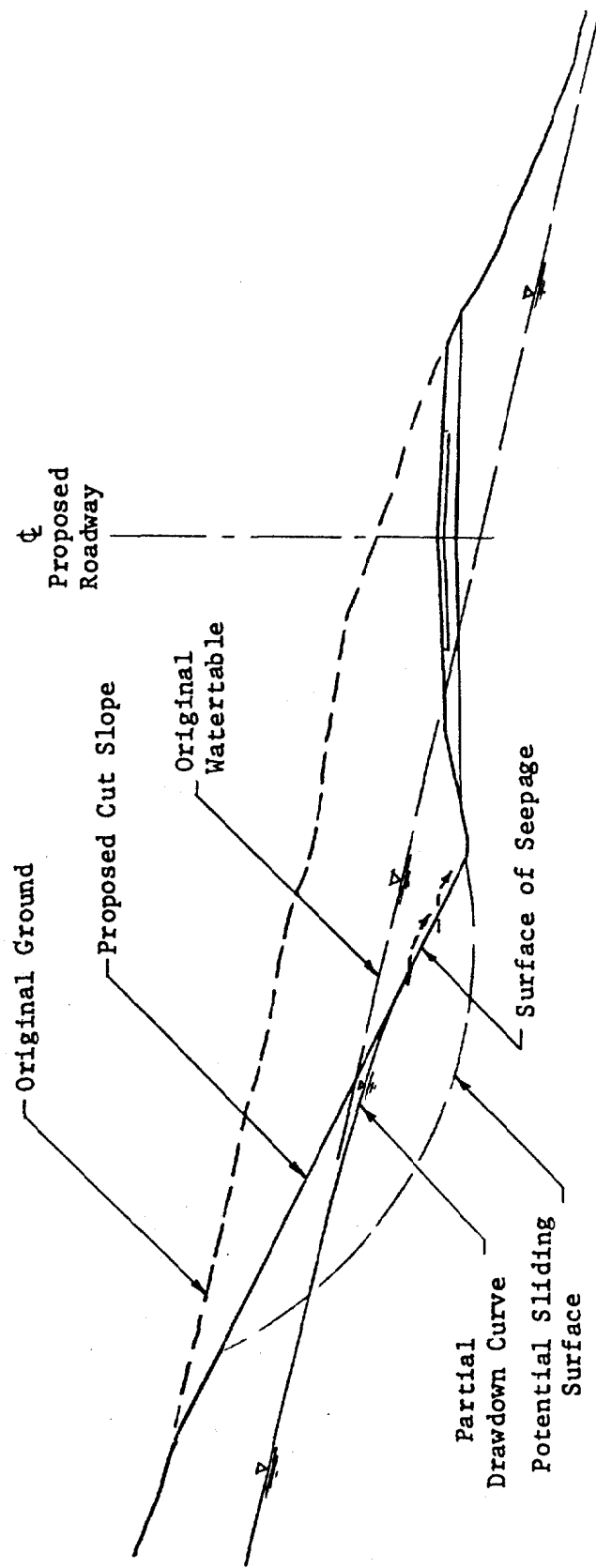

Figure 1. Potentially Unstable Cut Slope Resulting From Uncontrolled Groundwater Flow

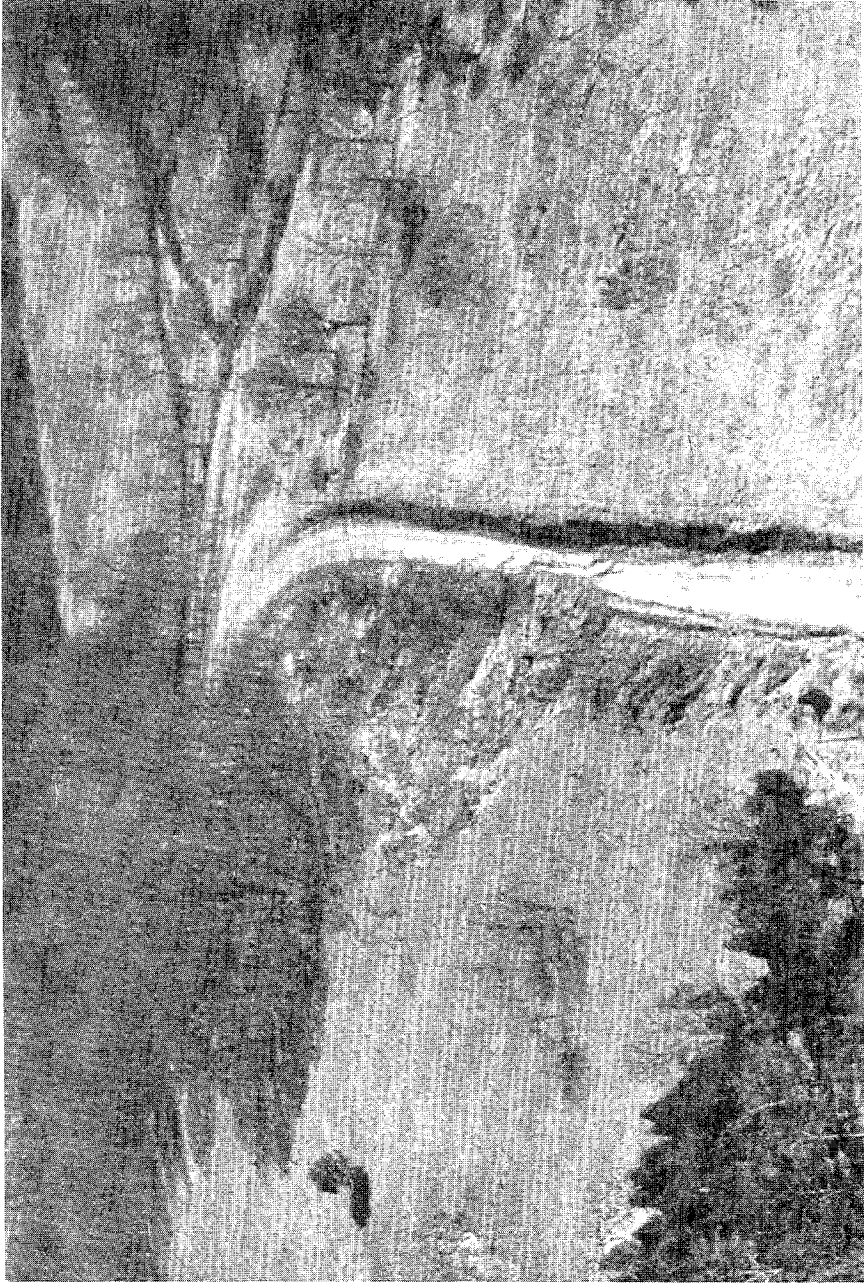

Figure 2. Typical Cut Slope Failure - Secondary Route 6339, Moore County, Tennessee (Photo Courtesy of William D. Trolinger, Tennessee Department of Transportation)

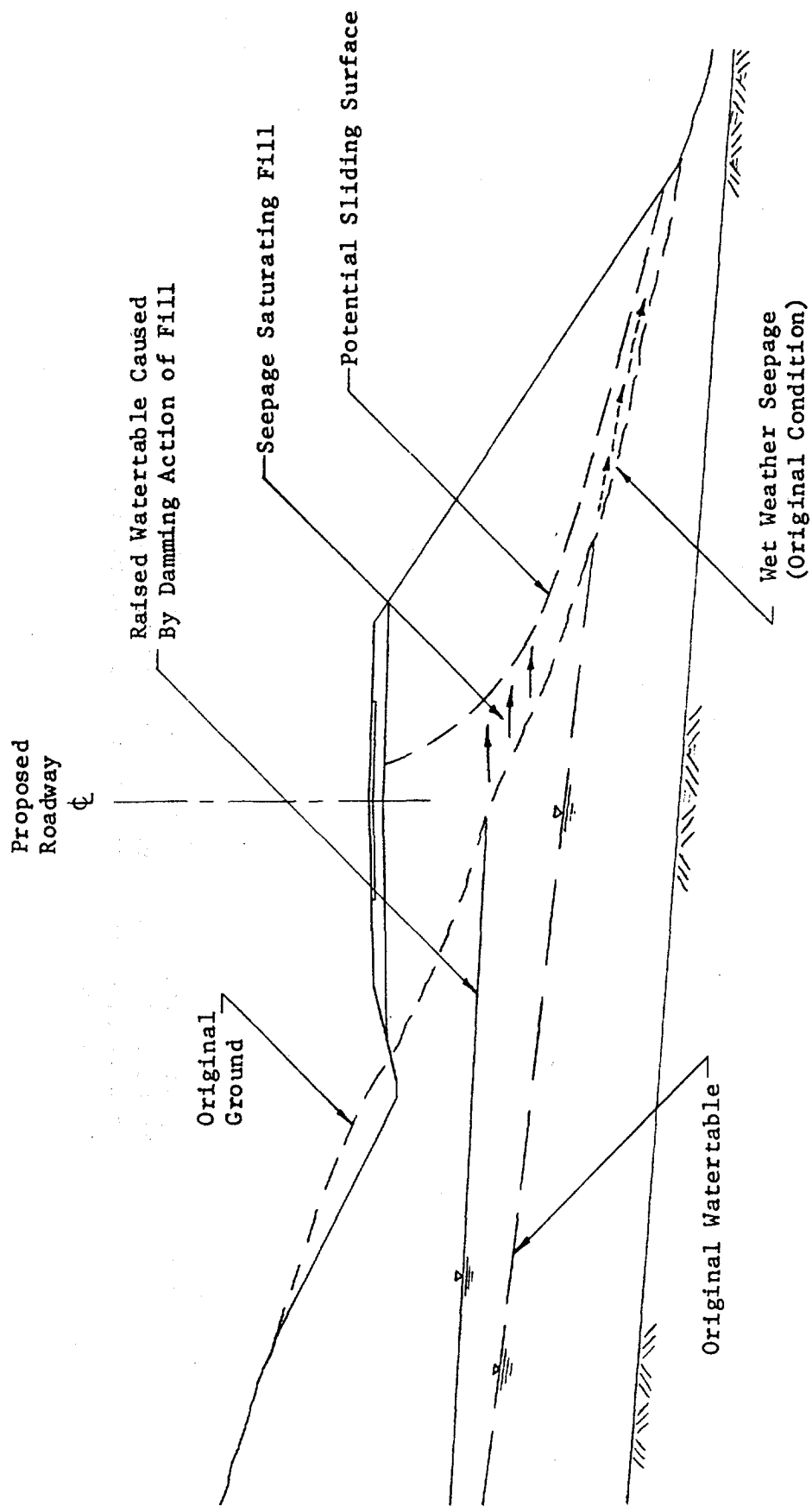
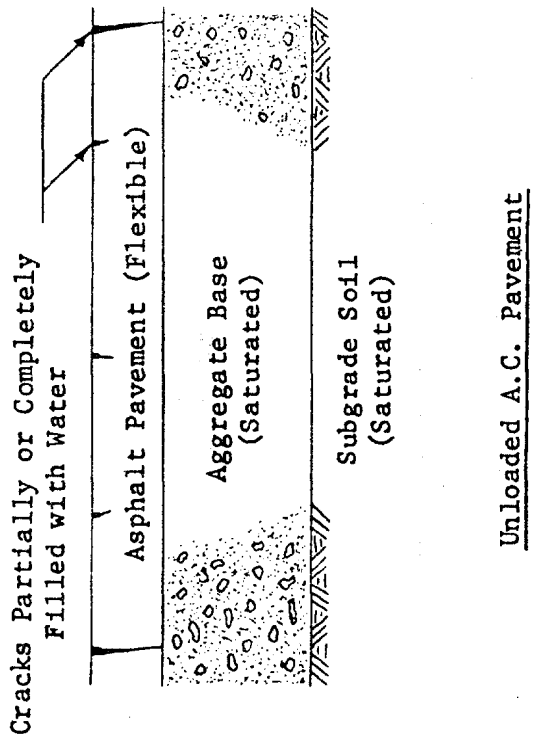
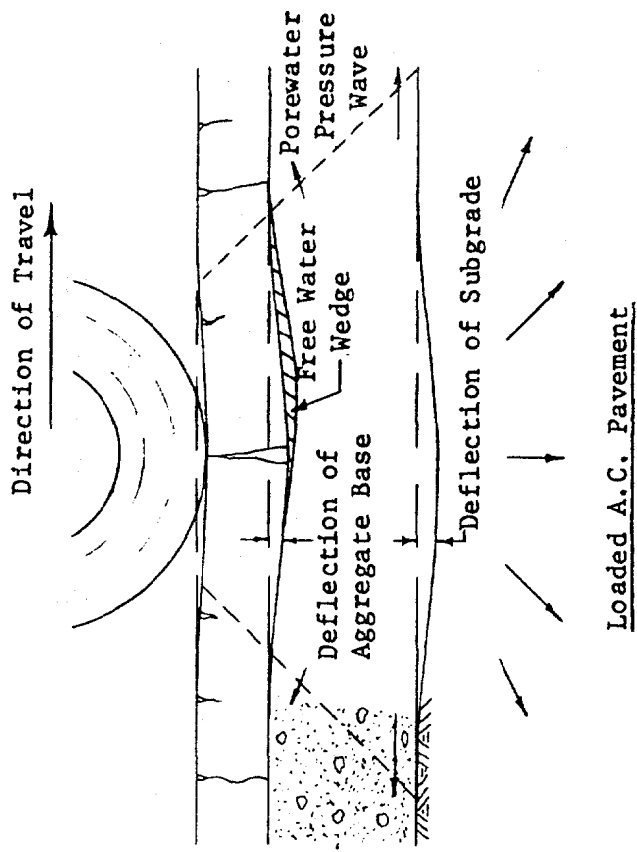

Figure 3. Potentially Unstable Fill Slope Resulting From The Damming of Wet Weather Groundwater Flow

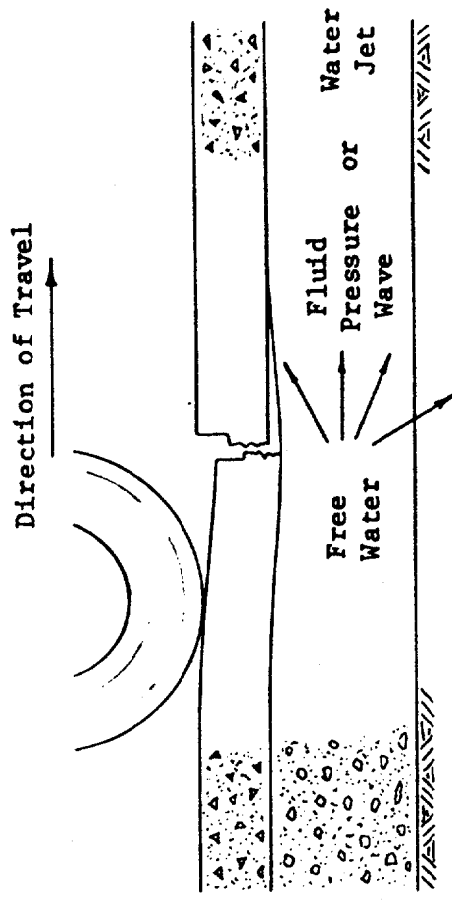

Figure 4. Typical Slope Failure in Sidehill Fill - State Route 30, Rhea County, Tennessee (Photo Courtesy of William D. Trolinger, Tennessee Department of Transportation)



Note: Vertical dimensions of deformations are exaggerated for clarity.

Figure 5. Action of Free Water in A.C. Pavement Structural Sections Under Dynamic Loading (16)



Subgrade Soil
(Saturated)

Unloaded P.C.C. Pavement
(a)

(b)

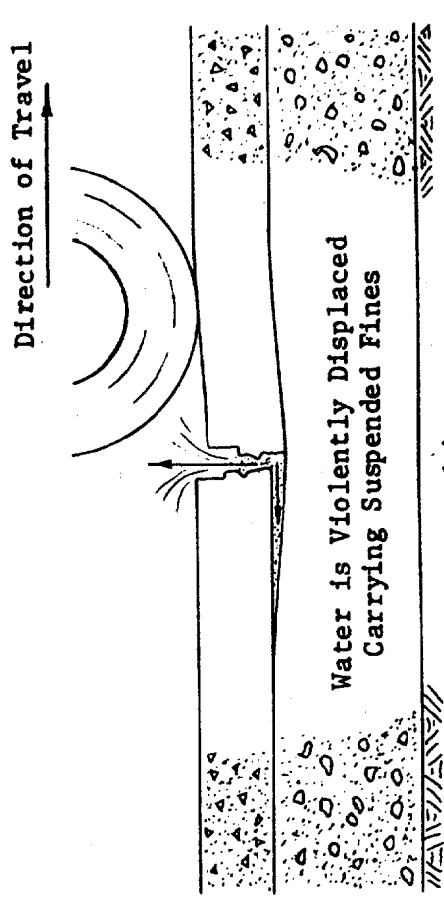

(c)

Loaded P.C.C. Pavement

Note: Vertical dimensions of deformations are exaggerated for clarity.

Figure 6. Pumping Phenomena Under Portland Cement Concrete Pavements (16)

of traffic because of the localized compaction or permanent deformation of the underlying materials caused by slab deflection. When the base and subgrade are saturated and free water exists beneath the joint, an approaching wheel load causes the trailing edge of the slab to deflect downward (see Figure 6b), sending a fluid pressure wave or water jet in a forward direction. As the wheel passes over the joint, the trailing slab rebounds upward as the leading edge of the next slab is deflected downward (see Figure 6c). This results in erosion of material from under the leading edges, ejection of water and fines from the joints, and the deposition of some material under the trailing edges (17). Should this pumping continue for any extended period of time, faulting may occur and the pavement slabs may crack because of the lack of adequate support (5,16,18). Distress in pavement slabs can also be caused by pumping along the edges of the pavement. These phenomena have been studied extensively and, although a number of remedial measures have been suggested, it appears that the most effective approach to the problem is to prevent the accumulation of water beneath the pavement slabs by means of a combination of effective joint seals and subsurface drainage (5,16).

Another adverse effect that uncontrolled moisture can have on pavement systems results from the several phenomena which are collectively referred to as frost action (19,20). Frost action requires the presence of a readily available supply of subsurface moisture, frost susceptible soils, and a sustained period of subfreezing temperatures. If all these requisites are satisfied, then moisture will migrate through the capillary fringe (Sec. 1.3) toward the freezing front to feed the growth of ice lenses, as illustrated in Figure 7. During the active freezing period, the growth of ice lenses can result in substantial heave of the overlying pavement structure. This can cause significant damage to a pavement, particularly if differential frost heaving is experienced. However, the most potentially destructive effect of frost action is associated with the loss of support during spring thaw. The thawing of the ice lenses leaves the subgrade soil saturated, or possibly supersaturated, resulting in a substantial reduction in its strength. Moreover, since the thawing generally takes place from the top down, the only way the excess moisture can drain from the subgrade soil is by flowing into any available voids that may exist in the pavement structural section, as shown in Figure 8. If the pavement structure (base, subbase) is not adequately drained, it may become saturated with the water being squeezed from the subgrade and the destructive mechanisms previously discussed (Figure 5 and 6) may become operative. The resulting pavement deterioration is generally referred to as spring breakup (19,20).

The frequent or sustained presence of excess moisture in pavement components and intermittent exposure to cycles of freezing and thawing can result in the loss of structural integrity. In Portland cement concrete pavements containing certain aggregates, this may appear as D-cracking (21,22), and as stripping or accelerated weathering in bituminous mixtures (23). In either case there is evidence that excluding

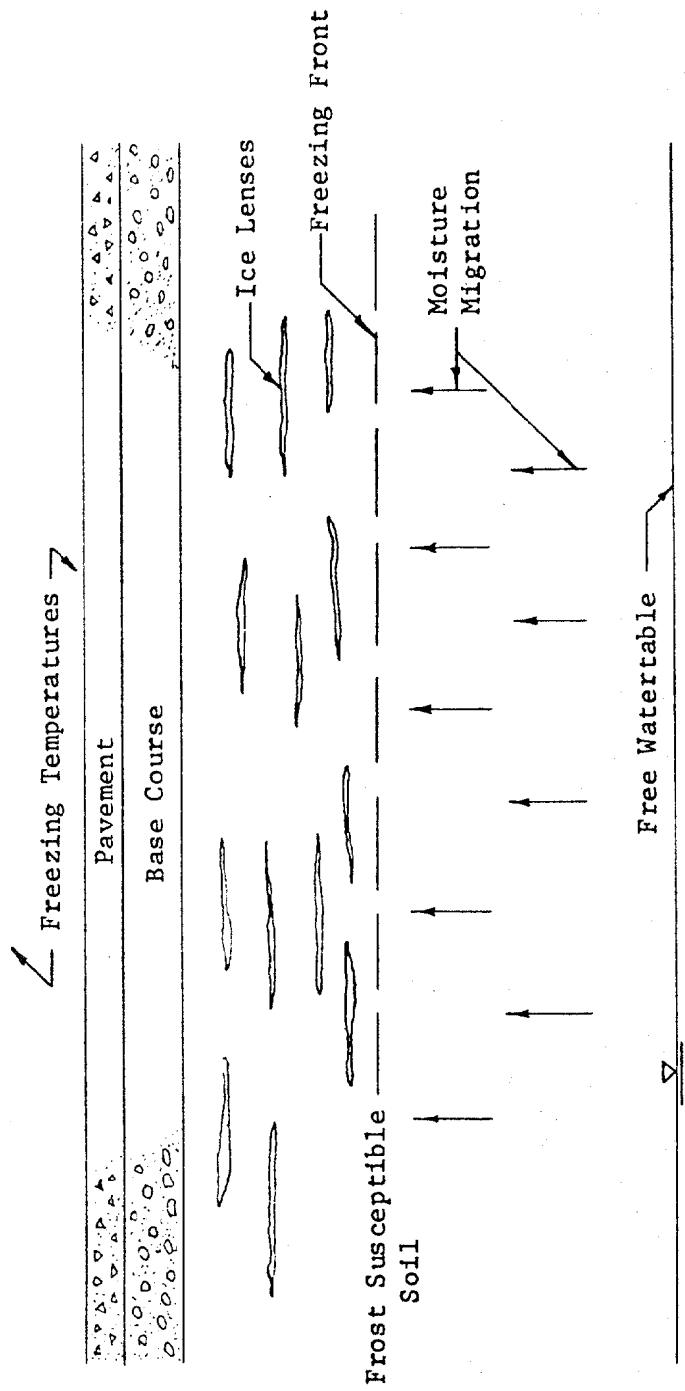

Figure 7. Capillary Moisture Migrating Toward Freezing Front To Feed The Growth of Ice Lenses

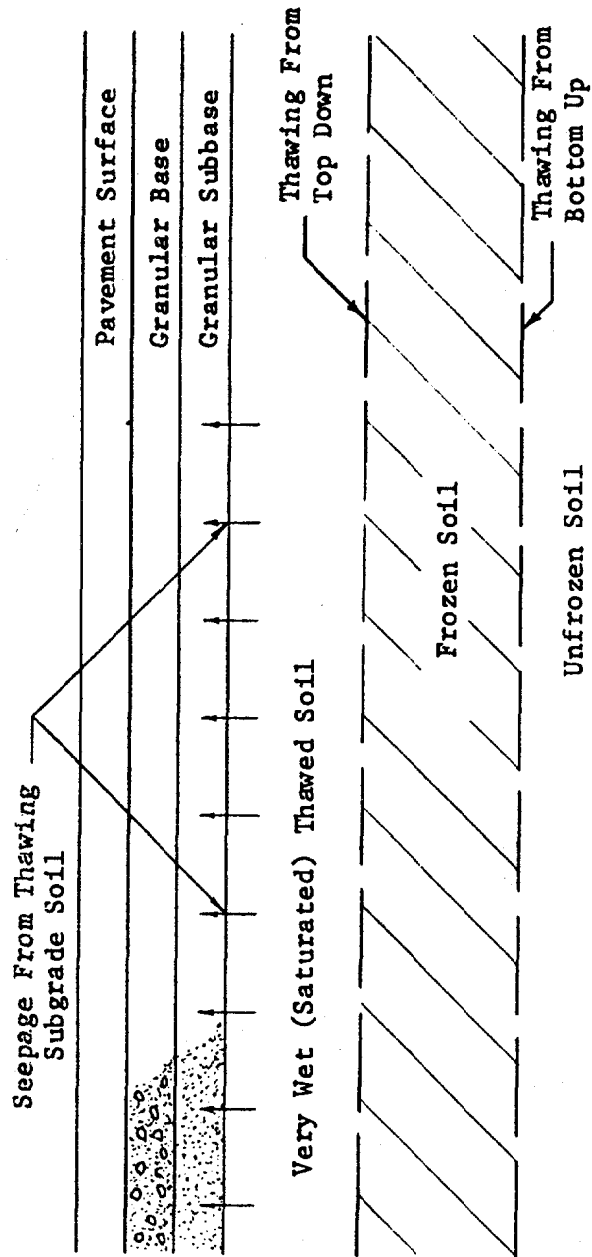

Figure 8. Seepage of Meltwater From Ice Lenses Into Pavement Structural Section

excess moisture or providing for its rapid removal with appropriate drainage can be beneficial in minimizing damage from these causes (5).

1.2.3 Economic Considerations. In the preceding paragraphs, many of the adverse effects of excessive and uncontrolled subsurface water on highway performance have been discussed. However, in many instances, the economic considerations can overshadow the physical aspects of unsatisfactory highway performance. For example, in several areas of the United States, very large annual expenditures are required for remedial construction and maintenance connected with landslides (13,24). In many cases, it has been found that uncontrolled subsurface waters have played an important role in causing the failures. In most instances, the corrective measures have included the installation of some type of subsurface drainage (13,24). Although definitive records are rarely available, it is very likely that the lack of adequate subsurface drainage also leads to large annual expenditures for pavements, in the form of shortened life and increased maintenance and rehabilitation costs (5,16,25). The economic comparisons and cost-benefit analyses that are available have demonstrated that there can be a very substantial long term economic advantage in providing for adequate subsurface drainage where needed as part of the original design and construction (5,16).

1.3 - Occurrence and Movement of Subsurface Water

1.3.1 Types of Subsurface Water. Subsurface water can exist in a variety of forms, including (a) water vapor, (b) bound moisture (c) capillary moisture, and (d) gravitational or free water (6,7,10,12).

Water vapor is generally present in the pores above the zone of saturation. Although water movement in the vapor phase has been studied extensively, for our purposes the total amount of water transmitted in the vapor phase can be considered negligible, and it will not be given further consideration.

Bound moisture is generally considered to be of two types: (a) hygroscopic (absorbed) moisture and (b) oriented (pellicular) water. Hygroscopic moisture is so tightly bound to the surface of the soil particles that it is considered to be immobile, and it can only be removed after being transformed into the vapor phase by some means, such as drying at elevated temperatures. The oriented moisture is not considered to be as tightly bound as hygroscopic moisture. Although it can be moved under the action of an attraction gradient, it will not flow under the force of gravity and, therefore, will not be given further consideration.

Capillary moisture is water held in the pores of a soil above the level of saturation (water table, free water surface, or phreatic line) under the action of surface tension forces, as shown in Figure 9a. The height of the capillary fringe and the shape of the moisture-tension

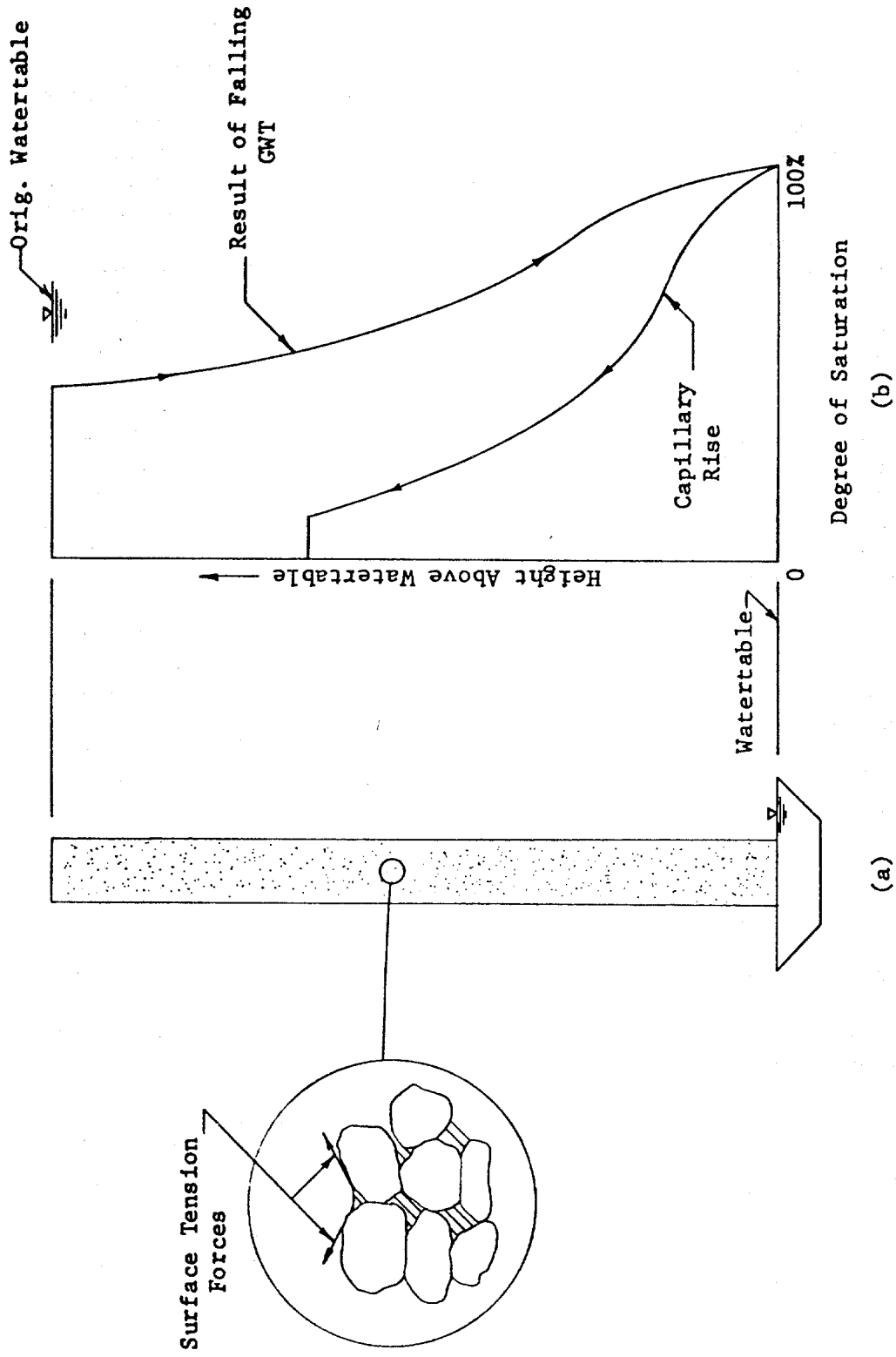

Figure 9. Capillary Moisture as a Function of The History of Water table Position (28)

curve is a function of the pore size distribution in the soil, which is related to its grain size distribution and density (26,27). Figure 9b shows that the degree of saturation resulting from capillarity is also a function of the history of the position of the water table (28). Direct consideration of this phenomenon in seepage analysis is difficult, but it can be considered indirectly by modifying the concept of porosity (see Sec. 2.3). It is important to recognize that since capillary moisture is held in the pores of the soil above the free water surface, against the force of gravity, it cannot be removed by gravity. Thus, the only means available for the control of capillary moisture are through lowering the water table with appropriate subdrainage or providing for a positive barrier (27) against capillary rise.

Gravitational or free moisture is water in liquid form that is free, as its name implies, to move under the force of gravity and/or hydraulically induced pressure gradients. It will, therefore, obey the laws of fluid mechanics and hydraulics. The control of free water will be our primary concern hereafter, and it will be for this purpose that the subsurface drainage will be designed.

1.3.2 Sources of Subsurface Water. The analysis and design of highway subsurface drainage systems involves the consideration of subsurface water from a wide variety of sources. However, it is convenient to consider these sources of drainable subsurface water in two broad general categories: (a) groundwater, which is defined as the water existing in the natural ground in the zone of saturation below the water table and (b) infiltration, which is defined (for the purposes of this publication) as surface water that gets into the pavement structural section by seeping down through joints or cracks in the pavement surface, through voids in the pavement itself, or from ditches along the side of the road.

The main source of groundwater is precipitation, which may penetrate the soil directly or may enter streams, lakes or ponds and percolate from these temporary storage areas to become groundwater. This source may be supplemented by artificial recharge in the form of irrigation. The occurrence of groundwater from these sources is illustrated schematically in Figure 10. The groundwater shown in Figure 10 is part of a "gravity-flow system" in that one of the boundaries defining the flow domain is a free water surface. Another common occurrence of groundwater is in the "artesian system" as illustrated in Figure 11. Under these circumstances, a "perched" water table may exist and the water in the confined or partially confined aquifer may be under substantial fluid pressure.

Although the free water from melting ice lenses commonly exists above the water table, as shown in Figure 8, it is generally considered that this is groundwater. The water that feeds the growth of ice lenses originates at the base of the capillary fringe (i.e. at the water table), and no frost action could take place without water from this source.

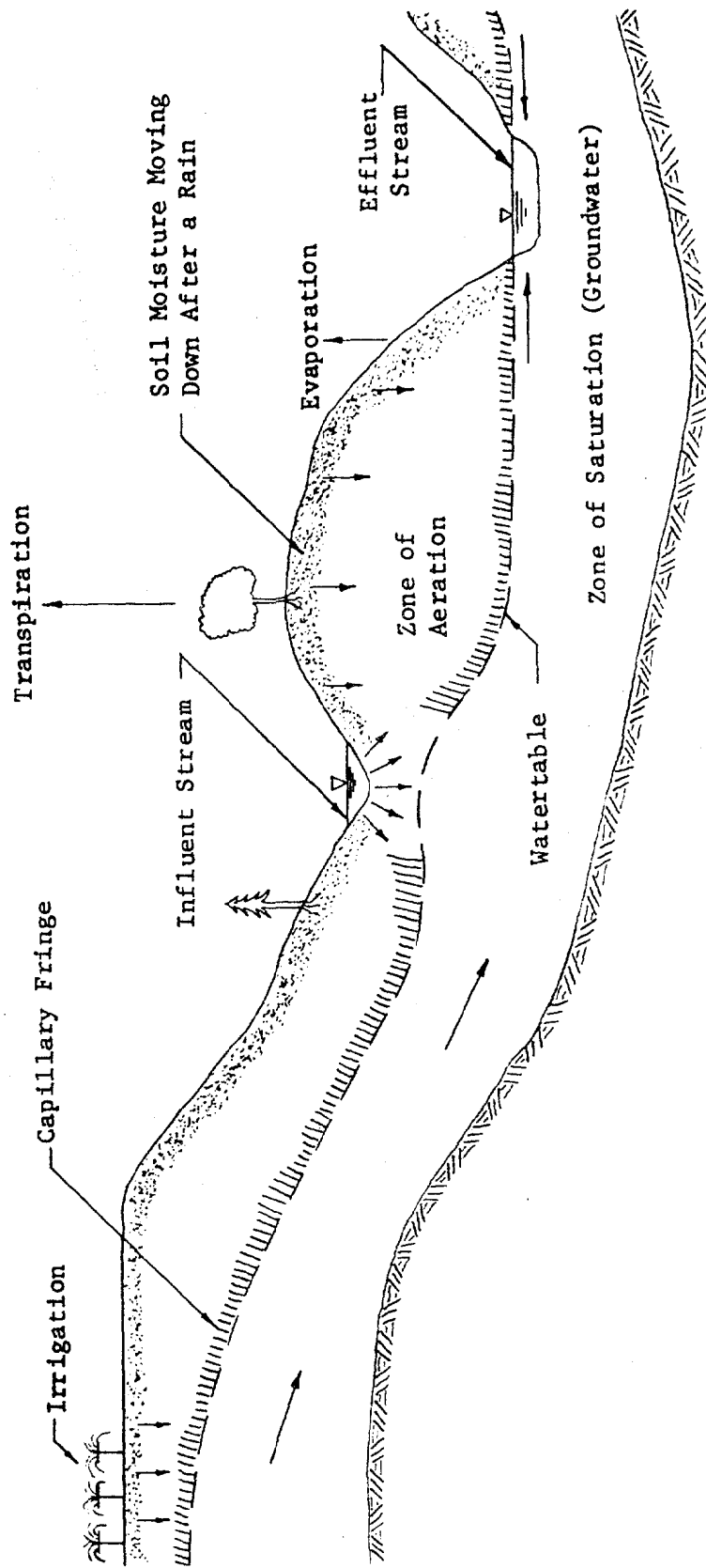

Figure 10. Schematic Illustration of the Occurrence of Groundwater in a Gravity-Flow System

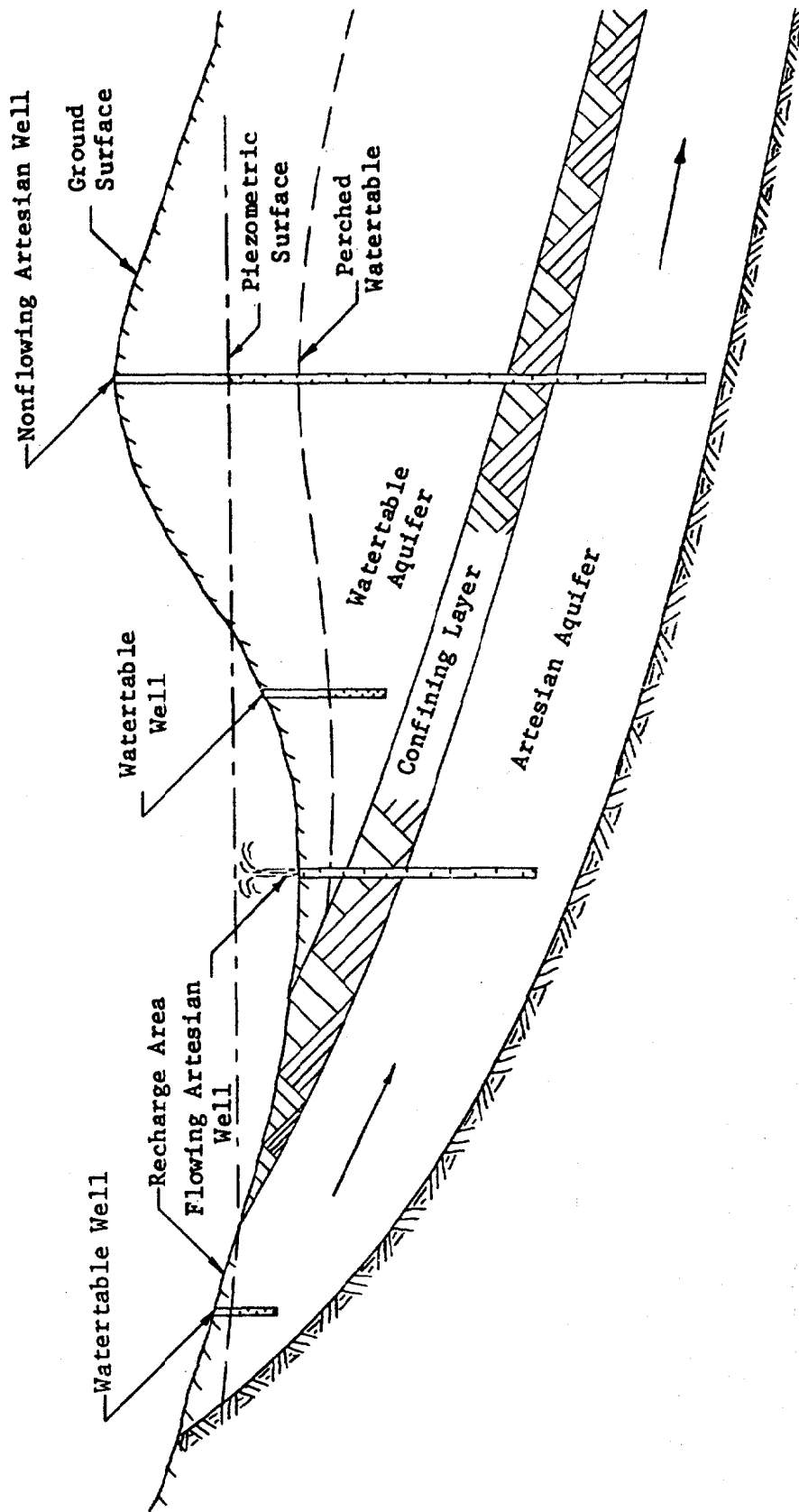

Figure 11. Schematic Illustration of the Occurrence of Groundwater in an Artesian System

The main source of water that infiltrates into the pavement structural section is also precipitation. Water that falls on the surface of the pavement shoulders or median can get into the pavement surface, base and subbase through a variety of entrance points as illustrated in Figure 12. In the case of concrete pavements, the greatest amount of infiltration would be expected to occur along longitudinal and transverse construction joints and at the joints between the concrete slabs and the shoulders. However, as time goes on, additional infiltration may take place through cracks in the concrete slabs and shoulders (5,16,29). For bituminous pavements, the primary initial sources of infiltration may be along the longitudinal joints at the shoulders and the construction joints between strips of paving. Additional longitudinal and transverse cracking may occur after a time, even in well designed and constructed bituminous pavements, providing additional sources of infiltration (5,16,29). Moreover, some water may seep downward through voids in the pavement surface itself, although this is not commonly thought of as being one of the major sources of infiltration (29).

The infiltration of water into the pavement structural section would appear, on the face of it, to be a simple phenomenon. However, the interaction between the type and frequency of openings permitting infiltration, the rate of water supply, and the permeability and ambient moisture conditions of the underlying materials is most complex. Thus, the estimation of the amount of infiltration that must be controlled by subsurface drainage requires careful consideration. This is discussed in greater detail in Section 3.2.1.

1.3.3 Seepage (Movement) of Subsurface Water. Generally, seepage is defined as the movement, or flow, of a fluid through a permeable porous medium. In particular, the fluid with which we are concerned is water, and the permeable porous media are soils, rock and the structural elements of pavements. The porosity is defined as the ratio of the volume of the pore spaces to the total volume of the material. The extent to which porous media will permit fluid flow, i.e., its permeability, is dependent upon the extent to which the pore spaces are interconnected and the size and shape of the interconnections (10,30).

Based on his classic experiments on the flow of water through sand filter beds, Darcy (31) concluded in 1856 that the flow of water through porous media is governed by a simple linear law (Darcy's Law), which is generally stated in the form

$$v = ki, \quad (1)$$

where v is the discharge velocity; k is a constant of proportionality, called the coefficient of permeability; and i is the hydraulic gradient, i.e., the ratio of change of total head, h , with respect to distance, s ,

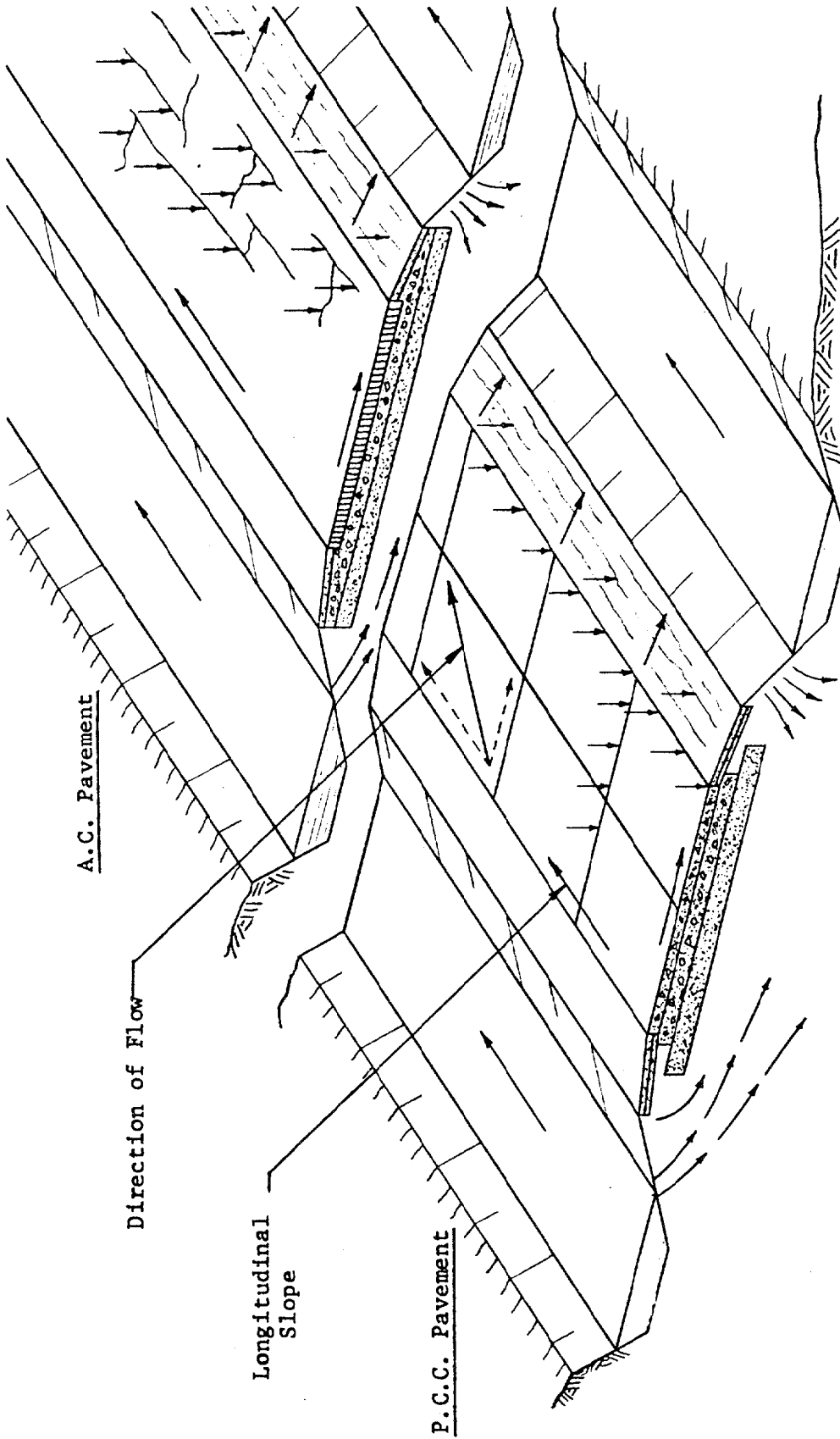

Figure 12. Points of Entrance of Water Into Highway
Pavement Structural Sections (16)

in the direction of flow. In its most general form, the hydraulic gradient can be expressed as

$$i = - \frac{\partial h}{\partial s} \quad (2)$$

although, quite commonly, the total derivative dh/ds , or the finite difference form $\Delta h/\Delta s$, is employed. Equation (1) can be put in a more useful form by multiplying by the cross-sectional area, A , of the flow domain. This yields an expression for the flow rate, q , in the form

$$q = kiA \quad (3)$$

The validity of Darcy's Law is known to be contingent upon the existence of laminar flow (10,27,30,32,33). For most natural soils and low permeability granular materials, this condition will be satisfied over a wide range of hydraulic gradients. However, for more open graded granular materials the flow may become nonlaminar, even at relatively low hydraulic gradients (27,32,34). Under these circumstances, it is still possible to use Darcy's Law for practical seepage analysis if appropriate consideration has been given to this phenomenon in evaluating the coefficient of permeability. This is explained in greater detail in Section 2.3.2.

It should be noted, at this stage, that the coefficient of permeability, upon which equations (1) and (3) depend, varies over a very wide range, depending on the nature of the porous media (see Sec. 2.3.2) through which flow is taking place. In natural deposits, and even in some compacted soils, it may be much greater in one direction than in another (6,7,8,10,12). This phenomenon should be considered, whenever possible, in arriving at practical solutions to highway subdrainage problems.

The movement of groundwater in the vicinity of a highway may be governed entirely by natural phenomena and hydraulic gradients that are the direct outgrowth of the controlling topographic, hydrologic and geological features as shown in Figures 10 and 11. More often than not, however, the highway construction causes some kind of disruption in the natural pattern of flow. For example, a highway cut may intersect the existing water table as shown in Figure 1, or a fill may serve to dam the natural flow of groundwater as shown in Figure 3. The installation of subsurface drainage to control this groundwater results in a further alteration of the flow pattern. The final configuration of the flow domain is dependent upon both the

initial groundwater flow conditions and the characteristics of the subsurface drainage system that is installed.

On the other hand, the movement of infiltration in the pavement structural section is governed largely by the permeability of the components of the pavement system, the longitudinal grade of the roadway and the pavement cross (transverse) slope. The general patterns of surface and subsurface flow associated with infiltration are shown for a Portland cement concrete pavement in Figure 13. Although, the joint and crack patterns (points of inflow) are different for a bituminous concrete pavement, the geometry of the surface and subsurface flow is essentially the same as that shown in Figure 13.

1.4 - Types and Uses of Highway Subdrainage

1.4.1 Classifications of Highway Subdrainage. Systems of highway subsurface drainage can be classified in a variety of ways according to; (a) the source of the subsurface water they are designed to control, (b) the function they perform, and (c) their location and geometry. It is important, at this point, that these classifications be put in perspective and that the associated terminology be understood in order to avoid confusion in later sections of this manual.

A groundwater control system, as the name implies, refers to subsurface drainage specifically designed to remove and/or control the flow of groundwater. Similarly, an infiltration control system is designed to remove water that seeps into the pavement structural section. Often, however, subdrainage may be required to control water from both sources. Although some of the physical features of the two subdrainage systems may be different, quite commonly they are very much alike (see Chapters III and IV).

A subsurface drainage system may perform one or more of the following functions: (a) interception or cutoff of the seepage above an impervious boundary; (b) draw-down or lowering of the water table; and (c) collection of the flow from other drainage systems. These functions are illustrated in Figures 14, 15 and 16 respectively. Although a subdrainage system may be designed to serve one particular function, commonly it will be expected to serve more than one function. For example, the interceptor drain shown in Figure 14 not only cuts off the flow from the left, but it draws down the water table so that it does not break out through the cut slope.

The most common way of identifying subdrainage systems is in terms of their location and geometry. Familiar classifications of this type include; (a) longitudinal drains, (b) transverse and horizontal drains, (c) drainage blankets, and (d) well systems. These will be discussed in detail in Sections 1.4.2, 1.4.3, 1.4.4 and 1.4.5, respectively. It should be noted that these types of subdrainage may be designed to

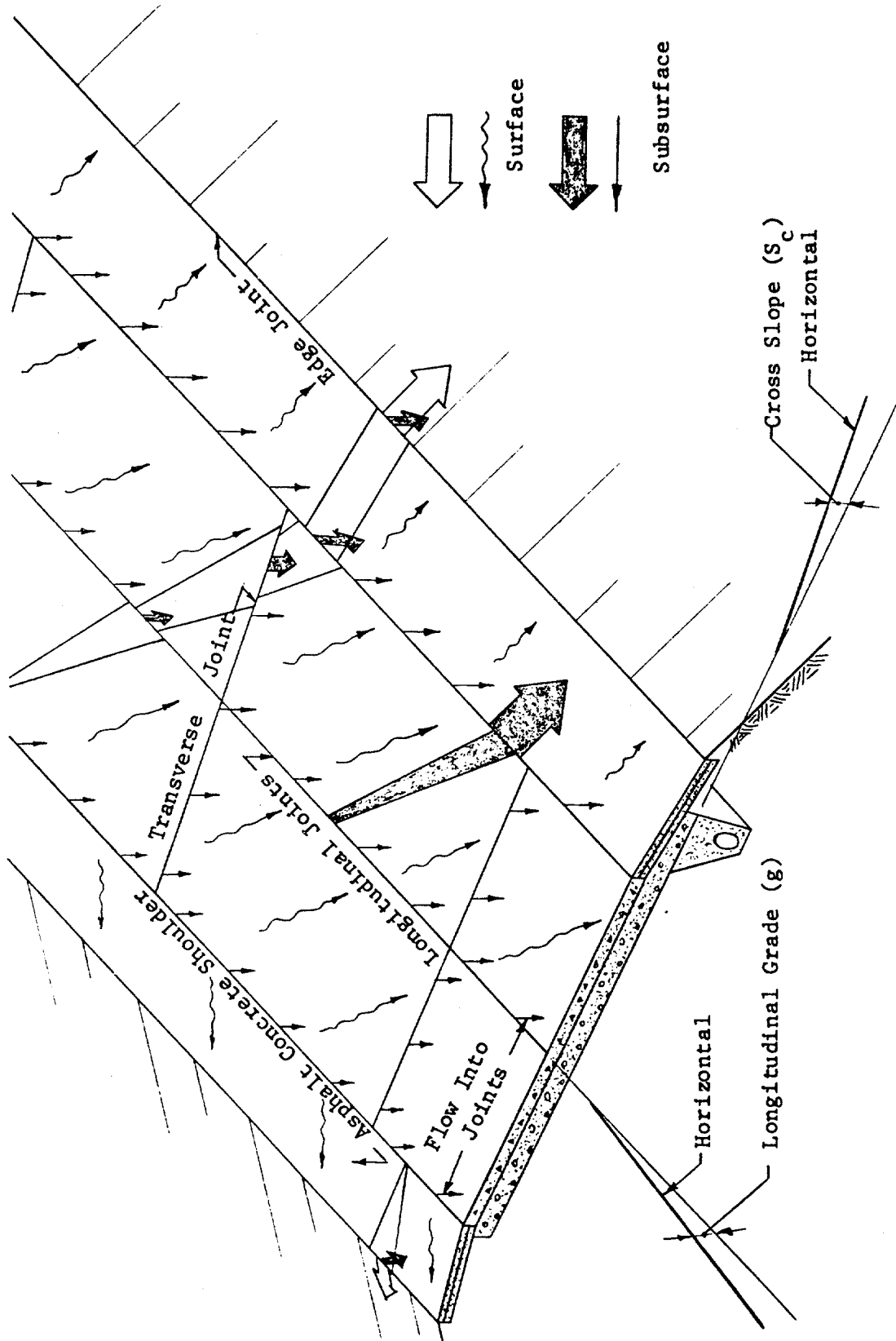

Figure 13. Paths of Flow of Surface and Subsurface Water in Portland Cement Concrete Pavement Structural Sections (16)

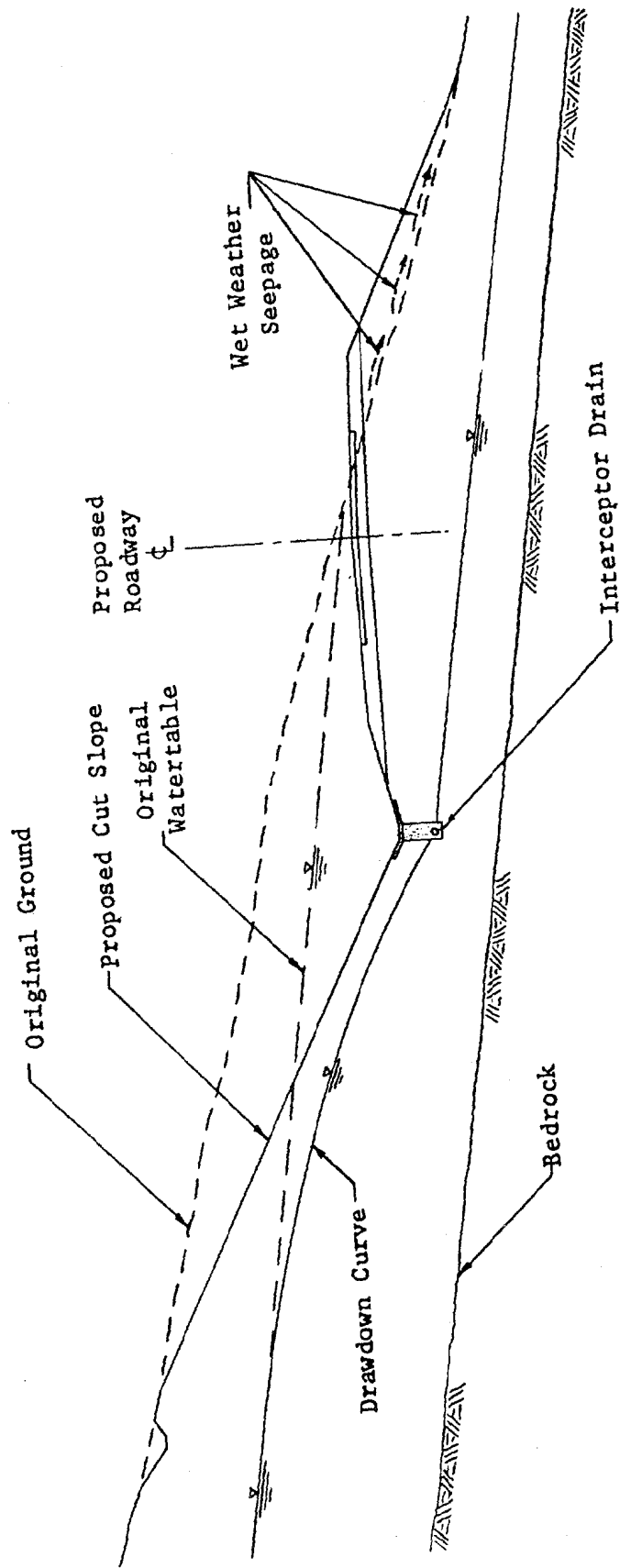

Figure 14. Longitudinal Interceptor Drain Used to Cut Off Seepage and Lower the Groundwater Table

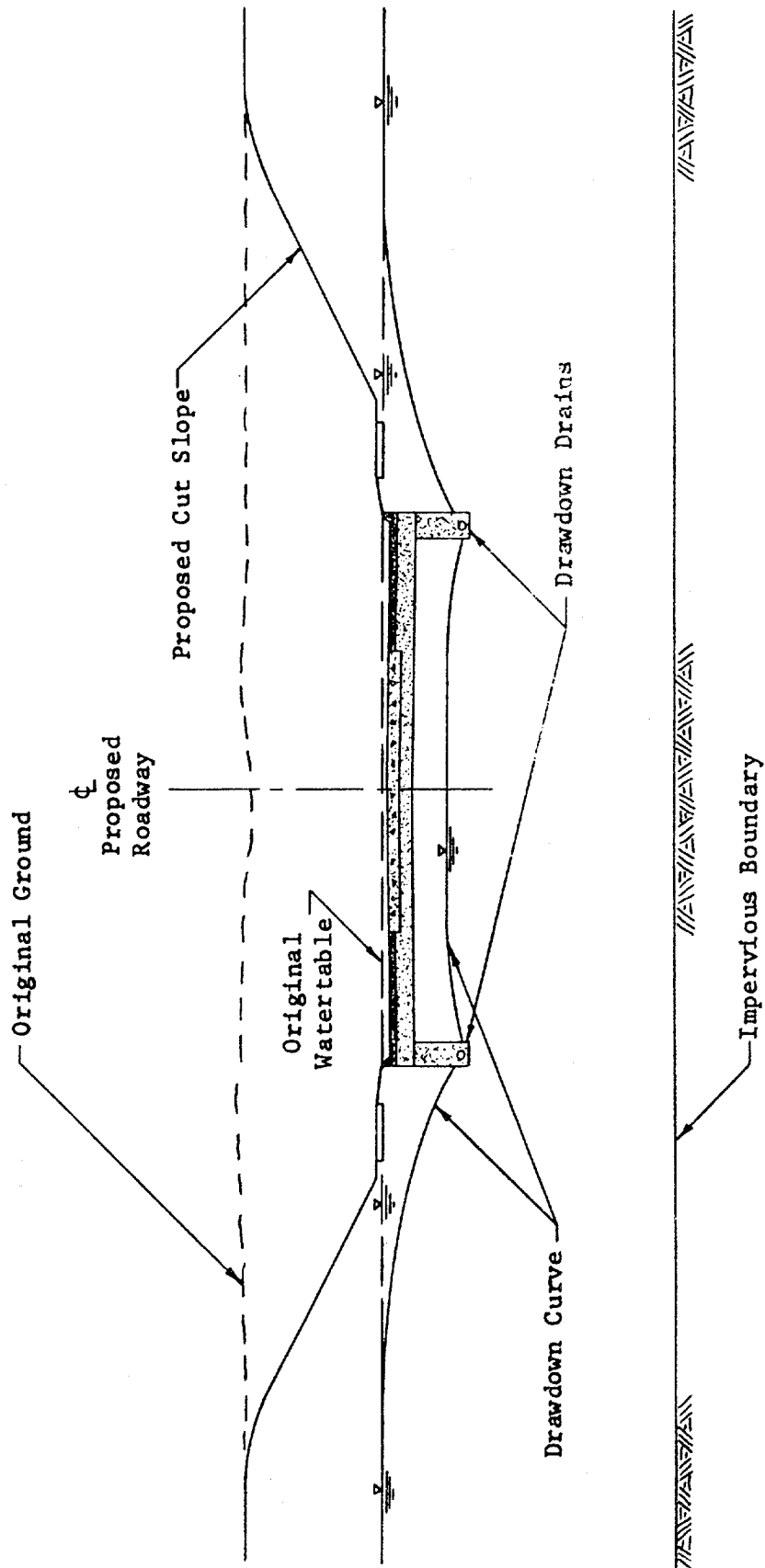

Figure 15. Symmetrical Longitudinal Drains Used To Lower The Water Table

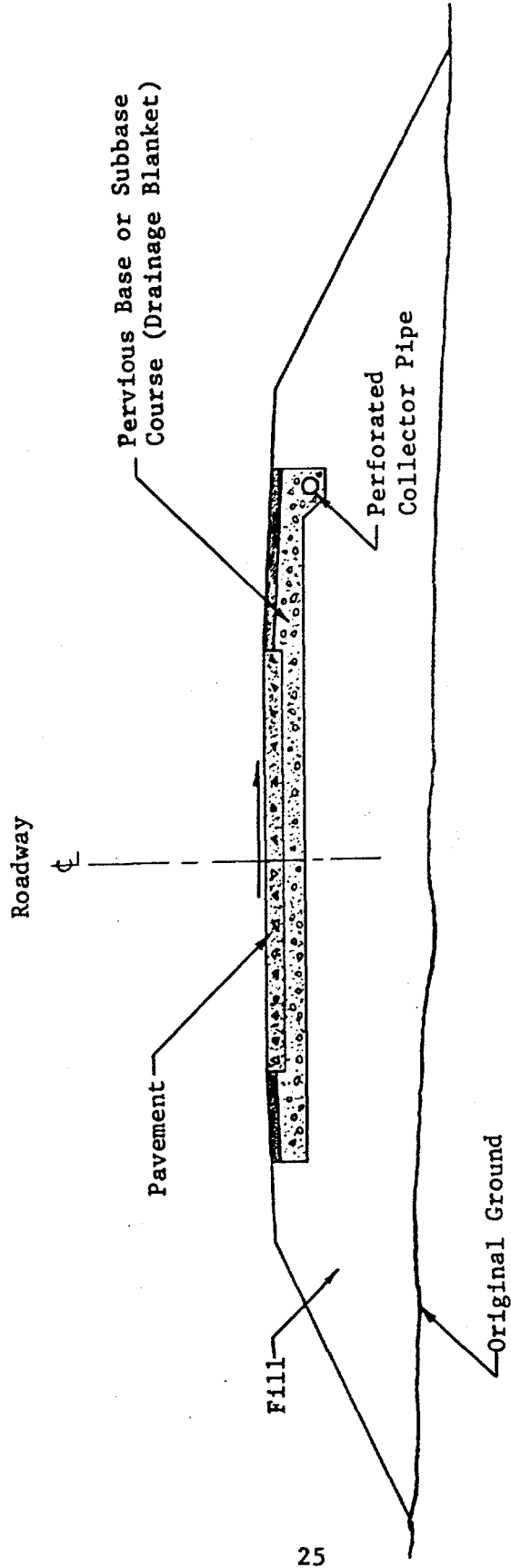

Figure 16. Longitudinal Collector Drain Used to Remove Water Seeping Into Pavement Structural Section.

control both groundwater and infiltration and/or to perform any of the functions outlined above.

1.4.2 Longitudinal Drains. As the name implies, a longitudinal drain is located essentially parallel to the roadway centerline both in horizontal and vertical alignment. It may involve a trench of substantial depth, a collector pipe and a protective filter of some kind, as shown in Figure 14 and 15; or it may be less elaborate, as shown in Figure 16. The degree of sophistication employed in the design of longitudinal drains will depend upon the source of the water that is to be drained and the manner in which the drain is expected to function (see Chapters III and IV).

Sometimes, systems of longitudinal drains of different types can be employed effectively. An example of such an application is presented in Figure 17, which shows a multiple drain installation in a superelevated section of an expressway cut in a wet hillside. In order to intercept the flow and draw down the water table below the left cut slope, it was necessary to use two lines of relatively deep longitudinal drains. As shown in Figure 17, the collector drain (beneath the left shoulder) serves to drain any water that may get into the base or subbase of the left lanes as a result of infiltration or frost action. A similar function is performed by the shallow collector drain along the left edge of the right lanes.

The combination of groundwater conditions and highway cross-sections shown in Figures 14, 15, and 17 were such that the groundwater could be intercepted and/or drawn down well below the pavement sections with no more than two lines of longitudinal underdrains. However, this is not always possible, particularly when the water table is very high and the roadway section is very wide, as shown in Figure 18. In this case, the flow of groundwater might have saturated the subgrade and the pavement structural section over at least a part of its width if the third longitudinal drain had not been installed beneath the median. Even more complicated roadway geometries are possible, and more elaborate subdrainage configurations may be required for modern highways, particularly in the vicinity of interchanges.

1.4.3 Transverse and Horizontal Drains. Subsurface drains that run laterally beneath the roadway are classified as transverse drains. These are commonly located at right angles to the roadway centerline, although in some instances, they may be skewed in the so-called "herringbone" pattern.

Transverse drains may be used at pavement joints to drain infiltration and groundwater in bases and subbases. This is particularly desirable where the relationship between the transverse and longitudinal grades is such that flow tends to take place more in the longitudinal direction than in the transverse direction. An example of this type of installation is shown in Figure 19. In this illustration,

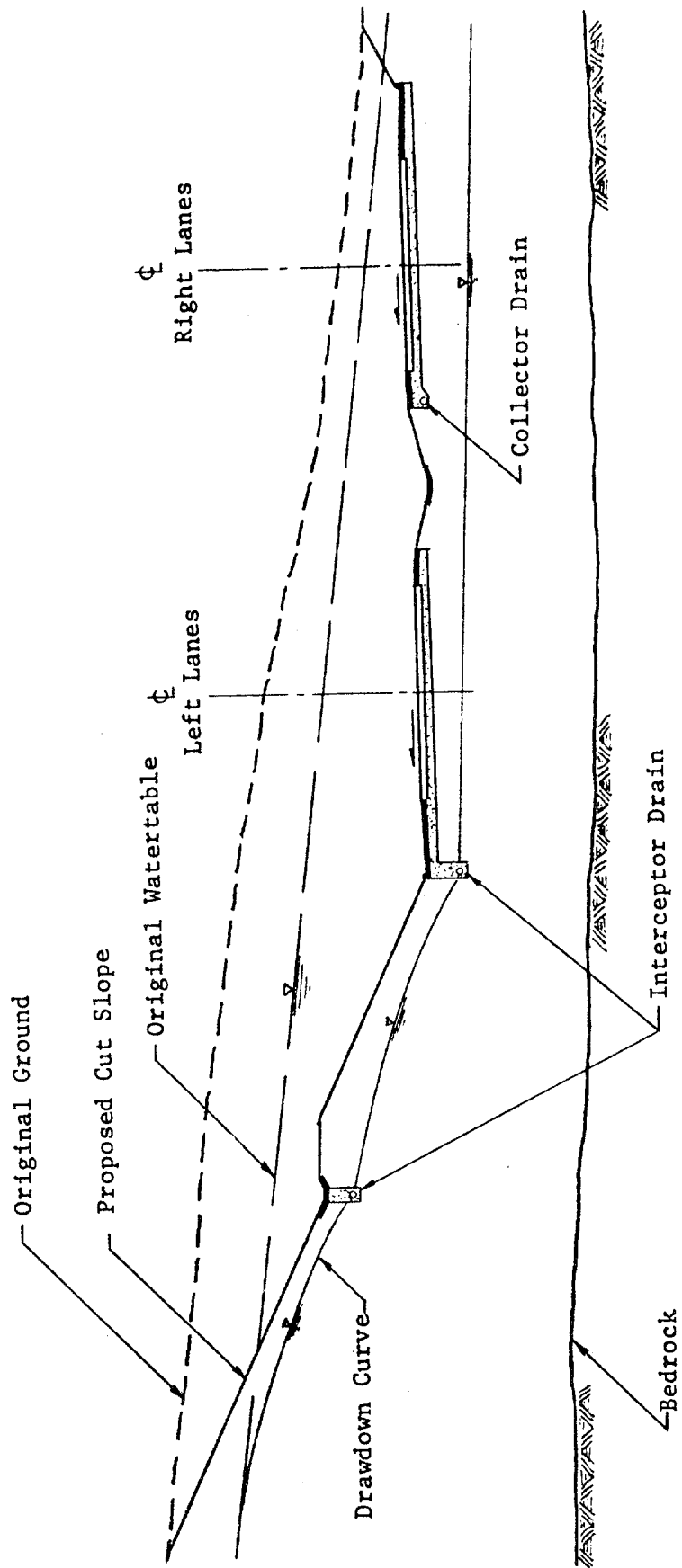

Figure 17. Multiple, Multipurpose, Longitudinal Drain Installation.

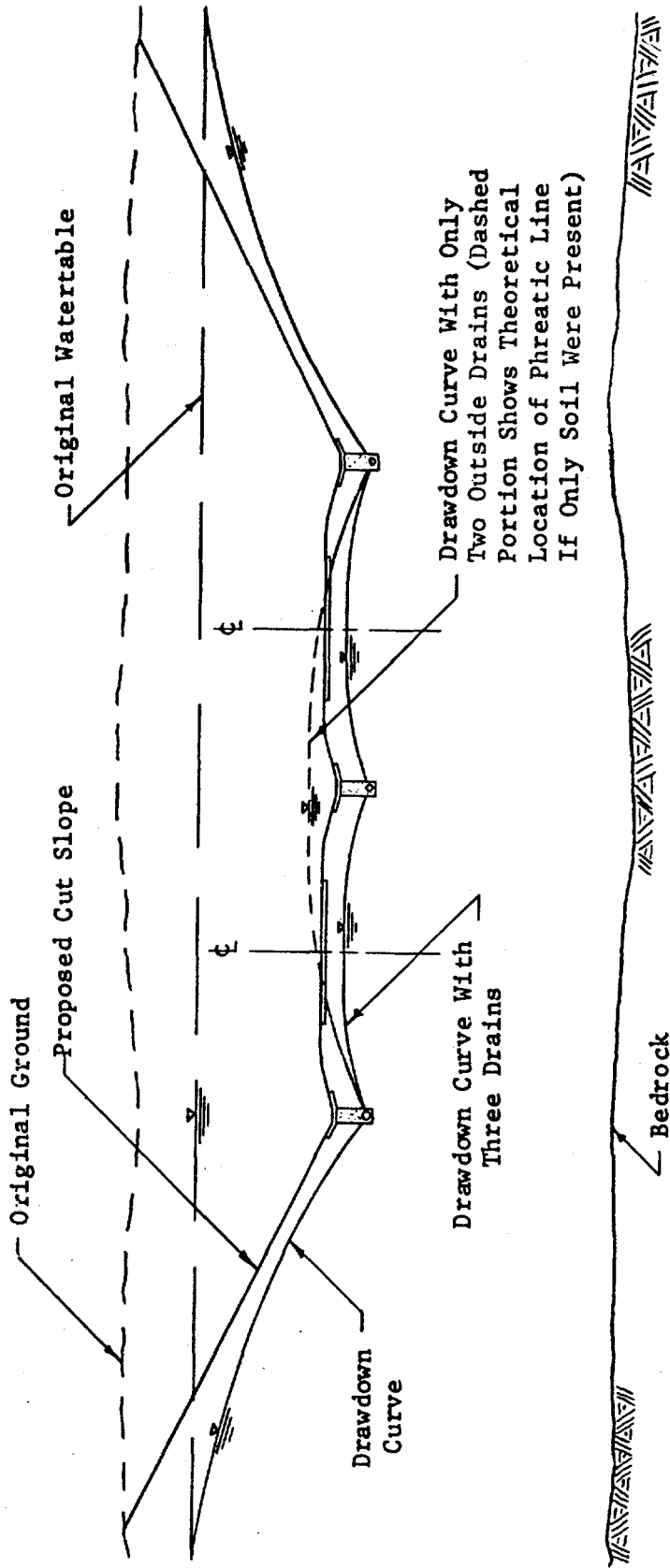

Figure 18. Multiple Longitudinal Drawdown Drain Installation

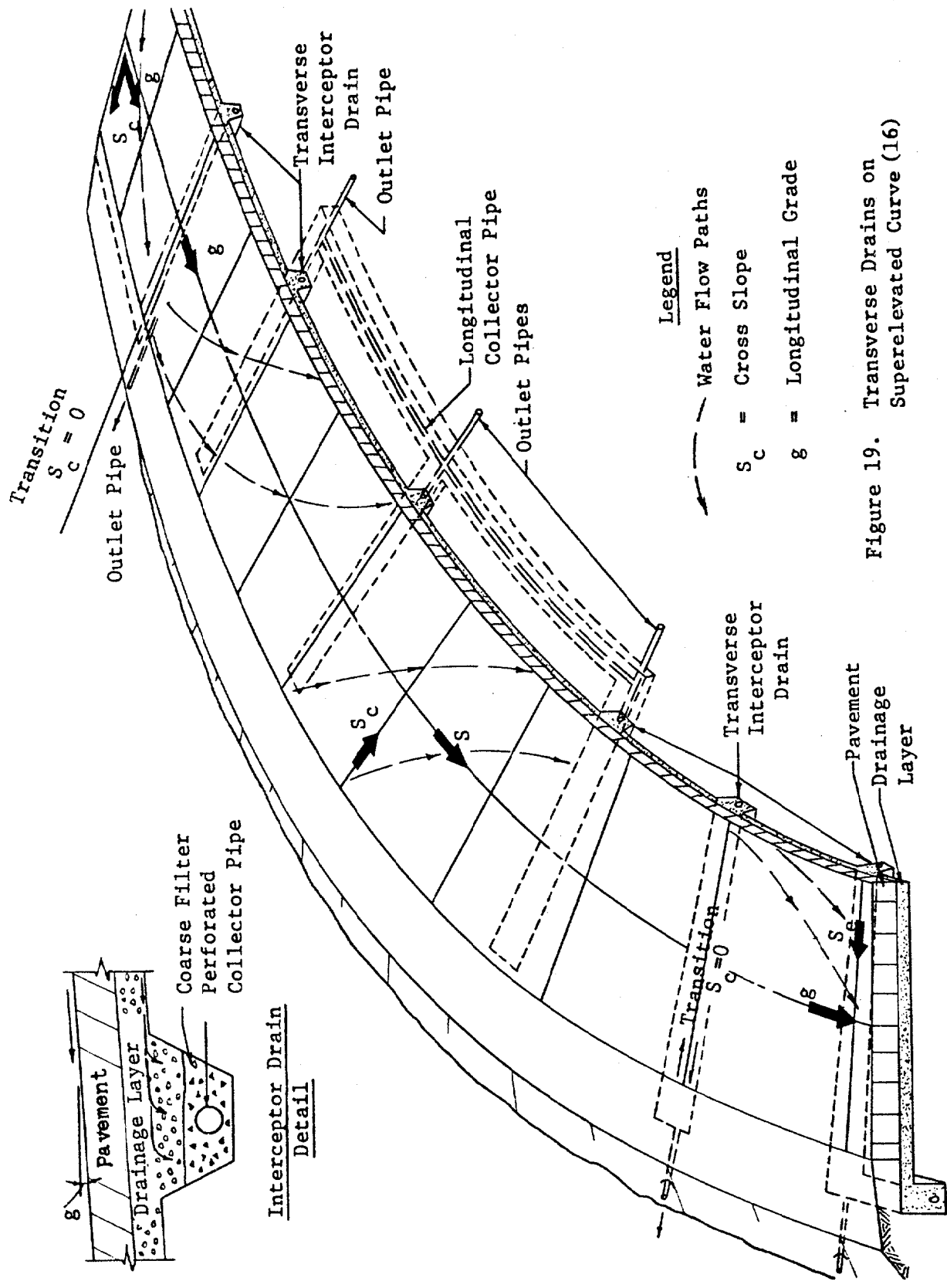

Figure 19. Transverse Drains on Super-elevated Curve (16)

the transverse drains have been used in conjunction with a horizontal drainage blanket and longitudinal collector drain system. This can provide a very effective means for rapid removal of water from the pavement section.

Transverse drains may involve a trench, collector pipe and protective filter, as shown in Figure 19, or they can consist of simple "french drains" (i.e. shallow trenches filled with open graded aggregate), although this is not generally recommended. As with longitudinal drains, the degree of sophistication employed depends on the source of the subsurface water and the function of the drain.

When the general direction of the groundwater flow tends to be parallel to the roadway (this occurs commonly when the roadway is cut more or less perpendicular to the existing contours), transverse drains can be more effective than longitudinal drains in intercepting and/or drawing down the water table. This application is illustrated in Figure 20.

Some caution should be exercised in the use of transverse drains in areas of seasonal frost, since there has been some experience with pavements undergoing a general frost heaving except where transverse drains were installed, thus leading to poor riding quality during winter months.

Horizontal drains consist of nearly horizontal pipes drilled into cut slopes or sidehill fills to tap springs and relieve porewater pressures (See Sec. 4-5, p. 135). In ordinary installations, the ends of the perforated small diameter drain pipes are simply left projecting from the slope and the flow is picked up in drainage ditches. However, in more elaborate installations, drainage galleries or tunnels may be required to carry large flows, and some type of pipe collector system may be used to dispose of the water outside of the roadway limits (11). An example of a drainage installation of this type, used in connection with a landslide stabilization project (11,35), is shown in Figures 21a and 21b.

1.4.4 Drainage Blankets. Generally speaking, the term drainage blanket is applied to a very permeable layer whose width and length (in the direction of flow) is large relative to its thickness. Properly designed drainage blankets can be used for effective control of both groundwater and infiltration.

The horizontal drainage blanket can be used beneath or as an integral part of the pavement structure to remove water from infiltration or to remove groundwater from both gravity and artesian sources. Although relatively pervious granular materials are often utilized for base and subbase courses, these layers will not function as drainage blankets unless they are specifically designed and constructed to do so. This requires an adequate thickness of material with a very high

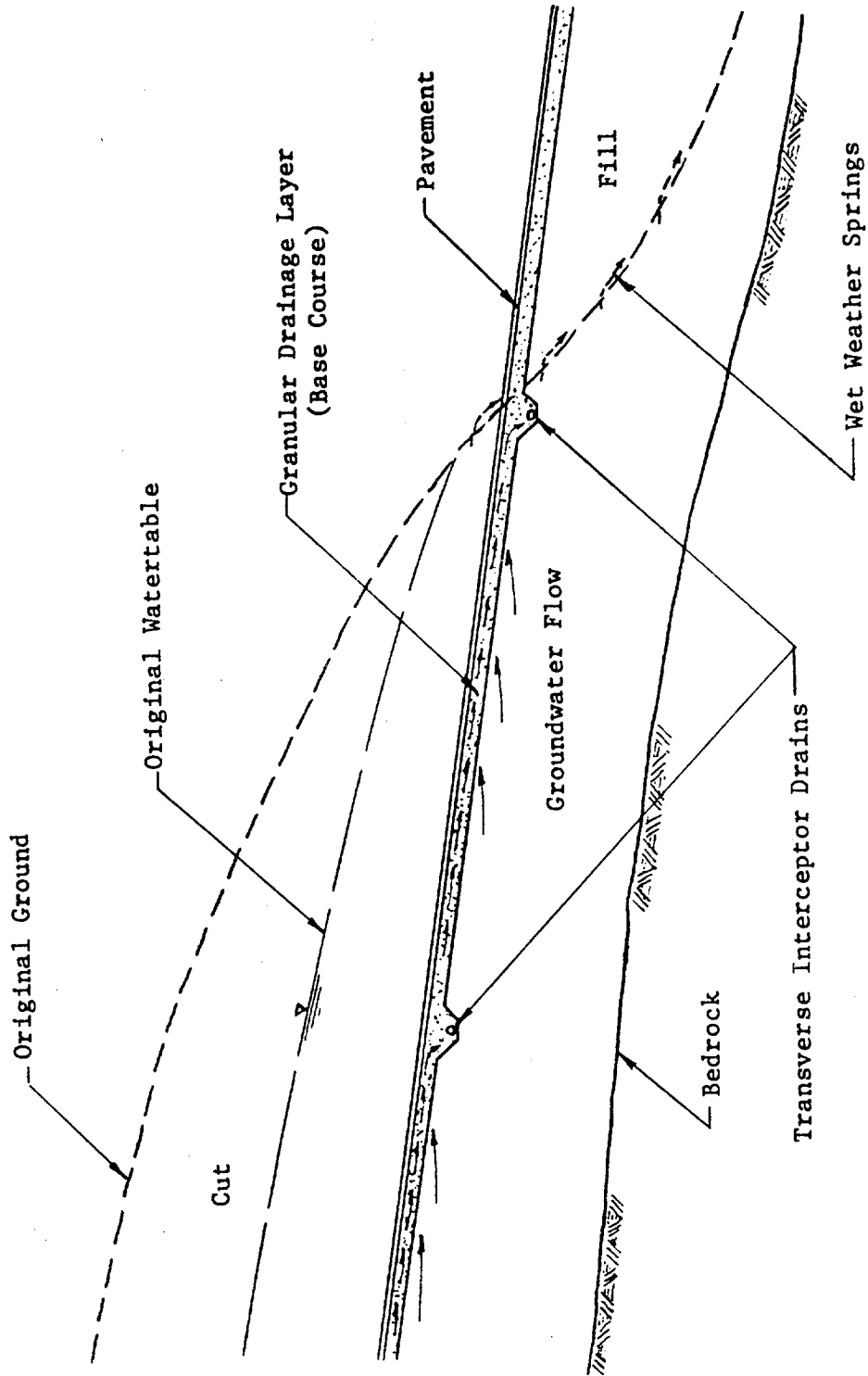

Figure 20. Transverse Interceptor Drain Installation In Roadway Cut With Alignment Perpendicular To Existing Contours

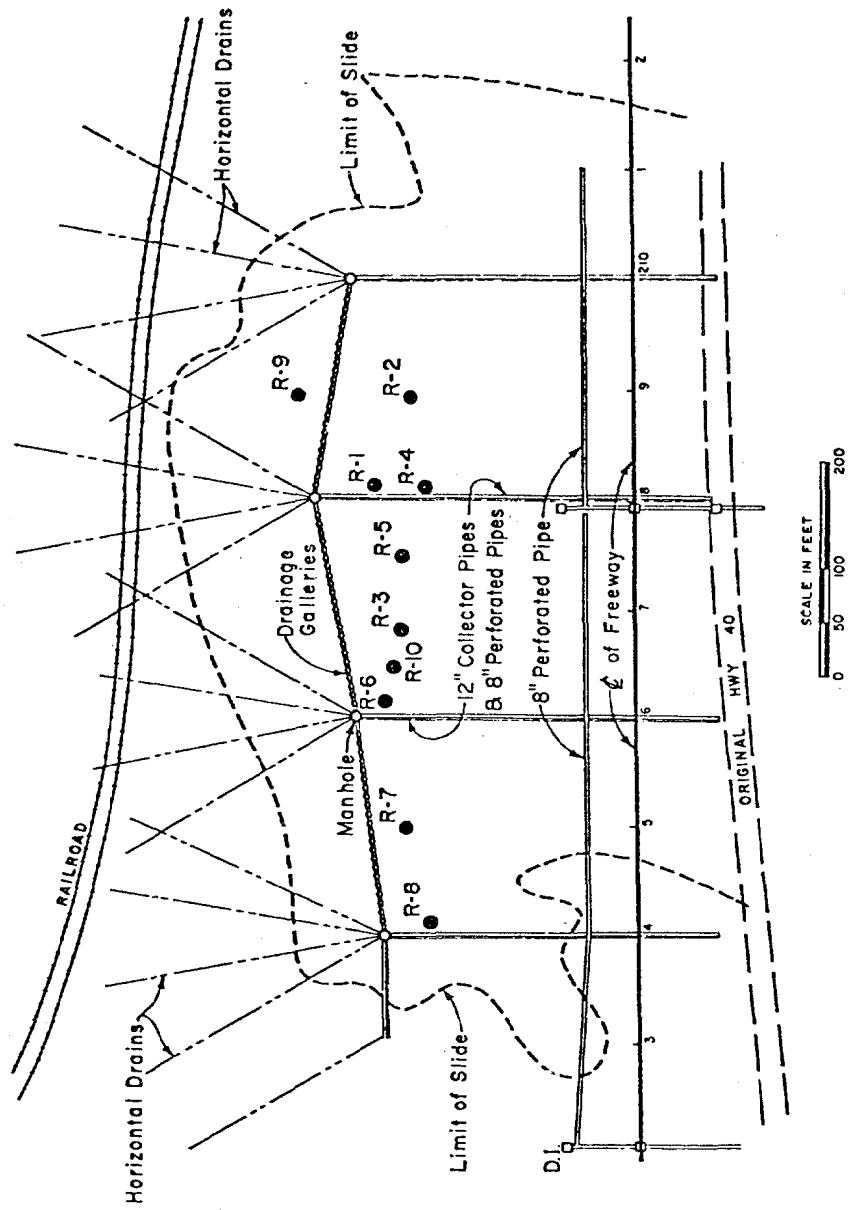

Figure 21a. Plan Showing Drainage Details and Boring Locations At Towle Slide (35)

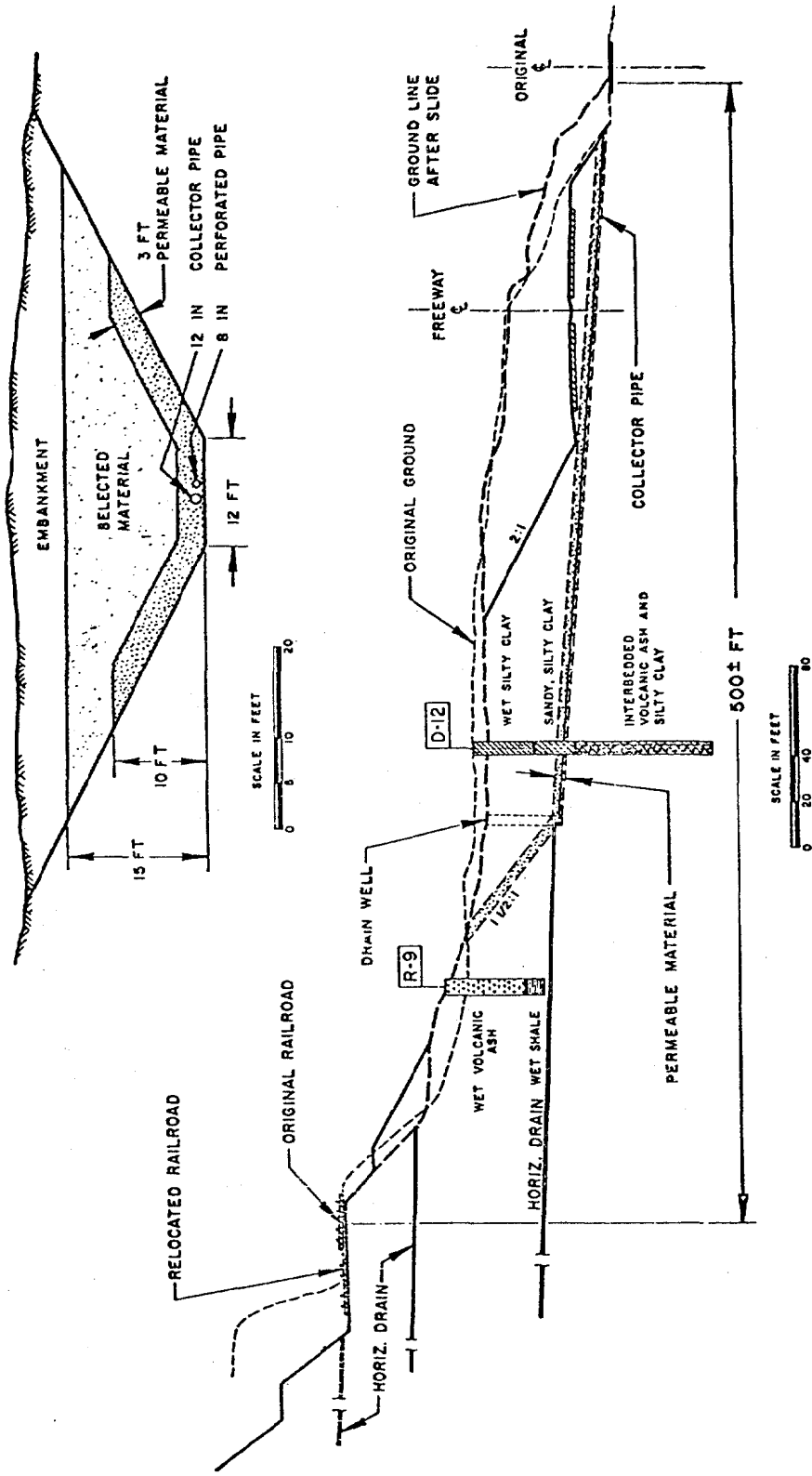

Figure 21b. Profile And Typical Section of Drainage Trench At Towle Slide (35)

coefficient of permeability, a positive outlet for the water collected, and, in some instances, the use of one or more protective filter layers (5,16).

Two types of horizontal drainage blanket systems are shown in Figure 22. In Figure 22a, a horizontal blanket drain is used in connection with shallow longitudinal collector drains to control both infiltration and the flow of groundwater from an artesian source. Note that a protective filter layer has been used to prevent the subgrade soil from being washed into and, thus clogging the drainage layer. In Figure 22b, a horizontal blanket drain is used to remove water that has seeped into the pavement by infiltration alone. In this case, the outlet has been provided by "daylighting" the drainage blanket (open graded base course). However, it is not uncommon for this type of outlet to become clogged and cease to function effectively. A more positive means of outletting the drainage blanket would have been through the use of the longitudinal drain shown dashed in Figure 22b. In any event, the subbase has also been designed as a filter in this instance to prevent intrusion of the subgrade soil into the base course under the action of traffic (27). When the longitudinal grade is large enough to control the direction of flow, transverse drains may be required to outlet the drainage blanket as shown in Figure 19.

Drainage blankets can be used effectively to control the flow of groundwater from cut slopes and beneath sidehill fills. Examples of these uses are illustrated in Figures 23 and 24, respectively. As shown in Figure 23, the drainage blanket used in connection with a longitudinal drain, can help to improve the surface stability (relieve sloughing) of cut slopes by preventing the development of a surface of seepage (see Figure 1) and by its buttress action. The blanket drain shown in Figure 24 prevents the trapping of wet weather flow beneath the fill and minimizes the buildup of high porewater pressures that can lead to slope instability (see Figures 3 and 4).

1.4.5 Well Systems. Systems of vertical wells can be used to control the flow of groundwater and relieve porewater pressures in potentially troublesome highway slopes. In this application, they may be pumped for temporary lowering of the water table during construction or simply left to overflow for the relief of artesian pressures. More often, however, they are provided with some sort of collection system so that they are freely drained at their bottoms. This may be accomplished by the use of tunnels, drilled-in pipe outlets (11), or horizontal drains. Typical well drainage systems that were used to help in the stabilization of wet slopes are shown in Figures 21a and 21b (35) and Figure 25 (36).

Sand filled vertical wells (sand drains) can be used to promote accelerated drainage of soft and compressible foundation materials which are undergoing consolidation (the squeezing out of water) as a result of the application of a surface loading such as that produced by a highway embankment (11,37,38,39,40). An installation of this type

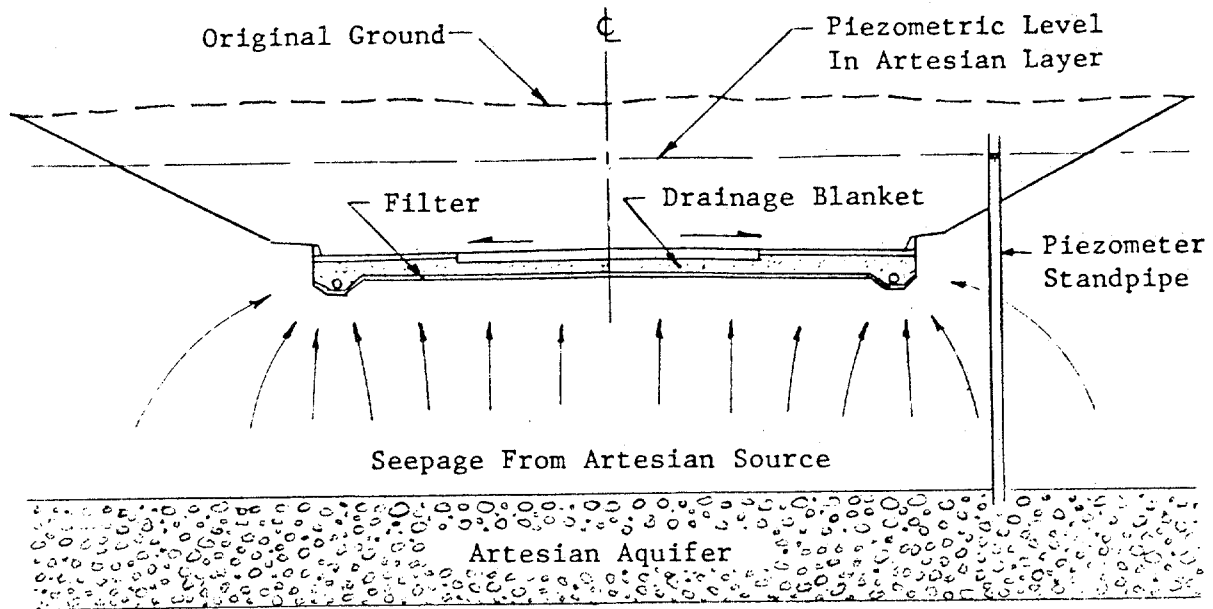

(a)

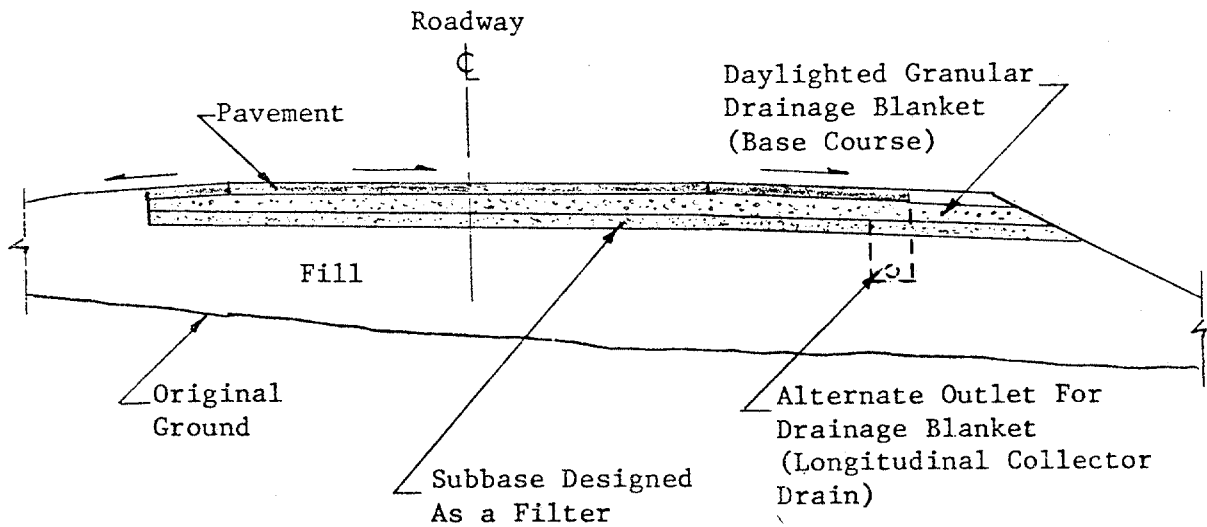

(b)

Figure 22. Applications of Horizontal Drainage Blankets.

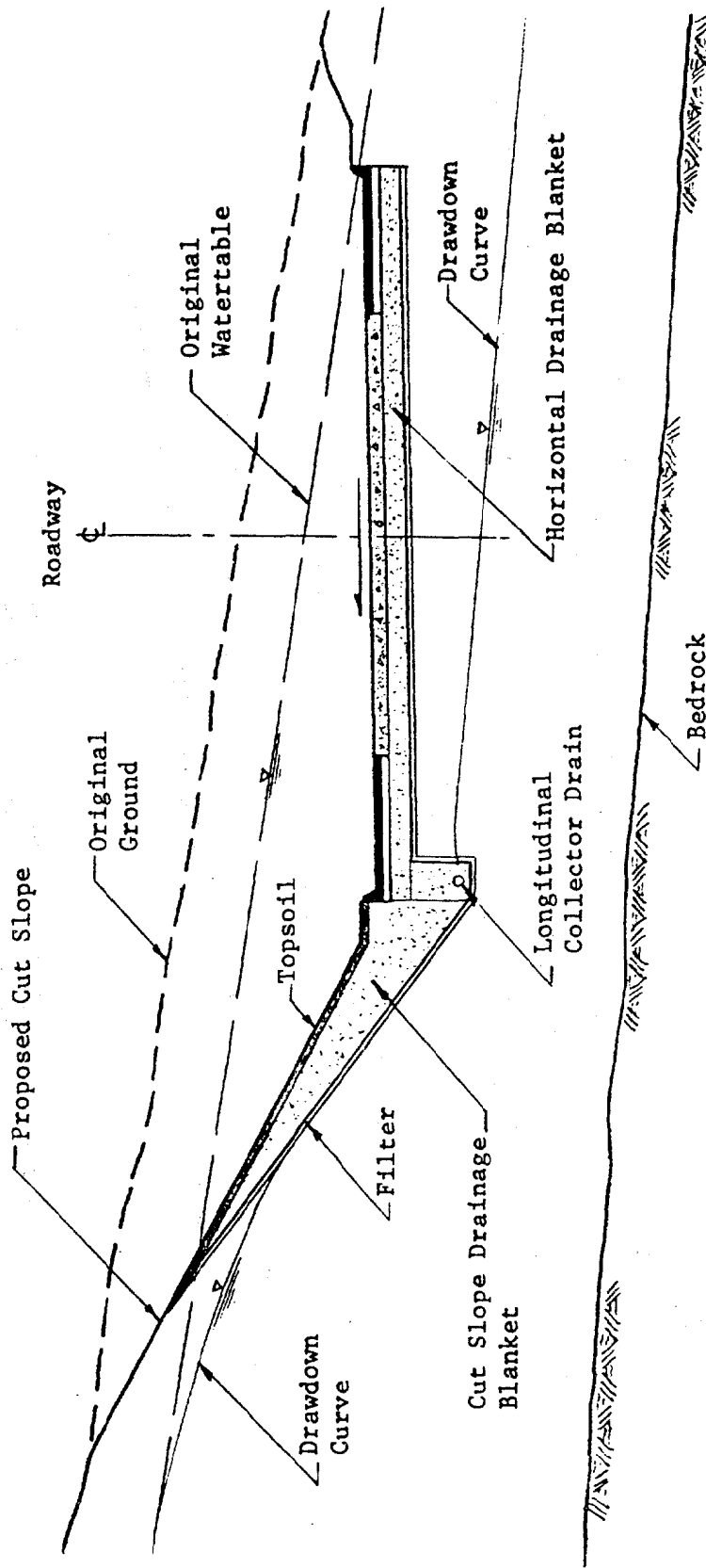

Figure 23. Drainage Blanket (Wedge) On Cut Slope Drained By Longitudinal Collector Drain

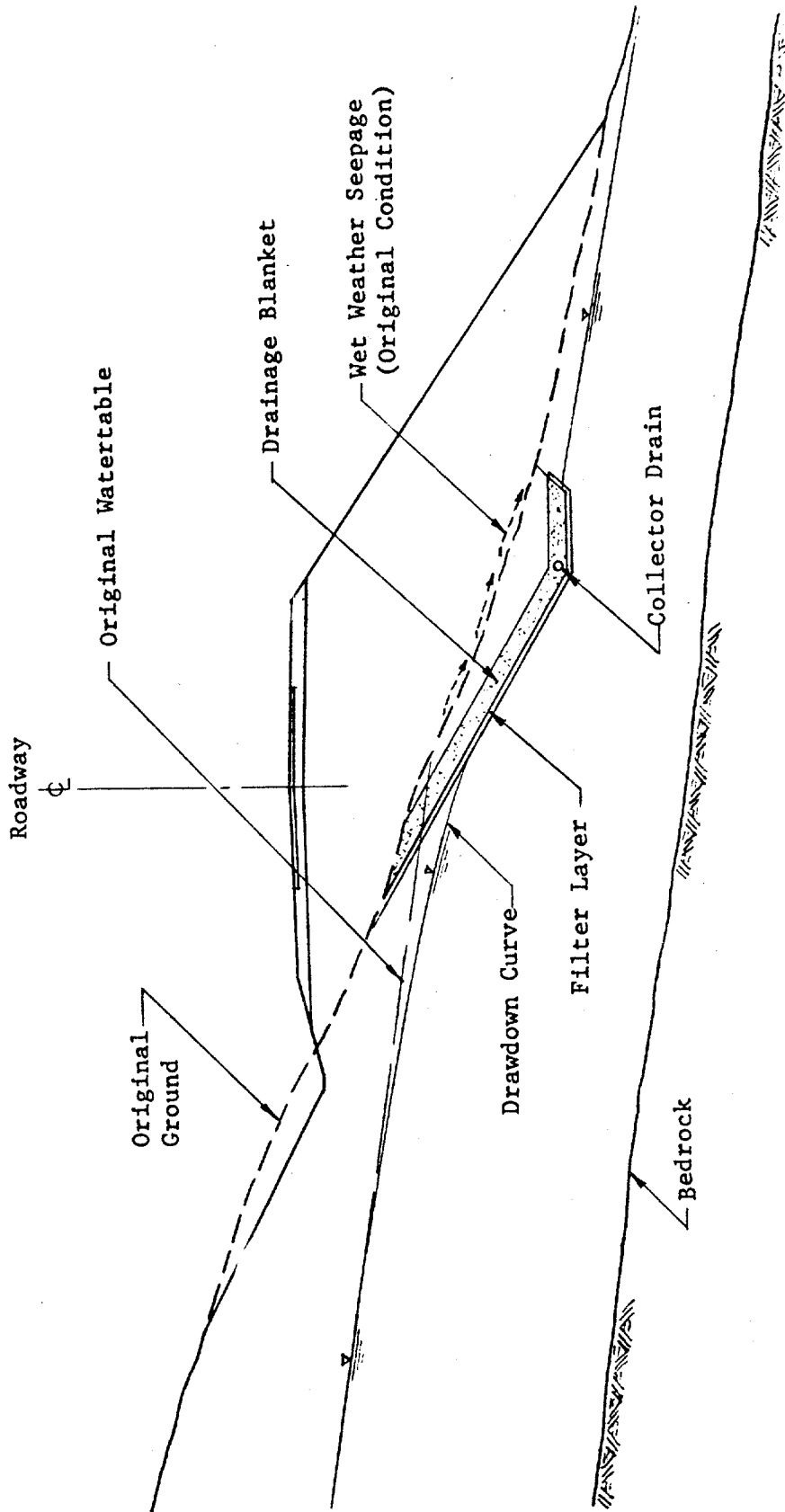
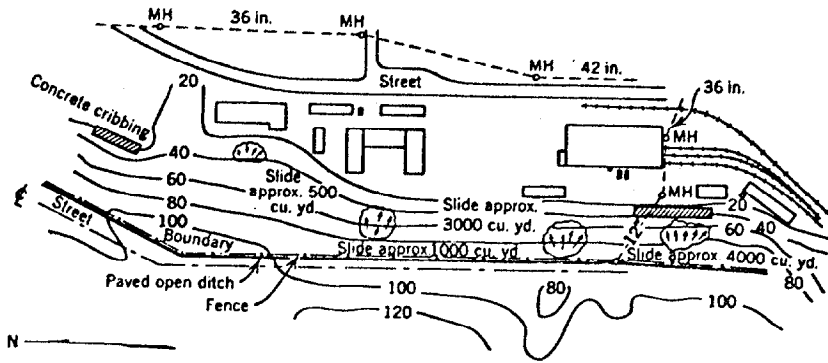
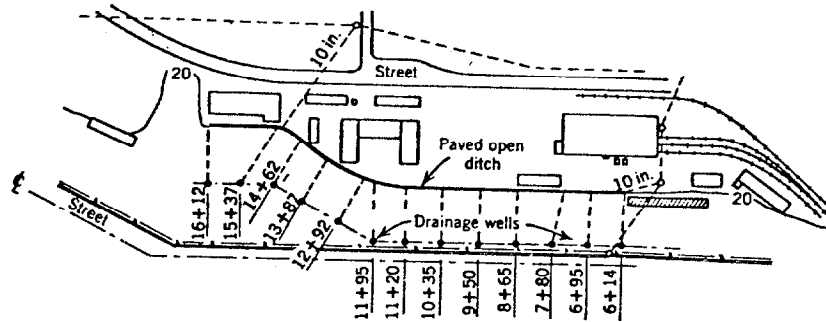

Figure 24. Drainage Blanket Beneath Sidehill Fill Outletted by Collector Drain.



(a) Plan of Effected Area



(b) Layout of Drainage System

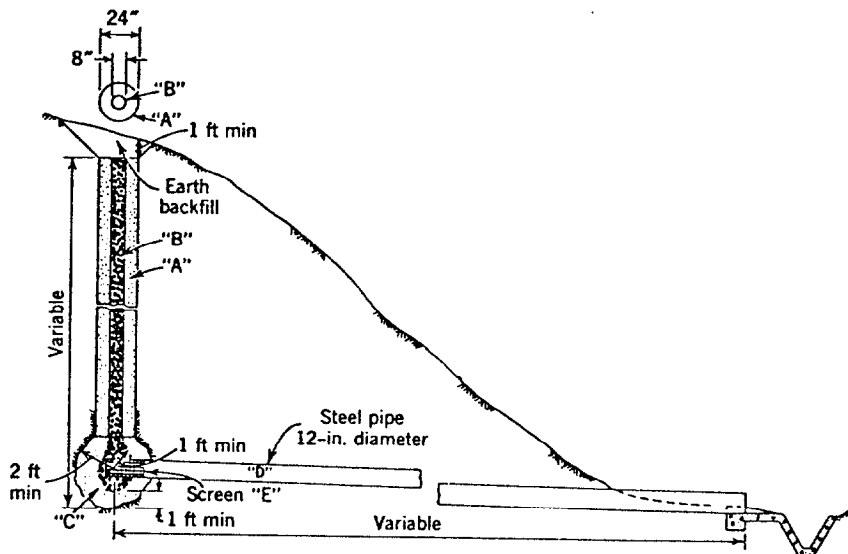

(c) Details of Wells Used For Drainage

Figure 25. Well System Used For Draining Unstable Slope (36)

is illustrated schematically in Figure 26. The design and construction of sand drains for foundation stabilization is a rather specialized undertaking requiring detailed consideration and understanding of the three dimensional consolidation process (38,40). Thus, this aspect of highway subdrainage is considered to be outside the scope of this publication and it will not be given further consideration.

1.4.6 Miscellaneous Drainage. Frequently, during the course of highway construction and maintenance operations, local seepage conditions are encountered which require subsurface drainage to remove the excess moisture or relieve porewater pressures. These conditions may require small drainage blankets with pipe outlets, longitudinal or transverse drains, or some combination of these drainage systems (11). Although subdrainage of this type is highly individualized, its importance should not be minimized and its design should be approached with the same care as the design of more elaborate subdrainage systems.

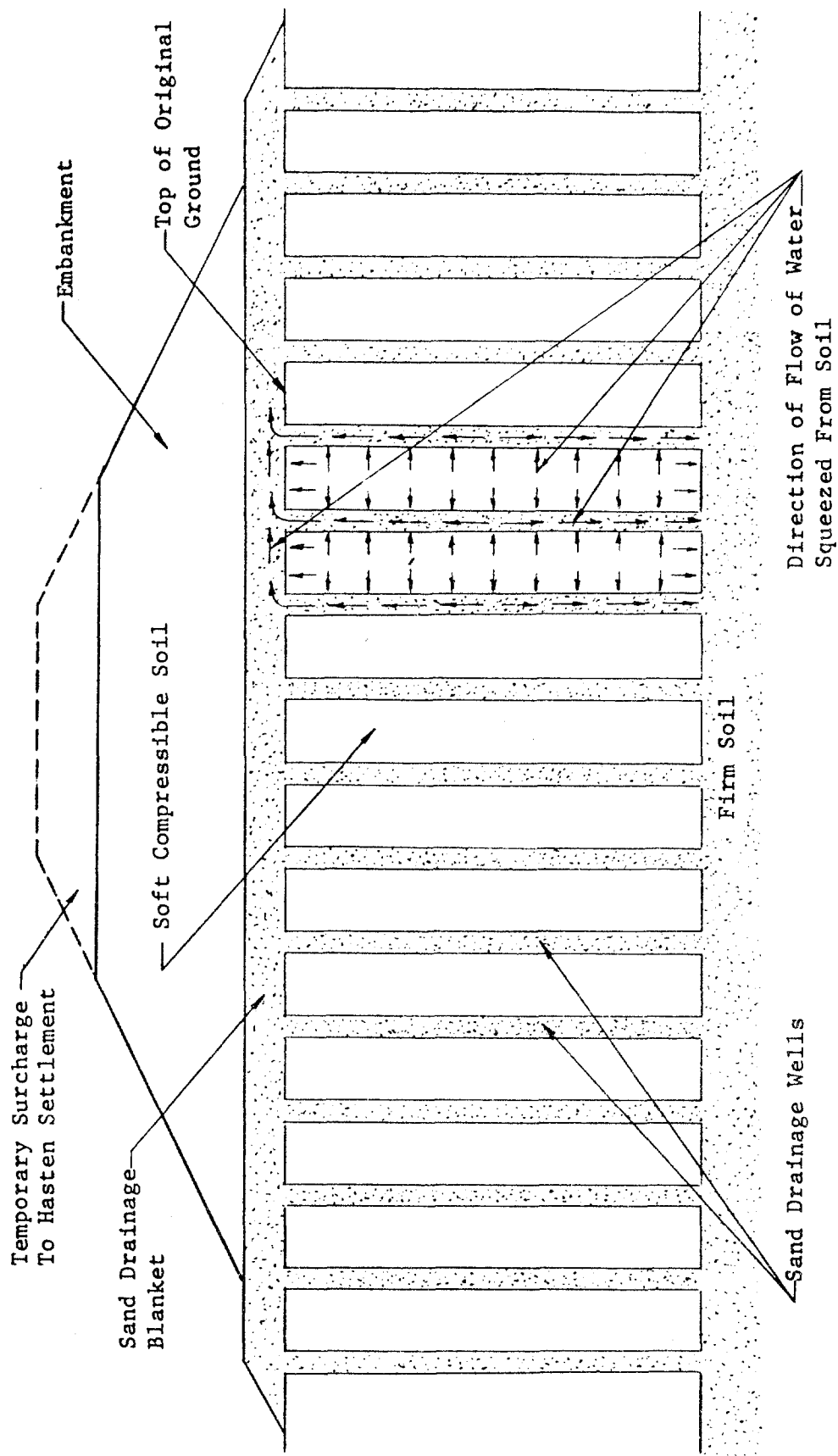

Figure 26. Typical Sand Drainage Well Installation

Chapter II - DATA REQUIRED FOR ANALYSIS AND DESIGN

2.1 - General

The validity of the analysis and design procedures presented in the following chapters is dependent, to a large degree, upon the accuracy and completeness of the data upon which the computations are based. Unfortunately, the nature of the seepage phenomena and materials involved is such that the determination of exact input data is impractical, if not impossible. However, every effort should be made to develop input data that is as realistic as possible while preserving an appropriate measure of conservatism.

The data required for analysis and design of subsurface drainage can be placed in four general categories: (a) the geometry of the flow domain; (b) the properties of the materials; (c) the climatological data; and (d) miscellaneous considerations.

The geometry of the flow domain involves both the geometric design of the highway and the prevailing subsurface conditions. It helps to define the various subsurface drainage problems and provides the boundary conditions that govern their solution.

The fundamental material properties are an important aid to classifying materials and helping to predict how they will perform, particularly with respect to their ability to transmit the flow of water (i.e. their permeability).

The climatological data provide an important insight into the fundamental source of all subsurface water (i.e. precipitation) and the potentially adverse effects of frost action.

There are a number of other considerations that may have an influence on the design of subdrainage systems. These include the impact of the subdrainage system on the existing groundwater regime and other aspects of design; the influence of a subdrainage system, or lack of it, on the sequence of construction operations; and the economic considerations related to the use of subsurface drainage.

2.2 - Geometry of the Flow Domain

2.2.1 Highway Geometry. Almost all of the geometric design features of a highway can exert some influence upon the analysis and design of subsurface drainage. Therefore, before attempting to undertake this work, the designer should be armed with as much information as possible on these features. Included should be sufficiently detailed profiles and cross-sections to permit assembly of the following data for each section of roadway under consideration:

(a) longitudinal grades; (b) transverse grades (including super-elevation); (c) widths of pavement and shoulder surface, base and sub-base; (d) required thickness of pavement elements based on normal structural design practice for the particular area under consideration; (e) depths of cuts and fills; (f) recommended cut and fill slopes; and (g) details of ditches and other surface drainage facilities. Much of this information might be obtained from a detailed set of "typical cross-sections". However, a set of roadway cross-sections showing original ground and at least the gross features (i.e. cut and fill slopes, ditches, etc.) of the proposed construction is considered to be a necessity.

In addition, it is considered desirable to have a topographic map of the highway corridor upon which the final highway alignment has been superimposed. This map should be prepared to such a scale (100 or 200 scale) that features pertinent to both surface and sub-surface drainage can be clearly identified. For example, streams, lakes, and seasonally wet areas above the highway may constitute known boundaries to the flow domain. There is also some evidence that landslide potential, and thus, the potential need for subsurface drainage, can be predicted by careful evaluation of selected topographic features (24).

As indicated in Section 1.3.3, and shown qualitatively in Figure 13, the flow of water in the pavement structural section (drainage layer) may be largely controlled by the longitudinal grade of the roadway, g and its cross slope, S_c . This is shown in a more quantitative fashion in Figure 27. It can be demonstrated (12) that the length of the flow path, L , can be expressed as

$$L = W\sqrt{1 + (g/S_c)^2}, \quad (4)$$

where W is the width of the drainage layer, as shown in Figure 27. The slope of the flow path, S , is given by the expression (12)

$$S = \sqrt{S_c^2 + g^2} \quad (5)$$

The values of the various combinations of longitudinal and transverse grades to be encountered on the project should be tabulated in a form convenient for the calculation of L and S for possible use in analysis and design (see Section 3.3). However, there are two anomalies associated with this work that may be encountered. First, it is clear that whenever the transverse grade approaches zero, the length of the flow path given by Equation (4) approaches infinity. In practice, this particular relationship between longitudinal and transverse grades will be a local one, and the length of the flow path will be governed by the grades of adjacent sections of roadway and/or the distance to the nearest transverse drain. Second, it is obvious that, if either the cross slope or the longitudinal grade is varying with the stationing along the roadway, the flow path

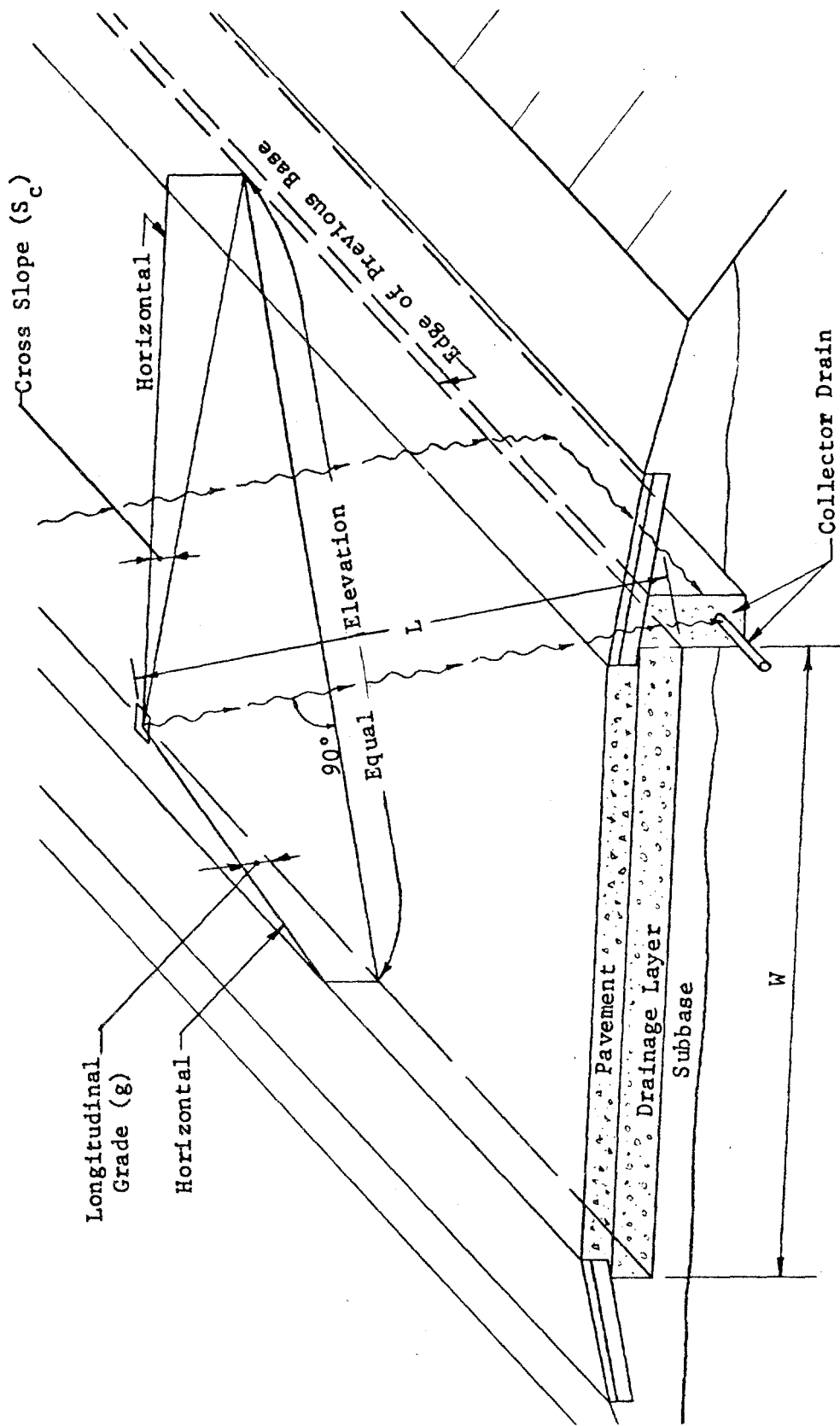

Figure 27. Path of Subsurface Water in Drainage Layer

cannot be linear as shown in Figure 27, but will be curved, as shown in Figure 19. Under these circumstances, some approximation will have to be introduced (see Example 16 in Section 3.3). In any event, this type of data constitutes an important input to analysis and design of subdrainage to control some types of groundwater and water from infiltration. Therefore, particular care should be taken in assembling this information.

2.2.2 Subsurface Geometry. The nature and limits of the flow domain, i.e., its subsurface boundaries, should be accurately established. In general, this will require a thorough program of subsurface exploration and geologic evaluation. This work should be sufficiently detailed to permit the development of soil and rock profiles and to define the prevailing groundwater conditions. In many parts of the nation, agricultural and/or geological maps are available that can be very useful in planning the subsurface exploration program. It should be noted, at this point, that good subsurface explorations are a vital part of the basic design procedure for highways (41), and very little additional work of a special nature is required for the analysis and design of subsurface drainage systems.

The various methods of subsurface exploration and sampling have been described in detail in numerous publications (41,42,43), and no attempt will be made to repeat this information here. However, some helpful suggestions and recommendations will be presented.

Often, a great deal of valuable information pertaining to existing subsurface drainage conditions can be obtained by careful examination of the site in the field. This can be especially true if the visitation can be made during, or just following, a wet period. It may be possible to observe wet-weather springs or other evidence of intermittent seepage that might not show up during some dryer period. In addition, the type and condition of the vegetation in the area may give some clue to the soil and groundwater conditions. Lush green foliage and the presence of species of plants and trees that are known to require a high water table can be significant indicators of potential groundwater problems.

During the subsurface explorations, special attention should be directed at obtaining all possible data that might relate in any way to subsurface drainage. Any evidence of artesian pressures or loss of wash water during drilling should be noted, and any unusual stratification (e.g. granular layers or lenses within a more cohesive stratum) should be recorded. The sampling should be coordinated so that representative samples are obtained for laboratory testing from all strata that may be involved in the seepage phenomenon. This includes cut materials that will later be placed in fills. When it is known or suspected that there may be significant seasonal fluctuations in the water table, it is considered to be good practice to install plastic tubing in the bore holes so that the water table level can be monitored over some period of time. Such installations are not expensive and can provide much valuable information.

Under some circumstances, it may become desirable to conduct special tests to evaluate the in-situ permeability of materials during the subsurface explorations (see Section 2.3.2). This need should be anticipated in advance, if possible, so that the subsurface explorations can be properly programmed to provide the most information for the lowest possible cost.

2.3 - Properties of Materials

2.3.1 Index Properties. The index properties of materials are considered to be those which help to identify and classify the material. They may also be an important indicator of material performance. In assembling pertinent data for the analysis and design of subsurface drainage, we are primarily concerned with those properties which exert an influence on seepage phenomena. Included in this category are: (a) grain size characteristics, (b) plasticity characteristics (Atterberg limits), and (c) soil classification (see Section 2.3.2).

For natural soils which may exist within the flow domain, either in cuts or fills, representative samples should be subjected to grain size analysis using standard test methods (44). This is particularly important where it is anticipated that protective filters may be required to prevent finer soil particles from being washed or "pumped" into drainage layers. For granular materials to be used in base, subbase, drainage blankets, filters, etc., it is considered highly desirable that representative samples of the actual construction materials be subjected to grain size analysis. However, it is recognized that this may not always be practical, and it may be necessary to work from the specified gradation limits for these materials. In some instances, the subdrainage analysis and design procedures may lead to the modification of existing gradation specifications or the development of new criteria for establishing gradation limits.

The Atterberg limits (45,46) of natural soils along with their grain size distributions permit the soils to be classified in a meaningful way with respect to their behavioral characteristics. Although a variety of soil classifications are in use (47,48,49), there appears to have been more work done in relating the permeability, capillarity and frost susceptibility of soils with their Unified Soil Classification (20,48,50) than with any other system. Thus, it is recommended that sufficient laboratory data be developed for representative soil samples to permit their classification by this system.

2.3.2 Performance Characteristics. While there are a wide range of engineering properties of materials with which we must be concerned in highway design, for the purposes of this publication, we will consider only those properties that control the flow of subsurface water. Thus, included in the data required for analysis and design are (a) the

coefficient of permeability, k , (b) the effective porosity (yield capacity), n' , and (c) the frost susceptibility of the material. In addition, it may be necessary to assemble data on other performance characteristics which govern these parameters.

Among the material properties which may influence the coefficient of permeability are (a) the grain size distribution, (b) the packing (dry density, void ratio, porosity), (c) the mineralogical composition, (d) the nature of the permeant, and (e) the degree of saturation (28). Moreover, it would appear that most of the properties influencing the coefficient of permeability also influence capillarity and the yield capacity. This will be given further consideration later in this section.

The coefficient of permeability can be determined by (a) in-situ measurement, (b) laboratory testing, (c) theoretical analysis, and (d) empirical methods.

Ideally, the coefficient of permeability should be determined by in-situ measurements, and it is recommended that this practice be followed whenever possible. There are a variety of reliable techniques that have been developed for making determinations of this type in natural soils and rock (51,52). In addition, procedures have been developed for evaluating the in-situ coefficient of permeability in bases, subbases, and drainage layers (52,53). However, obtaining the coefficient of permeability of compacted drainage layers after they are in place cannot be considered a design function. It is rather, an inspection or control function designed to assure that the coefficient of permeability falls within limits established by some other means as being desirable for the particular subsurface drainage system under consideration.

When field evaluation of the coefficient of permeability is not feasible, then the use of laboratory determinations is highly recommended, particularly for fill materials, bases, subbases and other drainage layers. The laboratory methods are well known and are considered to be reliable (27,28,34,54,55). Commonly, the materials are compacted to the anticipated field moisture and density conditions for testing. There is, however, a problem associated with determining the coefficient of permeability for coarse granular materials. As noted in Section 1.3.3, the flow in these materials may become nonlaminar, even at low hydraulic gradients, invalidating Darcy's Law. Under these circumstances, there are two procedures that can be used to allow for the reduced efficiency caused by turbulence. One procedure is to estimate the range of hydraulic gradients to be experienced in the field and to perform the laboratory tests at these hydraulic gradients. When this is done, errors from turbulence are largely eliminated because the measured coefficient, although not a true Darcy coefficient, should have the correct magnitude for estimating the seepage quantities and velocity at the test gradient. An alterna-

tive procedure is to establish the true Darcy permeability by performing the laboratory tests under small hydraulic gradients that ensure laminar flow and then to apply a correction factor to account for the reduced efficiency caused by turbulence at greater hydraulic gradients than used in the tests. The details of this procedure and typical correction factors have been presented by Cedergren (See Reference 11, pp. 139-145 and pp. 195-196).

Throughout the years, many theoretical and empirical equations have been devised for estimating the coefficient of permeability of porous media (28,56,57). The most reliable of these, however, seem to have been developed by empirical modification of purely theoretical equations (57). For the most part, these equations are not suitable for use in the practical analysis and design of highway subdrainage and, therefore, they will not be given further consideration.

Although field or laboratory evaluation of the coefficient of permeability is considered desirable, in practice it is often necessary for the designer to estimate the coefficient of permeability empirically without the benefit of these refinements. Several approaches are available for doing this, but they all depend upon some kind of correlation between the coefficient of permeability and such properties as grain size characteristics, dry density, and porosity or void ratio. One method that reportedly has been used with some success utilizes a relationship between permeability, specific surface and porosity (58).

One typical set of values of the coefficient of permeability and a general indication of the degree of permeability is given in Table 1

Table 1. Typical values of soil permeability

<u>Soil Description</u>	<u>Coefficient of Permeability k(ft./day)¹</u>	<u>Degree of Permeability</u>
Medium and Coarse Gravel	>30.0	High
Fine gravel; coarse, medium and fine sand; dune sand.	30.0 to 3.0	Medium
Very fine sand; silty sand; loose silt; loess; rock flour.	3.0 to 0.03	Low
Dense silt; dense loess; clayey silt; silty clay.	0.03 to 0.0003	Very Low
Homogeneous clays	<0.0003	Impervious

¹Note that 1 ft./day is equivalent to 3.529×10^{-4} cm/sec.

as a function of the grain size characteristics of the material. In Table 2, ranges of values of coefficient of permeability are given as a function of the Unified Soil Classification and the relative degree of permeability (59). In Table 3, average values of the coefficient

Table 2. Approximate correlation between permeability and Unified Soil Classification (59)¹

<u>Unified Soil Classification</u>	<u>Relative Permeability</u>	<u>Coefficient of Permeability k(ft./day)</u>
GW	Pervious	2.7 to 274
GP	Pervious to Very Pervious	13.7 to 27,400
GM	Semipervious	2.7×10^{-4} to 27
GC	Impervious	2.7×10^{-5} to 2.7×10^{-2}
SW	Pervious	1.4 to 137
SP	Semipervious to Pervious	0.14 to 1.4
SM	Impervious to Semipervious	2.7×10^{-4} to 1.4
SC	Impervious	2.7×10^{-5} to 0.14
ML	Impervious	2.7×10^{-5} to 0.14
CL	Impervious	2.7×10^{-5} to 2.7×10^{-3}
OL	Impervious	2.7×10^{-5} to 2.7×10^{-2}
MH	Very Impervious	2.7×10^{-6} to 2.7×10^{-4}
CH	Very Impervious	2.7×10^{-7} to 2.7×10^{-5}

of permeability are given as a function of the Unified Soil Classification void ratio and dry density (50).

In using Table 1,2 and 3, the general manner in which the coefficient of permeability varies with the controlling soil properties should be understood. With respect to grain size, finer soils can, in general be expected to have lower permeabilities, and well graded soils can be expected to be less permeable than more uniform soils. With respect to density, a decrease in permeability should be expected with increased dry density. Furthermore, it should also be recognized that the permeabilities given in Tables 1,2 and 3 are typical values for homogeneous and isotropic soil or aggregate masses, and that aniso-

¹When placed as well-constructed rolled-earth embankment with moisture-density control.

Table 3. Average values of soil permeabilities (50)

<u>Unified Soil Classification</u>	<u>Dry Density lbs/cu.ft.</u>	<u>Void Ratio* e</u>	<u>Coefficient of Permeability k(ft./day)</u>
GW	119	-	73.973 + 35.616
GP	110	-	175.242 + 93.151
GM	114	-	8.219 x 10 ⁻⁴
GC	115	-	8.219 x 10 ⁻⁴
SW	119 + 5	0.37 + -	-
SP	110 + 2	0.50 + 0.03	4.110 x 10 ⁻²
SM	114 + 1	0.48 + 0.02	2.055 + 1.315 x 10 ⁻²
SM-SC	119 + 1	0.41 + 0.02	2.192 + 1.644 x 10 ⁻³
SC	115 + 1	0.48 + 0.01	8.219 + 5.479 x 10 ⁻⁴
ML	103 + 1	0.63 + 0.02	1.616 + 0.630 x 10 ⁻³
ML-CL	109 + 2	0.54 + 0.03	3.561 + 1.917 x 10 ⁻⁴
CL	108 + 1	0.56 + 0.01	2.191 + 0.821 x 10 ⁻⁴
MH	82 + 4	1.15 + 0.12	4.343 + 2.739 x 10 ⁻⁴
CH	94 + 2	0.80 + 0.04	1.369 + 1.369 x 10 ⁻⁴

*Average values were obtained from more than 1500 soil samples compacted to the Standard Proctor maximum dry density. The + entry indicates 90 percent confidence limits for the average values.

tropy, stratification, naturally occurring cracks and fissures, etc., can have a dramatic effect on the in-situ permeability.

It is of particular importance in the analysis of subsurface drainage systems to be able to estimate the coefficient of permeability of granular drainage and filter materials. Figure 28 has been prepared to help in this regard. It was developed by correlating statistically the measured coefficients of permeability for a large number of samples (26,27,34,60,61) with those properties known to exert an influence on permeability. The results showed that the most significant properties were the effective grain size, D_{10} , the porosity, n , and the percent passing the No. 200 sieve, p_{200} . These three parameters explained over 91 percent of the variation in the coefficient of permeability. For convenience, a conversion has been made, so that dry density is used in the chart instead of porosity. It is particularly important to note that the amount of fines (P_{200}) exerts a marked influence on the coefficient of permeability for granular materials. Thus, a small increase in the amount of fines can cause a large decrease in the coefficient of permeability (5,16,27). Since Figure 28 was developed from data on granular bases and subbases, its applicability is necessarily limited to these types of materials. An additional aid to estimating the coefficient of permeability is given in Figure 29, which shows typical gradations and permeabilities of open graded bases and filter materials (5,16).

Although the effective porosity, or yield capacity, n' , commonly appears in the literature in the solutions to problems involving time-dependent drainage, criteria for estimating numerical values of this parameter are not generally given (5,6,7,10,12). However, as noted earlier, there does appear to be some evidence (26,27,62) to support the belief that some kind of relationship should exist between the effective porosity, n' , and the coefficient of permeability, k . On this basis, Figure 30 was developed by correlating statistically the measured values of effective porosity with the measured coefficient of permeability for soils of varying gradations and densities (27,32). While Figure 30 does provide the designer with a simple and reasonably reliable way to estimate effective porosity, it should be used with caution, particularly at the extremities where data were lacking (high values) or were quite scattered (low values).

A knowledge of the frost susceptibility of subgrade soils and the depth of frost penetration (see Section 2.4.2) can provide the designer with some insight into the extent of the subsurface drainage required to control frost action and the amount of water that must be removed by suitable drainage layers during periods of thawing in order to prevent the saturation of the pavement structural section. Rapid removal of the melt water from thawing ice masses (19,20) is considered to be an essential factor in limiting both the duration and magnitude of the reduction in supporting power of the subgrade, base and subbase during periods of spring thaw (5,16,20,63). Although many different test methods and criteria for evaluating frost susceptibility have

$$k = \frac{6.214 \times 10^5 (D_{10})^{1.478} (n)^{6.654}}{(F_{200})^{0.597}} \quad (\text{ft./day})$$

$$n = \text{Porosity} = \left(1 - \frac{\gamma_d}{62.4G}\right)$$

G = Specific Gravity
(Assumed = 2.70)

P200 - Percent Passing No. 200 Sieve

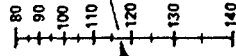
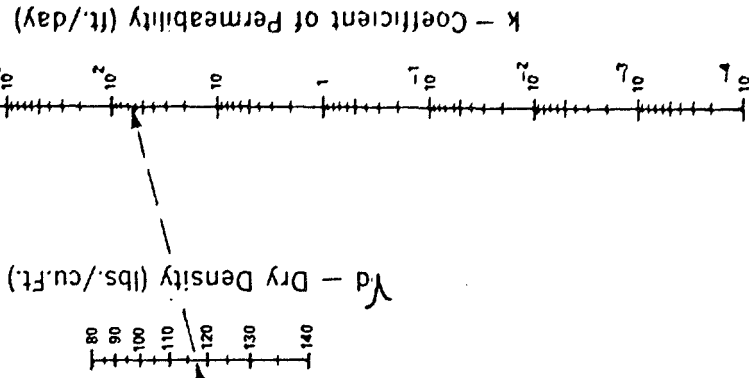
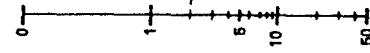
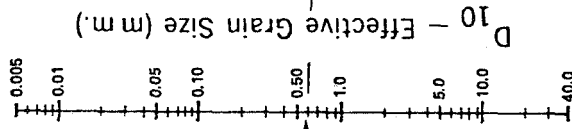

Example:

P₂₀₀ = 2%

D₁₀ = 0.6 mm

γ_d = 117 lb./cu.ft.

Read:

k = 65 ft./day

Figure 28. Chart For Estimating Coefficient of Permeability of Granular Drainage and Filter Materials

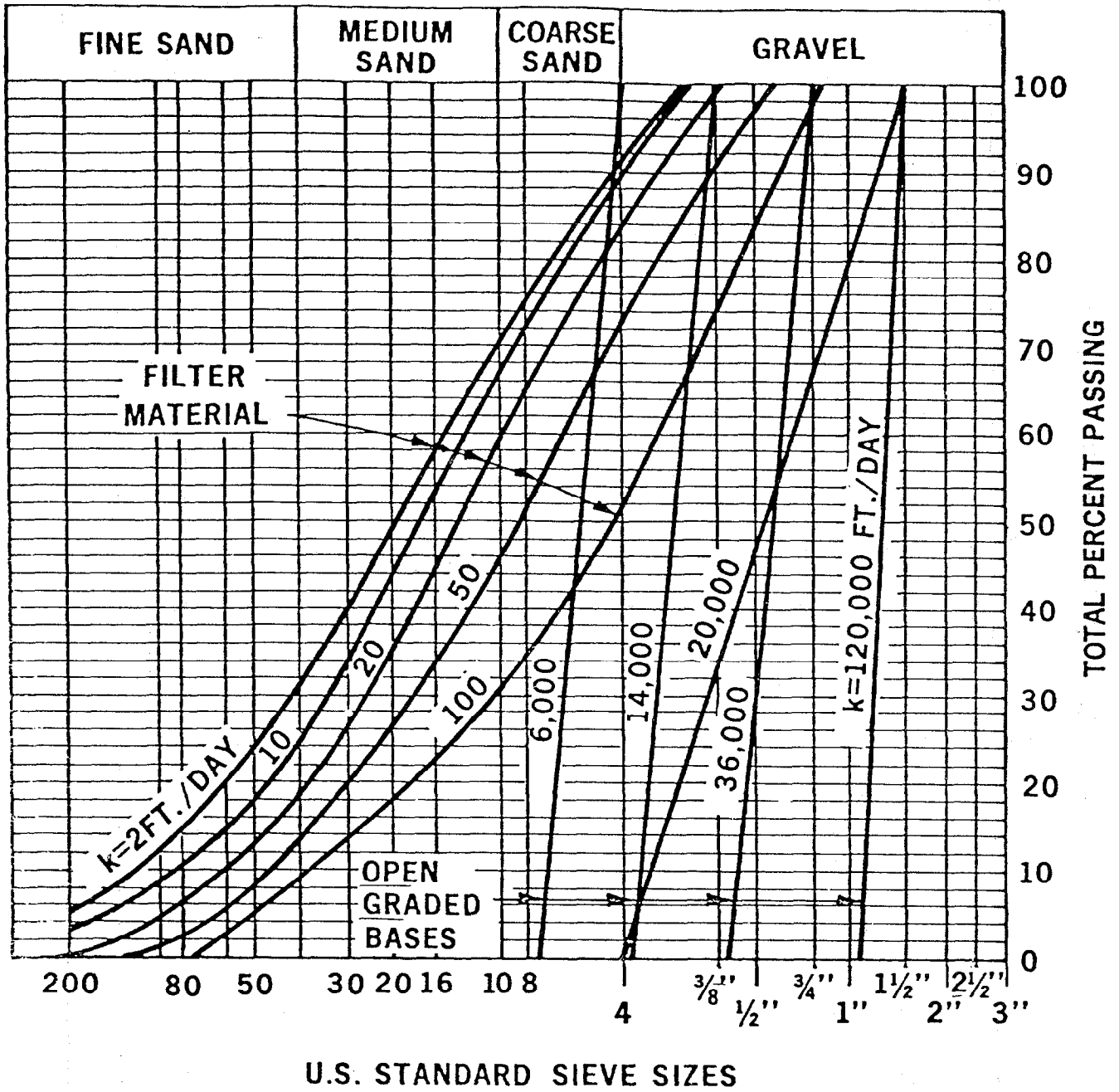

Figure 29. Typical Gradations and Permeabilities of Open Graded Bases and Filter Materials (5,16)

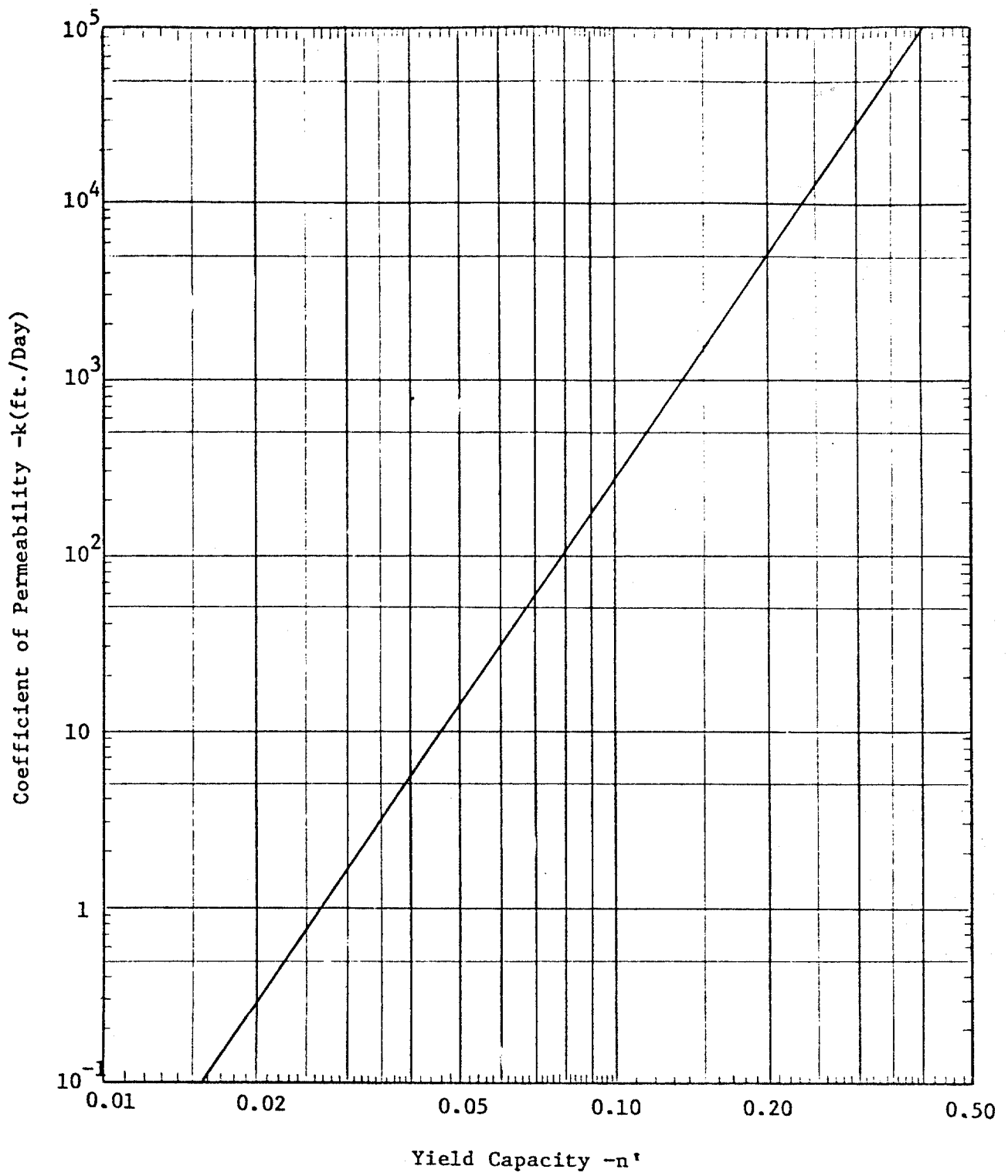

Figure 30. Chart For Determining Yield Capacity (Effective Porosity)

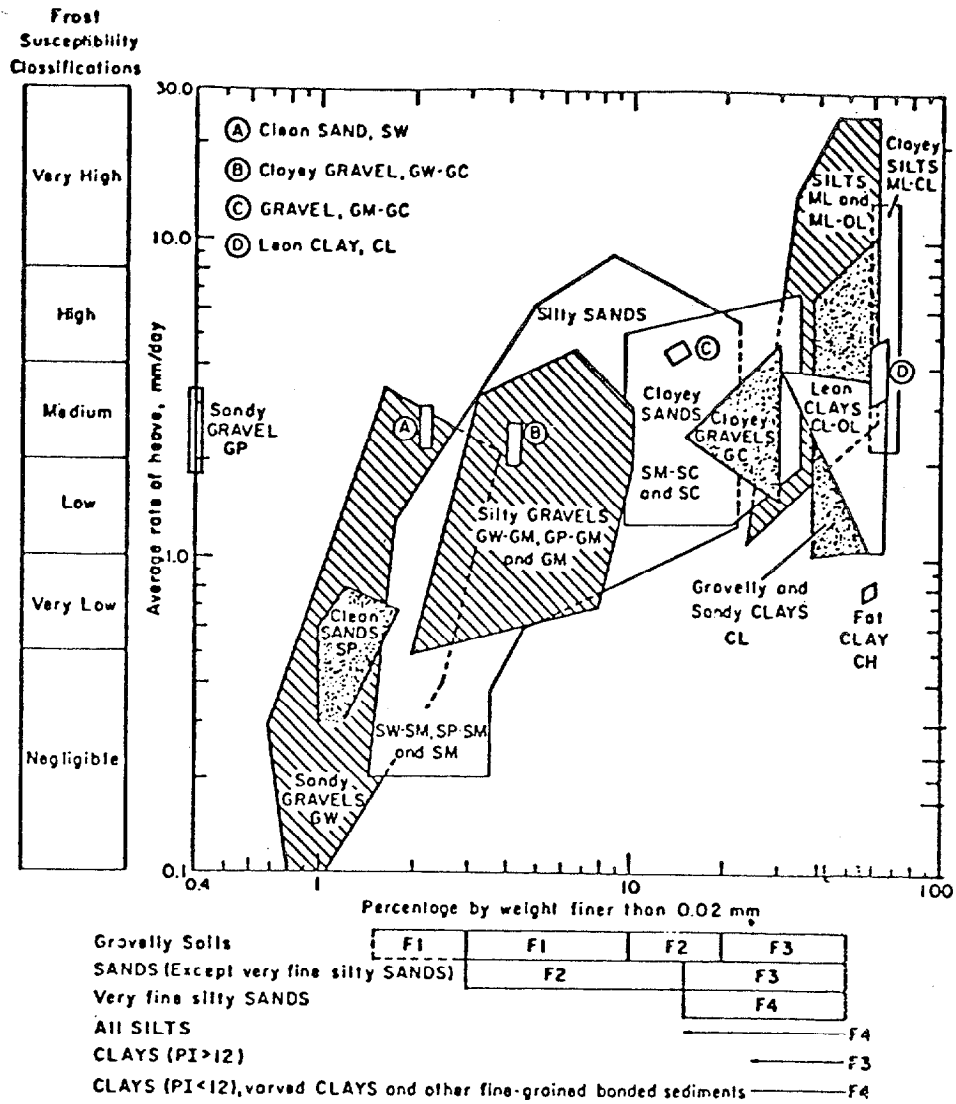

Figure 31. Summary of Results of All Standard Laboratory Freezing Tests Performed by The Corps of Engineers Between 1950 and 1970 (64)

been considered (19,20), there does not appear to be, as yet, a single proven, simple and reliable test or criterion for frost susceptibility adaptable to general highway design use (20). However, some relative indication of frost susceptibility can be obtained from Figure 31, which summarizes the results of standard laboratory freezing tests made by the Corps of Engineers from 1950 to 1970 (64). The F1 to F4 frost design classification groups (65), used by the Corps of Engineers for pavement design purposes, are also shown in Figure 31.

2.4 - Climatological Data

2.4.1 Precipitation. Although a precise understanding of the frequency, intensity and duration of precipitation in an area is not generally necessary for the detailed design of highway subsurface drainage, it can be helpful in defining the seriousness of the problem and in devising solutions. Generally, groundwater problems occur more frequently and are more serious in areas of high rainfall. Under these circumstances fluctuations in groundwater level may correlate reasonably well with amount of precipitation. On the other hand, there is some evidence that the infiltration of rainfall into pavement sections is dependent more upon duration of rainfall than intensity or frequency (29). Thus, there may be areas in the United States where there are no significant problems with respect to groundwater. However, this does not necessarily mean that no water will ever infiltrate into the pavement structural section (see Section 3.2.1).

The United States National Weather Service publishes records of precipitation in a variety of forms. Of particular interest and value are the maps which show rainfall intensity as a function of frequency and duration (66). A typical map of this type, giving the 1 hour/1 year frequency precipitation rates, is shown in Figure 32. The rainfall rates shown on this map were recommended by Cedergren (5,16) as the basis for computing infiltration rates into pavement structural sections. This will be discussed in greater detail in Section 3.2.1.

2.4.2 Depth of Frost Penetration. Some indication of the depth to which freezing temperatures may penetrate into the pavement or underlying subgrade can be helpful in assessing the seriousness of possible frost action. A number of theoretical relationships have been developed over the years which permit a reasonably reliable prediction of frost depth based upon air or pavement freezing indices and the thermal properties of the pavement elements and the subgrade (19,20,67,68). The most reliable of these formulas appears to be the modified Berggren equation (67,68). While maps giving average or maximum depths of frost penetration (69,70,71, 72) may be very helpful (e.g. see Figure 33,) they should be used with caution, because of the extreme variations in frost depth that can occur as a function of elevation and latitude (68). Ideally, well kept records of accurately measured depths of frost penetration would provide the best source of frost depth data. However, the availability of accurate weather records and the use of the digital

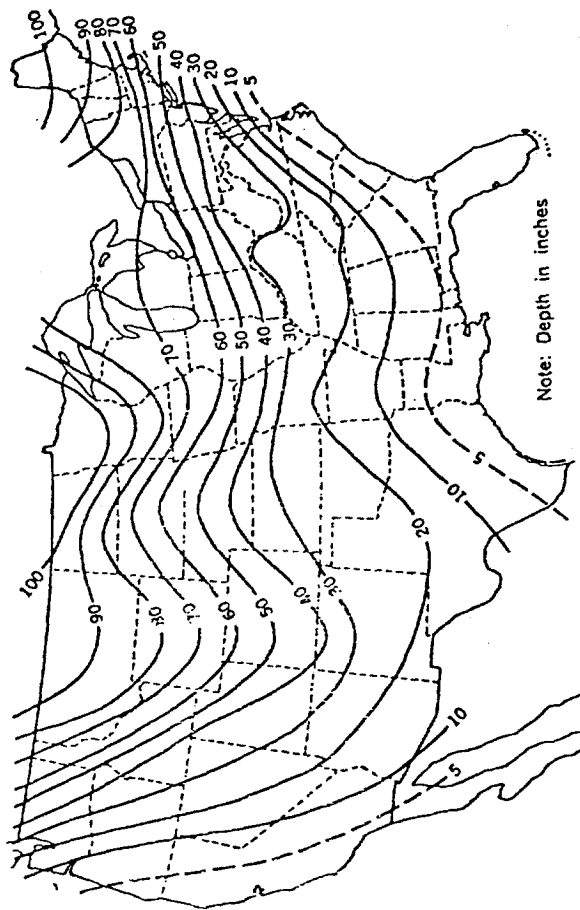

Figure 33. Maximum Depth of Frost Penetration
In The United States (69)

computer permit reliable individual predictions of local frost penetration to be made relatively easily and quickly (68).

2.5 - Miscellaneous Considerations

In addition to assembling the rather detailed data outlined in the preceding sections, the designer should give some attention to a number of considerations that may have either a direct or indirect influence on the design of subsurface drainage. These considerations include (a) the impact of the proposed subdrainage system on the existing regime and other aspects of design; (b) the sequence of construction operations; and (c) the economic factors associated with design and construction of highway subsurface drainage.

The designer should consider what effect the proposed subsurface drainage might have on the beneficial uses of groundwater and the consequences of redirecting the surface and subsurface flow of water. For example, in the process of lowering the watertable by means of highway subdrainage, the water level in nearby wells could be lowered or the wells could be dried up altogether. Although it might not be possible to avoid such occurrences, these possibilities should be explored and given consideration in right-of-way negotiations. It is also possible that outlets from subsurface drainage systems may direct water away from existing watercourses, causing minor flooding and/or erosion, if appropriate consideration is not given to this matter.

Frequently, it is desirable to control the sequence of construction operations so that subsurface drainage is installed as an early operation, or as the work progresses, in order that subsequent construction operations can be conducted "in-the-dry". On the other hand, under some circumstances, it may be better to control the timing of the installation of subsurface drainage until all work, that could result in contamination of drainage materials, has been completed (see Chapter 5). In any event, unless the need for a special sequence of construction operations is anticipated and provided for in the specifications, the completed subsurface drainage may not adequately perform the function for which it was designed.

Data should be assembled on the cost and availability of materials that may be used in the various subsurface drainage systems. Economic comparisons based on these data may be particularly important with respect to the design of drainage for pavement structural sections. This is because both strength and permeability will influence the design. In some instances, the permeability required for drainage may be achieved with cheap, readily available, granular materials that are also satisfactory from a structural standpoint. More commonly, however, it will be necessary to effect an economic trade-off between permeability and structural integrity. The comparison of the cost of

alternate designs should include some consideration of the possible cost of maintenance and/or pavement rehabilitation, if less than adequate pavement drainage is provided (5,16,25). In addition, the designer should not overlook the possibility that a subsurface drainage problem, and the resultant drainage system costs, can sometimes be avoided by appropriate changes in roadway alignment and grade.

Chapter III - PAVEMENT DRAINAGE

3.1 - General

The recommended procedure for the analysis and design of drainage for pavement structural sections involves the following steps:

- (1) Assemble all available data on highway and subsurface geometry, index properties and performance characteristics of soils and materials, precipitation and frost penetration, and miscellaneous considerations, as outlined in Chapter II.
- (2) Determine the net inflow, or quantity of water, that must be removed by the pavement drainage system. The gross inflow would consist of water from all sources that might contribute to the possible saturation of the pavement section under consideration, including groundwater, infiltration and melt water from thawing ice lenses (where frost action is present) in the subgrade soil. In computing the net inflow, an allowance should be made for any natural outflow that can take place by vertical seepage into the soil beneath the pavement.
- (3) Analyze and/or design pavement drainage layer(s) to provide for the rapid removal of the net inflow determined in Step 2. This should include an evaluation of the need for filter layers or special treatment of the subgrade (see Section 3.3).
- (4) Analyze and/or design collection system(s) to provide for the disposal of water removed by the pavement drainage layers. This includes the location and sizing of longitudinal and transverse collector drains, selection of filter material, and determination of outlet spacing.
- (5) Conduct a critical evaluation of the results of Steps 3 and 4 with respect to potential long-term performance, construction, maintenance and economics of the proposed pavement drainage system.

It should be understood that Steps 3, 4 and 5 are interdependent, and it may be necessary to pursue certain aspects of all three steps simultaneously or in some order other than that in which they were presented. For example, the thickness of the required drainage layers is governed, in part, by the distance the water has to flow to reach an outlet. This distance is controlled by the type and geometry of the selected collection system, which in turn may be governed by the economics associated with the cost and availability of granular drainage materials and pipe.

3.2 - Quantity of Water to be Removed

3.2.1 Infiltration. It was noted in Section 1.3.2 that the infiltration of water into pavement structural sections is a most complex phenomenon. Indeed, it depends upon an intricate interaction between the size and frequency of openings permitting infiltration, the rate at which water is applied to the pavement surface, and the ambient moisture conditions, permeability and overall drainage capabilities of the underlying layers. Unfortunately, we do not yet have a valid practical analytical solution to this problem. Theoretical studies of uniformly porous pavements, using transient flow analysis, have provided some insight into the problem (73), but they have not given us a realistic basis for estimating infiltration rates for the general design of highway pavement drainage. A qualitative evaluation of the mechanisms associated with infiltration (29) has shown that, given an adequate supply of water, the amount of infiltration will be a direct function of the ability of the base course to remove this water. Thus, within limits, the better the drainage capabilities of the base course, the higher will be the rate of infiltration. Conversely, if we select a high infiltration rate for design purposes, we automatically require that the base course be quite thick and have a very high coefficient of permeability in order to carry this water laterally, at a low hydraulic gradient, to a suitable outlet. Such a practice would certainly lead to conservative results, but it might prove to be unrealistic and uneconomical in many instances.

As one approach to this problem, Cedergren (5,16) has suggested that estimates of the amount of infiltration to be removed by the drainage layers be based on design precipitation rates. He recommends that the design infiltration rate be obtained by multiplying the 1 hour/1 year frequency precipitation rate (Figure 32) by a coefficient between 0.50 and 0.67 for portland cement concrete pavements and 0.33 to 0.50 for bituminous concrete pavements. However, the results of infiltration tests performed on pavements in Connecticut (29) suggested that the duration of rainfall is a more critical factor than the intensity. Moreover, it was found that the amount of infiltration could be related directly to cracking, and it was recommended that, for design purposes, the infiltration rate be taken as 2.4 cubic foot/day/foot of crack.

Obviously, more research is needed to clarify this matter. However, until more information becomes available, it will be necessary to adopt some realistically conservative method for estimating infiltration rates. Although both of the above criteria are empirical, it appears that the latter is more rational, and, since it is based upon field measurements, it has been adopted as a partial basis for estimating infiltration rates. Therefore, it is recommended that a uniform design infiltration rate, q_i , be estimated using the following expression:

$$q_i = I_c \left[\frac{N_c}{W} + \frac{W_c}{WC_s} \right] + k_p, \quad (6)$$

where q_i is the design infiltration rate (cubic feet/day/square foot of drainage layer), I_c is the crack infiltration rate (cubic feet/day/foot of crack), N_c is the number of contributing longitudinal cracks, W_c is the length of contributing transverse cracks or joints (feet), W is the width of granular base or subbase subjected to infiltration (feet), C_s is the spacing of transverse cracks or joints (feet), and k_p is the rate of infiltration (numerically equal to the coefficient of permeability) through the uncracked pavement surface (cubic feet/day/square foot).

For Portland cement concrete pavements and most dense graded, well compacted, bituminous concrete pavements, k_p is probably relatively insignificant and can be ignored. However, there is some evidence that the initial permeability of some bituminous concrete pavements may be quite significant until they have been subjected to the sealing action of traffic for a few months. Moreover, for "porous pavements" (73), the value of k_p may be very significant. No general criteria have been established or adopted for selecting design values of k_p under these circumstances. Instead, it is recommended that each case be considered individually, with design values of k_p being developed on the basis of carefully controlled laboratory or field tests.

It is recommended that a value of I_c of 2.4 cfd/f be used for most design applications. However, where it can be demonstrated that the frequency, intensity and duration of local precipitation are such that the recommended design infiltration rate cannot be supplied except infrequently, then it may be possible to use lower values of I_c . Conversely, it may be necessary to adopt higher values of I_c if local observations of infiltration and pavement performance indicate that this additional degree of conservatism is warranted.

For "normal" cracking or joints on new pavements, it is recommended that the value of N_c be taken as

$$N_c = (N + 1) \quad (7)$$

where N is the number of traffic lanes. This may be conservative on superelevated sections, where the uppermost crack or joint may not intercept very much flow. Where the pavement drainage is to be designed for other than "normal" cracking, N_c should be taken as the equivalent number of continuous contributing longitudinal cracks.

It is recommended that the "normal" values of C_s be taken as the regular transverse joint spacing for new Portland cement concrete pavements and as the anticipated average transverse crack spacing for new continuously reinforced Portland cement concrete and bituminous concrete pavements. A value of C_s of 40 feet has been suggested for new bituminous concrete pavements (29). However, "normal" transverse cracking

as a result of thermal and moisture changes can be extremely variable, especially in continuously reinforced concrete pavements, where such factors as slab thickness and percentage of reinforcement may exert an important influence (74). Therefore, it is recommended that "normal" design values of C_s be developed on the basis of local observations of regular transverse cracking for the type of pavement under consideration. If, however, the pavement drainage is to be designed for other than "normal" cracking, then an average crack spacing consistent with the degree of assumed structural damage should be selected.

Example No. 1 - Infiltration Into a Rigid Pavement Section.

Consider a new Portland cement concrete pavement consisting of two 12' traffic lanes with 10' dense graded bituminous concrete shoulders, as shown in Figure 34. The transverse pavement joints are to be placed at 20' intervals. It will be assumed in this case that infiltration through the uncracked pavement surface will be insignificant, i.e., $k_p = 0$. Using Equation (6), with $I_c = 2.4$ cfd/f; $N_c = (N + 1) = 3$; $C_s =$ Transverse Joint Spacing = 20'; $W_c = 44'$; and $W = 24'$; gives

$$q_i = 2.4 \left[\frac{3}{24} + \frac{44}{24(20)} \right] = 0.52 \text{ Say } \underline{0.5} \text{ cfd/sf.}$$

In Example 1, the conservative assumption has been made that the bituminous concrete shoulders will have transverse thermally induced cracks developing at the same interval as the pavement joints. In addition, it has been assumed, for the purpose of computing q_i , that the width of the granular layer, W , receiving infiltration is only 24'. However, in designing the drainage layer, it will be assumed that q_i is applied uniformly to the full width of the granular material (see Example 13).

Example No. 2 - Infiltration Into a Flexible Pavement Section.

Consider a new bituminous concrete pavement for two lanes of a 4 lane divided expressway. The traffic lanes are 12' wide, with a 4' inside shoulder and a 10' outside shoulder, as shown in Figure 35. For "normal" cracking; $N_c = 3$; $C_s =$ Say 40'; $W_c = 38'$; and $W = 24'$. Thus, with $I_c = 2.4$, and assuming $k_p = 0$, Equation (6) gives

$$q_i = 2.4 \left[\frac{3}{24} + \frac{38}{24(40)} \right] = 0.395 \text{ Say } \underline{0.4} \text{ cfd/sf.}$$

3.2.2 Groundwater. Frequently, it is possible to intercept the flow of groundwater and/or draw down the free water surface (see Figures 14, 15, 17, and 18) so that little or no water gets into the pavement section from this source. However, under some circumstances, it may not be possible to control the flow of groundwater in this way, and

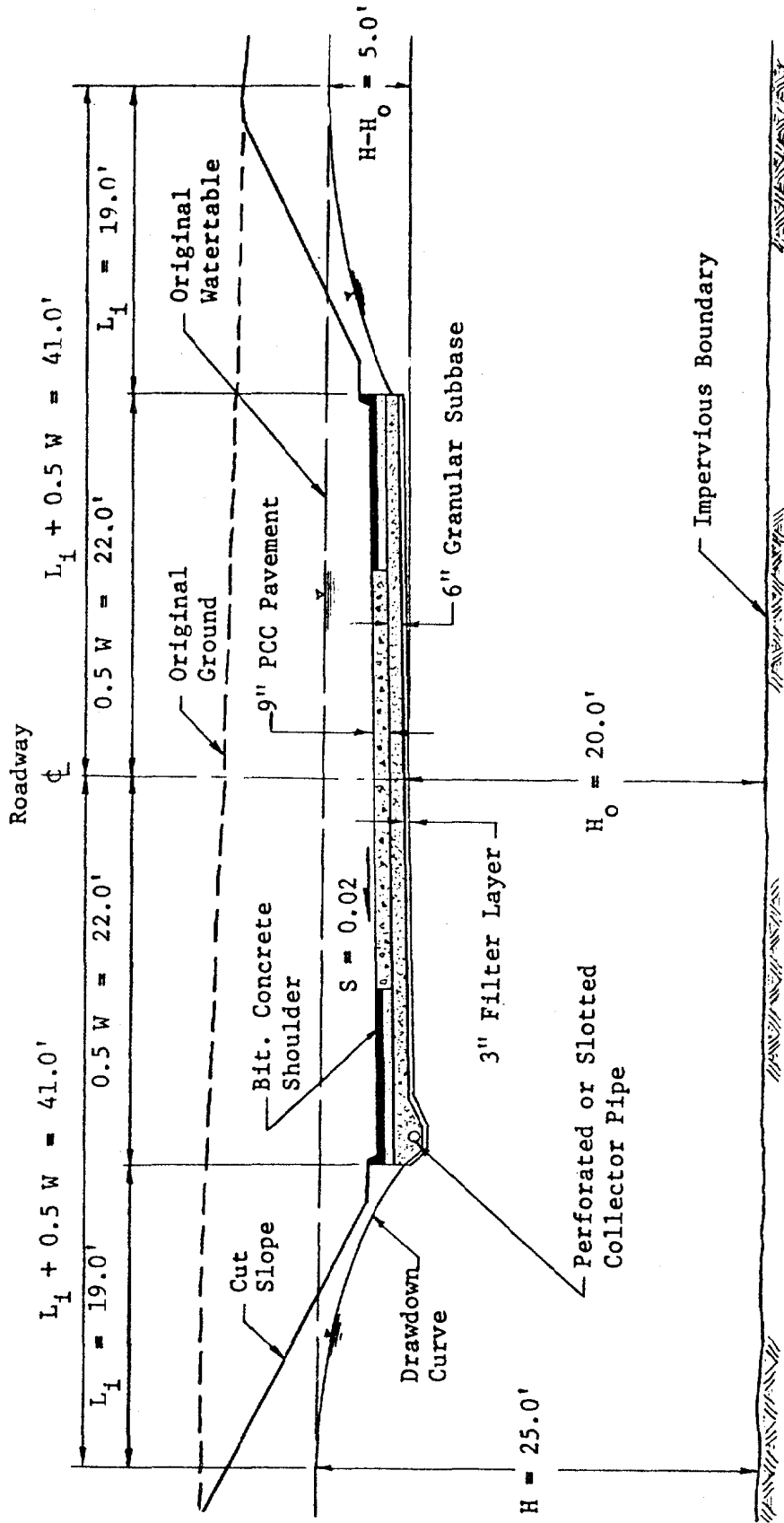

Figure 34. Rigid Pavement Section In Cut-Dimensions And Details For Examples 1, 3, 11, 13, 14 and 17.

it will be necessary to include seepage from this source in designing pavement drainage. Two possible sources of groundwater should be considered: (a) gravity drainage, as shown in Figure 15; and, (b) artesian flow, as illustrated in Figure 22a.

For the case of gravity drainage, the average inflow rate, q_g , can be estimated by means of a flow net analysis (11), or by the use of Figure 36, which was prepared to facilitate approximate computations of this type (12,75). In either case, the first step will be the determination of the "radius of influence" or drawdown influence distance, which can be estimated, for practical purposes, by means of the expression (75)

$$L_i = 3.8 (H - H_o), \quad (8)$$

where L_i is the influence distance (feet) and $(H - H_o)$ is the amount of drawdown (feet). See Figure 36.

Once the value of L_i has been determined, Figure 36 can be used to determine the total quantity of upward flow, q_2 , into the drainage blanket. The average inflow rate can then be computed from the relationship

$$q_g = \frac{q_2}{0.5W}, \quad (9)$$

where q_g is the design inflow rate from gravity drainage (cubic feet/day/square foot of drainage layer), q_2 is the total upward flow into one half of the drainage blanket (cubic feet/day/linear foot of roadway), and W is the width of the drainage layer (feet). Although the solution given in Figure 36 is based upon a symmetrical configuration of gravity flow, very little error is introduced if the flow conditions are not exactly symmetrical because of roadway cross slope, variation in depth of the impervious boundary, etc. Under these conditions, the use of average values of H , H_o and L_i in Figure 36 will be satisfactory.

Example No. 3 - The Gravity Flow of Groundwater Into a Pavement Drainage Layer. Consider the flow situation shown in Figure 34. The native soil is a silty sand with a measured coefficient of permeability, k , of 0.34 fpd. The average drawdown, determined from Figure 34, is $(H - H_o) = (25.0 - 20.0) = 5.0'$. Thus, the influence distance can be determined from Equation (8) as $L_i = 3.8(5) = 19.0'$. Entering Figure 36 with $(L_i + 0.5W)/H_o = (19.0 + 22)/20 = 2.05$, and $W/H_o = 44/20 = 2.2$, it is found that $k(H - H_o)/2q_2 = 0.74$. Therefore, $q_2 = 0.34(5)/2(0.74) = 1.15$ cfd/f. Finally, the average inflow rate from the gravity flow of groundwater can be calculated from Equation (9) as $q_g = q_2/0.5W = 1.15/22 = \underline{0.052}$ cfd/sf.

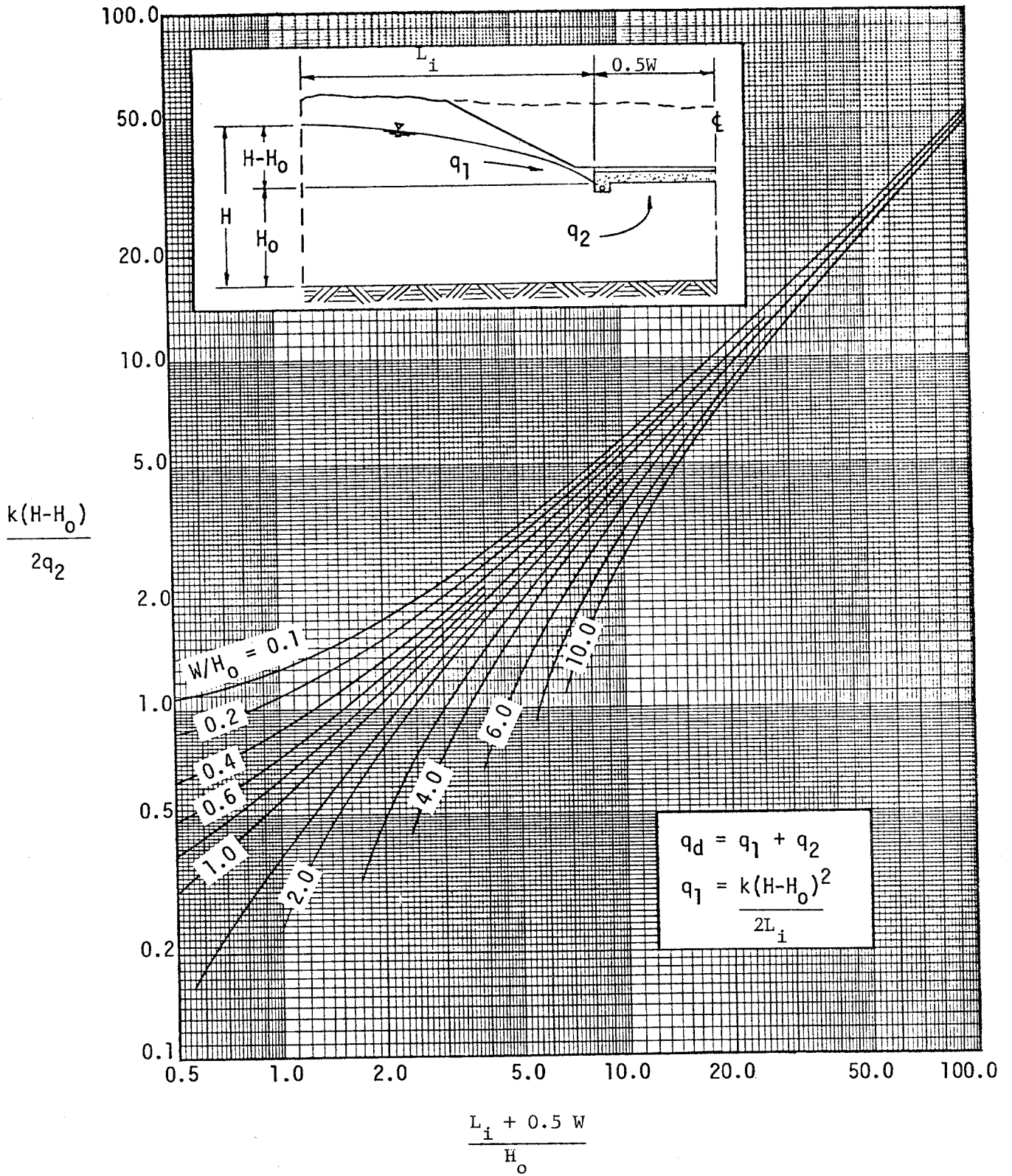

Figure 36. Chart for Determining Flow Rate in Horizontal Drainage Blanket (12,75)

In the actual design of a drainage system, such as that shown in Figure 34, some gravity seepage in addition to q_g would have to be considered. This flow is designated as q_1 in Figure 36, and its magnitude would be $q_1 = k(H - H_0)^2/2L_1 = 0.34(5)^2/2(19.0) = 0.224$ cfd/f. The q_1 flow from the left side would only be considered in the design of the collector drain. However, in this case, the q_1 flow from the right side would have to be carried over to the left side to the collector drain and, thus, would have to be considered in the design of the drainage blanket (See Example 13).

For the case of artesian flow, the average inflow rate can be estimated by the use of flow nets (5,11) or, very simply, by the use of Darcy's Law, i.e. Equation (3), in the form

$$q_a = k \frac{\Delta H}{H_0} \quad (10)$$

where q_a is the design inflow rate from artesian flow (cubic feet/day/square foot of drainage layer), ΔH is the excess artesian head (feet), and H_0 is the thickness of subgrade soil between the artesian aquifer and the drainage layer, as shown in Figure 37.

Example No. 4 - The Artesian Flow of Groundwater Into a Pavement Drainage Layer. Consider the flow situation shown in Figure 37. The subgrade soil above the artesian aquifer is a clayey silt with a coefficient of permeability, k , of 0.07 fpd. A piezometer installed during the course of the subsurface exploration program at this site showed that the piezometric head of the water in the artesian layer was about 8 feet above the bottom of the proposed pavement drainage layer, as shown in Figure 37. Using Equation (10), with $\Delta H = 8.0'$, $H_0 = 15.0'$, and $k = 0.07$ fpd, gives

$$q_a = \frac{0.07(8.0)}{15.0} = 0.037 \text{ cfd/sf.}$$

It should be noted at this point that the quantity of groundwater that flows into pavement drainage layers is often relatively small when compared to the quantity of infiltration. This shows up very clearly when the computed inflow rates of Examples 1 and 2 are compared with those of Examples 3 and 4. However, it should not be automatically concluded that inflow from groundwater sources can be neglected. The designer should estimate the inflow from all sources, since the cumulative effect of small inflows from several sources may be quite significant.

3.2.3 Melt Water From Ice Lenses. The amount of water, in the form of ice, that accumulates in a highway subgrade as a result of frost action is a function of the frost susceptibility of the subgrade soil,

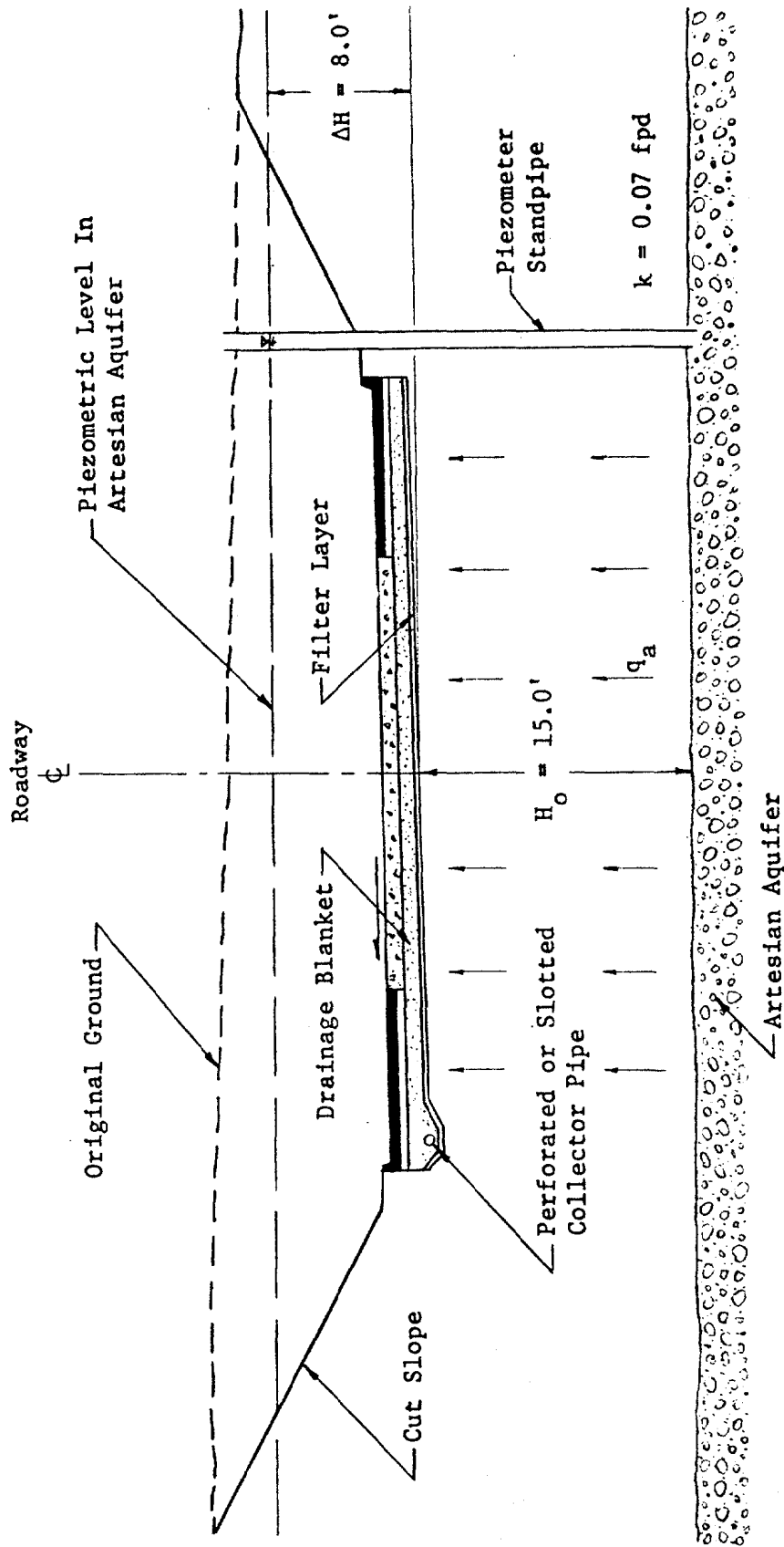

Figure 37. Artesian Flow of Groundwater Into a Pavement Drainage Layer - Dimensions and Details for Example 4

the availability of groundwater to feed the growth of ice lenses, and the severity and duration of subfreezing temperatures. The rate at which this water seeps from the soil upon thawing is dependent upon the rate of thawing, the permeability of the thawed soil, the effectiveness of the pavement drainage system, and the stresses imposed by the overlying pavement structure and vehicular traffic. Obviously, the problem is very complex, and an exact solution for the rate of inflow to a granular drainage layer from a thawing subgrade soil is not presently available. However, a reasonable estimate of the design inflow rate can be made by appropriate use of Figure 38.

Figure 38 was developed by assuming that the drainage of a thawed subgrade soil can be represented by the one-dimensional consolidation model that forms the basis of the Terzaghi consolidation theory (76). A similar approach was suggested by Moulton and Schaub (77) as a means for predicting the duration of the period of reduced subgrade support following thawing.

The rate of seepage from the consolidating soil is a maximum immediately following thawing, and it decreases quite rapidly as time goes on. Since the maximum rate of drainage exists for only a short period of time, the design inflow rate, q_m , presented in Figure 38, was taken as the average occurring during the first day (24 hours) following thawing. Although it is felt that this is quite conservative, it is possible that pavement drainage layers designed on this basis might become saturated for as much as 6 hours following thawing. If this condition cannot be tolerated, then it may be necessary to design for more rapid drainage as described in Section 3.3.1.

The determination of q_m from Figure 38 involves the use of a value of laboratory heave rate or the frost susceptibility classification shown in Figure 31. Since the results of laboratory freezing tests on specific soils are rarely available, the selection of a heave rate or frost susceptibility classification, for use in Figure 38, must depend at present upon the exercise of experience and judgment, preferably based upon observations of frost action in local soils. In lieu of this experience and judgment, the conservative guidelines presented in Table 4 are recommended. These guidelines are based on the data presented in Figure 31.

The determination of q_m from Figure 38 also involves the use of σ_p , the stress imposed on the subgrade soil by the pavement structure above it. The value of σ_p (in pounds/square foot) can be determined simply by calculating the weight of a one foot square column of the pavement structure above the subgrade.

Example No. 5 - The Flow Into a Pavement Drainage Layer From a Thawing Subgrade Soil. Consider the case of a 9" thick concrete pavement with a 6" thick granular subbase, designed as a drainage layer, overlying a silty subgrade soil. The soil has 39 percent of its particles finer than 0.02 mm and classifies as an ML soil under

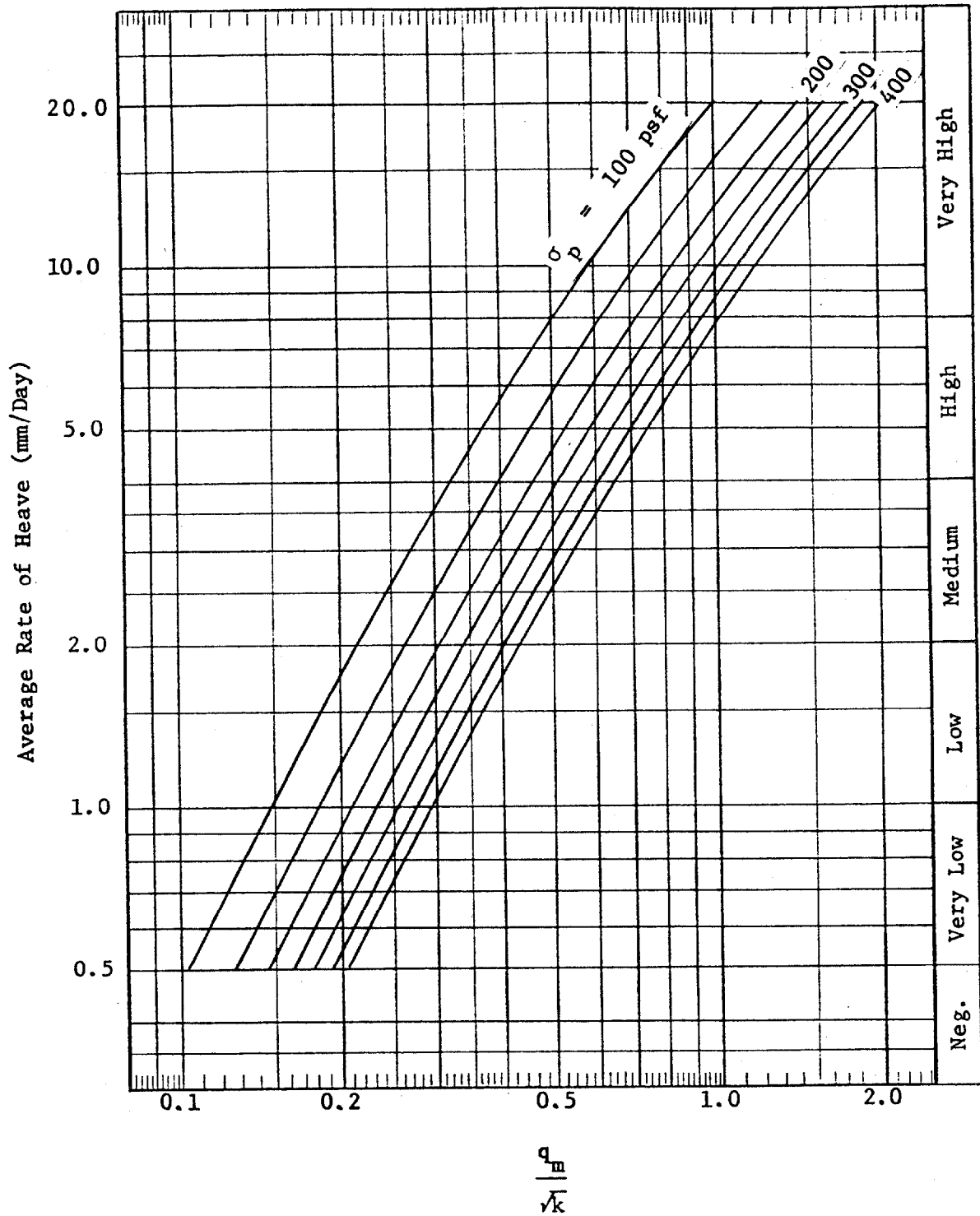

Figure 38. Chart for Estimating Design Inflow Rate of Melt Water From Ice Lenses

Table 4. Guidelines for selection of heave rate or frost susceptibility classification for use in Figure 38.

<u>Unified Classification</u>		Percent < 0.02 mm	Heave Rate mm/day	<u>Frost Suscept. Classification</u>
<u>Soil Type</u>	<u>Symbol</u>			
Gravels and Sandy Gravels	GP	0.4	3.0	Medium
	GW	0.7-1.0	0.3-1.0	Neg. to Low
		1.0-1.5	1.0-3.5	Low to Medium
		1.5-4.0	3.5-2.0	Medium
Silty and Sandy Gravels	GP-GM	2.0-3.0	1.0-3.0	Low to Medium
	GW-GM	3.0-7.0	3.0-4.5	Medium to High
	GM			
Clayey and Silty Gravels	GW-GC	4.2	2.5	Medium
	GM-GC	15.0	5.0	High
	GC	15.0-30.0	2.5-5.0	Medium to High
Sands and Gravelly Sands	SP	1.0-2.0	0.8	Very Low
	SW	2.0	3.0	Medium
Silty and Gravelly Sands	SP-SM, SW-SM, SM	1.5-2.0	0.2-1.5	Neg. to Low
		2.0-5.0	1.5-6.0	Low to High
		5.0-9.0	6.0-9.0	High to Very High
		9.0-22.0	9.0-5.5	
Clayey and Silty Sands	SM-SC SC	9.5-35.0	5.0-7.0	High
Silts and Organic Silts	ML-OL, ML	23.0-33.0	1.1-14.0	Low to Very High
		33.0-45.0	14.0-25.0	Very High
		45.0-65.0	25.0	Very High
Clayey Silts	ML-CL	60.0-75.0	13.0	Very High
Gravelly and Sandy Clays	CL	38.0-65.0	7.0-10.0	High to Very High
Lean Clays	CL	65.0	5.0	High
	CL-OL	30.0-70.0	4.0	High
Fat Clays	CH	60.0	0.8	Very Low

the Unified Soil Classification system. The groundwater and temperature conditions at the pavement site are both conducive to frost action. It is assumed that the coefficient of permeability, k , of the thawed subgrade soil is 0.05 feet per day.

Based upon assumed unit weights of 150 pcf and 125 pcf for the pavement and subbase, respectively, the value of $\sigma_p = 150(9/12) + 125(6/12) = 175$ psf. The heave rate for this soil can be estimated from Table 4 by interpolation as $14 + (6/12)11 = 19.5$ say 20 mm/day. Entering Figure 38 with a heave rate of 20 mm/day, and $\sigma_p = 175$ psf, yields $q_m/\sqrt{k} = 1.32$. Therefore, $q_m = 1.32 \sqrt{0.05} = 0.295$ say 0.3 cfd

It should be noted that the subgrade soil in Example 5 had a very high potential frost susceptibility. This, coupled with a relatively high coefficient of permeability for the given soil (see Tables 2 and 3) led to a rather high value of q_m . In general, it would be expected that the design inflow rate from this source would be substantially lower than the value obtained in Example 5. However, Example 5 does serve as a reminder that sources of inflow other than infiltration can be quite important and should not be neglected.

3.2.4 Vertical Outflow. Under certain conditions, some of the water that may infiltrate and accumulate in a pavement structural section may seep vertically out of the pavement layers through the underlying soil strata. Since this vertical seepage tends to decrease the amount of water that must be carried by the pavement drainage system, it should be given very careful consideration.

There are a wide variety of subsurface conditions under which vertical seepage may take place. However, for the purpose of discussion, these can be placed in three broad general categories: (1) the flow is directed toward a watertable, either horizontal or sloping, existing at some depth below the pavement section (Figure 39); (2) the subgrade soil or embankment is underlain at some depth by a stratum whose permeability is very high relative to that of the subgrade or embankment material, thus promoting very nearly vertical flow (Figure 40); and (3) the flow is directed vertically and laterally through the underlying embankment and its foundation to exit through a surface of seepage on the embankment slope and/or through the foundation (Figure 41).

When the existing watertable is horizontal, or very nearly horizontal, some vertical flow out of the pavement structural section can take place. However, steady-state flow cannot be achieved under these conditions, as illustrated in Figure 39a. Theoretically, as soon as a sufficient amount of infiltration takes place, vertical outflow, q_v (cfd/sf), will be initiated under a unit hydraulic gradient (i.e. $q_v/k = 1$). However, if the infiltration is sustained for any significant period of time, the flow domain will expand as the time dependent position of free water surface (saturation line) moves outward and upward (see Figure 39a). As

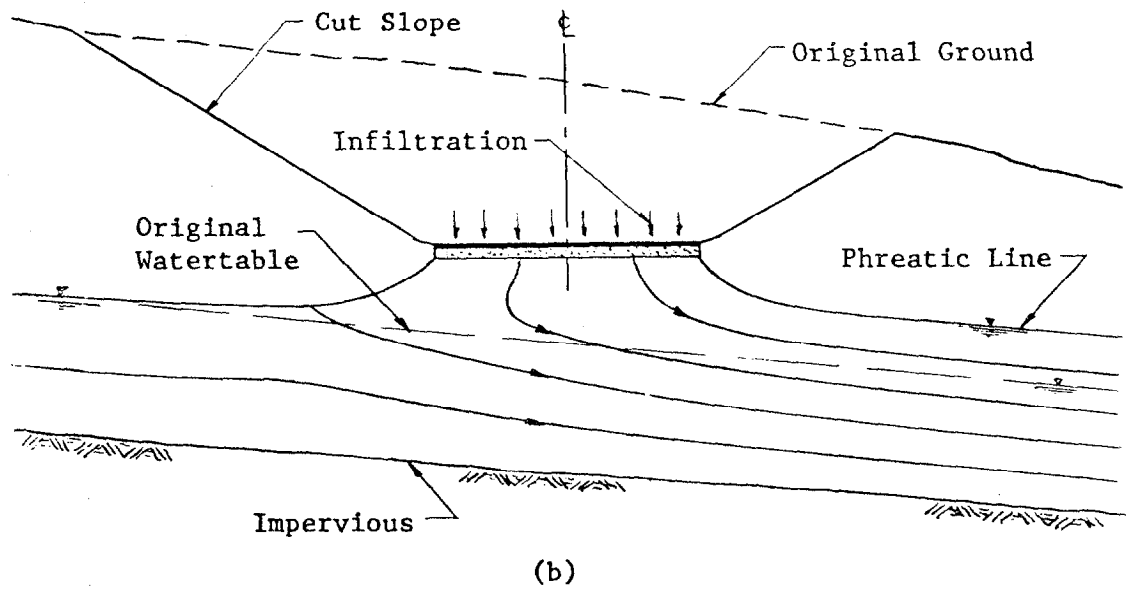
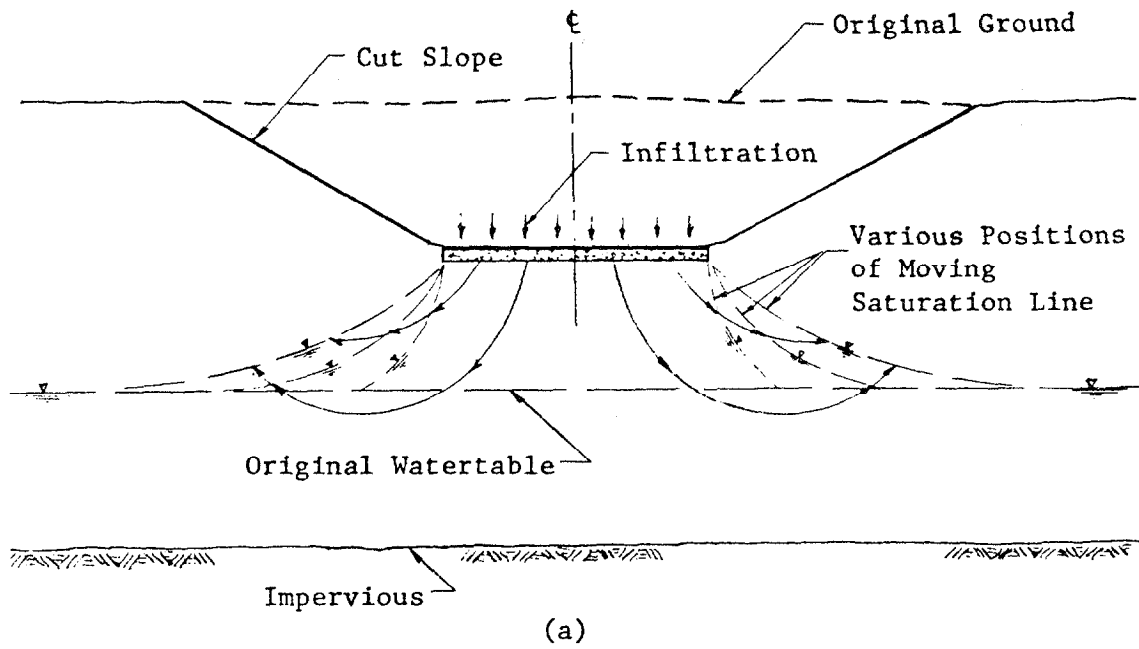
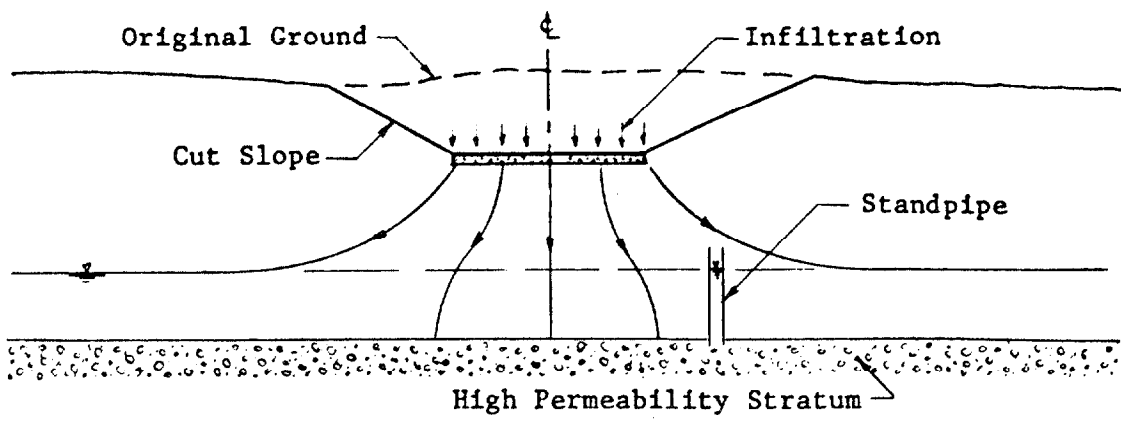
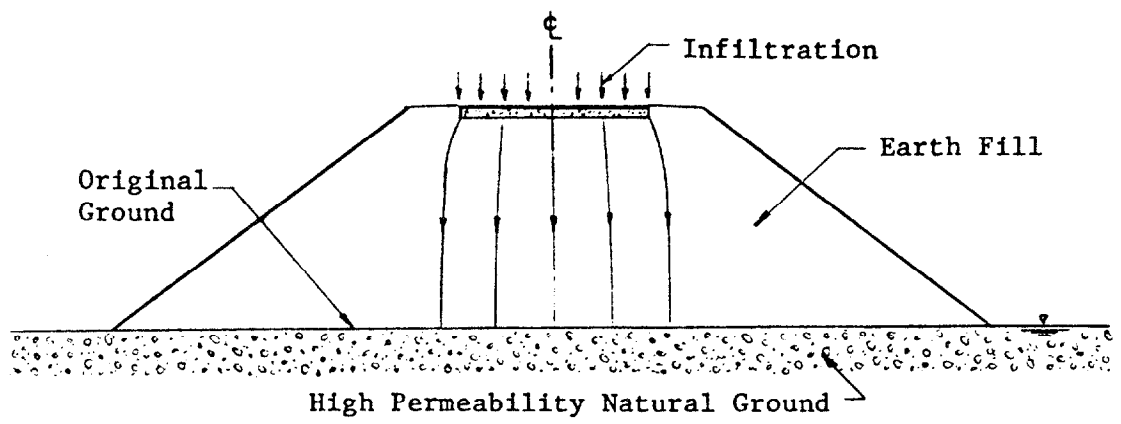

Figure 39. Vertical Outflow Toward An Underlying Watertable



(a)



(b)

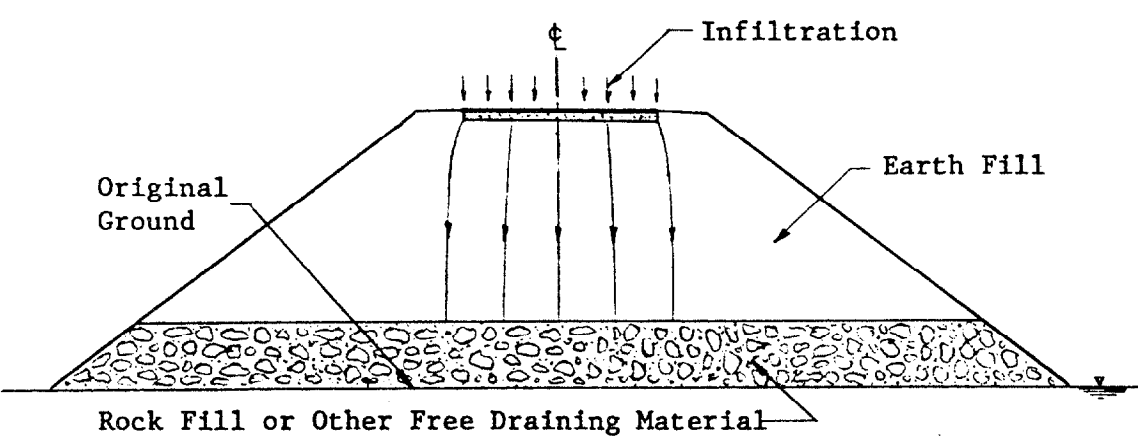

(c)

Figure 40. Vertical Outflow Toward An Underlying Layer of Very High Permeability

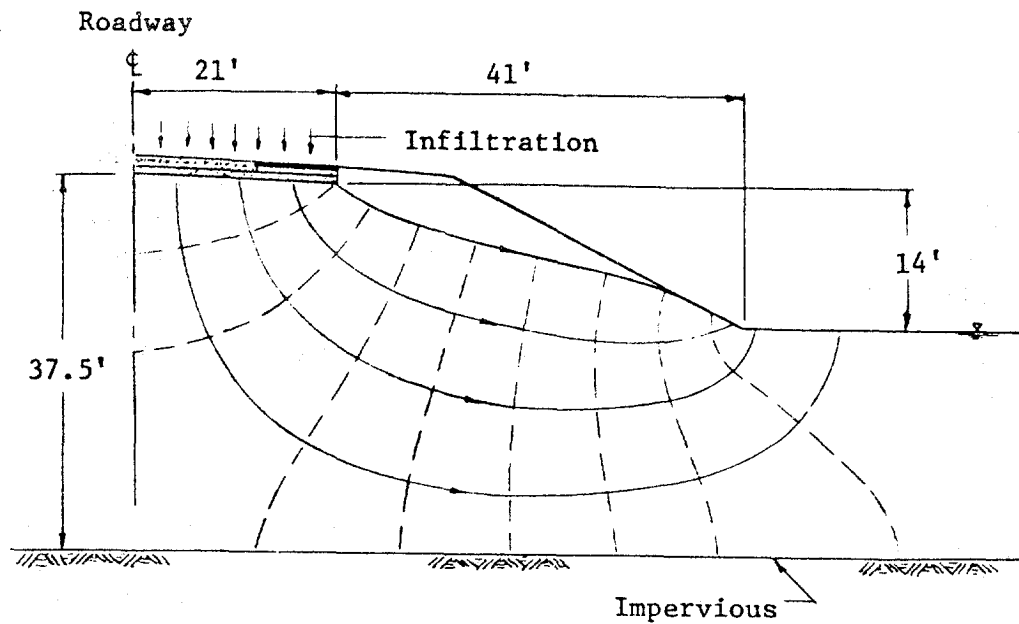

(a)

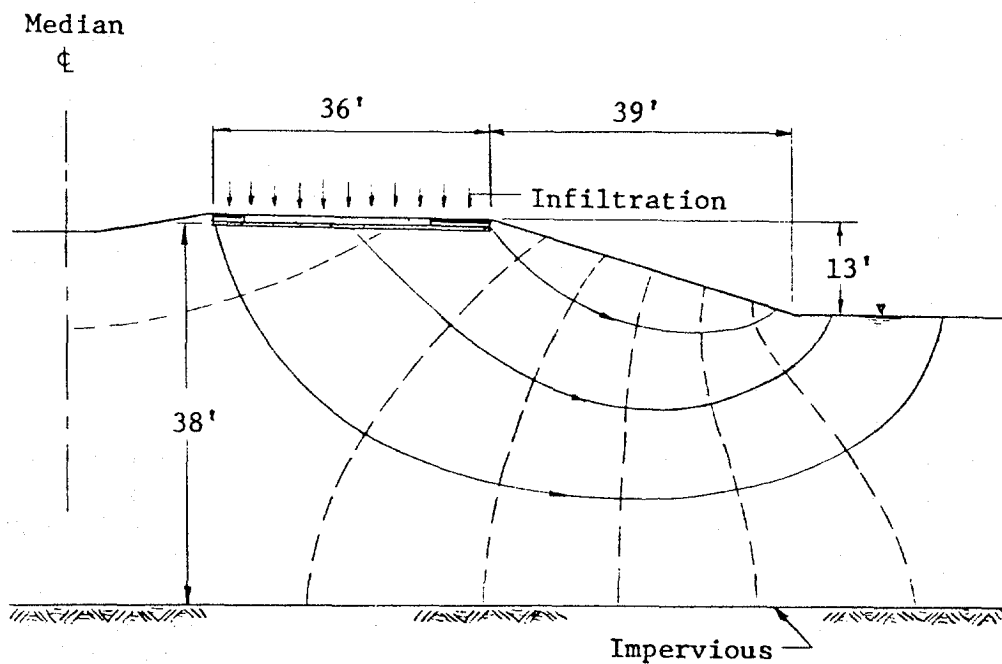

(b)

Figure 41. Vertical And Lateral Outflow Through Embankment And Its Foundation

this occurs, the average hydraulic gradient and, therefore, q_v will decrease until the rainfall induced infiltration ceases or the watertable rises to the bottom of the pavement section. Of course, in the latter case the vertical flow rate would reduce to zero. Unsteady flow problems, such as this, can be solved by means of a series of transient flow nets as described by Cedergren (11). One such flow net is shown in Figure 42. For situations such as this, the total quantity of outflow can be calculated by means of the well known expression

$$q = k\Delta h \frac{N_f}{N_d}, \quad (11)$$

where q is the rate of flow in cfd/f, Δh is the total head loss through the flow domain in feet, k is the coefficient of permeability in feet/day, N_f is the number of flow paths contained by the flow net, and N_d is the number of potential drops indicated by the flow net.

Example No. 6 - Transient Flow From a Pavement Structural Section Toward An Underlying Horizontal Watertable. Consider the transient flow situation shown in Figure 42. At the particular instant for which this flow net can be considered valid, the total flow, q , from the half of the pavement section shown, can be estimated by means of Equation (11). Using $\Delta h = 8.8'$, $N_f = 5$, and $N_d = 6.5$, Equation (11) gives $q/k = 8.8(5)/6.5 = 6.76$ sf/f. The average outflow rate, q_v , is then obtained by dividing the total outflow by the width of the pavement section involved, i.e. $0.5W = 16'$ in this case. Thus,

$$\frac{q_v}{k} = \frac{q}{0.5Wk} = \frac{6.76}{16} = \underline{0.42} \text{ sf/sf}$$

Example 6 shows that, while the average hydraulic gradient can be expected to decrease considerably from its initial value of unity, it can sometimes remain at a relatively high value for some time following the initiation of flow. However, it should be recognized that in Example 6 the effect of infiltration, other than that introduced through the pavement, has been ignored. In reality, rainfall of long duration, which could be expected to produce infiltration through the pavement for a prolonged period of time, would also produce downward percolation through the surrounding soil, thus tending to raise the general level of the watertable and further reduce the outflow from the pavement section. Consequently, it is recommended that caution be exercised in applying the above method to estimate vertical outflow toward an underlying horizontal watertable. If it can be demonstrated with reliability that the watertable will remain well below the level of the pavement even during prolonged wet weather, then vertical outflow of this type should be considered in design. However, in the absence of such data, it is probably advisable for design purposes to consider vertical outflow toward a horizontal watertable to be negligible.

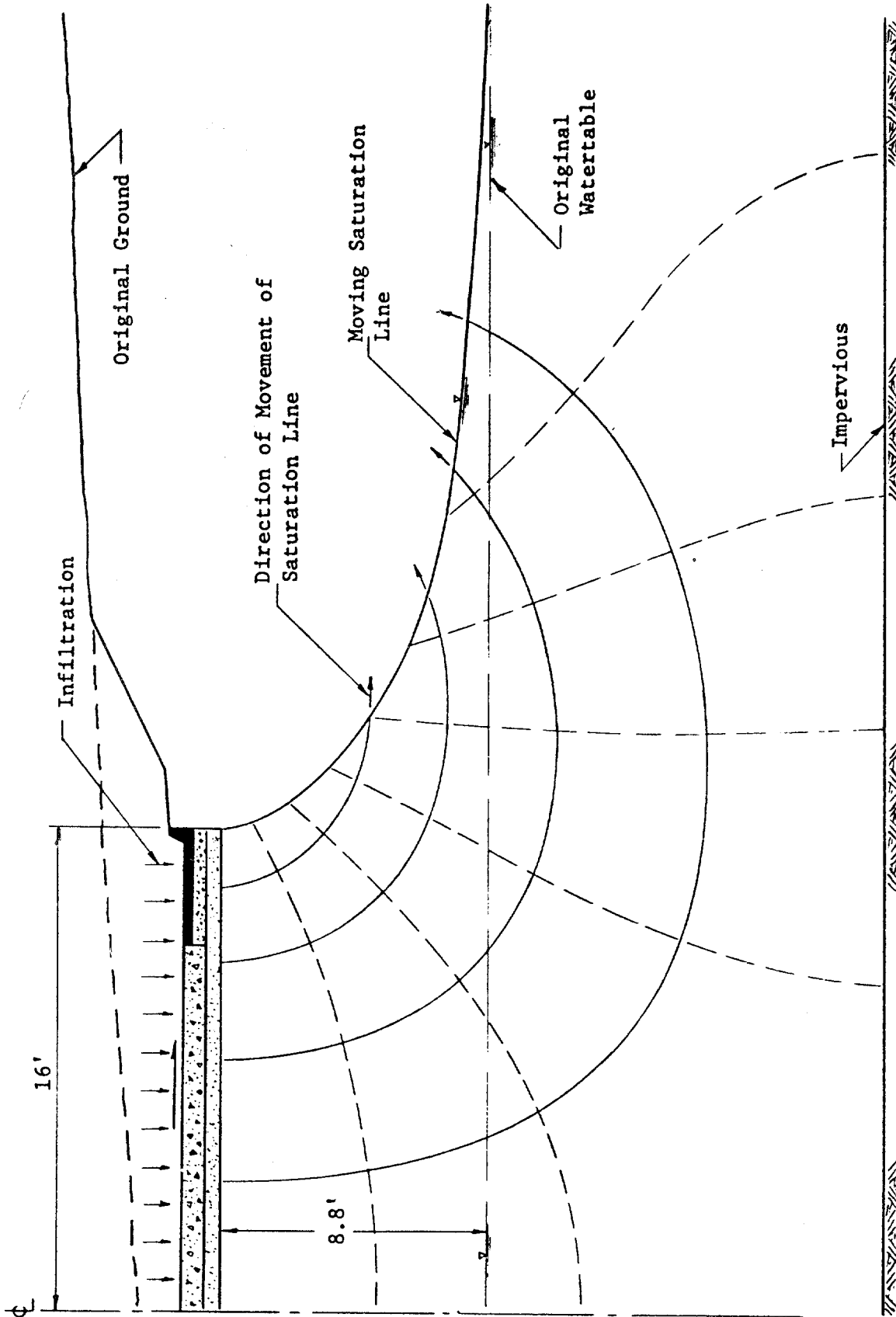

Figure 42. Transient Flow Net For the Case of Vertical Outflow Toward An Existing Horizontal Watertable - Dimensions and Details for Example 6

When the existing watertable below the pavement section is sloping, as shown in Figure 39b, steady state vertical outflow can take place, providing the infiltration is maintained for a sufficiently long period of time. As indicated above for the horizontal watertable, as soon as sufficient infiltration takes place, vertical outflow would be initiated under a unit hydraulic gradient. This hydraulic gradient would gradually decrease and finally become constant when steady state flow was achieved. At this point, the minimum vertical outflow rate would exist. This outflow rate can be estimated by means of flow net analysis, using a steady state flow net, as described by Cedergren (11), or by using the approximate solution (12) given in Figure 43.

Example No. 7 - Steady Flow From a Pavement Structural Section Toward a Sloping Watertable. Consider the flow situation shown in Figure 39b, and in the upper portion of Figure 43, for the case where the depth of the approach flow, H , is 10', the depth from the bottom of pavement section to the impervious boundary, D_r , is 50', the width of the pavement section, W , is 36', and the slope of the watertable and underlying impervious layer, S , is 0.1. Entering Figure 43 with $W/D_r = 36/50 = 0.72$, and $H/D_r = 10/50 = 0.2$, it is found that $q_v/Sk = 1.1$. Therefore, $q_v/k = 1.1S = 1.1(0.1) = 0.11$ sf/sf. If the subgrade soil in this case were a relatively well graded sand, with a coefficient of permeability, k , of 2.0 fpd, the vertical outflow would be $q_v = 2(0.11) = 0.22$ cfd/sf. (Compare with the infiltration, q_i , in Examples 1 and 2.) On the other hand, if the subgrade soil had been a silty fine sand, with a coefficient of permeability of 0.1 fpd, then the outflow rate would only have been $q_v = 0.1(0.11) = 0.011$ cfd/sf.

If the watertable were to rise during a period of wet weather to a point where it was only 10' below the pavement section, i.e. to the point where $H = 40'$, then entering Figure 43 with $H/D_r = 40/50 = 0.80$, and $W/D_r = 0.72$, it is found that $q_v/Sk = 0.28$, and $q_v/k = 0.028$ sf/sf. Under these conditions, the vertical outflow through the well graded sand would be reduced from 0.22 cfd/sf to $q_v = 2(0.028) = 0.056$ cfd/sf.

Example 7 shows that the vertical outflow toward a sloping watertable can vary considerably, depending upon the geometry of the problem and the permeability of the subgrade soil. Consequently, when using Figure 43 for estimates of outflow rate, the designer should select the input parameters with realistic conservatism, recognizing the possibility of seasonal variations in the watertable.

When the subgrade soil or embankment, upon which the pavement is supported, is underlain by a high permeability (free draining) stratum, as shown in Figure 40, the vertical outflow can be quite significant, depending upon the magnitude of the permeability of the soil between the pavement and the free draining layer. In the situation shown in Figure 40a, the average hydraulic gradient of the vertical outflow,

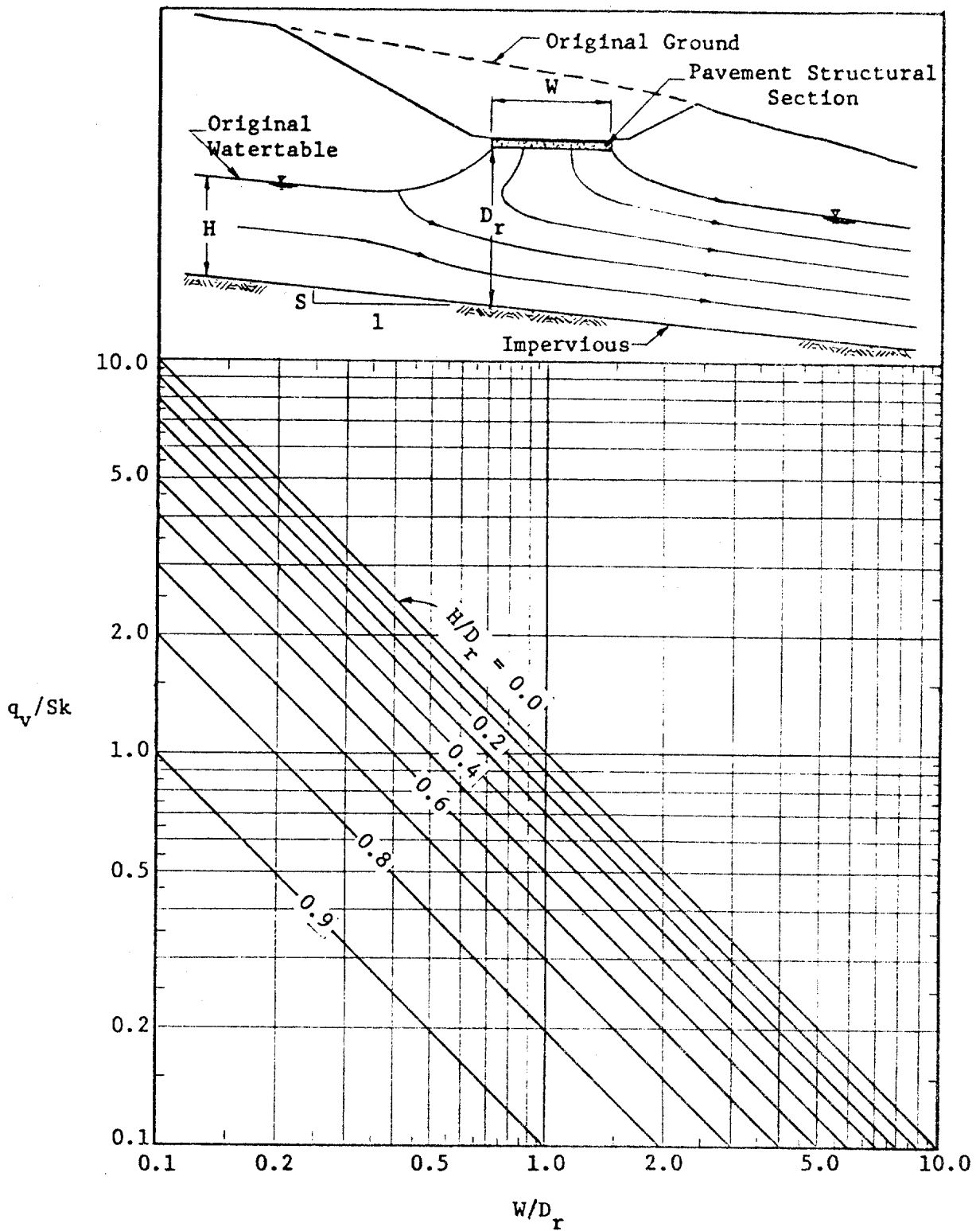

Figure 43. Chart For Estimating Vertical Outflow From Pavement Structural Section Through Subgrade Soil To a Sloping Underlying Watertable (12)

i.e. q_v/k , is a function of the width of the pavement section, W , the depth, D_u , to the underlying high permeability stratum, and the piezometric head, H_u , along its upper boundary. This functional relationship is shown graphically in Figure 44, which was developed (12) to facilitate the estimation of q_v/k . It is obvious from Figure 44 that if the value of $H_u = 0$, i.e. the watertable is at or below the top of the high permeability stratum, the average hydraulic gradient of the vertical outflow is unity. For other values of H_u , the average hydraulic gradient, q_v/k , can be determined directly from Figure 44.

Example No. 8 - Vertical Outflow From A Pavement Structural Section Through The Subgrade To An Underlying High Permeability Layer. Consider the flow situation shown in Figure 40a, and in the upper portion of Figure 44, for the case where the depth to the free draining layer, D_u , is 50', the head along its upper boundary, H_u , is 10', and the width of the pavement section, W , is 36'. Entering Figure 44 with $H_u/D_u = 10/50 = 0.20$ and $W/D_u = 36/50 = 0.72$, it is found that $q_v/k = \underline{0.96}$ sf/sf.

If the piezometric head along the upper boundary of the free draining layer were to increase to 40', then entering Figure 44 with $H_u/D_u = 40/50 = 0.80$, and $W/D_u = 0.72$, it is found that q_v/k would decrease to $q_v/k = 0.385$ sf/sf.

Example 8 shows that vertical drainage of the type shown in Figure 40a can be remarkably effective even under relatively adverse conditions, being limited in effectiveness more by the coefficient of permeability of the subgrade soil than by the geometry of flow region. This is also true of the flow situations shown in Figures 40b and 40c, where the average hydraulic gradient of the vertical outflow is always unity.

Based upon the relatively high effectiveness of the potential vertical drainage introduced by flow situations such as that shown in Figure 40c, it is recommended that designers give serious consideration to the selective placement of available rock fill or other free draining material at the base of highway embankments. Actually, this high permeability layer can be placed at any level in the fill. However, great care must be taken to assure that this high permeability layer is properly drained. Experience in Kansas (78) has indicated that layers of porous rock fill encased in less permeable fill may collect water from above until they approach saturation and precipitate serious slope stability problems.

Vertical outflows for situations, such as those shown in Figure 41, can be estimated by constructing flow nets, similar to those shown, and using Equation (11), or by the appropriate use of Figure 45, which was prepared (12) to simplify this type of computation. Although the relationship shown in Figure 45 is approximate, it does produce reasonably reliable estimates of vertical outflow very quickly and easily.

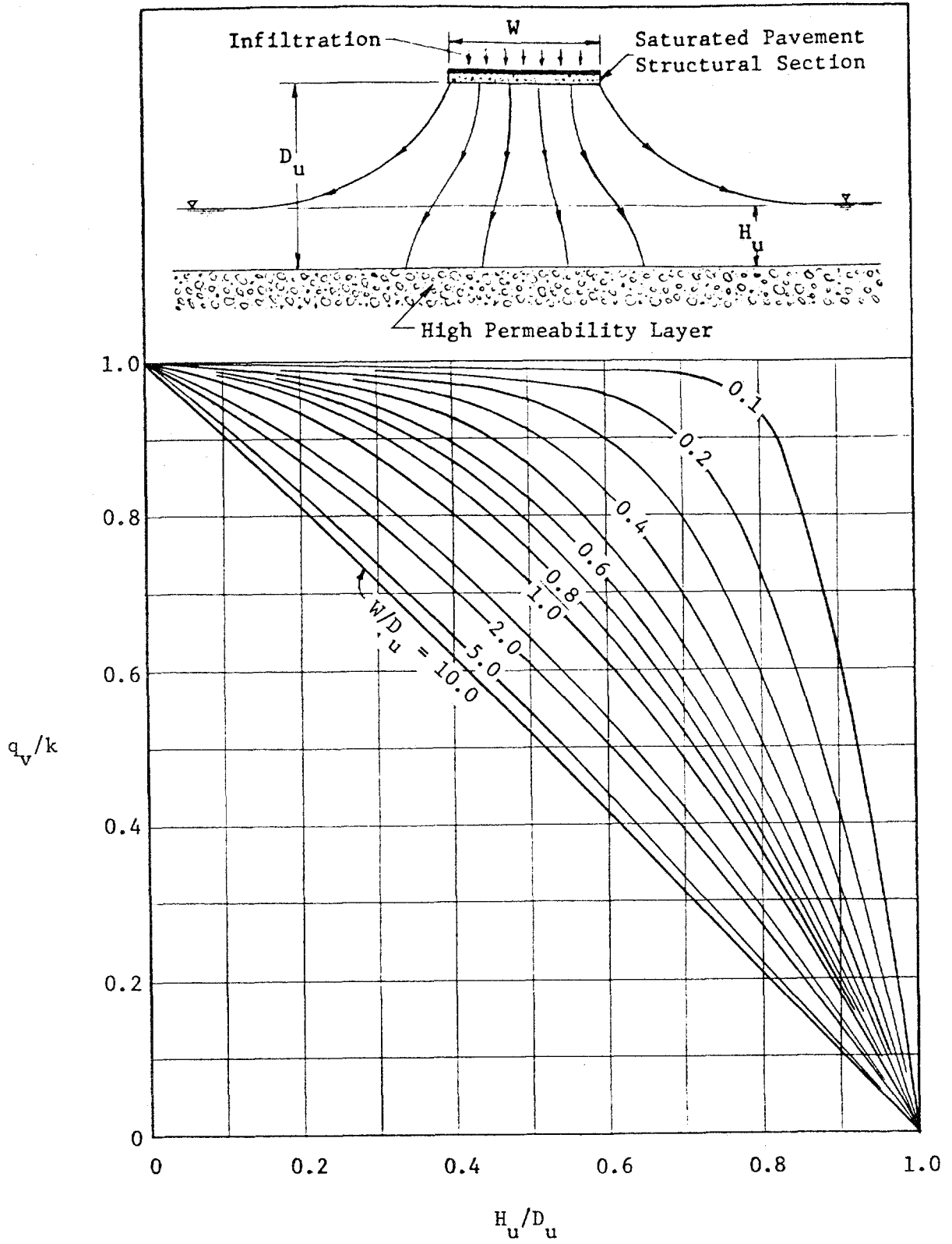

Figure 44. Chart For Estimating Vertical Outflow From a Pavement Structural Section Through The Subgrade To An Underlying High Permeability Layer (12)

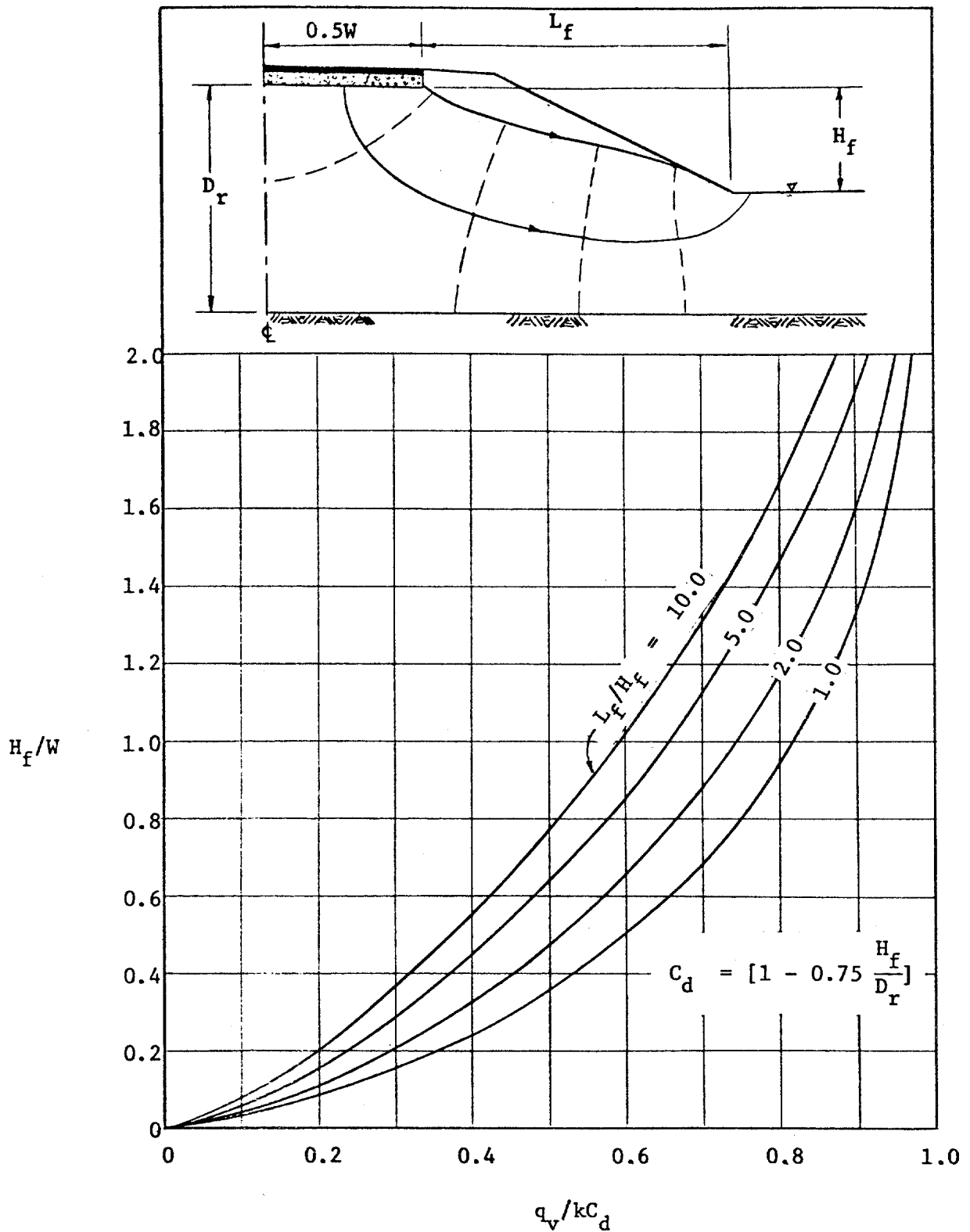

Figure 45. Chart For Estimating Vertical Outflow From a Pavement Structural Section Through Embankment And Foundation Soil (12)

Example No. 9 - Symmetrical Outflow From a Pavement Structural Section Through An Embankment and Its Foundation. Consider the flow situation shown in Figure 41a. Using flow net analysis and Equation (11), with $N_f = 3.6$, $N_D = 9$, and $\Delta h = 14'$, it is found that $q/k = 14(3.6)/9 = 5.6$ sf/f. The average flow rate, q_v , can then be obtained by dividing the total flow, q , by the width of the pavement contributing to the flow, i.e. $21'$. Thus, $q_v/k = q/0.5W = 5.6/21 = 0.267$ sf/sf. Now, for comparison, entering Figure 45 with $H_f/W = 14/42 = 0.333$, and $L_f/H_f = 41/14 = 2.93$, gives $q_v/kC_d = 0.38$ sf/sf. Since the dimensionless depth correction factor, $C_d = 1 - 0.75 H_f/D_r = 1 - 0.75(14)/37.5 = 0.72$, $q_v/k = 0.72(0.38) = 0.274$ sf/sf.

The vertical outflow through an embankment and its foundation is not always symmetrical as in Figure 41a and Example 9. Often the flow is asymmetrical as shown in Figure 41b. In order to use Figure 45 to estimate the outflow for this condition, it is necessary to take the value of the contributing pavement width, W , as being twice its actual value. For example, if the actual pavement width was $40'$, a value of $W = 80'$ would be used in Figure 45.

Example No. 10 - Asymmetrical Outflow From a Pavement Structural Section Through An Embankment and Its Foundation. Consider the situation shown in Figure 41b. Entering Figure 45 with $H_f/W = 13/2(36) = 0.18$, and $L_f/H_f = 39/13 = 3.0$, it is found that $q_v/kC_d = 0.25$ sf/sf. Since $C_d = 1 - 0.75(13)/38 = 0.743$, $q_v/k = 0.743(0.25) = 0.186$ sf/sf. With respect to the flow net solution, it is noted that, in Figure 41b, only two of the flow paths involve seepage from the pavement section. Therefore, using Equation (11) with $N_f = 2$, $N_D = 6.2$, and $\Delta h = 13'$, we get $q/k = 13(2)/6.2 = 4.9$ sf/f, and $q_v/k = 4.9/36 = 0.136$ sf/sf.

It is clear from the preceding paragraphs and Examples 6 through 10 that the amount of the vertical outflow can vary considerably with the geometry of the flow domain. However, it is also evident that the coefficient of permeability of the underlying soil exerts an extremely important and, perhaps, predominant influence on the magnitude of q_v . Thus, the designer should be careful to select a realistic, but conservative (low), value of the coefficient of permeability of use in design.

3.2.5 Net Inflow. The net inflow, q_n , for which the pavement drainage system is to be designed should include inflow from all possible sources, with an appropriate allowance being made for any vertical outflow that might take place. In Sections 3.2.1 through 3.2.3, the major sources of inflow were discussed and methods of computing design inflow rates were presented. These include inflows from infiltration, q_i , from the gravity drainage of groundwater, q_g , from an artesian source below the pavement, q_a , and from melt water from thawing ice lenses, q_m . In Section 3.2.4, vertical outflow

was discussed and methods of computing the design vertical outflow rate, q_v , were explained. In selecting the appropriate combination of these flow rates for design, it should be recognized that the mechanisms which lead to these flows are not always operative at the same time. For example, consider the situation shown in Figure 34 and the inflow rate computations of Examples 1 and 3. In this case, inflows from infiltration, q_i , and the gravity flow of groundwater, q_g , would have to be considered. In addition, since the subgrade is in all likelihood frost susceptible, the inflow from meltwater from thawing ice lenses, q_m , should also be considered. However, since frozen fine grained soils are very nearly impermeable, it is unlikely that flow from both groundwater and meltwater sources would occur at the same time (see Figure 8). Consequently, it is recommended that the combination of q_i and q_g , or q_i and q_m , that gives the maximum flow be used for design of this particular pavement drainage system. Obviously, there could be no vertical outflow in this case. In fact, downward vertical outflow can never take place while upward inflow from any other source is occurring.

Consideration of all the important probable combinations of inflows and outflow leads to the following set of relationships for computing net design inflow, q_n .

$$q_n = q_i \quad (12)$$

$$q_n = q_i + q_g \quad (13)$$

$$q_n = q_i + q_a \quad (14)$$

$$q_n = q_i + q_m \quad (15)$$

$$q_n = q_i - q_v \quad (16)$$

As implied by Equations (12) through (16), it is recommended that inflow from infiltration, q_i , always be included in the design of the pavement drainage system. The recommended use of Equations (12) through (16) is summarized in Table 5. In using Table 5, it should be recalled that the probability that frost action will be experienced is dependent upon the presence of a frost susceptible soil (Table 4), an available groundwater source to feed the growth of ice lenses, and the severity and duration of subfreezing temperatures (20).

Example No. 11 - Net Inflow To A Rigid Pavement Section in Cut.

Consider the situation shown in Figure 34 and the data of Examples 1 and 3. In addition, it is known that the subgrade soil, a silty sand with a coefficient of permeability, k , of 0.34 fpd (Example 3), has 3 percent of its particles less than 0.02 mm in diameter and classifies as an SM soil by the Unified System. Assuming that the roadway is located in a climate with temperatures conducive to frost action, we find from Table 4 by interpolation that the subgrade soil has a medium heave rate of about 3.0 mm/day. Assuming

Table 5. Guidelines for using Equations (12) through (16) to compute net inflow, q_n , for design of pavement drainage

<u>Highway Cross-Section</u>	<u>Groundwater Inflow</u>	<u>Visual Reference</u>	<u>Frost Action</u>	<u>Net Inflow Rate, q_n, Recommended For Design</u>
Cut	Gravity	Fig. 34	Yes No	Max. of Eq. (13) and (15) Equation (13)
Cut	Artesian	Fig. 37	Yes No	Max. of Eq. (14) and (15) Equation (14)
Cut	None	Figs. 14, 15, 17, 18 and 23	Yes No	Equation (15) Equation (12)
Cut	None	Figs. 39 and 40a	Yes No	Equation (15) Equation (16)
Fill	None	Figs. 40b, 40c and 41	Yes No	Equation (15) Equation (16)

unit weights of 150 pcf and 125 pcf for pavement and subbase, respectively, we find that $\sigma_p = 150(9/12) + 125(9/12) = 206.3$ psf. Entering Figure 38 with a heave rate of 3.0 mm/day and $\sigma_p = 206.3$ psf, it is found that $q_m/\sqrt{k} = 0.39$. Therefore, $q_m = 0.39\sqrt{0.34} = 0.23$ cfd/sf. It was found in Example 1 that $q_i = 0.52$ cfd/sf and in Example 3 that $q_g = 0.052$ cfd/sf. From Table 5 and the above results, it is clear that Equation (15) will produce the maximum net inflow, and the pavement drainage system should be designed for $q_n = q_i + q_m = 0.52 + 0.23 = 0.75$ cfd/sf. However, if the roadway were located in a warmer climate, where frost action was not a problem, then Equation (13) would govern, and the drainage system should be designed for $q_n = q_i + q_g = 0.52 + 0.052 = 0.572$ say 0.57 cfd/sf.

Example No. 12-Net Inflow To Flexible Pavement Section in Fill. Consider the situation shown in Figure 35 and the data of Example 2. In addition, it is known that the embankment material is a relatively coarse glacial till with a coefficient of permeability, k , of 0.08 fpd. The foundation soil is a glacial lake deposit of very permeable sand and gravel with the watertable located at substantial depth. Since this situation is similar to that shown in Figure 40b, we can take $q_v/k = 1.0$. Therefore, $q_v = 0.08(1.0) = 0.08$ cfd/sf. Since the likelihood of frost action in this case is small, Equation (16) governs the computation of the net inflow rate (see Table 5), and, taking q_i from Example 2 as 0.395 cfd/sf, we

get $q_n = q_i - q_v = 0.395 - 0.08 = 0.315$ say 0.32 cfd/sf.

3.3 - Analysis and Design of Drainage Layers

3.3.1 Thickness and Permeability. Once the design inflow rate, q_n has been computed, it is a simple matter to determine the thickness, H_d , and permeability, k_d , of the drainage layer required to transmit this inflow to a suitable outlet. In fact, the ability of the drainage layer to transmit water when flowing full (or at constant depth) is directly related to the product of the layer thickness (or depth of flow) and its permeability. This quantity ($H_d \cdot k_d$) is referred to as the "coefficient of transmissibility" and has been used in the analysis and design of drainage layers (5,16). However, for the purposes of this manual the solution presented graphically in Figure 46 has been adopted and is recommended.

The use of Figure 46 permits the determination of the maximum depth of flow, H_m , in a drainage layer when values of the design inflow rate, q_n , the permeability of the drainage layer, k_d , the length of the flow path, L , and the slope of the drainage layers, S , along the flow path are known. Conversely, it is possible to determine the required coefficient of permeability, k_d , of the drainage layer, if the maximum depth of flow, H_m , and the other parameters are known.

Figure 46 was developed (12) on the basis of the assumption of steady inflow uniformly distributed across the surface of the pavement section. Although this condition does not really exist in practice, it can be demonstrated that the use of the recommended procedures for determining q_n , and the use of Figure 46, leads to conservative results.

In order to avoid saturation of the drainage layer by the inflow, q_n , it should be properly outletted (see Section 3.4), and its thickness, H_d , should be selected so that it exceeds the maximum theoretical depth of flow, H_m . However, it may not always be economically feasible to provide a drainage layer with a thickness and permeability such that it will never become saturated. Under these circumstances it may be more practical to design a drainage layer that will limit the time period during which saturation occurs to a relatively short duration, say a few hours. Figure 47 was developed (27,79) to permit analysis of the time dependent drainage of a saturated layer and to facilitate design of drainage layers on this basis.

Example No. 13 - Analysis of a Drainage Layer Beneath a Rigid Pavement in Cut. Consider the case shown in Figure 34 and analyzed in Examples 1, 3 and 11. In addition, it is proposed to use a locally available material for subbase, whose specified gradation band is such that it has a minimum D_{10} of 2.3 mm and a maximum P_{200} of 3 percent. No laboratory or field permeability test results are available for the material. Therefore, as an approximation, entering Figure 28 with $P_{200} = 3.0\%$, $D_{10} = 2.3$ mm, and an assumed $\gamma_d = 120$ pcf, it is found that $k_d \approx 300$ fdp. Now,

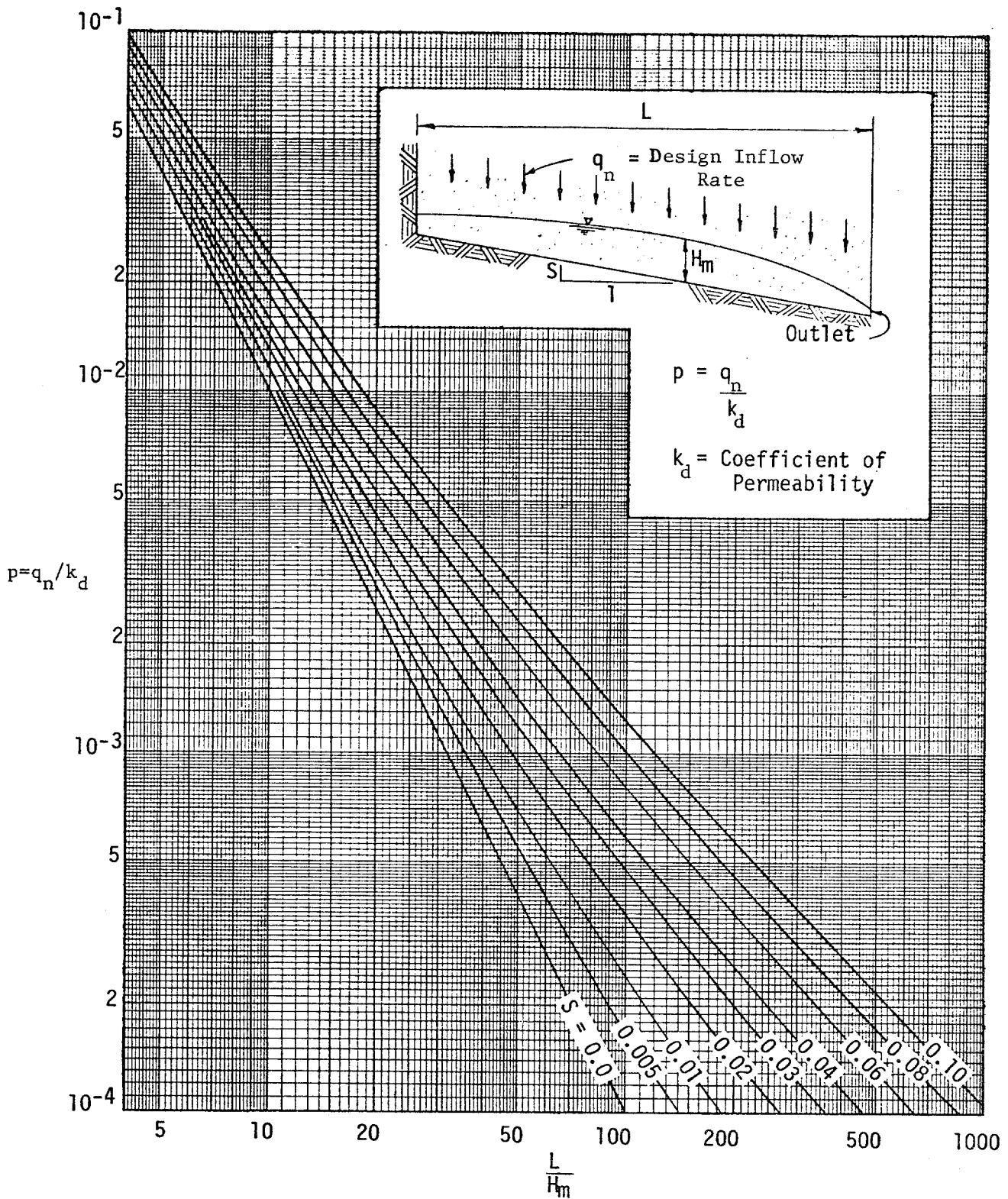

Figure 46. Chart for Estimating Maximum Depth of Flow Caused by Steady Inflow (12)

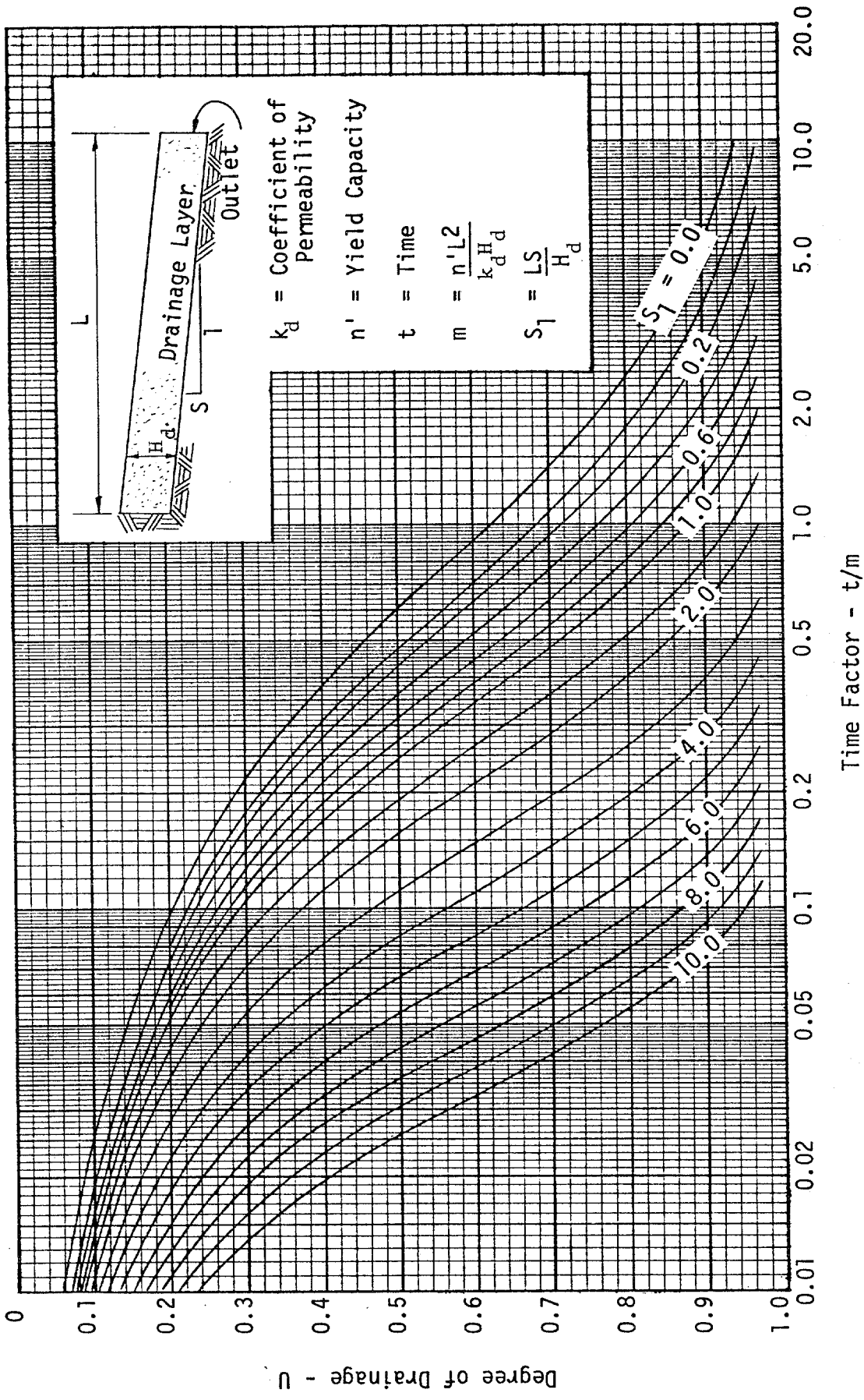

Figure 47. Time Dependent Drainage of Saturated Layer (27,79)

it was noted in Example 3 that the quantity of groundwater flow, $q_1 = 0.224$ cfd/f, would have to be carried across the roadway from the right side to the collector pipe along the left edge of the pavement section. Using Equation (3) (Darcy's Law) with $i = S = 0.02$, the thickness of the subbase to be allocated to the q_1 flow becomes $0.224/300(0.02) = 0.0373'$ or say 0.5 inches. Thus, the depth of subbase available to carry $q_n = 6.0'' - 0.5'' = 5.5''$. Letting $H_m = 5.5'' = 5.5/12 = 0.458'$, and entering Figure 46 with $S = 0.02$ and $L/H_m = 44/0.458 = 96$, it is found that the required inflow-permeability ratio, $p = 3.8 \times 10^{-4}$. Now, recalling from Example 11 that $q_n = 0.78$ cfd/sf, the required coefficient of permeability is $k_d = q_n/p = 0.78/(3.8 \times 10^{-4}) = 2053$ fpd. Since the required coefficient of permeability is more than the estimated actual permeability, it appears that the proposed subbase will not provide adequate drainage and will become saturated.

Let us now determine the time required to obtain 50 percent drainage of the subbase once it has become saturated and the inflow ceases. Entering Figure 47 with $U = 0.5$ and $S_1 = LS/H_d = 44(0.02)/0.5 = 1.76$, the time factor is found to be $t/m = 0.17$. From Figure 30, with $k = k_d = 300$ fpd, it is found that $n' = 0.102$. Thus, $m = n'L^2/k_dH_d = 0.102(44)^2/300(0.5) = 1.316$, and $t = 0.17 m = 0.17(1.316) = 0.224$ days or 5.4 hours. This might be considered as an adequate drainage time for a lightly traveled rural roadway. However, for a heavily loaded urban highway, it would probably be considered inadequate and some redesign would be indicated.

In Example 13, it was found that a locally available subbase material did not have a high enough coefficient of permeability to prevent the subbase from becoming saturated by infiltration and melt water from ice lenses and that it would require over five hours to obtain 50 percent drainage once the inflow had ceased. When situations such as this develop in practice, and it is decided that some modification in the design is necessary, then four possible courses of action are available. One approach would be to adjust the specified gradation band for the base or subbase to provide for the required coefficient of permeability, while holding the base or subbase thickness constant. A second approach might be to increase the thickness of the available base or subbase material to provide the required coefficient of transmissibility. A third approach might be to replace a portion of the base or subbase with an open graded drainage layer of very high permeability. A fourth approach might embody some practical and economical combination of the first three methods.

Example No. 14 - Modification of the Design of Drainage Layer Beneath a Rigid Pavement in Cut. Consider the case shown in Figure 34 and analyzed in Example 13. Let us assume that the

drainage of the subbase, as designed, is interpreted as being inadequate and some redesign is considered to be desirable. The simplest approach, from the design standpoint, would simply be to adjust the specified gradation band to achieve the required coefficient of permeability. Based on the analysis of Example 13, let us assume that a value of $k_d \approx 2000$ fpd will be adequate. Entering Figure 28 with $k_d = 2000$ fpd, $\gamma_d = 120$ pcf and $p_{200} = 3.0\%$, it is found that the required minimum D_{10} size must be changed to 8.5 mm. Although this would represent a substantial shift in the specified gradation band, it could probably be achieved with a simple and economical screening operation. Figure 28 shows that the desired result (i.e. $k_d \approx 2000$ fpd) could also be achieved, without a major shift in the subbase gradation band, simply by specifying that the subbase material be substantially free of particles passing the No. 200 sieve (i.e. $p_{200} = 0$). This could be achieved by washing the fines from the available subbase material, although, under some circumstances, this might not be economically feasible, and it could have an adverse effect on the stability of the material.

The apparent alternative to providing a high permeability subbase, in this case, would be to increase the thickness of the available subbase material to provide for adequate drainage. Remembering that q_n was determined in Example 11 to be 0.78 cfd/sf, and entering Figure 46 with $p = q_n/k_d = 0.78/300 = 3.6 \times 10^{-3}$ and $S = 0.02$, it is found that $L/H_m = 26$. Thus, $H_m = L/26 = 44/26 = 1.69'$ or 20.3". If the additional thickness required to transmit the q_1 flow across the roadway (Example 13) is added, then $H_d =$ say 21" should be used. The cost of this rather excessive thickness of subbase should be compared with the cost of processing that might be required to provide a subbase material with a substantially higher coefficient of permeability than presently available. Possibly some compromise can be achieved that will result in the most economical adjustment in subbase gradation and thickness that will satisfy the drainage requirements at this site.

Example No. 15 - Analysis of Drainage Layers Beneath a Flexible Pavement Section in Fill. Consider the situation shown in Figure 35 and analyzed in Examples 2 and 12. In addition, as designed, the aggregate subbase must meet the specified gradation requirements shown in Figure 50. Since the water must drain out through the daylighted subbase course, the minimum¹ length of the flow path is found, from Figure 35, to be $L = 44$ feet. Taking the maximum depth of flow in the

¹In accordance with Equation (4) the actual length of the flow path, L , would be governed by the cross-slope S_c and the longitudinal grade, g . The minimum length of the flow path would thus correspond to the case where $g = 0$.

subbase equal to its thickness (i.e. $H_m = 1.0'$) and entering Figure 46 with $L/H_m = 44/1.0 = 44$ and $S = 0.04$ (superelevated section), it is found that $p = q_n/k_d = 1.7 \times 10^{-3}$. Since it was found in Example 12 that $q_n = 0.32$ cfd/sf, the required $k_d = q_n/(1.7 \times 10^{-3}) = 0.32/(1.7 \times 10^{-3}) = 188$ fpd. Now, from Figure 50, it is determined that D_{10} for the subbase is 0.11 mm and $P_{200} = 7$. Assuming $\gamma_d = 125$ pcf, it is estimated from Figure 28 that k_d for the specified subbase material is 0.8 fpd. Since the actual coefficient of permeability is much less than that required (i.e. $k_d = 0.8$ fpd \ll 188 fpd), the pavement structural section as designed will undoubtedly become saturated.

In order to check the time required to obtain 50 percent drainage of the saturated subbase after the inflow ceases, we enter Figure 47 with $U = 0.5$ and $S_1 = LS/H_d = 44(0.04)/1.0 = 1.76$ and find that $t/m = 0.17$. Entering Figure 30 with $k = k_d = 0.8$ fpd, it is found that $n' = 0.026$. Thus, $m = n'L^2/k_dH_d = 0.026(44)^2/0.8(1.0) = 62.9$, and $t = 0.17 m = 0.17(62.9) = \underline{10.7}$ days required to achieve 50 percent drainage. Obviously, these drainage conditions are not satisfactory for a heavily traveled 4 lane highway, and more effective subsurface drainage must be provided.

In situations, such as that described in Example 15, a satisfactory modification of the pavement drainage might be accomplished by any of the four methods previously discussed (see Example 14). In addition, the drainage can be greatly improved by shortening the length of the flow path and providing a positive outlet for the water collected. This can be accomplished by the use of suitable collector drains, as shown in Figures 16, 19, 22b, and 49. The design of such collector systems is discussed in detail in Section 3.4.

Example No. 16 - Design of Pavement Drainage Layers Beneath a Flexible Pavement Section in Fill. Figure 48 shows the plan and profile of a portion of the northbound lanes of an interstate highway on fill. The pavement and subsurface conditions for this portion of the roadway are as described in Examples 2 and 12. The original design of the pavement structural section was as shown in Figure 35. However, it was demonstrated in Example 15 that the pavement system drainage provided by this original design was entirely inadequate. Thus, it is considered desirable to effect a redesign that will provide for adequate drainage of the pavement structural section. To this end, a subsurface drainage system, consisting of a permeable drainage blanket and appropriate collector drains, is proposed, as shown in Figure 49.

A locally available crushed stone, satisfying the gradation band shown in Figure 50, is proposed for use in the drainage blanket. From Figure 50, $D_{10} = 4.8$ mm, $P_{200} = 0$ percent, and assuming

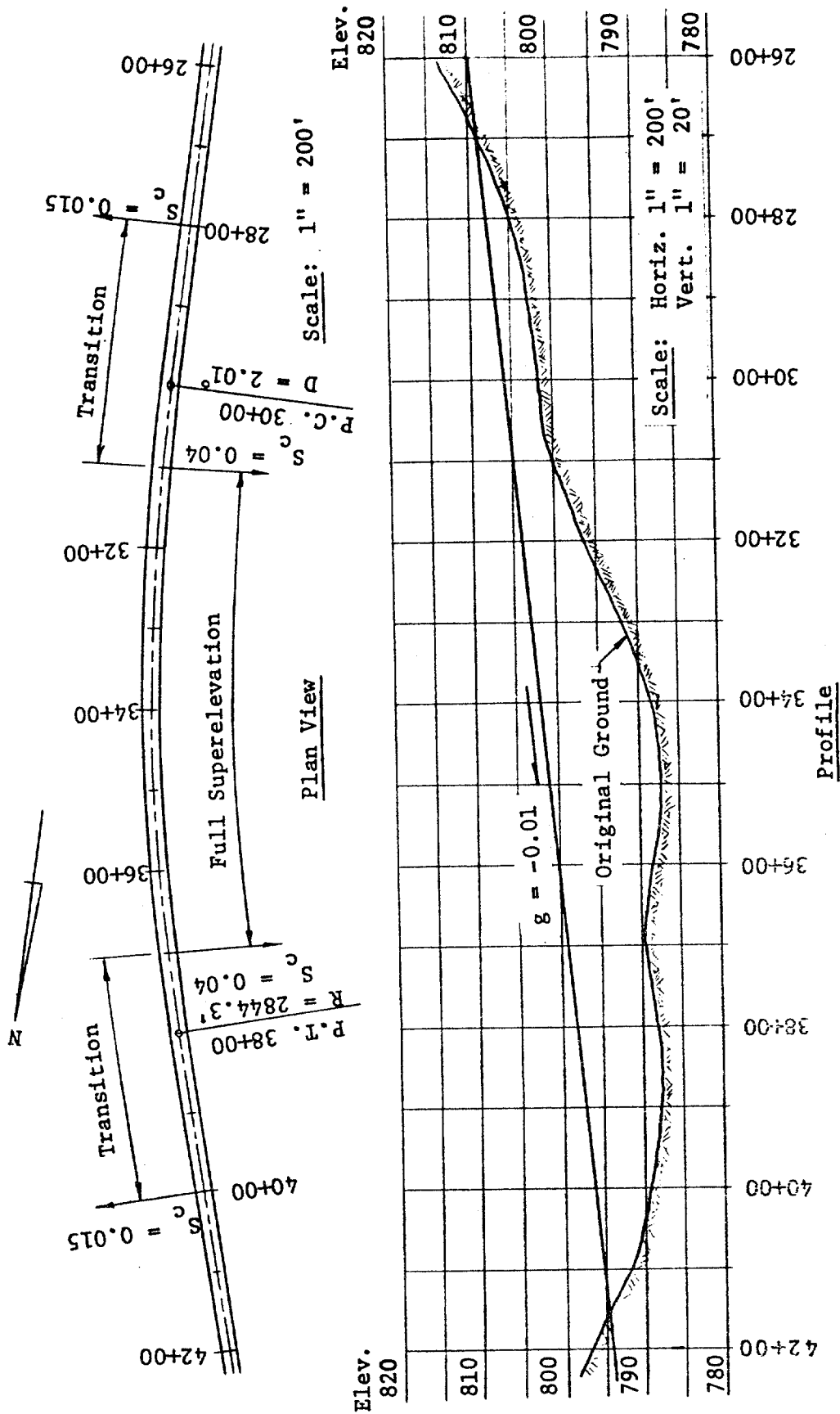

Figure 48. Plan and Profile of Proposed Roadway - Dimensions and Details for Example 16.

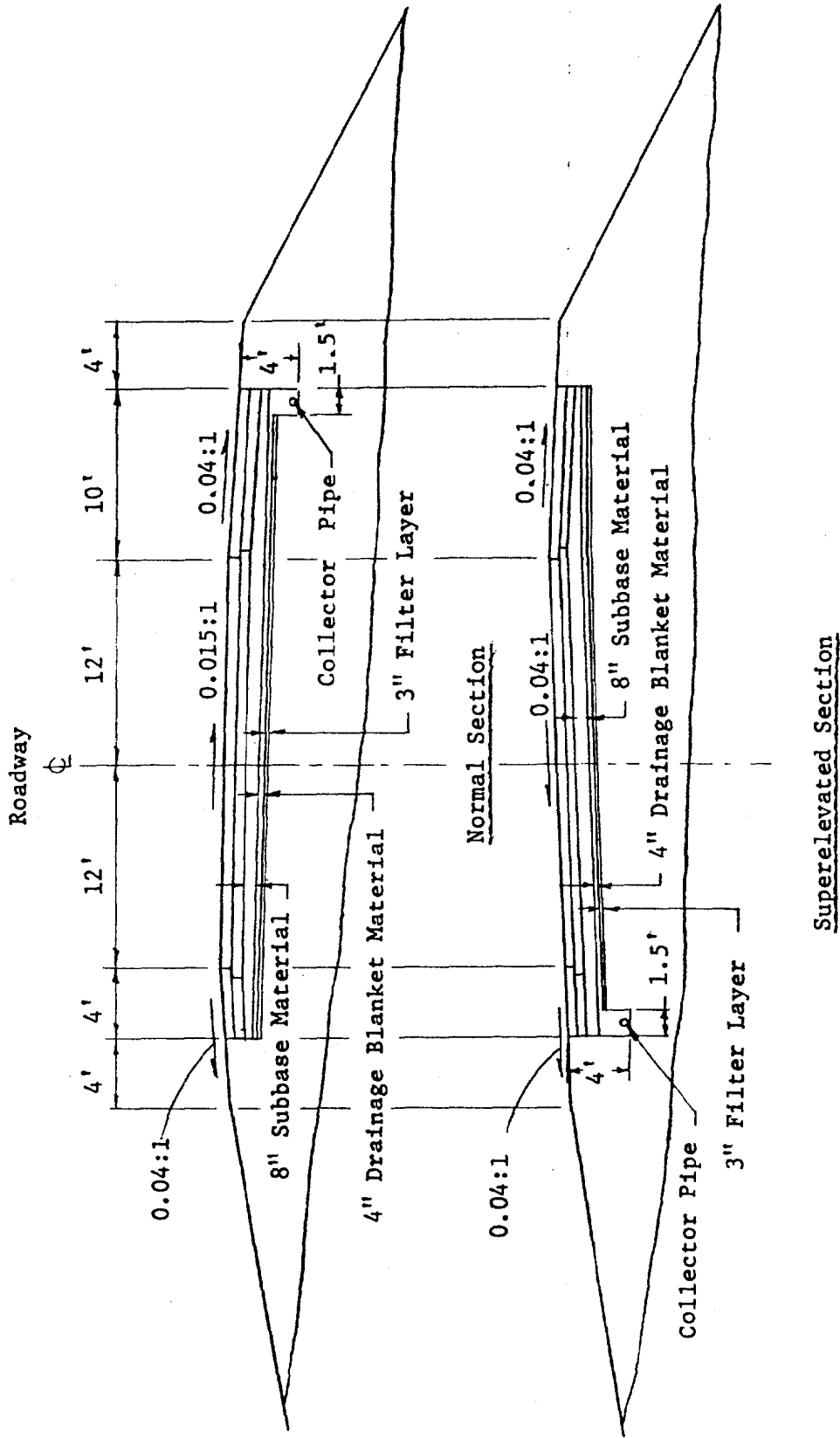
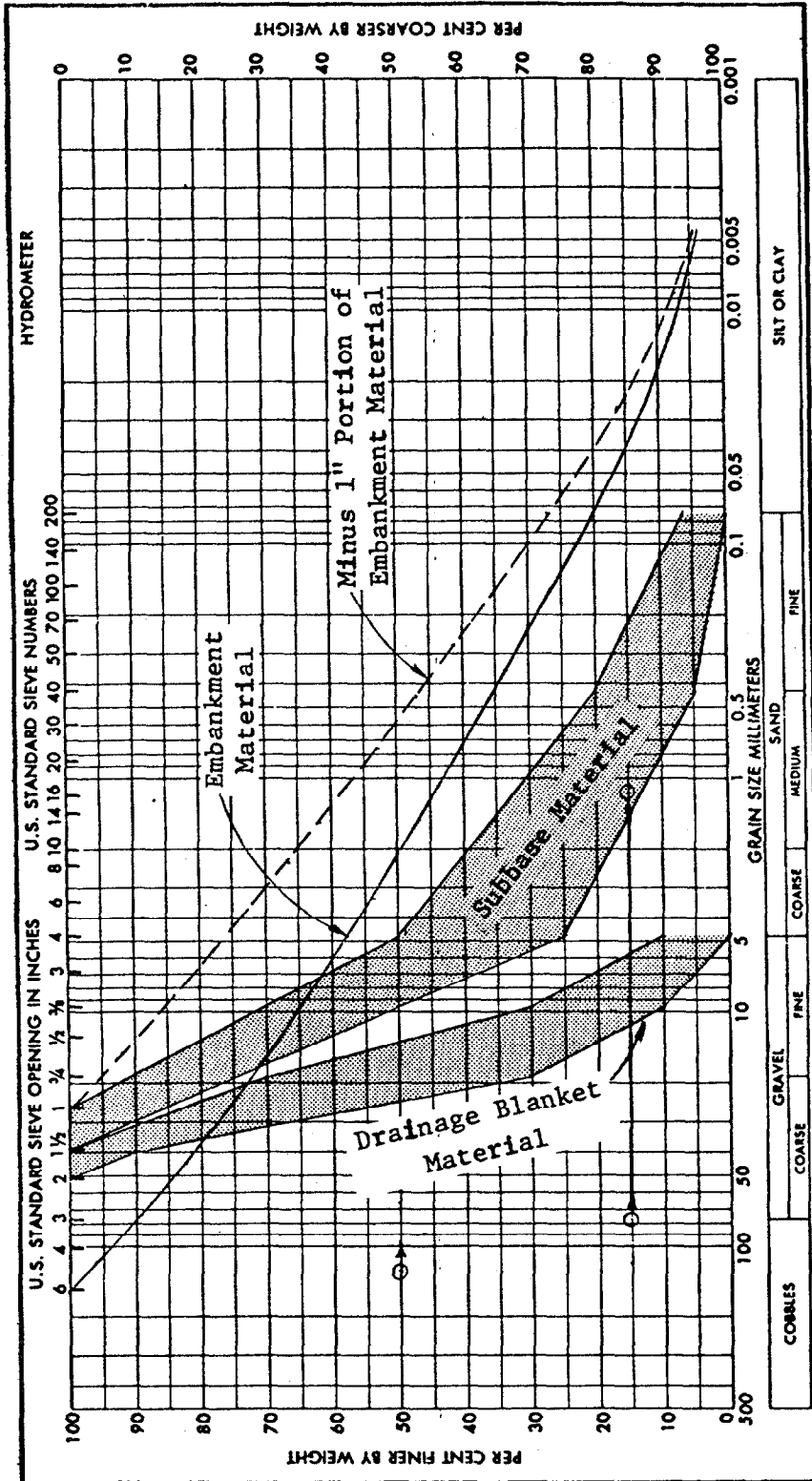

Figure 49. Proposed Subsurface Drainage System for Flexible Pavement on Fill-Dimensions and Details for Example 16.



○-Filter Criteria For Drainage Layer as Filter and Subbase as Protected Soil.

Figure 50. Gradation Bands for Subbase, Drainage Layer, and Embankment Material - Examples 16 and 18.

$\gamma_d = 125$ pcf, it is estimated, with the help of Figure 28, that the minimum $k_d \approx 2500$ fpd.

In designing the proposed drainage system, it is desirable to have some idea of the direction in which water will flow in the drainage blanket. Often this can be determined by inspection, but, in some cases, the preparation of flow diagrams such as that shown in Figure 51 can be helpful. This diagram was constructed by drawing a series of smooth curves, representing the flow paths, perpendicular to the pavement contours. Since the required thickness of the drainage blanket will be a function of the length of the flow path, it is also desirable to decide upon the location and spacing of collector drains as a first step. With reference to Figures 48, 49 and 51, it appears that the following system of collector drains will limit the length of the flow path in the drainage blanket to a reasonable value (i.e. from about 39' to about 55')¹.

<u>Station(s)</u>	<u>Type of Collector</u>
Sta. 27+00	Transverse at gradepoint
Sta. 27+00 to 28+80, Rt.	Longitudinal
Sta. 28+80	Transverse - Outlet Right
Sta. 29+20	Transverse - Outlet Left
Sta. 29+20 to 38+80, Lt.	Longitudinal - Outlet Sta. 34+00, Lt.
Sta. 38+80	Transverse - Outlet Left
Sta. 39+20	Transverse - Outlet Right
Sta. 39+20 to 41+50, Rt.	Longitudinal - Outlet 41+50, Rt.

Two of the most critical locations with respect to the thickness of the drainage blanket will be in the regions where the cross slope approaches zero, i.e. Sta. 28+80 to 29+20 and Sta. 38+80 to 39+20. In these areas, it is found from Figure 51 that the length of the flow path, L , will be about 45' and its average slope, S , will be very close to the longitudinal grade (i.e. $S = 0.01$). Recalling from Example 12 that $q_n = 0.32$ cfd/sf, and entering Figure 46 with $p = q_n/k_d = 0.32/2500 = 1.28 \times 10^{-4}$ and $S = 0.01$, it is found that $L/H_m = 155$. Thus, the maximum depth of flow is $H_m = L/155 = 45/155 = 0.29 = 3.5''$. Another pair of critical locations are the areas just uphill from Sta. 28+80 and downhill from Sta. 39+20. In these areas, the maximum length of the flow path, L , will be found from Figure 51 to be about 55' and its average slope, S , will be about 0.012. Entering Figure 46 with $p = 1.28 \times 10^{-4}$ and $S = 0.012$, it is found that $L/H_m = 165$. Thus, the maximum depth of flow is $H_m = L/165 = 55/165 = 0.33' = 4.0''$.

¹Note that, where the flow paths are curved, Equations 4 and 5 are no longer valid and conservative empirical estimates of L and S are required.

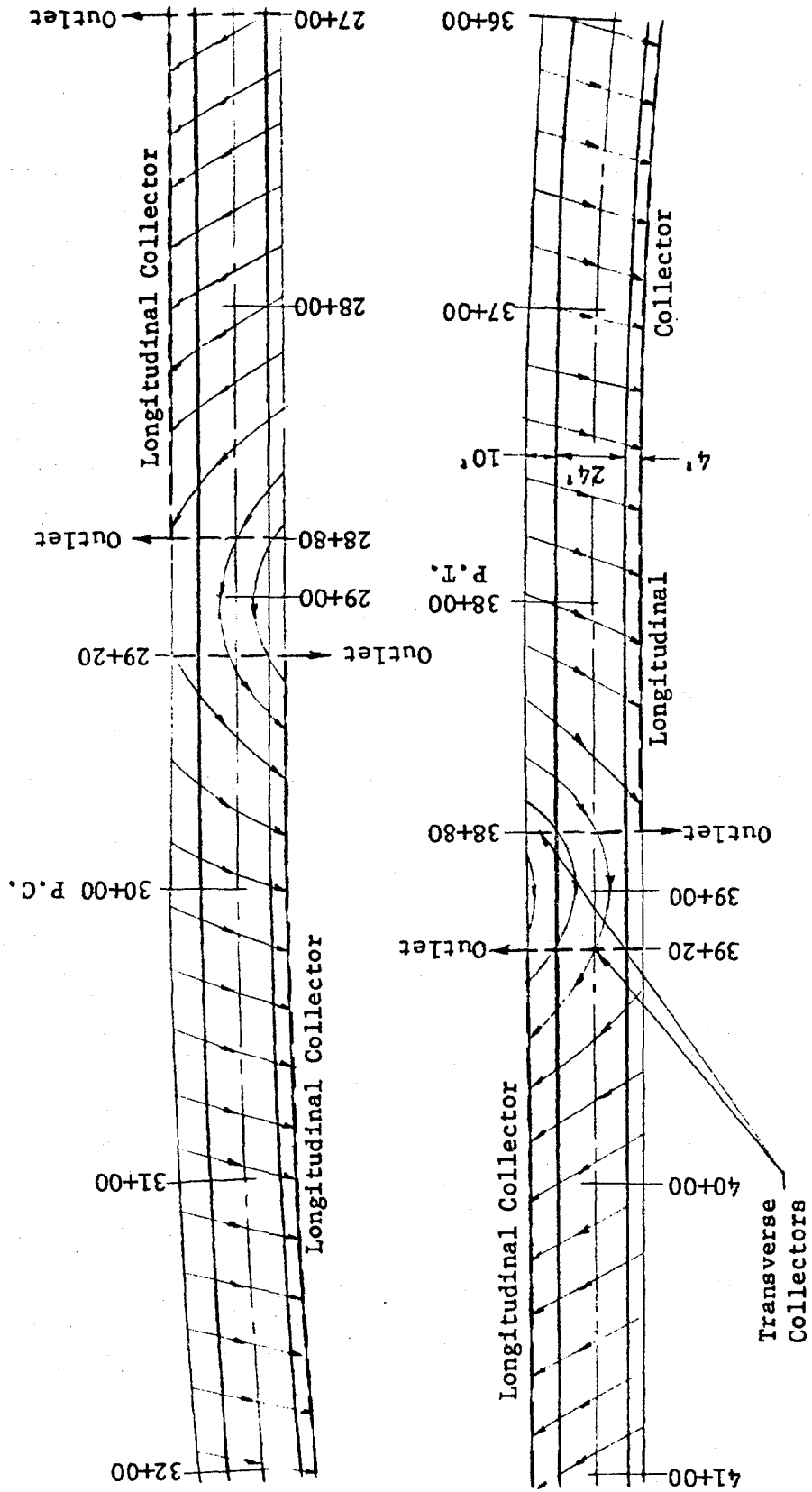

Figure 51. Layout of Proposed Drainage System Showing Direction of Flow in Drainage Layer - Details and Dimensions for Example 16.

Based on the above analysis, it appears that a drainage layer thickness $H_d = H_m(\text{max.}) = 4.0''$ will be satisfactory for this stretch of roadway. If the drainage layer material can be assumed to have the same structural integrity as the dense graded aggregate subbase, then 4'' of subbase can be replaced by 4'' of drainage layer material leading to the structural section shown in Figure 49.

3.3.2 Filter Requirements. It has long been recognized (5,11) that, when water flows from a fine grained soil into a coarser one, there is a tendency for particles of the finer soil to be washed into the voids of the coarse soil. This can lead to clogging and an overall reduction of permeability. It has also been established (5,11,27) that this tendency for intrusion of fines into the pores of a granular material can be initiated or aggravated by the pumping action caused by the repetitive loading of traffic. Thus, it is particularly important that measures be taken to prevent pavement drainage layers from becoming contaminated in this way.

In order to protect the drainage layers from intrusion of fines and related phenomena, the granular material must satisfy certain filter criteria. If these criteria are not satisfied, then a protective filter must be designed and placed between the fine and coarse soils to prevent intrusion and clogging. Commonly, this protective filter consists of a layer of granular soil whose gradation and other characteristics satisfy established filter criteria. However, in recent years a number of different types of drainage fabrics and mats have become available and have been used for this purpose (5,80,81,82,83,104). A comprehensive summary of the properties of various drainage fabrics, their uses and current design standards is included in Reference 104. The choice between aggregate filters and drainage fabric should be based on a careful evaluation of the history of performance, availability and economy.

Although there are numerous sets of criteria that have been developed to guide the design of protective granular filters (84, 85,86,87), the following criteria have been adopted for this manual, and their use is recommended:

$$(D_{15})_{\text{filter}} \leq 5 (D_{85})_{\text{protected soil}} \quad (17)$$

$$(D_{15})_{\text{filter}} \geq 5 (D_{15})_{\text{protected soil}} \quad (18)$$

$$(D_{50})_{\text{filter}} \leq 25 (D_{50})_{\text{protected soil}} \quad (19)$$

$$(D_5)_{\text{filter}} \geq 0.074 \text{ mm} \quad (20)$$

$$(CU)_{\text{filter}} = \frac{(D_{60})_{\text{filter}}}{(D_{10})_{\text{filter}}} \leq \quad (21)$$

The requirements of Equation (19) can be waived when the soil to be protected is a medium to high plasticity clay. When the soil to be protected contains a substantial amount of coarse material, it is recommended that the design be based upon the gradation of that portion of the material finer than one inch in size.

Example No. 17 - Analysis and Design of Filter Layer Beneath a Rigid Pavement in Cut. Consider the situation shown in Figure 34 and analyzed in Examples 1, 3, 11 and 13. The gradation curves for the various materials involved are given in Figure 52. From Figure 52, the parameters needed for analysis and design are found to be $(D_{85})_s = 0.65$ mm, $(D_{50})_s = 0.13$ mm, and $(D_{15})_s = 0.036$ mm.

The first step is to check to see if the subbase material satisfies the stated filter criteria:

$$(D_{15})_f \leq 5 (D_{85})_s = 5(0.65) = 3.25 \text{ mm}$$

$$(D_{15})_f \geq 5 (D_{15})_s = 5(0.036) = 0.18 \text{ mm}$$

$$(D_{50})_f \leq 25 (D_{50})_s = 25(0.13) = 3.25 \text{ mm}$$

$$\text{Max. (CU)}_{sb} = \frac{17.0}{2.4} = 7.0 < 20$$

These results are plotted on Figure 52, and it can be seen that the proposed subbase material does not satisfy the requirements, and a filter layer must be provided. A locally available concrete sand, whose gradation does satisfy these requirements is represented in Figure 52. However, it will be necessary to check to be certain that this sand will not infiltrate and clog the pores of the subbase material (i.e. the subbase must now be considered to be the filter and the filter must be considered to be the soil to be protected)

$$(D_{15})_{sb} \leq 5 (D_{85})_f = 5(1.7) = 8.5 \text{ mm}$$

$$(D_{15})_{sb} \geq 5 (D_{15})_f = 5(0.37) = 1.85 \text{ mm}$$

$$(D_{50})_{sb} \leq 25 (D_{50})_f = 25(0.25) = 13.0 \text{ mm}$$

These criteria are plotted on Figure 52, and it can be seen that the concrete sand will make a satisfactory filter, although the finest sand satisfying the gradation band should be avoided if possible. Although, theoretically, a very thin filter layer should be satisfactory, for practical purposes it is recommended that the filter layer be no less than 3" thick as shown in Figure 34.

Example No. 18 - Analysis and Design of Filter Layer Beneath a Flexible Pavement on Fill. Consider the situation shown in

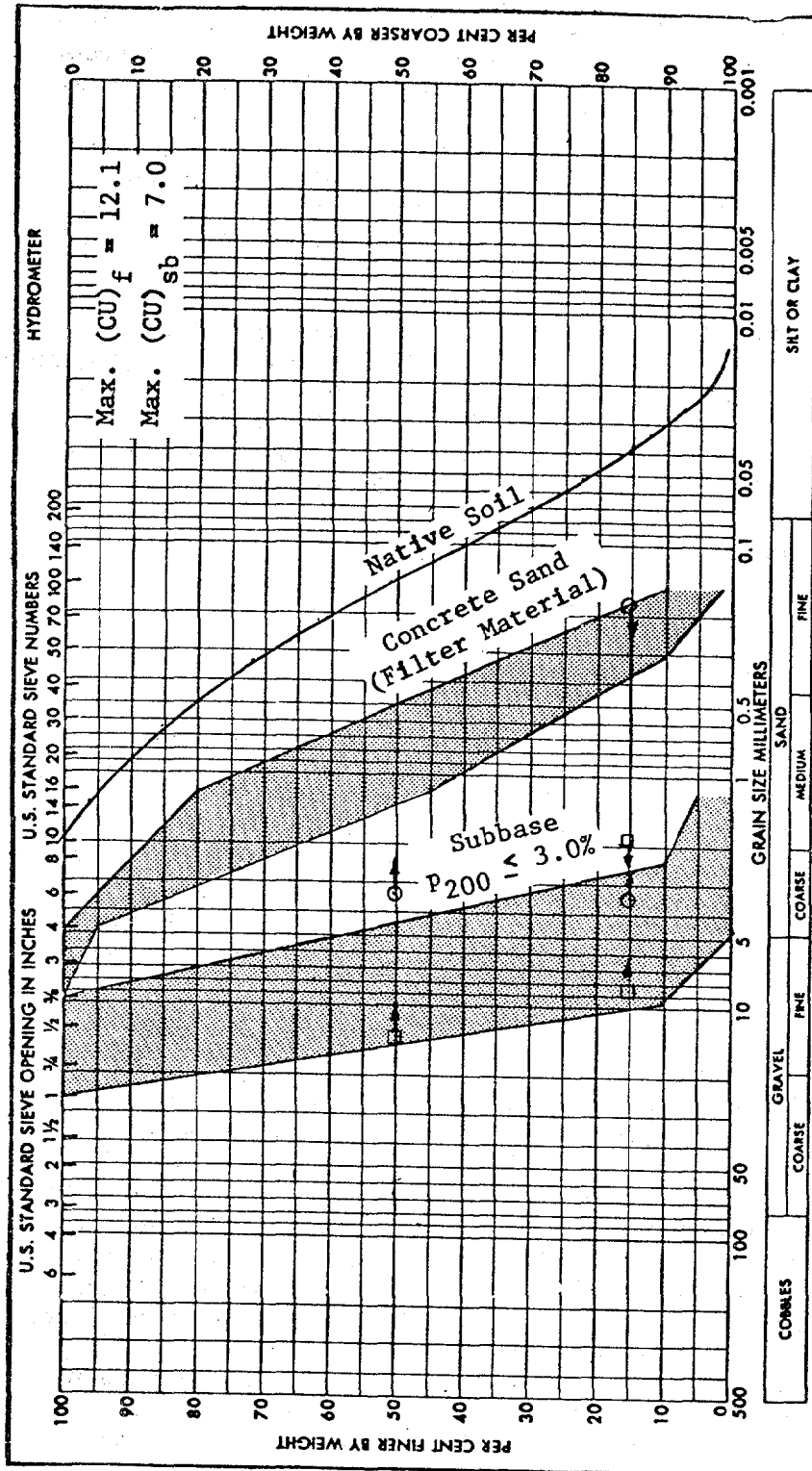

- Filter Criteria to Protect Natural Soil
- Filter Criteria to Protect Filter Material Against Intrusion of Subbase

Figure 52. Gradation Bands for Subbase, Filter Layer and Subgrade Material - Example 17.

Figure 49 and analyzed in Example 16. The gradation curves for the fill material, subbase and granular drainage layer are shown in Figure 50. As noted in Example 17, the first step in a situation such as this would be to check to see if the subbase material would satisfy the filter criteria. If it would, then it might be possible to "sandwich" the drainage layer between layers of subbase. However, it is obvious from Figure 50 that the subbase will not satisfy the criteria of Equations (20) and (21), and a filter layer must be designed.

Since the embankment soil contains a substantial amount of coarse material, the filter design should be based on the gradation of that portion of the soil passing the 1" sieve. This "corrected" gradation is shown dashed in Figure 50 and solid in Figure 53. From these figures the parameters needed for design are found to be $(D_{85})'_s = 9.2$ mm, $(D_{50})'_s = 0.60$ mm, and $(D_{15})'_s = 0.022$ mm.

$$(D_{15})'_f \leq 5 (D_{85})'_s = 5(9.2) = 46 \text{ mm}$$

$$(D_{15})'_f \geq 5 (D_{15})'_s = 5(0.022) = 0.11 \text{ mm}$$

$$(D_{50})'_f \leq 25 (D_{50})'_s = 25(0.60) = 15 \text{ mm}$$

These criteria are plotted in Figure 53, and it is obvious that the locally available concrete sand does satisfy the filter criteria. Thus, a 3" layer of this sand should be used as a filter between the fill material and the drainage layer as shown in Figure 49. A check should be made to determine if the drainage layer material is safe against intrusion of the subbase material. The results of such a check (shown plotted on Figure 50) show that the drainage layer is safe against intrusion of fines from the subbase.

3.3.2 Special Considerations. In the preceding sections, only a relatively few examples of analysis and design of drainage layers have been presented. The designer should recognize that many possible design configurations exist that satisfy the criteria recommended herein. For example, some designers would recommend that the pervious drainage layer be placed directly beneath the surface bituminous or Portland cement concrete layers and above the aggregate base and/or subbase layers rather than being placed beneath these layers as was done in Example 16 (Figure 49). The preparation of alternate designs, in which special consideration is given to the cost and availability of materials, is highly recommended. It is only by this means that the designer can be provided with a rational basis for selecting the design that offers the best possibility of achieving satisfactory long term performance at the lowest possible cost. The cost of preparing alternate designs is low compared to the savings that can be

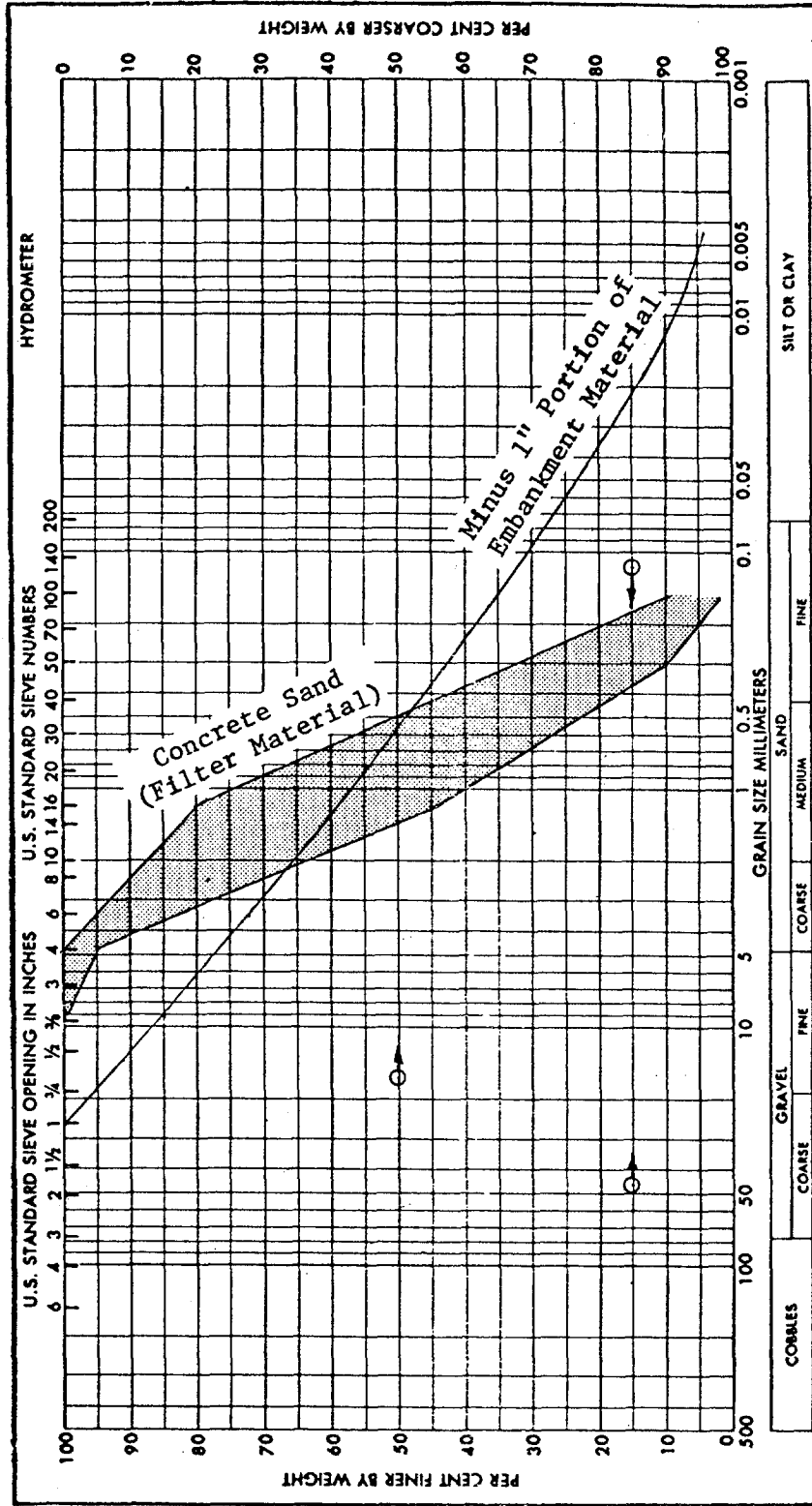

○ Filter Criteria For Concrete Sand as Filter Layer and Embankment as Protected Soil.

Figure 53. Gradation Bands For Filter Layer and Embankment Material - Example 18.

achieved in materials and construction.

Special consideration should be given to the stability of granular drainage layer and filter materials during construction. Experience has shown that, while certain open graded drainage layer and filter materials are stable when confined, they may lack the stability required for ease in placement and compaction (88). For example, in California (88) it was found that it was necessary to stabilize the open graded drainage layer with asphalt in order to achieve the stability needed during construction. Often, stability can be achieved with a minor adjustment in gradation with very little sacrifice in permeability.

3.4 - Analysis and Design of Collection Systems

3.4.1 General Considerations. The collection system consists of a set of perforated or slotted pipes that is utilized to remove water from the pavement drainage layers and to convey it to suitable outlets outside of the roadway limits. The design of such systems includes consideration of (a) the type of pipe to be utilized, (b) the location and depth of transverse and longitudinal collectors and their outlets, (c) the slope of the collector pipes, (d) the size of the pipes, (3) and provisions for adequate filter protection to provide sufficient drainage capacity and to prevent flushing of drainage aggregates into the pipes through the slots or perforations.

A wide variety of types and sizes of suitable pipes is readily available in most localities, thus making the selection of the pipe dependent upon the specific soil conditions at the site, load requirements, required durability of the pipe, and environmental considerations, including the possible presence of corrosive conditions. These factors, evaluated in conjunction with practical and economic considerations, establish the criteria necessary for pipe selection. Existing ASTM and AASHTO specifications and manufacturer's design recommendations should be given due consideration in this process. Often, precedents, established on the basis of experience and history of performance, will play an important role in the pipe selection process. Although the value of such precedents should not be minimized, they should not be allowed to rule out the possible consideration of new materials and/or innovative designs.

As shown in Section 3.3.1, and particularly in Example 16, the required thickness and permeability of a pavement drainage layer are very dependent upon the length of the path the water must take in flowing out of this layer. The length of this flow path, in turn, is largely dependent upon the location of the longitudinal and transverse collector drains. Thus, this interdependency implies that the design of the collection system and pavement drainage layers must proceed simultaneously. However, as indicated in Example 16, it

is recommended that the location of collector drains be established first. The drainage layer can then be designed, and any possible changes in the collection system, which may be suggested by this process, can then be made.

In many instances, the longitudinal roadway grade or the cross slope governs the grade of the collector pipes, i.e. the pipes are simply set at a constant depth below the roadway surface. However, practical construction and operational factors dictate that slopes of collector pipes should not be less than 1 percent for smooth bore pipes and 2 percent for corrugated pipes. Thus, in areas where the longitudinal grade or cross slope is very flat it may be necessary to steepen the grade of the collector pipe to meet these minimum requirements. Since the size and flow capacity of the collectors will be dependent in part upon the pipe gradient, in some instances, it may be advisable to consider the steepening of the pipe gradient in order to achieve a reduction in pipe size. Minimum recommended diameters for PVC pipes and all other pipes are 3 inches and 4 inches, respectively (16).

3.4.2 Longitudinal Collectors. The position of the longitudinal collectors within the roadway cross-section and their depth is dependent upon a number of factors, including the desirability of draining the shoulder area, the likelihood of frost action, the depth of frost penetration, and economic considerations. In many situations, where there is no significant depth of frost penetration and where it is not necessary to attempt to draw down a high groundwater table, the longitudinal collector pipes can be placed in shallow trenches as shown in Figure 54. However, where it is desirable to draw down a high groundwater table, or where there is a substantial depth of frost penetration, deeper trenches should be used as shown in Figure 55. Obviously, construction economies result from the use of the shallower trenches. The longitudinal collector drain can be placed just outside of the joint between pavement and shoulder, as shown in Figures 54a and 55a, in order to prevent an accumulation of water and to minimize the possibility of pumping at this critical location. However, if it is considered desirable to drain and protect the whole shoulder area, then it is recommended that the longitudinal collector be placed at the outer edge of the shoulder as shown in Figures 54b and 55b. It should be understood, however, that this practice can result in a significantly increased length of the flow path in the granular drainage blanket with a resultant increase in the required thickness of this material. As noted in Section 3.3.2, the designer should recognize that many possible design configurations exist, and that Figures 54 and 55 illustrate only a few of these. Again, the preparation of alternate designs accompanied by appropriate economic analysis is highly recommended.

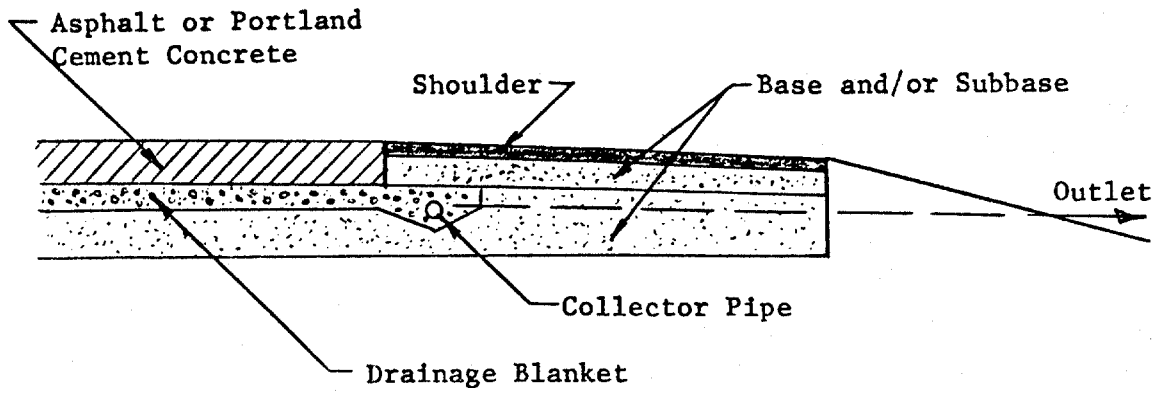

(a)

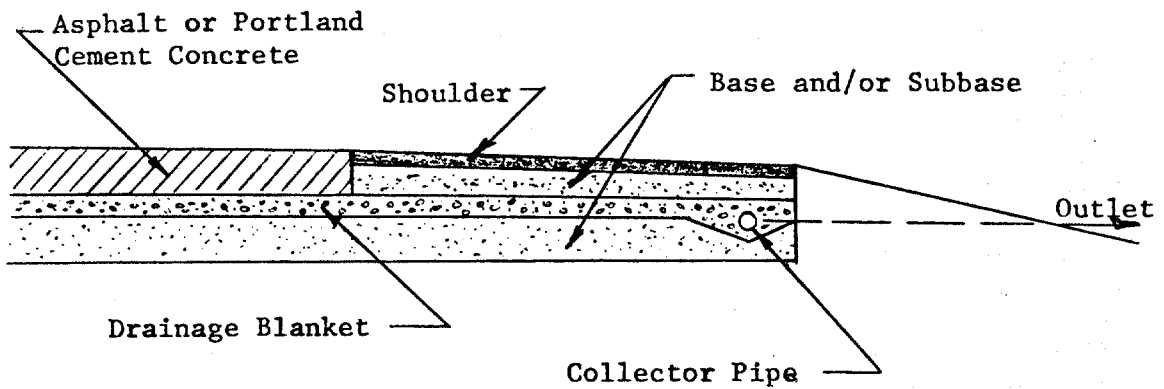

(b)

Figure 54. Typical Location of Shallow Longitudinal Collector Pipes

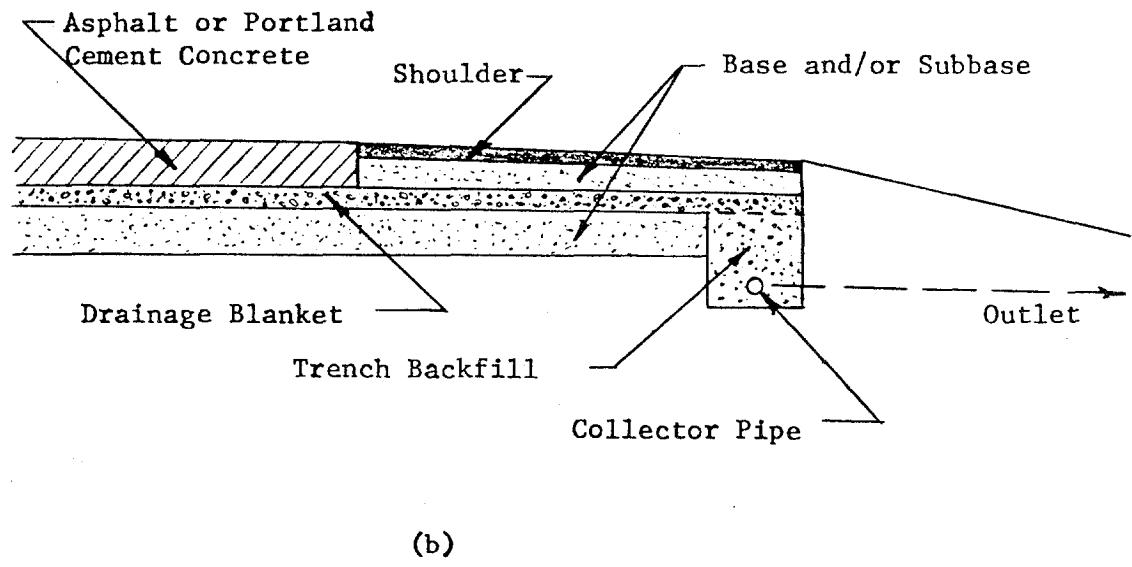
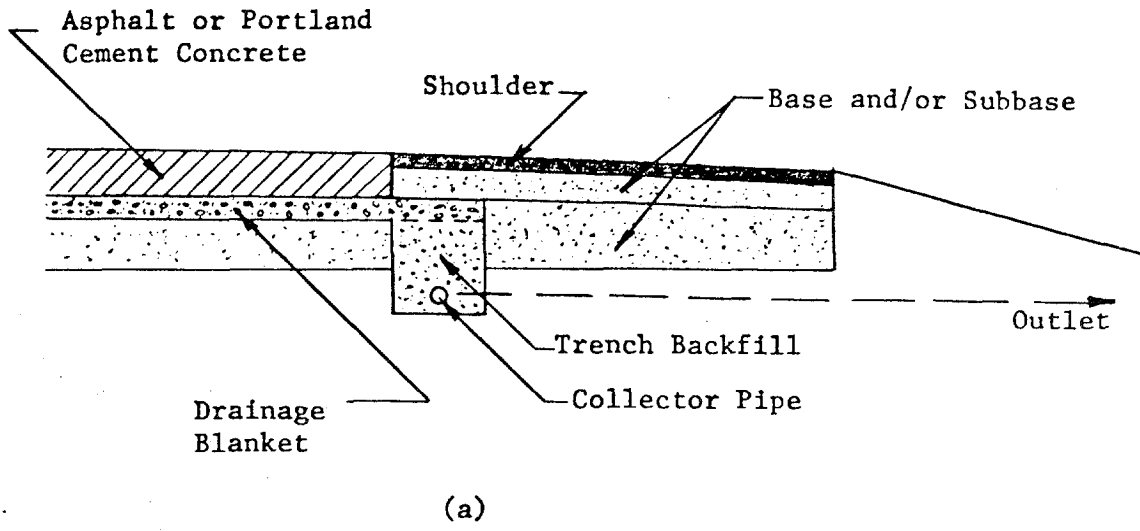

Figure 55. Typical Location of Deep Longitudinal Collector Pipes

It was noted in Section 3.4.1 that the size of a longitudinal collector pipe will be influenced by the pipe gradient, g . There are a number of other parameters on which the pipe diameter D_p , is also dependent. These include the quantity of water, q_d , entering the pipe per running foot, the distance between outlets, L_o , and the hydraulic characteristics of the pipe (i.e. the Manning roughness coefficient, n_f). A convenient nomogram relating these parameters has been suggested by Cedergren (5,16) for use in selecting collector pipe diameters and outlet spacings. An adaptation of that nomogram is presented in Figure 56. The magnitude of q_d can be estimated by multiplying the net design inflow, q_n , by the length of the flow path, L , in the drainage blanket, i.e.

$$q_d = q_n \cdot L. \quad (22)$$

Since, as illustrated in Figure 51, the length of the flow path can vary along the roadway under consideration, some judgement must be exercised in selecting a value of L for use in Equation 22. Of course, the most conservative thing to do is to use the maximum length of flow path for the particular collector pipe section being analyzed. However, since a certain element of conservatism is built into Figure 56, using an average value of L for the pipe section under analysis would certainly not be unreasonable.

Figure 56 can be used in several different ways. If the pipe gradient and outlet spacing have been established, as in Example 16, then the required pipe diameter can be picked directly from the nomogram. On the other hand, Figure 56 could also be used to establish the maximum outlet spacing for various combinations of pipe size and hydraulic gradient.

Example No. 19 - Selection of Diameter of Longitudinal Collector Pipes. Consider the situation given in Example 16, with the collector pipe locations and outlet spacings shown in Figure 51. It can be seen from Example 16 and Figure 51 that the longest distance between outlets occurs for the section of longitudinal collector pipe between stations 34+00 and 38+80. Thus, the outlet spacing, L_o , for use in this analysis will be $L_o = 3880 - 3400 = 480'$. Between Sta. 34+00 and Sta. 38+80 the length of the flow path, L , varies between a minimum of about 40' and a maximum of about 53'. Since the length of the flow path will be nearer to the minimum value over most of this distance, a value of $L = 45'$ should be amply conservative. Now, recalling from Example 12 that the net inflow rate for this situation is $q_n = 0.32$ cfd/sf, and using Equation 22 gives $q_d = q_n \cdot L = 0.32(45) = 14.4$ cfd/ft. Entering Figure 56 with $q_d = 14.4$, $L_o = 480$, and $g = 0.01$, it is found that the required pipe diameter would be $D_p = 2.7''$ for smooth bore pipe and 3.7'' for corrugated pipe. However, practical considerations would dictate that a minimum diameter of $D_p = \underline{3.0''}$ be used for

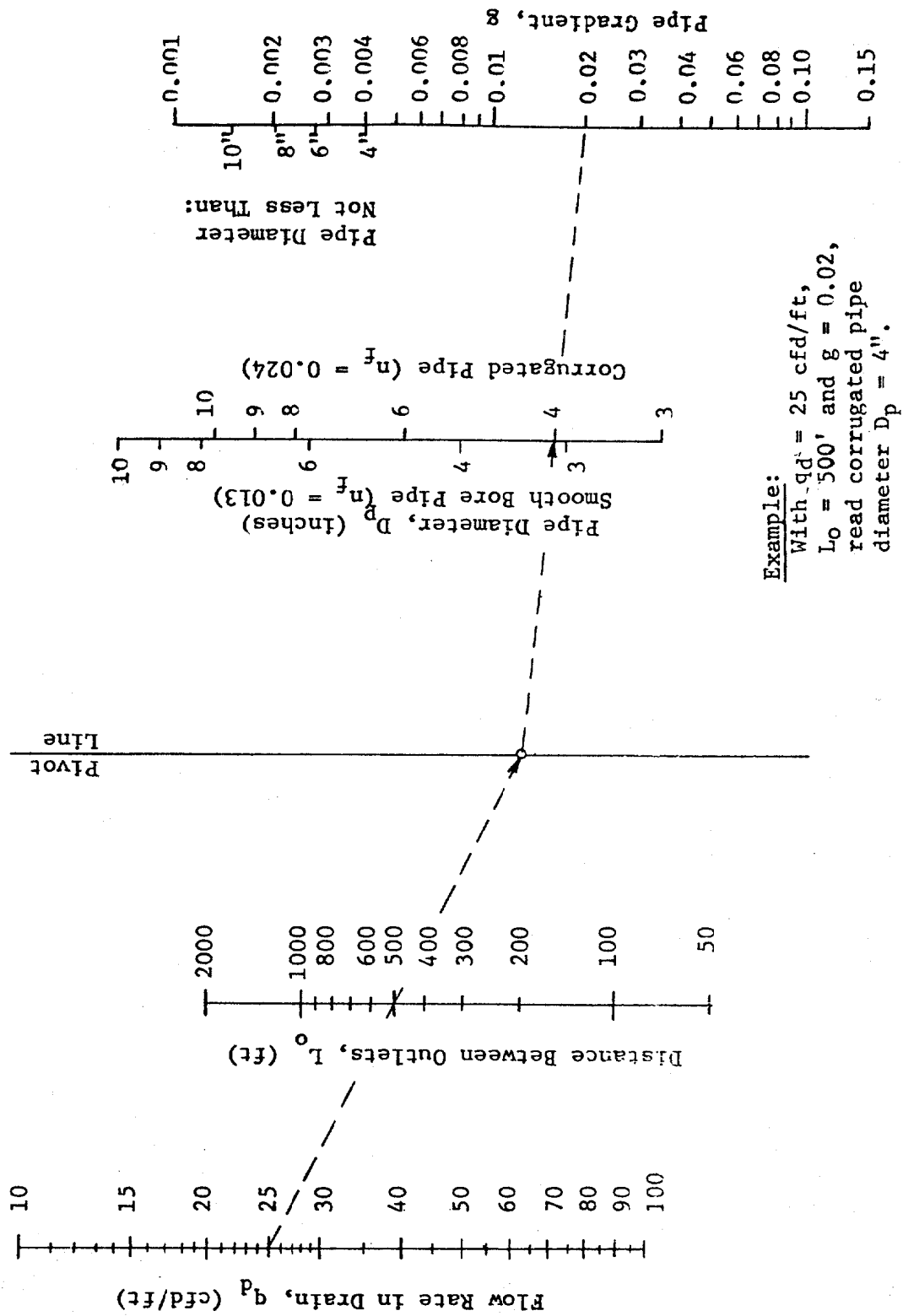

Figure 56. Nomogram Relating Collector Pipe Size with Flow Rate, Outlet Spacing and Pipe Gradient - Adapted From Cedergren (5,16)

smooth bore pipe and $D_p = 4.0''$ for corrugated pipe for this situation.

Although in Example 19 it was found that the minimum collector pipe diameters, recommended in Section 3.4.1, would be adequate for the given conditions, it should be recognized that the minimum pipe diameter and maximum outlet spacing may be controlled by equipment and procedures used for cleaning the collector system in those instances where cleaning of the pipes is anticipated as part of the overall maintenance operation.

As part of the design of the collection system, its drainage capacity should be checked, and it should be analyzed to be sure that there is adequate filter protection to prevent flushing of the drainage aggregates into the pipes through the slots or perforations. Although several different sets of filter criteria are available for the latter analysis, the following have been adopted for this manual and their use is recommended:

$$\text{For slotted pipe, } (D_{85})_{\text{filter}} > 1/2 \text{ Slot width} \quad (23)$$

$$\text{For circular holes, } (D_{85})_{\text{filter}} > 1.0 \text{ Hole Diameter} \quad (24)$$

Where the collector drain is located in a shallow trench as shown in Figure 54, unless a graded filter is required by Equations 23 and 24, the pipe will normally be surrounded by high permeability drainage blanket material and there will be no problem with respect to the drainage capacity of the system. However, for those cases where groundwater, frost penetration or other considerations dictate the use of deeper trenches, as shown in Figure 55, care should be taken to be sure that the trench backfill has an adequate permeability to freely transmit the water carried to it by the drainage blanket. This can be checked by the use of Equation 3, with $q = q_d$, $i = 1$ and taking the area of flow as the trench width, $2b$, times 1.0. Thus, the required permeability of the trench backfill, k_t , becomes

$$k_t = q_d / 2b \quad (25)$$

Example No. 20 - Determination of Required Permeability of Collector Trench Backfill. Consider the situation shown in Figure 49 and the conditions of Example 16. From Figure 51, the maximum length of the flow path is $L = 55'$, and, from Example 12, the net design inflow is $q_n = 0.32$ cfd/sf. Thus, from Equation 22, the maximum rate of flow entering the drain will be $q_d = q_n \cdot L = 0.32 (55) = 17.5$ cfd/ft. Therefore, using Equation 25 with a trench width, $2b$, equal to 1.5' (Figure 49), the minimum required trench backfill permeability becomes $k_t = q_d / 2b = 17.6 / 1.5 = 11.7$ fpd. Obviously, if the trench is backfilled with the selected drainage blanket material ($k = 2500$ fpd), there will be no problem with the

drainage capacity of the system. If, however, for economic reasons, or for any other reason, some other material is selected for trench backfill, it should have an absolute minimum coefficient of permeability greater than 11.7 or say 12 fpd. Actually, a coefficient of permeability several times greater than this would probably be desirable in order to minimize the potentially detrimental effects of construction activities (See Section 5.2.1).

When there is a possibility that water may move from the subgrade soil into the trench of a collector drain, then adequate filter protection should be provided to prevent silting up of the trench backfill material. In the case of a shallow trench, the filter layer used to protect the drainage blanket can be extended under the collector pipe as shown in Figure 34. For deeper trenches this filter protection can often be achieved by lining the trench with a suitable drainage fabric before placing the trench backfill. This matter will be given further consideration in Section 4.6.

Cedergren (5,16) recommended that collector pipes be placed on compacted bedding material with perforations or slots down in order to reduce the possibility of sedimentation in the pipe and to reduce the potential static level of water in the trench. However, in extremely wet or muddy conditions, where maintaining the trench and bedding materials in a free draining condition may be difficult, it may be desirable to place collector pipes with the perforations or slots up or oriented somewhat laterally depending upon the direction of flow toward the collector pipe.

3.4.3 Transverse Collectors. There are no rules for establishing the location of the transverse collector drains. However, once the preferred direction of flow within the pavement drainage layer has been established, as indicated in Figure 51 for Example 16, it is a simple matter to select trial locations of the transverse collectors so as to control the length of the flow path in such a way that reasonably consistent thicknesses of drainage layers are produced. Of course, transverse collector drains should always be provided at critical locations, such as at gradepoints and adjacent to superelevation transition zones, where the cross slope approaches zero. Transverse collectors (interceptor drains) will be required at more frequent intervals where the longitudinal grade is steep relative to the cross slope and where a groundwater condition such as that illustrated in Figure 20 is present.

Many features of the design of longitudinal collector drains are also applicable to transverse collectors. Included in these are the requirements for minimum pipe size and gradient (Section 3.4.1), adequate depth to minimize the effects of freezing, and adequate filter protection to prevent both the flushing of drainage aggregates into pipe perforations and slots and the clogging of the drain backfill by fines carried into the drain by groundwater (Section 3.4.2).

As noted in Section 1.4.3, there has been some adverse experience associated with the installation of transverse drains in areas of seasonal frost, where a general frost heaving has occurred except where the transverse drains were installed, thus leading to poor riding quality during winter months. The possibility of such occurrences should be given careful consideration during the design stage. If the use of transverse drains is considered absolutely necessary under these conditions, then consideration should be given to methods of minimizing the frost heaving and its effects (20).

3.4.4 Outlets. Generally, outlets are provided at convenient intervals in the collection system to convey the collected water to a suitable and safe exit point (usually a ditch). Pipe used for this purpose alone does not have to be perforated and is placed in a ditch backfilled with low permeability soil. One of the design considerations in the outlet system is to prevent piping along the outlet pipe. Usually this can be accomplished by using suitable backfill materials and proper placement and compaction procedures. However, if suitable materials are not available, then the use of cutoff collars or other similar devices may be desirable.

The location of outlets is often dictated in part by topographic and geometric features of the highway and the overall drainage pattern adjacent to the highway. Thus, the selection of the outlet spacing may not be governed by analysis and design considerations, but may be controlled by the availability of suitable outlet points that will permit the free and unobstructed exit of the water without generating drainage problems on adjacent private property or other parts of the highway system. Since the size of the longitudinal collector pipes is dependent upon the outlet spacing, this feature of the collection system should be given very careful consideration (Section 3.4.2).

Perhaps the controlling feature of the outlet system is the exit point. It must be protected from natural and man-made hazards. This protection generally consists of a combination of screens or valves and markers. Screens are generally adequate to prevent small animals or birds from nesting or depositing debris in the pipes. However, the screens should be designed to be displaced outward under a small head of water. This feature will provide protection against an internal stoppage should debris or soil from any source accumulate at the outlet. If high flows can be expected to occur in the outfall ditches (i.e., to a level above the outlet pipe location), flap valves can be utilized to prevent backflow or deposition of debris.

Installation of outlet markers is mandatory if short and long term protection is to be provided and if the outlets are to be easily located by maintenance personnel. Irrespective of the type of post used it should be placed immediately adjacent to the outlet, extend approximately 24"-30" above the ground, and contain a suitable identification marker.

The purpose of the post is to identify the location of and protect the outlet. However, some concern has been expressed relative to their potential hazard to motorists. Thus, in high motorist hazard risk areas, light metal poles might be selected in lieu of heavier wooden posts. Some consideration should also be given to the use of concrete headwalls, constructed flush with the slope, as an alternate method of protecting the outlets. This type of protection has been used in Illinois (Illinois Standard No. 2362) with apparent success. Other criteria for selection of the specific type of outlet protection include: availability, cost, climate (particularly, frost action), corrosion/attack potential, ease of installation, and anticipated maintenance requirements and costs.

A recommended detail for an outlet pipe and marker is pictured in Figure 57. This detail is based on recommendations published by the Federal Highway Administration (16). It should be noted that the invert of the outlet pipe is located a minimum of 12 inches above the flow line of the ditch. If the outlet is located in a common junction box with a storm drain, the invert of the outlet pipe should be a minimum of 6 inches above the maximum predicted water surface in the junction box.

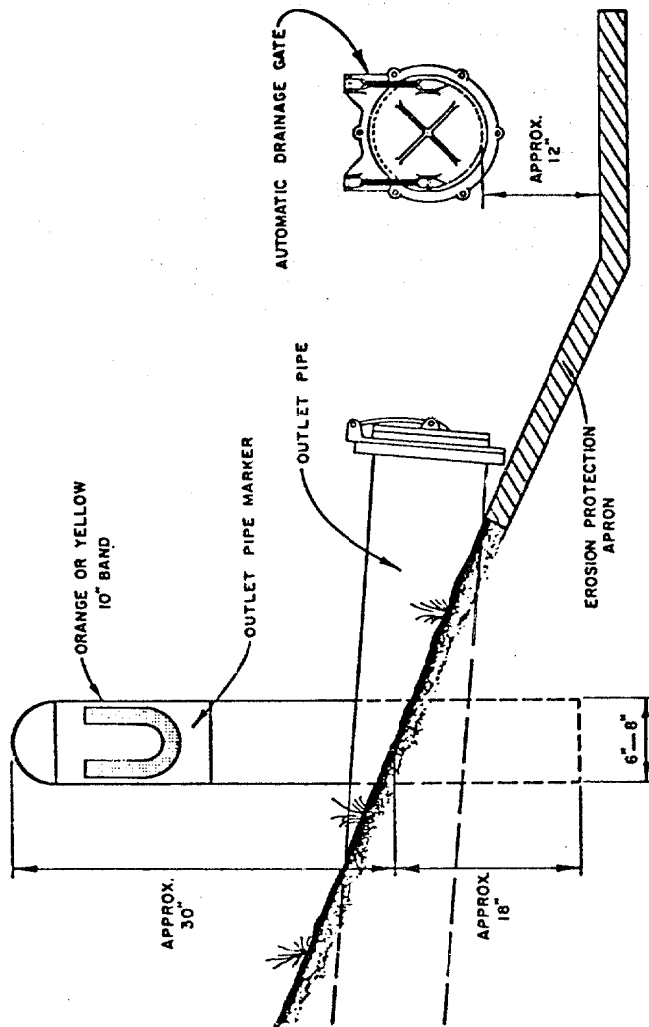

Figure 57. Recommended Detail for Outlet Pipe and Marker (16)

Chapter IV - CONTROL OF GROUNDWATER

4.1 - General

In recent years, there has been a growing awareness nationally of the need for subsurface drainage systems that will effectively drain water from the pavement structural system and thus minimize its detrimental effects. Workshops dealing with water in pavements (89) have been conducted, and guidelines for the design of subsurface drainage systems for pavement structural sections have been published (5,16). Chapter 3 of this Manual dealt exclusively with this subject. Although much of the emphasis associated with this work has been on the removal of moisture that infiltrates through the surface of the pavement, it has long been recognized (5) that the control of groundwater away from the pavement is an essential part of any effective highway subsurface drainage system.

Commonly the design of groundwater drainage systems is based on empirical "rules of thumb," which have been developed by trial and error over a period of years, or on the rather tedious graphical technique involving the use of flow nets (11,90). It is the purpose of this Chapter to present some rational, approximate analytical methods for the design of the most common groundwater control systems, such as the interceptor drains shown in Figures 14 and 58 and the symmetrical drawdown drains shown in Figure 15 (75). Although, at present, it has not been possible to eliminate all elements of empiricism, the methods presented are based in fundamental seepage theory.

Although other types of groundwater control measures are briefly discussed, no effort has been made to present an analytical treatment of these methods. Indeed, with the exception of two recent publications dealing with the design of horizontal drains (93,94), very little information of a specific analytical nature appears in the literature. Thus, to some extent, the designer must still rely on fundamental concepts, i.e. Darcy's Law (Equations 2 and 3) and the use of flow nets (11,90).

4.2 - Longitudinal Interceptor Drains

Let us consider the case of the unconfined flow of groundwater over a sloping impervious boundary toward a single interceptor drain, as illustrated in Figure 59. A solution for the shape of the drawdown curve for this situation, which was developed by R. E. Glover of the United States Bureau of Reclamation, was presented by Donnan (91). This solution, which was based on an adaptation of Dupuit theory (8), took the form

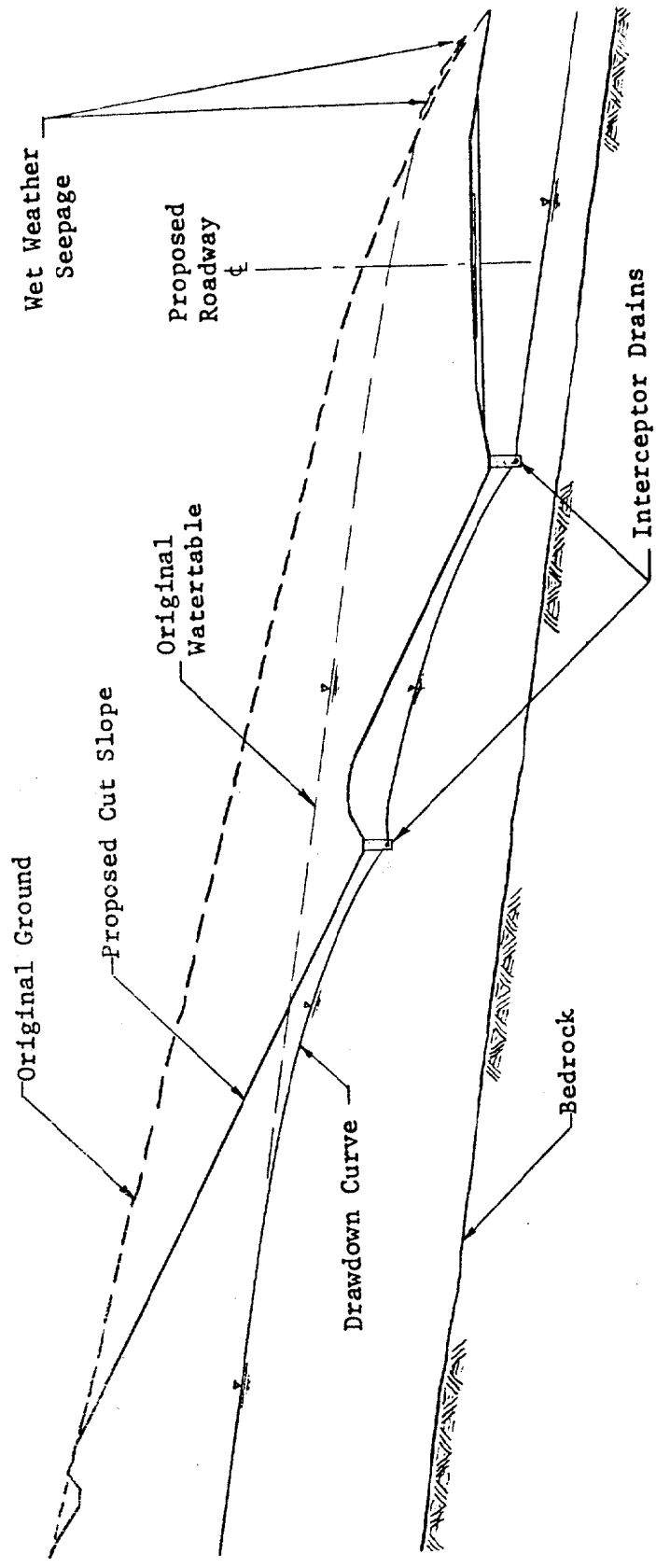

Figure 58. Multiple Interceptor Drain Installation.

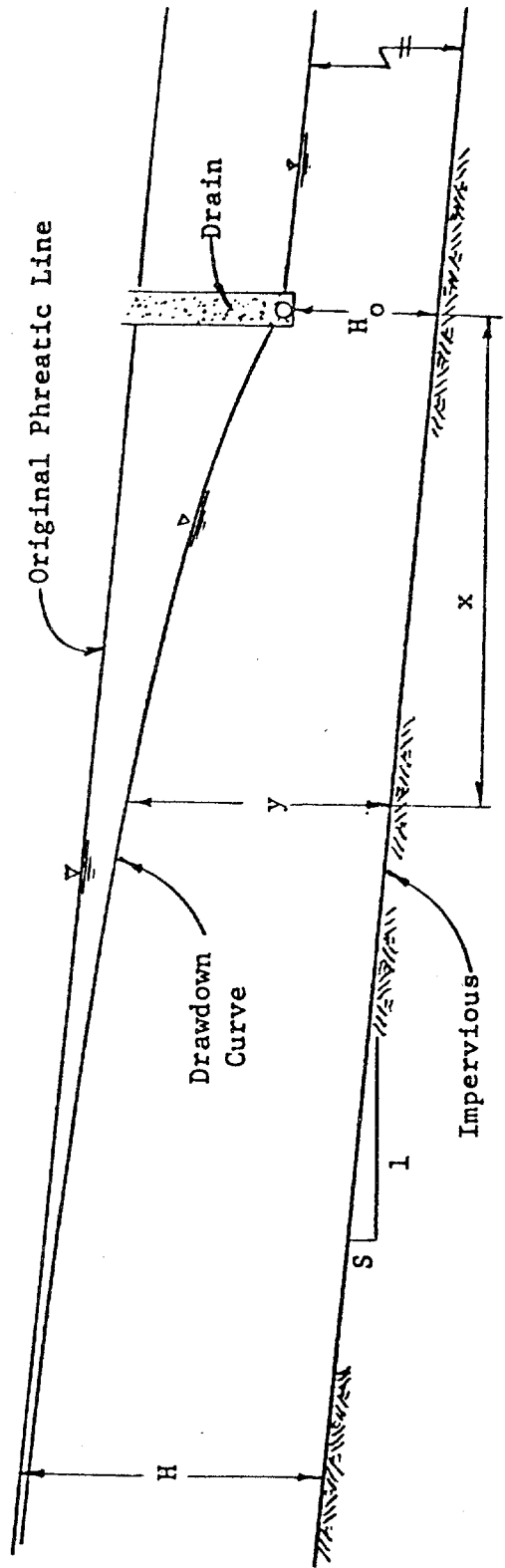

Figure 59. Flow Toward a Single Interceptor Drain

$$x = \frac{H \log \frac{H-H_0}{H-y} - (y - H_0)}{S}, \quad (26)$$

where x and y are the coordinates of a point on the drawdown curve, as shown in Figure 59, H is the height of the original groundwater table above an impervious boundary of slope S , and H_0 is the height of the drain above the impervious boundary. An examination of Figure 59 and Equation 26 shows that the drawdown curve becomes asymptotic to the original free water surface (phreatic line) at infinity. Dealing with this boundary condition in practical problems is awkward; and, consequently, most solutions to gravity flow problems of this type have assumed that there is a finite distance, L_i , from the drain at which the drawdown can be considered to be insignificant, and at which, for practical purposes, y equals H , as shown in Figure 60. As noted in Section 3.2.2, this distance, L_i , to the point of insignificant drawdown is generally referred to as the "radius of influence."

In an effort to investigate interceptor drains of this type, Keller and Robinson (92) conducted a laboratory study in which, for practical purposes, the conditions shown in Figure 60 were duplicated by the use of a finite source of seepage located at a distance, L_i , from the drain. They found that Glover's equation, i.e. Equation 26, checked the experimental data when modified into the following form:

$$Sx = H' \log \frac{H'-H_0}{H'-y} - (y - H_0), \quad (27)$$

where H' is a point on a fictitious extension of the drawdown curve as shown in Figure 60. Substituting in Equation 27 for the condition that $y = H$ when $x = L_i$ leads to the relationship

$$SL_i = H' \log \frac{H'-H_0}{H'-H} - (H - H_0), \quad (28)$$

from which the value of H' can be determined for known values of S , L_i , H and H_0 .

Keller and Robinson (92) also found that the quantity of flow into the drain, q_d , could be determined from the relationship

$$q_d = q_0 \frac{(H'-H_0)}{H}, \quad (29)$$

Note: In Equation 26 and throughout this chapter, the term \log is used to represent the natural logarithm.

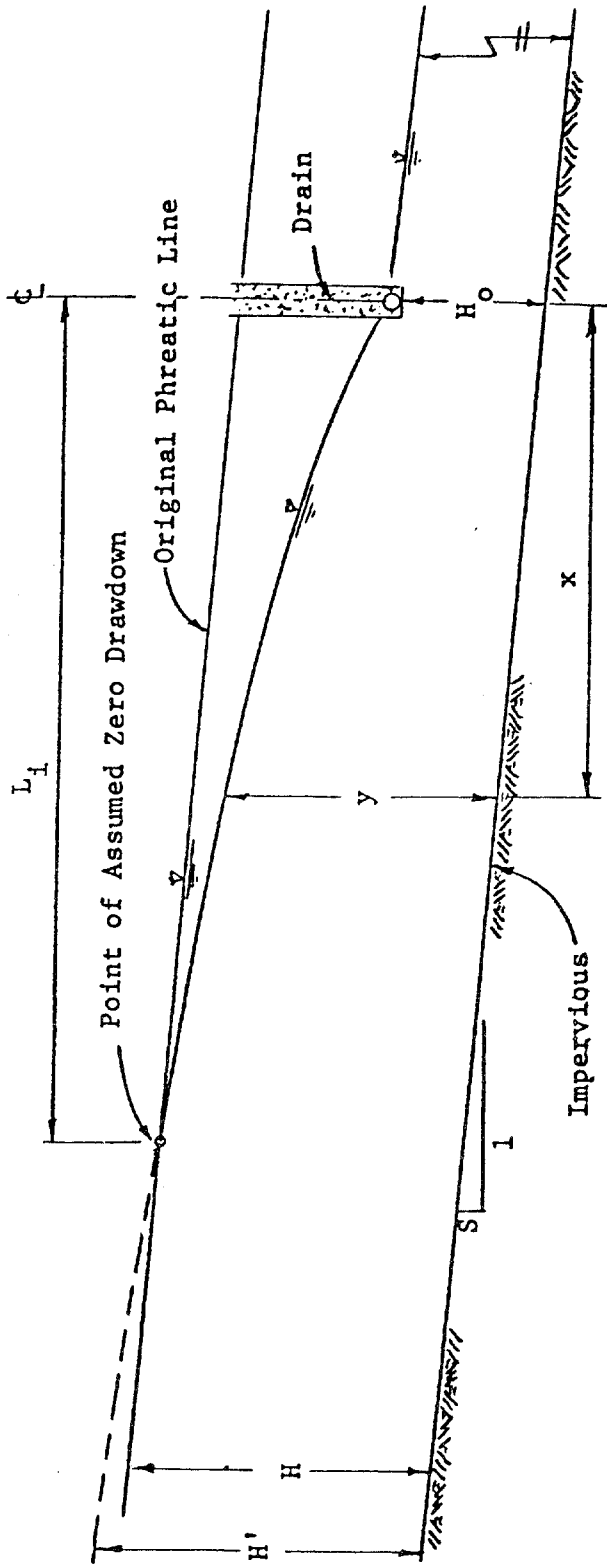

Figure 60. Flow Toward a Single Interceptor Drain When the Drawdown Can be Considered to be Insignificant at a Finite Distance, L_f From the Drain

where q_o is the magnitude of the approach flow, given by

$$q_o = kHS, \quad (30)$$

where k is the coefficient of permeability of the porous medium. A complete solution to the problem can thus be obtained from Equations 27, 28, 29 and 30. For convenience, Equations 28, and 29 have been combined in dimensionless form and solved by computer to prepare Figure 61, from which q_d/kHS and H'/H can be determined in terms of known values of SL_1/H and H_o/H . The same computations provided the data by which, through a change of variables, Figure 62 was prepared. Figure 62 permits the determination of the location of the drawdown curve, by giving values of Sx/y for known values of H_o/y and $(H'-H_o)/y$. In practice, a series of values of y , between H_o and H , are assumed, and Figure 62 is used to assist in the determination of the corresponding values of x .

In order to use Figures 61 and 62 for any highway drainage problem, it is necessary to have an estimate of the distance, L_1 , beyond which the drawdown can be considered to be insignificant. As noted in Section 3.2.2, this distance can be approximated for practical purposes (75) by means of Equation 8.

Example No. 21 - Analysis of a Longitudinal Interceptor Drain.

Let us consider the proposed construction shown in Figure 14 and, for this problem, (a) compute the reduced flow rate, q_d/k , into the drain and (b) plot the location of the drawdown curve (free water surface). The detailed dimensions of the problem are given in Figure 63. In order to keep the left branch of the free water surface from breaking out through the cut slope and to lower the right branch of the free water surface well below the pavement structural system, the underdrain was set below the ditch line at a depth of 5 feet. It is proposed to pave the ditch over the drain to avoid infiltration and clogging.

Referring to Equation 8, an estimate of the value of the influence distance, L_1 , is given as $L_1 = 3.8(H - H_o) = 3.8(14) = 53.2'$, Say $53'$. From Figure 61, with $SL_1/H = 0.15(53)/20 = 0.398$ and $H_o/H = 6/20 = 0.3$, it is found that $q_d/kHS = 1.57$ and $H'/H = 1.84$ [therefore $H' = 1.84(20) = 36.8'$]. The above calculations form the basis for computing the reduced flow rate as $q_d/k = 1.75HS = 1.57(20)(0.15) = 4.71'$. The reduced flow rate could also be computed from the flow net, which has been included in Figure 63 for comparison purposes, as $q_d/k = \Delta H N_f / N_d = 21(6)/28 = 4.50'$. Knowing the reduced flow rate, it is a simple matter to compute the actual flow rate, q_d , in the drain for any assumed or measured value of the coefficient of permeability, k .

From Figure 63, with $H' = 36.8'$, and the following assumed values of the y coordinates, the x coordinates of the drawdown curve

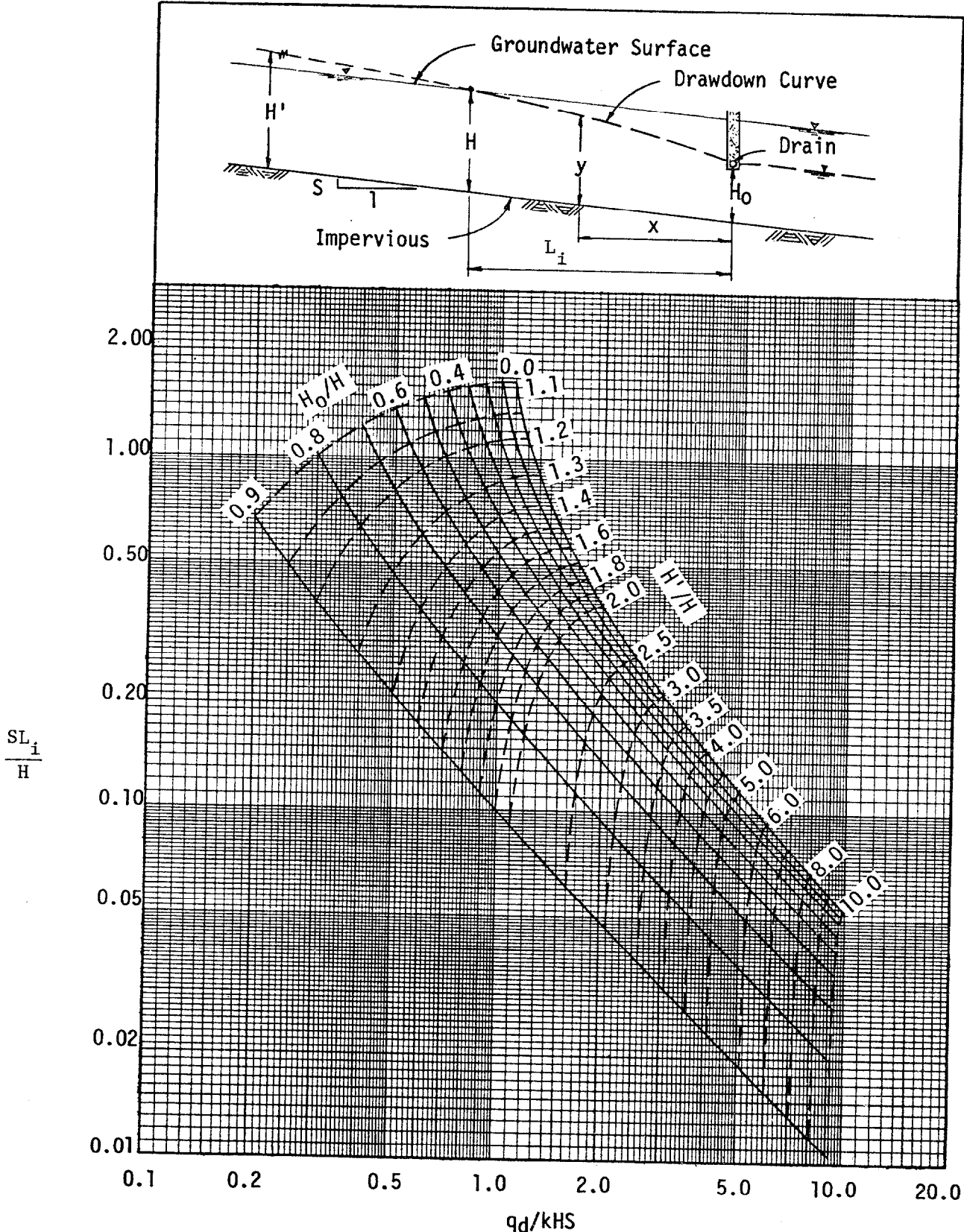

Figure 61. Chart for Determining Flow Rate in Interceptor Drains (75)

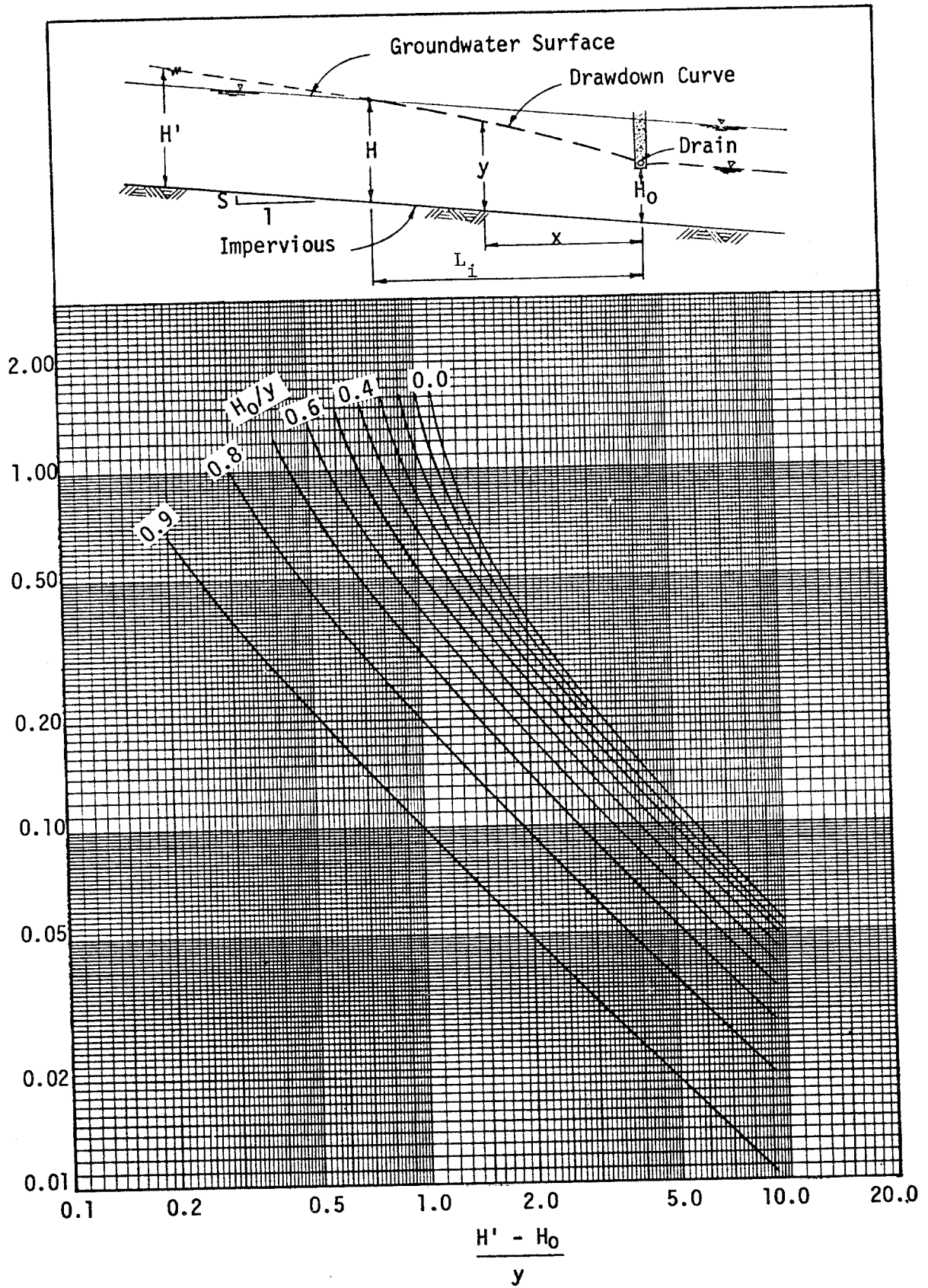

Figure 62. Chart for Determining Drawdown Curves for Interceptor Drains (75)

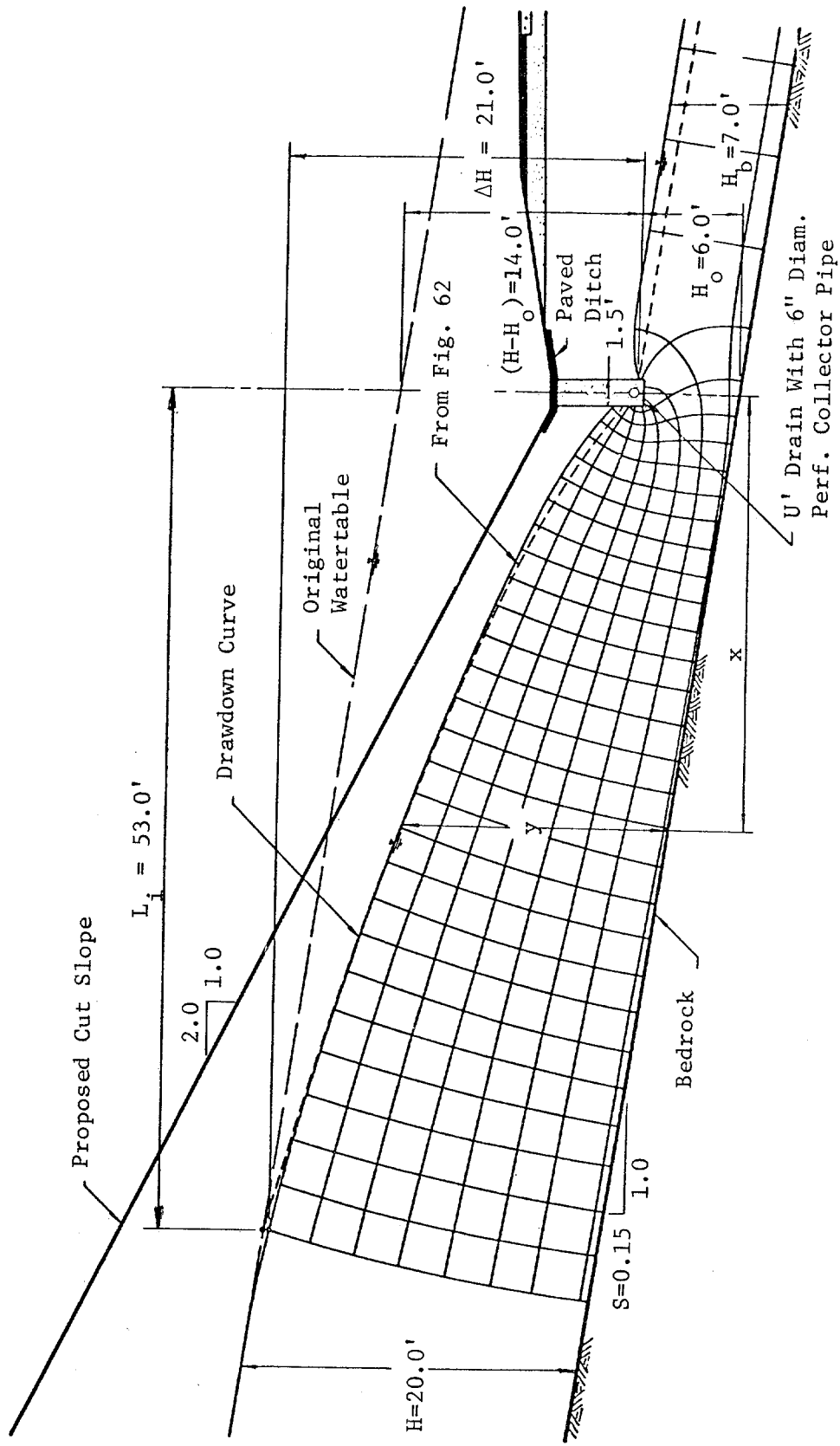

Figure 63. Example No. 21 - Flownet, Dimensions and Details

can be determined as follows:

<u>y</u>	<u>H_o/y</u>	<u>$(H'-H_o)/y$</u>	<u>Sx/y</u>	<u>x</u>
7.4	0.811	4.16	0.041	2.0
8.8	0.682	3.48	0.080	4.7
10.2	0.588	3.02	0.117	8.0
11.6	0.517	2.66	0.149	11.5
13.0	0.462	2.37	0.190	16.5
14.4	0.417	2.14	0.226	21.7
15.8	0.380	1.95	0.265	27.9
17.2	0.349	1.79	0.310	35.5
18.6	0.323	1.66	0.350	43.4

This drawdown curve is plotted dashed in Figure 63. This curve is only approximate, but it can be used as a starting point for constructing the flow net (11,90) which ultimately yields a more accurate location of the free water surface as shown in Figure 63.

Although the method of analysis illustrated in Example 21 yields a complete solution to the problem of a single interceptor drain, it should be recognized that the selection of the proper location of the drain involves considerable judgement and may even involve a trial and error process, particularly if the drain is being used to lower the watertable and reduce porewater pressures to achieve a certain measure of slope stability.

4.3 - Multiple Interceptor Drains

A subsurface drainage system consisting of multiple interceptor drains, such as shown in Figure 58, can be designed by using the principles outlined above and considering each drain separately. However, in order to properly define the boundary conditions for each of the upper drains correctly, it is necessary to establish the location of the limiting streamline above which the flow pattern is essentially that of a single drain installed in the flow domain above a sloping impervious boundary. In essence, this establishes an impervious boundary for each upper drain roughly parallel to the lower sloping impervious boundary. Flow net studies, conducted by using an electric analog, have shown that boundaries of this type can be established by drawing a line parallel to the sloping impervious boundary and located at a depth below the drain equal to 1/10 to 1/12 of the drain spacing (75). This is an adaptation of the generalized "method of fragments," which, according to Aravin and Numerov (7), was first proposed by Pavlovsky in Russia in 1935, and which was introduced into the United States, for fragments in series, by Harr (8) in 1962. In this instance, the flow "fragments" are considered to be in parallel.

Example No. 22 - Analysis of a Multiple Interceptor Drain Installation. Let us consider the proposed construction situation shown in Figure 58, which represents a deeper portion of the cut shown in Figure 14, and thus requires two drains to cut off and drawdown the watertable to prevent it from breaking out through the slope and to keep water from this source out of the pavement structure. The detailed dimensions of the problem are shown in Figures 64 and 65. The location and depth of the drains was established by trial, taking into consideration the desirability of maintaining the free water surface below the cut slope. The dimensions given in Figure 64 are those required to solve the problem using the method of fragments and Figures 61 and 62.

From Equation 8, the values of the practical influence distance for the drains will be $L_{i1} = 3.8(H_1 - H_{01}) = 3.8(19 - 6) = 49.7' < 63' \text{ (1)}$ (use 49') and $L_{i2} = 3.8(H_2 - H_{02}) = 3.8(19.25 - 5.25) = 53.2'$ (use 53'). For drain No. 1, entering Figure 61 with $SL_1/H_1 = 0.15(49)/19 = 0.387$ and $H_{01}/H_1 = 6/19 = 0.316$, it is found that $q_{d1}/kH_1S = 1.58$ and $H'_1/H_1 = 1.90$ [therefore $H'_1 = 1.90(19) = 36.1'$]. A similar calculation for drain No. 2 yielded $q_{d2} = kH_2S = 1.57$ and $H'_2 = 35.6'$.

From the above calculations, the reduced flow rates for the drains can be computed as $q_{d1}/k = 1.58H_1S = 1.58(19)(0.15) = 4.50'$ and $q_{d2}/k = 1.57H_2S = 1.57(19.25)(0.15) = 4.53'$. Based on the flow net, shown for comparison purposes in Figure 65, it is found that $q_{d1}/k = \Delta H_1 N_{f1} / N_{d1} = 22.5(3)/15 = 4.50$ and $q_{d2}/k = \Delta H_2 N_{f2} / N_{d2} = 21(3)/14 = 4.50'$.

Using the method illustrated in Example 21, the data shown in Figure 64 were used with Figure 62 to determine the location of the x_1, y_1 and x_2, y_2 coordinates of the drawdown curve. The resulting curve was then plotted as the dashed line in Figure 65. It can be seen that the comparison between this approximate curve and the more exact free water surface generated by the flow net solution is quite good.

Again, as noted in Section 4.2, it should be recognized that the selection of the depth and vertical and horizontal spacing of the drains is largely a matter of judgement and may require several trials before the optimum configuration is achieved.

4.4 - Symmetrical Drawdown Drains

In order to solve a problem such as that shown in Figure 15, the

(1) For the case where the influence distance calculated from Equation 8 is greater than the drain spacing, then the drain spacing should be used for L_i in the remaining computations.

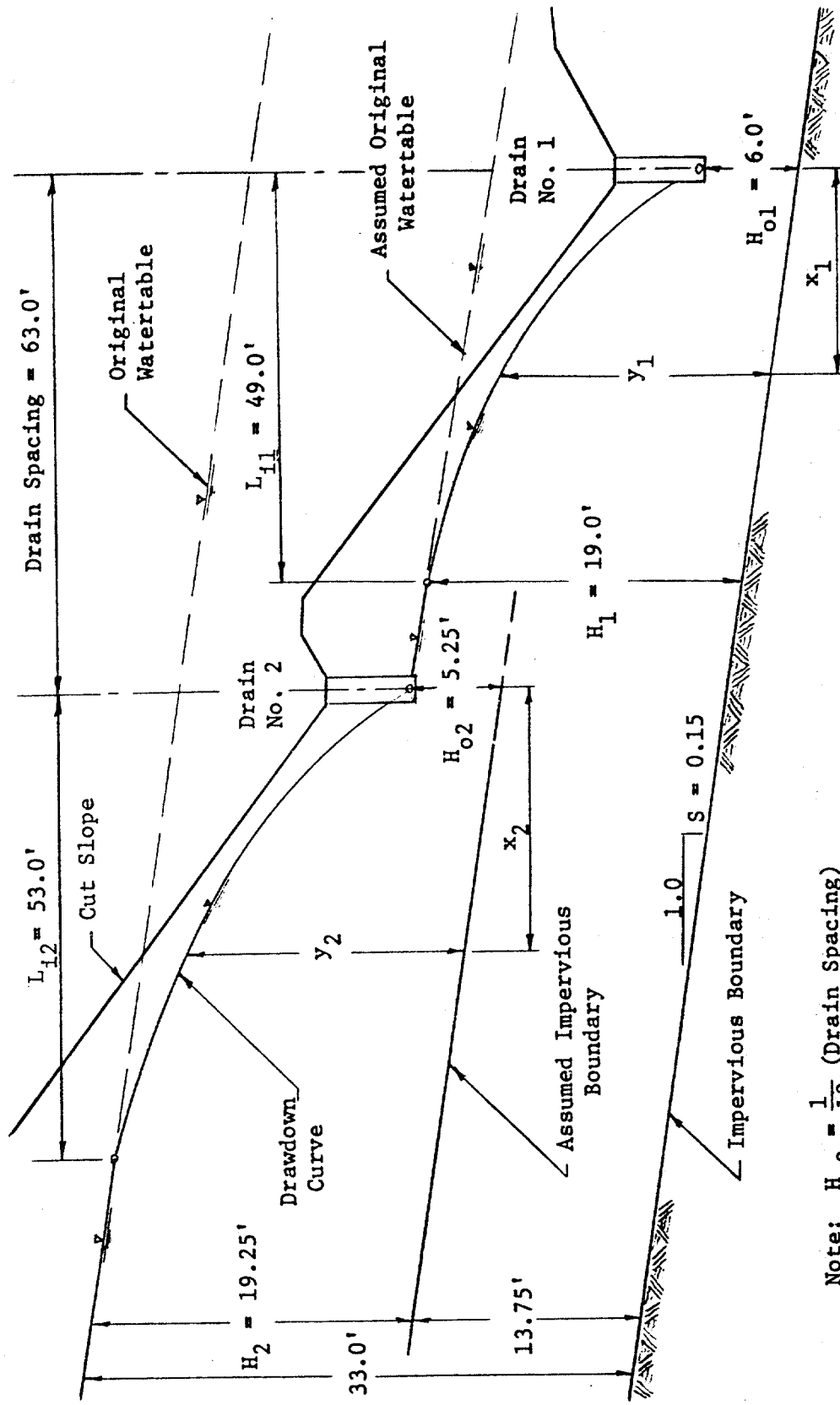

Not To Scale

Figure 64. Example No. 22 - Dimensions and details required for the use of Figures 61 and 62.

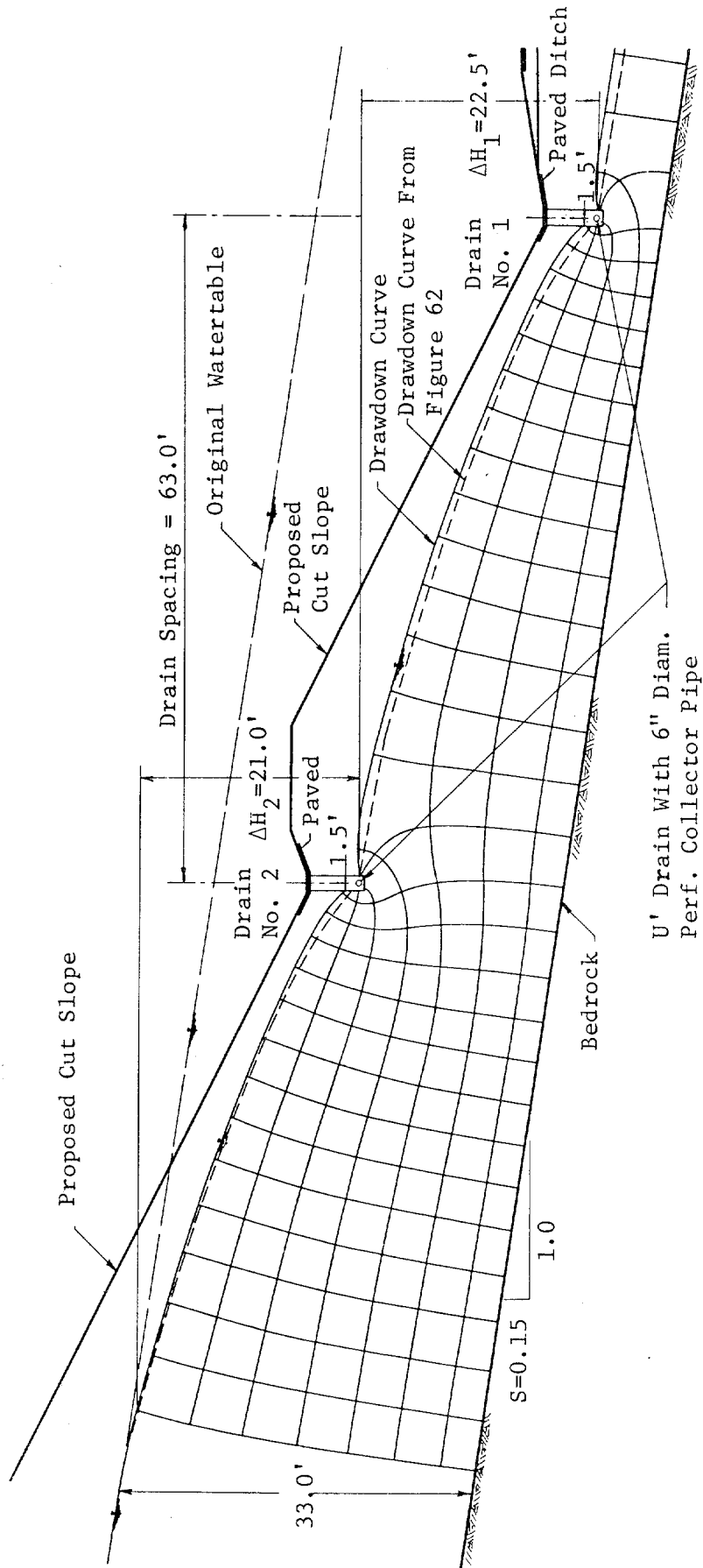

Figure 65. Example No. 22 - Flow Net, Dimensions and Details

method of fragments may be used with the flow domain broken up into fragments as shown in Figure 66. Basically, this amounts to assuming that there is a horizontal streamline existing at the level of the drain. Flow net analyses have shown that this is not an unreasonable assumption.

The quantity of flow into the drain from Fragment No. 1, q_1 , can be estimated from Dupuit theory (8) to be

$$q_1 = \frac{k(H - H_o)^2}{2(L-b)} \quad (31)$$

The drawdown curve for Fragment No. 1 can be determined from the relation

$$x = (L-b) + \frac{1}{2H_{sm}} \left\{ y - \sqrt{y^2 - H_{sm}^2} - (H-H_o) - \sqrt{(H-H_o)^2 - H_{sm}^2} - H_{sm}^2 \log \left[\frac{y + \sqrt{y^2 - H_{sm}^2}}{(H-H_o) + \sqrt{(H-H_o)^2 - H_{sm}^2}} \right] \right\}, \quad (32)$$

where $m = 0.43\pi$. Equation 32 was derived using the modification of Dupuit theory suggested by Gilboy (100). For convenience, Equation 32 has been put in dimensionless form and solved by computer to prepare Figure 67, which can be used to determine the x and y coordinates of the drawdown curve.

The solution to the problem represented by Fragment No. 2 in Figure 66 has been presented by Aravin and Numerov (7). They showed that the flow rate, q_2 , for this situation could be computed from the relation

$$q_2 = \frac{k(H-H_o)}{\frac{L_i}{H_o} - \frac{1}{\pi} \log \left(\frac{1}{2} \sinh \frac{\pi b}{H_o} \right)}, \quad (33)$$

and that the value of the piezometric head at the roadway centerline, $(H_d - H_o)$, could be determined from the relation

$$(H_d - H_o) = \frac{q_2}{\pi k} \log \left(\coth \frac{\pi b}{2H_o} \right) \quad (34)$$

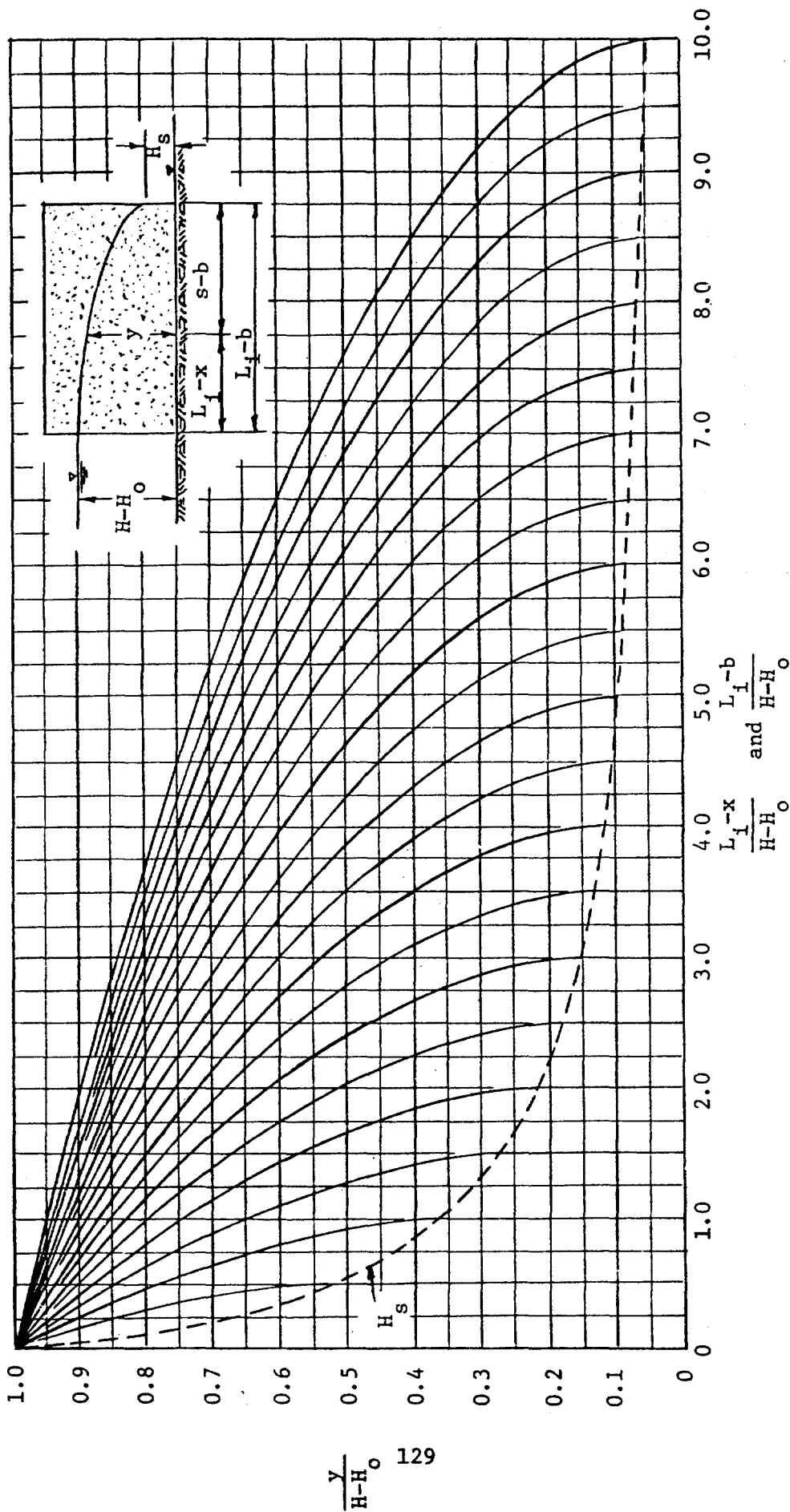

Figure 67. Free Water Surfaces Based on Gilboy Modification of Dupuit Theory

Equations 33 and 34 were solved by computer and used to prepare Figures 68 and 69, respectively. Figure 68 can be used to determine the quantity of flow, q_2 , entering the drain from Fragment No. 2 in terms of known values of H , H_0 , b , and k . The total quantity of flow entering the drain, q_d , would be the sum of the flows from the two fragments,

$$q_d = q_1 + q_2 \quad (35)$$

In the method of solution proposed here, it is assumed that the right branch of the drawdown curve can be approximated by the piezometric level along the upper boundary of Fragment No. 2. Thus, Figure 69 can be used to estimate the location of the drawdown curve between the drain and the roadway centerline.

Example No. 23 - Analysis of Symmetrical Drawdown Drains. It is proposed to construct a two lane depressed roadway in an urban area as shown in Figure 15. In connection with this proposed construction it is desired to design a system of symmetrical longitudinal under-drains to draw the groundwater down as far as possible below the bottom of the granular base course, as shown in Figure 15. The detailed dimensions of the problem are shown in Figure 70. The depth of the drains was established by trial, taking into consideration the desirability of producing the maximum drawdown without getting into excessively deep excavation (the trench depth below the bottom of roadway excavation was limited to 5 feet).

Referring to Equation 8, an estimate of the value of the influence distance, L_i , is given as $L_i = 3.8(H - H_0) = 3.8(7.0) = 26.6'$, Say $27'$. Now, entering Figure 68 with $b/H_0 = 0.75/18.5 = 0.041$ and $L_i/H_0 = 27/18.5 = 1.46$, it is found that $k(H-H_0)/q_2 = 2.08$. Thus, $q_2/k = (H-H_0)/2.08 = 7/2.08 = 3.36'$. Now, from Equation 31, the $q_1/k = (H-H_0)^2/2(L-b) = (7)^2/2(27-0.75) = 0.93'$. Therefore, the total reduced flow rate to the drain becomes, from Equation 35, $q_d/k = q_1/k + q_2/k = 3.36' + 0.93' = 4.29'$. Based on the flow net shown in Figure 70, with $\Delta H = (H-H_0) = 7.0'$, $q_d/k = \Delta H N_f/N_d = 7.0(7.4)/11.8 = 4.39'$.

Referring to Figures 69 and 70, the right branch of the drawdown curve can be determined by taking various values of x' in Figure 70 as $W/2$ in Figure 69 and considering y' in Figure 70 as $(H_d - H_0)$ in Figure 69 as follows (noting that $b/H_0 = 0.041$ and $q_2/k = 3.36'$ from previous computations):

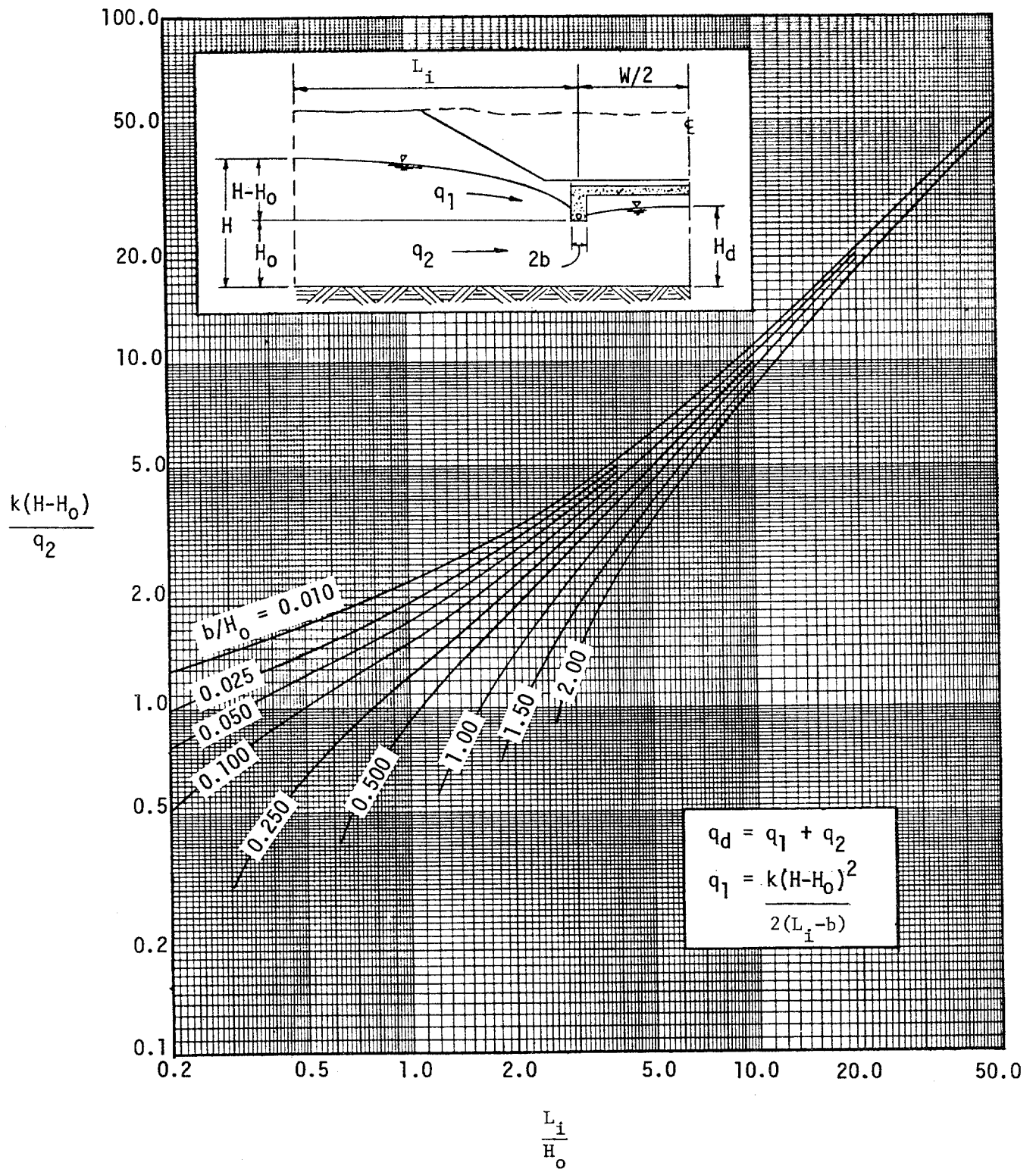

Figure 68. Chart for Determining Flow Rate in Symmetrical Underdrains

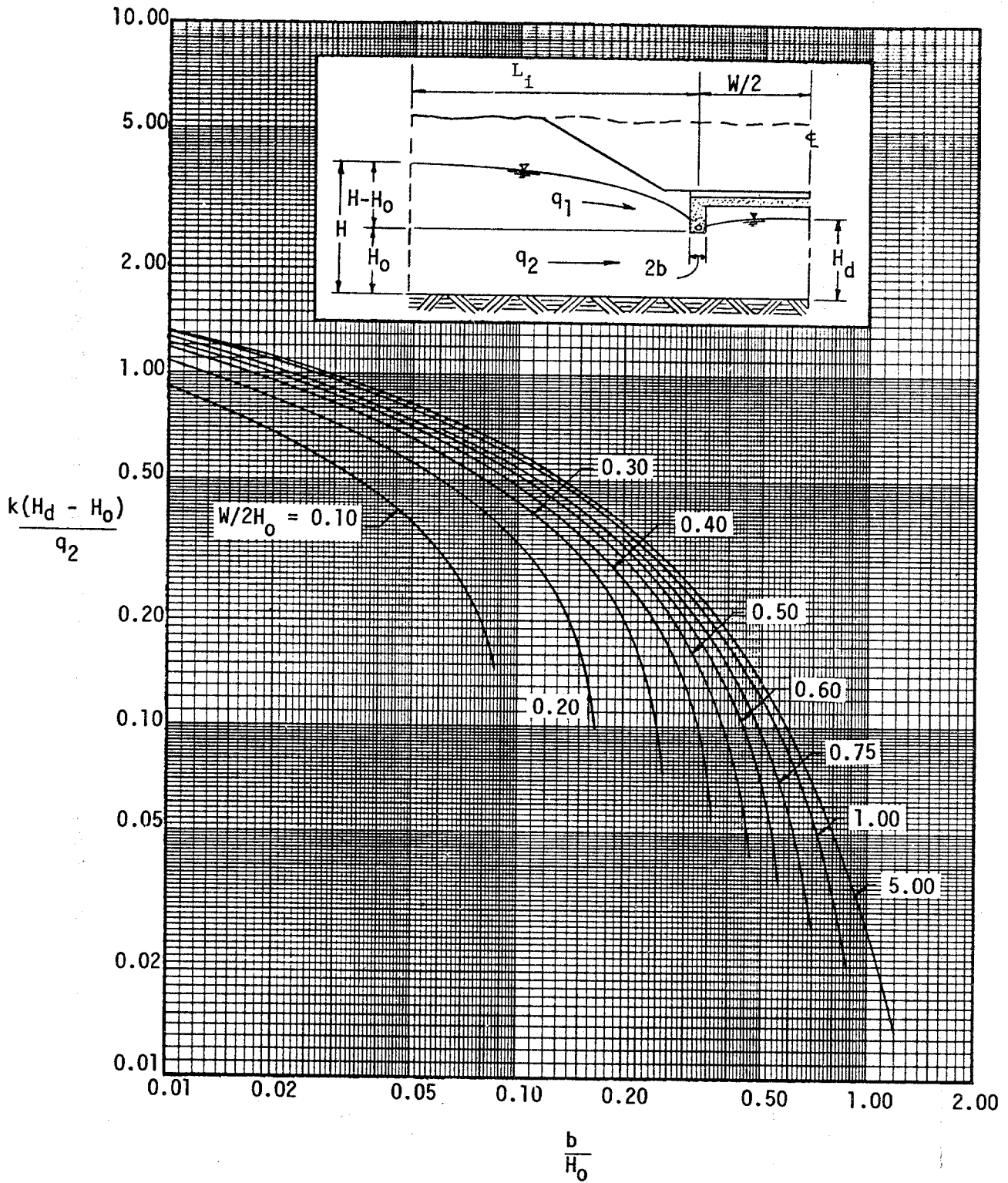

Figure 69. Chart for Determining the Maximum Height of Free Water Surface Between Symmetrical Underdrains

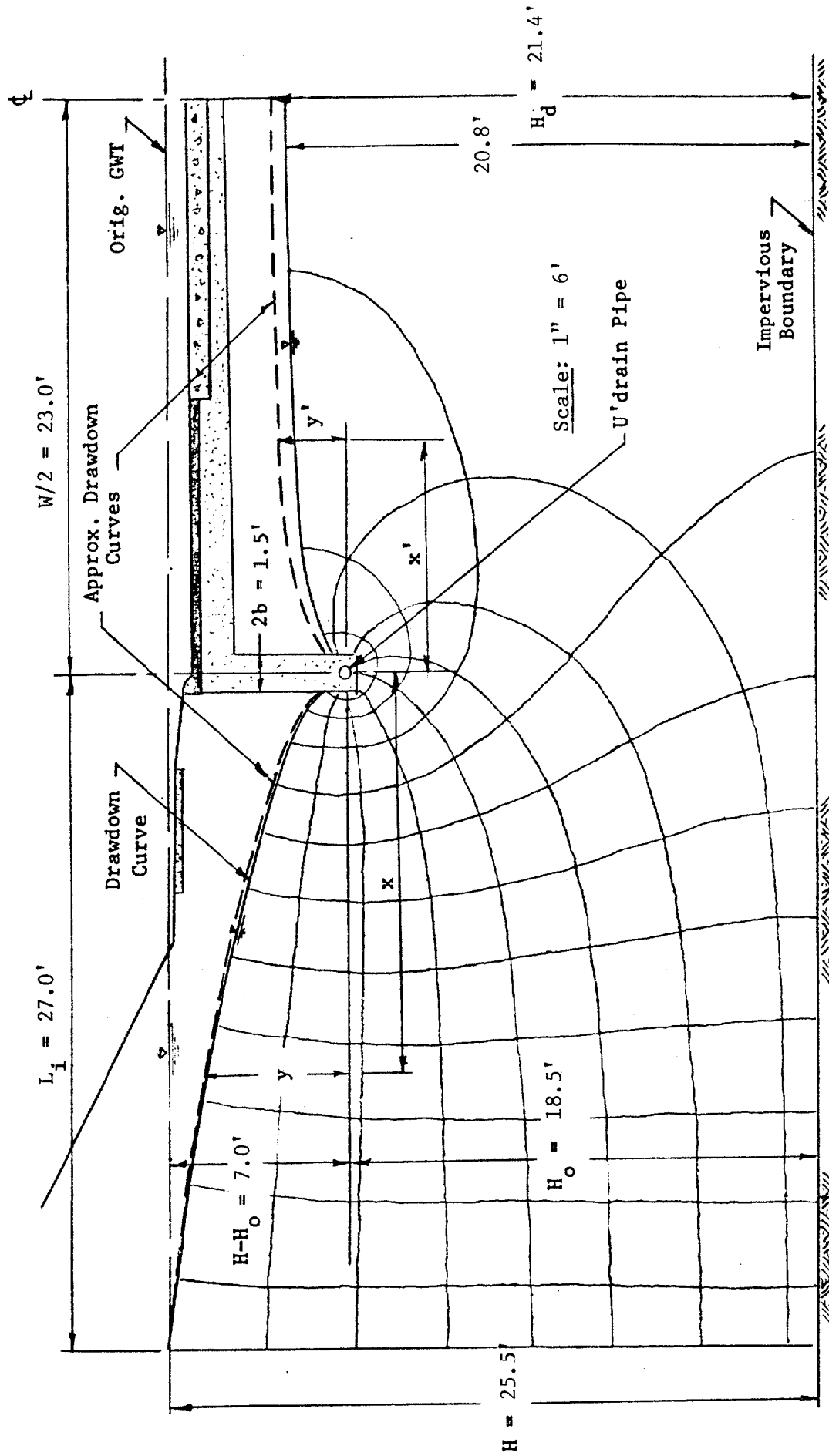

Figure 70. Example No. 23 - Flow Net, Dimensions, and Details

$x' = W/2$	$W/2H_o$	$\frac{k(H_d - H_o)}{q_2}$	$y' = (H_d - H_o)$
2.0	0.108	0.47	1.57
4.0	0.216	0.64	2.15
6.0	0.324	0.73	2.45
8.0	0.432	0.78	2.62
15.0	0.811	0.85	2.85
23.0	1.243	0.87	2.92

Now, referring to Figure 70, the left branch of the drawdown curve can be determined from Figure 67 by noting that $(L_i - b)/H - H_o = (27 - 0.75)/7 = 3.75$. Thus, for various assumed values of y , the values of x can be determined with the help of Figure 67 as follows:

$y/(H - H_o)$	$(L_i - x)/(H - H_o)$	$(L_i - x)$	y	x
0.13	3.75	26.25	0.91	0.75
0.20	3.70	25.90	1.40	1.10
0.40	3.30	23.10	2.80	3.90
0.60	2.55	17.85	4.20	9.15
0.80	1.40	9.80	5.60	17.20
1.00	0.00	0.00	7.00	27.00

These approximate drawdown curves are shown dashed in Figure 70. It can be seen that, although this method produces a free water surface that is slightly high, the comparison between it and the more exact free water surface produced by flow net analysis is not bad.

For the special case where the underdrain cannot be placed sufficiently deep to drawdown the groundwater table below the granular drainage blanket of the pavement system, the flow rate to this layer can be estimated by the use of Figure 36, which was presented in Section 3.2.2.

4.5 - Miscellaneous Groundwater Control Measures

In addition to the common interceptor and drawdown drains, discussed in Sections 4.2, 4.3 and 4.4, there are a number of other groundwater control measures that have been used in connection with highway construction (See Section 1.4). The most common of these are (a)

blanket drains used on cut slopes or in stabilization trenches, as shown in Figures 23 and 24, respectively; (b) horizontal or parallel drains, used in connection with cut or fill stabilization (See, for example, Figures 21a and 21b); and (c) local surface drains, used primarily to tap and remove the water from localized springs and other sources of seepage beneath highway fills.

Although little appears in the literature with respect to the analysis and design of the types of blanket drains shown in Figure 23 and 24, this can be handled very simply with the use of flow nets and Darcy's Law (11). The most important considerations in designing these systems are to be sure that they possess adequate drainage capacity to rapidly remove all of the water that seeps into them and to be sure that adequate filter protection is provided to prevent clogging of the drainage blanket material. The former requirement can be met by using a sufficient thickness of high permeability drainage aggregate so that the drain will never flow full. The latter requirement can be met by the use of one or more filter layers satisfying the requirements of Equations 17 through 21, in Section 3.3.2. Although aggregate filters are shown in Figure 23 and 24, suitable drainage fabrics may be used in their place, where the history of performance of these fabrics has proven them to be satisfactory.

Although the use of horizontal drains has become almost routine in some states (11,35,93,94,95,96,97,98,99), as noted in Section 4.1, very little of a specific nature has been written on the analysis and design of these systems. However, a procedure for the analysis of parallel horizontal drains has recently been developed and presented by Prellwitz (94). This procedure permits the designer to evaluate the effectiveness of various drain spacings in lowering the watertable above and between the drains. Used with appropriate stability analysis, this procedure then allows the designer to consider various drainage alternatives.

It is not uncommon during the course of a subsurface investigation for a highway, or during construction, to discover springs or other localized areas of seepage, in the foundation areas of embankments. These sources of seepage must be tapped and adequately drained if the integrity of the foundation and stability of the embankment are to be maintained. Several typical schemes for accomplishing this objective have been presented by Cedergren (11) and are illustrated in Figure 71. The key to successful use of the drainage control measures illustrated in Figure 71 lies in providing the proper combination of high drainage capacity with appropriate filter protection. Often this can be satisfactorily accomplished by constructing the local drains with a core of very high permeability aggregate within an envelope of filter aggregate or drainage fabric. The same care should be exercised in the design, construction and maintenance of the outlets of these drains as was recommended for the outlets of longitudinal and transverse collector drains (See Section 3.4.4).

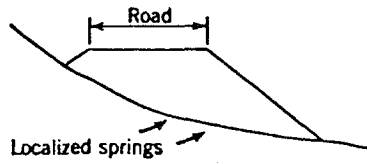

(a)

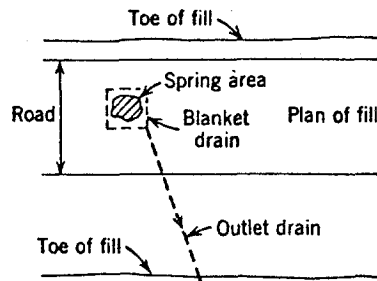

(b)

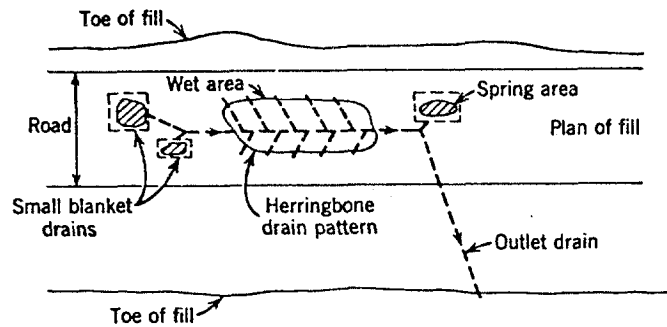

(c)

Figure 71. Localized Surface Drains. (a) Cross-Section of Fill. (b) Draining a Single Spring. (c) Draining a Group of Springs. After Cedergren (11)

4.6 - Filter Protection in Groundwater Control

The filter criteria for the protection of drainage aggregates (Section 3.3.2) and to prevent drain fill from washing into the perforations or slots in collector pipes (Section 3.4.2) are the same for groundwater control systems as for pavement drainage systems. Thus, the filter design practices illustrated in Examples 17 and 18 are entirely applicable to groundwater control systems. However, it should be recognized that the direction of flow of the water in groundwater control systems can sometimes be quite different than in pavement drainage systems. This difference in flow direction, of course, must be taken into consideration in the design of the drains. This is particularly important in the case of interceptor and drawdown drains, where the seepage enters the drain through the sides and bottom of the drainage trench, rather than entering the top of the trench as is the case for many longitudinal and transverse collector drains (See Figure 55).

The desirability of protecting the drain trench backfill from the intrusion of fines that can clog the drain, while maintaining the high permeability required for adequate drainage capacity, and protecting against the washing of drain fill into pipe perforations or slots, often leads to conflicting requirements that necessitate special treatment. It is a simple matter to utilize the filter requirements of Section 3.3.2 to select a drain trench backfill that will provide sufficient permeability and protect against clogging. However, quite commonly, drain fill selected on this basis will not satisfy the requirements of Equation 23 or 24 to prevent the flushing of the drain fill into the collector pipe slots or perforations. Under these circumstances, one solution is to utilize a graded filter system, where the collector pipe is protected by coarse drain fill meeting the requirements of Equation 23 or 24. This coarse drain fill must also satisfy the filter criteria of Section 3.3.2 with respect to the fine drain fill material. A typical arrangement of this type, which has been used with some success, is shown in Figure 72. One way of eliminating the envelope of coarse drain fill, shown in Figure 72, would be by wrapping the perforated or slotted pipe with suitable drainage fabric. An alternate solution is to select a drain fill that will satisfy the requirements of Equation 23 or 24, and to protect against the intrusion of fines from the surrounding soil by enveloping the drain fill in a suitable drainage fabric, as shown in Figure 73.

One very important requirement for interceptor drains is that they be sealed at the top to prevent the infiltration of surface water which may carry fines that can clog the drain fill. Ideally, this is best accomplished by the use of a paved ditch above the drain, as illustrated in Figures 63, 65 and 72. However, in lieu of a paved ditch, the top of the drain should be sealed with at least 12 inches of well compacted clayey soil, as shown in Figure 73.

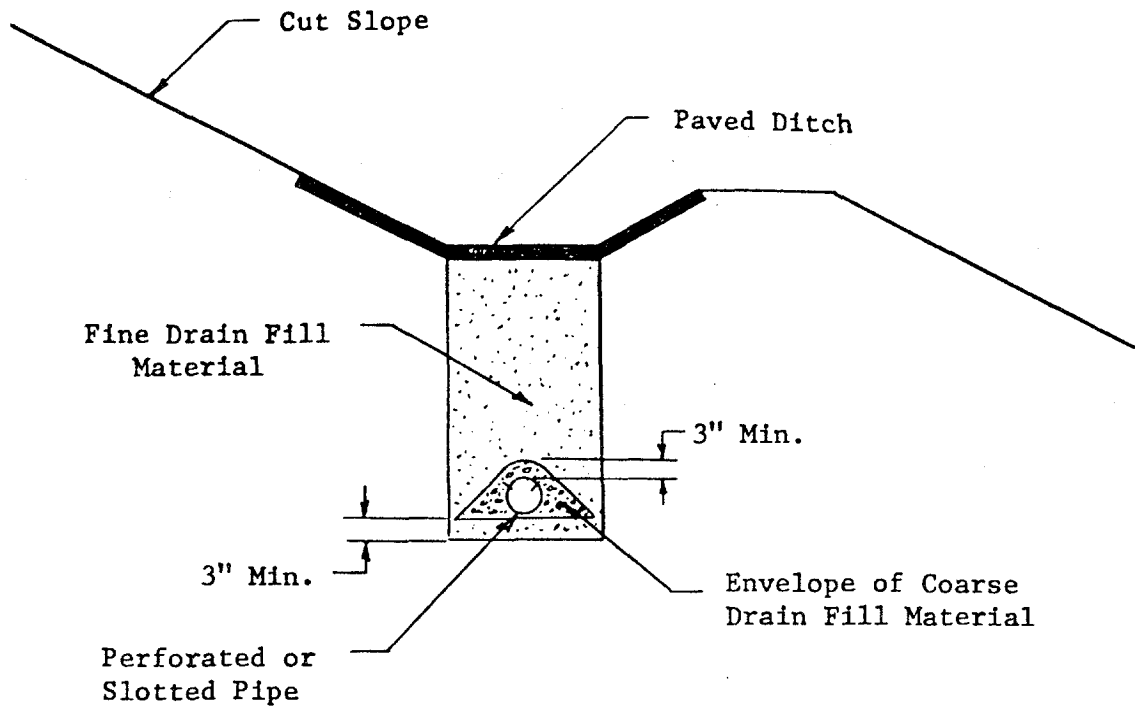

Figure 72. Typical Filter System for Interceptor Drain Using Only Filter Aggregates

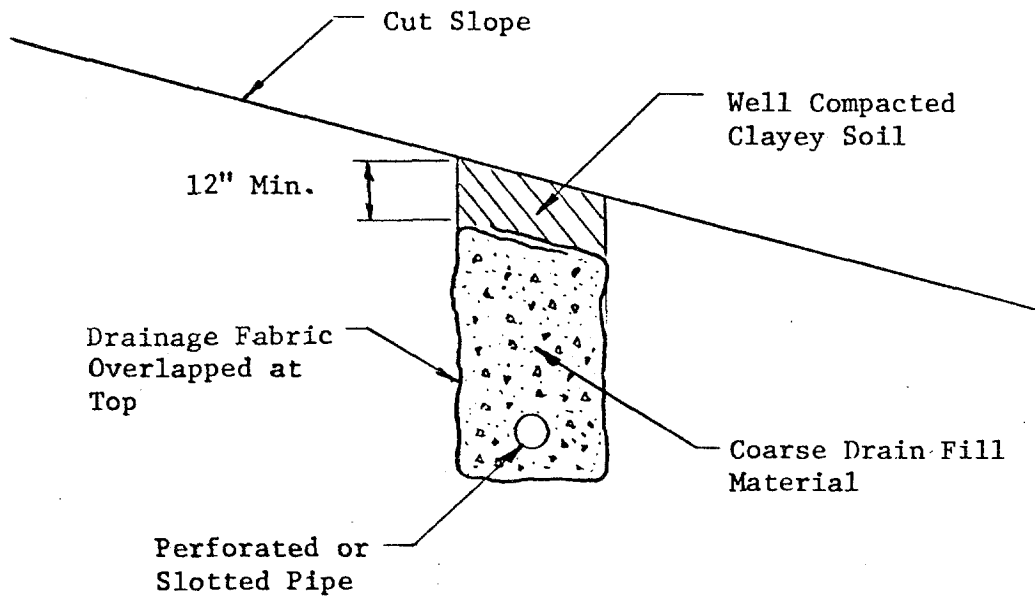

Figure 73. Typical Filter System for Interceptor Drain Using Coarse Filter Aggregate and Drainage Fabric

One way of avoiding some of the difficulties associated with the interceptor drain filter systems described above is through the use of prefabricated "fin" drains similar to those described by Healy and Long (101). Although several versions of this type of drain have been marketed, they all basically consist of a fin having vertical channels and covered with drainage fabric. The channels are connected into a pipe so that the water enters through the drainage fabric, runs down the channels into the pipe, and is carried away from the site. Typical components of the system are shown in Figure 74, and the installation method is illustrated in Figure 75. This system has the advantage that it can be installed in very narrow trenches, saving excavation costs, and it does not generally require any special backfill, thus saving on filter aggregates.

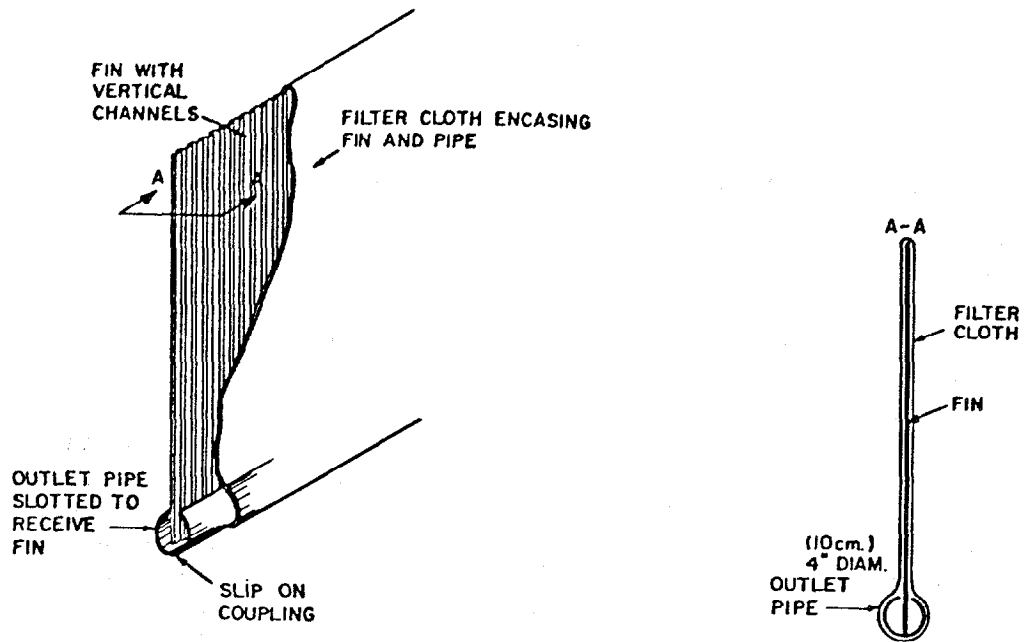

Figure 74. Typical Components of Prefabricated Fin Drains (101)

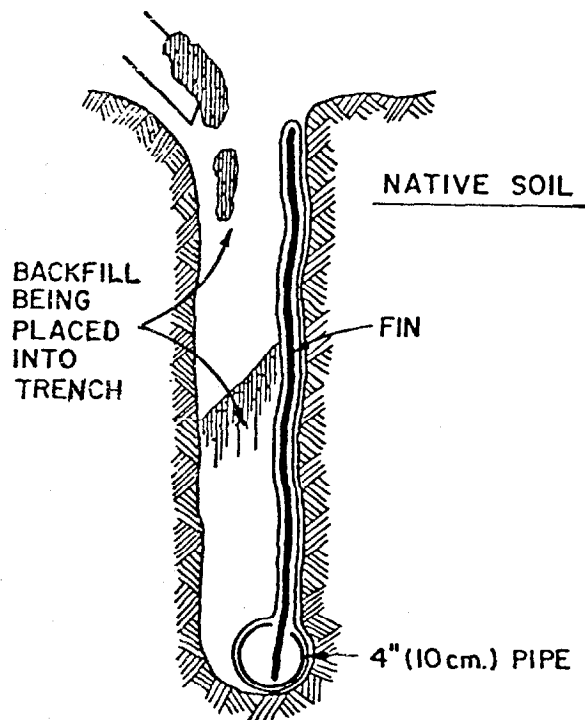

Figure 75. Installation of Prefabricated Fin Drain in Trench (101)

Chapter V - CONSTRUCTION AND MAINTENANCE

5.1 - General

The satisfactory long term performance of subsurface drainage systems is dependent upon careful construction and maintenance as well as proper design. Although the implementation of these two activities follows the design process, they must receive appropriate attention at the design stage to insure that an integrated plan is developed; starting with construction and continuing through the design life of the system. Thus, plans and specifications should include specific requirements with respect to construction activities to insure that completed subsurface drainage systems will function as designed. In addition, the full range of necessary maintenance operations should be anticipated and design features included which will facilitate these activities.

5.2 - Construction Operations

5.2.1 General Precautions. All surfaces on which drainage materials are placed should be well compacted, stable, dry, free from loose material, and completed to true line and grade. Verification of these conditions should precede the construction of the drainage system. Temporary measures should be taken to prevent the intrusion of foreign material into any portion of the drainage system due to construction operations and natural rainfall events during and immediately following construction. Ideally, the time between preparation of the subgrade and the trenches for the drainage system and construction of the system itself should be kept to a minimum. In addition, continuing protection of the system should be provided until such time it is adequately protected by the pavement and/or backfill. Ideally, the construction specifications should include provisions for verifying the satisfactory performance of all components of the system before it is covered up and direct access is limited by subsequent construction.

The satisfactory long term performance of a properly designed and constructed system is dependent on maintaining the drainage materials, collection pipes, and outlet pipes in a free draining condition and at the proper slopes and grades. The former condition can generally be satisfied using graded aggregates or filter cloth and appropriate filter design criteria whereas satisfaction of the latter condition is dependent on the initial grading and settlement characteristics of the embankment and/or the natural foundation. Thus, measures should be taken to insure uniform grading, with no depressions or pockets to collect water, and to minimize post-construction settlement or reduce its effects on the operation of the subsurface drainage system.

Suitable filter and drainage materials must possess adequate stability, durability, permeability, and effective porosity. These properties are generally a function of the mineralogical and gradation characteristics of the aggregates as well as its placement dry density. It is particularly important that adequate permeability be obtained. Thus, it is recommended that the fines content (percent passing the No. 200 Sieve) of drainage aggregates be limited to a value that will ensure adequate permeability (See Figure 28 on page 51).

In most drainage layer applications, the aggregates serve a dual role; i.e., as a drainage medium and as a filter medium. The continued satisfactory performance of the drain in both functions is largely dependent on adherence to available design criteria for filter and drainage layers followed by appropriate construction practices, including careful inspections and quality control, and follow-up maintenance.

Good construction practice dictates careful placement of the drainage materials to minimize segregation and prevent contamination with foreign materials. The former problem can be minimized by utilizing proper stockpiling techniques and thoroughly dampening the materials immediately prior to placement. Quality control tests for compliance with gradation specifications should be made on samples taken from the drainage layer after placement. However, this does not preclude the need for preconstruction quality control testing of samples taken from stockpiles of the drainage layer materials.

Particular care should be taken during construction to avoid the contamination of drainage layers or filter materials. Partially completed structural sections should not be used as haulroads, and every effort should be made to keep traffic off these sections until they are protected by the pavement. Earth and other materials should be kept off the tires and tracks of construction vehicles and equipment to avoid the dropping of these materials on the surface of drainage layers. Preventive measures should also be taken to keep rainfall and other surface water from washing fines into the surface of drainage or filter layers and, thus, reducing their permeability.

Backfill of drainage trenches should immediately follow the placement of the collector pipes. The material should be placed in a manner to minimize segregation and prevent disruption of the collector pipes and filter cloth (if present). Adequate provisions must be taken to ensure that proper separation of materials is provided during the placement and compaction of filter systems.

Construction specifications should require sufficient compaction to prevent settlement of the overlying pavement or shoulder under the impact loading of traffic. Care must be taken not to cause damage or disruption of the collector pipe system during the compaction process.

The placement of filter layers in the trench should be consistent with the direction(s) of flow into the collector pipe system. Whereas the relative locations of the filter zones should be identified during the design process and specified in the plans, it is important that the appropriateness of the design recommendations be verified by field inspections prior to and during construction. Quality control provisions and safeguards that will require removal of damaged pipes or contaminated materials must be incorporated into the specifications.

Although the outletting of base, subbase and drainage layers by "daylighting" them onto slopes or into ditches is not recommended (Section 1.4.4), economics or other considerations may dictate that this be done under some circumstances. It should be emphasized that this method of outletting granular drainage layers requires very careful design (Example No. 15), construction and maintenance. Such a scheme presents a somewhat more difficult maintenance situation because of the difficulty in providing positive protection against contamination of the outflow surface as well as erosion of the layer surface and backflow into the layer. The proper evaluation of the flow elevation in the adjacent ditch and assessment of the effect of this flow on the operation of the drain are important. Perhaps, a system of this type is best utilized in a fill, if at all.

5.2.2 Sequence of Construction Operations and Inspection. Systematic and timely construction practices accompanied by appropriate quality control testing and inspection are important elements in the long term satisfactory performance of a subsurface drainage system. Construction of the system should not begin until: adequate preparation of the foundation and subgrade has been accomplished; sufficient materials required for the construction of the system are available; and it is possible to construct somewhat self-contained sections of the system in a timely manner and provide adequate protection against damage to or contamination of the system. In general, the sequence of construction operations for a subsurface drainage system should have the following pattern:

1. Preparation of subgrade and/or foundation;
2. Excavation of collector and outlet pipe trenches;
3. Placement of bedding material and installation of perforated pipe in collector trenches;
4. Installation of outlet pipes in appropriate trenches (bedding aggregate not required);
5. Placement and compaction of collection and outlet trench backfill in compliance with construction plans and specifications;
6. Placement and compaction of base drainage layer with underlying filter aggregate or filter fabric as necessary;
7. Installation of outlet appurtenances and markers;

8. Construction of pavement and shoulders; and
9. Seeding of right of way and ditches.

The inspection activities associated with these construction activities are summarized in Table 6.

5.3 - General Maintenance

Irrespective of the proper design and construction of a subsurface drainage system, some maintenance will be required to insure that the system continues to operate in a satisfactory fashion. In other words, no action or lack of action should be allowed to reduce the efficiency of the system. To the extent possible, all features of the system should be designed for minimum future maintenance. However, every operating condition for the system cannot always be anticipated. Thus, a program of continuing regular inspections, preventive-type maintenance, and repair-type maintenance must be anticipated.

5.3.1 Cleaning of Collector Pipes. It might be anticipated that sediment could be deposited in collector pipes due to inadequate pipe gradients, uneven settlement of the system and/or a heavy sediment load. In anticipation of such a possibility, clean-out boxes or risers at various locations within the pipe network could be designed into the system. In addition, the pipe network should be designed in such a way that right angle turns are eliminated. If a routine inspection of the system suggests the possibility of reduced efficiency, the collector pipe network should be flushed using large quantities of clean water. If clean-out facilities such as those described above were not included, then cleaning would require back flushing and, perhaps, "snaking" through the outlet pipes.

5.3.2 Maintenance of Outlets. The outlet system, whether it consist of a series of pipes or a daylighted drainage aggregate, must be maintained in a free-flow condition throughout the life of the facility. With respect to pipe outlets, the principal concerns would be the blockages due to weed growth, siltation of the adjacent ditch, debris from the roadway or slope, if in a cut section, and activity of animals or man. In addition, flap valves installed on outlets to minimize blockages due to animal activity or backflow could become stuck because of some of the aforementioned causes as well as damage to or corrosion of the valve hinge. Only through periodic inspection can these circumstances be identified and subsequently rectified. Such inspections should be made prior to seasonal periods of heavy rainfall as well as following particularly heavy rainfall events and/or at least once every three months.

In addition to the outlets themselves, the outlet markers should be maintained in good condition. Damaged markers should be repaired or replaced immediately. Any marker destroyed or damaged during

Table 6. Summary of recommended inspection activities associated with subsurface drainage system installation

<u>Construction Activity</u>	<u>Inspection Activity</u>
1. Subgrade/foundation preparation	Visual observation plus verification of grades
2. Trenches	<ul style="list-style-type: none"> a. Visual observation plus verification of width, locations, lines, and grades b. Visual verification of use of proper placement and compaction technique c. Test verification of specified gradation, thickness, and density (1)
3. Installation of collector/outlet pipe system	<ul style="list-style-type: none"> a. Verification of grades b. Continuity test of collector/outlet pipe system
4. Backfilling collector pipe trenches	<ul style="list-style-type: none"> a. Visual and dimensional verification of proper filter layer placement b. Visual verification of use of proper placement and compaction technique c. Test verification of specified gradations, thicknesses, and densities (1)
5. Backfilling outlet pipe trenches	<ul style="list-style-type: none"> a. Visual verification of use of proper backfill material, placement procedure, and compaction procedure b. Test verification of specified density and moisture content
6. Placement of base drainage layer	<ul style="list-style-type: none"> a. Visual verification of proper placement and compaction procedures b. Dimensional verification of specified thickness, width, and grade for drainage layer c. Test verification of specified gradation and density (1)

(1) Samples of filter aggregates for gradation tests should be taken from the layer after compaction.

other construction or maintenance activities should be immediately reported to the appropriate department for replacement or repair.

5.3.3 Miscellaneous Maintenance and Other Considerations. Careful periodic inspections are the key to adequate maintenance of the subsurface drainage system. However, other related maintenance activities associated with the pavement, pavement shoulder, surface drainage systems, ice/snow control and removal, right-of-way mowing, etc., can all have an impact on the operation and maintenance of the subsurface drainage system. Although the operation of the subsurface drainage system might not take precedence over one of the aforementioned activities, it must not be relegated to an insignificant status. For example, although mowing is an essential maintenance activity, it has a potentially detrimental effect on the outlet system. That is, the mowing machines could damage the outlets through impact with the outlets during the mowing operations. If the likelihood of such an occurrence is high, use of erosion control aprons or chemical weed control could be utilized in lieu of mowing.

Maintenance that insures the efficient collection and removal of surface water will also generally improve the operation of the subsurface drainage system. Timely repairs of damage to surface drainage structures, pipes, ditches, etc., will contribute to the proper operation of the subsurface drainage system. Likewise, timely and cautious repairs of damaged pavement and pavement shoulder sections will be beneficial to the underdrain system. In particular, it has recently been dramatically demonstrated (102) that proper sealing of pavement cracks and joints can greatly reduce the infiltration reaching the pavement drainage system. This is especially true with respect to the joint between pavement and shoulder.

The department responsible for the care of the subsurface drainage systems should maintain detailed as-built plans of the systems to facilitate subsequent repairs and replacements. In addition, a separate record of the location of drainage facilities, particularly outlets, should be maintained so that these facilities can be easily located by maintenance personnel. Inspection records should be kept along with records of each maintenance activity required by the system. If these records are kept in a continuous fashion they may suggest the need for some more substantial efforts to prevent the recurrence of some continuing maintenance problem. This department must also be diligent to gather and assess information concerning the modification of conditions adjacent to the subsurface drainage system. Any modification or change that would adversely affect the operation of the subsurface drainage system should be corrected promptly to mitigate the potentially detrimental effects.

5.4 - Subsurface Drainage and Pavement Rehabilitation

Adequate attention should be given to the performance of existing subsurface drainage systems or the construction of new or extended systems in conjunction with pavement rehabilitation projects. The

Asphalt Institute (103) has posed four general questions that should be answered by surface and subsurface drainage investigations for pavement rehabilitation:

1. Is the original design adequate for drainage of the existing road?
2. What changes in design are necessary to insure the drainage inadequacies, which may be a contributing factor to structural distress, are corrected?
3. If the original drainage system was adequate, have environmental or structural changes taken place since it was built that require reconstruction of the system?
4. Does present or projected land use in areas adjacent to the road indicate that surface drainage flow patterns have changed or are likely to change, thus rendering existing drainage facilities inadequate?

Existing systems should be inspected for satisfactory operation and appropriate action taken to repair and/or extend the system in a manner compatible with the physical and economic constraints of the project. Careful consideration must be given to the potential effects of the pavement rehabilitation work on the continued operation of the subsurface drainage system as well as the surface drainage system. Ring (25) identified a number of potential drainage problems associated with pavement rehabilitation projects. These problems may be localized or extend over long portions of the pavement. He identified the following categories of problems:

1. Shallow side ditches
2. Blockage of subsurface drainage due to widening
3. Permeable shoulders and medians
4. Pumping rigid pavements
5. Impermeable aggregate drainage layers
6. Reduction of drainage capacity of curbed pavements due to overlays
7. Water in open-graded bases (trench section)
8. Drainage of open-graded plant mix seals

Ring recommended (25) that the pavement rehabilitation scheme be a balanced design consisting of improved drainage (surface and subsurface) and structural repairs in conjunction with an overlay.

As cited above, Ring pointed out several potential problems associated with entrapment of water when a pavement is widened. Care must be taken to insure that base course materials utilized for widening purposes have permeabilities that exceed those for the existing base course materials or that other provisions are provided to remove the entrapped water. For example, lateral drains at joints and cracks, edge (longitudinal) drains or combined edge and joint drains are all

possible systems for improving subsurface drainage. However, Cedergren (16) warned that such drains may not be particularly effective if the existing base does not have sufficient permeability to convey substantial water to the drainage system. In such a situation, Cedergren recommended that a trial edge drain installation of 200 to 300 feet be constructed in an area when it is thought that such a system could be beneficial. Flow from the system can then be monitored and pavement performance can be evaluated to determine the potential beneficial effects of the system. Such information can then provide a basis for expanding the system to encompass other portions of the pavement. If portions of the pavement are removed in zones of particularly poor drainage, complete subsurface drainage systems including the adequate drainage layer can be installed. Typical rehabilitative drainage systems are pictured in Figures 76 through 79.

The one common factor associated with all rehabilitative subsurface drainage systems is the attempt to shorten the flow path length. Since it is impossible to increase the permeability of the existing base course, the only viable option is to shorten the path the water has to flow to be removed from the pavement system. Without extensive reconstruction, this can generally be accomplished only by remedial work at the boundaries of the existing pavement. A potentially beneficial rehabilitative subsurface drainage system is that pictured in Figure 78. If a new shoulder is to be constructed or the existing one reconstructed, an option such as that pictured in Figure 79 is possible. Either of these remedial systems assist in removing water from the existing base but are limited in their success (drawdown and time-dependent rate) by the length of the flow path, the transverse slope, and the permeability of the existing base course (see Figure 46). Using the procedures found in earlier sections (e.g., 3.3.1), and knowing the physical dimensions and coefficient of permeability of the existing base course, would allow an estimate of the potential beneficial effect of edge drain construction on the removal of water from the section. Thus, both analytical and/or empirical methods can be utilized to judge the potential success of various rehabilitative subsurface drainage systems.

A summary of generalized drainage problems in pavement rehabilitation and their possible solutions are contained in Table 7.

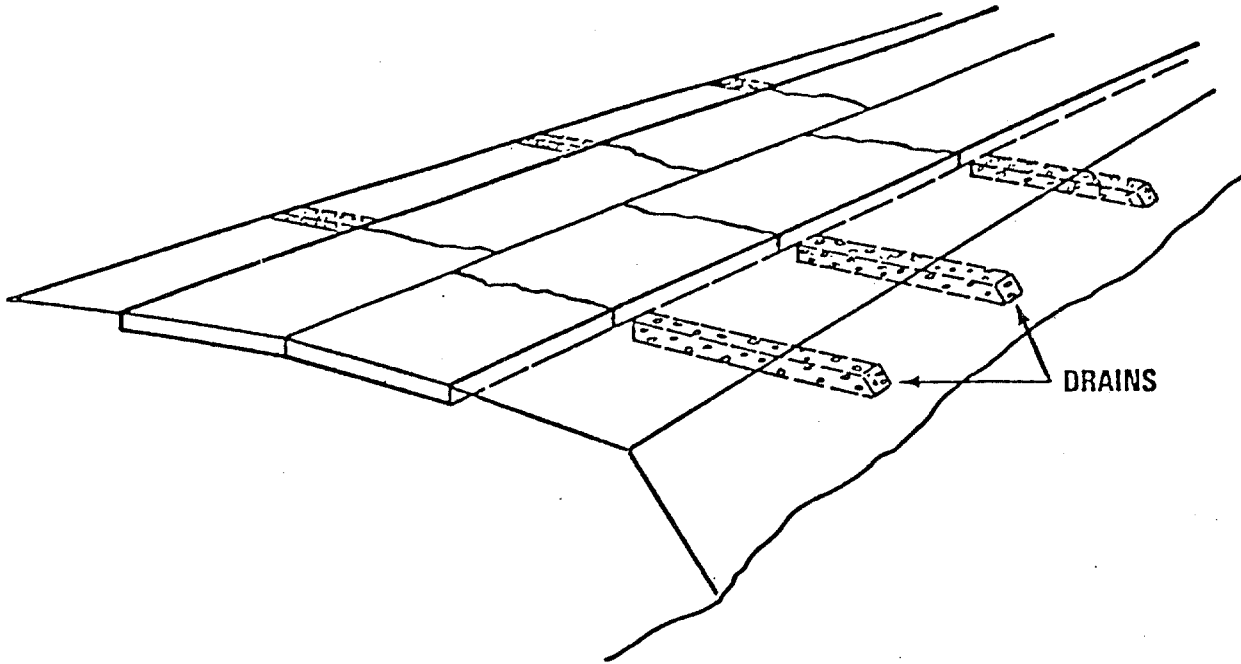

Figure 76. Drains at Cracks and Joints (25)

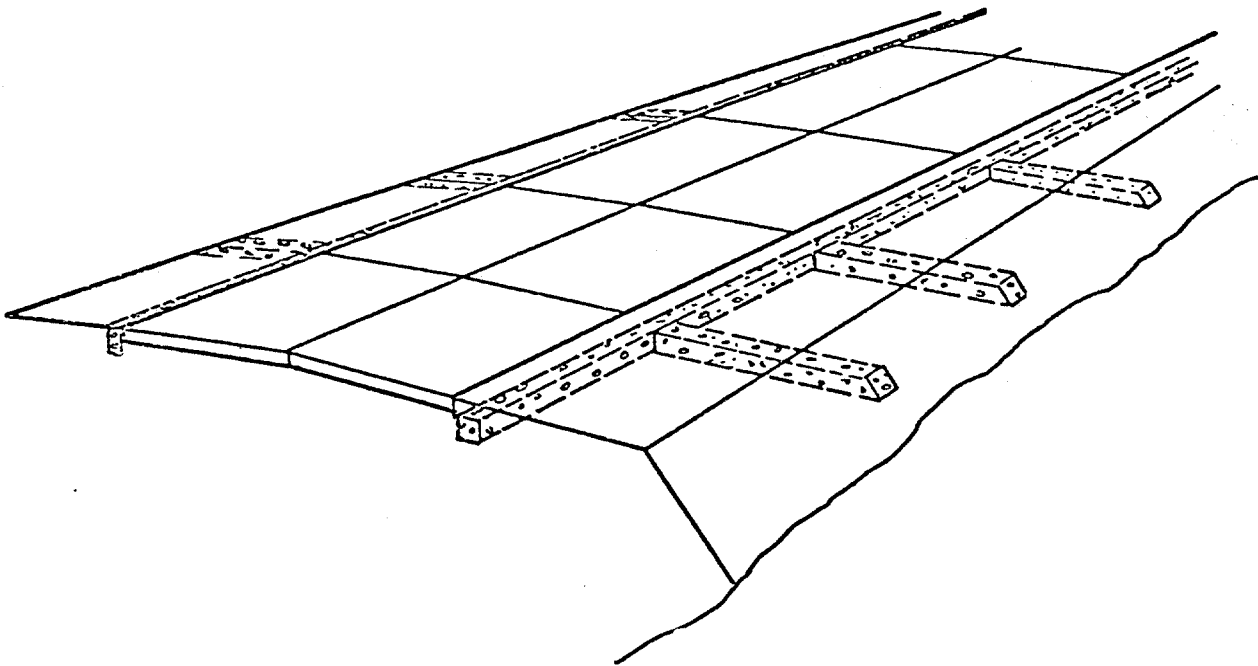

Figure 77. Combined Edge and Joint Drains (25)

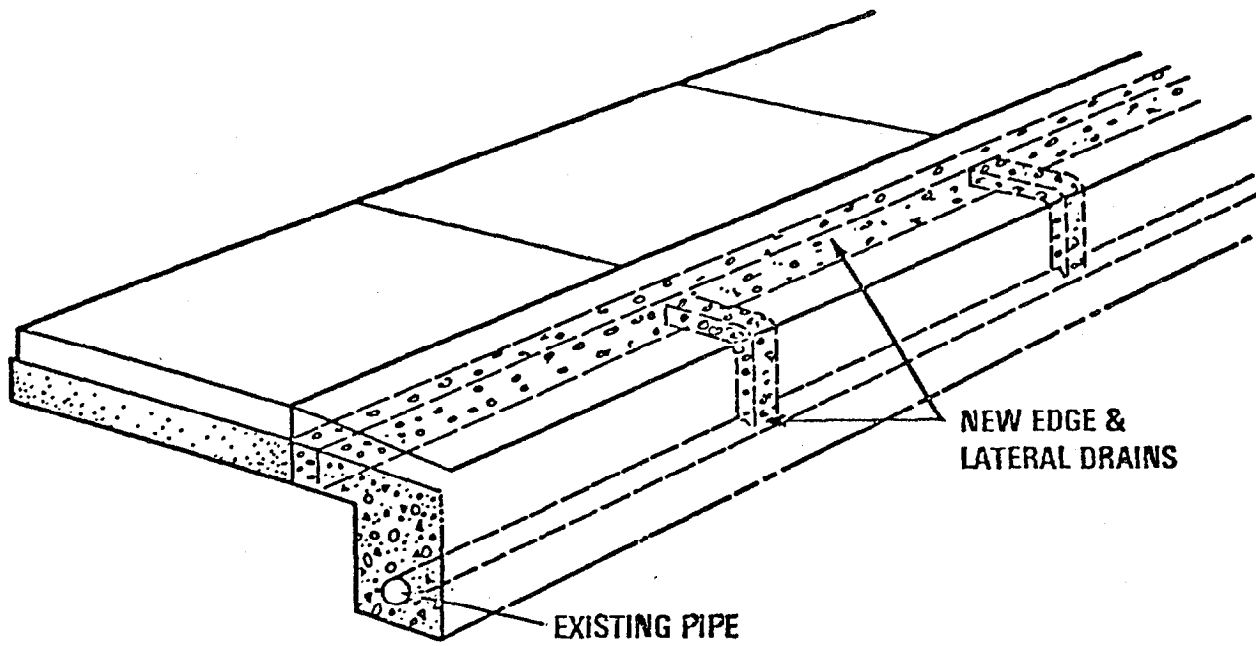

Figure 78. Utilizing New Edge and Lateral Drains With Existing Drain Pipe (25)

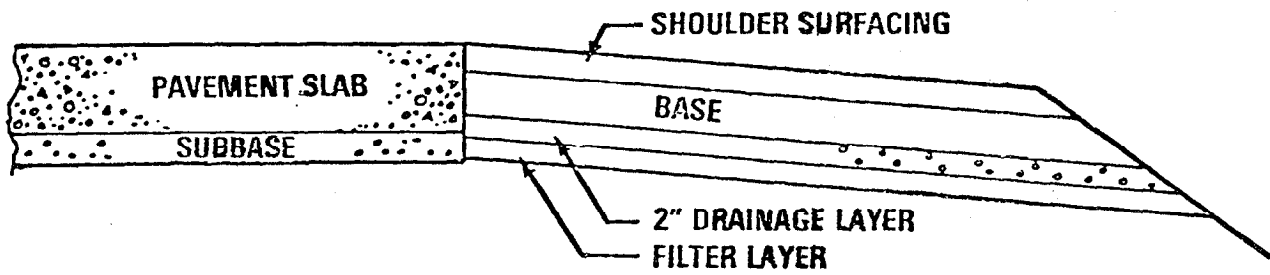

Figure 79. Providing New Drainage Capabilities Through the Shoulder (25)

Table 7. Description of drainage problems in pavement rehabilitation and their possible solution (adapted from Ring (25)).

<u>Drainage Problem</u>	<u>Description of Problem</u>	<u>Possible Solution(s) to Problem</u>
Shallow side ditches	Water flowing or standing in shallow ditches can produce softening of shoulders and the subgrade. Raising the pavement grade does not eliminate this effect.	Deepen and/or remove debris from ditches or construct curb, gutter, drop inlet, and culvert system.
Blockage of subsurface drainage due to widening	Widening can produce inadvertent blockage of daylighted drainage layers and pipe drain outlets into ditches. Also, low permeability base course materials utilized in widening construction can block drainage from the existing base course.	Proper design and inspection can reduce the potential for inadvertent blockages from occurring. Base courses under widened portions of pavements should have permeabilities exceeding that of the existing base course, or edge and lateral drains should be constructed to stop water accumulating in the existing base.
Permeable shoulders and medians	Unpaved shoulders and medians act as a potential source of water for the pavement structure.	Pave shoulders and portions of medians, however, ensure that this construction does not block existing subsurface drainage. See item cited immediately above.
Pumping rigid pavements	Fines from subbase or subgrade become dislodged from the soil fabric and/or stress carrying system, due to the softening (weakening) effect of water, and are flushed or pumped through a joint in a rigid pavement as traffic passing over the joint produces a differential movement due to load transfer.	Three possibilities exist: (1) subsealing and/or mudjacking, (2) pavement overlay with sufficient thickness to prevent reflective cracking or considerably reduce deflections(a), and (3) improvement of internal drainage. Other options include combinations of the possibilities cited above.

(a) Overlay thicknesses ranging from 3 1/2 - 4 1/2 inches may be required to prevent reflective cracking.

Table 7. Description of Drainage problems in pavement rehabilitation and their possible solution (adapted from Ring (25)). (continued).

<u>Drainage Problem</u>	<u>Description of Problem</u>	<u>Possible Solution(s) to Problem</u>
Impermeable aggregate drainage layers	Slow draining aggregate base courses (due to low permeability aggregates, no or poor outletting or both) permit prolonged contact between water and subgrade which allows softening (weakening) of the subgrade and possibly the migration of fines into the base or subbase.	For an existing pavement, only two viable options exist: provide improved means for surface water interception and removal and/or provide positive outlets for base courses by the use of longitudinal collector drain systems (Figure 77).
Reduction in drainage capacity of curbed pavements due to overlays	Freeboard between surface of pavement and top of curb is reduced due to placement of overlay, thus reducing area available for water flow. Under such circumstances the water will flow further into the street, overtop the curb or both. Curb overflow water will likely find its way into the pavement structure.	Raise curbs in conjunction with overlay or pave shoulders.
Water in open-graded bases	Infiltrating water is entrapped in open-graded aggregates due to non-existent or poorly designed outlet systems. Presence of entrapped water can lead to loss of strength by subgrade and significant detrimental frost action.	Again, the problem is best attacked by a combination of methods, including: sealing of pavement surface, cracks and joints in pavement and construction of joint drains (Figure 76) or longitudinal drains with lateral drains through the shoulder (Figure 77). If shoulders are in poor condition it may be possible to reconstruct them with a drainable base (Figure 79) and, possibly, collector and outlet pipe system.

Table 7. Description of drainage problems in pavement rehabilitation and their possible solution (adapted from Ring (25)). (continued).

<u>Drainage Problem</u>	<u>Description of Problem</u>	<u>Possible Solution(s) to Problem</u>
'ockets of frost susceptible soils	Localized areas of frost susceptible soils beneath pavements contribute to differential frost heave and accompanying pavement roughness.	Most effective treatment is removal of frost susceptible soils and replacement with non-frost susceptible soil or aggregate. Lowering the groundwater table might help reduce the supply of water to the frost susceptible pocket, thus minimizing the heave potential, but will not be a completely effective solution.
Pockets of unstable subgrade	These areas can generally be identified by local pavement distress patterns. They may be produced any one or combination of many factors such as: peat pockets, localized springs and groundwater seepage, inoperative subsurface drainage systems, etc.	Water-related problems can generally be helped or solved by the placement of localized drainage systems. Replacement or in-place stabilization is about the only effective means of improving a materials-related problem.
Broken and clogged pipes and pipe outlets	Broken or clogged pipes or outlets act like obstructions or dams which retard or completely inhibit flow through the drainage system. Affected region may be localized and give appearance of unstable subgrade pocket as cited above.	Replacement or repair of observable damaged pipes and outlets would be an initial step. Back flushing and/or "snaking" drain pipe and collector systems is another possibility.

REFERENCES

1. Oglesby, C. H. and Hewes, L. I., Highway Engineering, John Wiley and Sons, Inc., New York, Second Edition, 1963.
2. O'Flaherty, C. A., Highways, Edward Arnold Publishers, London, England, 1967.
3. McAdam, J. L., "Report to the London Board of Agriculture," London, England, 1820.
4. Cedergren, H. R., /KOA, "Appendix A - Literature Review Abstracts," Development of Guidelines for the Design of Pavement Subdrainage Systems, Phase I, Final Technical Report, March, 1971.
5. Cedergren, H. R., Drainage of Highway and Airfield Pavements, John Wiley and Sons, New York, 1974.
6. Polubarinova-Kochina, P. Ya., Theory of the Motion of Ground Water, Gostekhizdat, Moscow, 1952.
7. Aravin, V. I. and Numerov, S. N., Theory of Fluid Flow in Undeformable Porous Media, Gostekhizdat, Moscow, 1953.
8. Harr, M. E., Groundwater and Seepage, McGraw Hill, New York, 1962.
9. DeWiest, R. J. M., Geohydrology, John Wiley and Sons, New York, 1965.
10. Muskat, M., The Flow of Homogeneous Fluids Through Porous Media, J. W. Edwards, Publisher, Ann Arbor, Michigan, 1946.
11. Cedergren, H. R., Seepage, Drainage and Flow Nets, Second Edition, John Wiley and Sons, New York, 1977.
12. Moulton, L. K., Groundwater, Seepage and Drainage, a Textbook on Groundwater and Seepage Theory and its Applications, in preparation, 1979.
13. Landslides and Engineering Practice, Special Report No. 29, Edited by Edwin B. Eckel, Highway Research Board, Washington, D.C., 1958.
14. Barenberg, E. J., and Thompson, O. O., Behavior and Performance of Flexible Pavements in the University of Illinois Pavement Test Track, Highway Engineering Series No. 36, Illinois Cooperative Highway Research Program Series No. 108, Urbana, Illinois, January, 1970.

15. Kalcheff, I. V., "Characteristics of Graded Aggregates as Related to Their Behavior Under Varying Loads and Environments," Presented at Conference on Utilization of Graded Aggregate Base Materials in Flexible Pavements Sponsored by National Crushed Stone Association, Oak Brook, Illinois, March 25-26, 1974.
16. Cedergren, H. R., Arman, J. A. and O'Brien, K. H., Development of Guidelines for the Design of Subsurface Drainage Systems for Highway Pavement Structural Sections, Final Report, Federal Highway Administration, Washington, D. C., February, 1973.
17. Stowe, W. W., Handy, R. L. and Fero, J. P., "Model Evaluation of Soil Factors Affecting Rigid Pavement Pumping," Highway Research Record No. 111, Highway Research Board, Washington, D. C., 1966.
18. Spellman, D. L., "Faulting of Concrete Pavements," Highway Research Record No. 407, Highway Research Board, Washington, D. C., 1972.
19. Johnson, A. W., Frost Action in Roads and Airfields, A Review of Literature, Special Report No. 1, Highway Research Board, Washington, D. C., 1952.
20. Roadway Design in Seasonal Frost Areas, National Cooperative Highway Research Program Synthesis of Practice No. 26, Transportation Research Board, Washington, D. C., 1974.
21. Stark, D., "Field and Laboratory Studies of the Effect of Subbase Type on the Development of D-Cracking," Highway Research Record No. 342, Highway Research Board, Washington, D. C., 1970.
22. Verbeck, G., Klieger, P., Stark, D. and Teske, W., "Interim Report on D-Cracking of Concrete Pavements in Ohio," Portland Cement Association, Research and Development Laboratories, Skokie, Illinois, March, 1972.
23. Majidzadeh, K., and Brovold, F. N., State of the Art: Effect of Water on Bituminous Mixtures, Special Report No. 98, Highway Research Board, Washington, D. C., 1968.
24. Hall, G. A., "The Development of Design Criteria for Soil Slopes on West Virginia Highways," Dissertation Submitted to the Graduate School of West Virginia University in Partial Fulfillment of the Requirements for the Degree of Doctor of Philosophy, Morgantown, West Virginia, 1974.

25. Ring, G. W., "Drainage and Pavement Rehabilitation," Pavement Rehabilitation: Proceedings of a Workshop, Report No. FHWA-RD-74-60, Federal Highway Administration, Washington, D. C., June, 1974.
26. Lane, K. S., and Washburn, D. E., "Capillarity Tests by Capillarimeter and by Soil Filled Tubes," Proceedings, Highway Research Board, 1946.
27. Barber, E. S., and Sawyer, C. L., "Highway Subdrainage," Public Roads, Vol. 26, No. 12, February, 1952.
28. Lambe, T. W. and Whitman, R. V., Soil Mechanics, John Wiley and Sons, 1969.
29. Ridgeway, H. H., "Infiltration of Water Through the Pavement Surface," Transportation Research Record No. 616, Transportation Research Board, Washington, D. C., 1976.
30. Scheidegger, A. E., The Physics of Flow Through Porous Media, University of Toronto Press, Third Edition, 1974.
31. Darcy, H., "Les Fontaines publiques de la ville de Dijon," Paris, 1856.
32. Strohm, W. E., Nettles, E. H. and Calhoun, C. C., "Study of Drainage Characteristics of Base Course Materials," Highway Research Record No. 203, Highway Research Board, Washington, D. C., 1967.
33. Dudgeon, C. R., "Experimental Study of Flow of Water Through Coarse Granular Media," Houille Blanche, Vol. 21, No. 7, 1966.
34. Yemington, E.G., "A Low-Head Permeameter for Testing Granular Materials," Permeability of Soils, ASTM Special Technical Publication No. 163, American Society for Testing Materials, Philadelphia, PA, 1963.
35. Smith, J. W., and Cedergren, H. R., "Cut Slope Design and Landslides," Special Technical Publication No. 322, American Society for Testing Materials, Philadelphia, PA, 1963.
36. Palmer, L. A., Thompson, J. B., and Yeomans, C. M., "The Control of a Landslide by Subsurface Drainage," Proceedings, Highway Research Board, Washington, D. C., 1950.

37. Porter, O. J., "Studies of Fill Construction Over Mud Flats Including a Description of Experimental Construction Using Vertical Sand Drains to Hasten Stabilization," Proceedings, Highway Research Board, Washington, D. C., Vol. 18, Part II, 1938.
38. Barron, R. A., "Consolidation of Fine Grained Soils by Drain Wells," Transactions, American Society of Civil Engineers, Vol. 113, 1948.
39. Rutledge, P. C., and Johnson, S. J., "Review of Uses of Vertical Sand Drains," Bulletin 173, Highway Research Board, Washington, D. C., 1958.
40. Richart, F. E., "Review of the Theories for Sand Drains," Transactions, American Society of Civil Engineers, Vol. 124, 1957.
41. Aquisition and Use of Geotechnical Information, National Cooperative Highway Research Program Synthesis of Practice No. 33, Highway Research Board, Washington, D. C., 1976.
42. Hvorslev, M. J., "Subsurface Exploration and Sampling of Soils for Civil Engineering Purposes," Engineering Foundation, New York, N. Y., 1949.
43. Manual on Foundation Investigations, American Association of State Highway and Transportation Officials, Washington, D. C., 1978.
44. "Standard Method for Particle-Size Analysis of Soils," Designation D422-63, 1978 Annual Book of ASTM Standards, Part 19, American Society for Testing Materials, Philadelphia, PA, 1978.
45. "Standard Test Method for Liquid Limit of Soils," Designation D423-66, 1978 Annual Book of ASTM Standards, Part 19, American Society for Testing Materials, Philadelphia, PA, 1978.
46. "Standard Test Method for Plastic Limit and Plasticity Index of Soils," Designation D424-59, 1978 Annual Book of ASTM Standards, Part 19, American Society for Testing Materials, Philadelphia, PA, 1978.
47. "Report of Committee on Classification of Materials for Subgrades and Granular Type Roads," Proceedings, Highway Research Board, Washington, D. C., 1945.
48. Corps of Engineers, U. S. Army, "The Unified Soil Classification System," Waterways Experiment Station, Technical Memorandum 3-357, Vicksburg, Mississippi, 1953.

49. Federal Aviation Administration, "Airport Paving", AC 150/5320-6 H, U.S. Department of Transportation, Washington, D. C. 1967.
50. United States Department of the Interior, Design of Small Dams, Bureau of Reclamation, Second Edition, 1974.
51. Milligan, V., "Field Measurement of Permeability in Soil and Rock," State of the Art Paper, Proceedings, ASCE Conference on In Situ Measurement of Soil Properties, Vol. II, N. C. State University, 1975.
52. Kent, J., "The Development of a Field Permeability Testing Device for Highway Base and Subbase Courses," A Problem Report, Submitted to the Graduate School of West Virginia University in Partial Fulfillment of the Requirements for the Degree of Master of Science in Civil Engineering, Morgantown, West Virginia, 1978.
53. Moulton, L. K. and Seals, R. K., Determination of the In Situ Permeability of Base and Subbase Course, Final Report, Report No. FHWA-RD-79-88, Federal Highway Administration, Washington, D.C., May 1979.
54. "Standard Test Method for Permeability of Granular Soils (constant Head)", Designation No. 2434-68, 1978 Annual Book of ASTM Standards, Part 19, American Society for Testing Materials, Philadelphia, PA, 1978.
55. "Appendix VII: Permeability Tests," Laboratory Soils Testing, EM1110-2-1906, U. S. Army Corps of Engineers, November 30, 1970.
56. Leonards, G. A., Editor, Foundation Engineering, McGraw-Hill Book Company, Inc., New York, 1962.
57. Loudon, A. G., "The Computation of Permeability From Simple Soil Tests," Geotechnique, Vol. 3, 1953.
58. State of New York Department of Transportation, Test Procedure for Specific Surface Analysis, Soil Test Procedure STP-1, Soil Mechanics Bureau, August, 1973.
59. Sherard, J. L., Woodward, R. J., Gizienski, S. F., and Clevenger, B. S., Earth and Earth-Rock Dams, John Wiley and Sons, Inc., New York, 1963.
60. Chu, T. Y., Davidson, D. T., and Wickstrom, A. E., "Permeability Test For Sands," Permeability of Soils, ASTM Special Technical Publication No. 163, American Society for Testing Materials, Philadelphia, PA, 1955.

61. Smith, T. W., Cedergren, H. R., and Reyner, C. A., "Permeable Materials for Highway Drainage," Highway Research Record No. 68, Highway Research Board, Washington, D. C., 1964.
62. Winterkorn, H. F., "Water and Its Conduction In Soils," Special Report No. 40, Highway Research Board, Washington, D. C., 1958.
63. Ring, G. W., "Drainage Practices for Longer Pavement Life," Presented at the National Crushed Stone Association Workshop, McCormick Place, Chicago, Illinois, January 30, 1974.
64. Kaplar, C. W., "A Laboratory Freezing Test To Determine the Relative Frost Susceptibility of Soils," Technical Report TR250, Cold Regions Research and Engineering Laboratory (CRREL), U.S. Army Corps of Engineers, 1974.
65. "Pavement Design for Frost Conditions," TM5-818-2, Department of the Army, 1965.
66. U. S. Department of Commerce, Rainfall Frequency Atlas of the United States, Technical Paper No. 40, U. S. Weather Bureau, May, 1961.
67. Aldrich, H. P., "Frost Penetration Below Highway and Airfield Pavements," Bulletin No. 135, Highway Research Board, Washington, D. C., 1956.
68. Moulton, L. K., "Prediction of the Depth of Frost Penetration in West Virginia for Pavement Design Purposes," Dissertation Submitted to the Graduate School of West Virginia University in Partial Fulfillment of the Requirements for the Degree of Doctor of Philosophy, Morgantown, West Virginia, 1968.
69. Sowers, G. B., and Sowers, G. F., Introductory Soil Mechanics and Foundations, The Macmillan Company, New York, 1961.
70. Haley, J. F., "Frost Considerations in Highway Pavement Design: Eastern United States," Highway Research Record No. 33, Highway Research Board, Washington, D. C., 1963.
71. Allemeier, K. A., and Cook, L. J., "Frost Considerations in Highway Pavement Design: East-Central United States," Highway Research Record No. 33, Highway Research Board, Washington, D. C., 1963.
72. Fredrickson, F. C., "Frost Considerations in Highway Pavement Design: West-Central United States," Highway Research Record No. 33, Highway Research Board, Washington, D. C., 1963.

73. Jackson, T. J., and Ragan, R. M., "Hydrology of Porous Pavement Parking Lots," Journal of the Hydraulics Division, American Society of Civil Engineers, Vol. 100, No. HY12, December, 1974.
74. Burke, J. E., and Dhamrait, J. S., A Twenty-Year Report on the Illinois Continuously Reinforced Pavement, Research and Development Report No. 17, State of Illinois, Department of Public Works and Buildings, Division of Highways, Bureau of Research and Development, October, 1974.
75. Moulton, L. K., "Design of Subsurface Drainage Systems for the Control of Groundwater," Presented at the 58th Annual Meeting of the Transportation Research Board, Washington, D. C., January, 1979.
76. Taylor, D. W., Fundamentals of Soil Mechanics, John Wiley and Sons, Inc., New York, 1948.
77. Moulton, L. K. and Schaub, J. H., "A Rational Approach to the Design of Flexible Pavements to Resist the Detrimental Effects of Frost Action," Highway Research Record No. 276, Highway Research Board, Washington, D. C., 1969.
78. Clark, P. C., Crumpton, C. F., and Gilliland, W. J., "Vertical Drains for Highway Embankments in Kansas," Transportation Research Record No. 616, Transportation Research Board, Washington, D. C., 1976.
79. Casagrande, A., and Shannon, W. L., "Base Course Drainage for Airport Pavements," Proceedings of the American Society of Civil Engineers, Vol. 77, June, 1951.
80. Calhoun, C. C., Jr., "Development of Design Criteria and Acceptance Specifications for Plastic Filter Cloths," Technical Report S-72-7, U. S. Army Waterways Experiment Station, June, 1972.
81. Calhoun, C. C., Jr., Compton, J. R. and Strohm, W. E., "Performance of Plastic Filter Cloths as a Replacement for Granular Filter Materials," Highway Research Record No. 373, Highway Research Board, Washington, D. C., 1971.
82. Marks, B. D., "The Behavior of Aggregate and Fabric Filters in Subdrainage Applications," University of Tennessee, Knoxville, Tennessee, 1975.
83. Steward, J., Williamson, R. and Mohnney, J., Guidelines for Use of Fabrics in Construction and Maintenance of Low Volume Roads, Report No. FHWA-TS-78-205, Federal Highway Administration, Washington, D. C., June, 1977.

84. Bertram, G. E., "An Experimental Investigation of Protective Filters," Publication No. 267, Graduate School of Engineering, Harvard University, January, 1940.
85. Karpoff, K. P., "The Use of Laboratory Tests to Develop Design Criteria for Protective Filters," Proceedings, Vol. 55, American Society for Testing Materials, Philadelphia, PA, 1955.
86. Corps of Engineers, U. S. Army, "Investigation of Filter Requirements for Underdrains," Technical Memorandum No. 183-1, Waterways Experiment Station, Vicksburg, Mississippi, December, 1941.
87. United States Department of Agriculture, Soil Conservation Service, "Tentative Guides for Determining the Gradation of Filter Materials," Soil Mechanics Note No. 1, May 1, 1968.
88. Gray, W. C., Hannon, J. B., and Forsyth, R. A., Performance of Two Layer Asphalt Stabilized Drainage Blankets for Highway Subdrainage, Report No. CA-DOT-TL-2618-1-74-25, State of California, Department of Transportation, Division of Highways, Sacramento, California, June, 1974.
89. Water in Pavements, Detailed Report, Sponsored by Federal Highway Administration Offices of Research, Development, Engineering and Highway Operations, Washington, D.C. 1973.
90. McClelland, B. and Gregg, L. E., "Methods of Analysis of Flow Problems for Highway Subdrainage," Proceedings of the Highway Research Board, 1944.
91. Donnon, W. W., "Drainage of Agricultural Lands Using Interceptor Lines," Journal of the Irrigation and Drainage Division of ASCE, IR 1, March, 1959.
92. Keller, J. and Robinson, A. R., "Laboratory Research on Interceptor Drains," Journal of the Irrigation and Drainage Division of ASCE IR 3, September, 1959.
93. Kenney, T. C., Pazin, M., and Choi, W. S., "Design of Horizontal Drains for Soil Slopes," Journal of the Geotechnical Engineering Division of ASCE, No. GT 11, November, 1977.
94. Prellwitz, Rodney W., "Analysis of Parallel Drains for Highway Cut Slope Stabilization," Transportation Research Record No. 705, Transportation Research Board, Washington, D.C., 1979.

95. Smith, T. W., and Stafford, G. V., "Horizontal Drains on California Highways," Journal of the Soil Mechanics and Foundations Division, ASCE, Vol. 83, SM3, 1957.
96. Huculak, N. A. and Brawner, C. O., "The Use of Horizontal Drains in Landslide Stabilization," Proceedings, 42nd Annual Canadian Good Roads Conference, 1961.
97. Royster, D. L., "Horizontal Drains and Horizontal Drilling: An Overview," Presented at the 59th Annual Meeting of the Transportation Research Board, Washington, D.C., January, 1980.
98. Trolinger, W. D., "Rockwood Embankment Slide, 2001+00 - 2018+00, a Horizontal Drain Case History," Presented at the 59th Annual Meeting of the Transportation Research Board, Washington, D.C., January, 1980.
99. Barrett, R. K., "Use of Horizontal Drains, Case Histories From The Colorado Division of Highways," Presented at the 59th Annual Meeting of the Transportation Research Board, Washington, D.C., January, 1980.
100. Gilboy, G., "Hydraulic-Fill Dams," Proceedings International Committee on Large Dams, Stockholm, 1933.
101. Healey, K. A. and Long, R. P., "Prefabricated Filter-Fin For Subsurface Drains," Journal of the Irrigation and Drainage Division of ASCE, IR 4, December, 1972.
102. Dempsey, Barry J., and Robnett, Quentin L., "Influence of Precipitation, Joints and Sealing on Pavement Drainage," Transportation Research Record No. 705, Transportation Research Board, Washington, D.C., 1979.
103. The Asphalt Institute, Asphalt Overlays and Pavement Rehabilitation, Manual 17, 1969.
104. Bell, J. R., R. G. Hicks, et. al., Evaluation of Test Methods and Use Criteria for Geotechnical Fabrics in Highway Applications, Interim Report, Prepared for the Federal Highway Administration by the Department of Civil Engineering and Transportation Research Institute, Oregon State University, July, 1979.

