

GEORGIA DOT RESEARCH PROJECT 19-11

FINAL REPORT

**SAFETY AND ILLUMINATION OF RURAL
AND SUBURBAN ROUNDABOUTS
(PHASE II)**



**OFFICE OF PERFORMANCE-BASED
MANAGEMENT AND RESEARCH**

**600 WEST PEACHTREE NW
ATLANTA, GA 30308**

| | | | |
|---|---|---|--------------------------|
| 1. Report No. FHWA-GA-21-1911 | 2. Government Accession No. N/A | 3. Recipient's Catalog No. N/A | |
| 4. Title and Subtitle Safety and Illumination of Rural and Suburban Roundabouts (Phase II) | | 5. Report Date December 2021 | |
| | | 6. Performing Organization Code N/A | |
| 7. Author(s) Michael O. Rodgers, Ph.D. (https://orcid.org/0000-0001-6608-9333); Franklin Gbologah, Ph.D. (https://orcid.org/0000-0003-0235-4278); Anqi Wei (https://orcid.org/0000-0003-1041-1754) Soonkie Nam, Ph.D. (https://orcid.org/0000-0003-1037-640X) | | 8. Performing Organization Report No. N/A | |
| 9. Performing Organization Name and Address Georgia Tech Research Corporation School of Civil and Environmental Engineering 790 Atlantic Dr. NW, Atlanta, GA 30332 Phone: (404) 385-0569 Email: michael.rodgers@ce.gatech.edu | | 10. Work Unit No. N/A | |
| | | 11. Contract or Grant No. RP19-11 | |
| 12. Sponsoring Agency Name and Address Georgia Department of Transportation Office of Performance-based Management and Research 600 West Peachtree St. NW Atlanta, GA 30308 | | 13. Type of Report and Period Covered Final Report (March 2018 – December 2021) | |
| | | 14. Sponsoring Agency Code N/A | |
| 15. Supplementary Notes Prepared in cooperation with the U.S. Department of Transportation, Federal Highway Administration. | | | |
| 16. Abstract <p>This project focused on establishing the relationship between the presence/absence or levels of illumination and other geometric and traffic characteristics on nighttime safety at rural and suburban roundabouts. Eighty roundabouts from thirty-seven counties across Georgia were selected to provide a wide range of conditions in terms of illumination layout, illumination levels, number of legs, number of circulating lanes, daily entering volumes, approach speeds, etc. for field measurements of illumination levels. Urban roundabouts with significant pedestrian activity were excluded.</p> <p>Field data collection at each site included both direct measurements of illumination levels as well as a civil site survey to verify the geometric characteristics of the roundabout and were conducted by measurement teams from Georgia Institute of Technology and Georgia Southern University. The resulting data were processed, joined, and aggregated to the individual site level and used to establish statistical relationships between observed nighttime crash rates, severity, and crash types (e.g., single vs. multiple vehicles, impaired drivers, etc.) and underlying geometric factors and measured illuminance levels. The variation in observed crash rates were modeled against known parameters of the roundabouts to develop a predictive model as to how single vehicle nighttime crash rates were impacted by illumination and other factors.</p> <p>As expected, multiple vehicle crashes showed no statistically significant dependence on illumination levels as the vehicles themselves, through their head- and taillights, are important contributors to nighttime visibility at the roundabout. This was not the case for single vehicle crashes. Single vehicle crashes were shown to increase for 3-leg roundabouts for illumination values less than 5 lux. No such trend was observed in either 4 or 5-leg roundabouts and these sites showed no statistically significant variation in nighttime single vehicle crash rates at any level of illumination. An overarching conclusion of the study is that there was no observed evidence of illumination values exceeding 5 lux resulting in a statistically significant reduction in nighttime crash rates for rural and suburban roundabouts.</p> <p>These results suggest that for rural and suburban roundabouts with no significant pedestrian volumes, illumination values significantly lower than current standards may still prove effective as a safety treatment and that, in the absence of a need to protect pedestrians or cyclists at nighttime at a particular location, a reduction in lighting levels or the use of passive retroreflective safety treatments may be a cost-effective treatment.</p> | | | |
| 17. Keywords Intersections; Roundabouts; Lighting | | 18. Distribution Statement No Restriction | |
| 19. Security Classification (of this report) Unclassified | 20. Security Classification (of this page) Unclassified | 21. No. of Pages 347 | 22. Price Free |

GDOT Research Project No. 19-11

Final Report

**SAFETY AND ILLUMINATION OF RURAL AND SUBURBAN
ROUNDBOUTS (PHASE II)**

By

Michael O. Rodgers, Ph.D.¹

Regents' Researcher and Adjunct Regents' Professor

Franklin Gbologah, Ph.D.¹

Research Engineer II

Anqi Wei¹

Graduate Research Assistant

Soonkie Nam, Ph.D.²

Assistant Professor

School of Civil and Environmental Engineering, Georgia Institute of Technology¹

Department of Civil Engineering and Construction, Georgia Southern University²

Contract with
Georgia Department of Transportation

In cooperation with
U.S. Department of Transportation
Federal Highway Administration

March 2023

The contents of this report reflect the views of the authors, who are responsible for the facts and accuracy of the data presented herein. The contents do not necessarily reflect the official views of the Georgia Department of Transportation or the Federal Highway Administration. This report does not constitute a standard, specification, or regulation.

SI* (MODERN METRIC) CONVERSION FACTORS

APPROXIMATE CONVERSIONS TO SI UNITS

| Symbol | When You Know | Multiply By | To Find | Symbol |
|--|-----------------------------|-----------------------------|-----------------------------|---------------------|
| LENGTH | | | | |
| in | inches | 25.4 | millimeters | mm |
| ft | feet | 0.305 | meters | m |
| yd | yards | 0.914 | meters | m |
| mi | miles | 1.61 | kilometers | km |
| AREA | | | | |
| in ² | square inches | 645.2 | square millimeters | mm ² |
| ft ² | square feet | 0.093 | square meters | m ² |
| yd ² | square yard | 0.836 | square meters | m ² |
| ac | acres | 0.405 | hectares | ha |
| mi ² | square miles | 2.59 | square kilometers | km ² |
| VOLUME | | | | |
| fl oz | fluid ounces | 29.57 | milliliters | mL |
| gal | gallons | 3.785 | liters | L |
| ft ³ | cubic feet | 0.028 | cubic meters | m ³ |
| yd ³ | cubic yards | 0.765 | cubic meters | m ³ |
| NOTE: volumes greater than 1000 L shall be shown in m ³ | | | | |
| MASS | | | | |
| oz | ounces | 28.35 | grams | g |
| lb | pounds | 0.454 | kilograms | kg |
| T | short tons (2000 lb) | 0.907 | megagrams (or "metric ton") | Mg (or "t") |
| TEMPERATURE (exact degrees) | | | | |
| °F | Fahrenheit | 5 (F-32)/9 or (F-32)/1.8 | Celsius | °C |
| ILLUMINATION | | | | |
| fc | foot-candles | 10.76 | lux | lx |
| fl | foot-Lamberts | 3.426 | candela/m ² | cd/m ² |
| FORCE and PRESSURE or STRESS | | | | |
| lbf | poundforce | 4.45 | newtons | N |
| lbf/in ² | poundforce per square inch | 6.89 | kilopascals | kPa |
| APPROXIMATE CONVERSIONS FROM SI UNITS | | | | |
| Symbol | When You Know | Multiply By | To Find | Symbol |
| LENGTH | | | | |
| mm | millimeters | 0.039 | inches | in |
| m | meters | 3.28 | feet | ft |
| m | meters | 1.09 | yards | yd |
| km | kilometers | 0.621 | miles | mi |
| AREA | | | | |
| mm ² | square millimeters | 0.0016 | square inches | in ² |
| m ² | square meters | 10.764 | square feet | ft ² |
| m ² | square meters | 1.195 | square yards | yd ² |
| ha | hectares | 2.47 | acres | ac |
| km ² | square kilometers | 0.386 | square miles | mi ² |
| VOLUME | | | | |
| mL | milliliters | 0.034 | fluid ounces | fl oz |
| L | liters | 0.264 | gallons | gal |
| m ³ | cubic meters | 35.314 | cubic feet | ft ³ |
| m ³ | cubic meters | 1.307 | cubic yards | yd ³ |
| MASS | | | | |
| g | grams | 0.035 | ounces | oz |
| kg | kilograms | 2.202 | pounds | lb |
| Mg (or "t") | megagrams (or "metric ton") | 1.103 | short tons (2000 lb) | T |
| TEMPERATURE (exact degrees) | | | | |
| °C | Celsius | 1.8C+32 | Fahrenheit | °F |
| ILLUMINATION | | | | |
| lx | lux | 0.0929 | foot-candles | fc |
| cd/m ² | candela/m ² | 0.2919 | foot-Lamberts | fl |
| FORCE and PRESSURE or STRESS | | | | |
| N | newtons | 0.225 | poundforce | lbf |
| kPa | kilopascals | 0.145 | poundforce per square inch | lbf/in ² |

TABLE OF CONTENTS

| | |
|--|-----------|
| EXECUTIVE SUMMARY | 1 |
| CHAPTER 1. INTRODUCTION | 11 |
| Project Purpose | 11 |
| Roundabout Illumination Requirement | 12 |
| Roundabout Illumination Level Recommendations | 13 |
| Roundabout Illumination and Safety Analysis | 14 |
| CHAPTER 2. REVIEW OF ROUNDABOUT SAFETY AND ILLUMINATION IMPACTS | 17 |
| Roundabout Impact on Safety | 17 |
| Impact on Vehicle Crashes..... | 17 |
| Impact on Non-Vehicle Road Users | 21 |
| Safety-Influencing Features of Roundabouts..... | 23 |
| Illumination Impact on Intersection Safety..... | 27 |
| Before-and-After Studies..... | 27 |
| Cross-sectional Studies | 29 |
| Issues with Before-and-After and Cross-sectional Studies | 32 |
| Other Studies Using Different Analysis Methods | 34 |
| Approaches for Quantifying Illumination’s Impact..... | 36 |
| Night-to-Day Ratios | 36 |
| Odds Ratio | 37 |
| Empirical Bayes Method | 38 |
| Negative Binomial Regression | 42 |
| Quantity and Quality of Roadway Illumination | 45 |
| Reflection of Light (Luminance) from Pavement Surface | 50 |
| Nature of Pavement Surface | 50 |
| Pavement Reflectivity and Observational Angle | 50 |
| Relationship between Luminance and Illuminance..... | 51 |
| Safety Analysis | 52 |
| Identifying Intersection Related Crashes | 52 |
| Sources of Bias in Crash Data Analysis | 55 |
| CHAPTER 3. DATA COLLECTION AND PREPARATION | 58 |
| Minimum Data Requirements | 58 |
| Selection of Roundabouts..... | 60 |
| Selection of Control Sites..... | 67 |

| | |
|--|------------|
| Crash data collection | 71 |
| Pre-Analysis Processing of Crash Data..... | 73 |
| Traffic Data Collection | 81 |
| Extracting AADT Information for Intersection Legs..... | 82 |
| Treatment of Extracted AADT Information | 83 |
| Computation of Intersection Daily Entering Volume..... | 85 |
| Intersection Characteristics Data Collection..... | 86 |
| Quantitative Illumination Data Collection | 90 |
| Tripod-Mounted Digital Camera Photographic Roadway Lighting Measurement | 90 |
| Drone Mounted Digital Camera Photographic Roadway Lighting Measurement | 98 |
| Merge All Datasets for Analysis | 105 |
| Normalization Factors to Control Secular Trend Effect in Crash Data..... | 107 |
| Final Data Aggregation | 109 |
| CHAPTER 4. ROUNDABOUT SITE-LEVEL ANALYSIS AND DISCUSSION | 111 |
| Overview of prepared data used in analysis..... | 111 |
| Roundabout Operational Characteristics | 111 |
| Roundabout Illuminance Conditions | 118 |
| Roundabout Geometric Characteristics | 121 |
| Observed Variation of Illuminance with crash rate | 124 |
| Model development..... | 129 |
| Roundabouts with Average Maintained Horizontal Illuminance Level Greater than 5 Lux | 132 |
| Roundabouts with Average Maintained Horizontal Illuminance Level Less than 5 Lux | 135 |
| CHAPTER 5. ROUNDABOUT APPROACH-LEVEL ANALYSIS AND DISCUSSION | 141 |
| Data overview | 141 |
| Roundabout Approach Illumination Conditions | 141 |
| Stepwise linear REGRESSION ANALYSIS | 146 |
| Multi-lane approach analysis..... | 149 |
| Single-lane approach analysis..... | 152 |
| Safety Impacts of Horizontal Curvature | 154 |
| Safety Impacts of Colored Truck Aprons..... | 155 |
| Safety Impacts of Quantified Illumination Levels | 159 |

| | |
|--|------------|
| CHAPTER 6. CONCLUSIONS AND RECOMMENDATIONS | 173 |
| Project Summary | 173 |
| Study Findings..... | 175 |
| Based on the roundabout site-level and approach-level analyses discussed in Chapter 4 and Chapter 5, conclusions regarding the safety benefits of different illumination levels under various roadway and traffic conditions can be derived from the corresponding results..... | 175 |
| Roundabout site-level analysis..... | 175 |
| Roundabout approach-level analysis | 177 |
| Study Limitations..... | 179 |
| Recommendations | 179 |
| APPENDIX A. EVALUATION OF ALTERNATIVES TO TRADITIONAL ROUNABOUT LIGHTING | 181 |
| APPENDIX B. A LIST OF SELECTED ROUNABOUTS IN THE STUDY..... | 201 |
| APPENDIX C. ORIGINAL AND RECODED DRIVER/OPERATOR CONTRIBUTING FACTORS..... | 281 |
| APPENDIX D. ALGORITHM FOR ASSIGNING DAY PERIOD TO CRASH – PYTHON SCRIPT..... | 284 |
| APPENDIX E. INTERSECTION SAFETY FEATURE INVENTORY – CIVIL SURVEY..... | 285 |
| APPENDIX F. PHOTOGRAPHIC AUDIT OF STREET LIGHTING AT SELECTED RURAL INTERSECTIONS IN GEORGIA – FIELD DEPLOYMENT DOCUMENT | 303 |
| APPENDIX G. DRONE IMAGE STANDARD OPERATING PROCEDURE..... | 323 |
| REFERENCES..... | 327 |

LIST OF FIGURES

| | |
|--|-----|
| Figure 1. Image. Geometric Layout of a Roundabout. | 24 |
| Figure 2. Image. Comparison of a Non-Modern Roundabout and a Modern Roundabout | 62 |
| Figure 3. Map. Roundabout Locations | 66 |
| Figure 4. Map. Initial Control Sites and Roundabout Locations | 69 |
| Figure 5. Map. Roundabout with Verified Construction Year of 2008 in Saint Simons Island, GA. | 74 |
| Figure 6. Image. A Selected Roundabout Leg with the Corresponding AADT Value for Year 2010 highlighted..... | 83 |
| Figure 7. Chart. Extracted AADT Values for GT-5022 Roundabout Leg Showing an Outlier Value | 84 |
| Figure 8. Chart. Extracted AADT Values for GT-5022 Roundabout Leg with Correction Made to Outlier Value..... | 84 |
| Figure 9. Table. Annual Vehicle Miles Traveled in Georgia | 85 |
| Figure 10. Photo. Intersection Survey Data Reporting Form | 87 |
| Figure 11. Image. Roundabout Approach with the Luminance Measurement Area Highlighted in Yellow (Tripod-mounted camera image)..... | 92 |
| Figure 12. Image. Roundabout Approach Images Taken at +2.0, -2.0, -3.0 Exposure Levels (from left to right)..... | 92 |
| Figure 13. Image. A typical nighttime image of a roundabout taken for luminance analysis with the tripod mounted DSLR camera..... | 95 |
| Figure 14. Map. Roundabout Sites Surveyed by Georgia Tech Team and Georgia Southern University Team..... | 96 |
| Figure 15. Photo. A Team Member Holding the Drone in the Field During a Test Flight (left) and another Team Member Landing the Drone during Field Work at Night..... | 101 |
| Figure 16. Photo. Mechanical Range of the DJI Gimbal Connector 2.0 | 101 |
| Figure 17. Image. A Typical Nighttime Image of a Roundabout Taken for Luminance Analysis with the Drone-Mounted Zenmuse® Camera | 102 |
| Figure 18. Image. Roundabout Approach with Four Luminance Measurement Areas Highlighted in Yellow (Drone images)..... | 104 |
| Figure 19. Chart. Plot of Georgia Crash rate by Year Fitted to a Second Order Polynomial..... | 108 |
| Figure 20. Chart. Number of Data Years Available per Roundabout Location | 112 |
| Figure 21. Chart. Number of Roundabout Installations per Year in Study List | 112 |
| Figure 22. Map. GIS Map Showing Roundabout Installation Year | 113 |
| Figure 23. Chart. Observed Average Nighttime Crash Rates by Year for Roundabouts Installed before 2013 | 114 |
| Figure 24. Map. GIS Map Showing Total Nighttime Crash Rates (per MEV) | 115 |
| Figure 25. Chart. Total Crash Rates and Single Vehicle Crash Rates at Studied Roundabouts | 116 |

| | |
|---|-----|
| Figure 26. Chart. Total Crash Rates and Injury & Fatal Crash Rates at Studied Roundabouts | 116 |
| Figure 27. Chart. Total Crash Rates and Impaired Driver Crash Rates at Studied Roundabouts for Study Period | 117 |
| Figure 28. Chart. Total Crash Rates and Non-Dry Pavement Crash Rates at Roundabouts for Study Period | 117 |
| Figure 29. Chart. Average Crash Rate by Crash Type for All Studied Roundabouts | 118 |
| Figure 30. Photo. Observed Illumination Schemes and Luminaire Arrangements in the Field..... | 118 |
| Figure 31. Chart. Range of Average Illuminance at Studied Roundabouts..... | 119 |
| Figure 32. Chart. Distribution of Roundabouts in 5-Lux Illuminance Bins | 120 |
| Figure 33. Map. GIS Map Showing Measured Illuminance Levels in Lux..... | 120 |
| Figure 34. Photo. Nighttime Aerial View of Typical Roundabout Lighting in 5-Lux Illuminance Bins | 121 |
| Figure 35. Chart. Distribution of Roundabouts by Type, Configuration, and State Highway Routes. | 122 |
| Figure 36. Chart. Distribution of Posted Advisory Speed Limits at Selected Roundabouts | 123 |
| Figure 37. Chart. Distribution of Minimum Stopping Sight Distance at Selected Roundabouts | 124 |
| Figure 38. Chart. Variation of Multi-vehicle Crash Rates with Illuminance for All Selected Sites..... | 125 |
| Figure 39. Chart. Variation of Single-vehicle Crash Rates with Illuminance for All Selected Sites..... | 126 |
| Figure 40. Chart. Variation of Single-vehicle Crash Rates with Illuminance for Different Roundabout Leg Configurations..... | 127 |
| Figure 41 . Chart. Variation of Single-vehicle Crash Rates with Illuminance for Different Posted Roundabout Advisory Speed limits | 128 |
| Figure 42 . Chart. Variation of Single-vehicle Crash Rates with Illuminance for Different Stopping Sight Distance | 129 |
| Figure 43. Chart. Variation of Single-vehicle Crash Rates with Illuminance for 3-legged Roundabouts | 131 |
| Figure 44. Table. Regression Model Results of All Studied Sites with Illuminance Level ≥ 5 Lux..... | 133 |
| Figure 45. Table. Regression Model Results of All Studied Sites with Illuminance Level ≥ 5 Lux (Replaced with Variable ' <i>MaxRoundaboutAdvisorySpeed</i> ≥ 35 ')..... | 134 |
| Figure 46. Table. Regression Model Results of 3 Leg Roundabouts with Illuminance Level < 5 Lux | 136 |
| Figure 47. Table. Regression Model Results of All 3 Leg Roundabout Sites | 137 |
| Figure 48. Table. Regression Model Results of All 4 and 5 Leg Roundabout Sites with Illuminance Level < 5 Lux | 138 |
| Figure 49. Table. Regression Model Results of All 4 and 5 Leg Roundabout Sites | 139 |
| Figure 50. Table. Regression Model Results of all 4 and 5 Leg Roundabout Sites with Marked Pedestrian Crosswalks | 140 |

| | |
|---|-----|
| Figure 51. Table. Regression Model Results of All 4 and 5 Leg Roundabout Sites without Marked Pedestrian Crosswalks | 140 |
| Figure 52. Chart. Distribution of Luminance Measured at Yield Line on Approaches..... | 143 |
| Figure 53. Chart. Luminance Distribution among Roundabout Approaches | 144 |
| Figure 54. Chart. Variation of Single-vehicle Crash Rate with Luminance (Yield Line) | 145 |
| Figure 55. Chart. Variation of Single-vehicle Crash Rate with Luminance (Mid- SSD) | 145 |
| Figure 56. Chart. Variation of Single-vehicle Crash Rate with Luminance (SSD)..... | 146 |
| Figure 57. Chart. Variation of Estimated Single-vehicle Crash Rate with Luminance (SSD)..... | 147 |
| Figure 58. Photo. Roundabout approaches with uniformity levels <3:1 and >3:1 respectively..... | 152 |
| Figure 59. Table. Results of case control analysis regarding the presence of colored truck aprons | 157 |
| Figure 60. Table. Results of case control analysis regarding the presence of ambient lighting..... | 158 |
| Figure 61. Chart. Fraction of total single-vehicle crashes vs. fraction of total MEV | 160 |
| Figure 62. Chart. Fraction of total single-vehicle crashes vs. fraction of total MEV ordered by luminance measured at the yield line | 164 |
| Figure 63. Chart. Fraction of total single-vehicle crashes vs. fraction of total MEV ordered by luminance measured at the midpoint of SSD..... | 166 |
| Figure 64. Chart. Fraction of total single-vehicle crashes vs. fraction of total MEV ordered by luminance measured at the point of SSD | 166 |
| Figure 65. Chart. Fraction of total single-vehicle crashes vs. fraction of total MEV ordered by luminance measured at SSD..... | 168 |
| Figure 66. Chart. Fraction of total single-vehicle crashes vs. fraction of total MEV ordered by luminance measured at SSD..... | 169 |
| Figure 67. Chart. Fraction of total single-vehicle crashes vs. fraction of total MEV comparison between approaches ordered by luminance measured at yield line and SSD..... | 171 |

LIST OF TABLES

| | |
|--|-----|
| Table 1. Recommended Horizontal Illuminance for Roundabouts | 14 |
| Table 2. Merits and Demerits of Negative Binomial Regression Models | 45 |
| Table 3. Default Distances Used by States to Identify Intersection Safety Area | 54 |
| Table 4. List of Final Selected Roundabouts (Part I)..... | 63 |
| Table 5. List of Final Selected Roundabouts (Part II) | 64 |
| Table 6. List of Final Selected Roundabouts (Part III)..... | 65 |
| Table 7. List of Initial Control Sites | 68 |
| Table 8. Distribution of Initial Control Sites by Counties | 70 |
| Table 9. List of Initial Crash Data Attribute Fields | 72 |
| Table 10. Original and Recoded Entries for Collision Manner Attribute..... | 75 |
| Table 11. Recoded Entries for Driver/Operator Contributing Factors | 76 |
| Table 12. Original and Recoded Surface Condition Entries..... | 77 |
| Table 13. Inventory Table Data Fields | 88 |
| Table 14. A summary of technical specifications of Canon T3 and T5 cameras | 94 |
| Table 15. Survey Dates of Selected Sites | 97 |
| Table 16. Summary technical specifications of Zenmuse X5S™ camera..... | 100 |
| Table 17. Normalization Factors for Controlling Secular Trend Effect in Crash Data | 108 |
| Table 18. Additional Variables Defined for Model Development | 130 |
| Table 19. Results of Regression Models with Different Illuminance Cut-off Points..... | 132 |
| Table 20. Regression Model Results of All Studied Roundabout Approaches | 148 |
| Table 21. Crash rate comparison between approaches with luminance (yield line) <= 0.2 cd/m ² and > 0.2 cd/m ² | 149 |
| Table 22. Crash rate comparison between approaches with luminance (SSD) <= 0.075 cd/m ² and > 0.075 cd/m ² | 150 |
| Table 23. Crash rate comparison between approaches with luminance uniformity level >= 3 and < 3..... | 151 |
| Table 24. Regression model results of single-lane roundabout approaches | 153 |
| Table 25. Crash rate comparison between approaches with and without horizontal curves..... | 154 |
| Table 26. Crash rate comparison between approaches with and without colored truck aprons | 155 |
| Table 27. Cross tabulating crash occurrence against the presence of colored truck aprons | 156 |
| Table 28. Results of case control analysis based on approaches with ambient lighting..... | 157 |
| Table 29. Results of case control analysis based on approaches without ambient lighting..... | 157 |
| Table 30. Number of approaches with MEV/year >= 1 million and < 1 million under the conditions of with and without approach lighting..... | 162 |
| Table 31. Crash rates for approaches with MEV/year >= 1 million and < 1 million under the conditions of with and without approach lighting..... | 163 |

| | |
|--|-----|
| Table 32. Results of case control analysis based on approach illumination conditions. | 169 |
| Table 33. Results of case control analysis based on the presence ambient lighting..... | 170 |

LIST OF ABBREVIATIONS

| | |
|--------|--|
| AADT | Annual Average Daily Traffic |
| AASHTO | American Association of State Highway and Transportation Officials |
| Ave | Avenue |
| Blvd | Boulevard |
| BTS | Bureau of Transportation Statistics |
| CIE | International Commission on Illumination |
| CMF | Crash Modification Factors |
| DC | Day Crashes |
| DEV | Daily Entering Volume |
| Dr | Drive |
| DSLR | Digital Single Lens Reflex |
| EB | Empirical Bayes |
| FHWA | Federal Highway Administration |
| ft | feet |
| GDOT | Georgia Department of Transportation |
| GEARS | Georgia Electronic Accident Reporting System |
| GEE | Generalized Estimating Equation |
| GIS | Geographic Information System |

| | |
|---------|--|
| GPS | Global Positioning System |
| GSU | Georgia Southern University |
| GT | Georgia Institute of Technology |
| HPS | High-pressure Sodium |
| HSM | Highway Safety Manual |
| Hwy | Highway |
| IES | Illuminating Engineering Society |
| IESNA | Illuminating Engineering Society for North America |
| ISO | Sensitivity to Light |
| LED | Light-emitting Diode |
| MEV | Million Entering Vehicles |
| MPH | Miles Per Hour |
| NCHRP | National Cooperative Highway Research Program |
| ND | Night/Day |
| NM | Negative Multinomial Regression Model |
| PDO | Property Damage Only |
| Pkwy | Parkway |
| RC-Link | Roadway Characteristics |
| Rd | Road |
| RENB | Random Effects Negative Binomial Regression Model |

| | |
|----------|------------------------------------|
| RR | Risk Ratio |
| RPM | Raised Reflective Pavement Markers |
| R square | Coefficient of Determination |
| SPF | Safety Performance Function |
| SR | State Route |
| SSD | Stopping Sight Distance |
| St | Street |
| TIFF | Tag Image File Format |
| VMT | Vehicle Miles Traveled |

EXECUTIVE SUMMARY

This project focused on establishing the relationship between the presence/absence or levels of illumination and other geometric and traffic characteristics on nighttime safety at rural and suburban roundabouts and extend and confirm the preliminary results of Phase I. Eighty roundabouts from 37 counties across Georgia were selected to provide a wide range of conditions in terms of illumination layout, illumination levels, number of legs, number of circulating lanes, daily entering volumes, approach speeds, etc. for field measurements of illumination levels. Urban roundabouts with significant pedestrian activity were specifically excluded.

Field data collection at each site included both direct measurements of illumination levels as well as a civil site survey to verify the geometric characteristics of the roundabout and were conducted by measurement teams from Georgia Institute of Technology and Georgia Southern University. Both teams used the same measurement and survey protocols with one site measured by both teams to ensure consistency of observations. In addition to the ground-based photographic and civil survey protocols, the Georgia Tech team also made illuminance measurements using a drone platform.

Historical data on the sites were obtained from a variety of sources. The GDOT RC-link database was used to extract traffic data that were used to determine average daily entry volumes, Crash data were obtained from the GDOT crash reporting website and GDOT staff. Roundabout locations, opening year data, and surrounding land uses were

determined using satellite imagery from Google® Streetmaps and/or Google® Earth. Ultimately, three sites were eliminated from analysis due to data limitations (two lacked crash data and one lacked traffic data) leaving a total of 77 sites for analysis.

The resulting data were processed, joined, and aggregated to both site and approach levels, and used to establish statistical relationships between observed nighttime crash rates, severity, and crash types (e.g., single vs. multiple vehicles, impaired drivers, etc.) and underlying geometric factors and measured illuminance conditions from both site-level and approach-level perspectives. The variation in observed crash rates were modeled against roundabout parameters to develop a predictive model as to how single vehicle nighttime crash rates were impacted by illumination and other factors.

For purposes of the site-level analysis, the illumination data (in lux) were subdivided into five categories (Low=0-5 lux, mid-Low=6-10 lux, mid-high=10-15 lux, high=15-20 lux, and super-high>20 lux) as well as examined at the individual site level. Each illumination category included a similar number of sites. Nighttime aerial images of typical roundabouts in each category are shown in Figure 1.

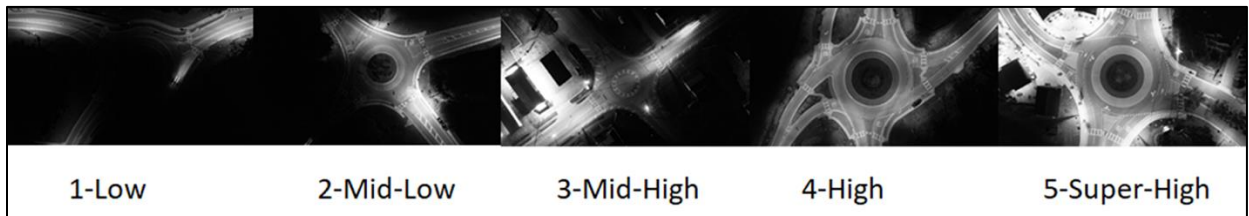

Figure 1. Photo. Nighttime Aerial View of Typical Roundabout Illuminance in 5-Lux Bins

As expected, multiple vehicle crashes showed no statistically significant dependence on illumination levels as the vehicles themselves, through their head- and taillights, are important contributors to nighttime visibility at the roundabout. Figure 2 shows the variation in observed crash rates for Single-vehicle crashes for both individual sites the average value for the illumination bins. The latter results are presented for both a site-weighted (i.e., the arithmetic average individual site crash rates included in the bin) and a volume-weighted (i.e., total crashes recorded for sites within the bin divided by the total volume of all sites within the bin) crash rates. These results show an increase in observed single-vehicle crash rates for the lowest illumination levels on a site-weighted basis. The volume-weighted results do not show the same dependence.

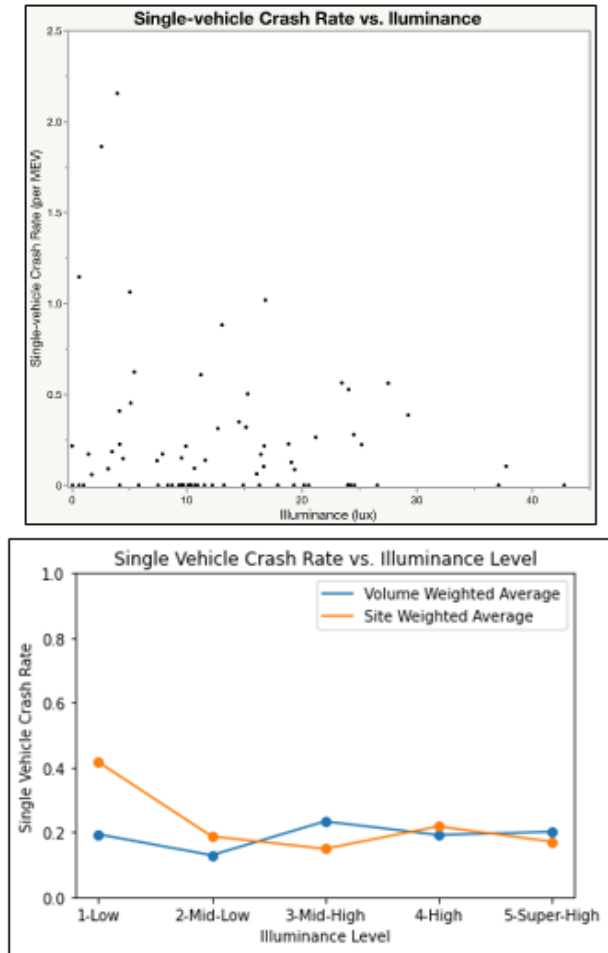

Figure 2. Chart. Variation of single-vehicle crash rates with illuminance for all studied sites

Much of the variability shown in the data from Figure 2 was associated with differences in response to illumination for roundabout sites with 3-legs versus either 4 or 5 legs.

Many of these differences are believed to be due to the stochastic nature of the data (i.e., most roundabouts have either 0 or 1 crash over the period) and the much greater range of annual entry volumes for the 3-leg roundabouts. These results are shown in Figure 3:

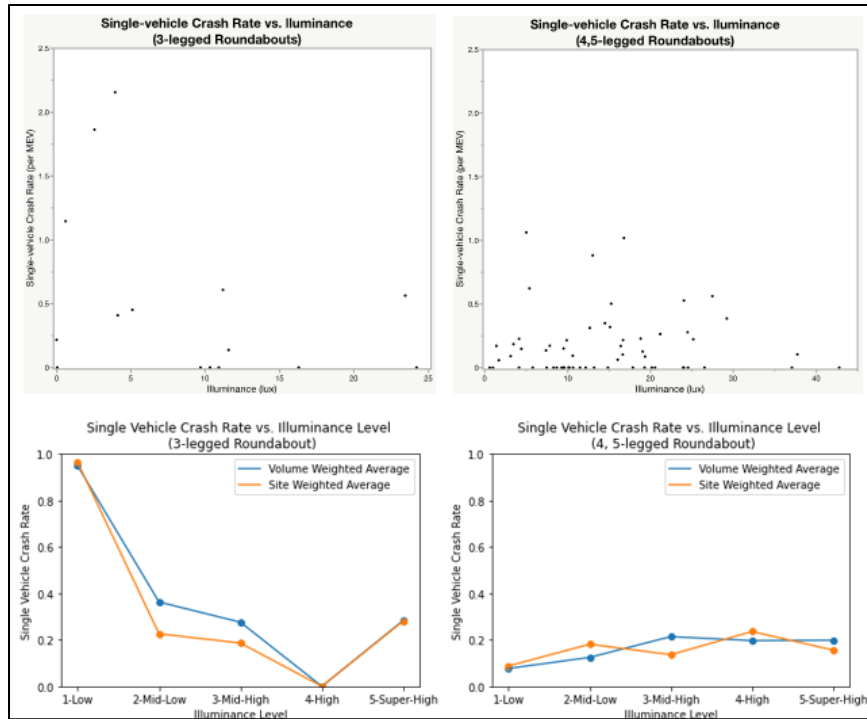

Figure 3. Chart. Single-vehicle crash rates for different roundabout leg configurations

When combined, these results give us significant insight as to how illumination levels may impact overall crash rates on a site-level basis. Observation of Figure 1 shows *no measurable trend in collisions between motor vehicles (i.e., multiple vehicle collisions) at any level of nighttime illumination* for the study sites. This is not the case for single-vehicle crashes with the lowest levels of illumination showing the highest observed crash rates (see Figure 2). Interestingly, this trend is almost entirely driven by a single subsegment of the study sites, those having only three-legs. This effect can be seen in Figure 3. While Figure 3 shows higher single-vehicle crash rates for low levels of illumination among 3-leg roundabouts, that trend is not seen in the four/five-leg roundabouts. These results are born out in the statistical modeling results, which confirm

that there are no statistically significant predictive variables relating crash rate to illumination for four/five-leg roundabouts at any level of illumination and none for three-leg roundabouts above 5 lux.

For the approach-level analysis, the luminance data (in cd/m²) were observed at multiple locations along the approach. These were: 1) within the circular pathway at the point of yield line; 2) a ten-foot long section along the approach centered at one-half of the stopping sight distance (Mid-SSD), and 3) a ten-foot long section at and beyond the stopping sight distance (SSD) along each approach. To establish the relationship between extent and levels of approach lighting and approach-level single-vehicle nighttime crash rates, a stepwise regression model was undertaken. Because of the significant safety impacts of additional approach travel lanes observed from the modeling results, separate analyses were conducted for multi-lane approaches and single-lane approaches.

For multi-lane approaches, analysis of the crash rates under different illumination conditions revealed that providing lighting along the approach to ensure the visibility of the yield line, especially within the area between the yield line and the stopping sight distance, resulted in significantly greater safety benefits than providing lighting inside the roundabout circle alone. This result was not observed for single lane approaches. By ordering the single-lane approach data based on measured yield-line luminance levels and comparing the fraction of total single-vehicle crashes against the fraction of total entering volumes, it is found (Figure 4) that approaches with luminance levels lower than 0.075 cd/m² at the yield line tend to have, on average, higher single-vehicle crash rates. Observations from Figure 5 further suggest that crashes are more likely to occur on

single-lane approaches with uniformly low luminance levels (less than 0.04 cd/m^2) provided within the stopping sight distance. However, there's also little evidence that providing higher levels of illumination at the approach yield line will generate any additional safety benefits, if the approach illumination can ensure the roundabout entrance is visible to drivers from the stopping sight distance.

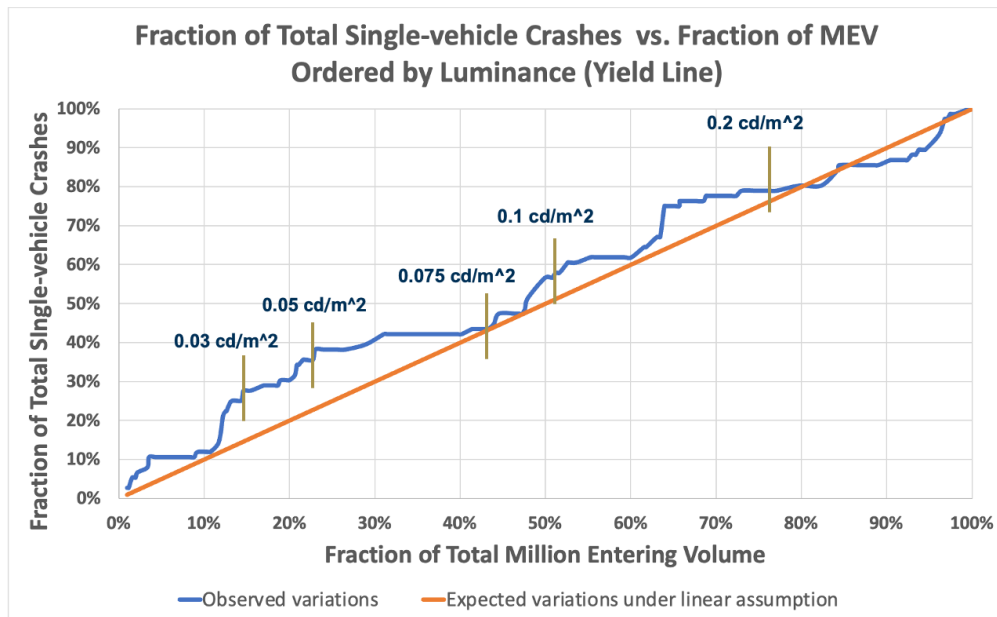

Figure 4. Chart. Fraction of total single-vehicle crashes vs. fraction of total MEV ordered by luminance measured at the yield line

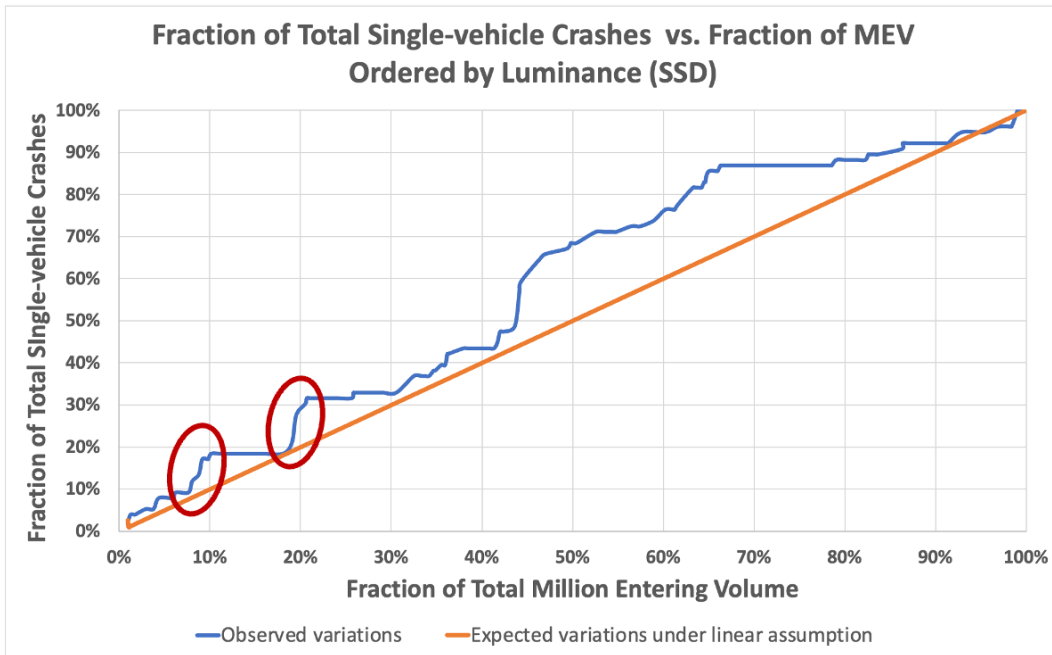

Figure 5. Chart. Fraction of total single-vehicle crashes vs. fraction of total MEV ordered by luminance measured at SSD

Together, these results may be summarized as: *The major overarching finding from this study is that, for the rural and suburban roundabouts included in this study, on a site-level basis, there is no statistically significant relationship between either single or multi-vehicle crash rates and illumination for observed circle illumination levels exceeding 5 lux. On an approach-level basis, if illumination of the circle only can ensure visibility of yield line to drivers from the stopping sight distance with the effects of ambient lighting taken into consideration (i.e., greater than or equal to 0.075 cd/m²), then little additional safety benefit can be anticipated by providing higher levels of approach illumination.*

These results are significant in that current IES guidance suggest a minimum illumination level of 8 lux for even the lowest volume roundabouts and that transition lighting is recommended for all roundabouts which are along non-continuously lit roadways.

Recommendations

Based on the conclusions drawn from this study, the following recommendations are made to assist GDOT decisions, on a project level basis, about the type and extent of active illumination and/or passive safety treatments for rural and suburban roundabouts.

- As this study did not include any roundabouts with the potential for any significant nighttime pedestrian volumes, current illumination practices should be maintained for these types of roundabouts until additional studies are conducted. This would include virtually all urban roundabouts.
- The results of the study suggest that nighttime lighting can provide certain benefits in terms of reducing single-vehicle crashes even if the average maintained horizontal illumination levels are lower than current IES standards (potentially as low as 5 lux).
- For multi-lane roundabout approaches or single-lane approaches with right-turn bypass lanes present, the installation of roadway lighting should be considered along the approaches to ensure the visibility of approach configurations as well as roadway signs and pavement markings.
- For single-lane roundabouts, nighttime lighting should be provided to ensure the visibility of yield line for drivers on each approach from the minimum stopping sight distance, especially with the presence of ambient lighting. This can often be accomplished with only circle illumination as safety benefits become limited for illumination levels higher than 0.075 cd/m^2 at the corresponding SSD.

- The observed significance of passive treatment factors (e.g., centerline rumble strips, crosswalk markings, etc.) affecting nighttime single-vehicle crash rates at lower illumination levels suggests that additional passive safety measures, (e.g., high reflectance pavement markings, etc.) should be considered for potential applications.
- Roundabouts should not be posted with advisory speed limits exceeding 35 MPH.

CHAPTER 1. INTRODUCTION

PROJECT PURPOSE

Modern roundabouts have proven to be highly effective at reducing both overall crash rates and crash severity (NCHRP 2010) relative to conventional stop-controlled or signalized intersections due to their unique geometric design and operational features. Because of these safety benefits, the Georgia Department of Transportation (GDOT) has significantly increased the number of roundabouts deployed within the State of Georgia over the last decade and plans to greatly increase this number in the future. Current GDOT design policy (GDOT 2019) requires that roundabouts in urban areas be illuminated to national design standards to ensure both pedestrian and intersection visibility at nighttime. Roundabouts in suburban and rural areas are evaluated on a case-by-case basis to determine illumination requirements. However, at present, there is only limited guidance regarding how to match illumination requirements with safety needs at a roundabout site even though the significant initial and ongoing costs of illumination can strongly influence cost-effectiveness and feasibility of roundabout installations in these suburban and rural areas.

The degree to which the spatial extent of illumination and/or its absence on certain approaches influences roundabout safety based on the conditions present at a specific site is, at present, relatively poorly known. This project aims to determine the statistical relationships between the presence/absence or levels of illumination and particular geometric, traffic, and other characteristics of currently installed roundabouts and the observed crash

rate history at these sites by incorporating both longitudinal and cross-sectional data. Through an understanding of the design tradeoffs between safety and the extent of illumination, this project aims to assist GDOT in deciding, on a project-level decision basis, the type and extent of active illumination and/or passive retroreflective treatments that should be applied to rural and suburban roundabouts on both a roundabout and roundabout approach basis based on specific roadway and traffic conditions. These passive treatments have the potential to augment, or in some cases replace, conventional illumination treatment. As a part of this study, an examination of potential passive treatments as well as alternative lighting methods was conducted. The results of this review are presented in Appendix A.

Roundabout Illumination Requirement

As roundabouts differ from conventional intersections in both the geometric layout and traffic operations, nighttime navigation through a roundabout can become a challenging task for drivers, especially under low visibility conditions. The FHWA requires that adequate lighting be provided at roundabouts to enable drivers to perceive the layout and operation of the intersection in time to make the appropriate maneuvers (FHWA 2000). Based on consideration of a roundabouts' unique design and operational characteristics, the general guidelines and benefits for roundabout illumination include:

- At a roundabout, illumination should be extended beyond the intersection to help drivers more easily detect pedestrians from a distance. This could effectively reduce the pedestrian-involved crash rates, especially in areas with high

pedestrian activity, as the pedestrian crosswalks are usually located at least one vehicle length before the yield line (Illuminating Engineering Society 2008).

- At a roundabout, drivers only need to check for conflicting traffic from the left side when approaching the yield line, thus adequate lighting at the entrance could help drivers identify potential conflicts in a more responsive way, and further reduce delays and increase roundabout capacity.
- At a roundabout, illumination within the circle could help drivers better visualize the deflection of the travel paths and the existence of the central island, which would potentially reduce single-vehicle crash rates and navigation delays due to drivers' lack of familiarity with the site.

Roundabout Illumination Level Recommendations

To evaluate the adequacy of illumination on roadways, the common recommended criterion is luminance, which refers to the amount (quantity and quality) of light reflected from the pavement surface. However, in terms of the conflict areas within intersections, another criterion, illuminance, which measures the amount of light falling onto and spreading over the pavement surface, is more frequently used. For roundabouts on continuously lighted streets, the Illuminating Engineering Society (IES) design guide (Illuminating Engineering Society 2008) provides recommended horizontal illuminance levels for a combination of different roadway functional classifications (i.e., Major roadway, collectors, and local streets) and pedestrian area classifications (i.e., High, medium, and low pedestrian nighttime volume areas). These recommendations are shown in Table 1. For roundabouts on streets that are not continuously lighted, it is recommended that the illuminance values corresponding to the local/local functional road

classification be used. It should be noted that these illuminance levels are based on the same criteria for intersection lighting recommended in the American National Standard Practice for Roadway Lighting (Illuminating Engineering Society 2008).

Table 1. Recommended Horizontal Illuminance for Roundabouts

| Functional Classification | Maintained Average Horizontal Illuminance in Lux/FC for different pedestrian area classifications | | | Uniformity Level (E_{avg}/E_{min}) |
|---------------------------|---|----------|----------|--|
| | High | Medium | Low | |
| Major/Major | 34.0/3.4 | 26.0/2.6 | 18.0/1.8 | 3:1 |
| Major/Collector | 29.0/2.9 | 22.0/2.2 | 15.0/1.5 | 3:1 |
| Major/Local | 26.0/2.6 | 20.0/2.0 | 13.0/1.3 | 3:1 |
| Collector/Collector | 24.0/2.4 | 18.0/1.8 | 12.0/1.2 | 4:1 |
| Collector/Local | 21.0/2.1 | 16.0/1.6 | 10.0/1.0 | 4:1 |
| Local/Local | 18.0/1.8 | 14.0/1.4 | 8.0/0.8 | 6:1 |

(Source: Illuminating Engineering Society 2008)

In addition, for drivers to detect pedestrians within the crosswalks in time, IES further recommends that the average vertical illuminance for a series of points 1.5 meters (5ft) in height, along the centerline of the crosswalk and extending to the edge of the roadway, spaced at 0.5 meters (1.65ft), for each approach, should be equal to the required horizontal illuminance and uniformity level.

Roundabout Illumination and Safety Analysis

The preferred analytical approach for most current highway safety studies is to use the framework of the Highway Safety Manual *Predictive Method* (AASHTO 2010). The *Predictive Method* is based on calibrated “safety performance functions” (SPF) to determine the crash rate for a given facility type under specified “standard conditions”. Different classes of roadway (e.g., rural two-lane highways) are associated with different

functional forms for the SPF and a modified Empirical-Bayesian approach is used to determine coefficient values. The impact of changes to the standard conditions are treated as “crash modification factors” (CMF) that are log ratios of the crash rate with the change to that of the standard conditions. Importantly, these CMFs are population-weighted (overall) impacts for treatments (modification of standard conditions) and do not directly consider sub-populations unless the data are stratified along these variables. For purposes of this study, the observed crash records were stratified into subpopulations based on the number of vehicles involved, the existence of impaired drivers and reduced visibility due to weather conditions.

A case-control approach was also used to correct the background secular trend that is inherent in the historical crash data used in the subsequent regression-based approaches (e.g., the HSM predictive method). Then, separate Bayesian-type Regression models (e.g., the HSM EB approach) were established for each subpopulation to determine the influence of illumination on crash frequency at roundabouts. This two-step analytical framework is designed to ensure that the maximum possible value will be obtained from data collected by the project. This approach was developed based on the review of existing literature regarding various methods of quantifying illumination’s impact on roadway and intersection safety, which will be discussed in Chapter 2.

The basic technical approach of the project was to collect and analyze data from a sample of rural and suburban roundabouts located in 37 counties in Georgia to determine the statistical relationships between the presence/absence or levels of illumination and observed crash rates from both roundabout site-level and approach-level perspectives.

Chapter 3 describes the selection procedures employed to identify the appropriate roundabouts and corresponding control sites for the study, as well as the methods used for the collection and processing of site-level and approach-level datasets related to roadway characteristics, traffic activity, luminance conditions, and crash history data. From these processed datasets, an overall Bayesian-type regression model was used to identify the subpopulations and stratifications at both site and approach-levels. Based on these stratifications, separate regression models were developed to quantify the impacts of roundabout illumination and other factors on observed single-vehicle crash frequency on a site-level basis. For the approach-level analysis, a combination of methods including stepwise regression models, case control studies, multiple measurements, etc., were used. The detailed process and results of the site-level and approach-level analyses are discussed in Chapter 4 and Chapter 5 respectively. Chapter 6 provides a summary of project conclusions, limitations, and recommendations.

CHAPTER 2. REVIEW OF ROUNDABOUT SAFETY AND ILLUMINATION IMPACTS

ROUNDABOUT IMPACT ON SAFETY

Roundabouts have significantly fewer conflict points than conventional stop-controlled or signalized intersections (Flannery 2001; Lenters 2005). The roundabout conflict points also tend to have crash types with much lower rates of severe injuries than their conventional intersection counterparts. A roundabout's geometric design and operational features force drivers to reduce speed, regardless of posted speed limits, and promote better driver behavior (Isebrands et al. 2014). Their overall safety advantages have made them the preferred alternatives in many instances; for example, in Sweden, major road intersections with high pedestrian and/or cyclist volume are being converted to roundabouts (Azhar and Svante 2011).

Impact on Vehicle Crashes

The conversion of a stop-controlled or signalized intersection to a roundabout has been found to offer substantial reductions in crash frequency and crash rate (Retting et al. 2001). One of the earliest studies (Troutbeck 1993) indicated a 74 percent reduction in the injury crash rate after the conversion of 73 conventional intersections in Australia. Similarly, an analysis of 181 converted intersections in the Netherlands (Schoon and van Minnen 1994) reported a 47 percent, 71 percent, and 81 percent reduction in all crashes, injury crashes, and severe crashes, respectively. A Swedish study (Hydén and Várhelyi 2000) investigated the safety, time, and environmental effects of large-scale use of

roundabouts in a Swedish urban area. In that study, 21 high-risk signalized and unsignalized intersections were replaced with small roundabouts. The results showed a statistically significant reduction in speeds at the intersections and on road segments between roundabouts; however, there was no change in speeds on the segments not bounded by roundabouts.

Highly significant reductions of 38 percent in all crashes, 76 percent in injury crashes, and 90 percent in fatal and severe injury crashes were estimated in an empirical Bayes study (Retting et al. 2001) of the conversion of 24 stop-controlled and signalized intersections to roundabouts. Another study (Persaud et al. 2001) used the Empirical Bayes (EB) procedure to analyze the conversion of 19 stop-controlled and 4 signalized intersections. The authors estimated an approximately 40 percent reduction in all crashes, 80 percent reduction in injury crashes, and 90 percent reduction in fatal and incapacitating injury crashes. Further subgrouping analysis of converted single-lane urban stop-controlled intersections indicated a 72 percent reduction in all crashes and an 88 percent reduction in injury crashes. Similar analysis for the conversion of rural single-lane stop-controlled intersections showed a 58 percent reduction in all crashes and an 82 percent reduction in injury crashes, while converted signalized intersections showed a 35 percent reduction in all crashes and a 74 percent reduction in injury crashes.

Authors in a study (De Brabander and Vereeck 2007) conducted in Belgium evaluated safety at 95 roundabouts and 230 conventional intersections. Their results showed that roundabouts reduce injury crashes by 39 percent, severe injury crashes by 17 percent, and light injury crashes by 38 percent. Another study (Rodegerdts et al. 2007b) reported the

results of a before-and-after safety analysis of converted intersections in Australia, France, and the United States. In Australia there was a 41 percent reduction in all crashes, a 45 percent reduction in injury crashes, and a 63 percent reduction in fatal crashes after the conversion of 230 intersections. Similarly, 83 converted intersections in France showed a 78 percent reduction in injury crashes and an 82 percent reduction in fatal crashes. Finally, crash data from converted U.S. intersections showed a 45 percent reduction in all crashes and an 81 percent reduction in injury crashes.

NCHRP Report 572 (Rodegerdts et al. 2007a) presented the results of an EB analysis of crash data from 55 roundabouts in the United States, indicating a 35 percent and a 76 percent reduction in all and injury crashes, respectively. However, a separate analysis of nine high-speed locations indicated larger safety benefits with a 71 percent reduction in all crashes and an 87 percent reduction in injury crashes. In a similar study (Isebrands 2009) 17 high-speed rural intersections that were converted to roundabouts from predominantly two-way stop-controlled intersections were analyzed. Using an average of 4.6 years of before and 5.5 years of after crash data, the author found reductions of 84 percent and 89 percent for injury crash frequency and crash rate, respectively. Also, angle crashes reduced by 86 percent, while fatal crashes reduced by 100 percent. In another study (Isebrands and Hallmark 2012), the authors developed a crash prediction model for 19 converted high-speed rural roundabouts from six U.S. states. The before and after data both averaged 5.2 years. Using a negative binomial regression model, the results showed statistically significant reductions of 63 percent for all crashes and 88 percent for injury crashes. A separate EB analysis yielded consistent results of 62–67 percent reduction for all crashes and 85–87 percent reduction for injury crashes.

Another study (Uddin et al. 2012) used the EB procedure with 2.5 years of both before and after data to analyze safety at two previously stop-controlled interchange-terminal roundabouts. The results indicated a 38 percent and 60 percent reduction in all and injury crash frequency, respectively. Crash data from 332 converted roundabouts in Denmark were evaluated (Jensen 2013) evaluated after correcting for general crash trends and regression-to-the-mean effects. The author estimated overall safety benefits of 27 percent and 60 percent for all and for injury crashes, respectively. Also, fatalities were reduced by 87 percent, and property damage only (PDO) crashes were reduced by 16 percent.

Gross et al. (2013) analyzed 28 converted signalized intersections using EB as well as negative binomial regression. The EB analysis showed a 21 percent and a 66 percent reduction in all and injury crashes, respectively. However, the safety benefit decreased with increasing entering AADT. The cross-sectional analysis also corroborated decreasing safety benefit with increasing entering AADT. Finally, Qin et al. (2013) used the EB procedure to analyze the safety performance of 24 converted intersections from Wisconsin. With an average of 3 years of before and after data, an unbiased estimate of a 9.2 percent reduction in all crashes and 52 percent reduction in injury crashes was estimated.

A known and well established characteristic of roundabouts is that they force drivers to reduce speed. Isebrands et al. (2014) undertook a study to verify this phenomenon at high-speed rural locations. They evaluated the change in average approach speed between roundabouts and two-way stop-controlled intersections, as well as between roundabouts with approach rumble strips and those without rumble strips. The study included four

roundabouts and two two-way stop-controlled intersections. The findings indicated that the mean speed 100 feet from the roundabout yield line was approximately 2.5 mph lower than the mean speed 100 feet from the stop-controlled intersection stop bar. Mean speeds at roundabout locations with rumble strips were 4.3 and 3.3 mph lower at 100 feet and 250 feet from the yield line, respectively, than roundabouts without rumble strips.

Roundabouts are relatively new in the United States and the data availability requirements of the state-of-the-art empirical Bayes (EB) analysis evaluation procedure hinders most transportation agencies from conducting local safety evaluations, forcing them to rely on national estimates that may not be applicable to local conditions. In a GDOT sponsored study (Gbologah et al. 2019), the researchers developed a time-dependent form of the Highway Safety Manual predictive (EB) method and used it to evaluate 23 roundabouts in Georgia. Their findings showed 37 – 48 percent reduction and 51 – 60 percent reduction in average crash frequency respectively for all crashes and injury/fatal crashes at four-leg roundabouts that were converted from stop-controlled and conventional intersections. Furthermore, as a group, three-leg and four-leg roundabouts converted from stop-controlled and conventional intersections collectively experienced 56 percent reduction and 69 percent reduction in injury/fatal crashes respectively.

Impact on Non-Vehicle Road Users

De Brabander and Vereeck (2007) argue that roundabout injury reductions could vary greatly among various subgroups in crashes. They observed that while the total number of crashes involving vulnerable road users reduced by 14 percent on average at all roundabouts, the same statistic went up by 28 percent at roundabout locations that were

previously signalized. The authors concluded that signalized intersections protect vulnerable road users more effectively than roundabouts. Vulnerable road users were defined as pedestrians, cyclists, moped drivers, and motorcyclists. Also, Daniels et al. (2008) evaluated bicyclist safety at 91 roundabouts in Belgium using a before-and-after methodology and found that, after conversion, injuries increased by 27 percent while fatal or serious injuries increased by 41–46 percent. Furthermore, in built-up areas there was a 48 percent and 77 percent increase in injury and fatal or serious crashes, respectively. Outside built-up areas, the results were not statistically significant.

To understand why roundabouts pose a proportionately higher risks to bicyclists, Møller and Hels (2008) surveyed 1019 bicyclists at 5 roundabouts in Denmark, seeking their perception of risk in roundabouts. The survey respondents were between the ages of 18 and 85. The surveys were administered Tuesdays through Thursdays between 7:30 a.m. and 4:30 p.m. The authors measured risk in two dimensions: (1) perceived risk of being involved in a crash, and (2) perceived danger. These dimensions require cognitive judgment and an emotional response, respectively. The authors found that underestimation of risk and lack of knowledge about traffic rules may be significant contributing factors in vehicle–bicycle crashes at roundabouts. Also, the study showed that perceived risk is influenced by factors such as age and gender of the cyclist, design features, and traffic volume. Finally, the authors observed that roundabouts with a cycle facility are perceived as safer than those without it. However, they note that the possible safety benefits of bicycle facilities may be reduced because cyclists may increase risk-taking behavior given decreased perceived risk.

Daniels et al. (2010a) attempted to shed light on the variation in safety performance of roundabouts by analyzing 90 roundabouts in Flanders, Belgium. The authors used state-of-the-art cross-sectional risk models based on crash data, geometric data, and traffic data. During the analyses, the authors detected under dispersion in the data, so they used gamma modeling techniques in addition to Poisson modeling. The study results indicate that roundabouts with cycle lanes performed worse than those with cycle paths (i.e., dedicated paths for bicyclists at more than 1 m from the roadway).

SAFETY-INFLUENCING FEATURES OF ROUNDABOUTS

The safety and operational performance of roundabouts can be negatively impacted by inadequate geometric design and site characteristics. Flannery (2001) used case studies to review the geometric characteristics and safety of roundabouts from Maryland, Florida, and Nevada. That author found that (1) inadequate sight distances hinder the free flow of vehicles into the roundabout, forcing drivers to reduce speeds considerably; (2) lack of adequate deflection encourages drivers not to slow down, with some of them driving over the island apron; and (3) operating roundabouts with low volume/capacity ratio, especially in multilane roundabouts, can encourage high speeds through the roundabout and lane crossings.

Next, Lenters (2005) explained some geometric design features of roundabouts that influence safety:

- Sharply increasing the angle between arms reduces crash frequency; thus, roundabouts with equally spaced arms may be safer.

- Increasing entry width produces significant increases in crash frequency. A roundabout design that applies entry flaring in combination with moderate entry path curvature can offer improved capacity and balanced safety performance.
- Increasing circulating width increases crash frequency.
- Very small values of entry path radius must be avoided. However, these values are usually large and need to be reduced. Optimum values will depend on entry and circulating flows.
- Increasing the half-width provides a very small reduction in crashes.

Figure 1 shows these safety features on a typical roundabout geometric layout.

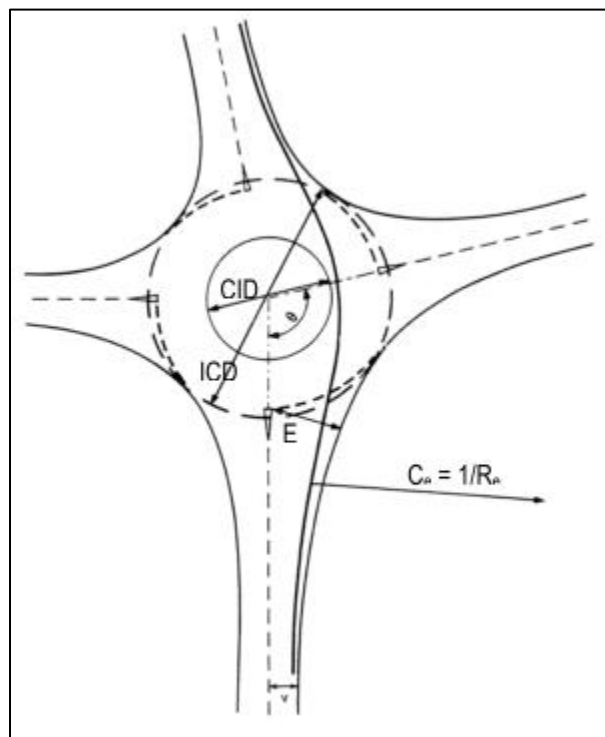

Figure 1. Image. Geometric Layout of a Roundabout.
Adapted from Lenters (2005)

The geometry of roundabouts is such that making a change in one geometric element can reduce the probability of one crash type, but can also increase the odds for other crash

types. Lenters (2005) also performed a safety audit of roundabouts in Canada and made the following additional observations about the effect of roundabout geometric elements on crashes.

- Even though a good deflection is desirable for safety, designs with entry path curvatures that are too tight, as with perpendicular or sharply curved entries, can increase crashes resulting from loss of control on the roundabout approaches.
- Inconspicuous central island and/or splitter islands are the primary contributing factors to loss-of-control crashes because drivers that are unfamiliar with the layout often do not receive sufficient visual information to adjust speed and path.
- Inadequate stopping sight distance limits vertical sight and makes it difficult for drivers to see the yield line or the central island and splitter island. This results in drivers overshooting the entry or failing to brake in time. Insufficient sight distance to the left near the entry can result in entry-circulating crashes while providing visibility that is beyond 15 m from the yield line to the right of the entry, can encourage drivers to compete for gaps.
- Increasing the deflection with smaller inscribed circles provides better safety for bicycles.
- Improper lane designation contributes to exit crashes.
- Positive contrast lighting and vertical luminance are essential for pedestrian and signage visibility.

In a similar study, Montella (2011) investigated crash contributory factors and their interdependencies at 15 urban roundabouts located in Naples, Italy, using crash data from 2003 to 2008. The study analyzed 274 crashes, finding that the most common crash contributory factor was geometric design, including: (1) an excessive radius of deflection

associated with rear-end and angle crashes at entry, (2) an excessively low angle of deviation associated with angle crashes at entry, and (3) an excessive radius of deflection of the left approach associated with angle crashes. Poor markings contributed to more than half of the crashes, with missing yield lines or symbols being associated with angle crashes at entry, and missing, faded, or poorly located pedestrian crossings being associated with pedestrian crashes at exit. Inadequate pavement friction was found to be the most common pavement contributory factor, being associated with one-third of all crashes.

Zirkel et al. (2013) evaluated the influence of sight distance on safety at low-volume single-lane roundabouts by analyzing 72 roundabout approaches from 19 single-lane roundabouts. Their findings showed that increasing sight distance increases the risk of crash occurrence as well as the speed differential between the approach and entry to the roundabout. However, the authors acknowledged that other parameters not included in the study could also contribute to the variability in crashes and crash rates.

Hammond et al. (2014) also investigated the effect of additional lane lengths on roundabout operational characteristics, using delay as the performance measure. The authors defined an additional lane as a lane used to increase the entry and/or exit widths at roundabouts. It may be a flared lane or lane with sufficient taper length. Delay was measured within 250 feet of the yield line. The authors analyzed a hypothetical four-leg, double-lane roundabout with additional lanes at both entry and exit. They varied the lengths of these additional lanes to study their effect on operations. Based on the findings from the hypothetical roundabout, similar additional lane lengths were applied to a

calibrated and validated model of an existing roundabout. The findings indicate that shorter lengths of additional lanes (and flares) of 50 to 150 feet provided the best operational performance.

ILLUMINATION IMPACT ON INTERSECTION SAFETY

Review of the literature on illumination and intersection safety shows that most of these studies were conducted using either a before and after analysis method or a cross-sectional method comparing roundabouts with lighting to those without lighting. A few of the studies have been compelled to use methods other than these two because of their inherent limitations.

Before-and-After Studies

Walker and Roberts (1976) analyzed crash data from 47 rural at-grade intersections in Iowa using crash data which spanned 3 years before and after lighting was installed. The study assumed that nighttime traffic volume was 0.27 times the existing daily traffic volume. The results showed a reduced crash rate of 0.91 per million entering vehicles (MEV) in the after period compared to 1.89 per MEV in the before period. Also, it was generally found that the impact of lighting was less for low volume roads with daily traffic volumes less than 3500 vehicles per day. After this study ended and in the wake of the 1973 energy crisis, the Iowa Department of Transportation commissioned another study (Marks 1977) to investigate the *Effects of Reduced Intersection Lighting on Nighttime Accident Frequency*. The study analyzed crash data from 19 pairs of intersections with similar geometrics and one intersection out of each pair had some

lights turned off to produce a lighting differential. The results showed that the nighttime crash rate at the rural intersections with full lighting was 1.06 while the nighttime accident rate at the rural intersections with reduced (i.e., lit but not to contemporary standards) lighting was 1.01. Based on the results, it was concluded that the lighting level of lighted rural at-grade intersections does not have a significant effect on the accident frequency if the conflict area is at least partially illuminated.

In 1999, Preston and Schoenecker (1999) undertook a study of 12 rural Minnesota intersections associated with installation of lighting to determine the relative changes in crash frequencies and other crash characteristics. They reported findings of about a 40 percent reduction in nighttime crash rates at the 5% significance level and indicated a 20 percent crash severity reduction at the 10% significance level. Also, Green et al. (2003) investigated the effect of roadway lighting on driver safety using crash data from nine Kentucky intersections. This study was severely limited by sample size and no statistical tests were reported but the results indicated a 45 percent reduction in nighttime crash frequency after installing lights.

Next, Isebrands et al. (2010) also used a Poisson regression model to evaluate the change in expected crash frequencies after installation of lighting at 33 rural intersections where rural intersection is defined as an intersection that is at least 1 mile away from any development or 1 mile away from signalized intersection on the same roadway. Both the before and after data had at least 3 years of information and the Poisson model included intersection related variables such as night/day, before/after installation, number of intersection legs, posted speed limits, intersection control type, presence of turn lanes,

and presence of a horizontal or vertical curve. Using a significant threshold of 10%, the Poisson regression model revealed a statistically significant reduction in nighttime crash rate of 37 percent after lighting was installed. There was also a reduction in daytime crash rate of 4 percent, but this was not found to be statistically significant.

Cross-sectional Studies

Sometimes it is difficult to identify intersection locations with enough samples of before-and-after crash data where illumination was the only safety treatment applied during the study period. In such instances a cross-section study can be used. Cross-sectional studies compare an intersection with a particular attribute, in this case lighting, to a site without it.

Wortman and Lipinski (1974) evaluated the impacts of intersection lighting on crashes at rural highway intersections by analyzing 263 lighted intersection-data-years and 182 unlighted intersection data years. Their findings indicate an average night/total crash ratio of 0.25 for lighted intersections and average night/total crash ratio of 0.33 for unlighted intersections. This corresponds to a 24 percent reduction in night accidents. Later on Lipinski and Wortman (1978) analyzed 445 intersection-data-years and their results show a 22 percent reduction in night/day crash ratio, 45 percent reduction in nighttime crash rate, and 35 percent reduction in total crash rate at all intersections.

Also, Preston and Schoenecker (1999) performed a cross-sectional study of over 3400 intersections in Minnesota with crash data from 1995 to 1997 and their results indicate a 25 percent reduction in nighttime crash rate (0.63 to 0.47 per million entering vehicles)

and 8 percent reduction in injury severity. Similarly, Bruneau and Morin (2005) also evaluated the safety aspects of roadway lighting at rural and near-urban intersections in Quebec, Canada, by comparing unlit intersections with lit intersections. The lit intersections were made of those with standard lighting and non-standard lighting and there were both 3-legged and 4-legged intersections included. The study analyzed a total of 376 sites and the results which were statistically significant at the 5% level showed that rural intersection lighting can reduce night accident rate by 29% for non-standard lighting and by 39% for standard lighting.

Next, Isebrands et al. (2006) evaluated 3622 rural illuminated and unilluminated intersections in Minnesota. Their linear regression model indicated that the relevant variables that affect the ratio of nighttime accidents to total accidents were presence of lighting, volume, and number of intersection legs. Furthermore, the model showed that the expected ratio of nighttime to total crashes was 7 percent higher for unilluminated intersections than for illuminated intersections. Also, Hallmark et al. (2008) conducted a cross-sectional study of 223 rural intersections using a hierarchical Bayesian model with Poisson distribution. The authors found that the expected mean of nighttime accidents was 2.01 times higher for unlit intersections than for illuminated intersections.

Also, Donnell et al. (2011) estimated the safety effects of roadway lighting at intersections from Minnesota and California using a cross-sectional approach with four years of intersection data. They computed expected night-to-day crash ratios at intersections with and without roadway lighting and their results indicate 12 and 23

percent reductions in expected night-to-day accident ratios between intersections with and without lighting in Minnesota and California respectively.

More, recently Donnell (2015) undertook a study exploring statistical issues in relating lighting to safety. As part of this study, he compared two cross-sectional studies. Each analysis was undertaken using negative binomial regression, but the input data was treated differently. One analysis incorporated observed crash data while the other analysis used a propensity score – potential outcome framework. Propensity scores are estimated using binary logit regression to determine probability that an entity contains intersection lighting based on site-specific conditions in order to identify lighted and unlighted sites based on covariates. The results indicate a lighting safety benefit of 11.9 percent and 9.5 percent for the analysis based on observed data and propensity scores respectively.

In a GDOT sponsored study (Rodgers et al. 2016) to evaluate the feasibility of using a reduced roundabout illumination as a safety treatment for either uncontrolled or stop-controlled rural intersections, the authors evaluated relationship between roundabout illumination and safety using crash data covering years 2003 – 2013 from 13 roundabouts in Minnesota. Utilizing illumination data with three qualitative levels – None, Partial, and Full – their results indicated overwhelmingly that reduced illumination roundabouts would be an effective safety treatment for uncontrolled and stop-controlled rural intersections. Specifically, the results showed that about 68 – 83 percent of benefits that could be obtained by full illumination could be obtained by partial illumination. Partial illumination was defined as lighting that is focused on only the roundabout circle whereas

Full illumination includes lighting the roundabout circle as well as the transition zone on the intersection legs.

Issues with Before-and-After and Cross-sectional Studies

Before-and-after studies are faced with issues that can affect the statistical validity of results. First, such studies can give biased results due to the phenomenon called regression to the mean (Per Ole 2009; Retting et al. 2001). Usually, it is difficult to find a large sample of data for the before case and the after case. Therefore, these datasets usually cover a few years on either side of light installation. The mean of such data is easily affected by temporary events, and this can bias the results from a before-and-after case study. On the other hand, if the duration of the before and after samples are increased too much the study can be influenced by long-term trends that might no longer be true. Furthermore, a before-and-after study can also be faced with selection bias (Donnell et al. 2010) or endogeneity bias as referred to in other studies (Per Ole 2009). This bias arises due to the fact that a traffic safety countermeasure such as lighting is normally applied to a site with a recent or proportionately higher number of nighttime crashes. However, warrants for lighting are usually applied with other operational considerations so other safety influences may also be influencing the results.

On the other hand, cross-sectional studies mainly attempt to address the regression to the mean bias faced in before-and-after studies. In cross-sectional studies no treatment is applied to a site but rather sites with particular attributes are compared to those without. However, these studies also face a selection bias issue and so it is difficult to categorically make a case for causation (Donnell et al. 2010).

In order to address these challenges, different approaches have been adopted in some previous studies. Hauer (2005) proposed a before-and-after study in which the observed effect of a treatment is compared to an estimate of the expected number of crashes that would have occurred if the treatment had not been applied. Also, Donnell et al. (2010) points out that the empirical Bayes method has been advocated by (Hauer 1997) and (Persaud and Lyon 2007) as a way to address issues of selection bias. Bo et al. (2009) also developed a Full Bayesian Empirical approach that addresses issues of selection bias as well as the Empirical Bayes method.

The Empirical Bayes method provides several advantages including (Gross et al. 2013):

- Properly accounting for regression to the mean effects
- Overcoming difficulties in the use of crash rates to normalize for changes in before and after period traffic volumes
- Reducing the level of uncertainty in the estimate of the safety benefit
- Properly accounting for differences in crash experience and crash reporting practice when combining data and results from different jurisdictions.

However, the Empirical Bayes method also has some draw backs such as (Donnell 2015):

- Requiring installation dates and time-sequence
- Possible confounding with other “treatments”
- Adequate reference and treatment sites needed for evaluation.

Therefore, other researchers such as Donnell et al. (2010) have used cross-sectional studies with application of multivariate regression models that permit the controlling of other safety influences.

Other Studies Using Different Analysis Methods

Other previous studies have also used different approaches to study the impact of intersection illumination on accident reduction. In 1992 the International Commission on Illumination (CIE) published the results of a meta-analysis of 62 studies from 15 countries (International Commission on Illumination 1992). According to the study, 85 percent of the results showed lighting to be beneficial with about 30 percent of these results being statistically significant. Furthermore, this meta-analysis study observed accident reductions in the range of 13 percent to 75 percent. For rural intersections the reductions were in the range of 26 percent to 44 percent. Also, an economic analysis which was performed as part of the study showed that the benefits of illumination far outweighed the associated costs.

Next, Elvik (1995) also carried out a meta-analysis of 37 published studies from 11 countries. The studies were published from 1948 to 1989. The results showed a 65 percent reduction in nighttime fatal crashes, 30 percent reduction in nighttime injury accidents, and a 15 percent reduction in nighttime property-damage-only crashes at intersections and on road segments.

Per Ole (2009) estimated the safety effect of lighting on nighttime accidents on roads in Holland. He used the odds-ratio estimator effect and the ratio-of-odds ratio estimator

effect to evaluate the safety impacts. His results show that lighting can reduce the frequency of nighttime crashes by 50 percent on all roads and by 54 percent on rural roads. Also, the results show that adverse weather reduces the benefit of lighting on roads, showing a 26 percent during precipitation with snow and a 22 percent reduction when snow or ice covers the surface. He also measured the risk of injury accidents under various conditions; on lit rural roads the risk is 17 percent while on unlit roads the risk is 145 percent; during rainy conditions the risk on lit roads is 53 percent while on unlit roads it is 192 percent.

Donnell et al. (2010) notes that most published lighting-safety research have been focused on rural, stop-control intersections. The authors further stresses that given the advancement in highway safety research over the past 15 – 20 years there is a need to identify new and improved ways to estimate safety effects of intersection lighting. To this end, the authors developed a comprehensive framework using a negative binomial model. Their results indicate a much lower reduction in nighttime crash frequency, 7.6 percent, than what has been reported in previous published studies. However, when the authors analyzed the data without controlling for other safety influencing features a reduction of 28 percent in night crash frequency was observed. This is similar to previous studies and an indication that published benefits in previous studies which did not control for safety contributing features may have been over estimated. Also, the authors make a case for a complete lighting management system or database (to include variables such as luminance, illuminance, pole height, etc.) which is linkable to roadway inventory and crash records to help researchers to develop a complete understanding of safety impacts of fixed roadway lighting.

Bassani and Mutani (2012) investigated the effect of environmental lighting on driver behavior in terms of vehicle speeds. This investigation was carried out on six (2 and 3 lane) arterial roads, with posted speeds in the range of 31 to 43.5 mph, in the city of Turin, Italy. The results indicate that during daytime, operating speeds increase with illuminance and speeds are generally higher on sunny days than on cloudy days. In addition, the results show that nighttime speeds were higher than daytime speeds even though illuminance levels at night were lower than during the day. The authors explained this phenomenon as being due to the increased proportion of younger drivers during the nighttime compared to during the day. One limitation with the study was that the authors did not control for other speed influencing factors such as luminance uniformity from driver's perspective, driver alcohol level, and traffic volume.

APPROACHES FOR QUANTIFYING ILLUMINATION'S IMPACT

Many methods have been used to quantify the impact of roadway illumination on crashes. These methods range from naïve techniques that can suffer from dubious statistical soundness to very sophisticated approaches designed to overcome specific issues with other techniques.

Night-to-Day Ratios

Some studies quantified the impact of illumination by comparing night/day crash frequency ratios for lighted and unlighted conditions. This approach can be applied to both before/after studies and with/without studies. One of the main drawbacks of this frequency ratio is that it is unable to account for different traffic volumes between day

and night. Therefore, other studies used night/day crash rate ratios instead. For example, Box (1970) estimates that if 25 percent of driving occurs at night then a single nighttime crash is equivalent to three daytime crashes. In either case effectiveness of illumination is presumed if the night/day ratio is lower for illuminated condition than in the unilluminated condition (Rea et al. 2009). Lighting installation is hardly random because it is usually linked to expected high crash frequencies and this lack of randomness can often confound statistical results from the night/day ratio method. Also, lighting is often installed with other nighttime safety improvement features which are difficult to account for with this approach (Rea et al. 2009).

Odds Ratio

The odds ratio (Elvik 1995; International Commission on Illumination 1992) is a safety criterion which can be applied to both with/without or before/after (Rea et al. 2009). The ratio can be calculated as shown in Equation 1.

$$\frac{N_{lighted}}{N_{unlighted}} / \frac{D_{lighted}}{D_{unlighted}} \dots \dots \dots (1)$$

where N is the number of nighttime crashes and D is the number of daytime crashes. Although, not necessarily valid, the odds ratio is assumed to control for other nighttime safety improvement features because it separates the lighted sites from the unlighted sites (Rea et al. 2009). An odds ratio of one indicates no effect of lighting, a value less than one indicates effectiveness with a corresponding reduction in nighttime crash risk equal to difference between the ratio and one (Rea et al. 2009).

Empirical Bayes Method

The empirical Bayes method (EB) offers a way to address selection bias (Donnell et al. 2010) due to fact the lack of randomness in road lighting installation. Also, EB is able to account for regression to the mean while normalizing for the difference in traffic volume in the before and after periods (Hauer 1997; Persaud et al. 2001).

This method compares the change in crashes at a site in response to a specific treatment to the expected number of crashes that would have occurred in the absence of the treatment. The change in the number of crashes can be expressed as shown in Equation 2:

$$\beta - \lambda \dots \dots \dots (2)$$

β = expected number of crashes that would have occurred without the treatment

λ = actual number of crashes that occurred in with the treatment.

β can be estimated by first using a regression model (safety performance function (SPF)) to estimate the annual number crashes (P) that would be expected in the before period at other locations with similar geometrics, traffic volume, and other characteristics. This regression estimate is then combined with the crash count (χ) in the periods (η) before the treatment at a study site to estimate the expected annual number of crashes (m_b) at a site before the treatment was installed (Persaud et al. 2001). This is an important step because the crash count in the before period in itself is not a good estimate due to traffic volume

changes, regression to the mean effects, and trends in crash reporting (Hauer 1997; Persaud and Lyon 2007). The expected annual number of crashes before treatment, m_b , is estimated as shown in Equation 3:

$$m_b = w_1 (x) + w_2 (P) \dots \dots \dots (3)$$

W_1 and W_2 are weights estimated from the mean and variance of the regression estimate as shown in Equation 4 and Equation 5 respectively (Persaud et al. 2001):

$$w_1 = \frac{P}{k + \eta_b P} \dots \dots \dots (4)$$

$$w_2 = \frac{k}{k + \eta_b P} \dots \dots \dots (5)$$

k is a model specific constant which can be estimated from the regression as shown in Equation 6:

$$k = \frac{P^2}{Var(P)} \dots \dots \dots (6)$$

Next, the difference in traffic volume between the before period and the after period as well as the length of the after period need to be considered. First, the regression model must be used to estimate the annual number of crashes (Q) that would be expected at the other similar intersections in the after period. Next, the expected annual number of crashes at a study site in the after period must be estimated by multiplying the ratio (R) of

the annual regression predictions for the after and before period to the estimated expected annual crashes at a study site in the before period (Persaud et al. 2001):

$$R = \frac{Q}{P} \dots \dots \dots (7)$$

$$m_a = R * m_b \dots \dots \dots (8)$$

β can then be estimated by multiplying m_a with the length of the after period as shown in Equation 9:

$$\beta = m_a * \eta_a \dots \dots \dots (9)$$

The variances of the expected number of crashes in the after period and the actual crashes can be estimated as shown below in Equation 10 and Equation 11 respectively:

$$Var(\lambda) = \lambda \dots \dots \dots (10)$$

$$Var(\beta) = \frac{m_b * (R * \eta_a)^2}{\frac{k}{P} + \eta_b} \dots \dots \dots (11)$$

The safety effect of the treatment can be estimated as (a) reduction in expected number of crashes or (b) as a crash modification (Persaud et al. 2001). The reduction in expected number of crashes (δ) can be estimated from Equation 12.

$$\delta = \sum \beta - \sum \lambda \dots \dots \dots (12)$$

Also, the variance can be estimated as shown in Equation 13:

$$Var(\delta) = \sum Var(\beta) + \sum Var(\lambda) \dots \dots \dots (13)$$

The crash modification factor (θ) based on the Empirical Bayes method can also be calculated from Equation 14 and the variance can also be estimated from Equation 15:

$$\theta = \frac{\sum \lambda / \sum \beta}{1 + \frac{\sum Var(\beta)}{(\sum \beta)^2}} \dots \dots \dots (14)$$

$$Var(\theta) = \theta^2 \left[\frac{\frac{\sum Var(\lambda)}{(\sum \lambda)^2} + \frac{\sum Var(\beta)}{(\sum \beta)^2}}{(1 + \frac{\sum Var(\beta)}{(\sum \beta)^2})^2} \right] \dots \dots \dots (15)$$

Values of θ less than 1.0 indicate a crash reduction effect while values greater than one indicates adverse effect from lighting. Also, the percentage reduction or increase in the effect is given as 100 (1- θ) (Monsere and Fischer 2008).

The empirical Bayes method is state-of-the-art in assessing the effect of road safety improvement programs. However, in order to apply it to study the impact of illumination it requires separation of the crash data into before-after samples based on the illumination

installation date. Most often this information is not available; therefore, the method has been rarely used in the studies of illumination impacts.

Negative Binomial Regression

Due to the general inability to separate crash data into before and after sets based on lighting installation date, the Negative binomial regression has been the status-quo for safety studies assessing the impact of illumination because it only requires crash data to be separated into illuminated or unilluminated sets. The negative binomial regression is able to account for over-dispersion which is prevalent in crash data (Bhagavathula et al. 2015; Donnell et al. 2010) but can't be captured by other regression models including the Poisson regression model (Scott 1980). It has a functional form as shown in Equation 16:

$$\ln Y_i = \beta_0 + \beta_1 X_1 + \beta_2 X_2 + \dots + \beta_n X_n \dots \dots \dots (16)$$

Y_i = expected number of crashes at intersection i

X_1, X_2, \dots, X_n = represent the explanatory variables

$\beta_1, \beta_2, \dots, \beta_n$ = the coefficients of the explanatory variables.

Bhagavathula et al. (2015) argue that if only the nighttime crashes are used as a dependent measure, then the model discounts the number of day crashes and will result in either overestimation or underestimation of the other explanatory variables. Therefore, they propose using the number of day crashes (DC) as an offset variable in the model

since it won't change the underlying distribution. The functional form of the modified model is shown in Equation 17:

$$\ln Y_i = \beta_0 + \beta_1 X_1 + \beta_2 X_2 + \dots + \beta_n X_n + \ln(DC_i) \dots \dots \dots (17)$$

The variance of observed crashes λ at intersection i , can be estimated from Equation 18 (Donnell et al. 2010):

$$Var(\lambda_i) = E(\lambda_i)[1 + \alpha E(\lambda_i)] \dots \dots \dots (18)$$

where

α = over-dispersion parameter from the model

$E(\lambda_i)$ = expected crash frequency at intersection i .

The percent change in the number of night crashes for a one-unit increase in a continuous independent variable or when a categorical independent variable changes from one level to the next is expressed as the risk ratio (RR) and it can be estimated from Equation 19 (Bhagavathula et al. 2015):

$$RR = \exp(\beta_n) - 1 \dots \dots \dots (19)$$

If $RR < 1$, then the expected number of nighttime crashes decreases if the independent variable is increased by one-unit while other independent variables are held constant. If $RR > 1$, the effect of increasing the independent variable while holding other independent variables is to increase the expected number of nighttime crashes.

According to Donnell et al. (2010) if the crash database is structured such that there is only one row per intersection (i.e., individual intersection crash counts are summed over the entire analysis period), temporal correlation among crash counts will not be an issue. Conversely, if the crash database is structured as a panel (i.e., individual intersection counts for each year in the analysis period are entered as rows) then temporal correlation may be an issue. This temporal correlation will likely result in underestimating the standard errors of the model parameters (Green 2003). Therefore, they propose that panel structured data can be analyzed with the random effects negative binomial regression model (RENB) (Chin and Quddus 2003; Shankar et al. 1998), the generalized estimating equation (GEE) (Lord and Persaud 2000; Wang et al. 2006), or the negative multinomial (NM) (Ulfarsson and Shankar 2003) regression model.

The NB, RENB, and NM were compared by Ulfarsson and Shankar (2003) and the authors found that the NB outperformed the RENB while the NM outperformed the NB. The main differences between these two top models are that (a) standard errors were generally underestimated in the NB model and (b) the error term in the NM is section-specific rather than observation specific.

The negative binomial regression model is usually applied in cross-sectional studies to work around the limitations of the empirical Bayes method. However, applying the negative binomial in a cross-sectional study has its own strengths and limitations which have been summarized by Donnell (2015) and presented in Table 2 below.

Table 2. Merits and Demerits of Negative Binomial Regression Models

| Strength | Limitation |
|---|---|
| <ul style="list-style-type: none"> • Large number of sites with and without lighting can be identified • No time-sequence necessary | <ul style="list-style-type: none"> • No “change” to sites so causal effect is not possible to establish • Omitted variable bias possible • Possible site selection bias issues |

Quantity and Quality of Roadway Illumination

Four different studies (Cobb et al. 1979; Green and Hargroves 1979; Hargroves and Scott 1979; Scott 1980) that evaluated the relationship between illumination parameters (illuminance, luminance, uniformity, and glare) on crashes all concluded that luminance was statistically related to night/day crash frequency ratio. One of these four studies (Scott 1980) further estimated that within the luminance range of 0.5 – 2.0 cd/m², an increase in average surface luminance of 1.0 cd/m² results in a 35 percent reduction in nighttime crash frequency ratio. Similarly, in a review of 62 studies (International Commission on Illumination 1992) from 15 nations the CIE noted that crashes might increase as uniformity of lighting increases beyond a certain level due to reduction in contrast between an object and its surrounding visual environment.

Next, Oya et al. (2002) also evaluated illuminance at 18 trunk road intersections, each with at least 10000 AADT using one year of before data and 4 years of after data. Illuminance data were calculated for each intersection and the results show that illuminance levels of 30 lux or more can positively help to reduce nighttime crashes. This was found to be significant at the one percent level. Also, the study found that illuminance levels between 20 to 30 lux can reduce nighttime crashes even though the

study could not find any statistical significance for this category of lighting level. Next, a Japanese study (Minoshima et al. 2006) found that an illuminance of 10 lux or more is needed for drivers to have good visibility of pedestrians at an intersection and an illuminance uniformity ratio of 0.4 will make an intersection safer.

Medina et al. (2013) measured illuminance from three different sets of LEDs and one set of HPS luminaires and compared the measured values to estimates derived from computer analysis with AGi32[®] lighting software. The measurements were done on dry days and under skies with no full moon and the results show both close agreement and significant differences between measured values and software estimates. The authors attribute this to luminaire specific differences, underscoring the need to perform periodic audits to verify if in-situ lighting levels meet the design specifications.

Performing street lighting audits with hand-held meters over large sections of the roadway system can pose both a data collection and safety challenge for the data collection personnel. Efforts to overcome this challenge have resulted in the development of automatic mobile reading systems and the use of photographic methods that enable quicker data collection from either intersections or road segments. Zhou et al. (2009) developed a new measurement system for collecting illuminance data for Florida DOT. The system collects data every 17.5 feet from a vehicle moving at 30 mph through a computer linked to a lighting meter and a distance measuring instrument. An inverse square method is used to transform measurements made at the top of the moving vehicle to the equivalent measurements at six inches above the pavement and a Wilcoxon test

was used to compare the measurements. The results showed that the median differences between the two is not significantly different from zero.

Niaki et al. (2014) developed a method for performing illumination audits for intersections using light sensors attached to a handle and a data logger for recording both illumination and position via GPS coordinates. The method simplifies the time-consuming spot measurements of illuminance required at intersections by the existing measurement protocols. Measurement can be made by walking across the exit/entrance line of each intersection leg and then averaging to obtain the mean intersection illuminance. The results from a case study of 85 intersections in Montreal indicate that about 59 percent had sub-standard lighting level. Although this method can simplify the measurements compared to existing protocols, it increases the safety risk for both personnel and equipment since they must be in the active travel lane to collect data. Also, measurements with this method may lack luminance constancy since onsite voltage can fluctuate before all the intersections are walked across.

Jackett and Frith (2013) studied the relationship between road lighting levels and safety using 5 years of crash data and road lighting measurements from mid-block road sections in New Zealand. The lighting levels were obtained by the photographic method and 6th order polynomials were calibrated for pixel to luminance conversions at specific settings of camera exposure. The study included 152 mid-block road sections and the results showed that the most important performance measure in predicting expected crashes on road sections is average luminance and also uniformity is insignificant to predicting expected crashes on road sections. The authors note that a similar result was established

in an earlier study. Next the authors tried to apply the lighting data to intersections, but the results were not very strong compared to road sections. It should be noted that the photographic method the authors used in this study is fundamentally different from the photographic method (Gbologah 2015; Gbologah et al. 2016) used in this study. First, their pixel-to-luminance conversion approach was not linked to the camera's own calibration constant and therefore it is only applicable to the specific exposure conditions (Shutter Speed, F-Number, and ISO Sensitivity) used in the calibration. However, the approach used in this study is linked to the camera's calibration constant; therefore, it is applicable for all exposure conditions as long as the same camera is used. This is very important because light conditions can vary greatly in the field and the exposure conditions may need to be modified to get the best measurement. Second, applying the method to roundabouts requires a different approach because roundabouts, unlike conventional intersections, have a visual obstruction at the center making it impossible to see the entire travel path in one view.

Bhagavathula et al. (2015) investigated the effect of lighting quality and quantity on the night/day (ND) crash frequency ratios at rural intersections using negative binomial regression to model illuminance, luminance, and crash data from 99 lighted and unlighted intersections. The results indicate that a one lux increase in the average horizontal illuminance at all rural intersections corresponded to a seven percent reduction in the ND crash ratio. Also, for the lighted intersections, a one lux increase in average horizontal illuminance corresponded to a nine percent decrease in the ND crash ratio while for unlighted intersections a one lux increase in average horizontal illuminance corresponded to a 21 percent reduction in the ND crash ratio. The findings also showed that stop-

control intersections experience smaller ND crash ratios than signalized intersections while intersections with posted speed limit less than or equal to 40 mph also experienced lower ND crash ratios than those with posted speed limit greater than 40 mph.

In another study by Gibbons et al. (2015) the authors investigated the relationship between lighting level and crashes on roadways. Crash data were obtained from select states and the Highway Safety Information System while lighting measurements were collected in-situ with a mobile road lighting measurement system. The results showed that there was no benefit to illumination beyond a certain level on an urban interstate, which in the case of the study this level was about 5 lux. Therefore, the authors concluded that there is a potential to reduce lighting requirements on highways and freeways by as much as 50% while maintaining traffic safety. Also, the results indicate that the relationship between lighting level and safety was not as strong as that of lighting presence (lit or unlit) and safety.

In the first study to use quantitative illumination level data to evaluate a potential crash modification factor for roundabout illumination in the U.S., Gbologah (2015) used a negative binomial regression model to evaluate 39 roundabouts in Georgia. Utilizing crash data covering the years 2009 to 2014 his results showed that a 1 lux increase in average roundabout illumination will result in a 4.72 percent reduction in expected number of crashes.

In another GDOT sponsored study (Guin et al. 2016) of 43 rural intersections to evaluate the cost-effectiveness of illumination as a safety treatment at rural intersections in Georgia, researchers at the Georgia Institute of Technology showed that there is little or

no benefit to rural intersection illumination beyond a threshold of 12 lux. In addition, their results also showed that illuminance levels lower than the minimum recommended value of 8 lux could provide significant safety benefits.

REFLECTION OF LIGHT (LUMINANCE) FROM PAVEMENT SURFACE

Luminance measures reflected light from a surface and so it can be affected by the reflective properties of pavement materials. The same amount of incident illumination on different road pavements can show different luminance levels.

Nature of Pavement Surface

The reflection property of pavement surfaces is influenced by pavement material and surface wear (Gibbons 1997). A pavement is usually a mixture of aggregates and a binder material. The different sizes, shapes, and face angles of aggregates showing on a pavement surface, as well as surface wear on the pavement surface result in compound reflection. Also, it has been shown that a pavement that uses a concrete binder can have a reflectance of about 10 percent. On the other hand, a pavement that uses an asphalt binder can have a reflectance of about 5 percent and 15 percent respectively if dark color aggregates or light color aggregates are used (Gibbons 1997).

Pavement Reflectivity and Observational Angle

The reflection properties of pavement surfaces cause a compound (multiple) reflection of any incident light. Therefore, the brightness or intensity of the reflected light is dependent on the incidence angle and the observation angle of the eye. Consequently, available

luminance standards for street lighting design are tied to fixed observational angle. Both the CIE and IESNA luminance standards are based on an assumed 1° observational angle. The IESNA standard further assumes an observer eye level of 1.47 meters (4.82 feet) above the pavement and consequently an observer at a distance of 83.07 meters (272.54 feet). Also, the CIE standard assumes that the observer is at a distance of 60 meters (196.85 feet) from the first luminaire (Nicholas 1991).

Relationship between Luminance and Illuminance

Luminance (L) is a measure of the amount (quantity and quality) of light reflected off the pavement surface that is helpful for the driver to see the surface clearly. It is an indication of the brightness of the pavement surface. On the other hand, illuminance (E) is a measure of the amount of incident light (luminous flux) on the pavement surface. It is an indication of how well objects above the pavement surface can be seen. These two road illumination properties are related as shown in Equation 20 (Bassani and Mutani 2012);

$$L = q * E \cong \frac{\rho}{\pi} * E \dots \dots \dots (20)$$

L = the luminance in cd/m²

q = the luminance coefficient in cd/m²/lux

E = the illuminance in lux

ρ = the reflection coefficient.

The luminance coefficient varies across different points of the pavement surface (Fotios et al. 2005) because it depends on the pavement material, observer position, and the luminaire position relative to the point of interest. Casol et al. (2008) have shown that for the purposes of simplifying road lighting analysis a road surface can be assumed to be perfectly diffused with a reflection coefficient equal to πQ_0 . Many values of this modified reflection coefficient have been indicated in published studies; Uncu and Kayaku (2010) found an average value of 0.13 for asphalt roads while Fotios et al. (2005) also found an average value of 0.16 and 0.27 for asphalt and concrete road surface's respectively. Most current practitioners favor a lower asphalt value of 0.08.

SAFETY ANALYSIS

Identifying Intersection Related Crashes

The selection of intersection related crashes for analysis requires a systematic way to determine an intersection's safety influence area. The length of this influence area depends on the geometry, traffic control, and operating features (Abdel-Aty et al. 2009; North Carolina Department of Transportation 1999). Some states use a distance of 250 feet from the center of the intersection as the influence area (Abdel-Aty et al. 2009). Others also determine this area by considering the effect of left turning lanes (Abdel-Aty et al. 2009). Crashes that occur within the safety influence area but outside the physical limits of the intersection are often called "intersection related". Table 3 shows the distances used by different states.

In terms of previous studies there have been a lot of inconsistencies in the length of the safety influence area. Lyon et al. (2005) used a distance of 65.6ft from the center of the intersection to identify intersection related crashes for their study in Toronto. A distance of 150ft has also been used by Persaud et al. (2005) to identify rear-end collisions related to intersections. Next, Hardwood et al. (2003), Mitra et al. (2007), Donnell et al. (2010) all used a safety influence distance of 250ft to identify intersection related crashes. Cottrell and Mu (2005) also identified intersection related crashes in Utah based on stopping sight distance. Initially they applied a distance of 500ft for an average approach speed of 40 mph. However, they realized that a 100ft distance was applicable to most of their intersections and only two intersections needed the 500ft distance as influence area. Another study (Joksch and Kostyniuk 1998) of intersections from three different states applied varying influence area distances up to 350ft. Gbologah et al. (2015) also used a distance of 325 feet for from the center of the central island to identifying the intersection related crashes for roundabouts.

Abdel-Aty et al. (2009) argue that the main challenge in determining intersection related crashes is deciding the safety influence area upstream of the approach. Therefore, they undertook a study to investigate how the size of the intersection, left-turn lane length, through and left turning traffic volumes, skewness, and other intersection features affect the safety influence area upstream of approach. The study analyzed crash data from 177 regular four-legged intersections in Florida from 2000 to 2005. The results show that the approach upstream safety influence area is influenced by the through volume, approach speed, number of right lanes, and left-turn protection. The authors concluded that since

the approaches to an intersection can have varied attributes, it may be better to define the safety influence area of each approach separately.

Table 3. Default Distances Used by States to Identify Intersection Safety Area

| State | Length of Intersection Influence area from center of Intersection |
|---|--|
| Alaska | 200 feet |
| California | 250 feet |
| Colorado | 264 feet upstream of approach |
| Connecticut | 50 feet from stop bar |
| Delaware | 528 feet |
| Florida ^a | At Intersection: less than 50 feet Intersection related: 50 to 250 feet |
| Hawaii ^b | 75 feet, more if crash occurred in left turn lane |
| Iowa | Urban: 75 feet Rural: 150 feet Expressways: 300 feet High speed road: up to 1320 feet |
| Kansas | 150 feet, more if intersection is large |
| Maryland | 250 feet |
| Mississippi | 500 feet of upstream only |
| Missouri | 132 feet |
| Utah | 138 feet, more if intersection is large |
| Vermont | Determined by stopping sight distance, i.e., 275 feet for 40 mph |
| Virgin Islands | 100 feet |
| Note: ^a Crash reports show that police officers usually measure from stop bar and not center of intersection | |
| ^b Not stated in report if distance is from the center or edge | |

(Source: Abdel-Aty et al. 2009)

Sources of Bias in Crash Data Analysis

The following section highlights the various sources of bias that can affect the quality of crash data. These are very important issues that must be identified and corrected or considered when inferences from crash analysis are drawn.

Data Quality and Accuracy

The main source of crash data is the accident reports filed by police personnel on standardized forms (AASHTO 2010). For most property damage only (PDO) crashes the data comes from information provided by self-reporting citizens. Sources of error in the data may be due to typographic mistakes, terms used to describe a location, and subjectivity issues such as estimating property damage or excessive speed.

Crash Reporting Thresholds

Sometimes not all crashes are reported. This may be due to the minimum dollar value threshold used by states. Often states have to change this threshold to compensate for the effect of inflation. Such changes can make it impossible to make comparisons between different years. Also, a change in the minimum threshold is usually followed by a drop in the number of reported crashes. It is important to ensure that there was no change in the minimum threshold during the study period otherwise the drop could be misconstrued as an improvement in safety (AASHTO 2010).

Crash Frequency-Severity Indeterminacy

It has been found that crashes with higher severity are reported more reliably to police than crashes with lower severity. This often leads to a situation where it is difficult to

determine if a change in number of reported crashes is caused by an actual change in crashes, a shift in severity proportions, or a mix of the two (AASHTO 2010).

Different Crash Reporting Criteria for Jurisdictions

Different jurisdictions can have different requirements for reporting and recording crashes. This makes it difficult to develop statistical models to compare facilities from different jurisdictions. For example, differences in definition of crash severity terms and the use of AADT as opposed to ADT to indicate annual traffic volume can lead to inconsistencies in reported crash data across different jurisdictions (AASHTO 2010).

Natural Variability in Crash Frequency

Crashes are by nature random events. Therefore, expected crash frequency estimates based on analysis over a short-term can be significantly different from estimates based on long-term data. Short-term data may represent a typically high, medium, or low crash frequency and this fact may be difficult to determine (AASHTO 2010).

Regression to the Mean

Due to the natural variation in crash frequency, it is at times difficult to know if observed changes in crash frequencies are due to changes in site conditions or are due to natural fluctuations. Hauer (Hauer 1996) explains that it is statistically probable for a comparatively high observed frequency to be followed by a comparatively low frequency and vice-versa. This is known as regressing to the mean (AASHTO 2010). This implies that it is possible for any observed short-term trends (increasing or decreasing) at a site to change direction and regress towards the average frequency without any improvement or

deterioration of safety. Therefore, safety analysis to evaluate the effectiveness of treatments must consider this phenomenon otherwise the results may overestimate or underestimate the benefits.

Variation in Roadway Characteristics and Environment

A roadway or an intersection's characteristics change overtime. Changes in characteristics such as weather, traffic volume, and road alignment can make it difficult to attribute changes in expected crash frequencies to specific safety measures (AASHTO 2010). This problem is particularly important when long-term data is used in an effort to avoid the biases introduced by regression to the mean and natural variability in crash frequencies. It often limits the number of years of observed crash frequency data which can be included in a study (AASHTO 2010). Also, limitations due to roadway or intersection characteristics and environment needs to be addressed in studies that adopt a "before" and "after" methodology because the effectiveness of treatment can be overestimated or underestimated (AASHTO 2010).

CHAPTER 3. DATA COLLECTION AND PREPARATION

One main objective of this project is to evaluate various potential factors, such as roadway characteristics, traffic activity, intersection illumination, etc., that might influence nighttime traffic safety at suburban and rural roundabouts in Georgia. In order to conduct these analyses, a variety of existing data sources need to be collected, verified and combined. Moreover, it is also necessary to conduct onsite field observations to measure the extent and levels of existing illumination conditions at selected roundabouts. This chapter presents a discussion as to how these data were acquired, quality assured, combined and prepared for subsequent analysis.

MINIMUM DATA REQUIREMENTS

A successful safety analysis on nighttime traffic at rural and suburban roundabouts requires simultaneous availability of several types of information: police crash reports, roadway and intersection characteristics over time, historical and current traffic activity data, as well as observations regarding illumination levels for the selected roundabouts. Additionally, the analysis also requires historical sunrise/sunset and other data that, when combined with information of time-of-crash from the police crash reports, can be used to distinguish nighttime crashes from daytime crashes.

The police crash reports must provide case-by-case information on crashes within the study period. At a minimum it must include information such as:

- Date of crash

- Crash or case ID
- Time of crash
- Location of crash (preferably including roadway and intersecting roadway name(s), latitude/longitude, and rural/suburban designation)
- Crash severity (fatal, serious, injury, possible injury, and property-damage only (PDO))

The roadway data must include information that allows identification of different homogenous segments (name, roadway functional class, number of lanes, width of lanes, posted speed limits, median type, presence of safety treatments like rumble strips and roadside barrier). It must also contain information that enables the classification between one-way and two-way segments for accurate computation of intersection entering volumes.

The intersection characteristics data must include information on type (distinguished by leg configuration, number of circulating lanes, and inscribed diameter of the roundabout), presence of purpose-built illumination and levels, central island and treatment, presence of pedestrian crossings, skew angles or angle between the legs, presence of roundabout ahead warning signs, etc.). Similar data were required for the conventional intersections that served as control sites in this study.

Next, there must be reliable traffic volume data on the average annual daily traffic (AADT) for every intersection leg for each year within the analysis period. Lastly, historical sunrise and

sunset data with adjustments for daylight savings are needed to distinguish nighttime crashes from daytime crashes.

SELECTION OF ROUNDABOUTS

The roundabout selection process started with an initial GDOT-supplied database of 274 modern roundabouts/circular intersections located within the State of Georgia. These data contained twelve attribute fields including route name, county, GDOT district, congressional district, project number, status (e.g., open or under construction), open to traffic date, roundabout type, number of legs, diameter, latitude, and longitude. For roundabouts that had a status designated as “under construction”, the project team used the latitude/longitude information to crosscheck the status of these roundabouts from Google Earth[®] and Google Streetview[®] and filtered out those that were confirmed as still “under construction”. This filtering left a total of 226 roundabouts that could be considered for field study. These data were cross-referenced with a list of 50 roundabouts that were analyzed as part of the previous GDOT project *RP 15-07 Safety Evaluation of Roundabouts in Georgia* (Gbologah et al. 2019). This cross-referencing task identified four additional roundabouts, thus increasing the number of candidate roundabouts to 230.

Next, Google Streetview[®] was used to assess the suitability of each roundabout as a candidate site. Each roundabout was assigned a subjective candidacy rating of “Suitable”, “Not Suitable”, or “Possible”. These subjective ratings were informed by previous experience gained by the research team on working with Georgia roundabouts. This rating process identified 115

“Suitable” sites, 39 “Possible” sites, and 79 “Not Suitable” candidates. Some of the factors considered in the subjective ratings include:

- If the roundabout was located on a private but accessible property such as residential subdivision or office complex. These locations are unlikely to carry significant nighttime traffic volumes.
- If the roundabout was located on a private and restricted property such as military facility. Gaining access to these locations for nighttime data collection could be difficult or not allowed.
- If the roundabout was located on a public roadway. These locations were considered most favorable and therefore preferred.
- If the roundabout was located on a public but off-road facility like a park. These locations are also unlikely to carry any significant nighttime traffic.
- If roundabout meets the definition of a modern roundabout (see Figure 2). This was necessary to limit potential impact of differing design standards
- If the roundabout is also signalized. The presence of any type of traffic signals would confound the analysis and make it difficult to separate the safety effect of the signals from that of the roundabout itself.

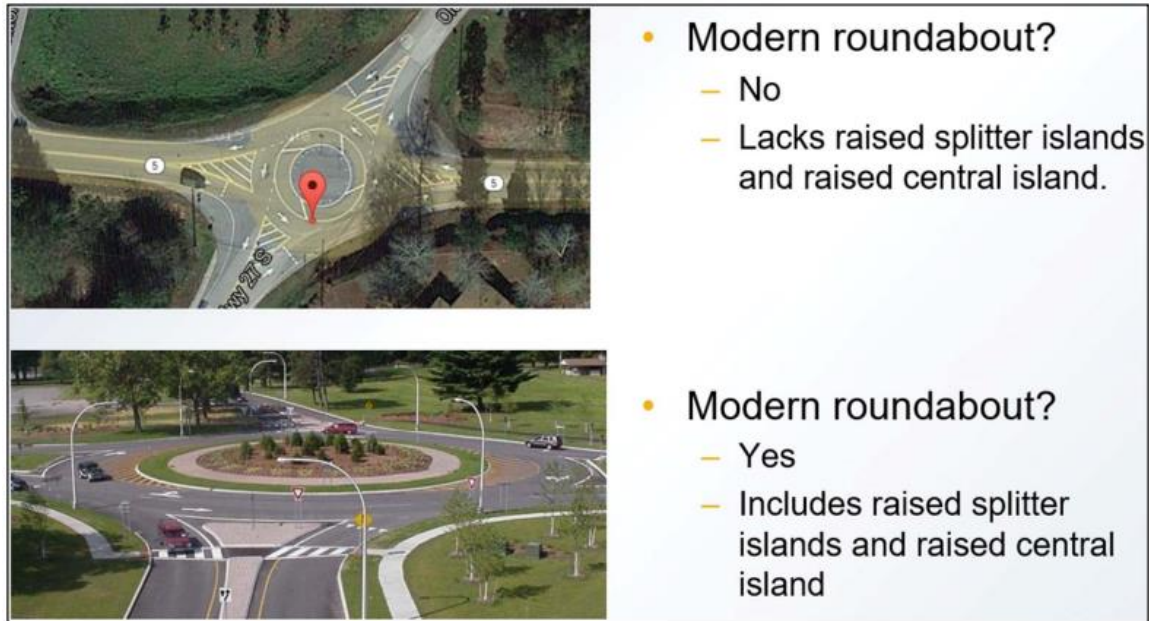

Figure 2. Image. Comparison of a Non-Modern Roundabout and a Modern Roundabout

The list of 230 roundabouts and their assigned candidacy ratings were submitted to GDOT staff for review. The final 80 roundabouts locations used in the study were selected from the group of 115 “Yes” candidates through a quasi-random process that sought to maintain the original spatial distribution. In addition, the construction year for each roundabout in the final set was verified by cross checking with Google Earth® satellite images. All the selected roundabouts were constructed before 2019 in order to ensure at least one year of available crash data in the after-construction period. Furthermore, the year in which a roundabout was first seen on the satellite images (assumed to be the year it was opened to traffic) was omitted from the analysis as the opening date within the year could not be established for some roundabouts. Table 4, Table 5, and Table 6 identify the 80 roundabouts selected for field data collection. Figure 3 shows a map of the final roundabout locations. Additional characteristics of the selected roundabouts can be found in [Appendix B](#).

Table 4. List of Final Selected Roundabouts (Part I)

| Site ID | Route Name | Latitude | Longitude | Year Opened |
|----------------|--|-----------------|------------------|--------------------|
| GSU-1 | SR 144\Belfast River Rd | 31.880854 | -81.261863 | 2015 |
| GSU-10 | SR 17\SR 119 | 32.330322 | -81.392672 | 2018 |
| GSU-12 | Frederica Rd\Lawrence Rd | 31.216389 | -81.375556 | 2006 |
| GSU-13 | Demere Rd\Frederica Rd | 31.159444 | -81.388611 | 2008 |
| GSU-14 | Ben Fortson Pkwy\Beach View Dr. | 31.047575 | -81.412683 | 2012 |
| GSU-15 | N Main St\Memorial Drive | 31.85 | -81.595833 | 2009 |
| GSU-16 | Scott Nixon Memorial Dr\Pleasant Home Rd | 33.493636 | -82.099344 | 2009 |
| GSU-17 | 4th Ave NE\Rowland Dr NE | 31.185443 | -83.765177 | 2012 |
| GSU-18 | 1st St NE\Tifton Hwy\Sylvester Hwy | 31.199336 | -83.787731 | 2016 |
| GSU-19 | W Main St(SR 57)\SR 18 | 32.85998 | -83.347288 | 2015 |
| GSU-2 | Burkhalter Rd\Pretoria Rushing Rd | 32.409945 | -81.730814 | 2017 |
| GSU-20 | College St\Oglethorpe St | 32.833781 | -83.644825 | 2014 |
| GSU-21 | SR 87(US 23)\Bass Rd | 32.936629 | -83.717325 | 2017 |
| GSU-22 | Lower Thomaston Rd \Lamar Rd\SR 74 | 32.851558 | -83.784861 | 2014 |
| GSU-23 | SR 22 (US 80)\Holley Rd | 32.800642 | -83.802458 | 2015 |
| GSU-24 | SR 247 Conn @ John E. Sullivan Rd | 32.606584 | -83.757531 | 2015 |
| GSU-3 | West Gentilly Rd\O'Neal Dr. | 32.422592 | -81.775439 | 2007 |
| GSU-4 | Forest Dr\Old Register Rd | 32.423825 | -81.790167 | 2009 |
| GSU-5 | Flight Safety Rd\Robert Miller Rd | 32.135589 | -81.188603 | 2014 |
| GSU-6 | America Ave\Robert Miller Rd | 32.138975 | -81.190417 | 2014 |
| GSU-7 | SR 223\SR 47 | 33.481299 | -82.315662 | 2015 |
| GSU-8 | Ronald Reagan Dr\Williamsburg Way | 33.545278 | -82.129444 | 2009 |
| GSU-9 | Market View Pkwy\Riverwood Pkwy | 33.576111 | -82.190833 | 2009 |
| GT-13R | Dawson Forrest Rd\SR 9 | 34.354167 | -84.051667 | 2006 |
| GT-18R | W Sandtown Rd SW\Villa Rica Rd | 33.926944 | -84.637778 | 2008 |
| GT-1C | SR 155\Fairview Rd | 33.610931 | -84.164819 | 2013 |
| GT-1R | Newnan Rd\Education Dr | 33.565758 | -85.045097 | 2011 |

Table 5. List of Final Selected Roundabouts (Part II)

| Site ID | Route Name | Latitude | Longitude | Year Opened |
|---------|-----------------------------------|-----------|------------|-------------|
| GT-22R | Hernance Dr NE\Brookhaven Ave | 33.872889 | -84.334639 | 2009 |
| GT-23R | N Decatur Rd NE\Lullwater Rd | 33.7875 | -84.329167 | 2004 |
| GT-24R | N Decatur Rd NE\Oxford Rd NE | 33.788333 | -84.325833 | 2011 |
| GT-25R | Klondike Rd\Rockland Rd | 33.675972 | -84.114861 | 2009 |
| GT-29R | SR 166\SR 5 | 33.613611 | -84.836944 | 2007 |
| GT-30R | Douglass Rd\Leeward Walk Cir | 34.076389 | -84.206667 | 2011 |
| GT-35R | Grimes Bridge Rd\Norcross St | 34.026111 | -84.344444 | 2011 |
| GT-42R | Lower Fayetteville Rd\E Broad St | 33.368056 | -84.779167 | 2009 |
| GT-44R | Grady Ave\Beauregard Blvd | 33.440833 | -84.4575 | 2011 |
| GT-5001 | Allgood Rd NE\Fairground St NE | 33.966944 | -84.5376 | 2012 |
| GT-5002 | McClure Bridge Rd\Irvindale Rd | 34.006389 | -84.151111 | 2012 |
| GT-5005 | SR 74 @ US 341 | 32.879444 | -84.090278 | 2010 |
| GT-5006 | US 27 ALT\Chiple (SR 18) | 32.969268 | -84.711607 | 2015 |
| GT-5007 | SR 16\Hwy 85 Connector | 33.254592 | -84.489261 | 2015 |
| GT-5008 | SR 138\Hemphill Rd | 33.557028 | -84.170653 | 2017 |
| GT-5009 | SR 92\Hood Ave | 33.457008 | -84.455847 | 2016 |
| GT-5010 | Kathi Ave\Hood Ave | 33.455994 | -84.452161 | 2017 |
| GT-5011 | Blackmon\Wal-Mart Driveway | 32.551969 | -84.897636 | 2016 |
| GT-5012 | Warm Springs Rd\Blackmon Rd | 32.546944 | -84.890278 | 2011 |
| GT-5013 | Lakefront Dr\St Marys Rd | 32.440892 | -84.912511 | 2015 |
| GT-5015 | Carbondale Rd SW\US 41 | 34.655323 | -84.978622 | 2019 |
| GT-5016 | Stave Tate Hwy\Cove Rd | 34.427222 | -84.276111 | 2009 |
| GT-5017 | SR 372\SR 369 | 34.277396 | -84.298919 | 2018 |
| GT-5018 | Hopewell Rd\A C Smith Rd | 34.323761 | -84.0732 | 2012 |
| GT-5019 | Hopewell Rd\Hubbard Town Rd | 34.31344 | -84.080103 | 2017 |
| GT-5020 | Hopewell Rd\Francis Rd\Cogburn Rd | 34.137767 | -84.284486 | 2015 |
| GT-5021 | Sardis Rd\Ledan Ext | 34.35606 | -83.892925 | 2017 |

Table 6. List of Final Selected Roundabouts (Part III)

| Site ID | Route Name | Latitude | Longitude | Year Opened |
|----------------|---------------------------------------|-----------------|------------------|--------------------|
| GT-5022 | SR 98\US 29 | 34.130082 | -83.217327 | 2019 |
| GT-5023 | Tallassee Rd\Whitehead Rd | 33.96871 | -83.43798 | 2015 |
| GT-5024 | SR 20\East Lake Rd | 33.501502 | -84.078567 | 2016 |
| GT-5025 | Colvin Dr\N Unity Cove Rd | 33.367548 | -84.081387 | 2009 |
| GT-5026 | Turner Lake Rd\Clark St | 33.59929 | -83.875961 | 2011 |
| GT-5027 | Main St (US 27 Alt) \HWY 5 | 33.491436 | -84.912297 | 2000 |
| GT-5028 | SR 14\Hal Jones Rd | 33.420027 | -84.772761 | 2018 |
| GT-5029 | SR 14\Green Top Rd | 33.421253 | -84.770944 | 2018 |
| GT-5030 | Travis Street\O'Kelly St SE | 33.664306 | -84.019722 | 2002 |
| GT-5031 | Oakland Ave SE \ O'Kelly St SE | 33.663701 | -84.018124 | 2018 |
| GT-5033 | Lees Mill Rd\Veterans Pkwy | 33.508785 | -84.50646 | 2013 |
| GT-5034 | SR 154\Cedar Grove Rd | 33.619094 | -84.671383 | 2014 |
| GT-5035 | County Line Rd NW\Burnt Hickory Rd NW | 33.998333 | -84.729167 | 2012 |
| GT-5036 | John Ward Rd SW\Cheatham Hill Rd | 33.93735 | -84.606286 | 2015 |
| GT-5037 | S Bethany Rd\Old Jackson Rd | 33.419717 | -84.090656 | 2018 |
| GT-5038 | Sandy Creek Rd\Veterans Pkwy | 33.4725 | -84.509283 | 2019 |
| GT-5039 | M.L.K. Jr. Dr\E Newnan Rd | 33.36307 | -84.779556 | 2016 |
| GT-5040 | SR 166\SR 154 | 33.6603998 | -84.6751292 | 2019 |
| GT-5041 | John Ward Road\Irwin Road | 33.919675 | -84.620157 | 2018 |
| GT-5043 | SR 140\Hembree Rd | 34.061239 | -84.346145 | 2017 |
| GT-5044 | Shelby Lane\Marketplace Blvd | 33.6569237 | -84.5015345 | 2018 |
| GT-5045 | Skip Spann Connector\Busbee Dr NW | 34.036723 | -84.574801 | 2017 |
| GT-5046 | Crabapple Rd\Heritage Walk | 34.088813 | -84.344484 | 2019 |
| GT-5047 | SR372\New Providence Rd | 34.119562 | -84.342421 | 2015 |
| GT-5048 | Holly Springs\Davis Rd | 34.026693 | -84.468304 | 2013 |
| GT-9R | Chatillon Rd\J.L. Todd Dr | 34.281111 | -85.165556 | 2009 |
| | | | | |

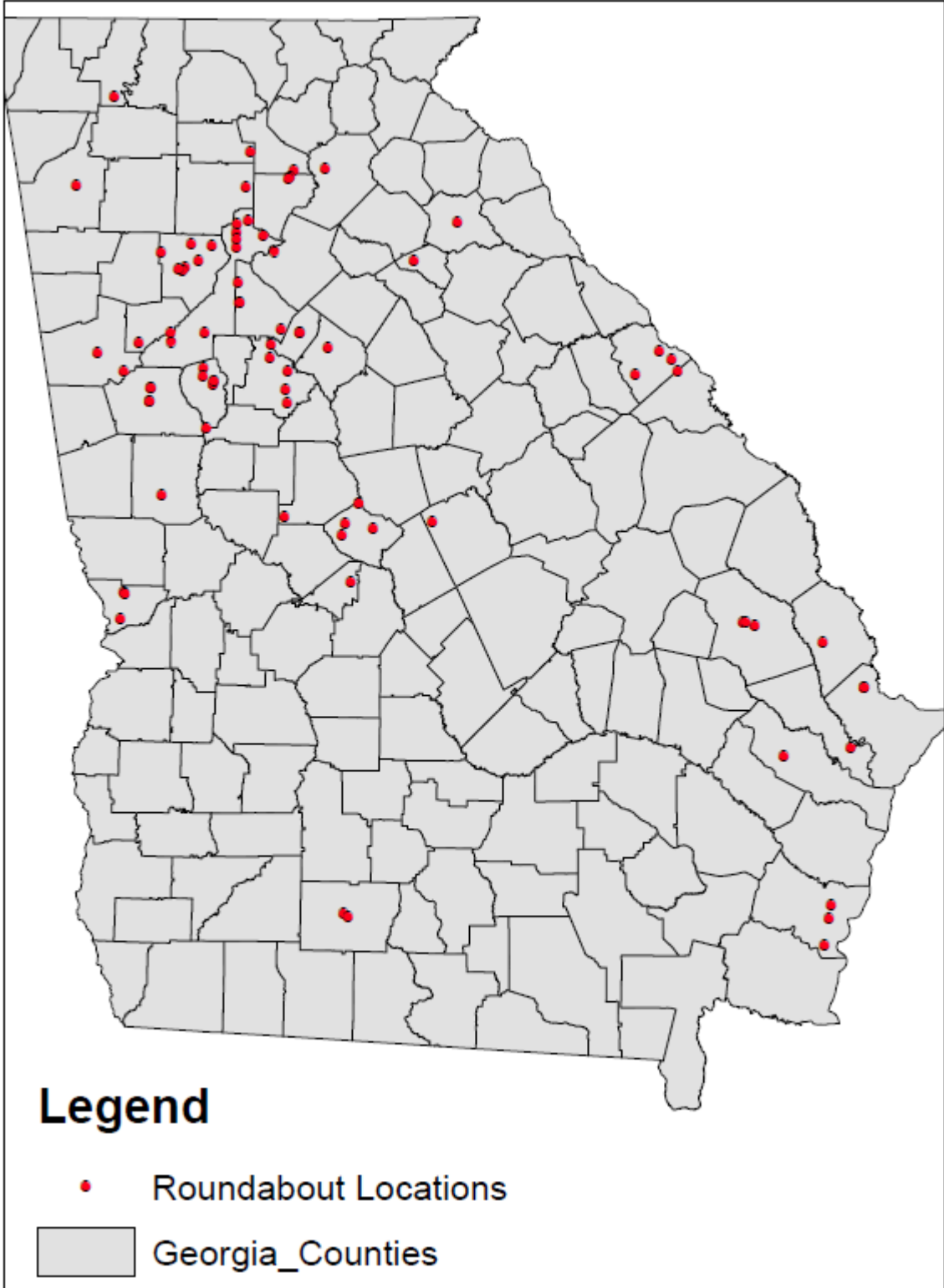

Figure 3. Map. Roundabout Locations

SELECTION OF CONTROL SITES

The study initially selected twenty-five controls sites to help estimate factors to correct the background secular trend that is inherent in crash data. The control sites were selected from available conventional intersections in the proximity of the study roundabouts. The search and identification of control sites was performed using Google[®] Maps. The criteria used in the selection of the control sites include:

- Intersections that had only one type of traffic control within the analysis period. These intersections were either stop-controlled, uncontrolled, or signalized intersections within the entire study period.
- Intersections with daily entering volumes (DEV) falling within the observed range of DEVs for the selected roundabouts.
- Intersections with the crossroad functional class that is representative of the functional class observed at the roundabouts within the same county.
- Intersections with similar geometry and lane configuration as the target nearby roundabout.
- Intersections with similar land use areas around them.
- Where there a multiple potential control sites in a county where roundabouts are studied, the study selected the site with the best available AADT information.
- Intersections are located on the same principal route that goes through the roundabout.

The 80 study roundabouts are located in 37 counties in Georgia and thus the control sites were not necessarily located in each county with a study roundabout. Table 7 shows the control sites and their locations while Figure 4 shows a map of both control site locations and roundabout

locations. Table 8 shows the count of roundabout locations and initial control locations by counties.

Table 7. List of Initial Control Sites

| Site ID | Route Name | Latitude | Longitude |
|----------------|---|-----------------|------------------|
| GT-5043-CS | Hembree Rd/Crabapple Rd | 34.061333 | -84.361014 |
| GT-5020-CS | Bethany Bend \Cogburn Rd | 34.119451 | -84.276630 |
| GT-5024-CS | Airline Rd\Conyers Rd (GA 20) | 33.478548 | -84.099424 |
| GT-5008-CS | Flat Rock Rd\GA 138 | 33.545783 | -84.186563 |
| GSU-20-CS | Forsyth St\College St | 32.836237 | -83.640424 |
| GT-25R-CS | Mall Pkwy\Klondike Rd | 33.698564 | -84.108393 |
| GT-42R-CS | E Broad St\Farmer St\Pinson St | 33.373692 | -84.791092 |
| GSU-13-CS | Sea Island Rd \ Frederica Rd | 31.183690 | -81.377211 |
| GSU-7-CS | Wrightsboro rd (GA 223) \ Lousiville Rd | 33.474318 | -82.262713 |
| GSU-18-CS | Old Doerun\GA 111\ W Bypass | 31.196040 | -83.796915 |
| GT-29R-CS | GA 166\Post Rd\Winston Rd | 33.624032 | -84.860307 |
| GT-5040-CS | GA\154\GA 70\ GA 92 | 33.650349 | -84.669787 |
| GT-5019-CS | SR9\Whitmire Dr\Red Rider Rd | 34.345657 | -84.059411 |
| GT-5027-CS | Newnan Bypass Rd\US 27 ALT\GA 34 | 33.395233 | -84.826182 |
| GT-5007-CS | GA 85\GA 16 | 33.293252 | -84.544597 |
| GT-5021-CS | Sardis Rd\Allison Rd\Antioch Rd | 34.343802 | -83.891059 |
| GT-5023-CS | Tallassee Rd\Vaughn Rd | 33.969928 | -83.446625 |
| GSU-10-CS | Hwy 21\Hwy 119\Madison St | 32.366292 | -81.318767 |
| GT-13R-CS | SR 9 E \ Hwy 53 | 34.367461 | -84.040792 |
| GT-5005-CS | Hwy 74\ Hwy 42 | 32.875759 | -83.995002 |
| GSU-15-CS | GA 38C \ N Main St | 31.855825 | -81.594240 |
| GT-5006-CS | Hwy 41\Hwy 194 | 32.894645 | -84.691951 |
| GSU-19-CS | Maddox\Hwy 540\Hwy 57 | 32.859350 | -83.379509 |
| GT-5026-CS | Clark Srt \ West St | 33.596864 | -83.867558 |
| GT-5017-CS | GA 20\GA 372 | 34.238494 | -84.288711 |

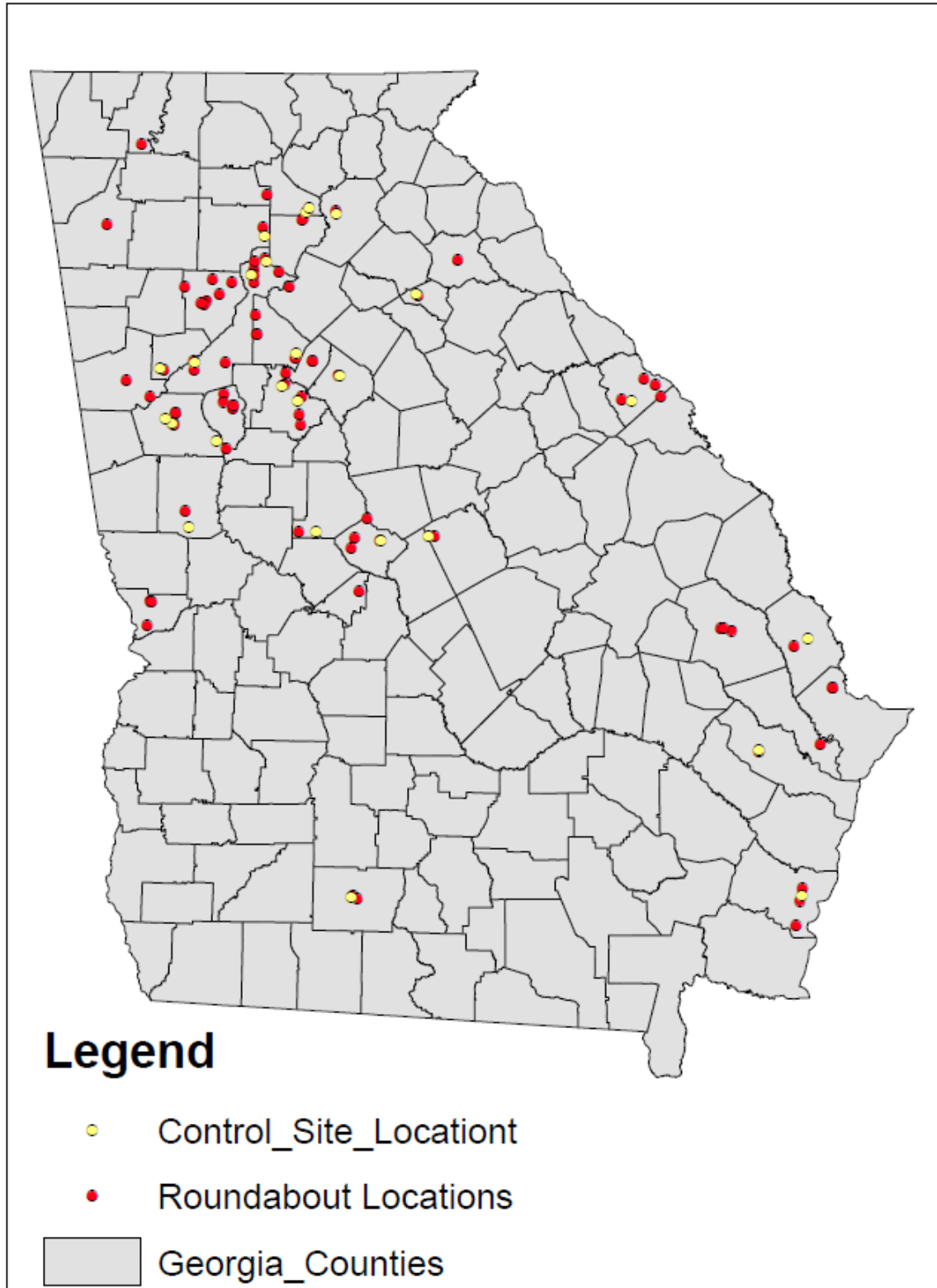

Figure 4. Map. Initial Control Sites and Roundabout Locations

Table 8. Distribution of Initial Control Sites by Counties

| County | Count of Roundabouts | Count of Control Sites |
|---------------|-----------------------------|-------------------------------|
| Fulton | 8 | 3 |
| Cobb | 7 | n/a |
| Fayette | 5 | n/a |
| Bibb | 4 | 1 |
| Coweta | 4 | 3 |
| DeKalb | 4 | 1 |
| Henry | 4 | 2 |
| Bulloch | 3 | n/a |
| Columbia | 3 | 1 |
| Glynn | 3 | 1 |
| Muscogee | 3 | n/a |
| Rockdale | 3 | n/a |
| Carroll | 2 | n/a |
| Chatham | 2 | n/a |
| Colquitt | 2 | 1 |
| Douglas | 2 | 1 |
| Forsyth | 2 | n/a |
| Bryan | 1 | n/a |
| Cherokee | 1 | 1 |
| Clarke | 1 | 1 |
| Dawson | 1 | 2 |
| Effingham | 1 | 1 |
| Floyd | 1 | n/a |
| Gwinnett | 1 | n/a |
| Hall | 1 | 1 |
| Liberty | 1 | 1 |
| Madison | 1 | n/a |
| Meriwether | 1 | 1 |
| Monroe | 1 | 1 |
| Newton | 1 | 1 |
| Peach | 1 | n/a |
| Pickens | 1 | n/a |
| Richmond | 1 | n/a |
| Spalding | 1 | n/a |
| Whitfield | 1 | n/a |
| Wilkinson | 1 | 1 |

CRASH DATA COLLECTION

The crash data of selected roundabout sites in this study were acquired from Numetrics®, a crash reporting portal of GDOT (<http://www.dot.ga.gov/DS/Crash>) and supplemented by additional information provided by GDOT Office of Traffic Operations staff. The web portal is publicly available and contains records of crashes occurred within the state of Georgia from 2013 to present year. There are 298 data selection filters offered by the portal that can be used to extract data based on users' needs. For this study, seven filters were deemed necessary for the crash data selection:

- Date and Time – This filter was set to start on January 1, 2013, and end on December 31, 2020.
- Area: County – This filter was set to the corresponding county name for each site
- Area: City – This was set to the corresponding city for each site.
- Intersecting Roadway – This filter was set to all the possible road names passing through the intersection.
- Roadway – This filter was set to all the possible road names passing through the intersection.
- Intersection Name (from Crash Report) – This filter was sometimes used as an alternative to the Intersecting Roadway and Roadway filters.
- Intersection Related – This filter was always set to “True”

During the data extraction process, the analysts were only able to obtain crash records for seventy-five of the eighty roundabout sites, the GDOT Office of Traffic Operations offered additional assistance in finding crash data for three sites and confirmed the unavailability of crash data for the other two sites. Therefore, eventually the researchers were able to gather crash data for seventy-eight of the eighty study sites, and the two locations for which no crash data were available are GSU 8 in Columbia County and GT 5025 in Henry County. The crash data for the seventy-five sites downloaded from the web portal by the research team include twenty-six attribute fields while the crash data for the additional three sites obtained via the assistance of GDOT Office of Traffic Operations staff included the same set of attribute fields. These twenty-six attributes and their explanations are shown in Table 9.

Table 9. List of Initial Crash Data Attribute Fields

| Attribute Name | Attribute Meaning |
|---------------------------------------|--|
| Date and Time | Date and time of the crash |
| Agency Name | Law enforcement department reporting the crash |
| Area: County | Name of county where crash occurred |
| Area: City | Name of city where crash occurred |
| Roadway | Name of road on which crash occurred |
| Intersection Name | Name of nearby intersection related to crash |
| KABCO Severity | Crash injury scaled used by law enforcement |
| Manner of Collision | Code for how collision happened |
| First Harmful Event | Indicates the first harmful event |
| SHSP Emphasis Areas | Risk factor(s) contributing to the crash based on strategic highway safety plan (SHSP) |
| # of Fatalities | Number of fatally injured people |
| # Serious Injuries | Number of seriously injured people |
| # Visible Injuries | Number of people with visible but non-serious injuries |
| # Complaint Injuries | Number of people with complaints of non-visible injuries |
| # of Vehicles | Number of vehicles involved in the crash |
| Operator / Driver Contributing Factor | Driver/operator risk factors that influenced crash |
| Roadway Contributing Factors | Roadway risk factors that influenced crash |

| | |
|---------------------------|---|
| Weather Conditions | Ambient weather conditions at the time of crash |
| Surface Condition | Road surface condition at the time of crash |
| Light Conditions | Light conditions at the time of crash |
| Latitude | Latitude of the crash location in WGS format |
| Longitude | Longitude of the crash location in WGS format |
| V1 Direction of Movement | The first vehicle's direction of movement at the time of crash |
| V2 Direction of Movement | The second vehicle's direction of movement at the time of crash |
| V1 Maneuver (Crash level) | The first vehicle's maneuver at the time of crash |
| V2 Maneuver (Crash level) | The second vehicle's maneuver at the time of crash |

Pre-Analysis Processing of Crash Data

The crash data for the seventy-eight sites were concatenated along the fields (columns) and processed into a format that can be used together with the other datasets (roadway and intersection inventory, illumination, and traffic) for analysis. The initial dataset of all observed crashes contained 2,795 records and were processed through Alteryx Designer® software. The key steps undertaken to process the dataset are described below.

Append Roundabout ID, Open Year, and Geocode

The first step of the crash data processing was to append the roundabout's *Sitecode*, *OpenYear* (*Open-to-traffic year*) and *Approach ID* information as well as the *Latitude* and *Longitude* of the center of the roundabout to each crash record. The *Sitecode* is a unique alpha-numeric number assigned to identify each roundabout so that collected data could be aggregated at the individual site level. In addition, as the approaches were labeled using alphabetical letters during the field data collection process, so for each roundabout, a corresponding Approach ID was assigned to each roundabout leg to allow data to be aggregated at the roundabout approach level for subsequent analysis as well. The *OpenYear* (*Open-to-traffic year*) information was used to

determine if the crash occurred prior to or after roundabout installation year, and each site's open-to-traffic year was set to be the first year the site is seen as a roundabout on Google® Earth satellite images. Figure 5 shows results of a typical Google® Earth analysis of satellite images to identify the *OpenYear* of a roundabout. This site is located in Saint Simons Island, GA, and because the roundabout is first seen in 2008 at this site, the *OpenYear* of this roundabout is determined to be 2008. Finally, the *Latitude* and *Longitude* of the roundabout center was used to calculate the direct distance between crash locations and the roundabout center to ascertain if the crash falls within the roundabout's safety influence area.



Figure 5. Map. Roundabout with Verified Construction Year of 2008 in Saint Simons Island, GA.

Consistent with prior GDOT studies, this study used a buffer distance of 325 feet to demarcate the safety influence area of the roundabout. All crashes falling outside of this zone were

discarded from the dataset. In total, 1,025 crash records were removed from the initial 2,795 records, resulting in 1,770 crash records remaining for subsequent analysis.

Treatment of Manner of Collision Information.

As discussed earlier, Table 9 These crash data include a *Manner of Collision* field that holds information describing how the crash occurred or the location of impact, and this information was used in classifying different crash types. Initially there were nine unique entries defined in this attribute field. These were regrouped into seven categories, as shown in Table 10. These recoded data were appended to the crash data as a new field named *Collision Type*.

Table 10. Original and Recoded Entries for Collision Manner Attribute

| Crash Data Collision Manner Entries | Recoded Collision Manner Entries |
|--|---|
| Right Angle Crash | Angle |
| Angle (Other) | Angle |
| Head On | Head-On |
| Left Angle Crash | Angle |
| Rear End | Rear End |
| Sideswipe-Same Direction | Sideswipe Same Direction |
| (None) | Null |
| Sideswipe-Opposite Direction | Sideswipe Opposite Direction |
| Not A Collision with Motor Vehicle | Non-Vehicle |

Treatment of Operator / Driver Contributing Factor

Similarly, the *Operator / Driver Contributing Factor* data in the original crash data were recoded for the analysis. This field contains eighty-one unique entries. The researchers recoded it into a new field called *Driver Contributing Factor* with fifteen unique entries. Due to the long list of the original unique entries and the text length of each of the entries, please refer to

Appendix C for side-by-side comparison of the original and recoded entries. Table 11 provides a list of the final fifteen variables used in the study.

Table 11. Recoded Entries for Driver/Operator Contributing Factors

| Recoded Driver Contributing Factors |
|--|
| Aggressive Driving |
| Distracted Driver |
| Failure to Yield |
| Following Too Close |
| Impaired Driver |
| Improper Lane Change |
| Improper Passing |
| Loss of Control |
| None |
| Over Speeding |
| Reckless Driving |
| Roadway Conditions |
| Vehicle Mechanical |
| Visibility |
| Wrong Way |

Treatment of Surface Condition

The *Surface Condition* attribute in the original data was recoded into a new field called *Not Dry Surface* as shown in Table 12. It is noted that only two out of the 1770 crash records were originally coded with a Surface Condition value of “Sand”.

Table 12. Original and Recoded Surface Condition Entries

| Unique Surface Condition Entries | Recoded Surface Condition Entries |
|---|--|
| Sand | Not Dry |
| Snow | Not Dry |
| Ice/Frost | Not Dry |
| Water (standing or moving) | Not Dry |
| Other | Not Dry |
| (None) | Not Dry |
| Dry | Dry |
| Wet | Not Dry |

Treatment of Date and Time

Since this study focuses on evaluating illumination impacts on roundabout nighttime safety, the obtained crash data were also separated into daytime and nighttime crashes. The original crash data provides date and time information as well as information on *Light Condition* at the time of crash. The possible values for *Light Condition* include Daylight, Dark-Not Lighted, Dusk, None, Dawn, and Dark-lighted. While these values could potentially be used to assign a daytime and nighttime period to each crash assuming it has been entered correctly and all police officers use the same definition for Dusk and Dawn. However, based on previous experiences of analyzing this attribute field, the research team chose to code light conditions based on the time of the crash relative to sunrise/sunset.

Therefore, the *Date and Time* information in the original crash data were exported together with their corresponding *Record ID* into a text file for subsequent analysis. A Python[®] script was used to analyze the crash *Date and Time* information along with the historical data on adjusted sunrise/sunset time in Georgia considering daylight savings time. The correction for daylight

savings time was necessary because the historical sunrise and sunset information is based on standard time. Next, the crash *Date and Time* was compared with the historical sunset/sunrise time to assign either nighttime or daytime attribute to each crash record, where nighttime was defined as the time period after the sunset and before the sunrise while daytime was defined as the opposite time period. These daytime/nighttime attribute values were then stored in a new variable named *Period* and exported by the Python[®] script to be merged with the crash dataset based on the *Record ID* information. This Python script used can be found in [Appendix D](#).

Before and After Filtering

Using the newly defined *CrashYear* attribute field, the study filtered out all crashes where:

- *CrashYear* value was less than or equal to the *OpenYear*. These are crashes that occurred at the location when the traffic control was not a roundabout. Also, this helps avoid using crashes that may have occurred during the construction period of the roundabout in the analysis.
- *CrashYear* is at least equal to 2013 but less than 2021. This was necessary because the study period starts in the year 2013 and ends in the year 2021.

These filters removed an additional 652 records, leaving 1,118 records in the crash dataset.

Daytime and Nighttime Filtering

Next, the study used the newly created *Period* field to separate the data into a nighttime set and daytime set. There were a total of 383 records (crashes) in the nighttime set and a total of 735 in the daytime set.

Identifying and Assigning Missing Zero Crashes

Based on the length of the study period and the *OpenYear* of the studied roundabouts, there could be 491 unique *Sitecode* and *CrashYear* combinations in total. However, an aggregated analysis of the previously created nighttime and daytime sets showed that there were only 186 and 252 *CrashYear* and *OpenYear* combinations respectively. It was found that the difference in the number of combinations was caused by unobserved zero crashes at certain locations for some of the years. Therefore, these “zero crash” records had to be manually inserted into both nighttime and daytime datasets for each site/year combination where zero crashes were observed.

Counting Crash Events

The original crash data contains fields that count crash severities at the person level but there are no corresponding fields for the crash severities at the crash level. For example, a record may indicate that a crash had 2 fatalities but there was no field to count that as a single crash event. The following crash severity person level counts that were included in the original data were transformed into crash events (crash level).

- Number of Fatalities
- Number of Serious Injuries
- Number of Visible Injuries
- Number Complaint Injuries

The following logic was used to count the crash level events. Crash level events were assigned based on the highest reported severity level. These crash level events were each appended to the crash data as new fields.

- Fatal Crash: If there was at least one fatality then the crash record is counted as a fatal crash event
- Serious Injury: If the number of fatalities is zero but the number of serious injuries is at least one then the crash record is counted as a serious injury crash event
- Visible Injury: If both the number of fatalities and number of serious crashes are zero but the number of visible injuries is at least one, then the crash record is counted as visible injury crash event
- Complaint Injury: If the number of fatalities, serious injuries and visible injuries are all zero, but the number of complaints is at least one then the crash record was counted as a complaint injury crash event.

Additionally, crashes with zero fatalities and injuries were classified as Property-Damage-Only (PDO) crash events. These crash level events were counted for both nighttime data and daytime data.

Roundabout Site Level and Approach Level Crash Data Aggregation

As this study aimed to conduct both site-level and approach-level analyses on the impacts of various factors on roundabout nighttime traffic safety, it was necessary to further classify the data at both the site- and approach-levels. For individual site level aggregation, the data can simply be assigned to each site according to the site code information that was previously attached to them during the filtering process; Assigning crashes at the approach level is more difficult, as assigning crashes that occur within the roundabout circle to an approach requires

additional information regarding the movement directions and maneuvers of the involved vehicle(s) when the crash occurred.

For each crash that occurred within the roundabout circular area, if the manner of collision indicates ‘Not A Collision with Motor Vehicle’, then it would be considered as a single-vehicle crash and its approach assignment would be decided based on the crash location, the direction of movement and the vehicle maneuver at the time of crash. For example, if the crash location suggests the crash happened within the roundabout circle between the northbound leg and eastbound leg, the direction of movement is ‘east’, and the vehicle maneuver is ‘Straight’, then this crash would be assigned to eastbound leg of that roundabout. And if the manner of collision indicates anything other than ‘Not A Collision with Motor Vehicle’, then this crash would be considered as a multi-vehicle crash. The approach assignment of this type of crashes would be determined based on crash locations as well as the direction of movement and vehicle maneuver of the first involved vehicle (V1), and the determination process is similar to the assignment process of single-vehicle crashes.

TRAFFIC DATA COLLECTION

The traffic data used in the study is based on average annual daily traffic (AADT) values published annually by GDOT as part of its roadway characteristics (RC-Link) Geographic Information System (GIS) files for the state highway network. These data were extracted using the location data for the roundabouts described earlier and were used to calculate average daily entering volume (DEV) estimates for each roundabout for each year. Any missing data year(s) data were imputed in two steps.

Extracting AADT Information for Intersection Legs

First the research team created an ArcGIS® project file and loaded all the annual GIS RC-Link files for the years 2010 to 2020 onto the map. Then the corresponding GIS layers were activated to obtain the AADT attributes for each link, and the roundabout locations were superimposed on the RC-Link layers to facilitate the visual identification of the road links associated with each roundabout.

For each roundabout site, the *Identify* tool in ArcGIS® was used to select each leg sequentially and to extract each link's AADT data within the period from 2010 to 2020 into a spreadsheet table for subsequent analysis. Although time-consuming, this visual identification process minimized the possibility of mis-identifying individual approaches, as the RC-Link data may change slightly from year-to-year. Since none of the study sites had an intersecting roadway that was a one-way route, the two-way AADT on each link were split evenly between the two opposing directions to obtain the one-way traffic volumes measured in each roundabout approach. This 50/50 split assumption was necessary because the actual split of traffic was not available in the RC-Link database files. And by using this method, the AADT information was extracted for each roundabout approach. It should be noted that because one site, GT-5009, could not be found in the annual GIS files, the AADT data could only be obtained for seventy-nine of the eighty sites. Figure 6 shows a selected roundabout leg with the 2010 AADT value highlighted in the Identify tool's window on the right.

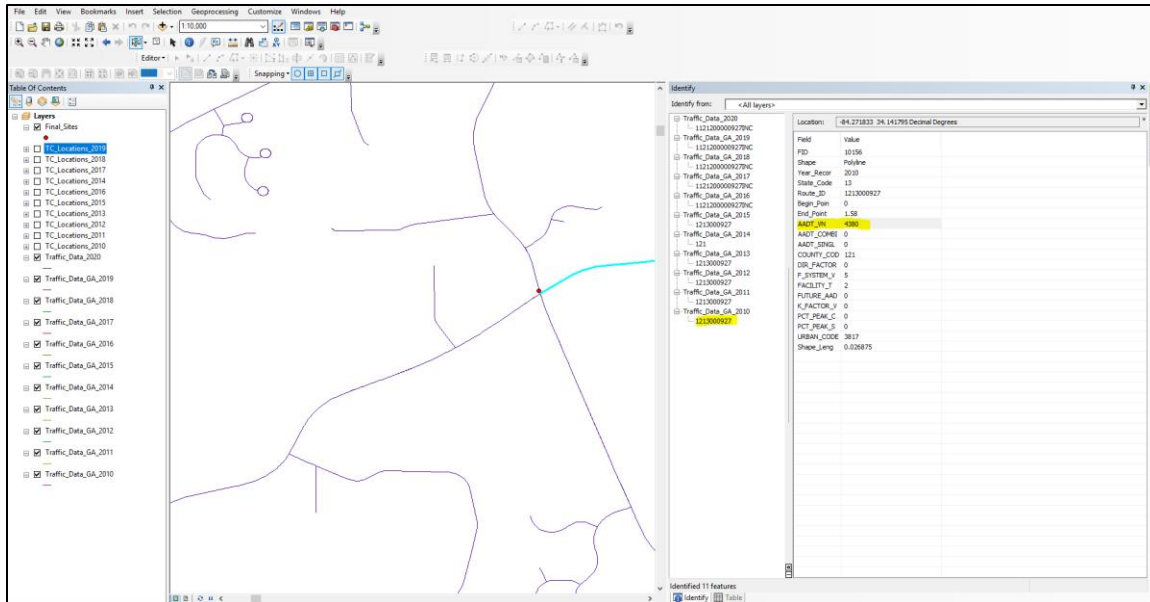

Figure 6. Image. A Selected Roundabout Leg with the Corresponding AADT Value for Year 2010 highlighted.

Treatment of Extracted AADT Information

The raw AADT values extracted from the GIS files had two main data quality issues. First, there were some instances of high outliers in the data for some roundabout legs. These outliers were identified by plotting the AADT values for each roundabout leg and visually identifying values that are significantly different from the long-term trend. Figure 7 illustrates this issue with an outlier value for year 2018. In these instances of outlier AADT values were replaced with the average of the prior and subsequent years as shown in Figure 8.

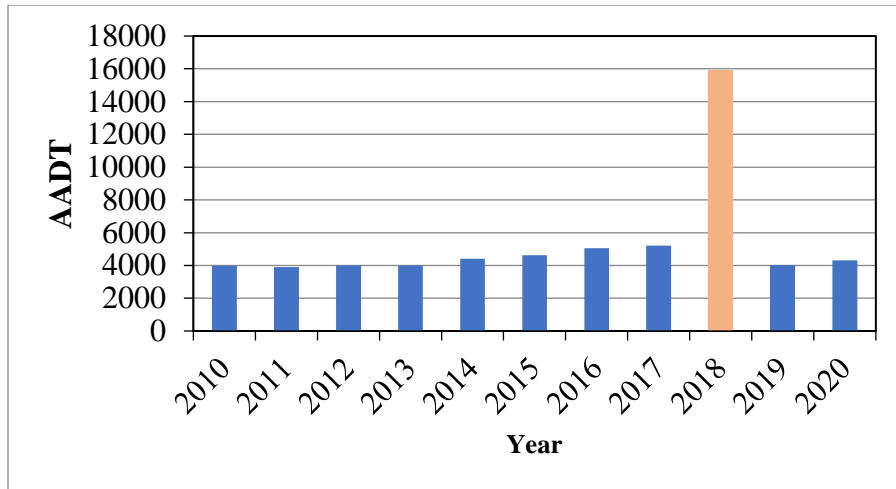

Figure 7. Chart. Extracted AADT Values for GT-5022 Roundabout Leg Showing an Outlier Value

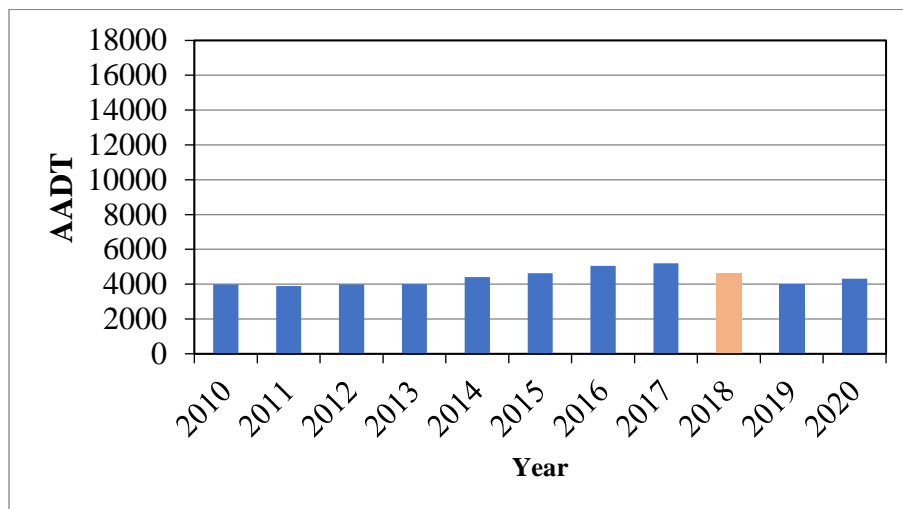

Figure 8. Chart. Extracted AADT Values for GT-5022 Roundabout Leg with Correction Made to Outlier Value

The second issue with the raw AADT values extracted is that there are instances of missing values for some roundabout legs. These missing values were imputed by applying an estimated annual growth rate in annual vehicle miles traveled (VMT) for Georgia over the study period. The imputation was done in a stepwise, year-to-year process for consecutive years with missing

data. Figure 9 shows the annual VMT in Georgia over the last decade. It can be seen that the difference in growth rate factor across the facility types within each year is fairly minor. Therefore, it is expected that these imputations will have a minimal impact on the analysis. The impact of using different rural and suburban growth rates was not evaluated but is also expected to be minimal. The annual VMT data used were downloaded from the Bureau of Transportation Statistics (BTS) data on state highway travel (BTS 2021). Using this approach, the research team created an AADT database for each roundabout location over an 11-year period.

| | Year | | | | | | | | | | |
|-----------------------|---------|---------|---------|---------|---------|---------|---------|---------|---------|---------|---------|
| | 2009 | 2010 | 2011 | 2012 | 2013 | 2014 | 2015 | 2016 | 2017 | 2018 | 2019 |
| Annual VMT (millions) | 109,258 | 111,722 | 108,454 | 107,488 | 109,355 | 111,535 | 118,107 | 122,802 | 124,733 | 131,456 | 133,128 |
| Growth Factor | n/a | 1.023 | 0.971 | 0.991 | 1.017 | 1.020 | 1.059 | 1.040 | 1.016 | 1.054 | 1.013 |

Figure 9. Table. Annual Vehicle Miles Traveled in Georgia

Computation of Intersection Daily Entering Volume

Based on the traffic volume data obtained at the roundabout approach level, the daily entering volume (DEV) for each individual site could be computed by summing all the corresponding approaches' AADT values. Then the estimated DEVs were multiplied by 365.25 to get the annual entering volumes of each roundabout. Since the study focuses more on nighttime traffic safety analysis, to estimate nighttime traffic data, the entering volumes were further split between nighttime and daytime assuming nighttime traffic takes up 24 percent of the daily total. While this assumption would affect absolute crash rate estimates, it has no impact on the relative changes of crash rates with any of the analyzed parameters.

INTERSECTION CHARACTERISTICS DATA COLLECTION

The initial intersection characteristics data for the selected roundabouts were obtained at roundabout approach level through a combination of desk study using Google Maps Streetview®; These were later supplemented by an onsite civil survey to inventory features that would have potential influences on nighttime safety. A civil survey manual that gives a detailed narrative of the entire survey process in the field can be found in [Appendix E](#). Figure 10 shows the data reporting form used in the civil survey. The survey was conducted on each connecting road up to about 400 feet upstream of the yield line. Two teams performed the survey: one from Georgia Tech and one from Georgia Southern University. The Georgia Tech team conducted fifty-seven surveys starting on 07/29/2021 and ending on 10/31/2021 while the Georgia Southern University team conducted twenty-three surveys starting on 08/13/2021 and ending on 09/25/2021.

| | | | | | | | |
|--|---|---|---|---|---|--------------------------|--------------------------|
| General | Date: | | | Comments | | | |
| | Time: | | | 1. Check mark for YES, X for No | | | |
| Intersection Info | Surveyor(s): | | | | | | |
| | Intersection ID: | | | | | | |
| | Name-Leg 1: | | | | | | |
| | Name-Leg 2: | | | | | | |
| | Name-Leg 3: | | | | | | |
| | Name-Leg 4: | | | | | | |
| | Latitude: | | | | | | |
| | Longitude: | | | | | | |
| | Type: | <input type="checkbox"/> 3-Leg Roundabout | <input type="checkbox"/> 4-Leg Roundabout | <input type="checkbox"/> 3-Leg Conv. Int. | <input type="checkbox"/> 4-Leg Conv. Int. | | |
| Approach Street Information | | Ref | Picture | Leg 1 | Leg 2 | Leg 3 | Leg 4 |
| Roundabout | Spinner Island | | 3 | Check | <input type="checkbox"/> | <input type="checkbox"/> | <input type="checkbox"/> |
| | Raised Spinner Island | | 3 | Check | <input type="checkbox"/> | <input type="checkbox"/> | <input type="checkbox"/> |
| | Raised Central Island | | 4 | Check | <input type="checkbox"/> | <input type="checkbox"/> | <input type="checkbox"/> |
| | Inscribed Diameter | | Feet | <input type="checkbox"/> | <input type="checkbox"/> | <input type="checkbox"/> | <input type="checkbox"/> |
| Conventional Intersection | # Thru Lanes at stop line | | # | | | | |
| | # Left-turn Lanes at stop line | | # | | | | |
| | # Thru Lanes @ 400 ft Upstream | | # | | | | |
| | # Left-turn Lanes @ 400 ft Upstream | | # | | | | |
| | Lane Width | | Feet | | | | |
| | Posted Speed Limit on Approach | 9 | MPH | | | | |
| | Intersection Ahead Warning Sign | 9 | Check | <input type="checkbox"/> | <input type="checkbox"/> | <input type="checkbox"/> | <input type="checkbox"/> |
| | Dist. From Edge to Nearest Threat (Pole Post/Barrier) | | Feet | | | | |
| Presence of Horizontal Curve within 400 ft | | Check | <input type="checkbox"/> | <input type="checkbox"/> | <input type="checkbox"/> | <input type="checkbox"/> | |
| Shoulder Width (Average if present on both sides) | | Feet | | | | | |
| Safety Improvements? | Median Width | | Feet | | | | |
| | Raised Median | 1 | Check | <input type="checkbox"/> | <input type="checkbox"/> | <input type="checkbox"/> | <input type="checkbox"/> |
| | Median Barrier | 2 | Check | <input type="checkbox"/> | <input type="checkbox"/> | <input type="checkbox"/> | <input type="checkbox"/> |
| | Transverse Markings on Approach | 7 | Check | <input type="checkbox"/> | <input type="checkbox"/> | <input type="checkbox"/> | <input type="checkbox"/> |
| | Rumble Strips across Approach Lane | 8 | Check | <input type="checkbox"/> | <input type="checkbox"/> | <input type="checkbox"/> | <input type="checkbox"/> |
| | Rumble Strips on Median Line | 8 | Check | <input type="checkbox"/> | <input type="checkbox"/> | <input type="checkbox"/> | <input type="checkbox"/> |
| | Rumble Strips along Shoulder | 8 | Check | <input type="checkbox"/> | <input type="checkbox"/> | <input type="checkbox"/> | <input type="checkbox"/> |
| Roadside Safety Barrier | 10 | Check | <input type="checkbox"/> | <input type="checkbox"/> | <input type="checkbox"/> | <input type="checkbox"/> | |
| Pedestrian Safety | Marked Crosswalk | 5 | Check | <input type="checkbox"/> | <input type="checkbox"/> | <input type="checkbox"/> | <input type="checkbox"/> |
| | Raised Crosswalk | 5 | Check | <input type="checkbox"/> | <input type="checkbox"/> | <input type="checkbox"/> | <input type="checkbox"/> |
| | Refuge Island at Crosswalk | 6 | Check | <input type="checkbox"/> | <input type="checkbox"/> | <input type="checkbox"/> | <input type="checkbox"/> |
| | Sidewalk Width (Average if present on both sides) | | Feet | | | | |
| 1. Data Collection Boundary Extends 400ft from Intersection Entry/Exit Point | | | | | | | |
| 2. Data is Required in All Shaded Cells | | | | | | | |

Figure 10. Photo. Intersection Survey Data Reporting Form

Roundabout Site Level Aggregation of Inventory Data

Once the approach level characteristics data were obtained, the data were further aggregated to the individual site level to prepare for the site-level analysis. At the approach level, a total of thirty-six data types were collected through the inventory survey, including existence of right-turn bypass lanes, number of approach lanes, number of circulating lanes, state route designation, posted speeds, crosswalk types, median types, rumble strips, central island treatment, ambient

lighting, angle between legs of roundabout, stopping sight distance, horizontal curve (within 400 feet upstream), and roadway cross-section design (i.e. urban or rural pattern). Out of these collected 36 data attributes, 8 were directly applicable at the roundabout level, and these include route names, county, latitude, longitude, open year, roundabout type (i.e., single or multilane), number of legs, and size (inscribed diameter). Then for each of the remaining twenty-four attributes, the approach level data were converted into site level data by taking the maximum values observed on all legs of every roundabout site. Table 13 shows the final variables and the according definitions. For more detailed information, please refer to the accompanying inventory data spreadsheets for the data dictionary.

Table 13. Inventory Table Data Fields

| Variable | Definition |
|---|---|
| Site ID | Site ID |
| OpenYear | Roundabout open-to-traffic year |
| Roundabout Type | Single-lane roundabout or multi-lane roundabout |
| No. of Legs | Number of legs of roundabout |
| Size | Inscribed diameter |
| No. Approach Lanes | Maximum number of approach lanes at a roundabout |
| No. of Circulating Lanes | Maximum number of circulating lanes within a roundabout |
| StateRoute/Hwy | Assign 1 only if at least one leg is designated |
| StateRoute/Hwy - Recode | Assign "Yes" if at least one leg is designated |
| Posted Roundabout Advisory Speed Limit | Maximum posted roundabout advisory speed limit at a roundabout |
| Posted Roundabout Advisory Speed Limit - Recode | Assign maximum posted roundabout advisory speed limit values into bins of 5 from 10 to 45 |
| Approach Posted Speed Limit | Maximum posted speed limit on the upstream approaches of a roundabout |
| Approach Posted Speed Limit - Recode | Assign max approach posted speed limit values into bins of 10 from 25 to 55 |
| YieldSign | Assign 1 if all legs are 1. 1 is present and 0 is absent |
| YieldSign-Recode | Assign "Yes" if <i>YieldSign</i> value is 1 |
| Roundabout Ahead Sign | Assign 1 if all legs are 1. 1 is present and 0 is absent |
| RoundaboutAheadSign-Recode | Recoded <i>Roundabout Ahead Sign</i> as Yes/No. Yes is 1 |
| MarkedCrosswalk | Assign 1 if all legs are 1. 1 is present and 0 is absent |
| MarkedCrosswalk-Recode | Recoded <i>MarkedCrosswalk</i> as Yes/No. Yes is 1 |
| RefugeIslandCrosswalk | Assign 1 if all legs are 1. 1 is present and 0 is absent |

| | |
|---|--|
| RefugeIslandCrosswalk-Recode | Assign "Yes" if all legs are "Yes" |
| RaisedMedian | Assign 1 if all legs are 1 |
| RaisedMedian-Recode | Assign "Yes" if all legs are "Yes" |
| MedianBarrier | Assign 1 if all legs are 1 |
| MedianBarrier-Recode | Assign "Yes" if all legs are "Yes" |
| TransverseMarkingApproach | Assign 1 if at least one is 1 |
| TransverseMarkingApproach-Recode | Assign "Yes" if at least one leg is 1 |
| RumbleStrips_Centerline | Assign 1 if at least one is 1 |
| RumbleStrips_Centerline-Recode | Assign "Yes" if at least one leg is 1 |
| RumbleStrips_AcrossRoad | Assign 1 if at least one is 1 |
| RumbleStrips_AcrossRoad-Recode | Assign "Yes" if at least one leg is 1 |
| RumbleStrips_AlongEdge | Assign 1 if at least one is 1 |
| RumbleStrips_AlongRoad-Recode | Assign "Yes" if at least one leg is 1 |
| RoadsideSafetyBarrier | Assign 1 if at least one is 1 |
| RoadsideSafetyBarrier-Recode | Assign "Yes" if at least one leg is 1 |
| SplitterIsland | Assign 1 if all legs are 1 |
| SplitterIsland-Recode | Assign "Yes" if all legs are "Yes" |
| RaisedSplitterIsland | Assign 1 if all legs are 1 |
| RaisedSplitterIsland-Recode | Assign "Yes" if all legs are "Yes" |
| CenTreat - TruckApron w/ Color | Assign 1 if at least one is 1 |
| CenTreat-TruckApron w/ Color-Recode | Assign "Yes" if at least one leg is 1 |
| CenTreat-w/ Plants | Assign 1 if at least one is 1 |
| CenTreat-w/ Plants-Recode | Assign "Yes" if at least one leg is 1 |
| CenTreat_Directional Signs (Chevron/one-way) | Assign 1 if at least one is 1 |
| CenTreat_Directional Signs (Chevron/one-way)-Recode | Assign "Yes" if at least one leg is 1 |
| CircleLight | Assign 1 if at least one is 1 |
| CircleLight-Recode | Assign "Yes" if at least one leg is 1 |
| ApproachLight | Assign 1 if at least one is 1 |
| ApproachLight - Recode | Assign "Yes" if Approach Light is 1 |
| AmbientLighting | Assign 1 if at least one is 1 |
| AmbientLighting-Recode | Assign "Yes" if at least one leg is 1 |
| PurposeBuiltLighting | Assign 1 if at least one is 1 |
| PurposeBuiltLighting-Recode | Assign "Yes" if at least one leg is 1 |
| HorizontalCurve | Assign 1 if at least one is 1 |
| HorizontalCurve-Recode | Assign "Yes" if at least one leg is 1 |
| CrossSection (urban(1)/rural (0)) | Assign 1 if all legs are 1 |
| Urban/Rural-Recode | Assign "Yes" if all legs are "Yes" |
| AngleBtwnLegs | Min angle between roundabout legs |
| StoppingSightDistance | Min stopping sight distance across the roundabout legs |

QUANTITATIVE ILLUMINATION DATA COLLECTION

Like most states, Georgia does not have archived intersection illumination-level data. Therefore, this study undertook a data collection effort whereby actual intersection illumination-level data were measured from the eighty roundabouts selected for study.

Roadway lighting measurement standards require illuminance measurements for conflict locations such as roadway intersections. Illuminance refers to the level of incident light on the roadway pavement. Current protocols for illuminance measurements require in-situ spot measures, with a hand-held illuminance meter, from an imaginary 6 X 6 ft. grid within the intersection area. This procedure requires both the data collection personnel and equipment in the active travel lanes, posing increased risk. Attempts to mitigate the risks using this method for all eighty intersections would require extensive traffic management and road closures with possible coordination between multiple agencies, including the police. This is likely to increase costs in terms of man-hours and measurement time.

Tripod-Mounted Digital Camera Photographic Roadway Lighting Measurement

Therefore, the researchers used a Photographic Roadway Lighting Measurement protocol that was developed at Georgia Tech. This protocol has been peer reviewed and published in the Transportation Research Record, Journal of the Transportation Research Board (Gbologah et al. 2016). This protocol offers a safe, rapid, and repeatable measurement method with a proven accuracy of +/- 4%. The protocol is an image-analysis approach that can be used to extract pixel-level luminance information from an image taken with a digital single lens reflex (DSLR) camera. The camera serves as a light measuring meter because the output from each element of

its imaging array is proportional to the luminance of some scene element modified by the optical properties of the lens system and the exposure settings of the camera. This protocol has also been used in a previous GDOT research on *Evaluation of the Cost-Effectiveness of Illumination as a Safety Treatment at Rural Intersections in Georgia* (Gbologah et al. 2016).

In summary, the protocol uses a tripod mounted DSLR camera at a height of 1.24 meters above the ground and 125 feet upstream of the yield line to take six monochromatic pictures of the intersection. Half the number of pictures are taken at aperture settings of F4 while the other half are taken at an aperture setting of F5. For each aperture setting, one overexposed picture is taken at an exposure level of +2.0 while the other two pictures are taken at underexposed exposure levels of -2.0 and -3.0. These images would first be taken from each roundabout approach in RAW (unprocessed) format, and then converted to the 16-bit TIFF image format, and inputted into an image analysis software, ImageJ[®] (Schneider et al. 2012), to extract the pixel information.

Since the purpose of illumination is to help drivers better visualize the travel paths deflected by the splitter island and detect conflicting traffic when entering the roundabout, an area of interest between the yield line and pedestrian crosswalks would be drawn on each image for illuminance analysis. While the white-painted transverse markings on the pavement surface would influence the illumination analysis results, it should be noted that the area of interest should also avoid the inclusion of any transverse markings. Figure 11 shows an example of the illuminance measurement area drawn on the road surface of an approach in the roundabout located at the intersection between Lees Mill Road and Veterans Parkway.



Figure 11. Image. Roundabout Approach with the Luminance Measurement Area Highlighted in Yellow (Tripod-mounted camera image)

Since sometimes the underexposed nighttime images can be too dark to identify the intersection layout correctly for image analysis, the overexposed images serve as a reference to draw the illuminance measurement area, as illustrated in Figure 12.



Figure 12. Image. Roundabout Approach Images Taken at +2.0, -2.0, -3.0 Exposure Levels (from left to right)

Once the area of interest has been identified, the “measure” function in the software would analyze the six images, and output the size of the selected area, the minimum, maximum, mean, and standard deviation of pixel values within that area of each image is outputted into a .csv file. Then the mean pixel values are extracted from the underexposed images and applied in Equation 21 to get the average luminance level of that specific approach.

$$\mathbf{Luminance} = \frac{\mathbf{Mean\ Pixel * Aperture^2}}{\mathbf{Exposure\ Time * ISO * K}} \quad (21)$$

where K is the calibrated constant for the camera. The luminance estimates were converted into the required illuminance values (Gbologah 2015; Gbologah et al. 2016) according to Equation 20 and then averaged for an overall roundabout illuminance.

$$L = q * E \cong \frac{\rho}{\pi} * E \quad (20)$$

where, L = the luminance in cd/m²

q = the luminance coefficient in cd/m²/lux

E = the illuminance in lux

ρ = the reflection coefficient.

This study used a reflection coefficient of 0.145, which is an average of the value recommended by Uncu and Kayaku (2010) and Fotios et al. (2005).

The study used two calibrated Canon® DSLR cameras; one camera was an EOS® Rebel T3 while the other was an EOS® Rebel T5. See Table 14 for the summary technical specifications

of the cameras. For a detail description of the camera settings, equipment setup and light measurement procedures in the field please see the Appendix F.

Table 14. A summary of technical specifications of Canon T3 and T5 cameras

| Item | T3 Value | T5 Value |
|---------------------------|-------------------------------|--------------------------|
| Lens | EFS 18-55 mm | EFS 18-55 mm |
| Sensor | 12.2 MP CMOS | 18.0 MP CMOS |
| ISO Range | 100 – 6400 | 100 – 6400 |
| Shutter Speed | 30 s – 1/4000 s and Bulb | 30 s – 1/4000 s and Bulb |
| Maximum Aperture | F4.0 – F25 | F3.5 – F22 |
| Field of View | 74° | 74° |
| Focus Distance | 0.25 meters – ∞ | 0.25 meters – ∞ |
| Maximum Resolution | 1920 x 1080 | 1920 x 1080 |
| Number of Focusing Points | 9 points | 9 points |
| Exposure Compensation | ± 5 stops in 1/3 or 1/2 stops | ± 5 stops in 1/3 stops |
| Image Processor | DIGIC 4 | DIGIC 4 |

All field measurements were conducted on the same days as the prior discussed intersection characteristics data collection. The measurements were made between 10PM – 4AM on only dry road pavements. This was necessary to maintain comparability between measurements at different sites as wet pavement changes the luminance from the pavement surface relative to dry conditions. The measurements were conducted by two survey teams: one from Georgia Tech (GT) and the other from Georgia Southern University (GSU). The GT team surveyed 57 roundabouts while the GSU team surveyed 23 roundabouts. Figure 13 shows a typical image taken during field data collection and Figure 14 shows the sites surveyed by the GT team and GSU teams. GSU mostly surveyed locations in southern Georgia. Table 15 presents information on the dates that each of the selected 80 roundabouts was surveyed.



Figure 13. Image. A typical nighttime image of a roundabout taken for luminance analysis with the tripod mounted DSLR camera

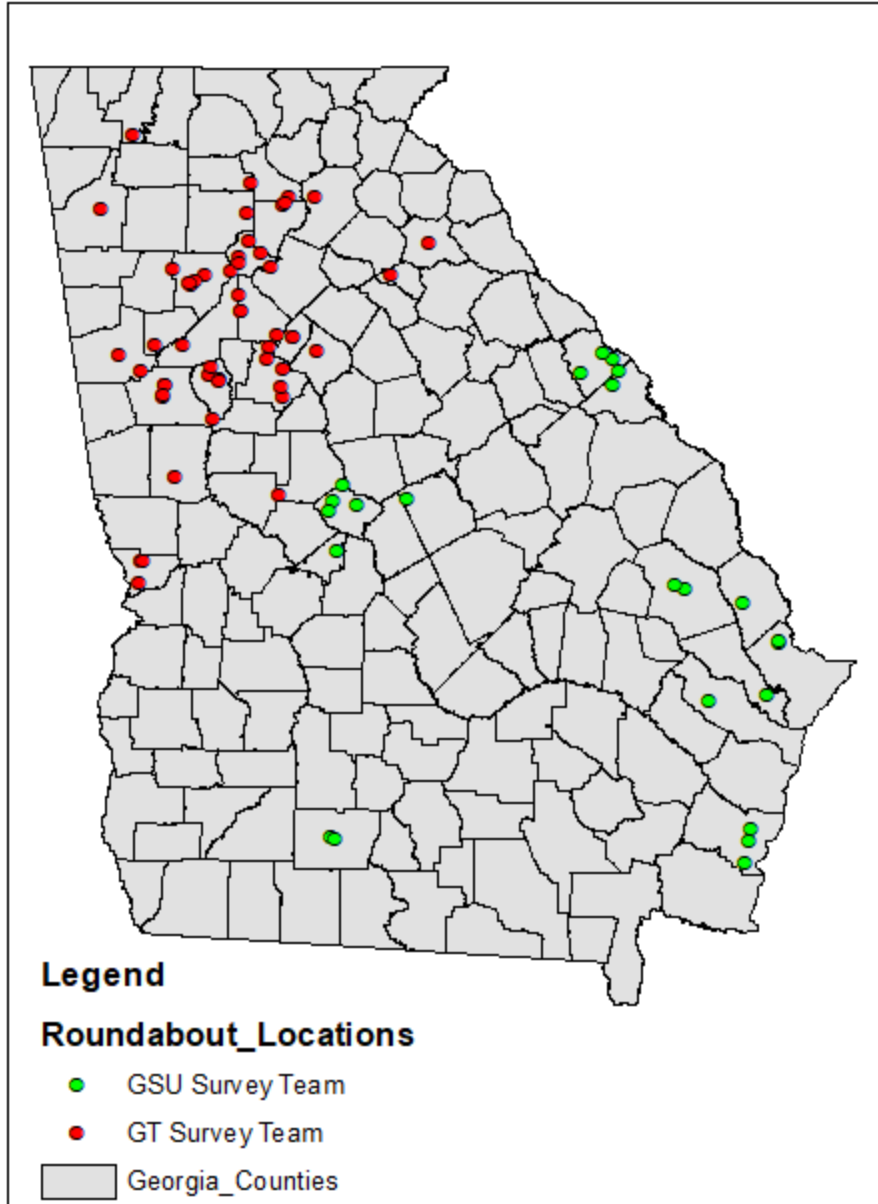

Figure 14. Map. Roundabout Sites Surveyed by Georgia Tech Team and Georgia Southern University Team.

Table 15. Survey Dates of Selected Sites

| Site Code | Survey Date | Site Code | Survey Date | Site Code | Survey Date |
|------------------|--------------------|------------------|--------------------|------------------|--------------------|
| GT-22R | 7/29/2021 | GT-5019 | 9/9/2021 | GSU-2 | 8/13/2021 |
| GT-23R | 7/29/2021 | GT-5020 | 9/9/2021 | GSU-3 | 8/13/2021 |
| GT-24R | 7/29/2021 | GT-5021 | 9/10/2021 | GSU-4 | 8/13/2021 |
| GT-30R | 7/30/2021 | GT-5022 | 9/10/2021 | GSU-17 | 8/26/2021 |
| GT-35R | 7/30/2021 | GT-5023 | 9/10/2021 | GSU-18 | 8/26/2021 |
| GT-5002 | 7/30/2021 | GT-5024 | 9/23/2021 | GSU-5 | 9/3/2021 |
| GT-13R | 8/5/2021 | GT-5025 | 9/23/2021 | GSU-6 | 9/3/2021 |
| GT-18R | 8/5/2021 | GT-5026 | 9/23/2021 | GSU-19 | 9/4/2021 |
| GT-5001 | 8/5/2021 | GT-5027 | 9/24/2021 | GSU-20 | 9/4/2021 |
| GT-1R | 8/6/2021 | GT-5028 | 9/24/2021 | GSU-21 | 9/4/2021 |
| GT-9R | 8/6/2021 | GT-5029 | 9/24/2021 | GSU-22 | 9/5/2021 |
| GT-29R | 8/10/2021 | GT-5030 | 9/30/2021 | GSU-23 | 9/5/2021 |
| GT-42R | 8/10/2021 | GT-5031 | 9/30/2021 | GSU-24 | 9/5/2021 |
| GT-44R | 8/10/2021 | GT-5033 | 9/30/2021 | GSU-10 | 9/10/2021 |
| GT-5005 | 8/11/2021 | GT-5034 | 10/1/2021 | GSU-7 | 9/11/2021 |
| GT-5006 | 8/11/2021 | GT-5035 | 10/1/2021 | GSU-8 | 9/11/2021 |
| GT-1C | 8/26/2021 | GT-5036 | 10/1/2021 | GSU-9 | 9/11/2021 |
| GT-25R | 8/26/2021 | GT-5037 | 10/14/2021 | GSU-16 | 9/11/2021 |
| GT-5008 | 8/26/2021 | GT-5038 | 10/14/2021 | GSU-1 | 9/23/2021 |
| GT-5007 | 8/27/2021 | GT-5039 | 10/14/2021 | GSU-15 | 9/23/2021 |
| GT-5009 | 8/27/2021 | GT-5040 | 10/15/2021 | GSU-12 | 9/25/2021 |
| GT-5010 | 8/27/2021 | GT-5041 | 10/15/2021 | GSU-13 | 9/25/2021 |
| GT-5011 | 9/2/2021 | GT-5043 | 10/15/2021 | GSU-14 | 9/25/2021 |
| GT-5012 | 9/2/2021 | GT-5044 | 10/22/2021 | | |
| GT-5013 | 9/2/2021 | GT-5045 | 10/22/2021 | | |
| GT-5015 | 9/3/2021 | GT-5046 | 10/22/2021 | | |
| GT-5016 | 9/3/2021 | GT-5047 | 10/23/2021 | | |
| GT-5017 | 9/3/2021 | GT-5048 | 10/31/2021 | | |
| GT-5018 | 9/9/2021 | | | | |

Drone Mounted Digital Camera Photographic Roadway Lighting Measurement

The tripod mounted DSLR camera based photographic protocol described above offers several advantages (speed, repeatability, and equipment cost) compared to the existing standard protocols. However, the process still has to be performed for each leg of the intersection. Therefore, as part of this study the researchers explored the possibility of using a calibrated drone-mounted digital camera for data collection. It is envisaged that a drone mounted system would further increase the speed of data collection by taking aerial images from one setup location as opposed to the tripod-mounted system where the data collection team have to setup and move equipment to each leg of the intersection.

The researchers calibrated a Zenmus X5S™ camera that can be attached to a DJI Inspire 2™ quadcopter drone. The Zenmuse® camera is a high-end professional camera used for aerial and ground imaging. It can support up to 20.8 megapixel still photos. The summary technical specifications of the camera are shown below in

Table 16. Standard camera settings and drone operating conditions used for data collection are provided in Appendix G. A “quadcopter-type” drone was used due to the stability of this platform which allows the drone to hold a hovering position without dithering in wind conditions not exceeding 15 MPH.

Table 16. Summary technical specifications of Zenmuse X5S™ camera

| Item | Value |
|--------------------|--|
| Lens | M4/3 Interchangeable lens |
| Sensors | 4/3 CMOS |
| ISO Range | Photo: 100 – 25600 Video: 100 – 6400 |
| Shutter Speed | Photo: 8s – 1/8000 s Video: 1/24 s – 1/8000 s |
| Maximum Aperture | F1.7 – F16 |
| Field of View | 72° |
| Focus Distance | 0.2 meters – ∞ |
| Maximum Resolution | 4096 x 2160 |

The Zenmuse® camera was calibrated using the same process (Gbologah et al. 2016) applied in the cases of the Canon® T3 and Canon® T5 DSLR cameras. The calibration process involved analyzing over 4000 images of scenes of known luminance and extracting pixel information.

Also, the study estimated the dark current pixel value for the Zenmuse® camera. This pixel value must be subtracted from every image taken by the camera. The dark current was estimated by following the same calibration procedure but with images taken in a completely dark room.

For field data collection, the camera was anchored to the drone via a detachable 3-axis DJI® Gimbal Connector 2.0 that facilitates remote control of the camera's photographic settings as well as mechanical pan, tilt, and pitch. The mechanical range for pan is $\pm 320^\circ$, for pitch is -130° to $+40^\circ$, and for tilt is $\pm 20^\circ$. The gimbal can be remote-controlled to align the camera so that it looks directly down (90°) with the drone hovering over a desired location. Figure 15 shows picture of a team member holding the drone in the field (left) and another team member landing the drone (right). Figure 16 gives a graphical representation of the gimbal's mechanical ranges.



Figure 15. Photo. A Team Member Holding the Drone in the Field During a Test Flight (left) and another Team Member Landing the Drone during Field Work at Night

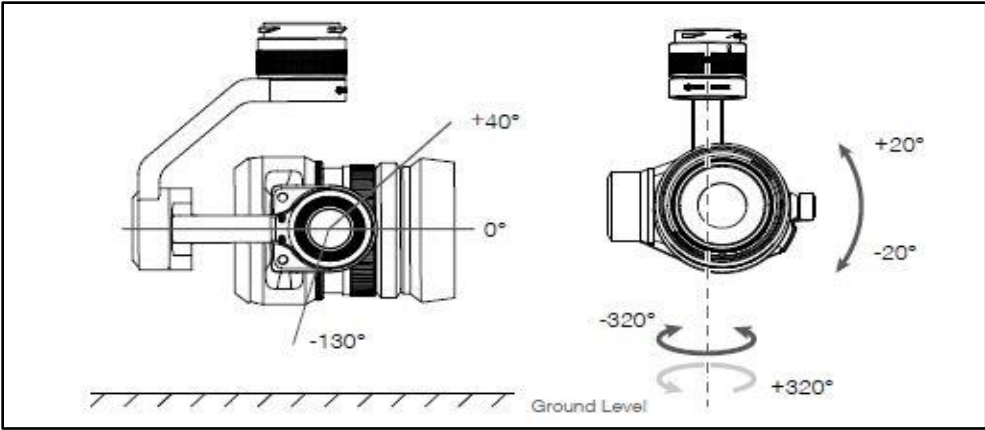

Figure 16. Photo. Mechanical Range of the DJI Gimbal Connector 2.0

Images for analyzing luminance for each approach were taken such that the center of the roundabout circle is aligned with the left edge of the image. With the camera's 72° field of view and drone hovering height of 390 feet it was possible to capture luminance information on an approach up to 465 feet from the center of a roundabout. Therefore, even for large roundabouts with a 150-foot inscribed circle diameter, the illumination data of an approach could be extracted up to 390 feet upstream from the yield line. Figure 17 shows a typical image of a roundabout approach taken with the drone mounted Zenmuse® camera.

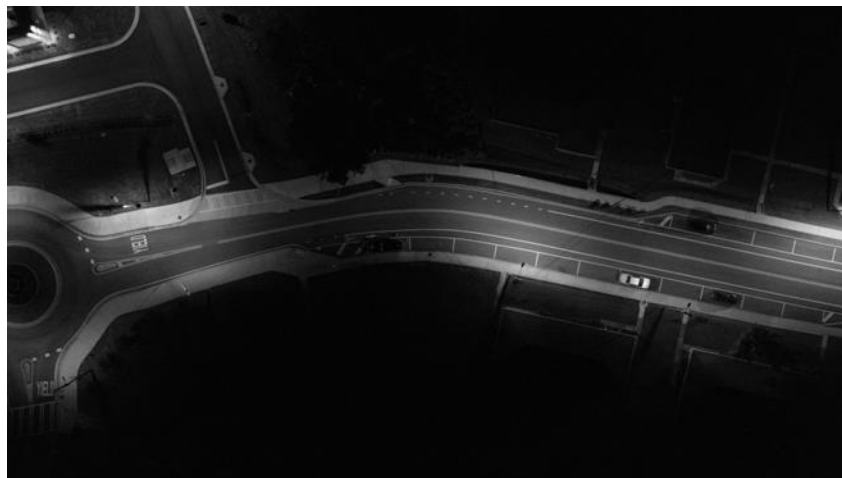

Figure 17. Image. A Typical Nighttime Image of a Roundabout Taken for Luminance Analysis with the Drone-Mounted Zenmuse® Camera

Like the tripod-mounted DSLR camera field data collection, all data collected with the drone-mounted Zenmuse® camera was done between 10PM – 4AM on dry nights. A total of six images were taken for each approach, three of them were taken at F4 aperture with the exposure level set at -3.0, -2.0, and +2.0, while the other three were taken at aperture of F5 with the same three exposure level settings. Since for drivers approaching a roundabout at night, the illumination level perceived by them should enable them to see the roundabout layout in time

and make appropriate maneuvers from a distance at a minimum of the safe stopping sight distance on that approach, and when drivers arrive at the approach yield line, the observed illumination level should continue ensuring the visibility of circular pathway and conflicting vehicles as well, thus, luminance level were measured separately within the circular pathway and at the point of yield line, halfway of stopping sight distance (Mid-SSD) and stopping sight distance (SSD) along each approach for the subsequent analysis to determine the presence and/or extent of illumination required for the roundabouts. The images taken for each approach were again input into the image analysis software ImageJ[®], and four illumination measurement areas were drawn within the center island, between the yield line and pedestrian crosswalks, at the midpoint of stopping sight distance and at the point of stopping sight distance on each roundabout approach to extract average pixel values from each area. Because the size of measurement areas could influence the illumination data evaluated at the same location, for every measurement area located at Mid-SSD and SSD, the area size was set to be around 150 sq ft to maintain consistency. Figure 18 shows an example of each of the four luminance measurement areas drawn on one approach of the roundabout located at the intersection between County Line Road NW and Burnt Hickory Road NW.

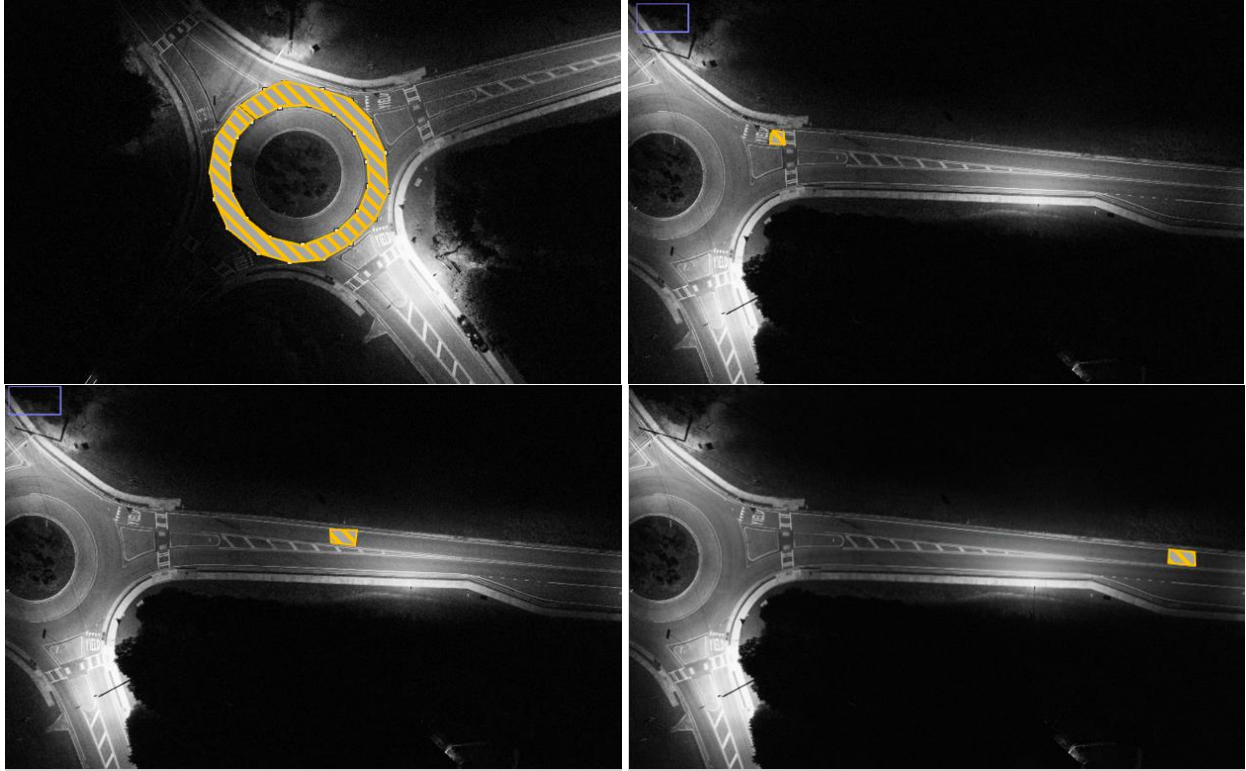

Figure 18. Image. Roundabout Approach with Four Luminance Measurement Areas Highlighted in Yellow (Drone images)

Same as the analysis process for the images taken by the tripod mounted DSLR camera, the extracted pixel data from the drone images were converted into luminance values to get the illumination level data for each roundabout approach. Then the approach-level luminance values were further converted into illuminance values and averaged over each roundabout's corresponding approaches to obtain illumination data on an individual site basis. It should be noted that data collection with T3 camera was conducted at all eighty roundabouts while data collection with the drone was conducted at only forty-five of the eighty roundabouts. These forty-five locations were all surveyed by the Georgia Tech data collection team.

MERGE ALL DATASETS FOR ANALYSIS

At this stage, various collected datasets regarding roundabout crash records, site characteristics, traffic volumes and illumination levels were merged into one roundabout level database and one approach level databased for further analysis. This process is described below:

For roundabout (site) level database:

- Both nighttime and daytime crash data were aggregated by *Sitecode* and *CrashYear*.
- The traffic data were aggregated by *Sitecode* and *TrafficYear*.
- The illuminance data were aggregated by *Sitecode*
- The inventory data were aggregated by *Sitecode*.

For approach level database:

- Both nighttime and daytime crash data were aggregated by *Sitecode*, *Approach ID*, and *CrashYear*
- The traffic data were aggregated by *Sitecode*, *Approach ID*, and *TrafficYear*
- No need to aggregate inventory data and illuminance data since they were initially collected at approach level.

As mentioned prior, site GT-5009 had no traffic data because it could not be found in the GIS RC-Link files. Therefore, the crash data for this site were removed from subsequent analysis. Also, as mentioned, prior crash data were found for only seventy-eight sites. Thus, the total number of sites available for subsequent safety analysis was seventy-seven.

The research team first joined the nighttime and daytime datasets separately with the traffic data by matching the *Sitecodes* (combined with *Approach ID* for the approach level database) and then matching *CrashYear* to *TrafficYear*. After this initial join, the expanded nighttime and daytime dataset were combined with both illuminance data and inventory data by matching the *Sitecode* (combined with *Approach ID* for the approach level database) values. This resulted in a total of 685 nighttime records and 972 daytime records aggregated by *Sitecode* and *CrashYear*. For each dataset, the illuminance field was also recoded to create another field holding five lux bins for illuminance up to 20 lux and above.

After combining the datasets, each was further processed to create crash event types for single vehicle crashes (*SingleVehicleCrash*) from the *CollisionType* field, impaired driver crashes (*ImpairedDriverCrash*) from the *Driver Contributing Factor* field, and wet pavement crashes (*NotDryPavementCrash*) from the *Not Dry Surface* field. In addition, the annual entering volume for each *Sitecode* and *CrashYear* pair was calculated by multiplying the daily entering volume (DEV) by 365.25. Also, since the study period was from 2013 to 2020, a new field for roundabout open year (*RoundaboutOpenYear*) was created such that any site with OpenYear less than 2013 was assigned a value of 2013. This was necessary for subsequent appending of crash number normalization factors that were developed to control for background secular trend in the crash data.

NORMALIZATION FACTORS TO CONTROL SECULAR TREND EFFECT IN CRASH DATA

As discussed earlier, the study obtained crash data and traffic data from 25 control sites with the aim of developing normalization factors that could be applied to crash data to limit the effect of secular trends in the data. However, during the preparation of factors the researchers concluded that a more robust set of factors would be more beneficial than that provided by only 25 sites. Therefore, the normalization factors were developed using total crashes in Georgia and vehicle-miles-traveled in Georgia. The total crashes for each year were extracted from GDOT Georgia Electronic Accident Reporting System (GEARS) for years 2010 to 2020. The VMT for Georgia for each year were extracted from Bureau of Transportation Statistics data (BTS 2021). To estimate the secular correction factors, the average crash rate per year was calculated for each year by dividing the total number of crashes by VMT. Next, a second order polynomial was fitted to the calculated crash rates for 2011 – 2019 and the regression equation was then used to estimate a crash rate for all years. Finally, the estimated crash rates were normalized to the year 2020 value such that the derived factor is multiplicative. Figure 19 shows the second order polynomial fit and resulting equation. Equation 22 shows the formula for calculating the normalized factor for each year. Table 17 shows the estimated normalization factors.

$$\mathbf{Normalization\ Factor}_{year=t} = \frac{(2020 - t) * \mathbf{Est. Crash Rate}_{year=2020}}{\sum_{year=t}^{year=2020} \mathbf{Est. Crash Rate}} \quad (22)$$

where t is the crash year of interest for which the normalization factor is to be applied.

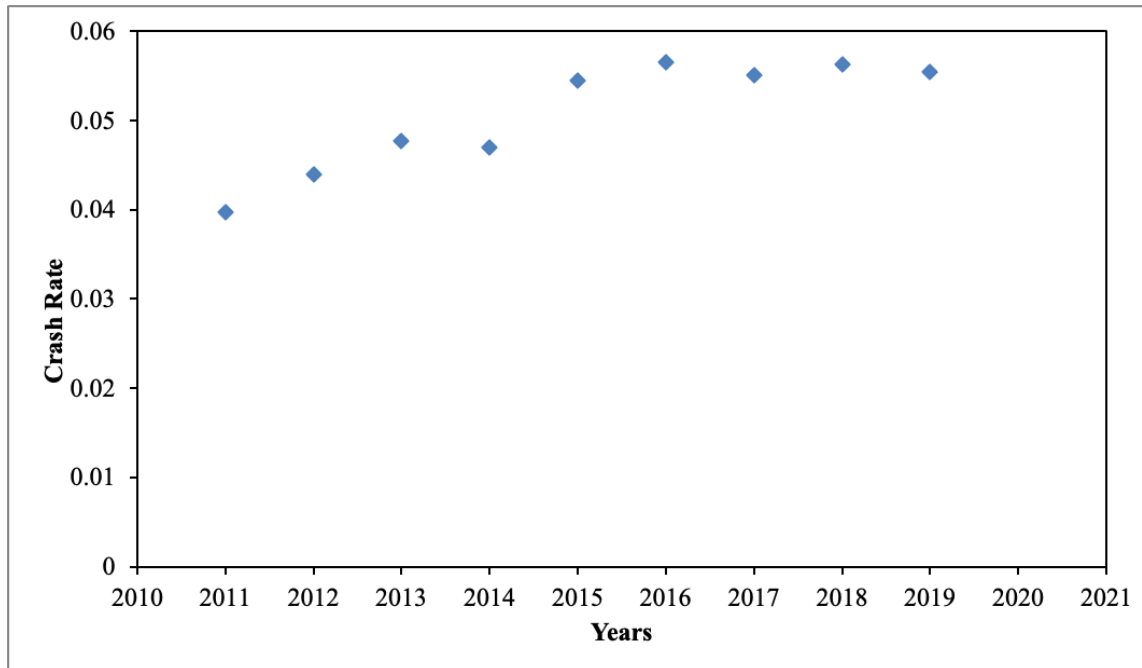

Figure 19. Chart. Plot of Georgia Crash rate by Year Fitted to a Second Order Polynomial

Table 17. Normalization Factors for Controlling Secular Trend Effect in Crash Data

| Crash Year | Total - All Crashes | Vehicle Mile Traveled (Millions) | Crash Rate | Estimated Crash Rate | Normalization Factor |
|------------|---------------------|----------------------------------|------------|----------------------|----------------------|
| 2010 | n/a | 7701940 | n/a | 0.0869 | 1.0527 |
| 2011 | 299528 | 7533740 | 0.0398 | 0.0919 | 1.0371 |
| 2012 | 336325 | 7647000 | 0.0440 | 0.0963 | 1.0242 |
| 2013 | 370835 | 7780350 | 0.0477 | 0.1001 | 1.0137 |
| 2014 | 383172 | 8155110 | 0.0470 | 0.1031 | 1.0054 |
| 2015 | 443634 | 8137621 | 0.0545 | 0.1055 | 0.9994 |
| 2016 | 465350 | 8239779 | 0.0565 | 0.1073 | 0.9954 |
| 2017 | 465285 | 8442325 | 0.0551 | 0.1083 | 0.9935 |
| 2018 | 478866 | 8512550 | 0.0563 | 0.1088 | 0.9936 |
| 2019 | 475990 | 8594567 | 0.0554 | 0.1085 | 0.9958 |
| 2020 | 389259 | n/a | n/a | 0.1076 | 1.0000 |

FINAL DATA AGGREGATION

For the roundabout level database, the extended nighttime dataset and the extended daytime dataset were aggregated to intersection level by grouping their records by *Sitecode*. This aggregation was used to create the following new fields for use in subsequent analysis:

- *SumTotalCrashes*: this represents the sum of all crashes at a roundabout site over the entire study period.
- *SumInjuryFatalCrashes*: this represents the sum of all injury and fatal crashes at a roundabout for the entire study period.
- *SumSingleVehicleCrashes*: this represents the sum of all single vehicle crashes at a roundabout site over the entire study period.
- *SumImpairedCrashes*: this represents the sum of all impaired driver crashes at a roundabout site over the entire study period.
- *SumNotDryCrashes*: this represents the sum of all non-dry pavement crashes at a roundabout site over the entire study period.
- *SumEnteringVolume*: this represents the sum of all annual entering volumes at a roundabout site over the entire study period.

Next, the estimated normalization factors (used to correct the correct the data from the years the roundabout was active to the reference (2020) condition as described in the previous section) were appended to the rows in the combined database for nighttime as well as the combined database for daytime. In each case the *CrashYear* was used to establish the join. The final nighttime and daytime datasets each contained forty-nine fields and seventy-seven records.

Similar to the above aggregation process, in terms of the roundabout approach level database, the extended nighttime dataset and daytime dataset were aggregated by grouping the records by Sitecode and Approach ID. Corresponding new fields regarding the sum of different types of crash events were also generated at the roundabout approach level, and the final nighttime datasets each contained forty-nine fields and 171 records.

CHAPTER 4. ROUNDABOUT SITE-LEVEL ANALYSIS AND DISCUSSION

OVERVIEW OF PREPARED DATA USED IN ANALYSIS

In determining how illumination influenced observed crash rates at rural and suburban roundabouts, complete datasets were available for seventy-seven out of the eighty roundabouts sites for field data collections. Three locations were omitted from the final analysis due to various issues including missing crash data (sites GSU-8 and GT-5025) and missing traffic data (site GT-5009).

Roundabout Operational Characteristics

For the seventy-seven studied sites, the number of data years available for each site varies based on their installation years, with the minimum being 1-year and the maximum being 8-years (i.e., from 2013-2020). It should be noted that out of these seventy-seven sites, there are thirty-two sites that were installed prior to 2013 and thus analysis of these sites used the full 8-years of available crash and traffic data. Figure 20 illustrates the number of available data years per site. Figure 21 and Figure 22 respectively show the numerical and geographical distribution of roundabout installation years among the seventy-seven roundabouts studied.

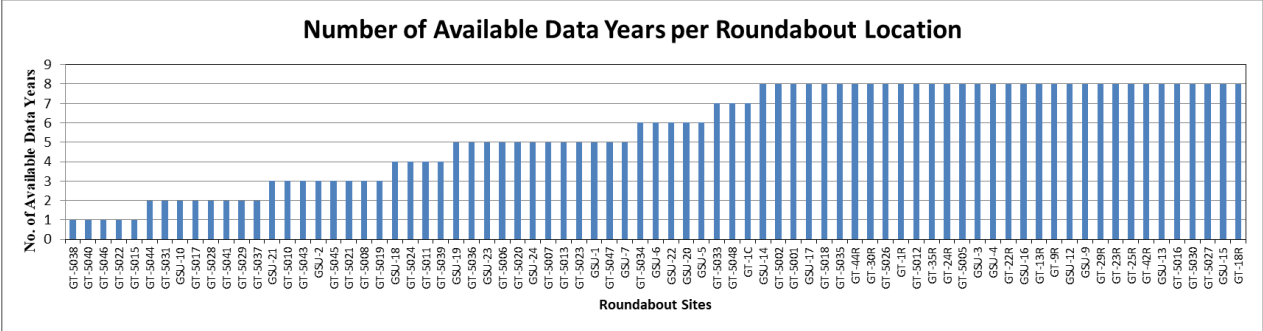

Figure 20. Chart. Number of Data Years Available per Roundabout Location

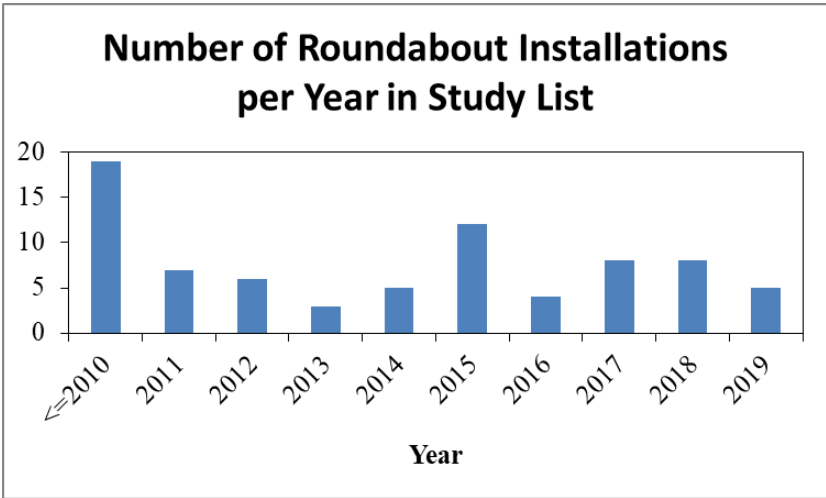

Figure 21. Chart. Number of Roundabout Installations per Year in Study List

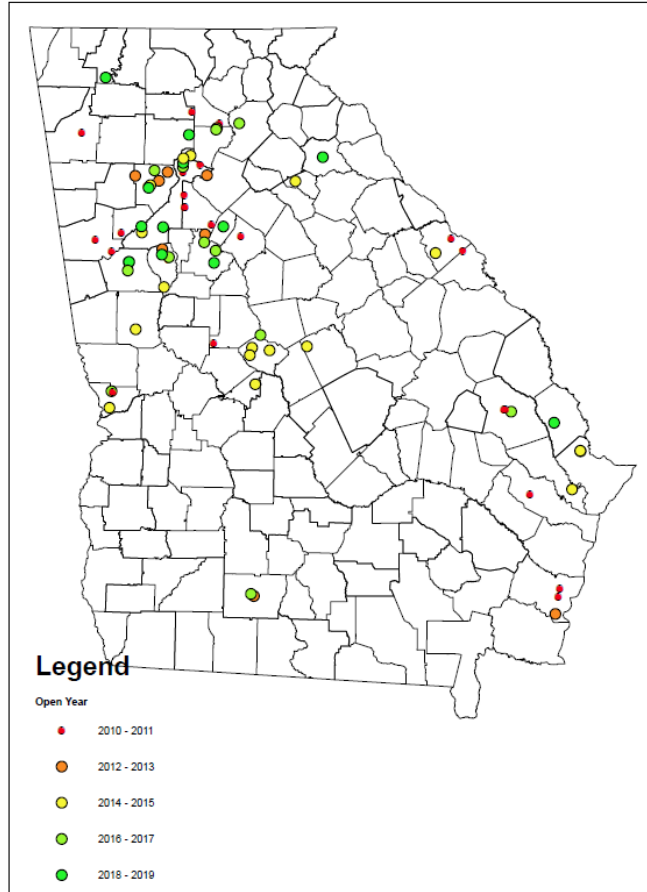

Figure 22. Map. GIS Map Showing Roundabout Installation Year

Over the entire analysis period, a total of 1088 crashes were observed and 369 of them occurred during nighttime and were the focus of subsequent analysis. Since 32 of the roundabouts were in existence prior to 2013, the beginning of the analysis period, these roundabouts were used to examine the secular variation in nighttime vehicle crash rate over the analysis period. The results of a site-weighted average crash rate analysis (see Figure 23) indicates a decreasing trend from 2015 to 2018, otherwise the trend had been increasing.

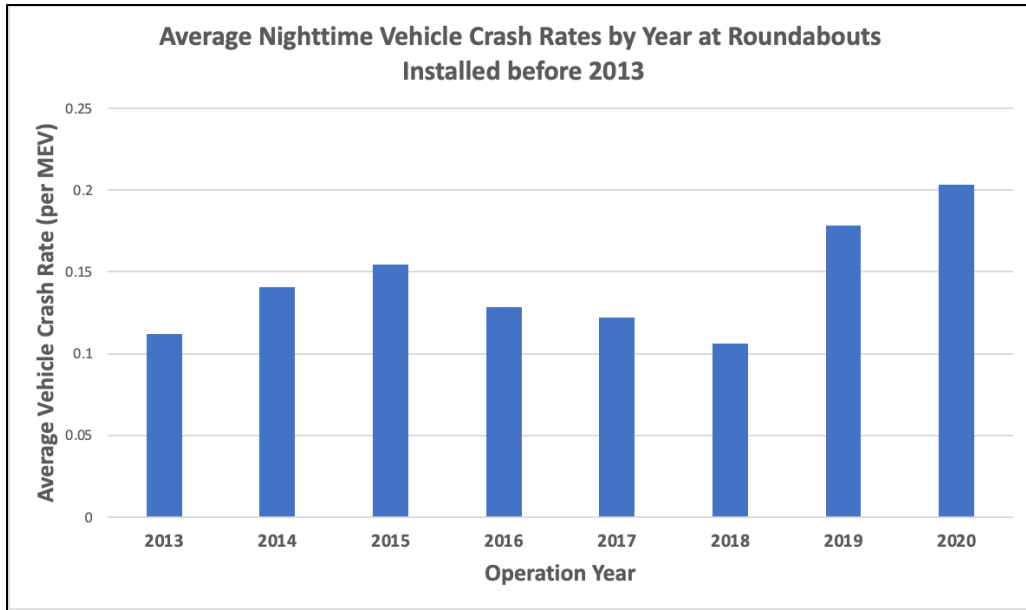

Figure 23. Chart. Observed Average Nighttime Crash Rates by Year for Roundabouts Installed before 2013

Due to the differences in roundabout installation years, factors were developed to normalize the crash rate to a year 2020 equivalent in order to limit the potential effects of secular trends in the data. Figure 24 shows the distribution of this normalized crash rate for total crashes across the roundabout sites.

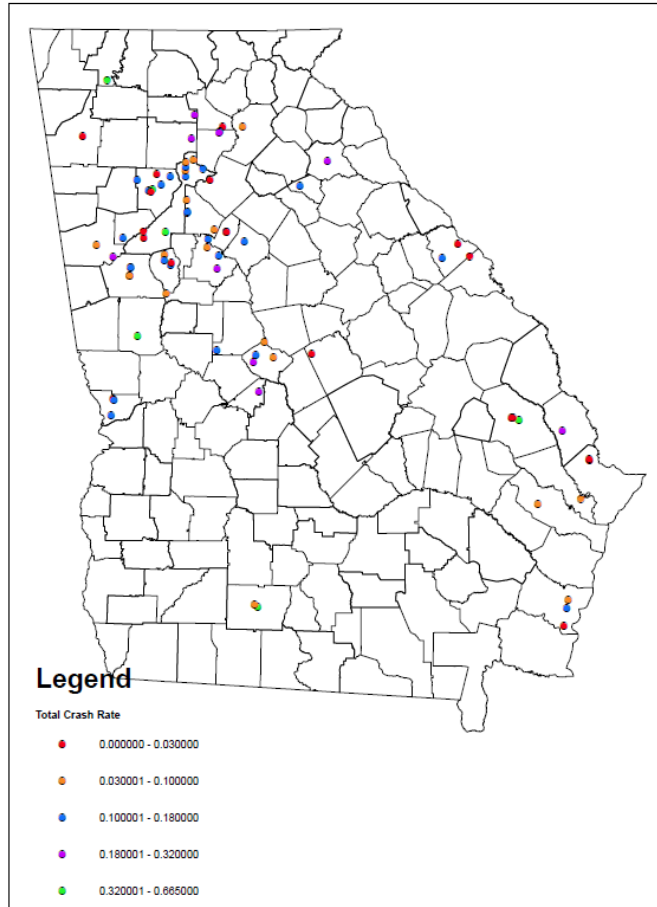

Figure 24. Map. GIS Map Showing Total Nighttime Crash Rates (per MEV)

Apart from the total crash rate, the injury/fatal crash rate, single-vehicle crash rate, impaired-driver crash rate, and non-dry pavement crash rate for each site were also analyzed. Figure 25 through Figure 28 presents plots of injury/fatal crash rates, single vehicle crash rates, impaired driver crash rates, and non-dry pavement crash rates superimposed respectively over total crash rates. It can be inferred from the charts that for the group of roundabouts studied, generally the highest crash rates after total crashes in descending order are single crashes, non-dry crashes, injury/fatal crashes, and impaired-driver crashes. This inference is also supported by the volume-weighted average crash rates for each crash type as is shown in Figure 29.

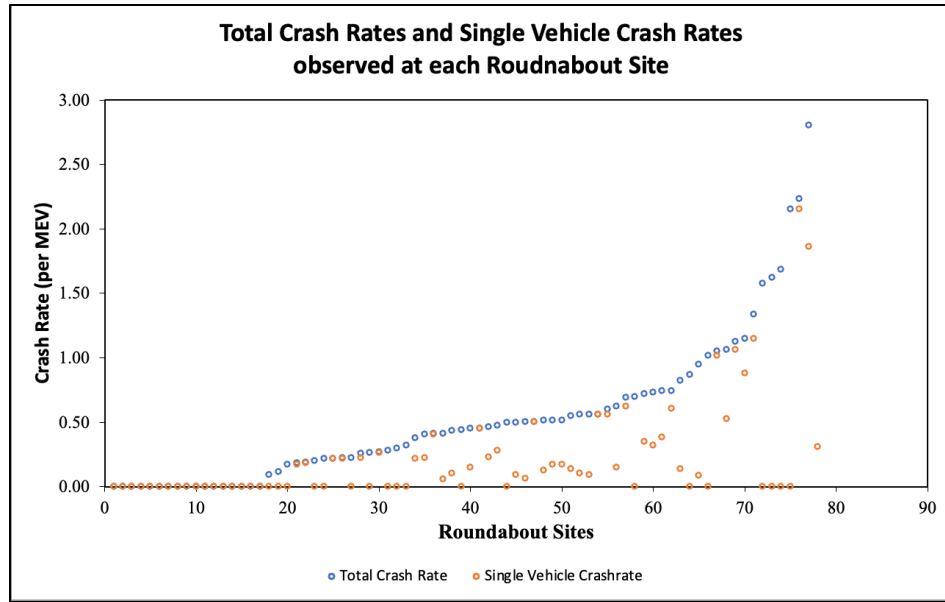

Figure 25. Chart. Total Crash Rates and Single Vehicle Crash Rates at Studied Roundabouts

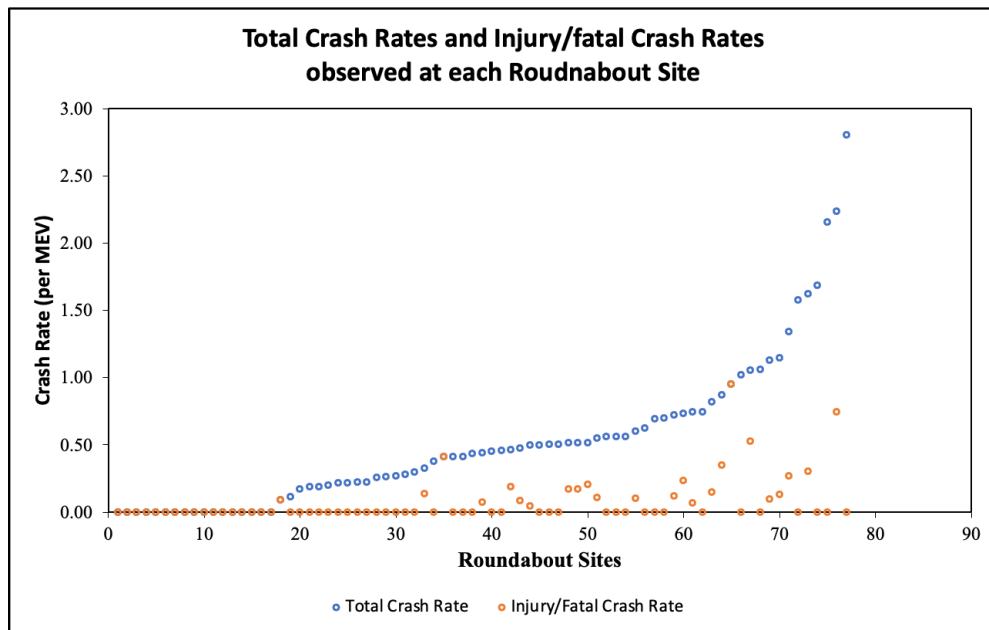

Figure 26. Chart. Total Crash Rates and Injury & Fatal Crash Rates at Studied Roundabouts

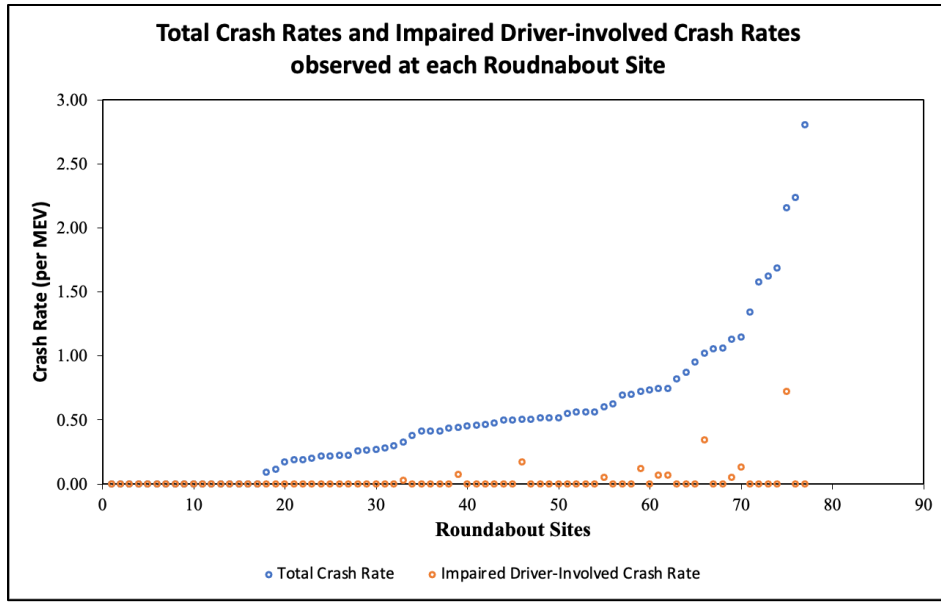

Figure 27. Chart. Total Crash Rates and Impaired Driver Crash Rates at Studied Roundabouts for Study Period

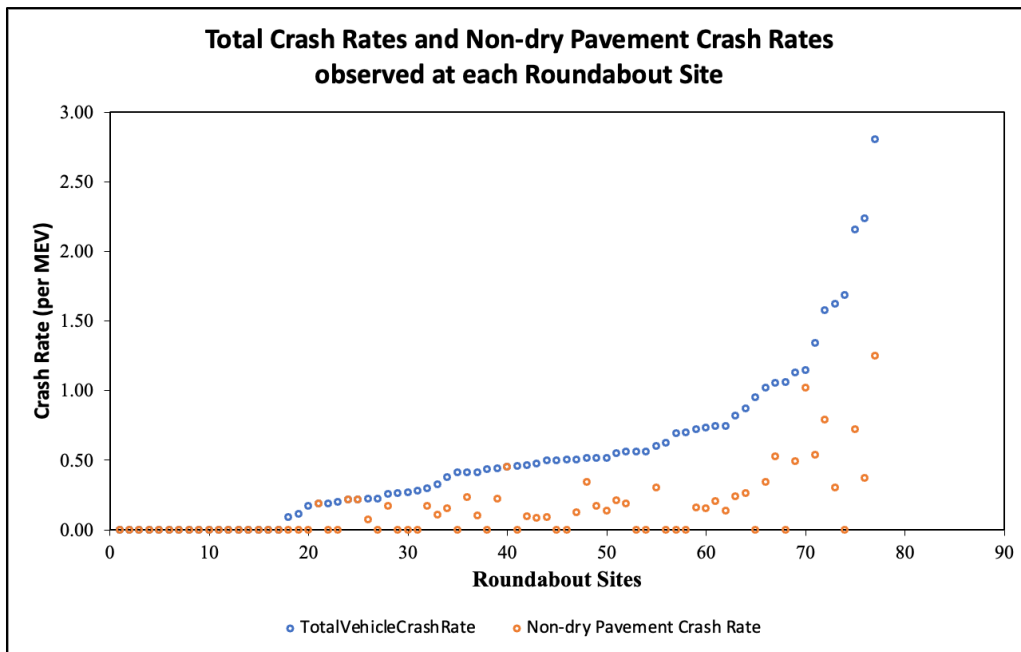

Figure 28. Chart. Total Crash Rates and Non-Dry Pavement Crash Rates at Roundabouts for Study Period

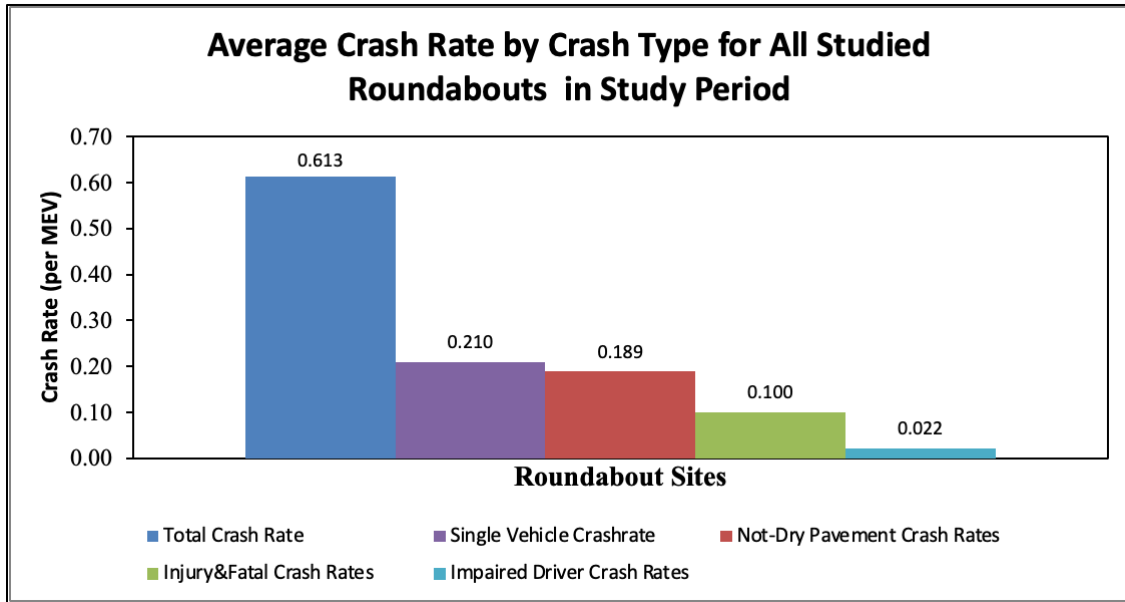
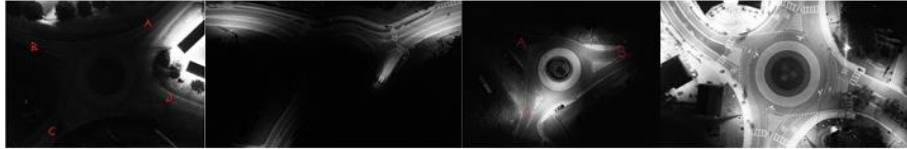

Figure 29. Chart. Average Crash Rate by Crash Type for All Studied Roundabouts

Roundabout Illuminance Conditions

Different luminaire arrangements were observed in the field. These arrangements were classified into three illumination layouts: none, partial, and full lighting. Figure 30 shows the positions/arrangement of luminaires corresponding to these three layouts.



| | | | | |
|----------------------------|------|-------------------|------------------|-----------------------------------|
| Luminaire Position | None | Approach Lighting | Circle Lighting | Both Approach and Circle Lighting |
| Illumination Design/Layout | None | Partial Lighting | Partial Lighting | Full Lighting |

Figure 30. Photo. Observed Illumination Schemes and Luminaire Arrangements in the Field

Due to the implementation of different types of illumination layouts, the illuminance conditions (lux) also vary significantly across the 80 measurement sites. For each site, the illuminance was measured near the entrance into the circulating path for each approach and then averaged over the entire roundabout to get a single estimate. Figure 31 shows the range of average illuminance measured at the studied roundabout sites. Intuitively one would have expected to see clear clustering/breaks in the values. However, the observed illuminance appears to be largely continuous within the range.

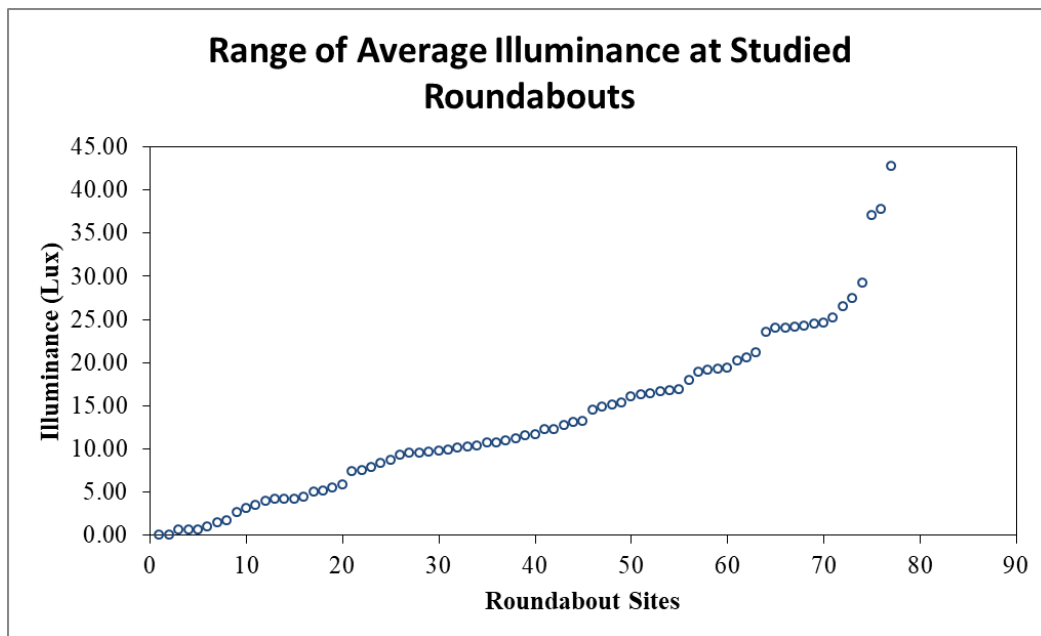

Figure 31. Chart. Range of Average Illuminance at Studied Roundabouts

Classification of the illuminance values into bins at 5-lux increments (Figure 32) divides the observations in five, roughly equal, categories as was the intent of the selection process. The geographic distribution of the estimated illuminance for each site is shown in Figure 33.

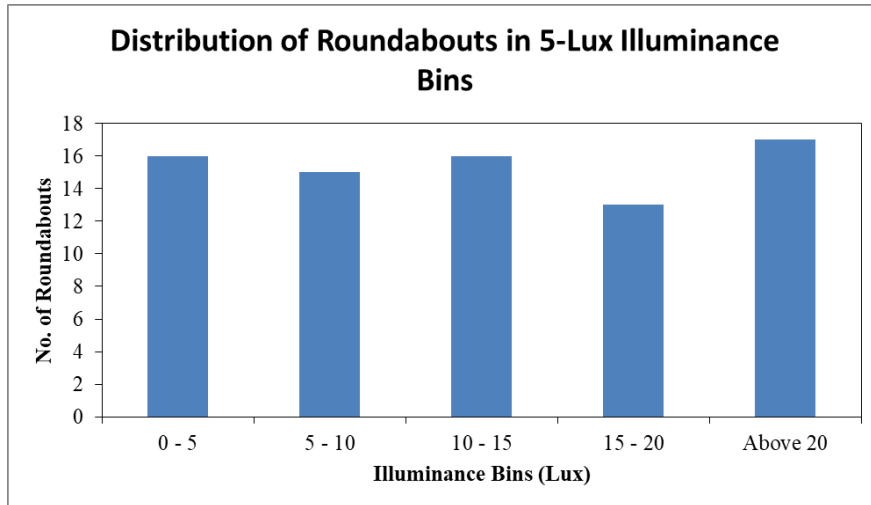

Figure 32. Chart. Distribution of Roundabouts in 5-Lux Illuminance Bins

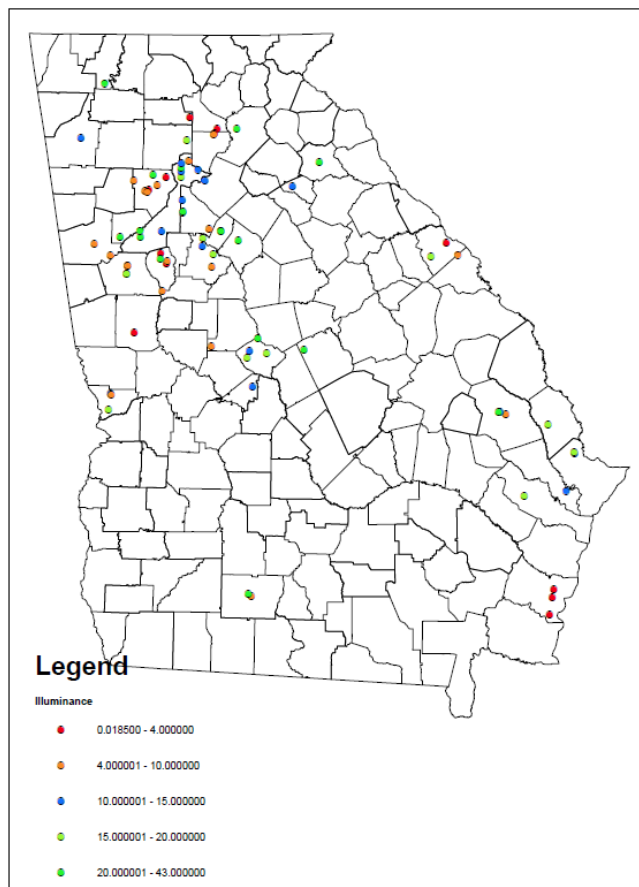

Figure 33. Map. GIS Map Showing Measured Illuminance Levels in Lux

To illustrate the typical appearance of a roundabout within each illumination bin, Figure 34 shows the nighttime aerial views of typical roundabout lighting in each of the 5-lux bins.

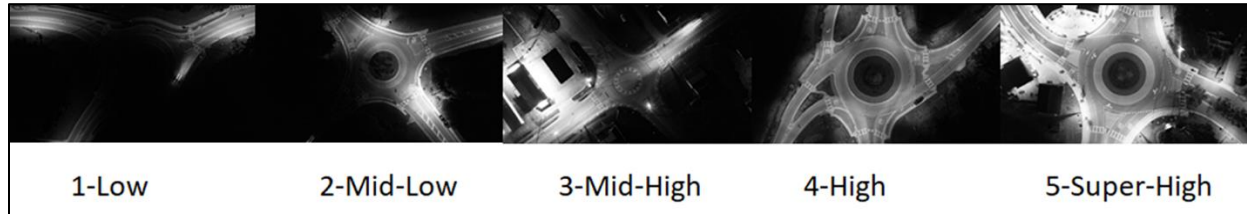

Figure 34. Photo. Nighttime Aerial View of Typical Roundabout Lighting in 5-Lux Illuminance Bins

Roundabout Geometric Characteristics

The sites selected in this study include both single-lane and multi-lane roundabout types, accounting for 91 percent (70 sites) and 9 percent (7 sites) of sites, respectively. In terms of leg configuration, 4-legged roundabouts were most common comprising 77 percent of the sample (59 sites), followed by 3-legged roundabouts constituting 19 percent (15 sites). The number of 5-legged roundabouts is small, especially within the rural and suburban areas, and only 3 of them were included in this study, accounting for 4 percent of the site population. In addition, thirty-two of the seventy-seven sites (42 percent) have at least one crossroad that is a designated state highway. Figure 35 depicting the distribution of the studied sites based on roundabout types, leg configurations, and the crossroads with state highway designation.

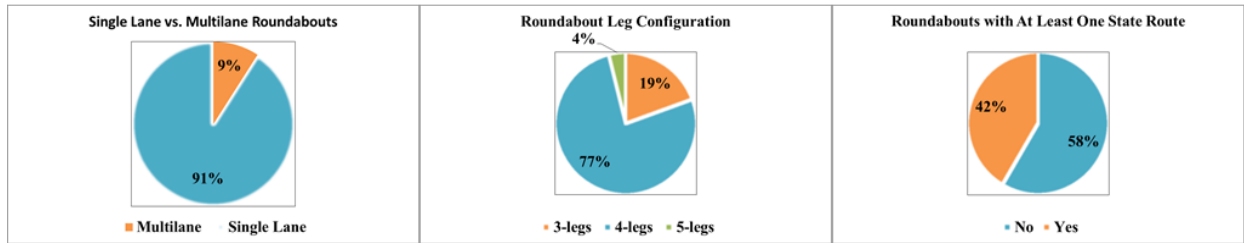

Figure 35. Chart. Distribution of Roundabouts by Type, Configuration, and State Highway Routes.

During the data collection process, various roundabout advisory speed limit signs were observed to be posted near the entrance of each roundabout approach. These speeds range from 10 MPH to 45 MPH. It should be noted that nine sites did not have any posted advisory speed limit signs. Figure 36 shows the distribution of the observed posted advisory speed limits. These posted advisory speed limits may, or may not, have any correlation to actual circulating speeds that were not measured in this study. The geometry of most of these sites would suggest actual circulating speeds of less than or equal to 25 MPH when navigating through the roundabouts. Thus, these advisory speed limits were used as a surrogate measure representing a range of geometric and/or traffic conditions that led to these posted advisory limits. These factors may vary with jurisdiction.

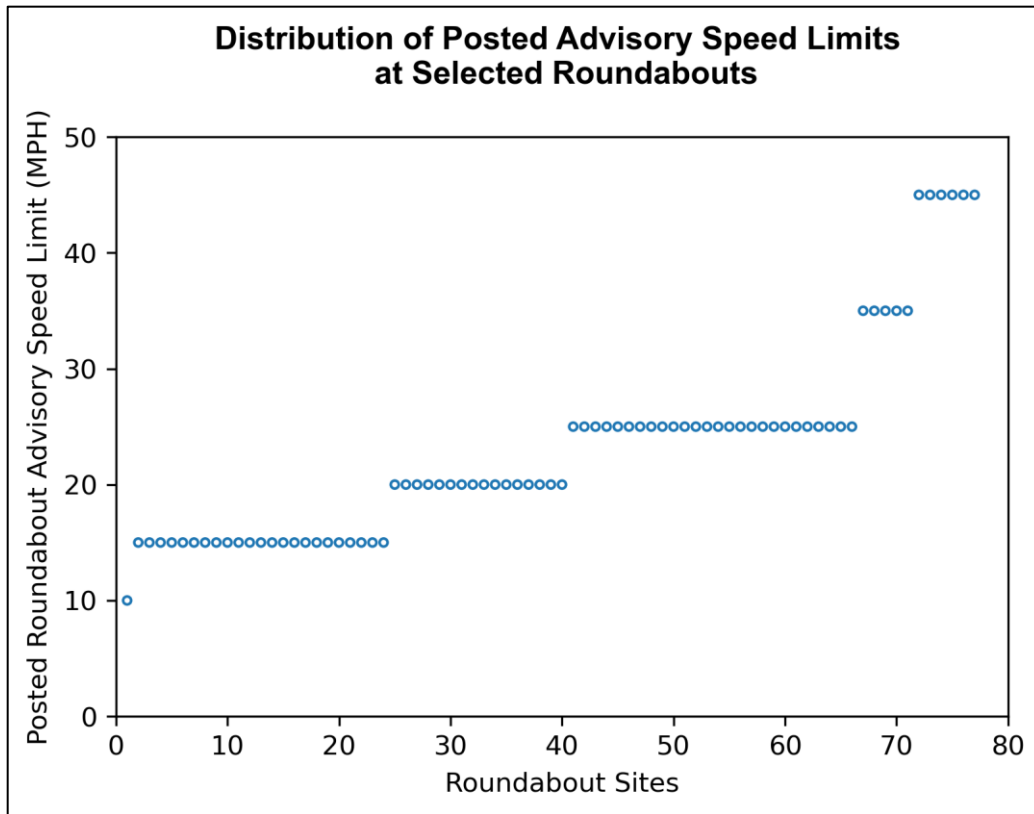

Figure 36. Chart. Distribution of Posted Advisory Speed Limits at Selected Roundabouts

A driver’s ability to detect a roundabout ahead and safely complete the navigation task, along with approach speed, influences the calculated stopping sight distance (SSD). Therefore, SSD was computed at the approach level based on the posted upstream speed limit and an assumed driver’s reaction time of 2.5 seconds. The minimum estimated SSD at each roundabout was used in the analysis. The distribution of these minimum SSD values is presented in Figure 37. The observed range is from 76 ft. to 492 ft.

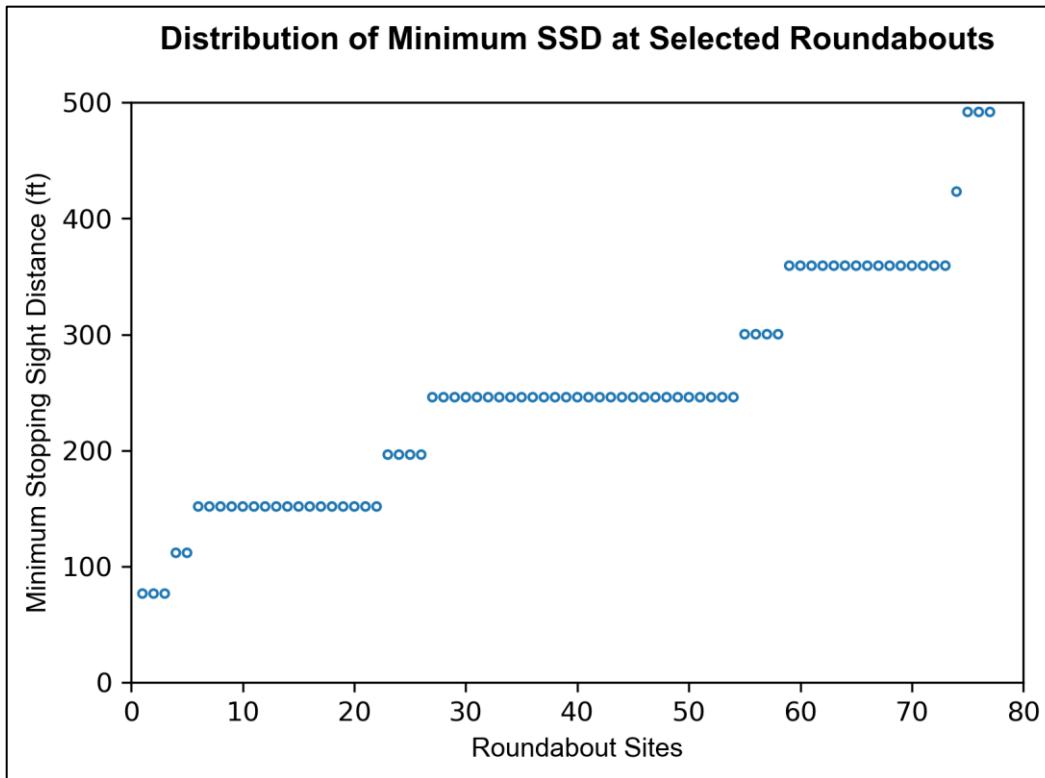

Figure 37. Chart. Distribution of Minimum Stopping Sight Distance at Selected Roundabouts

OBSERVED VARIATION OF ILLUMINANCE WITH CRASH RATE

The crash data were segmented into multi-vehicle crashes and single-vehicle crashes.

Identification of single vehicle crashes is based on the “Non Vehicle” collision type in the data.

A nighttime multi-vehicle crash involves the influence of headlights from at least one additional vehicle, that provides additional illumination for conflict detection. Therefore, roundabout illumination would be expected to have less influence on multi-vehicle crash rates relative to that of single-vehicle crashes. This hypothesis is supported by the results shown in Figure 38 that compares measured illumination values to average multi-vehicle crash rates for each site

normalized to 2020 levels. There is no observable trend in the data points and a fitted line of multi-vehicle crash rates by site remains almost constant across illuminance values.

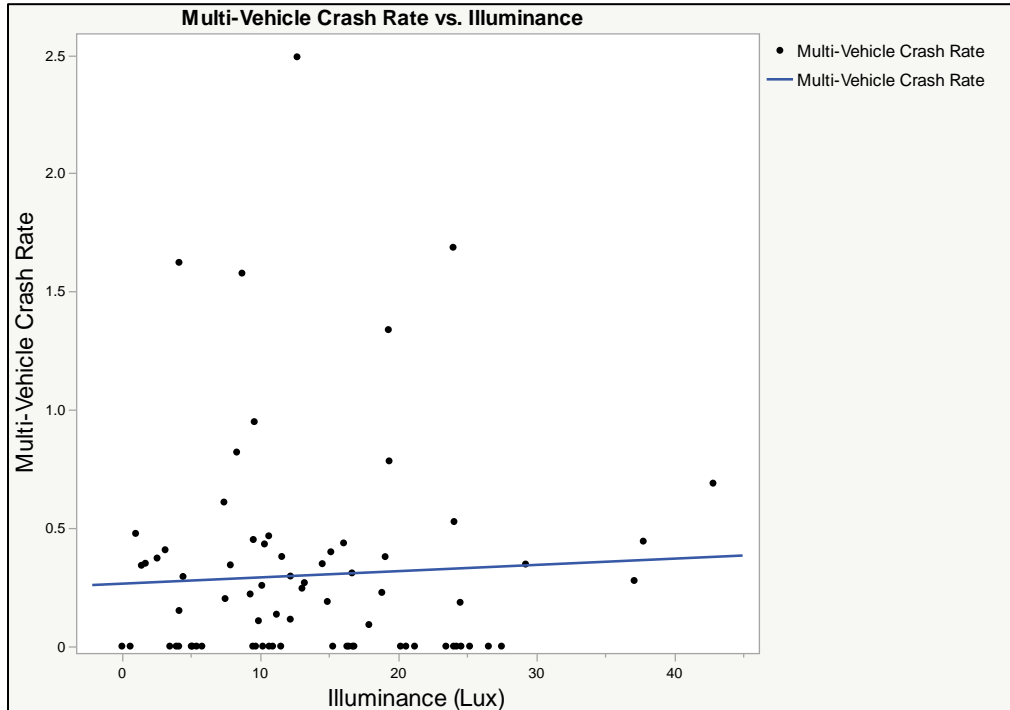

Figure 38. Chart. Variation of Multi-vehicle Crash Rates with Illuminance for All Selected Sites

Based on these results, the remaining analysis focused on determining the relationship between the illumination and single-vehicle crash rates. Different scenarios were also considered to identify the existence of any hidden variables that could potentially affect the impact of illumination on crash rates. Figure 39 illustrates the relationship between observed illumination levels and normalized single vehicle crash rates both on an individual site basis and averaged into 5-lux bins. The 5-lux bin results are further presented as both site-weighted (i.e. the arithmetic average of the crash rates for all sites included in the bin) and volume-weighted (i.e. total crashes recorded for sites within the bin divided by the total volume of all sites within the

bin) crash rates. These results show an increase in observed single-vehicle crash rates for the lowest illumination levels on a site-weighted basis. The volume-weighted results do not show the same dependence.

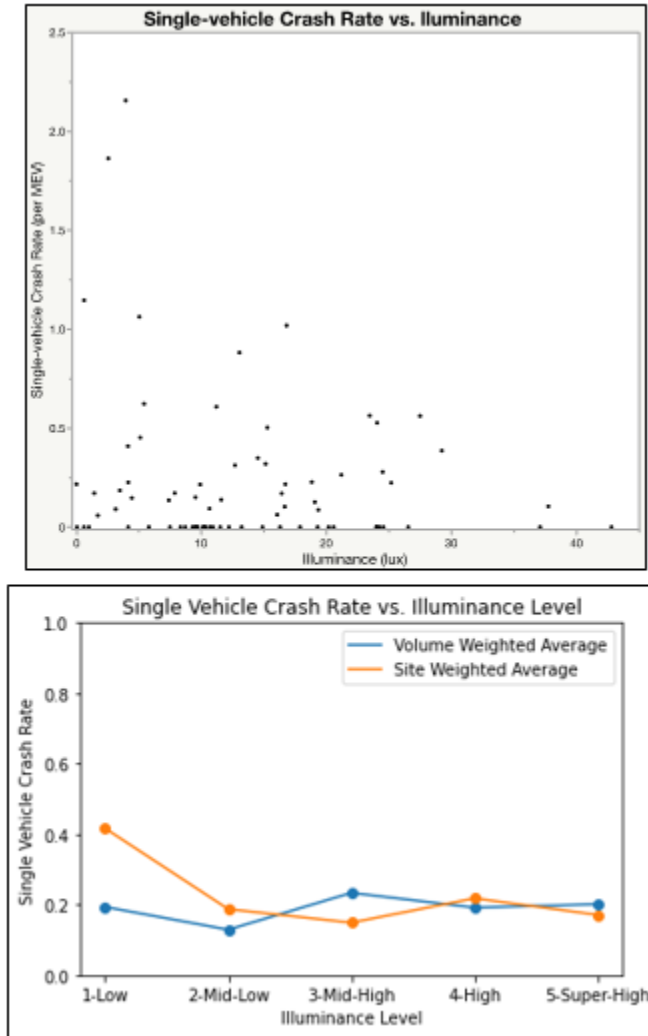

Figure 39. Chart. Variation of Single-vehicle Crash Rates with Illuminance for All Selected Sites

Additionally, the observed relationship between the illuminance and single-vehicle crash rates differ by the number of roundabout legs. As illustrated in Figure 40, both the site-weighted and

volume-weighted average crash rates increase for the lowest illumination levels while the 4- and 5-legged roundabouts do not show this trend.

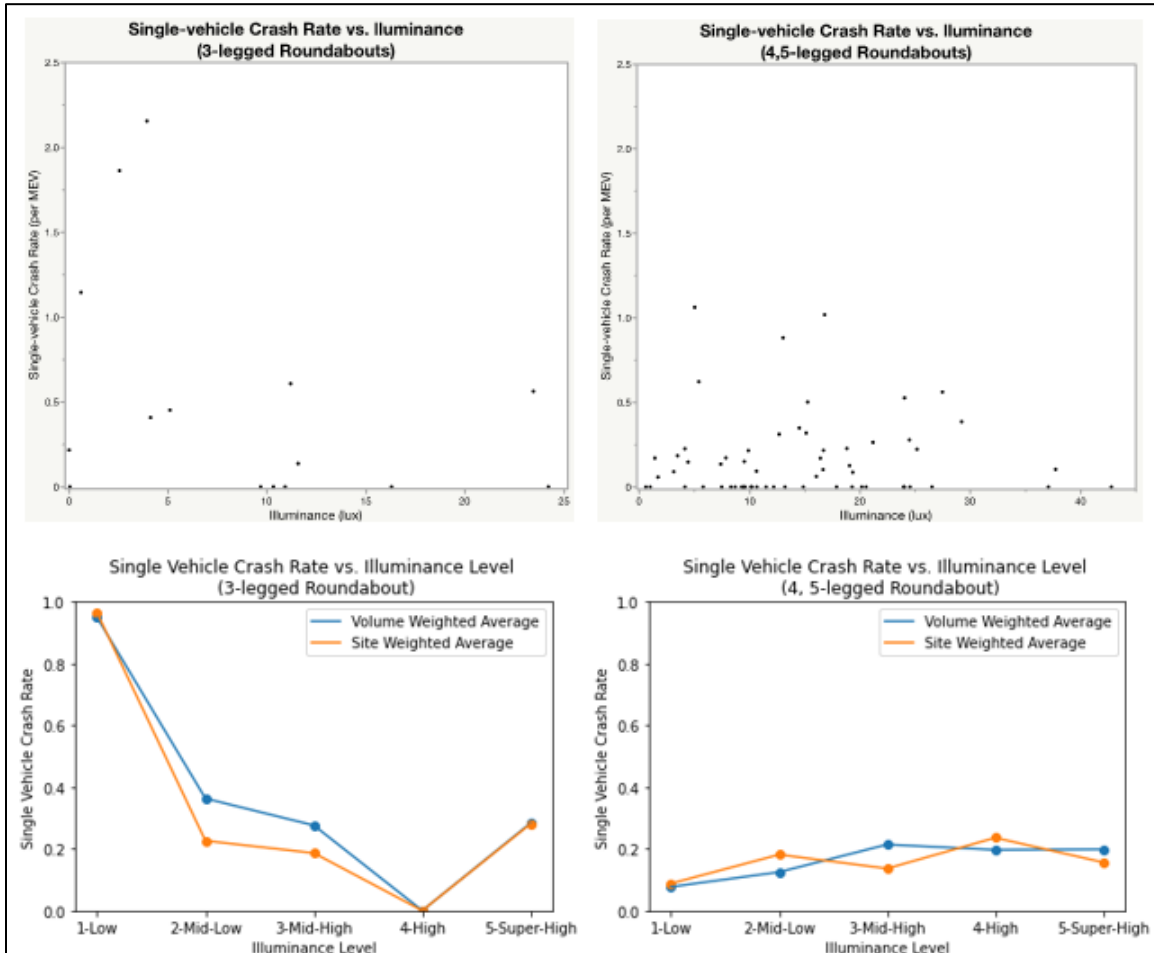

Figure 40. Chart. Variation of Single-vehicle Crash Rates with Illuminance for Different Roundabout Leg Configurations

Apart from the roundabout leg configurations, analysis showed that the variations of single-vehicle crash rates with illuminance levels could also depend on the advisory speed limits posted at the entrance of each roundabout site. When the advisory speed limit is 35 MPH and less, the crash rates were similar to that shown by the complete data. The few sites with advisory speed limits higher than 35 MPH showed a the crash rate that varied substantially with illuminance but,

given the limited number of sites meeting this criteria, the results were not statistically significant. These observations are shown in Figure 41.

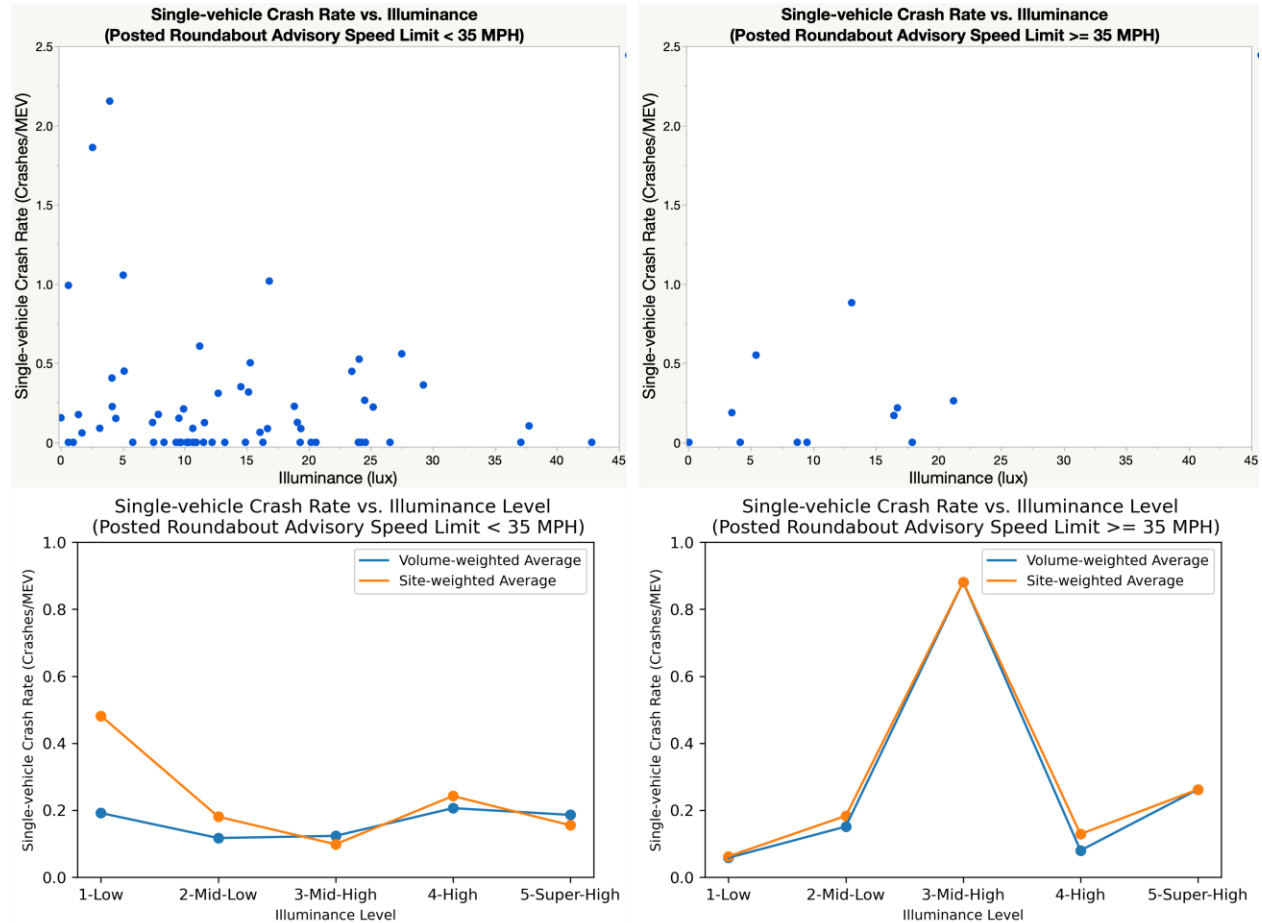

Figure 41 . Chart. Variation of Single-vehicle Crash Rates with Illuminance for Different Posted Roundabout Advisory Speed limits

In addition to the posted advisory speed limits, stopping sight distance (SSD) was shown to have an influence on crash rates at lower illumination levels. Based on the variations of average crash rates at each illumination level, shown in Figure 42, when the SSD is less than 350ft, the single-vehicle crash rates remain almost constant under different levels of illuminance. However, for SSD greater than 350ft, low illumination levels have a significant negative impact on the single-

vehicle crash rates.

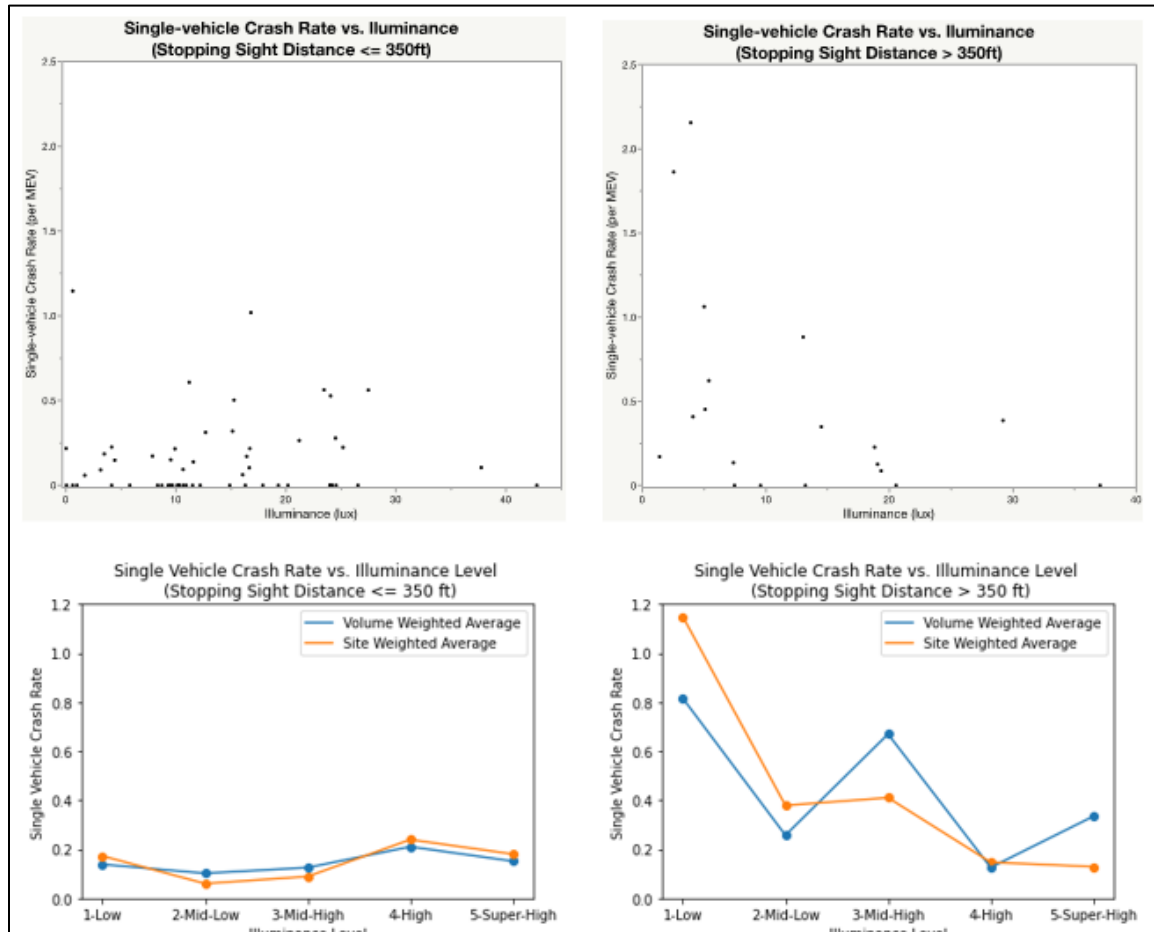

Figure 42 . Chart. Variation of Single-vehicle Crash Rates with Illuminance for Different Stopping Sight Distance

MODEL DEVELOPMENT

Based on the pre-analysis of the relationships between the single-vehicle crash rates and illuminance levels under conditions with different site characteristics, it can be inferred that the roundabout leg configurations, the posted advisory speed limit, and the stopping sight distance at each site would affect the safety impacts of illuminance in terms of the single-vehicle crashes.

Therefore, the following additional variables shown in Table 18 were developed during the model development process to account for the potential correlations between these variables.

Table 18. Additional Variables Defined for Model Development

| Variable | Meaning |
|--------------------------------|---|
| Illuminance<4SSD | If the site illuminance is less than 4 lux, then the variable equals the minimum stopping sight distance of the site, otherwise, equals the average minimum stopping sight distance across all sites, which is 178 ft |
| Illuminance<10SSD | If the site illuminance is less than 10 lux, then the variable equals the minimum stopping sight distance of the site, otherwise, it equals the average minimum stopping sight distance across all sites, which is 178 ft |
| Illuminance<4 | If the site illuminance is less than or equal to 4 lux, then the variable equals 1, otherwise 0 |
| Illuminance<10 | If the site illuminance is less than or equal to 10 lux, then the variable equals 1, otherwise 0 |
| Illuminance<4MaxApproachSpeed | If the site illuminance is less than 4 lux, then the variable equals the maximum posted speed limit on the approach of the site, otherwise, it equals the average posted speed limit across all sites, which is 28 MPH |
| Illuminance<10MaxApproachSpeed | If the site illuminance is less than 10 lux, then the variable equals the maximum posted speed limit on the approach of the site, otherwise, it equals the average posted speed limit across all sites, which is 28 MPH |
| Leg3 | If the site is a 3-legged roundabout, then the variable equals 1, otherwise 0 |
| MaxRoundaboutAdvisorySpeed≥35 | If the maximum posted roundabout advisory speed limit of the site is equal to or greater than 35 MPH, then the variable equals 1, otherwise 0 |

The cut-off points in the illuminance related variables were selected based on both the plot and model analysis results. As indicated in Figure 42 the single-vehicle crash rates don't have any dependence on the illuminance levels in terms of the 4 or 5-legged roundabout sites, while for the 3-legged ones, there's a negative relationship between the two variables. Since the number of sites with zero crash rate begins to increase when the roundabout illuminance is greater than 10 lux, the single-vehicle crash data were first split into two sub-categories at the 10-lux point, and the illuminance effect on crash rates were examined separately for each category. The results of this analysis are shown in Figure 43. This figure shows that when the roundabout illumination level has reached 10 lux and above, no significant safety benefits with respect to the single-

vehicle crashes would be obtained with the increase in illuminance for these 3-legged roundabouts.

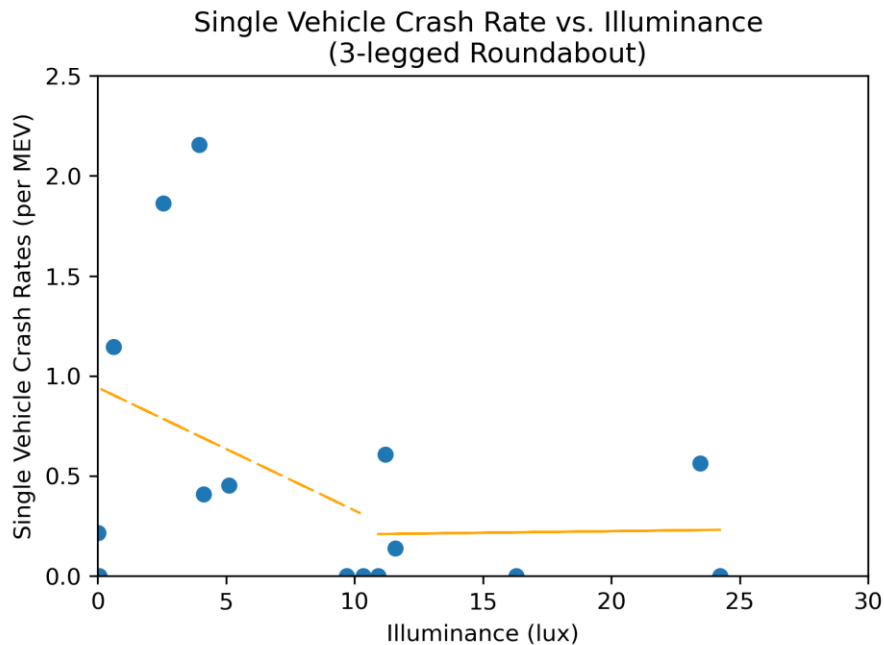

Figure 43. Chart. Variation of Single-vehicle Crash Rates with Illuminance for 3-legged Roundabouts

In addition to the above analysis, the relationship between observed crash rates and illumination were examined using a stepwise regression model. For the crash data collected at the 3-legged roundabout sites, a trial cut-off point (value for which the overall dataset was divided) was initially set as 10 lux based on the previous results, and additional variables ‘*Illuminance<10SSD*’, ‘*Illuminance<10MaxApproachSpeed*’ and ‘*Illuminance<10*’ were included in the model. Additional illumination cut-off points of 8, 6, 5, 4 and 3 lux were also examined to determine the cut-off point that provided the best results based on BIC and R-squared criteria. As shown in Table 19, 4 lux were found to be the most reasonable cut-off point that would yield the best model results.

Table 19. Results of Regression Models with Different Illuminance Cut-off Points

| Evaluation Criteria | Different Values of Illuminance Cut-off Points (lux) | | | | | |
|-----------------------|--|---------|---------|---------|---------|---------|
| | 10 | 8 | 6 | 5 | 4 | 3 |
| R-squared (maximized) | 0.6479 | 0.6473 | 0.6473 | 0.7498 | 0.8764 | 0.5101 |
| BIC (minimized) | 25.7573 | 25.7813 | 25.7813 | 23.3415 | 12.7557 | 36.1274 |

Therefore, the crash dataset was split into two samples with one under the condition of site illuminance being less than 5 lux (i.e., corresponding to the lowest illumination category) and one under the condition of site illuminance being equal to or greater than 5 lux (i.e., the remaining four illumination categories) for the subsequent model development. Separate models were established and analyzed for each data sample to examine the illuminance’s conditional safety impacts.

Roundabouts with Average Maintained Horizontal Illuminance Level Greater than 5 Lux

Among the seventy-seven studied roundabout sites, sixty-one of them have illuminance levels reaching above 5 lux either due to the installed luminaires or the presence of ambient lighting. A stepwise regression model was used to identify the potential explanatory variables of single-vehicle crash rates observed at these sites. The results (see Figure 44) indicate that the advisory speed limits posted at the roundabout entrance would have significant influence on the single-vehicle crash rates depending on whether the posted roundabout advisory speed limit is less than 35 MPH or not.

| Stepwise Fit for Single-vehicle Crash Rate | | | | | | | | | |
|--|-------------------------------------|--|------------|-------------|-----------|-----------|----------|----------|---|
| SSE | DFE | RMSE | RSquare | RSquare Adj | Cp | p | AICc | BIC | |
| 3.3512553 | 53 | 0.2514582 | 0.1224 | 0.1058 | 0.1784423 | 2 | 8.663926 | 14.21534 | |
| Current Estimates | | | | | | | | | |
| Lock | Entered | Parameter | Estimate | nDF | SS | "F Ratio" | "Prob>F" | | |
| <input checked="" type="checkbox"/> | <input checked="" type="checkbox"/> | Intercept | 0.36155233 | 1 | 0 | 0.000 | 0.000 | | 1 |
| <input type="checkbox"/> | <input type="checkbox"/> | RoundaboutOpenYear | 0 | 1 | 0.010385 | 0.162 | 0.6893 | | |
| <input type="checkbox"/> | <input type="checkbox"/> | 2020_DEV | 0 | 1 | 0.011813 | 0.184 | 0.66978 | | |
| <input type="checkbox"/> | <input type="checkbox"/> | Illuminance | 0 | 1 | 0.011961 | 0.186 | 0.66783 | | |
| <input type="checkbox"/> | <input type="checkbox"/> | Illuminance_Recode{3-Mid-High&5-Super-High-2-Mid-Low&4-High} | 0 | 1 | 0.088921 | 1.417 | 0.23925 | | |
| <input type="checkbox"/> | <input type="checkbox"/> | Illuminance_Recode{3-Mid-High-5-Super-High} | 0 | 1 | 0.006277 | 0.098 | 0.756 | | |
| <input type="checkbox"/> | <input type="checkbox"/> | Illuminance_Recode{2-Mid-Low-4-High} | 0 | 1 | 0.024354 | 0.381 | 0.53994 | | |
| <input type="checkbox"/> | <input type="checkbox"/> | Roundabout Type{Multilane-Single Lane} | 0 | 1 | 0.029068 | 0.455 | 0.50297 | | |
| <input type="checkbox"/> | <input type="checkbox"/> | No. of Legs | 0 | 1 | 0.002229 | 0.035 | 0.85315 | | |
| <input type="checkbox"/> | <input type="checkbox"/> | InscribedDiameter | 0 | 1 | 0.021292 | 0.332 | 0.56668 | | |
| <input type="checkbox"/> | <input type="checkbox"/> | Max_No. Approach Lanes | 0 | 1 | 0.000944 | 0.015 | 0.90415 | | |
| <input type="checkbox"/> | <input type="checkbox"/> | Max_No. of Circulating Lanes | 0 | 1 | 0.012134 | 0.189 | 0.66558 | | |
| <input type="checkbox"/> | <input type="checkbox"/> | StateRoute/Highway_On_Atleast_One_Route{No-Yes} | 0 | 1 | 0.050084 | 0.789 | 0.37852 | | |
| <input type="checkbox"/> | <input type="checkbox"/> | Posted Roundabout Advisory Speed Limit | 0 | 1 | 0.004402 | 0.068 | 0.79473 | | |
| <input type="checkbox"/> | <input checked="" type="checkbox"/> | Posted Roundabout Advisory Speed Limit-Recode{20_Max&15_Max&25_Max-45_Max} | -0.2029377 | 1 | 0.467248 | 7.390 | 0.00885 | | |
| <input type="checkbox"/> | <input type="checkbox"/> | Posted Roundabout Advisory Speed Limit-Recode{20_Max-15_Max&25_Max} | 0 | 1 | 0.141304 | 2.289 | 0.13634 | | |
| <input type="checkbox"/> | <input type="checkbox"/> | Posted Roundabout Advisory Speed Limit-Recode{15_Max-25_Max} | 0 | 1 | 0.00233 | 0.036 | 0.84987 | | |
| <input type="checkbox"/> | <input type="checkbox"/> | Approach Posted Speed Limit-Recode{25_Max-45_Max&55_Max&35_Max} | 0 | 1 | 0.141009 | 2.284 | 0.13676 | | |
| <input type="checkbox"/> | <input type="checkbox"/> | Approach Posted Speed Limit-Recode{45_Max&55_Max-35_Max} | 0 | 1 | 0.082475 | 1.312 | 0.25727 | | |
| <input type="checkbox"/> | <input type="checkbox"/> | Approach Posted Speed Limit-Recode{45_Max-55_Max} | 0 | 1 | 0.040733 | 0.640 | 0.42742 | | |
| <input type="checkbox"/> | <input type="checkbox"/> | YieldSign_At_All_Entrances{No-Yes} | 0 | 1 | 0.025652 | 0.401 | 0.5293 | | |
| <input type="checkbox"/> | <input type="checkbox"/> | Roundabout_Ahead_Warning_On_All_Approaches{No-Yes} | 0 | 1 | 0.009291 | 0.145 | 0.70534 | | |
| <input type="checkbox"/> | <input type="checkbox"/> | Marked_Crosswalks{No-Yes} | 0 | 1 | 0.141606 | 2.294 | 0.13592 | | |
| <input type="checkbox"/> | <input type="checkbox"/> | RefugeIsland_In_Crosswalks{No-Yes} | 0 | 1 | 0.062088 | 0.982 | 0.3264 | | |
| <input type="checkbox"/> | <input type="checkbox"/> | Transverse_Markings{Yes-No} | 0 | 1 | 0.004879 | 0.076 | 0.78415 | | |
| <input type="checkbox"/> | <input type="checkbox"/> | Centerline_RumbleStrips_On_Atleast_One_Approach{Yes-No} | 0 | 1 | 0.050892 | 0.802 | 0.37467 | | |
| <input type="checkbox"/> | <input type="checkbox"/> | RumbleStripsAcrossRoad | 0 | 1 | 0.00356 | 0.055 | 0.81501 | | |
| <input type="checkbox"/> | <input type="checkbox"/> | IlluminationDesign/Layout{Full-Partial} | 0 | 1 | 0.012246 | 0.191 | 0.66414 | | |
| <input type="checkbox"/> | <input type="checkbox"/> | Edge_Rumble_Strips_On_Atleast_One_Approach{No-Yes} | 0 | 1 | 0.000165 | 0.003 | 0.95986 | | |
| <input type="checkbox"/> | <input type="checkbox"/> | Roadside_Safety_Barrier{No-Yes} | 0 | 1 | 0.050095 | 0.789 | 0.37846 | | |
| <input type="checkbox"/> | <input type="checkbox"/> | Raised_Splitter_Islands{No-Yes} | 0 | 1 | 0.025652 | 0.401 | 0.5293 | | |
| <input type="checkbox"/> | <input type="checkbox"/> | Truck_Aproan_with_Color{No-Yes} | 0 | 1 | 0.023838 | 0.373 | 0.54428 | | |
| <input type="checkbox"/> | <input type="checkbox"/> | Central_Treatment_Plants{No-Yes} | 0 | 1 | 0.014639 | 0.228 | 0.63491 | | |
| <input type="checkbox"/> | <input type="checkbox"/> | Central_Treatment_Chevron_Signs{No-Yes} | 0 | 1 | 0.002644 | 0.041 | 0.84023 | | |
| <input type="checkbox"/> | <input type="checkbox"/> | Ambient_Lighting{Yes-No} | 0 | 1 | 0.003703 | 0.058 | 0.81141 | | |
| <input type="checkbox"/> | <input type="checkbox"/> | Cross-section_Design{Rural Cross Design-Urban Cross Design} | 0 | 1 | 0.025163 | 0.393 | 0.53326 | | |
| <input type="checkbox"/> | <input type="checkbox"/> | Min_AngleBtwnLegs | 0 | 1 | 0.000413 | 0.006 | 0.93652 | | |
| <input type="checkbox"/> | <input type="checkbox"/> | StoppingSightDistance{Feet} | 0 | 1 | 0.118953 | 1.914 | 0.17247 | | |

Figure 44. Table. Regression Model Results of All Studied Sites with Illuminance Level ≥ 5 Lux

For better model interpretation, an additional binary variable

‘*MaxRoundaboutAdvisorySpeed* ≥ 35 ’ was defined as 1 for sites with posted roundabout advisory speed limit being equal to or greater than 35 MPH and 0 otherwise. This variable was used to replace the previous posted roundabout advisory speed limit related variables, and the corresponding model results indicate that compared with the standard condition of single-vehicle crash rate being 0.159 per MEV, if the posted advisory speed limit at the roundabout entrance is

equal to or greater than 35 MPH, then the predicted single-vehicle crash rate would increase to 0.565 per MEV, which is nearly three times higher than the standard condition, as shown in Figure 45. Besides, when the site average horizontal illuminance level reached 5 lux and above, no strong evidence were observed to indicate the dependence of the single-vehicle crash rates on the illuminance related variables.

| Stepwise Fit for Single-vehicle Crash Rate | | | | | | | | | |
|--|-------------------------------------|---|------------|-------------|-----------|-----------|----------|----------|--|
| SSE | DFE | RMSE | RSquare | RSquare Adj | Cp | p | AICc | BIC | |
| 3.3512553 | 53 | 0.2514582 | 0.1224 | 0.1058 | -6.139521 | 2 | 8.663926 | 14.21534 | |
| Current Estimates | | | | | | | | | |
| Lock | Entered | Parameter | Estimate | nDF | SS | "F Ratio" | "Prob>F" | | |
| <input checked="" type="checkbox"/> | <input checked="" type="checkbox"/> | Intercept | 0.1586146 | 1 | 0 | 0.000 | 1 | | |
| <input type="checkbox"/> | <input type="checkbox"/> | RoundaboutOpenYear | 0 | 1 | 0.010385 | 0.162 | 0.6893 | | |
| <input type="checkbox"/> | <input type="checkbox"/> | 2020_DEV | 0 | 1 | 0.011813 | 0.184 | 0.66978 | | |
| <input type="checkbox"/> | <input type="checkbox"/> | Illuminance | 0 | 1 | 0.011961 | 0.186 | 0.66783 | | |
| <input type="checkbox"/> | <input type="checkbox"/> | Illuminance_Recode{3-Mid-High&5-Super-High-2-Mid-Low&4-High} | 0 | 1 | 0.088921 | 1.417 | 0.23925 | | |
| <input type="checkbox"/> | <input type="checkbox"/> | Illuminance_Recode{3-Mid-High-5-Super-High} | 0 | 1 | 0.006277 | 0.098 | 0.756 | | |
| <input type="checkbox"/> | <input type="checkbox"/> | Illuminance_Recode{2-Mid-Low-4-High} | 0 | 1 | 0.024354 | 0.381 | 0.53994 | | |
| <input type="checkbox"/> | <input type="checkbox"/> | Roundabout Type{Multilane-Single Lane} | 0 | 1 | 0.029068 | 0.455 | 0.50297 | | |
| <input type="checkbox"/> | <input type="checkbox"/> | No. of Legs | 0 | 1 | 0.002229 | 0.035 | 0.85315 | | |
| <input type="checkbox"/> | <input type="checkbox"/> | InscribedDiameter | 0 | 1 | 0.021292 | 0.332 | 0.56668 | | |
| <input type="checkbox"/> | <input type="checkbox"/> | Max_No. Approach Lanes | 0 | 1 | 0.000944 | 0.015 | 0.90415 | | |
| <input type="checkbox"/> | <input type="checkbox"/> | Max_No. of Circulating Lanes | 0 | 1 | 0.012134 | 0.189 | 0.66558 | | |
| <input type="checkbox"/> | <input type="checkbox"/> | StateRoute/Highway_On_Atleast_One_Route{No-Yes} | 0 | 1 | 0.050084 | 0.789 | 0.37852 | | |
| <input type="checkbox"/> | <input type="checkbox"/> | Approach Posted Speed Limit-Recode{25_Max-45_Max&55_Max&35_Max} | 0 | 1 | 0.141009 | 2.284 | 0.13676 | | |
| <input type="checkbox"/> | <input type="checkbox"/> | Approach Posted Speed Limit-Recode{45_Max&55_Max-35_Max} | 0 | 1 | 0.082475 | 1.312 | 0.25727 | | |
| <input type="checkbox"/> | <input type="checkbox"/> | Approach Posted Speed Limit-Recode{45_Max-55_Max} | 0 | 1 | 0.040733 | 0.640 | 0.42742 | | |
| <input type="checkbox"/> | <input type="checkbox"/> | YieldSign_At_All_Entrances{No-Yes} | 0 | 1 | 0.025652 | 0.401 | 0.5293 | | |
| <input type="checkbox"/> | <input type="checkbox"/> | Roundabout_Ahead_Warning_On_All_Approaches{No-Yes} | 0 | 1 | 0.009291 | 0.145 | 0.70534 | | |
| <input type="checkbox"/> | <input type="checkbox"/> | Marked_Crosswalks{No-Yes} | 0 | 1 | 0.141606 | 2.294 | 0.13592 | | |
| <input type="checkbox"/> | <input type="checkbox"/> | RefugeIsland_In_Crosswalks{No-Yes} | 0 | 1 | 0.062088 | 0.982 | 0.3264 | | |
| <input type="checkbox"/> | <input type="checkbox"/> | Transverse_Markings{Yes-No} | 0 | 1 | 0.004879 | 0.076 | 0.78415 | | |
| <input type="checkbox"/> | <input type="checkbox"/> | Centerline_RumbleStrips_On_Atleast_One_Approach{Yes-No} | 0 | 1 | 0.050892 | 0.802 | 0.37467 | | |
| <input type="checkbox"/> | <input type="checkbox"/> | RumbleStripsAcrossRoad | 0 | 1 | 0.00356 | 0.055 | 0.81501 | | |
| <input type="checkbox"/> | <input type="checkbox"/> | IlluminationDesign/Layout{Full-Partial} | 0 | 1 | 0.012246 | 0.191 | 0.66414 | | |
| <input type="checkbox"/> | <input type="checkbox"/> | Edge_Rumble_Strips_On_Atleast_One_Approach{No-Yes} | 0 | 1 | 0.000165 | 0.003 | 0.95986 | | |
| <input type="checkbox"/> | <input type="checkbox"/> | Roadside_Safety_Barrier{No-Yes} | 0 | 1 | 0.050095 | 0.789 | 0.37846 | | |
| <input type="checkbox"/> | <input type="checkbox"/> | Raised_Splitter_Islands{No-Yes} | 0 | 1 | 0.025652 | 0.401 | 0.5293 | | |
| <input type="checkbox"/> | <input type="checkbox"/> | Truck_Aproan_with_Color{No-Yes} | 0 | 1 | 0.023838 | 0.373 | 0.54428 | | |
| <input type="checkbox"/> | <input type="checkbox"/> | Central_Treatment_Plants{No-Yes} | 0 | 1 | 0.014639 | 0.228 | 0.63491 | | |
| <input type="checkbox"/> | <input type="checkbox"/> | Central_Treatment_Chevron_Signs{No-Yes} | 0 | 1 | 0.002644 | 0.041 | 0.84023 | | |
| <input type="checkbox"/> | <input type="checkbox"/> | Ambient_Lighting{Yes-No} | 0 | 1 | 0.003703 | 0.058 | 0.81141 | | |
| <input type="checkbox"/> | <input type="checkbox"/> | Cross-section_Design{Rural Cross Design-Urban Cross Design} | 0 | 1 | 0.025163 | 0.393 | 0.53326 | | |
| <input type="checkbox"/> | <input type="checkbox"/> | Min_AngleBtwnLegs | 0 | 1 | 0.000413 | 0.006 | 0.93652 | | |
| <input type="checkbox"/> | <input type="checkbox"/> | StoppingSightDistance{Feet} | 0 | 1 | 0.118953 | 1.914 | 0.17247 | | |
| <input checked="" type="checkbox"/> | <input checked="" type="checkbox"/> | MaxRoundaboutAdvisorySpeed>=35 | 0.40587546 | 1 | 0.467248 | 7.390 | 0.00885 | | |

Figure 45. Table. Regression Model Results of All Studied Sites with Illuminance Level >= 5 Lux (Replaced with Variable ‘MaxRoundaboutAdvisorySpeed≥35’)

Roundabouts with Average Maintained Horizontal Illuminance Level Less than 5 Lux

3-Leg Roundabouts

For the remaining 16 sites with average horizontal illuminance level less than 5 lux, as illustrated in Figure 40 and Figure 43, the effects of illuminance were shown to differ based on the number of roundabout legs, therefore separate models were developed for the 3-legged and 4,5-legged roundabouts accordingly.

There are in total of six 3-legged roundabouts with illuminance level maintained at less than 5 lux included in the dataset. Considering the relatively small sample size, a manual stepwise regression method was employed to prevent the model from over-fitting. Through the investigation of how inclusion, exclusion and interaction of different variables would affect the model's goodness-of-fit, the final obtained model is shown in Figure 46. The results suggest that roundabouts with lighted circular path / central island tend to have higher single-vehicle crash rates compared with those without circle lighting installed. However, this inference is unlikely to be valid. Only a small fraction of observed sites did not have any form of circle lighting and only one site within this category met that criterion and this site had a near-zero crash rate. Thus, the most likely interpretation is that this one site is somehow different from the rest either randomly, or due to some systematic factor. Putting aside this consideration, the remaining five sites in this low (<5 lux) illumination condition showed a significantly higher average crash rate than their better illuminated counterparts.

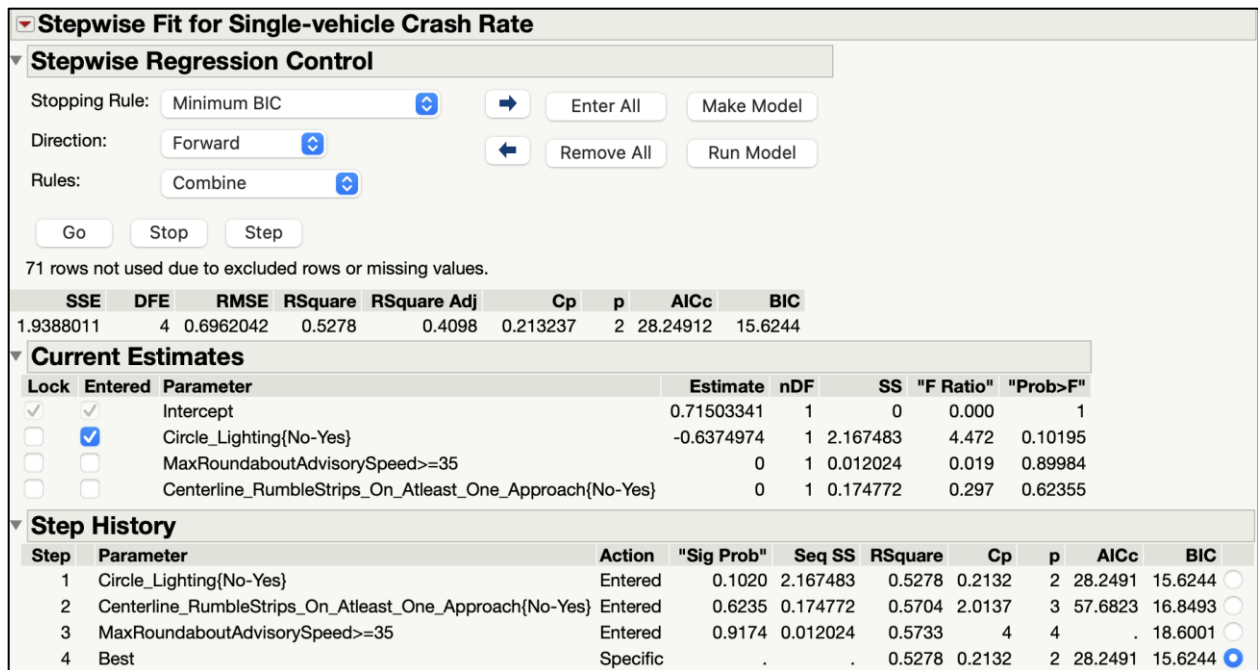

Figure 46. Table. Regression Model Results of 3 Leg Roundabouts with Illuminance Level < 5 Lux

Therefore, another model was developed with the inclusion of all the 3-legged roundabouts regardless of the illumination conditions. Based on the previous model, additional variables ‘*Illuminance<4SSD*’, ‘*Illuminance<4*’ and ‘*Illuminance<4MaxApproachSpeed*’ were included into the explanatory variables set. The model obtained after the iterative stepwise regression process indicates that compared with the standard condition with no specific illumination treatments implemented, the installation of lighting within the roundabout circular areas would lead to an increase of 0.30 single-vehicle crashes per MEV in the predicted crash rate, which is consistent to the previous model results. The existence of rumble strips in the centerline of at least one approach in the roundabout site was also found to be associated with higher crash rates. While the decision of rumble strips implementation is usually based on the presence of intersecting state route/highway as well as the corresponding posted speed limit in the approach,

thus the presence of rumble strips could be identified as a substitute variable for other characteristics that result in a higher likelihood of single-vehicle crash occurrence. Additionally, when the site average horizontal illuminance is maintained above 5 lux, the predicted single-vehicle crash rate would be 0.49 per MEV. While with respect to the sites with luminance level below 5 lux, the predicted crash rate would significantly depend on the stopping sight distance, ranging from 0.17 per MEV to 2.2 per MEV.

| SSE | DFE | RMSE | RSquare | RSquare Adj | Cp | p | AICc | BIC |
|-----------|-----|-----------|---------|-------------|-----------|---|----------|----------|
| 0.8334936 | 11 | 0.2752674 | 0.8764 | 0.8427 | 3.0251137 | 4 | 15.88213 | 12.75572 |

| Current Estimates | | | | | | | |
|-------------------------------------|-------------------------------------|---|------------|-----|----------|-----------|----------|
| Lock | Entered | Parameter | Estimate | nDF | SS | "F Ratio" | "Prob>F" |
| <input checked="" type="checkbox"/> | <input checked="" type="checkbox"/> | Intercept | -0.732577 | 1 | 0 | 0.000 | 1 |
| <input type="checkbox"/> | <input checked="" type="checkbox"/> | Circle_Lighting(No-Yes) | -0.2947423 | 1 | 0.589214 | 7.776 | 0.01763 |
| <input type="checkbox"/> | <input checked="" type="checkbox"/> | Centerline_RumbleStrips_On_Atleast_One_Approach(No-Yes) | -0.5458179 | 1 | 1.059802 | 13.987 | 0.00327 |
| <input type="checkbox"/> | <input checked="" type="checkbox"/> | Illuminance<4SSD | 0.00683661 | 1 | 5.186468 | 68.448 | 4.74e-6 |
| <input type="checkbox"/> | <input type="checkbox"/> | Max_Approach_Speed | 0 | 1 | 0.002088 | 0.025 | 0.87724 |

| Step History | | | | | | | | | |
|--------------|---|----------|------------|----------|---------|--------|---|---------|---------|
| Step | Parameter | Action | "Sig Prob" | Seq SS | RSquare | Cp | p | AICc | BIC |
| 1 | Illuminance<4SSD | Entered | 0.0006 | 4.120981 | 0.6109 | 20.572 | 2 | 24.6047 | 24.547 |
| 2 | Centerline_RumbleStrips_On_Atleast_One_Approach(No-Yes) | Entered | 0.0079 | 1.202166 | 0.7891 | 8.1121 | 3 | 19.2358 | 18.068 |
| 3 | Circle_Lighting(No-Yes) | Entered | 0.0176 | 0.589214 | 0.8764 | 3.0251 | 4 | 15.8821 | 12.7557 |
| 4 | Max_Approach_Speed | Entered | 0.8772 | 0.002088 | 0.8768 | 5 | 5 | 21.6778 | 15.4261 |
| 5 | Best | Specific | . | . | 0.8764 | 3.0251 | 4 | 15.8821 | 12.7557 |

Figure 47. Table. Regression Model Results of All 3 Leg Roundabout Sites

4 and 5 Leg Roundabouts

A majority of the seventy-seven studied sites were 4-legged roundabouts while only 3 were 5-legged ones. Since the illuminance effects appear to be similar at these two types of roundabout sites, they were combined as one single dataset and ten of these sites were found to have a horizontal illuminance level below 5 lux. Based on these ten sites, a similar manual stepwise regression process was used to avoid model overfitting and the final results are presented in Figure 48. The results suggest that in terms of the 4 and 5 leg roundabouts, the presence of

ambient lighting might lead to a decrease in the predicted single-vehicle crash rates, since it would serve as additional lighting sources that could improve the visual performance of the roundabout at nighttime. But still, due to the limited number of crash records reported in these studied sites, such inference would not have much reliability unless more single-vehicle crash data are collected and analyzed to yield similar results.

| SSE | DFE | RMSE | RSquare | RSquare Adj | Cp | p | AICc | BIC | |
|-------------------------------------|-------------------------------------|--------------------------|------------|-------------|----------|-----------|----------|----------|---------|
| 0.0197629 | 7 | 0.0531345 | 0.7199 | 0.6399 | 2.717484 | 3 | -17.8865 | -24.6762 | |
| Current Estimates | | | | | | | | | |
| Lock | Entered | Parameter | Estimate | nDF | SS | "F Ratio" | "Prob>F" | | |
| <input checked="" type="checkbox"/> | <input checked="" type="checkbox"/> | Intercept | 0.03082679 | 1 | 0 | 0.000 | 1 | | |
| <input type="checkbox"/> | <input checked="" type="checkbox"/> | Illuminance | 0.02743149 | 1 | 0.016072 | 5.693 | 0.04846 | | |
| <input type="checkbox"/> | <input checked="" type="checkbox"/> | Ambient_Lighting{Yes-No} | -0.0551493 | 1 | 0.028769 | 10.190 | 0.01523 | | |
| <input type="checkbox"/> | <input type="checkbox"/> | Illuminance<4SSD | 0 | 1 | 0.002111 | 0.717 | 0.42946 | | |
| Step History | | | | | | | | | |
| Step | Parameter | Action | "Sig Prob" | Seq SS | RSquare | Cp | p | AICc | BIC |
| 1 | Ambient_Lighting{Yes-No} | Entered | 0.0238 | 0.03473 | 0.4922 | 6.1805 | 2 | -17.935 | -21.028 |
| 2 | Illuminance | Entered | 0.0485 | 0.016072 | 0.7199 | 2.7175 | 3 | -17.887 | -24.676 |
| 3 | Illuminance<4SSD | Entered | 0.4295 | 0.002111 | 0.7498 | 4 | 4 | -10.016 | -23.503 |
| 4 | Best | Specific | . | . | 0.7199 | 2.7175 | 3 | -17.887 | -24.676 |

Figure 48. Table. Regression Model Results of All 4 and 5 Leg Roundabout Sites with Illuminance Level < 5 Lux

To solve the data limitation issue, another model was built covering all the 4 and 5 leg roundabout sites without filtering out those with average illuminance greater than 5 lux. Based on the previously identified cut-off points in the illuminance variable, additional variables ‘*Illuminance<4SSD*’, ‘*Illuminance<4*’ were again considered in the model input. The results obtained from the stepwise regression model are shown in Figure 49. With the standard condition of single-vehicle crash rate being 0.12 per MEV, the only variable that implied significant relationships with the crash rates was the presence of marked crosswalks on the roundabout approach. If there’s any approaches not installed with marked pedestrian crosswalks, then a reduction of 0.08 per MEV would be expected to occur on the single-vehicle crash rates,

roughly two thirds of the baseline value. It is likely that, as for the presence of centerline rumble strips, the presence of marked crosswalks is probably indicative of the presence of other confounding variables at the site rather than the effect of the treatment itself. Consistent with the previous analysis results, the crash rate showed no dependence on the average horizontal illuminance levels observed at 4 and 5 leg roundabouts.

| SSE | DFE | RMSE | RSquare | RSquare Adj | Cp | p | AICc | BIC | |
|-------------------------------------|---|---|------------|-------------|-----------|-----------|----------|----------|---------|
| 3.3606951 | 60 | 0.2366677 | 0.0822 | 0.0669 | 2.5122362 | 2 | 1.633005 | 7.600615 | |
| ▼ Current Estimates | | | | | | | | | |
| Lock | Entered | Parameter | Estimate | nDF | SS | "F Ratio" | "Prob>F" | | |
| <input checked="" type="checkbox"/> | <input checked="" type="checkbox"/> | Intercept | 0.12002857 | 1 | 0 | 0.000 | 1 | | |
| <input type="checkbox"/> | <input type="checkbox"/> | Illuminance | 0 | 1 | 0.011158 | 0.197 | 0.65915 | | |
| <input type="checkbox"/> | <input checked="" type="checkbox"/> | Marked_Crosswalks{No-Yes} | -0.081357 | 1 | 0.301056 | 5.375 | 0.02385 | | |
| <input type="checkbox"/> | <input type="checkbox"/> | StoppingSightDistance{Feet} | 0 | 1 | 0.076799 | 1.380 | 0.24485 | | |
| <input type="checkbox"/> | <input type="checkbox"/> | Illuminance<4 | 0 | 1 | 0.054193 | 0.967 | 0.32945 | | |
| <input type="checkbox"/> | <input type="checkbox"/> | Illuminance<4SSD | 0 | 1 | 0.00886 | 0.156 | 0.69433 | | |
| <input type="checkbox"/> | <input type="checkbox"/> | Circle_Lighting{No-Yes} | 0 | 1 | 0.030139 | 0.534 | 0.46786 | | |
| <input type="checkbox"/> | <input type="checkbox"/> | Centerline_RumbleStrips_On_Atleast_One_Approach{Yes-No} | 0 | 1 | 0.107403 | 1.948 | 0.16805 | | |
| ▼ Step History | | | | | | | | | |
| Step | Parameter | Action | "Sig Prob" | Seq SS | RSquare | Cp | p | AICc | BIC |
| 1 | Marked_Crosswalks{No-Yes} | Entered | 0.0239 | 0.301056 | 0.0822 | 2.5122 | 2 | 1.63301 | 7.60062 |
| 2 | Centerline_RumbleStrips_On_Atleast_One_Approach{Yes-No} | Entered | 0.1681 | 0.107403 | 0.1115 | 2.5783 | 3 | 1.90717 | 9.71396 |
| 3 | StoppingSightDistance{Feet} | Entered | 0.0968 | 0.152352 | 0.1532 | 1.8351 | 4 | 1.3032 | 10.8674 |
| 4 | Illuminance<4 | Entered | 0.1811 | 0.096626 | 0.1795 | 2.0953 | 5 | 1.79636 | 13.0319 |
| 5 | Circle_Lighting{No-Yes} | Entered | 0.7619 | 0.004966 | 0.1809 | 4.0059 | 6 | 4.2406 | 17.0565 |
| 6 | Illuminance | Entered | 0.9408 | 0.000304 | 0.1810 | 6.0004 | 7 | 6.87722 | 21.1773 |
| 7 | Illuminance<4SSD | Entered | 0.9844 | 2.143e-5 | 0.1810 | 8 | 8 | 9.62133 | 25.304 |
| 8 | Best | Specific | . | . | 0.0822 | 2.5122 | 2 | 1.63301 | 7.60062 |

Figure 49. Table. Regression Model Results of All 4 and 5 Leg Roundabout Sites

Once the presence of marked pedestrian crosswalk at 4 and 5 leg roundabouts was found to be significantly related to the single-vehicle crash rate, two models were further developed respectively for the 4 and 5 leg roundabouts with and without the installation of marked pedestrian crosswalks to verify if any other hidden variables were missing. 47 out of 62 sites were found to have marked pedestrian crosswalks installed, and the results based on the data collected at these 47 sites and the other 15 sites are shown in Figure 50 and Figure 51 respectively. The regression results confirmed that no other variables would have any significant

influence on determining the single-vehicle crash rates based on the collected data, and the intercepts estimated for each condition also suggest that the single-vehicle crash rates were observed to be higher at sites with the presence of marked pedestrian crosswalks on every roundabout approach although, as discussed above, it is likely that this results is the aggregate of several factors rather an effect of the treatment in isolation.

| SSE | DFE | RMSE | RSquare | RSquare Adj | Cp | p | AICc | BIC | |
|-------------------------------------|-------------------------------------|-----------------------------|------------|-------------|----------|-----------|----------|----------|---------|
| 3.2543953 | 46 | 0.2659844 | 0.0000 | 0.0000 | -1.49614 | 1 | 12.15632 | 15.58388 | |
| Current Estimates | | | | | | | | | |
| Lock | Entered | Parameter | Estimate | nDF | SS | "F Ratio" | "Prob>F" | | |
| <input checked="" type="checkbox"/> | <input checked="" type="checkbox"/> | Intercept | 0.20138559 | 1 | 0 | 0.000 | 0.000 | 1 | |
| <input type="checkbox"/> | <input type="checkbox"/> | Illuminance | 0 | 1 | 0.034904 | 0.488 | 0.48847 | | |
| <input type="checkbox"/> | <input type="checkbox"/> | StoppingSightDistance(Feet) | 0 | 1 | 0.096907 | 1.381 | 0.24609 | | |
| <input type="checkbox"/> | <input type="checkbox"/> | Illuminance<4SSD | 0 | 1 | 0.010078 | 0.140 | 0.71024 | | |
| <input type="checkbox"/> | <input type="checkbox"/> | Illuminance<4 | 0 | 1 | 0.078686 | 1.115 | 0.29664 | | |
| <input type="checkbox"/> | <input type="checkbox"/> | Circle_Lighting{No-Yes} | 0 | 1 | 0.041438 | 0.580 | 0.45014 | | |
| Step History | | | | | | | | | |
| Step | Parameter | Action | "Sig Prob" | Seq SS | RSquare | Cp | p | AICc | BIC |
| 1 | StoppingSightDistance(Feet) | Entered | 0.2461 | 0.096907 | 0.0298 | -0.792 | 2 | 13.0209 | 18.0132 |
| 2 | Illuminance<4 | Entered | 0.2837 | 0.082325 | 0.0551 | 0.1079 | 3 | 14.1735 | 20.6217 |
| 3 | Circle_Lighting{No-Yes} | Entered | 0.7560 | 0.006978 | 0.0572 | 2.0147 | 4 | 16.5778 | 24.3651 |
| 4 | Illuminance | Entered | 0.9156 | 0.000829 | 0.0575 | 4.0036 | 5 | 19.2016 | 28.2025 |
| 5 | Illuminance<4SSD | Entered | 0.9526 | 0.000267 | 0.0576 | 6 | 6 | 21.9693 | 32.0486 |
| 6 | Best | Specific | . | . | 0.0000 | -1.496 | 1 | 12.1563 | 15.5839 |

Figure 50. Table. Regression Model Results of all 4 and 5 Leg Roundabout Sites with Marked Pedestrian Crosswalks

| SSE | DFE | RMSE | RSquare | RSquare Adj | Cp | p | AICc | BIC | |
|-------------------------------------|-------------------------------------|-----------------------------|------------|-------------|-----------|-----------|----------|----------|---------|
| 0.1062999 | 14 | 0.0871369 | 0.0000 | 0.0000 | -2.197015 | 1 | -26.675 | -26.2589 | |
| Current Estimates | | | | | | | | | |
| Lock | Entered | Parameter | Estimate | nDF | SS | "F Ratio" | "Prob>F" | | |
| <input checked="" type="checkbox"/> | <input checked="" type="checkbox"/> | Intercept | 0.03867155 | 1 | 0 | 0.000 | 0.000 | 1 | |
| <input type="checkbox"/> | <input type="checkbox"/> | Illuminance | 0 | 1 | 0.003052 | 0.384 | 0.54605 | | |
| <input type="checkbox"/> | <input type="checkbox"/> | StoppingSightDistance(Feet) | 0 | 1 | 3.066e-5 | 0.004 | 0.9521 | | |
| <input type="checkbox"/> | <input type="checkbox"/> | Illuminance<4SSD | 0 | 1 | 0.000084 | 0.010 | 0.92074 | | |
| <input type="checkbox"/> | <input type="checkbox"/> | Illuminance<4 | 0 | 1 | 0.000101 | 0.012 | 0.91322 | | |
| <input type="checkbox"/> | <input type="checkbox"/> | Circle_Lighting{No-Yes} | 0 | 1 | 0.001602 | 0.199 | 0.6629 | | |
| Step History | | | | | | | | | |
| Step | Parameter | Action | "Sig Prob" | Seq SS | RSquare | Cp | p | AICc | BIC |
| 1 | Illuminance | Entered | 0.5460 | 0.003052 | 0.0287 | -0.507 | 2 | -23.93 | -23.988 |
| 2 | Circle_Lighting{No-Yes} | Entered | 0.5040 | 0.003928 | 0.0657 | 1.0936 | 3 | -20.694 | -21.862 |
| 3 | Illuminance<4SSD | Entered | 0.7707 | 0.000799 | 0.0732 | 3.0124 | 4 | -16.148 | -19.275 |
| 4 | StoppingSightDistance(Feet) | Entered | 0.9135 | 0.000122 | 0.0743 | 5 | 5 | -10.334 | -16.585 |
| 5 | Best | Specific | . | . | 0.0000 | -2.197 | 1 | -26.675 | -26.259 |

Figure 51. Table. Regression Model Results of All 4 and 5 Leg Roundabout Sites without Marked Pedestrian Crosswalks

CHAPTER 5. ROUNDABOUT APPROACH-LEVEL ANALYSIS AND DISCUSSION

DATA OVERVIEW

To analyze the conditional impacts of illumination level perceived by drivers at different locations when navigating through the roundabout on the observed single-vehicle crash rates, quantitative illumination data extracted from the four measurement areas defined in the drone images as well as the crash records, traffic volume, and geometric characteristics data were obtained for each roundabout approach. Since drone data collection was conducted only on forty-five out of seventy-seven studied roundabout sites, and among these forty-five sites, eight were 3-leg roundabouts, thirty-six were 4-leg roundabouts and one was 5-leg roundabout, so for the approach-level analysis, complete datasets were available for 171 approaches.

Roundabout Approach Illumination Conditions

The illumination condition on a roundabout approach is influenced by the existence of both ambient lighting and approach lighting. For any roundabout that has adjacent properties like gas stations, factories, etc. illuminated at night, the corresponding approaches would be considered as having ambient lighting present. Among the 171 approaches studied in this project, ninety-five of them (55.6%) are under the influence of ambient lighting while seventy-six of them (44.4%) are not. Then with the presence of ambient lighting taken into consideration, the installation of lighting on roundabout approaches is further determined on a case-by-case basis in Georgia. For the collected 171 approaches, 109 of them (63.7%) have at least one luminaire

installed along the approach while 62 (36.3%) were observed to have no approach lighting present. For these 62 unilluminated approaches, 35 of them also do not have access to ambient lighting, indicating vehicle headlights will be the only light source for drivers on these approaches when entering roundabouts.

Affected by the existence of ambient lighting and approach lighting, the quantitative illumination condition measured from the drone images of roundabout approaches would vary significantly among each approach as well as different locations along each approach. Since one main goal of the project is to evaluate the impacts of approach illumination level on the single-vehicle crash rates, and drivers' perception of illumination condition can directly influence their abilities to identify roundabout layout and make appropriate maneuvers when approaching the roundabouts, thus, luminance was used as a measure of the amount of light reflected from the roadway surface to drivers' eyes for the approach-level analysis.

To evaluate the amount of light perceived by drivers when entering the roundabouts, the luminance level was first measured at the entrance into the circulating path for each approach, and the distribution of luminance level within the area between yield line and pedestrian crosswalk was observed to be positively skewed with a range of 0.01 cd/m^2 to 1.19 cd/m^2 , as shown in Figure 52. Among 171 roundabout approaches, 69 of them (40%) have the luminance level below the common minimum standard value 0.075 cd/m^2 required for roundabout lighting, and only 6 approaches (3.5%) were found to have luminance level equal to or greater than 0.5 cd/m^2 .

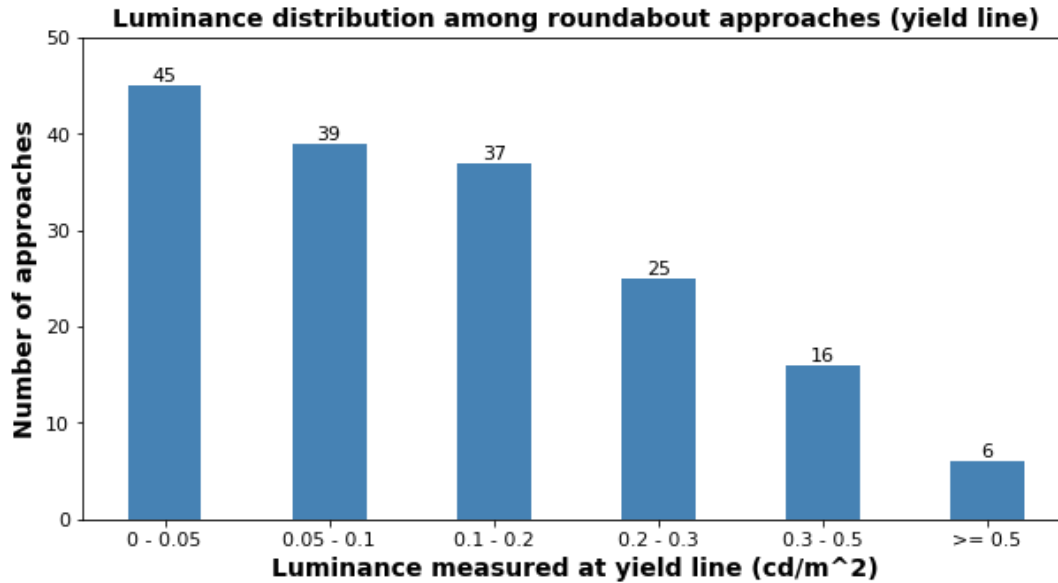

Figure 52. Chart. Distribution of Luminance Measured at Yield Line on Approaches

Due to different types of luminaire layout observed in the studied roundabouts, luminance level was also measured at both the midpoint between yield line and stopping sight distance (SSD) and at the point of stopping sight distance (SSD) along each leg to understand drivers' perception of illumination conditions as they arrive at the roundabout. Figure 32 demonstrates the distribution of luminance data measured at three locations along each approach and based on the number differences observed between the three locations in each luminance group, it can be inferred that drivers would experience an increase in the illumination level when reaching the roundabout entrance compared to driving on the approach in most roundabout sites due to the presence of circle lighting.

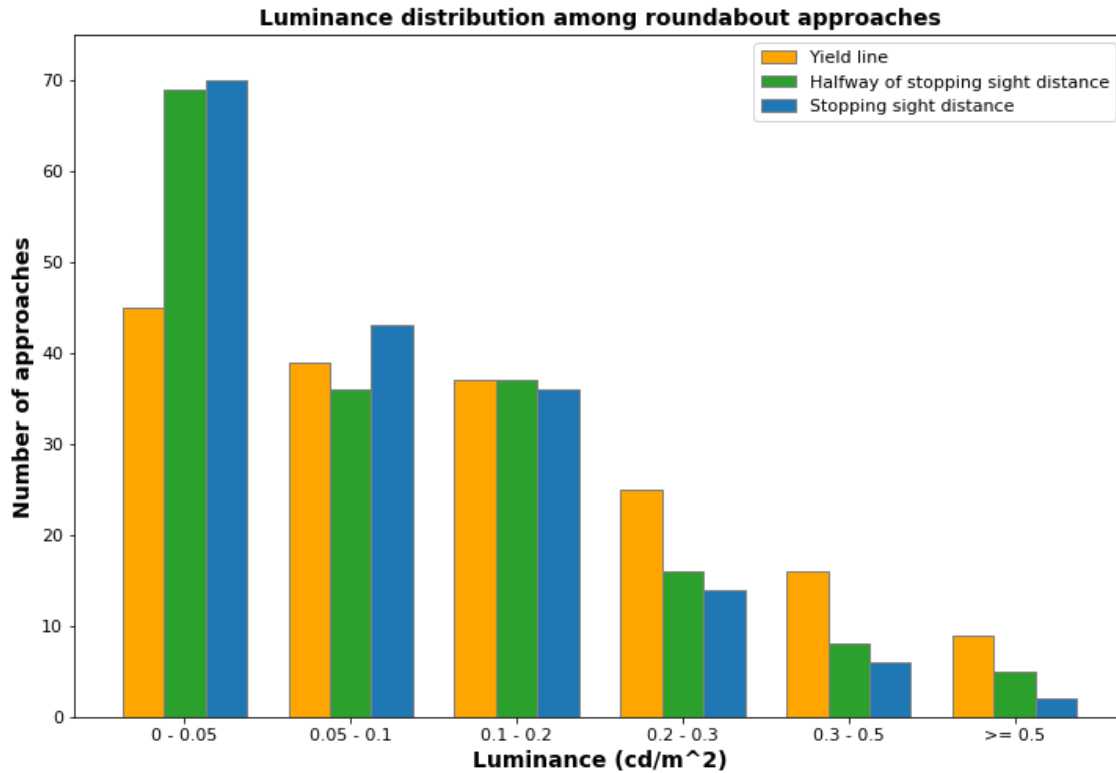

Figure 53. Chart. Luminance Distribution among Roundabout Approaches

Variation of crash rates with luminance

As one of the project goals is to determine the spatial extent of illumination on roundabout approaches based on roadway and traffic conditions to match with safety needs, due to the luminance differences observed at three locations along each approach, it is necessary to analyze the specific impacts of illumination level on single-vehicle crashes at each approach location separately. The relationships between single-vehicle crash rates and luminance values measured at yield line, the midpoint between the yield line and SSD, and the point of SSD are shown in Figure 54 - Figure 56 below.

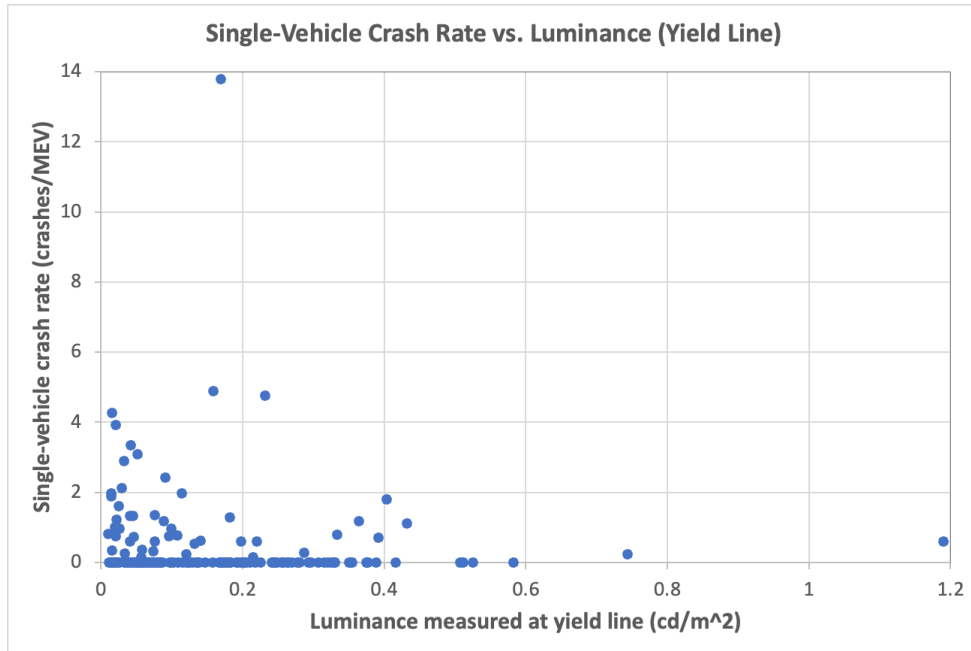

Figure 54. Chart. Variation of Single-vehicle Crash Rate with Luminance (Yield Line)

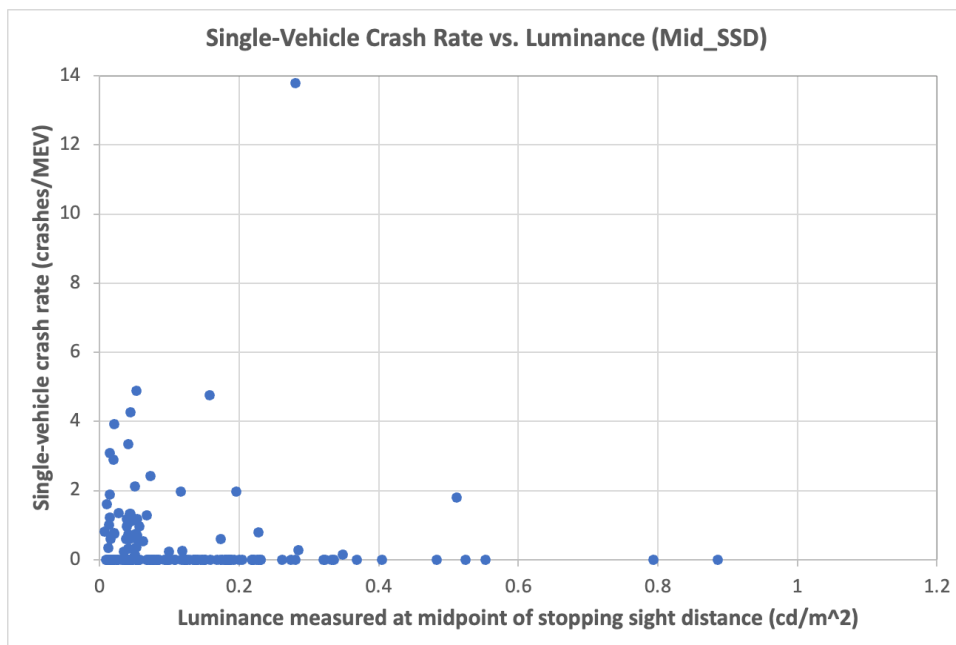

Figure 55. Chart. Variation of Single-vehicle Crash Rate with Luminance (Mid-SSD)

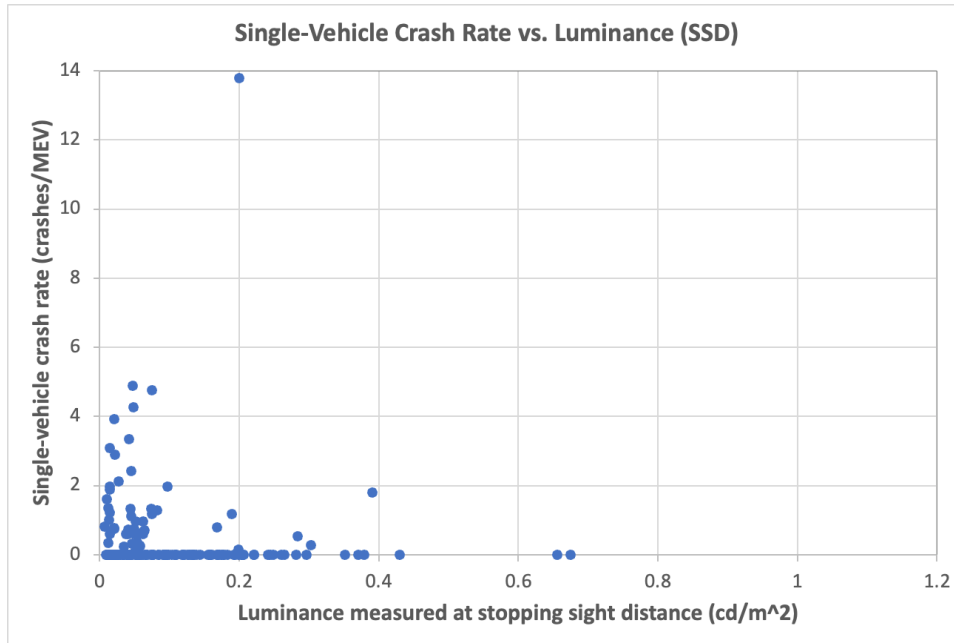

Figure 56. Chart. Variation of Single-vehicle Crash Rate with Luminance (SSD)

Although many approaches do not have any crashes recorded during the data collection period, the overall trend observed in approaches with crashes suggests that luminance levels of greater than or equal to 0.2 cd/m² at the yield line and 0.075 cd/m² at the SSD are associated with significantly lower single-vehicle crash rates. Additionally, the results also imply that the safety benefits obtained from the increase in luminance above these values may yield only relatively small improvements in safety performance.

STEPWISE LINEAR REGRESSION ANALYSIS

To analyze the illumination impacts on nighttime safety and identify potential contributing factors that could influence such illumination impacts on the roundabout approach level, a variety of regression-based models were used. However, because the majority of approaches (122 out of 171 approaches) have zero crashes occurred during the observation period, and these

zero crashes could also be explained by either non-reported crashes or low exposure since all sites are located in suburban and rural areas and the observation period was relatively short, so during the modeling process, the zero crash rates were substituted with estimated crash rates by assuming the number of crashes on those zero-crash approaches would follow a Poisson distribution. To approximate the actual crash rate on each approach, first the upper limit of the possible crash rate was calculated based on the assumption that the probability of a single-vehicle crash occurs on the approach given the collected traffic volume during the observation period would be 90%, then the approximated crash rate was obtained by taking the half of the calculated upper limit. The variation of estimated single-vehicle crash rates with luminance measured at the stopping sight distance is illustrated in Figure 57.

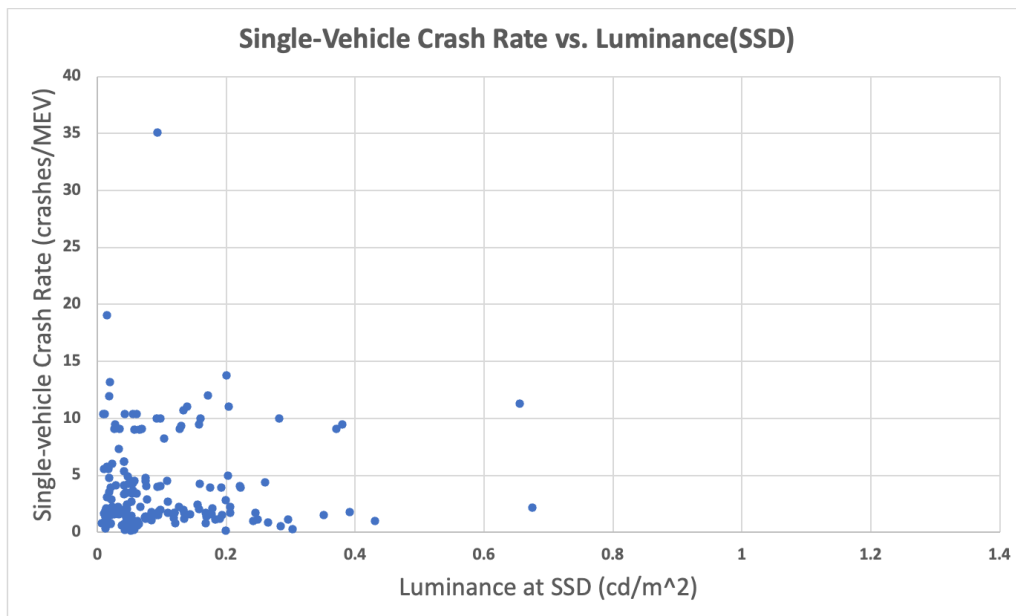

Figure 57. Chart. Variation of Estimated Single-vehicle Crash Rate with Luminance (SSD)

To further determine the quantitative relationship between single-vehicle crash rates and the measured approach luminance as well as other potential explanatory variables, a multi-linear

stepwise regression model was developed to accommodate for the combination of both approximated and actual recorded crash rates. Based on the data collected from the 171 approaches, 41 potential explanatory variables were initially included in the regression model, then after the iterative variable selection process, three variables were identified to have statistically significant influence on the estimated single-vehicle crash rates, and the corresponding results are summarized in Table 3.

Table 20. Regression Model Results of All Studied Roundabout Approaches

| Parameters | Estimated Coefficient | P-value |
|---------------------------------------|------------------------------|----------------|
| Intercept | 4.554 | 1 |
| Multi-lane approach (y/n) | -2.507 | 0.0096 |
| Presence of approach lighting (y/n) | 2.235 | 0.0016 |
| Presence of colored truck apron (y/n) | -2.355 | 0.0017 |

It should be noted that the ‘multi-lane approach’ variable in this model not only includes roundabout approaches with two or more lanes for traffic, but also includes single-lane approaches with a right-turn bypass lane present. As indicated by the model results, the existence of colored truck aprons in the roundabout center and additional travel lanes on the approach could lead to a decrease in the estimated single-vehicle crash rates, while the installation of lighting along the approach might have a negative impact on crash rates.

However, since the multi-lane approaches tend to be located in large roundabout sites with heavy traffic volumes, and the roundabout size as well as the traffic volumes are also considered as determining factors for the installation of colored truck aprons and approach lighting, thus, certain correlations might exist between the three significant explanatory variables. To account for the potential influence of the number of approach lanes on the other two variables, separate

analyses were conducted for the multi-lane approaches and single-lane approaches to understand each of the identified variables' specific impacts on the single-vehicle crash rates.

MULTI-LANE APPROACH ANALYSIS

Among the 171 approaches collected in the dataset, 23 of them were recorded as multi-lane approaches due to the existence of additional travel lanes and/or bypass lanes. While there are 3 approaches located in roundabouts with the absence of colored truck aprons, none of them have any single-vehicle crashes that occurred during the observation period. Additionally, as all the approaches have lighting installed both inside the roundabout circle as well as along the approaches, whether the illumination level has any influences on the occurrence of single-vehicle crashes is unclear judging by the absence/presence of approach lighting alone. Therefore, based on the pre-analysis results regarding crash variation with quantitative illumination measurement, the multi-lane approach crash rates were evaluated separately between approaches with luminance level measured at the yield line being $\leq 0.2 \text{ cd/m}^2$ and $> 0.2 \text{ cd/m}^2$ as well as approaches with luminance level measured at stopping sight distance being $\leq 0.075 \text{ cd/m}^2$ and $> 0.075 \text{ cd/m}^2$.

Table 21. Crash rate comparison between approaches with luminance (yield line) $\leq 0.2 \text{ cd/m}^2$ and $> 0.2 \text{ cd/m}^2$

| Luminance (Yield line) $\leq 0.2 \text{ cd/m}^2$ | Number of approaches | Number of single-vehicle crashes | Crash rate (Crashes per MEV) |
|--|----------------------|----------------------------------|------------------------------|
| Yes | 10 | 1 | 0.0106 |
| No | 13 | 4 | 0.0788 |

Table 22. Crash rate comparison between approaches with luminance (SSD) ≤ 0.075 cd/m^2 and > 0.075 cd/m^2

| Luminance (SSD) ≤ 0.075 cd/m^2 | Number of approaches | Number of single- vehicle crashes | Crash rate (Crashes per MEV) |
|---|---------------------------------|--|---|
| Yes | 3 | 4 | 0.1489 |
| No | 20 | 1 | 0.0085 |

As indicated by the comparison results shown in Table 21 and

Table 22 above, 4 out of 5 single-vehicle crashes were reported on approaches with luminance level being above 0.2 cd/m^2 at the yield line area, and with the consideration of traffic volumes, approaches with higher luminance level provided at the roundabout entrance also tend to have higher crash rates. Contrary to these negative safety impacts of yield line illumination, approaches with more than 0.075 cd/m^2 luminance level provided at the stopping sight distance were observed to have significantly lower single-vehicle crash rates compared to approaches with worse illumination conditions provided at the same location. Based on the differences observed in the relative crash rate improvements as well as the luminance thresholds between the two illuminated locations, it can be inferred that for multi-lane approaches, more safety benefits could be achieved by lower illumination level provided near the stopping sight distance than near the yield line.

Because crashes were observed to be more likely to occur on approaches with significant difference between SSD and yield line luminance levels, the influence of the uniformity of luminance within the roundabout circle was also evaluated. A “uniformity level”, which is defined as the ratio between the average luminance level and the minimum luminance level, was used as an indicator to measure the light distribution within the approach area. Thus, a region

with perfect uniformity would have an index of 1:1 with progressively higher values indicating a less uniform distribution of luminance. Since the recommended value for roundabout illumination uniformity level is 3:1 or smaller in the American National Standard Practice for Roadway Lighting (Illuminating Engineering Society 2000), the observed crash rates were compared between approaches with uniformity level being less than 3:1 (more uniform) and greater than or equal to 3:1 (less uniform). Based on the comparison results in Table 23, it can be concluded that the single roundabout with less uniform illumination had a significantly higher crash rate. While being only a single roundabout, this result must be used with caution.

Table 23. Crash rate comparison between approaches with luminance uniformity level ≥ 3 and < 3

| Uniformity level ≥ 3 | Number of approaches | Number of single-vehicle crashes | Crash rate (Crashes per MEV) |
|---|-----------------------------|---|-------------------------------------|
| Yes | 1 | 3 | 0.1469 |
| No | 22 | 2 | 0.0160 |

Although the sample size is limited, the substantial differences observed from crash rates between the two datasets could still imply that the light uniformity level along each approach has the potential to strongly influence drivers' perception of roundabout layout when approaching the roundabout entrance and thus leading to a potential increase in single-vehicle crash rates as illumination becomes less uniform. Figure 58 shows the typical roundabout illumination layouts under different uniformity level conditions ($<3:1$ and $>3:1$).



Figure 58. Photo. Roundabout approaches with uniformity levels $<3:1$ and $>3:1$ respectively.

In the interest of caution, it is recommended that for multi-lane approaches and single-lane approaches with right-turn bypass lanes present, the installation of roadway lighting should be considered at the approach stopping sight distance to ensure the visibility of approach configurations as well as roadway signs and pavement markings. While all the multi-lane approaches evaluated in this project have approach lighting installed, some of the streetlamps were observed not emitting light at night during the field data collection period, so maintenance work should be scheduled more frequently. Apart from that, transition lighting could also be considered to allow drivers' eyes to adjust from the changes in lighting intensity between the approach SSD and yield line, especially for approaches with high luminance levels provided at the yield line.

SINGLE-LANE APPROACH ANALYSIS

To evaluate the impacts of illumination and other roundabout geometric characteristics on nighttime safety for single-lane approaches, a stepwise multilinear regression model was built based upon the dataset collected from 148 single-lane approaches. Three independent variables

were identified and their relationships with the estimated single-vehicle crash rates were demonstrated in Table 24.

Table 24. Regression model results of single-lane roundabout approaches

| Parameters | Estimated Coefficient | P-value |
|--|------------------------------|----------------|
| Intercept | 3.4599 | 1 |
| Presence of horizontal curvature (y/n) | 1.7942 | 0.0048 |
| Presence of ambient lighting (y/n) | 1.1142 | 0.0664 |
| Presence of colored truck apron (y/n) | -0.9735 | 0.1501 |

Because approaches with horizontal curves often require better roadway visibility and more complicated driving maneuvers, while the presence of ambient lighting can sometimes become a distraction to drivers and result in roadway objects being darker than the roadside objects, so the presence of horizontal curvature and ambient lighting are more likely to increase the nighttime crash rates observed on single-lane approaches, as implied by the model results. In addition, the absence of colored truck aprons at the roundabout center was also found to be a contributing factor of single-vehicle crashes. One possible explanation is that colored truck aprons might help drivers better understand the roadway configurations and make them more cautious when entering the roundabouts, leading to a decrease in the observed crash rates.

Since the estimated single-vehicle crash rate was selected as the dependent variable in the model, so to further examine the effects of identified explanatory variables on the actual crash rates observed on these single-lane approaches, each variable was evaluated separately during the subsequent analysis.

Safety Impacts of Horizontal Curvature

For roundabout approaches, horizontal curvatures are usually applied to provide a transition between two intersecting roadways and can help reduce approach speeds because the changes in roadway alignment could make approaching drivers more alerted to the surrounding environment. However, as indicated by the results of single-lane approach model, the presence of horizontal curves was found to be associated with higher estimated single-vehicle crash rates. Therefore, to better understand the safety impacts of this variable, the actual single-vehicle crash rates were analyzed for approaches with and without horizontal curves separately, and results are listed in Table 25.

Table 25. Crash rate comparison between approaches with and without horizontal curves

| Presence of horizontal curves | Number of approaches | Number of single-vehicle crashes | Crash rate (Crashes per MEV) |
|--------------------------------------|-----------------------------|---|-------------------------------------|
| Yes | 47 | 17 | 0.0714 |
| No | 101 | 59 | 0.0728 |

Contrary to the model implications, the comparison results suggest that no significant differences were observed regarding the actual crash rates between single-lane approaches with and without horizontal curves. While the model was developed for substituted crash rates based on the assumption that these crash rates would follow a Poisson distribution, the differences observed between the regression model results and comparison results indicate that ‘the presence of horizontal curves’ variable could just be an artifact of using the estimated crash rates instead of actual observed crash rates for the single-lane approach analysis.

Safety Impacts of Colored Truck Aprons

Similar to the descriptive analysis of horizontal curvature, the actual crash rates were compared between single-lane approaches with and without the presence of colored truck aprons to evaluate the relationship between observed single-vehicle crashes and colored truck aprons.

Table 26. Crash rate comparison between approaches with and without colored truck aprons

| Presence of colored truck aprons | Number of approaches | Number of single-vehicle crashes | Crash rate (Crashes per MEV) |
|---|-----------------------------|---|-------------------------------------|
| Yes | 41 | 9 | 0.0483 |
| No | 107 | 67 | 0.0777 |

As indicated in Table 26, 9 single-vehicle crashes were reported on 41 approaches with colored truck aprons present, and the corresponding crash rate is 0.0483 crashes per MEV. While for the 107 approaches without colored truck aprons, the observed crash rate is 0.0777 crashes per MEV. Although this measurable difference observed in crash rates under the two circumstances could imply that the presence of colored truck aprons would contribute to the occurrence of single-vehicle crashes, it is also possible that the contribution might be the effects of other potential confounding variables as drivers could mistake colored truck aprons for being part of the raised central island due to their decorative appearances under poor visibility conditions. Therefore, considering the relatively rare occurrences of single-vehicle crashes, a case control analysis was conducted to examine if the installation of colored truck apron is a risk factor for the crashes observed on single-lane approaches.

Case control analysis

To evaluate the association between the presence of colored truck aprons and the occurrence of crashes, the cases and controls in this analysis were selected based on whether the single-vehicle crash rates reported on approaches are above zero or not. Among the 102 approaches identified as controls, the odds of having colored truck aprons, which was computed as the probability of zero-crash approaches with colored truck aprons present divided by the probability of zero-crash approaches without colored truck aprons present, is 2. While for the 46 case approaches, the odds of having colored truck aprons are 5.57, and results can be found in Table 27.

Table 27. Cross tabulating crash occurrence against the presence of colored truck aprons

| | Cases | Controls | Total |
|--|--------------|-----------------|--------------|
| Approaches with colored truck aprons | 39 | 68 | 107 |
| Approaches without colored truck aprons | 7 | 34 | 41 |
| Total | 46 | 102 | 148 |

By using the “epiR” package provided in R[®] analysis software, the odds ratio was estimated to be 2.79 with a 95% confidence interval being [1.13, 6.88], which suggests a positive association between the presence of colored truck aprons and single-vehicle crash rates, as shown in the results output from R[®] in Figure 59.

| | Outcome + | Outcome - | Total | Prevalence * | Odds |
|-----------|-----------|-----------|-------|--------------|-------|
| Exposed + | 39 | 68 | 107 | 36.4 | 0.574 |
| Exposed - | 7 | 34 | 41 | 17.1 | 0.206 |
| Total | 46 | 102 | 148 | 31.1 | 0.451 |

Point estimates and 95% CIs:

```

-----
Odds ratio                2.79 (1.13, 6.88)
Attrib fraction (est) in the exposed (%)  63.88 (6.82, 87.67)
Attrib fraction (est) in the population (%) 54.35 (4.77, 78.12)
-----

```

Uncorrected chi2 test that OR = 1: chi2(1) = 5.195 Pr>chi2 = 0.023

Fisher exact test that OR = 1: Pr>chi2 = 0.029

Wald confidence limits

CI: confidence interval

* Outcomes per 100 population units

Figure 59. Table. Results of case control analysis regarding the presence of colored truck aprons

Since in addition to the colored truck aprons, the presence of ambient lighting was also found to be a risk factor of single-vehicle crashes by case control analysis, so to further examine the ambient lighting’s potential confounding effects, a stratified analysis was performed by controlling the variable. Table 28 and Table 29 show the results of case control analysis controlling for the effects of ambient lighting.

Table 28. Results of case control analysis based on approaches with ambient lighting

| | Cases | Controls | Total |
|--|--------------|-----------------|--------------|
| Approaches with colored truck aprons | 16 | 35 | 51 |
| Approaches without colored truck aprons | 3 | 28 | 31 |
| Total | 19 | 63 | 82 |
| Odds ratio point estimates and 95% CIs: 4.27 (1.13, 16.12) | | | |
| Yates corrected chi2 test that OR = 1: chi2(1) = 5.098 Pr > chi2 = 0.024 | | | |
| Fisher exact test that OR = 1: Pr > chi2 = 0.031 | | | |

Table 29. Results of case control analysis based on approaches without ambient lighting

| | Cases | Controls | Total |
|--|--------------|-----------------|--------------|
| Approaches with colored truck aprons | 23 | 33 | 56 |
| Approaches without colored truck aprons | 4 | 6 | 10 |
| Total | 27 | 39 | 66 |
| Odds ratio point estimates and 95% CIs: 1.05 (0.26, 4.12) | | | |
| Yates corrected chi2 test that OR = 1: chi2(1) = 0.000 Pr > chi2 = 1.000 | | | |
| Fisher exact test that OR = 1: Pr > chi2 = 1.000 | | | |

Based on the odds ratios and the corresponding 95% confidence intervals obtained under the above two conditions, there is no evidence for an association between single-vehicle crashes and colored truck aprons for single-lane approaches without ambient lighting present, whereas under

the condition of providing ambient lighting, the presence of colored truck aprons was observed to significantly reduce the odds of crash occurrences on the approaches. Therefore, it can be inferred that the presence of ambient lighting is a confounder for the relationship between colored truck aprons and single-vehicle crash rates. This inference can also be confirmed by analyzing the distribution of ambient lighting existence among approaches with and without colored truck aprons installed, as demonstrated in Figure 60.

| | Outcome + | Outcome - | Total | Prevalence * | Odds |
|-----------|-----------|-----------|-------|--------------|------|
| Exposed + | 51 | 31 | 82 | 62.2 | 1.65 |
| Exposed - | 56 | 10 | 66 | 84.8 | 5.60 |
| Total | 107 | 41 | 148 | 72.3 | 2.61 |

Point estimates and 95% CIs:

| | |
|---|---------------------------|
| Odds ratio | 0.29 (0.13, 0.66) |
| Attrib fraction (est) in the exposed (%) | -237.63 (-752.72, -43.75) |
| Attrib fraction (est) in the population (%) | -114.58 (-278.85, -21.54) |

Uncorrected chi2 test that OR = 1: $\chi^2(1) = 9.370$ Pr> $\chi^2 = 0.002$

Fisher exact test that OR = 1: Pr> $\chi^2 = 0.003$

Wald confidence limits

CI: confidence interval

* Outcomes per 100 population units

Figure 60. Table. Results of case control analysis regarding the presence of ambient lighting

The results suggest that among approaches with ambient lighting present, the odds of approaches located in roundabouts with colored truck aprons installed is only 0.29 times the odds among approaches without ambient lighting present. Considering the confounding effects of ambient lighting identified during the stratified analysis, the presence of colored truck aprons can be viewed as a surrogate variable for ambient lighting in terms of the influence on single-vehicle crash rates. However, it should be noted that the identified association between the presence of ambient lighting and colored truck aprons is not a proof of causal relationship. Because normally for roundabouts with high levels of ambient lighting, the abutting facilities tend to attract high

volumes of traffic, which might lead to the application of various safety treatments, including colored truck aprons. Thus, to establish the relationship between ambient lighting and colored truck aprons, more sample data should be collected from the roundabout approaches located in rural and suburban areas.

Safety Impacts of Quantified Illumination Levels

According to the analyses of linear regression models and case control studies, both the presence of approach lighting and presence of ambient lighting variables have been identified as contributing factors to nighttime single-vehicle crash rates. It should be noted that during the linear modeling process, since crash rate has always been selected as the dependent variable, the usage of crash rate instead of crash frequency would implicitly assume that there is a linear relationship between crash rate and intersection entering volumes. However, this assumption might not be necessarily true in the real world, as intersections with higher traffic volumes tend to employ more safety countermeasures to avoid crashes, which could usually result in less crashes than expected for that level of volumes. Therefore, the influence of traffic volume was first evaluated to test whether the assumption is valid based on the collected dataset.

Analysis of approach entry volume data

To analyze the variation patterns observed from crash rates with the increase in traffic volumes, the fraction of total single-vehicle crashes was plotted against the fraction of total million entering volumes for the entire dataset. Because traffic volume and crash data were initially collected based on approach level, the total entering volumes and crashes for the entire dataset can be computed by simply taking the sum of each approach. After sorting the dataset based on

approach annual volumes in ascending order, the orange line in Figure 61 shows the expected variation pattern if single-vehicle crash rate has a purely linear relationship with intersection MEV, that is, given the fraction of total entering volumes, the corresponding fraction of total crashes observed from these volumes should be the same. Then for the real-world situation, using the same approach order, the relative contributions of different fractions of traffic volumes to fractions of single-vehicle crashes are illustrated by the blue line in Figure 61.

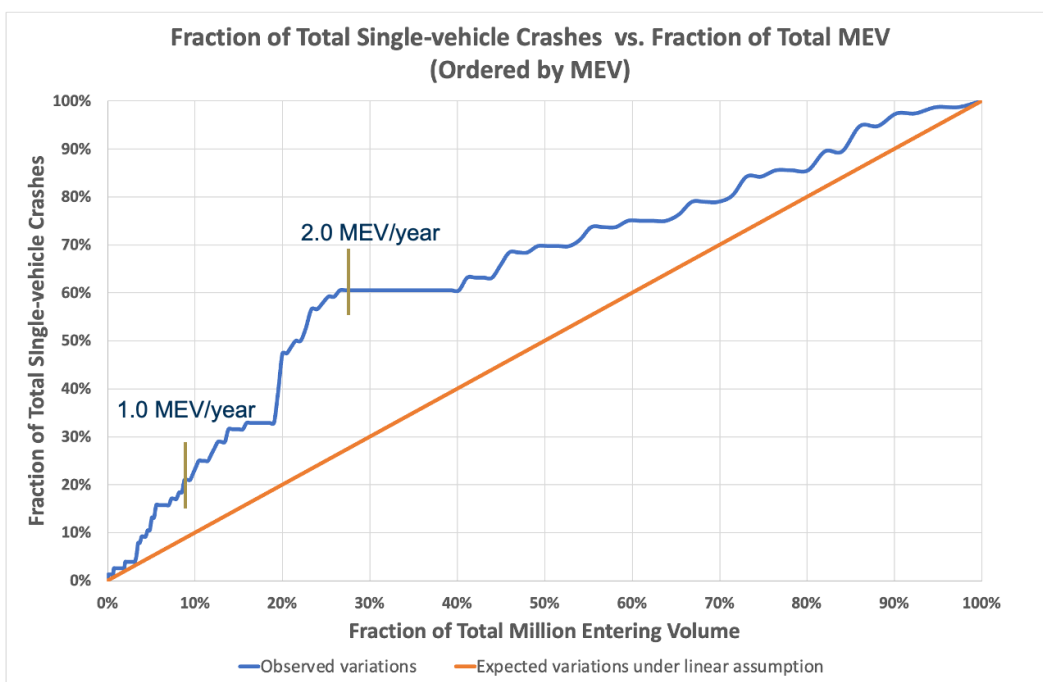

Figure 61. Chart. Fraction of total single-vehicle crashes vs. fraction of total MEV

Based on the ordered approach annual volumes, two threshold points were added to the blue line to create three volume intervals. The first interval represents all the single-lane approaches with annual traffic being less than 1 MEV per year, and for 10% of total traffic volumes observed among these approaches, 20% of total crashes occurred during the entire analysis period.

Likewise, the combination of the first and second intervals include approaches with annual

traffic being less than 2 MEV per year. About 60% of total crashes were reported among these approaches, but the according traffic volumes were only around 26% of the total. Because the slope of the blue line represents the derivative of crashes, and slopes in the first and second intervals are much steeper compared to the third ones, so it can be concluded from Figure 61 that for single-lane approaches with annual traffic volumes less than 2 MEV per year, the observed crash rates are substantially higher than approaches with more entering volumes.

As single-vehicle crash rates are proven to have a non-linear relationship with traffic volumes, the approach volume variable is no longer appropriate to be applied to linear models. Since approaches with higher volumes also tend to have more safety treatments to lower crash rates, so to test whether approach illumination would influence the associations between crash rates and approach annual traffic volumes, the dataset was divided based on the presence of approach lighting and whether approaches have annual traffic less than 1 MEV per year or not. The approach distribution and the corresponding aggregated crash rates under the conditions of with and without the presence of approach lighting are shown in Table 30 and

Table 31.

Table 30. Number of approaches with MEV/year \geq 1 million and $<$ 1 million under the conditions of with and without approach lighting

| | No approach lighting | Approach lighting | Total |
|---|-----------------------------|--------------------------|--------------|
| Approaches with MEV/year \geq 1 million | 37 | 32 | 69 |
| Approaches with MEV/year $<$ 1 million | 42 | 37 | 79 |
| Total | 79 | 69 | 148 |

Table 31. Crash rates for approaches with MEV/year \geq 1 million and $<$ 1 million under the conditions of with and without approach lighting

| | No approach lighting | Approach lighting |
|---|-----------------------------|--------------------------|
| Approaches with MEV/year \geq 1 million | 0.0587 | 0.0523 |
| Approaches with MEV/year $<$ 1 million | 0.1224 | 0.1305 |

While the approach numbers and aggregated crash rates under the conditions of different traffic volume levels are quite similar regardless of the presence of approach lighting, indicating approach lighting does not have any significant effects on the relationship between approach traffic volumes and crash rates, that does not implicitly mean there are also no correlations between such relationship and quantified approach illumination levels. Since one main goal of the project is to evaluate the safety impacts of quantified illumination conditions measured on each approach, luminance data were used to represent approach illumination levels for the subsequent analysis.

Analysis of approach luminance level data

To examine the approach luminance impacts on the association between nighttime crash rates and annual traffic volumes, the dataset was first sorted based on the luminance values measured at each approach yield line in ascending order, then the fraction of total single-vehicle crashes was plotted against the fraction of total entering volumes, as demonstrated in Figure 62.

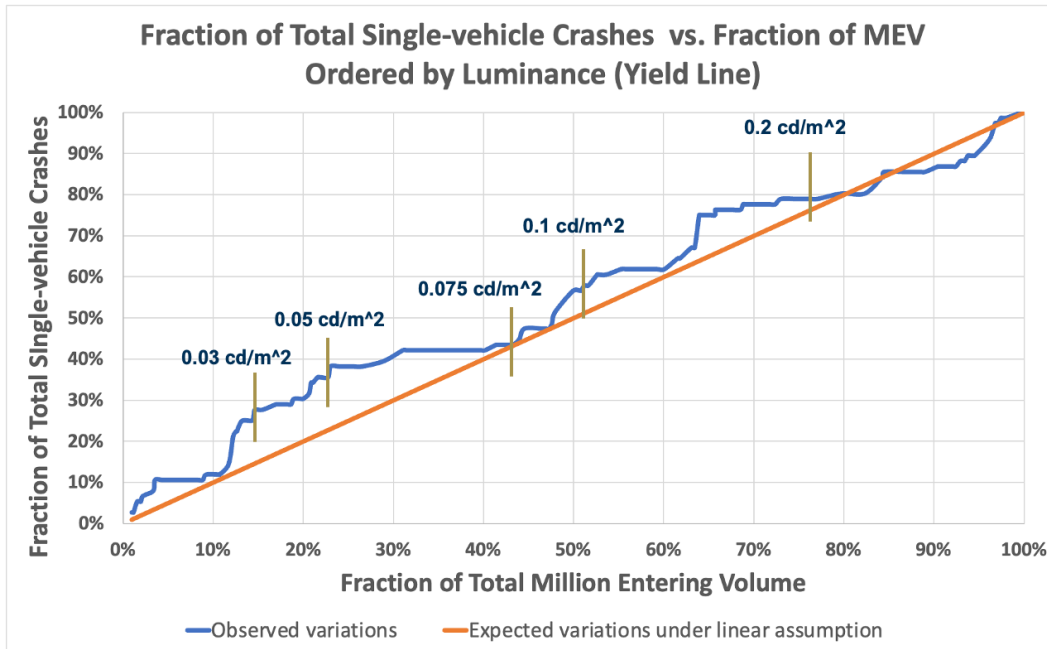

Figure 62. Chart. Fraction of total single-vehicle crashes vs. fraction of total MEV ordered by luminance measured at the yield line

Same as Figure 61 in the approach entry volume analysis, the orange line represents the expected increment of crash fraction as volume fraction increases under the linear relationship assumption, and the blue line represents the actual variations observed from the dataset. Because the dataset was sorted based on yield line luminance values, so approaches located near the origin are the ones with the lowest luminance level provided at the yield line, and approaches near the 100% endpoint are the ones with the highest luminance levels. In addition, five specific luminance points were identified and labeled in Figure 62 to classify all the single-lane approaches based on six luminance intervals, and approximately 50% of total traffic occurred on approaches with yield line luminance level being below 0.1 cd/m².

As indicated by the differences observed between the two lines, the most significant deviation first occurs at the point where the measured approach luminance is 0.05 cd/m², then the observed

crash variation line (blue line) flattens out to meet the expected variation line (orange line) at 0.075 cd/m^2 luminance level, and roughly follows the expected variation line afterwards as the luminance level gets higher. Since for approaches with luminance level below 0.075 cd/m^2 , the observed crash variation line has always been above the expected line, thus, it can be inferred that approaches with luminance level lower than 0.075 cd/m^2 provided at the yield line tend to have higher single-vehicle crash rates than the expected crash rates under linear assumption. While for approaches with yield line luminance being above 0.075 cd/m^2 , the small differences between the two lines suggest that crash rates reported on these approaches are substantially lower due to the safety benefits obtained by illumination.

Similar to the analysis for yield line luminance, the dataset was also sorted according to the approach luminance values measured at the midpoint of SSD and at the point of SSD, and the fraction of total single-vehicle crashes was again compared with the fraction of total entering volumes under those two situations separately. Figure 63 and Figure 64 illustrate the comparison results for the two sorted dataset.

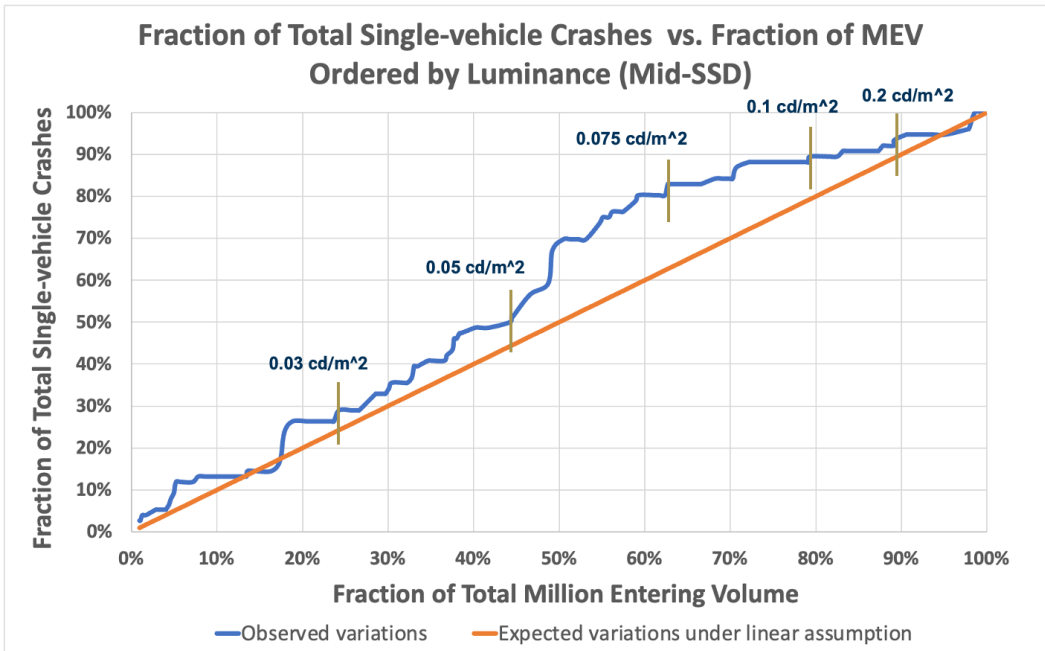

Figure 63. Chart. Fraction of total single-vehicle crashes vs. fraction of total MEV ordered by luminance measured at the midpoint of SSD

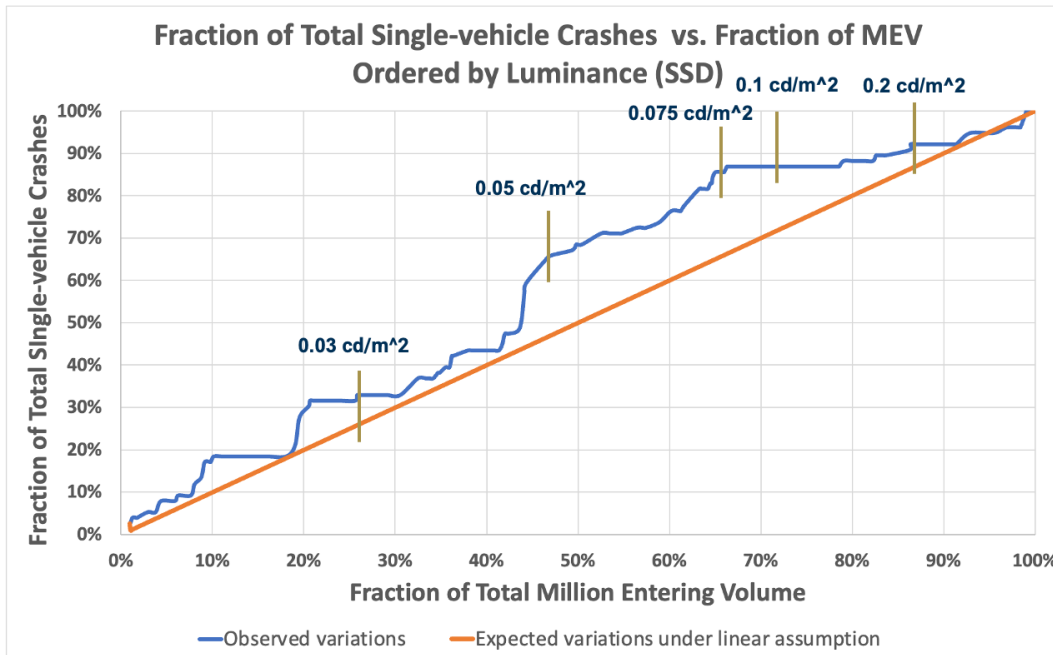

Figure 64. Chart. Fraction of total single-vehicle crashes vs. fraction of total MEV ordered by luminance measured at the point of SSD

The same set of five luminance points were also marked in Figure 63 and Figure 64, and the differences in terms of the corresponding locations associated with entering volumes between the two charts can be explained by the influence of illumination provided within the roundabout circles. Nevertheless, the crash variations within the same luminance intervals ranging from 0.03 cd/m² to 0.2 cd/m² and above are similar between the two charts, and by comparing the observed and expected crash variation lines, the largest deviation occurs at the point associated with luminance level being 0.075 cd/m² for both charts as well. However, one obvious difference noticed between the two charts is that there are three areas in the observed crash variation line in Figure 64 that have significantly higher slopes compared to the line in Figure 63, which implies that approaches within these particular areas could have certain features that will contribute to higher single-vehicle crash rates. And to identify the potential contributing factors, case control method was used for comparing the approaches that fall into the three special areas with the rest of single-lane approaches to see if there is any disproportional feature distribution among them.

The first two special areas located around the 10% and 20% volume fraction points were marked in red as shown in Figure 65, and 13 approaches were found to fit in these areas. Then a case control analysis was conducted with these 13 approaches being cases and the remaining 135 approaches being controls.

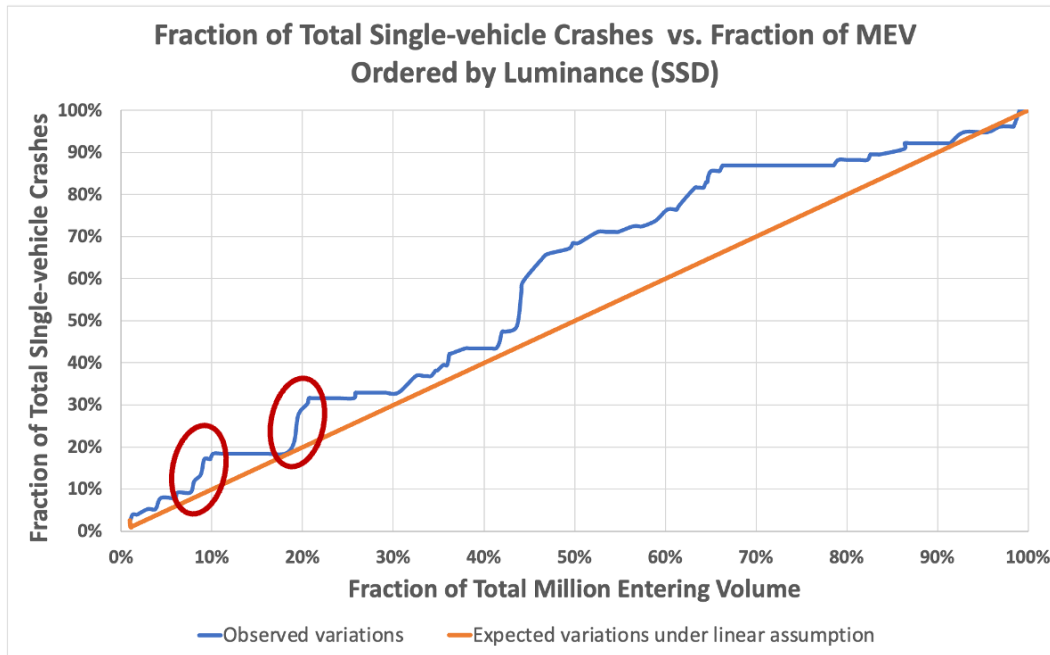

Figure 65. Chart. Fraction of total single-vehicle crashes vs. fraction of total MEV ordered by luminance measured at SSD

After testing against all the possible explanatory variables and their combinations, the only significant variable identified was a binary variable dependent on whether the approach luminance level measured at SSD and the yield line is less than 0.025 cd/m^2 and 0.04 cd/m^2 respectively or not. Based on whether the approaches satisfy the criteria defined in the identified variable, the corresponding crash rates computed for the cases and controls are listed in Table 32. Since the odds ratio of approaches that experience high crash rates when satisfying the luminance criteria compared to not satisfying the luminance criteria is 12.8, so for single-lane approaches with consistently low luminance level provided from the stopping sight distance to the yield line, the approach single-vehicle crash rates can be expected to be much higher compared to approaches with better illumination conditions provided.

Table 32. Results of case control analysis based on approach illumination conditions.

| | Cases | Controls | Total |
|---|-------|----------|-------|
| Approach SSD luminance < 0.025 cd/m² & yield line luminance < 0.04 cd/m² | 8 | 15 | 23 |
| Other | 5 | 120 | 125 |
| Total | 13 | 135 | 148 |
| Odds ratio point estimates and 95% CIs: 12.80 (3.71, 44.21) | | | |
| Yates corrected chi2 test that OR = 1: chi2(1) = 19.292 Pr > chi2 = <0.001 | | | |
| Fisher exact test that OR = 1: Pr > chi2 = <0.001 | | | |

Additionally, the third area with another steep slope observed is located around the midrange of the total entering volumes, as shown in Figure 66, and a case control analysis was performed to identify what specific characteristics that are common among these approaches could potentially lead to the corresponding high crash rates.

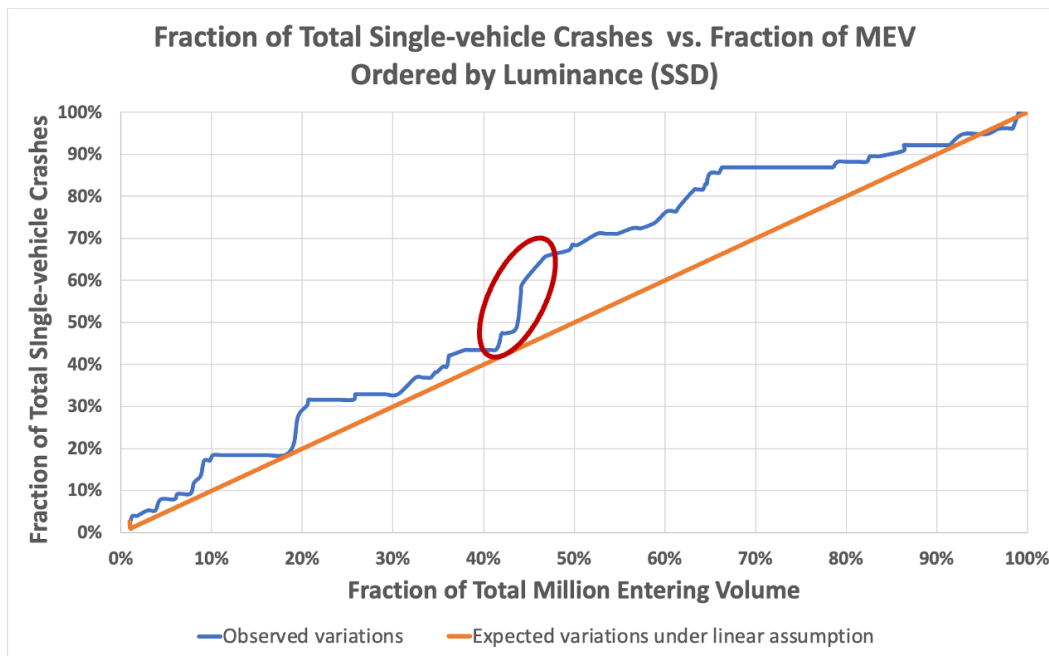

Figure 66. Chart. Fraction of total single-vehicle crashes vs. fraction of total MEV ordered by luminance measured at SSD

For the case control analysis, 9 out of 148 approaches were selected as cases, and results suggest that the only significant risk factor to case approaches is the presence of ambient lighting variable. According to the results shown in Table 33, it can be inferred that higher crash rates are more likely to occur among approaches with no ambient lighting present compared to approaches provided with ambient lighting. This inference is also consistent with the results concluded from the safety impact analysis with respect to the presence of colored truck apron variable, which further confirms the general observation that the presence of ambient lighting can be considered as a contributing factor to nighttime single-vehicle crash rates on single-lane approaches.

Table 33. Results of case control analysis based on the presence ambient lighting

| | Cases | Controls | Total |
|--|--------------|-----------------|--------------|
| Approaches with ambient lighting present | 1 | 81 | 82 |
| Approaches without ambient lighting | 8 | 58 | 66 |
| Total | 9 | 139 | 148 |
| Odds ratio point estimates and 95% CIs: 0.09 (0.01, 0.74) | | | |
| Yates corrected chi2 test that OR = 1: chi2(1) = 5.820 Pr > chi2 = 0.016 | | | |
| Fisher exact test that OR = 1: Pr > chi2 = 0.011 | | | |

Finally, to further determine the extent of active illumination required along the roundabout approaches with the effects of ambient lighting taken into consideration, the relationships between the fraction of total crashes and fraction of total traffic volume observed under the conditions of sorting the dataset based on approach yield line luminance and SSD luminance were compared. The corresponding two crash variation lines were plotted in Figure 67, and the deviations observed between these two lines simply indicate that even the same level of illumination provided at different approach locations can achieve different safety benefits. For

example, the decrease in crash rates due to the approach yield line luminance level increasing from 0.075 cd/m² to 0.2 cd/m² is substantially higher compared to the crash rate decrease obtained from the same amount of luminance increase provided at approach SSD.

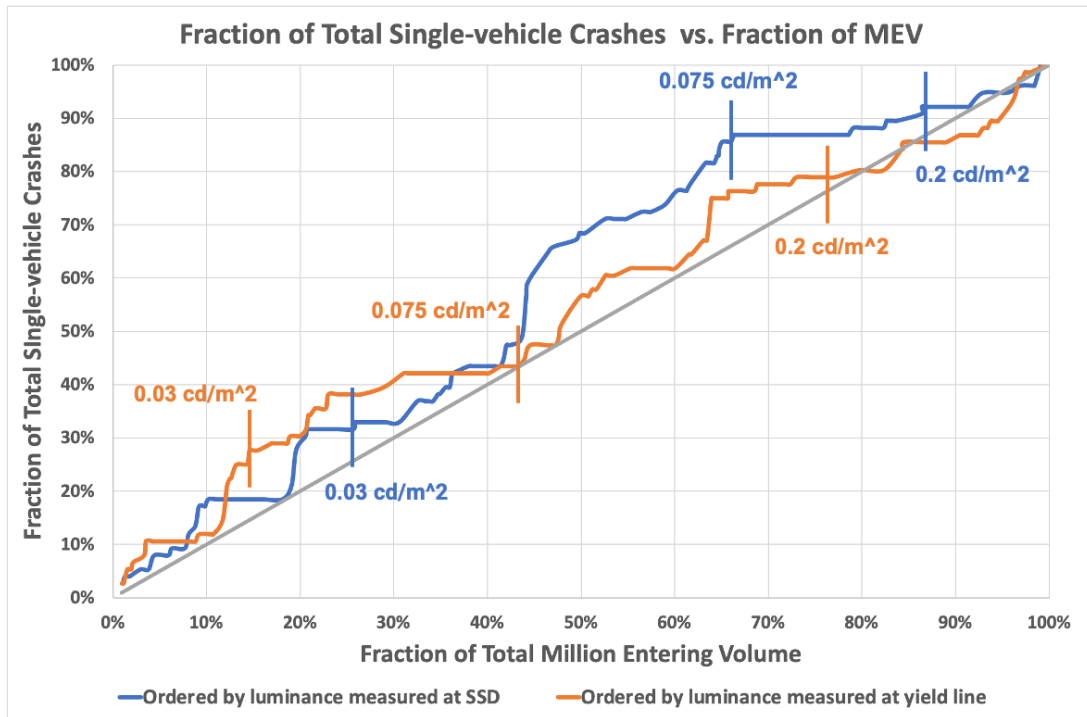

Figure 67. Chart. Fraction of total single-vehicle crashes vs. fraction of total MEV comparison between approaches ordered by luminance measured at yield line and SSD

In spite of the differences observed between the two conditions, there is no indication regarding preferences among the two locations for illumination consideration. Since for locations around either the yield line or SSD, when the luminance level reaches 0.075 cd/m², the corresponding crash variation lines both start to closely follow the expected crash variation line, indicating the safety improvement achieved by approach illumination. Therefore, as long as the provided illumination can ensure the approach yield line or the roundabout entrance is visible to approaching drivers from a stopping sight distance, it can be expected that single-vehicle crashes

will be avoided by a significant extent. Additionally, there is also little evidence that more safety benefits can be gained by providing higher levels of illumination.

CHAPTER 6. CONCLUSIONS AND RECOMMENDATIONS

PROJECT SUMMARY

This project focused on establishing the relationship between the presence/absence and/or levels of illumination and other geometric and operational characteristics on nighttime safety at modern roundabouts in Georgia. The studied roundabouts were selected to provide a wide range of conditions in terms of geometric layout, illumination levels, intersection daily entering volumes, etc. Field data collection at each of the selected sites included direct measurements of existing illumination levels at night, as well as a civil site survey to verify the geometric characteristics of the roundabout. These data collection activities were conducted by measurement teams from Georgia Tech and Georgia Southern University, and both teams used the same civil site survey and ground-based photographic roadway lighting measurement protocols. To ensure consistency of observations, a test measurement was also performed on one site by both teams prior to data collection. In addition to the civil survey and ground-based photographic roadway lighting measurement protocols, the Georgia Tech team also employed an aerial-based photographic roadway lighting measurement method to measure illumination levels along roundabout approaches using a drone platform.

The other operational and geometric characteristics of the selected roundabouts were obtained from a variety of data sources. The traffic count data for each roundabout approach were extracted from the GDOT RC-Link database, and further used to determine the average daily entry volumes for each roundabout site. The crash history data observed within the study area were mostly obtained from the GDOT crash portal Numetrics[®] with some additional data

provided by GDOT employees and assigned to each roundabout approach based on crash locations. Geolocation characteristics of roundabouts like site locations and surrounding land use were determined by the use of satellite imagery from Google[®] Maps, and/or Google[®] Earth.

The resulting datasets were first processed, combined, and aggregated to both roundabout site-level and approach-level resolutions, then the two datasets were used to separately establish statistical relationships between observed nighttime crash rates and underlying geometric, operational characteristics as well as measured illumination conditions from both an individual site perspective and an approach perspective. Additionally, the impacts of identified contributing factors on the correlations between approach crash rates and traffic volumes were further analyzed to help determine the spatial extent of active illumination required for roundabouts to match with desired safety needs while also considering the existence of other safety treatments.

DATA COLLECTION

A key aspect of this project was the development of and application of methods to rapidly collect quantitative information on luminance levels at operational intersections. Since current standard protocols for roadway illumination measurement require in-situ spot measurements, data collection involves a both a significant labor cost and requires researchers to be physically present in the intersection. This project adopted a photographic roadway lighting measurement protocol that offers a safe and repeatable measurement method with a proven accuracy of +/- 4%. Additionally, to further increase the data collection efficiency, a drone mounted DSLR camera was calibrated and used in the photographic protocol for the approach illumination data collection. Luminance measurements by the drone-mounted camera were found to closely agree with luminance measurements made by other approaches (i.e., photographic and spot

measurements). This approach holds promise of significantly reducing cost for collection of luminance data.

STUDY FINDINGS

Based on the roundabout site-level and approach-level analyses discussed in [Chapter 4](#) and [Chapter 5](#), conclusions regarding the safety benefits of different illumination levels under various roadway and traffic conditions can be derived from the corresponding results.

Roundabout site-level analysis

The results shown in [Chapter 4](#) reveal a wide range of variability in the observed rates for both single- and multiple-vehicle crashes between various roundabouts included in the study. While not surprising given the relatively small number of crashes present in individual sites, analysis of the overall trends of the crashes versus illumination levels gives us significant insight as to how illumination levels impact overall crash rates. Observation of Figure 41 shows **no measurable trend in collisions between motor vehicles (i.e., multiple-vehicle collisions) at any level of nighttime illumination** for the study sites. While perhaps not surprising, given the presence of head- and taillights on motor vehicles that aid in identification, this result provides support to typical assumptions in this regard.

The same is not the case for single-vehicle crashes (i.e., crashes not with a motor vehicle), for which the lowest levels of illumination showed the highest observed crash rates (see Figure 42). Interestingly, this trend is almost entirely driven by a single subsegment of the study sites: those having only three legs. This effect can be seen in Figure 43, which shows the observed crash

rates versus illumination level for three-leg and four/five-leg roundabouts. While Figure 43 for the three-leg roundabouts shows higher single-vehicle crash rates for low levels of illumination, that trend is not seen in the four/five-leg roundabouts (also Figure 43), which shows no demonstrable trend in single-vehicle crash rates with illumination. This result is borne out in the modeling results, which confirm that there are no statistically significant predictive variables relating crash rate to illumination for four/five-leg roundabouts. Significantly, the modeling results for the three-leg roundabouts **do** show a dependence on illumination at levels below about 4 lux, but not for higher illumination conditions.

Together, these results may be summarized as follows: The major overarching finding from the site-level analyses is that, for the rural and suburban roundabouts included in this study, there is no statistically significant relationship between either single- or multivehicle crash rates and illumination for observed illumination levels exceeding 5 lux. This result is significant in that current IES guidance suggests a minimum illumination level of 8 lux for even the lowest volume roundabouts and significantly higher levels of illumination for roundabouts located on higher functional class roadways.

Other specific conclusions from the site-level analysis include:

- For roundabouts with advisory speeds of 35 mph or less, there was no statistically significant relationship between observed single-vehicle crash rates and illumination for roundabouts possessing an average maintained horizontal illumination value greater than 5 lux.

- For three-leg roundabouts with average maintained horizontal illuminance less than 5 lux, crash rates increased as illumination declined and stopping sight distance increased. No such influence was seen from three-leg roundabouts with average horizontal illuminance of greater than 10 lux. Nor was such relationship observed for four- or five-leg roundabouts, although the number of cases was low. For three-leg roundabouts at these low-illuminance (<5 lux) levels, the presence of centerline rumble strips and/or circle lighting was also shown to impact crashes, although these effects are likely due to confounding factors impacting a few sites rather than broader trends.
- For four- and five-leg roundabouts with average maintained horizontal illumination less than or equal to 5 lux, the number of crashes was too low to make a reliable inference of the influence of variables.

Roundabout approach-level analysis

For the approach-level analysis, the illumination conditions were represented by the luminance values measured at three locations along each approach: the entrance into the circulating path, the midpoint between yield line and stopping sight distance, and the point of stopping sight distance. Based on the measured luminance values and other datasets collected at the approach-level, a multi-linear stepwise regression model was developed, and the modeling results indicate that the nighttime single-vehicle crash rates can significantly be influenced by the presence of approach lighting and colored truck aprons as well as having additional travel lanes on the approach.

Since multi-lane approaches tend to be located in large roundabouts with heavy traffic volumes and more safety treatments, analyses were conducted separately for multi-lane approaches and

single-lane approaches, considering the potential confounding effects of additional approach travel lanes. By comparing the results obtained from the analyses of those two datasets, it is observed that for multi-lane approaches, providing lighting along the approach to ensure the visibility of the yield line, especially within the area between the yield line and the stopping sight distance, can have significantly more safety benefits than providing lighting inside the roundabout circle alone. While for single-lane approaches, compared with approach lighting, the presence of ambient lighting was found to have a stronger impact on nighttime single-vehicle crash rates.

Additionally, due to the non-linear relationship observed between approach entry volume and single-vehicle crash rate as shown in Figure 61, correlations between the fraction of total single-vehicle crashes and the fraction of total entering volumes were further explored for a more robust analysis. Results show that approaches with luminance level lower than 0.075 cd/m^2 provided at the yield line tend to have on average higher single-vehicle crash rates, but there's also little evidence indicates that providing higher levels of illumination at the approach yield line will generate any additional safety benefits. Moreover, observations from Figure 65 also suggest that nighttime single-vehicle crashes are more likely to occur on single-lane approaches with uniformly low luminance levels (less than 0.04 cd/m^2) provided from the yield line to the stopping sight distance, but if a slightly higher level of illumination can be provided within that area to ensure the roundabout entrance is visible to approaching drivers from a stopping sight distance, then it can also be expected that single-vehicle crashes will be avoided by a significant extent.

Study Limitations

Before discussing the findings of this study, it is important to note some of its limitations. First, this study focused on modern roundabouts in rural and suburban areas, specifically at locations *without a significant number of pedestrians during nighttime hours*. As a consequence, results from this *study cannot be used to evaluate the needs for roundabout illumination for pedestrian safety*. Second, although the study incorporated a significant number of roundabout sites (i.e., 80), the low crash rates at roundabouts means that the study's conclusions are based on a relatively small number of crashes (about 1,000, of which only about 350 are from single-vehicle crashes whose rates are most sensitive to illumination) and the possibility of hidden systematic errors or low-probability random errors influencing these results cannot be entirely excluded. Third, the major metrics used for the quantitative evaluation of illumination, *the illuminance near the entrance to the roundabout circle and the luminance near the stopping sight distance at each roundabout approach, may not be fully correlated with a driver's ability to detect the roundabout and to determine the proper wayfinding activities at some distance from the roundabout*.

RECOMMENDATIONS

Based on the conclusions drawn from this study, the following recommendations are made to assist GDOT decisions, on a project-level basis, about the type and extent of active illumination and/or passive safety treatments for rural and suburban roundabouts.

- As this study did not include any roundabouts with the potential for any significant nighttime pedestrian volumes, current illumination practices should be maintained for

these types of roundabouts until additional studies are conducted. This would include virtually all urban roundabouts.

- The results of the study suggest that nighttime lighting can provide certain benefits in terms of reducing single-vehicle crashes even if the average maintained horizontal illumination levels are lower than current IES standards (potentially as low as 5 lux).
- For multi-lane roundabout approaches or single-lane approaches with right-turn bypass lanes present, the installation of roadway lighting should be considered along the approaches to ensure the visibility of approach configurations as well as roadway signs and pavement markings.
- For single-lane roundabouts, nighttime lighting should be provided to ensure the visibility of yield line for drivers on each approach from the minimum stopping sight distance, especially with the presence of ambient lighting. This can often be accomplished with only circle illumination as safety benefits become limited for illumination levels higher than 0.075 cd/m^2 at the corresponding SSD.
- The observed significance of passive treatment factors (e.g., centerline rumble strips, crosswalk markings, etc.) affecting nighttime single-vehicle crash rates at lower illumination levels suggests that additional passive safety measures, (e.g., high reflectance pavement markings, etc.) should be considered for potential applications.

APPENDIX A. EVALUATION OF ALTERNATIVES TO TRADITIONAL ROUNABOUT LIGHTING

This appendix discusses various roundabout lighting alternatives that have been proposed and evaluated by researchers with the intention of enhancing roundabout visibility at nighttime while saving cost and energy consumptions.

CONVENTIONAL ROUNDABOUT ILLUMINATION SCHEMES

Perimetric Illumination

Currently per FHWA policy, most roundabouts use pole-mounted luminaires installed at the exterior of the roundabout circle to light the roadway (Figure 1).



Figure 1. Image. Perimetric illumination [3]

For the visibility and perception aspect, perimeter illumination maintains lighting continuity, front lights the approach signs, provide strong illumination for critical bicycle and pedestrian areas but is weakest in the central island.

Approach and Transition Lighting

Since entering a roundabout from the connected approaches would usually require drivers' adaptation of vision and lower speed, many existing roundabout lighting standards would recommend including approach lighting to enhance the roundabout visibility and safety. However, the cost-benefits still remain unclear, especially for suburban/rural roundabouts.

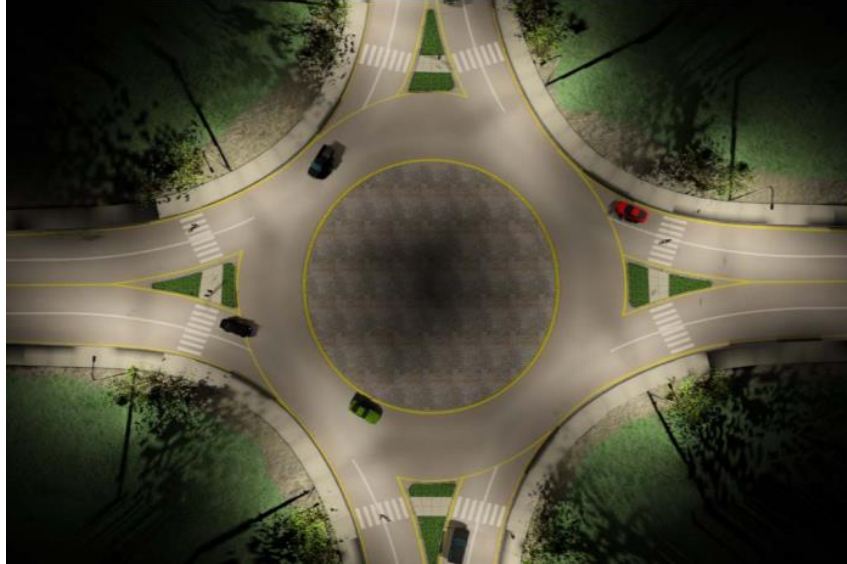

Figure 2. Image. Roundabout with approach lighting [4]

Some studies have proved that approach lighting is critical in creating good visibility throughout the roundabout. Lutkevich et al. (2005) reviewed 20 roundabouts in Maryland and compared the roundabout peripheral lighting with and without approach lighting, using both site data analysis and computer models. They discovered that the contrast values for the pedestrians were considerably higher for the roundabout with approach lighting [4]. Additionally, approach lighting could also add continuity of illumination between the illuminated areas and roundabouts, making the roundabouts located in unlit areas more visible from a distance [1].

In terms of safety impacts, Brewer et al. (2017) examined the effectiveness of illumination at high-speed approaches for roundabouts and found that several studies have proved lighting could decrease night-time crashes, but no study addressed the speed reduction [5]. Rodgers et al. (2016) used crash data from Minnesota to analyze the safety impacts on roundabout illumination. Results indicate that although converting from partial to full illumination could lead to 39% reductions in nighttime crash rate, partial illumination only can achieve up to 83% of benefits gained from full illumination [6].

While for some roundabouts where approach lighting couldn't be provided due to certain reasons like financial budget, many guidelines would also suggest transition lighting along each

approach. This could help drivers adjust their visions from lighting level change, and the recommended minimum transition zone length should depend on the approaching roadways' speed limits [5].

Pedestrian Crosswalks Lighting

Since pedestrian crosswalks at roundabouts are positioned in less-expected locations, inadequate lighting in this area might largely increase the risk of pedestrian injuries. As crash reports show that the fatal pedestrian crash rates at nighttime in unlighted areas are almost three times higher than daytime [7], many guidelines like NCHRP 672 recommend providing adequate illumination for pedestrian crossing and bicycle merging areas [1].

While crosswalks are typically lighted by overhead light fixtures from directly above, to increase positive contrast between pedestrians and backgrounds, recent FHWA guidance and other research advise engineers to position light poles ahead of crosswalks in both entry and exit lanes [9]. In addition to increasing the positive contrast, crosswalk lighting should also consider the vertical illuminance on pedestrians [7]. Bullough et al. (2012), have argued that conventional overhead lighting system aren't optimized to produce high levels of visibility of pedestrians for approaching drivers and may result in negative contrast [10], although these conclusions are disputed by other experts.



Figure 3. Image. Bollard crosswalk lighting system at night [8]

Another potential benefit of bollard level lighting is improvement in visual performance. Bullough et al. (2012) conducted several field experiments to evaluate bollard luminaires along roundabout crosswalks, the results from either the RVP model or the respondents both indicated that the bollard-level crosswalk lighting could produce sufficient vertical illuminance levels to maintain positive contrast throughout the crosswalk [11]. However, these results have not been extensively replicated by other studies. Moreover, the push button control used by the bollard system allows the luminaires to produce a relatively low, glare-free light level when not in use, while still making them highly visible to pedestrians and drivers [8]. However, during use, these systems tend to produce high levels of glare for drivers that may offset some, or all, of the safety benefits from these systems.

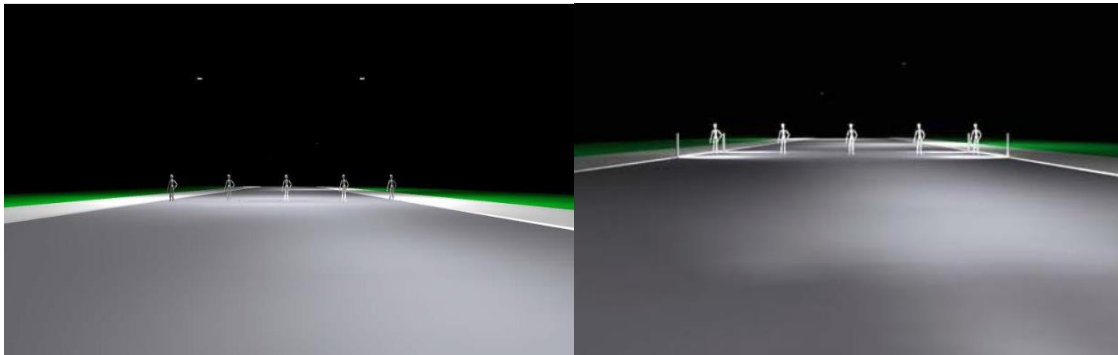

Figure 4. Image. Vertical luminance under overhead street lighting and Bollard level crosswalk lighting [8]

An additional benefit to the use of bollards is that they could aid pedestrians in wayfinding and navigation, similar to that of overhead lighting. The findings of previous research related to the impact of bollard-level lighting all suggest that using bollard luminaires for pedestrian crosswalks, particularly at areas where crosswalks might otherwise not be expected, for example at mid-block locations [8]. Moreover, they could also act as architectural elements to help delineate the location of crosswalks to drivers during both daytime and nighttime [7].

Apart from the safety impacts, bollard-level lighting also has a potential advantage over conventional lighting systems in energy consumption. Bullough et al. (2017) tested the bollard lighting system in comparison with the outdoor overhead luminaires and discovered that use of overhead luminaires had increased energy use, mainly because the higher mounting heights requires the power to increase approximately with the square of the mounting height [12], although some, or all, of this benefit may be offset by the need for additional fixtures. Furthermore, by locating luminaires close to the target pedestrians, power levels and the resulting energy use can also be greatly reduced, although increased glare on neighboring approaches would be a potential safety concern.

PAVEMENT MARKINGS AND SIGNS

For the unlighted roundabouts, especially those located in rural areas, NCRHP report 672 suggests the use of reflective pavement markers and retroreflective signs (including chevrons supplementing the ONE-WAY signs) as an alternative [1]. Many research findings show that these markings and signs can be a very cost-effective approach to provide visual guidance, delineate the roundabouts and influence vehicle operations, etc.

Raised Reflective Pavement Markers

Raised reflective pavement markers (RPM) are generally employed to supplement pavement markings along the roadway centerlines and edge lines. They have the benefit of additional visibility at night or during inclement weather conditions [13]. For the roundabout applications, researchers recommend using RPMs to delineate the approach, entry curves and circulating lanes. Additionally, they can also be utilized on the approaches to the roundabouts as a traffic calming measure [14].

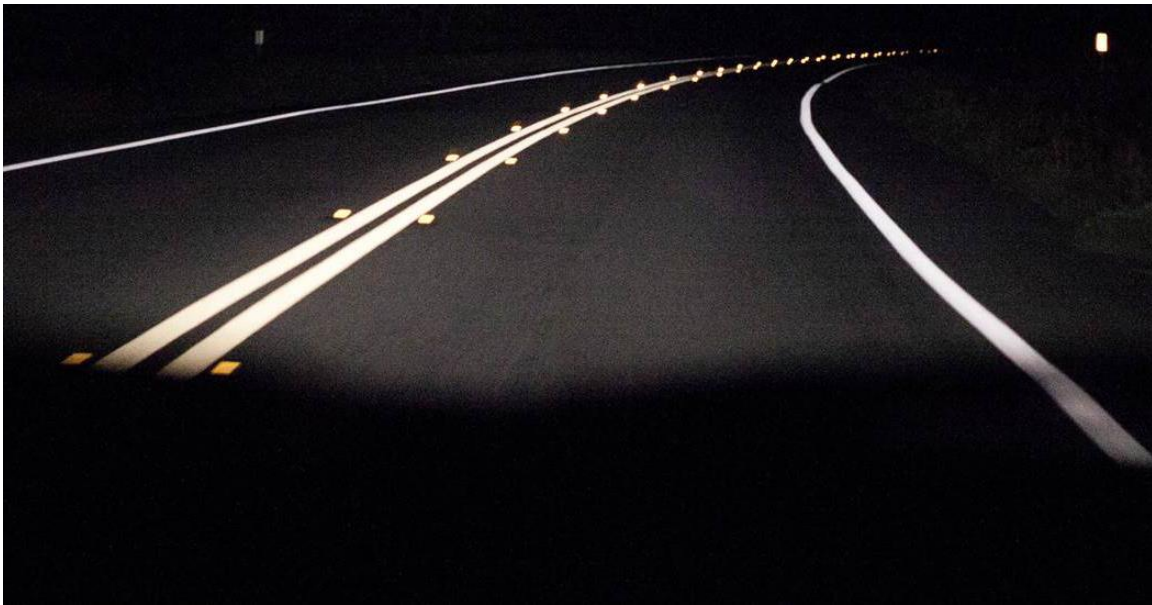

Figure 5. Image. Raised reflective pavement markers

In general, RPMs tend to have visibility distances between 300 and 400 m before they reach the threshold defined by an RVP value of zero [17]. Bullough et al. (2020) measured the luminance of new, used RPM samples and the alternatives under low-beam headlight illumination. The laboratory data showed that while used RPMs had luminance 20% to 30% lower than new RPMs, such reductions were of little consequence to visual performance [18].

To understand the impacts of RPMs on road users, Hall et al. (1987) examined the short-and long-term effects of RPMs on rural two-lane highways and found that vehicles tend to move away from the centerline on curves while vehicle speed and placement variability were also slightly reduced with the addition of chevrons and raised pavement markers [15].

RPMs' influence on road users further leads to the evaluation of safety effectiveness. Das et al. (2013) analyzed the RPMs' impact on freeway crashes with nine years of data of Louisiana. The analysis results indicated that RPM has significant effect in reducing nighttime crashes at all AADT levels, but there are no safety benefits for RPM on urban freeways due to lighting conditions [16]. Liu et al. (2018) studied the crash rate on state and county roadways under various conditions to find that RPMs' effects in decreasing crash rates are most significant for those happened in nighttime wet weather conditions [17].

Chevron Signs

Most roundabouts employ ONE-WAY signs to indicate circulations around the central islands. While these signs may not be sufficiently visible to approaching drivers especially for large roundabouts at night, warning chevrons or chevron alignment signs could be installed as a supplement to increase the conspicuity of roundabout's central island, and further reduce the risks of entry-circulating collisions [19].

Researchers recommend that chevron signs should be provided for each approach lane and located on the central island opposite the entrances ([1], [14]). The guideline NCHRP 672 replaced the previous signs with black-and-white chevron signs that will be installed at roundabouts only. Therefore, the consistent and uniform use of this sign will remind road users of entering the roundabouts ahead [1].



Figure 6. Image. Chevron signs at roundabouts

Apart from the ability to provide advance warnings, chevron signs were also proved to contribute to speed control and lane position guidance. Hall et al. (1987) evaluated the effects of chevrons on driver behavior at rural, horizontal curves and discovered that chevron signs could lead to vehicles moving away from the centerline and slightly reduced vehicle speed and placement variability, same as raised pavement markers [15]. Zhao et al. (2015) investigated chevron signs' influence on drivers' performance at horizontal curves at daytime using driving simulators. Results showed that placing chevrons close to the driving direction could help decrease speeds regardless of curve radius. Moreover, chevron signs encourage participants to drive in a more proper and stable lane position within curves [20].

Post-mounted Delineators

Post-mounted delineator (PMD) is another frequently adopted method to delineate the roadway alignment because of the reflective materials and comparable height to the headlights of vehicles [21]. According to the MUTCD, delineators are particularly beneficial at locations where the alignment might be confusing or unexpected. A key advantage of delineators is that they can remain visible even when the roadway is wet, or snow covered. Thus, they appear to be effective guidance devices especially at night and during adverse weather [22].

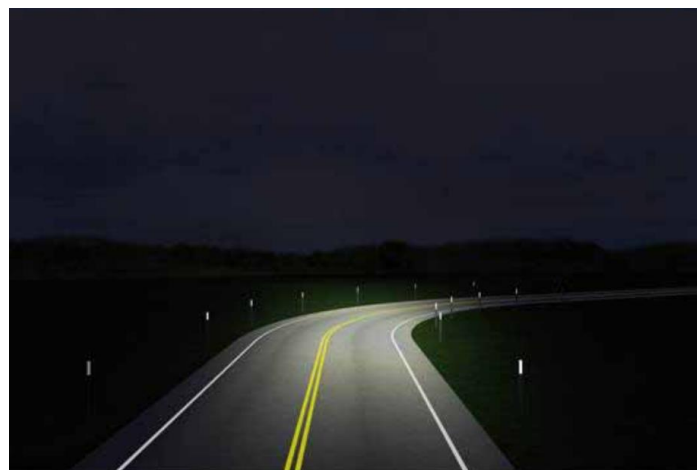

Figure 7. Image. Post mounted delineators on both sides of the road [25]

Previous research has focused on studying the PMDs' influences on vehicle operations mainly from three aspects: vehicle lateral placement, driving speed and curve feature detection

distance. Nygårdhs et al. (2014) investigated different delineator post configurations' impacts on driver speed in nighttime traffic and discovered that the addition of delineator posts did lead to increased driver speed in curves with a large radius but does not influence the already low speed in small curves [23]. Schumann et al. (2000) conducted a field study using frequency analysis of steering behavior and discovered that adding post-mounted delineators to regular lane markings tended to decrease compensatory steering actions [24]. Molino et al. (2010) analyzed the effectiveness of different PMD combined treatments for curves in rural two-lane roads at night and found that the PMDs enhanced by streaming LED lights solution yielded the best performance in reducing speed in curves and increasing curve feature detection distance, compared with other treatments like pavement markings [25].

And to be compared with other roadway treatments, Krammes et al. (1991) evaluated the operational effectiveness of RPMs and PMDs at horizontal curves. Both the short- and intermediate-term data suggest that the new RPMs provided better path delineation and higher driving speed through the curves [26]. Rosey et al. (2008) studied four perceptual treatments' effects on drivers' lateral control abilities and observed that the trajectories are not significantly influenced by post-delineators treatment whatever the section of road, which might imply that the drivers used more horizontal markings than vertical ones [27].

While in terms of the direct safety impacts, Galgamuwa et al. (2018) estimated the CMFs of chevrons and PMDs based on the lane-departure crash data collected from 2013 to 2015. The analysis results implied that both chevrons (CMF=0.65) and post-mounted delineators (CMF=0.64) tend to have crash reduction effects on fatal and injury lane-departure crashes [28].

INTELLIGENT ROAD STUDS

Although the reflective markings and signs can be cost-effective, they all have a key limitation which they must rely on the reflection of light from vehicle headlights. While due to the limited range of headlights within the circular roadways of roundabouts, active road studs were developed and applied in the road networks.



Figure 8. Image. Actively illuminated road studs with nearside red studs, center-line white studs, and offside amber studs [29]

One key benefit of intelligent road studs is that they can increase the forward illumination from the current 100m to approximately 900m for road users. With increased visibility, drivers could be formed in advance about the potential roadway changes. Moreover, the intelligent road studs could also detect the surrounding environments and automatically activate various levels of illumination [29].

Relative studies have also shown that the implementation of the intelligent road studs has a positive impact on driver behaviors. Shahar et al. (2014) compared the nighttime driving performance with active road studs to the unlit condition on a country road. The analysis indicated that the studded condition induced slightly faster speeds while demonstrating better lateral vehicle control than the unlit condition in curves [30]. Llewellyn et al. (2015) investigated the intelligent road studs' effectiveness of improving vehicle operations at spiral-marked roundabouts and the comparison data showed a reduction in lane transgression activity regardless of vehicle types, maneuvers, and flow rates. This improvement in lane discipline could further decrease the potential of vehicle collisions and reduce the costs of accidents [31].

Apart from the usage as guidance devices, intelligent road studs could also be applied as warning signs. O'Connor et al. (2005) analyzed the effectiveness of intelligent road studs to provide delineation under poor visibility conditions and to flash as warning signs. The trial showed that the flashing studs do result in a reduction in speeds, increase in headway and reduced lane change maneuvers. Additionally, the application of studs also tends to have a potential financial benefit due to the relatively cheaper installation costs [32].

ECOLUMINANCE APPROACH

Ecoluminance is an approach to roundabout lighting using a combination of illumination from landscape lighting to provide visual delineation, pedestrian-level lighting to provide lighting for hazard areas, and luminance from roadside vegetation to reinforce delineation, and retroreflective elements to provide cues about geometry [33].

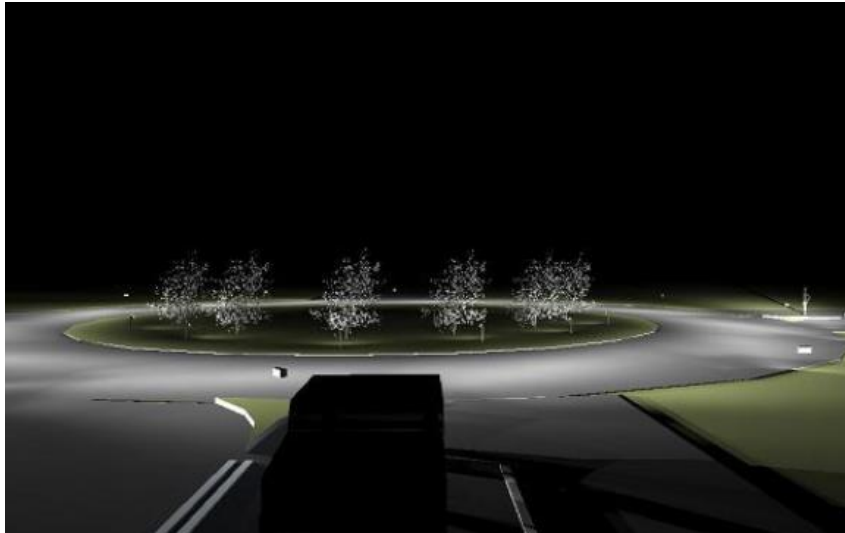

Figure 9. Image. Roundabout with ecoluminance solution [33]

Visual Performance

For the roundabout application, Bullough et al. (2012) applied the ecoluminance approach on a newly constructed roundabout in New York and the photometric measurements of light levels showed that pedestrians and roadway elements were visible to drivers. The team also studied the performance of different light sources, namely HPS and LED, and data indicated that the white roadway illumination to be more visually effective and safer than yellower HPS illumination [33].

To further understand the contribution of landscape lighting and vegetation, Bullough et al. (2013) analyzed three ecoluminance alternatives and found that the solution without landscape lighting could improve the visibility of pedestrians and the presence of vegetation but reduce the roadway luminance, while the solution using landscape lighting had increased both the average

luminance and contrast. While in terms of the vegetation in the central island, results showed that they could not only provide delineation to identify the inner edge of roadway, but also reduce glare from oncoming traffic at the opposite end of roundabouts. Moreover, the simulation results also indicated a potential improvement in visibility due to the relatively low luminance from the vegetation when pavement is wet [34]. The latter being dependent on the relative orientation of the driving directions.

Driver Behaviors

To analyze the influence of ecoluminance approach on driver behaviors, the same study carried out by Bullough et al. (2012) observed the approaching vehicle speeds with the ecoluminance system installed and with the conventional lighting installed through two short term demonstrations. The collected data revealed little difference and suggested that the ecoluminance approach tends to have little measurable impact [33].

Energy Use and Costs

Due to the combination of luminaires and ecological features, the ecoluminance approach is believed to have the potential in reducing energy use and operating costs. Pîrlea et al. (2014) used a simulation software to compare the performance of conventional lighting system and the ecoluminance-based one for a newly designed roundabout. They discovered that in order to obtain similar illuminance levels, the lighting system based on ecoluminance concept could save approximately 20% of energy use [35]. While the field experiment carried out by Bullough et al. (2012) showed a 75% decrease in energy consumption using ecoluminance approach. These huge energy savings could be resulted from the lower mounting height of luminaires and the direct illumination towards objective areas [33].

In terms of the operating costs, Bullough et al. (2012) also conducted an economic analysis and data indicated that the lifecycle costs were similar for an ecoluminance-based system versus

an HPS one [33]. However, it can be expected that as the installation cost of LEDs decreases, ecoluminance approach might soon have an advantage over the HPS one.

CONCLUSIONS

| Lighting alternatives | | Visual performance |
|---|--|---|
| Conventional lighting schemes and supplements | Central illumination | <ol style="list-style-type: none"> 1. Improve perception of the roundabout at a distance 2. Provide positive contrast for exit guide signs 3. Inadequate vertical lighting levels without additional lighting 4. Create a greater risk of glare ^[1] |
| | Perimeter illumination | <ol style="list-style-type: none"> 1. Provide good visual guidance on the circulatory roadway 2. Maintain lighting continuity 3. Provide strongest illumination for critical bicycle and pedestrian areas 4. Weakest illumination in central island limit visibility of roundabout at a distance ^[1] |
| | Approach lighting | <ol style="list-style-type: none"> 1. Add continuity of illumination between the illuminated areas and roundabouts ^[1] 2. Improve the visibility of roundabouts at a distance ^[1] 3. Provide higher contrast for pedestrians ^[4] |
| | Bollard crosswalk lighting | <ol style="list-style-type: none"> 1. Produce sufficient vertical illuminance levels to maintain positive contrast throughout the crosswalk ^[11] 2. Produce a relatively low, glare-free light level when not in use while still remain highly visible ^[8] |
| Pavement markings and signs | Raised reflective pavement markers (RPM) | <ol style="list-style-type: none"> 1. Provide additional visibility at night or during inclement weather conditions ^[13] 2. Help delineate the approach, entry curves and circulating lanes ^[14], provide better path delineation than PMDs ^[26] 3. Visibility distances between 300 and 400 m before RVP value reach 0 ^[17] 4. Little difference in visual performance between used and new RPMs ^[18] |

| | | |
|--------------|--------------------------------|--|
| | Chevron alignment signs | <ol style="list-style-type: none"> 1. Increase the conspicuity of roundabout's central island ^[19] 2. Improve the visibility of ONE-WAY signs especially for large roundabouts at night ^[19] |
| | Post mounted delineators (PMD) | <ol style="list-style-type: none"> 1. Help delineate the roadway especially with confusing or unexpected alignment ^[22] 2. Remain visible and provide good visual guidance at night and during adverse weather ^[22] |
| | Intelligent road studs | <ol style="list-style-type: none"> 1. Increase the forward illumination from the current 100m to approximately 900m for road users ^[29] 2. Detect the surrounding environments and automatically activate the required level of illumination ^[29] 3. Provide delineation under poor visibility conditions |
| Ecoluminance | | <ol style="list-style-type: none"> 1. Provide visibility of pedestrians and roadway elements to drivers ^[33] 2. Increase the average luminance and contrast within the roundabout 3. Provide delineation to identify the inner edge of roadway, but also reduce glare from oncoming traffic at the opposite end of roundabouts due to the vegetation in the central island 4. Improve the visibility when pavement is wet because of the relatively low luminance from the vegetation |

| Lighting alternatives | | Safety impacts | |
|--|------------------------|---|--|
| | | Road user behaviors | Accident risks |
| Conventional lighting schemes and supplement | Perimeter illumination | \ | <ol style="list-style-type: none"> 1. Poles may need to be located in critical conflict areas and may increase crash risks ^[1] |
| | Approach lighting | Help drivers adjust their visions from lighting level change ^[5] | <ol style="list-style-type: none"> 1. Decrease nighttime crash rates ^[5,6] |

| | | | |
|-----------------------------|------------------------------------|---|---|
| | Bollard crosswalk lighting | <ol style="list-style-type: none"> 1. Aid pedestrians in navigation and identifying appropriate street crossing locations ^[8] 1. Help delineate the location of crosswalks to drivers during both daytime and nighttime ^[7] | \ |
| | Raised reflective pavement markers | <ol style="list-style-type: none"> 1. Keep vehicles moving away from the centerline on curves ^[15] 2. Slightly reduce vehicle speed and placement variability with the addition of chevrons ^[15] | <ol style="list-style-type: none"> 1. Reduce nighttime crashes at all AADT levels on suburban roadways ^[16] Decrease the risk of crashes happened in nighttime wet weather conditions ^[17] |
| Pavement markings and signs | Chevron alignment signs | <ol style="list-style-type: none"> 1. Remind road users of entering the roundabouts ahead ^[1] 2. Keep vehicles moving away from the centerline ^[15] 3. Help decrease approaching speeds regardless of curve radius ^[15,20] 2. Encourage drivers to drive in a more proper and stable lane position within curves ^[20] | <ol style="list-style-type: none"> 2. Effective in reducing fatal and injury lane-departure crashes (CMF=0.65) ^[28] |
| | Post mounted delineators | <ol style="list-style-type: none"> 1. Increase driver speed only in curves with a large radius ^[23] 2. Decrease compensatory steering actions ^[24] 4. Increase curve feature detection distance when enhanced by streaming LED lights ^[25] | <ol style="list-style-type: none"> 1. Effective in reducing fatal and injury lane-departure crashes (CMF=0.64) ^[28] |

| | | | |
|--------------|------------------------|---|---|
| | Intelligent road studs | <ol style="list-style-type: none"> 1. Induce slightly faster speeds ^[30] 2. Reduce lane transgression activity ^[31] 3. Alert\ direct traffic instantly by switching the colors ^[32] | \ |
| Ecoluminance | | <ol style="list-style-type: none"> 1. Have little measurable impact on driver behaviors ^[33] | \ |

References

- [1] Rodegerdts, Lee August. Roundabouts: An informational guide. Vol. 672. Transportation Research Board, 2010.
- [2] Illuminating Engineering Society of North America. Design Guide for Roundabout Lighting. Publication IES DG-19-08. , New York, February 2008.
- [3] Pratelli, Antonio. "Setting for compact roundabout optimal lighting plans." WIT Transactions on The Built Environment 96 (2007).
- [4] Lutkevich, Paul, and Patrick Hasson. "An examination and recommendation for current practices in roundabout lighting." Transportation research circular E-C083 (2005): 15p-15p.
- [5] Brewer, Marcus A., Tomas E. Lindheimer, and Susan T. Chrysler. Strategies for effective roundabout approach speed reduction. No. MN/RC 2017-14. Minnesota. Dept. of Transportation. Research Services & Library, 2017.
- [6] Rodgers, Michael O., et al. Evaluation of Current Practice for Illumination at Roundabouts: Safety and Illumination of Roundabouts (Phase I). No. FHWA-GA-15-12-01. Georgia. Dept. of Transportation, 2016.
- [7] Frering, Daniel C., et al. Web-Based Training for FHWA Roadway Lighting Workshop Module 4: Other Roadway Lighting Topics. No. FHWA-SA-18-035. United States. Federal Highway Administration. Office of Safety, 2018.
- [8] Bullough, John D., and Nicholas P. Skinner. "Demonstrating urban outdoor lighting for pedestrian safety and Security." (2015).
- [9] CTC and Associates . New Approaches for Roundabout Lighting to Enhance Pedestrian Safety. Minnesota Department of Transportation, Saint Paul, 2014.
- [10] Bullough, John D., and Leora C. Radetsky. Sustainable roadway lighting seminar. No. C-13-05. New York State Energy Research and Development Authority, 2014.
- [11] Bullough, John D., and Nicholas P. Skinner. "Vehicle lighting and modern roundabouts: implications for pedestrian safety." SAE International journal of passenger cars-mechanical systems 5.2012-01-0268 (2012): 195-198.
- [12] Bullough, John D., and Nicholas P. Skinner. "Real-World demonstrations of novel pedestrian crosswalk lighting." Transportation research record 2661.1 (2017): 62-68.
- [13] Robinson, Bruce W., et al. Roundabouts: An informational guide. No. FHWA-RD-00-067; Project 2425. United States. Federal Highway Administration, 2000.
- [14] Thomas, Grant, and Alan Nicholson. "Rural Roundabouts and Their Application in New Zealand." Institution of Professional Engineers New Zealand (IPENZ) Transportation Group. Technical Conference Papers 2003 Institution of Professional Engineers New Zealand. 2003.
- [15] Hall, J. "Effects of chevrons, post-mounted delineators, and raised pavement markers on driver behavior at roadway curves." (1987).
- [16] Das, Subasish, et al. "Investigating Safety Impact of Raised Pavement Markers on Freeways in Louisiana 2." International Journal of Engineering Research and Innovation 5.2 (2013).

- [17] Liu, Xiang, et al. Evaluation of Raised Pavement Markers. No. FHWA NJ-2018-004. New Jersey Department of Transportation, 2018.
- [18] Bullough, John D., and Xiang Liu. "Assessing the visibility of raised pavement markers and alternative forms of delineation." *Transport* 35.1 (2020): 98-107.
- [19] Weber, Philip, and Scott Richie. "Internationally Recognized Roundabout Signs." Transportation Research Board. National Roundabout Conference. Source: www.docstoc.com/docs/24545077/internationally-recognized-roundabout-signs, Colorado. 2005.
- [20] Zhao, Xiaohua, et al. "The effect of chevron alignment signs on driver performance on horizontal curves with different roadway geometries." *Accident Analysis & Prevention* 75 (2015): 226-235.
- [21] Stamataidis, Nikiforos, and A. Vest. "Means to Reduce Operating Speeds on Curves." Proceedings of the SIIV2004 II International Congress, Florence, Italy. 2004.
- [22] Federal Highway Administration (2000) Manual on Uniform Traffic Control Devices for Streets and Highways. U.S. Department of Transportation.
- [23] Nygårdhs, Sara, et al. "The effect of different delineator post configurations on driver speed in night-time traffic: A driving simulator study." *Accident Analysis & Prevention* 72 (2014): 341-350.
- [24] Schumann, Josef. Post-mounted delineators and perceptual cues for long-range guidance during night driving. University of Michigan, Ann Arbor, Transportation Research Institute, 2000.
- [25] Molino, John A., et al. Simulator evaluation of low-cost safety improvements on rural two-lane undivided roads: Nighttime delineation for curves and traffic calming for small towns. No. FHWA-HRT-09-061. Turner-Fairbank Highway Research Center, 2010.
- [26] Krammes, Raymond A., and Kevin D. Tyer. "Post-mounted delineators and raised pavement markers: their effect on vehicle operations at horizontal curves on two-lane rural highways." *Transportation Research Record* 1324 (1991).
- [27] Rosey, Florence, et al. "Impact of perceptual treatments on lateral control during driving on crest vertical curves: a driving simulator study." *Accident Analysis & Prevention* 40.4 (2008): 1513-1523.
- [28] Galgamuwa, Uditha, and Sunanda Dissanayake. "Safety Effectiveness of Chevrons and Postmounted Delineators in Reducing Lane-Departure Crashes." International Conference on Transportation and Development 2018: Connected and Autonomous Vehicles and Transportation Safety. Reston, VA: American Society of Civil Engineers, 2018.
- [29] Reed, Nick. Driver behaviour in response to actively illuminated road studs: a simulator study. TRL Limited, 2006.
- [30] Shahar, Amit, and Roland Brémond. "Toward smart active road studs for lane delineation." 2014.
- [31] Llewellyn, Richard. "Lighting the Way: The Use of Intelligent Road Studs at Spiral-Marked Roundabouts." European Transport Conference 2015 Association for European Transport (AET). 2015.

[32] O'Connor, Linda, Joanne Casey, and Faber Maunsell. "TRIAL AND EVALUATION OF INTELLIGENT ROAD STUDS FOR HAZARD WARNING." 12th World Congress on Intelligent Transport SystemsITS AmericaITS JapanERTICO. 2005.

[33] Bullough, John D., et al. Demonstration of roundabout lighting based on the ecoluminance approach. No. C-08-03. New York State Energy Research and Development Authority, 2012.

[34] Bullough, John D. "Ecoluminance: a new approach to visual guidance for roadways." *International journal of sustainable transportation* 8.2 (2013): 127-150.

[35] Pîrlea, Elena Otilia, and Gabriel Ispas. "About a method of improving lighting systems for roudabouts." *Revista Romana de Inginerie Civila* 5.2 (2014): 103.

APPENDIX B. A LIST OF SELECTED ROUNDABOUTS IN THE STUDY

All images of roundabout sites shown in this appendix were sourced from Google[®] Maps satellite images.

ROUNABOUT ID: #GT-13R

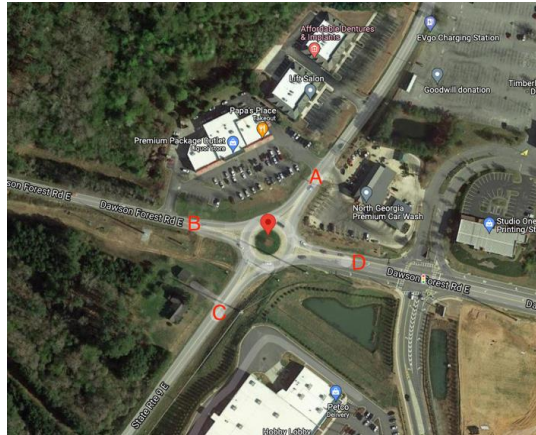

Road Names: Dawson Forest Rd E/ Dawson Forest Rd E/ Lumpkin Camp Ground Rd S/Lumpkin Camp Ground Road S
 Latitude: 34.354339
 Longitude: -84.051697
 Opening Year: 2006
 Number of Legs: 4
 Inscribed Circle Diameter (ft): 140
 Presence of Truck Apron: No
 Posted Speed at Entry (mph) : 15
 Ambient Lighting: Yes
 Circle Lighting: No

| Approach | Number of Lanes on Approach | Number of Circulating Lanes Crossing Approach | Presence of Pedestrian Crossing | State Route | Posted Speed on the approach (mph) | Roundabout Ahead Sign | Yield Sign | Approach lighting | Stopping sight distance (ft) | Horizontal Curves | Cross Design |
|----------|-----------------------------|---|---------------------------------|-------------|------------------------------------|-----------------------|------------|-------------------|------------------------------|-------------------|--------------|
| A | 1 | 1 | No | Yes | 40 | Yes | Yes | No | 300 | No | Rural |
| B | 1 | 1 | No | No | 45 | Yes | Yes | No | 359 | No | Rural |
| C | 1 | 1 | No | Yes | 50 | Yes | Yes | No | 423 | No | Rural |
| D | 1 | 1 | No | No | 45 | Yes | Yes | No | 359 | No | Rural |

ROUNABOUT ID: #GT-18R



Road Names: Villa Rica Rd/ Villa Rica Rd/ West Sandtown Rd SW/ West Sandtown Rd SW
 Latitude: 33.92704
 Longitude: -84.63778
 Opening Year: 2008
 Number of Legs: 4
 Inscribed Circle Diameter (ft): 115
 Presence of Truck Apron: Yes
 Posted Speed at Entry (mph) : 15
 Ambient Lighting: No
 Circle Lighting: Yes

| Approach | Number of Lanes on Approach | Number of Circulating Lanes Crossing Approach | Presence of Pedestrian Crossing | State Route | Posted Speed on the approach (mph) | Roundabout Ahead Sign | Yield Sign | Approach lighting | Stopping sight distance (ft) | Horizontal Curves | Cross Design |
|----------|-----------------------------|---|---------------------------------|-------------|------------------------------------|-----------------------|------------|-------------------|------------------------------|-------------------|--------------|
| A | 1 | 1 | Yes | No | 45 | Yes | Yes | No | 359 | No | Urban |
| B | 1 | 1 | Yes | No | 45 | Yes | Yes | Yes | 359 | No | Urban |
| C | 1 | 1 | Yes | No | 45 | Yes | Yes | No | 359 | No | Rural |
| D | 1 | 1 | Yes | No | 45 | Yes | Yes | Yes | 359 | No | Rural |

ROUNDABOUT ID: #GT-1C



Road Names: Fairview Rd / E Fairview Rd SW / Snapfinger Rd
 Latitude: 33.610942
 Longitude: -84.1648
 Opening Year: 2013
 Number of Legs: 4
 Inscribed Circle Diameter (ft): 150
 Presence of Truck Apron: Yes
 Posted Speed at Entry (mph) : 20
 Ambient Lighting: Yes
 Circle Lighting: Yes

| Approach | Number of Lanes on Approach | Number of Circulating Lanes Crossing Approach | Presence of Pedestrian Crossing | State Route | Posted Speed on the approach (mph) | Roundabout Ahead Sign | Yield Sign | Approach lighting | Stopping sight distance (ft) | Horizontal Curves | Cross Design |
|----------|-----------------------------|---|---------------------------------|-------------|------------------------------------|-----------------------|------------|-------------------|------------------------------|-------------------|--------------|
| A | 1 | 1 | Yes | No | 45 | Yes | Yes | No | 359 | No | Urban |
| B | 1 | 1 | Yes | Yes | 55 | Yes | Yes | No | 492 | No | Rural |
| C | 1 | 1 | Yes | No | 35 | Yes | Yes | Yes | 246 | No | Rural |
| D | 1 | 1 | Yes | Yes | 55 | Yes | Yes | Yes | 492 | No | Rural |

ROUNDABOUT ID: #GT-1R

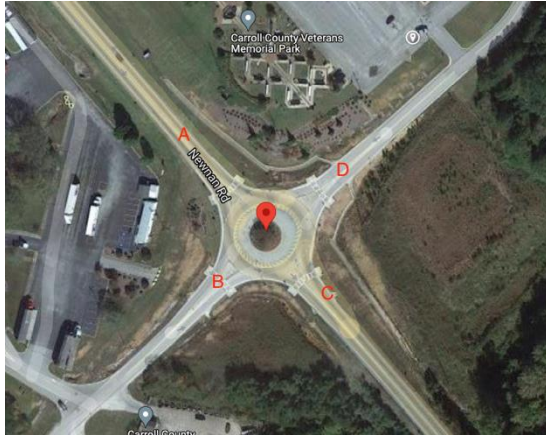

Road Names: Newnan Rd/ Education Dr
 Latitude: 33.565767
 Longitude: -85.045059
 Opening Year: 2011
 Number of Legs: 4
 Inscribed Circle Diameter (ft): 140
 Presence of Truck Apron: No
 Posted Speed at Entry (mph) : 25
 Ambient Lighting: Yes
 Circle Lighting: Yes

| Approach | Number of Lanes on Approach | Number of Circulating Lanes Crossing Approach | Presence of Pedestrian Crossing | State Route | Posted Speed on the approach (mph) | Roundabout Ahead Sign | Yield Sign | Approach lighting | Stopping sight distance (ft) | Horizontal Curves | Cross Design |
|----------|-----------------------------|---|---------------------------------|-------------|------------------------------------|-----------------------|------------|-------------------|------------------------------|-------------------|--------------|
| A | 1 | 1 | Yes | Yes | 45 | Yes | Yes | No | 359 | No | Rural |
| B | 1 | 1 | Yes | No | 25 | Yes | Yes | No | 152 | No | Rural |
| C | 1 | 1 | Yes | Yes | 45 | Yes | Yes | No | 359 | No | Rural |
| D | 1 | 1 | Yes | No | 25 | No | Yes | No | 152 | No | Urban |

ROUNDABOUT ID: #GT-22R



Road Names: Hermance Dr NE/ Hermance Dr NE/ Brookhaven Ave
 Latitude: 33.872903
 Longitude: -84.334632
 Opening Year: 2009
 Number of Legs: 3
 Inscribed Circle Diameter (ft): 120
 Presence of Truck Apron: Yes
 Posted Speed at Entry (mph) : 20
 Ambient Lighting: Yes
 Circle Lighting: Yes

| Approach | Number of Lanes on Approach | Number of Circulating Lanes Crossing Approach | Presence of Pedestrian Crossing | State Route | Posted Speed on the approach (mph) | Roundabout Ahead Sign | Yield Sign | Approach lighting | Stopping sight distance (ft) | Horizontal Curves | Cross Design |
|----------|-----------------------------|---|---------------------------------|-------------|------------------------------------|-----------------------|------------|-------------------|------------------------------|-------------------|--------------|
| A | 1 | 1 | Yes | No | 25 | Yes | Yes | Yes | 152 | No | Urban |
| B | 1 | 1 | Yes | No | 25 | No | Yes | Yes | 152 | No | Urban |
| C | 1 | 1 | Yes | No | 25 | Yes | Yes | Yes | 152 | No | Urban |

ROUNDABOUT ID: #GT-23R



Road Names: N Decatur Rd/ N Decatur Rd/ Lullwater Rd
 Latitude: 33.787434
 Longitude: -84.329151
 Opening Year: 2004
 Number of Legs: 3
 Inscribed Circle Diameter (ft): 90
 Presence of Truck Apron: Yes
 Posted Speed at Entry (mph) : 15
 Ambient Lighting: No
 Circle Lighting: Yes

| Approach | Number of Lanes on Approach | Number of Circulating Lanes Crossing Approach | Presence of Pedestrian Crossing | State Route | Posted Speed on the approach (mph) | Roundabout Ahead Sign | Yield Sign | Approach lighting | Stopping sight distance (ft) | Horizontal Curves | Cross Design |
|----------|-----------------------------|---|---------------------------------|-------------|------------------------------------|-----------------------|------------|-------------------|------------------------------|-------------------|--------------|
| A | 1 | 1 | Yes | No | 30 | Yes | Yes | Yes | 196 | Yes | Urban |
| B | 1 | 1 | Yes | No | 30 | Yes | Yes | No | 196 | Yes | Urban |
| C | 1 | 1 | Yes | No | 25 | Yes | Yes | No | 152 | No | Urban |

ROUNDABOUT ID: #GT-24R



Road Names: Oxford Rd NE/ N Decatur Rd/ N Decatur Rd/ Oxford Rd NE/ Dowman Dr
 Latitude: 33.788356
 Longitude: -84.325612
 Opening Year: 2011
 Number of Legs: 4
 Inscribed Circle Diameter (ft): 130
 Presence of Truck Apron: Yes
 Posted Speed at Entry (mph) : 15
 Ambient Lighting: Yes
 Circle Lighting: Yes

| Approach | Number of Lanes on Approach | Number of Circulating Lanes Crossing Approach | Presence of Pedestrian Crossing | State Route | Posted Speed on the approach (mph) | Roundabout Ahead Sign | Yield Sign | Approach lighting | Stopping sight distance (ft) | Horizontal Curves | Cross Design |
|----------|-----------------------------|---|---------------------------------|-------------|------------------------------------|-----------------------|------------|-------------------|------------------------------|-------------------|--------------|
| A | 1 | 1 | Yes | No | 30 | Yes | Yes | Yes | 196 | No | Urban |
| B | 2 | 1 | Yes | No | 25 | Yes | Yes | Yes | 152 | No | Urban |
| C | 1 | 1 | Yes | No | 30 | No | Yes | Yes | 196 | No | Urban |
| D | 1 | 1 | Yes | No | 25 | Yes | Yes | Yes | 152 | Yes | Urban |

ROUNDABOUT ID: #GT-25R



Road Names: Rockland Rd/ Rockland Rd/ Klondike Rd/ Klondike Rd
 Latitude: 33.675992
 Longitude: -84.114903
 Opening Year: 2009
 Number of Legs: 4
 Inscribed Circle Diameter (ft): 130
 Presence of Truck Apron: Yes
 Posted Speed at Entry (mph) : 20
 Ambient Lighting: No
 Circle Lighting: Yes

| Approach | Number of Lanes on Approach | Number of Circulating Lanes Crossing Approach | Presence of Pedestrian Crossing | State Route | Posted Speed on the approach (mph) | Roundabout Ahead Sign | Yield Sign | Approach lighting | Stopping sight distance (ft) | Horizontal Curves | Cross Design |
|----------|-----------------------------|---|---------------------------------|-------------|------------------------------------|-----------------------|------------|-------------------|------------------------------|-------------------|--------------|
| A | 1 | 1 | Yes | No | 40 | Yes | Yes | Yes | 300 | No | Rural |
| B | 1 | 1 | Yes | No | 45 | Yes | Yes | No | 359 | Yes | Urban |
| C | 1 | 1 | Yes | No | 45 | Yes | Yes | Yes | 359 | No | Rural |
| D | 1 | 1 | Yes | No | 45 | No | Yes | No | 359 | No | Rural |

ROUNDABOUT ID: #GT-29R



Road Names: Duncan Memorial Hwy/ Duncan Memorial Hwy/ Bill Arp Rd/ Bill Arp Rd
 Latitude: 33.6136
 Longitude: -84.836881
 Opening Year: 2007
 Number of Legs: 4
 Inscribed Circle Diameter (ft): 130
 Presence of Truck Apron: No
 Posted Speed at Entry (mph) : 15
 Ambient Lighting: Yes
 Circle Lighting: Yes

| Approach | Number of Lanes on Approach | Number of Circulating Lanes Crossing Approach | Presence of Pedestrian Crossing | State Route | Posted Speed on the approach (mph) | Roundabout Ahead Sign | Yield Sign | Approach lighting | Stopping sight distance (ft) | Horizontal Curves | Cross Design |
|----------|-----------------------------|---|---------------------------------|-------------|------------------------------------|-----------------------|------------|-------------------|------------------------------|-------------------|--------------|
| A | 1 | 1 | Yes | Yes | 45 | Yes | Yes | Yes | 359 | No | Urban |
| B | 1 | 1 | Yes | Yes | 55 | Yes | Yes | No | 492 | No | Urban |
| C | 1 | 1 | Yes | Yes | 45 | Yes | Yes | Yes | 359 | No | Urban |
| D | 1 | 1 | Yes | Yes | 55 | Yes | Yes | No | 492 | No | Urban |

ROUNDABOUT ID: #GT-30R



Road Names: Southlake Dr/ Leeward Walk Cir/ Douglas Rd/ Douglas Rd
 Latitude: 34.076468
 Longitude: -84.206796
 Opening Year: 2011
 Number of Legs: 4
 Inscribed Circle Diameter (ft): 115
 Presence of Truck Apron: Yes
 Posted Speed at Entry (mph) : 15
 Ambient Lighting: Yes
 Circle Lighting: Yes

| Approach | Number of Lanes on Approach | Number of Circulating Lanes Crossing Approach | Presence of Pedestrian Crossing | State Route | Posted Speed on the approach (mph) | Roundabout Ahead Sign | Yield Sign | Approach lighting | Stopping sight distance (ft) | Horizontal Curves | Cross Design |
|----------|-----------------------------|---|---------------------------------|-------------|------------------------------------|-----------------------|------------|-------------------|------------------------------|-------------------|--------------|
| A | 1 | 1 | Yes | No | 35 | Yes | Yes | No | 246 | Yes | Urban |
| B | 1 | 1 | Yes | No | 30 | Yes | Yes | Yes | 196 | Yes | Urban |
| C | 1 | 1 | Yes | No | 35 | Yes | Yes | No | 246 | Yes | Urban |
| D | 1 | 1 | Yes | No | 30 | Yes | Yes | Yes | 196 | Yes | Urban |

ROUNDABOUT ID: #GT-35R

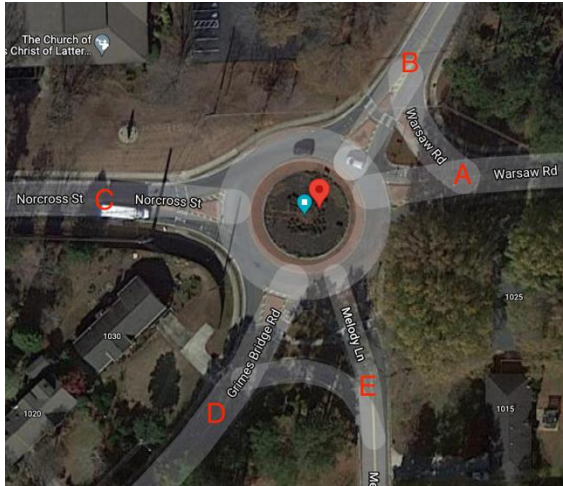

Road Names: Norcross St/ Warsaw Rd/ Grimes Bridge Rd/ Grimes Bridge Rd/ Melody Ln
 Latitude: 34.026226
 Longitude: -84.344746
 Opening Year: 2011
 Number of Legs: 5
 Inscribed Circle Diameter (ft): 130
 Presence of Truck Apron: Yes
 Posted Speed at Entry (mph) : 15
 Ambient Lighting: Yes
 Circle Lighting: Yes

| Approach | Number of Lanes on Approach | Number of Circulating Lanes Crossing Approach | Presence of Pedestrian Crossing | State Route | Posted Speed on the approach (mph) | Roundabout Ahead Sign | Yield Sign | Approach lighting | Stopping sight distance (ft) | Horizontal Curves | Cross Design |
|----------|-----------------------------|---|---------------------------------|-------------|------------------------------------|-----------------------|------------|-------------------|------------------------------|-------------------|--------------|
| A | 2 | 1 | Yes | No | 35 | Yes | Yes | No | 246 | No | Urban |
| B | 1 | 1 | Yes | No | 35 | Yes | Yes | Yes | 246 | No | Urban |
| C | 1 | 1 | Yes | No | 35 | Yes | Yes | Yes | 246 | No | Urban |
| D | 2 | 1 | Yes | No | 35 | Yes | Yes | Yes | 246 | Yes | Urban |
| E | 1 | 1 | Yes | No | 25 | Yes | Yes | No | 152 | Yes | Urban |

ROUNDABOUT ID: #GT-42R



Road Names: E Broad St/ E Newnan Rd/ E Broad St/ Greison Trail
 Latitude: 33.368122
 Longitude: -84.779261
 Opening Year: 2009
 Number of Legs: 4
 Inscribed Circle Diameter (ft): 130
 Presence of Truck Apron: No
 Posted Speed at Entry (mph) :
 Ambient Lighting: No
 Circle Lighting: Yes

| Approach | Number of Lanes on Approach | Number of Circulating Lanes Crossing Approach | Presence of Pedestrian Crossing | State Route | Posted Speed on the approach (mph) | Roundabout Ahead Sign | Yield Sign | Approach lighting | Stopping sight distance (ft) | Horizontal Curves | Cross Design |
|----------|-----------------------------|---|---------------------------------|-------------|------------------------------------|-----------------------|------------|-------------------|------------------------------|-------------------|--------------|
| A | 1 | 1 | Yes | No | 35 | Yes | Yes | Yes | 246 | No | Urban |
| B | 1 | 1 | Yes | No | 35 | Yes | Yes | Yes | 246 | No | Urban |
| C | 1 | 1 | Yes | No | 45 | Yes | Yes | Yes | 359 | No | Urban |
| D | 1 | 1 | Yes | No | 45 | Yes | Yes | Yes | 359 | No | Rural |

ROUNDABOUT ID: #GT-44R



Road Names: Grady Ave/ Grady Ave/ Beauguard Blvd/ Beauguard Blvd
 Latitude: 33.441022
 Longitude: -84.457578
 Opening Year: 2011
 Number of Legs: 4
 Inscribed Circle Diameter (ft): 120
 Presence of Truck Apron: No
 Posted Speed at Entry (mph) : 15
 Ambient Lighting: Yes
 Circle Lighting: Yes

| Approach | Number of Lanes on Approach | Number of Circulating Lanes Crossing Approach | Presence of Pedestrian Crossing | State Route | Posted Speed on the approach (mph) | Roundabout Ahead Sign | Yield Sign | Approach lighting | Stopping sight distance (ft) | Horizontal Curves | Cross Design |
|----------|-----------------------------|---|---------------------------------|-------------|------------------------------------|-----------------------|------------|-------------------|------------------------------|-------------------|--------------|
| A | 1 | 1 | No | No | 35 | Yes | Yes | No | 246 | No | Rural |
| B | 1 | 1 | Yes | No | 35 | Yes | Yes | No | 246 | No | Urban |
| C | 2 | 1 | Yes | No | 35 | Yes | Yes | No | 246 | No | Urban |
| D | 1 | 1 | No | No | 35 | Yes | Yes | No | 246 | No | Urban |

ROUNABOUT ID: #GT-5001



Road Names: Fairground Street and Allgood Road/Chicopee Dr
 Latitude: 33.966962
 Longitude: -84.537605
 Opening Year: 2012
 Number of Legs: 4
 Inscribed Circle Diameter (ft): 100
 Presence of Truck Apron: Yes
 Posted Speed at Entry (mph) : 25
 Ambient Lighting: Yes
 Circle Lighting: Yes

| Approach | Number of Lanes on Approach | Number of Circulating Lanes Crossing Approach | Presence of Pedestrian Crossing | State Route | Posted Speed on the approach (mph) | Roundabout Ahead Sign | Yield Sign | Approach lighting | Stopping sight distance (ft) | Horizontal Curves | Cross Design |
|----------|-----------------------------|---|---------------------------------|-------------|------------------------------------|-----------------------|------------|-------------------|------------------------------|-------------------|--------------|
| A | 1 | 1 | Yes | No | 15 | No | Yes | Yes | 77 | No | Urban |
| B | 2 | 1 | Yes | No | 35 | Yes | Yes | Yes | 246 | No | Urban |
| C | 3 | 1 | Yes | No | 40 | Yes | Yes | Yes | 300 | No | Urban |
| D | 1 | 1 | Yes | No | 25 | Yes | Yes | Yes | 152 | No | Urban |

ROUNDABOUT ID: #GT-5002

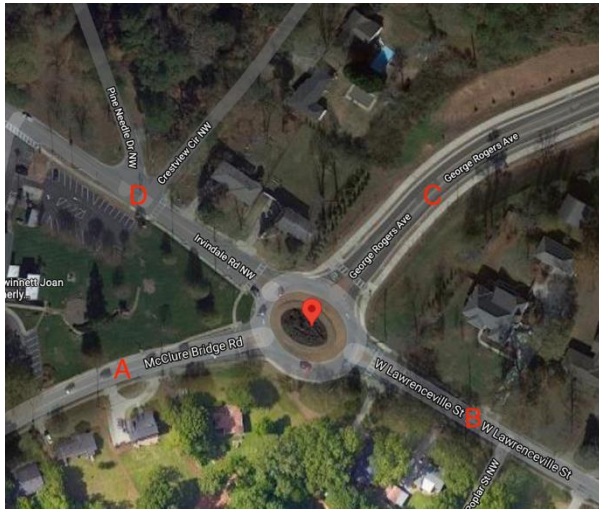

Road Names: West Lawrenceville Street/McClure Bridge Road/Irvindale Road/Ridgeway Rd Ext.
 Latitude: 34.006616
 Longitude: -84.151004
 Opening Year: 2012
 Number of Legs: 4
 Inscribed Circle Diameter (ft): 170
 Presence of Truck Apron: Yes
 Posted Speed at Entry (mph) : 15
 Ambient Lighting: No
 Circle Lighting: Yes

| Approach | Number of Lanes on Approach | Number of Circulating Lanes Crossing Approach | Presence of Pedestrian Crossing | State Route | Posted Speed on the approach (mph) | Roundabout Ahead Sign | Yield Sign | Approach lighting | Stopping sight distance (ft) | Horizontal Curves | Cross Design |
|----------|-----------------------------|---|---------------------------------|-------------|------------------------------------|-----------------------|------------|-------------------|------------------------------|-------------------|--------------|
| A | 1 | 1 | Yes | No | 35 | Yes | Yes | Yes | 246 | Yes | Urban |
| B | 1 | 1 | Yes | No | 35 | Yes | Yes | Yes | 246 | No | Urban |
| C | 1 | 1 | Yes | No | 35 | Yes | Yes | Yes | 246 | Yes | Urban |
| D | 1 | 1 | Yes | No | 35 | Yes | Yes | Yes | 246 | No | Urban |

ROUNDABOUT ID: #GT-5005



Road Names: highway 74 /US 341
 Latitude: 32.879497
 Longitude: -84.090189
 Opening Year: 2010
 Number of Legs: 4
 Inscribed Circle Diameter (ft): 150
 Presence of Truck Apron: Yes
 Posted Speed at Entry (mph) : 45
 Ambient Lighting: Yes
 Circle Lighting: Yes

| Approach | Number of Lanes on Approach | Number of Circulating Lanes Crossing Approach | Presence of Pedestrian Crossing | State Route | Posted Speed on the approach (mph) | Roundabout Ahead Sign | Yield Sign | Approach lighting | Stopping sight distance (ft) | Horizontal Curves | Cross Design |
|----------|-----------------------------|---|---------------------------------|-------------|------------------------------------|-----------------------|------------|-------------------|------------------------------|-------------------|--------------|
| A | 1 | 1 | Yes | Yes | 45 | Yes | Yes | Yes | 359 | No | Urban |
| B | 1 | 1 | Yes | Yes | 45 | Yes | Yes | Yes | 359 | No | Urban |
| C | 1 | 1 | Yes | Yes | 45 | Yes | Yes | Yes | 359 | No | Urban |
| D | 1 | 1 | Yes | Yes | 45 | Yes | Yes | Yes | 359 | No | Urban |

ROUNDABOUT ID: #GT-5006

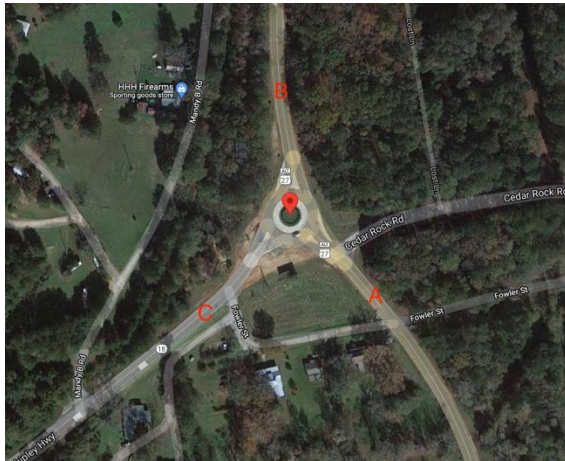

Road Names: Chipley Hwy/Cedar Rock Rd/Roosevelt Hwy
 Latitude: 32.969243
 Longitude: -84.711599
 Opening Year: 2015
 Number of Legs: 3
 Inscribed Circle Diameter (ft): 120
 Presence of Truck Apron: No
 Posted Speed at Entry (mph) : 20
 Ambient Lighting: No
 Circle Lighting: Yes

| Approach | Number of Lanes on Approach | Number of Circulating Lanes Crossing Approach | Presence of Pedestrian Crossing | State Route | Posted Speed on the approach (mph) | Roundabout Ahead Sign | Yield Sign | Approach lighting | Stopping sight distance (ft) | Horizontal Curves | Cross Design |
|----------|-----------------------------|---|---------------------------------|-------------|------------------------------------|-----------------------|------------|-------------------|------------------------------|-------------------|--------------|
| A | 1 | 1 | No | Yes | 55 | Yes | Yes | No | 492 | Yes | Rural |
| B | 1 | 1 | No | Yes | 55 | Yes | Yes | No | 492 | No | Rural |
| C | 1 | 1 | No | Yes | 55 | Yes | Yes | No | 492 | Yes | Rural |

ROUNDABOUT ID: #GT-5007



Road Names: Newnan Rd/Hwy 85 Connector/Hollowville Rd
 Latitude: 33.25461
 Longitude: -84.48925
 Opening Year: 2015
 Number of Legs: 4
 Inscribed Circle Diameter (ft): 150
 Presence of Truck Apron: Yes
 Posted Speed at Entry (mph) : 25
 Ambient Lighting: Yes
 Circle Lighting: Yes

| Approach | Number of Lanes on Approach | Number of Circulating Lanes Crossing Approach | Presence of Pedestrian Crossing | State Route | Posted Speed on the approach (mph) | Roundabout Ahead Sign | Yield Sign | Approach lighting | Stopping sight distance (ft) | Horizontal Curves | Cross Design |
|----------|-----------------------------|---|---------------------------------|-------------|------------------------------------|-----------------------|------------|-------------------|------------------------------|-------------------|--------------|
| A | 1 | 1 | Yes | Yes | 55 | Yes | Yes | Yes | 492 | No | Urban |
| B | 1 | 1 | Yes | Yes | 45 | Yes | Yes | Yes | 359 | No | Urban |
| C | 1 | 1 | Yes | Yes | 55 | Yes | Yes | Yes | 492 | No | Rural |
| D | 1 | 1 | Yes | Yes | 45 | Yes | Yes | Yes | 359 | No | Urban |

ROUNDABOUT ID: #GT-5008



Road Names: W Hemphill Rd/Hemphill Rd/ Hwy 138
 Latitude: 33.557028
 Longitude: -84.170653
 Opening Year: 2017
 Number of Legs: 4
 Inscribed Circle Diameter (ft): 180
 Presence of Truck Apron: Yes
 Posted Speed at Entry (mph) : 20
 Ambient Lighting: Yes
 Circle Lighting: Yes

| Approach | Number of Lanes on Approach | Number of Circulating Lanes Crossing Approach | Presence of Pedestrian Crossing | State Route | Posted Speed on the approach (mph) | Roundabout Ahead Sign | Yield Sign | Approach lighting | Stopping sight distance (ft) | Horizontal Curves | Cross Design |
|----------|-----------------------------|---|---------------------------------|-------------|------------------------------------|-----------------------|------------|-------------------|------------------------------|-------------------|--------------|
| A | 1 | 1 | No | Yes | 55 | Yes | Yes | No | 492 | No | Rural |
| B | 1 | 1 | No | No | 40 | Yes | Yes | No | 300 | Yes | Rural |
| C | 1 | 1 | No | Yes | 55 | Yes | Yes | No | 492 | Yes | Rural |
| D | 1 | 1 | No | No | 40 | Yes | Yes | No | 300 | No | Rural |

ROUNDABOUT ID: #GT-5009



Road Names: Hood Ave/Forest Ave
 Latitude: 33.457008
 Longitude: -84.455847
 Opening Year: 2016
 Number of Legs: 4
 Inscribed Circle Diameter (ft): 162
 Presence of Truck Apron: No
 Posted Speed at Entry (mph) : 20
 Ambient Lighting: Yes
 Circle Lighting: Yes

| Approach | Number of Lanes on Approach | Number of Circulating Lanes Crossing Approach | Presence of Pedestrian Crossing | State Route | Posted Speed on the approach (mph) | Roundabout Ahead Sign | Yield Sign | Approach lighting | Stopping sight distance (ft) | Horizontal Curves | Cross Design |
|----------|-----------------------------|---|---------------------------------|-------------|------------------------------------|-----------------------|------------|-------------------|------------------------------|-------------------|--------------|
| A | 1 | 1 | No | No | 45 | Yes | Yes | Yes | 359 | Yes | Urban |
| B | 1 | 1 | No | No | 35 | Yes | Yes | No | 246 | No | Urban |
| C | 1 | 1 | Yes | No | 45 | Yes | Yes | No | 359 | No | Urban |
| D | 1 | 1 | Yes | No | 35 | Yes | Yes | No | 246 | Yes | Urban |

ROUNDABOUT ID: #GT-5010

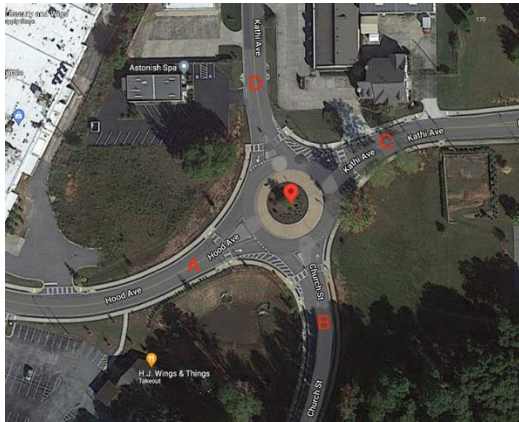

Road Names: Hood Ave/Church St/Kathi Ave
 Latitude: 33.455994
 Longitude: -84.452161
 Opening Year: 2017
 Number of Legs: 4
 Inscribed Circle Diameter (ft): 120
 Presence of Truck Apron: No
 Posted Speed at Entry (mph) : 20
 Ambient Lighting: Yes
 Circle Lighting: Yes

| Approach | Number of Lanes on Approach | Number of Circulating Lanes Crossing Approach | Presence of Pedestrian Crossing | State Route | Posted Speed on the approach (mph) | Roundabout Ahead Sign | Yield Sign | Approach lighting | Stopping sight distance (ft) | Horizontal Curves | Cross Design |
|----------|-----------------------------|---|---------------------------------|-------------|------------------------------------|-----------------------|------------|-------------------|------------------------------|-------------------|--------------|
| A | 1 | 1 | Yes | No | 25 | Yes | Yes | Yes | 152 | Yes | Urban |
| B | 1 | 1 | Yes | No | 25 | Yes | Yes | Yes | 152 | Yes | Urban |
| C | 1 | 1 | Yes | No | 25 | Yes | Yes | Yes | 152 | Yes | Urban |
| D | 1 | 1 | Yes | No | 25 | Yes | Yes | Yes | 152 | Yes | Urban |

ROUNDABOUT ID: #GT-5011

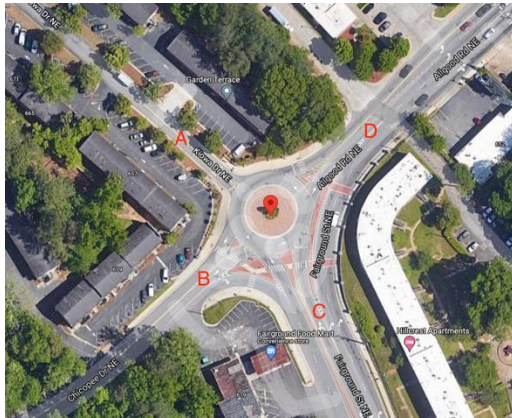

Road Names: Blackmon Rd/Walmart entrance
 Latitude: 32.551969
 Longitude: -84.897636
 Opening Year: 2016
 Number of Legs: 4
 Inscribed Circle Diameter (ft): 130
 Presence of Truck Apron: Yes
 Posted Speed at Entry (mph) : 15
 Ambient Lighting: Yes
 Circle Lighting: Yes

| Approach | Number of Lanes on Approach | Number of Circulating Lanes Crossing Approach | Presence of Pedestrian Crossing | State Route | Posted Speed on the approach (mph) | Roundabout Ahead Sign | Yield Sign | Approach lighting | Stopping sight distance (ft) | Horizontal Curves | Cross Design |
|----------|-----------------------------|---|---------------------------------|-------------|------------------------------------|-----------------------|------------|-------------------|------------------------------|-------------------|--------------|
| A | 1 | 1 | Yes | No | 25 | Yes | Yes | Yes | 152 | No | Urban |
| B | 1 | 1 | Yes | No | 45 | Yes | Yes | No | 359 | Yes | Rural |
| C | 1 | 1 | No | No | 25 | No | No | Yes | 152 | Yes | Rural |
| D | 1 | 1 | Yes | No | 25 | Yes | Yes | No | 152 | No | Urban |

ROUNDABOUT ID: #GT-5012

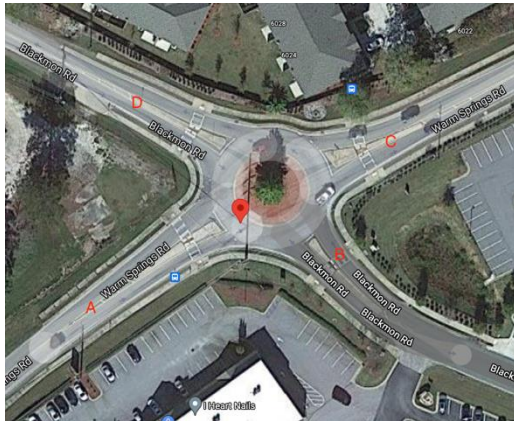

Road Names: Blackmon Rd/Warm Springs Rd
 Latitude: 32.546944
 Longitude: -84.890278
 Opening Year: 2011
 Number of Legs: 4
 Inscribed Circle Diameter (ft): 105
 Presence of Truck Apron: Yes
 Posted Speed at Entry (mph) : 15
 Ambient Lighting: Yes
 Circle Lighting: Yes

| Approach | Number of Lanes on Approach | Number of Circulating Lanes Crossing Approach | Presence of Pedestrian Crossing | State Route | Posted Speed on the approach (mph) | Roundabout Ahead Sign | Yield Sign | Approach lighting | Stopping sight distance (ft) | Horizontal Curves | Cross Design |
|----------|-----------------------------|---|---------------------------------|-------------|------------------------------------|-----------------------|------------|-------------------|------------------------------|-------------------|--------------|
| A | 1 | 1 | Yes | No | 40 | Yes | Yes | No | 300 | No | Urban |
| B | 1 | 1 | Yes | No | 30 | Yes | Yes | Yes | 196 | Yes | Urban |
| C | 1 | 1 | Yes | No | 40 | Yes | Yes | No | 300 | No | Urban |
| D | 1 | 1 | Yes | No | 45 | Yes | Yes | No | 359 | No | Urban |

ROUNDABOUT ID: #GT-5013



Road Names: St. Marys Rd/Lakefront Dr/Northstar Dr
 Latitude: 32.440892
 Longitude: -84.912511
 Opening Year: 2015
 Number of Legs: 4
 Inscribed Circle Diameter (ft): 135
 Presence of Truck Apron: Yes
 Posted Speed at Entry (mph) : 15
 Ambient Lighting: Yes
 Circle Lighting: Yes

| Approach | Number of Lanes on Approach | Number of Circulating Lanes Crossing Approach | Presence of Pedestrian Crossing | State Route | Posted Speed on the approach (mph) | Roundabout Ahead Sign | Yield Sign | Approach lighting | Stopping sight distance (ft) | Horizontal Curves | Cross Design |
|----------|-----------------------------|---|---------------------------------|-------------|------------------------------------|-----------------------|------------|-------------------|------------------------------|-------------------|--------------|
| A | 1 | 1 | Yes | Yes | 35 | Yes | Yes | No | 246 | Yes | Rural |
| B | 1 | 1 | Yes | Yes | 25 | Yes | Yes | No | 152 | No | Urban |
| C | 1 | 1 | Yes | Yes | 35 | Yes | Yes | No | 246 | No | Urban |
| D | 1 | 1 | Yes | Yes | 20 | Yes | Yes | No | 112 | No | Rural |

ROUNABOUT ID: #GT-5015



Road Names: Carbondale Rd SW / Tilton Rd / US 41
 Latitude: 34.655323
 Longitude: -84.978622
 Opening Year: 2019
 Number of Legs: 4
 Inscribed Circle Diameter (ft): 206
 Presence of Truck Apron: No
 Posted Speed at Entry (mph) : 25
 Ambient Lighting: Yes
 Circle Lighting: Yes

| Approach | Number of Lanes on Approach | Number of Circulating Lanes Crossing Approach | Presence of Pedestrian Crossing | State Route | Posted Speed on the approach (mph) | Roundabout Ahead Sign | Yield Sign | Approach lighting | Stopping sight distance (ft) | Horizontal Curves | Cross Design |
|----------|-----------------------------|---|---------------------------------|-------------|------------------------------------|-----------------------|------------|-------------------|------------------------------|-------------------|--------------|
| A | 1 | 1 | Yes | Yes | 45 | Yes | Yes | No | 359 | No | Urban |
| B | 1 | 1 | Yes | No | 45 | Yes | Yes | No | 359 | No | Urban |
| C | 1 | 1 | No | Yes | 45 | Yes | Yes | No | 359 | No | Urban |
| D | 1 | 1 | No | No | 25 | Yes | Yes | Yes | 152 | No | Urban |

ROUNDABOUT ID: #GT-5016



Road Names: Cove Rd/Steve Tate Hwy
 Latitude: 34.427222
 Longitude: -84.276111
 Opening Year: 2009
 Number of Legs: 3
 Inscribed Circle Diameter (ft): 150
 Presence of Truck Apron: Yes
 Posted Speed at Entry (mph) : 20
 Ambient Lighting: No
 Circle Lighting: Yes

| Approach | Number of Lanes on Approach | Number of Circulating Lanes Crossing Approach | Presence of Pedestrian Crossing | State Route | Posted Speed on the approach (mph) | Roundabout Ahead Sign | Yield Sign | Approach lighting | Stopping sight distance (ft) | Horizontal Curves | Cross Design |
|----------|-----------------------------|---|---------------------------------|-------------|------------------------------------|-----------------------|------------|-------------------|------------------------------|-------------------|--------------|
| A | 1 | 1 | No | Yes | 25 | Yes | Yes | No | 152 | No | Rural |
| B | 1 | 1 | No | Yes | 25 | Yes | Yes | No | 152 | No | Rural |
| C | 1 | 1 | No | No | 25 | Yes | Yes | No | 152 | No | Rural |

ROUNABOUT ID: #GT-5017



Road Names: SR 372 / SR 369
 Latitude: 34.277396
 Longitude: -84.298919
 Opening Year: 2018
 Number of Legs: 4
 Inscribed Circle Diameter (ft): 160
 Presence of Truck Apron: Yes
 Posted Speed at Entry (mph) : 25
 Ambient Lighting: Yes
 Circle Lighting: Yes

| Approach | Number of Lanes on Approach | Number of Circulating Lanes Crossing Approach | Presence of Pedestrian Crossing | State Route | Posted Speed on the approach (mph) | Roundabout Ahead Sign | Yield Sign | Approach lighting | Stopping sight distance (ft) | Horizontal Curves | Cross Design |
|----------|-----------------------------|---|---------------------------------|-------------|------------------------------------|-----------------------|------------|-------------------|------------------------------|-------------------|--------------|
| A | 2 | 1 | Yes | Yes | 55 | Yes | Yes | Yes | 492 | Yes | Urban |
| B | 1 | 1 | Yes | Yes | 55 | Yes | Yes | Yes | 492 | No | Urban |
| C | 2 | 1 | Yes | Yes | 55 | Yes | Yes | Yes | 492 | Yes | Urban |
| D | 1 | 1 | Yes | Yes | 55 | Yes | Yes | Yes | 492 | No | Urban |

ROUNDABOUT ID: #GT-5018

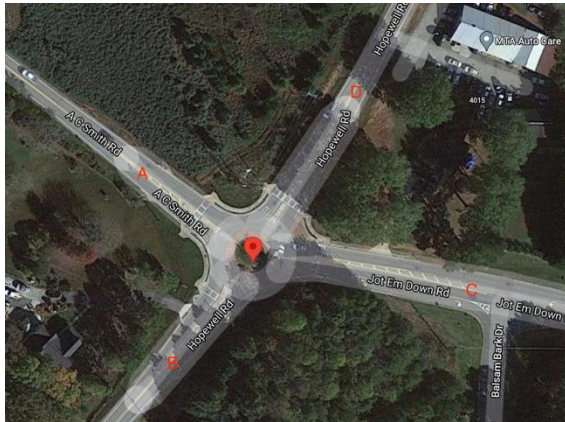

Road Names: Hopewell Rd\A C Smith Rd
 Latitude: 34.323761
 Longitude: -84.0732
 Opening Year: 2012
 Number of Legs: 4
 Inscribed Circle Diameter (ft): 90
 Presence of Truck Apron: Yes
 Posted Speed at Entry (mph) : 20
 Ambient Lighting: No
 Circle Lighting: Yes

| Approach | Number of Lanes on Approach | Number of Circulating Lanes Crossing Approach | Presence of Pedestrian Crossing | State Route | Posted Speed on the approach (mph) | Roundabout Ahead Sign | Yield Sign | Approach lighting | Stopping sight distance (ft) | Horizontal Curves | Cross Design |
|----------|-----------------------------|---|---------------------------------|-------------|------------------------------------|-----------------------|------------|-------------------|------------------------------|-------------------|--------------|
| A | 1 | 1 | Yes | No | 50 | Yes | Yes | No | 423 | No | Urban |
| B | 1 | 1 | Yes | No | 50 | Yes | Yes | No | 423 | No | Urban |
| C | 1 | 1 | Yes | No | 50 | Yes | Yes | No | 423 | No | Urban |
| D | 1 | 1 | Yes | No | 50 | Yes | Yes | No | 423 | No | Urban |

ROUNDABOUT ID: #GT-5019

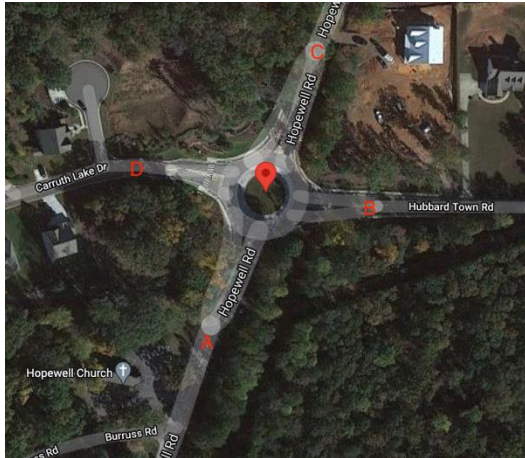

Road Names: Hopewell Rd\Hubbard Town Rd
 Latitude: 34.31344
 Longitude: -84.080103
 Opening Year: 2017
 Number of Legs: 4
 Inscribed Circle Diameter (ft): 140
 Presence of Truck Apron: No
 Posted Speed at Entry (mph) : 15
 Ambient Lighting: Yes
 Circle Lighting: Yes

| Approach | Number of Lanes on Approach | Number of Circulating Lanes Crossing Approach | Presence of Pedestrian Crossing | State Route | Posted Speed on the approach (mph) | Roundabout Ahead Sign | Yield Sign | Approach lighting | Stopping sight distance (ft) | Horizontal Curves | Cross Design |
|----------|-----------------------------|---|---------------------------------|-------------|------------------------------------|-----------------------|------------|-------------------|------------------------------|-------------------|--------------|
| A | 1 | 1 | Yes | No | 50 | Yes | Yes | No | 423 | No | Urban |
| B | 1 | 1 | Yes | No | 45 | Yes | Yes | No | 359 | No | Urban |
| C | 1 | 1 | Yes | No | 50 | Yes | Yes | No | 423 | No | Urban |
| D | 1 | 1 | Yes | No | 45 | Yes | Yes | No | 359 | Yes | Urban |

ROUNDABOUT ID: #GT-5020

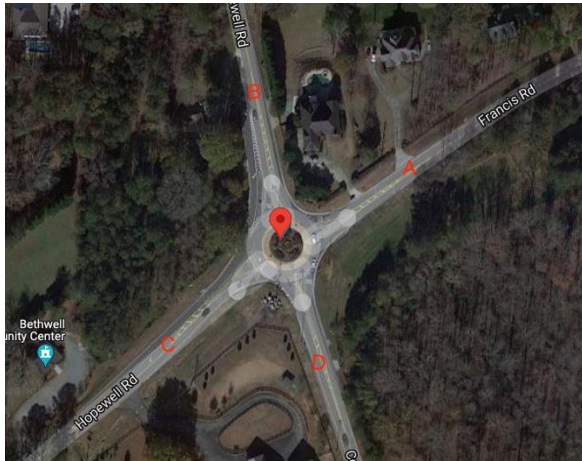

Road Names: Hopewell Rd\Francis Rd\Cogburn Rd
 Latitude: 34.137767
 Longitude: -84.284486
 Opening Year: 2015
 Number of Legs: 4
 Inscribed Circle Diameter (ft): 120
 Presence of Truck Apron: Yes
 Posted Speed at Entry (mph) : 25
 Ambient Lighting: No
 Circle Lighting: Yes

| Approach | Number of Lanes on Approach | Number of Circulating Lanes Crossing Approach | Presence of Pedestrian Crossing | State Route | Posted Speed on the approach (mph) | Roundabout Ahead Sign | Yield Sign | Approach lighting | Stopping sight distance (ft) | Horizontal Curves | Cross Design |
|----------|-----------------------------|---|---------------------------------|-------------|------------------------------------|-----------------------|------------|-------------------|------------------------------|-------------------|--------------|
| A | 1 | 1 | No | No | 40 | Yes | Yes | No | 300 | No | Rural |
| B | 2 | 1 | No | No | 45 | Yes | Yes | No | 359 | No | Urban |
| C | 1 | 1 | No | No | 45 | Yes | Yes | No | 359 | No | Urban |
| D | 1 | 1 | No | No | 40 | Yes | Yes | No | 300 | No | Urban |

ROUNDABOUT ID: #GT-5021

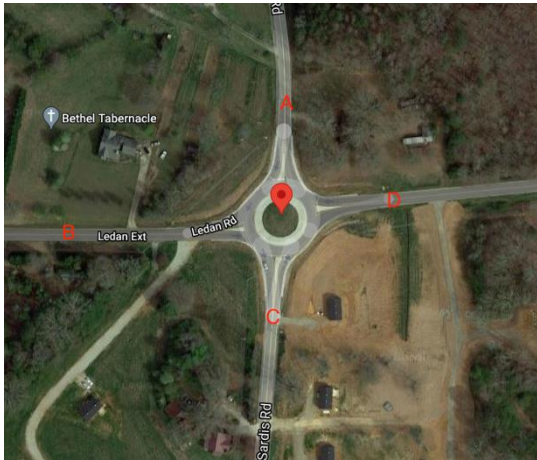

Road Names: Sardis Rd\Ledan Ext
 Latitude: 34.35606
 Longitude: -83.892925
 Opening Year: 2017
 Number of Legs: 4
 Inscribed Circle Diameter (ft): 145
 Presence of Truck Apron: No
 Posted Speed at Entry (mph) : 45
 Ambient Lighting: No
 Circle Lighting: Yes

| Approach | Number of Lanes on Approach | Number of Circulating Lanes Crossing Approach | Presence of Pedestrian Crossing | State Route | Posted Speed on the approach (mph) | Roundabout Ahead Sign | Yield Sign | Approach lighting | Stopping sight distance (ft) | Horizontal Curves | Cross Design |
|----------|-----------------------------|---|---------------------------------|-------------|------------------------------------|-----------------------|------------|-------------------|------------------------------|-------------------|--------------|
| A | 1 | 1 | No | No | 45 | Yes | Yes | No | 359 | No | Rural |
| B | 1 | 1 | No | No | 45 | Yes | Yes | No | 359 | No | Rural |
| C | 1 | 1 | No | No | 35 | Yes | Yes | No | 246 | Yes | Rural |
| D | 1 | 1 | No | No | 25 | Yes | Yes | No | 152 | No | Rural |

ROUNDABOUT ID: #GT-5022



Road Names: Illa-Comer Rd (SR 98)\General Daniels (US 29)
 Latitude: 34.130082
 Longitude: -83.217327
 Opening Year: 2019
 Number of Legs: 4
 Inscribed Circle Diameter (ft): 122
 Presence of Truck Apron: Yes
 Posted Speed at Entry (mph) : 25
 Ambient Lighting: Yes
 Circle Lighting: Yes

| Approach | Number of Lanes on Approach | Number of Circulating Lanes Crossing Approach | Presence of Pedestrian Crossing | State Route | Posted Speed on the approach (mph) | Roundabout Ahead Sign | Yield Sign | Approach lighting | Stopping sight distance (ft) | Horizontal Curves | Cross Design |
|----------|-----------------------------|---|---------------------------------|-------------|------------------------------------|-----------------------|------------|-------------------|------------------------------|-------------------|--------------|
| A | 2 | 1 | Yes | Yes | 35 | Yes | Yes | Yes | 246 | No | Urban |
| B | 1 | 1 | Yes | Yes | 45 | Yes | Yes | Yes | 359 | No | Urban |
| C | 1 | 1 | Yes | Yes | 45 | Yes | Yes | Yes | 359 | No | Urban |
| D | 1 | 1 | Yes | Yes | 45 | Yes | Yes | Yes | 359 | No | Urban |

ROUNDABOUT ID: #GT-5023



Road Names: Tallassee Rd\Whitehead Rd
 Latitude: 33.96871
 Longitude: -83.43798
 Opening Year: 2015
 Number of Legs: 3
 Inscribed Circle Diameter (ft): 140
 Presence of Truck Apron: Yes
 Posted Speed at Entry (mph) : 25
 Ambient Lighting: No
 Circle Lighting: Yes

| Approach | Number of Lanes on Approach | Number of Circulating Lanes Crossing Approach | Presence of Pedestrian Crossing | State Route | Posted Speed on the approach (mph) | Roundabout Ahead Sign | Yield Sign | Approach lighting | Stopping sight distance (ft) | Horizontal Curves | Cross Design |
|----------|-----------------------------|---|---------------------------------|-------------|------------------------------------|-----------------------|------------|-------------------|------------------------------|-------------------|--------------|
| A | 1 | 1 | Yes | No | 35 | Yes | Yes | No | 246 | No | Urban |
| B | 1 | 1 | Yes | No | 35 | Yes | Yes | No | 246 | No | Urban |
| C | 1 | 1 | Yes | No | 35 | Yes | Yes | Yes | 246 | No | Urban |

ROUNDABOUT ID: #GT-5024



Road Names: SR 20\East Lake Rd
 Latitude: 33.501502
 Longitude: -84.078567
 Opening Year: 2016
 Number of Legs: 4
 Inscribed Circle Diameter (ft): 145
 Presence of Truck Apron: Yes
 Posted Speed at Entry (mph) : 15
 Ambient Lighting: No
 Circle Lighting: Yes

| Approach | Number of Lanes on Approach | Number of Circulating Lanes Crossing Approach | Presence of Pedestrian Crossing | State Route | Posted Speed on the approach (mph) | Roundabout Ahead Sign | Yield Sign | Approach lighting | Stopping sight distance (ft) | Horizontal Curves | Cross Design |
|----------|-----------------------------|---|---------------------------------|-------------|------------------------------------|-----------------------|------------|-------------------|------------------------------|-------------------|--------------|
| A | 1 | 1 | Yes | No | 45 | Yes | Yes | No | 359 | Yes | Urban |
| B | 2 | 1 | Yes | Yes | 45 | Yes | Yes | No | 359 | No | Urban |
| C | 1 | 1 | Yes | No | 45 | Yes | Yes | No | 359 | Yes | Urban |
| D | 1 | 1 | Yes | Yes | 45 | Yes | Yes | No | 359 | No | Urban |

ROUNABOUT ID: #GT-5025



Road Names: Colvin Dr @ N Unity Cove Rd
 Latitude: 33.367548
 Longitude: -84.081387
 Opening Year: 2009
 Number of Legs: 3
 Inscribed Circle Diameter (ft): 115
 Presence of Truck Apron: No
 Posted Speed at Entry (mph) : 15
 Ambient Lighting: No
 Circle Lighting: No

| Approach | Number of Lanes on Approach | Number of Circulating Lanes Crossing Approach | Presence of Pedestrian Crossing | State Route | Posted Speed on the approach (mph) | Roundabout Ahead Sign | Yield Sign | Approach lighting | Stopping sight distance (ft) | Horizontal Curves | Cross Design |
|----------|-----------------------------|---|---------------------------------|-------------|------------------------------------|-----------------------|------------|-------------------|------------------------------|-------------------|--------------|
| A | 1 | 1 | No | No | 45 | Yes | Yes | No | 359 | No | Rural |
| B | 1 | 1 | No | No | 45 | Yes | Yes | No | 359 | Yes | Rural |
| C | 1 | 1 | No | No | 45 | Yes | Yes | No | 359 | Yes | Rural |

ROUNDABOUT ID: #GT-5026



Road Names: Turner Lake Rd @ Clark St
 Latitude: 33.59929
 Longitude: -83.875961
 Opening Year: 2011
 Number of Legs: 4
 Inscribed Circle Diameter (ft): 150
 Presence of Truck Apron: Yes
 Posted Speed at Entry (mph) : 20
 Ambient Lighting: No
 Circle Lighting: Yes

| Approach | Number of Lanes on Approach | Number of Circulating Lanes Crossing Approach | Presence of Pedestrian Crossing | State Route | Posted Speed on the approach (mph) | Roundabout Ahead Sign | Yield Sign | Approach lighting | Stopping sight distance (ft) | Horizontal Curves | Cross Design |
|----------|-----------------------------|---|---------------------------------|-------------|------------------------------------|-----------------------|------------|-------------------|------------------------------|-------------------|--------------|
| A | 1 | 1 | Yes | No | 35 | Yes | Yes | Yes | 246 | No | Urban |
| B | 1 | 1 | Yes | No | 35 | Yes | Yes | Yes | 246 | No | Urban |
| C | 1 | 1 | Yes | No | 35 | Yes | Yes | Yes | 246 | Yes | Urban |
| D | 1 | 1 | Yes | No | 45 | Yes | Yes | Yes | 359 | No | Urban |

ROUNDABOUT ID: #GT-5027



Road Names: Main St (US 27 Alt) \HWY 5
 Latitude: 33.491436
 Longitude: -84.912297
 Opening Year: 2000
 Number of Legs: 4
 Inscribed Circle Diameter (ft): 90
 Presence of Truck Apron: No
 Posted Speed at Entry (mph) : 15
 Ambient Lighting: Yes
 Circle Lighting: Yes

| Approach | Number of Lanes on Approach | Number of Circulating Lanes Crossing Approach | Presence of Pedestrian Crossing | State Route | Posted Speed on the approach (mph) | Roundabout Ahead Sign | Yield Sign | Approach lighting | Stopping sight distance (ft) | Horizontal Curves | Cross Design |
|----------|-----------------------------|---|---------------------------------|-------------|------------------------------------|-----------------------|------------|-------------------|------------------------------|-------------------|--------------|
| A | 1 | 1 | Yes | Yes | 35 | Yes | Yes | No | 246 | No | Rural |
| B | 1 | 1 | Yes | Yes | 35 | Yes | Yes | Yes | 246 | No | Rural |
| C | 1 | 1 | Yes | Yes | 35 | Yes | Yes | No | 246 | No | Rural |
| D | 1 | 1 | Yes | Yes | 35 | Yes | Yes | No | 246 | No | Rural |

ROUNDABOUT ID: #GT-5028

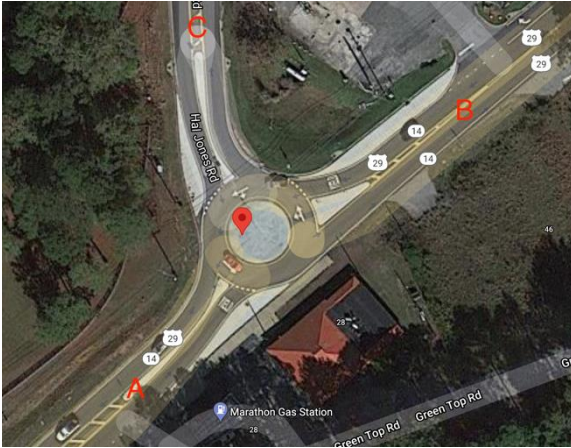

Road Names: SR 14\Hal Jones Rd
 Latitude: 33.420027
 Longitude: -84.772761
 Opening Year: 2018
 Number of Legs: 3
 Inscribed Circle Diameter (ft): 88
 Presence of Truck Apron: No
 Posted Speed at Entry (mph) : 25
 Ambient Lighting: Yes
 Circle Lighting: Yes

| Approach | Number of Lanes on Approach | Number of Circulating Lanes Crossing Approach | Presence of Pedestrian Crossing | State Route | Posted Speed on the approach (mph) | Roundabout Ahead Sign | Yield Sign | Approach lighting | Stopping sight distance (ft) | Horizontal Curves | Cross Design |
|----------|-----------------------------|---|---------------------------------|-------------|------------------------------------|-----------------------|------------|-------------------|------------------------------|-------------------|--------------|
| A | 1 | 1 | No | Yes | 45 | Yes | Yes | No | 359 | No | Urban |
| B | 1 | 1 | No | Yes | 45 | Yes | Yes | No | 359 | No | Urban |
| C | 1 | 1 | No | No | 45 | Yes | Yes | No | 359 | Yes | Urban |

ROUNDABOUT ID: #GT-5029



Road Names: SR 14\Green Top Rd
 Latitude: 33.421253
 Longitude: -84.770944
 Opening Year: 2018
 Number of Legs: 3
 Inscribed Circle Diameter (ft): 80
 Presence of Truck Apron: No
 Posted Speed at Entry (mph) : 25
 Ambient Lighting: No
 Circle Lighting: Yes

| Approach | Number of Lanes on Approach | Number of Circulating Lanes Crossing Approach | Presence of Pedestrian Crossing | State Route | Posted Speed on the approach (mph) | Roundabout Ahead Sign | Yield Sign | Approach lighting | Stopping sight distance (ft) | Horizontal Curves | Cross Design |
|----------|-----------------------------|---|---------------------------------|-------------|------------------------------------|-----------------------|------------|-------------------|------------------------------|-------------------|--------------|
| A | 1 | 1 | No | Yes | 45 | Yes | Yes | No | 359 | No | Urban |
| B | 1 | 1 | No | Yes | 45 | Yes | Yes | No | 359 | No | Urban |
| C | 1 | 1 | No | No | 45 | Yes | Yes | No | 359 | No | Rural |

ROUNDABOUT ID: #GT-5030



Road Names: Travis Street\Hardin Street\O'Kelly St SE
 Latitude: 33.664306
 Longitude: -84.019722
 Opening Year: 2002
 Number of Legs: 3
 Inscribed Circle Diameter (ft): 85
 Presence of Truck Apron: Yes
 Posted Speed at Entry (mph) : 25
 Ambient Lighting: Yes
 Circle Lighting: Yes

| Approach | Number of Lanes on Approach | Number of Circulating Lanes Crossing Approach | Presence of Pedestrian Crossing | State Route | Posted Speed on the approach (mph) | Roundabout Ahead Sign | Yield Sign | Approach lighting | Stopping sight distance (ft) | Horizontal Curves | Cross Design |
|----------|-----------------------------|---|---------------------------------|-------------|------------------------------------|-----------------------|------------|-------------------|------------------------------|-------------------|--------------|
| A | 1 | 1 | No | No | 30 | Yes | Yes | Yes | 196 | Yes | Urban |
| B | 1 | 1 | No | No | 25 | Yes | Yes | Yes | 152 | Yes | Urban |
| C | 1 | 1 | Yes | No | 25 | Yes | Yes | Yes | 152 | Yes | Urban |

ROUNDABOUT ID: #GT-5031



Road Names: Oakland Ave SE \ O'Kelly St SE
 Latitude: 33.663701
 Longitude: -84.018124
 Opening Year: 2018
 Number of Legs: 4
 Inscribed Circle Diameter (ft): 120
 Presence of Truck Apron: Yes
 Posted Speed at Entry (mph) : 25
 Ambient Lighting: Yes
 Circle Lighting: Yes

| Approach | Number of Lanes on Approach | Number of Circulating Lanes Crossing Approach | Presence of Pedestrian Crossing | State Route | Posted Speed on the approach (mph) | Roundabout Ahead Sign | Yield Sign | Approach lighting | Stopping sight distance (ft) | Horizontal Curves | Cross Design |
|----------|-----------------------------|---|---------------------------------|-------------|------------------------------------|-----------------------|------------|-------------------|------------------------------|-------------------|--------------|
| A | 1 | 1 | Yes | No | 25 | Yes | Yes | Yes | 152 | Yes | Urban |
| B | 1 | 1 | Yes | No | 30 | Yes | Yes | No | 196 | No | Urban |
| C | 1 | 1 | No | No | 30 | Yes | Yes | No | 196 | Yes | Urban |
| D | 1 | 1 | Yes | No | 30 | Yes | Yes | Yes | 196 | No | Urban |

ROUNDABOUT ID: #GT-5033

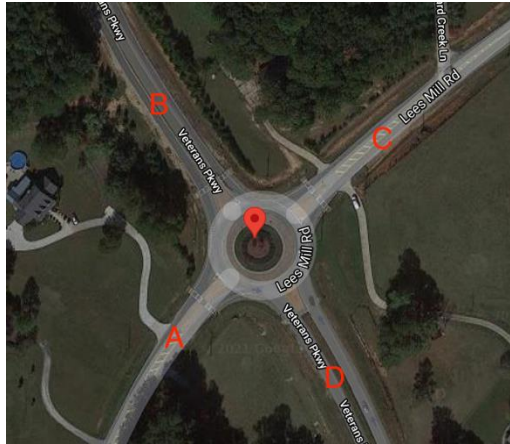

Road Names: Lees Mill Rd\Veterans Pkwy
 Latitude: 33.508785
 Longitude: -84.50646
 Opening Year: 2013
 Number of Legs: 4
 Inscribed Circle Diameter (ft): 152
 Presence of Truck Apron: Yes
 Posted Speed at Entry (mph) :
 Ambient Lighting: No
 Circle Lighting: Yes

| Approach | Number of Lanes on Approach | Number of Circulating Lanes Crossing Approach | Presence of Pedestrian Crossing | State Route | Posted Speed on the approach (mph) | Roundabout Ahead Sign | Yield Sign | Approach lighting | Stopping sight distance (ft) | Horizontal Curves | Cross Design |
|----------|-----------------------------|---|---------------------------------|-------------|------------------------------------|-----------------------|------------|-------------------|------------------------------|-------------------|--------------|
| A | 1 | 1 | Yes | No | 35 | Yes | Yes | No | 246 | Yes | Rural |
| B | 1 | 1 | Yes | No | 45 | Yes | Yes | No | 359 | No | Rural |
| C | 1 | 1 | Yes | No | 35 | Yes | Yes | No | 246 | No | Rural |
| D | 1 | 1 | Yes | No | 45 | Yes | Yes | No | 359 | No | Rural |

ROUNDABOUT ID: #GT-5034

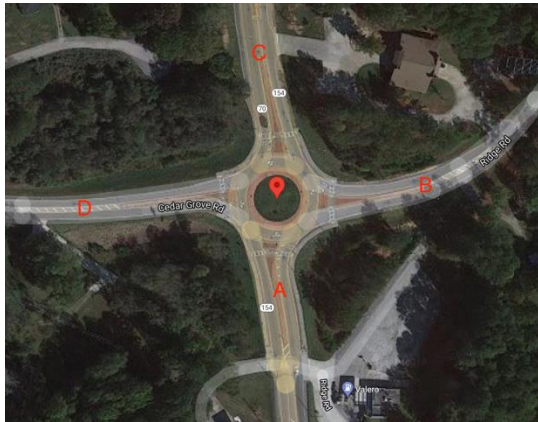

Road Names: SR 154\Cedar Grove Rd
 Latitude: 33.619094
 Longitude: -84.671383
 Opening Year: 2014
 Number of Legs: 4
 Inscribed Circle Diameter (ft): 147
 Presence of Truck Apron: Yes
 Posted Speed at Entry (mph) : 25
 Ambient Lighting: No
 Circle Lighting: Yes

| Approach | Number of Lanes on Approach | Number of Circulating Lanes Crossing Approach | Presence of Pedestrian Crossing | State Route | Posted Speed on the approach (mph) | Roundabout Ahead Sign | Yield Sign | Approach lighting | Stopping sight distance (ft) | Horizontal Curves | Cross Design |
|----------|-----------------------------|---|---------------------------------|-------------|------------------------------------|-----------------------|------------|-------------------|------------------------------|-------------------|--------------|
| A | 1 | 1 | Yes | Yes | 35 | Yes | Yes | Yes | 246 | No | Urban |
| B | 1 | 1 | Yes | No | 45 | Yes | Yes | Yes | 359 | Yes | Rural |
| C | 1 | 1 | Yes | Yes | 55 | Yes | Yes | Yes | 492 | No | Urban |
| D | 1 | 1 | Yes | No | 45 | Yes | Yes | Yes | 359 | No | Rural |

ROUNDABOUT ID: #GT-5035

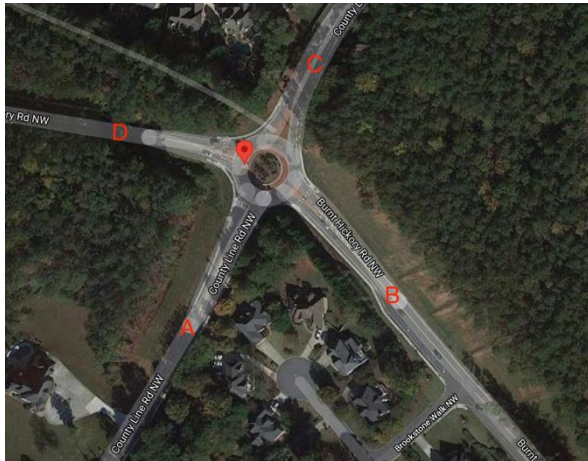

Road Names: County Line Rd NW\Burnt Hickory Rd NW
 Latitude: 33.998333
 Longitude: -84.729167
 Opening Year: 2012
 Number of Legs: 4
 Inscribed Circle Diameter (ft): 120
 Presence of Truck Apron: Yes
 Posted Speed at Entry (mph) : 15
 Ambient Lighting: No
 Circle Lighting: Yes

| Approach | Number of Lanes on Approach | Number of Circulating Lanes Crossing Approach | Presence of Pedestrian Crossing | State Route | Posted Speed on the approach (mph) | Roundabout Ahead Sign | Yield Sign | Approach lighting | Stopping sight distance (ft) | Horizontal Curves | Cross Design |
|----------|-----------------------------|---|---------------------------------|-------------|------------------------------------|-----------------------|------------|-------------------|------------------------------|-------------------|--------------|
| A | 1 | 1 | Yes | No | 35 | Yes | Yes | No | 246 | No | Urban |
| B | 1 | 1 | Yes | No | 40 | Yes | Yes | Yes | 300 | No | Urban |
| C | 1 | 1 | Yes | No | 35 | Yes | Yes | No | 246 | Yes | Urban |
| D | 1 | 1 | Yes | No | 40 | Yes | Yes | No | 300 | No | Rural |

ROUNDABOUT ID: #GT-5036

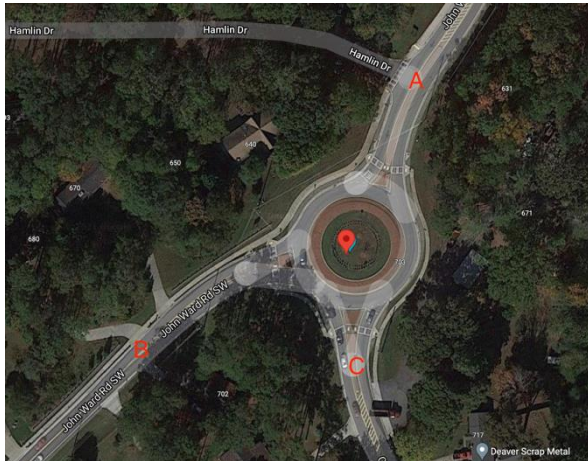

Road Names: John Ward Rd SW\Cheatham Hill Rd
 Latitude: 33.93735
 Longitude: -84.606286
 Opening Year: 2015
 Number of Legs: 3
 Inscribed Circle Diameter (ft): 150
 Presence of Truck Apron: Yes
 Posted Speed at Entry (mph) : 15
 Ambient Lighting: No
 Circle Lighting: Yes

| Approach | Number of Lanes on Approach | Number of Circulating Lanes Crossing Approach | Presence of Pedestrian Crossing | State Route | Posted Speed on the approach (mph) | Roundabout Ahead Sign | Yield Sign | Approach lighting | Stopping sight distance (ft) | Horizontal Curves | Cross Design |
|----------|-----------------------------|---|---------------------------------|-------------|------------------------------------|-----------------------|------------|-------------------|------------------------------|-------------------|--------------|
| A | 1 | 1 | Yes | No | 45 | Yes | Yes | No | 359 | Yes | Urban |
| B | 1 | 1 | Yes | No | 45 | Yes | Yes | No | 359 | Yes | Urban |
| C | 1 | 1 | Yes | No | 45 | Yes | Yes | No | 359 | Yes | Urban |

ROUNDABOUT ID: #GT-5037



Road Names: S Bethany Rd\Old Jackson Rd
 Latitude: 33.419717
 Longitude: -84.090656
 Opening Year: 2018
 Number of Legs: 4
 Inscribed Circle Diameter (ft): 125
 Presence of Truck Apron: Yes
 Posted Speed at Entry (mph) : 20
 Ambient Lighting: No
 Circle Lighting: Yes

| Approach | Number of Lanes on Approach | Number of Circulating Lanes Crossing Approach | Presence of Pedestrian Crossing | State Route | Posted Speed on the approach (mph) | Roundabout Ahead Sign | Yield Sign | Approach lighting | Stopping sight distance (ft) | Horizontal Curves | Cross Design |
|----------|-----------------------------|---|---------------------------------|-------------|------------------------------------|-----------------------|------------|-------------------|------------------------------|-------------------|--------------|
| A | 1 | 1 | No | No | 45 | Yes | Yes | Yes | 359 | Yes | Urban |
| B | 1 | 1 | No | No | 45 | Yes | Yes | Yes | 359 | No | Rural |
| C | 1 | 1 | No | No | 45 | Yes | Yes | Yes | 359 | Yes | Urban |
| D | 1 | 1 | No | No | 45 | Yes | Yes | Yes | 359 | No | Rural |

ROUNABOUT ID: #GT-5038



Road Names: Sandy Creek Rd\Veterans Pkwy
 Latitude: 33.4725
 Longitude: -84.509283
 Opening Year: 2019
 Number of Legs: 4
 Inscribed Circle Diameter (ft): 140
 Presence of Truck Apron: No
 Posted Speed at Entry (mph) : 20
 Ambient Lighting: Yes
 Circle Lighting: Yes

| Approach | Number of Lanes on Approach | Number of Circulating Lanes Crossing Approach | Presence of Pedestrian Crossing | State Route | Posted Speed on the approach (mph) | Roundabout Ahead Sign | Yield Sign | Approach lighting | Stopping sight distance (ft) | Horizontal Curves | Cross Design |
|----------|-----------------------------|---|---------------------------------|-------------|------------------------------------|-----------------------|------------|-------------------|------------------------------|-------------------|--------------|
| A | 2 | 1 | Yes | No | 45 | Yes | Yes | Yes | 359 | No | Urban |
| B | 2 | 1 | Yes | No | 45 | Yes | Yes | Yes | 359 | Yes | Urban |
| C | 2 | 1 | Yes | No | 45 | Yes | Yes | Yes | 359 | No | Urban |
| D | 1 | 1 | No | No | 35 | Yes | Yes | Yes | 246 | Yes | Urban |

ROUNDABOUT ID: #GT-5039



Road Names: M.L.K. Jr. Dr\ E Newnan Rd
 Latitude: 33.36307
 Longitude: -84.779556
 Opening Year: 2016
 Number of Legs: 4
 Inscribed Circle Diameter (ft): 130
 Presence of Truck Apron: No
 Posted Speed at Entry (mph) :
 Ambient Lighting: Yes
 Circle Lighting: Yes

| Approach | Number of Lanes on Approach | Number of Circulating Lanes Crossing Approach | Presence of Pedestrian Crossing | State Route | Posted Speed on the approach (mph) | Roundabout Ahead Sign | Yield Sign | Approach lighting | Stopping sight distance (ft) | Horizontal Curves | Cross Design |
|----------|-----------------------------|---|---------------------------------|-------------|------------------------------------|-----------------------|------------|-------------------|------------------------------|-------------------|--------------|
| A | 1 | 1 | Yes | No | 35 | Yes | Yes | Yes | 246 | No | Urban |
| B | 1 | 1 | Yes | No | 20 | Yes | Yes | Yes | 112 | Yes | Urban |
| C | 1 | 1 | Yes | No | 35 | Yes | Yes | Yes | 246 | Yes | Urban |
| D | 1 | 1 | Yes | No | 35 | Yes | Yes | Yes | 246 | Yes | Urban |

ROUNDABOUT ID: #GT-5040



Road Names: Duncan Memorial Hwy (SR 166)\SR 154
 Latitude: 33.6603998
 Longitude: -84.6751292
 Opening Year: 2019
 Number of Legs: 3
 Inscribed Circle Diameter (ft): 160
 Presence of Truck Apron: Yes
 Posted Speed at Entry (mph) : 20
 Ambient Lighting: No
 Circle Lighting: Yes

| Approach | Number of Lanes on Approach | Number of Circulating Lanes Crossing Approach | Presence of Pedestrian Crossing | State Route | Posted Speed on the approach (mph) | Roundabout Ahead Sign | Yield Sign | Approach lighting | Stopping sight distance (ft) | Horizontal Curves | Cross Design |
|----------|-----------------------------|---|---------------------------------|-------------|------------------------------------|-----------------------|------------|-------------------|------------------------------|-------------------|--------------|
| A | 2 | 2 | Yes | Yes | 35 | Yes | Yes | Yes | 246 | Yes | Urban |
| B | 2 | 2 | Yes | Yes | 55 | Yes | Yes | Yes | 492 | Yes | Urban |
| C | 2 | 1 | Yes | Yes | 35 | Yes | Yes | Yes | 246 | No | Urban |

ROUNABOUT ID: #GT-5041

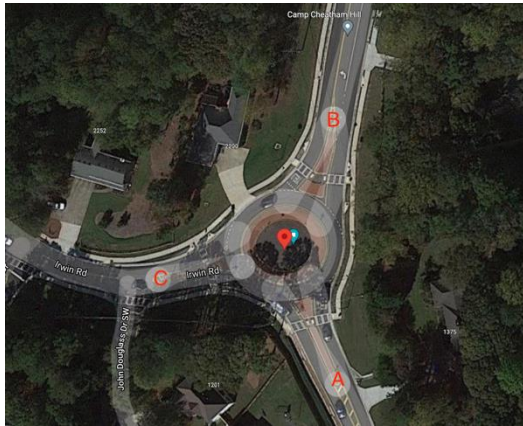

Road Names: John Ward Road\Irwin Road
 Latitude: 33.919675
 Longitude: -84.620157
 Opening Year: 2018
 Number of Legs: 3
 Inscribed Circle Diameter (ft): 90
 Presence of Truck Apron: Yes
 Posted Speed at Entry (mph) : 20
 Ambient Lighting: No
 Circle Lighting: Yes

| Approach | Number of Lanes on Approach | Number of Circulating Lanes Crossing Approach | Presence of Pedestrian Crossing | State Route | Posted Speed on the approach (mph) | Roundabout Ahead Sign | Yield Sign | Approach lighting | Stopping sight distance (ft) | Horizontal Curves | Cross Design |
|----------|-----------------------------|---|---------------------------------|-------------|------------------------------------|-----------------------|------------|-------------------|------------------------------|-------------------|--------------|
| A | 1 | 1 | Yes | No | 25 | Yes | Yes | Yes | 152 | No | Urban |
| B | 2 | 1 | Yes | No | 25 | Yes | Yes | Yes | 152 | No | Urban |
| C | 1 | 1 | Yes | No | 25 | Yes | Yes | Yes | 152 | Yes | Urban |

ROUNDABOUT ID: #GT-5043

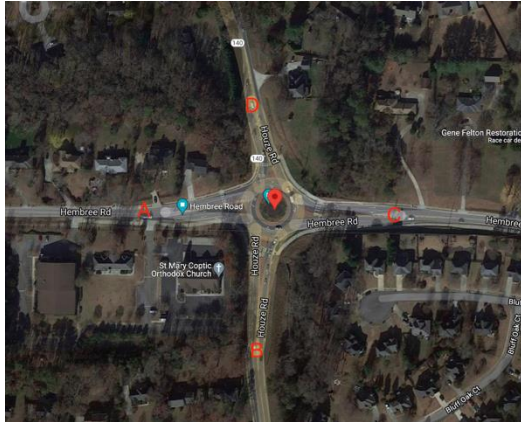

Road Names: SR 140\Hembree Rd
 Latitude: 34.061239
 Longitude: -84.346145
 Opening Year: 2017
 Number of Legs: 4
 Inscribed Circle Diameter (ft): 163
 Presence of Truck Apron: Yes
 Posted Speed at Entry (mph) : 25
 Ambient Lighting: No
 Circle Lighting: Yes

| Approach | Number of Lanes on Approach | Number of Circulating Lanes Crossing Approach | Presence of Pedestrian Crossing | State Route | Posted Speed on the approach (mph) | Roundabout Ahead Sign | Yield Sign | Approach lighting | Stopping sight distance (ft) | Horizontal Curves | Cross Design |
|----------|-----------------------------|---|---------------------------------|-------------|------------------------------------|-----------------------|------------|-------------------|------------------------------|-------------------|--------------|
| A | 2 | 2 | Yes | No | 35 | Yes | Yes | Yes | 246 | No | Urban |
| B | 1 | 2 | Yes | Yes | 35 | Yes | Yes | Yes | 246 | Yes | Urban |
| C | 2 | 1 | Yes | No | 40 | Yes | Yes | Yes | 300 | No | Urban |
| D | 2 | 2 | Yes | Yes | 35 | Yes | Yes | Yes | 246 | No | Urban |

ROUNDABOUT ID: #GT-5044



Road Names: Shelby Lane \ Marketplace Blvd
 Latitude: 33.6569237
 Longitude: -84.5015345
 Opening Year: 2018
 Number of Legs: 4
 Inscribed Circle Diameter (ft): 75
 Presence of Truck Apron: Yes
 Posted Speed at Entry (mph) :
 Ambient Lighting: Yes
 Circle Lighting: Yes

| Approach | Number of Lanes on Approach | Number of Circulating Lanes Crossing Approach | Presence of Pedestrian Crossing | State Route | Posted Speed on the approach (mph) | Roundabout Ahead Sign | Yield Sign | Approach lighting | Stopping sight distance (ft) | Horizontal Curves | Cross Design |
|----------|-----------------------------|---|---------------------------------|-------------|------------------------------------|-----------------------|------------|-------------------|------------------------------|-------------------|--------------|
| A | 1 | 1 | Yes | No | 25 | Yes | Yes | Yes | 152 | No | Urban |
| B | 1 | 1 | Yes | No | 25 | Yes | Yes | Yes | 152 | No | Urban |
| C | 1 | 1 | Yes | No | 25 | Yes | Yes | Yes | 152 | No | Urban |
| D | 1 | 1 | Yes | No | 25 | Yes | Yes | Yes | 152 | No | Urban |

ROUNDABOUT ID: #GT-5045



Road Names: Skip Spann Connector
 Latitude: 34.036723
 Longitude: -84.574801
 Opening Year: 2017
 Number of Legs: 4
 Inscribed Circle Diameter (ft): 150
 Presence of Truck Apron: Yes
 Posted Speed at Entry (mph) : 25
 Ambient Lighting: No
 Circle Lighting: Yes

| Approach | Number of Lanes on Approach | Number of Circulating Lanes Crossing Approach | Presence of Pedestrian Crossing | State Route | Posted Speed on the approach (mph) | Roundabout Ahead Sign | Yield Sign | Approach lighting | Stopping sight distance (ft) | Horizontal Curves | Cross Design |
|----------|-----------------------------|---|---------------------------------|-------------|------------------------------------|-----------------------|------------|-------------------|------------------------------|-------------------|--------------|
| A | 2 | 1 | Yes | No | 35 | Yes | Yes | Yes | 246 | No | Urban |
| B | 1 | 2 | Yes | No | 35 | Yes | Yes | Yes | 246 | No | Urban |
| C | 2 | 1 | Yes | No | 35 | Yes | Yes | Yes | 246 | Yes | Urban |
| D | 2 | 1 | Yes | No | 35 | Yes | Yes | Yes | 246 | Yes | Urban |

ROUNDABOUT ID: #GT-5046



Road Names: Crabapple Rd \ Crabapple Dr \ Heritage Walk
 Latitude: 34.088813
 Longitude: -84.344484
 Opening Year: 2019
 Number of Legs: 4
 Inscribed Circle Diameter (ft): 170
 Presence of Truck Apron: Yes
 Posted Speed at Entry (mph) : 25
 Ambient Lighting: Yes
 Circle Lighting: Yes

| Approach | Number of Lanes on Approach | Number of Circulating Lanes Crossing Approach | Presence of Pedestrian Crossing | State Route | Posted Speed on the approach (mph) | Roundabout Ahead Sign | Yield Sign | Approach lighting | Stopping sight distance (ft) | Horizontal Curves | Cross Design |
|----------|-----------------------------|---|---------------------------------|-------------|------------------------------------|-----------------------|------------|-------------------|------------------------------|-------------------|--------------|
| A | 2 | 1 | Yes | Yes | 35 | Yes | Yes | Yes | 246 | No | Urban |
| B | 1 | 2 | Yes | No | 35 | Yes | Yes | Yes | 246 | Yes | Urban |
| C | 2 | 1 | Yes | Yes | 35 | No | Yes | Yes | 246 | No | Urban |
| D | 1 | 2 | Yes | No | 35 | Yes | Yes | Yes | 246 | Yes | Urban |

ROUNDABOUT ID: #GT-5047



Road Names: SR372 \ New Providence Rd
 Latitude: 34.119526
 Longitude: -84.342546
 Opening Year: 2015
 Number of Legs: 4
 Inscribed Circle Diameter (ft): 165
 Presence of Truck Apron: Yes
 Posted Speed at Entry (mph) : 25
 Ambient Lighting: No
 Circle Lighting: Yes

| Approach | Number of Lanes on Approach | Number of Circulating Lanes Crossing Approach | Presence of Pedestrian Crossing | State Route | Posted Speed on the approach (mph) | Roundabout Ahead Sign | Yield Sign | Approach lighting | Stopping sight distance (ft) | Horizontal Curves | Cross Design |
|----------|-----------------------------|---|---------------------------------|-------------|------------------------------------|-----------------------|------------|-------------------|------------------------------|-------------------|--------------|
| A | 1 | 1 | Yes | Yes | 35 | Yes | Yes | Yes | 246 | Yes | Urban |
| B | 2 | 1 | Yes | No | 35 | Yes | Yes | Yes | 246 | Yes | Urban |
| C | 2 | 2 | Yes | Yes | 35 | Yes | Yes | Yes | 246 | Yes | Urban |
| D | 1 | 2 | Yes | No | 35 | Yes | Yes | No | 246 | No | Urban |

ROUNDABOUT ID: #GT-5048

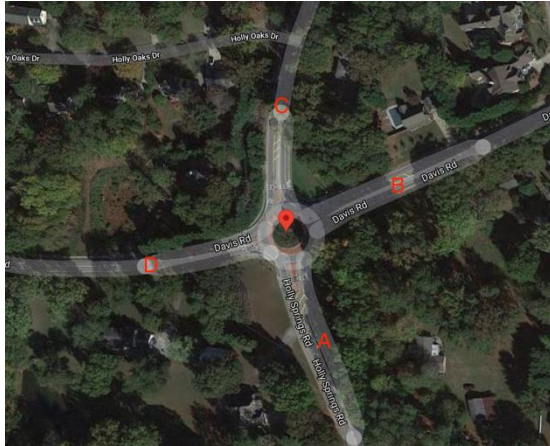

Road Names: Holly Springs Rd \ Davis Rd
 Latitude: 34.026711
 Longitude: -84.468319
 Opening Year: 2013
 Number of Legs: 4
 Inscribed Circle Diameter (ft): 110
 Presence of Truck Apron: Yes
 Posted Speed at Entry (mph) : 15
 Ambient Lighting: No
 Circle Lighting: Yes

| Approach | Number of Lanes on Approach | Number of Circulating Lanes Crossing Approach | Presence of Pedestrian Crossing | State Route | Posted Speed on the approach (mph) | Roundabout Ahead Sign | Yield Sign | Approach lighting | Stopping sight distance (ft) | Horizontal Curves | Cross Design |
|----------|-----------------------------|---|---------------------------------|-------------|------------------------------------|-----------------------|------------|-------------------|------------------------------|-------------------|--------------|
| A | 1 | 1 | Yes | No | 35 | Yes | Yes | Yes | 246 | Yes | Urban |
| B | 1 | 1 | Yes | No | 35 | Yes | Yes | Yes | 246 | No | Urban |
| C | 1 | 1 | Yes | No | 35 | Yes | Yes | Yes | 246 | Yes | Urban |
| D | 1 | 1 | Yes | No | 35 | Yes | Yes | No | 246 | Yes | Urban |

ROUNDABOUT ID: #GT-9R



Road Names: Chatillon Rd/ Chatillon Rd/ J L Todd Dr/ Riverside Industrial Park NE
 Latitude: 34.281111
 Longitude: -85.165556
 Opening Year: 2009
 Number of Legs: 4
 Inscribed Circle Diameter (ft): 110
 Presence of Truck Apron: No
 Posted Speed at Entry (mph) : 15
 Ambient Lighting: Yes
 Circle Lighting: Yes

| Approach | Number of Lanes on Approach | Number of Circulating Lanes Crossing Approach | Presence of Pedestrian Crossing | State Route | Posted Speed on the approach (mph) | Roundabout Ahead Sign | Yield Sign | Approach lighting | Stopping sight distance (ft) | Horizontal Curves | Cross Design |
|----------|-----------------------------|---|---------------------------------|-------------|------------------------------------|-----------------------|------------|-------------------|------------------------------|-------------------|--------------|
| A | 1 | 1 | Yes | No | 35 | Yes | Yes | Yes | 246 | No | Urban |
| B | 1 | 1 | Yes | No | 25 | No | Yes | No | 152 | No | Urban |
| C | 1 | 1 | Yes | No | 35 | Yes | Yes | No | 246 | No | Urban |
| D | 1 | 1 | Yes | No | 25 | No | Yes | No | 152 | No | Urban |

ROUNDABOUT ID: #GSU-1



Road Names: SR 144 @ Belfast River Rd
 Latitude: 31.880854
 Longitude: -81.261863
 Opening Year: 2015
 Number of Legs: 4
 Inscribed Circle Diameter (ft): 120
 Presence of Truck Apron: No
 Posted Speed at Entry (mph) : 25
 Ambient Lighting: Yes
 Circle Lighting: Yes

| Approach | Number of Lanes on Approach | Number of Circulating Lanes Crossing Approach | Presence of Pedestrian Crossing | State Route | Posted Speed on the approach (mph) | Roundabout Ahead Sign | Yield Sign | Approach lighting | Stopping sight distance (ft) | Horizontal Curves | Cross Design |
|----------|-----------------------------|---|---------------------------------|-------------|------------------------------------|-----------------------|------------|-------------------|------------------------------|-------------------|--------------|
| L1 SB | 2 | 1 | Yes | Yes | 45 | Yes | Yes | Yes | 359 | No | Urban |
| L2 NB | 2 | 1 | Yes | Yes | 45 | Yes | Yes | Yes | 359 | No | Urban |
| L3 EB | 1 | 1 | Yes | No | 45 | Yes | Yes | Yes | 359 | No | Rural |
| L4 WB | 2 | 1 | Yes | No | 45 | Yes | Yes | Yes | 359 | No | Urban |

ROUNDABOUT ID: #GSU-10



Road Names: SR 17\SR 119
 Latitude: 32.330322
 Longitude: -81.392672
 Opening Year: 2018
 Number of Legs: 4
 Inscribed Circle Diameter (ft): 140
 Presence of Truck Apron: Yes
 Posted Speed at Entry (mph) : 20
 Ambient Lighting: Yes
 Circle Lighting: Yes

| Approach | Number of Lanes on Approach | Number of Circulating Lanes Crossing Approach | Presence of Pedestrian Crossing | State Route | Posted Speed on the approach (mph) | Roundabout Ahead Sign | Yield Sign | Approach lighting | Stopping sight distance (ft) | Horizontal Curves | Cross Design |
|----------|-----------------------------|---|---------------------------------|-------------|------------------------------------|-----------------------|------------|-------------------|------------------------------|-------------------|--------------|
| L1 SB | 1 | 1 | Yes | Yes | 35 | Yes | Yes | Yes | 246 | Yes | Urban |
| L2 NB | 1 | 1 | Yes | Yes | 35 | Yes | Yes | Yes | 246 | Yes | Rural |
| L3 EB | 1 | 1 | Yes | Yes | 35 | Yes | Yes | Yes | 246 | No | Urban |
| L4 WB | 1 | 1 | Yes | Yes | 35 | Yes | Yes | Yes | 246 | No | Urban |

ROUNDABOUT ID: #GSU-13

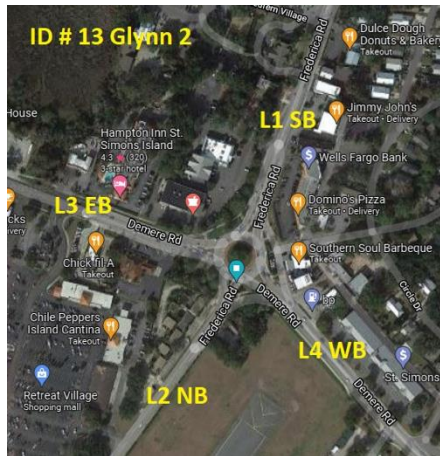

Road Names: Demere Rd\Frederica Rd
 Latitude: 31.159444
 Longitude: -81.388611
 Opening Year: 2008
 Number of Legs: 4
 Inscribed Circle Diameter (ft): 170
 Presence of Truck Apron: Yes
 Posted Speed at Entry (mph) : 20
 Ambient Lighting: Yes
 Circle Lighting: No

| Approach | Number of Lanes on Approach | Number of Circulating Lanes Crossing Approach | Presence of Pedestrian Crossing | State Route | Posted Speed on the approach (mph) | Roundabout Ahead Sign | Yield Sign | Approach lighting | Stopping sight distance (ft) | Horizontal Curves | Cross Design |
|----------|-----------------------------|---|---------------------------------|-------------|------------------------------------|-----------------------|------------|-------------------|------------------------------|-------------------|--------------|
| L1 SB | 2 | 2 | Yes | No | 35 | Yes | Yes | No | 246 | No | Urban |
| L2 NB | 2 | 2 | Yes | No | 35 | Yes | Yes | No | 246 | No | Urban |
| L3 EB | 2 | 2 | Yes | No | 35 | Yes | Yes | No | 246 | No | Urban |
| L4 WB | 2 | 2 | Yes | No | 35 | Yes | Yes | No | 246 | No | Urban |

ROUNDABOUT ID: #GSU-14



Road Names: Ben Fortson Pkwy\Beach View Dr.
 Latitude: 31.047575
 Longitude: -81.412683
 Opening Year: 2012
 Number of Legs: 4
 Inscribed Circle Diameter (ft): 130
 Presence of Truck Apron: Yes
 Posted Speed at Entry (mph) : 15
 Ambient Lighting: Yes
 Circle Lighting: Yes

| Approach | Number of Lanes on Approach | Number of Circulating Lanes Crossing Approach | Presence of Pedestrian Crossing | State Route | Posted Speed on the approach (mph) | Roundabout Ahead Sign | Yield Sign | Approach lighting | Stopping sight distance (ft) | Horizontal Curves | Cross Design |
|----------|-----------------------------|---|---------------------------------|-------------|------------------------------------|-----------------------|------------|-------------------|------------------------------|-------------------|--------------|
| L1 SB | 1 | 1 | Yes | No | 25 | Yes | Yes | Yes | 152 | Yes | Rural |
| L2 NB | 1 | 1 | Yes | No | 25 | Yes | Yes | Yes | 152 | Yes | Urban |
| L3 EB | 1 | 1 | Yes | Yes | 25 | Yes | Yes | No | 152 | No | Rural |
| L4 WB | 1 | 1 | Yes | No | 25 | No | Yes | Yes | 152 | No | Urban |

ROUNDABOUT ID: #GSU-15



Road Names: N Main St\Memorial Drive
 Latitude: 31.85
 Longitude: -81.595833
 Opening Year: 2009
 Number of Legs: 4
 Inscribed Circle Diameter (ft): 120
 Presence of Truck Apron: Yes
 Posted Speed at Entry (mph) : 15
 Ambient Lighting: No
 Circle Lighting: Yes

| Approach | Number of Lanes on Approach | Number of Circulating Lanes Crossing Approach | Presence of Pedestrian Crossing | State Route | Posted Speed on the approach (mph) | Roundabout Ahead Sign | Yield Sign | Approach lighting | Stopping sight distance (ft) | Horizontal Curves | Cross Design |
|----------|-----------------------------|---|---------------------------------|-------------|------------------------------------|-----------------------|------------|-------------------|------------------------------|-------------------|--------------|
| L1 SB | 1 | 1 | Yes | No | 25 | Yes | Yes | Yes | 152 | No | Rural |
| L2 NB | 1 | 1 | Yes | No | 25 | Yes | Yes | Yes | 152 | Yes | Urban |
| L3 EB | 1 | 1 | Yes | No | 25 | Yes | Yes | Yes | 152 | Yes | Urban |
| L4 WB | 1 | 1 | Yes | No | 25 | Yes | Yes | Yes | 152 | No | Urban |

ROUNDABOUT ID: #GSU-16



Road Names: Scott Nixon Memorial Dr @ Pleasant Home Rd
 Latitude: 33.493636
 Longitude: -82.099344
 Opening Year: 2009
 Number of Legs: 4
 Inscribed Circle Diameter (ft): 130
 Presence of Truck Apron: No
 Posted Speed at Entry (mph) :
 Ambient Lighting: No
 Circle Lighting: Yes

| Approach | Number of Lanes on Approach | Number of Circulating Lanes Crossing Approach | Presence of Pedestrian Crossing | State Route | Posted Speed on the approach (mph) | Roundabout Ahead Sign | Yield Sign | Approach lighting | Stopping sight distance (ft) | Horizontal Curves | Cross Design |
|----------|-----------------------------|---|---------------------------------|-------------|------------------------------------|-----------------------|------------|-------------------|------------------------------|-------------------|--------------|
| L1 SB | 1 | 1 | No | No | 35 | Yes | Yes | No | 246 | Yes | Urban |
| L2 NB | 1 | 1 | No | No | 35 | No | Yes | No | 246 | Yes | Urban |
| L3 EB | 1 | 1 | No | No | 35 | No | Yes | No | 246 | No | Urban |
| L4 WB | 1 | 1 | No | No | 35 | No | Yes | No | 246 | Yes | Urban |

ROUNDABOUT ID: #GSU-17



Road Names: 4th Ave NE\Rowland Dr NE
 Latitude: 31.185443
 Longitude: -83.765177
 Opening Year: 2012
 Number of Legs: 5
 Inscribed Circle Diameter (ft): 120
 Presence of Truck Apron: Yes
 Posted Speed at Entry (mph) :
 Ambient Lighting: Yes
 Circle Lighting: Yes

| Approach | Number of Lanes on Approach | Number of Circulating Lanes Crossing Approach | Presence of Pedestrian Crossing | State Route | Posted Speed on the approach (mph) | Roundabout Ahead Sign | Yield Sign | Approach lighting | Stopping sight distance (ft) | Horizontal Curves | Cross Design |
|----------|-----------------------------|---|---------------------------------|-------------|------------------------------------|-----------------------|------------|-------------------|------------------------------|-------------------|--------------|
| L1 SB | 1 | 1 | No | No | 30 | No | Yes | No | 196 | No | Urban |
| L2 NB | 1 | 1 | No | No | 35 | No | Yes | Yes | 246 | No | Urban |
| L3 NE | 1 | 1 | No | No | 30 | No | Yes | No | 196 | No | Urban |
| L4 SW | 1 | 1 | No | No | 30 | No | Yes | No | 196 | No | Urban |
| L5 NW | 1 | 1 | No | No | 30 | No | Yes | Yes | 196 | No | Urban |

ROUNDABOUT ID: #GSU-18

Road



Names: 1st St NE\Tifton Hwy\Sylvester Hwy
 Latitude: 31.199336
 Longitude: -83.787731
 Opening Year: 2016
 Number of Legs: 4
 Inscribed Circle Diameter (ft): 155
 Presence of Truck Apron: Yes
 Posted Speed at Entry (mph) : 20
 Ambient Lighting: Yes
 Circle Lighting: Yes

| Approach | Number of Lanes on Approach | Number of Circulating Lanes Crossing Approach | Presence of Pedestrian Crossing | State Route | Posted Speed on the approach (mph) | Roundabout Ahead Sign | Yield Sign | Approach lighting | Stopping sight distance (ft) | Horizontal Curves | Cross Design |
|----------|-----------------------------|---|---------------------------------|-------------|------------------------------------|-----------------------|------------|-------------------|------------------------------|-------------------|--------------|
| L1 SB | 1 | 1 | Yes | No | 35 | Yes | Yes | Yes | 246 | No | Urban |
| L2 NB | 1 | 1 | Yes | No | 45 | Yes | Yes | Yes | 359 | No | Urban |
| L3 NEB | 2 | 1 | Yes | Yes | 45 | Yes | Yes | Yes | 359 | No | Urban |
| L4 SWB | 2 | 1 | Yes | Yes | 45 | Yes | Yes | Yes | 359 | Yes | Urban |

ROUNDABOUT ID: #GSU-19



Road Names: W Main St(SR 57)\SR 18
 Latitude: 32.85998
 Longitude: -83.347288
 Opening Year: 2015
 Number of Legs: 4
 Inscribed Circle Diameter (ft): 176
 Presence of Truck Apron: Yes
 Posted Speed at Entry (mph) : 25
 Ambient Lighting: Yes
 Circle Lighting: Yes

| Approach | Number of Lanes on Approach | Number of Circulating Lanes Crossing Approach | Presence of Pedestrian Crossing | State Route | Posted Speed on the approach (mph) | Roundabout Ahead Sign | Yield Sign | Approach lighting | Stopping sight distance (ft) | Horizontal Curves | Cross Design |
|----------|-----------------------------|---|---------------------------------|-------------|------------------------------------|-----------------------|------------|-------------------|------------------------------|-------------------|--------------|
| L1 SB | 1 | 1 | Yes | Yes | 45 | Yes | Yes | Yes | 359 | No | Urban |
| L2 NB | 1 | 1 | Yes | Yes | 45 | Yes | Yes | Yes | 359 | No | Urban |
| L3 EB | 1 | 1 | Yes | Yes | 45 | Yes | Yes | Yes | 359 | No | Urban |
| L4 WB | 1 | 1 | Yes | Yes | 45 | Yes | Yes | Yes | 359 | No | Urban |

ROUNDABOUT ID: #GSU-2



Road Names: Burkhalter Rd\Pretoria Rushing Rd
 Latitude: 32.409945
 Longitude: -81.730814
 Opening Year: 2017
 Number of Legs: 4
 Inscribed Circle Diameter (ft): 80
 Presence of Truck Apron: Yes
 Posted Speed at Entry (mph) :
 Ambient Lighting: Yes
 Circle Lighting: Yes

| Approach | Number of Lanes on Approach | Number of Circulating Lanes Crossing Approach | Presence of Pedestrian Crossing | State Route | Posted Speed on the approach (mph) | Roundabout Ahead Sign | Yield Sign | Approach lighting | Stopping sight distance (ft) | Horizontal Curves | Cross Design |
|----------|-----------------------------|---|---------------------------------|-------------|------------------------------------|-----------------------|------------|-------------------|------------------------------|-------------------|--------------|
| L1 SB | 1 | 1 | Yes | No | 35 | Yes | Yes | Yes | 246 | No | Rural |
| L2 NB | 1 | 1 | Yes | No | 35 | Yes | Yes | Yes | 246 | No | Rural |
| L3 EB | 1 | 1 | Yes | No | 45 | Yes | Yes | Yes | 359 | No | Rural |
| L4 WB | 2 | 1 | Yes | No | 35 | Yes | Yes | Yes | 246 | No | Rural |

ROUNDABOUT ID: #GSU-20



Road Names: College St\Oglethorpe St
 Latitude: 32.833781
 Longitude: -83.644825
 Opening Year: 2014
 Number of Legs: 4
 Inscribed Circle Diameter (ft): 110
 Presence of Truck Apron: No
 Posted Speed at Entry (mph) :
 Ambient Lighting: No
 Circle Lighting: Yes

| Approach | Number of Lanes on Approach | Number of Circulating Lanes Crossing Approach | Presence of Pedestrian Crossing | State Route | Posted Speed on the approach (mph) | Roundabout Ahead Sign | Yield Sign | Approach lighting | Stopping sight distance (ft) | Horizontal Curves | Cross Design |
|----------|-----------------------------|---|---------------------------------|-------------|------------------------------------|-----------------------|------------|-------------------|------------------------------|-------------------|--------------|
| L1 SB | 1 | 1 | Yes | No | 30 | Yes | Yes | Yes | 196 | Yes | Urban |
| L2 NB | 1 | 1 | Yes | No | 30 | Yes | Yes | Yes | 196 | No | Urban |
| L3 EB | 1 | 1 | Yes | No | 30 | Yes | Yes | Yes | 196 | No | Urban |
| L4 WB | 1 | 1 | Yes | No | 30 | Yes | Yes | Yes | 196 | No | Urban |

ROUNDABOUT ID: #GSU-21



Road Names: SR 87(US 23)\Bass Rd
 Latitude: 32.936629
 Longitude: -83.717325
 Opening Year: 2017
 Number of Legs: 4
 Inscribed Circle Diameter (ft): 90
 Presence of Truck Apron: No
 Posted Speed at Entry (mph) : 25
 Ambient Lighting: No
 Circle Lighting: Yes

| Approach | Number of Lanes on Approach | Number of Circulating Lanes Crossing Approach | Presence of Pedestrian Crossing | State Route | Posted Speed on the approach (mph) | Roundabout Ahead Sign | Yield Sign | Approach lighting | Stopping sight distance (ft) | Horizontal Curves | Cross Design |
|----------|-----------------------------|---|---------------------------------|-------------|------------------------------------|-----------------------|------------|-------------------|------------------------------|-------------------|--------------|
| L1 SB | 1 | 1 | No | Yes | 55 | Yes | Yes | No | 492 | No | Rural |
| L2 NB | 1 | 1 | No | Yes | 55 | Yes | Yes | No | 492 | No | Rural |
| L3 EB | 1 | 1 | No | No | 45 | Yes | Yes | No | 359 | No | Rural |
| L4 WB | 1 | 1 | No | No | 45 | Yes | Yes | No | 359 | No | Rural |

ROUNDABOUT ID: #GSU-22



Road Names: Lower Thomaston Rd \Lamar Rd\SR 74\Johnson Rd
 Latitude: 32.851558
 Longitude: -83.784861
 Opening Year: 2014
 Number of Legs: 5
 Inscribed Circle Diameter (ft): 250
 Presence of Truck Apron: Yes
 Posted Speed at Entry (mph) : 25
 Ambient Lighting: No
 Circle Lighting: Yes

| Approach | Number of Lanes on Approach | Number of Circulating Lanes Crossing Approach | Presence of Pedestrian Crossing | State Route | Posted Speed on the approach (mph) | Roundabout Ahead Sign | Yield Sign | Approach lighting | Stopping sight distance (ft) | Horizontal Curves | Cross Design |
|----------|-----------------------------|---|---------------------------------|-------------|------------------------------------|-----------------------|------------|-------------------|------------------------------|-------------------|--------------|
| L1 SB | 1 | 1 | Yes | No | 45 | Yes | Yes | Yes | 359 | No | Rural |
| L2 NB | 1 | 1 | Yes | No | 45 | Yes | Yes | Yes | 359 | No | Rural |
| L3 SEB | 1 | 1 | Yes | Yes | 55 | Yes | Yes | Yes | 492 | No | Rural |
| L4 WB | 1 | 1 | Yes | Yes | 55 | Yes | Yes | Yes | 492 | No | Rural |
| L5 NEB | 1 | 1 | Yes | No | 45 | Yes | Yes | Yes | 359 | Yes | Rural |

ROUNDABOUT ID: #GSU-23



Road Names: SR 22 (US 80)\Holley Rd
 Latitude: 32.800642
 Longitude: -83.802458
 Opening Year: 2015
 Number of Legs: 4
 Inscribed Circle Diameter (ft): 160
 Presence of Truck Apron: Yes
 Posted Speed at Entry (mph) : 25
 Ambient Lighting: No
 Circle Lighting: Yes

| Approach | Number of Lanes on Approach | Number of Circulating Lanes Crossing Approach | Presence of Pedestrian Crossing | State Route | Posted Speed on the approach (mph) | Roundabout Ahead Sign | Yield Sign | Approach lighting | Stopping sight distance (ft) | Horizontal Curves | Cross Design |
|----------|-----------------------------|---|---------------------------------|-------------|------------------------------------|-----------------------|------------|-------------------|------------------------------|-------------------|--------------|
| L1 SB | 1 | 1 | Yes | No | 35 | Yes | Yes | Yes | 246 | No | Rural |
| L2 NB | 1 | 1 | Yes | No | 35 | Yes | Yes | Yes | 246 | No | Rural |
| L3 EB | 1 | 1 | Yes | Yes | 35 | Yes | Yes | Yes | 246 | No | Rural |
| L4 WB | 1 | 1 | Yes | Yes | 35 | Yes | Yes | Yes | 246 | No | Rural |

ROUNDABOUT ID: #GSU-24



Road Names: SR 247 Conn @ John E. Sullivan Rd
 Latitude: 32.606584
 Longitude: -83.757531
 Opening Year: 2015
 Number of Legs: 4
 Inscribed Circle Diameter (ft): 155
 Presence of Truck Apron: Yes
 Posted Speed at Entry (mph) : 45
 Ambient Lighting: No
 Circle Lighting: Yes

| Approach | Number of Lanes on Approach | Number of Circulating Lanes Crossing Approach | Presence of Pedestrian Crossing | State Route | Posted Speed on the approach (mph) | Roundabout Ahead Sign | Yield Sign | Approach lighting | Stopping sight distance (ft) | Horizontal Curves | Cross Design |
|----------|-----------------------------|---|---------------------------------|-------------|------------------------------------|-----------------------|------------|-------------------|------------------------------|-------------------|--------------|
| L1 SB | 1 | 1 | Yes | No | 45 | Yes | Yes | Yes | 359 | No | Rural |
| L2 NB | 2 | 1 | Yes | No | 45 | Yes | Yes | Yes | 359 | No | Rural |
| L3 EB | 1 | 1 | Yes | Yes | 45 | Yes | Yes | Yes | 359 | No | Rural |
| L4 WB | 1 | 1 | Yes | Yes | 45 | Yes | Yes | Yes | 359 | No | Rural |

ROUNDABOUT ID: #GSU-3



Road Names: West Gentilly Rd @ O'Neal Dr.
 Latitude: 32.422592
 Longitude: -81.775439
 Opening Year: 2007
 Number of Legs: 4
 Inscribed Circle Diameter (ft): 90
 Presence of Truck Apron: No
 Posted Speed at Entry (mph) : 15
 Ambient Lighting: Yes
 Circle Lighting: Yes

| Approach | Number of Lanes on Approach | Number of Circulating Lanes Crossing Approach | Presence of Pedestrian Crossing | State Route | Posted Speed on the approach (mph) | Roundabout Ahead Sign | Yield Sign | Approach lighting | Stopping sight distance (ft) | Horizontal Curves | Cross Design |
|----------|-----------------------------|---|---------------------------------|-------------|------------------------------------|-----------------------|------------|-------------------|------------------------------|-------------------|--------------|
| L1 SB | 1 | 1 | Yes | No | 15 | Yes | Yes | Yes | 77 | No | Urban |
| L2 NB | 1 | 1 | No | No | 15 | Yes | Yes | Yes | 77 | Yes | Rural |
| L3 EB | 1 | 1 | No | No | 15 | Yes | Yes | Yes | 77 | No | Rural |
| L4 WB | 1 | 1 | No | No | 15 | Yes | Yes | Yes | 77 | Yes | Urban |

ROUNDABOUT ID: #GSU-4



Road Names: Forest Dr\Old Register Rd
 Latitude: 32.423825
 Longitude: -81.790167
 Opening Year: 2009
 Number of Legs: 4
 Inscribed Circle Diameter (ft): 100
 Presence of Truck Apron: No
 Posted Speed at Entry (mph) : 15
 Ambient Lighting: No
 Circle Lighting: Yes

| Approach | Number of Lanes on Approach | Number of Circulating Lanes Crossing Approach | Presence of Pedestrian Crossing | State Route | Posted Speed on the approach (mph) | Roundabout Ahead Sign | Yield Sign | Approach lighting | Stopping sight distance (ft) | Horizontal Curves | Cross Design |
|----------|-----------------------------|---|---------------------------------|-------------|------------------------------------|-----------------------|------------|-------------------|------------------------------|-------------------|--------------|
| L1 SB | 1 | 1 | Yes | No | 15 | Yes | Yes | Yes | 77 | Yes | Rural |
| L2 NB | 1 | 1 | No | No | 15 | Yes | Yes | Yes | 77 | No | Rural |
| L3 EB | 1 | 1 | No | No | 15 | Yes | Yes | Yes | 77 | No | Urban |
| L4 WB | 1 | 1 | No | No | 15 | Yes | Yes | Yes | 77 | Yes | Urban |

ROUNDABOUT ID: #GSU-5

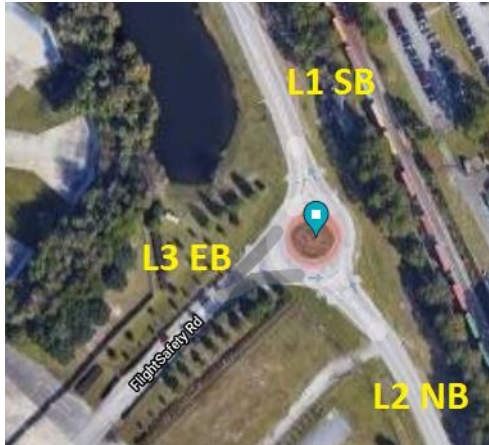

Road Names: CR 9/Gulfstream Rd\Robert Miller Rd
 Latitude: 32.135589
 Longitude: -81.188603
 Opening Year: 2014
 Number of Legs: 3
 Inscribed Circle Diameter (ft): 136
 Presence of Truck Apron: Yes
 Posted Speed at Entry (mph) : 25
 Ambient Lighting: Yes
 Circle Lighting: Yes

| Approach | Number of Lanes on Approach | Number of Circulating Lanes Crossing Approach | Presence of Pedestrian Crossing | State Route | Posted Speed on the approach (mph) | Roundabout Ahead Sign | Yield Sign | Approach lighting | Stopping sight distance (ft) | Horizontal Curves | Cross Design |
|----------|-----------------------------|---|---------------------------------|-------------|------------------------------------|-----------------------|------------|-------------------|------------------------------|-------------------|--------------|
| L1 SB | 1 | 1 | Yes | No | 40 | Yes | Yes | Yes | 300 | No | Rural |
| L2 NB | 1 | 1 | Yes | No | 40 | Yes | Yes | Yes | 300 | No | Rural |
| L3 EB | 1 | 1 | Yes | No | 35 | Yes | Yes | Yes | 246 | No | Rural |

ROUNDABOUT ID: #GSU-6

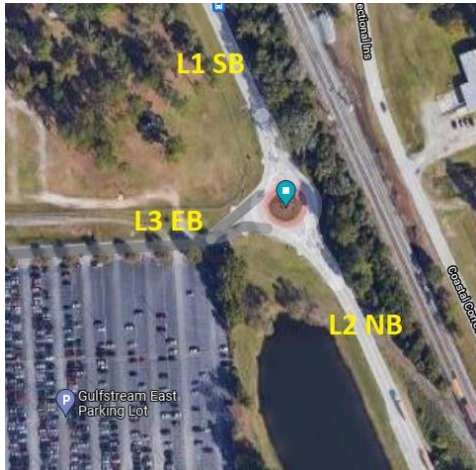

Road Names: CR 9/Gulfstream Rd\Unnamed Rd
 Latitude: 32.138975
 Longitude: -81.190417
 Opening Year: 2014
 Number of Legs: 3
 Inscribed Circle Diameter (ft): 136
 Presence of Truck Apron: Yes
 Posted Speed at Entry (mph) : 25
 Ambient Lighting: Yes
 Circle Lighting: Yes

| Approach | Number of Lanes on Approach | Number of Circulating Lanes Crossing Approach | Presence of Pedestrian Crossing | State Route | Posted Speed on the approach (mph) | Roundabout Ahead Sign | Yield Sign | Approach lighting | Stopping sight distance (ft) | Horizontal Curves | Cross Design |
|----------|-----------------------------|---|---------------------------------|-------------|------------------------------------|-----------------------|------------|-------------------|------------------------------|-------------------|--------------|
| L1 SB | 1 | 1 | Yes | No | 40 | Yes | Yes | Yes | 300 | No | Rural |
| L2 NB | 1 | 1 | Yes | No | 40 | Yes | Yes | Yes | 300 | No | Rural |
| L3 EB | 1 | 1 | Yes | No | 35 | Yes | Yes | Yes | 246 | No | Rural |

ROUNDABOUT ID: #GSU-7



Road Names: SR 223\SR 47
 Latitude: 33.481299
 Longitude: -82.315662
 Opening Year: 2015
 Number of Legs: 4
 Inscribed Circle Diameter (ft): 160
 Presence of Truck Apron: Yes
 Posted Speed at Entry (mph) : 25
 Ambient Lighting: Yes
 Circle Lighting: Yes

| Approach | Number of Lanes on Approach | Number of Circulating Lanes Crossing Approach | Presence of Pedestrian Crossing | State Route | Posted Speed on the approach (mph) | Roundabout Ahead Sign | Yield Sign | Approach lighting | Stopping sight distance (ft) | Horizontal Curves | Cross Design |
|----------|-----------------------------|---|---------------------------------|-------------|------------------------------------|-----------------------|------------|-------------------|------------------------------|-------------------|--------------|
| L1 SB | 2 | 1 | Yes | Yes | 55 | Yes | Yes | Yes | 492 | No | Rural |
| L2 NB | 2 | 1 | Yes | Yes | 55 | Yes | Yes | Yes | 492 | No | Rural |
| L3 EB | 1 | 1 | Yes | Yes | 55 | Yes | Yes | Yes | 492 | No | Rural |
| L4 WB | 1 | 1 | Yes | Yes | 55 | Yes | Yes | Yes | 492 | No | Rural |

ROUNDABOUT ID: #GSU-8



Road Names: Ronald Reagan Dr\Williamsburg Way
 Latitude: 33.545278
 Longitude: -82.129444
 Opening Year: 2009
 Number of Legs: 4
 Inscribed Circle Diameter (ft): 135
 Presence of Truck Apron: Yes
 Posted Speed at Entry (mph) : 15
 Ambient Lighting: Yes
 Circle Lighting: No

| Approach | Number of Lanes on Approach | Number of Circulating Lanes Crossing Approach | Presence of Pedestrian Crossing | State Route | Posted Speed on the approach (mph) | Roundabout Ahead Sign | Yield Sign | Approach lighting | Stopping sight distance (ft) | Horizontal Curves | Cross Design |
|----------|-----------------------------|---|---------------------------------|-------------|------------------------------------|-----------------------|------------|-------------------|------------------------------|-------------------|--------------|
| L1 SB | 1 | 1 | Yes | No | 15 | Yes | Yes | No | 77 | No | Urban |
| L2 NB | 1 | 1 | Yes | No | 15 | Yes | Yes | No | 77 | Yes | Urban |
| L3 EB | 1 | 1 | Yes | No | 15 | Yes | Yes | No | 77 | No | Urban |
| L4 WB | 1 | 1 | Yes | No | 15 | Yes | Yes | No | 77 | Yes | Urban |

ROUNDABOUT ID: #GSU-9



Road Names: Market View Pkwy\Riverwood Pkwy
 Latitude: 33.576111
 Longitude: -82.190833
 Opening Year: 2009
 Number of Legs: 3
 Inscribed Circle Diameter (ft): 140
 Presence of Truck Apron: Yes
 Posted Speed at Entry (mph) :
 Ambient Lighting: Yes
 Circle Lighting: No

| Approach | Number of Lanes on Approach | Number of Circulating Lanes Crossing Approach | Presence of Pedestrian Crossing | State Route | Posted Speed on the approach (mph) | Roundabout Ahead Sign | Yield Sign | Approach lighting | Stopping sight distance (ft) | Horizontal Curves | Cross Design |
|----------|-----------------------------|---|---------------------------------|-------------|------------------------------------|-----------------------|------------|-------------------|------------------------------|-------------------|--------------|
| L1 SB | 1 | 1 | Yes | No | 35 | Yes | Yes | No | 246 | Yes | Rural |
| L2 NB | 1 | 1 | No | No | 35 | Yes | Yes | No | 246 | Yes | Urban |
| L3 EB | 1 | 1 | No | No | 35 | Yes | Yes | No | 246 | No | Urban |

**APPENDIX C. ORIGINAL AND RECODED DRIVER/OPERATOR
CONTRIBUTING FACTORS**

| Unique Operator / Driver Contributing Factors | Recorded Entries |
|--|-------------------------|
| ["No Contributing Factors", "Other"] | None |
| Disregard Other Traffic Control | Failure to Yield |
| ["Changed Lanes Improperly", "No Contributing Factors"] | Improper Lane Change |
| Following Too Close | Following Too Close |
| ["Disregard Stop Sign/Signal", "No Contributing Factors", "No Contributing Factors"] | Failure to Yield |
| ["No Contributing Factors", "Under the Influence (U.I.)"] | Impaired Driver |
| ["Driver Condition", "No Contributing Factors"] | Impaired Driver |
| Too Fast for Conditions | Over Speeding |
| ["Inattentive or Other Distraction (Distracted)", "No Contributing Factors", "No Contributing Factors", "No Contributing Factors"] | Distracted Driver |
| Exceeding Speed Limit | Over Speeding |
| ["Not Visible (Object, Person, or Vehicle)", "Not Visible (Object, Person, or Vehicle)"] | Visibility |
| ["Driver Lost Control", "No Contributing Factors"] | Loss of Control |
| ["No Contributing Factors", "Wrong Side of Road"] | Wrong Way |
| Surface Defects | Roadway Conditions |
| Reckless Driving | Aggressive Driving |
| ["Misjudged Clearance", "No Contributing Factors"] | Following Too Close |
| ["No Contributing Factors", "Not Visible (Object, Person, or Vehicle)"] | Visibility |
| ["Following Too Close", "No Contributing Factors", "No Contributing Factors", "No Contributing Factors"] | Following Too Close |
| ["Inattentive or Other Distraction (Distracted)", "No Contributing Factors"] | Distracted Driver |
| Other Interior Distraction (Distracted) | Distracted Driver |
| ["Exceeding Speed Limit", "No Contributing Factors"] | Over Speeding |
| ["Failure to Yield", "No Contributing Factors", "No Contributing Factors"] | Failure to Yield |
| ["No Contributing Factors", "No Contributing Factors"] | None |
| Mechanical or Vehicle Failure | Vehicle Mechanical |
| ["No Contributing Factors", "Texting (Distracted)"] | Distracted Driver |
| ["Following Too Close", "No Contributing Factors"] | Following Too Close |
| Improper Turn | Wrong Way |
| Under the Influence (U.I.) | Impaired Driver |
| ["Failure to Yield", "No Contributing Factors"] | Failure to Yield |
| ["Other", "Reaction to Object or Animal"] | Distracted Driver |
| ["No Contributing Factors", "Occupant Distraction (Distracted)"] | Distracted Driver |
| ["Inattentive or Other Distraction (Distracted)", "No Contributing Factors", "No Contributing Factors"] | Distracted Driver |
| ["Inattentive or Other Distraction (Distracted)", "Other"] | Distracted Driver |
| ["Changed Lanes Improperly", "No Contributing Factors", "No Contributing Factors"] | Improper Lane Change |
| ["Following Too Close", "No Contributing Factors", "No Contributing Factors"] | Following Too Close |
| ["No Contributing Factors", "No Contributing Factors", "Too Fast for Conditions"] | Over Speeding |
| Inattentive or Other Distraction (Distracted) | Distracted Driver |
| ["Misjudged Clearance", "Reaction to Object or Animal"] | Following Too Close |
| ["No Contributing Factors", "Surface Defects"] | Roadway Conditions |
| ["Aggressive Driving", "No Contributing Factors"] | Aggressive Driving |

| | |
|--|----------------------|
| Wrong Side of Road | Wrong Way |
| ["Following Too Close","No Contributing Factors","Other"] | Aggressive Driving |
| ["Improper Turn","No Contributing Factors"] | Wrong Way |
| ["Following Too Close","Other"] | Aggressive Driving |
| Driver Lost Control | Loss of Control |
| Changed Lanes Improperly | Improper Lane Change |
| ["Failure to Yield","Reaction to Object or Animal"] | Failure to Yield |
| Other | None |
| ["Improper Turn","Inattentive or Other Distraction (Distracted)"] | Distracted Driver |
| (None) | None |
| ["Disregard Other Traffic Control","No Contributing Factors"] | Failure to Yield |
| Disregard Stop Sign/Signal | Failure to Yield |
| ["Failure to Yield","Failure to Yield"] | Failure to Yield |
| Reaction to Object or Animal | Distracted Driver |
| ["Misjudged Clearance","Other"] | Following Too Close |
| ["Failure to Yield","No Contributing Factors","No Contributing Factors","No Contributing Factors"] | Failure to Yield |
| ["Driver Lost Control","No Contributing Factors","No Contributing Factors"] | Loss of Control |
| ["No Contributing Factors","Talking on Hand-Held Device (Distracted)"] | Distracted Driver |
| ["Inattentive or Other Distraction (Distracted)","Inattentive or Other Distraction (Distracted)"] | Distracted Driver |
| Misjudged Clearance | Following Too Close |
| ["Failure to Yield","Other"] | Failure to Yield |
| ["Improper Passing","No Contributing Factors"] | Improper Passing |
| ["Changed Lanes Improperly","Failure to Yield"] | Failure to Yield |
| ["Improper Backing","No Contributing Factors"] | Reckless Driving |
| Disregard Police - Evasion | Reckless Driving |
| No Contributing Factors | None |
| Failure to Yield | Failure to Yield |
| Vision Obscured | Visibility |
| ["Other","Other"] | None |
| ["No Contributing Factors","Vision Obscured"] | Visibility |
| ["Improper Passing of School Bus","Other"] | Improper Passing |
| ["No Contributing Factors","No Contributing Factors","Other"] | None |
| ["No Contributing Factors","Too Fast for Conditions"] | Over Speeding |
| ["Disregard Stop Sign/Signal","No Contributing Factors"] | Failure to Yield |
| ["Distracted","No Contributing Factors"] | Distracted Driver |
| Driver Condition | Impaired Driver |
| Following too Close,Other Activity - Mobile Device | Following Too Close |
| Failed to Yield | Failure to Yield |
| Following too Close,Other Interior Distraction (Di | Following Too Close |
| Following too Close,Misjudged Clearance | Following Too Close |
| Following too Close | Following Too Close |

APPENDIX D. ALGORITHM FOR ASSIGNING DAY PERIOD TO CRASH – PYTHON SCRIPT

```

#Import required Python Modules
import pandas as pd

#Read the date and time information into a pandas dataframe
df = pd.read_csv('DayNightCodedDates.csv')
#Convert the Date and Time field into a pandas datetime object
df['timeStamp'] = pd.to_datetime(df['Date and Time'])

##Extract the Hour, Mins, Year, Month, and Day and append them as new columns in the dataframe
df['Hour'] = df['timeStamp'].apply(lambda time: time.hour)
df['Mins'] = df['timeStamp'].apply(lambda x: str(x).split(':')[1])
df['Year'] = df['timeStamp'].apply(lambda time: time.year)
df['Month'] = df['timeStamp'].apply(lambda time: time.month)
df['Day'] = df['timeStamp'].apply(lambda time: time.day)

#Define a function that will be used to increase the Hour of crashes between start and end of daylight savings by 1 hour
def HourMins (x):
    return 100*int(x[0])+int(x[1])

#For each Hour and Min information for a crash record, the check if daylight savings is in effect and combine the values
#into a four digit text of HHMM. Store this value in a new column called HourMin
df['HourMin'] = df[['Hour', 'Mins']].apply(HourMins,axis=1)

#Create another function that stores the Year, Month, and Day information as a six digit YYYYMMdd text
def YMD (m):
    tyear = str(m[0])
    tmonth = str(m[1])
    if int(tmonth) < 10:
        tmonth = ''.join(['0',tmonth])
    tday = str(m[2])
    if int(tday) < 10:
        tday = ''.join(['0',tday])

    return ''.join([tyear,tmonth,tday])

#Create a new column called YMD and transform all Year, Month, and Day information and store in the new column
df['YMD'] = df[['Year', 'Month', 'Day']].apply(YMD,axis=1)

#Create dictionaries to store sunrise and sunset information
ds_rise = {}
ds_set = {}
#read the sunset and sunrise information into the dictionaries
for i in range (9,22):
    filename = str(2000 + i) + 'ds.csv'
    df_ds = pd.read_csv(filename,header=None, names=['YMD','Rise','Set'])

    for index, row in df_ds.iterrows():
        #print(row)
        ds_rise[row[0]]= row[1]
        ds_set[row[0]]= row[2]

# read the daylight saving data for each year into a panda dataframe
df_sav = pd.read_csv('DST.csv', header = None, names=['Year','Start','End'])
#create new dictionaries and store the daylight savings data from the dataframe in them
ds_start = {}
ds_end = {}
for index,row in df_sav.iterrows():
    ds_start[row[0]]=row[1]
    ds_end[row[0]] = row[2]

#create a list called period. Analyze all the information and store the nighttime or daytime assignments in the period list
period= []

for index, row in df.iterrows():
    if int(row[9]) >= ds_start[row[5]] and int(row[9]) <= ds_end[row[5]]:
        ds_rise[int(row[9])] = ds_rise[int(row[9])] + 100
        ds_set[int(row[9])] = ds_set[int(row[9])] + 100

    if row[8] < ds_rise[int(row[9])] or row[8] > ds_set[int(row[9])]:
        period.append("nighttime")
    else:
        period.append("daytime")

#store the period list in a new column called Period in the dataframe
df['Period'] = period
#drop some columns and write the final data frame having Recod ID, and daytime or nighttime assignments to a csv file
df.to_csv("AppendedDayTimes.csv",index=False)

```

Civil Survey Manual – Inventory of Features Influencing Intersection Safety



Georgia Tech College of Engineering

**School of Civil and
Environmental Engineering**

OVERVIEW – DETERMINING THE SAFETY INFLUENCE AREA OF AN INTERSECTION

The selection of intersection related crashes for analysis requires a systematic way to determine an intersection's safety influence area. The length of this so-called influence area depends on the geometric design, traffic control, and operating features (Abdel-Aty et al. 2009; North Carolina Department of Transportation 1999). Some states use a distance of 250 feet from the center of the intersection to determine if the crash is within this influence area (Abdel-Aty et al. 2009). Other states also determine this area by considering the effect of left turning lanes (Abdel-Aty et al. 2009). Table 1 shows the distances used by different states.

There have been many inconsistencies in the length of the safety influence area used in previous studies. Lyon et al (Abdel-Aty et al. 2009; Lyon et al. 2005) used a distance of 65.6 ft from the center of the intersection to identify intersection related crashes for their study of intersections in Toronto. A distance of 150 ft has also been used by Persaud et al (Abdel-Aty et al. 2009; Persaud et al. 2005) to identify rear-end collisions related to intersections. Next, Hardwood et al (Abdel-Aty et al. 2009; Hardwood et al. 2003), Mitra et al (Abdel-Aty et al. 2009; Mitra et al. 2007), Donnell et al (Donnell et al. 2010) all used a safety influence distance of 250ft to identify intersection related crashes. Cottrell and Mu (Abdel-Aty et al. 2009; Cottrell and Mu 2005) also identified intersection related crashes in Utah based on the stopping sight distance. Initially they applied a distance of 500ft for an average approach speed of 40 mph. However, they realized that a 100ft distance was applicable to most of their intersections and only two intersections needed the 500ft distance as influence area. Another study (Abdel-Aty et al. 2009; Joksch and Kostyniuk 1998) of intersections from three different states applied varying influence area distances ranging from 350ft to 7ft.

Abdel-Aty et al (Abdel-Aty et al. 2009) argue that the main challenge in determining intersection related crashes is deciding the safety influence area upstream of the approach. The authors performed a study to investigate how the size of the intersection, left-turn lane length, through and left turning traffic volumes, skewness and other intersection features affect the safety influence area upstream of approach. The study analyzed crash data from 177 regular four-legged intersections in Florida from 2000 to 2005. The results show that the approach upstream safety influence area is influenced by the through volume, approach speed, number of right lanes and left turn protection. The authors concluded that since the approaches to an intersection can have different attributes, it may be advantageous to define the safety influence area of each approach separately.

Table 1 Default Distances Used by Different States to Identify Intersection Safety Area
 (Source: reference (Abdel-Aty et al. 2009))

| State | Length of Intersection Influence area from center of Intersection |
|---|--|
| Alaska | 200 feet |
| California | 250 feet |
| Colorado | 264 feet upstream of approach |
| Connecticut | 50 feet from stop bar |
| Delaware | 528 feet |
| Florida ^a | At Intersection: less than 50 feet Intersection related: 50 to 250 feet |
| Hawaii ^b | 75 feet, more if crash occurred in left turn lane |
| Iowa | Urban: 75 feet Rural: 150 feet Expressways: 300 feet High speed road: up to 1320 feet |
| Kansas | 150 feet, more if intersection is large |
| Maryland | 250 feet |
| Mississippi | 500 feet of upstream only |
| Missouri | 132 feet |
| Utah | 138 feet, more if intersection is large |
| Vermont | Determined by stopping sight distance, i.e., 275 feet for 40 mph |
| Virgin Islands | 100 feet |
| | |
| Note: ^a Crash reports show that police officers usually measure from stop bar and not center of intersection | |
| ^b Not stated in report if distance is from the center or edge | |

INTERSECTION SAFETY FEATURE INVENTORY – CIVIL SURVEY

Required Field Equipment

- Compass
- GPS device
- Traffic safety vest for each team member
- Survey-crew-ahead signs
- Two traffic cones
- Metered wheel
- 25 feet tape measure
- Laser distance meter (Bosch GLM 50)
- Laser target card
- Laser enhancement glasses

Safety precautions

Survey crew must wear a traffic safety vest at all times. The vest must be on before they set off from their base to the intersection site(s). The vest must be worn on top of all other clothing. No one must work at any of the intersection sites without a safety vest. The survey must be carried out by at least two surveyors; one can serve as a lookout to warn of impending hazard while the other does the main survey work. *Crew members should not enter the active travel lane at any time.* There is no required measurement that will require crew members to be in the active travel lane.

All state-specific safety guidelines should be followed including those outlined in the GDOT Automated Survey Manual. The GDOT Automated Survey Manual can be downloaded at the web address below.

<http://www.dot.ga.gov/doingbusiness/policiesmanuals/roads/surveymanual/surveymanual.pdf>

Supplemental safety guidelines can be obtained from the ‘Survey Safety Handbook’ of the Florida DOT and the ‘Caltrans Survey Manual’ of the California DOT. The links to these two documents are given below.

<http://www.dot.state.fl.us/surveyingandmapping/documentsandpubs/safety.pdf>

http://www.dot.ca.gov/hq/row/landsurveys/SurveysManual/02_Surveys.pdf

Data Collection Boundary

Data shall be collected within a boundary of 400 feet from the entry/exit point of each intersection leg. The stop lines should be used to delineate exit and entry points. See Figure 1. In situations where the 400 feet point from a survey intersection is closer to an adjacent intersection (less than 400 feet from the stop line of the adjacent intersections), the boundary on that leg should be set at the half-way mid-block point.

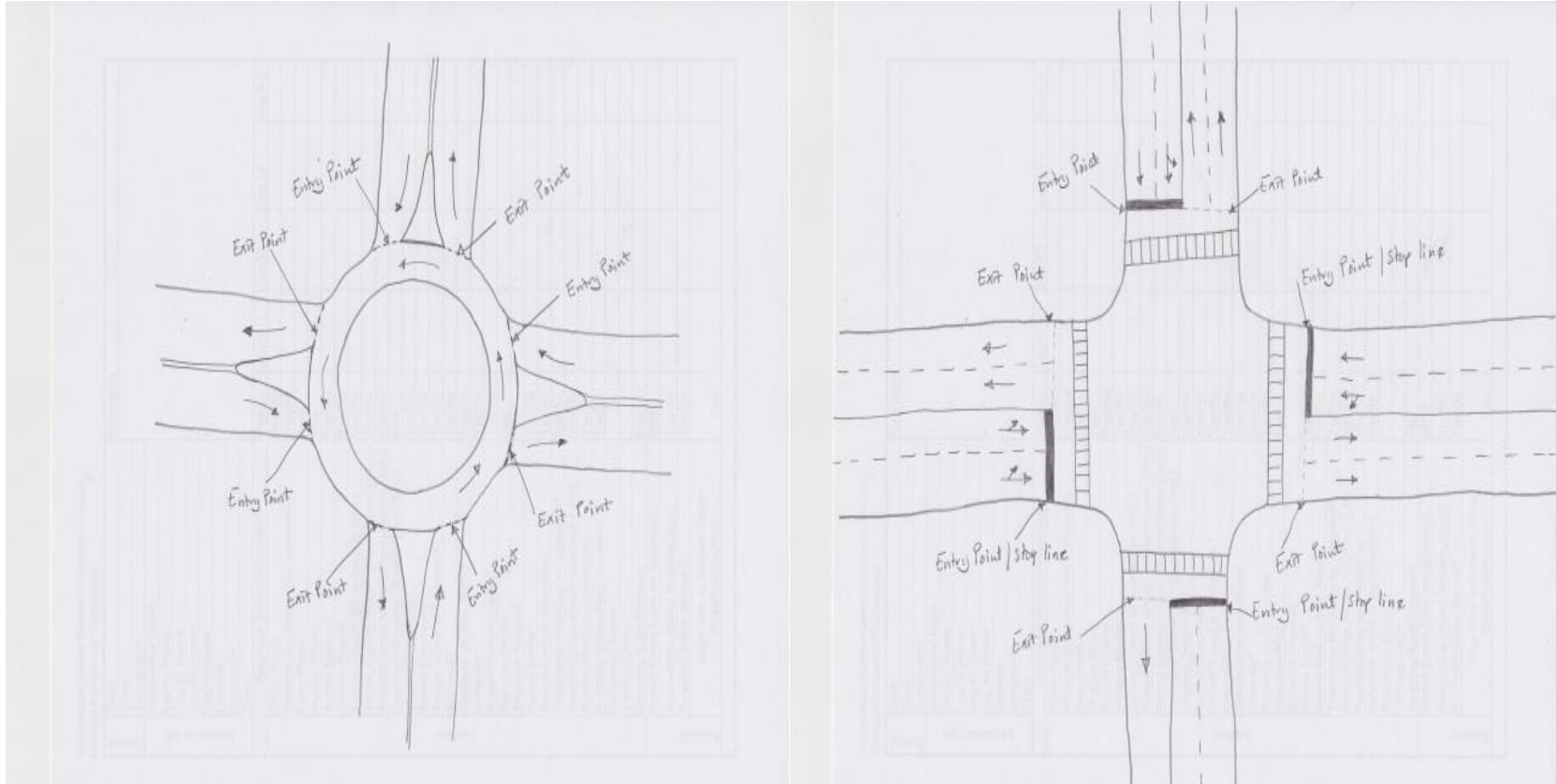

Figure 1 Location of Entry and Exit points at Roundabouts and Conventional Intersections

Geocoding of Intersections

The latitude and longitude of each intersection surveyed shall be recorded. The reference point shall be within 30 feet buffer around the intersection. The latitude and longitude values should be recorded as decimal degrees.

Measuring the Width of Travel Lanes

In order to avoid crew members entering the active travel lanes to measure the widths, the survey team has been furnished with a Bosh GLM 50 laser distance meter, a laser target card, and laser enhancement glasses to be worn during daytime to enhance the ability to see the red beam laser in sunlight. *Please measure the lane width on the intersection boundary on the leg (see the Data Collection Boundary session discuss prior)*

To measure the lane width on a two-way road

- Use the laser meter and the laser target card to measure the entire road width from one edge of the pavement to the other.
- One crew member should have the laser meter on one edge while another crew member holds the laser target card at the other end. **WARNING: In order to avoid eye damage, crew members holding the card should never look at the laser meter while he is holding the card.**
- Beam the laser across the travel lanes to hit the target. Note the width of the two-way road as displayed on the screen of the meter.
- Divide the measured distance by the number of lanes to obtain the width of each lane.

To measure lane width on a divided highway (with wide median island)

- Measure the edge-to-edge road width for only the in-coming approach lanes.
- One crew member should hold the laser meter on the edge of pavement closer to the shoulder while the target card is held at the edge of the pavement closer to the median with the crew member safely located on the median island.
- Beam the laser across the travel lanes to hit the target. Note the width of the two-way road as displayed on the screen of the meter.
- Divide the measured distance by the number of lanes to obtain the width of each lane.

WARNING: If the median island is not sufficiently wide or otherwise does not provide a safe refuge for the surveyor, the approach should be treated similar to a road with no median and the total width should be divided by the number of lanes across both oncoming and outgoing lanes.

Data Recording

1. First, complete a sketch of the intersection layout. Choose the appropriate basic layout form shown in Figure 2 or Figure 3 depending on the intersection type. The basic layouts provided are for 4-leg intersections. Corresponding sketch for three-leg intersections should be made by crossing out one of the intersection legs.
2. Include, in the layout, a sketch of any abutting properties within 40 meters of the stop lines.
WARNING: Surveyors should not trespass on any private property.
3. Indicate the true North direction with a North Arrow on the intersection layouts.
4. Assign intersection leg direction based on direction of vehicle traveling towards the intersection on the approach. For example, the Northbound (NB) approach is the one on which vehicles traveling towards the intersection are heading NB
5. Record the survey results on the Data Recording Form shown in Figure 4.
6. Record the presence of other possible lighting source(s) other than purposely built streetlights at the intersection. For example, a Gas Station, Shop, or House.
7. The completed data forms must be scanned (including the sketch of the intersection layout) and emailed to the analysis team at Georgia Tech within 24 hours of any field survey.
8. Copies of the data must also be stored on the supplied 4TB external hard drive and returned to the Georgia Tech team after all data collection activities have been completed.
9. The intersection identification number can be obtained from list of survey intersections.

Please see Appendix 1 for a sample intersection with completed data recording forms

Please see Appendix 2 for images of typical roadway elements required on the survey form.

Please see Appendix 3 for labeled diagrams of typical conventional intersection and roundabout layout

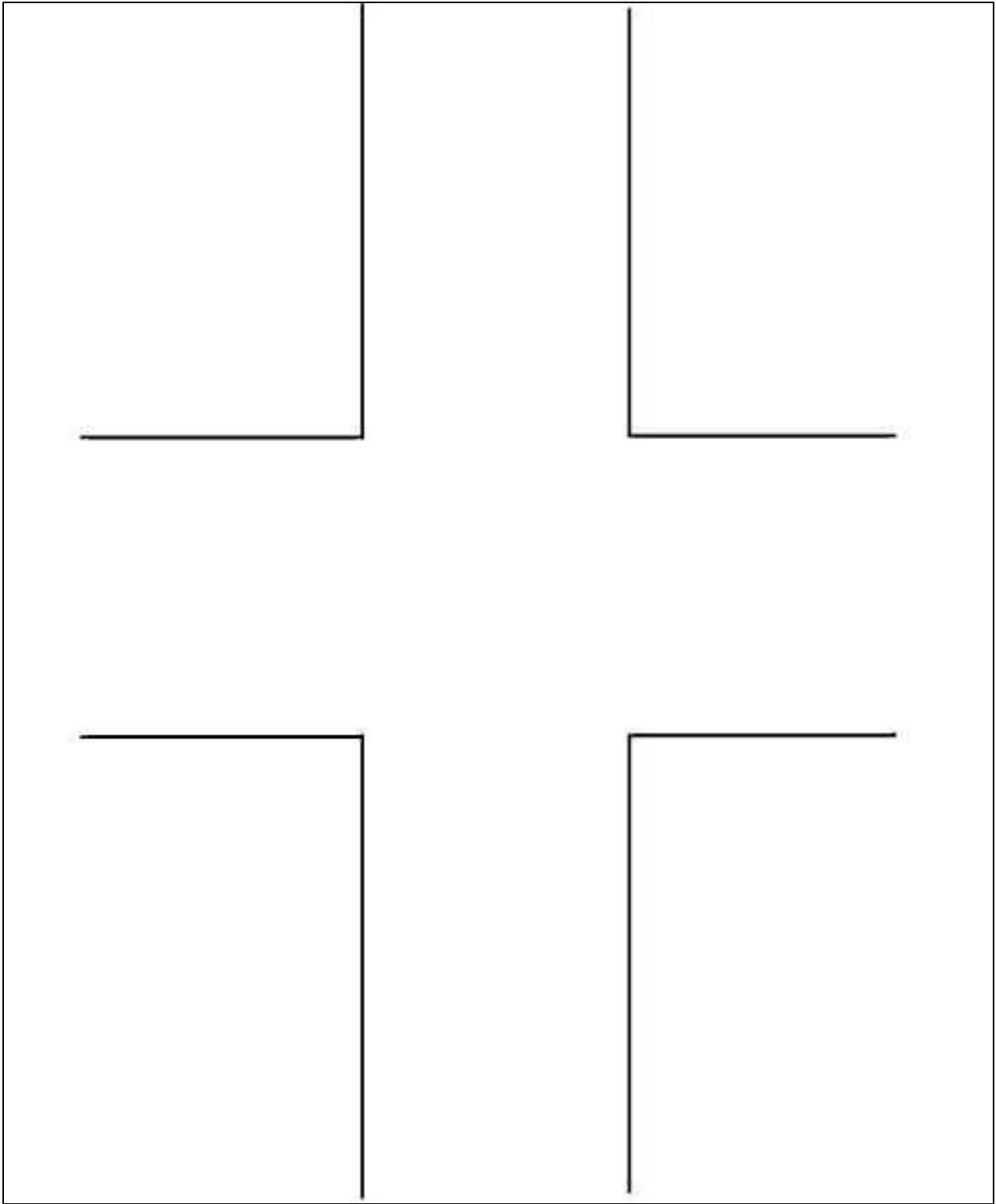

Figure 2 Basic Layout of a Conventional Intersection

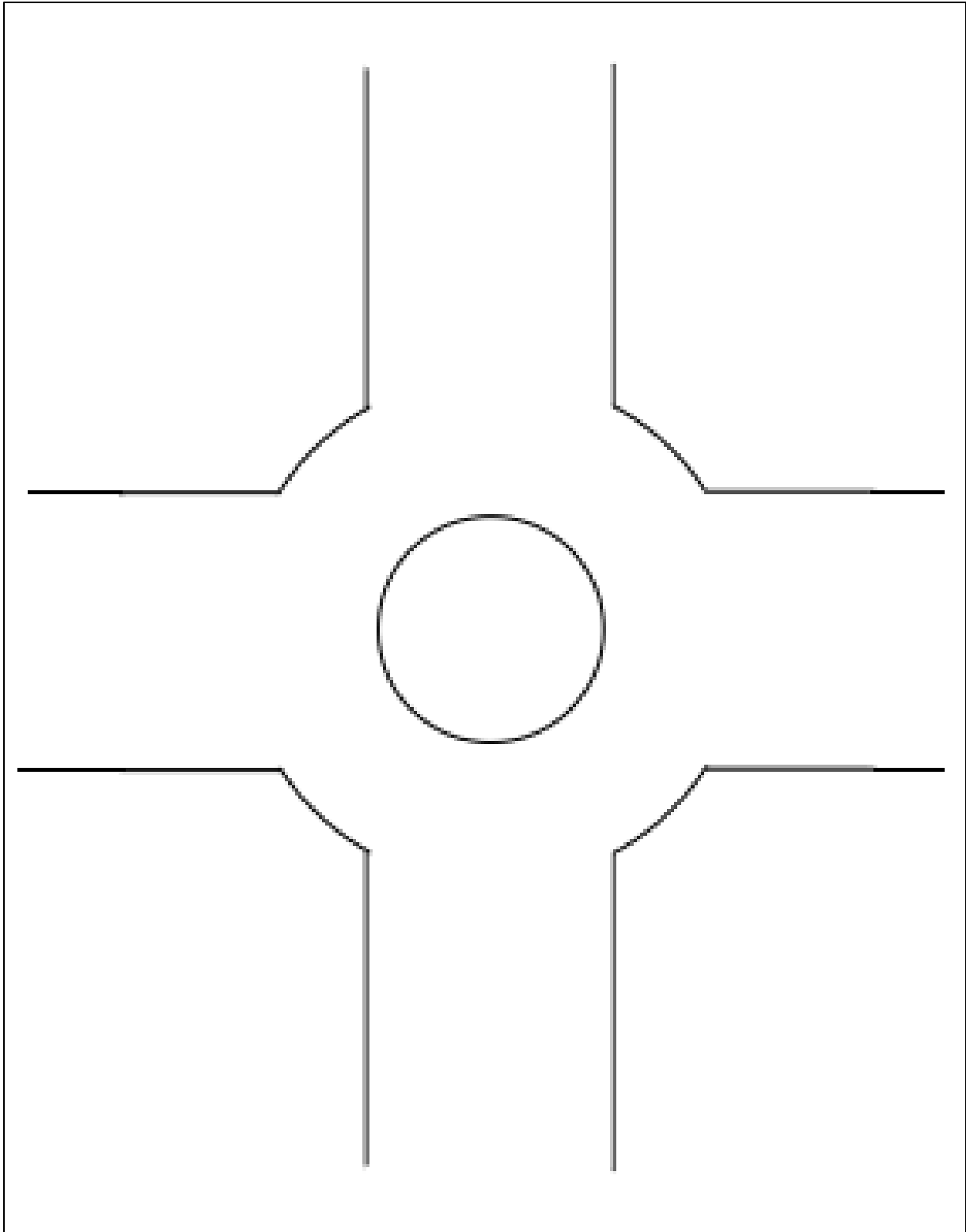
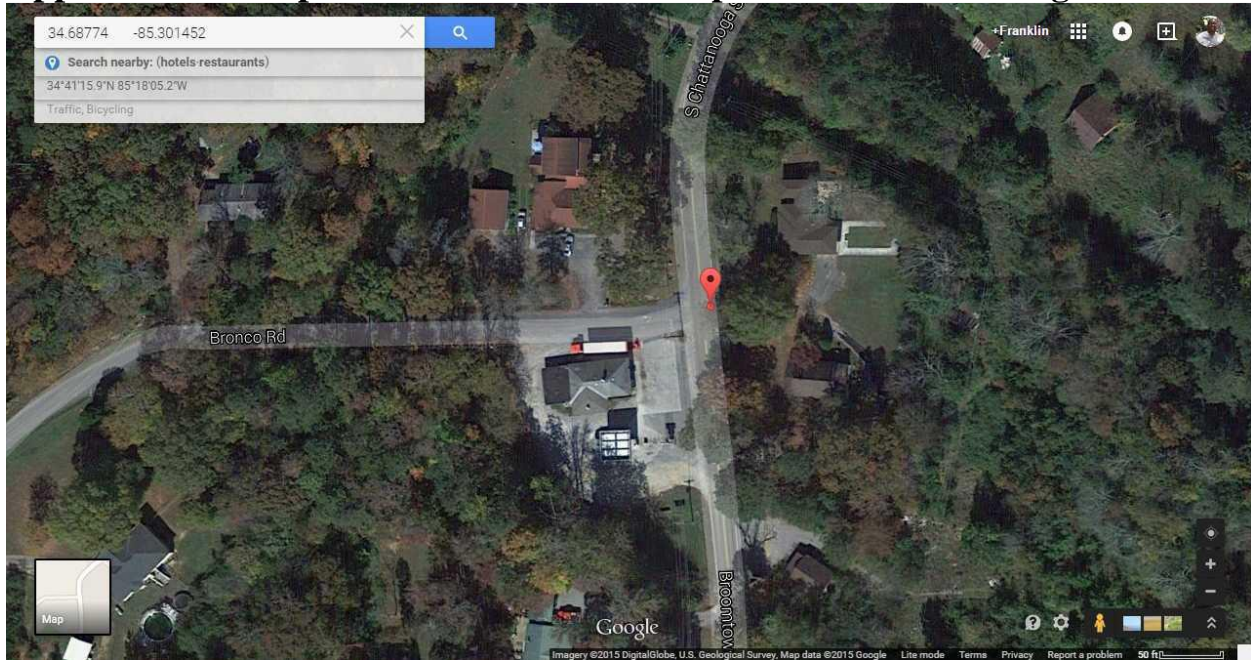

Figure 3 Basic Layout of a Roundabout

| | | | | | | | | |
|--|---|---------------------------------------|---|---|--------------------------|--------------------------|--------------------------|--------------------------|
| General | Date: | | | Comments | | | | |
| | Time: | | | 1. Check mark for YES, X for No | | | | |
| | Surveyor(s): | | | | | | | |
| Intersection Info | Intersection ID: | | | | | | | |
| | Name-Leg 1: | | | | | | | |
| | Name-Leg 2: | | | | | | | |
| | Name-Leg 3: | | | | | | | |
| | Name-Leg 4: | | | | | | | |
| | Latitude: | | | | | | | |
| | Longitude: | | | | | | | |
| Type: | <input type="checkbox"/> 3-Leg Rndabt | <input type="checkbox"/> 4-Leg Rndabt | <input type="checkbox"/> 3-Leg Conv. Int. | <input type="checkbox"/> 4-Leg Conv. Int. | | | | |
| Approach Street Information | | | Ref Picture | Leg 1 | Leg 2 | Leg 3 | Leg 4 | |
| Roundabout | Splitter Island | | 3 | Check | <input type="checkbox"/> | <input type="checkbox"/> | <input type="checkbox"/> | <input type="checkbox"/> |
| | Raised Splitter Island | | 3 | Check | <input type="checkbox"/> | <input type="checkbox"/> | <input type="checkbox"/> | <input type="checkbox"/> |
| | Raised Central Island | | 4 | Check | <input type="checkbox"/> | <input type="checkbox"/> | <input type="checkbox"/> | <input type="checkbox"/> |
| | Inscribed Diameter | | | Feet | <input type="checkbox"/> | <input type="checkbox"/> | <input type="checkbox"/> | <input type="checkbox"/> |
| Conventional Intersection | # Thru Lanes at stop line | | | # | | | | |
| | # Left-turn Lanes at stop line | | | # | | | | |
| | # Thru Lanes @ 400 ft Upstream | | | # | | | | |
| | # Left-turn Lanes @ 400 ft Upstream | | | # | | | | |
| | Lane Width | | | Feet | | | | |
| | Posted Speed Limit on Approach | | 9 | MPH | | | | |
| | Intersection Ahead Warning Sign Dist. From Edge to Nearest Threat (Pole/Post/Barrier) | | 9 | Check | <input type="checkbox"/> | <input type="checkbox"/> | <input type="checkbox"/> | <input type="checkbox"/> |
| Presence of Horizontal Curve within 400 ft | | | Check | <input type="checkbox"/> | <input type="checkbox"/> | <input type="checkbox"/> | <input type="checkbox"/> | |
| Shoulder Width (Average if present on both sides) | | | Feet | | | | | |
| Safety Improvements? | Median Width | | | Feet | | | | |
| | Raised Median | | 1 | Check | <input type="checkbox"/> | <input type="checkbox"/> | <input type="checkbox"/> | <input type="checkbox"/> |
| | Median Barrier | | 2 | Check | <input type="checkbox"/> | <input type="checkbox"/> | <input type="checkbox"/> | <input type="checkbox"/> |
| | Transverse Markings on Approach | | 7 | Check | <input type="checkbox"/> | <input type="checkbox"/> | <input type="checkbox"/> | <input type="checkbox"/> |
| | Rumble Strips across Approach Lane | | 8 | Check | <input type="checkbox"/> | <input type="checkbox"/> | <input type="checkbox"/> | <input type="checkbox"/> |
| | Rumble Strips on Median Line | | 8 | Check | <input type="checkbox"/> | <input type="checkbox"/> | <input type="checkbox"/> | <input type="checkbox"/> |
| | Rumble Strips along Shoulder | | 8 | Check | <input type="checkbox"/> | <input type="checkbox"/> | <input type="checkbox"/> | <input type="checkbox"/> |
| Roadside Safety Barrier | | 10 | Check | <input type="checkbox"/> | <input type="checkbox"/> | <input type="checkbox"/> | <input type="checkbox"/> | |
| Pedestrian Safety | Marked Crosswalk | | 5 | Check | <input type="checkbox"/> | <input type="checkbox"/> | <input type="checkbox"/> | <input type="checkbox"/> |
| | Raised Crosswalk | | 5 | Check | <input type="checkbox"/> | <input type="checkbox"/> | <input type="checkbox"/> | <input type="checkbox"/> |
| | Refuge Island at Crosswalk | | 6 | Check | <input type="checkbox"/> | <input type="checkbox"/> | <input type="checkbox"/> | <input type="checkbox"/> |
| | Sidewalk Width (Average if present on both sides) | | | Feet | | | | |
| 1. Data Collection Boundary Extends 400ft from Intersection Entry/Exit Point | | | | | | | | |
| 2. Data is Required in All Shaded Cells | | | | | | | | |

Figure 4 Data Reporting Form

Appendix 1 – Sample Intersection with Completed Data Recording Form



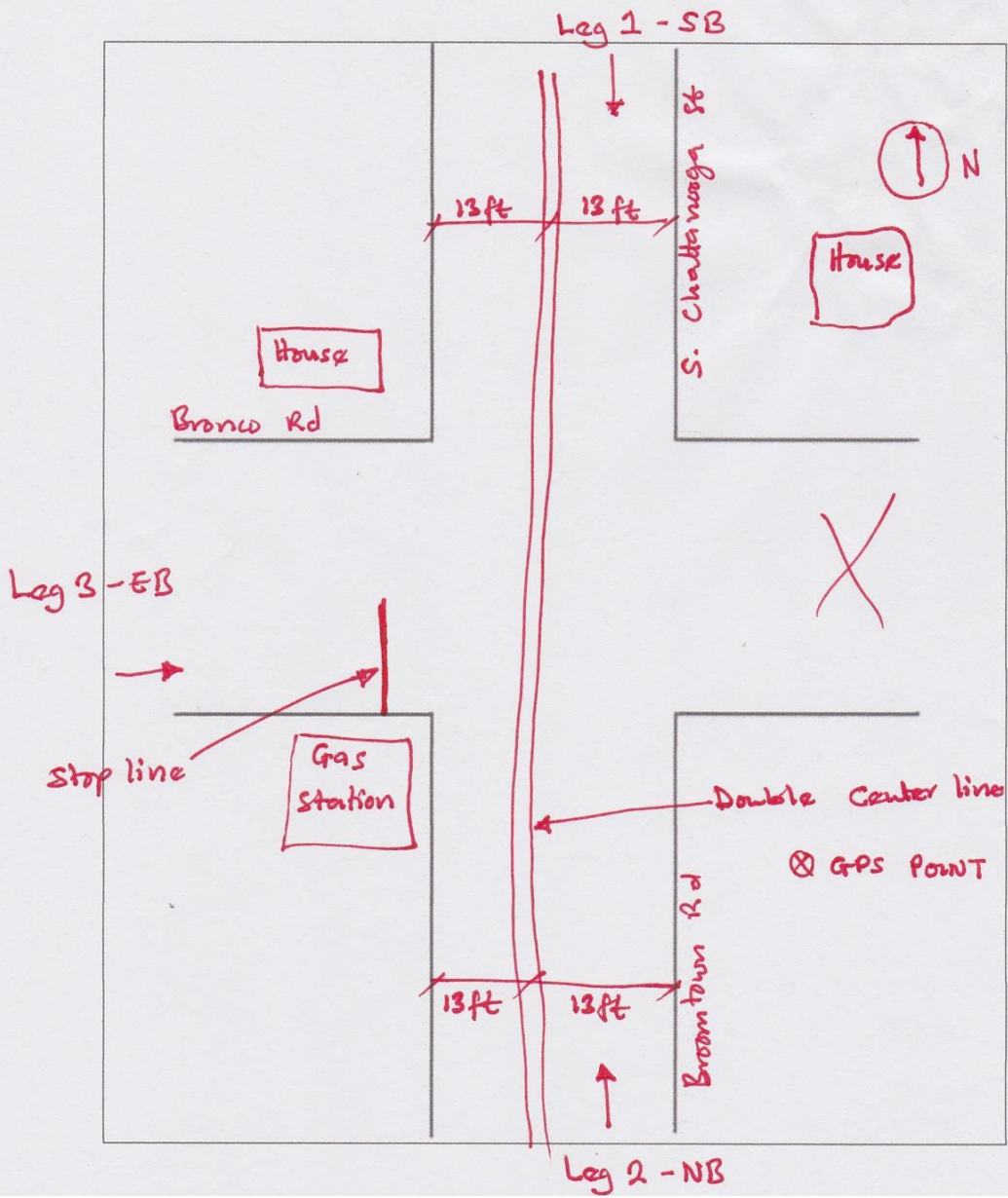

| | | | | | | | |
|--|--|-------------------|---|-------------------------------------|-------------------------------------|-------------------------------------|--------------------------|
| General | Date: | 2/22/2015 | Comments | | | | |
| | Time: | 14:30 ET | 1. Check mark for YES, X for No | | | | |
| Intersection Info | Surveyor(s): | Franklin, James | - Gas station at corner of Bronco & Broomtown - speed signs & mail boxes very close to edge. | | | | |
| | Intersection ID: | 22 | | | | | |
| | Name-Leg 1: | S. Chittanooga St | | | | | |
| | Name-Leg 2: | Broomtown Rd | | | | | |
| | Name-Leg 3: | Bronco Rd | | | | | |
| | Name-Leg 4: | NA | | | | | |
| | Latitude: | 34.68744 | | | | | |
| Longitude: | -85.301452 | | | | | | |
| Type: | <input type="checkbox"/> 3-Leg Rndabt <input type="checkbox"/> 4-Leg Rndabt <input checked="" type="checkbox"/> 3-Leg Conv. Int. <input type="checkbox"/> 4-Leg Conv. Int. | | | | | | |
| Approach Street Information | | Ref. Picture | Leg 1 | Leg 2 | Leg 3 | Leg 4 | |
| Roundabout | Splitter Island | 3 | Check | <input checked="" type="checkbox"/> | <input checked="" type="checkbox"/> | <input checked="" type="checkbox"/> | <input type="checkbox"/> |
| | Raised Splitter Island | 3 | Check | <input checked="" type="checkbox"/> | <input checked="" type="checkbox"/> | <input checked="" type="checkbox"/> | <input type="checkbox"/> |
| | Raised Central Island | 4 | Check | <input checked="" type="checkbox"/> | <input checked="" type="checkbox"/> | <input checked="" type="checkbox"/> | <input type="checkbox"/> |
| | Inscribed Diameter | Feet | | <input checked="" type="checkbox"/> | <input checked="" type="checkbox"/> | <input checked="" type="checkbox"/> | <input type="checkbox"/> |
| Conventional Intersection | # Thru Lanes at stop line | # | | 1 | 1 | 0 | |
| | # Left-turn Lanes at stop line | # | | 0 | 0 | 1 | |
| | # Thru Lanes @ 400 ft Upstream | # | | 1 | 1 | 1 | |
| | # Left-turn Lanes @ 400 ft Upstream | # | | 0 | 0 | 0 | |
| | Lane Width | Feet | | 13 | 13 | 13 | |
| | Posted Speed Limit on Approach | 9 | MPH | | 25 | 25 | 35 |
| | Intersection Ahead Warning Sign | 9 | Check | <input checked="" type="checkbox"/> | <input checked="" type="checkbox"/> | <input checked="" type="checkbox"/> | <input type="checkbox"/> |
| Dist. From Edge to Nearest Threat (Pole/Post/Barrier) | Feet | | 3 | 3 | 3 | | |
| Presence of Horizontal Curve within 400 ft | Check | | <input checked="" type="checkbox"/> | <input checked="" type="checkbox"/> | <input checked="" type="checkbox"/> | <input type="checkbox"/> | |
| Shoulder Width (Average if present on both sides) | Feet | | 0 | 0 | 0 | | |
| Safety Improvements? | Median Width | Feet | | 0 | 0 | 0 | |
| | Raised Median | 1 | Check | <input checked="" type="checkbox"/> | <input checked="" type="checkbox"/> | <input checked="" type="checkbox"/> | <input type="checkbox"/> |
| | Median Barrier | 2 | Check | <input checked="" type="checkbox"/> | <input checked="" type="checkbox"/> | <input checked="" type="checkbox"/> | <input type="checkbox"/> |
| | Transverse Markings on Approach | 7 | Check | <input checked="" type="checkbox"/> | <input checked="" type="checkbox"/> | <input checked="" type="checkbox"/> | <input type="checkbox"/> |
| | Rumble Strips across Approach Lane | 8 | Check | <input checked="" type="checkbox"/> | <input checked="" type="checkbox"/> | <input checked="" type="checkbox"/> | <input type="checkbox"/> |
| | Rumble Strips on Median Line | 8 | Check | <input checked="" type="checkbox"/> | <input checked="" type="checkbox"/> | <input checked="" type="checkbox"/> | <input type="checkbox"/> |
| Pedestrian Safety | Rumble Strips along Shoulder | 8 | Check | <input checked="" type="checkbox"/> | <input checked="" type="checkbox"/> | <input checked="" type="checkbox"/> | <input type="checkbox"/> |
| | Roadside Safety Barrier | Check | | <input checked="" type="checkbox"/> | <input checked="" type="checkbox"/> | <input checked="" type="checkbox"/> | <input type="checkbox"/> |
| | Marked Crosswalk | 5 | Check | <input checked="" type="checkbox"/> | <input checked="" type="checkbox"/> | <input checked="" type="checkbox"/> | <input type="checkbox"/> |
| | Raised Crosswalk | 5 | Check | <input checked="" type="checkbox"/> | <input checked="" type="checkbox"/> | <input checked="" type="checkbox"/> | <input type="checkbox"/> |
| Refuge Island at Crosswalk | 6 | Check | <input checked="" type="checkbox"/> | <input checked="" type="checkbox"/> | <input checked="" type="checkbox"/> | <input type="checkbox"/> | |
| Sidewalk Width (Average if present on both sides) | Feet | | 0 | 0 | 0 | | |
| 1. Data Collection Boundary Extends 400ft from Intersection Entry/Exit Point | | | | | | | |
| 2. Data is Required in All Shaded Cells | | | | | | | |

Appendix 2 – Images of Typical Roadway Elements

1. An Example of a Raised Median



Michael Ronkin, *Designing Streets for Pedestrians and Bicyclists*

2. Examples of Median Barrier



3. Examples of Splitter Island (Left: Raised Splitter Island, Right: Raised Splitter Island with a Depressed Crosswalk)



4. Examples of Central Island (Left: Raised Central Island, Right: Flat or Unraised Central Island)



5. Examples of Crosswalk (Left: Marked, Center: Unmarked, Right: Raised)



6. Examples of Refuge Island (A Place where Pedestrians can rest within the median)



7. Examples of Transverse Lane Marking



8. Examples of Rumble Strips (Left: Centerline Rumble Strips, Middle: Lane Rumble Strips, Right: Shoulder Rumble Strips)



9. Examples of Junction Ahead Signs (Left: 3-way Junction Ahead, Middle: 4-way Junction Ahead, Right: Roundabout Ahead)



Appendix 3 - Labeled Diagrams of Typical Conventional Intersection and Roundabout Layout

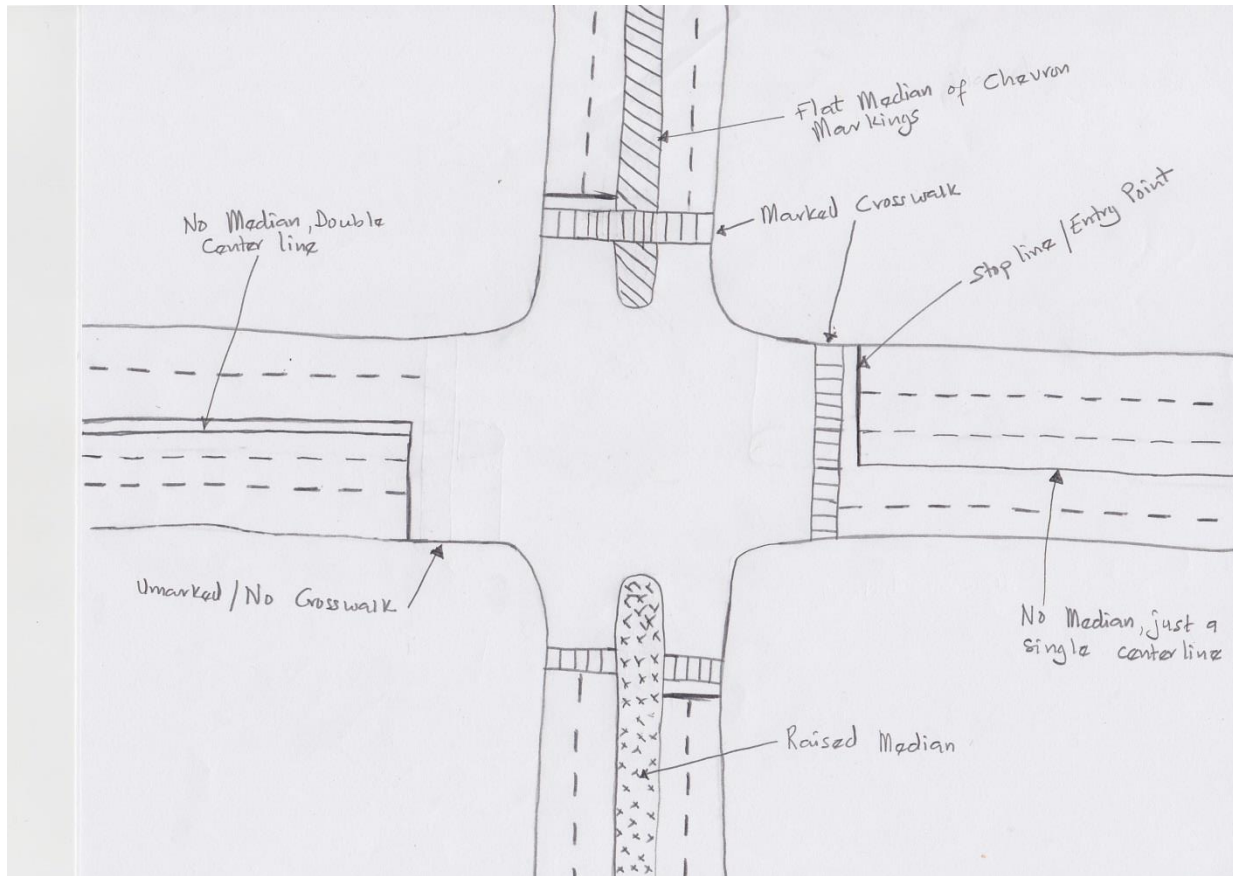

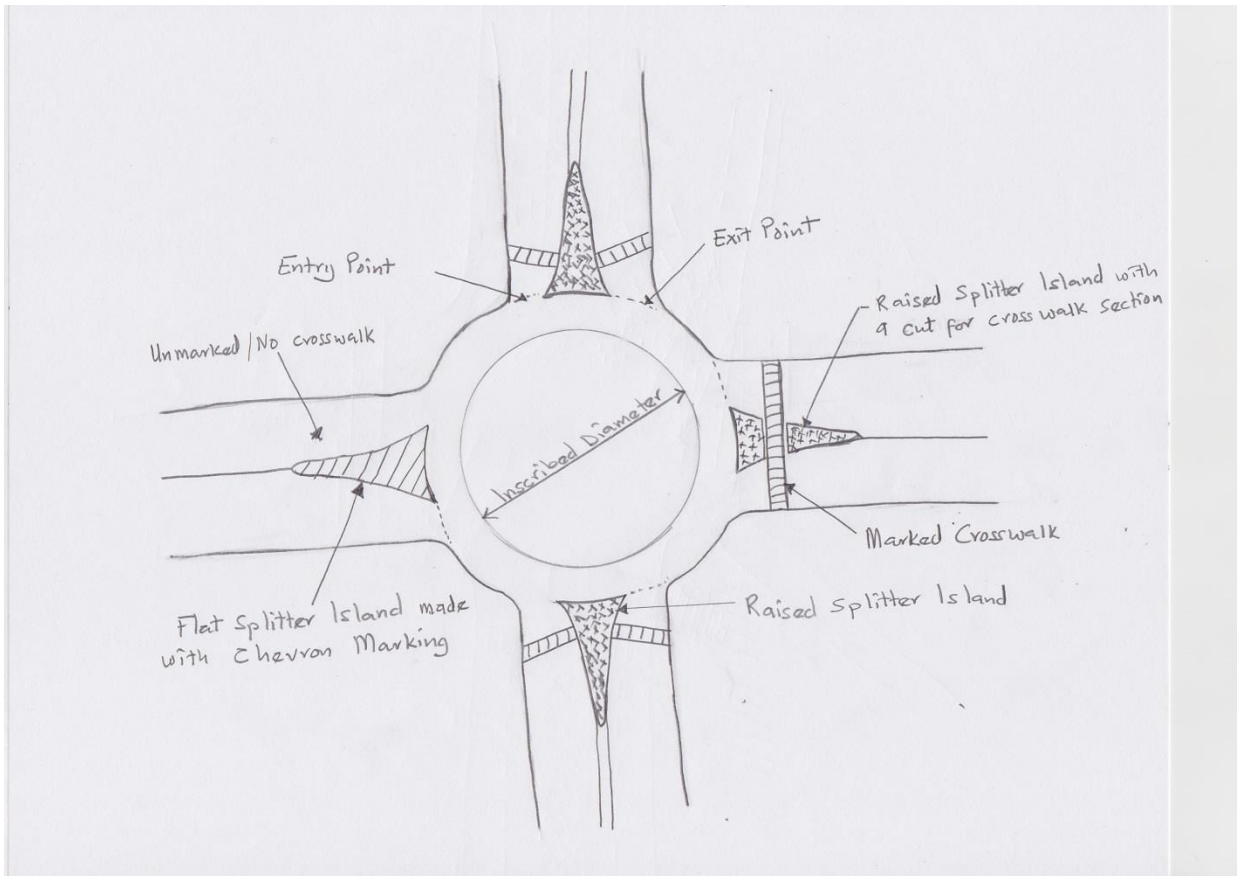

REFERENCES

1. Abdel-Aty, M., X. Wang, and J. Santos, Identifying Intersection-Related Traffic Crashes for Accurate Safety Representation. In Institute of Transportation Engineers. ITE Journal, No. 79(12), 2009, pp. 38-44.
2. North Carolina Department of Transportation. North Carolina Crash Report Instruction Manual. 1999.
3. Lyon, C., A. Haq, B. Persaud, and S. Kodama, Safety Performance Functions for Signalized Intersections in Large Urban Areas: Development and Applications to Evaluation Left-Turn Priority Treatment. In Transportation Research Record: Journal of the Transportation Research Board, No. 1908, 2005.
4. Persaud, B., F. Council, C. Lyon, K. Eccles, and M. Griffith, Multijurisdictional Safety Evaluation of Red Light Cameras. In Transportation Research Record: Journal of the Transportation Research Board, No. 1922, 2005.
5. Hardwood, D., K. Bauer, I. Potts, D. Torbic, K. Richard, E. Rabbani, E. Hauer, L. Elefteriadou, and M. Griffith, Safety Effectiveness of Intersection Left and Right Turn Lanes. In Transportation Research Record: Journal of the Transportation Research Board, No. 1840, 2003.
6. Mitra, S., S. Washington, and I. Van Schalkwyk. Important Omitted Spatial Variables in Safety Models: Understanding Contributing Crash Causes at Intersections. TRB 86th Annual Meeting Compendium of Papers. 2007. Washington, DC.
7. Donnell, E.T., R.J. Porter, and V.N. Shankar, A Framework for Estimating the Safety Effects of Roadway Lighting at Intersections. In SAFETY SCIENCE, No. 48(10), 2010, pp. 1436-1444.
8. Cottrell, D. and S. Mu. Utah Intersection Safety: Recurrent Crash Sites: Identification, Issues and Factors. 2005. University of Utah, Mountain Plains Consortium
9. Joksch, H. and L. Kostyniuk. Modeling Intersection Crash Counts and Traffic Volume. FHWA-RD-98-096, 1998. Washington, DC

**APPENDIX F. PHOTOGRAPHIC AUDIT OF STREET LIGHTING AT
SELECTED RURAL INTERSECTIONS IN GEORGIA – FIELD DEPLOYMENT
DOCUMENT**

**Photographic Audit of Street Lighting at
Selected Rural Intersections in Georgia**

Field Deployment Document



Georgia Tech College of Engineering

**School of Civil and
Environmental Engineering**

1. BACKGROUND

Street lighting is a proven nighttime crash countermeasure which serves to augment nighttime visibility for road users. The established protocol for auditing the adequacy of street lighting at intersections involves very tedious spot measurements of incident light levels (illuminance) from points on an imaginary grid of 6ft by 6ft over the intersection area. This protocol makes it difficult to:

- Perform audits efficiently.
- Reproduce/verify previous measurements.
- Obtain consistent luminance readings during measurements due to changes in luminance caused by voltage fluctuations in the AC systems that power street lights.

The photographic auditing method offers an alternative auditing approach and a remedy for the prior-mentioned challenges of gridded spot measurements. It uses image analysis techniques to link pixel intensity in an image to scene luminance (pavement brightness perceived by road users).

A team of researchers at Georgia Tech have successfully calibrated a digital single lens reflex (SLR) camera for photographic auditing of rural intersections in Georgia.

2. EQUIPMENT REQUIRED FOR FIELD SURVEYS

- Cannon EOS Rebel T3 SLR digital camera
- Two fully charged batteries for digital camera
- Two 4GB SD cards for storing images of intersections and scanned copies of filled data recording forms.
- An Extech-HD450 illuminance meter
- One extra 9V battery for illuminance meter
- Traffic safety vests for all team members
- Two traffic cones
- 165 feet or 50 meters long measuring tape.
- Metered wheel
- Compass
- GPS device
- Flashlight
- Intersection Identification Cards
- An external time device such as a digital wristwatch or a mobile phone device.
- A Tripod with capability to mount a camera. *The tripod should be tall enough to allow the top surface of the tripod to be 1.24 m (49 in) above the ground (measured at the center of the three legs) when tripod is fully set up.*

3. HOW TO SETUP THE TRIPOD

1. Tripod height must always be *set such that the top surface of the tripod is at 1.24 m (49 in) above the ground (measured at the center of the three legs) when tripod is fully set up.*



2. The mounting piece on the tripod must be balanced horizontally so that the digital camera will also be balanced in the horizontal plane when it is mounted.

4. SETTING UP THE CAMERA

Inserting/Removing Batteries and SD Card

To insert the battery and/or SD card please follow the steps below.

1. Slide the lever as shown by the arrows and open the cover. Be careful not to push the cover further back otherwise the hinge might break.

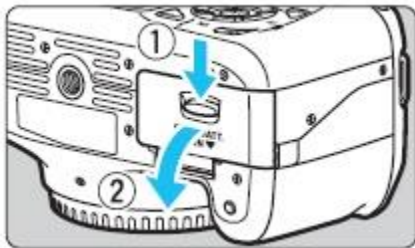

2. Insert the battery end with the contacts. Push gently until the battery locks in place.

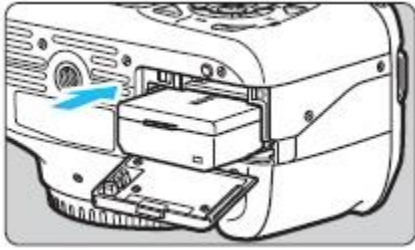

3. Insert the SD card with the labeled face toward the back of the camera. Push it gently all the way.

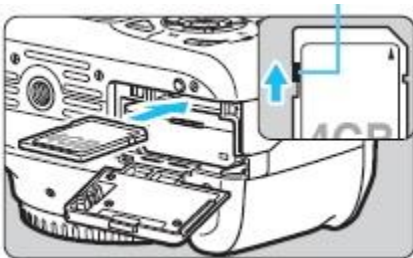

4. Close the cover by pressing it until it snaps shut.



To remove the battery/card make sure the power switch is in the <OFF> position then open the cover. If “Recording ...” is displayed on the LCD screen, close the cover.

5. Press the battery release lever as shown by the arrow and remove the battery.



6. Gently push in the card and let go. The card will stick out then pull the card.

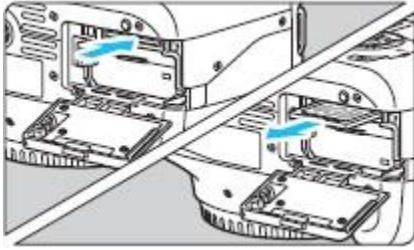

7. Close the cover until it snaps shut.

Turning the Camera On and Off



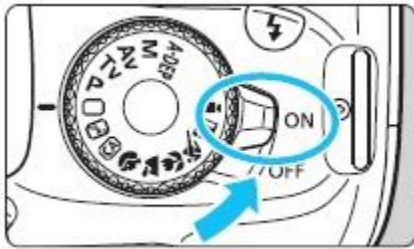

Turn the power switch to the <ON> position as shown in the image below. To save battery power, the camera turns off automatically after about 30 seconds of non-operation. To turn on the camera again, just press the shutter button halfway

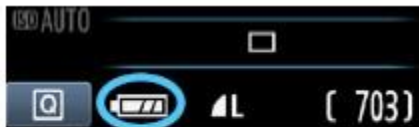

Checking the Battery Level

When the power switch is set to <ON>, the battery level will be indicated in one of four levels on the LCD screen:



-  : Battery level is OK.
-  : Battery level is less than half full.
-  : Battery will be exhausted soon. (Blinks)
-  : Battery must be recharged.

Date and Time

The date and time on the camera are preset. No further adjustment is necessary. In case a new setting is needed please consult the Camera Instructions Manual.

5. SETTING THE IMAGE SHOOTING FUNCTIONS

There are several shooting functions which must all be set before field measurements of street luminance.

Shooting Mode

Set the mode dial to <M> as shown in the picture on the right. This is the manual shooting mode



Accessing the Quick Control Screen

1. Turn the power switch to the <ON> position or if in live shooting mode (LCD screen view) tap the camera icon above the <Q> button to escape out of the live shooting mode.
2. Press the <Q> button for the quick control screen to appear



3. Press the cross keys (Up, Down, Right, Left) to select the function to be set. Then turn the main dial over the shutter button to change the setting. Figure 1 presents a labeled diagram of the quick control screen under the manual shooting mode.

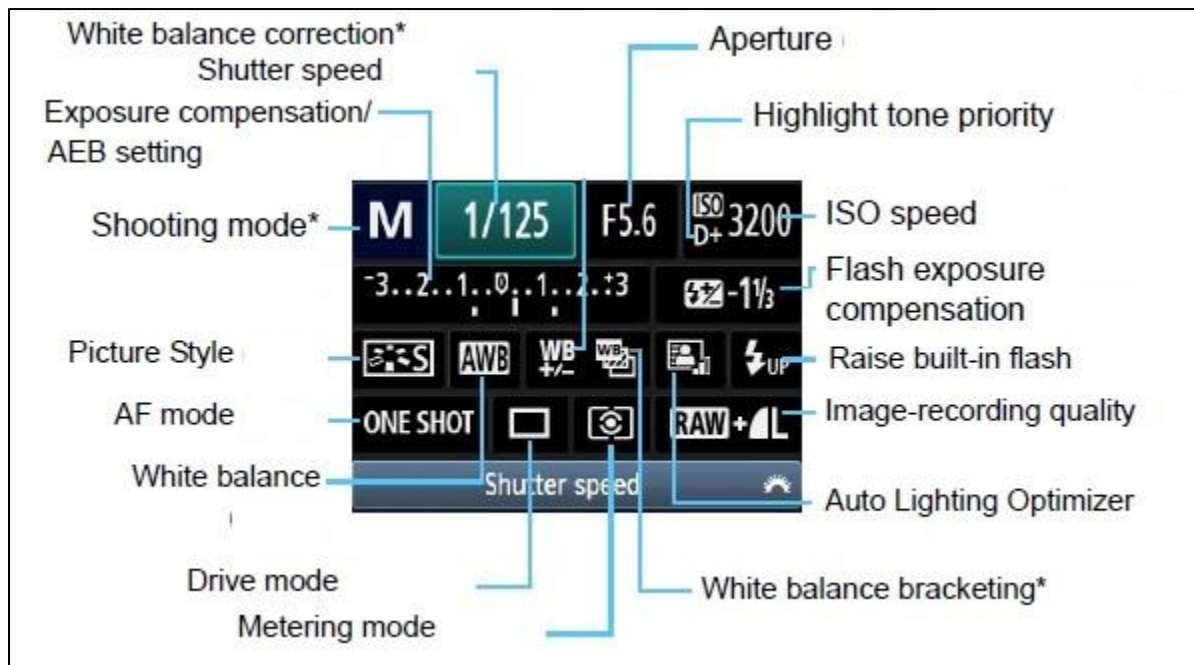

Figure 1 Quick Control Screen. Items with * can't be controlled from this screen.

Correct Settings for the Image Shooting Functions

The correct settings for the functions available on the quick access screen are as given below.

1. **Shooting Mode:** <M> (*Manual*)
2. **Shutter Speed:** This setting will vary based on the exposure level setting. Note: Exposure level setting is discussed in a later section.

3. Aperture: *two aperture settings* will be used in the field; <F5.0> and <F4.0>
4. ISO: the *ISO setting* should be maintained at <3200> *always*.
5. *Exposure Compensation/AEB Setting*: this should be *set to OFF*, i.e., no indicators on the scale
6. *Flash Exposure Compensation*: should be *maintained at Zero (± 0) always*
7. *Picture Style*: this setting should be kept at <Monochrome 0, 0, N, N> *always*. It is important that the monochrome settings always read 0, 0, N, N.
8. *White Balance*: this should be *set to <AWB> always*. This is the auto white balance setting.
9. *Auto Lighting Optimizer*: this should be *set to <OFF> always*.
10. Raise Built-in Flash: The built-in flashlight should never be raised during shooting.
11. *AF Mode*: This should be *set to <ONE SHOT> always*
12. *Self-timer*: This should be *set to 2 seconds*.
13. *Metering Mode*: This should always be *set to <Evaluative metering> always*.
14. *Image Recording Quality*: This should be *set to <RAW> always*.



Figure 2 Quick control screen showing correctly set shooting functions

6.0 SHOOTING IMAGES IN THE FIELD

Please follow the following steps to shoot images in the field. Please note that all field images shall be taken based on a predetermined combination of aperture and exposure level explained in this section.

Field Precautions

1. An intersection survey must be carried out by *at least two people*.
2. Survey crew must wear a *traffic safety vests* at all times. The vest must be on before they set off from their base to the intersection site(s). The vest must be worn on top of all other clothing. No one must work at any of the intersection sites without a safety vest.
3. *The survey crew must keep off the active travel lanes at all times.*

4. One team member must always serve as a lookout to inform other members of impending hazard. The lookout can also be the one that takes the illuminance readings (discussed later). ***The job of the lookout is not to control traffic.***
5. Survey vehicles must be parked off the road at any available free parking spot close to the intersection such as a gas station or store front. Turn off all lights including headlights and emergency lights if the free parking spot is within 60 meters of intersection.
6. If it is necessary to park the vehicle on the road shoulder, then it should be parked ***at least 60 meters*** away from the intersection to avoid being in the camera's view. ***The emergency/hazard lights must be turned on.***
7. ***All the headlights (high beam and low beam) of the crew's vehicle must be turned off.***
8. Use the ***two traffic cones*** to provide additional visibility of surveyors by placing them behind the tripod in the direction of on-coming vehicles at intervals of 50 ft.
9. ***No surveys will be carried out on wet pavement.*** Allow sufficient time for pavements to be fully dry after rains before performing any surveys. Any water on the pavement surface will affect the photographic luminance readings.
10. Also, pictures must only be taken when there are ***no approaching vehicles/headlights*** towards the intersections from any of the legs.

All state-specific safety guidelines should be followed including those outlined in the GDOT Automated Survey Manual. The GDOT Automated Survey Manual can be downloaded at the web address below.

<http://www.dot.ga.gov/doingbusiness/policiesmanuals/roads/surveymanual/surveymanual.pdf>

Supplemental safety guidelines can be obtained from the 'Survey Safety Handbook' of the Florida DOT and the 'Caltrans Survey Manual' of the California DOT. The links to these two documents are given below.

<http://www.dot.state.fl.us/surveyingandmapping/documentsandpubs/safety.pdf>
http://www.dot.ca.gov/hq/row/landsurveys/SurveysManual/02_Surveys.pdf

Camera and Tripod Position

For each of the survey intersections, images will be captured from all of the intersection legs. Therefore, the steps below will be repeated for each intersection leg.

1. Starting from the stop line, measure a distance of 38 meters or 125 feet in the direction of incoming traffic (away from the intersection) along the road edge.
2. Make a mark on the road shoulder and set up the tripod over this position. Thus, the tripod shall be positioned at a distance of 38 meters or 125 feet from the stop line on the approach.
3. Where the stop line is not marked, the corner of the intersecting roads can be fairly assumed as the stop line. However, if the corner position is used as the start line on one leg of the intersection, then it must be used on all the other legs for consistency.
4. Setup the tripod over a level surface. Steep slopes on road shoulders must be avoided.

5. Mount the digital SLR camera on the tripod with the camera's view facing the intersection. The intersection must be centered in the view.
6. For each leg of the intersection, ***the mounted camera and tripod must not be moved or shifted until all the pictures for that leg have been taken.*** It is very important that the set of pictures from one leg covers the same shooting area for automated image analysis algorithm to work effectively. Ensure that the camera is firmly screwed onto the tripod to avoid shifts in the camera's view area during shooting.

Live View Shooting

Live view shooting should be used to take pictures in the field. Live view shooting allows you to shoot while viewing the image on the camera's LCD monitor.

1. Press the <Camera> button on the right side of the LCD screen to see the live view image on the LCD screen.



2. Press the <Shutter> button halfway to see where the AF points are focusing in the image. If necessary, adjust the camera's direction by using the appropriate adjusting screw on the tripod's headpiece.
3. Press the <Shutter> button completely. The picture will be taken in two seconds and the captured image will be displayed on the LCD screen until image review ends. Then the camera will return to Live View shooting automatically.
4. To exit live view shooting press the Camera Button again.

Choosing the Aperture

As mentioned prior, two aperture settings of F4.0 and F5.0 will be used to capture images in the field. To change or choose any of these aperture settings.

1. Escape from Live View Shooting Mode by pressing the <Camera> button
2. Press the <Q> button to access the quick control screen.
3. Use the cross keys to select the aperture function.
4. Turn the <Main Dial> above the shutter button to choose the desired aperture setting.

Sometimes, depending on the focus setting on the lens it will not be possible to choose a desired aperture setting. If that happens follow the steps below

5. Turn the focusing ring on the lens a little in either clockwise or anticlockwise direction. Then turn the <Main Dial> above the shutter button again. If you still can't choose the desired aperture turn the focusing ring again and repeat the process. If you are turning the focusing ring in the wrong direction you will realize when you turn the <Main Dial> above the shutter

that the available aperture settings are moving away from the desired. This shows that you should be turning the focusing ring in the opposite direction.

Choosing the Exposure Level

Images will be taken at three exposure levels which can be assessed from the exposure level indicator on the LCD screen. The exposure levels are +2.00, -2.00, and -3.00. For each intersection leg, images will be taken at these exposure levels for both F4.00 and F5.00 apertures. Thus, six images will be taken from each leg of the intersection. To choose the exposure level you must first choose the desired aperture from the quick control screen as described in the previous section. Next, follow the steps below.

1. Press the <Camera> button to go into Live Shooting Mode. The LCD screen will show the view of the intersection.
2. The *exposure level scale* will be displayed in the middle of the screen at bottom. It is a graduated number scale with a positive axis (1 to 3) to the right, zero (0) in the middle, and a negative axis (1 to 3) to the left.
3. Press the shutter button halfway and release it. The current exposure level will be indicated by a white bar below the scale. Turn the <Main Dial> above the shutter button to move the indicator bar to the desired exposure level. If the indicator bar display turns off, you can bring it back by pressing the shutter button halfway.
4. ***Please note that the camera is set up to use 1/3-stops on the exposure level scale.*** This means that there are three scale points between the labeled exposure levels on the scale. For example, transition from 0 to -1 will require that three turns of the <Main Dial> corresponding to -1/3, -2/3, and -1.

Order of Shots

At every intersection the following order should be followed in taking the pictures. Step 1 to Step 3 will be done just once for each intersection.

1. Take a picture of the intersection's identification card. The card could be held up by one team member or could be placed on the sidewalk for the picture to be taken. The intersection identification card is a piece of square cut paper or card with the number corresponding to the ID written on it. See Table 1, Table 2, and Table 3 in Appendix D for the IDs and other details of the survey intersections.
2. Take a picture of the external time device (digital wristwatch or mobile phone) with the time displayed on it.
3. Take a picture of the crossroad names on the signpost if one is available. This will usually be at one corner of the intersection.

Step 4 to Step 7 would be repeated on each intersection leg after the camera and tripod have been correctly positioned and have been made ready to shoot.

4. Set the camera's aperture to F4.0
 - a. Adjust the shutter speed to set the exposure level indicator to +2.00 and take a picture of the intersection. Record the shutter speed for the current aperture and exposure level

- b. Adjust the shutter speed to set the exposure level indicator to -2.00 and take the picture of the intersection. Record the shutter speed for the current aperture and exposure level
 - c. Adjust the shutter speed to set the exposure level indicator to -3.00 and take the picture of the intersection. Record the shutter speed for the current aperture and exposure level
- 5. Set the camera's aperture to F5.0
 - a. Adjust the shutter speed to set the exposure level indicator to +2.00 and take a picture of the intersection. Record the shutter speed for the current aperture and exposure level
 - b. Adjust the shutter speed to set the exposure level indicator to -2.00 and take the picture of the intersection. Record the shutter speed for the current aperture and exposure level
 - c. Adjust the shutter speed to set the exposure level indicator to -3.00 and take the picture of the intersection. Record the shutter speed for the current aperture and exposure level
- 6. Move the tripod and camera to the next leg of the intersection and repeat Step 4 and Step 5 after the equipment is properly set up.
- 7. For each intersection surveyed check the observed lighting conditions in the appropriate column of the data recording form. Ambient lighting refers to lighting from surrounding properties (such as gas stations, stores, houses etc.) that give some level of brightness to the intersection. The options on the form are
 - a. Purpose-built lighting (NO) and Ambient lighting (NO)
 - b. Purpose-built lighting (NO) and Ambient lighting (YES)
 - c. Purpose-built lighting (YES) and Ambient lighting (YES)
 - d. Purpose-built lighting (YES) and Ambient lighting (NO)
 - e. Flashing amber (YES)
 - f. Flashing amber (NO)
 - g. Traffic Signal (YES)
 - h. Traffic Signal (NO)

7.0 HOW TO USE THE ILLUMINANCE METER

An EXTECH-HD450 illuminance meter will be used to record illuminance at a fixed location at each intersection. The chosen location should be such that the recorder does not block the incident light to the sensor. This could preferably be a corner of the intersection where the second recorder can also watch out for approaching vehicles at the same time. ***The Light sensor, cable, and the reader must be on the ground during measurement.*** Do not hold the sensor in your hands.

The illuminance meter has already been set up and no additional setup is required by the survey team. Please follow the steps below to properly operate the illuminance meter

1. The measurement units must always be set to Lux. Pressing the <UNITS> button will toggle the measurement units between Lux and FC (foot candles).
2. The illuminance range must always be set to '400 Lux'. There are four illuminance ranges and pressing the "RANGE APO" button will toggle the range between these. The other ranges are '4k Lux', '40k Lux', and '400k Lux'.



Figure. Picture of the illuminance meter. Left picture shows the screen with the correct illuminance range. Right picture shows the meter with the sensor cable stretched out.

Do not use the recording function. Attempting to manually trigger it can cast a shadow of the recorder over the light sensor.

3. The sensor's cable should be stretched out so that the recorder can read the displayed values from a distance without blocking incident light on the sensor.
4. Press the power for the meter to start reading the incident light value continuously.
5. Record one illuminance reading per intersection leg just before the intersection pictures are taken for the leg. Therefore, the number of recordings will be equal to the number of intersection legs.

8.0 FIELD DATA RECORDING FORM AND CHECK LISTS

The field data reporting form and a checklist for required equipment and field data are given below. The sketched intersection layout on the data recording form should be modified for a "T" or three leg intersection by crossing out the non-existent leg. Also, care should be taken when assigning the intersection leg directions. ***The directions are based on vehicle traveling into the intersection.*** Therefore, a Northbound (NB) designation should be given to the leg on which vehicles entering the intersection are traveling north rather than the leg on which vehicles exiting the intersection are traveling north. Also, the directions are general; a Northeast direction from the compass can be taken as Northbound.

1. The shaded cells on the form represent cells where data is required for correct analysis. Any form with an empty shaded cell cannot be considered as complete (use "NA" to fill cells if no data is available for the cell).
2. The list at the back of the form serves as a checklist for quality assurance purposes and must have a check mark placed at the end of each row to confirm completion.

| FIELD DATA RECORDING FORM | | | | Intersection Layout | | | |
|--|--------------------------|--------------------------|-------|--|-------|-------|-------|
| Intersection ID: | | | | | | | |
| No of Intersection Legs: | | | | | | | |
| Name of Cross Road 1: | | | | | | | |
| Name of Cross Road 2: | | | | | | | |
| Lighting Condition | Yes | No | | | | | |
| Ambient Lighting | <input type="checkbox"/> | <input type="checkbox"/> | | | | | |
| Purpose-built Lighting | <input type="checkbox"/> | <input type="checkbox"/> | | | | | |
| Traffic Signal | <input type="checkbox"/> | <input type="checkbox"/> | | | | | |
| Flashing Amber | <input type="checkbox"/> | <input type="checkbox"/> | | | | | |
| Check the correct Yes or No Column | | | | Cross-out the non-existent leg for T-junctions | | | |
| Shutter speed value should be written in full; e.g. 1/60 | | | | | | | |
| Approach direction is based on vehicle traveling into the intersection | | | | | | | |
| Approach Road Name: | | | | Illuminance (cd/m ²): | | | |
| Approach | | 1 - SB | | | | | |
| Aperture F4.0 | | | | Aperture F5.0 | | | |
| Exposure Level | +2.00 | -2.00 | -3.00 | Exposure Level | +2.00 | -2.00 | -3.00 |
| Shutter Speed | | | | Shutter Speed | | | |
| Approach Road Name: | | | | Illuminance (cd/m ²): | | | |
| Approach ID | | 2 - NB | | | | | |
| Aperture F4.0 | | | | Aperture F5.0 | | | |
| Exposure Level | +2.00 | -2.00 | -3.00 | Exposure Level | +2.00 | -2.00 | -3.00 |
| Shutter Speed | | | | Shutter Speed | | | |
| Approach Road Name: | | | | Illuminance (cd/m ²): | | | |
| Approach ID | | 3- EB | | | | | |
| Aperture F4.0 | | | | Aperture F5.0 | | | |
| Exposure Level | +2.00 | -2.00 | -3.00 | Exposure Level | +2.00 | -2.00 | -3.00 |
| Shutter Speed | | | | Shutter Speed | | | |
| Approach Road Name: | | | | Illuminance (cd/m ²): | | | |
| Approach ID | | 4 - WB | | | | | |
| Aperture F4.0 | | | | Aperture F5.0 | | | |
| Exposure Level | +2.00 | -2.00 | -3.00 | Exposure Level | +2.00 | -2.00 | -3.00 |
| Shutter Speed | | | | Shutter Speed | | | |
| Date: | | | | | | | |
| Names of Team Members: | | | | | | | |
| Comments: | | | | | | | |
| pg. 1/2 | | | | | | | |

| | | | |
|--|--------------------------|--|---------|
| | | | |
| Equipment Check List before Field Deployment | | | |
| 1. Digital Camera (Cannon EOS Rebel T3) | <input type="checkbox"/> | | |
| 2. Two Fully Charged Batteries for Digital Camera | <input type="checkbox"/> | | |
| 3. Two 4GB SD Cards for storing data | <input type="checkbox"/> | | |
| 4. Illuminance Meter Set; Sensor and Recorder (Extech HD450) | <input type="checkbox"/> | | |
| 5. Extra 9V Battery for Illuminance Meter | <input type="checkbox"/> | | |
| 6. Traffic Safety Vests for All Team Members | <input type="checkbox"/> | | |
| 7. Two Traffic Cones | <input type="checkbox"/> | | |
| 8. Measuring Tape (165 feet or 50 meters) | <input type="checkbox"/> | | |
| 9. Metered Wheel | <input type="checkbox"/> | | |
| 10. Compass | <input type="checkbox"/> | | |
| 11. GPS Device | <input type="checkbox"/> | | |
| 12. Flash Light | <input type="checkbox"/> | | |
| 13. Intersection ID Cards | <input type="checkbox"/> | | |
| 14. Time Device | <input type="checkbox"/> | | |
| Data Recording Check List for each Intersection | | | |
| 15. Picture of Intersection ID | <input type="checkbox"/> | | |
| 16. Picture of Crossroads name on the sign post | <input type="checkbox"/> | | |
| 17. Picture of External Time Device with Time Displayed | <input type="checkbox"/> | | |
| 18. Tripod Positioned at 38 m or 125 ft | <input type="checkbox"/> | | |
| 19. Tripod Height set at 1.24 m (49 inches) | <input type="checkbox"/> | | |
| 20. Illuminance Taken at a Corner at Ground Level | <input type="checkbox"/> | | |
| 21. Light Conditions Recorded | <input type="checkbox"/> | | |
| 22. Names of Crossroads Recorded | <input type="checkbox"/> | | |
| 23. Leg 1 Direction Recorded | <input type="checkbox"/> | | |
| 24. Leg 2 Direction Recorded | <input type="checkbox"/> | | |
| 25. Leg 3 Direction Recorded | <input type="checkbox"/> | | |
| 26. Leg 4 Direction Recorded | <input type="checkbox"/> | | |
| 27. Number of Intersection Legs Recorded | <input type="checkbox"/> | | |
| *Very Important | | | |
| 1. For each leg of the intersection, the mounted camera and tripod must not be moved or shifted until all the pictures for that leg have been taken. It is very important that picture sets must cover the same area for automated image analysis algorithm to work. | | | |
| 2. Please ensure that all the list above has been followed and a check mark placed in the box at the end of the row | | | |
| 3. Please ensure that all the shaded cells on page one have data recorded in them | | | |
| | | | pg. 2/2 |

9.0 SUMMARY INSTRUCTIONS

Below is a summary of the instructions that should be followed.

1. Before starting out, go through the equipment check list at the back of the data recording form and make sure all the equipment has been packed into the vehicle for the field trip
2. Park the vehicle off the road and turn off the headlights and emergency lights if it is within 60 m of the intersection.
3. If the vehicle can't be parked off road, then park the vehicle at least 60 m (200 ft) from intersection and away from the travel lanes, put on the traffic safety vest before coming out of the vehicle and turn on the emergency hazard lights of the vehicle. Turn off the vehicle headlights so that the light from the vehicle does not compromise the data that will be collected.
4. Insert the battery and SD card into the camera. Take a picture of the intersection ID, the external time device, and crossroad names sign.
5. Set up the tripod at a distance of 38 m (125 ft) from the stop line (intersection corner if stop line is not marked)
6. Set up the tripod such that the top surface of the tripod is at 1.24 m (49 in) above the ground (measured at the center of the three legs) when tripod is fully set up.
7. Check to ensure that the camera is in the correct shooting mode.
8. Mount the camera on the tripod and orient it so that the view through the lens faces the intersection.
9. Turn on the camera and set the aperture from the quick control screen.
10. Use the shutter speed to set the exposure level.
11. Take an illuminance reading before you start taking the set of pictures on an intersection leg.
12. Take a picture of the intersection at each of these exposure levels to +2.00, -2.00, and -3.00
13. Do not move or shift the mounted camera and tripod until all the pictures have been taken for each intersection leg. Then move the tripod and camera and set up on another intersection leg.
14. Repeat Step 5 through Step 13 for each intersection leg.
15. All the shaded cells on the data form are required data fields. Go through the data recording check list and ensure that all the required data has been collected.

Data Retrieval and Storage

1. All the field data (digital images and scanned copies of the data recording forms) shall be forwarded within 24 hours of field work to the Georgia Tech team for analysis and feedback (if necessary)
2. The survey team must also archive a copy of the digital images and scanned copies of the field data on the supplied 4TB external hard drive.

APPENDIX A: PARTS OF THE CAMERA

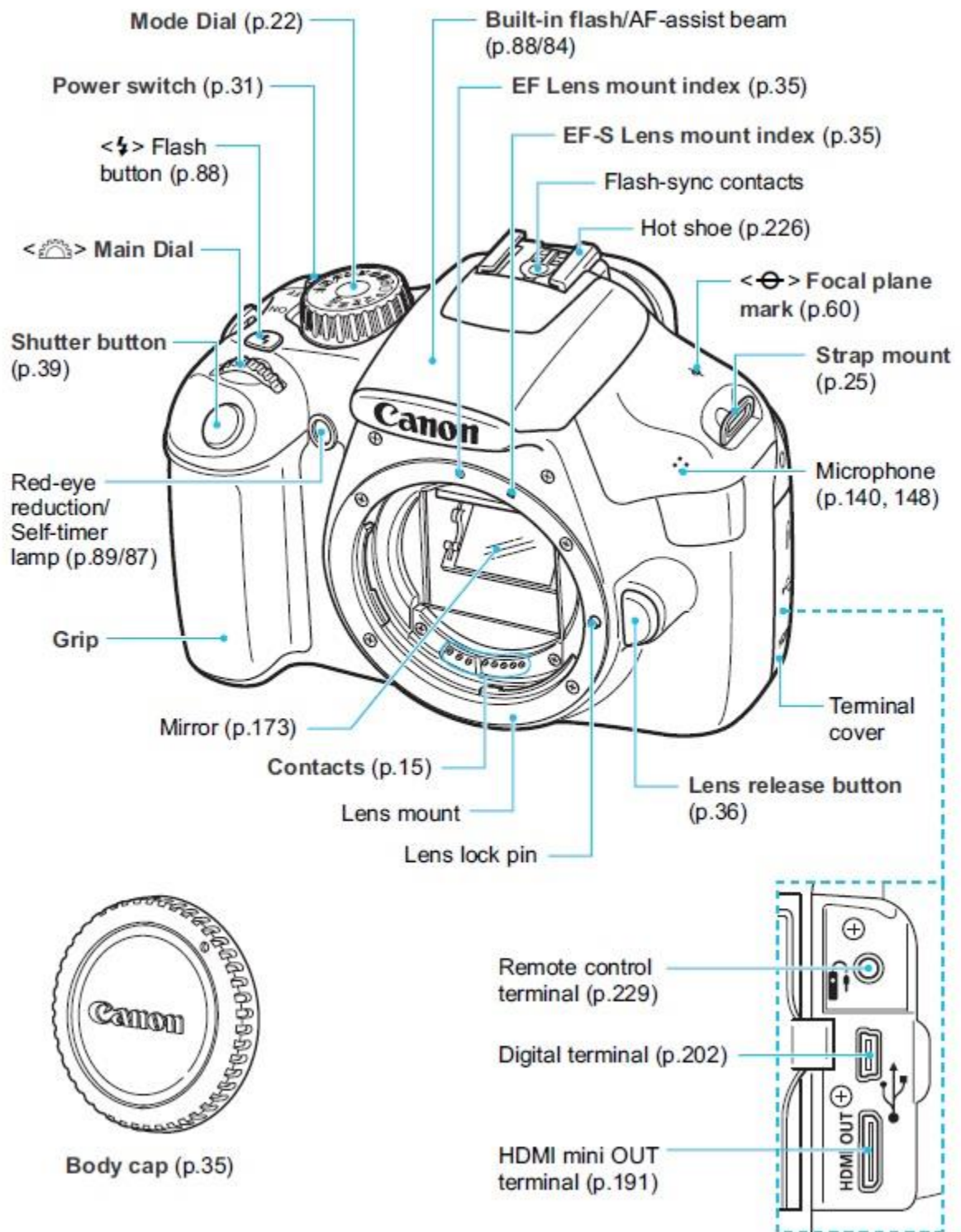

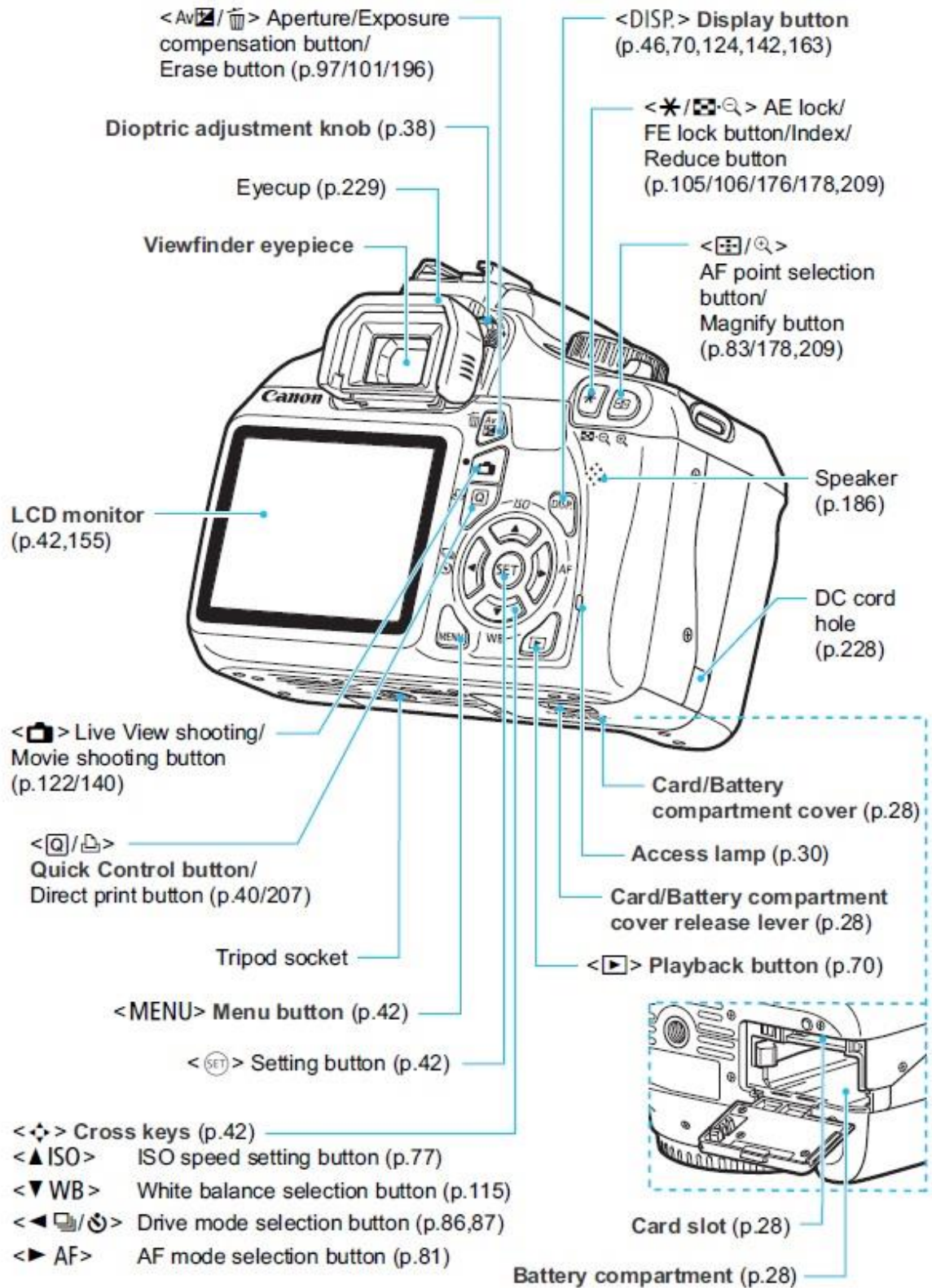

APPENDIX B: CAMERA HANDLING PRECAUTIONS

- The Canon Rebel T3 camera is a precision instrument. Do not drop it or subject it to physical shock
- The camera is not waterproof. Avoid any kind of contact with water and avoid storage in a high humidity environment.
- Never leave the camera near anything that has a strong magnetic field such as a magnet or electric motor.
- Avoid using or leaving the camera near anything emitting strong radio waves such as large antenna.
- Do not leave the camera in excessive heat such as in a car in direct sunlight. High temperatures can cause the camera to malfunction.
- Use a blower to blow away dust on the lens, viewfinder, reflex mirror, and focusing screen. Do not use cleaners that contain organic solvents to clean the camera body or lens
- Do not touch the camera's contacts with your fingers to avoid corroding them.
- If the camera is suddenly brought in from the cold into a warm room, condensation may form on the internal parts. To avoid condensation, first put the camera in a sealed plastic bag or its packaging and box and let it adjust to the warmer temperature before taking it out of the bag.
- If condensation forms do not use the camera. Remove the lens, card, and battery from the camera, and wait until the condensation has evaporated before using the camera.
- Avoid storing the camera where there are corrosive chemicals such as a darkroom or chemical lab.

APPENDIX C: EXAMPLE INTERSECTION WITH FILLED FORM

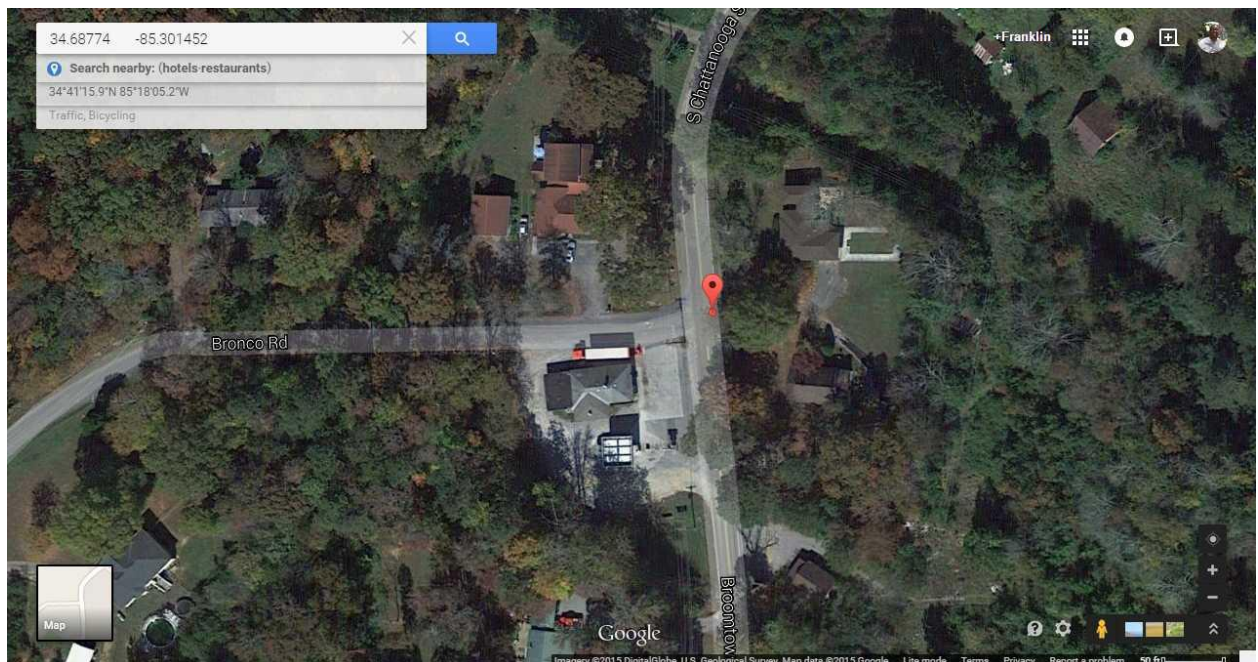

| FIELD DATA RECORDING FORM | | | | Intersection Layout | | | | | |
|--|--|-------------------------------------|-------|--|--------|-------|-------|-----------------------------------|---------|
| Intersection ID: | 22 | | | | | | | | |
| No of Intersection Legs: | 3 | | | | | | | | |
| Name of Cross Road 1: | S. Chatt. / Broomtown | | | | | | | | |
| Name of Cross Road 2: | Bronco | | | | | | | | |
| Lighting Condition | Yes | No | | Check the correct Yes or No Column | | | | | |
| Ambient Lighting | <input checked="" type="checkbox"/> | <input type="checkbox"/> | | Cross-out the non-existent leg for T-junctions | | | | | |
| Purpose-built Lighting | <input checked="" type="checkbox"/> | <input type="checkbox"/> | | | | | | | |
| Traffic Signal | <input type="checkbox"/> | <input checked="" type="checkbox"/> | | | | | | | |
| Flashing Amber | <input type="checkbox"/> | <input checked="" type="checkbox"/> | | | | | | | |
| Shutter speed value should be written in full; e.g. 1/60 | | | | Approach direction is based on vehicle traveling into the intersection | | | | | |
| Approach Road Name: | S. Chattanooga St | | | Approach ID | 1 - SB | | | Illuminance (cd/m ²): | 30.0 |
| Aperture F4.0 | | | | Aperture F5.0 | | | | | |
| Exposure Level | +2.00 | -2.00 | -3.00 | Exposure Level | +2.00 | -2.00 | -3.00 | | |
| Shutter Speed | 1/10 | 1/160 | 1/320 | Shutter Speed | 1/6 | 1/100 | 1/200 | | |
| Approach Road Name: | Broomtown Rd | | | Approach ID | 2 - NB | | | Illuminance (cd/m ²): | 31.0 |
| Aperture F4.0 | | | | Aperture F5.0 | | | | | |
| Exposure Level | +2.00 | -2.00 | -3.00 | Exposure Level | +2.00 | -2.00 | -3.00 | | |
| Shutter Speed | 1/8 | 1/125 | 1/250 | Shutter Speed | 1/5 | 1/80 | 1/160 | | |
| Approach Road Name: | Bronco Rd | | | Approach ID | 3 - EB | | | Illuminance (cd/m ²): | 31.0 |
| Aperture F4.0 | | | | Aperture F5.0 | | | | | |
| Exposure Level | +2.00 | -2.00 | -3.00 | Exposure Level | +2.00 | -2.00 | -3.00 | | |
| Shutter Speed | 1/10 | 1/160 | 1/320 | Shutter Speed | 1/6 | 1/100 | 1/200 | | |
| Approach Road Name: | NA | | | Approach ID | 4 - WB | | | Illuminance (cd/m ²): | NA |
| Aperture F4.0 | | | | Aperture F5.0 | | | | | |
| Exposure Level | +2.00 | -2.00 | -3.00 | Exposure Level | +2.00 | -2.00 | -3.00 | | |
| Shutter Speed | NA | NA | NA | Shutter Speed | NA | NA | NA | | |
| Date: | 2/25/15 | | | | | | | | |
| Names of Team Members: | Franklin Etobogah | | | | | | | | |
| Comments: | Gas station @ corner of Bronco & Broomtown | | | | | | | | |
| | | | | | | | | | pg. 1/2 |

| Equipment Check List before Field Deployment | |
|--|-------------------------------------|
| 1. Digital Camera (Cannon EOS Rebel T3) | <input checked="" type="checkbox"/> |
| 2. Two Fully Charged Batteries for Digital Camera | <input checked="" type="checkbox"/> |
| 3. Two 4GB SD Cards for storing data | <input checked="" type="checkbox"/> |
| 4. Illuminance Meter Set; Sensor and Recorder (Extech HD450) | <input checked="" type="checkbox"/> |
| 5. Extra 9V Battery for Illuminance Meter | <input checked="" type="checkbox"/> |
| 6. Traffic Safety Vests for All Team Members | <input checked="" type="checkbox"/> |
| 7. Two Traffic Cones | <input checked="" type="checkbox"/> |
| 8. Measuring Tape (165 feet or 50 meters) | <input checked="" type="checkbox"/> |
| 9. Metered Wheel | <input checked="" type="checkbox"/> |
| 10. Compass | <input checked="" type="checkbox"/> |
| 11. GPS Device | <input checked="" type="checkbox"/> |
| 12. Flash Light | <input checked="" type="checkbox"/> |
| 13. Intersection ID Cards | <input checked="" type="checkbox"/> |
| 14. Time Device | <input checked="" type="checkbox"/> |
| Data Recording Check List for each Intersection | |
| 15. Picture of Intersection ID | <input checked="" type="checkbox"/> |
| 16. Picture of Crossroads name on the sign post | <input checked="" type="checkbox"/> |
| 17. Picture of External Time Device with Time Displayed | <input checked="" type="checkbox"/> |
| 18. Tripod Positioned at 38 m or 125 ft | <input checked="" type="checkbox"/> |
| 19. Tripod Height set at 1.24 m (49 inches) | <input checked="" type="checkbox"/> |
| 20. Illuminance Taken at a Corner at Ground Level | <input checked="" type="checkbox"/> |
| 21. Light Conditions Recorded | <input checked="" type="checkbox"/> |
| 22. Names of Crossroads Recorded | <input checked="" type="checkbox"/> |
| 23. Leg 1 Direction Recorded | <input checked="" type="checkbox"/> |
| 24. Leg 2 Direction Recorded | <input checked="" type="checkbox"/> |
| 25. Leg 3 Direction Recorded | <input checked="" type="checkbox"/> |
| 26. Leg 4 Direction Recorded | <input type="checkbox"/> NA |
| 27. Number of Intersection Legs Recorded | <input checked="" type="checkbox"/> |
| *Very Important | |
| 1. For each leg of the intersection, the mounted camera and tripod must not be moved or shifted until all the pictures for that leg have been taken. It is very important that picture sets must cover the same area for automated image analysis algorithm to work. | |
| 2. Please ensure that all the list above has been followed and a check mark placed in the box at the end of the row | |
| 3. Please ensure that all the shaded cells on page one have data recorded in them | |
| pg. 2/2 | |

APPENDIX G. DRONE IMAGE STANDARD OPERATING PROCEDURE

The following standard operating procedures are used by the data collection team for image data collection.



Georgia Tech College of Engineering
**School of Civil and
Environmental Engineering**

Before Departure to the Field

- Ensure that there is no event near the roundabout location that will generate large crowds because drones must not be flown over a large crowd.
- Check for Notice to Airmen (NOTAM) for the vicinity of the roundabout and local weather forecast. Field trips should proceed only if no rain is forecast, temperatures are in the range of -4 to 104°F and wind speeds do not exceed 15 MPH. For best results, wind speeds should not exceed 8 MPH.
- Check the FAA's B4UFLYapp to ensure that the planned location is not in a restricted air space or has not been designated as a temporary no fly zone.
- Ensure that all batteries for the remote controller and the Intelligent Flight Batteries are fully charged.
- Ensure that no member of the team is under the influence of alcohol or drugs.
- Any team member who is fatigued or impacted by emotional or psychological stress must not go into the field.
- Ensure the DJI GO 4 app or DJI GS PRO app and the aircraft's firmware have been upgraded to the latest version.
- Ensure that the gimbal is detached from the drone during travel to and from the site.

Preflight

- Ensure that all propellers are in good condition and securely tightened.
- Rotate each propeller to ensure that it moves freely without touching any part of the drone.
- Check to ensure that the gimbal can rotate freely before powering it on.
- Ensure that the lens cover is off, and the lens is clean and free of stains.
- Ensure that the memory card has at least 10 GB of available data space.
- Ensure that the camera settings match specifications for flight. The standard specifications are:

| Standard Zenmuse X5S Specifications for Roundabout Video Recording | |
|---|--|
| Parameters | Labeled Settings |
| Camera Mode | Auto (400 ft) |
| Resolution | 20.8 megapixels |
| Exposure Value | Manual (take images at -3, -2, and +2) |
| ISO Setting | 3200 |
| White Balance | Default |
| Auto Focus | Enabled |
| Shooting Mode | Single Shot (enabled) |
| Shutter Speed | Auto |
| Aperture | Manual (take images at 4 and 5) |
| Color Mode | Black and White |

- All field personnel must stay clear of the rotating propellers. The aircraft must only be touched by hand while the power is off.
- Observe the surroundings and develop an emergency landing plan in case the drone cannot be returned to the takeoff point.
- Ensure that the drone’s takeoff and landing positions are clear of overhead power lines and/or tree branches.
- Ensure that Wi-Fi on any mobile device is turned off to avoid causing interference to the remote controller.
- Use a high beam flashlight to inspect and ensure that the planned take-off and landing path do not have any overhead power cables that may otherwise not be very visible at night.

During Flight

- A drone’s altitude should never be allowed to exceed 400 ft AGL.
- A drone’s altitude should be in the range of 390 ± 5 ft.
- Drone should be flown such only half of the roundabout circle is captured. This ensures that pictures of a roundabout leg capture as much of the upstream areas of the approach as possible.

- In case of an emergency landing or loss of power that causes a free-fall crash of the drone, ***do not attempt to catch the drone. The rotating propellers can cause significant body harm.***
- The pilot and observer(s) must maintain a visual line of sight to the drone at all times.
- The pilot must not answer any incoming phone calls or use the features of their mobile device while controlling the drone.
- In the instance of low battery warning or dangerous wind speed warning, land the drone immediately at a safe location.
- Do not remove the micro-SD card while the drone is powered on.

Post Flight

- The aircraft must only be picked up while the power is off.
- Detach the gimbal from the drone and put both in secure travel mode before departing to base or to another measurement location.
- Do not connect the aircraft system to any USB interface that is older than version 2.0.
- Download the recorded videos from the SD card onto an external storage device or laptop.

REFERENCES

- AASHTO (2010). *Highway Safety Manual, 1st Ed. Vol 1*. American Association of State Highway and Transportation Officials, Washington DC.
- Abdel-Aty, M., Wang, X., and Santos, J. (2009). "Identifying Intersection-Related Traffic Crashes for Accurate Safety Representation." In *Institute of Transportation Engineers. ITE Journal*, No. 79(12), p.p 38-44.
- Azhar, A.Svante, B. (2011). "Signal Control of Roundabouts." In *Procedia - Social and Behavioral Sciences*, No. 16, p.p 729-738.
- Bassani, M.Mutani, G. (2012). "Effects of Environmental Lighting Conditions on Operating Speeds on Urban Arterials." In *Transportation Research Record: Journal of the Transportation Research Board*, No. 2298(-1), p.p 78-87.
- Bhagavathula, R., Gibbons, R., and Edwards, C. (2015). "Relationship between Roadway Illumination Level and Nighttime Rural Intersection Safety." In *Transportation Research Record: Journal of the Transportation Research Board*, No. 2485, p.p 8.
- Bo, L., Bhagwant, P., Craig, L., and Ravi, B. (2009). "Validation of a Full Bayes Methodology for Observational before-after Road Safety Studies and Application to Evaluation of Rural Signal Conversions." In *Accident Analysis & Prevention*, No. 41, p.p 574-580.
- Box, P. (1970). "Relationship between Illumination and Freeway Accidents." Illuminating Research Institute New York.
- Bruneau, J.F.Morin, D. (2005). "Standard and Nonstandard Roadway Lighting Compared with Darkness at Rural Intersections." In *Transportation Research Record: Journal of the Transportation Research Board*, No. 1918, p.p 116-122.
- BTS (2021). "State Highway Travel." (October 13, 2020).
- Bullough, J., Snyder, J., Skinner, N., Capo, R., Rizzo, P., and Besenecker, U. (2014). "Demonstration and Evaluation of New Approaches for Roundabout Lighting." *Transportation Research Board 93rd Annual Meeting*. Washington, DC.
- Casol, M., Fiorentin, P., and Scroccaro, A. (2008). "On Road Measurements of the Luminance Coefficient of Paving." *16th IMEKO TC4 Symposium Exploring New*

Frontiers of Instrumentation and Methods for Electrical and Electronic Measurements, . Florence, Italy.

- Chin, H.C. Quddus, M.A. (2003). "Applying the Random Effect Negative Binomial Model to Examine Traffic Accident Occurrence at Signalized Intersections." In *Accident Analysis & Prevention*, No. 35(2), p.p 253-259.
- Cobb, J., Hargroves, R.A., Marsden, A.M., and Scott, P. (1979). "Road Lighting and Accidents." *Meeting of the International Commission on Illumination (CIE)*. Kyoto, Japan.
- Cottrell, D. Mu, S. (2005). "Utah Intersection Safety: Recurrent Crash Sites: Identification, Issues and Factors." University of Utah, Mountain Plains Consortium.
- Daniels, S., Brijs, T., Nuyts, E., and Wets, G. (2010a). "Explaining Variation in Safety Performance of Roundabouts." In *Accident Analysis & Prevention*, No. 42(2), p.p 393-402.
- Daniels, S., Nuyts, E., and Wets, G. (2008). "The Effects of Roundabouts on Traffic Safety for Bicyclists: An Observational Study." In *Accident Analysis & Prevention*, No. 40(2), p.p 518-526.
- De Brabander, B. Vereeck, L. (2007). "Safety Effects of Roundabouts in Flanders: Signal Type, Speed Limits and Vulnerable Road Users." In *Accident Analysis & Prevention*, No. 39(3), p.p 591-599.
- Donnell, E. (2015). "Statistical Issues in Relating Roadway Lighting to Safety." *Transportation Research Board 94th Annual Meeting*. Washington, DC.
- Donnell, E., Porter, R.J., Shankar, V.N., Gross, F., Hu, W., Gemar, M., and Oh, J. (2011). "Estimating the Safety Effects of Roadway Lighting at Intersections: A Cross-Sectional Study Approach." *90th Annual Meeting of the Transportation Research Board*. Washington D.C.: Transportation Research Board.
- Donnell, E.T., Porter, R.J., and Shankar, V.N. (2010). "A Framework for Estimating the Safety Effects of Roadway Lighting at Intersections." In *SAFETY SCIENCE*, No. 48(10), p.p 1436-1444.
- Elvik, R. (1995). "Meta-Analysis of Evaluations of Public Lighting as Accident Countermeasure." In *Transportation Research Record*, No. (1485), p.p 112-123.
- FHWA. (2000). "Roundabouts : An Informational Guide." FHWA-RD-00-067,

- Flannery, A. (2001). "Geometric Design and Safety Aspects of Roundabouts." In *Transportation Research Record, No. 1751*(1), p.p 76.
- Fotios, S., Boyce, P., and Ellis, C. (2005). "The Effect of Pavement Material on Road Lighting Performance." PPAD 9/100/77 UK.
- Gbologah, F. *The Impacts of Illumination Level on Nighttime Safety at Roundabouts*. Doctoral Dissertation. Georgia Institute of Technology. Atlanta, GA. 2015
- Gbologah, F., Guin, A., Purcell, R., and Rodgers, M. (2016). "Calibration of a Digital Camera for Rapid Auditing of in-Situ Intersection Illumination." *95th Annual Meeting of the Transportation Research Board*. Washington, DC: Transportation Research Board.
- Gbologah, F., Guin, A., Purcell, R., and Rodgers, M. (2016). "Evaluation of the Cost-Effectiveness of Illumination as a Safety Treatment at Rural Intersections." G.D.o. Transportation
- Gbologah, F., Samoylov, A., Guin, A., Hunter, M., Pass, D., and Rodgers, M. (2015). "Evaluation of Roundabout Illumination and Safety." In *Submitted to Journal of Accident Prevention and Analysis, No.*
- Gbologah, F.E., Guin, A., and Rodgers, M.O. (2019). "Safety Evaluation of Roundabouts in Georgia." In *Transportation Research Record: Journal of the Transportation Research Board, No. 2673*(7), p.p pp 641-651.
- GDOT (2019). "Design Policy Manual. In (Vol. Revision 5.11)." G.D.o. Transportation, Editor: Atlanta, GA.
- Gibbons, R. *Influence of Pavement Reflectivity on Target Visibility*. University of Waterloo. 1997
- Gibbons, R., Guo, F., Du, J., Medina, A., Lutkevich, P., Terry, T., and Li, Q. (2015). "Linking Road Lighting and Crash Safety." *Transportation Research Board 94th Annual Meeting*. Washington, DC.
- Green, E.R., Agent, K.R., Barret, M.L., and Pigman, J.G. (2003). "Roadway Lighting and Driver Safety." KTC-03-12/SPR247-02-IF,
- Green, J.Hargroves, R.A. (1979). "A Mobile Laboratory for Dynamic Road Lighting Measurement." In *Lighting Research & Technology, No. (11)*, p.p 7.

- Green, W.H. (2003). *Econometric Analysis, Fifth Ed.* Prentice hall, Upper Saddle River, NJ.
- Gross, F., Lyon, C., Persaud, B., and Srinivasan, R. (2013). "Safety Effectiveness of Converting Signalized Intersections to Roundabouts." In *Accident Analysis and Prevention, No. 50*, p.p 234-241.
- Guin, A., Rodgers, M.O., Gbolagah, F., Purcell, R., Georgia Tech Research, C., Georgia Department of, T., and Federal Highway, A. (2016). "Evaluation of the Cost-Effectiveness of Illumination as a Safety Treatment at Rural Intersections."
- Hallmark, S., Hawkins, N., Omar, S., Hans, Z., Kinsensaw, C., Orellano, M., and Isebrands, H. (2008). "Strategies to Address Nighttime Crashes at Rural, Unsignalized Intersections." Center for Transportation and Education, Iowa State University.
- Hammond, S., Hunter, C., and Chang, K. (2014). "The Effect of Additional Lane Length on Roundabout Delay". *Transportation Research Board 93rd Annual Meeting*. Washington DC: Transportation Research Board.
- Hardwood, D., Bauer, K., Potts, I., Torbic, D., Richard, K., Rabbani, E., Hauer, E., Elefteriadou, L., and Griffith, M. (2003). "Safety Effectiveness of Intersection Left and Right Turn Lanes." In *Transportation Research Record: Journal of the Transportation Research Board, No. 1840*.
- Hargroves, R.A.Scott, P. (1979). "Measurements of Road Lighting and Accident Results." In *Public Lighting, No. (44)*, p.p 8.
- Hauer, E. (1996). "Statistical Test of Difference between Expected Accident Frequencies." In *TRANSPORTATION RESEARCH RECORD, No. (1542)*, p.p 24-29.
- Hauer, E. (1997). *Observational before-after Studies in Road Safety*. Pergamon, , Oxford, OX, U.K. ; Tarrytown, N.Y., U.S.A.
- Hauer, E. (2005). "Cause and Effect in Observational Cross-Sectional Studies in Road Safety." *Transportation Research Board Annual Meeting*.
- Hydén, C.Várhelyi, A. (2000). "The Effects on Safety, Time Consumption and Environment of Large Scale Use of Roundabouts in an Urban Area: A Case Study." In *Accident Analysis & Prevention, No. 32(1)*, p.p 11-23.

- Illuminating Engineering Society, "Roadway Lighting ", ANSI/IESNA RP-8-00 Reaffirmed 2005. Illumination Engineering Society of North America, New York.
- Illuminating Engineering Society, "Design Guide for Roundabout Lighting", IES DG-19-08. Illuminating Engineering Society of North America, New York.
- International Commission on Illumination. (1992). "Road Lighting as an Accident Countermeasure." Publication No. 93, Central Bureau of the CIE Vienna.
- International Commission on Illumination, "Cie 115:2010 Lighting of Roads for Motor and Pedestrian Traffic 2nd Edition", CIE Central Bureau, Austria.
- Isebrands, H. (2009). "Crash Analysis of Roundabouts at Highspeed Rural Intersections." In *Transportation Research Record: Journal of the Transportation Research Board*, No. 2096, p.p 7.
- Isebrands, H.Hallmark, S. (2012). "Statistical Analysis and Development of Crash Prediction Model for Roundabouts on High-Speed Rural Roadways." In *Transportation Research Record: Journal of the Transportation Research Board*, No. 2312(-1), p.p 3-13.
- Isebrands, H., Hallmark, S., Hans, Z., McDonald, T., Preston, H., and Storm, R. (2006). "Safety Impacts of Street Lighting at Isolated Rural Intersection - Part 2." MN/RC-2006-35, Minesota Department of Transportation
- Isebrands, H., Hallmark, S., and Hawkins, N. (2014). "Effects of Approach Speed at Rural High-Speed Intersections." In *Transportation Research Record: Journal of the Transportation Research Board*, No. 2402(-1), p.p 67-77.
- Isebrands, H., Hallmark, S., Li, W., McDonald, T., Storm, R., and Preston, H. (2010). "Roadway Lighting Shows Safety Benefits at Rural Intersections." In *Journal of Transportation Engineering*, No. 136(11), p.p 949-955.
- Jackett, M.Frith, W. (2013). "Quantifying the Impact of Road Lighting on Road Safety — a New Zealand Study." In *IATSS Research*, No. 36(2), p.p 139-145.
- Jensen, S. (2013). "Safety Effects of Converting Intersections to Roundabouts." *92nd Annual Meeting of the Transportation Research Board*. Washington, DC.
- Joksch, H.Kostyniuk, L. (1998). "Modeling Intersection Crash Counts and Traffic Volume." FHWA-RD-98-096, Washington, DC.

- Lenters, M. (2005). "Safety Auditing of Roundabouts." *National Roundabout Conference*. Colorado.
- Lipinski, M.E.Wortman, R.H. (1978). "Effect of Illumination on Rural at-Grade Intersection Accidents." In *Transportation Research Record*, No. (611), p.p 3.
- Lord, D.Persaud, B. (2000). "Accident Prediction Models with and without Trend: Application of the Generalized Estimating Equations Procedure." In *Transportation Research Record: Journal of the Transportation Research Board*, No. 1717(-1), p.p 102-108.
- Lyon, C., Haq, A., Persaud, B., and Kodama, S. (2005). "Safety Performance Functions for Signalized Intersections in Large Urban Areas: Development and Applications to Evaluation Left-Turn Priority Treatment." In *Transportation Research Record: Journal of the Transportation Research Board*, No. 1908.
- Marks, V. (1977). "Effects of Reduced Intersection Lighting on Nighttime Accident Frequency." Project HR-1003A, Iowa Department of Transportation.
- Medina, J., Avrenli, K., and Benekohal, R. (2013). "Field and Software Evaluation of Illuminance from Led Luminaires for Roadway Applications." In *Transportation Research Record: Journal of the Transportation Research Board*, No. 2384(-1), p.p 55-64.
- Minoshima, O., Oka, K., Ikehara, K., and Inukai, N. (2006). "Research on Accident Reduction by Intersection Lighting." *Road Engineering Association of Asia and Australia (REAAA)*. Philippines.
- Mitra, S., Washington, S., and Van Schalkwyk, I. (2007). "Important Omitted Spatial Variables in Safety Models: Understanding Contributing Crash Causes at Intersections." *TRB 86th Annual Meeting Compendium of Papers*. Washington, DC.
- Møller, M.Hels, T. (2008). "Cyclists' Perception of Risk in Roundabouts." In *Accident Analysis & Prevention*, No. 40(3), p.p 1055-1062.
- Monsere, C.M.Fischer, E.L. (2008). "Safety Effects of Reducing Freeway Illumination for Energy Conservation." In *Accident Analysis & Prevention*, No. 40(5), p.p 1773-1780.
- Montella, A. (2011). "Identifying Crash Contributory Factors at Urban Roundabouts and Using Association Rules to Explore Their Relationships to Different Crash Types." In *Accident Analysis and Prevention*, No. 43, p.p 1451-1463.

- NCHRP. (2010). "Roundabouts: An Informational Guide, 2nd Ed." NCHRP 672, Transportation Research Board.
- Niaki, M., Saunier, N., Miranda-Moreno, L., Amador, L., and Bruneau, J.-F. (2014). "Method for Road Lighting Audit and Safety Screening at Urban Intersections." In *Transportation Research Record: Journal of the Transportation Research Board*, No. 2458, p.p 27-36.
- Nicholas, J. (1991). "A Road Lighting Survey Method for Accidents Sites." Report No. 4,
- North Carolina Department of Transportation. (1999). "North Carolina Crash Report Instruction Manual."
- Oya, H., Ando, K., and Kanoshima, H. (2002). "A Research on Interrelation between Illuminance at Intersections and Reduction in Traffic Accidents." In *Journal of Light & Visual Environment*, No. 26(1), p.p 1_29-1_34.
- Per Ole, W. (2009). "Effects of Road Lighting: An Analysis Based on Dutch Accident Statistics 1987–2006." In *Accident Analysis and Prevention*, No. 41, p.p 123-128.
- Persaud, B., Council, F., Lyon, C., Eccles, K., and Griffith, M. (2005). "Multijurisdictional Safety Evaluation of Red Light Cameras." In *Transportation Research Record: Journal of the Transportation Research Board*, No. 1922.
- Persaud, B., Lyon, C. (2007). "Empirical Bayes before–after Safety Studies: Lessons Learned from Two Decades of Experience and Future Directions." In *Accident Analysis & Prevention*, No. 39(3), p.p 546-555.
- Persaud, B., Retting, R., Garder, P., and Lord, D. (2001). "Safety Effect of Roundabout Conversions in the United States: Empirical Bayes Observational before-after Study." In *Transportation Research Record: Journal of the Transportation Research Board*, No. 1751(-1), p.p 1-8.
- Preston, H., Schoenecker, T. (1999). "Safety Impacts of Street Lighting at Isolated Rural Intersections." 1999-17, Minnesota Department of Transportation.
- Qin, X., Bill, A., Chitturin, M., and Noyce, D. (2013). "Evaluation of Roundabout Safety." *92nd Annual Meeting of the Transportation Research Board*. Washington, DC.
- Rea, M., Bullough, J., Fay, C., Brons, J., Derlofske, J., and Donnell, E. (2009). "Review of the Safety Benefits and Other Effects of Roadway Lighting." NCHRP 5-19, NCHRP Washington, DC.

- Retting, R., Persaud, B., Garder, P., and Lord, D. (2001). "Crash and Injury Reduction Following Installation of Roundabouts in the United States." In *American Journal of Public Health*, No. 91(4), p.p 628 - 631.
- Rodegerdts, L., Blogg, M., Wemple, E., Myers, E., Kyte, M., Dixon, K., List, G., Flannery, A., Troutbeck, R., Brilon, W., Wu, N., Persaud, B., Lyon, C., Harkey, D., and Carter, D. (2007a). "Roundabouts in the United States." NCHRP 572, Transportation Research Board.
- Rodegerdts, L., Blogg, M., Wemple, E., Myers, E., Kyte, M., Dixon, M., List, G., Flannery, A., Troutbeck, R., Brilon, W., Wu, N., Persaud, B., Lyon, C., Harkey, D., and Carter, D. (2007b). "Nchrp Web-Only Document 94 - Appendixes to Nchrp 572: Roundabouts in the United States.": Transportation Research Board, Washington, DC.
- Rodgers, M., Hunter, M., Samoylov, A., Gbologah, F., and Berrebi, S. (2016). "Evaluation of Current Practice for Illumination at Roundabouts: Safety and Illumination of Roundabouts (Phase 1)." Georgia De[a Transportation
- Schmidt, S., Long, S., and Harper, J. (2014). "Economic and Technical Feasibility of Led Lighting on State Routes in Missouri." *Transportation Research Board 93rd Annual Meeting*. Washington, DC: Transportation Research Board.
- Schneider, C., Rasband, W., and Eliceiri, K. (2012). "Nih Image to Imagej: 25 Years of Image Analysis." In *Nature Methods*, No. 9(7), p.p 4.
- Schoon, C.van Minnen, J. (1994). "The Safety of Roundabouts in the Netherlands." In *Traffic Engineering Control*, No., p.p 142-148.
- Scott, P. (1980). "The Relationship between Road Lighting Quality and Accident Frequency." LR 929,
- Shankar, V., Albin, R., Milton, J., and Mannering, F. (1998). "Evaluating Median Crossover Likelihoods with Clustered Accident Counts: An Empirical Inquiry Using the Random Effects Negative Binomial Model." In *Transportation Research Record: Journal of the Transportation Research Board*, No. 1635(-1), p.p 44-48.
- Troutbeck, R. (1993). "Capacity and Design of Traffic Circles in Australia." In *Transportation Research Record*, No. 1368, p.p 68-74.
- Uddin, W., Headrick, J., and Sullivan, J. (2012). "Performance Evaluation of Roundabouts for Traffic Flow Improvements and Crash Reductions at a Highway

- Interchange in Oxford, Ms." *91st Annual Meeting of the Transportation Research Board*. Washington, DC.
- Ulfarsson, G.Shankar, V. (2003). "Accident Count Model Based on Multiyear Cross-Sectional Roadway Data with Serial Correlation." In *Transportation Research Record: Journal of the Transportation Research Board*, No. 1840(-1), p.p 193-197.
- Uncu, I.Kayaku, M. (2010). "Analysis of Visibility Level in Road Lighting Using Image Processing Techniques." In *Scientific Research and Essays*, No. 5(18), p.p 6.
- Walker, F.W.Roberts, S.E. (1976). "Influence of Lighting on Accident Frequency at Highway Intersections." In *Transportation Research Record*, No. (562), p.p 73-78.
- Wang, X., Abdel-Aty, M., and Brady, P. (2006). "Crash Estimation at Signalized Intersections: Significant Factors and Temporal Effect." In *Transportation Research Record: Journal of the Transportation Research Board*, No. 1953(-1), p.p 10-20.
- Wortman, R.H.Lipinski, M.E. (1974). "Rural at-Grade Intersection Illumination."
- Zhou, H.G., Pirinccioglu, F., and Hsu, P. (2009). "A New Roadway Lighting Measurement System." In *Transportation Research Part C-Emerging Technologies*, No. 17(3), p.p 274-284.
- Zirkel, B., Park, S., McFadden, J., Angelastro, M., and McCarthy, L. (2013). "Influence of Sight Distance on Crash Rates and Operating Speeds at Low-Volume Single-Lane Roundabouts in the United States." In *Transportation Research Record: Journal of the Transportation Research Board*, No. 2389(-1), p.p 42-50.