

# A Gravity Model Integrating Land-Use and Transportation Policies for Sustainable Development: Case Study of Fresno, California

Chih-Hao Wang, PhD   Na Chen, PhD



# Mineta Transportation Institute

Founded in 1991, the Mineta Transportation Institute (MTI), an organized research and training unit in partnership with the Lucas College and Graduate School of Business at San José State University (SJSU), increases mobility for all by improving the safety, efficiency, accessibility, and convenience of our nation's transportation system. Through research, education, workforce development, and technology transfer, we help create a connected world. MTI leads the [Mineta Consortium for Transportation Mobility \(MCTM\)](#) funded by the U.S. Department of Transportation and the [California State University Transportation Consortium \(CSUTC\)](#) funded by the State of California through Senate Bill 1. MTI focuses on three primary responsibilities:

## Research

MTI conducts multi-disciplinary research focused on surface transportation that contributes to effective decision making. Research areas include: active transportation; planning and policy; security and counterterrorism; sustainable transportation and land use; transit and passenger rail; transportation engineering; transportation finance; transportation technology; and workforce and labor. MTI research publications undergo expert peer review to ensure the quality of the research.

## Education and Workforce

To ensure the efficient movement of people and products, we must prepare a new cohort of transportation professionals who are ready to lead a more diverse, inclusive, and equitable transportation industry. To help achieve this, MTI sponsors a suite of workforce development and education opportunities. The Institute supports educational programs offered by the

Lucas Graduate School of Business: a Master of Science in Transportation Management, plus graduate certificates that include High-Speed and Intercity Rail Management and Transportation Security Management. These flexible programs offer live online classes so that working transportation professionals can pursue an advanced degree regardless of their location.

## Information and Technology Transfer

MTI utilizes a diverse array of dissemination methods and media to ensure research results reach those responsible for managing change. These methods include publication, seminars, workshops, websites, social media, webinars, and other technology transfer mechanisms. Additionally, MTI promotes the availability of completed research to professional organizations and works to integrate the research findings into the graduate education program. MTI's extensive collection of transportation-related publications is integrated into San José State University's world-class Martin Luther King, Jr. Library.

---

## Disclaimer

The contents of this report reflect the views of the authors, who are responsible for the facts and accuracy of the information presented herein. This document is disseminated in the interest of information exchange. MTI's research is funded, partially or entirely, by grants from the California Department of Transportation, the California State University Office of the Chancellor, the U.S. Department of Homeland Security, and the U.S. Department of Transportation, who assume no liability for the contents or use thereof. This report does not constitute a standard specification, design standard, or regulation.

Report 23-03

# A Gravity Model Integrating Land-Use and Transportation Policies for Sustainable Development: Case Study of Fresno, California

Chih-Hao Wang, PhD

Na Chen, PhD

April 2023

A publication of the  
Mineta Transportation Institute  
Created by Congress in 1991

College of Business  
San José State University  
San José, CA 95192-0219



# TECHNICAL REPORT DOCUMENTATION PAGE

<b>1. Report No</b> 23-03	<b>2. Government Accession No.</b>	<b>3. Recipient's Catalog No.</b>	
<b>4. Title and Subtitle</b> A Gravity Model Integrating Land-Use and Transportation Policies for Sustainable Development: Case Study of Fresno, California		<b>5. Report Date</b> April 2023	
		<b>6. Performing Organization Code</b>	
<b>7. Authors</b> Chih-Hao Wang, PhD Na Chen, PhD		<b>8. Performing Organization Report</b> CA-MTI-2222	
<b>9. Performing Organization Name and Address</b> Mineta Transportation Institute College of Business San José State University San José, CA 95192-0219		<b>10. Work Unit No.</b>	
		<b>11. Contract or Grant No.</b> ZSB12017-SJAUX	
<b>12. Sponsoring Agency Name and Address</b> State of California SB1 2017/2018 Trustees of the California State University Sponsored Programs Administration 401 Golden Shore, 5th Floor Long Beach, CA 90802		<b>13. Type of Report and Period Covered</b>	
		<b>14. Sponsoring Agency Code</b>	
<b>15. Supplemental Notes</b>			
<b>16. Abstract</b> <p>The idea of urban compaction has been long proposed and promoted to address the problem of urban sprawl in many American cities. However, successful cases of implementation in this regard are still rare in the United States. This study uses a classic gravity model, TELUM (Transportation, Economic, and Land-Use Model) to examine the extent to which a land-use or transportation policy must be regulated to make the urban compaction occur in a typical auto-dependent city—Fresno, California. Five scenarios are considered (BL, L1, L2, T1, and T2), in which the baseline (BL) is a natural growth scenario. Without any policy interventions, the city will inevitably expand outward. The L1 (high-intensity zoning) and L2 (growth boundary) results suggest that high-density zoning and growth boundary policies could enable the compaction. The T1 (location impedance) and T2 (carbon tax) results reveal that transportation interventions would create barriers among regions/areas and therefore should be carefully used for compaction. This study not only adds to the literature on urban modeling but also contributes to the practice of smart growth or new urbanism policies for sustainability.</p>			
<b>17. Key Words</b> Urban compaction, Sustainability, Urban modeling, Land-use planning, Transportation planning		<b>18. Distribution Statement</b> No restrictions. This document is available to the public through The National Technical Information Service, Springfield, VA 22161.	
<b>19. Security Classif. (of this report)</b> Unclassified	<b>20. Security Classif. (of this page)</b> Unclassified	<b>21. No. of Pages</b> 35	<b>22. Price</b>



Copyright © 2023

By **Mineta Transportation Institute**

All rights reserved.

DOI: 10.31979/mti.2023.2222

Mineta Transportation Institute  
College of Business  
San José State University  
San José, CA 95192-0219

Tel: (408) 924-7560  
Fax: (408) 924-7565

Email: [mineta-institute@sjsu.edu](mailto:mineta-institute@sjsu.edu)  
[transweb.sjsu.edu/research/2222](http://transweb.sjsu.edu/research/2222)

# ACKNOWLEDGMENTS

This research was supported by a 2022 research grant awarded by the Fresno State Transportation Institute (FSTI) at California State University, Fresno through the California State University Transportation Consortium. The authors thank Editing Press for editorial services, as well as MTI staff.

# CONTENTS

Acknowledgments .....	vi
List of Figures .....	viii
List of Tables .....	ix
Executive Summary.....	1
1. Introduction .....	2
1.1 Motivation .....	2
1.2 Background and Objectives.....	3
2. Method and Data.....	5
2.1 TELUM (Transportation, Economic, and Land-Use Model).....	5
2.2 Policy Scenarios .....	6
2.3 Data .....	7
3. Results .....	11
3.1 Baseline (BL).....	11
3.2 High-Density Zoning (L1).....	13
3.3 Growth Boundary (L2) .....	15
3.4 Locational Transportation Impedance (T1).....	17
3.5 Carbon Tax (T2).....	19
4. Summary & Conclusions.....	22
Bibliography .....	24
About the Authors .....	25



# LIST OF FIGURES

Figure 1. Fresno Land Cover Changes .....	3
Figure 2. The Modeling Process in TELUM .....	6
Figure 3. Population and Employed Residence of 2019.....	9
Figure 4. Land Uses in 2019 and Designed Land-use Scenarios .....	9
Figure 5. Population Predictions of BL.....	12
Figure 6. Employed Residence Predictions of BL.....	12
Figure 7. Land Use Predictions of BL .....	13
Figure 8. Population Changes Between BL and L1.....	14
Figure 9. Employed Residence Changes Between BL and L1.....	14
Figure 10. Land-use Changes Between BL and L1 .....	15
Figure 11. Population Changes Between BL and L2.....	16
Figure 12. Employed Residence Changes Between BL and L2.....	16
Figure 13. Land-use Changes Between BL and L2 .....	17
Figure 14. Population Changes Between L2 and T1 .....	18
Figure 15. Employed Residence Changes Between L2 and T1 .....	18
Figure 16. Land-use Changes Between L2 and T1.....	19
Figure 17. Population Changes Between L2 and T2 .....	20
Figure 18. Employed Residence Changes Between L2 and T2 .....	20
Figure 19. Land-use Changes Between L2 and T2.....	21

# LIST OF TABLES

Table 1. Descriptive Statistics of Data for TELUM..... 8

# Executive Summary

Fresno, California has continuously expanded outward, like most cities in the United States. Such a spatial pattern is called “urban sprawl,” which is the least preferred urban form for most planners. Urban sprawl consumes more land and energy for travel, and therefore results in higher greenhouse gas emissions and greater financial burdens. To address this problem, the idea of “urban compaction” has been long discussed, but it is still rare to see a successful case in the real world. To better understand how land-use and transportation policies can help with compaction, urban models can be used to examine these policies. Some of these models have been successfully developed for forecasting future developments and widely used in many cities across the world. TELUM (Transportation, Economic, and Land-Use Model) is selected here because of its ability to allocate future developments that are subject to land availability and transportation impedance.

Five scenarios are considered. The BL (baseline) scenario assumes that the city grows naturally without any policy interventions. The results show that Fresno will inevitably expand outward due to the lack of available vacant developable land within the city’s boundary. The L1 (high-density zoning) scenario increases the availability of vacant developable land in the urban core area. The results show that urban compaction would occur and complete the process in the next 30 years when two layers of usable land are added to the urban core areas. Building on the L1 scenario, the L2 (growth boundary) scenario applies a growth boundary by employing a zero-development policy in the rural areas. The results suggest that this policy speeds up the process of urban compaction and makes the city more compact as compared to the L1 results. The T1 (locational impedance) scenario builds on L2 and decreases travel cost in the urban core areas by 50% and doubles that in the rural areas. The results reveal that this policy essentially creases transportation barriers among the urban core, suburban, and rural regions.

Future activities would tend to interact with those in their own regions. The urban core areas will attract further future development because of lower travel costs and a stronger local economy. Developments will drop in suburban areas because of their weaker economy. Rural areas will see greater growth when the local economy matures. The T2 (carbon tax) scenario penalizes long travel across the city. Therefore, future activities would interact with those nearby, resulting in spatial autocorrelation. The results will break the smooth spatial pattern and produce an unevenly distributed one. To put it simply, the goal would become to make a multicentric compact city out of a monocentric compact one. This spatial pattern might suggest the idea of TOD (Transit Oriented Development), which connects those small-area clusters with a complete transit network.



# 1. Introduction

## 1.1 Motivation

Fresno, California is the kind of city that continuously spreads out instead of building up over time. In past decades, any local resident could easily observe that the city has been spreading out to the north (e.g., those in the north from Copper Ave) and to the east (e.g., those in the southeast from Fowler Ave). Edge cities can even be found along Highway 41 toward Madera County, such as the newly built Tesoro Viejo neighborhood. Figure 1 shows the spatial pattern of a great number of expansions that have spread outward from downtown (1900) to the shades of purple (1951), blue (1970), green (1970), yellow (1996), and, most recently, brown (2021). Note that such an expansion pattern also applies to Clovis, which is a relatively smaller city located in the northeast in Figure 1 (not shown) and shares its border with Fresno (comprising a metropolitan area). In this study, we call these historical expansions “urban sprawl” because they spread out in a low-density form.

Urban sprawl can be explained using several concepts that have been widely elaborated in many planning textbooks, including auto dependency, cheaper building costs, preference for “big” and private, as well as some other historical and cultural reasons. According to local planner Keith Woodcock, the expansion in Fresno can be seen as a type of “green-field” development, which is preferred by many developers in Fresno because it is easier to, as Woodcock says, “pull off.” It is worth noting that urban sprawl has been long considered an unsustainable urban form because it takes more land, makes it harder to provide public services, and makes people drive more and therefore produces more greenhouse emissions. For this reason, compaction has been suggested by many planners as a more sustainable and desirable urban form.

To arrest urban sprawl, a compact form can be a goal, achieved either by providing incentives in the city core or increasing costs in the outskirts. The former could be put into practice through an impact fee and/or carbon tax. The latter could be implemented via TOD (transportation-oriented development), complete streets, urban design, capital investments, and urban safety. Fresno has used this idea to infill in the Blackstone and Kings Canyon corridor and install Bus Rapid Transit (BRT) along roads in these corridors. Another option to address this problem is to appeal to supply and demand. Through land-use planning, we could provide more space in the city core (e.g., high-density zoning) and restrict developments in the outskirts (e.g., growth boundary). Although there are some renewed apartments with a higher density in downtown Fresno, high-density zoning is still unpopular with many, which means implementation might require more education about the concept of compact development (according to Woodcock).

Figure 1. Fresno Land Cover Changes

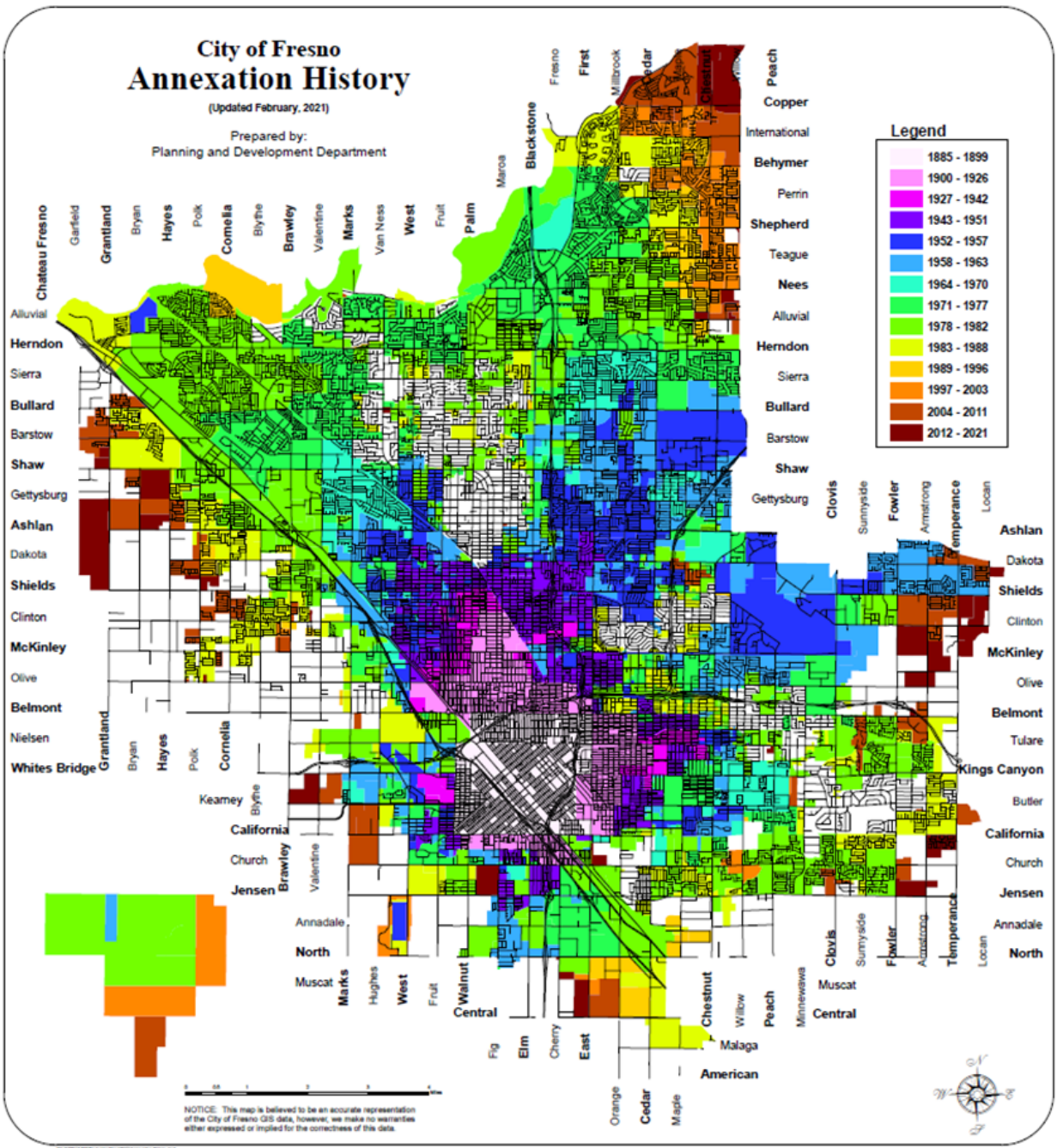

Source: City of Fresno

## 1.2 Background and Objectives

American cities have been spreading, many taking a polycentric form during growth and urban decentralization (Anas et al., 1998). On the one hand, some older towns were incorporated into an annexation as an additional core attached to the original city core. On the other hand, some

new cities emerged, termed “edge cities,” which serve as nodes of a transportation network, often away from the original city core (Garreau, 1991). A city’s spatial structure is essentially a result of market processes, but it is also subject to the intervention of government policies, such as transportation investments and land-use restrictions (Anas et al., 1998). In planning, compaction has been long regarded as an ideal urban form to guide future developments toward sustainability (Echenique et al., 2012). “Compaction” refers to a high-density urban form which can help reduce vehicle travel (i.e., energy consumption and greenhouse gas emissions) and increase social diversity (Randolph, 2003). Thus, this urban form is often promoted to arrest urban sprawl and address climate-change-induced problems by planners who believe in smart growth and new urbanism.

A variety of urban models have been developed to evaluate proposed urban development policies for planning objectives, including (1) gravity-based models, (2) econometric models, (3) spatial input-output models, and (4) microsimulation models (Waddell, 2002; Iacono et al., 2008). The gravity model specifies interactions of aggregated activities between locations in a transportation network, with some advantages, such as a simple model structure, moderate data demands, and relatively straightforward estimation (Zhou et al., 2009). For instance, the classical Lowry’s gravity model uses the economic base theory to estimate future development locations for mobility and accessibility improvement (Putman, 2010). Furthermore, this model can be used to test how land-use planning (both provisions and restrictions) and transportation policies (carbon tax or locational intervention) would affect the allocation of future development. Therefore, such an urban model allows planners to predict the possible consequences of a range of policy scenarios for sustainable/compact development (Casper et al., 2009).

Helping Fresno move toward sustainability requires understanding the effects of varied transportation and land-use policies, such as public transit and bike lanes, a carbon tax, high-density zoning, and growth boundary, which have been neglected in past literature. Therefore, this study provides a necessary research framework for comprehensively evaluating a variety of transportation or land-use policies for the promotion of a compact city and sustainability in Fresno. The objectives of this study are as follows:

- To investigate how proposed transportation and land-use policies can guide future development in Fresno, giving the city a sustainable compact urban form.
- To better understand how much effort in transportation impedance and land-use restriction is required to achieve the proposed urban reform in Fresno.
- To provide planning information for promoting California’s cap-and-trade program to reduce the impacts of greenhouse gas emissions and transportation on climate change.



## 2. Method and Data

### 2.1 TELUM (Transportation, Economic, and Land-Use Model)

To fulfill the gap mentioned above, a gravity model, TELUM (Transportation, Economic, and Land-Use Model), is used to better understand how a transportation or land-use policy can help with the compaction of future developments, while accounting for urban economies and physical limitations (i.e., transportation impedance and land availability) in a simulation. TELUM, developed by Dr. Putman at the University of Pennsylvania, is a widely-used integrated interactive software package for evaluating the effects of transportation improvement projects or land-supply restrictions on population, employment, and land uses (Casper et al., 2009). TELUM uses a series of computer modules, which are linked to a suite of transportation models, to spatially allocate future population/households (TELUM-RES), employment (TELUM-EMP), and land uses (LANCON) in the study region, based on such inputs as households by income groups, jobs by employment sectors, and land consumption and availability for future growth (Casper et al., 2009). The modules and the flow of information between them in TELUM is presented in Figure 2. In a simulation, TELUM-EMP first employs economic base theory to estimate basic employment (e.g., agriculture, manufacturing, information), using the parameters calibrated from the data between the base and lag years. TELUM-RES converts the estimated basic employment into non-basic employment (e.g., retails, services), uses the results to calculate future households, and then utilizes a gravity model to allocate them, subject to travel costs and land availability. Finally, LANCON calculates land consumption and presents the results across the study region. Therefore, TELUM is a suitable urban model for exploring whether or not transportation and land-use policies can help shift Fresno's current urban form to a compact one, how much effort in these two planning tools is required to make the shifting occur, and how long it will take to complete the process.

Figure 2. The Modeling Process in TELUM

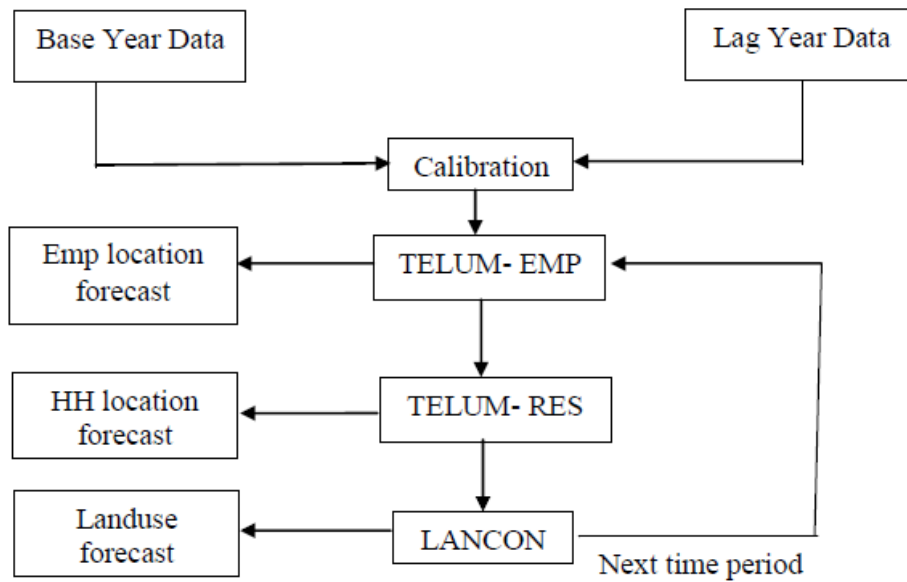

Source: Putman, 2010

## 2.2 Policy Scenarios

Five scenarios are considered: (1) baseline (BL); (2) high-density zoning (L1); (3) growth boundary (L2); (4) locational impedance (T1); and (5) carbon tax (T2). The BL scenario is used as a benchmark forecast for further comparison with the other scenarios. The L1 and L2 scenarios can be seen as land-use policies for intervening in future development, while T1 and T2 serve as transportation policies for the same purpose. The BL scenario assumes natural growth using the calibrated parameters from the data of population, households, employments, and land uses between 2014 and 2019.

The L1 scenario adds additional layers to the existing usable land in the city’s core, which is essentially the existing residential, industrial, commercial, and vacant land. In this scenario, we will examine how many additional layers of usable land would be enough to bring future development back to the city’s core. The results of this scenario can shed light on the implementation of high-density zoning policies. The L2 scenario, building on the assumption of the L1, restricts land availability in the outskirts to reduce push-out developments. Again, we will investigate to what level land availability must be reduced in order to see the effect.

Building on the assumptions of L2, the T1 scenario changes the transportation impedance matrix by doubling travel cost in the outskirts and halving it in the city core. It is worth noting that this policy is locational, meaning that the model will punish new developments expanding outward. The T2 scenario, on the other hand, punishes long-distance travel by squaring travel cost in the

impedance matrix. This is similar to other policies, such as a carbon tax. In this simulation, the model is expected to encourage clustering interactions across the study region. In sum, TELUM will show how a gravity model responds to these assumptions, and the findings will provide insight into the problem of promoting a sustainable/compact city by arresting urban sprawl.

### 2.3 Data

The study region is defined as the City of Fresno and City of Clovis together with an outer circle of rural areas, as presented in Figure 3. Data preparation for the designed scenarios in TELUM includes population, households by income, and employed residence by economic sectors at the census tract level, using the US Census Bureau's 2014 (lag year) and 2019 (base year) 5-year ACS/LODES data. The data also includes current land uses across the study region, aggregated from the Fresno County computer data systems and transportation impedance, calculated by the network analysis package in ArcGIS using the US Census Bureau's 2019 TIGER and Fresno County computer data systems shapefiles. The descriptive statistics of the data input are presented in Table 1. The average population increases from 4,535 in 2014 to 4,762 in 2019. The average households also follow this pattern between 2014 and 2019. The two values—population of 4,762 and 1,540 households—suggest that Fresno's average household size is around three. The households were divided into different household income groups (not presented), using thresholds of \$35,000 (medium), \$50,000 (upper medium), and \$100,000 (high). The employed residence was also divided into different economic sectors, including agriculture (primary), manufacturing combined with construction and information (secondary), retail (tertiary), and finance and professional services (quaternary). With the exception of agriculture, the average employed residence increases from 2014 to 2019 in all the other sectors. From Table 1, residential (385) is the primary land use in Fresno, as compared to industrial (75) and commercial (72). Vacant developable land (386) is also aggregated, and unusable land refers to land which has been preserved or is planned to be preserved (255).



Table 1. Descriptive Statistics of Data for TELUM

Variable	Mean	S. D.	Min	Max
<i>Socio-Economics (#)</i>				
Household (2014)	1,452.9	532.7	270	4,011
Household (2019)	1,540.9	590.1	344	4,590
Population (2014)	4,535.0	1,601.2	1,089	11,380
Population (2019)	4,762.3	1,824.8	1,041	12,379
Total Employment (2014)	1,729.6	2,360.3	21	18,152
Agriculture (2014)	34.0	89.8	0	833
Manufacturing (2014)	239.9	514.2	0	3,052
Retail (2014)	313.9	570.1	0	4,216
Finance & Professional (2014)	1,141.8	1,820.2	21	15,926
Total Employment (2019)	1,951.5	2,407.0	28	16,389
Agriculture (2019)	29.2	64.1	0	386
Manufacturing (2019)	264.9	546.5	0	3,268
Retail (2019)	358.8	746.0	0	7,282
Finance & Professional (2019)	1,298.6	1,808.9	28	14,293
<i>Land Use (Acre)</i>				
Residential	385.7	464.6	0.2	3,935.6
Commercial	72.3	72.2	0	460.5
Industrial	75.3	257.1	0	2,281.0
Street	162.7	128.7	37.5	873.3
Vacant Developable	386.3	1,566.3	0	11,282.8
Unusable	255.3	382.1	47.8	3,673.8
No. of Observations				149

The spatial distributions of population and employed residence in 2019 are presented in Figure 3. Two new growth cores (shades of yellow) in the west (Highway City) and central southeast (Roosevelt) essentially imply a strong outward expansion force in the study region. Figure 1 also confirms this observation (shades of brown). Basic economic employed residences (construction, manufacturing, information) cluster along Highway 99 and Backstone Ave. and in eastern new developments. Non-basic economic employed residence (retail, financial and professional services) group along main streets, such as Blackstone, Shaw, and Herndon.

Figure 3. Population and Employed Residence of 2019

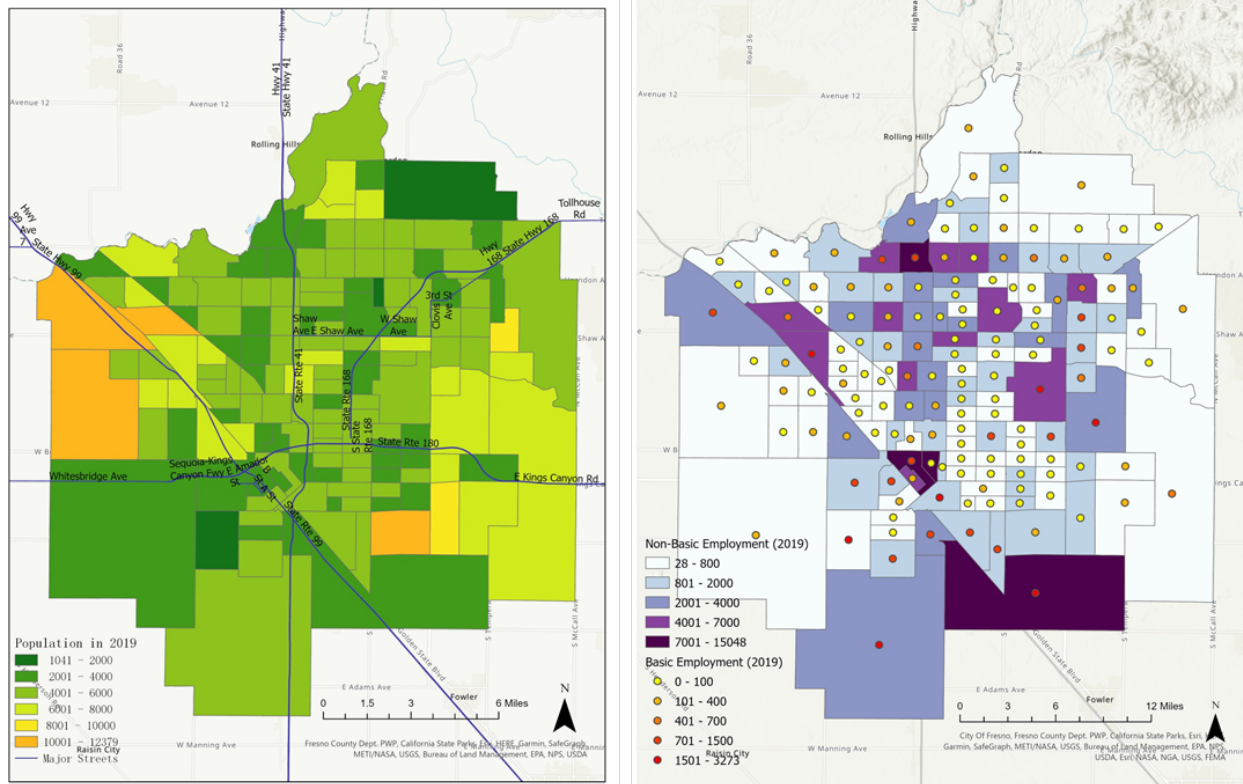

Figure 4. Land Uses in 2019 and Designed Land-use Scenarios

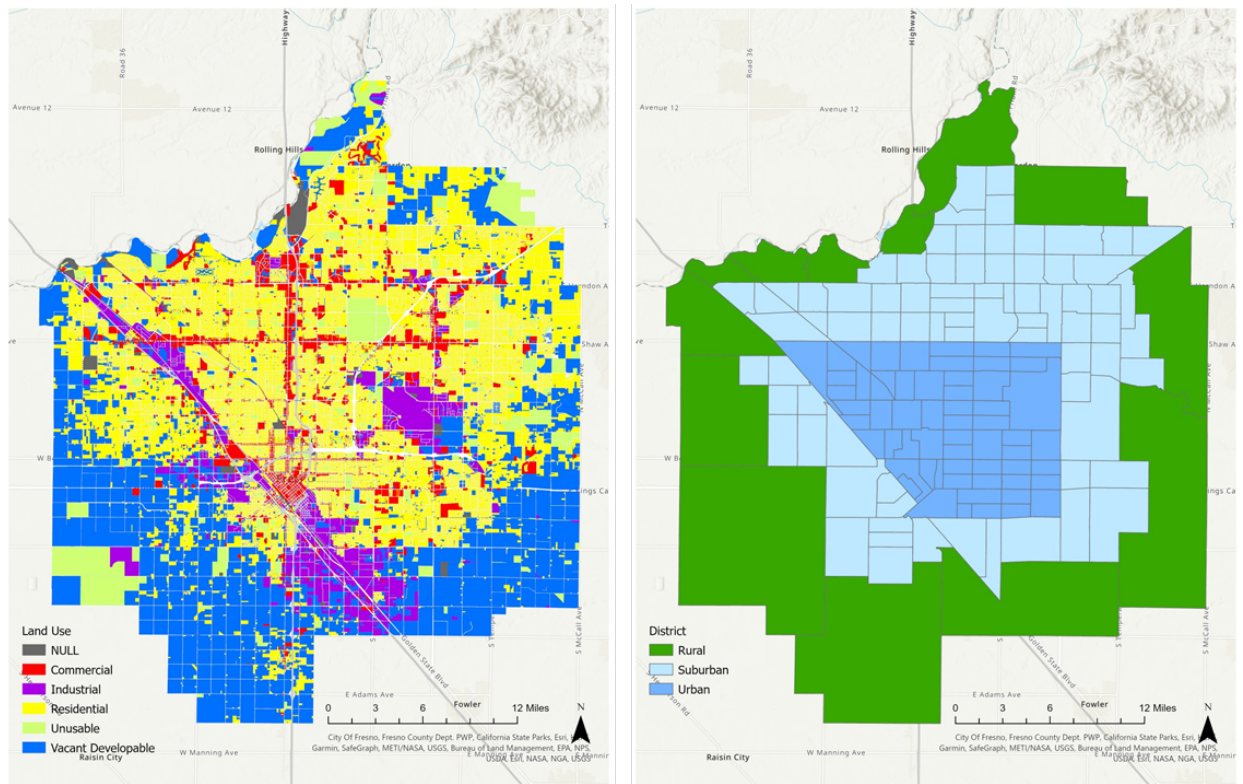

Figure 4 presents current land uses and designed land-use scenarios. Industrial and commercial land essentially follow the abovementioned pattern of basic and non-basic employed residence. Residential uses fill the rest of the land within the city boundary, while vacant developable land is in the outskirts as a circle. For the designed land-use scenarios, we added two additional layers of usable land (the existing residential, industrial, commercial, and vacant developable land) to the original usable land within the urban core area (shades of dark blue) for the L1 scenario. For the L2 scenario, we simply lower the vacant developable land in the rural outskirts (shade(s) of green) to zero to restrict developments. Finally, for the T1 scenario, we cut off travel costs by 50% in the urban core area (shades of dark blue) and double that in the outskirts rural areas (shades of green) to arrest urban sprawl.

## 3. Results

The simulation results are presented as the spatial distribution of population, employed residence, and land uses in 2029, 2039, and 2049 for the baseline, high density zoning, growth boundary, locational impedance, and carbon tax scenarios. Note that these simulations were run under an assumption of linear population growth from 2024 to 2049. Therefore, the results focus on how future activities interact across the study region subject to general preference (e.g., location choices) and physical conditions (e.g., land supply and transportation impedance). The mapping of predicted population shows whether future development moves toward the urban core over time. The mapping of employed residence illustrates the economic driver over the study region. The mapping of land uses represents the resulting consumption of vacant developable land from the designed land-use policies. Thus, the maps of the simulation results reveal which land-use/transportation policy would help with urban compaction and what level of policy intervention would make it happen.

### 3.1 Baseline (BL)

The simulation results for the baseline scenario are presented in Figures 5, 6, and 7. Under such a “do-nothing” scenario, the city will inevitably expand outward over time (see Figure 5). The reason is physical: there is currently minimal vacant developable land available within the city’s boundary. As a result, future development must take land from the rural area, which results in further urban sprawl. In Figure 6, the economic driver (employed residence) clusters along Highway 99 and Herndon Avenue, most likely due to lower transportation impedance. In Figure 7, future land consumption also supports the finding of urban sprawl. It is worth noting that the simulation results here might not reflect true future development because we define the study region as a closed system in a relatively small spatial scale without considering activities from outside regions. Nevertheless, the results still point out that future development will expand outward due to the lack of available land within the city’s boundary. If these future developments are allowed to move outside of the study region, we would expect higher transportation costs due to commuting for these activities. If not, higher house prices will be expected across the city based on the rules of supply and demand. Neither of these supports sustainable development for Fresno.

Figure 5. Population Predictions of BL

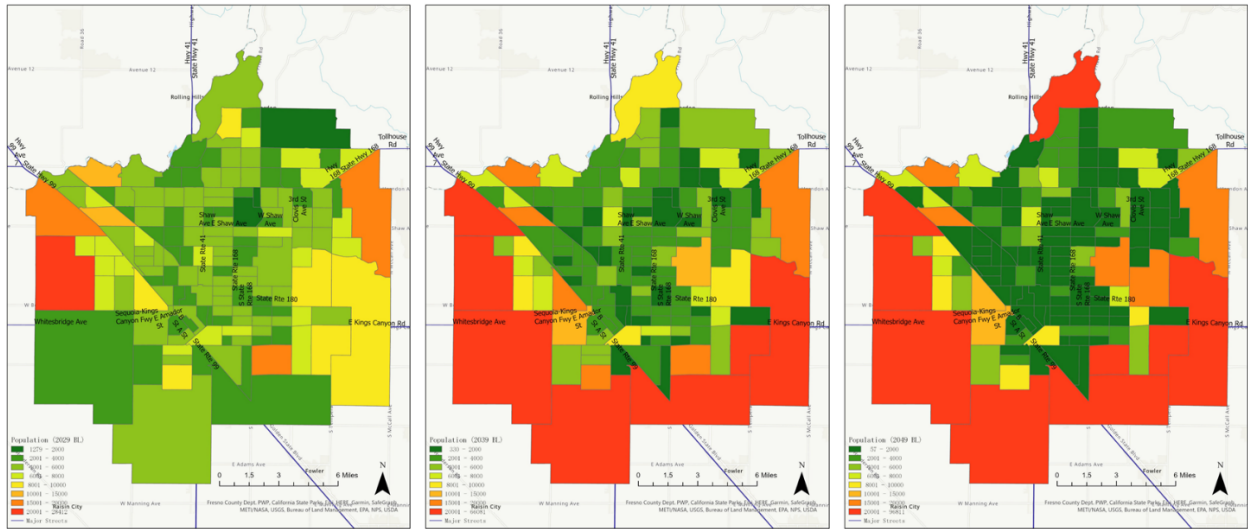

Figure 6. Employed Residence Predictions of BL

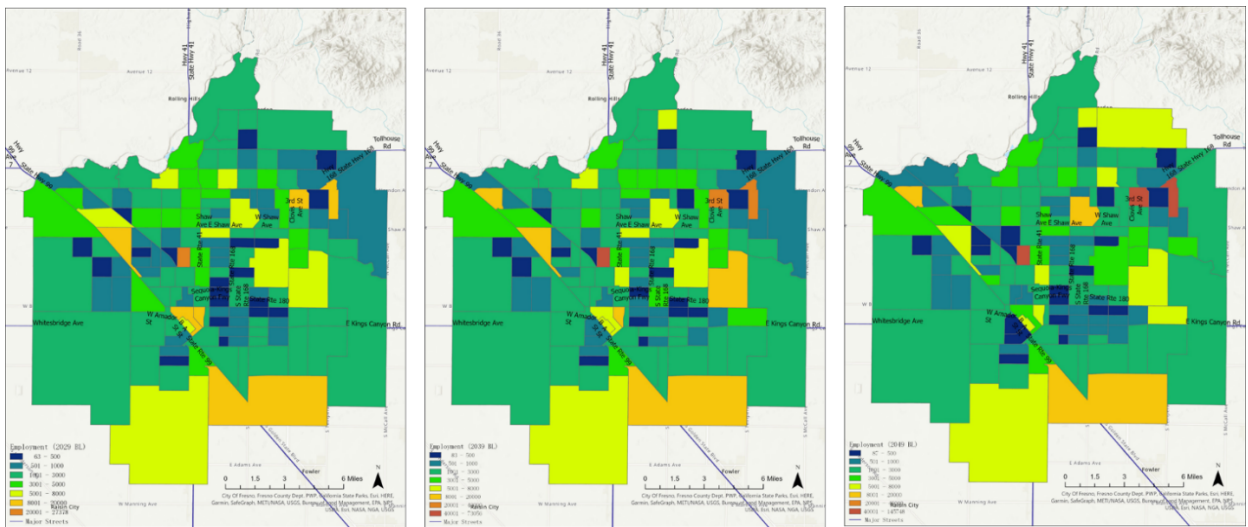
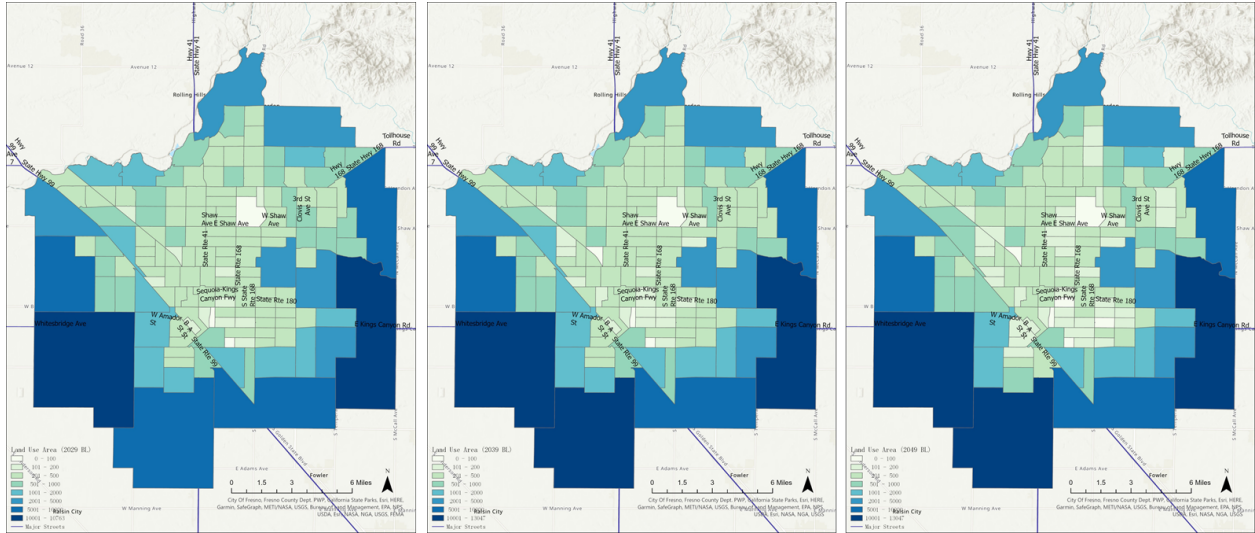



Figure 7. Land Use Predictions of BL



### 3.2 High Density Zoning (L1)

For the L1 and L2 scenarios, we present the changes of population, employed residence, and land uses between the baseline and each land-use policy for comparison. Figure 8 presents the population changes between the baseline (BL) and high-density zoning (L1) scenario. This policy effectively pulls future development back to the urban core (shades of blue), especially in 2039 and 2049. This result occurs under the assumption that there are two additional layers of usable land assigned to the urban core. In other words, we tripled the original usable land in the urban core areas, or we rezoned these areas to allow a three-story building or construction. We also tested the scenario by only adding an additional layer, and the results showed that the urban core and the rural areas compete for future developments; hence we consider that at least a zoning which allows for three-story buildings would be enough to help with urban compaction. Figure 10 presents land-use changes between the BL and L1 scenarios, which also supports this policy’s effectiveness. In Figure 9, employed residence does not see great changes between the two scenarios. We consider that the land-use policy does have some influence, but the future economy mainly depends on the existing economic body and transportation conditions.

Figure 8. Population Changes Between BL and L1

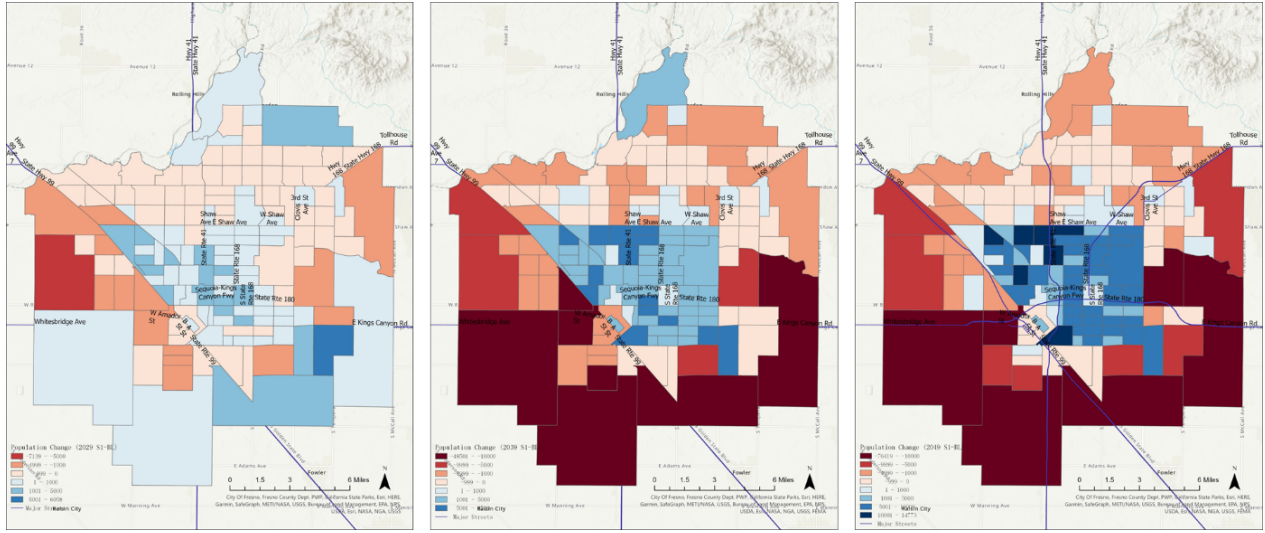

Figure 9. Employed Residence Changes Between BL and L1

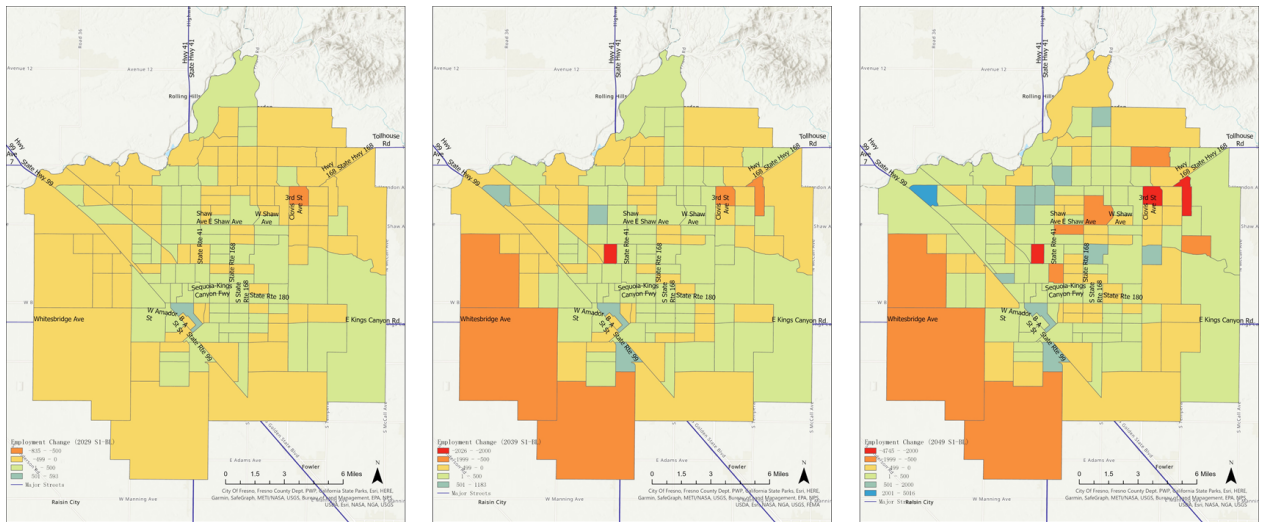
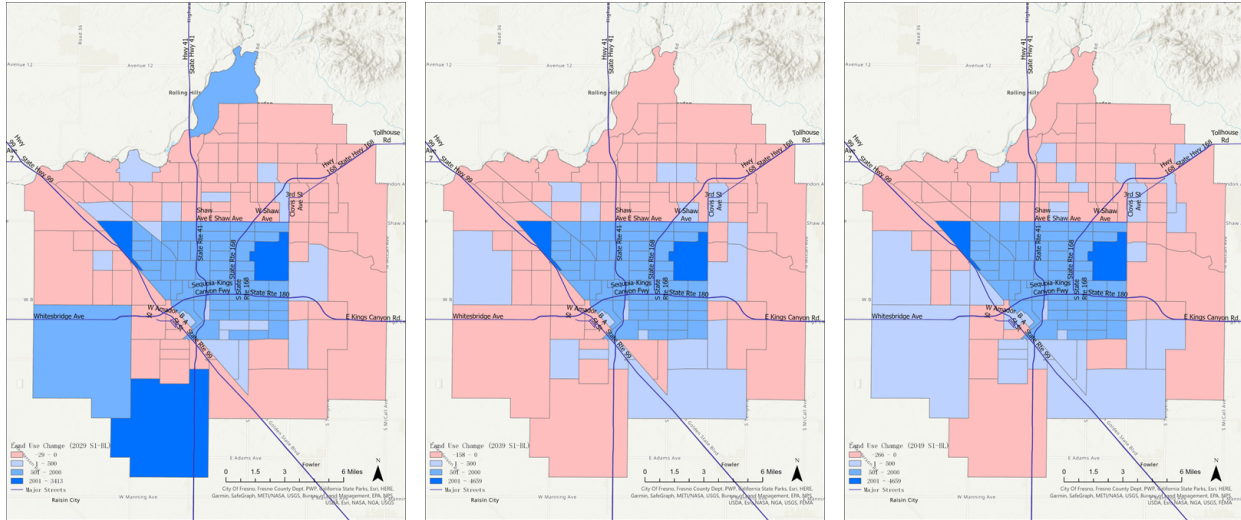

Figure 10. Land-use Changes Between BL and L1



### 3.3 Growth Boundary (L2)

Similarly, we present the difference in simulation results between the BL and L2 scenarios in Figures 11, 12, and 13. The L2 scenario is built on the assumption of the L1 scenario, and the purpose is to see whether the additional land-use policy (e.g., a growth boundary) would enhance the compaction or speed up the process. Figure 11 shows that the zero policy of land availability in the rural areas does speed up the initial process of compaction in 2029, and results in a spill-over effect in 2049 (i.e., positive population changes expanding out of the urban core into the suburban area). Figure 13 supports this finding, namely, that a large negative land-use change was found between BL and L2 in rural areas. It is hard to say that this policy would enhance the compaction, since the L1 scenario has been strong enough for this purpose. Nevertheless, we believe that the L1 scenario should be considered first because the zero policy in the rural areas is unlikely to work if there is no space for future development in the urban core. Employed residence changes in Figure 12 are remarkably similar to those in Figure 9 since the setting of the L2 scenario does not change the economic body and transportation conditions. It is worth noting that the two land-use scenarios help create a more compact Fresno and therefore help reduce travel miles and greenhouse gas emissions, although these two scenarios do not directly apply any transportation policy elements. A denser Fresno would also help public transit ridership by promoting Bus Rapid Transit (BRT) or Transit Oriented Development (TOD) for sustainable development. Furthermore, from a planning perspective, a denser city is also essential for some smart growth ideas such as mixed-uses, walkability, and complete streets. The results of these two scenarios point to the effectiveness of land-use policies on the compaction of a city toward sustainability.

Figure 11. Population Changes Between BL and L2

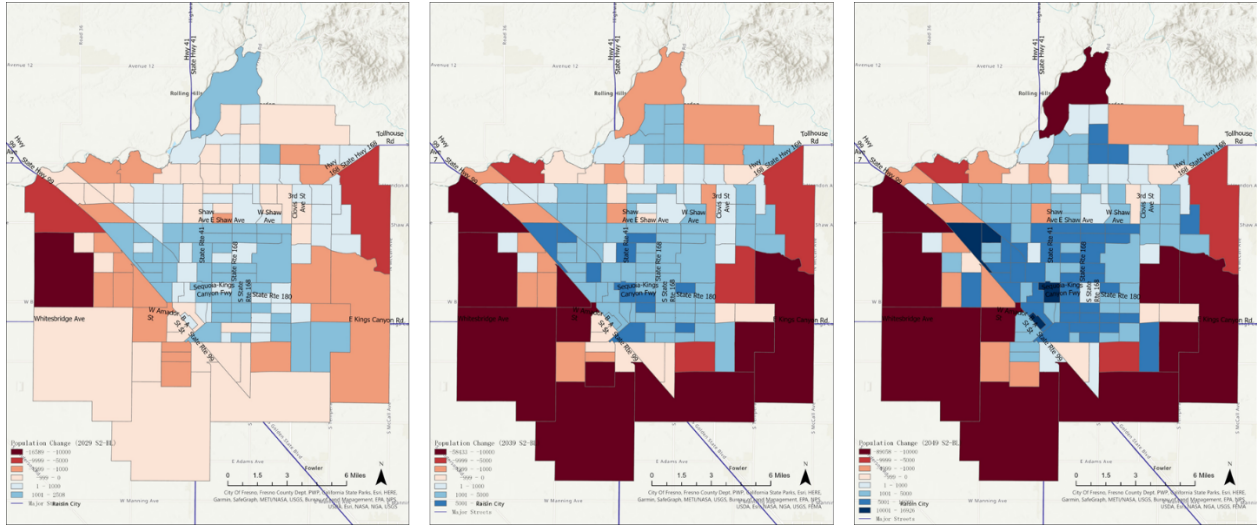

Figure 12. Employed Residence Changes Between BL and L2

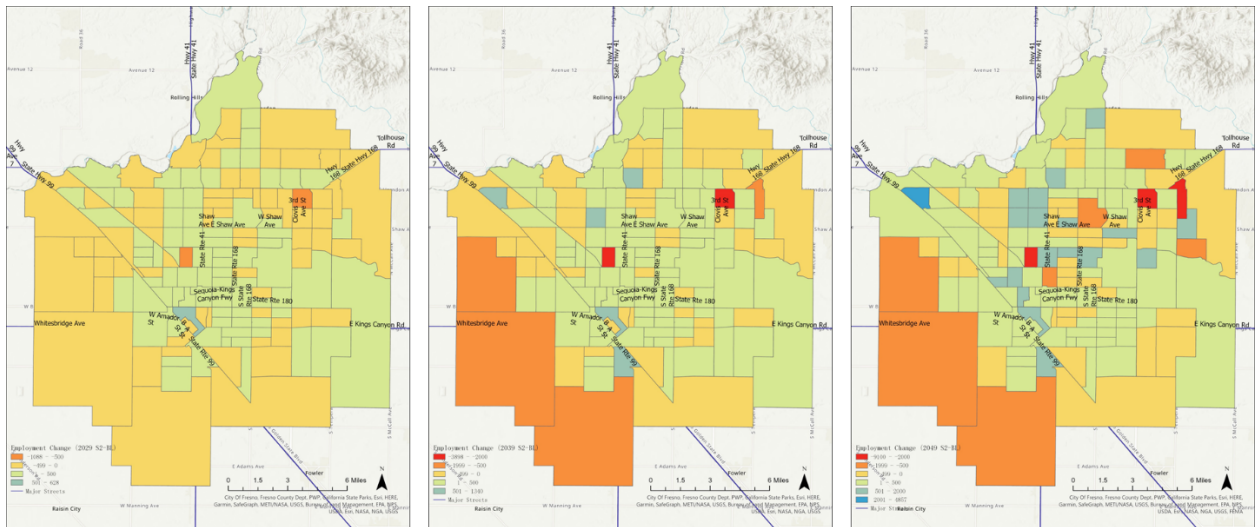
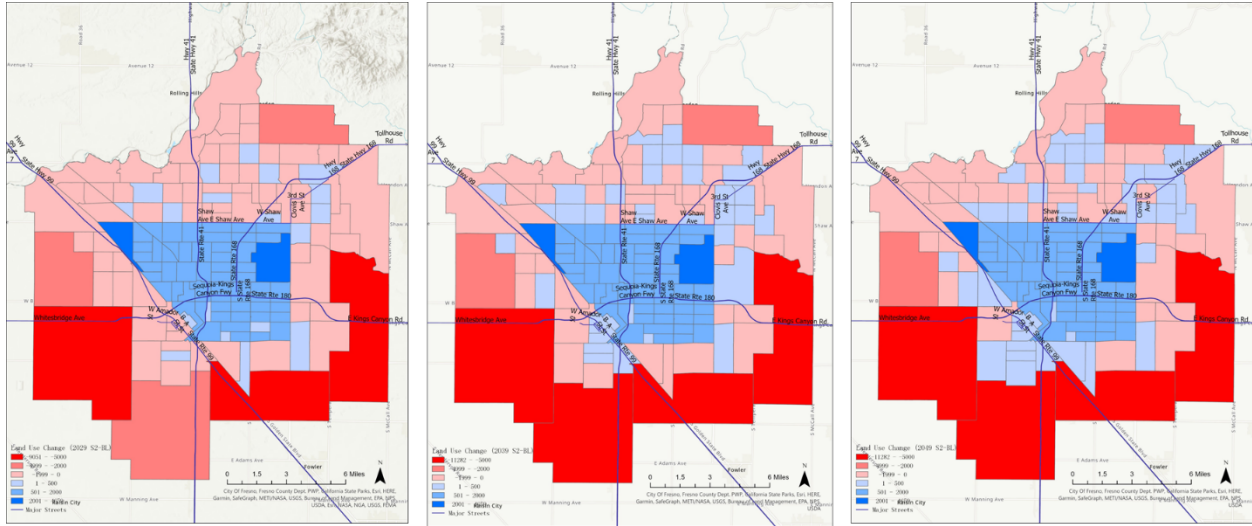



Figure 13. Land-use Changes Between BL and L2



### 3.4 Locational transportation impedance (T1)

The T1 and T2 scenarios are built on the assumptions of the L2 scenario to explore whether transportation policies would be of any further help for urban compaction. In the T1 scenario, we lowered travel cost by 50% in the urban core areas and doubled it in the rural areas (see Figure 4), while all the other conditions remain the same as the L2 scenario. The difference between the T1 and L2 results are presented in Figures 14, 15, and 16 for comparison. Interestingly, at first glance it might not be easy to find meaningful results in these maps. For this reason, it would be helpful to disclose exactly what this scenario created for Fresno. We believe that this scenario essentially produced transportation barriers between the three divided regions (urban core, suburban, and rural areas). TELUM is a gravity model and therefore it is naturally sensitive to such transportation barriers. As a result, future activities would tend to interact with those within their own region rather than with those in the other regions. Therefore, the suburban areas (shades of light blue in Figure 4) would be affected most by this policy because most activities in this region were designed to support those in the urban core areas. The urban core would attract further developments due to the low travel costs and strong local economy. The rural areas would also see little future development when the local economy matures.

Figure 15 presents the employed residence change between the T1 and L2 scenarios. These maps support the above-mentioned interpretations, according to which the suburban areas see some significant drops (shades of red), while the urban core areas see some significant increases (shades of dark blue) in 2039 and 2049. These results continue to affect the population allocation (see Figure 14), especially those areas which most use the convenience of transportation infrastructure such as Highways 99, 168, and 180. Figure 16 shows minor land-use changes between the two scenarios. It is worth noting that the changes between the L2 and T1 scenarios are not as large as those between the L1 and L2 ones, suggesting that transportation policies would be less effective on the allocation of future developments as compared to land-use policies. In any case, this policy

is suitable to implement at the regional level, since it creates transportation barriers, which is very similar to the effect of barriers to trade. For the purposes of urban compaction, it might work to apply this policy in the rural areas to restrict spatial interactions within the city's boundary.

Figure 14. Population Changes Between L2 and T1

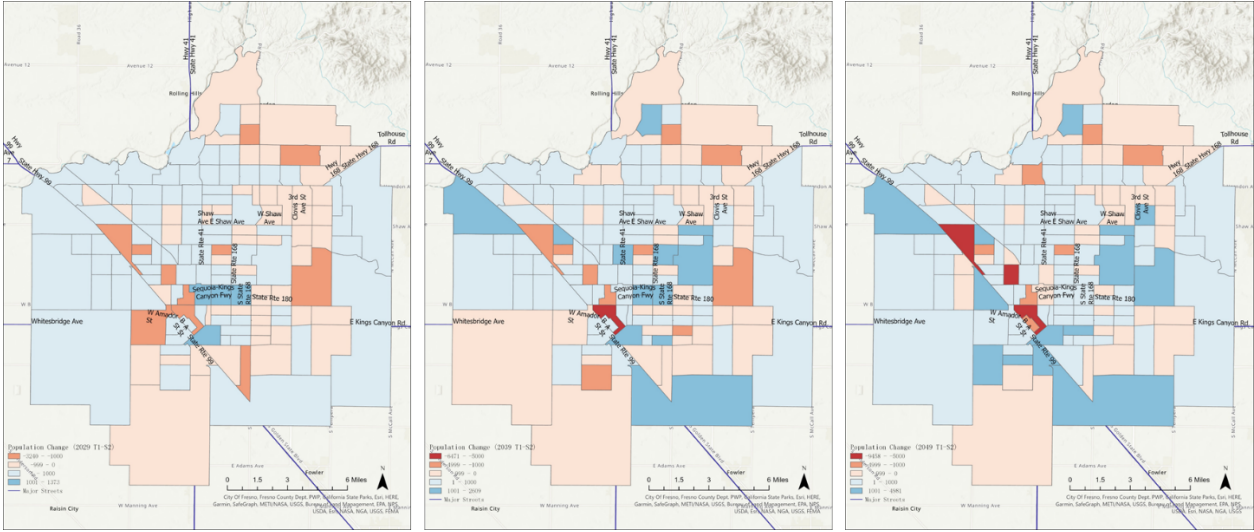

Figure 15. Employed Residence Changes Between L2 and T1

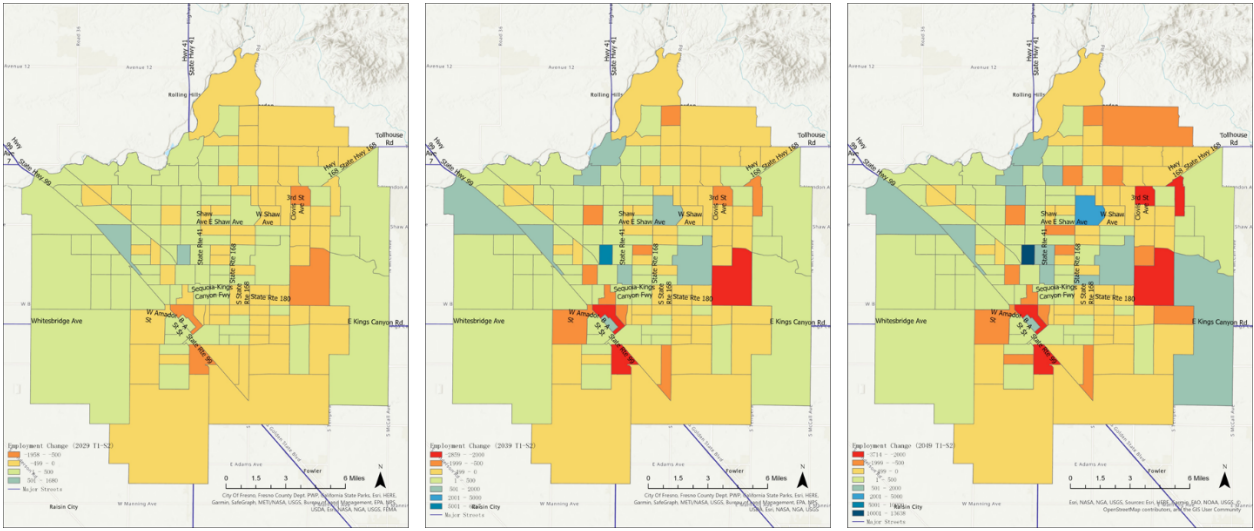
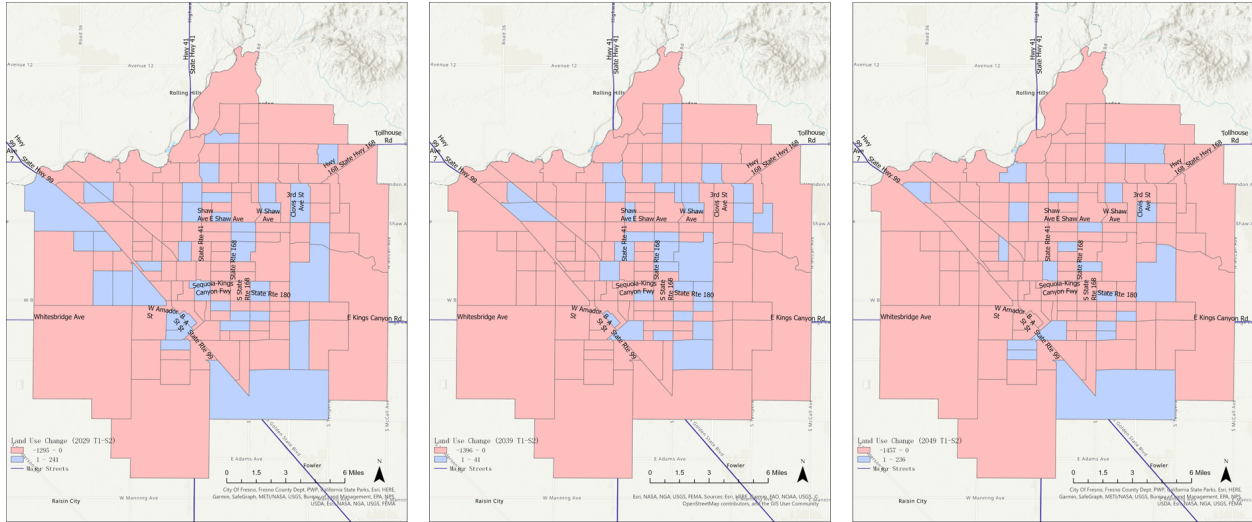



Figure 16. Land-use Changes Between L2 and T1



### 3.5 Carbon Tax (T2)

The T2 scenario builds on the L2 scenario to square travel cost. The difference between the T2 and L2 results is presented in Figures 17, 18, and 19. The idea of this policy is similar to a carbon tax in that longer travel will be punished more than shorter travel. Therefore, we expect that future activities would interact with each other within a smaller geographical area. In Figure 17, the population changes between L2 and T2 present a pattern of spatial autocorrelation across the study region so that both positive and negative changes cluster in a small area. Those positive-change clusters take shape most likely due to a stronger local economic body which serves as the driver of future developments as presented in Figure 11 (shades of dark blue). The same consideration also applies to those negative-change clusters, where there is a weaker local economic body. This small-area clustering of future activities breaks the original smooth spatial pattern and produces an uneven distributed outcome.

The abovementioned uneven spatial pattern of population changes also applies to that of employed residence changes (Figure 18), which essentially represent the economic driver of future developments. Similar to the T1 results, Figure 19 shows that land-use changes are all minor, implying that the effect of transportation policies on land uses is less than that of land-use policies. It is worth noting that a policy such as a carbon tax might not promote a compact city and would change the urban form into an unevenly distributed one. In this case, the goal would no longer be to make a monocentric compact city but rather a multicentric compact one. If this policy is considered an important measure for the reduction of greenhouse gas emissions, planners would have to learn how to respond to this change to keep running the city efficiently. A possible solution could be to establish very affordable public transit to compensate for the increased travel cost of driving. Another possibility is to implement the idea of TOD (Transit Oriented Development),

which connects those small-area clusters with a complete transit network that residents can walk or bike within their own areas and use transit for longer travel times to interact with activities in another small cluster. These ideas are, of course, experimental and require further exploration.

Figure 17. Population Changes Between L2 and T2

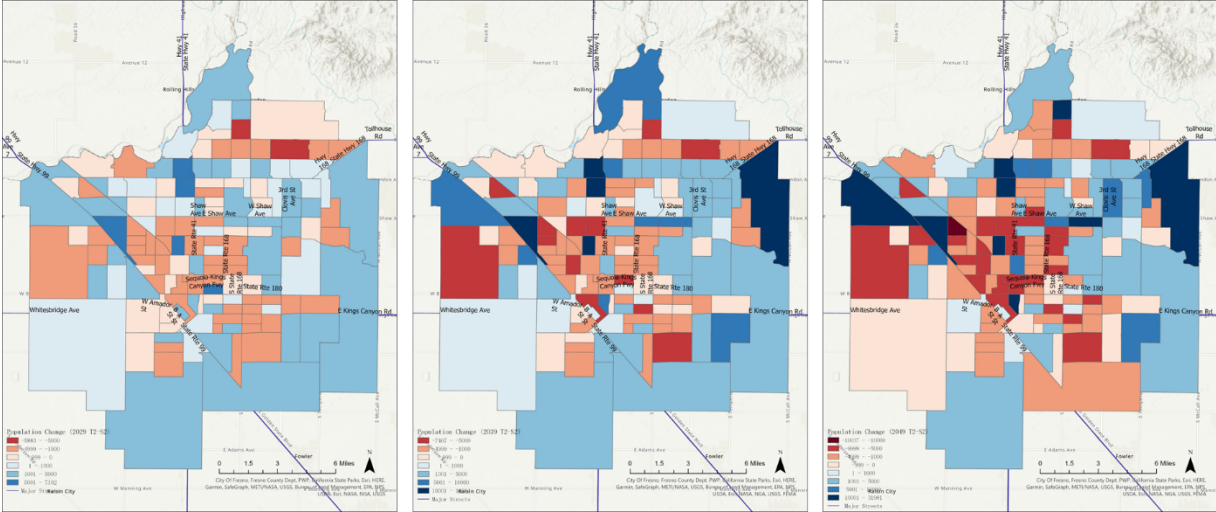

Figure 18. Employed Residence Changes Between L2 and T2

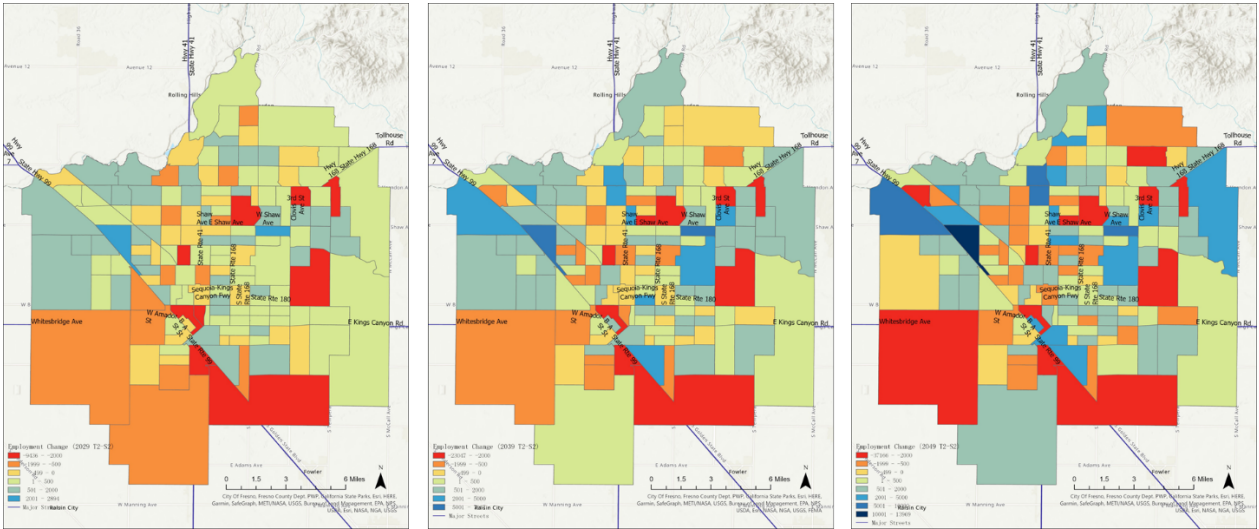
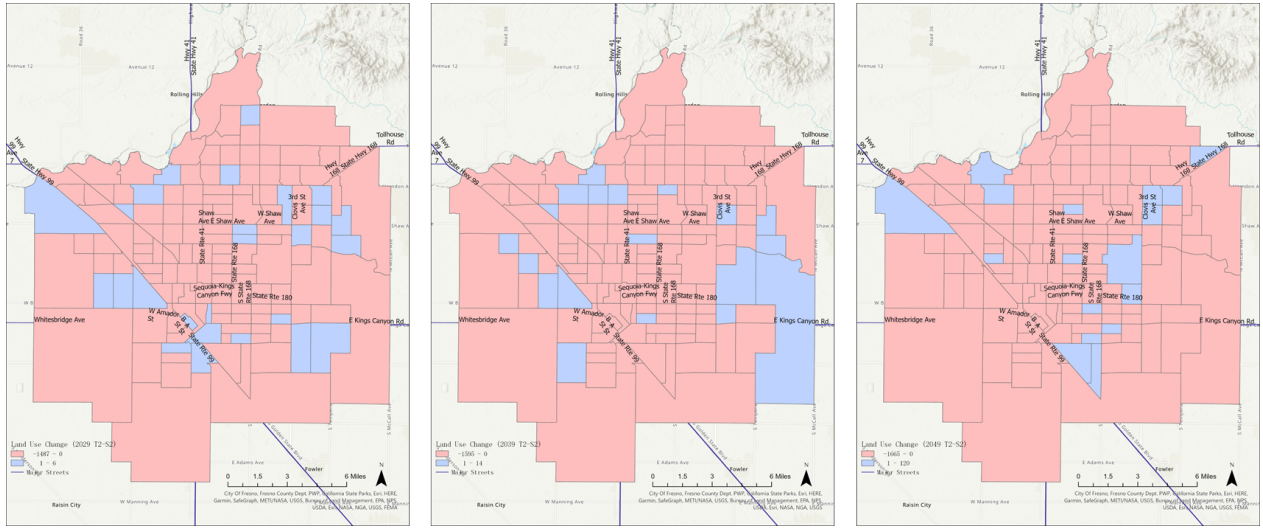

Figure 19. Land-use Changes Between L2 and T2



## 4. Summary & Conclusions

This study aims to solve a longstanding urban planning problem (i.e., urban sprawl) through a new methodological approach of operating a classic urban gravity model, TELUM. Urban models have been used to forecast future city developments and, therefore, planners would be able to prepare for providing adequate land use as well as transportation and public infrastructure and facilities. Most studies have only focused on the function of forecasting in these urban models but have largely neglected the possibility that these urban models can be operated in the reverse direction. For instance, one can easily use an urban model to simulate what will happen if a high-density zoning policy is implemented in a city. Nevertheless, this study uses an urban model to test the extent to which a high-density zoning policy should be implemented to initiate the process of urban compaction. This study also applies this approach to other policies in order to promote a sustainable compact city, including a growth boundary, locational transportation impedance, and carbon tax.

Fresno, California is selected as the study region for this proposed methodological approach. The key findings are summarized as follows.

**BL (baseline):** This scenario assumes that the city grows naturally without any policy interventions. The results are used as a benchmark for further comparisons. TELUM results show that the city will inevitably expand outward due to the lack of available vacant developable land within the city's boundary. In a word, the "do-nothing" policy will exacerbate the issue of urban sprawl in Fresno.

**L1 (high-density zoning):** The L1 scenario increases the availability of vacant developable land in urban core areas. The results show that the urban core would compete with the rural areas for attracting future developments if one additional layer of usable land is added in the urban core areas. Until two layers of usable land are added, urban compaction would occur and make a meaningful change to the city in the next 20 years.

**L2 (growth boundary):** Building on the high-density zoning policy, the L2 scenario applies a growth boundary by lowering the amount of vacant developable land to zero in rural areas. The results suggest that the growth boundary, indeed, speeds up the process of urban compaction by about 10 years and makes the city more compact as compared to L1's results.

**T1 (locational impedance):** Building on the assumptions of the L2 scenario, the T1 scenario decreases travel cost in the urban core areas by 50% and doubles that in the rural areas. Interestingly, the results reveal that this policy essentially creates transportation barriers between the regions defined in this study (urban, suburban, and rural areas). Future activities would accordingly interact within their own regions. The urban core areas will see more future developments because of lower travel costs and stronger local economies. On the other hand, the suburban areas will lose development due to poorer travel and economic conditions. The rural areas will see more

developments when the local economy matures. The effect of this scenario is remarkably similar to that of barriers to trade.

T2 (carbon tax): This scenario aims to punish long travel across the study region by squaring travel cost. We expect that future activities would interact with those nearby to avoid penalties. Therefore, future developments will cluster with those that are more alike, resulting in spatial autocorrelation. Thus, the goal will be to create a multicentric compact city from a monocentric compact one. The idea of TOD (Transit Oriented Development) might help with this goal by connecting those small-area clusters with a complete transit network.

From the results, the current usable land in the city's core must increase threefold to initiate the compaction process for Fresno (L1), and a policy restricting land supply in the outskirts, such as growth boundary, would speed up the compaction process (L2). Land-use planning is evident as an effective measure for promoting urban compaction. Building on the proposed land-use policy, the designed transportation interventions produce mixed results: (1) locational impedance does not seem to help urban compaction; (2) an extreme carbon tax policy might result in a multicentric compact city; and (3) both of the two interventions do not speed up the urban compaction process. From the T2 results, future activities would cluster in a small area if long travel is heavily penalized. In this case, TOD could be integrated into such a transportation policy to connect the resulting clusters.

The idea of urban compaction has been discussed for decades in planning, but it is still rare to see a successful case in the real world. The proposed research framework can be used in any city to evaluate how a transportation or land-use policy would affect the urban form, how much effort is required to make a difference, and how long it will take to complete the compaction process. Five scenarios were considered, and the results provide insight into the practice of some sustainable policies, such as smart growth and new urbanism. More policy scenarios are necessary to test their effectiveness for promoting urban compaction. Evaluating all possible scenarios, however, was beyond the scope of this study and remains an area for future research.

# Bibliography

1. Anas, A., Arnott, R., and Small, K. A. (1998). Urban spatial structure. *Journal of Economic Literature* 36(3): 1426–1464.
2. Casper, C., O'Brien, J., Lupa, M., Dimitrijevic, B., and de Araujo, M. (2009). Application of TELUM by the pikes peak, Colorado, area council of governments: Lessons learned in Colorado springs. *Transportation Research Record: Journal of the Transportation Research Board*: 45-53.
3. City of Fresno website: [https://www.fresno.gov › sites › Annexation-History](https://www.fresno.gov/sites/Annexation-History)
4. Echenique, M. H., Hargreaves, A. J., Mitchell, G., et al. (2012). Growing cities sustainably. *Journal of the American Planning Association* 78(2): 121–137.
5. Garreau, J. (1991). *Edge city: Life on the new frontier*.
6. Iacono, M., Levinson, D., and El-Geneidy, A. (2008). Models of transportation and land use change: A guide to the territory. *Journal of Planning Literature* 22: 323-340.
7. Putman, S. H. (2010). DRAM residential location and land use model: 40 years of development and application. *Residential Location Choice*: 61-76.
8. Randolph, J. (2003). *Environmental Land Use Planning and Management*. Washington DC: Island Press.
9. Waddell, P., Borning, A., Noth, M., Freier, N., Becke, M., and Ulfarsson, G. (2003). Microsimulation of urban development and location choices: Design and implementation of UrbanSim. *Networks and Spatial Economics* 3: 43-67.
10. Zhou, B., Kockelman, K., & Lemp, J. (2009). Applications of integrated transport and gravity-based land use models for policy analysis. *Transportation Research Record: Journal of the Transportation Research Board*: 123-132.



# About the Authors

## **Chih-Hao Wang**

Dr. Chih-Hao Wang is an Associate Professor of the Department of Geography and City & Regional Planning at California State University, Fresno, where he has taught since 2014. He received his PhD (2013) and master's (2010) degrees in City and Regional Planning from The Ohio State University. Dr. Wang's research focuses on environmental planning from the perspective of natural hazard mitigation. His research interests also include the application of spatial statistics to the analysis of spatial or social interactions in earthquake settings, as well as water management, transportation planning, and community development. His research has been published in journals of environmental planning, transportation, and geography.

## **Na Chen**

Dr. Na Chen is an Associate Professor in the School of Government at the Sun Yat-sen University in Guangzhou, China. She received her bachelor's in Public Policy (2008) from Sun Yat-sen University, her master's in Community Planning and Public Administration (2011) from Auburn University, AL, and her PhD in City and Regional Planning (2016) from The Ohio State University. She then worked as a postdoctoral scholar in the Department of Technology Management at the University of California, Santa Cruz. Her research interests include transportation planning, activity-based travel behavior modeling, accessibility, activity space, transportation equity, land-use modeling, spatial econometrics, and Geographic Information System applications for urban planning. Dr. Chen has published many papers in peer-reviewed journals and presented at international conferences in her areas of expertise.

# MTI FOUNDER

---

**Hon. Norman Y. Mineta**

## MTI BOARD OF TRUSTEES

---

**Founder, Honorable Norman Mineta\*\*\***  
Secretary (ret.),  
US Department of Transportation

**Chair, Will Kempton**  
Retired Transportation Executive

**Vice Chair, Jeff Morales**  
Managing Principal  
InfraStrategies, LLC

**Executive Director, Karen Philbrick, PhD\***  
Mineta Transportation Institute  
San José State University

**Winsome Bowen**  
President  
Authentic Execution, Corp

**David Castagnetti**  
Partner  
Dentons Global Advisors

**Maria Cino**  
Vice President  
America & U.S. Government  
Relations Hewlett-Packard Enterprise

**Grace Crunican\*\***  
Owner  
Crunican LLC

**Donna DeMartino**  
Retired Transportation Executive

**John Flaherty**  
Senior Fellow  
Silicon Valley American  
Leadership Form

**Stephen J. Gardner\***  
President & CEO  
Amtrak

**Rose Guilbault**  
Board Member  
San Mateo County  
Transit District (SamTrans)

**Kyle Christina Holland**  
Senior Director,  
Special Projects, TAP Technologies,  
Los Angeles County Metropolitan  
Transportation Authority (LA Metro)

**Ian Jefferies\***  
President & CEO  
Association of American Railroads

**Diane Woodend Jones**  
Principal & Chair of Board  
Lea + Elliott, Inc.

**Therese McMillan**  
Retired Executive Director  
Metropolitan Transportation  
Commission (MTC)

**Abbas Mohaddes**  
CEO  
Econolite Group Inc.

**Stephen Morrissey**  
Vice President – Regulatory and  
Policy  
United Airlines

**Toks Omishakin\***  
Secretary  
California State Transportation  
Agency (CALSTA)

**Marco Pagani, PhD\***  
Interim Dean  
Lucas College and  
Graduate School of Business  
San José State University

**April Rai**  
President & CEO  
Conference of Minority  
Transportation Officials (COMTO)

**Greg Regan\***  
President  
Transportation Trades Department,  
AFL-CIO

**Paul Skoutelas\***  
President & CEO  
American Public Transportation  
Association (APTA)

**Kimberly Slaughter**  
CEO  
Sysra USA

**Tony Tavares\***  
Director  
California Department of  
Transportation (Caltrans)

**Jim Tymon\***  
Executive Director  
American Association of  
State Highway and Transportation  
Officials (AASHTO)

\* = Ex-Officio  
\*\* = Past Chair, Board of Trustees  
\*\*\* = Deceased

---

## Directors

**Karen Philbrick, PhD**  
Executive Director

**Hilary Nixon, PhD**  
Deputy Executive Director

**Asha Weinstein Agrawal, PhD**  
Education Director  
National Transportation Finance  
Center Director

**Brian Michael Jenkins**  
National Transportation Security  
Center Director

