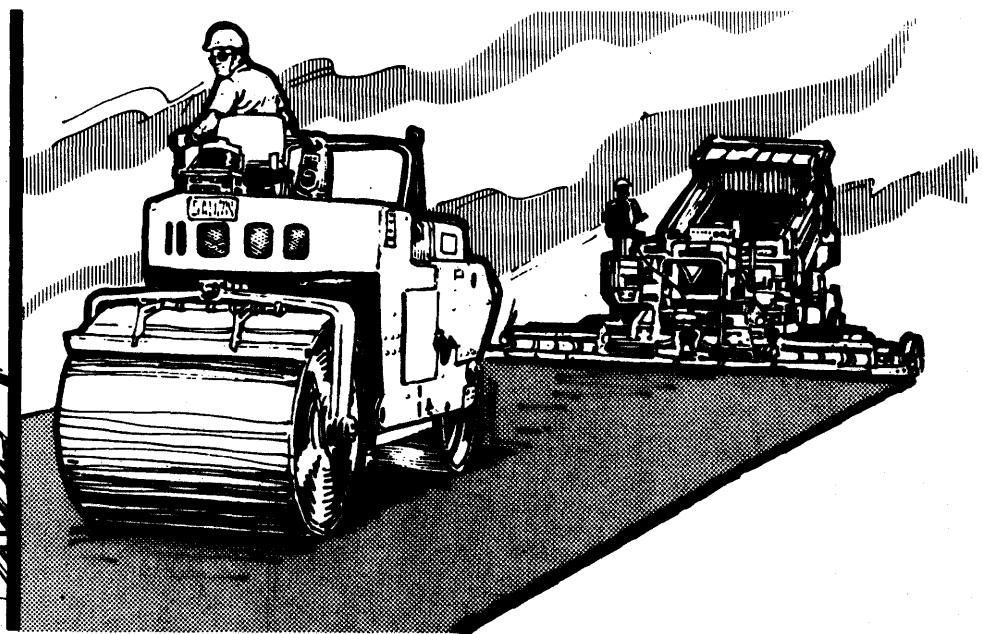


TRUNK

# INSPECTORS' TRAINING COURSE MANUAL

FINAL VERSION

## PRINCIPLES OF CONSTRUCTION OF QUALITY HOT-MIX ASPHALT PAVEMENTS



Prepared under contract by The Asphalt Institute,  
College Park, Maryland, for the Federal Highway  
Administration, U.S. Department of Transportation,  
Washington, D.C.

FHWA-80-R-00426  
August 1982

TRUNK

**This document is disseminated under the sponsorship of the U.S. Department of Transportation in the interest of information exchange. The United States Government assumes no liability for the contents or use thereof. The contents of this manual reflect the views of the contractor, who is responsible for the accuracy of the data contained herein. The contents do not necessarily reflect the official policy of the U.S. Department of Transportation; and this manual does not constitute a standard, specification or regulation. The United States Government does not endorse products or manufacturers. Trade or manufacturers' names appear herein solely because they are considered essential to the object of the publication.**

## PREFACE

This manual is designed to provide novice hot-mix asphalt pavement inspectors with the knowledge needed to perform their duties. It also serves as a source of information from which experienced inspectors and others involved in asphalt pavement construction can refresh their knowledge and review current inspection practices.

This publication utilizes the standard specifications and tests of the American Association of State Highway and Transportation Officials (AASHTO) as the primary source of reference. Customary English units of measurement are used as the principal indicators, followed by metric conversions in parentheses. The metric terminology identifying sieve sizes varies from that of the U.S.A. Standard Sieve Size Designations.

Although able to stand alone as an inspectors' manual, this text is part of a comprehensive course of instruction which includes visual aids and an instructor's manual. Information on supplementary materials is available from the Federal Highway Administration, 400 7th Street, S.W., Washington, D.C., or The Asphalt Institute, College Park, Maryland 20740.

**Many competent men and women serve as professional asphalt plant and paving inspectors; however, in this manual only masculine pronouns are used in reference to inspectors and their duties. This convention is intended to avoid awkwardness in style and in no way reflects sexual bias on the part of the authors.**

**All reasonable care has been taken in the preparation of this Manual. However, The Asphalt Institute can accept no responsibility for the consequences of any inaccuracy or omission. The Asphalt Institute does not endorse products or manufacturers. Trade or manufacturers' names appear herein solely because they are considered necessary to the object of this publication.**





# CONTENTS

	Page
<b>Preface</b> .....	iii
<b>List of Figures</b> .....	viii
<b>List of Tables</b> .....	xiii
<b>SECTION 1: IMPORTANCE OF INSPECTION AND THE INSPECTOR</b> .....	1
1.1 Introduction .....	1
1.2 Purpose of Inspection .....	2
1.3 Inspector's Authority .....	2
1.4 Inspector's Relationship with Contractor .....	2
1.5 Qualifications of Inspector .....	3
1.6 Sampling and Testing .....	4
1.7 Equipment .....	4
1.8 Records .....	5
1.9 Safety .....	6
1.10 Specific Inspector Responsibilities .....	6
1.11 Summary .....	6
<b>SECTION 2: MATERIALS</b> .....	9
2.1 Inspector Objectives .....	9
2.2 Introduction .....	9
2.3 Asphalt .....	10
2.4 Aggregate .....	36
2.5 Materials Summary .....	55
<b>SECTION 3: MIX DESIGN</b> .....	57
3.1 Inspector Objectives .....	57
3.2 Introduction .....	57
3.3 Mixture Characteristics and Behavior .....	57
3.4 Properties Considered in Mix Design .....	60
3.5 Evaluation and Adjustment of Mix Design .....	66
3.6 Applications of Mix Design Testing .....	68
3.7 Summary of Mix Design—General .....	70
3.8 Marshall Mix Design Method—Introduction .....	70
3.9 Conducting Marshall Mix Design .....	71
3.10 Analyzing Marshall Test Results .....	79
3.11 Summary of Marshall Mix-Design Method .....	83
3.12 Hveem Mix-Design Method—Introduction .....	83
3.13 Conducting the Hveem Mix Design .....	84
3.14 Analyzing Hveem Test Results .....	92
3.15 Summary of Hveem Mix Design Method .....	96
<b>SECTION 4: PLANT OPERATIONS</b> .....	97
4.1 Inspector Objectives .....	97
4.2 Introduction .....	97
4.3 Responsibilities of the Plant Inspector .....	97

## CONTENTS (Continued)

	Page
4.4 Purpose and Layout of Plant .....	98
4.5 Materials .....	100
4.6 Similar Operations: Batch Plants and Drum-Mixers .....	111
4.7 Inspection of Hot-Mix .....	125
4.8 Hot-Mix Sampling and Testing .....	126
4.9 Safety .....	135
4.10 Summary .....	136
4.11 Batch Plant Operations .....	136
4.12 Introduction .....	136
4.13 History of Batch Plants .....	137
4.14 Batch Plant Operations and Components .....	138
4.15 Aggregate Cold Feed .....	139
4.16 Aggregate Drying and Heating .....	141
4.17 Screening and Storage of Hot Aggregate .....	145
4.18 Pulling Material From the Hot Bins .....	156
4.19 Introducing the Asphalt .....	156
4.20 Temperature of Mixtures .....	157
4.21 Plant Scales .....	158
4.22 Pugmill Mixing .....	160
4.23 Batch Plant Automation .....	163
4.24 Plant Inspection Guidelines .....	165
4.25 Drum-Mix Plant Operations .....	166
4.26 Introduction .....	167
4.27 History of Drum-Mix Plants .....	168
4.28 Drum-Mix Plant Operations and Components .....	168
4.29 Aggregate Storage and Feed .....	169
4.30 Asphalt Metering .....	173
4.31 Drum-Mix Operation .....	174
4.32 Surge Silo and Weigh Scales .....	175
4.33 Summary of Drum Mixers .....	175
<b>SECTION 5: PLACING OPERATIONS .....</b>	<b>177</b>
5.1 Inspector Objectives .....	177
5.2 Introduction .....	177
5.3 Preparation for Paving .....	179
5.4 Paving Equipment .....	191
5.5 Delivery of Hot-Mix .....	202
5.6 Placing Procedures .....	205
5.7 Inspection of Mat .....	207
5.8 Summary of Placing Procedures .....	213
<b>SECTION 6: COMPACTION .....</b>	<b>215</b>
6.1 Inspector Objectives .....	215
6.2 Introduction .....	215
6.3 Compaction Principles .....	217

## CONTENTS (Continued)

	<b>Page</b>
6.4 Rollers .....	221
6.5 Rolling Procedures .....	233
6.6 Pavement Acceptance, Requirements and Verification .....	240
6.7 Summary .....	243

## APPENDICES

	<b>Page</b>
APPENDIX A: MISCELLANEOUS TABLES AND FIGURES .....	245
APPENDIX B: TYPICAL TERMINOLOGY .....	252
APPENDIX C: RANDOM SAMPLING TECHNIQUES .....	259
C.01 Selecting Sampling Locations in Trucks Hauling Asphalt Mixture .....	259
C.02 Selecting Sampling Locations at Pavement Site .....	261
APPENDIX D: AASHTO And ASTM TESTS .....	264
APPENDIX E: GRADATION ANALYSIS OF AGGREGATES .....	266

## LIST OF FIGURES

Figure		Page
2.1	Typical Distillation Temperatures and Products .....	12
2.2	Typical Refining Process .....	13
2.3	Requirements for Asphalt Cement Graded by Viscosity .....	14
2.4	Requirements for Asphalt Cement Graded by Viscosity Based on Residue from Rolling Thin Film Oven Test .....	15
2.5	Penetration Test .....	16
2.6	Penetration Grading System (AASHTO M 20) .....	16
2.7	Variation in Viscosity of Two Penetration Graded Asphalts at Different Temperatures .....	19
2.8	Variation in Viscosity of Two Viscosity-Graded Asphalts at Different Temperatures .....	19
2.9	Hardening of Asphalt after Exposure to High Temperature .....	20
2.10	Capillary Tube Viscometer in Temperature Bath .....	21
2.11	Pouring Asphalt Cement Sample into Viscometer .....	22
2.12	Penetration Test .....	23
2.13	Flashpoint Tests; Cleveland Open Cup Test; Pensky- Martens Test .....	24
2.14	Thin Film Oven Test .....	25
2.15	Rolling Thin Film Oven Test .....	25
2.16	Ductility Test .....	26
2.17	Determining Specific Gravity Using Pycnometer .....	27
2.18	Guideline Temperature for Storage and Handling of Asphalt Products .....	30
2.19	Guide for Loading Asphalt Products .....	31
2.20	Temperature-Volume Corrections for Asphalt .....	32
2.21	Examples of Different Aggregates .....	38
2.22	Sieve Analysis .....	43
2.23	Typical Composition of Asphalt Concrete .....	35
2.24	Typical Exponential Gradation Chart and Example of Grading Band .....	46
2.25	Typical Sieve Sizes .....	47
2.26	Sieve Analysis Data Converted to Aggregate Gradation .....	48
2.27	Semi-Log Chart Curve .....	49
2.28	Exponential Chart Curve .....	50
2.29	Various Types of Aggregate Specific Gravities .....	52
2.30	Los Angeles Abrasion Machine .....	53
2.31	Aggregate of Various Shape and Surface Textures .....	54
3.1	Illustration of VMA in a Compacted Mix Specimen .....	59
3.2	Voids in Mineral Aggregate (VMA Requirement) .....	59
3.3	Causes and Effects of Pavement Instability .....	61
3.4	Causes and Effects of Lack of Durability .....	62
3.5	Causes and Effects of Permeability .....	63
3.6	Causes and Effects of Workability Problems .....	64

## LIST OF FIGURES (Continued)

Figure		Page
3.7	Causes and Effects of Poor Fatigue Resistance .....	65
3.8	Causes and Effects of Poor Skid Resistance .....	65
3.9	Fuller Maximum Density Curves Based on Standard Semi- log Grading Chart .....	66
3.10	Maximum Density Curves Based on FHWA 0.45 Power Gradation Chart .....	67
3.11	Drying the Aggregate Sample .....	72
3.12	Determining Specific Gravity of an Aggregate Sample .....	73
3.13	Preparing Test Specimens in Marshall Molds .....	74
3.14	Marshall Drop Hammer Compacting Mix Specimen .....	75
3.15	Specimen in Marshall Apparatus .....	76
3.16	Gauge Readings, Marshall Stability Test .....	77
3.17	Marshall Flow Measurement Specimen and Flow Meter Reading .....	78
3.18	Example Plotted Curves Showing Test Results for Series of Five Marshall Specimens .....	80
3.19	Marshall Design Criteria .....	82
3.20	Minimum Percent VMA .....	82
3.21	Drying the Aggregate Sample .....	85
3.22	Determining Specific Gravity of an Aggregate Sample .....	86
3.23	Table of Surface Area Factors .....	87
3.24	Saturating an Aggregate Sample with Kerosene (CKE Test) .....	88
3.25	Rodding Mixture Sample in Mold .....	89
3.26	Mechanical Compactor Compacting Mixture Sample .....	89
3.27	Stabilometer Test .....	90
3.28	Swell Test Apparatus .....	92
3.29	Suggested Test Report Form Showing Test Data for a Typical Mix Design by the Hveem Method .....	93
3.30	Example Graphs Showing Unit Weight, Percent Air Voids, and Stabilometer Values for Test Mixture Specimens .....	94
3.31	Table of Hveem Mix Design Criteria .....	95
3.32	Pyramid Chart Used to Determine Optimum Asphalt Content .....	96
3.33	Example of Pyramid Procedures .....	99
4.1	Cutaway View of Typical Batch Plant .....	98
4.2	Typical Drum Mix Plant .....	99
4.3	Typical Layout of Batch Plant and Drum Mix Plant .....	100
4.4	(A) Correct and (B) Incorrect Methods for Storing Aggre- gate Containing Large and Small Particles .....	101
4.5	Stockpiling by Crane .....	102
4.6	Stockpiling with Dozer .....	103
4.7	Size of Samples .....	104

## LIST OF FIGURES (Continued)

Figure		Page
4.8	(Top) Mechanical Splitting Method; (Bottom) Quartering Method .....	105
4.9	A Series of Asphalt Storage Tanks .....	106
4.10	Asphalt Return Line .....	107
4.11	Asphalt Sampling Device for Vehicle or Storage Tank .....	108
4.12	Silo Filler Feeding System .....	109
4.13	Typical Three-Bin Cold Feed System .....	112
4.14	Typical Types of Cold Feed Systems: A. Continuous Belt Feeder, B. Vibratory Feeder, and C. Apron Flow Feeder .....	113
4.15	Example Calibration Chart for Aggregate Feeders .....	117
4.16	Calibration Chart .....	118
4.17	A Typical Cyclone Dust Collector .....	120
4.18	Typical Wet Scrubber .....	120
4.19	Typical Baghouse .....	121
4.20	Typical Storage Structure Configuration .....	122
4.21	Large-Capacity Insulated Asphalt Concrete Storage Silos .....	123
4.22	Typical Truck Scale and Platform .....	124
4.23	Possible Causes of Deficiencies in Hot Plant-Mix Paving Mixtures. A-Applies to Batch and Drum-Mix Plants; B-Applies to Batch Plants; C-Applies to Drum-Mix Plants .....	126
4.24	Measuring Temperature of Mix in Truck .....	127
4.25	Suggested Schedule of Sampling and Testing .....	128
4.26	Preliminary Inspection Report .....	130
4.27	Inspector's Plant Check List .....	132
4.28	Daily Report Form .....	134
4.29	Typical Batch Plant .....	137
4.30	Basic Plant Operations Shown (A) In Flow-Chart Form and (B) Schematically .....	138
4.31	Major Batch Plant Components .....	139
4.32	Cold-Feed System .....	140
4.33	Typical Dryer .....	142
4.34	Flights: (A) Typical Design and (B) Function .....	143
4.35	Typical Types of Pyrometers: (A) Indicating Pyrometer, and (B) Recording Pyrometer .....	144
4.36	Pyrometer Located at Discharge Chute of Dryer .....	146
4.37	Cutaway View Showing Details of Flow of Material Through Screens and Bins .....	147
4.38	Screening Unit .....	148
4.39	Diagram of a Diaphragm Type Cut-Off .....	149
4.40	Segregation of Aggregates in Hot Bins .....	150
4.41	Correct Use of Sampling Device .....	150
4.42	Example of Job Gradation .....	151
4.43	Results of Example Hot-Bin Analysis .....	152

## LIST OF FIGURES (Continued)

Figure		Page
4.44	Results of First Trial Estimate .....	153
4.45	Results of Second Trial Estimate .....	153
4.46	Results of Third Trial Estimate .....	154
4.47	How Cumulative Scale Settings Are Used To Control Material Amounts Pulled From Hot Bins .....	156
4.48	Typical Asphalt Measuring and Delivery System .....	157
4.49	Typical Asphalt Hot-Mixing Temperatures .....	158
4.50	Typical Arrangement of Plant Scales .....	159
4.51	Overfilled Pugmill .....	161
4.52	Underfilled Pugmill .....	161
4.53	Pugmill "Live Zone" .....	161
4.54	Steps in a Typical Batch-Plant Cycle .....	162
4.55	Automatic Controls for Batch Plants .....	164
4.56	Control Station for Automated Plant .....	165
4.57	Typical Drum-Mix Plant .....	167
4.58	Basic Drum-Mix Plant .....	168
4.59	Master Cold-Feed Control .....	171
4.60	Typical Sampling Device .....	171
4.61	Typical In-Line Belt Weigher .....	172
4.62	Asphalt Inlet .....	173
4.63	Zones in Drum Mixer .....	174
5.1	Typical Inspector's Diary Entry .....	179
5.2	Cold Planer .....	181
5.3	Correctly Placed Leveling Wedges Ensure Smoother Pavements .....	182
5.4	Limits for Multiple-Layer Leveling Wedges Should Be Determined by Level .....	182
5.5	Correctly Placed Leveling Wedges for Overcoming Excessive Crown .....	182
5.6	Grade and Line Stakes .....	184
5.7	A Typical Asphalt Distributor .....	187
5.8	Proper Angling of Nozzles .....	188
5.9	Spray-Bar Height and Coverage .....	188
5.10	Spraying Temperature Ranges for Prime and Tack Coat .....	190
5.11	A Typical Paver Unit .....	191
5.12	Paver Power Unit and Screed Unit .....	193
5.13	Forces Acting on the Screed .....	193
5.14	Tamping Bar .....	195
5.15	Vibratory Type Screed .....	196
5.16	Mat Thickness and Crown Controls .....	196
5.17	Automatic Screed Reference System .....	198
5.18	Types of Haul Trucks .....	200
5.19	Illustration of Load Ticket .....	203

## LIST OF FIGURES (Continued)

Figure		Page
5.20	Typical Mat Problems and Their Probable Causes .....	207
5.21	Checking Mat Thickness With a Depth Gauge .....	209
5.22	Taking Core Sample of Finished Pavement .....	211
5.23	Measuring Mat Thickness of Core .....	211
5.24	Using Wrapping Paper (A) or a Board (B) to Form a Transverse Joint .....	212
6.1	Pavement Durability vs. Air Voids .....	216
6.2	Forces at Work During Compaction .....	217
6.3	Heat Checking (Side View) .....	220
6.4	Heat Checking (Top View) .....	220
6.5	Steel-Tired Tandem Roller .....	222
6.6	Force Exerted on Mat by Steel Rollers .....	222
6.7	Proper Direction of Roller Travel .....	224
6.8	Improper Direction of Travel .....	224
6.9	Typical Pneumatic-Tired Roller .....	225
6.10	Forces Exerted by Pneumatic Roller During Compaction .....	226
6.11	Action of Tire During Kneading Procedures .....	227
6.12	Single Drum Vibratory Roller .....	228
6.13	Double Vibratory Roller .....	228
6.14	Off-Center Weights, Called Eccentrics, on a Spinning Shaft Create Vibrations .....	230
6.15	Illustration of Amplitude .....	231
6.16	Relationship between Speed and Frequency .....	231
6.17	Vibration Modes .....	232
6.18	Time Allowed for Compaction, Based on Temperature and Thickness of Mat and Temperature of Underlying Base .....	234
6.19	Nuclear Density Gauge .....	235
6.20	Rolling a Transverse Joint .....	237
6.21	Rolling a Hot Longitudinal Joint .....	238
6.22	Density Tests .....	242
6.23	Summary Table of Influences of Compaction .....	244
C-1	Schematic Diagram Illustrating Lot, Sample, Subsample and Sample Unit .....	260
E-1	Job Aggregates and Specification Plotted on Conventional Aggregate Grading Chart .....	269
E-2	Trial-and-Error Calculations for Combining Two Aggregates .....	270
E-3	Solution for Proportioning Two Aggregates .....	271
E-4	Adjusting Percentages by Volume to Percentage by Weight .....	272
E-5	Adjusting Gradation by Wasting .....	273



## LIST OF TABLES

<b>Table</b>		<b>Page</b>
A-1	Conversion Factors (Customary to Metric Units) .....	247
A-2	Weight and Volume Relations for Various Types of Compacted Asphalt Pavements .....	248
A-3	Composition of Asphalt Concrete .....	250
A-4	Typical Uses of Asphalt Cements .....	251
C-1	Random Numbers for General Sampling Procedure .....	262
D-1	Authoritative Methods of Test as Commonly Specified .....	265



# SECTION 1

## IMPORTANCE OF INSPECTION AND THE INSPECTOR

### 1.1 INTRODUCTION

The inspector's job is a vital one in every road construction project. It is the job of ensuring that the pavement design as described in the plans and specifications produces a strong, durable, reliable pavement in the roadway. The inspector's job is one that demands knowledge, awareness, keen observational skills, and diplomacy. It is among the toughest jobs in the industry.

Most road and highway construction in the United States is performed under contract. One party (the contractor) agrees to perform certain work that meets specified standards. In return for this work, the contractor is paid by the other contractual party (the owner) who is often a local, state or federal government agency. The contract between contractor and owner includes plans and specifications that must be followed during pavement construction or be met by the finished pavement. Whether or not these requirements are fulfilled determines the quality level of the finished pavement and how well the pavement will serve the public.

Because asphalt hot-mix pavement construction is complex, plans and specifications are often detailed and lengthy. Ensuring that they are followed precisely demands that the owner have an agent acting as his eyes and ears, an agent who is on-hand throughout the construction process. That agent is the inspector. It is the inspector's duty to see that construction operations produce the results called for by the plans and specifications. In this capacity, he has the responsibility to identify deviations from project specifications and to bring them to the attention of the contractor, but generally does not have the authority to approve changes in specifications.

Obviously, the inspector is a very important person. At the same time, he may be one of the newest, youngest and most inexperienced individuals on the job. This means that the average new inspector is thrust into a position of considerable authority with little or no preparation. This course attempts to correct that situation. It aims at introducing the hot-mix asphalt inspector to the knowledge required in inspection work.

Knowledge is the path every inspector must follow to improve his performance. Whether an inspector is new to the job or an old hand, his learning never stops, because new developments that affect his job are constantly appearing. Additionally, every inspector needs to refresh his knowledge periodically, to brush up on procedures that are used infrequently. This manual is a good source of refresher information, as well as a basic text for instructing the novice.

A manual alone, however, is not enough. It must be used in conjunction with other learning tools. The most effective learning tool is on-the-job training. The jobsite is where things that an inspector must know are happening. It is the ideal place to ob-

serve, to ask questions, to get answers. On the job, the novice inspector develops inspection skills first-hand and discovers what occurs during hot-mix asphalt construction and why certain methods achieve certain results. Combined with this course of instruction, on-the-job training provides the inspector with the necessary tools of his profession.

## **1.2 PURPOSE OF INSPECTION**

The purpose of inspecting asphalt construction is to ensure the quality of the work—to verify that the finished pavement meets project requirements. To accomplish this, the asphalt inspector must be familiar with the parts of the construction contract that apply to his job.

The *contract* is the agreement between the owner or contracting agency and the contractor. It states the obligations of both parties, including labor, materials, performance and payment. While there are many documents that make up the construction contract, the inspector is concerned primarily with the plans and specifications. Together, plans and specifications explain requirements that the contractor must fulfill to build a satisfactory pavement and get paid in full for his work.

*Plans* are the contract documents that show the location, physical aspects, and dimensions of the work. The plans include layouts, profiles, cross-sections and other details.

Specifications are the written technical directions and requirements for the work. Also, the standard specifications and the special provisions complement the plans by providing instructions that are not indicated on the drawings. Specifications are the means of communication among the designer, the contractor, and the inspector. Specifications are particularly important to the inspector's job. They are the rules by which he must referee the game of construction.

## **1.3 INSPECTOR'S AUTHORITY**

The inspector is assigned by the project engineer, and his authority originates in the construction contract. As a rule, the inspector's authority is found in the specifications. The inspector assists the project engineer in determining that the work done and the materials used meet contract requirements. The inspector has authority to reject defective material and to advise the contractor that payment will be withheld for work that is being done improperly. Additional authority may be delegated to him by the project engineer.

## **1.4 INSPECTOR'S RELATIONSHIP WITH CONTRACTOR**

It is always helpful, and often required, that a preconstruction conference be held between the inspection and engineering personnel of the owner and the contractor's supervisory personnel. At such a meeting the plans and specifications are reviewed, material deliveries and construction techniques discussed, traffic control procedures agreed upon, specific project responsibilities and lines of authority defined, and any other necessary items that may have a bearing on the project are discussed.

One of the most important aspects of the inspector's job is his relationship with the

contractor. This relationship affects the management of the project. A good personal rapport assists the inspector in resolving problems that might arise. When dealing with the contractor and his personnel, the inspector should be friendly, but he must be firm and impartial in making decisions. If the inspector experiences difficulties with the contractor, he should immediately inform the project engineer.

The inspector will assist himself, as well as the contractor, by trying to understand the project from the contractor's point of view. The inspector is primarily interested in quality (how good the pavement is); the contractor is primarily interested in quantity (how much pavement is placed in a given time). Under no condition should the inspector permit a reduction in quality in the interests of quantity. However, as long as pavement quality is maintained, the inspector should assist the contractor's efforts to place hot-mix as efficiently as is practical.

The inspector has the obligation to influence the construction process so that the best possible roadway results. He cannot simply take a passive role when observing a problem. He must be willing to help solve it. For example, after observing a particular situation, the inspector may be able to suggest a change in procedures that could improve the quality of the work while increasing the efficiency of the operation. Such a suggestion benefits both the contractor and the owner.

When offering assistance in solving problems, however, the inspector must be careful to avoid involving himself in the supervision of construction. He should avoid giving the impression that he wants to control the work, and he must never issue an order to the contractor's workers. Assuming supervision of the work puts the inspector in the undesirable position of judging the quality of work done by means that he dictated.

## **1.5 QUALIFICATIONS OF INSPECTOR**

The personal attributes required of an inspector go beyond those expected of an ordinary workman or technician. The inspector must be honest. He must conduct himself in a fair, straightforward manner. While under stress, he must be able to maintain his composure and make good decisions. He must have keen common sense for making competent decisions. He must be frank and sincere in his relationships with people and must be a skilled diplomat, able to handle tough situations without arousing hostility. Above all, he must be observant and be capable of keeping good records.

An inspector should have a high school education. Some technical study and/or construction experience are helpful. As a minimum, however, the inspector must be able to perform accurate mathematical calculations and should be familiar with the fundamentals of engineering equations. It is essential that he knows how to read and understand plans, specifications and other contract documents in order to understand the requirements of the work.

Although not responsible for the design of roadways, the inspector should understand the basic engineering principles involved. He should be familiar with the characteristics of materials and know the principles of material testing, including the interpretation of test results.

The inspector must have specialized knowledge pertaining to his particular job. For example, a plant inspector must have a thorough working knowledge of asphalt plants, but he must also have a broad general knowledge of asphalt materials, pro-

duction, and construction procedures. Practical experience with asphalt mix production, roadway construction, and asphalt laboratory testing is a valuable asset.

If all the qualifications of an inspector could be reduced to four, they would be: (a) knowledge, (b) common sense, (c) observational skills, and (d) courtesy. The basic summary of each is presented below.

- (a) *Knowledge*—The inspector must know about the work that he is inspecting. He should be familiar with materials, equipment and asphalt hot-mix pavement construction procedures. The more knowledgeable an inspector is, the better prepared he is to perform his duties.
- (b) *Common Sense*—A good inspector must have abundant common sense. While common sense is no substitute for knowledge, it is the means of interpreting the specifications to properly enforce their intent. Common sense grows out of knowledge, but it cannot be learned out of a book.
- (c) *Observational skills*—An inspector can act only on what he observes. What is not seen is missed. Thus, it is important not only for an inspector to look carefully at everything going on around him, but also to *see* what he looks at. “Seeing” in this context means thinking carefully about what the eyes observe. Without seeing, an inspector can observe an incorrect condition and not realize it.
- (d) *Courtesy*—A major part of the inspector’s job is to inform the contractor when unsatisfactory conditions exist or when the specifications are not being met. The contractor expects valid criticism and objections from the inspector, yet the inspector’s manner of presenting comments can often become the source of poor relations between contractor and inspector. Experience shows that it is not *what* is said, so much as the *way* it is said that is important. Gruff, bossy and sarcastic comments are unacceptable from any inspector, even if given in answer to a contractor’s aggravating remarks.

Once contractor-inspector relations deteriorate, the work suffers. Since the inspector’s primary concern is to preserve the quality of the work, he should show common courtesy at all times, even when tempted not to.

## 1.6 SAMPLING AND TESTING

Sampling and testing are methods of evaluating the quality of the work. The inspector must know what sampling is to be performed at the plant and at the roadway, the manner and location in which samples are to be taken, and the number of samples required for a given unit of work. It is the inspector’s responsibility to ensure that representative samples are obtained. He must also verify that samples are identified with the proper time and date and the location of the source. The inspector should be familiar with the procedures for tests he must conduct and should follow those procedures to ensure accurate results. If laboratory testing of samples is required, the inspector should follow-up to ensure that tests are made as scheduled and that results are promptly evaluated.

## 1.7 EQUIPMENT

There are certain tools that the inspector must use to perform his duties. In addition to a set of plans and specifications, he should have the following items on hand:

- Thermometer.
- Forms, notebooks and scratch pads.
- Pencils, lumber crayons and spray-paint marker.
- Straightedge and/or string line.
- Six-foot ruler and 100-foot steel tape.
- Flashlight.
- Hammer and shovel.
- Camera with flash attachment (optional).

## 1.8 RECORDS

One of the most important functions of the inspector is to keep accurate records and reports. Records and reports are necessary to determine compliance with contract requirements and substantiate payments to the contractor. Records and reports should be kept current and submitted on schedule. They should be neat and legible.

The inspector is usually given standard forms for routine reporting. The forms may require daily, weekly, or monthly reporting, depending on the data to be submitted. Report forms normally include items such as date, location of the work, weather conditions, test results, equipment in use, equipment idle, source of materials, and production rates.

In addition to the standard forms, the inspector should keep a written narration or a diary of the principal activities that occur. It should contain every possible bit of information concerning the work being inspected, including information such as weather conditions, important conversations, visitors on site, verbal orders received, unusual incidents, equipment breakdowns, length of work stoppages, number of men and types of equipment affected by work stoppages, and changes in appearance of the material. If an item seems unusually important, it should be recorded and analyzed in sufficient detail to make it fully understandable at some later date.

The importance of entries listed in the inspector's diary cannot be over-emphasized. The information recorded may never be needed or reviewed, but, if it is ever needed, it will be needed badly. The notebook information is a reference for performance of similar future work, a reference in the event of legal action or litigation by any interested party, and, possibly most important, a source of clues for investigators in the event the job fails. There is nothing too trivial to be included in the inspector's notebook, and the very act of recording will help the inspector to learn and remember.

Records and reports are used to determine quantities of materials for payment. In this regard, they ensure that the contractor is paid for his production, and that all the materials are used on the roadway. The basis for calculation of material quantities, such as field measurements and truck load weights, should be indicated on the inspector's report. The quantity records must be complete and accurate to account for all materials. Wasted and rejected material quantities should be identified so that totals can be checked by audit.

Substantiating documents must be retained to verify the quantity records. For example, a roadway inspector has the job of collecting weigh-load slips from the truck drivers at the point of delivery and ensuring that the materials recorded on the load slips are used in the work. The inspector should collect the load slips himself. He

should not allow the construction foreman to collect the slips and periodically give them to him.

Adding up the quantities listed on the slips provides information on the actual production for the day, information that can be checked against plant records. Furthermore, an accurate record of the load slips minimizes the possibility of material being diverted from the job.

Photographs of the work provide a valuable supplement to the written records and reports, and should be taken routinely during construction. They should be identified by subject, location, direction from which taken, and date. Photographs are especially helpful in cases where work has been disputed or rejected.

## **1.9 SAFETY**

Safety is the business of everyone on the job, but the inspector must be alert to ensure that safe working conditions and practices are maintained on the project. For the inspector, safety begins with himself. He should set an example in the use of personal safety equipment such as hard hats, gloves and protective clothing. In addition, he must see that the safety requirements specified in the contract are adhered to. This may involve monitoring equipment operation and the use of such items as barricades, warning lights and reflectors.

## **1.10 SPECIFIC INSPECTOR RESPONSIBILITIES**

Below are listed typical duties that an asphalt inspector may be required to perform. Details of the procedures regarding these duties can be found in appropriate sections of this manual.

### *Typical Duties of an Asphalt Inspector*

- Sampling asphalt at the refinery, terminal or mix plant.
- Sampling hot-mix at the plant and paver.
- Testing asphalt and hot-mix.
- Investigating aggregate at source for compliance with specification requirements.
- Monitoring proportioning and mixing procedures at the plant or project site.
- Determining asphalt content and aggregate gradation in plant mix.
- Determining and verifying mix properties for comparison with target properties of the mix design.
- Determining that contractor's equipment meets specification requirements.
- Inspecting handling, laying, and rolling operations at the jobsite.
- Determining thickness of compacted mixture.
- Determining density and percent compaction of the finished pavement.
- Keeping records.

## **1.11 SUMMARY**

The inspector is the agent of the project owner, charged with the responsibility of ensuring that the plans and specifications of the job are followed during construction.



This responsibility demands that the inspector be honest, sincere, knowledgeable, and courteous. It demands also that he develop the skill of observation and the common sense required to do the job effectively. In addition, the inspector must be able to keep neat, legible, thorough records of work as it progresses.

During construction, the inspector has the authority to identify and point out to the contractor situations in which job plans and specifications are not being followed. He also has the authority to reject or suspend payment for any work that does not meet job requirements. However, he does not have the authority to supervise the contractor's workers or to give orders.

Central to maintaining work quality and conditions, the inspector must have a friendly, workable relationship with the contractor—a relationship in which both parties understand and respect each other's viewpoints.

Although desired qualities for prospective inspectors can be listed, the bottom line is this: To do a professional job, the inspector must *want* to do a good job, *know* how to do it, and the *go about it* in a manner that contributes favorably to the project.



## SECTION 2

### MATERIALS

#### 2.1 INSPECTOR OBJECTIVES

At the conclusion of this section of the manual, the inspector should:

- Understand the properties of asphalt cement and the asphalt grading systems used.
- Recognize the principal tests for identifying certain properties of asphalt.
- Know the procedures for safe and proper storage, handling and sampling of asphalt cements.
- Understand the various aggregate properties and know the tests for identifying each of them.
- Recognize the desirable properties of asphalt and aggregate mixtures.

#### 2.2 INTRODUCTION

##### 2.2.A *Background*

The modern use of asphalt for road and street construction began in the late 1800s, and grew rapidly with the emerging automobile industry. Since that time, asphalt technology has made giant strides; so that today the equipment and techniques used to build asphalt pavement structures are highly sophisticated.

One rule that has remained constant throughout asphalt's long history in construction is this: A pavement is only as good as the materials and workmanship that go into it. No amount of sophisticated equipment can make up for use of poor materials or poor construction practices.

This section of the manual is a discussion of materials used in quality hot-mix asphalt pavements—what they are, how they behave, and how to tell whether or not particular materials are suitable for a paving project. It is basic information that an inspector must have in order to make sound inspection decisions.

##### 2.2.B *General Description*

Asphalt pavements are composed of two materials: asphalt and aggregate (rock). There are many different types of asphalts and many different types of aggregates. Consequently, it is possible to make different kinds of asphalt pavements. Among the most common types of asphalt pavements are (for definitions see Appendix B):

- Asphalt concrete (dense-graded asphalt hot-mix);
- Open-graded asphalt friction course;
- Sand asphalt hot-mix;
- Sheet asphalt hot-mix;
- Emulsified asphalt mixes (cold mixes).

Asphalt concrete pavement is the highest quality type of asphalt pavement. It consists of well-graded aggregate and asphalt cement, which are heated and blended together in exact proportions at a hot-mix plant. When all the aggregate particles are uniformly coated, the hot mixture is hauled to the construction site, where asphalt pavers spread it on to the prepared roadbed. Before the mixture cools, rollers compact (compress) it into a final pavement to achieve a specified density.

Other pavement types are produced and placed in similar ways. Cold-mix pavements use emulsified asphalts or cutbacks; they require little or no heating of materials and can often be produced at the construction site without a central plant. Only asphalt concrete (dense-graded asphalt hot-mix) is discussed in this manual.

### ***2.2.C Inspector's Responsibilities***

An inspector is not responsible for selecting the materials to be used in a pavement. That is the job of the contractor and the pavement designer. The inspector is responsible to a large extent, however, for the way the materials are handled, stored, sampled, mixed, hauled, placed, and compacted. He may have to check such things as material sources, grades, types, temperatures, and moisture contents. The inspector should also be prepared to review and interpret pavement mixture design data, laboratory test results, and specifications, when necessary, as well as to perform samplings and on-project tests.

The inspector will be unable to do his job without a working knowledge of the materials from which an asphalt concrete pavement is made, particularly material characteristics and their role in pavement performance. He must also understand how improper handling of materials can adversely affect their properties, and ultimately, their behavior in the finished pavement. Having such information will give him the confidence to make proper day-to-day decisions and will eliminate the role of guesswork in the job, ensuring that good quality control is maintained.

As with other aspects of inspecting, materials inspection and control demands accurate and thorough documentation. Facts, figures, dates, names, locations and conditions are important elements in your daily record-keeping. Experience has taught veteran inspectors over the years that a scrap of information that seems unimportant when recorded can later turn out to be the very piece of information needed to analyze a serious problem.

Each organization has specific forms for documentation. Additionally, an inspector should keep records of his observations in diary form. An inspector serves as the eyes and ears of an organization.

## **2.3 ASPHALT**

Asphalt is a black, cementing material that varies widely in consistency from solid to semisolid (soft solid) at normal air temperatures. When heated sufficiently, asphalt softens and becomes a liquid, which allows it to coat aggregate particles during hot-mix production.

Asphalt is made up largely of a hydrocarbon called bitumen. Consequently, asphalt is often called a bituminous material.

Virtually all asphalt used in the United States is produced by modern petroleum

refineries and is called petroleum asphalt. The degree of control allowed by modern refinery equipment permits the production of asphalts with specific characteristics suited to specific applications. As a result, different asphalts are produced for paving, roofing and other special uses.

Paving asphalt, commonly called asphalt cement, is a highly viscous (thick), sticky material. It adheres readily to aggregate particles and is therefore an excellent cement for binding together aggregate particles in a hot-mix pavement. Asphalt cement is an excellent waterproofing material and is unaffected by most acids, alkalies (bases) and salts. This means that a properly constructed asphalt concrete pavement is waterproof and resistant to many types of chemical damage.

Asphalt changes when it is heated and/or aged. It tends to become hard and brittle and to lose some of its ability to adhere to aggregate particles. These changes can be minimized by understanding the properties of asphalt and taking steps during construction to ensure that the finished pavement is built in a way that will retard the aging process (see Sections 4, 5 and 6).

### **2.3.A Source and Nature of Asphalt**

Because asphalt is used for many purposes, there is sometimes confusion about where asphalt comes from, how it is refined, and how it is classified into grades. There is similar confusion about terms related to asphalt properties and use. It is the purpose of this section to discuss the source and nature of paving asphalt in sufficient detail for a clear understanding of fundamental concepts. A glossary of common terms related to asphalt is found in Appendix B at the back of this manual.

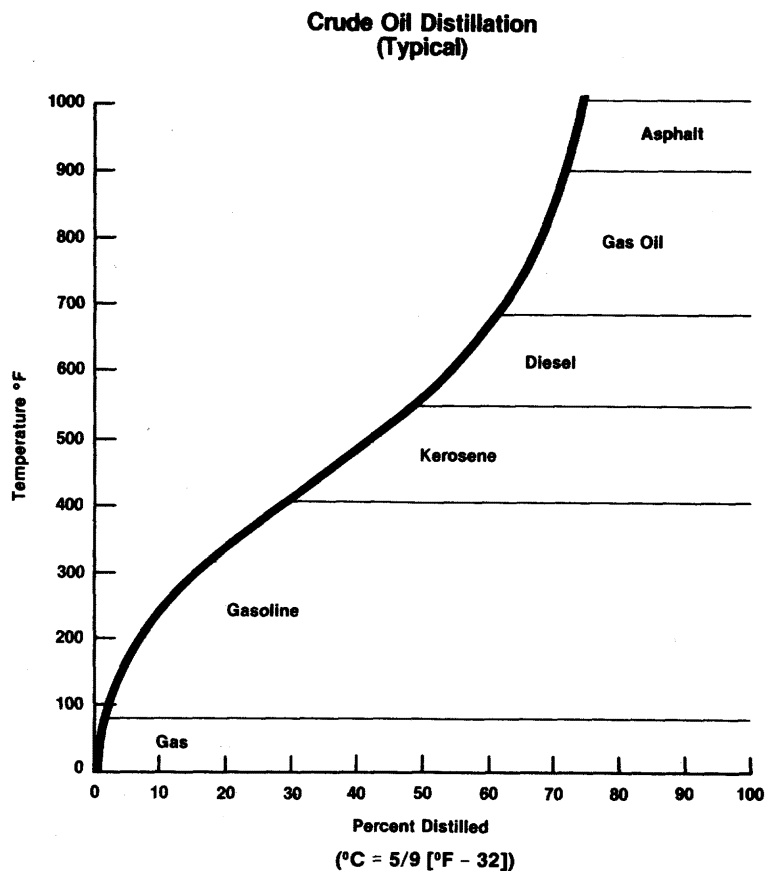
**2.3.A.1 Petroleum Refining**—Crude petroleum is refined by distillation, a process in which various fractions (products) are separated out of the crude. Distillation is accomplished by raising the temperature of the crude petroleum in stages. As shown in Figure 2.1, different fractions separate at different temperatures.

The lighter fractions are separated by simple distillation. The heavier distillates, often referred to as gas oils, can be separated only by a combination of heating and applying a vacuum. As indicated in Figure 2.1, asphalt may be produced by vacuum distillation at a temperature of about 900°F (480°C). This temperature may vary somewhat, depending on the crude petroleum being refined or the grade of asphalt being produced.

Figure 2.2 is a schematic illustration of a typical refinery. It shows the flow of petroleum during the refining process.

**2.3.A.2 Asphalt Refining**—Different types of asphalt are required for different applications. To produce asphalts that meet specific requirements, refiners must have a way to control the properties of the asphalts they produce. This is often accomplished by blending crude petroleum of various types together before processing. Blending allows refiners to combine crudes that contain asphalts of varying characteristics in such a way that the final product will have exactly the characteristics required by the asphalt user.

Once the crude petroleum have been blended together, there are two processes by which asphalt can be produced from them: vacuum distillation and solvent extrac-



**FIGURE 2.1—Typical Distillation Temperatures and Products.**

tion. As discussed above, vacuum distillation involves separating the asphalt from the crude by applying heat and a vacuum. In the solvent extraction process, additional gas oils are removed from the crude, leaving residual asphalt.

Once asphalts have been processed, they may be blended together in certain proportions to produce intermediate grades of asphalt. Thus, a highly viscous (very thick) asphalt and a less viscous asphalt can be combined to produce an asphalt with an intermediate viscosity.

In summary, crude petroleum or crude petroleum blends are used to produce asphalts with specific characteristics. Asphalt is separated from the other fractions in the crude by either vacuum distillation or solvent extraction.

### **2.3.B Classification, Chemical and Physical Properties of Asphalt**

**2.3.B.1 Classification and Grades of Asphalt**—Paving asphalts are classified into three general types:

- Asphalt cement;
- Cutback asphalt; and
- Emulsified asphalt.

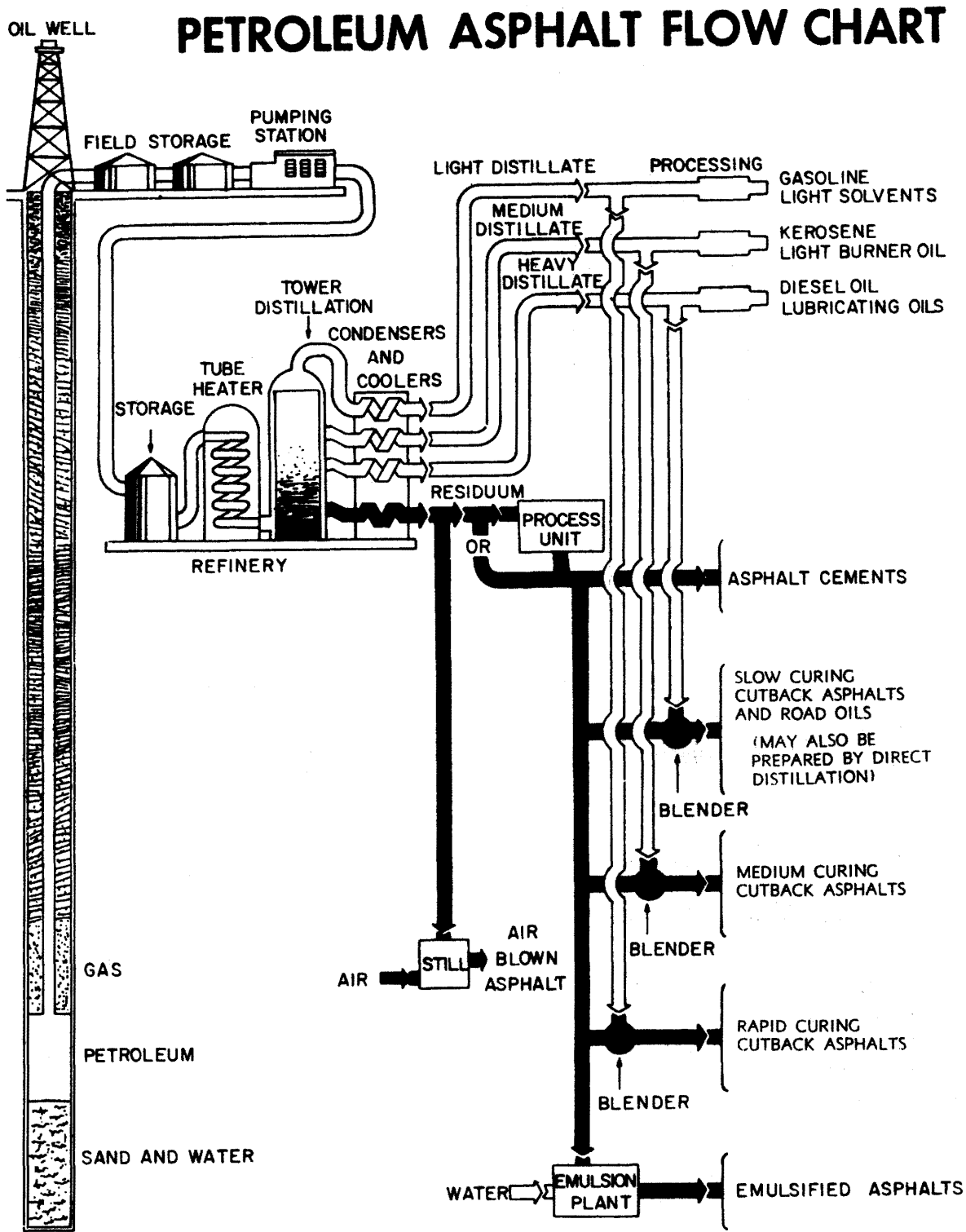


FIGURE 2.2—Typical Refining Process.

Each is defined in Appendix B. Cutbacks and emulsions are used almost entirely for cold mixing and spraying and will not be discussed further in this section.

Asphalt cements are graded according to three different systems. They are: viscosity, viscosity after aging, and penetration. Each system provides for several different grades, each with a different consistency.

The system most widely used in the United States is based on asphalt viscosity. Figure 2.3 presents the system in chart form. Agencies use either Table 1 or Table 2. In actual practice, some highway agencies have modified the parameters of the system to meet their specific needs. The inspector should refer to his own agency's asphalt specifications.

In the viscosity system, the poise (see Appendix B for definition) is the standard unit of measurement for absolute viscosity. Referring to Figure 2.3, notice that the higher the number of poises, the more viscous the asphalt. AC-2.5 (asphalt cement with a viscosity of 250 poises at 140°F or 60°C) is referred to as a "soft" asphalt. AC-40 (asphalt cement with a viscosity of 4000 poises at the same temperature), is known as a "hard" asphalt.

**REQUIREMENTS FOR ASPHALT CEMENT GRADED BY VISCOSITY AT 60° C (140° F)**  
(Grading based on original asphalt)

TEST	VISCOSITY GRADE					
	AC-2.5	AC-5	AC-10	AC-20	AC-30	AC-40
Viscosity, 60° (140° F), poises	250± 50	500± 100	1000± 200	2000± 400	3000± 600	4000± 800
Viscosity, 135° C (275° F), Cs-minimum	125	175	250	300	350	400
Penetration, 25° C (77° F), 100 g, 5 sec.-minimum	220	140	80	60	50	40
Flash point, COC, C (F)-minimum	162(325)	177(350)	219(425)	232(450)	232(450)	232(450)
Souability in trichlorethylene, percent-minimum	99.0	99.0	99.0	99.0	99.0	99.0
Tests on residue from Thin-Film Oven Test:						
Loss on heating, percent-maximum (optional) <sup>2</sup>		1.0	0.5	0.5	0.5	0.5
Viscosity, 60° C (140° F), poises-maximum	1000	2000	4000	8000	12000	16000
Ductility 25° C (77° F), 5 cm per minute, cm-minimum	100 <sup>1</sup>	100	75	50	40	25
Spot test (when and as specified) <sup>2</sup> with:						
Standard naphtha solvent	Negative for all grades					
Naphtha-Xylene-solvent, % Xylene	Negative for all grades					
Heptane-Xylene-solvent, % Xylene	Negative for all grades					

<sup>1</sup> If ductility is less than 100, material will be accepted if ductility at 15.6° C (60° F) is 100 minimum.

<sup>2</sup> The use of the spot test is optional. When it is specified, the Engineer shall indicate whether the standard naphtha solvent, the naphtha-xylene solvent, or the heptane-xylene solvent will be used in determining compliance with the requirement, and also, in the case of xylene solvent, the percentage of xylene to be used.

<sup>3</sup> The use of loss on heating requirement is optional.

**FIGURE 2.3—Requirements for Asphalt Cement Graded by Viscosity (AASHTO M 226).**



Several Western states grade asphalts according to their viscosities after aging. The idea is to identify what the viscosity characteristics will be after it is placed in the pavement. To simulate aging in the asphalt plant during mixing, the asphalt is to be tested by a given standard aging exposure test in the laboratory. The asphalt residue that remains after aging is then graded according to its viscosity. Again, the poise is the standard unit of measurement. Figure 2.4 outlines the various grades possible under this system.

**REQUIREMENTS FOR ASPHALT CEMENT  
GRADED BY VISCOSITY AT 60C (140F)  
(Grading based on residue from Rolling Thin Film Oven Test)**

TESTS ON RESIDUE FROM AASHTO TEST METHOD T 240 <sup>1</sup>	VISCOSITY GRADE				
	AR-10	AR-20	AR-40	AR-80	AR-160
Viscosity, 60 C (140 F), poise	1000 ± 250	2000 ± 500	4000 ± 1000	8000 ± 2000	16000 ± 4000
Viscosity, 135 C (275 F), Cs-minimum	140	200	275	400	550
Penetration, 25 C (77 F), 100 g, 5 sec.- minimum	65	40	25	20	20
Percent of original Pen., 25 C (77 F)- minimum	—	40	45	50	52
Ductility, 25 C (77 F), 5 cm per min., cm minimum	100 <sup>2</sup>	100 <sup>2</sup>	75	75	75
<b>TESTS ON ORIGINAL ASPHALT</b>					
Flash Point, COC, C (F)-minimum	205 (400)	219 (425)	227 (440)	232 (450)	238 (460)
Solubility in Trichloroethylene, percent- minimum	99.0	99.0	99.0	99.0	99.0

<sup>1</sup>AASHTO T 179 (Thin-Film Oven Test) may be used, but AASHTO T 240 shall be the referee method.

<sup>2</sup>If ductility is less than 100, material will be accepted if ductility at 15.6 C (60 F) is 100 minimum.

**FIGURE 2.4—Requirements for Asphalt Cement Graded by Viscosity Based on Residue from Rolling Thin Film Oven Test (AASHTO M 226).**

In the Figure 2.4, the designation “AR” stands for “Aged Residue.” Notice that AR-10 (viscosity of 1000 poises) is referred to as a “soft” asphalt, while AR-160 (viscosity of 16000 poises) is referred to as “hard.”

The third method of grading asphalts is by penetration testing. Figure 2.5 shows the penetration test being performed. A standard needle is allowed to sink into the asphalt sample under a specific load. The distance that the needle penetrates the sample in a given time is measured in tenths of a millimeter (0.1 mm). Grade 200-300 indicates that under specific conditions, the needle penetrated 20-30 decimillimeters into the sample. This indicates a “soft” asphalt. Grade 40-50, on the other hand, indicates a “hard” asphalt into which the needle was able to penetrate only 4 to 5 deci-millimeters. Figure 2.6 shows the range of grades possible under this system.

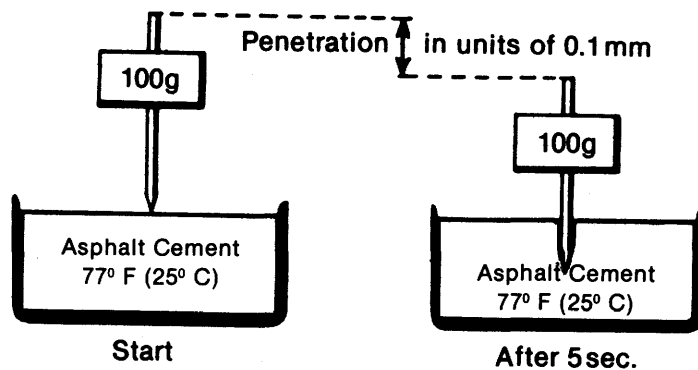


FIGURE 2.5—Penetration Test.

REQUIREMENTS FOR A SPECIFICATION FOR ASPHALT CEMENT  
AASHTO M 20

	Penetration Grade									
	40-50		60-70		85-100		120-150		200-300	
	Min.	Max.	Min.	Max.	Min.	Max.	Min.	Max.	Min.	Max.
Penetration at 25C (77F) 100 g, 5 sec . . . .	40	50	60	70	85	100	120	150	200	300
Flash point, Cleveland Open Cup . . . . .	450	...	450	...	450	...	425	...	350	...
Ductility at 25C (77F) 5 cm. per min., cm . .	100	...	100	...	100	...	100	...	...	...
Solubility in trichloroethylene percent . . . .	99	...	99	...	99	...	99	...	99	...
Thin-film oven test, 1/8 in. (3.2 mm), 163C (325F) 5 hour . . . . .	...	0.8	...	0.8	...	1.0	...	1.3	...	1.5
Loss on heating, percent . . . . .	...	0.8	...	0.8	...	1.0	...	1.3	...	1.5
Penetration, of residue, percent of original	58	...	54	...	50	...	46	...	40	...
Ductility of residue at 25C (77F) 5 cm. per min., cm . . . . .	...	...	50	...	75	...	100	...	100	...
Spot test (when and as specified (see Note 1) with):										
Standard naphtha solvent	Negative for all grades									
Naphtha-xylene solvent, percent xylene	Negative for all grades									
Heptane-xylene solvent, percent xylene	Negative for all grades									

NOTE: The use of the spot test is optional. When it is specified, the Engineer shall indicate whether the standard naphtha solvent, the naphtha-xylene solvent, or the heptane-xylene solvent will be used in determining compliance with the requirement, and also, in the case of the xylene solvents, the percentage of xylene to be used.

FIGURE 2.6—Penetration Grading System (AASHTO M 20).

In all three grading systems, the charts list asphalt properties beyond viscosity and penetration—properties such as ductility, flashpoint, etc. These properties and the tests by which they are determined are discussed later in this section.

**2.3.B.2 Chemical Properties of Asphalt**—Asphalt has unique chemical properties that make it a very versatile road building material. Asphalt technologists and pavement designers have learned to identify and characterize these properties and use them to best advantage in the pavement structure. A brief introduction to the more

important properties will help the inspector to understand the nature of hot-mix pavements, leading to better quality control.

Notice that none of the charts describing the three asphalt grading systems mentions chemical composition. This may be surprising, because chemical composition is certainly among the most accurate means of identifying the properties of any substance. However, there are a number of reasons why chemistry has not entered into the grading systems:

- There is currently no standard test for the chemical composition of asphalts that is mutually acceptable to sellers, buyers and users of the material.
- Existing tests for analyzing chemical composition require sophisticated equipment and technical expertise not readily available in most laboratories where asphalt testing is done.
- The relationship between an asphalt cement's chemical composition and its behavior in a pavement structure is still uncertain. Many questions in this regard remain unanswered.

Despite these facts, some discussion of asphalt chemistry will help you to understand the nature of the material.

Basically, asphalt is composed of various hydrocarbons (molecular combinations of hydrogen and carbon) and traces of sulphur, oxygen, nitrogen and other elements. When dissolved in a solvent such as heptane, asphalt can be separated into two major parts: asphaltenes and maltenes.

Asphaltenes do not dissolve in heptane. When separated from the maltenes, asphaltenes are usually black or dark brown in color and look something like coarse graphite powder. Asphaltenes give asphalt its color and hardness.

Maltenes dissolve in heptane. They are viscous liquids composed of resins and oils. The resins are usually amber or dark-brown heavy liquids, the oils are lighter colored. The resins provide the adhesive qualities (stickiness) in asphalt while the oils act as a medium in which the asphaltenes and resins are carried. The proportion of asphaltenes and maltenes in asphalts can change due to a number of factors, including high temperatures, exposure to oxygen and light, type of aggregate used in the pavement mixture, and the thickness of the asphalt film on the aggregate particles. The changes that occur include: evaporation of the more volatile components, oxidation (combination of hydrocarbon molecules with molecules of oxygen), polymerization (combination of two or more molecules to form a single heavier molecule), and other chemical reactions that can significantly influence the properties of the asphalt. During these reactions, the resins gradually turn into asphaltenes and the oils convert into resins, resulting in an overall increase in asphalt viscosity. This increase in viscosity with aging is illustrated in Figure 2.9 in the discussion of measuring asphalt viscosity following a standard aging test.

**2.3.B.3 Physical Properties of Asphalt**—The physical properties of asphalt that are of most interest to highway design, construction, and maintenance personnel are: durability, adhesion, temperature susceptibility, and aging and hardening. Each is discussed below in detail.

- *Durability*

Durability is the measure of how well an asphalt retains its original characteristics when exposed to normal weathering and aging processes. It is a property judged primarily through pavement performance, and is therefore difficult to define in terms of the asphalt alone. This is because pavement performance is affected by mix design, aggregate characteristics, construction workmanship, and other variables, as much as by the durability of the asphalt.

Nonetheless, there are routine tests used to approximate asphalt durability. They are the Thin Film Oven Test (TFOT) and the Rolling Thin Film Oven Test (RTFOT). Both involve the heating of thin films of asphalt; they are discussed later in this section.

- *Adhesion and Cohesion*

Adhesion is the asphalt's ability to stick to the aggregate in the paving mixture. Cohesion is the asphalt's ability to hold the aggregate particles firmly in place in the finished pavement.

The ductility test does not directly measure adhesion or cohesion; rather, it tests a property of the asphalt that is considered by some to be related to adhesion and cohesion. Consequently, the test is a pass-fail type that can indicate only whether or not the sample is sufficiently ductile to meet minimum requirements.

- *Temperature Susceptibility*

All asphalts are thermoplastic; that is, they become harder (more viscous) as their temperature decreases and softer (less viscous) as their temperature increases. This characteristic is known as temperature susceptibility, and is one of asphalt's most valuable assets. Temperature susceptibility varies among asphalts from differing petroleum sources, even if the asphalts are of identical grade.

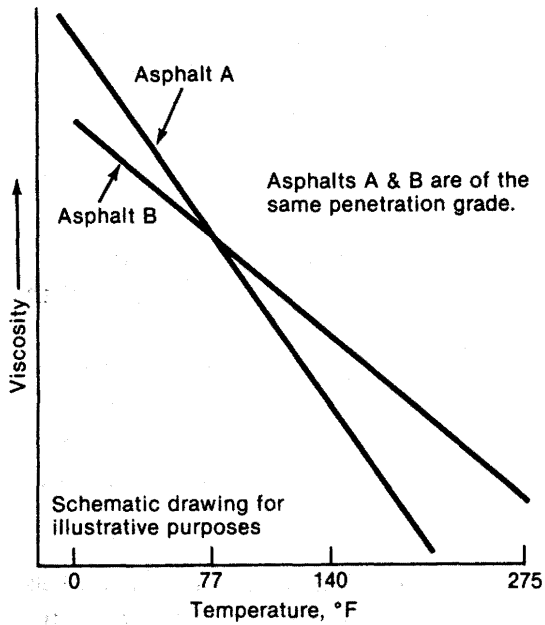
Figure 2.7 illustrates this point. The figure shows the temperature susceptibilities of two asphalts (Asphalt A and Asphalt B) that are of identical penetration grade but are from different crude sources. Note that at 77°F (25°C), the viscosities of the two asphalts match. At all other temperatures, however, their viscosities are different. This is because the two asphalts have different temperature susceptibilities.

The same can be true also of two asphalts of identical viscosity grade, but derived from different crude sources. Figure 2.8, for example, shows that Asphalt C and Asphalt D have identical viscosities at the viscosity test temperature of 140°F (60°C). At all other temperatures, however, their viscosities differ.

The conclusion is that asphalts derived from different sources can have different temperature susceptibilities regardless of the grading system utilized.

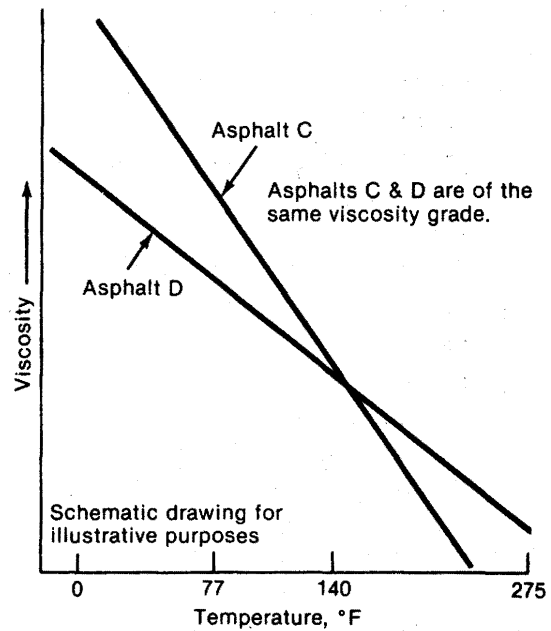
Knowing the temperature susceptibility of the asphalt being used in a paving mixture is important because it indicates the proper temperature at which to mix the asphalt with aggregate and the proper temperature at which to compact the mixture on the roadbed. Referring to Figure 2.7, you can see that at any temperature above 77°F (25°C)—which includes all construction temperatures—Asphalt A will be less viscous (more fluid) than Asphalt B. As a result, the temperature required to make Asphalt A fluid enough to properly coat all the aggregate particles in the mix is lower than the temperature needed to get the same

results from Asphalt B. The same is true of proper compaction temperatures. It might be necessary to compact a mix with Asphalt A at a lower temperature than a mix with Asphalt B.



**FIGURE 2.7—Variation in Viscosity of Two Penetration Graded Asphalts at Different Temperatures.**  
 $(^{\circ}\text{C} = 5/9 [^{\circ}\text{F} - 32])$

**FIGURE 2.8—Variation in Viscosity of Two Viscosity-Graded Asphalts at Different Temperatures.**  
 $(^{\circ}\text{C} = 5/9 [^{\circ}\text{F} - 32])$

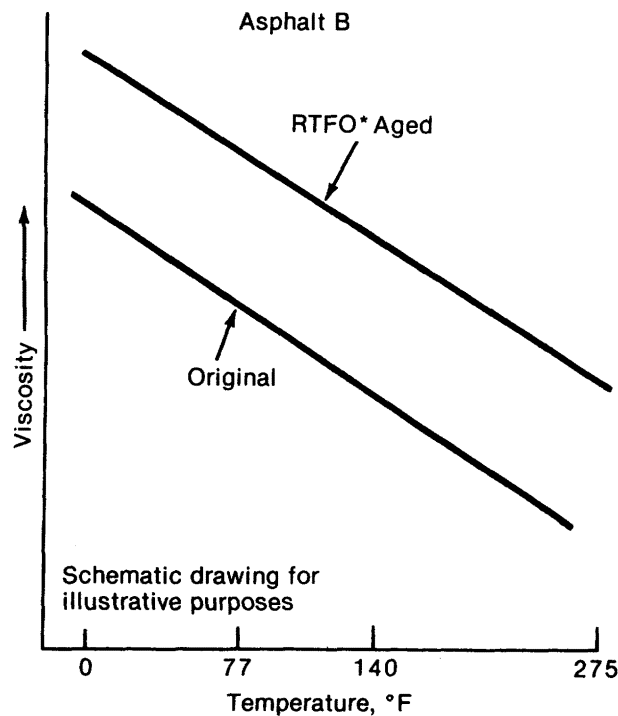


It should be understood that it is vitally important for an asphalt to be temperature susceptible. It must be fluid enough at elevated temperatures to permit it to coat the aggregate particles during mixing and to allow these particles to move past each other during compaction. It must then become viscous enough at normal air temperatures to hold the aggregate particles in place in the pavement.

- *Hardening and Aging*

Asphalt tends to harden in the paving mixture during construction and in the pavement itself. The hardening is caused primarily by oxidation (asphalt combining with oxygen), a process that occurs most readily at higher temperatures (such as construction temperature) and in thin asphalt films (such as the film coating aggregate particles).

During mixing, asphalt is both at a high temperature and in thin films as it coats the aggregate particles. This makes mixing the stage at which the most severe oxidation and hardening usually occurs. Figure 2.9 shows the increase in viscosity caused by heating a thin film of asphalt. The viscosity range of the original material (before the Rolling Thin Film Oven Test) is significantly lower than after the heating test.



**FIGURE 2.9—Hardening of Asphalt after Exposure to High Temperatures.**  
(°C = 5/9 [°F - 32])

\*RTFO — Rolling Thin Film Oven Test, used to simulate asphalt exposure in a pugmill.

Not all asphalts harden at the same rate when heated in thin films. Therefore, each asphalt used should be tested to determine its aging characteristics so that construction techniques can be adjusted to minimize hardening. Such ad-

justments usually involve mixing the asphalt with the aggregate at the lowest possible temperature for the shortest practical time.

The hardening of asphalt continues in the pavement after construction. Again, oxidation and polymerization are the chief causes. These processes can be retarded by keeping the number of connected voids (air spaces) in the final pavement low, and the asphalt coating on the particles thick.

### 2.3.C Testing Properties of Asphalt Cement

This section describes in general terms the tests for determining and measuring the following: viscosity, penetration, flashpoint, aging and hardening, ductility, solubility and specific gravity. The ASTM references that describe in detail the equipment and procedures related to each test are listed in Appendix D.

**2.3.C.1 Viscosity**—Paving job specifications usually call for certain asphalt viscosity values at 140°F (60°C) and 275°F (135°C). The viscosity at 140°F (60°C) is the viscosity used to grade asphalt cement. It represents asphalt viscosity at the maximum temperature the pavement is likely to experience while in service. The viscosity at 275°F (135°C) approximates the viscosity of the asphalt during mixing and laydown. Knowing the consistency of a particular asphalt at these two temperatures helps to determine whether or not that asphalt is suitable for the pavement being designed.

The viscosity test at 140°F (60°C) uses a capillary tube viscometer (Figure 2.10), a calibrated glass tube that measures the flow of asphalt. The viscometer is mounted in a temperature-controlled water bath and is preheated to 140°F (60°C). A sample of asphalt cement heated to the same temperature is then poured into the large end of the viscometer (Figure 2.11).

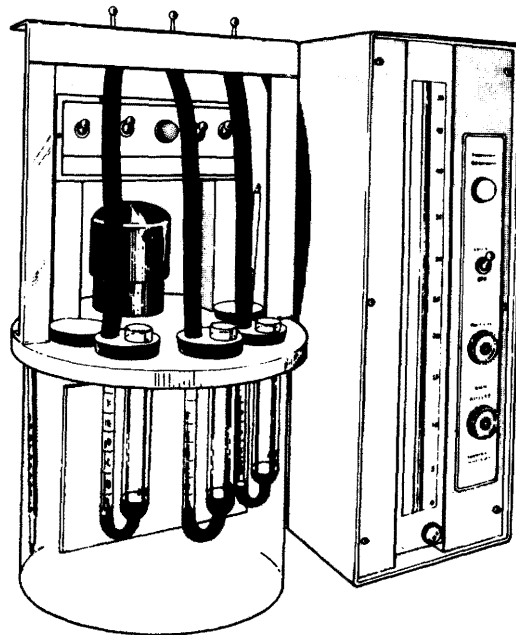
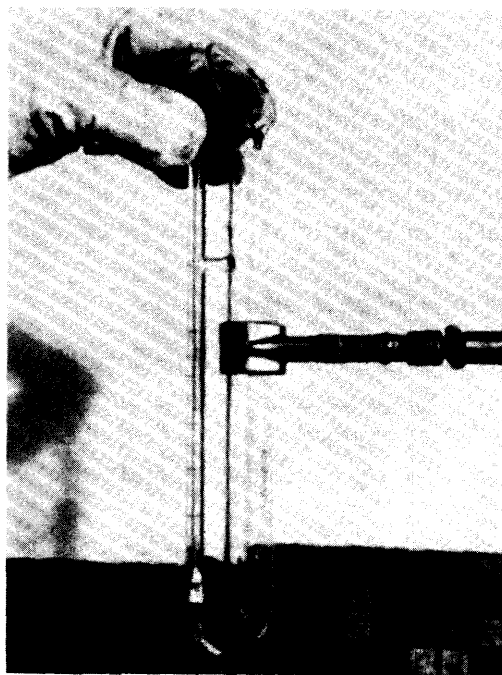


FIGURE 2.10—Capillary Tube Viscometer in Temperature Bath.



**FIGURE 2.11—Pouring Asphalt Cement Sample into Viscometer.**

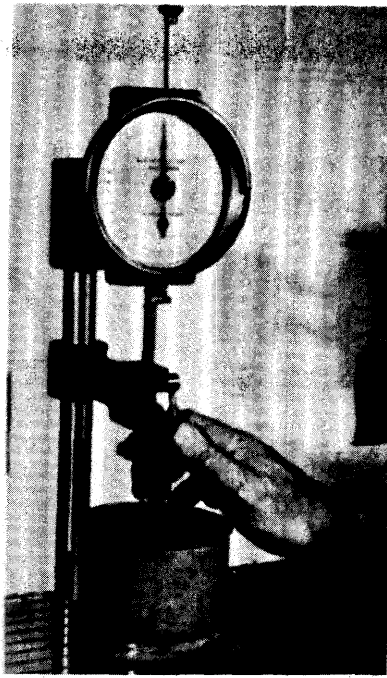
Because asphalt cement at 140°F (60°C) is too viscous to flow readily through the narrow opening in the capillary tube, a partial vacuum is applied to the small end of the tube to draw the asphalt through. As the asphalt begins to flow, its progress from one mark on the tube to the next is carefully timed. This measured time is easily converted to poises, the standard unit measurement for asphalt viscosity.

The viscosity test at 275°F (135°C) is similar to the test described above; however, some adaptations are required due to the higher temperature. First, because water would boil away at 275°F (135°C), a clear oil is used for the temperature-controlled bath. Secondly, because asphalt cement at 275°F (135°C) is fluid enough to flow through the viscometer tube without assistance from a vacuum, a type of viscometer that can be used without a vacuum is employed. Thirdly, because gravity and not a vacuum is used to induce flow through the tube, the viscosity measurement is converted into centistokes instead of poises (see Appendix B for definitions).

**2.3.C.2 Penetration**—The penetration test is another measure of consistency. It is included in viscosity-based specifications to ensure that asphalt cements with unsuitably low penetration values at 77°F (25°C) are identified and not used.

The standard penetration test consists of bringing a sample of asphalt cement to a temperature of 77°F (25°C) in a temperature-controlled water bath. A needle of prescribed dimensions under a load of 100 gm is brought to bear on the surface of the asphalt cement for exactly five seconds (Figure 2.12). The distance that the needle penetrates into the asphalt cement is recorded in units of 0.1 mm. The number of units is called the “penetration” of the sample.





**FIGURE 2.12—Penetration Test.**

**2.3.C.3 Flashpoint**—The flashpoint of an asphalt cement is the lowest temperature at which volatile materials separate from a sample in sufficient concentration to “flash” in the presence of an open flame. Flashpoint must not be confused with firepoint, which is the lowest temperature at which the asphalt cement will catch fire and burn. Flashpoint involves only instantaneous combustion of the volatile fractions separating from the asphalt.

The flashpoint of an asphalt cement is determined to identify the maximum temperature at which it can be handled and stored without danger of flashing. This is important information since asphalt cement is usually heated in storage to keep its viscosity low enough so that the material can be pumped.

The basic procedure for determining flashpoint is to gradually heat a sample of asphalt cement in a brass cup while periodically holding a small flame over the surface of the sample (Figure 2.13). The temperature at which an instantaneous flashing of vapors occurs across the surface is taken to be the flashpoint. The Cleveland Open Cup Test is the most common procedure for determining flashpoint; however, the Pensky-Martens Test is sometimes used. Both serve the same purpose.

**2.3.C.4 Thin Film Oven (TFO) Test and Rolling Thin Film Oven (RTFO) Test**—These tests are not true tests. They are procedures that expose a sample of asphalt to conditions that approximate those that occur during hot-mix plant operations. Viscosity or penetration tests made on the sample after TFO or RTFO procedures are used to measure the anticipated hardening of the material during construction and pavement service.

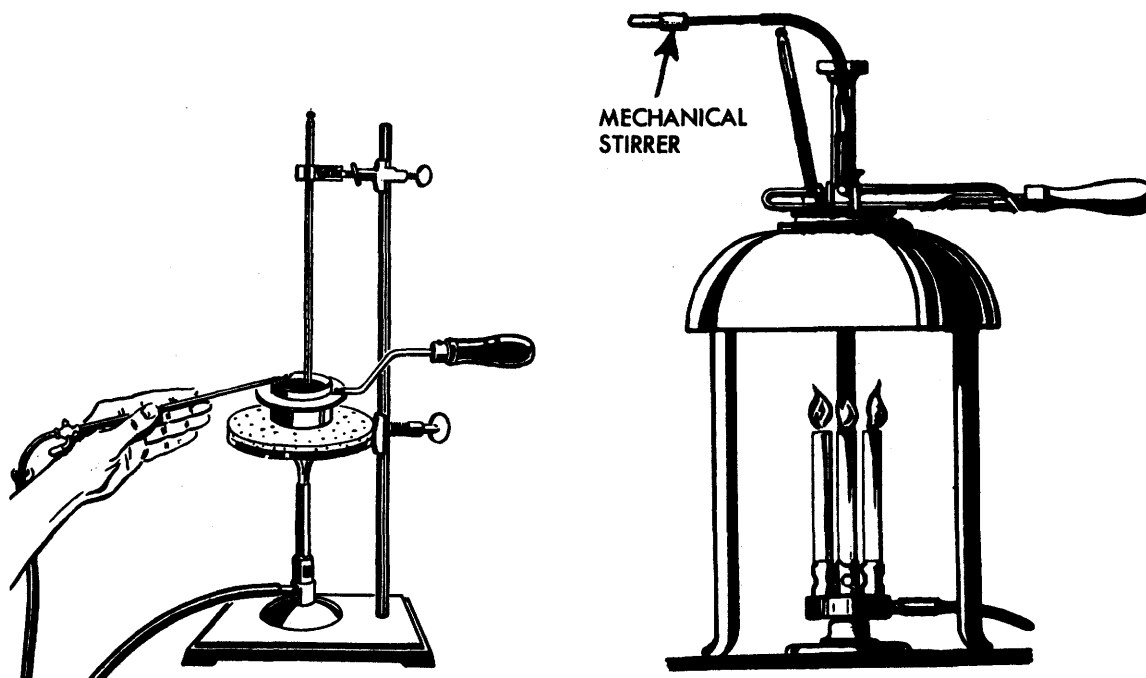


FIGURE 2.13—Flashpoint Tests; (left) Cleveland Open Cup Test, (rt) Pensky-Martens Test.

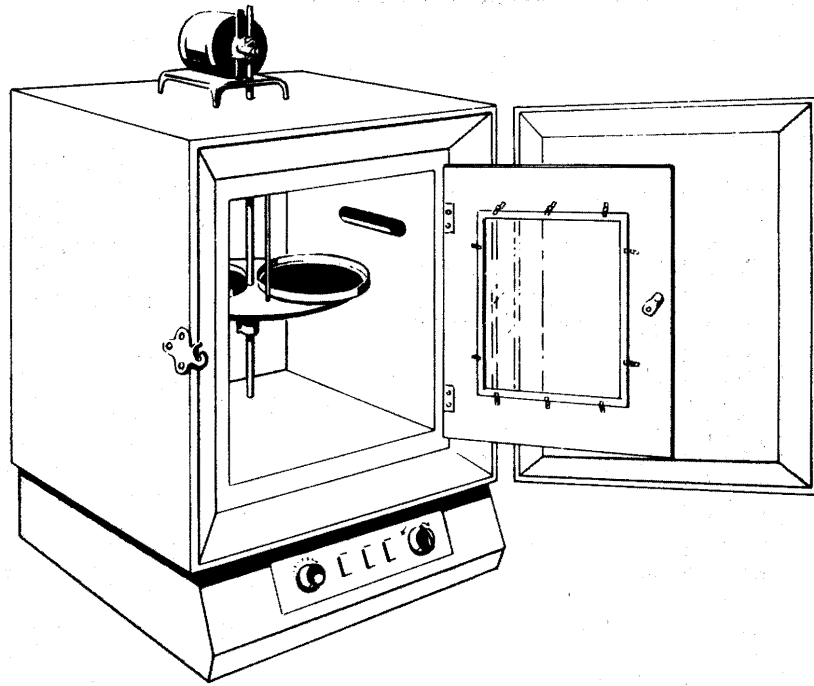
The TFO procedure involves placing a measured sample of asphalt cement into a flat-bottomed pan so that the sample covers the pan bottom to a depth of about  $\frac{1}{8}$ -inch (3 mm). The sample and pan are then placed on a rotating shelf in an oven (Figure 2.14) and kept at a temperature of 325°F (163°C) for five hours. The artificially-aged and hardened sample is then tested for its viscosity value, penetration value, or both.

The RTFO procedure has been developed by agencies in the Western United States. It has the same purpose as the TFO test, but uses different equipment and procedures.

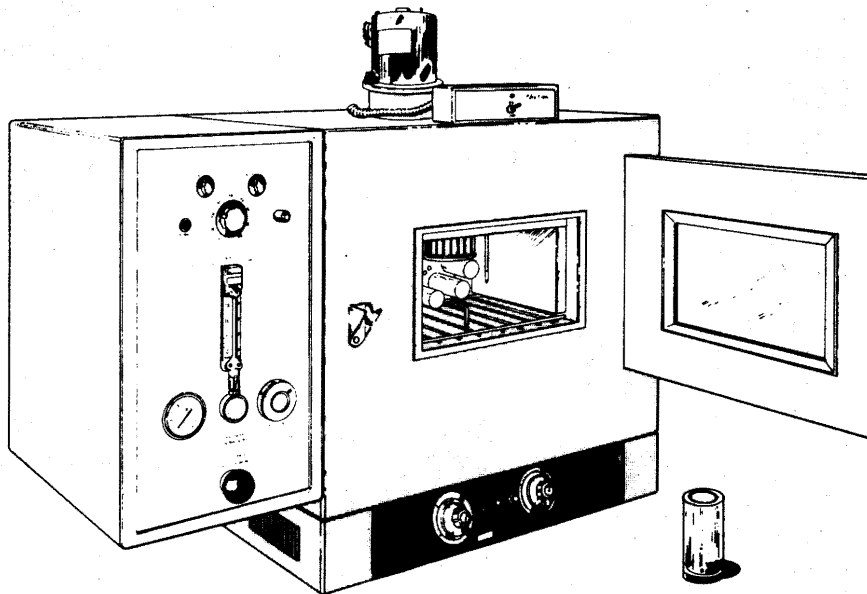
As Figure 2.15 shows, the equipment required for a RTOF test includes a specially-designed oven and a specially-designed bottle used as a container for the test sample. The asphalt cement sample is placed in the bottle. The bottle is placed on its side on a rotating shelf, which rolls the bottle continuously in the oven (kept at 375°F (163°C)). The rotation of the bottle continuously exposes fresh films of asphalt cement. Once during each rotation, the bottle opening passes an air jet which removes accumulated vapors from the bottle.

The advantages of the RTFO test over the TFO tests are that the RTFO oven accommodates a larger number of samples than the TFO oven, and less time is required to harden the samples in the RTFO test than in the TFO test.

**2.3.C.5 Ductility**—Ductility is a measure of how far a sample of asphalt cement can be stretched before it breaks into two parts. Ductility is measured by an “extension” test in which a briquette of asphalt cement is extended or stretched at a specific rate

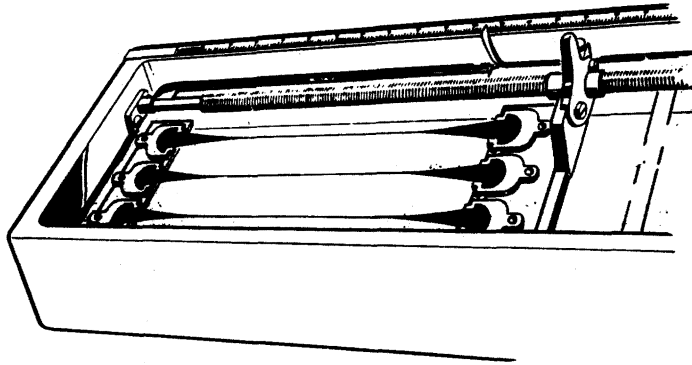


**FIGURE 2.14—Thin Film Oven Test.**



**FIGURE 2.15—Rolling Thin Film Oven Test.**

and temperature (Figure 2.16). Extension is continued until the thread of asphalt cement joining the two halves of the sample breaks. The length of the thread of material at the moment it breaks is measured in centimeters and is designated as the sample's ductility value.



**FIGURE 2.16—Ductility Test.**

**2.3.C.6 Solubility**—The solubility test is a procedure for measuring the purity of an asphalt cement. A sample is immersed in a solvent (trichlorethylene) in which the active cementing constituents of the sample dissolve. Impurities such as salts, free carbon, and nonorganic contaminants, do not dissolve, but remain in particle form. These insoluble impurities are filtered out of the solution, and are measured as a proportion of the original sample.

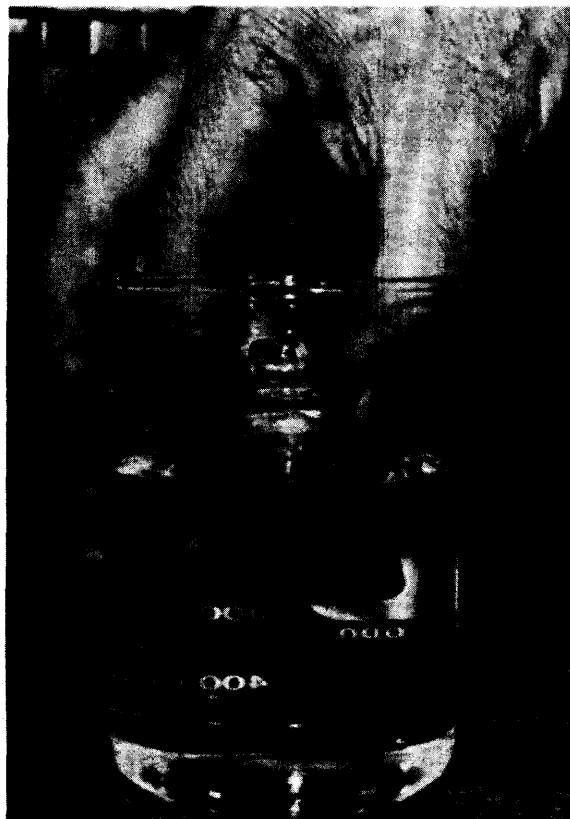
**2.3.C.7 Specific Gravity**—Specific gravity is the ratio of the weight of any volume of a material to the weight of an equal volume of water, both at a specified temperature. As an example, a substance with a specific gravity of 1.6 weighs 1.6 times as much as water.

The specific gravity of an asphalt cement is not normally indicated in the job specifications. Nonetheless, knowing the specific gravity of the asphalt cement being used is important for two reasons.

- Asphalt expands when heated and contracts when cooled. This means that the volume of a given amount of asphalt cement will be greater at higher temperatures than at lower ones. Specific gravity measurements provide a yardstick for making temperature-volume corrections, which are discussed later.
- Specific gravity of the asphalt is essential in the determination of the percentage of voids (air spaces) in the compacted pavement.

Specific gravity is usually determined by the pycnometer method (Figure 2.17) (AASHTO T 228). Because specific gravity varies with the expansion and contraction of asphalt cement at different temperatures, results are normally expressed in terms

of Sp. Gr. (Specific Gravity) at a given temperature for both the material and the water used in the test. (Example: Sp. Gr. 1.05 at 60°/60°F (15.6°/15.6°C) means that the specific gravity of the asphalt cement tested is 1.05 when both the asphalt cement and the water are at 60°F (15.6°C).)



**FIGURE 2.17—Determining Specific Gravity Using Pycnometer (AASHTO T 228).**

### ***2.3.D Asphalt Handling, Storage and Sampling***

The safety record for handling, storing and sampling asphalt is good. Nonetheless, there have been accidents resulting in property damage, personal injury and loss of life. To prevent such mishaps, everyone must know and follow good safety practices. When an accident does occur, everyone must know how to react and what first-aid treatment is appropriate.

The inspector should be aware of the potential sources of contamination that might exist where asphalt is stored or handled. Because an inspector may be required to collect asphalt samples for testing, he should also be able to identify and avoid practices that lead to contamination of samples. Finally, he should understand the changes in volume that asphalt undergoes when heated or cooled. This knowledge is especially important when comparing asphalt quantities measured at different temperatures.

**2.3.D.1 Safe Handling of Hot Asphalt**—At an asphalt plant, asphalt temperatures commonly exceed 300°F (149°C). Metal surfaces of plant equipment often range between 150°F (66°C) and 200°F (93°C). Consequently, momentary contact with hot asphalt or with plant equipment, including tanks, pipelines, dryers, boilers, and boiler houses, can severely burn exposed flesh. Four general precautions against such painful and sometimes disfiguring burns are:

- Be aware of where burn hazards are located.
- Use designated walk areas and stay clear of hazardous situations.
- Always wear appropriate work clothing.
- Know and follow all plant safety procedures related to handling hot material and equipment.

If a burn does occur, follow these general treatment guidelines:

- In the case of local asphalt skin burns, apply cold water or an icepack to reduce the heat in the asphalt and the skin.
- In cases where burns cover more than 10 percent of the body (approximately the skin area of one arm or half a leg), apply lukewarm water instead of cold water. Lukewarm water will reduce the temperature of the asphalt and skin without causing shock which could be induced by applying cold water or ice to major burns.
- Do not remove the asphalt from the skin.
- Do not cover the burned area with a bandage.
- Have a physician examine the burn immediately.

Hydrogen sulfide is a product of the reaction between hydrogen and sulphur naturally present in asphalt. In low concentrations, hydrogen sulfide is not dangerous; however, in the high concentrations sometimes found in storage tanks and other closed areas, it can be lethal. To prevent overexposure to hydrogen sulfide fumes, follow these guidelines:

- Keep your face at least two feet away from asphalt tank hatch openings.
- Stay upwind of open hatches.
- Avoid breathing fumes when opening hatch covers or taking samples.

In case of overexposure to hydrogen sulfide fumes, do the following:

- Move victim immediately to fresh air.
- Administer oxygen if breathing is difficult.
- Start artificial respiration if breathing stops.
- Have victim examined by a physician immediately.

**2.3.D.2 Storing Asphalt**—At a stationary asphalt plant, asphalt is stored in heated, insulated tanks, the average capacity being about 20,000 gallons (76,000 liters). Smaller trailer-mounted tanks are used for portable plants. Their capacity is generally about one-half that of the stationary tanks.

To keep stored asphalt fluid enough to be pumped readily, storage tanks are equipped with steam heating coils, hot oil coils, or gas-fired or electric heaters. Cer-

tain precautions regarding tank temperatures must be followed to ensure safety. They are:

- Check and record tank temperatures regularly.
- When taking tank temperatures, use an instrument designed for that purpose.
- Avoid taking temperature readings near the heating coils, the tank shell or the tank bottom. Such readings are generally inaccurate indications of the overall asphalt temperature.
- From a safety standpoint, it is desirable to store asphalt at a temperature as far as possible below the flashpoint. Remember that the values reported by the flashpoint tests are specific to the test procedures and not necessarily representative of the vapor space atmospheres existent in storage. Consequently, an asphalt's flashpoint in storage may vary considerably from the flashpoint-determined in the laboratory. Figure 2.18 presents guidelines for storing and handling various types and grades of asphalt. While not intended as rigid rules, these guidelines serve to indicate storage temperatures found to be safe, while being effective for maintaining asphalt fluidity, environmental regulations, and agency specifications.
- Check storage tanks and coils regularly for signs of damage or leakage.

Trucks and railroad cars that normally carry asphalt, may sometimes carry other petroleum products. Because of this, nonasphaltic residues are sometimes found in tankers about to be loaded with asphalt; residues that could contaminate the asphalt cargo. This contamination can result not only in asphalt that does not meet specifications, but also increases danger of fire or explosion. Investigations have shown that many off-specifications samples have flashpoints too low. For example, 0.1 percent of diesel oil in asphalt cement may lower the flashpoint as much as 50°F (27°C) (Pensky-Martens flashpoint test), and increase the penetration as much as 10 points. Such contamination amounts to only one part in a thousand, but the effects on the asphalt properties are substantial. To minimize these hazards, follow Figure 2.19 when loading asphalt into tanks previously used to transport other products.

**2.3.D.3 Sampling Asphalt**—The only way to know whether the asphalt cement delivered to the plants meets specifications is to take samples of the material and have those samples tested in a laboratory. For meaningful test results, the samples must be representative of the entire shipment. Contamination or other alteration of the sample before testing is likely to produce misleading test results. Such results could be used to reject an entire shipment of asphalt cement, even though the asphalt does in fact meet specifications. Details on sampling asphalt are contained in Section 4.5.

### **2.3.E Temperature-Volume Relationships**

Asphalt expands when heated and contracts when cooled. These changes in volume can cause confusion because, regardless of the temperature at which asphalt is shipped and stored, the basis for payments and project records is the asphalt's volume at 60°F (15°C). Consequently, when 5,000 gallons (18,927 liters) of asphalt at 300°F (149°C) is delivered, its volume at 60°F (15°C) must be calculated and recorded.

Type & Grade	Specific Reference	Min. Flash °F (°C)	(Storage) Temperature °F (°C)
AC-2.5	AASHTO M226	325 (163)	320 (160)
-5		350 (177)	330 (166)
-10		425 (219)	345 (174)
-20		450 (232)	350 (177)
-40		450 (232)	350 (177)
AR-1000	AASHTO M226	400 (205)	325 (163)
-2000		425 (219)	335 (168)
-4000		440 (227)	350 (177)
-8000		450 (232)	350 (177)
-16000		460 (238)	350 (177)
Pen 40-50	AASHTO M20	450 (232)	350 (177)
60-70		450 (232)	350 (177)
85-100		450 (232)	350 (177)
120-150		425 (219)	350 (177)
200-300		350 (177)	335 (168)
MC-30	AASHTO M82	100 (38)	130 (54)
-70		100 (38)	160 (71)
-250		150 (66)	195 (91)
-800		150 (66)	210 (99)
-3000		150 (66)	210 (99)
RC-70	AASHTO M81	— —	160 (71)
-250		80 (27)	195 (91)
-800		80 (27)	210 (99)
-3000		80 (27)	210 (99)
SC-70	ASTM D 2026	150 (66)	160 (71)
-250		175 (79)	195 (91)
-800		200 (93)	210 (99)
-3000		225 (107)	210 (99)
All Grades of Emulsified Asphalt	AASHTO M140 & 208	— —	180 (82)

FIGURE 2.18—Guideline Temperature for Storage and Handling of Asphalt Products.

The calculation involved is rather simple. It requires that the inspector know two pieces of information:

- The temperature of the asphalt.
- The asphalt's specific gravity.

The asphalt's temperature and its specific gravity are used to locate the proper correction factor on one of the tables in Figure 2.20. These tables have been in use for at least three decades and are the only data currently available for temperature corrections above 300°F (149°C). Nonetheless, the accuracy of the tables is not guaranteed.

When the inspector knows the asphalt's temperature and the necessary correction factor, the following formula is used to calculate the asphalt's volume at 60°F (15°C):

$$V = V_t (CF)$$



LAST PRODUCT IN TANK	PRODUCT TO BE LOADED			
	Asphalt Cement	Cutback Asphalt	Cationic Emulsion	Anionic Emulsion
Asphalt Cement	OK to load	OK to load	Empty to no Measurable Quantity	Empty to no Measurable Quantity
Cutback Asphalt	Empty to no Measurable Quantity	OK to load	Empty to no Measurable Quantity	Empty to no Measurable Quantity
Cationic Emulsion	Empty to no Measurable Quantity	Empty to no Measurable Quantity	OK to load	Empty to no Measurable Quantity
Anionic Emulsion	Empty to no Measurable Quantity	Empty to no Measurable Quantity	Empty to no Measurable Quantity	OK to load
Crude Petroleum and residual fuel oils	Empty to no Measurable Quantity	Empty to no Measurable Quantity	Empty to no Measurable Quantity	Empty to no Measurable Quantity
Any product not listed above	Tank must be cleaned	Tank must be cleaned	Tank must be cleaned	Tank must be cleaned

FIGURE 2.19—Guide for Loading Asphalt Products.

where,

$V$  = Volume at 60°F (15°C)

$V_t$  = Volume at given temperature

CF = Correction Factor from Figure 2.20.

The following example illustrates how the calculation is made.

**EXAMPLE:**

A truck has just delivered 5,000 gallons (18,927 liters) of asphalt at a temperature of 300°F (149°C). The Specific Gravity (Sp. Gr.) of the asphalt is 0.970. What would the asphalt's volume be at 60°F (15°C)?

Because the asphalt Specific Gravity is above 0.966, the tables for Group 0 (Figure 2.20) are used to find the correction factor. For 300°F, the correction factor listed is 0.9187.

Therefore,

$$\begin{aligned}
 V &= 5,000 \text{ gallons} \times 0.9187 \text{ OR} \\
 &18,927 \text{ liters} \times 0.9187 \\
 &= 4,594 \text{ gallons OR} \\
 &17,388 \text{ liters}
 \end{aligned}$$

# GROUP O (°F)

GROUP O—SPECIFIC GRAVITY AT 60°F ABOVE 0.966

LEGEND: t = observed temperature in degrees Fahrenheit  
M = multiplier for correcting oil volumes to the basis of 60°F

t	M	t	M	t	M	t	M	t	M
0	1.0211	50	1.0035	100	0.9861	150	0.9689	200	0.9520
1	1.0208	51	1.0031	101	0.9857	151	0.9686	201	0.9516
2	1.0204	52	1.0028	102	0.9854	152	0.9682	202	0.9513
3	1.0201	53	1.0024	103	0.9851	153	0.9679	203	0.9509
4	1.0197	54	1.0021	104	0.9847	154	0.9675	204	0.9506
5	1.0194	55	1.0017	105	0.9844	155	0.9672	205	0.9503
6	1.0190	56	1.0014	106	0.9840	156	0.9669	206	0.9499
7	1.0186	57	1.0010	107	0.9837	157	0.9665	207	0.9496
8	1.0183	58	1.0007	108	0.9833	158	0.9662	208	0.9493
9	1.0179	59	1.0003	109	0.9830	159	0.9658	209	0.9489
10	1.0176	60	1.0000	110	0.9826	160	0.9655	210	0.9486
11	1.0172	61	0.9997	111	0.9823	161	0.9652	211	0.9483
12	1.0169	62	0.9993	112	0.9819	162	0.9648	212	0.9479
13	1.0165	63	0.9990	113	0.9816	163	0.9645	213	0.9476
14	1.0162	64	0.9986	114	0.9813	164	0.9641	214	0.9472
15	1.0158	65	0.9983	115	0.9809	165	0.9638	215	0.9469
16	1.0155	66	0.9979	116	0.9806	166	0.9635	216	0.9466
17	1.0151	67	0.9976	117	0.9802	167	0.9631	217	0.9462
18	1.0148	68	0.9972	118	0.9799	168	0.9628	218	0.9459
19	1.0144	69	0.9969	119	0.9795	169	0.9624	219	0.9456
20	1.0141	70	0.9965	120	0.9792	170	0.9621	220	0.9452
21	1.0137	71	0.9962	121	0.9788	171	0.9618	221	0.9449
22	1.0133	72	0.9958	122	0.9785	172	0.9614	222	0.9446
23	1.0130	73	0.9955	123	0.9782	173	0.9611	223	0.9442
24	1.0126	74	0.9951	124	0.9778	174	0.9607	224	0.9439
25	1.0123	75	0.9948	125	0.9775	175	0.9604	225	0.9436
26	1.0119	76	0.9944	126	0.9771	176	0.9601	226	0.9432
27	1.0116	77	0.9941	127	0.9768	177	0.9597	227	0.9429
28	1.0112	78	0.9937	128	0.9764	178	0.9594	228	0.9426
29	1.0109	79	0.9934	129	0.9761	179	0.9590	229	0.9422
30	1.0105	80	0.9930	130	0.9758	180	0.9587	230	0.9419
31	1.0102	81	0.9927	131	0.9754	181	0.9584	231	0.9416
32	1.0098	82	0.9923	132	0.9751	182	0.9580	232	0.9412
33	1.0095	83	0.9920	133	0.9747	183	0.9577	233	0.9409
34	1.0091	84	0.9916	134	0.9744	184	0.9574	234	0.9405
35	1.0088	85	0.9913	135	0.9740	185	0.9570	235	0.9402
36	1.0084	86	0.9909	136	0.9737	186	0.9567	236	0.9399
37	1.0081	87	0.9906	137	0.9734	187	0.9563	237	0.9395
38	1.0077	88	0.9902	138	0.9730	188	0.9560	238	0.9392
39	1.0074	89	0.9899	139	0.9727	189	0.9557	239	0.9389
40	1.0070	90	0.9896	140	0.9723	190	0.9553	240	0.9385
41	1.0067	91	0.9892	141	0.9720	191	0.9550	241	0.9382
42	1.0063	92	0.9889	142	0.9716	192	0.9547	242	0.9379
43	1.0060	93	0.9885	143	0.9713	193	0.9543	243	0.9375
44	1.0056	94	0.9882	144	0.9710	194	0.9540	244	0.9372
45	1.0053	95	0.9878	145	0.9706	195	0.9536	245	0.9369
46	1.0049	96	0.9875	146	0.9703	196	0.9533	246	0.9365
47	1.0046	97	0.9871	147	0.9699	197	0.9530	247	0.9362
48	1.0042	98	0.9868	148	0.9696	198	0.9526	248	0.9359
49	1.0038	99	0.9864	149	0.9693	199	0.9523	249	0.9356

FIGURE 2.20—Temperature-Volume Corrections for Asphalt.

# GROUP O continued (°F)

**GROUP O—SPECIFIC GRAVITY AT 60°F ABOVE 0.966**

**LEGEND: t = observed temperature in degrees Fahrenheit  
M = multiplier for correcting oil volumes to the basis of 60°F**

t	M	t	M	t	M	t	M	t	M
250	0.9352	300	0.9187	350	0.9024	400	0.8864	450	0.8705
251	0.9349	301	0.9184	351	0.9021	401	0.8861	451	0.8702
252	0.9346	302	0.9181	352	0.9018	402	0.8857	452	0.8699
253	0.9342	303	0.9177	353	0.9015	403	0.8854	453	0.8696
254	0.9339	304	0.9174	354	0.9011	404	0.8851	454	0.8693
255	0.9336	305	0.9171	355	0.9008	405	0.8848	455	0.8690
256	0.9332	306	0.9167	356	0.9005	406	0.8845	456	0.8687
257	0.9329	307	0.9164	357	0.9002	407	0.8841	457	0.8683
258	0.9326	308	0.9161	358	0.8998	408	0.8838	458	0.8680
259	0.9322	309	0.9158	359	0.8995	409	0.8835	459	0.8677
260	0.9319	310	0.9154	360	0.8992	410	0.8832	460	0.8674
261	0.9316	311	0.9151	361	0.8989	411	0.8829	461	0.8671
262	0.9312	312	0.9148	362	0.8986	412	0.8826	462	0.8668
263	0.9309	313	0.9145	363	0.8982	413	0.8822	463	0.8665
264	0.9306	314	0.9141	364	0.8979	414	0.8819	464	0.8661
265	0.9302	315	0.9138	365	0.8976	415	0.8816	465	0.8658
266	0.9299	316	0.9135	366	0.8973	416	0.8813	466	0.8655
267	0.9296	317	0.9132	367	0.8969	417	0.8810	467	0.8652
268	0.9293	318	0.9128	368	0.8966	418	0.8806	468	0.8649
269	0.9289	319	0.9125	369	0.8963	419	0.8803	469	0.8646
270	0.9286	320	0.9122	370	0.8960	420	0.8800	470	0.8643
271	0.9283	321	0.9118	371	0.8957	421	0.8797	471	0.8640
272	0.9279	322	0.9115	372	0.8953	422	0.8794	472	0.8636
273	0.9276	323	0.9112	373	0.8950	423	0.8791	473	0.8633
274	0.9273	324	0.9109	374	0.8947	424	0.8787	474	0.8630
275	0.9269	325	0.9105	375	0.8944	425	0.8784	475	0.8627
276	0.9266	326	0.9102	376	0.8941	426	0.8781	476	0.8624
277	0.9263	327	0.9099	377	0.8937	427	0.8778	477	0.8621
278	0.9259	328	0.9096	378	0.8934	428	0.8775	478	0.8618
279	0.9256	329	0.9092	379	0.8931	429	0.8772	479	0.8615
280	0.9253	330	0.9089	380	0.8928	430	0.8768	480	0.8611
281	0.9250	331	0.9086	381	0.8924	431	0.8765	481	0.8608
282	0.9246	332	0.9083	382	0.8921	432	0.8762	482	0.8605
283	0.9243	333	0.9079	383	0.8918	433	0.8759	483	0.8602
284	0.9240	334	0.9076	384	0.8915	434	0.8756	484	0.8599
285	0.9236	335	0.9073	385	0.8912	435	0.8753	485	0.8596
286	0.9233	336	0.9070	386	0.8908	436	0.8749	486	0.8593
287	0.9230	337	0.9066	387	0.8905	437	0.8746	487	0.8590
288	0.9227	338	0.9063	388	0.8902	438	0.8743	488	0.8587
289	0.9223	339	0.9060	389	0.8899	439	0.8740	489	0.8583
290	0.9220	340	0.9057	390	0.8896	440	0.8737	490	0.8580
291	0.9217	341	0.9053	391	0.8892	441	0.8734	491	0.8577
292	0.9213	342	0.9050	392	0.8889	442	0.8731	492	0.8574
293	0.9210	343	0.9047	393	0.8886	443	0.8727	493	0.8571
294	0.9207	344	0.9044	394	0.8883	444	0.8724	494	0.8568
295	0.9204	345	0.9040	395	0.8880	445	0.8721	495	0.8565
296	0.9200	346	0.9037	396	0.8876	446	0.8718	496	0.8562
297	0.9197	347	0.9034	397	0.8873	447	0.8715	497	0.8559
298	0.9194	348	0.9031	398	0.8870	448	0.8712	498	0.8556
299	0.9190	349	0.9028	399	0.8867	449	0.8709	499	0.8552

FIGURE 2.20—Temperature-Volume Corrections for Asphalt (continued).

# GROUP 1

(°F)

GROUP 1—SPECIFIC GRAVITY AT 60°F OF 0.850 TO 0.966

LEGEND: t = observed temperature in degrees Fahrenheit  
M = multiplier for correcting oil volumes to the basis of 60°F

t	M	t	M	t	M	t	M	t	M
0	1.0241	50	1.0040	100	0.9842	150	0.9647	200	0.9456
1	1.0237	51	1.0036	101	0.9838	151	0.9643	201	0.9452
2	1.0233	52	1.0032	102	0.9834	152	0.9639	202	0.9448
3	1.0229	53	1.0028	103	0.9830	153	0.9635	203	0.9444
4	1.0225	54	1.0024	104	0.9826	154	0.9632	204	0.9441
5	1.0221	55	1.0020	105	0.9822	155	0.9628	205	0.9437
6	1.0217	56	1.0016	106	0.9818	156	0.9624	206	0.9433
7	1.0213	57	1.0012	107	0.9814	157	0.9620	207	0.9429
8	1.0209	58	1.0008	108	0.9810	158	0.9616	208	0.9425
9	1.0205	59	1.0004	109	0.9806	159	0.9612	209	0.9422
10	1.0201	60	1.0000	110	0.9803	160	0.9609	210	0.9418
11	1.0197	61	0.9996	111	0.9799	161	0.9605	211	0.9414
12	1.0193	62	0.9992	112	0.9795	162	0.9601	212	0.9410
13	1.0189	63	0.9988	113	0.9791	163	0.9597	213	0.9407
14	1.0185	64	0.9984	114	0.9787	164	0.9593	214	0.9403
15	1.0181	65	0.9980	115	0.9783	165	0.9589	215	0.9399
16	1.0177	66	0.9976	116	0.9779	166	0.9585	216	0.9395
17	1.0173	67	0.9972	117	0.9775	167	0.9582	217	0.9391
18	1.0168	68	0.9968	118	0.9771	168	0.9578	218	0.9388
19	1.0164	69	0.9964	119	0.9767	169	0.9574	219	0.9384
20	1.0160	70	0.9960	120	0.9763	170	0.9570	220	0.9380
21	1.0156	71	0.9956	121	0.9760	171	0.9566	221	0.9376
22	1.0152	72	0.9952	122	0.9756	172	0.9562	222	0.9373
23	1.0148	73	0.9948	123	0.9752	173	0.9559	223	0.9369
24	1.0144	74	0.9944	124	0.9748	174	0.9555	224	0.9365
25	1.0140	75	0.9940	125	0.9744	175	0.9551	225	0.9361
26	1.0136	76	0.9936	126	0.9740	176	0.9547	226	0.9358
27	1.0132	77	0.9932	127	0.9736	177	0.9543	227	0.9354
28	1.0128	78	0.9929	128	0.9732	178	0.9539	228	0.9350
29	1.0124	79	0.9925	129	0.9728	179	0.9536	229	0.9346
30	1.0120	80	0.9921	130	0.9725	180	0.9532	230	0.9343
31	1.0116	81	0.9917	131	0.9721	181	0.9528	231	0.9339
32	1.0112	82	0.9913	132	0.9717	182	0.9524	232	0.9335
33	1.0108	83	0.9909	133	0.9713	183	0.9520	233	0.9331
34	1.0104	84	0.9905	134	0.9709	184	0.9517	234	0.9328
35	1.0100	85	0.9901	135	0.9705	185	0.9513	235	0.9324
36	1.0096	86	0.9897	136	0.9701	186	0.9509	236	0.9320
37	1.0092	87	0.9893	137	0.9697	187	0.9505	237	0.9316
38	1.0088	88	0.9889	138	0.9693	188	0.9501	238	0.9313
39	1.0084	89	0.9885	139	0.9690	189	0.9498	239	0.9309
40	1.0080	90	0.9881	140	0.9686	190	0.9494	240	0.9305
41	1.0076	91	0.9877	141	0.9682	191	0.9490	241	0.9301
42	1.0072	92	0.9873	142	0.9678	192	0.9486	242	0.9298
43	1.0068	93	0.9869	143	0.9674	193	0.9482	243	0.9294
44	1.0064	94	0.9865	144	0.9670	194	0.9478	244	0.9290
45	1.0060	95	0.9861	145	0.9666	195	0.9475	245	0.9286
46	1.0056	96	0.9857	146	0.9662	196	0.9471	246	0.9283
47	1.0052	97	0.9854	147	0.9659	197	0.9467	247	0.9279
48	1.0048	98	0.9850	148	0.9655	198	0.9463	248	0.9275
49	1.0044	99	0.9846	149	0.9651	199	0.9460	249	0.9272

FIGURE 2.20—Temperature-Volume Corrections for Asphalt (continued).

## GROUP 1 continued (°F)

GROUP 1—SPECIFIC GRAVITY AT 60°F OF 0.850 TO 0.966

LEGEND: t = observed temperature in degrees Fahrenheit  
M = multiplier for correcting oil volumes to the basis of 60°F

t	M	t	M	t	M	t	M	t	M
250	0.9268	300	0.9083	350	0.8902	400	0.8724	450	0.8550
251	0.9264	301	0.9080	351	0.8899	401	0.8721	451	0.8547
252	0.9260	302	0.9076	352	0.8895	402	0.8717	452	0.8543
253	0.9257	303	0.9072	353	0.8891	403	0.8714	453	0.8540
254	0.9253	304	0.9069	354	0.8888	404	0.8710	454	0.8536
255	0.9249	305	0.9065	355	0.8884	405	0.8707	455	0.8533
256	0.9245	306	0.9061	356	0.8881	406	0.8703	456	0.8529
257	0.9242	307	0.9058	357	0.8877	407	0.8700	457	0.8526
258	0.9238	308	0.9054	358	0.8873	408	0.8696	458	0.8522
259	0.9234	309	0.9050	359	0.8870	409	0.8693	459	0.8519
260	0.9231	310	0.9047	360	0.8866	410	0.8689	460	0.8516
261	0.9227	311	0.9043	361	0.8863	411	0.8686	461	0.8512
262	0.9223	312	0.9039	362	0.8859	412	0.8682	462	0.8509
263	0.9219	313	0.9036	363	0.8856	413	0.8679	463	0.8505
264	0.9216	314	0.9032	364	0.8852	414	0.8675	464	0.8502
265	0.9212	315	0.9029	365	0.8848	415	0.8672	465	0.8498
266	0.9208	316	0.9025	366	0.8845	416	0.8668	466	0.8495
267	0.9205	317	0.9021	367	0.8841	417	0.8665	467	0.8492
268	0.9201	318	0.9018	368	0.8838	418	0.8661	468	0.8488
269	0.9197	319	0.9014	369	0.8834	419	0.8658	469	0.8485
270	0.9194	320	0.9010	370	0.8831	420	0.8654	470	0.8481
271	0.9190	321	0.9007	371	0.8827	421	0.8651	471	0.8478
272	0.9186	322	0.9003	372	0.8823	422	0.8647	472	0.8474
273	0.9182	323	0.9000	373	0.8820	423	0.8644	473	0.8471
274	0.9179	324	0.8996	374	0.8816	424	0.8640	474	0.8468
275	0.9175	325	0.8992	375	0.8813	425	0.8637	475	0.8464
276	0.9171	326	0.8989	376	0.8809	426	0.8633	476	0.8461
277	0.9168	327	0.8985	377	0.8806	427	0.8630	477	0.8457
278	0.9164	328	0.8981	378	0.8802	428	0.8626	478	0.8454
279	0.9160	329	0.8978	379	0.8799	429	0.8623	479	0.8451
280	0.9157	330	0.8974	380	0.8795	430	0.8619	480	0.8447
281	0.9153	331	0.8971	381	0.8792	431	0.8616	481	0.8444
282	0.9149	332	0.8967	382	0.8788	432	0.8612	482	0.8440
283	0.9146	333	0.8963	383	0.8784	433	0.8609	483	0.8437
284	0.9142	334	0.8960	384	0.8781	434	0.8605	484	0.8433
285	0.9138	335	0.8956	385	0.8777	435	0.8602	485	0.8430
286	0.9135	336	0.8952	386	0.8774	436	0.8599	486	0.8427
287	0.9131	337	0.8949	387	0.8770	437	0.8595	487	0.8423
288	0.9127	338	0.8945	388	0.8767	438	0.8592	488	0.8420
289	0.9124	339	0.8942	389	0.8763	439	0.8588	489	0.8416
290	0.9120	340	0.8938	390	0.8760	440	0.8585	490	0.8413
291	0.9116	341	0.8934	391	0.8756	441	0.8581	491	0.8410
292	0.9113	342	0.8931	392	0.8753	442	0.8578	492	0.8406
293	0.9109	343	0.8927	393	0.8749	443	0.8574	493	0.8403
294	0.9105	344	0.8924	394	0.8746	444	0.8571	494	0.8399
295	0.9102	345	0.8920	395	0.8742	445	0.8567	495	0.8396
296	0.9098	346	0.8916	396	0.8738	446	0.8564	496	0.8393
297	0.9094	347	0.8913	397	0.8735	447	0.8560	497	0.8389
298	0.9091	348	0.8909	398	0.8731	448	0.8557	498	0.8386
299	0.9087	349	0.8906	399	0.8728	449	0.8554	499	0.8383

FIGURE 2.20—Temperature-Volume Corrections for Asphalt (continued).

The volume of the particular asphalt at 60°F (15°C) is therefore, 4,594 gallons or 17,388 liters.

## 2.4 AGGREGATE

Aggregate, also referred to as rock, granular material, and mineral aggregate, is any hard, inert mineral material used in graduated particles or fragments as part of a hot-mix asphalt pavement. Typical aggregates include sand, gravel, crushed stone, slag, and rock dust. Aggregate makes up 90-95 percent by weight and 75-85 percent by volume of most pavement structures. Because it provides most of the load-bearing characteristics of the pavement, pavement performance is heavily influenced by the choice of a proper aggregate for a particular job.

### 2.4.A Aggregate Classification

Rock is divided into three general types: sedimentary, igneous, and metamorphic (Figure 2.21). These classifications are based upon the way in which each type is formed.

**2.4.A.1 Sedimentary**—Sedimentary rocks are formed by the accumulation of sediment (fine particles) in water or as water deposits. Sediment may consist of mineral particles or fragments (as in the case of sandstone and shale), the remains or products of animals (certain limestones), plants (coal), the end products of chemical action or evaporation (salt, gypsum) or combinations of these types of materials.

Two terms often applied to sedimentary rocks are *siliceous* and *calcareous*. Siliceous sedimentary rocks are those which contain a high percentage of silica. Those rocks which contain a high percentage of calcium carbonate (limestone) are called calcareous.

Sedimentary rock is characteristically found in layers (strata) in the earth's crust. This stratification is the direct result of the way sedimentary rock is formed—from layered deposits of fine particles often spread over ancient lake or sea bottoms.

**2.4.A.2 Igneous**—Igneous rocks consist of molten material (magma) that has cooled and solidified. There are two types of igneous rock: *extrusive* and *intrusive*.

Extrusive igneous rock is formed from material that has poured out onto the earth's surface during a volcanic eruption or similar geologic activity. Because exposure to the atmosphere allows the material to cool quickly, the resulting rock has a glass-like appearance and structure. Rhyolite, andesite and basalt are examples of extrusive rock.

Intrusive rock forms from magma trapped deep within the earth's crust. Trapped in the earth, the magma cools and hardens slowly, allowing a crystalline structure to form. Consequently, intrusive igneous rock is crystalline in structure and appearance; examples being granite, diorite, and gabbro. Earth movement and erosion processes bring intrusive rock to the earth's surface, where it can be quarried and used.

**2.4.A.3 Metamorphic**—Metamorphic rock is generally sedimentary or igneous rock that has been changed by intense pressure and heat within the earth, and strong

chemical reactions. Because such formation processes are complex, it is often difficult to determine exact origin of a particular metamorphic rock.

Many types of metamorphic rock have a distinct characteristic feature: the minerals are arranged in parallel planes or layers. Splitting the rock along its planes is much easier than splitting it in other directions. Metamorphic rock that exhibits this type of structure is termed *foliated*. Examples of foliated rock are gneisses and schists (formed from igneous material) and slate (formed from shale, a sedimentary rock).

Not all metamorphic rock is foliated. Marble (formed from limestone) and quartzite (formed from sandstone) are common types of metamorphic rock without foliation.

#### **2.4.B Aggregate Sources**

Aggregates for asphalt paving are generally classified according to their sources. They include: natural aggregates, processed aggregates, and synthetic or artificial aggregates.

**2.4.B.1 Natural Aggregates**—Natural aggregates are aggregates that are used in their natural form, with little or no processing. They are made up of particles produced by a natural erosion and degradation process, such as the action of wind, water, moving ice, and chemicals. The shape of the individual particles is largely a result of the agents acting on them. Glaciers, for example, often produce rounded boulders and pebbles. Similarly, flowing water produces smoothly rounded particles.

The two major types of natural aggregates used in pavement construction are *gravel* and *sand*. Gravel is usually defined as particles 6.35 mm ( $\frac{1}{4}$  in.) or larger in size. Sand is defined as particles smaller than 6.35 mm ( $\frac{1}{4}$  in.) but larger than 0.075 mm (No. 200). Particles smaller than 0.075 mm (No. 200) are considered mineral filler, made up primarily of silt and clay.

Gravels and sands are further classified by their source. Materials quarried from an open pit and used without further processing are referred to as *pit-run* materials; and similarly, materials taken from stream banks are referred to as *bank-run* materials.

Gravel deposits vary widely in composition, but usually contain some sand and silt. Sand deposits also ordinarily contain some clay and silt. Beach sands (some of which are now far inland) are comprised of particles of fairly uniform size, while river sand often contains larger proportions of gravel, silt and clay.

**2.4.B.2 Processed Aggregates**—Processed aggregates are aggregates that have been crushed and screened in preparation for use. There are two basic sources of processed aggregates: natural gravels that are crushed to make them more suitable for use in asphalt pavement mixtures, and fragments of bedrock and large stones that must be reduced in size before being used for paving.

Rock is crushed for three reasons; to change the surface texture of the particles from smooth to rough, to change particle shape from round to angular, and to reduce and improve the distribution and range (gradation) of particle sizes. In the case of bedrock fragments and large stones, the primary purpose of crushing is to reduce the stones to workable size. Changes in surface texture and particle shape are also important, however.

## GENERAL CLASSIFICATION OF ROCKS

Class	Type	Family
Sedimentary	Calcareous	Limestone Dolomite
	Siliceous	Shale Sandstone Chert Conglomerate <sup>1</sup> Breccia <sup>1</sup>
Metamorphic	Foliated	Gneiss Schist Amphibolite Slate
	Nonfoliated	Quartzite Marble Serpentinite
Igneous	Intrusive (coarse-grained)	Granite <sup>2</sup> Syenite <sup>2</sup> Diorite <sup>2</sup> Gabbro Periodotite Pyroxenite Hornblendite
	Extrusive (fine-grained)	Obsidian Pumice Tuff Rhyolite <sup>2,3</sup> Trachyte <sup>2,3</sup> Andesite <sup>2,3</sup> Basalt <sup>2</sup> Diabase

<sup>1</sup> May also be composed partially or entirely of calcareous materials.

<sup>2</sup> Frequently occurs as a porphyritic rock.

<sup>3</sup> Included in general term "felsite" when constituent minerals cannot be determined quantitatively.

**FIGURE 2.21—Different Aggregates Classifications.**



Screening the materials after crushing results in particles of specific gradation range of sizes. Maintaining specific aggregate gradations is a critical element in producing quality pavements. For reasons of economy, however, crushed material is often used just as it comes from the crusher, with little or no screening. Proper control of the crushing operation determines whether the resulting aggregate gradation meets job requirements. Crushed, unscreened aggregate is known as *crusher-run* aggregate and is used satisfactorily for many pavement construction projects. However, it is essential to ensure that the crushing operations is continually monitored to produce aggregates that satisfy gradation specifications.

Crushing some types of rocks, such as limestone, produces substantial quantities of small chips and smaller particles. In most operations, this fraction is separated from all particles 6.35 mm ( $\frac{1}{4}$  in.) in diameter or larger and is used as a crushed sand aggregate or processed further to a maximum particle size of 0.60 mm (No. 30).

**2.4.B.3 Synthetic Aggregates**—Synthetic or artificial aggregates do not exist in nature. They are the product of chemical or physical processing of materials. Some are by-products of industrial production processes such as ore refining; others are produced specifically for use as aggregate by processing raw materials.

Blast-furnace slag is the most commonly used by-product aggregate. It is a nonmetallic substance that rises to the surface of molten iron during the smelting process. When drawn off the surface of the iron, the slag is reduced into small particles, either by quenching it immediately in water or crushing it after it has cooled.

Manufactured synthetic aggregates are relatively new in the paving industry. They are manufactured by firing clay, shale, processed diatomaceous earth, volcanic glass, slag, and other materials. The end products are typically light-weight and have unusually high resistance to wear. Synthetic aggregates have been used in bridge-deck and roof-deck paving, as well as pavement surface layers where maximum skid resistance is required.

#### **2.4.C Aggregate Production, Stockpiling, Handling and Sampling**

When the source of aggregates used in a paving project is located near the plant site, the inspector may have some responsibility for monitoring aggregate processing. Such processing includes excavating soil layers (overburden) over gravel deposits, working the deposits to retrieve suitable aggregate, and separating aggregate particles into stockpiles.

Procedures for handling and stockpiling aggregates vary from job to job, since most contracting agencies do not specify handling and stockpiling procedures. Instead, an agency usually requires a contractor to meet aggregate gradation specifications. These specifications may have to either be met during manufacturing or stockpiling, or not until the paving mixture is produced and placed. In any case, an inspector should be aware of how handling and stockpiling practices—both good and bad—affect aggregate suitability.

Regardless of whether agency specifications call for aggregate gradations to be met during manufacturing, stockpiling or mixture production, sampling and testing are

the means of verifying that specifications are met. Certain sampling procedures must be followed to ensure that samples selected are representative.

**2.4.C.1 Production of Aggregates**—When an inspector is involved with monitoring aggregate production, he should become familiar with geologic data relating to the aggregate deposit and specifications that have been established for working the deposit.

Where sand or gravel is involved, special care must be taken to remove the soil overburden (soil covering the deposit) without contaminating the aggregate. This is particularly important where the overburden contains clay, vegetation, or other materials that can adversely affect pavement performance. Some overburden material may provide an acceptable filler; however, adding it to the aggregate by simply working it into the deposit as the aggregate is removed seldom produces an aggregate mixture with the proper proportion of filler. Consequently, overburden material suited for use as mineral filler should be removed from the deposit, screened, and added later to the processed aggregate. This method allows for careful control of mineral filler content in the final mixture.

Operations in pits and quarries often must work around clay lenses (lens-shaped deposits), shale seams (layers) and other deposits of unsuitable material embedded in the aggregate deposit. To avoid contamination of the aggregate and to ensure uniform aggregate gradation, excavation may have to be done along a horizontal bench (level) or from bottom to top on a vertical face of the deposit.

It is essential to thoroughly evaluate produced aggregates after crushing and screening to ascertain that they meet quality and gradation requirements. At commercial production facilities where aggregate production is more or less continuous throughout the paving season, one or two quality evaluations per season may be satisfactory. Where an operation is starting up for the first time, evaluations of aggregate prior to their use in paving mixtures should be done regularly.

**2.4.C.2 Stockpiling**—Good stockpiling procedures are crucial to the production of top-quality asphalt hot-mix. When stockpiled properly, aggregates retain their proper gradation. When stockpiled poorly, aggregate particles segregate (separate by size), and gradation varies at different levels within the stockpile. The inspector should be aware of the effect of various stockpiling practices on aggregate gradation and should encourage good practices at all times.

Before aggregates are delivered to a plant site, the contractor should be prepared for their arrival. Firm, clean surfaces should be made ready and precautions should be taken to keep stockpiles separated to prevent intermingling that often leads to loss of proper gradation. Separation is achieved either by keeping stockpiles widely spaced, by using bulkheads between stockpiles, or by storing aggregate in bins. Where bulkheads are used, they should be strong enough to withstand aggregate weight and should extend to the full depth of the stockpiles.

Sands, crushed fined aggregate, and aggregates consisting of a single-sized particle—especially small particles—can be stockpiled by almost any method with very little, if any, segregation. Materials containing particles ranging from large (coarse)

to small (fine), however, require certain stockpiling precautions. Segregation of such aggregates can be minimized if the coarse material and fine material are separated at the site, then blended in proper proportion just prior to the mixing operations. Where such practices are not followed, however, certain stockpiling guidelines should be followed. The first guideline is to control the shape of the stockpile. When aggregate containing both coarse and fine materials is heaped into a stockpile with sloped sides, the coarse particles tend to roll down the slope and accumulate at the bottom.

The best method of stockpiling aggregates consisting of a range of different-sized particles is to build the stockpile in layers. Such layers minimize segregation by gravity. If the aggregate is delivered by truck, truckloads should be dumped close together over the surface of the stockpile, in which case the volume of each truckload will determine the thickness of each layer. When a crane is used to stockpile aggregate, each bucketload should be placed, not cast, adjacent to another to ensure uniform layer thickness.

Mineral fillers are usually stored in bins, silos, or bags to prevent them from blowing away in wind and being exposed to moisture that might cake or harden them.

**2.4.C.3 Handling**—All handling degrades (breaks down) individual aggregate particles to some extent, and, where different-sized aggregate particles are involved, causes particle segregation. Therefore, handling should be kept at a minimum to prevent degradation and segregation that could make the aggregate unsuitable for use.

Necessary handling includes removing aggregate from stockpiles for further processing and for mixing in the hot-mix plant. There are no set rules for this operation, but one general guideline is usually applicable. It is to use a front-end loader or clamshell to remove material from a near-vertical face of the stockpile. Having a bulldozer or other tracked vehicle working on top of the stockpile increases the probability of serious degradation.

**2.4.C.4 Sampling**—During the process of producing, stockpiling, and handling aggregates, good quality control procedures require tests to:

- Ensure that only satisfactory material is used in the paving mixture, and
- Provide a permanent record as evidence that the materials meet job specifications.

Obviously, it is not practical to test all the aggregate being produced or to test all the contents of a stockpile. It is feasible only to test samples of these materials. For test results to be accurate for all the aggregate being used, the sample selected must be truly representative of all the aggregate. Proper sampling techniques are, therefore, very important (see Section 4.5).

Quantities for aggregate sampling are discussed in Section 4.5. Included is information on the recommended weight of a sample based upon the maximum particle size of the aggregate. In addition, remember that more representative samples are usually taken from an aggregate feed belt or chute than from a stockpile or bin.

Statistical sampling is beyond the scope of this discussion. Should it be needed, ASTM designation D 3665, Standard Practice for Random Sampling, outlines satisfactory procedures for such sampling (See Appendix C).

#### 2.4.D. Aggregate Properties and Evaluation

In a dense-graded asphalt hot-mix pavement, aggregate makes up 90-95 percent by weight of the paving mixture. This makes the quality of the aggregate used a critical factor in pavement performance. However, in addition to quality, there are other criteria that go into the selection of an aggregate for a particular paving job; criteria such as cost and availability. An aggregate that meets cost and availability requirements, however, must still have certain properties to be considered suitable for use in quality hot-mix asphalt pavement. These properties include:

- Maximum particle size and gradation
- Cleanliness
- Toughness
- Particle shape
- Surface texture
- Absorptive capacity
- Affinity for asphalt.

Each is discussed below.

**2.4.D.1 Maximum Particle Size and Gradation**—All hot-mix asphalt pavement specifications require aggregate particles to be within a certain range of sizes and for each size of particle to be present in a certain proportion. This distribution of various particle sizes within the aggregate used is called the *aggregate gradation* or *mix gradation*. To determine whether or not an aggregate gradation meets specifications requires an understanding of how particle size and gradation are measured.

- **Maximum Particle Size**

Because specifications list a maximum particle size for each aggregate used, the size of the largest particles in the sample must be determined. There are two designations for maximum particle size:

- Maximum size, designated as the smallest sieve through which 100 percent of the aggregate sample particles pass, and
- Nominal maximum size, designated as the largest sieve that retains any of the aggregate particles but generally not more than 10 percent for the larger sized aggregates.

To illustrate the difference between the two designations, consider this example:

A sample of aggregate to be used in a paving mixture is put through a sieve analysis. All of the aggregate particles (100 percent) pass through the 25 mm (1-in.) sieve (the sieve which has openings measuring 25 mm (1-in.)). The coarsest aggregate particles are trapped on the 19 mm (3/4-in.) sieve, the sieve directly below the 25 mm (1-in.) sieve. In this case, the *maximum size* is 25 mm (1-in.). The *nominal maximum size* is 19 mm (3/4 in.).

A paving mixture is classified according to either its maximum size or its nominal maximum size. Therefore, according to the maximum size of the aggregate described in the example, the mix would be termed a 25 mm (1-in.) mix; according to its nominal maximum size, the mixture would be a 19 mm (3/4 in.) mix.

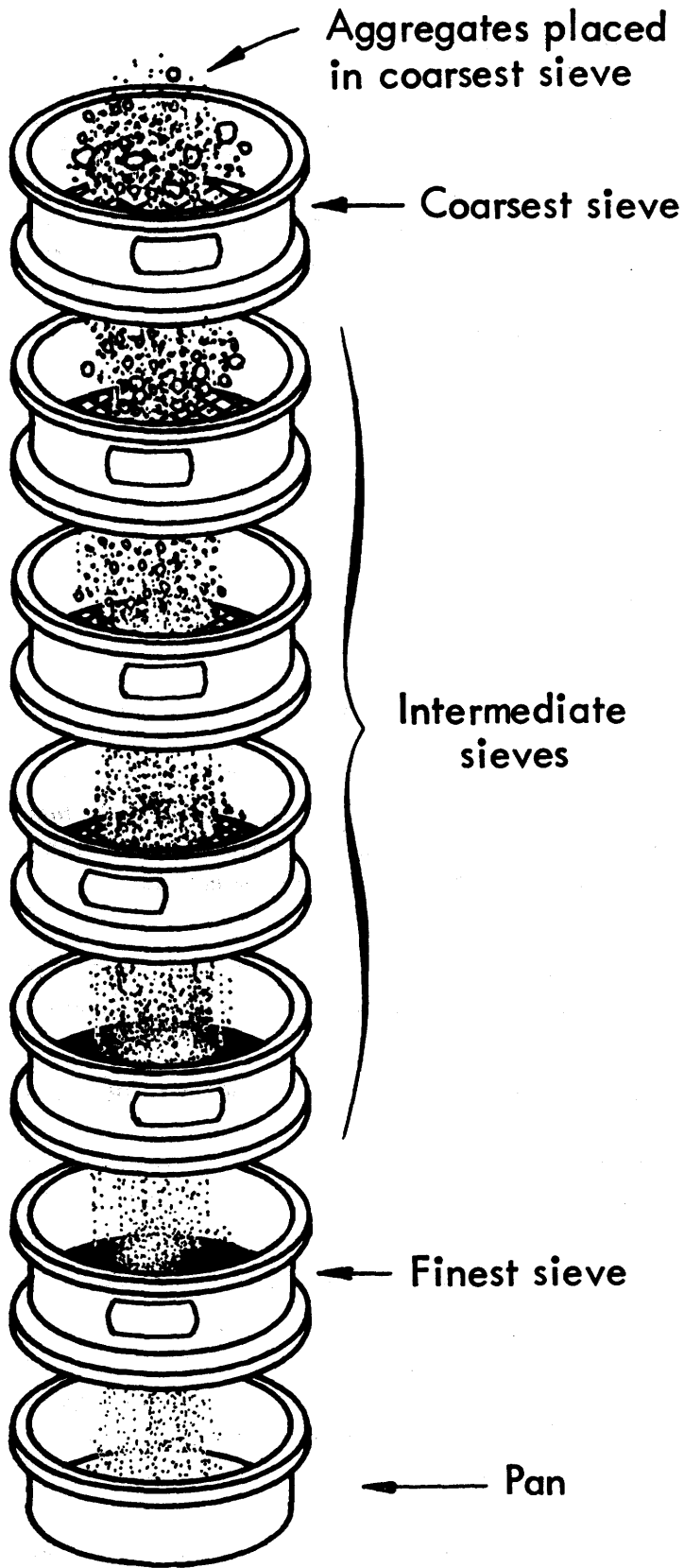


Figure 2.22—Sieve Analysis.

SIEVING

- *Aggregate Gradations*

Particle gradation is determined by a sieve or gradation analysis of aggregate samples. A sieve analysis involves running the sample through a series of sieves, each of which has openings of specific sizes (Figure 2.22). Sieves are designated by the size of their openings. Coarse particles are trapped in the upper sieves; medium-sized particles pass through to the mid-level sieves; fines pass through to the lowest sieves.

The aggregate gradation or mix gradation considers the percentage (by weight) of the total sample that passes through each sieve. It is determined by weighing the contents of each sieve following the sieve analysis, then subtracting the weight of the contents of each sieve from the weight of the entire sample.

Asphalt concretes are graded by the percentages of different-sized aggregate particles they contain. Figure 2.23 illustrates five different asphalt concrete grades and their aggregate contents.

For the purpose of description, certain terms are used in referring to aggregate fractions. They are:

- Coarse aggregate—Material retained by the 2.36 mm (No. 8) sieve.
- Fine aggregate—Material passing the 2.36 mm (No. 8) sieve.
- Mineral filler—Fractions of fine aggregate that passes 0.60 mm (No. 30) sieve.
- Mineral dust—Fraction of fine aggregate passing the 0.075 mm (No. 200) sieve.

Mineral filler and mineral dust occur naturally with many aggregates and are produced as a by-product of crushing many types of rock. They are essential for producing a mixture that is dense, cohesive, durable, and resistant to water penetration, however, having just a small percentage too much or too little of mineral filler or dust can cause the paving mixture to appear excessively dry or excessively rich (that is, the paving mixture will appear as though it contains too little or too much asphalt). Such changes in the mixture can occur with small changes in the amount or the character of the filler dust used. Consequently, the type and amount of filler dust used in any asphalt paving mixture must be carefully controlled.

Aggregate gradation specifications for a given job can be presented graphically; Figure 2.24 is a typical gradation chart. On the chart, sieve sizes are presented horizontally in both metric and customary units and percent passing is shown vertically. The specifications for the particular job are represented by the region between the thin solid lines. The paving mixture formula is represented by the heavy solid line. The job control grading bank—established as the target for gradation control on this job—lies within the region bounded by the dotted lines.

Using Figure 2.24, let's examine what a gradation chart tells us. Taking the 9.5 mm ( $\frac{3}{8}$ -in.) sieve as an example, we see that the job control grading band permits between 65 percent and 80 percent of the aggregate to pass through. The job mix formula calls for 72 percent of the aggregate to pass through the 9.5 mm ( $\frac{3}{8}$ -in.) sieve. During mixing and construction, however, between 65 percent and 80 percent passing is the range used. A gradation chart allows an inspector to understand quickly and easily the gradations required by the specification grading band, job-mix formula, and job control grading band.

Sieve numbers and size most often used in grading aggregate for asphalt paving mixers are shown on Figure 2.25.

<i>Mix Designation and Nominal Maximum Size of Aggregate</i>					
<i>Sieve Size</i>	<i>37.5 mm (1½ in.)</i>	<i>25.0 mm (1 in.)</i>	<i>19.0 mm (¾ in.)</i>	<i>12.5 mm (½ in.)</i>	<i>9.5 mm (⅜ in.)</i>
<i>Total Percent Passing (by weight)</i>					
<b>50 mm (2 in.)</b>	<b>100</b>	—	—	—	—
<b>37.5 mm (1½ in.)</b>	<b>90 to 100</b>	<b>100</b>	—	—	—
<b>25.0 mm (1 in.)</b>	—	<b>90 to 100</b>	<b>100</b>	—	—
<b>19.0 mm (¾ in.)</b>	<b>56 to 80</b>	—	<b>90 to 100</b>	<b>100</b>	—
<b>12.5 mm (½ in.)</b>	—	<b>56 to 80</b>	—	<b>90 to 100</b>	<b>100</b>
<b>9.5 mm (⅜ in.)</b>	—	—	<b>56 to 80</b>	—	<b>90 to 100</b>
<b>4.75 mm (No. 4)</b>	<b>23 to 53</b>	<b>29 to 59</b>	<b>35 to 65</b>	<b>44 to 74</b>	<b>55 to 85</b>
<b>2.36 mm (No. 8)*</b>	<b>15 to 41</b>	<b>19 to 45</b>	<b>23 to 49</b>	<b>28 to 58</b>	<b>32 to 67</b>
<b>1.18 mm (No. 16)</b>	—	—	—	—	—
<b>0.60 mm (No. 30)</b>	—	—	—	—	—
<b>0.30 mm (No. 50)</b>	<b>4 to 16</b>	<b>5 to 17</b>	<b>5 to 19</b>	<b>5 to 21</b>	<b>7 to 23</b>
<b>0.15 mm (No. 100)</b>	—	—	—	—	—
<b>0.075 mm (No. 200)**</b>	<b>0 to 5</b>	<b>1 to 7</b>	<b>2 to 8</b>	<b>2 to 10</b>	<b>2 to 10</b>
<b>Asphalt Cement, weight percent of Total Mixture†</b>	<b>3 to 8</b>	<b>3 to 9</b>	<b>4 to 10</b>	<b>4 to 11</b>	<b>5 to 12</b>
<b>Suggested Coarse Aggregate Size Numbers (see Table 11-4)</b>					
	<b>4 and 67 or 4 and 68</b>	<b>5 and 7 or 57</b>	<b>67 or 68 or 6 and 8</b>	<b>7 or 78</b>	<b>8</b>

\*In considering the total grading characteristics of an asphalt paving mixture the amount passing the 2.36 mm (No. 8) sieve is a significant and convenient field control point between fine and coarse aggregate. Gradings approaching the maximum amount permitted to pass the 2.36-mm (No. 8) sieve will result in pavement surfaces having comparatively fine texture, while gradings approaching the minimum amount passing the 2.36-mm (No. 8) sieve will result in surfaces with comparatively coarse texture.

\*\*The material passing the 0.075 mm (No. 200) sieve may consist of fine particles of the aggregates or mineral filler, or both. It shall be free from organic matter and clay particles and have a plasticity index not greater than 4 when tested in accordance with Method D 423 and Method D 424.

†The quantity of asphalt cement is given in terms of weight percent of the total mixture. The wide difference in the specific gravity of various aggregates, as well as a considerable difference in absorption, results in a comparatively wide range in the limiting amount of asphalt cement specified. The amount of asphalt required for a given mixture should be determined by appropriate laboratory testing or on the basis of past experience with similar mixtures, or by a combination of both.

**FIGURE 2.23—Typical Composition of Asphalt Concrete.**

The two methods for determining aggregate gradation are: dry sieve analysis and washed-sieve analysis. Dry sieve analysis alone is often coarser graded aggregate. When aggregate particles are coated with dust or silt-clay material, however, a washed sieve analysis should be performed.

### Dry Sieve Analysis

- Samples for analysis are reduced by mechanical splitter or by quartering.
- Fine and coarse materials are separated using a 2.36 mm (No. 8) sieve.
- Samples are dried to a constant weight.
- Coarse and fine samples are sieved separately.
- Weights of the fractions (portions) retained in each sieve and in the pan beneath the sieves are determined, as is the gradation for each sample (fine and coarse).
- A procedure for sieve analysis is contained in AASHTO T 27.

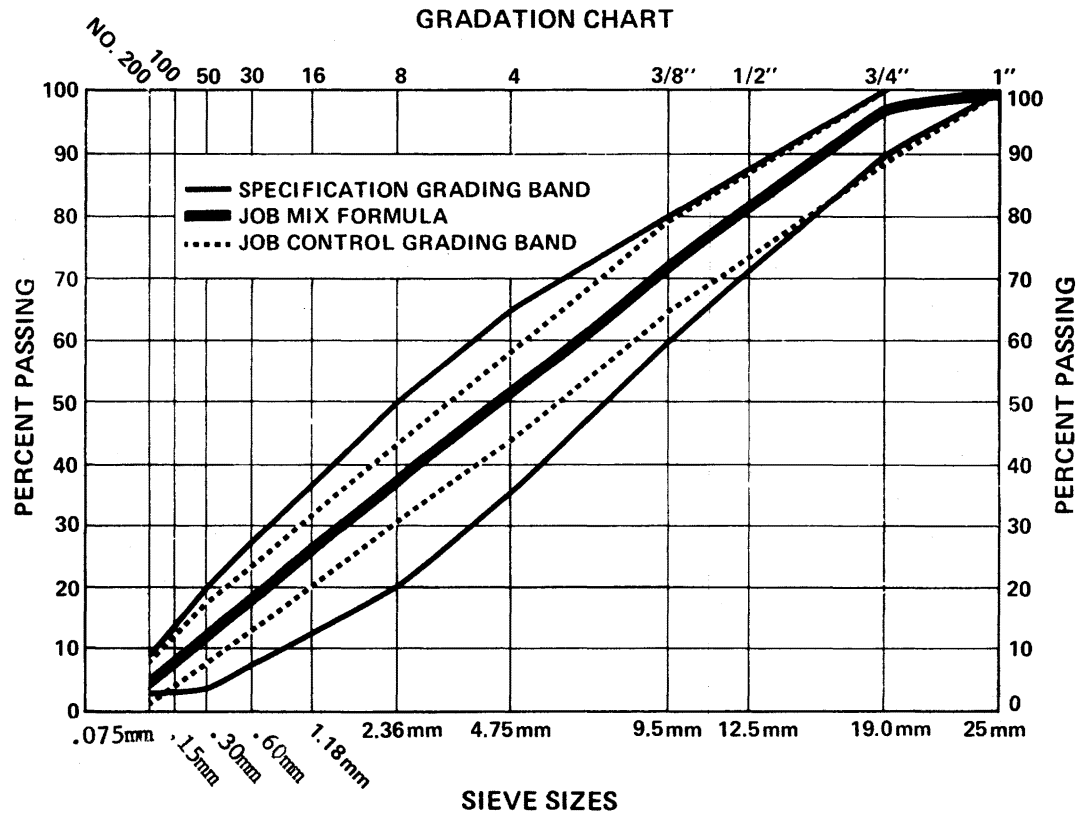


Figure 2.24—Typical Exponential Gradation Chart and Example of Grading Band.

### Washed-Sieve Analysis

- Tests samples for washed-sieve analysis after being reduced, separated, dried and weighed, are then washed thoroughly to remove dust and silt-clay material.
- After washing, the samples are again dried and weighed. The difference between the weight before washing and the weight after washing determines the amount by weight of dust and silt-clay material in the original sample.
- A procedure for washed-sieve analysis is contained in AASHTO T 11.



Coarse Aggregate Sieve Designation		Fine Aggregate Sieve Designation	
Metric	U.S. Customary	Metric	U.S. Customary
63 mm	2-1/2 in.	2.36 mm	No. 8
50 mm	2 in.	1.18 mm	No. 16
37.5 mm	1-1/2 in.	0.60 mm	No. 30
25.0 mm	1 in.	0.30 mm	No. 50
19.0 mm	3/4 in.	0.15 mm	No. 100
12.5 mm	1/2 in.	0.075 mm	No. 200
9.5 mm	3/8 in.		
4.75 mm	No. 4		

FIGURE 2.25—Typical Sieve Sizes.

**2.4.D.2 Aggregate Calculations**—Several aggregate calculation procedures required for the production of asphalt hot-mix are explained in the following section. Inspectors are expected to be able to perform these calculations or to assist in the interpretation of the data calculated by others. Included are calculations for: gradation analysis, proportioning, and specific gravity.

- *Gradation Analysis*

The method of determining the percentage of various-sized particles from the weights of fractions obtained by sieve analysis is illustrated in Figure 2.26. Gradations are expressed either in total percent passing (the total percent by weight of aggregate sample that passes through a given sieve), total percent retained (the total percent by weight of aggregate sample retained by a given sieve), and total passing and retained (the total percent by weight of aggregate sample that passes through a given sieve, and is retained on the next smaller sieve).

After being calculated, aggregate gradation is often plotted as a grading curve. Two types of curves in general use are: the semi-log chart curves and the exponential chart curves.

The semi-log chart shown in Figure 2.27 is similar to that seen earlier in Figure 2.24, where job-mix formula, job control grading band, and specification grading band are plotted. The line shown in Figure 2.27 is plotted using information from a dry sieve analysis.

The percent passing each sieve is recorded as a point on the appropriate vertical line. When one point is plotted for each sieve and its percent passing, the points are connected by a continuous line. The line represents the grading curve of the aggregate analyzed. By plotting the curve of the gradation specifications (Figure 2.24), one can tell immediately if the aggregate gradation falls within those specifications.

The exponential chart is set up with the various sieve sizes charted horizontally in powers of 0.45. Figure 2.28 shows the same gradation curve on the semi-log charts in Figure 2.27.

Sieve Size	Ret. ea. Sieve (grams)	Passing ea. sieve (grams)	Total Percent Passing	Total Percent Retained	Passing-Retained,* Percent
19.0 mm (3/4-in.)	0	1135	100	0	5
12.5 mm (1/2-in.)	56	1079	95	5	15
9.5 mm (3/8-in.)	171	908	80	20	23
4.75 mm (No. 4)	262	646	57	43	18
2.36 mm (No. 8)	203	443	39	61	16
0.60 mm (No. 30)	182	261	23	77	6
0.30 mm (No. 50)	68	193	17	83	5
0.15 mm (No. 100)	57	136	12	88	4.5
0.075 mm (No. 200)	51	85	7.5	92.5	7.5
Pan	85				

Total = 1135

\*Passing designated sieve, retained on next smaller size.

FIGURE 2.26—Sieve Analysis Data Converted to Aggregate Gradation.

- *Proportioning Calculations*

The analysis of aggregate gradations and the combining of aggregates to obtain the desired gradation are important steps in hot-mix design. The aggregate gradation must meet the gradation requirements of the project specifications and yield a mix design that meets the criteria of the design method. And, the gradation should be made up of the most economical proper aggregates to be found.

Appendix E outlines a recommended schedule for analyzing aggregates for asphalt paving mix design. The methods illustrated by these examples are applicable to blending and adjusting the aggregate gradation in laboratory control of the mix, in production control of aggregates, and in plant control during construction.

In combining aggregates, precise proportions of each must be determined to meet the target gradation. Sophisticated mathematical procedures in addition to those shown in Appendix E have been developed to calculate those proportions.

- *Specific Gravity Calculations*

The specific gravity of an aggregate is the ratio between the weight of a given volume of the aggregate and the weight of an equal volume of water. Specific gravity provides a means of expressing the weight-volume characteristics of materials. These characteristics are especially important in manufacturing pavement mixtures because the aggregate and asphalt in a mixture are proportioned by weight.

A ton of aggregate with a low specific gravity has a greater volume (takes up more space) than a ton of aggregate with a higher specific gravity. Consequently, more asphalt must be added to a ton of aggregate with a low specific gravity (greater volume) in order to coat all the aggregate particles, than must be added to a ton of aggregate with a high specific gravity (lesser volume).

Sample No. \_\_\_\_\_  
 Source \_\_\_\_\_  
 Materials \_\_\_\_\_

### AGGREGATE GRADING CHART

Project \_\_\_\_\_  
 Location \_\_\_\_\_  
 Date \_\_\_\_\_

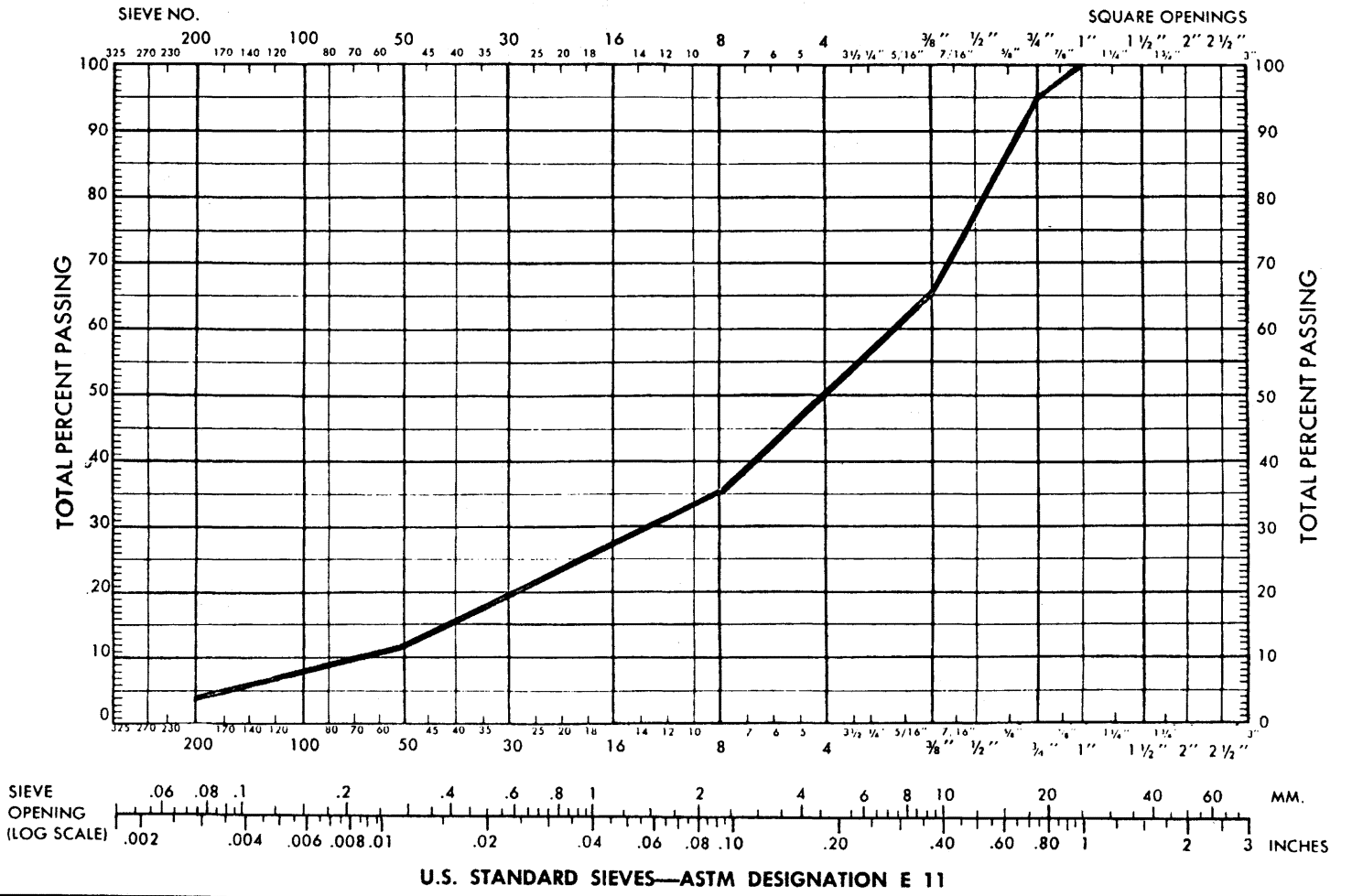


FIGURE 2.27—Semi-Log Chart Curve.

UNITED STATES BUREAU OF PUBLIC ROADS 0.45 POWER GRADATION CHART

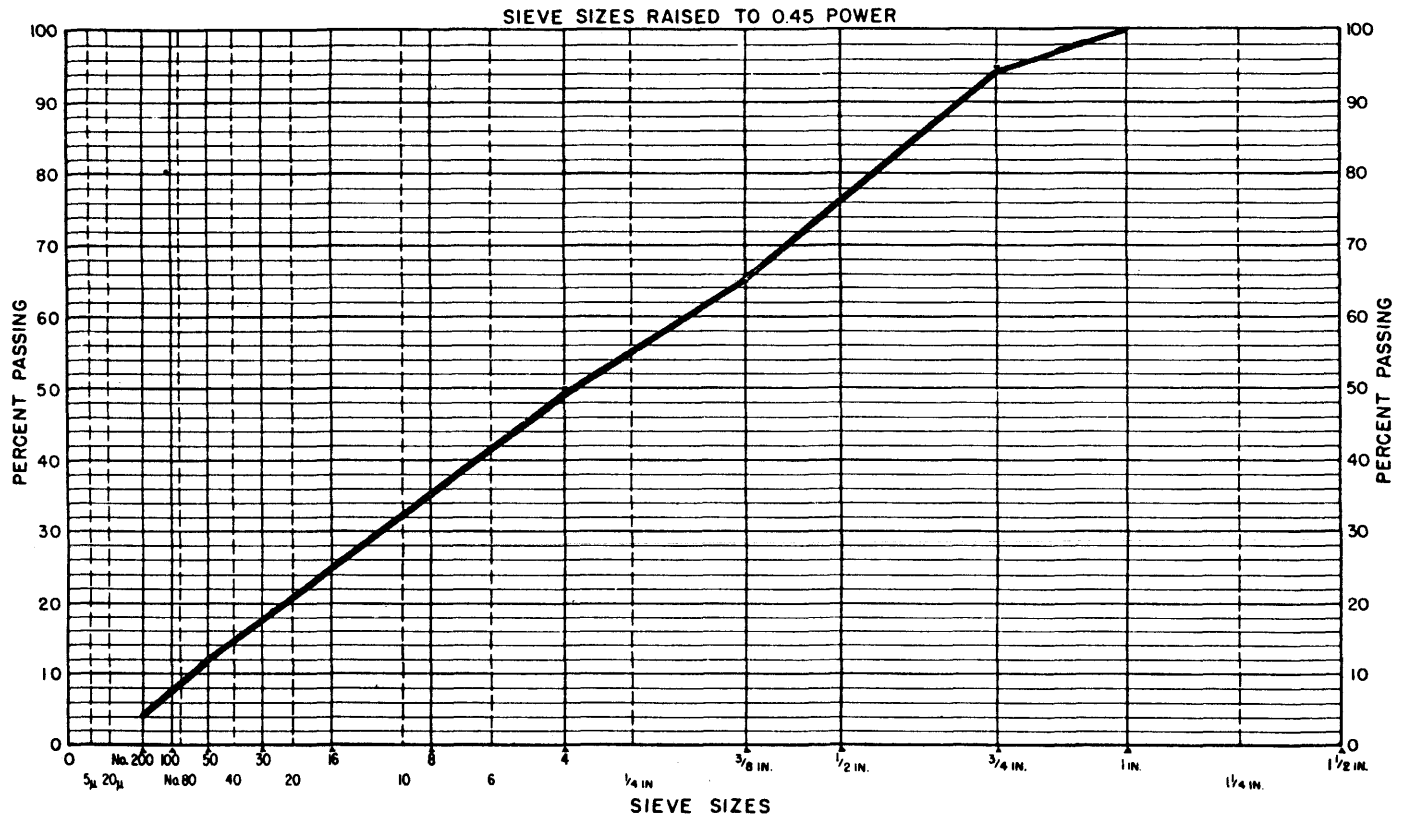


FIGURE 2.28—Exponential Chart Curve.

A second important reason for knowing the specific gravity of the aggregate used in a paving mixture is to aid in calculating the percentage of air voids (air spaces) in the final compacted mixtures. As will be explained in Section 3, Mix Design, all paving mixtures must include a certain percentage (by volume) of air spaces or voids. These spaces perform important functions in the finished pavement. The only means of calculating the percentage of air voids in a given volume of a paving mixture is to measure the specific gravity of a paving mixture sample and then subtract the specific gravities of the aggregate and asphalt contained in the sample. The result is an indication of the sample's volume of air voids.

All aggregates are porous to varying degrees. Because porosity affects the amount of asphalt needed to coat aggregate particles and the percentage of air voids in the final mixture, three types of specific gravity measurements have been developed to take the porosity of an aggregate into consideration (Figure 2.29). They are:

- Bulk specific gravity
- Apparent specific gravity, and
- Effective specific gravity.

Bulk specific gravity is the specific gravity of a sample, including all pores in the sample.

Apparent specific gravity does not consider pores and capillaries that would fill with water during soaking to be part of the sample's volume.

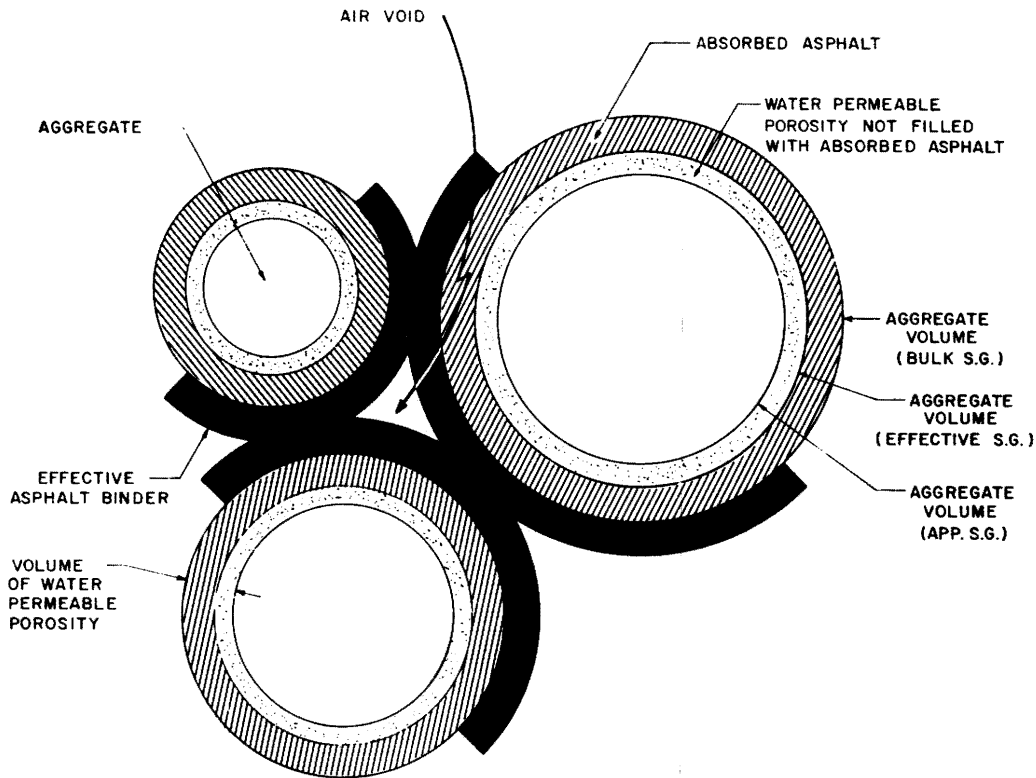
Effective specific gravity excludes from the sample's volume all pores and capillaries that absorb asphalt.

Bulk specific gravity assumes that pores which absorb water do not absorb asphalt. Apparent specific gravity assumes that all water-permeable pores do absorb asphalt. Except in rare cases, neither assumption is true. Therefore, effective specific gravity, which discriminates between water-permeable and asphalt-permeable pores, most nearly approaches the correct value for use in hot-mix calculations.

**2.4.D.3 Cleanliness**—Job specifications usually place a limit on the types and amounts of unsuitable material (vegetation, shale, soft particles, lumps of clay, etc.) permitted in the aggregate, particularly if the aggregate is known to contain quantities of such material. Excessive amounts of such material can have an adverse effect on pavement performance.

Aggregate cleanliness can be determined often by visual inspection, but a washed sieve analysis, in which the weight of an aggregate sample before washing is compared to its weight after washing, gives an accurate measurement of the percentage of unsuitable material finer than 0.075 mm (No. 200). The sand-equivalent test (AASHTO T 176) is a method of determining the relative proportion of detrimental fine dust and clay-like material in the fraction (portion) of aggregate passing the 4.75 mm (No. 4) sieve.

**2.4.D.4 Toughness**—Aggregates must be able to resist abrasion (wearing away) and degradation (breaking apart) during manufacture, placing, and compaction of the



**FIGURE 2.29—Various Types of Aggregate Specific Gravities.**

pavement mixture and during the service life of the pavement under actual traffic. Aggregates at or near the pavement surface must be tougher (more resistant) than aggregates used in the lower layers of the pavement structure. This is because upper pavement layers receive the full stress and wear from traffic loads.

The Los Angeles Abrasion Test (AASHTO T 96) measures an aggregate's resistance to wear or abrasion. The test equipment is illustrated in Figure 2.30.

**2.4.D.5 Particle Shape**—Particle shape (Figure 2.31) influences the workability of the paving mix during placement as well as the amount of force necessary to compact the mixture to the required density. During pavement life, particle shape also influence the strength of the pavement structure.

Because irregular, angular particles tend to interlock when compacted, they usually resist displacement (movement) in the final pavement. Best interlocking is generally obtained with sharp-cornered, cubical-shaped particles, obtained by crushing. However, round particles such as those comprising most natural gravels and sands, are used successfully in asphalt paving mixtures, particularly dense-graded types.

Many asphalt pavement mixtures contain both angular and round particles. The coarse (large) aggregate particles are usually crushed stone or crushed gravel that give the pavement strength; the fine (small) aggregate particles are usually a natural sand, which gives the mixture necessary workability.



FIGURE 2.30—Los Angeles Abrasion Machine.

**2.4.D.6 Surface Texture**—Surface texture (Figure 2.31) of aggregate particles is another factor that determines not only the workability and final strength of a paving mixture, but also the skid resistant characteristics of the pavement surface. Some consider it more important than particle shape. A rough, sandpaper-like texture increases pavement strength because it prevents particles from moving easily past one another and provides a higher coefficient of surface friction for safer traffic operations.

In addition, asphalt films cling more readily to rough surfaces than to smooth ones. Because natural gravels usually have smooth surface textures, they are often crushed during processing. Crushing produces rough surface textures on the fractured faces, as well as changing particle shape.

There is no standard method for evaluating surface texture directly. Like particle shape, it is a characteristic reflected in mixture strength tests and in workability of the mixture during construction.

**2.4.D.7 Absorptive Capacity**—All aggregates are porous, some more than others. How porous an aggregate is determines how much liquid it absorbs when soaked in a bath.

The capacity of an aggregate to absorb water (or asphalt) is important information. If an aggregate is highly absorptive, it will continue to absorb asphalt after initial mixing at the plant, leaving less asphalt on its surface to bond aggregate particles together. Because of this, a porous aggregate requires significantly more asphalt to make a suitable mixture than a less porous aggregates does.



**FIGURE 2.31—Aggregate of Various Shape and Surface Textures.**

Highly porous, highly absorptive aggregates are not used normally, unless they possess other characteristics that make them desirable despite their high absorptive capacity. Examples of such materials are blast furnace slag and other synthetic or manufactured aggregates, which are highly porous, but are also lightweight and abrasion-resistant.

**2.4.D.8 Affinity for Asphalt**—An aggregate's affinity for asphalt is its tendency to accept and retain an asphalt coating. Limestone, dolomite, and traprock have high affinities for asphalt and are referred to as hydrophobic (water-hating) because they resist the efforts of water to strip asphalt from them.

Hydrophilic (water-loving) aggregates have low affinities for asphalt. Consequently, they tend to separate from asphalt films when exposed to water. Siliceous aggregates (e.g., quartzite and some granites) are examples of aggregates that are prone to stripping and must be used cautiously.

Why hydrophobic and hydrophilic aggregates behave as they do is not clearly understood. Nonetheless, there are several test methods for determining their affinity for asphalt and the tendency toward stripping. In one such test, the uncompacted aggregate-asphalt mixture is soaked in water and the coated particles are then evaluated visually. In another test, commonly known as the immersion-compression test, two specimens of the mixture are prepared. One is soaked in water and the other is not. Both are then tested for strength. The difference in strength between the two samples is considered to indicate the aggregate's susceptibility to stripping.



## **2.5 MATERIALS SUMMARY**

An asphalt hot-mix pavement is composed of asphalt and aggregate heated and blended into a uniform mixture.

Almost all asphalt used today is refined from crude petroleum. Asphalt cement (paving asphalt) is classified either by its viscosity or by penetration. Among the physical properties of asphalt most important to paving are: durability, adhesion and cohesion, temperature susceptibility, and resistance to hardening and aging. Typical tests of asphalt include tests designed to determine an asphalt cement's viscosity, penetration, flashpoint, aging and hardening characteristics, ductility, solubility and specific gravity.

Because asphalt is a hydrocarbon and is kept hot during storage, handling and sampling, certain precautions must be taken to prevent injury from burns and poisonous fumes. Additionally, asphalt must be stored, handled and sampled properly to prevent its being contaminated and made unsuitable for paving.

Because asphalt expands and contracts with changes in temperature, the inspector must be able to calculate temperature-volume corrections to maintain proper records and to ensure adherence to job specifications.

Aggregates are classified as sedimentary, igneous or metamorphic, depending upon the manner in which they are formed. Paving aggregates include natural aggregates, processed aggregates, synthetic and artificial aggregates, and mineral filler.

During aggregate production, stockpiling, handling and sampling care must be taken to avoid contamination, degradation and segregation. Specific techniques have been developed to minimize effects that can make an aggregate unsuitable for use in paving.

Aggregate properties of special interest in paving are particle size and gradation, cleanliness, toughness, particle shape, surface texture, absorptive capacity, and affinity for asphalt. In the course of producing asphalt hot-mix, aggregate calculations required to ensure adherence to specifications include gradation analysis, proportioning calculations, and determination of specific gravity.

A thorough understanding of the materials used in asphalt hot-mix paving is a necessary tool for the paving inspector. Turning that understanding into a working knowledge will assist the inspector in making accurate, reliable day-to-day decisions.



## SECTION 3

### MIX DESIGN

#### 3.1 INSPECTOR OBJECTIVES:

At the conclusion of this section of the manual, the inspector should:

- Understand the purpose of the Marshall Method/Hveem Method.
- Know the principal procedures involved in the Marshall Method/Hveem Method.
- Understand the relationship between Marshall Method/Hveem Method data and paving job specifications.
- Recognize the causes of typical paving mixture deficiencies.

#### 3.2 INTRODUCTION

In a hot-mix asphalt paving mixture, asphalt and aggregate are blended together in precise proportions. The relative proportions of these materials determines the physical properties of the mix and, ultimately, how the mix will perform as a finished pavement. There are two commonly-used design methods for determining suitable proportions of asphalt and aggregate in a mixture. They are the Marshall Method and the Hveem Method.

Both design methods are widely used for the design of hot-mix paving. The selection and use of either of these mix design methods is principally a matter of engineering preference, since each method has certain unique features and advantages. Either method can be used with satisfactory results.

#### 3.3 MIXTURE CHARACTERISTICS AND BEHAVIOR

When a sample paving mixture is prepared in the laboratory, it can be analyzed to determine its probable performance in a pavement structure. The analysis focuses on four characteristics of the mixture and the influence those characteristics are likely to have on mix behavior. The four characteristics are:

- Mix density
- Air voids
- Voids in the mineral aggregate
- Asphalt content.

##### 3.3.A Density

The density of the compacted mix is its unit weight (the weight of a specific volume of mix). Density is particularly important to the inspector, because high density of the finished pavement is essential for lasting pavement performance.

In mix design testing and analysis, density of the compacted specimen is usually expressed in pounds per cubic foot ( $\text{lb}/\text{ft}^3$ ) or kilograms per cubic meter ( $\text{kg}/\text{m}^3$ ). It is calculated by multiplying the bulk specific gravity of the mix by the density of water ( $62.416 \text{ lb}/\text{ft}^3$  ( $1,000 \text{ kg}/\text{m}^3$ )). The density determined in the laboratory becomes the standard by which density of the finished pavement is determined to be adequate or inadequate. Because on-site compaction rarely can achieve the densities achieved by standard laboratory compaction methods, specifications usually require pavement density to be a percentage of laboratory density.

### **3.3.B Air Voids**

Air voids are small air spaces or pockets of air that occur between the coated aggregate particles in the final compacted mix. A certain percentage of air voids is necessary in all dense-graded highway mixes to allow for some additional pavement compaction under traffic and to provide spaces into which small amounts of asphalt can flow during this subsequent compaction. The allowable percentage of air voids (in laboratory specimens) is between 3 percent and 5 percent for surface courses and base courses, depending on the specific design.

The durability of an asphalt pavement is a function of the air-void content. The reason for this is the fact that the lower the air voids, the less permeable the mixture becomes. Too high an air-void content provides passageways through the mix for the entrance of damaging air and water. Too low a voids content, on the other hand, can lead to flushing, a condition in which excess asphalt squeezes out of the mix to the surface.

Density and void content are directly related. The higher the density, the lower the percentage of voids in the mix, and vice versa. Job specifications usually require pavement density that allows as low an air void content as is practical, preferably less than 8 percent.

### **3.3.C Voids in the Mineral Aggregate**

Voids in the mineral aggregate (VMA) are the air-void spaces that exist between the aggregate particles in a compacted paving mixture, including spaces filled with asphalt.

VMA represents the space that is available to accommodate the effective volume of asphalt (i.e., all of the asphalt except the portion lost by absorption into the aggregate) and the volume of air voids necessary in the mixture. The more VMA in the dry aggregate, the more space is available for the films of asphalt. Based on the fact that the thicker the asphalt film on the aggregate particles the more durable the mix, specific minimum requirements for VMA are recommended and specified as a function of the aggregate size. Figure 3.1 illustrates VMA and Figure 3.2 presents specific requirements.

Minimum VMA values should be adhered to so that a durable asphalt film thickness can be achieved. Increasing the density of the gradation of the aggregate to a point where below-minimum VMA values are obtained leads to thin films of asphalt and a dry-looking, low-durability mix. Therefore, economizing in asphalt content by lowering VMA is actually counter-productive and detrimental to pavement quality.

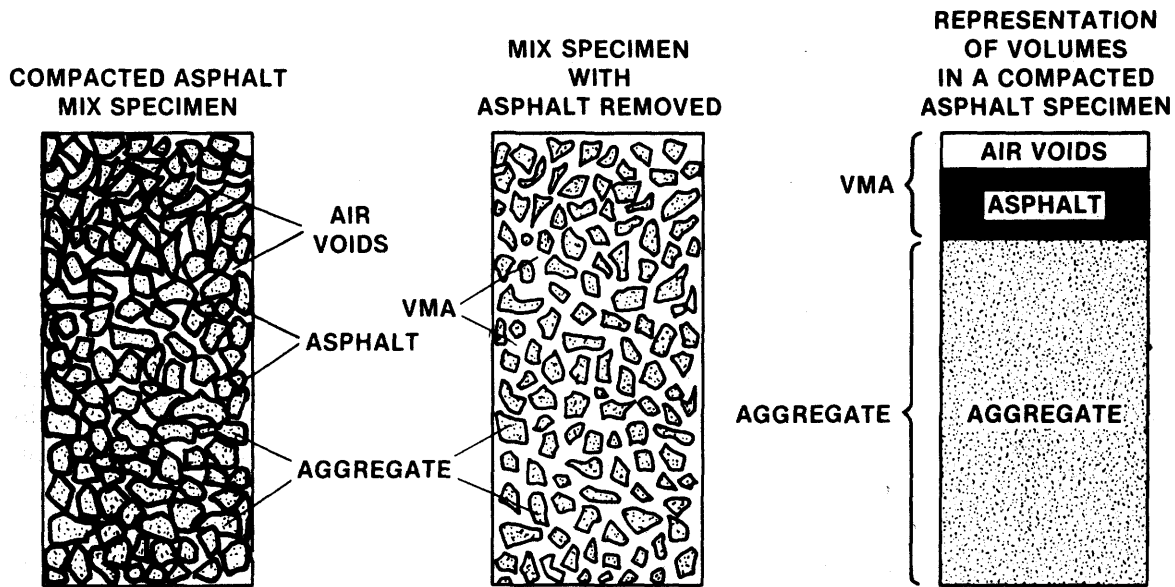


FIGURE 3.1—Illustration of VMA in a Compacted Mix Specimen (Note: For simplification the volume of absorbed asphalt is not shown).

### MINIMUM PERCENT VOIDS IN MINERAL AGGREGATE (VMA)

U.S.A. Standard Sieve Designation*	Nominal Maximum Particle Size ‡ in.*	Minimum Voids in Mineral Aggregate, Percent
1.18 mm (No. 16)	0.0469	23.5
2.36 mm (No. 8)	0.093	21
4.75 mm (No. 4)	0.187	18
9.5 mm (3/8 in.)	0.375	16
12.5 mm (1/2 in.)	0.500	15
19.0 mm (3/4 in.)	0.750	14
25.0 mm (1 in.)	1.0	13
37.5 mm (1 1/2 in.)	1.5	12
50 mm (2 in.)	2.0	11.5
63 mm (2 1/2 in.)	2.5	11

\*Standard Specification for Wire Cloth Sieves for Testing Purposes, AASHTO Designation M 92.

‡For processed aggregate, the nominal maximum particle size is the largest sieve size listed in the applicable specification upon which any material is permitted to be retained.

FIGURE 3.2—Voids in Mineral Aggregate (VMA Requirements).

### **3.3.D Asphalt Content**

The proportion of asphalt in the mixture is critical and must be accurately determined in the laboratory and then precisely controlled on the job. The asphalt content for a particular mix is established by using the criteria (discussed later) dictated by whichever mix design method is being used.

The optimum asphalt content of a mix is highly dependent on aggregate characteristics such as gradation and absorptiveness. Aggregate gradation is directly related to optimum asphalt content. The finer the mix gradation, the larger the total surface area of the aggregate and the greater the amount of asphalt required to uniformly coat the particles. Conversely, because coarser mixes have less total aggregate surface area, they demand less asphalt.

The relationship between aggregate surface area and optimum asphalt content is most pronounced where filler material (very fine aggregate fractions which pass through the 0.075 mm (No. 200 sieve) is involved. Small increases in the amount of filler in a gradation can literally absorb much of the asphalt content, resulting in a dry, unstable mix. Small decreases have the opposite effect: too little filler results in too rich (wet) a mixture. Variations in filler content will cause changes in mix properties, from dry to wet. If a mix contains too little or too much mineral filler, however, arbitrary adjustments to correct the situation are likely to worsen it. Instead, proper sampling and testing should be done to determine the cause of the variations and, if necessary to establish a new mix design.

The absorptiveness (ability to absorb asphalt) of the aggregate used in the mix is critical in determining optimum asphalt content, because enough asphalt must be added to the mix to allow for absorption and still coat the particles with an adequate film. When discussing absorbed and unabsorbed asphalt, technologists discuss two types of asphalt content: total asphalt content and effective asphalt content.

Total asphalt content is the amount of asphalt that must be added to the mixture to produce the desired mix qualities. Effective asphalt content is the volume of asphalt not absorbed by the aggregate; the amount of asphalt that effectively forms a bonding film on the aggregate surfaces. Effective asphalt content is calculated by subtracting the amount of absorbed asphalt from the total asphalt content.

The absorptiveness of an aggregate is obviously an important consideration in determining the asphalt content of a mixture. It is generally known for established aggregate sources, but requires careful testing where new aggregate sources are being used.

### **3.4 PROPERTIES CONSIDERED IN MIX DESIGN**

Good hot-mix asphalt pavements function well because they are designed, produced and placed in such a way as to give them certain desirable properties. There are several properties that contribute to the quality of hot-mix pavements. They include stability, durability, impermeability, workability, flexibility, fatigue resistance and skid resistance.

Ensuring that a paving mixture has each of these properties is a major goal of the mix-design procedure. Therefore, the inspector should be aware of what each of the properties is, how it is evaluated, and what it means in terms of pavement performance.

### 3.4.A Stability

Stability of an asphalt pavement is its ability to resist shoving and rutting under loads (traffic). A stable pavement maintains its shape and smoothness under repeated loading; an unstable pavement develops ruts (channels), ripples (washboarding or corrugation) and other signs of shifting of the mixture.

Because stability specifications for a pavement depend on the traffic expected to use the pavement, stability requirements can be established only after a thorough traffic analysis. Stability specifications should be high enough to handle traffic adequately, but not higher than traffic conditions require. Too high a stability value produces a pavement that is too stiff and therefore less durable than desired.

The stability of a mixture depends on internal friction and cohesion. Internal friction among the aggregate particles (interparticle friction) is related to aggregate characteristics such as shape and surface texture. Cohesion results from the bonding ability of the asphalt. A proper degree of both internal friction and cohesion in a mix prevents the aggregate particles from being moved past each other by the forces exerted by traffic.

In general, the more angular the shape of the aggregate particles and the more rough their surface texture, the higher the stability of the mix will be.

Where aggregates with high internal friction characteristics are not available, more economical mixtures using aggregate with lower friction values can be used where light traffic is expected.

The binding force of cohesion increases with increasing loading (traffic) rate. Cohesion also increases as the viscosity of the asphalt increases, or as the pavement temperature decreases. Additionally, cohesion will increase with increasing asphalt content, up to a certain point. Past that point, increasing asphalt content creates too thick a film on the aggregate particles, resulting in loss of interparticle friction. Insufficient stability in a pavement has many causes and effects. Figure 3.3 list some of them.

#### LOW STABILITY

Causes	Effects
Excess asphalt in mix	Washboarding, rutting, and flushing or bleeding
Excess medium size sand in mixture	Tenderness during rolling and for period after construction, difficulty in compacting
Rounded aggregate, little or no crushed surfaces	Rutting and channeling

FIGURE 3.3—Causes and Effects of Pavement Instability.

### 3.4.B Durability

The durability of an asphalt pavement is its ability to resist factors such as changes in the asphalt (polymerization and oxidation), disintegration of the aggregate, and

stripping of the asphalt films from the aggregate. These factors can be the result of weather, traffic, or a combination of the two.

Generally, durability of a mixture can be enhanced by three methods. They are: using maximum asphalt content, using a dense gradation of stripping-resistant aggregate, and designing and compacting the mixture for maximum impermeability.

Maximum asphalt content increases durability because thick asphalt films do not age and harden as rapidly as thin ones do. Consequently, the asphalt retains its original characteristics longer. Also, maximum asphalt content effectively seals off a greater percentage of interconnected air voids in the pavement, making it difficult for water and air to penetrate. Of course, a certain percentage of air voids must be left open in the pavement to allow for expansion of the asphalt in hot weather.

A dense gradation of sound, tough, stripping-resistant aggregate contributes to pavement durability in three ways. A dense gradation provides closer contact among aggregate particles. This enhances the impermeability of the mixture. A sound, tough aggregate resists disintegration under traffic loading; and stripping-resistant aggregate resists the action of water and traffic, which tend to strip the asphalt film off aggregate particles and lead to raveling of the pavement. Under some conditions, the resistance of a mixture to stripping can be increased by the use of antistripping additives, or a mineral filler such as hydrated lime.

Designing and compacting the mixture to give the pavement maximum impermeability minimizes the intrusion of air and water into the pavement. See *Impermeability* below.

A lack of sufficient durability in a pavement can have several causes and effects. Figure 3.4 presents a list of some of them.

### POOR DURABILITY

Causes	Effects
Low asphalt content	Dryness or raveling
High void content through design or lack of compaction	Early hardening of asphalt followed by cracking or disintegration
Water susceptible (hydrophilic) aggregate in mixtures	Films of asphalt strip from aggregate leaving an abraded, raveled, or mushy pavement

FIGURE 3.4—Causes and Effects of Lack of Durability.

#### 3.4.C Impermeability

Impermeability is the resistance of an asphalt pavement to the passage of air and water into or through it. This characteristic is related to the void content of the compacted mixture, and much of the discussion on voids in the mix design sections relates to impermeability. Even though void content is an indication of the potential for pas-



sage of air and water through a pavement, the character of these voids is more important than the number of voids. The size of the voids, whether or not the voids are interconnected, and the access of the voids to the surface of the pavement all determine the degree of impermeability.

Although impermeability is important for durability of compacted paving mixtures, virtually all asphalt mixtures used in highway construction are permeable to some degree. This is acceptable as long as it is within specified limits. Causes and effects of poor impermeability values in normal dense-graded asphalt pavements are shown in Figure 3.5.

### MIX TOO PERMEABLE

Causes	Effects
Low asphalt content	Thin asphalt films will cause early aging and raveling.
High voids content in design mix	Water and air can easily enter pavement causing oxidation and disintegration.
Inadequate compaction	Will result in high voids in pavement leading to water infiltration and low strength.

**FIGURE 3.5—Causes and Effects of Permeability.**

#### **3.4.D Workability**

Workability describes the ease with which a paving mixture can be placed and compacted. Mixtures with good workability are easy to place and compact; those with poor workability are difficult to place and compact. Workability can be improved by changing mix design parameters, aggregate source, and/or gradation.

Harsh mixtures (mixtures containing a high percentage of coarse aggregate) have a tendency to segregate during handling and also may be difficult to compact. Through the use of trial mixes in the laboratory, additional fine aggregate and perhaps asphalt, can be added to a harsh mix to make it more workable. Care should be taken to ensure that the altered mix meets all other design criteria, such as void content and stability.

Too high a filler content can also affect workability. It can cause the mix to become gummy, making it difficult to compact.

Workability is especially important where quite a bit of hand placement and raking (luting) around manhole covers, sharp curves, and other obstacles is required. It is important that mixtures used in such areas are highly workable.

Mixtures that can be too easily worked or shoved are referred to as tender mixes. Tender mixes are too unstable to place and compact properly. They are often caused by a shortage of mineral filler, too much medium-sized sand, and smooth, rounded aggregate particles, and/or too much moisture in the mix.

Although not normally a major contributor to workability problems, asphalt does

have some effect on workability. Because the temperature of the mix affects the viscosity of the asphalt, too low a temperature will make a mix unworkable, too high a temperature may make it tender. Asphalt grade may also affect workability, as may the percentage of asphalt in the mix.

Figure 3.6 lists some of the causes and effects related to workability of paving mixtures.

<b>POOR WORKABILITY</b>	
<b>Causes</b>	<b>Effects</b>
<b>Large maximum-sized particle</b>	<b>Rough surface, difficult to place</b>
<b>Excessive coarse aggregate</b>	<b>May be hard to compact</b>
<b>Too low a mix temperature</b>	<b>Uncoated aggregate, not durable, rough surface, hard to compact</b>
<b>Too much medium-sized sand</b>	<b>Mix shoves under roller, remains tender</b>
<b>Low mineral filler content</b>	<b>Tender mix, highly permeable</b>
<b>High mineral filler content</b>	<b>Mix may be dry or gummy, hard to handle, not durable</b>

**FIGURE 3.6—Causes and Effects of Workability Problems.**

### ***3.4.E Flexibility***

Flexibility is the ability of an asphalt pavement to adjust to gradual settlements and movements in the subgrade without cracking. Since virtually all subgrades either settle (under loading) or rise (from soil expansion), flexibility is a desirable characteristic for all asphalt pavements.

An open-graded mix with high asphalt content is generally more flexible than a dense-graded, low asphalt content mix. Sometimes the need for flexibility conflicts with stability requirements, so that trade-offs have to be made.

### ***3.4.F Fatigue Resistance***

Fatigue resistance is the pavement's resistance to repeated bending under wheel loads (traffic). Research shows that air voids (related to asphalt content) and asphalt viscosity have a significant effect on fatigue resistance. As the percentage of air voids in the pavement increases, either by design or lack of compaction, pavement fatigue life (the length of time during which an in-service pavement is adequately fatigue-resistant) is drastically shortened. Likewise, a pavement containing asphalt that has aged and hardened significantly has reduced resistance to fatigue.

The thickness and strength characteristics of the pavement and the supporting power of the subgrade also have a great deal to do with determining pavement life and

preventing load-associated cracking. Thick, well supported pavements do not bend as much under loading as thin or poorly supported pavements do. Therefore, they have longer fatigue lives.

Figure 3.7 presents a list of causes and effects of poor fatigue resistance.

### POOR FATIGUE RESISTANCE

Causes	Effects
Low asphalt content	Fatigue cracking
High design voids	Early aging of asphalt followed by fatigue cracking
Lack of compaction	Early aging of asphalt followed by fatigue cracking
Inadequate pavement thickness	Excessive bending followed by fatigue cracking

FIGURE 3.7—Causes and Effects of Poor Fatigue Resistance.

#### 3.4.G Skid Resistance

Skid resistance is the ability of an asphalt surface to minimize skidding or slipping of vehicle tires, particularly when wet. For good skid resistance, tire tread must be able to maintain contact with the aggregate particles instead of riding on a film of water on the pavement surface (hydroplaning). Skid resistance is typically measured in the field at 40 mi/hr (64.4 km/hr) with a standard tread tire under controlled wetting of the pavement surface.

A rough pavement surface with many little peaks and valleys will have greater skid resistance than a smooth surface. Best skid resistance is obtained with rough-textured aggregate in a relatively open-graded mixture with an aggregate of about 9.5 mm ( $\frac{3}{8}$  in.) to 12.5 mm ( $\frac{1}{2}$  in.) maximum size. Besides having a rough surface, the aggregates must resist polishing (smoothing) under traffic. Calcareous aggregates polish more easily than siliceous aggregates. Unstable mixtures that tend to rut or bleed (flush asphalt to the surface) present serious skid resistance problems.

A list of causes and effects relating to poor skid resistance is shown below in Figure 3.8.

### POOR SKID RESISTANCE

Causes	Effects
Excess asphalt	Bleeding, low skid resistance
Poorly textured or graded aggregate	Smooth pavement, potential for hydroplaning
Polishing aggregate in mixture	Low skid resistance

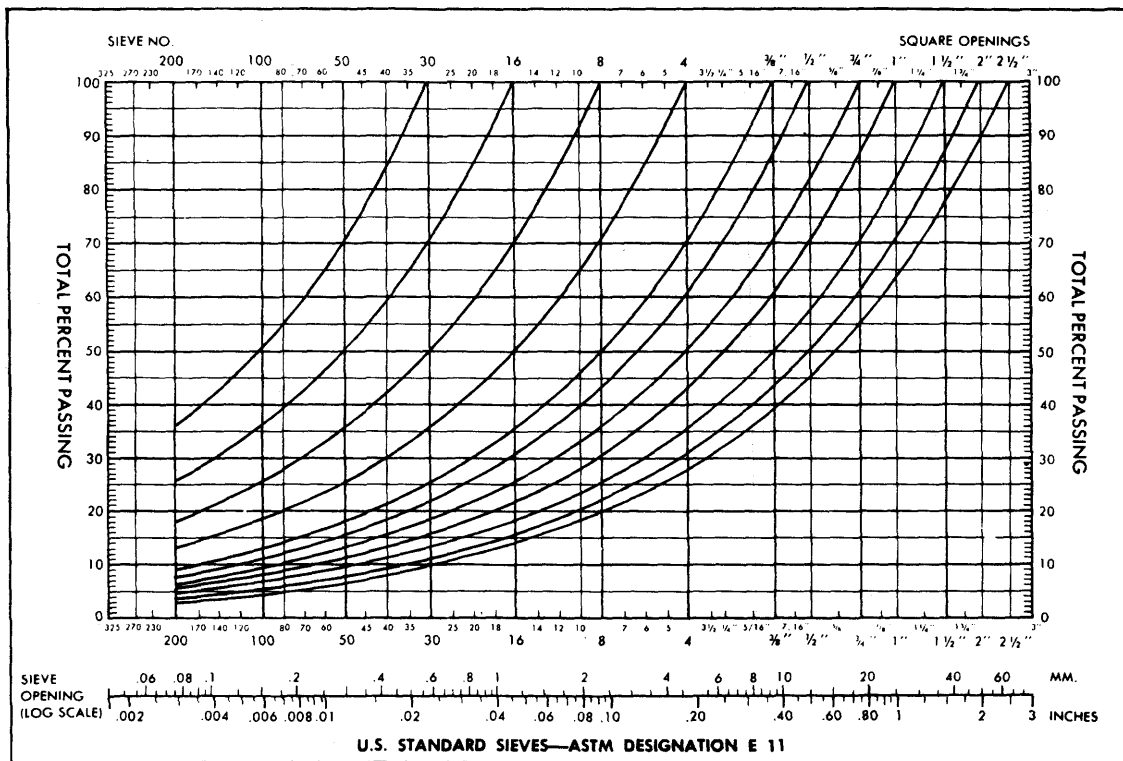
FIGURE 3.8—Causes and Effects of Poor Skid Resistance.

### 3.5 EVALUATION AND ADJUSTMENT OF MIX DESIGN

In the process of developing a specific mix design, it is necessary to make several trial mixes to find one that meets all the criteria of the design method used. The evaluation of each trial mix serves as a guide for adjusting the trials that follow.

Initial trial mixes for establishing the job-mix formula must have an aggregate gradation that is within job specifications. Where initial trial mixes fail to meet the design criteria, it is necessary to modify or, in some cases, redesign the mix using a different aggregate gradation.

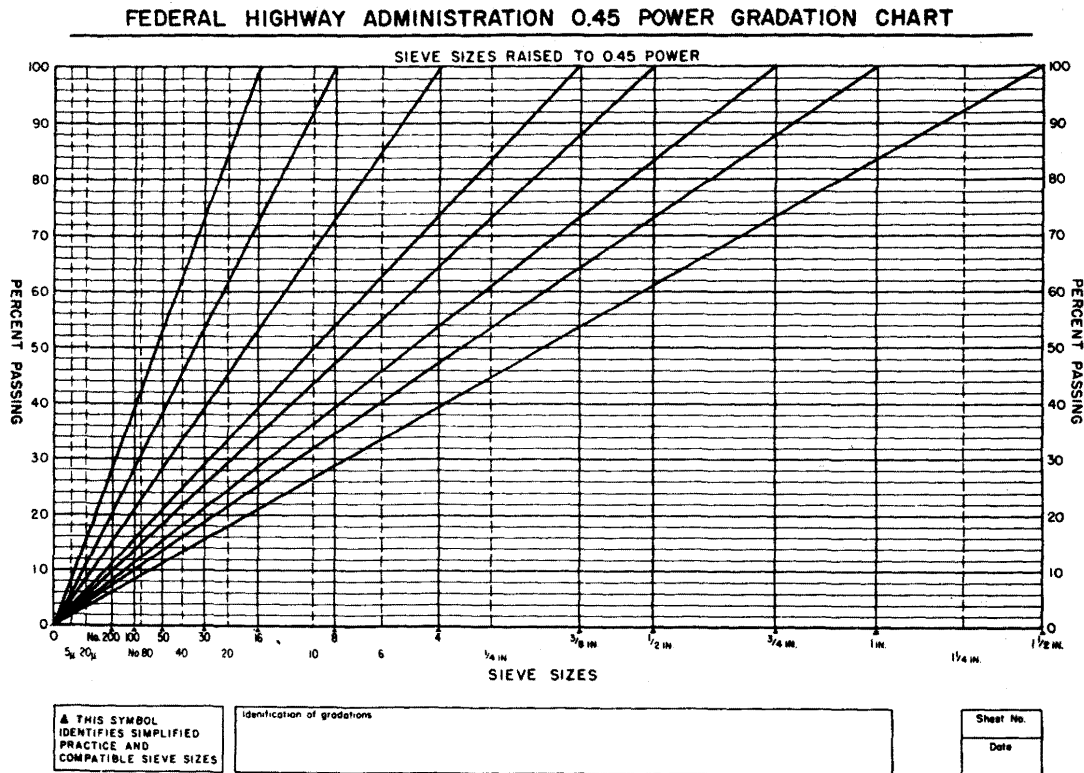
Grading curves are helpful in making necessary adjustments in mix designs. For example, curves determined from the Fuller maximum density equation (Figure 3.9) represent maximum density and minimum voids in mineral aggregate (VMA) conditions. Paving mixtures with such curves have void contents that may be too low. Usually, deviations from these curves will result in lower densities and higher VMA. The extent of change in density and VMA depends on the amount of adjustment made in fine or coarse aggregate content of the mix.



**FIGURE 3.9—Fuller Maximum Density Curves Based on Standard Semi-log Grading Chart.**

Figure 3.10 shows maximum density curves plotted on a Federal Highway Administration grading chart (based on a scale raising sieve openings to the 0.45 power).

Many designers find the FHWA chart convenient for adjusting aggregate gradations. The curves on a FHWA chart may be determined from the Fuller maximum density equation or by drawing a straight line from the origin at the lower left of the chart to the desired nominal maximum particle size at the top. For processed aggregate, the nominal maximum particle size is the largest sieve size listed in the applicable specification upon which any material is permitted to be retained. Gradations that closely approach this straight line usually have low VMA values and must be adjusted away from it. Such adjustments increase VMA values, allowing the use of enough asphalt to obtain maximum durability without the mixture flushing.



**FIGURE 3.10—Maximum Density Curves Based on FHWA 0.45 Power Gradation Chart.**

The following is a general guide for adjusting a trial mix in order to meet design criteria. The heading of each subsection describes the mixture condition needing correction. The suggestions outlined may not apply in all cases.

### 3.5.A Voids Low, Stability Low

Voids may be increased in a number of ways. One is to increase VMA by adding either additional coarse or additional fine aggregate to the mixture. Increasing VMA provides more space in the mixture for additional air voids.

Another way to increase voids is to lower asphalt content. This can be done only if excess asphalt is in the mix and the asphalt content is not reduced below the point where film thickness and, subsequently, pavement durability, are reduced below acceptable levels.

Increasing the amount of crushed materials in the mix provides rough surface textures and angular particle shapes that enhance VMA and interparticle friction. With some aggregates (quartz and similar rock types), however, the freshly fractured faces are as smooth as the water-worn faces, and an appreciable increase in stability is not achievable by crushing alone.

### ***3.5.B Voids Low, Stability Satisfactory***

Low void content can cause flushing after the pavement has been exposed to traffic for a period of time. Insufficient void content can also result in instability and flushing when degradation of the aggregate occurs. For these reasons, mixes low in voids should be adjusted by one of the methods given above, even though the stability appears satisfactory.

### ***3.5.C Voids Satisfactory, Stability Low***

Low stability when voids and aggregate grading are satisfactory may indicate some deficiencies in the aggregate. Consideration should be given to improving the quality by taking steps described in 3.5.A.

### ***3.5.D Voids High, Stability Satisfactory***

High voids are, frequently, though not always, associated with high permeability. Therefore, even when mix stability is satisfactory, excessive void content should be reduced. This can be done usually by increasing the mineral dust content of the mix. In some cases, however, aggregate gradation must be adjusted to increase density.

### ***3.5.E Voids High, Stability Low***

When the voids are high and the stability low, the void content should be reduced by the methods discussed above. If this adjustment does not improve both void content and stability, the type of aggregate used must be revised, as described above in 3.5.A.

## **3.6 APPLICATIONS OF MIX DESIGN TESTING**

For the inspector, the importance of mix properties and mix design procedures is in the way they relate to construction control and inspection. The agency or authority responsible for paving construction usually establishes the mix design method and design requirements, which form an essential part of the construction specifications for asphalt pavements. It is the responsibility of the engineer and the inspector to ensure that the specifications are met.

Mix design tests are a means of establishing specifications and checking that the paving mixture used on the roadway meets those specifications. Normally, mix design testing has four important applications in the overall construction. These are:

- Preliminary design
- Source acceptance
- Job-mix control
- Asphalt concrete compaction criteria.

### ***3.6.A Preliminary Design Testing***

The principal purpose of preliminary design testing is to determine if prospective sources can provide aggregate that satisfies both gradation and mix design specifications. Results of preliminary design testing also indicate whether or not design requirements can be obtained practically within the framework of the specifications.

### ***3.6.B Source-Acceptance Testing***

The main objective of source-acceptance testing is to determine the most economical blend of aggregates that will satisfy both gradation and mix-design requirements. The test ensures the selection of proper materials and permits the contractor to begin stockpiling these materials at the job site.

### ***3.6.C Job-Mix and Routine Control Testing***

Job-mix control testing determines whether or not the paving mixture produced by using the job-mix formula meets all specifications requirements. The job-mix formula is the "recipe" used by the plant to produce the final paving mixture. It includes information on the gradation of the aggregate materials and the selected asphalt content. Because variations in the mix are inevitable during production, the job-mix formula has built-in tolerances that allow for reasonable variations in gradation and asphalt content.

Job-mix control tests are performed at the start of plant production and in conjunction with calibrating the plant.

Routine control testing is also important for quality control. It involves periodically sampling the mixture produced by the plant and testing the properties of the samples. The results of the tests are compared with the job-mix control tests and the overall specification requirements. In those instances where irregularities occur and the limits of the job-mix formula are exceeded, appropriate corrections will be required at the plant. Occasionally, where the situation warrants, it may be necessary to reevaluate and redesign the paving mixture.

### ***3.6.D Asphalt Concrete Compaction Criteria***

Laboratory-prepared mix design specimens generally are used to establish a target density for the mixture. To establish a realistic target density, samples of the actual plant mixture are compacted on the job site or in the field laboratory. A series of density measurements are then taken on the control section or test strip of the actual finished pavement. These measurements are done by core sampling or by using a nuclear density gauge.

Typical specifications require that each lot of the compacted base and surface will be accepted when the average of the five density determinations is equal to or greater

than 96 percent, and when no individual determination is lower than 94 percent, of the average density of the six laboratory-prepared specimens.

### **3.7 SUMMARY OF MIX DESIGN—GENERAL**

The foregoing discussion provides a general view of significance of mix design. The design of asphalt paving mixes is largely a matter of selecting and proportioning materials to obtain the desired properties in the finished construction. The overall objective of the design procedure is to determine an economical blend and gradation of aggregates (within the limits of the project specifications) and asphalt that yields a mix having:

- Sufficient asphalt to ensure a durable pavement.
- Adequate mix stability to satisfy the demands of traffic without distortion or displacement.
- Voids content high enough to allow for a slight amount of additional compaction under traffic loading without flushing, bleeding, and loss of stability, yet low enough to keep out harmful air and moisture.
- Sufficient workability to permit efficient placement of the mix without segregation.

The selected mix design is usually the most economical one which will satisfactorily meet all of the established criteria. Mix design is a tool used in control. It is utilized in material acceptance, job mix control and final pavement compaction.

### **3.8 MARSHALL MIX DESIGN METHOD—INTRODUCTION**

#### ***3.8.A Background***

The concept of the Marshall Method of designing paving mixtures was developed by Bruce Marshall, formerly Bituminous Engineer with the Mississippi State Highway Department.

The Marshall test in its present form originated from an investigation started by the U.S. Army Corps of Engineers in 1943. Various methods for the design and control of asphalt mixtures were compared and evaluated to develop a simple method of asphalt pavement mixture design and control.

Since the Marshall Method utilized equipment that was easily portable, the Corps decided to adopt the Marshall Method and to develop and adapt it for both design and control of bituminous pavement mixtures in the field. Through very extensive laboratory research, traffic tests and correlation studies, the Corps of Engineers improved and added certain features to Marshall's test procedure and ultimately developed mix-design criteria.

#### ***3.8.B. Purpose***

The purpose of the Marshall Method is to determine the optimum asphalt content for a particular blend of aggregate. The method also provides information about the



properties of the resulting asphalt hot mix and establishes optimum density and void content that must be met during pavement construction.

As presented in this section, the Marshall Method is applicable only to hot-mix asphalt paving mixtures using penetration or viscosity-graded asphalt cements and containing aggregates with maximum sizes of 25.0 mm (1 in.) or less. The method may be used for both laboratory design and field control of asphalt hot-mix paving.

### **3.8.C General Description**

The Marshall Method uses standard test specimens 2½ in. (64 mm) high and 4 in. (102 mm) in diameter. A series of specimens, each containing the same aggregate blend but varying in asphalt content, is prepared using a specific procedure to heat, mix and compact the asphalt aggregate mixtures.

The two principal features of the Marshall Method of mix design are a density-voids analysis and a stability flow test of the compacted test specimens.

### **3.8.D Inspector's Responsibilities**

An inspector does not normally conduct mix design procedures; however, he is responsible for project adherence to the end result of those procedures—the mixture specifications.

Being familiar with the mix-design procedure enables the inspector to understand how specifications are formulated. It also develops an understanding of the relationships between materials, specifications, and the final product. This understanding equips the inspector to analyze problems that might occur regarding behavior or qualities of the asphalt hot mix at the plant or the paving site.

## **3.9 CONDUCTING MARSHALL MIX DESIGN**

This is a general description of the procedures followed in the Marshall Mix design. The complete and detailed procedure that must be followed is contained in AASHTO T 245 (ASTM D 1559).

### **3.9.A Preparation for Conducting Marshall Procedures**

As discussed in the Materials Section of this manual, different aggregates and asphalts have different characteristics. These characteristics have a direct impact on the nature of the pavement itself. The first step in the design method, then, is to determine what qualities (stability, durability, workability, skid-resistance, etc.) the paving mixture must have and to select a type of aggregate and a compatible type of asphalt that will combine to produce those qualities. Once this is done, test preparations can begin.

#### **3.9.A.1 Selection of Material Samples**

The first preparation for testing is to gather samples of the asphalt and the aggregate that will be used in the actual paving mixture. It is important that the asphalt samples have characteristics *identical* to those of the asphalt that will be used in the final hot-mix. The same is true of the aggregate samples. The reason is simple: data derived

from the mix design procedures determine the formula or “recipe” for the actual paving mixture. The recipe can be accurate only if the ingredients tested in the laboratory have characteristics identical to those of the ingredients used in the final product.

A wide variety of serious problems, ranging from poor workability of the mix to premature failure of the pavement itself, are historical results of variances between materials tested and the materials actually used.

### **3.9.A.2 Aggregate Preparation**

The viscosity-temperature relationship for the asphalt cement to be used must already be known to establish laboratory mixing and compaction temperatures. Consequently, the preliminary procedures focus on the aggregate, with the purpose of accurately identifying aggregate characteristics. These procedures include drying the aggregate, determining specific gravity of the aggregate, and conducting a wash-sieve analysis.

- ***Drying the Aggregate***

The Marshall Method demands that aggregates tested be as free from moisture as is practical. This prevents unwanted moisture from affecting test results.

A sample of each aggregate to be tested is placed in a separate tray and heated in an oven to a temperature of 230°F (110°C), as shown in Figure 3.11. The heated sample is then weighed and the weight recorded.

The sample is thoroughly heated a second time, after which it is again weighed and its weight recorded. This procedure is repeated until the sample’s weight remains constant through two successive heatings, indicating that as much moisture as possible has been evaporated away.



**FIGURE 3.11—Drying the Aggregate Sample.**

- **Wash-Sieve Analysis**

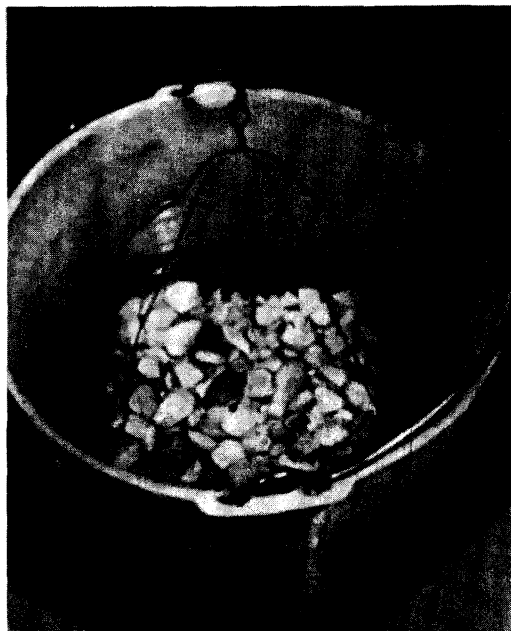
Wash-sieve analysis is a procedure used to identify the proportions of different-sized particles in the aggregate samples. This information is important because mixture specifications must state what proportions of different-sized aggregate particles the hot-mix must contain to produce a final product with the desired characteristics.

The wash-sieve analysis involves the following steps:

- 1) Each aggregate sample is dried and weighed.
- 2) Then each sample is washed thoroughly over a 0.075 mm (No. 200) sieve, to remove any mineral dust coating the aggregate.
- 3) The washed samples are dried following the heating and weighing procedure described above under *Drying the Aggregate*.
- 4) The dry weight of each sample is recorded. By comparing sample weights taken before washing to sample weight taken after, the amount of mineral dust can be determined.
- 5) For detailed steps of the procedure refer to AASHTO T 11.

- **Determining Specific Gravity**

The specific gravity of any substance is the weight-volume ratio of a unit of that substance compared to the weight-volume ratio of an equal unit of water (see Materials section). The specific gravity of an aggregate sample is determined by comparing the weight of a given volume of the aggregate to the weight of an equal volume of water at the same temperature (Figure 3.12). The specific gravity is expressed in multiples of the specific gravity of water (which is always equal to 1). For example, an aggregate sample which weighs two-and-one-half times as much as an equal volume of water has a specific gravity of 2.5.



**FIGURE 3.12—Determining Specific Gravity of an Aggregate Sample.**

Calculating the specific gravity of the dry sample of aggregate establishes a reference point for later specific gravity measurements taken to determine the proportions of aggregate, asphalt, and air voids in the test methods.

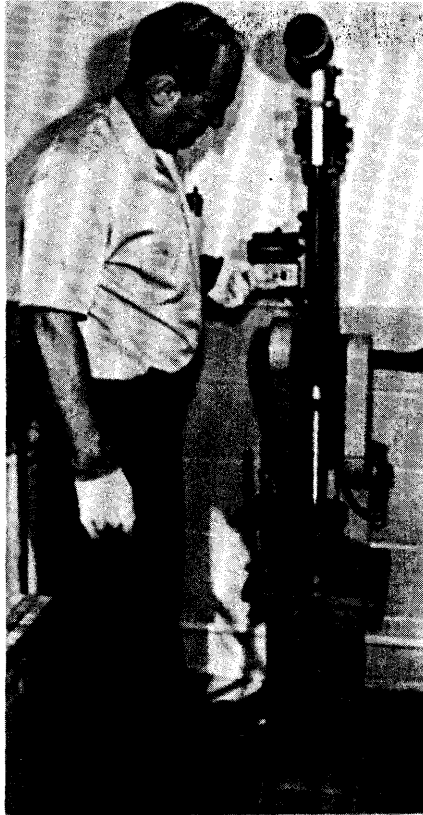
**3.9.A.3 Preparing Mixture Test Samples**—Test samples of possible paving mixtures are prepared, each containing a slightly different amount of asphalt. The range of asphalt contents used in the test samples is determined from previous experience with the aggregates in the mix. The range gives the laboratory a starting point for determining an exact asphalt content for the final mixture. The aggregate portion of the mixtures is formulated from the results of the sieve analysis.

Samples are prepared as follows:

- 1) Asphalt and aggregate are heated and thoroughly mixed together until all aggregate particles are coated. This simulates the heating and mixing processes at a plant.
- 2) The hot asphalt mixtures are placed in preheated Marshall molds (Figure 3.13) in preparation for compaction by the Marshall drop hammer, which is also heated so it does not chill the mix surface when it strikes the mix.
- 3) The specimens are compacted by blows from the Marshall hammer (Figure 3.14). The number of hammerblows (35, 50 or 75) depends on the amount of traffic that the mix is being designed for. Both sides of each specimen receive the same number of compacting blows. Thus, a 35-blow Marshall specimen actually receives a total of 70 blows. A 50-blow specimen receives 100 impacts. After compaction is completed the specimens are cooled and then removed from the molds.



**FIGURE 3.13—Preparing Test Specimens in Marshall Molds.**



**FIGURE 3.14—Marshall Drop Hammer Compacting Mix Specimen.**

### **3.9.B Marshall Test Procedure**

There are three test procedures in the Marshall test method. They are: a determination of bulk specific gravity, measurement of Marshall stability and flow, and analysis of specimen density and voids content.

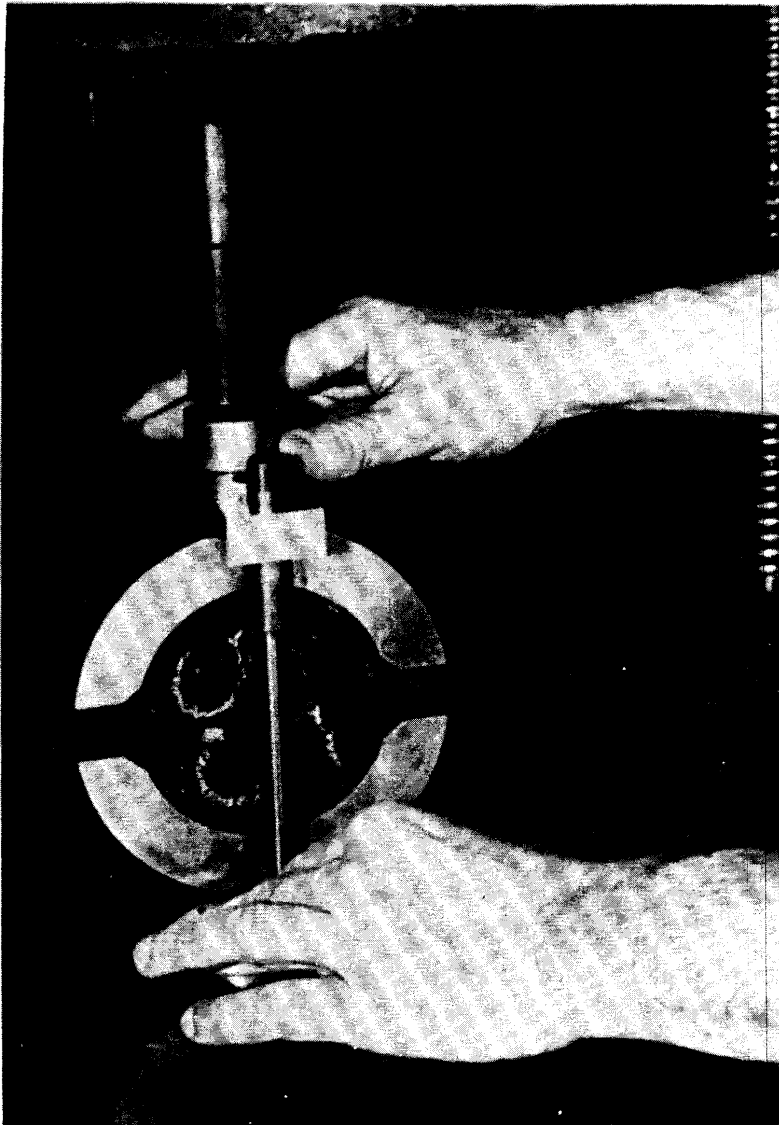
**3.9.B.1 Bulk Specific Gravity Determination**—As soon as the freshly compacted specimens have cooled to room temperature, the bulk specific gravity (Materials Section) of each specimen is determined. This measurement is essential for an accurate density/air voids analysis. Bulk specific gravity is determined by using AASHTO procedure T 166.

**3.9.B.2 Stability and Flow Tests**—Stability testing aims at measuring the mix's resistance to deformation under loads. Flow testing measures the amount of deformation that occurs in the mix under loading.

The test procedure is as follows:

- 1) The specimens are heated in a water bath to 140°F (60°C), which represents the warmest in-service temperature that the pavement will normally experience.
- 2) The 140°F (60°C) specimen is removed from the water bath, damp dried, and quickly placed in the Marshall apparatus (Figure 3.15). The apparatus consists of a device for exerting a load on the specimen and gauges for measuring the load and measuring flow.

- 3) The testing load is applied to the specimen at a constant rate of 2 in. (51 mm) per minute until failure occurs. Failure is defined as the maximum load the specimen will withstand.
- 4) The load at failure is recorded as the Marshall stability value and the flow meter reading is recorded as the flow value.



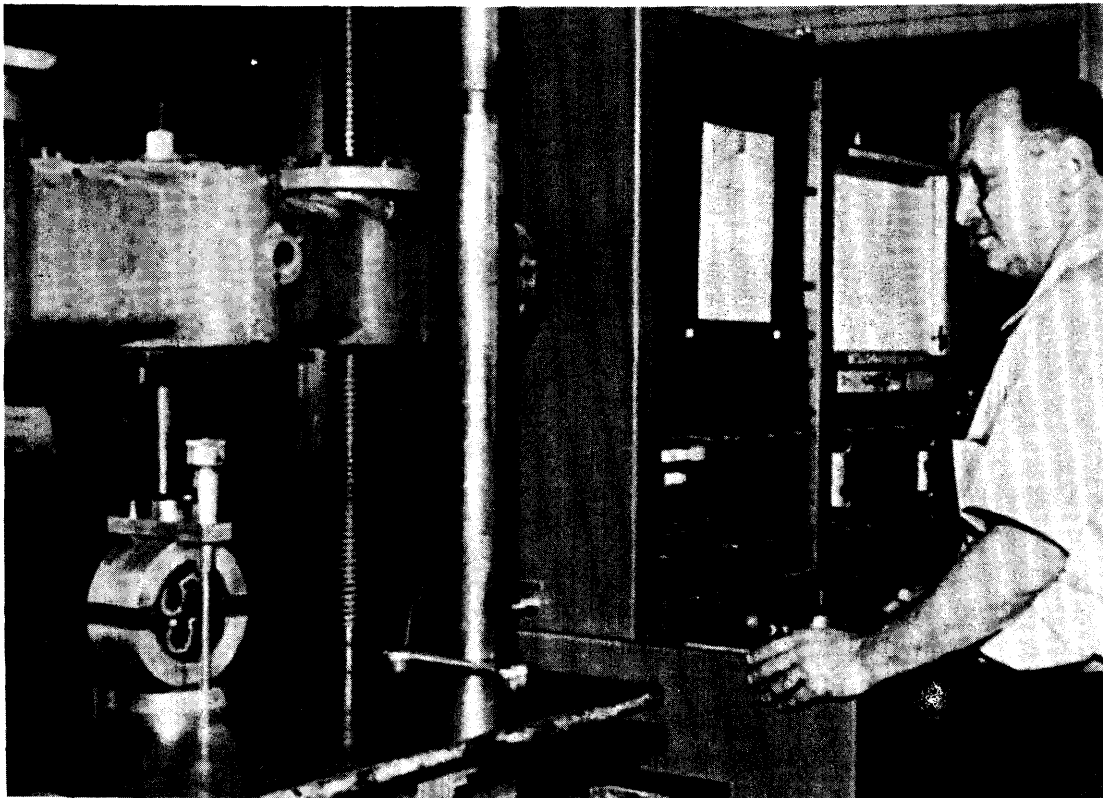
**FIGURE 3.15—Specimen  
in Marshall Apparatus.**

**3.9.B.3 Marshall Stability Value**—The Marshall stability value is a measurement of the load under which the specimen totally yields or fails. Figure 3.16 shows a gauge for reading stability values. During the test, when a load is slowly applied, the upper and lower head of the testing apparatus get closer together and the load on the specimen increases, and the reading on the dial gauge slowly increases. After the maximum load has been reached, loading is discontinued. The maximum load indicated by the gauge is the Marshall Stability Value.

Because Marshall stability indicates the resistance of the mix to deformation, there is a natural tendency to think that if a certain stability value is good, a much higher value must be much better. This tendency, however, will lead to the use of mixes with stability values that are too high.

For many engineering materials, the strength of the material frequently is a measure of its quality; however, this is not necessarily the case with hot-mixed asphalt paving. Extremely high stability often is obtained at the expense of durability.

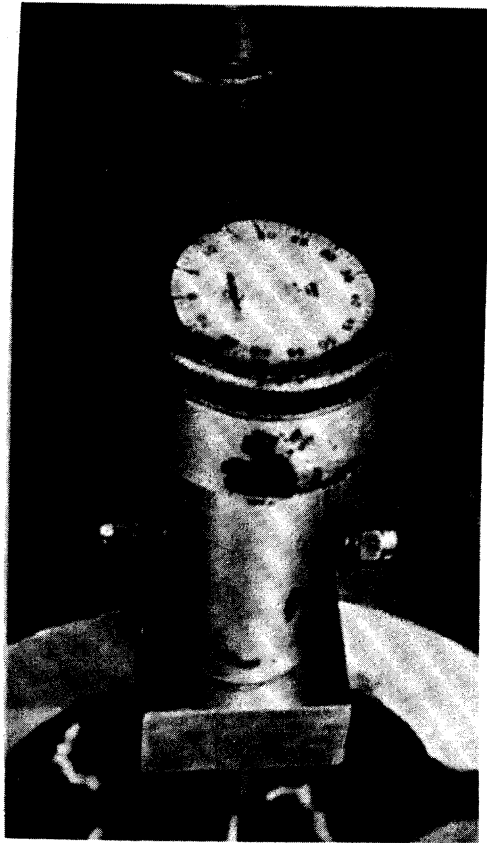
**3.9.B.4 Marshall Flow Value**—Marshall flow, measured in one one-hundredths of an inch, represents the total deformation of the specimen. Figure 3.17 illustrates a typical flow meter that measures specimen deformation that occurs during Marshall testing. The deformation is a decrease in the vertical diameter of the specimen.



**FIGURE 3.16—Gauge Readings, Marshall Stability Test.**

Mixes that have very low flow values and abnormally high Marshall stability values are considered too brittle and rigid for pavement service. Those with high flow values are considered too plastic and have a tendency to distort easily under traffic loads.

**3.9.B.5 Density and Voids Analysis**—Upon completion of the stability and flow tests, a density and voids analysis is performed for each series of test specimens. The purpose of the analysis is to determine the percentage of air voids in the compacted mix.



**FIGURE 3.17—Marshall Flow Measurement Specimen and Flow Meter Reading.**

- *Voids Analysis*

The air voids are the small pockets or air between the asphalt-coated aggregate particles. The percent air voids are calculated from the bulk specific gravity of each compacted specimen and the maximum specific gravity of the paving mixture (no voids). The latter is calculated from the specific gravities of the asphalt and aggregate in the mix, with an appropriate allowance made for the amount of asphalt absorbed by the aggregate, or it can be determined directly by a standard test, (AASHTO T 209) on an uncompacted sample of mix. The bulk specific gravity of compacted specimens are determined by weighing specimens in air and immersed in water.

- *Unit Weight Analysis*

The average unit weight for each sample is determined by multiplying the bulk specific gravity of the mix by  $62.4 \text{ lb/ft}^3$  ( $1000 \text{ kg/m}^3$ ).

- *VMA Analysis*

The voids in the mineral aggregate, VMA, are defined as the intergranular void space between the aggregate particles in a compacted paving mixture that includes the air voids and the effective asphalt content, expressed as a percent of the total volume. The VMA is calculated on the basis of the bulk specific gravity of the aggregate and is expressed as a percentage of the bulk volume of the compacted pav-



ing mixture. Therefore, the VMA can be calculated by subtracting the volume of the aggregate determined by its bulk specific gravity from the bulk volume of the compacted paving mixture.

### **3.10 ANALYZING MARSHALL TEST RESULTS**

#### ***3.10.A Plotting Test Results***

To understand the characteristics of each specimen in a test series, laboratory technicians plot the Marshall test results on charts or graphs. By studying the charts, they can determine which specimen in the series best meets all the criteria for the finished pavement. The proportions of asphalt and aggregate in that specimen become the proportions used in the final mixture.

Figure 3.18 shows five Marshall test result charts. On each chart is plotted test values. The values are represented by dots. The first chart shows the Marshall stability values; the second the Marshall flow values; the third the unit weights (densities); the fourth the percentages of air voids; and the fifth the percentages of voids in the mineral aggregate. On each chart, the dots representing the values are connected by lines forming a smooth curve.

#### ***3.10.B Trends in Test Data***

When plotted on to charts, such as the ones in Figure 3.18, test results usually reveal reasonably consistent trends in the relationship between asphalt content and mix properties. Below are listed trends that can be seen by studying individual charts in Figure 3.18.

- Up to a certain point, stability values increase as asphalt content increases. Beyond a certain percentage of asphalt in the mixture, however, stability decreases (Chart 1).
- Flow values increase with increasing asphalt content (Chart 2).
- The curve for unit weight (density) of total mix is similar to the stability curve, except that the maximum unit weight normally occurs at a slightly higher asphalt content than the maximum stability (Chart 3).
- The percent of air voids decreases with increasing asphalt content (Chart 4).
- The percent voids in the mineral aggregate generally decreases to a minimum value then increases with increasing asphalt contents (Chart 5).

#### ***3.10.C Determination of Optimum Asphalt Content***

The optimum (best possible) asphalt content of the final paving mix is determined from test data described above. In making this determination, generally consideration is given to three of the test property curves, namely the curves representing the following values:

- Stability
- Unit weight
- Percent of air voids

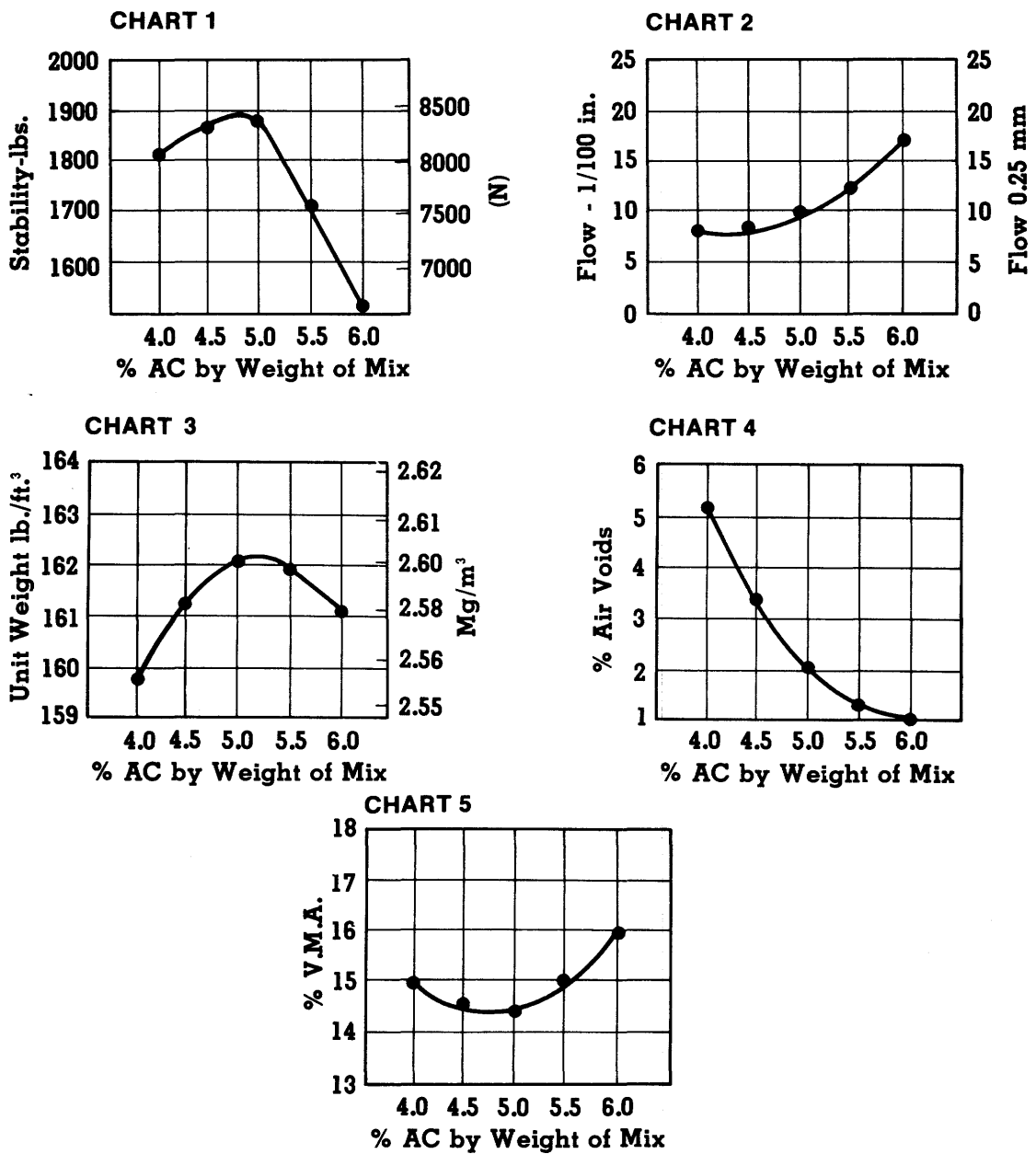


FIGURE 3.18—Example Plotted Curves Showing Test Results for Series of Five Marshall Specimens.

In consulting the charts, we are looking for the asphalt content that corresponds with the highest stability and the highest unit weight, and which results in a void content at about the middle of the range recommended for the type of pavement being designed. Referring to Chart 1 in Figure 3.18, we see that stability is highest at an asphalt content of 4.8 percent. Chart 3 shows that an asphalt content of 5.1 percent results in the greatest unit weight. Chart 4 shows that an asphalt content of 4.3 percent produces a voids content of 4 percent—the median for a heavily trafficked surface mix (see *Marshall Design Criteria*, below).

Taking the average of the three percentages yields the optimum asphalt content.

Thus:

$$\left. \begin{array}{l} 4.8\% \\ 5.1\% \\ 4.3\% \end{array} \right\} \frac{14.2}{3} = 4.7 \text{ percent} = \text{optimum asphalt content}$$

### 3.10.D Verifying Design Criteria

When the optimum asphalt content has been determined from the Marshall test data, it must be checked to be certain that it satisfies Marshall Design Criteria. The first step in doing this is to find out what the optimum asphalt content (in the case of the example, 4.7 percent) means in terms of properties. Referring again to the charts in Figure 3.18, we find that an asphalt content of 4.7 percent indicates the following property values:

- Stability (Chart 1) ..... 1,880 lb (8,363N)
- Flow (Chart 2) ..... 9
- Percent air voids (Chart 4) ..... 3.0

We can now compare the values for the three properties with the values recommended by The Asphalt Institute for the Marshall Design Criteria (Figure 3.19). The stability value of 1,880 lbs (8,363N) exceeds the minimum criteria of 1,500 lbs. The flow value of 9 falls within the criteria range of 8 to 16. The percent air voids of 3.0 satisfies the lower limit of 3.

Marshall Method Mix Criteria <sup>1</sup>	Light Traffic <sup>2</sup>		Medium Traffic <sup>2</sup>		Heavy Traffic <sup>2</sup>	
	Surface & Base		Surface & Base		Surface & Base	
	Min.	Max.	Min.	Max.	Min.	Max.
Compaction, number of blows each end of specimen	35		50		75	
Stability, lb. (*N)	500 (2224)	—	750 (3336)	—	1500 (6672)	—
Flow, 0.25 mm (0.01 in.)	8	20	8	18	8	16
Percent Air Voids	3	5	3	5	3	5
Percent Voids in Mineral Aggregate (VMA)	(See Figure 3.20)					

<sup>1</sup>All criteria, not stability value alone, must be considered in designing an asphalt paving mix. Hot-mix asphalt bases that do not meet these criteria when tested at 140°F (60°C) are satisfactory if they meet the criteria when tested at 100°F (38°C) and are placed 4 in. (100 mm) or more below the surface. This recommendation applies only to regions having a range of climatic conditions similar to those prevailing throughout most of the United States. A different lower test temperature may be considered in regions having more extreme climatic conditions.

<sup>2</sup>Traffic Classifications:

Light: Traffic conditions resulting a Design EAL < 10<sup>4</sup>.

Medium: Traffic conditions resulting a Design EAL between 10<sup>4</sup> and 10<sup>6</sup>.

Heavy: Traffic conditions resulting in a Design EAL > 10<sup>6</sup>.

\*N = Newton

(Mix Design Methods for Asphalt Cements [MS-2] The Asphalt Institute)

**FIGURE 3.19—Asphalt Institute Marshall Design Criteria**

The minimum allowable percent voids in mineral aggregate can also be checked using Figure 3.20 and comparing it to the VMA of the specific aggregate gradation.

U.S.A. Standard Sieve Designation*	Nominal Maximum Particle Size		Minimum Voids in Mineral Aggregate, Percent
	in.*		
1.18 mm (No. 16)	0.0469		23.5
2.36 mm (No. 8)	0.093		21
4.75 mm (No. 4)	0.187		18
9.5 mm (3/8 in.)	0.375		16
12.5 mm (1/2 in.)	0.500		15
19.0 mm (3/4 in.)	0.750		14
25.0 mm (1 in.)	1.0		13
37.5 mm (1 1/2 in.)	1.5		12
50 mm (2 in.)	2.0		11.5
63 mm (2 1/2 in.)	2.5		11

\*Standard Specification for Wire Cloth Sieves for Testing Purposes, AASHTO Designation M 92.

**FIGURE 3.20—Minimum Percent VMA.**

### ***3.10.E Selecting a Mix Design***

The mix design selected for use in a pavement is usually the one which most economically meets all of the established criteria. In extreme cases, when it is not possible or practicable to meet the requirements of the design criteria, a tolerance of one percent of air voids may be permitted. However, the maximum allowable flow value should not be exceeded nor the minimum stability value be disregarded. Any variations in design criteria should be allowed only under unusual conditions, unless the service behavior of a specific aggregate mixture indicates such a variant paving mix to be satisfactory.

## **3.11 SUMMARY OF MARSHALL MIX DESIGN METHOD**

The foregoing discussion provides a general overview of the Marshall Method of Mix Design and its use in controlling the quality of paving construction. There are many details of the test procedure that were not discussed here. They are more appropriate for in-depth discussion and training of technicians who actually conduct the test procedures. The material that was presented should provide the inspector with a better understanding of the relationship of the Marshall Method of Mix Design to pavement construction, so that he may better interpret the factors that lead to deficiencies in plant-mix pavements and imperfections in finished pavements.

## **3.12 HVEEM MIX-DESIGN METHOD—INTRODUCTION**

### ***3.12.A Background***

The concepts of the Hveem Method of designing paving mixtures was developed by Francis N. Hveem, formerly Materials and Research Engineer with the California Division of Highways.

The Hveem test in its present form originated from investigations started by the California Highway Department in 1940. It involves determining an approximate asphalt content by Centrifuge Kerosene Equivalent test and then subjecting specimens at that asphalt content, and at higher and lower asphalt contents to a stability test. A swell test on a specimen exposed to water is also made.

This design procedure continues to be the primary mix design method used in California and a number of other states.

### ***3.12.B Purpose***

The purpose of the Hveem Method is to determine the optimum asphalt content for a particular blend of aggregate. It also provides information about the properties of the resulting asphalt hot-mix.

The Hveem Method as presented here is applicable only to hot-mix asphalt paving mixtures using penetration or viscosity graded asphalt cements and containing aggregate with maximum sizes of 25.0 mm (1 in.) or less. The method may be used for both laboratory design and field control of asphalt hot-mix paving.

### **3.12.C General Description**

The Hveem Method utilizes a series of tests to determine optimum asphalt content. The procedures included are:

- Centrifuge Kerosene Equivalent (CKE) test to determine an approximate asphalt content.
- Preparation of test specimens at the approximate asphalt content and at lower and higher asphalt contents.
- Stability test to evaluate resistance to deformation.
- Swell test to determine effect of water on volume change and permeability of specimen.

Each of these procedures is presented in detail in this section.

## **3.13 CONDUCTING THE HVEEM MIX DESIGN**

This is a general description of the procedures followed in the Hveem Mix Design. The complete and detailed procedure that must be followed is contained in AASHTO T 246 and T 247. (ASTM D 1560 and D 1561).

### **3.13.A Preparation for Conducting Hveem Procedures**

As discussed in the Materials section of this manual, different aggregates and asphalts have different characteristics. These characteristics have a direct impact on the nature of the pavement itself. The first step in the design method is to determine what qualities (stability, durability, workability, skid-resistance, etc.) the paving mixture must have and to select a type of aggregate and a compatible type of asphalt that will combine to produce those qualities. Once this is done, test preparations can begin.

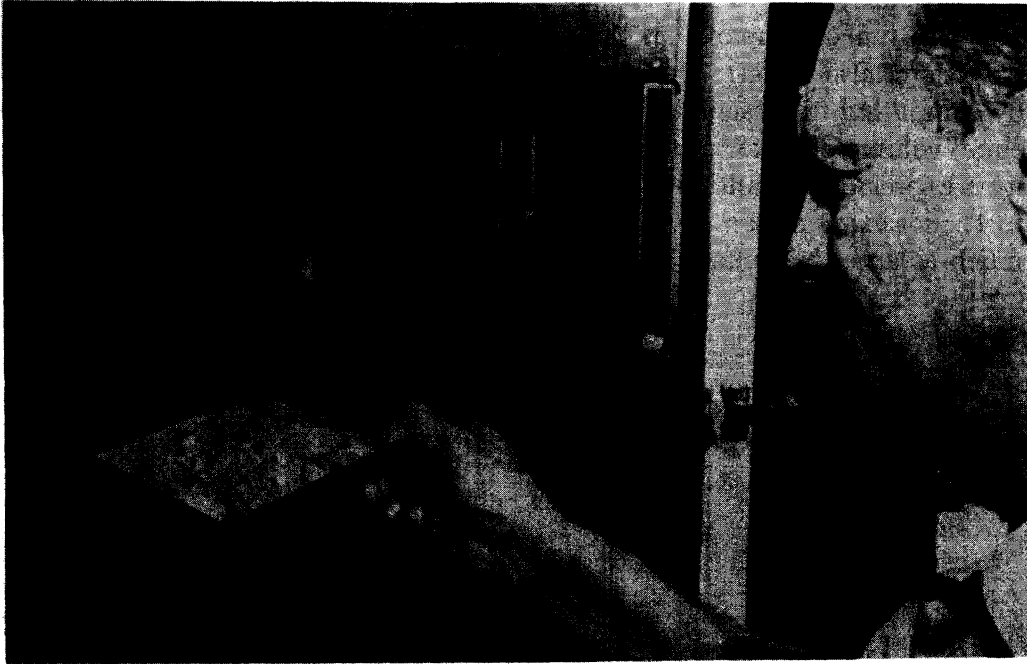
**3.13.A.1 Selection of Material Samples**—The first preparation for testing is to gather samples of the asphalt and the aggregate that will be used in the actual paving mixture. It is important that the asphalt samples have characteristics *identical* to those of the asphalt that will be used in the final hot mix. The same is true of the aggregate samples. The reason is simple: data derived from the mix design procedures determine the formula or “recipe” for the actual paving mixture. The recipe can be accurate only if the ingredients tested in the laboratory have characteristics identical to those of the ingredients used in the final product.

A wide variety of serious problems, ranging from poor workability of the mix to premature failure of the pavement itself, are historical results of variances between materials tested and the materials actually used.

**3.13.A.2 Aggregate Preparation**—Because the characteristics of an asphalt are known when the grade of the asphalt is selected, there is no required preparation of asphalt in the Hveem Method. Preliminary procedures focus on the aggregate, with the purpose of accurately identifying aggregate characteristics. These procedures include drying the aggregate, determining specific gravity of the aggregate, conducting a wash-sieve analysis, determining aggregate surface area, and determining coarse aggregate surface capacity.

- *Drying the Aggregate*

Aggregates are dried to a constant weight at a temperature of 230°F (110°C) before use in the Hveem Method (Figure 3.21). The heated sample is then weighed and the weight recorded on the proper form.



**FIGURE 3.21—Drying the Aggregate Sample.**

The sample is thoroughly heated a second time, after which it is again weighed and its weight recorded. This procedure is repeated until the sample's weight remains constant through two successive heatings, indicating that as much moisture as possible has been evaporated away.

- *Wash-Sieve Analysis*

Wash-sieve analysis is a procedure designed to identify the proportions of different-sized particles in the aggregate samples. This information is important because mixture specifications must state what proportions of different-sized aggregate particles the hot mix must contain to produce a final product with the desired characteristics.

The wash-sieve analysis involves the following steps:

- 1) Each aggregate sample is dried and weighed.
- 2) Then each sample is washed thoroughly over a 0.075 mm (No. 200) sieve, to remove any mineral dust coating the aggregate.
- 3) The washed samples are dried following the heating and weighing procedure described above under *Drying the Aggregate*.

4) The dry weight of each sample is recorded. By comparing sample weights taken before washing to sample weights taken after, the amount of mineral dust can be determined.

5) For detailed steps of this procedure refer to AASHTO T 11.

- *Determining Specific Gravity*

The specific gravity of any substance is the weight-volume ratio of a unit of that substance compared to the weight-volume ratio of an equal unit of water (see Materials section). The specific gravity of an aggregate sample is determined by comparing the weight of a given volume of the aggregate to the weight of an equal volume of water at the same temperature (Figure 3.22). The specific gravity is expressed in multiples of the specific gravity of water (which is always equal to 1). For example, an aggregate sample which weighs two-and-one-half times as much as an equal volume of water has a specific gravity of 2.5.

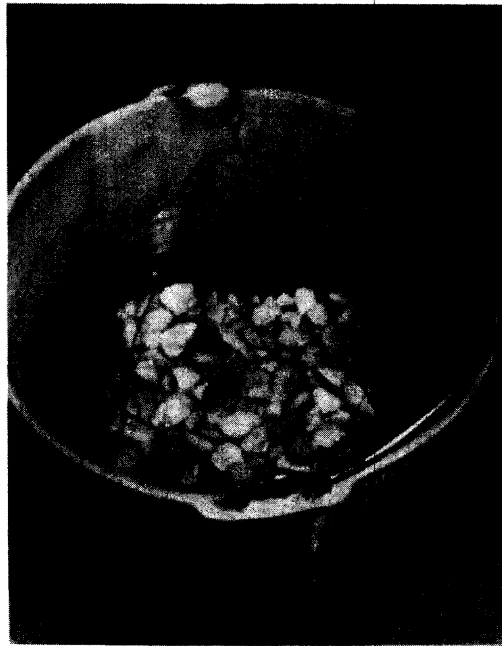


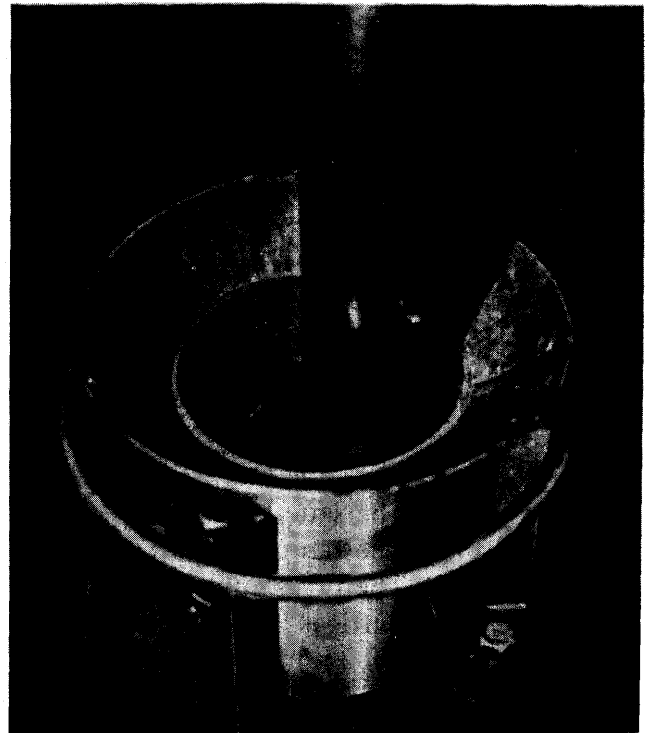
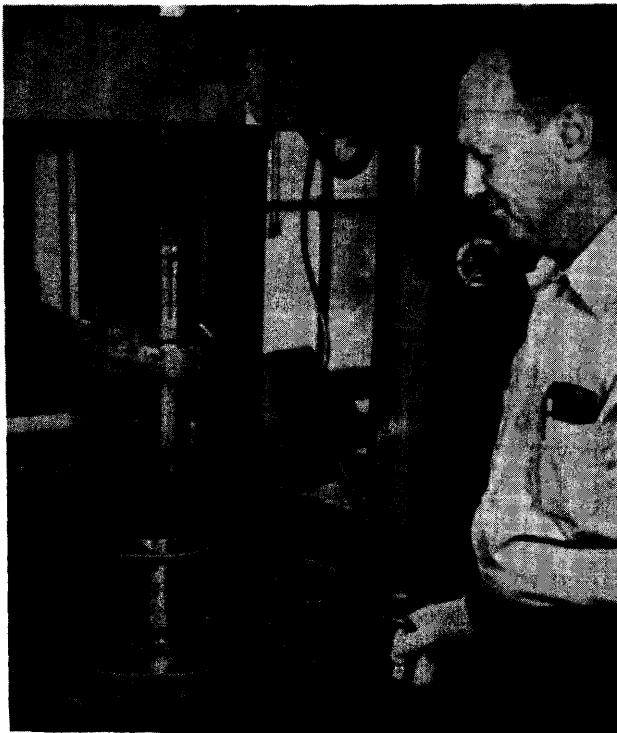
FIGURE 3.22 DETERMINING SPECIFIC GRAVITY OF AGGREGATE







**FIGURE 3.25—Rodding Mixture Sample in Mold.**



**FIGURE 3.26—Mechanical Compactor Compacting Mixture Sample.**

### 3.13.B Hveem Test Procedure

The Hveem Method of Mix Design includes three test procedures: a stabilometer test, a bulk-density determination, and a swell test.

**3.13.B.1 Stabilometer Test**—The stabilometer test is designed to measure the stability of the test mixture by subjecting it to specific stresses. The compacted test specimen is placed inside the stabilometer device, where it is surrounded by a close-fitting rubber membrane (Figure 3.27). A vertical load is exerted on the sample and the resulting lateral (horizontal) pressure that develops is measured.

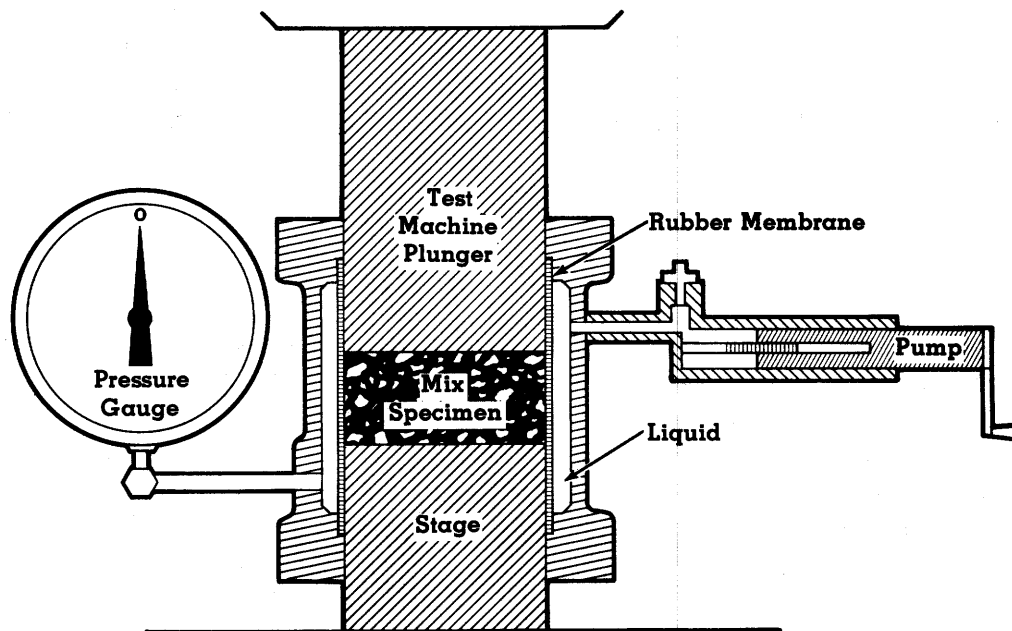


FIGURE 3.27—Stabilometer Test.

The vertical pressure simulates the effects of pneumatic-tired loads repeated over a long period of time.

Stabilometer results depend largely on internal friction (resistance) of the aggregates and considerably less on the consistency of the asphalt.

The Stabilometer test is conducted as follows:

- 1) The sample is heated to 140°F (60°C).
- 2) The sample is placed in the stabilometer as shown in Figure 3.27.
- 3) The pressure in the stabilometer is raised to 5 psi (34.5 kPa).
- 4) Vertical loading is applied at a testing head speed of 0.05 inches per minute (0.02 mm/s) until a 6000 lbs. (26.7 kN) load is reached.
- 5) Readings of the lateral pressure at specified loads are taken and recorded.
- 6) The vertical load is reduced to 1000 lbs. (4.45 kN) and a displacement measurement is made with the displacement pump.

- 7) The Hveem stability value for the sample is calculated using the information derived from the stabilometer test. The resulting stabilometer value(s) is based on the idea that an asphalt mix has properties somewhere between a liquid and a rigid solid. The value of S is derived from an arbitrary scale of 0 to 100, on which zero corresponds to a liquid having no measurable internal resistance to slowly applied loads and 100 corresponds to a hypothetical solid that transmits no measurable lateral pressure under a given load.

**3.13.B.2 Voids Analysis**—The air voids are the small pockets of air between the asphalt coated aggregate particles. The percent air voids are calculated from the bulk specific gravity of each compacted specimen and the maximum specific gravity of the paving mixture (no voids). The latter is calculated from the specific gravities of the asphalt and aggregate in the mix, with an appropriate allowance made for the amount of asphalt absorbed by the aggregate, or it can be determined directly by a standard test (AASHTO T 209) on an uncompacted sample of mix.

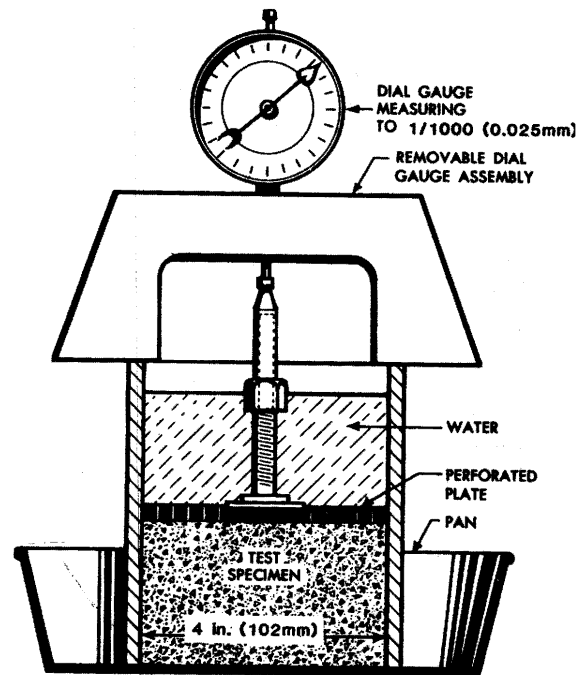
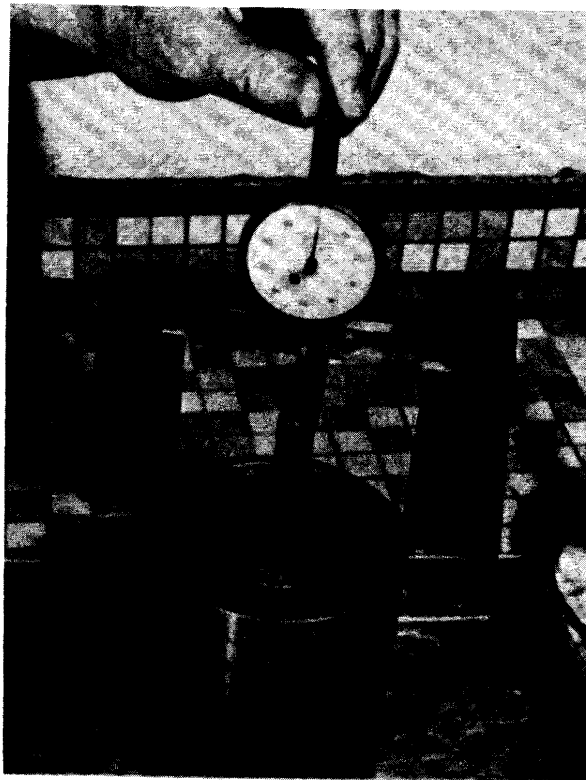
The bulk specific gravity of compacted specimens are determined by weighing specimens in air and immersed in water.

**3.13.B.3 Swell Test**—Water is the enemy of all pavement structures. Consequently, a pavement mixture design must aim at giving the final pavement adequate water-resistance to ensure its durability. The swell test measures the amount of water that percolates into or through a specimen and the amount of swelling the water causes. It also measures the mixture's permeability—its ability to allow water to seep through it.

The device used to conduct the swell test is illustrated in Figure 3.28.

The swell test procedure is as follows:

- The specimen, in its compaction mold, is placed in an aluminum pan and is covered with a perforated bronze plate.
- A dial gauge is mounted over the test specimen in such a way that its stem touches the bronze plate.
- A specific amount of water is poured into the mold, directly onto the bronze plate.
- The distance between the upper lip of the mold and the surface of the water is measured and the measurement is recorded.
- The specimen is allowed to sit submerged for twenty-four hours.
- A reading is taken from the dial gauge. This reading indicates how much the surface of the test sample has risen due to swelling.
- The distance between the upper lip of the mold and the surface of the water is measured again. The difference between this measurement and that taken twenty-four hours earlier indicates how much water has seeped through the specimen. It is therefore a measurement of the specimen's permeability.



**FIGURE 3.28—Swell Test Apparatus.**

### 3.14 ANALYZING HVEEM TEST RESULTS

The results of stabilometer testing, bulk density determination, and voids content measurements are recorded on a typical worksheet (Figure 3.29) and are plotted on graphs as shown in Figure 3.30. Each dot on the graph represents the test value achieved by a specimen or series of test specimens. The dots are connected by a continuous line to form a smooth curve. These graphs are used to compare the characteristics of the test mixture samples.

The suitability of the hot-mix design by the Hveem method is determined on the basis of whether or not the asphalt content and aggregate grading satisfy the requirements listed in the table shown in Figure 3.31.

The optimum asphalt content is normally the highest percentage that the mixture will accommodate without reducing stability or void content below minimum values. The optimum asphalt content is determined by comparing three test mixture characteristics, namely stabilometer values, percentages of air voids, and tendency to flush or bleed. Pyramid charts, similar to the one illustrated in Figure 3.32 are used to make the comparisons and to determine which test mixture is best for the pavement being designed.

Trial Mix Series: 1-B  
 53% CA; 47% FA

**HOT-MIX DESIGN DATA**  
 by the  
**HVEEM METHOD**

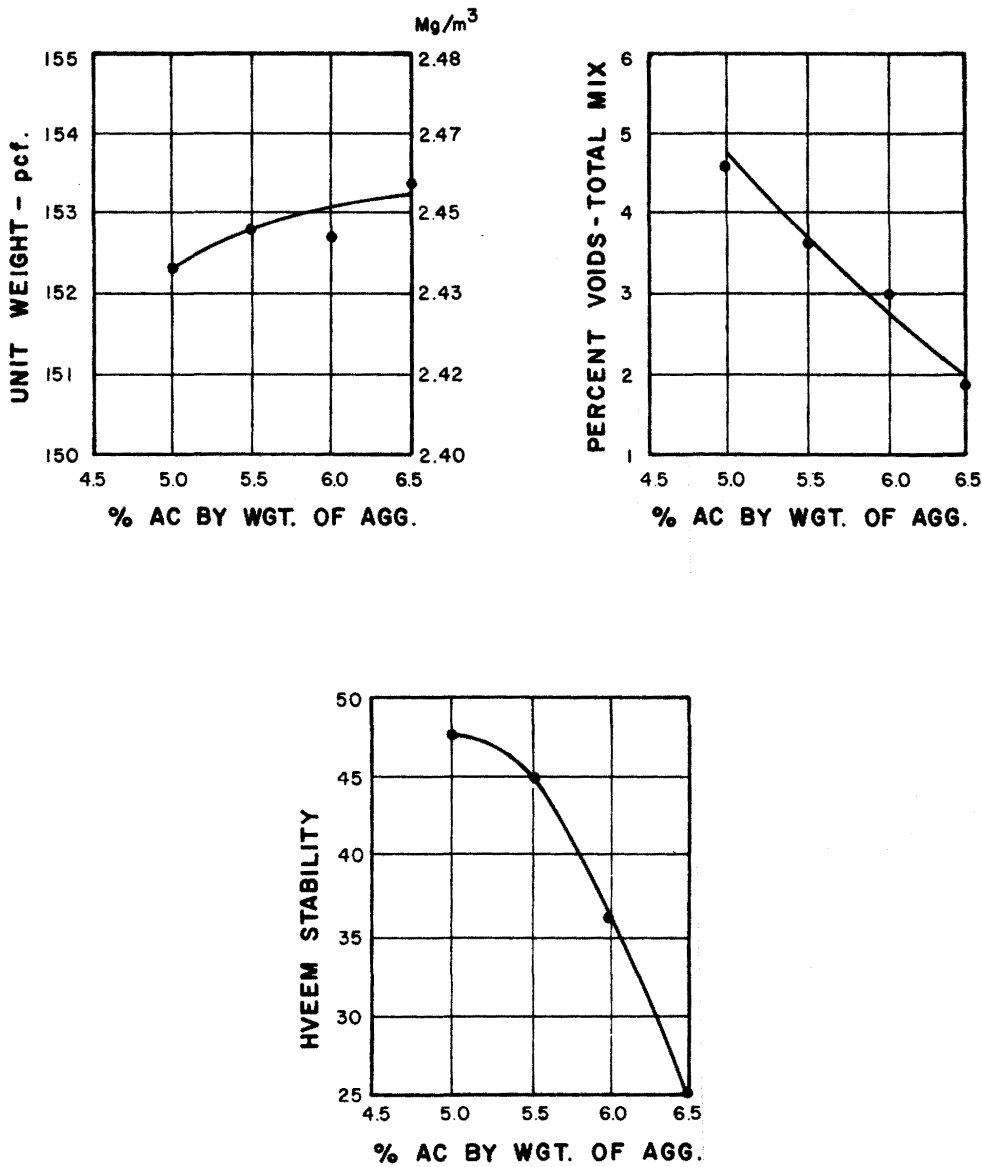
Project: F1-008-8(3)  
 Location: Rye-South  
 Date: August 4, 1982

Sp. Gr. Asp. Cem. 1.012 Asp. Cem. AC-10 Avg. Bulk Sp. Gr. Agg. = 2.760				Lab. No. for Asp. Cem. Used: 53-0741 Lab. Nos. for Agg. Used: 53-1252; 53-1253						
<b>GRADATION, CKE, and PERCENT ASPHALT</b>										
Sieve Size mm (in. or No.)	19.0 (3/4)	12.5 (1/2)	9.5 (3/8)	4.75 (4)	2.36 (8)	1.18 (16)	0.60 (30)	0.30 (50)	0.15 (100)	0.075 (200)
Specification Limits	100	100 80	90 70	70 50	50 35		29 18		16 8	10 4
% Passing S. A. Factors Surface Area, ft <sup>2</sup> /lb*	100	91	76 2	60 2 1.2	42 4 1.7	32 8 2.6	23 14 3.2	16 30 4.8	12 60 7.2	6 160 9.6
CKE: FA = 2.8; CA = 2.8 K <sub>f</sub> = 1.0; K <sub>c</sub> = 1.3; K <sub>m</sub> = 1.0; Total SA <u>32.3</u> ft <sup>2</sup> /lb. (6.62 m <sup>2</sup> /kg) Estimated % Asp. Cem. by Wgt. of Agg. using CKE Tests only 5.5 Recommended % Asp. Cem. by Wgt. of Agg. using Mix Design Criteria 5.0										
Specimen Identification	A		B		C		D			
% Asp. Cem. by Wgt. of Agg.	5.0		5.5		6.0		6.5			
% Asp. Cem. by Wgt. of Mix	4.76		5.21		5.66		6.10			
Wgt. in Air-grams	1211.0		1223.3		1230.8		1235.9			
Wgt. in Water-grams	714.9		723.8		727.6		733.3			
Bulk Volume-cc.	496.1		499.5		503.2		502.6			
Bulk Sp. Gr.	2.441		2.449		2.446		2.459			
Max. Sp. Gr.	2.559		2.540		2.522		2.504			
% Voids-Total Mix	4.6		3.6		3.0		1.8			
Unit Wgt.-pcf. (kg/m <sup>3</sup> )	152.3(2.439)		152.8(2.448)		152.6(2.446)		153.4(2.457)			
Total Load-lbs. (kN)	Unit Load-psi (MPa)	<b>STABILOMETER</b>								
500 (2.22)	40 (0.28)	9		9		9		10		
1000 (4.45)	80 (0.55)	12		12		15		16		
2000 (8.90)	160 (1.10)	15		16		24		26		
3000 (13.34)	240 (1.65)	21		22		30		38		
4000 (17.79)	320 (2.21)	28		30		42		55		
5000 (22.24)	400 (2.76)	36		39		55		83		
6000 (26.69)	480 (3.31)	50		52		62		105		
Displacement-turns		2.40		2.50		2.46		2.50		
Stability Value		48		45		36		25		

Jones  
 Inspector

\* Surface Area, m<sup>2</sup>/kg = 0.204816 ft<sup>2</sup>/lb

**FIGURE 3.29—Suggested Test Report Form Showing Test Data for a Typical Mix Design by the Hveem Method.**



**FIGURE 3.30—Example Graphs Showing Unit Weight, Percent Air Voids, and Stabilometer Values for Test Mixture Specimens.**

The procedures used to determine the optimum asphalt content are shown in Figure 3.33.

- 1) Record in Step 1 of the pyramid, the asphalt contents used for preparing the mixture specimens being analyzed. Record them in order of increasing amounts from left to right with the maximum asphalt content in the square on the right.

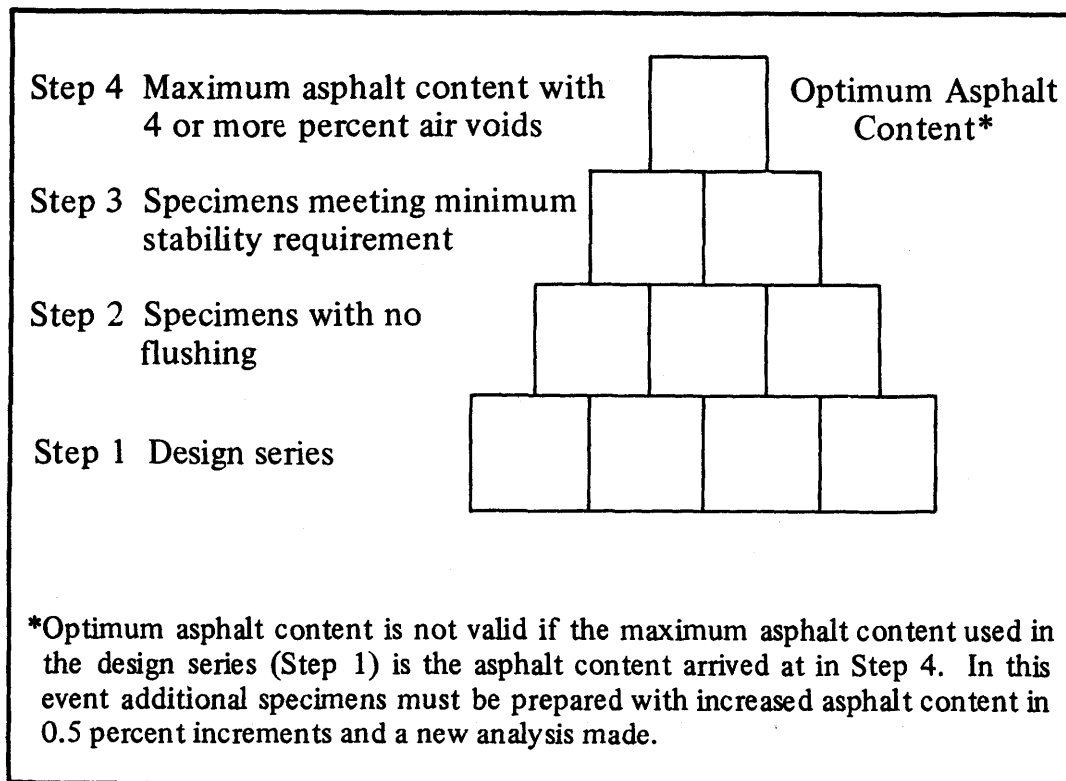
Traffic Category	Heavy		Medium		Light	
Test Property	min.	max.	min.	max.	min.	max.
Stabilometer Value Swell	37	—	35	—	30	—
less than 0.030 inch (0.762 mm)						

**NOTES:**

1. Although not a routine part of this design method, an effort is made to provide a minimum percent air voids of approximately 4 percent.
2. All criteria, and not stability value alone, must be considered in designing an asphalt paving mix.
3. Hot-mix asphalt bases, which do not meet the above criteria when tested at 140°F (60°C) should be satisfactory if they meet the criteria when tested at 100°F (38°C) and are placed 4 inches (102 mm) or more below the surface. This recommendation applies only to regions having climatic conditions similar to those prevailing throughout most of the United States. Guidelines for applying the lower test temperature in regions having more extreme climatic conditions are being studied.

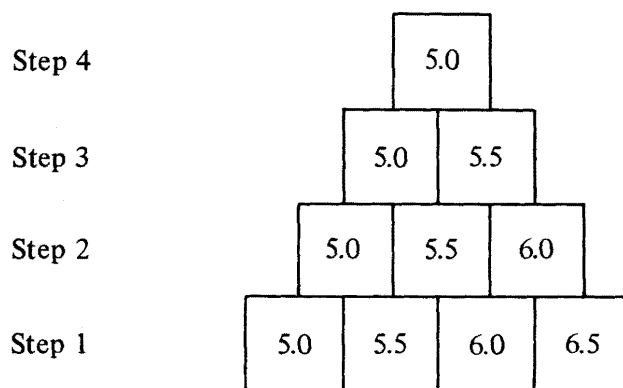
*(Mix Design Methods for Asphalt Concrete [MS-2] The Asphalt Institute.)*

**FIGURE 3.31—Asphalt Institute Hveem Design Criteria.**



**FIGURE 3.32—Pyramid Chart Used to Determine Optimum Asphalt Content.**

- 2) Select from Step 1 the three highest asphalt contents that do not exhibit moderate or heavy surface flushing and record them in Step 2. Surface flushing and/or bleeding is considered "slight" if the surface has a slight sheen. It is considered "moderate" if sufficient free asphalt is apparent to cause paper to stick to the surface but no distortion is noted. Surface flushing is considered "heavy" if there is sufficient free asphalt to cause surface bubbling or specimen distortion after compaction.
- 3) Select from Step 2 the two highest asphalt contents that provide the specified minimum stabilometer value and enter them in Step 3.
- 4) Select from Step 3 the highest asphalt content that has at least 4.0 percent air voids and enter it in Step 4. This is the optimum asphalt content. However, if the maximum asphalt content used in Step 1 is the asphalt content entered on Step 4, additional specimens with increased asphalt content must be prepared and a new optimum asphalt content determination made. This is because a greater asphalt content than the maximum tested might prove to be better for the pavement design.



**FIGURE 3.33—Example of Pyramid Procedures.**

### 3.15 SUMMARY OF HVEEM MIX DESIGN METHOD

The purpose of the Hveem Method of mix design is to determine the proper proportions of asphalt and aggregate that a paving mixture must contain to produce a pavement with specific characteristics. The method includes preparatory procedures for identifying gradation, surface area, and surface capacity of the aggregate. From these preparatory steps, an approximate asphalt content for the mixture is calculated. Test specimens of paving mixtures with slightly varying asphalt contents are prepared using methods that simulate actual pavement mixture production conditions.

Test samples are then subjected to three tests: the stabilometer test, bulk density determinations, and the swell test. Results of these tests are correlated and used to select the particular mix design that exhibits optimum pavement characteristics.



## SECTION 4

### PLANT OPERATIONS

#### 4.1 INSPECTOR OBJECTIVES

At the conclusion of this manual section, the inspector should:

- Understand the function of an asphalt plant.
- Know the two basic types of asphalt plants and the major components of each.
- Recognize the proper procedures for handling, storing, and sampling aggregate.
- Know the items that should appear in an inspector's plant records.
- Understand the operation of cold aggregate feed systems.
- Recognize items to be checked in a visual inspection of hot-mix.
- Understand basic sampling and testing procedures for checking hot-mix characteristics.
- Know safety considerations necessary for safe and efficient plant operation.

#### 4.2 INTRODUCTION

An asphalt plant is an assembly of mechanical electronic equipment where aggregates are blended, heated, dried and mixed with asphalt to produce a hot asphalt mix meeting specified requirements. An asphalt plant may be small or it may be large. It may be stationary (located at a permanent location) or it may be portable (moved from job to job). In general, however, every plant can be categorized as either (1) a batch plant (Figure 4.1), or (2) a drum mix plant (Figure 4.2). The differences between batch plants and drum mix plants are described later.

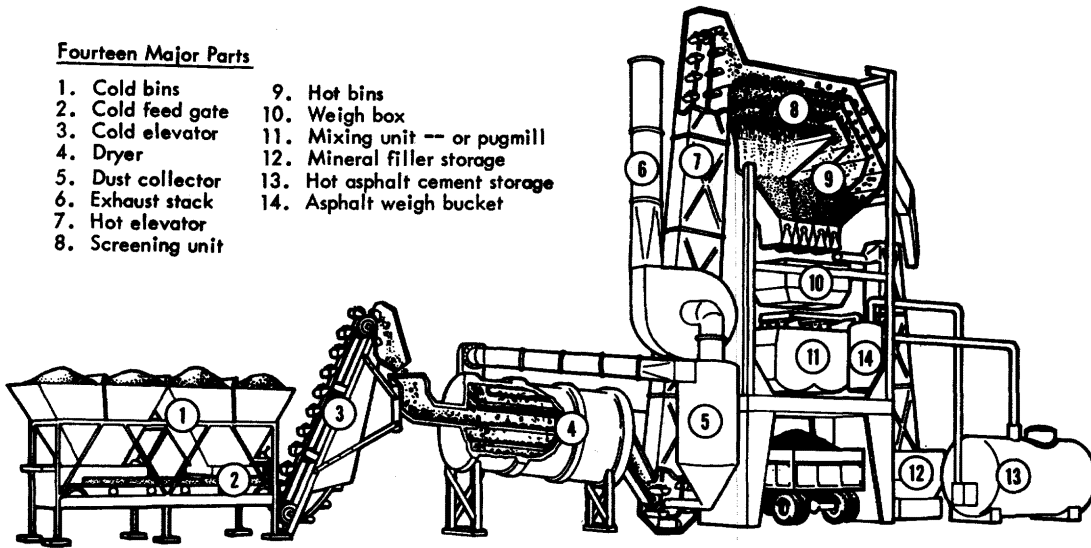
#### 4.3 RESPONSIBILITIES OF THE PLANT INSPECTOR

The plant inspector is a key member of the team that shares responsibility for producing a quality mix. His primary function is to observe plant operation and to sample finished products for mix compliance. The inspector must know both "how" and "why" the work is to be done. He should be aware of all that is going on and bring to the attention of the plant supervisor any detected problems or potential problems. However, an inspector should never assume responsibility for adjusting any plant controls or setting any dials, gauges or meters.

It is important that the inspector maintain an attitude of cooperation and helpfulness, while being firm but fair in making decisions and remaining faithful to his responsibilities.

Fourteen Major Parts

- |                   |                                |
|-------------------|--------------------------------|
| 1. Cold bins      | 9. Hot bins                    |
| 2. Cold feed gate | 10. Weigh box                  |
| 3. Cold elevator  | 11. Mixing unit -- or pugmill  |
| 4. Dryer          | 12. Mineral filler storage     |
| 5. Dust collector | 13. Hot asphalt cement storage |
| 6. Exhaust stack  | 14. Asphalt weigh bucket       |
| 7. Hot elevator   |                                |
| 8. Screening unit |                                |



**FIGURE 4.1—Cutaway View of Typical Batch Plant.**  
(Courtesy Tennessee Department of Transportation).

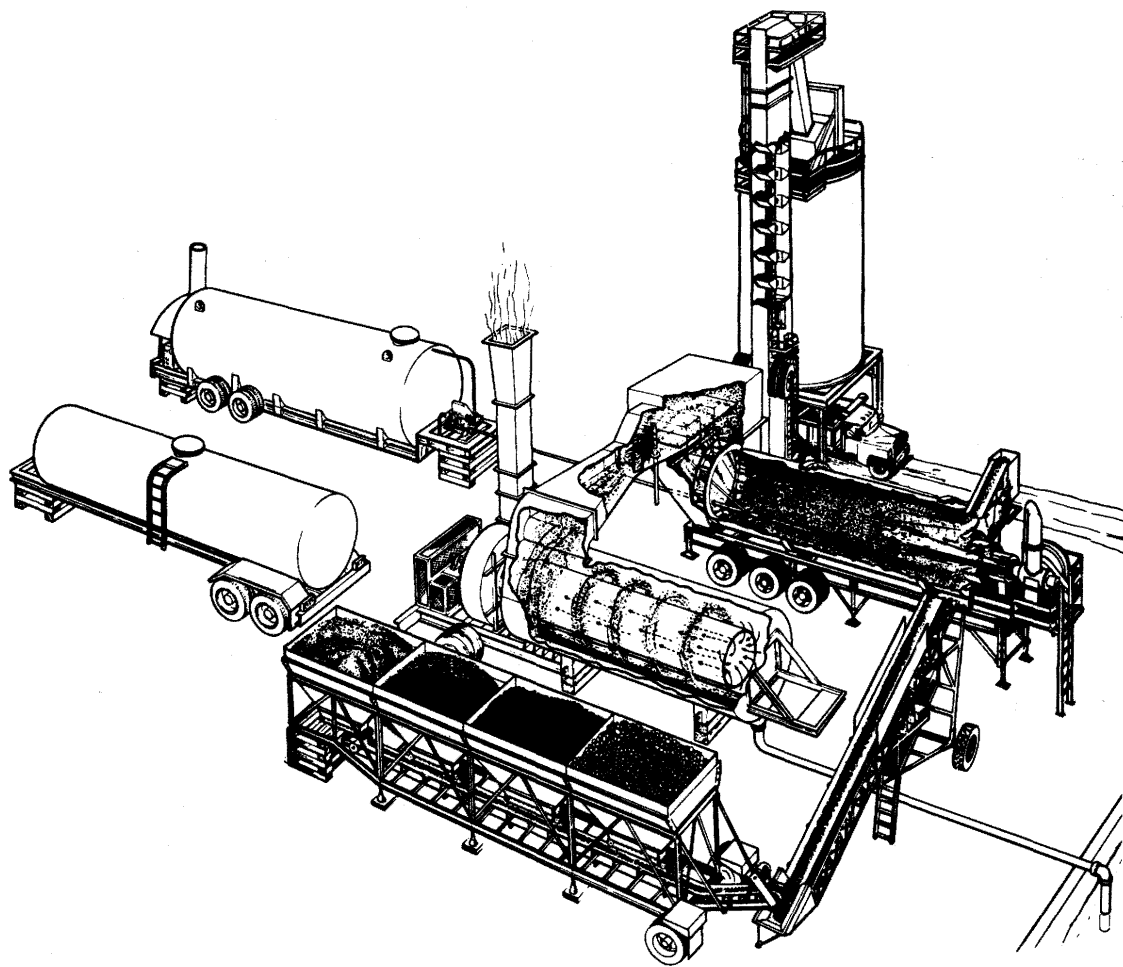
In general the duties of an inspector include:

- Sampling, testing and evaluating materials for specification compliance.
- Knowing the procedure for properly calibrating asphalt meters and aggregate feeders.
- Monitoring plant operations to ensure proper heating and drying of aggregate, proper asphalt temperature, correct distribution of materials, and uniform production of hot-mix asphalt concrete meeting specifications.
- Maintaining complete and accurate formal records.
- Maintaining a personal diary of plant operation.
- Practicing plant safety procedures, being constantly on the alert for any hazardous conditions or practices, and bringing such conditions or practices to the attention of the appropriate authority.

The inspector also must be aware of all Federal, State and local regulations and ordinances relating to the operation of the plant—such as air and water pollution restrictions, anti-noise requirements, restricted hours of operation, etc. Violations of any such regulations should be pointed out to the contractor.

#### **4.4 PURPOSE AND LAYOUT OF PLANT**

Regardless of the type of hot-mix plant, the basic purpose is the same. That purpose is to produce a hot mixture containing the desired proportions of asphalt and aggregate and meeting all specifications. Both types of plants, batch plants and drum mix



**FIGURE 4.2—Typical Drum Mix Plant.  
(Courtesy Barber-Greene Company).**

plants are designed to accomplish this purpose. The difference between the two plant types is that batch plants dry and heat the aggregate, then, in a separate mixer, combine the aggregate with asphalt one batch at a time; drum mix plants dry the aggregate and blend it with asphalt in a continuous process and in the same piece of equipment. Physical similarities and differences between the two plant types are illustrated in Figure 4.3.

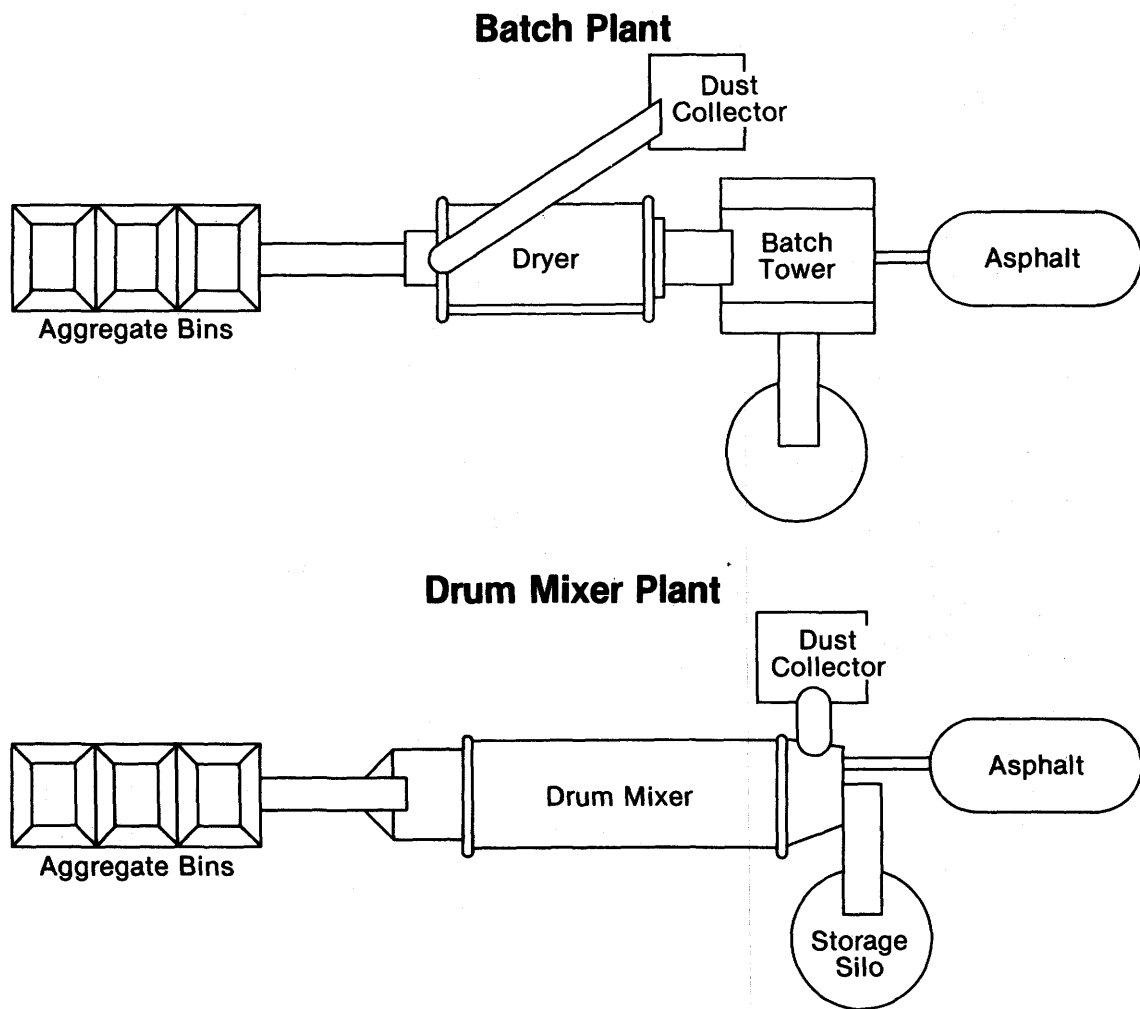


FIGURE 4.3—Typical Layout of Batch Plant and Drum Mix Plant.

## 4.5 MATERIALS

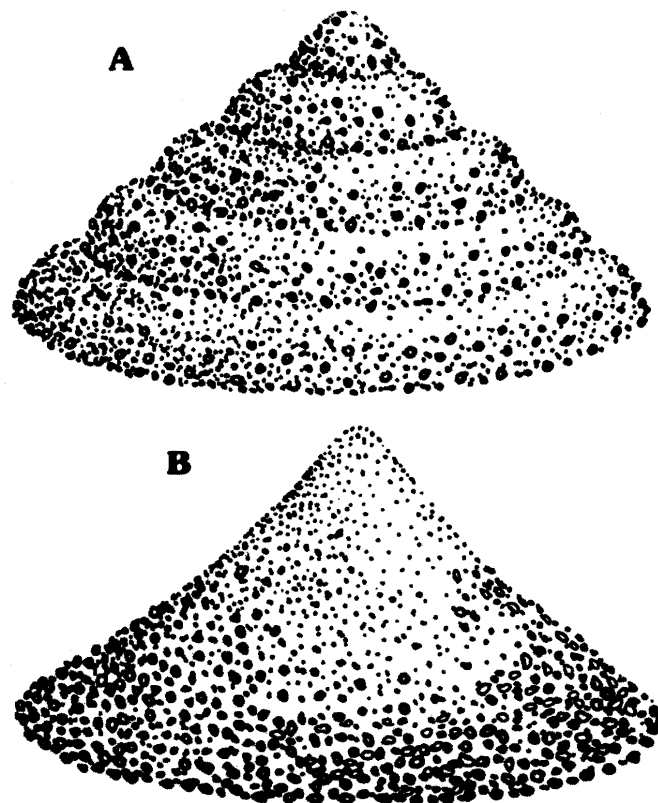
The quality of hot mix produced can only be as good as that of the materials going into the plant. Therefore, one of the inspector's primary duties is to ensure that an adequate supply of suitable materials is available prior to and during plant operations. The following sections discuss the handling and control of both asphalt and aggregate. The principles presented are common to all asphalt concrete plants.

### 4.5.A. Storage and Handling of Aggregates

It is the responsibility of the inspector to see that aggregates are stored and handled in a manner which minimizes degradation and segregation and avoids contamination. The stockpile area should be clean and stable to prevent contamination. Provisions

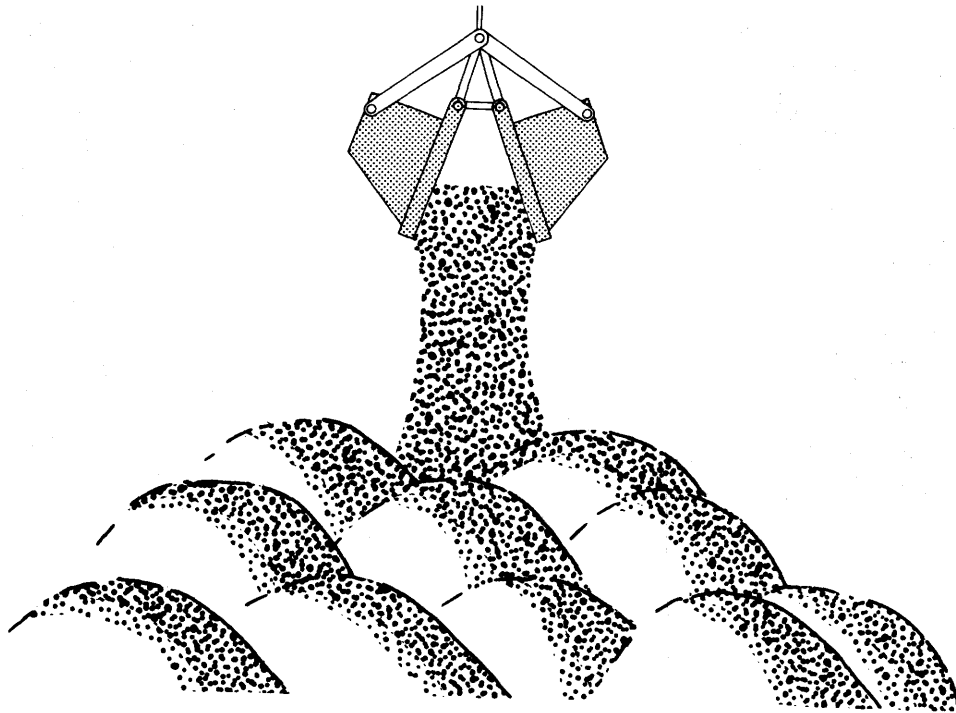
must be made to prevent intermingling of different aggregates. Such provisions include sufficient space to allow clear separation of the aggregate piles or use of bulkheads between stockpiles. If bulkheads are used, they should extend to the full height of the stockpile to prevent overflowing. Also, they should be strong enough not to rupture under stress.

The manner in which aggregates must be handled during stockpiling depends on the nature of the material. Fine-graded aggregates (such as sands and fine screenings) and one-sized coarse aggregates do not require the same careful handling as a coarse aggregate mixture composed of several particle sizes. Sands, crushed fine aggregate and single sized aggregates—especially the smaller sizes—can be handled and stockpiled in almost any manner with little, if any, segregation. Aggregate blends however, require special handling. For example, if material containing both coarse and fine particles is placed in a stockpile with sloping sides (a cone shape) segregation is sure to occur as the larger particles roll down the slope (Figure 4.4.B). Such segregation can be minimized by building a stockpile in layers (Figure 4.4.A).



**FIGURE 4.4—(A) Correct and (B) Incorrect Methods For Storing Aggregate Containing Large and Small Particles.**

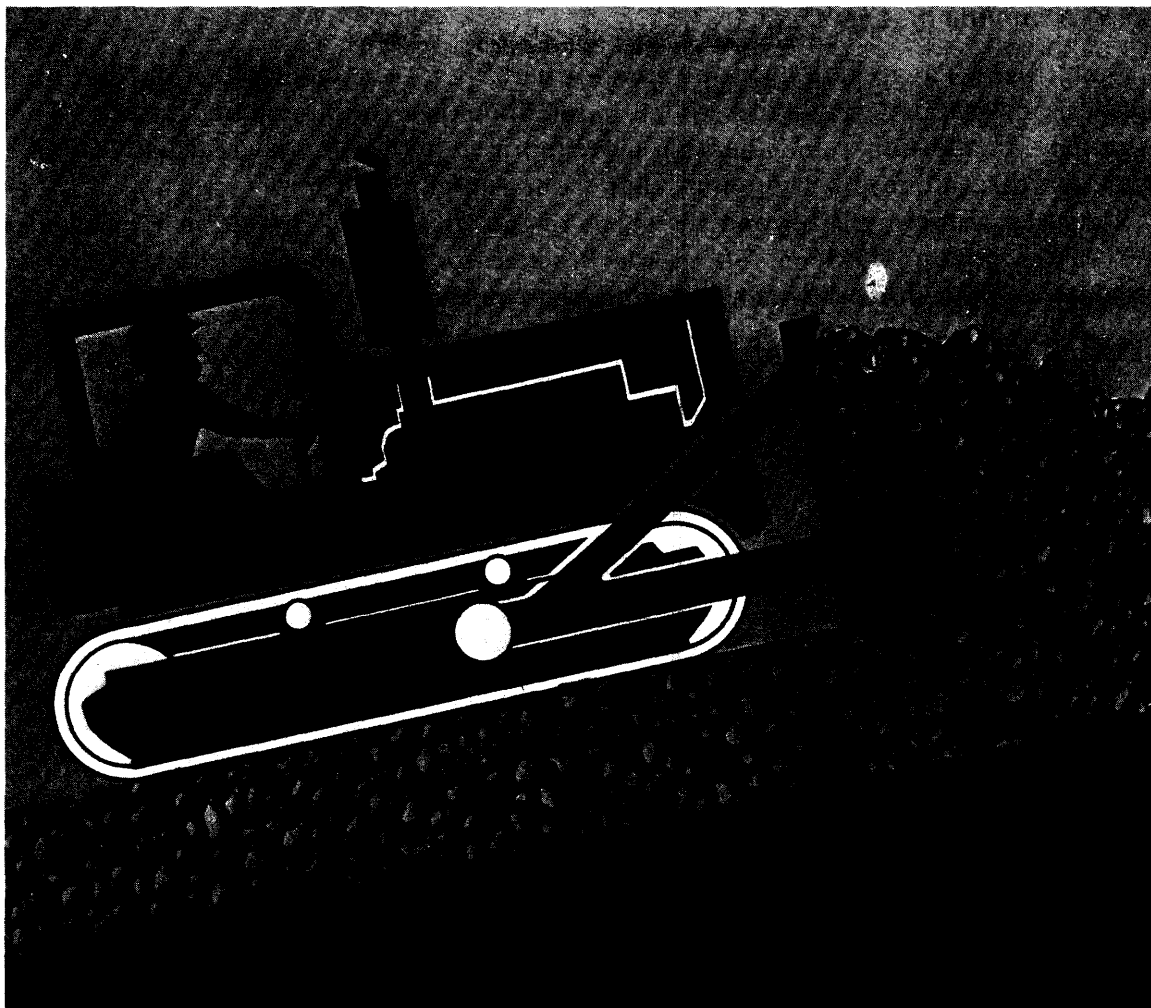
If the aggregates are delivered by truck, a layered stockpile can be formed by dumping the loads close together over the entire stockpile surface. The size of the truckloads governs the thickness of the layer. When stockpiling with a crane, bucketloads should be deposited (not cast) adjacent to one another to form a layer of uniform thickness. As Figure 4.5 shows, each layer should be completed before the next higher layer is begun.



**FIGURE 4.5—Stockpiling by Crane**

If a bulldozer is used to build the stockpile, the dozer should deposit the aggregate so that the pile builds up in uniform layers. Each layer should be no more than four feet thick. Manipulation of aggregates with bulldozers should be held to a minimum, because each movement of the aggregate can cause both segregation and degradation.

If dozers are permitted to be operated on stockpiles of aggregates, they should not be worked continuously in a trough at a certain level. If a dozer is worked too long in a trough at the same level, the fine material produced by this grinding action of the dozer tracks will work its way into the lower portion of the ramp being used by the dozer (Figure 4.6). The material then requires rescreening before it can be used in the mixture. Otherwise, it must be wasted. This problem is not limited to the use of dozers and other tracked vehicles; it occurs also when tubber-tired equipment is used.



**FIGURE 4.6—Segregation caused by dozer.**

Samples of aggregate should be tested at regular intervals to make sure that the stockpile maintains a uniform gradation. Each sample from a stockpile must be a composite, or mixture, of aggregates taken from different levels of the pile—near the top, at the middle, and near the bottom. A wood or metal shield shoved vertically into the pile just above the point of sampling will prevent loose aggregate particles from sliding down into sampling areas.

For sampling, use a square point shovel with turned-up edges that form a scoop. Insert the shovel blade horizontally into the stockpile and remove a scoopful of material. Be careful not to spill any particles. Place the aggregate in a bucket. Subsequent scoopfuls are placed in the same bucket.

Be sure to obtain one scoopful of aggregates from a sampling location at each level of the stockpile. It is important that the sample locations not be in a vertical line. They should be staggered around or within the pile to ensure a representative sample.

#### 4.5.B Sampling of Aggregate

Quantities for aggregate sampling are shown in Figure 4.7. Included is information on the recommended weight of a sample based upon the maximum particle size of the aggregate. In addition, remember that more representative samples are usually taken from an aggregate feed belt or chute than from a stockpile or bin.

Statistical sampling is beyond the scope of this discussion. Should it be needed, ASTM designation D 3665, Standards Practice for Random Sampling, outlines satisfactory procedures for such sampling (see Appendix C).

Nominal Maximum Size of Particles, Passing Sieve			Minimum Weight of Field Samples <sup>a</sup>	
mm	lb	Fine Aggregate Alternate		kg
2.36	No. 8	.....	10	5
4.75	No. 4	.....	10	5
<b>Coarse Aggregate</b>				
9.5	3/8 in.	.....	10	5
12.5	1/2 in.	.....	20	10
19.0	3/4 in.	.....	30	15
25.0	1 in.	.....	50	25
37.5	1-1/2 in.	.....	70	30
50.0	2 in.	.....	90	40
63	2-1/2 in.	.....	100	45
75	3 in.	.....	125	60
90	3-1/2 in.	.....	150	65

<sup>a</sup> The samples prepared for tests shall be obtained from the field sample by quartering or other suitable means to insure a representative portion.

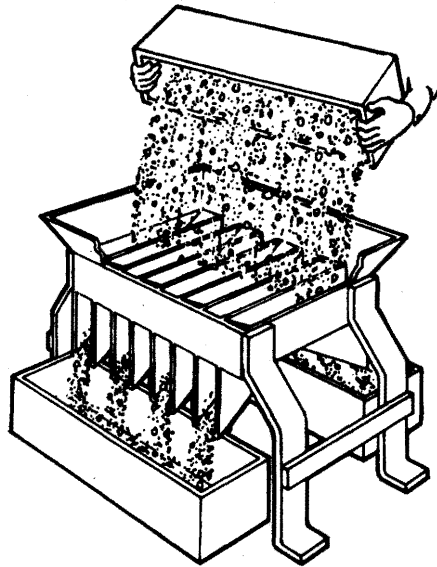
FIGURE 4.7—Size of Samples.

After selecting an aggregate sample, it is sometimes necessary to reduce the size (volume) of the sample to one more convenient for handling and testing. Because reducing a sample presents an opportunity for segregation to occur, care must be taken to preserve the sample's integrity. Two sample reduction methods are illustrated in Figure 4.8. Generally, the mechanical splitter is preferred for use with coarse aggregate or dry fine aggregate. Quartering is the best method when the aggregate sample is wet. AASHTO designation T 248 describes both methods in detail.

#### 4.5.C Storage and Handling of Asphalt

Asphalt quantities stored at the plant must be sufficient to allow uniform plant operation, even when delayed shipments and testing time are taken into account. Most plants have at least two asphalt tanks—one working tank and one or more storage tanks (Figure 4.9). Where more than one grade of asphalt is required for a job, at least one tank will be needed for each grade.



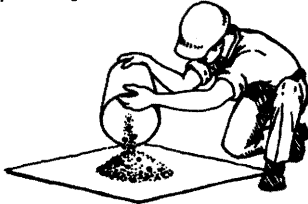


### Mechanical Splitting Method

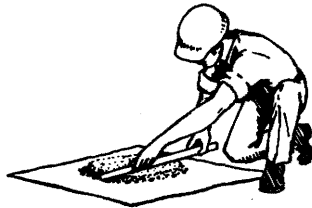
#### Sample Quartering

Sample sizes can also be reduced by quartering. The quartering method should be used when splitters are not available. Quartering simply requires a quartering cloth and a stick or rod -- and is done as follows:

1. Pour contents from sample bucket onto quartering cloth.



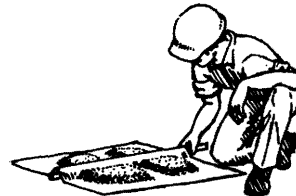
2. Level sample on quartering cloth -- using rod.



3. Insert rod under the middle of the quartering cloth and lift both ends of rod to divide the sample into two equal parts.



4. Repeat step 3, dividing the sample into four parts.

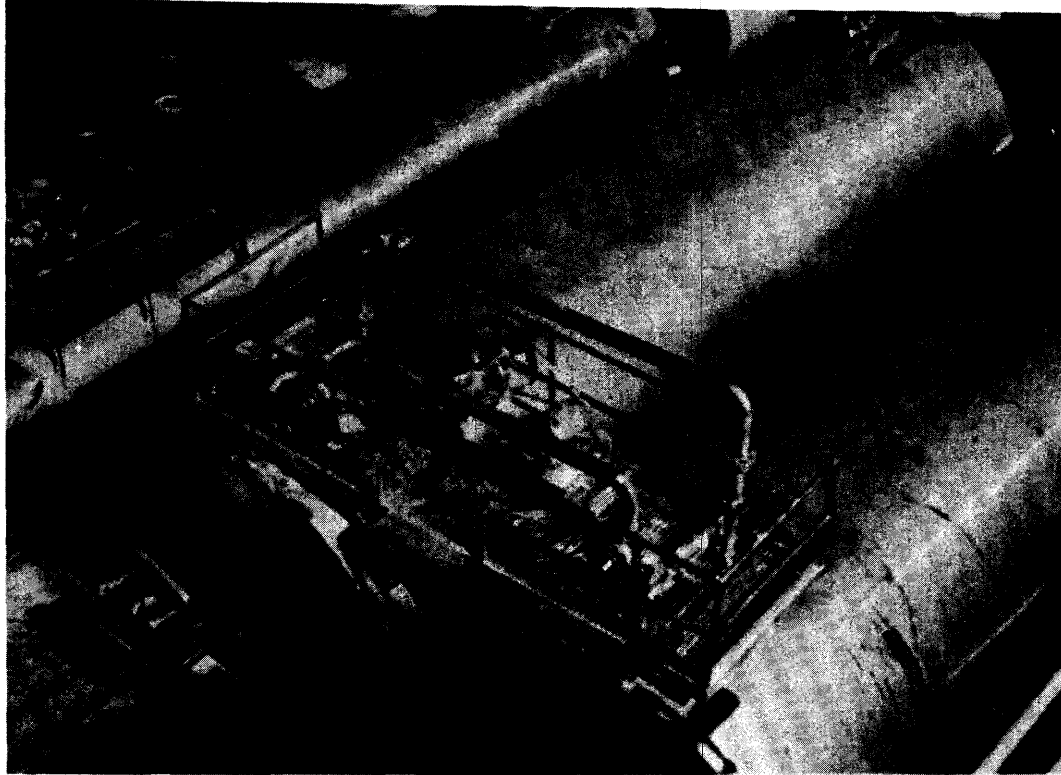


5. Retain any two diagonally opposite parts for testing.

If the sample is still not small enough, repeat the quartering procedure.

### Quartering Method

FIGURE 4.8—Aggregate Sample Reduction.



**FIGURE 4.9—A Series of Asphalt Storage Tanks.**

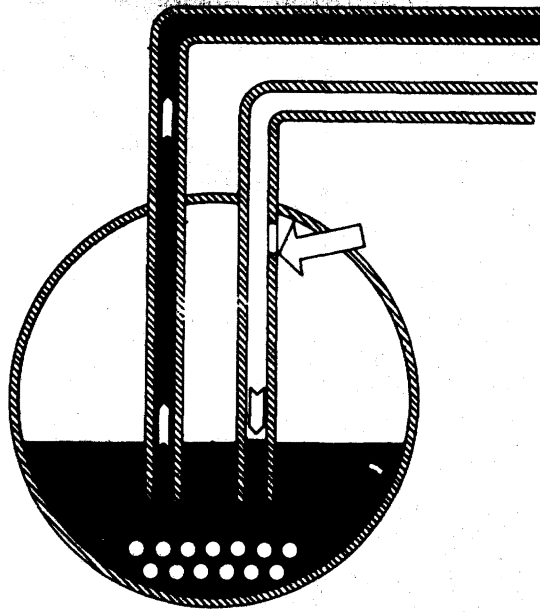
Asphalt storage tanks should be calibrated so that the amount of material remaining in the tank can be determined at any time. They also must be heated to keep the asphalt fluid enough to move through the delivery and return lines. Heating is done electrically or by circulating hot oil through coils in the tank. Regardless of the heating method used, an open flame must never come in contact with the tank.

Where circulating hot oil is used, the oil level in the reservoir of the heating unit should be checked frequently. A drop in the level could indicate leakage of the hot oil into the tank, leakage which results in contamination of the asphalt.

All transfer lines, pumps and weigh buckets also must have heating coils or jackets so that the asphalt will remain fluid enough to pump. One or more thermometers should be placed in the asphalt feed system to ensure control of the asphalt temperature. Additional information on taking asphalt temperature is found in Section 2.3.

Return lines discharging into the storage tank should be submerged below the asphalt level in the tank at all times to prevent the asphalt from oxidizing during circulation (Figure 4.10). To break the vacuum in the lines when the pump is reversed, and to clear the lines, two or three vertical slots must be cut in the return line within the tank, but above the high level mark of the stored asphalt.

A valve or a spigot may be installed in the circulating system to allow sampling of the asphalt. When sampling from the circulating system, exercise extreme care, as pressure in the lines may cause the hot asphalt to splatter.



**FIGURE 4.10—Asphalt Return Line.**

#### **4.5.D Sampling Asphalt**

Normally asphalt samples are taken from a sampling valve on a vehicle tank or storage tank. Here are a few important rules to follow when sampling asphalt:

- To ensure that samples are representative of the entire shipment, take them from the sampling valves provided for that purpose (Figure 4.11). Dip samples taken from the top of a tank are not normally representative. Other sampling methods are described in AASHTO T 40, and particular agency specifications.
- Use only new, clean, dry sample containers.
- Allow at least a quart of asphalt cement to drain out of the valve before taking samples. This cleans out the valve and the lines and helps to provide a representative sample.
- Seal filled containers immediately with clean, dry, tight-fitting lids. Wipe any spilled material from the container with a clean, dry cloth, NEVER with a cloth dipped or soaked in solvent.
- Label all containers clearly. Do not label container lids, because once a labeled lid is removed, it will be impossible to identify the sample in the container. Do all labeling with a wick marking pen. Use tags only when there is no danger of their being lost in transit.
- Follow all safety precautions for handling and storing hot asphalt. Remember, asphalt cement is hot when sampled, so wear protective clothing (gloves, face shield, long-sleeved shirt) to protect from burns and splattering.

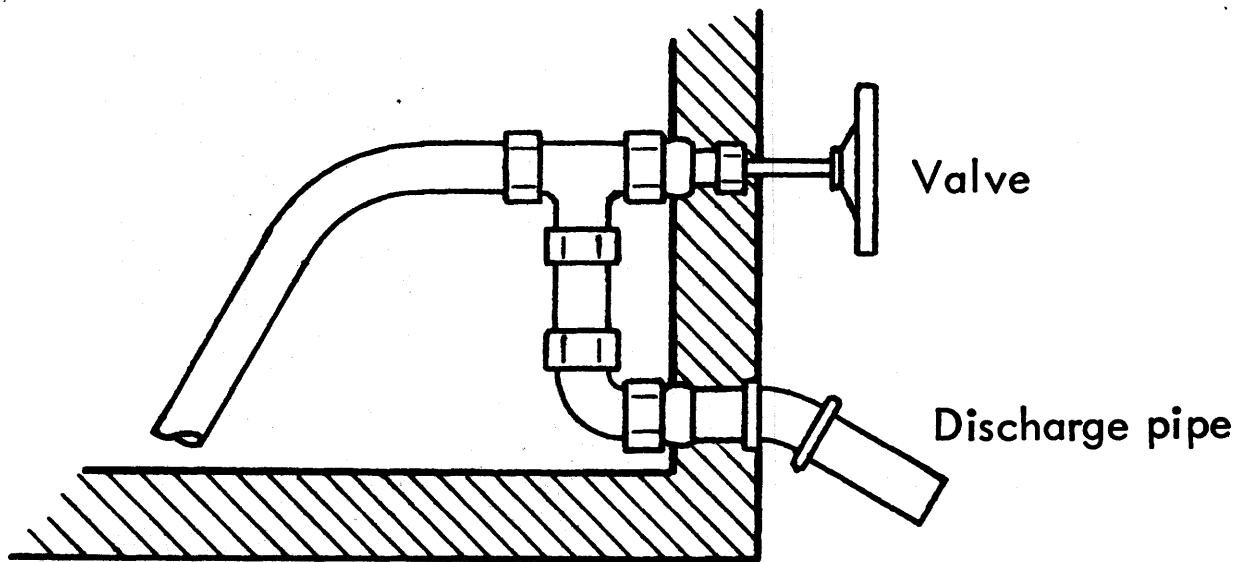


FIGURE 4.11—Asphalt Sampling Device for Vehicle or Storage Tank.

#### 4.5.E Handling and Feeding Mineral Filler

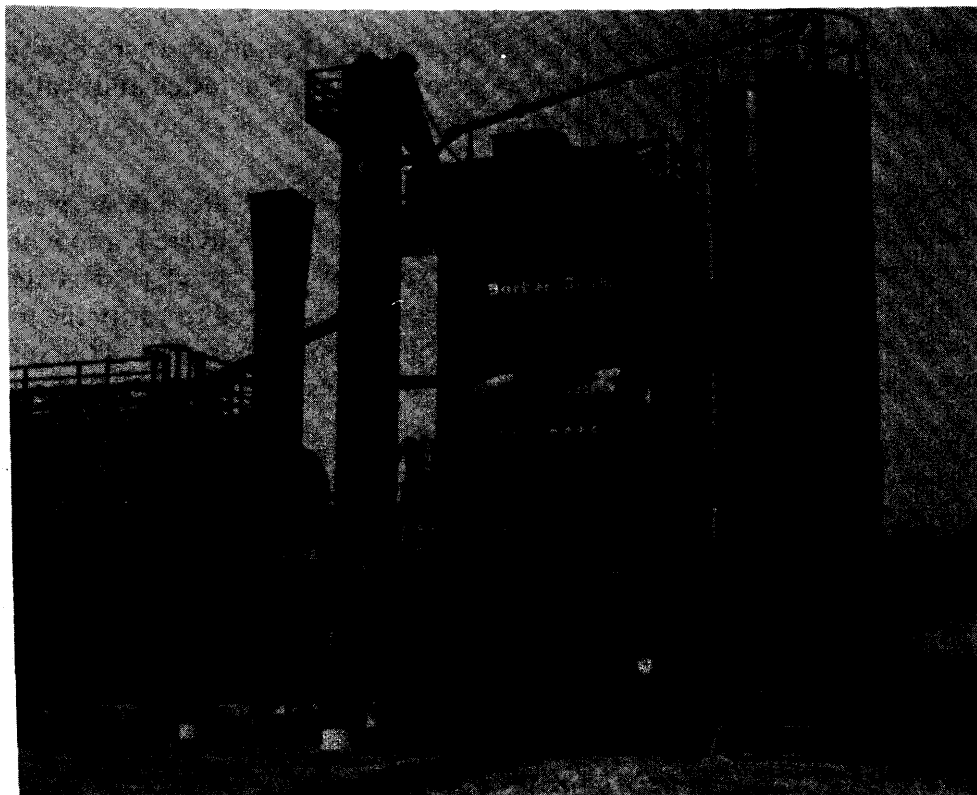
**4.5.E.1 Storage and Handling**—Mineral filler is subject to caking or hardening from moisture. Therefore, separate storage is provided to protect filler from dampness. In plant operations where fines usage is high, a bulk fines system with storage silo for maintaining several days' supply of fines is often used (Figure 4.12). Such a system can have either a pneumatic or mechanical device for feeding filler into the plant. In pneumatic systems mineral filler is entrained in an airstream and is handled as a fluid, offering accurate control and eliminating plugging.

The pneumatic system generally consists of a receiving hopper, screw conveyor, dust-tight elevator, and silo (Figure 4.12). The elevator charges the silo, from which filler is metered into the plant. The silo may also be charged directly from suitably equipped filler transport trucks. The mineral filler is normally introduced into the mix in the weigh hopper of the batch plant. In some plants a separate weighing system may be provided.

In a drum plant the mineral filler is introduced pneumatically, through a pipe, at the same location in the drum as the asphalt.

In plants where the volume of fines used does not justify a bulk silo, a bag feeding system may be used. The system consists of a ground-mounted feeder, dust-tight elevator, surge hopper, vane feeder or screw conveyor, and an overflow chute.

In both bulk and bag systems, final metering of the filler into the mix is accomplished through a variable speed vane, screw or belt feeder, depending on the material to be handled and the capacity required. In each case, the filler feed mechanism is interlocked with the aggregate and asphalt feed mechanisms to ensure uniform proportioning.



**FIGURE 4.12—Silo Filler Feeding System  
(Courtesy Barber-Greene Company).**

Filler handling also involves a plant's dust collection system. Dust collectors are designed to capture mineral filler escaping from the aggregate mixture and return it to the plant for incorporation into the hot-mix.

Where excess fines are encountered in the raw aggregate feed, a by-pass system can be employed to receive the filler collected by the dust collector. The required amount of filler is then fed back to the mix and any surplus amounts are diverted to a storage bin for disposal or other use.

**4.5.E.2 Control of Feeding—**When the mineral filler is added to the mix its proportioning must be exact. Consequently, the flow of filler into the plant must be carefully controlled and checked frequently.

The percentage of filler entering the hot-mix can be calculated very simply by measuring the amount of filler consumed by the plant during the production of a given amount of hot-mix.

When mineral filler is supplied and stored in bulk, it is generally impractical to measure the amount in storage. Instead calibration of the feeding and weighing mechanisms must be checked closely and frequently.

#### **4.5.F. Material Records**

Sufficient materials should be on hand to prevent a stop and start type of operation. All materials that are to be used in the mix should be sampled, tested and evaluated for compliance with the quality specifications for the job.

**4.5.F.1. Aggregates**—As aggregates are received at the plant site, a description of the material should be recorded, noting the date and quantity delivered, and whether or not the material has been tested before delivery. If it has been tested, the test identification number should be recorded and samples taken as required to verify the test data. The size and frequency of such check samples will vary with the policy of the specifying agency and should be spelled out in their specifications or operating manual.

If the material has not been tested before delivery, random samples should be obtained and testing done to ensure compliance with *all* specifications. At a minimum tests should be made for size and grading (sieve analysis), cleanliness (washed sieve analysis), and sand equivalent. Frequently, samples are taken for absorption, specific gravity, toughness (soundness), and tendency to strip (affinity for asphalt), and are forwarded to the central laboratory.

Records for non-pretested materials should include:

- Name of owner or seller.
- Location of supply source.
- Approximate quantity available.
- Quantity represented by each sample.

**4.5.F.2. Asphalt**—In most instances asphalt comes from a pretested source and is accepted by certification. Even so, a record must be kept of all deliveries of asphalt cement to the asphalt plant. The following information should be included in those records:

- Project identification.
- Date of delivery.
- Delivery invoice number.
- Pretest number.
- Asphalt quantity by weight or calculated volume based on direct measurement. Where the volume is calculated, the following information must be furnished:
  - a) Calibration chart identification.
  - b) Beginning measurement—before unloading.
  - c) Ending measurement—after unloading.
  - d) Temperature of asphalt.
  - e) Temperature correction factor for reducing to equivalent gallons at 60° F (15° C).
  - f) Equivalent gallons.
  - g) Sample number of check sample taken.

**4.5.F.3. Other Materials**—Similar records should be kept on all other materials, such as mineral filler additives, that are to be incorporated into the mix.

## 4.6 SIMILAR OPERATIONS: BATCH PLANTS AND DRUM-MIXERS

Certain plant operations are common to both the batch plants and drum mix plants. These operations include:

- Cold aggregate storage and feeding.
- Dust control and collection.
- Mix storage.
- Weighing and handling.

Each of these four topics is discussed under separate headings below.

Also common to all plants is the importance of uniformity and balance, both in materials used and in plant operations. Uniformity ensures that the hot-mix consistently meets job specifications. It encompasses uniformity of materials, uniformity of material proportioning, and continuous, uniform operation of all plant components. Changes in material characteristics or proportions and intermittent stops and starts in plant operations make producing a hot-mix meeting job specifications extremely difficult.

Balance involves careful coordination of all elements of production. Balancing material quantities to plant production and, balancing plant production and pavement placing operations guarantee a continuous, uniform production and placement effort.

Uniformity and balance are best ensured by careful preparation. Materials must be sampled and tested and plant components carefully inspected and calibrated before production begins.

### 4.6.A Aggregate Storage and Cold Feed

**4.6.A.1 General Description**—The aggregate storage and cold feed system moves cold (unheated) aggregate from storage into the plant.

The cold aggregate feed is the first major component of the hot-mix asphalt plant. The cold feeder may be charged by one or a combination of three methods:

- (1) Open-top bins with two, three or four compartments, usually fed by a crane clamshell bucket or by a front-end loader.
- (2) Tunnel under stockpiles separated by bulkheads. Materials are stockpiled over the tunnel by belt conveyor, truck, crane, or front-end loader.
- (3) Bunkers or large bins. These usually are fed by trucks, car unloaders, or bottom-dump freight cars emptying directly into the bunkers.

When charging the cold bins (see Figure 4.13), care should be exercised to minimize segregation and degradation of the aggregate. These can be prevented by taking the same precautions outlined for proper stockpiling. Enough materials should be maintained in all bins to provide a constant and uniform flow.

If the stockpile level above the tunnel is maintained by a dragline or clamshell, the operator must be careful not to pick up material from the same position in the stockpile in successive withdrawals.

When a front-end loader is used, the operator should not pick up material from the

storage stockpile at ground level. The scoop should be held high enough above the ground to prevent contamination when filling.

When trucks are used to charge the bin, they should deposit their loads directly above the feeder.

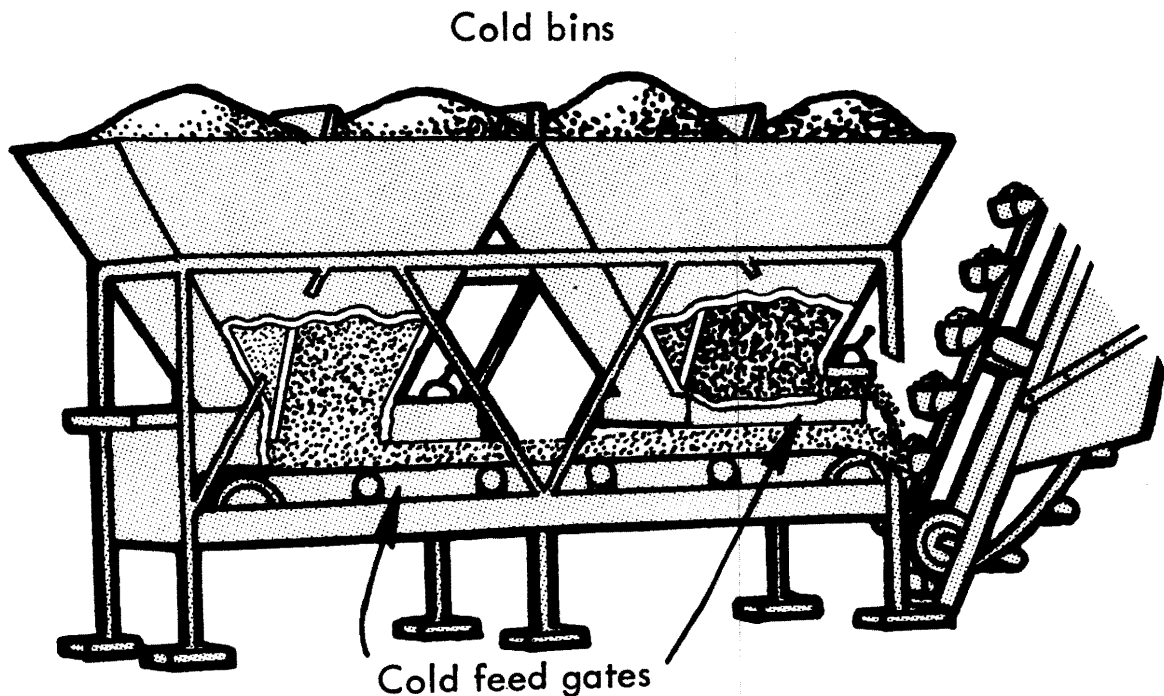
When the stockpile is replenished by overhead belts or elevating conveyors, the free falling materials should be controlled by baffles or perforated chimneys.

Aggregate feeder units should be located beneath storage bins or stockpiles, or in positions that will ensure a uniform flow of aggregates.

Gates located at the bottom of the bins feed controlled amounts of the different aggregates on to the conveyor and/or bucketline, carry the aggregates to the dryer. Feeder controls regulate the amount of aggregate flowing from each bin, thereby providing a continuous, uniform flow of properly-graded aggregate mixture to the plant.

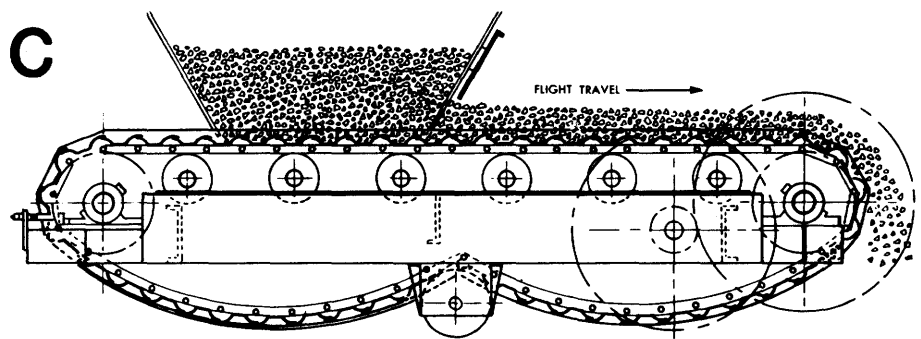
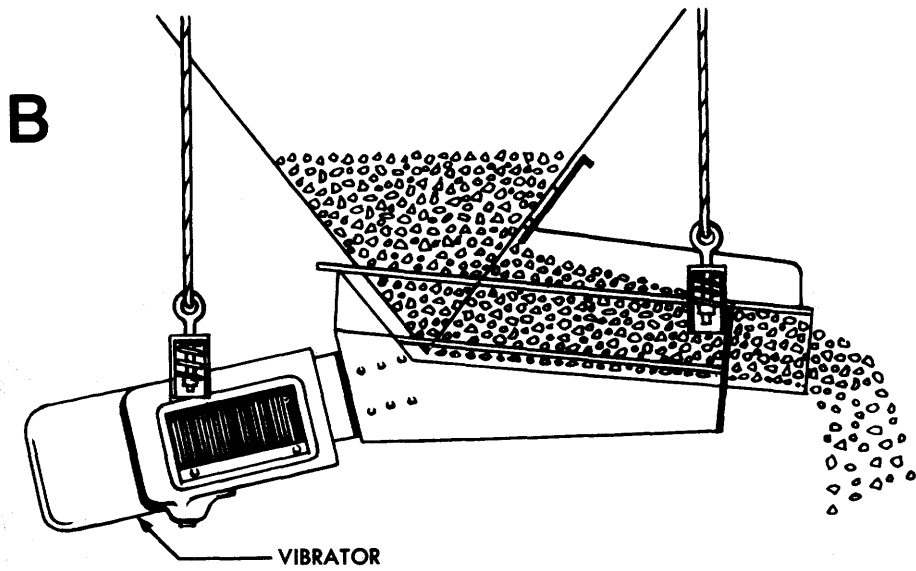
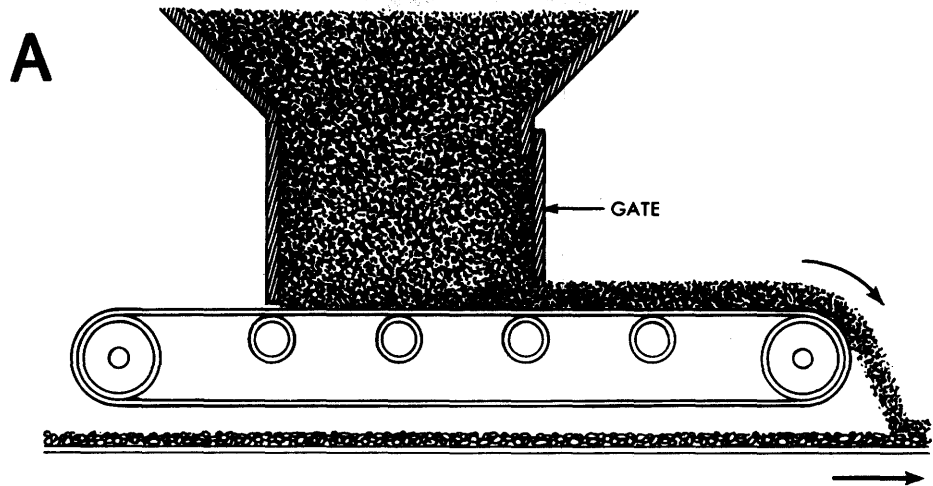
There are several different types of cold feeders. Among the most common are: (1) continuous belt type, (2) vibratory type, and (3) apron flow type. Each is illustrated in Figure 4.14.

Generally, continuous belt feeders are considered best for fine aggregates. Any of the three types of feeders are usually satisfactory for handling coarse aggregates.



**FIGURE 4.13—Typical Three-Bin Cold Feed System  
(Courtesy Tennessee Department of Transportation).**





**FIGURE 4.14—Typical Types of Cold Feed Systems: A. Continuous Belt Feeder, B. Vibratory Feeder, and C. Apron Flow Feeder.**

**4.6.A.2 Ensuring Proper Feeder Functions**—Because a uniform flow of proper-sized aggregates is so important to hot-mix production, the inspector should check before and during production to be certain that the feeder system is functioning properly. Conditions that the inspector can check to help ensure proper feeder function include:

- Correct sizes of aggregates in stockpiles and cold bins.
- No segregation of aggregates.
- No intermixing of aggregate stocks.
- Accurately calibrated, set and secured feeder gates.
- No obstructions in feeder gates or in cold bins.
- Correct speed control settings.

**4.6.A.3 Calibrating and Setting Feeders**—The cold aggregate feeder gates must be calibrated, set and secured to ensure a uniform flow of aggregate. While this calibration is the responsibility of the contractor, the inspector should be aware of methods and procedures used.

The gates should be calibrated for each type and size of aggregate used. Manufacturers often furnish approximate calibrations for gate openings for their equipment, but the only accurate way to set the gates is to prepare calibration charts based on the aggregates to be used in the mix. The inspector should examine the calibration charts of the cold feeders so that he is aware of the production rate settings used during production.

There are two methods for calibrating the cold aggregate feeders: (1) adjustable gate openings with fixed speed belt feeders, and (2) semi-fixed gate openings with variable speed belt feeders.

#### *Adjustable Gate Openings with Fixed Speed Belt Feeders*

In this method, calibration is done by first opening one gate to 25 percent or less of maximum and then starting the feeder. When the feeder is running at approximately the same rate at which it will operate during actual production, the aggregate that flows from the open gate during a certain time interval is collected in a container and weighed. If the gate being calibrated is a type that discharges directly on to the main feeder system conveyor belt, the flow of material per minute for the gate opening being checked is determined from the equation:

$$q = \frac{WR}{r(1+m)}$$

where

q = rate of flow of dry aggregate (lb. per minute)

W = weight of aggregate measured (lb.)

r = length of belt section where material was removed (in feet)

R = belt speed in feet per minute; and

m = moisture content of aggregate

(NOTE: In the interest of simplicity, only standard units are shown for calculations of aggregate calibration.)

On cold feeder systems such as continuous belt and apron flow types, where the gates discharge on to a small conveyor instead of a large, main conveyor, the flow of material can be calculated using the number of revolutions of the small belt. In doing so, the equation above is used, however,

$r$  = the number of revolutions of the small belt during aggregate collection, and  
 $R$  = belt revolutions per minute (rate of revolution).

The operation is repeated for three or more different openings of each gate. When multiple calculations have been done for each gate that will be used during production, a calibration chart is prepared. On the chart, gate openings in inches are plotted on the horizontal scale, and the dry weight of aggregate in pounds per-minute is plotted on the vertical scale.

Once the calibration chart has been constructed, the exact gate openings needed for production are determined using the required aggregate flow rate.

To do this, the following formula is used:

$$Q = \frac{TP}{3}$$

where

$Q$  = required rate of flow (lb. per minute)

$T$  = plant production (tons per hour)

$P$  = percent by weight of total mix.

The following sample problem shows the method used for developing a calibration chart (Figure 4.15) and determining proper cold-feed gate openings. Once the exact gate openings have been determined, the gates are set in proper position and secured.

The asphalt concrete mix design for the job being done requires four aggregate components: (1) coarse crushed stone (20 percent), (2) intermediate crushed stone (40 percent), (3) fine aggregate (30 percent), and (4) filler (10 percent). Each of these four components is loaded into a separate cold-feed bin.

Bin #1 contained the coarse crushed stone required for the mix. During the calibration test runs, the gate on Bin#1 was run at four different openings (2 inches, 4 inches, 6 inches, and 8 inches) and the aggregate flow was collected and weighed. Because the type of system used features the gates discharging directly on to a main conveyor in the equation  $q = \frac{WR}{r}(1-m)$ ,  $r$  = length of the belt section in feet and  $R$  = belt speed in feet per minute.

For the 2-inch gate opening, the following data were gathered from the test run:

<u>Gate opening</u> 2	<u>W (weight of aggregate in lbs.)</u> 31.5	<u>R (belt rate in feet/minute)</u> 250
<u>r (number of feet of belt from which aggregate was removed for weighing)</u> 5		<u>m (aggregate moisture content in percent)</u> 3

Using the equation,  $q = \frac{WR}{r(1+m)}$   
 $q = \frac{(31.5)(250)}{5(1+.03)}$   
 $q = 1529$

When opened 2 inches, then, the gate on Bin #1 delivered coarse aggregate at a rate of 1529 lbs./minute.

Below are shown data and rate calculation results for other Bin #1 gate openings and gate openings for the other bins.

Bin #1 Crushed Stone (coarse)

<u>Gate Opg. (in.)</u>	<u>W (lbs.)</u>	<u>R (ft./min.)</u>	<u>r (ft.)</u>	<u>m (%)</u>	<u>q (lbs./min.)</u>
2	31.5	250	5	3	1529
4	68.8	250	5	3	3340
6	83.6	250	4	3	5073
8	79.9	250	3	3	6464

Bin #2 Crushed Stone (intermediate)

<u>Gate Opg. (in.)</u>	<u>W (lbs.)</u>	<u>R (ft./min.)</u>	<u>r (ft.)</u>	<u>m (%)</u>	<u>q (lbs./min.)</u>
2	28.6	250	5	6	1349
4	59.4	250	5	6	2802
6	71.2	250	4	6	4198
8	68.7	250	3	6	5401

Bin #3 Fine Aggregate

<u>Gate Opg. (in.)</u>	<u>W (lbs.)</u>	<u>R (ft./min.)</u>	<u>r (ft.)</u>	<u>m (%)</u>	<u>q (lbs./min.)</u>
2	24.7	250	5	3	1199
4	47.4	250	5	3	2301
6	70.0	250	5	3	3398
8	86.5	250	4	3	4199

Bin #4 Filler

<u>Gate Opg. (in.)</u>	<u>W (lbs.)</u>	<u>R (ft./min.)</u>	<u>r (ft.)</u>	<u>m (%)</u>	<u>q (lbs./min.)</u>
2	18.5	250	5	4	889
4	41.6	250	5	4	2000
6	60.3	250	5	4	2899
8	74.9	250	5	4	3601

With the calibration chart completed, the proper gate openings for each cold bin can be determined. In making this determination, the discharge rate of each gate must be balanced with the discharge rates of the other gates to ensure proper gradation of the mix.

Gate openings are dependent upon the projected plant production in tons per hour. For the example problem consider the target plant production rate to be 250 tons per hour. Gate openings that will produce that rate are calculated by using the equation:

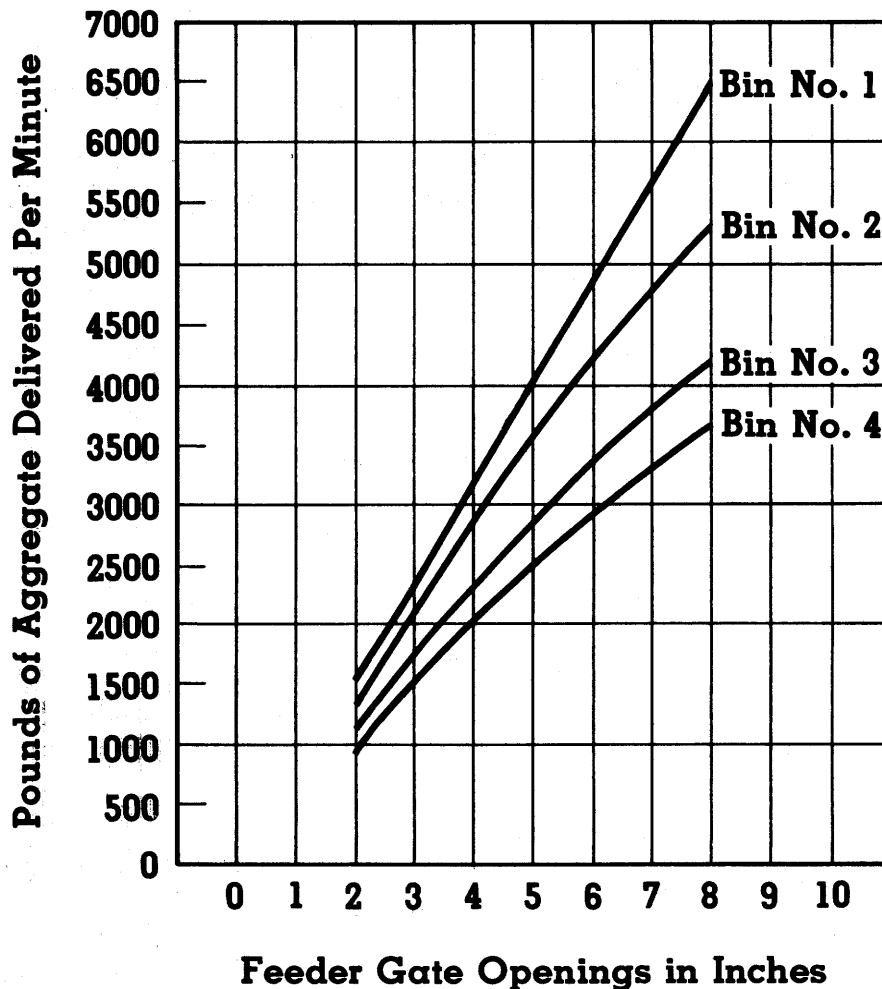


FIGURE 4.15—Example Calibration Chart for Aggregate Feeders.

$$Q = \frac{TP}{3}$$

In the example the aggregate proportions required in the job mix are:

Coarse Crushed Stone .....	20%	(Bin #1)
Intermediate Crushed Stone .....	40%	(Bin #2)
Fine Aggregate .....	30%	(Bin #3)
Filler .....	10%	(Bin #4)

The target flow rate from each bin can be calculated as shown below:

Bin #1 Crushed Stone - Coarse

$$Q = \frac{TP}{3} = \frac{250 \times 20}{3} = 1667 \text{ lbs./minute}$$

Referring to the calibration chart (Figure 4.15), we find that the Bin #1 gate opening that will allow an aggregate flow rate of 1667 lbs./ minute is  $2\frac{1}{2}$  inches. Using the same method, gate openings calculated for the other bins are:

Bin #2 .....	4½ inches
Bin #3 .....	4½ inches
Bin #4 .....	2 inches

*Semi-Fixed Gate Openings with Variable Speed Belt Feeders*

In many modern plants, the cold feed gates are not adjusted for every range, but are controlled by variable speed belt feeders and vibrating feeders (measured in revolutions per minute, [RPM] ).

To increase or decrease the amount of cold feed from a given bin, the RPM of the belt is increased or decreased according to the desired production rate.

To bring about this calibration, all cold feeds are filled with their respective sizes of aggregates. The plant is then started and the first feeder is set to run a given RPM. Once the plant is running uniformly, the amount of material discharged during a particular time period, say 30 minutes, is collected and weighed. This procedure for the same bin or feeder is repeated for at least three calibrations (20, 50, and 70 RPM, for example). The production rate for the first feeder at each of these settings is calculated and plotted on a chart similar to the one shown in Figure 4.16. The procedure is repeated for each of the remaining feeders.

To determine RPM settings for each feeder, for a selected rate of total production, a procedure similar to that shown in the preceding example is followed.

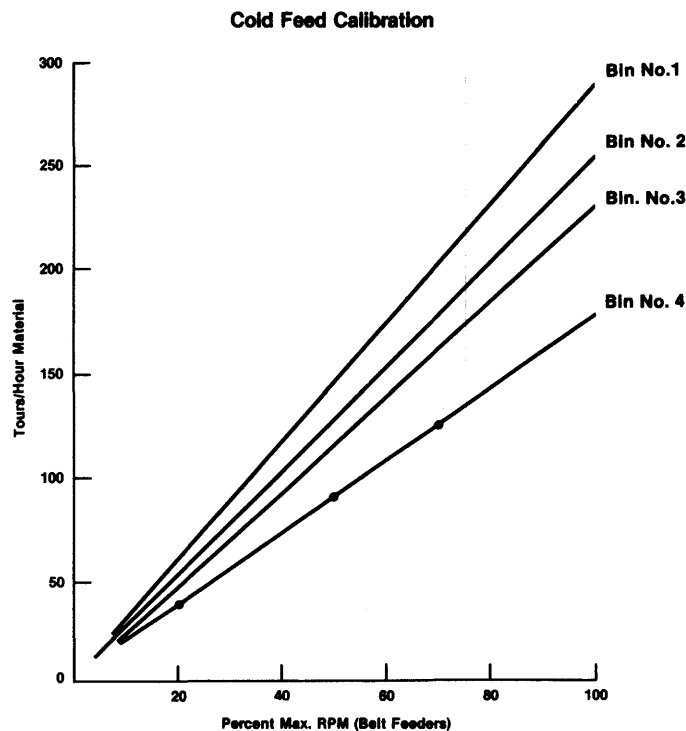


FIGURE 4.16—Calibration Chart.

Calibration information, gate opening measurements, and feeder speed (RPM) should be recorded by the inspector as part of his diary. The data are also kept on file at the plant laboratory.

#### **4.6.B. Dust Control and Collection Systems**

Enforcement of air pollution regulations or codes is usually done by the local pollution control agency. However, since the dust control system is integrated with plant operation, the inspector should at least be aware of the controls and equipment necessary to meet these standards.

**4.6.B.1 General Description**—Asphalt plant manufacturers recognize the problem of air pollution and have developed equipment that restricts the escape of pollutants from their plants. Even so, during the operation of an asphalt plant some gaseous and particulate pollutants may escape into the air. These pollutants must be limited to meet established clean air regulations. The contractor is required to be familiar with the state and local laws concerning air pollution.

Air pollution control codes and regulations affecting asphalt plants normally include a combination of stack emissions. The standard visual method uses a chart for grading the density of smoke. The chart illustrates the colors and transparency of various densities of smoke. Checks on emissions are made by matching the color and density of the exhaust plume just above the plant stack to one of the areas on the chart. The visual method does not accurately determine the amount of polluting material being released because black smoke appears denser than white dust. Consequently, more accurate electronic opacity meters, using photoelectric cells to measure the passage of light, are replacing the opacity charts.

More definitive standards are based on the quantity of particulates issuing from the stack. The most common requirement sets an upper limit on the weight of the particles being released as compared to the volume of gas released with them. Other standards relate the quantity of particulates emitted to the weight of the material being produced.

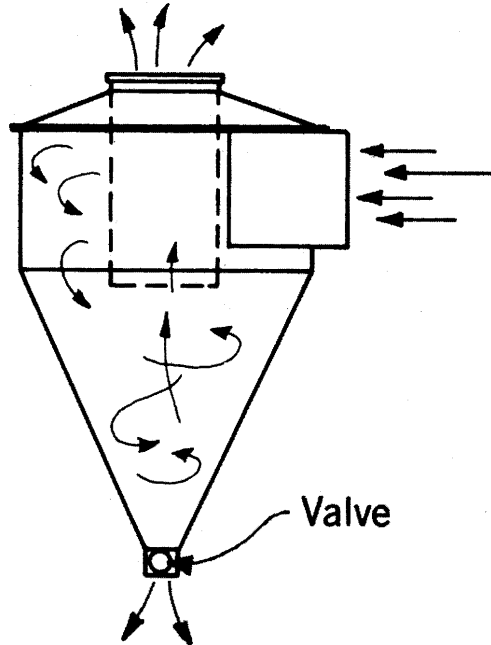
A major air pollution concern at an asphalt plant centers around the combustion unit. Dirty, clogged burners and improper air-fuel mixtures result in excessive smoke and other undesirable combustion products. Continual close attention to the cleanliness and adjustment of the burners and accessory equipment is important.

Another source of air pollution at an asphalt plant is aggregate dust. Dust emissions are greatest from the plant's rotary dryer, where dust collectors commonly are used to meet anti-air-pollution requirements.

Three types of dust collectors are commonly used to capture the dust from the dryer. They are the centrifugal dust collectors, wet scrubbers, and baghouses (fabric filters). Each type is discussed below. When the aggregate is especially dusty, two or more of these devices may have to be used in sequence.

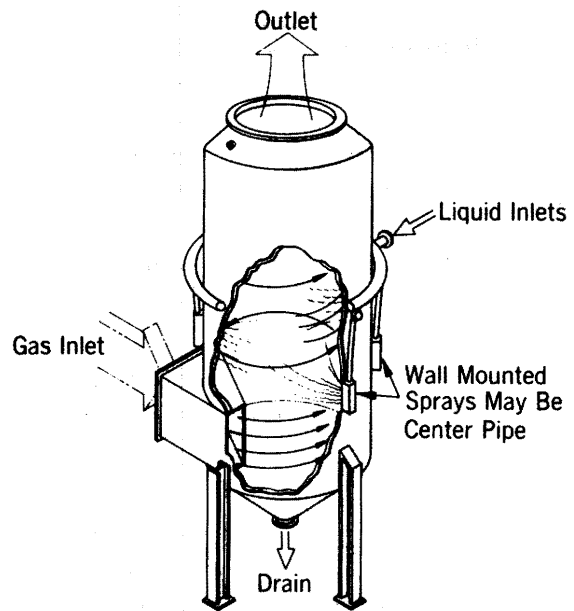
Some of the dust emitted from a plant is fugitive dust—dust escaping from parts of the plant other than the primary dust collectors. A scheduled maintenance program is required to keep fugitive dust to a minimum.

**4.6.B.2 Centrifugal Dust Collectors**—Centrifugal dust collectors (cyclone type collectors) operate on the principle of centrifugal separation. The exhaust from the top of a dryer sucks the smoke and fine materials into the cyclone where it is spiralled around (Figure 4.17). Large particles hit the outside wall and drop to the bottom of the cyclone; dust and smoke are discharged through the top of the collector. The fines collected at the bottom of the cyclone are picked up by a dust-return auger and may be returned to the plant or wasted.



**FIGURE 4.17—A Typical Cyclone Dust Collector.**

**FIGURE 4.18—Typical Wet Scrubber.**





Wet scrubbers are relatively efficient devices, however, they have certain drawbacks. First, the dust entrapped in the water is not recoverable. Second, the waste water containing the dust must be properly handled to prevent it from becoming another source of pollution. Additionally, wet scrubbers need a large source of water, since they can use more than 300 gallons per minute. Most wet scrubbers are used in combination with a cyclone collector. The cyclone collects coarser materials and the wet scrubber removes the fines.

**4.6.B.4 Baghouses (Fabric Filters)**—A baghouse (Figure 4.19) is a large metal housing containing hundreds of synthetic, heat-resistant fabric bags, usually silicone-treated to increase their ability to collect very fine particles of dust. A baghouse functions much the same way as a vacuum cleaner. A large vacuum fan creates a suction within the housing, which draws in dirty air and filters it through the fabric of the bags. To handle the huge volume of exhaust gases from the aggregate dryer, a very large number of bags (a typical unit may contain as many as 800) are required.

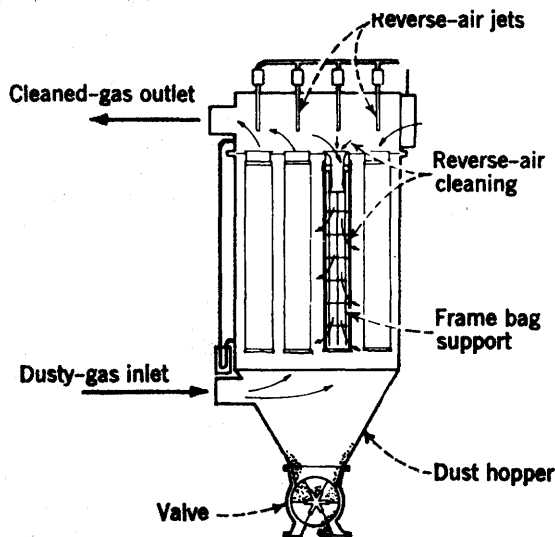
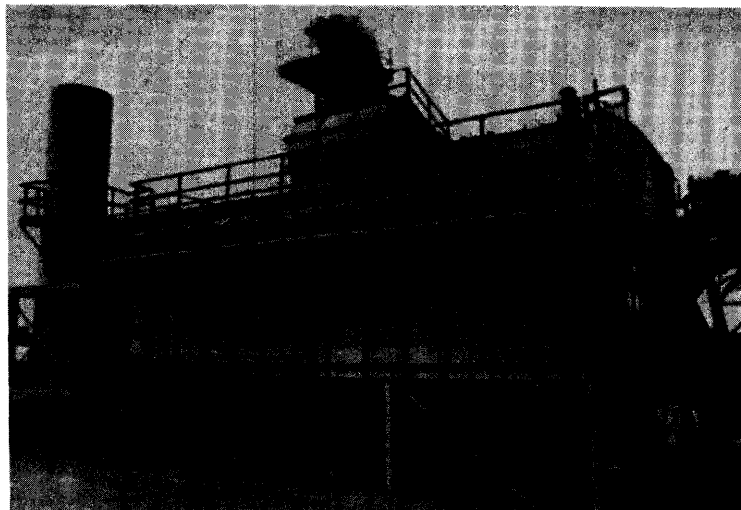


FIGURE 4.19—Typical Baghouse.



In the past, centrifugal dust collectors have been the most common type used, especially in rural areas. However, under today's more stringent pollution laws, the centrifugal dust collectors are usually used in combination with another type—either a wet scrubber or a baghouse.

**4.6.B.3 Wet Scrubbers**—The purpose of a wet scrubber (Figure 4.18) is to entrap dust particles in water droplets and remove them from the exhaust gases. This is done by breaking up the water into small droplets and bringing those droplets into direct contact with the dust-laden gases. As the figure illustrates, gases from the dryer are introduced into a chamber through one inlet while water is sprayed into the chamber from nozzles around the periphery.

A baghouse is divided into a dirty gas chamber and a clean gas chamber. The filter bags are contained in the dirty gas chamber, into which the air from the dryer enters. The flow of air carrying the dust particles passes through the fabric of the filter bags, depositing the dust on the surface of the bag. The air then continues on to the clean gas chamber. During operation the fabric filter traps large quantities of dust. Eventually, the dust accumulates into a “dust cake” which must be removed before it reduces or stops the flow of gas through the filter. There are many ways of cleaning the bags in a collector, but the most common methods are to flex the bags, back-flush the bags with clean air, or both flex and back-flush. Dust removed from the bags drops into an auger at the bottom of the baghouse and is transferred to a storage silo, often for use in the hot mix.

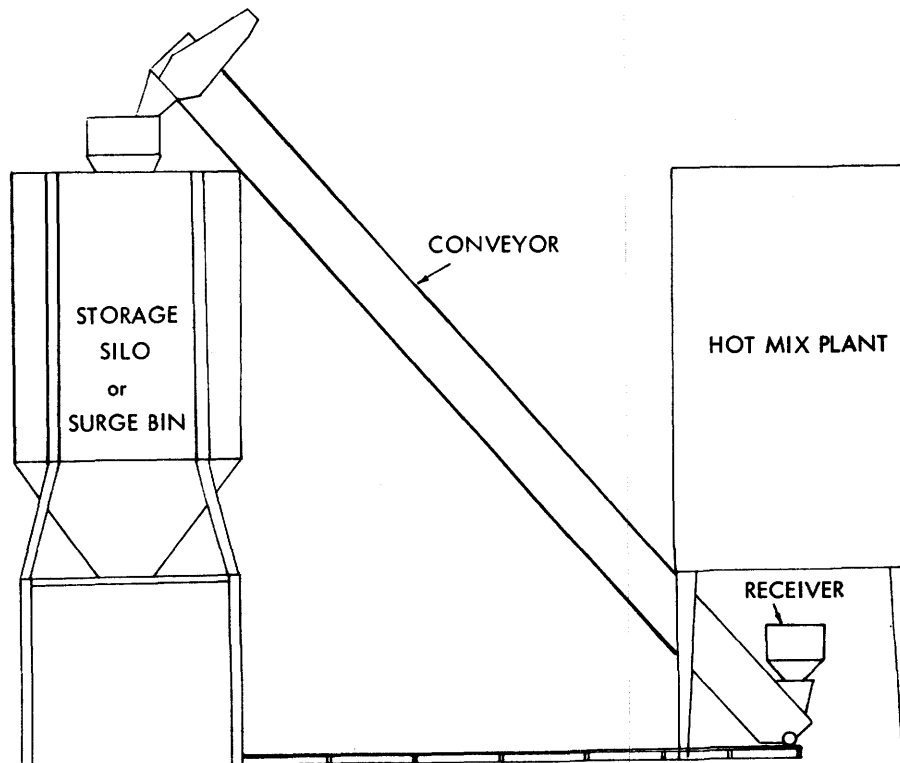


FIGURE 4.20—Typical Storage Structure Configuration.

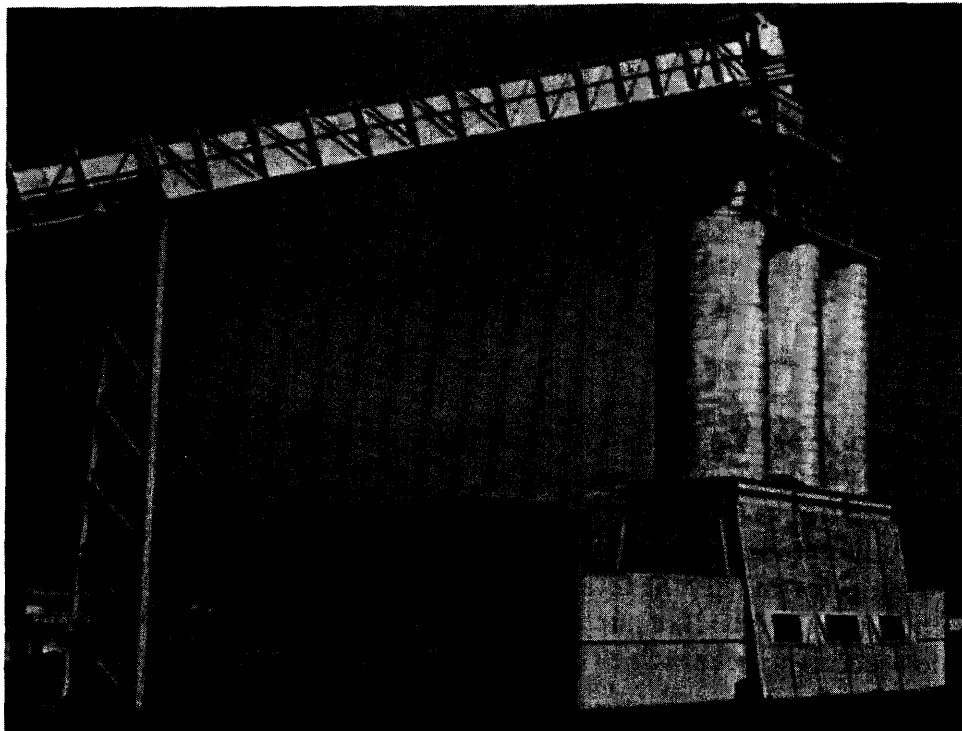
#### **4.6.C Hot-Mix Storage**

To prevent plant shutdowns due to temporary interruptions of paving operations or shortages of trucks to haul material from the plant to the paving site, most asphalt plants are equipped with storage silos (surge bins) for temporary storage of asphalt hot mix. Newly-made hot-mix is deposited by conveyor or hot elevator into the top of the bin or silo (Figure 4.20) and is discharged into trucks from the bottom. Insulated silos or bins (Figure 4.21) can store hot-mix up to 12 hours with no significant loss of heat or quality. Capacities range as high as several hundred tons. Non-insulated storage structures are usually quite small and can store hot-mix only for short periods of time.

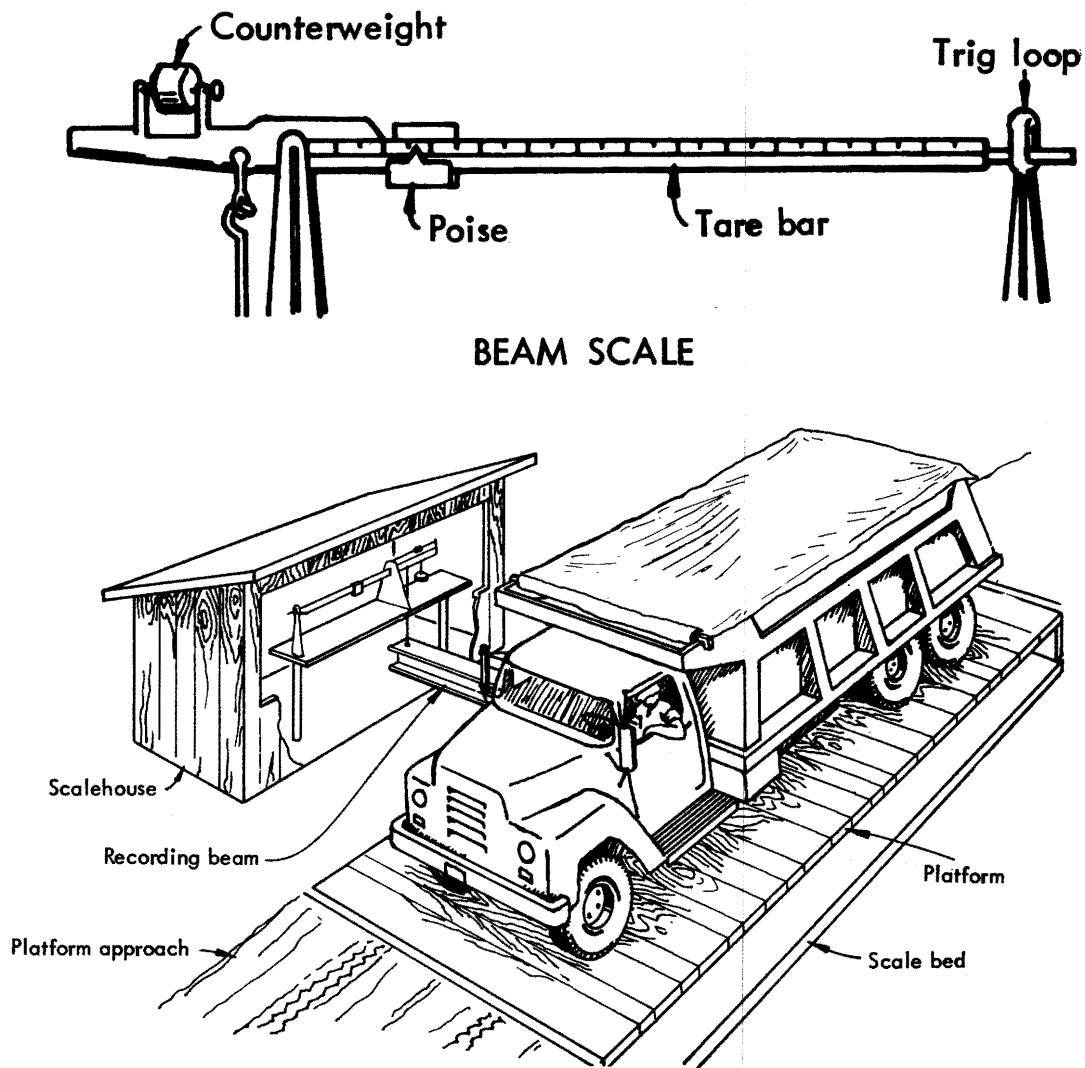
Storage silos work well if certain precautions are followed, but they can cause segregation of the mix if not used properly. It is good practice to use a baffle plate or similar device at the discharge end of the conveyor used to load the silo. The baffle helps to prevent the mix segregating as it drops into the bin. It is also recommended to keep the hopper at least one-third full to avoid segregation as the hopper empties and to help to keep the mix hot.

#### **4.6.D Weighing and Hauling**

Asphalt hot-mix is hauled to paving sites in trucks. Hauling trucks vary by size and type, but uniformity of equipment is very desirable in any hot-mix paving operation. The trucks should be inspected carefully before use. For accurate material control, truckloads of hot-mix must be weighed at the plant.



**FIGURE 4.21—Large-Capacity Insulated Asphalt Concrete Storage Silos.**



**FIGURE 4.22—Typical Truck Scale and Platform.**

**4.6.D.1 Determining The Weight of Material Delivered**—The quantity of hot-mix delivered from plant to paving site can be determined by either of two methods: (1) weighing loaded trucks on scales, or (2) using a plant's automatic recording system (in the case of fully-automated plants). When truck scales are used they must be of the type which indicates directly the total weight of the truck. They must be horizontal and of sufficient size to weigh all of a truck's axles at one time. The most common type of truck scale used is the beam scale (Figure 4.22).

The accuracy of truck scales must be checked periodically. For this purpose, the contractor loads a truck with some type of material, weighs the loaded truck on the scales, and then weighs it on another set of certified truck scales. Truck scales must also be balanced before use.

During a normal day's operation, the inspector should check frequently to make sure that the scale is in balance. The scale can be thrown out of balance when trucks leave mud or other foreign matter on the platform. If there is very little foreign matter on the platform, the scale can be rebalanced by adjusting the counterweight. If adjusting the counterweight will not balance on the scale, the platform will have to be cleaned. If, after the platform is cleaned, the scale still does not balance, plant operations must be stopped until the scale is working properly.

In addition to periodic checks of the scale and platform, each truck must be randomly tared (weighed when empty) and a permanent record of the tare weight maintained in the scale house.

Electronic automated printout weigh tickets are now accepted by a number of states and other agencies. These tickets usually will contain the gross, tare and net weights.

#### **4.7 INSPECTION OF HOT-MIX**

The plant inspector's duties do not end with checking weights of truckloads. He must also make frequent visual checks of the mix as it is being discharged from the plant into the truck and as it is leaving the plant on the way to the paving site. Many serious problems in the mix can be detected by a careful visual inspection.

Temperature control is stressed in all phases of hot-mix asphalt production. It is a primary factor in controlling quality. A visual inspection can often detect whether or not the temperature of a load of mix is within the proper range. Blue smoke rising from a truckload of mix is often an indication of overheating. If the mix temperature is too low, the mix may appear sluggish as it is deposited in the truck and may show a nonuniform distribution of asphalt. An abnormally high peak in a truckload may also indicate underheating.

An abnormally high peak can also be an indication that the asphalt content of the mixture is too low. On the other hand, if the mix slumps (fails to peak properly) in the truck, it may be due to excessive asphalt or excessive moisture.

There are many common causes of visible nonuniformity in the mix. Figure 4.23 is a handy reference by which the inspector can identify problems in mixes and possible causes of those problems.

Although visual inspections are important, they are not enough. The inspector must also take measurements. The most common measurement is that of the mix temperature. Normally the temperature of the completed asphalt concrete mixture is taken in the truck. The inspector should always let the truck drivers know what he is doing so the truck remains stationary during mix inspections.

The best way to determine the temperature of the mix is with a dial and armored-stem thermometer (Figure 4.24). The stem should be inserted sufficiently deep (at least 6" [150 mm], into the mixture, and the material should be in direct contact with the stem.

A gun-type infrared thermal meter may also be used. It is an instrument that measures reflective heat from a surface. Because an infrared thermal meter detects only surface heat, its temperature readings may not be accurate for material in the middle of the load. To overcome this problem, the inspector should aim the instrument at the stream of mix as it leaves the discharge gate of the mixer or surge bin.

Aggregates Too Wet	Inadequate Bunker Separation	Aggregate Feed Gates Not Properly Set	Over-Rated Dryer Capacity	Dryer Set Too Steep	Improper Dryer Operation	Temp. Indicator Out of Adjustment	Aggregate Temperature Too High	Worn Out Screens	Faulty Screen Operation	Bin Overflows Not Functioning	Leaky Bins	Segregation of Aggregates in Bins	Carryover in Bins Due to Overloading Screens	Aggregate Scales Out of Adjustment	Improper Weighing	Feed of Mineral Filler Not Uniform	Insufficient Aggregates in Hot Bins	Improper Weighing Sequence	Insufficient Asphalt	Too Much Asphalt	Faulty Distribution of Asphalt to Aggregates	Asphalt Scales Out of Adjustment	Asphalt Meter Out of Adjustment	Undersize or Oversize Batch	Mixing Time Not Proper	Improperly Set or Worn Paddles	Faulty Dump Gate	Asphalt and Aggregate Feed Not Synchronized	Occasional Dust Shakedown in Bins	Irregular Plant Operation	Faulty Sampling	
		A																														Asphalt Content Does Not Check Job Mix Formula
	A	A						B	B	B	B	A	A	B	B	B	A							B	B	B	C	B			A	Aggregate Gradation Does Not Check Job Mix Formula
	A	A						B	B	B	A	A	B	B	B	A								B	B			C	B		A	Excessive Fines in Mix
A			A	A	A	A	A																						A		Uniform Temperatures Difficult to Maintain	
										B			B	B										B								Truck Weights Do Not Check Batch Weights
														B	B						A	A	B	C	B	B	C					Free Asphalt on Mix in Truck
																		B								B						Free Dust on Mix in Truck
A			A	A	A	A													A		A	B	C	B	B	B	C		A			Large Aggregate Uncoated
								B	B	A	A	A	B	B	B	A	B				A	B	C	B	B	B	C	B	A			Mixture in Truck Not Uniform
																	B				A		B	B	B				A			Mixture in Truck Fat on One Side
					A																A	A	B	C	B			C		A		Mixture Flattens in Truck
	A				A	A	A																						A			Mixture Burned
A			A	A	A	A		B											A		B	C	B				C		A			Mixture Too Brown or Gray
													B	B	B	A					A	A	B	C	B			C		A		Mixture Too Fat
					A	A	A																						A			Mixture Smokes in Truck
A			A	A	A	A																							A			Mixture Steams in Truck
					A	A	A												A										A	A		Mixture Appears Dull in Truck

Types of Deficiencies That May Be Encountered in Producing Plant-Mix Paving Mixtures.

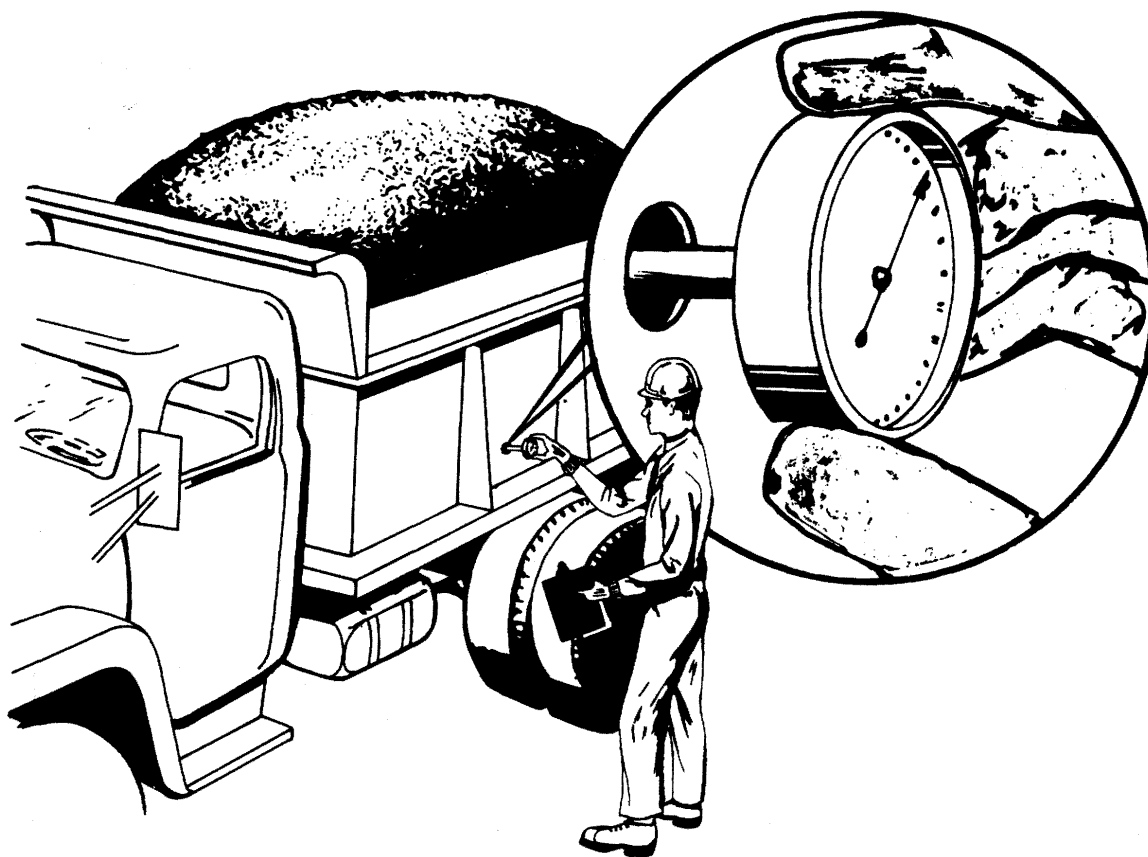
FIGURE 4.23—Possible Causes of Deficiencies in Hot Plant-Mix Paving Mixtures. A—Applies to Batch and Drum Mix Plants; B—Applies to Batch Plants; C—Applies to Drum Mix Plants.

Infrared thermal meters give fast general readings, but should be used with extreme caution in determining contract compliance. Frequent calibration checks are necessary, because the adjustment knob is easy to move accidentally.

#### 4.8 HOT-MIX SAMPLING AND TESTING

##### 4.8.A Purpose

Sampling and testing of hot-mix asphalt concrete are the two most important functions in plant control. Data derived from sampling and testing determines



**FIGURE 4.24—Measuring Temperature of Mix in Truck.**

whether or not the final product meets specifications. For this reason, sampling and testing procedures must be followed exactly to ensure that results give a true picture of mix qualities and characteristics.

In many cases, the inspector must both sample and test material. In other cases, he may simply be responsible for sampling. Regardless of his responsibilities on a particular project, a competent inspector must be able to get representative samples, conduct field laboratory tests, and interpret test data. Without these abilities, he is unable to determine accurately whether or not the paving mixture meets job criteria.

#### **4.8.B Scheduling**

A schedule of sampling and testing procedures normally will be specified by the contracting agency. The schedule includes information on the frequency, size and location of sampling, as well as tests to be performed. Figure 4.25 presents a suggested sampling and testing schedule.

Sample of	(1) Minimum Sample Frequency	(2) Minimum Size of Sample	Test to be Performed	Test Method Designation
Uncompacted Mix	2 Daily	20 lbs. (9.0 kg)	Complete Extraction	AASHTO T-168 (ASTM D 979) AASHTO T-164 (ASTM D 2172) AASHTO T-30
Uncompacted Mix	2 Daily	15 lbs (6.8 kg)	Density Stability	AASHTO T-209 (ASTM D 2041) Project Specification Requirements

Notes:

(1) Sample frequency will be governed by instructions of the contracting agency and by the immediate conditions surrounding the given project.

(2) Sample size may be governed by instructions of the contracting agency. For special conditions sample size may vary.

FIGURE 4.25—Suggested Schedule of Sampling and Testing.

#### 4.8.C Sampling

The most important consideration in sampling is to be certain that the sample taken is representative of the entire load of mix from which the sample is taken. Procedures for taking samples, labeling sample containers and preventing sample contamination are described in Section 4.5, *Materials*.

#### 4.8.D Testing

In addition to testing hot mix temperature (Section 4.7, Inspection of Hot-Mix), there are a number of tests used to determine whether or not hot-mix meets job specifications. They include:

- Extraction test.
- Sieve analysis test.
- Density and stability analysis.

**4.8.D.1 Extraction Test (AASHTO T 168)**—An extraction test measures asphalt content and provide aggregate for gradation analysis. It is the final check on all individual operations that have gone into producing the mixture and can be of considerable assistance in evaluating mix quality.

When the test shows repeated fluctuations in extractins and gradings, careful inspection should be made of the cold feeders, screen deck, paddles, and asphalt spray bar. In addition, mixing time and proportioning should be checked.



**4.8.D.2 Sieve Analysis Test (AASHTO T 11 T 27)**—A sieve analysis should be performed on the extracted aggregate as a check on the gradation specification (mix design).

**4.8.D.3 Density and Stability Analysis (AASHTO T 209, T 245 or T 246 and T 247)**—Density determinations of the finished pavement are necessary to ensure proper consolidation of the mix. These tests are run on samples submitted by the paving inspector. Ordinarily, specifications require that a pavement be compacted to a minimum percent of either maximum theoretical density, or of density obtained by laboratory compaction. In the former use, the plant inspector should obtain specific gravities of the various mix components from the central laboratory in order to compute the theoretical density. When density is expressed in terms of the density of laboratory-compacted specimens, these specimens must be compacted and their actual density measured according to the method designated by the contracting agency.

Representative samples of the hot mixture are lifted at the mixing plant and check-tested for design properties. (See Figure 3.19 or Figure 3.31).

#### **4.8.E INSPECTION RECORDS**

The inspector must keep adequate records. Records furnish the basis on which compliance with specifications is determined and on which payments are made. They should, therefore, be clear, complete, and accurate. Records also provide a history of the construction and the materials that went into the project. As such, they furnish a basis for all future studies and evaluation of the project.

To be valid, records and reports must be completed at the time of a given test or measurement, and kept up to date. A diary should be kept on every project. The initial entry should record standard information: the project number, plant location, type and make of plant, source of materials, names of key personnel, and other pertinent data. Any changes in this basic information should be recorded as they occur. In addition to dates and routine weather comments, the diary should include a narrative describing principal plant activities and daily operations. Unusual events should be noted, particularly those which might have an adverse effect on the paving mix.

Figure 4.26 shows a sample Preliminary Inspection Report that the inspector can use together with the checklist (Figure 4.27) when inspecting plant condition. The preliminary reports used on a particular job may vary from the sample; however, the items included will probably be similar.

Figure 4.28 presents a series of check lists that the inspector can use in evaluating plant conditions and readiness for production. Notice that the list includes items to be checked for all plants, as well as items relating only to inspection of either batch plants or drum-mix plants. The inspector should keep this check list in mind when studying the following sections on batch plants and drum-mix plants.

**PRELIMINARY INSPECTION REPORT—HOT-MIX PLANT**

Project \_\_\_\_\_ County \_\_\_\_\_ State \_\_\_\_\_ Date \_\_\_\_\_

**Plant Information**

Type of Plant: Batch \_\_\_\_\_ Drum Mixer \_\_\_\_\_ Permanent \_\_\_\_\_ Portable \_\_\_\_\_  
 Make \_\_\_\_\_ Model or Serial No. \_\_\_\_\_

General Condition \_\_\_\_\_

Stockpiles:	No.	Aggr. Size	Type of Feeder	Remarks

Source of Aggregate \_\_\_\_\_

Stockpile Partitions or Bulkheads: Adequate \_\_\_\_\_ Inadequate \_\_\_\_\_

Method of Handling Stockpiles to Feeders: Clam \_\_\_\_\_ Loader \_\_\_\_\_ Other \_\_\_\_\_

If other, explain \_\_\_\_\_

Remarks (stockpile) \_\_\_\_\_

Dryer: Make \_\_\_\_\_ Model No. \_\_\_\_\_ Size: Dia. \_\_\_\_\_  
 Fuel \_\_\_\_\_ Type of Burner \_\_\_\_\_ Rated Cap. \_\_\_\_\_

Remarks \_\_\_\_\_

Heat Indicating Device: \_\_\_\_\_

Make \_\_\_\_\_ Limit \_\_\_\_\_ Graduated to \_\_\_\_\_ Degrees

Is it adjustable? \_\_\_\_\_ Time required for 10° change \_\_\_\_\_

Location of Tube \_\_\_\_\_

Remarks \_\_\_\_\_

Dust Collector: \_\_\_\_\_

Make \_\_\_\_\_ Type \_\_\_\_\_

Control of Return \_\_\_\_\_

Remarks \_\_\_\_\_

**Plant Storage Bins and Screens:**

Bin #	Screen Opening	Screen Area	Avg. Aggr. Size	Condition of Overflow Pipes	Remarks

Carryover - Bin No. 2 \_\_\_\_\_ No. 3 \_\_\_\_\_ No. 4 \_\_\_\_\_

Remarks \_\_\_\_\_

Scales	Make	Type	Capacity	Graduations	Date Sealed
Aggregate					
Asphalt					
Platform					

(Page 1)

**FIGURE 4.26—Preliminary Inspection Report.**

**<sup>1</sup>Test Hopper** \_\_\_\_\_  
**Remarks** \_\_\_\_\_  
 \_\_\_\_\_

**<sup>1</sup>Pugmill: Make** \_\_\_\_\_ **Capacity** \_\_\_\_\_ **R.P.M.** \_\_\_\_\_  
**Condition of pugmill and paddles** \_\_\_\_\_  
 \_\_\_\_\_

**<sup>1</sup>Pugmill Timing Device:** \_\_\_\_\_  
**Make** \_\_\_\_\_ **Accuracy** \_\_\_\_\_  
**Type of signal** \_\_\_\_\_ **Interlocking? Yes** \_\_\_\_\_ **No** \_\_\_\_\_  
**Remarks** \_\_\_\_\_  
 \_\_\_\_\_

**Asphalt Line Thermometer:** \_\_\_\_\_  
**Make** \_\_\_\_\_ **Limits** \_\_\_\_\_ **Gradations** \_\_\_\_\_  
**Location** \_\_\_\_\_

**Asphalt Tanks: No. and Capacities** \_\_\_\_\_  
**Circulating Pipe Discharge End below Asphalt Surface? Yes** \_\_\_\_\_ **No** \_\_\_\_\_  
**Method of Heating** \_\_\_\_\_  
**Tanks Calibrated? Yes** \_\_\_\_\_ **No** \_\_\_\_\_ **Automatic Plant Cut-off** \_\_\_\_\_  
**Remarks** \_\_\_\_\_  
 \_\_\_\_\_

**<sup>1</sup>Storage Bin Signal System:** \_\_\_\_\_  
**Type** \_\_\_\_\_ **Automatic Cut-off Yes** \_\_\_\_\_ **No** \_\_\_\_\_  
**Remarks** \_\_\_\_\_  
 \_\_\_\_\_

**<sup>2</sup>Asphalt Fluidmeter:** \_\_\_\_\_  
**Make** \_\_\_\_\_  
**Asphalt Lines and Pump-Steam Jacketed? Yes** \_\_\_\_\_ **No** \_\_\_\_\_  
**Remarks** \_\_\_\_\_  
 \_\_\_\_\_

**<sup>2</sup>Auto. Plant Aggregate Feeders:** \_\_\_\_\_  
**Mechanical** \_\_\_\_\_ **Electric** \_\_\_\_\_ **Interlocking with asphalt pump? Yes** \_\_\_\_\_ **No** \_\_\_\_\_  
**Revolution Counter** \_\_\_\_\_ **Reads to** \_\_\_\_\_ **Revolution** \_\_\_\_\_  
**Remarks** \_\_\_\_\_  
 \_\_\_\_\_

**Sampling Facilities: From Storage Bins** \_\_\_\_\_  
**Type of Sampling Device** \_\_\_\_\_  
**From Asphalt Tanks** \_\_\_\_\_  
<sup>2</sup>**From Automatic Feeders** \_\_\_\_\_

**Additional Information and Remarks** \_\_\_\_\_  
 \_\_\_\_\_  
 \_\_\_\_\_

**Inspected By** \_\_\_\_\_ **Approved By** \_\_\_\_\_  
 Plant Technician Resident Engineer

<sup>1</sup>Pertains to batch plants only.  
<sup>2</sup>Pertains to drum mix plants only.

(Page 2)

FIGURE 4.26—Preliminary Inspection Report. (Continued)

# **INSPECTOR'S PLANT CHECK LIST**

## **Check List For Material Handling and Storage**

1. Do aggregates meet specifications?
2. Are proper sizes being produced?
3. Is aggregate storage satisfactory?
4. Are stockpiles separated properly?
5. Are stockpiles constructed properly?
6. Is stockpiled aggregate handled correctly?
7. Is segregation being controlled?
8. Is mineral filler being kept dry?

## **Check List for Cold Feed**

1. Does cold feed set-up comply with specifications?
2. Do cold feed bins contain proper size aggregates?
3. Are cold feed bins charged properly?
4. Do cold aggregate feeders perform satisfactorily?
5. Are cold aggregate feeders calibrated?
6. Are cold aggregate feeder gates set correctly?
7. Are all cold aggregates feeding continuously?

## **Check List for Asphalt Heating, Circulating and Temperature of Mixture**

1. Is asphalt uniformly heated to the temperature specified?
2. Have all lines been checked for leaks?
3. Is the specified temperature of the mixture and its components being maintained?

## **Check List for Drum Mix Plant**

1. Have aggregate feeds been calibrated?
2. Has asphalt feed been calibrated?
3. Are aggregate and asphalt feeds interlocked?
4. Are all plant parts in good condition and adjustment?
5. Is the asphalt at the proper temperature when introduced into the drum?

## **Check List for Batch Plant**

1. Do scales comply with specifications?
2. Have scales been calibrated?
3. Have scales been checked for tolerance?
4. Does asphalt bucket tare properly?
5. Does weigh box hang free?
6. Are mixer parts in good condition and adjustment?
7. Is proper size batch being mixed?
8. Is bin withdrawal in proper sequence?
9. Is asphalt distribution uniform along the pugmill?

**FIGURE 4.27—Plant Check List.**

10. Are aggregates and asphalt at proper temperatures when introduced into the weighing receptacles?
11. Do any valves or gates leak?
12. Is mixing time adequate?
13. Are scale points set properly for batch weights?
14. Are mixer shafts revolving at proper speed?
15. Are the screen capacities sufficient to handle the maximum feed from the dryer?
16. Are screens clean?
17. Are screens worn or broken?
18. Is the carry-over irregular or excessive?
19. Are hot bin partitions sound?
20. Are overflow chutes free-flowing?
21. Is bin balance being maintained?
22. Is access for sampling adequate?

#### **Check List for Dryer and Drum Collector**

1. Do dryer and dust collector comply with specifications?
2. Is the aggregate properly dried?
3. Are the aggregates at the proper temperature?
4. Are dryer components in balance?
5. Is dryer in balance with other plant components?
6. Is the heat indicating device installed correctly?
7. Has the heat indicating device been checked for accuracy?
8. Is dust collector in balance with dryer?
9. Are collected fines from the dust collector wasted, or fed back uniformly in the desired amount?

#### **Check List for Sampling and Testing**

1. Are sufficient samples being taken?
2. Are samples representative?
3. Are all tests being conducted properly?
4. Are test results available soon enough to be effective?

#### **Check List for Records**

Are records complete and up-to-date?

#### **Check List for Miscellaneous Responsibilities**

1. Have truck beds been inspected?
2. Are truck beds drained after spraying?
3. Do trucks meet specification requirements?
4. Are trucks equipped with tarpaulins or covers?
5. Is the mix of uniform appearance?
6. Is the general appearance of the mix satisfactory?
7. Is the temperature of the mix uniform and satisfactory?
8. Does the mix satisfy the placing requirements?
9. Have your assistants been properly instructed?
10. Are safety measures being observed?

### ASPHALT PLANT INSPECTOR'S DAILY REPORT

PROJECT 1-708-A1 (4) & (5) COUNTY Washita STATE OK DATE 6/20/74  
 MATERIAL: Stones Co. AT Job site REPORT NO. 16  
 MIXED BY Stones Co. AT Road project  
 CONSIGNED TO Kallelic Batch MIX TIME PER BATCH 56 SECONDS  
 TYPE OF PLANT \_\_\_\_\_

#### MATERIALS

ASPHALT	KIND	SOURCE	CAR OR TRUCK NO.				DATE RECEIVED				AMOUNT					
	AC-20	Refinery	truck #33-Karr Co.				6/20				4,000 gal.					
AC-20	"	truck #21-Karr				6/20				4,000 gal.						
AGGREGATE	KIND	SOURCE	2 1/2"	1 1/2"	1"	3/4"	3/8"	3/4"	#4	#8	#16	#30	#50	#100	#200	
COARSE	Cr. stone	Zeigler Co.	100	71.0	36.4	10.3	2.3	1.1	0.4	0.3	0.2	0.2	0.2	0.1		
	Cr. stone	Zeigler Co.				100	84.8	65.5	31.9	19.7	13.3	9.0	6.6	3.0		
INTER-MEDIATE	Cr. stone	Zeigler Co.														
	Sand	Jones pit					100	98.8	91.3	87.0	67.7	49.9	16.9	8.1		
FINE	Sand	Jones pit														
	limestone	Kilin lime Co.									100	96.2	89.7	71.3		
FILLER	limestone	Kilin lime Co.														
	limestone	Kilin lime Co.														
COMBINED GRADATION	COARSE 28 %		INTERMEDIATE 43 %		FINE 25 %		FILLER 4 %									
JOB-MIX FORMULA			100	91.9	81.9	68.4	53.1	40.8	34.4	26.7	20.3	10.1	4.7			
			100	90.0	78.0	70.0	66.5	48.5	33.5	24.5	18.0	11.0	4.0			

#### ANALYSIS OF HOT BIN AGGREGATES

BIN NO.	2 1/2"	1 1/2"	1"	3/4"	3/8"	3/4"	#4	#8	#16	#30	#50	#100	#200
1						100	99.2	78.1	68.0	41.6	19.7	3.2	
2				100	98.5	61.0	8.7	4.8	1.0	0.6	0.3	0.3	
3			100	98.4	62.5	11.7	4.3	2.0	1.8	0.4	0.3	0.3	0.2
4			100	90.0	9.6	2.4	1.1	0.6	0.4	0.2	0.2	0.1	0.1
MINERAL FILLER										100	98.8	89.7	71.3

SAND EQUIVALENT VALUE 76 CORRECTION FACTOR FROM WASHED ANALYSIS (- #200) 1.04

#### BATCH WEIGHTS, LBS., OR LBS. PER REVOLUTION

MIX TYPE	BIN 1	BIN 2	BIN 3	BIN 4	FILLER	ASPHALT	TOTAL
% of Total Mix	34.0	26.5	18.9	11.3	3.8	6.5	100.0
surface	1360	1090	765	455	160	220	4000

#### ANALYSIS OF MIX

SAMPLE	HOUR	TEMP. °F	2 1/2"	1 1/2"	1"	3/4"	3/8"	3/4"	#4	#8	#16	#30	#50	#100	#200	ASPH.
41	10:10	285			100	98.0	81.0	68.0	62.8	40.8	34.1	26.3	19.2	11.2	4.9	6.6
42	2:30	279			100	91.1	80.6	68.9	65.3	41.9	34.0	25.7	18.6	10.0	3.6	5.3
43	6:20	280			100	91.7	81.6	69.0	64.8	41.3	34.2	26.0	19.9	10.4	4.6	5.5
Averages for day —		281			100	91.6	81.0	68.0	64.3	41.1	34.1	26.0	19.2	10.5	4.4	5.6
JOB MIX FORMULA			100	90.0	78.0	70.0	66.5	48.5	33.5	24.5	18.0	11.0	4.0	5.6		

#### TEMPERATURE OF MIX, °F

TIME	8:15 a.m.	9:30	10:10	11:20	12:45 p.m.	1:40	2:30	3:35	4:30	5:20	6:10
°F	284	286	285	281	273	277	279	280	281	280	278

#### CHARACTERISTICS OF MIX

SAMPLE LOCATION	TIME OR LOAD NO.	THEORETICAL DENSITY	SPECIMEN DENSITY	% THEO. DENSITY	STABILITY	FLOW, .01 INCH	COHESION METER VALUE
from truck	9:30 a.m.	2.549	2.447	96.0	1976	10	
from truck	5:35 p.m.	2.549	2.465	96.7	2160	11	

WEATHER: A.M. cloudy warm P.M. clear & hot TEMPERATURE: A.M. 61 °F, P.M. 84 °F.

PLANT OPERATED: \_\_\_\_\_ PRODUCTION: \_\_\_\_\_ TYPE OF MIX: \_\_\_\_\_

FROM 6:30/12:40 TONS PREVIOUS 22,129 samples 41-2-3 & 4 surface

TO 11:25/6:16 TONS TODAY 1,098

SAMPLE NO. 59 REPRESENTS 886 TONS OF surface FOR DATES 6/19/74

SAMPLE NO. 44 REPRESENTS 1098 TONS OF surface FOR DATES 6/20/74

REMARKS: Samples 39 & 44 sent to central lab.

SIGNED Dabeke  
PLANT INSPECTOR, RESIDENT ENGINEER, ETC.

(Note—This report is intended as a guide. When more materials are being used, or more than one mix type is being produced, additional spaces may be necessary.)

FIGURE 4.28—Daily Report Form.

A daily summary report of plant activities also should be kept. On the heading of this form, the same information should be recorded as shown on the diary report. There should be a summary of the results of all tests performed during the day and a tabulation of the amounts of material received and used. A sample daily report form is shown in Figure 4.28.

A record also should be kept of the locations in which the asphalt mixture is placed in the roadway; by lanes, courses, and stations. This information is taken from the separate report forms completed at the paving site.

#### 4.9 SAFETY

The asphalt plant inspector must always be safety-conscious and on the alert for potential dangers to personnel and property. Safety considerations cannot be overemphasized.

*Dust* is particularly hazardous. It is not only a threat to lungs and eyes, but it may contribute to poor visibility, especially when trucks, front-end loaders, or other equipment are working around the stockpiles or cold bins. Reduced visibility in work traffic is a prime cause of accidents.

*Noise* can be a double hazard also. It is harmful to hearing and can distract workers' awareness of moving equipment or other dangers.

*Moving belts transporting aggregates* should be a constant concern, as should belts to motors and sprocket and chain drives. All pulleys and belts and drive mechanisms should be covered or otherwise protected. Loose clothing that can get caught in machinery should never be worn at an asphalt plant.

*Good housekeeping* is essential for plant safety. The plant and yard should be kept free of loose wire or lines, pipes, hoses or other obstacles. High voltage lines, field connections and wet ground surfaces are another hazard an inspector should look out for. Any loose connections, frayed insulation or improperly grounded equipment should be reported immediately.

*Plant workers should not work on stockpiles while the plant is in operation.* No one should walk or stand on the stockpiles or on the bunkers over the feeder gate openings. Many persons have been pulled down into the material and buried alive so quickly that they had no warning.

*Burner flames* and high temperatures around plant dryers are obvious hazards. Control valves that can be operated from a safe distance should be installed on all fuel lines. Flame safety devices also should be installed on all fuel lines. Smoking should not be permitted near asphalt or fuel storage tanks. Check frequently for leaks in oil heating lines and steam lines or jacketing on the asphalt distribution lines. Be sure safety valves are installed in all steam lines, and that they are in working order. Make use of screens, barrier guards and shields as protection from steam, hot asphalt, hot surfaces and similar dangers.

When handling *heated asphalt*, use chemical goggles and a face-shield. All shirt collars should be worn closed and cuffs buttoned at the wrist. Gloves with gauntlets that extend up the arm should be worn loosely so that they can be flipped off easily if covered with hot asphalt. Pants without cuffs should extend over boot tops.

The inspector should exercise *extreme care when climbing around the screen deck*,

inspecting the screens and hot bins or collecting hot bin samples. He should require that there be covered or protected ladders or stairways to provide safe access to all parts of the plant. All stairs and platforms should be provided with secure handrails. He (and all workers around the plant site) should always wear a hard hat when not under cover.

*Truck traffic patterns* should be planned with both safety and convenience in mind. Trucks entering the plant to pick up a load of hot-mix should not have to cross the path of loaded trucks leaving the plant. Also trucks should not have to back up.

#### **4.10 SUMMARY**

This section has introduced the inspector to the basic concepts and machinery for proportioning and blending asphalt and aggregate at a mixing plant. It has identified two types of plants—batch and drum mix—and has discussed the similarities between them. General material handling and storing procedures have been described, along with sampling, testing and safety procedures. The sections that follow discuss in detail the particular operations unique to either the batch plant or the drum-mix plant.

#### **4.11 BATCH PLANT OPERATIONS**

*Objectives*—The purpose of this section is to describe the functions unique to the batch plant. It will develop in the inspector the skills needed to recognize that the plant is operating in such a manner as to produce an end-product that meets job specifications. Specifically, upon completing study of this section of the manual, the inspector should:

- Know the major components of a batch plant.
- Understand the purpose and function of each component.
- Recognize potential problems that may occur during plant operation and describe specific measures that can be taken to prevent such problems.
- Understand a plant inspector's specific responsibilities.

In addition, he should have developed a strong awareness of potential safety hazards and the need for constantly being alert for unsafe practices.

#### **4.12 INTRODUCTION**

Batch plants get their name from the fact that, during operation, they produce hot-mix in batches, producing one batch at a time, one after the other. The size of a batch varies according to the capacity of the plant's pugmill (the mixing chamber where aggregate and asphalt are blended together). A typical batch is about 6,000 lb. (2,720 kg).

Batch plants are distinguished from continuous-type plants, such as drum-mixers, which produce hot-mix in a steady flow.



#### 4.13 HISTORY OF BATCH PLANTS

The basic operations of an asphalt plant—drying, screening, proportioning, and mixing—were first combined into an asphalt plant around 1870. Early plants, although crude by today's standards, formed the basis for hot-mix production during the nineteenth century.

By 1900, plants had been improved somewhat to include aggregate bins, cold elevators, rotary dryers, hot elevators, asphalt tanks, and mixing platforms. Mixing platforms featured an aggregate measuring box, an asphalt bucket, and pugmill mounted high enough to allow horse-drawn carts to pass underneath.

By 1930, plants were producing 800 to 1,000 tons per eight-hour day. In the 1930s and 1940s the introduction of conveyor belts and the development of better gates and feeders resulted in better cold-feed systems. Larger dryers came into common use. Cyclone type dust collectors, springless scales, the first electronic automatic weighing systems, time locks on the mixing cycles, and recording pyrometers appeared.

The trend towards larger, higher-capacity plants was the predominant development of the 1950s. However, adoption of automatic burner controls and automation of the proportioning and cycling functions also came into use early in this period.

The 1960s saw a proliferation of automatic control systems, with full automation of the proportioning and mixing process, as well as automated burner control systems.

The two most significant developments of the 1970s were the emergence of computerized plant control systems and improvements in noise and dust control, stemming from the promulgations of governmental health and safety regulations.

Throughout all the changes to the batch plant, the fundamental process—drying, screening, proportioning and mixing—has remained. In today's batch plant (Figure 4.29), the basic design of the equipment for performing these operations has changed little since 1940.

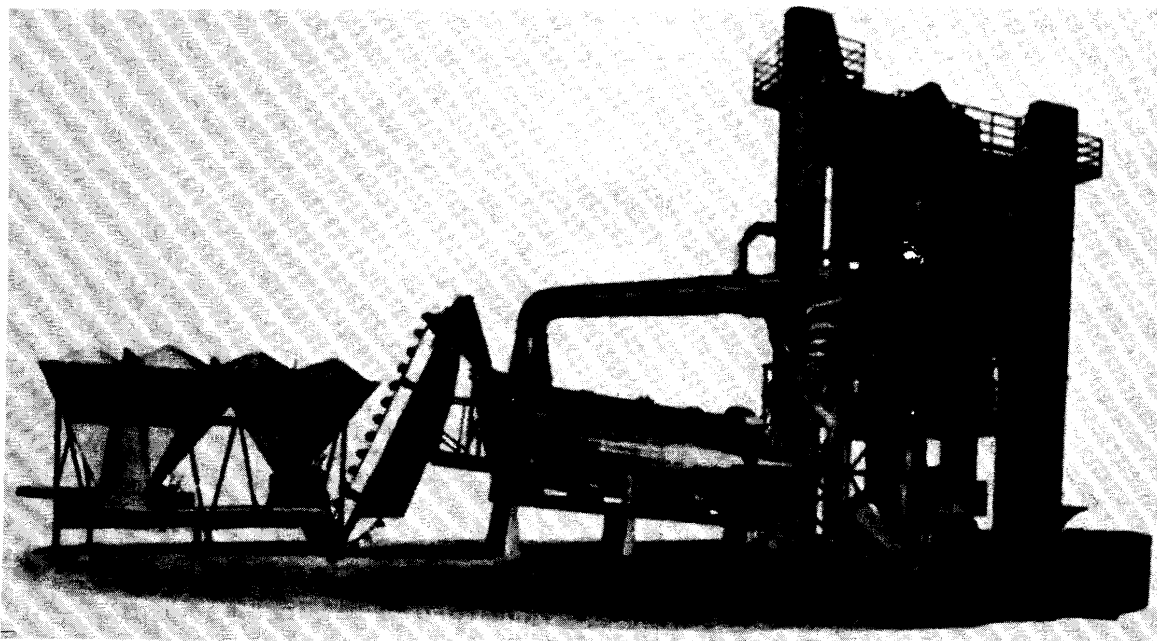


FIGURE 4.29—Typical Batch Plant.

#### 4.14 BATCH PLANT OPERATIONS AND COMPONENTS

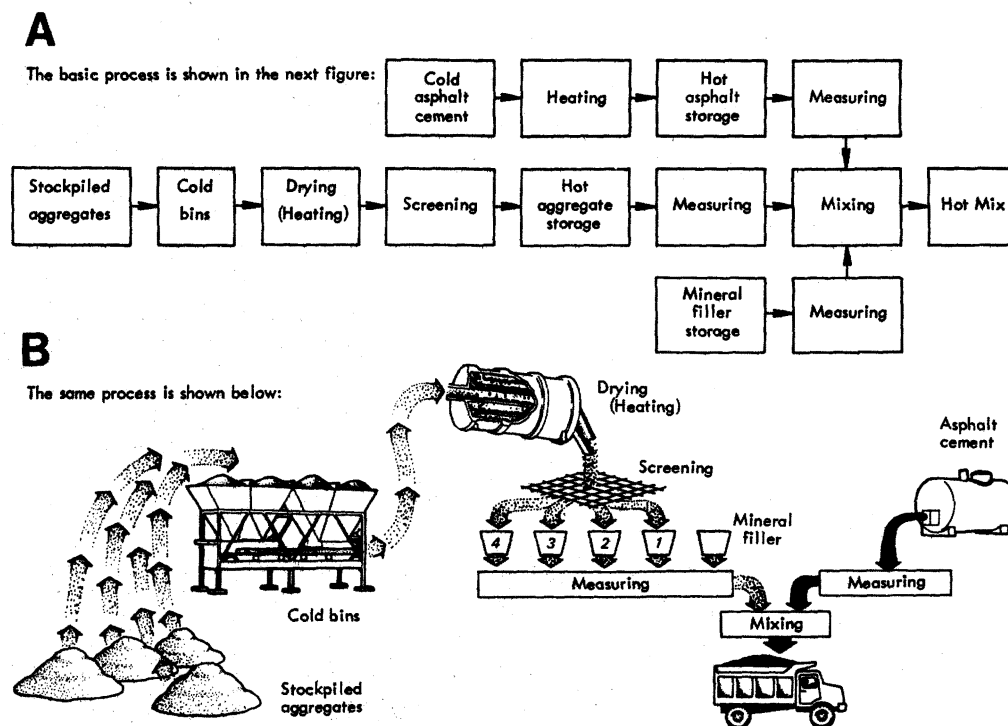
At an asphalt batch plant, aggregates are blended, heated and dried, proportioned, and mixed with asphalt cement to produce a hot asphalt mix. A plant may be small or large, depending on the type and quantity of asphalt mix being produced. It may also be stationary or portable.

Certain basic operations are common to all batch plants. They are:

- Aggregate storage and cold feeding.
- Aggregate drying and heating.
- Screening and storage of hot aggregates.
- Storage and heating of asphalt.
- Measuring and mixing of asphalt and aggregate.
- Loading of finished hot-mix.

Figure 4.30 illustrates the sequence of these operations.

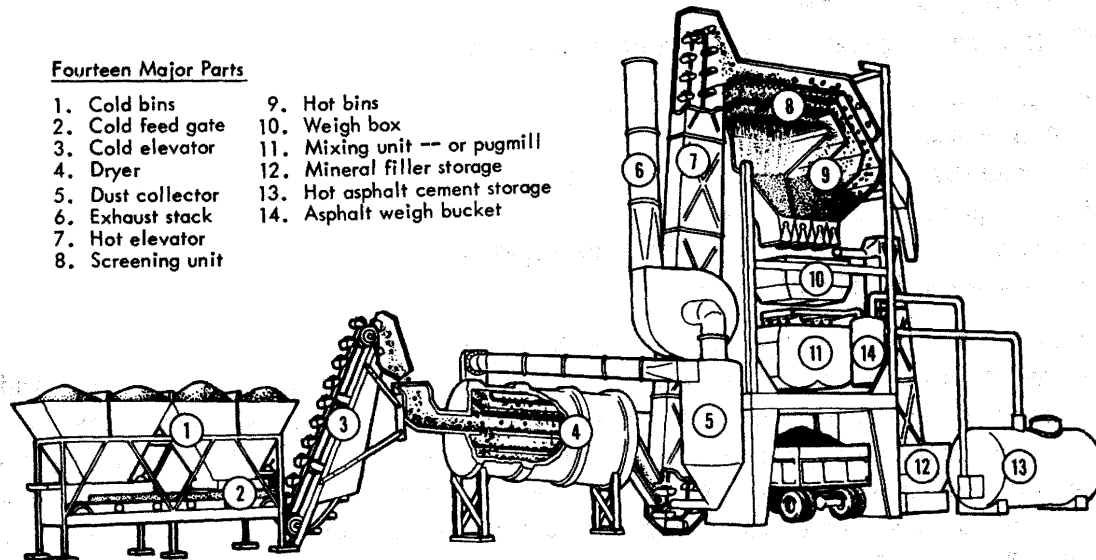
Aggregates are removed from storage or stockpiles in controlled amounts and passed through a dryer where they are dried and heated. The aggregates then pass over a screening unit that separates the material into different sized fractions and deposits them into bins for hot storage. The aggregates and mineral filler (when used) are then withdrawn, in controlled amounts, combined with asphalt and thoroughly mixed in a batch. The mix is loaded into trucks and hauled to the paving site.



**FIGURE 4.30—Basic Batch Plant Operations Shown (A) In Flow-Chart Form and (B) Schematically.**

(Courtesy Tennessee Department of Transportation)

Figure 4.31 illustrates the major components of a typical asphalt batch plant. Each component or group of related components is discussed in detail in sections that follow; however, an overview of the processes involved in plant operations will help the inspector to understand the functions and relationships of the various plant components.



**FIGURE 4.31—Major Batch Plant Components. (Modern plants also include a baghouse in addition to the dust collector shown in number 5 above.)**  
(Courtesy of Tennessee Department of Transportation).

Cold (unheated) aggregates stored in the cold bins (1) are proportioned by cold-feed gates (2) on to a belt conveyor or bucket elevator (3), which delivers the aggregates to the dryer (4), where they are dried and heated. Dust collectors (5) remove undesirable amounts of dust from the dryer exhaust. Remaining exhaust gases are eliminated through the plant exhaust stack (6). The dried and heated aggregates are delivered by hot elevator (7) to the screening unit (8), which separates the material into different-sized fractions and deposits them into separate hot bins (9) for temporary storage. When needed, the heated aggregates are measured in controlled amounts into the weigh box (10). The aggregates are then dumped into the mixing chamber or pugmill (11), along with the proper amount of mineral filler, if needed, from mineral filler storage (12). Heated asphalt cement from the hot asphalt cement storage tank (13) is pumped into the asphalt weigh bucket (14) which weighs the asphalt cement prior to delivering it to the mixing chamber or pugmill where it is combined thoroughly with the aggregates and mineral fillers if used. From the mixing chamber the asphalt hot-mix is deposited into a waiting truck or delivered into storage.

#### 4.15 AGGREGATE COLD FEED

The handling, storage and cold feed of aggregates, in a batch plant is similar to that in other types of plants. Much of the common information related to this area is discussed in Section 4.6. Particular to batch plants are the three items discussed below.

They are: (1) uniform cold feed, (2) proportioning cold aggregates, and (3) cold-feed inspection.

#### **4.15.A Uniform Cold Feeding**

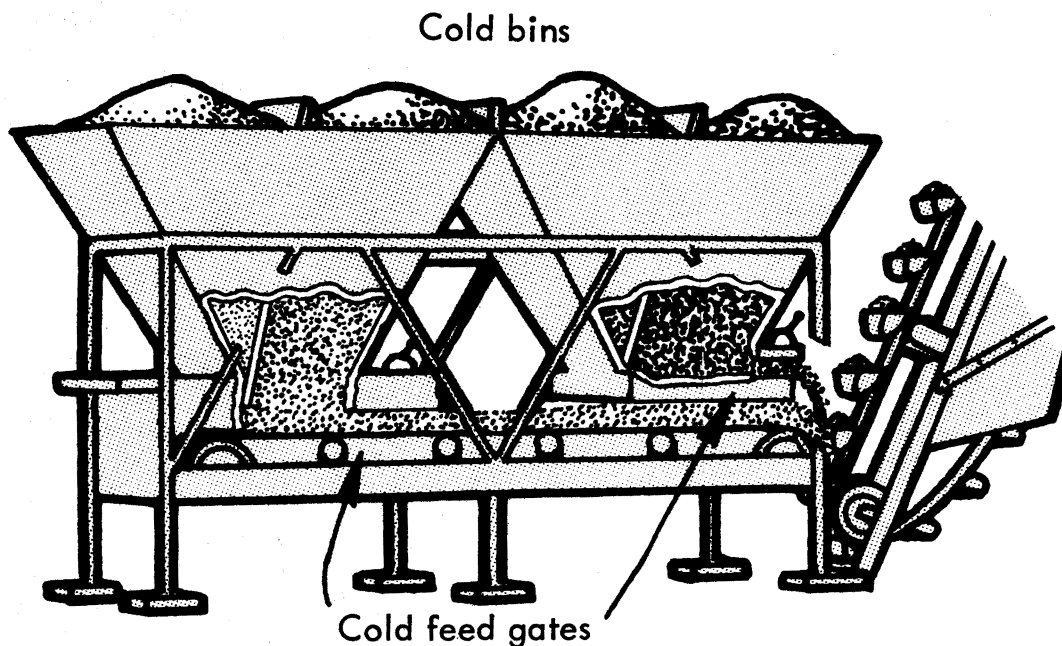
Fine and coarse aggregate of different sizes are placed into separate cold bins (Figure 4.32). The bins should be kept sufficiently full at all times to be sure there is enough material to ensure a uniform flow through the feeder. Uniform cold feeding is necessary for several reasons. Among them are:

- Erratic feeding from the cold bins may cause some of the hot bins to overfill while others run low on materials.
- Wide variations in quantity of a specific aggregate at the cold feed (particularly in the fine aggregate) can cause considerable change in temperature of the aggregates leaving the dryer.
- Excessive cold feed can overload the dryer or the screens.

All of these problems contribute to a non-uniform mix at the plant which in turn will cause problems on the road. Controlling the cold feed, then, is the key to all subsequent operations.

#### **4.15.B Proportioning of Cold Aggregates**

Accurate proportioning of cold aggregates is important because, except for the small amount of degradation that may occur during drying and screening, the aggre-



**FIGURE 4.32—Cold Feed System.**

gate gradation in the hot bins is dependent on the cold feed. To ensure that the hot bins remain in balance, (contain the correct proportions of different sized aggregates to produce the desired mix gradation), the proportions of aggregates leaving the cold bins must be carefully monitored and controlled.

If the sieve analysis of the cold-feed material shows any significant difference from the requirements of the job-mix formula, the quantities being fed by the various cold-feed bins must be adjusted to correct the gradation. This does not require recalibrating the gate openings but simply adjusting the gate openings based on data from the calibration charts.

#### ***4.15.C Inspection of the Cold Feed***

The inspector should observe the gate calibration procedure. During production, the inspector should periodically check gate-opening indicators, to be certain that gate openings remain properly set.

The inspector should frequently observe the feed in order to detect any variations in the amount of aggregates being fed. Sluggish feed might be caused by roots or clumps of earth clogging the gates by material bridging over the gates instead of flowing through. Sluggish feed also may be the result of excessive aggregate moisture or other factors that impede a uniform flow of material to the dryer. If one or more gates appear to be causing trouble, the inspector should bring it to the attention of the contractor.

### **4.16 AGGREGATE DRYING AND HEATING**

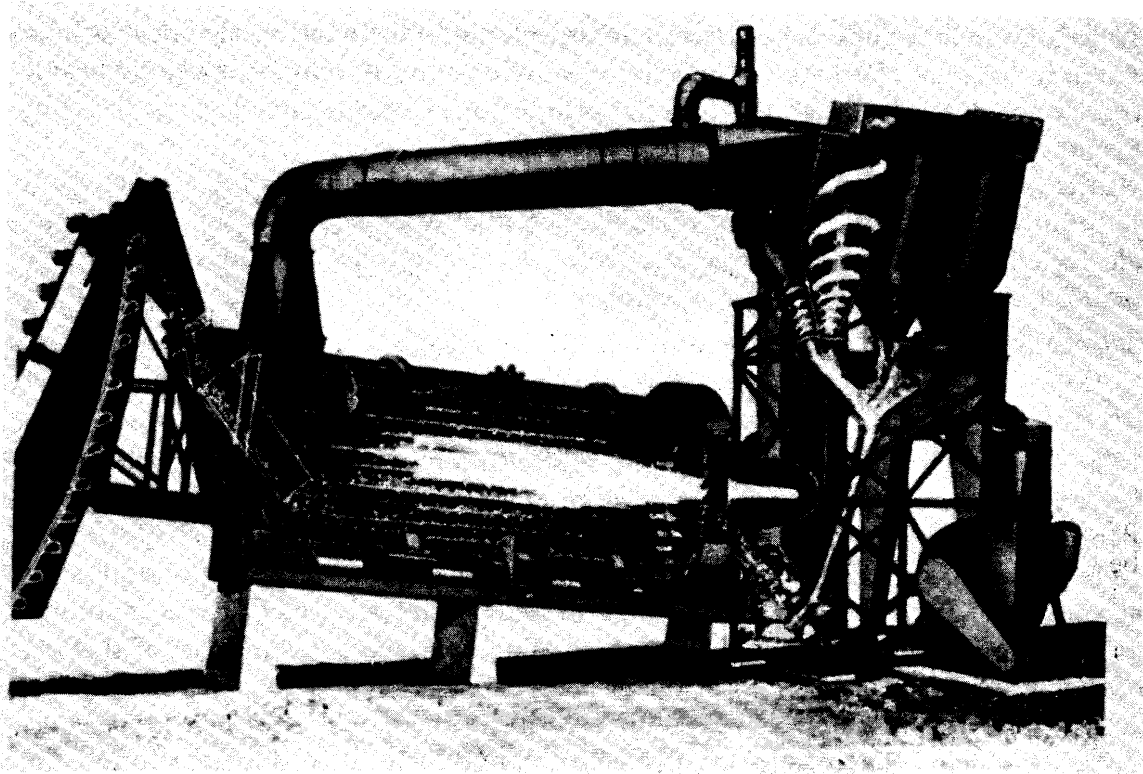
From the cold bins, aggregates are delivered to the dryer. The dryer accomplishes two things: (1) it removes moisture from the aggregates and (2) it raises the aggregate temperature to the desired level.

Of importance to the inspector are: (1) basic dryer operation, (2) temperature control, (3) calibration of temperature indicators, and (4) moisture checks. Each is discussed under a separate heading below.

#### ***4.16.A Dryer Operation***

The conventional batch plant dryer is a revolving cylinder ranging from 5 to 10 feet (1.5 to 3 m) in diameter and 20 to 40 feet (6 to 12 m) in length. It includes an oil or gas burner with a blower fan to provide the primary air for combustion of the fuel, and an exhaust fan to create a draft through the dryer. (Figure 4.33). The drum also is equipped with longitudinal troughs or channels, called flights, that lift the aggregate and drop it in veils through the burner flame and hot gases (Figure 4.34). The slope of the dryer, its rotation speed, diameter, length and the arrangement and number of flights determine the length of time that the aggregate will spend in the dryer.

For efficient dryer operation, the air that is combined with the fuel for combustion must be in balance with the amount of fuel oil being fed into the burner. The exhaust fan creates the draft of air that carries the heat through the dryer and removes the moisture. Imbalance among these three elements causes serious problems. With fuel oil, lack of sufficient air or excess flow of fuel oil can lead to incomplete combustion of



**FIGURE 4.33—Typical Dryer.**

the fuel. The unburned fuel leaves an oily coating on the aggregate particles, a coating that can adversely affect the finished mixture.

A quick way to check in coating of the aggregate is suspected is to place a shovel full of aggregate being discharged from the dryer in a bucket of water. An oily film will float to the surface. A slight film is not of concern; however, a heavy film on the surface of the water requires immediate attention.

Imbalance between draft air and blower air velocities can cause a back pressure within the drum. This creates a “puff-back” of exhaust at the burner end of the drum, indicating that draft air velocity is insufficient to accommodate the air pressure created by the burner blower. In such a case, either the resistance to draft air must be reduced or blower air pressure decreased.

Generally, dryers are designed to be most efficient when heating and drying aggregates having a given (typically 5 percent) moisture content. If the aggregate moisture content is higher than that for which the dryer is designed, the aggregates being fed to the dryer must be reduced in quantity. Consequent to this reduction, there is a drop in the dryer’s hourly capacity.

Dryers with natural gas or liquid petroleum burners rarely develop combustion problems. However, imbalances among gas pressure, combustion air and draft may still occur.

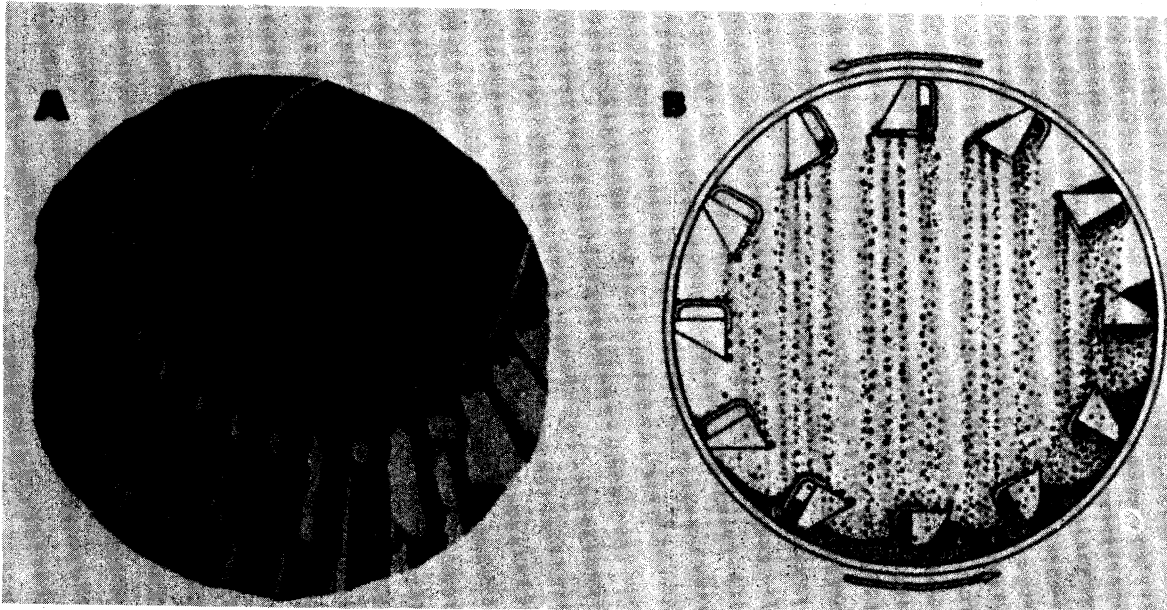
Because of its fuel consumption, drying is the most expensive operation in the mix production. It is also one of the most common bottlenecks in plant operation. The

production rate of the entire plant is dependent upon the dryer's efficiency. Asphalt concrete cannot be produced any faster than the aggregate can be dried and heated.

#### **4.16.B Temperature Control**

Proper aggregate temperature is essential. The temperature of the aggregate, not the asphalt, controls the temperature of the mix. The layer of asphalt put on each particle of aggregate during mixing assumes the temperature of that aggregate almost instantaneously. Aggregates that are heated to an excessive temperature can harden the asphalt during mixing. Underheated aggregates are difficult to coat thoroughly with asphalt and the resulting mix is difficult to place on the roadway.

A temperature-measuring device called a pyrometer is used to monitor aggregate temperature as the material leaves the dryer. There are two types: (1) indicating pyrometers and (2) recording pyrometers (Figure 4.35). The recording head of a pyrometer is usually located in the plant control room. The indicating pyrometer can be located at the discharge chute of the dryer (Figure 4.36).



**FIGURE 4.34—Flights: (A) Typical Design and (B) Function.**

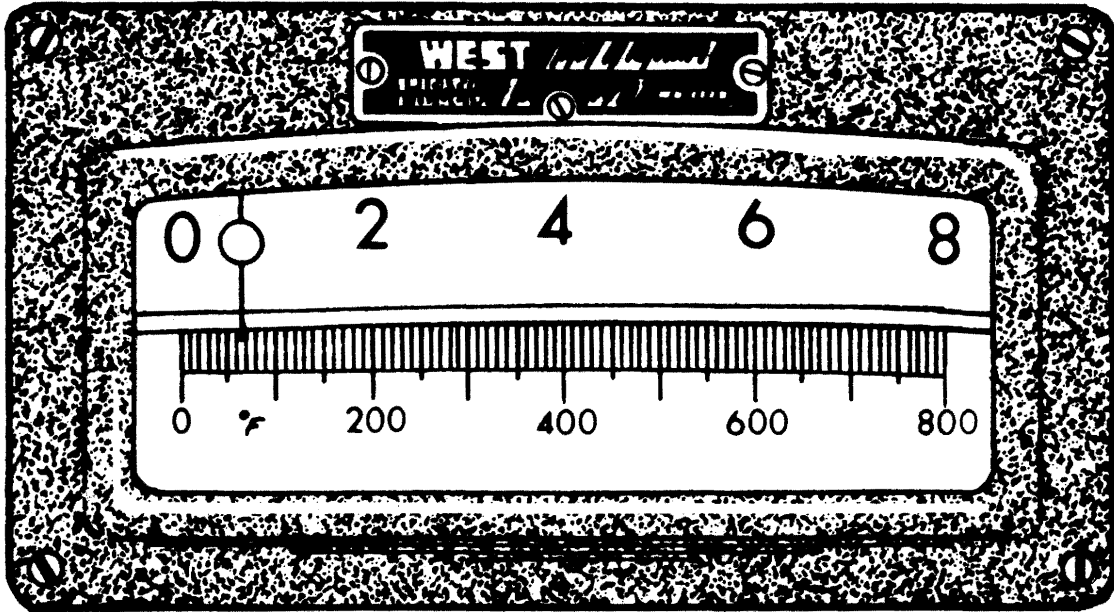
A good temperature-indicating device assists the plant inspector by providing:

- Accurate temperature records, and
- Indications of temperature fluctuations that suggest lack of control and uniformity in drying and heating operations.

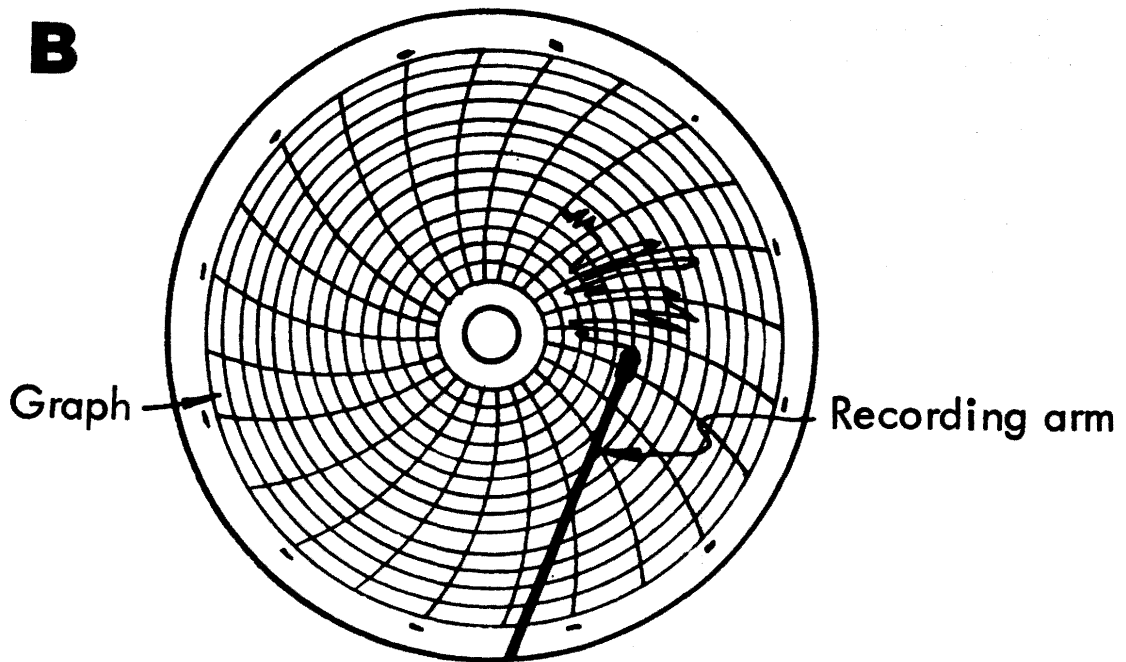
#### **4.16.C. Calibration**

Both types of electrical temperature-indicating devices (pyrometers) (Figure 4.35) are quite similar in operation. In each the sensing element, which is a shielded

**A**



**B**



**FIGURE 4.35—Typical Types of Pyrometers: (A) Indicating Pyrometer, and (B) Recording Pyrometer.**  
(Courtesy Tennessee Department of Transportation)



thermocouple, protrudes into the main hot aggregate stream in the discharge chute of the dryer.

Pyrometers are sensitive instruments that measure the very small electrical current induced by the heat of the aggregate passing over the sensing element. The head (indicating element) of the device must be completely shielded from heat and plant vibrations. Usually, it is located several feet away from the dryer and is connected to its sensing element by wires. Any change in the connecting wire length, size, splices or couplings affects the calibration of the device, so that it must be recalibrated after any changes.

The major difference between recording pyrometers and indicating pyrometers is that indicating pyrometers give a dial or digital reading while recording pyrometers record aggregate temperatures on paper in graph form, thus providing a permanent record.

The best way to check the accuracy of a pyrometer is to insert the device's sensing element and an accurately calibrated thermometer in a hot oil or asphalt bath. Being cautious of the bath's flash point, slowly heat the bath above the temperature expected of the dried aggregate, and compare the readings of the two instruments.

Another means to check a temperature-indicating device is to take several shovel-fuls of hot aggregate from the dryer discharge chute and dump them in a pile on the ground, then take another shovelful and place it, shovel and all, on top of the pile. The pile keeps the shovelful of aggregate hot while its temperature is taken. Inserting the entire stem of an armored thermometer into the aggregate in the shovel will give a temperature reading that can be compared to the reading on the pyrometer. Several thermometer readings may be necessary to get accurate temperature data.

#### **4.16.D Moisture Check**

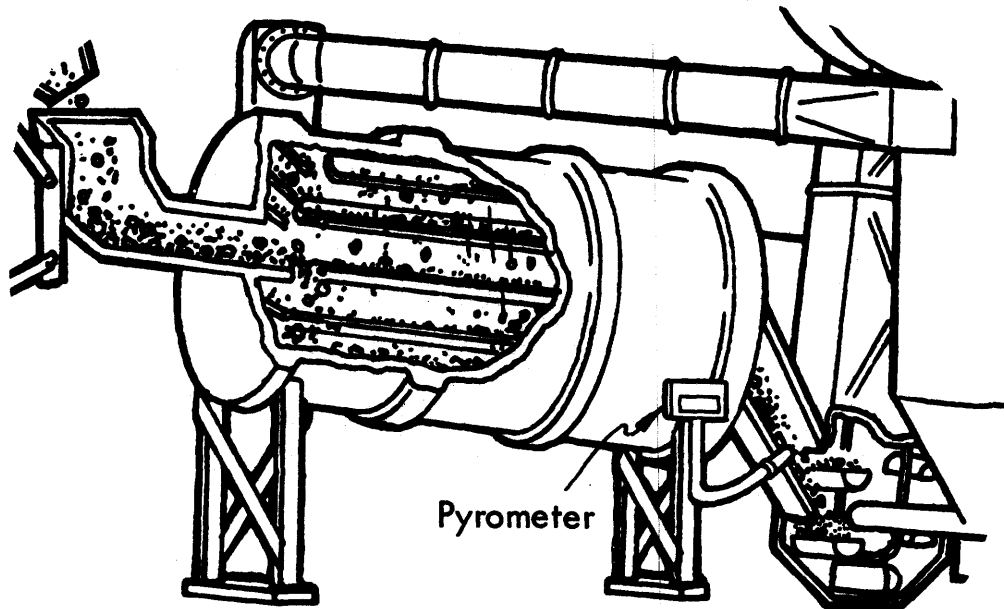
Quick checks for moisture in the hot aggregate can be made at the same time as temperature indicator checks. Quick moisture checks are useful in determining whether more precise laboratory moisture tests should be run.

To make a quick moisture check, a pile of hot aggregate from the dryer discharge should be built up and a shovelful of aggregate placed on top of it. Then, the inspector should study the shovelful of aggregate as follows:

- (1) Observe the aggregate for escaping steam or damp spots. These are signs of incomplete drying or porous aggregate releasing internal moisture which may or may not be detrimental. This type of visual check becomes more accurate as the inspector becomes more familiar with the aggregate being used.
- (2) Take a dry, clean mirror, shiny spatula or other reflective item which is at normal ambient temperature or colder, and pass it over the aggregate slowly and at a steady height. Observe the amount of moisture that condenses on the reflective surface. With practice, the inspector will be able to detect excessive moisture fairly consistently.

#### **4.17 SCREENING AND STORAGE OF HOT AGGREGATE**

After the aggregates have been heated and dried, they are carried by a hot elevator (an enclosed bucket conveyor) to the gradation unit. In the gradation unit, the hot



**FIGURE 4.36—Pyrometer Located at Discharge Chute of Dryer.**  
(Courtesy Tennessee Department of Transportation)

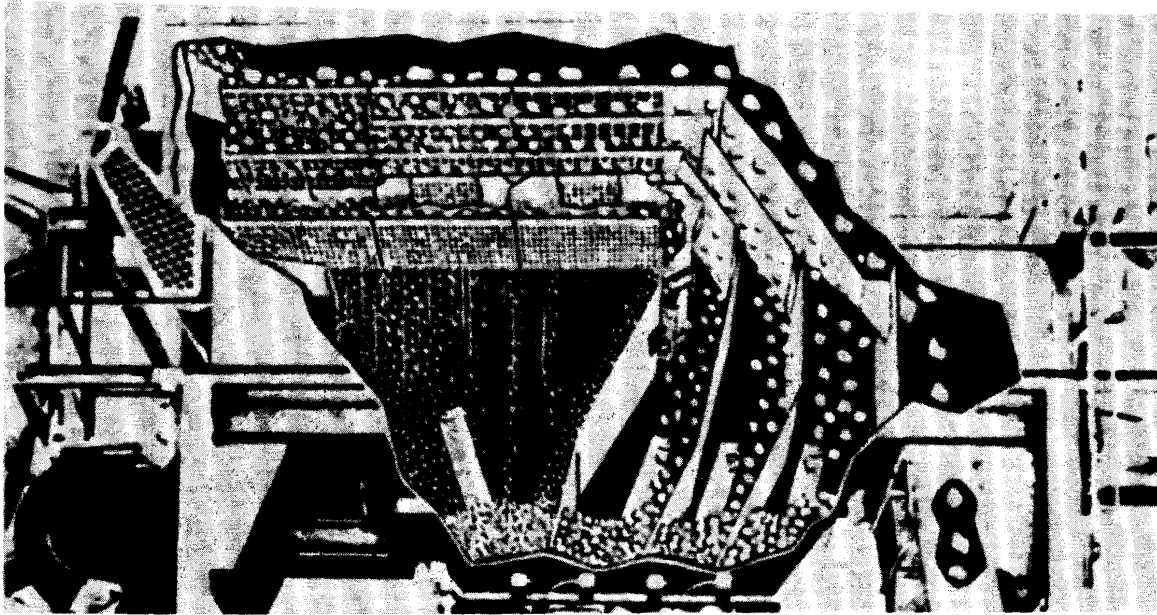
aggregate passes over a series of screens that separate it into various-sized fractions and deposit those fractions in “hot” bins (Figure 4.37).

#### **4.17.A Hot Screens**

The screening unit includes a set of several different-sized vibrating screens (Figure 4.38). The first in the series of screens is a scalping screen which rejects and carries off oversized aggregates. This is followed by one or two intermediate-sized screens, decreasing in size from top to bottom. At the bottom of the stack is a sand screen.

The screens serve to separate the aggregates into specific sizes. To perform this function properly, the total screen area must be large enough to handle the total amount of feed delivered. Here again, the screens must be clean and in good condition. The capacity of the screens must be in balance with the capacity of the dryer and the capacity of the pugmill. When too much material is fed to the screens or the screen openings are plugged, many particles which should pass through, ride over the screens and drop into a bin designated for a larger size of particle. Similarly, when screens are worn or torn, resulting in enlarged openings and holes, oversized material will go into bins intended for smaller-sized aggregate. Any misdirection of a finer aggregate into a bin intended to contain the next larger size fraction is called “carry-over.”

Excessive carry-over can add to the amount of fine aggregate in the total mix, thus increasing the surface area to be covered with asphalt. If the amount of carry-over is unknown or if it fluctuates, particularly in the No. 2 bin, it can seriously affect the mix design in both gradation and asphalt content. Excessive carry-over can be detected by a sieve analysis of the contents of the individual hot bins and must be corrected



**FIGURE 4.37—Cutaway View Showing Details of Flow Material Through Screens and Bins.**

immediately by cleaning the screens or reducing the quantity of material coming from the cold feed, or both. Some carry-over is permitted in normal screening and the permissible amount of carry-over in each bin is usually specified.

The No. 2 bin (intermediate fine aggregate) is the critical bin for carry-over. This is the bin that will receive the finest aggregate in carry-over and which will affect the asphalt demand of the mix the most. Typically, the carry-over in the No. 2 bin should not exceed 10 percent. Running a sample of the No. 2 bin material over a 2.36 mm (No. 8) sieve will indicate the amount of carry-over.

To prevent excessive carry-over, daily visual inspection of the screens for cleanliness and overall condition is recommended, preferably before starting each day's operation.

#### **4.17.B. Hot Bins**

Hot bins are used to temporarily store the heated and screened aggregates in the various sizes required. Each bin is an individual compartment or a segment of a large compartment divided by partitions. A properly sized hot-bin installation should be large enough to hold sufficient material of each size when the mixer is operating at full capacity. The partitions must be tight, free from holes and high enough to prevent intermingling of the aggregates.

Hot bins usually have indicators that tell when the aggregates fall below a certain level. These indicators may be either electronic or mechanical. One such electronic indicator (diaphragm type) is mounted on the side of the bin (Figure 4.39). The

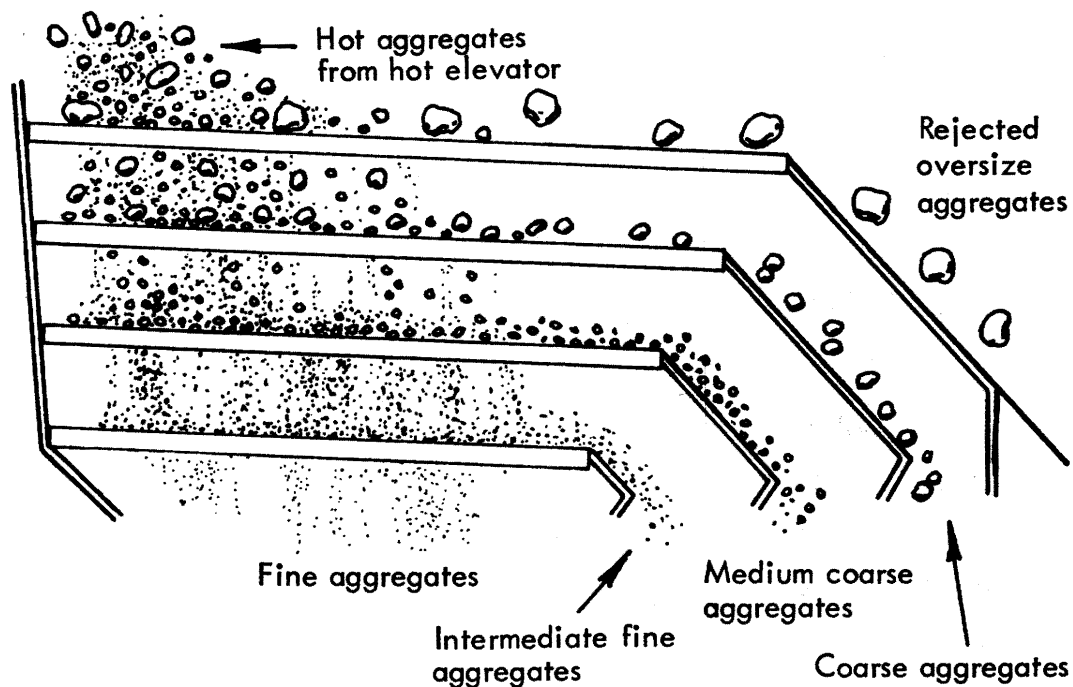


FIGURE 4.38—Screening Unit.

pressure of the aggregates in the bin makes it work. When the aggregate level drops below the indicator, an electrical contact turns on a warning light.

Each bin should be equipped with an overflow pipe to prevent excess amounts of aggregate from backing up into the other bins. The overflow pipes should be set to stop overflowing of the bins. When a bin overfills, the screen above it rides on the aggregate, resulting in a heavy carry-over and possible damage to the screen. Overflow vents should be checked frequently to make sure they are free flowing.

Sometimes the very fine aggregate will hang up in the corners of the fine aggregate bin. When this build-up collapses, it can result in an excessive amount of fines in the mix. This rush of fine materials usually occurs when the aggregate level in the bin is drawn down too low. The solution is to maintain proper aggregate level in the bin. Also, fillet plates welded into the corners of the bin will minimize the build-up of the fines.

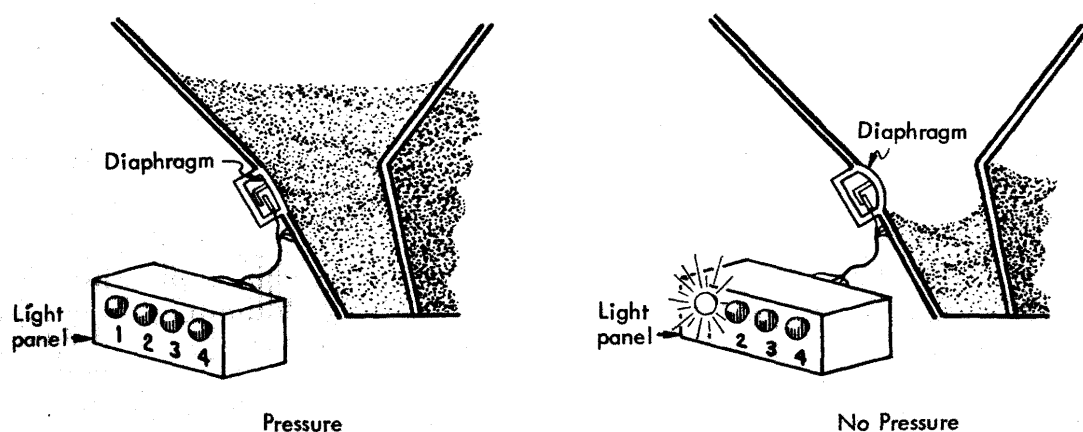
Other potential obstacles to a good mix include shortage of material in one bin (and excess in another), worn gates in the bottom of a bin (allowing leakage of aggregate into the weigh hopper) and sweating of the bin walls (caused by condensation of moisture).

Hot bins should not be allowed to run empty. Bin shortages or excesses are corrected by adjusting the cold feed. For example, if the coarse bin is overflowing while the others remain at satisfactory level, the cold-bin feed supplying most of the coarse aggregate should be reduced slightly.

It is not good practice to make two feed adjustments at once. For example, if the total feed is deficient and also one bin is running a little heavy, it is better to adjust the total feed first and then make an adjustment to the feed on the one bin that is running heavy.

If the gate at the bottom of a bin is worn and leaking material, it must be repaired or replaced immediately. Leakage from a hot bin can adversely affect gradation of the final mixture.

Sweating occurs when moisture vapor in the aggregate and in the air condense on the bin's walls. It happens usually at the beginning of the day's operations or when the coarse aggregate is not thoroughly dry. Sweating may cause the accumulation of dust that results in excessive surges of fines in the mix. Mineral filler and dust from the baghouse should be stored separately in a moisture-proof silo and fed directly into the weigh hopper.

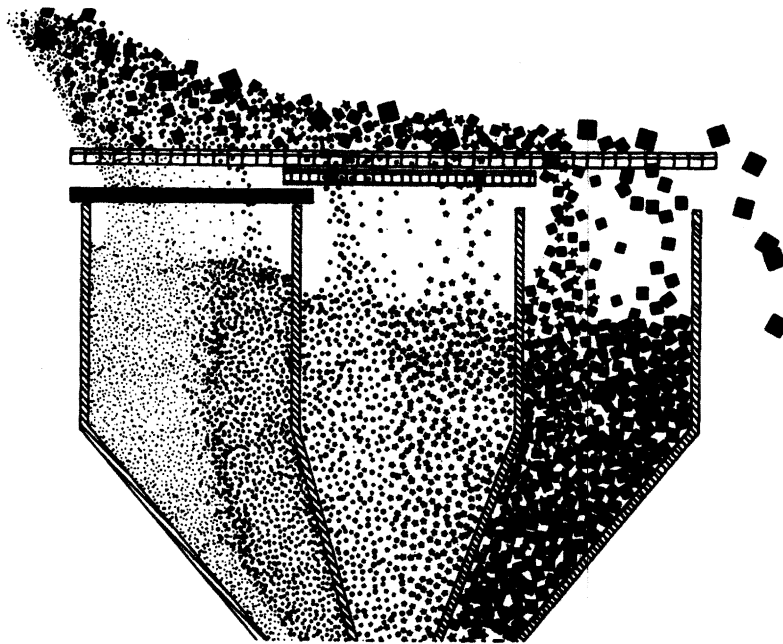


**FIGURE 4.39—Diagram of a Diaphragm Type Cut-Off.**  
(Courtesy Tennessee Department of Transportation).

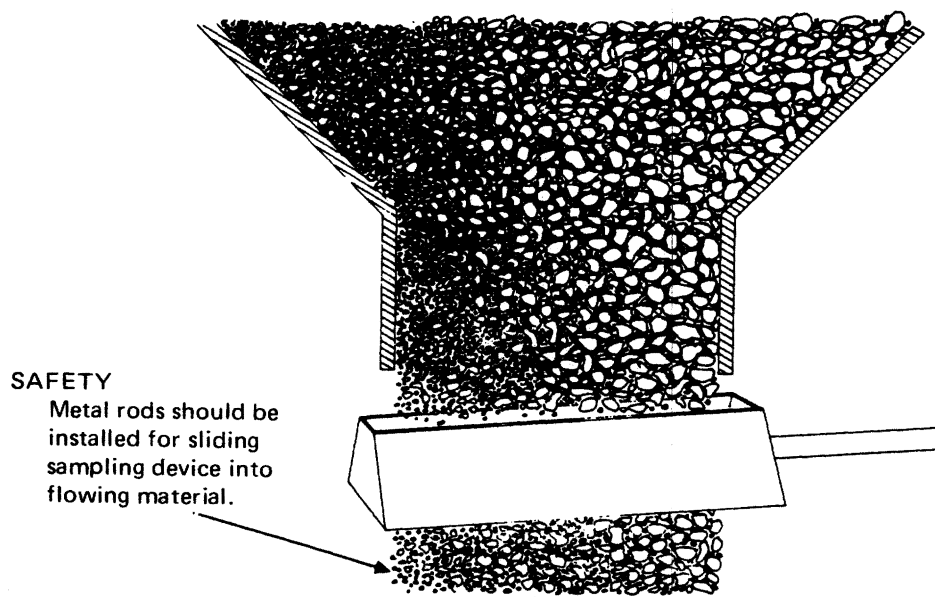
#### **4.17.C Hot Bin Sampling**

Modern hot-mix asphalt plants are equipped with devices for sampling hot aggregate from the bins. They divert the flow of aggregates from the feeders or gates under the bins into sample containers. It is essential that such sampling devices be located to collect representative samples of the material in the bins.

From the flow of material over the plant screens, fine particles fall to one side of each bin and coarse particles to the other (Figure 4.40). When material is drawn from the bin by opening a gate at the bottom, the stream consists predominantly of fine material at one edge and coarse material at the other. Therefore, the position of the sampling device in the stream of material discharged from a bin determines whether the sample will be composed of a fine portion, a coarse portion, or an accurate representation of the material in the bin (Figure 4.41). This condition is especially critical in the No. 1 (fine) bin, since the material in this bin strongly influences the amount of asphalt required in the mix.



**FIGURE 4.40—Segregation of Aggregates in Hot Bins (Note Segregation Within Each Bin).**



**SAFETY**

Metal rods should be installed for sliding sampling device into flowing material.

**FIGURE 4.41—Correct Use of Sampling Device.**

Stratification (vertical layering) of sizes in the fine bin can also occur. It may be caused by variations of grading in the stockpiles or by erratic feeding of the cold aggregate. When this form of segregation exists, representative samples cannot be obtained even when the sampling device is used correctly.

#### 4.17.D Calibration

Normally it is the contractor's responsibility to calibrate the hot plant; however, the inspector should observe and be aware of the procedures used to arrive at an aggregate combination that meets the job-mix formula.

To produce the desired aggregate combination, the content of each bin must be analyzed. To analyze the hot bins, the first step is to start the plant and the cold feed, the dryer and the screens. When the plant reaches operating condition, such that the material in the bins is representative of the proportions established at the cold gates, a sample of aggregate is taken from each bin. The aggregate samples are then graded. Once the gradation of material in each hot bin is determined, the exact percentage to be pulled from each bin to meet the design mix can be calculated. This is done by a trial and error method. To understand this procedure, study the following example.

#### Example

Examination of the bin content begins with analyzing the mix design of the asphalt concrete being produced. In this case, the mix design specifies the aggregate gradation presented in Figure 4.42. The figure shows an example of both target gradation values (job mix formula) and acceptable ranges (specification range).

<u>Sieve</u>	<u>Percent Passing</u>	<u>Job-Mix Formula</u>	<u>Specification Range</u>
25.0 mm (1 inch)	100.0	100.0	100
19.0 mm (3/4 inch)	97.0	97.0	90 - 100
9.5 mm (3/8 inch)	68.0	68.0	56 - 80
4.75 mm (No. 4)	48.0	48.0	35 - 65
2.36 mm (No. 8)	37.0	37.0	23 - 49
0.30 mm (No. 50)	12.0	12.0	5 - 19
0.075 mm (No. 200)	5.0	5.0	2 - 8

FIGURE 4.42—Example of Job Gradation

In determining proper calibration of the hot-bin feeds, the job-mix formula is the starting point. It is necessary to determine what percentage of each size of the aggregate in the hot bin should be incorporated into the mix in order to meet the design specifications.

First the gradation of material in each of the hot bins is determined (Figure 4.43).

Sieve Size	25.0 mm (1 in.)	19.0 mm (3/4 in.)	9.5 mm (3/8 in.)	4.75 mm (No. 4)	2.36 mm (No. 8)	0.30 mm (No. 50)	0.075 mm (No. 200)
<b>Hot-Bin Gradations</b>	<b>Percent Passing</b>						
Bin #1 B1	100	100	100	100	99.2	25.0	3.2
Bin #2 B2	100	100	98.5	51.0	8.7	0.5	0.3
Bin #3 B3	100	98.4	11.7	4.3	2.0	0.3	0.2
Bin #4 B4	100	60.0	5.9	1.1	0.5	0.2	0.1
Mineral Filler MF	100	100	100	100	100	96.2	76.2

FIGURE 4.43—Results of Example Hot-Bin Analysis.

The combined gradation is then determined by a trial and error method.

#### *First Trial Estimate*

Aggregate proportions are estimated for the first trial. The material passing the 2.36 mm (No. 8) and 0.075 mm (No. 200) is used as a starting point. The job-mix formula requires 37.0 percent to pass the 2.36 mm (No. 8). Bin No. 1, the fine aggregate, contains 99.2 percent of minus 2.36 mm (No. 8) material. Therefore, an estimate of Bin No. 1's contribution to the final gradation is 37 percent times 99.2 percent, equalling 36.7 percent. Rounding this off, the estimate of Bin No. 1 material will be set at 40 percent subject to correction for mineral filler.

Of the four bins, Bin No. 1 carries most of the minus 0.075 mm (No. 200) material, in this case 3.2 percent. If 40 percent of Bin No. 1 is used, then 40 percent times 3.2 percent equals 1.3 percent of minus 0.075 mm (No. 200) supplied by this bin. Since the job-mix formula requires a total of 5.0 percent minus 0.075 mm (No. 200) material, then the mineral filler bin must provide the remaining 3.7 percent. The mineral filler bin contains 76.2 percent of minus 0.075 mm (No. 200). Multiplying 76.2 percent by the 3.7 percent of filler still requires results in 4.8 percent or rounded to 5 percent. Thus the mineral filler bin will provide 5 percent of the total aggregate.

However, using 40 percent of the material from Bin No. 1 and 5 percent of the material from the mineral filler bin will result in too much filler in the final mix. To avoid this, 5 percent is subtracted from the total to be drawn from Bin No. 1, reducing Bin No. 1's contribution to 35 percent.

So far, then, the estimate of material to be supplied from Bin No. 1 and the mineral filler bin will make up 40 percent of the total gradation. This leaves 60 percent to come from the other three bins. The easiest means of dividing this percentage is evenly among the three bins. Thus Bins No. 2, No. 3, and No. 4 each contribute 20 percent of total aggregate in the first trial estimate.

In Figure 4.44 the estimated percentages for each bin is multiplied by the aggregate gradations contained in that bin.

#### *Second Trial Estimate*

The combined totals in Figure 4.42 are then compared to the job-mix formula. The combined total percentage for the minus 0.075 mm (No. 200) is satisfactory, so no changes to mineral filler are needed. The material passing the 2.36 mm (No. 8) exceeds job-mix formula, also there is too much passing the 4.75 mm (No. 4); thus Bin No. 1 should be reduced. Since there is enough material passing sieves above 4.75 mm (No. 4) (No. percentages of Bin No. 2 and Bin No. 3 should be increased while remaining Bin



Sieve Size	25.0 mm (1 in.)	19.0 mm (3/4 in.)	9.5 mm (3/8 in.)	4.75 mm (No. 4)	2.36 mm (No. 8)	0.30 mm (No. 50)	0.075 mm (No. 200)
	<i>Percent Passing</i>						
<b>Specification Range</b>	100	90-100	56-80	35-65	23-49	5-19	2-8
<b>Job-Mix Formula</b>	100	97	68	48	37	12	5
<hr/>							
<i>Hot-Bin Gradation</i>	<i>Percent Passing</i>						
<b>Bin No. 1 B1</b>	100	100	100	100	99.2	25.0	3.2
<b>Bin No. 2 B2</b>	100	100	98.5	51.0	8.7	0.5	0.3
<b>Bin No. 3 B3</b>	100	98.4	11.7	4.3	2.0	0.3	0.2
<b>Bin No. 4 B4</b>	100	60.0	5.9	1.1	0.5	0.2	0.1
<b>Mineral Filler MF</b>	100	100	100	100	100	96.2	76.2
<hr/>							
<b>Trial No. 1</b>	<b>Try 35% B1, 20% B2, 20% B3, 20% B4 and 5% MF</b>						
<b>B1 × 0.35</b>	35	35	35	35.0	34.7	8.8	1.1
<b>B2 × 0.20</b>	20	20	19.7	10.2	1.7	0.1	0.1
<b>B3 × 0.20</b>	20	19.7	2.3	0.9	0.4	0.1	0
<b>B4 × 0.20</b>	20	12.0	1.2	0.2	0.1	0	0
<b>MF × 0.05</b>	5	5.0	5.0	5.0	5.0	4.8	3.8
<b>Total</b>	100	91.7	63.2	51.3	41.9	13.8	5.0

**FIGURE 4.44—Results of First Trial Estimate.**

No. 4 is decreased accordingly. Adjustments of 5 percent seem a good choice for a second trial calculation. So keeping the mineral filler bin the same at 5 percent, Bin No. 1 is reduced to 30 percent, Bins No. 2 and No. 3 are increased to 25 percent each and Bin No. 4 is reduced to 15 percent. In Figure 4.45 the estimated percentages for the second trial for each bin is multiplied by the aggregate contained in that bin.

Sieve Size	25.0 mm (1 in.)	19.0 mm (3/4 in.)	9.5 mm (3/8 in.)	4.75 mm (No. 4)	2.36 mm (No. 8)	0.30 mm (No. 50)	0.075 mm (No. 200)
	<i>Percent Passing</i>						
<b>Specification Range</b>	100	90-100	56-80	35-65	23-49	5-19	2-8
<b>Job-Mix Formula</b>	100	97	68	48	37	12	5
<hr/>							
<i>Hot-Bin Gradation</i>	<i>Percent Passing</i>						
<b>Bin No. 1 B1</b>	100	100	100	100	99.2	25.0	3.2
<b>Bin No. 2 B2</b>	100	100	98.5	51.0	8.7	0.5	0.3
<b>Bin No. 3 B3</b>	100	98.4	11.7	4.3	2.0	0.3	0.2
<b>Bin No. 4 B4</b>	100	60.0	5.9	1.1	0.5	0.2	0.1
<b>Mineral Filler MF</b>	100	100	100	100	100	96.2	76.2
<hr/>							
<b>Trial No. 2</b>	<b>Try 30% B1, 25% B2, 25% B3, 15% B4 and 5% MF</b>						
<b>B1 × 0.30</b>	30	30.0	30.0	30.0	29.8	7.5	1.0
<b>B2 × 0.25</b>	25	25.0	23.4	12.8	2.2	0.1	0.1
<b>B3 × 0.25</b>	25	24.6	3.0	1.1	0.5	0.1	0.1
<b>B4 × 0.15</b>	15	9.0	0.9	0.2	0.1	0	0
<b>MF × 0.05</b>	5	5.0	5.0	5.0	5.0	4.8	3.8
<b>Total</b>	100	93.6	62.3	49.1	37.6	12.5	5.0

**FIGURE 4.45—Results of Second Trial Estimate.**

When the calculations for all the bins are finished and the combined totals are tallied, the results of the second set of estimates can be compared to the job-mix formula.

### Third Trial Estimate

The percentages of material passing the 0.075 mm (No. 200), 0.30 mm (No. 50) and 2.36 mm (No. 8) are satisfactory, so the mineral filler bin and Bin No. 1 need no further adjustment. However, there is not enough minus 19.0 mm (3/4 in.) or minus 9.5 mm (3/8 in.) while the percent passing the 4.75 mm (No. 4) is slightly high. For the third trial calculation Bins No. 2 and No. 3 are increased to get more coarse material and Bin No. 4 again reduced. So keeping the mineral filler bin the same at 5 percent and Bin No. 1 at 30 percent, Bins No. 2 and 3 are increased to 28 percent and Bin No. 4 reduced to 9 percent. In Figure 4.46 the estimated percentages for this third trial for each bin is multiplied by the aggregate contained in that bin.

Sieve Size	25.0 mm (1 in.)	19.0 mm (3/4 in.)	9.5 mm (3/8 in.)	4.75 mm (No. 4)	2.36 mm (No. 8)	0.30 mm (No. 50)	0.075 mm (No. 200)
	<i>Percent Passing</i>						
Specification Range	100	90-100	56-80	35-65	23-49	5-19	2-8
Job-Mix Formula	100	97	68	48	37	12	5
<hr/>							
<i>Hot-Bin Gradation</i>							
	<i>Percent Passing</i>						
Bin No. 1 B1	100	100	100	100	99.2	25.0	3.2
Bin No. 2 B2	100	100	98.5	51.0	8.7	0.5	0.3
Bin No. 3 B3	100	98.4	11.7	4.3	2.0	0.3	0.2
Bin No. 4 B4	100	60.0	5.9	1.1	0.5	0.2	0.1
Mineral Filler MF	100	100	100	100	100	96.2	76.2
<hr/>							
Trial No. 3	Try 30% B1, 28% B2, 28% B3, 9% B4 and 5% MF						
B1 × 0.30	30	30	30	30	29.8	7.5	1.0
B2 × 0.28	28	28	27.6	14.3	2.4	0.1	0.1
B3 × 0.28	28	27.6	3.3	1.2	0.6	0.1	0.1
B4 × 0.09	9	5.4	0.5	0.1	0	0	0
MF × 0.05	5	5.0	5.0	5.0	5.0	5.0	3.8
Total	100	96.0	66.4	50.6	37.8	12.5	5.0

FIGURE 4.46—Results of Third Trial Estimate.

The third combined aggregate gradation is close enough to the job-mix formula, and within the tolerances allowed for the job. This set of bin percentages, then, becomes the basis for calibrating the hot aggregate feed system.

Once the proportions of material required from each bin has been determined, calculations are made to determine the weight of the asphalt cement and the weight of the aggregates to be pulled from each bin to produce a single batch of asphalt hot-mix. The first step is to select the production batch size. Batch size depends upon the capacity of the plant's pugmill (mixing chamber). For this example, assume that the plant's pugmill has a 6,000-lb (2722 kg) capacity. At maximum production rate, then, each batch of asphalt hot-mix produced will weigh 6,000 lb. (2722 kg).

Also assuming a 6 percent asphalt cement content in the final mix, the information known can be summarized as follows:

Batch Weight .....	6,000 lb. (2722 kg)
Percent Asphalt Cement.....	6 percent
Bin No. 1 (percent of total aggregate) .....	30 percent
Bin No. 2 (percent of total aggregate) .....	28 percent
Bin No. 3 (percent of total aggregate) .....	28 percent
Bin No. 4 (percent of total aggregate) .....	9 percent
MF (percent of total aggregate) .....	5 percent

From this information, the weight of asphalt cement in each batch can be calculated by multiplying the batch weight by the percentage of asphalt in each batch:

$$6,000 \text{ lbs.} \times .06 \text{ (6 percent)} = 360 \text{ lb}$$

$$(2,722 \text{ kg} \times .06 \text{ (6 percent)}) = 163 \text{ kg}$$

The total weight of aggregates in each batch is determined by subtracting the weight of the asphalt cement from the total batch weight:

$$6,000 \text{ lbs.} - 360 \text{ lbs.} = 5,640 \text{ lbs.}$$

$$(2,722 \text{ kg} - 163 \text{ kg} = 2,559 \text{ kg})$$

Knowing the total weight of all aggregates needed for a batch of asphalt hot-mix allows calculation of the weights (amounts) of aggregate to be pulled from the bins. This calculation is shown below.

<u>Bin</u>	<u>Proportion Percent</u>		<u>Aggregate Weight</u>		<u>Required Weight</u>
No. 1	30 percent	×	5,640 lbs.	=	1,692 lbs.
			(2,564 kg)	=	(769 kg)
No. 2	28 percent	×	5,640 lbs.	=	1,579 lbs.
			(2,564 kg)	=	(718 kg)
No. 3	28 percent	×	5,640 lbs.	=	1,579 lbs.
			(2,564 kg)	=	(718 kg)
No. 4	9 percent	×	5,640 lbs.	=	508 lbs.
			(2,564 kg)	=	(231 kg)
MF	5 percent	×	5,640 lbs.	=	282 lbs.
			(2,564 kg)	=	(128 kg)

Batch weights are generally rounded to the nearest 5 pounds (or kilogram); therefore, the weights to be pulled are:

No. 1 Bin	1,690 lbs.	(770 kg)
No. 2 Bin	1,580 lbs.	(720 kg)
No. 3 Bin	1,580 lbs.	(720 kg)
No. 4 Bin	510 lbs.	(230 kg)
MF	280 lbs.	(130 kg)
<hr/>		
Total.....	5,640 lbs.	(2,570 kg)

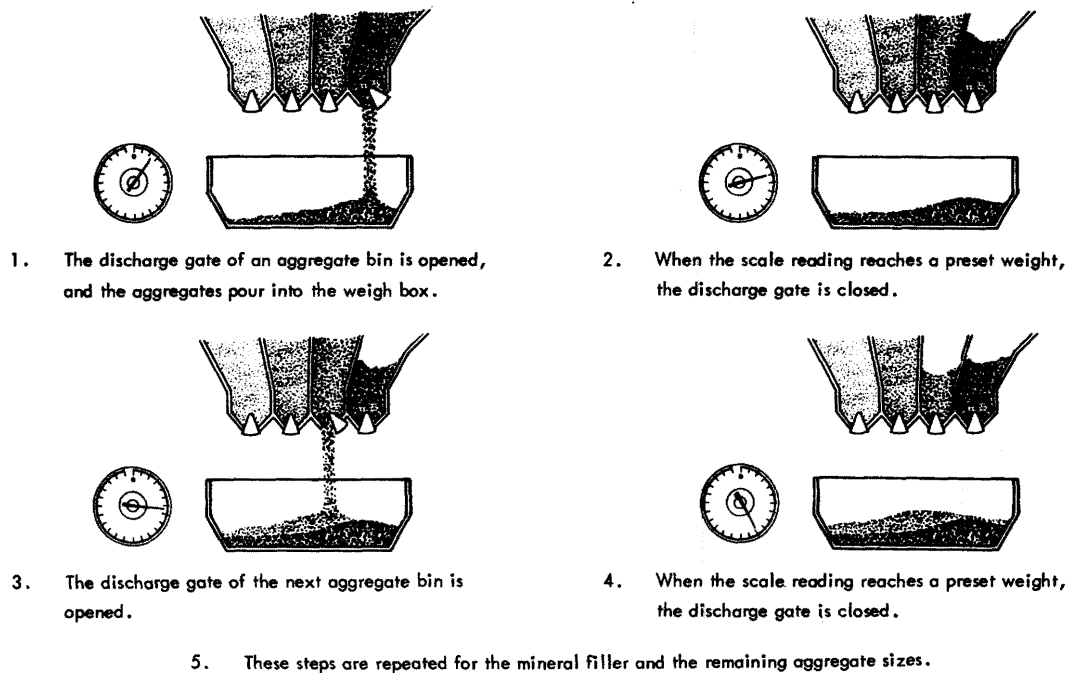
## 4.18 PULLING MATERIAL FROM THE HOT BINS

From the hot bins the aggregates are withdrawn for deposit into a weigh hopper. The weigh hopper is suspended from scale beams and weighs accumulatively the amounts of aggregate entering it.

The order in which the bins dump their proportions of aggregates into the weigh hopper is determined by the contractor or the producer. Usually, coarse aggregates are drawn first, the intermediate-sized aggregates next, and the fine aggregates last. This sequence is designed to place the fine fractions at the top of the weigh hopper, where they cannot leak out through the gate at the bottom of the weigh hopper. This system also allows the most efficient utilization of the available volume in the weigh hopper.

When the pulling sequence is determined, the weights to be drawn from the hot bins are marked on the scale dial. Because the scales indicate the weights cumulatively, the dial must be marked accordingly. Figure 4.47 illustrates how the cumulative scale settings shown above are used to control the proportion of aggregates pulled from each bin.

This is how aggregates and mineral filler are weighed in a batch plant:

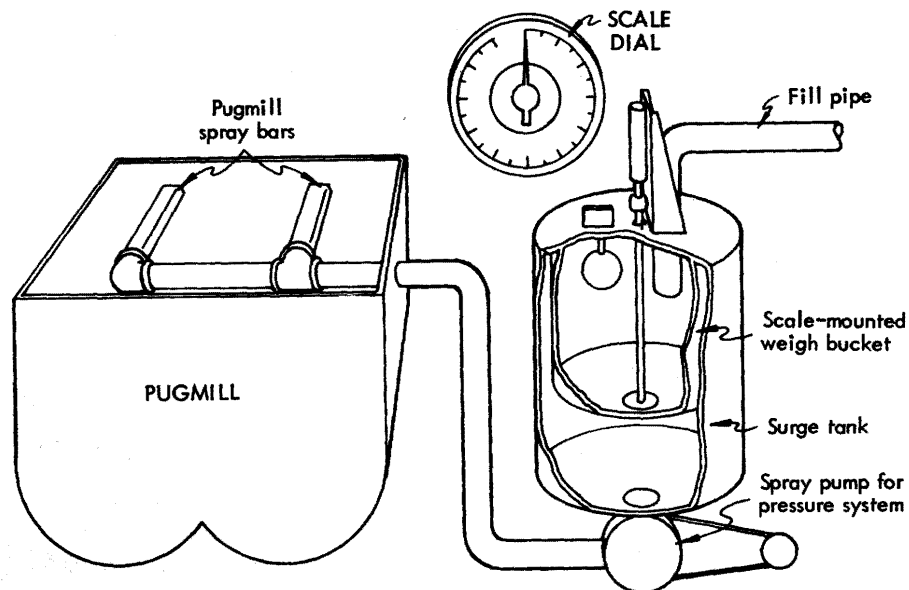


**FIGURE 4.47—How Cumulative Scale Settings Are Used To Control Material Amounts Pulled From Hot Bins.**  
(Courtesy Tennessee Department of Transportation).

## 4.19. INTRODUCING THE ASPHALT

From the weigh hopper, the aggregates are deposited into the plant's pugmill (mixing chamber), where they are blended with the proper proportion of asphalt. In a typical plant system, asphalt is weighed separately in a weigh bucket before being

introduced into the pugmill. When the weight of asphalt in the bucket reaches a predetermined level, a valve in the delivery line closes to prevent excess asphalt from being discharged into the bucket. The asphalt is then pumped through spray bars into the pugmill (Figure 4.48). Asphalt buckets should be checked for accuracy. Ideally, they should be checked first thing in the morning. In the morning, new asphalt loosens some of the old asphalt that accumulated the previous day on the sides and bottom of the bucket. Loss of this accumulated asphalt changes the tare weight of the bucket.



Asphalt cement is weighed separately in a scale-mounted weigh bucket.

**FIGURE 4.48—Typical Asphalt Measuring and Delivery System.**  
(Courtesy Tennessee Department of Transportation).

Malfunctioning of the asphalt distribution system results in nonuniform distribution of the asphalt in the mixture. Visual inspection and tests of the finished mix usually will reveal any functional problems with the system. Generally there is no problem with asphalt distribution system.

#### 4.20. TEMPERATURE OF MIXTURES

Both asphalt and aggregate must be heated before they are combined in the pugmill—the asphalt to make it fluid enough to pump, and the aggregate to make it dry and hot enough to produce a finished mix at the desired temperature.

Asphalt is a thermoplastic material that decreases in viscosity with increasing temperature. The relationship between temperature and viscosity, however, may not be the same for different sources or types and grades of asphalt. (See Section 2 *Materials*).

The temperature of the aggregate controls the temperature of the mixture. Normally, a mixing temperature is specified, based on factors relating to placement and

compacting conditions. Another consideration is the temperature required to dry the aggregate sufficiently to obtain a satisfactory mix.

Mixing should be done at as low a temperature as will provide for complete coating of the aggregate particles and a mixture of satisfactory workability. Figure 4.49 provides a guide to typical mixture temperature ranges.

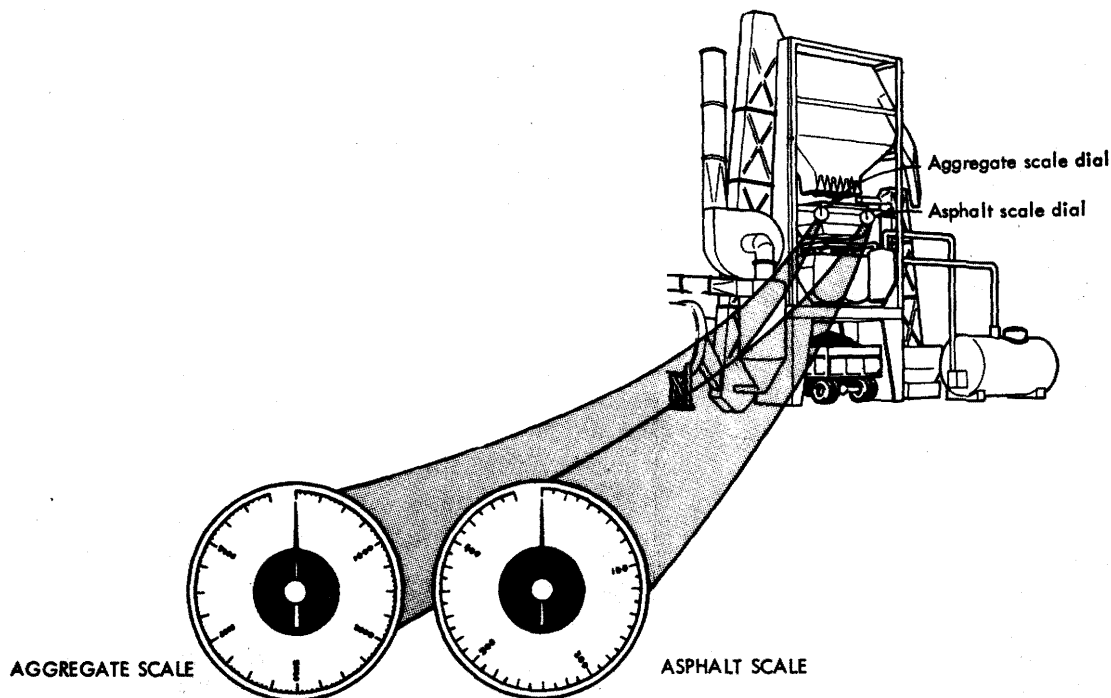
Type and Grade of Asphalt	Pugmill Mixture Temperatures <sup>1</sup>	
	Dense-Graded Mixes	
Asphalt Cements	°F	°C
<b>Asphalt Cements</b>		
AC-2.5	235-280	115-140
AC-5	250-295	120-145
AC-10	250-315	120-155
AC-20	265-330	130-165
AC-40	270-340	130-170
AR-1000	225-275	105-135
AR-2000	275-325	135-165
AR-4000	275-325	135-165
AR-8000	275-325	135-165
AR-16000	300-350	150-175
200-300 pen.	235-305	115-150
120-150 pen.	245-310	120-155
85-100 pen.	250-325	120-165
60-70 pen.	265-335	130-170
40-50 pen.	270-350	130-175

**FIGURE 4.49—Typical Asphalt Hot-Mixing Temperatures (Temperature of mixture immediately after discharge from the pugmill rather than temperature of asphalt cement).**

#### 4.21 PLANT SCALES

Scales are used to weigh out both asphalt and aggregates. Asphalt scale dials are usually graduated at 2-pound intervals while aggregate scale dials are usually in 5-pound intervals. Scale dials should be located where the operator can see them clearly. One arrangement of the scales near the weigh box is shown in Figure 4.50. The scale dial may be remotely located on the central station (Figure 4.56).

Scales may be one of two types: (1) springless dial and (2) beam. Both types have essentially the same general parts—levers, supports, and indicators. On all scales, the lever system, knife edges and bearings should be checked frequently for cleanliness, and to be sure that no moving part is binding against any other part. Any bind or drag on the system of scales will cause the scale dial to give an erroneous indication. The dial needle should be free swinging and register zero at no load. One of the most common causes of scale malfunction is the build-up of asphalt dust, or corrosion and dulling of the knife edges in the lever system. Also, particles of aggregate have been known to lodge in the scale supports and obstruct the free movement of the levers.



**FIGURE 4.50—Typical Arrangement of Plant Scales.  
(Courtesy Tennessee Department of Transportation).**

Before beginning production, the aggregate weigh hopper scales and the asphalt bucket scales should be checked with standard weights. In some States scales are required to be checked periodically by an official agency. This does not relieve the contractor from his responsibility to maintain the accuracy of the scales.

The inspector may request a check test with standard weights, if he suspects the scales have gone out of adjustment during production.

When the plant is first set up, the bins should be loaded to capacity and the plant should be allowed to stand 24 hours or longer to allow the plant to settle before the scales are tested.

After the plant is in operation, the aggregate scales should be tested periodically. This is done in three steps: (1) checking them for balance when empty, (2) weighing a full batch into them, then (3) adding weights and verifying that the scale readings increase. The asphalt scale is checked periodically in essentially the same manner.

In a few cases, asphalt is added to the pugmill from a fluid metering device rather than a weigh bucket. Such metering devices are volume displacement mechanisms that must also be checked periodically for accuracy. Because metering devices give readings in terms of volume displacement but the asphalt cement for the mixture is calculated by weight, a correlation between meter readings and material weights must be established. A simple means of establishing this correlation is to follow these steps:

- Take a meter reading on a tared container.
- Pump a known weight of asphalt into the container.
- Take a second reading from the meter.
- Divide the weight of the asphalt by the difference between the first and second meter readings. The result indicates how much weight corresponds to one division on the meter.

Both the viscosity and the unit weight of asphalt change with a change in temperature. When the temperature is increased, the viscosity decreases. The unit weight decreases at a rate of about 1 percent for every 25° - 30° F (14 to 16° C) increase in temperature. Some asphalt meters have built-in temperature compensation devices that correct the flow of asphalt when temperature changes occur. When a meter without a temperature compensating device is used, it is necessary to adjust the delivery setting whenever a change in asphalt temperature occurs.

#### 4.22 PUGMILL MIXING

The chamber in which the asphalt and aggregates are mixed is called a pugmill. A twin-shaft mixer is used in virtually all modern asphalt plants. It consists of a lined mixing chamber with two horizontal shafts on which several paddle shanks, each with two paddle tips, are mounted. The paddle tips are adjustable and fairly easily replaced.

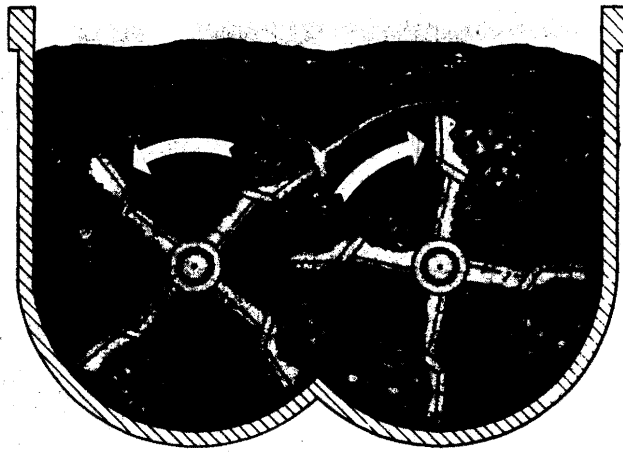
In general, the paddles must be set so that there are no "dead areas" in the pugmill. A dead area is a place where material can accumulate out of reach of the paddles and not be thoroughly mixed. Dead areas can be avoided by being certain that clearance between the paddle tips and the liner is less than one-half the maximum aggregate size. Paddles that have worn considerably or are broken should be readjusted or replaced prior to plant start-up.

Nonuniform mixing may occur if the mixer is over-filled (see Figure 4.51). At maximum operating efficiency the paddle tips should be barely visible at the surface of the material during mixing. If the material level is too high, the uppermost material tends to "float" above the paddles and is not thoroughly mixed. Conversely, in a pugmill containing too little material (Figure 4.52), the tips of the paddles rake through the material without actually mixing it.

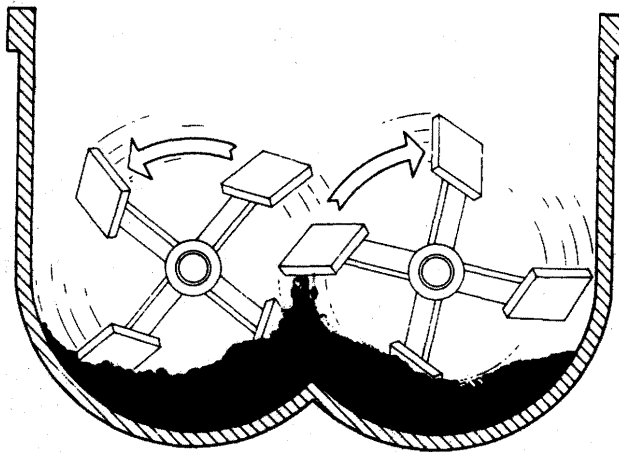
Either of these two problems can be avoided by following the manufacturer's pugmill batch rating recommendation. Normally the manufacturer's rating is based on a percentage of the capacity of the pugmill's "live zone." This live zone (Figure 4.53) is the net volume in cubic feet (m<sup>3</sup>) below a line extending across the top arc of the inside body shell radius with shafts, liners and paddles and tips deducted.

Figure 4.54 illustrates the mixing cycle during which asphalt, aggregates, and mineral filler are blended in asphalt hot-mix in the pugmill. The length of time between the opening of the weigh box (hopper) gate (Step 1 in the figure) and the opening of the pugmill discharge gate (Step 4) is referred to as the batch mixing time. The batch mixing time must be long enough to produce an homogenous mixture of evenly distributed and uniformly coated aggregate particles. However, if the mixing time is too long, the lengthy exposure of the thin asphalt film to the high aggregate temperature in the presence of air can adversely affect the asphalt and reduce the durability of the mix. To monitor batch mixing time, most job specifications require use of some type of timing device.

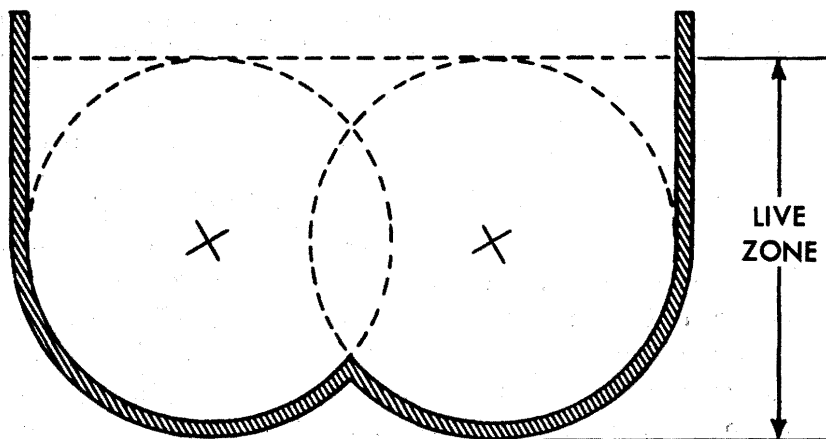




**FIGURE 4.51—Overfilled Pugmill.**

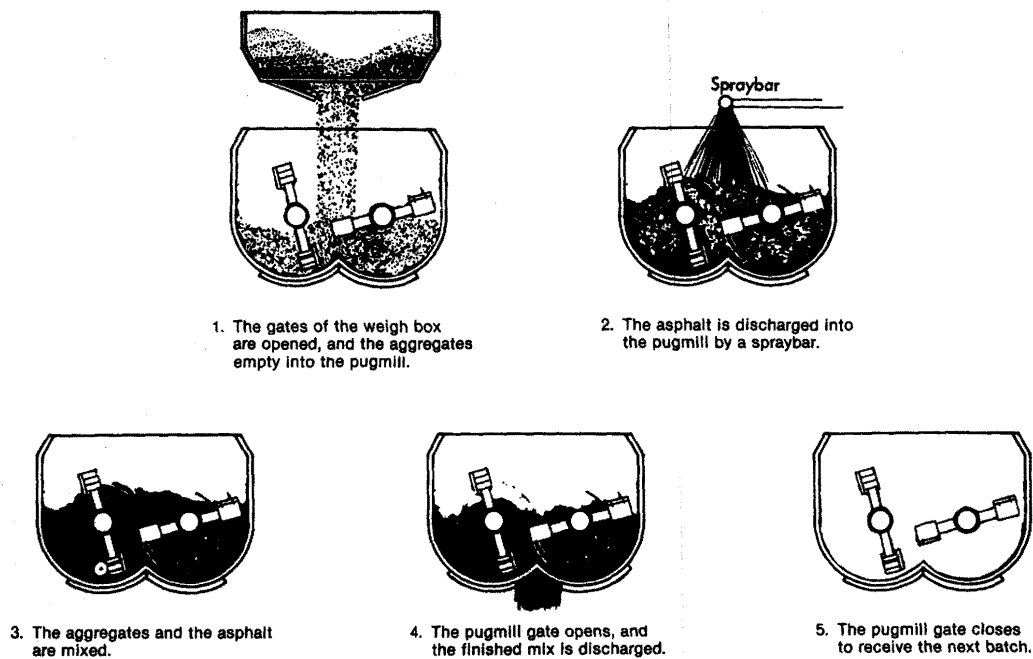


**FIGURE 4.52—Underfilled Pugmill.**



**FIGURE 4.53—Pugmill "Live Zone."**

Mixing time may be set within specification limits for each mix in a specific plant by the procedure described in AASHTO Designation T 195, Determining Degree of Particle Coating of Bituminous-Aggregate Mixtures, or ASTM Designation D 2489, Degree of Particle Coating of Bituminous-Aggregate Mixtures. This system bases the degree of mixing on the percentage of coarse particles that are 100 percent coated with asphalt and correlates it with mixing time.



**FIGURE 4.54—Steps in a Typical Batch-Plant Cycle.**

Coarse particles only are used because they are the last to be coated in the mixing process. Typical minimum percentages required for specification compliance are 90 percent fully coated for base mixes and 95 percent fully coated for surface mixes. The least time needed for the pugmill to produce a batch meeting the minimum coating requirement is set as the minimum mixing time.

The following is an outline of this procedure for determining mixing time. It is suggested that to start determination of mixing time, the plant begins operation on a 30 second mix cycle.

- (1) Samples of the hot-mix are taken immediately after discharge from the pugmill, from three alternate truck loads of mixture.
- (2) The samples are immediately sieved, while hot, through a 9.5mm (3/8 in.) and 4.75mm (No. 4) sieve for material with maximum 4.75mm (3/8 in.) size. The sample should be large enough to yield 200 to 500 coarse particles on the sieve. The sieve should not be overloaded. If it is necessary, the sample can be sieved in two or three operations. Shaking of the sieve should be kept to a minimum.

- (3) The particles are placed on a clean surface, in one-particle layer and counted immediately.
- (4) Each particle is then examined in direct sunlight. If even a small speck of uncoated stone is noted, the particle is classified as "partially coated." Thoroughly coated particles are classified as "completely coated."
- (5) The percent of particles coated is computed using the following formula:  

$$\text{Percent coated} = \frac{\text{Number of Completed Coated Particles} \times 100}{\text{Total Number of Particles}}$$
- (6) If the average of the three samples is greater than specified a lower mixing time can be tried. Steps 1, 2, 3, 4, 5 are repeated until the lowest mixing time is found that yields the specified percentage. If the average is less than specified the mixing time is increased in 5-second intervals until the desirable condition is reached.

#### 4.23 BATCH PLANT AUTOMATION

Modern batch plants are classified into three categories, depending upon their degree of automation: (1) manual, (2) semi-automatic, and (3) automatic. In manual plant operation, each phase of the batching is performed by manipulation of a lever, a switch or a button. Even in the manual plants, however, pneumatic or hydraulic cylinders actuated by electric switches have replaced the hand levers of early plants. Also, all plants, regardless of their classification, utilize power operation of the weighing, mixing and discharge devices. Power equipment operates bin gates, fines feeders, asphalt supply and spray valves, weigh box discharge gate, and pugmill discharge gate.

The semi-automatic plant is one in which a number of the several phases of batching is accomplished automatically. Most semi-automatic plants are arranged so that the operations of the weigh box discharge gate, the asphalt weigh bucket, the wet mixing, and the operation of the pugmill discharge gate are operated automatically. Limit switches ensure that all functions occur in the proper sequence.

The fully automatic plant is almost completely self-acting. Once mix proportions and timers are set and plant operation is begun, the plant machinery repeats the weighing and mixing cycle until the operator stops it or until a shortage of material or some other extraordinary event causes the plant controls to halt operation.

The principal controls on an automatic batch plant include:

- Automatic cycling control.
- Automatic proportioning control.
- Automatic dryer control.
- A console control panel.
- Formula setting.
- Tolerance controls.
- Batching interlocks.
- Recording unit.

A listing of the various automatic controls is provided in Figure 4.55.

<b>Plant Element</b>	<b>Automatic Control</b>	<b>Function</b>
<b>Cold Aggregate Feed</b>	<b>Bin Gate Operators</b>	<b>Vary gate opening to control amount of material metered</b>
	<b>Feed Belt Drive</b>	<b>Varies speed of belt to control amount of material metered from each compartment</b>
<b>Asphalt System</b>	<b>Tank Heater Pump Bucket</b>	<b>Keeps asphalt at proper temperature Controls timing and rate of feed Weighs out, within tolerances, amount of asphalt called for in batch; delivers asphalt to pugmill</b>
<b>Mineral Filler System</b>	<b>Elevator, Screw</b>	<b>Stops feed when proper weight is delivered</b>
<b>Dryer</b>	<b>Burner</b>	<b>Adjusts heating rate to heat aggregates to proper temperature</b>
<b>Dust Collector</b>	<b>Motor Controller</b>	<b>Activates unit when plant starts up</b>
<b>Hot Bins</b>	<b>Indicator</b>	<b>Shows level of material</b>
<b>Weigh Hopper</b>	<b>Scales</b>	<b>Weighs out, within tolerances, amount of each aggregate material called for in a batch; stops batching if any material is short</b>
	<b>Gate Operator</b>	<b>Dumps completed batch into mixer and closes gate</b>
<b>Pugmill</b>	<b>Cycling Mixer</b>	<b>Repeats batch to produce full load Times wet mix cycle</b>
	<b>Mixer Gate Operator</b>	<b>Dumps finished batch into hauler and closes gate</b>

**FIGURE 4.55—Automatic Controls for Batch Plants.**

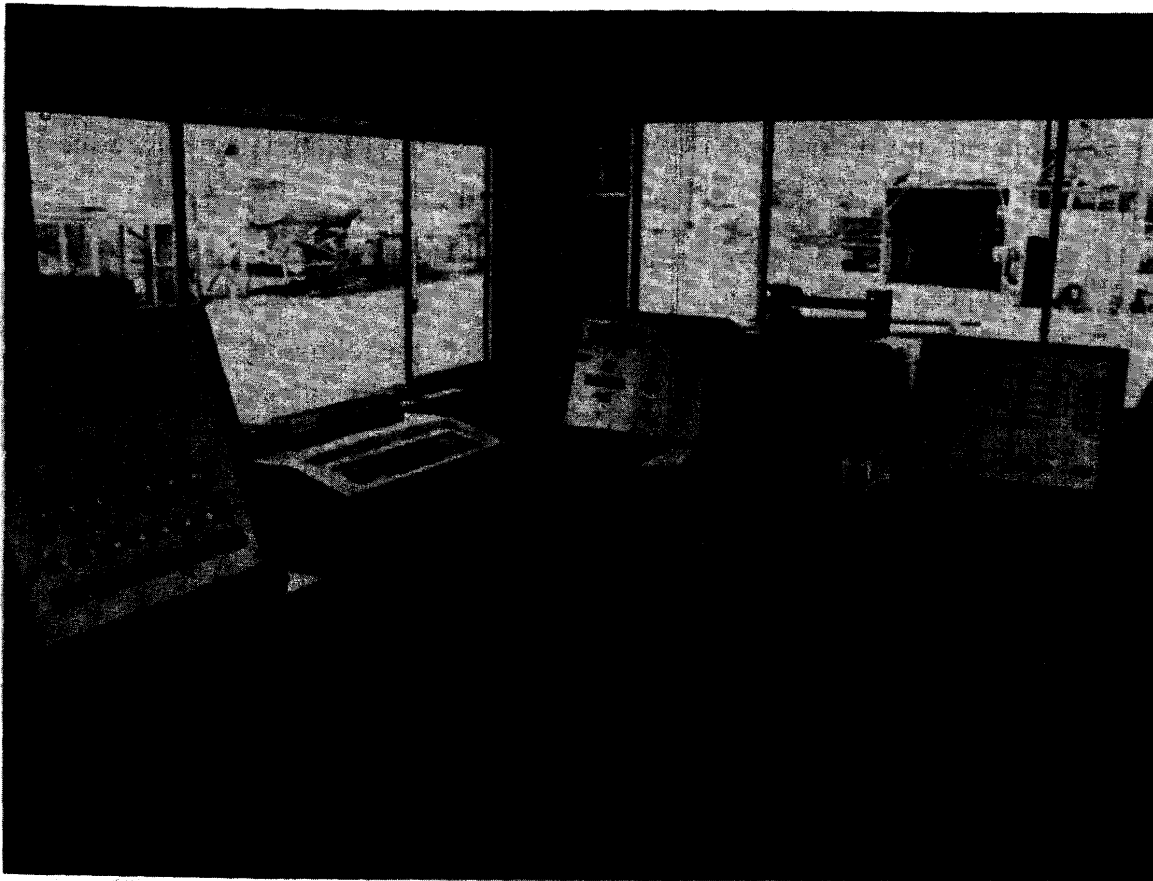
The automatic cycling control draws aggregates and asphalt according to a pre-set batching formula. The opening and closing of the weigh hopper, discharge gate, asphalt valve, and the pugmill discharge gate are activated automatically, without any intermediate manual control. The system includes pre-set timing devices to control the desired period of the wet mixing cycle and automatic equipment is available to determine if the quantities drawn are within the specifications limits. Settings on these devices should be checked for accuracy at least once a week.

The automatic proportioning control and the automatic cycling control work together through pre-set interlock devices. The inspector must become familiar with the particular plant in which he is working and know how to check the function of interlock system.

The automatic dryer control automatically regulates the temperature of the aggregates discharged from the dryer within a pre-set range.

The batching console control panel contains all the switches and circuits for automatic batching, including the batch weight pre-set controls, interlock controls, tolerance controls, and limit switches. The console is usually located within a separate air-conditioned room (Figure 4.56), to exclude the influences of heat, dust, and vibration which can cause malfunctions in the system.

The recording unit is connected to the scale circuitry. It automatically provides record of the weights of materials incorporated into each batch of mix. The record may be in the form of a graph-strip chart where a continuous line represents material weights or a continuous tape of printed numbers that represent batching weights.



**FIGURE 4.56—Control Station for Automated Plant.**

#### **4.24 PLANT INSPECTION GUIDELINES**

Regardless of whether a batch plant is manual, semi-automatic or completely automatic, certain basic plant components and functions must be inspected regularly to ensure that the plant is capable of producing hot-mix that meets specifications and is indeed doing so. Below is a list of items that the inspector should include on this list of items to be checked regularly at all types of batch plants.

### *Batch Plant Inspection Items*

1. Observe accurate proportioning of cold feed aggregates.
  - To ensure proper blend of materials to meet predetermined job-mix formula.
  - To ensure the proper balance of material in the hot bins.
2. Scales zero properly and record accurately.
  - Scale lever systems kept clean.
  - All scale lever rods, knife edges, etc., should be shielded where possible.
3. Asphalt bucket tared properly.
4. Aggregate weigh box hanging free.
5. Mixer condition and function.
  - Mixer parts in good condition and adjusted.
  - Proper size batch being mixed.
6. Sufficient mixing time.
7. Uniform asphalt and aggregate distribution in the pugmill.
8. Valve and gate leaks needing repair.
9. Proper aggregate and asphalt temperature when these materials are introduced into the weighing receptacles.
10. Worn or damaged screens.
11. Moisture content of aggregate after it leaves the dryer.
12. All proper safety requirements being met.

At plants where an automatic control panel is used, the following items should be added to the inspector's check-list:

### *Automatic Control Panel Inspection Items*

1. Input or formula data correct.
2. Bin withdraw order in proper sequence.
3. Automatic switch in "on" position.
4. Mix timers correctly set.
5. All control switches in correct position.

When a plant uses an automatic recording device, the inspector should check the following items regularly:

### *Automatic Recorder Inspection Items*

1. Printouts check accurately against material input and scales.
2. Aggregate printouts refer to proper bins.
3. Keyboard of recorder is covered.
4. Printout readings remain continuous.

## **4.25 DRUM-MIX PLANT OPERATIONS**

### *Objective*

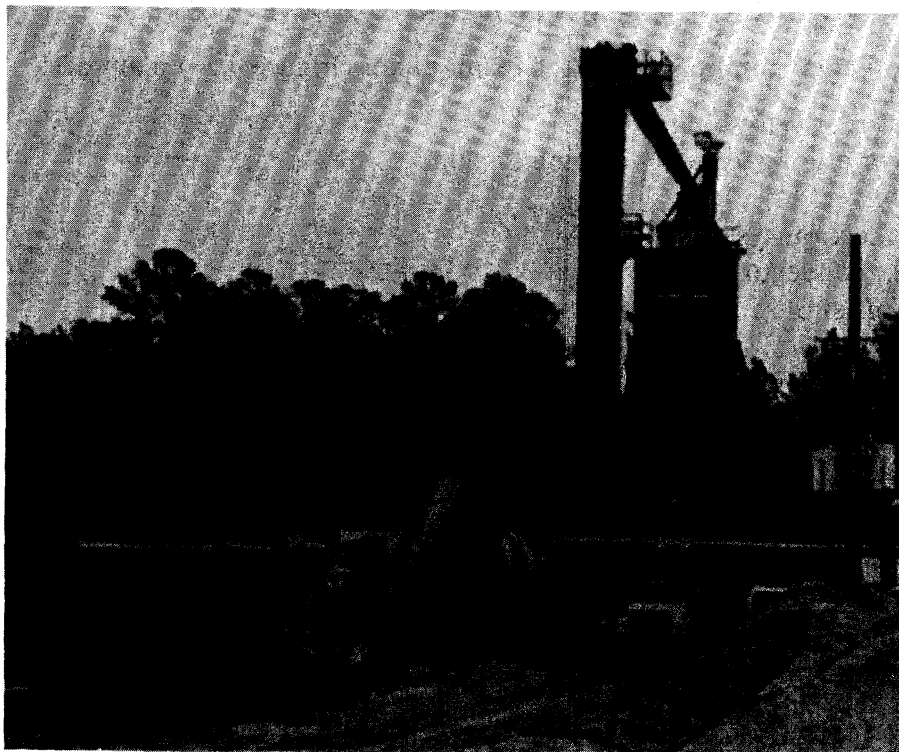
The purpose of this section is to describe functions unique to drum-mix plants and to develop in the inspector the skills needed to ensure that the plant is operating in such a manner as to produce a paving mixture that meets job specifications. Specifically, upon completing study of this section of the manual, the inspector should be able to:

- List the major components of a drum-mix plant.
- Explain the purpose of each component.
- Describe how each component works.
- Outline the process as materials flow through a drum plant.
- Recognize potential problems that may occur and describe specific measures that should be taken to prevent such problems.
- Prescribe corrective measures to be taken in the event that deficiencies are detected in the mix.

In addition, the inspector should have developed a strong awareness of potential safety hazards associated with drum-mix plants and the need for constantly being alert for unsafe practices.

#### **4.26 INTRODUCTION**

Drum mixing is a relatively simple process of producing asphalt hot-mix. The mixing drum (Figure 4.57) from which this type of plant gets its name is very similar in appearance to a batch plant dryer drum. The difference between drum-mix plants and batch plants is that, in drum-mix plants the aggregate is not only dried and heated within the drum, but also mixed with the asphalt cement. There are no gradation screens, hot bins, weigh hoppers or pugmills in a drum-mix plant. Aggregate gradation is controlled at the cold feed.



**FIGURE 4.57—Typical Drum-Mix Plant.  
(Courtesy Barber-Greene Company)**

As the aggregates (correctly proportioned at the cold feed) are introduced into the drum-mix plant for drying, the asphalt cement is also introduced into the drum. The rotation of the drum provides the mixing action that thoroughly blends asphalt cement and the aggregates. As the mix is discharged from the drum it is carried to a surge bin from which it is subsequently loaded into trucks.

#### 4.27 HISTORY OF DRUM-MIX PLANTS

Drum mixing of asphalt concrete materials was originally introduced about 1910. More than one hundred small drum-mix plants were operated until the mid-1930s, when they were replaced by continuous-mix and batch-type plants of greater production capacity. The drum-mixing process was resurrected in a revised form in the late 1960s.

In recent years, drum-mix plants, also called drum-mixers and dryer-drums, have become widely used in the hot-mix asphalt industry. Introduced on a wide scale in the early 1970s, drum-mix plants quickly gained popularity among contractors due to their portability, efficiency and economy. Drum-mixers also have the ability to produce large quantities of high-quality mix at relatively low temperatures or at conventional temperatures.

Several drum-mixing processes have been developed in both the United States and Europe. Common to each process is the heating, drying and coating of aggregate with asphalt cement within the dryer-drum.

#### 4.28 DRUM-MIX PLANT OPERATIONS AND COMPONENTS

The fundamental components of the drum mixer (Figure 4.58) plant are:

- Aggregate cold-feed bins.
- Conveyor and aggregate weighing system.
- Drum mixer.
- Dust collection system.
- Hot-mix conveyor.
- Mix surge silo.
- Control van.
- Asphalt Storage Tank.

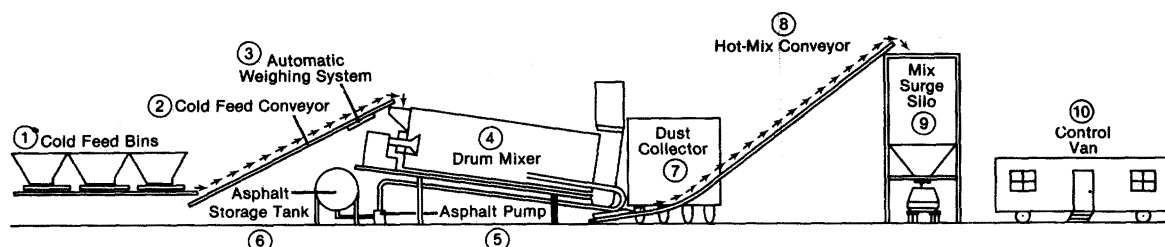


FIGURE 4.58—Basic Drum-Mix Plant.



Referring to Figure 4.58 above, the following is a brief, general description of the sequence of processes involved in a typical drum-mix plant operation: Controlled gradations of aggregates are deposited in the cold feed bins (1) from which they are fed in exact proportions on to a cold-feed conveyor (2). An automatic aggregate weighing system (3) monitors the amount of aggregate flowing into the drum mixer (4). The weighing system is interlocked with the controls on the asphalt storage pump (5) which draws asphalt from a storage tank (6) and introduces it into the drum where asphalt and aggregate are thoroughly blended by the drum's rotating action. A dust collection system (7) captures excess dust escaping from the drum. From the drum, the hot-mix asphalt concrete is transported by hot-mix conveyor (8) to a surge silo (9) from which it is loaded into trucks and hauled to the paving site. All plant operations are monitored and controlled from instruments in the control van (10).

The mixing process is essentially the same in all drum mixing plants. Methods of feeding the materials to the dryer, however, may differ.

The production of hot-mix that meets job specification is most easily accomplished when the various parts and functions of the plant are in balance; that is, when they are properly coordinated to work together as a smooth-working unit. Also essential for consistent and high quality hot-mix asphalt is uniform (uninterrupted) plant operation. Accurate proportioning of materials is entirely dependent on the uniform flow of those materials. Plant stops and starts adversely affect mix quality.

To ensure balance and uniformity necessary to produce hot-mix asphalt concrete that meets specifications in all respects, the following control equipment is required for all plants:

- Separate cold feed controls for each aggregate size.
- Interlocking controls of aggregate cold feed, asphalt delivery and additive delivery to the drum.
- Automatic burner controls.
- Primary dust collector that can feed back collected material into the system or waste the dust.
- Sensors to measure temperature of the hot mixture at drum discharge.
- Gate controls on surge hopper.
- Moisture compensator.

Controls and monitoring devices are usually housed in the control van, where there is good visibility of the entire operation.

#### **4.29 AGGREGATE STORAGE AND FEED**

In a drum-mix plant, mix gradation and uniformity are entirely dependent on the cold-feed system. Proper care must be exercised not only in production of the aggregate, but also in storage. The contractor should provide for receiving and handling aggregates in such a way that there is no danger of contamination or intermingling. Among other things, this means providing clean surfaces on which to place the materials.

Stockpiles must be properly graded, and it is recommended that stockpiles be split into different-sized fractions to properly control the gradation of the mix. Practices

vary with respect to the sizes of aggregates that are separated into different stockpiles. However, for well-graded mixes ranging from 12.5mm to 25mm (1/2 to 1 in) in maximum size, at least two stockpiles must be made.

For mixes with greater than 25mm. (1 in.) maximum aggregate size it may be desirable to further separate the aggregate by employing three stockpiles. Without this stockpile separation it may be difficult to maintain the proper gradation control.

Segregation can be prevented by constructing stockpiles in lifts not exceeding 4 ft (1.2 m), and removing aggregate from the upper areas of the stockpile, thereby minimizing sloughing of the side slopes.

Segregated stockpiles, if uncorrected prior to entrance into the mixing plant, will result in mix gradation difficulties. It should be the plant operator's option to either establish and maintain non-segregated stockpiles, or to initially construct stockpiles in the most economical manner and subsequently correct any deficiencies in uniformity before the aggregate is fed into the mixing plant. Regardless of the method of handling, all efforts should be directed at delivering the correct, uniformly-graded aggregate blend to the mixing plant.

Since the typical drum-mix plant, unlike a batch plant, does not incorporate a gradation screening unit, the aggregate must be proportioned prior to its entry into the mixing drum; this is essential. The most efficient way to accomplish this is with a multiple-bin cold-feed system equipped with precision belt feeders for the control of each aggregate. Under each bin is a belt feeder on to which the aggregate is proportioned. Precise controls (Figure 4.59) are used here to feed the exact proportions on to the belt.

The plant should be equipped with provisions to conveniently obtain representative samples of the full flow of material from each cold feed and the total cold feed. The inspector or technician will be required to run sieve analysis of dried aggregate from these samples.

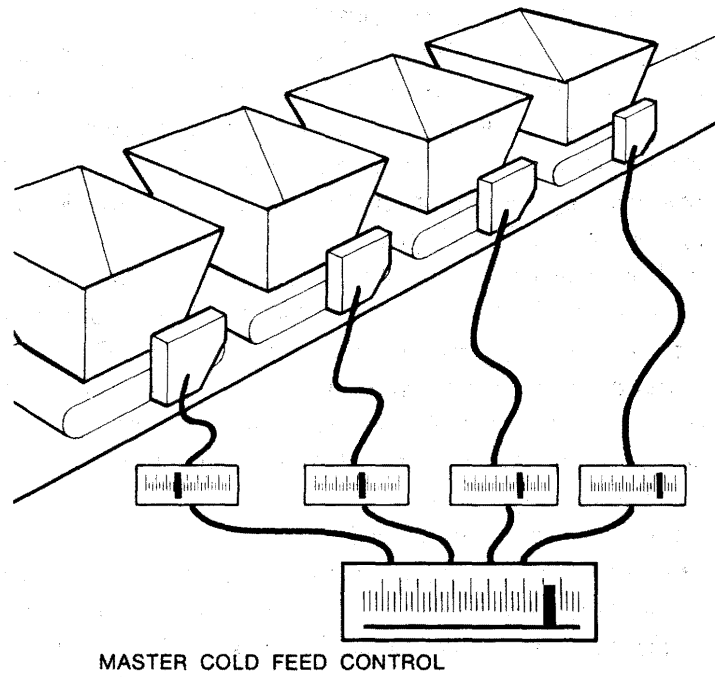
Cold feed control consists of the following:

1. Sieve analysis of aggregate in each bin.
2. Calibrate feeders—both gate opening and belt speed.
3. Establish bin proportions.
4. Set gate openings and belt drive speeds.

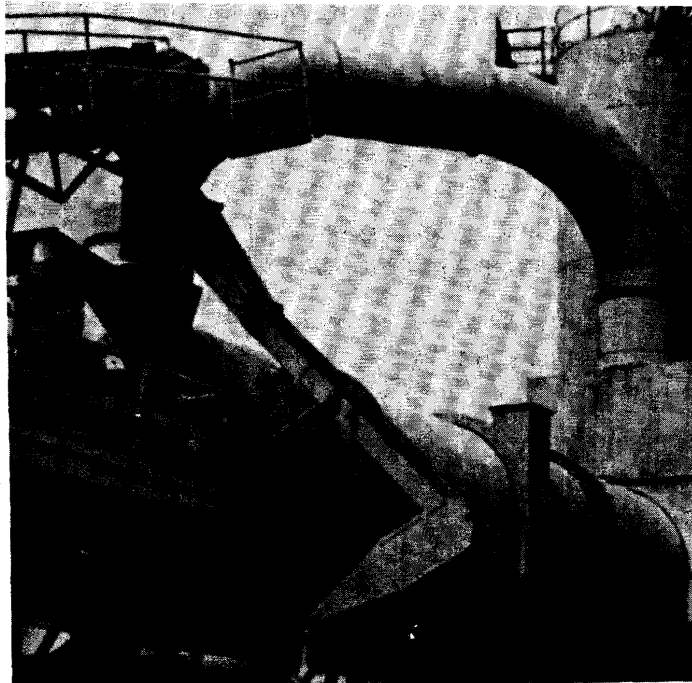
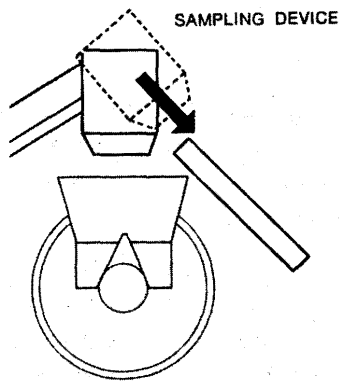
Once calibrated, the gate openings should be checked frequently to ensure that they remain properly set. All settings should be considered tentative because the cold aggregate used in the mix may vary in grading and moisture content, which may require adjustment of the gates to maintain a uniform flow.

To calibrate the aggregate metering system and to plot a cold-feed capacity chart, a sampling device or method to obtain samples is necessary. The device should permit the flow of aggregate to be diverted to a collection container for accurate weight checks of timed aggregate samples (Figure 4.60). Such devices are usually installed at the end of the conveyor belt just prior to entry into the drum mixer.

Drum-mix plants require a continuous weighing system on the cold feed conveyor belts. In-line belt weighers, also called weigh bridges (Figure 4.61) are continuous belt-weighing devices used for this purpose. Combined aggregates passing over the conveyor belt are continuously weighed and a readout (in the control trailer) indicates



**FIGURE 4.59—Master Cold Feed Control.**  
 (Courtesy Barber-Greene Company)



**FIGURE 4.60—Typical Sampling Device.**

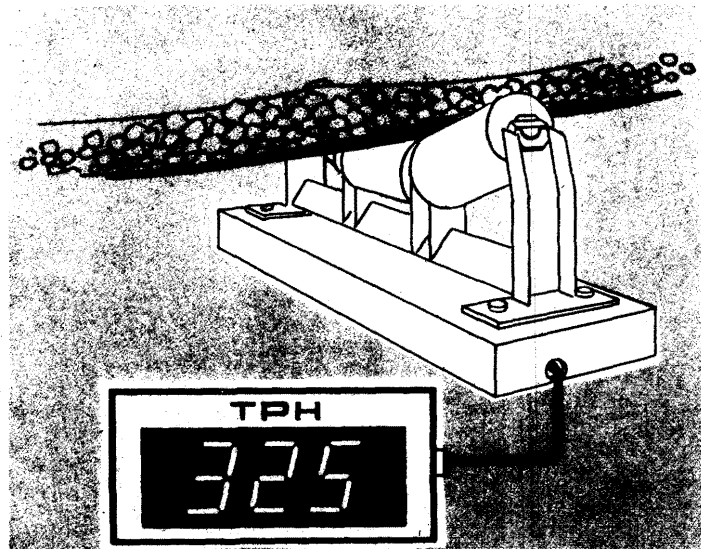
the weight of the flow over the scale at any given instant. No material should ever be diverted from the conveyor belt after it passes the belt weigher.

Figure 4.61 shows one of the conveyor idlers (designated the weigh idler) of the belt weigher is mounted on a pivoted scale carriage. As the loaded belt passes over this idler, the weight is read in tons per hour and a reading displayed at the control console in the control van or trailer. This reading is normally corrected to account for moisture in the aggregate (since dry-aggregate data is used to establish the required percentage of asphalt) and is a key reading in the monitoring plant operations.

The in-line belt weigher is usually located midway between the head and tail pulley of the cold feed belt conveyor. This location tends to lessen variations in reading caused by impact loading, roll-back of aggregate or changes in belt tension. Means can be provided for conveniently diverting aggregates into trucks, front-end loaders, or other containers for checking the accuracy of the belt weigher. The device should be accurate within  $\pm 0.5$  percent when tested for accuracy.

In drum-mix plants the aggregate is weighed before drying. Since the undried material may contain an appreciable amount of moisture that can influence the aggregate's weight an accurate measurement of aggregate moisture content is important. From the measurement, adjustments can be made to the automatic asphalt metering system to ensure that the amount of asphalt delivered to the drum is proper for the amount of aggregate minus its moisture content.

The inspector should monitor the moisture content of the cold feed aggregate before beginning each day's operation and again about the middle of the day, and the contractor should adjust the moisture control equipment accordingly. If the moisture content is believed to vary during the day, it should be checked more frequently. The moisture content may be determined manually or electronically. Provisions should be made for electronically correcting wet aggregate weight readings to dry aggregate weight readings.



**FIGURE 4.61—Typical In-Line Belt Weigher.**  
(Courtesy Barber-Greene Company)

#### 4.30 ASPHALT METERING

The drum-mixer is typically equipped with a device (Figure 4.62) to add asphalt to the aggregate inside the drum mixer.

The asphalt metering and delivery system is a continuous mechanical proportioning system interlocked with the aggregate weigh system to ensure the exact asphalt content of the mix. The weight of aggregate going into the mixer, as measured by the weigh belt, is the basis of determining the quantity of asphalt delivered into the drum.

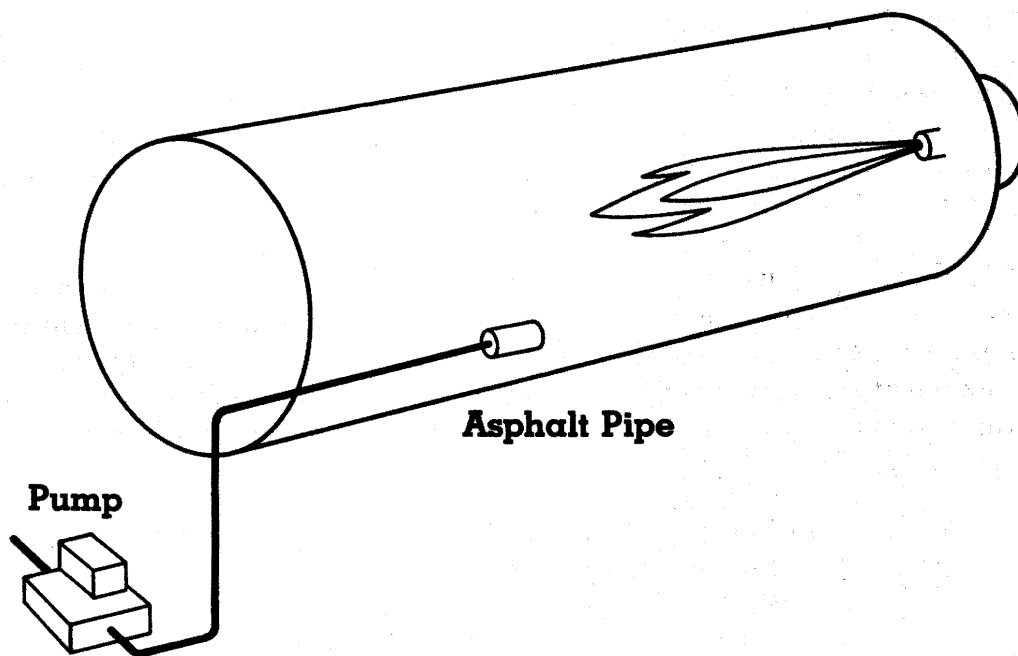


FIGURE 4.62—Asphalt Inlet.

The proportioning of asphalt is accomplished by establishing the necessary rate of asphalt delivery in gallons per minute to match the aggregate delivery in tons of dry aggregate per hour. The asphalt cement delivery rate is increased or decreased proportionately according to the corrected dry weight measurement of aggregate passing over the belt scale. The rate of asphalt delivery is indicated on a rate meter on the control panel.

Typically, the rates of delivery of aggregate and asphalt cement are recorded on continuously recording circular graphs located in the control van. The graphs provide both monitoring and a permanent record of the proportioning of asphalt cement and total aggregate.

## 4.31 DRUM-MIX OPERATION

### 4.31 A. Basic Description

The heart of the drum-mix plant is the mixer itself. It is similar in design and construction to a conventional batch plant rotary dryer, except that a drum-mixer not only dries aggregate but also blends the aggregate and asphalt together into a hot mixture.

The drum-mixer can be divided into two sections or zones: (1) a primary or radiation zone and (2) a secondary or convection/coating zone (Figure 4.63).

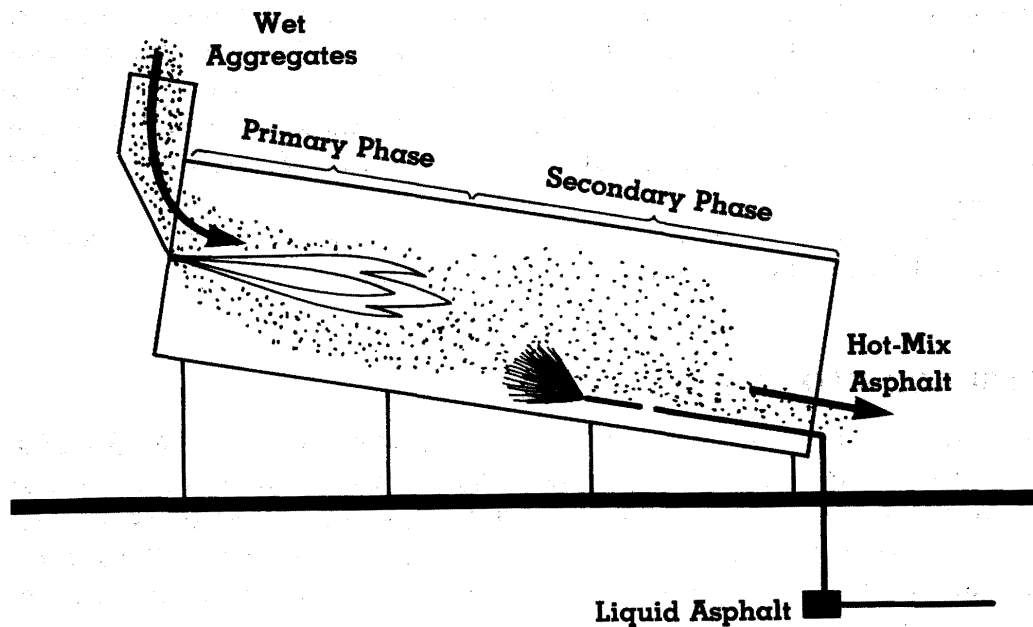


FIGURE 4.63—Zones in Drum Mixer

Aggregates enter the primary zone, where heat from the burner dries and heats them. They then move to the secondary zone, where asphalt is added and aggregates and asphalt are thoroughly blended. Continued convection drying also occurs in the secondary zone. The mixture of hot asphalt and moisture released from the aggregate produces a foaming mass that traps the fine material (dust) and aids in the coating of the larger particles.

Within the drum it is important that the aggregate not only rotate with the revolving motion of the drum but also spread out sufficiently to make heating and drying of all particles quick and efficient. To direct the aggregate flow and spread the aggregates into a veil across the cross-section of the drum, drum-mixers are equipped with flights.

Spiral flights, located at the charging (burner) end of the drum direct wet aggregate into the drum in such a way as to attain uniform drum loading. Tapered lifting flights then pick up the aggregates and drop them in an even veil through the burner flame.

Subsequent flights direct the aggregate through the drum and continue to drop it in veils through the cross-section of the drum.

Mix temperature is monitored continuously by a sensing device at the discharge end of the drum mixer. The temperature recorder and other indicators are located in the control van along with the burner controls.

A suitable means should be provided for inspecting and sampling the mixture at the discharge of the drum.

#### **4.31.B Burner Operation and Control**

The purpose of the burner inside the drum-mixer is to provide the heat necessary to heat and dry the aggregates used in the final mixture. The burners provide this heat by burning fuel—oil, gas, or both.

When oil is burned, low pressure air drafts are used to atomize the fuel oil for burning. Burners using natural gas and LPG can be low-pressure or high-pressure units. In all cases, the fuel feed and air blower must be balanced to ensure that the proper proportions of fuel and air are being introduced into the burner for efficient combustion. Lack of balance can lead to incomplete burning of the fuel, which, especially in the case of fuel oil or diesel fuel can leave an oily coating on the aggregate particles.

Such imbalances between fuel feed and air flow can be corrected by either decreasing the fuel feed rate or increasing the blower or draft air.

#### **4.32 SURGE SILO AND WEIGH SCALES**

In a drum-mix operation, which produces a continuous flow of fresh asphalt hot-mix, it is necessary to have a surge silo for temporary storage of the material and for controlled loading of trucks. A weigh system may be connected to the holding bin of the silo to monitor the amount of material loaded into each truck. Weight measurements are normally recorded by the weigh system control panel, located in the control van or trailer.

#### **4.33 SUMMARY OF DRUM MIXERS**

The basic components of the drum-mix plant have just been discussed, together with, the necessity of close control of aggregate gradation in the cold bins and the control of aggregate and asphalt feeding into the drum mixer. The basic functions of the drum mixer, which combines the materials into asphalt hot-mix was also discussed.

Drum-mix plant inspection procedures must be followed to ensure that materials are proportioned correctly and properly mixed at the desired temperature. These procedures include inspecting the proportioning equipment, sampling and testing the aggregate gradation, determining aggregate moisture content, and monitoring mix temperature. Frequent samples of the hot-mix should be analyzed to determine whether or not the hot mix asphalt concrete produced meets job specifications.





## SECTION 5

### PLACING OPERATIONS

#### 5.1 INSPECTOR OBJECTIVES

At the conclusion of this section of the manual, the inspector should:

- Understand all procedures for placing hot-mix asphalt.
- Be familiar with the principles of the asphalt paver and the floating screed.
- Understand the principles and functions of an automatic screed control.
- Recognize how to plan and control a paving operation at a definite width and thickness.
- Know how to match and/or construct transverse and longitudinal joints.
- Understand placing and mix deficiencies and how they might be corrected.

#### 5.2 INTRODUCTION

##### *5.2.A Background*

Nowhere in the construction of hot-mix asphalt pavements are the efforts and skills of an inspector more apparent than in the placing of the hot-mix in the roadway. The inspector's knowledge and surveillance of the paving operation can mean the difference between a durable, smooth-riding pavement and a rough, unsound pavement that is a nuisance to drive on.

During paving operations, the inspector has two primary responsibilities. They are:

- To be certain that contract specifications are met, and
- To provide the contractor every opportunity to meet the job specifications in the most cost-effective manner.

Meeting the first responsibility guarantees the public a pavement that will perform well for a long time. Meeting the second ensures the cooperation of the contractor, which is essential for the construction of a quality pavement.

To meet these responsibilities, the inspector must have a cordial, cooperative relationship with the contractor. He must thoroughly understand the job specifications. He must be familiar with the equipment necessary to perform paving operations and the proper use of the equipment.

Because communication is essential for successful paving operations, a construction conference should be held before work begins. Such a conference allows the project engineer, the paving superintendent, the contractor, the inspector, and others directly involved with the operation the opportunity to discuss topics such as the following:

- Who is authorized to receive orders from the engineer and who is authorized to deliver such orders to the contractor.
- Revisions of schedule or specifications.
- Use of new equipment or test methods.
- Plant and paver production rates.
- Traffic control.
- Record keeping.
- Special equipment or personnel requirements.
- Construction of a control strip.

The construction conference is the time for questions to be answered, problems to be solved, and channels of communication and command to be established. It is a time to establish relationships with everyone involved in the project so that confusion and friction can be avoided once paving operations begin.

### ***5.2.B Inspector's Responsibilities***

The paving inspector should be thoroughly familiar with the specifications and see that they are complied with during the paving operation.

He should ensure that each load of mix is satisfactory, that data from the truck tickets is recorded accurately, and that the paver is operated properly. Should any deficiencies appear in the mat during placing, he should make sure corrections are made before the mix cools.

He should pay attention to details such as proper thickness of the spread, proper crown, properly constructed and matched joints, and surface texture and uniformity.

He should monitor the temperature of the hot-mix to ensure that proper mix temperature is maintained during the paving operation.

He should maintain a diary or a record for future reference and record anything unusual or events that may be useful at a later date.

He should appreciate his responsibility. He should be tactful in his dealings with the contractor and in his requests for corrective action when necessary.

He must keep accurate, detailed records. In addition to the information included on haul tickets, there are other important items that must be recorded as part of the permanent records. Any unusual occurrences or changes in construction methods, equipment, appearance, or handling properties of the mix should be noted in the diary along with the station (location) on the roadway where the change was made.

The daily diary is for the inspector's convenience during construction, but on completion of construction it should become a part of the permanent records of the project. A page from a typical inspector's diary is shown in Figure 5.1.

In addition to the information shown above, the inspector should include summaries of test reports of density of pavement samples for each type of mixture used. The inspector should also note any delays and their causes, as well as list all visitors to the project.

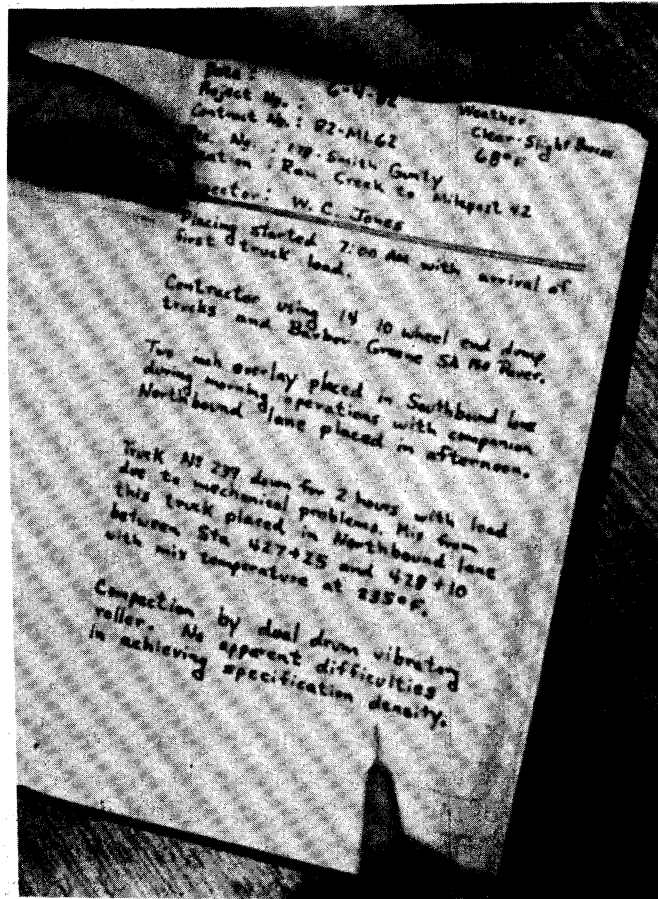


FIGURE 5.1—Typical Inspector's Diary Entry.

### 5.3 PREPARATION FOR PAVING

#### 5.3.A Surface Inspection and Preparation

Hot-mix asphalt can be placed on a variety of surfaces, including:

- Subgrade (soil).
- Granular base course (aggregate).
- Existing asphalt pavement.
- Existing portland cement concrete pavement.

Certain inspection and control procedures are common to the preparation of all of these surfaces. Others pertain only to one or two types of surfaces. Items to be performed and checked for each type are described below.

**5.3.A.1 Subgrade**—The subgrade (soil) under a pavement is the foundation for the pavement. Regardless of the type of pavement to be placed, the subgrade must meet

certain specification requirements. It must be strong enough to support the pavement and the expected traffic. It must also be properly graded to ensure good drainage and a smooth, safe, properly-banked or crowned riding surface. It must be thoroughly and uniformly compacted to the required density.

During inspection of the subgrade, the inspector should look for areas of soft or yielding soil that are too weak to properly support the paving equipment. Such areas should be corrected prior to paving. Checks should be made of both the transverse (width-wise) and longitudinal length-wise) grade of the subgrade. If either is not within tolerance, the grade must be corrected, by removing material, or by adding and compacting material similar to that already in place.

If a full-depth pavement is to be placed, special precautions must be taken. A full-depth pavement is one in which asphalt is used as the aggregate binder in all courses (layers) above the subgrade. The hot-mix is placed directly on the subgrade.

For a full-depth pavement to be placed properly, the subgrade surface must be firm, hard and unyielding, and must be free of loose particles and accumulations of dust. In small areas, handbrooms can be used to remove loose particles. In more extensive areas, powerbrooms are recommended. If the dust is the result of drying of the subgrade surface, water from a water tank can be used to dampen the surface and bind the dust particles.

**5.3.A.2 Base Course**—A base course can be either a layer of granular material (aggregate) placed on the subgrade and compacted or, in the case of full-depth pavement, a layer of asphalt concrete. In either case, the base must be uniform in strength and within grade tolerances as required by the specifications. In addition, the surface should be free of debris and accumulations of dust.

**5.3.A.3 Asphalt Pavement**—When placed on top of an existing asphalt pavement, an asphalt concrete layer is called a hot-mix overlay. An overlay is designed to rehabilitate and strengthen an old pavement, extending its life and correcting surface irregularities.

To ensure a good overlay, the existing asphalt pavement must be properly prepared. Potholes and unstable sections must be repaired. Slight depressions must be cleaned out and filled with new material; deep depressions should be cut out of the pavement and replaced with a new material. If the base course or the subgrade beneath a section of the old pavement is unsuitable, it too should be replaced. Uneven joints must be leveled and cracks must be filled and sealed.

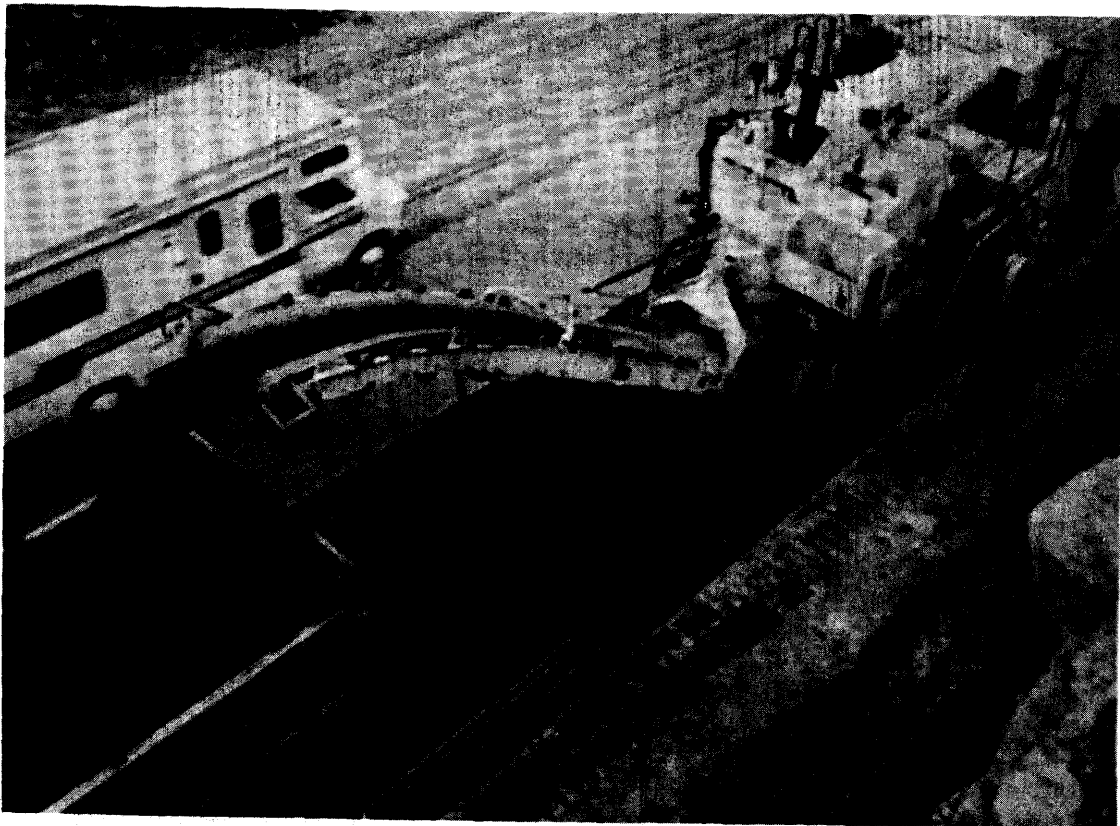
Occasional high spots can be removed by a heater-planer, a machine that heats the old pavement surface and then planes it off to a predetermined depth. Cold milling machines do the same job without first heating the pavement surface. (Figure 5.2)

When the surface is distorted, the construction of leveling courses and/or leveling wedges is required to restore proper line and cross-section. When thin surfacing courses are to be used, it is especially important that prior correction of the surface contour be made. Planing may be required in areas where maintenance of a minimum clearance and/or the matching of an existing elevation are necessary.

Leveling wedges are patches of asphalt plant mix used to level sags and depressions in an old pavement prior to the surfacing operation. The placing of leveling wedges is part of the leveling-course operation.

Leveling wedges should be placed in two layers if they are from 3 to 6 in. (75 to 150mm) in thickness. Wedges thicker than 6 in. (150mm) should be placed in compacted layers of not more than 3 in. (75mm). In placing multiple layers the shortest length layer should be placed first, with the successive layer or layers extending over or covering the short ones. See Figure 5.3 for illustrations of the correct and incorrect ways of making leveling wedges. If the incorrect method were used, as shown in the lower illustration, there would be a tendency for a series of steps to develop at each joint because of the difficulty of feathering out asphalt mixtures at the beginning and end of a layer. A bump at these joints is apt to reflect through to the final surface.

Where wedging of dips requires multiple layers, sufficient levels should be taken to plot profiles and cross-sections accurately. From these, the grade of the proposed correction and the lineal limits of the successive layers should be determined so that the inspector and the contractor can be given definite stationing for starting and terminating the spreader or motor grader passes (Figure 5.4). Figure 5.5 illustrates the correct way to place leveling wedges for overcoming excessive crown.



**FIGURE 5.2—Cold Planer (Courtesy of CMI Corporation).**

CORRECT



INCORRECT



FIGURE 5.3—Correctly Placed Leveling Wedges Ensure Smoother Pavements.

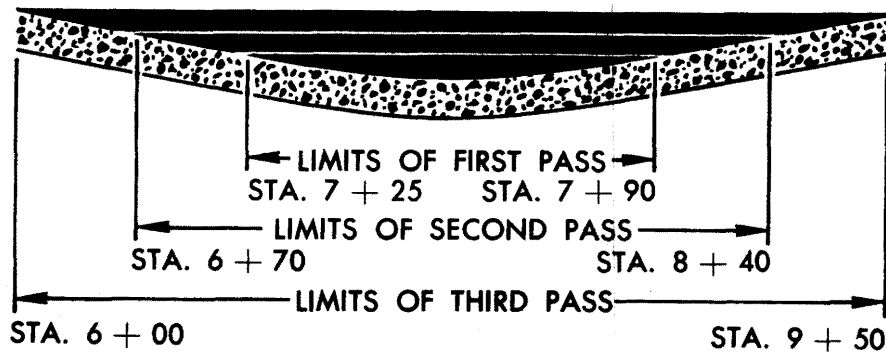


FIGURE 5.4—Limits for Multiple-Layer Leveling Wedges Should be Determined by Level.



FIGURE 5.5—Correctly Placed Leveling Wedges for Overcoming Excessive Crown.

**5.3.A.4 Portland Cement Concrete (PCC) Pavement**—Overlaying portland cement concrete pavement demands special preparation. First, uneven joints and moving slabs (pavement sections) must be identified. Slabs must be stabilized either by undersealing or by breaking and seating. Contract specifications generally dictate which method to use.

### *Undersealing*

Undersealing is a method for stabilizing moving slabs and filling voids that may have developed under them. Generally, this operation includes:

- Drilling holes in the depressed or unstable slab.
- Filling voids under the slab with asphalt cement of a type specified for undersealing. The asphalt is heated and pumped under the slab under pressure.
- Plugging the holes in the slab with wooden plugs until the asphalt underneath cools and solidifies.
- Filling holes with mix.

### *Breaking and Seating*

Breaking and seating is exactly what its name implies; breaking an unstable slab into pieces and seating the pieces firmly into the subgrade. Breaking and seating cannot be used where the pcc pavement has already been overlaid with hot-mix or where the pcc pavement has been reinforced with steel.

Generally, the breaking and seating procedure is as follows:

- A trench parallel to the edge of the slab and deeper than the thickness of the slab is dug. This provides a drainage channel for the escape of moisture trapped under the slab.
- The slab is broken into pieces with a drop hammer.
- The pieces are seated into the subgrade by rolling them with a roller of specified weight.
- The seated pieces are covered with hot-mix.

When either undersealing or breaking and seating is performed, the inspector must keep accurate records of the number of gallons of asphalt used and the number of hours of operation of rollers and drop hammers. These records are important for determining how much the contractor is to be paid for these items.

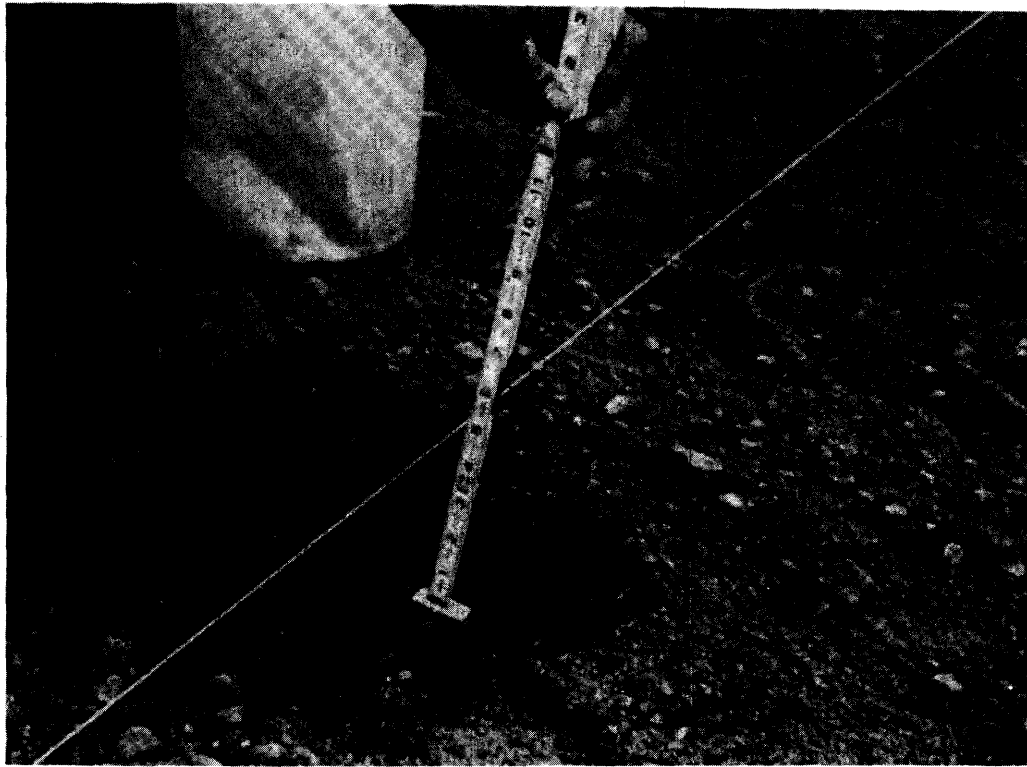
### *5.3.B Adjusting Street Fixtures*

Before an overlay operation, manholes, catch-basins and utility appurtenances must be raised so that they will be level with the surface of the overlay. In the case of manholes, ring-type collars are used to raise the height. Often these appurtenances may have to be removed so that layers of brick or concrete can be built up under them. Whenever excavation is required to change the height of a fixture, backfill material must meet job specifications.

After they are raised, but prior to the overlay being placed, exposed fixtures must be marked by flags or barricades so as not to present a hazard to traffic.

### *5.3.C Horizontal and Vertical Grade Control*

In new pavement construction both horizontal and vertical grade control must be established to ensure that the finished pavement is constructed in accordance with the project plan location and profile. A survey crew will normally establish the centerline of the proposed pavement and erect grade and line stakes in the subgrade, parallel to and at a fixed distance from the centerline on either side of the roadway, (Figure 5.6).



**FIGURE 5.6—Grade and Line Stakes.**

On straight lengths of road, the stakes are usually placed at 100-foot (30 m) intervals; on curves they are set more closely together.

Although it is the responsibility of the contractor to place stakes and lines to keep the distributor and the paving machine properly aligned, it is the duty of the paving inspector to check the accuracy of the alignment and grade.

Transverse (width-wise) grades can be checked by placing stakes of a known length (referred to as control stakes) on either side of pavement layout and running a stringline between them. The stringline readily exposes deviations in grade.

An alternative method is to fabricate three standards from wood or metal that can be used for establishing a line of sight grade. The standards may be telescoping by using a  $\frac{3}{16}$  in. (9.5mm) inside diameter pipe in which a  $\frac{1}{4}$  in. (6.3mm) diameter metal rod is placed. A set screw in the pipe will allow an adjustment for the height of the inner rod. The total height of each standard should be approximately  $3\frac{1}{2}$  ft. (1.1m). By adjusting the standards to the same height and placing them in a line on the grade being checked, sighting across the top of the standards will quickly identify irregularities in the grade.

If the standards are to be used for establishing elevation as well as checking grade line, one standard can have graduated marks in units of inches or tenths of feet. Utilizing the graduated standard with the other two and a hand level, the inspector can measure the approximate elevation as well as the deviation in the grade. In order to



do this, one standard must be placed on an established grade point of known elevation, while the inspector sights through the hand level adjacent to the graduated standard.

This method is particularly useful when a motor grader is being used for fine-grading on prepared base or when a leveling course of asphalt concrete is being placed with a blade.

Grade and elevation corrections are done by either building up or cutting away sections of subgrade. Such corrections can be done by hand on small sections, but major corrections are usually done by a motor grader.

Where irregular roadway surfaces require a high degree of leveling, the best method by which this can be accomplished is by placing a taut stringline that the paver can use as a reference line. Various types of wire and cord can be used; blocks, as well as grade stakes with adjustable guides, can be used to support the stringline.

The line is stretched and anchored at intervals of 300 to 500 feet (91 to 152 m) and supported on 25-foot (8 m) centers. If there is a sharp change in grade, it is necessary to shorten the distance between the line anchors. If the line is left in place overnight, it should be checked the next morning, as moisture may change the tension of the cord, allowing some sag. It is also necessary to locate the line in an area which will not be interfered with by traffic. On curves, the distance between anchors should be shortened and the supports placed at closer intervals to maintain the alignment of the curve.

### **5.3.D Prime Coats and Tack Coats**

Prime coats and tack coats are applications of liquid asphalt applied to base material or lower layers of the pavement.

**5.3.D.1 Prime Coats**—A prime coat is a sprayed application of a medium curing cutback asphalt or emulsified asphalt applied to a base course of untreated material. When a medium-curing cutback (solvent-diluted) asphalt is used, it is applied heavily enough to penetrate into the base material. When an emulsified asphalt is used, it must be mixed into the base material by a motor grader, rotary mixer or other type equipment.

A prime coat has three purposes:

- It helps to prevent the possibility of a slip plane developing between the base course and the surface course.
- It prevents the base material from shifting under traffic before the first course is placed.
- It protects the base courses against weather.

Application rates for prime coats vary with the type of asphalt used. For a medium-curing cutback asphalt, MC-30, 40 or 250, application ranges between 0.2 to 0.5 gallons per square yard (0.9 to 2.3 litres/m<sup>2</sup>); when an emulsified asphalt SS-1, 1h, CSS-1, 1h, is used, application rates vary between 0.1 to 0.3 gallons per square yard per inch of depth (0.5 to 1.4 litres/m<sup>2</sup>/25mm). Exact application rates are determined by the project engineer.

Occasionally, too much cutback asphalt might be applied. Even after a normal curing time (about 24 hours), some of the asphalt still has not been absorbed into the

base. To prevent bleeding of the prime coat up through the asphalt concrete or creating a slip plane, the excess cutback should be blotted with clean sand. Blotting involves spreading clean sand over the prime coated surface and rolling it with a pneumatic-tired roller. Before hot-mix asphalt can be placed on the prime coated base, however, excess sand must be swept away. Excess sand left in place will prevent a good bond between base course and asphalt layers. Prior to paving, the primed base should be inspected to make sure it is in proper condition.

**5.3.D.2 Tack Coats**—Tack coats are applications of asphalt (usually emulsified asphalt) sprayed on to the surface of an existing pavement prior to an overlay. The purpose of a tack coat is to promote the bond of the old and new pavement layers. Tack coats are also used where the hot-mix contacts the vertical face of curbs, gutters, cold pavement joints and structures.

Tack coats should not be applied during periods of cold or wet weather. Best results are obtained if the road surface is dry, has a surface temperature above 80° F (27° C) and there is no threat of rain. Tack coats are normally applied on the day the overlay is being placed.

Before the emulsion breaks (the water in the emulsified asphalt begins to evaporate and the asphalt begins to bond with the old pavement surface), a tack-coated surface is slick. Traffic should be kept off the tack coat until no hazardous condition exists, and should be warned of the probability of the emulsion splattering when driven over. The overlay should not be placed until the tack coat has cured to the point where it is tacky to the touch.

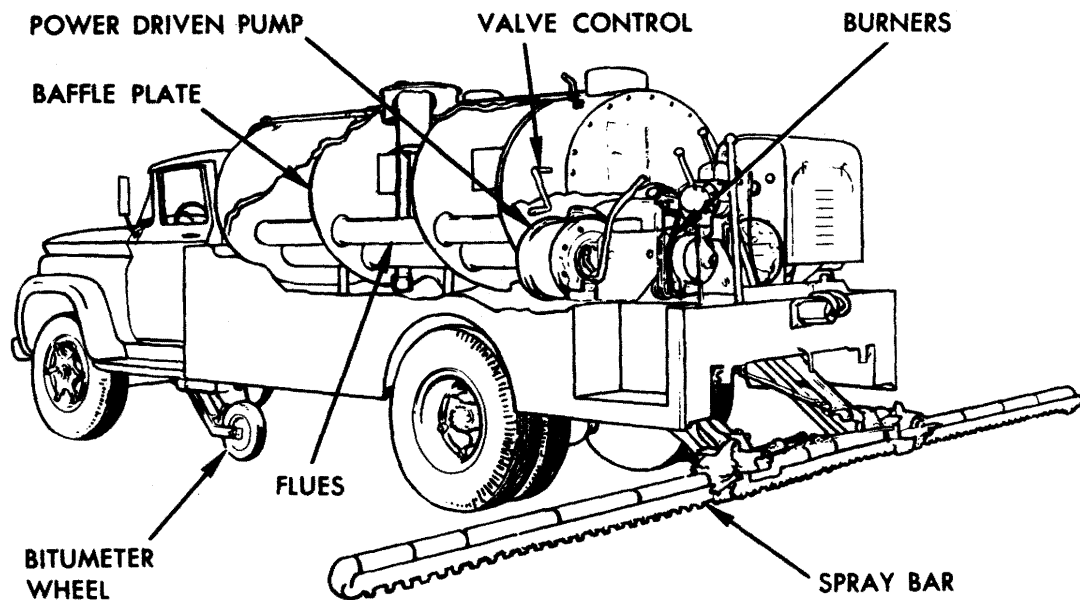
The application rate for tack coats is normally 0.05 to .15 gallons of diluted emulsion SS-1, 1h, CSS-1, 1h, per square yard (0.25 to 0.70 litres/m<sup>2</sup>). Too little tack coat will not provide a bond where needed, while too much can cause slippage between the old and new pavement layers. In addition, too much could cause bleeding into the overlay mix and loss of mixture stability. The exact application rate should be determined by the project engineer.

Although other asphalts can be used for tack coats, a diluted emulsified asphalt (one part water to one part emulsified asphalt) gives the best results for the following reasons:

- Diluted emulsified asphalt flows easily from the distributor, allowing a more uniform application of the tack coat.
- Emulsion is diluted to provide enough volume for the distributor to function at normal speed (application rate).

When applying either prime coats or tack coats, care must be taken to prevent asphalt from being sprayed onto curbs, gutters, bridge decks, guardrails, or passing automobiles.

**5.3.D.3 The Asphalt Distributor**—Prime coats and tack coats are applied usually by an asphalt distributor. As shown in Figure 5.7, an asphalt distributor is a truck-mounted or trailer-mounted asphalt tank with pumps, spray bars, and appropriate controls for regulating the rate at which asphalt leaves the spray-bar nozzles. A distributor normally includes an oil-fired or gas-fired heating system to maintain the asphalt at the proper application temperature, and a hand-held spray attachment for



**FIGURE 5.7—A Typical Asphalt Distributor.**

applying asphalt to areas inaccessible to the spray bars. The heating system is not normally used for emulsions. When the distributor is not in use, a circulation pumping system keeps the asphalt in motion to prevent the asphalt from solidifying and clogging the spray bar and nozzles.

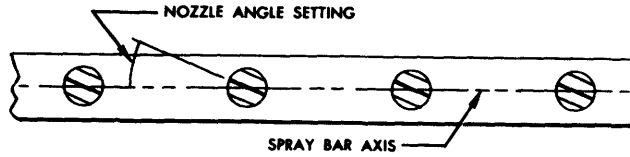
A medium-curing cutback asphalt, which is usually applied at an elevated temperature, should not be put into a distributor that had previously contained an emulsion unless it is certain that no water remains in the distributor.

#### *Spray Bar Adjustment*

For normal use, the spray bar of the distributor should be adjusted so that the vertical axes of the nozzles are perpendicular to the roadway. Nozzles should also be set at an angle of 15 to 30 degrees of the horizontal axis of the spray-bar (Figure 5.8) to prevent the fan-shaped spray patterns of each nozzle from interfering with one another. Each nozzle should be set at the same angle.

Another key spray-bar adjustment that is essential for uniform prime or tack coat coverage is adjustment of the spray-bar height. As Figure 5.9 shows, the fan-shaped spray patterns from the nozzles overlap to different degrees, depending on the distance between the spray-bar and the surface to be covered. The spray-bar should be set high enough above the roadway for the surface to receive double coverage. This height will vary according to the nozzle spacing of the spray-bar.

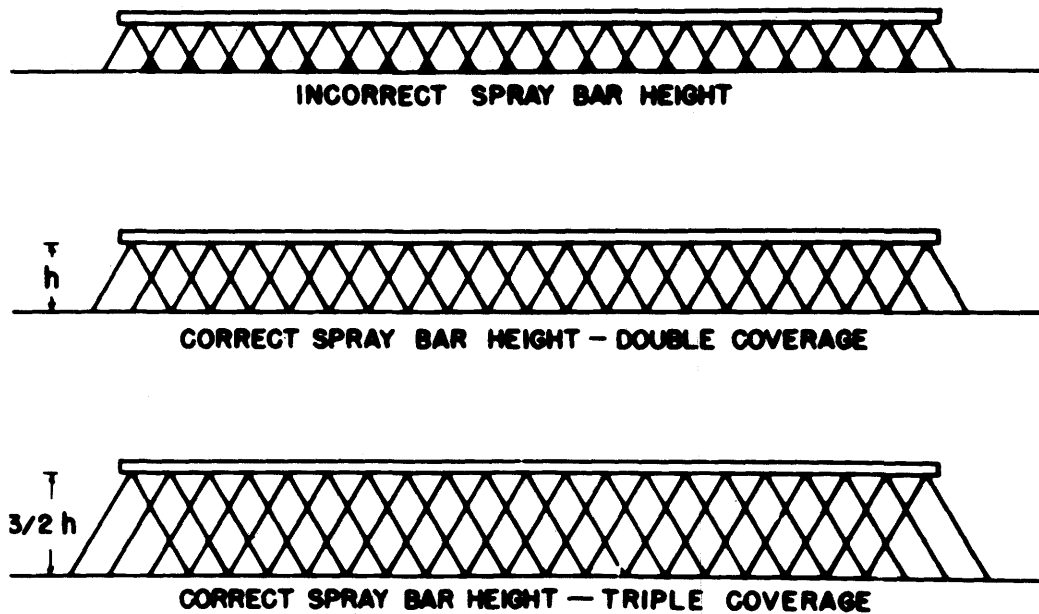
On some distributors, as asphalt is sprayed (and the load lightens) the truck's rear springs rise, raising the distributor and changing the height of the spray-bar. Me-



**FIGURE 5.8—Proper Angling of Nozzles.**

**NOTE**

On occasion, some operators will set end nozzles at a different angle (60 to 90 degrees with respect to the spray-bar) in an attempt to obtain a good edge. This practice should **NOT** be permitted as it will produce a fat streak on the edge and rob the adjacent spray fan of the lap from this nozzle. A curtain on the end of the bar or a special end-nozzle with all nozzles set at the same angle will provide more uniform coverage and make a better edge.



**FIGURE 5.9—Spray-Bar Height and Coverage.**

chanical devices are usually available that automatically correct the spray-bar height as this change occurs.

The importance of uniform application of asphalt (prime and tack) is essential. Transverse spread should be allowed to vary no more than 15 percent. The longitudinal spread should not vary more than 10 percent. To ensure the correct application, the distributor must be calibrated before it is used. Then the transverse and longitudinal spread rates variations should be checked periodically to determine if the distributor is operating within these limits. A procedure for checking these spread variations in the field has been standardized by ASTM D 2995.

### *Distributor Controls*

There are three types of control devices common to most distributors. They are a valve system that controls the flow of asphalt, a pump tachometer or pressure gauge that registers pump output, and a bitumeter with odometer that indicates both the speed of the distributor in number of feet per minute and the total distance traveled by the distributor. All three controls are essential for measuring the quantity of asphalt being applied to the road surface.

The bitumeter should be checked periodically to be certain it is accurately registering the distributor's speed during spraying operations. A buildup of asphalt on the bitumeter wheel is a major cause of bitumeter error. The wheel should therefore be kept clean.

A bitumeter test is conducted on a straight and level length of road. A distance of either 500 or 1000 feet (175 or 350 m) is marked off. The distributor is then driven at a constant speed over the marked distance and the trip is timed with a stopwatch. The time elapsed on the stopwatch is used to calculate the distributor's speed in feet (metre) per minute. This speed is compared with the bitumeter dial reading recorded during the test run. The procedure is repeated, with the distributor driven at a different speed on each run. Discrepancies between the reading on the bitumeter dial and the speeds calculated from elapsed times on the stopwatch are noted and are used as correcting factors when spraying operations begin.

### *Measuring Asphalt*

Asphalt used for prime coats or tack coats is often paid for by the gallon (or litre). This means that the contents of the distributor must be measured both before and after spray applications. The difference between the first measurement and the second indicates the amount of material applied to the road. Some distributors have flow gauges that register the amount of asphalt pumped. These gauges must be zeroed (set to zero) before spraying begins and must be read immediately after spraying is completed.

All distributors are equipped with measuring sticks furnished by the manufacturer. They are marked in increments of 25 or 50 gallons (95 litre or 190 litre), depending on the tank size.

When measuring the amount of asphalt in a distributor, it is important to also take the temperature of the material. An accurate asphalt temperature is required to ascertain that the asphalt is at the temperature specified for spraying, and provide the necessary information for making temperature-volume corrections (See Section 2, *Materials*).

### Calculating Load Coverage

It is important to know how much roadway can be covered by the asphalt contained in the distributor. The "length of spread" of a distributor load is calculated in U.S. Customary units using the following formula:

$$L = \frac{9T}{WR}$$

Where: L = Length of spread in feet  
T = Total gallons in distributor  
W = Sprayed width of roadway (in feet)  
R = Rate of application (in gallons per square yard)

### Suggested Spraying Temperatures

Figure 5.10 is a chart listing suggested spraying temperatures for various types and grades of asphalt commonly used for prime coating and tack coating.

Type and Grade of Asphalt	Temperature Range	
	°F	°C
SS-1	70-160	(20-70)
SS-1h		
CSS-1	70-160	(20-70)
CSS-1h		
MC-30*	85 +	(30 +)
MC-70*	120 +	(50 +)
MC-250*	165 +	(75 +)

\*Application temperatures may, in some cases, be above the flashpoints of some materials. Care must be taken to prevent fire or explosion.  
The maximum temperature (cutback asphalt) shall be below that at which fogging occurs.

FIGURE 5.10—Spraying Temperature Ranges for Prime and Tack Coat.

### 5.3.E Spreading with a Motor Grader

Motor graders sometimes are used for spreading asphalt plant mixes in base and leveling courses. In spreading a course with a motor grader blade, the principal advantage offered by the longer wheelbase of the grader is the elimination of excessive humps, sags, and irregularities in the subgrade or old pavement on which the mix is to be placed. Another benefit gained by laying a course with a motor grader is a rough-textured surface on which to place the next course. Sometimes an end plate on the blade of the motor grader is helpful. It permits a surge of material to be carried across the width of the blade without excessive waste and segregation.

When placing a leveling course, and when the motor grader operator manipulates his controls properly, he will leave more material in the depressions and less material at the humps and the roller immediately behind will compact this material, gradually building up a smooth, firm plane on which to place the succeeding course or courses.

When an automatic blade control is used on a motor grader, it holds the blade to the transverse slope set on the dial regardless of the terrain and position of the grader frame. By using a string or wire-line, set to proper grade, and a pointer on the end of the grader blade, the operator is able to maintain accurate longitudinal alignment while the automatic blade control holds the blade to proper cross section.

## 5.4 PAVING EQUIPMENT

Paving operations include delivery of hot-mix asphalt to the job site, placement of the mixture on the roadway, and compaction of the mixture to its target density. The delivery and placement of hot mix is discussed in this section; compaction is discussed in Section 6.

The inspector has specific responsibilities related to delivery and placement of the mix beginning with a thorough familiarity with the equipment used.

### 5.4.A Pavers

Pavers are self-propelled machines (Figure 5.11) designed to place the asphalt mixture on the roadway to a specific depth and to provide initial compaction of the mat (layer of mixture in place).

The two major parts of a typical paver are the power or tractor unit and the screed unit (Figure 5.12).

**5.4.A.1 Power Unit**—The tractor unit provides moving power for the paver wheels or tracks and for all powered machinery on the paver. The tractor unit includes the receiving hopper, feed conveyor, flow control gates, distributing augers (or spreading screws), power plant (engine), transmissions, dual controls, and operator's seat.

In operation, the tractor unit power plant (engine) propels the paver, pulls the screed (leveling) unit, and provides power to the other components through transmissions. Hot-mix is deposited in the hopper, from where it is carried by the feed conveyor through the flow control gates to the distributing augers (spreading screws).

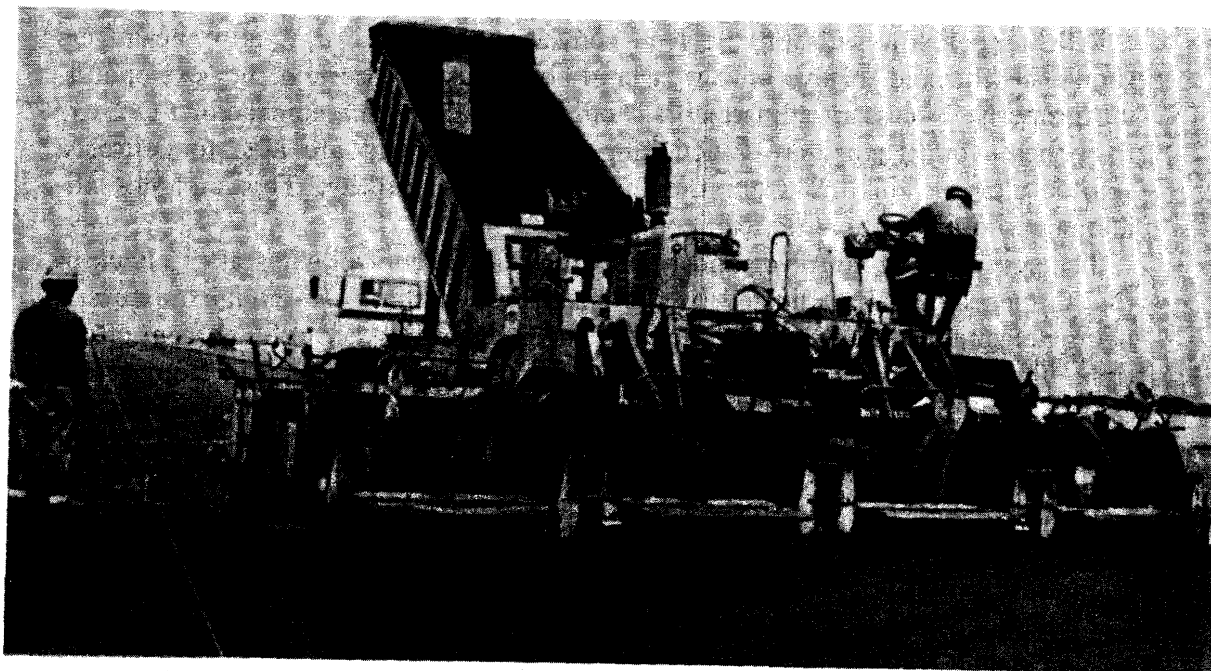


FIGURE 5.11—A Typical Paver Unit.

The augers distribute the mix evenly across the full width of the paver for uniform placement on to the roadway surface. These operations are controlled by the paver operator by means of dual controls within easy reach of the operator's seat.

To ensure that the paver functions properly, several items should be checked prior to commencement of paving.

- *Tires or Tracks*

If the paver is equipped with pneumatic tires, tire condition and air pressure must be checked. It is particularly important for the pressure to be the same in tires on both sides of the paver. If the paver moves on tracks (crawlers), the tracks should be checked to be certain they are snug but not tight, and drive sprockets should be checked for excessive wear. Low tire pressure or loose crawlers can cause unnecessary movement of the paver, transmitted to the screed unit, resulting in an uneven pavement surface. There should be no buildup of material on tires or on tracks.

- *Governor*

The governor on the engine must also be checked to be sure that there is no periodic surge in the engine RPM. If it is not working properly, there can be a lag in power when the engine is loaded (strained). Such a lag causes temporary failure of the vibrators or tamping bars in the screed unit, resulting in a stretch of pavement that is less dense or contains slightly less material than the immediately adjacent area. After rolling, such an area shows up as a transverse ripple in the pavement. A power lag can also interfere with the smooth and consistent operation of electronic screed controls.

- *Hopper, Flow Gates and Auger*

The hopper, the slats on the feed conveyor, the flow gates, and the augers should be checked for excessive wear and observed to be certain they are operating properly. Necessary adjustments should be made by the contractor to ensure that these components are functioning as designed and are able to deliver a smooth flow of mixture from the hopper to the roadway. This includes adjustments to any automatic feed controls.

The speed of the conveyor and the opening of the control gates at the back of the hopper should be adjusted by the contractor so that just enough mixture is being delivered to the augers to keep the augers operating about 85 percent of the time. This will allow a uniform quantity of mix to be maintained in front of the screed. If additional mix is required to allow an increase in the thickness being placed, the flow control gates should be adjusted. Augers should be kept about three-quarters full of mixture during paver operations.

**5.4.A.2 Screed Unit**—The screed unit has two major functions. It strikes off the mix in a manner that meets specifications for thickness and smoothness and it provides initial compaction of the mixture.

A typical screed unit is comprised of the following; screed tow arms, screed plate, heating unit, tamping bars, vibratory attachments or a combination of both, and controls.



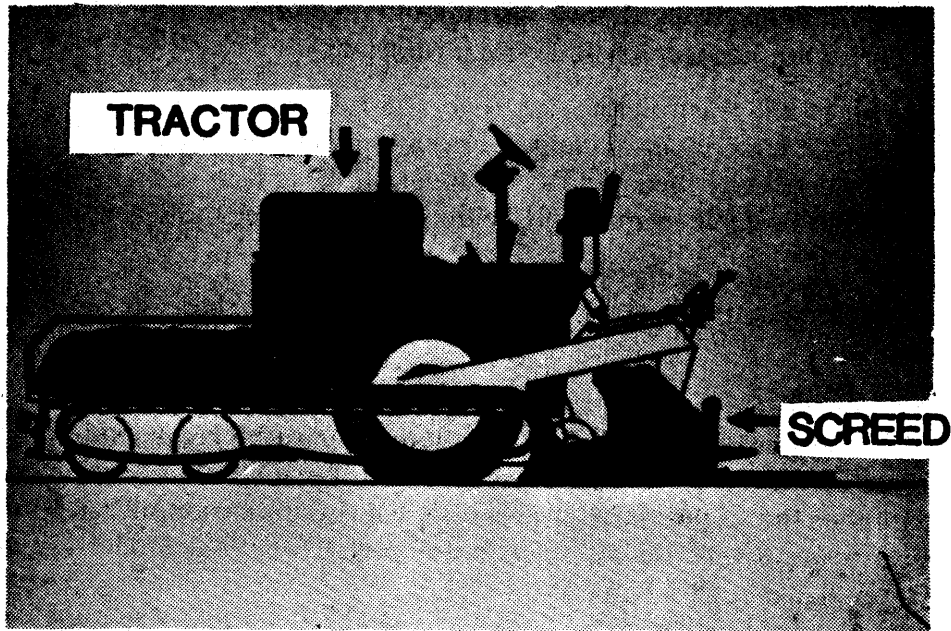


FIGURE 5.12—Paver Power Unit and Screed Unit.

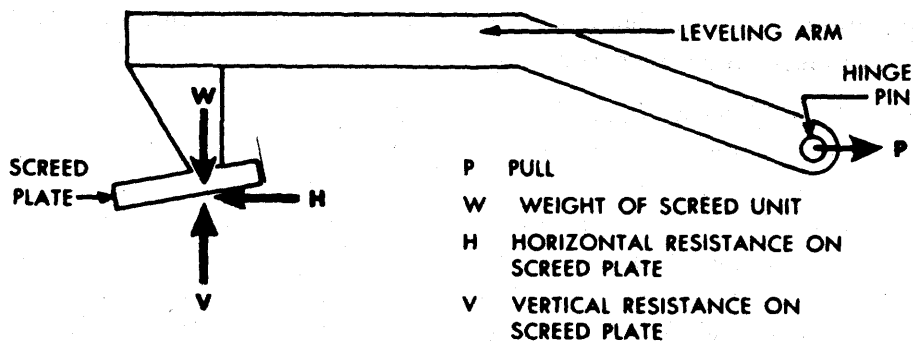


FIGURE 5.13—Forces Acting on the Screed.

In operation, the screed is pulled along behind the tractor unit. The long screed pull-arms are pivoted, which permits the screed to have a floating action as it travels along the road. As the tractor unit pulls the screed into the mix, the screed seeks the level at which the path of the screed is parallel to the direction of pull. At this level all of the forces acting on the screed are in balance as the paver moves down the road. The screed plate irons the surface of the mixture, leaving the mat to a depth that conforms with job specification. Mat thickness and crown shape are regulated by screed controls. Tamping bars or vibratory attachments then compact the mat slightly, in preparation for rolling.

The screed acts automatically toward maintaining times and tends to bring all the forces acting on it into balance. These forces include:

- Forward pull by the tractor (P).
- The force of the material in the augers and moving against the screed (H).
- The downward force of the screed's own weight; (W) and
- The upward-lifting force of materials being crowded under the screed (V).

The forces are illustrated in Figure 5.13

Attaining proper mat thickness is a matter of balancing these forces with one another.

For example:

- To maintain forward motion of the screed force P must be greater than force H.
- To increase the thickness of the mat, tilt the screed plate so that more material is crowded under the screed plate. The screed will rise until the finished surface is again in a plane parallel to the direction of pull. Force V will decrease at this point and be balanced by Force W.
- To reduce mat thickness, tilt the screed plate so that less material crowds under the screed plate.

The amount and condition of material leaving the auger can change the equilibrium of the four forces. Excessive flow of material increases force H. A cold, stiff mix will increase H and to some extent V. An excessively hot, fluid mix decreases H and V. Stopping and starting the paver also causes changes in equilibrium among the forces. The key to controlling the action of the screed is to maintain in a uniform manner those forces acting on the screed.

The secret of good paver operations, then, is balance and uniformity—balance of the forces and uniformity to maintain that balance. When balance and uniformity are attained, the screed path follows the paver in a plane parallel to that of the pivot point. As the paver goes up over an irregularity, the pivot point rises. The screed begins to rise also, but because it reacts to changes in elevation more slowly than the pivot point does, the screed rises very little and thereby maintains the plane of the surface of the mat over the irregularity, thus reducing the abruptness of the irregularity. The same is not true of long irregularities (i.e., longer than several lengths of the paver). Grade line irregularities of this type should be corrected prior to placing surface courses with the paver.

Screeds with tamping bars and vibratory mechanisms are designed to strike off then compact the mixture slightly as it is placed. There are two purposes to this screed action. It achieves maximum leveling of the mat surface, and it ensures that minimum distortion of the mat surface will occur with subsequent rolling. Because different screed compaction systems function differently, they are discussed separately below.

### *Tamping Bar-Types*

Tamping bar-type screed compactors compact the mix, strike off the excess thickness, and tuck the material under the screed plate for leveling. As Figure 5.14 shows, the tamping bar has two faces: a beveled face on the front that compacts the material

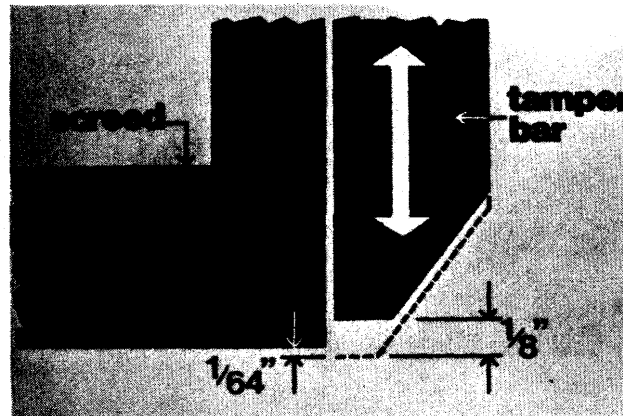


FIGURE 5.14—Tamping Bar (1. in. = 25mm).

as the screed is pulled forward and a horizontal face that imparts some compaction, but primarily strikes off excess material so that the screed can ride smoothly over the mat being laid.

The adjustment that limits the range of downward travel of the tamping bar is the single most important adjustment affecting the appearance of the finished mat. At the bottom of its stroke, the horizontal face should extend  $1/64$  of an inch (0.4 mm)—about the thickness of a fingernail—below the level of the screed plate. If the bar extends down too far, mix builds up on the screed face which tends to scuff the surface of the mix being placed. In addition, the tamping bar will lift the screed slightly on each downward stroke, often causing a rippling of the mat surface.

If the horizontal face of the tamping bar is adjusted too high (either by poor adjustment or due to wear of the bottom of the horizontal face), the bar does not strike off excess mix from the mat. Consequently, the screed plate begins to strike off the material, which results in surface pitting of the mix being placed as the leading edge of the screed plate drags the larger rocks forward. Therefore, the tamper bars should always be checked before operating the paver. It should be adjusted by the contractor if necessary, and before it approaches knife-edge thinness it should be replaced.

#### *Vibrating Types*

The operation of vibratory screeds is similar to that of tamping screeds, except that the compactive force is generated either by electric vibrators, rotating shafts with eccentric weights or hydraulic motors (Figure 5.15). On some pavers both the frequency (number of vibrations per minute) and the amplitude (range of motion) of the vibrators can be adjusted. In others, the frequency remains constant and only the amplitude can be adjusted.

Frequency and amplitude must be set in accordance with the type of paver, the thickness of the mat, the speed of the paver, and the characteristics of the mixture being placed. Once set, the frequency and amplitude do not normally need adjustment until mat thickness or mix characteristics change.

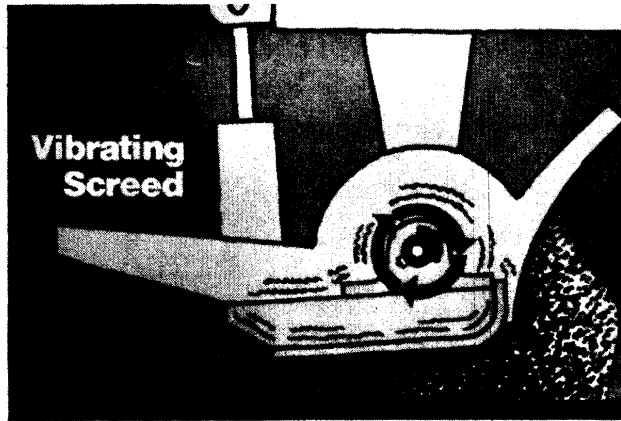


FIGURE 5.15—Vibratory Type Screed.

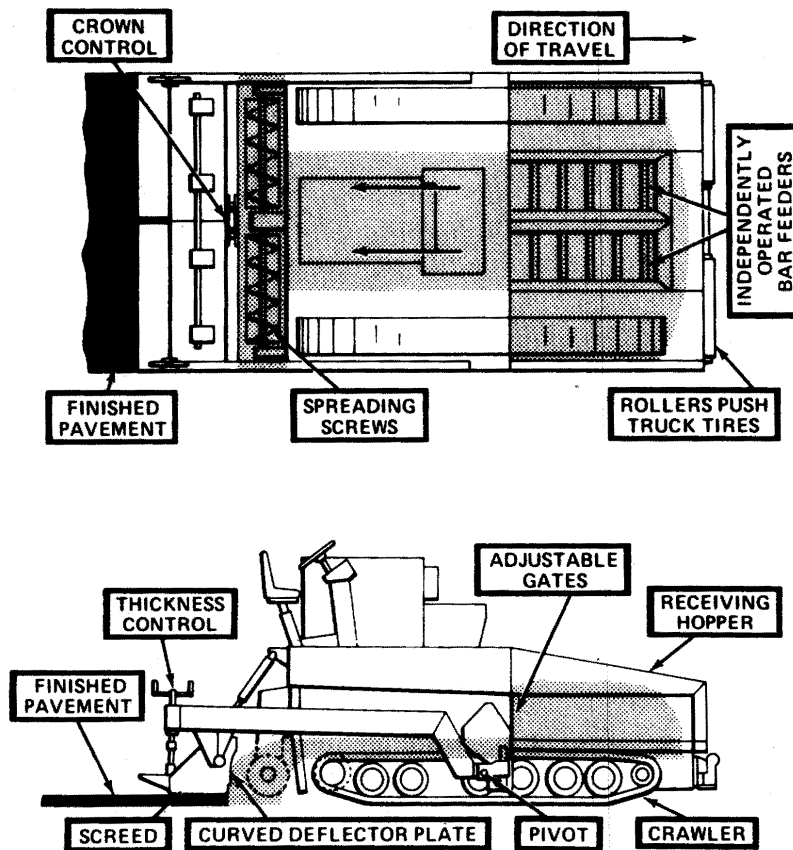


FIGURE 5.16—Mat Thickness and Crown Controls.

Some vibratory screeds require a pre-strike-off unit. This unit is a rounded mold board that controls the amount of mix passing under the screed.

**5.4.A.3 Screed Controls**—In operating the screed, two types of controls are essential, control of the thickness of the mat, and control of the crown formed in the mat for proper drainage. Both functions are regulated by controls built into the paver (Figure 5.16).

It is important to understand that, when the paver is operating, control adjustments made to the screed take time to go into effect. For example, when a thickness control screw is adjusted to change the thickness of the mat, the paver is likely to move a distance of several feet before the change is completed and the mat is produced in the new thickness. For this reason, it is necessary that a screed operator know the effective delay involved in making adjustments to a particular screed unit and be able to anticipate adjustments accordingly.

Furthermore, it is important that after such adjustment of the thickness controls, the paver be allowed to travel far enough for the correction to be completed before another adjustment is made. Excessive adjustment or over-control of the thickness controls is one of the principal contributors to poor pavement smoothness.

The condition of the screed unit is important if a high quality mat is to be placed. Wear points should be checked to be sure that the screed control linkage is snug.

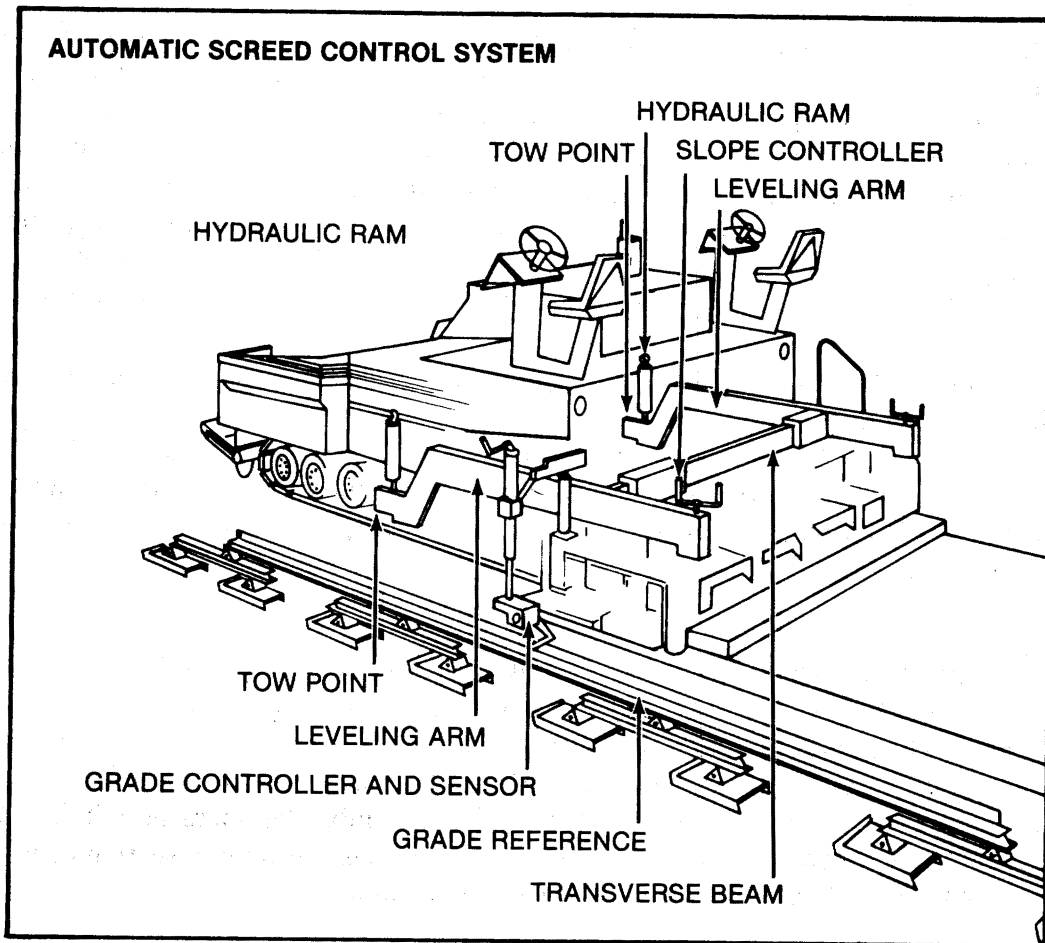
Of course, screed plates should also be checked regularly for signs of wear such as pitting and warping. The plates should always be properly adjusted by the contractor before paving begins. Both the leading and trailing edges of the screed have a crown adjustment. The leading edge should always have slightly more crown than the trailing edge to provide a smooth flow of material under the screed. Too much lead crown, however, results in an open texture along the edges of the mat, just as too little results in open texture in the center. Crown adjustments may be made independently or simultaneously during the paving operation.

**5.4.A.4 Automatic Screed Controls**—The screed controls just mentioned must be adjusted by the screed operator as paving progresses. Automatic screed controls, however, are designed to adjust automatically to place a uniform mat of desired thickness, grade and shape (Figure 5.17).

- *Types and Operating Principles*

Automatic screed controls can be used in several different ways, but all automatic screed control operations require a reference system for the automatic system to follow. This reference can be the base on which the asphalt hot-mix is being placed, the lane next to the material being placed, or a stringline. If, for example, a stringline is used as a reference, the automatic control will follow the height of the stringline exactly, so that the mat conforms to it. Obviously, then, the placement of the stringline (or other reference system) must be precise.

In addition to reference systems such as those described in the preceding paragraph, automatic screed controls can also follow traveling reference systems. In such a traveling reference system, a ski is attached to a control arm, and this ski notes changes in base contours and adjusts the screed automatically to compensate.



**FIGURE 5.17—Automatic Screed Reference System.**

A stringline or traveling reference system allows the automatic control to adjust screed height as necessary to maintain proper longitudinal (length-wise) grade of the pavement. To maintain proper transverse (width-wise) grade, automatic screed controls use a system attached to a beam running between the two screed pull arms.

A pendulum in the slope control housing moves side-to-side with changes in the transverse grade of the roadway, triggering necessary adjustments in the slope control mechanism.

Automatic control systems have several advantages over manually-controlled screed systems. Among them are:

- Automatic controls that can compensate for changes in grade and slope more quickly than a screed operator.
- Automatic controls help disassociate the screed from erratic vertical movement of the tractor unit.
- Automatic controls adjust the screed towpoints to enable the screed to follow a path parallel to the grade and slope of the reference system, which may be different from the path plane of the tractor unit.

- *Selecting a Reference System*

Which of the two types of reference systems—stationary or traveling—to use with an automatic screed control depends on four factors. They are the condition of the surface on which the mat is to be placed, the degree of precision required in the grade and slope of the finished pavement, the thickness of the mat, and the amount of material available for the project. If the surface on which the mat is to be placed has a good longitudinal grade along its centerline, but an unsatisfactory transverse grade, a traveling reference run along the centerline can be used effectively to provide the desired mat thickness at the centerline and the transverse slope control used to establish the outside grade.

If the longitudinal grade is erratic, a stringline should be placed to ensure a proper longitudinal grade.

If the existing surface has a good profile both longitudinally and transversely, automatic screed controls may be unnecessary. The self-leveling ability of the screed may be sufficient. If automatic controls were used, however, a traveling reference system would be adequate.

**5.4.A.5 *Screed Heaters***—The screed is equipped with heaters used to heat the screed plate at the start of each new paving operation. The heaters are not used to heat the mix during paving operation. If the screed is not initially heated, the mix will tear and the texture will look open and coarse, as if the mix were too cold. Sometimes when there is a hurry to unload the day's first truck-load of mix, the operator will allow the mix to heat the screed plate. This practice almost always results in a section of unsatisfactory pavement laid while the screed is being heated.

**5.4.A.6 *Screed Accessories***—Three types of commonly used screed accessories are screed extensions, cut-off shoes, and slope plates.

Screed extensions are attachments that widen the screed, allowing the paver to place a wider-than-normal mat. Extensions make it possible to pave widths up to 24 feet (7.3 m) in a single pass.

Cut-off shoes have the opposite function. They are metal plates inserted into the screed to reduce the width of the mat being placed.

Slope plates are metal plates that shape the edge of the mat to a 45° slope.

**5.4.A.7. *Truck Hitches***—The purpose of a truck hitch on the front of the paver hopper is to keep the truck dumping hot mix into the hopper in contact with the paver. If, during dumping, the truck and the paver separate, and hot-mix spills, it must be cleaned up before the paver passes over it.

There are two types of truck hitches in common use:

- One type utilizes an extension that reaches under the truck and hooks onto the truck's rear axle.
- The other system uses retractable rollers that are attached to the truck push bar and grip the outer side of the truck's rear wheels. They revolve with the wheels while the truck dumps its load into the hopper.

**5.4.A.8 Pivoted Truck Push-Rollers**—The pivoted push-roller is a device mounted on the front of the paver that adjusts when alignment between the truck and the paver is uneven. The device reduces the uneven force exerted on the paver by the misaligned truck, minimizing interference in the steering of both vehicles.

**5.4.B Haul Trucks**

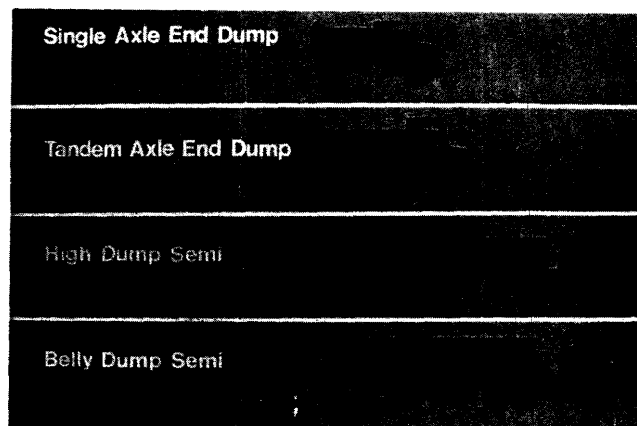
Hot-mix is delivered to the jobsite by trucks. The inspector must be certain that the mixture being delivered is within specifications and that it is being delivered in a manner that is safe.

**5.4.B.1 General Information**—Various types of trucks are used to deliver hot-mix to the jobsite. The two most common types are end-dump trucks and bottom-dump trucks (Figure 5.18). Details regarding use of each type are presented in later sections. Presented below is general information pertinent to all types of trucks used for hauling asphalt hot mix.

**5.4.B.2 Condition of Haul Trucks**—Trucks must have metal beds, and the beds must be clean, smooth and free of holes. All trucks must meet minimum safety criteria. Each truck must be clearly numbered for easy identification and must be equipped with a tarpaulin.

Before being loaded, the truck bed must be cleaned of foreign material and hardened asphalt and then lightly coated with a release agent (lubricant) that assists in preventing fresh hot-mix asphalt from sticking to the surfaces of the bed. After the bed is coated, any excess release agent must be drained from the bed. Before loading, the truck must also be weighed to establish a tare weight (unloaded weight). The tare weight is later subtracted from the loaded weight of the truck to determine the weight of hot-mix the truck is hauling.

The number of trucks required on the project is determined by many factors: the mix production rate at the plant, the length of the haul, the type of traffic encountered, and the expected time needed for unloading.



**FIGURE 5.18—Types of Haul Trucks.**



**5.4.B.3 Types of Haul Trucks**—Each type of truck used for hot-mix delivery must have certain physical features in order to properly haul and discharge into the paver. Below are listed a few guidelines for the two most common types of trucks.

#### *End-Dump Trucks*

An end-dump truck must first be inspected to be certain the rear of the bed overhangs the rear wheels enough to discharge mix into the paver hopper. If it does not, an apron with side plates must be added to increase the overhang and prevent spillage of mix in front of the paver.

The bed must also be of a size that will fit into the hopper without pressing down on the paver. The hydraulic system for the truck-bed hoist should be frequently inspected to guard against hydraulic fluid leakage. Such leakage on the roadway surface will prevent good bonding between the roadway and the new mat. If enough oil is spilled that the mix can absorb it, the mix can become unstable at that spot. As a result, leaking trucks should not be used.

Tarpaulins should be pulled over the mixture during hauling in cool weather or on long hauls to protect the mixture from excessive cooling. A cool mix forms lumps and a crust over its surface. If a tarp is used, care must be taken to be sure it is securely fastened to the top of the truck bed so that cold air cannot funnel under it.

During delivery, the driver must direct the truck squarely against the paver, and should stop the truck a few inches from the paver, before the truck tires make contact with the paver roller bar. Backing the truck against the paver can force the screed back into the mat leaving a bump in the pavement even after the mat is rolled.

The truck bed must be raised slowly. When the mix is dumped too rapidly, segregation occurs—as the coarser aggregates will roll down the sides of the load.

#### *Bottom-Dump Trucks*

Bottom-dump trucks can be used where a motor grader is spreading the mix or where a pickup device is used to feed the windrow left by the truck into the paver hopper.

There are two common methods for unloading bottom-dump trucks. One method involves the use of a spreader box designed to be operated under the gates of the truck. The amount of material placed in the windrow is governed by the width of the spreader box opening. The disadvantage to this method is that the spreader box can restrict the amount of material to less than the required amount.

The second method is to use chains to control the dump gate opening. This is the most commonly used procedure. Automatic devices are available for controlling gate openings; however, their use is somewhat limited because of the additional cost.

Variations in the size of the windrow deposited by the bottom-dump for pickup by the paver and irregularities in the surface on which the material is to be placed will cause variations in the amount of material fed to the paver hopper. This often causes variations in the finished surface. It is therefore essential that the windrow deposited by the truck be as uniform as possible. If the windrow is deficient in size, material can be added to it to keep the paver from starving. If the windrow contains too much mix, a short gap in depositing with the next truck will compensate for the excess. The windrow length must also be controlled, particularly in cool weather. Windrowed material will cool below spreading and compaction temperatures in cool weather, par-

ticularly when delay occurs because of paver malfunction. To prevent excessive cooling of the mix in cold weather, the limit of windrow should be no more than one truck load ahead of the pick up machine.

If the loader and paver are directly coupled, vibration of the pick-up device may be transmitted into the paver, and cause ripples and roughness in the mat surface. These vibrations generally result from worn and defective parts, or from improper mounting or adjustment.

## **5.5 Delivery of Hot-Mix**

### **5.5.A.2 Load Tickets**

Load tickets (Figure 5.19) provide essential records for the control of project operations quality, and quantity of mix delivered. Although different systems are used by various agencies, certain items related to tickets remain generally the same from project to project. Load tickets—numbered consecutively—are generally issued at the plant. They state the project number, the origin of the load, time loaded, the temperature and weight of the load, the truck number and the type of mix, and where the mix was placed. It will also list the weight of the mixture and its temperature (as recorded at the roadway).

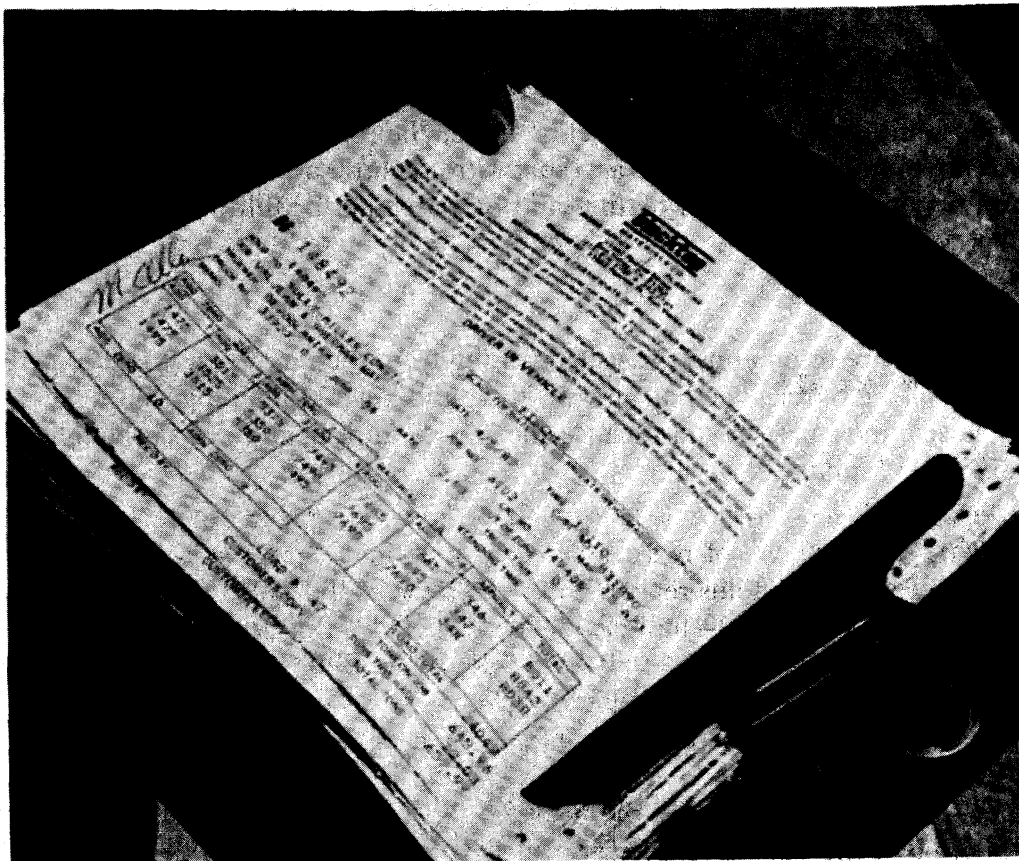
Several things of importance to the inspector are contained on these tickets. First, the numbering of the tickets consecutively will show whether or not a truck arrived at the paver in an order different from which it was loaded. This could be due to breakdown of the truck, traffic problems, or whatever, but it will give the inspector an idea of the length of time that the material has been loaded. If the period of time was longer than what would be considered normal, then the mix must be checked more thoroughly than usual for proper temperature and for lumps formed due to cooling. If serious temperature problems are detected, the load should be rejected. It is important for the inspector to collect the load tickets from each truck as the truck is dumping. In this manner, he can be assured that no loads intended for his project were diverted.

### **5.5.B Visual Inspection of the Mix**

During the pre-construction conference, mix inspection procedures should be thoroughly discussed. Although the mix is inspected at the plant, there are times when the plant inspector may inadvertently overlook an inferior load resulting from a plant malfunction. Some of these deficiencies can be readily noticed by the placing inspector prior to dumping. When the temperature is checked or the truck bed is raised, these deficiencies are readily apparent. Some indications of hot-mix deficiencies that may require close inspection and possible corrective action are:

- *Blue Smoke*

Blue smoke rising from the mix in the truck or the spreader hopper may indicate an overheated batch. The temperature should be checked immediately.



**FIGURE 5.19—Illustration of Load Ticket.**

- *Stiff Appearance*

Generally, a load that appears stiff or has an unusually high peak, may be too cool to meet specifications. The temperature should be checked. If it is below the optimum placing temperature, but within the acceptable temperature range, immediate steps should be taken to correct the low temperature and decrease the possibility of having to waste loads of mix.

- *Mix Slumped in Truck*

Normally the material in the truck is in the shape of a dome. If a load lies flat or nearly flat, it may contain too much asphalt or excessive moisture. Close inspection should be made at once. Excess asphalt also may be detected under the screed as excessive shininess on the mat surface. A mix containing a large amount of coarse aggregate might be mistaken for an over-asphalted mix because of its shiny appearance. Such a mix, however, usually will not slump in the haul truck.

- *Lean, Dull Appearance*

A mix that contains too little asphalt can generally be detected immediately in the truck or in the spreader hopper by its lean (dry), granular appearance, improper

coating of the aggregate, and a lack of typical shiny black lustre. Lack of sufficient asphalt in the mix can be detected on the road by its lean, brown, dull appearance on the surface and unsatisfactory compaction under the roller. Excess fine aggregate can cause a mix to have the same look as a mix with too little asphalt. Excess fines can be detected by inspecting the mix texture and by watching for shifting of the mix under the roller.

- *Rising Steam*

Excess moisture often appears as steam rising from the mix when it is dumped into the hopper of the paver. The hot-mix may be bubbling and popping as if it were boiling. Excessive moisture may also cause the mix to appear and act as though it contains excessive asphalt.

- *Segregation*

Segregation of the aggregates in the mix may occur during paving because of improper handling or it may have happened at some point prior to the mix reaching the paver. In any case, corrective action should be taken immediately. The cause of the segregation should be corrected at its source.

- *Contamination*

Mixes can become contaminated by a number of foreign substances, including spilled gasoline, kerosene, oil, rags, paper, trash and dirt. The contamination can be removed if it is not too extensive; however, a load that has been thoroughly contaminated should be rejected.

- *Bleeding*

While non-petroleum-based agents are recommended for spraying truck beds, some agencies still allow diesel fuel to be used. Excess diesel fuel that collects in the truck bottom can be absorbed by the mix. In the pavement, the fuel dilutes the asphalt and causes it to ooze (bleed) to the surface, resulting in what is termed a "fat spot." Also, the excess diesel fuel may leach the asphalt from the hot-mix with which it comes into contact. Hot-mix contaminated with diesel fuel should be removed and replaced.

### **5.5.C Calculating Paver Yield**

The load weight is used to check the yield of the paver (length of pavement section per truck load of mix). The starting point is to know how much the mixture weighs after compaction. Once that information is obtained, measurements of the mat placed and some simple calculations can tell whether the paver yield is close to that expected. Study the following example (for simplicity, U.S. Customary units are used):

**PROBLEM:**

A truck delivers 15 tons (30,000 pounds) of hot-mix to the paver. The paver is placing a mat  $12\frac{1}{2}$  feet wide and  $1\frac{1}{2}$  inch thick (compacted). The mixture has an in-place density of 144 pounds per cubic foot. How long a section (how many linear feet) of pavement should the paver be able to place using the 15 tons?

**SOLUTION:**

- (1) A cubic foot of mixture weighs 144 pounds. A square foot of the mat 1-inch thick contains 12 pounds of mix.

$$\frac{144}{12} = 12 \text{ lbs/ft}^2 \text{ per inch}$$

- (2) Since the mix is being placed 12½ feet wide, 1½ inches thick, the weight of mix per linear foot of paving is

$$12\frac{1}{2} \times 1\frac{1}{2} \times 12 \times 1 = 225 \text{ lbs.}$$

- (3) By dividing the weight of the truck load (30,000 lb.) by the mixture weight per linear foot (225 lb.), it is determined how many linear feet of pavement the paver should be able to place using the load.

Therefore:

$$\frac{30,000}{225} = 133\frac{1}{3} \text{ linear feet}$$

**ANSWER:**

The paver should be able to pave 133⅓ linear feet of pavement with the load delivered by the truck.

Taking the calculation one step further, one ton of mix will pave 8.89 feet.

This information can be used to check the accumulated total weight from the load tickets against the actual number of feet placed. It can also be used to determine the amount of hot-mix required to pave a given length of road. And toward the end of the day, it can be used to calculate how much mix is needed to finish a length of roadway and, therefore, when the plant should stop production.

## **5.6 PLACING PROCEDURES**

### **5.6.A Coordinating Plant and Paver**

Uniformity of operations is essential in asphalt hot-mix paving. Uniform, continuous operations of the paver produces the highest quality pavement.

There is no advantage in the paver traveling at a speed that requires the mix to be supplied faster than the plant can produce it. Trying to pave too quickly can result in the paver having to stop frequently to wait for trucks to bring more mix. If the wait is too long (more than a few minutes on a cool day) the smoothness of the pavement will suffer when the paver starts up again as the mix in the paver that has cooled off is used up.

Obviously, then, it is essential that plant production and paving operations be coordinated. The paver must be continuously supplied with enough mix, and at the same time, the trucks should not have to wait a long time to discharge their loads into the paver hopper.

### ***5.6.B Screed Adjustment During Paving***

If the mat being placed is uniform and satisfactory in texture, and the thickness is correct, no screed adjustments are required. But when adjustments are required, they should be made in small increments and time should be allowed between the adjustments to permit the paver screed to complete reaction to the adjustments sequentially.

It is equally important that the thickness controls on the screed not be adjusted excessively either in amount or frequency. Every adjustment of the thickness controls results in a change in elevation of the mat surface. Excessive changes in the surface elevation at the edge of the first mat are extremely difficult to match in the companion lane when constructing the longitudinal joint.

### ***5.6.C Width of Spread***

Successive lifts of mix should not be constructed directly over each other, but offset not less than 6 in. (150 mm) on alternate sides of the centerline on succeeding lifts. For example, on a 24-ft (7.3 m) pavement, the first course (lane) is 12½ ft (3.8 m) wide and the next lane 11½ ft (3.5 m) wide. This prevents a continuous vertical seam through the completed pavement along the longitudinal joint. On narrow roads, 20 ft (6.1 m) in width or less, the course which requires the use of a cut-off shoe should be laid first, with the other side being laid full width of the screed. On the final (top) course, a cut-off shoe should be used on both passes so that the joint is located on the centerline.

Alignment of the mat is dependent on the accuracy of the guideline provided for the pavement operator and his alertness in following it. Attention to this detail is vital to the construction of a satisfactory longitudinal joint, since only a straight edge can be properly matched to make the joint.

On a wide roadway, where multiple lanes are being placed, it is generally best to place the lane adjacent to the crown first, and then match the adjoining lane to it.

### ***5.6.D Handwork***

There are places on many jobs where spreading with a paver is either impractical or impossible. In these cases, hand spreading may be permitted. Placing and spreading by hand should be done very carefully and the material distributed uniformly so there will be no segregation of the coarse aggregate and the asphalt. When the asphalt mix is dumped in piles, it should be placed far enough ahead of the shovelers to necessitate moving the entire pile. Also, sufficient space should be provided for the workmen to stand on the base and not on the mixed material. If the asphalt mix is broadcast with shovels, almost complete segregation of the coarse and fine portions of the mix will result. A mixture placed by hand will have a different surface appearance than the same mixture placed by machine.

The material should be deposited from the shovels into small piles and spread with lutes. In the spreading process, all material should be thoroughly loosened and evenly distributed. Any part of the mix that has formed into lumps and does not break down easily should be discarded. After the material has been placed and before rolling starts, the surface should be checked with templates and straightedges and all irregularities corrected.

Insufficient or Non-Uniform Tack Coat	Improperly Cured Prime or Tack Coat	Mixture Too Coarse	Excess Fines in Mixture	Insufficient Asphalt	Excess Asphalt	Improperly Proportioned Mixture	Unsatisfactory Batches in Load	Excess Moisture in Mixture	Mixture Too Hot or Burned	Mixture Too Cold	Poor Spreader Operation	Spreader in Poor Condition	Excessive Moisture in Subsoil	Excessive Prime Coat or Tack Coat	Excessive Hand Raking	Labor Careless or Unskilled	Excessive Segregation in Laying	Operating Finishing Machine Too Fast	
					X	X	X							X					Bleeding
			X					X	X										Brown, Dead Appearance
					X	X	X							X			X		Rich or Fat Spots
		X	X			X	X			X	X	X			X	X	X	X	Poor Surface Texture
X	X	X				X	X			X	X	X			X	X	X	X	Rough Uneven Surface
		X		X		X	X			X	X	X			X	X	X		Honeycomb or Raveling
		X								X	X	X			X	X	X		Uneven Joints
			X		X	X				X						X			Roller Marks
X	X		X		X	X	X	X			X	X			X				Pushing or Waves
			X	X		X							X						Cracking (Many Fine Cracks)
													X						Cracking (Large Long Cracks)
		X				X			X	X	X								Rocks Broken by Roller
		X		X		X		X	X	X	X						X	X	Tearing of Surface During Laying
X	X		X		X	X		X	X				X	X					Surface Slipping on Base

*Types of Pavement Imperfections  
That May Be Encountered In  
Laying Plant Mix  
Paving Mixtures.*

**FIGURE 5.20—Typical Mat Problems and Their Probable Causes.**

### 5.7 INSPECTION OF MAT

The inspector must be able to identify deficiencies in the finished pavement and understand possible causes of those deficiencies. Figure 5.20 is a table of common pavement problems and their probable causes. In referring to the table, keep in mind that a given deficiency may have several possible causes. In many cases, sampling and testing is the only reliable means for analyzing a pavement problem.

The following sections discuss in detail several of the major items on a pavement inspection list.

### **5.7.A Temperature of the Mix**

The mix temperature is usually checked in the truck; however, occasionally it should be checked behind the paver. This is particularly important early in the day when both the surface on which the material is being placed and the air are cool. It must also be checked whenever the mix appears to be cold or when the breakdown roller is falling behind.

Mat temperature is taken by inserting the thermometer stem into the uncompacted mat to the mid-point of the mat's thickness and compacting the mat against the stem by lightly tamping the mat surface with one foot.

### **5.7.B Pavement Surface Appearance**

**5.7.B.1 Surface Texture**—The texture of the unrolled mat should appear uniformly dense, both transversely and longitudinally.

If tearing or open texture appears only at the beginning of a day's run, it is probably caused by the screed not being heated sufficiently. If a tear appears under screed extensions, the alignment of the extension and the tamping bars and vibrators need to be checked.

When an inspection of the mat reveals obvious segregation, the cause should be determined and corrected immediately.

- **Tearing or Scuffing**

Tearing often occurs in a mix that is too cold, and which appears open and coarse. Tearing and scuffing will also result from improper setting of a paver equipped with a tamping bar in the screed unit.

- **Texture Irregularities**

A mix containing excess moisture will not lay properly and will have the appearance of a cold mix or an over-asphalted mix. In addition to possibly tearing, the mix will bubble and blister.

**5.7.B.2 Surface Smoothness**—Pavement smoothness is adversely affected by a lack of uniformity in the paving operations, improper aggregate gradations, variations in paver speed, improper operation of trucks and poor joint-construction practices.

- **Lack of Uniformity**

Stopping the paver can cause roughness in the pavement. Every time the paver stops, there is a possibility of the screed leaving a mark on the surface of the mat. If the screed settles into the mix, it causes the automatic sensor to act as if the paver has traveled into a depression. As the paver starts off, the screed lays a thicker mat. This continues until the sensor recognizes the excessive thickness and decreases the slope of the screed. Then a dip is developed until the screed levels out, approximately 30 feet (9.1m) from where the paver stopped.

Rough pavements also result from changes in amounts of material introduced in front of the screed: If there is not enough material in front of the screed, the screed will drop. If there is too much material in front of the screed, it will rise.



- *Improper Aggregate Gradation*

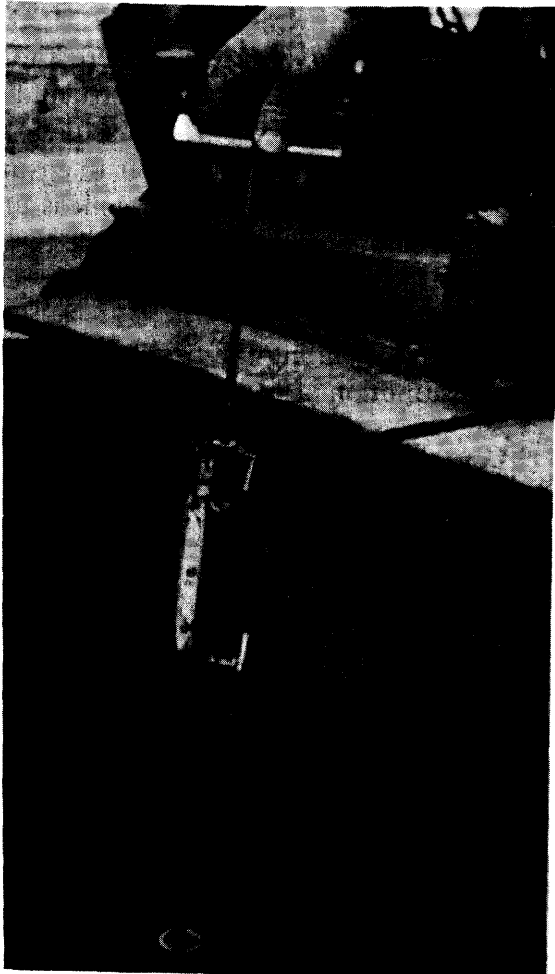
Excessively coarse aggregate may result in a harsh mix that creates a coarse texture and an uneven surface. Excessive fines may cause a low stability in the mix and permit ripples to form.

### *5.7.C Pavement Crown*

If there is an open or torn texture at the center of the mat behind the paver, additional lead crown is needed in the front edge of the screed. This forces more mix into the central portion of the screed, closing the texture. If the tears occur on the outer edge, there may be too much crown in the leading edge, forcing too much material in the center and too little at the edges. Reducing the center crown slightly will distribute more material toward the edges and provides a more uniform mat.

### *5.7.D Pavement Geometrics*

Geometrics refers to the physical size and shape of the finished pavement, including the longitudinal grade, transverse grade, alignment, crown, and thickness.



**FIGURE 5.21—Checking Mat Thickness With a Depth Gauge.**

Checking the geometrics of a finished mat begins with knowing the typical section plan for the pavement. All measurements must be compared with the plans to determine whether the pavement's size and shape are acceptable.

Longitudinal grade, transverse grade, alignment and smoothness can be checked with stringlines, straight edges, and measuring tapes as well as line-of-sight devices, using grade and elevation markers as reference points.

Pavement thickness must be measured both before and after compaction in order to determine the amount of roll-down (decrease in thickness) or compaction that occurs from rolling. Before compaction, mat thickness can be determined by using a depth gauge (Figure 5.21), or by extending a straightedge over the edge of the mat and measuring the distance between the straightedge and base.

After compaction, measuring with the straightedge is repeated. Also, cores of compacted mixtures are cut out of the finished pavement for measurement and testing (Figure 5.22). Generally, it is easier to measure the depth of the mat by this method shown in Figure 5.23.

### **5.7.E Joints**

Pavement joints are seams between adjacent mats. There are two types of pavement joints: transverse joints and longitudinal joints.

**5.7.E.1 Transverse Joints**—A transverse joint occurs at any point where the paver ends work and then resumes work at a subsequent time. A poorly-constructed transverse joint is noticeable as a pronounced bump in the pavement. Consequently, the inspector must be on hand whenever a transverse joint is made in order to ensure it is done properly. Discovering hours after construction that a transverse joint is unsatisfactory does no good, because joint construction can only be corrected while the mix is still hot and workable. Once the mix cools, corrections can be made only by cutting out and replacing the joint.

Transverse joints are constructed in two steps: (1) ending the first lane or width of pavement at the close of work and (2) at the resumption of pavement operations at the start of work at a subsequent time.

#### **• Ending a Lane**

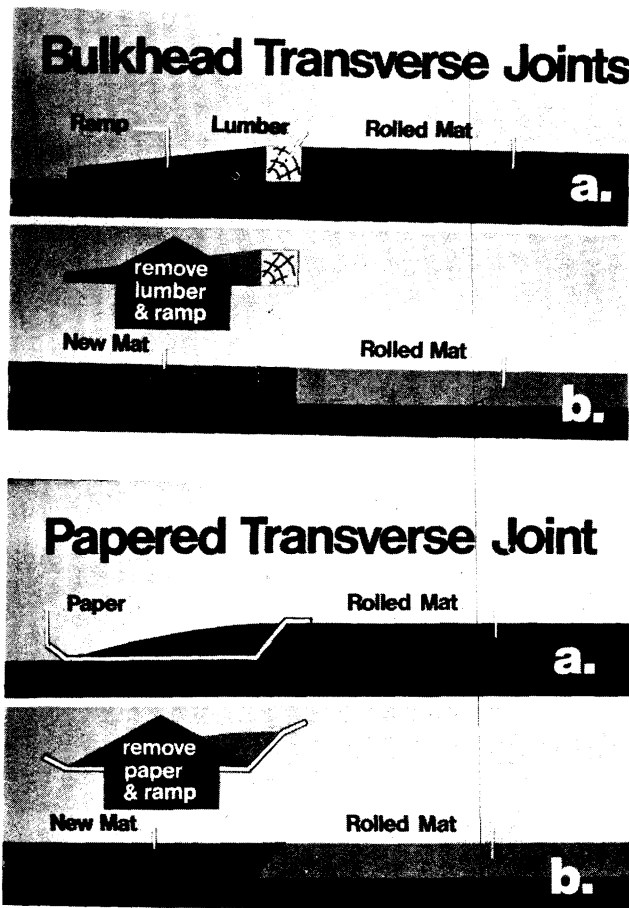
When terminating paving operations at the end of a day's work, the pavement mat must be cut off vertically so that a full depth lift can be placed squarely against it. When paving operations are resumed, this requirement can be satisfied by the following procedure:

- (1) When the paver is placing the last load of the day, it is shifted into low gear as it approaches the location of the proposed joint.
- (2) As the hopper empties and the amount of material in the screed chamber decreases below normal operating level, the paver is stopped.
- (3) The screed is raised and the paver moved out of the way.
- (4) Asphalt hot-mix is then shoveled away from the end of the mat to form a clean, vertical edge.
- (5) A board or heavy wrapping paper is placed along the edge as shown in Figure 5.24.
- (6) The material that was shoveled away in Step 4 is replaced and used to form a taper.

**FIGURE 5.22—Taking Core Sample of Finished Pavement.**



**FIGURE 5.23—Measuring Mat Thickness of Core.**



**FIGURE 5.24—Using Wrapping Paper (A) or a Board (B) to Form a Transverse Joint.**

• *Resumption of Paving Operations*

When construction is ready to resume, the following procedure is used to form a suitable transverse joint.

- (1) The taper of material is removed along with the board or paper.
- (2) A straightedge is used to check the longitudinal grade of the mat.  
Because the paver was running out of material as it laid the last few feet of mat, it is possible that those last few feet taper slightly (ramp down) from the specified level of the mat. If this is the case, a new transverse edge must be cut behind the point where the ramping down begins.
- (3) The vertical face of the mat is tack-coated.
- (4) The paver is backed up to the edge of the mat and the screed rested on the mat surface.
- (5) The screed is heated while it rests on the mat. This provides some heat to the material at the edge of the mat.
- (6) The heated screed is raised and shims as thick as the difference between the uncompacted mat are positioned under its ends.

- (7) The truck with the first load of hot-mix is backed carefully to the hopper. During discharge of the mix from the truck bed to the paver, it is essential that the truck not bump the paver and cause it to move.
- (8) The paver starts forward in a low gear.
- (9) Once the paver has moved away, excess hot-mix is cleaned off the surface of the mat and the evenness of the joint is checked with a straightedge.
- (10) If a joint is satisfactory, a 6-in. (150 mm) width of the hot-mix is rolled transversely and the joint checked for smoothness. If the joint is satisfactory, transverse rolling is continued in 6 to 12 in. (150 to 300 mm) wide increments until the entire width of the roller is on the new hot-mix. If straightedging shows an uneven joint, the surface of the new mat must be scarified while still warm and workable. Scarification is done preferably with tined lute. Excess material can then be removed or additional material added, and the joint rolled. During rolling, timbers should be placed along the edges of the mat to prevent the roller from driving off the longitudinal edge and distorting it.

**5.7.F.2 Longitudinal Joints**—Longitudinal joints occur wherever mats are laid side-by-side. There are two types of longitudinal joints: hot joints and cold joints.

- **Hot Joints**

Hot joints are formed by two pavers operating in echelon. The screed of the rear paver is set to overlap the mat of the front paver by 1 or 2 inches (25 to 50 mm).

The advantages of a hot joint are that the two mats are automatically matched in thickness, the density on both sides of the joint is uniform because both sides are compacted together and the hot mats form a solid bond. The disadvantage is that traffic cannot move in one of the lanes while the other is being paved. Both lanes are blocked simultaneously.

- **Cold Joints**

In a cold joint, one lane is placed and compacted; the companion lane is placed against it and compacted. Special precautions must be followed to ensure a joint of good quality.

The base on which the companion lane is to be placed should be broomed if necessary. The edge to be joined should be tack coated.

The paver screed should be set to overlap the first mat by 1 or 2 inches (25 to 50 mm). The elevation of the screed above the surface of the first mat should be equal to the amount of roll-down expected during compaction of the new mat.

The coarse aggregate in the material overlapping the cold joint should be carefully removed and wasted. This leaves behind only the finest portion of the mixture, which will be tightly pressed into the compacted lane at the time the joint is rolled.

## **5.8 SUMMARY OF PLACING PROCEDURE**

During construction of an asphalt hot-mix pavement, the inspector has the responsibility to see that contract plans and specifications are met and that the contractor has every opportunity to perform the work in the most cost-effective manner. All pav-

ing operations should be preceded by a construction conference during which details of the work can be discussed and all questions answered.

Hot-mix can be placed on subgrade, granular base, asphalt pavement or portland cement pavement. In all cases, the surface must be properly graded and free of excess dust and debris before paving begins. Asphalt and portland cement concrete pavement must be repaired before being overlaid with a hot-mix mat. Before paving, the inspector should check the grade and alignment of the surface to be paved to be certain there is agreement with the project plans and profile.

Prime coats and tack coats are applied by a calibrated asphalt distributor at a rate determined by the flow of the asphalt from the tank and the distributor's forward speed. Proper spraying temperatures should be followed in all prime coating and tack coating operations.

The paving machine consists of two major units: a tractor unit and a screed unit. The tractor unit includes the power plant and all control systems for delivering power to systems throughout the paver. The screed unit places the hot-mix mat and includes controls for regulating mat thickness.

The inspector should be familiar with the various types of screeds and screed controls and should be aware of the importance of uniformity and balance in all paving operations.

During delivery of hot-mix, the inspector must collect and check haul tickets and keep detailed records of all deliveries. In addition, the inspector should check paver yield using calculations based on load weights noted on the haul tickets.

The inspector should check the temperature and quality of each load delivered to the job site, and keep records of the findings. He should inspect the mat behind the paver, checking such items as surface texture and smoothness, geometrics, consistency, and suitability of both longitudinal and transverse joints.

## SECTION 6

### COMPACTION

#### 6.1 INSPECTOR OBJECTIVES

At the conclusion of this section of the manual, the inspector should:

- Understand the principles of the compaction process.
- Be familiar with the standard rolling equipment that is utilized.
- Recognize why rolling operations must be adjusted to compensate for variations in mix properties and environmental conditions.
- Understand how to ensure a finished pavement meeting texture, surface, and density requirements.

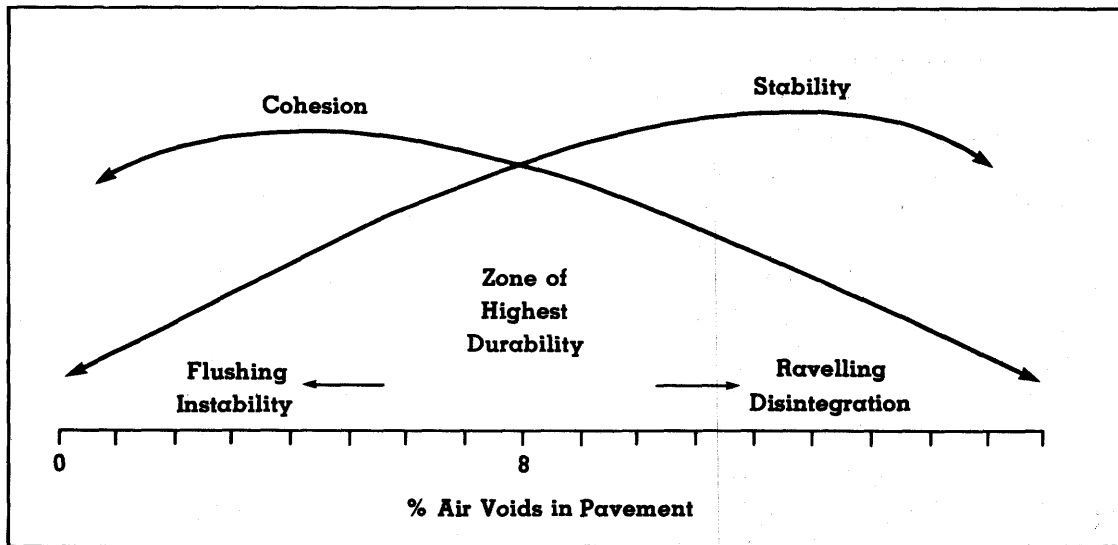
#### 6.2 INTRODUCTION

##### *6.2.A Background*

Compaction is the process of compressing a given volume of asphalt hot-mix into smaller volume. It is accomplished by pressing together the asphalt coated aggregate particles, thereby eliminating most of the air voids (spaces) in the mix and increasing the density (weight to volume ratio) of the mixture. Compaction is considered successful when the finished mat reaches optimum void content and density.

The need for a pavement to be compacted to its optimum density is better understood when the effect of air, water, and traffic on an undercompacted pavement is realized. The voids in an undercompacted mix tend to be interconnected and permit the intrusion of air and water throughout the pavement. Air and water carry oxygen which oxidizes the asphalt binder in the mix causing it to become brittle. Consequently, the pavement itself will ultimately fail as it can no longer withstand the repeated deflections of traffic loads. The internal presence of water at freezing temperatures can also cause an early failure in the pavement from expansion of the freezing water.

A pavement which has not been adequately compacted during construction will rut or groove from the traffic that is channelized over it. However, unless some voids are left in the compacted mix, the pavement will flush and tend to become unstable due to the reduction of voids content under traffic and thermal expansion of the asphalt. The desired as-constructed void content is 8 percent or below for the dense-graded mixes. At this level, the voids are usually not interconnected. Figure 6.1 is a graphic presentation of the effect of air voids on pavement durability. When the air void content is too high, the pavement will tend towards raveling and disintegration. When there is too low an air-void content, there is a danger of the pavement flushing and becoming unstable.



**FIGURE 6.1—Pavement Durability vs. Air Voids.**

By pressing the aggregate particles close together into a position in which the asphalt can hold them, compaction accomplishes two important goals. It develops the strength and stability of the mix. Additionally, it closes gaps through which water and air would otherwise penetrate and cause faster aging, freeze-thaw damage, and stripping.

### **6.2.B General Description**

Compaction is done by any of several types of compactors, or rollers—vehicles which, by their weight or by exertion of dynamic force, compact the pavement mat by driving over it in a specific pattern.

Compaction aims at producing a mat of specific density (target density). Pavement density is measured by any of several tests listed in Section 6.6.

Although the compaction process appears rather simple and straightforward, it is, in reality, a procedure requiring skill and knowledge on the part of the roller operator and the inspector. Both must have a thorough understanding of the mechanics of compaction and the factors that affect the compaction effort.

### **6.2.C Inspector's Responsibilities**

Compaction is the final stage of hot-mix asphalt paving operations. It is the stage at which the full strength of the mixture is developed and the smoothness and texture of the mat are established. Consequently, during the compaction process, the inspector must be particularly observant.

In addition to keeping accurate detailed records and observing that the operation is performed safely, the inspector must also be sure that compaction is done properly



and that the finished pavement meets all specifications. To achieve this, the inspector must understand the compaction procedure and the equipment involved. The inspector must take samples of the compacted mat or take readings with special instruments to determine mix density, tolerance and smoothness.

### 6.3 COMPACTION PRINCIPLES

#### 6.3.A Mechanics of Compaction

The mechanics of compaction involve three forces at work during the compaction process. They are: the compressive force of the rollers, the forces within the mix that resist the force of the rollers, and the supporting forces provided by the stable surface beneath the mat. Compaction and density can be obtained only when the mix being compacted can be adequately confined.

For compaction to occur, the compressive force of the roller, coupled with the opposing supporting forces provided by the stable surface under the mat, must overcome the forces in the mat that resist compaction. Figure 6.2 illustrates this concept.

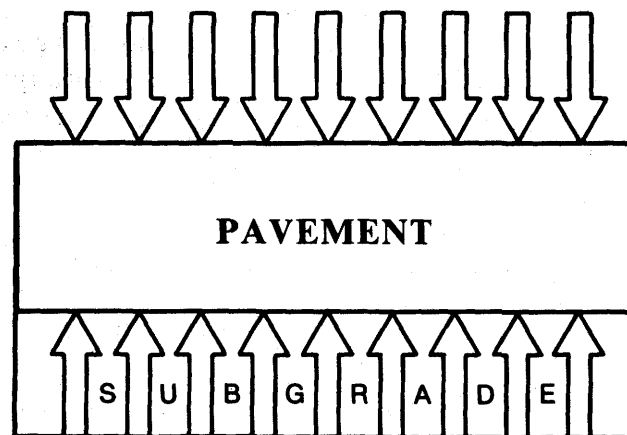


FIGURE 6.2—Forces at Work During Compaction.

The compressive force of the rollers comes from either the weight of the rollers or a combination of weight and dynamic energy provided by the rollers.

The supporting forces in the subgrade result from the subgrade's stability and firmness. Similarly, the resisting forces within the mix are the result of friction between the aggregate particles (interparticle friction) and the viscosity of the asphalt. The resisting forces in the mix increase as mix density increases and as the mix cools. When mix density and temperature reach a point where the resisting forces equal the compressive force of the rollers and the resistant forces of the subgrade, equilibrium is reached and the compaction process is complete.

### **6.3.B Factors Affecting Compaction**

Factors affecting compaction can be categorized into three classes:

- Mix properties.
- Environmental conditions.
- Layer (lift) thickness.

**6.3.B.1 Mix Properties**—Properties of various asphalts and aggregates have a pronounced effect on the workability of mixes at different temperatures. These properties, and the temperature of the mix at the time of compaction, must be considered when deciding on a compaction procedure.

#### **• Aggregate**

Gradation, surface texture and angularity are the primary aggregate characteristics that affect workability of the mix. As the maximum aggregate size or percentage of coarse aggregate in the mix increases, the workability decreases and greater compactive effort is required to achieve target density. Similarly, a rough surface texture, as opposed to a smooth, glassy aggregate surface, results in a more stable mixture and requires greater compactive effort. Mixtures that are produced from gravels frequently are more rounded than quarry rock and thus more workable.

Natural sands are often added to mixes in the interests of economy. Too much sand, particularly in the middle particle sizes—around the 0.60mm mesh sieve (No. 30)—will result in tender mixes (mixes with high workability, but low stability). Tender mixes are easily overstressed by heavy rollers and too much rolling. They are often susceptible to scuffing and displacement by traffic after several weeks in place.

The fines or filler content in the mix will also affect the compaction process. It is the combination of filler and asphalt that provides the binding force in asphalt hot-mix pavements; therefore, the mix should contain sufficient fines to combine with the asphalt to produce the necessary cohesion when the mix cools. The addition of mineral filler will help to offset the tenderness or slow-setting properties of mixes containing too much sand. Conversely, if a mix contains too many fines it will become “gummy” and very difficult to compact.

#### **• Asphalt**

At room temperatures asphalt is virtually a solid whereas at 250°-300°F (121°-149°C) it is a fluid. For a mix to be properly compacted, the asphalt in it must be fluid enough to permit the aggregate particles to move past one another. In effect then, the asphalt acts as a lubricant during compaction. As the mix cools, the asphalt loses fluidity (becomes more viscous). At temperatures below 185°F (85°C), the asphalt, in combination with the fines in the mix, begins to bind the aggregate particles firmly in place. Consequently, compaction of the mix is extremely difficult once the mix has cooled to 185°F (85°C).

The grade of asphalt that is used and the temperature at which the mix is produced determine its viscosity. Other factors being equal, a higher viscosity asphalt in the mix may require a slightly higher compaction temperature and/or greater compactive effort.

The asphalt quantity in the mix will also affect workability. As the asphalt content increases, the film thickness of the asphalt on the aggregate particles increases. At compaction temperatures, this increased film thickness increases the lubricating effect of the asphalt and up to a certain point makes compaction easier.

#### ● *Mix Temperature*

The temperature at which an asphalt mixture is produced affects both the ease of compaction and the time it takes for the mix to cool to 185°F (85°C)—the minimum temperature at which densification can take place. Up to a certain point the hotter the mix, the more fluid the asphalt and the less resistant the mix is to compaction. The upper limit for mix temperature is approximately 325°F (163°C). Higher temperatures may result in damage to the asphalt. Within these limiting values 325°-185° F (163°-85°C), the best temperature to begin rolling (compaction) is the maximum temperature at which the mix will support the roller without moving horizontally.

At the time of placement, the mix temperature is uniform throughout the thickness of the mat. However, the top and bottom surfaces cool more rapidly than the interior because they are in contact with the cooler air and subgrade.

Heat checking is a rather common occurrence during compaction of asphalt concrete mixes, particularly when the mix is placed in thin lifts. Figure 6.3 is a vertical side view of heat checking in a mix being compacted. Heat checking happens most frequently when the tiller wheel of the roller is in front in the direction of travel during the breakdown pass. The horizontal arrows shown between the surface of the mix and the dotted line represent the horizontal thrust of the tiller wheel in the mix. The curve to the right of the figure represents the temperature profile in a layer approximately 2 inches (50 mm) thick. The temperature at the surface is 250°F (121°C). The temperature at the mid-point is 290°F (143°C), while the temperature at the bottom is between 250 and 260°F (121 and 127°C).

The illustration shows the most frequent reason for heat checking. The tiller wheel has sunk some depth into the mix and is exerting a horizontal thrust which must be resisted by the mix itself. Since the mix is hottest at its mid-point, the asphalt viscosity is lower there than at the surface. Because of the horizontal force of the wheel, the mix tends to move horizontally at some depth (illustrated by the dotted line in the figure). This means that the mix at the surface must also move. But the surface of the mix is stiffer due to its lower temperature, and responds by cracking in order to move along with the mix at the lower depth. This results in the so-called hairline cracks to the level that horizontal movement is occurring in the mix, generally 3/8 to 1/2 inch (9.5 to 12.5 mm) in depth. These are shown by the vertical lines behind the roller drum.

A top view of the hairline cracks that result from heating checking is shown in Figure 6.4. They tend to be 3 to 4 inches (75 to 100 mm) long, unconnected with each other. If they were connected and extended, they would form a crescent as shown in this figure. A crescent-shaped crack in an asphalt mixture is typical of the slippage movement. This is exactly what happens under a roller when heat checking occurs with the slippage occurring in the mix at the depth shown by the dotted line in Figure 6.3, i.e., the mix is slipping within itself. As in any type of slippage distress, the crescent opens in the direction of the forces causing the slippage. In the case of heat checking, the hair crack pattern usually opens up in the direction of rolling when the unpowered tiller wheel is leading.

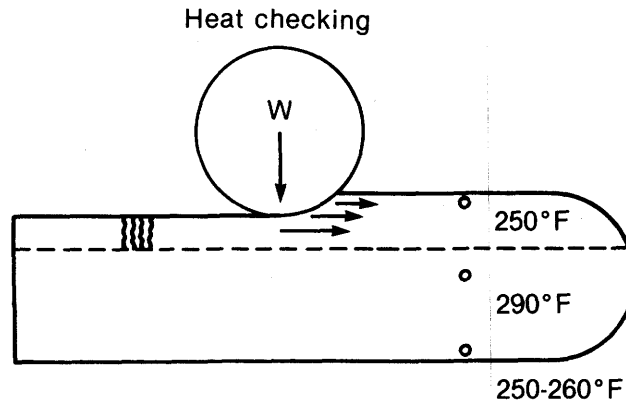


FIGURE 6.3—Heat Checking (Side View)  $^{\circ}\text{C} = 5/9 (^{\circ}\text{F} - 32)$ .

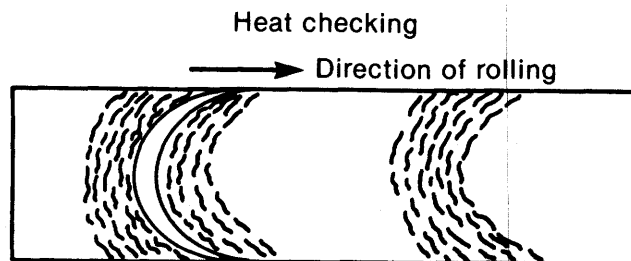


FIGURE 6.4—Heat Checking (Top View).

The same type of crack pattern shown for heat checking can also occur if slippage is occurring at a greater depth, such as at the surface on which an asphalt lift is being placed. In this case, the cracks have the same general configuration. However, they are longer, open up wider, 1/4 to 1 inch (6.25 to 25.0 mm) and extend through the mix to the level of horizontal movement. Again slippage is occurring but at a greater depth.

It is a rare case when heat checking occurs under a drive-wheel of a steel roller. It almost always occurs under the tiller wheel. Steel-wheeled rollers should not have the tiller wheel ballasted. The heavier the weight in the small diameter wheel, the deeper it sinks into the mix with a resulting increase of horizontal force being imparted during the rolling operation, and the greater likelihood of heat checking or other slippage distress.

**6.3.B.2 Environmental Effects**—As explained above, the rate at which the mix cools affects the length of time during which density can and must be achieved. Ambient (air) temperature, humidity, wind, and the temperature of the surface under the mix

affect the rate of cooling. Cool air temperatures, high humidity, strong winds, and cool surfaces alone or together shorten the time in which compaction must take place. This may make compaction more difficult.

**6.3.B.3 Layer Thickness**—Generally speaking, it is easier to achieve target density in thicker layer (lifts) of asphalt concrete than in thinner ones. This is because the thicker the mat the longer it retains its heat and the longer the time during which compaction can be achieved. This can be used to advantage when rolling lifts of highly stable mixes that are difficult to compact, or when paving in weather that can cause rapid cooling of thin mats.

Alternatively, increased course thickness can permit lower mix temperatures to be used because of the reduced rate of cooling.

## 6.4 ROLLERS

Self-propelled rollers are normally required for the compaction of asphalt concrete mixtures. Towed-type rollers should not be used, but hand-held rollers or vibrating plates can be used in small areas inaccessible to larger rollers. Typical self-propelled compaction rollers include the following three types.

- Steel-tired tandem.
- Pneumatic-tired.
- Vibrating.

Before any roller is used on a project it should be inspected to see that it is in good mechanical condition. Where applicable, the following items should be checked:

- Total weight of roller.
- Weight per inch of width (steel-wheeled rollers).
- Average ground contact pressure (pneumatic-tired rollers).

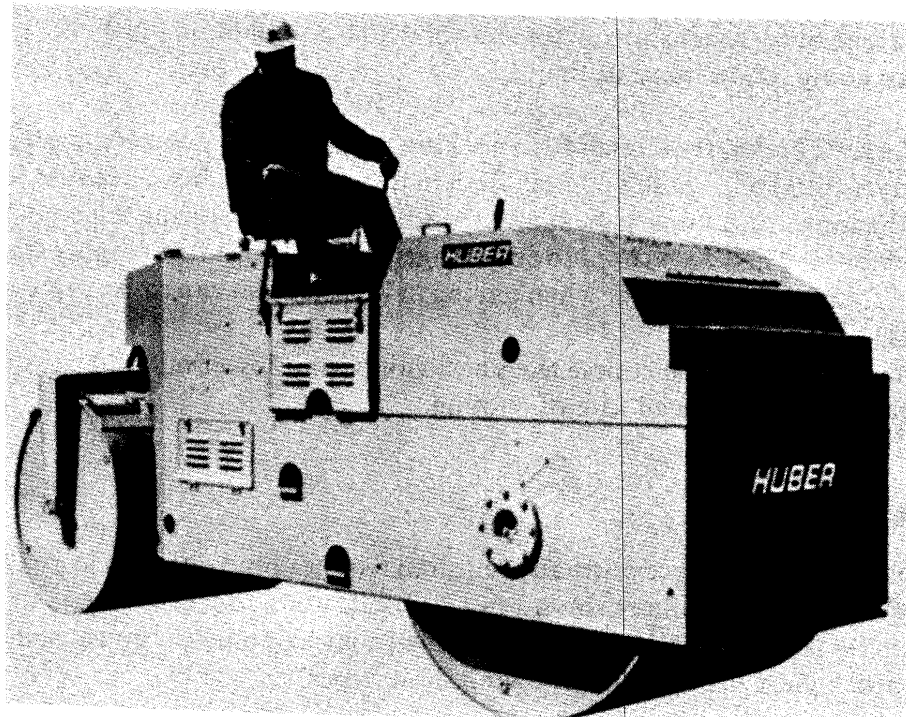
Details regarding use and inspection of specific types of rollers are presented in the following sub-sections.

### 6.4.A Steel-Tired Tandem Rollers

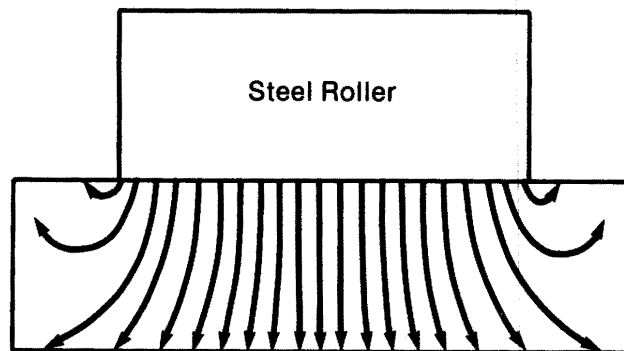
**6.4.A.1 Description**—Steel-tired tandem rollers have steel wheels or rollers, generally mounted on two tandem axles, as shown in Figure 6.5. Typical two-axle tandem rollers vary in weight from 3 to 14 tons (2.7 to 13 Mg) or more. On most, ballast can be added to the wheels to increase weight. For streets, highways and other heavy-duty pavement construction, a minimum gross weight of 10 tons (9.1 Mg) is required. Steel-wheeled tandem rollers can be used for breakdown (initial) rolling, intermediate rolling, and finish (final) rolling passes. For finish rolling the minimum weight required is usually 8 to 10 tons (7.2 to 9.1 Mg).

Tandem steel-tired rollers should provide a minimum of 250 lb. weight per linear inch (4465 kg per metre) of width on the compaction roll (drive wheel) when used for breakdown or intermediate rolling.

Steel-wheel rims should be checked for wear using a sharp metal straightedge. The



**FIGURE 6.5—Steel-Tired Tandem Roller  
(Courtesy of the Huber Corporation).**



**FIGURE 6.6—Force Exerted on Mat by Steel Rollers.**

roller should not be used if the rolling drum is grooved or pitted. Scrapers for keeping the rollers clean and wetting pads to keep the rollers wet so that they do not pick up asphalt during the rolling operation should be replaced if they are worn excessively.

**6.4.A.2 Operating Principles**—Figure 6.6 illustrates the force exerted by a steel roller on an asphalt concrete mixture when the surface under the mixture is firm. The arrows indicate the direction of lines of force through the mat.

Notice that the lines of force directly under the roller extend through the mat to the subgrade. The firm subgrade exerts an equal force upward. The mixture between the roller and the subgrade is compacted by the two forces acting in opposite directions.

The lines of force radiating from the edges of the roller, however, follow a circular path back toward the surface of the mat where there is no opposing force. Along these lines of force, the only resistance to the compactive effort of the roller is the internal resistance of the mixture. Because this lack of confinement at the edge of the roller is unlikely to produce an adequately densified mat under the edges of the roller, the roller must overlap the previous pass with subsequent passes. These subsequent passes place the partially compacted sections of the mat directly under the roller. Interaction of the forces exerted by the roller, subgrade, and confinement from the side can complete the compaction process.

Orientation of the roller is critical in most cases, particularly during initial compaction. The roller's direction of travel should be such that the powered wheel passes over the uncompacted mix first.

Figure 6.7 illustrates the correct use of a steel-wheeled roller. The drive-wheel is ahead of the tiller wheel in the direction of travel on the uncompacted mix. It can be seen that there is a vertical force downward caused by the weight of the wheel. The arrows concentric with the steel wheel represent the rotational force on the wheel, which is transmitted to the mix as the roller is propelled. This concentric force tends to move the mix under the wheel rather than to push it away. The resultant of these forces is more nearly a direct vertical force than the resultant of the forces under the tiller wheel.

Figure 6.8 illustrates a steel tandem roller being used incorrectly on an asphalt concrete mixture. The tiller wheel is in front in the direction of travel. This can be a critical mistake on some mixes, particularly during the breakdown pass. Since the tiller wheel is a dead wheel without power of its own, there is a tendency for it to push the mix away from itself, causing a wave in front. An analysis within the mix reveals two forces. One is a vertical force downward, and the other is a horizontal force forward. For compaction of a mix, the desirable movement of all aggregate particles is vertically downward. Little, if any, densification occurs as a result of horizontal movement within the mix. As a matter of fact, horizontal movement of the mix can actually result in a reduction of density.

There are other reasons for the drive-wheel to be on the mix ahead of the tiller wheel, particularly during the breakdown pass of the roller. Since the drive-wheel has the largest diameter it presses with a flatter contact surface on the mix. Therefore, the horizontal force from the wheel is minimized. Because the drive-wheel has a larger diameter than the tiller wheel it does not sink as deep into the mix. This also reduces the horizontal component of force imparted by the wheel. The drive-wheel is the heaviest wheel and is considered to be the compaction wheel. Since the best time to compact is when the resistance is the least, while the mix is hot, the breakdown pass should be done with the compaction wheel on the mix first.

The weight of the roller is transmitted to the mix through the contact pressure that is exerted under the wheels. Therefore, the contact pressure under the wheels should not exceed the supporting capability of the mix being compacted. Usually, heavier rollers

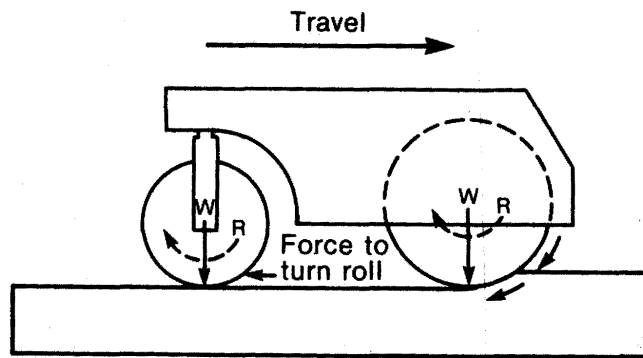


FIGURE 6.7—Proper Direction of Roller Travel.

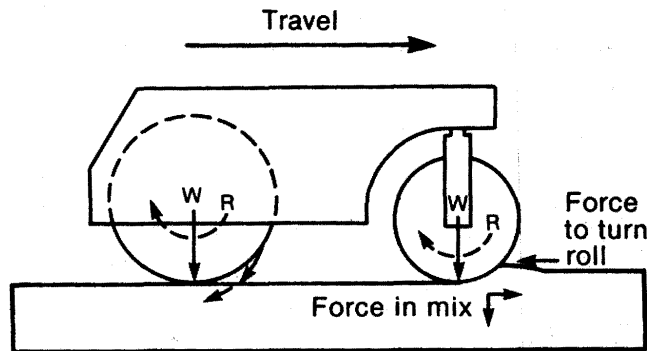


FIGURE 6.8—Improper Direction of Travel.

can be used on harsher, more stable mixtures, particularly for breakdown passes. Somewhat lighter rollers might be necessary on less stable mixes.

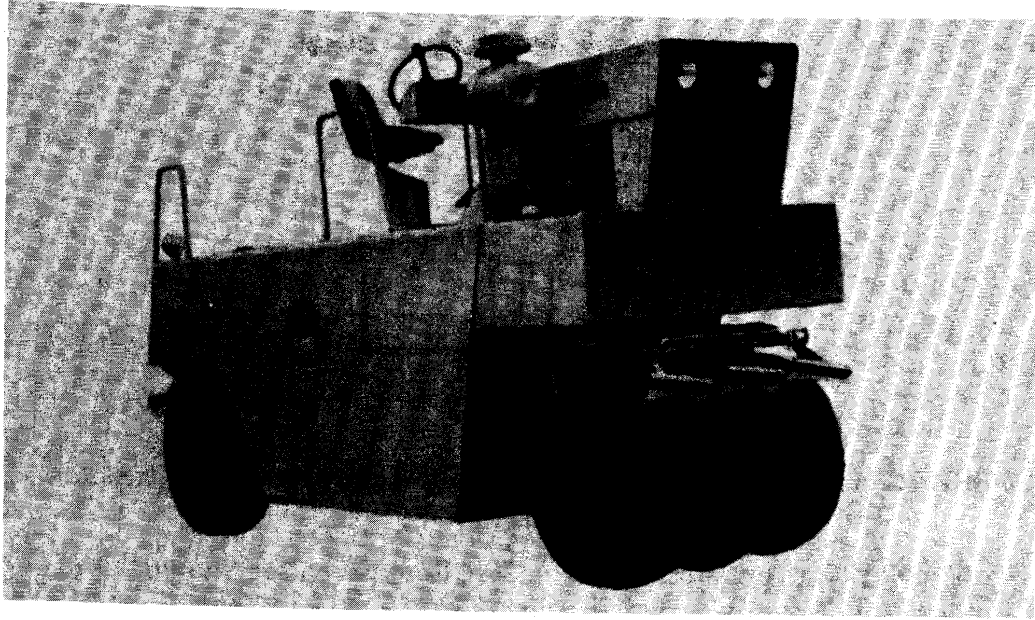
#### 6.4.B Pneumatic-Tired Rollers

**6.4.B.1 Description**—Pneumatic-tired rollers have rubber tires instead of steel tires or drums. They generally feature two tandem axles, with 3 to 4 tires on the front axle and 4 to 5 tires on the rear (Figure 6.9). The wheels oscillate; that is, they move up and down independently of one another.

Pneumatic-tired rollers can be ballasted to adjust their gross weight and, depending on size and type, may vary from 10 to 35 tons (9 to 32 Mg). More important than gross weight, however, is the weight per wheel which should range from 3000 to 3500 lb. (680 to 907 kg) if the pneumatic-tired roller is to be used for breakdown or compaction rolling.

Pneumatic-tired rollers may be equipped with 15, 17, 20 or 24-inch (380, 430, 510 610mm) wheels and for asphalt compaction should have smooth tire treads. The tires





**FIGURE 6.9—Typical Pneumatic-Tired Roller  
(Courtesy American Hoist and Derrick Company).**

must be inflated to nearly equal pressures with variation not exceeding 5 psi (35 kPa) to apply uniform pressure during rolling.

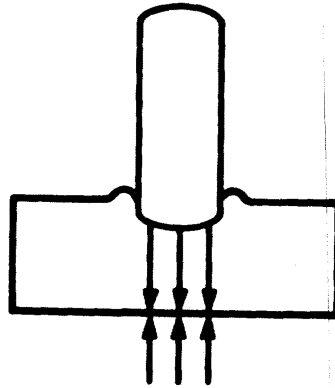
**6.4.B.2 Operating Principles**—Pneumatic-tired rollers may be used for two types of rolling; breakdown and intermediate rolling for compaction, and conditioning a finished asphalt surface. The two processes are different and require different operating procedures.

Figure 6.10 illustrates the actions of a pneumatic-tired roller when used for breakdown and intermediate rolling. The arrows illustrate typical lines of force in the mat.

As in the case of steel-wheeled rollers, when pneumatic-tired rollers are used, the mix being compacted must be adequately confined for proper densification. Uniform subgrade strength may be more critical when pneumatic rollers are used because the individual wheels can exert high stress on small areas of subgrade weakness—areas that wide, rigid steel drums tend to bridge.

When a rubber-tired roller is used for breakdown rolling, very little horizontal movement of the mix occurs in the direction of travel. This is due to the fact that each tire flattens slightly as it drives over the mix, permitting almost all of the compactive force to be exerted vertically on the mat. Horizontal movement of the mix in the direction of travel occurs only if the tire diameter is too small and the tire sinks into the mix. Excessive sinking is an indication that the roller being used is unsuited for breakdown rolling. As with steel-wheel rollers, the drive wheels of the pneumatic tire roller should be toward the paver.

There is some horizontal movement of the mix under a pneumatic tire, but it tends to be at right angles to the direction of travel. It may cause small bumps in the mix immediately adjacent to the tire. These small bumps normally are of no significance,



**FIGURE 6.10—Forces Exerted by Pneumatic Roller During Compaction.**

and will be rolled out by subsequent passes. Enough passes should be made to eliminate such bumps as well as any tire marks (ruts) in the mat surface. Because the tires must be allowed to heat up to avoid mix sticking to them during breakdown and intermediate rolling, no water is used on the tires of a pneumatic roller. Mix will stick to the tires during the warm-up period, but once they are hot this will cease. Skirts placed around the tires will shorten the warm-up period and help keep the tires hot, particularly in cool or windy weather. Desirable pneumatic-tire roller requirements for breakdown and compaction rolling are:

- A per-wheel weight of 3000 to 3500 lb. (1360 to 1590 kg).
- 20 in. (510 mm) minimum wheel diameter.
- Tire inflation pressure of 70 to 75 psi (483 to 517 kPa) when cold and 90 psi (620 kPa) when hot.

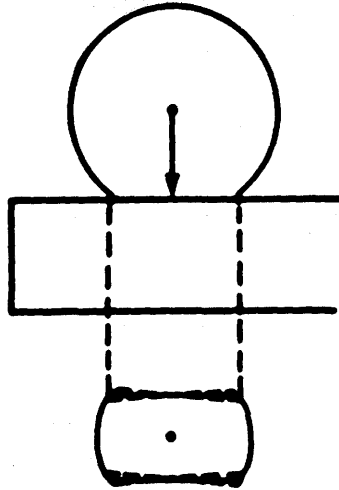
These recommended tire pressures are applicable for most mixes but can be reduced if necessary for mixes with fairly low stability.

The kneading action of a pneumatic-tired roller can also be employed to improve or toughen an asphalt pavement surface after normal paving operations are completed. It can be performed as much as two weeks after the pavement has been placed, provided the weather is warm and the pavement surface temperature is at least 100°F (38°C). The kneading operation can reduce pavement permeability and increase pavement resistance to scuffing or abrasion by traffic. Some increase in pavement density has also been attributed to this subsequent rolling operation. Figure 6.11 illustrates the action of a pneumatic tire during kneading operations.

Pneumatic-tired rollers are also ideal for correcting heat checking in the mat surface. As discussed earlier, heat checking is the appearance of short [2 to 4 in. (50 to 100 mm)] disconnected hairline cracks after one or more passes of static steel-wheel roller.

When a pneumatic-tire roller is used for kneading a finished asphalt surface the desirable requirements are:

- A 1500 lb. (680 kg) minimum weight per wheel.
- A 15 in. (380 mm) minimum wheel diameter.
- A 50 to 60 psi (345-415 kPa) tire pressure.



**FIGURE 6.11—Action of Tire During Kneading Procedures.**

**6.4.B.3 Pavement Durability as Related to Pneumatic-Tire Rolling**—The ability of pneumatic-tire rollers to provide a more tightly-knit, traffic resistant surface than steel rollers was recognized years ago when they were first employed for the intermediate rolling of asphalt concrete pavements. Normally, however, they should not be used for breakdown rolling of surface courses.

Subsequent testing indicated that pneumatic-tired rollers will achieve about the same pavement compaction as steel-wheeled rollers.

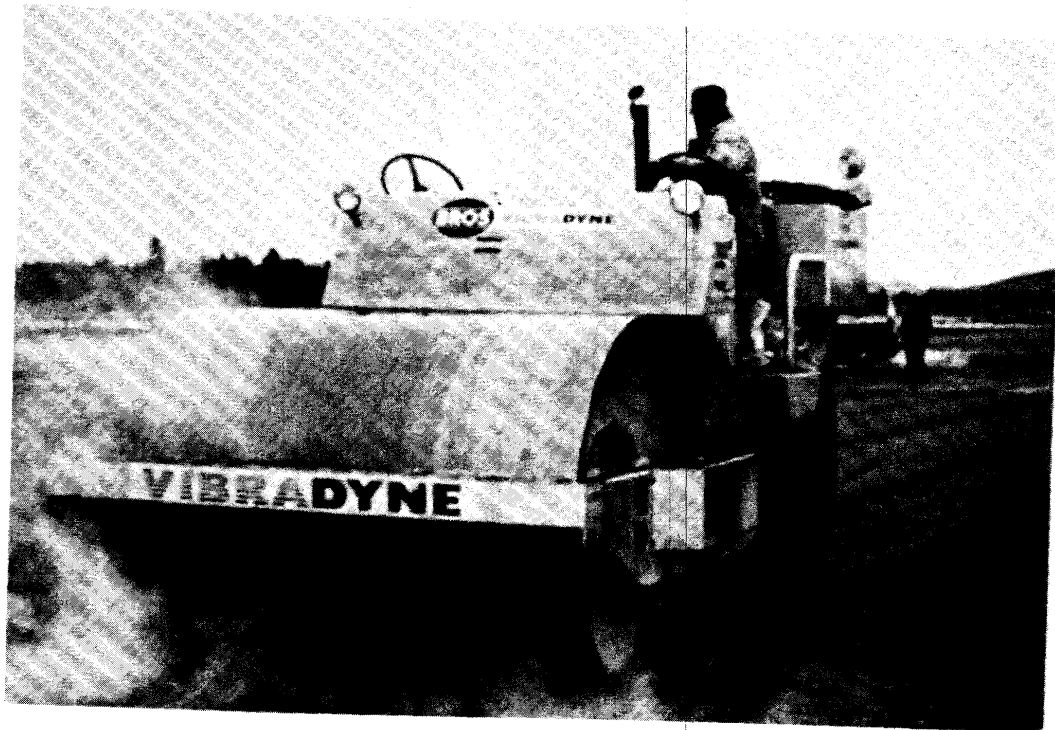
In asphalt concrete overlay construction, the first (leveling) course is most often placed on an irregular surface that has been rutted or disfigured by traffic. The ability of the pneumatic-tired roller to apply uniform pressure over its full width makes it desirable to be used where it is needed most—in the wheel tracks. The bridging action of steel-wheeled rollers may prevent them from being as effective in similar situations.

#### **6.4.C Vibratory Rollers**

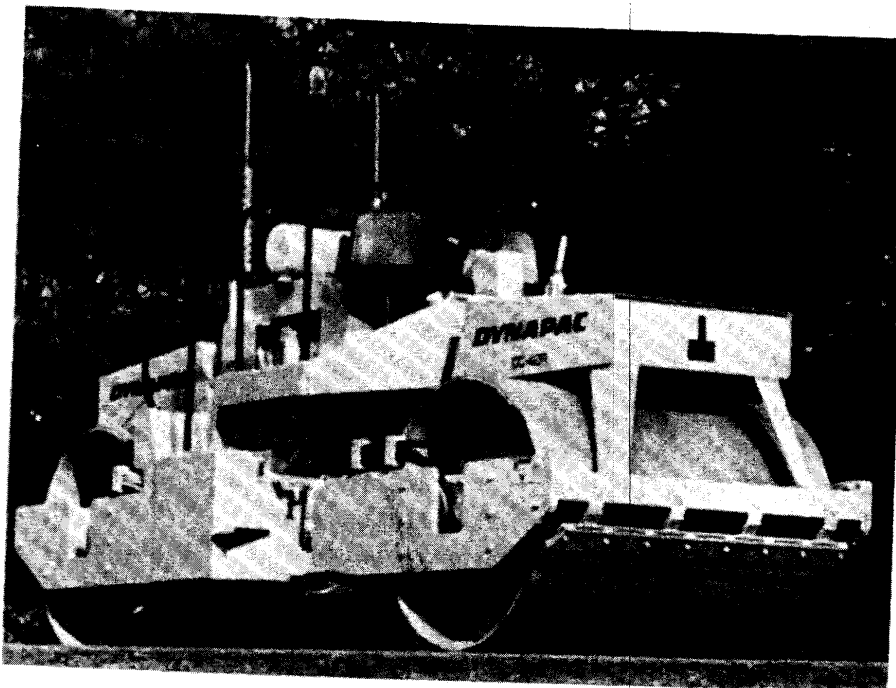
**6.4.C.1 Description**—Vibratory rollers provide compactive force by a combination of weight and vibration of their steel compaction rolls, commonly referred to as drums. Those used for asphalt concrete compaction are self-propelled and vary in weight from 7 to 17 tons (6 to 15 Mg). There are two basic models, the single drum units (Figure 6.12) and the double drum (tandem) units (Figure 6.13).

Propulsion for single drum models is provided by steel or pneumatic-tired wheels. Propulsion for the double (tandem) drum models is usually provided by both drums, although there is at least one brand that features two steel drive-wheels mounted between the vibrating drums. The drums on vibratory rollers vary from 3 to 5 feet (0.9 to 1.5m) in diameter and 4 to 8 feet (1.2 to 2.4m) in width. Their static weight in terms of drum width is generally between 160 to 180 lb. per in. (2.9 to 3.2 kg per mm).

The engine providing power for propulsion also powers the hydraulically driven



**FIGURE 6.12—Single-Drum Vibratory Roller  
(Courtesy of The Bros Company, Inc.).**



**FIGURE 6.13—Double-Drum Vibratory Roller  
(Courtesy Dynapac Mfg. Co.)**

vibrating unit. Vibrations are generated by a rotating eccentric weight inside the drum, the speed of which determines the *frequency*, or vibrations per minute (vpm), of the drum. The weight and distance from the shaft of the eccentric determines the *amplitude* (amount) of the impact force that is generated. Both the frequency and amplitude of vibrations are controlled independently of roller travel and engine speed.

The vibration frequency of rollers used for asphalt concrete compaction is generally between 2000 to 3000 vibrations per minute (vpm), depending on the model and manufacturer. Some models provide only one or two specific frequency settings, while others may provide a full range of frequencies within certain limits; for instance 1800 to 2400 vpm.

**6.4.C.2 Operating Principles**—Vibratory rollers achieve compaction through a combination of three factors. They are:

- Weight
- Impact forces (roller vibration)
- Vibration response in the mix.

Weight has been discussed in connection with steel-wheeled tandem rollers and pneumatic-tired rollers. The impact forces are those generated by vibration of the compaction drum and are regulated by controlling the frequency and amplitude of the vibration. The amount of impact force required to obtain optimum densification of the mat varies with the temperature and properties of the asphalt hot-mix, the thickness of the mat, and the support provided by the surface on which the mat is placed. It will also vary with the drum diameter and the width and the ratio of the roller's static weight and dynamic (impact) force.

The vibration response in the mixture is the way the mix reacts to the forces exerted upon it. As with other types of rollers, the mixture will compact easily or with difficulty depending on its temperature, cohesion, particle shape and texture, confinement, and other factors. What varies when vibratory rollers are used is that repetitive dynamic forces are being exerted on the mixture.

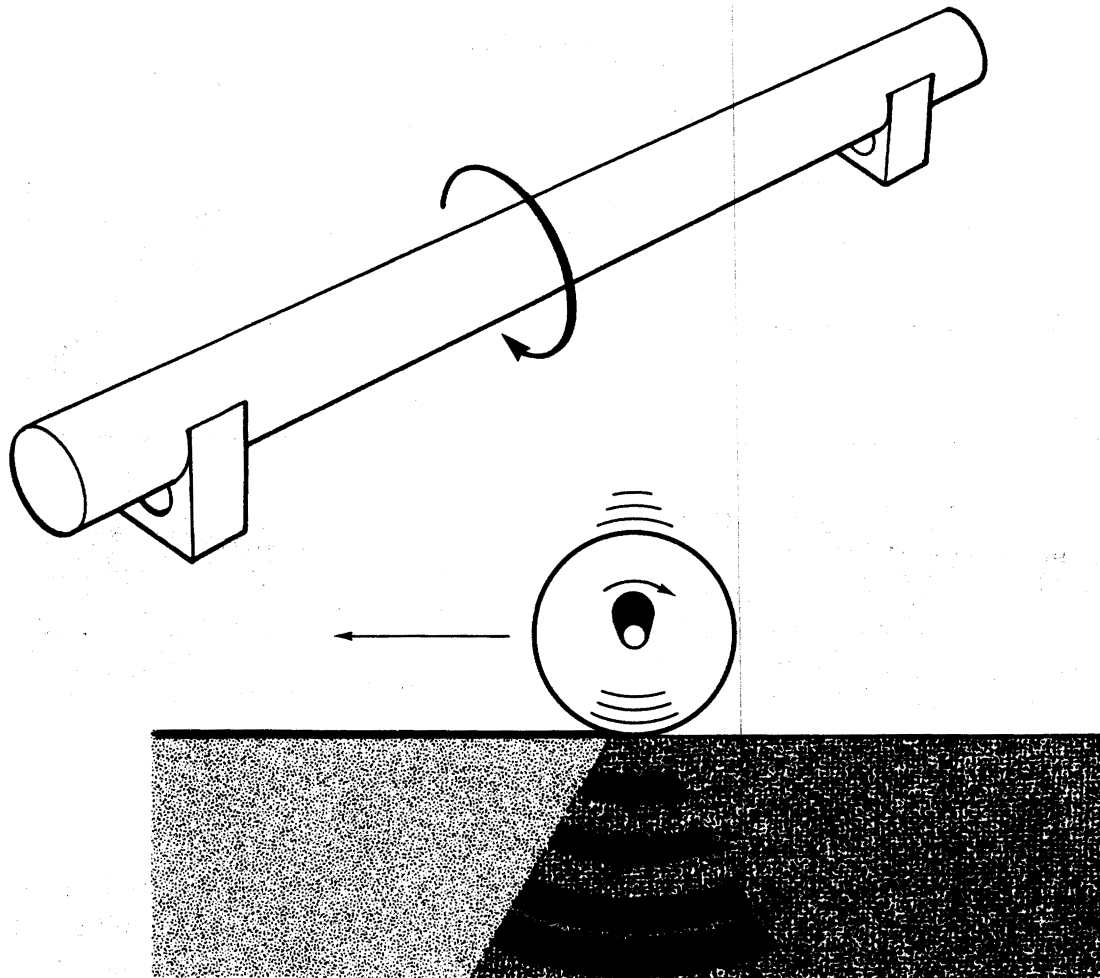
**6.4.C.3 Impact Forces**—To use a vibratory roller effectively it is necessary to have some understanding of the definitions used to describe the forces involved:

- *Frequency*

Roller drum vibrations are produced by off-center weights, called eccentrics, on a spinning shaft. The speed of the shaft sets the frequency (the number of vibrations, or downward impacts, per minute).

Frequency is defined as the number of cycles per minute; a single cycle being one full turn of the eccentric. The eccentric is an off-center weight fastened to a shaft in the drum, Figure 6.14. (A few rollers may have vibratory shafts mounted outside of the drum, in the frame.) As the shaft spins, the eccentric creates an outward force. The heavier the eccentric the greater the force. The farther it is from the shaft the greater the force. And, the faster it spins the greater the force.

As the roller moves ahead, its vibrating drum produces a rapid sequence of impacts on the surface it is rolling. These impacts are equal to the frequency of vibration. For any given roller speed, the higher the frequency used the smaller the impact spacing and the smoother the surface will be.



**FIGURE 6.14—Off-center Weights, Called Eccentrics, on a Spinning Shaft Create vibrations.**

For each roller, the manufacturer's advice on frequency should be used.

- *Amplitude*

The roller drum moves up and down as it vibrates (Figure 6.15). When it changes direction in its up-and-down movement it is momentarily at rest, just as the roller itself is when it changes direction. Amplitude, then, is the greatest movement in one direction of a vibrating roller drum from a position at rest. It is controlled by the weight and distance from shaft of the eccentric and the weight of the roller drum. For any given drum weight, the heavier the eccentric and the farther away it is from the shaft the higher the amplitude will be. On most heavy tandem vibratory rollers, amplitude can be varied by the operator to suit paving conditions. For each roller, the manufacturer's advice on amplitude should be used.

## Amplitude

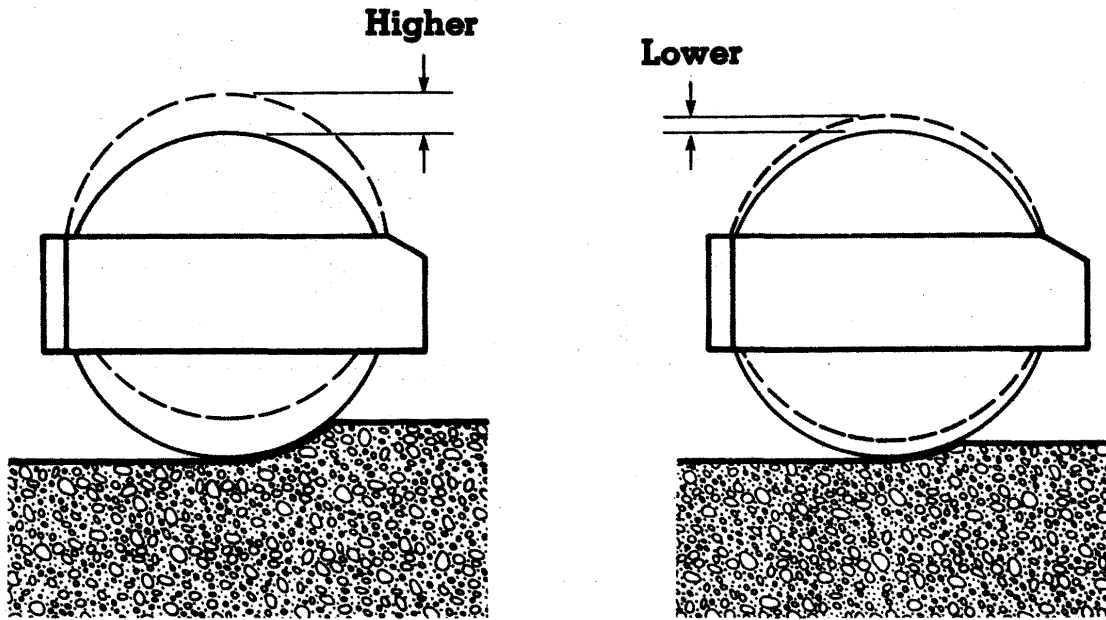


FIGURE 6.15—Illustration of Amplitude.

**6.4.C.4 Use of Vibratory Rollers**—To ensure smoothness under vibratory compaction, the frequency and roller speed should be matched so that there will be at least ten downward impacts of the vibration per foot of travel of the roller. The relationship between speed and frequency is illustrated in Figure 6.16. As the speed of the roller increases for a given frequency of vibration, the spacing of the impacts grows farther apart. In asphalt mixtures, it is generally agreed that the most desirable method is to use the maximum rated frequency with the speed of the roller adjusted to provide the desired impact spacing.

Figure 6.17 illustrates four different modes of using a vibratory roller equipped with two vibrating wheels. The first mode shows the roller being used without vibration. It simply acts as a static steel-wheeled tandem roller. The second mode shows the use of vibration on the trailing wheel with the leading wheel in the static mode. This mode

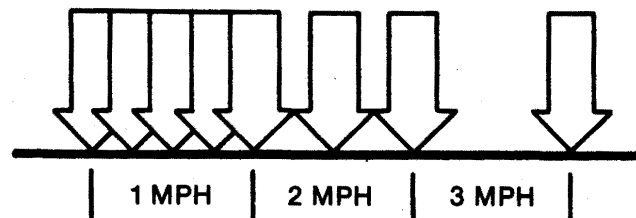


FIGURE 6.16—Relationship between Speed and Frequency (1 mph = 1.6 km/hr).

may be desirable on mixes that have borderline stability. The third mode illustrates the use of vibration with both wheels when being used on a stable mix in order to achieve the maximum compactive energy. The fourth mode illustrates vibration on the leading wheel of the roller and is sometimes used to achieve compaction with this wheel while the trailing wheel in the static condition provides a smoother finish. The selection of the mode of operation should be tailored to the mix being placed and the conditions of the project.

In utilizing vibratory equipment, keep in mind that the energy imparted by the vibratory wheel must be absorbed in the mix being compacted. Controlling the amplitude permits the operator to vary the force developed from the wheel and, therefore, the energy imparted to the mix. Amplitude adjustments may be necessary for every change in the mix being placed. For example, a change in the lift thickness, mix temperature, mix gradation, filler content, and asphalt content may require adjustment in the amplitudes being used. It is important that the roller should be vibrating only when it is moving. If vibration continues while the roller is standing still or changing direction, each vibrating wheel will leave an indentation in the pavement at the stopping point. Most modern rollers have automatic cut-offs for vibration when the roller stops moving.

Generally, vibration should not be used for compacting thin overlays. This is particularly true with sandy mixes. In thin overlays, there is frequently insufficient material to absorb the energy imparted by the vibrating rollers. The energy therefore passes through the mix being compacted, and rebounds from the surface of the pavement being overlaid. It re-enters the mix being placed, and decompacts it. For situations of this type, the vibratory roller should be used in the static mode. The rolling speed whether being used in the vibratory or static mode, should not exceed 3 mph (4.8 km/h). This rolling speed is the same as the maximum recommended for static steel-wheeled rollers and pneumatic-tired rollers.

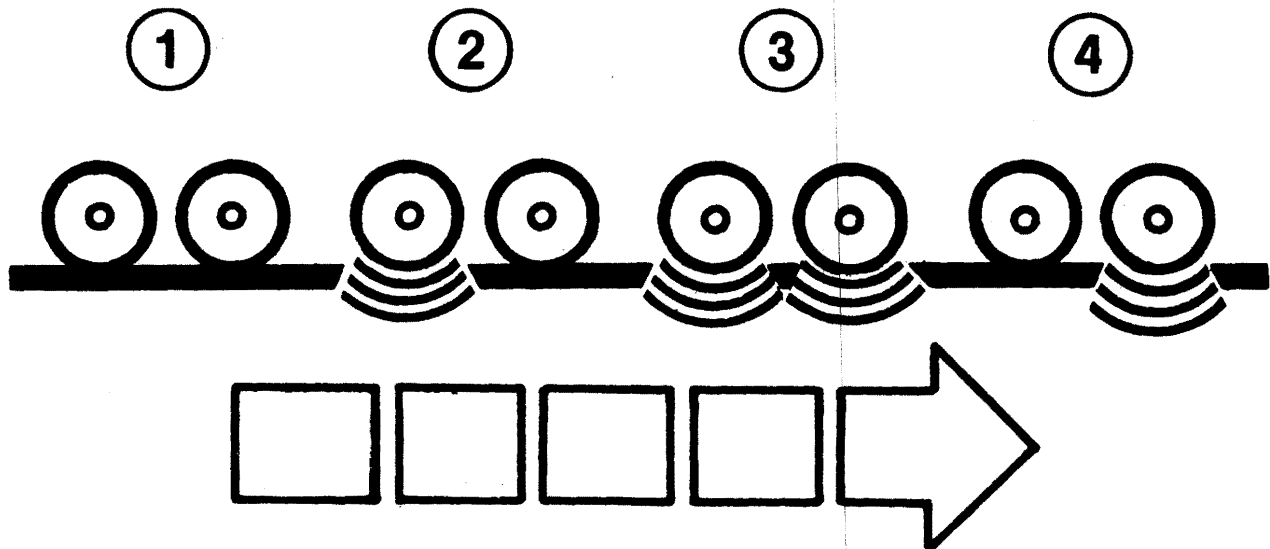


FIGURE 6.17—Vibration Modes.



## 6.5 ROLLING PROCEDURES

### 6.5.A General

The degree of density that is achieved in a hot asphalt mixture is dependent on the amount of compactive effort that is applied before the mix cools to 185°F (85°C). We have already examined some of the variables that will affect the length of time in which compaction must be accomplished. One that has been only briefly mentioned is the rate of mix production. Increasing roller speed will not compensate for increased production rates; it will simply reduce the amount of compactive effort that is applied to a given area of pavement surface in a given time interval.

Additional rollers may be needed with an increase in production if the given roller cannot achieve the desired compaction and still keep up with plant production. The number of rollers provided must be tailored to the conditions of the specific job and be adequate to obtain the desired compaction.

### 6.5.B Calculating Roller Requirements

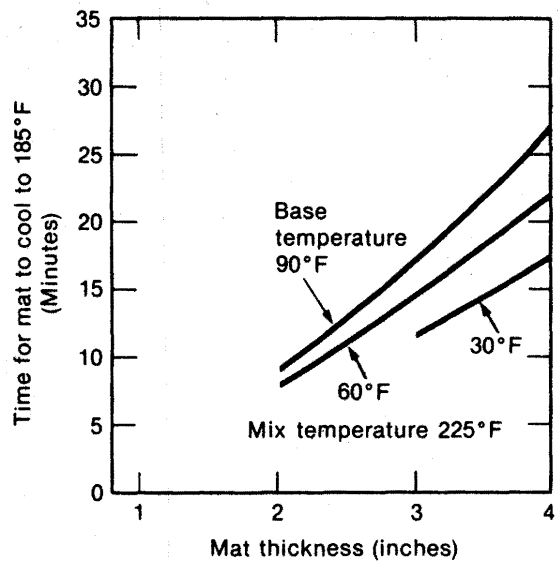
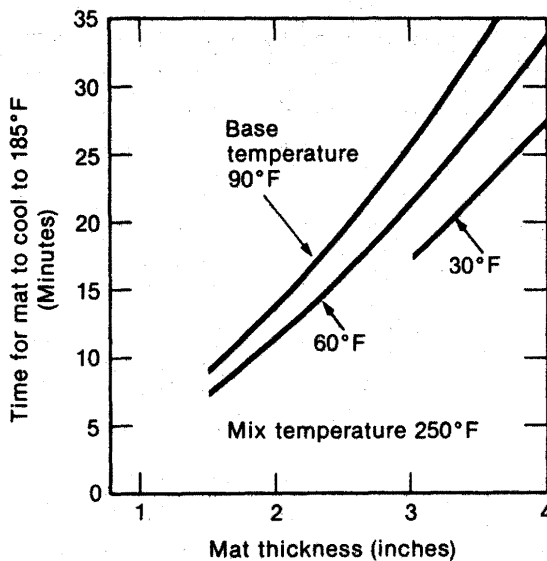
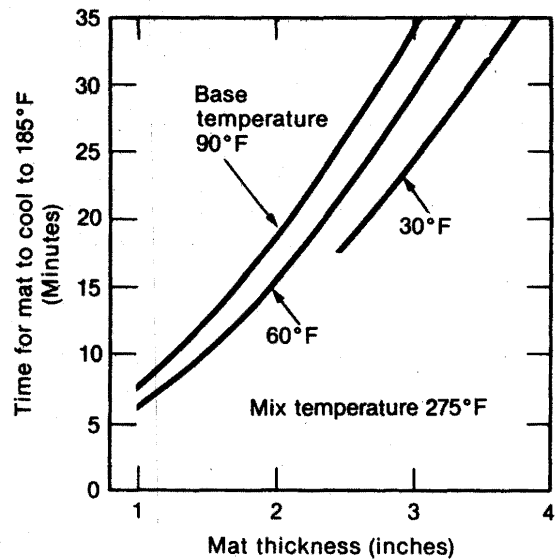
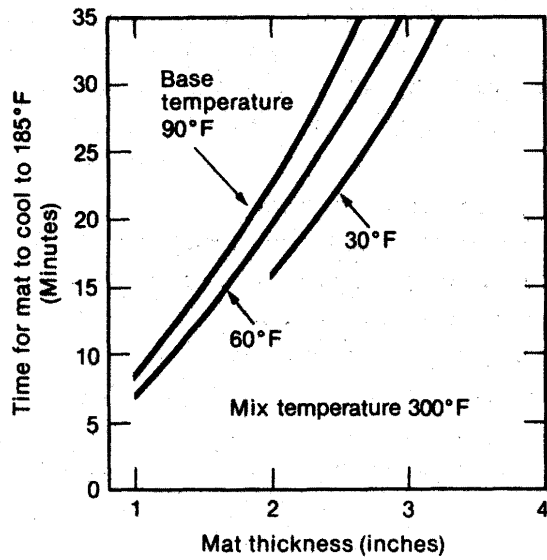
While it is the contractor's responsibility to determine roller requirements based on contract specifications, the inspector is an essential part of this determination. The exact number of coverages (passes) that will be required to obtain adequate density is initially unknown. This is due to some uncertainty about the mixtures rate of cooling, among other things. These uncertainties are cleared up by careful observation, measuring, and testing during the early stages of the paving operation. It is generally desirable that the roller stay as close behind the paver as possible.

A number of studies have been made on the cooling rates of mixes under varying conditions of mix temperature, lift thickness and base temperature. Temperature is a fairly accurate estimate of the time interval in which density must be achieved. (See Figure 6.18.) This estimate can be used to determine the number of rollers required on the job.

A test strip will establish the rolling pattern to assure achievement of the required density (See Section 6.6.A.3), the proper riding quality, and to attain the optimum production rates with the given roller. In virtually all cases where test strips are used, the rollers meet the density requirements and produce a good riding surface.

A rolling pattern that will provide the most uniform coverage of the lane being paved should be planned and used. Rollers are produced in a number of widths. A single pattern that applies to all of them cannot be designed. For this reason, the best rolling pattern for each roller being used should be worked out on a test strip.

- (1) Before rolling the test pattern decide how the roller will be operated for:
  - a. Rolling speed
  - b. Lap pattern for paving width
  - c. Number of passes
  - d. Selection of roller operating zone behind paver.
- (2) If the test pattern does not pass—a series of new test patterns should be run. The following procedure is recommended:



**Figure 1 — Times for asphalt to cool to 185°F.**

Wind velocity—10 knots. Atmospheric temperature—same as base.

Note: "Base Temperature" is the temperature of the surface upon which the asphalt mat is placed.

\*185°F is the temperature of the mat measured ¼ to ½ inch below the mat surface. The average temperature of the entire mat thickness when this temperature is reached, is approximately 175°F.

On a subgrade (base temperature) of 30°F, placing of thicknesses less than those shown on the curves is not recommended.

(Conversion: 1 inch = 25mm, °C = 5/9 [°F - 32])

**FIGURE 6.18—Time Allowed for Compaction, Based on Temperature and Thickness of Mat and Temperature of Underlying Base.**

- a. Slow the roller down.
  - b. Take a 15 second nuclear count with a nuclear density gauge (Figure 6.19) after each pass or round trip until passing density is indicated by the nuclear count.
  - c. Try a higher speed using the same number of passes. Use the nuclear gauge to see if passing density is still reached, if so, then continue increasing roller speed with same number of passes until density fails to pass, then cut speed back to the highest speed, which meets density in the fewest number of passes.
  - d. The correct rolling speed is always a balance between rolling fast for productivity and rolling to meet density and finish requirements. Therefore, if the selected speed obtains density, but leaves surface blemishes, reduce speed until blemishes disappear.
- (3) The rolling pattern for the test strip should be the same pattern that will be used on the job.
- Do not run a slower pattern than you intend to use on the job.
  - Do not use more passes than you intend to use on the job, otherwise you will find that the roller will have a problem in keeping up with the paver.
- (4) It is very important to recognize that all operating techniques are governed by the mix behavior during the rolling process. It will vary from job-to-job and from lift-to-lift. Rules are, therefore, not absolute, but only considered as guidelines.

#### 6.5.C Sequence of Rolling Operations

As mentioned before, there are three types of rolling operations. They are:

- Initial (breakdown) rolling—The first pass of the roller on the freshly placed mat.
- Intermediate Rolling—All subsequent passes by the roller(s) to obtain required density before the mix cools to 185° F (85° C).
- Finish rolling—Rolling done solely for the improvement of the surface while the mix is still warm enough to permit removal of any roller marks.

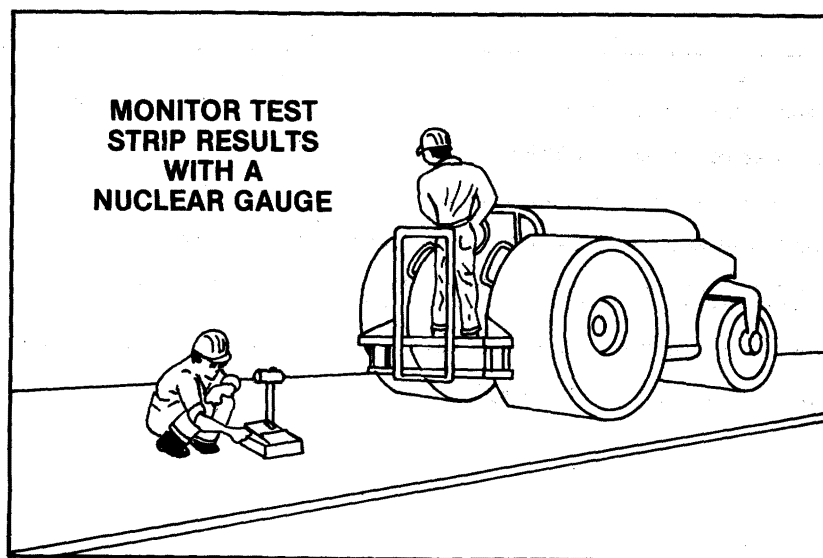


FIGURE 6.19—Nuclear Density Gauge.

Within the first two operations, a sequence must be followed to ensure a mat of specified density, shape, and smoothness. The sequence dictates which parts of the mat are rolled first and which last, and varies for thin lifts and thick lifts.

**6.5.C.1 Thin Lifts**—When rolling a thin lift (a lift of less than 2 in. (50 mm) compacted thickness) in single-lane width or full width, use the following sequence:

- (1) Transverse joints.
- (2) Outside edge.
- (3) Initial or breakdown rolling, beginning on the low side and progressing toward the high side.
- (4) Intermediate rolling, same procedure as (3).
- (5) Finish rolling.

When paving in echelon, or abutting a previously placed lane or other lateral restraint, the mix should be rolled in the following sequence:

- (1) Transverse joints.
- (2) Longitudinal joints.
- (3) Outside edge.
- (4) Initial or breakdown rolling, beginning on the low side and progressing toward the high side.
- (5) Intermediate rolling, same procedure as (4).
- (6) Finish rolling.

**6.5.C.2 Thick Lifts**—When placing a thick lift (a lift of 4 in. (100 mm) or more compacted thickness) in single-lane width or full width, roll the mix in the following sequence:

- (1) Transverse joints.
- (2) Initial or breakdown rolling, beginning edge 12 to 15 in. (300-380 mm) from the lower unsupported edge and progressing toward the other edge.
- (3) Outside edge. When within 12 in. (300 mm) of the unsupported edge, the roller should advance toward the edge in approximately 4-in. (100 mm) increments in successive passes.
- (4) Intermediate rolling, beginning on the low side and progressing toward the high side.
- (5) Finish rolling.

When placing thick lifts in echelon, or when abutting a previously placed lane or other lateral restraint, roll the mix in the following sequence:

- (1) Transverse joint.
- (2) Longitudinal joint.
- (3) Initial or breakdown rolling, beginning at the longitudinal joint and progressing toward the outside edge.
- (4) Outside edge. When within 12 in. (300 mm) of the unsupported edge, the roller should advance toward the edge in approximately 4-in. (100mm) increments in successive passes.

- (5) Intermediate rolling, beginning on the low side and progressing toward the high side.
- (6) Finish rolling.

#### 6.5.D Specific Rolling Procedures

**6.5.D.1 Rolling Transverse Joints**—When the transverse joint is made next to an adjoining lane, the first pass is made with a static steel-wheeled roller moving along the longitudinal joint for a few feet. The surface is then straightedged and corrections made, if necessary. The joint is then rolled transversely, with all except about 6 in. (150 mm) of the wheel width on the previously laid material (Figure 6.20). This operation should be repeated with successive passes, each covering an additional 6 to 8 in. (150 to 200 mm) of the new mat until the entire width of a drive roll is on the new mix.

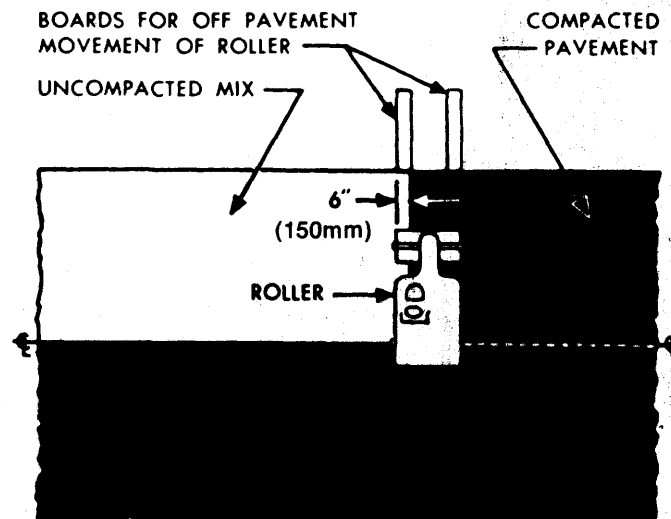


FIGURE 6.20—Rolling a Transverse Joint.

During transverse rolling, boards of the proper thickness should be placed at the edge of the pavement to give the roller a surface to drive on to once it passes the edge of the mat (Figure 6.20). If boards are not used, transverse rolling must stop 6 to 8 in. (150 to 200 mm) short of the outside edge to prevent damaging it, and the edge must be compacted later during longitudinal rolling.

**6.5.D.2 Rolling Longitudinal Joints**—When using static steel-wheeled or pneumatic-tired rollers to roll longitudinal joints, only 4 to 6 in. (100 to 150 mm) of the roller width should ride on the newly-placed lane on the first pass. The bulk of the width should ride on the previously compacted side of the joint. In each subsequent pass, more and more of the roller width is allowed on to the fresh mat, until the entire width is on the new mixture.

A different procedure is employed with vibratory rollers. The roller drums are extended only 4 to 6 in. (100 to 150 mm) on to the previously compacted lane with the rest of the drum width riding on the newly placed mixture. The roller continues to move along this line until a thoroughly compacted, neat joint is obtained.

For compaction purposes, longitudinal joints can be categorized into two categories: hot and cold. Each requires a different compaction procedure.

- *Hot Joints*

A hot joint is one between two lanes placed at approximately the same time; i.e., by pavers working in echelon. This produces the best longitudinal joint because both lanes are at, or near, the same temperature when rolled. The material becomes a single mass under the roller and there is little or no difference in density between the two lanes. When paving in echelon, the breakdown roller following the lead paver leaves 3 to 6 in. (75 to 150 mm) of the common edge or joint between the pavers unrolled. This common joint is then compacted by the roller following the second paver on his first pass. In order to accomplish this effectively, the second paver and roller should keep as close as possible to the first paver to ensure that a uniform density is obtained across the joint. The roller following the second paver compacts the seam on its first pass (Figure 6.21).

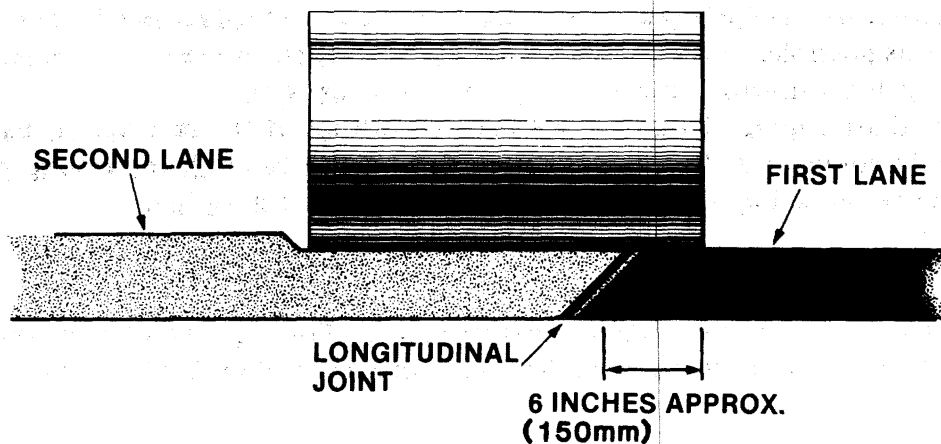


FIGURE 6.21—Rolling a Hot Longitudinal Joint.

- *Cold Joints*

A cold joint is one between two lanes, one of which has cooled overnight or longer before the adjoining lane is placed. Because of the difference in temperature between the two lanes, there is almost always a difference in density between the two sides of the joint, regardless of the rolling technique used.

Longitudinal joint compaction seldom ends with uniform density on both sides of the joint. In most cases there is a low density zone at the joint in the lane placed first and a high density zone at the joint in the abutting lane. The only practical solution to this difficulty appears to be echelon paving or full-width paving. Echelon paving allows the joint to be compacted while the asphalt mixture is hot on both sides. But, as

most asphalt paving is done in single lanes, the next best solution is to roll the joint as soon as possible. In any case, longitudinal joints should be rolled directly behind the paver.

**6.5.D.3 Rolling Edges**—Except in echelon and thick-lift paving, the edges of the pavement should be rolled concurrently with the longitudinal joint. In rolling edges, roller wheels should extend 2 to 4 in. (50 to 100 mm) beyond the pavement edge, provided that lateral displacement of the mix is not excessive.

After longitudinal joints and edges have been compacted, breakdown rolling should follow immediately.

**6.5.D.4 Breakdown Rolling**—Breakdown rolling may be accomplished with static or vibratory steel-wheeled rollers.

It is important to start the rolling operation on the low side of the mat (usually the outside of the lane being paved) and progress toward the high side. The reason is that hot mixtures tend to migrate toward the low side of the mat during compaction. If rolling is started on the high side, migration is much more pronounced than if rolling starts from the low side. When adjoining lanes are placed, the same rolling procedure should be followed but only after compaction of the longitudinal joint.

**6.5.D.5 Intermediate Rolling**—Intermediate rolling should follow breakdown rolling as closely as possible, while the asphalt mix is still well above the minimum temperature at which densification can be achieved [185°F (85°C)].

Intermediate rolling should be continuous until all of the mix placed has been thoroughly compacted. Regardless of the type of rollers used, the rolling pattern should be developed in the same manner as for breakdown rolling.

**6.5.D.6 Finish Rolling**—Finish rolling is done solely for the improvement of the surface. It should be accomplished with steel-tired, static-weight tandems or vibratory tandems without vibration while the material is still warm enough for removal of roller marks.

**6.5.D.7 Compacting Inaccessible Areas**—When the asphalt mix is spread in areas that are inaccessible to rollers, compaction can be done by small hand operated vibrating plate compactors. The plates on these compactors are usually between 1 to 3 square ft. (0.1 to 0.3m<sup>2</sup>).

### **6.5.E. Special Rolling Procedures**

**6.5.E.1 Steep Grades**—Normal grades offer no particular problem for any of the roller types. On steep grade, however, a variation in rolling procedure may be necessary. In these situations a substantial portion of the forces imparted by the roller will be directed in the downhill direction potentially causing increased movement of the mix parallel to the slope. To offset this tendency, the following variations in rolling might be desirable:

- *Static steel-wheeled rollers*

When using steel-wheeled rollers reverse the roller so that the tiller wheel is in the direction of paving. The lighter weight and pushing action of this roll will offset the tendency of the mix to move downhill and impart additional stability to the mix before the drive roll passes over it.

- *Pneumatic-tired rollers*

Do not use pneumatic-tired rollers for breakdown.

- *Vibratory rollers*

Operate in static mode for initial rolling until stability is developed in the mix to permit low amplitude vibration.

**6.5.E.2 Cold Weather Paving**—Asphalt mixtures cool very quickly when placed on cold surfaces in cold weather. Also, thin lifts cool more rapidly than thick lifts. If paving must be done in cold weather, then there is an obvious advantage in placing the mix in thick lifts to gain additional time for the compaction process.

**6.5.E.3 Pavement Overlays**—When overlaying an existing pavement which has extensive rutting in the wheel paths, a leveling course to eliminate surface irregularities should be employed. A pneumatic-tired roller is very useful in compacting leveling courses. Pneumatic-tired rollers can apply uniform pressure on the uneven surface without bridging over the wheel paths where adequate density is most critical.

## 6.6 PAVEMENT ACCEPTANCE, REQUIREMENTS AND VERIFICATION

### 6.6.A Acceptance Requirements

The quality of the finished pavement depends on how successfully the compaction process is completed. Three criteria are used in judging the acceptability of a finished mat. They are; surface texture, surface tolerance, and density. It is the inspector's responsibility to ensure that each criterion is fulfilled.

**6.6.A.1 Surface Texture**—Defects in surface texture can be due to errors in mixing, handling, paving or compacting. An asphalt mixture that is defective due to improper mixing, handling or placing should be removed and replaced prior to compaction. Defects that show up during compaction and that cannot be corrected by additional rolling, should be replaced with fresh hot asphalt mixture and compacted before the surrounding mat cools below 185° F (85° C). Care must be taken to ensure that proper grade is maintained and surface tolerance complied with in any repaired area.

**6.6.A.2 Surface Tolerance**—Variations in surface smoothness should not exceed ¼ in. (6 mm) under a 10-foot (3 m) straightedge placed at right angles to the centerline and ⅛ in. (3 mm) when placed parallel to the centerline. In some instances a rolling straight-edge which measures and records surface variations on a continuous chart is used. The variations so recorded are summed up and reported as surface roughness in inches per miles (millimeters per kilometer).



**6.6.A.3 Density**—Pavement density is determined to be acceptable or unacceptable by comparing it to the target density established in the laboratory from the field sample. Pavement density is permitted to vary from target density by an average percentage established in the job specifications.

There are three basic methods for determining target density. They are; percent of laboratory density, percent of theoretical maximum density, and test section (control strip) density. The intent of all three methods is to obtain a compacted pavement which, on the average, will contain typically 8 percent or less voids.

- *Percent of Laboratory Density*

This method is particularly applicable to Marshall compaction procedures on large projects where field laboratories are employed. A target density is determined for each lot or unit of mix production (usually one day's production) by taking the average density of four or more laboratory-prepared specimens taken from trucks delivering mix to the job site (see Appendix for Random Sampling Procedures). The specimens are compacted in the Marshall apparatus in accordance with AASHTO Test Method T 245 with two exceptions:

- The temperature of the mix should approximate the temperature at the paver with no re-heating being permitted, and
- The number of compactive blows (35, 50 or 75) should be the same as was used in the mix design.

The advantage of this procedure is that the resulting target densities will closely represent actual daily mix production and compensate for slight variations in the mix that occur from day to day.

- *Percent of Theoretical Maximum Density*

In this method the target density is determined by calculating what the unit weight of the mix would be if it were densified to a totally voidless mass. This is determined by AASHTO Test Method T 209.

- *Test Section (control strip) Density*

The target density is determined by constructing a control strip of pavement at the beginning of each lift or course being placed. The control strip is part of the paving project itself. It should be at least 500 feet (152 m) long and constructed to the same width and thickness as the rest of the course it represents.

The contractor places and compacts the control strip with the equipment and the rolling pattern and at the temperature that he proposes to use for the job.

Compaction begins as soon as possible after the mix is placed and continues until no appreciable increase in density is obtained and/or until the mix cools to 185° F (85° C). The target density is determined by averaging the results of a specified number of density tests taken at randomly selected sites within the control strip.

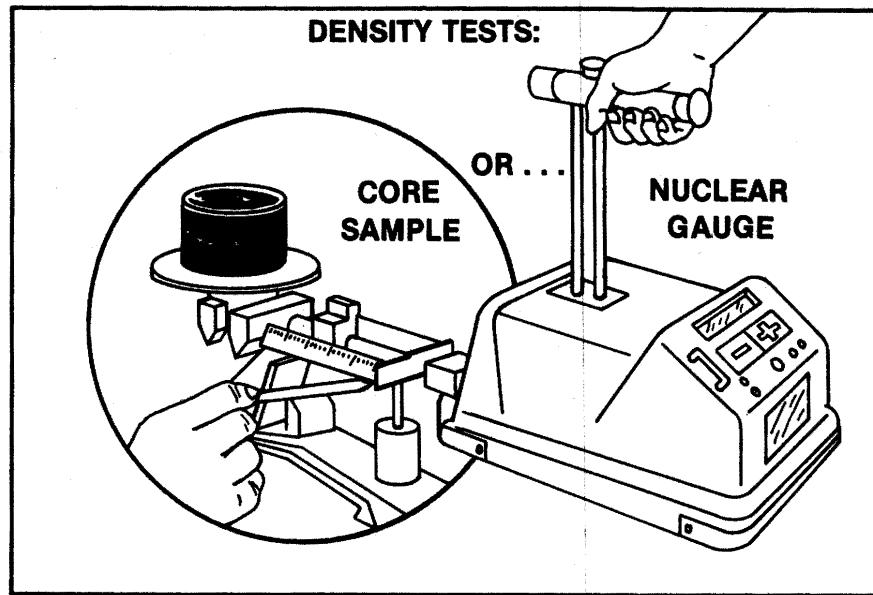
If the target density of the control strip is typically less than 92 percent of maximum theoretical density or 96 percent of laboratory prepared specimens of the same mix, densification is considered inadequate. (This target density is recommended by the Asphalt Institute; agency specification may differ.) A new

control strip should be constructed incorporating necessary changes in compaction temperature, equipment and/or rolling procedures.

### **6.6.B Acceptance Requirement Verification**

**6.6.B.1 Testing**—Testing to verify field compaction can be done by either obtaining cores from the pavement or testing with a nuclear density gauge (Figure 6.22). Nuclear density readings still should be correlated with core densities.

Cores are cylindrical samples that are cut out of the pavement. The cores are tested in a laboratory to verify the acceptability of the mat.



**FIGURE 6.22—Density Tests.**

Nuclear density gauges have two advantages over core sampling. These advantages are that they are fast and easy to use and are non-destructive.

Testing by either method is done on a random sampling basis, with a minimum of a specified number of density tests or pavement cores being tested for each lot of mix (usually one day's production). The average of the densities obtained by the tests must meet one or more of the following typical criteria depending on the method used to establish target density: 96 percent of laboratory density; 92 percent of maximum theoretical density; 99 percent of control strip density.

**6.6.B.2 Sampling**—Samples obtained to verify density should be removed with a diamond tipped power saw or coring machine to minimize damage or distortion of the pavement and samples. If the pavement has not cooled to ambient temperature for the full depth of the sample, ice or dry ice may be used to expedite the cooling process.

Care must be exercised in obtaining and transporting samples from the field. Mix samples obtained for target density determination should be transported in insulated

containers and as quickly as possible to minimize loss of heat prior to preparation of the specimen.

## 6.7 SUMMARY

Compaction is the process of compressing a given volume of asphalt hot-mix into a smaller volume in order to increase the strength and stability of the mix and close gaps through which water and air can penetrate and cause damage. Figure 6.23 contains a summary of items influencing compaction.

Several factors determine how easily and effectively a mixture can be compacted. Among these factors are: mix properties, environmental factors, layer (lift) thickness, and others such as subgrade stiffness.

Three types of rollers are commonly used: Steel-wheeled rollers, consisting of steel rollers mounted on two or more tandem axles, pneumatic-tired rollers, which use rubber tires instead of steel wheel, and vibratory rollers, which employ steel drums designed to vibrate against the mat.

Compaction must be completed before the mixture cools to 185°F (85°C).

The goal of compaction is to produce a mat of a certain density. The density of a mat can be measured by taking core samples or by testing with a nuclear density gauge. The results of these tests are compared against a "target density" established for the project. Target density is determined by either percent of laboratory density, percent of theoretical maximum density, or test strip (control section) density.

In addition to density, surface texture and surface tolerances of the mat are considered in determining whether or not a compaction procedure has been successful.

<i>Aggregate</i>		
• Smooth Surfaced	Low interparticle friction	Use light rollers Lower mix temperature
• Rough Surfaced	High interparticle friction	Use heavy rollers
• Unsound	Breaks under steel-wheeled rollers	Use sound aggregate Use pneumatic rollers
• Absorptive	Dries mix—difficult to compact	Increase asphalt in mix
<i>Asphalt</i>		
• Viscosity		
— High	Particle movement restricted	Use heavy rollers Increase temperature
— Low	Particles move easily during compaction	Use light rollers Decrease temperature
• Quantity		
— High	Unstable & plastic under roller	Decrease asphalt in mix
— Low	Reduced lubrication—difficult compaction	Increase asphalt in mix Use heavy rollers
<i>Mix</i>		
• Excess Coarse Aggregate	Harsh mix—difficult to compact	Reduce coarse aggregate Use heavy rollers
• Oversanded	Too workable—difficult to compact	Reduce sand in mix Use light rollers
• Too Much Filler	Stiffens mix—difficult to compact	Reduce filler in mix Use heavy rollers
• Too Little Filler	Low cohesion—mix may come apart	Increase filler in mix
<i>Mix temperature</i>		
• High	Difficult to compact—mix lacks cohesion	Decrease mixing temperature
• Low	Difficult to compact—mix too stiff	Increase mixing temperature
<i>Course Thickness</i>		
• Thick Lifts	Hold heat—more time to compact	Roll normally
• Thin Lifts	Lose heat—less time to compact	Roll before mix cools Increase mix temperature
<i>Weather Conditions</i>		
• Low Air Temperature	Cools mix rapidly	} Roll before mix cools Increase mix temperature increase lift thickness
• Low Surface Temperature	Cools mix rapidly	
• Wind	Cools mix—crusts surface	

\* Corrections may be made on a trial basis at the plant or job site. Additional remedies may be derived from changes in mix design.

FIGURE 6.23—Summary Table of Influences of Compaction.

## **APPENDICES**

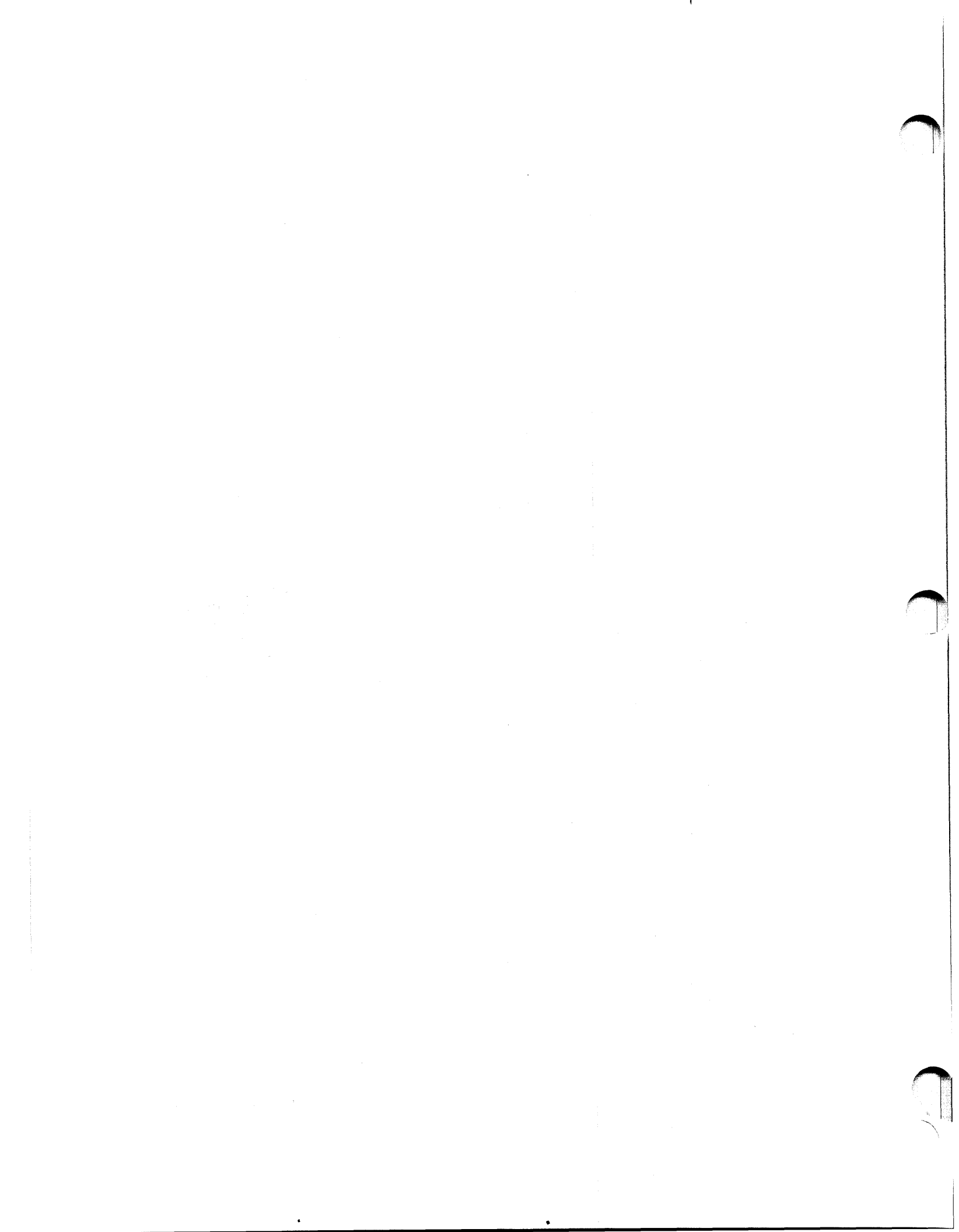
**Appendix A: Miscellaneous Tables and Figures**

**Appendix B: Typical Terminology**

**Appendix C: Random Sampling Plans**

**Appendix D: AASHTO and ASTM Tests**

**Appendix E: Gradation Analysis of Aggregates**



## APPENDIX A

### MISCELLANEOUS TABLES AND FIGURES

The following pages include tables and figures that may be of value to the asphalt inspector.

#### TABLE A-1 CONVERSION FACTORS

(Customary to Metric units)

To convert from	To	Multiply by
acre .....	metre <sup>2</sup> (m <sup>2</sup> ) .....	4 046.856
acre .....	hectometre <sup>2</sup> (hm <sup>2</sup> ) .....	0.404 686
<b>Atmosphere</b>		
(technical = 1kgf/cm <sup>2</sup> ) .....	kilopascal (kPa) .....	98.066 50
barrel (42 gal.) .....	decimetre <sup>3</sup> (dm <sup>3</sup> ) or litre (l) .....	158.987 3
BTU (International Table) ..	kilojoule (kJ) .....	1.055 056
bushel .....	decimetre <sup>3</sup> (dm <sup>3</sup> ) .....	35.239 1
dyne .....	micronewton (μN) .....	10.000 0
dyne/centimetre <sup>2</sup> .....	pascal (Pa) .....	0.100 0
Fahrenheit (temperature) ...	Celsius (°C) .....	$t_c = (t_f - 32)/1.8$
foot .....	metre (m) .....	0.304 80
foot <sup>2</sup> .....	metre <sup>2</sup> (m <sup>2</sup> ) .....	0.092 903
foot <sup>3</sup> .....	metre <sup>3</sup> (m <sup>3</sup> ) .....	0.028 317
	litre (l) .....	28.317 0
foot-pound-force .....	joule (J) .....	1.355 818
foot/minute .....	metre/second (m/s) .....	0.005 08
foot/second <sup>2</sup> .....	metre/second <sup>2</sup> (m/s <sup>2</sup> ) .....	0.304 80
gallon (U.S. liquid) .....	decimetre <sup>3</sup> (dm <sup>3</sup> ) or litre (l) .....	3.785 412
	metre <sup>3</sup> (m <sup>3</sup> ) .....	0.003 785
gallon/minute .....	decimetre <sup>3</sup> /second (dm <sup>3</sup> /s) or litre/second (l/s) .....	0.063 09
gallon/yard <sup>2</sup> .....	decimetre <sup>3</sup> /metre <sup>2</sup> (dm <sup>3</sup> /m <sup>2</sup> ) or litre/metre <sup>2</sup> (l/m <sup>2</sup> ) .....	4.527 314
horsepower (electric) .....	kilowatt (kW) .....	0.746 0
inch .....	millimetre (mm) .....	25.400 0
inch <sup>2</sup> .....	centimetre <sup>2</sup> (cm <sup>2</sup> ) .....	6.451 60
inch <sup>2</sup> .....	millimetre <sup>2</sup> (mm <sup>2</sup> ) .....	645.160 0
inch <sup>3</sup> .....	centimetre <sup>3</sup> (cm <sup>3</sup> ) .....	16.387 06
inch/second .....	metre/second (m/s) .....	0.025 40
inch of mercury (60° F) .....	pascal (Pa) .....	3 376.850
inch/second <sup>2</sup> .....	metre/second <sup>2</sup> (m/s <sup>2</sup> ) .....	0.025 40
kilogram (kg) .....	ton (metric) .....	0.001 00
kip (1 000 lbf) .....	kilonewton (kN) .....	4.448 222
kip/inch <sup>2</sup> .....	megapascal (MPa) .....	6.894 757
mile (U.S. statute) .....	kilometre (km) .....	1.609 344
mile <sup>2</sup> .....	kilometre <sup>2</sup> (km <sup>2</sup> ) .....	2.589 988
mile/hour .....	kilometre/hour (km/hr) .....	1.609 344
minute (angle) .....	radian (rad) .....	0.000 290 89
ounce-force .....	newton (N) .....	0.278 013 9

(Continued on next page)

**Table A-1 (Continued)**

ounce-mass	gram (g)	28.349 52
ounce-fluid	centimetre <sup>3</sup> (cm <sup>3</sup> )	29.573 53
	litre (l)	0.029 574
pint (U.S. liquid)	litre (l)	0.473 176 5
poise (absolute viscosity)	pascal-second (Pa-s)	0.100 000
pound-force (lbf)	newton (N)	4.448 222
	kilonewton (kN)	0.004 448
pound-force-inch	newton-metre (N.m)	0.112 984 8
pound-force/foot <sup>2</sup>	pascal (Pa)	47.880 26
pound-force/inch <sup>2</sup> (psi)	kilopascal (kPa)	6.894 757
pound-mass	kilogram (kg)	0.453 592 4
pound-mass/foot <sup>2</sup>	kilogram/metre <sup>2</sup> (kg/m <sup>2</sup> )	4.882 428
pound-mass/foot <sup>3</sup>	kilogram/metre <sup>3</sup> (kg/m <sup>3</sup> )	16.018 46
	megagram/metre <sup>3</sup> (Mg/m <sup>3</sup> )	0.016 018
pound-mass/inch <sup>3</sup>	kilogram/decimetre <sup>3</sup> (kg/dm <sup>3</sup> )	27.679 90
	kilogram/metre <sup>3</sup> (kg/dm <sup>3</sup> )	119.826 4
pound-mass/gallon (U.S. liquid)	kilogram/decimetre <sup>3</sup> (kg/dm <sup>3</sup> )	0.119 826
	kilopascal (kPa)	6.894 757
psi	decimetre <sup>3</sup> (dm <sup>3</sup> ) or litre (l)	0.946 352 9
quart (U.S. liquid)	kilogram (kg)	1 000.000 0
ton (metric)	kilogram (kg)	907.184 7
ton (short-2 000 lb)	kilogram (kg)	1 016.046 1
ton (long-2 240 lb)	kilogram/metre <sup>3</sup> (kg/m <sup>3</sup> )	1 186.552 7
ton-mass/yard <sup>3</sup>	metre (m)	0.914 40
yard	metre <sup>2</sup> (m <sup>2</sup> )	0.836 127 4
yard <sup>2</sup>	metre <sup>3</sup> (m <sup>3</sup> )	0.764 554 9
yard <sup>3</sup>		

**TABLE A-2 WEIGHT AND VOLUME RELATIONS FOR VARIOUS TYPES OF COMPACTED ASPHALT PAVEMENTS**

	lb/ft <sup>3</sup>	lb/yd <sup>3</sup>	lb/yd <sup>2</sup> /in. depth
<b>NOTE:</b>	100	2700	75
Because of the considerable variations of specific gravity, gradation, and other characteristics of mineral aggregates, weight per unit volume of compacted asphalt pavement varies considerably. Exact weights per unit volume should be determined in the laboratory from samples taken from the pavement or prepared in the laboratory with the same materials as used in the field.	105	2835	79
	110	2970	82
	115	3105	86
	120	3240	90
	125	3375	94
	130	3510	97
	135	3645	101
	140	3780	105
	145	3915	109
	150	4050	112
	155	4185	116
	160	4320	120

(Continued on next page)



**Table A-2 (Continued)**

	Range	Range	Range	Frequently Used for Preliminary Estimate
Penetration Macadam	110-135	2970-3645	82-101	95
Open Graded	115-140	3105-3780	86-105	100
Coarse Graded	130-150	3510-4050	97-112	105
Dense Graded	135-155	3645-4185	101-116	110
Fine Graded	130-150	3510-4050	97-112	105
Stone Sheet	130-150	3510-4050	97-112	105
Sand Sheet	120-140	3240-3780	90-105	100
Fine Sheet	120-140	3240-3780	90-105	100
Mixed-in-place Macadam	110-135	2970-3645	82-101	95
Mixed-in-place Dense Graded	110-135	2970-3645	82-101	95
Mixed-in-place Sand Asphalt	100-125	2700-3375	75-94	85

**NOTE:**

	kg/dm <sup>3</sup>	kg/m <sup>3</sup>	kg/m <sup>2</sup> /cm depth
Because of the considerable variations of specific gravity, gradation, and other characteristics of mineral aggregates, mass per unit volume of compacted asphalt pavement varies considerably. Exact mass per unit volume should be determined in the laboratory from samples taken from the pavement or prepared in the laboratory with the same materials as used in the field.	1.60	1 600	16
	1.70	1 700	17
	1.80	1 800	18
	1.90	1 900	19
	2.00	2 000	20
	2.10	2 100	21
	2.20	2 200	22
	2.30	2 300	23
	2.40	2 400	24
	2.50	2 500	25
	2.60	2 600	26

	Range	Range	Range	Frequently Used for Preliminary Estimate
Penetration Macadam	1.75-2.15	1 750-2 150	17.5-21.5	20.0
Open Graded	1.85-2.25	1 850-2 250	18.5-22.5	21.0
Coarse Graded	2.10-2.40	2 100-2 400	21.0-24.0	22.5
Dense Graded	2.15-2.50	2 150-2 500	21.5-25.0	23.5
Fine Graded	2.10-2.40	2 100-2 400	21.0-24.0	22.5
Stone Sheet	2.10-2.40	2 100-2 400	21.0-24.0	22.5
Sand Sheet	1.90-2.25	1 900-2 250	19.0-22.5	21.0
Fine Sheet	1.90-2.25	1 900-2 250	19.0-22.5	21.0
Mixed-in-place Macadam	1.75-2.15	1 750-2 150	17.5-21.5	20.0
Mixed-in-place Dense Graded	1.75-2.15	1 750-2 150	17.5-21.5	20.0
Mixed-in-place Sand Asphalt	1.60-2.00	1 600-2 000	16.0-20.0	18.0

**TABLE A-3 COMPOSITION OF ASPHALT CONCRETE**

<i>Mix Designation and Nominal Maximum Size of Aggregate</i>					
<i>Sieve Size</i>	<i>37.5 mm (1-1/2 in.)</i>	<i>25.0 mm (1 in.)</i>	<i>19.0 mm (3/4 in.)</i>	<i>12.5mm (1/2 in.)</i>	<i>9.5 mm (3/8 in.)</i>
<i>Total Percent Passing (by weight)</i>					
50 mm (2 in.)	100	—	—	—	—
37.5 mm (1-1/2 in.)	90 to 100	100	—	—	—
25.0 mm (1 in.)	—	90 to 100	100	—	—
19.0 mm (3/4 in.)	56 to 80	—	90 to 100	100	—
12.5 mm (1/2 in.)	—	56 to 80	—	90 to 100	100
9.5 mm (3/8 in.)	—	—	56 to 80	—	90 to 100
4.75 mm (No. 4)	23 to 53	29 to 59	35 to 65	44 to 74	55 to 85
2.36 mm (No. 8)*	15 to 41	19 to 45	23 to 49	28 to 58	32 to 67
1.18 mm (No. 16)	—	—	—	—	—
0.60 mm (No. 30)	—	—	—	—	—
0.30 mm (No. 50)	4 to 16	5 to 17	5 to 19	5 to 21	7 to 23
0.15 mm (No. 100)	—	—	—	—	—
0.075 mm (No. 200)**	0 to 5	1 to 7	2 to 8	2 to 10	2 to 10
<b>Asphalt Cement, weight percent of Total Mixture†</b>	<b>3 to 8</b>	<b>3 to 9</b>	<b>4 to 10</b>	<b>4 to 11</b>	<b>5 to 12</b>

\* In considering the total grading characteristics of an asphalt paving mixture the amount passing the 2.36 mm (No. 8) sieve is a significant and convenient field control point between fine and coarse aggregate. Gradings approaching the maximum amount permitted to pass the 2.36-mm (No. 8) sieve will result in pavement surfaces having comparatively fine texture, while gradings approaching the minimum amount passing the 2.36-mm (No. 8) sieve will result in surfaces with comparatively coarse texture.

\*\* The material passing the 0.075 mm (No. 200) sieve may consist of fine particles of the aggregates or mineral filler, or both. It shall be free from organic matter and clay particles and have a plasticity index not greater than 4 when tested in accordance with Method T-89 and Method T-90.

† The quantity of asphalt cement is given in terms of weight percent of the total mixture. The wide difference in the specific gravity of various aggregates, as well as a considerable difference in absorption, results in a comparatively wide range in the limiting amount of asphalt cement specified. The amount of asphalt required for a given mixture should be determined by appropriate laboratory testing or on the basis of past experience with similar mixtures or by a combination of both.

**TABLE A-4—TYPICAL USES OF ASPHALT CEMENTS**

Type of Construction	Asphalt Cements														
	Viscosity Graded - Original					Viscosity Graded - Residue					Penetration Graded				
	AC-40	AC-20	AC-10	AC-5	AC-2.5	AR-16000	AR-8000	AR-4000	AR-2000	AR-1000	40-50	60-70	85-100	120-150	200-300
<b>Asphalt-Aggregate Mixtures</b>															
<b>Asphalt Concrete and Hot Laid Plant Mix</b>															
<b>Pavement bases and surfaces</b>															
Highways	X	X	X	X	X <sup>1</sup>	X	X	X	X	X <sup>1</sup>	X	X	X	X	X <sup>1</sup>
Airports		X	X	X			X	X				X	X	X	
Parking areas	X	X	X			X	X	X			X	X	X		
Driveways		X	X				X	X				X	X		
Curbs		X					X					X			
Industrial floors	X	X				X	X				X	X			
Blocks	X					X					X				
Groins	X	X				X	X				X	X			
Dam facings	X	X				X	X				X	X			
Canal and reservoir linings	X	X				X	X				X	X			

<sup>1</sup> For use in cold climates.

## APPENDIX B

### TYPICAL TERMINOLOGY PERTAINING TO ASPHALT PAVEMENT CONSTRUCTION

#### (\*ASTM Definitions)

**AGGREGATE**—A hard granular material of mineral composition such as sand, gravel, slag, or crushed stone, used for mixing in graduated fragments.

Types:

**COARSE AGGREGATE**—Aggregate retained on the 2.36mm (No. 8) sieve.

**COARSE-GRADED AGGREGATE**—One having a continuous grading in sizes of particles from coarse through fine with a predominance of coarse sizes.

**DENSE-GRADED AGGREGATE**—An aggregate that has a particle size distribution such that when it is compacted, the resulting voids between the aggregate particles, expressed as a percentage of the total space occupied by the material, are relatively small.

**FINE AGGREGATE**—That passing the 2.36mm (No. 8) sieve.

**FINE-GRADED AGGREGATE**—One having a continuous grading in sizes of particles from coarse through fine with a predominance of fine sizes.

**OPEN-GRADED AGGREGATE**—One containing little or no mineral filler in which the void spaces in the compacted aggregate are relatively large.

**WELL-GRADED AGGREGATE**—Aggregate graded from the maximum size down to filler with the object of obtaining an asphalt mix with a controlled void content and high stability.

**AGGREGATE STORAGE BINS\***—Bins that store the necessary aggregate sizes and feed them to the dryer in substantially the same proportions as are required in the finished mix.

**ASPHALT\***—A dark brown to black cementitious material in which the predominating constituents are bitumens which occur in nature or are obtained in petroleum processing. Asphalt is a constituent in varying proportions of most crude petroleums.

**ASPHALT CEMENT\***—A fluxed or unfluxed asphalt specially prepared as to quality and consistency for direct use in the manufacture of asphalt pavements.

**ASPHALT CONCRETE**—High quality, thoroughly controlled hot mixture of asphalt cement and well-graded, high quality aggregate, thoroughly compacted into a uniform dense mass.

**ASPHALT LEVELING COURSE**—A course (asphalt aggregate mixture) of variable thickness used to eliminate irregularities in the contour of an existing surface prior to a superimposed treatment or construction.

**ASPHALTENES\***—The high molecular weight hydrocarbon fraction precipitated from asphalt by a designated paraffinic naphtha solvent at a specified solvent-asphalt ratio.

**ASPHALT ROCK (Rock Asphalt)**—Porous rock such as sandstone or limestone that has become impregnated with natural asphalt through geologic process.

**AUTOMATIC CYCLING CONTROL\***—A control system in which the opening and closing of the weigh hopper discharge gate, the bituminous discharge valve, and the pugmill discharge gate are actuated by means of self-acting mechanical or electrical machinery without any intermediate manual control. The system includes preset timing devices to control the desired periods of dry and wet mixing cycles.

**AUTOMATIC DRYER CONTROL\***—A system that automatically maintains the temperature of aggregates discharged from the dryer within a preset range.

**AUTOMATIC PROPORTIONING CONTROL\***—A system in which proportions of the aggregate and asphalt fractions are controlled by means of gates or valves which are opened and closed by means of self-acting mechanical or electronic machinery without any intermediate manual control.

**BANK GRAVEL\***—Gravel found in natural deposits, usually more or less inter-mixed with fine material, such as sand or clay, or combinations thereof; gravelly clay, gravelly sand, clayey gravel, and sand gravel indicate the varying proportions of the materials in the mixture.

**BASE COURSE**—The layer of material immediately beneath the surface or intermediate course. It may be composed of crushed stone, crushed slag, crushed or uncrushed gravel and sand, or combinations of these materials. It also may be bound with asphalt.

**BATCH PLANT\***—A manufacturing facility for producing asphalt paving mixtures that proportions the aggregate constituents into the mix by weighed batches and adds asphalt material by either weight or volume.

**BITUMEN\***—A class of black or dark-colored (solid, semisolid, or viscous) cementitious substances, natural or manufactured, composed principally of high molecular weight hydrocarbons, of which asphalts, tars, pitches, and asphaltites are typical.

**BLAST-FURNANCE SLAG\***—The nonmetallic product, consisting essentially of silicates and alumino-silicates of lime and of other bases, that is developed simultaneously with iron in a blast furnace.

**BLEEDING OR FLUSHING**—Is the upward movement of asphalt in an asphalt pavement resulting in the formation of a film of asphalt on the surface. The most common cause is too much asphalt in one or more of the pavement courses, resulting from too rich a plant mix, an improperly constructed seal coat, too heavy a prime or tack coat, or solvent carrying asphalt to the surface. Bleeding or flushing usually occurs in hot weather.

**CHANNELS (RUTS)**—Grooves that may develop in the wheel tracks of a pavement. Channels may result from consolidation or lateral movement under traffic in one or more of the underlying courses, or by displacement in the asphalt surface layer itself. They may develop under traffic in new asphalt pavements that had too little compaction during construction or from plastic movement in a mix that does not have enough stability to support the traffic.

**CLINKER\***—Generally a fused or partly fused by-product of the combustion of coal, but also including lava and portland-cement clinker, and partly vitrified slag and brick.

**COAL TAR\***—A dark brown to black cementitious material produced by the destructive distillation of bituminous coal.

**COMPACTION**—The act of compressing a given volume of material into a smaller volume. Insufficient compaction of the asphalt pavement courses may result in channeling on the pavement surface. Compaction is usually accomplished by rolling.

**CONSISTENCY**—Describes the degree of fluidity or plasticity of asphalt cement at any particular temperature. The consistency of asphalt cement varies with temperature; therefore, it is necessary to use a common or standard temperature when comparing the consistency of one asphalt cement with another. The standard test temperature is 140° F (60° C).

**CONTINUOUS MIX PLANT**—A manufacturing facility for producing asphalt paving mixtures that proportions those aggregate and asphalt constituents into the mix by a continuous volumetric proportioning system without definite batch intervals.

**CORRUGATIONS (WASHBOARDING) AND SHOVING**—Are types of pavement distortion. Corrugation is a form of plastic movement typified by ripples across the asphalt pavement surface. Shoving is a form of plastic movement resulting in localized bulging of the pavement surface. These distortions usually occur at points where traffic starts and stops, on hills where vehicles brake on the downgrade, on sharp curves, or where vehicles hit a bump and bounce up and down. They occur in asphalt layers that lack stability. Lack of stability may be caused by a mixture that is too rich in asphalt, has too high a proportion of fine aggregate, has coarse or fine aggregate that is too round or too smooth, or has asphalt cement that is too soft. It may also be due to excessive moisture, contamination due to oil spillage, or lack of aeration when placing mixes using liquid asphalts.

**CRACKS**—Breaks in the surface of an asphalt pavement. The common types are:

**ALLIGATOR CRACKS**—Interconnected cracks forming a series of small blocks resembling an alligator's skin or chicken-wire, caused by excessive deflection of the surface over unstable subgrade or lower courses of the pavement.

**EDGE JOINT CRACKS**—Are the separation of the joint between the pavement and the shoulder, commonly caused by the alternate wetting and drying beneath the shoulder surface. Other causes are shoulder settlement, mix shrinkage, and trucks straddling the joint.

**LANE JOINT CRACKS**—Longitudinal separations along the seam between two paving lanes caused by a weak seam between adjoining spreads in the courses of the pavement.

**REFLECTION CRACKS**—Cracks in asphalt overlays that reflect the crack pattern in the pavement structure underneath. They are caused by vertical or horizontal movements in the pavement beneath the overlay, brought on by expansion and contraction with temperature or moisture changes.

**SHRINKAGE CRACKS**—Are interconnected cracks forming a series of large blocks usually with sharp corners or angles. Frequently they are caused by volume change in either the asphalt mix or in the base or subgrade.

**SLIPPAGE CRACKS**—Are crescent-shaped cracks that are open in the direction of the thrust of wheels on the pavement surface. They result when there is a lack of good bond between the surface layer and the course beneath.

**CRUSHER-RUN\***—The total unscreened product of a stone crusher.

**CUTBACK ASPHALT**—Asphalt cement which has been liquefied by blending with petroleum solvents (also called diluents), as for the RC and MC cutback asphalts. Upon exposure to atmospheric conditions the diluents evaporate, leaving the asphalt cement to perform its function.

**RAPID-CURING (RC) ASPHALT**—Cutback asphalt composed of asphalt cement and a naphtha or gasoline-type diluent of high volatility.

**MEDIUM-CURING (MC) ASPHALT**—Cutback asphalt composed of asphalt cement and a kerosene-type diluent of medium volatility.

**SLOW-CURING (SC) ASPHALT**—Cutback asphalt composed of asphalt cement and oils of low volatility.

**ROAD OIL**—A heavy petroleum oil, usually one of the Slow-Curing (SC) grades.

**DELIVERY TOLERANCES\***—Permissible variations from the exact desired proportions of aggregate and bituminous material as delivered into the pugmill.

**DENSITY**—The degree of solidity that can be achieved in a given mixture which will be limited only by the total elimination of voids between particles in the mass.

**DENSIFICATION**—The act of increasing the density of a mixture during the compaction process.

**DISTORTION**—Pavement distortion is any change of the pavement surface from its original shape.

**DRYER\***—An apparatus that will dry the aggregates and heat them to the specified temperatures.

**DUCTILITY**—The ability of a substance to be drawn out or stretched thin. While ductility is considered an important characteristic of asphalt cements in many applications, the presence or absence of ductility is usually considered more significant than the actual degree of ductility.

**DURABILITY**—The property of an asphalt paving mixture that describes its ability to resist disintegration by weathering and traffic. Included under weathering are changes in the characteristics of the asphalt, such as oxidation and volatilization, and changes in the pavement and aggregate due to the action of water, including freezing and thawing.

**EMULSIFIED ASPHALT**—An emulsion of asphalt cement and water that contains a small amount of an emulsifying agent, a heterogeneous system containing two normally immiscible phases (asphalt and water) in which the water forms the continuous phase of the emulsion, and minute globules of asphalt form the discontinuous phase. Emulsified asphalt may be of either the anionic, electronegatively charged asphalt globules, or cationic, the electropositively charged asphalt globule types, depending upon the emulsifying agent.

**EMULSIFIED ASPHALT MIX (COLD MIX)**—A mixture of emulsified asphalt and aggregate; produced in a central plant (plant mix) or mixed at the road site (mixed-in-place).

**FATIGUE RESISTANCE**—The ability of asphalt pavement to withstand repeated flexing or slight bending caused by the passage of wheel loads. As a rule, the higher the asphalt content, the greater the fatigue resistance.

**FLEXIBILITY**—The ability of an asphalt pavement structure to conform to settlement of the foundation. Generally, flexibility of the asphalt paving mixture is enhanced by high asphalt content.

**FULL-DEPTH ASPHALT PAVEMENT**—The term FULL-DEPTH (registered by The Asphalt Institute with the U.S. Patent Office) certifies that the pavement is one in which asphalt mixtures are employed for all courses above the subgrade or improved subgrade. A Full-Depth asphalt pavement is laid directly on the prepared subgrade.

**GRADE DEPRESSIONS**—Are localized low areas of limited size, which may or may not be accompanied by cracking.

**HOT AGGREGATE STORAGE BINS\***—Bins that store the heated and separated aggregates prior to their final proportioning into the mixer.

**HOT-LAID PLANT MIXTURE**—Plant mixes that must be spread and compacted while at an elevated temperature. To dry the aggregate and obtain sufficient fluidity of the asphalt (usually asphalt cement), both must be heated prior to mixing—giving the origin to the term “hot-mix”.

**IMPERMEABILITY**—The resistance an asphalt pavement has to the passage of air and water into or through the pavement.

**LIFT**—A layer or course of paving material applied to a base or a previous layer.

**MANUAL PROPORTIONING CONTROL\***—A control system in which proportions of the aggregate and asphalt fractions are controlled by means of gates or valves which are opened and closed by manual means. The system may or may not include power assist devices in the actuation of gate and valve opening and closing.

**MESH\***—The square opening of a sieve.

**MINERAL DUST**—The portion of the fine aggregate passing the 0.075mm (No. 200) sieve.

**MINERAL FILLER**—A finely divided mineral product at least 70 percent of which will pass a 0.075mm (No. 200) sieve. Pulverized limestone is the most commonly manufactured filler, although other stone dust, hydrated lime, portland cement, and certain natural deposits of finely divided mineral matter are also used.

**NATURAL (NATIVE) ASPHALT**—Asphalt occurring in nature which has been derived from petroleum by natural processes of evaporation of volatile fractions leaving the asphalt fractions. The native asphalt of most importance are found in the Trinidad and Bermudez Lake deposits. Asphalt from these sources often is called lake asphalt.

**OPEN-GRADED ASPHALT FRICTION COURSE**—A pavement surface course that consists of a high-void, asphalt plant mix that permits rapid drainage of rainwater through the course and out the shoulder. The mixture is characterized by a large percentage of one-sized coarse aggregate. This course prevents tire hydroplaning and provides a skid-resistant pavement surface.

**PAVEMENT STRUCTURE**—A pavement structure with all its courses of asphalt-aggregate mixtures, or a combination of asphalt courses and untreated aggregate courses placed above the subgrade or improved subgrade.

**PENETRATION\***—The consistency of a bituminous material expressed as the distance in tenths of a millimetre (0.1mm) that a standard needle penetrates vertically a sample of the material under specified conditions of loading, time, and temperature.

**PENETRATION GRADING**—Of asphalt cements is a classification system based on penetration in 0.1mm at 25°C (77°F). There are five standard paving grades, 40-50, 60-70, 85-100, 120-150, and 200-300.

**PLANT SCREENS\***—Screens located between the dryer and hot bins which separate



the heated aggregates into the proper hot bin sizes.

**POISE**—A centimeter-gram-second unit of absolute viscosity, equal to the viscosity of a fluid in which a stress of one dyne per square centimeter is required to maintain a difference of velocity of one centimeter per second between two parallel planes in the fluid that lie in the direction of flow and are separated by a distance of one centimeter.

**RAVELLING**—The progressive separation of aggregate particles in a pavement from the surface downward or from the edges inward. Ravelling is caused by lack of compaction, construction of a thin lift during cold weather, dirty or disintegrating aggregate, too little asphalt in the mix, or overheating of the asphalt mix.

**SAND ASPHALT**—A mixture of sand and asphalt cement or cutback or emulsified asphalt. It may be prepared with or without special control of aggregate grading and may or may not contain mineral filler. Either mixed-in-place or plant mix construction may be employed. Sand asphalt is used in construction of both base and surface courses.

**SHEET ASPHALT**—A hot mixture of asphalt cement with clean angular, graded sand and mineral filler. Its use ordinarily is confined to surface course, usually laid on an intermediate or leveling course.

**SIEVE\***—In laboratory work an apparatus in which the operatures are square for separating sizes of material.

**SKID RESISTANCE**—The ability of an asphalt paving surface, particularly when wet, to offer resistance to slipping or skidding. The factors for obtaining high skid resistance are generally the same as those for obtaining high stability. Proper asphalt content and aggregate with a rough surface texture are the greatest contributors. The aggregate must not only have a rough surface texture, but also resist polishing. Aggregates containing non-polishing minerals with different wear or abrasion characteristics provide continuous renewal of the pavement's texture, maintaining a skid-resistant surface.

**SOLUBILITY**—A measure of the purity of an asphalt cement. The portion of the asphalt cement that is soluble in a specified solvent such as trichloroethylene. Inert matter, such as salts, free carbon, or non-organic contaminants are insoluble.

**STABILITY**—The ability of asphalt paving mixture to resist deformation from imposed loads. Stability is dependent upon both internal friction and cohesion.

**STOKE**—A unit of kinematic viscosity, equal to the viscosity of a fluid in poises divided by the density of the fluid in grams per cubic centimeter.

**SUBBASE**—The course in the asphalt pavement structure immediately below the base course is called the subbase course. If the subgrade soil is of adequate quality, it may serve as the subbase.

**SUBGRADE**—The soil prepared to support a structure or a pavement system. It is the foundation or the pavement structure. The subgrade soil sometimes is called "basement soil" or "foundation soil."

**SUBGRADE, IMPROVED**—Subgrade, improved as a working platform (1) by the incorporation of granular materials or stabilizers such as asphalt, lime, or portland cement, prepared to support a structure or a pavement system, or (2) any course or courses of select or improved material placed on the subgrade soil below the pavement structure. Subgrade improvement does not affect the design thickness of the pavement structure.

**VISCOSITY**—Is a measure of the resistance to flow. It is one method of measuring the consistency of asphalt.

**ABSOLUTE VISCOSITY**—A method of measuring viscosity using the poise as the basic measurement unit. This method utilizes a partial vacuum to induce flow in the viscometer.

**KINEMATIC VISCOSITY**—A method of measuring viscosity using the stoke as the basic measurement unit.

**VISCOSITY GRADING**—Is a classification system of asphalt cements based on viscosity ranges at 140°F (60°C). A minimum viscosity at 275°F (135°C) is also usually specified. The purpose is to prescribe limiting values of consistency at these two temperatures. 140°F (60°C) approximates the maximum temperature of asphalt pavement surface in service in the U.S.; 275°F (135°C) approximates the mixing and laydown temperatures for hot asphalt pavements. There are five grades of asphalt cement based on the viscosity of the original asphalt at 140°F (60°C).

**VOIDS**—Empty spaces in a compacted mix surrounded by asphalt coated particles.

**VOID VOLUME**—Total empty spaces in a compacted mix.

**WET MIXING PERIOD**—The interval of time between the beginning of application of asphalt material and the opening of the mixer gate.

**WORKABILITY**—The ease with which paving mixtures may be placed and compacted.

## APPENDIX C

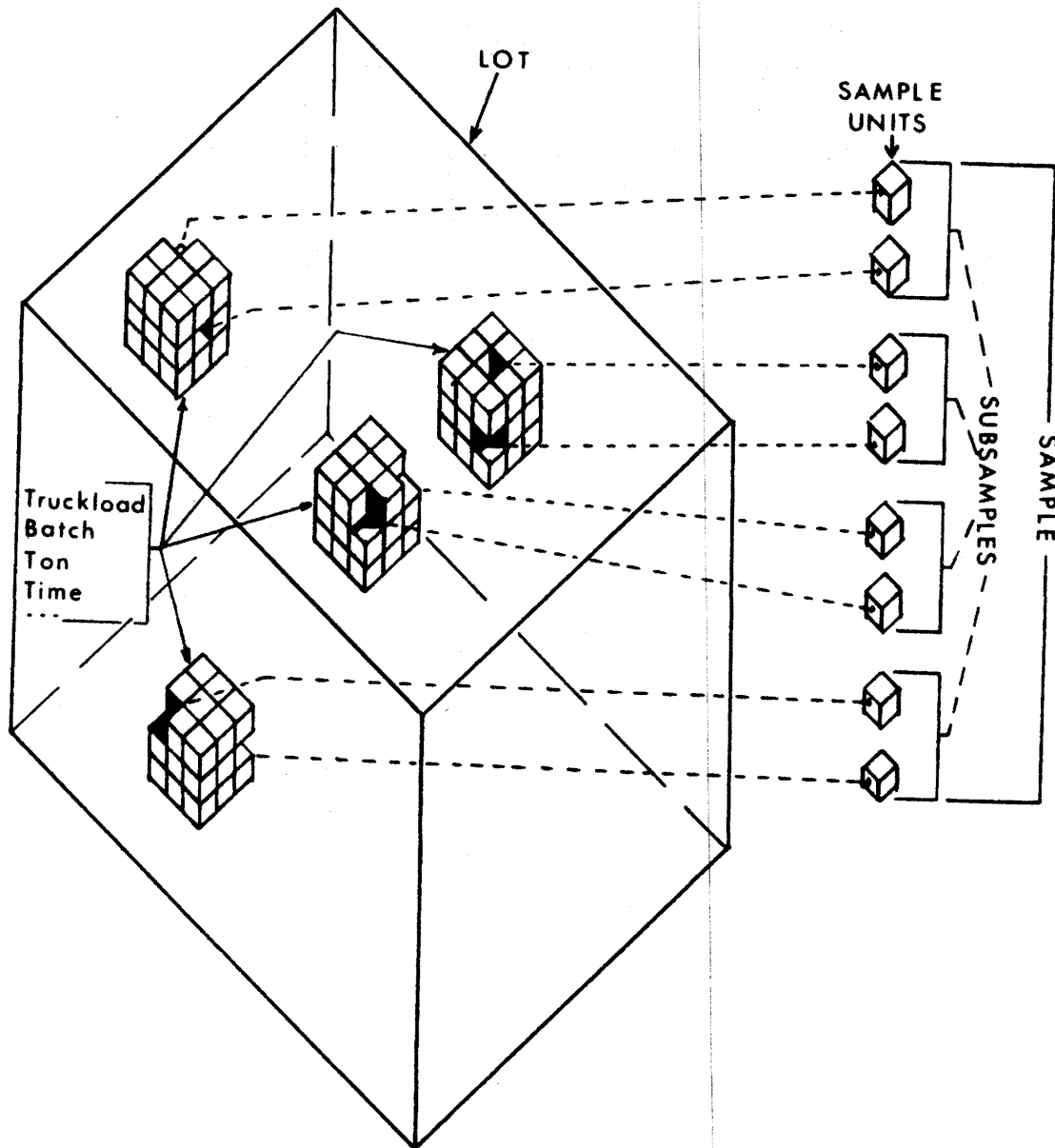
### RANDOM SAMPLING PLANS

**C.01 SELECTING SAMPLING LOCATIONS IN TRUCKS HAULING ASPHALT MIXTURE (Procedure No. 1)**—The following definitions apply (see also Figure C-1):

- **Lot**—a quantity of material that one desires to control. It may represent a day's production, a specified tonnage, a specified number of truckloads, a specified time period during production.
- **Sample**—a segment of a lot chosen to represent the total lot. It may represent any number of subsamples.
- **Subsample**—a segment of a sample, taken from a unit of the lot, i.e., a specified ton, a specified time, a specified truckload.
- **Sample Unit**—a portion of subsample taken from a unit of a lot and combined with one or more other sample units to make up a subsample.

In this procedure the following steps are necessary to select the sampling locations:

- (1) Select the lot size—it can be time (hours), an average day's production (tons), a selected tonnage [example: 2,000 tons (1815 mg)] or a selected number of truckloads. (A lot size of a day's production is recommended for this procedure as being convenient and easy to randomize.)
- (2) Select the number of samples desired per lot. One sample per lot, made up of *four* subsamples, is the minimum recommended.
- (3) Select the number of locations in each truckload from which sampling units of asphalt mixtures will be taken to combine into one subsample. *Two* sampling units per subsample are recommended.
- (4) Assign each truckload of mixture in the lot a number, beginning with 1 for the first truckload and number them successively to the highest number in the lot. Find the truckload numbers for sampling by the following procedure:
  - Place consecutively numbered [1 through \_\_\_\_\_ one-inch (25 mm)] square pieces of cardboard, equal to the number of truckloads in the lot, into a container (such as a bowl). Mix them thoroughly before each drawing.
  - Draw a number of cardboard squares from the container equal to the number of subsamples desired for the lot. The numerals on the cardboard squares will be the truckloads to be sampled.
- (5) Choose for each subsample desired the location in the truckload for each of the sampling units. Use the following steps:
  - Divide the truck beds into equal quadrants and number them 1 through 4 in any order desired.
  - Place four consecutively numbered [1 through 4, one-inch (25 mm)] square pieces of cardboard into a container (such as a bowl). Mix them thoroughly before each drawing.



**FIGURE C-1—Schematic diagram illustrating *Lot, Sample, Subsample, and Sample Unit.***

- Draw out an amount of cardboard squares equal to the number of sample units desired. The numerals on each square drawn represent the quadrants from which the sample will be taken. Replace the cardboard squares and repeat this step for each sample unit of each subsample to be taken.

C.02 SELECTING SAMPLING LOCATIONS AT PAVEMENT SITE (Procedure No. 2)—Table C-1 contains random numbers for the general sampling procedure. To use this table for selecting locations for sampling or testing the following steps are necessary:

- (1) *For compacted pavement sampling or testing locations*, use each day's run as a separate section.
- (2) Determine the number of sampling locations within a section by selecting the maximum *average* longitudinal distance desired between samples and dividing the length of the section by the maximum average longitudinal distance.
- (3) Select a column of random numbers in Table C-1 by placing 28 one-inch (25 mm) square pieces of cardboard, numbered 1 through 28, into a container (such as a bowl), shaking them to get them thoroughly mixed, and drawing one out.
- (4) Go to the column of random numbers identified with the number drawn from the container. In sub-column A, locate all numbers equal to and less than the number of sampling locations per section desired.
- (5) Multiply the total length of the section by the decimal values in sub-column B, found opposite the numbers located in sub-column A. Add the result to the station number at the beginning of the section to obtain the station of the sampling location.
- (6) Multiply the total width of the proposed pavement in the section by the decimal values in sub-column C, found opposite the numbers located in sub-column A, then subtract one-half the total width of the proposed pavement from the result to obtain the offset distance from the centerline to the sampling location. A positive (+) number will be the distance to the *right* of centerline and a negative (-) number will be the distance to the *left* of centerline. If only one lane of pavement is involved, the total width will be the lane width and the offset distance will be measured from the left edge of the lane.





# APPENDIX D

## AASHTO AND ASTM TESTS

### TABLE D-1 AUTHORITATIVE METHODS OF TEST AS COMMONLY SPECIFIED

	AASHTO	ASTM
<b>Asphalt Cement</b>		
<b>A. Asphalts</b>		
Viscosity .....	T201	D2170
<i>(See also Saybolt Furol test, at high temperatures, or ASTM Method of Test E102)</i>	T202	D2171
Penetration .....	T49	D5
Flash Point .....	T48	D92
<i>(See also Pensky-Martens flash point test, AASHTO Method of Test T73 and ASTM Method of Test D93)</i>		
Thin Film Oven Test .....	T179	D1754
Rolling Thin Film Oven Test .....	T240	D2872
Ductility .....	T51	D113
Solubility .....	T44	D2042
Specific Gravity .....	T228	D70
Softening Point .....	T53	D2398
<b>Rapid-Curing and Medium-Curing Asphalt</b>		
Viscosity .....	T201	D2170
<i>(See also Saybolt Furol test, AASHTO Method of Test T72 or ASTM Method of Test D88)</i>		
Flash Point .....	T79	D1310
Distillation .....	T78	D402
Tests on Residue .....		
Water in Asphalt .....	T55	D95
Specific Gravity .....	T227	D3142
<b>Slow-Curing Asphalt</b>		
Viscosity (See RC and MC Asphalts) .....	T201	D2170
Flash Point (See Asphalt Cements) .....	T48	D92
Distillation .....	T78	D402
Asphalt Residue of 100 Penetration .....	—	D243
Ductility .....	T51	D113
Solubility (See Asphalt Cements and RC and MC Asphalts) .....	T44	D2042
Water in Asphalt .....	T55	D95
Specific Gravity .....	T227	D3142

*(Continued on next page)*



**TABLE D-1 (Continued)**

**Emulsified Asphalt**

Viscosity .....	T59	D244
Residue from Distillation .....	T59	D244
Settlement .....	T59	D244
Demulsibility .....	T59	D244
Sieve Test .....	T59	D244
Tests on Residue ( <i>Aggregate Coating-Water Resistance Test</i> ) .....	T59	D244
Particle Charge Test .....	T59	D244
Storage Stability .....	T59	D244
Oil Distillate .....	T59	D244

**Blown Asphalt**

Softening Point .....	T53	D2398 D36
Penetration .....	T49	D5
Loss on Heating .....	T47	D6

**B. Mineral Aggregates**

**Sieve Analysis**

<b>Dry Sieve Analysis</b>		
Coarse and Fine Aggregates .....	T27	C136
Mineral Filler .....	T37	D546
Sand Equivalent .....	T176	D2419
Abrasion (Wear) .....	T96	C131
<b>Specific Gravity</b>		
Coarse Aggregate .....	T85	C127
Fine Aggregate .....	T84	C128
Filler .....	T100 or T133	D854 or C188
Unit Weight .....	T19	C29
Moisture .....	T255	C566

**C. Asphalt Paving Mixtures**

Marshall Test .....	T245	D1559
<b>Hveem Method</b>		
Stabilometer and Cohesimeter Test .....	T246	D1560
Kneading compactor .....	T247	D1561
Density .....	T166	D1188 or D2776
Voids .....	—	—
Extraction .....	T164	D2172
Recovery of Asphalt .....	T170	D1856
Moisture and/or Volatile Distillates .....	—	D255
Alternate Methods .....	T110	D1461
Swell .....	—	—
Maximum Specific Gravity .....	T209	D2041

## APPENDIX E

### GRADATION ANALYSIS OF AGGREGATES

**PLAN FOR AGGREGATE ANALYSIS FOR JOB MIX FORMULAS**—For determining job mix formulas, the plan for aggregate analysis will be governed to some extent by the number of aggregate stockpiles and the number of bin separations being used in the production of the paving mix. The purpose of this phase of mix design is to establish the job mix formula that defines the actual gradation and asphalt content to be obtained in the finished construction.

The following outlines the laboratory operations that normally apply to the testing of aggregates for establishing job mix formulas. It will be necessary at times to modify this plan to suit the control features of the central proportioning and mixing plant.

(a) Secure representative samples from each aggregate stockpile including filler, to be used in the production of the asphalt paving mix.

(b) Dry all aggregate samples to constant weight at 220°F (105°C) to 230°F (110°C). Separate pans should be used for each aggregate sample.

(c) Perform washed sieve analysis and specific gravity tests on each representative sample from the respective stockpiles.

(d) Compute the blend of aggregates required to produce the desired mix gradation, using the full gradation for each separate aggregate.

(e) Adjust the cold aggregate feeder controls to obtain the desired aggregate blend and combined gradation.

(f) Perform washed sieve analysis on a representative sample of each aggregate size separation produced in the plant. These samples should be lifted from the plant bins only after the gradation unit of the plant has attained normal operation.

(g) Compute the blend proportions and batch weights of the sized aggregates and filler required to produce one batch mix (for laboratory design tests) of the desired gradation. It is preferable to use the same weight of aggregate for each batch in a trial mix series.

(h) Prepare test specimens and design mix in accordance with the procedure prescribed for the mix design method being used.

(i) Adjust plant controls to obtain the asphalt content and blend proportions of aggregates desired in the paving mix.

(j) Perform washed sieve analysis on representative samples of extracted aggregate as required to determine that the desired gradation is being obtained in the finished mix.

**BLENDING AGGREGATES BY WEIGHT**—Determining the proportions of two or more aggregates, to blend for a gradation within the specification limits, is largely a matter of trial and error, although graphical methods may often be used to

advantage. It is always desirable first to plot the sieve analyses for all aggregates to be used as shown in Figure E.1. In this way it is often possible to make a visual estimate of the blend proportions required.

**BASIC FORMULA**—Regardless of the number of aggregates combined or of the method by which the proportions are determined, the basic formula expressing the combination is

$$P = Aa + Bb + Cc \text{ etc.} \quad (1)$$

where

- P = the percentage of material passing a given sieve for the combined aggregates A, B, C, etc.;
- A, B, C, etc. = percentage of material passing a given sieve for aggregates A, B, C, etc.; and
- a, b, c, etc. = proportions of aggregates, A, B, C, etc. used in the combination and where the total = 1.00.

The combined percentages, P, in Eq. 1 should closely agree with the desired percentages for the combination for the different sieve sizes. None should fall outside the established grading specification limits. Obviously, there may be several acceptable combinations. An optimum combination would be one in which the percentages of the blend are in as close agreement as possible to the desired percentages originally set up.

Sophisticated mathematical procedures have been developed that will determine an optimum combination of aggregates. Even with a calculator, however, these methods are involved and time-consuming. Usually a trial-and-error method guided by a certain amount of reasoning is the easiest procedure to determine a satisfactory combination.

**GRAPHICAL SOLUTIONS**—Graphical methods have been devised for determining combinations of aggregates to obtain a desired gradation. Like mathematical methods, some graphical methods are quite complicated. As the number of aggregates to be combined is increased, the graphical method becomes even more complicated. For two and sometimes three aggregate materials, graphical solutions may be used to advantage over trial-and-error methods. In other instances, graphical methods may be used to indicate the starting point for trial-and-error solutions.

#### *Proportioning Determinations*

**COMBINING TWO AGGREGATES**—The basic formula for combining two aggregates is:

$$P = Aa + Bb \quad (2)$$

Since  $a + b = 1$ , then  $a = 1 - b$ . Substituting this into Eq. 2 and solving for b:

$$b = \frac{P - A}{B - A} \quad (3)$$

An expression for a, can also be found:

$$a = \frac{P - B}{A - B} \quad (4)$$

Assume that a single aggregate stockpile is to be blended with sand to meet grading requirements for an asphalt paving mixture. These are given in Figure E-2a as aggregates A and B. To make determination:

- (1) Examine the two gradations to determine which aggregate will contribute most of the material for certain sizes. In this case, most of the minus 2.36 mm (No. 8) aggregate will be furnished by aggregate B.
- (2) Using the percentages for the 2.36 mm (No. 8) sieve and substituting into Eq. 3, the proportions are determined to meet the midpoint of the specification (Figure E-2b).
- (3) Inspection of the blended gradation shows the percent passing 0.075 mm (No. 200) close to the lower specification limit. Increase the proportion of aggregate B (in this case to 0.55) and compute the gradation of the revised blend (Figure E-2c).
- (4) Inspection now shows the gradation is critical on the 0.60 mm (No. 30) sieve. Reduce the proportion of aggregate B to 0.52 or 0.53 and compute the gradation of the revised blend (Figure E-2d).

The two aggregates may be combined graphically (Figure E-3) as follows:

- (1) The percents passing the various sizes for aggregate A are plotted on the right-hand vertical scale (representing 100 percent aggregate A).
- (2) The percents passing the various sizes for aggregate B are plotted on the left-hand vertical scale (representing 100 percent aggregate B).
- (3) Connect the points common to the same size with straight lines, and label.
- (4) For a particular size, indicate on the straight line where the line crosses the specification limits measured on the vertical scale. (Note that for the 9.5 mm (3/8") size, two points are plotted on the line at 70 and 90 percent on the vertical scale.)
- (5) That portion of the line between the two points represents the proportions of aggregates A and B, measured on the horizontal scale, that will not exceed specification limits for that particular size.
- (6) The portion of the horizontal scale designated by two vertical lines, when projected vertically, is within specification limits for all sizes and represents the limits of proportions possible for satisfactory blends. In this case, 43 to 54 percent of aggregate A and 46 to 57 percent of aggregate B will meet specifications when blended. It can also be seen that the percent of blended material passing the 0.60 mm (No. 30) and 0.075 mm (No. 200) sieves will be the critical or controlling values for keeping the blend within specification limits.
- (7) For blending, usually the midpoint of that horizontal scale is selected for the blend. In this case, 48 percent aggregate A and 52 percent aggregate B.

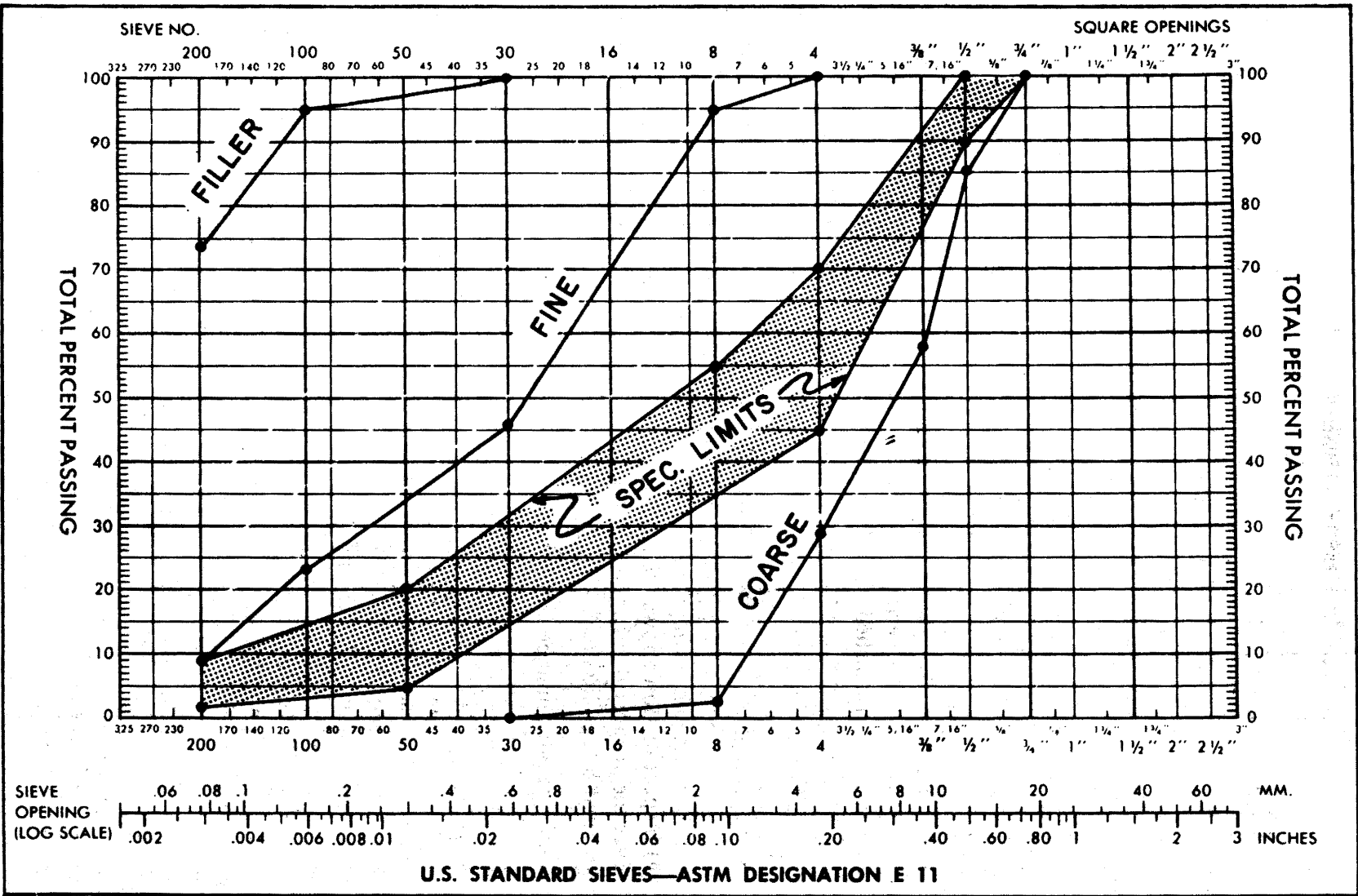


Figure E-1—Job aggregates and specification plotted on conventional aggregate grading chart

Sieve	PERCENT PASSING								
	19.0mm 3/4"	12.5mm 1/2"	9.5mm 3/8"	4.75mm 4	2.36mm 8	0.60mm 30	0.30mm 50	0.15mm 100	0.075mm 200
Spec.	100	80-100	70-90	50-70	35-50	18-29	13-23	8-16	4-10
Aggr. A	100	90	59	16	3.2	1.1	0	0	0
Aggr. B	100	100	100	96	82	51	36	21	9.2

(a) Grading Specification and sieve analyses of aggregates

$$\text{For 2.36 mm (No. 8), } b = \frac{P - A}{B - A} = \frac{42.5 - 3.2}{82 - 3.2} = 0.50, a = 1 - 0.50 = 0.50$$

Sieve	PERCENT PASSING								
	19.0mm 3/4"	12.5mm 1/2"	9.5mm 3/8"	4.75mm 4	2.36mm 8	0.60mm 30	0.30mm 50	0.15mm 100	0.075mm 200
.50 x A	50	45.0	29.5	8.0	1.6	0.6	0	0	0
.50 x B	50	50.0	50.0	48.0	41.0	25.0	18.0	10.5	4.6
Total	100	95.0	79.5	56.0	42.6	25.6	18.0	10.5	4.6
Spec.	100	80-100	70-90	50-70	35-50	18-29	13-23	8-16	4-10

Minus 0.075 mm (No. 200) low, increase b to 0.55, a to 0.45

(b) First trial combination

Sieve	PERCENT PASSING								
	19.0mm 3/4"	12.5mm 1/2"	9.5mm 3/8"	4.75mm 4	2.36mm 8	0.60mm 30	0.30mm 50	0.15mm 100	0.075mm 200
.45 x A	45	40.5	26.6	7.2	1.4	0.5	0	0	0
.55 x B	55	55.0	55.0	52.8	45.1	28.0	19.8	11.5	5.1
Total	100	95.5	81.6	60.0	46.5	28.5	19.8	11.5	5.1
Spec.	100	80-100	70-90	50-70	35-50	18-29	13-23	8-16	4-10

Minus 0.60 mm (No. 30) high, let b = 0.52, a = 0.48

(c) Second trial combination

Sieve	PERCENT PASSING								
	19.0mm 3/4"	12.5mm 1/2"	9.5mm 3/8"	4.75mm 4	2.36mm 8	0.60mm 30	0.30mm 50	0.15mm 100	0.075mm 200
.48 x A	48	43.2	28.3	7.7	1.5	0.5	0	0	0
.52 x B	52	52	52	49.9	42.6	26.5	18.7	10.9	4.8
Total	100	95.2	80.3	57.6	44.1	27.0	18.7	10.9	4.8
Spec.	100	80-100	70-90	50-70	35-50	18-29	13-23	8-16	4-10

(d) Third trial combination

Figure E-2— Trial-and-error calculations for combining two aggregates.

**ADJUSTING FOR DIFFERENT SPECIFIC GRAVITIES**—Aggregate gradations and grading curves are determined and expressed in percentages of total weight. Grading specifications, however, are established to meet volumetric requirements in the asphalt paving mix.

As long as the specific gravities of the combined aggregate materials are reasonably alike, the percentages by weight may be interpreted as percentages by volume for all practical purposes. When the specific gravities of the individual aggregates differ significantly (usually by 0.20 or more), the aggregate proportions should be adjusted.

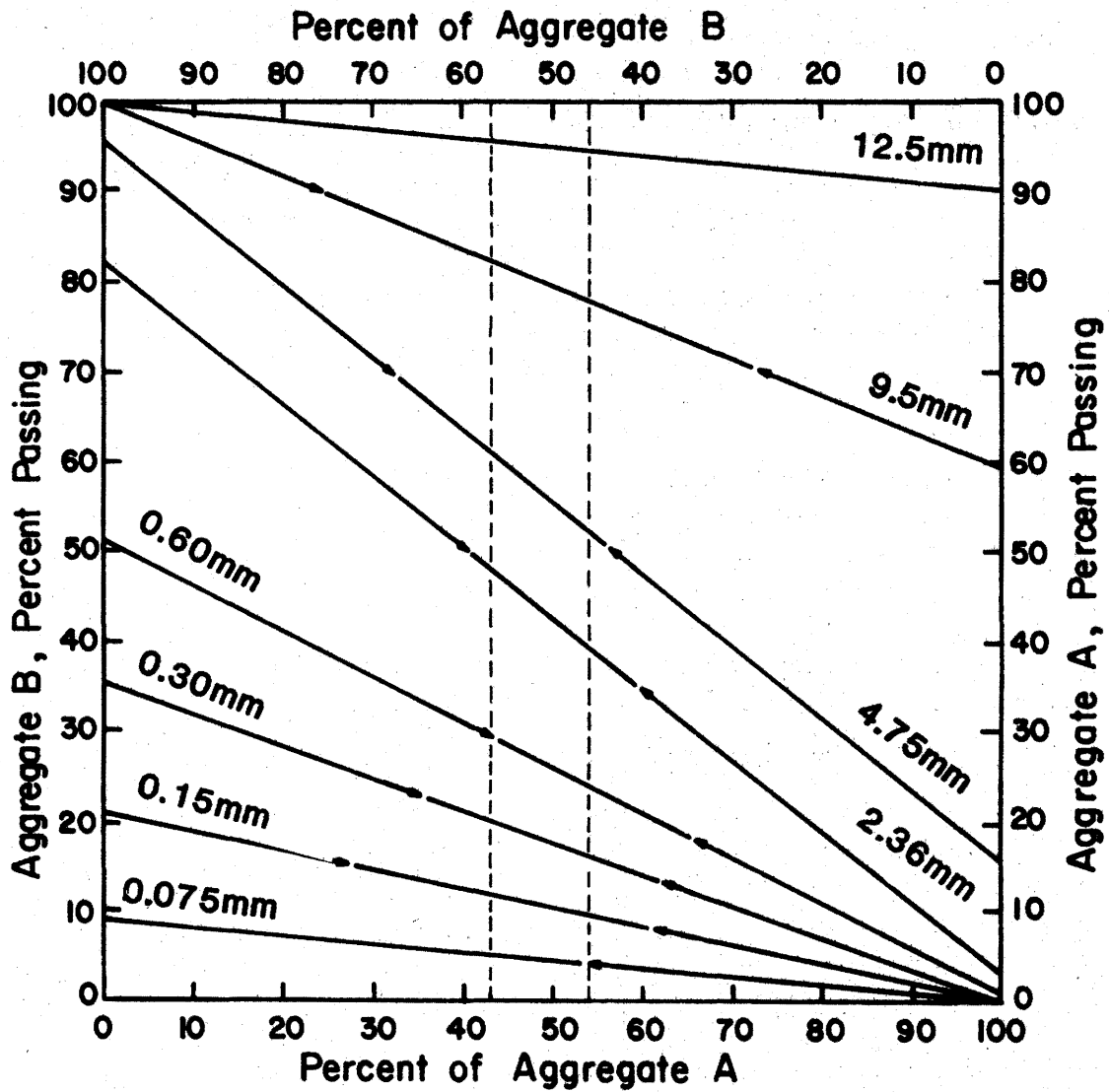


Figure E-3—Solution for proportioning two aggregates.

The adjustment is based on the fact that:

$$\text{VOLUME} \times \text{SPECIFIC GRAVITY} = \text{WEIGHT}$$

Assume the following combination was calculated for three aggregates having different specific gravities:

Aggregate	Sp Gr	Proportion
A	1.00	0.52
B	2.00	0.45
C	3.00	0.03

Calculations for adjustments are shown in Figure E-4

Aggr.	Percent Vol.	Sp Gr	(1)	(2)
			Weight	Percent Wt.
A	52.0	1.00	52.00	34.4
B	45.0	2.00	90.00	59.6
C	3.0	3.00	9.00	6.0
Total	100.0	—	151.00	100.0

(1) Weight = Vol. x Sp Gr

(2) Percent Wt. =  $\frac{\text{Individual Weight, } W}{\text{Total Weight}} \times 100 = \frac{W}{151} \times 100$

Figure E-4—Adjusting percentages by volume to percentages by weight

**ADJUSTING BY WASTING**—Where the main source of aggregate is a local roadside pit, it is often the case that crusher-run aggregates are either coarser or finer than desired. If the gradation is coarser than desired, finer material can usually be blended with the crusher-run aggregate. But for gradations that have an excess of fines, the most economical adjustment is usually made by wasting a portion of the fine fraction. Most crushing plants will make the separations on the 4.75 mm (No. 4) or possibly 2.36 mm (No. 8) screen. Where an excess on a smaller size occurs, the correction is made by wasting a portion of the minus 4.75 mm (No. 4) or 2.36 mm (No. 8) fraction. The amount of waste is expressed as a percent, considering the total crusher-run material as 100 percent.

The formulas for analysis of gradations before and after wasting are as follows:

(Sizes above waste screen)

$$R_b = \frac{R_2 R_a}{R_1} \quad (5)$$

(Sizes below waste screen)

$$P_b = \frac{P_2 P_a}{P_1} \quad (6)$$



Sieve	19.0mm	12.5mm	9.5mm	4.75mm	2.36mm	0.60mm	0.15mm	0.075mm
	3/4"	1/2"	3/8"	4	8	30	100	200
Spec.	100	80-100	70-90	55-73	40-55	20-30	10-18	4-10
% Pass, P <sub>a</sub>	100	98	87	75	54	28	17	9
% Ret, R <sub>a</sub>	0	2	13	25				
Adj % Ret, R <sub>b</sub>	0	2	16	30				
Adj % Pass, P <sub>b</sub>	100	98	84	70	50	26	16	8.4

$$P_b = \frac{P_2}{P_1} \quad P_a = \frac{70}{75} \quad P_a = 0.93 P_a \quad R_b = \frac{R_2}{R_1} \quad R_a = \frac{30}{25} \quad R_a = 1.20 R_a$$

$$\text{Waste, } W = \frac{100 (P_1 - P_2)}{(100 - P_2)} = \frac{100 (75 - 70)}{(100 - 70)} = 16.7\%$$

(a) Calculations based on adjusting percent passing 4.75 mm (No. 4)

Sieve	19.0mm	12.5mm	9.5mm	4.75mm	2.36mm	0.60mm	0.15mm	0.075mm
	3/4"	1/2"	3/8"	4	8	30	100	200
Spec.	100	80-100	70-90	55-73	40-55	20-30	10-18	4-10
% Pass, P <sub>a</sub>	100	95	85	70	53	31	16	9
% Ret, R <sub>a</sub>	0	5	15	30				
Adj % Ret, R <sub>b</sub>	0	6	18	37				
Adj % Pass, P <sub>b</sub>	100	94	82	63	48	28	14	8.1

$$P_b = \frac{P_2}{P_1} \quad P_a = \frac{28}{31} \quad P_a = 0.90 P_a \quad R_b = \frac{R_2}{R_1} \quad R_a = \frac{37}{30} \quad R_a = 1.23 R_a$$

$$\text{Waste, } W = \frac{100 (P_1 - P_2)}{(100 - P_2)} = \frac{100 (70 - 63)}{(100 - 63)} = 18.9\%$$

(b) Calculations based on adjusting percent passing 0.60 mm (No. 30)

Figure E-5—Adjusting gradation by wasting

where

P<sub>a</sub>, R<sub>a</sub> = percent passing, or retained, of given size before wasting;

P<sub>b</sub>, R<sub>b</sub> = adjusted percent passing, or retained, of given size after wasting;

P<sub>1</sub>, R<sub>1</sub> = percent passing, or retained, of waste size before wasting; and

P<sub>2</sub>, R<sub>2</sub> = percent passing, or retained, of waste size after wasting.

The percent of waste,  $W$ , is found as follows:

$$W = \frac{(P_1 - P_2) 100}{(100 - P_2)} \quad (7)$$

Assume that a single aggregate stockpile is being produced from a local roadside pit. The specification limits and crusher-run gradation are shown in Figure E-5a. Note that the 4.75 mm (No. 4) size is above specification limits and that the other percentages approach the upper limits of the specification. A portion of the minus 4.75 mm (No. 4) fraction will be wasted to reduce the percent passing 4.75 mm (No. 4) from 75 to 70. The adjusted percentages of the passing 4.75 mm (No. 4) sizes are found using Eq. 6 as shown. The percentages of the retained 4.75 mm (No. 4) sizes are first converted to percent-retained and the adjusted percent retained on 4.75 mm (No. 4) determined. The percentages of coarse sizes are found using Eq. 5 and reconvert to percent passing. The percent of waste of the passing 4.75 mm (No. 4) fraction is then found using Eq. 7.

Assume, in this case, that the 0.60 mm (No. 30) size exceeds specification limits. Therefore, a sufficient amount of the minus 4.75 (No. 4) fraction will be wasted to reduce the 0.60 mm (No. 30) from 31 percent to 28 percent (Figure E-5b).

In this case,  $P_1$  and  $P_2$  for the fine fraction are values for the 0.60 mm (No. 30) sieve. When the adjusted percentages are obtained,  $R_1$  and  $R_2$  for the 4.75 mm (No. 4) sieve are used for the coarse fraction.

1945

...

...

...

...

