

Study of the Impacts of Implements of Husbandry on Bridges

Volume II: Rating and Posting Recommendations

August 2017



Sponsored by

Iowa Highway Research Board (IHRB Project TR-613)

Iowa Department of Transportation (InTrans Projects 9-364 and 11-399)

Federal Highway Administration Transportation Pooled Fund TPF-5(232)

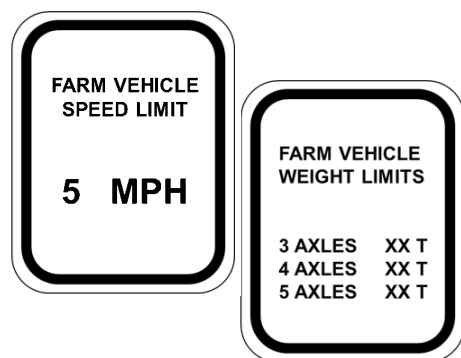

About the Bridge Engineering Center

The mission of the Bridge Engineering Center (BEC) is to conduct research on bridge technologies to help bridge designers/owners design, build, and maintain long-lasting bridges.

About the Institute for Transportation

The mission of the Institute for Transportation (InTrans) at Iowa State University is to develop and implement innovative methods, materials, and technologies for improving transportation efficiency, safety, reliability, and sustainability while improving the learning environment of students, faculty, and staff in transportation-related fields.

Disclaimer Notice

The contents of this report reflect the views of the authors, who are responsible for the facts and the accuracy of the information presented herein. The opinions, findings and conclusions expressed in this publication are those of the authors and not necessarily those of the sponsors.

The sponsors assume no liability for the contents or use of the information contained in this document. This report does not constitute a standard, specification, or regulation.

The sponsors do not endorse products or manufacturers. Trademarks or manufacturers' names appear in this report only because they are considered essential to the objective of the document.

Iowa State University Non-Discrimination Statement

Iowa State University does not discriminate on the basis of race, color, age, ethnicity, religion, national origin, pregnancy, sexual orientation, gender identity, genetic information, sex, marital status, disability, or status as a U.S. veteran. Inquiries regarding non-discrimination policies may be directed to Office of Equal Opportunity, 3410 Beardshear Hall, 515 Morrill Road, Ames, Iowa 50011, Tel. 515-294-7612, Hotline: 515-294-1222, email eooffice@iastate.edu.

Iowa Department of Transportation Statements

Federal and state laws prohibit employment and/or public accommodation discrimination on the basis of age, color, creed, disability, gender identity, national origin, pregnancy, race, religion, sex, sexual orientation or veteran's status. If you believe you have been discriminated against, please contact the Iowa Civil Rights Commission at 800-457-4416 or Iowa Department of Transportation's affirmative action officer. If you need accommodations because of a disability to access the Iowa Department of Transportation's services, contact the agency's affirmative action officer at 800-262-0003.

The preparation of this report was financed in part through funds provided by the Iowa Department of Transportation through its "Second Revised Agreement for the Management of Research Conducted by Iowa State University for the Iowa Department of Transportation" and its amendments.

The opinions, findings, and conclusions expressed in this publication are those of the authors and not necessarily those of the Iowa Department of Transportation or the U.S. Department of Transportation Federal Highway Administration.

Technical Report Documentation Page

1. Report No. IHRB Project TR-613 and TPF-5(232)		2. Government Accession No.		3. Recipient's Catalog No.	
4. Title and Subtitle Study of the Impacts of Implements of Husbandry on Bridges Volume II: Rating and Posting Recommendations				5. Report Date August 2017	
				6. Performing Organization Code	
7. Author(s) Lowell Greimann (orcid.org/0000-0003-2488-6865), Brent Phares (orcid.org/0000-0001-5894-4774), Ping Lu (orcid.org/0000-0002-9427-2415), and Katelyn Freeseaman (orcid.org/0000-0003-0546-3760)				8. Performing Organization Report No. InTrans Projects 9-364 and 11-399	
9. Performing Organization Name and Address Bridge Engineering Center Iowa State University 2711 South Loop Drive, Suite 4700 Ames, IA 50010-8664				10. Work Unit No. (TRAVIS)	
				11. Contract or Grant No.	
12. Sponsoring Organization Name and Address Iowa Highway Research Board Iowa Department of Transportation 800 Lincoln Way Ames, IA 50010				13. Type of Report and Period Covered Volume II: Final Report	
14. Sponsoring Agency Code IHRB Project TR-613 and TPF-5(232)					
15. Supplementary Notes Visit www.intrans.iastate.edu for color pdfs of this and other research reports.					
16. Abstract <p>The objectives of this study were to develop guidance for engineers on how implements of husbandry loads are resisted by traditional bridges, with a specific focus on bridges commonly found on the secondary road system; provide recommendations for accurately analyzing bridges for these loading effects; and make suggestions for the rating and posting of these bridges.</p> <p>To achieve the objectives, the distribution of live load and dynamic impact effects for different types of farm vehicles on three general bridge types—steel-concrete, steel-timber, and timber-timber—were investigated through load testing and analytical modeling. The types of vehicles studied included, but were not limited to, grain wagons/grain carts, manure tank wagons, agriculture fertilizer applicators, and tractors.</p> <p>Once the effects of these vehicles had been determined, a parametric study was carried out to develop live load distribution factor (LLDF) equations that account for the effect of husbandry vehicle loads. Similarly, recommendations for dynamic effects were also developed. The live load distribution factors and dynamic load allowances are covered in the first volume of the report.</p> <p>Finally, suggestions on the analysis, rating, and posting of bridges for husbandry implements were developed. Those suggestions are covered in this volume of the report.</p> <p>The third volume of the report contains six appendices that include the 19 mini-reports for field tested and analytically modeled steel-concrete, steel-timber, and timber-timber bridges, the farm implement and bridge inventories for the project, and survey responses.</p>					
17. Key Words bridge loads—bridge posting—bridge rating—dynamic load allowance— husbandry implements—live load testing				18. Distribution Statement No restrictions.	
19. Security Classification (of this report) Unclassified.		20. Security Classification (of this page) Unclassified.		21. No. of Pages 73	22. Price NA

STUDY OF THE IMPACTS OF IMPLEMENTS OF HUSBANDRY ON BRIDGES

**Volume II: Rating and Posting Recommendations
August 2017**

Principal Investigator

Brent Phares, Director
Bridge Engineering Center, Iowa State University

Co-Principal Investigator

Terry Wipf, Professor and Chair
Civil, Construction, and Environmental Engineering, Iowa State University

Authors

Lowell Greimann, Brent Phares, Ping Lu, and Katelyn Freesman

Sponsored by

Iowa Highway Research Board,
(IHRB Project TR-613),
Iowa Department of Transportation, and
Federal Highway Administration
Transportation Pooled Fund (TPF-5(232))

Preparation of this report was financed in part
through funds provided by the Iowa Department of Transportation
through its Research Management Agreement
with the Institute for Transportation
(InTrans Projects 9-364 and 11-399)

A report from

**Bridge Engineering Center and
Institute for Transportation**

Iowa State University

2711 South Loop Drive, Suite 4700

Ames, IA 50010-8664

Phone: 515-294-8103 / Fax: 515-294-0467

www.intrans.iastate.edu

TABLE OF CONTENTS

ACKNOWLEDGMENTS	ix
THREE-VOLUME EXECUTIVE SUMMARY	xi
1. INTRODUCTION	1
1.1 Problem Statement	1
1.2 Research Objectives and Scope	2
1.3 Research Methodology	2
1.4 Three-Volume Report Organization	2
1.5 Methodology for Rating and Posting Recommendations (Volume II)	3
1.6 Volume II Organization	3
2. GENERIC AGRICULTURAL RATING VEHICLE AND SIGNAGE.....	4
2.1 Vehicle Descriptions	4
2.2 Moment Envelopes	6
2.3 Controlling Husbandry Vehicles.....	10
2.4 Generic Agricultural Rating Vehicles.....	13
2.5 Moment Ratios.....	14
2.5.1 Generic Agricultural versus Husbandry Vehicle Comparison Results.....	15
2.5.2 Rating and Posting Vehicles versus Husbandry Vehicle Comparison Results	20
3. OPERATING RATINGS, OPERATING RATING RATIOS, AND LEGAL AGRICULTURAL VEHICLE MODELS	25
3.1 Operating Ratings and Operating Rating Ratios.....	25
3.2 Legal Agricultural Vehicles	43
4. SUMMARY OF SURVEY RESPONSES	46
5. RATING EXAMPLES	47
5.1 Example 1. Short-Span Bridge	47
5.1.1 Load Factor Rating	47
5.1.2 Interior Girder Non-Composite Moment Capacity.....	48
5.1.3 Moments in Interior Girder	48
5.1.4 Dynamic Load Allowance, IM	49
5.1.5 Live Load Plus Impact	49
5.1.6 Rating Factors	49
5.1.7 Operating Ratings	49

5.2 Example 2. Long-Span Bridge.....	51
5.2.1 Load Factor Rating	51
5.2.2 Interior Girder Non-Composite Moment Capacity	51
5.2.3 Moments in Interior Girder	52
5.2.4 Dynamic Load Allowance, IM:	52
5.2.5 Live Load Plus Impact	53
5.2.6 Rating Factors	53
5.2.7 Operating Rating	53
6. POSTING SIGNAGE	55
6.1 MUTCD Requirement for Post Signs	55
6.2 Posting or Speed Limit Signs for Agricultural (Farm) Vehicles	56
7. SUMMARY AND CONCLUSIONS FOR RATING AND POSTING RECOMMENDATIONS (VOLUME II)	58
REFERENCES	61

LIST OF FIGURES

Figure 1. HL-93 – AASHTO design vehicle	4
Figure 2. HS20 and NRL - rating vehicles	5
Figure 3. SHVs and Type 4 Truck - posting vehicles.....	6
Figure 4. Single-span bridge, Bridge1_1, moment envelopes and critical locations for 121 husbandry vehicles.....	7
Figure 5. Two-span bridge, Bridge2_1, moment envelopes and critical locations for 121 husbandry vehicles.....	8
Figure 6. Three-span bridge, Bridge3_1, moment envelopes and critical locations for 121 husbandry vehicles.....	9
Figure 7. Four-span bridge, Bridge4_1, moment envelopes and critical locations for 121 husbandry vehicles.....	9
Figure 8. Three-axle husbandry vehicle.....	10
Figure 9. Four-axle husbandry vehicle	11
Figure 10. Five-axle husbandry vehicle.....	12
Figure 11. Three-axle controlling vehicles	13
Figure 12. Four-axle controlling vehicle	13
Figure 13. Five-axle controlling vehicles	13
Figure 14. Three-axle generic agricultural rating vehicles, AV3	14
Figure 15. Four-axle generic agricultural rating vehicle, AV4.....	14
Figure 16. Five-axle generic agricultural rating vehicles, AV5.....	14
Figure 17. Moment ratio plot for AV/husbandry for single-span bridges	16
Figure 18. Moment ratio plot for AV/husbandry for two-span bridges.....	17
Figure 19. Moment ratio plot for AV/husbandry for three-span bridges.....	18
Figure 20. Moment ratio plot for AV/husbandry for four-span bridges	19
Figure 21. Bridge3_16 moment envelopes for AV3 and V3-26.....	20
Figure 22. Moment ratios for rating and posting husbandry vehicles for single-span bridges.....	21
Figure 23. Moment ratios for rating and posting husbandry vehicles for two-span bridges	22
Figure 24. Moment ratios for rating and posting husbandry vehicles for three-span bridges	23
Figure 25. Moment ratios for rating and posting husbandry vehicles for four-span bridges.....	24
Figure 26. AV3 ratios for one-span bridges.....	26
Figure 27. AV4 ratios for one-span bridges.....	27
Figure 28. AV5 ratios for one-span bridges.....	28
Figure 29. AV3 ratios for two-span bridges	29
Figure 30. AV4 ratios for two-span bridges	30
Figure 31. AV5 ratios for two-span bridges	31
Figure 32. AV3 ratios for three-span bridges	32
Figure 33. AV4 ratios for three-span bridges	33
Figure 34. AV5 ratios for three-span bridges	34
Figure 35. AV3 ratios for four-span bridges.....	35
Figure 36. AV4 ratios for four-span bridges.....	36
Figure 37. AV5 ratios for four-span bridges.....	37
Figure 38. AV3 ratio versus minimum span length.....	38
Figure 39. AV4 ratio versus minimum span length.....	39
Figure 40. AV5 ratio versus minimum span length.....	40

Figure 41. Minimum AV OR ratio versus minimum span length – rating vehicles	41
Figure 42. Minimum AV OR ratio versus minimum span length – posting vehicles	42
Figure 43. Effects of short span on OR ratio	43
Figure 44. Posting AV vehicles, AV3a and AV3b	43
Figure 45. Posting AV vehicles, AV4a and AV4b	43
Figure 46. Posting AV vehicles, AV5a, AV5b, and AV5c.....	44
Figure 47. Posting sign for a shorter bridge.....	50
Figure 48. Posting sign for a longer bridge.....	54
Figure 49. Bridge posting signage options provided by the MUTCD	55
Figure 50. Farm vehicle speed limit sign.....	56
Figure 51. Farm vehicle posting signs	57

LIST OF TABLES

Table 1. Vehicle weights.....	45
Table 2. Girder geometry for Example 1 short-span bridge	47
Table 3. Girder geometry for the example long-span bridge.....	51

ACKNOWLEDGMENTS

The research team would like to acknowledge the Iowa Highway Research Board, the Iowa Department of Transportation (DOT), and the Federal Highway Administration for sponsoring this research with support from the following Transportation Pooled Fund TPF-5(232) partners:

- Illinois
- Iowa (lead state)
- Kansas
- Minnesota
- Nebraska
- Oklahoma
- Wisconsin
- Wisconsin

The authors would like to express their gratitude to the Iowa DOT and the other pooled fund state partners for their financial support and technical assistance and also thank the USDA Forest Products Laboratory for their support of this project. In addition, the authors would like to acknowledge the support of the Iowa DOT Office of Bridges and Structures staff members, who continually provide great insight, guidance, and motivation for practical and implementable research.

THREE-VOLUME EXECUTIVE SUMMARY

The deterioration of bridges is a prevalent issue in the US. A portion of that deterioration comes from the frequent subsection of bridges to oversized loads. Of those oversized loads, implements of husbandry are of particular interest. Although states differ in their definition, an implement of husbandry can generally be thought of as a vehicle used to carry out agricultural activities. These vehicles often carry heavy loads, and little is known on how husbandry implements affect today's bridges.

The behavior of bridges with these vehicles, particularly regarding live load distribution and impact, is not explicitly enveloped within the design, rating, and posting vehicles presented in current American Association of State Highway and Transportation Officials (AASHTO) specifications. Because of the large axle loads and varying axle spacings, the current AASHTO vehicles, such as the HL-93 design truck and the HS20 rating truck, may not accurately represent husbandry implements.

The objectives of this research, presented in a three-volume report series, were to develop guidance for engineers on how implements of husbandry loads are resisted by traditional bridges, with a specific focus on bridges commonly found on the secondary road system; provide recommendations for accurately analyzing bridges for these loading effects; and make suggestions for the rating and posting of these bridges

Volume I focuses on the impacts of husbandry implements on actual bridges by way of field testing as well as analytical finite element models. With these data, the objective was to develop equations and limits for dynamic load allowances and live load distribution factors that apply directly to husbandry vehicles.

Included in the testing were bridges with steel girders with both concrete and timber decks as well as bridges with timber girders and timber decks. Field testing was conducted on 19 of the bridges in this collection. Brief reports for each of the 19 bridges are in Volume III: Appendices.

The data collected from field tests were used to determine a reasonable bound for impact factors for husbandry implements as well as to get a base understanding of how live load moments created by husbandry vehicles are distributed among girders. In addition to the field tests, finite element models were created for the 19 bridges and calibrated with the field test results. Using these models as guidelines, finite element modes were created for 151 bridges included in the inventory (also included in Volume III: Appendices). The finite element models were subjected to the loads of 121 typical husbandry vehicles inventoried (also included in Volume III: Appendices) and modeled using finite element analysis.

Results show that the impact factors currently presented in the AASHTO specifications are too low for husbandry vehicles. Similarly, provisions provided by AASHTO for live load distribution are, in some cases, drastically different from live load distribution factors determined from loading the 151 bridges with the 121 husbandry vehicles. Volume I provides

recommendations on upper limits for dynamic load allowances as well as several equations for determining live load distribution specifically for husbandry implements.

The purpose of the work covered in Volume II was to determine whether current AASHTO rating and posting vehicles can be used to accurately represent husbandry implements. Using software generated by the Bridge Engineering Center at Iowa State University's Institute for Transportation, AASHTO vehicles and the same 121 husbandry vehicles inventoried and used in the Volume I work were theoretically driven across 174 bridges (several of which were also included in the study in Volume I).

With the moments produced by both the AASHTO and husbandry vehicles on these bridges, comparisons were made between moment envelopes for both vehicle types as well as for theoretical operating ratings for both vehicle types. Results showed that the vehicles provided in AASHTO specifications do not accurately represent the effects caused by husbandry vehicles. In addition, on shorter span bridges, husbandry vehicles tend to produce lower operating ratings than the AASHTO vehicles. On longer span bridges, husbandry vehicles seem to lead to higher operating ratings than AASHTO vehicles.

Volume II presents the development of an overarching husbandry vehicle, recommendations on signage and posting for husbandry vehicles, as well as bridge rating examples, for both short and long span bridges, using updated distribution and impact factors as presented in Volume I.

Finally, Volume III is a collection of appendices referenced in Volumes I and II. Appendices A, B, and C are a series of mini reports for the 19 field tested bridges from Volume I. Appendix D includes detailed information of the 121 farm vehicles used for the study. Appendix E is a detailed inventory of the 151 bridges from Volume I and 174 bridges used in Volume II. Appendix F includes the survey sent to the state departments of transportation and responses to questions about their rules and regulations for husbandry implements on bridges.

1. INTRODUCTION

In the US, bridges are typically designed and load rated based on the specifications provided by the American Association of State Highway and Transportation Officials (AASHTO). These specifications were developed to ensure the safety of bridges for traditional highway vehicles. As a part of both the design and rating process, live loads in the form of a typical highway truck are distributed across the various structural elements to determine the shear and moments in those elements. Although the process to determine these shear and moments can be quite intensive, the process has been simplified to a degree through the use of the live load distribution factors (LLDFs) and the dynamic load allowance (IM) specified by the AASHTO standards and LRFD specifications (AASHTO 1996, AASHTO 2010).

LLDFs can be broadly defined as the ratio of the maximum live-load effect in a component to the maximum live-load effect in a system when using beam-line model techniques (Barker and Puckett 2013). LLDFs were developed to examine the bridge's capability to resist traditional highway-type vehicles (e.g., trucks, which tend to have relatively consistent widths and other characteristics) (AASHTO 1996, AASHTO 2010). AASHTO defines the dynamic load allowance, IM, as an increase in the applied static force effects to account for the dynamic interaction between the bridge and moving loads.

While the AASHTO specifications are generally thought to be conservative when used to predict the response of bridges to highway-type vehicles, concerns have been raised about their applicability to non-highway vehicles such as husbandry implements, which often have large axle loads and varying axle spacings.

1.1 Problem Statement

As of 2013, there were 607,380 bridges in the US (ASCE 2013), with the majority of these bridges found on secondary roadways and generally thought of as "rural" bridges. Statistics show that 13 percent of the rural bridges are structurally deficient and 10 percent are functionally obsolete (Orr 2012). Combining these statistics indicates that there are a large number of bridges in rural settings that do not meet current design standards, although this does not necessarily mean they are unsafe.

At the same time, changing technology in farming has led to heavier farm vehicles in a variety of configurations. While these vehicles are developed for use on a farm, they commonly travel on the roadway system as well. These vehicles tend to have different wheel spacing, gauge widths, wheel footprints, and dynamic coupling characteristics than traditional highway vehicles, which means they are likely resisted differently than the vehicles addressed by AASHTO specifications (Wood and Wipf 1999, Phares et al. 2005, Seo et al. 2013).

Currently, an engineer who wants to assess a bridge's ability to resist implements of husbandry must make many assumptions and use best judgement. Therefore, there is a need to provide engineers with the tools to accurately assess how highway bridges resist these atypical vehicles.

1.2 Research Objectives and Scope

The objectives of this study were to develop guidance for engineers on how implements of husbandry loads are resisted by traditional bridges, with a specific focus on bridges commonly found on the secondary road system; provide recommendations for accurately analyzing bridges for these loading effects; and make suggestions for the rating and posting of these bridges.

1.3 Research Methodology

To achieve the objectives, the distribution of live load and dynamic impact effects for different types of farm vehicles on three general bridge types—steel-concrete, steel-timber, and timber-timber—were investigated by load testing and analytical modeling. The types of vehicles studied included, but were not limited to, grain wagons/grain carts, manure tank wagons, agriculture fertilizer applicators, and tractors.

Once the effects of these vehicles had been determined, a parametric study was carried out to develop live load distribution factor (LLDF) equations that account for the effect of husbandry vehicle loads. Similarly, recommendations for dynamic effects were also developed. Finally, suggestions on the analysis, rating, and posting of bridges for husbandry implements were developed.

1.4 Three-Volume Report Organization

This final report is presented in three volumes and summarizes the results of this project as follows.

Volume I: Live Load Distribution Factors and Dynamic Load Allowances

Volume II: Rating and Posting Recommendations

Volume III: Appendices

The appendices in Volume III are referenced in Volumes I and II. Volume III includes the following:

- Appendix A. Field Tested Steel-Concrete Bridges
- Appendix B. Field Tested Steel-Timber Bridges
- Appendix C. Field Tested Timber-Timber Bridges
- Appendix D. Farm Implement Inventory
- Appendix E. Bridge Inventory
- Appendix F. Survey Responses

1.5 Methodology for Rating and Posting Recommendations (Volume II)

Tools that can be used for rating and posting of bridges for implements of husbandry were studied. Generic agricultural vehicle models were created that encompass the moments produced by the 121 husbandry vehicles traveling over the 174 bridges (some of which were identified in Volume I). Ratings and specification-type parameters can be generated from these generic vehicles, which lead to recommendations on the analysis, rating, and posting of bridges for implements of husbandry.

Survey responses regarding current weight limits on bridges from several state departments of transportation (DOTs) were collected to gain an understanding of how these husbandry and generic agricultural vehicles compare to vehicles of legal weight. The gross-vehicle weight limit and axle weight limit, which have been enforced by many states, were used to create a legal version of agricultural vehicles, which can be used for posting vehicles. The bridge restriction signs were also studied for this project.

1.6 Volume II Organization

This report is organized into seven chapters. Following this introduction in Chapter 1, Chapter 2 outlines the development of the generic agricultural vehicles. The chapter's first section lays out the terminology used in this report, the second section presents the moment effects produced by the 121 husbandry vehicles on the 174 bridges, the third and fourth sections describe how three generic agricultural vehicles were developed to encompass the effects of the existing 121 husbandry vehicles, and the fifth section of this chapter compares the 121 husbandry vehicles with (1) the three generic agricultural vehicles and (2) the current rating and posting vehicles.

Chapter 3 explores operating ratings of existing rating and posting vehicles as well as the generic agricultural vehicles. Operating rating ratios are also reported in this chapter as a way to determine which vehicles have the lowest rating on a given bridge. By considering the gross-vehicle weight and axle weight limits that have been enforced in many states, legal version agricultural vehicle models were created, which can potentially be used as posting vehicles. Chapter 4 provides a brief summary of survey responses regarding current legal weight limits. The complete survey responses are presented in Volume III – Appendix F. Survey Responses. Chapter 5 provides two examples of rating bridges for husbandry vehicles. Chapter 6 includes suggestions as to how signs should be adapted to best accommodate husbandry vehicles. Finally, Chapter 7 presents a summary of the results and offers conclusions on analysis, rating, and posting for implements of husbandry.

2. GENERIC AGRICULTURAL RATING VEHICLE AND SIGNAGE

In this chapter, three generic agricultural rating vehicles are developed such that the structural response of all the bridges listed in Appendix E of Volume III due to these generic vehicles is an upper bound to the response of the bridges due to the 121 vehicles listed in Appendix D in Volume III.

2.1 Vehicle Descriptions

A variety of vehicles are used this study, so several terms have been defined to assist in discussing these vehicles. The term “husbandry vehicle” refers to the 121 real farm vehicles introduced in Volume I of this report and further discussed in this Volume II. Vehicle information can be found in Appendix D of Volume III. The term “generic agricultural rating vehicle” describes the representative vehicles developed in this study to serve as a bound for all husbandry vehicles. The generic agricultural rating vehicles are sometimes referred to as AV vehicles in this report. “Design vehicle” corresponds to those vehicles used to determine design loads on a bridge (vehicles such as AASHTO HL-93). This vehicle is presented in Figure 1.

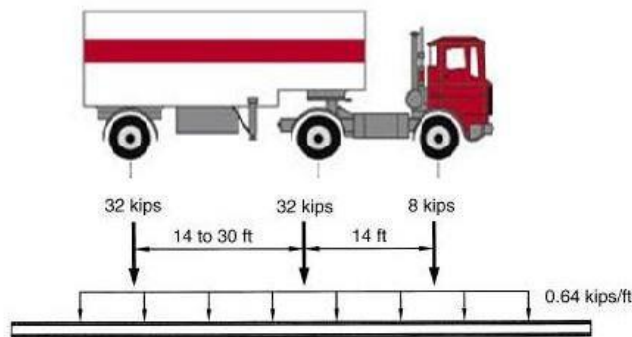

Truck drawing ©2010 National Precast Concrete Association

Figure 1. HL-93 – AASHTO design vehicle

“Rating vehicles,” as shown in Figure 2, are those vehicles used to conduct load rating screening on a bridge.

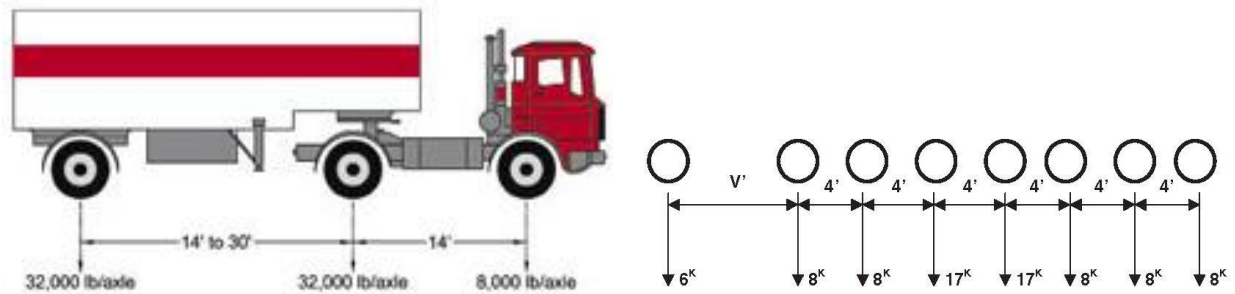

V = Variable drive axle spacing = 6 ft 0 in. to 14 ft 0 in., and use spacing that produces maximum load effects.
 Neglected axles that do not contribute to the maximum load effect under consideration.
 Maximum GVW = 80 kips. Axle gage width = 6 ft 0 in.

Truck drawing (left) ©2010 National Precast Concrete Association; diagram (right) ©2007 National Cooperative Highway Research Program

Figure 2. HS20 and NRL - rating vehicles

These vehicles include AASHTO HS20, NRL6, and NRL14. NRL refers to “notional rating load,” and the values of 6 ft and 14 ft represent the minimum and maximum drive axle spacings, respectively (Sivakumar et al. 2007). NRL is a rating vehicle model that envelopes all special hauling vehicles (SHVs). “Posting vehicles,” as found in Figure 3, are vehicles that are used on posting signs if a bridge does not have a rating deemed sufficient. Single unit posting vehicles include SHVs (i.e., SU4, SU5, SU6, SU7) and Type 4 trucks. A single unit truck is referred to as an SU, and the values 4, 5, 6, and 7 reference the number of axles on each vehicle (Sivakumar et al. 2007). These vehicles can be seen in Figure 3.

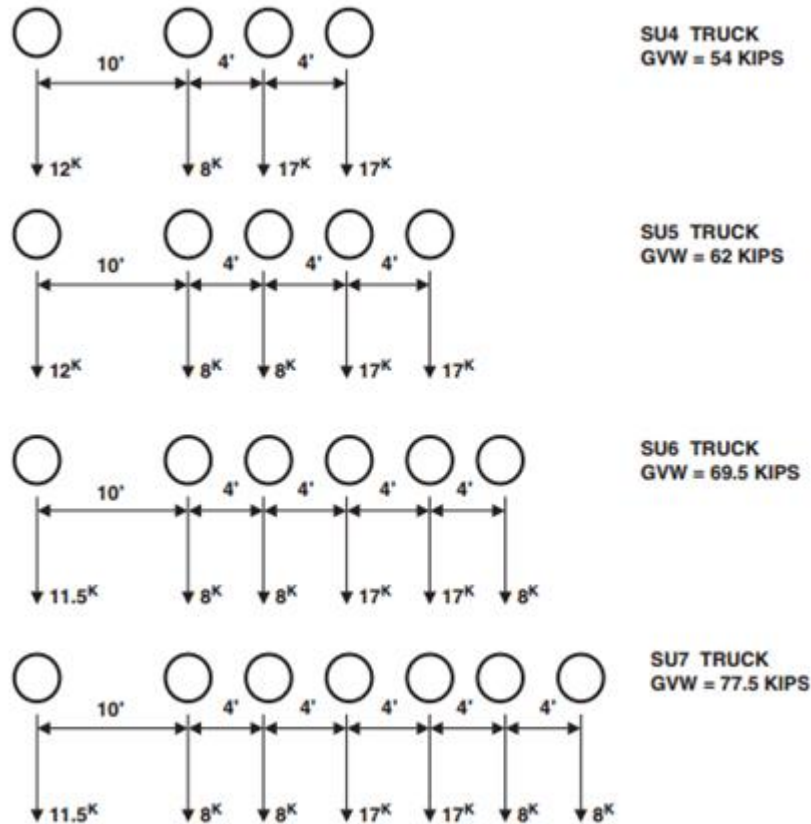

©2007 National Cooperative Highway Research Program



Iowa DOT Attachment E to I.M. 2.120 July 18, 2013

Figure 3. SHVs and Type 4 Truck - posting vehicles

2.2 Moment Envelopes

Through the use of a computational/analytical model called BEC analysis, each of the 121 husbandry vehicles made simulated crossings over each of the 174 bridges from left-to-right and right-to-left. BEC analysis is beam line analysis software that was developed by the Bridge Engineering Center. It is capable of analyzing a bridge beam or girder with various boundary conditions and member geometries. It also allows the structural response of a beam to be analyzed under moving loads, and the software generates envelopes of maximum moments and strains. The software was configured to output the analysis results at 200 points along the bridge as the husbandry vehicles were driven across them. The analytical model calculated the moment values for each vehicle at the 200 analysis points along the bridge. The moment values were used

to create a plot of all the husbandry vehicle moment envelopes for every bridge. Figures 4 through 7 show example moment envelopes for sample one-span, two-span, three-span and four-span bridges, respectively, along with the critical locations marked in each span. Note that the figures shown only portray the vehicles driven left-to-right.

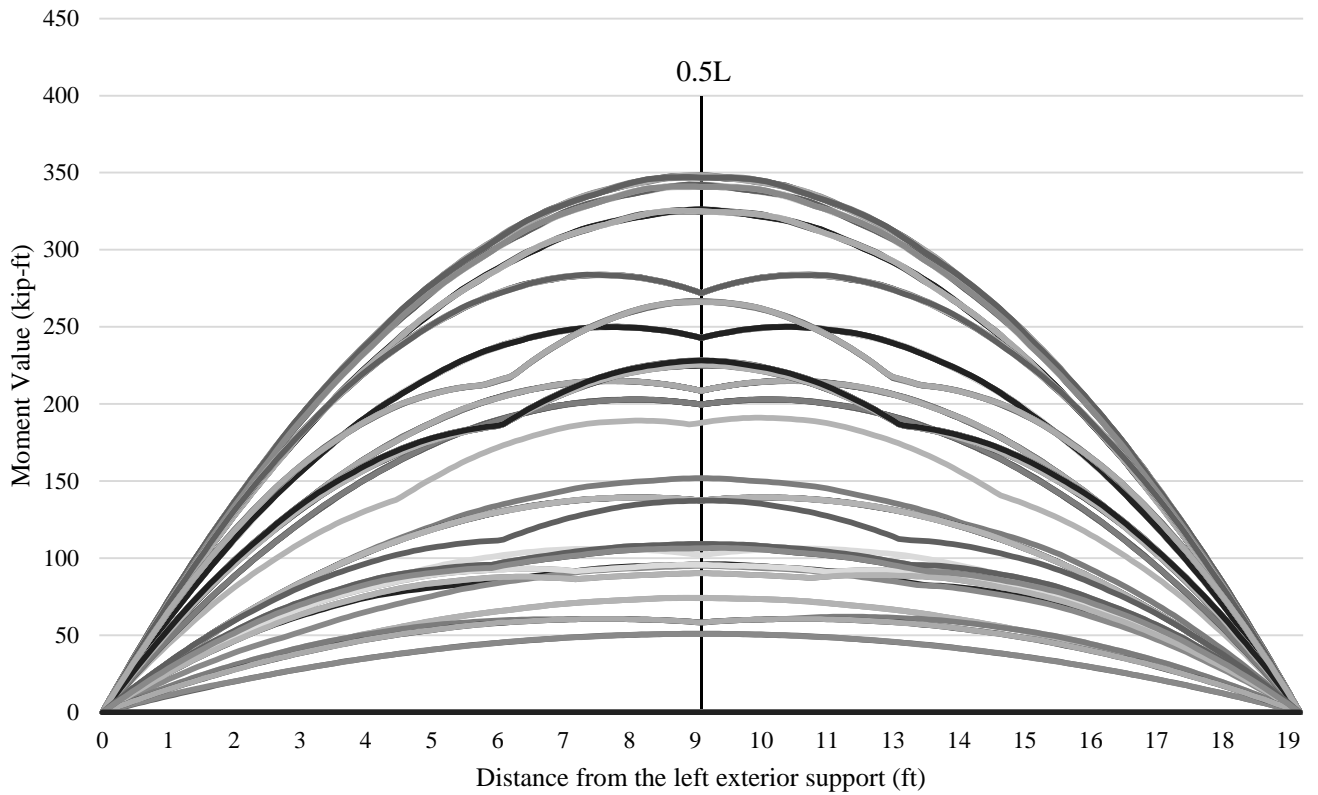

Figure 4. Single-span bridge, Bridge1_1, moment envelopes and critical locations for 121 husbandry vehicles

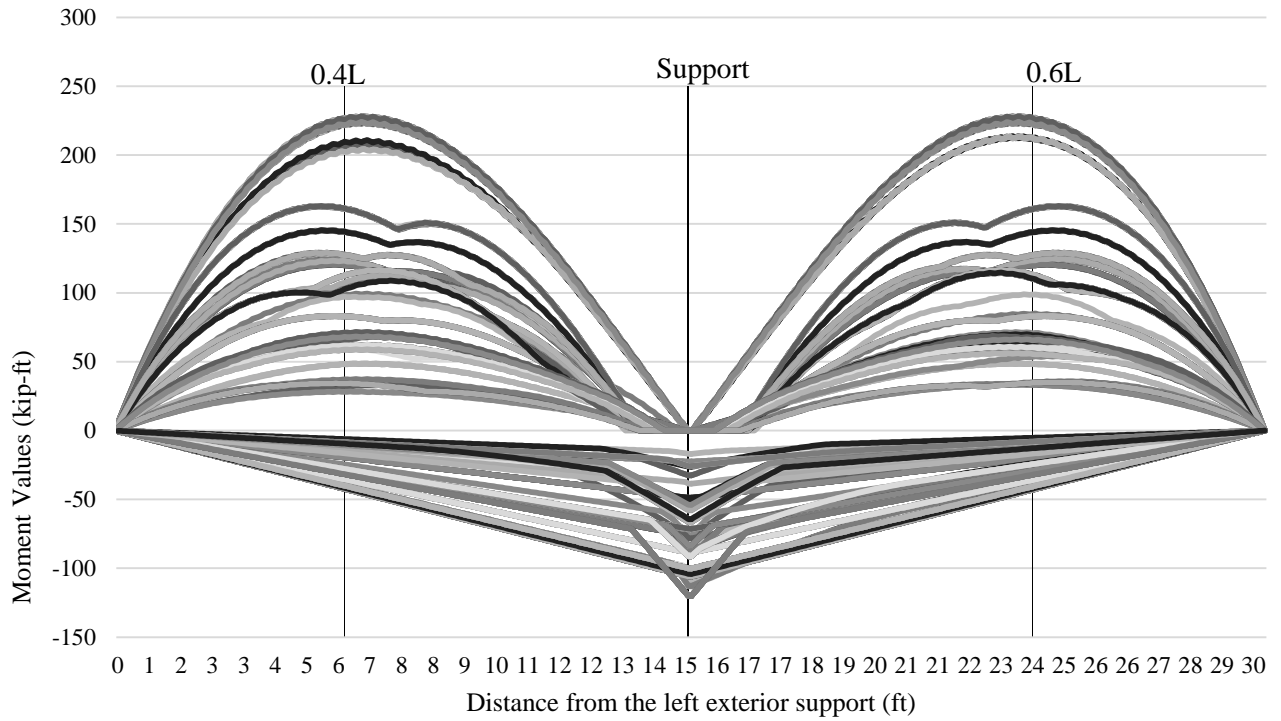

Figure 5. Two-span bridge, Bridge2_1, moment envelopes and critical locations for 121 husbandry vehicles

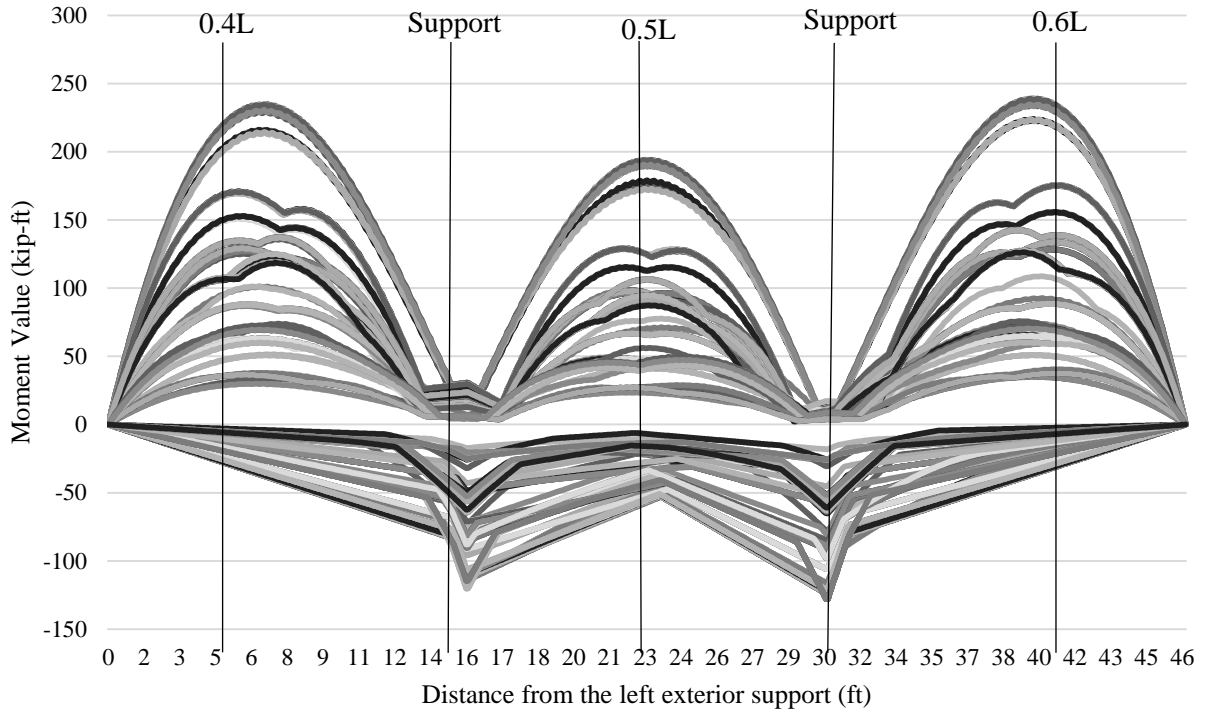

Figure 6. Three-span bridge, Bridge3_1, moment envelopes and critical locations for 121 husbandry vehicles

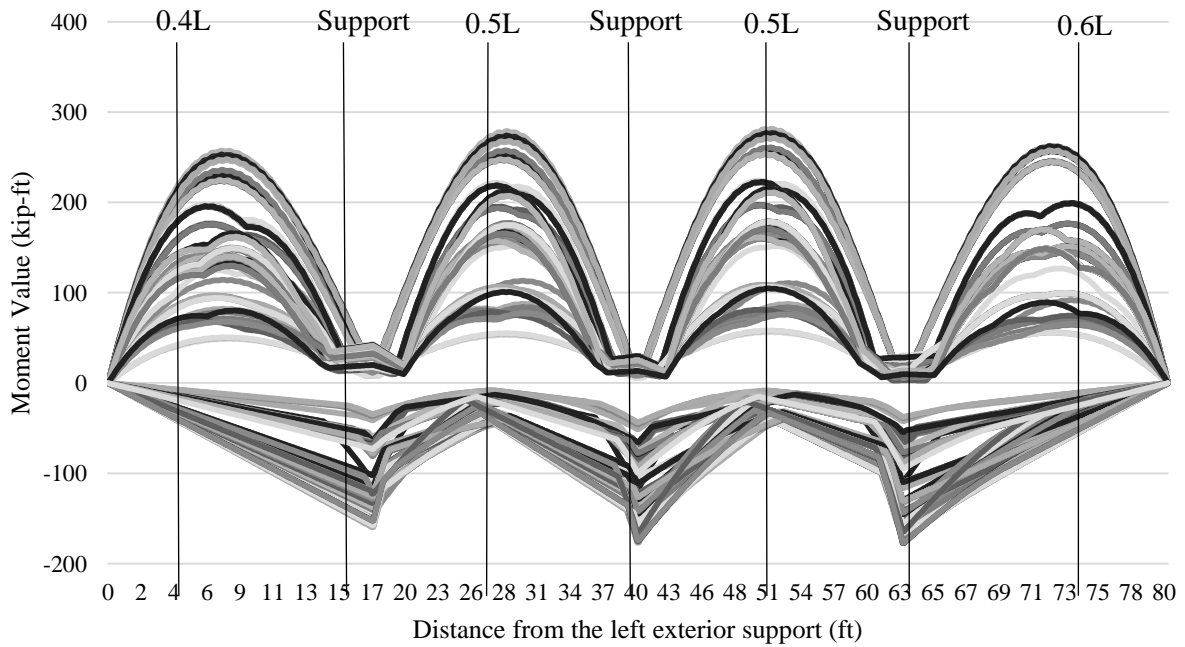

Figure 7. Four-span bridge, Bridge4_1, moment envelopes and critical locations for 121 husbandry vehicles

2.3 Controlling Husbandry Vehicles

From these envelopes, the husbandry vehicles that bounded the response of the other vehicles were determined for each bridge. These bounding vehicles were found by determining which vehicle produced the maximum positive and negative moment values at each of the 200 analysis points. This was done for all bridges. The resulting controlling vehicles are listed in Tables 1 through 3 for three-, four-, and five-axle vehicles, respectively. Axle weights and spacings are listed in each table, with a drawing under each (Figures 8 through 10) to define the columns of values in Tables 1 through 3 (respectively).

Table 1. Three-axle controlling vehicles for all bridges

Vehicle	Axles	A01WT (kips)	A02WT (kips)	A03WT (kips)	A01SPC (ft)	A02SPC (ft)
V3-1	3	20.17	20.17	68.70	11.48	19.53
V3-2	3	20.17	20.17	73.38	11.48	24.62
V3-4	3	11.53	11.53	68.70	9.87	18.83
V3-5	3	11.53	11.53	73.38	9.87	23.92
V3-8	3	18.84	18.66	73.38	11.25	24.00
V3-11	3	11.80	15.90	73.38	10.67	24.00
V3-14	3	20.24	16.06	73.38	12.92	24.62
V3-18	3	20.24	20.24	15.66	12.92	23.92
V3-20	3	8.07	8.07	68.70	7.65	19.53
V3-21	3	8.07	8.07	73.38	7.65	24.62
V3-23	3	31.61	16.16	16.16	13.67	6.83
V3-25	3	6.72	6.72	68.70	7.17	19.53
V3-26	3	6.72	6.72	73.38	7.17	24.62
V3-29	3	23.00	23.00	68.70	12.83	19.53
V3-30	3	23.00	23.00	73.38	12.83	24.62
V3-34	3	22.50	22.50	73.38	12.83	24.62
Max		31.61	23.00	73.38	13.67	24.62
Min		6.72	6.72	15.66	7.17	6.83
Avg		16.51	15.53	64.73	10.77	21.71

Yellow highlighting indicates the bounding vehicles

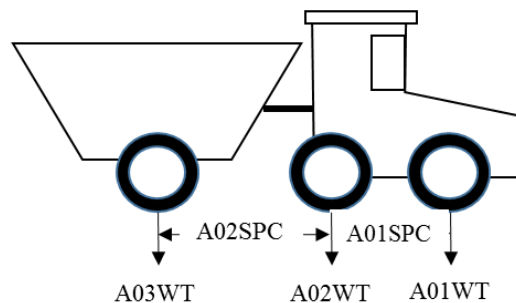

Figure 8. Three-axle husbandry vehicle

Table 2. Four-axle controlling vehicle for all bridges

Vehicle	Axles	A01WT (kips)	A02WT (kips)	A03WT (kips)	A04WT (kips)	A01SPC (ft)	A02SPC (ft)	A03SPC (ft)
V4-1	4	17.30	17.46	16.60	16.72	4.00	4.00	4.00
V4-2	4	20.17	20.17	43.51	43.51	11.48	21.87	6.50
V4-3	4	11.53	11.53	43.51	43.51	9.87	21.17	6.50
V4-4	4	18.84	18.66	43.51	43.51	11.25	21.50	6.50
V4-5	4	11.80	15.90	43.51	43.51	10.67	21.50	6.50
V4-8	4	20.17	20.17	36.18	36.18	11.48	24.99	5.58
V4-26	4	20.24	16.06	43.51	43.51	12.92	21.87	6.50
V4-31	4	8.07	8.07	43.51	43.51	7.65	21.87	6.50
V4-36	4	6.72	6.72	43.51	43.51	7.17	21.87	6.50
V4-41	4	23.00	23.00	43.51	43.51	12.83	21.87	6.50
Max		23.00	23.00	43.51	43.51	12.92	24.99	6.50
Min		6.72	6.72	16.60	16.72	4.00	4.00	4.00
Avg		15.78	15.77	40.09	40.10	9.93	20.25	6.16

Yellow highlighting indicates the bounding vehicle

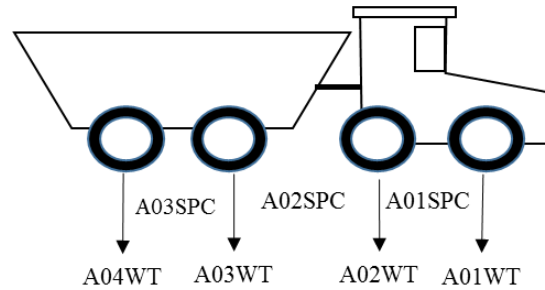

Figure 9. Four-axle husbandry vehicle

Table 3. Five-axle controlling vehicles for all bridges

Vehicle	Axles	A01WT (kips)	A02WT (kips)	A03WT (kips)	A04WT (kips)	A05WT (kips)	A01SPC (ft)	A02SPC (ft)	A03SPC (ft)	A04SPC (ft)
V5-1	5	20.17	20.17	34.44	34.44	34.44	11.48	18.62	6.50	6.50
V5-2	5	11.53	11.53	34.44	34.44	34.44	9.87	17.92	6.50	6.50
V5-3	5	18.84	18.66	34.44	34.44	34.44	11.25	18.00	6.50	6.50
V5-4	5	11.80	15.90	34.44	34.44	34.44	10.67	18.00	6.50	6.50
V5-5	5	20.17	20.17	24.83	24.83	24.83	11.48	24.28	5.17	5.17
V5-13	5	20.24	16.06	24.83	24.83	24.83	12.92	24.00	5.17	5.17
V5-15	5	20.24	16.06	34.44	34.44	34.44	12.92	18.62	6.50	6.50
V5-18	5	8.07	8.07	34.44	34.44	34.44	7.65	18.62	6.50	6.50
V5-19	5	6.72	6.72	24.83	24.83	24.83	7.17	24.00	5.17	5.17
V5-21	5	6.72	6.72	34.44	34.44	34.44	7.17	18.62	6.50	6.50
V5-22	5	23.00	23.00	24.83	24.83	24.83	12.83	24.00	5.17	5.17
V5-24	5	23.00	23.00	34.44	34.44	34.44	12.83	18.62	6.50	6.50
V5-27	5	22.50	22.50	34.44	34.44	34.44	12.83	18.62	6.50	6.50
Max		23.00	23.00	34.44	34.44	34.44	12.92	24.28	6.50	6.50
Min		6.72	6.72	24.83	24.83	24.83	7.17	17.92	5.17	5.17
Avg		16.39	16.04	31.48	31.48	31.48	10.85	20.15	6.09	6.09

Yellow highlighting indicates the bounding vehicles

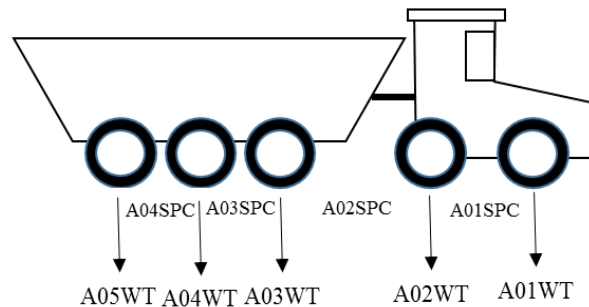

Figure 10. Five-axle husbandry vehicle

Note that all 121 husbandry vehicles were labeled according to the number of axles they had. In Tables 1 through 3, the first number denotes the number of axles and the second number represents the vehicle's number. For example, the notation V5-1 refers to the first five-axle vehicle (listed in Table 3). Note that only three-, four-, and five-axle farm vehicles were found to be control vehicles.

By critically evaluating the characteristics of these controlling vehicles, test vehicles were developed based upon similarities and trends. A few of the husbandry vehicles controlled in most locations on most bridges, and these vehicles are highlighted in the tables above. The test vehicles shown in Figures 11 through 13 were then generally modeled after these controlling husbandry vehicles. Variable spacing was incorporated into the test vehicles to account for the varied spacing in the original husbandry vehicles.

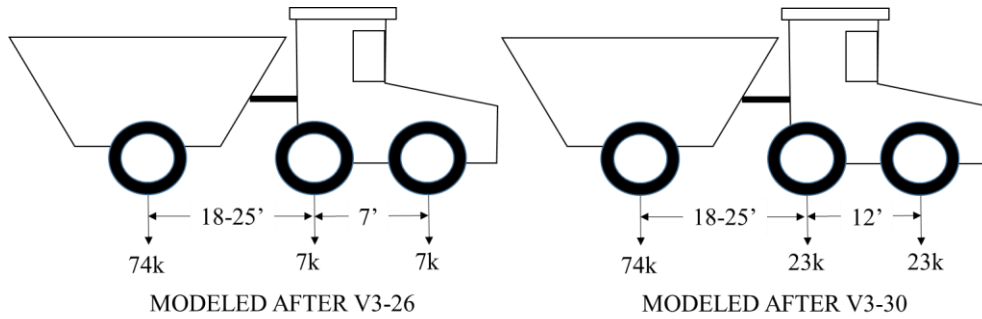

Figure 11. Three-axle controlling vehicles

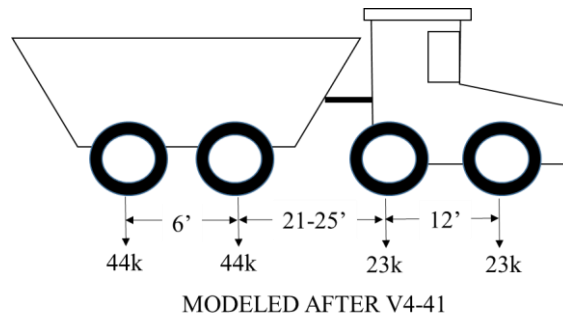

Figure 12. Four-axle controlling vehicle

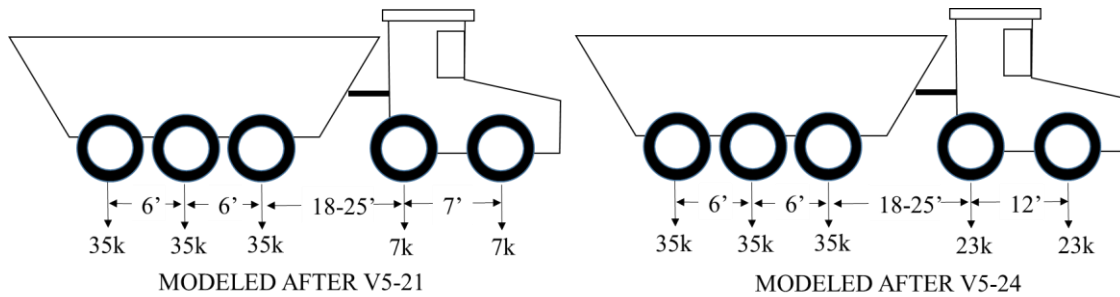

Figure 13. Five-axle controlling vehicles

2.4 Generic Agricultural Rating Vehicles

The test vehicles were slightly modified to create generic agricultural rating vehicles that would envelope the original 121 husbandry vehicles, identified as AV3, AV4, and AV5, as shown in Figures 14 through 16, respectively.

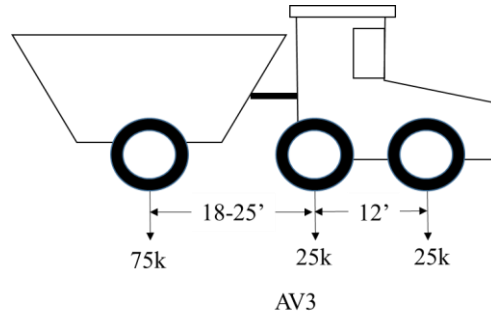

Figure 14. Three-axle generic agricultural rating vehicles, AV3

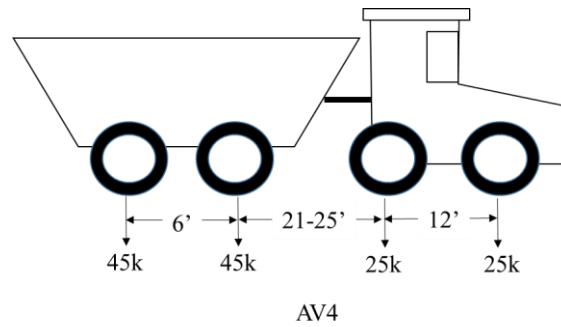

Figure 15. Four-axle generic agricultural rating vehicle, AV4

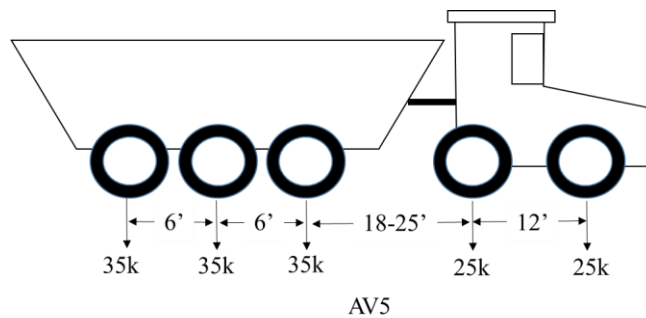

Figure 16. Five-axle generic agricultural rating vehicles, AV5

The generic vehicles were analyzed as previously described to assess whether they would bound the moment envelopes of the 121 husbandry vehicles. Existing rating and posting vehicles were also analyzed for comparison with the husbandry vehicles and the generic agricultural vehicles. Again, all vehicles were run from left-to-right and from right-to-left.

2.5 Moment Ratios

The comparisons for all the vehicles were evaluated using moment ratios at critical locations along the bridge spans. This methodology for evaluating notional vehicles was adopted from a similar study, conducted by John Kulicki and Dennis Mertz (Kulicki and Mertz 1991), which altered the AASHTO loading specifications into their present form, that is, HL-93. Only simply

supported and two-span bridges were considered in Kulicki's study, with the critical location for the simply supported bridge selected at midspan (0.5L), and for the two-span bridge at four-tenths of the span length from each end of the bridge (0.4L) and at the interior support. Those same locations were used for this study, as shown in Figures 4 and 5. For the three-span bridges utilized in this study, the critical locations were four-tenths the span length from each end of the bridge (0.4L), the interior supports, and half of the middle span (0.5L), as shown in Figure 6. The locations used for four-span bridges were four-tenths the span length from each end of the bridge (0.4L), the interior supports, and midspan for the center spans (0.5L), as shown in Figure 7. It should be pointed out that the dynamic impact factor and live load distribution factor are not included in the moment ratio calculation. In other words, the IM and LLDF are taken as being the same for all types of vehicles.

2.5.1 Generic Agricultural versus Husbandry Vehicle Comparison Results

As with Kulicki's study, the moment ratio between the proposed generic agricultural vehicle moment and maximum moment of the 121 existing husbandry vehicles at each location was calculated using Equation 1. The three-axle generic agricultural vehicles (AV3) were compared only to the three-axle vehicles included in the 121 existing husbandry vehicles, the AV4 only to the four-axle husbandry vehicles, and the AV5 only to the five-axle husbandry vehicles.

$$MR_{AV3} = \frac{M_{AV3}}{M_{3-axle}} \quad (1)$$

Where M_{AV3} is the maximum moment from the AV3 vehicle at the critical location and M_{3-axle} is the maximum moment for the three-axle husbandry vehicles at the critical location.

Moment ratios were calculated at the critical locations for all bridges. To display how the vehicles compare, the highest and lowest moment ratios of all AV vehicles at all critical locations were plotted for each bridge for one-, two-, three-, and four-span bridges, respectively, as shown in Figures 17 through 20. These figures indicate that the AV vehicles bound the husbandry vehicles, as both the minimum and maximum ratios are above or very near one in all cases.

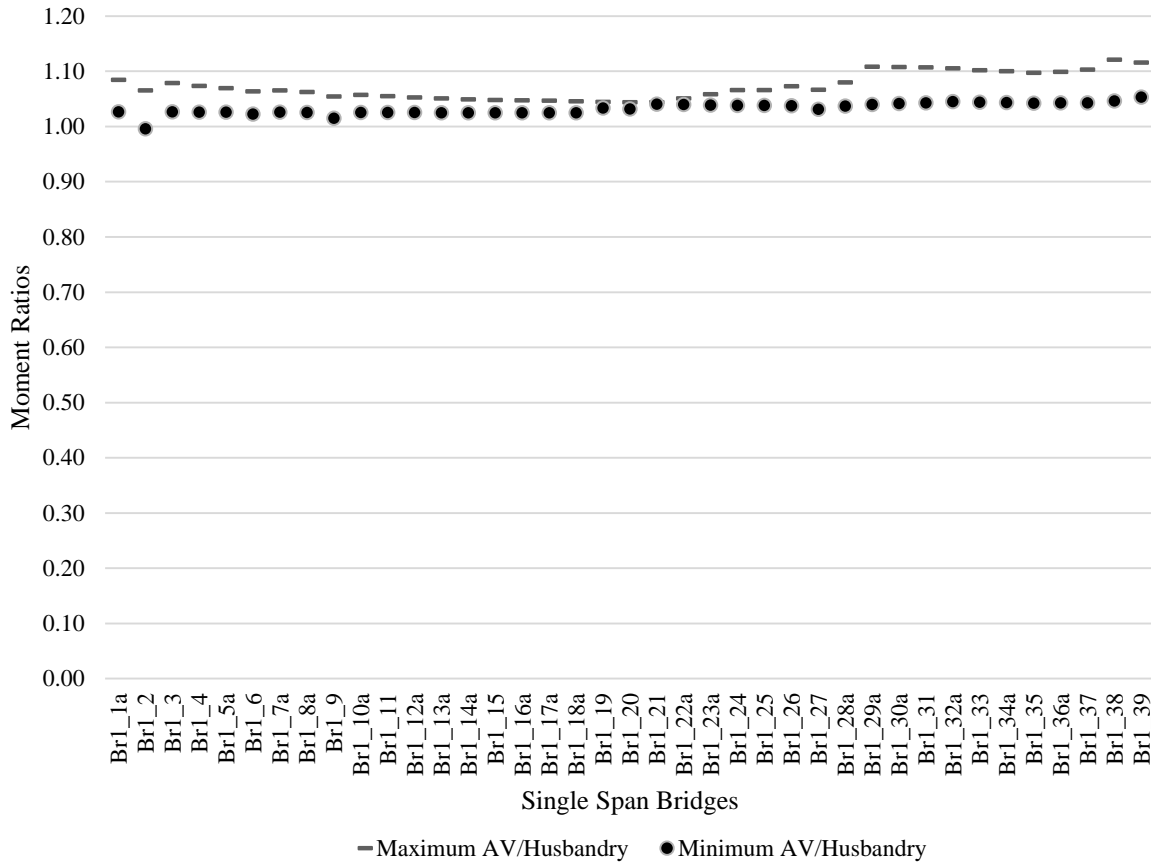

Figure 17. Moment ratio plot for AV/husbandry for single-span bridges

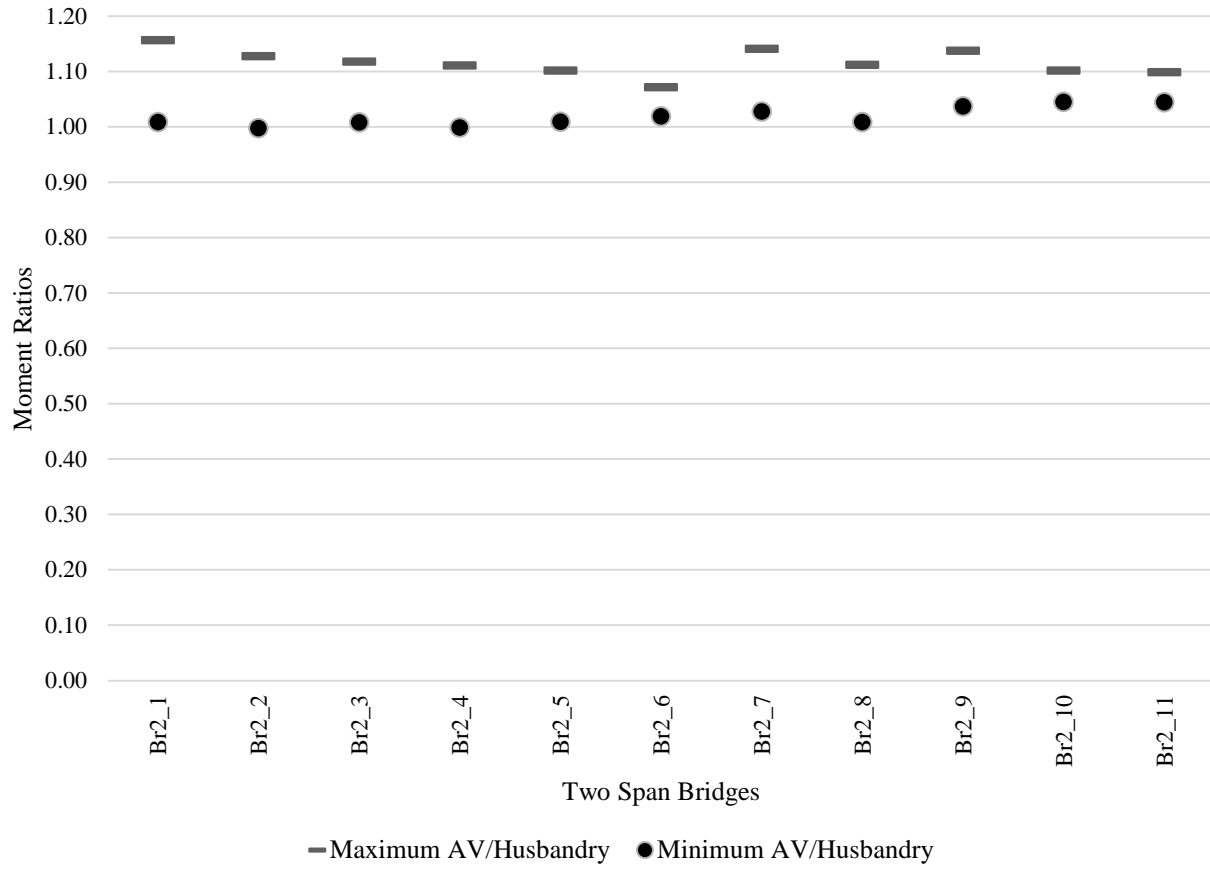

Figure 18. Moment ratio plot for AV/husbandry for two-span bridges

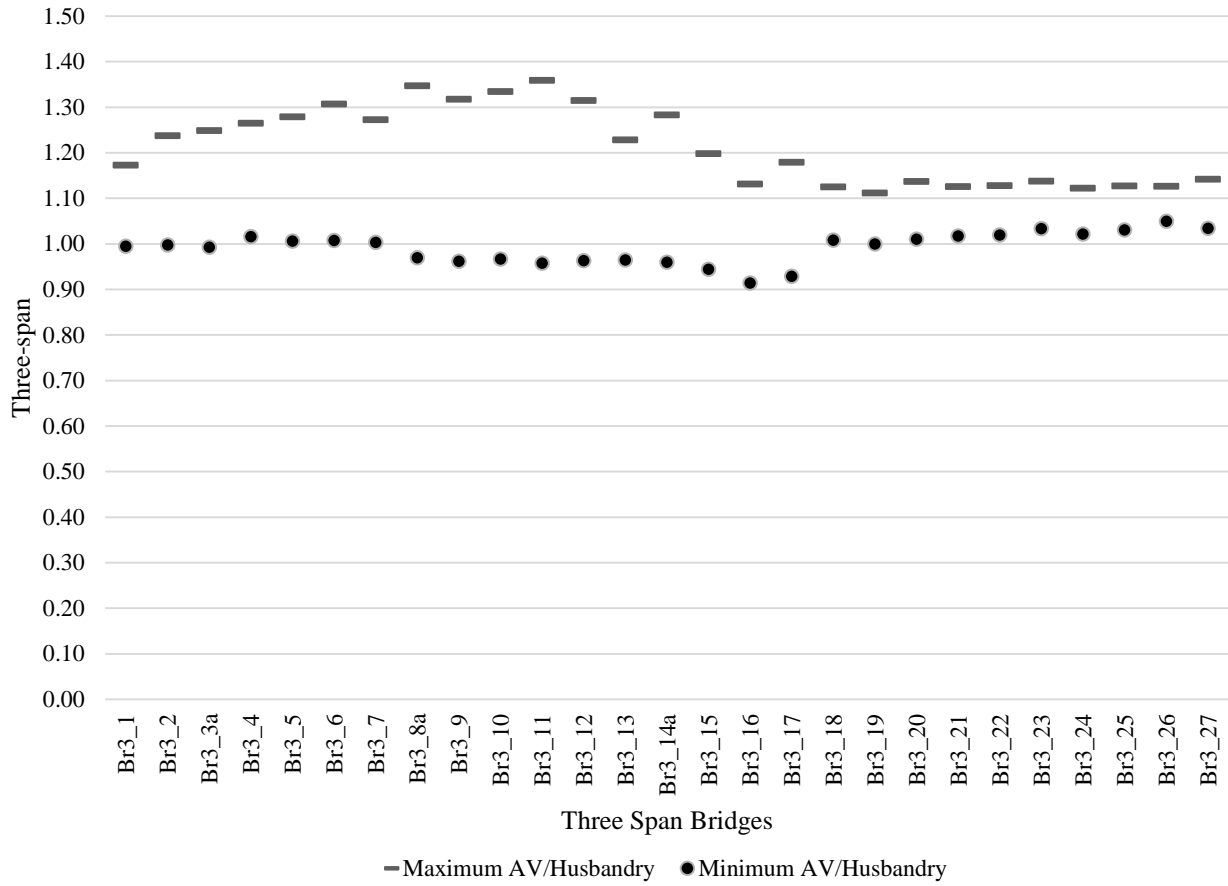

Figure 19. Moment ratio plot for AV/husbandry for three-span bridges

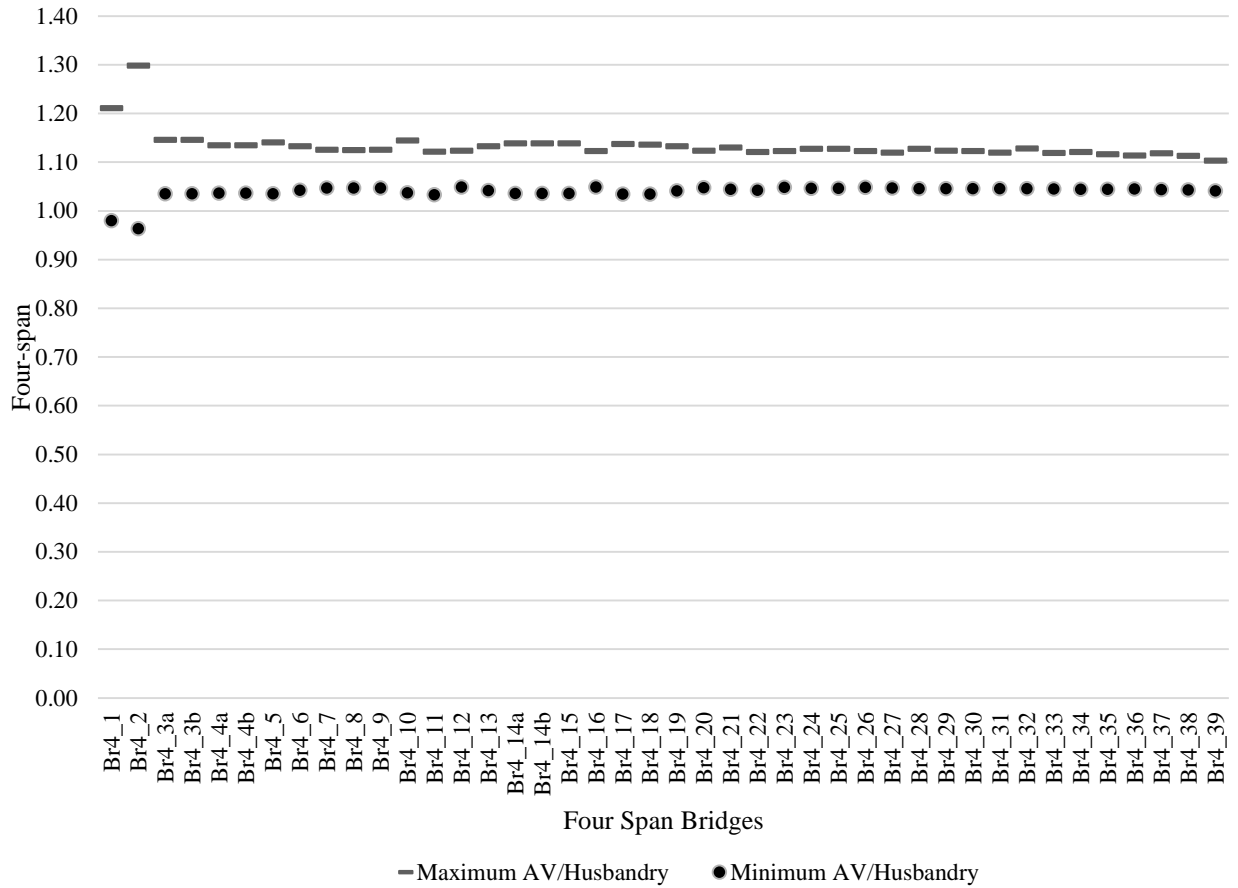

Figure 20. Moment ratio plot for AV/husbandry for four-span bridges

In a few locations on the three- and four-span bridges, the moment ratio values for the AV vehicles fell below 1.0. The lowest moment ratio value of 0.91 is for Bridge3_16 in Figure 19. The moment value is produced by the negative moment of the 25 foot AV3 vehicle (Figure 14), and vehicle V3-26 (Figure 11), at 0.4L on the first span. Figure 18 illustrates the moment envelope for only these two vehicles and shows that the 0.4L point of the first span is more critical for positive moment.

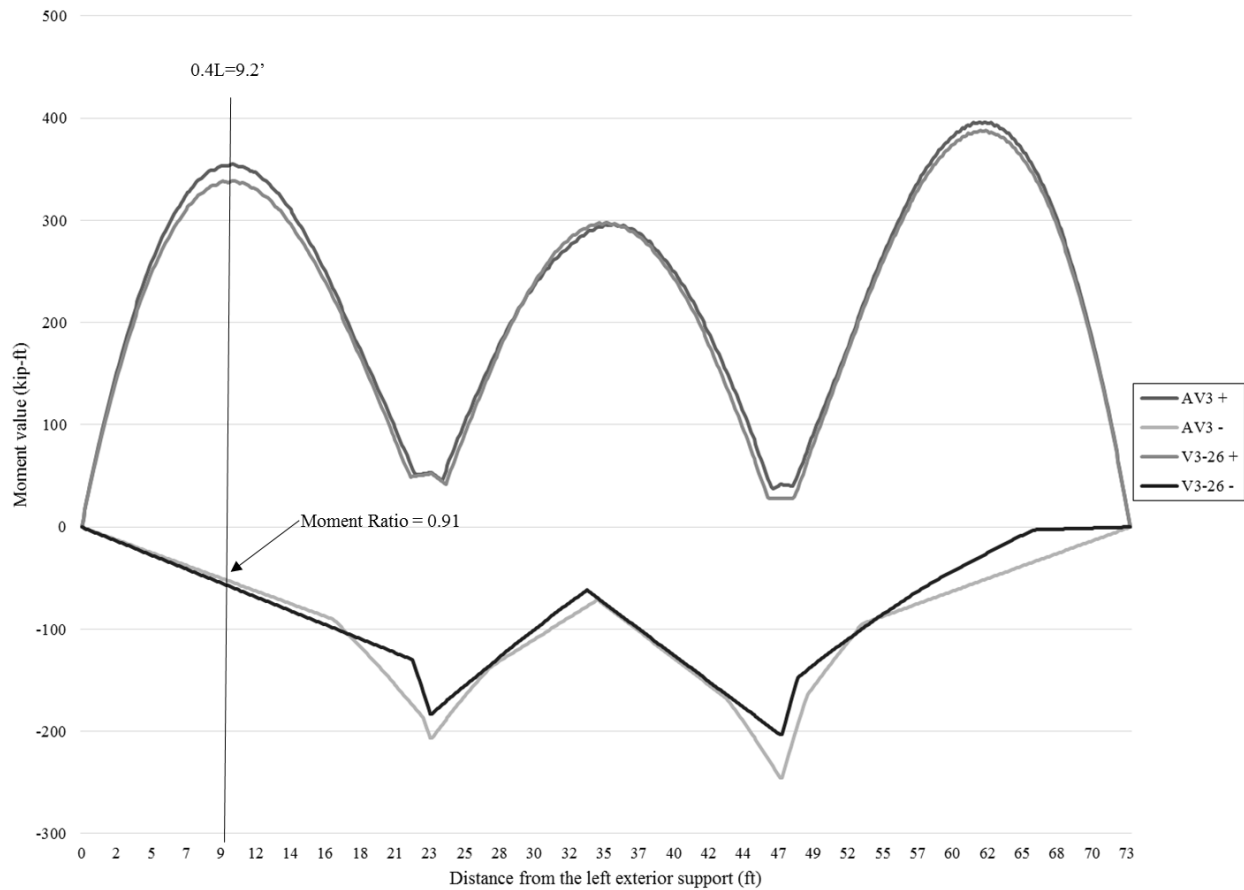

Figure 21. Bridge3_16 moment envelopes for AV3 and V3-26

The other three-span bridge moment ratios that fell below 1.0 were also for the negative moment at 0.4L of the first span and are connected to the same two vehicles. This 0.4L location is usually more critical for positive moments and the negative moment is usually less critical, so this non-conservativeness seems acceptable. Therefore, the AV vehicles serve as an acceptable bound for the husbandry vehicles.

2.5.2 Rating and Posting Vehicles versus Husbandry Vehicle Comparison Results

Very similar to the way moment ratios were calculated for the AV vehicles, moment ratios for existing rating and posting vehicles were also calculated. The only difference in the calculations was that the moments at the critical locations for the rating or posting vehicle were compared to the moments of all husbandry vehicles combined and were not separated into three-, four-, and five-axle vehicles. Equation 2 shows the formula for the moment ratio of the HS20 truck. All other rating and posting vehicles were calculated in a similar fashion.

$$MR_{HS20} = \frac{M_{HS20}}{M_{All}} \quad (2)$$

Where M_{HS20} is the maximum moment of the HS20 at the critical location and M_{All} is the maximum moment of all the husbandry vehicles at the critical location.

Figures 22 through 25 provide the moment ratios for the rating and posting vehicles shown in Figures 2 and 3 for one-, two-, three-, and four-span bridges. Only the maximum ratios for each vehicle are shown.

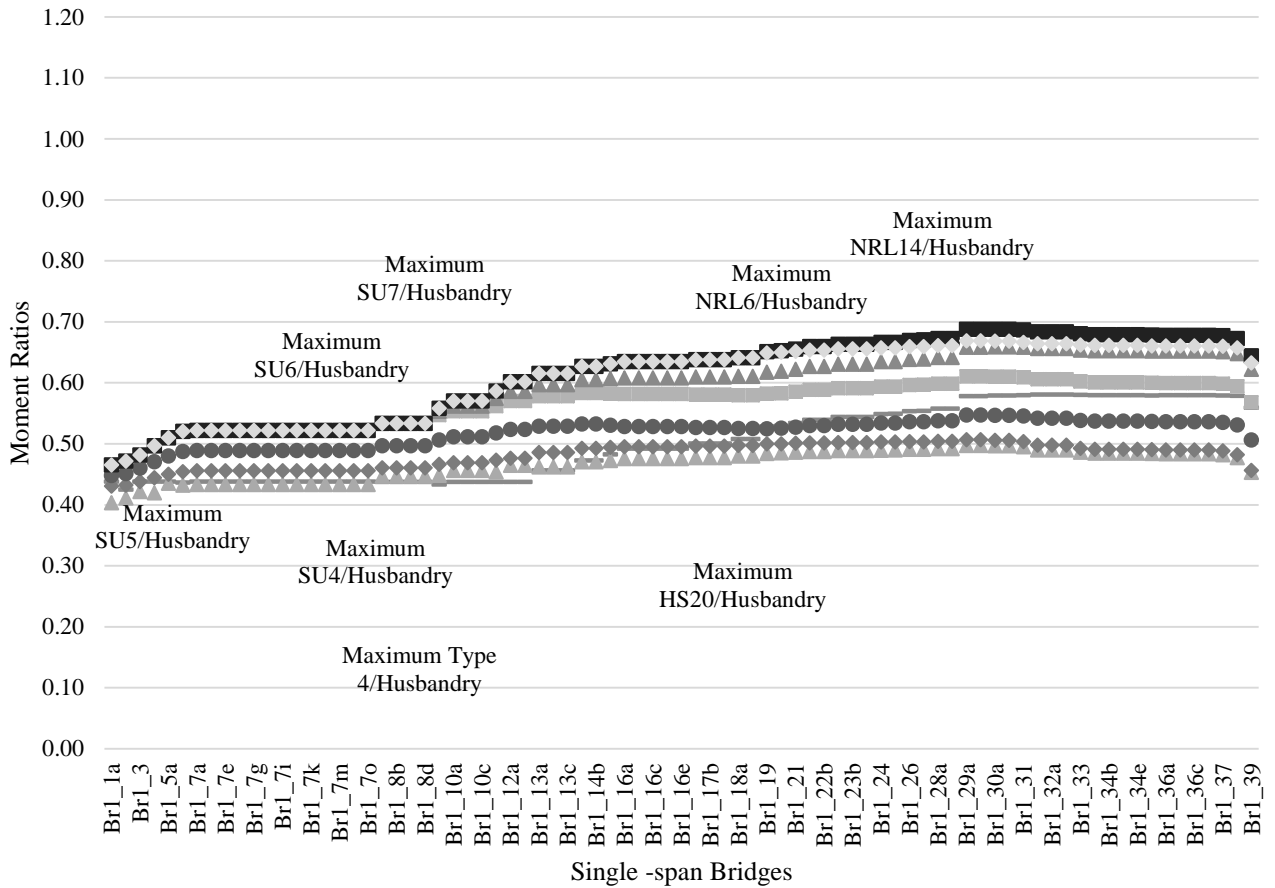

Figure 22. Moment ratios for rating and posting husbandry vehicles for single-span bridges

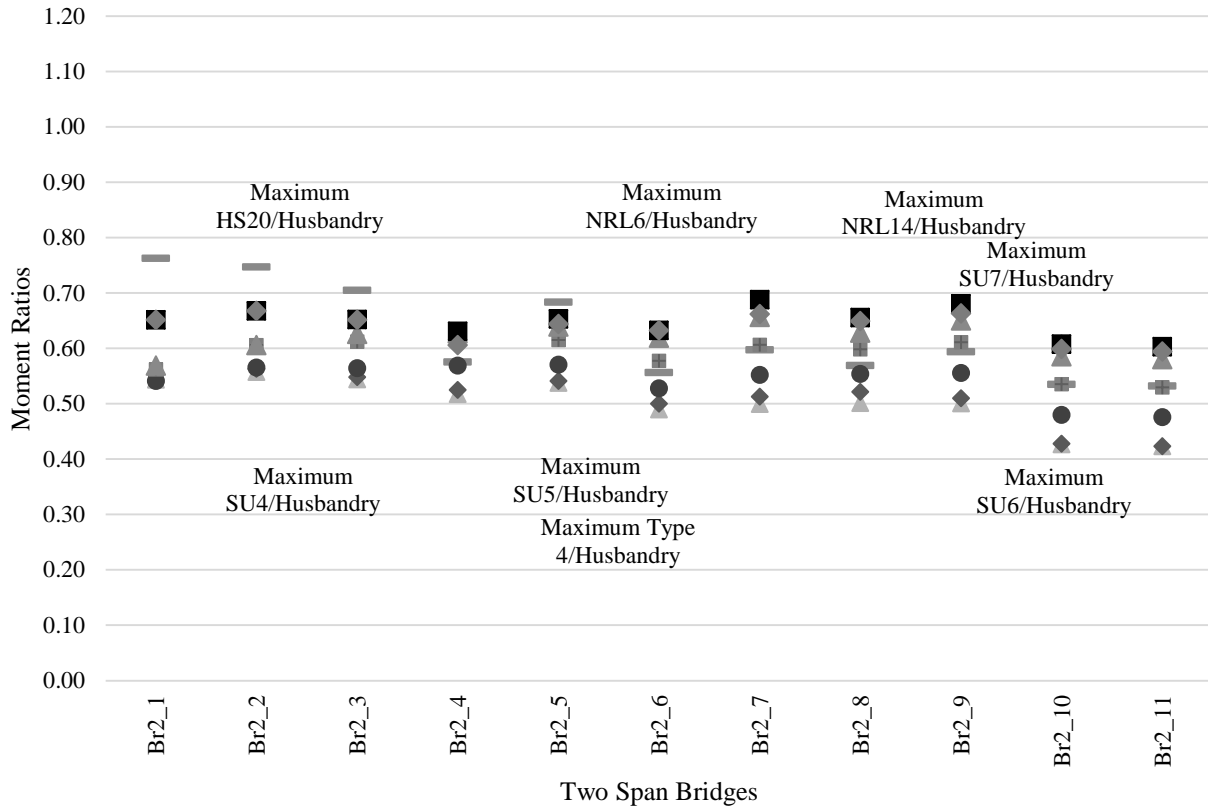

Figure 23. Moment ratios for rating and posting husbandry vehicles for two-span bridges

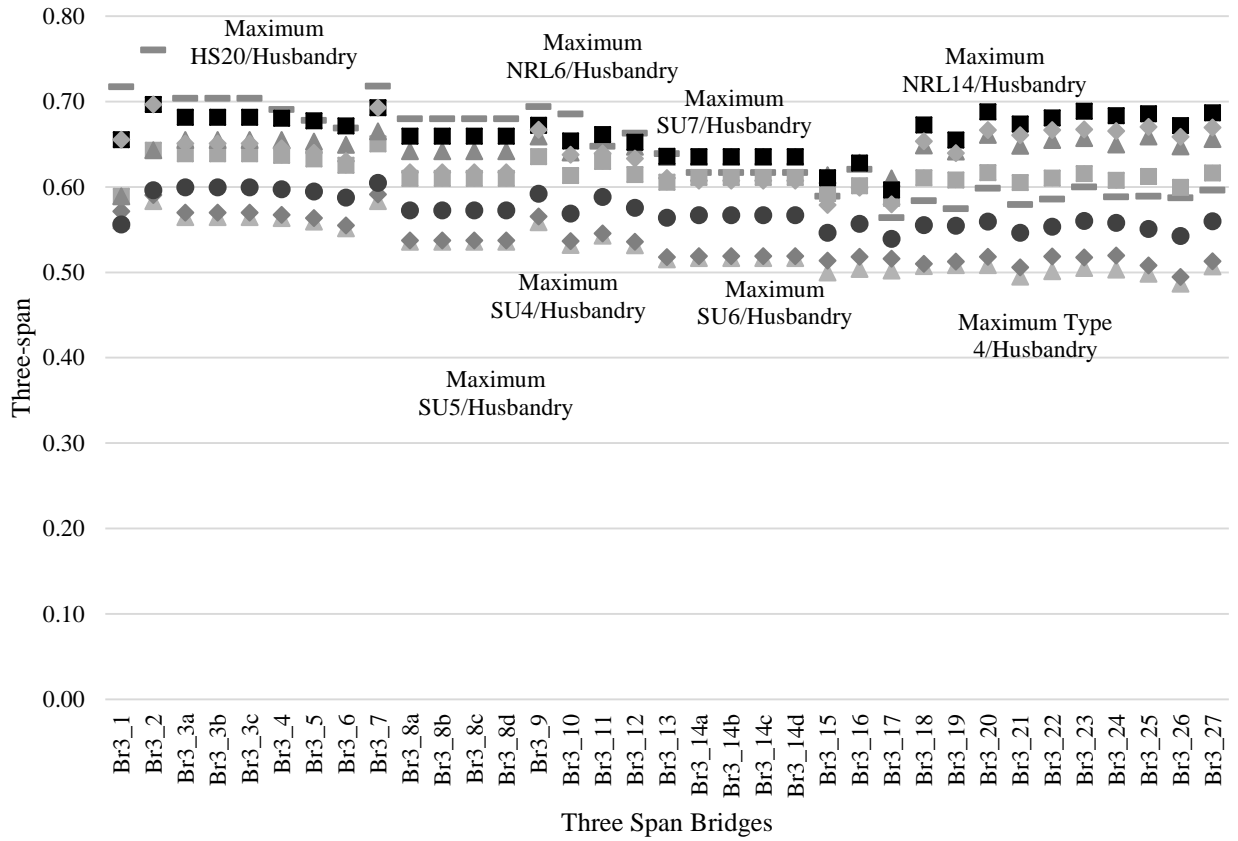

Figure 24. Moment ratios for rating and posting husbandry vehicles for three-span bridges

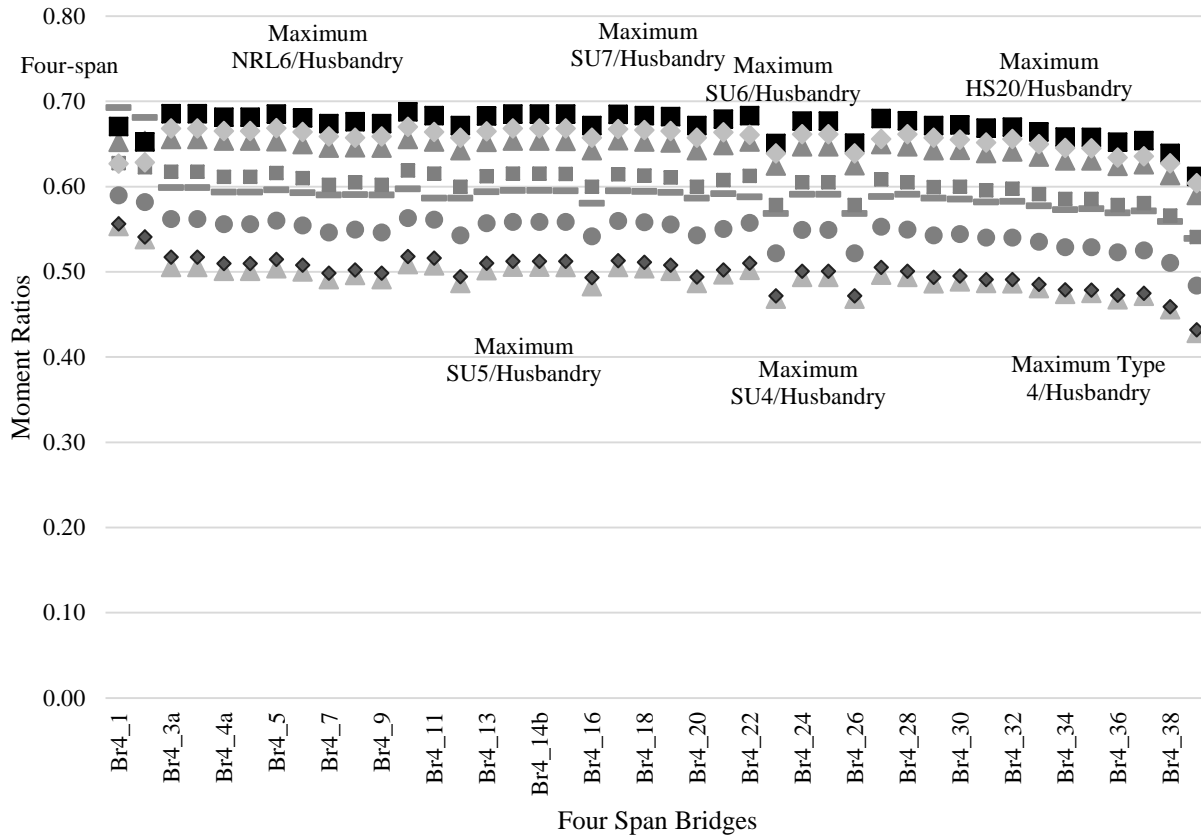

Figure 25. Moment ratios for rating and posting husbandry vehicles for four-span bridges

Unlike with the AV vehicles, the rating and posting vehicles have moment ratios significantly less than one. This indicates that current vehicles used to determine bridge ratings and postings do not always capture the effects of implements of husbandry (when neglecting differences in distribution factor and/or dynamic impact factor).

3. OPERATING RATINGS, OPERATING RATING RATIOS, AND LEGAL AGRICULTURAL VEHICLE MODELS

3.1 Operating Ratings and Operating Rating Ratios

Operating level load ratings generally describe the maximum permissible live load which a bridge may carry. This is known as the bridge's operating rating (OR) and is determined by Equation 3. It comes from multiplying the bridge rating factor (RF) by the rating vehicle weight. For example, the operating rating for an HS20 is given as follows:

$$OR_{HS20} = (RF_{HS20})(W_{HS20}) \quad (3)$$

Where the RF_{HS20} is the rating factor for an HS20 truck and W_{HS20} is the weight of the HS20 truck. The rating factor for a bridge for an HS20 truck is provided in Equation 4:

$$RF_{HS20} = \frac{(\phi M_n - \gamma_{DL} M_{DL})}{(\gamma_{LL})(M_{HS20})} \quad (4)$$

Where ϕM_n is the bridge moment capacity at the critical section, γ_{DL} is an adjustment factor for dead load moment capacity, M_{DL} is the bridge dead load moment at the critical section, γ_{LL} is an adjustment factor for live load moment capacity, and M_{HS20} is the moment produced by the HS20 truck at the critical section.

Because the HS20 truck is not a real truck that operates on these bridges, it is helpful to know the operating ratings for other types of vehicles. If it is assumed that the critical section for the vehicle for which the operating rating is desired occurs at the same location as the HS20, then a relationship between the operating rating for the HS20 and the operating rating for the vehicle of interest can be generated, as detailed in Equation 5. With this assumption and the assumption that the two vehicles have the same live load distribution factor and/or impact factor, the estimated operating ratings for other vehicles, V , are given as follows:

$$OR_V = \frac{(OR_{HS20})(M_{HS20})(W_V)}{(W_{HS20})(M_V)} \quad (5)$$

Where OR_V is the operating rating for the vehicle of interest, OR_{HS20} is the operating rating for the HS20 truck, M_{HS20} is the moment at the critical section produced by the HS20 truck, W_V is the weight of the vehicle of interest, W_{HS20} is the weight of an HS20 truck, and M_V is the moment at the critical section produced by the vehicle of interest. The operating rating for the HS20 is known for 158 of the 174 bridges from the bridge inventory in Appendix E of Volume III.

If two operating ratings were calculated for a bridge, the vehicle that produced the lower operating rating would control the rating and/or posting. One way to compare operating ratings is to define operating rating ratios (OR ratios):

$$\text{OR Ratio} = \frac{\text{OR}_{\text{AV}}}{\text{OR}_{\text{Rating or Posting Vehicle}}} \quad (6)$$

In this calculation, the dynamic impact factor and LLDF are assumed to be the same for all vehicles.

Because the goal is to determine if AV vehicles need to be used for posting, OR ratios of interest are the operating ratings of the AV3, AV4, and AV5 vehicles divided by the operating ratings of the rating and posting vehicles. If an OR ratio is less than one, the AV vehicle would control the rating/posting; likewise, if the OR ratio is greater than one, then the current posting or rating vehicle would control the rating/posting. Figures 26 through 28 depict the OR ratios for AV3, AV4, and AV5, respectively, for the one-span bridges.

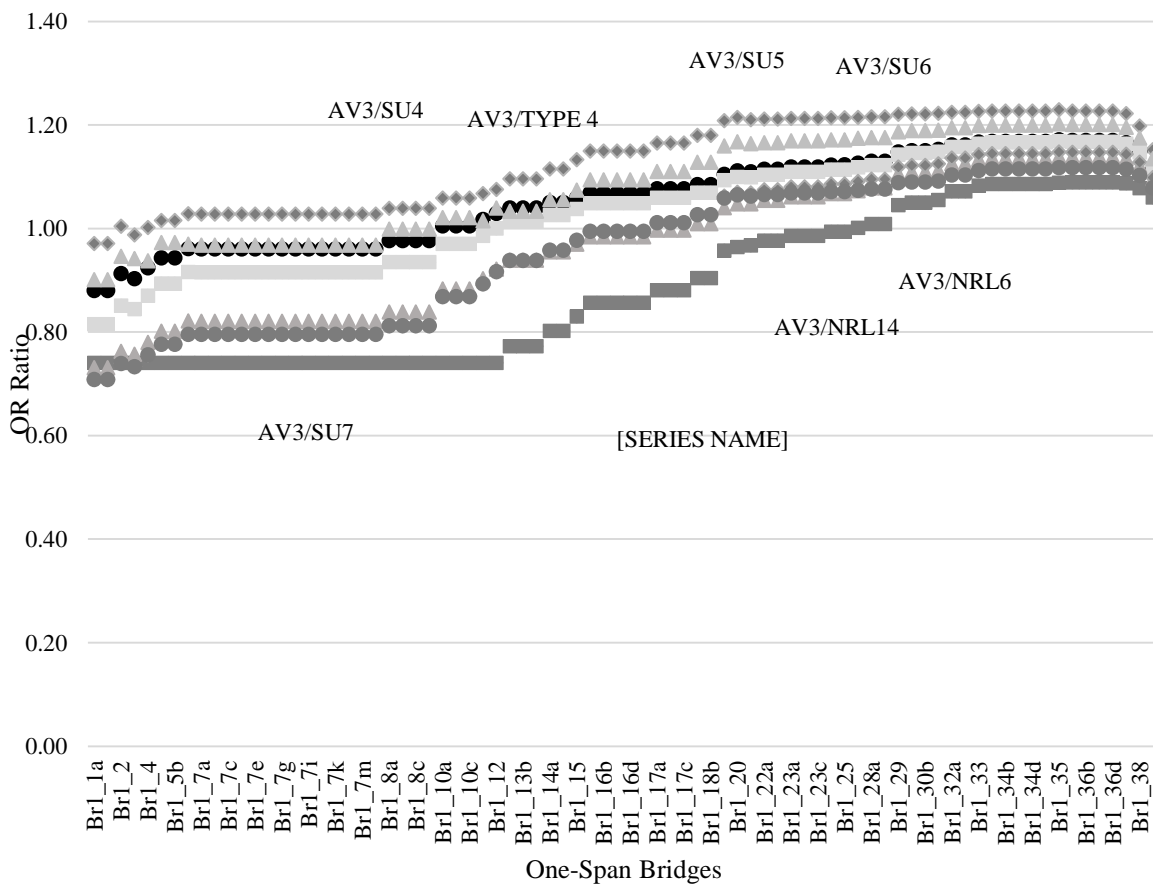

Figure 26. AV3 ratios for one-span bridges

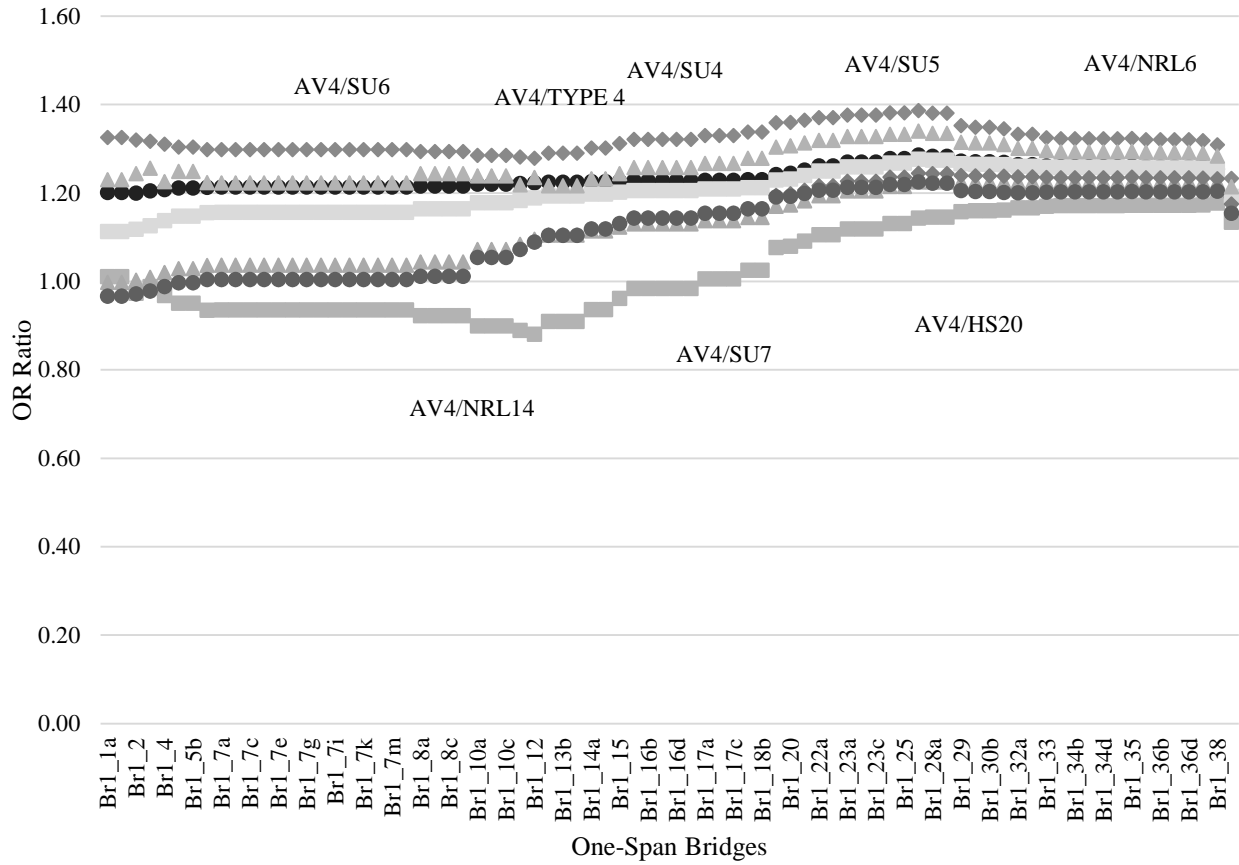

Figure 27. AV4 ratios for one-span bridges

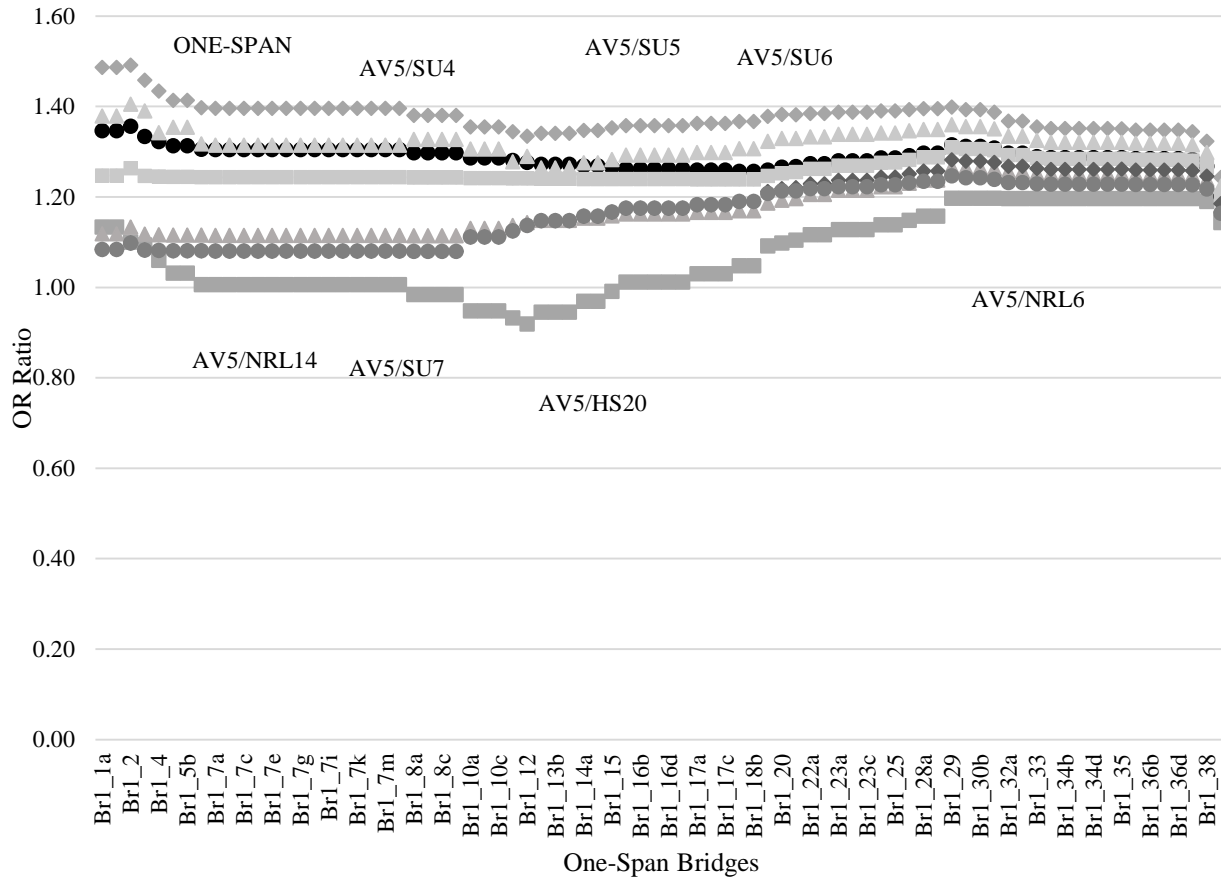

Figure 28. AV5 ratios for one-span bridges

For all one-span bridges, several of the AV ratios are less than one; however, for those ratios that are less than one, AV3 is the minimum. For example AV3/HS20, AV4/HS20, and AV5/HS20 are all less than 1 for bridge Br1_12 (0.74, 0.88, and 0.92, respectively), but the AV3 ratio is the smallest; therefore, AV3 would control the rating for this bridge. Although HS20 is a rating vehicle, the same explanation holds true for posting vehicles (SU4, SU5, SU6, SU7, and Type 4) as well; however, rather than having a value less than one controlling the rating, a value less than one would instead indicate that the AV3 controls the bridge posting, if the bridge needs to be posted for all these vehicles (i.e., all AVs and all rating and posting vehicles). With regard to posting for this bridge, the OR ratios of AV3/SU4, AV4/SU4, and AV5/SU4 are generally greater than one, so none of the AV vehicles would control the posting (if this bridge has been posted for SU4). For two-span and three-span bridges (Figures 29 through 31 and Figures 32 through 34, respectively), where this phenomenon occurs, the result is the same as with the one-span bridges; that is, the AV3 controls the posting or rating over AV4 and AV5.

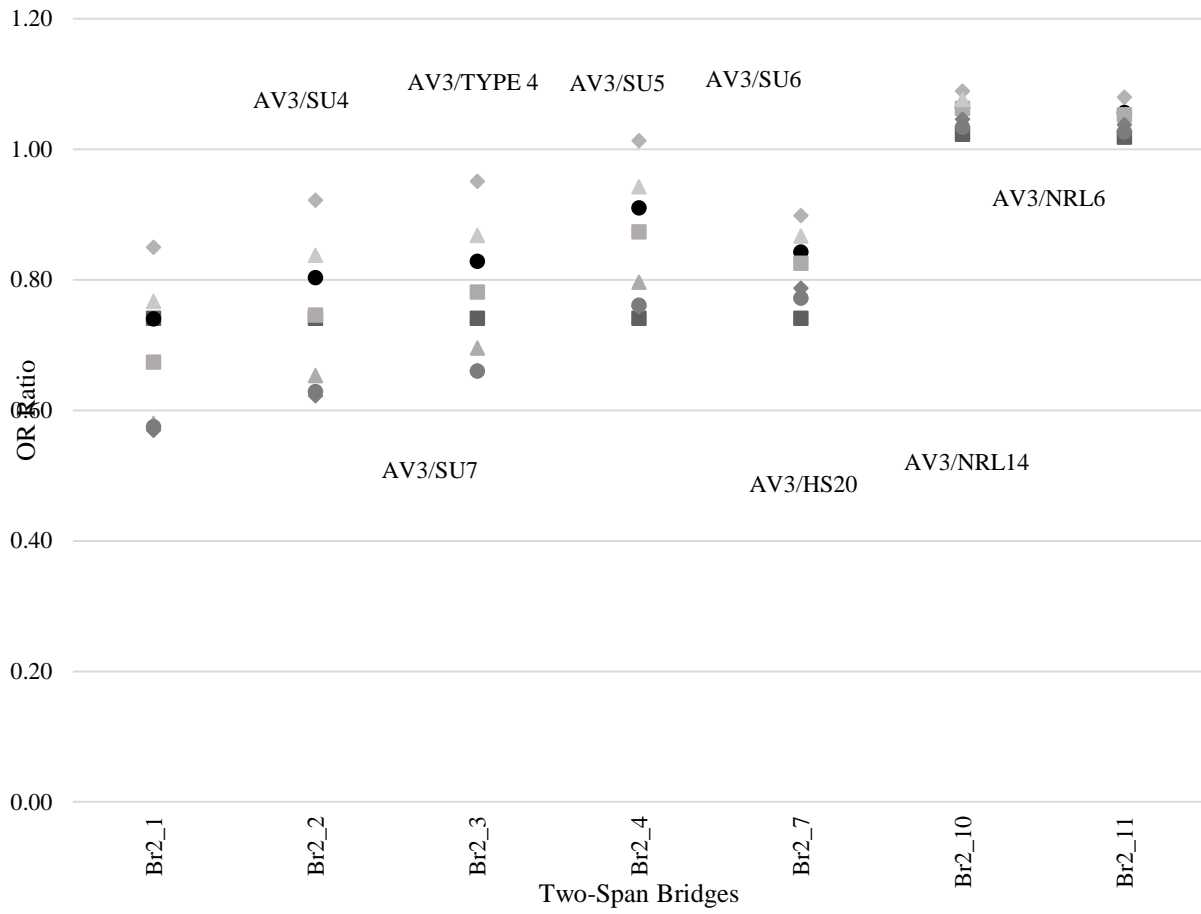

Figure 29. AV3 ratios for two-span bridges

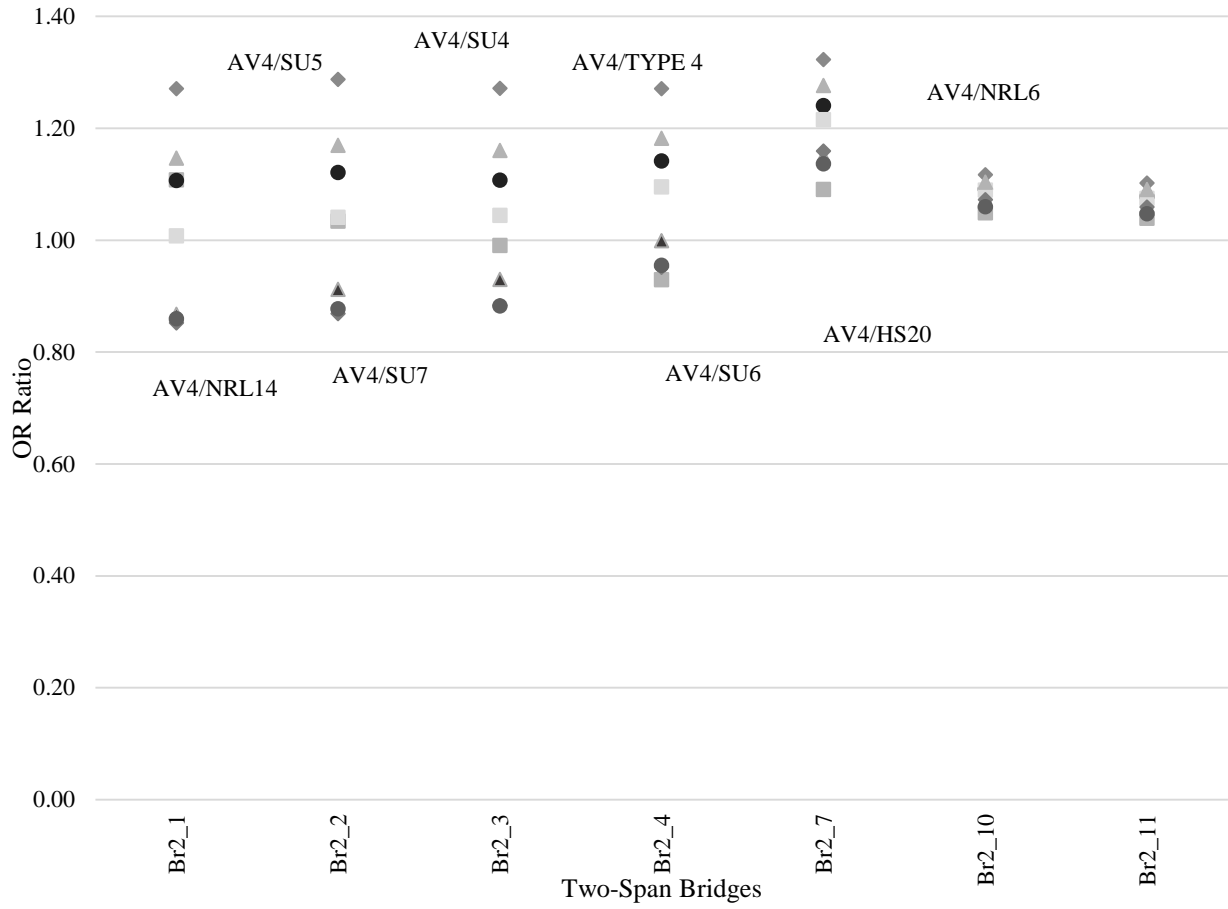

Figure 30. AV4 ratios for two-span bridges

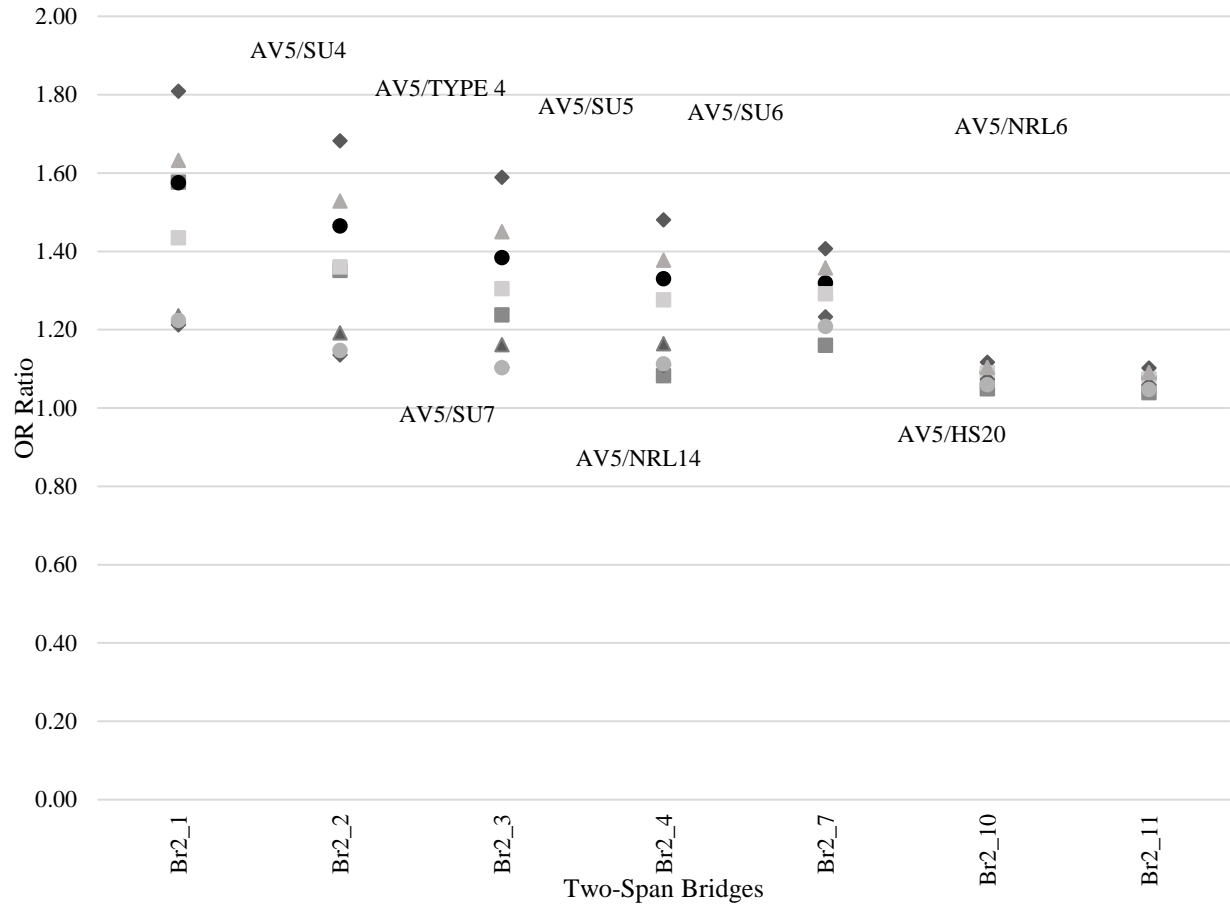

Figure 31. AV5 ratios for two-span bridges

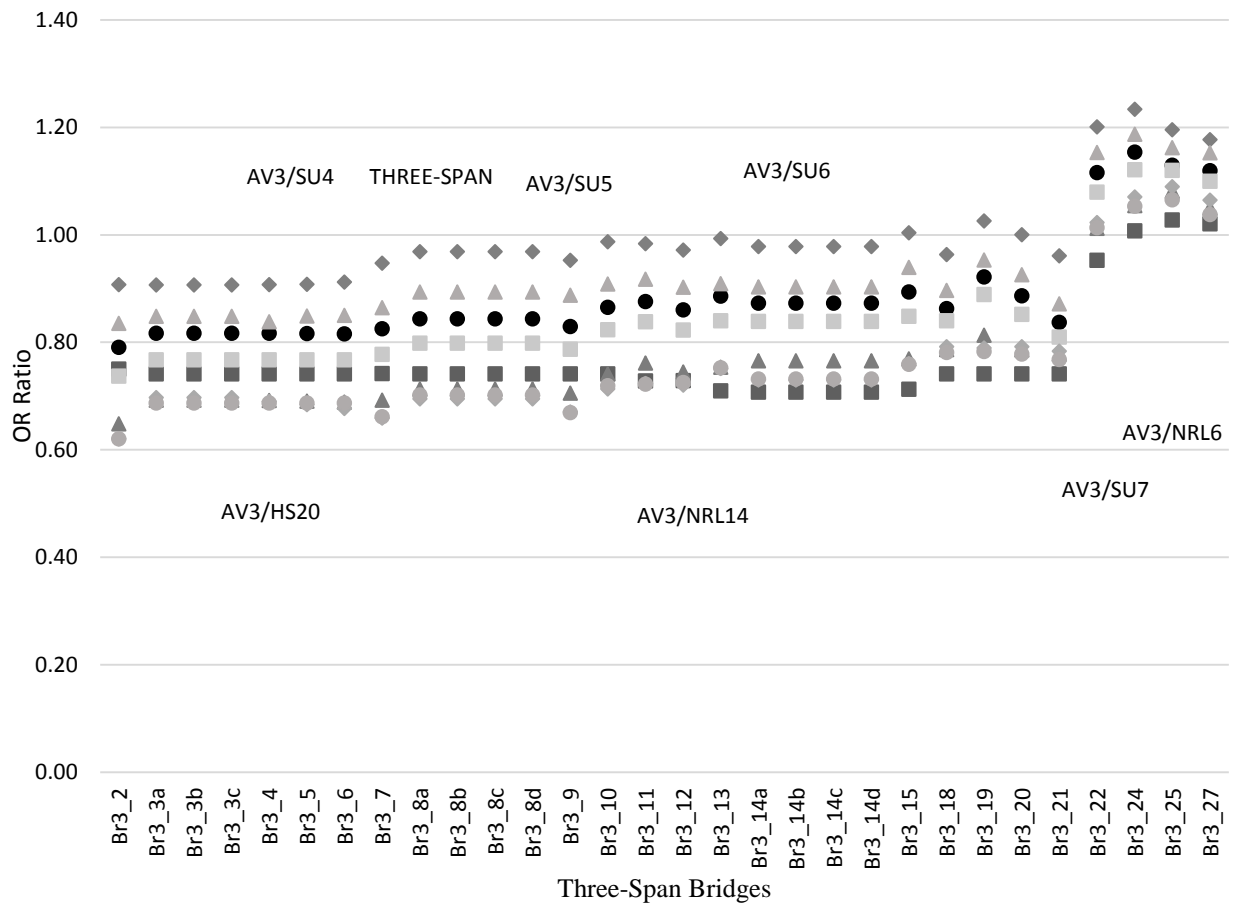

Figure 32. AV3 ratios for three-span bridges

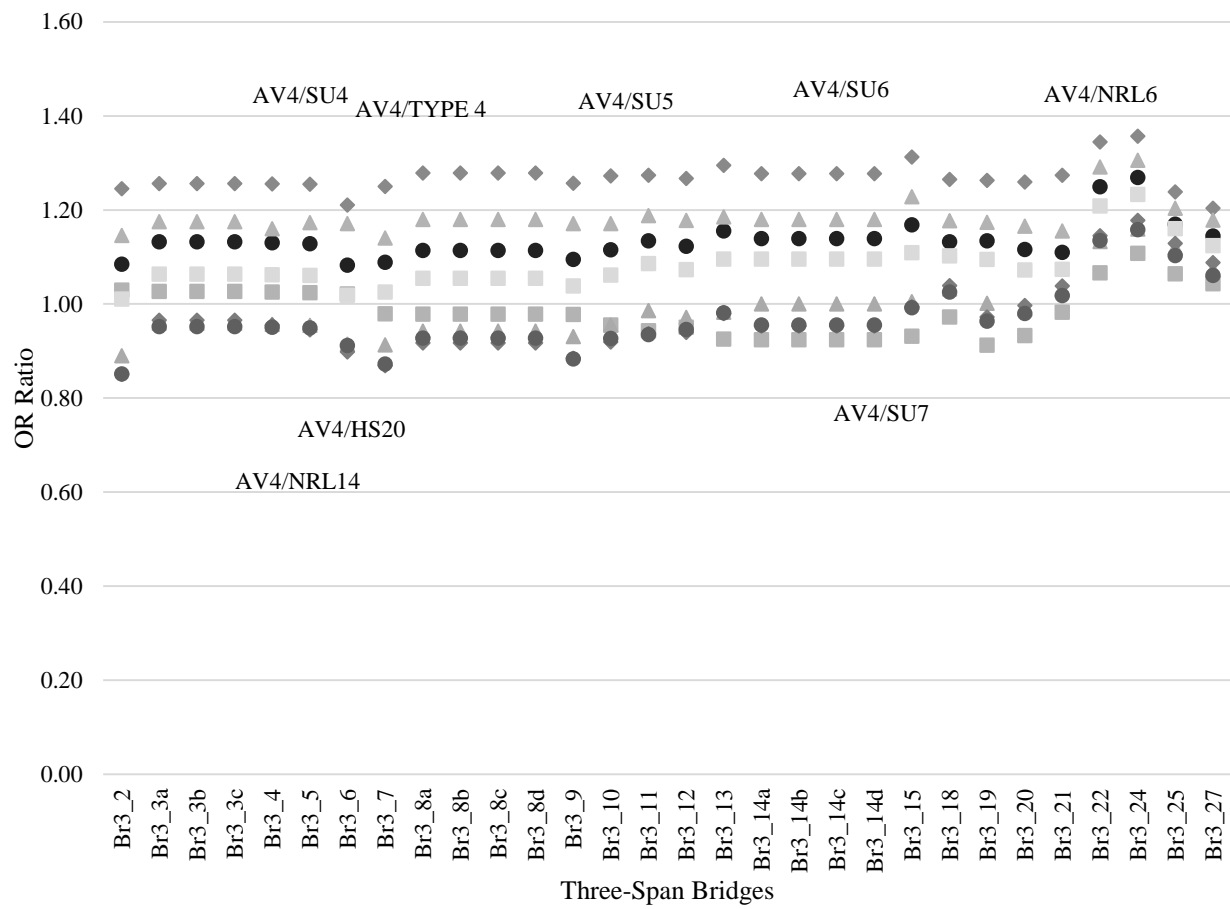

Figure 33. AV4 ratios for three-span bridges

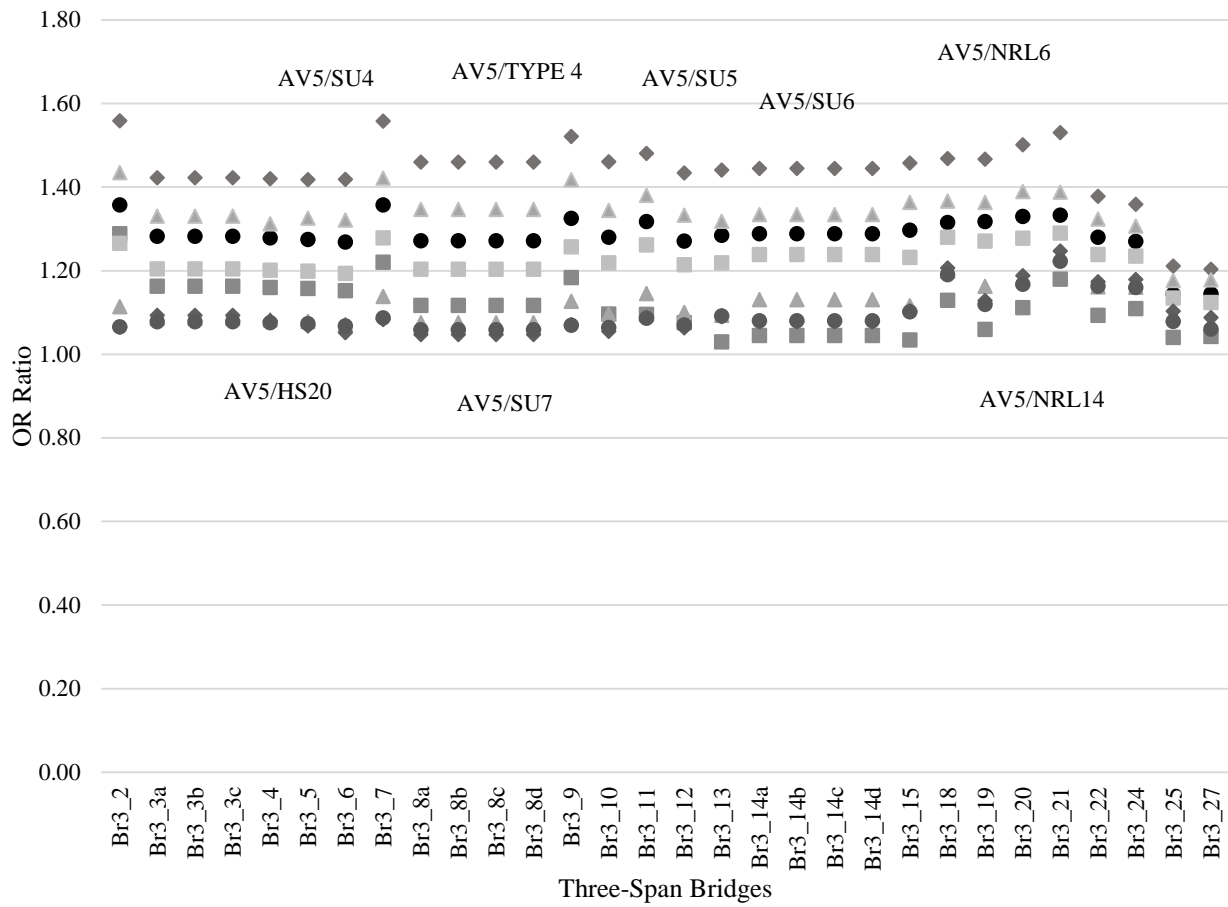

Figure 34. AV5 ratios for three-span bridges

In several of these cases, the AV3/SU4 OR ratio is less than one and the AV3 vehicle would control the posting. The AV3 controls the AV rating for the four-span bridges in all but two instances (Figures 35 through 37).

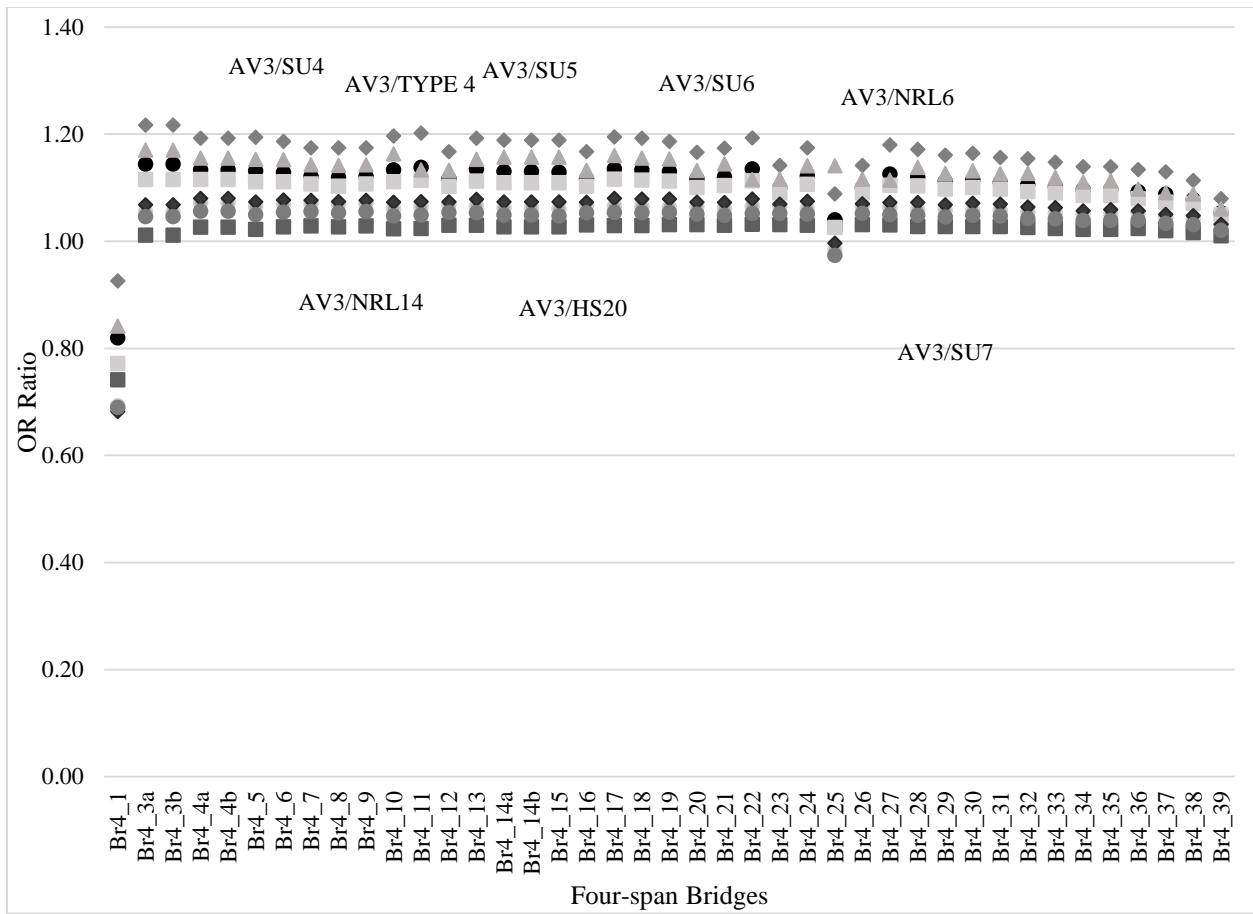

Figure 35. AV3 ratios for four-span bridges

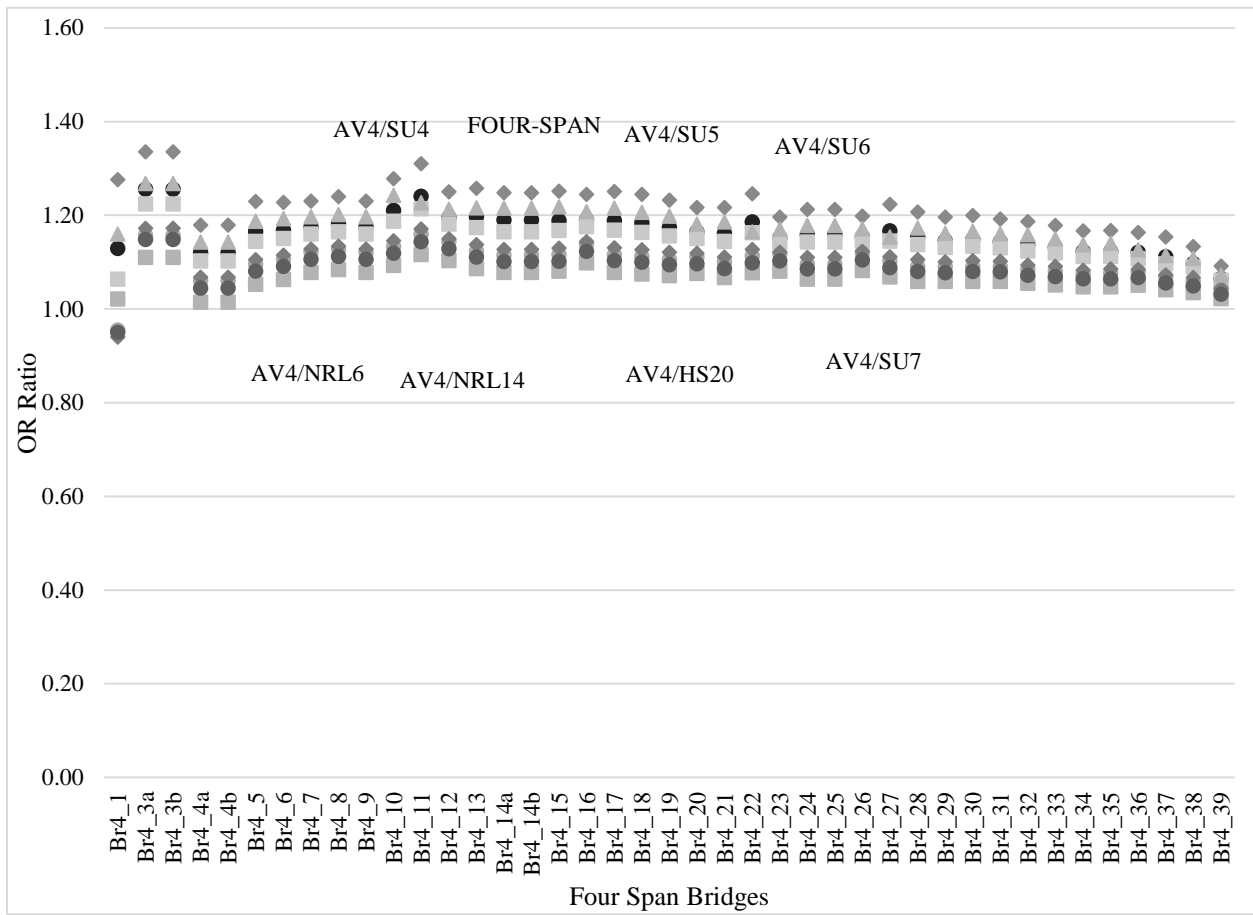

Figure 36. AV4 ratios for four-span bridges

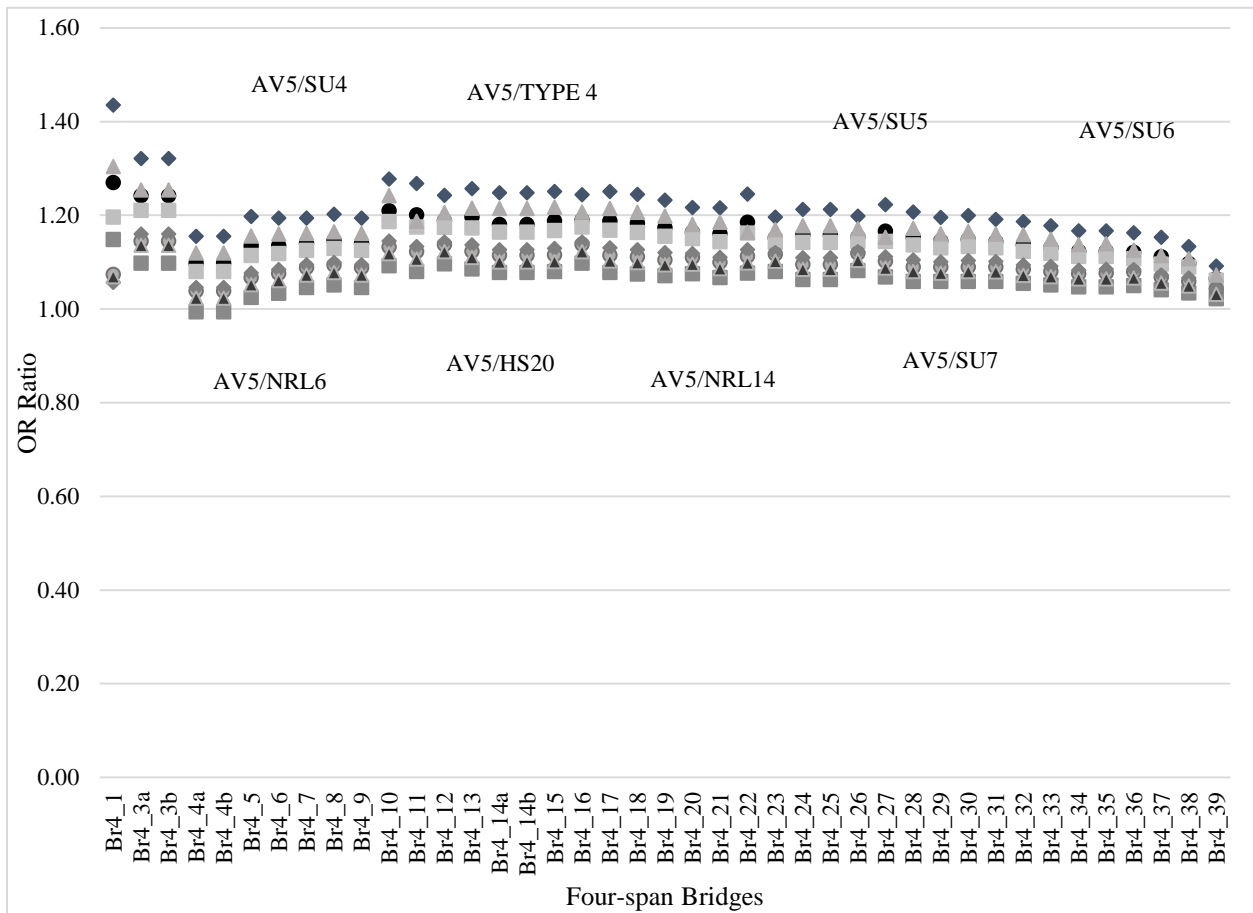

Figure 37. AV5 ratios for four-span bridges

These two instances include the AV/HS20 for Bridges Br4_4a and Br4_4b. For these two cases, the minimum AV ratio is controlled by AV5; however, the ratio for all four is equal to 0.99 – very near one. The SU4 controls the posting for the four-span bridges, except for Br4_1.

Figures 38 through 40 show the AV3, AV4, and AV5 versus the minimum span length for one-, two-, three-, and four-span bridges combined.

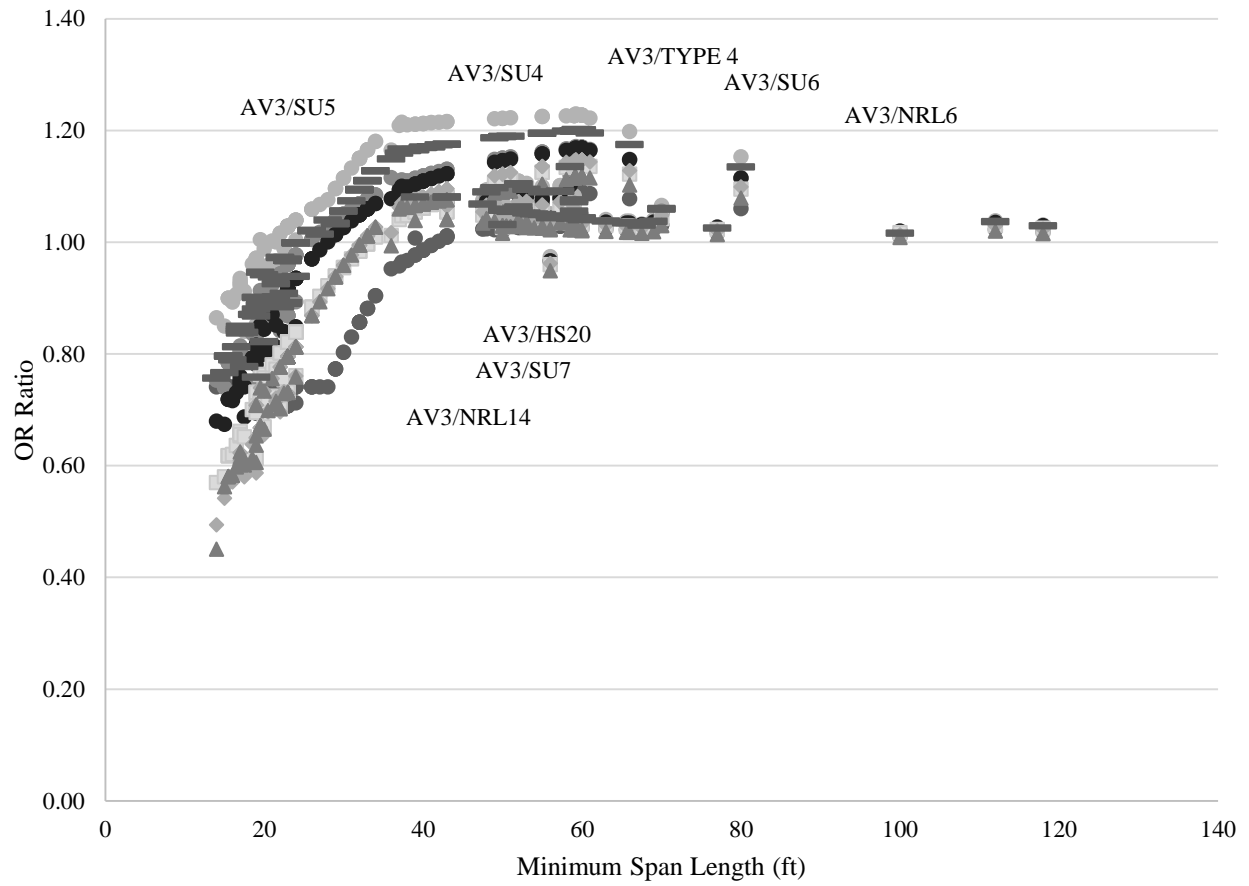

Figure 38. AV3 ratio versus minimum span length

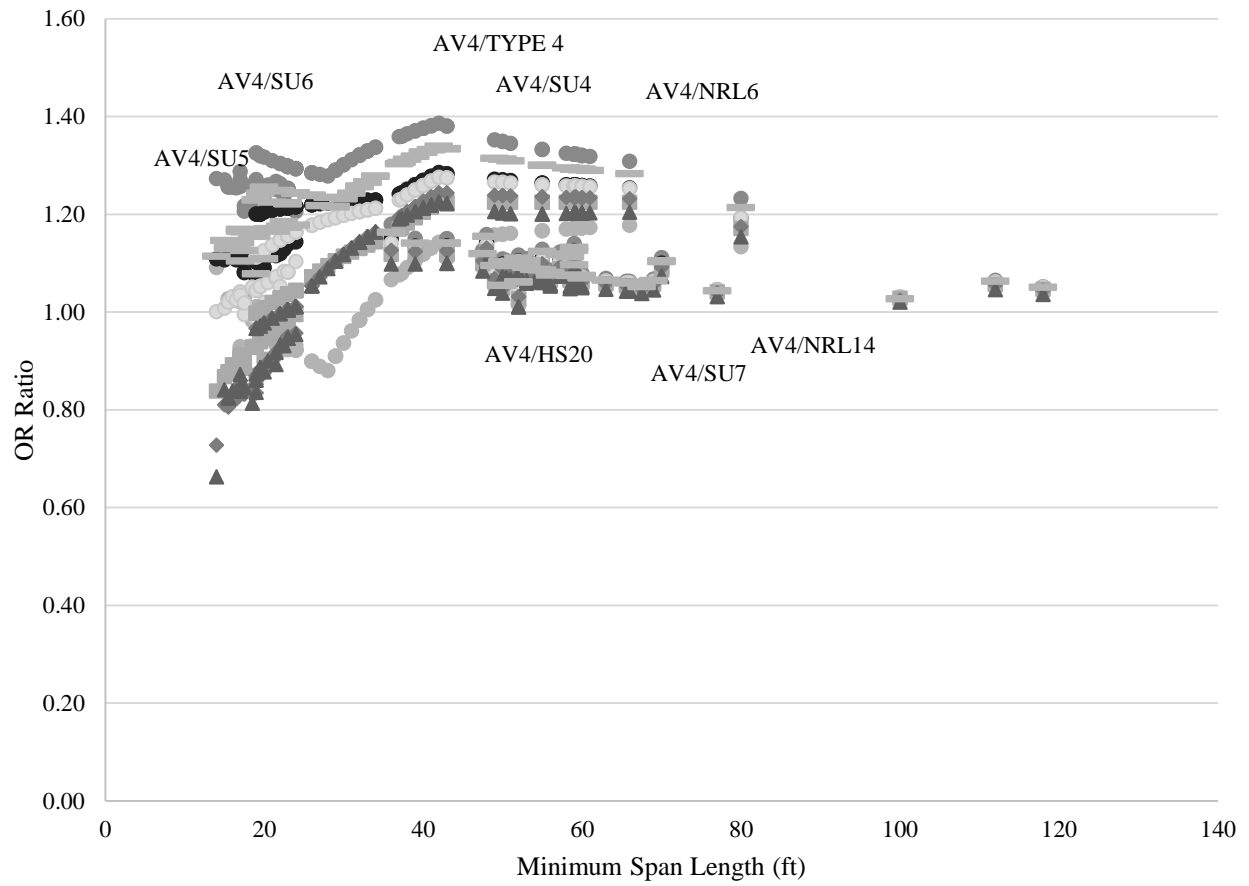

Figure 39. AV4 ratio versus minimum span length

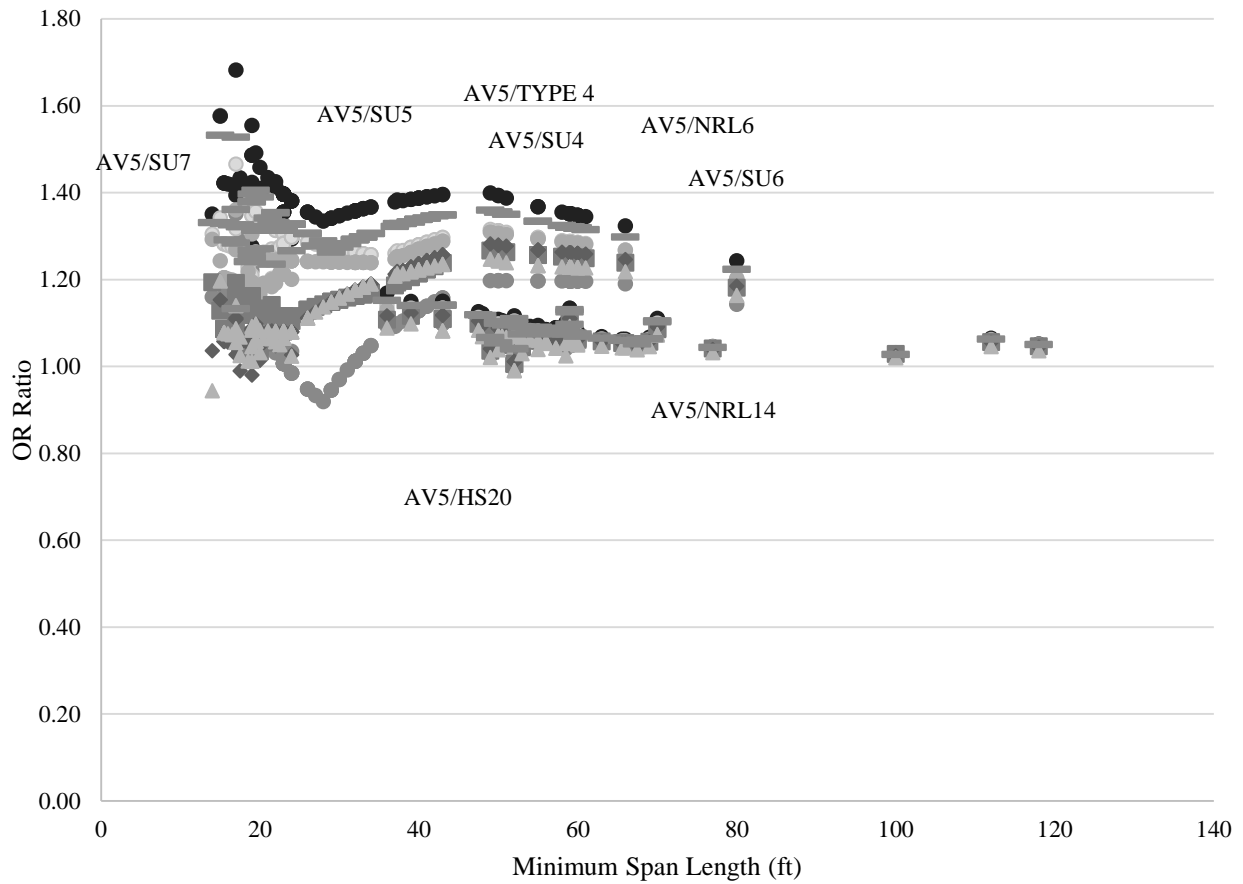

Figure 40. AV5 ratio versus minimum span length

For all three figures, the concentration of ratios less than one are located in the regions of shorter minimum span lengths. This is even more evident in Figure 41 and Figure 42, which show the minimum AV ratio for rating vehicles and the minimum AV ratio for posting vehicles, respectively.

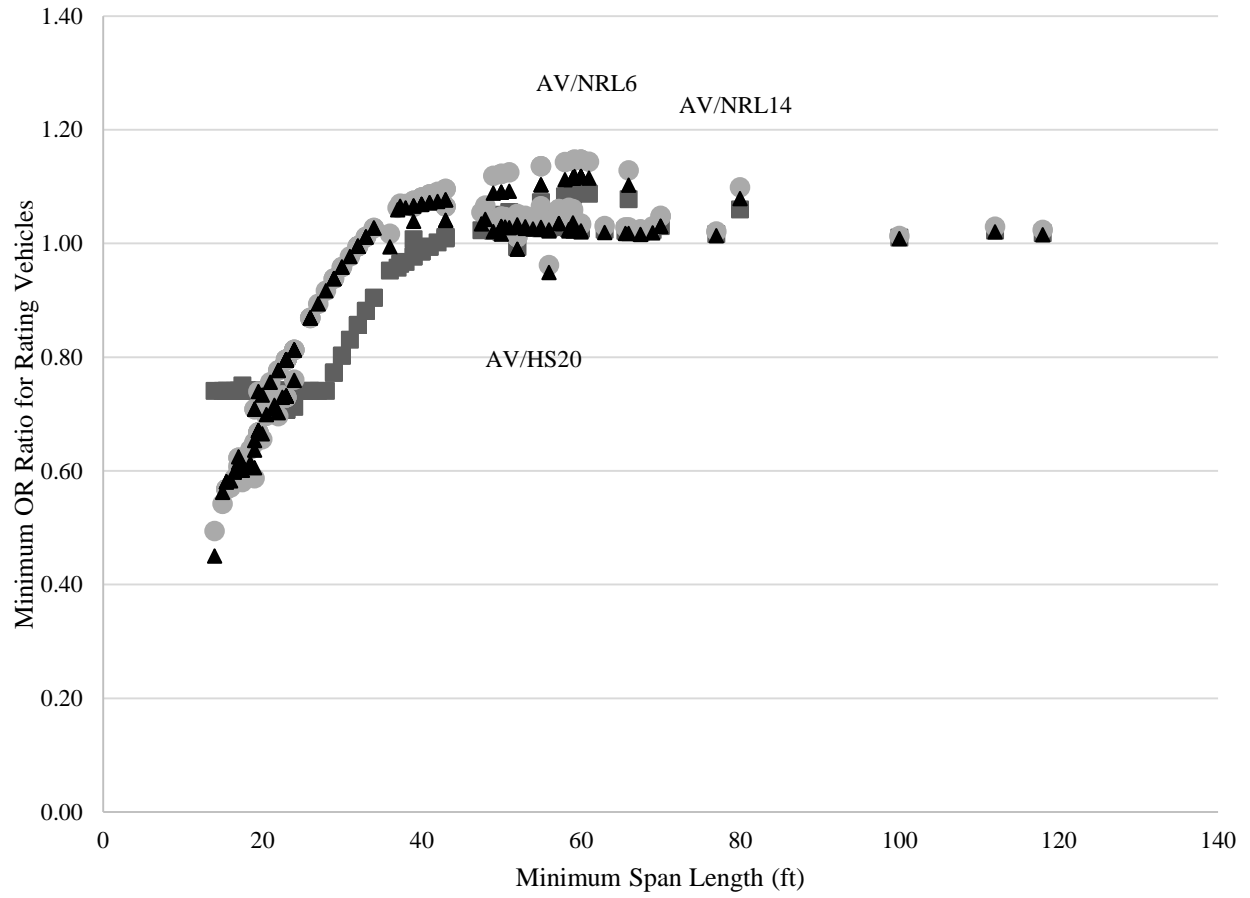

Figure 41. Minimum AV OR ratio versus minimum span length – rating vehicles

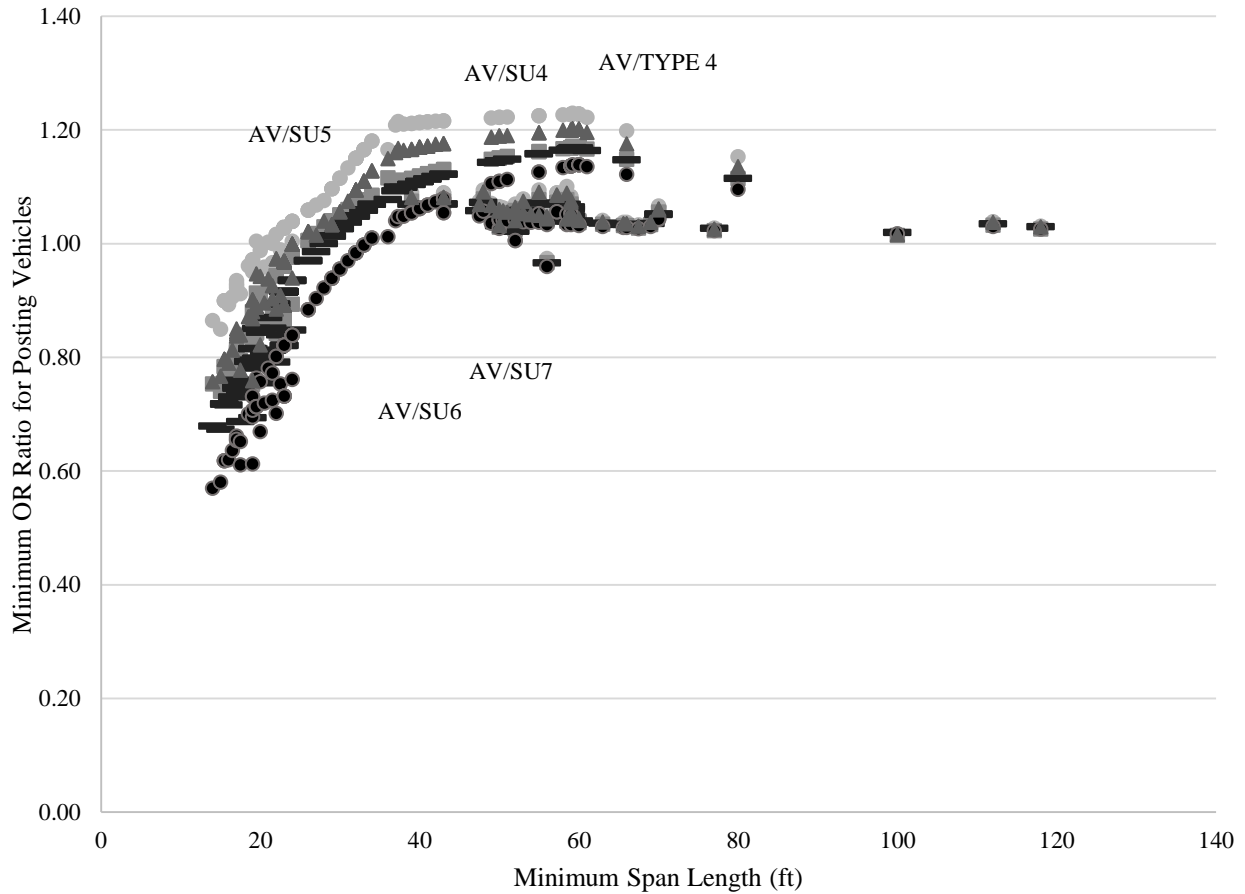

Figure 42. Minimum AV OR ratio versus minimum span length – posting vehicles

Only the shorter spans tend to show ratios lower than one, which leads to the observation that the AV vehicles control posting and rating on shorter span bridges. For longer span bridges—spans longer than approximately 40 feet—posting and rating is controlled by existing posting and rating vehicles.

In all cases, except the two mentioned previously where the minimum ratio is less than one, the AV vehicle that controls posting and rating is AV3. Low OR ratios result from AV3 vehicles on short-span bridges because the AV3 has a heavy rear point load (Figure 43). This, in combination with the axle spacing, means that on short-span bridges, the maximum effects occur when the rear point load acts alone at mid-span (see Figure 43).

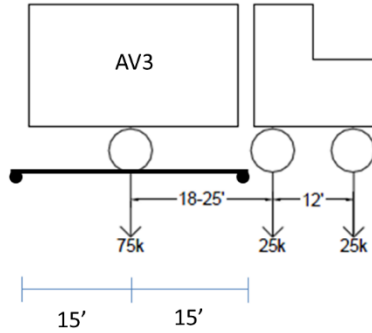

Figure 43. Effects of short span on OR ratio

3.2 Legal Agricultural Vehicles

National weight standards require that legal loads should meet the following limits: (1) a single-axle limit of 20k, (2) a tandem axle limit of 34k, (3) a gross-vehicle limit of 80k, and (4) bridge formula B. These apply to commercial vehicle operations on the Interstate Highway System. For agricultural vehicles, only a very few states (e.g., Kansas) adopt the standards; instead, most states enforce limits of (1) gross-vehicle weight (GVW) $\leq 80k$ and (2) axle weight $\leq 20k$ (see Chapter 4 for more details). By applying these GVW and axle weight limits, possible legal agricultural vehicle models were created as shown in Figures 44 through 46.

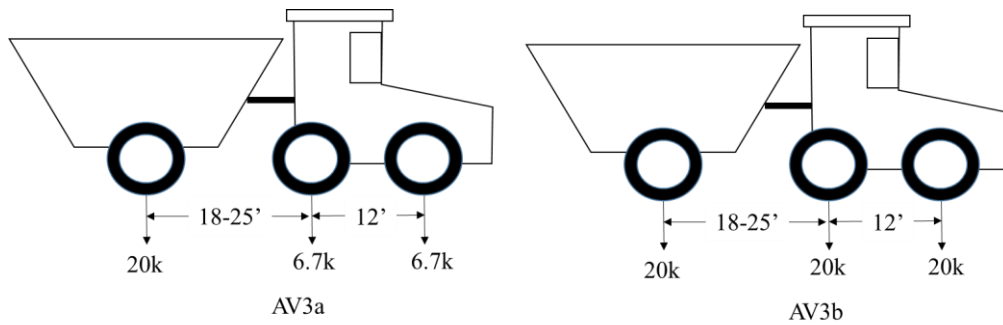

Figure 44. Posting AV vehicles, AV3a and AV3b

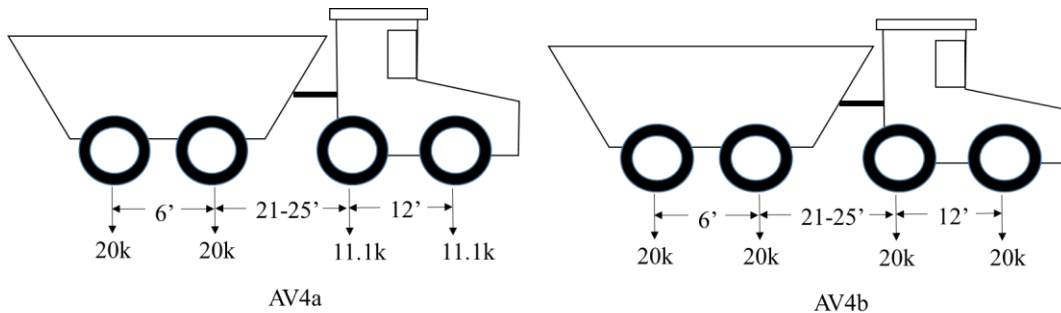

Figure 45. Posting AV vehicles, AV4a and AV4b

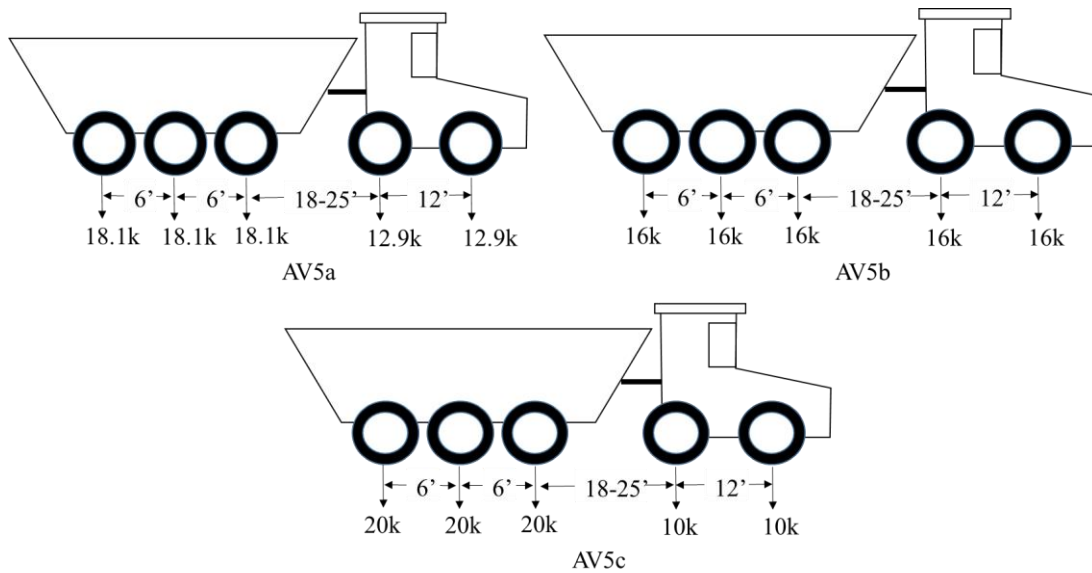

Figure 46. Posting AV vehicles, AV5a, AV5b, and AV5c

In these figures, axle weights of AV3a, AV4a, and AV5a are proportional to those of AV3, AV4, and AV5, respectively. The OR and OR ratios for AV3a, AV4a, and AV5a are the same as those of each AV counterpart. Although AVb and AVc are not proportional, they also satisfy legal truck limits for many states. Table 4 shows the AV, design, rating, and posting vehicle weights. The legal AVs are potential candidates to be used as posting vehicles.

Table 1. Vehicle weights

Vehicle	Weight (tons)
AV3	62.5
AV3a	16.7
AV3b	30
AV4	70
AV4a	31.1
AV4b	40
AV5	77.5
AV5a	40
AV5b	40
AV5c	40
HS20	36
SU4	27
SU5	31
SU6	34.75
SU7	38.75
NRL6	40
NRL14	40
TYPE 4	27.25

4. SUMMARY OF SURVEY RESPONSES

To obtain a better understanding of current state regulations governing legal bridge weight limits, a survey was sent to each state DOT. The survey addressed the states' definitions of implements of husbandry as well as their single-axle and gross-vehicle weight restrictions on bridges. The questionnaire and detailed responses provided can be found in Volume III – Appendix F. Survey Responses. The responses were based off of a typical three-axle husbandry vehicle, a diagram of which is provided in Figure F-1 in Volume III – Appendix F. Figure F-1 is similar to Figure 8 and Table 1.

Twenty-two states participated in the survey: Alabama, Alaska, Arizona, Arkansas, California, Colorado, Florida, Hawaii, Illinois, Kansas, Minnesota, Missouri, Nevada, New York, Ohio, Oklahoma, Pennsylvania, South Dakota, Vermont, Virginia, Washington, and West Virginia. The survey responses show that there is much variation on rules and definitions from state to state.

The responses regarding the definition of an implement of husbandry seem to follow a general trend, in that most states regard an “implement of husbandry” as a vehicle used specifically for agricultural purposes. However, some states do not have a legal definition at all; whereas, others have criteria as specific as axle weight and tire configuration.

Where husbandry vehicle weight limits are concerned, these results are scattered as well, except in the case of bridges with posted weight limits; all states except one (Virginia) require implements of husbandry to comply with posted bridge weight limits. For gross-vehicle weight on unposted bridges, several states follow the federal bridge formula—with the most common weight limit being 80,000 pounds—while others consider implements of husbandry exempt from these limits. Single-axle weight limits typically trend toward 20,000 pounds per axle, although some states allow husbandry vehicles to be exempt from these regulations.

The survey revealed that there is no consistency among states regarding bridge weight limits for implements of husbandry. In many cases, implements of husbandry and the generic agricultural rating vehicles violate current bridge weight limit regulations.

5. RATING EXAMPLES

These rating examples have been included to demonstrate rating and posting on shorter span bridges and longer span bridges. The conclusion from Chapter 3 was developed under the assumption that distribution factors, dynamic load allowance, and the location of critical sections were the same for all vehicle types. These examples implement the distribution and impact factors generated in Volume I for husbandry vehicles as well as the correct live load moments (generated by the BEC software used to calculate moments in Volume II) for each vehicle type. Chapter 5 studied only operating ratings for strength requirements—excluding inventory ratings and service requirements—so only those ratings will be shown here. Distribution factors for flexure were developed in Volume I. Therefore, these examples focus on rating the bridges for flexural effects. In addition, because of the limited information provided for each bridge, only interior girders will be rated. It is unknown whether the deck acts compositely with the girders, therefore, non-composite section properties are used. Load factor rating method is used for both examples.

5.1 Example 1. Short-Span Bridge

FHWA No. 93091 (Bridge 1_12 from Volume II; Table 1c – Bridge 3 from Volume I)

Bridge Type: Steel girders-Concrete deck

Year built: 1995

Number of spans: 1

Minimum span length: 28 ft

Skew: 45°

Roadway width: 20.3 ft (multi-lane)

Number of girders and spacing: 9 steel girders @ 2.54 ft on center

Slab: 9.5 in concrete

$F_y = 36$ ksi (built after 1962 (Iowa DOT Bridge Rating Manual 5.7.1))

$f'_c = 3.0$ ksi (built after 1959) (AASHTO MBE Table 6A.5.2.1-1)

Table 2. Girder geometry for Example 1 short-span bridge

Top Flange Depth (in.)	Top Flange Width (in.)	Web Depth (in.)	Web Width (in.)	Bottom Flange Depth (in.)	Bottom Flange Width (in.)
0.455	6.745	13.98	0.285	0.455	6.745

5.1.1 Load Factor Rating

Rating factor and operating rating 5 equations can be found in Volume II, Chapter 4. Equation 3 refers to operating ratings, while Equation 4 calculates rating factors.

5.1.2 Interior Girder Non-Composite Moment Capacity

Non-composite section properties:

$$\bar{y} = 7.45 \text{ in from bottom of bottom flange}$$

$$I_x = 385 \text{ in}^4$$

$$S_x = 51.7 \text{ in}^3$$

$$K_g = 9[385 \text{ in}^4 + ((2)(0.455 \text{ in} \times 6.745 \text{ in}) + (0.285 \text{ in} \times 13.98 \text{ in}))(7.45 \text{ in} + (9.5 \text{ in}/2))]^2$$

$$K_g = 17,021 \text{ in}^4$$

$$M_n = M_y = F_y S = (36 \text{ ksi})(51.7 \text{ in}^3)/12 \text{ in/ft} = 155.1 \text{ ft-kips}$$

5.1.3 Moments in Interior Girder

Dead load:

$$W_{\text{slab}} = (9.5 \text{ in}/12 \text{ in/ft})(2.54 \text{ ft})(0.150 \text{ kcf}) = 0.30 \text{ kips/ft}$$

$$W_{\text{girder}} = (1.06)[(13.98 \text{ in})(0.285 \text{ in}) + (2)(0.455 \text{ in})(6.745 \text{ in})]/144 \text{ in}^2/\text{ft}^2 (0.490 \text{ kcf}) = 0.04 \text{ kips/ft}$$

- includes additional 6% weight for connections

$$W_{\text{total}} = 0.30 \text{ kips/ft} + 0.04 \text{ kips/ft} = 0.34 \text{ kips/ft}$$

$$\text{MDL} = (0.34 \text{ kips/ft})(28 \text{ ft})^2/8 = 33.1 \text{ ft-kips}$$

Live load (using BEC software):

$$M_{\text{HS20}} = \text{moment from HS20 truck} = 252 \text{ ft-kips}$$

$$M_{\text{SU7}} = \text{moment from SU7 vehicle} = 302 \text{ ft-kips}$$

$$M_{\text{AV3}} = \text{moment from AV3 vehicle} = 525 \text{ ft-kips (because this is a short-span bridge, maximum effects occur when the rear 75 kip axle acts alone at mid-span)}$$

Distribution factor:

$$DF_{\text{HS20}} = DF_{\text{SU7}} = S/11$$

(AASHTO standard specifications Table 3.23.1. Note that the values presented in this table refer to a single wheel line; to get a distribution per axle, multiple this value by 1/2.)

$$DF_{\text{HS20}} = DF_{\text{SU7}} = 2.54 \text{ ft}/11 = 0.231$$

$$DF_{\text{AV3}} = \left(\frac{S}{29.2}\right)^{0.41} \left(\frac{S}{L}\right)^{0.12} \left(\frac{K_g}{12Lt_s^3}\right)^{-0.01} \quad \text{(Volume I, Section 4.3.1.1.2, Equation 21)}$$

$$DF_{\text{AV3}} = \left(\frac{2.54}{29.2}\right)^{0.41} \left(\frac{2.54}{28}\right)^{0.12} \left(\frac{17,021}{12(28)(9.5)^3}\right)^{-0.01} = 0.283$$

These values correspond to the values shown in Figure 25, Volume 1. This bridge is similar to Bridge 4 in the figure.

The skew correction factor will be conservatively taken as 1 for all vehicles (Section 4.3.1.3, Volume I).

The AV3 vehicle was not developed with the notion of changing gauge width, but rather, only with the idea of changing axle spacing and axle weights. Because of this, the distribution factor developed for the 121 husbandry vehicles will be used in place of the distribution factor for varying gauge width.

5.1.4 Dynamic Load Allowance, IM

$$IM_{HS20} = IM_{SU7} = 50/(L + 125) \leq 0.3 \text{ (AASHTO Standard Specifications Equation 3-1)}$$

$$IM_{HS20} = IM_{SU7} = 50/(28 + 125) = 0.327 > 0.3, \text{ therefore, } IM = 0.3$$

$$IM_{AV3} = 100/(L + 125) \leq 0.6 \text{ (Section 4.2, Volume I)}$$

$$IM_{AV3} = 100/(28 + 125) = 0.654 < 0.6, \text{ therefore, } IM = 0.6$$

5.1.5 Live Load Plus Impact

$$M_{LL+IM} = (M)(DF)(1 + IM)$$

$$M_{LL+IM_HS20} = (252 \text{ ft-kips})(0.231)(1+0.3) = 75.7 \text{ ft-kips}$$

$$M_{LL+IM_SU7} = (302 \text{ ft-kips})(0.231)(1+0.3) = 90.7 \text{ ft-kips}$$

$$M_{LL+IM_AV3} = (525 \text{ ft-kips})(0.283)(1+0.6) = 237.7 \text{ ft-kips}$$

5.1.6 Rating Factors

Reduction factors, $\phi = 1.0$ and $\gamma_{LL} = \gamma_{DL} = 1.3$

$$RF_{HS20} = \frac{155.1 \text{ ft-kip} - 1.3(33.1 \text{ ft-kip})}{1.3(75.7 \text{ ft-kip})} = 1.14$$

$$RF_{SU7} = \frac{155.1 \text{ ft-kip} - 1.3(33.1 \text{ ft-kip})}{1.3(90.7 \text{ ft-kip})} = 0.95$$

$$RF_{AV3} = \frac{155.1 \text{ ft-kip} - 1.3(33.1 \text{ ft-kip})}{1.3(237.7 \text{ ft-kip})} = 0.36$$

5.1.7 Operating Ratings

$$W_{HS20} = 36 \text{ tons}$$

$$W_{SU7} = 38.75 \text{ tons}$$

$$W_{AV3} = 62.5 \text{ tons}$$

$$OR_{HS20} = (1.14)(36 \text{ tons}) = 41.0 \text{ tons}$$

$$OR_{SU7} = (0.95)(38.75 \text{ tons}) = 36.8 \text{ tons}$$

$$OR_{AV3} = (0.36)(62.5 \text{ tons}) = 22.5 \text{ tons}$$

On this shorter span bridge, AV3 controls both rating and posting vehicles. For states that have no weight limits for farm vehicles, a potential sign would look similar to the mock-up in Figure 47.

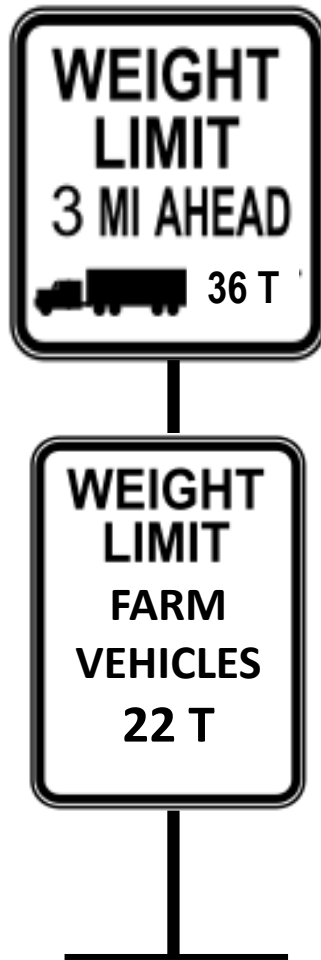

Figure 47. Posting sign for a shorter bridge

For states that have the total weight and axle weight limits enforced for farm vehicles, AV3a is a possible posting vehicle. As the OR for AV3a is higher than the weight of the vehicle, which is 16.7 Tons, the bridge does not need to be posted for AV3a.

5.2 Example 2. Long-Span Bridge

FHWA No. 60660 (Bridge 1_32b from Volume II; Table 1b – Bridge 21 from Volume I)

Bridge Type: Steel girder-Concrete deck

Year built: 1956

Number of spans: 1

Minimum span length: 55 ft

Skew: 0°

Roadway width: 20.0 ft (multi-lane)

Number of girders and spacing: 3 steel girders @ 9.5 ft on center

Slab: 7 in concrete

$F_y = 33$ ksi (built between 1936 and 1962) (Iowa DOT Bridge Rating Manual 5.7.1)

$f'_c = 2.5$ ksi (built before 1959) (AASHTO MBE Table 6A.5.2.1-1)

Table 3. Girder geometry for the example long-span bridge

Top Flange Depth (in.)	Top Flange Width (in.)	Web Depth (in.)	Web Width (in.)	Bottom Flange Depth (in.)	Bottom Flange Width (in.)
0.688	10	28.63	0.548	0.688	10

5.2.1 Load Factor Rating

Rating factor and operating rating equations can be found in Volume II, Chapter 4. Equation 3 refers to operating ratings, while Equation 4 calculates rating factors.

5.2.2 Interior Girder Non-Composite Moment Capacity

Non-composite section properties:

$\bar{y} = 15.00$ in from bottom of bottom flange

$I_x = 4,029$ in⁴

$S_x = 268.6$ in³

$K_g = 10[4,029 \text{ in}^4 + ((2)(0.688 \text{ in} \times 10 \text{ in}) + (0.548 \text{ in} \times 28.63 \text{ in}))(15.00 \text{ in} + (7 \text{ in}/2))^2]$

$K_g = 141,113$ in⁴

$M_n = M_y = F_y S = (33 \text{ ksi})(268.6 \text{ in}^3)/12 \text{ in/ft} = 738.7 \text{ ft-kips}$

5.2.3 Moments in Interior Girder

Dead Load:

$$W_{\text{slab}} = (7 \text{ in}/12 \text{ in}/\text{ft})(9.5)(0.150 \text{ kcf}) = 0.83 \text{ kips}/\text{ft}$$

$$W_{\text{girder}} = (1.06)[(28.63 \text{ in})(0.548 \text{ in})+(2)(0.688 \text{ in})(10 \text{ in})]/144 \text{ in}^2/\text{ft}^2 (0.490 \text{ kcf}) = 0.11 \text{ kips}/\text{ft}$$

includes additional 6% weight for connections

$$W_{\text{total}} = 0.83 \text{ kips}/\text{ft} + 0.11 \text{ kips}/\text{ft} = 0.94 \text{ kips}/\text{ft}$$

$$\text{MDL} = (0.94 \text{ kips}/\text{ft})(55 \text{ ft})^2/8 = 354.5 \text{ ft-kips}$$

Live Load (using BEC software):

$$M_{\text{HS20}} = \text{moment from HS20 truck} = 710 \text{ ft-kips}$$

$$M_{\text{Type}_4} = \text{moment from SU7 vehicle} = 599 \text{ ft-kips}$$

$$M_{\text{AV3}} = \text{moment from AV3 vehicle} = 1150 \text{ ft-kips}$$

Distribution Factor, DF:

$$DF_{\text{HS20}} = DF_{\text{Type}_4} = S/11$$

(AASHTO Standard Specifications Table 3.23.1; note that the values presented in this table refer to a single wheel line; to get a distribution per axle, multiple this value by 1/2.)

$$DF_{\text{HS20}} = DF_{\text{Type}_4} = 9.5 \text{ ft}/11 = 0.864$$

$$DF_{\text{AV3}} = \left(\frac{S}{29.2}\right)^{0.41} \left(\frac{S}{L}\right)^{0.12} \left(\frac{K_g}{12L_t^3}\right)^{-0.01} \quad (\text{Volume I, Section 4.3.1.1.2, Equation 21})$$

$$DF_{\text{AV3}} = \left(\frac{9.5}{29.2}\right)^{0.41} \left(\frac{9.5}{55}\right)^{0.12} \left(\frac{141,113}{12(55)(7)^3}\right)^{-0.01} = 0.514$$

These values correspond to the values shown in Figure 25, Volume 1, Bridge 21.

The AV3 vehicle was not developed with the idea of varying gauge width, but rather, only on varying axle spacing and axle weights. Because of this, the distribution factor developed for the 121 husbandry vehicles will be used in place of the distribution factor for varying gauge width.

5.2.4 Dynamic Load Allowance, IM:

$$IM_{\text{HS20}} = IM_{\text{Type}_4} = 50/(L + 125) \leq 0.3 \text{ (AASHTO Standard Specifications Equation 3-1)}$$

$$IM_{\text{HS20}} = IM_{\text{Type}_4} = 50/(55 + 125) = 0.28 < 0.3, \text{ therefore, } IM = 0.28$$

$$IM_{\text{AV3}} = 100/(L + 125) \leq 0.6 \text{ (Section 4.2, Volume I)}$$

$$IM_{\text{AV3}} = 100/(55 + 125) = 0.56 < 0.6, \text{ therefore, } IM = 0.56$$

5.2.5 Live Load Plus Impact

$$M_{LL+IM} = (M)(DF)(1 + IM)$$

$$M_{LL+IM_HS20} = (710 \text{ ft-kips})(0.864)(1+0.28) = 785.2 \text{ ft-kips}$$

$$M_{LL+IM_Type_4} = (599 \text{ ft-kips})(0.864)(1+0.28) = 662.8 \text{ ft-kips}$$

$$M_{LL+IM_AV3} = (1150 \text{ ft-kips})(0.514)(1+0.56) = 922.1 \text{ ft-kips}$$

5.2.6 Rating Factors

Reduction factors, $\phi = 1.0$ and $\gamma_{LL} = \gamma_{DL} = 1.3$

$$RF_{HS20} = \frac{738.7 \text{ ft-kip} - 1.3(354.5 \text{ ft-kip})}{1.3(785.2 \text{ ft-kip})} = 0.27$$

$$RF_{Type_4} = \frac{738.7 \text{ ft-kip} - 1.3(354.5 \text{ ft-kip})}{1.3(662.8 \text{ ft-kip})} = 0.32$$

$$RF_{AV3} = \frac{738.7 \text{ ft-kip} - 1.3(354.5 \text{ ft-kip})}{1.3(922.1 \text{ ft-kip})} = 0.23$$

5.2.7 Operating Rating

$$W_{HS20} = 36 \text{ tons}$$

$$W_{Type_4} = 27.25 \text{ tons}$$

$$W_{AV3} = 62.5 \text{ tons}$$

$$OR_{HS20} = (0.27)(36 \text{ tons}) = 9.7 \text{ tons}$$

$$OR_{Type_4} = (0.32)(27.25 \text{ tons}) = 8.7 \text{ tons}$$

$$OR_{AV3} = (0.23)(62.5 \text{ tons}) = 14.4 \text{ tons}$$

On this longer span bridge, AV3 will not control over either rating or posting vehicles. A potential sign would look as shown in Figure 48.

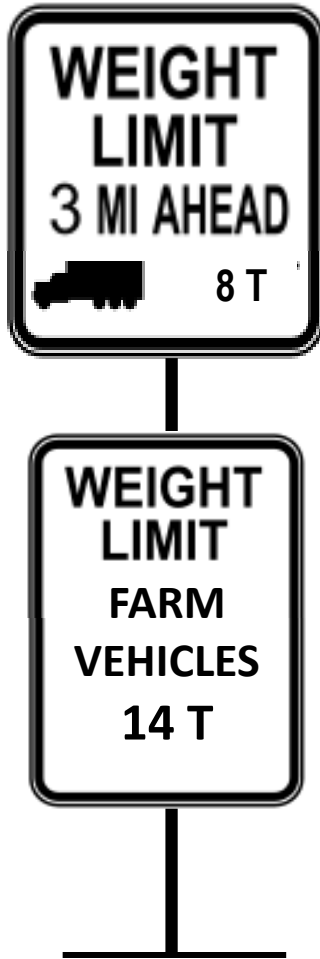

Figure 48. Posting sign for a longer bridge

Notice that the bridge will need to be posted no matter whether AV3 or AV3a is used as the posting vehicle.

6. POSTING SIGNAGE

According to the AASHTO Manual for Bridge Evaluation section 6A.8, “When the maximum legal load under state law exceeds the safe load capacity of a bridge, restrictive load posting shall be required” and “the posting signs shall conform to the Manual on Uniform Traffic Control Devices (MUTCD).” It is also stated in the AASHTO MBE that “in some cases, lower speed limits will reduce impact loads to the extent that lowering the weight limit may not be required”. Following AASHTO MBE and MUTCD, possible speed limit and load posting signs for agriculture vehicles are presented.

6.1 MUTCD Requirement for Post Signs

Five posting sign options are provided in the MUTCD as shown in Figure 49.

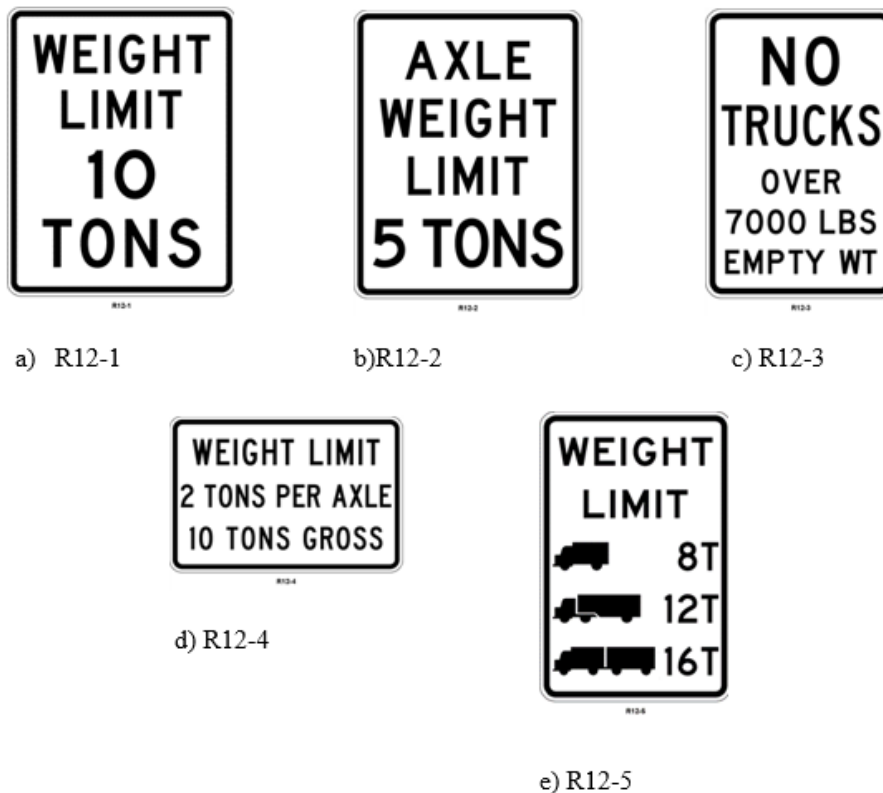

Figure 49. Bridge posting signage options provided by the MUTCD

The options are as follows:

1. “The Weight Limit (R12-1, Figure 49a) sign carrying the legend WEIGHT LIMIT XX TONS may be used to indicate vehicle weight restrictions including load”
2. “Where the restriction applies to axle weight rather than gross load, the legend may be AXLE

WEIGHT LIMIT XX TONS or AXLE WEIGHT LIMIT XX LBS” (R12-2, Figure 49b)

3. “To restrict trucks of certain sizes by reference to empty weight in residential areas, the legend may be NO TRUCKS OVER XX TONS EMPTY WT or NO TRUCKS OVER XX LBS EMPTY WT” (R12-3, Figure 49c)
4. “In areas where multiple regulations of the type described in Paragraphs 1 through 3 are applicable, a sign combining the necessary messages on a single sign may be used, such as WEIGHT LIMIT XX TONS PER AXLE, XX TONS GROSS” (R12-4, Figure 49d)

“Posting of specific load limits may be accomplished by use of the Weight Limit symbol sign (R12-5, Figure 49e). A sign containing the legend WEIGHT LIMIT on the top two lines, and showing three different truck symbols and their respective weight limits for which restrictions apply may be used, with the weight limits displayed to the right of each symbol as XX T. A bottom line legend stating GROSS WT may be included if needed for enforcement purposes.”

6.2 Posting or Speed Limit Signs for Agricultural (Farm) Vehicles

Possible legal agricultural vehicle models are created and shown in Chapter 3, Figures 41 to 43. They can potentially be used as posting vehicles. When the load rating of a bridge is lower than the weight of the legal agricultural vehicle, according to AASHTO MBE, load restrictions or speed restrictions should be applied. To avoid overly or less conservative postings and to avoid confusion, it is recommended that a separate posting (or speed limit) sign be used for agricultural vehicles. An example of a speed limit sign for farm vehicles is shown in Figure 50.

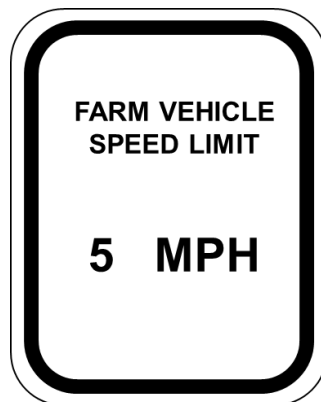

Figure 50. Farm vehicle speed limit sign

When speed limit is not sufficient to avoid the load posting of a bridge, a posting sign will be needed. Multiple possible posting signs are depicted in Figure 51.

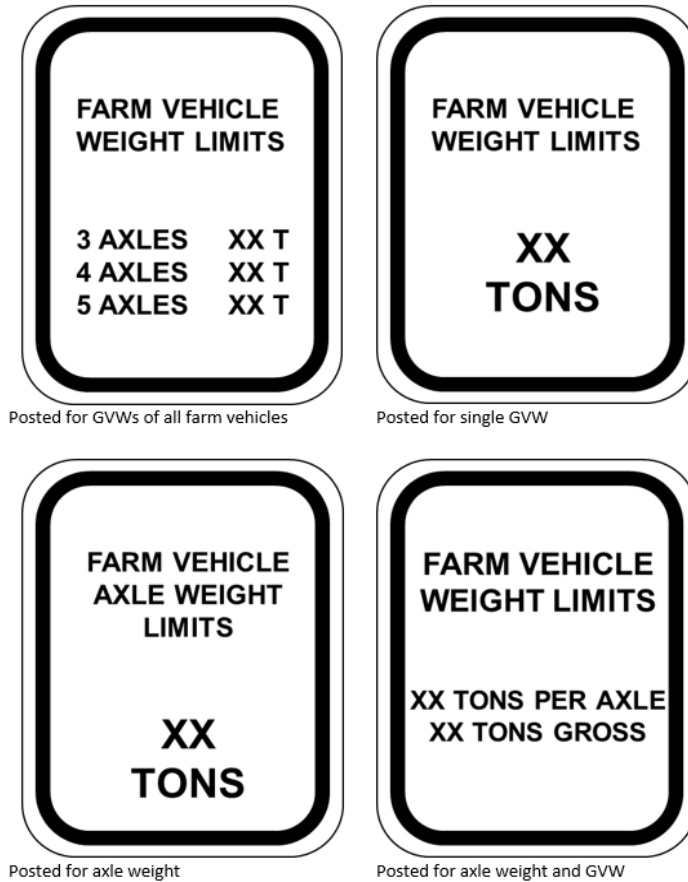

Figure 51. Farm vehicle posting signs

As shown in Figure 51, the possible signs include posting the following:

- Number of axles of three different agricultural vehicles and their respective weight limits (upper left)
- One single GVW limit (upper right)
- One single-axle weight limit (lower left)
- Weight limits for GVW and axle weight (lower right)

When a single gross-vehicle weight (upper right) or single-axle weight (lower left) or a combination of the two (lower right) are used, the posting would most likely be controlled by the three-axle agricultural vehicles and the posting would be overly conservative for agricultural vehicles with more axles, especially for short-span bridges.

7. SUMMARY AND CONCLUSIONS FOR RATING AND POSTING RECOMMENDATIONS (VOLUME II)

The objective of this study was to develop guidance for engineers to help them understand how implements of husbandry loads are resisted by traditional bridges—with a specific focus on bridges commonly found on the secondary road system—to provide recommendations for accurately analyzing bridges for their loading effects and to make recommendations for the rating and posting of such bridges.

To achieve this objective, as Volume I focused on, the lateral distribution of live load and dynamic impact effects for different types of farm vehicles on three general bridge types were investigated by using load testing and analytical modeling. Volume II, which is presented here, concentrated on providing recommendations for bridge rating tools.

This work was completed by conducting an analytical study on the effects produced by 121 husbandry vehicles on 174 bridges. From these studies, generic agricultural vehicle models (i.e., AV3, AV4, and AV5) were created. Ratings and codified-type parameters may be generated from these generic vehicles, which will ultimately lead to recommendations on the analysis, rating, and posting of bridges for implements of husbandry.

With the generic agricultural rating vehicles, moment ratios were calculated by comparing the moments of the generic, rating, and posting vehicles to the moments of the 121 husbandry vehicles. These ratios showed that current posting and rating vehicles do not always envelop the effects of the implements of husbandry (i.e., moment ratios were less than 1.0); whereas, the generic agricultural vehicles AV3, AV4, and AV5 do envelop the husbandry vehicles. As mentioned before, in moment ratio calculations, the dynamic impact factor and LLDF are taken as the same for all types of vehicles. In general, the IM of husbandry vehicles is larger than that of other trucks, while the LLDF is smaller.

After determining that the AV vehicles sufficiently captured the behavior of husbandry vehicles, studies were carried out to determine how they can be used for bridge rating and posting practices. This was done through two major efforts: (1) calculating the operating rating ratio between AVs and rating and posting vehicles and (2) creating legal version agricultural vehicle models by including the gross-vehicle weight and axle weight limits that have been enforced by many states.

From the operating ratios (and the assumption that all vehicles had the same distribution and impact factors), the conclusion was drawn that on short-span bridges (less than approximately 40 ft) AV vehicles—and specifically AV3—might control rating and/or posting. Conversely, on bridges with spans longer than approximately 40 ft, current rating and posting vehicles would control the rating and/or posting. By creating legal version agricultural vehicle models, the legal AVs can be used as potential posting vehicles. It is also worth noting that for some states, the AV3 vehicle may be appropriate if implements of husbandry are not required to conform to the Bridge Formula.

Following the AASHTO MBE and MUTCD, possible bridge restriction signs, including speed limit signs and load posting signs, are proposed. Using a separate restriction sign for farm vehicles is considered to be a practical way to ensure bridge safety while avoiding over-posting for other types of vehicles when the bridge is subjected to husbandry implement loads.

REFERENCES

- AASHTO. 2011. *Manual for Bridge Evaluation*, 2nd Edition, with 2011, 2013, 2014, and 2015 Interim Revisions. American Association of State Highway and Transportation Officials, Washington, DC.
- . 2010. *AASHTO LRFD Bridge Design Specifications*. 5th Edition, American Association of State Highway and Transportation Officials, Washington, DC.
- . 2002. *Standard Specifications for Highway Bridges*. 17th Edition, American Association of State Highway and Transportation Officials, Washington, DC.
- . 1996. *Standard Specifications for Highway Bridges*. 16th Edition, American Association of State Highway and Transportation Officials, Washington, DC.
- ASCE. 2013. *Report Card for America's Infrastructure*, Reston, VA.
www.infrastructurereportcard.org/.
- Barker, R. M., and J. A. Puckett. 2013. *Design of Highway Bridges*. 3rd Edition, John Wiley & Sons, Inc., Hoboken, NJ.
- FHWA. 2009. *Manual on Uniform Traffic Control Devices, With 2012 Revisions 1 & 2*. Federal Highway Administration, Washington, DC.
- HDR. 2013. *Iowa DOT Office of Bridges and Structures: Bridge Rating Manual*. Iowa Department of Transportation, Ames, IA.
siims.iowadot.gov/IowaDOT_BridgeRatingManual.pdf.
- Iowa DOT. 2013. *Attachment E to I.M. 2.120: Iowa Legal Trucks Diagrams*. July 18, 2013. Iowa Department of Transportation, Office of Local Systems, Ames, IA.
www.iowadot.gov/local_systems/publications/im/2120e.pdf.
- Kulicki, J. M. and D. R. Mertz. 1991. A New Live Load Model for Bridge Design. *Proceedings of 8th Annual International Bridge Conference*, June 10–12. Pittsburgh, PA.
- Munkelt, G. 2010. HL93 Truck Loads vs. HS20 Truck Loads. *Precast Inc. Magazine*, July 28, 2010. precast.org/2010/07/hl93-truck-loads-vs-hs20-truck-loads/.
- Orr, C. 2012. Rural Areas on Road to Infrastructure Crisis. *Stateline Midwest*, Vol. 21, No. 1, p. 7. www.csgmidwest.org/policyresearch/documents/ruralroads.pdf.
- Phares, B. M., T. J. Wipf, and H. Ceylan. 2005. *Impacts of Overweight Implements of Husbandry on Minnesota Roads and Bridges*. Minnesota Department of Transportation, St. Paul, MN.
- Seo, J., B. Phares, and T. Wipf. 2013. Lateral Live-Load Distribution Characteristics of Simply Supported Steel Girder Bridges Loaded with Implements of Husbandry. *Journal of Bridge Engineering*, Vol. 19, No. 4.
- Sivakumar, B., F. Moses, G. Fu, and M. Ghosn. 2007. *NCHRP REPORT 575: Legal Truck Loads and AASHTO Legal Loads for Posting*. National Cooperative Highway Research Program, Washington, DC.
- Wood, D. L. and T. J. Wipf. 1999. *Heavy Agricultural Loads on Pavements and Bridges*. Engineering Research Institute, Iowa State University, Ames, IA.