

Engineering Research Institute

RESIDUAL STRESSES AND FATIGUE BEHAVIOR
OF WELDED STRUCTURAL MEMBERS

by

Ti-ta Lee

and

D. M. Wilson

Project HR-94
Highway Research Board
Iowa State Highway Commission

IOWA DEPARTMENT OF TRANSPORTATION
LIBRARY
800 LINCOLN WAY
AMES, IOWA 50010

Project 501-S

January, 1967

Iowa State University
Ames, Iowa

TA1
1o8p
501-S

report

Final

RESIDUAL STRESSES AND FATIGUE BEHAVIOR
OF WELDED STRUCTURAL MEMBERS

by

Ti-ta Lee

and

D. M. Wilson

January, 1967

TABLE OF CONTENTS

	Page
INTRODUCTION	1
PART I. FATIGUE OF WELDED STRUCTURAL MEMBERS - A STUDY OF LITERATURE	
INTRODUCTION	2
Objective	2
Fatigue Failures	2
Factors Affecting Fatigue Strength	3
FATIGUE OF NON-WELDED MEMBERS	11
Effect of Stress Concentration	11
Effect of Residual Stresses	13
Combined Effect of Residual Stresses and Stress Concentration	22
CHARACTERISTICS OF WELDED STRUCTURAL MEMBERS	25
Description of Welds	25
Stress Concentration in Welded Members	26
Residual Stresses in Welded Members	27
FATIGUE OF WELDED STRUCTURAL MEMBERS	30
Effect of Stress Concentration	30
Effect of Residual Stresses	36
Combined Effect of Residual Stresses and Stress Concentration	39
Effect of Welded Area	40
CONCLUSIONS	42
PART II. EXPERIMENTAL INVESTIGATION	
PILOT TEST SERIES	45
Test Program	45
Material Properties	45
Fabrication of Specimens	45
Temperature Distribution during Welding	50
Measurement of Welded Areas	50
Residual Stress Distribution	52
Fatigue Tests	57
Discussion	62
Additional Fatigue Test	64
EFFECT OF WELD REMOVAL ON RESIDUAL STRESS DISTRIBUTION	70
Test Program	70
Fabrication of Specimens	70
Residual Stress Measurement	72
Discussion	72

MAIN TEST SERIES	79
Test Program	79
Test Specimens	79
Residual Stress Distribution	81
Fatigue Testing System	81
Fatigue Tests	89
Discussion	98
GENERAL DISCUSSION	102
CONCLUSIONS	107
ACKNOWLEDGMENTS	108
REFERENCES	109

RESIDUAL STRESSES AND FATIGUE

BEHAVIOR OF WELDED STRUCTURAL MEMBERS

INTRODUCTION

A research project entitled "Residual Stresses and Fatigue Behavior of Welded Structural Members" was conducted at the Structural Research Laboratory of the Engineering Research Institute at Iowa State University under the sponsorship of the Iowa State Highway Commission. The objective of the project was to study experimentally the fatigue behavior of flange plates in welded beam sections as influenced by different residual stress distributions which are caused by different sizes of welds.

In connection with the project, a survey of literature on the fatigue of welded structural members was conducted.^{(1)*} The result of this survey including a set of conclusions is presented in Part I of this report.

Plate type specimens with longitudinal weld beads running along the center lines of the specimens were subjected to axial repetitive loading to simulate the behavior of the flange plates. Residual stresses were measured on a number of specimens with different plate widths and weld areas. The overall test program is given in Table 1. The program is divided into the following sections: (1) pilot test series, consisting of 13 specimens; (2) a study of the effect of weld removal on residual stress distribution, and (3) main test series, consisting of 9 specimens. Although the details and the results of items (1) and (2) have been presented in a previous report⁽²⁾ most of the information is included in this report for completeness and convenience in discussion. The program and the test results for the main test series are presented in detail in this report. The complete experimental investigation is presented in Part II of this report.

* Numbers in parenthesis refer to references listed at the end of this report.

PART I. FATIGUE OF WELDED STRUCTURAL MEMBERS

A. STUDY OF LITERATURE

INTRODUCTION

Objective

The objective of this study is to review pertinent literature and summarize the results of past research work on the influence of stress concentration, residual stresses, and weld area on the fatigue behavior of welded structural members.

The study will not be limited to that of longitudinally bead-welded specimens, since specimens with longitudinal fillet, butt, and groove welds have the same residual stress distribution, if not quantitatively at least qualitatively, as that of bead-welded specimens. Although the residual stress distribution will be similar, the severity of stress concentration and the area of weld will vary.

Studies on transverse welded specimens are also cited when it is possible to relate them to longitudinally welded specimens or when information on certain characteristics of longitudinally welded specimens is lacking.

The effect of residual stresses and stress concentration on the fatigue behavior of non-welded specimens has been studied rather thoroughly compared to their welded counterparts. Extensive references are made to non-welded specimens, since by combining the results of tests on both welded and non-welded specimens, it is possible to develop a better understanding of the fatigue behavior of the former.

Fatigue Failures

Fatigue can be defined as the action which takes place in a material causing deterioration and failure after a repetitive application of stress. In most materials there is a reduction in strength due to repeated loading. Thus, a material may be able to withstand a certain static load without any

sign of failure, but if the same material is subjected to this load for many times failure will possibly occur.

Before a steel member fractures under a static load, there is usually a large amount of plastic deformation, thus giving the engineer an indication of the upcoming fracture. An important characteristic of a fatigue fracture is that, even with very ductile materials, failure may occur without any apparent plastic deformation and the material could even fail when stressed repeatedly below its elastic limit.

The beginning of a fatigue fracture is, at times, very difficult to detect. The initial crack, which signifies the first phase of failure, is often microscopic and invisible to the naked eye. Also fatigue failures may propagate from internal discontinuities, making any type of surface examination not entirely reliable.

Fatigue failures in structures, such as bridges, usually do not appear until the structure has been in service for a long time. Although there is no established theoretical approach to predict fatigue failures, it has been possible to design reasonably safe structures by applying experimental data with suitable factors of safety.

Factors Affecting Fatigue Strength

Compared to the static strength of a structure, the fatigue strength is a very complex subject. In earlier studies of fatigue behavior of structural steel members, many inconsistencies were found in the results. Later studies have shown that these inconsistencies, for the most part, can be attributed to the fact that fatigue behavior is influenced by many variables. Reemsnyder⁽³⁾ has categorized the variables affecting fatigue strength as follows:

A. Load spectrum

1. Range of stress
2. State of stress
3. Repetition of stress
 - a. Regular or random
 - b. Frequency
 - c. Rest periods
4. Understressing or overstressing

B. Nature and condition

1. Prior stress history
 - a. Presence or absence of residual stresses
 - b. Work hardening
2. Size and shape of specimen
 - a. Presence of notches
 - b. Size effects
3. Metallurgical structure
 - a. Microstructure, grain size, and chemical composition
 - b. Mechanical properties
4. Welding
 - a. Mechanical
 - b. Metallurgical

C. Environment

1. Temperature
2. Atmosphere

In order to fully appreciate the results of fatigue tests, some insight into the influence of these variables is needed. A brief discussion of the variables affecting fatigue strength follows:

A. Load spectrum

1. Range of stress--The permissible range of stress, i.e., the algebraic difference between the maximum and minimum stress in a stress cycle, decreases with an increase in the maximum stress. Thus, for a given fatigue life the greatest permissible range of stress is when the loading is completely reversed, a tensile stress to an equal compressive stress. The permissible range then decreases as the maximum stress increases, approaching zero as the maximum stress approaches the ultimate tensile strength of the material.
2. State of stress--A material may be subjected to axial, bending, or torsional stresses during the loading process depending upon the type of loading used. The fatigue strength will vary depending on the loading condition used. For example, fatigue strengths determined in axial stress may be up to 25% lower than those determined in bending.⁽⁴⁾
3. Repetition of stress
 - a. Regular or random-- Stress cycles may be regular or random in nature. The case where the same stress cycle is repeated over and over is termed regular loading, and where the stress cycles vary is termed random loading. The random, or variable loadings, are used to simulate service conditions. The majority of fatigue tests, however, use regular patterns of loading.
 - b. Frequency--It is generally accepted that the fatigue limit increases almost negligibly up to a speed of about 5000 cycles per minute. At higher speeds there may be a substantial increase in the fatigue limit.

For most fatigue tests the frequency of loading is between zero and 5000 cycles per minute and thus has little or no effect.

- c. Rest periods--A fatigue test is often halted from time to time giving the specimen what is called a rest period. It is generally agreed that rest periods have little effect on the fatigue behavior. Some data is available, however, which indicates that under certain conditions the fatigue limit is improved by rest periods. (4.5)
4. Understressing or overstressing--It has been found that the fatigue limit of a metal is increased by understressing. Understressing consists of applying a large number of stress cycles slightly below the fatigue limit of the material. If, after understressing, the magnitude of the stress cycles is increased in small increments (a process commonly called coxing), a substantial increase in the fatigue resistance will result. (5) In contrast to understressing, overstressing, or the application of cyclic stress above the fatigue limit, seems to decrease the fatigue life. (3)

B. Nature and condition

1. Prior stress history--Most structures contain internal stresses caused by fabrication methods, thermal treatments, etc. Also, because of prestressing techniques and prior loadings, structures are often subjected to high stresses before loading. The existence of any of these stresses may influence the fatigue behavior of a structure.

- a. Presence or absence of residual stresses --Most authorities tend to believe that compressive residual stresses increase the fatigue strength and tensile residual stresses tend to decrease it. However, at present there is no general agreement on the exact nature of the influence which residual stress plays in the fatigue behavior of steel members.
- b. Work hardening--A metal structure during fabrication or service may be subjected to stresses which cause plastic deformation of the metal. This plastic deformation may increase the elastic strength of the material and thus increase the resistance of the material towards further plastic deformation. This process of increasing the elastic strength is called work hardening. Most writers seem to agree that work hardening is advantageous to the fatigue behavior of the metal.

2. Size and shape of specimen

- a. Presence of notches--The presence or absence of notches is probably the most important factor influencing the fatigue strength of a specimen. Even a slight indentation, caused by a hammer blow during construction of a structure, may seriously impair its fatigue strength. Any type of notch, either mechanical, caused by accident or purposely designed in a structure, or metallurgical, such as a slag inclusion, decreases the fatigue strength of a structure. The exact influence of the notch varies widely with the magnitude

of the cyclic stress and the type of material being studied. The effect of the stress concentration, due to these notches, will be discussed in detail later.

b. Size effects--The attempts to study the fatigue behavior of structures on small scale models have had varied success. Most studies have indicated that the fatigue limit varies little with the size of the specimen. However, data are also available which indicate a decrease in the fatigue limit with an increase in the size of the specimen.⁽⁶⁾ The size effect is even more critical on specimens containing notches.

3. Metallurgical structure--The metallurgical structure of a material is governed by the shape and orientation of crystals, the size of the crystals, and the chemical composition. The mechanical properties of materials are changed by changes in the metallurgical structure.

a. Microstructure--For structural steel, the microstructure may consist mainly of pearlite, austenite, ferrite, or martensite depending on the heating and cooling conditions to which the steel is subjected. Steels composed mainly of martensite usually have higher fatigue strengths.

Grain size--With a change in microstructure there is also a change in the size of the crystals. Test results have indicated that as the grain size increases the fatigue limit decreases.

Chemical composition--The chemical composition of steels has an important effect on the fatigue behavior of steel.

This effect is discussed thoroughly in other writings. (3,7)

b. Mechanical properties--The ultimate tensile strength and yield strength are the mechanical properties most often related to fatigue strength. An increase in the ultimate strength or yield strength of a material will result in an increase in the fatigue limit, but the increase in the fatigue limit will be less, sometimes considerably less, than the increase in the yield strength or ultimate strength.

4. Welding--The process of welding usually has an adverse effect on the fatigue behavior of a structure or specimen. The influence of the weld on the fatigue behavior can be attributed to both mechanical and metallurgical phenomena.

a. Mechanical--Welding produces severe residual stresses and geometrical discontinuities in a structure. The weld also changes the cross sectional area of the structure unless the weld is ground off. The mechanical properties of a specimen or structure may be greatly changed in the region of the weld due to the intense heat liberated during the welding process. Also the weld metal has different mechanical properties than the base metal.

b. Metallurgical--Due to the extensive amount of heat generated during welding there is usually a change in the microstructure of the base metal in the vicinity of the weld.

C. Environment

1. Temperature--In general, it can be said that the fatigue limit varies inversely with the temperature. For low temperatures

the fatigue limit is increased and for high temperatures the fatigue limit is decreased.

2. Atmosphere--Atmospheric conditions which cause corrosive action of a metal are extremely detrimental when the material is subjected to fatigue loading. This process of corrosion during fatigue loading is called corrosion fatigue. Even under normal atmospheric conditions this corrosion fatigue takes place because of the chemical reaction between oxygen and the metal. Thus, the fatigue limit of a metal is decreased when the metal is in contact with water and increased when tested in a vacuum.

FATIGUE OF NON-WELDED MEMBERS

Effect of Stress Concentration

The presence of stress concentration probably influences the fatigue behavior of a structure more than any other factor with respect to the nature and condition of the structure. Fatigue cracks in structures usually start at some external or internal discontinuity. For convenience, the term "notch" will be used interchangeably with stress concentration to represent any irregularities, internal or external in the following discussion.

It is generally agreed that for polished steel specimens, an increase in tensile strength will result in an increase in fatigue limit. The relationship between fatigue limit and tensile strength is approximately linear except for steels of extremely high tensile strength. For notched steel specimens there is a large reduction in the fatigue limit when compared to polished specimens. The reduction in fatigue limit increases as the tensile strength increases, that is, higher strength steels are more notch sensitive than the lower strength steels. However, there seems to exist a limiting tensile strength above which there is little or no increase in the fatigue limit of the notched specimens due to increase in tensile strength⁽⁸⁾.

Tests, cited by Cazaud⁽⁵⁾, give an indication of the effect of notches on rotating bending fatigue limits. Results were given for notched and unnotched test specimens for various steels. The tensile strengths of the steels tested were 48.4, 76.8, 121.0 and 142.2 ksi. The fatigue limits of the polished specimens were 27.0, 38.4, 48.4 and 59.7 ksi, respectively. The fatigue limits of the corresponding notched specimens were 21.4, 25.0, 32.7 and 38.4 ksi, respectively. Note that the notches

reduced the fatigue limit more in the high strength steels than in the low strength steels.

Notch sensitivity also varies with the type and severity of notch, the size of the specimen, and the nature of the applied stress⁽⁹⁾.

Most authors tend to agree that the larger the theoretical stress concentration is the greater the influence of the notch on reducing the fatigue strength will be. Peterson's results, as cited in Lessels⁽¹⁰⁾, illustrated that as the theoretical stress concentration factor K_t decreased, the fatigue strength reduction factor tends toward the theoretical value of K_t . The fatigue strength reduction factor is defined as the ratio of the fatigue strength of a specimen without stress concentration to that of a similar specimen with stress concentration at the same life time. Thus, the less severe notch may have a greater influence than would be normally expected.

The size of a specimen also has an important influence on the notch sensitivity of a specimen. Peterson⁽¹⁰⁾ found that as the diameter of the notched specimen increases the strength reduction factor increases.

It appears that, however severe the notch, the strength reduction factor rarely exceeds a value of 3. This is probably correct for specimens up to 3 inches in diameter, but for larger components of over 10 inches in diameter, the strength reduction factor may at times almost equal the theoretical value of K_t . Thus, it is in these large components that stress concentrations are most dangerous⁽⁹⁾.

Heywood and Phillips⁽⁹⁾ have studied the effect of fatigue life on notch sensitivity. Results were obtained for a specimen with a transverse hole subjected to oscillating tension. Their results illustrated that as the fatigue life increases the strength reduction factor increases. Thus, as the severity of the applied stress increases, the reduction in

fatigue strength as compared to a plain specimen decreases.

In static tests, stress concentration has a negligible effect on the ultimate tensile strength of a ductile material. This is not the case for fatigue loading. The preceding paragraphs clearly show that the presence of a notch reduces the fatigue strength of a material.

In summary, the following statements can be made concerning the influence of stress concentration on the fatigue strength of notched non-welded members.

1. High strength steels are more notch sensitive than low strength steels. There may be a limiting tensile strength at which any increase in the fatigue strength due to higher tensile strength is practically negligible.
2. The larger the stress concentration factor the greater the influence of a notch on the fatigue strength.
3. For mild notches the strength reduction factor tends to approach the stress concentration factor. Thus, the less severe notches may have a greater influence on fatigue strength than one would imagine.
4. As the size of the member increases, with the stress concentration factor remaining constant, the influence of the notch on the fatigue strength also increases.
5. As the magnitude of the applied stress increases the influence of the notch decreases.

Effect of Residual Stresses

Introduction to Residual Stresses. Residual stresses may be defined as those stresses in the structural members with no external loading acting. Similar to the case of mechanically produced stresses, the principle of superposition applies in the case of residual stresses also.

According to Lepison (11), the four basic causes of residual stresses are mechanical loading, thermal variation, bulk phase transformation, and phase precipitation. In order to better comprehend the causes of residual stresses, these causes are discussed briefly in the following paragraphs.

Residual stresses are caused by mechanical means when loading is sufficient to cause plastic deformation. This loading must be non-uniform, that is, parts of the body must be more highly stressed than the others. As long as a portion of the body is stressed in the plastic range, residual stresses will remain after unloading.

Thermal variation causes residual stresses when temperature distribution causes differing degrees of expansion and contraction, with the result of some plastic deformation.

Bulk phase transformation results in the formation of residual stresses, because particular phase transformations require a change in volume. The changes in volume are hindered by the presence of neighboring crystals and thus interlocked stresses are produced. (11)

Phase precipitation is a process in which, due to a condition of supersaturation, one phase is precipitated and disperses itself through the grains of the matrix. This process affects the mechanical properties of the material, especially the hardness. The process of change in mechanical properties due to phase precipitation is often called precipitation hardening or age hardening (11). Phase precipitation causes a volume change, resulting in the formation of residual stresses.

Some of the common operations which introduce or change residual stresses are differential cooling during and after rolling, cold working, handling and erection, welding and fabrication, temperature treatments, case hardening, casting, and rolling.

Residual stresses are often classified as macrostresses and microstresses. Macro stresses are stresses which extend over a large portion of the metal and result from plastic deformation produced by thermal and mechanical stresses. Macro stresses may exist in any continuous medium.

Residual stresses are referred to as microstresses if they are confined to the individual grains. Microstresses differ from macrostresses on more than just a matter of scale. Microstresses arise from the differences in the elastic and thermal properties of the grains. It is this anisotropic behavior and heterogeneity of a crystalline material that make microstresses possible. From the previous discussion it is obvious that bulk phase transformation and phase precipitation are causes of microstresses. Thermal and mechanical stresses may also influence microstresses, but to what extent, if any, is not clearly known.

In general, there seems to be little known about the exact nature and magnitude of microstresses. Most researchers tend to discuss residual stresses on a macrolevel rather than on the more elusive microlevel. The term residual stress in this report is used at the macrolevel.

Fading of Residual Stresses Residual stresses have little effect on the static strength of a material because usually such stresses are erased by plastic flow. During cyclic loading, however, the variation in residual stresses is not as well known. Residual stresses may change or fade during cyclic stressing, and at times may even be induced.

Pattinson and Dugdale⁽¹²⁾ have investigated the fading, or relaxation, of residual stresses in mild steel beams. The $\frac{1}{2}$ -inch square beams were bent, annealed, and then straightened to produce a controlled amount of residual stress. The steel had a lower yield point of 30.2 ksi. The steel test pieces showed a maximum tensile residual stress of 12.8 ksi. The beams were tested in reversed bending, and testing was halted at intervals

in order to determine the magnitude of the residual stresses. Stress amplitudes of 8.0 and 26.2 ksi reduced the residual stresses to 9.0 and 5.0 ksi respectively at 10,000,000 cycles. Initially there was a rapid fading of stresses in the steel and as the number of cycles increased the rate of fading gradually decreased. As can be seen, the larger the stress amplitude is, the greater is the amount of fading. The applied stresses never exceeded the yield point of the material and yet fading was considerable.

Most authors tend to agree that fading is quite prominent in mild steel specimens, particularly if the applied stresses approach the yield strength of the material.

Pattinson and Dugdale⁽¹²⁾ also conducted similar tests on a hard aluminum alloy with a 0.1% proof stress of 62.4 ksi. The aluminum specimens had an initial residual stress of 14.8 ksi. For various stress amplitudes the value of the residual stress remained almost constant to 1,000,000 cycles and then started to fade quite rapidly. The fading was much more rapid and to a greater degree in the mild steel than in the harder aluminum alloy. For steels of high hardness, some investigators have found little or no change of residual stress during fatigue loading⁽¹³⁾.

Buhler and Buchholtz, as cited by Forrest⁽⁴⁾, studying the fading of residual stresses on quenched specimens of various steels, have found that relaxation of residual stresses could occur even though the maximum applied stress was considerably below the initial yield stress of the steels.

One series of investigations found that residual stresses in a steel which has been hardened by heat treatment will relax considerably less than those in steel which has been softened or annealed. This was found to be particularly true if the applied stresses were low and the fatigue life was long⁽¹⁴⁾.

Taira and Murakami⁽¹⁵⁾ have conducted a series of tests on the fading of surface residual stresses on small, unnotched, plate-type specimens of medium carbon steel (S25C) (0.126-inch thick). The specimens were tested in reversed bending. The residual stresses were induced in the specimens by plastic stretching and shot peening. The as-annealed steel had a yield strength of 38.1 ksi and an ultimate strength of 66.6 ksi, while the shot peened steel had a yield strength of 45.5 ksi and an ultimate strength of 73.3 ksi. Note that shot peening improved the mechanical properties of the metal. This was probably due to a change in microstructure at the surface of the metal during shot peening rather than the influence of residual stresses.

The surface residual stress after plastic stretching was 14.2 ksi compression compared to 65.4 ksi compression for the shot peened specimen. With respect to the fading of the residual stresses at various stress amplitudes, a nearly straight line relationship was obtained between the ratio of the measured residual stress to the initial residual stress and the logarithm of the cycle ratio n/N , where N is the fatigue life and n is the life at which the residual stress is measured.

The fading of the residual stresses was more rapid when the initial residual stress was of a relatively low magnitude. For the shot peened specimens, with the higher initial residual stress, it was observed that there was still a significant amount of residual stress in the material at the time of failure, particularly at low stress amplitudes. In general, the fading of residual stresses occurred at a faster rate and was of a larger magnitude as the stress amplitude increased in size.

Fading as Affected by Stress Concentration Fatigue fracture often propagates from a discontinuity. Therefore, in order to study the effect of residual stresses on fatigue strength, it is important to study the

fading of residual stresses in the vicinity of a discontinuity.

Taira and Murakami⁽¹⁶⁾ have studied the fading of residual stresses in small notched plate specimens subjected to reversed bending. The material used was medium carbon S45C steel with a yield strength of 53.2 ksi and an ultimate strength of 93.7 ksi. The residual stresses were induced by plastic stretching in the specimens and were measured by an X-ray diffraction procedure. The applied stresses used in plastic stretching were 0.8 and 1.0 of the yield strength of the material.

For the specimen which was subjected to a nominal stress of 0.8 of the yield strength of the specimen, the residual compressive stresses were found to be 22.8 ksi and 18.5 ksi at the notch root and at a point 0.0787 inches below it, respectively. For those specimens stretched by 53.2 ksi nominal stress, the residual compressive stresses were found to be 27.0 ksi at the notch root and 21.4 ksi at a point 0.0787 inches below the notch root.

The fading of residual stresses due to alternating stressing in reversed bending was examined on the two specimens at the stress amplitudes of 11.4 and 21.4 ksi. There was a steep first stage of fading and slower second stage of fading. Also, the higher the stress amplitude the more pronounced was the fading. Fading was also more pronounced at the notch root than at a point below the notch root. The rate and magnitude of fading of residual stresses for notched specimens was similar in nature to the fading of plain specimens.

For high strength steels, most investigators tend to agree that the rate and magnitude of the relaxation of residual stresses is decreased when the specimen is notched.

Formation of Residual Stresses due to Alternating Stressing Up to

this point information has been presented which illustrates the fading of residual stresses due to cyclic loading. As mentioned earlier, residual stresses may also be induced during cyclic loading.

Buhler and Buchholtz⁽⁹⁾ have reported that longitudinal residual compressive stresses were introduced after alternately stressing annealed specimens of carbon steels at stress amplitudes near the fatigue limit of the material.

Taira and Murakami⁽¹⁷⁾ have conducted fatigue tests in reversed bending of 0.126-inch thick, plate-type, annealed steel specimens to study the changes in residual stresses during alternating stressing. The materials studied were low carbon steel (S15C) and medium carbon steel (S40C). The S15C steel had a lower yield point of 34.4 ksi and an ultimate strength of 63.5 ksi. The S40C steel had a lower yield point of 54.4 ksi and an ultimate strength of 89.5 ksi.

The initial residual stresses were very small. The specimens were subjected to stress amplitudes slightly above and below the fatigue limits of the specimens. For the S15C steel specimens the fatigue limit was 28.4 ksi and for the S40C steel specimen it was 31.3 ksi.

When the specimens were subjected to cyclic loading, the surface residual stresses (compressive in nature) reached a maximum value at about 100,000 cycles and then faded gradually. The maximum value reached was 15 and 30 ksi for the S15C and S40C steel respectively. The magnitude of the residual stresses were higher for harder material and for higher magnitude of stress amplitude.

The formation of residual stresses during cyclic loading may be more significant when the specimen contains a notch. If, for example, a notched specimen is subjected to a static tensile load, plastic flow may occur in the vicinity of the notch. When the load is removed, residual compressive stresses will occur in the vicinity of the notch. Even if the material is stressed in the plastic region throughout the entire cross section, residual stresses will still be induced when the load is released⁽¹⁸⁾. This phenomenon is only true for notched specimens, because if an unnotched specimen is stressed so that its entire cross section is plastic, residual stresses will not form. In fact, if initial residual stresses were present they would probably be removed. It is expected, therefore, that notched specimens would be more susceptible to formation of residual stresses during cyclic loading.

Effect of residual stresses on fatigue behavior It is generally accepted that in static load tests, residual stresses are of little influence on most materials. Under fatigue loading, however, the effect of residual stresses is not clear. Most authors believe that tensile residual stresses tend to lower the fatigue strength and compressive residual stresses tend to raise it.

Horger and Niefert⁽⁴⁾ induced compressive surface residual stresses by cold working on normalized and tempered 2-inch diameter axles of SAE 1045 steel and then subjected the axles to fatigue loading. They found an increase in fatigue limit from 13 to 33 ksi. Axles 6 inches in diameter showed a similar increase in the fatigue limit.

Sigwart⁽¹⁹⁾ summarized the test results on specimens of non-alloyed steels with 0.33 to 0.57% carbon. The specimens were heated to 600°C and then quenched in ice water. The residual compressive stresses obtained reached values between 25.0 and 53.8 ksi. An increase in compressive

residual stresses resulted in an increase in the fatigue limit.

In the tests conducted by Buhler and Buchholtz⁽²⁰⁾ residual stresses below 30 ksi generally did not greatly change the bending fatigue strength of small specimens with a diameter of 0.30 inches. It was also conducted that only with high tensile residual stresses will there be a decrease in the fatigue limit. A maximum decrease of about 15 per cent was found.

In another investigation⁽²⁰⁾, structural steels were subjected to heat treatment, and compressive residual stresses amounting to about 20 to 55 ksi were found on the surface of the specimens. The fatigue limits were increased by 6 to 22 per cent compared to stress-free specimens.

The fading of tensile residual stresses in mild steel and hard aluminum alloy beams tested by Pattinson and Dugdale⁽¹²⁾ was discussed earlier. Beams containing tensile residual stresses as well as stress-free beams were fatigue tested in reversed bending. The tensile residual stresses of 12.8 ksi in the steel beams reduced the fatigue limit from 29.8 to 26.4 ksi. The tensile residual stresses of 14.8 ksi in the aluminum beam reduced the fatigue strength at 10,000,000 cycles from 26.8 to 19.4 ksi. The fading of residual stresses was much more rapid in the mild steel than in the hard aluminum alloy. This may be the reason why the residual stress had such a greater effect on the fatigue strength of the aluminum alloy.

The fading of compressive residual stresses in small unnotched, plate specimens of medium carbon steel, studied by Taira and Murkami⁽¹⁵⁾ was also discussed earlier. Stretched, shot peened, and untreated (as-annealed) specimens were subjected to bending fatigue. The fatigue limit was increased from 30.6 to 32.0 ksi through plastic stretching and increased to 36.6 ksi through shot peening. The greater contribution of residual stress in the case of the shot peened specimens probably resulted from the larger amount

of residual stress and its smaller degree of fading.

The effect of residual stresses on the fatigue behavior of all materials is not identical. This is attributed to the fact that residual stresses fade during repeated loading and that this phenomena of fading varies with the properties of the material. Fading is generally more prominent in soft materials than in hard materials. Thus, the fatigue strength of a material will vary depending on the rate of fading of the residual stress and the amount of fading which takes place throughout the fatigue life of the material.

The amount of fading of residual stresses is reduced as the magnitude of the applied stresses decreases. Therefore, the influence of residual stresses will probably be greater when the fatigue life is long and the applied stresses are low.

If residual compressive stresses are introduced during cyclic loading, these stresses may act to improve the fatigue characteristics of the metal. At the present time, information is lacking concerning the effect of these induced residual stresses on the fatigue strength.

Combined Effect of Residual Stresses and Stress Concentration

Residual stresses are similar to mechanical stresses in that residual stresses also increase in magnitude in the vicinity of stress concentrations. Because of this, one would tend to believe that the residual stresses would play a more important role in the fatigue behavior of material with notches than in the case of notch-free materials.

Taira and Murakami⁽¹⁶⁾ conducted fatigue tests in reversed bending on four kinds of specimens, plain specimens without a notch, notched specimens not stretched, notched specimens stretched by 0.8 of the yield strength, and notched specimens stretched to the yield strength. The fading of the residual

stresses was discussed earlier. The notches in the specimen which was not stretched decreased the fatigue limit from 37.0 to 13.5 ksi. The residual compressive stresses in the vicinity of the notch were beneficial to the fatigue behavior of the notched specimens. The fatigue limit was increased from 13.5 to 17.1 ksi for an initial residual stress of 22.8 ksi and from 13.5 to 18.5 ksi for an initial residual stress of 27.0 ksi. The effect of stress concentration caused by the notch was much more pronounced than the effect of residual stresses on the fatigue limit. The lower the initial residual stress the greater is the increase in fatigue strength.

The influence of residual stresses on the fatigue strength of a structure increases with an increase in residual stress. In the vicinity of notches, the residual stresses are increased and thus, the influence of residual stresses will be greater in the notched specimen. Of course, the residual stresses will tend to fade in the vicinity of a notch under repeated loading, but because of the higher initial residual stresses there will be larger residual stresses retained in a specimen throughout its fatigue life.

The combined influence of residual stresses and stress concentration should vary considerably with the strength of the material. It has been shown previously that when acting separately, both the influence of stress concentration and residual stresses will be more prominent in the higher strength steels. The notch effect has been shown to reduce considerably the fatigue strength of high strength steels to such an extent that they may have little or no advantage over lower strength steels.

One series of investigation⁽¹⁴⁾ has shown that when tensile residual stresses were present around the root of a sharp notch, specimens of mild steel were appreciably stronger than those of high strength steel. This phenomenon could be attributed to two sources. First, the notch effect is

more significant in the higher strength steels. Secondly, the tensile residual stresses will not relax to any great extent in the high strength steels as they did in the mild steel.

The influence of the notch and residual stresses will also vary with the magnitude of the repeated stresses. It was found that the notch influence decreased as the applied stresses increased⁽⁹⁾. The fact that fading of residual stresses decreases with a decrease in the applied stresses has been discussed previously. Thus, the combined influence of the notch and residual stresses may be very prominent when the applied stresses are small and the fatigue life long.

Lepison and Juvinal⁽¹¹⁾ have summarized the effect of residual stresses on fatigue strength. According to them, some materials such as mild steel are not seriously weakened by the presence of internal stress, even if the specimen contains a notch. The greater the softness and plasticity of the material, the less the influence of the notch and residual stress.

CHARACTERISTICS OF WELDED STRUCTURAL MEMBERS

Description of Welds

The American Welding Society defines a weld as "a localized coalescence of metal wherein coalescence is produced by heating to suitable temperatures, with or without the application of pressure, and with or without the use of filler metal". The filler metal either has a melting point approximately the same as the base metals or has a melting point below that of the base metals but above 800°F.

In the process of welding, a great amount of heat is generated. Much of the heat escapes to the atmosphere, but a large percentage of it is transferred to the metal being welded. Much of the heat that is transferred to the base metal is localized in the fusion zone of the weld and diminishes through the heat-affected zone and into the surrounding metal. The fusion zone is the area of the base metal which is melted and fused with the weld metal. In this fusion zone there is a degree of intergranular mixing of weld metal and base metal. The heat-affected zone is that portion of the base metal surrounding the fusion zone which has not been melted but has undergone metallurgical change during the welding process⁽¹⁴⁾.

This report is concerned basically with the behavior of longitudinal welds. The welds studied will be confined, for the most part, to longitudinal fillet, groove, butt, and bead welds.

Many factors affect the metallurgy, size, geometry and mechanical properties of a weld. The most important factors are: welding process, methods used to apply the weld, position of welding, and others directly related to the application of the weld.

The method used to apply the weld, either automatic, semi-automatic, or manual, plays an important part in the quality of weld produced. The position of welding, whether horizontal, vertical, etc., also influences the

the characteristics of a weld.

There are many other factors directly related to the application of the of the weld which influences the weld. For instance, in a submerged arc weld, the wire size, type of wire, flux, voltage, current, and electrode speed all play important roles in the resulting weld,

With so many influencing factors a certain type of weld may have many possible variations in characteristics.

Stress Concentration in Welded Members

Because of the many influential factors mentioned in the preceding section, stress concentrations formed in welded members are quite erratic in nature. In fact, the variations in stress concentration may even vary somewhat for the same type of weld with all factors influencing the weld characteristics theoretically constant.

External stress concentration due to welds in welded members may result from weld reinforcement, weld surface roughness, toe cracks, undercutting, or other notch-like details⁽²²⁾. A toe crack occurs in the base metal at the toe of the weld which is the junction between the face of the weld and the base metal. Undercutting occurs when a groove is melted into the base metal adjacent to the toe of a weld and is left unfilled by the weld metal. Cracks will at times form in the weld metal itself.

Internal stress concentration due to welds may result from cracks, slag inclusions, porosity, lack of penetration, or lack of fusion⁽²²⁾. Root cracks may occur in the weld or base metal at the points at which the bottom of the weld intersects the base metal surfaces. Underbead cracks may occur in the heat-affected zone, and do not extend to the surface of the base metal. Porosity is caused by entrapped gases which result in cavities being formed in the weld metal. These cavities are often called blow holes or gas pockets. Slag inclusions consist of non-metallic solid

material which is entrapped in the weld metal or between the weld metal and the base metal.

Because the discontinuities may vary widely in severity and type, one can discuss stress concentration in welded members only in a general manner.

Residual Stresses in Welded Members

The magnitude and distribution of residual stresses in welded plates is mainly influenced by the geometry of the plate, the type of weld, the speed of welding, and the rate of cooling. The heat of welding varies with the size of the weld. The larger the size of the weld made with one pass, with other variables remaining constant, the more the amount of heat which will be generated. Welded structures, unless stress relieved, will often contain extremely high residual stresses, both compressive and tensile in nature.

Because of the extreme heat produced during welding, the member will expand. If the member is being attached to a second member, a rigid connection will form while the base metals are still very hot. On cooling, the base metal will tend to contract. However, this contraction is hindered by attached members and thus, residual stresses due to the reaction of the attached members will occur. Of course, if the member is detached from its adjacent members, these mechanical stresses will be relieved.

Even without attachment to adjacent members, the non-uniform distribution of heat in a welded member results in thermal stresses and plastic deformation, which in turn result in residual stresses.

The stresses arising through heating and cooling of the base metal are called thermal stresses. They may be in one direction on heating and in the other on cooling. The stresses that arise in the cooling of the weld metal are also called contraction or shrinkage stresses, and the stress system remaining in the material after welding is called the residual stress. The stresses in the weld metal, due to hindered contraction, are tension in

all directions and are proportional in intensity to the dimensions of the weld. Thus, the maximum stress is in the direction of welding, longitudinally. The transverse stress is next highest in intensity and the stress in the direction of the thickness is the least. (23)

Most authorities seem to believe that the maximum residual stress due to welding is the yield strength of the material corresponding to the existing system of stress and temperature. It is noted that certain temperature and cooling rates will change the mechanical properties of a material, including the yield strength.

Albritton, (24) in measuring the residual stresses in the vicinity of a weld, found lower values than anticipated. He attributed this to the yield strength of the base metal decreasing, due to the heat absorbed during welding. On the other hand, Rao and Tall (25), while investigating the residual stresses in welded steel, observed that the tensile residual stresses in the vicinity of the welds were about 50 per cent above the yield strength of the base metal. They concluded that the heat, due to welding, changed the mechanical properties of the base metal in the vicinity of the weld, increasing the yield strength by about 50 per cent.

Included in Rao and Tall's study (25) was an investigation of the residual stress distribution for a wide range of plate and weld sizes. Although their investigation was concerned with both longitudinal edge and center welds; only the results for the center welds will be discussed here. The plates varied from 4 to 20 inches in width and from $\frac{1}{2}$ to 1 inch in thickness. The plates were welded with either single or double-V grooves along the center of the specimens to simulate actual built-up shapes. The distribution of residual stresses in the plates was approximately parabolic in shape, except in the vicinity of the welds. For very wide plates, tensile stresses were also recorded at the edges of the plates. It was also noted that for

the center welded plates there was no significant variation in residual stresses between successive welding passes.

Most of the knowledge on the magnitude and distribution of residual stresses in welded plates has been derived from actual measurements in welded plates. The mathematical analysis for the magnitude and distribution of residual stresses in welded plates is complicated and not very exact. Simple cases have been analyzed based on approximate assumptions. Early analytical work was carried out by Gruning, Boulton and Martin, Rodgers and Fetcher, and Weiner⁽²⁵⁾.

Recently, Tall⁽²⁶⁾ carried out a theoretical study on residual stresses in welded plates. The method is applicable to both center- and edge-welded plates. Once the temperature distribution is obtained, the thermal stresses are calculated and hence the residual stresses. The analysis is a step-by-step method which takes into account the history of cooling and the variation in mechanical properties. The accuracy of the method is limited by a knowledge of the variation of mechanical properties and the heat losses during welding. Until further work is conducted on the heat losses and heat input for various sizes of welds, computational methods for determining residual stresses due to welding will not be reliable.

FATIGUE OF WELDED STRUCTURAL MEMBERS

Effect of Stress Concentration

It is generally accepted that stress concentration is probably the most important factor influencing the fatigue behavior of non-welded members with respect to the nature and condition of the specimen. It follows that the same can be said about welded members. The process of welding causes stress concentration that largely determines the fatigue behavior of a welded member.

Stress concentrations formed in welded members are erratic in nature. Because of this, the influence of stress concentration on the fatigue behavior of welded members has not been studied to the same degree as their non-welded counterparts. Most of the studies conducted to date relate the effect of different types and sizes of welds to the fatigue strength.

Fall⁽²⁷⁾ investigated the bending fatigue strengths of butt-welded, steel plates of 50 and 90 ksi yield strengths. The results showed that the fatigue limit of the lower strength steel was near yield, but the fatigue limit of the higher strength steel was considerably below yield and had an advantage of only 4 ksi over the lower strength steel. It was concluded that the shape of the weld bead was the most important variable affecting fatigue strength and that the stress concentrations in welded members have a much greater influence on the higher strength steels.

Fall's results are substantiated by Gilligan and England⁽³⁾. They investigated the effects of transverse butt welds on the zero to tension fatigue strength of various types of steels. Their results showed that at 100,000 cycles the fatigue strengths were considerably reduced by the presence of transverse butt welds, and at 2,000,000 cycles any advantage of one steel over another due to tensile strength appeared to be voided.

Fatigue tests conducted by Sanders, Derecho, and Munse⁽²⁸⁾ are one of the few to actually study in detail the effects of external geometry on the fatigue behavior of welded specimens. Fatigue tests were conducted on as-welded transverse butt-welded specimens, and simulated butt-welded specimens with simulated weld reinforcement machined from the base metal. The two main parameters studied were the radius at the toe of the weld r and the flank angle Θ .

The specimens were axially loaded in fatigue and although the number of tests were limited, the following conclusions were observed:

1. As the radius of the toe increases for the same stress cycle and angle Θ , the fatigue strength increases. The influence of the radius r tends to diminish as the flank angle Θ decreases, becoming negligible when Θ is less than about 15 degrees.
2. As the flank angle Θ is decreased for the same stress cycle and radius r , the fatigue strength increases. The influence of the flank angle seemed to diminish as the radius r increased and appeared to be negligible for values of r greater than $\frac{1}{4}$ inch.
3. The detrimental effect of the weld reinforcement decreases with an increase in the cyclic maximum stress.

Briefly then, it was concluded that any reduction in stress concentration caused an increase in the fatigue strength. The lesser effect of the weld reinforcement at the higher loads can probably be attributed to plastic flow and redistribution of stresses.

The results just stated are for transverse butt welds, but the information can probably be considered as somewhat representative of the conditions at the end of a longitudinal weld under axial loading.

Newman and Gurney⁽⁴⁾ have studied the influence of the flank angle Θ on the pulsating tensile fatigue strength at 2,000,000 cycles of axially loaded,

full penetration transverse butt welds in steel plates, free from significant internal defects. All tests were conducted on as-welded specimens and the flank angle ϕ varied directly with the size of the weld; that is ϕ was large for large size welds. As ϕ increased the fatigue strength decreased, and for small flank angles (in this study about 30 degrees) the influence of the flank angle ϕ on the fatigue strength was relatively constant. These tests studied only one weld parameter. It is expected that other variables such as weld surface roughness and internal stress concentrations influenced the results somewhat.

No study of a similar nature has been conducted on specimens with longitudinal welds. Tests studying precise parameters of various stress concentration in longitudinal welds are necessary in order to understand exactly the influence of stress concentration on the fatigue behavior of longitudinally welded specimens.

Unfortunately the majority of studies conducted on stress concentration have been concerned with simply the removal of the stress concentration due to weld reinforcement and then comparing those specimens with stress concentration to those with stress concentration removed. The common method of reducing stress concentration in longitudinal welds is to grind off the entire weld flush to the base metal, or since the greatest stress concentration in longitudinal welds usually occurs at the ends, to grind off the ends of the welds to a smooth transition.

Zeyen⁽⁷⁾ conducted some early tests on the removal of weld reinforcement from transverse butt welds in steel with a yield point of 52 ksi and a tensile strength of 77 ksi. The specimens tested were subjected to pulsating tensile fatigue. All fatigue strengths were based on failure at 2,000,000 cycles. The butt-welded specimens with the weld reinforcement removed had considerably lower fatigue strengths (33.4 ksi) than those of:

the plain plates (42.7 ksi) but there was still considerable improvement over the as-welded specimens (24.0 ksi).

Kaufmann⁽⁷⁾ conducted an interesting study on the effect of stress concentration on both longitudinal and transverse welds. Mild steel which had a yield point of 30.7 ksi and a tensile strength of 52.7 ksi was used. The fatigue tests were conducted in pulsating tension and the strengths were determined at 2,000,000 cycles. The weld beads, deposited on both sides of the specimens, were 2 or 8 inches long and were left as-welded, or smoothed so as to make a gradual transition to the level of the plate. Models of plain mild steel, machined to simulate notch-free longitudinal and transverse beads, were also tested. The specimens with the ends machined were approximately 28 per cent stronger than the as-welded specimens in both cases. The models of mild steel which were free from notches were 12 to 27 per cent stronger than the welded specimens with the machined ends, indicating that machining does not remove all stress concentrations.

Other tests conducted by Kaufmann⁽⁷⁾ compared the fatigue strength of longitudinal bead welds with the ends of the welds ground off and with the entire weld ground off. Again, tests were conducted in pulsating tension and the fatigue strengths were evaluated at 2 million cycles. His results indicate that grinding off the entire weld improves the fatigue strength 20 per cent compared to simply grinding off the ends of the welds.

The effect of weld reinforcement on the fatigue strength of longitudinal single-V and double-V butt welds was summarized by Munse⁽²²⁾. Grinding off the welds improved the zero-to-tension fatigue strength of the single-V welds at 100,000 and 2,000,000 cycles by 20 per cent and 11 per cent, respectively, and for double-V welds, by 12 per cent and 17 per cent, respectively.

Wilson, Munse, and Snyder⁽²²⁾ made a limited study on fatigue behavior of longitudinal, partial penetration butt welds. By grinding off the weld, the zero-to-tension fatigue strength was improved by 16 per cent at 100,000 cycles and by 6 per cent at 2,000,000 cycles.

Wilson, Munse, and Snyder⁽²⁹⁾ continued their study to consider 1/4-inch and 3/16-inch longitudinal, partial penetration butt welds. In this series both the weld reinforcement and mill scale were ground off. Grinding off the welds increased the fatigue strength for the 1/4-inch weld by 11 per cent at 100,000 and by 0 per cent at 2,000,000 cycles. For the 3/16-inch weld the figures were 22 per cent and 13 per cent, respectively.

Kommerell⁽³⁾ conducted a series of tests on the effect of machining the ends of longitudinal fillet welds. The tests, conducted under completely reversed cyclic loading on mild steel St37 indicate that fairing the ends of the weld with a smooth transition increases the fatigue strength. For convex fillet welds the fatigue strength at 2 million cycles was increased from 11.4 to 12.8 ksi and for concave fillet welds from 15.6 to 17.0 ksi. For both types of specimens tested with as-weld or machined ends, the convex fillet weld had a lower fatigue strength than the concave fillet weld even though the weld area was larger for the convex weld.

Weck⁽³⁰⁾ supported Kommerell's results by stating that the fatigue strength of fillet-welded joints is unaffected by the size of the weld within fairly wide limits, and once the fillet welds exceed a certain minimum size no further increase in fatigue strength can be obtained by increasing the throat thickness or the length of the weld. Weck felt that the stress concentration due to the form of the fillet-welded joint and the contour of the weld was more critical than the size of the weld.

Weck⁽³⁾ continuing his investigation of the effect of geometry in fillet welds, also found that if two similar fillet welds of equal sizes,

one concave and the other convex, were tested in fatigue, the concave weld would have a higher fatigue strength even though its throat area was smaller.

A study and review of reported fatigue data for tests of welded joints, structural details of welds and welded members were made in 1955 and 1956 by the University of Illinois⁽³¹⁾. From the comparison of the results given for the longitudinal butt-welded joints with the reinforcement machined off and the results for the plain plates, it appears that with careful grinding the longitudinal butt weld can be almost 100 per cent effective under fatigue loading.

A study by Gurney⁽⁹⁾ indicates that automatic, longitudinal welds have higher fatigue strengths than manual, longitudinal welds. This may be attributed to the greater control in automatic welding, a reduction in surface roughness, and the probability of less internal defects. It was also noted that manual longitudinal butt welds have a higher fatigue strength than the manual longitudinal fillet welds.

In summary, the following statements can be made concerning the effect of stress concentration due to welds on the fatigue behavior of longitudinally welded members:

1. Stress concentration is probably the most significant factor influencing fatigue strength with respect to the nature and condition of the member.
2. The exact influence of stress concentration on the fatigue behavior due to a certain type of weld is difficult to analyze because of the erratic nature of the stress concentrations which are formed during welding. Also different types of joint details will result in different discontinuities.

3. The radius at the toe of the weld and the flank angle may be the most significant discontinuities affecting the fatigue behavior.
4. The fatigue strength decreases as the severity of the discontinuity increases.
5. Removal of weld reinforcement will significantly increase the fatigue strength of a longitudinally welded member. Removal of the entire weld reinforcement improves the fatigue strength more than simply removing the reinforcement at the ends of the welds.

Effect of Residual Stresses

The effect of residual stresses on the fatigue behavior of welded members is not clear as their non-welded counterparts and there tends to be disagreement over the effect of these residual stresses in welded members. In fact, some authors believe that residual stresses have little or no effect on the fatigue behavior of welded specimens. By studying the information on the effect of residual stresses on non-welded members it is not difficult to see that residual stresses play some role in the fatigue behavior of welded members.

Kaufmann⁽⁷⁾ has investigated the influence of residual stresses on the pulsating tensile fatigue strength of specimens of mild steel with patches of beads deposited longitudinally. The residual stresses in the as-welded specimens were found by a sectioning method and were as high as 30 ksi which was the elastic limit of the base metal. Bead-welded specimens were tested as-welded, stress relieved at 1200°F, annealed at 1700°F, with the ends of beads machined off, or with the entire bead machined off. Both the stress-relieved and the annealed specimens indicated a higher fatigue strength than the as-welded specimens. These tests indicate that the heat treatment lowered the residual stresses and thus increased the fatigue strength.

Zeyen⁽⁷⁾ has investigated the effects of different heat treatments and preheating on the fatigue resistance of butt-welded and bead-welded specimens of low-alloy steel. Zero-to-tension fatigue tests were conducted and the fatigue strengths were determined at 2,000,000 cycles. The base metal had a yield strength of 52.0 ksi and a tensile strength of 77.0 ksi. The fatigue strength of the unwelded base metal was 42.7 ksi with mill scale and 50.5 ksi when ground on all sides. These values were little affected by heat treatment. The longitudinal beads were down the center of the specimen (3.2 in. X 22 in.) and were eight inches long. The butt-welded specimens were little affected by the heat treatments, but the fatigue strength of bead welded specimens were for the most part improved by the heat treatments. Preheating had a beneficial influence on the fatigue strength of transverse bead welds only. The beneficial effect of the heat treatment on the majority of welded specimens again illustrates the influence of the residual stresses.

Kaufmann⁽⁷⁾ observed the influence of residual stresses upon the fatigue strength of fillet welds, which were positioned at an angle to the direction of stressing. Stress relieving at 1200^oF resulted in an increase of the pulsating tension fatigue limit from 15.6 to 17.6 ksi. Compressive residual stresses were induced at the ends of the fillet welds by depositing small bead welds near each end. This raised the fatigue limit to 19.5 ksi. These tests seem to indicate that residual compressive stresses tend to raise the fatigue strength.

Munse⁽²²⁾, based on summarized results of many previous works, indicated that for the single-V butt weld with reinforcement on, fatigue strengths were substantially improved by low temperature stress relief.

More recently, Nordmark⁽³²⁾ has investigated the effects of residual stresses on the fatigue strength of longitudinal butt welds in aluminum

plates (5456-H321). The as-welded specimens were shot peened or stress relieved. Shot peening produced high compressive residual stresses at the surface and thermal treatment reduced residual welding stresses to a low magnitude. Axial fatigue tests showed that because of the surface compressive stresses produced by peening, the improvement in fatigue life was greater than that produced by thermal stress relief.

Weck⁽³⁰⁾ has stated that numerous investigations carried out on welded joints have shown no significant difference between the fatigue strength of joints tested in the as-welded condition and those which have been stress relieved. In 1955, Soate, Hebrant, Lewis and Venicher⁽³⁰⁾ found a reduction of 10 per cent in the fatigue limit due to residual welding stresses. Weck questioned the results and attributed the reduction in fatigue limit to scatter of test results.

It seems that stress raisers, such as notches on the surface of a welded joint, have a much greater effect on fatigue strength than the residual stresses. However, on the basis of information presented in this section and in the section on the effect of residual stresses on non-welded members, it does not seem appropriate to state that residual stresses have no effect on the fatigue strength. It appears that compressive residual stresses tend to increase the fatigue strength of welded members and tensile residual stresses tend to lower it. The exact influence of residual stresses on welded members for various details is a problem which needs to be studied experimentally to a greater extent.

As mentioned earlier, the influence of residual stresses on the fatigue behavior of non-welded members has been investigated in greater detail than that of welded members. It is possible to combine the results for welded and non-welded members and obtain a better indication of the influence of residual stresses on the fatigue behavior of the welded members.

The following statements can be made concerning the influence of residual stresses on the fatigue behavior of longitudinally welded members:

1. Residual compressive stresses tend to increase the fatigue strength and residual tensile stresses tend to lower it.
2. The fatigue failure in longitudinally welded members often occurs in the vicinity of the weld. This is probable because the tensile residual stresses near the weld act to decrease the fatigue strength.
3. Various heat treatments will reduce the magnitude of the tensile residual stresses and will result in an increase in the fatigue strength.
4. Shot peening the as-welded member will induce compressive residual stresses and improve the fatigue strength of the member.
5. The residual stresses will probably fade in a welded specimen as they do in a non-welded specimen. The rate and degree of fading will increase as the strength of the base metal decreases.
6. Because of the possible increase in the yield strength of the base metal in the vicinity of the weld, due to the heating and cooling conditions of the welding process, the fading of the residual stresses may be somewhat hindered.
7. Because of the extremely high residual stresses in a welded member, there will probably be substantial residual stresses remaining at the fatigue life of the member.
8. The influence of the residual stresses on the fatigue behavior will decrease as the magnitude of the applied stresses increases.

Combined Effect of Residual Stresses and Stress Concentration

At the present time, the effect of residual stresses on the fatigue behavior of welded members is not entirely understood. Therefore, one can only speculate what the combined influence of residual stresses and stress

concentration would be. It seems as though no experimental studies have been conducted to specifically investigate this combined effect. However, in welded members the combined effect would always be present since it is almost impossible in a welded member, even if the weld is ground off, to avoid all stress concentration.

It may be expected that there is a larger influence of residual stresses for the more severe stress concentrations. This could be attributed to the residual stresses concentrating around the notches. Also, if residual stresses fade as they do in their non-welded counterparts, the fading would probably be restricted by the stress concentrations⁽³³⁾.

For the same degree of stress concentration, one would expect the influence of residual stresses to be more in a welded member than in a non-welded member. This is because significant stress concentration and tensile residual stresses occur in the weld or in the base metal near the weld. It is in this region that a fatigue failure often originates.

Because of the discontinuities due to welding, compressive residual stresses may actually be formed in the vicinity of the discontinuities in a welded specimen due to applied cyclic stresses. These compressive residual stresses could improve the fatigue strength of the specimen.

Effect of Weld Area

Under static loading, the greater the cross sectional area of the specimen is for the same type of material, the greater the ultimate load will be. The same is not necessarily true in the case of welded members under fatigue loading.

Zeyen⁽⁷⁾, in tests on steel specimens with longitudinal bead welds, observed that specimens with a longitudinal bead on one side had a pulsating tensile fatigue strength at 2,000,000 cycles of 34.2 ksi. With beads on both sides the fatigue strength was increased to 35.6 ksi. In this case an

increase in the weld area resulted in a slight increase in fatigue strength.

Kaufmann's tests⁽⁷⁾ of a similar nature contradict those by Zeyen. He found that depositing weld beads on both sides was more detrimental to the fatigue strength than when the bead was only on one side. Thus, an increase in weld area resulted in a decrease in fatigue strength.

Kommerell's results⁽³⁾ support Kaufmann's tests. For longitudinal fillet welded specimens, the steel specimens with convex fillet welds had a lower fatigue strength than concave fillet-welded specimens, even though the weld area was larger for the convex specimen. The fatigue strengths were determined at 2,000,000 cycles under completely reversed cyclic loading.

If fatigue strength is dependent on cross sectional area alone, the fatigue strength will increase with an increase in weld size and area. In general, it appears that residual stresses and stress concentration, especially stress concentration, are much more influential variables on fatigue behavior than weld area.

On the other hand, considering the variation of stress concentration with external area, it is likely that the stress concentration in welded members becomes more pronounced as the size of the weld is increased.

Weck⁽³⁾ has stated that, in the case of fillet welds, the weld shape is much more important than the weld area with respect to its influence on the fatigue strength. Some fatigue tests have shown that grinding off the weld and removing completely the external weld area will cause a substantial increase in fatigue strength⁽⁷⁾.

This also illustrates that the stress concentration has a more significant influence on fatigue behavior than the weld area.

Weld area is thus significant in the fatigue behavior of welded members only to the extent to which it influences the stress concentration and the residual stresses.

CONCLUSIONS

This study is concerned with the effect of residual stresses and stress concentration, due to longitudinal welds, on the fatigue behavior of structural members. Literature on the fatigue behavior of both welded and non-welded members were reviewed and the results summarized. Non-welded members were studied in order to better understand the fatigue behavior of the welded members.

On the basis of the literature review and summary contained in this part of the report, the following conclusions may be reached:

1. Stress concentration is probably the most important variable, affecting the fatigue behavior with respect to the nature and condition of a welded member. The effect of stress concentration seems to overshadow the effect of residual stresses.
2. The exact effect of stress concentration on the fatigue behavior is difficult to analyze because of the erratic nature of the discontinuities which are formed during welding. It is probable that the flank angle and the radius at the toe of the weld reinforcement are the two most significant factors related to discontinuities which affect the fatigue behavior.
3. The fatigue strength decreases as the severity of the discontinuity increases.
4. As the size of the welded member increases, the influence of the discontinuity on the fatigue behavior increases.
5. Welded members of higher strength steels are more notch sensitive than members of lower strength steels. There may be a limiting tensile strength at which any increase in the tensile strength of the base metal will have little or no effect on the fatigue behavior of the welds.

6. Tensile residual stresses tend to lower the fatigue strength and compressive residual stresses tend to raise the fatigue strength of welded members. For longitudinally welded specimens, tensile residual stresses near the yield strength of the base metal will exist in the vicinity of the weld.
7. Heat treatments will reduce the magnitude of the residual stresses and shot peening will induce compressive residual stresses in a welded member. Both of these processes will result in an increase in the fatigue strength.
8. The influence of residual stresses on the fatigue behavior of welded members will also vary with the rate and degree of fading of residual stresses. Any reduction in the rate or degree of relaxation will probably cause the residual stresses to have a greater influence on the fatigue behavior.
9. The relaxation or fading of residual stresses is less in high strength steels than in low strength steels.
10. The higher the magnitude of the initial residual stresses, the greater the residual stresses will be at the fatigue life of a member. Therefore, the residual stresses may have a larger influence on the fatigue behavior of a welded member when the initial residual stress is large.
11. The influence of residual stresses may be more prominent in welded members containing severe discontinuities. The residual stresses will be concentrated around the notches and the fading may be restricted by the more severe stress concentrations.
12. Residual stresses may be induced in a member due to the cyclic loading. These induced residual stresses if compressive in nature may improve the fatigue behavior of the member.

13. The fatigue behavior of welded members is improved by removing the reinforcement at the ends of a weld. It is improved to a greater extent by removing all of the weld reinforcement. Removal of the entire weld reinforcement does not significantly reduce the magnitude of the residual stresses. However, any reduction in fatigue strength, when comparing a plain specimen and a welded specimen with the reinforcement ground off, can not be attributed solely to residual stresses. This is due to the fact that removal of the weld reinforcement will not remove all discontinuities.
14. The influence of both stress concentration and residual stresses is more significant at long lives and low applied stresses.
15. Weld area is significant in the fatigue behavior of welded members only to the extent in which the weld area influences stress concentration and residual stresses.

PART II. EXPERIMENTAL INVESTIGATION

PILOT TEST SERIES

Test Program

There were eleven 3-inch wide specimens and two 5-inch wide specimens in the pilot test series. The 3-inch wide specimens were all identical except the size of longitudinal weld along the center line of the specimen. The dimensions for the 3-inch wide specimen are shown in Fig. 1. The complete test program is given in Table 1.

The description of test specimens and the fatigue testing for the 5-inch wide specimens is given at the end of this chapter. All other sections in this chapter pertain to 3-inch wide specimens.

Material Properties

All specimens were fabricated from A36 steel. The mechanical and chemical properties of the material as given in the mill report are shown in Table 2. Two additional tension coupon tests were conducted to substantiate the results of the mill report. The results of these tension tests are summarized in Table 3.

Fabrication of Specimens

The steel plates for the specimens were flame cut from a large piece of steel plate. After removing the flame hardened edges with a shaper, the specimens were machined to their final dimensions. The machined edges of specimens were polished using a soft wheel belt sander. Finally the surfaces of the specimens were shot blasted to remove mill scale.

The longitudinal welds were applied semi-automatically by an experienced welder using the submerged arc welding process. Welding data for three different sizes of welds are summarized in Table 4. The specimens were placed horizontally and were clamped during welding. The weld was first

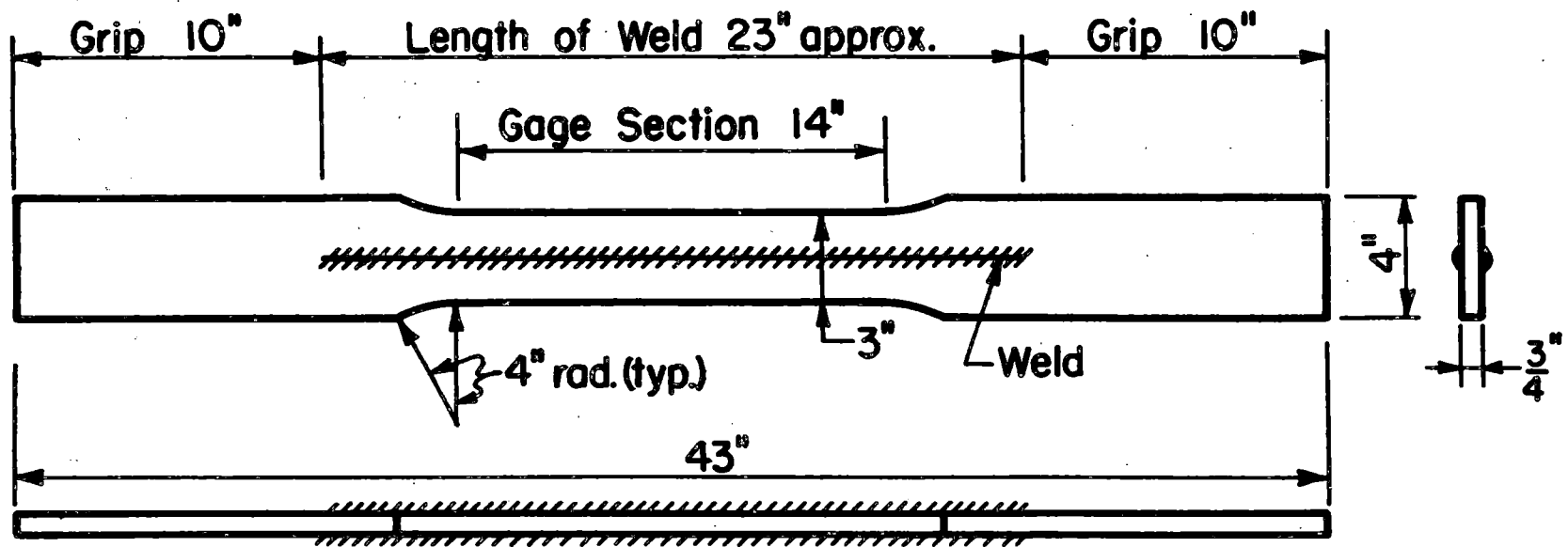

Fig. 1 Pilot Test Specimens

Table 1

Over-All Test Program

No.	Specimens		Weld* Size	Test Conditions
	Width(in)	Thickness(in)		
Pilot Test Series				
PT-1	3	3/4	None	Fatigue 25-50ksi**
PT-2	3	3/4	None	Fatigue 25-50 ksi
PT-3	3	3/4	Small	Fatigue 25-50 ksi
PT-4	3	3/4	Small	Fatigue 25-50 ksi
PT-5	3	3/4	Medium	Fatigue 25-50 ksi
PT-6	3	3/4	Medium	Fatigue 25-50 ksi
PT-7	3	3/4	Large	Fatigue 25-50 ksi
PT-8	3	3/4	Large	Fatigue 25-50 ksi
PT-9	3	3/4	Small	Residual Stress Measurement
PT-10	3	3/4	Medium	
PT-11	3	3/4	Large	
PT-12	5	1/2	None	Not Tested
PT-13	5	1/2	Large	Fatigue 25-50 ksi
Effect of Weld Removal on Residual Stress Distribution				
PT-14	5	1/2	Large	Residual Stress Measurement
PT-15	5	1/2	Large	
Main Test Series				
T-11	5	1/2	None	Fatigue 25-50 ksi
T-21	5	1/2	Small	Fatigue 2-34 ksi
T-31	5	1/2	Medium	Fatigue 2-34 ksi
T-32	5	1/2	Medium	Fatigue 2-34 ksi
T-41	5	1/2	Large	Fatigue 2-32 ksi
T-42	5	1/2	Large	Fatigue 2-34 ksi
T-23	5	1/2	Small	Residual Stress Measurement
T-33	5	1/2	Medium	
T-43	5	1/2	Large	

* Relative. For actual sizes, see Tables 5 and 13.

** Tensile stress, nominal except T-42.

Table 2. Properties of Specimen Material
for PT-1 Through PT-11 (Mill
Report)

Mechanical Properties:

Tensile Strength	71.9 ksi
Yield Point	46.2 ksi
% Elongation in 8 in.	27.3 %

Chemical Analysis:

Carbon	0.25 %
Manganese	0.92 %
Phosphorus	0.01 %
Sulfur	0.04 %
Silicon	0.04 %

Table 3. Results of Tension Coupon Tests for PT-1 Through
PT-11

Specimen	T-1	T-2	Average
Tensile Strength (ksi)	77.4	77.9	77.6
Yield Point (ksi)	43.5	42.5	43.0
Proportional Limit (ksi)	40.8	40.5	40.6
Modulus of Elasticity (ksi x 10 ³)	31.3	30.2	30.8
Elongation in 2 in. (%)	47.7	46.7	47.2
Reduction in Area (%)	54.5	53.7	54.0

Table 4. Welding Data for Specimens PT-3 Through PT-11

Specimens	PT-3, -4, -9	PT-5, -6, -10	PT-7, -8, -11
Wire	L-70, 5/64 in.	Same	Same
Flux	780	Same	Same
Voltage (volts)	32	Same	Same
Current (amps)	400	Same	Same
Electrode Speed (in/min.)	40	20	15
Approx. length of Weld (in.)	23	Same	Same
Approx. Width of Weld (in.)	0.380	0.526	0.647
Approx. Weld Material Deposited on One Side (lbs./ft.)	0.056	0.110	0.148
Size of Weld	Small	Medium	Large

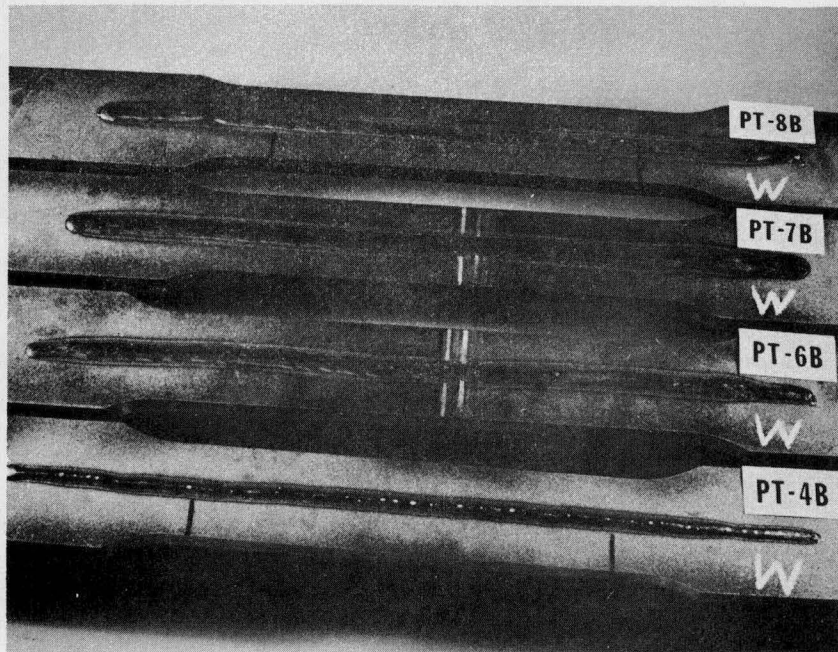

Fig. 2 Specimens with Longitudinal Center Welds

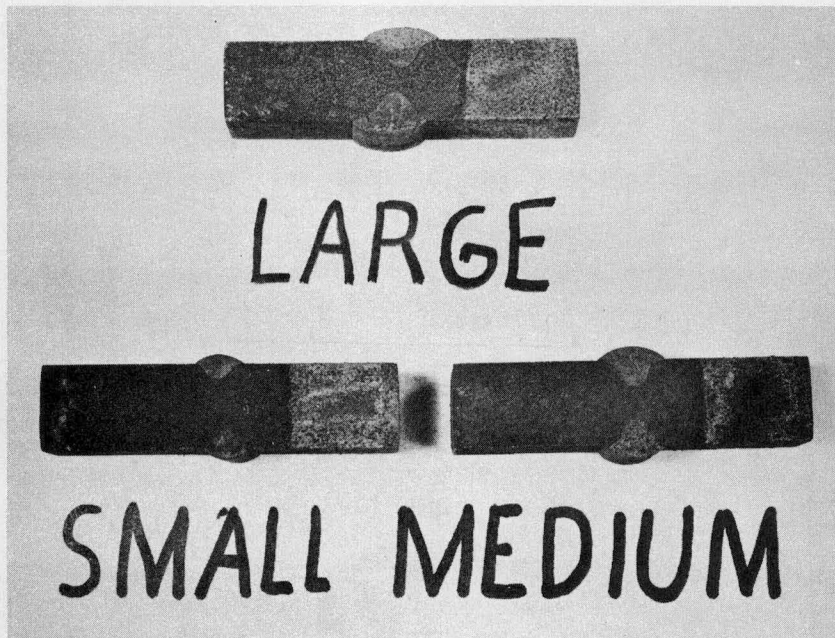

Fig. 4 Different Sizes of Welds as Brought Out by Etching

applied to one side of the specimen. The specimen was then allowed to cool before the other side was welded. Figure 2 shows the photographs of four welded specimens.

Temperature Distribution During Welding

Residual stresses due to welding vary with the amount of heat absorbed by the base metal during the welding process. Therefore, it was decided to measure temperature distribution across the transverse direction in the test specimen during welding. This was accomplished by using temperature indicating paints and pellets with rating varying from 100^oF to 3000^oF.

The results of temperature measurements for specimens with three different sizes of welds are shown in Fig. 3. These temperature distributions correspond to those existing when only one side of the specimen had been welded. Notice that, because of moving heat source associated with welding, only the maximum temperature reached at any time during the complete process of welding could be measured.

Measurements of Weld Areas

In order to measure the area of welds, segments of three welded specimens, PT-9, PT-10 and PT-11, approximately 1/2 inch in width were boiled in a solution of muriatic acid (equal parts by volume of hydrochloric acid and water) for approximately 15 minutes until the fusion zones of the welds became clearly visible. Photographs of the segments after the etching are shown in Fig. 4.

The width and the depth of each weld were measured with a small steel scale, graduated to 0.01 in. The area of the weld was measured by first tracing the shape of the weld on a sheet of paper and then obtaining the area by means of a planimeter.

Two segments were used for the measurement of each size of weld. Since each segment has four weld cross sections, a total of eight measure-

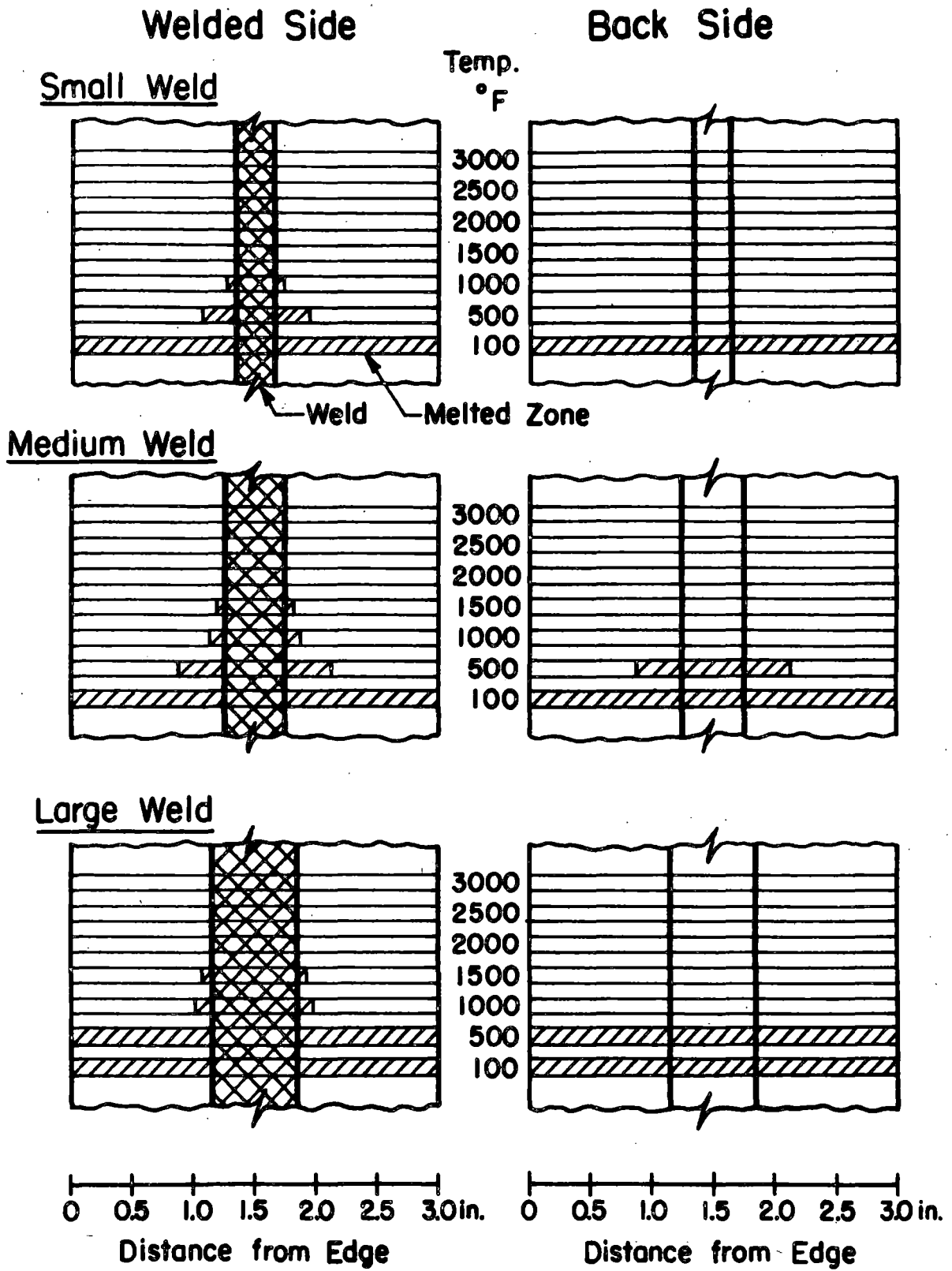

Fig. 3 Distribution of Temperature during Welding as Indicated by Melting of Temperature Indicating Paints

ments were made for each size of weld. The average sizes of welds are summarized in Table 5. The nomenclature used in Table 5 is illustrated in Fig. 5.

The weld dimensions measured are plotted against the weight of weld deposit in Fig. 6 and 7. The variation of external area with respect to weight deposited shows a fairly good linear relation. Also it appears that there exists a maximum depth of weld which can be obtained if all variables related to the weld were kept constant except the speed of welding.

Table 5. Size of Welds for Specimens PT-9, PT-10, and PT-11

Specimens	PT-9	PT-10	PT-11
Size of Welds	Small	Medium	Large
A^t --total area (in ²)	0.0530	0.1155	0.1352
A^e --external area (in ²)	0.0193	0.0415	0.0495
A^i --internal area (in ²)	0.0337	0.0740	0.0857
d^i --total depth (in)	0.214	0.369	0.369
d^t --external depth (in)	0.069	0.105	0.100
d^e --internal depth (in)	0.145	0.264	0.269
b^i --width (in)	0.380	0.526	0.647
Weight deposited on one side (lbs/ft)	0.056	0.110	0.148
$r = \frac{2 A^e}{\text{Plate area}} \times 100\%$	1.72	3.69	4.40

Residual Stress Distribution

Residual stresses in the longitudinal direction were measured for the weld specimens with small, medium and large welds. The method of sectioning⁽³⁴⁾ was used for this purpose. Figure 8 shows a photograph of a specimen after sectioning. The residual stress distribution for the three specimens is shown in Fig. 9. The maximum (tensile) and minimum

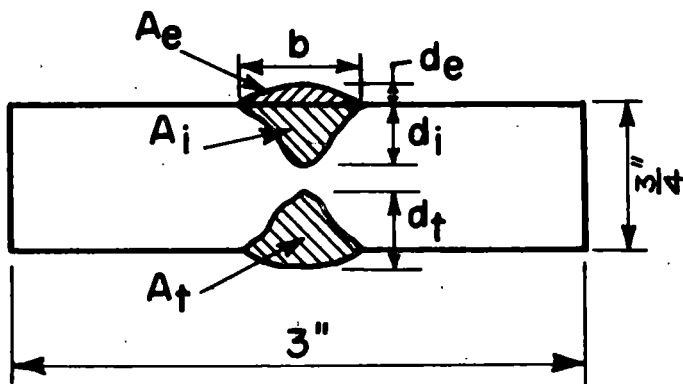
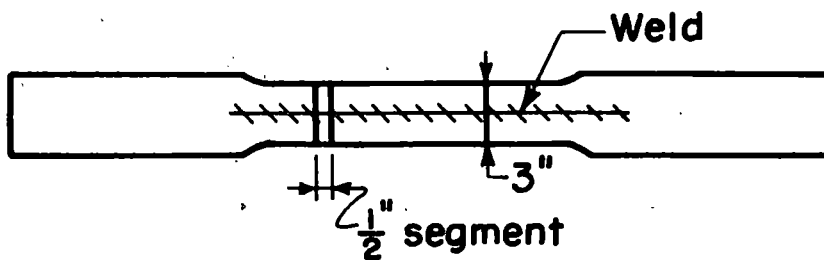

Fig. 5 Nomenclature for Weld Area Measurement

- A_t = total area of one fusion zone
- A_e = external area of one fusion zone
- A_i = internal area of one fusion zone
- d_t = total depth of one fusion zone
- d_e = external depth of one fusion zone
- d_i = internal depth of one fusion zone

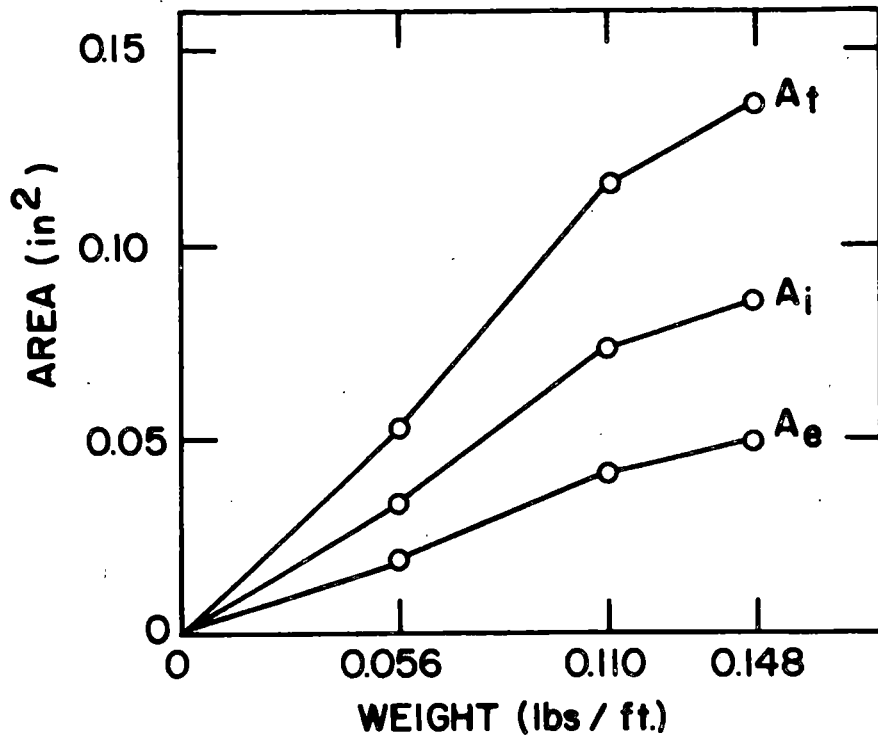

Fig. 6 Weld Areas vs Weight of Weld Deposit

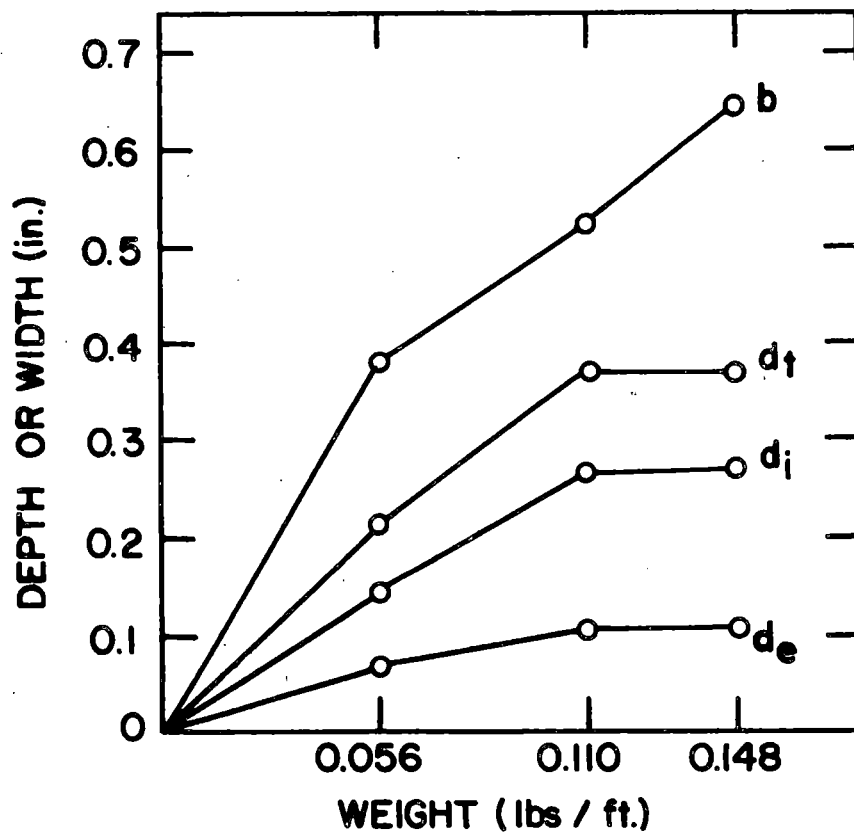

Fig. 7 Dimensions of Welds vs Weight of Weld Deposit

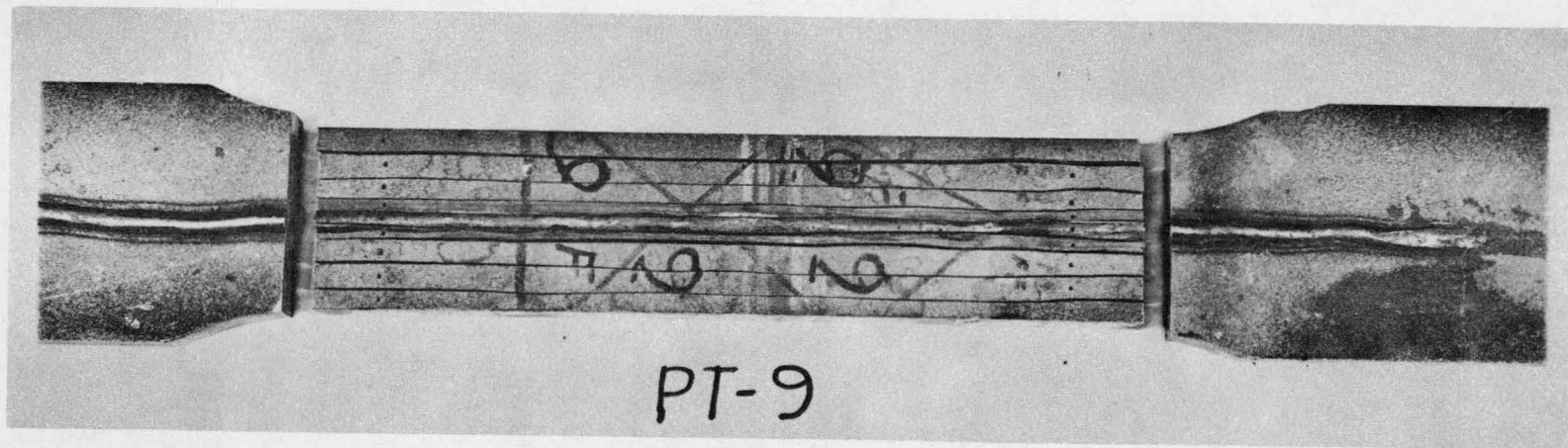

Fig. 8 Specimen PT-9 after Sectioning

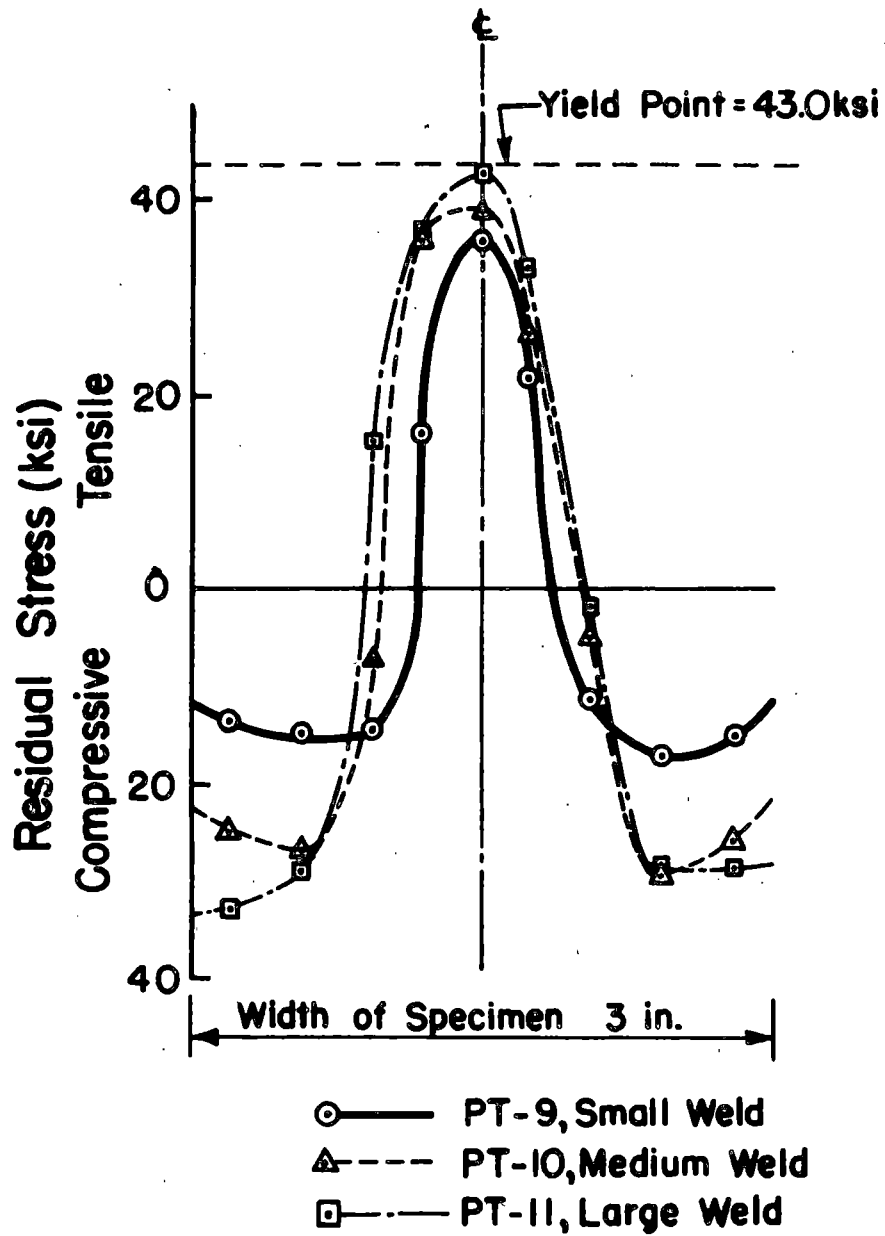

Fig. 9 Residual Stress Distribution (PT -9, PT-10, PT-11)

(compressive residual stresses (ksi) for PT-9, PT-10 and PT-11 are: 35.8, -17.2; 39.0, -.28.8; and 42.5, -32.6, respectively.

The variation of the maximum (tensile) and minimum (compressive) residual stresses as a function of the weight of weld deposited is illustrated in Fig. 10. It appears that, for the range of weld sizes used, the larger the size of the weld, the higher the tensile residual stress at the center of the specimen and the higher the compressive residual stress at the edge of the specimen.

Fatigue Tests

Fatigue tests for the pilot test series were conducted at Fritz Engineering Laboratory, Lehigh University, Bethlehem, Pa., using an Amsler Alternating Stress Testing Machine which has a maximum dynamic capacity of 200 kips.

There were eight fatigue specimens: two plain (PT-1, PT-2), two with small size welds (PT-3, PT-4), two with medium size welds (PT-5, PT-6) and two with large size welds (PT-7, PT-8). The nominal cross sectional area of the specimens was 2.25 in^2 at the reduced section. The ends of the welds were ground flush with plate surfaces in PT-4, PT-6 and PT-8. All specimens were loaded axially. A stress range of 25 ksi tension to 50 ksi tension was used.

Photographs illustrating the locations of fractures and the fracture surfaces are shown in Figs. 11-14.

The two plain specimens, PT-1 and PT-2, did not fail after more than 5×10^6 cycles.

Specimen PT-3 failed at 1,465,500 cycles in the gage section (Fig. 11). The fatigue fracture propagated from the weld on one of the surfaces. This can be seen in Fig. 14. The details of fracture surface for PT-3 are shown in Fig. 15. No defect was visible at the fracture section, however. It is

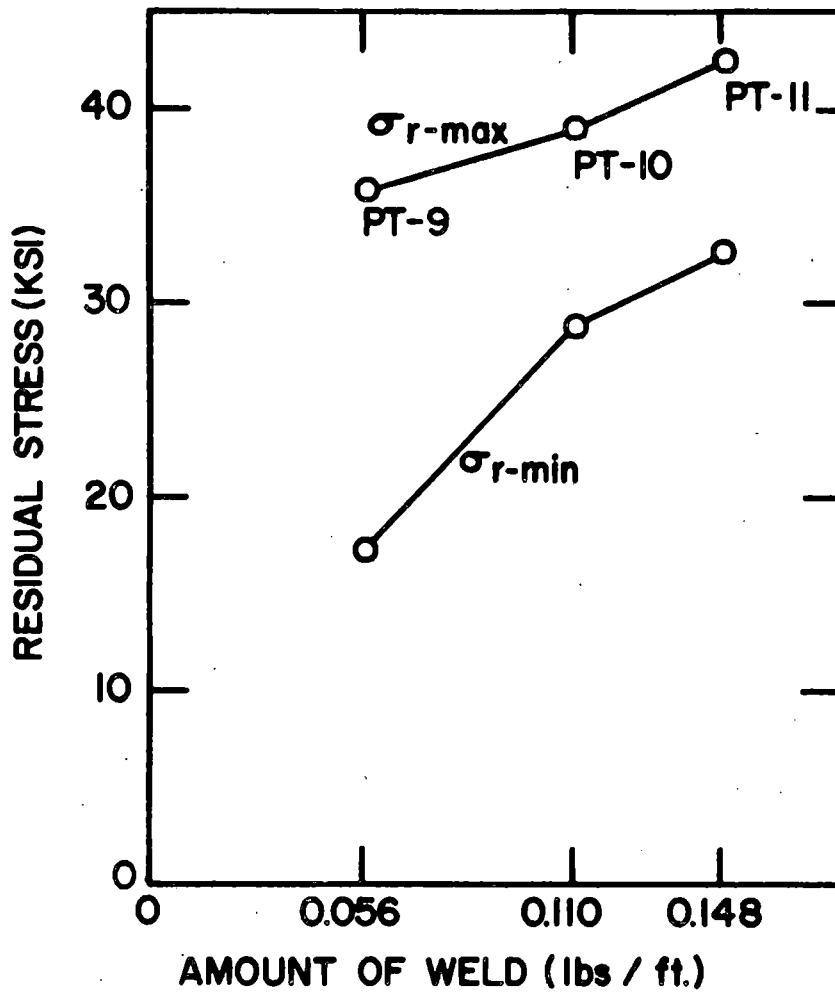

Fig. 10 Maximum and Minimum Residual Stresses vs Weight of Weld Deposit

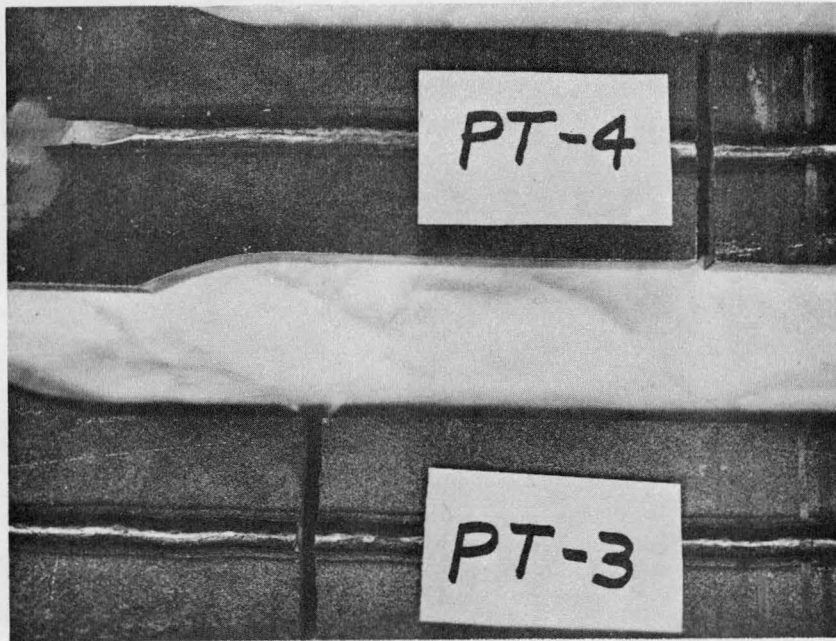

Fig. 11 Location of Fractures (PT-3, PT-4)

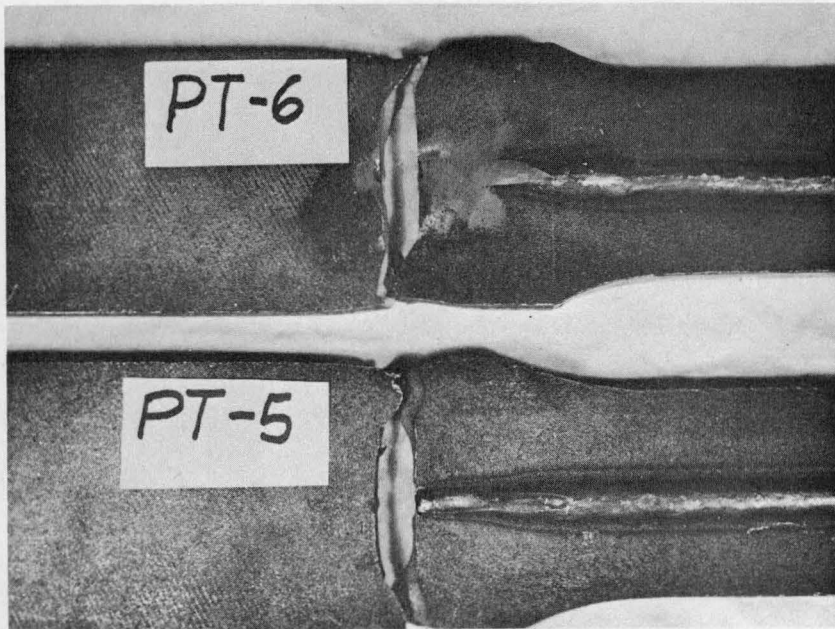

Fig. 12 Location of Fractures (PT-5, PT-6)

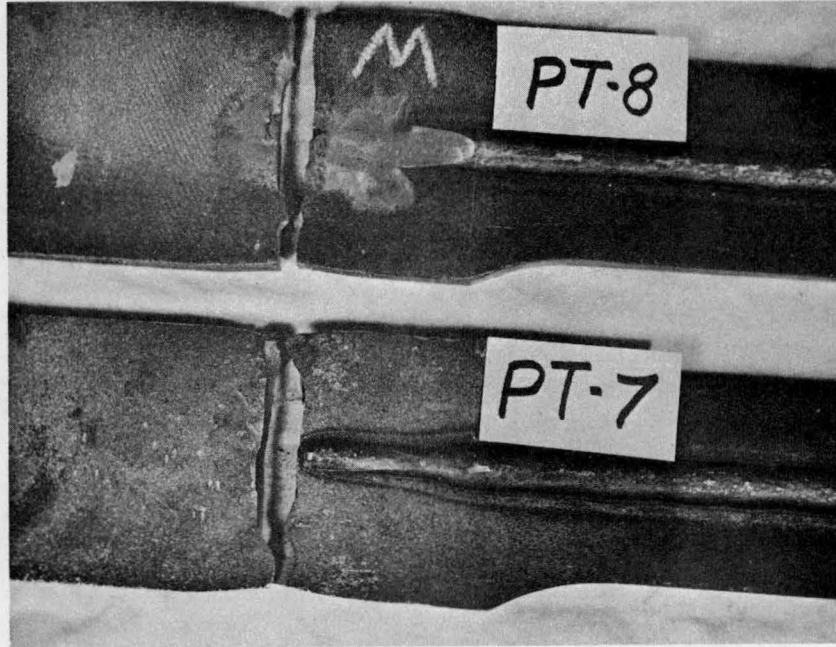

Fig. 13 Location of Fractures (PT-7, PT-8)

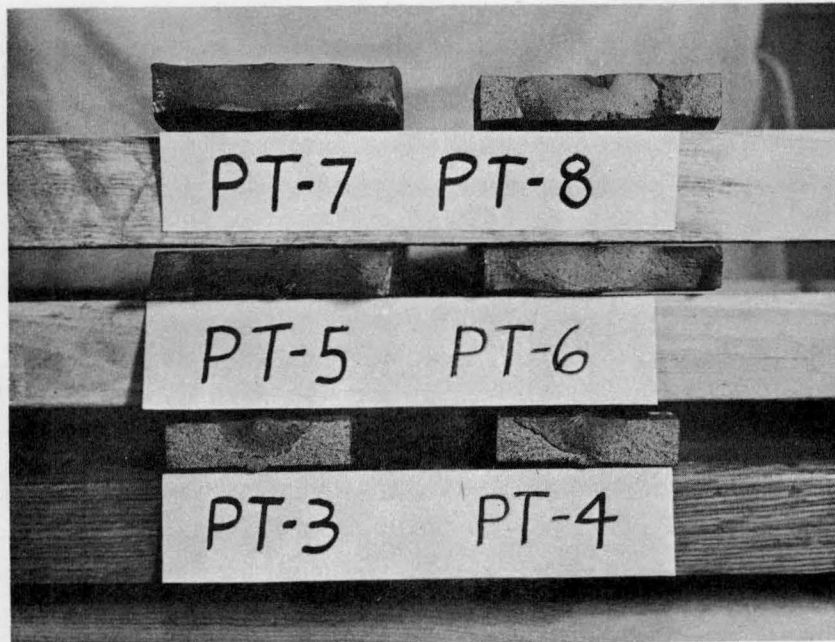

Fig. 14 Fracture Surfaces



Fig. 15 Details of Fracture Surface for PT-3

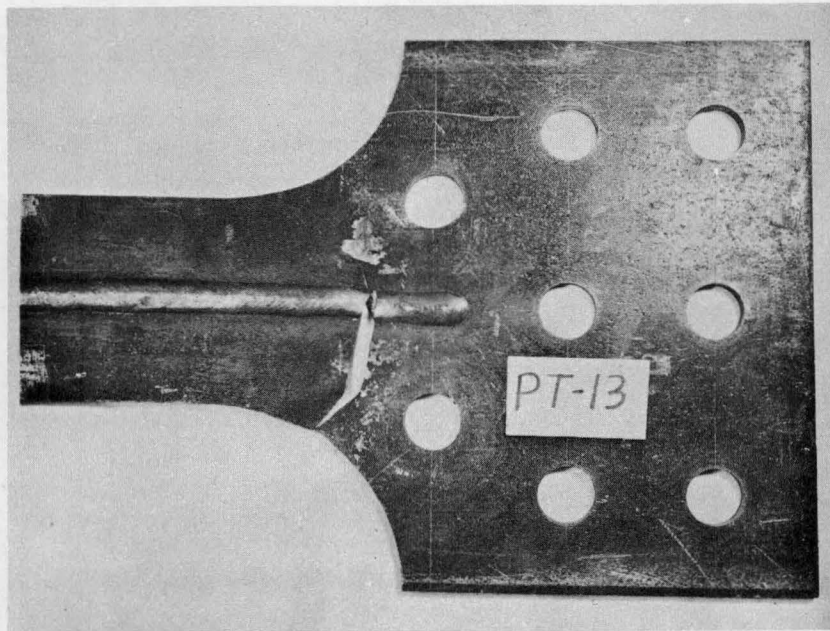

Fig. 19 Fatigue Failure of PT-13

noted that this specimen had a significant discontinuity at the end of weld.

Specimen PT-4 also failed in the gage section (Fig. 11) and at 1,958,300 cycles. The failure mode is similar to that of PT-3 (Fig. 14).

Specimens PT-5, PT-6, PT-7 and PT-8 all failed in the grip section after approximately one to one and a half million cycles. In all four cases, fatigue failure propagated from a hole at the end of the weld. The final fracture of the specimens appears to be a ductile type fracture (Figs. 12-14).

The results of these fatigue tests are summarized in Table 7. Note that the applied stresses are computed by multiplying the nominal stresses by the ratio of the nominal area (2.25 in^2) to the total area (Table 6).

Discussion

The magnitudes and distribution of residual stress due to welding (shown in Fig. 9) are similar to those measured by other investigators⁽³⁵⁾. It appears that within the range of weld sizes used, if everything else is kept constant, the lower the speed of the welding, or the larger the size of the weld, the higher the magnitudes of the maximum and minimum residual stresses will be. It was felt, however, that a wider specimen would be desirable in order to obtain a better distribution of residual stresses. It is also apparent from Fig. 9 that a larger difference between the medium size weld and the large size weld should have been introduced for a better and wider spread of the magnitudes of the variable.

Welding definitely has an effect on the fatigue strength of steel members. This is clearly indicated by the fact that none of the plain plate specimens failed after five million cycles of repetitive loading while all the welded specimens failed after less than two million cycles of repetitive loading of the same magnitudes.

Table 6. Actual Cross Sectional Dimensions of Specimens (PT-1 to PT-8)

Specimen	Average Width (in)	Average Thickness (in)	Average Area ₂ (in ²)	Total Area* (in ²)
PT-1	2.945	0.753	2.218	2.218
PT-2	3.001	0.753	2.259	2.259
PT-3	2.970	0.755	2.243	2.281
PT-4	2.911	0.754	2.194	2.232
PT-5	2.991	0.755	2.257	2.340
PT-6	2.978	0.753	2.241	2.324
PT-7	2.978	0.754	2.247	2.346
PT-8	2.938	0.754	2.216	2.315

* Average area plus $2A_e$ as given in Table 5.

Table 7. Results of Fatigue Tests (PT-1 to PT-8)

Specimen No.	Size of Weld	Nominal Stress (ksi)	Applied Stress (ksi)	No. of Cycles at Failure	Location of Failure
PT-1	None	25-50	25.4-50.7	5,285,300	No failure
PT-2	None	25-50	24.9-49.8	6,049,700	No Failure
PT-3	Small	25-50	24.7-49.3	1,465,500	In gage section
PT-4	Small	25-50	25.2-50.4	1,958,300	In gage section*
PT-5	Medium	25-50	24.0-48.1	1,043,100	At end of weld
PT-6	Medium	25-50	24.2-48.4	966,200	At end of weld*
PT-7	Large	25-50	24.0-48.0	1,661,000	At end of weld
PT-8	Large	25-50	24.3-48.6	1,617,400	At end of weld*

* Welds were ground down flush with plate surface to enable gripping over the end of weld.

The number of cycles at failure for the welded specimens are plotted against the amount of weld deposit in Fig. 16. It is recalled that both PT-3 and PT-4 failed in the gage section while all the other weld specimens, PT-5 through PT-8 failed at the end of the weld in the grip section. It was noted early in the series of tests that failure was occurring at the end of the weld instead of inside the gage section as anticipated. Thus the ends of the welds on PT-4, PT-6 and PT-8 were ground down flush with the plate surfaces to enable gripping over the ends of welds in an attempt to avoid stress concentrations at these locations. Grinding of weld ends simply exposed the existing undercuts or introduced notches due to grinding operation. No beneficial effect on fatigue life was observed, as shown in Fig. 16. The lower fatigue lives of PT-5 through PT-8 can only be attributed to the existence of an undercut or notch at the end of the weld. With smaller size of weld, the danger of undercut at ends lessens. This explains why PT-3 and PT-4 failed in the gage section.

Since the maximum stress applied was 50 ksi, which exceeded the yield stress of 43 ksi, the residual stress due to welding presumably disappeared after the first cycle of loading. These eight fatigue tests clearly pointed out that stress concentration associated with welding reduces the fatigue strength of welded steel members, whether the stress concentration is due to obvious undercut (PT-5 through PT-8) or due to some other weld defect (PT-3, PT-4).

Additional Fatigue Test

For 3-inch wide specimens, it was found that four welded specimens failed in fatigue at the end of the weld, indicating that a specimen with a wider grip width may be required. Furthermore, it was desired to have a specimen with wider gage section in order to obtain a better residual stress distribution. Specimens PT-12 and PT-13 were designed with these requirements in mind. Figure 17 shows the dimensions of these specimens. A rather sharp transition between the grip area and the gage section was dictated by the requirement to

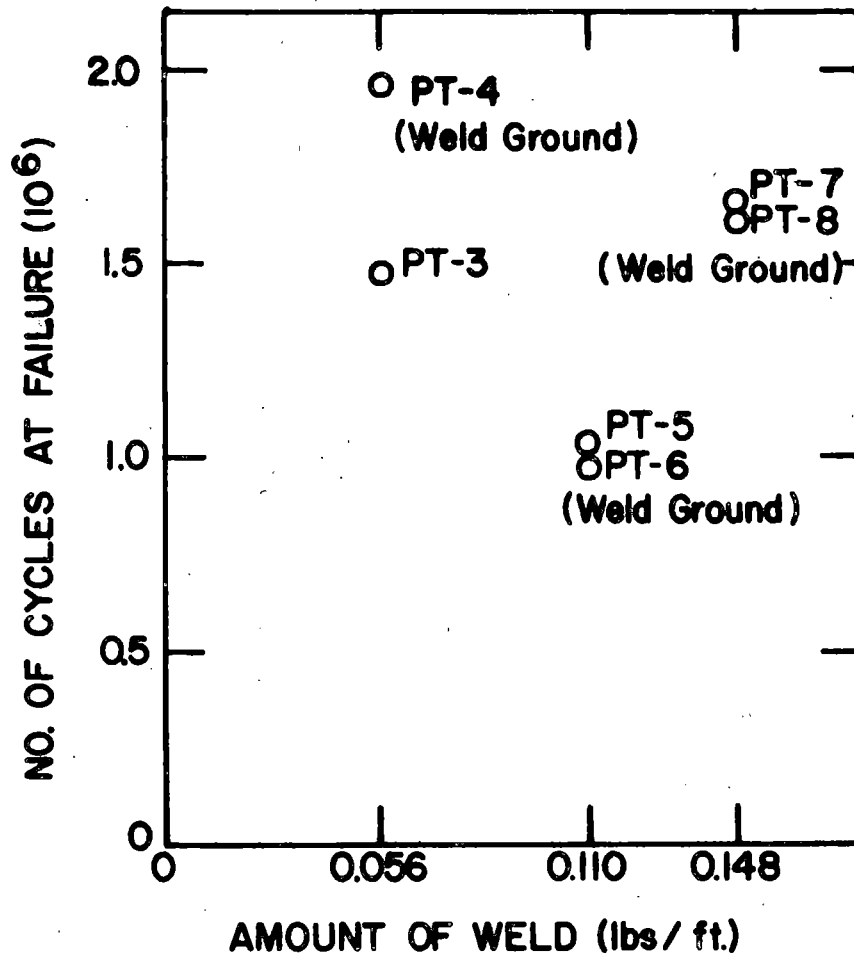

Fig. 16 Number of Cycles at Failure vs Amount of Weld

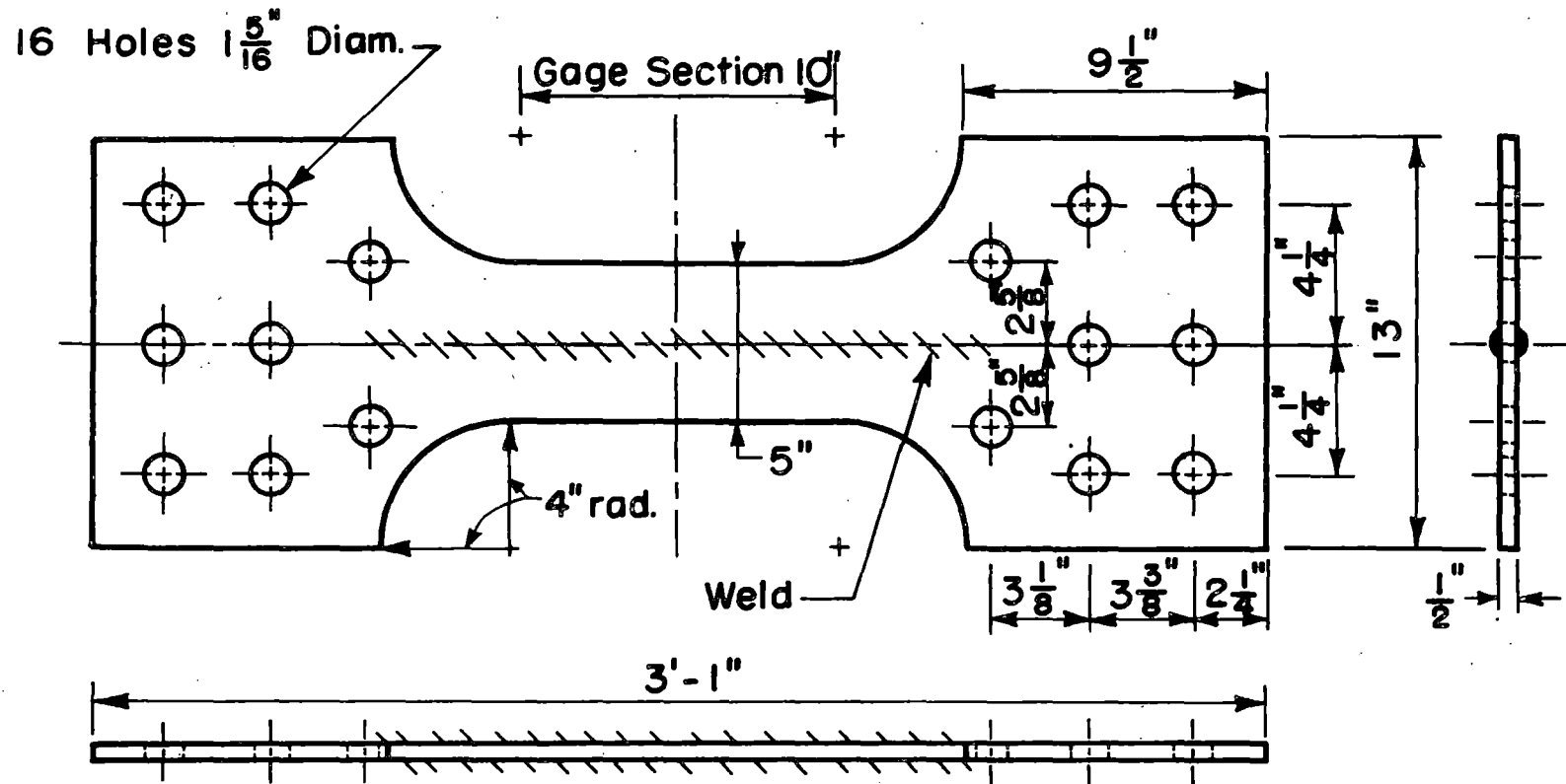

Fig. 17 Specimens PT-12 and PT-13

keep the total length of the specimen within the limitation of the testing machine.

A36 steel plates were used to fabricate these specimens. The material properties of the specimens were determined by a tension coupon test. The results of this test are summarized in Table 8.

The fabrication of these specimens was done in the same way as that of pilot test specimens. Specimen PT-12 is a plain specimen while specimen PT-13 has a weld along the longitudinal center line. The welding data for PT-13 are shown in Table 8.

Table 8. Results of Tension Coupon Test for PT-12 Through PT-15

Specimen	T-3
Tensile Strength (ksi)	61.5
Yield Point (ksi)	40.5
Proportional Limit (ksi)	39.4
Modulus of Elasticity (ksi x 10 ³)	31.0
Elongation in 2 in. (%)	45.2
Reduction in Area (%)	53.8

The temperature distribution on PT-13 during welding was obtained as in earlier tests. The results is shown in Fig. 18. Note again that this temperature distribution corresponds to those existing when the first side of the specimen was welded. There is also an indication of the existence of a temperature gradient through the thickness of the plate.

Residual stress measurements were not made on specimen PT-13. Since PT-13 was welded under more or less the same condition as PT-15, the residual stress distribution in PT-15 (Fig. 24) can be used to approximate that in PT-13.

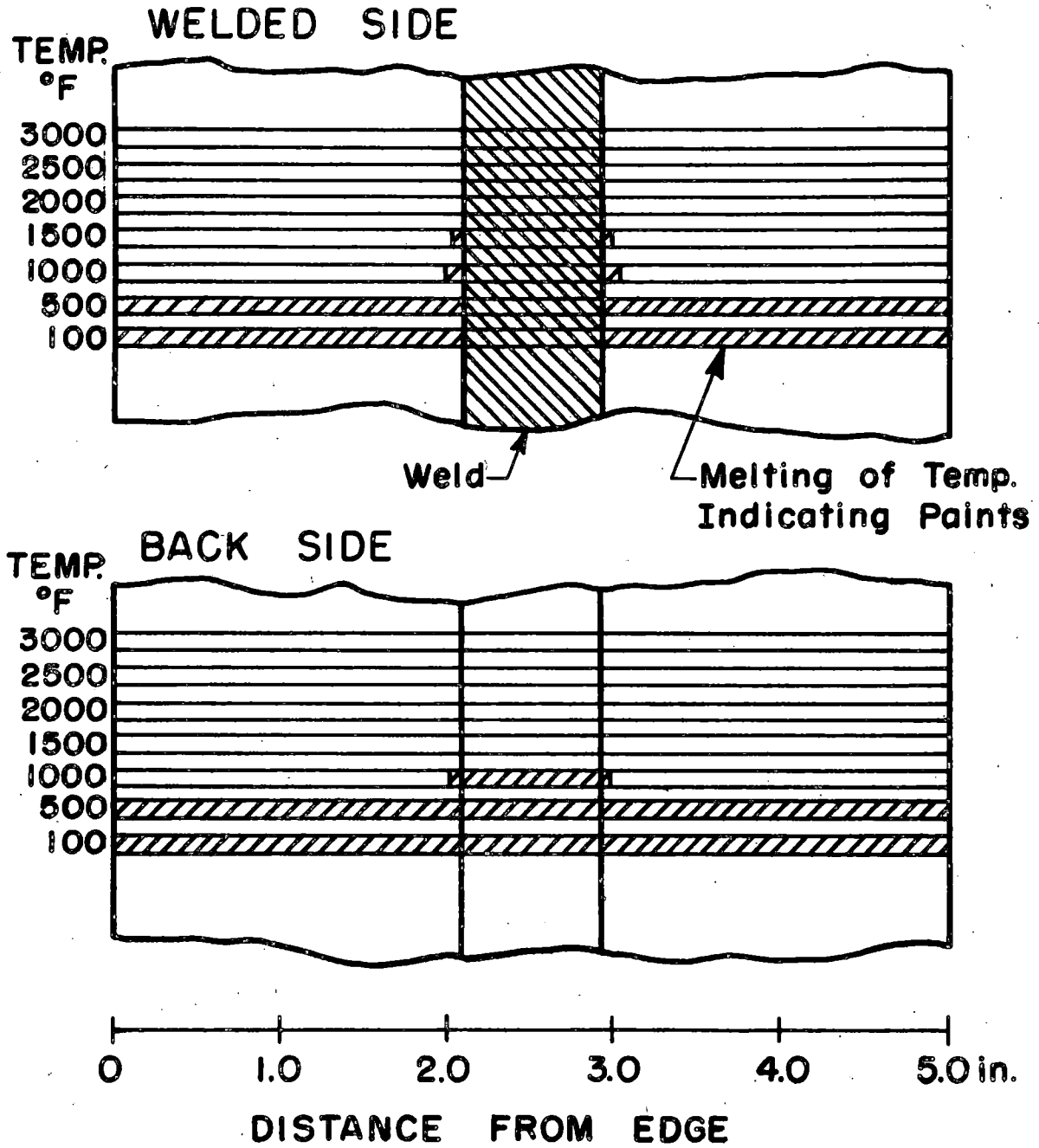

Fig. 18 Temperature Distribution During Welding for PT-13

By using a special end adaptor for gripping the specimen, the same fatigue testing machine used in the pilot test series was also used to test specimen PT-13.

Initially a cyclic loading of 25 to 50 ksi tension to tension was applied. The specimen did not fail after 4.5 million cycles. The loading was then increased from 27.5 to 55 ksi and the specimen finally failed after an additional 1.9 million cycles. The failure (Fig. 19, see page 61) apparently initiated at a point in the transition from the gage section to the grip area. It propagated from the surface of the specimen in between the weld and the edge of the specimen.

The failure condition of specimen PT-13 indicates that the specimen designed has a weakness in the transition area and thus is not satisfactory. Since specimen PT-12 is obviously stronger than PT-13 and would probably fail as PT-13 did, no fatigue test was conducted for specimen PT-12.

EFFECT OF WELD REMOVAL ON RESIDUAL STRESS DISTRIBUTION

Test Program

Since many of the previous specimens had failed in the vicinity of stress concentrations in the weld, it was deemed necessary to find exactly what effect grinding off the weld had on the residual stress distribution in the base metal. For this purpose, specimens PT-14 and PT-15 were conceived (Fig. 20). On PT-14 the weld was ground off and on PT-15 the weld was left intact. The specimens were divided into three sections in order to determine the distribution of residual stresses at different locations on the specimens.

Fabrication of Specimens

The 36 in. long, 5 x 1/2 in. plate type specimens were flame-cut from the same plate used to fabricate PT-12 and PT-13. No work was done with respect to edge or surface finish.

The welds were applied in the same manner as in PT-13 except that the welding speed was changed from 10 to 13 in. per minute (Table 9). The welds extended the entire length of the specimens. The complete weld on both surfaces of PT-14 was ground off flush with the plate surface.

Temperature distributions were not recorded, but because of the close similarity in welding procedure between these two specimens and PT-13, the temperature distributions would be almost identical to that shown in Fig. 18.

Table 9. Welding Data for Specimens PT-13 Through PT-15

Specimens	PT-13	PT-14 and PT-15
Wire	L-70, 3/32 in.	Same
Flux	780	Same
Voltage (volts)	34	Same
Current (amps)	325	Same
Electrode Speed (in./min.)	10	13
Approx. Length of weld (in.)	21.5	total length
Approx. Width of Weld (in.)	27/32 in.	25/32
Weld Material Deposited on One Side (lbs/ft)	0.172	0.133

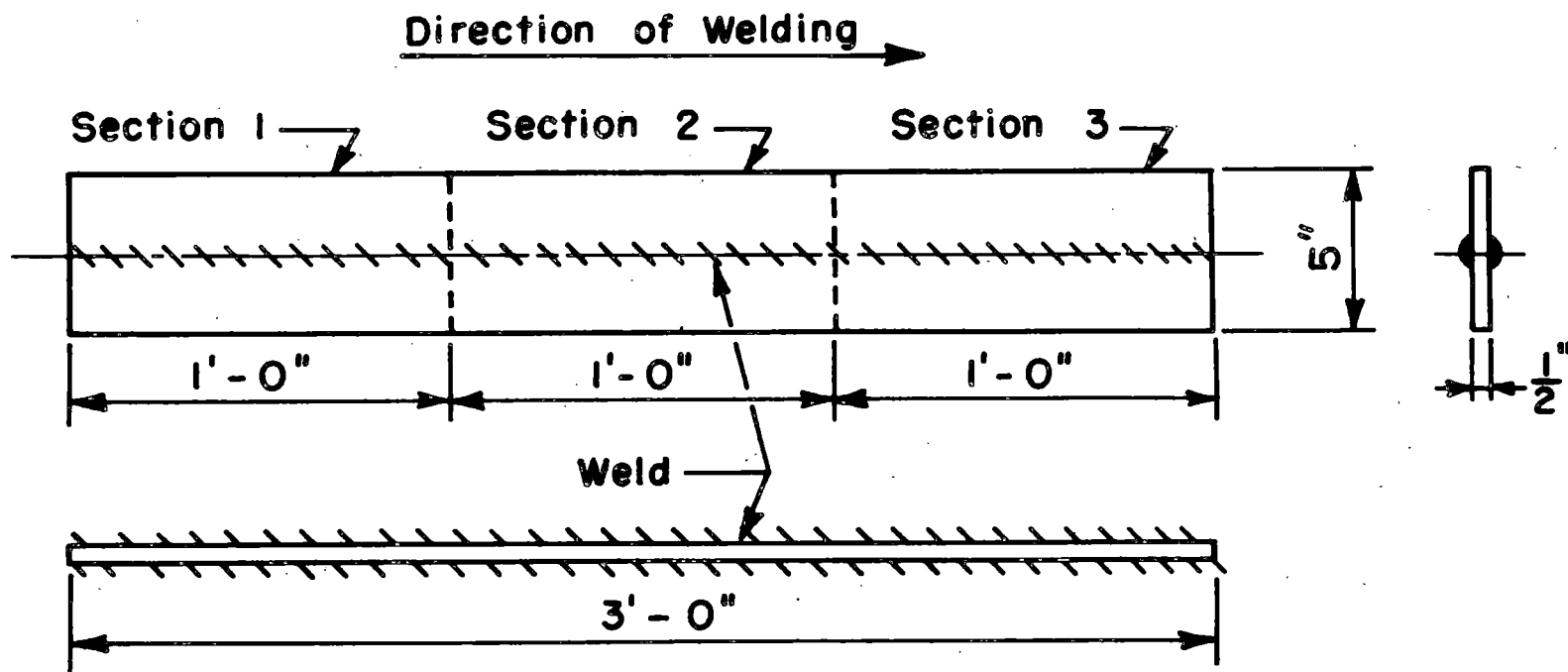

Fig. 20 Dimension of Specimens PT-14 and PT-15

Residual Stress Measurements

Longitudinal residual stresses were measured for the two welded specimens, PT-14 and PT-15 using the method of sectioning. Thirteen pairs of gage holes were drilled on each surface for each of the three sections in the specimen.

Initial readings were taken and then the specimens were sawed into three sections and a second set of readings was obtained. Readings were also taken on a mild steel bar for temperature compensation. From the difference between these two sets of readings, changes in strains were calculated. The changes in strains were then converted into changes in stresses. These changes in stresses represent the portions of longitudinal residual stresses relieved as a result of sawing the specimen into three sections. Figures 21 and 22 indicate the magnitudes and distributions of these relieved residual stresses.

After the sections were sawed into strips similar to those shown in Fig. 8 the final set of readings was obtained. From the initial and final readings, the residual stresses originally in existence in each section were computed. The magnitudes and distribution of residual stresses in PT-14 and PT-15 for all three sections are shown in Figs. 23 and 24.

Discussion

The purpose of this part of the program was to investigate the effect of weld removal on the residual stress distribution. Figure 25 compares the residual stress distribution in the center section for PT-14 (weld removed) and PT-15 (weld left intact). As shown in this figure, while the maximum and minimum residual stresses in PT-15 are 51.9 and -25.3 ksi, respectively, the corresponding figures for PT-14 are 42.0 and -20.6 ksi, indicating a decrease of approximately 20 per cent. The patterns of residual stress distribution for both PT-14 and PT-15 are the same.

It is interesting to note that no obvious difference was observed between the residual stress measured at the center section and at the end sections. This is the case with both PT-14 and PT-15 as shown in Figs. 23 and 24. With a longer specimen, it is expected that the residual stress distribution at the center section will be somewhat different from that at the end section.

The differences in magnitudes of stresses between Figs. 23 and 21 for PT-14 and between Figs. 24 and 22 for PT-15 indicate that most of the residual stresses were caused by the restraining effect of the neighboring plate strips.

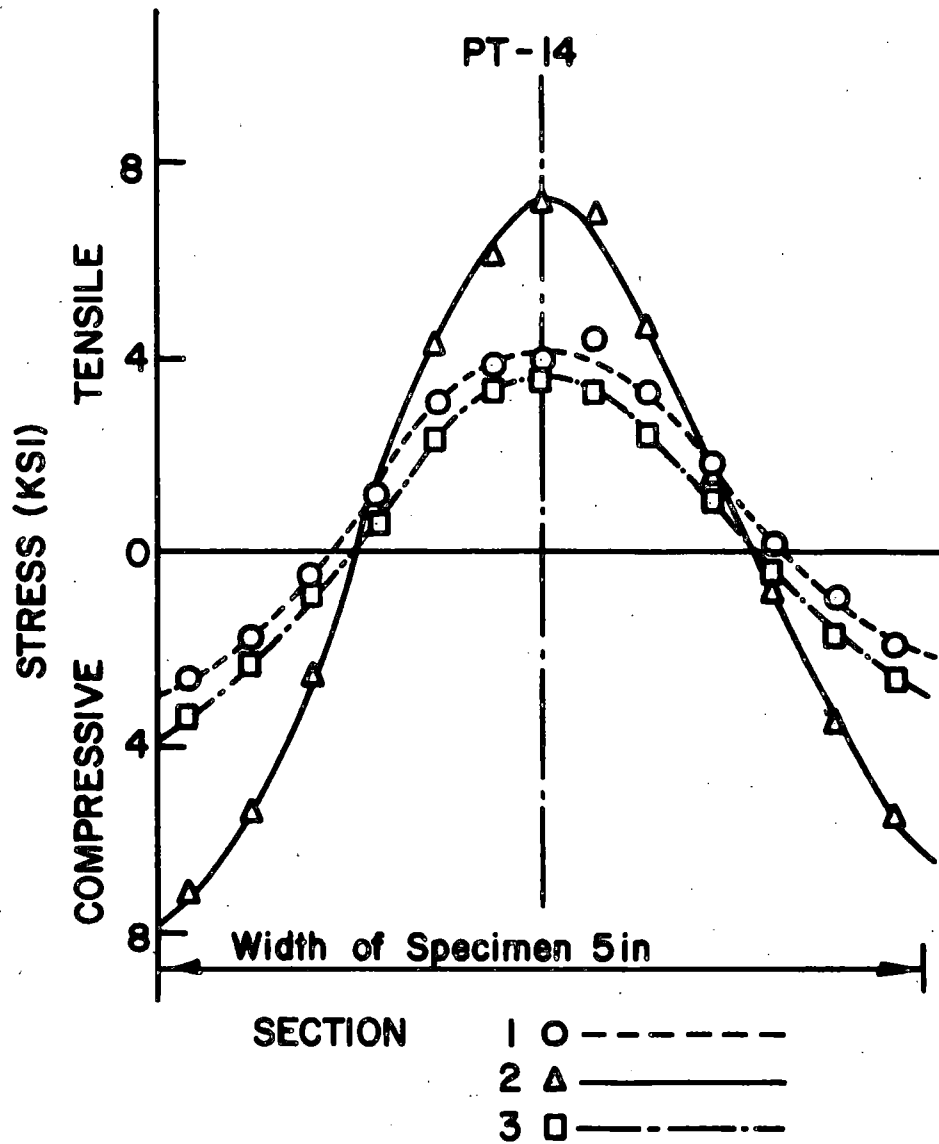

Fig. 21 Residual Stresses Relieved Due to Sawing of Specimen into Sections (PT-14)

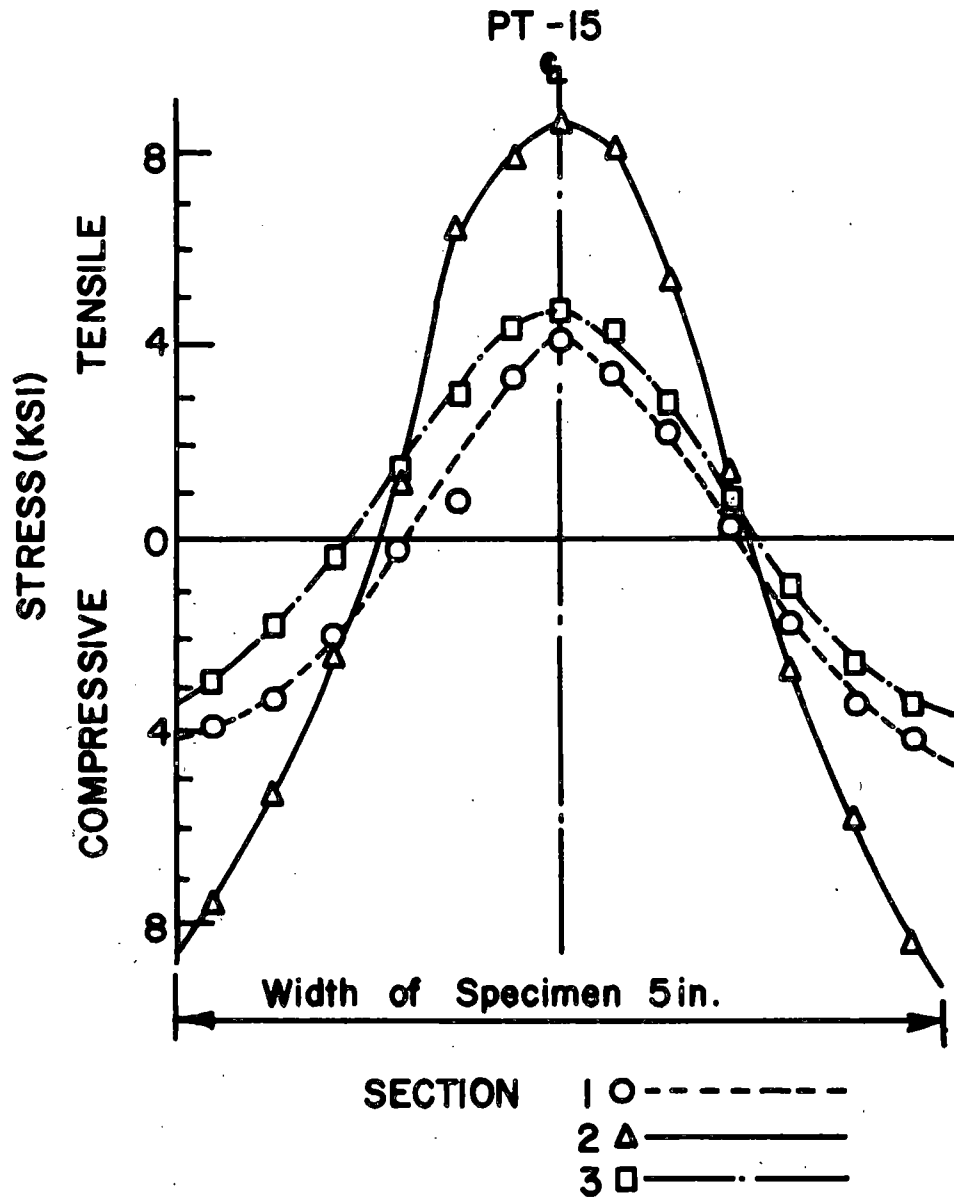

Fig. 22 Residual Stresses Relieved Due to Sawing of Specimen into Sections (PT-15)

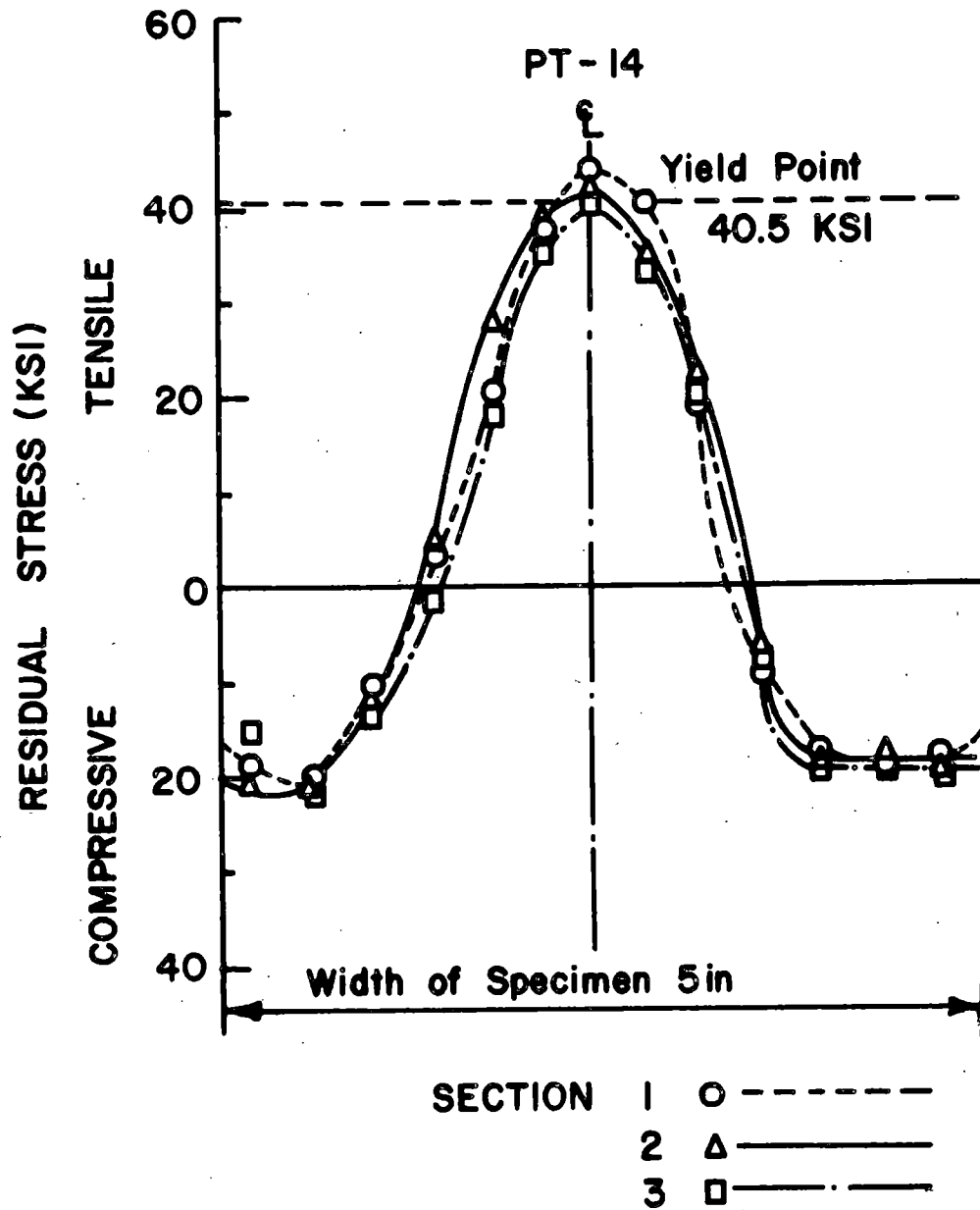

Fig. 23 Residual Stress Distribution (PT-14)

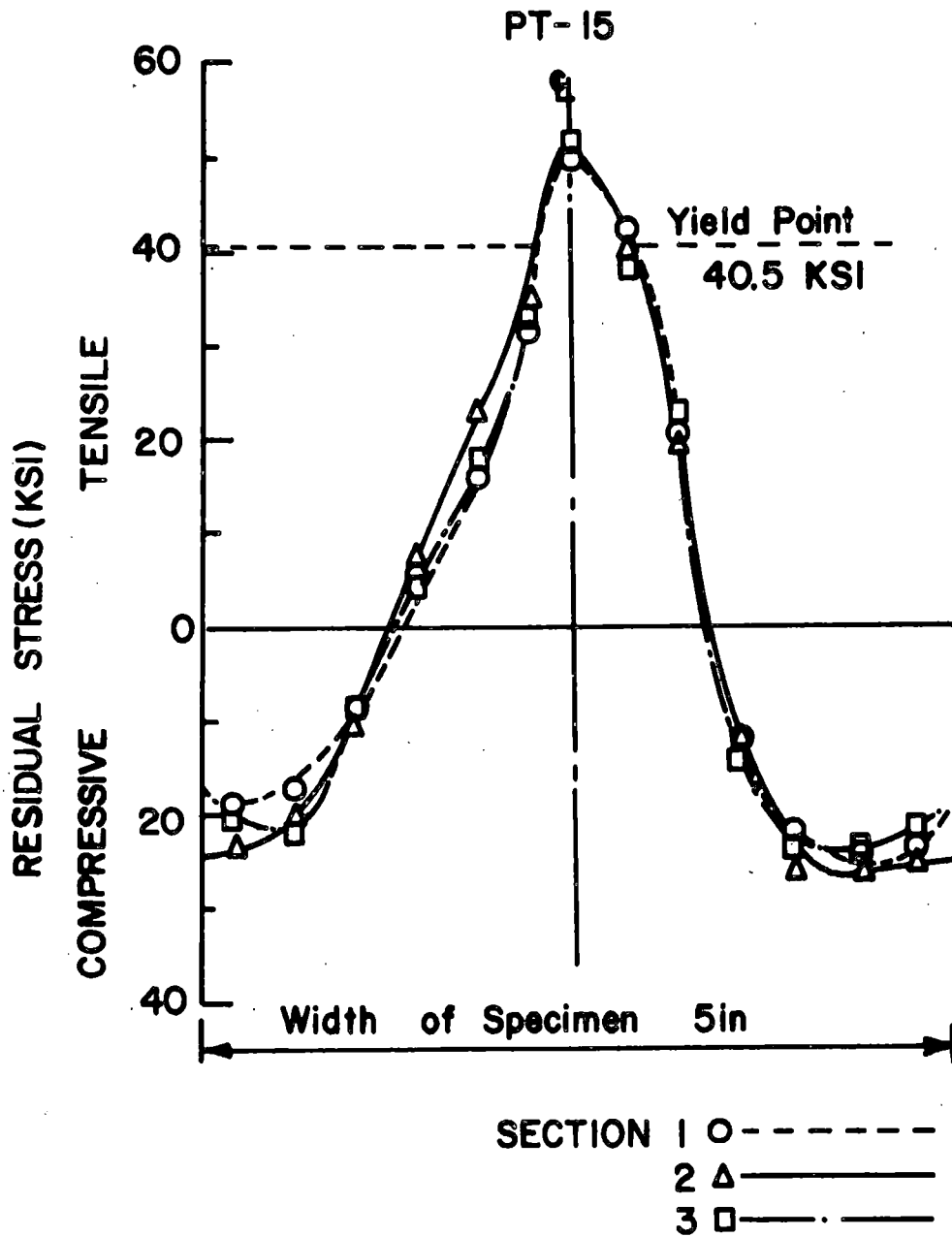

Fig. 24 Residual Stress Distribution (PT-15)

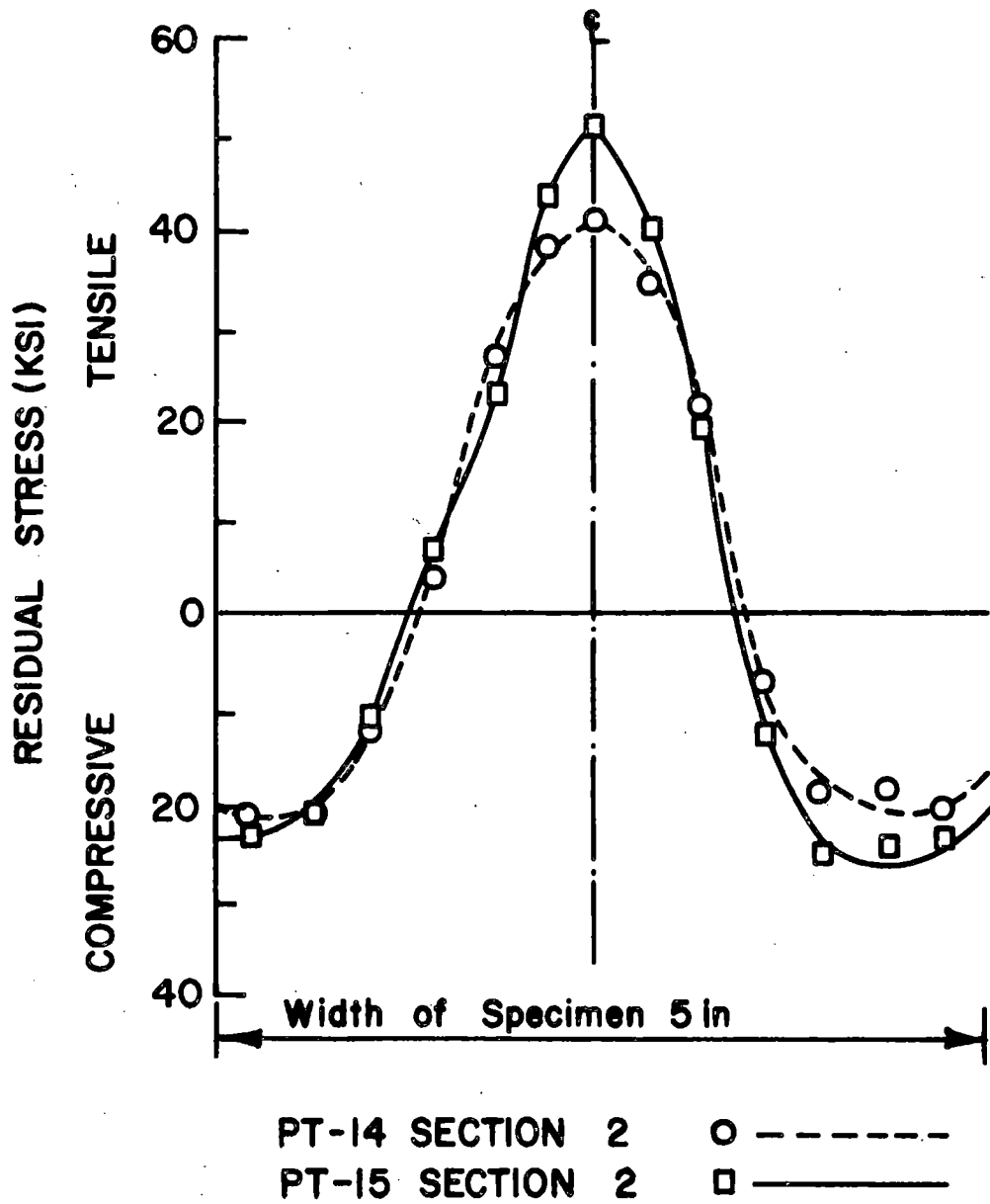

Fig. 25 Effect of Weld Removal on Residual Stress Distribution

MAIN TEST SERIES

Test Program

The main test series consisted of six fatigue tests and three residual stress measurements. Specimen T-11 was a plain plate specimen. All other specimens had longitudinal center welds of either small, medium or large size. Note that these welds were not the same sizes as those of the pilot test series. The complete test program is summarized in Table 1.

Test Specimens

A typical specimen designed for the main test series is shown in Fig. 26. Notice that the width of the gage section was 5 inches compared to 3 inches for a pilot test specimen. Ample transition length was provided between the gage section and the grip area. The danger of having a weld discontinuity was avoided by extending the longitudinal weld to full length of the specimen with weld starting and ending outside the specimen.

All specimens were fabricated from 60-inch long A36 UM plates. The properties of material as given in the mill report are summarized in Table 10. The results of tension coupon tests, which were conducted to substantiate the values in the mill report, are tabulated in Table 11.

In fabricating the specimen, the steel plate was machined to its final dimension and the machined edges were polished smooth using different grades of sand papers. The specimen was then shot blasted using S-280 grit Wheelabrator Steel Abrasive in order to remove mill scale.

The longitudinal welds were applied automatically using the submerged arc-welding process. Welding data for three sizes of welds are summarized in Table 12. The automatic welding process resulted in smooth uniform welds for the specimens, thus eliminating most of the geometrical discontinuities due to welding.

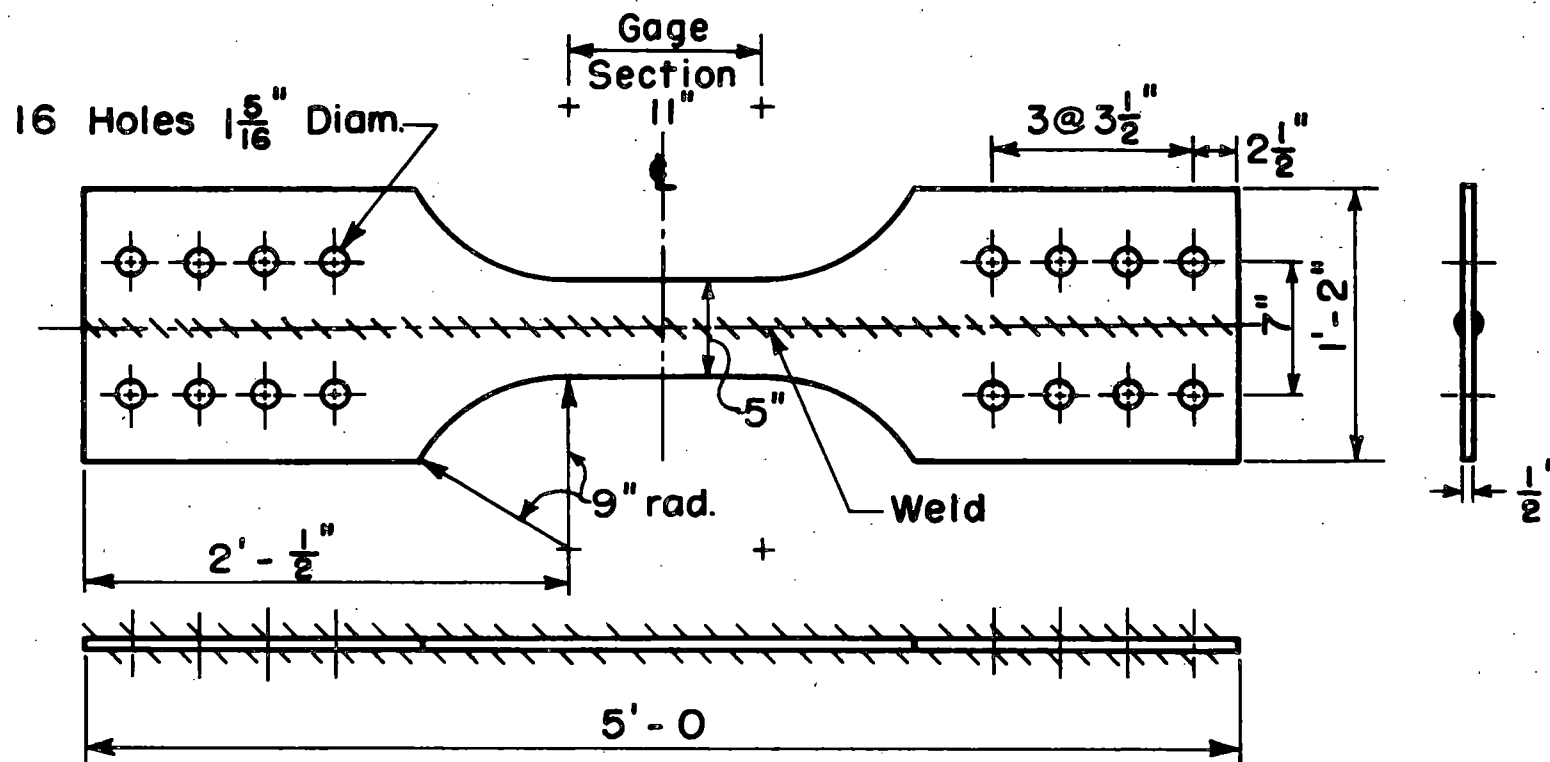

Fig. 26 Main Test Specimens

In order to measure the areas and dimensions of welds, segments of specimens were boiled in a solution of muriatic acid for approximately 15 minutes until the fusion zones of the welds became clearly visible. After the etching, the weld outlines were traced on a sheet of paper and the areas and dimensions of welds were measured by a planimeter and a steel scale, respectively. A set of weld outlines as traced is shown in Fig. 27. The average areas and dimensions of welds are summarized in Table 13. The nomenclature used in this table is illustrated in Figs. 5 and 28. As shown in Table 13, the ratio of the total external weld area to the cross sectional area of the plate ranged from 1.12 to 9.28 per cent. This ratio range was considered to be a practical one. The variations of weld areas and dimensions are plotted against the weight of weld deposit in Figs. 29 and 30. As expected, the external area varies linearly with respect to the weight deposited. There is relatively insignificant increase in the weld depth as the weld deposit increases.

Residual Stress Distribution

Longitudinal residual stresses were measured for three specimens with different sizes of welds, namely T-23, T-33 and T-43. The method of sectioning (34) was used. Changes in strains were measured by a Whittemore strain gage with 10 inch gage length. The distribution of residual stresses for the three specimens are shown in Fig. 31. The maximum (tensile) and minimum (compressive) residual stresses (ksi) for T-23, T-33 and T-43 are: 51.4, -15.0, 50.4, -27.3, and 21.0, -27.9, respectively.

Fatigue Testing System

The fatigue tests in the main test program were conducted at Iowa State University by means of the fatigue testing system newly installed in the Structural Research Laboratory of the Engineering Research Institute.

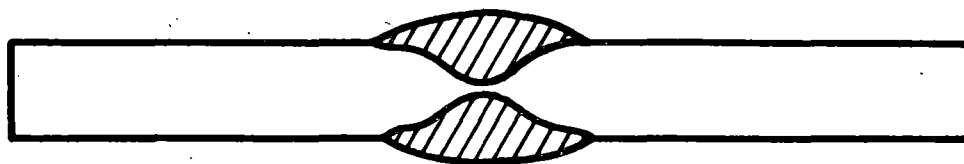

Large Weld

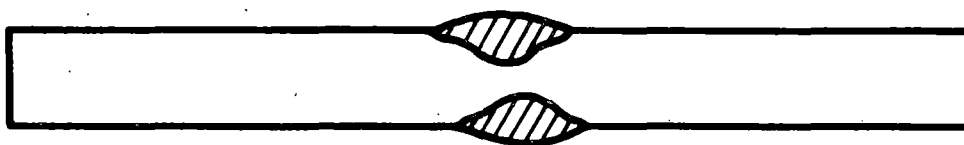

Medium Weld

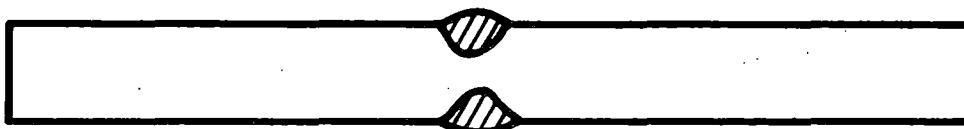

Small Weld

Scale: Actual Size

Fig. 27 Weld Outlines

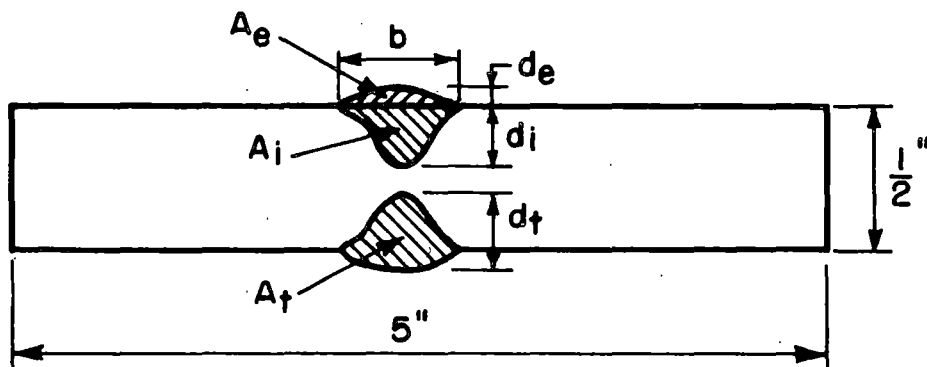
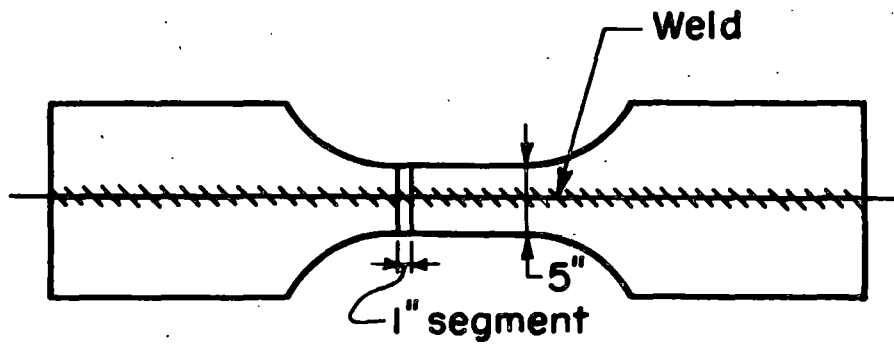

Fig. 28 Weld Area Measurement
 Note: See Fig. 5 for nomenclature

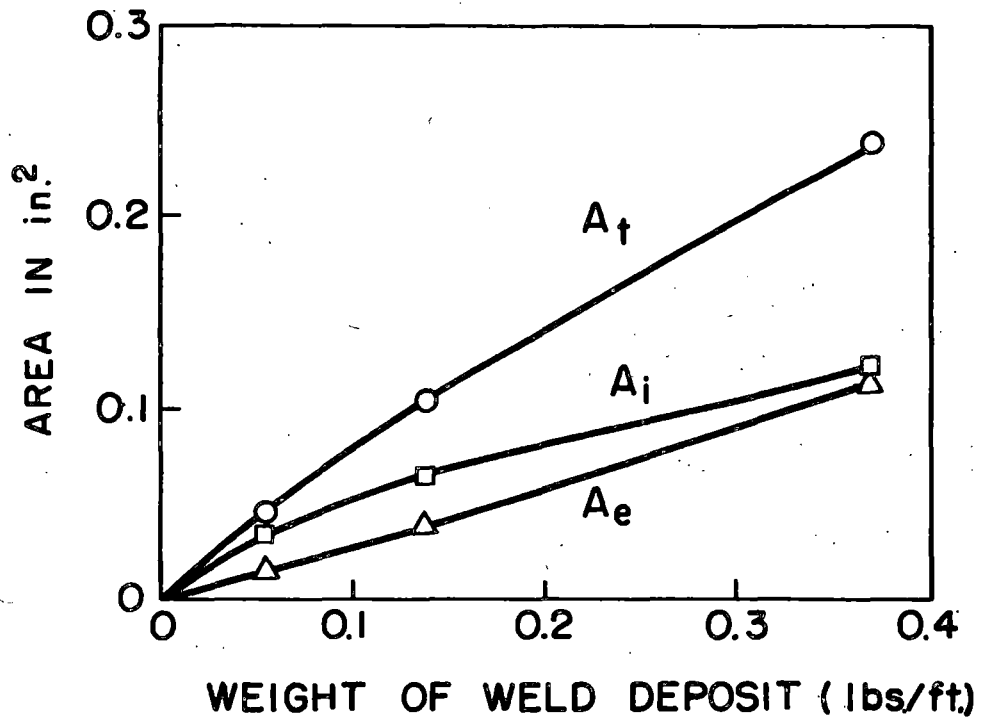

Fig. 29 Weld Areas vs Weight of Weld Deposit

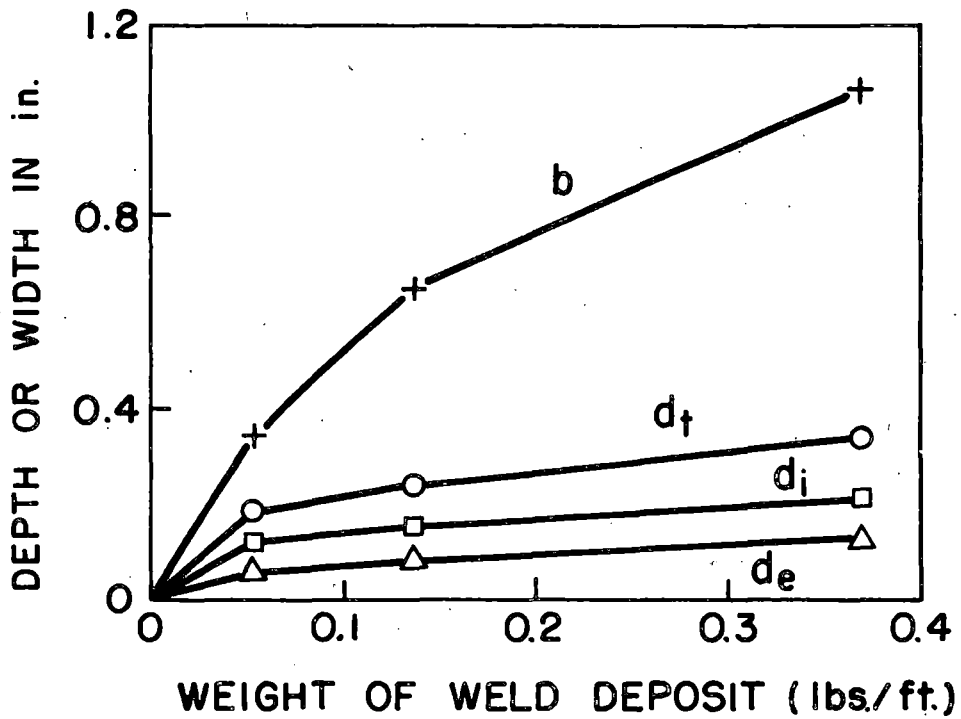

Fig. 30 Dimensions of Welds vs Weight of Weld Deposit

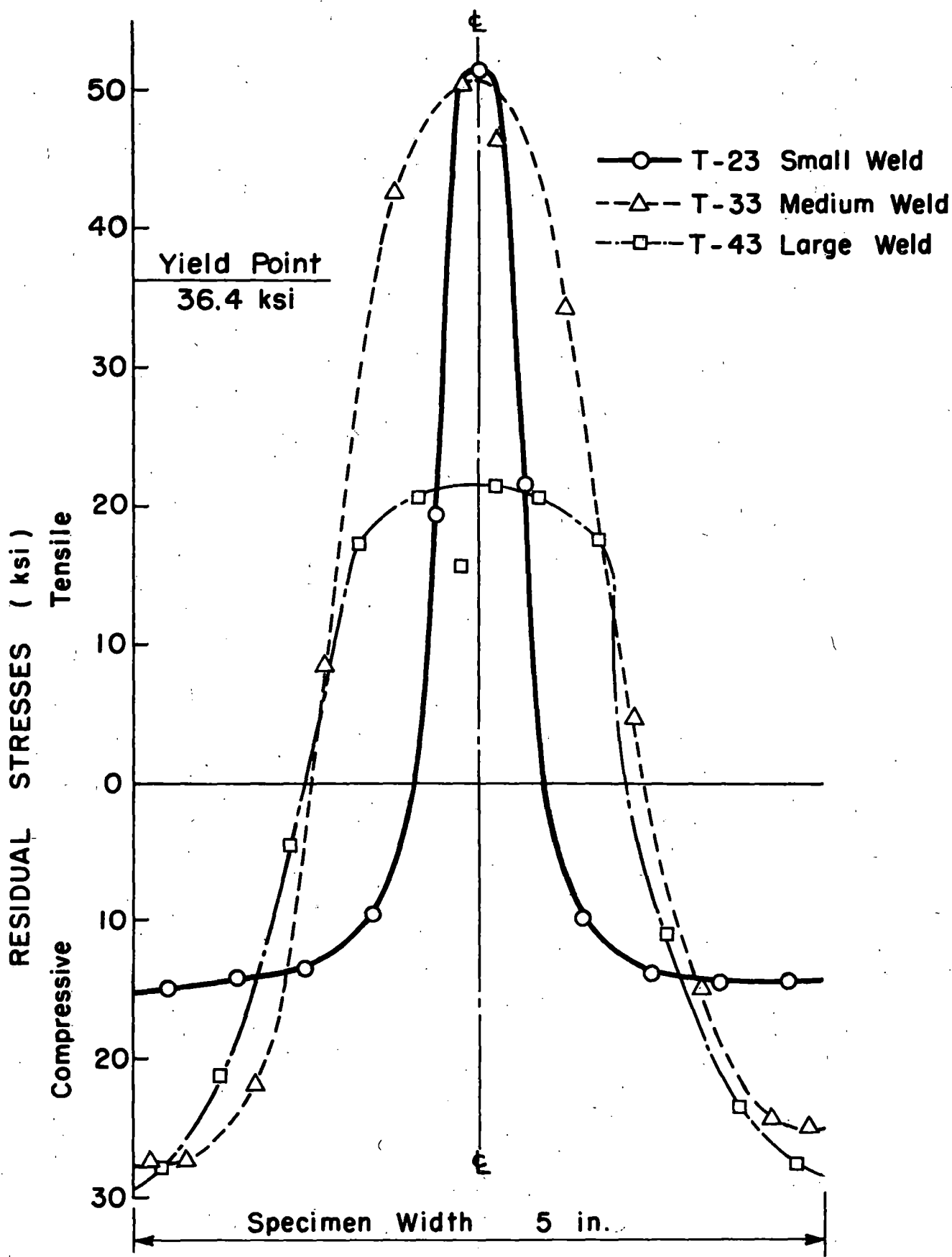

Fig. 31 Residual Stress Distribution

Table 10. Properties of Specimen Material
For Main Test Series
(Mill Report)

Mechanical Properties

Tensile strength	67.46 ksi
Yield Point	38.31 ksi
% Elongation in 8 in.	30.2

Chemical Analysis

Carbon	0.22 %
Manganese	0.72 %
Phosphorous	0.01 %
Sulfur	0.023 %

Table 11. Results of Tension Coupon Tests
(Main Test Series)

Specimen	T - 1	T - 2	T - 3	Average
Tensile Strength (ksi)	66.1	66.4	66.4	66.3
Yield Point (ksi)	35.8	36.3	37.2	36.4
Modulus of Elasticity (ksi x 10 ³)	28.6	29.0	29.0	28.9
Elongation in 8 in. (%)	28.8	25.7	29.6	28.0
Reduction in Area (%)	30.5	30.7	29.9	30.4

Table 12. Welding Data
(Main Test Series)

Weld Size	Small	Medium	Large
Diameter of Rod (in)	3/32	same	same
Current (amp)	400	same	same
Voltage (volts)	32	same	same
Electrode speed (in/min)	43	16	6
Weight deposited on one side (lbs/ft)	0.054	0.137	0.370

Table 13. Dimension of Welds
(Main Test Series)

Weld Size	Small	Medium	Large
A_t = total area (in ²)	0.048	0.105	0.237
A_t^e = external area (in ²)	0.014	0.039	0.116
A_t^i = internal area (in ²)	0.034	0.066	0.121
d_t^i = total depth (in)	0.18	0.23	0.34
d_t^e = external depth (in)	0.06	0.08	0.13
d_t^i = internal depth (in)	0.12	0.15	0.21
b_t^i = width (in)	0.34	0.65	1.06
weight deposited on one side (lbs/ft)	0.054	0.137	0.370
$r = \frac{2A_e}{\text{Plate Area}} \times 100\%$	0.12	3.12	9.28

The fatigue testing system consists of a hydraulic actuator of 50 kips maximum capacity, a 20 gpm hydraulic pump, a console which controls the operation of the system and a large basic testing frame. The fatigue testing system, except the basic testing frame, was manufactured by Research Incorporated, Minneapolis, Minnesota. The basic testing frame was designed to test beam specimens of up to 22-foot span. Since in the present test series the specimens are to be subjected to axial repetitive loading, it was necessary to design a special test set-up. Figure 32 shows the complete fatigue testing frame designed for this purpose. Notice while the top beam is fixed, the bottom beam is a loading beam which is supported by a 3-3/4 inch diameter pin at one end and movable at the other end under the action of the hydraulic actuator. With the specimen placed in-between, a maximum axial load of more than 150 kips can be applied to the specimen with the 50-kip actuator. The large mass of the bottom loading beam limits the maximum machine speed to approximately 2 cycles per second under the maximum load. Later, a new smaller bottom beam was designed and fabricated to replace the larger one in order to

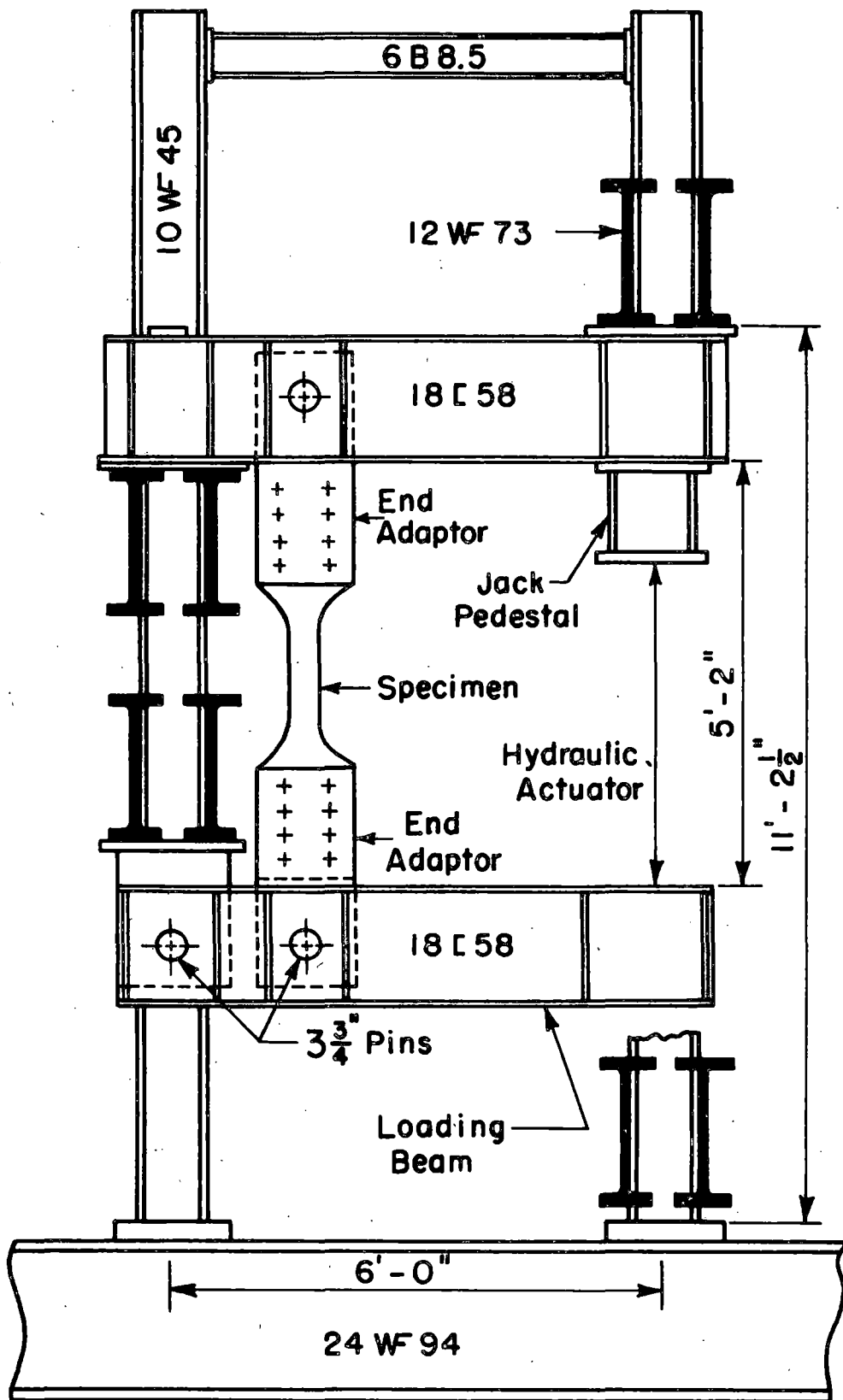

Fig. 32 Fatigue Testing Frame

increase the machine speed. Figure 33 shows the photograph of the testing frame with this smaller bottom beam. The console and the pump can be seen in the background.

Fatigue Tests

Preparatory Work Laboratory work needed for testing a specimen under axial repetitive loading consists of the following::

- 1) Measurement of actual dimensions of the test specimen.
- 2) Application of SR-4 strain gages for calibration purpose.
- 3) Placing the specimen in the test set-up.
- 4) Calibration of load applied to the specimen.
- 5) Application of pre-determined axial repetitive loading.

Cross sectional dimensions of each specimen tested are measured at several locations in the gage section. The average dimensions thus obtained are listed in Table 14. The total area in this table was computed by adding twice the external weld area to the average area in the previous column. The magnitude of the external weld area was obtained from Table 13.

Table 14. Actual Cross Sectional Dimensions of Specimens
(Main Test Series)

Specimen	Average Width (in)	Average Thickness (in)	Average Area (in ²)	Total Area* (in ²)
T-11	4.988	0.501	2.500	2.500
T-21	5.031	0.510	2.566	2.594
T-31	5.010	0.501	2.511	2.589
T-33	4.987	0.500	2.494	2.572
T-41	4.993	0.510	2.547	2.779
T-42	4.888	0.496	2.427	2.659

* Average area plus $2A_e$ as given in Table 13

Except for specimen T-42, at least four SR-4 gages were applied to each test specimen in order to calibrate the actual magnitude of load introduced in the specimen as a result of applying a certain magnitude of load at the

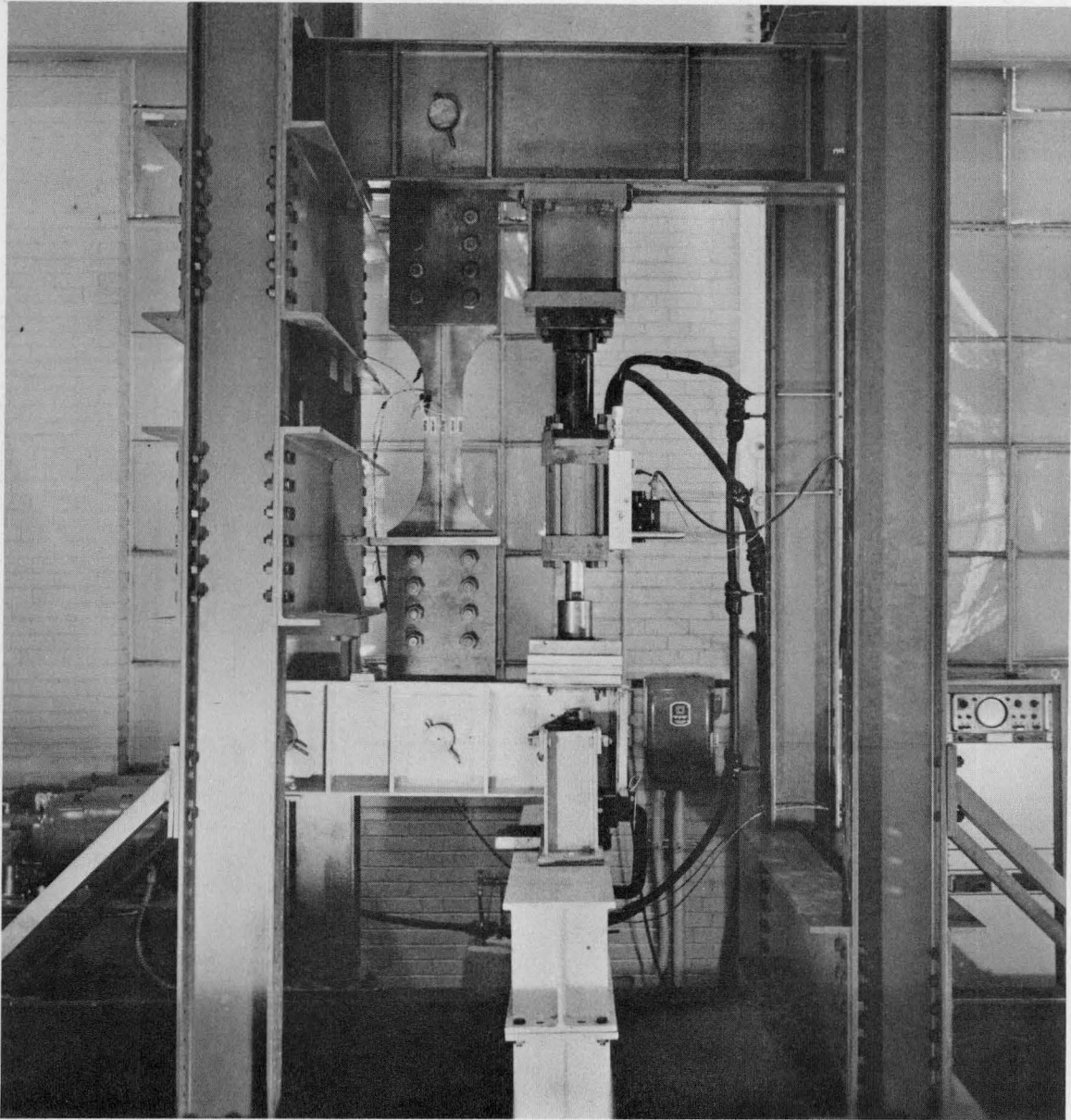

Fig. 33 Fatigue Testing System

end of the loading beam through a displacement of the actuator. The results of the calibration establish (1) the correct lever ratio for the loading beam, and (2) the magnitude of eccentricity in loading in the specimen.

The specimen was first placed between the end adapters with the A325 high strength bolts inserted but not tightened. A small load was applied and the bolts then tightened to snug tight plus one half nut rotation by means of an impact wrench. Strain readings were then taken for a series of increments of loading to establish a calibration curve.

For all specimens with strain gages, the results of calibration indicate that the established lever ratios agree very closely with the designed values. Some eccentricities were found to exist, however. The relative magnitudes of the width of the specimen make it almost impossible to avoid eccentricity in the width direction of the specimen. The warping which resulted from welding also introduces eccentricity in both width and thickness directions. The existence of eccentricities is illustrated in Fig. 34 in terms of stress distributions as measured on specimen cross sections. The stresses are reduced to a constant average stress of 100. Notice that the left edge of the cross section is the edge closer to the fulcrum of the loading beam.

Description of Fatigue Tests Specimen T-11 was tested under a nominal stress range of 25 to 50 ksi tension, at a frequency of 2.5 cycles per second using the originally designed large loading beam. The main purpose of this particular test was to check out the test set-up and to determine the maximum frequency that can be used. It was found that the overall test set-up performed as required except that the loading beam was somewhat too heavy as to make it impossible to run the testing at a higher frequency. This test was discontinued after 292,400 cycles.

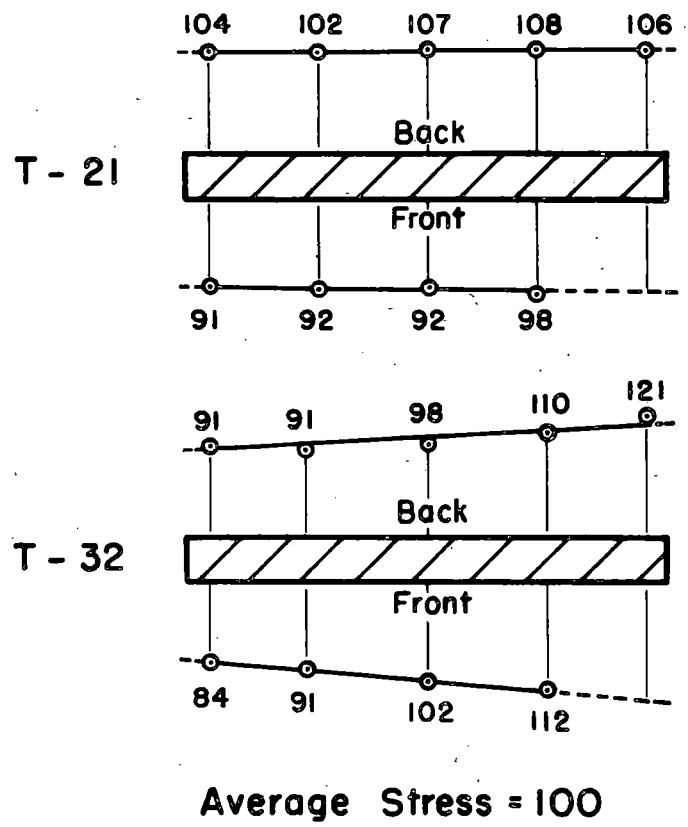
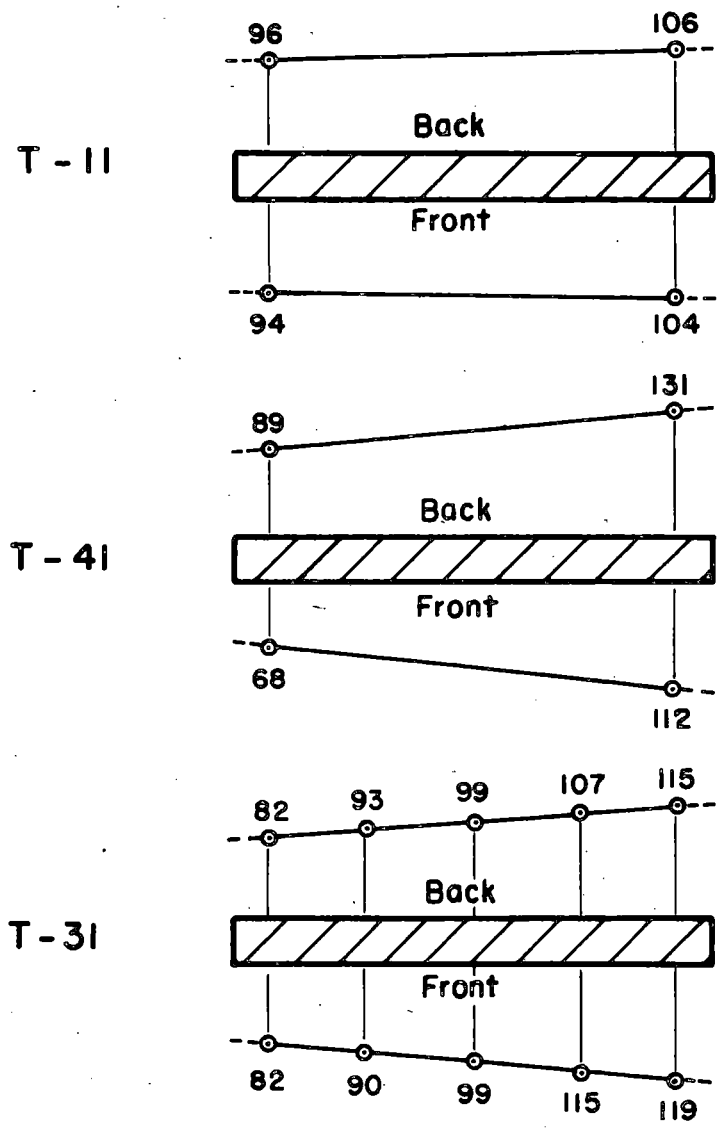

Fig. 34 Stress Distribution Patterns

Specimen T-41 was tested under a nominal stress range of 2 to 32 ksi tension. It was first tested using the large loading beam at a speed of 2.3 cycles per second until the number of cycles reached 2,840,350. At that time the large loading beam was replaced by a smaller one and the test was resumed at a speed of 4.0 cycles per second. The test was discontinued after the specimen survived 3,120,360 cycles of repetitive loading without a failure.

Since specimen T-41 was potentially the weakest one because it has the largest weld, and since it did not fail under 2 to 32 ksi, the next specimen, T-31, was tested under a nominal stress range of 2 to 34 ksi tension at a speed of 3.2 cycles per second. Fatigue failure occurred in the gage section at 1,463,030 cycles. The location of the failure is shown in Fig. 35. The inspection of the fracture surface, Fig. 36, revealed no evidence of weld defect.

Specimen T-21 was next tested under a nominal stress range of 2 to 34 ksi tension at a speed of 3.2 cycles per second. Again the specimen survived 3,657,410 cycles of the repetitive loading without a failure. Note that there was a major machine breakdown at 2,045,960 cycles and the testing was halted for 50 days.

Specimen T-32 was tested under the same nominal stress range as that of T-31 and T-21. Although it is not apparent from the result of static calibration, Fig. 34, it has a considerable eccentricity in the thickness direction, attributable to warping of the specimen due to welding. As a result, it has not been possible to operate the machine at a speed higher than 1.5 cycles per second. The specimen finally failed in the gage section at 2,740,000 cycles. The location of the failure is shown in Fig. 37, and the fracture surfaces are shown in Fig. 38. Again there was no visible weld defect. During testing of T-32 the testing machine suffered another

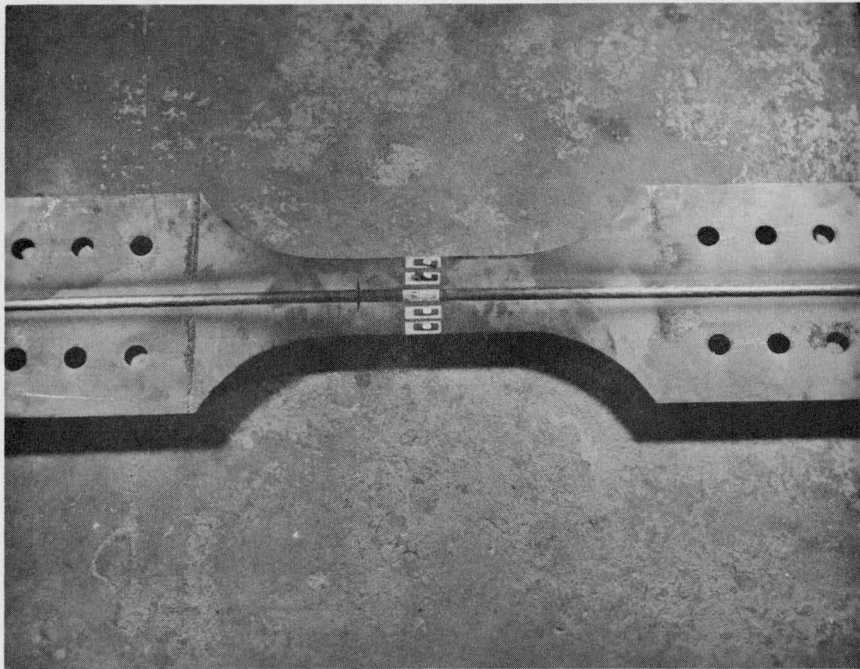

Fig. 35 Location of Failure (T-31)

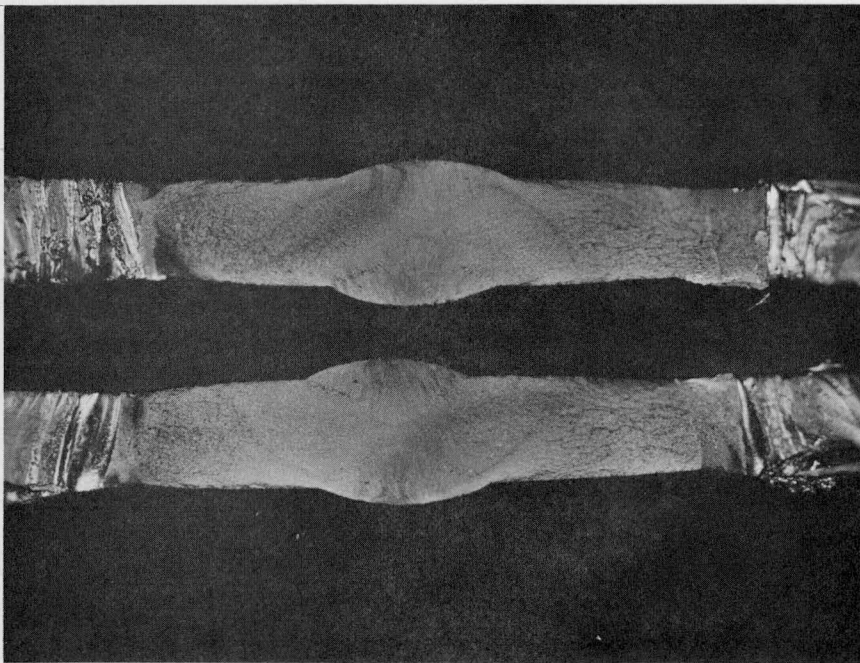

Fig. 36 Fracture Surfaces (T-31)

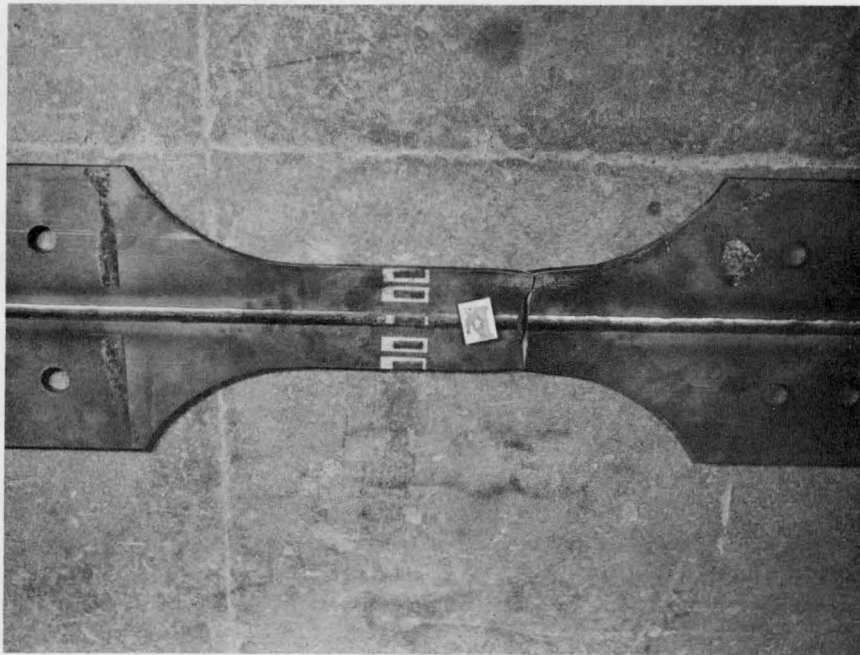

Fig. 37 Location of Failure (T-32)

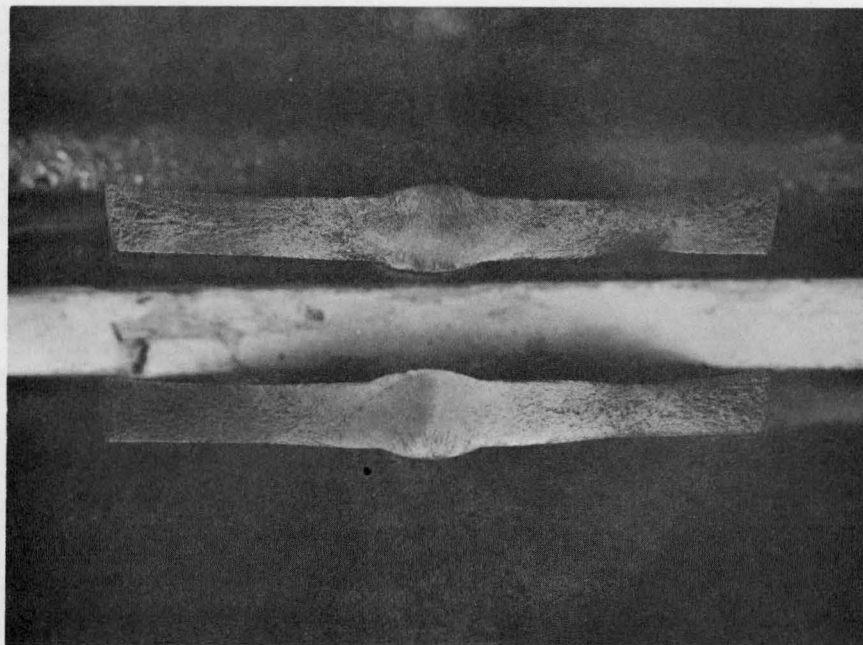

Fig. 38 Fracture Surfaces (T-32)

major breakdown after 1,899,540 cycles and the testing was halted for 30 days.

The last specimen tested was T-42. The specimen was subjected to an actual stress range of 2 to 34 ksi tension. It was first tested using the small loading beam at a speed of 1.8 cycles per second until 493,060 cycles. At that time a stiffener plate in the small loading beam fractured and it was necessary to replace it with the large loading beam. A speed of 1.4 cycles per second was used throughout the rest of the test. During this period, however, the testing was halted for three more times because of troubles in the pump, and in the hydraulic actuator. A total of 114 days were lost during the entire test period of 166 days. The specimen finally failed at the transition zone at 2,146,070 cycles. The location of failure and the fracture surfaces for T-42 are shown in Figs. 39 and 40. The inspection of the fracture surfaces indicated that the failure might have been initiated at a small surface defect approximately 1/2 inches from the edge of the weld.

The results of these six fatigue tests are summarized in Table 15. Note that the applied stresses are computed by multiplying the nominal stresses by the ratios of the average area to the total area (Table 14). It is also to be noted that the stress in the specimen due to the weight of the loading beam and other related parts has been estimated and is a part of the applied stress.

Table 15. Results of Fatigue Tests (Main Test Series)

Specimen	Size of Weld	Nominal Stress (ksi)	Applied Stress (ksi)	No. of Cycles at Failure	Location of Failure
T-11	None	25-50	25.0-50.0	292,400	No failure
T-21	Small	2-34	1.9-32.8	3,657,410	No failure
T-31	Medium	2-34	1.9-32.8	1,463,030	In gage section
T-32	Medium	2-34	1.9-33.0	2,740,000	In gage section
T-41	Large	2-32	1.8-28.8	3,120,360	No failure
T-42	Large	-	2.0-34.0	2,146,070	In transition section

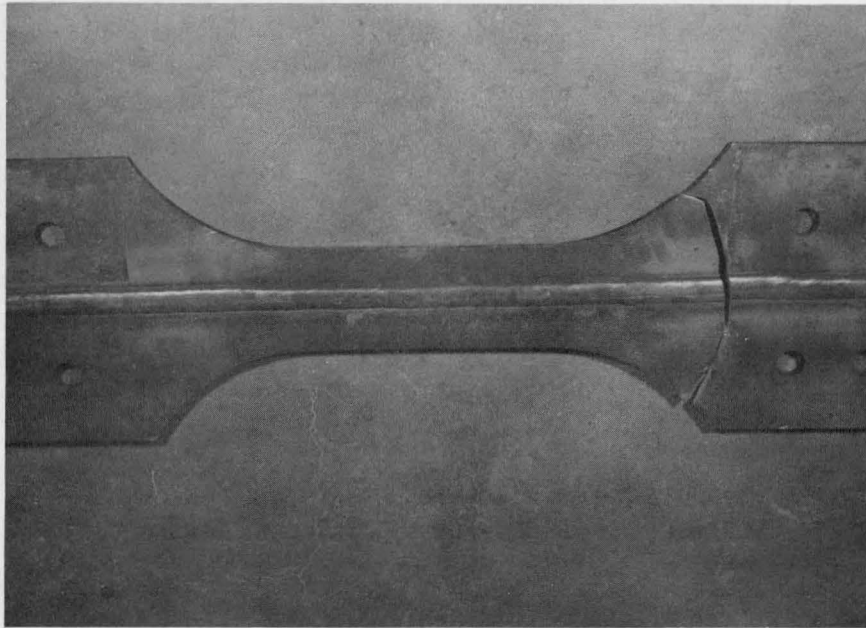

Fig. 39 Location of Failure (T-42)

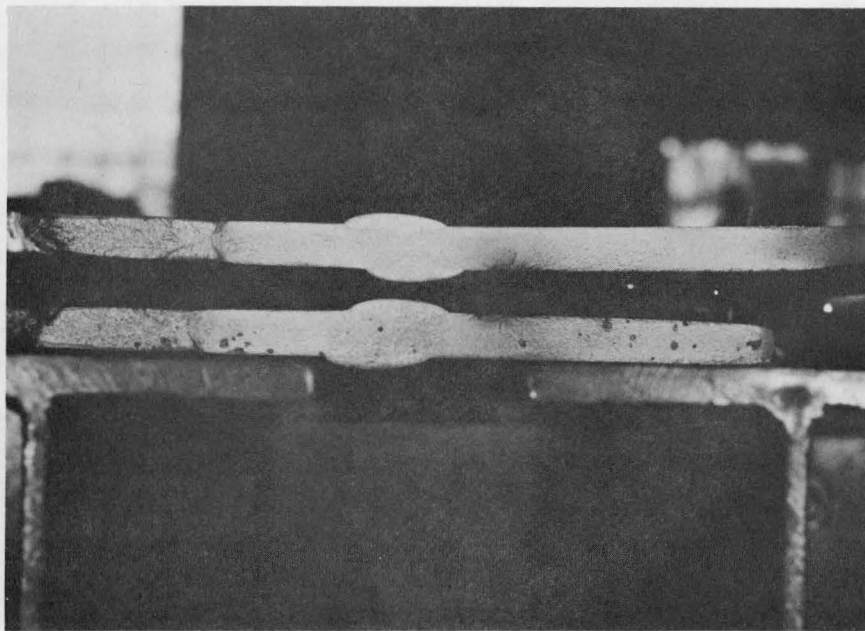

Fig. 40 Fracture Surfaces (T-42)

Discussion

Figure 31 shows the distributions of residual stress in the specimens with small (T-23), medium (T-33), and large (T-43) weld. The following points are worth noticing from this figure:

- (1) The maximum tensile residual stresses in T-23 and T-33 exceed the yield point of the steel plate considerably.
- (2) The maximum tensile residual stress in T-43 is considerably smaller than the yield point of the steel plate.
- (3) The maximum compressive residual stress in T-23 is about one half of those in T-33 and T-43.

The weld on specimen T-43 has a total external area in excess of 9 per cent of the plate area and has a width of 1.06 inches which is 20 per cent of the plate width (See Table 13 and Fig. 27). Because of this, the temperature differential between the weld and the other part of the plate was not as large as the other two specimens, namely, T-23 and T-33. This is probably the reason for the lower maximum tensile residual stress in T-43.

The weld for specimen T-23 is a very small weld with an external depth of only 0.06 inches and a width of 0.34 inches. Since the temperature in the steel near the arc must reach a certain degree (approximately 3000^oF) during arc-welding process, no matter how small the weld is, the high maximum tensile residual stress in specimen T-23 can be expected.

The curves in Fig. 31 show three considerably different types of residual stress distribution. From these curves it appears that the larger the size of weld, the more uniform the residual stress distribution tends to be.

With respect to fatigue testing in this series, one may wonder whether the results have been influenced by the rest periods which occurred during testing of specimens T-21, T-32 and T-42.

Moore and Putnam⁽⁵⁾ have shown that the momentary rests from alternating stress have no appreciable effect on fatigue strength so long as the applied

stress is less than the elastic limit. Work by Bollenrath and Cornelius⁽⁵⁾, and by Wilson and others⁽³⁶⁾ have indicated similar results. On the other hand, Daeves, Gerold and Schülz⁽⁵⁾ found an increase in fatigue life in soft iron and carbon steels when test pieces were subjected to alternating stresses superior to the fatigue limit, and then left at rest. The effect of rest period was larger for longer rest duration and smaller number of cycles preceding rest periods. In one test they found an increase in fatigue life of almost 50 per cent for a rest period of 72 hours after 5600 cycles of stressing at ± 55 kg. per sq. mm. No information is available when the rest period exceeds 72 hours.

Since none of the specimens was tested above the elastic limit, and since the first rest period occurred only after a considerable number of stress cycles for each case (after 2.0 million cycles for T-21, 1.9 million cycles for T-32, and 0.5 million cycles for T-42), it may be assumed that for these tests rest periods probably did not influence the fatigue life to an appreciable degree. It is noted that at least, T-21 has survived 2 million cycles and T-32, 1.9 million cycles before the occurrence of rest periods.

The results of five fatigue tests are summarized in Fig. 41. Theoretical S-N curves for plain plate specimens (Curve A) and longitudinal butt weld specimens with weld reinforcements on and off (Curves B and C) are also shown in this figure. These theoretical curves are based on the following formulas⁽²²⁾:

$$F_n = S(N/n)^k \quad (1)$$

where F_n = the fatigue strength computed for failure at n cycles with $n < 2$ million cycles.

S = the stress which produced failure in N cycles.

k = the slope of the logarithmic S-N curve: 0.14 for plain plate specimens, and 0.13 for longitudinal butt weld specimens,

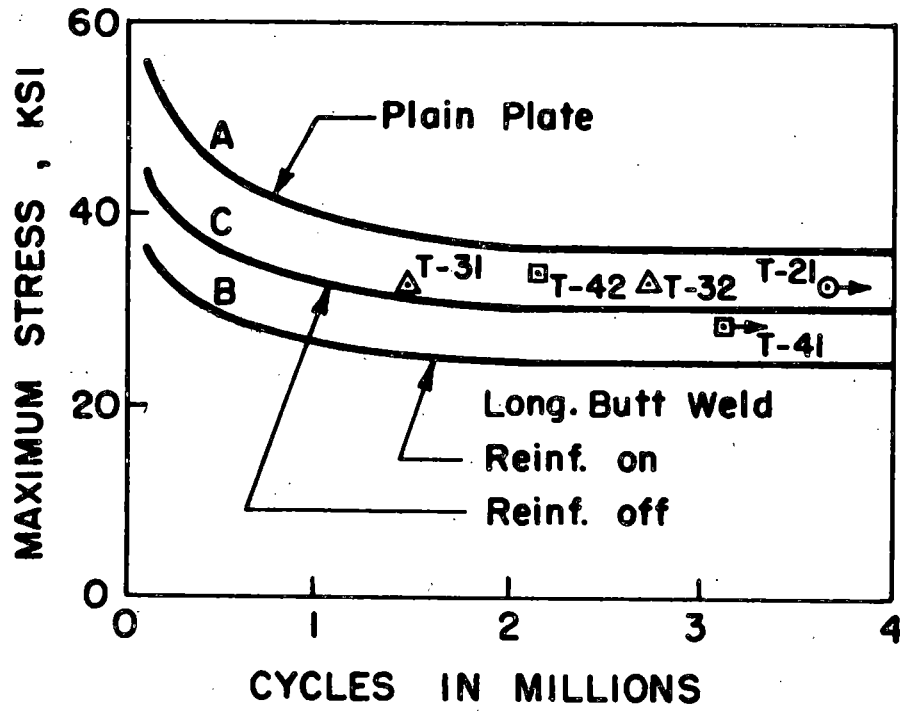

Fig. 41 Results of Fatigue Tests - Main Test Series

and

$$F_{2,000,000} = 20\text{ksi} + \frac{\text{ultimate tensile strength in ksi}}{4} \quad (2)$$

for the plain plate specimens. For longitudinal butt weld specimens with reinforcements on and off, the values of $F_{2,000,000}$ are taken to be 24.5 ksi and 30.2 ksi, respectively, based on the work of Nordmark and Harris⁽²²⁾.

The yield (σ_y) and ultimate (σ_u) strengths of materials used in the fatigue tests from which the above values were obtained are: 39.3 ksi and 66.4 ksi, and 38.4 ksi and 60.1 ksi, respectively, compared to 36.4 ksi and 66.3 ksi in the main test series.

It is interesting to note that the test results are bound by curves A and B and are rather close to curve C, reflecting the differences between specimens with weld beads and butt welded specimens, and the smoothness in weld beads applied.

Further analysis of test data is given in the next chapter.

GENERAL DISCUSSION

Fatigue Strength from Test Results

In order to have a common basis for comparisons, the fatigue tests results from both the pilot test series and the main test series are used to compute the fatigue strength at 2,000,000 cycles for each specimen. The standard formula (Formula 1) given at the end of the previous chapter was used for this purpose. The results of computations are shown in Table 16. Notice that for specimens which did not fail or which failed after 2 million cycles, the values of $F_{2,000,000}$ are the same as the maximum stresses in accordance with the assumption of Formula 1. In the following sections, the discussion of fatigue strength will be based on $F_{2,000,000}$ unless otherwise specified.

Table 16. Fatigue Strength at 2,000,000 Cycles

Specimen	Maximum Stress ksi	Cycles at Failure 10^6	Fatigue Strength at 2 million Cycles	
			ksi	Effect of Welding
PT-1	50.7	5.285 ⁽¹⁾	50.7	1.000 ⁽³⁾
PT-2	49.8	6.050 ⁽¹⁾	49.8	1.000 ⁽³⁾
PT-3	49.3	1.466	47.3	0.943
PT-4	50.4	1.958	50.2	1.000
PT-5	48.1	1.043	44.2	0.880
PT-6	48.4	0.966	44.0	0.870
PT-7	48.0	1.661	46.8	0.933
PT-8	48.6	1.617	47.2	0.940
T-21	32.8	3.657 ⁽¹⁾	32.8	0.897
T-31	32.8	1.463	31.4 ⁽²⁾	0.859
T-32	33.0	2.740 ⁽¹⁾	33.0 ⁽²⁾	0.902
T-41	28.8	3.120 ⁽¹⁾	28.8+ ⁽²⁾	0.787
T-42	34.0	2.146	34.0+ ⁽²⁾	0.929

(1) Specimens did not fail.

(2) Specimens failed after 2 million cycles.

(3) $F_{2,000,000}$ divided by the equivalent strengths of plain specimens;
50.2 ksi for PT-series and 36.6 for T-series.

Comparison with Other Similar Tests

The results of tests on plain specimens (PT-1, PT-2) compared well with tests done by Wilson and others⁽³⁶⁾. They reported an average fatigue strength of 50.0 ksi on the basis of four tests with structural steel specimen having 35.4 ksi σ_y and 64.0 ksi σ_u .

For stress cycles of $\frac{1}{2}$ tension to tension, Hartman and Munse⁽²²⁾ reported an average fatigue strength of 56.0 ksi for Hy-80 steel longitudinally butt-welded specimens preheated to 200°F. The steel has average σ_y of 82.2 ksi and σ_u of 102.0 ksi. The average fatigue strength of PT-3 to PT-8 is 47.0 ksi. Preheating and higher strength contribute to increase in fatigue strength. On the other hand, application of butt weld to two pieces of plates tends to decrease fatigue strength more than simple application of weld beads to a single plate surface, because of higher probability of having geometrical and/or metallurgical discontinuities in the former. Hartman and Munse's test specimens were manually welded while the pilot test specimens were welded semi-automatically. Because of the number of variables involved here, a direct comparison is difficult.

For stress cycles of 2.0 ksi to tension, Harris and Nordmark⁽²²⁾ reported test results on longitudinal butt weld specimens of structural carbon steel with weld reinforcements on and off. Their results are compared to the results of main test series in Table 17. Parts of their results have been used in establishing theoretical curves B and C in Fig. 41. Table 17 and Fig. 41 show that the main test results are very close to that of longitudinal butt weld specimens with reinforcement off. A higher strength in the main test series can be attributed to a higher ultimate strength, smaller weld deposit, and less probability of discontinuities within the weld.

Effect of Welding on Fatigue Strengths

The fatigue strengths at 2 million cycles for the welded specimens are compared to the corresponding strengths for the plain specimens on the last column in Table 16. The average strength of PT-1 and PT-2 is used for the

strength of plain specimen in the pilot test series, while a value computed on the basis of Formula (2), 36.6 ksi, is used for the same in the main test series.

It is obvious from Table 16 that welding of longitudinal beads decreased the fatigue strengths of the specimens. The average reduction in the pilot test series is 7.3%, and in the main test series, 12.5%. The fact that both PT-1 and PT-2 survived more than 5 million cycles while other pilot test specimens all failed before 2 million cycles under the same stress cycles also clearly indicate the effect of bead welding.

The reduction in the fatigue strength in the bead-welded specimens can be attributed to stress concentrations and residual stresses. The maximum

Table 17. Comparison of Results for 2.0-Tension Stress Cycles

	Tests by Harris and Nordmark ⁽²²⁾				Main Tests
	Longitudinal Butt Weld				Bead
Type of Weld	Manual Arc				Auto
Welding Process	On	On	Off	Off	On
Reinforcement	Structural Carbon				A36
Type of Steel	39.3	39.7	38.9	38.4	36.4
Yield Strength (ksi)	66.4	61.4	59.7	60.1	66.3
Ultimate Strength (ksi)	24.5	26.3	29.6	30.2	32.0
Fatigue Strength (ksi)	2	3	3	4	5
No. of Tests					

stress in the pilot test series is 50 ksi which is larger than the yield strength of the specimens. Thus, the residual stress due to welding was presumably lost during the first cycle of test and the strength reduction can be attributed primarily to the existence of stress concentrations. The

beads on the main test specimens are all quite smooth as a result of automatic welding. Although this reduces the probability of having severe external discontinuities due to weld reinforcements, the effect of stress concentration on the strength reduction can not be eliminated.

Effect of Residual Stresses on Fatigue Strength

It is reasonable to assume that if residual stress has any effect on the fatigue strength, then the effect must be a function of the magnitude of maximum tensile residual stress because of the local nature of a typical initiation of fatigue failure. On the other hand, it has been found in this study and other previous research that the maximum tensile residual stress will occur at the weld with a magnitude close to or exceeding the yield stress, usually irrespective of welding conditions. The only exception to this was found in specimen T-43 where the maximum tensile residual stress is 21.0 ksi, apparently due to a more uniform temperature distribution because of a large weld size. The fatigue tests on the identical specimens T-41 and T-42, however, do not show any particularly noticeable increase or decrease in the fatigue strengths compared to those with higher maximum tensile residual stresses (Table 16). Since the applied maximum stresses in the main test series are already quite close to the yield stress of 36.4 ksi, at which residual stresses presumably will be erased, it is doubtful any maximum applied stress between 28.8 ksi and 36.4 ksi will bring out any substantial influence of the residual stresses on fatigue strength. Furthermore, since all except one specimen in the main test series survived more than 2 million cycles under the high maximum stress of 28.8 ksi plus, it may be concluded that residual stress has no practical ill-effect on the fatigue strength of steel plates with longitudinal weld beads. This conclusion is consistent with one of the conclusions from the study of literature in which it is stated that the influence of residual stresses is more significant at longer lives and lower applied stresses.

Effect of Weld Size on Fatigue Strength

Three different sizes of welds were introduced in the pilot test specimens. The external areas of weld ($2A_e$) amounted to 1.72%, 3.69% and 4.40% of the plate area, respectively. No apparent correlation between the sizes of the weld and the fatigue strengths was observed, except that the specimens with small welds failed in the gage section with somewhat higher strength (Table 7).

There were also three sizes of welds in the main test series. The ratio of external areas of weld to the plate area were 1.12%, 3.12% and 9.28%, respectively. The specimen with small welds (T-21) appeared to be somewhat stronger than the others (Table 15). There was no appreciable difference in fatigue strength between specimens with medium and large size welds.

In view of these results, it may be stated that the effect of weld area on the fatigue strength is important only to the extent that a larger weld area is more susceptible to produce severe stress concentrations than the smaller ones.

CONCLUSIONS

The following conclusions are drawn based on the results of the experimental investigation presented in this report:

- (1) Welding, even merely depositing bead welds, definitely has an adverse effect on the fatigue strength of steel members.
- (2) Fatigue strength of a bead-welded specimen is larger than that of an otherwise identical longitudinal butt weld specimen and smaller than that of an otherwise identical plain plate specimen. It is close to that of a longitudinal butt weld specimen with weld reinforcement removed.
- (3) Stress concentration due to welding is much more detrimental to the fatigue strength of a welded specimen than the existence of residual stresses.
- (4) Residual stresses due to welding has no practical ill-effect on the fatigue strength of steel plates with longitudinal weld beads, if 2 million cycles is considered to be a satisfactory fatigue life.
- (5) The size of weld is important to an extent that larger size weld is more susceptible to severe stress concentrations than the smaller ones.
- (6) The beginning and/or the end of weld bead is a potential weak point with respect to fatigue. Grinding off weld ends may not help improve the fatigue strength unless the grinding is done with extreme caution.
- (7) The removal of weld reinforcement decreases the magnitudes of maximum tensile and compressive residual stresses.

ACKNOWLEDGEMENTS

The investigation described in this report was conducted at the Structural Research Laboratory of the Engineering Research Institute at Iowa State University under the sponsorship of the Iowa State Highway Commission. The authors wish to acknowledge the help of Mr. S. E. Roberts, Research Engineer, Mr. C. A. Pestotnik, Bridge Engineer, Mr. P. F. Barnard, Structural Engineer, Mr. Y. H. Gee, Assistant Bridge Engineer, all of the Iowa State Highway Commission, for their constructive advice on the matters related to this research and their continued interest in this research project.

The United States Steel Corporation generously contributed steel plates for the main test specimens. The assistance of Mr. J. R. Van Nort on this matter is very much appreciated.

Fatigue tests in the pilot test program were conducted at Fritz Engineering Laboratory, Lehigh University, Bethlehem, Pa.

The authors also wish to express their appreciation to Pittsburgh-Des Moines Steel Company in Des Moines, Iowa; Messrs. Vern Sutter, Jim Watkins, and Clarence Bradshaw, all of Pittsburgh-Des Moines Steel Company, for shot-blasting and welding of the specimens.

All machine work was done at the Machine Shop of the Engineering Research Institute at Iowa State. The authors wish to acknowledge the help of Mr. C. N. Spicer, supervisor of the Machine Shop, and his capable and cooperative crew.

The authors also express their appreciation to Dr. W. W. Sanders, Jr., who helped them in many ways to keep the fatigue testing system at Iowa State in working condition.

REFERENCES

1. Wilson, D. M. The effect of residual stress and stress concentration due to longitudinal welds on the fatigue behavior of structural members. Unpublished M.S. Thesis, Iowa State University. 1967.
2. Lee, T. T. and Wilson, D. M. Fatigue strength and residual stresses of steel plates with longitudinal weld beads. Special Report, Iowa Engineering Experiment Station. May, 1966.
3. Reemsnyder, H. S. The fatigue behavior of structural steel weldments: a literature survey. Fritz Engineering Laboratory Report No. 284.1. Lehigh University. 1961.
4. Forrest, P. G. Fatigue of metals. New York, New York, Addison-Wesley Publishing Co., Inc. 1962.
5. Cazaud, R. Fatigue of metals. London, Chapman and Hall, Ltd. 1953.
6. Pope, J. A. Criteria of failure under complex stresses. In Pope, J. A., ed. Metal fatigue. pp. 24-54. London, England, Chapman and Hall, Ltd. 1959.
7. Spraragen, W. and Rosenthal, D. Fatigue strength of welded joints. Welding Journal 21: 297s-347s. 1942.
8. Battelle Memorial Institute. Prevention of the failure of metals under repeated stress. New York, New York, John Wiley and Sons, Inc. 1941.
9. Pope, J. A. Stress concentration factors. In Pope, J. A. ed. Metal fatigue. pp. 55-80. London, England, Chapman and Hall, Ltd. 1959.
10. Lessels, John M. Strength and resistance of metals. New York, New York, John Wiley and Sons, Inc. 1954.
11. Lepison, Charles and Juvinall, Robert O. Handbook of stress and strength. New York, New York, The Macmillan Co. 1963.
12. Pattinson, E. J. and Dugdale, D. S. Fading of residual stresses due to repeated loading. Metallurgia 66: 228-230. 1959.
13. Dolan, T. J. Residual stress, strain hardening and fatigue. In Rassweiler, Gerald M. and Grube, William L., eds. Internal stresses and fatigue in metals. pp. 285-310. New York, New York, Elsevier Publishing Company. 1959.
14. Anderson, M. H. and Ekberg, C. E. Fatigue and residual stress investigation of composite prestressed steel beams. Mimeographed. Ames, Iowa, Engineering Experiment Station, Iowa State University of Science and Technology. 1963.

15. Taira, Shuji and Murakami, Yasunori. Effect of residual stresses on fatigue strength. In Japan Congress on Testing Materials, Editorial Committee eds. Proceedings of the Fifth Japan Congress on Testing Materials. pp. 27-31. Kyoto, Japan, The Japan Society for Testing Materials. 1962.
16. Taira, Shuji and Murakami, Yasunori. Residual stresses produced by plastic tension in notched plate specimens and fatigue strength. Japan Society of Mechanical Engineers Bulletin 4: 453-460. 1961.
17. Taira, Shuji and Murakami, Yasunori. On the residual stresses due to alternating stressing of annealed steels. Japan Society of Mechanical Engineers Bulletin 4: 41-45. 1961.
18. Polakowski, N. H. and Ripling, E. J. Strength and structure of engineering materials. Englewood Cliffs, New Jersey, Prentice-Hall, Inc. 1966.
19. Sigwart, H. Influence of residual stresses on the fatigue limit. In the Institution of Mechanical Engineers and The American Society of Mechanical Engineers. Proceedings of the International Conference on Fatigue of Metals. pp. 272-281. London, England, Institution of Mechanical Engineers. 1956.
20. Hempel, M. R. Surface condition and fatigue strength. In Rassweiler, Gerald M. and Grube, William L., eds. Internal stresses and fatigue in metals. pp. 311-336. New York, New York, Elsevier Publishing Company. 1959.
21. Welding handbook. 3rd ed. New York, New York, American Welding Society. 1950.
22. Munse, W. H. Fatigue of welded steel structures. New York, New York, Welding Research Council. 1964.
23. Bruckner, W. H. Metallurgy of welding. New York, New York, Pitman Publishing Corporation. 1954.
24. Albritton, O. W. Residual stresses in a weld with one free surface. Welding Journal 43: 86s-91s. 1964.
25. Rao, N. R. N. and Tall, L. Residual stresses in welded plates. Welding Journal 40: 468s-480s. 1961.
26. Tall, Lambert. Residual stresses in welded plates: a theoretical study. Welding Journal 42: 10s-23s. 1954.
27. Fall, H. W., Brugioni, D. L., Randall, M. D. and Monroe, R. E. Improvement of low cycle fatigue strength of high strength steel weldments. Welding Journal 41: 145s-153s. 1962.
28. Sanders, W. W., Derecho, A. T. and Munse, W. H. Effect of external geometry on fatigue behavior of welded joints. Welding Journal 44: 49s-55s. 1965.

29. Wilson, Wilbur M., Munse, Willaim H. and Snyder, I. Starling. Fatigue strength of various types of butt welds connecting steel plates. University of Illinois Engineering Experiment Station Bulletin Series No. 384. 1950.
30. Weck, R. The fatigue problem in welded construction. In The Institution of Mechanical Engineers and The American Society of Mechanical Engineers. Proceedings of the International Conference on Fatigue of Metals. pp. 704-712. London, England, Institution of Mechanical Engineers. 1956.
31. Welding handbook. 5th ed. New York, New York, American Welding Society. 1962.
32. Nordmark, G. E. Peening increases fatigue strength of welded aluminum. Metal Progress 84, No. 5: 101-103. Nov. 1963.
33. Kudryavtsev, I. V. The influence of internal stresses on the fatigue endurance of steel. In the Institution of Mechanical Engineers and The American Society of Mechanical Engineers. Proceedings of the International Conference of Fatigue of Metals. pp. 317-325. London, England, Institution of Mechanical Engineers. 1956.
34. Huber, A. W. Residual strain measurement. Fritz Engineering Laboratory Report No. 220A. 17. Lehigh University. March 1955.
35. Nagaraja Rao, N. R., and Tall, L. Residual stresses in welded plates. Welding Journal 40: pp. 468-S. 1961
36. Wilson, W. M., Bruckner, W. H., Coombe, J. V. and Wilde, R. A. Fatigue tests of welded joints in structural steel plates. University of Illinois Engineering Experiment Station Bulletin Series No. 327. 1941.