

Laboratory and Field Evaluation of a Composite Glued-Laminated Girder to Deck Connection

Final Report
February 2019

**NATIONAL
CENTER
FOR WOOD
TRANSPORTATION
STRUCTURES**



IOWA STATE UNIVERSITY
Institute for Transportation

Sponsored by
Iowa Highway Research Board
(IHRB Project TR-680)
Iowa Department of Transportation
(InTrans Project 14-511)

About the National Center for Wood Transportation Structures

The mission of the NCWTS is to bring together academia, government, and industry to efficiently complete research, demonstration, and education that result in durable, cost-effective wood transportation structures to improve the transportation infrastructure of America and the world.

About the Bridge Engineering Center

The mission of the Bridge Engineering Center (BEC) is to conduct research on bridge technologies to help bridge designers/owners design, build, and maintain long-lasting bridges.

Disclaimer Notice

The contents of this report reflect the views of the authors, who are responsible for the facts and the accuracy of the information presented herein. The opinions, findings and conclusions expressed in this publication are those of the authors and not necessarily those of the sponsors.

The sponsors assume no liability for the contents or use of the information contained in this document. This report does not constitute a standard, specification, or regulation.

The sponsors do not endorse products or manufacturers. Trademarks or manufacturers' names appear in this report only because they are considered essential to the objective of the document.

Iowa State University Non-Discrimination Statement

Iowa State University does not discriminate on the basis of race, color, age, ethnicity, religion, national origin, pregnancy, sexual orientation, gender identity, genetic information, sex, marital status, disability, or status as a U.S. veteran. Inquiries regarding non-discrimination policies may be directed to Office of Equal Opportunity, 3410 Beardshear Hall, 515 Morrill Road, Ames, Iowa 50011, Tel. 515-294-7612, Hotline: 515-294-1222, email eooffice@iastate.edu.

Iowa Department of Transportation Statements

Federal and state laws prohibit employment and/or public accommodation discrimination on the basis of age, color, creed, disability, gender identity, national origin, pregnancy, race, religion, sex, sexual orientation or veteran's status. If you believe you have been discriminated against, please contact the Iowa Civil Rights Commission at 800-457-4416 or Iowa Department of Transportation's affirmative action officer. If you need accommodations because of a disability to access the Iowa Department of Transportation's services, contact the agency's affirmative action officer at 800-262-0003.

The preparation of this report was financed in part through funds provided by the Iowa Department of Transportation through its "Second Revised Agreement for the Management of Research Conducted by Iowa State University for the Iowa Department of Transportation" and its amendments.

The opinions, findings, and conclusions expressed in this publication are those of the authors and not necessarily those of the Iowa Department of Transportation.

Technical Report Documentation Page

1. Report No. IHRB Project TR-680	2. Government Accession No.	3. Recipient's Catalog No.	
4. Title and Subtitle Laboratory and Field Evaluation of a Composite Glued-Laminated Girder to Deck Connection		5. Report Date February 2019	
		6. Performing Organization Code	
7. Author(s) Travis Hosteng (orcid.org/0000-0002-2059-1296) and Brent Phares (orcid.org/0000-0001-5894-4774)		8. Performing Organization Report No. InTrans Project 14-511	
9. Performing Organization Name and Address Bridge Engineering Center Iowa State University 2711 South Loop Drive, Suite 4700 Ames, IA 50010-8664		10. Work Unit No. (TRAIS)	
		11. Contract or Grant No.	
12. Sponsoring Organization Name and Address Iowa Highway Research Board Iowa Department of Transportation 800 Lincoln Way Ames, IA 50010		13. Type of Report and Period Covered Final Report	
		14. Sponsoring Agency Code IHRB Project TR-680	
15. Supplementary Notes Visit www.intrans.iastate.edu for color pdfs of this and other research reports.			
16. Abstract <p>Buchanan County, Iowa, has been working with the National Center for Wood Transportation Structures and a timber fabricator to develop the next-generation timber bridge. The goal is to increase the structural efficiency of timber bridges and increase longevity by (1) creating a composite deck-girder system and (2) using an epoxy overlay. These design elements have the potential to increase viable bridge options for use not only on Iowa's roadways, but nationally and internationally as well.</p> <p>The bridge system developed for this research was a composite glue-laminated (glulam) girder-deck system utilizing epoxy for the connection and an epoxy overlay wearing surface on the deck. This design was investigated through small- and large-scale laboratory testing of the composite epoxy connection and a field demonstration bridge built utilizing this girder to deck connection detail and epoxy overlay.</p> <p>The small-scale tests showed that the best overall joint connection is an epoxy and lag bolt connection. The joints with epoxy at least tripled the shear capacity of the lag bolt joint, and addition of mechanical fasteners to the epoxy connection marginally increased performance. The large-scale laboratory tests showed a small increase in the load capacity and movement of the neutral axis when the deck panels are affixed to the girders, both of which indicate potential composite action. Furthermore, the epoxied connection exhibited an improved composite connection over the lag bolt connection.</p> <p>Three live load tests on the field demonstration bridge in 2015, 2016, and 2017 indicated that transverse load distribution for all load cases was adequate. The composite action observed was not likely substantial enough to be accounted for in design. The chip seal shows signs of cracking at the transverse deck panel joints, but because of the epoxy the joints remain sealed and show no signs of moisture intrusion on the underside of the deck. The epoxy wearing surface on the deck performed better as an impermeable joint filler than a wearing surface.</p>			
17. Key Words composite structures—epoxy—timber bridges—wooden bridges		18. Distribution Statement No restrictions.	
19. Security Classification (of this report) Unclassified.	20. Security Classification (of this page) Unclassified.	21. No. of Pages 85	22. Price NA

LABORATORY AND FIELD EVALUATION OF A COMPOSITE GLUED-LAMINATED GIRDER TO DECK CONNECTION

**Final Report
February 2019**

Co-Principal Investigators

Travis Hosteng, Co-Director and Bridge Research Specialist
National Center for Wood Transportation Structures and
Bridge Engineering Center, Iowa State University

Brent Phares, Director
Bridge Engineering Center, Iowa State University

Authors

Travis Hosteng and Brent Phares

Sponsored by
Iowa Highway Research Board and
Iowa Department of Transportation
(IHRB Project TR-680)

Preparation of this report was financed in part
through funds provided by the Iowa Department of Transportation
through its Research Management Agreement with the
Institute for Transportation
(InTrans Project 14-511)

A report from
Bridge Engineering Center
Iowa State University
2711 South Loop Drive, Suite 4700
Ames, IA 50010-8664
Phone: 515-294-8103 / Fax: 515-294-0467
www.intrans.iastate.edu

TABLE OF CONTENTS

ACKNOWLEDGMENTS	ix
EXECUTIVE SUMMARY	xi
1. INTRODUCTION	1
2. OBJECTIVE	2
3. FIELD DEMONSTRATION BRIDGE	3
3.1 Location	3
3.2 Design	3
3.3 Construction	9
4. PERFORMANCE EVALUATION OF COMPOSITE ACTION AND THE EPOXY OVERLAY	16
4.1 Laboratory Testing Protocol	16
4.2 Field Testing Protocol	32
5. TEST RESULTS	35
5.1 Laboratory Testing Results	35
5.2 Field Testing Results	39
6. SUMMARY AND CONCLUSIONS	51
REFERENCES	53
APPENDIX A: PLAN DRAWINGS FOR SUBSTRUCTURE AND SUPERSTRUCTURE OF BUCHANAN COUNTY BRIDGE	55
APPENDIX B: FLEXOLITH LOW MODULUS EPOXY COATING AND BROADCAST OVERLAY SYSTEM	71

LIST OF FIGURES

Figure 1. Location of composite timber bridge in Buchanan County, Iowa.....	3
Figure 2. Cross-section of composite timber bridge abutment, page 3/3 in Appendix A	4
Figure 3. Elevation View of composite timber bridge abutment, page U.01 in Appendix A.....	4
Figure 4. Composite timber bridge decorative abutment finish	5
Figure 5. GRS approach subbase, page U.04 in Appendix A.....	5
Figure 6. Lap splice edges on deck panels of the composite timber bridge	6
Figure 7. Predrilled holes in deck panels of the composite timber bridge.....	6
Figure 8. Cross-section view of composite timber bridge, page 2/3 in Appendix A.....	7
Figure 9. Elevation view of composite timber bridge, page 1/3 in Appendix A	7
Figure 10. Epoxy chip seal wearing course on the composite timber bridge	8
Figure 11. Guardrail on the composite timber bridge.....	9
Figure 12. Composite timber bridge abutment during construction	10
Figure 13. Girders of composite timber bridge in place	11
Figure 14. Girder anchor assembly for the composite timber bridge	12
Figure 15. Glulam deck panels prior to unloading	13
Figure 16. Placement of deck panels on composite timber bridge	14
Figure 17. Composite timber bridge, Buchanan County, Iowa	15
Figure 18. Small-scale laboratory specimen dimensions.....	17
Figure 19. Small-scale specimen with lag screws	18
Figure 20. Small-scale specimen with epoxy and lag screws.....	19
Figure 21. Small-scale specimen with epoxy and GRK screws	21
Figure 22. Small-scale specimen with epoxy and GRK screws removed	22
Figure 23. Small-scale specimen in the Satec machine for testing.....	23
Figure 24. Girder spacing at abutments with neoprene pad.....	23
Figure 25. Lap splice edges on glulam deck panels for Large-Scale Specimens 1 and 2	24
Figure 26. Precast concrete deck panels utilized on Large-Scale Specimen 3	25
Figure 27. Large-Scale Specimen 1 prior to load testing.....	26
Figure 28. Installation of glulam deck sections on Large-Scale Specimen 2 using epoxy.....	28
Figure 29. Installation of glulam deck sections on Large-Scale Specimen 2 using epoxy.....	29
Figure 30. Large-Scale Specimen 3 during fabrication	30
Figure 31. Loading setup for large-scale specimens.....	31
Figure 32. Instrumentation layout for large-scale specimens	32
Figure 33. Strain gages and displacement transducers at girder-deck interface.....	32
Figure 34. Typical instrumentation setup for testing of the composite timber bridge.....	33
Figure 35. Instrumentation of composite timber bridge for live load testing	33
Figure 36. Load cases for composite timber bridge live load testing (looking north).....	34
Figure 37. Shear strength of small-scale laboratory specimens.....	35
Figure 38. Strain history, large-scale laboratory lag bolt glulam deck specimen.....	36
Figure 39. Strain history, large-scale laboratory epoxied glulam deck specimen	37
Figure 40. Strain history, large-scale laboratory concrete deck specimen	38
Figure 41. Peak deflections at midspan for Load Case 3, 2016.....	40
Figure 42. Peak deflections at midspan for Load Case 3, 2017.....	41
Figure 43. Load fraction per girder for Load Case 1	42
Figure 44. Load fraction per girder for Load Case 2	43

Figure 45. Load fraction per girder for Load Case 3	44
Figure 46. Load fraction per girder for Load Case 4	45
Figure 47. Load fraction per girder for Load Case 5	46
Figure 48. Epoxy wearing surface May 2015	49
Figure 49. Epoxy filling predrilled lag screw holes.....	50

LIST OF TABLES

Table 1. Large-scale specimen load test data.....	38
Table 2. Bottom flange peak strains	47
Table 3. Neutral axis location (feet from bottom of girder), midspan, 2015	48
Table 4. Neutral axis location (feet from bottom of girder), midspan, 2016.....	48
Table 5. Neutral axis location (feet from bottom of girder), midspan, 2017	48

ACKNOWLEDGMENTS

The authors would like to thank the Iowa Department of Transportation (DOT) and Iowa Highway Research Board (IHRB) for sponsoring this project.

EXECUTIVE SUMMARY

Buchanan County, Iowa, has been working with the National Center for Wood Transportation Structures and a timber fabricator to develop the next-generation timber bridge. The goal with the development of this concept is to increase the structural efficiency of timber bridges and increase longevity by (1) creating a composite deck-girder system and (2) using an epoxy overlay. If successful, these design elements have the potential to increase viable bridge options for use not only on Iowa's roadways, but nationally and internationally as well.

The bridge system developed for this research was a composite glue-laminated (glulam) girder-deck system utilizing epoxy for the connection as well as an epoxy overlay wearing surface on the deck. Investigation of this design involved two primary focus areas: small- and large-scale laboratory testing of the composite epoxy connection and a field demonstration bridge built utilizing this girder to deck connection detail and epoxy overlay.

For the laboratory evaluation, small-scale tests were conducted on four different girder to deck connection types: lag bolts (typical connection detail), epoxy only, epoxy with lag bolts, and epoxy with GRK screws. The results show that the best overall joint connection is the epoxy and lag bolt connection, followed by the epoxy-only, epoxy screw, and lag bolt-only connections. The three joints with epoxy at least tripled the shear capacity of the lag bolt joint, and addition of mechanical fasteners to the epoxy connection made a minor increase in performance.

Large-scale laboratory tests were conducted on three two-girder systems: transverse glulam deck panels lag-screwed to the girders, transverse glulam deck panels epoxied to the girders, and precast concrete panels either epoxied to the girders or connected via shear studs and grout pockets. A non-composite control consisted of the first specimen with the glulam deck panels simply resting on the girders, unattached. The results show a small increase in the load capacity and movement of the neutral axis when the deck panels are affixed to the girders, both of which indicate potential composite action. Furthermore, the epoxied connection exhibited an improved composite connection over the lag bolt connection.

For the field portion of this work, a demonstration bridge was designed and constructed in Buchanan County, Iowa. Three live load tests were completed, one each in 2015, 2016, and 2017. Transverse load distribution for all load cases was found to be adequate and as expected in design. Some level of composite action was observed, though not likely substantial enough to be accounted for in design. The chip seal shows signs of cracking at the transverse deck panel joints, but since the joints were previously filled with epoxy, the joints have remained sealed and showed no signs of moisture intrusion on the underside of the deck.

Lastly, the epoxy wearing surface applied to the deck of the demonstration bridge performed better as an impermeable joint filler than a wearing surface. In the future, the combination of an initial epoxy overlay to fill the joints and seal the gaps, followed by a well-designed asphalt wearing surface, may be the key to prolonging the life of these structures.

1. INTRODUCTION

The structural capabilities of timber have been widely known for centuries, as evidenced by the fact that it has been a primary building material for many generations. Recently, there have been even further improvements to timber construction components in that they are now being specially fabricated into highly engineered cross-sections. Unfortunately, the integration and use of these engineered timber materials/sections in bridge construction has been slow to progress, at least in the United States, in large part due to the negative perception of timber. The negative perception that timber has obtained, and unfortunately sustained, over the years is in large part due to timber bridges that have performed poorly. These timber bridges performed poorly not because of material inadequacies, but because of insufficient design, protection, and maintenance and their less-than-ideal performance, often related more to serviceability than structural adequacy. However, when properly designed and protected from elements such as water, insects, and fire, timber is a structurally capable, cost-effective, and aesthetically pleasing material suitable for many structural applications.

In response to the negative performance and perception of timber bridges in the past, significant research has been completed related to the development of design details, improved preservatives, and advanced engineered concepts for modern timber bridges. As a result, the performance of these types of structures has been greatly enhanced; unfortunately, the perceptions of these structures has not been enhanced to the same degree.

In the search for additional bridge replacement alternatives, the Buchanan County Engineer has been working with the National Center for Wood Transportation Structures and a timber fabricator to develop the next-generation timber bridge. The goal with the development of this concept is to increase the structural efficiency of timber bridges and increase longevity by (1) creating a composite deck-girder system and (2) applying an epoxy overlay. If successful, these design elements have the potential to increase viable bridge options for use on Iowa's roadways as well as nationally and internationally. Furthermore, successful implementation, monitoring, and performance reporting of a timber bridge may be just what timber needs to shine some light on its negative perception shadow.

The work detailed in this report outlines a research project undertaken in Buchanan County, Iowa, aimed at investigating the effectiveness of a composite glue-laminated (glulam) girder-deck system and the use of an epoxy overlay wearing surface on the deck.

2. OBJECTIVE

The objective of the project was to aid in the development of the next-generation timber bridge as follows:

- Perform laboratory and field testing of an innovative, field-installed girder to deck connection detail that potentially results in a composite structure
- Document the construction of the Buchanan County Bridge using video and other formats
- Perform a field performance evaluation that includes measuring changes in live load response over time and documenting the performance of the thin epoxy overlay

3. FIELD DEMONSTRATION BRIDGE

3.1 Location

The composite timber bridge is located on Quasqueton Diagonal Blvd., approximately one-half mile north of the city of Quasqueton in Buchanan County, Iowa, (see Figure 1) and near Cedar Rock State Park, which was a factor in the overall design. The project replaced the existing 54 ft long x 22 ft wide steel girder bridge with a 70 ft long x 40 ft wide composite glulam timber bridge.

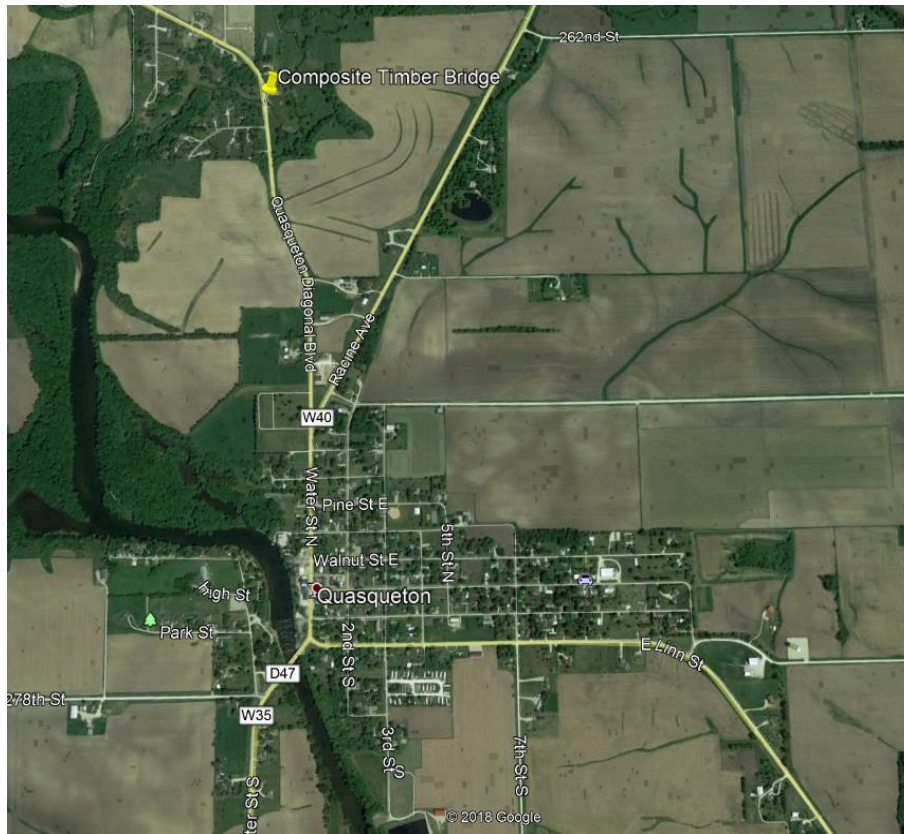

Figure 1. Location of composite timber bridge in Buchanan County, Iowa

3.2 Design

Design for this project was a joint effort undertaken by the Buchanan County Engineer's Office (Buchanan County) and Gruen-Wald Engineered Laminates (GWEL), Inc. from Tea, South Dakota. Buchanan County provided the design for the substructure, and GWEL provide the design for the superstructure. Complete plan drawings for the substructure and superstructure are included in Appendix A.

3.2.1 Substructure – Buchanan County Engineer’s Office

The substructure of the bridge is composed of concrete abutments supported on steel h-pile sections. Figure 2 illustrates the cross-section and Figure 3 shows the elevation view of the abutments.

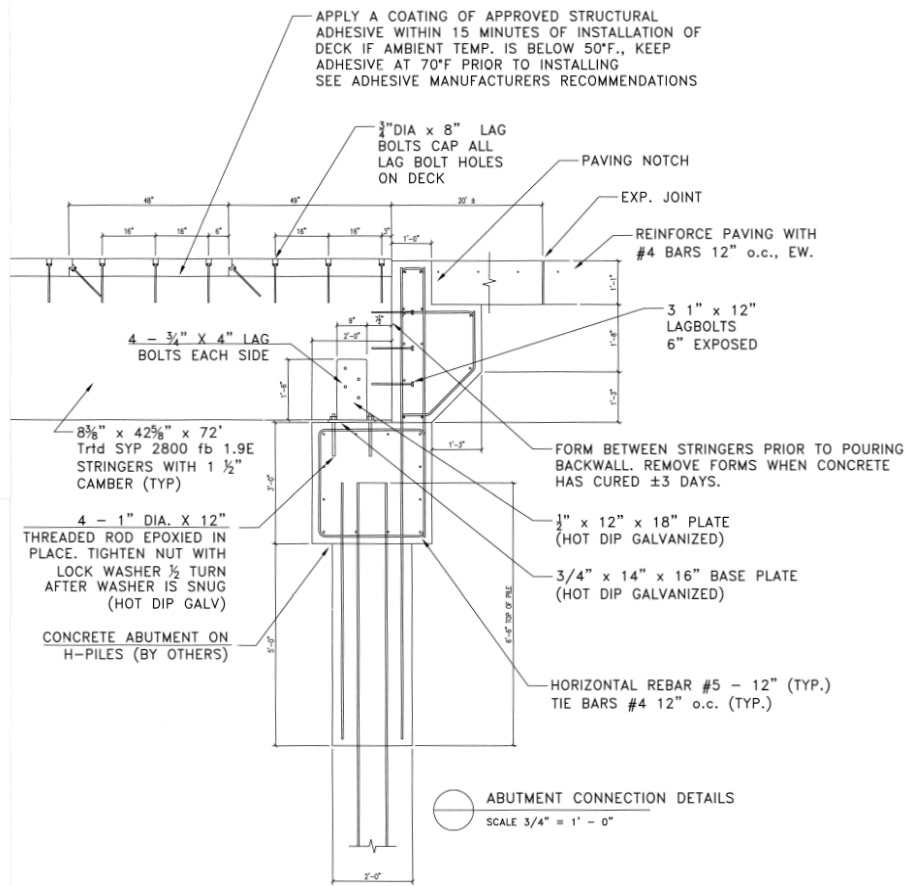

Figure 2. Cross-section of composite timber bridge abutment, page 3/3 in Appendix A

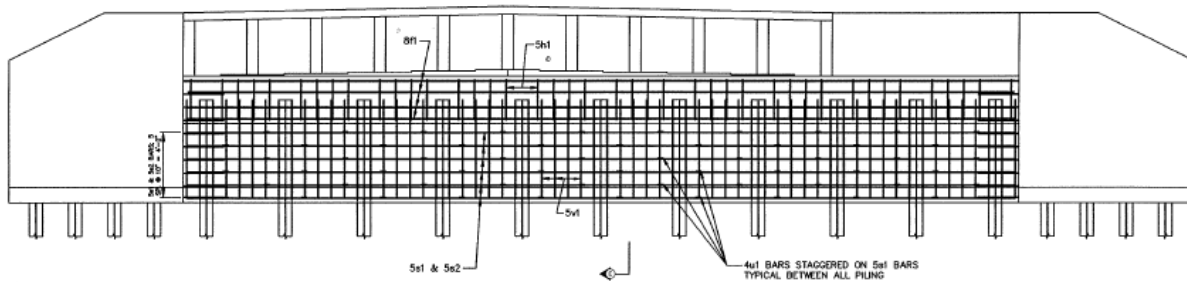

Figure 3. Elevation View of composite timber bridge abutment, page U.01 in Appendix A

The abutment caps, backwall, and wing walls are cast-in-place concrete with architectural detailing; the architectural detailing of the abutments was due to the bridge’s proximity to Cedar

Rock State Park, which includes a Frank Lloyd Wright–designed home from the 1950s, and was designed to complement the local history (see Figure 4).



Figure 4. Composite timber bridge decorative abutment finish

In addition, geosynthetic-reinforced soil (GRS) was utilized for the approach paving subbase. Figure 5 illustrates the details for the GRS approach subbase.

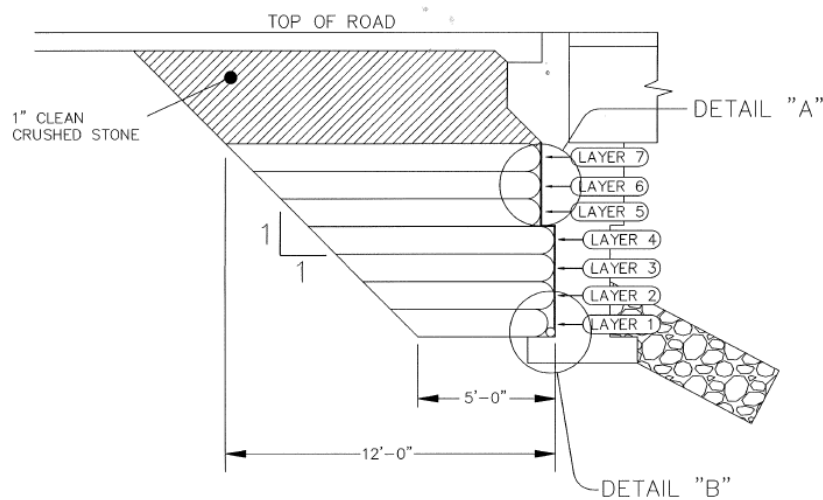

Figure 5. GRS approach subbase, page U.04 in Appendix A

3.2.2 Superstructure – Gruen-Wald Engineered Laminates (GWEL), Inc.

The superstructure for this project was developed and designed according to HL-93 specifications. The superstructure consists of 11 8.75 in. x 42.625 in. x 72 ft long southern

yellow pine (SYP) glulam timber girders on 4 ft centers, with a design bending stress (f_b) of 2800 psi, a modulus of elasticity of $1.9 \times 10^6 \text{ in.}^4$, and 1.5 in. of camber at midspan. The deck consists of a total of 36 4 in. x 24 in. x 40 ft long transverse glulam deck panels. The deck panels have factory milled lap splice edges and predrilled holes for all hardware (see Figure 6 and Figure 7).



Figure 6. Lap splice edges on deck panels of the composite timber bridge



Figure 7. Predrilled holes in deck panels of the composite timber bridge

Diaphragms are located at approximate quarter point locations and made up of glulam blocks measuring 5.375 in. x 23.75 in. x 39.5 in. The diaphragms are bevel cut to facilitate the sloped deck and sit flush with the bottom of the deck. Figure 8 illustrates the cross-section of the superstructure, and Figure 9 illustrates an elevation view of the superstructure.

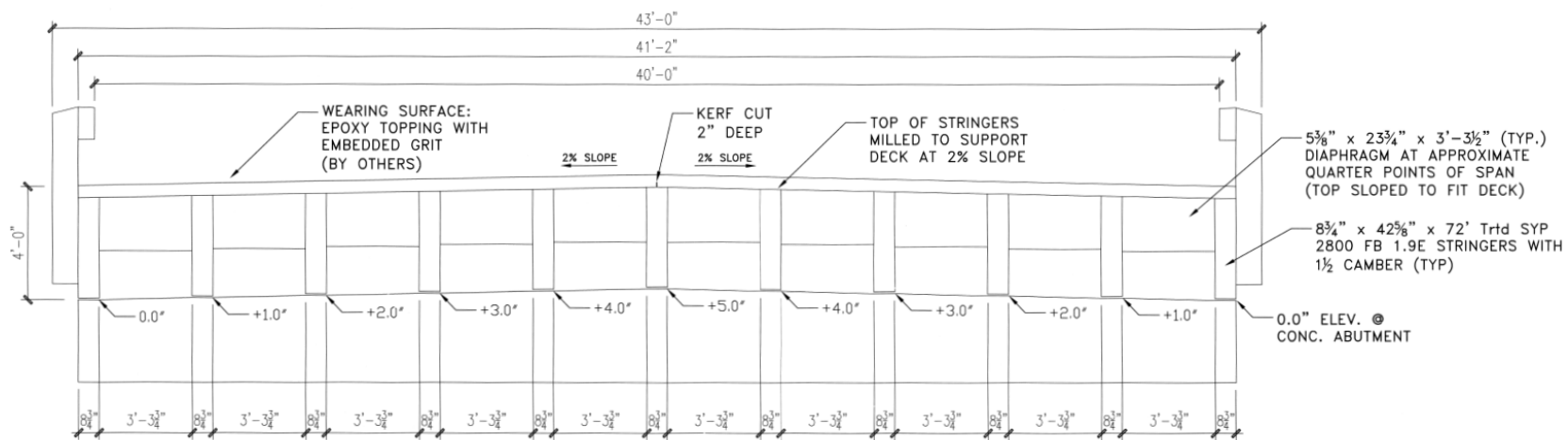

Figure 8. Cross-section view of composite timber bridge, page 2/3 in Appendix A

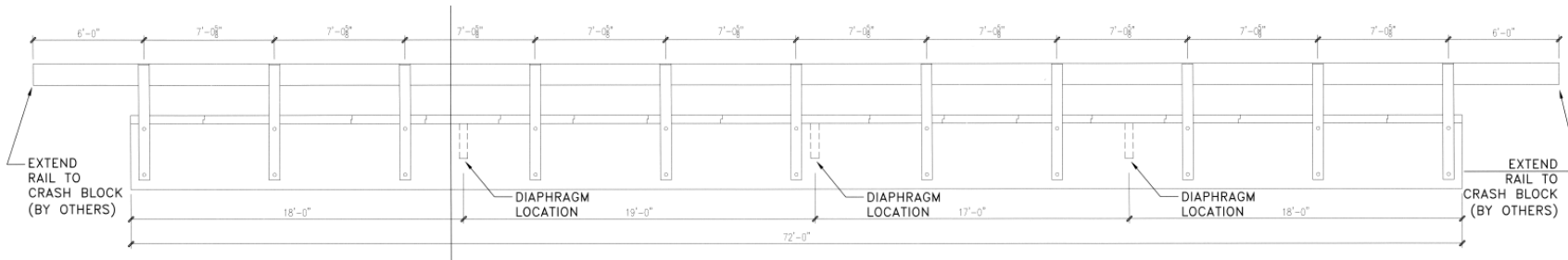

Figure 9. Elevation view of composite timber bridge, page 1/3 in Appendix A

As noted previously, one of the key features of this bridge was developing composite action between the girder and deck sections. To achieve this, the design called for the deck and girder sections to be epoxied together. The epoxy used for the girder to deck connection was Henkel HBE452, and the process of installing the epoxy is detailed below.

In addition to the composite action detail, a second key detail in the design of this bridge was the wearing surface. The wearing surface for this structure was detailed to be epoxy overlay with chips rather than asphalt or running planks, which are typically used for the wearing course on timber bridges. Placement of epoxy overlays does not allow for variances in thickness and as a result requires that the cross-slope of the bridge be designed into the girder elevations for proper drainage. For comparison, use of an asphalt overlay would allow the owner to use a consistent elevation for all girders and vary the thickness of the wearing course from the edge of the deck to the centerline of the bridge to create a cross-slope for drainage. As a result, the girders for the composite timber bridge are set on a staggered elevation abutment cap, as shown in Figure 8. In addition, the tops of the girders were milled at the factory to allow the deck panels to sit flush on the girders and facilitate a 2% slope of the deck for drainage. The epoxy specified and used as the wearing course was Flexolith Low Modulus Epoxy Coating and Broadcast Overlay System from the Euclid Chemical Company. Product specifications for Flexolith product are provided in Appendix B. Figure 10 shows the bridge deck after the epoxy chip seal wearing course was installed.



Figure 10. Epoxy chip seal wearing course on the composite timber bridge

Due to extreme weather conditions at the time of installation, only one layer of epoxy was installed, rather than the two called for in the plans. The following year, after field testing was

conducted, the bridge was overlaid with a chipseal wearing course in lieu of an additional epoxy overlay for cost reasons.

The guardrail for the composite timber bridge was composed of glulam posts and rails. Design of the rail sections was to restrain an 80,000 lbs vehicle impacting at a 15° angle. Figure 11 shows the guardrail of the bridge.



Figure 11. Guardrail on the composite timber bridge

3.3 Construction

Construction of the composite timber bridge was completed by a Buchanan County workforce and followed traditional construction methods. The construction process began with removal of the existing steel/concrete bridge, then excavation widening of the hydraulic opening for the new abutments, and subsequently construction of the new substructure and superstructure.

Construction of the abutments involved first driving the steel h-piles, followed by fabricating the cast-in-place concrete abutment caps and wing walls and placing rip-rap around the abutment for scour protection. Figure 12 illustrates the demolition of the old abutments and construction of the new abutments at various stages.

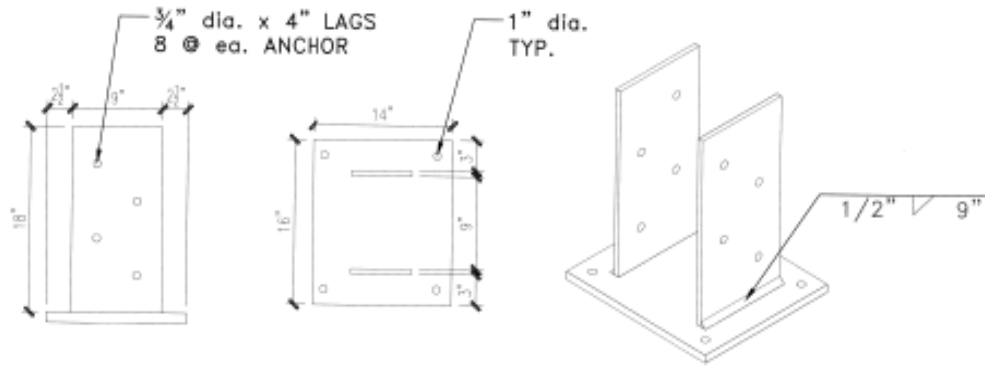

Figure 12. Composite timber bridge abutment during construction

Following construction of the substructure, erection of the glulam superstructure commenced. First, the glulam girders were set, beginning on the west side, setting one girder, installing necessary diaphragms, setting the adjacent girder, and so on. Once all 11 of the girders were in place, as shown in Figure 13, the ends of each girder were connected to the abutment cap with galvanized anchor assemblies, as shown in Figure 14, and formwork for the abutment diaphragm was constructed.



Figure 13. Girders of composite timber bridge in place



ANCHOR ASSEMBLY
SCALE 1 1/2" = 1' - 0"

Girder anchor assembly, page 3/3 in Appendix A



Girder anchor assembly in the field

Figure 14. Girder anchor assembly for the composite timber bridge

Once the girders and diaphragms were in place, the glulam deck panels were delivered to the site for placement on the bridge. Figure 15 shows the truckload of deck panels awaiting unloading.



Figure 15. Glulam deck panels prior to unloading

Placement of the deck panels began at the south end and progressed to the north. The procedure for affixing the deck panels to the girders included the following steps: (1) picking the panel with the crane using three bolts installed in predrilled holes in the deck panels (Figure 16a); (2) applying the epoxy to the top of the girders using a pneumatic gun (Figure 16b) and 1/4 in. v-notch trowel (Figure 16c); (3) setting the panels in place, back side first, to ensure tight fit of the lap splice (Figure 16d); and (4) toe-nailing panels to girders with 3/8 in. x 8 in. GRK fasteners (Figure 16e and Figure 16f) through predrilled holes until firm contact between the deck panel and girders was achieved. Due to the frigid temperatures, 0°F to 5°F, during construction, the epoxy was stored in a heated trailer to facilitate easier application both through the gun and with the trowel.



(a) Swinging deck panels



(b) Placing epoxy on tops of girders



(c) Troweling epoxy with 1/4 in. v-notch trowel



(d) Placing second deck panel



(e) 3/8 in. x 8 in. GRK fasteners



(f) Toe-nailing GRK fasteners through deck

Figure 16. Placement of deck panels on composite timber bridge

The deck on this bridge was designed with no overhang at the edges; therefore, since the ends of the deck panels are flush with the exterior face of the exterior girders, the guardrail posts were installed at the same time as the deck panels. This allowed for the remainder of the guardrail to be installed immediately after the deck panels were finished.

Once the superstructure (i.e., girder, deck, and guardrail) was installed, the concrete abutment diaphragms were poured. As soon as adequate time had been allowed for curing of the abutment

diaphragms, the remaining formwork was removed, the GRS approaches were installed, and the concrete approach slabs were paved.

The final step in completion of the structure was the application of the epoxy wearing surface, which was completed by Buchanan County. As noted above, the epoxy used for the wearing surface overlay was Flexolith Low Modulus Epoxy Coating and Broadcast Overlay System from the Euclid Chemical Company (see Appendix B). The epoxy is a two-component mix that was mixed in a large rubber bucket that was carried by hand across the deck, poured onto the deck, and spread with a broom. Flint aggregate was subsequently spread by hand. Because of various surface irregularities of the deck (predrilled anchor holes, transverse joints, the joint between the end of the deck and the abutment backwalls) being filled with epoxy, the final quantity of epoxy ended up being slightly short of what was needed for adequate coverage. This created areas where the flint was not sufficiently bonded to the timber deck due to inadequate epoxy thickness. As a result, the following year Buchanan County placed a chip seal on the bridge over the epoxy overlay.

In addition to construction documentation by personnel on-site, prior to construction of the Buchanan County Bridge, the research team installed a remote monitoring camera on the southeast corner of the bridge site on an existing power pole. The camera allowed for real-time viewing of the construction process via the internet, as well as recording of still photos (Figure 17) periodically each day during construction to facilitate a time-lapse video of the entire construction process at the end of the project.



Figure 17. Composite timber bridge, Buchanan County, Iowa

4. PERFORMANCE EVALUATION OF COMPOSITE ACTION AND THE EPOXY OVERLAY

To adequately evaluate the level of composite action obtained from the epoxied girder-deck connection specified in the design of the composite timber bridge, two primary tasks were undertaken: (1) laboratory tests on small- and large-scale specimens to evaluate the shear strength of the detailed composite connection and (2) live-load testing of the composite timber bridge on three separate occasions, (a) immediately after construction, (b) one year after the initial test, and (c) two years after the initial test. In addition, to evaluate the performance of the epoxy overlay specified in the bridge design, the condition of the wearing surface was monitored periodically after construction by both the research team and Buchanan County staff.

4.1 Laboratory Testing Protocol

To evaluate the viability of the proposed composite action connection detail, two types of laboratory tests were conducted. The first involved testing small-scale specimens to evaluate the shear strength of the connection, and the second involved testing large-scale specimens to evaluate the composite action. The two tests allowed the research team to study the performance of various connection details, not just the epoxy connection, in different configurations.

4.1.1 Small-Scale Specimens

Small-scale specimens were designed and fabricated to evaluate the performance of several girder-deck connection details for glulam timber structures. In total, four connection details were evaluated with the small-scale specimens: (1) traditional lag screw connection, (2) traditional lag screw connection with the addition of epoxy, (3) epoxy connection with the GRK screws left in place, and (4) epoxy connection with the GRK screws removed. The individual specimens consisted of one girder section measuring 10 in. x 12 in. x 18 in. and two deck sections, each measuring 5 1/8 in. x 12 in. x 20 in., one deck section attached to either side of the girder. See Figure 18 for specimen dimensions. For each of the four alternatives, three specimens were fabricated, tested, and evaluated. During testing, the applied load and the slip between the simulated girder and the simulated deck sections were monitored.

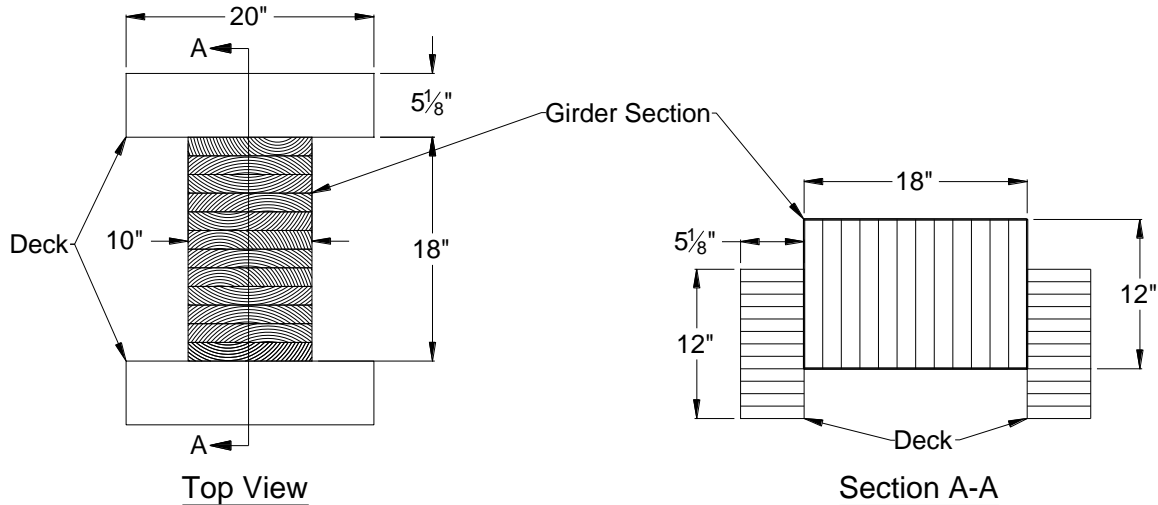

Figure 18. Small-scale laboratory specimen dimensions

4.1.1.1 Lag Screw Connection Detail

The lag screw connection detail is one of the more common and traditional means of connecting glulam deck panels to glulam girders. This detail typically involves field-drilling a pilot hole through the transverse glulam deck panel into the top of the glulam girders. Alternatively, predrilled holes can be ordered from the factory, then, once the panels are in place in the field, the pilot holes can be transferred to the top of the girders. Once the holes have been drilled and preservative applied to the untreated wood in the holes, galvanized lag screws are driven through the holes either with a pneumatic or electric impact drill. To facilitate a smooth wearing surface afterwards, the lag screws are countersunk to recess the screw heads below the surface of the deck. Drawbacks to this connection method include the labor required for predrilling the holes and driving the lag screws and the potential for exposing untreated wood to moisture via the prebored holes if not treated properly or not treated at all, as is sometimes the case. Figure 19 illustrates a small-scale specimen utilizing lag bolts for the deck to girder connection. Each deck section was affixed to the girder section using one lag screw, as shown in Figure 19.



Figure 19. Small-scale specimen with lag screws

4.1.1.2 Lag Screw plus Epoxy Connection

This connection is a combination of traditional and new girder-deck connection methods. After the holes were predrilled on these specimens, and prior to installing the lag screws, epoxy was applied to the girder sections; subsequently, the physical connection with the lag screws was completed. These specimens were utilized to evaluate whether any additional strength was added to lag screw connection via the addition of the epoxy. Figure 20 illustrates a small-scale specimen with the deck sections epoxied and lag-screwed to the girder section.



Figure 20. Small-scale specimen with epoxy and lag screws

4.1.1.3 Epoxy Connection with GRK Screws

This connection detail is the basis for this testing and involves using a two-part epoxy (Henkel HBE452), the same as that used in the composite timber bridge, to bond the glulam deck sections to the top of the glulam girder sections. There were no formal guidelines to follow for developing this connection since this had never been attempted previously, so the process involved modifying and following basic fundamentals recommended by glulam manufacturers for connecting timber elements with adhesives and following recommendations from the epoxy supplier.

The procedure used in the composite timber bridge to epoxy the deck panels to the girders was also used in the laboratory to epoxy the small-scale deck sections to the girder sections. The first step was to apply the epoxy to the top of the girder section using a pneumatic caulk gun and then evenly spread the epoxy over the entire top surface of the girder section using a 1/4 in. v-notch trowel. Once the epoxy was evenly spread, the deck panel sections were placed on top of the girder section, and pressure was applied to ensure proper contact and coverage of the epoxy on both substrates. Proper contact was achieved by driving GRK screws thru predrilled holes in the panel sections into the girder section until epoxy began to press out of the deck-girder joint on both sides of the girder. For these first three epoxied specimens, the GRK screws were left in

place; these specimens would then be representative of how the composite timber bridge was fabricated in the field. Figure 21 illustrates a small-scale specimen with the deck sections epoxied to the girder section and the GRK screws left intact.



(a) End view of specimen showing epoxy connection



(b) Side view of specimen showing GRK screws

Figure 21. Small-scale specimen with epoxy and GRK screws

4.1.1.4 Epoxy Connection, GRK Screws Removed

This connection detail followed the same construction sequence as the previous specimens; however, once the epoxy had been given sufficient time to cure, the GRK screws were removed. The goal with this testing was to evaluate the strength of the epoxy-bonded connection alone without additional fasteners. Note that though most of the GRK screws were able to be removed, some were not because they had effectively been epoxied into their holes. One or two were not able to be removed at all, and one twisted off at the interface between the deck and girder during removal. Shown in Figure 22 is a small-scale specimen that has an epoxy connection and the GRK screws removed, as evidenced by the two holes in the side of the deck panel section.



Figure 22. Small-scale specimen with epoxy and GRK screws removed

4.1.2 Small-Scale Specimen Testing

The small-scale tests consisted of testing each specimen in a pure shear configuration by performing push-off tests in a Satec machine. These tests have been used previously to study numerous types of shear connectors, and they simulate two girder to deck connection interfaces, allowing for the direct determination of connection capacity (and for making comparisons between connection alternatives). Figure 23 shows the test setup.



Figure 23. Small-scale specimen in the Satec machine for testing

4.1.3 Large-Scale Specimens

In total, three specimens were tested for the full-scale tests, each specimen consisting of two full-scale glulam girders and a transverse panelized deck system. The girders measured 8.875 in. x 2 ft 0.875 in. x 41 ft long. Spacing of the two girders in each specimen was 48 in. on-center, and the end bearing for each girder was 12 in. at both abutments using 1 in. neoprene pads (see Figure 24).



Figure 24. Girder spacing at abutments with neoprene pad

Two different deck materials were evaluated in this testing: the first two specimens incorporated glulam deck panels to replicate what was utilized in the composite timber bridge, and the third specimen utilized a precast concrete panel deck and was included to evaluate potential composite connections for this material combination. The glulam deck panels used in this specimen measured 5.125 in. x 4 ft x 8 ft and had factory-milled lap splice edges like the panels in the composite timber bridge (see Figure 25); the precast concrete deck panels utilized in the third specimen measured 7 in. x 4 ft x 8 ft.

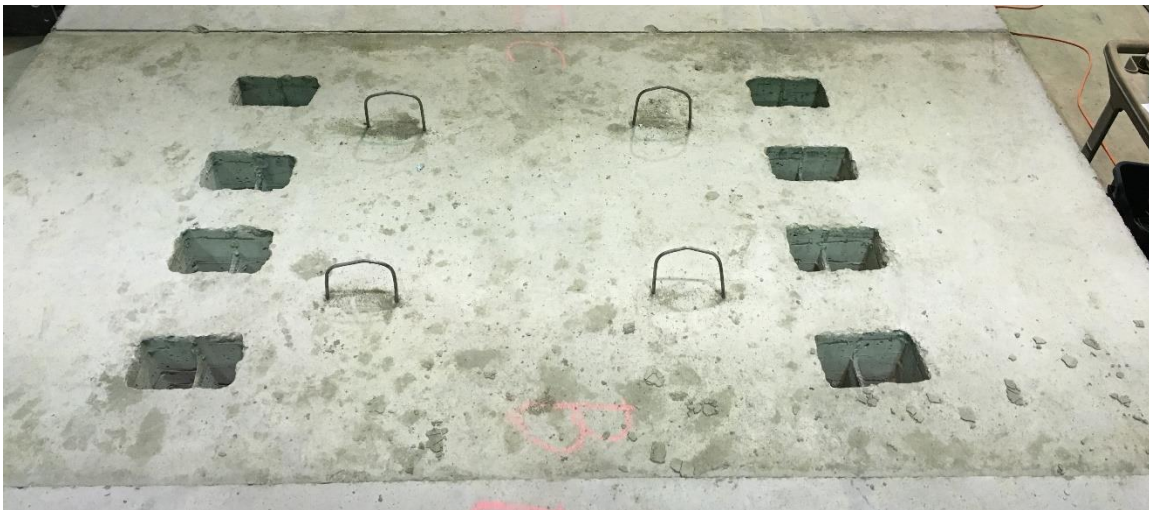

Figure 25. Lap splice edges on glulam deck panels for Large-Scale Specimens 1 and 2

Approximately half of the panels were fabricated with grout pockets (see Figure 26) for connection to the girders, and the others were fabricated as standard precast panels.



(a) Concrete deck panels without grout pockets



(b) Concrete deck panels with grout pockets

Figure 26. Precast concrete deck panels utilized on Large-Scale Specimen 3

4.1.3.1 Large-Scale Specimen 1 – Glulam Girders, Glulam Deck, Lag Bolts

Specimen 1 included a transverse glulam deck panel system and was tested in two configurations. The first configuration involved the glulam deck panels simply resting on the girders with no mechanical or bonding connection; the results from this test were used to provide performance data on a true non-composite (NC) bridge for comparison with the other specimens. The second configuration involved the glulam deck panels affixed to the girders using predrilled holes and lag screws, as previously discussed in the small-scale specimen section; the results from this configuration represent a baseline behavior of glulam bridges built in the field using conventional construction techniques. Figure 27 illustrates the large-scale specimen with the deck panels attached to the girders using lag bolts.



(a) Glulam deck panels lag-screwed to girders on Large-Scale Specimen 1



(b) Large-Scale Specimen 1 erected and being prepped for testing

Figure 27. Large-Scale Specimen 1 prior to load testing

4.1.3.2 Large-Scale Specimen 2 – Glulam Girders, Glulam Deck, Epoxy

Large-Scale Specimen 2 included a transverse glulam deck panel system similar to Large-Scale Specimen 1. However, for Large-Scale Specimen 2 the deck panels were attached to the girders using epoxy and GRK screws, as was done on the composite timber bridge. The procedure for installing the deck panels was exactly the same as was used in the field on the composite timber bridge. Figure 28 illustrates the construction sequence for Large-Scale Specimen 2 in the laboratory: (a) epoxy being applied to the top of the girder, (b) epoxy being spread using a 1/4 in. v-notch trowel, (c) epoxy prior to placement of the deck sections, (d) the deck section being placed on top of the epoxied girders, (e) GRK screws used to provide adequate contact between the deck sections and the girders, and (f) the interface between the deck sections and the girders showing proper contact between the two members, as evidenced by the excess epoxy being pressed from between the deck and the girder.



(a) Epoxy applied to girder



(b) 1/4 in. v-notch trowel spreading epoxy



(c) Epoxy evenly spread on girder



(d) Deck placement on epoxied girder



(e) GRK screws thru deck into girder



(f) Deck-girder interface after installation

Figure 28. Installation of glulam deck sections on Large-Scale Specimen 2 using epoxy

Illustrated in Figure 29 is Large-Scale Specimen 2 after installation of all deck panel sections, prior to testing.



Figure 29. Installation of glulam deck sections on Large-Scale Specimen 2 using epoxy

4.1.3.3 Large-Scale Specimen 3 – Glulam Girders, Precast Concrete Deck Panels

The final large-scale specimen, Large-Scale Specimen 3, included transverse precast concrete deck panels on glulam girders, as noted previously. Of the nine precast concrete panels installed on the girders, four were cast with grout pockets. Within each grout pocket, two lag screws were drilled into the tops of the girders, and then each void was filled with non-shrink grout for attaching the panels to the tops of the glulam girders. The remaining five panels were affixed to the tops of the girders using the same epoxy procedure as used for Large-Scale Specimen 2. However, no type of mechanical fasteners were used with the epoxied concrete panels; the dead weight of the panels themselves was assumed to create sufficient pressure on the joint to ensure proper bonding of the epoxy to both substrates. Figure 30 illustrates Large-Scale Specimen 3 during several states of fabrication.

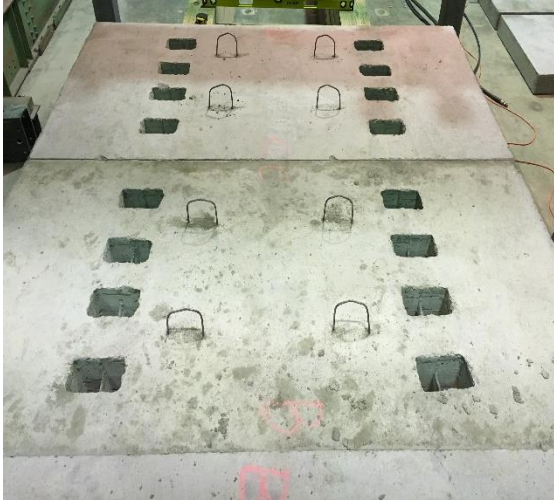

(a) Precast panels with grout pockets



(b) Precast panels for epoxy connection



(c) Precast panels with grout pockets



(d) Application of epoxy for precast panels



(e) Epoxyed joint btw panel and girder

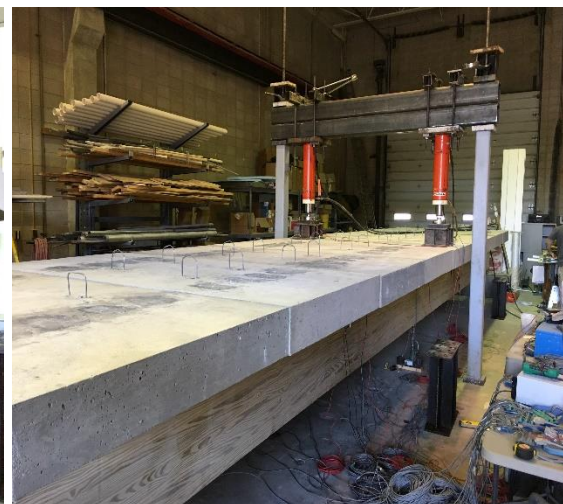

(f) Completed Specimen 3 prior testing

Figure 30. Large-Scale Specimen 3 during fabrication

4.1.4 Large-Scale Specimen Testing

The test configuration for these large-scale specimens included a steel test frame erected such that vertical loads could be placed on the top of the deck at midspan. Two vertical loads, applied by hydraulic actuators, were utilized and spaced 6 ft apart, with each load applied on a footprint sized to represent a typical HS-20 wheel load (see Figure 31).

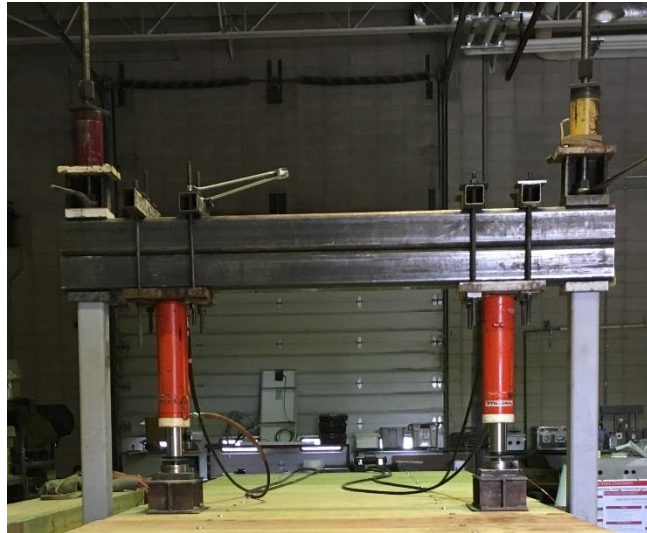

Figure 31. Loading setup for large-scale specimens

Instrumentation for the large-scale specimen testing was focused on evaluation of composite action and global system performance. As such, instrumentation was focused at midspan for global performance evaluation and quarter span for composite action evaluation. Strain gages were installed at midspan as well as at one quarter span location to evaluate peak strain and composite action, respectively. Plunger-style displacement transducers were installed at both quarter span locations for evaluation of slip and uplift of the deck at the girder-deck interface. Strain gages were installed on both girders on the bottom flange of the girder, on the side of the girder approximately 2 in. below the deck, and on the underside of the deck adjacent to the girder. Displacement transducers were installed horizontally at the girder-deck interface to measure slip between the girder and deck; in addition, displacement transducers were installed across two deck panel joints to measure opening and closing of these joints under loading. Displacement transducers were also installed vertically at the girder-deck interface and were used to evaluate uplift of the deck panels from the girders. Figure 32 illustrates the instrumentation layout for all three large-scale specimens.

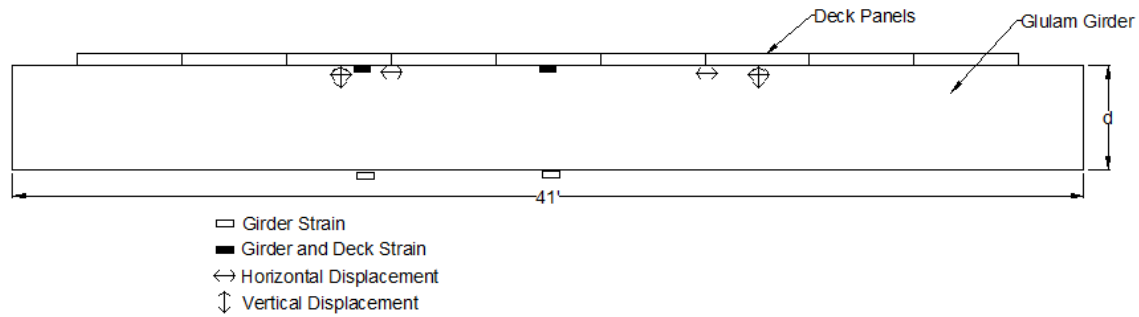

Figure 32. Instrumentation layout for large-scale specimens

Figure 33 illustrates the strain gages and displacement transducers installed for testing of the large-scale specimens.

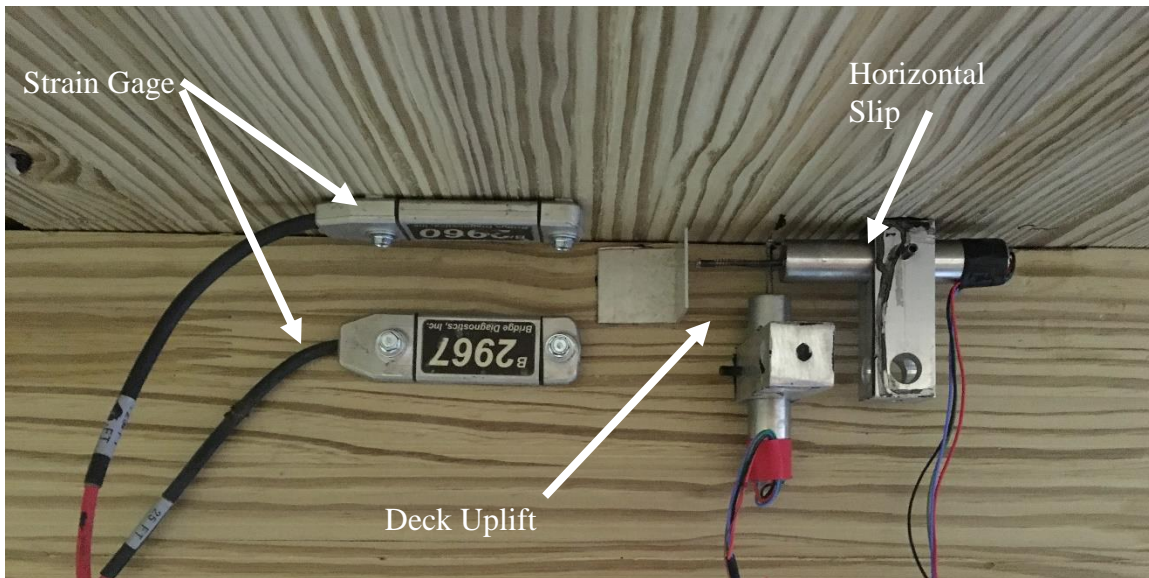

Figure 33. Strain gages and displacement transducers at girder-deck interface

4.2 Field Testing Protocol

In addition to the laboratory testing on this project, live load tests were also conducted on the completed composite timber bridge at three separate times: (1) immediately following completion of construction prior to opening to traffic (May 2015), (2) approximately one year after the first testing (May 2016), and (3) in August 2017, three years and three months following construction.

4.2.1 Instrumentation

The initial load test utilized only strain gages, while the subsequent load tests utilized both strain gages and displacement transducers at the request of the designer. Instrumentation of the bridge

involved the use of Bridge Diagnostics, Inc. (BDI) Intelliducers (strain gages) and displacement transducers (for the 2016 and 2017 tests only), all connected to BDI’s wireless STS3 system for data collection. Figure 34 illustrates a typical instrumentation setup.



Figure 34. Typical instrumentation setup for testing of the composite timber bridge

For the initial load test, strain gages were installed on each girder such that composite action of each girder as well as the global performance (transverse load distribution, peak strains, etc.) of the bridge could be evaluated. Subsequent load tests incorporated the same number and arrangement of strain gages but also included seven displacement transducers. Figure 35 illustrates a midspan cross-section view of the composite timber bridge along with the girder labels and locations of the strain gages and displacement transducers for the live load testing.

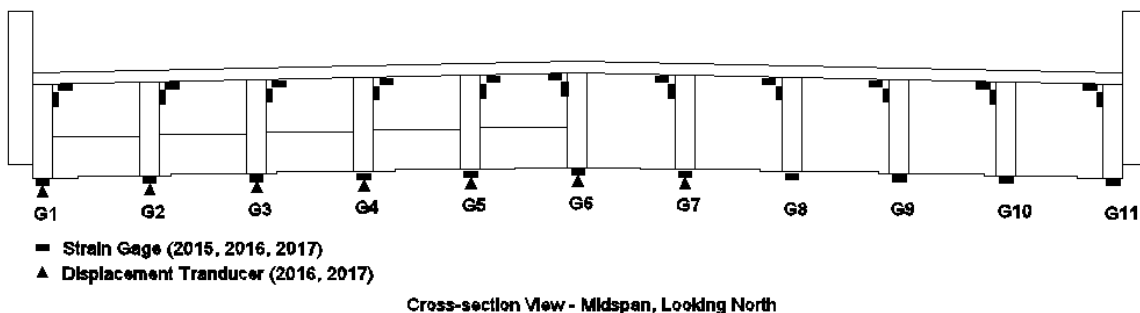

Figure 35. Instrumentation of composite timber bridge for live load testing

For each of the 11 girders, a strain gage was installed on the bottom of the girder, a second installed approximately 2 in. below the girder-deck interface, and a third installed on the underside of the deck approximately 2 in. from the edge of the girder. All strain gages were oriented longitudinally on the bridge. In addition, displacement transducers were installed on the bottom flange of girders G1 through G7 to measure global deflection.

4.2.2 Loading

For all three live load tests, the bridge was loaded with a tandem axle dump truck with a total weight of 49,680 lbs, 48,020 lbs, and 50,440 lbs in 2015, 2016, and 2017, respectively. For all tests and all load cases, the load truck traveled across the bridge from south to north at a crawl speed. See Figure 36 for the positioning of the load truck for all three load tests.

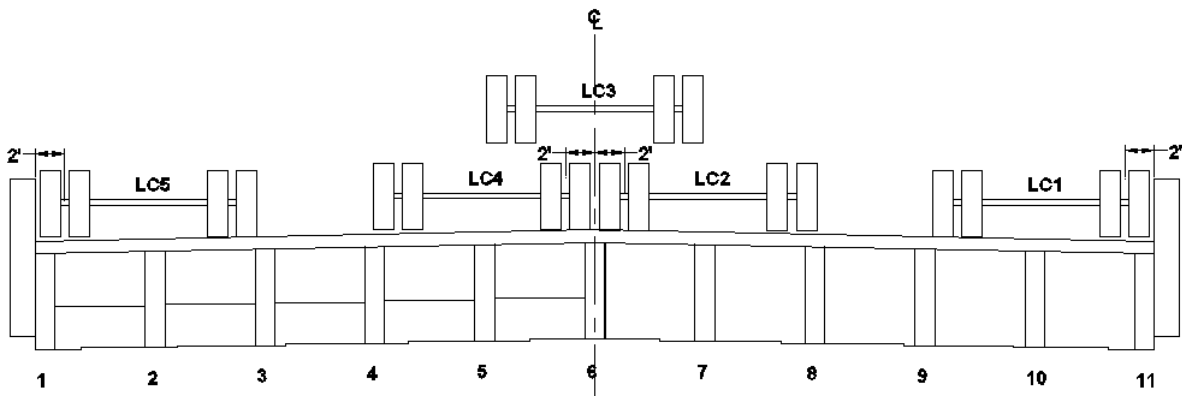

Figure 36. Load cases for composite timber bridge live load testing (looking north)

Load Case 1 had the load truck positioned with the center of its passenger wheel line 2 ft from the east guardrail face. Load Case 2 had the load truck positioned with the center of its driver wheel line 2 ft east of the centerline of the bridge. Load Case 3 had the load truck positioned centered on the centerline of the bridge. Load Case 4 had the load truck positioned with the center of its passenger wheel line 2 ft west of the centerline of the bridge. Load Case 5 had the load truck positioned with the center of its driver wheel line 2 ft from the west guardrail face. The positioning of Load Cases 2 and 4 was such that by code they could be considered simultaneously, via superposition, for a two-lane loaded case.

5. TEST RESULTS

5.1 Laboratory Testing Results

5.1.1 Small-Scale Specimens

To properly evaluate the bond strength of the epoxied girder to deck connection, small-scale push-out tests were performed in the laboratory. Four small-scale connection details, with three specimens each, were evaluated: (1) traditional lag screw connection, (2) traditional lag screws with the addition of epoxy, (3) epoxy connection with GRK screws, and (4) epoxy connection with the GRK screws removed after the epoxy set. For comparison purposes, the loading data was converted to pounds per square inch (psi) at shear failure.

Illustrated in Figure 37 are the calculated shear stresses for all 12 specimens. In addition, for each specimen group a black line is shown that indicates the average shear stress for that connection type.

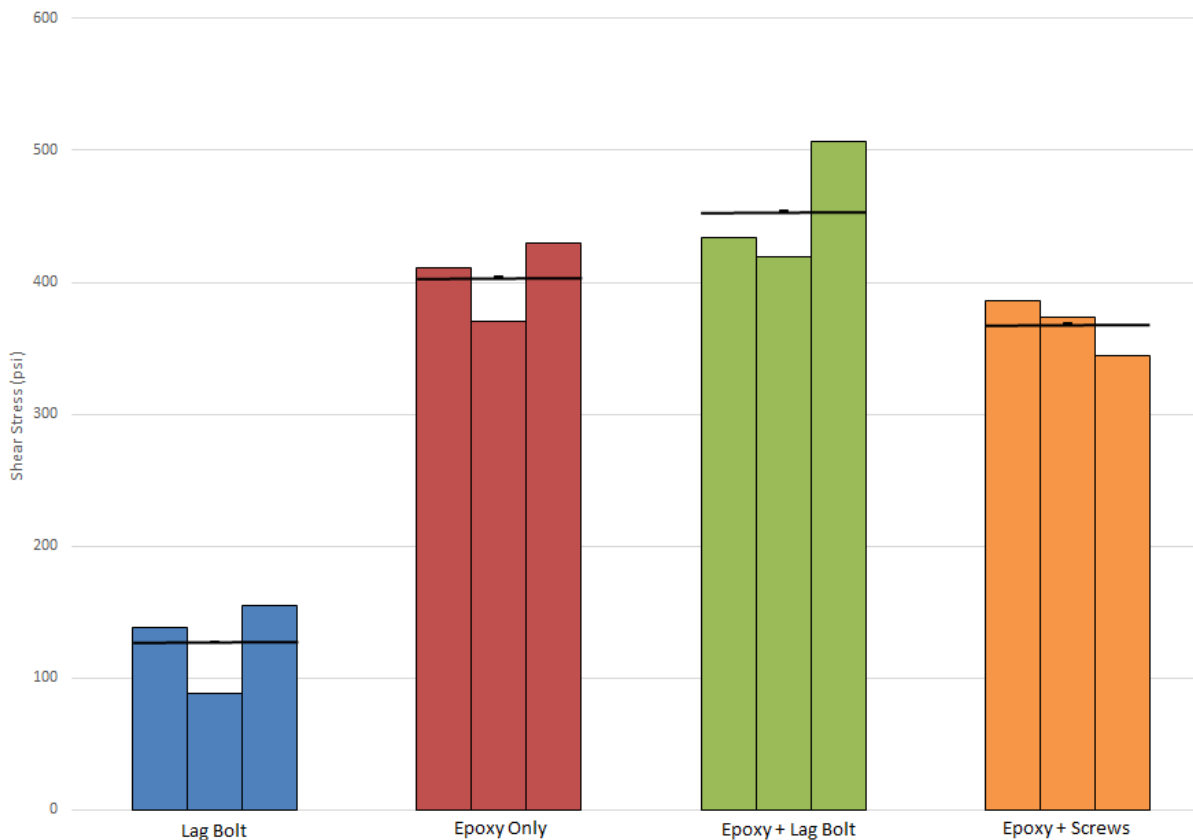

Figure 37. Shear strength of small-scale laboratory specimens

The first thing that stands out is that epoxy alone provides more than double the shear resistance of the traditional lag screw connection detail. Second, addition of mechanical fasteners (i.e., lag

screws or GRK screws) to the epoxy connection provides mixed results: adding lag screws to the epoxy connection resulted in a slight increase in the shear strength, while adding GRK screws to the epoxy connection slightly reduced the shear strength. There are two possible reasons for this discrepancy. First, the cross-section difference between the two fasteners alone suggests that the lag screws might have improved shear resistance compared to the GRK screws. Second, during fabrication it was noted that tightening of the deck sections to the girder sections was more easily achieved using the lag screws, thereby potentially creating a more even bonding surface for the epoxy on both surfaces.

5.1.2 Large-Scale Specimens

Illustrated in Figures 38, 39, and 40 are the strain history plots for the loading of the three individual large-scale laboratory specimens, bolted glulam deck, epoxied glulam deck, and precast concrete deck, respectively.

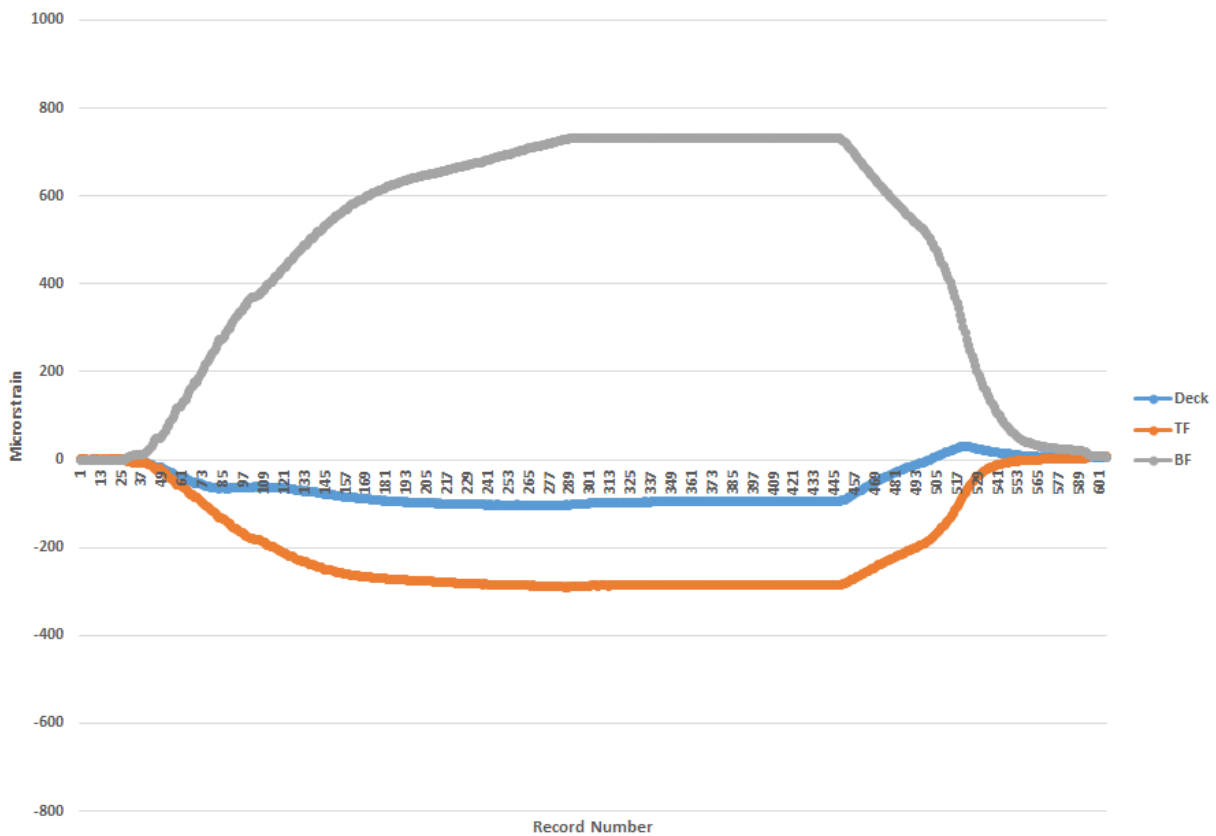

Figure 38. Strain history, large-scale laboratory lag bolt glulam deck specimen

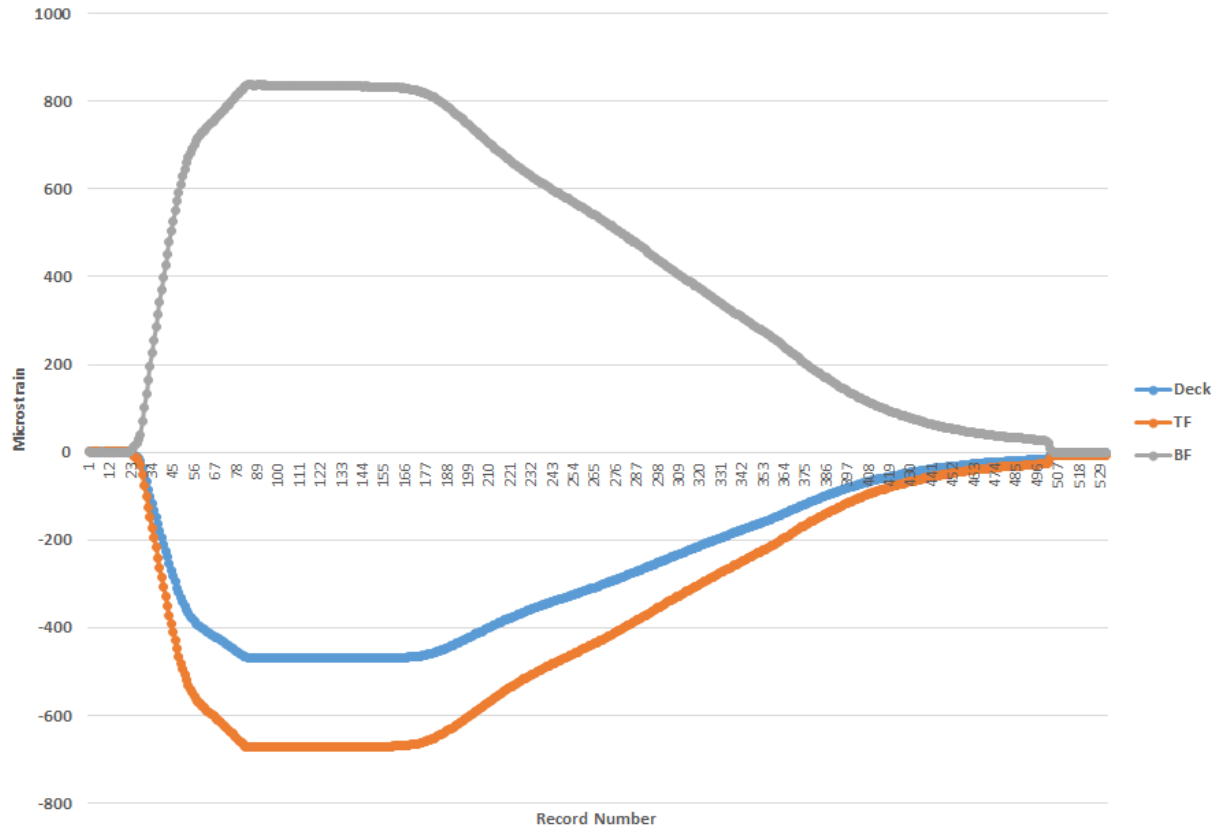

Figure 39. Strain history, large-scale laboratory epoxied glulam deck specimen

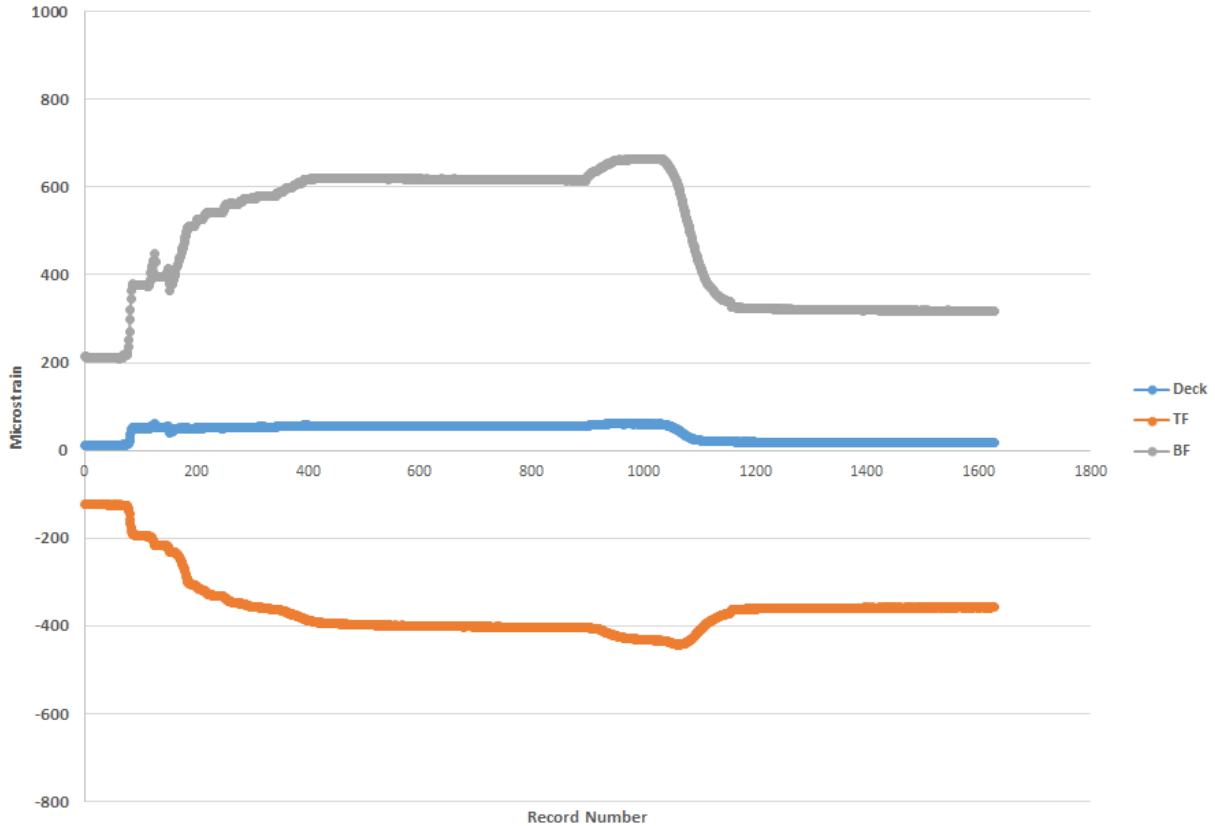

Figure 40. Strain history, large-scale laboratory concrete deck specimen

The data in these three graphs are taken from the strain gages at the near quarter point so as to eliminate the effects of the applied load on the measured data. In all three graphs, three key strains are presented: the strain in the bottom flange of the glulam girder (BF), the strain in the top flange of the glulam girder (TF), and the strain in the underside of the deck adjacent to the girder (Deck). Evaluation of these key strains reveals several characteristics of the system, including peak tensile strain in the glulam girder at that cross-section, validation of elastic behavior, and simultaneous comparison of these three strains, which allows for a determination of the composite action of the system. First, peak strain achieved in the specimens at this cross-section was approximately 825 microstrain; peak tensile strain at midspan was measured to be approximately 1,200 microstrain for the first two specimens and over 5,800 microstrain for the concrete deck specimen. These peak strains as well as other data are presented in Table 1.

Table 1. Large-scale specimen load test data

	Peak Load (k)	Global Defl. (in.)	Deck/Girder Slip (in.)	Peak Girder Strain	Peak Deck Strain	Ave. Deck Joint Delta (in.)
Bolts	20.2	2.75	0.004	1215	103.0	0.042
Epoxy	20.4	2.47	0.004	1252	470.0	0.017
Concrete	18.3	3.17	0.080	5882	60.5	0.032

Further evaluation of Figures 38, 39, and 40 indicates that the first two specimens remained elastic throughout the load testing and that the last specimen, with the concrete deck, exhibited signs of both tensile and shear failure under load and thus the residual strains in the system after unloading. It should also be noted that the shear dead weight of the concrete deck panels resulted in approximately 100 to 200 microstrain prior to application of the load at midspan.

5.2 Field Testing Results

5.2.1 Global Deflection Results (2016 and 2017 Tests)

As noted previously and illustrated in Figure 35, global displacement of the girders was measured at the midspan of girders G1 thru G7 in 2016 and 2017. Instrumentation wasn't available to instrument all 11 girders with displacement transducers; however, the focus here was mainly on how deflection under service loads compares to design deflection limitations. Additionally, if the strain distribution indicates a symmetric transverse distribution of load, the same can be assumed for the deflections.

Live load deflection limits for timber bridges are typically expressed as a fraction of the span of the bridge in inches. *Timber Bridges: Design, Construction, Inspection, and Maintenance* (Ritter 1990) recommends limiting the maximum deflection due to short-term applied loads to $L/360$, where L = span in inches. The peak measured deflection of any girder due to any load case was 0.63 in. at girder G2 for Load Case 5 (Figure 36). For this bridge, with a span of 72 ft (864 in.), the maximum allowable deflection would be calculated as $864/360 = 2.4$ in. This is more than 3.5 times the measured deflection of the bridge at an interior girder.

Though not all girders were instrumented with deflection transducers, a good approximation of the load distribution can be ascertained by looking at the peak strains of the seven girders that were instrumented. Illustrated in Figure 41 are the peak strains for girders G1 through G7 for Load Case 3.

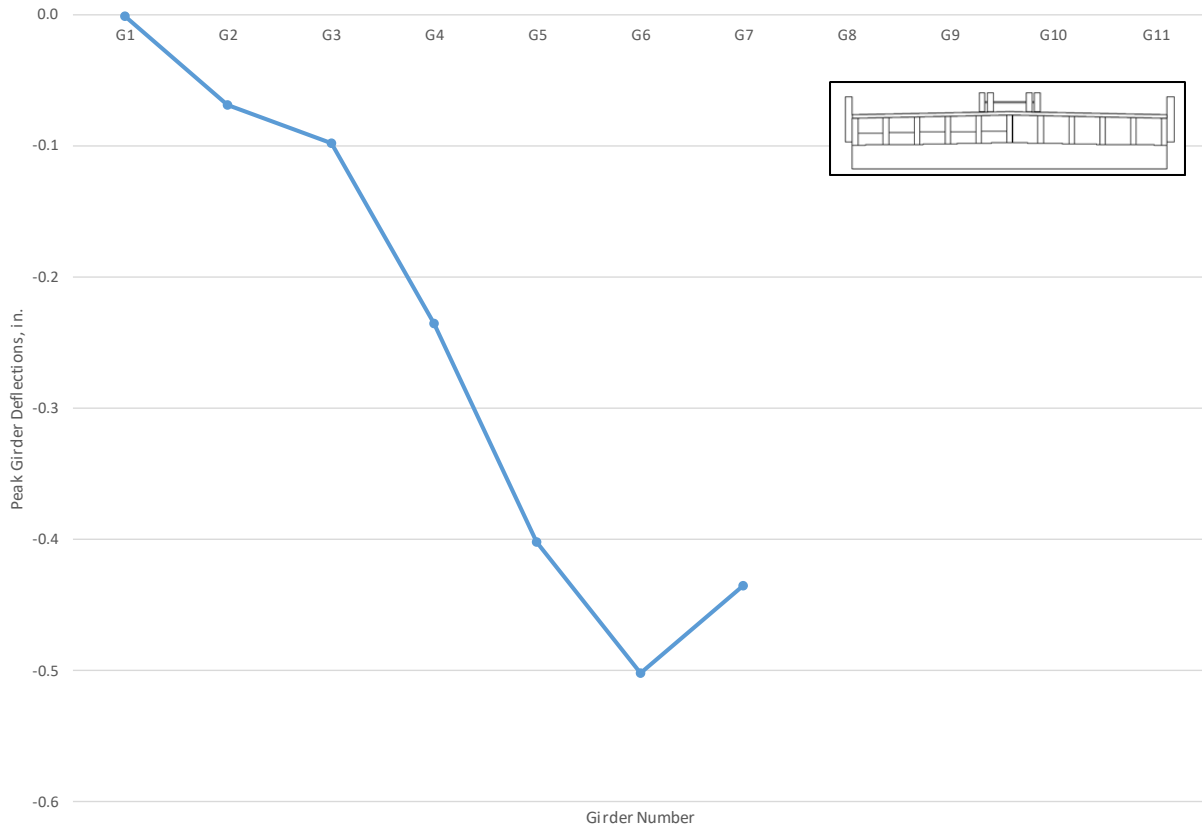

Figure 41. Peak deflections at midspan for Load Case 3, 2016

The first thing that stands out in Figure 41 is that the peak is at girder G6. We would typically expect to see a rounded curve or flattening of the deflection curve at the girders under the load truck (G5 through G7). One possible explanation for the more pronounced peak deflection occurring at G6 is that the deck panels are not continuous across the full width of the bridge, but rather are split directly above G6. This creates a pivot point in the deck above G6, effectively transferring additional load to that girder when the load truck is centered above it. Illustrated in Figure 42 are the peak girder deflections for the same seven girders one year later, in 2017; we see good correlation in the deflection curve and a slight increase in peak deflection over the year between the load tests. The increase in deflection can be partially attributed to the increase in the weight of the load vehicle from 48,020 lbs in 2016 to 50,440 lbs in 2017.

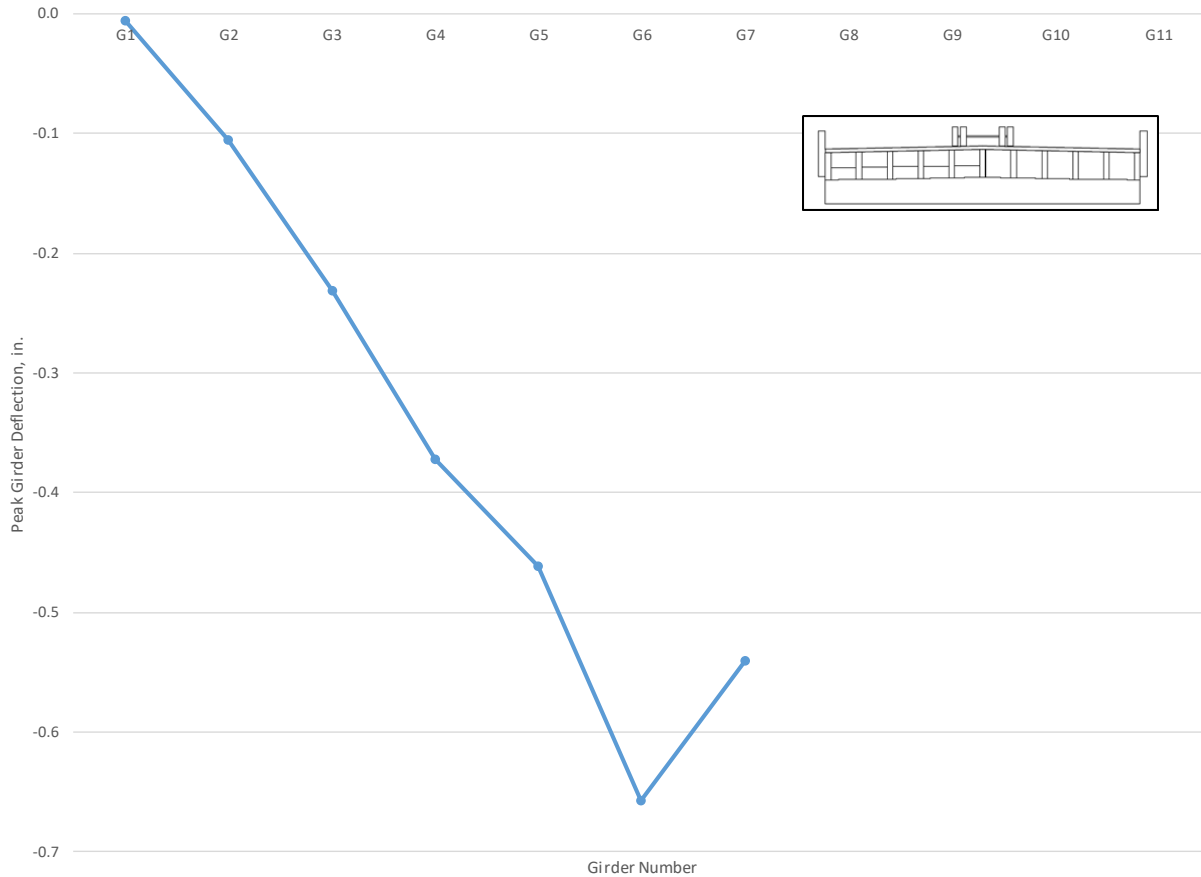

Figure 42. Peak deflections at midspan for Load Case 3, 2017

5.2.2 Strain Results (2015, 2016, and 2017 Tests)

Strain data were collected with the passage of the load truck at the locations illustrated in Figure 35. The focus with the strain data was to look at transverse load distribution, peak strains, as well as the composite action resulting from the bond between the deck panels and the glulam girders.

5.2.2.1 Transverse Load Distribution

Illustrated in Figures 43 through 47 are transverse load distribution comparison plots for all five load cases. Each plot displays the load fraction curve for that load case for all three load tests conducted on the bridge.

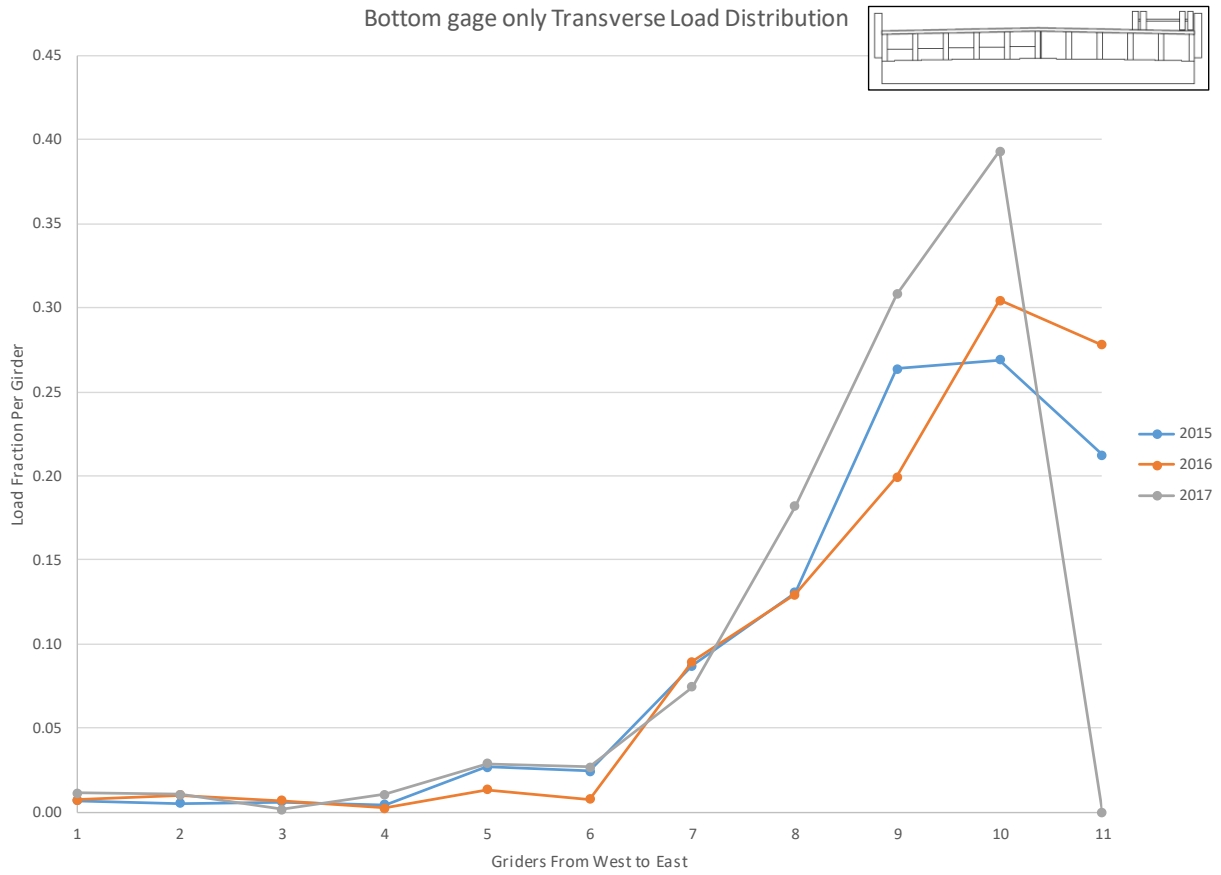

Figure 43. Load fraction per girder for Load Case 1

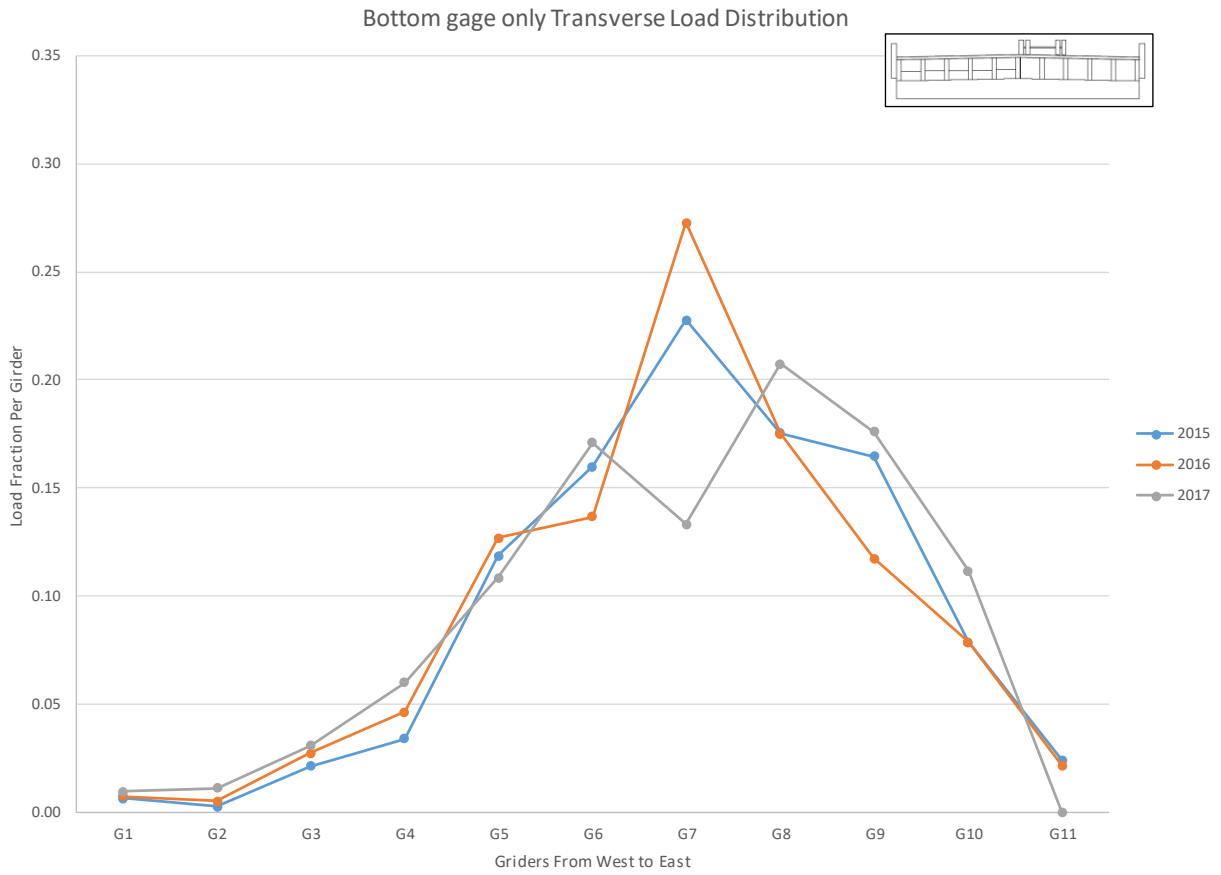

Figure 44. Load fraction per girder for Load Case 2

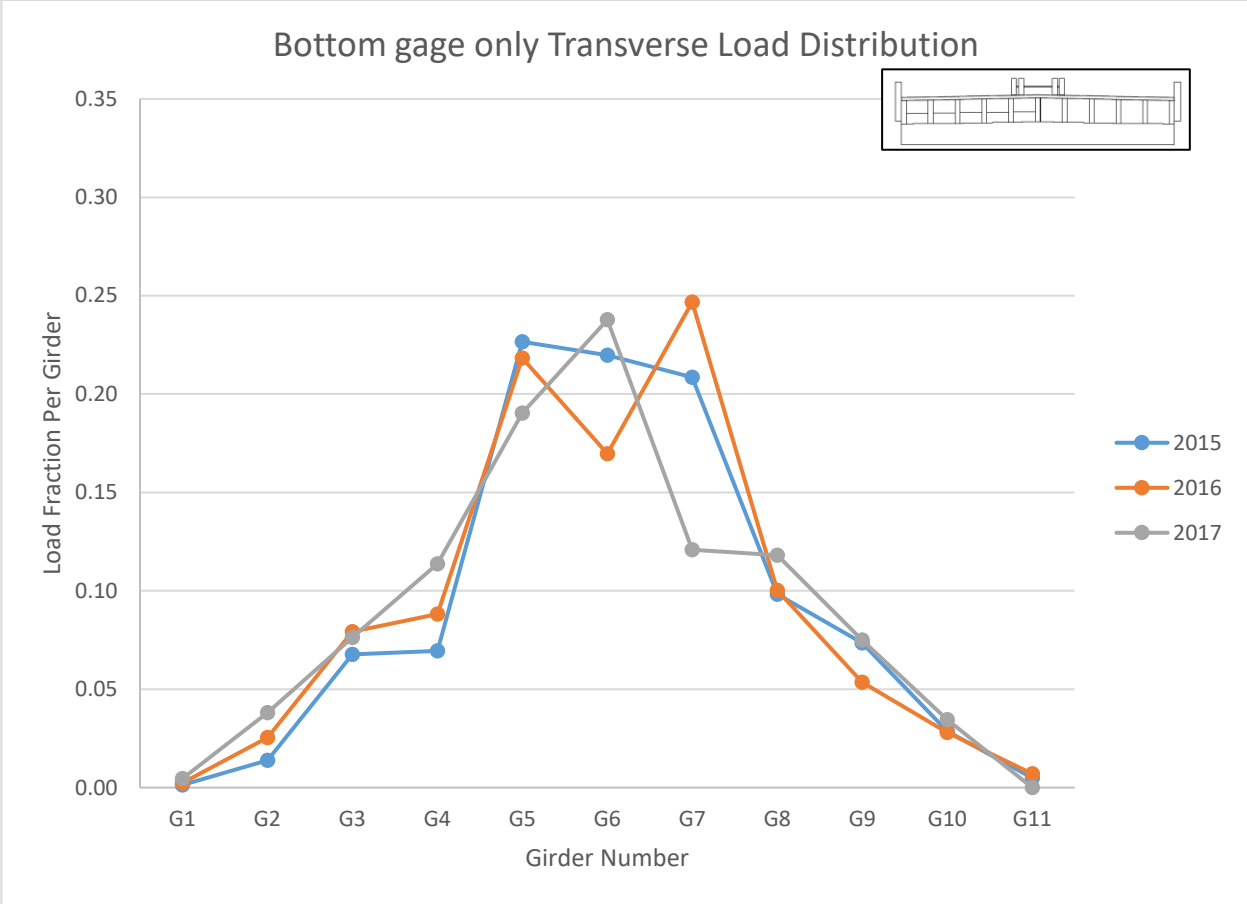

Figure 45. Load fraction per girder for Load Case 3

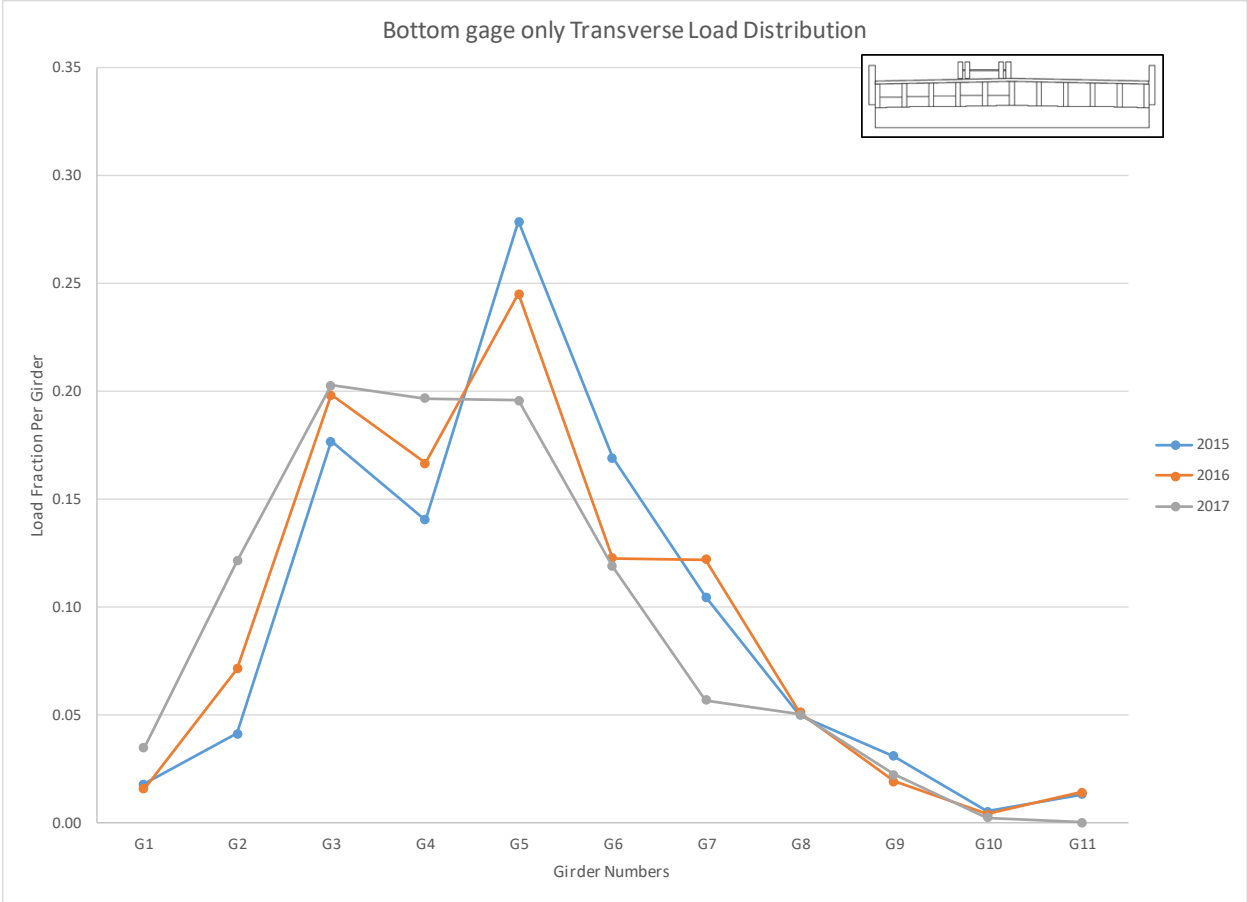

Figure 46. Load fraction per girder for Load Case 4

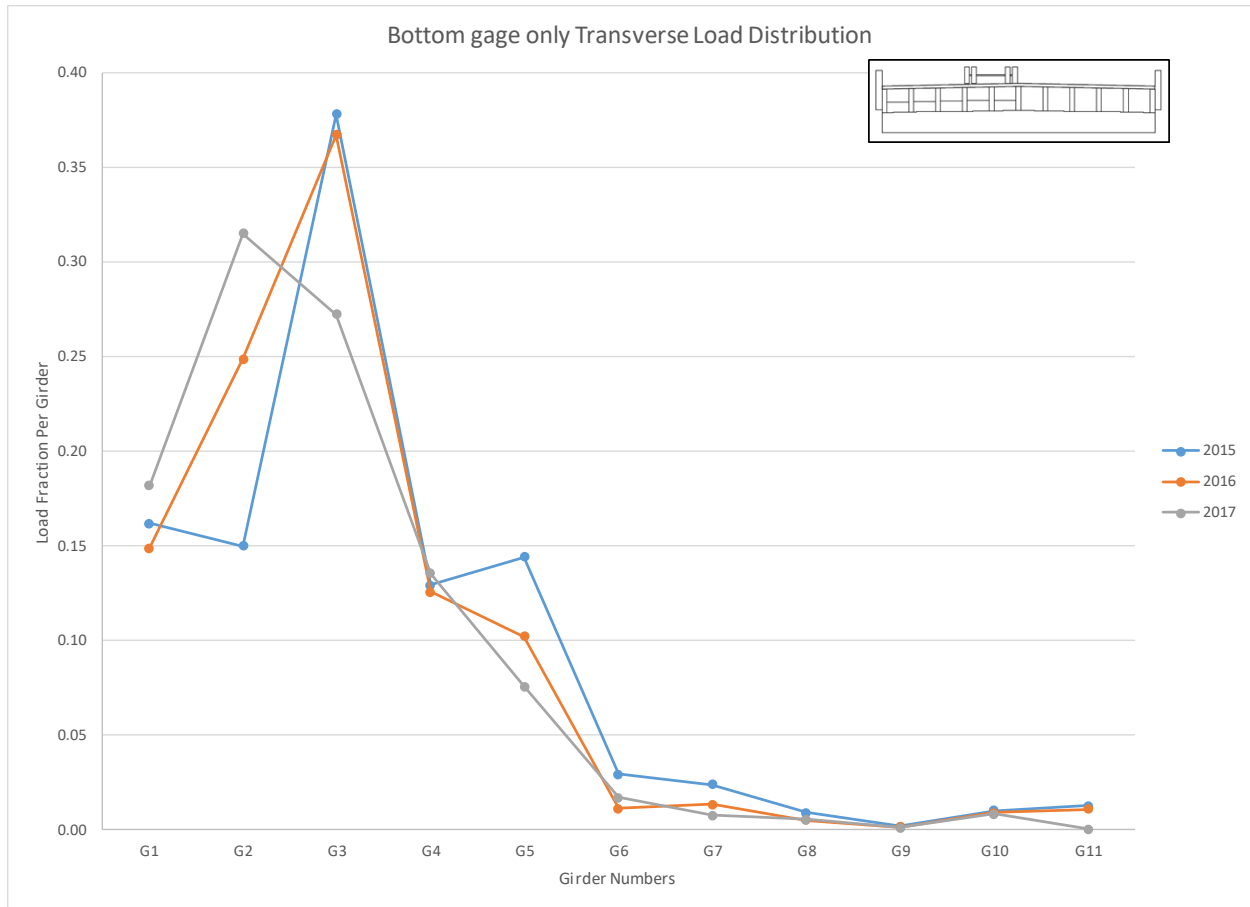

Figure 47. Load fraction per girder for Load Case 5

In general, there is good correlation between the load distribution curves for all three years; there are slight variances for individual girders, which can be attributed to the variance in the strain readings often found when measuring strain on timber members. Looking at Load Case 3 in Figure 45, there is a symmetric distribution of load on either side of girder G6 centered below the load truck. Similarly, comparing Figures 43 and 47 and Figures 44 and 46, there is also good symmetry, indicating good transverse load distribution regardless of truck position.

5.2.2.2 Peak Strains

Listed in Table 2 are the peak bottom flange strains at midspan for all three load tests conducted on the composite timber bridge.

Table 2. Bottom flange peak strains

Load Case	2015	2016	2017
LC1	199	249	254
LC2	182	236	157
LC3	185	227	182
LC4	219	233	176
LC5	258	337	274

Per the manufacturer specifications on the design plans, the design bending strength and modulus of elasticity of the girders are 2,800 psi and 1.9×10^6 psi, respectively. Using the basic strength of the materials equations we find that the maximum stress due to the applied loads is 640.3 psi for Load Case 5 in 2016. This is roughly 23% of the design bending strength of 2,800 psi.

Further inspection of Table 2 shows higher peak strains near the exterior girders when the load truck is positioned near the curb line, as in Load Cases 1 and 5; this is as would be expected, because there are fewer beams for load distribution near the deck edge. Lastly, comparing the peak strains from year to year we see that 2015 and 2017 compare relatively well, even though the load truck was slightly heavier in 2017. However, the load test in 2016 resulted in larger measured strains compared to the other two years. The cause of this temporary increase in measured strain is unknown.

5.2.2.3 Composite Action

As noted previously, three strain transducers were installed at each girder at the midspan of the bridge, with one on the bottom flange of the girder, one near the top flange of the girder, and one on the underside of the deck panels adjacent to the girders (see Figure 35). An estimation of the level of composite action exhibited by each girder of the bridge was accomplished utilizing the measured strains from each cluster of three transducers. Due to small strains recorded in the girders located away from the load path and error in the strain readings due to the inherent properties of timber, calculation of the neutral axis was only completed for the girders nearest to the load path.

For reference, the non-composite neutral axis location for the girders would be 21.3 in. (1.77 ft) from the bottom of the girders; furthermore, a fully composite section with the neutral axis in the deck would have a neutral axis location measuring 3.55 to 3.88 ft from the bottom of the girders. Inspection of Tables 3 through 5 indicates that, at best, there is some level of composite action in the system, with the neutral axis location ranging from the NC location to a maximum of 2.4 ft. Note that the calculated values of the neutral axis location are shown below the NC neutral axis location of 1.77 ft.

Table 3. Neutral axis location (feet from bottom of girder), midspan, 2015

Load Case	Girder Number (1-West, 11-East)										
	1	2	3	4	5	6	7	8	9	10	11
LC1	-	-	-	-	2.0	1.5	1.9	1.8	1.9	2.1	1.8
LC2	-	-	2.1	1.5	2.1	1.7	1.9	1.9	1.9	1.8	-
LC3	-	-	2.4	1.6	2.1	2.0	2.1	1.9	2.0	-	-
LC4	-	1.2	2.5	1.6	2.2	2.2	2.1	1.8	2.1	-	-
LC5	1.3	1.3	2.4	1.3	2.0	2.2	2.0	-	-	-	-

Table 4. Neutral axis location (feet from bottom of girder), midspan, 2016

Load Case	Girder Number (1-West, 11-East)										
	1	2	3	4	5	6	7	8	9	10	11
LC1	-	-	-	-	1.9	2.4	2.1	1.8	1.9	1.9	1.8
LC2	-	-	2.0	1.9	2.0	1.8	2.2	1.8	1.7	1.8	-
LC3	-	-	2.2	1.8	2.1	2.2	2.2	1.9	1.7	-	-
LC4	-	2.0	2.4	1.8	2.2	2.0	2.3	1.7	2.4	-	-
LC5	1.4	2.1	2.3	1.9	2.0	1.2	1.6	-	-	-	-

Table 5. Neutral axis location (feet from bottom of girder), midspan, 2017

Load Case	Girder Number (1-West, 11-East)										
	1	2	3	4	5	6	7	8	9	10	11
LC1	-	-	-	-	1.9	2.7	1.5	2.0	1.5	2.0	1.5
LC2	-	-	1.9	1.7	1.7	1.7	1.5	2.1	1.6	1.9	-
LC3	-	-	1.8	1.6	1.7	1.5	1.5	2.0	1.6	-	-
LC4	-	2.0	1.8	1.5	1.7	1.9	1.3	1.8	2.0	-	-
LC5	1.3	1.8	1.5	1.6	1.6	2.0	1.7	-	-	-	-

Based on an analysis of the data, several potential explanations exist for the neutral axis being calculated below the NC location, though the true cause is unknown. First, in most cases the neutral axis dips below the NC location either at girder G4, which consistently had erratic strain readings for all load tests conducted on the bridge, or at the exterior girders. Second, the top flange and deck strains directly below the load are significantly affected, resulting in misleading strain readings. One additional observation regarding a comparison of the three neutral axis tables is the apparent decrease in composite action in 2017. Though this could indicate a possible debonding of the deck panels from the girders, other factors may be the root of the problem. One potential explanation may be shrinking of the deck panels due to changes in moisture content. Laboratory testing has found that when the glulam deck panels shrink or are not placed tightly to adjacent deck panels initially during construction, the result is increased deflection and strain and decreased load resistance from the deck.

5.2.3 Epoxy Wearing Surface (2015 Test)

Visual inspection of the epoxy wearing surface applied to the bridge deck was completed during the live load test conducted in 2015. Initial findings by the research team were that the epoxy wearing surface was performing quite well in terms of a moisture barrier; however, much of the aggregate applied to the epoxy had been worn off by traffic, primarily in the wheel lines of the traffic lanes (see Figure 48).



Figure 48. Epoxy wearing surface May 2015

That said, the wearing surface does appear to provide an impermeable water tight barrier to the deck surface and inspection suggested that the epoxy filled all the predrilled bolt holes (see Figure 49) in the deck and, more importantly, the transverse joints between adjacent deck panels.



Figure 49. Epoxy filling predrilled lag screw holes

This seemed to provide a level of water tightness that the research team had not seen on a timber deck of this type. Furthermore, after three years of inspection, there does not appear to be any signs of water intrusion through any of the transverse joints on the underside of the deck.

6. SUMMARY AND CONCLUSIONS

Structurally, economically, and aesthetically, timber is a phenomenal building material, and in the past several decades advances in timber have been made by developments in engineered lumber and timber elements through research related to the topic. Still, a negative perception exists concerning the performance of timber as a bridge building material.

Today, with tightened budgets and increasing degradation of existing bridge inventories, city, county, and state offices are looking for structurally adequate and cost-effective bridge alternatives. In response to this search, Buchanan County, Iowa, has been working with the National Center for Wood Transportation Structures and a timber fabricator to develop the next-generation timber bridge. The goal with the development of this concept is to increase the structural efficiency of timber bridges and increase longevity by (1) creating a composite deck-girder system and (2) using an epoxy overlay. If successful, these design elements have the potential to increase viable bridge options for use not only on Iowa's roadways, but nationally and internationally as well.

The bridge system developed for this research was a composite glulam girder-deck system utilizing epoxy for the connection as well as an epoxy overlay wearing surface on the deck. Investigation of this design idea involved two primary focus areas: small- and large-scale laboratory testing of the composite epoxy connection and a field demonstration bridge built utilizing this girder to deck connection detail and epoxy overlay.

For the laboratory evaluation, small-scale tests were conducted on four different girder to deck connection types: lag bolts (typical connection detail), epoxy only, epoxy with lag bolts, and epoxy with GRK screws. Push-out tests were conducted to evaluate the ultimate shear strength of each connection type. According to the data, the best overall joint connection was the epoxy and lag bolt connection, with an approximate average shear stress of 450 psi, followed by the epoxy-only connection, the epoxy screw connection, and the lag bolt connection at 400 psi, 375 psi, and 125 psi, respectively. The numbers show that the three joints with epoxy at least tripled the shear capacity of the lag bolt joint, and addition of mechanical fasteners to the epoxy connection made a minor increase in performance.

The large-scale laboratory tests consisted of three two-girder systems spanning 41 ft. The first two-girder system had transverse glulam deck panels lag-screwed to the girders, the second two-girder system had transverse glulam deck panels epoxied to the girders, and the third two-girder system had precast concrete panels either epoxied to the girders or connected via shear studs and grout pockets. However, as stated in Section 5.1.2, the concrete panel specimen did not remain elastic throughout the experiment, thus making the data from this specimen flawed and unreliable. Initial test data were collected from the first specimen with the glulam deck panels simply resting on the girders, unattached, and were used as a non-composite control. Comparing the control data to the lag-bolted and epoxied specimens' data indicates a small increase in the load capacity and movement of the neutral axis when the deck panels are affixed to the girders, as would be expected, both of which are indicators of potential composite action. Furthermore, the epoxied connection exhibited approximately four times as much transfer of load into the deck

panels under the same loading, indicating that this should be an improved composite connection detail over the lag bolt connection. One observation made during testing was that the limiting factor for attaining true composite action with either of these connection details is not purely the deck to girder connection. To achieve a noticeable and accountable increase in composite action of the glulam system, the adjacent deck panels need to be installed as tightly as possible to one another to reduce and/or eliminate any gaps between the panels. Gaps between adjacent deck panels after they are affixed to the girders must first be closed under load/deflection before any load transfer, i.e., composite action behavior, can be attained between the girders and the deck.

For the field portion of this work, a demonstration bridge was designed and constructed in Buchanan County, Iowa. The substructure of the bridge is composed of concrete abutments supported on steel h-pile sections, and the superstructure consists of 11 8.75 in. x 42.625 in. x 72 ft long southern yellow pine glulam timber girders on 4 ft centers, with a design bending stress (f_b) of 2,800 psi, a modulus of elasticity of 1.9×10^6 in.⁴, and 1.5 in. of camber at midspan. The deck consists of a total of 36 4 in. x 24 in. x 40 ft long transverse glulam deck panels epoxied to the girders. The deck panels have factory-milled lap splice edges and predrilled holes for all hardware.

Three live load tests were completed on the structure, one post-construction in 2015, a second a year later in 2016, and a third a year after that in 2017. Midspan girder deflections along with strains in the girders and deck panels were collected during testing. Measured deflections and bottom flange girder strains indicate that transverse load distribution for all load cases is adequate and as expected in design. Based on the recommended maximum deflection limit of $L/360$, the maximum recommended deflection for this demonstration bridge would be 2.4 in., which is more than 3.5 times the measured deflection under live load. Peak tensile strains measured in the girders were approximately 337 microstrain, which corresponds to a stress of 640 psi, which is 23% of the design bending strength (2,800 psi) of the beams. Lastly, inspection of the girder and deck strains indicated some level of composite action, though the action is not likely substantial enough to be accounted for in design. The chip seal shows signs of cracking at the transverse deck panel joints. However, since the joints were previously filled with epoxy, the joints have remained sealed and at the time of the last inspection in 2017 showed no signs of moisture intrusion on the underside of the deck.

Lastly, the epoxy wearing surface applied to the deck of the demonstration bridge performed better as an impermeable joint filler than a wearing surface. Typical asphalt wearing surfaces on transverse glulam decks crack relatively quickly, unless designed appropriately, and subsequently allow moisture through the transverse deck panel joints. The epoxy used on the wearing surface filled all these joints and currently prevents moisture from getting through the joints. In the future, the combination of an initial epoxy overlay, to fill the joints and seal the gaps, followed by a well-designed asphalt wearing surface may be the key to prolonging the life of these structures.

REFERENCES

Ritter, M. A. 1990. *Timber Bridges: Design, Construction, Inspection and Maintenance*. United States Department of Agriculture, Forest Service, Washington, DC.

**APPENDIX A: PLAN DRAWINGS FOR SUBSTRUCTURE AND SUPERSTRUCTURE
OF BUCHANAN COUNTY BRIDGE**

BUCHANAN COUNTY SINGLE SPAN TIMBER BRIDGE

Project Number: LFM-10218--7X-10

LETTING DATE: NA

DRAWING APPROVAL
ALL SHOP DRAWINGS AND FALSEWORK DRAWINGS THAT REQUIRE APPROVAL SHALL BE APPROVED BY THE CONTRACTOR, THEN ACCEPTED BY THE BUCHANAN COUNTY ENGINEER.

THESE SHOP DRAWINGS SHALL NOT BE SENT TO I.D.O.T. OFFICE OF BRIDGES AND STRUCTURES.

04-20-10 281-1

THIS PROJECT SHALL BE CONSTRUCTED IN ACCORDANCE WITH THE REQUIREMENTS OF U.S. ARMY CORPS OF ENGINEERS 404 NATIONWIDE PERMIT NO. 3. A COPY OF THIS PERMIT IS AVAILABLE FROM THE BUCHANAN COUNTY ENGINEERS OFFICE UPON REQUEST. THE U.S. ARMY CORPS OF ENGINEERS RESERVES THE RIGHT TO VISIT THE SITE WITHOUT PRIOR NOTICE.

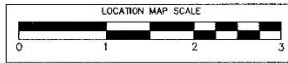

R-8W

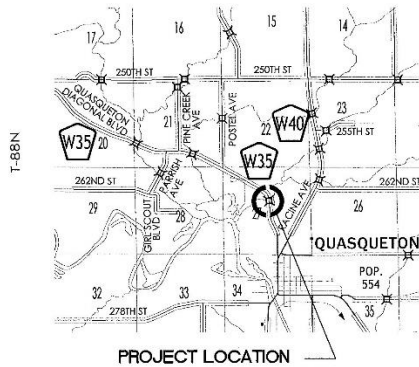

PROJECT LOCATION

IOWA
DEPARTMENT OF TRANSPORTATION
HIGHWAY DIVISION
PLANS OF PROPOSED IMPROVEMENT ON THE
FARM TO MARKET SYSTEM
BUCHANAN COUNTY
SINGLE SPAN TIMBER BRIDGE
70'-00" X 40'-00" TIMBER BRIDGE WITH A 0° SKEW

FHWA # 82080

Project Number: LFM-10218--7X-10

LOCATED ON QUASQUETON DIAGONAL BLVD. (W35) IN SECTION 27 OF LIBERTY TOWNSHIP, T-88-N, R-8-W. APPROX. ONE HALF MILE[S] NORTH OF THE CITY OF QUASQUETON OVER NASH CREEK

"THE IOWA DEPARTMENT OF TRANSPORTATION STANDARD SPECIFICATIONS FOR HIGHWAY AND BRIDGE CONSTRUCTION, SERIES 2012, PLUS GENERAL SUPPLEMENTAL SPECIFICATIONS, AND APPLICABLE SUPPLEMENTAL SPECIFICATIONS, DEVELOPMENTAL SPECIFICATIONS, AND SPECIAL PROVISIONS, SHALL APPLY TO THE CONSTRUCTION ON THIS PROJECT."

TRAFFIC CONTROL PLAN:

THIS ROAD WILL BE CLOSED TO THROUGH TRAFFIC BUT OPEN TO LOCAL TRAFFIC DURING CONSTRUCTION AS PROVIDED FOR IN ARTICLE 1107.0B, 2012 STANDARD SPECIFICATIONS PLUS CURRENT SUPPLEMENTAL SPECIFICATIONS. TRAFFIC CONTROL DEVICES, PROCEDURES, LAYOUTS, SIGNING AND PAVEMENT MARKINGS INSTALLED WITHIN THE LIMITS OF THIS PROJECT SHALL CONFORM TO THE "MANUAL ON UNIFORM TRAFFIC CONTROL DEVICES FOR STREETS AND HIGHWAYS" AS ADOPTED BY THE DEPARTMENT PER 761 OF THE IOWA ADMINISTRATIVE CODE (IAC) CHAPTER 130.

Scales: As Noted



2013 AVERAGE ANNUAL DAILY TRAFFIC: 1120 VEHICLES PER DAY

FHWA # 82080

Project Number: LFM-10218--7X-10

Sheet No. A.01

Project Number: LFM-10218--7X-10 FHWA # 82080

INDEX OF SHEETS	
No.	Description
A.01	TITLE SHEET
C.01	ESTIMATE OF QUANTITIES
C.02	GENERAL NOTES, STANDARD ROAD PLAN TAB
C.03	MISC. TABULATIONS
C.04	GUARDRAIL TABULATIONS
D.01	PLAN AND PROFILE
Q.01	BORING LOGS
U.01	ABUTMENT DETAILS
U.02	ABUTMENT DETAILS (CONTINUED)
U.03	REINFORCING BAR LIST
U.04	GEOSYNTHETICALLY REINFORCED BACKFILL
V.01	SITUATION PLAN LONG SECTION AND HYDROLOGY
1-3	TIMBER SUPERSTRUCTURE DESIGN

MILEAGE SUMMARY			
Div.	Location	Lin. Ft.	Miles
	FROM STA. 32+00 TO STA. 33+42.35	142.35	0.0270
	FROM STA. 33+42.35 TO STA. 34+12.35 (BRIDGE)	70.00	0.0133
	FROM STA. 34+12.35 TO STA. 35+00	87.65	0.0166
	TOTAL	300.00	0.0569

I hereby certify that this plan was prepared by me or under my direct personal supervision and that I am a duly Licensed Professional Engineer under the laws of the State of Iowa.

BRIAN KEIERLEBER, P.E. _____ Date _____

My license renewal date is December 31, 2014

Pages or sheets covered by this seal: _____

All sheets in set

Official Seal

Approved **BUCHANAN County**
Board of Supervisors

GENERAL NOTES & INFORMATION

DATA LISTED BELOW IS FOR INFORMATION PURPOSES ONLY AND SHALL NOT CONSTITUTE A BASIS FOR ANY EXTRA WORK ORDERS

CONTRACTOR IS TO USE DUE CAUTION WHEN WORKING OVER AND AROUND ALL TILE LINES. BREAKS IN THE TILE LINE DUE TO THE CONTRACTOR'S CARELESSNESS ARE TO BE REPLACED AT THEIR EXPENSE WITHOUT COST TO BUCHANAN COUNTY. ANY TILE BROKEN OR DISTURBED BY OUR CUT LINES WILL BE REPLACED AS DIRECTED BY THE ENGINEER

UTILITY COORDINATION SHALL BE PER ARTICLE 1107.15 OF THE STANDARD SPECIFICATIONS.

FINAL CLEANUP OF THE CONSTRUCTION AREA SHALL BE IN ACCORDANCE WITH SECTION 1104.08 OF I.D.O.T. STANDARD SPECIFICATIONS

A PRE CONSTRUCTION CONFERENCE WITH THE SUCCESSFULL BIDDER WILL BE HELD NO LESS THAN THREE WEEKS BEFORE STARTING THE PROJECT AND SHALL INCLUDE THE CONTRACTOR'S JOB SUPERINTENDENT.

CONTRACTOR IS TO USE DUE CAUTION WHEN WORKING AROUND ROW PINS AND SURVEY CONTROL POINTS WHICH ARE MARKED WITH AN OAK HUB AND CROSSING LATH. ANY PINS DISTURBED BY THE CONTRACTOR WILL BE REPLACED AT THE CONTRACTORS EXPENSE.

CONTRACTOR IS TO FURNISH, ERECT, AND MAINTAIN ALL NECESSARY TRAFFIC CONTROL DEVICES ON A 24 HOUR PER DAY, 7 DAY A WEEK BASIS DURING THE CONSTRUCTION PERIOD. CONTRACTOR SHALL PROVIDE A 24 HOUR CALL NUMBER FOR REPAIR OF DEFICIENCIES AFTER HOURS. CONSTRUCTION WILL BE SUSPENDED IN THE EVENT THAT ANY OF THE REQUIRED TRAFFIC CONTROL DEVICES ARE NOT LEGIBLE AND/OR OPERATIONAL AND SHALL REMAIN SUSPENDED UNTIL SUCH DEFICIENCY IS CORRECTED

THE ROAD WILL BE CLOSED IN THE AREA OF THE BRIDGE FOR ALL THROUGH TRAFFIC.

CONSTRUCTION STAKING TO BE DONE BY BUCHANAN COUNTY

CERTIFIED PLANT INSPECTION WILL BE REQUIRED ON THIS PROJECT

THERE WILL BE A CONSTRUCTION CAMERA ON SITE MOUNTED TO A POWER POLE. IT IS THE CONTRACTORS RESPONSIBILITY TO ENSURE THAT THIS CAMERA HAS POWER 24 HOURS PER DAY, 7 DAYS PER WEEK FOR THE DURATION OF CONSTRUCTION.

STANDARD ROAD PLANS

NUMBER	DATE	SHEETS	TITLE
BA-200	10/18/2011	2	STEEL BEAM GUARDRAIL COMPONENTS
BA-206	10/18/2011	1	STEEL BEAM GUARDRAIL FLARED END TERMINAL FOR CABLE CONNECTION
EW-301	4/19/2011	5	GUARDRAIL GRADING
EW-401	4/15/2014	1	TEMPORARY STREAM CROSSING, CAUSEWAY, OR EQUIPMENT PAD
SI-211	10/19/2010	3	OBJECT MARKER AND DELINEATOR PLACEMENT WITH GUARDRAIL
TC-252	4/17/2012	3	ROUTES CLOSED TO TRAFFIC

CERTIFIED PLANT INSPECTION

CERTIFIED PLANT INSPECTION SHALL APPLY
TO ALL ITEMS INVOLVING CONCRETE ON
THIS PROJECT.

70' 00" x 40' 00" Timber Bridge

Located on Quasqueton Diagonal Blvd. over Unnamed Creek
ABUTMENTS: FULL PIERS: NA

70'-00" SPAN

GENERAL NOTES, STD. ROAD PLAN TAB.

STATION: 33+77.35
BUCHANAN COUNTY, IOWA

SKEW: 0'
FHWA # 82080

AD

BUCHANAN COUNTY

PROJECT NO. LFM-10218--7X-10

C.02

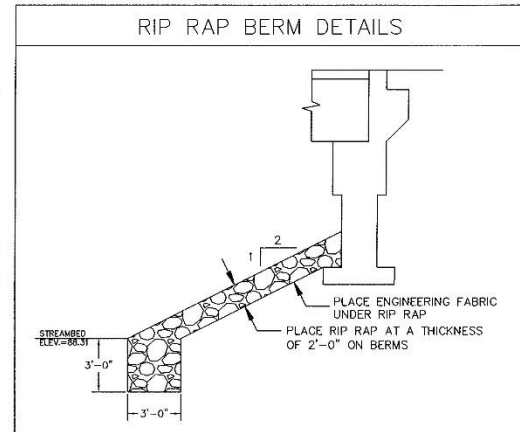
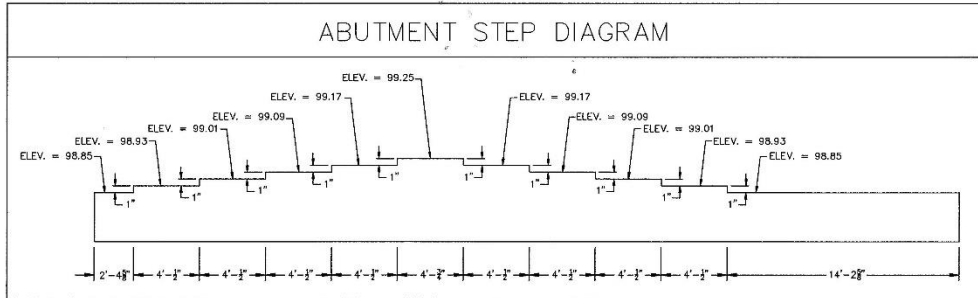

REMOVAL OF EXISTING BRIDGE		
		110-2 10-13-72
LOCATION	DESCRIPTION	DISPOSAL
33+77.35	52'x22' STEEL BEAM BRIDGE	Contractor
<p>Removal of the existing 52'x22' steel beam bridge with full concrete abutments shall be removed in accordance to Iowa DOT standard specifications. All debris material removed by the contractor shall become property of the contractor and removed from the project area.</p>		

TABULATION OF SAFETY CLOSURES			
Refer to Section 2518 of the Standard Specifications			
STATION	CLOSURE TYPE		REMARKS
	Road Qty.	Hazard Qty.	
32+00	1	—	South End of Project
33+40	—	1	South End of Bridge
34+15	—	1	North End of Bridge
35+00	1	—	North End of Project

70' 00" x 40' 00" Timber Bridge
 Located on Quasqueton Diagonal Blvd. over Unnamed Creek
 ABUTMENTS: FULL PIERS: NA
 70' 00" SPAN
 MISC. TABULATIONS
 STATION: 33+77.35 SKEW: 0°
 BUCHANAN COUNTY, IOWA FHWA # 82080

① Lanes to which the installation is adjacent A=Approach T=Trailing		GRADING FOR GUARDRAIL INSTALLATION										107-23 Modified						
LOCATION		DIMENSIONS (FEET)										EARTHWORK		REMARKS				
NO.	DIRECTION OF TRAFFIC	STATION	SIDE	STANDARD OR TYPICAL NUMBER	FORESLOPE AT GUARDRAIL	Z		X1	Y1	X2	Y2	X3	Y3		X4	Y4	SLOPE IN FRONT OF GUARDRAIL	EXCAVATION TOTAL FILL NEEDED
						A	T											
1	N	33+40.35	Right	EW-301	2:1	45.42	—	5'-3"	—	—	—	—	—	51'-1"	10	4	115.20	Suitable Class 13 channel and Class 23 excavation fit to be used to construct guardrail listers.
2	N	34+14.36	Right	EW-301	2:1	—	45.42	—	5'-3"	—	—	—	—	51'-1"	10	4	253.80	
3	S	34+14.36	Left	EW-301	2:1	45.42	—	5'-3"	—	—	—	—	—	51'-1"	10	4	145.10	
4	S	33+40.35	Left	EW-301	2:1	—	45.42	—	5'-3"	—	—	—	—	51'-1"	10	4	66.19	

STEEL BEAM GUARDRAIL AT CONCRETE BARRIER OR BRIDGE END POST													① See Standards for list of materials	
LOCATION POINT		LAYOUT LENGTHS				DELINEATORS AND OBJECT MARKERS				BID ITEMS ①				
NO.	STATION AND OFFSET	VT1	VF	VT2	ET Terminal (37.5')	TYPE	OBJECT MARKER			BARRIER TRANSITION SECTION	STEEL BEAM GUARDRAIL	BOLTED END ANCHOR		END TERMINAL
		TYPE 1	TYPE 2	TYPE 3	WHITE		OM2-2V	OM-3L	OM-3R				BA-201	
		LN. FT.	LN. FT.	LN. FT.	LN. FT.		NO.	NO.	NO.	NO.	LN. FT.	NO.	NO.	
1	33+40.35, 20.08'LL	0	0	0	40'-7"	—	—	—	1	—	—	—	1	
2	33+40.35, 20.08'RL	0	0	0	40'-7"	—	—	—	1	—	—	—	1	
3	34+14.36, 20.08'LL	0	0	0	40'-7"	—	—	—	1	—	—	—	1	
4	34+14.36, 20.08'RL	0	0	0	40'-7"	—	—	—	1	—	—	—	1	

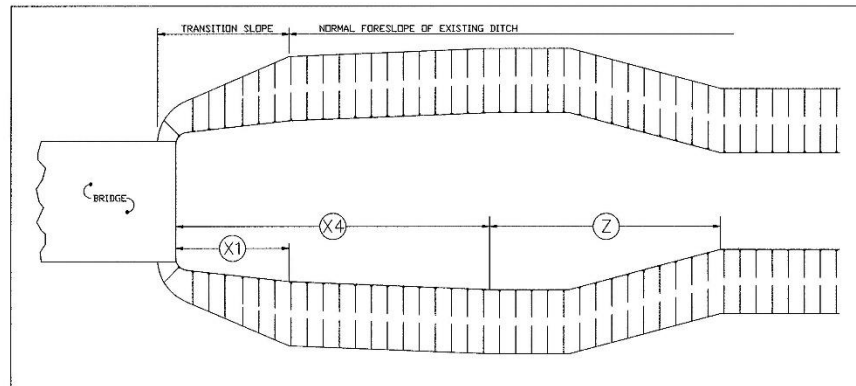

70' 00" x 40' 00" Timber Bridge
 Located on Quasqueton Diagonal Blvd. over Unnamed Creek
 ABUTMENTS, FULL PIERS, NA
 70'-00" SPAN
GUARDRAIL TABULATIONS
 STATION: 33+77.35 SKEW: 0°
 BUCHANAN COUNTY, IOWA FHWA # 82080

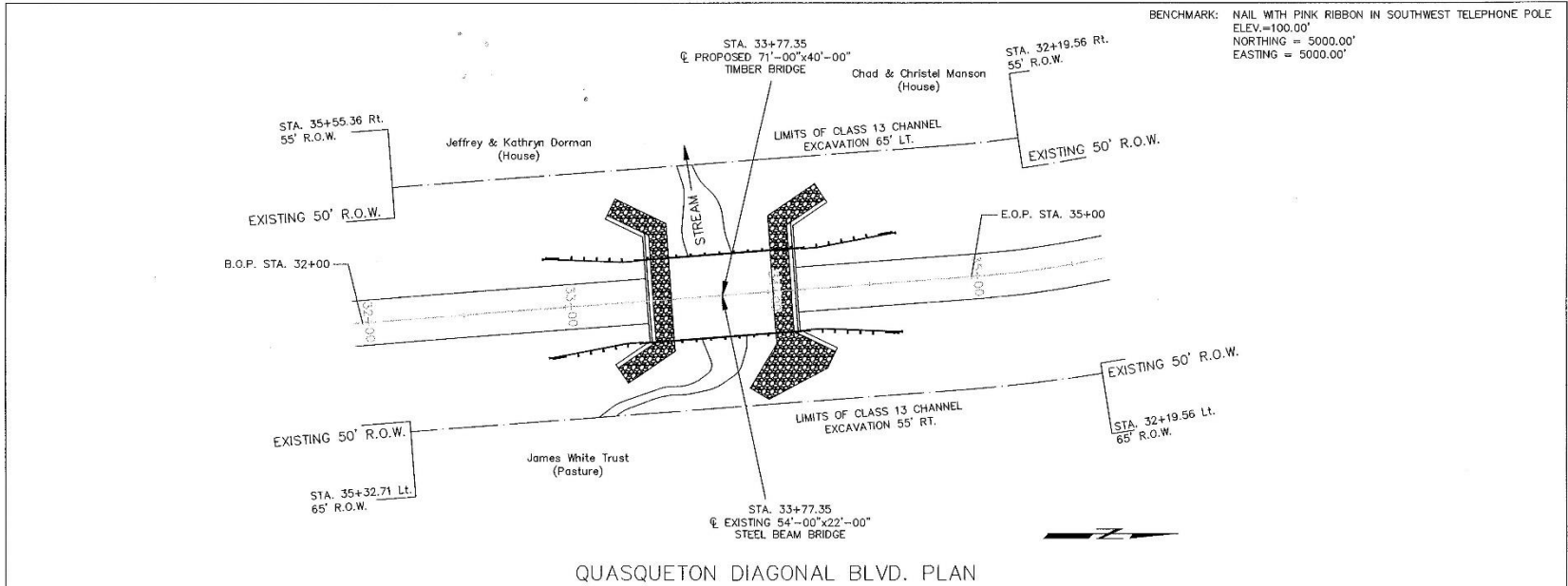

BENCHMARK: NAIL WITH PINK RIBBON IN SOUTHWEST TELEPHONE POLE
 ELEV. = 100.00'
 NORTHING = 5000.00'
 EASTING = 5000.00'

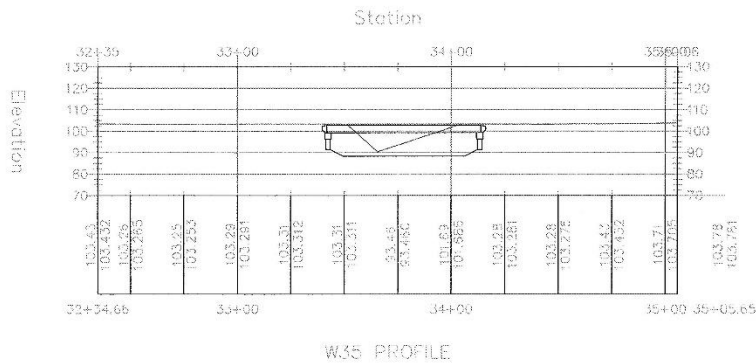

70' 00" x 40' 00" Timber Bridge
 Located on Quasqueton Diagonal Blvd. over Unnamed Creek
 ABUTMENTS: FULL PIERS: NA
 52' 00" SPAN
PLAN AND PROFILE
 STATION: 33+77.35 SKEW: 0°
 BUCHANAN COUNTY, IOWA FHWA # 82080

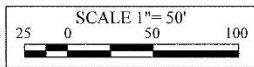

Drillers Log					
Hole ID	S.W. Abutment		Date Drilled	8/4/2004	
Property	W35		Location Desc.	North of Quasqueton	
Depth	Blow Count	Color	Texture	Moisture	Comments
4.9-6.9	3/5/6/6	Brown/Tan	Fine-Med	Slightly Moist	Fine to Medium Sand - Trace of Gravel
6.9-9.9	4/15/20/0	Lt. Brown	V. Fine-Fine	Very Moist	Fine Lean Clay with Fractured Lime and Silt
9.9-11.4	Bottom	Tan/Brown	V. Fine-Course	Slightly Moist	Fractured Lime with Brown Clay
11.9-21.4					Continuous Core Sampled

Drillers Log					
Hole ID	N.E. Abutment		Date Drilled	8/4/2004	
Property	W35		Location Desc.	North of Quasqueton	
Depth	Blow Count	Color	Texture	Moisture	Comments
3.5-5.5	2/2/3/2	Brown/Blk	Fine-Med	Slightly Moist	Fine Silt with Trace Gravel
5.5-8.5	1/3/13/0	Grey/Brwn	Fine-Med	Very Moist	Lean Silty Clay
8.8-10	Bottom	Tan/Brown	Fine-Course	Slightly Moist	Fractured Lime/Trace Clay

MOISTURE

Dry (D): no apparent moisture
Slightly Moist (SM): can feel moisture, but soil won't retain shape when molded
Moist (M): can feel moisture and will mold easily, yet crumbles upon kneading
Very Moist (VM): can feel much moisture, molds easily and doesn't crumble
Wet (W): can see moisture, leaves hand wet, usually below water table

CONSISTENCY

Very soft (VS): Thumb will penetrate soil more than 1 in.
Soft (S): Thumb will penetrate soil about 1 in.
Firm (F): Thumb will indent soil about ¼ in.
Hard (H): Thumb will not indent soil but readily indented with thumbnail
Very Hard (VH): Thumbnail will not indent soil

70' 00" x 40' 00" Timber Bridge
 Located on Quasqueton Diagonal Blvd. over Unnamed Creek
 ABUTMENTS: FULL PIER: NA
 70' 00" SPAN
BORING LOGS
 STATION: 33+77.35 SKEW: 0°
 BUCHANAN COUNTY, IOWA FHWA # 82080

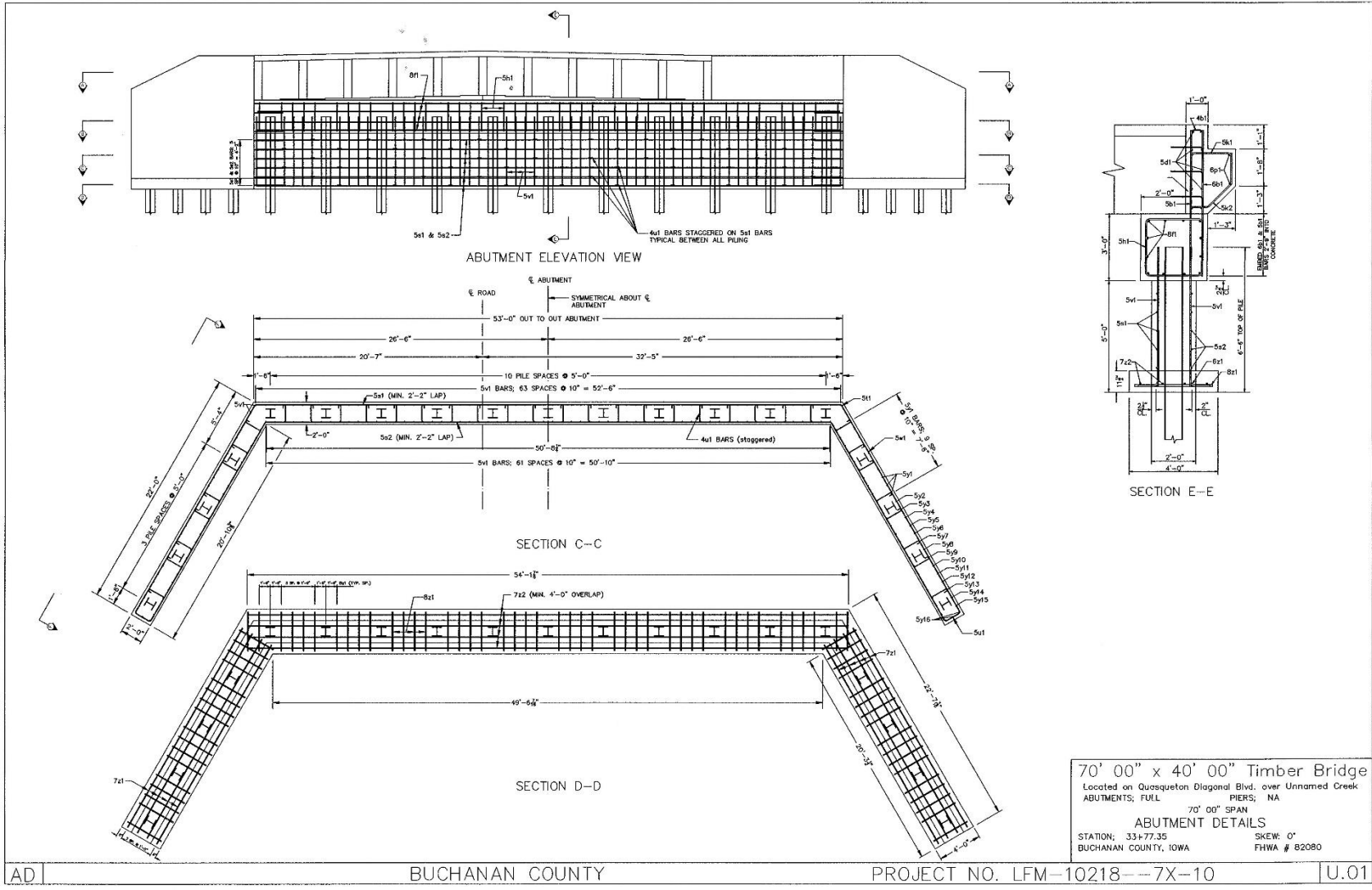

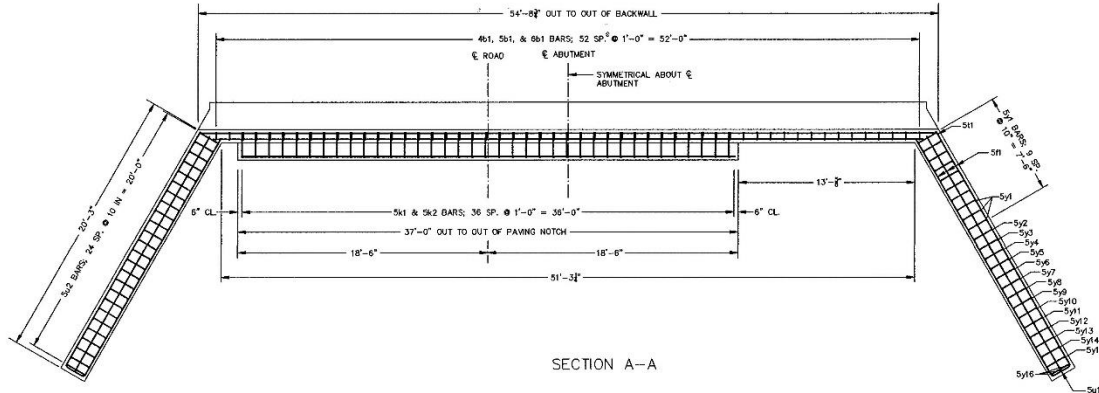

SECTION A-A

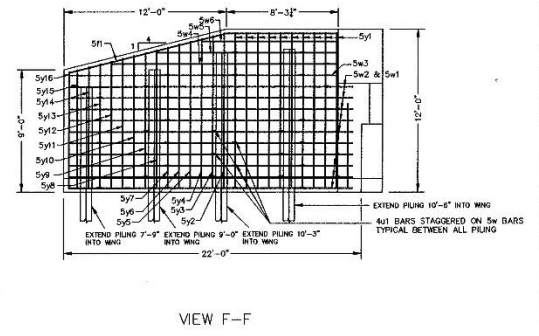

VIEW F-F

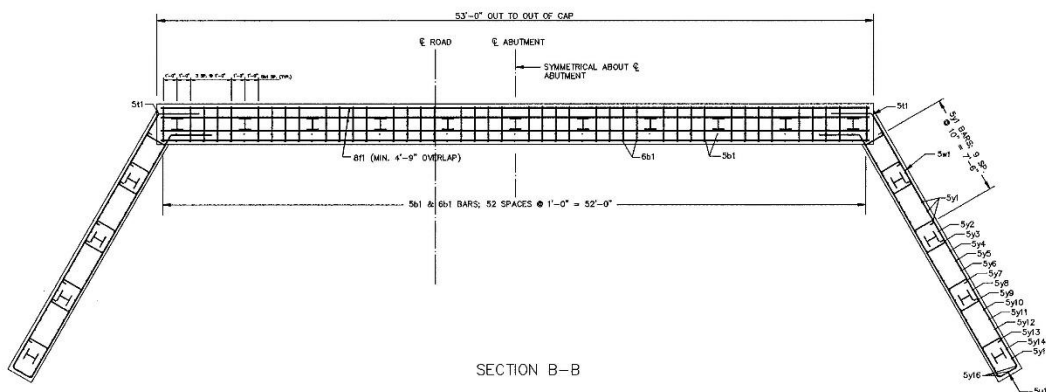

SECTION B-B

70' 00" x 40' 00" Timber Bridge
 Located on Quassquoton Diagonal Blvd. over Unnamed Creek
 ABUTMENTS: FULL PIER: NA
 70' 00" SPAN
 ABUTMENT DETAILS
 STATION: 334+77.35 SKREW: 0'
 BUCHANAN COUNTY, IOWA FHWA # 82080

REINFORCING BAR LIST ONE ABUTMENT					
BAR	SHAPE	LOCATION	QUANTITY	LENGTH	WEIGHT
4b1		BACKWALL, TIES	53	3'-7 3/4"	129
4u1		STEM AND WINGS, TIES	154	2'-6"	257
4u2		BACKWALL, BEAMS	33	1'-11 3/8"	43
5b1		BACKWALL, VERTICAL	53	6'-6 1/2"	362
5d1		BACKWALL, HORIZONTAL	20	27'-6"	574
5f1		WINGS, TOP, HORIZONTAL	6	20'-2 1/2"	127
5h1		CAP, HOOPS	42	11'-4"	497
5k1		BACKWALL, PAVING BLOCK	37	4'-8 1/2"	182
5k2		BACKWALL, PAVING BLOCK	37	3'-8 1/2"	142
5s1		STEM, FRONT, HORIZONTAL	12	27'-6"	344
5s2		STEM, BACK, HORIZONTAL	12	26'-6"	332
5t1		WING, STEM, TRANSITION	60	6'-0"	376
5u1		WINGS, END SPACERS	22	5'-7 1/2"	129
5u2		WINGS, TOP SPACERS	50	5'-6 1/4"	288
5v1		STEM, VERTICAL	128	6'-3"	835
5w1		WING, FRONT, HORIZONTAL	20	21'-0"	438
5w2		WING, BACK, HORIZONTAL	20	20'-1"	419
5w3		WING, TOP, HORIZONTAL	4	19'-10"	83
5w4		WING, TOP, HORIZONTAL	4	16'-8 3/8"	70
5w5		WING, TOP, HORIZONTAL	4	13'-4 5/8"	56
5w6		WING, TOP, HORIZONTAL	4	10'-8"	42
5y1		WING, VERTICAL	40	11'-6"	480
5y2		WING, VERTICAL	4	11'-5 1/2"	48
5y3		WING, VERTICAL	4	11'-3"	47
5y4		WING, VERTICAL	4	11'-1 1/2"	46
5y5		WING, VERTICAL	4	10'-10"	45
5y6		WING, VERTICAL	4	10'-7 1/2"	45
5y7		WING, VERTICAL	4	10'-5"	44
5y8		WING, VERTICAL	4	10'-2 1/2"	43
5y9		WING, VERTICAL	4	10'-0"	42
5y10		WING, VERTICAL	4	9'-9 1/2"	41
5y11		WING, VERTICAL	4	9'-7"	40
5y12		WING, VERTICAL	4	9'-4 1/2"	39
5y13		WING, VERTICAL	4	9'-2"	38
5y14		WING, VERTICAL	4	8'-11 1/2"	37
5y15		WING, VERTICAL	4	8'-9"	37
5y16		WING, VERTICAL	6	8'-7"	54
6b1		BACKWALL, VERTICAL	53	6'-6 1/2"	521
6p1		BACKWALL, PAVING BLOCK	2	36'-6"	110
8f1		CAP, HORIZONTAL	24	28'-7"	1,832
TOTAL REINFORCING STEEL (LBS)				9,314	

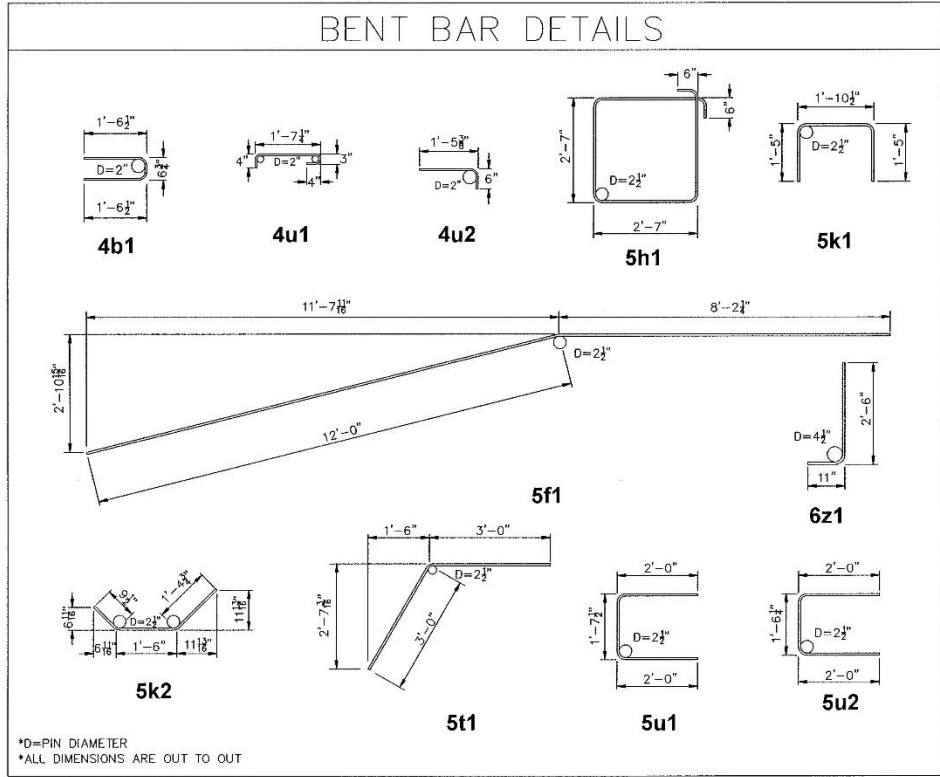

REINFORCING BAR LIST ONE FOOTING					
BAR	SHAPE	LOCATION	QUANTITY	LENGTH	WEIGHT
6t1		FOOTING STEM TIE	228	3'-5"	1,170
7t1		FOOTING WING LONGITUDINAL	8	20'-8"	335
7t2		FOOTING LONGITUDINAL	8	29'-0"	474
8t1		FOOTING TRANSVERSE	78	3'-6"	729
TOTAL REINFORCING STEEL (LBS)					2,711

70' 00" x 40' 00" Timber Bridge
 Located on Quasqueton Diagonal Blvd. over Unnamed Creek
 ABUTMENTS, FULL PIERS: NA
 70' 00" SPAN
REINFORCING BAR LIST
 STATION: 33+77.35 SKEW: 0°
 BUCHANAN COUNTY, IOWA FHWA # 82080

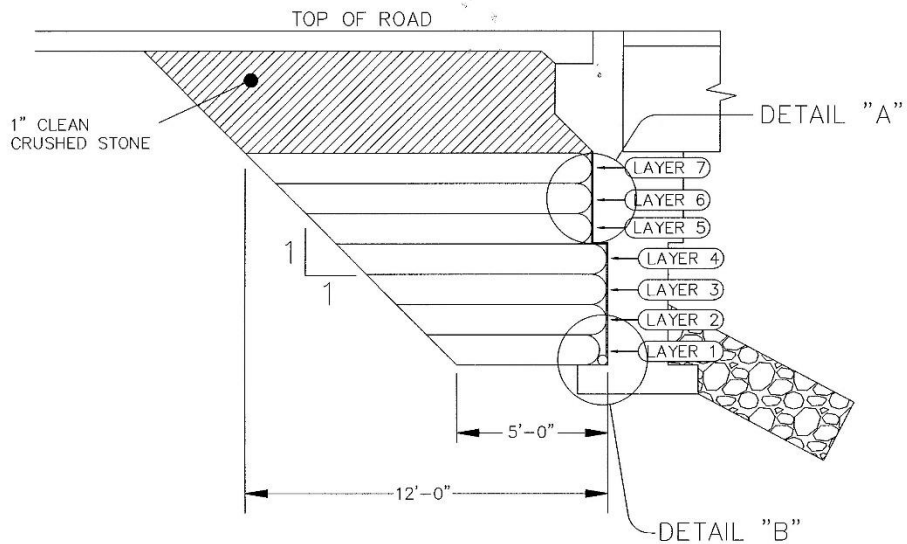

Geosynthetically Reinforced Backfill Layer Information				
Layer	Starting Elevation	Lift Thickness (INCHES)	Granular Backfill (CY)	Engineering Fabric (SY)
1	91.89	12	9.93	47.5
2	92.89	12	12.04	53.8
3	93.89	12	14.19	60.2
4	94.89	12	16.37	66.8
5	95.89	12	18.70	73.6
6	96.89	12	20.93	80.4
7	97.89	12	23.22	87.3
TOTAL			115.38	469.6

NOTES:
ALL COMPACTION SHALL MEET THE REQUIREMENTS OF TYPE "A" COMPACTION AS STATED IN THE 2012 STANDARD SPECIFICATIONS.

GRANULAR MATERIAL FOR THE GEOSYNTHETICALLY REINFORCED FOUNDATIONS SHALL CONSIST OF CLASS "A" CRUSHED STONE. OTHER MATERIALS MAY BE SUBMITTED TO THE PROJECT ENGINEER FOR APPROVAL.

THE POROUS BACKFILL LOCATED AROUND THE SUB DRAINS IS TO CONSIST OF GRADATION NO. 29, PER ARTICLE 4109.02

OUTLET OF SUBDRAIN SHALL BE A MINIMUM 12 IN. ABOVE STREAMBED. SUBDRAIN SHALL HAVE A CONSTANT SLOPE OF 1-2% TOWARDS OUTLET

CONTINUE SHEET WICK DRAIN BEHIND ABUTMENT UP TO THE TOP OF LAYER 7.

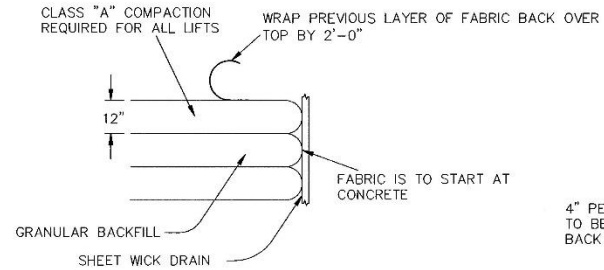

DETAIL "A"

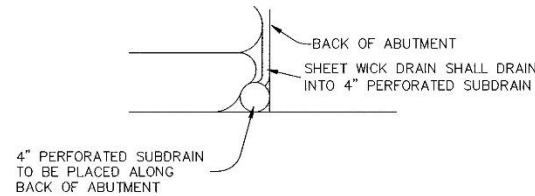

DETAIL "B"

70' 00" x 40' 00" Timber Bridge
 Located on Quasqueton Diagonal Blvd. over Unnamed Creek
 ABUTMENTS: FULL PIER: NA
 70' 00" SPAN
 GEOSYNTHETICALLY REINFORCED BACKFILL DETAILS
 STATION: 33+77.35 SKEW: 0°
 BUCHANAN COUNTY, IOWA FHWA # 82080

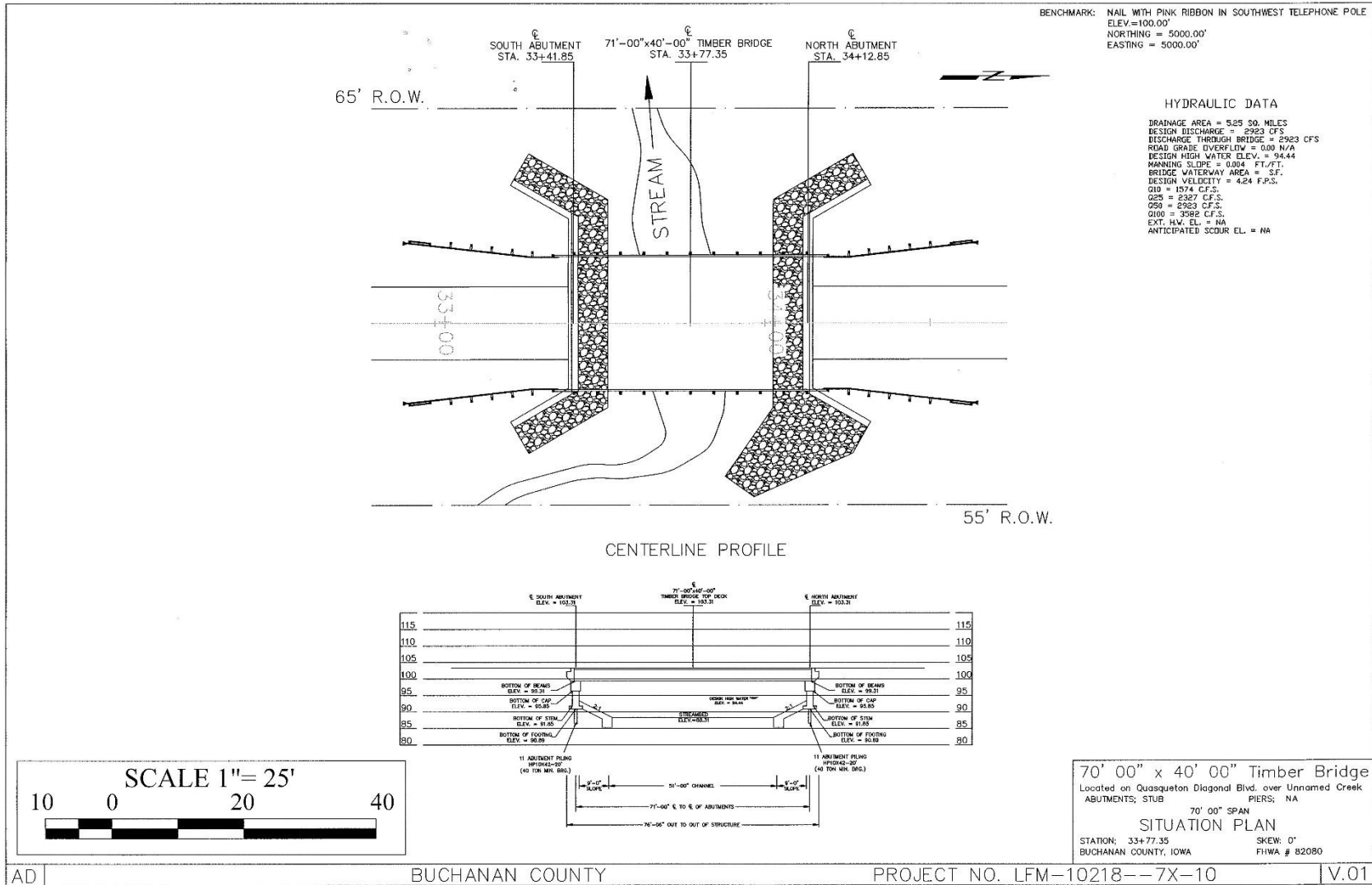

42' x 72' GRUEN-WALD MILLENIUM HL93 TREATED GLULAM COMPOSITE BRIDGE

THE BRIDGE SHALL BE DESIGNED FOR HL93 LOADING. THE RAIL SHALL BE BE DESIGNED TO RESTRAIN AN 80,000 LB VEHICLE IMPACTING AT 15° ANGLE

THE WOOD SHALL BE SOUTHERN YELLOW PINE TREATED TO 0.60 CCA. KDAT TO 14% (±) 5% MOISTURE CONTENT OR APPROVED EQUAL.

GLULAM DECK, STRINGER AND RAIL COMPONENTS SHALL BE PRODUCED IN COMPLIANCE WITH ANSI A.190.1.12 STANDARDS.

THE GLULAM MANUFACTURER SHALL BE THIRD PARTY INSPECTED BY APA EWS, AITC, OR OTHER APPROVED INSPECTION AGENCY.

ALL WOOD COMPONENTS TO HAVE A FACTORY COAT OF BOILED LINDSEED AFTER MILLING/DRILLING EXCEPT THE DECK SURFACE.

APPLY A FINAL COAT TO RAIL COMPONENTS AND EXPOSED STRINGERS (EXT. ONLY.) AFTER BRIDGE IS CONSTRUCTED

THE DECK SECTIONS SHALL BE PRECISION MILLED TO INSURE TOTAL CONTACT OF ADJACENT DECK EDGE SURFACES. USE THREE PICK POINTS WHEN INSTALLING.

THE DECK SECTIONS SHALL HAVE HENKEL HBE452 APPLIED TO THE CONTACT SURFACES IMMEDIATELY PRIOR TO INSTALLING AND SHALL BE SECURED IN PLACE WITHIN 20 MINUTES OF APPLICATION.

THE DECK TO STRINGER CONNECTION IS TO BE COATED WITH HENKEL HBE452 OR APPROVED EQUAL AND SHALL BE LOCKED TOGETHER USING THE HOT DIP GALVANIZED LAG BOLTS WITHIN 20 MINUTES OF APPLICATION.

ALL HOLES SHALL BE PREDRILLED BY THE MANUFACTURER WITH PLUGS SUPPLIED FOR CAPPING THE RECESSED HOLES.

ALL LAG SCREWS SHALL MEET OR EXCEED THE REQUIREMENTS OF ANSI/ASME STANDARD B 18.2.1 THEY SHALL BE HOT DIP GALVANIZED ACCORDING TO INDUSTRY STANDARDS. STAINLESS STEEL MAY BE SUBSTITUED.

ALL STEEL TO BE PRODUCED IN THE USA.

ALL LAG SCREWS SHALL HAVE HENKEL HBE 452 APPLIED TO THE THREADS EXCEPT FOR RAIL POSTS

CAP ALL COUNTER SUNK HARDWARE WITH TREATED WOOD PLUGS. SECURE IN PLACE WITH TITEBOND III.

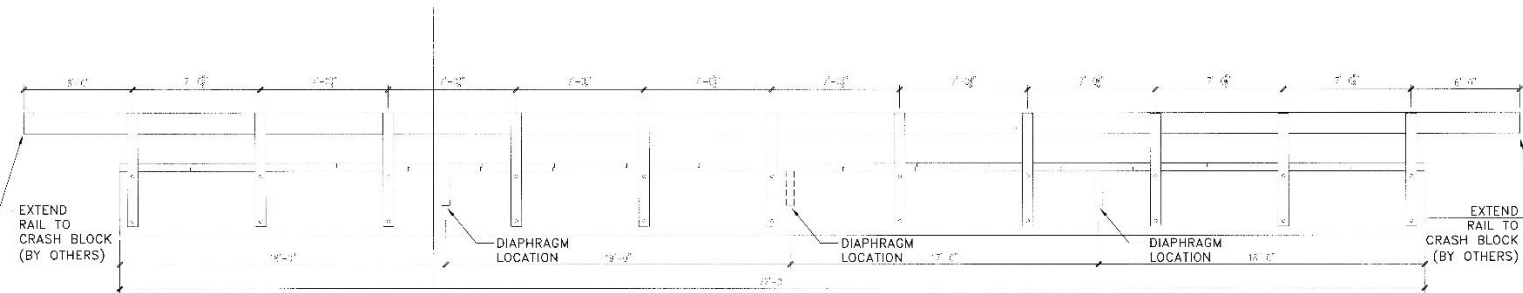
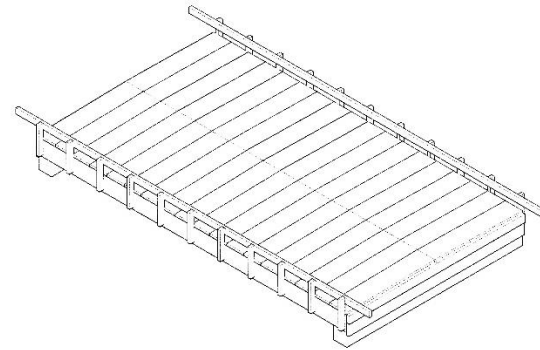

PROJECT: GRUEN-WALD MILLENIUM
LOCATION: HL93 GLULAM BRIDGE
LOCATION: CEDER BRIDGE

SHEET TITLE: TITLE

SCALE: VARIES

Gruen-Wald
Engineered Laminates, Inc

1101 N. Heritage Pkwy
TEA, SD 57064 8100
(605) 498-1290 011/CL
(605) 488-289 FAX



DATE: 08-14-14
DWN BY: LRJ
DESIGN BY:
CHK. BY:
REV:

SHEET NO.:

1/3

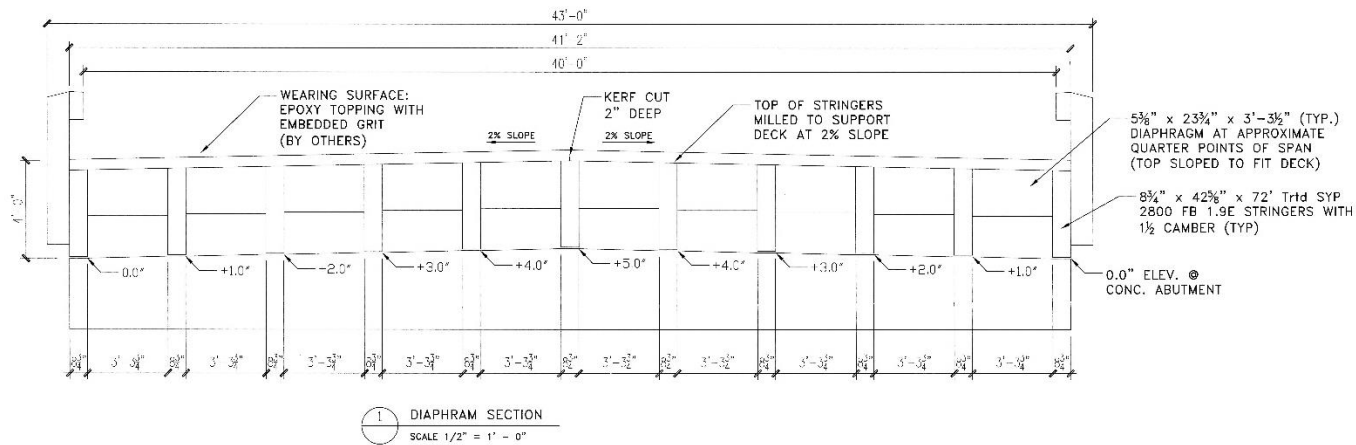
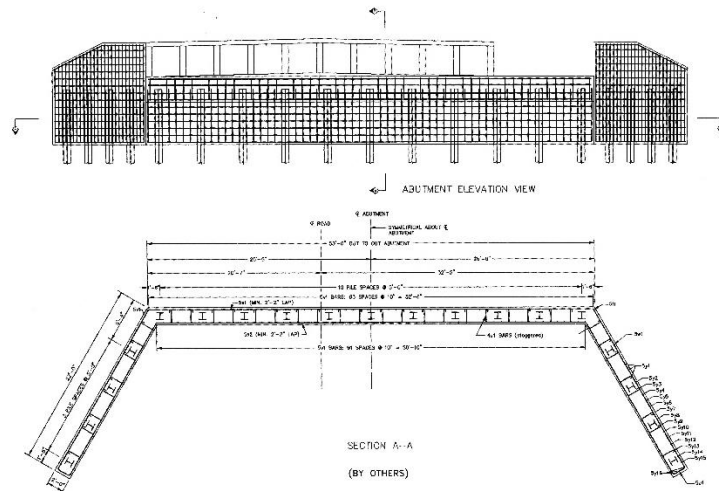

PROJECT: GRUEN-WALD MILLENIUM
 LOCATION: CEDER BRIDGE
 SHEET TITLE: ABUTMENT
 SCALE: VARIES

Gruen-Wald
 Engineered Laminates, Inc
 1101 N. Heritage Pkwy
 TEA, SD 57064-8700
 (605) 498-1290 OFFICE
 (605) 498-1299 FAX



DATE: 08-14-14
 DWN BY: LRJ
 DESIGN BY:
 CHK. BY:
 REV:

SHEET NO.:
 2/3

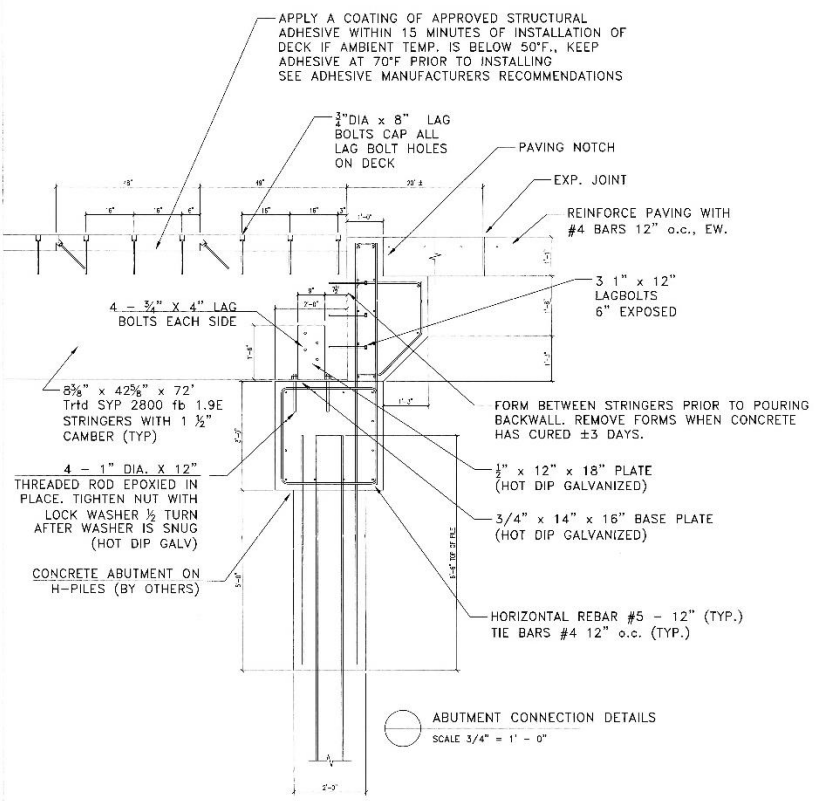
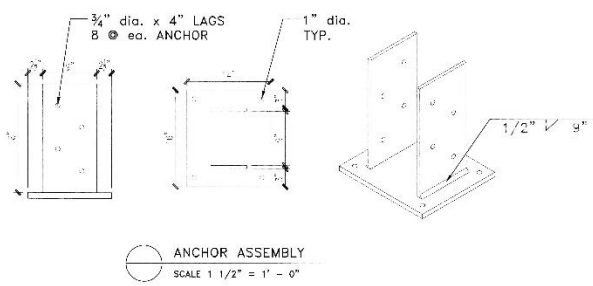
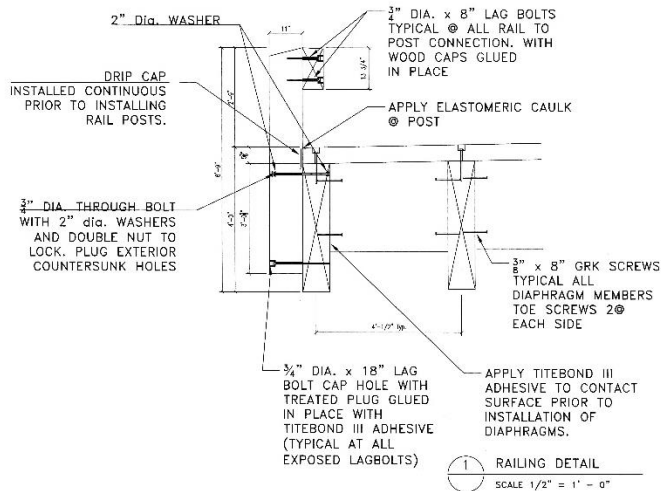

PROJECT: GRUEN-WALD MILLENIUM
GLULAM BRIDGE
LOCATION: CEDER BRIDGE
SHEET TITLE: DETAILS
SCALE: VARIES

Gruen-Wald
Engineered Laminates, Inc
1101 N. Heritage Pkwy
LLA, SD 57064-8100
(605) 498-1290 OFFICE
(605) 498-1299 FAX



DATE: 08-14-14
DWN BY: LRJ
DESIGN BY:
CHK. BY:
REV:

SHEET NO.:
3/3

APPENDIX B: FLEXOLITH LOW MODULUS EPOXY COATING AND BROADCAST

OVERLAY SYSTEM

The Euclid Chemical Company



FLEXOLITH

LOW MODULUS EPOXY COATING AND BROADCAST OVERLAY SYSTEM

EUCLID CHEMICAL

COATINGS - TRAFFIC DECK

DESCRIPTION

FLEXOLITH is a two-component, 100% solids, low modulus, moisture insensitive epoxy binder with properties which makes it suitable for use in applications where stress relief and resistance to mechanical and thermal movements are required. FLEXOLITH is formulated for low temperature applications, or where rapid cure is required.

PRIMARY APPLICATIONS

- Parking decks
- Bridges
- Factories
- Warehouses
- Loading docks
- Nosing repair applications

FEATURES/BENEFITS

- Rapid cure, minimizes down-time
- Can be used as a mortar or broadcast system
- Easy to use

TECHNICAL INFORMATION

Material Properties @ 75°F (24°C), 50% RH

Mixing Ratio, by volume (Part A:B)..... 1:1

Mixed Viscosity, cp
Brookfield Viscometer, Model RVT..... 1,700

Gel Time, ASTM C 881, Class B, min..... > 30

Tensile Strength, ASTM D 638, psi (MPa)
Final..... 2,700 (18.6)

Tensile Elongation, ASTM D 638, %..... 30 to 60

Compressive Strength, ASTM D 695, psi (MPa)
Final..... 5,000 (34.5)

Compressive Strength, ASTM C 109, psi (MPa)
(3 parts sand) mortar
@ 4 hours..... 1,400 (9.6)
@ 24 hours..... 7,040 (48.5)

Compressive Modulus, psi (MPa)..... 120,000 (827)

Flexural Strength, ASTM C 790, psi (MPa)
Final..... 5,123 (35.3)

Bond Strength, ASTM C 882, psi (MPa)
2 days..... 2,100 (14.5)
7 days..... 2,400 (16.5)

Chloride Permeability, ASTM C 1202, AASHTO T 77
Final..... < 100 coulombs

Hardness Shore D, ASTM D 2240, min..... 65

Water Absorption, ASTM D 570, 24 hr. %..... < 0.5

Thermal Compatibility, ASTM C 884..... passes

Effective Shrinkage, ASTM C 883..... passes

Appearance: FLEXOLITH is available in clear, light gray, dark gray, and tile red. Custom colors are available, but are subject to minimum order quantities.

COVERAGE

Coverage rates are for estimating purposes only. Surface temperature, porosity, and texture will determine actual material requirements.

Standard Broadcast Method: (ft ² /gal (m ² /L))	1st Coat	2nd Coat	Seal Coat
FLEXOLITH	40 to 50 (.98 to 1.23)	30 to 40 (.74 to .98)	100 to 120 (2.45 to 2.94)
Aggregate lbs/ft ² (kg/m ²)	1.2 to 1.5 (5.86 to 7.32)	1.5 to 2.0 (7.32 to 9.76)	-----
1/4" Bridge Deck Overlay: (ft ² /gal (m ² /L))	1st Coat	2nd Coat	3rd Coat HD 3/8" (9.5 mm)
FLEXOLITH	40 to 45 (.98 to 1.10)	22 to 25 (.54 to .61)	22 to 25 (.54 to .61)
Flint/Basalt Aggregate, lbs/ft ² (kg/m ²)	1.0 to 1.5 (4.88 to 7.32)	1.5 to 2.0 (7.32 to 9.76)	1.5 to 2.0 (7.32 to 9.76)
Trowel Down (mortar):	1st Coat	2nd Coat	Seal Coat
Neat FLEXOLITH (ft ² /gal (m ² /L))	200 (4.19)	-----	150 to 250 (3.68 to 6.14)
FLEXOLITH mortar @ 1/4" (6.3 mm)	-----	16 to 20 ft ² (1.49 to 1.86 m ²)	-----

**FLEXOLITH mortar consists of 1 gal (3.8 L) neat FLEXOLITH resin mixed with 2 to 3 gal (7.5 to 11.4 L) 20/40 mesh, clean & dried silica sand

FLEXOLITH

MASTER FORMAT #: 07 18 16

19215 Redwood Road • Cleveland, OH 44110
800-321-7628 t • 216-531-9596 f

www.euclidchemical.com

PACKAGING

FLEXOLITH is available in 4 gal (15 L) cases, 10 gal (38 L) units and 100 gal (378.5 L) units.

SHELF LIFE

2 years in original, unopened, properly stored package

SPECIFICATIONS/COMPLIANCES

ASTM C 881-99, Type III, Grade 1 Class B

AASHTO M 235, Type III, Grade 1

DIRECTIONS FOR USE

Surface Preparation: Concrete must be structurally sound, free of standing water, grease, oils, coatings, dust, curing compounds and other contaminants. Remove oil, grease smear and asphalt residue with trisodium phosphate or a strong detergent. For heavy oil contamination use steam cleaning in conjunction with a strong emulsifying detergent. Surface laitance must be removed. The preferred method of surface preparation is mechanical abrading. Mechanically abrade the surface to achieve a surface profile of at least CSP 4-6 in accordance with ICRI Guideline 310.2. Properly clean the profiled area.

If it is not possible to mechanically abrade, acid etch with 15% hydrochloric acid solution. Follow by pressure washing with copious amounts of water to neutralize the surface. The pH of the surface should be checked according to ASTM D 4262 after washing. Rinse thoroughly with potable water. After cleaning, repair defective concrete, honeycombs, cavities, joint cracks, voids and other defects by routing to sound material and patching as needed. Smooth precast and formed concrete surfaces must be cleaned, roughened and made absorptive by abrasive blasting or shotblasting. Following surface preparation, the cleaned surface should pull concrete when tested with an Elcometer or similar pull tester (ASTM D 4541). Before application of the coating, use the "Visqueen test" (ASTM D 4263) to evaluate moisture level in concrete. **New Concrete:** Allow to cure for a minimum of 28 days. Prepare surface as recommended above. **Old Concrete:** For a rapid cure repair, use a mortar of FLEXOLITH and clean aggregate. If portland cement repair materials are used, allow the repair to cure per the manufacturer's recommendations prior to coating. After repairing, a light brush blast is recommended prior to coating.

Mixing: Using a low speed drill motor and a "Jiffy" type mixer, mix the part A & B components separately for approximately 1 minute. **Binder:** Combine one part by volume of "A" with one part by volume of "B" and mix thoroughly for 3 minutes. Scrape the bottom and sides of mixing container, at least once. Mix just enough material that can be used within the working life. Do not aerate the mix.

Application: Broadcast Method: Apply mixed FLEXOLITH binder to the prepared surface using roller, notched squeegee or spray equipment. Eliminate any puddles with a quick light roller pass. Immediately broadcast clean, dry aggregate to full saturation until no wet spots appear. After the binder has cured, broom or vacuum excess aggregate. Repeat the procedure to build overlay thickness. For easier cleaning, an optional seal coat of FLEXOLITH may be applied. A more textured, and higher skid resistant sealed surface is obtained if FLEXOLITH LV is used as the seal coat. **Trowel-down:** FLEXOLITH mortar can be applied by trowel. Neat resin should be used as a prime coat prior to application of the mortar. **Aggregate for Skid Resistant Overlay:** The recommended aggregate for heavy duty applications (high traffic bridge decks, parking deck turn lanes, etc.) is #8 or #9 basalt, #8 or #9 flint rock, or another similarly graded non-slip aggregate containing at least 10% aluminum oxide. For other applications, or where specified, silica sand aggregate may be used.

CLEAN-UP

Clean tools and application equipment immediately after use with methyl ethyl ketone or acetone. Clean spills or drips while still wet with same solvent. Dried FLEXOLITH will require mechanical abrasion for removal.

PRECAUTIONS/LIMITATIONS

- Store at temperatures between 40°F to 90°F (4°C to 32°C). Protect from moisture and freezing.
- Do not aerate FLEXOLITH during mixing.
- If FLEXOLITH is to be exposed to chemicals contact EUCLID Technical Service for a suitable top coat.
- In cold weather applications, it is recommended that all materials used in the overlay be conditioned to at least 75°F (24°C) for at least 24 hours prior to use. Heating of the resins and aggregate will enhance cure times and improve material handling characteristics.
- In all cases, consult the Safety Data Sheet before use.

Rev. 11.14

WARRANTY: The Euclid Chemical Company ("Euclid") solely and expressly warrants that its products shall be free from defects in materials and workmanship for one (1) year from the date of purchase. Unless authorized in writing by an officer of Euclid, no other representations or statements made by Euclid or its representatives, in writing or orally, shall alter this warranty. EUCLID MAKES NO WARRANTIES, IMPLIED OR OTHERWISE, AS TO THE MERCHANTABILITY OR FITNESS FOR ORDINARY OR PARTICULAR PURPOSES OF ITS PRODUCTS AND EXCLUDES THE SAME. If any Euclid product fails to conform with this warranty, Euclid will replace the product at no cost to Buyer. Replacement of any product shall be the sole and exclusive remedy available and buyer shall have no claim for incidental or consequential damages. Any warranty claim must be made within one (1) year from the date of the claimed breach. Euclid does not authorize anyone on its behalf to make any written or oral statements which in any way alter Euclid's installation information or instructions in its product literature or on its packaging labels. Any installation of Euclid products which fails to conform with such installation information or instructions shall void this warranty. Product demonstrations, if any, are done for illustrative purposes only and do not constitute a warranty or warranty alteration of any kind. Buyer shall be solely responsible for determining the suitability of Euclid's products for the Buyer's intended purposes.

**THE INSTITUTE FOR TRANSPORTATION IS THE FOCAL POINT FOR TRANSPORTATION
AT IOWA STATE UNIVERSITY.**

InTrans centers and programs perform transportation research and provide technology transfer services for government agencies and private companies;

InTrans manages its own education program for transportation students and provides K-12 resources; and

InTrans conducts local, regional, and national transportation services and continuing education programs.



**IOWA STATE
UNIVERSITY**

Visit www.InTrans.iastate.edu for color pdfs of this and other research reports.