



**TECHNICAL REPORT 0-6859-1**  
TXDOT PROJECT NUMBER 0-6859

# A Planning Tool for Active Traffic Management Combining Microsimulation and Dynamic Traffic Assignment

Stephen D. Boyles  
C. Michael Walton  
Jennifer Duthie  
Ehsan Jafari  
Nan Jiang  
Alireza Khani  
Jia Li  
Jesus Osorio  
Venkatesh Pandey  
Tarun Rambha  
Cesar Yahia

April 2017; Published September 2018

<http://library.ctr.utexas.edu/ctr-publications/0-6859-1.pdf>



Technical Report Documentation Page

1. Report No. FHWA/TX-17/0-6859-1		2. Government Accession No.	3. Recipient's Catalog No.	
4. Title and Subtitle A Planning Tool for Active Traffic Management Combining Microsimulation and Dynamic Traffic Assignment (FHWA 0-6859-1)		5. Report Date April 2017; Published September 2018		
		6. Performing Organization Code		
7. Author(s) Stephen D. Boyles, C. Michael Walton, Jennifer Duthie, Ehsan Jafari, Nan Jiang, Alireza Khani, Jia Li, Jesus Osorio, Venkatesh Pandey, Tarun Rambha, Cesar Yahia		8. Performing Organization Report No. 0-6859-1		
9. Performing Organization Name and Address Center for Transportation Research The University of Texas at Austin 1616 Guadalupe Street, Suite 4.202 Austin, TX 78701		10. Work Unit No. (TRAIS)		
		11. Contract or Grant No. 0-6859		
12. Sponsoring Agency Name and Address Texas Department of Transportation Research and Technology Implementation Office P.O. Box 5080 Austin, TX 78763-5080		13. Type of Report and Period Covered Technical Report, 9/1/14-4/30/17		
		14. Sponsoring Agency Code		
15. Supplementary Notes Project performed in cooperation with the Texas Department of Transportation and the Federal Highway Administration.				
16. Abstract Active traffic management (ATM) strategies have been considered as a tool for congestion mitigation in the last few decades. They rely on real-time traffic observations to regulate the flow of traffic. This research focuses on developing tools for evaluating the effectiveness of ATM strategies for freeway corridors. The research efforts can be categorized into two parts. The first part performs a detailed microsimulation analysis for four ATM strategies commenting on their effectiveness under cases of recurring and non-recurring congestion and develops a hybrid microsimulation-DTA model to capture the combined microscopic and network-level impacts of an ATM strategy. The second part develops spreadsheet tools which are useful to predict effectiveness of an ATM strategy under different levels of data availability. Ramp metering, variable speed limits, and hard shoulder running are found effective on the Williamson County test network, whereas dynamic ramp control and freeway arterial coordinated operations do not lead to any significant improvement. We also find that ATM strategies can improve the performance over a corridor while simultaneously reducing the performance of frontage roads due to spillover effects. Our findings also indicate that a hybrid microsimulation-DTA model is useful for an accurate analysis. However, based on the network characteristics, changes in route choice patterns may/may not be significant. The regression models used in the spreadsheet tool in the second part provide a good fit to the simulation results and thus can be used as an initial tool for testing effectiveness of ATM strategies during planning stage.				
17. Key Words Active traffic management, dynamic traffic assignment, microsimulation		18. Distribution Statement No restrictions. This document is available to the public through the National Technical Information Service, Springfield, Virginia 22161; www.ntis.gov.		
19. Security Classif. (of report) Unclassified	20. Security Classif. (of this page) Unclassified	21. No. of pages 146		22. Price



THE UNIVERSITY OF TEXAS AT AUSTIN  
**CENTER FOR TRANSPORTATION RESEARCH**

## **A Planning Tool for Active Traffic Management Combining Microsimulation and Dynamic Traffic Assignment**

Stephen D. Boyles  
C. Michael Walton  
Jennifer Duthie  
Ehsan Jafari  
Nan Jiang  
Alireza Khani  
Jia Li  
Jesus Osorio  
Venktesh Pandey  
Tarun Rambha  
Cesar Yahia

---

CTR Technical Report:	0-6859-1
Report Date:	April 2017; Published September 2018
Project:	0-6859
Project Title:	Operational Analysis of Active Traffic Management Strategies
Sponsoring Agency:	Texas Department of Transportation
Performing Agency:	Center for Transportation Research at The University of Texas at Austin

Project performed in cooperation with the Texas Department of Transportation and the Federal Highway Administration.

Center for Transportation Research  
The University of Texas at Austin  
3925 W. Braker Lane  
Austin, TX 78759

<http://ctr.utexas.edu/>

## **Disclaimers**

**Author's Disclaimer:** The contents of this report reflect the views of the authors, who are responsible for the facts and the accuracy of the data presented herein. The contents do not necessarily reflect the official view or policies of the Federal Highway Administration or the Texas Department of Transportation (TxDOT). This report does not constitute a standard, specification, or regulation.

**Patent Disclaimer:** There was no invention or discovery conceived or first actually reduced to practice in the course of or under this contract, including any art, method, process, machine manufacture, design or composition of matter, or any new useful improvement thereof, or any variety of plant, which is or may be patentable under the patent laws of the United States of America or any foreign country.

**Notice:** The United States Government and the State of Texas do not endorse products or manufacturers. If trade or manufacturers' names appear herein, it is solely because they are considered essential to the object of this report.

## **Engineering Disclaimer**

NOT INTENDED FOR CONSTRUCTION, BIDDING, OR PERMIT PURPOSES.

## **Acknowledgments**

The authors express appreciation to the Project Manager, Wade Odell, for providing guidance throughout the project and for coordinating review of documents and update meetings with the Project Monitoring Committee, including Mohammad Al Hweil, Brian Burk, Ron Fuessel, Joseph Hunt, Charles Koonce III, Michael Pietrzyk, and David Rodrigues. Their input has been invaluable. The authors also thank the CTR staff who assisted with document preparation and project management, particularly Maureen Kelly and Ashley Savage Williams.

# Table of Contents

<b>Executive Summary .....</b>	<b>xvi</b>
<b>Chapter 1. Introduction.....</b>	<b>1</b>
1.1 Overview.....	1
1.2 Report Organization.....	2
<b>Chapter 2. Literature Review .....</b>	<b>3</b>
2.1 Speed Harmonization.....	5
2.2 Ramp Metering .....	7
2.3 Dynamic Temporary Shoulder Lane.....	8
2.4 Queue Warning.....	9
2.5 Coordinated Freeway-Arterial Operations.....	10
2.6 Dynamic Lane-Use Control.....	11
2.7 Dynamic Route Guidance/Signing/VMS.....	11
2.8 Truck Restrictions.....	13
2.9 Mainline Gap Metering.....	13
2.10 Construction Site Management.....	14
2.11 Transit Signal Priority.....	14
2.12 Summary.....	15
<b>Chapter 3. Identifying Potential ATM Strategies for Texas.....</b>	<b>16</b>
3.1 Existing ATM Deployment in Texas.....	16
3.2 Qualitative Evaluation of ATM Strategies .....	16
3.3 Testbed for Simulation Study .....	19
3.3.1 Williamson County Network .....	19
3.3.2 Available Data .....	20
<b>Chapter 4. Analysis Based on Micro-Simulation.....</b>	<b>22</b>
4.1 COM-based Microscopic Simulation Framework.....	22
4.1.1 Overview of Micro-Simulators .....	22
4.1.2 VISSIM-COM Modeling.....	23
4.1.3 Performance Measures.....	24
4.1.4 Model Calibration .....	25
4.2 Test Network Description and Calibration .....	26
4.3 ATM Strategies Microsimulation Analysis .....	29
4.3.1 Ramp Metering .....	29
4.3.2 Variable Speed Limits.....	33
4.3.3 Dynamic Lane Use Control .....	35
4.3.4 Freeway-Arterial Coordinated Operation .....	39
4.3.5 Combination of ATM Strategies (RM+VSL) .....	42
4.3.6 Conclusions.....	43
4.4 Microsimulation Analysis of Non-Recurring Congestion.....	43
4.4.1 Modeling Non-Recurring Congestion.....	44
4.4.2 Sensitivity Analysis .....	49
4.5 Conclusions.....	55

<b>Chapter 5. Analysis Based on Dynamic Traffic Assignment (DTA)</b> .....	<b>56</b>
5.1 DTA Modeling.....	56
5.2 Modeling and Calibrating Base Network in VISTA .....	58
5.3 Analysis of ATM Strategies .....	61
5.3.2 Ramp Metering .....	62
5.3.3 Variable Speed Limit .....	66
5.3.4 Dynamic Route Guidance .....	69
5.3.5 Hard Shoulder Running .....	72
5.3.6 Variable Speed Limit and Ramp Metering .....	74
5.4 Concluding Remarks.....	78
<b>Chapter 6. Analysis Based on Micro-DTA Integration</b> .....	<b>79</b>
6.1 Integration of VISSIM and VISTA .....	79
6.2 Analysis of ATM Strategies .....	82
6.2.1 Ramp Metering .....	82
6.2.2 Variable Speed Limits.....	84
6.2.3 Hard Shoulder Running .....	85
6.3 Concluding Remarks.....	87
<b>Chapter 7. Multi-scale Analysis</b> .....	<b>88</b>
7.1 Subnetwork Generation Techniques.....	88
7.2 Different Model Scales in VISTA .....	89
7.3 Modeling ATM Strategies with Varying Scales.....	91
7.3.1 Hard Shoulder Running .....	91
7.3.2 Ramp Metering .....	93
7.4 Concluding Remarks.....	94
<b>Chapter 8. Analysis of ATM Strategies under Different Data Availability Scenarios</b> .....	<b>95</b>
8.1 Software and Data Availability.....	95
8.2 Assumptions and Overview .....	96
8.3 Network Description.....	97
8.3.1 Ramp Metering .....	97
8.3.2 Variable Speed Limits.....	97
8.4 Running Simulation for Base Network of Each ATM Strategy .....	97
8.5 Regression Model for Each ATM Strategy .....	98
8.5.1 Ramp Metering .....	98
8.5.2 Variable Speed Limits.....	101
8.5.3 Dynamic Lane Use Control .....	102
8.6 Frameworks for Evaluating ATM Strategies.....	105
8.6.1 Scenario 2.....	105
8.6.2 Scenario 3.....	106
8.6.3 Scenario 4.....	106
8.6.4 Scenario 6.....	107
8.7 Concluding Remarks.....	107
<b>Chapter 9. Development of Spreadsheet Analysis Tools</b> .....	<b>108</b>
9.1 Inputs and Outputs to the Spreadsheet Tool .....	108
9.2 Preparation of Inputs.....	109
9.3 Spreadsheet Interface .....	110



9.4 Tutorial for the Spreadsheet Tool .....	112
9.4.1 Step 1: Identify location and time-period .....	112
9.4.2 Step 2: Select the candidate ATM strategy .....	112
9.4.3 Step 3: Select the segment where ATM strategy will be installed .....	113
9.4.4 Step 4: Determine data availability .....	113
9.4.5 Step 5: Prepare the inputs and use the spreadsheet tool.....	114
9.4.6 Step 6: Analyze the outputs and make conclusions .....	114
9.5 Concluding Remarks.....	115
<b>Chapter 10. Conclusion .....</b>	<b>116</b>
<b>References.....</b>	<b>119</b>
<b>Appendix A. ATM Strategy Questionnaire.....</b>	<b>127</b>

## List of Figures

Figure 2.1 A decision tree for VSL implementation (Allaby et al., 2007) .....	5
Figure 2.2 Overhead displays used along IH 5 .....	6
Figure 2.3 Increased throughput for temporary shoulder use in Germany (Mirshahi et al., 2007) .....	9
Figure 2.4 Queue warning system in Ontario, Canada (ENTERPRISE Pooled Fund Study, 2014).....	10
Figure 2.5 Dynamic message signs in Europe .....	12
Figure 2.6 Gap metering design.....	14
Figure 3.1 Williamson County network.....	19
Figure 4.1 VISSIM and MATLAB integration through COM interface .....	23
Figure 4.2 Example of graphical user interface of VISSIM-MATLAB integration.....	24
Figure 4.3 Car-following in Wiedemann’s model .....	26
Figure 4.4 Williamson County network with the highlighted segment selected for analysis.....	27
Figure 4.5 VISSIM representation of the segment selected for analysis .....	27
Figure 4.6 Plot of calibration errors in link flows for selected link IDs .....	28
Figure 4.7 Component object model (COM) interface used to model control algorithms in VISSIM.....	29
Figure 4.8 Location of ramp meters for the selected testbed .....	30
Figure 4.9 Plot of mainline travel time: ramp metering.....	31
Figure 4.10 Plot of maximum queue length on the on-ramps: ramp metering .....	31
Figure 4.11 Plot of the green ratio on the on-ramps: ramp metering.....	32
Figure 4.12 VSL control algorithm architecture (Allaby et al., 2007) .....	33
Figure 4.13 Mainline travel time with and without VSL control .....	34
Figure 4.14 Dynamic lane use: ramp merge control (Jones, et al., 2011) .....	35
Figure 4.15 Mainline travel time: ramp-based dynamic merge control.....	36
Figure 4.16 Mainline travel time measured between first two interchanges: ramp-based dynamic merge control .....	37
Figure 4.17 Average ramp queue length: ramp-based dynamic merge control .....	37
Figure 4.18 Implementation of HSR in VISSIM .....	38
Figure 4.19 Mainline travel time: HSR.....	39
Figure 4.20 Schematic representation of a CFA system.....	40
Figure 4.21 A switch control logic of freeway-arterial coordination .....	40
Figure 4.22 A CFA segment .....	41
Figure 4.23 Mainline travel time with and without VSL+RM .....	43
Figure 4.24 Location of non-recurring congestion on the network .....	44
Figure 4.25 Mainline travel time: ramp metering non-recurring congestion.....	45
Figure 4.26 Mainline travel time with VSL and non-recurrent congestion .....	46

Figure 4.27 Mainline travel time: DLUC near ramp merge with non-recurring congestion .....	47
Figure 4.28 Mainline travel time: HSR with non-recurring congestion .....	48
Figure 4.29 Mainline travel time: HSR non-recurring congestion with increased severity .....	50
Figure 4.30 Mainline travel time: HSR non-recurring congestion increased duration.....	51
Figure 4.31 Mainline travel time: HSR non-recurring congestion, upstream bottleneck.....	52
Figure 4.32 Mainline travel time: ramp metering sensitivity analysis.....	54
Figure 5.1 Overview of DTA procedure.....	57
Figure 5.2 Selected southbound IH-35 segment, with approximate locations of ramps .....	59
Figure 5.3 RMS error changes with fine-tuning calibration performed on the base network .....	60
Figure 5.4 Percentage link errors after fine-tuning calibration.....	60
Figure 5.5 The approximation process in VISTA.....	61
Figure 5.6 The locations of two ramp meters in the VISTA network .....	63
Figure 5.7 Variation of green ratios observed in VISSIM and the average value used in VISTA.....	64
Figure 5.8 Comparison of volumes for both the on-ramps before and after installing ramp meters .....	64
Figure 5.9 Comparison of the demand entering at on-ramps and exiting the network via the main lane .....	65
Figure 5.10 Comparison of travel time for vehicles using the on-ramps and the through corridor.....	65
Figure 5.11 Simulating the effects of VSL using DTA .....	67
Figure 5.12 Travel time for the corridor before and after installing VSL .....	68
Figure 5.13 Changes in link volumes for the sections where VSL is installed .....	68
Figure 5.14 VMS location and suggested alternate frontage route.....	69
Figure 5.15 VMS diverting traffic to arterials .....	71
Figure 5.16 Selected segment for the analysis: (a) hard shoulder implementation location in VISTA modeled as lane closure; (b) output of the VISSIM implementation of HSR.....	73
Figure 5.17 Change in volume-to-capacity ratio of the section after installing HSR.....	74
Figure 5.18 Time-dependent volumes on links with VSLs .....	74
Figure 5.19 Select link analysis before and after implementing ramp metering and VSL.....	77
Figure 6.1 Iterative procedure used for developing the hybrid model.....	80
Figure 6.2 Multi-resolution network modeling in VISTA and VISSIM .....	82
Figure 6.3 Average travel time on corridor in VISSIM.....	83
Figure 6.4 Speed limit variation and the travel time variation in VISSIM: (a) speed control output obtained from VISSIM, which is for the same for both iterations, (left) and (b) average travel time variation over the corridor (right) .....	84
Figure 6.5 Main lane travel time in VISTA and VISSIM.....	85
Figure 6.6 Average travel time in VISSIM for the HSR case .....	86

Figure 7.1 Scale 2 and 3 network: (a) Scale 3 network and (b) Scale 2 network .....	90
Figure 7.2 Scale 1 network .....	90
Figure 7.3 OD demand variation for HSR on the selected corridor for each of the three scales .....	91
Figure 7.4 Control strategy output: (a) control strategy output obtained after convergence; (b) occupancy reading for the HSR control detector for each of the three scales .....	92
Figure 7.5 Average travel time (in sec) along the main lanes for each of the three scales.....	92
Figure 7.6 OD demand variation after ramp metering for each of the three scales.....	93
Figure 7.7 Average travel time (in sec) along the main lanes for each of the three scales.....	94
Figure 8.1 Ramp metering base network for developing regression models.....	97
Figure 8.2 VSL base network for developing regression models.....	97
Figure 8.3 Percent change in corridor travel time compared to base case for ramp metering algorithms .....	99
Figure 8.4 Average on-ramp queue length compared to base case for ramp metering algorithms .....	99
Figure 8.5 Percent change in corridor travel time compared to base case for VSL algorithms .....	101
Figure 8.6 Percent change in corridor travel time compared to base case for dynamic merge control .....	103
Figure 8.7 Percent change in corridor travel time compared to base case for HSR .....	104
Figure 8.8 Abstract network used to model route choice impacts for the ramp metering case.....	106
Figure 8.9 Abstract network used to model route choice impacts for VSL case.....	106
Figure 9.1 Welcome screen of the spreadsheet tool .....	110
Figure 9.2 The screen prompting the user to choose one among three cases under the ramp metering strategy .....	111
Figure 9.3 Screen showing the no-data case for VSLs with separate regression models for both control algorithms .....	112
Figure 9.4 Abstraction of selected segment as a single entrance/exit pair ramp-metering network .....	113

## List of Tables

Table 2.1: Summary of commonly used ATM strategies .....	3
Table 3.1: Selection of planned and deployed ATM strategies in Texas .....	16
Table 3.2: SWOT analysis of ATM strategies.....	18
Table 4.1: Network performance: ramp metering.....	32
Table 4.2: VISSIM network performance with and without VSL control .....	34
Table 4.3: Network performance: HSR .....	39
Table 4.4: Network performance: freeway-arterial coordinated operation with recurrent congestion .....	42
Table 4.5: Network performance: ramp metering (RM) and VSLs combined .....	42
Table 4.6: Network performance: ramp metering (non-recurring congestion).....	45
Table 4.7: Network performance: VSL non-recurring congestion .....	46
Table 4.8: Network performance: DLUC near ramp merge with non-recurring congestion.....	47
Table 4.9: Network performance: HSR with non-recurring congestion.....	48
Table 4.10: Network performance: FACO with non-recurring congestion.....	49
Table 4.11: Network performance: HSR non-recurring congestion with increased severity .....	50
Table 4.12: Network Performance: HSR non-recurring congestion increased duration .....	51
Table 4.13: Network performance: HSR non-recurring congestion, upstream bottleneck.....	52
Table 4.14: Network performance sensitivity analysis—ramp metering (RM) .....	53
Table 5.1: Approximating ATM strategies in VISTA .....	62
Table 5.2: Network effects of VMS.....	70
Table 5.3: Travel time on corridor for different rerouting fractions.....	70
Table 5.4: Network effects of diverting traffic to arterials .....	71
Table 5.5: Travel times on main lanes after diverting traffic to arterials .....	72
Table 6.1: Approximation of ATM strategies in VISTA.....	81
Table 6.2: RMS value for the change in OD matrix from VISTA for ramp metering .....	82
Table 6.3: VISSIM and VISTA results for ramp metering.....	83
Table 6.4: Network-level system travel time (in hours) from VISTA.....	83
Table 6.5: RMS values of OD demand for VSL case.....	84
Table 6.6: RMS values for OD demand with HSR.....	85
Table 6.7: Status of hard shoulder with time for different iterations.....	86
Table 6.8: Change of total system travel time (in hours) across iterations.....	86
Table 7.1: Network statistics for the three scales in VISTA.....	89
Table 7.2: Average green ratios used in VISTA for different scales.....	93
Table 8.1: Different scenarios based on the level of data availability for recurring congestion .....	95

Table 8.2: Different scenarios based on the level of data availability for recurring congestion .....	96
Table 8.3: Control algorithms for ATM strategies considered and the inputs for which the base network was run.....	98
Table 8.4: $R^2$ values for ramp metering regression models .....	100
Table 8.5: $R^2$ values for VSL regression models .....	102
Table 8.6: $R^2$ values for dynamic merge control regression equations.....	104
Table 8.7: $R^2$ values for hard shoulder running regression equations.....	105
Table 9.1: Spreadsheet inputs for the ramp metering case analysis .....	109

## **List of Acronym and Abbreviations**

ATM	active traffic management
CAMPO	Capital Area Metro Planning Organization
CFA	coordinated freeway-arterial
COM	Component Object Model
DLUC	dynamic lane use control
DTA	dynamic traffic assignment
FACO	freeway-arterial coordinated operation
FHWA	Federal Highway Administration
GPS	global positioning system
HOT	high-occupancy toll
HOV	high-occupancy vehicle
HSR	hard shoulder running
ITS	intelligent transportation system
MoE	measure of effectiveness
OD	origin-destination
RMS	root mean square
SWOT	strength, weakness, opportunities, and threats
TSP	transit signal priority
VMS	variable message sign
VSL	variable speed limit
Wilco	Williamson County

## Executive Summary

Active traffic management (ATM) strategies are increasingly being considered a valuable tool to mitigate recurring and non-recurring congestion in urban areas. The increase in data availability and the advancement in models available to understand the current transportation systems have opened opportunities to study the effectiveness of ATM strategies in an informed way. This research provides a framework for analyzing the effectiveness of ATM strategies while considering both the corridor and network-level traffic impacts.

This study aims to answer two primary research questions:

1. How can the effectiveness of the ATM strategies be tested at a combined micro-simulation and network level—prior to implementation—using mathematical models that capture traffic flow dynamics and driver behavior?
2. How can the predictions on effectiveness be made under varying levels of data availability?

To answer the first question, the research team focused on developing a hybrid model for capturing the microsimulation and network-level impacts of ATM strategies. Our efforts consisted of two parts. The first part developed a COM-enabled microscopic traffic simulator capable of simulating advanced control logic, real-time sensing, and data acquisition processes with high resolution. The microsimulation model considered the impact of ATM strategies on frontage roads parallel to the freeway and models both recurring and non-recurring congestion. The second part developed a hybrid microsimulation-dynamic traffic assignment (DTA) model by approximating the impacts of ATM strategy from VISSIM in a DTA software, VISTA. The hybrid model can capture the corridor level impacts caused by vehicle-to-vehicle interactions in a microscopic setting and the network-level impacts in terms of the shift in route choice patterns of travelers over the long term in a DTA setting. The two models were integrated in an offline manner by an iterative procedure where one model provides input to the other and vice versa until convergence is achieved. A detailed microsimulation analysis was performed for four ATM strategies under recurring and non-recurring congestion patterns: ramp metering, variable speed limits, dynamic lane-use control (control near ramp merge and hard shoulder running), and freeway-arterial coordinated operations. A combination of ramp metering and variable speed limit was also analyzed against using the individual strategies alone. For hybrid DTA-microsimulation analysis three ATM strategies were examined in detail under recurring congestion patterns: ramp metering, variable speed limits, and hard shoulder running.

Following are the major findings pertaining to the first research question:

- For the recurring congestion scenario, ramp metering, variable speed limits, and hard shoulder running were found to improve the corridor travel time and network performance for the selected testbed. Certain control algorithms and their parameters were found to show an improvement of 5 to 16% in the system delay. The percent change for dynamic lane-use control near ramp merge and freeway-arterial coordinated operations was found insignificant.
- Ramp metering and variable speed limit led to a reduction in corridor travel time when combined, in comparison to the isolated use of each individual strategy.



However, the overall network performance decreased when the strategies were used in combination.

- For the non-recurring congestion scenario, all strategies led to a worse network performance as compared to the case without the strategy—except for variable speed limits, which showed a 27.2% reduction in system delay and freeway-arterial coordinated operations, creating a 15% reduction in system delay. The sensitivity analysis for hard shoulder running and ramp metering indicated that performance of these ATM strategies under non-recurring congestion depends on the location, severity and the duration of the incident. Specifically, hard shoulder running improved network performance when it was implemented at the location of the bottleneck instead of upstream of the bottleneck.

In terms of network-level impacts, the shift in route choice patterns caused by each ATM strategy was found insignificant. Ramp metering and variable speed limits were found to increase the total system travel time for the network; however, the effects on corridor congestion were marginal. The iterative microsimulation-DTA procedure in the hybrid model was found to converge in two to three iterations for each ATM strategy and produce consistent results from both its sub models.

The second research question was answered by developing a framework capable of making decisions on the effectiveness of ATM strategies for varying levels of data availability at both network and microscopic levels. We considered the following four cases for recurring congestion:

- The **no-data case** assumes that the agency has no data available to build or calibrate either a microsimulation or a DTA model.
- The **microsimulation-only case** assumes that the agency has real-time data available to build and calibrate the microsimulation model but has no data available to develop a DTA model.
- The **DTA-only case** assumes that the agency has access to strategic data to build a DTA model but has only limited access to the real-time data required to build a microsimulation model.
- The **microsimulation-DTA case** assumes that the agency has data available to build and calibrate the hybrid model.

For non-recurring congestion only the first two cases were considered, as the network-level shifts in route choices are insignificant under occurrences of incidents or short-term work zone delays. Regression models were developed to provide a measure of the impact of the ATM strategies under different levels of data availability. The regression models were derived by running multiple simulations on an abstract network of the corridor. The concept of artificial links was used to model the shift of travelers away from or towards the corridor with changes in corridor travel time. For the second question, three ATM strategies were considered: ramp metering, variable speed limits, and dynamic lane-use control.

Our findings indicate that the regression models provide a good fit to the simulation results and thus can be used as a planning tool for preliminary analysis of the effectiveness of ATM strategies. The spreadsheet tool (published as 0-6859-P1) includes two control algorithms for each ATM strategy.

The results from the analysis have several implications. First, the impacts of ATM strategies are observed beyond the freeway facility. For instance, an ATM strategy that shows a significant improvement in the mainline travel time, may lead to a worsened performance over the entire corridor including the frontage roads. The impact is also different under cases of recurring and non-recurring congestion. The location and severity of the bottleneck also impacts the success of the ATM strategy. This requires the agency deploying the ATM strategies to carefully consider the objective, scope and choice of ATM strategy and its control algorithm before its deployment. Second, for accurate evaluation of the effectiveness of ATM strategies it is desirable to consider both microscopic and network-level impacts, and this necessitates the integration of high-fidelity microsimulation and traffic assignment models. The hybrid model proposed in this research is one way of developing the integration. As shown in the first part of the research, the results predicted by individual models may differ and thus an integrated modeling is important for accurate analysis. Third, the network-level impacts of an ATM strategy beyond the corridor may or may not be significant for a given network. The propensity of travelers to change their current route depends on the attractiveness of the alternate routes. A careful analysis of travel time and capacities on all alternate routes to the selected corridor is thus recommended, even if the agency only develops a microsimulation model for the evaluation of ATM strategy. And last, generalizing the effectiveness of an ATM strategy from one simulation result to the other should be treated with caution. This is because the usefulness of an ATM strategy depends on several factors including corridor geometry, control algorithm, choice of location, and coordination between the strategies. Thus, the decisions derived from the regression models should only be used for preliminary planning purposes or for multiple scenario analysis. Before actual deployment of the ATM strategy, the research team recommends building a microsimulation model of the corridor for an accurate analysis of the impacts.

# Chapter 1. Introduction

## 1.1 Overview

With increasing levels of congestion on freeways and arterials, growing demand for travel, and financial and land use constraints that prevent infrastructure expansion, it is imperative that we manage roadway traffic in an efficient way. Such management has been made possible thanks to the emergence in the recent decades of intelligent transportation system (ITS) technologies that enable the design of operational strategies that function in real time and respond to current traffic, incident, and weather conditions.

The Federal Highway Administration (FHWA) defines active traffic management (ATM) as practices that manage recurring and non-recurring sources of congestion in a dynamic manner as a function of prevailing traffic conditions (Mirshahi et al., 2007). Recurring congestion is periodic and predictable and is caused by higher demand for travel during peak periods and by bottlenecks in the network. On the other hand, non-recurring congestion is less predictable and is caused by inclement weather or traffic incidents. Both these forms of congestion affect the level of service and result in delays that have far-reaching economic consequences. The goal of ATM strategies is to mitigate recurring and non-recurring congestion by using real-time data from the field and enabling operational strategies that communicate with the drivers via signals or messages to ensure a smoother flow of traffic.

ATM strategies are widely deployed around the world. Several agencies have implemented multiple ATM strategies that are designed to work in a coordinated manner. From a planning perspective, the decision to deploy ATM strategies poses two key challenges:

1. Of the wide variety of control strategies available, which are the subsets of control strategies that are best suited for an application?
2. How can the effectiveness of these strategies be tested at a network level—prior to implementation—using mathematical models that capture traffic flow dynamics and driver behavior?

An important component in the first challenge is to understand the infrastructure and data requirements of different ATM strategies. Addressing the second challenge is more critical, as deployment of a strategy often requires significant financial investments. Studying the effects at a local level (for instance, a single stretch of a freeway) might yield positive results, but the network-wide effects also need to be considered, as an ATM strategy might be effective at a local level but can worsen the performance elsewhere in the network. Thus, conducting a network-wide study with the right modeling tools is necessary to understand the impacts of ATM strategies.

This project sought to answer these questions and develop tools that can be used to assess the operational effectiveness of an ATM strategy for a freeway corridor. This was achieved by categorizing the research efforts into two broad areas: 1) developing hybrid models for corridors with ATM strategies that can capture the microscopic and network-level impacts, and 2) creating tools that can help a planning agency make decisions about ATM strategies at different levels of data availability. Chapters 3 through 7 focus on the first research question, while Chapters 8 and 9 focus on the second research question.

## **1.2 Report Organization**

This report is organized as follows. In chapter 2, we provide a comprehensive literature review of major ATM strategies focusing on their advantages, deployment criteria, and data requirements. In chapter 3, we describe the process of identifying a simulation testbed in Texas and narrowing down the ATM strategies to a short list, considering their feasibility, cost-effectiveness, and potential. In chapter 4, we present the analysis of ATM strategies using microscopic traffic simulation. In chapter 5, we present the analysis of ATM strategies using dynamic traffic assignment (DTA), a widely used tool to assess network-level impacts in dynamic settings. Chapter 6 describes an analysis leveraging microsimulation and DTA that was conducted and the hybrid model developed. In chapter 7, we analyze the impact of varying network scales on the predictions of the hybrid model developed in the previous chapter. Chapter 8 presents the development of the analysis tool at different levels of data availability in form of regression equations. Chapter 9 describes the spreadsheet-based tool and provides a tutorial for its use by a planning agency. The report in chapter 10 concludes with a highlight of key findings and scope of future work.

## Chapter 2. Literature Review

In this chapter, the literature on existing ATM strategies is reviewed. Specifically, for each of the existing ATM strategies, we survey its operational characteristics, its working methodology and data requirements, examples of some actual deployments, and challenges encountered with the ATM strategy in practice. Table 2.1 summarizes the role of different ATM strategies in improving the network conditions and their data requirements. The details are discussed in subsequent sections.

**Table 2.1: Summary of commonly used ATM strategies**

	<b>Potential Safety Benefits</b>	<b>Mobility Benefits</b>	<b>Action Range</b>	<b>Usually Coordinated with</b>	<b>Data Requirements/ Infrastructure Needs</b>
<b>Variable Speed Limits (VSL)/ Dynamic Speed Limits/Speed Harmonization</b>	Increases safety by reducing speed differences between lanes; reduces accidents in bad weather conditions	Harmonizes traffic by reducing propagation of shock waves; enhances road occupancy and flow on a roadway	Typically implemented on freeways and corridors with ramps; cooperative and connected VSL systems perform better	Ramp metering; hard shoulder running (HSR); queue warning; dynamic lane-use control in work zones	Traffic volume data, speed measurements on each lane, incident-detection equipment and weather data
<b>Ramp Metering</b>	Accident rates are reduced as total no. of merging vehicles are restricted	Maximizes throughput by delaying onset of flow breakdown;	Applied on freeway on-ramps with or without dedicated lanes for ramps	VSL; mainline gap metering; transit signal priority	Traffic volume measurements (using loop detectors) on main freeway, queue-length detectors on the ramp
<b>HSR/ Temporary Shoulder Running</b>	Doesn't affect road safety	Addresses capacity bottlenecks on the freeway network; delays onset of congestion	Typical on freeway/multi-lane highways with required width and quality of hard-shoulder	VSL; dynamic warning signs; transit priority	Same as VSL; closed-circuit television (CCTV) viewing for checking road blockage
<b>Dynamic Merge/Junction Control</b>	Same as ramp metering	Same as ramp metering	Applied where the number of downstream lanes is fewer than upstream lanes at the merge point	Ramp metering; mainline gap metering	Same as ramp metering

	<b>Potential Safety Benefits</b>	<b>Mobility Benefits</b>	<b>Action Range</b>	<b>Usually Coordinated with</b>	<b>Data Requirements/ Infrastructure Needs</b>
<b>Queue Warning</b>	Reduces secondary incidents caused by either recurrent or non-recurrent congestion; reduces severity and frequency of accidents	Results in closer headways, uniform driver behavior and overall safer driving	Same as VSL	VSLs; dynamic signing and re-routing	Traffic volume detectors, queue length detectors
<b>Coordinated Freeway-Arterial Operations</b>	Can help divert traffic on to arterials during incidents or inclement weather	Reduces delay and increases throughput on freeways and adjacent arterials	Freeways, frontage roads, and arterials	Ramp metering; dynamic route guidance	Traffic volumes on freeways and on/off ramps and near intersections on neighboring arterials; real-time incident and weather conditions
<b>Dynamic Route Guidance/ Dynamic Signing</b>	Warns and Informs the driver of the impending changes, and thus reduces human factor in causing accidents	Presents information about different routes and thus influences driver behavior towards less congested roadways	Freeways, frontage roads, and arterials	VSL, queue warning, coordinated operations,	Traffic volume and speed data, incident, and weather information
<b>Dynamic Lane-Use Control</b>	Helps travelers evacuate in the event of an emergency	Increases roadway capacity and travel time reliability	Freeways	Temporary shoulder running	Traveler demand on different directions of a freeway
<b>Mainline Gap Metering</b>	Can reduce rear end and side swiping crashes as merging is smoothly facilitated	Reduces system-wide delay by reducing delay for vehicles on on-ramps	Merging sections on freeways	Ramp metering	Loop detectors and signage to inform the gap that needs to be maintained
<b>Truck Restrictions</b>	Enhanced mobility for general traffic	Safer operations on lanes prohibited for truck operations	Freeways with larger heavy-vehicle proportion	VSL; HSR	Heavy-vehicle composition data; same data as VSL to decide speed limits

## 2.1 Speed Harmonization

Speed harmonization, also referred to as *variable speed limits (VSL)* or *dynamic speed limits*, is a commonly used strategy to enhance the safety and mobility on freeways and higher order roadways. Speed harmonization has two primary benefits: enhancing safety by reducing speed differentials between lanes (especially during congestion and during extreme weather conditions), and enhancing mobility by tackling shock-wave propagation due to internal disturbances in traffic streams and by increasing usage of roadway capacities. As an extension to those benefits, speed harmonization is beneficial in postponing or preventing the onset of congestion, enhancing freeway throughput, and reducing vehicular pollution.

The working mechanism of VSL involves control algorithms that are primarily governed by the volume on the roadway, and current speed measurements. Figure 2.1 shows one possible control measure.

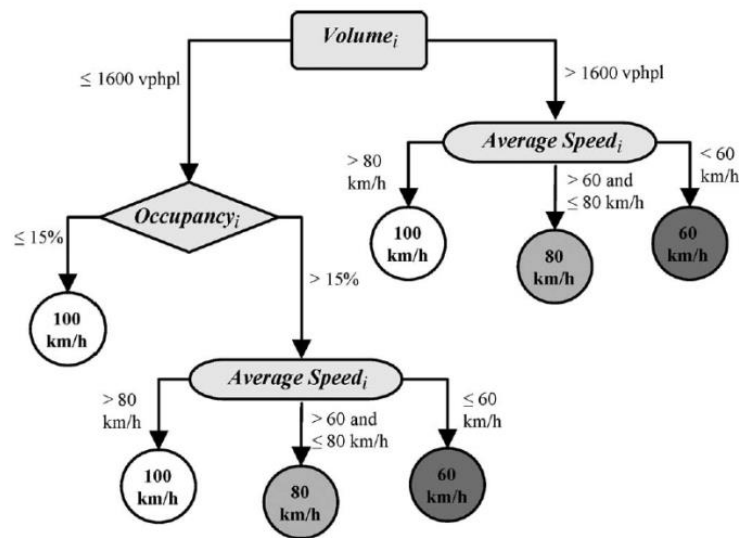

Figure 2.1 A decision tree for VSL implementation (Allaby et al., 2007)

If varying speed differentials are observed between lanes, and/or if volumes increase above a threshold, the speed limits are reduced. The typical way of implementing speed harmonization is to lower the speed limits during the congestion to reduce the inflow of vehicles from the upstream and ensure uniform dissipation of vehicles downstream. However, in some cases, if traffic volumes are low and the occupancy of road is not uniform, speed harmonization with higher speed limits is employed to bring uniformity across space. Figure 2.2 provides an example of overhead speed limit displays.



*Figure 2.2 Overhead displays used along IH 5*

Congestion occurring during peak hours often extends on longer road stretches and in such cases standalone VSL implementations fail to perform well. A network-wide VSL system accounts for this issue by ensuring that many VSL systems function together by linking through a control algorithm, thus addressing congestion on a larger scale. Grumert (2014) describes examples of connected VSL systems being employed in Europe, including the Motorway Control System in Sweden and the Netherlands, and the M-25 controlled motorway in the UK. Development of connected and cooperative VSL systems is a growing area of research. Grumert (2014) compares different algorithms that enhance the objectives of speed harmonization.

Practical implementations of speed harmonization have shown positive results in several European countries and US states. Metz et al. (1997) present a case study for controlled highways in Germany where speed harmonization resulted in a 14 to 34% lower injury rate per vehicle-km. VSLs could reduce crash potential by 5 to 17% by temporarily reducing the speed limits during risky traffic conditions (Lee et al., 2006). Nezamuddin et al. (2011) describe several speed harmonization projects that have enhanced safety on roadways. Key observations from their research include the following:

- Reduction in speeds, more compliance with traffic laws, and reduced injury accidents were observed for the M-25 motorway project in the UK;
- Significant impact on driver behavior was reported for a large majority of 1300 surveyed drivers on the A2 Motorway in the Netherlands;
- VSL systems deployed in work zones in Michigan led to the conclusion that VSL adds more utility for longer duration and simpler work zones; and
- A 50% decrease in the number of serious speed drops (a measure of the instability of traffic flow) was observed in the Utrecht and Rotterdam implementation of a VSL system.

Research studies have also justified the benefits of VSL systems in theory. Heydecker (2011) analyzed how traffic flow modeling is influenced by VSLs and showed through an example on UK motorways that VSL-equipped roadways experience enhanced throughput and increased flow. Geistefeldt (2011) showed that the main effect of VSLs is a significantly reduced variance of the capacity distribution function, i.e., VSLs lead to lower risk of traffic breakdown at moderate volumes.



The elements making VSL implementation a success include well-maintained infrastructure with relatively dense ITS deployment, strict and efficient enforcement strategies, and appropriate choice of the speed-control algorithm. Several studies in literature discuss different types of control strategies for VSLs and most of these are threshold-based controls. Grumert (2014) analyzes different control strategies, highlighting that the objective chosen for the algorithms has a decisive influence on the effects of the VSL system and that choice of a suitable algorithm is dependent on roadway traffic characteristics.

## 2.2 Ramp Metering

Arbitrary introduction of vehicles from on-ramps onto freeways leads to adjustment of headways of mainstream traffic (especially if their concentration is high). This adjustment leads to a series of braking vehicles; if vehicles continue to join the junction point, the freeway speed is reduced until the flow breaks down, leading to “phantom jam.” Controlling flow from the on-ramp onto a freeway facility reduces the possibility of flow breakdown by breaking up platoons of merging vehicles and by delaying the onset of congestion. Ramp metering restricts the flow by controlling the rate of entry of vehicles from an on-ramp.

Ramp metering relies on measurement of traffic conditions (loop detectors) on the main carriageway and attempts to maintain these at a target occupancy by restricting the flow from the on-ramp. Queue management systems (queue-length detectors) are also installed on slip roads to ensure that the queues do not interfere with local traffic. Two major criteria that are analyzed for installing a ramp meter at a location are traffic characteristics (velocity drop on the main road, volume on ramps, and higher values of combined flows) and physical characteristics (ramp geometry, optimal placement of stop-line) (UK Highway Manual).

Nezamuddin et al. (2011) summarize the safety benefits of several US implementations of ramp-metering projects as follows:

- A survey of traffic management centers in 1995 reported 15 to 50% reduction in accidents on freeway systems.
- Minneapolis/St. Paul freeways were tested for the impacts of shutting down extensive ramp-metering systems for a 6-week evaluation period, and the impacts on system were adverse, with around 26% increase in crashes, 14% reduction in peak period throughput, and 7% reduction in freeway speeds.
- Speed increase, reduction in accidents, and drop in injuries were observed as part of ramp-metering implementation in the Denver metering system (Colorado); Michigan DOT Surveillance and Driver Information System (SCANDI); IH-5 commuter route in Portland, Oregon; and the Washington DOT’s FLOW program of implemented metering on IH 5.

Ramp metering projects in Europe have been successful as well. Mirshahi et al. (2007) highlight a pilot project on the A40 motorway Germany that led to a 50% reduction in congestion during peak hours and a 40% decrease in incidents on ramps. A capacity increase of up to 5% has been observed on general-purpose lanes in the Netherlands, apart from the usual benefits such as an increase in motorway speeds and fewer incidents. A similar pilot project on the M6 motorway near Birmingham, England, which saw an increased vehicular flow (5%) and increased speeds (14 to 18%), has led to expansion of multiple ramp-metering projects across England.

Some emerging trends in usage of ramp metering include its integration with other ATM strategies. Dynamic sign usage allows for changes in the number of vehicles sent per cycle (Mirshahi et al., 2007). Integration with VSLs has been studied as a model predictive control method by Hegyi et al. (2005), which highlights how a predictive control can employ VSLs to maintain higher outflow even when ramp metering is unable to address congestion. Research on the types of algorithm used for local ramp metering strategies study the decisions on volume sent from a ramp in the next time interval as a function of total facility volume in the previous time interval and the density of a downstream link (Papageorgiou et al., 1997).

### **2.3 Dynamic Temporary Shoulder Lane**

Dynamic shoulder lanes are predominantly used to enhance the roadway capacity using the existing infrastructure. Also referred to as *peak-period shoulder lane usage* or *hard shoulder running (HSR)*, dynamic shoulder lanes allow usual traffic operations for normal traffic during peak periods on hard shoulders wide enough to accommodate vehicles of a certain size. Dynamic signs are used to indicate when the shoulder lane usage is operational.

By allowing vehicles to travel on shoulders, which are narrower than the usual lanes and with shoulders losing their function for providing safety, this practice is usually accompanied with lower speed limit operations (coupled with speed harmonization), restriction of special types of vehicles on shoulders, and restricted overtaking maneuvers.

Several US cities are currently employing this strategy to increase peak-period capacity on congested freeways, including Washington, D.C., Boston, Minneapolis, and Southern California. Minneapolis allows freeway shoulder lanes to be used only by transit buses during certain periods of day, promoting transit usage. Mirshahi et al. (2007) highlight some implementations of the same in different European countries. Hessen, Germany, implemented shoulder lane use as part of its integrated ITS, monitoring traffic volumes and making the shoulder lane accessible when a certain threshold is crossed. A 20% increase in capacity was observed. In the Netherlands, temporary right shoulder lane use, also referred as *rush hour lanes*, was observed to increase the overall capacity by 7 to 22%, and the traffic volumes up to 7% during congested periods (Mirshahi et al., 2007). Figure 2.3 shows the delay in the onset of congestion by the addition of the third lane in the form of temporary shoulder use. It also increases the overall throughput on the facility (Mirshahi et al., 2007).

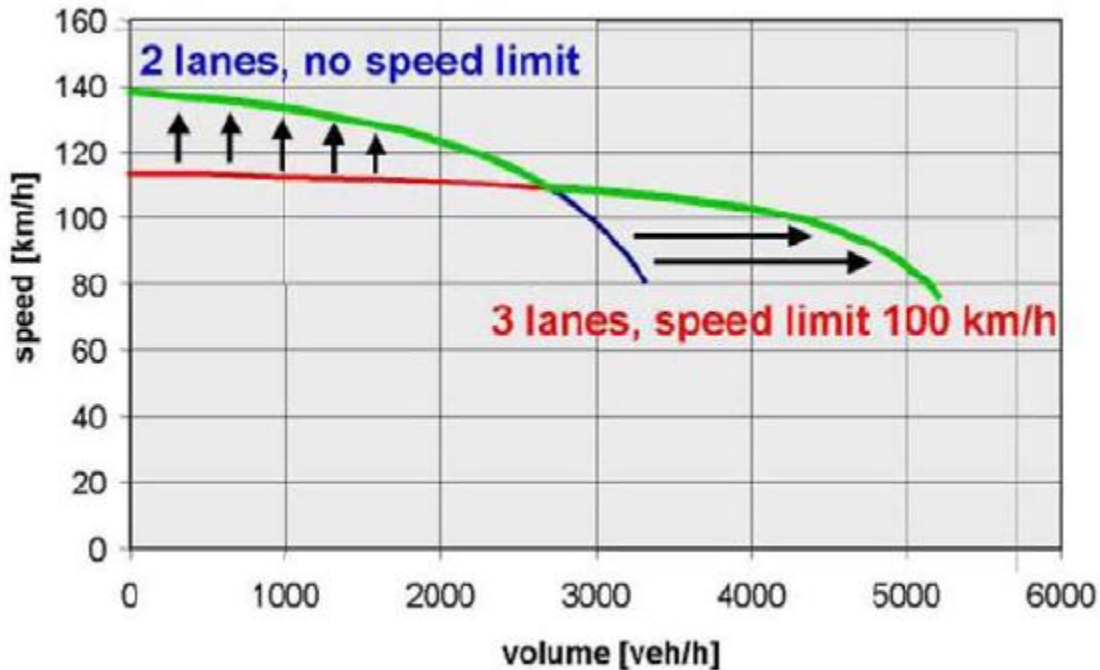

Figure 2.3 Increased throughput for temporary shoulder use in Germany (Mirshahi et al., 2007)

Implementation of shoulder use involves analysis of design and superelevation of the shoulder, which should be continuous and have design capability for repeated traffic loading. For a successful implementation, temporary shoulder usage comes coupled with lane-control signals, dynamic speed limit signals, dynamic message signs, CCTV cameras, roadway sensors, and emergency roadside telephones (Sisiopiku et al., 2009). When allowing shoulder use, lay-by and emergency refuge areas must be created for disabled vehicles. Geistefeldt (2012) shows that truck drivers have higher willingness to use the hard shoulder as a normal lane compared to passenger car drivers. Accident statistics in the same study suggested that temporary HSR does not affect road safety.

## 2.4 Queue Warning

In a queue-warning system ITS equipment is used to detect the formation of queues and warn the upstream traffic. Drivers, when warned, can expect upcoming situations that require emergency braking or slowing down, and thus tend to avoid queuing-related collisions. This strategy relates closely with dynamic signing, and involves the use of flashing lights and speed signs activated on the VSL signs. It is intended primarily to help reduce secondary incidents caused by either recurrent or non-recurrent congestion. It also helps delay the onset of congestion and yields environmental benefits through reduced emissions.

Mirshahi et al. (2007) describes a pilot study of queue warning on Motorway A8 in Germany between Stuttgart and Ulm, which resulted in “fewer accidents, reduced severity of accidents, considerable reduction in high travel speeds combined with a strong harmonization of all driving speeds, closer headways, more-uniform driver behavior, a slight increase in capacity, and overall safer driving.” The Motorway Control and Signaling System in the Netherlands, first deployed in 1981, provides warning for queues that result due to lane closures near incidents and

work zones. It has been observed to best trigger the system when the mean speed is reduced below a certain threshold (ENTERPRISE Pooled Fund Study, 2014).

The queue warning system on IH 610 West in Houston was reported to result in increased average speeds and reduced crash causing speed variances among lanes (Texas Transportation Institute, 2016). Queue warning systems in work zones alert drivers of traffic conditions ahead primarily to reduce the number and severity of rear-end crashes. Number of reported incidents was reduced by 66% after deploying a queue warning system in San Diego, California, and by 13.8% for a queue warning system in Madison County, Illinois (ENTERPRISE Pooled Fund Study, 2014). Notable reduction in rear-end collisions and increased safety was also observed in the Highway 402 queue warning system in Ontario (Figure 2.4).



Figure 2.4 Queue warning system in Ontario, Canada (ENTERPRISE Pooled Fund Study, 2014)

## 2.5 Coordinated Freeway-Arterial Operations

Freeways and arterials have long been managed by different agencies. While freeways are operated by state DOTs, arterials are operated by cities or counties. These organizations usually have different goals and objectives in managing traffic. However, travelers view freeways and arterials as a single entity in making travel related decisions. Thus, in order to obtain system-wide savings in mobility and safety, coordinated freeway-arterial (CFA) operations involve strategies that tackle freeways and neighboring arterials as a single corridor with a common objective and not as separate facilities. These strategies typically include coordinating signal timings on arterials, ramp metering or closures, and dynamic route guidance mechanisms. They are used to address both recurring and non-recurring sources of congestion and are implemented during peak hours, work zones, special events, and traffic incidents.

One key challenge in CFA operations is for agencies to work together and exchange data from road weather information systems, sensors, and surveillance cameras. A successful CFA operation requires integrating systems and personnel among institutions and sharing funds. Very few studies in literature have quantified the benefits of CFA operations at a system level. Simulation studies by the Virginia DOT, which handles the freeway and arterial operations in Springfield, Virginia, show improvements in throughput and delay for traffic being diverted off a freeway if the signals on the arterials are coordinated accordingly (Urbanik et al., 2006). A few

other studies simulated ramp metering and dynamic message signs in Anaheim, California (Logi et al., 2001) and San Antonio, Texas (Carter, 2000). A significant decrease in travel time (2–30%) in the first case study and delay reduction of 19% (compared to 16% if only freeways were managed) were found in the second case. In Seattle, Washington, simulations that integrated arterial and freeway advanced traveler information systems were found to reduce delay by 3.4% when compared with a 1.5% delay reduction if only freeways were considered (Wunderlich and Larkin, 1999). Simulation models using DYNASMART (Mahmassani et al., 1998) for the Dallas/Ft. Worth region found that coordinating signal timing of diamond and other arterial intersections along with route guidance could contribute to a 20 to 40% savings in travel time for all vehicles.

## **2.6 Dynamic Lane-Use Control**

Dynamic lane-use control (DLUC) is an ATM strategy that alters the purpose of certain lanes over time (usually during peak periods) to improve the overall efficiency of the system. Most common dynamic lane use strategies include managed lanes and dynamic contraflow lane reversal.

Managed lanes have been widely implemented in the US and over 30 cities have high-occupancy lanes covering over 2500 miles. These lanes are reserved for cars with more than two or three occupants (high-occupancy vehicle [HOV]). Compliance is usually enforced using video detectors, and access to these lanes is restricted at a few places (access at the remaining portions of the freeway is restricted using barriers). In many instances, HOV lanes are also open to single-occupancy vehicles for an additional toll. HOV lanes enjoy a higher level of service and result in more reliable travel times. Travelers are therefore incentivized to carpool or travel with other household members and chain trips, which results in fewer trips and in turn reduce congestion. For instance, in a survey conducted in the Boston metropolitan region, general purpose lanes on IH 93 had an average occupancy of 1.11 while the HOV lanes had an average occupancy of 2.97 (Sisiopiku et al., 2009).

Dynamic lane reversal or contra-flow is another form of lane use control that has been used in context of evacuation. In the event of a hurricane, there is a high demand to travel away from the coast. In such scenarios, lanes directed towards the coast are reversed, which increases the capacity for travelers to evacuate. Several DOTs have successfully used this strategy in the past. For instance, the Alabama DOT implemented lane reversal in 2004 and 2005 during hurricane Ivan and hurricane Dennis, respectively (Sisiopiku et al., 2010).

This idea of lane reversal has also been applied for managing traffic during peak hours. However, this method is effective if the demand for traffic in one direction is significantly higher than that in the other direction. Several regions have dynamic lane reversal mechanisms on HOV lanes (e.g., IH 395 in the Washington D.C. region, IH 35E in the Dallas area) that lets them operate in different directions during the AM and PM peak hours (Skowronek et al., 1999). Lane reversal is likely to grow in popularity with increasing interest in autonomous vehicles, as they can adjust to changes in roadway configurations with greater ease. Some studies (Hausknecht et al., 2011) have shown that dynamic lane reversal schemes in such settings can result up to 72% increase in throughput.

## **2.7 Dynamic Route Guidance/Signing/VMS**

Dynamic signing, including variable message signs (VMS), is an ATM strategy that involves providing real-time information to travelers. The exact type of information can include travel time estimates, route guidance, and incident information. These methods have widely been

implemented in the US and the rest of the world and have been successful in reducing congestion and enhancing safety, as they have significant impacts on route choice and vehicle speeds. In European countries, such as Germany and the Netherlands (Figure 2.5), dynamic signing has been used for providing alternate routes in the event of an incident, speed harmonization for different lanes, and temporary shoulder use (Mirshahi et al., 2007). Dynamic signing strategies used in Amsterdam (called *DRIP*—dynamic route information panels) have been found to result in a 25–33% drop in congestion levels (Middelham, 2003). Dynamic signing can also improve safety by facilitating speed harmonization and studies have shown that the likelihood of crashes reduces in concert with speed reduction (Oh et al., 2001; Lee et al., 2004).



*Figure 2.5 Dynamic message signs in Europe*

These signs are typically displayed using gantries. Other channels for disseminating traveler information such as cell phones, onboard global positioning system (GPS) units, and radio have also been widely used. Key issues that need to be considered in implementing them include reliability of information, integration with other ATM strategies such as VSLs, VMS location, and identification of the information that will improve mobility. Another important factor is that the information should involve little text and be easy to visually interpret without distracting drivers. For this reason, several efforts have been made to standardize the signage across different countries in Europe.

Dynamic route guidance systems can be classified into reactive and predictive systems (Schmitt and Jula, 2006). While reactive systems use current roadway conditions to provide route guidance (Pavlis and Papageorgiou, 1999; Minciardi and Gaetani, 2001; and Deflorio, 2003), predictive systems anticipate future levels of congestion based on currently provided information (Yang and Koutsopoulos, 1996). Since drivers are not mandated to follow the suggestions displayed by dynamic signs, their compliance is an important factor that needs to be considered when evaluating their effectiveness. The literature suggests that typically one in every three to five vehicles re-route upon receiving suggestions from a VMS (Erke et al., 2007 and Chatterjee et al., 2002). Another planning problem involves selecting locations for deploying VMS. Boyles and Waller (2011) studied this problem by identifying the optimal subset of locations for providing information that reduces the system-wide travel time. Heuristics such as simulated annealing and

local search were employed to find solutions to this problem on large networks. Chiu and Huynh (2007) also addressed a similar problem, but in the context of stochastic incidents.

## **2.8 Truck Restrictions**

Implemented usually in coordination with other ATM strategies, truck restrictions are imposed on roadways where traffic composition includes a large number of heavy vehicles. Heavy vehicles can slow regular traffic when merging, pose more safety issues, and cause greater environmental pollution. The purpose of truck restrictions is to integrate trucks in a smoother way with vehicles of other sizes. Typical strategies include lowering the speed limits for heavy vehicles, allotting the right-most lane for trucks, and considering specific operating behavior for trucks while designing algorithms for speed harmonization or ramp signal design.

Mirshahi et al. (2007) point out the specific implementation of truck restrictions for German motorways where the composition of heavy vehicles is around 10–12%, and identifies how speed harmonization requires specific rules when heavy vehicles are restricted to move in the right-most lane and cannot overtake slower vehicles. Denmark exercises truck prohibitions on certain stretches of Danish motorways. The Netherlands has had its truck restrictions in place since 1997, and these are typically in the form of time-of-day restrictions. A slight increase in capacity (up to 3%) and increase in the left-lane travel speed has been observed on Dutch motorways where trucks were restricted while allowing temporary shoulder usage. Similar time-of-day and overtaking restrictions exist on England's motorways. Similar practices are also in place in some US states. Zavoina et al. (1991) discuss methodologies to evaluate the operational effectiveness of left-lane truck restriction for the IH-20 Texas roadway.

## **2.9 Mainline Gap Metering**

Mainline gap metering is a very recent ATM strategy proposed by Jin et al. (2014) and has not been deployed in practice yet. When the volume of traffic on freeways is high, vehicles on ramps experience difficulty merging into main lanes due to lack of sufficient gap. This results in bottlenecks as well as increased probability of rear end and side-swiping collisions. Mainline gap metering strategies can create gaps, unlike ramp metering, which lets vehicles on ramps based on the available gap (and hence can result in higher delays for merging traffic).

The proposed implementation suggests warning the drivers that they are about to enter a zone that is gap metered and enforcing gap metering using dynamic signs that tell the drivers the spacing that needs to be maintained. Drivers maintaining less than the suggested gap need to slow down to create sufficient space for merging traffic (see Figure 2.6). The data required for this ATM strategy includes inductive loops or remote traffic microwave sensors to estimate the flows on the main lanes and ramps. Key implementation issues include potentially low compliance rates and creation of enforcement methods.

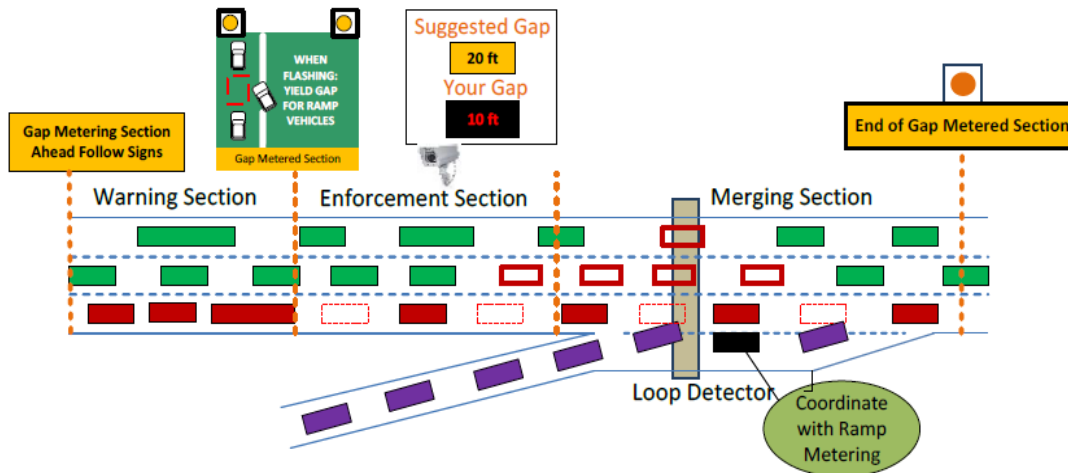

Figure 2.6 Gap metering design

Simulation studies were conducted on segments of IH 35 near Austin, Texas, using VISSIM. With a modest compliance rate of 20%, the savings in delay on main lanes was found to be 24%; in contrast, if only ramp metering were used, a 7% reduction in delay was observed. Further, if both ramp and gap metering were implemented, the savings in delay was found to be about 34%.

## 2.10 Construction Site Management

Integrating traffic operation in work zones located along freeways, construction site management analyzes and assesses the impacts of short-term construction projects on congestion and determines the optimal timing for construction projects. Mirshahi et al. (2007) document the usage of these management techniques on German freeways, estimating start times for projects to minimize congestion impacts. However, some maintenance-related projects are administered by outside contractors, who have been found to be less inclined towards using these tools to change their schedules for projects. Lee (2009) highlights one optimization method for integrating several work zones, by scheduling them in a manner to impact traffic the least, and demonstrates an 11.1% reduction in traffic delay for a sewer construction project in Taitung, Taiwan. Enforcement of such an ATM strategy has been difficult in practice, as most construction projects involve all-day operations and face safety issues if implemented during the night.

## 2.11 Transit Signal Priority

As part of promoting the usage of transit and managing congestion, transit signal priority (TSP) assigns longer green times to the approaches when a transit vehicle is detected close to an intersection. It utilizes sensors or probe vehicle technology to detect the proximity of a bus near a signalized controlled intersection. Dion et al. (2004) evaluated the potential benefits of implementing TSP along the Columbia Pike arterial corridor in Arlington, Virginia, and quantified the benefits to the buses that were provided priority. However, there is a tradeoff, as these benefits come at the expense of delays to other traffic. The TSP Planning and Implementation handbook (FHWA, 2005) documents a reduction of transit signal delay by 40% in two corridors in Tacoma, Washington; an average reduction of 15% in running time for PACE buses in the Chicago area; and a 25% reduction for transit services in Los Angeles. Primarily applicable for arterial corridors



with signalized intersections, TSP integrates well with signal optimization techniques and HSR for transit buses. The I-80 Integrated Corridor Mobility Project, in California's Bay Area, is one such smart-corridor project that is considering integrating TSP with arterial and freeway operations (80 Smart Corridor).

## **2.12 Summary**

This chapter discussed in detail the current ATM strategies in practice. Some of these ATM strategies—including VSLs, ramp metering, and HSR—are more widely used, while others have only recently been in use. The performance of the ATM strategies depends on the control algorithm used to regulate the traffic controller. In most cases, ATM strategies provide the desired congestion and safety benefits, but the success of an ATM strategy installation depends on the network and the demand using the corridor. This report aims to study the impacts of the commonly used ATM strategies under different network and demand levels and focuses on capturing the impact of the ATM strategy beyond the corridor where they are deployed.

## Chapter 3. Identifying Potential ATM Strategies for Texas

In this chapter, we identify the ATM strategies that were simulated on different network scenarios to quantify their benefits. These strategies were selected based on (1) survey results from TxDOT personnel, (2) information on existing and planned ATM deployments in Texas (see Table 3.1), (3) suitability to address recurring and non-recurring sources of congestion caused due to bottlenecks, and (4) strategies that have been proven to alleviate congestion. In addition, the data requirements for testing the effectiveness of these strategies are also listed. The survey used to collect information from the TxDOT personnel is described in Appendix A.

### 3.1 Existing ATM Deployment in Texas

The survey results indicated that dynamic message signs, VSL, and DLUC strategies are either in place or being planned for deployment. They also indicated that no performance metrics are currently being used to evaluate existing ATM strategies. This finding highlights the need for the quantitative analysis conducted in this project.

**Table 3.1: Selection of planned and deployed ATM strategies in Texas**

Location	ATM Strategy	Source
Dallas Integrated Corridor Management (US 75)	Dynamic message signs, TSP, HOV/HOT (high-occupancy toll) lanes, route diversion during incidents	Dallas Integrated Corridor Management (2013)
Houston Katy Freeway IH 10	HOV/HOT lanes (dynamic pricing) and incentives for transit usage	Mobility Investment Report
Arlington (SH 360), Houston (US 59)	Ramp metering	Chaudhary et al. (2004)
Harris County (Kuykendahl Road and Louetta Road)	Dynamic lane assignments	Dowling and Elias (2013)
IH 35 (Denton County)	Reversible managed lanes	TxDOT I35E Project
Ranger Hill in Eastland County on IH 20, Loop 1604 in San Antonio, IH 35 (Central Texas)	VSLs	TTI Policy Research Center

### 3.2 Qualitative Evaluation of ATM Strategies

This section summarizes the choice of ATM strategies based on their suitability for different types of congestion patterns, and their applicability in Texas corridors. The following types of congestion patterns are typically observed on the network:

- **Recurrent isolated bottleneck:** recurrent traffic queuing delays at specific locations, such as freeway merges, weaving segments, freeway interchanges, tolling stations, bridges, and tunnels.
- **Non-recurrent isolated bottleneck:** queuing delay caused by temporary events, such as sports, incidents, weather, and construction.
- **Congested route/corridor:** queuing delay caused by multiple bottlenecks along a route, where the spatiotemporal distribution of traffic demand plays an essential role.
- **Network gridlock:** traffic queues that block an entire network of intersecting streets or freeway sections, bringing traffic in all directions to a complete standstill.

Different ATM strategies can be used to combat each type of congestion pattern based on the applicability and feasibility in the region with respect to factors such as data availability and physical, legal, or budgetary constraints.

Based on the analysis of survey results and our analysis of trending ATM strategies in Texas and the United States, we identified the following set of ATM strategies suitable for Texas corridors, which we will analyze in the following chapters in this report:

- **Recurrent isolated bottleneck:** HSR, VSLs, and ramp metering
- **Non-recurrent isolated bottleneck:** VSLs, dynamic message signs/dynamic re-routing, and DLUC
- **Congested route/corridor:** VSLs, HSR, coordinated operations between different strategies

Network gridlock-based congestion is a rare phenomenon and can be avoided if other types of congestion are dealt with; furthermore, it is often highly dependent on arterial streets not controlled by TxDOT. For this reason, gridlock-based congestion falls outside the scope of the current project. Table 3.2 presents an analysis of strength, weakness, opportunities, and threats (SWOT analysis) for each selected ATM strategy.

**Table 3.2: SWOT analysis of ATM strategies**

<b>Selected ATM Strategy</b>	<b>Strengths</b>	<b>Weaknesses</b>	<b>Opportunities</b>	<b>Threats</b>
<b>VSLs</b>	Increased safety; enhanced usage of existing capacity, reduced propagation of shock waves	Additional data requirements, such as speed on each lane and incident detection; high cost of implementation	Coordination with all other strategies can prove very beneficial	Failure of ITS equipment; driver compliance
<b>Dynamic Message Signs/Dynamic Route Guidance</b>	Warns driver about the congestion and increases safety; suggests alternate uncongested routes for special events/incident congestion	Distraction for drivers if not placed appropriately	Existing sensor data can be employed easily; particularly useful in work zone areas	Reliability of information from road users based on sensor, driver compliance
<b>Ramp Metering</b>	Easy to implement; increases safety on freeway when number of merging vehicles is high; maintains operational speed on the freeway segment; improves capacity of freeway	Additional delay to merging vehicles; requires long ramps to accommodate queue of merging vehicles	Can be coordinated with VSLs and mainline gap metering	Safety threats for vehicles stopping on ramps; queue spill back to arterials
<b>Hard-Shoulder Usage</b>	Enhanced roadway capacity for congested roadways; easy extension as bus-only lanes increase transit reliability	Availability of hard shoulder and difficulty in safe operation; requires monitoring and police patrols; emergency refuge areas need to be created	Easy to implement for existing roadways with hard shoulders	Safety threats for vehicles traveling on the shoulder
<b>DLUC</b>	Managed lanes or HOV/HOT lanes provide reliable alternative and promotes car-pooling; lane-reversal techniques prove useful in increasing capacity for peak direction traffic and/or during evacuation	Under-utilization of capacity if not implemented well; requires special restrictions using signs/signals and monitoring	Coordination with VSL can prove effective; easy to implement with existing infrastructure	Safety threats for vehicles at merge/diverge locations

### 3.3 Testbed for Simulation Study

The research team identified a potential testbed location in Texas on which the DTA and microsimulation analysis was performed. The following factors influenced the choice of the testbed location:

1. Availability of data sources to calibrate the DTA and microsimulation models.
2. Presence of freeways and arterials that can capture route choice behavior of the drivers on larger scale and hence help in evaluating the system wide impacts of the ATM strategies.
3. Scope for testing the benefits of the proposed ATM strategies, such as existence of hard shoulders, HOT lanes, etc.
4. Presence of congestion issues that are commonly found in other Texas districts.

Based on these requirements, the Williamson County (Wilco) network was chosen as the testbed for the analysis in this project.

#### 3.3.1 Williamson County Network

Williamson County, located on the outskirts of Austin, is the fastest growing county in America; the rate of population growth in year 2010–2012 was 7.94% (Kotkin, 2013). Figure 3.1 highlights the primary network used for the analysis with the base-map from OpenStreetMap.



Figure 3.1 Williamson County network

The Williamson County network has two primary highway facilities: IH 35 and SH 130. Thus, it can capture the route-choice decisions made by long-distance travelers. The SH-130 corridor on the east and SH-45 corridor in the south are currently being operated as toll roads. Apart from freeways, the network also contains several arterial streets in and around Round Rock and Georgetown. There is a total of 3,956 links (including centroid connectors) and 2,001 nodes.

Current congestion issues in Williamson County include AM peak congestion on southbound IH 35 near Round rock at the interchange with W. Palm Valley Boulevard, and PM peak congestion on the northbound route at same location. There are frontage roads parallel to IH 35 near the point of congestion, which also experience spillover effects. This is a recurrent congestion pattern observed on typical weekdays. These locations will be a useful ground for testing ATM strategies meant for recurrent congestion, such as HSR, VSLs, and ramp metering. The following chapters will focus on these three ATM strategies for the selected testbed.

IH-35 segments in Williamson County also experience traffic incidents and delays due to accidents/lane-closures (as observed on live traffic incident reporting websites like Google Maps and the TxDOT ITS website). This project used these locations to estimate the effects of ATM strategies meant for dealing with non-recurrent congestion, including VSLs, dynamic message signs/dynamic re-routing, and DLUC.

The Wilco subnetwork was extracted from a DTA model of the entire CAMPO (Capital Area Metro Planning Organization) region. This regional DTA model was based on the preliminary CAMPO 2010 base network, which was updated to include additional network details and traffic signals. This DTA model was run in VISTA and the demand for the subnetwork was extracted from those runs. The subnetwork demand was then inflated based on an assumed growth rate of 2% per year from 2010 to 2014 across the entire matrix.

### **3.3.2 Available Data**

The research team has access to the following data, which was used for calibrating the network from above, and validating the DTA and microsimulation models.

#### *Tube Counts*

The number of vehicles passing a tube sensor installed at certain locations (for a period of 24 hours) was collected by the following sources:

- Counts conducted by the City of Round Rock in 2011–2012, obtained via HDR
- TxDOT 2010 saturation count stations
- Counts conducted by GRAM Traffic Counting for HDR – Fall 2013

#### *Turning Movement Counts*

For each approach at an intersection, the number of vehicles that turn left, right, or continue straight were recorded for a few intersections during the peak period.

- Counts from 2011–2013 collected by GRAM Traffic for HDR
- Counts from 2014 provided by HDR for the TxDOT 35 Mobility 35 project
- Counts from 2012 collected by the City of Round Rock and provided by HDR

- Counts conducted by GRAM Traffic for HDR in Fall 2013 (collected for Williamson County project)

### *Travel Time Runs*

Drivers in probe vehicles record time to traverse designated corridor sections from intersection to intersection. These sections are traversed as many times as possible during a 3-hour peak period. The sources for travel time runs include:

- Travel times collected by GRAM Traffic for HDR in Fall 2013
- Travel time collection by Center for Transportation Research (CTR) in 2013
- Additional travel times collected by HDR in Spring 2014

The fine-tuning of the calibration process using these data sources is described in following chapters.

## Chapter 4. Analysis Based on Micro-Simulation

ATM strategies refer to transportation system management and operations strategies that leverage advanced sensing (e.g., inductive loop, Bluetooth, and GPS-based probe detectors) and communication technologies to respond to dynamic traffic demand patterns adaptively and proactively. ATM strategies aim to allocate roadway resources, such as lane and intersection capacity, to accommodate varying traffic demand and non-recurrent events such as incidents. The different ATM strategies address different types of congestion, and their effect relies heavily on the control logics as well as implementation.

Successful deployment of ATM strategies requires a thorough consideration and accurate quantification of control logics, bottleneck/corridor characters, demand patterns, and driving behaviors. Microsimulation is the most commonly used tool as it offers accurate modeling details for the aforementioned factors. Modern microsimulation packages can allow traffic flow and control logics to be simulated at time resolutions on the order of a tenth of a second. This level of detail allows realistic congestion issues to be captured, such as capacity drop and stop-and-go waves.

This chapter provides a review of issues when applying the microsimulation tools to evaluate ATM strategies, as well as a detailed microsimulation analysis of representative ATM strategies on the Wilco test bed (a segment of IH 35 NB). We specifically focus on three ATM strategies identified after an initial screening, by considering their feasibility in Texas and deployment experiences in other states and nations. These strategies are ramp metering, VSL, and HSR. We give a brief review to the control algorithms for these strategies in section 4.2.

### 4.1 COM-based Microscopic Simulation Framework

#### 4.1.1 Overview of Micro-Simulators

A variety of commercial and non-commercial micro-simulators have been developed for replicating fine details of freeway and arterial systems. These micro-simulators have been widely used in evaluating operations impacts and predictive analytics related to transportation infrastructure planning and management. A brief overview on the representative micro-simulators is as follows:

- **CORSIM** was developed with guidance and support from the Federal Highway Administration. It consists of two sub-models, NETSIM and FRESIM, that respectively represent the traffic on urban streets, and freeways and highways. CORSIM and TRANSYT-7F are now distributed together. TRANSYT-7F enhances the traffic signal analysis in CORSIM.
- **Paramics** is targeted at planning professionals. It provides modeling features such as importing external models, integration with GIS and online maps, 3D graphics, vehicle-pedestrian interactions, and distributed processing.
- **VISSIM** is developed by PTV, and provides modeling features such as driving and routing behaviors, multi-modal transit operations, pedestrian and bicyclists, and 3D animation.



- **SUMO** (Simulation of Urban MObility) is a free and open-source traffic simulation suite that allows modeling intermodal traffic systems. It supports imports from other programs, such as OpenStreetMap, VISUM, VISSIM, and NavTeq.
- **Polaris** is an open-source simulation platform integrating the demand and traffic flow dynamics modeling in a multi-agent framework. It features high performance simulation that is based on parallel computing techniques.

Key factors to consider when selecting a traffic simulator include the following:

- **Model development:** this refers to the efforts (time and skills) required to code the network, demand, behavioral rules, and road/network control strategies.
- **Calibration and validation:** this refers to the flexibility, accuracy, and robustness of calibrating a model in the simulation software and validating it against empirical data.
- **Data input and output:** this refers to the data format the program can read, process and export. Common data format includes the shape files and spreadsheets.
- **Presentation of results:** this refers to the functionalities such as 2D/3D animation and visualization of simulation results.
- **Model fidelity:** this refers to the closeness of simulation results with empirical observations, behavioral rules, and principles.
- **Cost of software:** the cost of purchasing and maintaining the software.

#### 4.1.2 VISSIM-COM Modeling

In this study, the team chose to use the VISSIM and implemented the advanced control logics through integrating it with scientific computing software MATLAB, using the COM (Component Object Model) interface. A schematic representation of this framework is shown in Figure 4.1.

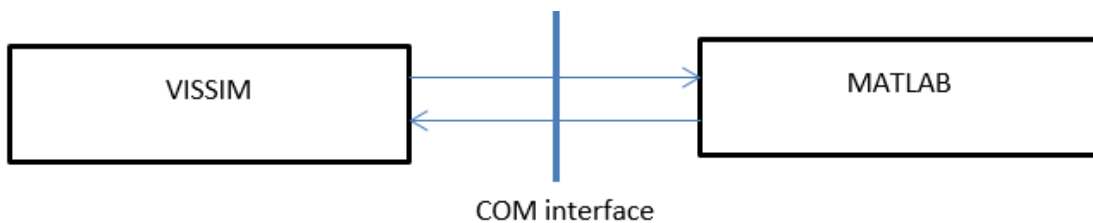

*Figure 4.1 VISSIM and MATLAB integration through COM interface*

Figure 4.2 shows a snapshot of VISSIM-MATLAB integration through the COM interface. The graphical user interface (GUI) shows a model of adaptive ramp metering. The front window is VISSIM (version 6.0), and the back window is MATLAB. In MATLAB, the ramp metering control logic is implemented, which was transmitted to VISSIM. The VISSIM performs simulation per its internal logic, and the simulation is animated. Meanwhile, VISSIM sends the traffic measurement to MATLAB in real time. This information, along with the signal state that MATLAB determines based on the measurement, are displayed in real-time traffic measurement and signal.

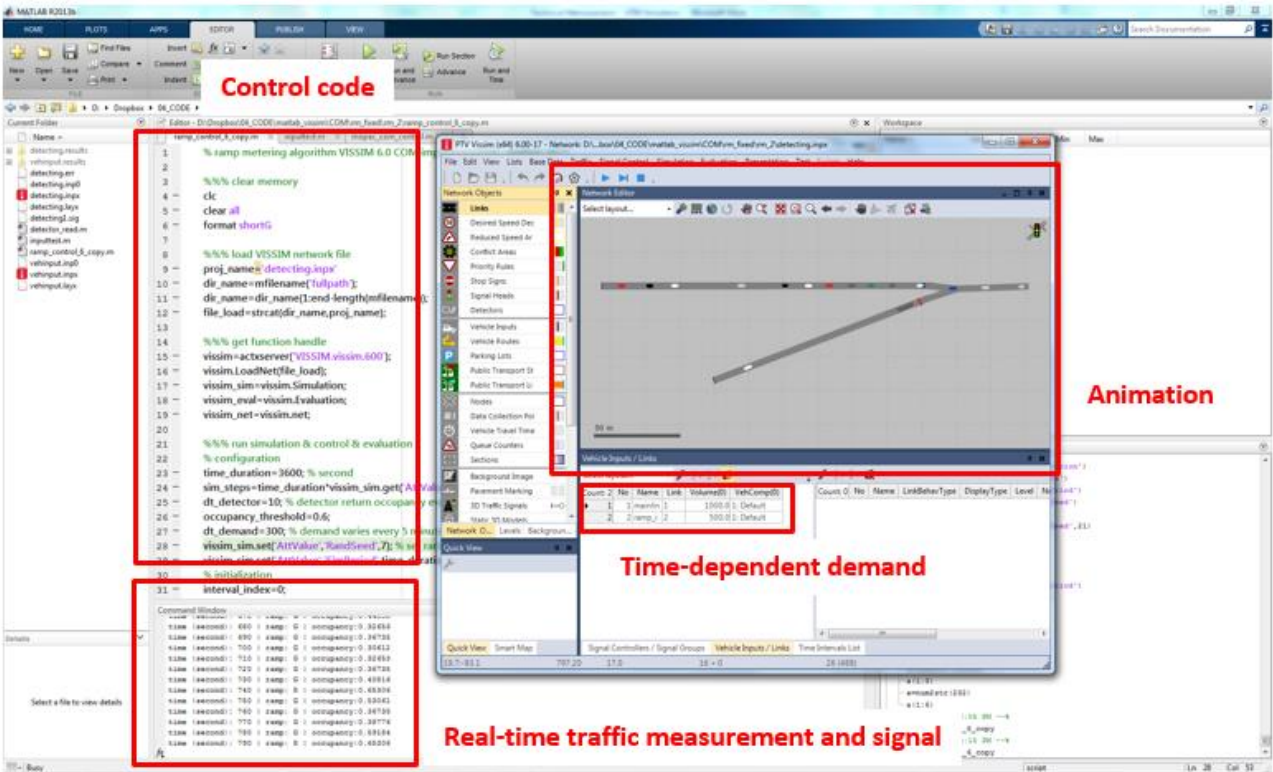

Figure 4.2 Example of graphical user interface of VISSIM-MATLAB integration

This hybrid approach features some significant advantages over existing approaches:

- Model development (especially the modeling of lane and intersection control) is more straightforward than using the VISSIM built-in VAP (Vehicle Actuated Programming) language. Through linking the MATLAB with VISSIM using the COM interface, the programming of detection and control logics can be done with MATLAB scripts, which is more mature and versatile.
- Data input and output can be done in MATLAB. This is especially useful when importing the external traffic demand profiles and recording signal timing plan at arbitrary time.
- VISSIM and MATLAB are available to the performing agency. Simulation programs are portable to properly configured computer environment.

#### 4.1.3 Performance Measures

We chose the following performance measures, which are time-dependent due to the dynamic traffic conditions and different control strategies.

- **Mainline Travel Time:** Traversal time of mainline traffic from entry of freeway mainline to exit of freeway mainline.
- **Mainline Throughput:** We look at throughput at two locations: entrance and exit of the mainline. Detectors are placed at these locations.

- **Ramp Queue Length:** Queue length on entry ramps to the mainline.

We deployed single loop detectors and queue counters in VISSIM to obtain relevant measurements and calculate the performance measures. These detectors are described as below:

- **Loop Detector:** In VISSIM, loop detectors can detect impulse (i.e., traffic count), vehicle ID, and occupancy for each simulation step. Through matching the vehicle IDs at entrance and exit of freeway mainline, the mainline travel time can be calculated. The traffic volume can also be calculated from vehicle IDs.
- **Queue Counter:** VISSIM also provides queue counters that provide queue length estimate. This estimate uses proprietary algorithms. Queue length is measured from the queue detector to upstream of the link at every simulation step.

Performance of traffic flow on a freeway corridor was measured with the following metrics:

- **Travel time** (corridor or trip-based) is the most direct measure of cost to travelers. When aggregated, it measures the total cost (in terms of time) to users of the system.
- **Travel time reliability** captures the consistency or dependency in travel times, as measured from day to day or across different times of day. The FHWA recommends travel time reliability as a key performance measure to manage and operate their transportation systems.
- **Traffic speed** is a traditional measure of level of service, as in the Highway Capacity Manual.
- **Queuing delay** is suited to characterize severity of congestion upstream of critical bottlenecks, such as freeway merges and weaving sections.
- **Throughput** (vehicle or passenger) measures the total service rate of the transportation system.

To measure these metrics from simulation, we used the built-in evaluation functions in VISSIM.

#### 4.1.4 Model Calibration

There are more than 100 microscopic traffic flow (car-following and gap acceptance) models, which differ much in model structure (equilibrium vs. non-equilibrium), number of parameters, and behavioral assumptions. In addition, the data available at different corridors are usually different. While high-resolution data are increasingly available (e.g., trajectory data), loop detector data are still a major source of freeway measurement, which is known to suffer from various quality problems due to detector deterioration. Due to these reasons, there does not exist a unified approach to calibrate the micro-simulation models.

In VISSIM, the underlying traffic model is Wiedemann's psycho-physical perception threshold model (see Figure 4.3 for a schematic illustration). This model features detailed characterization with driver behaviors under different scenarios. Because of the model complexity, calibrating and validating the driving (car-following) model in VISSIM requires detailed traffic data, such as naturalistic driving data or trajectory data (e.g., NGSIM).

In this project, the only available traffic data was 1-hour volume at selected locations. These data can be used to estimate dynamic origin-destination (OD) matrix, but is not sufficient to calibrate the driving model. Due to this reason, the team adopted the default parameters in VISSIM for traffic composition and desired speed distribution.

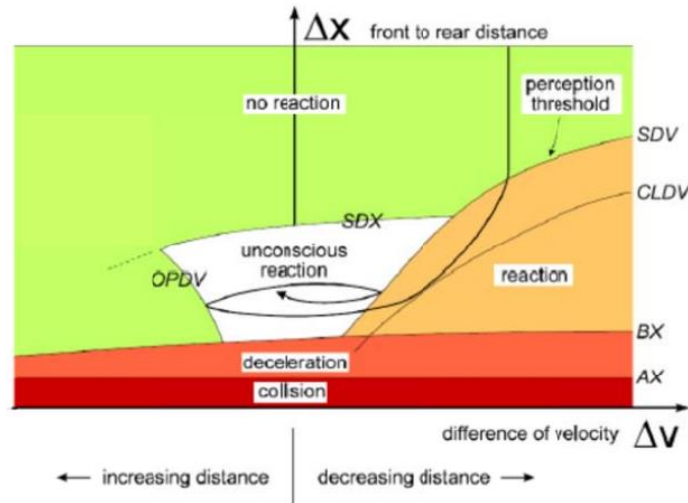

Figure 4.3 Car-following in Wiedemann's model

## 4.2 Test Network Description and Calibration

To perform microsimulation analysis of the ATM strategies, the Williamson County testbed described in the previous chapter was used. The team selected a segment of IH 35 SB for implementing ATM strategies. Frontage roads parallel to the IH-35 corridor were also included. The total length of this corridor is 3.7 miles. The perpendicular arterials were also included at the three interchanges. Figure 4.4 shows the segment as part of the larger Williamson County network, and Figure 4.5 shows the selected segment of the network built in the VISSIM software.

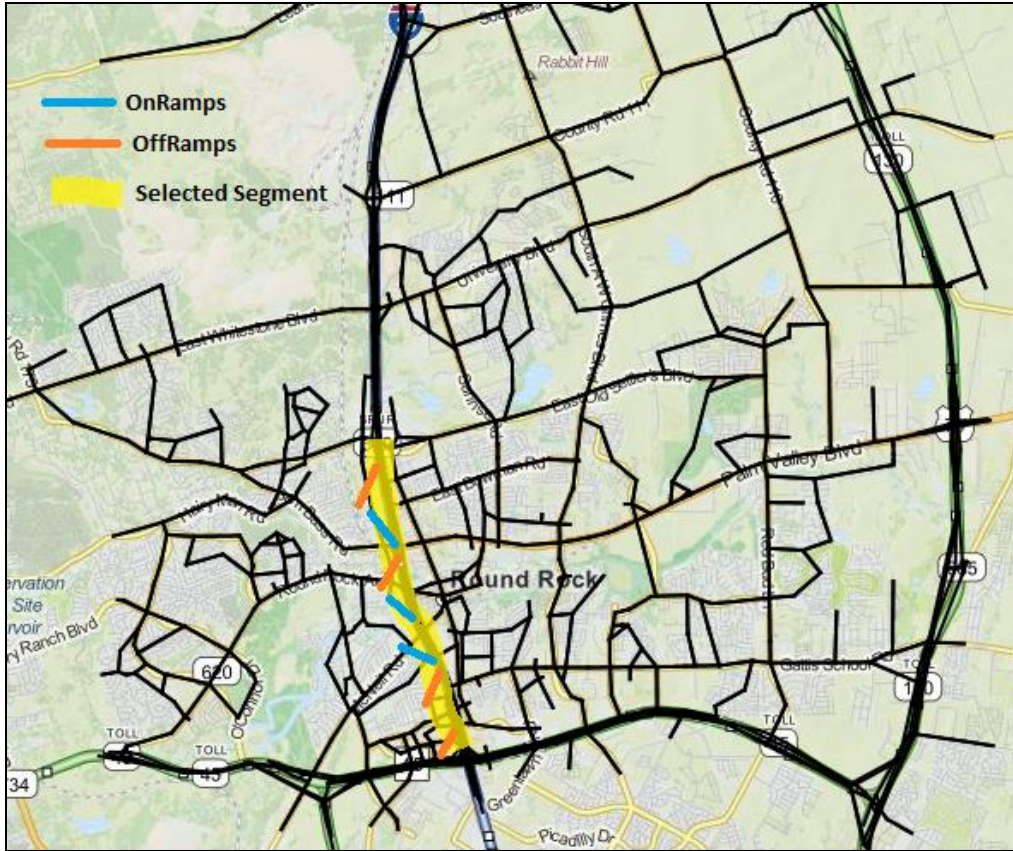

Figure 4.4 Williamson County network with the highlighted segment selected for analysis

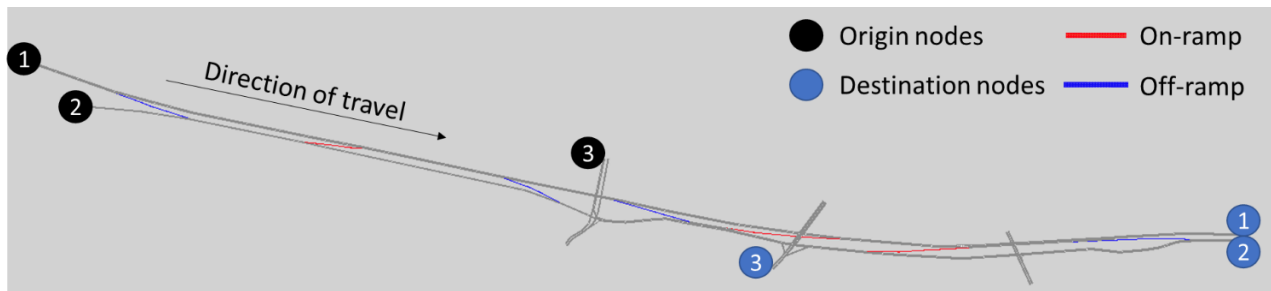

Figure 4.5 VISSIM representation of the segment selected for analysis

The demand for the updated VISSIM network was determined using the dynamic assignment tool in VISSIM. The OD matrix for the dynamic assignment procedure of VISSIM was determined from the calibrated DTA model in the VISTA software by counting the number of vehicles using a particular entry-exit pair. The dynamic assignment was run for 15 iterations and the observed flows were validated against the measured data from field measurements available from counts conducted by the City of Round Rock in 2011–2012, obtained via HDR.

The simulation was run for 5400 seconds (90 minutes), depicting the morning peak from 7:15 a.m. to 8:45 a.m. The demand was modeled only for an hour. The last half hour was provided to flush out the existing congestion in the network.

The movement of traffic at the interchange was modeled using fixed time signals. The field value of the cycle length, and the green time allocated to different phases were obtained from the DTA model. The turning movements at some intersections were ignored if the demand using those turning movements was significantly low.

The calibration was done for the demand values by comparing them against the observed field counts. Several attempts were made at updating the demand using trial and error. The calibration process was stopped when the error obtained was reasonably small. Figure 4.6 shows the plot of errors in link flow values at 17 observed locations. The average absolute calibration error in link flows for all the links was 14.43% while that for the links on mainline was 3.41%. The error was higher for links with lower flow values due to the percentage nature of the error. The calibrated model for then used for further analysis.

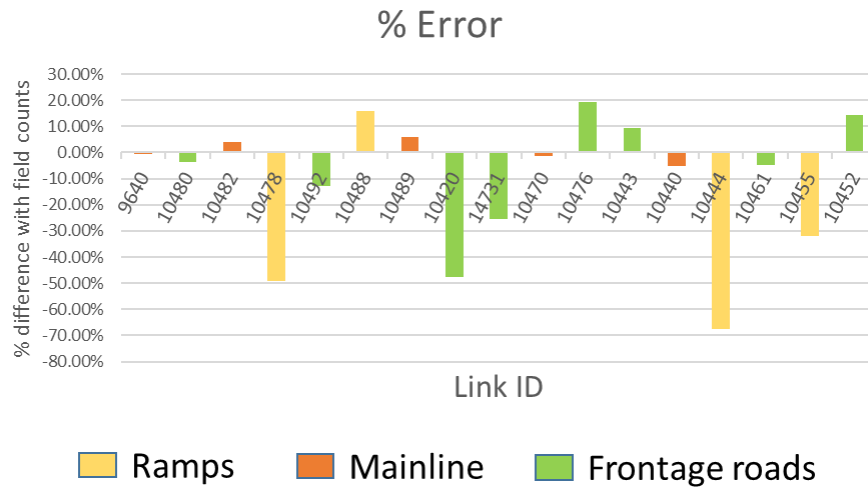

Figure 4.6 Plot of calibration errors in link flows for selected link IDs

To analyze the effectiveness of ATM strategies, the following performance metrics were chosen for the analysis:

1. Corridor travel time
2. Queue length on the on-ramps
3. Overall network performance including total system travel time, total delay, average travel speed, etc.
4. Delay at each node and delay for each 10-m segment on each link used for the purposes of understanding the development of congestion pattern

The primary purpose of modeling the frontage roads was to capture the impacts of ATM strategies implemented on a freeway segment over the frontage road segments. While modeling ATM strategies on the network with frontage roads, we assumed that travelers do not change their routes after installing an ATM strategy. This modeling choice was made because the current capabilities of the VISSIM microsimulation software do not allow en-route changes in travelers' routes when they are fixed as static routes. The VISSIM dynamic assignment routine also could not be used since controlling the ATM strategies using the COM interface does not allow running the simulation multiple times to reach the convergence required by the dynamic assignment. In

theory, this may be a limiting assumption, as travelers tend to change routes en route to avoid traveling on a congested road ahead. However, it still captures the impact of the spillover effect of the ATM strategies on freeway and provides a reasonable microsimulation test bed for analyzing the impact of an ATM strategy.

### 4.3 ATM Strategies Microsimulation Analysis

The ATM strategies were deployed in the VISSIM and the control logic was implemented using the COM interface implemented in scientific computing software MATLAB. A schematic representation of this framework is shown in Figure 4.7.

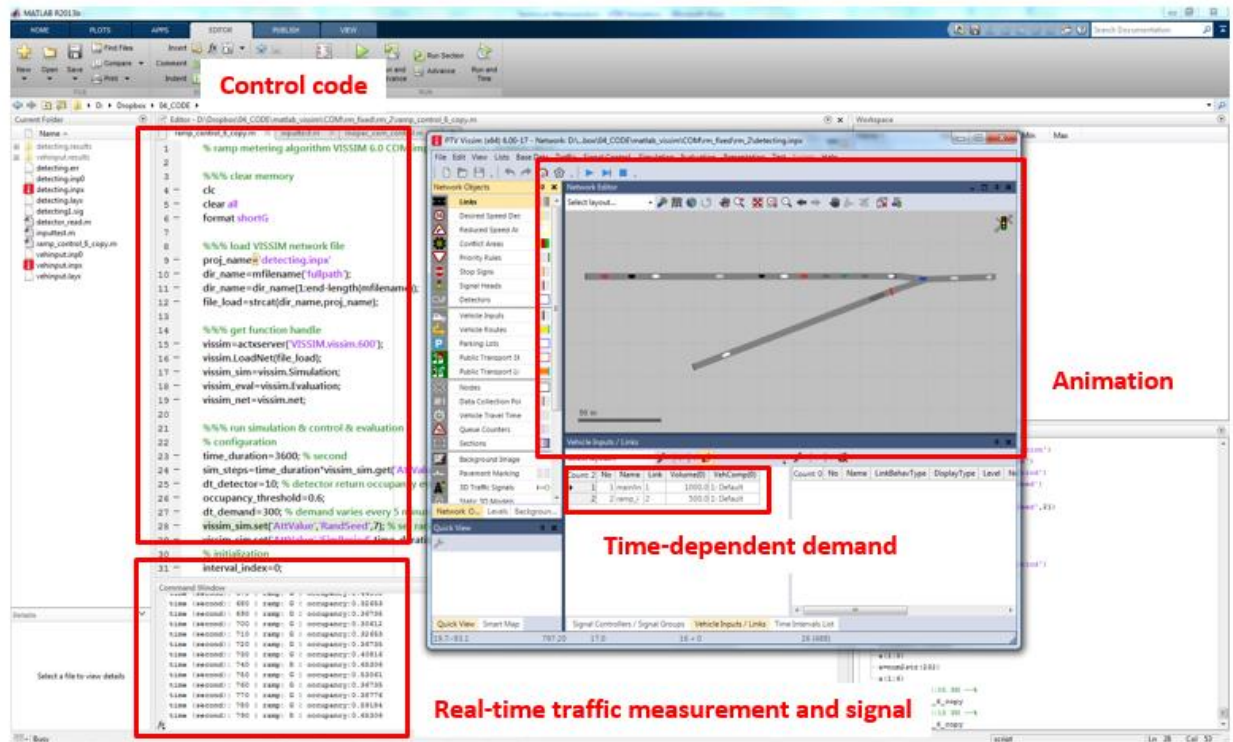

Figure 4.7 Component object model (COM) interface used to model control algorithms in VISSIM

In this project, we adopted feedback control algorithms for the three ATM strategies. Unlike in open-loop control or fixed time control, the spirit of feedback control lies in measuring the system state continuously and using those results in the defining control actions. To perform the analysis, three VISSIM runs were conducted each with and without the ATM strategy and the average of the three runs was used for analyzing the results presented in the following subsections.

#### 4.3.1 Ramp Metering

Ramp metering is the most commonly used ATM strategy, controlling the flow from an on-ramp onto a freeway facility and thus reducing the possibility of flow-breakdown by breaking platoons of merging vehicles and by delaying the onset of congestion. Ramp metering relies on measurement of traffic conditions on the main carriageway (or the mainline) and attempts to maintain these at a target occupancy by restricting the flow from the on-ramp.

To analyze the effectiveness of ramp metering for the selected testbed, ramp meters were installed on the two on-ramps as shown in Figure 4.8. The locations were selected based on the observed congestion pattern in the network and the bottleneck located downstream of the merge points of the on-ramps.

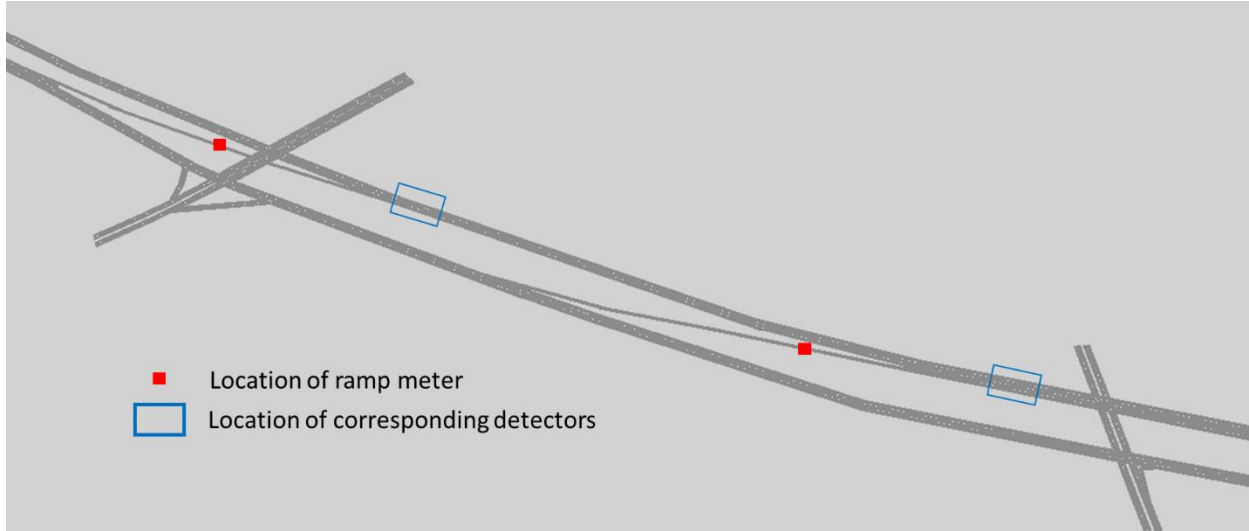

Figure 4.8 Location of ramp meters for the selected testbed

Most commonly used ramp metering algorithms control the rate of the flow from on-ramps based on the occupancy readings of the detectors downstream or upstream of the merge. For our analysis, two common used algorithms were used: ALINEA, proposed in Papageorgiou et al. (1991) and AD-ALINEA, proposed in Smaragdis et al. (2004). The underlying feature of ALINEA is common in both algorithms and is shown in equation (1), where  $r(k)$  is the ramp flow rate at time  $k$ ,  $o_{out}(k-1)$  is the measured occupancy at time  $k-1$ , and  $\hat{o}$  and  $K_R$  are the algorithm parameters indicating the desired downstream occupancy and regulator parameter respectively. The default values used for  $K_R$  and  $\hat{o}$  was 200 and 0.2 respectively.

$$r(k) = r(k-1) + K_R[\hat{o} - o_{out}(k-1)] \quad (1)$$

In addition to the underlying feedback feature of ALINEA, the algorithm in Smaragdis et al. (2004) also includes a queue-spillback correction where the ramp meter is set to green if the queue on the on-ramp spills back to the frontage roads. Further, an estimation routine is used which determines the value of  $\hat{o}$  using the measurements of downstream flow and occupancy in the previous timestep. The estimation routine updates the value of desired occupancy  $\hat{o}$  based on the estimated value of the derivative ( $D$ ) of downstream flow with respect to downstream occupancy:  $D = dq_{out}/do_{out}$ , where  $q_{out}$  is the downstream flow on the freeway. The simple-derivative estimation technique was used for our analysis, using the default parameters proposed in the paper. For further details, readers are referred to Smaragdis et al. (2004).

Figure 4.9 shows the plot of travel time for the base case, the case of ramp metering with Algorithm 1 (ALINEA) and the case of ramp metering with Algorithm 2 (AD-ALINEA). Figure 4.10 shows the plot of maximum queue length observed on the on-ramps for the three cases. Figure 4.11 shows the plot of green ratios obtained for both on-ramps, defined as the ratio of green time



in each cycle to the cycle length. A cycle length of 120 seconds was chosen for our analysis. The network performance results are detailed in Table 4.1.

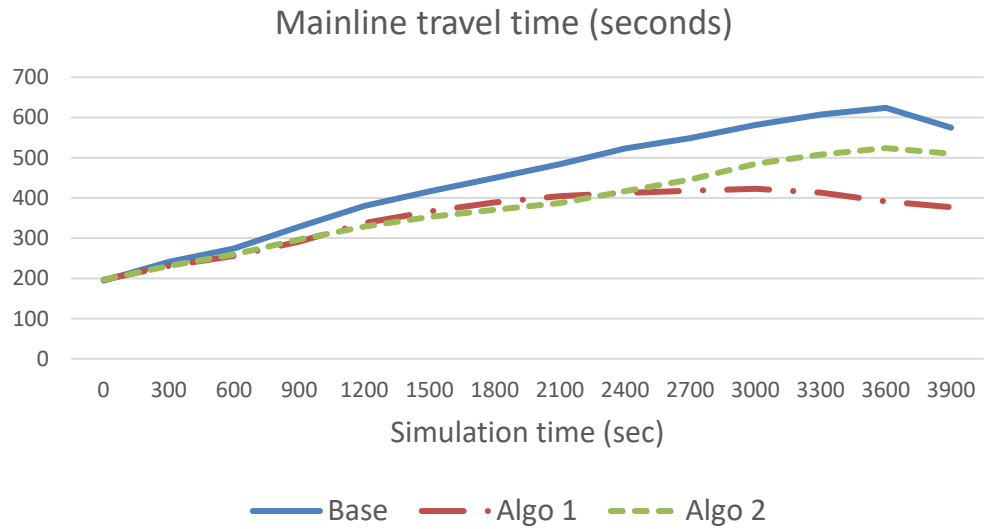

Figure 4.9 Plot of mainline travel time: ramp metering

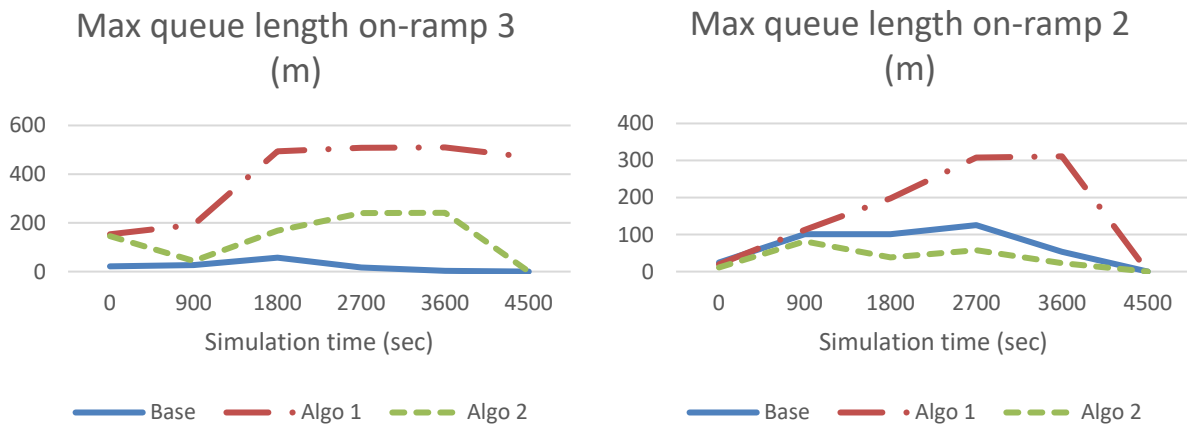

Figure 4.10 Plot of maximum queue length on the on-ramps: ramp metering

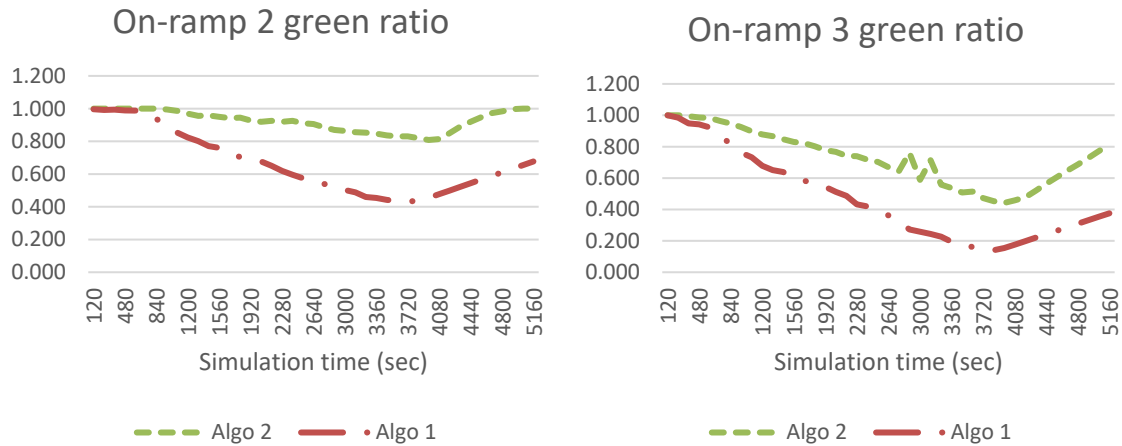

Figure 4.11 Plot of the green ratio on the on-ramps: ramp metering

Table 4.1: Network performance: ramp metering

	Base	Algo 1	Algo 2
<b>Average Delay (sec)</b>	213.03	199.33	176.99
<b>Avg Speed (km/hr)</b>	32.95	34.43	37.15
<b>Avg Stopped Delay (sec)</b>	35.63	57.11	31.8
<b>Total Distance (km)</b>	33209.16	33081.93	33223.14
<b>Total Travel time (hours)</b>	1009.50	965.64	897.58
<b>Total Delay (hours)</b>	663.31	620.70	551.14
<b>Total Stopped Delay (hours)</b>	110.95	177.85	99.03
<b>No. of Arrived Vehicles</b>	11210	11186	11210

The following observations and analysis can be made from the results:

1. After installing ramp metering, the corridor travel time is reduced. The reduction effects are significant in the latter half of the simulation. This is reasonable since ramp meter controls the flow of the vehicles on the ramp and thus prevents the capacity drop on the mainline, which leads to increased travel time. Algorithm 1 is more effective in reducing the corridor travel time than Algorithm 2; however, the effects are not significantly different.
2. The maximum queue lengths observed on the on-ramps increase after installing the ramp meters. Algorithm 1 generates longer queue lengths as compared to Algorithm 2 because Algorithm 2 overrides the ramp metering control if queue exceeds the on-ramp. The queue in Algorithm 1 spills back beyond the length of the on-ramp onto the frontage road and thus block the traffic on frontage roads.
3. The green ratio observed from both the algorithm follows a similar pattern: reduction from a full green time (ratio of 1) to a reduced green time as the congestion develops. It is interesting that even though the demand values reduce to zero after one hour of simulation (3600 sec simulation time), the ramp still continues to hold vehicles on the on-ramp and the green ratios improve gradually. This is because of the inherent property of the feedback-

based mechanism of ALINEA where ramp flow rate in the next timestep can only improve by the factor  $K_R$  from the previous timestep.

4. The network performance shown in Table 4.1 indicates that Algorithm 2 performs the best by reducing the overall delay of the travelers and the total system travel time. Algorithm 1 improves the travel time on the corridor; however, it shifts the delay to the travelers on frontage roads and thus leads to a significantly increased value of stopped delay. The average delay is lowest and the average speed is highest for Algorithm 2.

Algorithm 2 was more effective than Algorithm 1 for our selected testbed. The percentage reduction in total system travel time from Algorithm 2 was 11.08%. We concluded that ramp metering is an effective method for dealing with congestion on freeway corridors. Further research can be conducted in optimizing the parameters of the algorithm for better improvement in the performance.

### 4.3.2 Variable Speed Limits

VSLs are another commonly used ATM strategy that changes the values of speed limit in response to current traffic conditions (typically volume and occupancy) on freeway mainlines. The VSL strategy could make traffic speeds more uniform, reduce crash risks, and increase effective roadway capacity. In particular, when VSL is deployed upstream of a critical bottleneck, it can reduce the possibility of traffic flow breakdown by preventing oversaturation at this location.

In the selected corridor, we instrumented a VSL system between the two on-ramps where ramp meters were installed. The length of the VSL segment was approximately 1 mile. The primary purpose of this VSL was to mitigate the congestion at the downstream bottleneck, such that mobility and reliability improved. We employed a threshold-based VSL control algorithm proposed in Allaby et al. (2007). This algorithm uses the downstream detections of occupancy, speed, and traffic volume to adjust the speed limit. This algorithm consists of a set of criteria for determining the speed limit from traffic flow conditions. The algorithm architecture is shown in Figure 4.12.

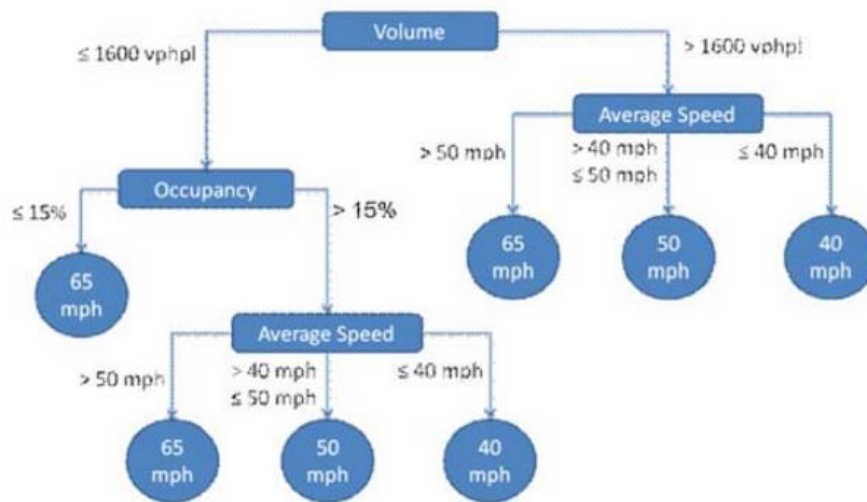
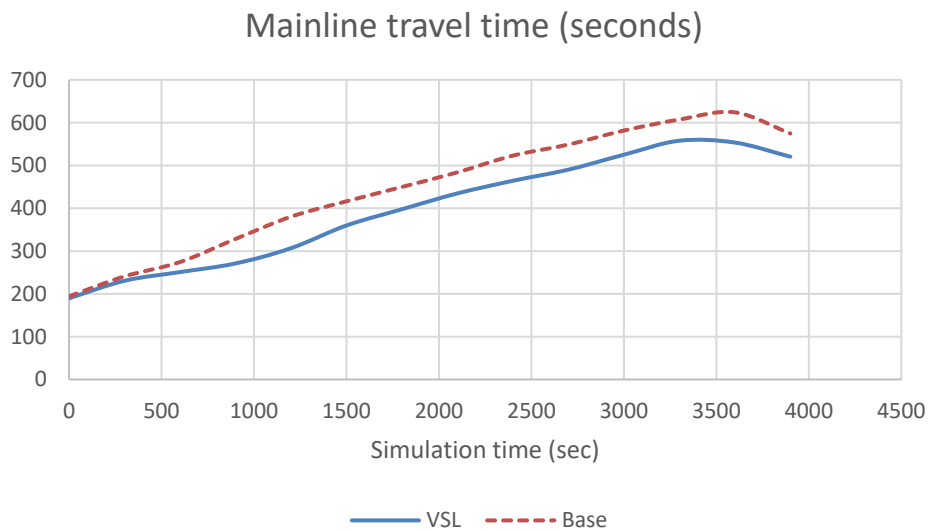

Figure 4.12 VSL control algorithm architecture (Allaby et al., 2007)

We implemented the VSL algorithm in VISSIM using the MATLAB-VISSIM COM interface and conducted multiple runs of simulations, in both base case (without freeway controls) and VSL controlled case. The major results are summarized in Table 4.2 and Figure 4.13.

**Table 4.2: VISSIM network performance with and without VSL control**

	VSL Controlled	Base Case	Percentage Improvement
<b>Average Delay (sec)</b>	177.33	213.03	<b>-16.8%</b>
<b>Avg Speed (km/hr)</b>	36.35	32.95	<b>10.3%</b>
<b>Avg Stopped Delay (sec)</b>	32.44	35.63	<b>-8.9%</b>
<b>Total Distance (km)</b>	33192.62	33209.16	-0.04%
<b>Total Travel time (sec)</b>	3287377	3634213	<b>-9.5%</b>
<b>Total Delay (sec)</b>	1986495	2387907.5	<b>-16.8%</b>
<b>Total Stopped Delay (sec)</b>	363343.85	399417.99	<b>-9.0%</b>
<b>No. of Arrived Vehicles</b>	11202	11210	-0.07%



*Figure 4.13 Mainline travel time with and without VSL control*

Table 4.2 summarizes the corridor performance for traffic using the mainlines. From the different performance metrics, we can see that in both cases the total travel distance and number of arrived vehicles are essentially identical. This is plausible as in the simulation all demands are cleared by the end of simulation. A significant improvement of traffic condition is observed when VSL is deployed, judging by the approximately 16.8% reduction of total delay and 10% increase of travel speed, as well as other relevant performance metrics. Table 4.2 gives an illustration of corridor travel time over different time periods. Consistent with the network performance, we observe that the VSL constantly improves the corridor speed. On average, the travel time with VSL is in the range of 20 to 80 seconds.

From the case study with VSL, we concluded that VSL showed a good promise to improve corridor-level traffic conditions. The improvements in travel delay and speed are both significant.

Considering that we adopted an existing algorithm without intentionally optimizing its parameters, this strategy presents further areas to explore. We envision that VSL would be effective when critical bottlenecks present (such as the freeway merging in this case) and traffic breakdown is easily triggered due to excessive demand.

### 4.3.3 Dynamic Lane Use Control

#### *Ramp-based dynamic merge control*

Dynamic merge control can be used to alleviate congestion that results due to conflicting traffic movements on freeway-ramp merging sections. Studies from the Netherlands indicate that optimizing the merging of two facilities using this strategy reduces mean travel time for vehicles on both the freeway and the ramp (Jones, et al., 2011). As shown in Figure 4.14, the rightmost lane on the main line is blocked to facilitate merging of ramp traffic. This strategy was implemented for our selected testbed. Specifically, the rightmost lane on sections of the freeway preceding all merging ramps was blocked for through traffic. The criteria for blocking through traffic on the rightmost lane relied on the occupancy measurements on the ramp. Furthermore, this strategy was implemented dynamically to account for varying demand on the ramp.

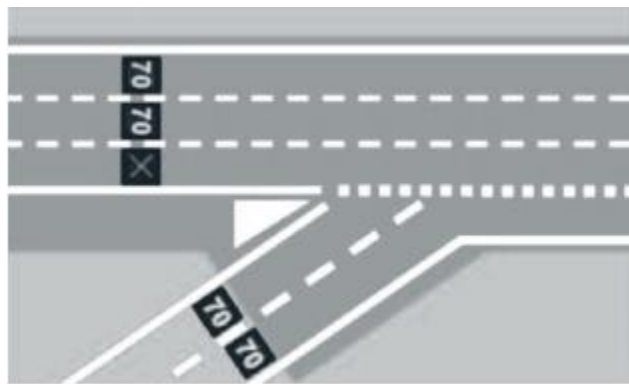

Figure 4.14 Dynamic lane use: ramp merge control (Jones, et al., 2011)

In practice, one could block vehicles on the rightmost lane with dynamic VMSs. This was simulated in VISSIM by blocking the rightmost lane for all types of vehicles in the simulation. Effectively, blocking lanes in VISSIM will ask blocked vehicles to switch lanes if such a maneuver is possible. Therefore, using this tool adequately resembles the use of a VMSs in practice.

The simulation was conducted for the same duration and travel demand. The VISSIM simulation was repeated for two different ramp occupancy thresholds. Those results were compared with base simulation results that give an indication of the network performance without implementing DLUC.

Contrary to results found in the literature, the dynamic lane use junction control strategy for merging ramps was not helpful in reducing travel time. Figure 4.15 plots the average travel time on the main corridor during different simulation time periods. The travel time is plotted for different ramp occupancy thresholds. It is clear that not only the travel time on the main corridor is higher when DLUC is implemented, but also the vehicles need more time to dissipate which corresponds to decreased efficiency. The poor performance of the ATM strategy is expected to be due to the high level of demand on the main line. Effectively, blocking one lane on the main line

would aggravate the already congested conditions. In Section 8.5, we describe tests of the dynamic merge control strategy for a generic network with a half-mile corridor with an on-ramp and a bottleneck. These results indicated that for certain demand levels and incident severity, the dynamic merge control strategy improved network conditions by 5 to 7%.

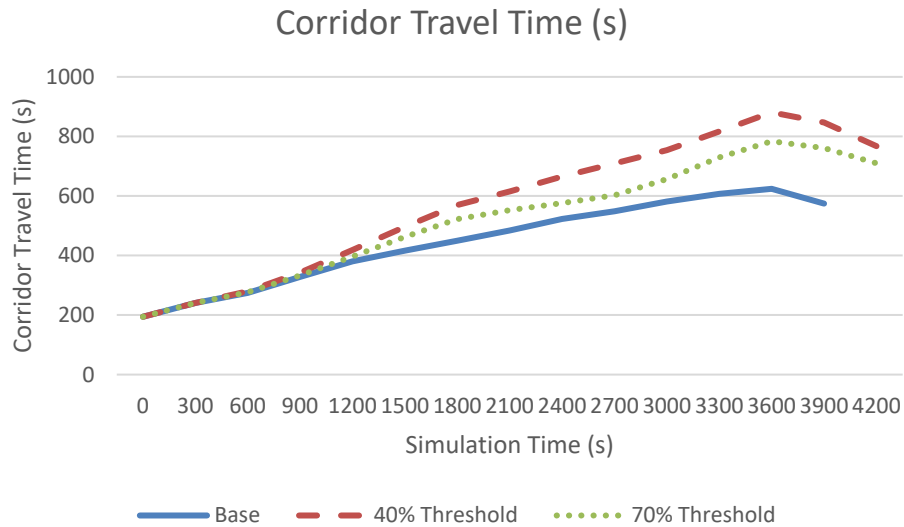

Figure 4.15 Mainline travel time: ramp-based dynamic merge control

The DLUC merge control strategy did not consistently increase the travel time for the section of the freeway between the two interchanges. As shown in Figure 4.16, the lowest travel time for different simulation time ranges alternated between the base case and DLUC with thresholds on ramp occupancy that are greater than 70%. Moreover, the average queue length on the on-ramps decreased significantly upon the use of DLUC. As shown in Figure 4.17, the average queue length decreased substantially even for a threshold on the ramp corresponding to an occupancy of 70%. Therefore, for a control strategy that has a high occupancy threshold, DLUC manages to reduce queues significantly while keeping the travel time on the main corridor close to the base travel time.

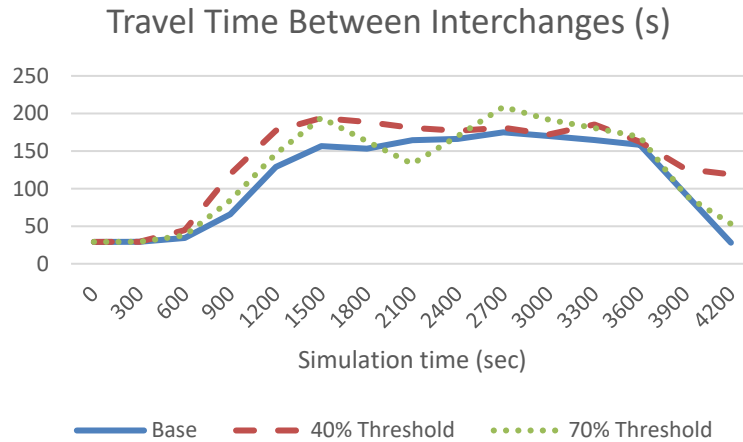

Figure 4.16 Mainline travel time measured between first two interchanges: ramp-based dynamic merge control

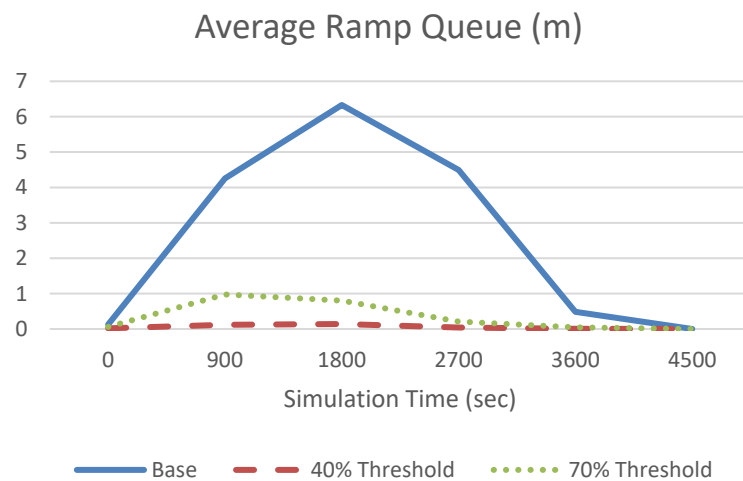

Figure 4.17 Average ramp queue length: ramp-based dynamic merge control

DLUC for ramp merging control also improved other aspects of network performance such as the average stopped delay. For the control strategy with a ramp threshold occupancy of 40%, the average stopped delay was reduced by 11%. However, this also corresponded to an increase in total delay by 10.8% due to increased travel time on the main corridor.

#### Dynamic Lane Use – Hard Shoulder Running

HSR has been used successfully in Europe to alleviate congestion by increasing the capacity of the roadway (Mirshahi, et al., 2007). In practice, HSR is implemented by using dynamic message signs that inform drivers when the shoulder is open. Moreover, HSR was shown to reduce the delay by 9–20% when there are bottlenecks (Hale, et al., 2016). In this work, HSR was modeled in VISSIM at an upstream location near a bottleneck in the base network. Specifically, the left-most lane of the freeway link that is located at the first merge was used as the

shoulder. This implementation enables the evaluation of HSR in terms reducing delays that result from the merging bottleneck. Therefore, the average threshold occupancy on detectors upstream of the merge bottleneck was used to dynamically decide on whether the shoulder lane should be open for traffic or not. The threshold occupancy indicates the occupancy level on the freeway above which the hard shoulder should be open. The implemented strategy was operated over 10-minute control steps such that the sudden changes in traffic due to hard shoulder availability are avoided. Figure 4.18 shows the hard shoulder as implemented on the base network.

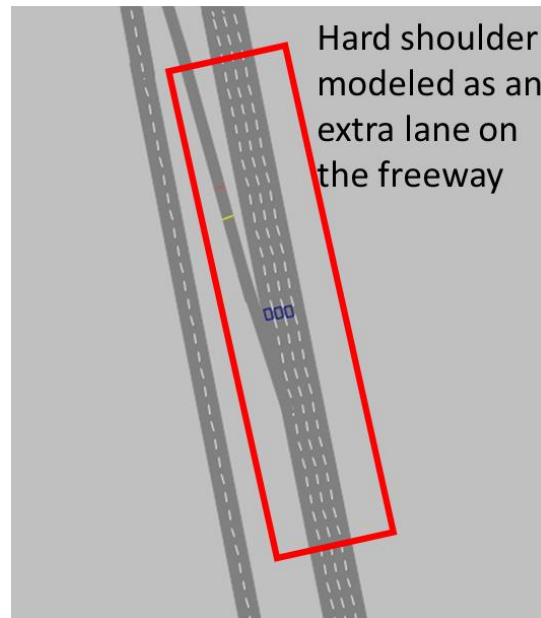

Figure 4.18 Implementation of HSR in VISSIM

The travel time across the entire corridor was measured before and after applying HSR. Figure 4.19 shows the results obtained from the simulation. As shown, the control strategy performs differently for different occupancy thresholds. Figure 4.19 indicates that for all threshold occupancies the *travel time on the main corridor improved*. Even a high threshold occupancy of 80% caused a reduction in travel time. It is also apparent that the marginal benefit in terms of reduction in travel time decreases for lower threshold values. That could be observed by noticing that the travel time on the main route was approximately the same for a 60% and a 40% occupancy threshold. This could be due to the sharp jump in occupancy at the bottleneck from about 30% to near 90% over one control step in the simulated network. Therefore, the effect of having different occupancy thresholds is less pronounced. A distribution of demand at the bottleneck that does not vary sharply might further indicate the comparative benefit of using different thresholds. Also, the primary contribution to reduction in travel time was at later stages of the simulation time, which is due to increased demand at late simulation stages.



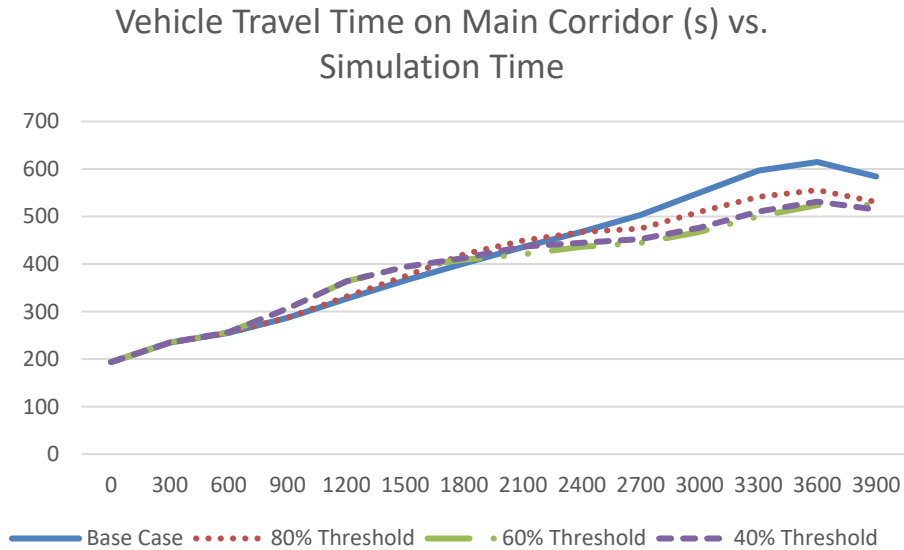

Figure 4.19 Mainline travel time: HSR

The network performance for different occupancy thresholds improved when HSR was implemented. Table 4.3 indicates that the average delay, total delay, and travel time decreased while the average speed increased. Moreover, the network performance improved consistently as the threshold occupancy was lowered.

Table 4.3: Network performance: HSR

	Base	80% Threshold	60% Threshold	40% Threshold
Average Delay (sec)	199.35	185.64	181.81	180.8
Avg Speed (km/hr)	34.45	35.96	36.49	36.61
Avg Stopped Delay (sec)	34.18	32.86	35.3	35.16
Total Distance (km)	33187.14	33212.5	33193.58	33190.85
Total Travel time (hours)	966.71	924.34	912.23	909.0
Total Delay (hours)	620.75	578.05	566.14	563.0
Total Stopped Delay (hours)	106.41	102.30	109.9	109.5
No. of Arrived Vehicles	11210	11210	11210	11210

The analysis of HSR indicates the potential benefit of using shoulder lane for adding extra capacity to the roadway. The calibration of the occupancy threshold should be done based on the occurring demand conditions.

#### 4.3.4 Freeway-Arterial Coordinated Operation

Freeway-arterial coordinated operation (FACO), sometimes known as CFA operations, is a strategy to coordinate ramp meters and neighboring traffic signals. The main purpose is to fully leverage the arterial and frontage road capacity and storage space, and at the meanwhile avoid queue spillover and ensuing gridlocks through the coordination of signals and ramp meters.

In the selected corridor, we devised a coordination strategy based on the idea of switching control. A schematic representation of the system is shown in Figure 4.20. In this system, detectors measure traffic flow conditions on freeway and on-ramps. The measurements are transmitted to corresponding controllers in upstream (marked with the same color in the figure). In this system, without loss of generality, we assume that the ramp meter is controlled by ALINEA algorithm. The upstream traffic signal is adjusted based on congestion level of the ramp. For a general traffic signal, its phases are categorized into two groups according to how it relates to ramp congestion.

- Feeding phases: if in a signal phase, arterial traffic flow is discharge to a selected ramp, this phase is called a feeding phase to the ramp.
- Non-feeding phases: all other phases are called non-feeding phases.

A simple switched logic was designed for the traffic signal control, as illustrated in Figure 4.21. Depending on the occupancy of measurement, the upstream traffic signal was switched between three modes. In each mode, the traffic signal adopts a fixed-time plan. When ramp occupancy exceeds a threshold value (we take it as 0.4 in this study), the green time of feeding phases was reduced so as to hold flow to be discharged to the ramps. With a similar rationale, when ramp occupancy is below a certain threshold value (here assumed 0.2), the green time of feeding phases was increased so as to fully utilize the ramp storage space.

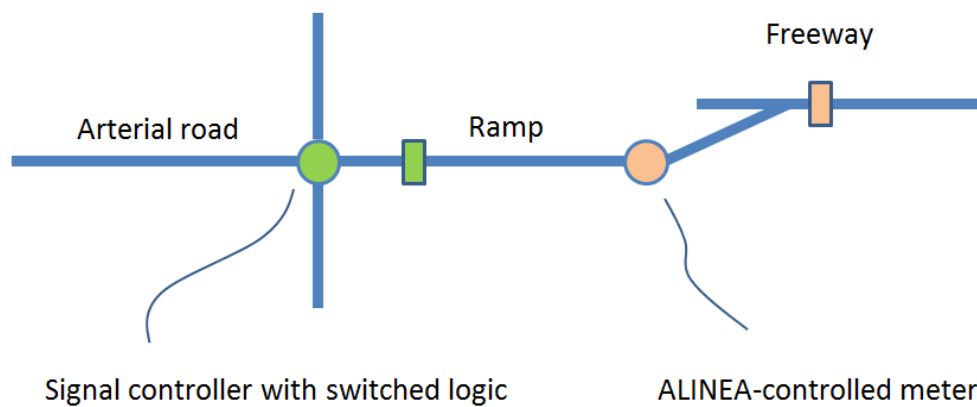

Figure 4.20 Schematic representation of a CFA system

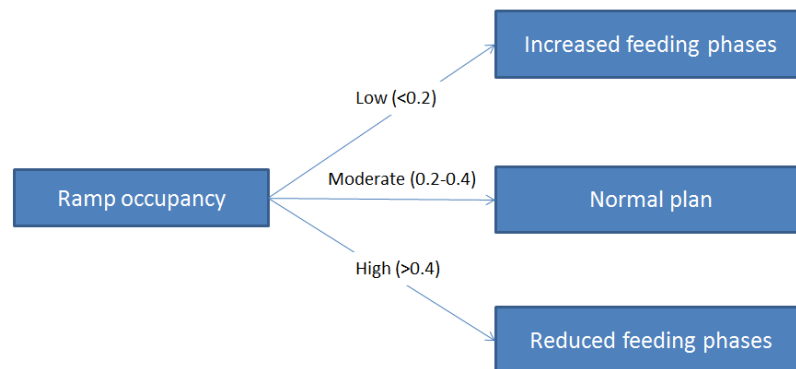
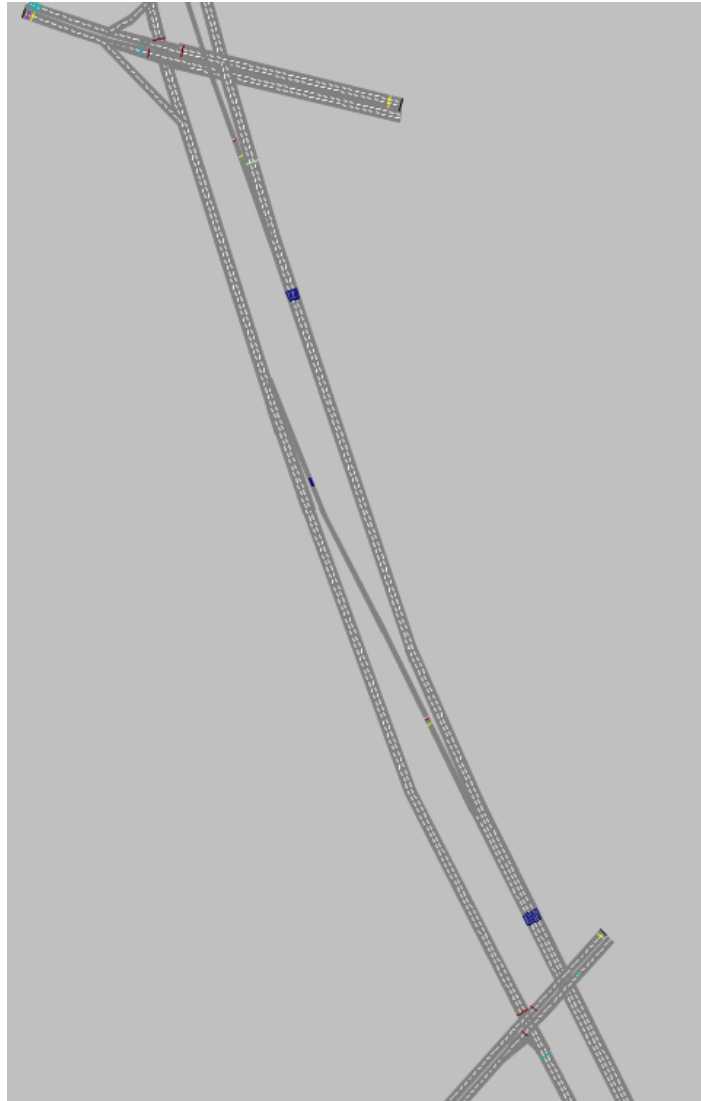

Figure 4.21 A switch control logic of freeway-arterial coordination

For this case study, there are two ramp meters and three traffic signals (their phase and timing are independent). An example of a CFA segment implemented is shown in Figure 4.22. Like previous case studies, we implemented this strategy using the COM interface. The CFA strategy was implemented on two signal-ramp segments.



*Figure 4.22 A CFA segment*

We compare two cases:

- Base case: traffic signal is fixed-time, independent of downstream ramp congestion level
- Coordinated case: traffic signal follows the aforementioned switched logic

Three simulation runs are conducted for each case, with the results presented in Table 4.4.

**Table 4.4: Network performance: freeway-arterial coordinated operation with recurrent congestion**

	<b>BASE</b>	<b>FACO</b>
Average Delay (sec)	132.55	132.32
Avg Speed (km/hr)	43.71	43.87
Avg Stopped Delay (sec)	46.65	47.42
Total Distance (km)	32868.69	33123.19
Total Travel time (sec)	2707313	2718371
Total Delay (sec)	1475318.74	1475687.37
Total Stopped Delay (sec)	519220.22	528844.12
No. of Arrived Vehicles	11019	11121

From Table 4.4, we observe that the CFA control appears to provide uniform improvement over the base case in terms of average delay and speed and total throughput, but the magnitude of improvement is marginal. One possible reason is that the recurrent demand level itself does not make the system seriously oversaturated. The ALINEA alone, when properly implemented, can handle such situation well. Another consideration is that the FAC strategy adopted in this study is simplified, which require minimal additional sensing and control infrastructures. This indicates a potential to achieve more significant improvement with FAC when more sophisticated strategies are developed.

#### 4.3.5 Combination of ATM Strategies (RM+VSL)

We also studied the case when ramp metering and VSL are implemented together. For simplicity, we do not assume coordination between these strategies. These strategies are adaptive based on respective detector measurements. The results are summarized in Table 4.5 and Figure 4.23.

**Table 4.5: Network performance: ramp metering (RM) and VSLs combined**

	<b>VSL+RM</b>	<b>VSL</b>	<b>RM</b>	<b>Base</b>
Average Delay (sec)	235.67	177.33	199.33	213.03
Avg Speed (km/hr)	30.11	36.35	34.43	32.95
Avg Stopped Delay (sec)	101.53	32.44	57.11	35.63
Total Distance (km)	32654.62	33192.62	33081.93	33209.16
Total Travel time (hours)	1084.391	913.1603	965.64	1009.50
Total Delay (hours)	731.1521	551.8042	620.70	663.31
Total Stopped Delay (hours)	314.9919	100.9288	177.85	110.95
No. of Arrived Vehicles	10993	11202	11186	11210

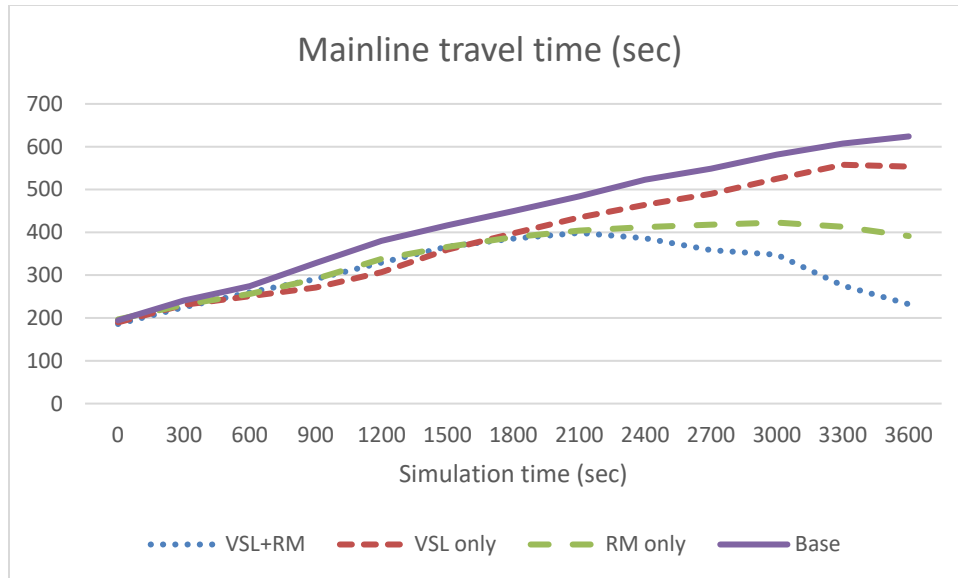

Figure 4.23 Mainline travel time with and without VSL+RM

We see that when two ATM strategies worked together but without coordination, the performance is not necessarily better than the base case. The corridor travel time is significantly better with the combination; however, due to the speed reduction caused by VSL, the ramp metering detector records high occupancy and thus the ramp is kept closed longer—leading to increased overall delay. Another possible reason for this degradation of performance is that without coordination, the two strategies respectively make reactions, which combined could be too conservative. This makes the system far from its optimal state (i.e., near capacity) and results in a 10% increase in system delay. The excessive stopped delay appears to justify this point to some extent.

#### 4.3.6 Conclusions

From the microsimulation analysis of different ATM strategies, we conclude that the performance of an ATM strategy depends significantly on the choice of control algorithm. Ramp metering, VSLs, and HSR are found to improve the overall performance of the corridor leading to reduced values of average delay and total system travel time. The freeway-arterial coordinated operation results indicate marginal improvement over the base case. DLUC near ramp merge resulted in an increased value of corridor travel time but led to lower values of observed queue length, thereby improving the overall network performance. Thus, DLUC can be an effective strategy for improving the overall network performance but not always for the mainline. On the contrary, the combined ramp metering and variable speed control strategy led to a reduction in the corridor travel time but worsened the overall network performance. This suggests that combination of ATM strategies should be carefully implemented. A possible coordination of ATM strategies can avoid the worsening of the impacts on network performance. The next section will analyze the effectiveness of each ATM strategy in presence of a non-recurring congestion.

#### 4.4 Microsimulation Analysis of Non-Recurring Congestion

Non-recurring congestion refers to congestion caused by unexpected or transient events such as accidents (Hallenbeck et al., 2003). This type of congestion pattern results in a drop of

capacity of the affected links for a certain duration. The objective of this section is to evaluate the effectiveness of ATM strategy under non-recurring congestion patterns.

#### 4.4.1 Modeling Non-Recurring Congestion

Reduced speed areas were used to model non-recurring congestion in VISSIM. A vehicle traveling through a reduced speed area obeys the reduced speed limit of that zone. We assumed 100% compliance in the reduced speed zone to model the incident impact. To analyze the performance of the chosen algorithm, non-recurring congestion was assumed to occur at a chosen location, for duration of 20 minutes, leading to reduction in speed limit from 100 km/hr to 50 km/hr.

The location of the non-recurring incident was between the second and the third interchange, as shown in Figure 4.24.

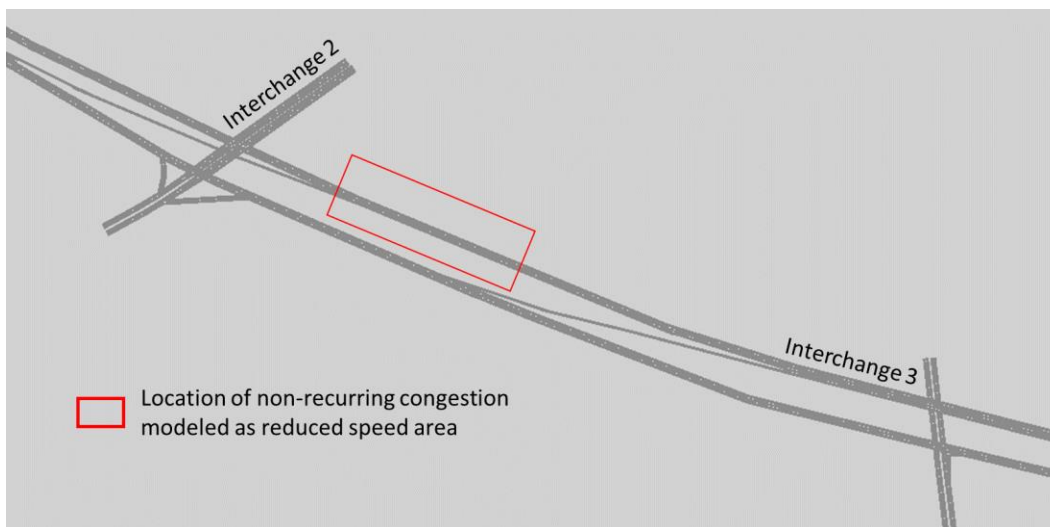

*Figure 4.24 Location of non-recurring congestion on the network*

The analysis of the performance of each ATM strategy is summarized in the following subsections.

##### *Ramp Metering*

The performance of the ALINEA algorithm, proposed in Papageorgiou (1991) (referred to as Algorithm 1 in the figures below) was compared against the base scenario considering the non-recurring congestion to occur. The ramp meters were installed on the two on-ramps as shown in Figure 4.8. The analysis results are shown in Figure 4.25 and Table 4.6. The label “NRC” in the graphs refers to non-recurring congestion.

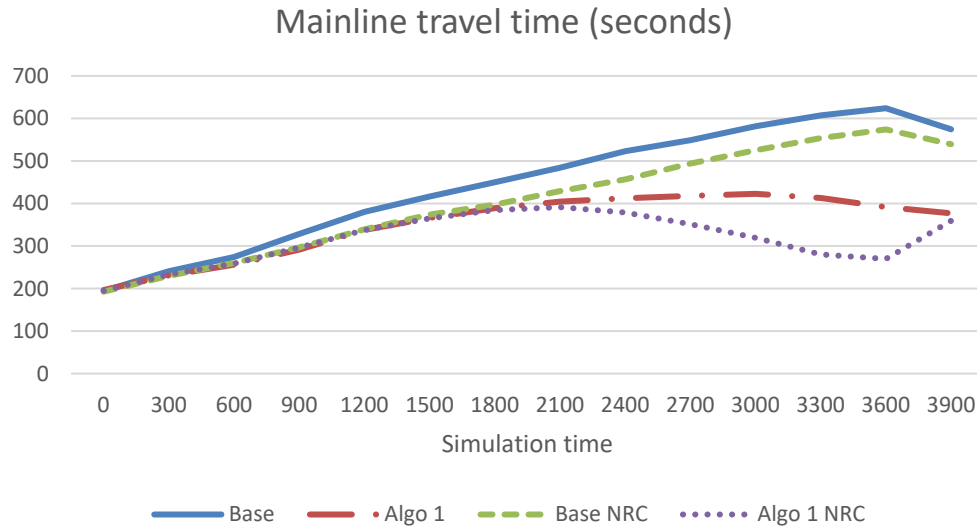

Figure 4.25 Mainline travel time: ramp metering non-recurring congestion

**Table 4.6: Network performance: ramp metering (non-recurring congestion)**

	<b>Base</b>	<b>Algo 1</b>	<b>Base NRC</b>	<b>Algo 1 NRC</b>
Average Delay (sec)	213.03	199.33	188.56	250.26
Avg Speed (km/hr)	32.95	34.43	35.39	29.58
Avg Stopped Delay (sec)	35.63	57.11	32.06	109.76
Total Distance (km)	33209.16	33081.93	33210.66	32652.07
Total Travel time (hours)	1009.50	965.64	940.21	1117.83
Total Delay (hours)	663.31	620.70	587.17	770.94
Total Stopped Delay (hours)	110.95	177.85	99.82	337.62
No. of Arrived Vehicles	11210	11186	11210	10938

The following observations can be made from this analysis:

1. After having a non-recurring congestion for a 20-minute duration, the travel time and average delay improved for the base network without any ATM strategy. This is a counter-intuitive result but is possible in practice where having a non-recurring congestion upstream can lead to slowing down of vehicles and thus can improve the corridor travel time. In some sense, the non-recurring congestion plays the role of VSLs.
2. The performance of ramp metering algorithm worsened for the non-recurring congestion case. The average delay is high; the total system travel time increased significantly and approximately 272 vehicles could not exit the simulation (apparent in the reduced value of number of arrived vehicles). This is because the non-recurring congestion led to an increase in the occupancy readings of the ramp metering detectors, which led to ramp closure for a significant period.

We thus conclude that ALINEA algorithm is not suitable for improving non-recurring congestion closer to the bottleneck for the current testbed. However, the performance of an algorithm also depends on location, severity, and duration of the incident.

*Variable Speed Limits*

The major results are summarized in Table 4.7 and Figure 4.26. VSL performed very well and provided substantial improvement over the base case. In particular, the mainline travel time and travel speeds both improved with VSL. However, we note that number of arriving vehicles decreased by 20.1%, an indication of lower system throughput.

**Table 4.7: Network performance: VSL non-recurring congestion**

	VSL Controlled	Base Case	Percentage Improvement
Average Delay (sec)	149.44	188.56	<b>-20.8%</b>
Avg Speed (km/hr)	41.57	35.39	<b>17.5%</b>
Avg Stopped Delay (sec)	28.56	32.06	<b>-10.9%</b>
Total Distance (km)	26681.11	33210.66	-19.7%
Total Travel time (sec)	2565156.5	3384756	<b>-24.2%</b>
Total Delay (sec)	1538024.6	2113812	<b>-27.2%</b>
Total Stopped Delay (sec)	278947.3	359352	<b>-22.4%</b>
No. of Arrived Vehicles	8951	11210	-20.1%

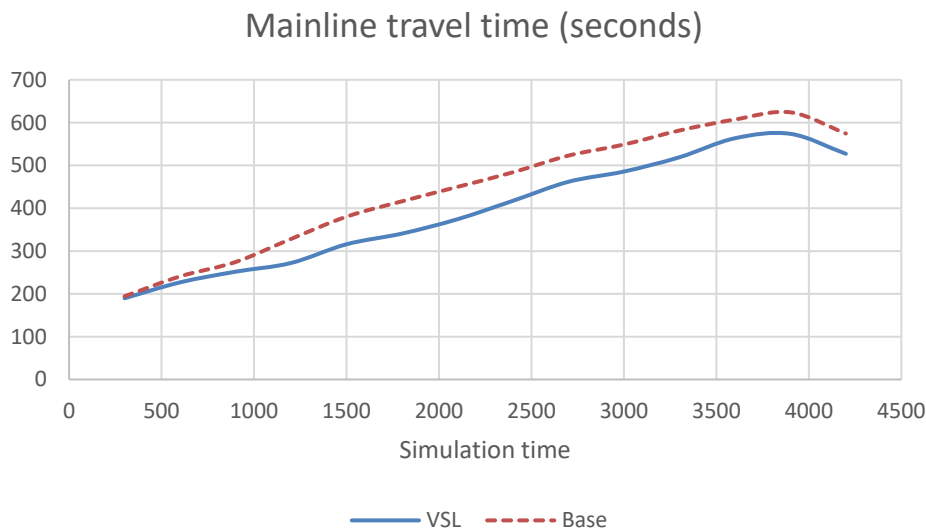

*Figure 4.26 Mainline travel time with VSL and non-recurrent congestion*



*DLUC: Ramp-Based Dynamic Merge Control*

As shown in Figure 4.27, the travel time on the main corridor when using the dynamic merge control strategy increased. This is due to the congested conditions on the main corridor as mentioned earlier. Moreover, similar to the without non-recurring congestion case, the average queue length on the on-ramps decreased significantly. The variation in network performance before and after implementing DLUC is shown in Table 4.8. The network performance is still worse under DLUC implementation. However, the stopped delay decreases when dynamic merge control is used. This is due to the reduction in queues on the on-ramps.

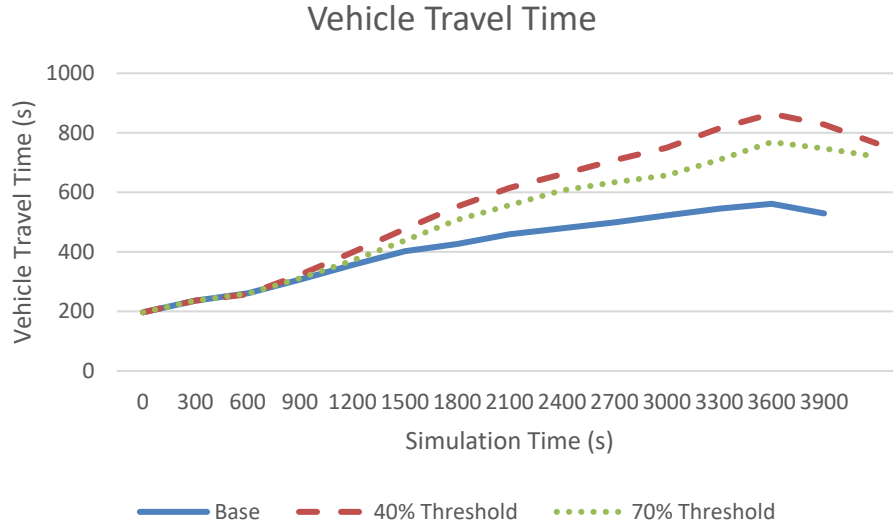

Figure 4.27 Mainline travel time: DLUC near ramp merge with non-recurring congestion

**Table 4.8: Network performance: DLUC near ramp merge with non-recurring congestion**

	<b>Base</b>	<b>70% Threshold</b>	<b>40% Threshold</b>
Average Delay (sec)	193.79	223.63	234.08
Avg Speed (km/hr)	34.78	31.7	30.74
Avg Stopped Delay (sec)	33.09	33.96	31.83
Total Distance (km)	33209.53	33195.3	33211.14
Total Travel time (hours)	955.51	1047.81	1080.44
Total Delay (hours)	603.43	696.33	728.92
Total Stopped Delay (hours)	103.03	105.76	99.13
No. of Arrived Vehicles	11210	11210	11210

*DLUC: Hard Shoulder*

The variation of travel time on the main corridor across different occupancy thresholds is given in Figure 4.28. As shown, HSR did not give consistent improvement over the base case. That is because HSR was implemented upstream at the first merge, while the bottleneck was created downstream. Even though HSR improves capacity upstream, the vehicles arrive at the bottleneck at a higher rate, which aggravates the conditions at the bottleneck. In contrast to HSR network

performance without the non-recurring congestion bottleneck, the network performance for 40% and 60% thresholds in this case was worse than the base case. Yet, for 80% threshold on occupancy HSR improved the network performance. This is possible because at 80% threshold the shoulder is only open at high congestion, and the capacity improvement due to use of HSR does not significantly increase the rate at which vehicles reach the downstream bottleneck throughout the simulation. Table 4.9 shows the variation in network performance of HSR for different thresholds and compared to the base of nonrecurring congestion.

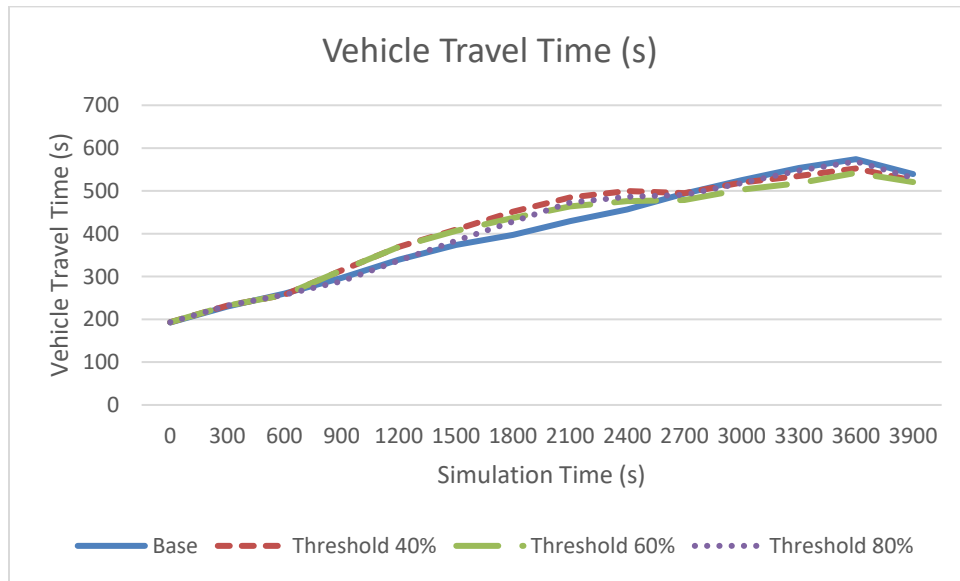

Figure 4.28 Mainline travel time: HSR with non-recurring congestion

Table 4.9: Network performance: HSR with non-recurring congestion

	Base	80% Threshold	60% Threshold	40% Threshold
Average Delay (sec)	188.56	187.7	189.45	193.18
Avg Speed (km/hr)	35.39	35.54	35.51	35.17
Avg Stopped Delay (sec)	32.06	32.8	36.51	38.34
Total Distance (km)	33210.66	33196.73	33176.05	33187.74
Total Travel time (hours)	940.20	937.32	942.48	954.17
Total Delay (hours)	587.17	584.46	589.96	601.53
Total Stopped Delay (hours)	99.81	102.13	113.69	119.38
No. of Arrived Vehicles	11210	11210	11210	11210

#### Freeway-Arterial Coordinated Operation

We conducted FACO with non-recurrent congestion and compared it with the base case (non-recurrent congestion without FACO). The network performance is summarized in Table 4.10. Unlike the recurrent congestion case, we observe that CFA control provides significant improvement over the base case when there is recurrent congestion. While the total throughput is

largely the same (not surprising because both case the total demand are cleared by the end of simulation), other performance metrics have a uniform 10–20% improvement. This comparison suggests when in case of serious non-recurrent congestion, FACO is a very promising strategy to distribute traffic over arterial and freeway so as to sustain the system efficiency at a good level.

**Table 4.10: Network performance: FACO with non-recurring congestion**

	<b>BASE NRC</b>	<b>FACO NRC</b>
Average Delay (sec)	159.52	134.23
Avg Speed (km/hr)	39.07	43.3
Avg Stopped Delay (sec)	56.03	48.41
Total Distance (km)	32875.11	32409.26
Total Travel time (sec)	3029031	2694413
Total Delay (sec)	1775429.39	1460439.88
Total Stopped Delay (sec)	623574.31	526718.24
No. of Arrived Vehicles	11018	10767

#### 4.4.2 Sensitivity Analysis

To model the impact of different congestion conditions, the non-recurring congestion analysis was repeated for an incident of higher severity (greater reduction in capacity), longer duration of the bottleneck, and different bottleneck location. The increased severity was modeled by reducing the speed to 15 km/hr instead of 50 km/hr. The increased duration was modeled by reducing the speed between 500 and 3000 seconds of the simulation time instead of 900–2100 sec. The alternative bottleneck location was chosen to be on the link after the first merge to the main corridor. The sensitivity analysis was performed for HSR and ramp metering.

##### *HSR, Downstream Bottleneck – Increased Severity*

First, the performance of the network was analyzed with an increased severity of the non-recurring congestion but without the use of HSR. This is referred to as the base case for this section. Then, HSR was used to evaluate if there are benefits over the base case. The threshold occupancy that was used for HSR is 40%. This implies that if the occupancy of the freeway at the first merge, where HSR is implemented, increases beyond 40%, then the shoulder will be opened. As expected for a downstream bottleneck with HSR implemented upstream, the network conditions worsened. This is shown in Figure 4.29 and Table 4.11. The reasons for this behavior are the same as those given in 4.3.3.

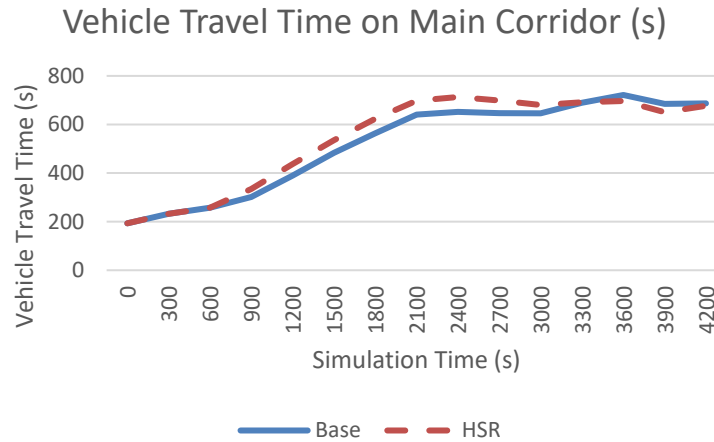

Figure 4.29 Mainline travel time: HSR non-recurring congestion with increased severity

**Table 4.11: Network performance: HSR non-recurring congestion with increased severity**

	<b>Base</b>	<b>HSR</b>
<b>Average Delay (sec)</b>	245.42	253.47
<b>Avg Speed (km/hr)</b>	29.2	28.55
<b>Avg Stopped Delay (sec)</b>	45.99	53.85
<b>Total Distance (km)</b>	33127.19	33101.79
<b>Total Travel time (hours)</b>	1135.41	1160.40
<b>Total Delay (hours)</b>	764.20	789.32
<b>Total Stopped Delay (hours)</b>	143.20	167.68
<b>No. of Arrived Vehicles</b>	11206	11191

#### *HSR Downstream Bottleneck – Increased Duration*

First, the performance of the network was obtained with increased duration but without the use of HSR. This is referred to as the base case for this section. Then, HSR was used to evaluate if there are benefits over the base case. The threshold occupancy used for HSR is 40%. This implies that if the occupancy of the freeway at the first merge, where HSR is implemented, increases beyond 40%, then the shoulder will be opened. As expected for a downstream bottleneck with HSR implemented upstream, the network conditions did not improve significantly. Yet, the results were inconclusive for this bottleneck scenario since HSR worsened conditions initially but improved them at subsequent stages. This is shown in Figure 4.30. Table 4.12 indicates that while HSR reduced the average delay, the average stopped delay increased. This could be due to vehicles benefiting from the increased capacity upstream, but then having to stop at the bottleneck downstream.

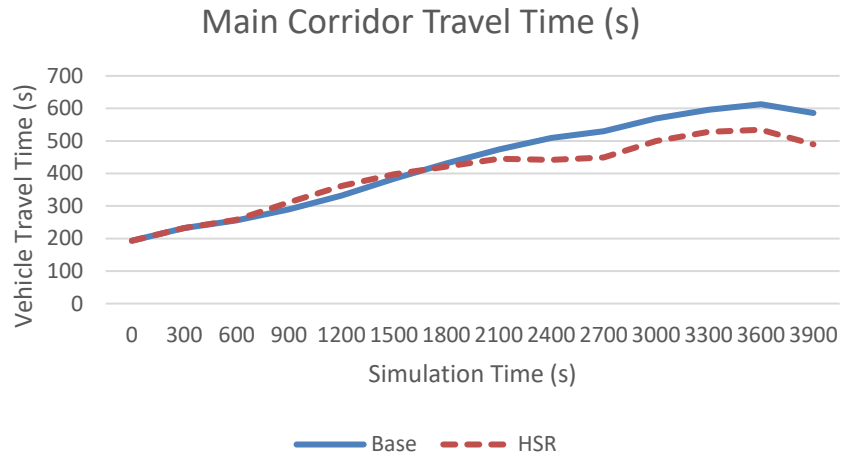

Figure 4.30 Mainline travel time: HSR non-recurring congestion increased duration

**Table 4.12: Network Performance: HSR non-recurring congestion increased duration**

	<b>Base</b>	<b>HSR</b>
<b>Average Delay (sec)</b>	201.86	177.91
<b>Avg Speed (km/hr)</b>	33.64	36.49
<b>Avg Stopped Delay (sec)</b>	35.01	36.21
<b>Total Distance (km)</b>	33197.77	33185.24
<b>Total Travel time (hours)</b>	988.64	914.27
<b>Total Delay (hours)</b>	628.55	553.98
<b>Total Stopped Delay (hours)</b>	109.029	112.74
<b>No. of Arrived Vehicles</b>	11210	11210

### HSR Upstream Bottleneck

First, the performance of the network was obtained with the bottleneck located upstream after the first freeway merge, but without the use of HSR. This is referred to as the base case for this section. Then, HSR was used to evaluate if there are benefits over the base case. Note that this case is different from the previous two in that HSR was applied at the same location of the bottleneck. This was expected to provide improvements in travel time since the additional lane effectively compensates for the reduced capacity. The threshold occupancy used for HSR is 40%. This implies that if the occupancy of the freeway at the first merge, where HSR is implemented, increases beyond 40%, then the shoulder will be opened. Figure 4.31 shows the travel time on the main corridor when HSR was implemented as compared to the base case. As expected, HSR reduced the travel time on the main corridor. Specifically, the average travel time per vehicle was reduced by about 5% (22 seconds). This corresponds to a total savings of 16 hours in travel time on the *main corridor*. For the entire network, the travel time over all vehicles decreased by 24.6 hours as shown in Table 4.13. The total delay for all vehicles across the entire network was reduced by 41 hours. This further indicates the benefit of HSR for the entire network (freeway and frontage roads).

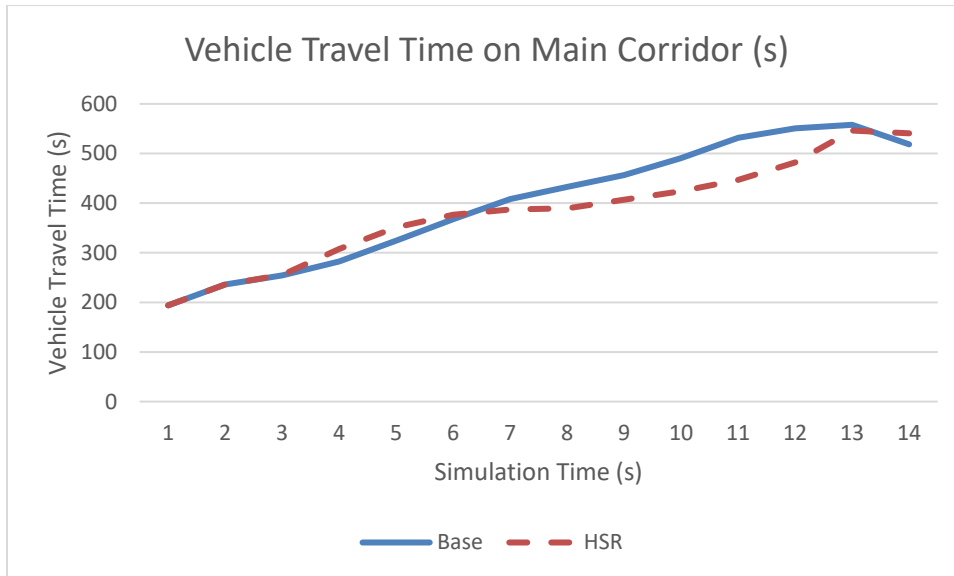

Figure 4.31 Mainline travel time: HSR non-recurring congestion, upstream bottleneck

**Table 4.13: Network performance: HSR non-recurring congestion, upstream bottleneck**

	<b>Base</b>	<b>HSR</b>
<b>Average Delay (sec)</b>	184.79	171.63
<b>Avg Speed (km/hr)</b>	35.78	36.76
<b>Avg Stopped Delay (sec)</b>	32.29	33.46
<b>Total Distance (km)</b>	33197.01	33199.88
<b>Total Travel time (hours)</b>	928.78	904.19
<b>Total Delay (hours)</b>	575.45	534.46
<b>Total Stopped Delay (hours)</b>	100.54	104.19
<b>No. of Arrived Vehicles</b>	11210	11210

The preceding sensitivity analysis conducted on the HSR case indicates that the performance of HSR depends on the location, severity and duration of the incident. Specifically, the location of the bottleneck is critical for the success of HSR. As shown, when HSR was implemented upstream of the bottleneck, the network conditions worsened since HSR was effectively increasing the rate at which vehicles arrived at the bottleneck. Meanwhile, when HSR was implemented at the location of the bottleneck, the network performance improved significantly. Considering the case of increased severity for downstream bottleneck, HSR led to an increase in total travel time by 3.29%. While for the case of increased duration of the downstream bottleneck, HSR led to a reduction in total travel time by 7.52%. This suggests that the decision of whether or not to operate HSR should depend on the location, duration and severity of the incident.

*Ramp Metering Sensitivity Analysis*

Similar to HSR, the sensitivity analysis of the ramp metering results were performed for each of three cases: increased severity of congestion, increased duration of congestion, and changed location of the bottleneck.

Table 4.14 and Figure 4.32 (a), (b), and (c) show the network performance analysis and the comparison of corridor travel time for each of the case.

**Table 4.14: Network performance sensitivity analysis—ramp metering (RM)**

Network performance from 0 to 5400 sec	Upstream Location		Increased duration		Increased Severity	
	RM	Base	RM	Base	RM	Base
Average Delay (sec)	263.69	188.68	220.77	201.86	323.49	245.42
Avg Speed (km/hr)	28.19	34.59	31.53	33.64	23.67	29.2
Avg Stopped Delay (sec)	127.03	42.66	89.89	35.01	137.64	45.99
Total Distance (km)	32450.69	33159.44	32754.23	33197.77	32465.49	33127.19
Total Travel time (hours)	1156.27	958.71	1043.62	988.64	1371.99	1135.42
Total Delay (hours)	811.47	587.54	687.07	628.56	1007.33	764.21
Total Stopped Delay (hours)	390.77	132.83	279.78	109.03	428.61	143.21
No. of Arrived Vehicles	10854	11206	11086	11210	11007	11206

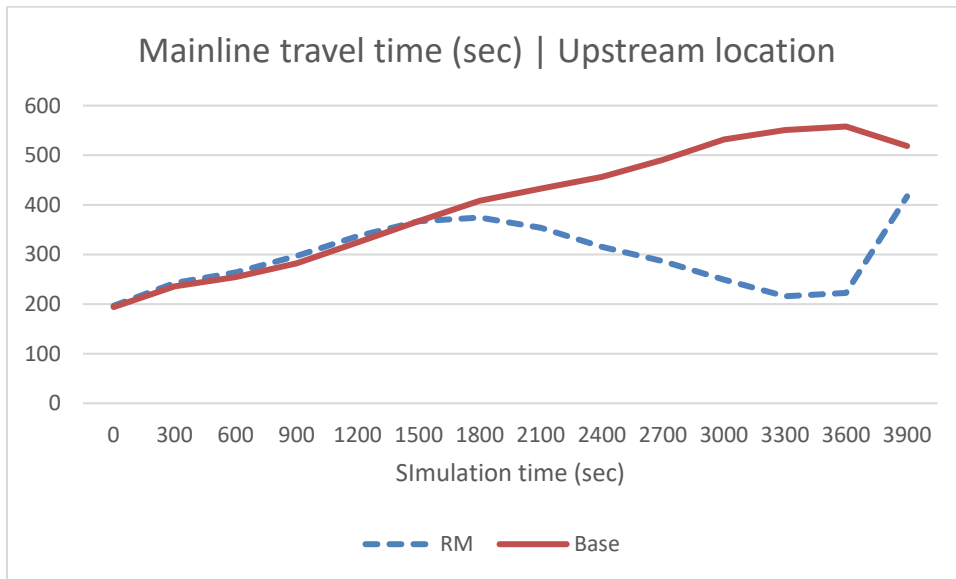

(a)

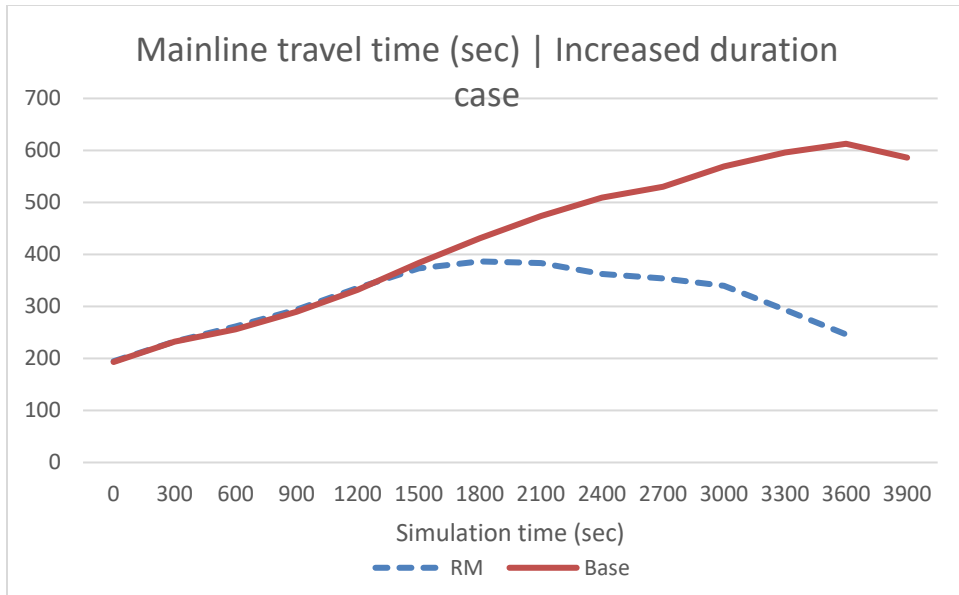

(b)

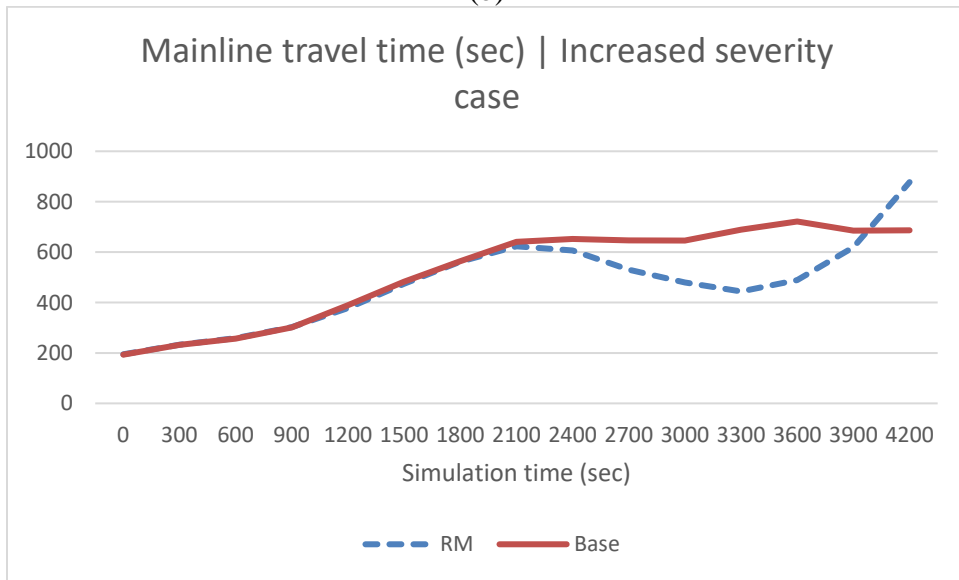

(c)

Figure 4.32 Mainline travel time: ramp metering sensitivity analysis

The following observations can be made from the analysis:

1. The ALINEA ramp metering algorithm worsens the network performance in comparison to the network without ramp metering for all the three cases. The average delays and total system travel time increase for all the three cases. In contrast, ramp metering improves the mainline travel time for all three cases during the earlier time steps. This is because the ramp metering algorithm holds a significant queue on the on-ramps, leading to improved performance of the mainline but worsened performance over the frontage roads, reducing the overall network performance.
2. For the case of upstream location of the bottleneck and the case of increased severity, ramp metering leads to higher corridor travel time closer to end of simulation. This is attributed



to the spillback of travelers exiting the earlier off-ramp towards frontage roads onto the mainline as the frontage road becomes heavily congested.

3. The percentage reduction in network performance (average delay, total system travel time, etc.) is different for different case and different network performance variables. In particular, the increased duration case leads to a marginal 9% increase in total system delay, whereas the increased severity and upstream location cases create a much worse scenario by increasing the delay by 31.8% and 38.2% respectively.

We conclude that the ALINEA ramp metering algorithm does not show improved overall performance under different scenarios of non-recurring congestion, although it leads to an improvement of corridor travel time. The network performance can be improved by overwriting the control predicted by the algorithm whenever the queue spillback causes congestion on the adjacent frontage roads and arterials.

## 4.5 Conclusions

The impacts of active traffic management strategies are multifold and can be complicated to characterize. Effective ATM deployment requires a thorough understanding and detailed modeling of various factors and their dynamical interplay, such as demand pattern, sensing and control systems, driver characters, and road geometry. Microsimulation can help capture these effects.

This chapter describes the research team's analysis of ATM strategies using VISSIM microsimulation tools. We focused on using microsimulation to evaluate ATM strategies on the Williamson County test bed. For this purpose, we chose four representative ATM strategies and implemented them within the VISSIM-COM framework. In addition, we discussed notable issues in conducting microsimulation-based evaluation, such as selection of micro-simulators, calibration and validation, and performance metrics.

A segment of IH 35 SB was selected as the simulation test bed for demonstrating the simulation evaluation programs and obtaining a preliminary insight into the effectiveness of the selected ATM strategies. Through before-and-after study with current level of travel demand in Williamson County, the positive effects of some of these strategies were confirmed. This indicates the potential for beneficially deploying these strategies to tackle the congestion problem in Williamson County. We also observed that the performance of ATM strategies depends on the chosen control algorithm. Ramp metering, VSLs, and HSR showed improved performance under cases of recurring congestion, whereas freeway-arterial coordinated operation showed improved performance under cases of non-recurring congestion. HSR showed improved performance under cases of non-recurring congestion when the shoulder is not located upstream of the bottleneck.

A major assumption in this analysis is that the demand level is dynamic (calibrated from the VISTA model) but exogenous. In the next step, the network-level route choice behavior was considered together with impacts of ATM strategies on congestion level—an analysis requiring hybrid modeling that can characterize the interplay of traffic control, traffic flow dynamics, and routing behaviors at multiple scales. The combined VISTA and VISSIM model is discussed in Chapter 6.

## **Chapter 5. Analysis Based on Dynamic Traffic Assignment (DTA)**

ATM strategies can impact traffic beyond the corridor on which they are implemented, primarily because travelers, in the long term, choose routes based on corridor performance. Thus, improving travel time along a corridor can attract more travelers. These changes in route patterns can cause congestion on other segments of the network, even while the selected corridor performs well under an ATM strategy. Analyzing the network-level impacts of ATM strategies is thus extremely important. These impacts should also be analyzed considering the time dependency of the control and demand. DTA, which can model route choice in large-scale networks, is thus an ideal method for studying network-level impacts of ATM strategies. Section 5.1 reviews the basic concepts of DTA, and provides some details about the DTA tool used for this study.

Several researchers have attempted to quantify the network-level impacts of adaptive measures using DTA; however, the research focusing on the network-level impacts of ATM strategies is limited. Yang et al. (2000) tested network-level impacts using MITSIMlab with Traffic Management Simulator integration. Chiu et al. (2011) discussed different applications of DTA for capturing the impacts of ITS technologies. Some of these applications included integrated freeway corridor management; traffic management for short- or long-term network disruptions; incident management; ITS evaluation and information provision; and multi-resolution regional traffic models. In a study by Hashemi and Abdelghany (2014), a simulation-based DTA model, DIRECT, was used for evaluating the active traffic management system for the US-75 corridor in Dallas, TX. Zhang et al. (2014) also used a simulation-based DTA model to develop an optimization meta-model to evaluate the transportation system performance under joint application of travel demand management and traffic control measures with simulation, and develops a surrogate approach for simulation-based optimization. Shelton et al. (2014) provided an application of simulation-based DTA analysis for analyzing impacts of active traffic and demand management techniques such as reversible lanes, ramp metering, and telecommuting on the IH-35 corridor in central Texas.

In this chapter, we describe the process of capturing the network-level impacts of different ATM strategies using DTA. Section 5.1 provides background on DTA software including VISTA, which is the software used for analysis for this project. In Section 5.2, details of the test network are presented and the calibration process used in VISTA is highlighted. Section 5.3 discusses the how various ATM strategies were implemented in VISTA and the results are analyzed. Conclusions on modeling network wide impacts using DTA are summarized in Section 5.4.

### **5.1 DTA Modeling**

DTA models capture the interaction between travel choices, traffic flows, and the time and cost measures of a network in a temporally coherent manner (Chiu et al., 2011). The structure of a DTA model is summarized in Figure 5.1.

There are two primary components of a DTA model: the route choice model allocating time-dependent demand to routes, and the dynamic network loading model that simulates travelers along their routes using traffic flow models and updating the travel time calculations (Yperman, 2007; Daganzo, 1994). These components are applied iteratively until an approximate dynamic user equilibrium is attained, which is defined as the flow pattern at which all travelers between same OD pair departing the origin at same time experience equal and minimal travel time.

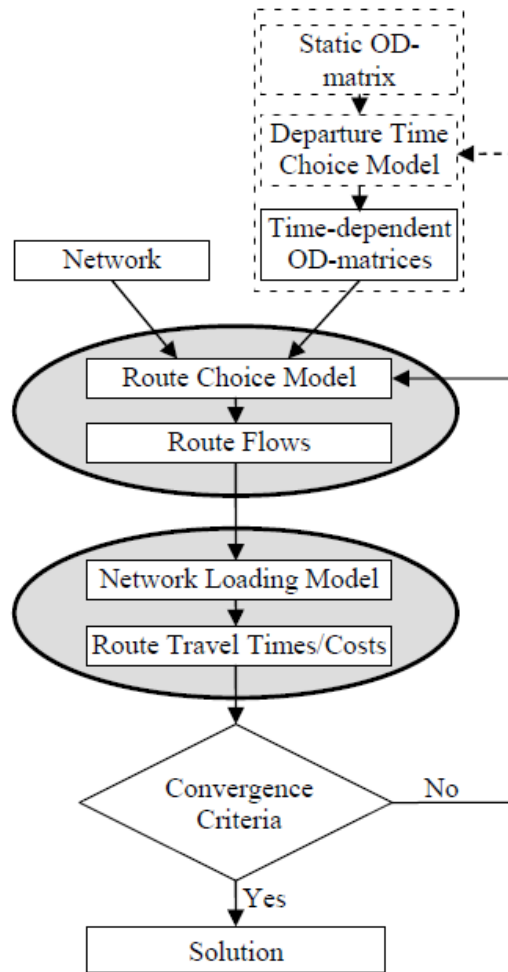

Figure 5.1 Overview of DTA procedure

DTA models in the literature can be classified into two categories—analytical and simulation-based DTA. Analytical DTA models formulate the equilibrium conditions as a variational inequality, but are limited in scope as they cannot be used for real-world applications and often fail to capture the effects of queuing and spillback. This makes simulation-based DTA models, which employ simulating vehicles based on traffic flow theories, a preferred choice of modeling. Simulation-based DTA models can operate at different scales of implementation. They can be broadly categorized into:

1. Macroscopic simulation models, which capture traffic flow propagation and trip-maker decisions on an aggregate level (INDY, METANET)
2. Mesoscopic simulation models, which govern vehicle movements at an aggregate level, while trip-maker decisions such as route choice are made individually (DynaMIT, DynaSMART, VISTA)
3. Microscopic simulation models, which capture routing and flow of each vehicle individually (TRANSIMS, DYNAMIQ, VISSIM)

The choice of granularity (macroscopic, microscopic, or mesoscopic) has significant implications for the real-time computational tractability of simulation-based DTA models. When using microscopic simulation models, one often must limit the size of the network to a corridor, which makes it impossible to capture the broader impacts of ATM strategies on other arterials or collectors in a network. Macroscopic models can be used to analyze large networks but do not capture the traffic dynamics of queuing and spillback realistically. Mesoscopic models, on the other hand, can handle large-scale city networks and model traffic evolution accurately, which makes them an appropriate tool for studying ATM strategies.

VISTA is mesoscopic simulation-based DTA software developed by Vista Transport Group from 2004 to 2009. It is currently operated and maintained by the Center for Transportation Research at The University of Texas at Austin. VISTA has been successfully used to test the impacts of several network-level changes in previous projects for the Texas Department of Transportation (0-4634, 0-4637, and 0-6575). VISTA as a DTA software offers the following advantages:

- It can capture the network-level impact for different time-varying changes in the network, including signals and lane closures.
- It has a web-based interactive user interface and hence is very easy to operate.
- It offers a visualization tool box for graphical interpretation of the simulation results called VizTool, which is accessible online.

## **5.2 Modeling and Calibrating Base Network in VISTA**

As described previously, the Wilco network was chosen as the test bed to test the implementation of different ATM strategies. The network has 1900 nodes and 3953 links. The southbound freeway segment on IH 35 between East Old Settlers' Boulevard and SH 45 is one of the most congested segments of the network, prompting its selection for the testing ATM strategies using VISTA and VISSIM.

Figure 5.2 highlights this segment of the Wilco network. It consists of the southbound IH-35 corridor with three on-ramps and four off-ramps. The first step was to fine-tune the calibration of the entire county network, and validate the flows on the freeway segments produced from the model with the tube-counts and loop detector data on selected links. The calibration process was performed with the objective of working on a network with realistic congestion patterns.

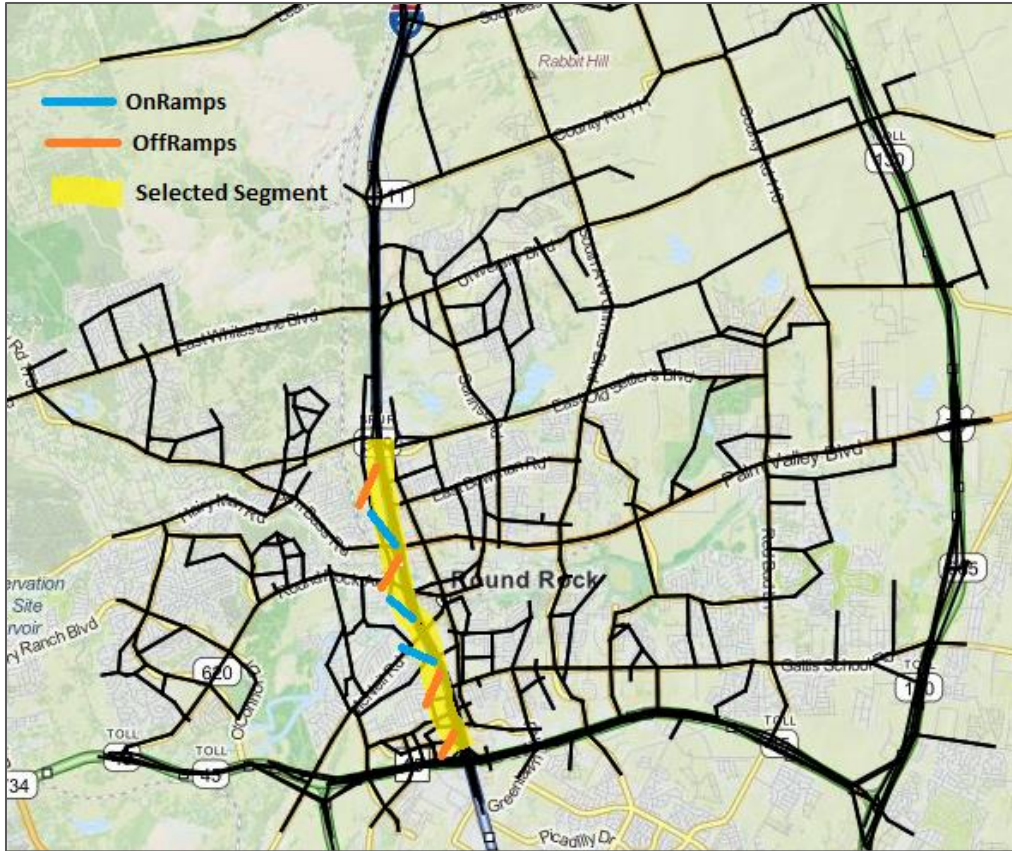

Figure 5.2 Selected southbound IH-35 segment, with approximate locations of ramps

The Wilco network available at CTR was already calibrated to provide traffic volumes that were close to real field counts. Only minor fine-tuning of model parameters was required to reduce the error in prediction of the traffic volume on the selected freeway segment.

For this purpose, the demand between OD pairs was modified by an informed trial-and-error process until the error in prediction of volumes reduced. A typical iteration for the fine-tuning involved identifying the links on the freeway segment with large differences between the observed and actual counts; identifying vehicles and OD pairs that utilize those links using the results from previous iteration; and finally updating the demand between those OD pairs.

Figure 5.3 shows the changes in root mean square (RMS) error for the entire network and for the freeway segment across fine-tuning iterations. Using these fine-tuning steps, the RMS error of the freeway segment was drastically reduced at the cost of marginally increasing the RMS error for the entire network. Further fine-tuning of the demand values was ineffective in reducing the errors. The resulting network was as used as the base case for testing the effectiveness of ATM strategies.

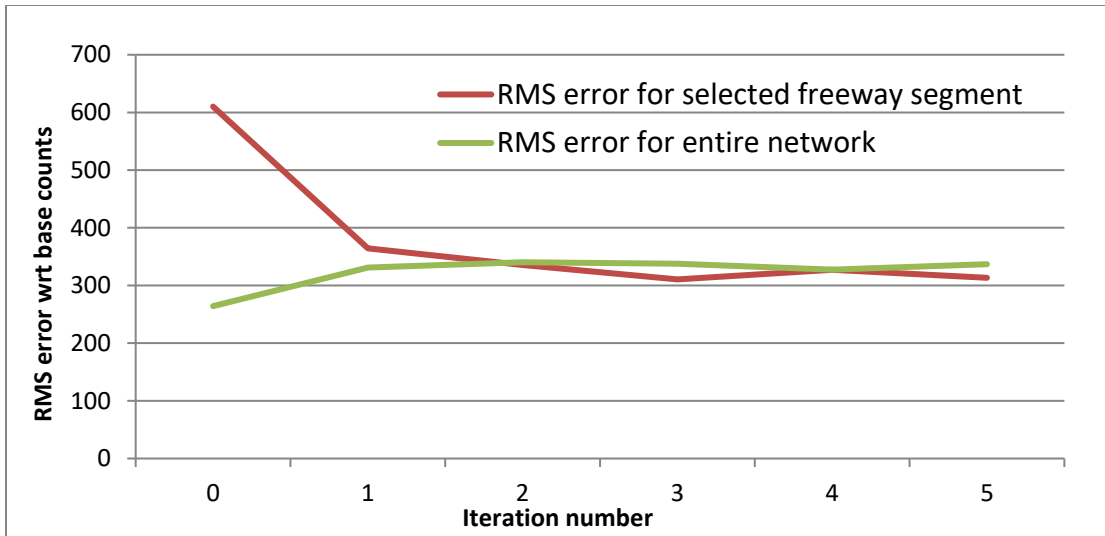

Figure 5.3 RMS error changes with fine-tuning calibration performed on the base network

Figure 5.4 highlights this percentage link error for each link in graphical form. While a small number of links exhibited large errors, they either did not belong to the corridor or were used by a very few vehicles.

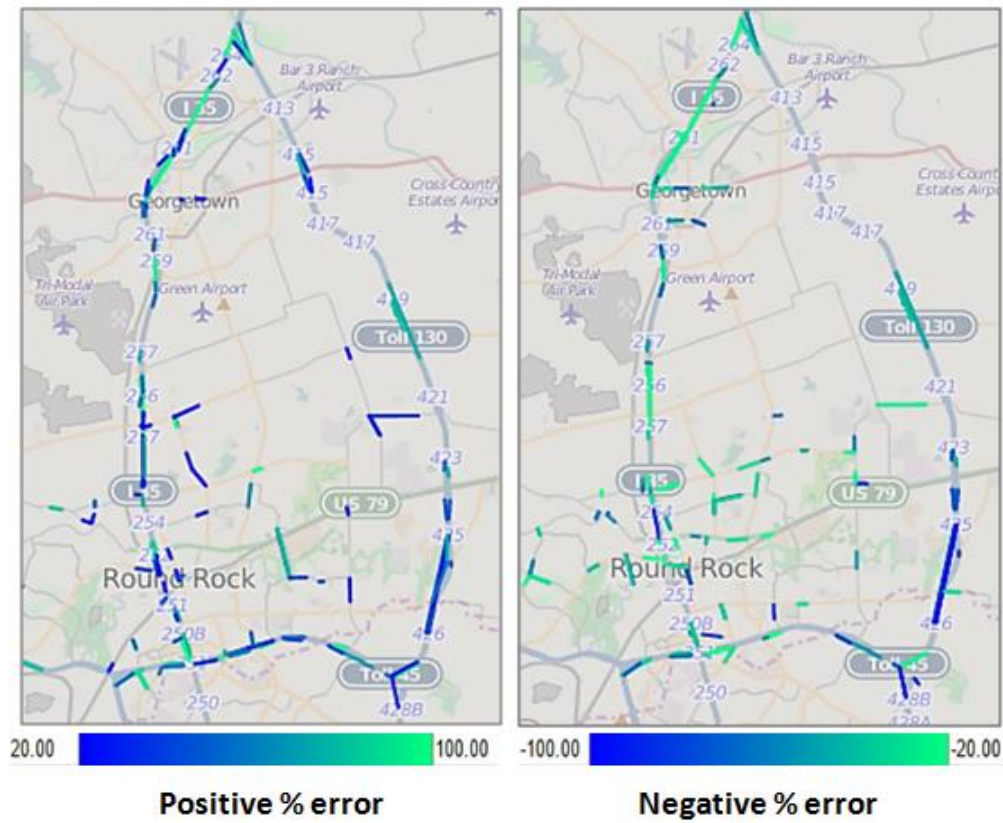

Figure 5.4 Percentage link errors after fine-tuning calibration

### 5.3 Analysis of ATM Strategies

This section explains how different ATM strategies were modeled in VISTA and analyzes the network-level impacts of each strategy.

DTA models rely on traffic flow theory, which assume a fundamental relationship/diagram between the speed, density, and flow parameters. Commonly used simulation-based DTA software makes simplifying assumptions about this fundamental relationship for computational tractability. For example, VISTA uses a trapezoidal fundamental relationship between flow and density. To capture the real-time effects of ATM strategy requires real-time adjustment of parameters such as speed limit changes. This can be achieved only if dynamic changes are made to the fundamental diagram.

Unfortunately, making dynamic changes to the fundamental diagram is not trivial and existing DTA software do not support such a feature. Thus, to assess the network-level impacts of an ATM strategy, we estimate the optimal control strategy using VISSIM and test its impact on the network using VISTA (Figure 5.5).

To incorporate the time-varying output from VISSIM, different methods were employed for each strategy. Table 5.1 demonstrates the approximation made for incorporating each of the ATM strategies in the VISTA model.

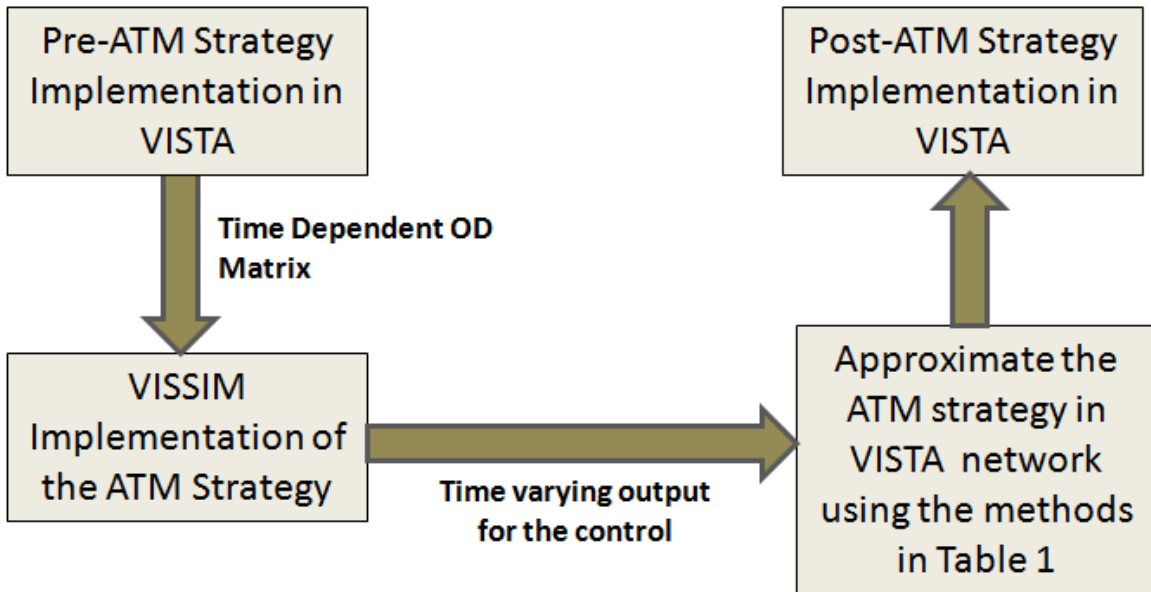

Figure 5.5 The approximation process in VISTA

**Table 5.1: Approximating ATM strategies in VISTA**

ATM Strategy	Input from the VISSIM model	Approximation made in the DTA model
VSLs	Time-varying speed limits in 5-minute bins	Replace speed limits with the time average of VSLs
Ramp Metering	Time-varying green ratios for each signal cycle of 2 minutes	Install a pre-timed signal at the ramp, and allocate green time based on the average green ratio
HSR	Time-varying operation (open or close) of the hard shoulder	Create an extra lane on the segment and close the lane for the times for which the hard shoulder is closed, otherwise keep it open
Dynamic Re-routing	N/A	Install VMSs at desired locations
VSLs with Ramp Metering	N/A	Combine the approximations for VSL and ramp metering

After making the above approximations, each ATM strategy case was run to obtain the results for the ‘after scenario.’ These approximations are different from the ones proposed in Nezamuddin et al. (2011) for evaluating the safety benefits of ATM strategies. In their project, parameters such as capacities and speed limits of various segments in VISTA were modified to match results from VISSIM. This approach does not capture the changes to route patterns effectively. Using the method suggested earlier, one can iterate back and forth between VISSIM and VISTA (i.e., closing the loop shown in Figure 5.5).

To test the effectiveness of ATM strategies, the following measures of effectiveness were employed:

- Change in total system travel time
- Travel time for the corridor for the before and after scenarios
- Volume between different OD elements

The following subsections provide a detailed analysis of the implementation and results of each ATM strategy.

### 5.3.2 Ramp Metering

Ramp metering has been the most widely used and studied ATM strategy. In this strategy, the inflows from on-ramps are regulated using a signal whose green times depend on the freeway flow rates and the on-ramp queue lengths. The ALINEA algorithm for ramp metering proposed by Papageorgiou et al. (1991) was implemented in VISSIM.

To test the network-level impacts of ramp metering, the signal installed on the ramp must change display based on the detector readings. However, DTA models typically do not let signal



timings change as a function of detector readings. To overcome this limitation, the ramp meter was represented by an isolated signal and the signal timings were decided based on the VISSIM results.

There are three on-ramps in the selected corridor, and two out of the three meet the geometric requirements of installing a ramp meter (Chaudhary and Messer, 2000). These two on-ramps were selected as the test locations of installing the ramp meter and are highlighted in Figure 5.6.

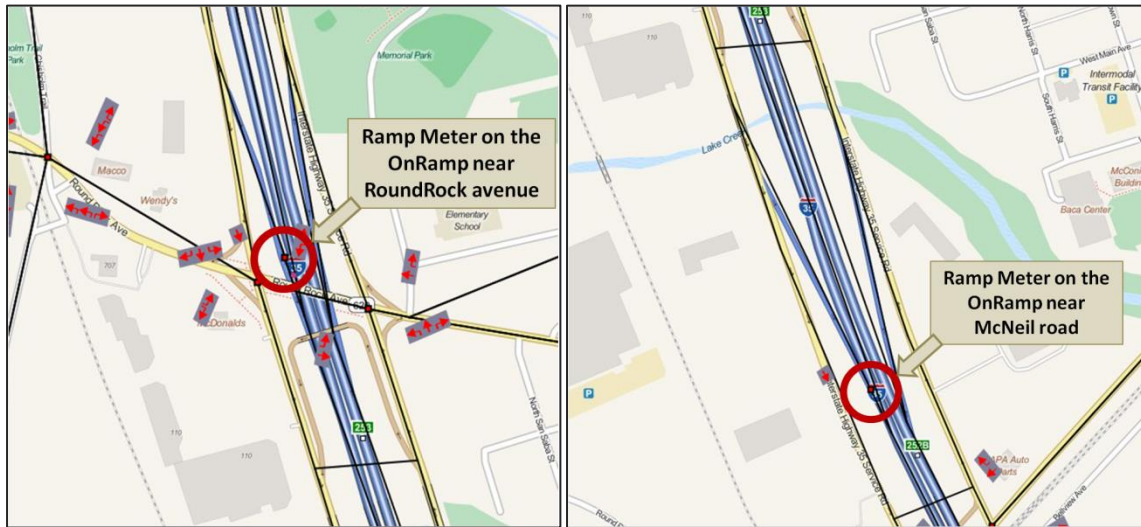

Figure 5.6 The locations of two ramp meters in the VISTA network

The same ramp meters were implemented in VISSIM using the ALINEA algorithm. The green ratios for a cycle time of 120 seconds were recorded at different points in time, and the average value of the green ratio was applied to the isolated signals in VISTA to approximate the effects of the ramp meter.

The green ratio supplied from VISSIM, and the average values used in VISTA are shown in Figure 5.7. The solid lines represent the green ratios obtained from VISSIM across different cycles, each of which is 120 seconds long. The average values used in VISTA were 0.51 for on-ramp 1 and 0.69 for on-ramp 2.

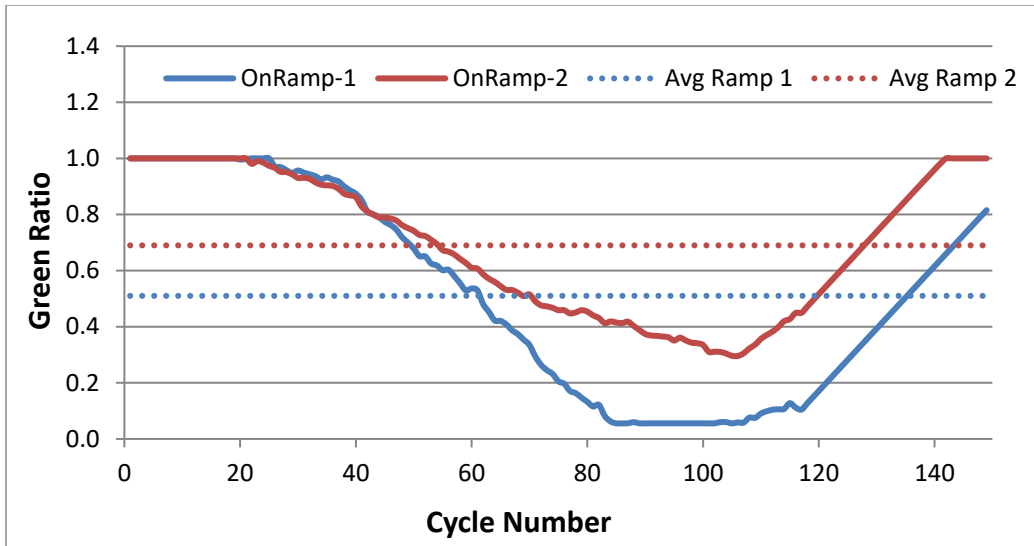

Figure 5.7 Variation of green ratios observed in VISSIM and the average value used in VISTA

After installing the signals with appropriate signal timings, the modified network was equilibrated using DTA.

The main observations from the VISTA output are:

1. The total system travel time increased from 23,197 hours in the base case to 23,493 hours in the ramp metering case. This corresponds to a 7.2 seconds extra delay per vehicle.
2. The volumes on the on-ramps decreased after installing the ramp meters. The change in volumes for both the on-ramps is highlighted in Figure 5.8. A similar decrease was observed in the number of vehicles using the on-ramps to exit the network along the main lanes (Figure 5.9).

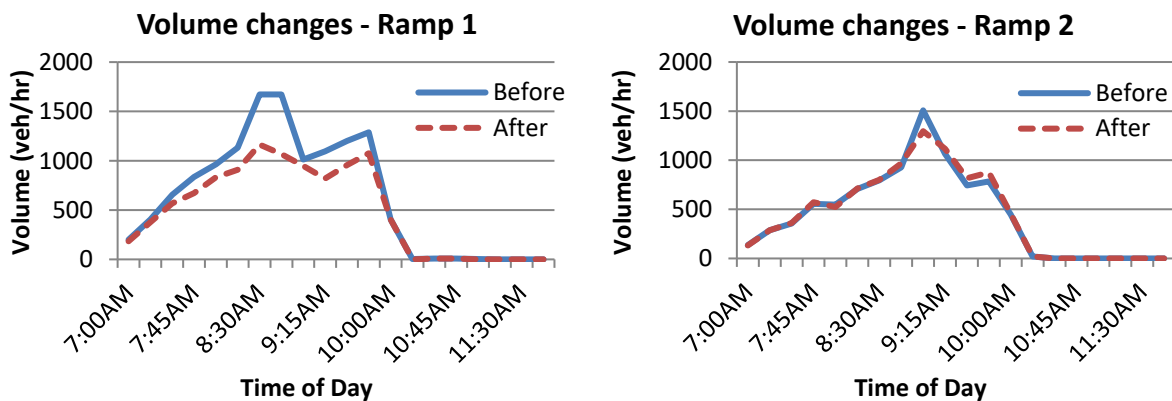

Figure 5.8 Comparison of volumes for both the on-ramps before and after installing ramp meters

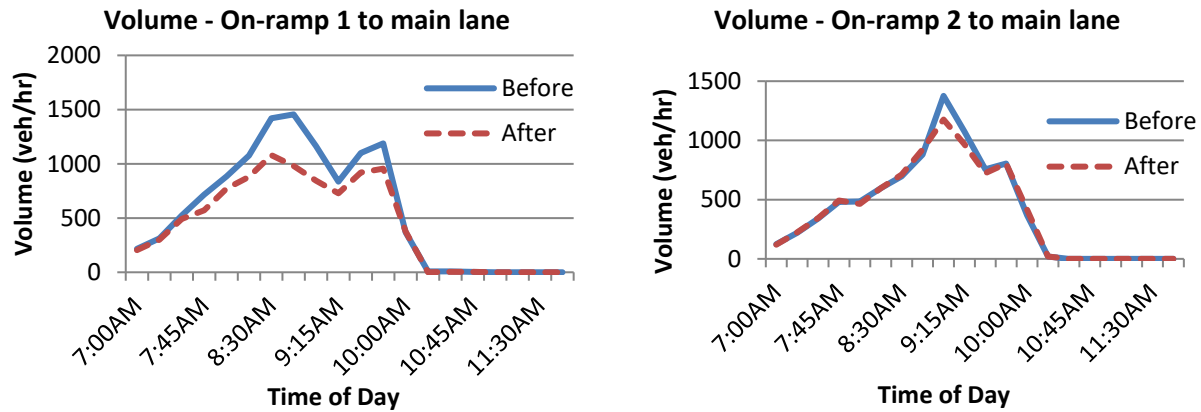

Figure 5.9 Comparison of the demand entering at on-ramps and exiting the network via the main lane

- The queue length for both the on-ramps was checked and no spillover was observed on the frontage roads.
- The travel time and volume along the entire main lane remained unchanged for a significant portion of the time.
- The travel time for vehicles entering the on-ramps and exiting the network through the main lane was found to increase from base case as the installation of signals causes additional delay.
- Average delay on the on-ramps because of the control signal was 11.1 seconds for ramp 1 and 2.2 seconds for ramp 2.
- Select link analysis visualization for the on-ramps using VizTool showed a shift in routes for vehicles using the on-ramps (Figure 5.10). However, the shift was very local in nature, with vehicles switching to the frontage roads parallel to the on-ramps.

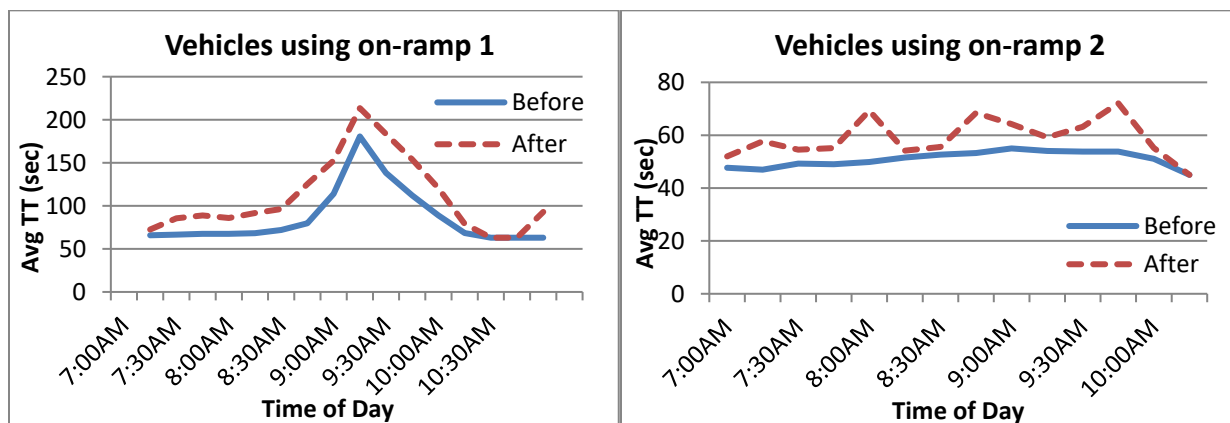

Figure 5.10 Comparison of travel time for vehicles using the on-ramps and the through corridor

From the results the following conclusions can be made.

- Travel time for the vehicles using the on-ramps increased, resulting in a decrease in the volume of the travelers using the on-ramp. This signifies a network-level shift in demand. However, the shift was not predominant as only a few travelers changed their routes.
- Given the current approximation to model ramp metering in VISTA, there was no (or significantly less) improvement in travel time for the through flows along the main lanes. This finding likely arose because the reduction in ramp volume using the freeway was not sufficient to improve the travel time of the corridor.
- The current installation of ramp metering increased the total system travel time for the system, and hence did not prove effective for the current case study.

### 5.3.3 Variable Speed Limit

VSLs are another widely used strategy to harmonize the flow of traffic and increase safety by reducing the speed differentials between the lanes. As the name suggests, this strategy involves modifying the speed limit on the freeway section with time.

For testing network-level impacts of VSL in a DTA implementation, the speed limits need to be modified based on the freeway volumes and speed differentials. Updating speed limits requires modifying the fundamental diagram in real time; however, current implementation of VISTA (or any other DTA-based software) uses a fixed fundamental diagram to describe the traffic flow on a link. Hence, to capture the approximate network-level impact, the average of the speed limit variation observed from the VISSIM implementation was used.

The segment between the two on-ramps was selected for implementing VSLs. Figure 5.11 (a) highlights the segments on the map where the VSL was implemented. The algorithm for VSL proposed by Allaby et al. (2007) was used. The choice of the segment was motivated by the possibility of testing coordination with the ramp metering. Figure 5.11 (b) shows the optimal variation in speed limits as observed in the VISSIM model and the average speed limit used in VISTA.

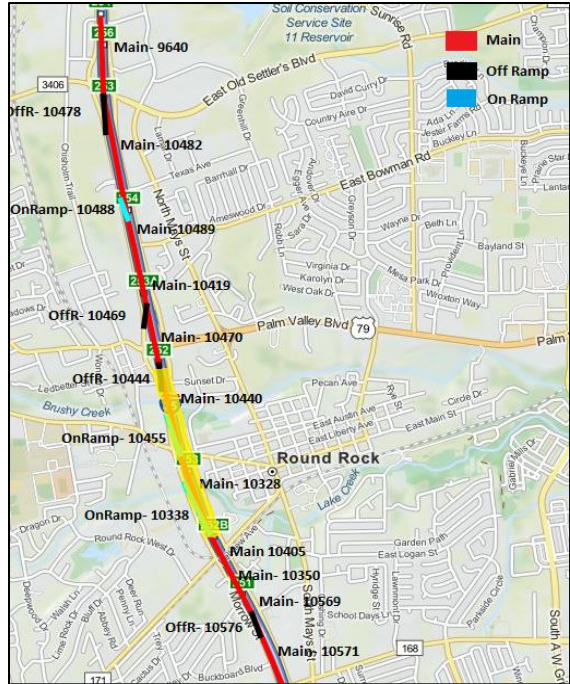

(a) Section of the selected segment where VSL is implemented

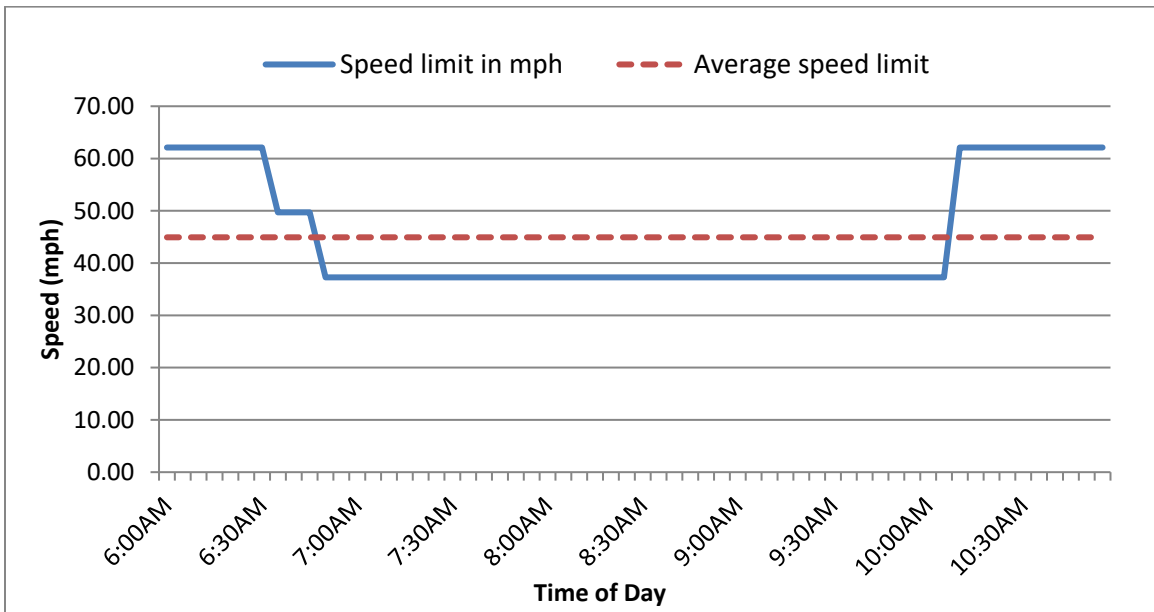

(b) Speed Limit variation as observed in VISSIM and the approximation average used in VISTA

Figure 5.11 Simulating the effects of VSL using DTA

We have the following observations from the results:

- The total system travel time increased from 23,197 hours to 23,284 hours, which equates to an increase of 2.4 seconds per vehicle.

- The average travel time for traversing the entire corridor was higher before and after the peak hour, but was fairly similar during the peak hour (Figure 5.12).
- The variation in link volumes for the links where VSL was installed is shown in Figure 5.13. The volumes on the links were observed to decrease, but only by a small amount.
- The paths taken by vehicles were not significantly different for any of the OD pairs, indicating that VSL had little network-level impact.

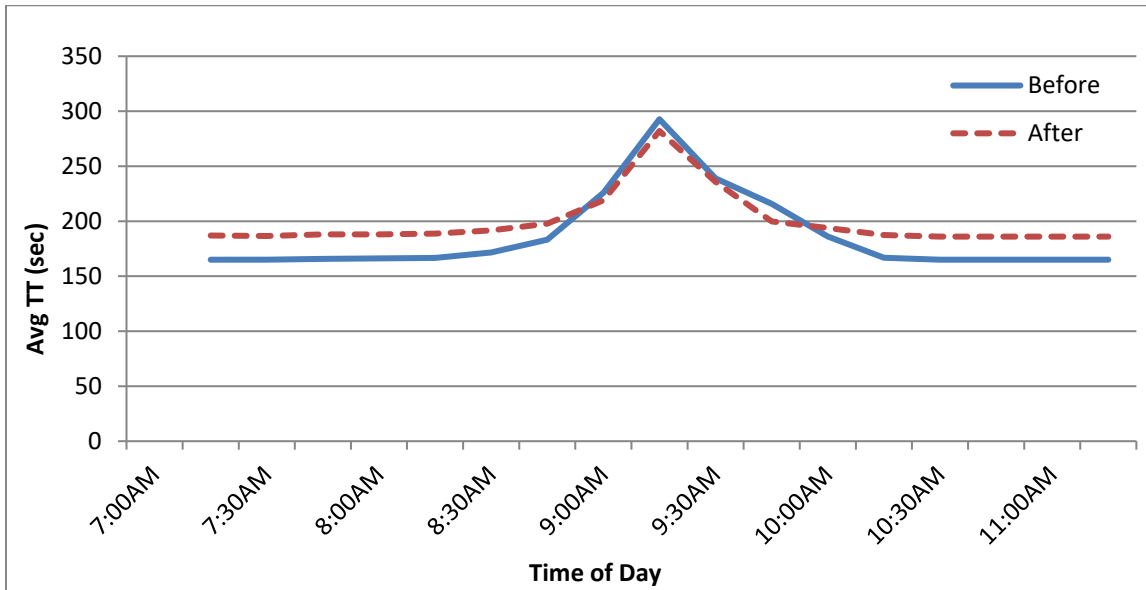

Figure 5.12 Travel time for the corridor before and after installing VSL

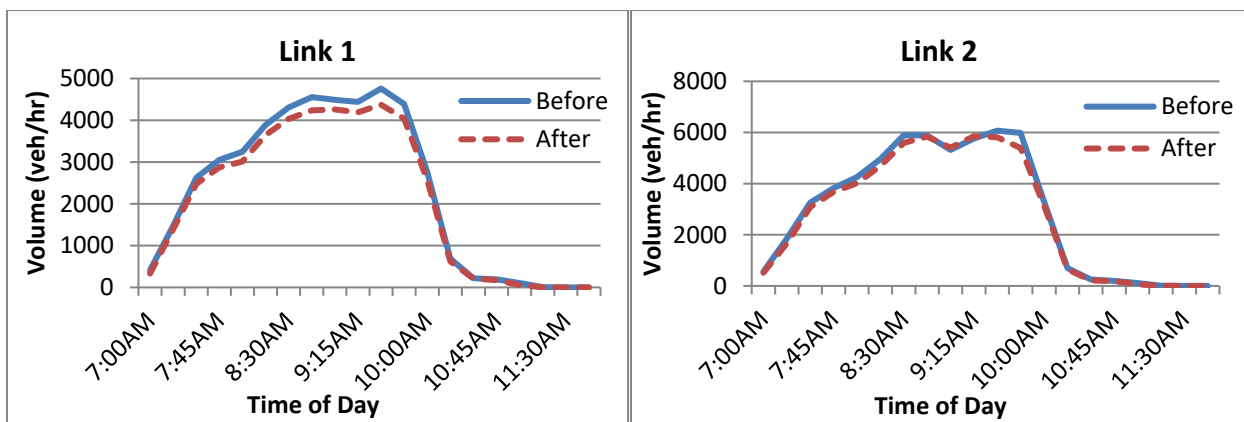

Figure 5.13 Changes in link volumes for the sections where VSL is installed

From the observations above, we can make the following conclusions:

- The decrease in travel time and the network-level route shifts for the VSL strategy is not very significant for the segment chosen for analysis.

- Choosing the average speed limit for the entire duration of simulation is a limiting approximation. It is likely that the poor performance of the VSL strategy during early and later AM peak was a result of using lower speed limits than the control prescribed by VISSIM.

### 5.3.4 Dynamic Route Guidance

The impact of dynamic route guidance on the corridor and the network performance was tested in VISTA. Specifically, a fraction of travelers was diverted to the frontage road to improve the main lane travel times. For this purpose, a VMS was installed at the location shown in Figure 5.14. The purple path indicates the frontage road while the main lanes are represented in red.



Figure 5.14 VMS location and suggested alternate frontage route

One would expect that shifting vehicles on to the frontage would decrease in the main lane travel times. However, as reported in Table 5.2 and Table 5.3, the opposite trend was observed, and increasing the flow on the frontage increased travel time on the corridor and also the total network travel time. This was true even at extremely low compliance rates of 0.1% (in which case just eight travelers are moved to the frontage roads). One possible reason for this result could be that the frontage roads are at capacity at equilibrium and increasing the flow on them would result in greater delays on the main lanes due to delay induced to due to merges and diverges.

**Table 5.2: Network effects of VMS**

	<i>Compliance</i>			
	<i>Base case</i>	<i>0.1%</i>	<i>0.5%</i>	<i>1%</i>
Network travel time (in hrs)	22883.01	22884.34	22886.05	22887.85
# of vehicles shifted	0	8	44	85

**Table 5.3: Travel time on corridor for different rerouting fractions**

<i>15-min interval</i>	<i>Base</i>	<i>Compliance = 0.1%</i>	<i>Compliance = 0.5%</i>	<i>Compliance = 1%</i>
6:00-6:15	165.00	165.00	165.00	165.00
6:15-6:30	165.05	165.05	165.34	165.68
6:30-6:45	165.73	165.73	165.72	167.46
6:45-7:00	166.19	166.19	166.71	167.39
7:00-7:15	166.64	167.07	167.31	167.53
7:15-7:30	171.45	171.90	172.94	173.25
7:30-7:45	181.32	181.51	181.56	182.12
7:45-8:00	228.12	228.89	229.99	230.57
8:00-8:15	298.01	298.56	299.14	299.90
8:15-8:30	246.70	247.27	248.53	249.07
8:30-8:45	211.99	212.68	213.11	213.96
8:45-9:00	187.25	187.59	188.10	189.60
9:00-9:15	167.08	167.08	168.09	168.46
9:15-9:30	165.00	165.00	165.00	167.42
9:30-9:45	165.00	165.00	165.00	165.00
9:45-10:00	165.00	165.00	165.00	165.00
10:00-10:15	165.00	165.00	165.00	165.00

Since diverting traffic to the frontage roads caused more congestion on the main lanes, we performed another series of similar experiments with a different VMS. In these experiments, the VMS was located further upstream and suggested an arterial route farther from the freeway as shown in Figure 5.15.



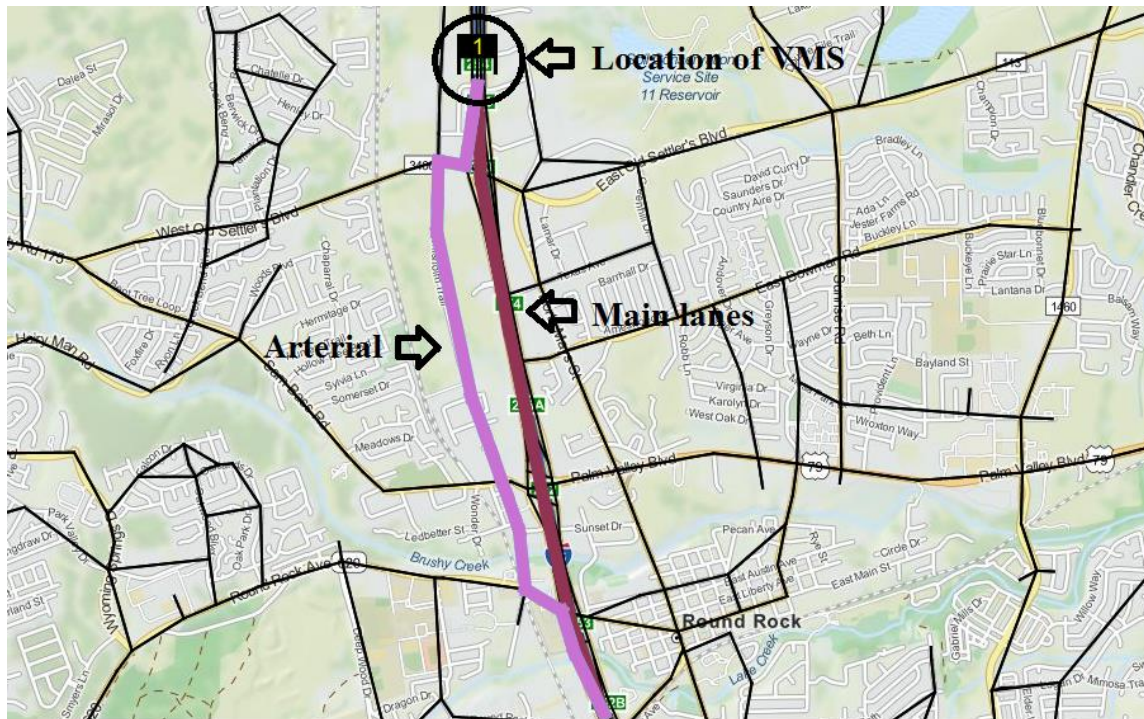

Figure 5.15 VMS diverting traffic to arterials

Table 5.4 and Table 5.5 show the results for three compliance levels: 0.1%, 0.25%, and 0.5%. For compliance levels of 0.25% and 0.5%, the travel times on the main lanes reduced significantly. However, the total network travel time increased when compared to the base case. The travel times on the main lanes were higher when the compliance level was 0.1%, which may again be a result of delays induced due to the merging and diverging of these vehicles.

**Table 5.4: Network effects of diverting traffic to arterials**

	<i>Compliance</i>			
	<i>Base case</i>	<i>0.1%</i>	<i>0.25%</i>	<i>0.5%</i>
Network travel time (in hrs)	22883.01	22900.24	22923.88	23059.76
# of vehicles shifted	0	84	203	420

**Table 5.5: Travel times on main lanes after diverting traffic to arterials**

<i>15-min interval</i>	<i>Base</i>	<i>Compliance = 0.1%</i>	<i>Compliance = 0.25%</i>	<i>Compliance = 0.5%</i>
6:00-6:15	165.00	165.00	165.00	165.00
6:15-6:30	165.05	165.05	165.05	165.05
6:30-6:45	165.73	165.72	165.73	165.66
6:45-7:00	166.19	166.17	166.19	166.26
7:00-7:15	166.64	166.68	166.61	166.59
7:15-7:30	171.45	171.42	171.42	171.69
7:30-7:45	181.32	180.62	180.30	179.68
7:45-8:00	228.12	229.94	229.09	223.33
8:00-8:15	298.01	301.08	296.66	279.90
8:15-8:30	246.70	250.11	247.46	218.68
8:30-8:45	211.99	213.89	212.54	183.43
8:45-9:00	187.25	188.43	188.39	177.96
9:00-9:15	167.08	167.07	167.09	167.07
9:15-9:30	165.00	165.00	165.00	165.00
9:30-9:45	165.00	165.00	165.00	165.00
9:45-10:00	165.00	165.00	165.00	165.00
10:00-10:15	165.00	165.00	165.00	165.00

In conclusion, location, alternate strategy, and compliance rates were all found to significantly influence the performance of dynamic route guidance systems. While this strategy may be used to free congestion on main lanes, one must be wary of the fact that it can potentially increase network travel time as the diverted traffic may experience higher travel times.

### 5.3.5 Hard Shoulder Running

Temporary hard shoulder usage is another ATM strategy that has been effectively used to increase the capacity of the freeway section without any physical expansion. A hard shoulder can be typically used as a separate lane when (a) its width is enough to carry traffic at safe speeds; (b) pavement quality is good enough; and (c) downstream lanes can handle the increased flow of traffic.

For the chosen Wilco network, the entire freeway section did not have the required width for HSR. However, in this report we assume that the width is sufficient and test a hypothetical scenario to understand the network-level impacts of HSR. Geistefeldt (2012) suggests that there are two typical cases of installation of hard shoulder:

1. Hard shoulder as a long weaving lane between on and off ramps, with lane addition and subtraction towards the start and end. This is used when heavy traffic exchange happens between the on and off ramps.
2. Hard shoulder as a continuous stretch for two or more segment between on and off ramps. This is useful when low volume of entering traffic and so the weaving operation is minimized.

The selected segment for the analysis of temporary hard shoulder was a continuous section between Old Settlers Boulevard and Palm Valley Boulevard, spanning one on-ramp and two off-ramps as shown in Figure 5.16. To allow for dynamic implementation of hard shoulder usage, results from VISSIM analysis were used. The same segment was analyzed in VISSIM, and the specific periods of time for which the threshold-based algorithm in VISSIM kept the hard shoulder open for traffic were noted. An additional lane was created for the highlighted segment in VISTA, and a closure on the lane was installed at times other than the specific periods noted from VISSIM. This implementation provides us an approximate estimate of the network-level impact of having additional capacity on a segment for a specific time of day.

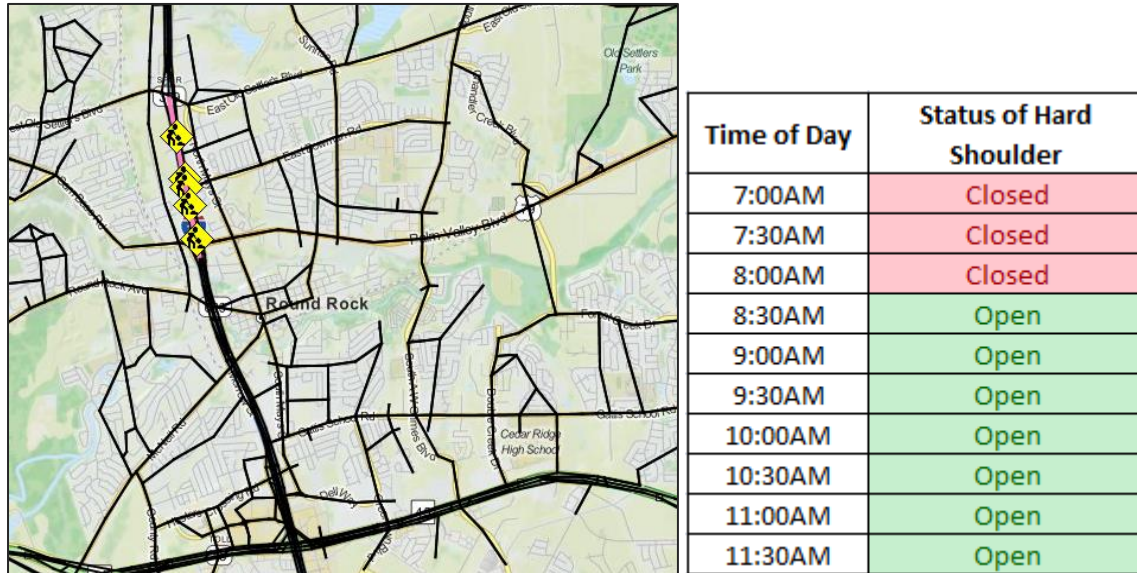

Figure 5.16 Selected segment for the analysis: (a) hard shoulder implementation location in VISTA modeled as lane closure; (b) output of the VISSIM implementation of HSR

The modified network was run in VISTA while keeping all other parameters fixed.

- The total system travel time for the hard shoulder case showed a slight decrease from 23,197 hours to 23,112 hours compared to the base case, which is equivalent to a decrease of 1.8 seconds for each vehicle.
- We also observed a decrease in volume-to-capacity ratios on the links at the time of day when the hard shoulder was open. Figure 5.17 highlights this change for the section where HSR was implemented.
- The travel time on the selected segment and the section where HSR was implemented remained almost identical.
- The travel volume on the through corridor decreased after installing HSR.
- The travel time on the link with hard shoulder that leads to the freeway with three lanes did not change, indicating that a bottleneck was not created after implementing HSR.

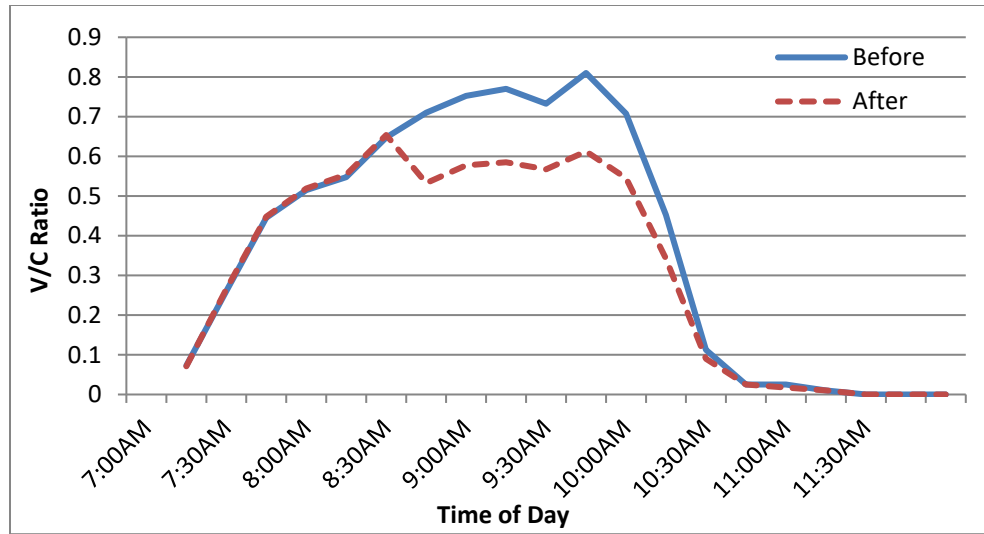

Figure 5.17 Change in volume-to-capacity ratio of the section after installing HSR

Our observations suggested very marginal network-level impacts due to hard shoulder. The travel time and the volumes on the corridor did not change significantly even though HSR made the corridor more attractive by adding capacities to the existing lanes.

### 5.3.6 Variable Speed Limit and Ramp Metering

ATM strategies can be used in combination to address congestion issues. In order to test the network wide impact of VSL and ramp metering, fixed time signals on the on-ramps along with reduced speed limits on the main lanes were implemented in VISTA. The control results obtained for the individual strategies from VISSIM were combined in VISTA.

1. The total system travel time after the simulation increased from 23,197 hours in the base case to 23,441 hours in the combined ATM strategy case, which is equivalent to a 6-second extra delay per vehicle.
2. The corridor travel time increased during the early and the late AM peak but decreased during the peak period as shown in Figure 5.18.

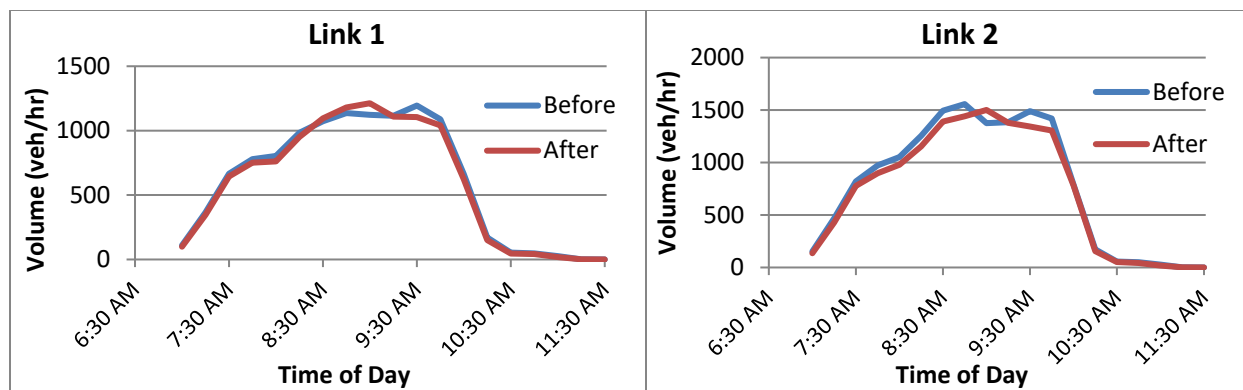
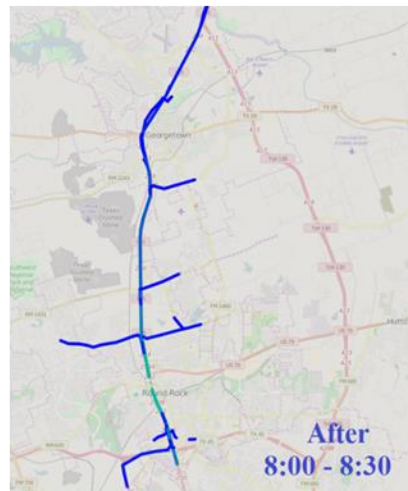
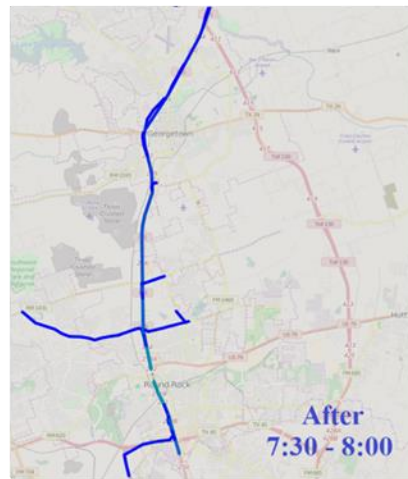
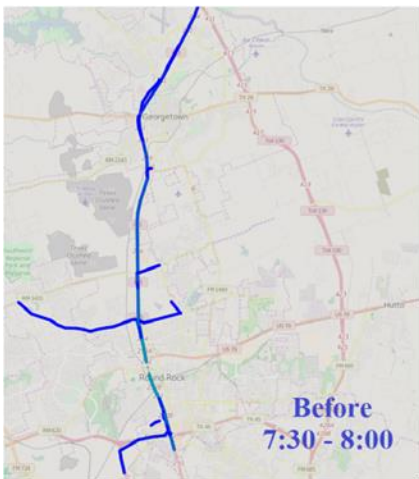
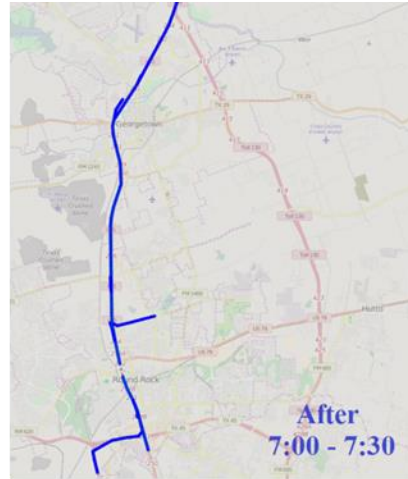
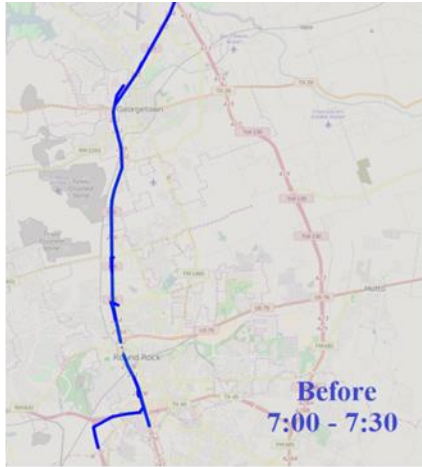
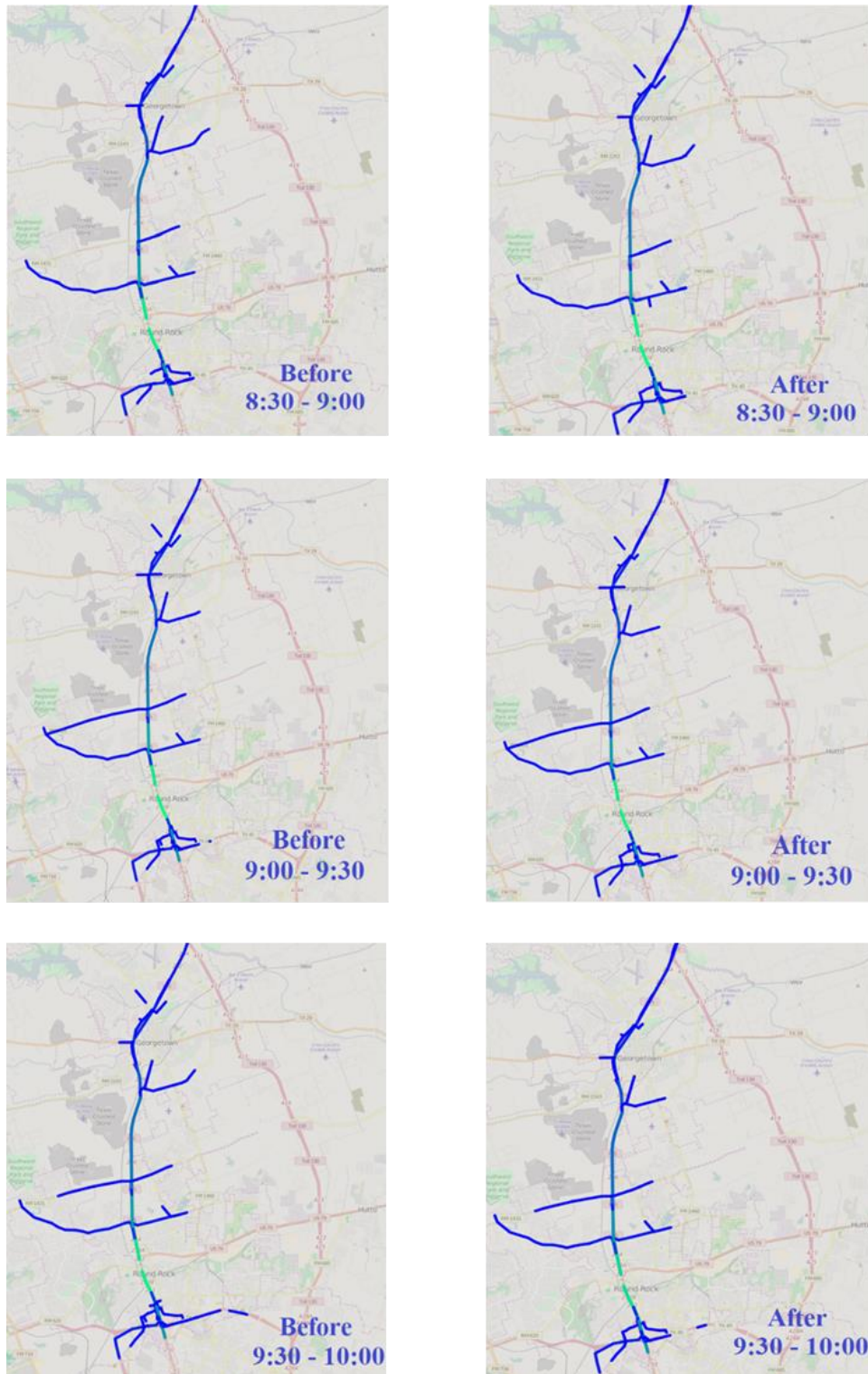

Figure 5.18 Time-dependent volumes on links with VSLs

3. The volumes on the links on which VSL was implemented remained the same for the early and late AM peak but there were slight variations during the peak period indicative of route choice changes.
4. Select link analysis was performed to study changes in route choice of travelers. Figure 5.19 (a) and Figure 5.19 (b) show the paths used by vehicles on the VSL-enabled link. Some minor changes in route patterns may be noticed. For instance, users in the after scenarios coming from Ranch-to-Market Road 1431 do not enter the main lanes between 8:30 and 9:00, as they would experience delay at the on-ramps. The results were aggregated for every 30 minutes and color coded (lighter color represents more flow).



(a) Results for 7:00AM – 8:30 AM



(b) Results for 8:30 AM – 10:AM

Figure 5.19 Select link analysis before and after implementing ramp metering and VSL

We can draw the following conclusions from the results:

- VSL along with ramp metering seemed to result in less travel time compared to using each of the strategies separately, though the performance is worse than the case without an ATM strategy.
- A few changes in travelers' route choices were noticed using a select link analysis. Thus, the combined strategies also did not impact the route choices as much. It would be interesting to see if the iterative procedure between ATM implementations in VISSIM and VISTA leads to greater improvement to main lane travel times and significant changes to route choice patterns.

## 5.4 Concluding Remarks

This chapter described tests of the impacts of five ATM strategies on the southbound IH-35 corridor in Williamson County. The study proposes different approximations to model ATM strategies in DTA software using the results from the microsimulation analysis. Given the limitations of current state of the art DTA software, the approximations are broad, but are enough to give a big picture analysis of the network-level impacts.

From the results and analysis, we notice that each ATM strategy was found to have network-level impacts that can be quantified by different parameters. The comparison of total system travel time, and the travel time and volume on the selected corridor form the primary measures of effectiveness (MoEs). Other MoEs (some of which are easy to obtain from a microsimulation)—such as ramp delay and queue length for the ramp-metering strategy; speed variation and gap analysis for the VSL strategy; and volume-to-capacity ratios and bottleneck analysis at a merge of the shoulder lane for the HSR strategy—can also be useful in assessing the impacts of ATM strategies. Another measure to assess network-level impacts is the shift in route patterns over time. This report demonstrates how VISTA can effectively analyze most of these MoEs. Specific results from the analysis indicate that the network-level impacts can be worse after installing the ATM strategy. For example, the total system travel time was found to be higher in case of ramp metering, VSL, and the combined VSL and ramp metering strategy. For the selected testbed, the shift in route patterns over time were found to be marginal for every ATM strategy. This is because the alternate routes to the selected corridor are very distant and the improvements caused by the ATM strategies were not sufficient to cause the shift.

To better predict the MoEs, we iterated between VISTA and VISSIM. Further, as observed, the results of the analysis were very sensitive to different parameters such as location and size of the installation segment, demand levels, and choice of parameters in control algorithm. The methods formulated in this chapter helped develop the spreadsheet-based tools described in Chapters 8 and 9.



## Chapter 6. Analysis Based on Micro-DTA Integration

Transportation systems can be modeled at different scales. Based on the level of detail, transportation models can be categorized into three types: *macroscopic models* (which approximate the travel times on a link using average flow rates, and thus help simulate large-scale networks); *mesoscopic models* (which model traffic dynamics such as shock-wave propagation and queue spillback, but are simplified enough to work well in medium-scale networks); and *microscopic models* (which accurately capture vehicle-to-vehicle interactions, and thus are limited in terms of the area they can simulate).

Each type of model offers certain advantages. While macroscopic models can be used to study network-level impacts by capturing changes in route choices, microscopic models can capture finer details of a localized network improvement or a real-time control strategy. Mesoscopic models offer the best of both worlds by simulating route choices and traffic dynamics. However, it is difficult to study the impacts of dynamic control strategies in a mesoscopic setting, which motivates us to integrate them with microscopic models.

### 6.1 Integration of VISSIM and VISTA

Model integration (or hybrid modeling, as it is often referred in the literature) has been studied by several researchers in the past. Hybrid models can be categorized into two types based on the methods they employ to integrate the component models:

- **Online hybrid model:** These models directly integrate the component models and run them **simultaneously**. Different portions of the network are modeled at a different granularity and at the boundaries of these portions, an online model provides a direct transition of same vehicle from one component model into another (of different resolution). Aimsun (Casas et al., 2010), TransModeler (Yang and Morgan, 2006), Inter Mezzo (Burghout et al., 2005), and METROSIM (Li et al., 2015) are some examples of online hybrid models.
- **Offline hybrid model:** These models simplify the areas of higher resolution into the model of lower resolution, and run the component models **independently**, and include “different methods to convert the network, demands, and routes from one model to another” (Tokishi and Chiu, 2013). These models are also referred as multi-resolution models. Example of such models include SATURN/DRACULA-MARS (Liu 2005), VISUM/VISSIM integration (Scherr and Adams, 2003), and the DynusT-VISSIM integration.

Achieving consistency between the integrated models is a prominent issue. Tokishi and Chiu (2013) propose a calibration technique to integrate the sub-models with the parent-model in an offline hybrid setting. Burghout et al. (2005) highlights three types of consistency that a hybrid model should exhibit: consistency in route description, route choice, and network details; consistency in traffic dynamics of the models at the boundaries; and consistency in the results obtained from both models. Offline hybrid models need more careful analysis to achieve consistency. But given the ease of integrating the components of different scales, this method was preferred for the current chapter.

The focus of this chapter is to study the integration between mesoscopic and microscopic simulation models to produce better models for testing the effectiveness of ATM strategies. This project combined the microsimulation modeling in the VISSIM software package and the DTA models in the VISTA software package using a multi-resolution or offline framework. While integrating the VISTA and VISSIM models, we sought to maintain model-level and process-level consistency between the two. In other words, we tested whether the results from both component models agree, when the inputs of the first model are the outputs of the second, and vice versa.

For the purposes of evaluating effectiveness of ATM strategies using combined models, the microsimulation model in VISSIM was integrated with the DTA model in VISTA. Figure 6.1 shows the iterative procedure used in the integration.

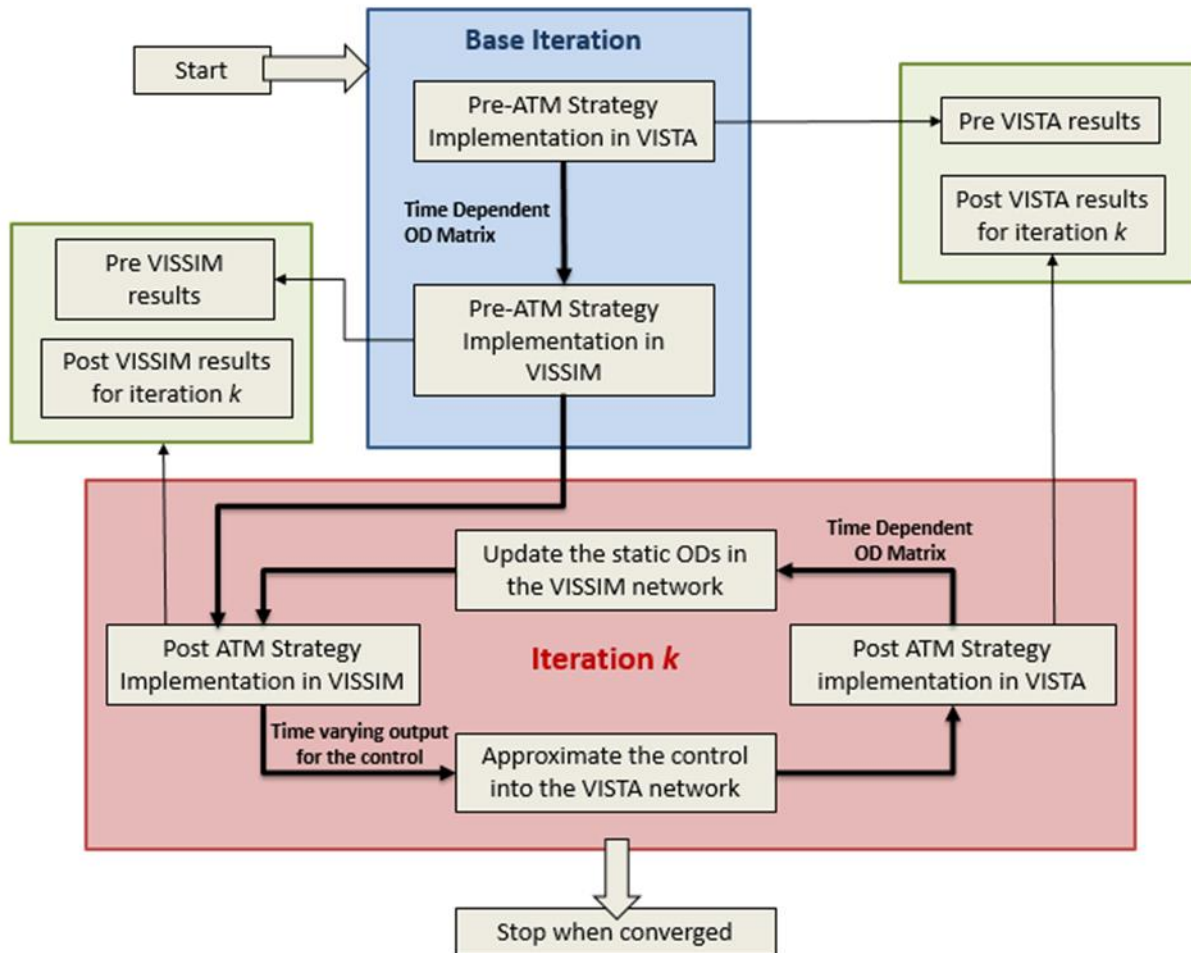

Figure 6.1 Iterative procedure used for developing the hybrid model

First, the base iteration was run in VISTA using the calibrated Williamson County network. The time-dependent OD matrix for our particular segment of analysis was then obtained from the DTA vehicle trajectories. This OD matrix was used as a static OD matrix for the Pre-ATM strategy implementation in VISSIM. The same OD matrix was then used for the Post-ATM strategy implementation in VISSIM, marking the start of the first iteration of integration of both models. The time-varying control output provided from VISSIM was then aggregated and modeled in

VISTA. The time-varying control and the type of approximation used for different ATM strategies differ and are highlighted in Table 6.1. This step is referred to as the Post ATM strategy implementation in VISTA. This implementation resulted in a time-dependent OD matrix, which was used to update the static ODs in VISSIM. The VISSIM model was then used to start the next iteration of an iterative process. After each iteration, the results from the VISSIM and VISTA simulations were stored for evaluation purposes.

The RMS error of the change in the OD matrix, between two successive iterations, was used to determine the convergence of the iterative modeling. If the RMS value is below a desired threshold, the iterative process is said to have converged. The process is also said to converge if the RMS value is high but the VISSIM’s time-varying control output does not change between successive iterations. The offline hybrid approach used for this chapter has both merits and demerits. While it offers a simple way to integrate the two components that model traffic at a different granularity, convergence of the iterative procedure is not guaranteed. Further, consistency of the results obtained from both the models needs to be evaluated separately

**Table 6.1: Approximation of ATM strategies in VISTA**

<b>ATM Strategy</b>	<b>Input from the VISSIM model</b>	<b>Approximation made in the DTA model</b>
VSLs	Time-varying speed limits for 5-minute intervals	Replace speed limits with the time average of VSLs
Ramp Metering	Time-varying green ratios for each signal cycle of 2 minutes	Install a pre-timed signal at the ramp, and allocate green time based on the average green ratio
HSR	Time-varying operation (open or close) of the hard shoulder	Create an extra lane on the segment and close the lane for the times for which the hard shoulder is closed; otherwise, keep it open

The southbound IH-35 corridor between Old Settlers Boulevard and SH 45 (part of the Wilco network used throughout the project) was analyzed. For a simplified analysis of feeding back the OD matrices from VISTA, we considered only the mainline network in VISSIM, excluding frontage roads. This chapter presents the results of testing effectiveness of three primary ATM strategies: VSLs, HSR, and ramp metering. Figure 6.2 shows the two networks used in VISTA and VISSIM.

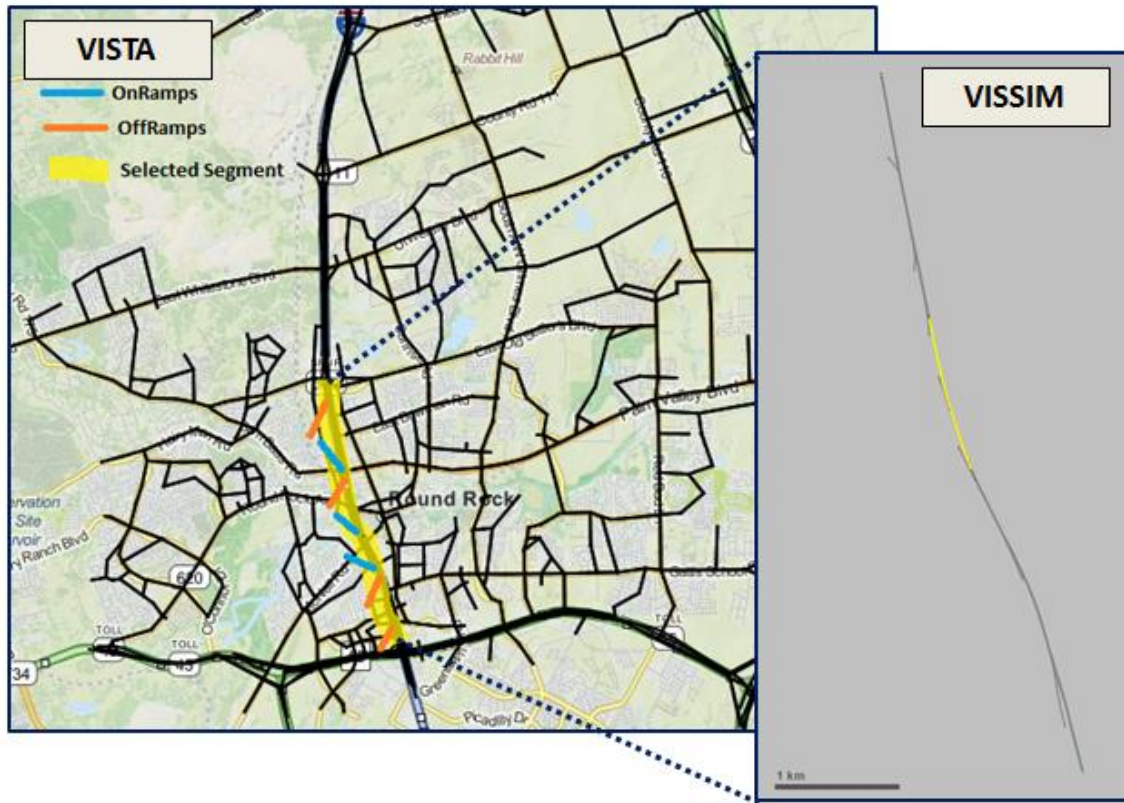

Figure 6.2 Multi-resolution network modeling in VISTA and VISSIM

## 6.2 Analysis of ATM Strategies

### 6.2.1 Ramp Metering

Average green ratios from ramp meters installed on two on-ramps were provided as inputs to VISTA. This caused changes to travelers' routes and the vehicle trajectories were used to estimate the new OD inputs for VISSIM. These steps were repeated till the route choices or the control outputs converged.

Table 6.2 shows the RMS error in the OD matrices between successive iterations in VISTA and Table 6.3 shows the optimal average green ratios from the VISSIM model.

**Table 6.2: RMS value for the change in OD matrix from VISTA for ramp metering**

<i>From Base case to Iteration 1</i>	<i>From Iteration 1 to Iteration 2</i>	<i>From Iteration 2 to Iteration 3</i>
18.34	22.18	16.76

**Table 6.3: VISSIM and VISTA results for ramp metering**

	<i>Iteration 1</i>	<i>Iteration 2</i>	<i>Iteration 3</i>	<i>Iteration 4</i>
Ramp 1 avg. green ratio	0.51	0.22	0.24	0.24
Ramp 2 avg. green ratio	0.69	0.76	0.81	0.79
Flow entering via Ramp 1	2820	2278	1370	1111
Flow entering via Ramp 2	2055	1996	2488	3276

As the values in Tables 6.2 and 6.3 indicate, there is a significant change in the control strategy, i.e., the green ratios change from 0.51 and 0.69 to 0.22 and 0.76 after we consider the effect of route changes. While successive iterations induce some changes to demand, the control strategy does not vary after three iterations. A closer analysis of the total demand from the two on-ramps entering the main lanes reveals two phenomena. First, the number of travelers entering the main lanes via the two on-ramps decreased after ramp meters was installed. Second, a significant number of travelers enter the main lane using Ramp 2 instead of Ramp 1 as the average green of the former gets higher. The results reinforce the importance of capturing the impact of control strategies on the route choice behavior, especially in such scenarios in which neighboring ramps are metered.

A comparison of the main lane travel time obtained using VISSIM for different iterations is shown in Figure 6.3. The values reported are averaged over 5-minute intervals. The travel times are almost the same after the first iteration as the control strategy does not vary significantly. The system travel time of the entire network, estimated using VISTA, was also found to converge very quickly after the first two iterations (see Table 6.4).

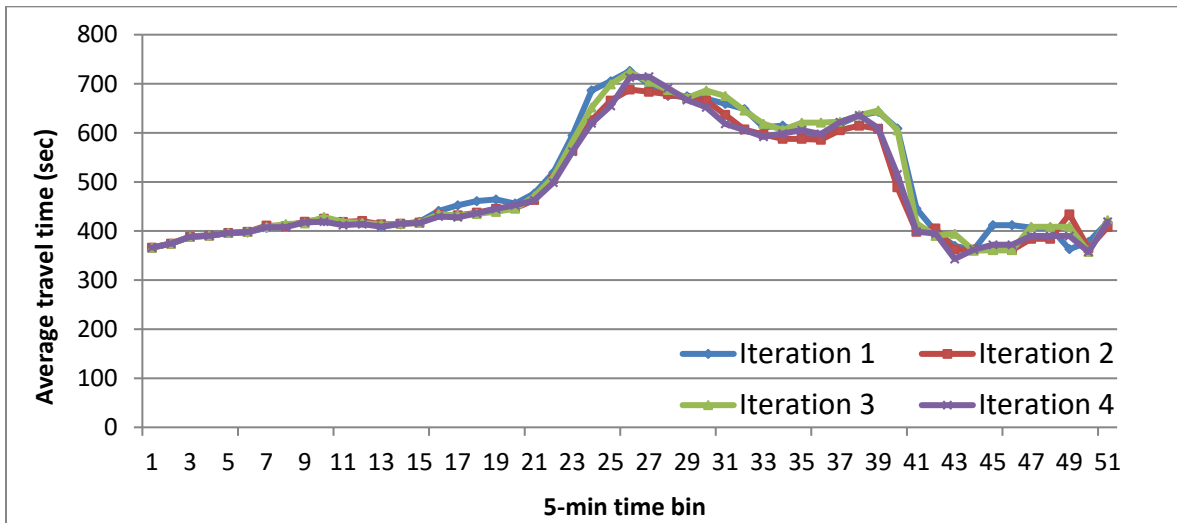
*Figure 6.3 Average travel time on corridor in VISSIM***Table 6.4: Network-level system travel time (in hours) from VISTA**

	<i>Iteration 1</i>	<i>Iteration 2</i>	<i>Iteration 3</i>	<i>Iteration 4</i>
Total system travel time	23472.85	23337.09	23380.38	23378.34

## 6.2.2 Variable Speed Limits

For the VSL case, two speed limit regulators were defined on a small segment of the selected corridor (see Chapter 4). The VISSIM simulations provided time-varying speed limits whose average was used to determine the speed limits in VISTA.

In the first iteration, the RMS change in the OD demand was found to be 11.593. The updated OD demand was used to run VISSIM again, but the control output remained the same. Thus, the model converged in a single iteration. Figure 6.4 shows the speed limit variation and the travel time variation in VISSIM for both iterations.

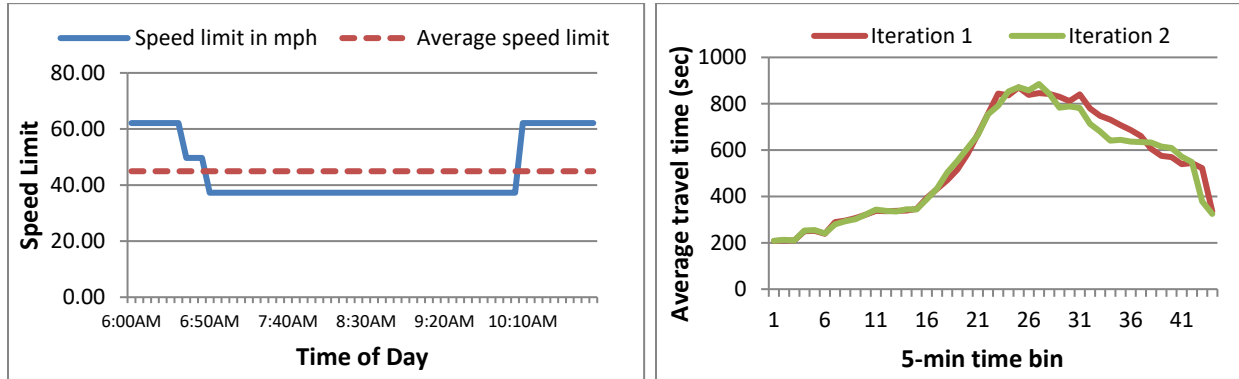

Figure 6.4 Speed limit variation and the travel time variation in VISSIM: (a) speed control output obtained from VISSIM, which is for the same for both iterations, (left) and (b) average travel time variation over the corridor (right)

To test the impact of VSL on route choices when there is more congestion on roadway, the OD demand for all OD pairs was increased by 25%, and the same iterative process was followed. In this case as well, the control strategies converged in a single iteration although the exact strategy was different. Table 6.5 highlights the RMS values of OD demand across iterations for both cases, and shows the evidence of convergence.

**Table 6.5: RMS values of OD demand for VSL case**

	<i>From Base case to Iteration 1</i>	<i>From Iteration 1 to Iteration 2</i>
Regular Demand	11.59	2.6
25% increase in Demand	42.07	3.7

A possible explanation for quick convergence could be that the control algorithm used from Allaby et al. (2007) is not very sensitive to changes in occupancy and volume. This indicates that the type of control strategy employed plays an important role in determining whether the hybrid models are necessary to accurately model an ATM strategy; in this case, it turns out they are not.

The results from the analysis indicate that VSL is only marginally effective in alleviating congestion for the regular demand case for the selected Wilco network. Our previous analysis highlights that total system travel time showed an increase after installing VSL, and the average travel time decreased only marginally during the peak hour. As before, the choice of the control algorithm and the approximation made to represent VSL in VISTA network are primary factors influencing the effectiveness of VSL on the Williamson County network.

To determine the consistency between VISSIM and VISTA, the average travel time for the main lanes were compared. Figure 6.5 highlights the differences in the results from both the simulation models. The two models are fairly consistent as the simulations provide similar trend for changes in travel time; however, congestion in VISTA sets in slightly later. The results from VISSIM are likely to be more reliable given that it captures vehicle interactions more accurately.

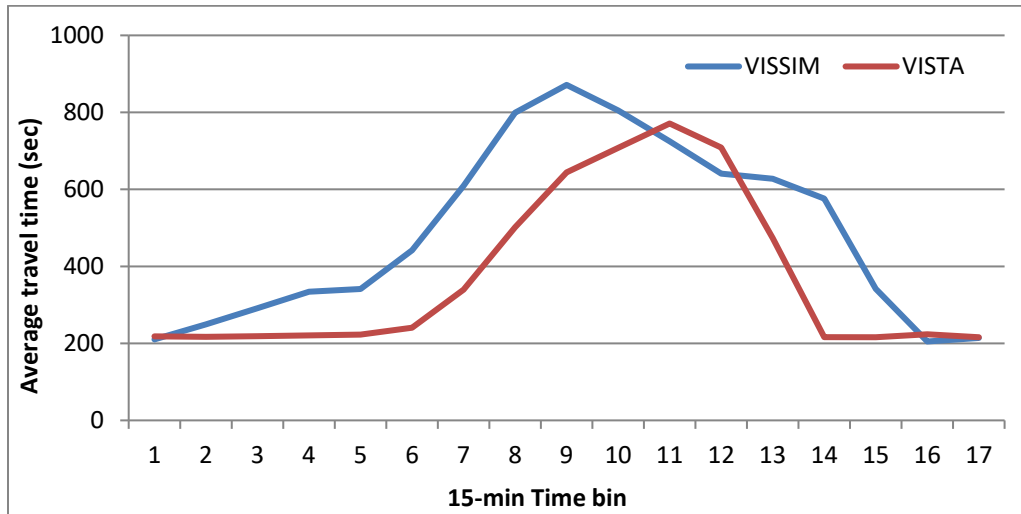

Figure 6.5 Main lane travel time in VISTA and VISSIM

### 6.2.3 Hard Shoulder Running

For the hard shoulder case, VISSIM provides the exact time duration of lane closure that was reproduced in VISTA.

The hard shoulder was found to converge in three to four iterations. Table 6.6 highlights the changes in the RMS values for OD matrices obtained from VISTA between iterations.

**Table 6.6: RMS values for OD demand with HSR**

<i>Base Case to Iteration 1</i>	<i>Iteration 1 to Iteration 2</i>	<i>Iteration 2 to Iteration 3</i>	<i>Iteration 3 to Iteration 4</i>
11.3145	8.535	3.4425	2.716

Although the OD demand remained nearly the same after two iterations, the control output varied significantly with every iteration. Table 6.7 shows the status of HSR over time for each iteration. The reason behind significant changes for different iterations was the choice of algorithm. The control algorithm decides to open the shoulder based on the occupancy values of upstream detectors. As soon as the values reach a threshold, it directs the shoulder to open in next time step. For such threshold-based control strategies, a value of average occupancy slightly above the threshold may allow the lane to be open, while a value slightly below may keep the lane closed, even if the occupancies themselves differ by a small amount. Another reason behind significant changes across iterations can be attributed to the stochastic nature of vehicle simulation in VISSIM.

**Table 6.7: Status of hard shoulder with time for different iterations**

Time (in seconds)	Iteration 1	Iteration 2	Iteration 3	Iteration 4
0-1800	Closed	Closed	Closed	Closed
1800-3600	Closed	Closed	Closed	Closed
3600-5400	Closed	Open	Open	Closed
5400-7200	Open	Open	Closed	Open
7200-9000	Closed	Closed	Open	Closed
9000-10800	Open	Closed	Open	Open
10800-12600	Open	Open	Closed	Open
12600-14400	Open	Closed	Open	Closed
14400-16200	Open	Closed	Open	Closed
16200-18000	Open	Closed	Open	Closed

The average travel times for 5-minute intervals are shown in Table 6.8. Even though the control strategy showed significant changes across iterations, the changes in travel time were not drastic.

**Table 6.8: Change of total system travel time (in hours) across iterations**

Base	Iteration 1	Iteration 2	Iteration 3	Iteration 4
23284	23070	23067	23127	23124

Figure 6.6 shows the total network travel time obtained from VISTA. As seen from the results of the base case and iteration 4, ignoring the impacts of route choice results in underestimating the total system travel time.

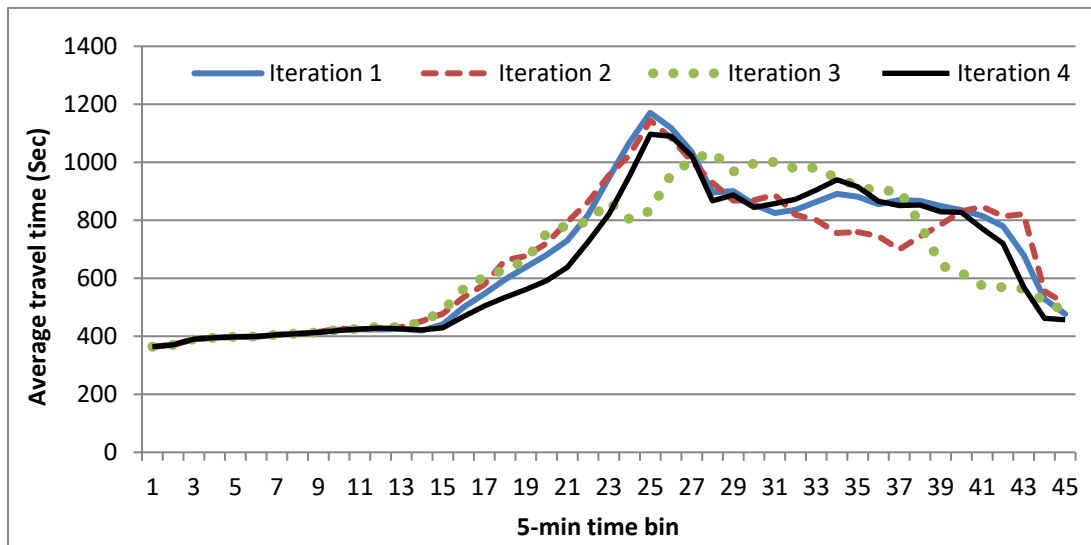

*Figure 6.6 Average travel time in VISSIM for the HSR case*



The results from the above analysis indicate that the HSR is an effective ATM strategy for the selected segment and decreases the total system travel time.

### **6.3 Concluding Remarks**

In this chapter, the research team looked at an iterative multi-resolution modeling approach for testing the effectiveness of three ATM strategies: ramp metering, VSL, and HSR. The control strategies obtained using VISSIM were approximated in VISTA to capture route changes, which served as an input to the next VISSIM iteration, and then this process was repeated. In most cases, the iterative procedure terminated within a few steps, possibly because the network topology presents fewer route choice opportunities. However, in the case of metering multiple ramps, the iterative procedure was beneficial in capturing route choice effects as travelers can decide which on-ramps to use to enter the freeway based on the average green ratios. The iterative procedure also was found to be effective in modeling the OD demand changes for HSR though the control strategy fluctuated across iterations.

## Chapter 7. Multi-scale Analysis

The effects of changes to a network can propagate to far located areas. Transportation practitioners are thus faced with the issue of determining the boundaries of a network. For instance, the infamous traffic jam on National Highway 110 in China spread nearly 60 miles after work zone closures at one freeway section reduced freeway capacity. In theory, it is always better to work with a network as large as possible. Doing so, however, presents additional challenges because modeling a large network requires more data and computation power for evaluating network improvement strategies. There is a tradeoff between the accuracy of the models and the resources required. Larger subnetworks provide a more accurate solution by capturing the long-term changes in the route choices of the travelers, but have larger memory and computation time requirements. Small subnetworks, which are faster to run, are beneficial for local-level analysis but do not capture the network-level impacts of planning modifications.

In this chapter, the research team explored this tradeoff by comparing the effects of two ATM strategies (ramp metering and HSR) on networks of different scales using a hybrid model consisting of VISTA and VISSIM.

### 7.1 Subnetwork Generation Techniques

Methods to determine the appropriate model scale, by observing the sensitivity of results, have received little attention in the research literature.

Several studies provide methods to construct subnetwork boundaries in a way that important network characteristics are preserved. Gemar (2013) identifies two primary issues associated with subnetwork analysis: (a) selection of an appropriate subnetwork based on the analysis region, and (b) identification of an appropriate treatment of the network outside. Typical methods to select subnetwork from a larger model include:

- *Radius-based selection*, where all links within a specified radius are included.
- *Used-path-based selection*, in which all paths that use the modified link(s) are included, including some potential paths that may be chosen by those users.
- *Selection based on changes in volumes and travel time*, where all links with significant changes in volume or travel time (determining which requires running the models on the complete network once) are selected.
- *Immediate-connection-based selection*, in which all links that are close to the modified link(s) are selected. Closeness is defined as the minimum number of links that are needed to connect a link to the modified link and is a user-specified size parameter.
- *Selection based on engineering judgment*, which is a combination of the above methods.

Choice of the particular subnetwork-selection method is specific to the type of project being evaluated (Gemar, 2013). For instance, an analysis on a grid network like downtown Austin would benefit from immediate connection-based selection, while an analysis on rural networks would be best done using path-based selection. However, the accuracy of any method depends on

the approximations used to incorporate elements outside the subnetwork since it is essential in capturing the route choice behavior of travelers.

Gemar et al. (2014) present a logit-based method to capture the variation in demand at the subnetwork boundary by estimating the differences in internal (subnetwork) travel times between the base and impact scenarios. Zhou et al. (2006) propose the use of a virtual link connecting the boundary nodes of the subnetwork to model the demand external to the subnetwork. Boyles (2012), and Jafari and Boyles (2016), highlight an accurate method of determining the parameters for the virtual link using bush-based sensitivity analysis of the equilibrium solution obtained from static traffic assignment. (For a comprehensive review of literature on these *network contraction* methods, see Jafari and Boyles, 2016.)

The analysis in this chapter does not compare the quantitative benefits of one form of subnetwork modeling over the other, as the field of subnetwork identification in DTA is still evolving and current software implementations do not incorporate the latest methods. Instead, the goal of this chapter is to assess the importance of selecting an appropriate scale, and understanding the impact of increasing network scale for the selected test network.

## 7.2 Different Model Scales in VISTA

To study the effects of model scale in VISTA, three different scales of the Wilco network were considered:

- Scale 1 considers only the southbound segment of IH 35 in VISSIM (using microsimulation alone).
- Scale 2 considers the southbound segment along with the parallel frontage roads and a small subnetwork around it (and is modeled using the hybrid approach involving VISTA and VISSIM).
- Scale 3 considers the entire Wilco network (and is modeled using the hybrid approach involving VISTA and VISSIM).

To create the Scale 2 network, a subnetwork comprising the freeway corridor and a few nearby arterials were selected to capture traveler route choices after implementing ATM strategies. Figure 7.1 and Figure 7.2 highlight the three model scales for the Wilco network, and Table 7.1 lists the network statistics for the three networks.

**Table 7.1: Network statistics for the three scales in VISTA**

	<i>Scale 1</i>	<i>Scale 2</i>	<i>Scale 3</i>
No. of mesoscopic links	19	1459	2638
No. of mesoscopic nodes	20	718	1282
No. of centroids	9	391	708
No. of centroid connectors	9	709	1315
No. of vehicles (Total OD demand)	20138	116044	145254

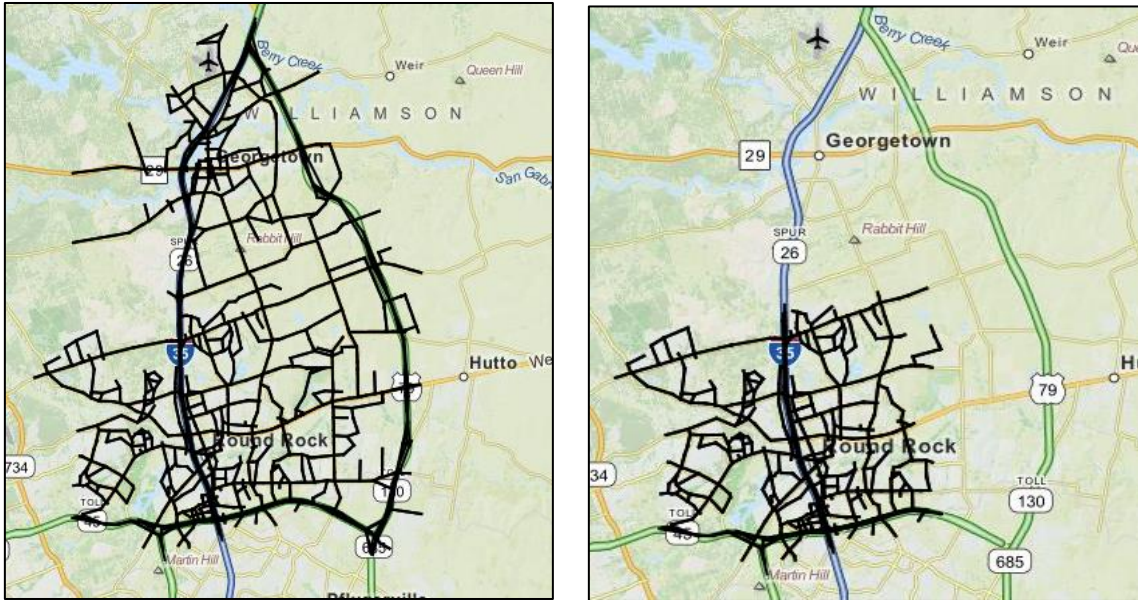

Figure 7.1 Scale 2 and 3 network: (a) Scale 3 network and (b) Scale 2 network

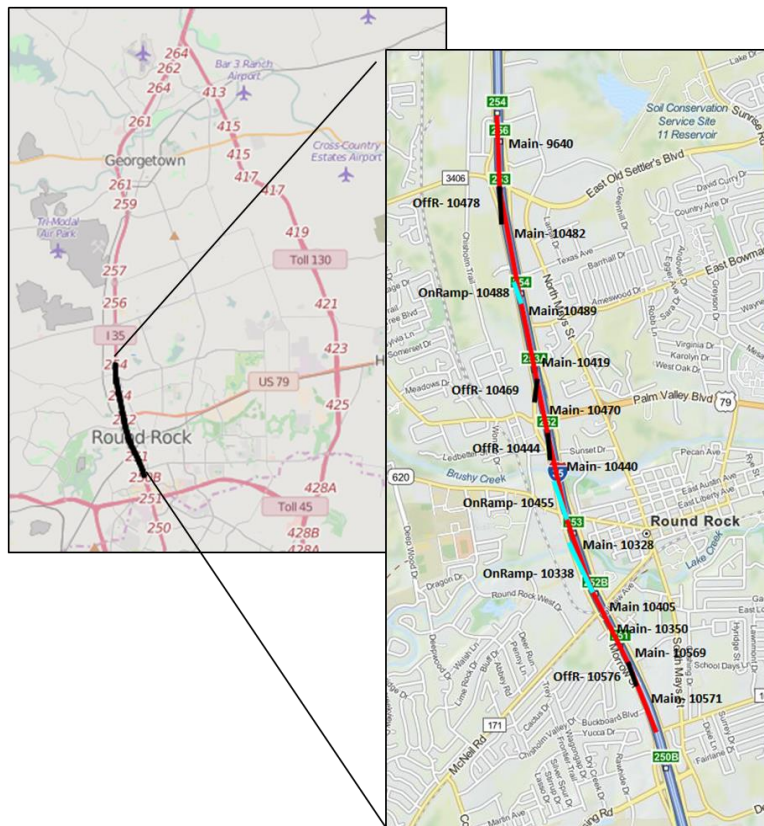

Figure 7.2 Scale 1 network

The objective of the analysis was to identify the impact of scale of the network on the results. Such an analysis helps a modeler select the right scale for building an either microsimulation, DTA, or combined micro-simulation/DTA model. HSR and ramp metering were selected for this purpose because these control strategies could be approximated in the DTA software with greater accuracy. From a computational requirements standpoint, each iteration of the hybrid Scale 3 model took about 1.5 to 2 times longer than one iteration on the Scale 2 network.

### 7.3 Modeling ATM Strategies with Varying Scales

#### 7.3.1 Hard Shoulder Running

Hard shoulder control was installed on the selected corridor in each of the three scales. VISSIM simulation was carried out on Scale 1 network with the DTA OD matrix from the complete network. Hybrid modeling between VISSIM and VISTA was performed for Scale 2 and Scale 3 networks. The Scale 2 and Scale 3 networks were run until the convergence was observed. The following characteristics were compared across different scales:

- Change in the mainline demand obtained from vehicle trajectory analysis in VISTA
- Changes in the predicted control strategy
- Change in the travel time estimates

Figure 7.3 shows the variation in the VISTA OD demand for the through vehicles on the main lanes.

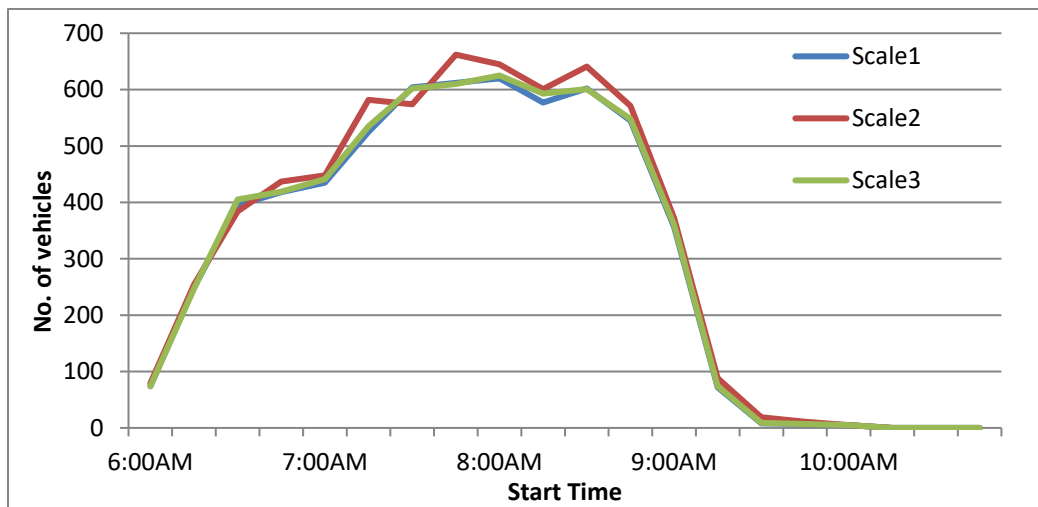

Figure 7.3 OD demand variation for HSR on the selected corridor for each of the three scales

Figure 7.4 (a) highlights the final convergent control strategy for each of the three scales. Figure 7.4 (b) shows the average occupancy readings based on which the control of hard shoulder was determined, and also the threshold occupancy value which was used for the control. Figure 7.5 shows the average travel time calculated over the entire corridor.

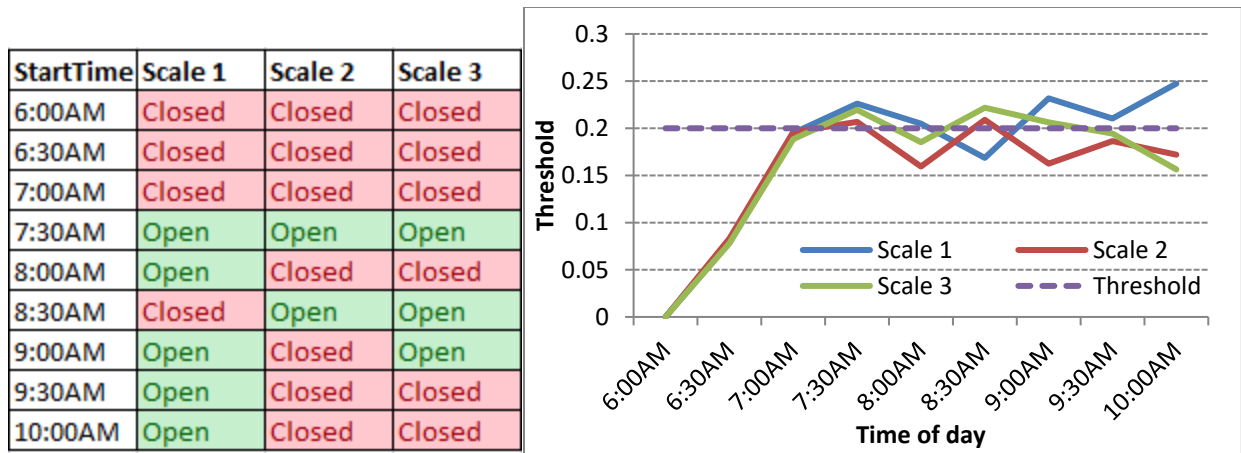

Figure 7.4 Control strategy output: (a) control strategy output obtained after convergence; (b) occupancy reading for the HSR control detector for each of the three scales

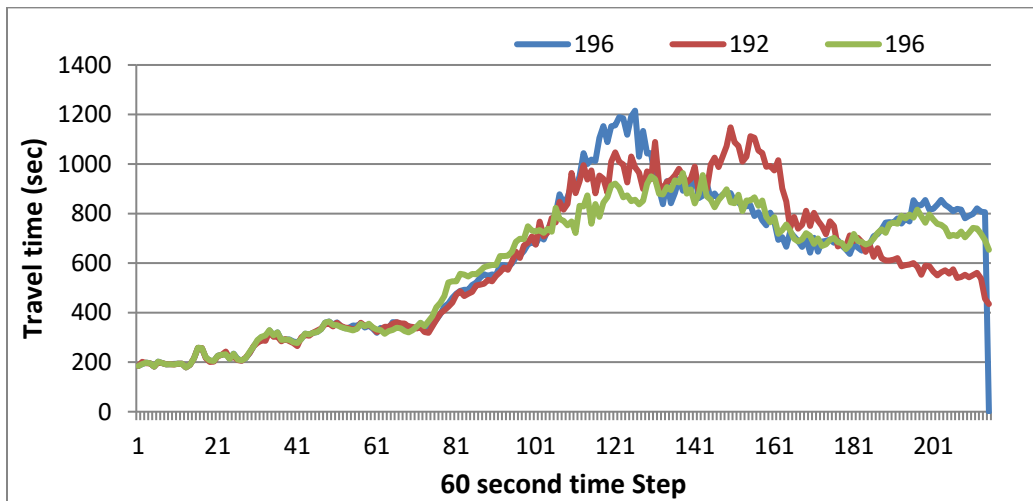

Figure 7.5 Average travel time (in sec) along the main lanes for each of the three scales

The following observations can be made from these plots.

- The results for each of the three scales are almost identical. This indicates that the route choices for the travelers are not significantly affected by the adopted control strategy.
- However, the results show that the actual control strategy can be different for different scales.
- The average travel times for Scales 1, 2, and 3 were found to be 607, 591, and 585 seconds.

In conclusion, there was a minor reduction in the travel times in the Scale 3 network as travelers have more route choice options. However, the differences were not significantly large and the Scale 1 network could be used to model HSR for the selected Wilco network as all the three scales led to similar results. Scale 1 network would also require least amount of effort in

running multiple evaluation scenarios since it is the smallest of the three, and has minimal data requirements.

### 7.3.2 Ramp Metering

Similar analysis was carried out for ramp metering in VISSIM and VISTA. The OD demand and optimal control parameters of the ramp meters are shown in Figure 7.6 and Table 7.2. There was a slight variation in the OD demand for Scale 2 but the optimal average green ratios were nearly the same.

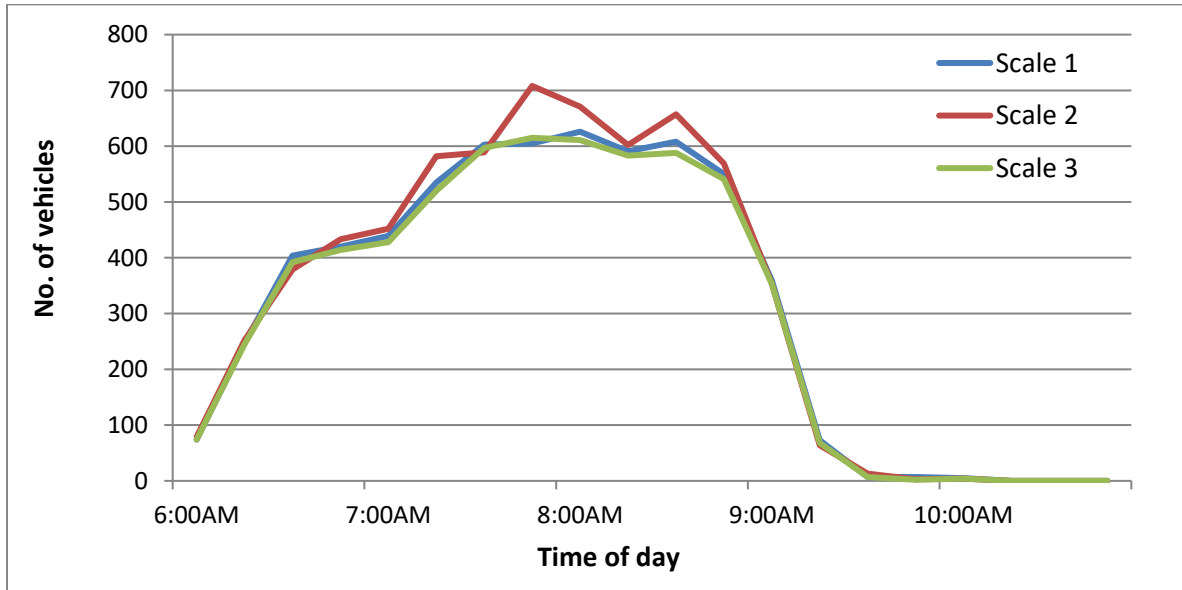

Figure 7.6 OD demand variation after ramp metering for each of the three scales

**Table 7.2: Average green ratios used in VISTA for different scales**

	<i>Scale 1</i>	<i>Scale 2</i>	<i>Scale 3</i>
Ramp 1 Avg. Green Ratio	0.23	0.22	0.24
Ramp 2 Avg. Green Ratio	0.81	0.78	0.79

As the predicted demand was slightly higher for the Scale 2 case, a similar trend was observed for the main lane travel times. The average travel time over the entire modeling horizon was found to 433 seconds for Scale 2 and 420 seconds for Scale 3, reinforcing the fact that a larger network can provide more route options to travelers.

However, as with HSR, the differences in the travel times do not make a compelling case for using a larger network that requires more data and computational power and thus a Scale 1 network can be used to study the impact of the ATM strategy (Figure 7.7).

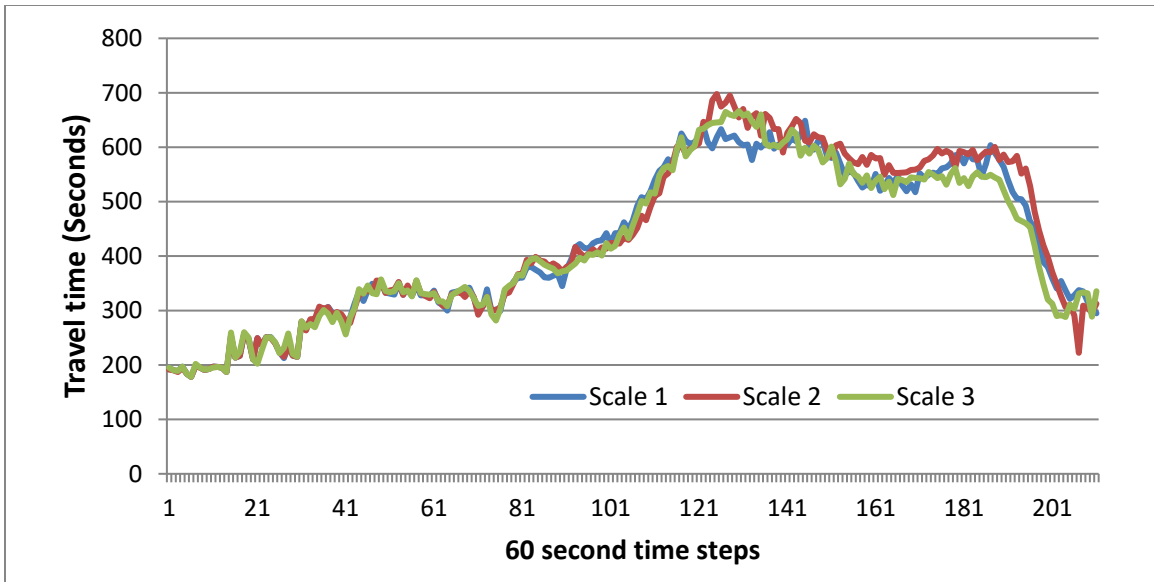

Figure 7.7 Average travel time (in sec) along the main lanes for each of the three scales

## 7.4 Concluding Remarks

This chapter described the sensitivity of results to network size for HSR and ramp metering. VSL was not considered for the analysis as the results from analysis in Chapter 6 indicated that route choice shift is insignificant in its case. The primary conclusion is that for the Williamson County network, the ATM strategies could have been modeled using a smaller network as they had a very little impact on route choices of travelers. In general, the choice of the right model scale is a function of the topology of the network. A network with several parallel/alternate routes that are equally attractive can cause changes to travelers' route choices and the problem of selecting the right scale is more important in such scenarios. The results are also specific to the control strategy adopted. For example, if a control strategy results in significant travel time savings, then the OD demand can be expected to change significantly, and a bigger network can be used to accurately model route choice. Thus, to assess if the size of subnetwork is sufficient, one complete run of the entire network should be performed with control strategy in place, and if changes in the demand are significant, further investigation should be performed to increase the size.



## Chapter 8. Analysis of ATM Strategies under Different Data Availability Scenarios

Testing the effectiveness of active traffic management strategies requires resources such as software and data. The most commonly used software programs are microsimulators, but these cannot model the network-level impacts of improvement strategies. To address this, we developed a hybrid approach that integrated microsimulators and DTA software. However, these hybrid approaches require a large amount of input and calibration data at both the operational and strategic levels. In many cases, practitioners may not have access to such software and data. This section addresses these issues of software and data availability.

### 8.1 Software and Data Availability

Based on the availability of microsimulators and DTA, we first identify four possible scenarios under recurring congestion as shown in Table 8.1 and two possible scenarios under non-recurring congestion as shown in Table 8.2. Scenario 1, which involves using DTA models in conjunction with microsimulation, serves as a “gold standard,” as it provides the benefits of both modeling environments. Using this hybrid approach, we can not only capture the effects of the ATM strategy on the freeway but can also predict its impacts on route choices of travelers in other parts of the network. However, the data and models required to achieve this ideal scenario may not be available.

Scenario 2 addresses cases in which microsimulation is available, but a DTA model is unavailable. In this scenario, using the microsimulation alone will likely provide over-optimistic results, as users’ route choices are not factored in the analysis. Scenario 3 addresses the converse case, in which microsimulation is unavailable but the modeler has access to DTA software. Scenario 4 addresses the case where neither microsimulation nor DTA software are available. For these latter scenarios, clearly the predictions are less exact. However, we develop procedures, which achieve the best analysis possible given the available resources.

Scenario 5 addresses the case for non-recurring congestion when microsimulation model is available. This scenario acts as a gold standard for the models under non-recurring congestion where the changes in routes are insignificant. The en-route changes in the routes of travelers are not considered as part of our study because of limited available research in this direction and difficulty in calibrating driver’s behavior to en-route changes. Scenario 6 addresses the case when no microsimulation model is available and captures the impact of non-recurring congestion for no-data case in the similar ways as scenario 4 does for recurring congestion.

**Table 8.1: Different scenarios based on the level of data availability for recurring congestion**

	<b>DTA available</b>	<b>DTA unavailable</b>
Microsimulator available	Scenario 1	Scenario 2
Microsimulator unavailable	Scenario 3	Scenario 4

**Table 8.2: Different scenarios based on the level of data availability for recurring congestion**

Microsimulator available	Microsimulator Unavailable
Scenario 5	Scenario 6

The focus of this section is to explain the methodology used to develop models that deal with the analysis for scenarios 2, 3, 4, and 6. The analysis is performed for three ATM strategies: ramp metering, VSLs, and DLUC.

## 8.2 Assumptions and Overview

One of the primary challenge to quantify the impacts of an ATM strategy for a general network is that there is limited scope of developing analytical models that can capture microsimulation and network-level impacts of an ATM strategy. Both the corridor level microsimulation model and the network-level DTA model rely on performing simulations to assess the performance of an ATM strategy. Thus, developing a surrogate model that can capture impact of an ATM strategy on any network under different levels of data availability requires making approximations.

Our analysis makes the following broad assumptions:

1. The analysis of ATM strategies is conducted on half-mile segments where the ATM strategy is deployed.
2. Due to the limitation in running the number of cases, the performance for an ATM strategy is evaluated only for two commonly used algorithms with a fixed choice of commonly used control parameters.
3. We replace DTA with a static traffic assignment model for the analysis in this section. The reason for this choice is the simplicity of static traffic assignment and its ability to capture route choice at a broader scale.
4. We assume that the analysis is performed for an hour and the performance measures are aggregated and represented by a single quantity. For example, instead of reporting the change in corridor travel time with time duration, we report the average corridor travel time over the desired period of interest. This approximation makes it easier to quantify the impacts of changes in performance with and without an ATM strategy.

The analysis is performed using a base microsimulation model built for each ATM strategy. The model is run for different combinations of demand and downstream bottleneck. A regression model is then fit to the data points generated from multiple simulations, which predicts the average performance measures given a particular set of input parameters. The changes in route choice patterns are captured using static traffic assignment where the network outside the modeled segment is approximated using artificial links. For dealing with different scenarios of data availability, the regression models are slightly modified. The following subsections detail the process.

### 8.3 Network Description

The analysis in this section considers smaller test networks with appropriate boundary conditions meant to replicate the local analysis for ATM strategies.

#### 8.3.1 Ramp Metering

The base network for ramp metering consists of a half-mile corridor with a ramp joining at the middle point. A ramp meter is installed on the ramp and the detectors are installed downstream of the merge point of on-ramp and the freeway. The freeway is assumed to follow a speed limit of 100km/hr or an equivalent 65mph and has three lanes as commonly observed in several freeways. The network used for the ramp metering analysis is shown in Figure 8.1.

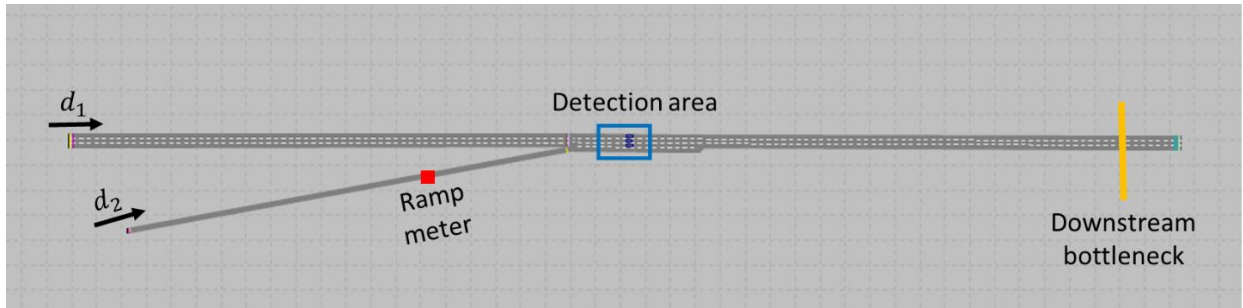

Figure 8.1 Ramp metering base network for developing regression models

A downstream bottleneck is installed at the end of the network to model the impacts of different congestion levels. The bottleneck is modeled in VISSIM using speed decision points where the intensity of congestion is regulated using the speed at the installed decision points. The demand for the network is controlled using the appropriate value of variables for mainline demand ( $d_1$ ) and ramp demand ( $d_2$ ).

#### 8.3.2 Variable Speed Limits

The base network for variable speed limits consists of a half-mile corridor with variable speed limits implemented at the upstream end and the detection area located downstream as shown in Figure 8.2. Similar to the ramp metering case, a reduced speed decision area is installed at the downstream end to model the downstream bottleneck. The demand is controlled using appropriate values for mainline demand variable ( $d_1$ ).

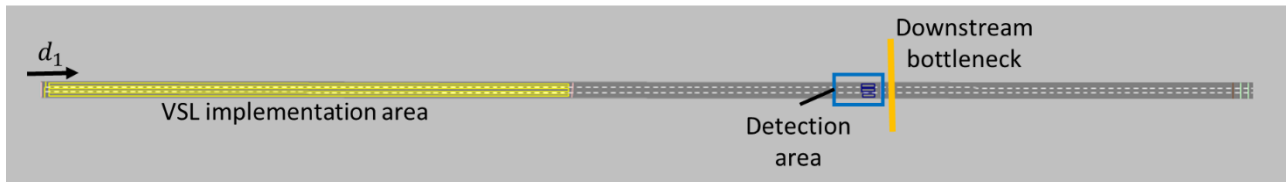

Figure 8.2 VSL base network for developing regression models

### 8.4 Running Simulation for Base Network of Each ATM Strategy

Simulations were run for the base networks for each ATM strategy considering the following parameters:

- The simulation is run for an hour (which can be considered the analysis hour for a real network).
- The demand is assumed to follow a uniform demand profile for first 45 minutes. The demand is set to zero for the last 15 minutes to ensure that the traffic flushes out of the network.
- The performance measures are reported between 5th and 45th minute of the simulation to account for warming up the network and setting the desired congestion.
- Three VISSIM runs are performed for each simulation and the average of each performance measure is reported from the run.

Table 8.3 summarizes the simulations conducted for base network for each ATM strategy with different combinations of input.

**Table 8.3: Control algorithms for ATM strategies considered and the inputs for which the base network was run**

ATM Strategy	Control algorithm	Inputs
Ramp Metering	ALINEA: Algo 1	Mainline demand ( $d_1$ ), ramp demand ( $d_2$ ), downstream bottleneck speed ( $s$ )
	AD-ALINEA: Algo 2	Mainline demand ( $d_1$ ), ramp demand ( $d_2$ ), downstream bottleneck speed ( $s$ )
VSLs	Speed-based threshold: Algo 1 (Allaby et al., 2007)	Mainline demand ( $d_1$ ), downstream bottleneck speed ( $s$ )
	Occupancy-based threshold: Algo 2	Mainline demand, downstream bottleneck speed
Dynamic Lane Use	Dynamic merge control – Ramp occupancy threshold of 40%	Mainline demand ( $d_1$ ), ramp demand ( $d_2$ ), downstream bottleneck speed ( $s$ )
	HSR – Main corridor occupancy threshold of 40%	Mainline demand, downstream bottleneck speed

Different combinations of input values were run for each ATM strategy. The following input value ranges were considered: 3000 veh/hr to 6000 veh/hr for the mainline demand ( $d_1$ ), 750 veh/hr to 1750 veh/hr for the ramp demand ( $d_2$ ), and 20 km/hr to 100 km/hr for the bottleneck speed ( $s$ ). To compare the results, each network was also run for the same combination of inputs without any ATM strategy. The following subsection describes the analysis of results for each ATM strategy.

## 8.5 Regression Model for Each ATM Strategy

### 8.5.1 Ramp Metering

The performance measures used for analysis of the ramp metering case are average corridor travel time, average queue length on the on-ramp, and percentage of time the queue length on the on-ramp exceeded its length. Figure 8.3 and Figure 8.4 show the plot of variation of percentage

change in travel time compared to base case and the average queue length on the on-ramp for different input combinations. It is observed that both control algorithms cause improvement over the base travel time for some combination of inputs; however, for the same combination of inputs, the queue lengths on the respective on-ramps are also high.

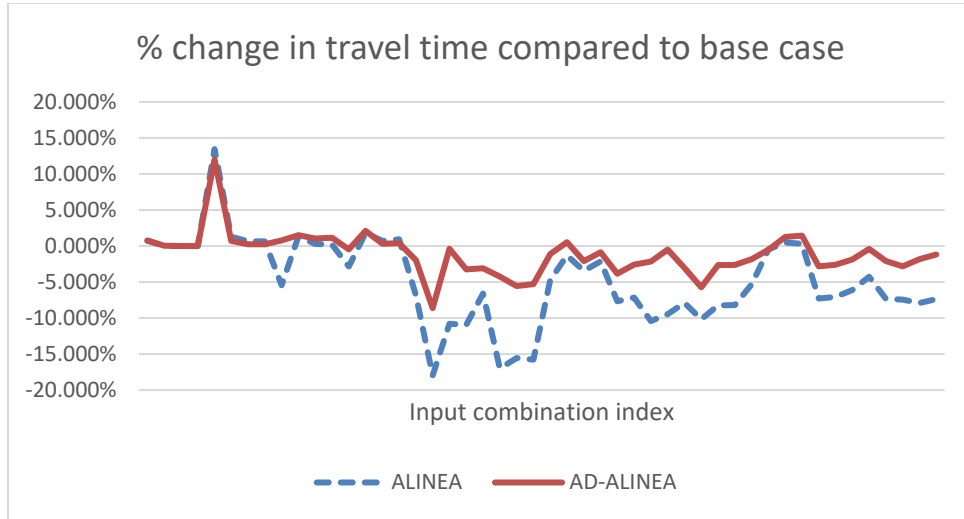

Figure 8.3 Percent change in corridor travel time compared to base case for ramp metering algorithms

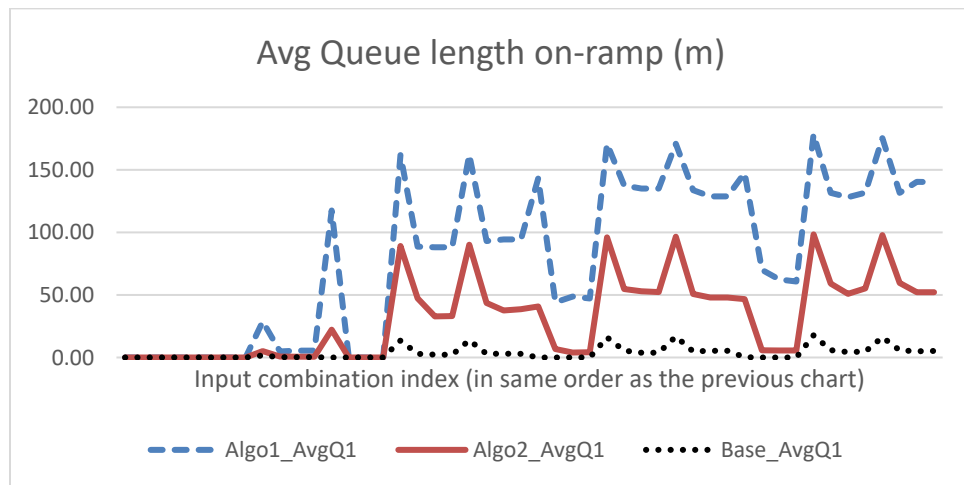

Figure 8.4 Average on-ramp queue length compared to base case for ramp metering algorithms

A close analysis of those input combinations reveals that ALINEA is effective in reducing corridor travel time when the demand on the corridor is below the capacity and demand on ramp is high enough to let the flow after the merge to reach beyond capacity. This leads to the well-known capacity drop, which reduces corridor travel time. However, with a ramp meter this drop can be avoided. It is important to note that the results were obtained for a constant level of demand. If the observed demand in the field is time-varying and increases with time, both the ramp metering algorithms can delay the onset of congestion. This also indicates that ramp metering can lead to an

improvement of corridor travel time, if combined with active strategies like route diversion from on-ramps when demand is increasing.

In order to quantify the improvement predicted by each control algorithm on the on-ramps, linear regression models were fit through the average travel time, average queue length on-ramp and percentage of time queue length exceeds on-ramp. Though the variation of these performance measures with respect to the input parameters is not linear, a regression equation will give us an idea on how to interpolate the prediction in performance of a ramp metering algorithm.

The following equations show the variation of performance measures with respect to input parameters for both the algorithms:

**Algorithm 1: ALINEA**

$$\begin{aligned}
 & \text{Corridor travel time (sec)} \\
 & \quad = 15.61604 + (0.024282 * d_1) + (0.009981 * d_2) + (-0.99957 * s) \\
 & \text{Average ramp queue length} \\
 & \quad = -102.721 + (0.036761 * d_1) + (0.055474 * d_2) + (-0.93948 * s) \\
 & \% \text{ time queue spills onramp (\%)} \\
 & \quad = 100 * [ -0.13826 + (0.0000417 * d_1) + (0.000538 * d_2) + (-0.00399 * s) ] \\
 & \text{Avg green ratio} = 1.20141 + (-0.00014 * d_1) + (-0.000077 * d_2) + (-0.002757 * s)
 \end{aligned}$$

**Algorithm 2: AD-ALINEA**

$$\begin{aligned}
 & \text{Corridor travel time (sec)} \\
 & \quad = 9.856786 + (0.025632 * d_1) + (0.014123 * d_2) + (-1.032268 * s) \\
 & \text{Average ramp queue length} \\
 & \quad = -54.6027 + (0.015532 * d_1) + (0.038647 * d_2) + (-0.61131 * s) \\
 & \% \text{ time queue spills onramp (\%)} \\
 & \quad = 100 * [ -0.00214 + (0.0000071 * d_1) + (0.0000337 * d_2) + (-0.00098 * s) ] \\
 & \text{Avg green ratio} = 1.12286 + (-0.00009 * d_1) + (-0.000044 * d_2) + (-0.002391 * s)
 \end{aligned}$$

Table 8.4 indicates the level of fit for the regression models.

**Table 8.4: R<sup>2</sup> values for ramp metering regression models**

	ALINEA		AD- ALINEA	
	R <sup>2</sup>	Adjusted R <sup>2</sup>	R <sup>2</sup>	Adjusted R <sup>2</sup>
<b>Corridor Travel Time</b>	0.728	0.709	0.730	0.712
<b>Avg Queue Length</b>	0.621	0.589	0.589	0.554
<b>% Time Queue Spills On-Ramp</b>	0.6919	0.6631	0.5344	0.4907
<b>Avg Green Ratio</b>	0.6311	0.600	0.642	0.612

The following observations can be made from the regression model equations:

1. The corridor travel time increases with both mainline and ramp demand and reduces with the increase in bottleneck discharge speed.

2. The percentage of time queue spills back from on-ramp and the average queue length increase with changes in the demand on the corridor. The impact of changes in ramp demand are more significant in increasing the queue length.
3. The average green ratio reduces for both the algorithm with increase in demand or bottleneck speed.

### 8.5.2 Variable Speed Limits

The performance measure used for the analysis was average corridor travel time. Figure 8.5 shows the plot of variation of percentage change in travel time compared to base case for different input combinations. It was observed that for any combination of inputs, the travel time on the corridor did not improve. However, the performance of the occupancy-based algorithm was better than the speed-limit-based algorithm.

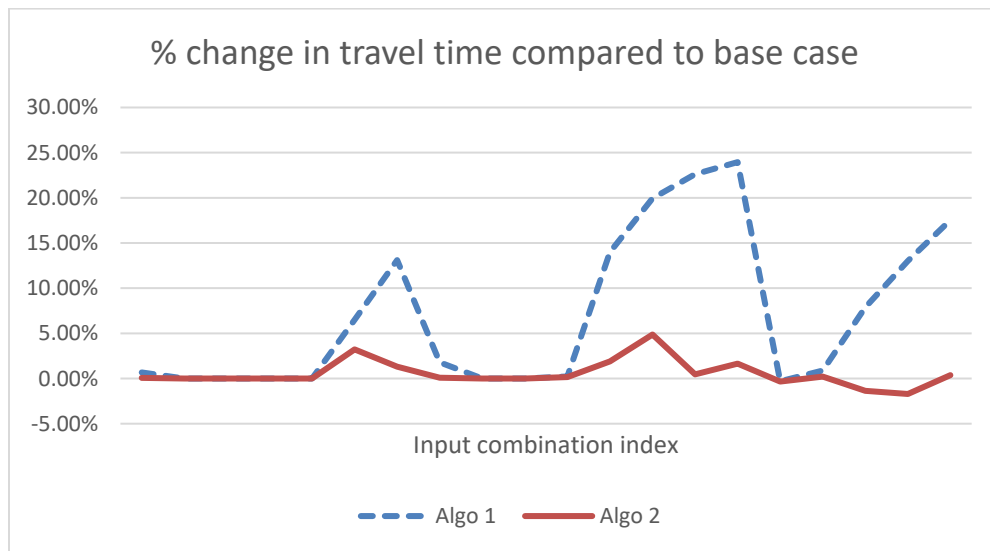

Figure 8.5 Percent change in corridor travel time compared to base case for VSL algorithms

The findings reveal an interesting result: under constant demand scenarios, VSLs can lead to reduction in corridor performance. The reason VSL was not very effective for any input combination is also because of the control algorithm used. The ideal method for VSL to prevent capacity drop is to ensure that vehicles enter the bottleneck at the same speed as the speed of discharge at the bottleneck; however, the algorithm is unable to determine the appropriate choice of algorithm for that purpose.

Even though the performance of VSL was not found significant, the results are useful in quantifying the increase in travel time for a VSL case considered. These quantifications were made using regression models. Quadratic terms in input were included in the regression model to improve the fit of the model. The following equations show the variation of the performance measures with respect to input parameters for both the algorithms:

#### Algorithm 1: Speed-based threshold

$$\text{Corridor Travel time} = \text{MAX}(28, \\ 82.903 + (17.5436 * d_1/1000) + (-0.60469 * d_1^2/1000000) \\ + (-27.7984 * s/10) + (1.70391 * s^2/100))$$

$$\text{Avg. Speed limit} = \text{MIN}(100, \\ 181.603 + (-40.2333 * d_1/1000) + (2.7121 * d_1^2/1000000) + (4.23972 \\ * s/10) + (-0.20969 * s^2/100))$$

#### Algorithm 2: Occupancy-based threshold

$$\text{Corridor Travel time} = \text{MAX}(28, \\ 108.3757 + (7.65813 * d_1/1000) + (0.327625 * d_1^2/1000000) \\ + (-28.9501 * s/10) + (1.77407 * s^2/100))$$

$$\text{Avg. Speed limit} = \text{MIN}(100, \\ 111.994 + (-19.4061 * d_1/1000) + (1.0303 * d_1^2/1000000) + (11.82468 \\ * s/10) + (-0.74675 * s^2/100))$$

Table 8.5 shows the level of fit for the regression models quantified using  $R^2$  value.

**Table 8.5:  $R^2$  values for VSL regression models**

	Density-threshold		Occupancy-threshold	
	$R^2$	Adjusted $R^2$	$R^2$	Adjusted $R^2$
<b>Corridor Travel Time</b>	0.810	0.759	0.781	0.722
<b>Avg Speed limit</b>	0.851	0.811	0.836	0.792

The  $R^2$  value indicates a good level of fit. The regression models indicate that with increasing demand and decreasing bottleneck speed the corridor travel time goes up and the average speed limit goes down, which is a reasonable prediction.

### 8.5.3 Dynamic Lane Use Control

#### *Dynamic Merge Control*

The performance of the dynamic merge control strategy described in Section 4.3.3 was evaluated for the same combinations of mainline demand, ramp metering, and bottleneck speed mentioned above. The threshold used for ramp occupancy was 40%. In other words, when the occupancy on the ramp increases above 40%, the vehicles on the right-most lane on the mainline are asked to merge to the two left-most lanes. The performance measure used for the analysis was average corridor travel time. Figure 8.6 shows the plot of variation of percentage change in travel time compared to base case and the average queue length on the on-ramp for different input combinations. The base case corresponds to the use of the same demand and bottleneck speed combinations, but without the use of the dynamic merge control strategy.

Figure 8.6 indicates that the performance of dynamic merge control ATM strategy depends on the specific values of mainline demand, ramp demand, and bottleneck severity. The results indicate that for all cases of mainline and ramp demand, if the bottleneck on the mainline is at the highest severity level (80% reduction in speed) the dynamic merge control increased mainline



travel time. This is expected since the strategy is closing the right-most lane on the main corridor based on ramp demand, regardless of the severity of the bottleneck. However, the ATM strategy provided the greatest improvement when the demand on the main corridor was low and the demand on the ramp was high. Specifically, the travel time decreased by 7% for those cases. Dynamic merge control also performed well when the mainline demand was high and the ramp demand was at intermediate levels. Yet, when both mainline and ramp demand were high, dynamic merge control did not improve conditions. This might be due to the combined effect of high mainline demand and prolonged closing of the right-most lane on the mainline due to high ramp demand.

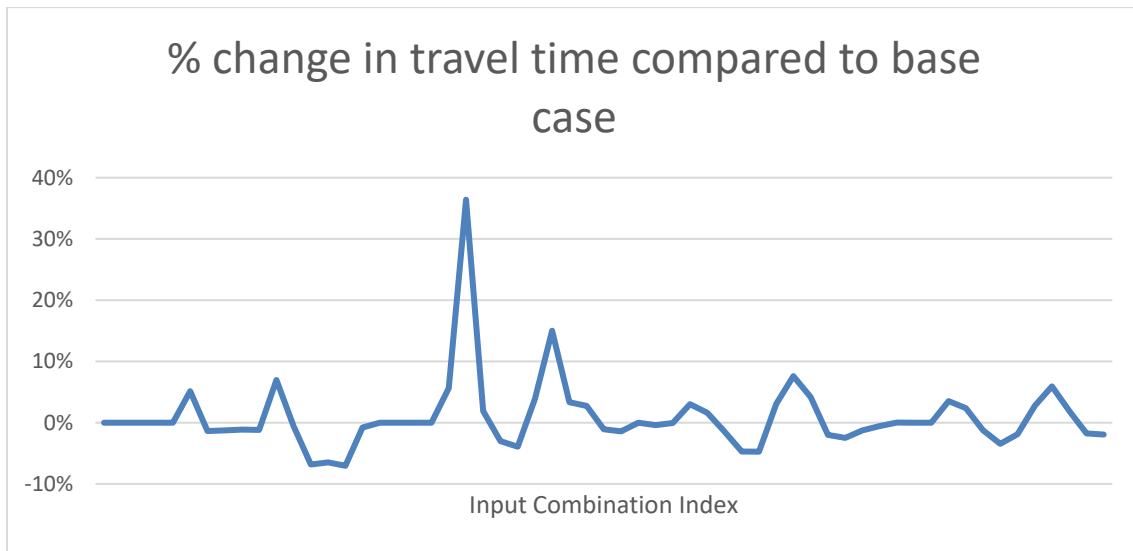

Figure 8.6 Percent change in corridor travel time compared to base case for dynamic merge control

In order to quantify the improvement predicted by the control algorithm, linear regression models were fit through the average travel time, average queue length on-ramp and percentage of time the right-most lane on the main corridor is open to through traffic. The regression for travel time indicated a good fit with an  $R^2$  value of 0.76. Moreover, the signs on the coefficients for the regression equation are as expected. The coefficients for the demand variables have positive coefficients indicating an increase in travel time on the main corridor as the demand increases. The coefficient for the speed variable has a negative coefficient indicating that the travel time on the main corridor decreases as the speed limit increases.

$$\text{Corridor Travel time (s)} = -15.92 + (0.03016 * d_1) + (0.0143 * d_2) + (-0.81032 * s)$$

$$\begin{aligned} \text{Average ramp queue length} \\ = 1.826 + (0.0001927 * d_1) + (-0.00042075 * d_2) + (-0.0225979 * s) \end{aligned}$$

$$\begin{aligned} \text{percent time right - most lane is open} \\ = 1.643 + (-5.733 * d_1/100000) + (-0.000863 * d_2) + (0.00255 * s) \end{aligned}$$

Table 8.6 shows the  $R^2$  and adjusted  $R^2$  values for the regression equations above.

**Table 8.6:  $R^2$  values for dynamic merge control regression equations**

	Dynamic Merge Control	
	$R^2$	Adjusted $R^2$
<b>Corridor travel time</b>	0.76	0.74
<b>Avg ramp queue length</b>	0.26	0.22
<b>% time right-most lane open</b>	0.90	0.89

*Hard Shoulder Running*

The performance of the HSR strategy described in section 4.3.3 was evaluated for the same combinations of mainline demand, ramp metering, and bottleneck speed mentioned above. The threshold used for main corridor occupancy was 40%. In other words, when the occupancy on the main corridor increases above 40%, the shoulder will be open for through traffic. Otherwise, the control strategy would close the shoulder at the next control step. The performance measure used for the analysis was average corridor travel time. Figure 8.7 shows the plot of variation of percentage change in travel time compared to base case. The base case corresponds to the use of the same demand and bottleneck speed combinations, but without the use of the hard shoulder. As shown in the figure, the hard shoulder always improved or did not affect the travel time. Reductions in average travel time reached 15% for specific combinations of demand and bottleneck speed. However, note that the shoulder used was at the same location where the bottleneck occurred. The location of the hard shoulder with respect to the bottleneck is crucial. Specifically, for the larger network tested in chapter 4, it was shown that when the dynamic shoulder lane was located upstream of the bottleneck, the travel time increased.

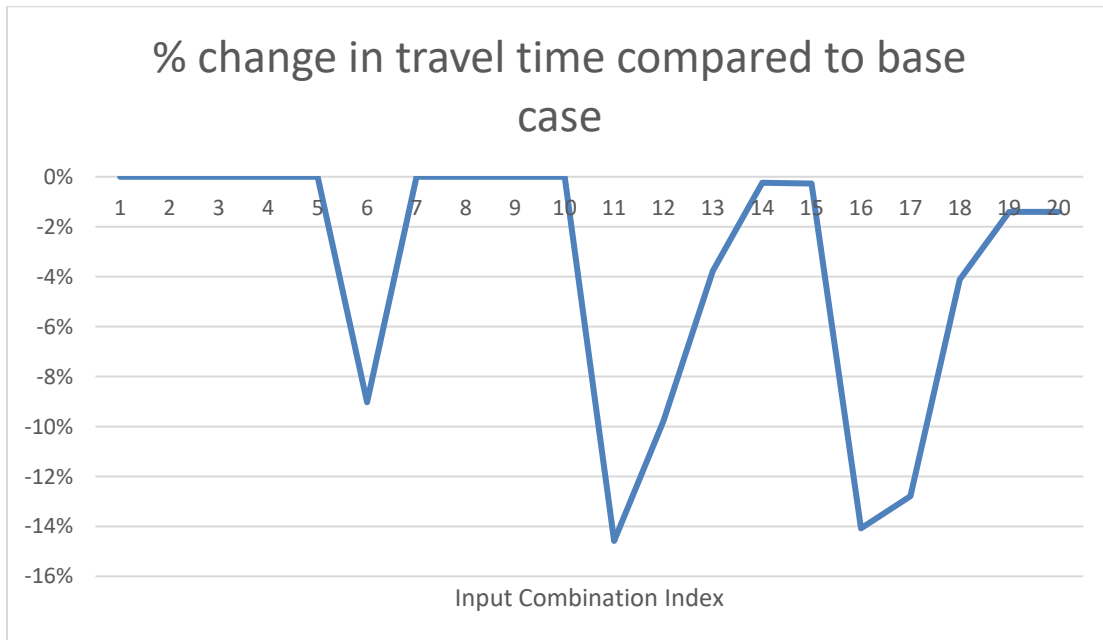

*Figure 8.7 Percent change in corridor travel time compared to base case for HSR*

As expected the results indicate that the hard shoulder improved conditions when the demand was high and the bottleneck speed was low. For the highest simulated demand level (6000 veh/hr), the use of the hard shoulder improved conditions for all possible cases of bottleneck speed.

For the lowest demand level (3000 veh/hr), the HSR did not change network conditions. That is because the occupancy on the main corridor did not trigger the opening of the hard shoulder lane for this demand level.

In order to quantify the improvement predicted by the control algorithm, linear regression models were fit through the average travel time, and percentage of time the hard shoulder was open to through traffic. The regression for travel time indicated a good fit with an  $R^2$  value of 0.76. Moreover, the signs on the coefficients for the regression equation are as expected. The coefficient for the demand variable has a positive coefficient indicating an increase in travel time on the main corridor as the demand increases. The coefficient for the speed variable has a negative coefficient indicating that the travel time on the main corridor decreases as the speed limit increases.

$$\begin{aligned} \text{Corridor Travel time (s)} &= 90.44 + (0.004517 * d_1) + (-0.88145 * s) \\ \text{percent time shoulder lane is open} \\ &= -0.33708 + (0.000221666 * d_1) + (-0.0059375 * s) \end{aligned}$$

Table 8.7 shows the  $R^2$  and adjusted  $R^2$  values for the HSR regression equations.

**Table 8.7:  $R^2$  values for hard shoulder running regression equations**

	Dynamic Merge Control	
	$R^2$	Adjusted $R^2$
<b>Corridor travel time</b>	0.76	0.73
<b>% time right-most lane open</b>	0.78	0.76

## 8.6 Frameworks for Evaluating ATM Strategies

The regression models developed so far can be used to estimate MoEs, even when the ideal modeling tools are unavailable. In this section, we revisit the six scenarios introduced at the beginning of this chapter and discuss the framework for evaluating ATM strategies in each of these cases.

### 8.6.1 Scenario 2

In this scenario, only a microsimulation model is available and no DTA model is available to capture the route choice impact. To quantify the route choice, the concept of artificial links is introduced. An artificial link models all the routes that exist beyond the selected corridor. The network with artificial link considers an abstraction of the original network with a hypothetical location of the origin and destination nodes. The networks in Figure 8.8 and Figure 8.9 show the abstraction of the network used for microsimulation each for ramp metering and VSL respectively, with artificial links shown as dotted lines and original links as part of the network shown as solid lines.

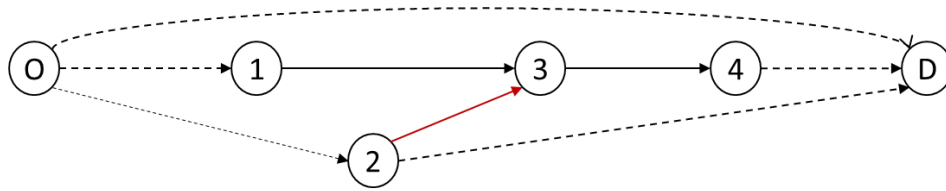

Figure 8.8 Abstract network used to model route choice impacts for the ramp metering case

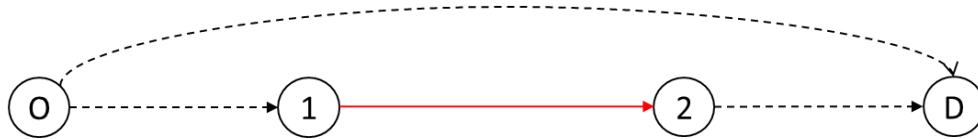

Figure 8.9 Abstract network used to model route choice impacts for VSL case

The objective under this scenario is to quantify the impacts of changes in routes of travelers if the travel time on the corridor changes. The following methodology was used to quantify that change:

- Generate input instances of different values of artificial link parameters (including capacity and free flow travel time).
- Run static traffic assignment for each generated instance and determine link flows on the mainline (and the ramp if applicable). These link flows serve as the demand for the corridor.
- Fit a regression model predicting the link flows as a function of the overall origin demand and the artificial link parameters.

The regression equations developed as part of this scenario were coded in the spreadsheet tool for each ATM strategy.

### 8.6.2 Scenario 3

This scenario assumes that a DTA software is available but no microsimulator is available to analyze the impact of an ATM strategy. If the DTA software has modules to incorporate ATM strategy in the model, then use of that model feature is recommended. Otherwise, the regression models developed from base analysis, which predict average speed limit or average green ratio as function of the input parameters of the model, are used. This predicted value of average speed limit or average green ratio can be used to make changes in the existing DTA model and run the analysis to capture the approximate microsimulation impact of an ATM strategy.

### 8.6.3 Scenario 4

This scenario assumes that no data is available. Under this circumstance, it is theoretically very difficult to make any prediction on performance of an ATM strategy. We thus assume that the transportation agency has access to mainline and ramp demand data and the approximate bottleneck located at the downstream end of the corridor. This data can be approximated from density analysis using Google maps or by observing the traffic over a one-day period and using it as an approximation.

The analysis in this scenario is divided into two parts: in the first part, it uses the regression models developed in section 5.4 to predict improvement in travel time after installation of the ATM strategy given the input parameters. If the improvement in corridor travel time is significant, the second part uses the regression models developed in Scenario 2 to capture the shift in the demand for a given improvement in corridor travel time.

#### **8.6.4 Scenario 6**

Since real-time detour is not modeled in our analysis, the analysis under this scenario is identical to the first part of scenario 4. The reduction in capacity due to a non-recurring congestion is captured by a suitable value of the downstream bottleneck. If the incident is assumed to happen upstream, suitable changes in the demand values is assumed be made.

### **8.7 Concluding Remarks**

In this chapter, we discussed methods to evaluate an ATM strategy when data and tools for strategic and operational analyses are not fully available. Specifically, four scenarios were considered in which microsimulation and DTA models were available or not available. In order to estimate MoE for ramp metering, several possible combinations of network parameters were first used to run hybrid models that capture vehicle-to-vehicle interactions and network-level route choices. The outputs of these hybrid models were used to develop regression equations for four commonly occurring network topologies. Finally, frameworks were designed for the four scenarios using the regression models.

## Chapter 9. Development of Spreadsheet Analysis Tools

This chapter describes the spreadsheet tools implementing the regression models developed in previous chapters. The tools offer a user-friendly interface to evaluate the effectiveness of ATM strategies for a given network. Three ATM strategies are considered: ramp metering, VSL, and DLUC. For each ATM strategy, the spreadsheet tool provides three cases based on the level of data availability:

- The **no-data case** assumes that the agency has no data available to build or calibrate either a microsimulation or a DTA model.
- The **microsimulation-only case** assumes that the agency has real-time data available to build and calibrate the microsimulation model but has no data available to develop a DTA model.
- The **DTA-only case** assumes that the agency has access to strategic data to build a DTA model but only limited access to real-time data to build a microsimulation model.

The framework used in developing the tools provides an approximate analysis and is useful in answering initial, planning level-questions. For example, a potential use of the tool could be in determining whether installing ramp metering on a particular on-ramp on IH 35 can help relieve congestion over the corridor in the long term. However, for assessing the precise impacts of an ATM strategy before its deployment, it is recommended that the agency develop a more detailed microsimulation model of the corridor if the tools developed in this project indicate potential benefits.

### 9.1 Inputs and Outputs to the Spreadsheet Tool

The inputs and outputs to the spreadsheet tool depend on the case being analyzed:

1. **No-data case (scenario 4 and 6):** This case requires the input of mainline demand, ramp demand (if applicable), and the downstream bottleneck discharge speed. It predicts the percentage improvement in the corridor travel time based on those inputs. If the percentage improvement is significant, this tool requires the input of the artificial link parameters and the total demand using the abstract network between nodes O and D. This input then predicts the shift in the mainline demand and the ramp demand possible from the predicted improvements. For non-recurring congestion (scenario 6), only the first set of input and output is used.
2. **Microsimulation-alone case (scenario 2):** This case requires two steps. First, the known demand from the microsimulation model is used to determine the artificial link parameters and the average green ratio for the ramp meter (obtained after the microsimulation run). Second, these values of artificial link parameters and average green ratio are used as inputs to the regression model, which predicts the updated demand for the microsimulation corridor as the output. This modified demand reflects the changes in route patterns of the travelers due to the reduced capacity of the on-ramp with ramp meter or due to improved capacity of the corridor with VSL.

- DTA-alone case:** Similar to the no-data case, this case requires the input of mainline demand, ramp demand (if applicable), and the downstream bottleneck discharge speed and predicts the average green ratio on the on-ramp with ramp meter installed. This green ratio can then be used in the DTA model as a signal to approximate the microscopic impact of the ramp meter.

Table 9.1 shows the table of inputs for different scenarios coded in the spreadsheet tool for ramp metering. The inputs for VSLs follow the same format except that there is no ramp demand and the average green ratio is replaced by the capacity improvement predicted by the VSL on the mainline corridor.

**Table 9.1: Spreadsheet inputs for the ramp metering case analysis**

Ramp Metering					
No-Data (Scenario 4)		Microsimulation Alone (Scenario 2)		DTA alone (Scenario 3)	
Inputs	Output	Input	Output	Input	Output
Mainline demand, ramp demand, downstream bottleneck discharge rate	% improvement in travel time on main corridor	Overall corridor demand, artificial link parameters, average green ratio	Updated mainline and ramp demand using the corridor	Mainline demand, ramp demand, downstream bottleneck discharge rate	Average green ratio
<i>If the improvement is significant</i>		<b>No-Data (Scenario 6)</b>			
2) Overall corridor demand, artificial link parameters	2) Updated mainline and ramp demand using the corridor		<b>Input</b> Mainline demand, ramp demand, downstream bottleneck discharge rate	<b>Output</b> % improvement in travel time on main corridor	

## 9.2 Preparation of Inputs

After selecting the candidate freeway segment where the effectiveness of an ATM strategy is to be analyzed, the following steps need to be followed to prepare the input for regression models requiring overall corridor demand and artificial link parameters as inputs:

- Locating origin and destination:** This step requires the selection of origin and destination nodes for the selected segment. The location of origin and destination nodes captures the scale of the network where the impact of long-term route choice of the travelers is considered. For example, the farther the location of the nodes from the actual segment, the larger the scale of the network where route choices take place. The choice of the locations can be determined based on the experience. As a general guideline, the

origin node can be considered two to three miles upstream of the segment, while the destination node can be considered two to three miles downstream.

- 2. Estimating artificial link parameters:** Conceptually, an artificial link represents all possible routes existing between two nodes. Thus, at first all possible alternate routes between the endpoints of the artificial link should be enumerated. Only major arterials, collector-distributor roads, or other freeways should be considered as alternate routes. The free-flow travel time on the artificial link can then be approximated as the average travel time on all identified alternate routes. The capacity of the artificial link can be approximated as the sum of capacities on all alternate routes.
- 3. Determining overall corridor demand:** The input OD demand represents an approximate value of the number of travelers that will be traversing the freeway in addition to the travelers that will be using the alternative routes adjacent to the freeway. This number can be estimated by adding the observed peak-hour flows on the corridor and all alternate routes to the corridor or from the results of static traffic assignment model of the complete network.

For models requiring the inputs of mainline demand, ramp demand, and bottleneck speed discharge, and with no other model available to provide this data, an approximate value of input parameters can be determined using Google maps or by observing the traffic in the desired region for a particular day.

### 9.3 Spreadsheet Interface

This section presents some screenshots of the spreadsheet interface. Figure 9.1 shows the welcome screen of the spreadsheet tool, which prompts the user to choose among ramp metering, VSL, and DLUC for the analyses.

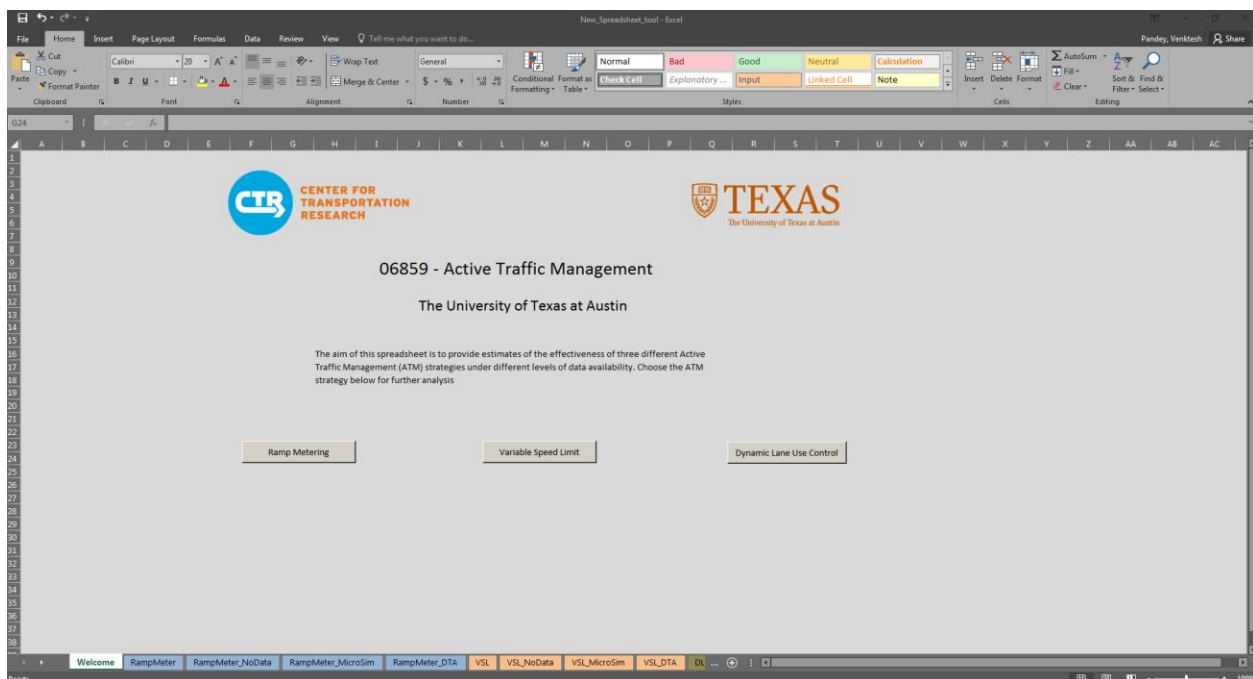

Figure 9.1 Welcome screen of the spreadsheet tool



Figure 9.2 shows the screen after selecting the ramp metering option at the welcome screen. This screen provides the user with a background of the ramp metering analysis and prompts the user to select one among the three cases: “no data,” “microsimulation-alone,” or “DTA-alone.”

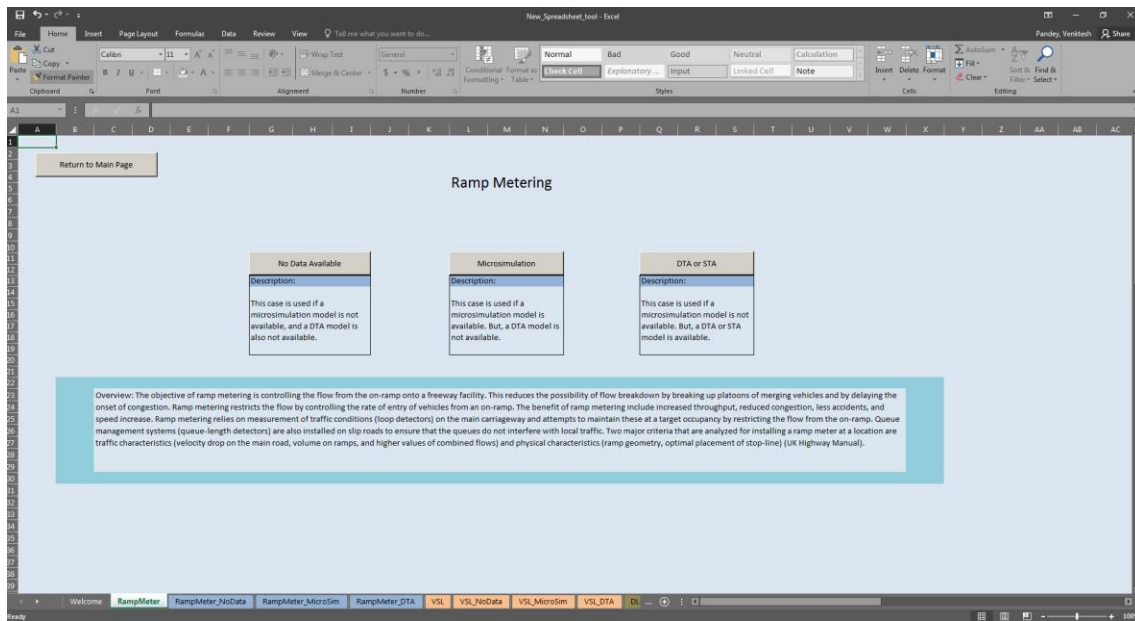

Figure 9.2 The screen prompting the user to choose one among three cases under the ramp metering strategy

Figure 9.3 shows the screen for the “no-data” case for VSLs. The screen offers an explanation for the input and output parameters and asks the user to provide inputs for the regression models based on the choice of control algorithm. The output of the regression models is presented in the adjacent cells.

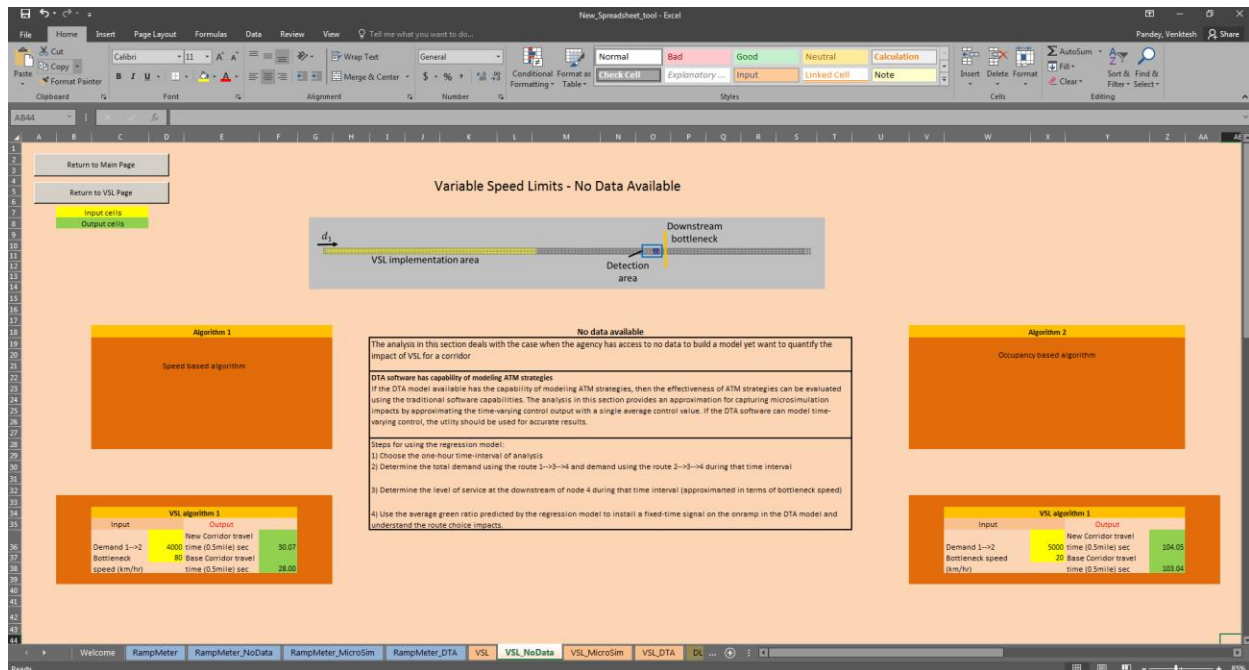

Figure 9.3 Screen showing the no-data case for VSLs with separate regression models for both control algorithms

## 9.4 Tutorial for the Spreadsheet Tool

This section outlines the systematic procedure for using the spreadsheet tool to evaluate the effectiveness of ramp metering or VSLs for a corridor.

### 9.4.1 Step 1: Identify location and time-period

This step requires the identification of the location where the effectiveness of an ATM strategy is being considered and the time-period of the analysis. The location can be an area within a city which has medium to high levels of congestion, since the effectiveness of ATM strategies is poor under extreme congestion levels. The availability of data is also a factor in selecting the location.

The time-period selected can be the peak hour if the congestion level is not extreme during peak hours, or hours preceding the peak hour if mitigating congestion earlier than peak hour can prevent the extreme onset of congestion.

### 9.4.2 Step 2: Select the candidate ATM strategy

This step requires the selection of candidate ATM strategies. This selection is based on the usefulness of ATM strategy in particular congestion scenarios and on the available infrastructure.

The ramp metering is a suitable candidate ATM strategy under the conditions when the ramp length is suitable to accommodate the queue generated by the meter and when the congestion is observed primary at the locations immediately downstream of the merge.

VSL is a suitable candidate ATM strategy when the infrastructure to measure speed data is available for different lanes and when the congestion pattern follows the stop-and-go oscillation behavior.

DLUC strategy near ramp merge is suitable where there is heavy ramp demand that leads to a capacity drop downstream of the bottleneck, but the mainline demand is not very high. Dynamic lane use as HSR is suitable where enough width is available for the shoulder to function as an extra lane under congestion.

### 9.4.3 Step 3: Select the segment where ATM strategy will be installed

This step identifies the segment where ATM strategy will be installed. For ramp metering an appropriate on-ramp location is selected, and for VSL the segment where speed limit need to be changed with time is selected. This step can be worked in conjunction with the previous step.

After the segment has been identified, the appropriate location of the nodes must be identified to build the abstract network. The location of origin and destination nodes are considered by factors described in Section 9.2. Figure 9.4 shows the abstract network for the selected segment.

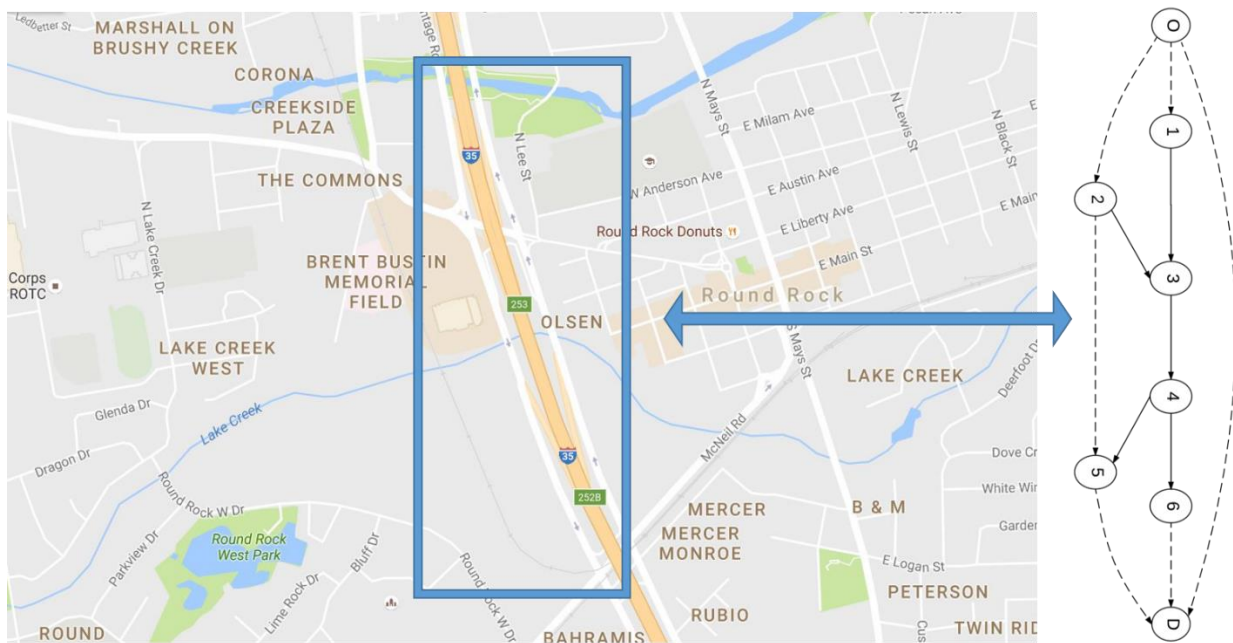

Figure 9.4 Abstraction of selected segment as a single entrance/exit pair ramp-metering network

### 9.4.4 Step 4: Determine data availability

This step requires collection of all available data and identifying the level of data availability to build either a microsimulation model, or a DTA model or both or none. The following four cases are possible:

1. The **no-data case** assumes that the agency has no data available to build or calibrate either a microsimulation or a DTA model.
2. The **microsimulation-only case** assumes that the agency has availability of real-time data to build and calibrate the microsimulation model but has no data available to develop a DTA model
3. The **DTA-only case** assumes that the agency only has access to strategic data to build a DTA model (or a static traffic assignment model) but has limited access to real-time data to build a microsimulation model

4. The **DTA-microsimulation case** assumes that the agency has enough data available to build both models.

#### **9.4.5 Step 5: Prepare the inputs and use the spreadsheet tool**

This section highlights the inputs required for the regression models for the first three cases of data availability.

##### *No-Data Case*

The artificial link parameters and the OD demand are determined by methods highlighted in Section 9.4. They are fed into the ‘No-data’ section of the spreadsheet tool under the particular ATM strategy.

##### *Microsimulation Alone Case*

The artificial link parameters are determined by the methods highlighted in Section 2.3. The OD demand is obtained as the accumulating the time-dependent demand for the three-hour period from the microsimulation model. The microsimulation model is then run for the generated demand and the average green ratio predicted by the installed ramp meter is used as an input to in the spreadsheet tool to predict the shift of demand for next iteration.

##### *DTA (or STA) Alone Case*

The artificial link parameters are determined by considering the travel time and capacity of the alternate routes in the DTA model. The OD demand is obtained by accumulating the time dependent demand from the DTA model.

##### *DTA-Microsimulation Case*

In this case, the spreadsheet tool is not used and the hybrid modeling procedure outlined earlier is followed. The procedure starts with running a base iteration in the DTA model to develop a time-dependent demand (OD matrix) for the microsimulation model. The ATM strategy is implemented in the microsimulation model and the control outputs are approximated in the DTA model to predict the shift in the demand patterns resulting in a new time OD matrix. This process is then repeated until a desired level of convergence is reached.

#### **9.4.6 Step 6: Analyze the outputs and make conclusions**

This step analyzes the output produced by the spreadsheet tool. The outputs can be studied based on the case of data availability:

1. The **no-data case** results predict the corridor travel time with and without installation of the ATM strategy. This is useful in the before-after analysis and can give a preliminary idea on the success of the ATM strategy. The maximum queue length predicted by the regression model is useful to check if the queue spills back into the arterials for the available ramp length.
2. The **microsimulation-only case** result predicts the new demand using the corridor under the obtained values of average green ratio or speed limit. This demand can then

be simulated for the three-hour period in the microsimulation model using the initial demand distribution. This provides us an updated value for the green ratio. The process can be repeated until consistent average green ratios are obtained.

3. The **DTA-only case** results predict the average green ratio or speed limit which can then be modeled in the DTA model as a fixed-time signal or reduction in speed limit respectively.

Sensitivity analysis should also be performed for each of the case under different levels of demand and different locations of origin and destination nodes.

## **9.5 Concluding Remarks**

This chapter described the spreadsheet tool developed to test effectiveness of ramp metering and VSL for a general network. Three cases indicating the different levels of data availability were considered for each ATM strategy. Regression models developed for each case were coded using Microsoft Excel macros and formulas. The detailed outline of the spreadsheet tool was presented in Section 9.4.

## Chapter 10. Conclusion

This project developed methods for testing the operational effectiveness of ATM strategies on freeway corridors. The ATM strategies considered were ramp metering, VSLs, DLUC (control near ramp merge and HSR), and freeway-arterial coordinated operations. A combination of ramp metering and VSL was also analyzed against using the individual strategies alone. The IH-35 southbound corridor in Williamson County was selected as the testbed for analysis.

The first part of the project generated a hybrid model for capturing both the microscopic and network-level traffic impacts. To create the hybrid model, we first developed a COM-enabled microscopic traffic simulator capable of simulating advanced control logics and real-time sensing and data acquisition processes with high resolution. This microsimulation model considers the impact of ATM strategies on frontage roads parallel to the freeway and models both recurring and non-recurring congestion.

To capture the network-level impacts, we built a network model using the DTA software VISTA. Since operation of ATM strategies necessitates dynamic changes in the traffic flow fundamental diagram with time, which most of the current DTA software do not support, the impact of each ATM strategy was modeled in VISTA as an approximation derived from the microsimulation. An offline hybrid model was built that integrates the results from both microsimulation and DTA software using an iterative procedure of improving the inputs of one model based on the results of the other and vice versa, as described in chapter 6.

Our results indicate that for recurring congestion on the selected testbed, ramp metering, VSLs, and HSR improved the corridor travel time and network performance. For non-recurring congestion, we found that VSLs and freeway arterial coordination improved network conditions. The sensitivity analysis for HSR and ramp metering indicated that performance of an ATM strategy under non-recurring congestion depends on the location, severity, and the duration of the incident. The location at which the hard shoulder is implemented relative to the bottleneck location is crucial for the success of that particular ATM strategy. In terms of network-level impacts, the shift in route choice patterns caused by each ATM strategy was found insignificant. Ramp metering and VSLs were found to increase the total system travel time for the network. However, this may be attributed to the choice of the VSL control algorithm and the approximation used to model VSL in the DTA model. The effects on corridor congestion were marginal. Moreover, the network scale analysis predicted lower total system travel time for networks with larger scale because more routes are available for travelers to re-route. However, the travel times were approximately identical for all scales and thus a smaller network scale was recommended for the DTA model because of lower data requirements for calibration. The developed hybrid model demonstrates how microsimulation and DTA models can be combined to assess the impacts of an ATM strategy on a network. The iterative microsimulation-DTA procedure in the hybrid model converged in two to three iterations for each ATM strategy and produced consistent results from both its sub models. The analysis also emphasized the need to maintain consistency in the inputs and results of both models.

The second part of the project developed analysis tools in the form of regression equations useful for evaluating the effectiveness of ATM strategies under different levels of data availability. We considered four cases of data availability:

- The **no-data case** assumes that the agency has no data available to build or calibrate either a microsimulation or a DTA model.

- The **microsimulation-only case** assumes that the agency has real-time data available to build and calibrate the microsimulation model but has no data available to develop a DTA model.
- The **DTA-only case** assumes that the agency can access strategic data to build a DTA model but has only limited access to real-time data to build a microsimulation model.
- The **microsimulation-DTA case** assumes that the agency has the available data to build and calibrate the hybrid model as developed in first part of the project.

Regression models were developed to provide a measure on the impact caused by the ATM strategy under different levels of data availability. The models were derived by running multiple simulations on an abstract network of the corridor. The concept of artificial links was used to model the shift of travelers away from or towards the corridor with changes in corridor travel time. The ATM strategies used for developing the regression models were ramp metering, VSLs, and DLUC. The regression models provide a good fit to the simulation results and thus can be used as a planning tool for preliminary analysis of effectiveness of ATM strategy. The six-step tutorial provided in Chapter 9 provides the guidelines for using the spreadsheet tool to test the effectiveness of the ATM strategies for general networks.

The results also point to a few challenges that should be addressed in future research:

1. The microsimulation analysis for ATM strategies under non-recurring congestion does not assume any en-route changes in decisions made by the drivers at each diverge location. This capability, though hard to implement in the VISSIM software, can offer realistic insights into online routing and its impacts on effectiveness of ATM strategies
2. Because of the approximation made and the use of concept of artificial links to model network diversion in static settings, the impacts predicted by the regression models could be subject to approximation errors compared to microsimulation. For precise analysis of the impacts of an ATM strategy, the research team recommends building a microsimulation model of the corridor.
3. The developed hybrid model for capturing the combined microsimulation-DTA impact is an offline hybrid model with a simplified static approximation of ATM strategy with the DTA software. As part of future work, these approximations can be improved and a better online version of the hybrid model can be considered for modeling purposes.
4. The project focused only on the most commonly used ATM strategies that appear most feasible for deployment in the near future under recurring congestion patterns. As part of future work, other ATM strategies can be analyzed following a similar approach.





## References

- 80 Smart Corridor. (2016). Retrieved December 2016, from <http://80smartcorridor.org/faqs/>
- Active Traffic Management. (2016). Retrieved December 2016, from <http://active-trafficdev.tamu.edu/>
- Allaby, P., Hellinga, B., & Bullock, M. (2007). Variable speed limits: Safety and operational impacts of a candidate control strategy for freeway applications. *Intelligent Transportation Systems, IEEE Transactions on*, 8(4), 671-680.
- Arbaiza, A., Conte, R., Desnouailles, C., Lucas, A., Blanch, M. T., Remeijn, H et al. (2008). The Mare Nostrum VMS Group: Enlarging the Long Distance Corridor. In *15th World Congress on Intelligent Transport Systems and ITS America's 2008 Annual Meeting*.
- Ben-Akiva, M., M. Bierlaire, J. Bottom, H. N. Koutsopoulos, and R. Mishalani. (1997) Development of a route guidance generation system for real-time application. *Proceedings of the 8th International Federation of Automatic Control Symposium on Transportation Systems, Chania, Greece*, 433-438.
- Boyles, S. D. (2012). Bush-based sensitivity analysis for approximating subnetwork diversion. *Transportation Research Part B: Methodological*, 46(1), 139-155.
- Boyles, S. D., & Waller, S. T. (2011). Optimal information location for adaptive routing. *Networks and Spatial Economics*, 11(2), 233-254.
- Burghout, W., Koutsopoulos, H., & Andreasson, I. (2005). Hybrid mesoscopic-microscopic traffic simulation. *Transportation Research Record: Journal of the Transportation Research Board* 1934, 218-255.
- Carter, M. (2000). Metropolitan Model Deployment Initiative: San Antonio Evaluation Report: Final Draft (No. EDL# 12883).
- Casas, J., Ferrer, J. L., Garcia, D., Perarnau, J., & Torday, A. (2010). Traffic simulation with AIMSUN. In *Fundamentals of Traffic Simulation* (pp. 173-232). Springer New York.
- Chatterjee, K., Hounsell, N. B., Firmin, P. E., & Bonsall, P. W. (2002). Driver response to variable message sign information in London. *Transportation Research Part C: Emerging Technologies*, 10(2), 149-169.
- Chaudhary, N. A., & Messer, C. J. (2000). *Ramp-Metering Design and Operations Guidelines for Texas* (No. FHWA/TX-01/2121-2,).
- Chaudhary, N. A., Tian, Z., Messer, C. J., & Chu, C. L. (2004). *Ramp metering algorithms and approaches for Texas* (No. FHWA/TX-05/0-4629-1,)

- Chiu, Y. C., & Huynh, N. (2007). Location configuration design for Dynamic Message Signs under stochastic incident and ATIS scenarios. *Transportation Research Part C: Emerging Technologies*, 15(1), 33-50.
- Chiu, Y. C., Bottom, J., Mahut, M., Paz, A., Balakrishna, R., Waller, T., & Hicks, J. (2011). Dynamic traffic assignment: A primer. *Transportation Research E-Circular*, (E-C153).
- Daganzo, C. F. (1994). The cell transmission model: A dynamic representation of highway traffic consistent with the hydrodynamic theory. *Transportation Research Part B: Methodological*, 28(4), 269-287.
- Dallas Integrated Corridor Management (ICM) Update. (2013). Retrieved December, 2016, from [http://www.nctcog.org/trans/committees/sttc/Itm\\_6.ICMSTTCApril2013.pdf](http://www.nctcog.org/trans/committees/sttc/Itm_6.ICMSTTCApril2013.pdf)
- Deflorio, F. P. (2003). Evaluation of a reactive dynamic route guidance strategy. *Transportation Research Part C: Emerging Technologies*, 11(5), 375-388.
- Dion, F., Rakha, H., and Zhang, Y. (2004). "Evaluation of Potential Transit Signal Priority Benefits along a Fixed-Time Signalized Arterial." *Journal of Transportation Engineering*, 130(3), 294–303
- Dowling, R. G., & Elias, A. (2013). *Active Traffic Management for Arterials* (Vol. 447). Transportation Research Board.
- DynusT. (2016). Retrieved December, 2016, from <http://dynust.net/>
- ENTERPRISE Pooled Fund Study. (2014). Retrieved December, 2016, from [http://enterprise.prog.org/Projects/2010\\_Present/iwz/QueueWarning\\_Summary\\_FINAL\\_June2014.pdf](http://enterprise.prog.org/Projects/2010_Present/iwz/QueueWarning_Summary_FINAL_June2014.pdf)
- Erke, A., Sagberg, F., & Hagman, R. (2007). Effects of route guidance variable message signs (VMS) on driver behaviour. *Transportation Research Part F: Traffic Psychology and Behaviour*, 10(6), 447-457.
- FHWA (2005) Transit Signal Priority: A Planning and Implementation Handbook.
- FHWA (2016). Active Traffic Management. Retrieved December, 2016, from <http://ops.fhwa.dot.gov/atdm/approaches/atm.htm>
- Gazis, D. C., Herman, R., & Rothery, R. W. (1961). Nonlinear follow-the-leader models of traffic flow. *Operations Research*, 9(4), 545-567.
- Geistefeldt, J. (2011). Capacity effects of variable speed limits on German freeways. *Procedia-Social and Behavioral Sciences*, 16, 48-56.
- Geistefeldt, J. (2012). Operational Experience with Temporary Hard Shoulder Running in Germany. *Transportation Research Record: Journal of the Transportation Research Board*, (2278), 67-73.

- Gemar, M. D. (2013). Subnetwork analysis for dynamic traffic assignment: methodology and application. PhD Dissertation, The University of Texas at Austin.
- Gemar, M., Bringardner, J., Boyles, S., & Machemehl, R. (2014). Subnetwork Analysis for Dynamic Traffic Assignment Models: Strategy for Estimating Demand at Subnetwork Boundaries. *Transportation Research Record: Journal of the Transportation Research Board*, 2466, 153-161.
- Grumert, E. (2014). Cooperative Variable Speed Limit Systems: Modeling and Evaluation using Microscopic Traffic Simulation.
- Hale, D., Jagannathan, R., Xyntarakis, M., Su, P., Jiang, X., Ma, J., Krause, C. (2016). Traffic Bottlenecks: Identification and Solutions. Federal Highway Administration.
- Hallenbeck, M. E., Ishimaru, J. M., Nee, J., & Rickman, T. D. (2003). Measurement of Recurring versus Non-Recurring Congestion: Technical Report. Washington State Department of Transportation.
- Hashemi, H., and Abdelghany, K. (2014). A Simulation Test-Bed for Evaluating Active Traffic Network Management Systems. Proceedings of the 21st Intelligent Transportation Systems (ITS) World Congress Conference. Detroit, MI, USA.
- Hausknecht, M., Au, T. C., Stone, P., Fajardo, D., & Waller, T. (2011, October). Dynamic lane reversal in traffic management. In *Intelligent Transportation Systems (ITSC), 2011 14th International IEEE Conference on* (pp. 1929-1934). IEEE.
- Hegyi, A., De Schutter, B., & Hellendoorn, H. (2005). Model predictive control for optimal coordination of ramp metering and variable speed limits. *Transportation Research Part C: Emerging Technologies*, 13(3), 185-209.
- Heydecker, B. G., & Addison, J. D. (2011). Analysis and modelling of traffic flow under variable speed limits. *Transportation Research Part C: Emerging Technologies*, 19(2), 206-217.
- Jafari, E., & Boyles, S. D. (2016). Improved bush-based methods for network contraction. *Transportation Research Part B: Methodological*, 83, 298-313.
- Jayakrishnan, R., H. Mahmassani, and T. Hu. (1994) An evaluation tool for advanced traffic information and management systems in urban networks. *Transportation Research Part C: Emerging Technologies* 2, 129-147.
- Jin, P. J., Fang, J., DeGaspari, M., & Walton, C. M. (2014). Gap Metering for Active Traffic Control at Freeway Merging Sections. In *Transportation Research Board 93rd Annual Meeting* (No. 14-5609).
- Jones, J., Knopp, M., K, F., Doctor, M., Howard, C., Laragan, G., Young, E. (2011). Freeway Geometric Design for Active Traffic Management in Europe. Federal Highway

Administration. Retrieved from  
<https://international.fhwa.dot.gov/pubs/pl11004/pl11004.pdf>

- Kotkin, Joel (2013) "America's Fastest-Growing Counties: The 'Burbs Are Back." Forbes.com. Accessed at <https://www.forbes.com/sites/joelkotkin/2013/09/26/americas-fastest-growing-counties-the-burbs-are-back/#34f60d18338a>
- Lee, C., Hellinga, B., & Saccomanno, F. (2006). Evaluation of variable speed limits to improve traffic safety. *Transportation Research Part C: Emerging Technologies*, 14(3), 213-228.
- Lee, C., Hellinga, B., & Saccomanno, F. (2004). Assessing safety benefits of variable speed limits. *Transportation Research Record: Journal of the Transportation Research Board*, (1897), 183-190.
- Lee, H. Y. (2009). Optimizing schedule for improving the traffic impact of work zone on roads. *Automation in Construction*, 18(8), 1034-1044.
- Li, P., Mirchandani, P., & Zhou, X. (2015). Hierarchical Multiresolution Traffic Simulator for Metropolitan Areas: Architecture, Challenges, and Solutions. *Transportation Research Record: Journal of the Transportation Research Board*, 2497, 63-72.
- Liu, R. (2005). The DRACULA dynamic network microsimulation model. In *Simulation approaches in transportation analysis* (pp. 23-56). Springer US.
- Logi, F., & Ritchie, S. G. (2001). Development and evaluation of a knowledge-based system for traffic congestion management and control. *Transportation Research Part C: Emerging Technologies*, 9(6), 433-459
- Mahmassani, H. S., Valdes, D. M., Machemehl, R. B., Tassoulas, J. S., & Williams, J. C. (1998). Integrated Arterial and Freeway Operation Control Strategies for IVHS Advanced Traffic Management Systems: Research Report. *Work*, 1468, 1.
- McTrans Center. (2016). Retrieved December, 2016, from <http://mctrans.ce.ufl.edu/>
- Metz, N., H. Schlichter & H. Schellenberg. (1997). Positive effects of a traffic control system on fuel consumption and exhaust emissions on the German A9 Autobahn. *International Journal of Vehicle Design* 18 (Special Issue), 354-367.
- Middelham, F. (2003, August). State of Practice in Dynamic Traffic Management in The Netherlands. In *Proceedings of the 10th IFAC Symposium on Control in Transportation Systems (CTS 2003)*.
- Minciardi, R., & Gaetani, F. (2001). A decentralized optimal control scheme for route guidance in urban road networks. In *Intelligent Transportation Systems, 2001. Proceedings. 2001 IEEE* (pp. 1195-1199). IEEE.

- Mirshahi, M., Obenberger, J. T., Fuhs, C. A., Howard, C. E., Krammes, R. A., Kuhn, B. T., et al. (2007). *Active Traffic Management: The Next Step in Congestion Management* (No. FHWA-PL-07-012).
- Mobility Investment Priorities Project Report. (2016). Retrieved December, 2016, from <http://mobility.tamu.edu/mip/corridors-pdfs/houston/HOU-22-IH-10-101713.pdf>
- Nezamuddin, N., Jiang, N., Zhang, T., Waller, S. T., & Sun, D. (2011). *Traffic Operations and Safety Benefits of Active Traffic Strategies on TxDOT Freeways* (No. FHWA/TX-12/0-6576-1).
- Oh, J. S., Jayakrishnan, R., Chen, A., & Yang, H. (2001). Parametric evaluation for route guidance systems with analysis of sustainable driver compliance. *Transportation Research Record: Journal of the Transportation Research Board*, 1771, 18-27.
- Papageorgiou, M., Hadj-Salem, H., & Blosseville, J. M. (1991). ALINEA: A local feedback control law for on-ramp metering. *Transportation Research Record*, 1320.
- Papageorgiou, M., Hadj-Salem, H., & Middelham, F. (1997). ALINEA local ramp metering: Summary of field results. *Transportation Research Record: Journal of the Transportation Research Board*, 1603(1), 90-98.
- Pavlis, Y., & Papageorgiou, M. (1999). Simple decentralized feedback strategies for route guidance in traffic networks. *Transportation Science*, 33(3), 264-278.
- PTV America. (n.d.). Retrieved December 2016, from <http://www.ptvamerica.com/vissim.html>
- Quadstone Paramics. (n.d.). Retrieved December 2016, from <http://www.paramics-online.com>
- Scherr, W., & Adams, D. (2003, April). An integrated model for planning and traffic engineering. In *Conference on the Application of Transportation Planning Methods* (p. 388).
- Schmitt, E., & Jula, H. (2006, September). Vehicle route guidance systems: classification and comparison. In *2006 IEEE Intelligent Transportation Systems Conference* (pp. 242-247). IEEE.
- Shelton, J., Valdez, G., Williams, T., Kuhn, B., Bricka, S., & Moran, M. (2014). *Active Transportation and Demand Management Texas Test Bed* (No. TTI/SRP/14/161408-1).
- Sisiopiku, V. P., Sullivan, A. J., Abro, A. M., Shinouda, M., Mouskos, K., & Barrett, C. (2010). *Development of a Dynamic Traffic Assignment Model to Evaluate Lane-Reversal Plans for I-65* (No. UTCA Report Number 07408). University Transportation Center for Alabama.
- Sisiopiku, V. P., Sullivan, A. J., Fadel, G., & Sikder, S. (2009). *Implementing active traffic management strategies in the US* (No. UTCA Report Number 08206). University Transportation Center for Alabama.

- Skowronek, D. A., Ranft, S. E., & Slack, J. D. (1999). *Investigation of HOV Lane Implementation and Operational Issues*. Research Report 7-3942, Texas Transportation Institute, The Texas A&M University System, College Station, Texas.
- Smaragdis, E., Papageorgiou, M., & Kosmatopoulos, E. (2004). A flow-maximizing adaptive local ramp metering strategy. *Transportation Research Part B: Methodological*, 38(3), 251-270.
- SYNCHRO - Trafficware. (2016). Retrieved December, 2016, from <http://www.trafficware.com/products/planninganalysis-software/>
- Texas A&M Transportation Institute, Policy Research Center (2016). Retrieved December, 2016, from <http://tti.tamu.edu/policy/researchers-examine-potential-use-of-variable-speed-limits-in-texas/>
- Tokishi, J., & Chiu, Y. C. (2013). Evaluation and Improvement of Consistency of Hybrid and Multi-Resolution Traffic Simulation Models. In 92nd Annual Meeting of the Transportation Research Board, Washington, DC.
- TTI Report - Queue Warning. (2016). Retrieved December, 2016, from <http://mobility.tamu.edu/mip/strategies-pdfs/active-traffic/technical-summary/Queue-Warning-4-Pg.pdf>
- TxDOT I35E Project (2016). Retrieved December, 2016, from <http://www.txdot.gov/government/partnerships/current-cda/i35e.html>
- UK Highway Manual-Interim Advice Note. (2006). Retrieved December, 2016, from [http://www.standardsforhighways.co.uk/pilots\\_trials/files/HA2006G.pdf](http://www.standardsforhighways.co.uk/pilots_trials/files/HA2006G.pdf)
- Urbanik, I. I., Humphreys, D., Smith, B., & Levine, S. (2006). *Coordinated freeway and arterial operations handbook* (No.FHWA-HRT-06-095).
- Wardrop, J. (1952) Some theoretical aspects of road traffic research. *Proceedings of the Institute of Civil Engineers, Part II*, 325-378.
- Wunderlich, K., & Larkin, J. (1999). Impacts of Supplementing Web-Based Urban Freeway ATIS With Parallel Arterial Travel-Time Data. In *Proceedings of 6th World Congress on Intelligent Transport Systems (ITS), held Toronto, Canada, november 8-12, 1999*.
- Yang, Q., & Koutsopoulos, H. N. (1996). A microscopic traffic simulator for evaluation of dynamic traffic management systems. *Transportation Research Part C: Emerging Technologies*, 4(3), 113-129.
- Yang, Q., & Morgan, D. (2006). Hybrid Traffic Simulation Model. In Transportation Research Board 85th Annual Meeting (No. 06-2582).

- Yang, Q., Koutsopoulos, H., & Ben-Akiva, M. (2000). Simulation laboratory for evaluating dynamic traffic management systems. *Transportation Research Record: Journal of the Transportation Research Board*, 1710, 122-130.
- Yperman, I. (2007). The link transmission model for dynamic network loading. Ph.D. dissertation, Katholieke Universiteit Leuven, Leuven, Belgium
- Zavoina, M. C., Urbanik, I. I., & Hinshaw, W. (1991). Operational evaluation of truck restrictions on I-20 in Texas. *Transportation Research Record*, (1320).
- Zhang, L., Chen, X. M., He, X., Xiong, C., & Zhu, Z. (2014). Bayesian Stochastic Kriging Metamodel for Active Traffic Management of Corridors. In *IIE Annual Conference Proceedings* (p. 1790). Institute of Industrial Engineers-Publisher.
- Zhou, X., Erdogan, S., & Mahmassani, H. (2006). Dynamic Origin—Destination Trip Demand Estimation for Subarea Analysis. *Transportation Research Record: Journal of the Transportation Research Board*, (1964), 176-184.





## Appendix A. ATM Strategy Questionnaire

The following set of questions was asked in the questionnaire sent to the TxDOT personnel to enquire about the existing state of congestion, perceived benefits of the ATM strategies, and their future deployments in the state of Texas.

### 1) Existing Congestion Issues

- Please rate the following factors in causing congestion in your district (1-10; 1=least significant, 10=most significant):
  - Driver behavior (e.g. aggressive/timid driving &/or merging, etc.)
  - Incident
  - Work zone construction
  - Adverse weather
  - Trucks, buses or other slow moving vehicles
  - Curves, narrow lane &/or other geometry factors
  - Insufficient road capacity
  - Lack of traveler information
  - Lack of signal control measures
  - Other (please specify)
- Please give the top three congested corridors or recurrent bottlenecks in your district.

### 2) Existing and Potential Active Traffic Management deployment

- Which of the following congestion relief measures are deployed in your district:
  - Dynamic message sign
  - Graphical route information panel
  - Speed harmonization
  - Variable Speed limit
  - Work zone queue warning
  - Weather information
  - HOT/HOT lane
  - Ramp metering
  - Freeway-arterial coordination
  - Dynamic lane use control (shoulder running, reversal lane)

- Transit priority signal
- Other (please specify)
- What has been your experience with the congestion relief measures deployed in your district?
- What new ATM measures does your district plan to deploy in next 5 years?
- What performance metrics does your district use to evaluate ATM measures?

### 3) Data Sources

- What types of data are regularly collected and archived in your district:
  - Single loop detector data
  - Dual loop detector data
  - Weight-in-Motion data
  - Bluetooth data
  - Cellular data
  - Street signal timing
  - Incident data
  - Weather data
  - AVL
  - Video
  - Construction
  - Special event
  - Other (please specify)
- What is the general availability of traffic data (e.g., only on freeways with a spacing of 2 miles, etc.)
- What data are available to you, besides those regularly collected? Please specify the data type and source.
- The primary usage of data:
  - Operations
  - Traveler information
  - Maintenance
  - Emergency response
  - Other (please specify)
- What do you envision the difficulty pertaining to data?

- Coverage
  - Type of data
  - Detector maintenance
  - Archiving
  - Data Analysis
  - Other (please specify)
- Is there currently a channel/mechanism for data sharing between your agency and other agencies or private sectors? If so, please give details.