



A report by the University of Vermont Transportation Research Center

Modeling the Emissions of Heavy-Duty Diesel Vehicles on Interstate 89/189 and US Route 7 in the Burlingtonh Area

Report # 09-006 | November 2009

Modeling the Emissions of Heavy-Duty Diesel Vehicles on Interstate 89/189 and US Route 7 in the Burlington Area

Final Report – November 2009

Prepared for the Vermont Agency of Transportation

Prepared by Andrew J. Weeks

**UVM Transportation Research Center
Farrell Hall
210 Colchester Avenue
Burlington, VT 05405
Phone: (802) 656-1312
Website: www.uvm.edu/transportationcenter**

Acknowledgements

The author and the UVM TRC would like to thank Bellavance Trucking and Terry Hill (Milton, Vermont) for providing a truck and driver to participate in the data collection process, and the Vermont Agency of Transportation staff and Nathan Belz (University of Vermont) for their time, effort, and insights during the study process and preparation of this report.

Disclaimer

The contents of this report reflect the views of the authors, who are responsible for the facts and the accuracy of the data presented herein. The contents do not necessarily reflect the official view or policies of the University of Vermont Transportation Research Center. This report does not constitute a standard, specification, or regulation.

Table of Contents

List of Tables	iv
List of Figures	iv
1. Introduction	1
1.1 Federal Weight Limits on Interstate System	1
1.2 Heavy Vehicle Operation.....	1
2. Comprehensive Modal Emissions Model.....	1
3. Data Collection for Real-World Drive Cycles.....	4
4. Drive Cycle Data Summary.....	5
4.1 Velocity and Acceleration.....	5
4.2 Grade and Elevation.....	7
5. Other CMEM Parameters.....	10
6. Results.....	10
6.1 Emissions Inventories and Grams-per-Mile Emission Rates.....	10
6.2 Diesel Fuel Use	12
7. Conclusion.....	13
References	14

List of Tables

Table 1: Velocity-Time Trace Summary	5
Table 2: Route Emission Inventories.....	11
Table 3: Route Emission Rates per Mile.....	11
Table 4: Route Fuel Use	12

List of Figures

Figure 1: Heavy-Duty Diesel Emissions Model Structure (9)	3
Figure 2: Study analysis routes – (a) Route US-7 and (b) Interstate I-89 & I-189 (8).....	4
Figure 3: Freightliner Tractor and Trailer Test Vehicle (far right)	5
Figure 4: I-89/I-189 Northbound Drive Cycles (Velocity-Time Plots).....	6
Figure 5: I-89/I-189 Southbound Drive Cycles (Velocity-Time Plots).....	6
Figure 6: US-7 Northbound Drive Cycles (Velocity-Time Plots)	7
Figure 7: US-7 Southbound Drive Cycles (Velocity-Time Plots)	7
Figure 8: I-89/I-189 Northbound Grade-Time Plots.....	8
Figure 9: I-89/I-189 Southbound Grade-Time Plots.....	8
Figure 10: US-7 Northbound Grade-Time Plots	9
Figure 11: US-7 Southbound Grade-Time Plots	9
Figure 12: CO ₂ Inventories by Route and Direction	11
Figure 13: NO _x Inventories by Route and Direction.....	12
Figure 14: Diesel Fuel Consumption Inventories by Route and Direction	13

1. Introduction

This study compares the modeled exhaust emissions for heavy-duty diesel vehicles of various weights traveling two different bi-directional routes through the Burlington, Vermont, area. The two routes are I-89/I-189, between the junction at US-7 and Exit 16 in Colchester, and US-7, between the same two locations. Currently, heavy vehicles exceeding 80,000 pounds are prohibited from traveling on the analyzed section of interstate highway without permit due to federal regulations, and instead travel through the Burlington area along the designated US-7 truck route. For the analysis, real-world velocity, acceleration, and roadway grade data are used to model the pollutant emissions using the Comprehensive Modal Emissions Model to ascertain the differences in emissions, if any, between the interstate and US-7 routes.

1.1 Federal Weight Limits on Interstate System

In 1956, the federal government issued the first vehicle weight limit of 73,280 pounds (lbs.) on the interstate system under the *Federal-Aid Highway Legislation of 1956*. The weight limit was later increased to the current 80,000 lbs. in 1974 when adopted by Congress as part of the *Federal-Aid Highway Amendment of 1974*, though interstate sections in some states were exempted from the new weight limits due to “grandfather” rights. Additionally, a weight formula that specifies the maximum weight carried on any group of two or more axles was developed to protect the bridge infrastructure (5).

1.2 Heavy Vehicle Operation

Due to their size and weight, heavy vehicles have unique operating characteristics. The large mass of heavy vehicles results in greater inertia and thus more power is required from the vehicle engines to accelerate and decelerate. Also, rates of acceleration are slower for heavy vehicles than light vehicles. Heavy vehicle mass, including loads, also requires added power to climb grades (6,7).

The truck’s power-to-weight ratio, usually described as energy per unit mass, is a common indicator of the vehicle’s ability to operate under load – accelerate, decelerate, and climb grades. Faster acceleration rates correspond to higher power-to-weight ratios, which today are found in increasingly lighter vehicles with powerful engines. Conversely, as vehicle weight increases, as in the case of heavy vehicles, the power-to-weight ratio decreases unless there is compensation from engine power. This is accomplished by putting more powerful engines in heavy vehicles, but increased power translates to higher fuel consumption and emissions.

2. Comprehensive Modal Emissions Model

The Comprehensive Modal Emissions Model (CMEM) was developed at the University of California, Riverside in collaboration with researchers from the University of Michigan and Lawrence Berkeley National Laboratory (1,9). As a modal emissions model, CMEM is capable of estimating tailpipe emissions of carbon monoxide (CO), hydrocarbons (HC), oxides of nitrogen (NO_x), and carbon dioxide (CO₂) on a second-by-second scale based on user-defined vehicle drive cycles and vehicle and engine

characteristics. A drive cycle is a second-by-second trace of vehicle speed versus time that allows the model to determine the vehicle’s operating conditions. A drive cycle can also include road grade and secondary engine load (i.e. air-conditioning) data, which can also affect emissions.

The advantage of CMEM’s modal emissions methodology is that the model captures on a micro-scale the variability of vehicle emissions due to vehicle operations, engine load, and roadway characteristics along a driving route. The benefit is an understanding of the emissions profile of individual roadway segments, as well as the changes in emissions due to traffic speed conditions and the management of traffic control devices, such as coordinated signals. Macro-scale models such as the US EPA’s MOBILE model (currently version 6.2) are typically used for regional emissions inventories using average speeds for roadway link aggregations but are not capable of the detailed, micro-scale estimations of modal models (the US EPA’s new MOVES model, currently in draft form, is a modal model similar to CMEM and is planned to replace MOBILE in 2010).

CMEM first included an emissions estimation process for light-duty vehicles (LDV), but later was expanded to include heavy-duty diesel vehicles (HDDV). Specifics about the development of the HDDV module are given in a 2004 paper, “Modal Emissions Model for Heavy-Duty Diesel Vehicles” (3). The importance of modeling HDDV emissions is clear because they contribute a significant portion of NO_x and particulate matter (PM) emissions in many areas even though they make up a relatively small fraction of the vehicle fleet (4).

CMEM’s heavy-duty diesel vehicle emissions model, shown in Figure 1, predicts second-by-second emissions based on three components: fuel rate (FR), engine-out emission indices (ratios of grams of emissions to grams of fuel, $g_{\text{emission}}/g_{\text{fuel}}$), and an emission “after-treatment pass fraction” (9). The after-treatment pass fraction is based on the presence of a diesel particulate trap device. The three components are given in the following formula for tail pipe emissions (9):

$$\text{tailpipe emissions} = FR \bullet \left(\frac{g_{\text{emissions}}}{g_{\text{fuel}}} \right) \bullet \text{after - treatment pass fraction}$$

In the formula, FR is time-based consumption of fuel in grams per second, and the after-treatment pass fraction is the ratio of tailpipe emissions to engine-out emissions. That is, if an emissions trap device is present and operational in the truck, the amount of tailpipe emissions would be less than the amount of engine-out emissions, which would make the after-treatment pass fraction less than 1.00.

Each module in the HDDV model shown in Figure 1 is described in detail in the CMEM user’s guide (9). The two required user inputs shown in the rounded boxes are the input operating variables and the model parameters. The input operating variables describe the second-by-second velocity, acceleration, roadway grade, and secondary loads of the truck. The model parameters include the characteristics of the truck (mass, size, engine power and displacement, gear system, etc.), ambient meteorological conditions (temperature, humidity, etc.), vehicle fleet composition (if more than one type of heavy vehicle is present).

The second-by-second velocity, acceleration, grade, and other physical factors determine the engine load. The CMEM user’s guide describes the engine power demand function, which determines the total tractive power (in kilowatts, kW) requirement on the truck at contact with the road, as (9):

$$P_{tract.} = (M \cdot a + M \cdot g \cdot \sin \theta + \frac{1}{2} Cd \cdot A \cdot \rho \cdot v + M \cdot g \cdot Cr \cdot \cos \theta) \cdot v / 1000$$

where M is the truck mass with appropriate inertial correction for rotating and reciprocating parts (kg), v is speed (meters/second), a is acceleration (meters/second²), g is the gravitational constant (9.81 meters/s²), and θ is the road grade angle in degrees, Cd is the coefficient of drag, A is the frontal surface area (meters²), ρ is the air density (kg/m³) and Cr is the coefficient of rolling resistance (9). The final value for engine power, as a function of tractive power and accessory power, is given by (9):

$$P = \frac{P_{tract.}}{\epsilon} + P_{acc}$$

where P is the second-by-second engine power output in kW, ϵ is vehicle drivetrain efficiency, and P_{acc} is the engine power demand associated with running losses of the engine and the operation of vehicle accessories such as air conditioning usage (9). CMEM then uses the estimated engine power demand to determine engine operation and fuel consumption rate, which translates to engine-out emissions prior to applying an emissions reduction when an after- treatment device is present.

In summary, given the instantaneous velocity, acceleration, roadway grade, and the truck’s characteristics, such as weight and engine specifics, the model estimates the engine load and corresponding fuel consumption and emissions.

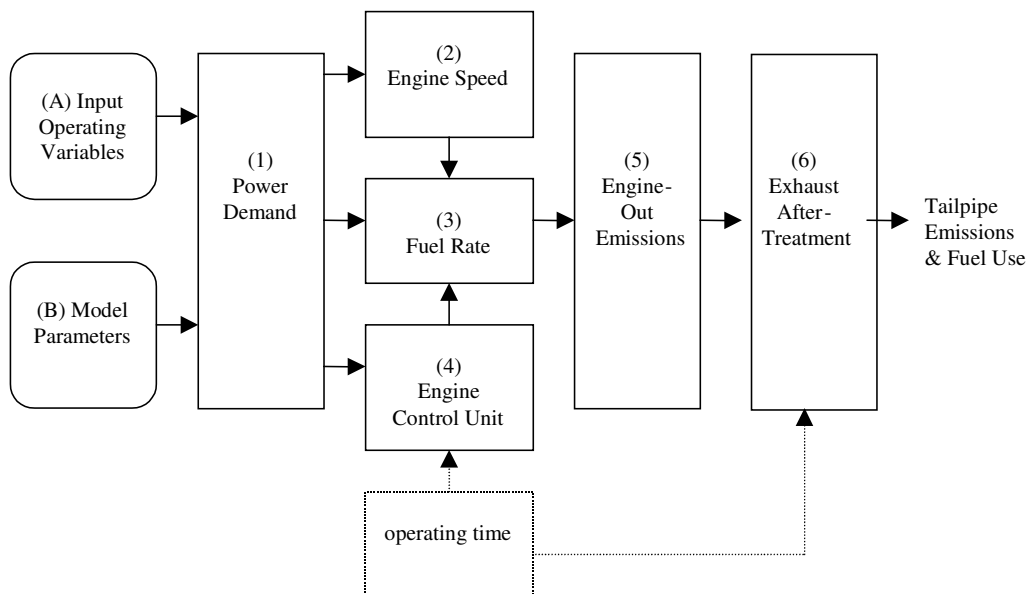
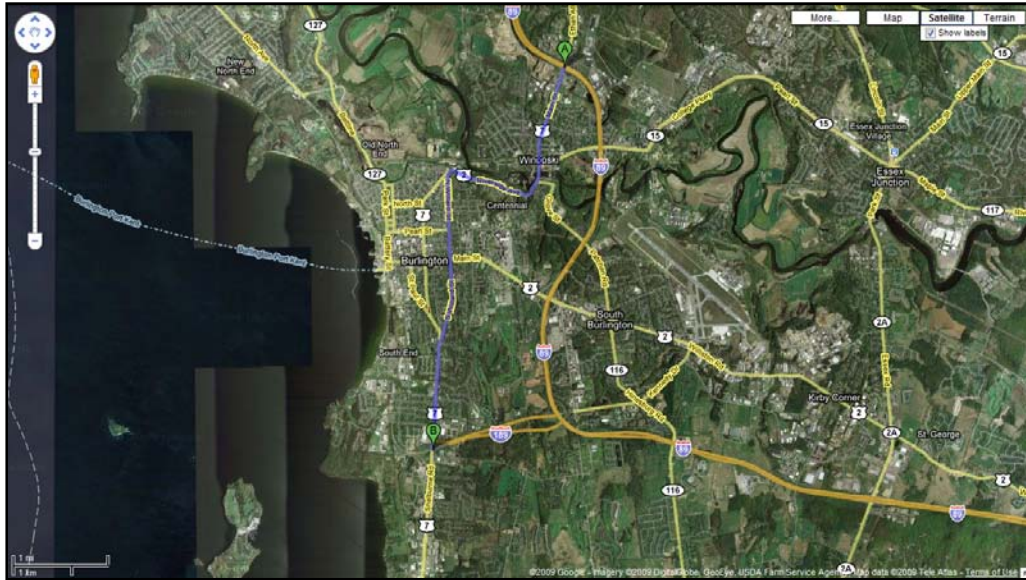

Figure 1: Heavy-Duty Diesel Emissions Model Structure (9)

3. Data Collection for Real-World Drive Cycles

Collection of truck speed trace (drive cycle) data was conducted on Tuesday, July 21st, 2009. One truck was driven along both directions of the two study routes during AM peak and off-peak periods, between 7:30 AM and 11:00 AM. The interstate analysis route included I-89 and I-189 between Exit 16 in Colchester and the junction of I-189 and US-7 in Burlington (see Figure 2a). The local route was US-7, with the same endpoints as the interstate route, and included a series of signalized and stop-controlled intersections (see Figure 2b).



(a) Route US-7, approx. 5.2 miles per direction

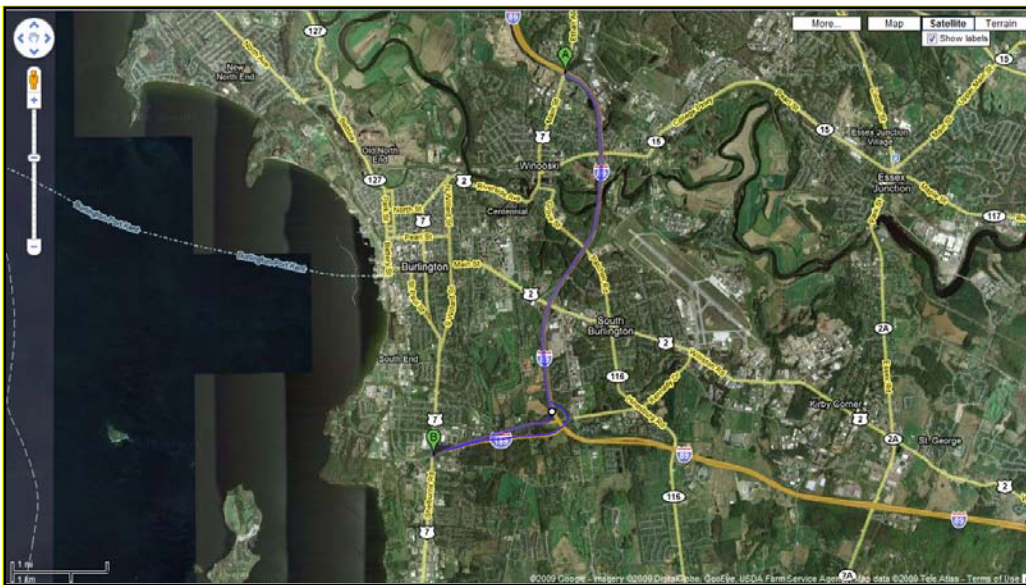

(b) Interstate I-89 & I-189, approx. 5.2 miles per direction

Figure 2: Study analysis routes – (a) Route US-7 and (b) Interstate I-89 & I-189 (8)

The vehicle used for data collection was a Freightliner tractor with a 53-foot trailer, hauling a 42,000-lb. load (not including the weight of the trailer itself). The total weight of the truck, trailer, and load was approximately 75,000 lbs. Figure 3 is an image of the test vehicle (on the far right).

A GeoStats GeoLogger (10) monitored position and velocity, second-by-second, while instantaneous acceleration and tilt data were collected using a SENSIR GP2x accelerometer with tilt meter (11). Both devices were mounted to the exterior of the vehicle with connections to a portable laptop computer to record the data.



Figure 3: Freightliner Tractor and Trailer Test Vehicle (far right)

4. Drive Cycle Data Summary

A total number of four drive cycles were collected for the interstate route, two per direction, and 4 drive cycles for the US-7 route, two per direction. Velocity and position were recorded every second, and acceleration and tilt meter readings were recorded every 0.0025 seconds (or 400 samples per second). Table 1 provides a general summary of each velocity-time trace.

Table 1: Velocity-Time Trace Summary

Route	Trip Duration (s)	Average Speed (mph)	Avg. Accel./Decel. (mph/s)	% Time Accel./Decel.	% Time Idling
US-7 Northbound #1	1,270	14.7	+0.63 / -0.90	79%	9%
US-7 Northbound #2	1,249	14.8	+0.72 / -0.85	78%	8%
US-7 Southbound #1	1,345	13.7	+0.59 / -0.73	79%	10%
US-7 Southbound #2	1,166	15.7	+0.67 / -0.86	78%	8%
I-89/I-189 Northbound #1	421	46.1	+0.51 / -0.41	91%	0%
I-89/I-189 Northbound #2	421	46.1	+0.50 / -0.34	89%	0%
I-89/I-189 Southbound #1	603	30.4	+0.29 / -0.40	75%	8%
I-89/I-189 Southbound #2	550	33.2	+0.46 / -0.47	74%	12%

4.1 Velocity and Acceleration

The velocity-time profiles for the northbound I-89/I-189 route were very similar, both having like average speeds and travel time durations (see Figure 4). The second run of the southbound I-89/I-189 began with a lower velocity due to on-ramp traffic at Exit 16 in Colchester, but downstream of the ramp, the test vehicle achieved similar travel speeds for both runs (see Figure 5). The significant drop in speed

and oscillating “stop-and-go” toward the end of both southbound interstate runs was due to queuing from the traffic signal on the ramps at the junction of I-189 and US-7. Spillback from the signal was more pronounced at the end of the first southbound interstate run, during the AM-peak, which is apparent because the test vehicle experienced crawl-like travel (speed less than 5 mph) for four traffic signal cycles. This increased idle time explains the lower average speeds for the southbound interstate runs compared to the northbound interstate runs, as indicated in Table 1.

The northbound and southbound US-7 velocity-time plots, shown in Figures 6 and 7, respectively, indicate that the driving characteristics along the routes consist of periods of low-speed cruising and frequent stops at signal or stop-controlled intersections, on-street parking maneuvers and other blockage events. Compared to the northbound interstate route, the travel time duration of the northbound US-7 route was approximately 3 times longer. The southbound US-7 route travel time duration was approximately 2 times longer than the southbound interstate. Again, the longer travel time durations on US-7 are solely due to lower average travel speeds, because the route distances are nearly identical.

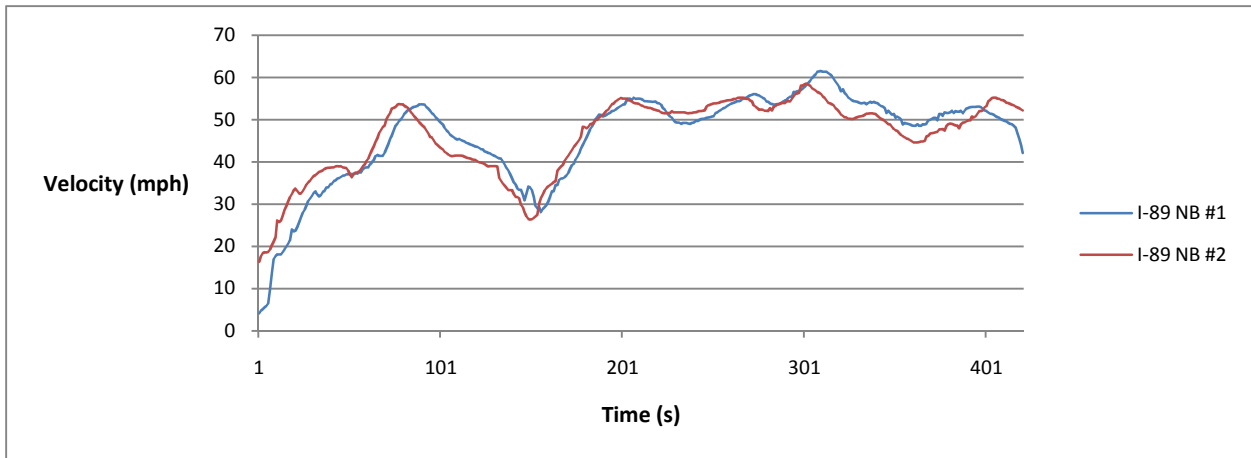

Figure 4: I-89/I-189 Northbound Drive Cycles (Velocity-Time Plots)

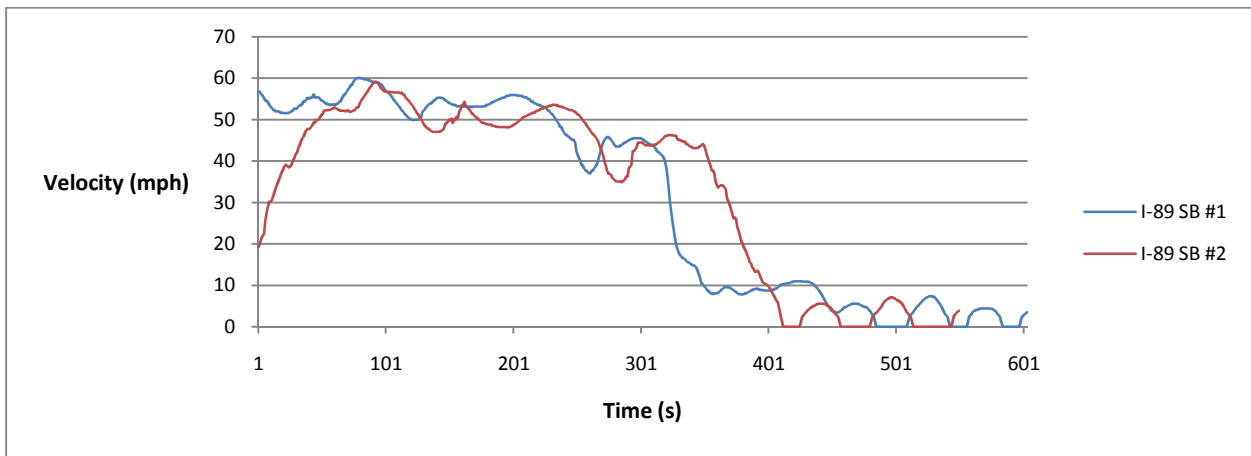

Figure 5: I-89/I-189 Southbound Drive Cycles (Velocity-Time Plots)

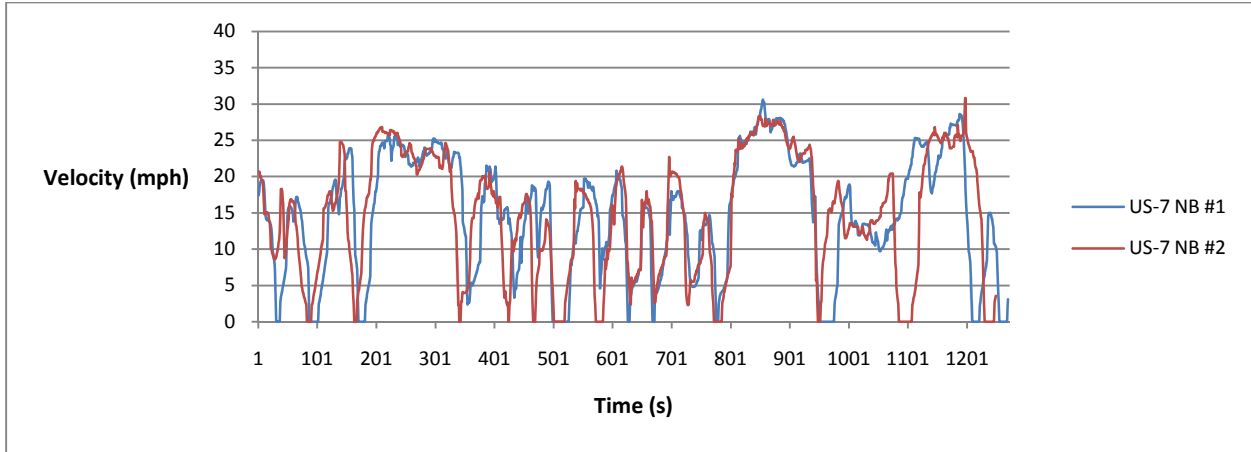

Figure 6: US-7 Northbound Drive Cycles (Velocity-Time Plots)

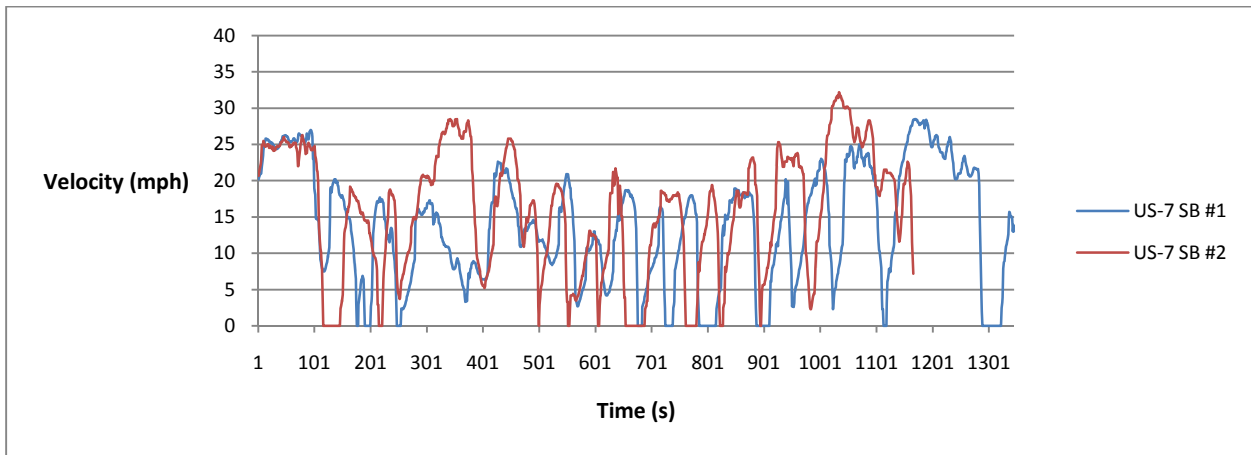

Figure 7: US-7 Southbound Drive Cycles (Velocity-Time Plots)

4.2 Grade and Elevation

Vehicle tilt data was collected by the on-board accelerometer during the route runs. The tilt data was collected at 400 samples per second, so filtering and down-sampling of the data was required subsequent to collection. The time-specific tilt data, which contained a significant amount of “noise” due to vibration of the test vehicle, the vehicle’s suspension, and unevenness of the roadway pavement, was compared with location-specific latitude-longitude elevation data and Vermont Agency of Transportation ARAN grade and elevation data (see Figures 8–11). The filtered tilt data, once compared against the ARAN and elevation data, was smoothed using a 20-period moving average.

Overall, the interstate route’s grade is smooth, with gradual changes, as expected of a specially graded roadway. Grades along the interstate route generally ranged between -5% and 5%. The US-7 routes have segments of steeper grades than those on the interstate. Specifically, northbound US-7 has two segments with sustained grades in excess of 5% - between Ledge Road and Cliff Street in Burlington and through downtown Winooski, including the traffic circulator. Southbound US-7 has some segments of positive grades in excess of 5% south of the Winooski River, along Riverside Avenue (see Figures 8–11).

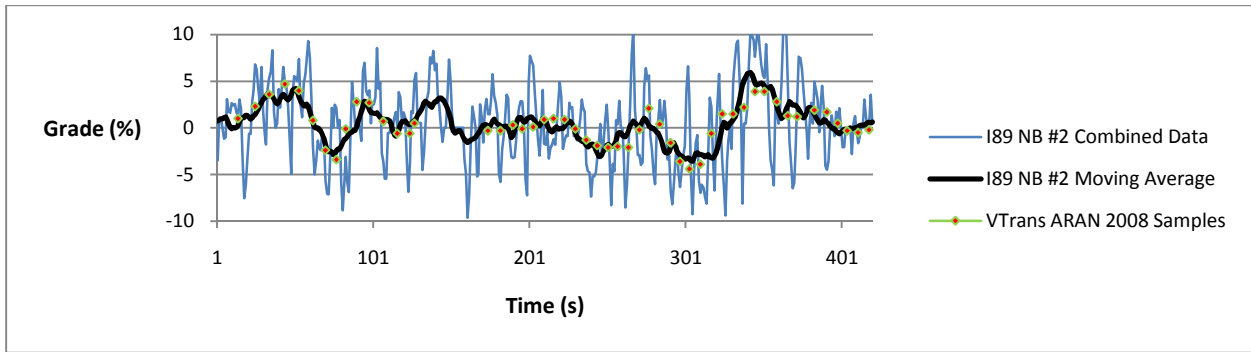
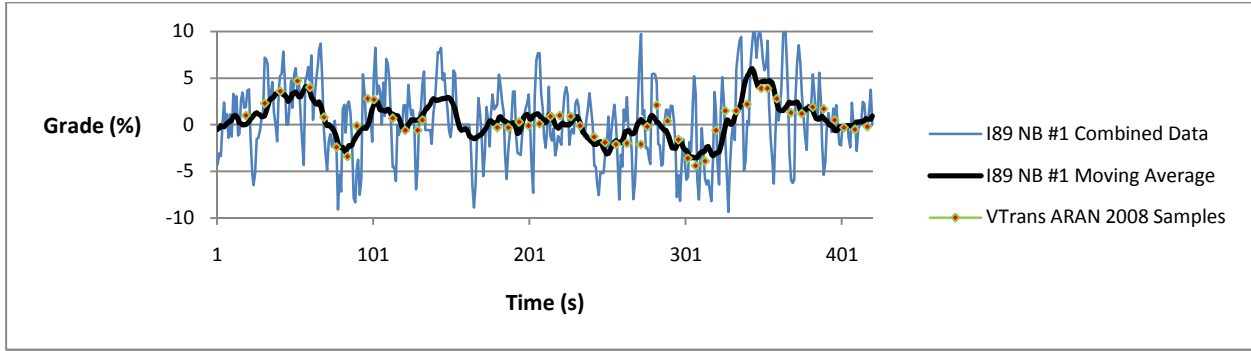

Figure 8: I-89/I-189 Northbound Grade-Time Plots

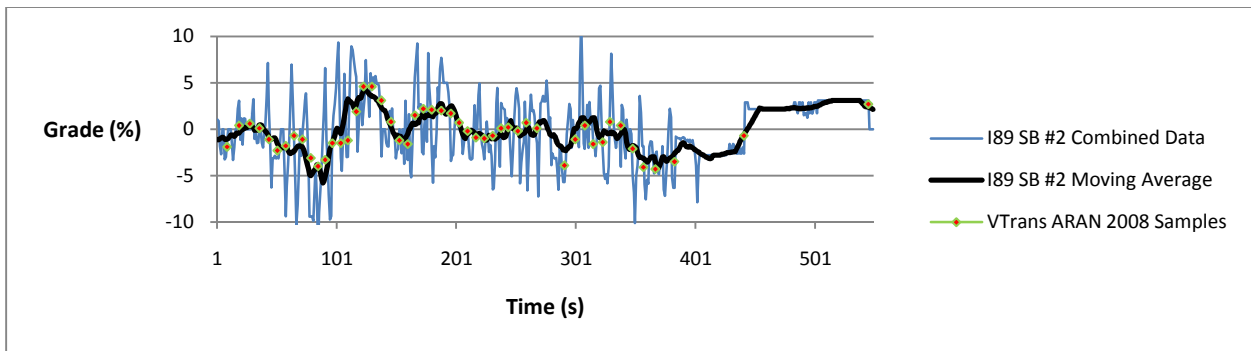
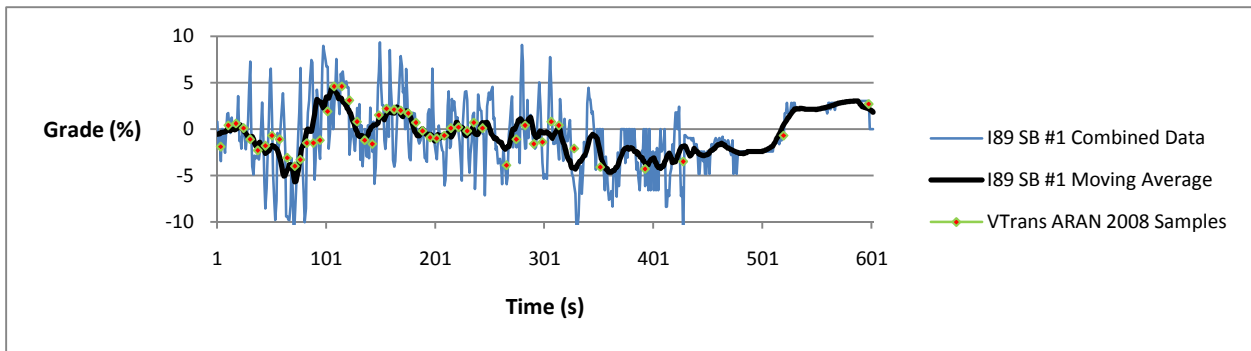

Figure 9: I-89/I-189 Southbound Grade-Time Plots

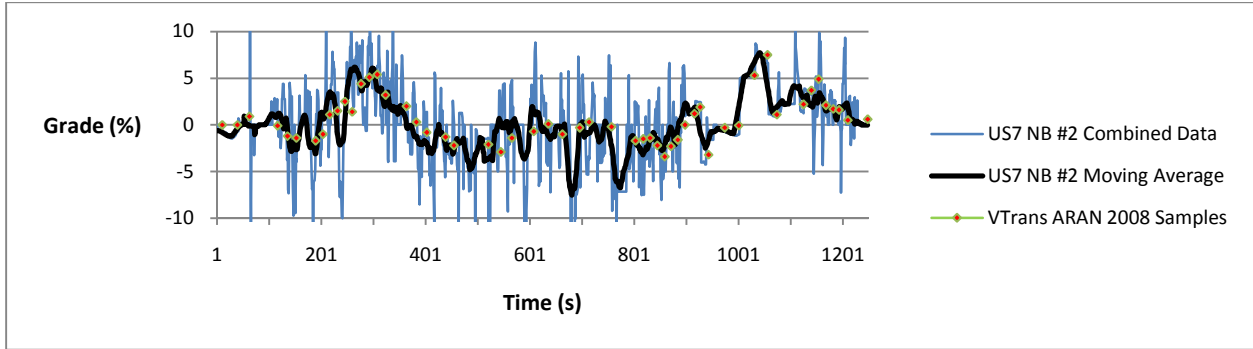
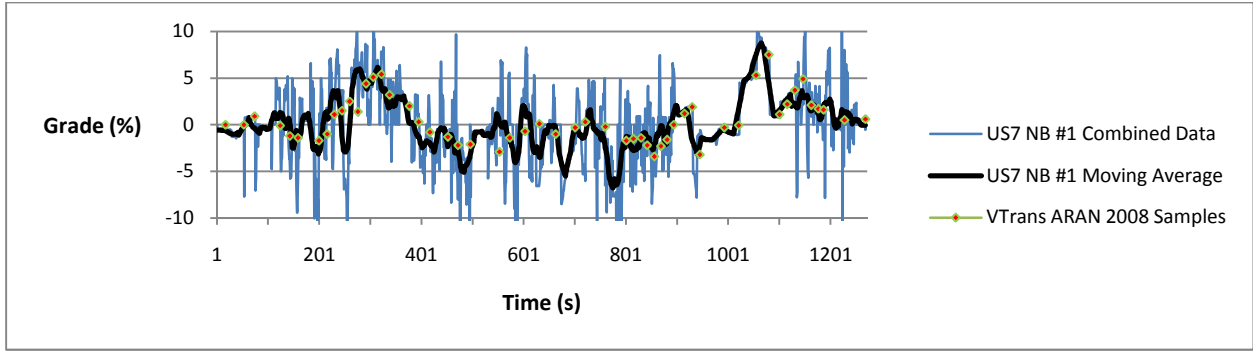

Figure 10: US-7 Northbound Grade-Time Plots

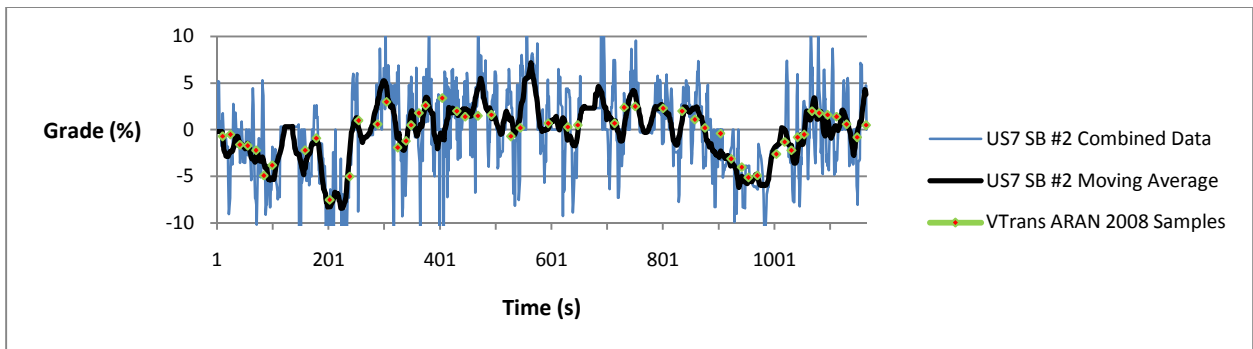
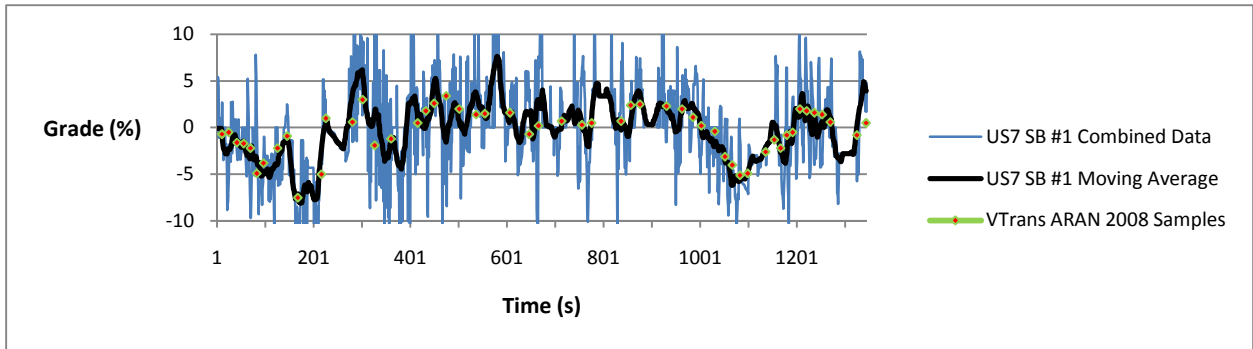

Figure 11: US-7 Southbound Grade-Time Plots

5. Other CMEM Parameters

A number of other user-defined parameters are available in CMEM, such as analysis vehicle characteristics, ambient weather conditions, and fuel and pollutant information. For the purposes of this analysis, most of these parameters were left at default because this study is interested in quantifying the emission differences for the same type of vehicle using different travel routes. Mass of the analysis vehicle's trailer, in this case a heavy-duty diesel vehicle, was specified so that the vehicle's total mass (tractor plus trailer) was 80,000 lbs. – the threshold of the current interstate weight limits – for one run, with repeated model runs at 90,000 lbs. and 100,000 lbs.

6. Results

CMEM version 3.01 (9) was run using the data collected from the eight real-world truck drives cycles. Each drive cycle was input as a second-by-second record of speed (mph), acceleration (mph/s), and grade (degrees).

CMEM provided a number of detailed results for each analysis run, including the estimated emission rates per distance, in grams/mile, and per time, in grams per second (g/s). With the computed length of the traveled route, based on the given drive cycle, CMEM also provided the emissions inventories, in total grams emitted for the entire route. The reported pollutants include carbon dioxide (CO₂), carbon monoxide (CO), hydrocarbons (HC), and oxides of nitrogen (NO_x, including NO and NO₂), as well as overall fuel consumption. CMEM, however, does not report particulate matter emissions.

6.1 Emissions Inventories and Grams-per-Mile Emission Rates

Among the exhaust inventories, CO₂ emissions constitute the largest mass, followed by NO_x. Emissions of hydrocarbons were the lowest of the modeled pollutants as expected for diesel vehicles. Table 2 summarizes the emissions inventories for the driving routes for the three modeled heavy-duty diesel vehicle weights – 80,000-lb., 90,000-lb., and 100,000-lb. – which include the tractor and trailer weights. Table 3 summarizes the per-mile emission rates.

The model results indicate that the average emissions inventories (total grams per route) were generally higher for the US-7 routes than for their interstate counterparts. Comparing the average emissions inventories for northbound US-7 and northbound I-89/I-189, the interstate emissions inventories were less than those of US-7 by approximately: 33-34% for CO₂, 42-44% for CO, 53-54% for HC, and 7-12% for NO_x for the three modeled vehicle weights. Comparing the average emissions inventories for southbound US-7 and southbound I-89/I-189, the interstate emissions inventories were less than those of US-7 by approximately: 49-50% for CO₂, 51-52% for CO, 52-53% for HC, 1-6% for NO_x. For the CO₂ inventory specifically, the reduction in emissions due to a truck traveling on the I-89/I-189 route instead of US-7 would be equivalent to removing approximately 3-5 light-duty vehicles from the road.

In one instance, an individual run on the southbound I-89/I-189 route resulted in higher modeled NO_x emissions than on southbound US-7. Specifically, the second southbound interstate run had higher NO_x emissions than the second US-7 run, even though the average of the two southbound I-89/I-189 runs

were less than the average of the two southbound US-7 runs. In general, the modeled NO_x emissions were quite comparable between the interstate and US-7, for both directions. Based on the values given in Table 2, Figures 12 and 13 summarize the specific emissions inventories of CO₂ and NO_x, respectively, for each route and direction for each of the three vehicle weights.

Table 2: Route Emission Inventories

Route	Total Route Emissions Inventories (grams)											
	80,000-lb. Vehicle				90,000-lb. Vehicle				100,000-lb. Vehicle			
	CO ₂	CO	HC	NO _x	CO ₂	CO	HC	NO _x	CO ₂	CO	HC	NO _x
US-7 NB #1	19,958	43.5	3.7	136	21,523	45.7	3.8	144	23,148	48.1	3.9	152
US-7 NB #2	20,080	43.5	3.7	136	21,712	45.9	3.8	144	23,399	48.3	3.9	153
US-7 SB #1	16,884	39.8	3.7	121	18,083	41.5	3.7	128	19,314	43.3	3.8	134
US-7 SB #2	15,893	36.5	3.3	112	17,116	38.2	3.4	118	18,354	40.0	3.4	125
I-89/I-189 NB #1	13,052	24.2	1.7	121	14,122	25.7	1.8	125	15,167	27.2	1.8	130
I-89/I-189 NB #2	13,302	24.5	1.7	130	14,501	26.3	1.8	135	15,610	27.9	1.8	140
I-89/I-189 SB #1	7,576	17.9	1.7	111	7,976	18.5	1.7	114	8,390	19.1	1.7	116
I-89/I-189 SB #2	9,216	19.5	1.6	119	9,873	20.5	1.7	123	10,535	21.4	1.7	127

Table 3: Route Emission Rates per Mile

Route	Emission rates per Mile (grams/mile)											
	80,000-lb. Vehicle				90,000-lb. Vehicle				100,000-lb. Vehicle			
	CO ₂	CO	HC	NO _x	CO ₂	CO	HC	NO _x	CO ₂	CO	HC	NO _x
US-7 NB #1	3,848	8.4	0.72	26.1	4,150	8.8	0.74	27.7	4,463	9.3	0.76	29.3
US-7 NB #2	3,909	8.5	0.72	26.4	4,227	8.9	0.74	28.1	4,556	9.4	0.76	29.8
US-7 SB #1	3,292	7.8	0.72	23.7	3,526	8.1	0.73	24.9	3,766	8.4	0.75	26.1
US-7 SB #2	3,113	7.1	0.64	21.9	3,353	7.5	0.66	23.2	3,595	7.8	0.67	24.4
I-89/I-189 NB #1	2,420	4.5	0.31	22.4	2,618	4.8	0.33	23.2	2,812	5.0	0.34	24.1
I-89/I-189 NB #2	2,465	4.5	0.32	24.0	2,687	4.9	0.33	25.1	2,893	5.2	0.34	26.0
I-89/I-189 SB #1	1,487	3.5	0.33	21.9	1,566	3.6	0.33	22.4	1,647	3.8	0.34	22.8
I-89/I-189 SB #2	1,816	3.8	0.32	23.5	1,945	4.0	0.33	24.3	2,075	4.2	0.34	25.0

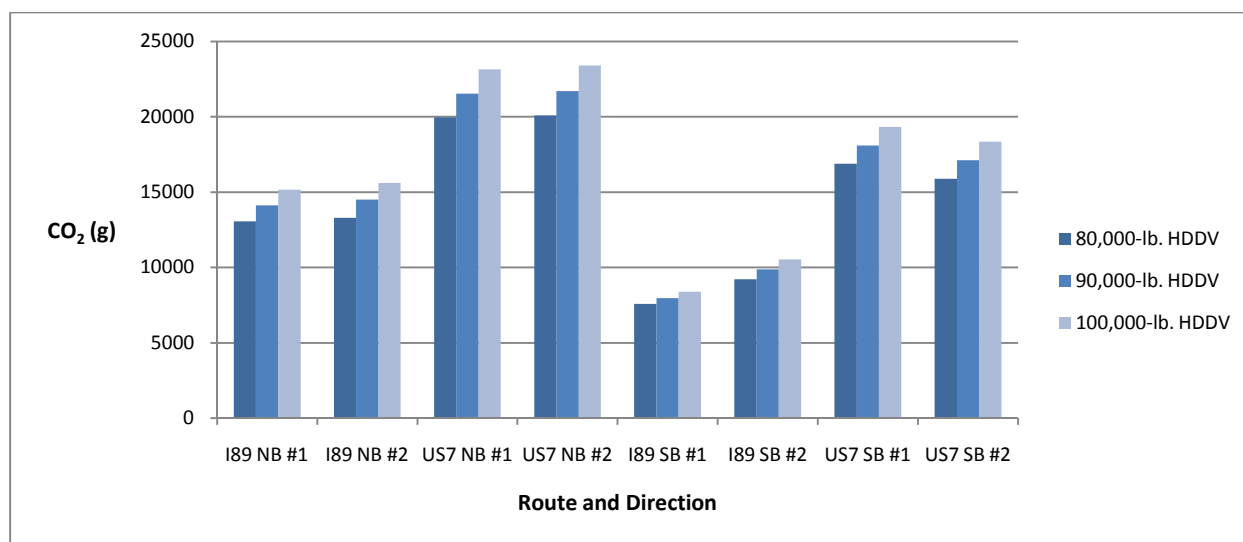

Figure 12: CO₂ Inventories by Route and Direction

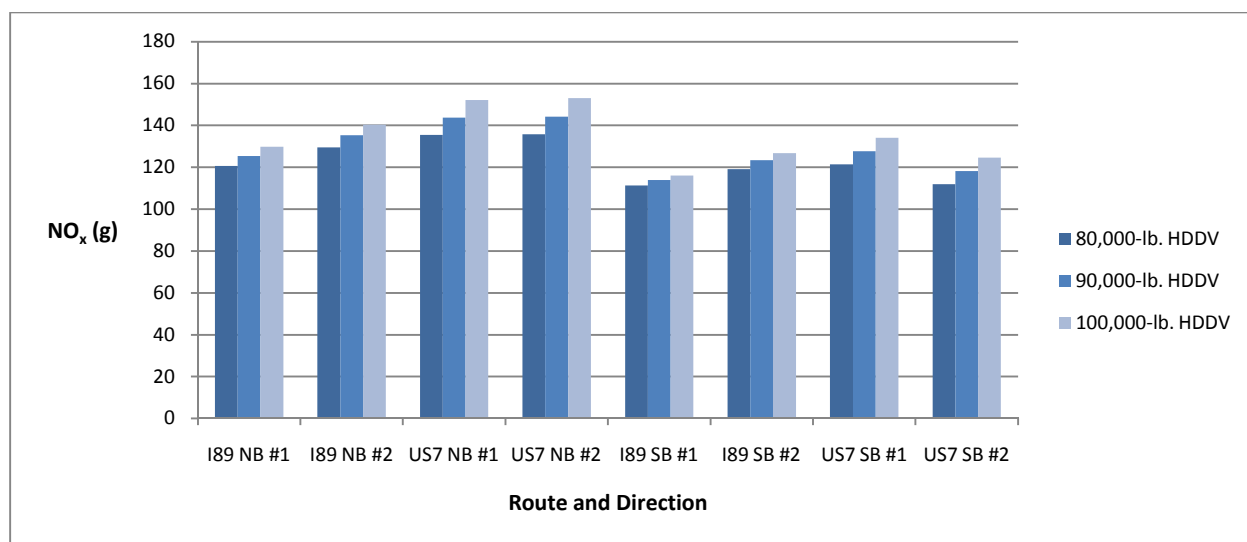

Figure 13: NO_x Inventories by Route and Direction

6.2 Diesel Fuel Use

By converting the CMEM fuel use inventories from grams to gallons of diesel and the per-mile fuel rates from grams-per-mile to gallons-per-mile, fuel savings for the interstate routes are apparent. Estimated diesel fuel use for the northbound I-89/I-189 route ranges from 1.27 gallons to 1.52 gallons, while the northbound US-7 route fuel use ranges from 1.94 gallons to 2.27 gallons, depending on vehicle weight and overall drive cycle. Southbound, the estimated diesel fuel use for I-89/I-189 ranges from 0.74 gallons to 1.02 gallons, while US-7 fuel use ranges from 1.54 gallons to 1.87 gallons, depending on vehicle weight and overall drive cycle. Therefore based on the model results, up to approximately one gallon of diesel fuel per truck could be saved per direction on the interstate route compared to the corresponding US-7 route.

Table 4 summarizes the diesel fuel use in gallons (assuming a typical density of 0.85 kg/l for diesel fuel) and the per-mile rates for the travel routes. Figure 14 summarizes the diesel fuel use inventories for each route and direction for each of the three vehicle weights.

Table 4: Route Fuel Use

Route	Route Total Fuel Use (gallons) and Per-Mile Fuel Use (gallons/mile)					
	80,000-lb. Vehicle		90,000-lb. Vehicle		100,000-lb. Vehicle	
	Total Fuel	Fuel per Mile	Total Fuel	Fuel per Mile	Total Fuel	Fuel per Mile
US-7 NB #1	1.94	0.373	2.09	0.403	2.25	0.433
US-7 NB #2	1.95	0.379	2.11	0.410	2.27	0.442
US-7 SB #1	1.64	0.319	1.75	0.342	1.87	0.365
US-7 SB #2	1.54	0.302	1.66	0.325	1.78	0.349
I-89/I-189 NB #1	1.27	0.235	1.37	0.254	1.47	0.273
I-89/I-189 NB #2	1.29	0.239	1.41	0.261	1.52	0.281
I-89/I-189 SB #1	0.74	0.144	0.77	0.152	0.81	0.160
I-89/I-189 SB #2	0.89	0.176	0.96	0.189	1.02	0.201

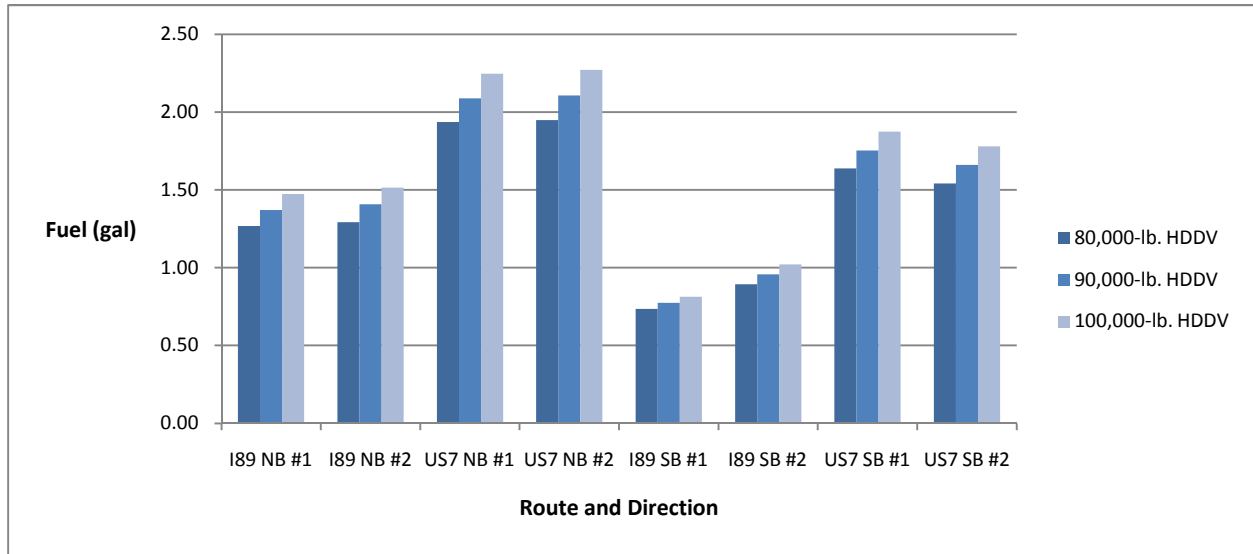

Figure 14: Diesel Fuel Consumption Inventories by Route and Direction

7. Conclusion

Pollutant emissions were modeled for heavy-duty diesel vehicles of varying weights using the CMEM model, with drive cycles for the analysis routes based on real-world measurements of velocity, acceleration, and roadway grade collected from a representative heavy-duty diesel vehicle. Results indicated that overall emissions inventories and per-mile emission rate were lower by up to about 50% for the I-89/I-189 routes compared to the US-7 routes. However, emissions of NO_x were very similar between the counterpart routes, and in one case, the southbound interstate’s NO_x emissions were greater than US-7, by approximately 2-6% depending on vehicle weight. Lastly, there would be an overall savings in diesel fuel use up to approximately one gallon per truck traveling on I-89/I-189 compared to US-7.

References

1. Barth, M., et al. NCHRP Project 25-11 Final Report: *Development of a Comprehensive Model Emissions Model*. Transportation Research Board National Research Council, April, 2000.
2. Barth, M., et al. "Estimating Emissions and Fuel Consumption for Different Levels of Freeway Congestion." *Transportation Research Record* 1664, Transportation Research Board National Research Council, Washington, D.C., 2003, pp. 47-57.
3. Barth, M., et al. "Modal Emissions Model for Heavy-Duty Diesel Vehicles." *Transportation Research Record* 1880, Transportation Research Board National Research Council, Washington, D.C., 2004, pp. 10-20.
4. Yanowitz, J., et al. "In-Use Emissions from Heavy-Duty Diesel Vehicles." *Environmental Science and Technology*, Vol. 34, No. 5, 2000, pp.729-740.
5. *Truck Weight Limits: Issues and Options*. Special Report 225, Transportation Research Board, Washington, D.C., 1990.
6. Harwood, D.W., et al. *Commercial Truck and Bus Safety: Synthesis 3 Highway/Heavy Vehicle Interaction*. Transportation Research Board, Washington, D.C., 2003.
7. Harwood, D.W., et al. *NCHRP Report 505: Review of Truck Characteristics as Factors in Roadway Design*. Transportation Research Board, Washington, D.C., 2003.
8. Google Maps. <<http://maps.google.com/maps>>
9. Scora, G. and Barth, M. *Comprehensive Modal Emissions Model (CMEM), version 3.01 User's Guide*. University of California, Riverside, Center for Environmental Research and Technology, June 2006.
10. GeoStats GeoLogger. < http://www.geostats.com/product_geo.htm>
11. SENSR GP2x USB Accelerometer/Tilt Meter. <<http://www.sensr.com/products/testing-and-development/gp2x.php>>