

ENTERPRISE Transportation Pooled Fund Study TPF-5 (231)



Countermeasures for Wrong-Way Driving on Freeways

PROJECT SUMMARY REPORT

Prepared by



September 2016

Acknowledgements

This document was prepared for the ENTERPRISE Transportation Pooled Fund TPF-5(231) program (<http://enterprise.prog.org/>). The primary purpose of ENTERPRISE is to use the pooled resources of its members from North America and the United States federal government to develop, evaluate, and deploy Intelligent Transportation Systems (ITS).

The photos on the cover page of this report were provided by the Texas Department of Transportation.

Project Champion

Willy Sorenson, Iowa Department of Transportation, was the ENTERPRISE Project Champion for this effort. The Project Champion serves as the overall lead for the project.

ENTERPRISE Members

The ENTERPRISE Board consists of a representative from each of the following member entities of the program.

- Georgia Department of Transportation
- Illinois Department of Transportation
- Iowa Department of Transportation
- Kansas Department of Transportation
- Michigan Department of Transportation
- Ministry of Transportation Ontario
- Minnesota Department of Transportation
- Oklahoma Department of Transportation
- Pennsylvania Department of Transportation
- Texas Department of Transportation
- Transport Canada
- USDOT Federal Highway Administration

Wrong-Way Freeway Countermeasure Deployments: Agency Contacts

The ENTERPRISE Program would like to acknowledge and thank the following individuals who participated in interviews and provided information about the wrong-way countermeasure deployments documented as a part of this project:

- Arizona DOT – Bashir Hassan, Andy Murray, Karim Rashid
- Central Florida Expressway – Corey Quinn, Bryan Homayouni
- Connecticut DOT – Colin Baummer
- Florida DOT – Raj Ponnaluri, Ping (Peter) Hsu, Chester Chandler, Terry Hensley
- Harris County Toll Road Authority – Captain Calvin Harvey
- Iowa DOT – Willy Sorenson
- Michigan DOT – Steve Shaughnessy, Tracie Leix
- Missouri DOT – Eddie Watkins, Jr., Matt Seggerman
- Ohio DOT – Derek Troyer, Mike McNeill
- Rhode Island DOT – Daniel Waugh
- Texas DOT – John Gianotti
- Washington State DOT – Rick Mowlds
- Wisconsin DOT – Stacey Pierce

Table of Contents

1.0	Introduction	1
2.0	The Wrong-Way Driving Problem	3
3.0	Literature and Guidance Resources	5
4.0	Wrong-Way Driving Countermeasures.....	7
4.1	Countermeasures Currently Deployed	8
4.2	Emerging Approaches and Technologies	14
4.2.1	Directional Rumble Strips	14
4.2.2	Integrated On-Road Detection, Tracking, and Notification Systems	14
4.2.3	In-Vehicle Alert Systems	16
5.0	Active Wrong-Way Countermeasure Deployments	17
5.1	Deployment Summaries.....	17
5.2	Highlights of Wrong-Way Countermeasures	18
5.2.1	Active Deployments that Do Not Include ITS/Technology.....	19
5.2.2	Active Deployments with ITS/Technology	23
6.0	Key Findings.....	30
6.1	Design and Implementation Considerations	30
6.2	Effectiveness	31
6.3	ITS/Technology Countermeasures.....	32
6.4	Posting Messages on DMS to Oncoming Traffic	33
6.5	Feedback from Local Motorists.....	34
6.6	Coordination and Education	34

Appendix A: Literature Search Summary

Appendix B: Deployment Summaries

References

1.0 Introduction

The ENTERPRISE Pooled Fund Program conducted this project to help increase members' understanding of current practices for wrong-way driving countermeasures on freeways, including those that utilize Intelligent Transportation System (ITS) technologies. The goal of this project was to create a repository for wrong-way countermeasure deployments to help ENTERPRISE agencies increase their understanding of countermeasure types, evaluation efforts and results as available, agency coordination efforts, and any feedback on the deployments from local motorists.

Project tasks included the following:

- **Task 1: Gather Information about Countermeasures to Mitigate Wrong-Way Driving:** This task conducted an online literature search to identify countermeasure types and active or planned deployments for further investigation. This task was completed in January 2015.
- **Task 2: Develop a Matrix of Deployments:** In this task, the research team contacted state departments of transportation (DOTs) to collect details about the selected wrong-way deployments and summarize key information in a matrix format. This task was completed in June 2015.
- **Task 3: Track Deployments and Assemble Evaluation Results:** This task tracked the selected wrong-way deployments from Task 2 over the course of approximately 12 months (June 2015 - July 2016) by conducting interviews with agency contacts to update the initial information collected, such whether additional sites were deployed, updates on lessons learned, and any evaluation results. Detailed deployment summaries were created as a part of this task.

Findings from the online literature search task revealed publications and resources that contain extensive guidance for assessing geometric roadway configurations to mitigate wrong-way driving. This project therefore focused on treatments applied to freeway ramps and mainlines (e.g. enhanced static signs, pavement marking improvements, ITS technologies, messages to oncoming traffic, alerts to Traffic Management Centers) being deployed to mitigate wrong-way driving.

The wrong-way countermeasure deployments documented in this report do not reflect all State Departments of Transportations' efforts to mitigate wrong-way driving on freeways. The agencies and deployments were chosen based on initial research to identify in-place and soon-to-be implemented countermeasures. Efforts were made to include a variety of countermeasure types as well as similar types of deployments so that similarities, differences, and trends could potentially be identified.

The remainder of this report contains the following sections:

[2.0 The Wrong-Way Driving Problem](#) – Presents a brief overview of the wrong-way driving problem, including U.S. crash and fatality data and factors associated with wrong-way crashes

[3.0 Literature and Guidance Resources](#) - Provides reference to the initial literature search conducted in January 2015 and lists key resources that provide guidance for agencies considering implementing improvements to help mitigate wrong-way driving.

[4.0 Wrong-Way Driving Countermeasures](#) - Presents an overview of wrong-way countermeasures currently deployed by agencies as well as emerging approaches and technologies.

[5.0 Active Wrong-Way Countermeasure Deployments](#) - Provides an overview of the active wrong-way countermeasure deployments documented during this project.

[6.0 Key Findings](#) - Summarizes key findings from the deployments tracked as a part of this project.

[Appendix A](#) - Includes the literature search summary conducted in January 2015, along with additional relevant publications the research team became aware of after the literature search was complete.

[Appendix B](#) - Contains all deployment summaries, with detailed information about each deployment documented during this project.

[References](#)

2.0 The Wrong-Way Driving Problem

This section presents an overview of the wrong-way driving problem, including U.S. fatality rate data and factors associated with wrong-way crashes.

U.S. Crash and Fatality Data

Wrong-way driving accounts for an average of approximately 350 fatalities per year in the United States. In 2012, the National Transportation Safety Board conducted a study that analyzed wrong-way crash data from the Fatality Analysis Reporting System (FARS) database, reporting an average of 357 fatalities per year due to wrong-way crashes from 2004-2009 (NTSB, 2012). A more recent study reported a similar average number of wrong-way driving fatalities -- 359 average per year from 2004-2011. This study also documented that the number of wrong-way crashes has remained fairly constant over this time period, while the total number of fatal crashes (all types) has decreased as shown in Figure 1 (Baratian-Ghorghi, Zhou & Shaw, 2014).

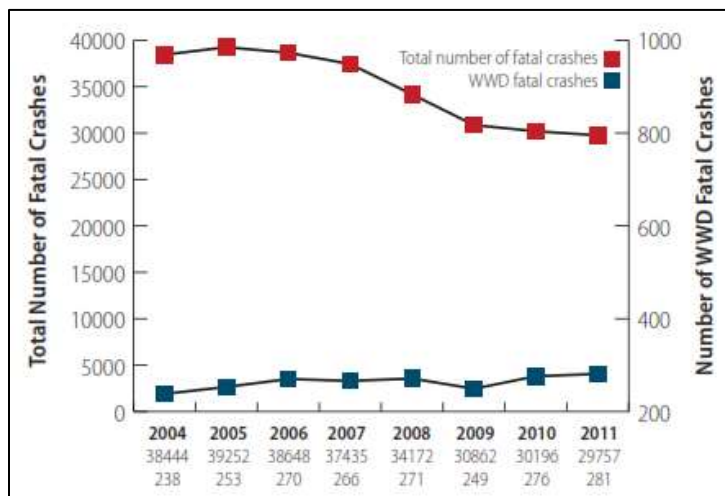

Figure 1: US Overall Fatal Crashes vs. Wrong-Way Fatal Crashes
(Source: Baratian-Ghorghi et al., 2014)

It is important to note that it is very difficult for agencies to quantify the number of wrong-way driving events that occur on their highway systems, due to drivers that self-correct or are intercepted by law enforcement before a crash occurs.

Factors Associated with Wrong-Way Crashes

In terms of factors associated with wrong-way crashes, key findings from the National Transportation Safety Board report (NTSB, 2012) indicate that:

- A substantial body of research supports the fact that **wrong-way collisions tend to have higher fatality rates than other accidents**;
- **Drivers impaired by alcohol and older drivers** are over-represented in wrong way crashes;
- The **primary origin** of wrong-way movements (when the origin can be determined) **is entering an exit ramp**;
- Wrong-way collisions **occur more frequently at night**; and
- A disproportionate number of wrong-way collisions **occur on the weekends**.

This NTSB report also indicates that wrong-way collisions tend to occur in the left-hand lane (for right-way traffic) most frequently because wrong-way drivers perceive this to be their right-hand driving lane.

Susceptible Freeway Entry Points

As noted above, the primary origin of wrong-way driving on freeways is when drivers enter the freeway at an interchange exit ramp rather than correctly entering at an entrance ramp. A comprehensive research and guidelines development effort conducted by the University of Illinois at Urban-Champaign (Zhou et al., 2012; Zhou & Rouholamin, 2014a) found the following interchange types to have relatively high wrong-way driving crashes:

- Partial Cloverleaf Interchanges (found to be most susceptible to wrong-way movements)
- Diamond Interchanges
 - Diamond Interchanges with continuous frontage road
 - Diamond interchanges without continuous frontage road
- Single point directional interchanges
- Freeway Feeders

Interviews conducted as a part of this project further indicate that partial cloverleaf interchanges are most commonly treated with countermeasures to help mitigate wrong-way driving events. Figure 2 shows a diagram of potential wrong-way movements in partial cloverleaf interchanges.

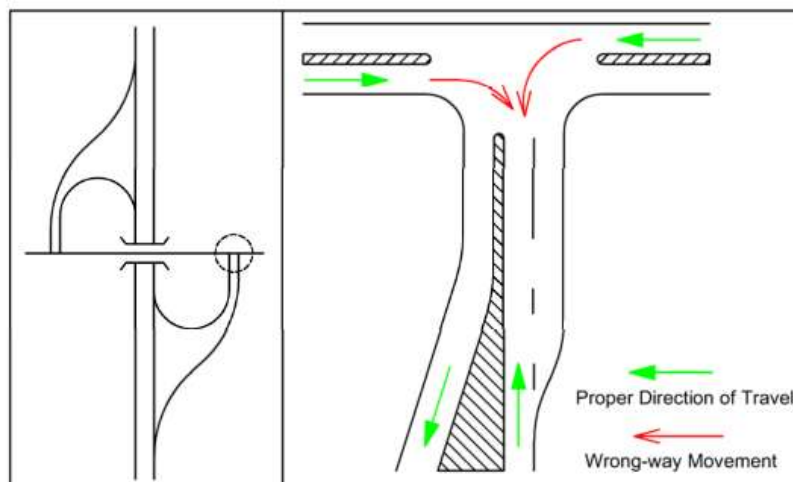

Figure 2: Potential Wrong-way Movements in Partial Cloverleaf Interchanges
(Zhou & Rouholamin, 2014a)

Though interchange exit ramps have been determined to be a primary origin point for wrong-way driving at freeways, at-grade intersections and other entry points should not be ignored. The Iowa DOT has deployed an on-road testbed on U.S. Hwy 30, which has a mix of interchanges and at-grade intersections. The testbed, centered at the city of Ames, Iowa, consists on high-definition radar on the mainline with alerts to select DOT staff when a wrong-way driver is detected. DOT staff review and compare alerts to video recordings from traffic cameras to verify actual wrong-way driving events and attempt to identify points of entry. Between July 2014 and mid-September 2016, 68% of entry points that could be identified occurred at at-grade intersections. Additionally, entries at “free-flowing” interchanges were also observed. See the [Iowa DOT Deployment Summary](#) in [Appendix B](#) for additional information about points of entry identified at this testbed.

3.0 Literature and Guidance Resources

The body of literature focused on understanding more about the wrong-way driving problem and potential mitigation strategies is steadily growing. This section provides reference to the initial literature search conducted at the beginning of the project, as well as a listing of published resources that provide guidance for agencies considering implementing improvements to help mitigate wrong-way driving.

Literature Search

During the first task of this project, a literature search was conducted to assist in identifying active deployments of wrong-way countermeasures to be documented and tracked during the course of the project. [Appendix A](#) contains a summary of the resources and deployments identified in this literature search, completed January 2015. As the project progressed and new literature was published, the research team became aware of additional publications that contain relevant information; these additional resources are also included in [Appendix A](#).

Key Resources with Practical Guidance

A number of resources exist to help agencies assess infrastructure configurations and consider countermeasure improvements to mitigate wrong-way driving. Though not an exhaustive list, the resources below contain information to help agencies assess current configurations and consider wrong-way driving countermeasures.

- [FHWA Wrong Way Driving Web Page](#) (Federal Highway Administration, 2016)
This website maintains a listing of technical materials, state and federal research, and other materials related to wrong-way driving and countermeasures, with web links to each resource.
- [Wrong Way Driving Road Safety Audit Prompt List](#) (Federal Highway Administration, 2013)
This resource is intended to focus specific attention on wrong-way driving issues and contributing factors, through a series of questions designed to help agency Road Safety Audit (RSA) teams identify potential safety issues, avoid overlooking important factors, and proactively identify potential issues. The prompts include considerations for design, signing and markings, time of day conditions, and seasonal or temporary conditions.
- [Guidelines for Reducing Wrong-Way Crashes on Freeways](#) (Zhou & Rouholamin, 2014a)
This report contains guidelines to assist traffic safety professionals with assessing geometric and signing configurations in the field and selecting improvements to be considered. Guidelines are supported by published research and best practices. In particular, the report provides extensive guidance for assessing and implementing geometric roadway configurations to help mitigate wrong-way driving. Guidelines are provided for the following countermeasures and mitigation strategies: Signs, Pavement Markings, Traffic Signals, Geometric design elements, Advanced technologies, Enforcement, Education. Figure 3 shows an excerpt from the report that provides guidance for pavement markings.

The report also contains a “Wrong-Way Entry Checklist Field Inspection Sheet” that can be used by agencies to document signage and geometric configurations to help with assessing the need for improvements. Figure 4 shows a portion of the checklist.

Design Guidelines	
General Considerations	
<ul style="list-style-type: none"> • Ensure that pavement markings complement the geometry of the location and provide positive guidance to drivers about proper direction and movement. • Ensure that pavement markings and signs are consistent with one another so they reinforce the information conveyed to drivers. • Consider various optional enhancements to pavement markings to increase conspicuity (particularly at night). 	
Marking	Guidelines
In-Lane Arrows	<ul style="list-style-type: none"> • Place appropriate lane-use arrows on the approach to and at intersections with ramps. • Avoid placing lane-use arrows where they can be misunderstood and possibly result in wrong-way maneuvers. • Consider using the wrong-way arrow along exit ramps.
Longitudinal Lines	<ul style="list-style-type: none"> • Use longitudinal lines to help drivers recognize the appropriate directions for travel. • Use lane line extensions to guide vehicles through ramp terminals with large turning radii. • Use painted islands between entrance and exit ramps.
Stop Lines	<ul style="list-style-type: none"> • Consider placing stop lines at the end of exit ramps.
Enhanced Delineation	<ul style="list-style-type: none"> • Use red retroreflective raised pavement markers (RPM) to enhance the visibility of pavement markings (lines, arrows, etc.) on exit ramps. • Use barrier delineators to warn wrong-way drivers.

Figure 3: Design Guidelines for Pavement Markings (Zhou & Rouholamin, 2014a)





Inspector:				
Route Information:				Date:
Ramp Description:				Time:
SIGN	CHECK IF	YES	NO	COMMENTS
	At least one present			
	In good condition			
	At least one present			
	In good condition			
	Present at location for cross under/over traffic			
	NO RIGHT TURN			
	NO LEFT TURN			
	NO U-TURN			
PAVEMENT MARKING	CHECK IF	YES	NO	COMMENTS
WRONG-WAY ARROWS	Present			
	Pieces in good condition			
Other Markings	Elephant tracks (turning guide line)			
	Stopping lines at end of exit ramp			
	Left/Right Turn Only Arrow			
GEOMETRIC DESIGN FEATURES	CHECK IF	YES	NO	COMMENTS
Raised Curb Median on the crossroad	Present			
	Present			
	Present			
Design to Discourage Wrong-Way Entry	Present			

Figure 4: Wrong-Way Entry Checklist (Zhou & Rouholamin, 2014a)

4.0 Wrong-Way Driving Countermeasures

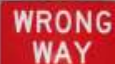
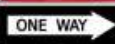
This section provides an overview of countermeasures for mitigating wrong-way driving. In addition, selected emerging approaches and technologies are described.

Table 1 lists several countermeasures that have been deployed by agencies. Each countermeasure is categorized as “preventative” or “reactive” as defined below:

- “Preventative” countermeasures include approaches intended to prevent wrong-way vehicles from entering or driving on freeways.
- “Reactive” countermeasures include approaches intended to stop wrong-way drivers once they have entered a section of roadway traveling in the incorrect direction (e.g. systems that detect wrong-way vehicle movements and provide alerts to the driver, to oncoming right-way traffic, or to traffic management/law enforcement personnel).

ITS/technology countermeasures are also indicated as such in Table 1.

Table 1: Wrong-Way Driving Countermeasures

Wrong Way Driving Countermeasures	
Preventative Countermeasures	Reactive Countermeasures
<ul style="list-style-type: none"> • Low-mounted Signs: WRONG WAY (WW), DO NOT ENTER (DNE), ONE WAY • Enhanced Static Signs: Signs angled at 45 degrees toward drivers, red reflective tape on sign posts (enhanced conspicuity for standard signs), additional signs along exit ramps, signs mounted on the same post, No Left Turn or No Right Turn signs • Enhanced Pavement Markings: Wrong-way arrows on exit ramps, raised reflective pavement markings, stop bars at exit ramps, pavement markings that guide drivers onto entrance ramps • Treatments Applied to Infrastructure: Painted island between exit/entrance ramps, red delineators along exit ramp • Modifications to Traffic Signals: Straight arrow signal to discourage left turns onto exit ramp • LED-Enhanced WW Signs: LEDs around sign border flash continuously (<i>ITS/technology</i>) • In-Pavement Lighting: Appears as stop bar at end of exit ramp; flash continuously (<i>ITS/technology</i>) • Geometric Design Elements & Modifications: Removal of obstructions in drivers’ view, raised medians and channelizing islands; corner/control radius improvements • Institutional Coordination: Multi-agency coordination, enforcement, public education, legislative modification. 	<ul style="list-style-type: none"> • Portable Tire Deflation Devices – Utilized by law enforcement during response efforts • Dynamic Alert Systems (<i>ITS/technology</i>) <ul style="list-style-type: none"> - Alerts/messages to wrong-way drivers - Alerts/messages to oncoming right-way traffic - Alerts to agency-operated traffic management centers - Alerts to law enforcement personnel • Detection with Alert Capability (<i>ITS/technology</i>) <ul style="list-style-type: none"> - Loop Detectors - Radar Detection - Video Detection - Magnetic Sensors - Microwave Sensors

4.1 Countermeasures Currently Deployed

As noted above, there are various wrong-way countermeasures that have been deployed. Table 2 provides photos as examples of some of the countermeasure types that are deployed in the field.

Table 2: Examples of Wrong-Way Driving Countermeasures

Examples of Wrong Way Driving Countermeasures
Low-mounted Signs at Exit Ramps (<i>Non-Technology, Proactive</i>) <ul style="list-style-type: none">- WRONG WAY (WW), DO NOT ENTER (DNE), or ONE WAY signs- Mounting heights vary, lower than 7 ft. standard height <p style="text-align: center;"><u>Examples of Low-Mounted Signs at Exit Ramps:</u></p>  <p style="text-align: center;">Low-mounted Signs (2 ft. height) – North Texas Transit Authority <i>(Source: Finley et al., 2014)</i></p>  <p style="text-align: center;">Low-mounted Signs (5 ft. height) <i>(Source: Provided by Connecticut DOT)</i></p>

Examples of Wrong Way Driving Countermeasures

Enhanced Static Signs at Exit Ramps (*Non-Technology/Proactive*)



Signs on Both Sides of Ramp; Two Signs on the Same Post
(Source: Provided by Ohio DOT)



Red Reflective Tape on Sign Posts, Signs on Both Sides of Ramp
(Source: Ouyang, 2013)



One Way Signs Mounted over DNE Signs
(Source: Provided by Ohio DOT)



Oversized Signs, DNE and WW Sign on Same Post
(Source: Provided by Arizona DOT)

Examples of Wrong Way Driving Countermeasures

Enhanced Pavement Markings at Interchange Ramps (*Non-Technology/Proactive*)



Wrong-Way Arrows at Exit Ramp
(Source: Tobias, 2015)



Raised Pavement Marker (RPM) Arrows at Exit Ramp
(Source: Ouyang, 2013)



Raised Pavement Markers (RPMs) at Exit Ramp
(Source: Provided by Arizona DOT)



Skip Lines to Guide Drivers onto Entrance Ramp, Stop Bar at End of Exit Ramp
(Source: Morena & Leix, 2012)



Route Designation Shield with Straight Arrow
(Source: Provided by FDOT)

Examples of Wrong Way Driving Countermeasures

Treatments to Infrastructure at Interchange Ramps (*Non-Technology/Proactive*)

- Painted island between exit/entrance ramps
- Red delineators along exit ramp (on guardrail or on delineator posts)

Examples of Treatments to Infrastructure at Interchange Ramps:



Painted Island between Exit/Entrance Ramps

(Source: Morena & Leix, 2012)



Red Delineators on Guardrail along Exit Ramp

(Source: Morena & Leix, 2012)

Portable Tire Deflation Devices (*Non-Technology, Reactive*)

- Portable devices used by law enforcement personnel during response efforts

Example of a Portable Tire Deflation Device



Portable Tire Deflation Device – Harris County Toll Road Authority

(Source: Thurman, 2013)

Examples of Wrong Way Driving Countermeasures

Modifications to Existing Traffic Signal Indicators (*Technology, Proactive*)

Example of Modification to Existing Traffic Signal Indicators:



Straight Arrow Indication near Exit Ramp
(Source: Provided by Rhode Island DOT)

Continuously Illuminated Signs and In-Pavement Lighting (*Technology, Proactive*)

- Enhanced Regulatory Signs: WRONG WAY signs with LED lights around border; LEDs blink continuously at night/low light or continuously day and night
- Internally Illuminated (in-pavement) Raised Pavement Markers

Examples of Continuously Illuminated Signs and In-Pavement Lighting



LEDs at WRONG WAY Sign Border, Flash Continuously at Night & Low Light
(Source: Provided by Texas DOT)



Internally Illuminated Raised Pavement Markers Create Illusion of Stop Bar
(Source: Provided by Florida DOT)

Examples of Wrong Way Driving Countermeasures

Dynamic Alert Systems (Technology, Proactive)



(Source: Ozkul, Lin & Chandler, 2016)



(Source: Provided by Central Florida Expressway)

Rectangular Rapid Flashing Beacons (RRFBs) on WRONG WAY Signs



Ramp Detection with Camera for Verification at Exit Ramp

(Source: Provided by Wisconsin DOT)



Vehicle-activated "Blank Out" DMS

(Source: Cooner et al., 2004)



DMS Message to Alert Oncoming Right-Way Traffic

(Source: Provided by Rhode Island DOT)

4.2 Emerging Approaches and Technologies

A number of emerging approaches to help mitigate wrong-way driving are currently being researched and tested around the country. A few examples of noteworthy approaches are described in this section.

4.2.1 Directional Rumble Strips

Research led by Albert Luo, Southern Illinois University-Edwardsville, and Huaguo Zhou, Auburn University, is determining the feasibility of using directional rumble strips (DRS) to help prevent wrong-way drivers from entering freeways at exit ramps. The DRS is a variation of transverse rumble strips, also referred to as in-lane rumble strips. When vehicles travel over conventional transverse rumble strips from either direction, they provide motorists with the same levels of sound and vibration. The DRS is designed to generate elevated noises and vibrations to warn wrong-way drivers, while providing normal noise and vibrations to slow down traffic in the right-way direction. (Zhou & Luo, 2015).

Initial research established a baseline by examining transverse rumble strips using field tests to measure the sound and vibrations generated from existing highway rumble strips. Literature review, national surveys of transportation practitioners and vendors, and initial field testing identified a number of designs for further investigation. Researchers are testing a number of concept designs to select the best configuration that will limit sound and vibrations for right-way drivers while alerting wrong-way drivers through elevated sound and vibrations. (Roadway Safety Institute, 2016).

4.2.2 Integrated On-Road Detection, Tracking, and Notification Systems

The following agencies are developing, testing, and implementing more integrated, comprehensive systems that integrate and coordinate multiple technologies to address wrong-way driving events.

Arizona Department of Transportation

A study conducted for the Arizona Department of Transportation (ADOT) by United Civil Group Corporation developed a conceptual system to detect a wrong-way driver upon entry, inform the errant driver of their mistake, notify the ADOT Traffic Operations Center (TOC) and law enforcement instantly, track the wrong-way vehicle on the highway system, and warn right-way drivers in the vicinity of the oncoming vehicle. A methodology, which applied performance measures and a scoring system, was used to select the detection element, notification element, and warning element for the proposed system. A pilot deployment plan was created as a part of the research, to outline steps for deploying the system. (Simpson & Bruggeman, 2015).

Figure 5 shows a diagram of the conceptual wrong-way detection and warning system with steps to detect, notify, inform, track, monitor, and warn. Per an interview conducted with ADOT staff as a part of this project on 7/20/16, a pilot deployment is underway.

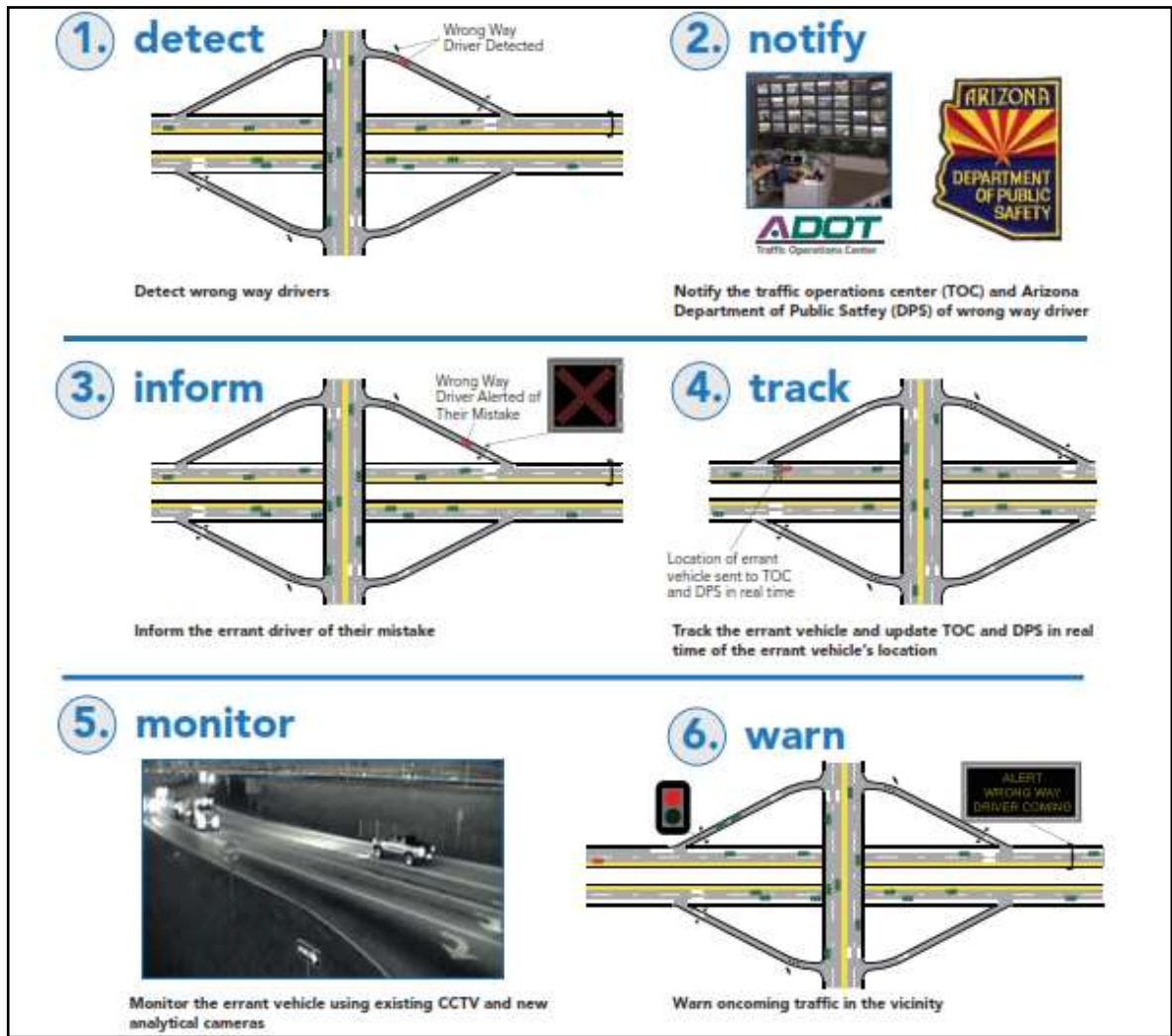

Figure 5: Concept for ADOT Wrong-Way Detection and Warning System (Simpson & Karimvand, 2015)

Texas Department of Transportation

The Texas A&M Transportation Institute conducted a project for the Texas Department of Transportation to develop a concept of operations, functional requirements, and high-level system design for a Connected Vehicle (CV) Wrong-Way Driving (WWD) Detection and Management System. This system was designed to detect wrong-way vehicles, notify the traffic management entities and law enforcement personnel, and alert affected travelers. The research team recommended the development of a proof-of-concept test bed at an off-roadway location before implementing a model field deployment of the system on an actual roadway in Texas. (Finley et al., 2016).

4.2.3 In-Vehicle Alert Systems

The potential for in-vehicle alert systems to warn motorists of wrong-way driving is growing as vehicle to infrastructure (V2I) and vehicle to vehicle (V2V) technologies continue to advance. In-vehicle alerts will, first and foremost, warn errant drivers with audible or visual alerts. In addition, connected vehicle systems have the potential to alert oncoming traffic when an errant driver is approaching. The following are examples where the automotive industry is developing in-vehicle alert systems for wrong-way driving:

- A new system developed by Daimler AG (primarily for use in Germany) was reported to be planned for Mercedes-Benz S-Class and E-Class model vehicles. The system consists of a camera inside the windshield, which visually identifies no-entry signs and alerts a vehicle's on-board electronics system and provides both an audible and visual alert to the driver. (Szczesny, 2013).
- Toyota unveiled a Reverse Warning Navigation System, designed to detect wrong-way driving on highways. According to Toyota, when the system recognizes wrong-way travel, visual and audible alerts warn the driver to stop and turn around. Toyota has not announced its plans to begin implementing its new safety features on production cars. (Archer, 2011).

5.0 Active Wrong-Way Countermeasure Deployments

This section provides an overview of active wrong-way countermeasure deployments documented during this project (June 2015 - July 2016). The deployments documented in this report do not reflect all State DOTs' efforts to mitigate wrong-way driving on freeways. The agencies and deployments were chosen based on initial research to identify in-place and soon-to-be implemented countermeasures. Efforts were made to include a variety of countermeasure types as well as similar types of deployments so that similarities, differences, and trends could potentially be identified. For each selected agency, one or more deployment summaries were created, based upon whether the countermeasure types varied significantly for each geographical area. Deployment summaries are included in [Appendix B](#) and include information collected via interviews with agency personnel and through additional research.

5.1 Deployment Summaries

Table 3 contains a list the active wrong-way deployments documented in this project. Interviews were initially conducted with representatives from each agency to gather details on wrong-way deployments. Follow-up interviews were again held after approximately 1 year to document any updates to the deployments such as lesson learned or evaluation results. Full deployment summaries documenting detailed information about each deployment can be found in [Appendix B](#). Hyperlinks from the Agency Name in Table 3 can be selected to quickly access each full deployment summary in [Appendix B](#).

Table 3: Wrong-Way Countermeasure Deployments

Wrong-Way Countermeasure Deployments (Select the Agency Name to View the Detailed Deployment Summary)	
Arizona DOT	Michigan DOT
Connecticut DOT	Missouri DOT
Florida: Central Florida Expressway	Ohio DOT
Florida DOT: Florida Turnpike Enterprise	Rhode Island DOT
Florida DOT: Statewide	Texas: Harris County Toll Road Authority
Florida DOT: Tallahassee	Texas DOT: San Antonio
Florida DOT: Tampa	Washington State DOT
Iowa DOT	Wisconsin DOT

Details described in each deployment summary include:

- Agency
- Agency Contact(s)
- Information Sources (i.e. references)
- Background
- Deployment Location
- Number of Sites
- Deployment Date(s)
- Test/Pilot or Long-term Deployment
- Countermeasure Type(s)
- Description of Countermeasures
- Evaluation Efforts/Results
- Coordination
- Guidelines or Standards
- Local/Public Response
- Lessons Learned
- Future Plans

5.2 Highlights of Wrong-Way Countermeasures

The following pages include tables that highlight key elements of each wrong-way deployment listed in Section 5.1, categorized by the following:

- Table 4: Active Deployments that Do Not Include ITS/Technology
- Table 5: Active Deployments with ITS/Technology

Deployment details listed in the tables on the following pages include:

- Agency
- Countermeasure Type(s)
- Primary Location(s)
- Number of Sites
- Deployment Date(s)
- Test/Pilot or Long-term Deployment
- Evaluation/Effectiveness Efforts or Results
- Standards, as applicable

5.2.1 Active Deployments that Do Not Include ITS/Technology

Table 4 provides a summary of details for nine (9) active deployments with countermeasures that do not include technology. These deployments typically include strategies such as static signing and/or pavement marking improvements. Select the agency name in Table 4 to access the full deployment summary in [Appendix B](#).

Table 4: Active Deployments that Do Not Include ITS/Technology

Active Deployments that Do Not Include ITS/Technology							
Agency	Preventative Countermeasures	Primary Location(s)	# of Sites	Deployment Date(s)	Test/Pilot or Long term	Evaluation Efforts/Results	Standards and Drawings
Arizona DOT	<p><u>Static Signing:</u></p> <ul style="list-style-type: none"> • Low-mounted WRONG WAY (WW) signs (3') • WW and DO NOT ENTER (DNE) signs mounted on same post • Red reflective strips on sign posts • Larger WW and DNE signs • WW signs on overhead structures <p><u>Pavement Markings:</u></p> <ul style="list-style-type: none"> • Wrong-way arrows with raised reflective pavement markers around arrows • Left-turn pavement marking guides 	Statewide	90 ramps	2014 - 2015	Long-term	Formal evaluation not planned due to random nature of WW crashes.	WW signing details provided.
Connecticut DOT	<p><u>Static Signing:</u></p> <ul style="list-style-type: none"> • Low-mounted WW and DNE signs (5') • Larger WW and DNE signs • Additional WW and DNE signs beyond standard minimums • Red reflective tape on posts <p><u>Pavement Markings:</u></p> <ul style="list-style-type: none"> • Wider stop bars (24") • Skip line extensions to entrance ramp • Double yellow line between ramps 	Statewide	700 ramps	Spring/Fall 2015	Long-term	Evaluation planned for 2-3 years after deployment.	Standard drawings provided.

Active Deployments that Do Not Include ITS/Technology

Agency	Preventative Countermeasures	Primary Location(s)	# of Sites	Deployment Date(s)	Test/Pilot or Long term	Evaluation Efforts/Results	Standards and Drawings
Florida DOT: Statewide		Statewide	Not specified, deployments ongoing	April 2015, ongoing	Long-term	Difficult to evaluate effectiveness due to the random nature of WW crashes.	Standard drawings provided
Michigan DOT	<u>Static Signing:</u> <ul style="list-style-type: none"> • Low-mounted WW & DNE signs (4') • Red reflective tape on sign posts 	Statewide	700 ramps	2012-2017	Long-term	Not decided - wait several years after full deployment.	Standard drawings provided
Michigan DOT		Statewide	256 ramps	2012-2017	Long-term	Not decided - wait several years after full deployment.	Standard drawings for low-mounted signs & red reflective posts provided. Ramp terminal details provided.

Active Deployments that Do Not Include ITS/Technology

Agency	Preventative Countermeasures	Primary Location(s)	# of Sites	Deployment Date(s)	Test/Pilot or Long term	Evaluation Efforts/Results	Standards and Drawings
Ohio DOT	<p><u>Static Signing:</u></p> <ul style="list-style-type: none"> • 2 WW signs on same post, lower sign at 3 ft. height • Dual directional route marker signs at end of ramp • Red reflective tape on sign posts • Additional signs beyond standard minimums <p><u>Pavement Markings:</u></p> <ul style="list-style-type: none"> • Extension lines to entrance ramp • Painted island between entrance/exit ramps • WW arrows on exit ramps (some locations) 	2 of 12 Districts: <ul style="list-style-type: none"> • District 6 in Central OH • District 2 in Northwest OH 	Not specified, deployments ongoing	District 6: 2008 District 2: 2013	Long-term	None planned due to random nature of WW crashes.	Wrong-way traffic control drawings provided
Rhode Island DOT	<p><u>Static Signing (varies by site):</u></p> <ul style="list-style-type: none"> • Type 11 signs (most reflective) • Low-mounted signs (4 ft.) • Oversized signs • “No Left Turn” mast arm signing • Signs on both sides of ramp • Red reflective sign post reflectors <p><u>Pavement Markings (varies by site):</u></p> <ul style="list-style-type: none"> • Arrows with recessed delineators • Extensions lines to entrance ramp <p><u>Other (varies by site):</u></p> <ul style="list-style-type: none"> • Straight arrow signal indication 	Statewide	Over 200 ramps	Spring 2015	Long-term		Details for signing and pavement marking configurations at ramps provided

Active Deployments that Do Not Include ITS/Technology

Agency	Preventative Countermeasures	Primary Location(s)	# of Sites	Deployment Date(s)	Test/Pilot or Long term	Evaluation Efforts/Results	Standards and Drawings
Washington State DOT	<p><u>Static Signing:</u></p> <ul style="list-style-type: none"> • Low-mounted signs (4') • Additional DNE and ONE WAY signs (some ramps) <p><u>Pavement Markings:</u></p> <ul style="list-style-type: none"> • WW pavement marking arrows • Skip line extensions to entrance ramp (side by side ramps) 	Statewide	48 interchanges	2012 - 2013	Long-term	Tracking # and location of WW instances reported by State Patrol before/after deployments.	Design details provided
Wisconsin DOT	<p><u>Static Signing:</u></p> <ul style="list-style-type: none"> • WW & DNE signs on same post, with lower WW sign at 3' height • Additional signs - both sides of ramp • Red reflective tape on sign posts • Added "No Left /Right Turn" signs • Added Freeway Entrance Signs at side by side ramps <p><u>Pavement Markings:</u></p> <ul style="list-style-type: none"> • Skip lines to entrance ramps • Additional turn arrows or WW arrows <p><u>Technology:</u></p> <ul style="list-style-type: none"> • WW signs with LED around border on each side of ramp - blinks continuously at night 	WisDOT Southeast Region	247 sites	Approx. 2013- 2015	Long-term	Tracking and logging WW events. Evaluation has not yet been conducted.	Details and agency standard/policy provided.

5.2.2 Active Deployments with ITS/Technology

Table 5 provides a summary details of thirteen (13) active deployments that utilize one or more ITS/technology approaches to mitigate wrong-way driving. These deployments may also include non-technology strategies such static signing or pavement marking improvements in the comprehensive treatment approach. Select the agency name in Table 5 to access the full deployment summary in [Appendix B](#).

Table 5: Active Deployments with ITS/Technology

Active Deployments with ITS/Technology								
Agency	Preventative Countermeasures	Reactive Countermeasures	Primary Location(s)	# of Sites	Deployment Date(s)	Test/Pilot or Long term	Evaluation Efforts/ Results	Standards and Drawings
Arizona DOT	None noted at these sites (See Table 4 for statewide improvements)		Phoenix area	5 ramps	Dec 2014 - Spring 2015	Test/Pilot	Plan to track and test technology.	No standards - test/pilot
Central Florida Expressway Authority	<u>Static Signing:</u> <ul style="list-style-type: none"> • Reflective strips on posts • Larger WW signs 		Orlando	5 ramps	2015	Test/Pilot	Univ. of Central Florida (UCF) conducting an evaluation	No standards- test/pilot

Active Deployments with ITS/Technology

Agency	Preventative Countermeasures	Reactive Countermeasures	Primary Location(s)	# of Sites	Deployment Date(s)	Test/Pilot or Long term	Evaluation Efforts/ Results	Standards and Drawings
Florida DOT: Florida Turnpike Enterprise	<p><u>Static Signing:</u></p> <ul style="list-style-type: none"> Oversized signs <p><u>Pavement Markings:</u></p> <ul style="list-style-type: none"> Additional WW arrows 		Homestead Extension of Florida Turnpike & Sawgrass Expressway - Miami/Ft. Lauderdale	<p>15 ramps</p> <p>12 mainline detection sites</p>	Mar. 2014 - Oct. 2014	Test/Pilot	Observations indicate WW drivers self-correct when encountering blinking LED WW signs.	No standards-test/pilot
Florida DOT: Tallahassee <i>(continued on next page)</i>		<p><u>Countermeasures:</u></p> <ul style="list-style-type: none"> WW driver: Vehicle-activated blank-out DMS that flashes “Wrong Way” 	I-10, Tallahassee	<p>Various sites (static signing and markings)</p> <p>4 urban ramps (Blank-out DMS)</p> <p>4 rural ramps (Internally Illuminated RPMs)</p>	2014 - 2016	Test/Pilot	Evaluation of internally illuminated RPMs is underway.	No standards-test/pilot

Active Deployments with ITS/Technology

Agency	Preventative Countermeasures	Reactive Countermeasures	Primary Location(s)	# of Sites	Deployment Date(s)	Test/Pilot or Long term	Evaluation Efforts/ Results	Standards and Drawings
Florida DOT: Tallahassee <i>(cont'd from previous page)</i>								
Florida DOT: Tampa	<u>Signing and Pavement Markings:</u> <ul style="list-style-type: none"> Exact configurations vary 		I- 275, Tampa	7 ramps	2014 - 2015	Test/Pilot		No standards-test/pilot

Active Deployments with ITS/Technology

Agency	Preventative Countermeasures	Reactive Countermeasures	Primary Location(s)	# of Sites	Deployment Date(s)	Test/Pilot or Long term	Evaluation Efforts/ Results	Standards and Drawings
Iowa DOT			US Hwy 30, Ames, IA vicinity	Signing and Markings - # sites not specified, 23.6 miles along US Hwy 30 Mainline Detection Testbed - 24 sites	Signing and Markings: 2015-ongoing Mainline detection: July 2014	Long-term for signing and pavement markings	July 2014- May 2016: Freeway point of entry identified for 26 of 43 confirmed WW events.	No standards in place.
Missouri DOT	Static Signing: <ul style="list-style-type: none"> Increased quantity WW, DNE, & ONE WAY signs - both sides of ramp 		St. Louis District	Increased static signs: 30 sites Detection and LED signs: 12 ramps	Nov. 2014- Nov. 2015	Long-term	5-year crash data analysis will likely be conducted.	

Active Deployments with ITS/Technology

Agency	Preventative Countermeasures	Reactive Countermeasures	Primary Location(s)	# of Sites	Deployment Date(s)	Test/Pilot or Long term	Evaluation Efforts/ Results	Standards and Drawings
Ohio DOT	None specifically noted. (See Table 4 for signing and pavement marking countermeasures.)		Columbus, OH	Not Specified	September 2015	Test/Pilot	None planned due to random nature of WW crashes. Observed drivers self-correcting	No standards–test/pilot
Rhode Island DOT			Metro areas, mostly in Providence area	24 ramps	May 2015	Long-term	No formal evaluation planned. Observed drivers braking and self-correcting.	None provided.

Active Deployments with ITS/Technology

Agency	Preventative Countermeasures	Reactive Countermeasures	Primary Location(s)	# of Sites	Deployment Date(s)	Test/Pilot or Long term	Evaluation Efforts/ Results	Standards and Drawings
Texas: Harris County Toll Road Authority			Westpark Tollway, Houston	Detection: 14 sites Blinking LED signs: approx. 20 ramps In-pavement lighting: 1 ramp (will be phased out)	Initial: 2008 Enhanced: 2011-2016	Long-term	In 2015, 28 of 40 (70%) wrong-way drivers detected by the system self-corrected.	None noted.
Texas DOT: San Antonio US281		<ul style="list-style-type: none"> Ramp detection in place but not in use as of May 2016 	US 281, San Antonio	Additional static signs and LED signs: 28 ramps	2012-2015	Long-term	34% reduction in monthly avg. rate of WW events (July 2012 to March 2016)	Some standards in San Antonio district, none yet statewide.

Active Deployments with ITS/Technology

Agency	Preventative Countermeasures	Reactive Countermeasures	Primary Location(s)	# of Sites	Deployment Date(s)	Test/Pilot or Long term	Evaluation Efforts/ Results	Standards and Drawings
Texas DOT: San Antonio I-10 and I-35	Static Signing: <ul style="list-style-type: none"> • Additional WW & DNE signs both sides of ramp • Red reflective tape on sign posts 		I-10 & I-35, San Antonio	4 sites	2013-2015	Long-term	Tracking WW events using TMC and 911 logs.	Some standards and processes in San Antonio District, none yet statewide.
Wisconsin DOT			Milwaukee area	Blinking LED signs: 3 ramps Detection with alert to TOC: 8 ramps	2013-2015	Long-term	Tracking and logging WW events. Evaluation has not yet been conducted.	Details and agency policy provided.

6.0 Key Findings

Key findings derived from the deployments tracked as a part of this project are summarized in this section. Relevant information from published literature is also cited where applicable. See [Appendix B](#) for details about each deployment, along with references and information sources for each deployment.

6.1 Design and Implementation Considerations

Key findings focused on design and implementation of wrong-way countermeasures are categorized by commonly used countermeasures, use of multiple countermeasures, methods to determine where wrong-way drivers are entering the freeway to help drive decision-making, statewide deployments and standards, and climate considerations.

- **Most Common Countermeasures:** The most commonly deployed countermeasures included the following non-technology treatments:
 - Additional signs beyond MUTCD standards (e.g. both sides of exit ramp)
 - Red reflective tape on sign posts for enhanced conspicuity
 - Oversized signs
 - Lowering sign heights - Lowering a single sign or mounting a second sign panel below a standard height sign on the same post
 - Pavement marking “skip line extensions” to guide drivers onto the entrance ramp
 - Wrong-way pavement marking arrows - Additional white wrong-way arrows or arrows enhanced with raised pavement markers (RPMs)
- **Use of Multiple Countermeasures:**
 - [Central Florida Expressway Authority](#): Noted that the pilot deployment is designed to perform as an entire “system,” with multiple strategies including ramp detection with camera for verification, flashing RRFBs on WRONG WAY signs to alert the wrong-way driver, alert to TMC, alert to oncoming right-way traffic, and data collection/logging to understand driver patterns.
 - [Florida DOT \(Florida Turnpike Enterprise\)](#): Results of a human factors study conducted for FDOT by Florida State University reported that lab and simulated studies suggest that increasing the number and diversity of countermeasures at interchanges can reduce confusion regarding highway entry points. (Boot et al., 2015)
- **Determination of Freeway Entry Points:**
 - [Iowa DOT](#): A testbed instrumented in Ames, Iowa consists of mainline detection and recorded video collected from traffic cameras to verify wrong-way driving events. The testbed is aimed at determining point of entry onto the freeway to help identify problematic interchanges and other trends. From July 2014 to May 2016, DOT staff determined the point of entry for 26 of 43 confirmed wrong-way driving events. Staff also observed more than 200 confirmed “pass-bys” on video, where right-way traffic passed by a wrong-way vehicle without a crash.
- **Statewide Deployments and Standards:**
 - The following agencies have implemented statewide deployments in an attempt to systematically address wrong-way driving: [Arizona DOT](#), [Connecticut DOT](#), [Florida DOT](#), [Michigan DOT](#), [Rhode Island DOT](#), and [Washington State DOT](#).

- [Connecticut DOT](#), [Florida DOT](#), [Michigan DOT](#), [Washington State DOT](#), [Wisconsin DOT](#), and [Ohio DOT](#) have adopted standards or policies for signing and pavement markings at freeway interchanges (either all ramps or selected ramp types).
- **Climate Considerations for Low-Mounted Signs:**
 - Mounting heights for low-mounted static signs (e.g. WRONG WAY or DO NOT ENTER signs) range from 2 ft. to 5 ft., compared to 7 ft. standard mounting height for urban areas.
 - Snow maintenance considerations have prompted agencies in northern regions or higher elevations to mount signs higher than 2 ft. but lower than 7 ft.; these deployments have not been in place long enough to determine effectiveness. Agencies reported no issues with damage to signs from snow removal operations.

6.2 Effectiveness

Determining the effectiveness of wrong-way driving countermeasures can be challenging, due to factors such as the random nature of wrong-way crashes or lack of “before” data. Evaluations also require agency resources, especially if attempting to track all wrong-way driving events including those that do not result in crashes. Evaluation results and anecdotal observations are summarized below.

- **“Young” Deployments:** Many of the deployments tracked as a part of this project have not been in place long enough to have sufficient “after” crash data to determine effectiveness of countermeasures deployed.
- **Difficult to Evaluate:** Several agencies noted the effectiveness of specific countermeasures will be difficult to evaluate due to the random nature of wrong-way crashes, lack of “before” data, and inconsistency due to deployments not concentrated in a specific area or along a corridor.
- **Evaluation Results and Anecdotal Observations:** Some agencies ([Texas DOT - San Antonio District](#), [Washington State DOT](#), [Wisconsin DOT](#), [Iowa DOT](#), [Harris County Toll Road Authority](#)) are tracking the number of wrong-way driving occurrences through 911 logs or reports to the TMC. Other agencies plan to conduct studies using crash data after deployments have been in place for several years ([Connecticut DOT](#), [Florida DOT- Tampa](#), [Missouri DOT](#)).

The following agencies reported evaluation results or observations regarding effectiveness:

- [Texas DOT \(San Antonio\)](#): Evaluation of enhanced signing (including LED-enhanced blinking WRONG WAY signs) at ramps along U.S. Hwy 281 showed a 34% reduction in the average monthly rate of TransGuide TMC wrong-way driving event logs from July 2012 to March 2016. Similar results were seen in San Antonio Police Department logs.
- [Harris County Toll Road Authority \(Texas\)](#): Deployed blinking LED lights around the sign border that blink continuously day and night. Data collected and visually verified in 2015 showed that 28 of 40 (70%) wrong-way drivers detected by the system self-corrected.
- Several agencies observed wrong-way drivers self-correcting (e.g. braking, turning around) when encountering “flashing” or “blinking” lights on WRONG WAY signs. This includes LEDs around sign borders and Rectangular Rapid Flashing Beacons (RRFBS) on signs.

Additional research on effectiveness:

- In California, countermeasures implemented in the early 1970s included low-mounted signs, WRONG WAY and DO NOT ENTER signs on the same post, sign placements visible to

driver at decision points, freeway entrance signs close to entrance ramps, and discontinued use of symbol right or left turn prohibited signs. These improvements reduced the frequency of wrong-way driving from 50-60 per month to 2-6 per month at 90% of problematic locations (Kaminski and Leduc, 2008).

- In Illinois, a preliminary evaluation of countermeasures that include additional WRONG WAY signs, oversized signs, red reflective tape on posts, wrong-way arrows, and dotted extension lines to guide drivers onto entrance ramps indicate a downward trend in the number of identified wrong-way driving crashes. Due to the short after period and small scale countermeasures implemented by several districts, this downward trend may be due to the random nature of crashes. (Zhou & Rouholamin, 2015).

6.3 ITS/Technology Countermeasures

Many agencies are utilizing ITS technologies to help mitigate wrong-way driving on freeways. This includes detection-based systems to trigger alerts to errant drivers and messages to TMCs and law enforcement, as well as continuously activated devices designed to catch drivers' attention at nighttime when wrong-way driving events are more common. Following are examples of ITS technologies used to deter wrong-way drivers.

- **Detection with Alert to TMC:**
 - Nearly all of the ITS/technology deployments include detection that sends an alert to the TMC in conjunction with the on-site functionality to trigger an alert to the wrong-way driver (e.g. trigger signs to flash). A few deployments have on-site detection only, with no communications back to the TMC.
- **Detection at Freeway Ramps and Mainlines:**
 - Detection types primarily consist of dual radar units and high-definition radar, with some use of in-pavement loop detectors.
 - Several agencies reported a preference for redundant detection systems to minimize "false positive" detections. This often includes two radar units and a camera that takes a photo of the vehicle after radar detection and sends the photo to TMC operators for verification. Agencies that first implemented a single detection unit and later switched to a redundant detection system reported far fewer "false positives."
 - Nearly all agencies with detection systems at exit ramps reported significant reductions in "false positives" over time by working with the vendor to troubleshoot and implement improvements with the detection system, especially when implementing redundancy.
 - [Iowa DOT](#) has systematically tracked wrong-way alerts from a series of side-fire high-definition radar detectors at mainline sites for nearly 2 years, noting a very high "false positive" detection rate of 98% (i.e. 98% of detection alerts received by DOT staff were not wrong-way events, per post-review of video footage at the detection sites.)
- **Passive vs. Reactive Systems:**
 - For deployments of blinking LEDs around the WRONG WAY Sign border, the following type of signs have been deployed:
 - "Passive" signs in which LEDs blink continuously day and night
 - "Passive" signs in which LEDs blink continuously during night or low light conditions

- “Reactive” vehicle-activated systems in which a wrong-way vehicle detected by a sensor at the site triggers the sign to blink
- [Texas DOT \(San Antonio District\)](#): The U.S. Hwy 281 deployment includes WRONG WAY signs with LED lights around the sign border that blink continuously at night or in low light conditions. Earlier research conducted by Texas DOT showed that 72% of WW driving events occurred at night.
- “Passive” systems such as those that flash or blink continuously do not require detection devices and are therefore less costly to install, operate, and maintain. However, detection systems do provide agencies with the ability to be alerted to wrong-way driving events and initiate response efforts.
- **Experimental Approaches:**
 - In-Pavement Lighting: [Florida DOT \(Tallahassee\)](#) deployed internally illuminated raised pavement markers that create the illusion of a stop bar at the end of the exit ramp. This in-pavement lighting flashes continuously at night; four (4) pilot sites have been deployed for testing in rural areas. In-pavement lighting at one exit ramp deployed by the [Harris County Toll Road Authority \(Texas\)](#) will be phased out due to maintenance issues.
 - Rectangular Rapid Flashing Beacons (RRFBS) on WRONG WAY signs: Deployed by [Central Florida Expressway Authority](#) and [Florida DOT \(Tampa\)](#). Technology evaluations are underway for both deployments.
- **Comprehensive and Automated Systems:**
 - [Harris County Tollway Authority \(Texas\)](#): Customized its video management software to automate and streamline response efforts. Upon detection of a wrong-way driver, an audible alarm sounds at the Incident Management Center (IMC). Nearby traffic cameras automatically pan toward the detection site, and a GIS-based wrong-way vehicle detection map shows the vehicle’s direction of travel to assist IMC operators with response efforts. Software customization allows operators to push one button to activate nearby DMS messages, as opposed to logging in and typing the message.
 - Arizona DOT and Texas DOT are developing and testing comprehensive “connected” systems that coordinate multiple technologies to detect wrong-way events, track errant drivers, and trigger automated alerts and response efforts. See Section 4.2.2 for details.

6.4 Posting Messages on DMS to Oncoming Traffic

Several agencies reporting that they post messages on Dynamic Message Signs (DMS) to alert oncoming right-way traffic when a wrong-way driving event occurs. Following are examples of messages posted and the process for posting the wrong-way messages.

- **Message Content:** The content of messages posted to DMS varies widely among agencies:
 - [Florida DOT \(Florida Turnpike Enterprise\)](#): WRONG WAY DRIVER REPORTED USE CAUTION
 - [Florida DOT \(Tampa\)](#): WRONG-WAY DRIVER ALERT USE EXTREME CAUTION
 - [Rhode Island DOT](#): WRONG-WAY DRIVER USE CAUTION
 - [Harris County Tollway Authority \(Texas\)](#): WARNING WRONG WAY DRIVER AHEAD; WARNING ALL TRAFFIC MOVE TO SHOULDER AND STOP

- [Texas DOT \(San Antonio District\)](#):
 - Current Message: WRONG WAY DRIVER REPORTED – USE EXTREME CAUTION
 - Plans to modify DMS messages to:
 - a) WARNING WRONG WAY DRIVER REPORTED (recommended)
 - b) WARNING WRONG WAY VEH REPORTED (alternative 15-character message)
- **Process for Posting Messages:**
 - Most agencies post messages on DMS to alert oncoming right-way traffic after operators visually confirm the wrong-way driver using traffic cameras.
 - [Texas DOT \(San Antonio District\)](#): TMC operators post the alert message on DMS upon receiving notification of detection at the ramp site; operators do not wait for visual verification from traffic cameras.

6.5 Feedback from Local Motorists

Agencies shared information about whether or not they have received feedback from motorists in areas where wrong-way driving countermeasures are deployed.

- **Limited Public Response:**
 - The majority of agency contacts reported receiving very limited or no feedback from motorists after implementing countermeasures (e.g. after installing new signs, changing pavement markings, etc.)
- **Potential Influences from Media Coverage:**
 - Several agencies noted that stories from the news media following wrong-way crashes tend to draw attention to the wrong-way driving issue, prompting public interest.
 - [Rhode Island DOT](#): Reported an anecdotal observation that wrong-way driving events tend to decrease after media stories on the topic, suggesting that public education campaigns may have a positive effect.

6.6 Coordination and Education

Coordination among DOTs and law enforcement, paired with educational efforts within local communities can be effective in helping to mitigate the wrong-way driving problem.

- Several agencies indicated that targeted efforts to address wrong-way driving have improved the DOT's degree of coordination with state or local law enforcement. This may involve working with law enforcement personnel to identify problem areas or to track wrong-way events.
- [Texas DOT \(San Antonio District\)](#): The San Antonio Wrong Way Task Force was formed in 2011 to address the growing issue of wrong-way driving. The Task Force has coordinated on capabilities, planned mitigation efforts, and began tracking wrong-way driving events. The Task Force conducted outreach to owners of drinking establishments near freeway interchanges to educate them about the issue of wrong-way driving. In addition, the San Antonio Police Department (SAPD) added "wrong-way driver" as one of the uses of an e-tone on police radio.
- [Missouri DOT](#): A multi-agency safety coalition which includes MoDOT and law enforcement personnel assisted in selecting I-44 in St. Louis as a pilot for deployment of mitigation strategies.
- [Florida DOT \(Tampa\)](#): DUI education efforts are underway, as a part of FDOT's Consistent, Predictable, Repeatable (CPR) practices.

Appendix A: Literature Search Summary

The following table contains a summary of resources and deployments identified in the initial literature search for this project, completed January 2015. The search was conducted in order to identify deployments for further documentation. As the project progressed and new literature was published, the research team became aware of additional publications that contain relevant information; these additional resources are also listed in this appendix.

Summary of Resources and Deployments (January 2015)	
Low-mounted Static Signs	<ul style="list-style-type: none"> • Caltrans: DO NOT ENTER and WRONG WAY Signs mounted together 2 ft. above the ground; One-Way arrow signs mounted 1.5 ft. above the ground. (Wrong-Way Driving Countermeasures, Kaminski Leduc, 2008; Countermeasures for Wrong-Way Movement on Freeways: Overview of Project Activities and Findings, Cooner, Cothron & Ranft, 2004) <ul style="list-style-type: none"> - NOTE: Countermeasures implemented by Caltrans in the early 1970s included low-mounted signs, WRONG WAY and DO NOT ENTER signs on the same post, sign placements visible to driver at decision points, freeway entrance signs close to entrance ramps, and discontinued use of symbol right or left turn prohibited signs. These improvements reduced the frequency of wrong-way driving from 50-60 per month to 2-6 per month at 90% of problematic locations (Kaminski and Leduc, 2008). • State of Virginia: Uses low-mounted DO NOT ENTER and WRONG WAY Signs mounted together on one post, as a standard practice. (Wrong-Way Driving Countermeasures, Kaminski Leduc, 2008; Countermeasures for Wrong-Way Movement on Freeways: Overview of Project Activities and Findings, Cooner et al., 2004) • Georgia DOT: Low-mounted DO NOT ENTER and WRONG WAY signs mounted on one post, 24-inch wide painted stop bar at the crossroad end of the ramp. (Wrong-Way Driving Countermeasures, Kaminski Leduc, 2008; Countermeasures for Wrong-Way Movement on Freeways: Overview of Project Activities and Findings, Cooner et al., 2004) • Texas: Low-mounted static wrong-way signage. Crash tested by Texas A&M (TTI). Installed at 28 locations in July 2011. Continuous monitoring. Effectiveness analyzed in August 2012. Incidents reported at various locations before and after sign placement. Some test locations had fewer but repeated incidents despite the lower signs. It was recommended to expand to include additional locations. (Proceedings of the 2013 National Wrong-Way Driving Summit, Zhou & Rouholamin, 2014b) • Michigan DOT: “Michigan Wrong Way Freeway Crashes” presentation by David Morena (FHWA) and Kim Ault (MDOT) describes low cost countermeasures on 161 Interchanges in Michigan, at an estimated cost of \$1,161,300 (117 of 161 interchanges treated or programmed, cost so far \$765,500.) Described signing standards at all exit ramps as: 4 foot bottom height with 3 foot reflective sheeting for WRONG WAY and DO NOT ENTER signs. (Proceedings of the 2013 National Wrong-Way Driving Summit, Zhou & Rouholamin, 2014b)

Summary of Resources and Deployments (January 2015)

	<ul style="list-style-type: none"> • Washington State DOT: Statewide implementation of low mounted signs and Type 5 pavement marking arrows at three types of interchanges: partial cloverleaf, two-way street across from exit ramp, and slip exit ramp. WSDOT is tracking number of wrong way movements reported by State Patrol before/after improvements. (interview with Rick Mowlds, WSDOT Signing Engineer, on 11/10/14.) • Texas A&M Transportation Institute: A closed-course study conducted at Texas A&M Transportation Institute found that lowering the height of the sign did not improve the ability of the alcohol-impaired driver to locate signs, identify background color, or read the legend, compared to the standard 7 ft. sign height. (Assessment of the Effectiveness of Wrong Way Driving Countermeasures and Mitigation Methods, Finley, Venglar, Iragavarapu, Miles, Park, Cooner & Ranft, 2014)
<p>Enhanced Static WRONG WAY and DO NOT ENTER Signs</p>	<ul style="list-style-type: none"> • Rhode Island DOT: Currently undertaking a wrong-way mitigation project. “All wrong-way signs located between two highway ramps will be angled 45 degrees to better grab the attention of potential wrong-way drivers.” (Ask the DOT: Wrong-way project will help save lives, Amoros, 2014) • Ohio: Placed additional Wrong-Way Signs on ramps and affixed red reflective tape to sign posts to enhance nighttime visibility. (Wrong-Way Driving Countermeasures, Kaminski Leduc, 2008; NCHRP Report 500 Volume 20: A Guide for Reducing Head-on Crashes on Freeways, Neuman, Nitzel, Antonucci, Nevill & Stein, 2008) • Texas DOT: A planned approach for the San Antonio area includes inspection and evaluation of all freeway ramps to consider enhanced signing (such as additional and/or larger wrong-way signs) and enhanced pavement markings. (The San Antonio Wrong Way Driver Initiative, Texas Department of Transportation, n.d.) • Connecticut DOT: Upgrading and standardizing signing and pavement markings at exit ramps for all limited access highways in the State. The new signs will be larger and more visible due to the high retro-reflectivity of the sign material and the use of red post delineator strips on the sign posts. The new pavement markings will be more visible and help guide drivers towards the entrance ramps. Data collection analysis will be performed to determine the effectiveness of the engineering countermeasures installed. (Wrong-Way Driving, Connecticut Department of Transportation, n.d.) • North Texas Toll Authority: Installed Red Reflective tape on “Wrong Way” and “Do Not Enter” signs at the Dallas North Tollway, Sam Rayburn Tollway, and President George Bush Turnpike exit ramps, total cost \$4,378. (Keeping NTTA Roadways Safe: Wrong-Way Driver Task Force Staff Analysis, North Texas Tollway Authority, 2009) • Arizona DOT: In June 2104, the Arizona DOT installed additional pavement markings and lower, larger wrong-way signs at six exit ramps in the Valley (Phoenix). “The larger wrong-way sign will be a standard on future construction projects when signs are due to be replaced” ADOT spokesman Doug Nintzel said. (Eastbound I-10 reopens after wrong-

Summary of Resources and Deployments (January 2015)

	<p>way crash, Cassidy, 2014) Larger "Do Not Enter" signs along the ramps are increased in size from 30 by 30 inches to 48 by 48 inches. Beneath them, the new "Wrong Way" signs measure 48 by 36 inches. The bottom of the lower signs will be located three feet from the ground, compared to the seven-foot clearance for wrong-way signs at most other state-highway interchanges. Also adding red reflective pavement markers in the shape of large arrows pointing the right way along the exit ramps. (ADOT to test 'Wrong Way' sign changes, add reflective pavement arrows at several Phoenix-area freeway interchanges, Arizona Department of Transportation, 2014)</p> <ul style="list-style-type: none"> • Michigan DOT: Combination of improvements made (or planned) at exit ramp areas include: low mounted "Wrong Way" and "Do Not Enter" signs, <i>reflective sheeting on "Wrong Way" and "Do Not Enter" sign posts</i>, stop bars at exit ramps, wrong-way pavement arrows at exit ramps, pavement marking extensions that guide crossroad left-turning traffic past the exit ramp onto the entrance ramp, paint the island between exit and entrance ramps at end of exit ramp, place red delineators along the exit ramp on guardrail or on delineator posts. (Where These Drivers Went Wrong, Morena & Leix, 2012)
Enhanced Pavement Markings	<ul style="list-style-type: none"> • North Texas Toll Authority: Installed <i>raised pavement marker arrows</i> at 47 DNT exit ramps, 37 SRT exist ramps, and 40 PGBT exit ramps (page 9) total cost \$39,499. <i>Markers appear white to those driving in the proper direction, but red to those who drive the wrong way.</i> (Keeping NTTA Roadways Safe: Wrong-Way Driver Task Force Staff Analysis, North Texas Tollway Authority, 2009) • Connecticut DOT: Upgrading and standardizing signing and pavement markings at exit ramps for all limited access highways in the State. The new <i>pavement markings will be more visible and help guide drivers towards the entrance ramps.</i> (Wrong-Way Driving, Connecticut Department of Transportation, n.d.) • Michigan DOT: Improvements at exit ramp areas include: low mounted "Wrong Way" and "Do Not Enter" signs, reflective sheeting on "Wrong Way" and "Do Not Enter" sign posts, <i>stop bars at exit ramps, wrong-way pavement arrows at exit ramps, pavement marking extensions that guide crossroad left-turning traffic past the exit ramp onto the entrance ramp</i>, paint the island between exit and entrance ramps at end of exit ramp, place red delineators along exit ramp on guardrail or on delineator posts. (Where These Drivers Went Wrong, Morena & Leix, 2012)
Treatments Applied to Infrastructure on Exit Ramps	<ul style="list-style-type: none"> • Michigan DOT: Improvements made (or planned) t exit ramp areas include: low mounted "Wrong Way" and "Do Not Enter" signs, reflective sheeting on "Wrong Way" and "Do Not Enter" sign posts, stop bars at exit ramps, wrong-way pavement arrows at exit ramps, pavement marking extensions that guide crossroad left-turning traffic past the exit ramp onto the entrance ramp, <i>paint the island between exit and entrance ramps</i> at end of exit ramp, <i>place red delineators along exit ramp on guardrail or on delineator posts.</i> (Where These Drivers Went Wrong, Morena & Leix, 2012)

Summary of Resources and Deployments (January 2015)

<p>On-Site Channelization by Property Owners</p>	<ul style="list-style-type: none"> Texas DOT: A planned approach in the San Antonio area includes working with property owners such as those near drinking establishments, to implement on-site channelization that helps prevent drivers from taking a wrong turn onto a frontage road or street. This involves <i>placing driveway curbs that separate the entering lanes from the exiting lanes and provides a curve in the direction of right-way travel for traffic exiting the development and entering a street or frontage road</i>. This is a voluntary action on the part of property owners. (The San Antonio Wrong Way Driver Initiative, Texas Department of Transportation, n.d.)
<p>Geometric Roadway Design Elements and Modifications</p>	<ul style="list-style-type: none"> Washington State: Conducted a 10-year study from 1986 to 1996 of an 80-mile section of I-82 that revealed 30 wrong-way crashes along the corridor. The study found that the most probable wrong-way entry location was a partial-cloverleaf interchange at I-82 and Highway 22 (i.e., looping ramps separated by concrete barriers that drivers could not see around). Then from May to December 2001, camera monitors recorded 18 wrong-way incidents at this location. As a result, the Washington DOT <i>removed stretches of the barriers at that and similar interchanges</i> in the South Central Region to provide drivers with better visibility of on-ramps. (Stop. You're Going the Wrong Way!, Moler, 2002) Multiple Locations and Approaches: Several geometric elements that are capable of discouraging wrong-way maneuvers are identified. Guidelines for implementing <i>improved geometric elements are provided for exit/entrance ramps, frontage roads, raised medians, channelizing islands, corner/control radius, and sight distance</i>. (Guidelines for Reducing Wrong-Way Crashes on Freeways, Zhou & Rouholamin, 2014a)
<p>Institutional Coordination</p>	<p><u>Multi-agency Coordination:</u></p> <ul style="list-style-type: none"> Texas DOT: The <i>San Antonio Wrong Way Driving Task Force</i> convened a group of stakeholders from the Texas Department of Transportation (TxDOT), the San Antonio Police Department (SAPD), the City of San Antonio Public Works Department (CoSA), the Bexar County Sheriff's Department (BCSD), the Federal Highway Administration (FHWA), and the Texas Transportation Institute (TTI) to coordinate efforts to address the wrong way driving issue in San Antonio. This allowed each agency to bring its own unique resources and experience to the effort, combining previous knowledge, available data, research efforts and lessons learned from each agency. (The San Antonio Wrong Way Driver Initiative, Texas Department of Transportation, n.d.) <p>Enforcement:</p> <ul style="list-style-type: none"> Multiple Locations: Strategies include law enforcement <i>coordination with DOT traffic management centers to expedite responses to wrong way</i> detections and/or reports, and <i>frequent DUI Task Force operations</i>. (Assessment of the Effectiveness of Wrong Way Driving Countermeasures and Mitigation Methods, Finley et al., 2014) <p>Public Education:</p> <ul style="list-style-type: none"> Multiple Locations: Strategies include <i>public awareness campaigns</i> related to driving impairment, efforts to <i>reduce involvement of older drivers in wrong way collisions</i>, and <i>targeted programs</i> to influence driving habits of particular

Summary of Resources and Deployments (January 2015)

groups. ([Assessment of the Effectiveness of Wrong Way Driving Countermeasures and Mitigation Methods](#), Finley et al., 2014)

Legislative Modification:

- **New York:** The New York Senate transportation committee approved legislation (S3452) that would *establish a new crime of aggravated reckless driving which would apply to drivers who drive the wrong way*, against the flow of traffic, either knowingly or because they are intoxicated. Aggravated reckless driving would be a class E felony, punishable by a prison sentence of up to four years. ([Senate passes legislation to create felony charges for wrong-way and reckless drivers](#), Skelos, 2012)
- **Ohio:** The Ohio State Legislature began *considering tougher fines for wrong way drivers*, with penalties including license suspensions, jail time, and fines. ([Ohio senators urge tougher fines for wrong-way drivers](#), Provance, 2012)

Pavement Spikes

- **Multi-State (U.S) Survey:** A 1989 Caltrans survey sent to chief traffic engineers in 50 states to find out what they are doing about WWV. 40 traffic engineers responded, none supported using parking-lot spikes, barriers, raised plates or curbs. It was found some devices caused damage to vehicles (including right way traveling vehicles, also some observed that when right way traveling vehicles see spikes, the reaction of some is to brake quickly. ([Keeping NTTA Roadways Safe: Wrong-Way Driver Task Force Staff Analysis](#), North Texas Tollway Authority, 2009)
- **Texas DOT:** Texas DOT reports that “tire spike strips are designed for very low-speed locations; manufacturers’ literature specifies that they are intended for installation at locations where speeds do not exceed 5 mph. They are not designed to work at high-speed, high-volume traffic locations such as freeway exit ramps. The placement of spike strips or other destructive devices cannot be considered by the Texas Department of Transportation due to the significant risk the installation of such a device would create for drivers traveling in the correct direction on the ramps.” ([The San Antonio Wrong Way Driver Initiative](#), Texas Department of Transportation, n.d.)

Summary of Resources and Deployments (January 2015)

<p>Illuminated Wrong-Way Signs</p>	<ul style="list-style-type: none"> <p>Texas DOT: Exit ramps in the San Antonio area have two LED Illuminated Wrong-Way Signs placed on each ramp, in addition to the standard Wrong Way Signs. The signs, which have flashing LED lights around the border of the sign, are photocell activated to operate continuously at night and in low light conditions. (The San Antonio Wrong Way Driver Initiative, Texas Department of Transportation, n.d.) A study conducted at the Texas A&M Transportation Institute assessed Texas DOT datasets from this deployment. Preliminary data on US 281 corridor in San Antonio suggests 36 percent reduction in monthly wrong way driving event rate; the impact on WWD crashes is still unknown due to the small number of crashes that occurred during the evaluation period. In the same study, a closed-course test indicated that alcohol-impaired drivers needed to be closer to a sign with flashing red LEDs around the border before they could read the legend, as compared to no LEDs. Making the sign larger, adding red reflective sheeting to the sign post, and adding red flashing LEDs around the border did not improve the alcohol-impaired driver’s ability to locate Wrong Way signs; however, participants felt that these three countermeasures caught their attention more than lower signs. (Assessment of the Effectiveness of Wrong Way Driving Countermeasures and Mitigation Methods, Finley et al., 2014)</p> <p>Wisconsin DOT: Two freeway ramps in the Milwaukee, WI area will be equipped with solar-powered Wrong Way signs that blink continuously from dusk to dawn. A total of nine ramps will also have detection capability with text messages sent to the DOT Operations Center and the Milwaukee County Sheriff’s Department. (Milwaukee County launches effort to halt wrong-way drivers on freeways, Jones, 2012)</p>
<p>In-Pavement Lighted Markings</p>	<ul style="list-style-type: none"> <p>Caltrans: In-pavement warning lights are used on exit ramps prone to wrong-way incidents. When a wrong-way vehicle drives over an inductive loop detector, it activates a series of warning lights imbedded in the pavement alerting the driver that he or she has entered an off-ramp or other restricted roadway. (Wrong-Way Driving Countermeasures, Kaminski Leduc, 2008; Countermeasures for Wrong-Way Movement on Freeways: Overview of Project Activities and Findings, Cooner et al., 2004)</p> <p>Caltrans: “In the mid-1970s, Caltrans experimented with using red runway-type pavement lights to warn wrong-way drivers in the San Diego area. The pavement lights proved effective in reducing wrong-way movements, but because the equipment was costly to install, about \$10,000 for each unit, and required constant maintenance, the project was discontinued.” (Stop. You're Going the Wrong Way!, Moler, 2002)</p>
<p>Dynamic Alert Systems</p>	<ul style="list-style-type: none"> <p>Missouri DOT: Implementing a pilot program to install solar-powered signs with sensors to detect vehicles moving in the wrong direction down exit ramps. When the vehicle has been detected, the signs will flash and will also alert local law enforcement. Fifteen signs (costing \$100,000) will be installed at eight locations along I-44. MoDOT plans to conduct local testing during both daylight and nighttime hours, and will also gather data over the next few years. (Missouri DOT to Test New Method of Wrong-Way Accident Prevention, Smith, 2014)</p>

Summary of Resources and Deployments (January 2015)

- **Rhode Island DOT:** Currently undertaking a wrong-way mitigation project. Identified 24 high-risk locations where detection systems will be installed, to immediately **flash a message to the driver traveling in the wrong direction, notify the state police, take a picture of the vehicle, and alert other motorists by displaying a message on overhead highway signs.** ([Ask the DOT: Wrong-way project will help save lives](#), Amoros, 2014; [Wrong Way Crash Avoidance](#), Rhode Island Department of Transportation, n.d.; [Wrong-way driving technology set to be installed in RI](#), Gaito & Sullivan, 2014)
- **Florida DOT:** The Florida DOT is using two separate pilot programs to detect wrong-way drivers. One pilot program, along Interstate 10, uses radar at freeway ramps to detect wrong-way drivers and activate **signs that flash "wrong way"** if a wrong-way driver is detected. The other pilot program, along the Homestead Extension of Florida's Turnpike near Miami, uses new software that detects a wrong-way driver and **alerts law enforcement.** (McCowan, 2013)
- **Florida DOT (Florida Turnpike):** Countermeasures to detect, alert, and potentially deter would be wrong-way driving were deployed at 15 interchanges on the Florida Turnpike system. Includes 6 interchanges and 10 ramps in Miami-Dade County, and 5 interchange ramps in Broward County. Includes **LED lighted wrong-way roadway signs** triggered by detection equipment, and **notification of law enforcement agencies.** (Huff, 2014)
- **New York State Thruway Authority (NYSTA):** NYSTA deployed **Doppler-radar-enhanced LED signs** to alert wrong way drivers before entering the Niagara Expressway (at the Southbound exit 9 off-ramp in Buffalo, and will also be installed at exit 10 on I-87/I-287 In Nyack. "Doppler radar is used to detect vehicles traveling the wrong way and when identified, **the sign flashes a customized LED message to alert the drivers of their error and instruct them to pull over and turn around** when it is safe to do so. The sign will also trigger **automatic alerts to other drivers** on the Thruway's variable message sign system, and **automatically alert the Thruway's Statewide Operations Center.**" ([Governor Cuomo Announces First in the Nation 'Wrong-Way' LED Signs Placed On Thruway](#), New York Governor's Press Office, 2013) Another source describes the alternating messages as "Wrong Way", "STOP", "Pull Over". Lists the cost per sign of \$10,000. ([High-tech sign seeks to prevent wrong-way drivers from entering Thruway](#), Michel, 2013)
- **Harris County Toll Road Authority (Texas):** Radar detectors are used to detect wrong-way vehicles entering the toll road. When detected, they **sound an audible alarm in the Traffic Operations Center (TOC)**, alerting operators to the wrong-way vehicle. GIS maps in the TOC are zoomed automatically to the location of the wrong-way vehicle, law enforcement is notified, and **(after verification) messages are posted to dynamic message signs (DMS)**, such as "Wrong way driver alert" and "All traffic move to Shoulder and Stop." ([Guidelines for Reducing Wrong-Way Crashes on Freeways](#), Zhou & Rouholamin, 2014a) The system was installed in 2009. As of an article January 2011, 23 wrong way drivers have been detected. Of those, 9 were charged with DWI. Article notes that they are moving toward the use of pucks for detection, stated as more accurate. ([New system to catch wrong-way drivers](#), Willey, 2011) According to a

Summary of Resources and Deployments (January 2015)

presentation from the Toll Authority, this project won the IBTTA 2009 Award for Excellence and was a keynote speaker at the National Wrong-way driving summit at University of Southern Illinois in Edwardsville in 2013. Reasons for wrong-way driving at this location: no toll collectors (all electronic), limited ramps (no exits for 8 miles), signage and roadway geometry. Doppler radar was selected after testing different systems. Video Analytics had too many false alarms due to vibrations. 2011 enhancements include: in-ground LED lighting to warn motorists at Post Oak and Richmond. **Flashing LED wrong-way signs installed at some locations**, and Sensys puck sensors are replacing radar devices. Self-correcting WWD alerts spiked in 2011 (41). ([HCTRA Incident Management's Rapid Response & Rapid Removal](#), Johnson & Harvey, 2013) Another article describes a wrong-way driver that entered the Toll road at a location downstream, not part of the Harris County Tollway, at an area not covered by the technology. ([Driver caught heading wrong way on Westpark Tollway](#), Willey, 2012) A study conducted at the Texas A&M Transportation Institute in 2014 evaluated before/after data from HCTRA for this deployment. Findings indicated that the detection systems (with camera verification and law enforcement response) can successfully be used to detect, verify, and document wrong way driving events. The systems provide wrong way driver entry points, a critical piece of information for helping to combat wrong way driving. ([Assessment of the Effectiveness of Wrong Way Driving Countermeasures and Mitigation Methods](#), Finley et al., 2014)

- **Texas DOT:** A planned approach for mainline freeway systems in the San Antonio area includes a Blank Out Dynamic Message Sign (DMS) connected to a radar unit is activated when a wrong-way vehicle is detected. After detection, **"WRONG WAY" is displayed on the blank out sign** to alert the wrong-way driver. ([The San Antonio Wrong Way Driver Initiative](#), Texas Department of Transportation, n.d.)
- **Texas DOT:** Texas DOT plans to use radar detection on exit ramps and mainlines, to detect wrong-way vehicle movements and provide **notification to traffic operators and San Antonio Police Department (SAPD) dispatchers**, and to activate LED Illuminated Wrong-Way Signs and Blank Out Signs. ([The San Antonio Wrong Way Driver Initiative](#), Texas Department of Transportation, n.d.)
- **Florida DOT:** A detection and warning system was installed on a bridge that was the site of several fatal wrong-way crashes. When loop detectors in the roadway detect a wrong-way driver, the system activates **flashing lights (with signage) on overhead wires spanning the bridge to warn oncoming traffic**. The system also **automatically notifies a nearby police station** of the incident. ([Wrong-Way Driving Countermeasures](#), Kaminski Leduc, 2008; [Countermeasures for Wrong-Way Movement on Freeways: Overview of Project Activities and Findings](#), Cooner et al., 2004)
- **Washington State DOT:** Deployed solar-powered and traditional-powered vehicle detection systems that use flashing lights, electronic LED signs, and video cameras. A wrong-way vehicle triggers the system, turning on **a red WRONG WAY electronic LED sign, flashing lights, and video camera which records the incident** for further evaluation. ([Wrong-Way Driving Countermeasures](#), Kaminski Leduc, 2008)

Summary of Resources and Deployments (January 2015)

	<ul style="list-style-type: none"> • New Mexico DOT: A directional traffic sensor system (DTSS) was deployed at an exit ramp in 1998 to detect wrong-way movements and provide two separate alerts. The first alert is a set of red flashing lights mounted on a traditional WRONG WAY sign that faces the wrong-way driver. Mounted to back of the WRONG WAY sign is a set of yellow flashing lights mounted on a STOP AHEAD sign that faces the oncoming traffic. (Wrong-Way Driving Countermeasures, Kaminski Leduc, 2008; Countermeasures for Wrong-Way Movement on Freeways: Overview of Project Activities and Findings, Cooner et al., 2004) • Wisconsin DOT: Nine freeway ramps in the Milwaukee, WI area will be equipped with detection capability. Upon detection, a text message will immediately be sent to the State Traffic Operations Center and the Milwaukee County Sheriff's Department. (Milwaukee County launches effort to halt wrong-way drivers on freeways, Jones, 2012)
On-Road Detection	<p>Radar Detection:</p> <ul style="list-style-type: none"> • Texas DOT: Texas DOT selected two types of radar detectors for evaluation as wrong-way driver countermeasures in the San Antonio area. (The San Antonio Wrong Way Driver Initiative, Texas Department of Transportation, n.d.) • Florida DOT (Florida Turnpike): Radar detection used to detect wrong-way movements, then activate LED signs and send a signal to the traffic center. (Huff, 2014) • New York State Thruway Authority (NYSTA): NYSTA deployed Doppler-radar-enhanced LED signs to alert wrong way drivers. (Governor Cuomo Announces First in the Nation 'Wrong-Way' LED Signs Placed On Thruway, New York Governor's Press Office, 2013) • Arizona DOT: Arizona Wrong Way Detection proof of concept evaluated Doppler radar. Results are included in the final report. (Wrong-way Vehicle Detection: Proof of Concept, Simpson, 2013) • Harris County Toll Road Authority (Texas): Doppler radar was initially selected after testing different systems. Video Analytics had too many false alarms due to vibrations. Sensys puck sensors are replacing radar devices. (HCTRA Incident Management's Rapid Response & Rapid Removal, Johnson & Harvey, 2013) <p>Video Detection</p> <ul style="list-style-type: none"> • Arizona DOT: Arizona DOT proof of concept tested video and thermal video sensors. Results are included in the final report. (Wrong-way Vehicle Detection: Proof of Concept, Simpson, 2013) • Iowa DOT/ENTERPRISE Pooled Fund: A controlled field test was conducted at three exit ramps, each with a camera equipped with a separate proprietary video analytics software system. The highest level of performance for 12 test drives was 100% detection of wrong way vehicles during the day and 83% detection rate at night. Slow vehicle speeds and nighttime lighting were factors that adversely impacted detection rates. (Next Generation Traffic Data and Incident Detection from Video, Preisen & Deeter, 2014)

Summary of Resources and Deployments (January 2015)

Magnetic Sensors

- **Arizona DOT:** Arizona Wrong Way Detection proof of concept evaluated magnetic sensors. Results are included in the final report. ([Wrong-way Vehicle Detection: Proof of Concept](#), Simpson, 2013)

Microwave Sensors

- **Arizona DOT:** Arizona Wrong Way Detection proof of concept evaluated microwave sensors. Results are included in the final report. ([Wrong-way Vehicle Detection: Proof of Concept](#), Simpson, 2013)

Loop Detectors

- **Florida DOT:** Loop detectors in the road detect wrong-way drivers, activating signage on overhead wires spanning the bridge to warn oncoming traffic and notifying law enforcement. ([Wrong-Way Driving Countermeasures](#), Kaminski Leduc, 2008; [Countermeasures for Wrong-Way Movement on Freeways: Overview of Project Activities and Findings](#), Cooner et al., 2004)

In-Vehicle Alert Systems

- **Daimler AG:** A new system developed by Daimler AG (primarily for use in Germany) is planned for Mercedes-Benz S-Class and E-Class model vehicles. The system consists of a camera inside the windshield, which visually identifies no-entry signs and alerts a vehicle's on-board electronics system and provides **both an audible and visual alert to the driver**. ([Daimler Debuts Alert System for Wrong-Way Drivers](#), Szczesny, 2013)
- **West Nippon Expressway Co. Ltd. (West NEXCO) and Nissan Motor Co. Ltd.:** West NEXO and Nissan have developed a Wrong-Way Alert Program using GPS data. The navigation system determines if the vehicle is driving against the normal flow of traffic, based GPS location, map data and vehicle speed. If the program determines that the vehicle is driving in the opposite direction, the navigation system provides **audible and visual warnings to the driver**. The article indicates that the program will be adopted in the Fuga Hybrid in October 2010, with other models to follow. ([West NEXCO and Nissan Develop a Wrong-Way Alert Program](#), Nissan Motor Co., 2010)
- **Toyota:** Toyota unveiled a Reverse Warning Navigation System, designed to detect wrong-way driving on highways. According to Toyota, when the system recognizes wrong-way travel, **visual and audible alerts warn the driver** to stop and turn around. Toyota has not announced its plans to begin implementing its new safety features on production cars. ([Toyota shows off new safety features](#), Archer, 2011)

The following table lists additional relevant resources that the research team became aware of after the initial literature search was completed.

Additional Relevant Resources (August 2016)	
Guidance Resources	<ul style="list-style-type: none"> • <u>FHWA Wrong Way Driving Web Page</u> (Federal Highway Administration, 2016): This website maintains a listing of technical materials, state and federal research, and other materials related to wrong-way driving and countermeasures, with web links to each resource. • <u>Wrong Way Driving Road Safety Audit Prompt List</u> (Federal Highway Administration, 2013): This resource is intended to focus specific attention on wrong-way driving issues and contributing factors, through a series of questions designed to help agency Road Safety Audit (RSA) teams identify potential safety issues, avoid overlooking important factors, and proactively identify potential issues. The prompts include considerations for design, signing and markings, time of day conditions, and seasonal or temporary conditions.
Preliminary Evaluation of Signing and Pavement Marking Improvements	<ul style="list-style-type: none"> • <u>Investigation of Contributing Factors Regarding Wrong-Way Driving on Freeways, Phase II</u> (Zhou & Rouholamin, 2015): A preliminary evaluation of countermeasures implemented by the Illinois DOT that include additional WRONG WAY signs, oversized signs, red reflective tape on posts, wrong-way arrows, and dotted extension lines to guide drivers onto entrance ramps indicate a clear downward trend in the number of identified wrong-way driving crashes. This evaluation compared wrong-way crash data from 2004-2009 (before the overall research effort began) to crashes from 2012-2013 (implementation of the countermeasures began in 2012). Due to the short after period and small scale countermeasures implemented by several districts, this downward trend may be due to the random nature of crashes. Additional data should be collected and analyzed as countermeasures are fully implemented statewide.
Statewide Assessment and Implementation of Countermeasures	<ul style="list-style-type: none"> • <u>Florida DOT Statewide Wrong Way Crash Study</u> (Kittelson & Associates, Inc., 2015): This report presents findings from a study that analyzed trends and contributing factors surrounding wrong-way driving on freeways and expressways in Florida. It also summarizes engineering countermeasures and presents an implementation plan to assist FDOT Districts with the prioritization and implementation of suggested countermeasures. The report presents an approach to systematically assess wrong way crashes and locations, and implement various “levels” of engineering countermeasures for implementation: Level 1a – Current MUTCD and FDOT Minimum Requirements; Level 1b - Proposed New FDOT Minimum Requirements; Level 2 – Enhanced Static Treatments & Signal Indications; Level 3 – Dynamic/ITS Treatments.

Additional Relevant Resources (August 2016)

<p>Integrated Detection, Tracking, and Notification Systems/ Connected Vehicles</p>	<ul style="list-style-type: none"> • <u>Detection and Warning Systems for Wrong-Way Driving</u> (Simpson & Bruggeman, 2015): A study conducted for the Arizona Department of Transportation (ADOT) developed a conceptual system to detect a wrong-way driver upon entry, inform the errant driver of their mistake, notify the ADOT Traffic Operations Center (TOC) and law enforcement instantly, track the wrong-way vehicle on the highway system, and warn right-way drivers in the vicinity of the oncoming vehicle. A methodology, which applied performance measures and a scoring system, was used to select the detection element, notification element, and warning element for the proposed system. A pilot deployment plan was created to outline steps for deploying the system. • <u>Conceptual Design of a Connected Vehicle Wrong-Way Driving Detection and Management System</u>. (Finley et al., 2016). The Texas A&M Transportation Institute developed a concept of operations, functional requirements, and high-level system design for a Connected Vehicle (CV) Wrong-Way Driving (WWD) Detection and Management System for the Texas Department of Transportation. This system was designed to detect wrong-way vehicles, notify the traffic management entities and law enforcement personnel, and alert affected travelers. The research team recommended the development of a proof-of-concept test bed at an off-roadway location before implementing a model field deployment of the system on an actual roadway in Texas.
<p>Use of Multiple Countermeasures</p>	<ul style="list-style-type: none"> • <u>Driving Simulator Studies of the Effectiveness of Countermeasures to Prevent Wrong Way Crashes</u> (Boot et al., 2015): Results of a human factors study conducted for FDOT by Florida State University reported that lab and simulated studies suggest that increasing the number and diversity of countermeasures at interchanges can reduce confusion regarding highway entry points.

Appendix B: Deployment Summaries

NOTE: Select the agency name below to access to the full deployment summary.

Arizona DOT

Connecticut DOT

Florida: Central Florida Expressway Authority

Florida DOT: Florida Turnpike Enterprise

Florida DOT: Statewide

Florida DOT: Tallahassee

Florida DOT: Tampa

Iowa DOT

Michigan DOT

Missouri DOT

Ohio DOT

Rhode Island DOT

Texas: Harris County Toll Road Authority

Texas DOT: San Antonio

Washington State DOT

Wisconsin DOT

**“Countermeasures for Wrong Way Driving on Freeways”
Deployment Summary
Arizona Department of Transportation**

Agency	Arizona Department of Transportation (ADOT)	
Agency Contacts	Bashir Hassan Email: BHassan@azdot.gov Phone: (602) 712-6913	Andy Murray Email: RMurray@azdot.gov Phone: (602) 712-6256
	Karim Rashid Email: KRashid@azdot.gov Phone: (602) 712-6785	
Information Sources	<ul style="list-style-type: none"> • Interview with Karim Rashid on 7/20/16 • Interview with Andy Murray on 3/10/15 • Interview with Bashir Hassan on 3/2/15 • Simpson, Sarah. (2013). <i>Wrong-way Vehicle Detection: Proof of Concept</i>. Arizona DOT Research Center. Phoenix, AZ. http://ntl.bts.gov/lib/47000/47400/47414/AZ697.pdf • Simpson, Sarah and Dave Bruggeman. (2015). <i>Detection and Warning System for Wrong-Way Driving</i>. Arizona DOT Research Center. Phoenix, AZ. https://apps.azdot.gov/ADOTLibrary/publications/project_reports/PDF/AZ741.pdf 	
Background	Arizona DOT is studying the issue of wrong-way driving, implementing countermeasures, and researching new large-scale detection/warning systems for potential future deployment.	
Deployment Location	Phoenix area, Statewide	
Number of Sites	<ul style="list-style-type: none"> • Improvements to Static Signs and Pavement Markings – 6 ramps in the Phoenix area (2014) and approximately 90 ramps statewide (2015) • Detection at Exit Ramps with Alerts to Drivers and Traffic Management Center (TMC) – 5 ramps 	
Deployment Dates	2014 – 2015	
Test/Pilot or Long-term	<ul style="list-style-type: none"> • Long-term: Improvements to Static Signs and Pavement Markings • Test/Pilot: Detection at Exit Ramps with Alerts to Drivers and TMC 	
Countermeasure Types	<ol style="list-style-type: none"> 1) Improvements to Static Signs and Pavement Markings 2) Detection at Entrance Ramps with Alerts to Drivers and TMC 	
Description of Countermeasures	<ol style="list-style-type: none"> 1) Improvements to Static Signs and Pavement Markings <ul style="list-style-type: none"> • Countermeasures: <ul style="list-style-type: none"> - Larger signs: WRONG WAY (WW) 48”w x 36”h and DO NOT ENTER (DNE) 48” x 48” - WW and DNE signs mounted on same post - Low mounted signs: 3’ minimum height - Optional red reflective strips on sign posts 	

- Wrong-way arrows with raised reflective markers surrounding the arrow at exit ramps
 - Left-turn pavement marking guides to assist drivers entering on entrance ramps
 - If an overhead sign structure is present, overhead WW signs and post mounted WW signs are installed (see photo below)
- Initial installation in summer 2014: Deployed at 6 intersections in the Phoenix area. Sites selected based on number of 911 calls reporting wrong-way events as recorded by the Arizona Department of Public Safety/State Patrol.
 - Wide-scale deployment in June 2015: Approximately 90 ramps statewide
 - See the following pages for “Wrong Way Signing” details provided by ADOT.
 - No formal evaluation planned. Wrong-way driving instances are very random. The intersections are not located close to one another, so it will be difficult to effectively track effectiveness of this countermeasure.



Improvements to Static Signs and Pavement Markings
(Source: Arizona DOT)

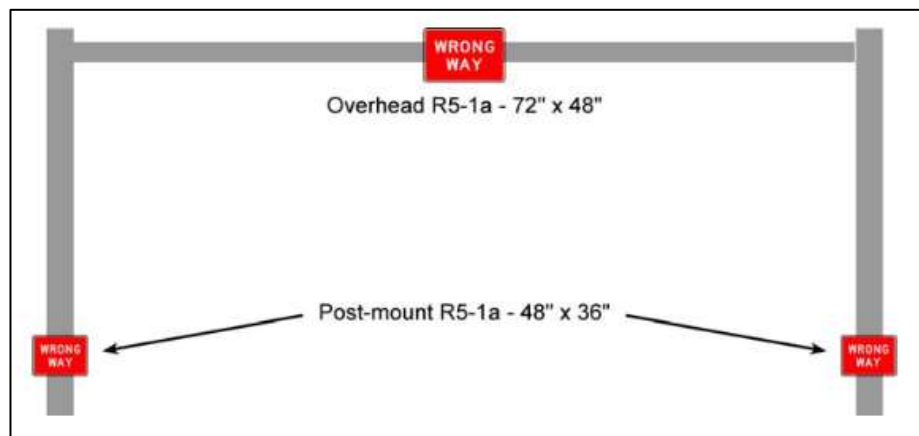

Overhead and post mounted WW signs
(Source: Arizona DOT)

	<p>2) Detection at Entrance Ramp with Alerts to Drivers and TMC Testing two products: High-Definition Radar and Vehicle-Activated Flashing LED WW Signs</p> <p><u>High-Definition Radar:</u></p> <ul style="list-style-type: none"> - Deployed at 2 intersections, both on AZ Hwy 101 (SB at Peoria and NB Glendale) - A fixed infrared camera is installed at the Glendale site only. When a wrong-way vehicle is detected by radar, the camera takes photos. An email alert is sent to the TMC after detection. - False alarms: After troubleshooting with the vendor, false alarms have been significantly reduced. However, the radar is still sensitive to large trucks and traffic queues, triggering false alarms. - Deployed in December 2014 <p><u>Vehicle-Activated Flashing LED WW Signs:</u></p> <ul style="list-style-type: none"> - Dual detection plus camera for verification - Upon 2nd detection (verification) of wrong-way movement, the system activates a WW sign with blinking LEDs around the border in an attempt to alert the driver. If the driver continues an alert is sent to the TMC. - 3 systems installed in the Phoenix area - Deployed Spring 2015
Evaluation Efforts	<ul style="list-style-type: none"> • Improvements to Static Signs and Pavement Markings at Exit Ramps – No formal evaluation is planned. It will be difficult to evaluate due to the random nature of wrong-way driving occurrences and dispersed deployment locations. • Detection at Entrance Ramp with Alerts to Drivers and TMC - Plans are in place to track and test the technology in-house at ADOT.
Coordination	ADOT works with the Arizona Department of Public Safety and local jurisdictions in responding to wrong-way driving events and planning for projects that implement improvements to help mitigate wrong-way driving.
Guidelines or Standards	See the following pages for “Wrong Way Signing” details provided by ADOT.
Local/Public Response	None noted
Lessons Learned	Lessons learned related to technology deployments: <ul style="list-style-type: none"> • When using radar detection, it is important to have a camera for visual verification. • It is advantageous to have two-stage radar detection. Often, wrong-way drivers will self-correct upon seeing the flashing WW signs which prevents the subsequent detection from occurring, limiting instances where the camera/photo is activated and notification is sent unnecessarily to the TMC. • Radar detection is less intrusive from a maintenance standpoint. Loop detectors require more maintenance because they are embedded in the pavement. • Cost and Operation Considerations: <ul style="list-style-type: none"> – ADOT’s detection/alert systems are connected to communications via a cellular modem. Cellular carries a “per-site” cost which can become expensive if deployed on a large scale at many sites. If a large-scale deployment is planned, try to

	<p>connect to existing communications infrastructure (e.g. fiber).</p> <ul style="list-style-type: none"> - The detection/alert systems do not need a power source to operate, as they are solar powered. However, this requires batteries so access to power is preferred over the long-term. • Cameras used for verification need ambient light present to operate properly at night when most wrong-way driving events occur. 																																																																								
<p>Related Research Efforts</p>	<p>Research Efforts:</p> <ul style="list-style-type: none"> • Phase 1: Wrong-way Vehicle Detection: Proof of Concept (Simpson, 2013) <p>The primary focus of this research was to determine the viability of existing detector systems to identify entry of wrong-way vehicles onto the highway system using five different technologies: microwave sensors, Doppler radar, video imaging, thermal sensors, and magnetic sensors. Results from the controlled test can be found in the Table below. The study results of this proof of concept effort verify that wrong-way vehicles can be detected using easily deploy able equipment that is currently available on the market. While each system tested over the trial period had missed or false calls, none of the systems were installed under the vendor’s ideal conditions.</p> <table border="1" data-bbox="456 793 1365 1157"> <caption>Table 11. Summary of Test Results for the Controlled Test Procedure</caption> <thead> <tr> <th>Device Type</th> <th>Detected Wrong-Way Vehicles</th> <th>Response Time</th> <th>Non-Intrusive</th> <th>Minimal Maintenance</th> <th>Night Operations</th> <th>Communication</th> <th>Ease of Installation</th> <th>No Missed Calls</th> <th>No False Calls</th> <th>Dual Function</th> <th>Low Cost</th> </tr> </thead> <tbody> <tr> <td>Microwave</td> <td>x</td> <td>x</td> <td>x</td> <td></td> <td>x</td> <td>x</td> <td>x</td> <td>x</td> <td></td> <td></td> <td>x</td> </tr> <tr> <td>Radar</td> <td>x</td> <td>x</td> <td>x</td> <td>x</td> <td>x</td> <td></td> <td>x</td> <td></td> <td>N/A</td> <td></td> <td></td> </tr> <tr> <td>Video</td> <td>x</td> <td>x</td> <td>x</td> <td></td> <td></td> <td>x</td> <td>x</td> <td></td> <td></td> <td>x</td> <td></td> </tr> <tr> <td>Thermal Sensor</td> <td>x</td> <td>x</td> <td>x</td> <td></td> <td>x</td> <td></td> <td>x</td> <td>x</td> <td>N/A</td> <td></td> <td></td> </tr> <tr> <td>Magnetic Detection</td> <td>x</td> <td>x</td> <td></td> <td>x</td> <td>x</td> <td>x</td> <td></td> <td></td> <td>x</td> <td>x</td> <td></td> </tr> </tbody> </table> <p style="text-align: center;">Summary of Test Results - Controlled Test Procedure (Source: Simpson, 2013)</p> <ul style="list-style-type: none"> • Phase 2: Detection and Warning System for Wrong-Way Driving (Simpson and Bruggeman, 2015) <p>This research developed a conceptual system to detect a wrong-way driver upon entry, inform the errant driver of their mistake, notify the ADOT Traffic Operations Center (TOC) and law enforcement instantly, track the wrong-way vehicle on the highway system, and warn right-way drivers in the vicinity of the oncoming vehicle. A methodology, which applied performance measures and a scoring system, was used to select the detection element, notification element, and warning element for the proposed system. In addition, a pilot deployment plan was created to outline steps for deploying the system.</p>	Device Type	Detected Wrong-Way Vehicles	Response Time	Non-Intrusive	Minimal Maintenance	Night Operations	Communication	Ease of Installation	No Missed Calls	No False Calls	Dual Function	Low Cost	Microwave	x	x	x		x	x	x	x			x	Radar	x	x	x	x	x		x		N/A			Video	x	x	x			x	x			x		Thermal Sensor	x	x	x		x		x	x	N/A			Magnetic Detection	x	x		x	x	x			x	x	
Device Type	Detected Wrong-Way Vehicles	Response Time	Non-Intrusive	Minimal Maintenance	Night Operations	Communication	Ease of Installation	No Missed Calls	No False Calls	Dual Function	Low Cost																																																														
Microwave	x	x	x		x	x	x	x			x																																																														
Radar	x	x	x	x	x		x		N/A																																																																
Video	x	x	x			x	x			x																																																															
Thermal Sensor	x	x	x		x		x	x	N/A																																																																
Magnetic Detection	x	x		x	x	x			x	x																																																															
<p>Future Plans</p>	<p>Detection and Warning System for Wrong-Way Driving: The detection, tracking, and warning system described in the research section above is moving forward as a pilot deployment.</p>																																																																								

314 WRONG WAY SIGNING

314.1 INTRODUCTION

The Wrong Way sign (R5-1a) should be used as a supplement to the Do Not Enter sign (R5-1) where experience indicates the need for such a sign on the basis of wrong way movements, or where an engineering evaluation indicates that it is desirable to install such signs because geometrics are conducive to wrong way entry. Locations where Wrong Way signs may be warranted include:

1. Where an exit ramp intersects a two-way crossroad or frontage road.
2. Where a one-way, right-turning roadway joins a two-way, undivided roadway.
3. At a divided roadway intersection where traffic from the crossroad may tend to enter the wrong side of the divided road.
4. Where direct access from abutting property to an exit ramp is permitted.
5. Where a one-way roadway becomes two-way.

Wrong Way signs shall not be installed in lieu of the standard regulatory and guide signs at freeway interchanges. These signs are used only to supplement the standard signing when an engineering evaluation indicates the supplementary signing to be desirable.

Approval for use of Wrong Way signs is not required for use on freeway exit ramps or similarly designed traffic intersections. **The use of Wrong Way signs at other locations shall be approved by the Regional Traffic Engineer before they are installed.**

At interchange exit ramp terminals where an exit ramp departing a freeway or highway intersects a crossroad in such a manner that wrong-way entry could inadvertently be made, DO NOT ENTER (R5-1) and WRONG WAY (R5-1a) signs are installed to inform road users and discourage wrong-way travel.

314.2 SIGN SIZE AND MOUNTING

For conventional roadways and expressways, sign sizes and mounting should be in accordance with the regulatory signs chapter of the MUTCD.

For new and reconstructed freeway traffic interchanges, or at freeway traffic interchanges where a sign rehabilitation or replacement project is replacing existing signs, the following signs or sign assemblies should be used:

- A. **DO NOT ENTER / WRONG WAY sign assembly:** this consists of a 48" x 48" R5-1 DO NOT ENTER sign placed above a 48" x 36" R5-1a WRONG WAY sign. The assembly should be installed at a minimum mounting height of 3 feet, measured vertically from the bottom of the WRONG WAY sign to the elevation of the near edge of the pavement. This sign assembly typically uses two 2 1/2T posts and foundations, with slip bases as appropriate, unless

ADOT Traffic Engineering Guidelines and Processes
 December 2015
 Section 300 - Signs

mounted on a signal pole or other support. Strips of red retroreflective sheeting may optionally be placed facing wrong-way traffic on the sign posts from the bottom of the sign to near the top of the foundation or slip base. See Figure 314-A for an illustration of the sign assembly, and the following sections and Figures 314-D through 314-H for examples of placement of this sign assembly.

- B. *Supplemental WRONG WAY sign (post mount):* This consists of a 48" x 36" R5-1a WRONG WAY sign at a minimum mounting height of 3 feet, measured vertically from the bottom of the bottom of the WRONG WAY sign to the elevation of the near edge of the pavement. This may be placed back to back with existing signs on a ramp. This sign is typically placed on each side of the exit ramp facing wrong-way traffic either approximately 250 feet upstream from the intersection, or on or at the lane control sign structure if one is present. Additional signs may be placed facing wrong-way traffic along the ramp based on engineering judgment. This sign assembly typically uses one 2 1/2S or 2 1/2T post and foundation with slip bases as appropriate. A strip of red retroreflective sheeting may optionally be placed facing wrong-way traffic on the sign post from the bottom of the sign to near the top of the foundation or slip base. If this sign is not placed back to back with other signs on the ramp, an OM2 series object marker may be installed facing traffic on the post or back of the sign panel along the inside edge of the panel. The lateral offset of these signs may be adjusted to improve visibility to wrong-way traffic or to not obstruct other signs along the ramp. See Figure 314-B for an illustration of the sign assembly.
- C. *Supplemental WRONG WAY sign (overhead mount):* This consists of a 72" x 48" R5-1a WRONG WAY sign placed facing wrong-way traffic on a lane control sign structure or other overhead sign structure. For ramps with two or three lanes at the sign structure location, typically only one sign is used, but two signs may optionally be used at ramps with four or more lanes. See Figure 314-C for an example of this type of signing.

Signs mounted at a 3 foot mounting height should not be placed where they will obstruct a pedestrian path, or in locations where on-roadway parking is expected. If it is impractical to place a sign assembly at the recommended location, it may be relocated or omitted.

Although historical practice was to place the DO NOT ENTER sign back-to-back with a STOP sign where stop control was in place for the exit ramp, this practice is not encouraged for large DO NOT ENTER / WRONG WAY assemblies, as the optimum mounting angle for the DO NOT ENTER / WRONG WAY sign assembly may not be the same optimum angle for the STOP sign, and because the STOP sign cannot be larger than the entire reverse side of the DO NOT ENTER / WRONG WAY assembly as recommended in the Regulatory Signs chapter of the MUTCD.

ADOT Traffic Engineering Guidelines and Processes
December 2015
Section 300 - Signs

Existing DO NOT ENTER and WRONG WAY signs in conformance with the Regulatory Signs chapter of the MUTCD may remain in place for the remainder of their service lives. If a single sign or assembly at a traffic interchange is damaged or needs replacement, it may be replaced by a sign similar to the existing or previous sign, or by a sign or signs as described in this document.

Figure 314-A. DO NOT ENTER / WRONG WAY Sign Assembly



314-3

ADOT Traffic Engineering Guidelines and Processes
December 2015
Section 300 - Signs

**Figure 314-B. Supplemental WRONG WAY Sign
(Post Mount)**

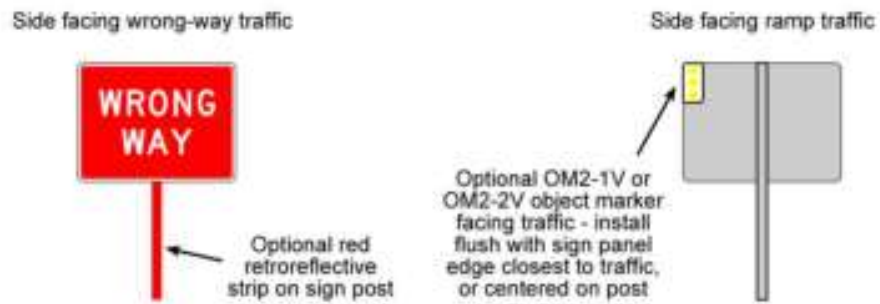

**Figure 314-C. Supplemental WRONG WAY Sign
(Post and Overhead Mount)**

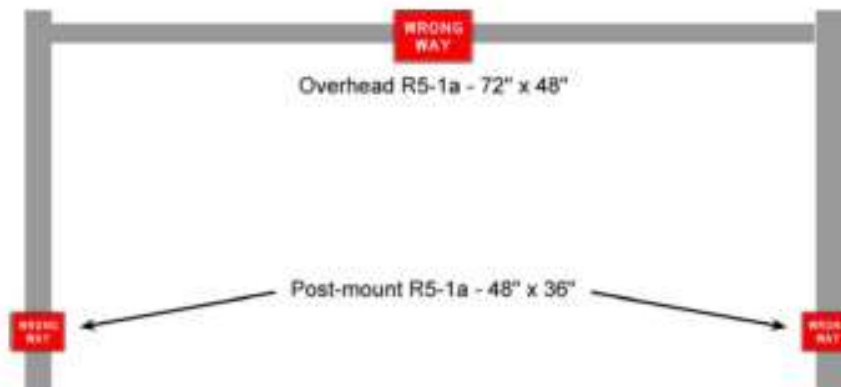

ADOT Traffic Engineering Guidelines and Processes
December 2015
Section 300 - Signs

314.3 DIAMOND INTERCHANGE OR ONE-WAY EXIT RAMP TERMINAL

- A. DO NOT ENTER / WRONG WAY assemblies should be installed adjacent to the left and right-hand sides of the exit ramp at or near the intersection of the crossroad. The sign assemblies should be oriented at an angle to the centerline of the ramp so the sign faces inward toward the ramp to improve visibility to turning traffic (see Figure 314-D). The appropriate orientation angle for each sign assembly should be determined and verified through field inspection.
- B. Additional WRONG WAY signs should be installed to the left and right-hand sides of the exit ramp upstream of the intersection in accordance with 314.2.B. If an overhead sign structure is present, overhead WRONG WAY signs should be installed in accordance with 314.2.C.
- C. Sign assemblies should be installed so that they do not obstruct the view of other signs or traffic signals at the intersection. Sign assemblies may be installed back to back with traffic signal assemblies on a traffic signal pole, but should not obstruct the signal indication or any pedestrian path. If it is impractical to place a sign assembly at the recommended location, it may be relocated or omitted.

Figure 314-D. Wrong Way Signing at Diamond Traffic Interchange or One-Way Exit Ramp Terminal
(other signs and devices at interchange omitted for clarity)

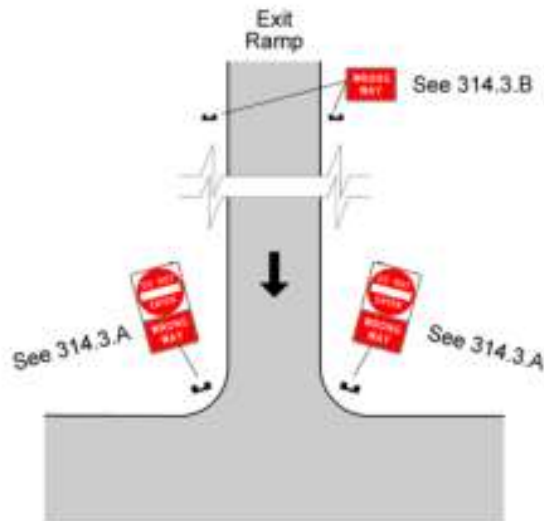

314-5

ADOT Traffic Engineering Guidelines and Processes
December 2015
Section 300 - Signs

314.4 SINGLE-POINT DIAMOND INTERCHANGE (WITH NO THROUGH FRONTAGE ROAD)

- A. DO NOT ENTER / WRONG WAY assemblies should be installed to the left and right-hand sides of each exit ramp at or near the intersection of the crossroad. The sign assemblies should be oriented to be approximately perpendicular to the centerline of the adjacent ramp (see Figure 314-E).
- B. Additional WRONG WAY signs should be installed to the left and right-hand sides of the ramp upstream of the intersection in accordance with 314.2.B. If an overhead sign structure is present, overhead WRONG WAY signs should be installed in accordance with 314.2.C.
- C. Sign assemblies should be installed so that they do not obstruct the view of other signs or traffic signals at the intersection. Sign assemblies may be installed back to back with traffic signal assemblies on a traffic signal pole, but should not obstruct the signal indication or any pedestrian path. If it is impractical to place a sign assembly at the recommended location, it may be relocated or omitted.

Figure 314-E. Wrong Way Signing at Single-Point Diamond Traffic Interchange (with no through frontage roads)
(other signs and devices at interchange omitted for clarity)

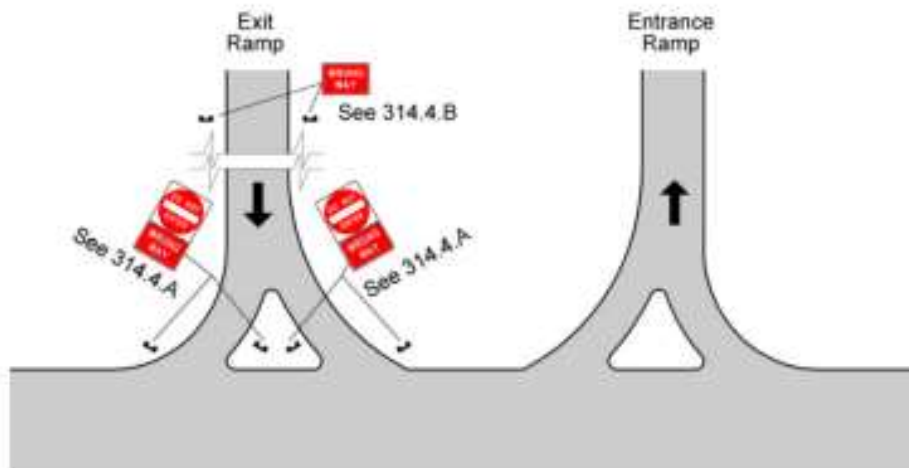

ADOT Traffic Engineering Guidelines and Processes
 December 2015
 Section 300 - Signs

314.5 SINGLE-POINT DIAMOND INTERCHANGE (WITH THROUGH FRONTAGE ROAD)

- A. **DO NOT ENTER / WRONG WAY** assemblies should be installed to the left and right-hand sides of each exit ramp at or near the intersection of the crossroad.
 1. The sign assemblies adjacent to the ramp for left turn movements should be oriented to be approximately perpendicular to the centerline of the ramp (see Figure 314-F).
 2. The sign assemblies adjacent to the ramp for through and right turn movements should be oriented at an angle to the centerline of the ramp so the sign faces inward toward the ramp to improve visibility to turning traffic (see Figure 314-F). The appropriate orientation angle for each sign assembly should be determined and verified through field inspection.
- B. Additional **WRONG WAY** signs should be installed to the left and right-hand sides of the ramp upstream of the intersection in accordance with 314.2.B. If an overhead sign structure is present, overhead **WRONG WAY** signs should be installed in accordance with 314.2.C.
- C. Sign assemblies should be installed so that they do not obstruct the view of other signs or traffic signals at the intersection. Sign assemblies may be installed back to back with traffic signal assemblies on a traffic signal pole, but should not obstruct the signal indication or any pedestrian path. If it is impractical to place a sign assembly at the recommended location, it may be relocated or omitted.

Figure 314-F. Wrong Way Signing at Single-Point Diamond Traffic Interchange (with through frontage roads)
 (other signs and devices at interchange omitted for clarity)

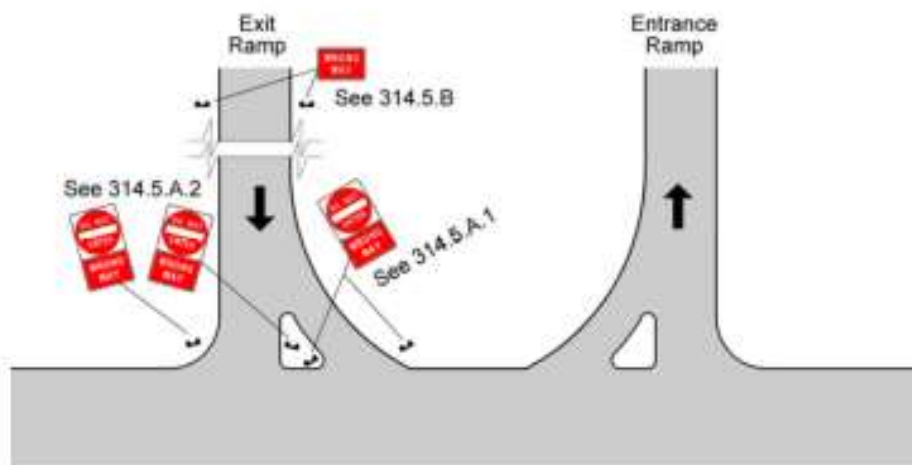

314-7

ADOT Traffic Engineering Guidelines and Processes
December 2015
Section 300 - Signs

314.6 PARTIAL CLOVERLEAF OR LOOP RAMP INTERCHANGE (WITHOUT RIGHT TURN ISLAND)

- A. A 48" x 60" R4-7b KEEP RIGHT sign with diagonal arrow should be installed in the median between the exit and entrance ramps.
- B. DO NOT ENTER / WRONG WAY assemblies should be installed adjacent to the left and right-hand sides of the exit ramp.
 - 1. The sign adjacent to the outside (non-median) edge of the ramp should be installed a short distance upstream from the upstream edge of the right turn island, but in a position that is readily visible to turning traffic. The sign assembly should be oriented at an angle to the centerline of the ramp so the sign faces inward toward the ramp to improve visibility to turning and entering traffic (see Figure 314-G). The appropriate orientation angle for each sign assembly should be determined and verified through field inspection.
 - 2. The sign adjacent to the median-side edge of the ramp should be installed a short distance upstream from where the alignment of the exit ramp diverges from the entrance ramp. The sign assembly should be oriented at an angle to the centerline of the ramp so the sign faces inward toward the ramp to improve visibility to turning and entering traffic (see Figure 314-G). The appropriate orientation angle for the sign assembly should be determined and verified through field inspection. The sign assembly should be placed so that it is not readily visible to traffic on the entrance ramp, as unpredictable behavior may result.
- C. Additional WRONG WAY signs should be installed to the left and right-hand sides of the ramp upstream of the intersection in accordance with 314.2.B. If an overhead sign structure is present, overhead WRONG WAY signs should be installed in accordance with 314.2.C.
- D. Sign assemblies should be installed so that they do not obstruct the view of other signs or traffic signals at the intersection. Sign assemblies may be installed back to back with traffic signal assemblies on a traffic signal pole, but should not obstruct the signal indication or any pedestrian path. If it is impractical to place a sign assembly at the recommended location, it may be relocated or omitted.

ADOT Traffic Engineering Guidelines and Processes
December 2015
Section 300 - Signs

314.7 PARTIAL CLOVERLEAF OR LOOP RAMP INTERCHANGE (WITH RIGHT TURN ISLAND)

- A. A 48" x 60" R4-7b KEEP RIGHT sign with diagonal arrow should be installed in the median between the exit and entrance ramps.
- B. DO NOT ENTER / WRONG WAY assemblies should be installed adjacent to the left and right-hand sides of the exit ramp and the right turn ramp.
 - 1. The sign adjacent to the outside (non-median) edge of the ramp should be installed a short distance upstream from the upstream edge of the right turn island, but in a position that is readily visible to turning traffic. The sign assembly should be oriented at an angle to the centerline of the ramp so the sign faces inward toward the ramp to improve visibility to turning and entering traffic (see Figure 314-H). The appropriate orientation angle for each sign assembly should be determined and verified through field inspection.
 - 2. The sign adjacent to the median-side edge of the ramp should be installed a short distance upstream from where the alignment of the exit ramp diverges from the entrance ramp. The sign assembly should be oriented at an angle to the centerline of the ramp so the sign faces inward toward the ramp to improve visibility to turning and entering traffic (see Figure 314-H). The appropriate orientation angle for the sign assembly should be determined and verified through field inspection. The sign assembly should be placed so that it is not readily visible to traffic on the entrance ramp, as unpredictable behavior may result.
- C. The sign assemblies adjacent to the ramp for the right turn movement should be oriented to be approximately perpendicular to the centerline of the ramp (see Figure 314-H).
- D. Additional WRONG WAY signs should be installed to the left and right-hand sides of the ramp upstream of the intersection in accordance with 314.2.B. If an overhead sign structure is present, overhead WRONG WAY signs should be installed in accordance with 314.2.C.
- E. Sign assemblies should be installed so that they do not obstruct the view of other signs or traffic signals at the intersection. Sign assemblies may be installed back to back with traffic signal assemblies on a traffic signal pole, but should not obstruct the signal indication or any pedestrian path. If it is impractical to place a sign assembly at the recommended location, it may be relocated or omitted.

ADOT Traffic Engineering Guidelines and Processes
December 2015
Section 000 - Signs

Figure 314-G. Wrong Way Signing at Partial Cloverleaf Traffic Interchange
(other signs and devices at interchange omitted for clarity)

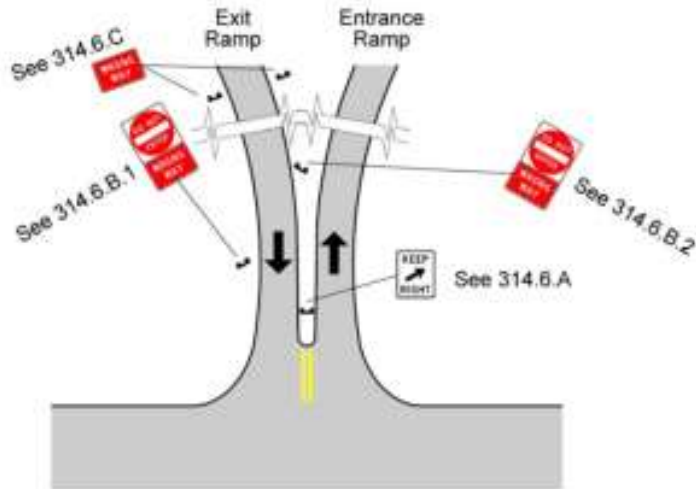
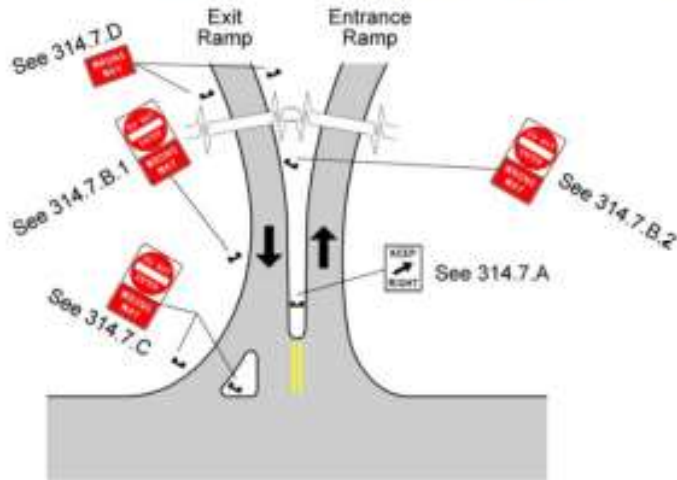

Figure 314-H. Wrong Way Signing at Partial Cloverleaf Traffic Interchange
(with right turn island)
(other signs and devices at interchange omitted for clarity)





314-10

“Countermeasures for Wrong Way Driving on Freeways”

Deployment Summary



Connecticut Department of Transportation

Agency	Connecticut Department of Transportation (Connecticut DOT)
Agency Contact	Colin R. Baummer Email: colin.baummer@ct.gov Phone: (860) 594-2733
Information Sources	<ul style="list-style-type: none"> • Email with edits to deployment summary from Colin Baummer on 5/16/16 • Interview with Colin Baummer on 1/15/15
Background	<ul style="list-style-type: none"> • Connecticut has the 4th highest crash rate (crashes per million vehicle miles) in the U.S. for wrong-way driving, with 4 or 5 wrong-way crashes per year. These were random crashes, not happening at any one location. The Connecticut DOT decided to apply a systematic approach for all ramps statewide. Signing was not consistent and many signs were faded so this was a good opportunity to upgrade all ramps using a systematic approach. • Connecticut DOT looked at best practices from other states when choosing countermeasure types.
Deployment Location	Statewide (systematic approach to treat all ramps statewide)
Number of Sites	700 limited access exit ramps
Deployment Dates	Spring/Fall 2015, with substantial completion statewide by 11/31/15
Test/Pilot or Long-term	Long-term deployment
Countermeasure Types	Improvements to Static Signing and Pavement Marking at Interchange Ramps
Description of Countermeasures	<p>Improvements to Static Signing and Pavement Marking at Interchange Ramps</p> <ul style="list-style-type: none"> • Bring current signs/stripping up to standard, as needed. <ul style="list-style-type: none"> - Install higher retro-reflectivity signs. - Re-paint wrong-way arrows and left/right arrows, as needed. • Mount larger, more visible signs at exit ramps (48" DNE signs, 42" by 24" WRONG WAY (WW) signs). • Lower height of WW and DNE signs (5 ft. height, no lower because of snow pileup under signs during winter) • Additional WW and DNE signs (2 DNEs and 4 or 5 WWs; beyond MUTCD minimums) • Red reflective delineator strips on sign posts • Wider stop bars (24" vs. 12" width) • In locations with adjacent on/off ramps:

	<ul style="list-style-type: none"> - Double yellow centerline between the ramps - Pavement marking extension lines to guide drivers onto entrance ramp at signalized locations  <p>Oversized, Lower Height Signs on Both Sides of Ramp (Source: Connecticut DOT)</p>  <p>Oversized WRONG WAY Sign with Red Delineator Strips on Posts (Source: Connecticut DOT)</p>
<p>Evaluation Efforts/Results</p>	<ul style="list-style-type: none"> • Connecticut DOT plans to conduct a before/after evaluation, comparing 2-3 years of crash data before the ramp improvements to 2-3 years of crash data after the improvements. • There have been 3 fatal crashes and at least one injury crash since the signs have been installed, but the amount of time elapsed is less than one year so Connecticut DOT hasn't yet compared this to any before data.
<p>Coordination</p>	<ul style="list-style-type: none"> • Connecticut DOT met with State Police personnel to gather input regarding their experiences with wrong-way events and reports of wrong-way drivers. • State Police reviewed preliminary layouts/plans with the DOT. Regional Metropolitan Planning Organizations (MPOs) are supportive as well.
<p>Guidelines or Standards</p>	<ul style="list-style-type: none"> • A standard approach was used to treat all exit ramps statewide. • Plan sheets are provided on the following pages.

Local/Public Response	Mostly support, however, there have been some complaints from property owners near exit ramps indicating that there are too many signs and the sign size is too large.
Lessons Learned	None noted
Future Plans	Connecticut DOT plans to evaluate more comprehensively when additional data is available.

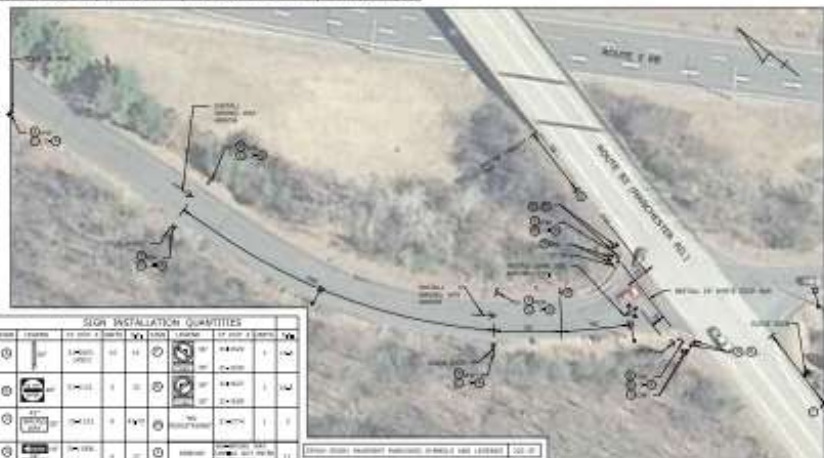
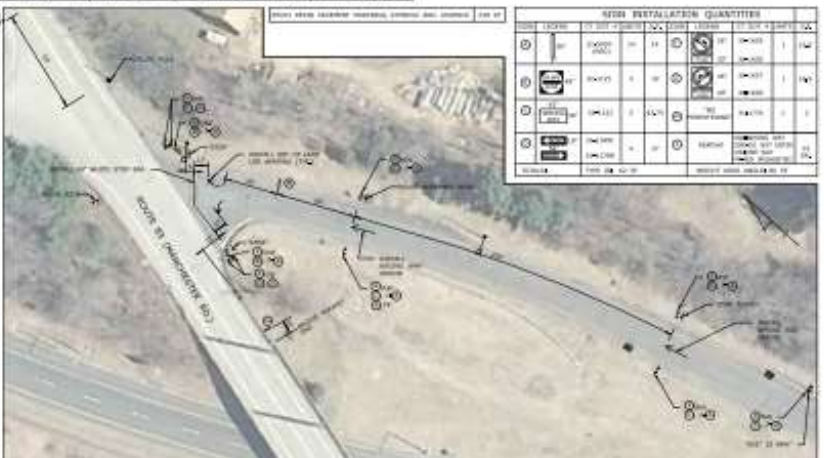
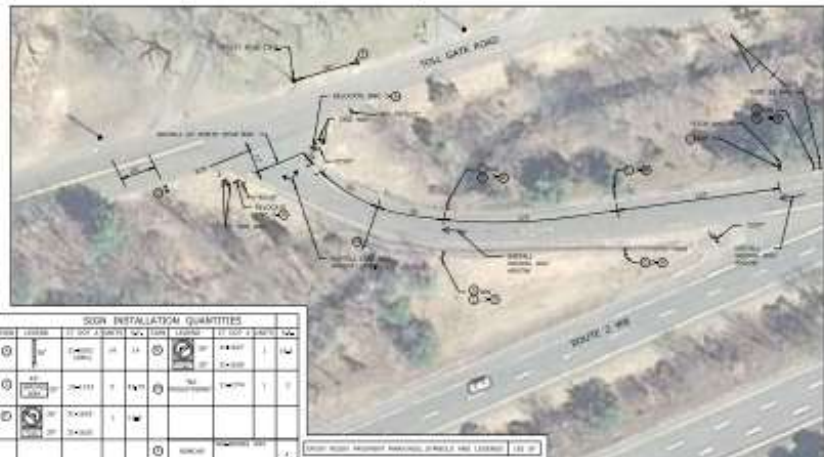
Connecticut DOT Plan Sheets (1 of 2)

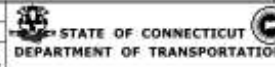
<p style="font-size: small; margin: 0;">HARLINE 002 03 EXIT # 10 TOWN GLASTONBURY RAMP 12x 80x204</p>  <table border="1" style="width: 100%; font-size: x-small; margin-top: 10px;"> <thead> <tr> <th colspan="10">SIGN INSTALLATION QUANTITIES</th> </tr> <tr> <th>NO.</th> <th>SYMBOL</th> <th>TO POST 1</th> <th>TO POST 2</th> <th>TO POST 3</th> <th>TO POST 4</th> <th>TO POST 5</th> <th>TO POST 6</th> <th>TO POST 7</th> <th>TO POST 8</th> </tr> </thead> <tbody> <tr> <td>1</td> <td>(Symbol)</td> <td>1</td> <td>1</td> <td>1</td> <td>1</td> <td>1</td> <td>1</td> <td>1</td> <td>1</td> </tr> <tr> <td>2</td> <td>(Symbol)</td> <td>1</td> <td>1</td> <td>1</td> <td>1</td> <td>1</td> <td>1</td> <td>1</td> <td>1</td> </tr> <tr> <td>3</td> <td>(Symbol)</td> <td>1</td> <td>1</td> <td>1</td> <td>1</td> <td>1</td> <td>1</td> <td>1</td> <td>1</td> </tr> <tr> <td>4</td> <td>(Symbol)</td> <td>1</td> <td>1</td> <td>1</td> <td>1</td> <td>1</td> <td>1</td> <td>1</td> <td>1</td> </tr> <tr> <td>5</td> <td>(Symbol)</td> <td>1</td> <td>1</td> <td>1</td> <td>1</td> <td>1</td> <td>1</td> <td>1</td> <td>1</td> </tr> <tr> <td>6</td> <td>(Symbol)</td> <td>1</td> <td>1</td> <td>1</td> <td>1</td> <td>1</td> <td>1</td> <td>1</td> <td>1</td> </tr> <tr> <td>7</td> <td>(Symbol)</td> <td>1</td> <td>1</td> <td>1</td> <td>1</td> <td>1</td> <td>1</td> <td>1</td> <td>1</td> </tr> <tr> <td>8</td> <td>(Symbol)</td> <td>1</td> <td>1</td> <td>1</td> <td>1</td> <td>1</td> <td>1</td> <td>1</td> <td>1</td> </tr> <tr> <td>9</td> <td>(Symbol)</td> <td>1</td> <td>1</td> <td>1</td> <td>1</td> <td>1</td> <td>1</td> <td>1</td> <td>1</td> </tr> <tr> <td>10</td> <td>(Symbol)</td> <td>1</td> <td>1</td> <td>1</td> <td>1</td> <td>1</td> <td>1</td> <td>1</td> <td>1</td> </tr> </tbody> </table>	SIGN INSTALLATION QUANTITIES										NO.	SYMBOL	TO POST 1	TO POST 2	TO POST 3	TO POST 4	TO POST 5	TO POST 6	TO POST 7	TO POST 8	1	(Symbol)	1	1	1	1	1	1	1	1	2	(Symbol)	1	1	1	1	1	1	1	1	3	(Symbol)	1	1	1	1	1	1	1	1	4	(Symbol)	1	1	1	1	1	1	1	1	5	(Symbol)	1	1	1	1	1	1	1	1	6	(Symbol)	1	1	1	1	1	1	1	1	7	(Symbol)	1	1	1	1	1	1	1	1	8	(Symbol)	1	1	1	1	1	1	1	1	9	(Symbol)	1	1	1	1	1	1	1	1	10	(Symbol)	1	1	1	1	1	1	1	1	<p style="font-size: small; margin: 0;">HARLINE 002 03 EXIT # 10 TOWN GLASTONBURY RAMP 12x 80x205</p>  <table border="1" style="width: 100%; font-size: x-small; margin-top: 10px;"> <thead> <tr> <th colspan="10">SIGN INSTALLATION QUANTITIES</th> </tr> <tr> <th>NO.</th> <th>SYMBOL</th> <th>TO POST 1</th> <th>TO POST 2</th> <th>TO POST 3</th> <th>TO POST 4</th> <th>TO POST 5</th> <th>TO POST 6</th> <th>TO POST 7</th> <th>TO POST 8</th> </tr> </thead> <tbody> <tr> <td>1</td> <td>(Symbol)</td> <td>1</td> <td>1</td> <td>1</td> <td>1</td> <td>1</td> <td>1</td> <td>1</td> <td>1</td> </tr> <tr> <td>2</td> <td>(Symbol)</td> <td>1</td> <td>1</td> <td>1</td> <td>1</td> <td>1</td> <td>1</td> <td>1</td> <td>1</td> </tr> <tr> <td>3</td> <td>(Symbol)</td> <td>1</td> <td>1</td> <td>1</td> <td>1</td> <td>1</td> <td>1</td> <td>1</td> <td>1</td> </tr> <tr> <td>4</td> <td>(Symbol)</td> <td>1</td> <td>1</td> <td>1</td> <td>1</td> <td>1</td> <td>1</td> <td>1</td> <td>1</td> </tr> <tr> <td>5</td> <td>(Symbol)</td> <td>1</td> <td>1</td> <td>1</td> <td>1</td> <td>1</td> <td>1</td> <td>1</td> <td>1</td> </tr> <tr> <td>6</td> <td>(Symbol)</td> <td>1</td> <td>1</td> <td>1</td> <td>1</td> <td>1</td> <td>1</td> <td>1</td> <td>1</td> </tr> <tr> <td>7</td> <td>(Symbol)</td> <td>1</td> <td>1</td> <td>1</td> <td>1</td> <td>1</td> <td>1</td> <td>1</td> <td>1</td> </tr> <tr> <td>8</td> <td>(Symbol)</td> <td>1</td> <td>1</td> <td>1</td> <td>1</td> <td>1</td> <td>1</td> <td>1</td> <td>1</td> </tr> <tr> <td>9</td> <td>(Symbol)</td> <td>1</td> <td>1</td> <td>1</td> <td>1</td> <td>1</td> <td>1</td> <td>1</td> <td>1</td> </tr> <tr> <td>10</td> <td>(Symbol)</td> <td>1</td> <td>1</td> <td>1</td> <td>1</td> <td>1</td> <td>1</td> <td>1</td> <td>1</td> </tr> </tbody> </table>	SIGN INSTALLATION QUANTITIES										NO.	SYMBOL	TO POST 1	TO POST 2	TO POST 3	TO POST 4	TO POST 5	TO POST 6	TO POST 7	TO POST 8	1	(Symbol)	1	1	1	1	1	1	1	1	2	(Symbol)	1	1	1	1	1	1	1	1	3	(Symbol)	1	1	1	1	1	1	1	1	4	(Symbol)	1	1	1	1	1	1	1	1	5	(Symbol)	1	1	1	1	1	1	1	1	6	(Symbol)	1	1	1	1	1	1	1	1	7	(Symbol)	1	1	1	1	1	1	1	1	8	(Symbol)	1	1	1	1	1	1	1	1	9	(Symbol)	1	1	1	1	1	1	1	1	10	(Symbol)	1	1	1	1	1	1	1	1
SIGN INSTALLATION QUANTITIES																																																																																																																																																																																																																																																	
NO.	SYMBOL	TO POST 1	TO POST 2	TO POST 3	TO POST 4	TO POST 5	TO POST 6	TO POST 7	TO POST 8																																																																																																																																																																																																																																								
1	(Symbol)	1	1	1	1	1	1	1	1																																																																																																																																																																																																																																								
2	(Symbol)	1	1	1	1	1	1	1	1																																																																																																																																																																																																																																								
3	(Symbol)	1	1	1	1	1	1	1	1																																																																																																																																																																																																																																								
4	(Symbol)	1	1	1	1	1	1	1	1																																																																																																																																																																																																																																								
5	(Symbol)	1	1	1	1	1	1	1	1																																																																																																																																																																																																																																								
6	(Symbol)	1	1	1	1	1	1	1	1																																																																																																																																																																																																																																								
7	(Symbol)	1	1	1	1	1	1	1	1																																																																																																																																																																																																																																								
8	(Symbol)	1	1	1	1	1	1	1	1																																																																																																																																																																																																																																								
9	(Symbol)	1	1	1	1	1	1	1	1																																																																																																																																																																																																																																								
10	(Symbol)	1	1	1	1	1	1	1	1																																																																																																																																																																																																																																								
SIGN INSTALLATION QUANTITIES																																																																																																																																																																																																																																																	
NO.	SYMBOL	TO POST 1	TO POST 2	TO POST 3	TO POST 4	TO POST 5	TO POST 6	TO POST 7	TO POST 8																																																																																																																																																																																																																																								
1	(Symbol)	1	1	1	1	1	1	1	1																																																																																																																																																																																																																																								
2	(Symbol)	1	1	1	1	1	1	1	1																																																																																																																																																																																																																																								
3	(Symbol)	1	1	1	1	1	1	1	1																																																																																																																																																																																																																																								
4	(Symbol)	1	1	1	1	1	1	1	1																																																																																																																																																																																																																																								
5	(Symbol)	1	1	1	1	1	1	1	1																																																																																																																																																																																																																																								
6	(Symbol)	1	1	1	1	1	1	1	1																																																																																																																																																																																																																																								
7	(Symbol)	1	1	1	1	1	1	1	1																																																																																																																																																																																																																																								
8	(Symbol)	1	1	1	1	1	1	1	1																																																																																																																																																																																																																																								
9	(Symbol)	1	1	1	1	1	1	1	1																																																																																																																																																																																																																																								
10	(Symbol)	1	1	1	1	1	1	1	1																																																																																																																																																																																																																																								
<p style="font-size: small; margin: 0;">HARLINE 002 03 EXIT # 11 TOWN GLASTONBURY RAMP 12x 80x206</p>  <table border="1" style="width: 100%; font-size: x-small; margin-top: 10px;"> <thead> <tr> <th colspan="10">SIGN INSTALLATION QUANTITIES</th> </tr> <tr> <th>NO.</th> <th>SYMBOL</th> <th>TO POST 1</th> <th>TO POST 2</th> <th>TO POST 3</th> <th>TO POST 4</th> <th>TO POST 5</th> <th>TO POST 6</th> <th>TO POST 7</th> <th>TO POST 8</th> </tr> </thead> <tbody> <tr> <td>1</td> <td>(Symbol)</td> <td>1</td> <td>1</td> <td>1</td> <td>1</td> <td>1</td> <td>1</td> <td>1</td> <td>1</td> </tr> <tr> <td>2</td> <td>(Symbol)</td> <td>1</td> <td>1</td> <td>1</td> <td>1</td> <td>1</td> <td>1</td> <td>1</td> <td>1</td> </tr> <tr> <td>3</td> <td>(Symbol)</td> <td>1</td> <td>1</td> <td>1</td> <td>1</td> <td>1</td> <td>1</td> <td>1</td> <td>1</td> </tr> <tr> <td>4</td> <td>(Symbol)</td> <td>1</td> <td>1</td> <td>1</td> <td>1</td> <td>1</td> <td>1</td> <td>1</td> <td>1</td> </tr> <tr> <td>5</td> <td>(Symbol)</td> <td>1</td> <td>1</td> <td>1</td> <td>1</td> <td>1</td> <td>1</td> <td>1</td> <td>1</td> </tr> <tr> <td>6</td> <td>(Symbol)</td> <td>1</td> <td>1</td> <td>1</td> <td>1</td> <td>1</td> <td>1</td> <td>1</td> <td>1</td> </tr> <tr> <td>7</td> <td>(Symbol)</td> <td>1</td> <td>1</td> <td>1</td> <td>1</td> <td>1</td> <td>1</td> <td>1</td> <td>1</td> </tr> <tr> <td>8</td> <td>(Symbol)</td> <td>1</td> <td>1</td> <td>1</td> <td>1</td> <td>1</td> <td>1</td> <td>1</td> <td>1</td> </tr> <tr> <td>9</td> <td>(Symbol)</td> <td>1</td> <td>1</td> <td>1</td> <td>1</td> <td>1</td> <td>1</td> <td>1</td> <td>1</td> </tr> <tr> <td>10</td> <td>(Symbol)</td> <td>1</td> <td>1</td> <td>1</td> <td>1</td> <td>1</td> <td>1</td> <td>1</td> <td>1</td> </tr> </tbody> </table>	SIGN INSTALLATION QUANTITIES										NO.	SYMBOL	TO POST 1	TO POST 2	TO POST 3	TO POST 4	TO POST 5	TO POST 6	TO POST 7	TO POST 8	1	(Symbol)	1	1	1	1	1	1	1	1	2	(Symbol)	1	1	1	1	1	1	1	1	3	(Symbol)	1	1	1	1	1	1	1	1	4	(Symbol)	1	1	1	1	1	1	1	1	5	(Symbol)	1	1	1	1	1	1	1	1	6	(Symbol)	1	1	1	1	1	1	1	1	7	(Symbol)	1	1	1	1	1	1	1	1	8	(Symbol)	1	1	1	1	1	1	1	1	9	(Symbol)	1	1	1	1	1	1	1	1	10	(Symbol)	1	1	1	1	1	1	1	1	<p style="font-size: small; margin: 0;">HARLINE 002 03 EXIT # 11 TOWN GLASTONBURY RAMP 12x 80x207</p>  <table border="1" style="width: 100%; font-size: x-small; margin-top: 10px;"> <thead> <tr> <th colspan="10">SIGN INSTALLATION QUANTITIES</th> </tr> <tr> <th>NO.</th> <th>SYMBOL</th> <th>TO POST 1</th> <th>TO POST 2</th> <th>TO POST 3</th> <th>TO POST 4</th> <th>TO POST 5</th> <th>TO POST 6</th> <th>TO POST 7</th> <th>TO POST 8</th> </tr> </thead> <tbody> <tr> <td>1</td> <td>(Symbol)</td> <td>1</td> <td>1</td> <td>1</td> <td>1</td> <td>1</td> <td>1</td> <td>1</td> <td>1</td> </tr> <tr> <td>2</td> <td>(Symbol)</td> <td>1</td> <td>1</td> <td>1</td> <td>1</td> <td>1</td> <td>1</td> <td>1</td> <td>1</td> </tr> <tr> <td>3</td> <td>(Symbol)</td> <td>1</td> <td>1</td> <td>1</td> <td>1</td> <td>1</td> <td>1</td> <td>1</td> <td>1</td> </tr> <tr> <td>4</td> <td>(Symbol)</td> <td>1</td> <td>1</td> <td>1</td> <td>1</td> <td>1</td> <td>1</td> <td>1</td> <td>1</td> </tr> <tr> <td>5</td> <td>(Symbol)</td> <td>1</td> <td>1</td> <td>1</td> <td>1</td> <td>1</td> <td>1</td> <td>1</td> <td>1</td> </tr> <tr> <td>6</td> <td>(Symbol)</td> <td>1</td> <td>1</td> <td>1</td> <td>1</td> <td>1</td> <td>1</td> <td>1</td> <td>1</td> </tr> <tr> <td>7</td> <td>(Symbol)</td> <td>1</td> <td>1</td> <td>1</td> <td>1</td> <td>1</td> <td>1</td> <td>1</td> <td>1</td> </tr> <tr> <td>8</td> <td>(Symbol)</td> <td>1</td> <td>1</td> <td>1</td> <td>1</td> <td>1</td> <td>1</td> <td>1</td> <td>1</td> </tr> <tr> <td>9</td> <td>(Symbol)</td> <td>1</td> <td>1</td> <td>1</td> <td>1</td> <td>1</td> <td>1</td> <td>1</td> <td>1</td> </tr> <tr> <td>10</td> <td>(Symbol)</td> <td>1</td> <td>1</td> <td>1</td> <td>1</td> <td>1</td> <td>1</td> <td>1</td> <td>1</td> </tr> </tbody> </table>	SIGN INSTALLATION QUANTITIES										NO.	SYMBOL	TO POST 1	TO POST 2	TO POST 3	TO POST 4	TO POST 5	TO POST 6	TO POST 7	TO POST 8	1	(Symbol)	1	1	1	1	1	1	1	1	2	(Symbol)	1	1	1	1	1	1	1	1	3	(Symbol)	1	1	1	1	1	1	1	1	4	(Symbol)	1	1	1	1	1	1	1	1	5	(Symbol)	1	1	1	1	1	1	1	1	6	(Symbol)	1	1	1	1	1	1	1	1	7	(Symbol)	1	1	1	1	1	1	1	1	8	(Symbol)	1	1	1	1	1	1	1	1	9	(Symbol)	1	1	1	1	1	1	1	1	10	(Symbol)	1	1	1	1	1	1	1	1
SIGN INSTALLATION QUANTITIES																																																																																																																																																																																																																																																	
NO.	SYMBOL	TO POST 1	TO POST 2	TO POST 3	TO POST 4	TO POST 5	TO POST 6	TO POST 7	TO POST 8																																																																																																																																																																																																																																								
1	(Symbol)	1	1	1	1	1	1	1	1																																																																																																																																																																																																																																								
2	(Symbol)	1	1	1	1	1	1	1	1																																																																																																																																																																																																																																								
3	(Symbol)	1	1	1	1	1	1	1	1																																																																																																																																																																																																																																								
4	(Symbol)	1	1	1	1	1	1	1	1																																																																																																																																																																																																																																								
5	(Symbol)	1	1	1	1	1	1	1	1																																																																																																																																																																																																																																								
6	(Symbol)	1	1	1	1	1	1	1	1																																																																																																																																																																																																																																								
7	(Symbol)	1	1	1	1	1	1	1	1																																																																																																																																																																																																																																								
8	(Symbol)	1	1	1	1	1	1	1	1																																																																																																																																																																																																																																								
9	(Symbol)	1	1	1	1	1	1	1	1																																																																																																																																																																																																																																								
10	(Symbol)	1	1	1	1	1	1	1	1																																																																																																																																																																																																																																								
SIGN INSTALLATION QUANTITIES																																																																																																																																																																																																																																																	
NO.	SYMBOL	TO POST 1	TO POST 2	TO POST 3	TO POST 4	TO POST 5	TO POST 6	TO POST 7	TO POST 8																																																																																																																																																																																																																																								
1	(Symbol)	1	1	1	1	1	1	1	1																																																																																																																																																																																																																																								
2	(Symbol)	1	1	1	1	1	1	1	1																																																																																																																																																																																																																																								
3	(Symbol)	1	1	1	1	1	1	1	1																																																																																																																																																																																																																																								
4	(Symbol)	1	1	1	1	1	1	1	1																																																																																																																																																																																																																																								
5	(Symbol)	1	1	1	1	1	1	1	1																																																																																																																																																																																																																																								
6	(Symbol)	1	1	1	1	1	1	1	1																																																																																																																																																																																																																																								
7	(Symbol)	1	1	1	1	1	1	1	1																																																																																																																																																																																																																																								
8	(Symbol)	1	1	1	1	1	1	1	1																																																																																																																																																																																																																																								
9	(Symbol)	1	1	1	1	1	1	1	1																																																																																																																																																																																																																																								
10	(Symbol)	1	1	1	1	1	1	1	1																																																																																																																																																																																																																																								
<p>1. THE CONTRACTOR SHALL BE RESPONSIBLE FOR THE PROTECTION OF ALL EXISTING UTILITIES AND STRUCTURES. 2. THE CONTRACTOR SHALL MAINTAIN ACCESS TO ALL ADJACENT PROPERTIES AT ALL TIMES. 3. THE CONTRACTOR SHALL MAINTAIN ADEQUATE TRAFFIC CONTROL THROUGHOUT THE PROJECT. 4. THE CONTRACTOR SHALL MAINTAIN ALL EXISTING SIGNS AND MARKINGS UNLESS OTHERWISE SPECIFIED. 5. THE CONTRACTOR SHALL MAINTAIN ALL EXISTING CURBS AND GUTTERS UNLESS OTHERWISE SPECIFIED. 6. THE CONTRACTOR SHALL MAINTAIN ALL EXISTING SIDEWALKS UNLESS OTHERWISE SPECIFIED. 7. THE CONTRACTOR SHALL MAINTAIN ALL EXISTING DRIVEWAYS UNLESS OTHERWISE SPECIFIED. 8. THE CONTRACTOR SHALL MAINTAIN ALL EXISTING LANDSCAPING UNLESS OTHERWISE SPECIFIED. 9. THE CONTRACTOR SHALL MAINTAIN ALL EXISTING TREES UNLESS OTHERWISE SPECIFIED. 10. THE CONTRACTOR SHALL MAINTAIN ALL EXISTING UTILITIES UNLESS OTHERWISE SPECIFIED.</p>		 <p>STATE OF CONNECTICUT DEPARTMENT OF TRANSPORTATION</p>		<p>WRONG WAY DRIVING COUNTERMEASURES</p>		<p>GLASTONBURY</p> <p>SIGNING AND PAVEMENT MARKINGS</p>		<p>171-383</p> <p>SPM-04</p> <p>03.06</p>																																																																																																																																																																																																																																									

Connecticut DOT Plan Sheets (2 of 2)

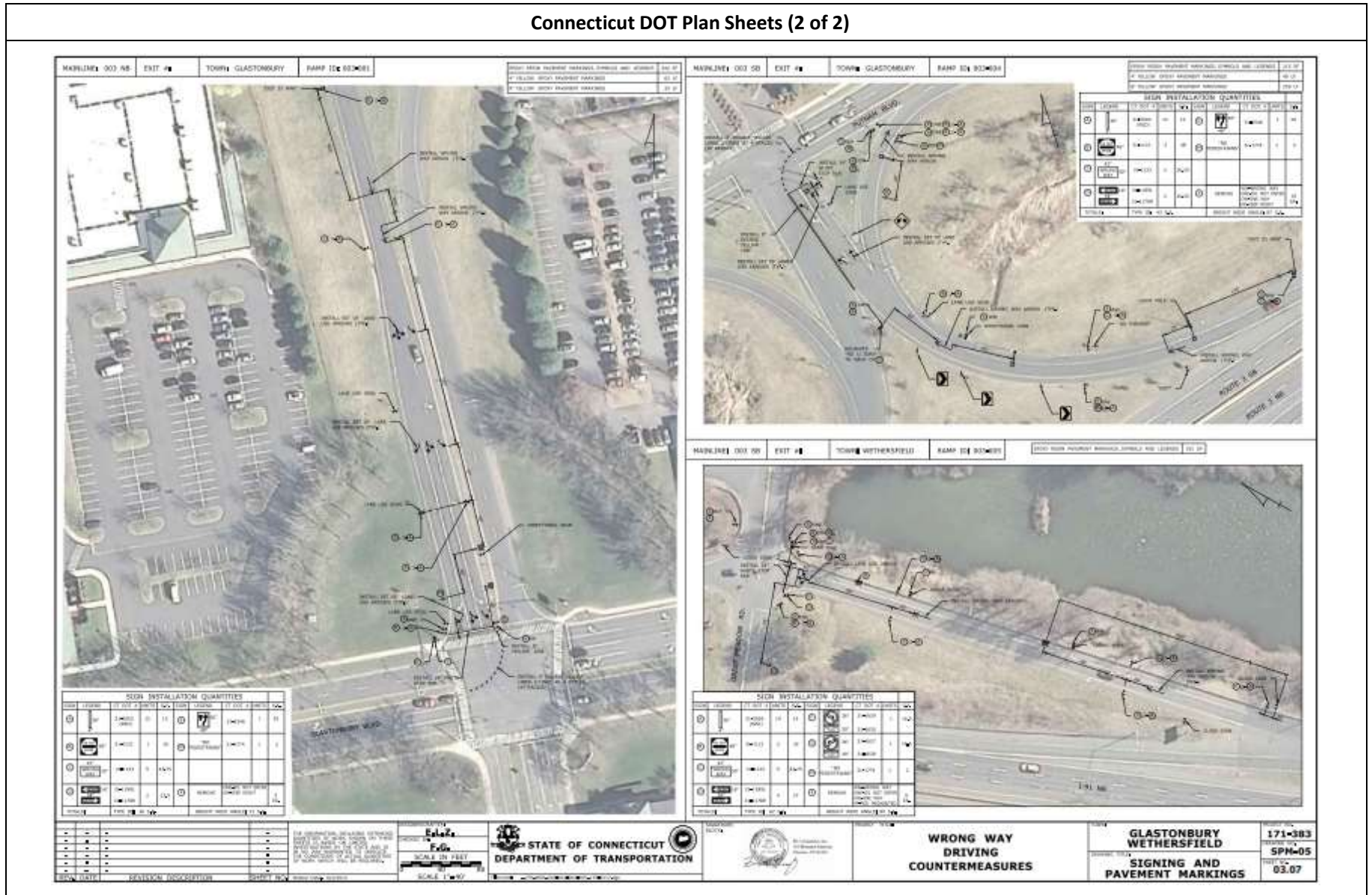

“Countermeasures for Wrong Way Driving on Freeways”

Deployment Summary

Central Florida Expressway Authority

Agency	Central Florida Expressway Authority
Agency Contact	Corey Quinn Email: corey.quinn@cfxway.com Phone: (407) 690-5000
Information Source	<ul style="list-style-type: none"> • Email from Bryan Homayouni on 7/21/16 • Interview with Corey Quinn on 1/28/15 • Homayouni, Bryan and Corey Quinn. <i>Wrong-Way Driving Detection and Prevention System: A Pilot Test Deployment</i> [presentation slides]. TRB Wrong Way Driving webinar, April 20, 2016. Retrieved April 21, 2016. http://onlinepubs.trb.org/Onlinepubs/webinars/160420.pdf • Al-Deek, Haitham, John Rogers, Adrian Sandt, Ahmad Alomari, and Frank Consoli. (May 2013). <i>Wrong Way Driving Incidents on OOCEA Toll Road Network, Phase-1 Study: What is the Extent of this Problem?</i> Final Research Report. Department of Civil, Environmental, and Construction Engineering, University of Central Florida. Available from http://ascelibrary.org/doi/abs/10.1061/9780784413586.032
Background	<p>The focus of this deployment is to provide alerts to confused drivers. Survey results indicate that only 1 of 10 people report wrong-way drivers; this is under-reported. This deployment aims to help confused drivers and warn right-way drivers.</p> <p>The design process eliminated pavement spikes because they are not intended for high-speed facilities. Parking lot testing was conducted on vehicle-activated flashing LED lights around WRONG WAY (WW) sign borders; it was determined that this approach may not be enough to capture the attention of motorists. Therefore, vehicle-activated red Rectangular Rapid Flashing Beacons (RRFBs) mounted to WW signs were chosen for driver alert.</p> <p>The deployment is designed to perform as “system,” with multiple strategies that include ramp detection with camera/photo for verification, alert to wrong-way driver, alert to the FDOT District 5 Regional Traffic Management Center (RTMC), alert to oncoming right-way traffic, and data collection/logging via a sensor system to understand WW driver patterns.</p> <p>Central Florida Expressway partnered with the University of Central Florida (UCF) to implement this project, utilizing results from research completed by UCF on wrong-way driving incidents on the Orlando Orange County Expressway Authority (OOCEA) toll road network.</p>
Deployment Location	Orlando, FL
Number of Sites	5 exit ramps
Deployment Dates	<ul style="list-style-type: none"> • First ramp: January 2015 • Ramps 2-5: June 2015

Test/Pilot or Long-term	Test/Pilot
Countermeasure Type	Ramp Detection with Rectangular Rapid Flashing Beacons (RRFBs) on WW Signs and Alert to RTMC
Description of Countermeasures	<p>Ramp Detection with Rectangular Rapid Flashing Beacons (RRFBs) on WW Signs and Alert to RTMC</p> <ul style="list-style-type: none"> • 4 WW signs with red RRFBs – 2 on each side of ramp • Rapid flashing beacon bars on top and bottom of WW sign panel • Slightly larger WW signs (48" x 36" R5-1A Sign) • Reflective strips on sign posts • When a wrong-way vehicle reaches the detection zone, the flashing WW signs are activated. Ramps are equipped with radar detection and a camera to confirm the wrong-way event and collect data about what the vehicle does. A photo is taken of the vehicle to verify the event. A photo and an alert (email and audible) are sent to the FDOT District 5 Regional Transportation Management Center (RTMC at which time RTMC operators alert FHP). <div style="text-align: center;">  <p>Rectangular Rapid Flashing Beacons (RRFBs) on WRONG WAY Signs (Source: Provided by Central Florida Expressway)</p> </div>
Evaluation Efforts/Results	The University of Central Florida (UCF) is in the process of conducting an evaluation of the test deployment.
Coordination	Coordination is occurring with the FDOT RTMC and local FHP.
Guidelines or Standards	None, as this is currently a test deployment.
Local/Public Response	Central Florida Expressway Authority has noted positive feedback from local news agencies including a TV Channel 9 report that indicates the program appears to be working. http://www.wftv.com/news/program-to-prevent-wrong-way-crashes-appears-to-be-working-expressway-authority-says_20160714212722/401211815
Lessons Learned	This study is a work in progress, the lessons learned will be documented in a final report when the evaluation is completed by UCF.
Future Plans	<ul style="list-style-type: none"> • 19 additional ramps expected to be deployed in summer 2016. • 10 additional ramps to be deployed by the spring of 2017.

“Countermeasures for Wrong Way Driving on Freeways”

Deployment Summary

Florida Department of Transportation: Florida Turnpike Enterprise

Agency	Florida Department of Transportation (FDOT): Florida Turnpike Enterprise	
Agency Contacts	Raj Ponnaluri Email: Raj.ponnaluri@dot.state.fl.us Phone: (850) 410-5616	
	John Easterling John.easterling@dot.state.fl.us 954-934-1620	Eric Gordin Eric.gordin@dot.state.fl.us 407-264-3316
Information Sources	<ul style="list-style-type: none"> • Interview with Raj Ponnaluri on 7/11/2016 • Interview with Raj Ponnaluri on 4/16/2015 • Ponnaluri, Raj. “Reducing Wrong-Way Entry Fatalities in Florida – A New FDOT Initiative.” <i>SunGuide® Disseminator</i> (Oct 2013): 1-3. Florida Department of Transportation. www.dot.state.fl.us/trafficoperations/Newsletters/2013/2013-Oct.pdf • Ponnaluri, Raj. “Wrong-Way Pilot Projects in Florida Update.” <i>SunGuide® Disseminator</i> (Mar 2014): 1-2. Florida Department of Transportation. www.dot.state.fl.us/trafficoperations/Newsletters/2014/2014-Mar.pdf • Ponnaluri, Raj. “Reducing Wrong-Way Entry Fatalities in Florida.” <i>SunGuide® Disseminator</i> (Sep 2014): 3-4. Florida Department of Transportation. www.dot.state.fl.us/trafficoperations/Newsletters/2014/2014-Sep.pdf • Easterling, John and Gordin, Eric. “FTE Wrong-Way Driving Pilot Project Shows Promise.” <i>SunGuide® Disseminator</i> (Feb 2015): 1-2. Florida Department of Transportation. www.dot.state.fl.us/trafficoperations/Newsletters/2015/2015-Feb.pdf • Kittelson & Associates, Inc. (2015). <i>Statewide Wrong Way Crash Study Final Report</i>. Florida Department of Transportation. Tallahassee, Florida. www.dot.state.fl.us/trafficoperations/PDF/Wrong%20Way%20Crash%20Study%20-%20Final%20Report-8-15.pdf • Boot, Walter R. et al. (2015). “Driving Simulator Studies of the Effectiveness of Countermeasures to Prevent Wrong-Way Crashes.” www.dot.state.fl.us/research-center/Completed_Proj/Summary_TE/FDOT-BDV30-977-10-rpt.pdf 	
Background	<p>A study commissioned by the Florida DOT (FDOT) in 2014 examined all state wrong-way crash data from 2009 to 2013. Incidents were categorized based on interchange type. Side by side ramps were found to have the most incidences. There were many occurrences at night, especially after bars closed, but occurrences were random.</p> <p>FDOT has developed a new signing and pavement marking standard. Additional technology countermeasures are implemented on a case-by-case basis.</p>	
Deployment Location	Florida Turnpike Enterprise (Homestead Extension of Florida Turnpike & Sawgrass Expressway), Miami-Ft. Lauderdale area	

<p>Number of Sites</p>	<ul style="list-style-type: none"> • 15 ramps <ul style="list-style-type: none"> - 10 ramps along Homestead Extension of Florida Turnpike - 5 ramps along Sawgrass Expressway • 12 mainline detection sites
<p>Deployment Dates</p>	<p>March 2014 – October 2014</p>
<p>Test/Pilot or Long-term</p>	<p>Test/Pilot deployment</p>
<p>Countermeasure Types</p>	<ol style="list-style-type: none"> 1) Signing and Pavement Marking Improvements 2) Detection and LED-Enhanced Signs at Exit Ramps 3) Mainline Detection with Alert to Traffic Management Center (TMC) 4) Alert to Oncoming Right-Way Traffic
<p>Description of Countermeasures</p>	<ol style="list-style-type: none"> 1) Signing and Pavement Marking Improvements <ul style="list-style-type: none"> • Oversized signs: DO NOT ENTER (DNE), WRONG WAY (WW), ONE WAY, No Left/U Turns, Keep Right) • Additional wrong-way arrows 2) Detection and LED-Enhanced Signs at Exit Ramps <ul style="list-style-type: none"> • Two radar devices (1 front-facing, 1 rear-facing) and a camera for verification and license plate capture • LED-Enhanced WW signs (blinking LED lights around sign border, activated by vehicle detection) • Alert to TMC 3) Mainline Detection with Alert to TMC <ul style="list-style-type: none"> • 12 mainline detection devices that trigger an alert to the TMC 4) Alert to Oncoming Right-Way Traffic <ul style="list-style-type: none"> • After visual verification, TMC posts message to DMS (shown below) within a 20-mile area in both directions. <div style="border: 1px solid black; padding: 10px; margin: 10px auto; width: fit-content;"> <p style="text-align: center;">WRONG WAY DRIVER REPORTED USE CAUTION</p> </div> <div style="text-align: right; margin-top: 10px;">  <p>Blinking LED Sign (Source: FDOT <i>SunGuide</i>® <i>Disseminator</i>, Feb. 2015)</p> </div>
<p>Evaluation Efforts/Results</p>	<p>Though monitoring and evaluation efforts require careful planning, indications are that in the vast majority of cases observed to date, wrong-way drivers self-corrected when encountering the blinking LED signs.</p>
<p>Coordination</p>	<p>FDOT, Florida Highway Patrol (FHP), the Lake Worth Regional Communications Center, and local law enforcement agencies coordinated closely on the use of the vendor’s web-based interface for monitoring alerts at ramp detection sites.</p>
<p>Guidelines or Standards</p>	<p>There is no standard approach for technology deployments; these are determined on a case-by-case basis.</p>

Local/Public Response	None observed to date.
Lessons Learned	Results of a human factors study conducted by Florida State University indicates that lab and simulated studies suggest that increasing the number and diversity of countermeasures at interchanges can reduce confusion regarding highway entry points. (Boot et al, 2015)
Future Plans	Florida Turnpike Enterprise plans to pursue a Request for Experimentation to deploy Rectangular Rapid Flashing Beacons (RRFB) on WW signs on the Turnpike system.

“Countermeasures for Wrong Way Driving on Freeways”

Deployment Summary

Florida Department of Transportation Statewide

Agency	Florida Department of Transportation (FDOT)
Agency Contact	Raj Ponnaluri Email: Raj.ponnaluri@dot.state.fl.us Phone: (850) 410-5616
Information Sources	<ul style="list-style-type: none"> • Interview with Raj Ponnaluri on 7/11/16 • Interview with Raj Ponnaluri on 4/16/15 • Florida Department of Transportation. “Wrong Way Driving – Statewide Initiative.” District 7 Safety Summit. 13 January, 2015. Presentation. www.tampabaytrafficsafety.com/SafetySummit/2015%20Resources/04%20%20D7%20Safety%20Summit%202015%20-%20Wrong%20Way%20Driving%20-%20Ponnaluri.pdf • Kittelson & Associates, Inc. (2015). <i>Statewide Wrong Way Crash Study Final Report</i>. Florida Department of Transportation. Tallahassee, Florida. www.dot.state.fl.us/trafficoperations/PDF/Wrong%20Way%20Crash%20Study%20-%20Final%20Report-8-15.pdf
Background	<p>A study commissioned by FDOT in 2014 examined all state wrong-way crash data (280 incidents) from 2009 to 2013. Incidents were categorized based on interchange type. Side by side ramps were found to have the most incidences. There were many occurrences at night, especially after bars closed, but occurrences were random.</p> <p>In April 2015, FDOT implemented a new signing and pavement marking standard. Additional technology countermeasures are implemented on a case-by-case basis.</p> <p>FDOT completed a study that analyzed trends and contributing factors surrounding wrong way driving on freeways and expressways. The study proposes systemic countermeasures to prevent or discourage wrong way occurrences and includes an implementation plan. (Kittelson & Associates, Inc., 2015)</p>
Deployment Location	Statewide
Number of Sites	Deployments ongoing
Deployment Date	New signing and pavement marking standard implemented in April 2015; deployments ongoing
Test/Pilot or Long-term	Long-term deployment
Countermeasure Types	<ol style="list-style-type: none"> 1) Signing and Pavement Marking Standard 2) Additional Technology Countermeasures Implemented on Case-by-Case Basis
Description of Countermeasures	<p>1) Signing and Pavement Marking Standard</p> <p>In April, 2015, FDOT implemented a new signing and pavement marking standard for the following ramp types: “Diamond Interchange Exit Ramp” and “Partial Cloverleaf/Trumpet Interchange Exit Ramp.” See the following pages for associated memo and design details.</p>

	<p><u>Signing:</u></p> <ul style="list-style-type: none"> • Optional signs beyond MUTCD minimums (now on both sides of ramp) <ul style="list-style-type: none"> - Second DO NOT ENTER sign - Second WRONG WAY sign - ONE WAY sign • Include NO RIGHT TURN and NO LEFT TURN signs • Low-mounted WRONG WAY signs (4 ft. mounting height) • Oversized WRONG WAY signs: 3.5 ft. x 2.5 ft. • Retroreflective strip on WRONG WAY sign supports <p><u>Pavement Markings:</u></p> <ul style="list-style-type: none"> • Dotted guide line striping for left turns between ramp entrances/exits and cross-streets • Retroreflective (yellow) paint on ramp median noes where applicable • Straight arrow and route interstate shield pavement marking in left-turn lanes • Include straight arrow and ONLY pavement message in outside lane approaching ramp entrance  <p style="text-align: center;">Straight Arrow, ONLY, & Interstate Shield (Source: FDOT Wrong Way Driving – Statewide Initiative presentation, 2015)</p> <p>2) Additional Technology Countermeasures Additional technology-based (ITS) countermeasures are implemented on a case-by-case basis.</p>
Evaluation Efforts/Results	It will be difficult to evaluate the effectiveness of the countermeasures due to the random nature of wrong-way crash occurrences.
Coordination	Driving under the influence (DUI) education efforts are underway, particularly in the Tampa area.
Guidelines or Standards	A new signing and pavement marking standard has been developed for future designs and to improve existing interchanges (diamond interchange exit ramps and partial cloverleaf/trumpet interchange exit ramps). See the following pages for associated memo and design details. Then standard is also included in Chapter 7 of the FDOT Plans Preparation Manual .
Local/Public Response	None observed

<p>Lessons Learned</p>	<ul style="list-style-type: none"> • Awareness of wrong-way driving in Florida has increased significantly both within FDOT and by the public, with media coverage and increased efforts at FDOT. • The new signing and pavement marking standard serves as a reference for improvements statewide. • Efforts to reduce wrong-way driving incidents have helped address other crash types such as lane departure crashes. • All countermeasures work together to help mitigate the wrong-way driving problem. • After a wrong-way incident, FDOT typically receives questions from the media and the public. FDOT has learned how to respond to these inquiries by having research findings available to draw from to assist with responding to inquiries.
<p>Future Plans</p>	<ul style="list-style-type: none"> • Future designs will be guided by the April 15, 2015 standard. Countermeasures will be implemented, per new standards, as interchanges/ramps come up for routine work. • FDOT recently signed an agreement to share data with the WAZE application (www.waze.com.) FDOT has requested WAZE to consider application options for wrong- way driving detection and notification. (Kittelson & Associates, Inc., 2015)



Florida Department of Transportation

RICK SCOTT
GOVERNOR

605 Suwannee Street
Tallahassee, FL 32399-0450

JIM BOXOLD
SECRETARY

ROADWAY DESIGN BULLETIN 15-08
TRAFFIC OPERATION BULLETIN 03-15
(FHWA Approved: April 14, 2015)

DATE: April 15, 2015

TO: District Directors of Transportation Operations, District Directors of Transportation Development, District Design Engineers, District Consultant Project Management Engineers, District Construction Engineers, District Maintenance Engineers, District Geotechnical Engineers, District Structures Design Engineers, District Roadway Design Engineers, District Traffic Operations Engineers, Program Management Engineers

FROM: *Michael Shepard* Michael Shepard, P.E., State Roadway Design Engineer
Mark Wilson Mark Wilson, P.E., Director, Office of Traffic Engineering & Operations

COPIES: Brian Blanchard, Tom Byron, David Sadler, Tim Lattner, Trey Tillander, Bruce Dana, John Krause, Robert Robertson, Bob Crim, Rudy Powell, Greg Schiess, Nicholas Finch (FHWA), Jeffrey Ger (FHWA), Chad Thompson (FHWA), Phillip Bello (FHWA)

SUBJECT: **Signing and Pavement Marking Standards at Ramp Intersections**

This bulletin introduces new minimum signing and pavement marking standards for interstate exit ramp intersections throughout the state of Florida to complement the Manual of Uniform Traffic Control Devices (MUTCD), 2009 Edition.

REQUIREMENTS

1. The new standard for signing and pavement marking at exit ramp intersections is illustrated in **Figures 7.8.1** "Diamond Interchange Exit Ramp" and **7.8.2** "Partial Cloverleaf/Trumpet Interchange Exit Ramp" and described as follows:
 - A. Include MUTCD "optional" signs
 - Second DO NOT ENTER sign
 - Second WRONG WAY sign
 - ONE WAY signs
 - B. Include NO RIGHT TURN and NO LEFT TURN signs

www.dot.state.fl.us

Florida DOT Signing and Pavement Marking Standards at Ramp Intersections (2 of 5)

Roadway Design Bulletin 15-08
Traffic Operations Bulletin 03-15
Signing and Pavement Marking Standards at Ramp Intersections

Page 2 of 3

- C. Use 3.5 ft. by 2.5 ft. WRONG WAY signs mounted at 4-foot height with retroreflective strip on sign supports (MUTCD, Figure 2A-1[E])
- D. Include 2-4 dotted guide line striping for left turns between ramps entrances/exits and cross-streets
- E. Include retroreflective paint (yellow) on ramp median nose where applicable
- F. Include a straight arrow and route interstate shield pavement marking in left-turn lanes extending from the far-side ramp intersection through the near-side ramp intersection to prevent premature left turns
- G. Include a straight arrow and ONLY pavement message in outside lane approaching the ramp exit

COMMENTARY

The FDOT Traffic Engineering and Operations Office conducted a study for wrong-way crashes occurring on interstate freeways and expressways throughout the state of Florida. Over the past years (2009-2013), 280 wrong-way crashes have occurred on Florida's freeways and expressways resulting in more than 400 injuries and 75 deaths. This bulletin requires the use of systemic signing and pavement marking countermeasures to deter wrong-way occurrences.

This bulletin complements design requirements established by the Traffic Engineering Manual (TEM), February 2015 Edition, Section 4.2.4 "Route Shields for Wrong Way Treatment". All signing and pavement markings included in this bulleting have corresponding pay item numbers on the Basis of Estimates Manual, 2015 Edition.

BACKGROUND

Prior to this bulletin the minimum MUTCD signing and pavement marking requirements for exit ramp intersections were accepted as the FDOT Standard. The study conducted has identified the need to provide additional direction to motorists and greater level of warning to errant drivers. The installation of these wrong-way driving countermeasures will provide a safer roadway.

IMPLEMENTATION

The requirements of this bulletin are effective immediately on all design-bid-build projects for which the design development is less than 90% complete (Phase III Submittal). These requirements should be employed on projects beyond 90% complete where implementation will not adversely impact the production schedule.

The requirements of this bulletin are effective immediately on all design-build projects for which the final RFP has not been released. Implementation of this bulletin for Design-build projects for which the final RFP has been released is at the discretion of the District.

www.dot.state.fl.us

Florida DOT Signing and Pavement Marking Standards at Ramp Intersections (3 of 5)

Roadway Design Bulletin 15-08
Traffic Operations Bulletin 03-15
Signing and Pavement Marking Standards at Ramp Intersections

Page 3 of 3

CONTACT(s)

Raj Ponnaluri, PhD, P.E., PTOE
Arterial Management System Engineer
Florida Department of Transportation
600 Suwannee Street; MS 36
Tallahassee FL 32399-0450
(850) 410-5418
Raj.Ponnaluri@dot.state.fl.us

Paul Hiers, P.E.
Roadway Design Criteria Administrator
Florida Department of Transportation
605 Suwannee Street, MS 32
Tallahassee, Florida 32399
Phone (850) 414-4324
Paul.Hiers@dot.state.fl.us

www.dot.state.fl.us

Florida DOT Signing and Pavement Marking Standards at Ramp Intersections (4 of 5)

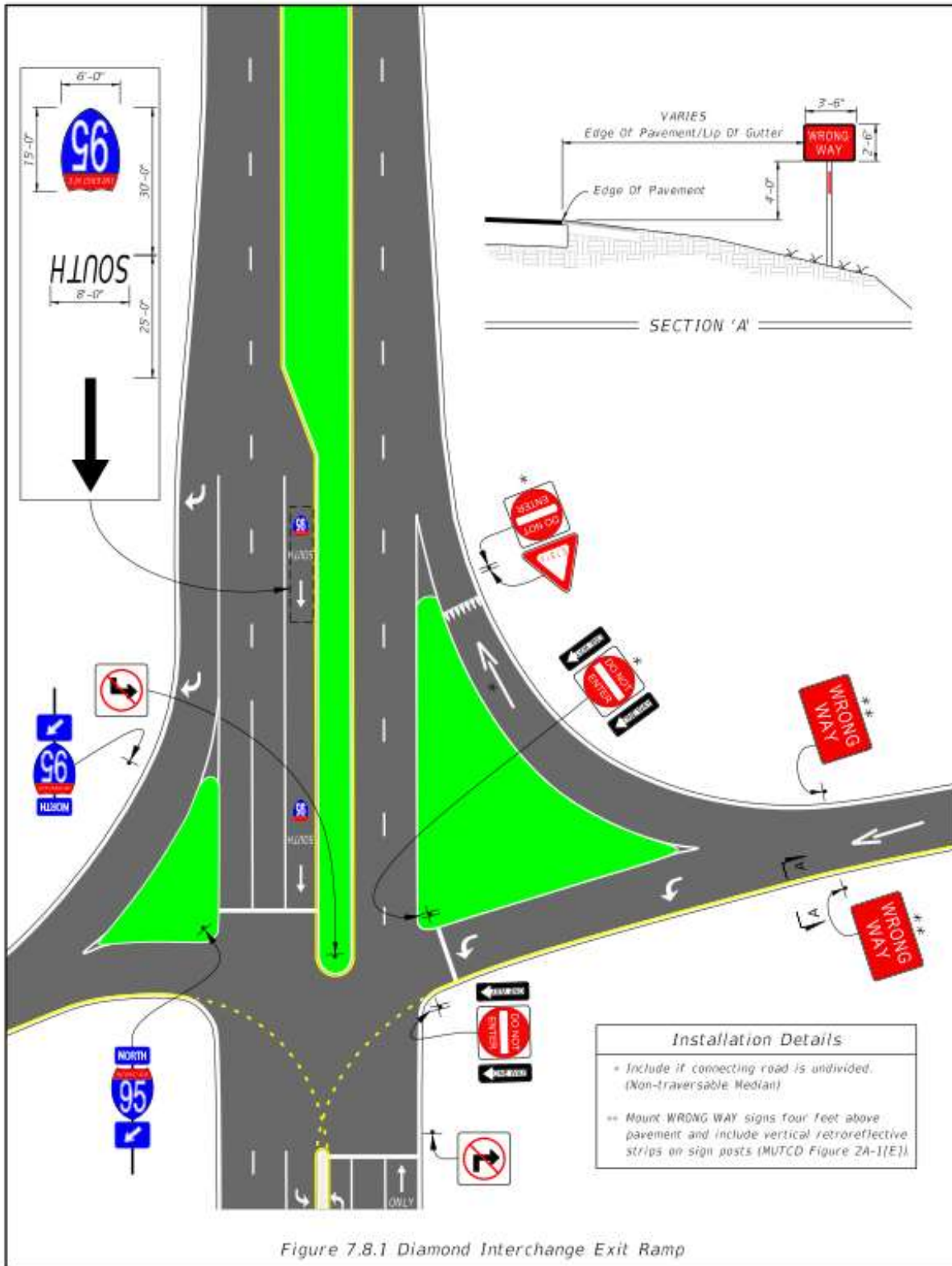

Florida DOT Signing and Pavement Marking Standards at Ramp Intersections (5 of 5)

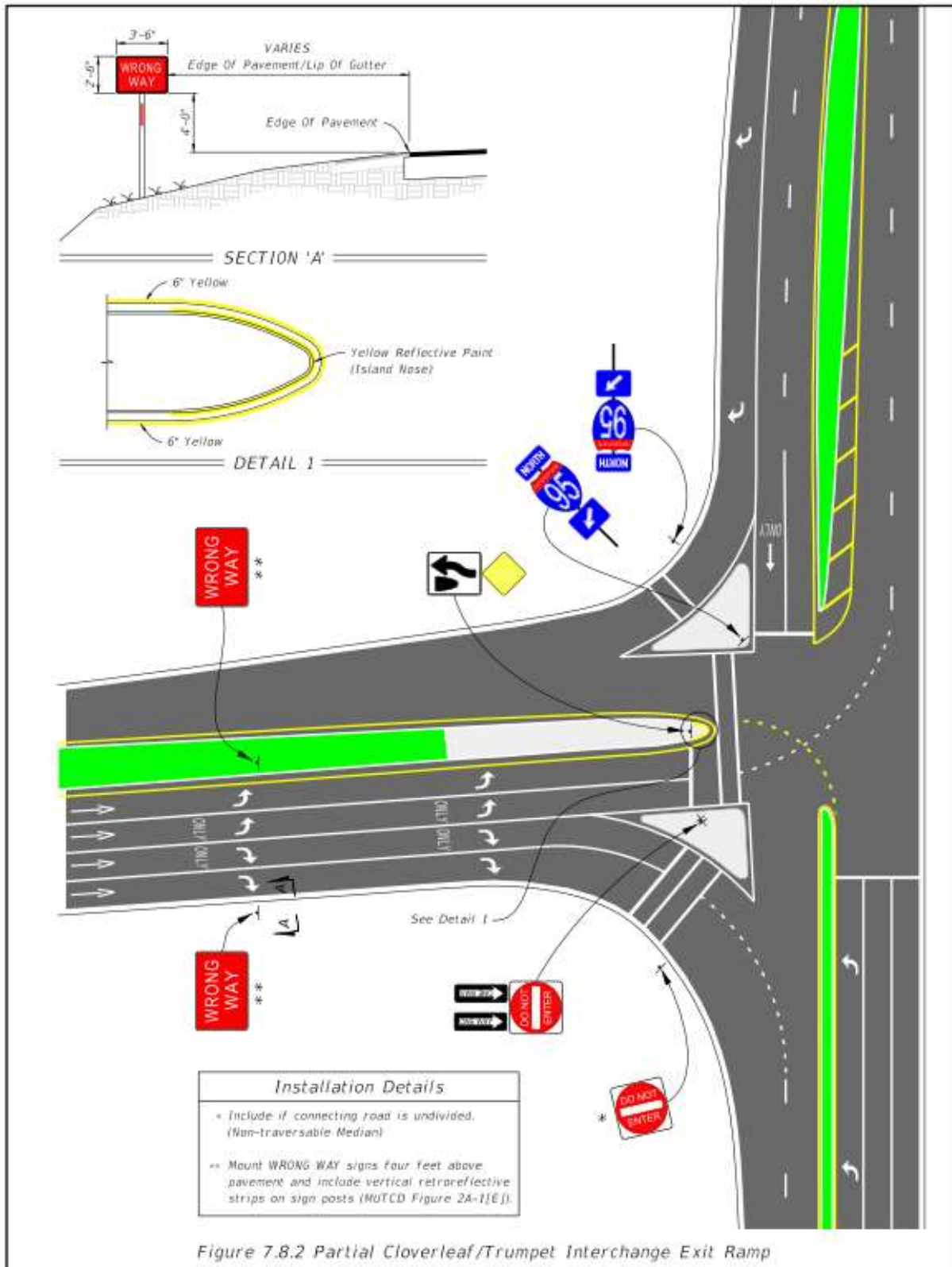

“Countermeasures for Wrong Way Driving on Freeways” Deployment Summary

Florida Department of Transportation Tallahassee

Agency	Florida Department of Transportation (FDOT): Tallahassee
Agency Contact	Raj Ponnaluri Email: Raj.ponnaluri@dot.state.fl.us Phone: (850) 410-5616
Information Sources	<ul style="list-style-type: none"> • Interview with Raj Ponnaluri on 7/11/2016 • Interview with Raj Ponnaluri on 4/16/2015 • Ponnaluri, Raj. “Wrong-Way Pilot Projects in Florida Update.” <i>SunGuide® Disseminator</i> (Mar 2014): 1-2. Florida Department of Transportation. www.dot.state.fl.us/trafficoperations/Newsletters/2014/2014-Mar.pdf • Ponnaluri, Raj. “Reducing Wrong-Way Entry Fatalities in Florida.” <i>SunGuide® Disseminator</i> (Sep 2014): 3-4. Florida Department of Transportation. www.dot.state.fl.us/trafficoperations/Newsletters/2014/2014-Sep.pdf • “Wrong Way Driving - Statewide Initiative” presentation, FDOT District 7 Safety Summit, January 13, 2015. www.tampabaytrafficsafety.com/SafetySummit/2015%20Resources/04%20%20D7%20Safety%20Summit%202015%20-%20Wrong%20Way%20Driving%20-%20Ponnaluri.pdf • Kittelson & Associates, Inc. (2015). <i>Statewide Wrong Way Crash Study Final Report</i>. Florida Department of Transportation. Tallahassee, Florida. www.dot.state.fl.us/trafficoperations/PDF/Wrong%20Way%20Crash%20Study%20-%20Final%20Report-8-15.pdf
Background	<p>A study commissioned by FDOT in 2014 examined all state wrong-way crash data (280 incidents) from 2009 to 2013. Incidents were categorized based on interchange type. Side by side ramps were found to have the most incidences. There were many occurrences at night, especially after bars closed, but occurrences were random.</p> <p>In April 2015, FDOT implemented a new signing and pavement marking standard. Additional technology countermeasures are implemented on a case-by-case basis.</p>
Deployment Locations	Tallahassee, FL (Interstate 10) and Rural Sites
Number of Sites	<ul style="list-style-type: none"> • Signing and Pavement Marking Improvements – Various sites (Tallahassee) • Vehicle-Activated LED “Blank Out” Signs – 4 Exit Ramps (Tallahassee) • Internally Illuminated Raised Pavement Markers – 4 Exit Ramps (Rural sites)
Deployment Date	<ul style="list-style-type: none"> • Signing and Pavement Marking Improvements – Spring 2014 • Vehicle-Activated LED “Blank Out” Signs – Spring 2014 • Internally Illuminated Raised Pavement Markers – Early 2016
Test/Pilot or Long-term	Test/Pilot Deployment

<p>Countermeasure Types</p>	<ol style="list-style-type: none"> 1) Signing Improvements 2) Pavement Marking and Geometric Improvements 3) Vehicle-Activated LED “Blank Out” Signs 4) Internally Illuminated Raised Pavement Markers at Exit Ramps
<p>Description of Countermeasures</p>	<p>Countermeasures vary by site but include one or more of the following:</p> <ol style="list-style-type: none"> 1) Signing Improvements <ul style="list-style-type: none"> • Oversized overhead WRONG WAY (WW) sign panels added to the back of existing guide sign trusses • Additional, larger WW signs at both sides of ramps • Larger DO NOT ENTER (DNE) signs and WW “panels” added below DNE signs • Larger “No Right Turn,” “No Left Turn,” and “No U-Turn” signs added along arterial roadway at exit ramp intersections 2) Pavement Marking and Geometric Improvements <ul style="list-style-type: none"> • Raised Reflective Pavement Marking (RRPMs) arrows • Pavement arrows with “ONLY” markings added to through lanes • I-10 pavement marking shields at beginning of left turn lanes to ramps • Additional turn movement pavement marking channelization in median openings • Median curb extensions to discourage early left turns <div data-bbox="898 449 1433 854" data-label="Image"> </div> <div data-bbox="898 867 1433 968" data-label="Caption"> <p>Larger “No Left Turn” and “No U-Turn” Signs (Source: <i>FDOT Wrong Way Driving - Statewide Initiative presentation, January 2015</i>)</p> </div> <div data-bbox="454 1287 1419 1682" data-label="Image"> </div> <div data-bbox="649 1690 1226 1755" data-label="Caption"> <p>I-10 Pavement Marking Shields (Source: <i>FDOT SunGuide Disseminator, Sept. 2014</i>)</p> </div>

3) Vehicle-Activated LED “Blank Out” Signs

- 4 ramps in Tallahassee
- At least 2 per ramp, one on each side
- Radar-activated signs remain blank until activated by a vehicle, then “WRONG WAY” message blinks



Vehicle-activated Blinking LED “Blank Out” Sign
(Source: *FDOT SunGuide Disseminator*, March 2014)

4) Internally Illuminated Raised Pavement Markers at Exit Ramps

- 4 exit ramps in rural areas
- Red in-pavement lighting that creates the illusion of a stop bar at the end of the exit ramp
- Continuously flashes at night and low-light conditions (ambient adjusted and solar powered)
- Tested at FDOT’s Traffic Engineering Research Lab (TERL)
- Approved for experimentation by FHWA



Internally Illuminated Raised Pavement Markers
Create Illusion of Stop Bar
(Source: *Florida DOT*)

Evaluation Efforts/Results



A formal evaluation on the internally illuminated raised pavement marker deployment is underway.

Coordination	None noted.
Guidelines or Standards	There is no standard approach for technology deployments; these are determined on a case-by-case basis.
Local/Public Response	None noted.
Lessons Learned	Internal research conducted by FDOT indicated that there is a tendency to focus on urban area crashes but rural areas cannot be ignored, especially since these areas typically have no lighting, low traffic, and could involve drivers under the influence.
Future Plans	FDOT is considering a statewide policy for lighting at interchanges, including those in rural areas.

“Countermeasures for Wrong Way Driving on Freeways” Deployment Summary

Florida Department of Transportation Tampa

Agency	Florida Department of Transportation (FDOT): Tampa	
Agency Contacts	Raj Ponnaluri Raj.ponnaluri@dot.state.fl.us (850) 410-5616	
	Ping (Peter) Hsu Ping.Hsu@dot.state.fl.us (813) 975-6251	Chester Chandler Chester.Chandler@dot.state.fl.us (813) 615-8610
Information Sources	<ul style="list-style-type: none"> • Interview with Raj Ponnaluri on 7/11/16 • Interview with Chester Chandler, Peter Hsu, and Terry Hensley on 3/26/15 • Interview with Raj Ponnaluri on 4/16/15 • Ponnaluri, Raj. “Reducing Wrong-Way Entry Fatalities in Florida – A New FDOT Initiative.” <i>SunGuide® Disseminator</i> (Oct 2013): 1-3. Florida Department of Transportation. www.dot.state.fl.us/trafficoperations/Newsletters/2013/2013-Oct.pdf • Ponnaluri, Raj. “Reducing Wrong-Way Entry Fatalities in Florida.” <i>SunGuide® Disseminator</i> (Sep 2014): 3-4. Florida Department of Transportation. www.dot.state.fl.us/trafficoperations/Newsletters/2014/2014-Sep.pdf • Ozkul, Seckin, Pei-Sung Lin, & Chester H. Chandler. (2015). <i>Evaluation on Impact of Red RRFB Implementation at Freeway Off-Ramps on Driving Behaviors Along Adjacent Arterials</i> [presentation slides]. Center for Urban Transportation Research, University of South Florida. 2015 FSITE Annual Meeting. www.floridasectionite.org/uploads/4/8/0/1/48016965/red_rrfbs_for_freeway_wwd_-_ozkul.pdf • Kittelson & Associates, Inc. (2015). <i>Statewide Wrong Way Crash Study Final Report</i>. Florida Department of Transportation. Tallahassee, Florida. www.dot.state.fl.us/trafficoperations/PDF/Wrong%20Way%20Crash%20Study%20-%20Final%20Report-8-15.pdf 	
Background	<p>A study commissioned by FDOT in 2014 examined all state wrong-way crash data (280 incidents) from 2009 to 2013. Incidents were categorized based on interchange type. Side by side ramps were found to have the most incidences. There were many occurrences at night, especially after bars closed, but occurrences were random.</p> <p>In April 2015, FDOT implemented a new signing and pavement marking standard. Additional technology countermeasures are implemented on a case-by-case basis.</p>	
Deployment Location	I-275 in Tampa, FL	
Number of Sites	<ul style="list-style-type: none"> • 7 ramps • Additional locations are being considered 	

Deployment Dates	December 2014 - February 2015
Test/Pilot or Long-term	Test/Pilot Deployment
Countermeasure Types	1) Rectangular Rapid Flashing Beacons (RRFB) on WRONG WAY (WW) signs at Exit Ramps 2) Detection with Alert to Transportation Management Center (TMC) and Messages to Oncoming Right-Way Traffic
Description of Countermeasures	<p>1) Rectangular Rapid Flashing Beacons on WW signs at Exit Ramps</p> <ul style="list-style-type: none"> • Radar detection with cameras for verification • Exploring loop detectors where radar won't work • Two signs per ramp, one on each side of ramp <div style="display: flex; justify-content: space-around; align-items: center;"> <div style="text-align: center;">  <p>RRFBs on WW Sign (Source: Florida DOT)</p> </div> <div style="text-align: center;">  <p>RRFBs on WW Sign (Source: FDOT SunGuide® Disseminator, Sept.)</p> </div> </div> <p>2) Detection with Alert to TMC and Messages to Oncoming Right-Way Traffic</p> <ul style="list-style-type: none"> • Radar and microwave detection at ramp sends alert to TMC/State Patrol • Ramps equipped with cameras also send photos of wrong-way event • False alarm rates have decreased significantly since the initial deployment; working with the vendor to troubleshoot false calls has made the system more reliable. • Mainline detection triggers message to right-way traffic. Operators visually confirm the wrong-way driver with traffic cameras then post a message (shown below) on DMS. <div style="text-align: center; border: 1px solid black; padding: 10px; margin: 10px auto; width: fit-content;"> <p>WRONG-WAY DRIVER ALERT USE EXTREME CAUTION</p> </div>

<p>Evaluation Efforts/Results</p>	<ul style="list-style-type: none"> • A short-term evaluation testing effectiveness of RRFBs on signs is being conducted by University of South Florida. (Ozkul, et al., 2015) <ul style="list-style-type: none"> – Majority of public survey participants favored RRFB combination with flashing top and bottom RRFBs on both sides of roadway. – Red RRFBs can effectively alert wrong-way drivers while not adversely impacting driver behaviors on adjacent arterials. • FDOT is monitoring RRFBs at ramps observationally. Initial results are positive, with observations showing drivers who self-correct after seeing the RRFB signs. • A 3-year crash analysis will be conducted, before and after the implementation, to measure effectiveness of red RRFBs installed at off-ramps and mainline microwave sensors on reducing wrong-way driving. (Ozkul, et al., 2015)
<p>Coordination</p>	<p>Driving Under the Influence (DUI) education efforts are underway as a part of FDOT’s CPR (Consistent, Predictable, Repeatable) Practices.</p>
<p>Guidelines or Standards</p>	<p>There is no standard approach for technology deployments; these are determined on a case-by-case basis.</p>
<p>Local/Public Response</p>	<p>A local news station conducted a "worth it or waste it" survey; a very positive response was conveyed that it would be worth it to spend taxpayer dollars on improvements to mitigate wrong-way driving.</p>
<p>Lessons Learned</p>	<p>RRFBs – evaluation underway</p>
<p>Future Plans</p>	<ul style="list-style-type: none"> • FDOT will continue to monitor deployments through observation and evaluation of crash data. • Additional deployments are being considered.

**“Countermeasures for Wrong Way Driving on Freeways”
Deployment Summary
Iowa Department of Transportation**

Agency Name	Iowa Department of Transportation (Iowa DOT)
Agency Contact	Willy Sorenson, P.E. Email: Willy.Sorenson@dot.iowa.gov Phone: (515) 239-1212
Information Sources	<ul style="list-style-type: none"> • Interviews with Willy Sorenson on 1/22/16, 6/8/16, and 9/7/16 • Preisen, Linda and Dean Deeter. (2014). <i>Next Generation Traffic Data and Incident Detection from Video</i>. Report Number ENT-2014-2. ENTERPRISE Pooled Fund Study TPF-5(231), Michigan DOT. Lansing, MI. www.enterprise.prog.org/Projects/2010_Present/nextgenerationvideo/ENT_VideoAnalytics_Report_Sept2014_FINAL.pdf
Background	<p>The Iowa DOT has deployed an on-road testbed that consists of devices to detect wrong-way events along U.S. 30 which has a mix of interchanges and at-grade intersections. The testbed, centered around the city of Ames, has been in place since July 2014. The testbed consists of high-definition radar detection devices located on the mainline with alerts to select DOT staff. Detected events are post-processed by DOT personnel to track confirmed events and false calls in an attempt to identify points of entry and determine the extent of occurrences.</p> <p>A controlled field test was conducted in November 2013 to test the capability of video analytics software to detect wrong-way events in real-time by processing video footage from traffic cameras.</p> <p>Wrong-way arrows have been deployed at all partial cloverleaf ramps. Enhanced static signing was implemented at 3 sites and spot treatments were implemented at other locations.</p>
Deployment Location	Ames, Iowa (U.S. Hwy 30) – 23.6 miles between Boone, IA and Nevada, IA
Number of Sites & Deployment Dates	<ul style="list-style-type: none"> • High definition radar detection: 24 mainline locations (July 2014 to present) • Video analytics detection: Traffic cameras at 3 exit ramps were equipped with video analytics software, and a controlled field test was conducted in November 2013. • Improvements Static Signing and Pavement Markings: <ul style="list-style-type: none"> – Enhanced signing at 3 exit ramps (July 2015, August 2015, and April 2016) – Wrong-way arrows at most interchanges and 2 at-grade intersections (Summer 2015)
Test/Pilot or Long-term	<ul style="list-style-type: none"> • Detection: Test/Pilot deployment • Improvements to Static Signing and Pavement Markings: Long-term deployment

<p>Countermeasure Types</p>	<p>1) High Definition Radar Detection at various mainline locations, with Alerts to DOT personnel for Post-Processing</p> <p>2) Video Analytics Software Detection with Alerts to DOT personnel</p> <p>3) Improvements to Static Signing and Pavement Markings</p>
<p>Description of Countermeasures</p>	<p>1) High-Definition Radar Detection at Various Mainline Locations, with Alerts to DOT personnel for Post-Processing</p> <ul style="list-style-type: none"> • Upon detection, an alert is sent to DOT personnel for post-processing. • Each detection event is reviewed, including camera footage at the site and along the U.S Highway 30 corridor, in attempt to determine: <ul style="list-style-type: none"> – Confirmed event or false call – Point of entry – Resulting vehicle action (e.g. self-correct within the ramp, any 911 calls reporting the wrong-way event, any response from law enforcement) • All wrong-way reports (911 calls, law enforcement responses) are tracked to determine whether a detection was made for actual wrong-way events. <p>2) Video Analytics Software Detection with Alerts to DOT personnel</p> <ul style="list-style-type: none"> • A controlled field test was conducted at 3 exit ramps, each with a camera equipped with a separate proprietary video analytics software system. • The highest level of performance for 12 test drives was 100% detection of wrong-way vehicles during the day and an 83% detection rate at night. • Slow vehicle speeds and nighttime lighting were factors that adversely impacted detection rates. <p>(Preisen and Deeter, 2014)</p> <p>3) Improvements to Static Signing and Pavement Markings</p> <ul style="list-style-type: none"> • Targeted improvements at known point-of-entry locations (2 interchanges and 1 at-grade intersection) <ul style="list-style-type: none"> – Red conspicuity tape, larger signs, 2 signs mounted on the same post, DNE signs installed on both sides, and wrong-way pavement marking arrows – See the following pages for photos before and after improvements • Spot Treatments <ul style="list-style-type: none"> – Red conspicuity tape on all DNE and WW signs – No Right Turn or No Left Turn signs at select locations – Added “Re-check Cross Traffic Before Entering” signs at select locations

Description of Countermeasures (continued)



Improvements at Lincoln Way Flyover Ramp: Signs on Both Sides of Ramp, Red Conspicuity Tape on Posts, Wrong-Way Arrows
(Source: Iowa DOT)



Improvements at 19th Street Interchange: Stacked DNE and WW Signs on Both Sides, Red Conspicuity Tape on Posts, Wrong-Way Arrows
(Source: Iowa DOT)



Improvements at Linn Street and U.S. 30 Intersection: DNE Signs on Both Sides of Highway, Wrong-Way Arrow Pavement Markings
(Source: Iowa DOT)

Evaluation Results

Results from Data Evaluation (July 2014 through May 2016):

Upon review of data from mainline detectors and footage from traffic cameras, key findings include:

- 43 wrong-way driving events were confirmed via video footage
- The most common time period for confirmed wrong-way events is 4:00-5:00 AM
- Approximately 1/3 of confirmed wrong-way events are reported through 911 calls
- 10-20% of confirmed wrong-way drivers are caught by law enforcement
- Radar detection:
 - Rate of False Calls: 98% of detections were false calls (i.e. 98% of detection alarms received were not wrong-way events, per post-review of video footage at the detection sites)
 - Rate of Confirmed Events: Nearly 60% of confirmed wrong-way events were detected by radar; approximately 40% were not detected.
 - Undetected wrong-way events are not necessarily due to inaccuracy of the radar technology itself and may occur as a result of problems such as incorrect configuration, lack of power, communication outages, or equipment in need of maintenance.

Results from Data Evaluation (July 2014 through Sept. 13, 2016)

- 51 wrong-way driving events were confirmed via video footage
- DOT staff identified the point of entry for 41 of 51 confirmed wrong-way events:
 - 28 of 41 (68%) points of entry were via at-grade intersections, while 13 of 41 (32%) points of entry were at interchanges. The photo below shows the common wrong-way vehicle movement path at an at-grade intersection.



Wrong-Way Entry Points Observed for At-Grade Intersections
(Source: Iowa DOT)

- 6 of the 13 wrong-way driving entries at interchanges occurred at free-flowing merge points. The photo below shows the vehicle path movement for this type of entry.



Wrong-Way Movements Observed at Interchange Entrance Ramps
(Source: Iowa DOT)

- Iowa DOT has observed over 200 confirmed “pass-bys” on video, where right-way traffic passed by a wrong-way vehicle without a crash. No wrong-way crashes have occurred on U.S. Hwy 30 during the test period through May 2016.

Coordination	DOT staff meet monthly with law enforcement to update each other, view videos of the last month’s wrong-way driving events, and discuss corrective action.
Guidelines or Standards	<ul style="list-style-type: none"> • No changes to statewide standards to date. • A new design drawing has been developed to guide future signing and pavement marking improvements at locations where wrong-way driving issues are observed.
Local/Public Response	None observed
Lessons Learned	<ul style="list-style-type: none"> • Side-fire radar produces too many false calls. • Locate sensors and cameras near points of entry.
Future Plans	Enhanced signing improvements are planned for all 25 miles of the U.S Hwy 30 corridor and will be implemented in summer 2016.

Iowa DOT Photos Showing Before and After Improvements (1 of 3)

19th Street Interchange in Nevada, IA

Before:



After (Completed July/August 2015):



Iowa DOT Photos Showing Before and After Improvements (2 of 3)

Lincoln Way Flyover in West Ames, IA

Before:



After (Completed 7-9-15):



Iowa DOT Photos Showing Before and After Improvements (3 of 3)

Linn Street and U.S. 30 Intersection in Boone, IA

Before:



After (Completed May 2016):



**“Countermeasures for Wrong Way Driving on Freeways”
Deployment Summary
Michigan Department of Transportation**

Agency	Michigan Department of Transportation (Michigan DOT)
Agency Contact	Steve Shaughnessy Email: shaughnessys@michigan.gov Phone: (517) 373-8950
Information Sources	<ul style="list-style-type: none"> • Email from Steve Shaughnessy on 7/6/16 • Interview with Tracie Leix (Michigan DOT) on 3/18/15 • Morena, David A. and Tracie J. Leix. (2012). <i>Where These Drivers Went Wrong</i>. Public Roads Magazine. Federal Highway Administration, US Department of Transportation. www.fhwa.dot.gov/publications/publicroads/12mayjune/05.cfm
Background	Michigan DOT began noticing that too many wrong-way driving crashes were occurring. FHWA Division safety staff and Michigan DOT safety engineering personnel began analyzing crash data and determined that left turns onto partial cloverleaf interchange ramps were problematic. Michigan DOT is focusing on implementing low-cost wrong-way countermeasures at this time.
Deployment Location	Statewide
Number of Sites	<ul style="list-style-type: none"> • 161 partial cloverleaf interchanges (256 exit ramps): Signing and pavement marking improvements • All exit ramps statewide (700 exit ramps): Low mounted signs and red reflective sheeting on posts
Deployment Dates	Began improvements in 2012, anticipate 5 years to complete.
Test/Pilot or Long-term	Long-term deployment
Countermeasure Type(s)	<ol style="list-style-type: none"> 1) Signing and Pavement Marking Improvements (256 exit ramps) 2) Low Mounted Signs and Red Reflective Sheeting on Sign Posts (700 ramps statewide) 3) Geometric Modification (one problematic interchange)
Description of Countermeasures	<ol style="list-style-type: none"> 1) Signing and Pavement Marking Improvements <ul style="list-style-type: none"> - 256 exit ramps • Low-mounted WRONG WAY (WW) & DO NOT ENTER (DNE) signs (4 ft.) • Red reflective sheeting on WW and DNE sign posts • Stop bars at exit ramps • Wrong-way pavement marking arrows on exit ramps • Pavement marking extensions that guide drivers onto entrance ramp • Paint island between exit and entrance ramps • Red delineators along exit ramp (on guardrail or on posts) • Lane assignment arrows at top of exit ramp (selected locations; not mandatory)



Red Reflective Sheeting on Sign Posts
(Source: Morena and Leix, 2012)



Stop Bar at End of Exit Ramp
(Source: Morena and Leix, 2012)



Red Delineators on Guardrail along Exit Ramp
(Source: Morena and Leix, 2012)

	<p>2) Low-Mounted Signs and Red Reflective Sheeting on Sign Posts</p> <ul style="list-style-type: none"> - All ramps statewide (700 ramps) • Revised signing standard to require low height WRONG WAY and DO NOTE ENTER signs (4 ft. height) and red reflective sheeting on sign posts at exit ramps. • Updates to signing per revised standard will be made as interchanges come up for routine work. Additional countermeasures may be implemented on a site-by-site basis. See signing details below. <p>3) Geometric Modification at One Problematic Interchange</p> <ul style="list-style-type: none"> • One partial cloverleaf interchange (I-94 and M-3 in Detroit) was experiencing a pattern of wrong-way crashes. • Michigan DOT implemented a lane separator system that prevents drivers from making left turns onto the exit ramps in this location. See ramp terminal details in the following pages.
Evaluation Efforts/Results	The countermeasures will be fully implemented by 2019, then Michigan DOT will need to wait several years before formally evaluating since wrong-way crashes occur infrequently. It will be difficult to quantify effectiveness due to the low number of crashes and the randomness of occurrences.
Coordination	Traffic incident management is a focus of Michigan DOT’s strategic highway safety plan. A traffic incident management group (DOT, tow truck companies, emergency management, law enforcement, fire department) meets regularly to work on strategic safety needs and initiatives. Wrong-way driving has been a topic for this group; Michigan DOT shared current countermeasure efforts and facilitated discussion of future needs and efforts to address wrong-way driving.
Guidelines or Standards	Revised signing standards to require low height signs and red reflective sheeting on sign posts at all exit ramps, regardless of the interchange type. See the following pages for this standard signing detail.
Local/Public Response	No feedback was observed related to the specific countermeasures implemented.
Lessons Learned	None noted.
Future Plans	Michigan DOT will continue to consider other types of countermeasure types in the future, but they are starting with low-cost improvements.

Michigan DOT Standard Signing Detail (1 of 4)

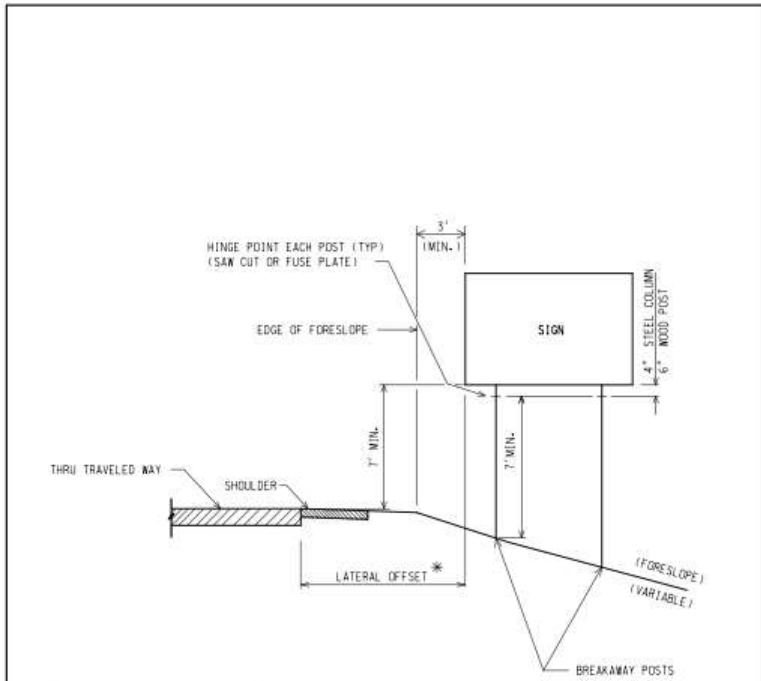

* THE LATERAL OFFSET SHALL BE 30' (MIN.) FOR MAINTENANCE PURPOSES.

**SIGN PLACEMENT-ELEVATION VIEW: FREEWAY
(FORESLOPE)**

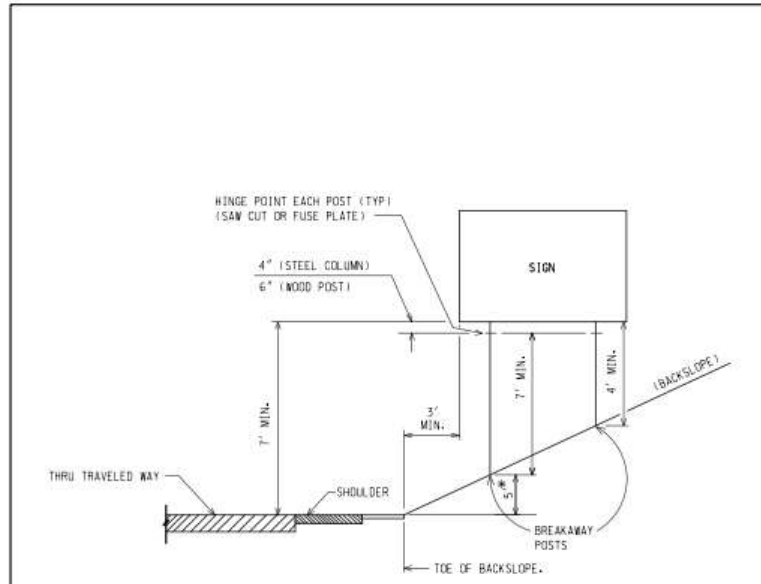

* IN DEPRESSED SECTIONS WITH 3:1 OR STEEPER BACKSLOPE, IF THE FRONT (TRAFFIC SIDE) POST CANNOT BE LOCATED AT 7' ABOVE SHOULDER ELEVATION, THEN A 3' MINIMUM OFFSET FROM THE TOE OF SLOPE SHALL BE MAINTAINED AND THE SIGN PROTECTED WITH AN APPROVED BARRIER. SEE GENERAL NOTE 5.

**SIGN PLACEMENT-ELEVATION VIEW: FREEWAY
(BACKSLOPE)**

	DEPARTMENT DIRECTOR T. Strickland	MICHIGAN DEPARTMENT OF TRANSPORTATION BUREAU OF HIGHWAY DEVELOPMENT STANDARD PLAN FOR			
	PREPARED BY: DESIGN DIVISION DRAWN BY: JHD CHECKED BY: JLL	APPROVED BY: <i>Randy R. Roth</i> DIRECTOR, BUREAU OF FIELD SERVICES	ROADSIDE SIGN LOCATIONS & SUPPORT SPACING		SHEET 1 OF 8
	APPROVED BY: <i>Michael A. Van Pelt</i> DIRECTOR, BUREAU OF HIGHWAY DEVELOPMENT	12/22/11 F.H.W.A. APPROVAL	12/08/11 PLAN DATE	SIGN-120-D	SHEET 1 OF 8

NOT TO SCALE

MICHIGAN DEPARTMENT OF TRANSPORTATION BUREAU OF HIGHWAY DEVELOPMENT STANDARD PLAN	12/22/11 F.H.W.A. APPROVAL	12/08/11 PLAN DATE	SIGN-120-D	SHEET 2 OF 8
--	-------------------------------	-----------------------	------------	-----------------

NOTE: THE ORIGINAL SIGNED COPY IS KEPT ON FILE AT THE MICHIGAN DEPARTMENT OF TRANSPORTATION.

Michigan DOT Standard Signing Detail (2 of 4)

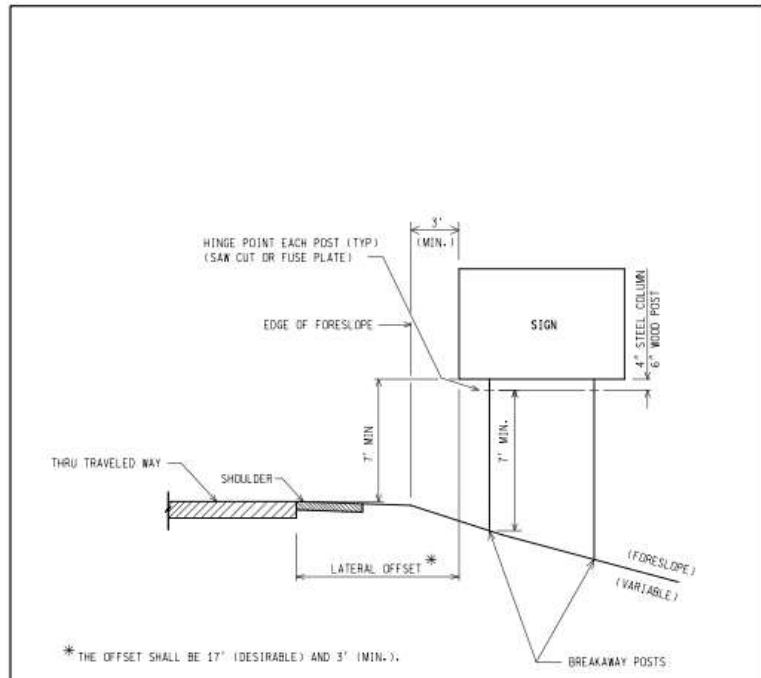

SIGN PLACEMENT-ELEVATION VIEW: NON-FREEWAY
(FORESLOPE)

NOT TO SCALE

MICHIGAN DEPARTMENT OF TRANSPORTATION BUREAU OF HIGHWAY DEVELOPMENT STANDARD PLAN	12/22/11 F.S.B.A. APPROVAL	12/08/11 PLAN DATE	SIGN-120-D	SHEET 3 of 8
NOTE: THE ORIGINAL SIGNED COPY IS KEPT ON FILE AT THE MICHIGAN DEPARTMENT OF TRANSPORTATION.				

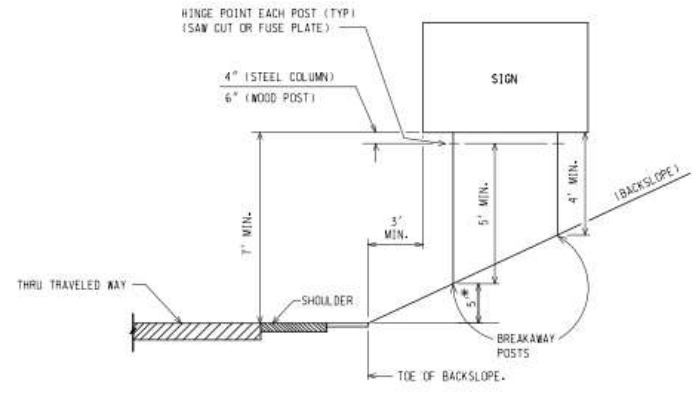

SIGN PLACEMENT-ELEVATION VIEW: NON-FREEWAY
(BACKSLOPE)

NOT TO SCALE

MICHIGAN DEPARTMENT OF TRANSPORTATION BUREAU OF HIGHWAY DEVELOPMENT STANDARD PLAN	12/22/11 F.S.B.A. APPROVAL	12/08/11 PLAN DATE	SIGN-120-D	SHEET 4 of 8
NOTE: THE ORIGINAL SIGNED COPY IS KEPT ON FILE AT THE MICHIGAN DEPARTMENT OF TRANSPORTATION.				

Michigan DOT Standard Signing Detail (3 of 4)

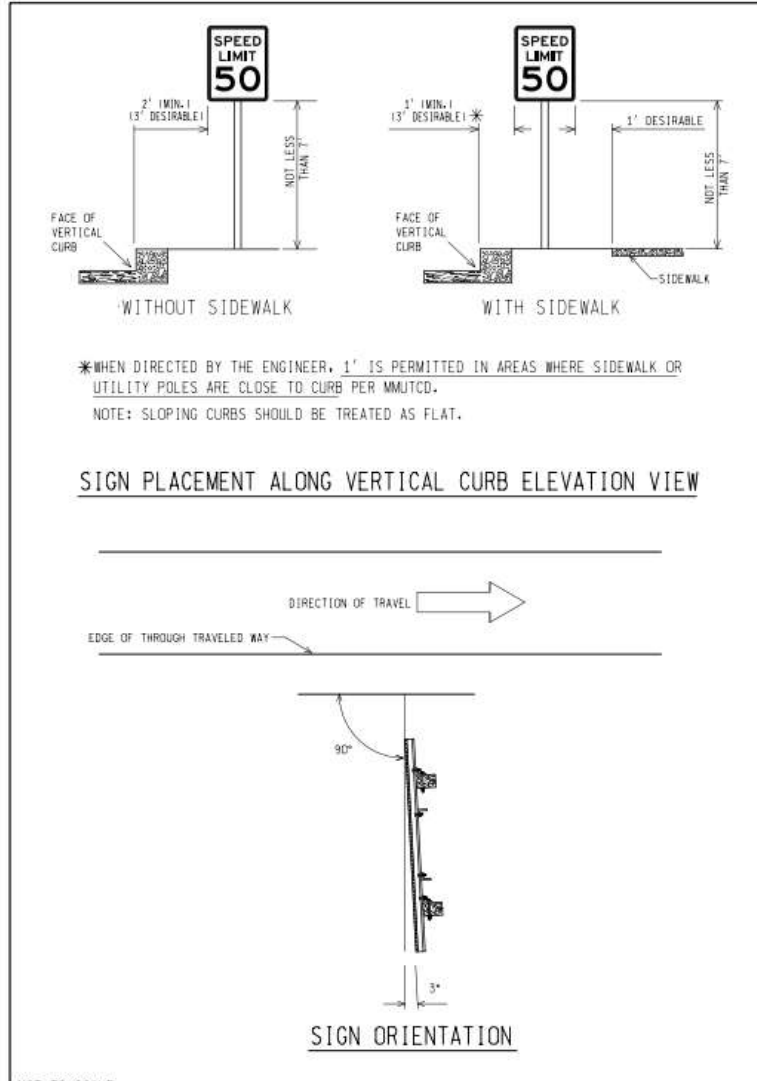

NOT TO SCALE

MICHIGAN DEPARTMENT OF TRANSPORTATION BUREAU OF HIGHWAY DEVELOPMENT STANDARD PLAN	12/22/11 F.R.I.L. APPROVAL	12/08/11 PLAN DATE	SIGN-120-D	SHEET 5 OF 8
--	-------------------------------	-----------------------	------------	-----------------

NOTE: THE ORIGINAL SIGNED COPY IS KEPT ON FILE AT THE MICHIGAN DEPARTMENT OF TRANSPORTATION.

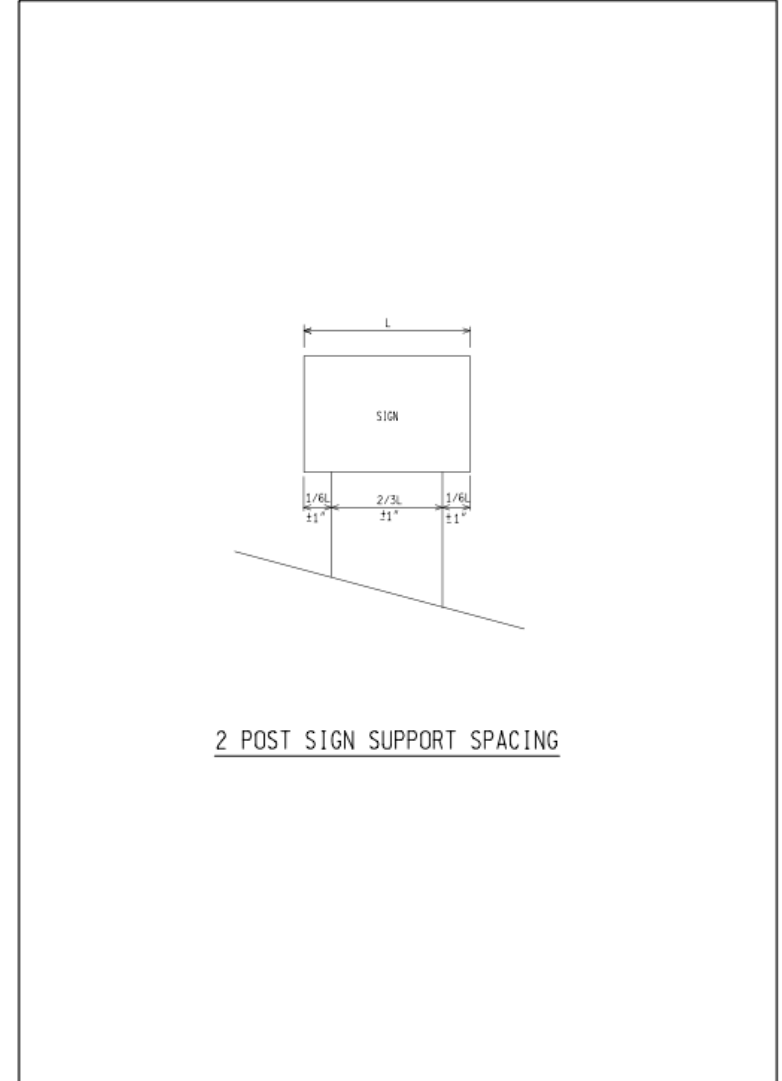

NOT TO SCALE

MICHIGAN DEPARTMENT OF TRANSPORTATION BUREAU OF HIGHWAY DEVELOPMENT STANDARD PLAN	12/22/11 F.R.I.L. APPROVAL	12/08/11 PLAN DATE	SIGN-120-D	SHEET 6 OF 8
--	-------------------------------	-----------------------	------------	-----------------

NOTE: THE ORIGINAL SIGNED COPY IS KEPT ON FILE AT THE MICHIGAN DEPARTMENT OF TRANSPORTATION.

Michigan DOT Standard Signing Detail (4 of 4)

SIGN BOTTOM HEIGHTS

CONVENTIONAL ROADS

- 7'- RURAL AREAS
- 7'- URBAN AREAS
- 7'- ALL CONDITIONS WHERE SIDEWALKS EXISTS

RAMPS/CROSSROADS

- 7'- RAMP AND CROSSROAD SIGNING (WITHOUT VERTICAL CURB)
- 7'- RAMP AND CROSSROAD SIGNING (WITH VERTICAL CURB)
- 7'- ALL CONDITIONS WHERE SIDEWALK EXISTS

- 4'- DO NOT ENTER AND WRONG WAY SIGNS (FOR FREEWAY RAMPS)

FREEWAYS/EXPRESSWAYS

- 7'- ROUTE MARKERS, WARNING AND REGULATORY SIGNS
- 7'- ALL OTHER FREEWAY/EXPRESSWAY SIGNS

NOTES:

1. PARKING SIGNS MOUNTED BELOW A PARENT SIGN MAY HAVE A BOTTOM HEIGHT 1' OR 1.5' (DEPENDENT ON SIGN SIZE) LESS THAN BOTTOM HEIGHTS LISTED FOR PARENT SIGNS.
2. BOTTOM HEIGHT OF ALL SIGNS ARE 7' EXCEPT THE FOLLOWING:
 OBJECT MARKERS- 4'
 MILE POST MARKERS- 4'
 WRONG WAY/DO NOT ENTER (FRWY RAMPS)- 4'
3. CONVENTIONAL ROAD-A STREET OR HIGHWAY OTHER THAN A FREEWAY OR EXPRESSWAY.
4. EXPRESSWAY-A DIVIDED HIGHWAY WITH PARTIAL CONTROL OF ACCESS.
5. FREEWAY-A DIVIDED HIGHWAY WITH FULL CONTROL OF ACCESS.

NOT TO SCALE

MICHIGAN DEPARTMENT OF TRANSPORTATION
BUREAU OF HIGHWAY DEVELOPMENT STANDARD PLAN

12/22/11
F.A.R.A. APPROVAL

12/08/11
PLAN DATE

SIGN-120-D

SHEET
7 OF 8

NOTE: THE ORIGINAL SIGNED COPY IS KEPT ON FILE AT THE MICHIGAN DEPARTMENT OF TRANSPORTATION.

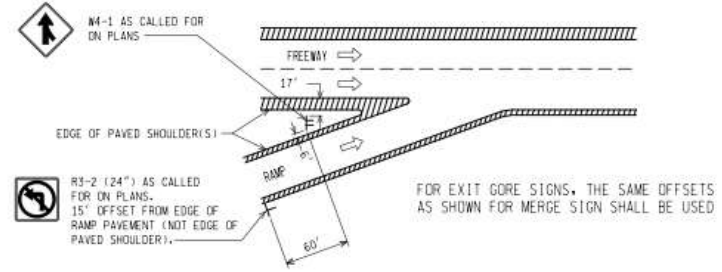

PLACEMENT OF MERGE & NO LEFT TURN SIGNS AT ENTRANCE RAMP

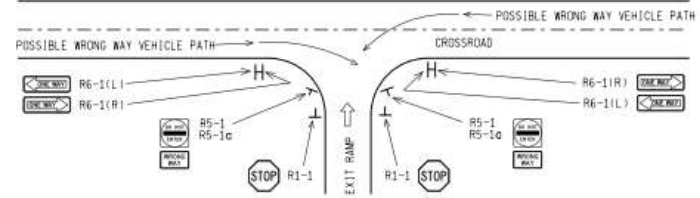

TYPICAL LOCATION OF R5-1 & R5-1c ON EXIT RAMPS. THESE SIGNS SHOULD BE TURNED APPROXIMATELY 20 DEGREES FROM THE CROSSROAD TO FACE THE PATHS OF POSSIBLE WRONG WAY VEHICLE MOVEMENTS.

PLACEMENT OF SIGNS AT EXIT RAMP TERMINALS

GENERAL NOTES:

1. LATERAL OFFSET CLEARANCE OF ALL SIGNS SHALL BE AS INDICATED UNLESS OTHERWISE SHOWN ON CONTRACT SIGN PLAN SHEETS OR IN THE PROPOSAL.
2. THE TERM "SIGN" AS USED ON THIS PLAN MEANS A SINGLE PANEL OR GROUP OF PANELS COMBINED TO FORM ONE INSTALLATION.
3. BOTTOM HEIGHT (BH) SHALL BE AS INDICATED ON SHEET 7 UNLESS OTHERWISE SHOWN ON THE ELEVATION SIGN PLAN SHEET OR IN THE PROPOSAL. BOTTOM HEIGHT IS THE DIFFERENCE IN ELEVATION OF THE NEAREST EDGE OF THE TRAVELED LANE AND BOTTOM OF THE SIGN.
4. SIGN LOCATIONS SHALL BE AS SHOWN UNLESS OTHERWISE SPECIFIED ON CONTRACT SIGN PLAN SHEETS OR IN THE PROPOSAL.
5. WHEN SIGNS ARE TO BE INSTALLED BEHIND CONCRETE BARRIER OR GUARDRAIL, THE NEAR EDGE OF SIGN SHOULD BE SET BACK A MINIMUM OF 3' MEASURED FROM THE BACK OF BARRIER OR GUARDRAIL POSTS. BREAKWAY SIGN POSTS ARE NOT REQUIRED AT THESE LOCATIONS.
6. FOR PLACEMENT OF STOP SIGNS AT CROSSROADS SEE MUTCD.
7. WRONG WAY AND DO NOT ENTER SIGN SUPPORTS FOR FREEWAY RAMPS SHALL HAVE RED REFLECTIVE SHEETING INSTALLED ON THE SIGN SUPPORTS.

NOT TO SCALE

MICHIGAN DEPARTMENT OF TRANSPORTATION
BUREAU OF HIGHWAY DEVELOPMENT STANDARD PLAN

12/22/11
F.A.R.A. APPROVAL

12/08/11
PLAN DATE

SIGN-120-D

SHEET
8 OF 8

NOTE: THE ORIGINAL SIGNED COPY IS KEPT ON FILE AT THE MICHIGAN DEPARTMENT OF TRANSPORTATION.

Michigan DOT Ramp Terminal Details (1 of 3)

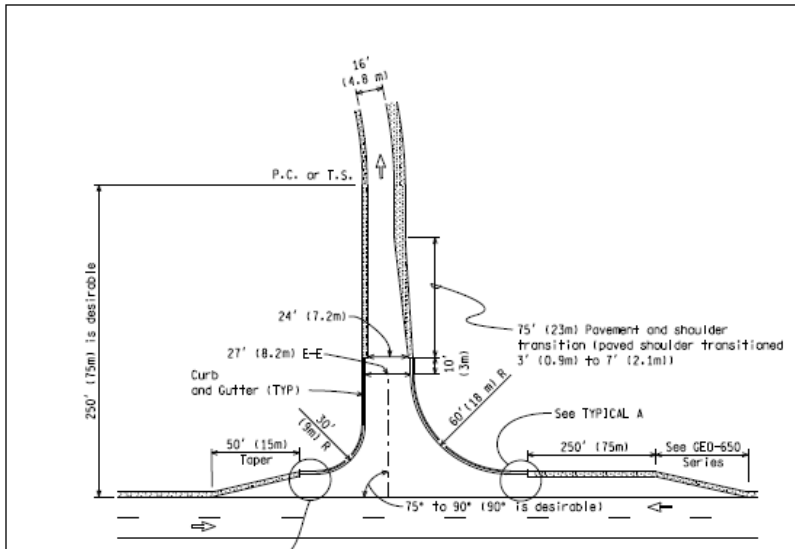

DETAIL 1
RAMP ENTRANCE

CURB RETURN OFFSET DETAILS TYPICAL FOR ALL DETAILS

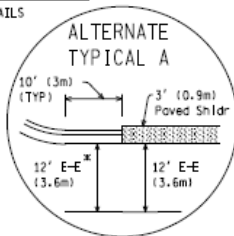
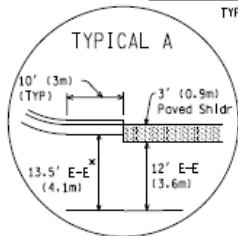

* See Note #6 on Sheet 5

NOT TO SCALE



DRAWN BY: DFK
CHECKED BY: EG & JAT
FILE: FM RD TR Typ Final Geo/mot traffic GEO-370-E.dgn REV.

GEOMETRIC DESIGN GUIDE FOR RAMP TERMINAL DETAILS

03/13/2015
PLAN DATE: GEO-370-E SHEET 1 OF 5

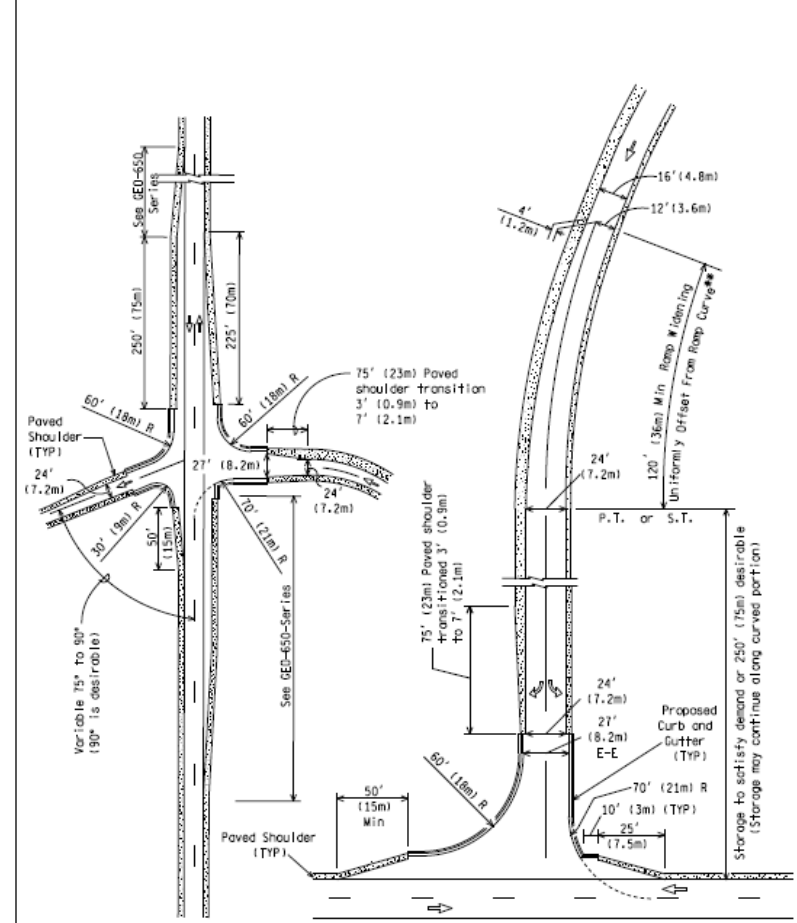

DETAIL 2
ENTRANCE RAMP
TERMINAL DESIGN
(Directional Passing Flare)

DETAIL 3
TWO LANE RAMP TERMINAL

** Widening for additional lane(s) should occur on the outside of the ramp (furthest from the mainline freeway). When it is not desirable to add lane(s) to the outside of the ramp, the desired widening should be clearly shown on the plans. See Standard Plan R-42-Series.

NOT TO SCALE

MICHIGAN DEPARTMENT OF TRANSPORTATION TRAFFIC AND SAFETY GEOMETRIC DESIGN GUIDE
FILE: FM RD TR Typ Final Geo/mot traffic GEO-370-E.dgn REV.

03/13/2015
PLAN DATE: GEO-370-E SHEET 2 OF 5

Michigan DOT Ramp Terminal Details (2 of 3)

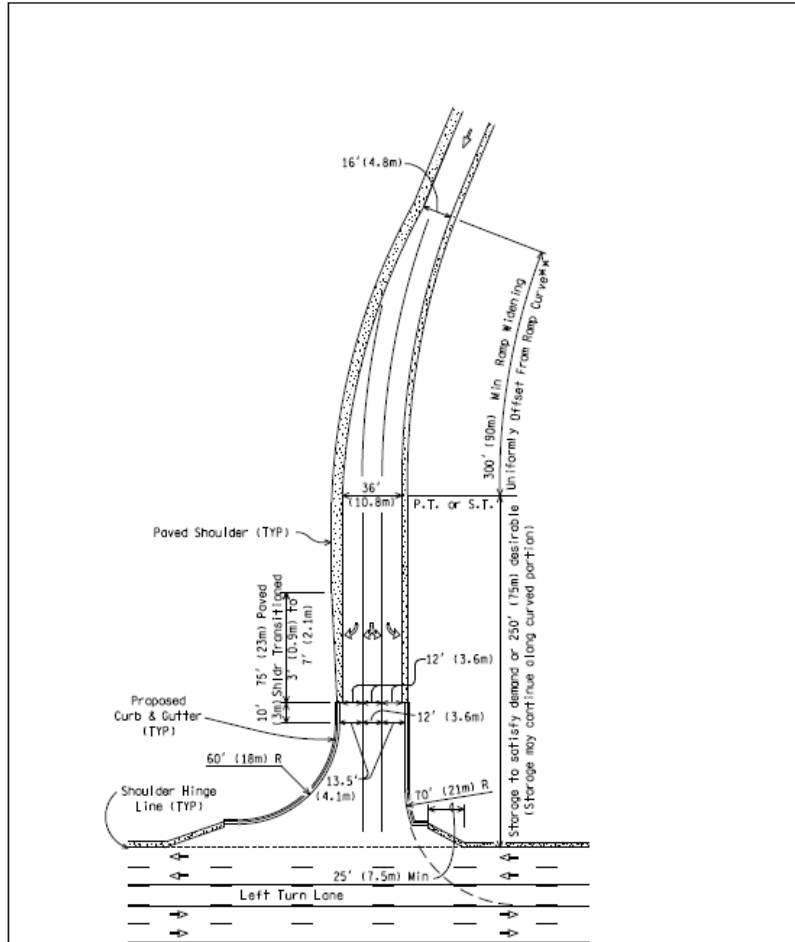

DETAIL 4
THREE LANE RAMP TERMINAL

** Widening for additional lanes should occur on the outside of the ramp (furthest from the mainline freeway). When it is not desirable to add lanes to the outside of the ramp, the desired widening should be clearly shown on the plans. See also Standard Plan R-42-Series.

NOT TO SCALE

MICHIGAN DEPARTMENT OF TRANSPORTATION TRAFFIC AND SAFETY GEOMETRIC DESIGN GUIDE	03/13/2015	GEO-370-E	SHEET 3 OF 5
FILE:PW RD TR Typ Final Geo/road traffic GEO-370-E.dgn	REV.	PLAN DATE	

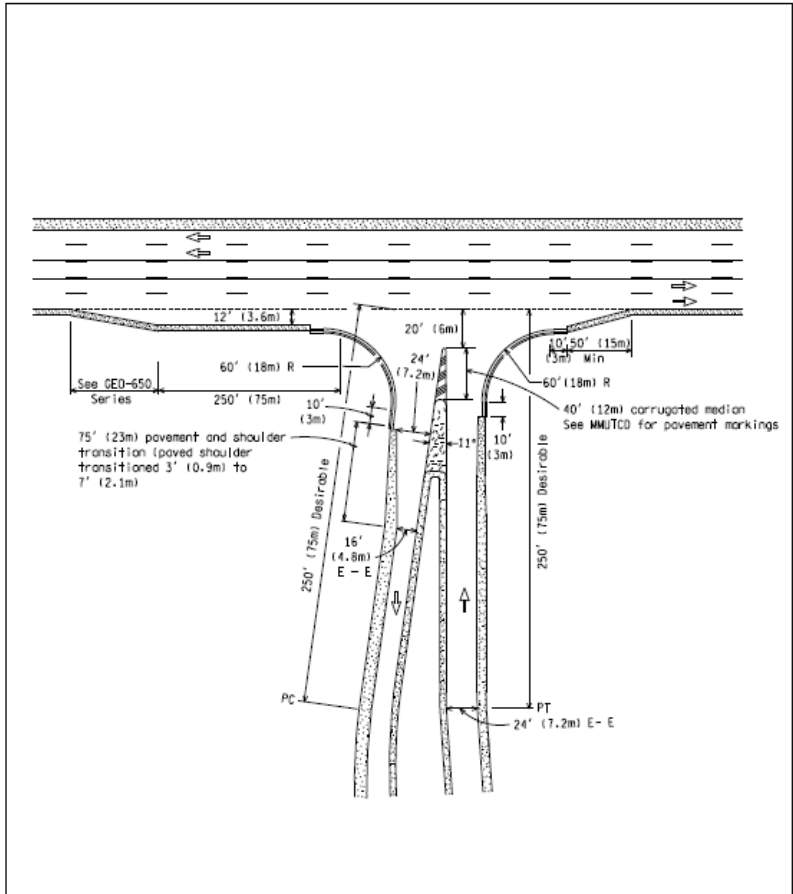

At unsignalized ramp terminals, it is desirable to redirect the left turns right from the ramp to an adjacent directional crossover when the median width can accommodate truck traffic (WB-65).

DETAIL 5
PARCLO ENTRANCE AND EXIT TERMINAL

NOT TO SCALE

MICHIGAN DEPARTMENT OF TRANSPORTATION TRAFFIC AND SAFETY GEOMETRIC DESIGN GUIDE	03/13/2015	GEO-370-E	SHEET 4 OF 5
FILE:PW RD TR Typ Final Geo/road traffic GEO-370-E.dgn	REV.	PLAN DATE	

Michigan DOT Ramp Terminal Details (3 of 3)

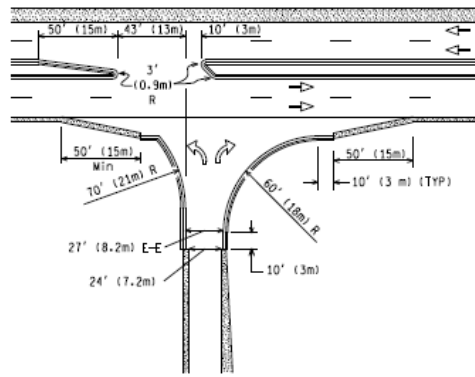

DETAIL 6
CURBED MEDIAN DETAIL

NOTES:

1. The dimensions used on this Geometric Design Guide are typical.
2. Where feasible, joint line and lane line markings shall coincide.
3. See Standard Plan R-42-Series for joint layout.
4. Clear vision areas and sight distance along the ramp and its terminals must be according to current MDOT practice. No hidden ramp or disappearing crossroad grades will be permitted.
5. Provide intersection sight distance at all exit ramp terminals.
6. Alternate Typical A may be used when construction and maintenance issues make the 13.5' (4.1m) curb setback undesirable or the crossroad is curbed.

NOT TO SCALE

MICHIGAN DEPARTMENT OF TRANSPORTATION TRAFFIC AND SAFETY GEOMETRIC DESIGN GUIDE	03/13/2015	GEO-370-E	SHEET
FILE:PW RD TR Typ Final_Geo/road_traffic/GEO-370-E.dgn REV.	PLAN DATE		5 OF 5

**“Countermeasures for Wrong Way Driving on Freeways”
Deployment Summary
Missouri Department of Transportation**

Agency	Missouri Department of Transportation (MoDOT)
Agency Contact	Eddie Watkins, Jr. Email: Eddie.WatkinsJR@modot.mo.gov Phone: (314) 650-5461
Information Sources	<ul style="list-style-type: none"> • Interview with Eddie Watkins, Jr. on 6/9/16 • Interview with Matt Seggerman (formerly with MoDOT) on 3/10/15
Background	<ul style="list-style-type: none"> • FHWA pointed out that Missouri is overrepresented in wrong-way crashes. The Safety department of Missouri DOT’s Central Office began analyzing and plotting the state’s wrong-way crashes and discovered that the St. Louis region had the majority of the state’s wrong-way crashes. Wrong-way crashes that occurred on freeways were mostly serious injury or fatal because of higher speeds. • The Missouri DOT (MoDOT) decided to target freeways to help reduce the total number of fatalities. All freeways in the St. Louis region were analyzed by reviewing crash reports and plotting the locations. MoDOT reached out to the local police department for feedback on where wrong-way drivers were entering the freeway. Ramp geometrics were then reviewed. • Instead of selecting random, spread-out locations to implement improvements, MoDOT decided to deploy countermeasures primarily at one saturated area (I-44) with a large Average Daily Traffic (ADT). This will enable MoDOT to conduct before-and-after studies of this location. <p><u>Wrong-way crash details for I-44 in St. Louis:</u> 2007 to 2013 wrong-way crashes were reviewed</p> <ul style="list-style-type: none"> - 25 crashes: 5 Fatal, 4 Disabling Injury, 7 Minor Injury, 9 Property Damage Only - 22 crashes occurred at night - Possibly 3 out of the 25 crashes were drug and alcohol related
Deployment Location	St. Louis, MO
Number of Sites	<ul style="list-style-type: none"> • Approximately 30 sites with increased quantity of Priority 1 signing • 8 exit ramps with blinking signs and alert to TMC • 4 sites with blinking signs only
Deployment Dates	<ul style="list-style-type: none"> • November 2014 and Ongoing - Increased quantity of priority 1 signing • November 2014 – 8 exit ramps with blinking signs and alert to TMC • November 2015 – 4 sites with blinking signs only
Test/Pilot or Long-term	Long-term

<p>Countermeasure Types</p>	<ul style="list-style-type: none"> • Increased Quantity of Priority 1 Signing • Blinking LED WRONG WAY (WW) Sign System with Alert to Traffic Management Center (TMC) • Blinking LED WRONG WAY (WW) Sign System without Alert to TMC
<p>Description of Countermeasures</p>	<p>1) Increased Quantity of Priority 1 Signing</p> <ul style="list-style-type: none"> • Doubled up priority 1 signing (ONE WAY, DO NOT ENTER (DNE), and WW signs); now one sign on each side of ramps • Deployed at exit ramps and divided highways including turn-arounds and at-grade crossings • Ongoing deployment in the St. Louis District – currently at approximately 30 sites • See the following pages for details: <ul style="list-style-type: none"> - Typical Standard for Increased Priority 1 Signing at Exit Ramp - Typical Standard for Increased Priority 1 Signing at Divided Highway <p>2) Blinking LED WRONG WAY (WW) Sign System with Alert to TMC</p> <ul style="list-style-type: none"> • Solar powered, radar-activated blinking WW signs: LEDs around sign border. • Alerts to Transportation Management Center (TMC): Two radar zones and one camera at each ramp site. When both radar zones and the camera are activated, an email and text alert are sent to the TMC. An alarm will sound, along with a popup window displaying snapshots of the violator. • No alert to oncoming right-way traffic. <div data-bbox="662 1094 1206 1524" data-label="Image"> </div> <p style="text-align: center;">LED WW Signs Blinking at Night (Source: Missouri DOT)</p> <ul style="list-style-type: none"> • ONE WAY signs and DNE signs are placed at the intersection. The first set of static WW signs are placed 100+ ft. down the ramp. The blinking WW sign is placed 100+ ft. further down the ramp. Each ramp had a slightly different configuration due to site conditions and in-place features or obstacles. • See the following pages for details: <ul style="list-style-type: none"> - Work Request Diagram for WB I-44 Off Ramp to Hampton Ave, Exit 286

	<p>3) Blinking LED WRONG WAY (WW) Sign System without Alert to TMC</p> <ul style="list-style-type: none"> • Radar-activated blinking WW signs with LEDs around sign border at 4 additional sites • No alert to TMC or right-way traffic
Evaluation Efforts/Results	<ul style="list-style-type: none"> • Wrong-way crashes are difficult to track; however, in the first year of deployment 6 wrong-way vehicles were detected. • No crash reports have been made since the installation of the blinking signs. • A 5-year crash data analysis will likely be conducted.
Coordination	<ul style="list-style-type: none"> • A multi-agency safety coalition, including law enforcement, is in place. • After determining that the St. Louis area accounted for the majority of wrong-way crashes, MoDOT reached out to the local police department to gather feedback on where wrong-way drivers were entering the freeway. • Working to get law enforcement from local municipalities added to the system to help with response and reduce TMC's step of calling law enforcement.
Guidelines or Standards	MoDOT has implemented a Typical Standard for Increased Quantity of Priority 1 Signing. (See following pages for details.)
Local/Public Response	No feedback from the public has been received or documented. A local news station has featured a story on the deployment.
Lessons Learned	Watch placement of detection devices, especially with roads next to exit ramps, to avoid false positives.
Future Plans	<ul style="list-style-type: none"> • MoDOT will monitor and implement the low-cost safety improvements (e.g. duplicate signing), ensure that appropriate signing and pavement markings are in place, and continue to add reflective strips to WW and DNE sign posts. • MoDOT may consider adding an alert to TMC at the 4 sites with blinking WW signs that currently do not alert TMC.

Missouri DOT Drawings/Details (1 of 2)

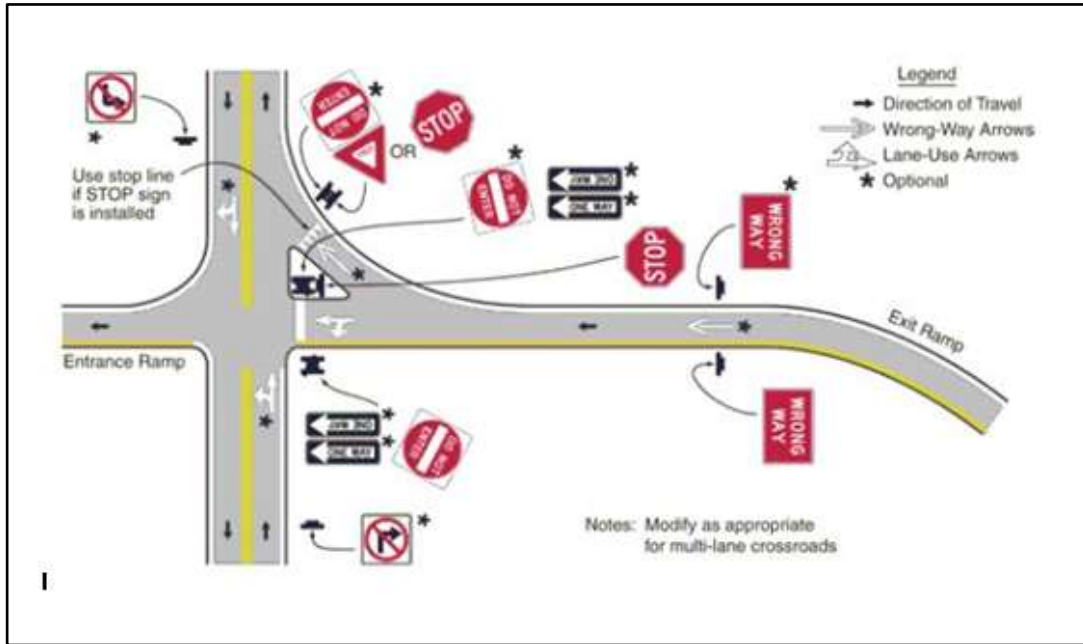

Typical Detail for Increased Priority 1 Signing at Exit Ramp



Typical Detail for Increased Priority 1 Signing at At-Grade Crossing

Missouri DOT Drawings/Details (2 of 2)

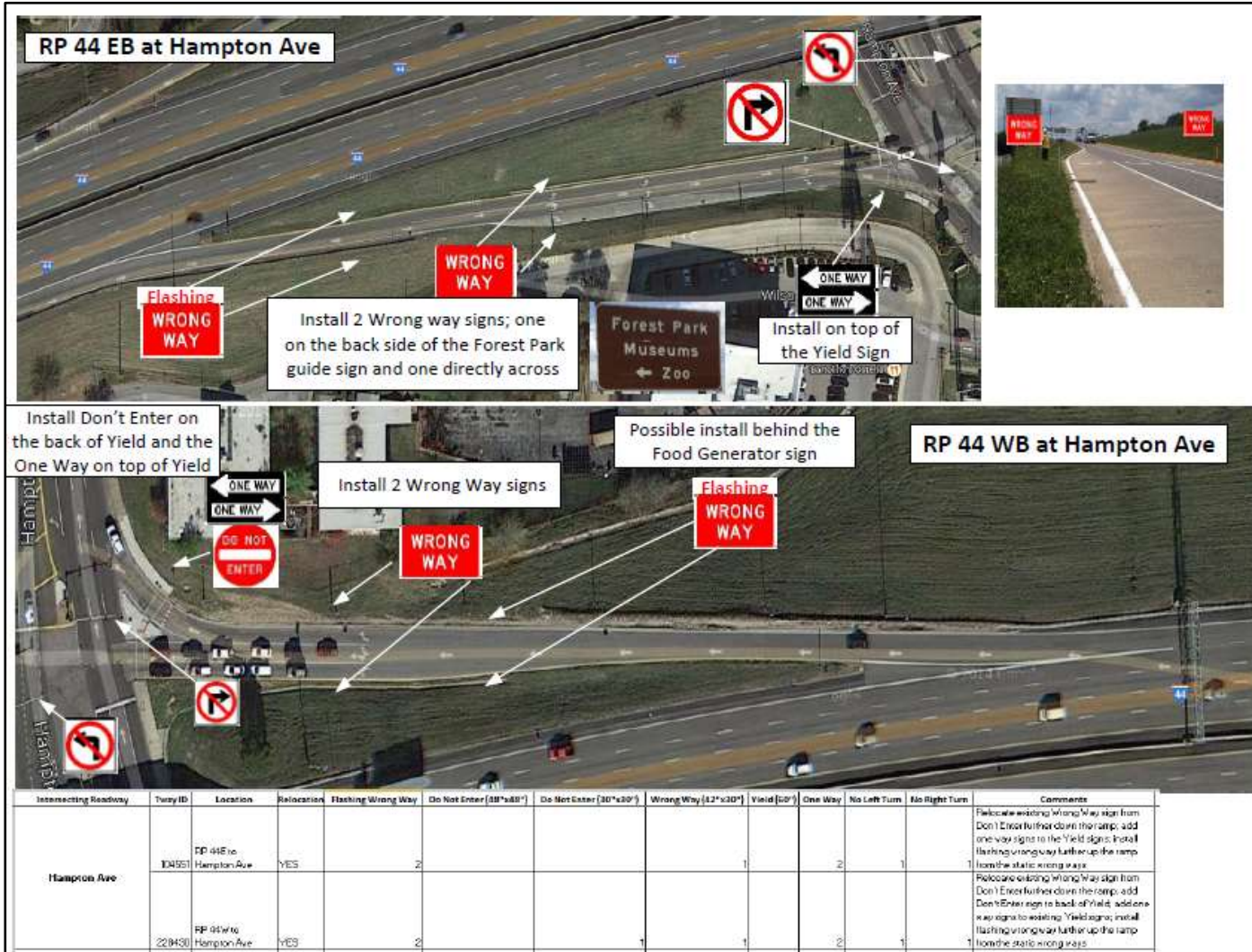

Work Request Diagram for WB I-44 Off Ramp to Hampton Ave, Exit 286

**“Countermeasures for Wrong Way Driving on Freeways”
Deployment Summary
Ohio Department of Transportation**

Agency	Ohio Department of Transportation (Ohio DOT)	
Agency Contacts	Derek Troyer Email: Derek.Troyer@dot.state.oh.us Phone: (614) 387-5164	Mike McNeill Email: Michael.McNeill@dot.state.oh.us Phone: (614) 387-1265
Information Source	<ul style="list-style-type: none"> • Interview with Mike McNeill on 6/8/2016 • Interview with Derek Troyer and Mike McNeill on 5/10/2015 	
Background	<p>Many districts have some sort of signage on exit ramps, but it is currently a mix of DO NOT ENTER (DNE) signs and WRONG WAY (WW) signs. Previous efforts have been primarily reactive, however, Ohio DOT is now attempting to implement signing and pavement marking improvements systematically at a statewide level.</p> <p>During a standardization effort, ODOT researched wrong-way crashes in 2015 and discovered that over the past 12 years, 75% of Ohio’s wrong-way crashes occurred within 5 of ODOT’s 12 districts. These five districts are largely urban and will be required to upgrade their signage. District 2 has already implemented the changes to its ramps and signage and improvements to urban areas in District 6 are almost complete.</p> <p>ODOT released a new standard construction drawing in 2016 to include revised standardized templates for future upgrades to ramp locations. These new templates and standardized processes will be utilized in rural districts as well as urban areas. This standard construction drawing is shown at the end of this deployment summary.</p>	
Deployment Locations	<ul style="list-style-type: none"> • District 6 (Central Ohio) • District 2 (Northwest Ohio) • Downtown Columbus, OH 	
Number of Sites	Continuing to grow, however the exact number is not known.	
Deployment Dates	<ul style="list-style-type: none"> • Signing and Pavement Marking Improvements: 2008 and 2013 • Detection with Dynamic Signing and Alerts: September 2015 	
Test/Pilot or Long-term	<ul style="list-style-type: none"> • Signing and Pavement Marking Improvements: Long-term deployments • Detection with Dynamic Signing and alerts: One pilot deployment 	
Countermeasure Types	<ol style="list-style-type: none"> 1) Static Signing and Pavement Marking Improvements 2) Detection with Dynamic Signing and Alerts 	
Description of Countermeasures	<ol style="list-style-type: none"> 1) Static Signing and Pavement Marking Improvements <ul style="list-style-type: none"> • Two WRONG WAY (WW) signs on the same post, lower sign mounted at 3 ft. • Pavement marking extension lines to guide drivers onto entrance ramp. 	

- Red reflective tape on sign posts: WW and DO NOT ENTER (DNE) signs.
- Dual directional route marker signs at end of ramps.
- Additional signs beyond MUTCD minimums (both sides of ramp).
- Yellow painted island between entrance and exit ramps.
- Wrong-way arrows on exit ramps. (At some locations, this is not standard. Implemented in District 2.)

District 6 (Central Ohio):

- Implemented in approximately 2008
- Implemented signing/pavement markings similar to drawings dated August 2013
- Systematic implementation, at all ramps in the district

District 2 (Northwest Ohio):

- Implemented in August 2013
- At all ramps: Increased the number of DNE and WW signs, now one sign on each side of ramp
- At side-by-side partial cloverleaf ramps: Implemented the entire improved design configuration



Two WW Signs on Same Post, Both Sides of Ramp, Red Reflective Tape on Posts
(Source: Ohio DOT)



Red Reflective Tape on Posts
(Source: Ohio DOT)

	<p><u>Drawings/Details:</u> See the following pages</p> <ul style="list-style-type: none"> • Wrong-Way Traffic Control for Partial Cloverleaf Interchanges (Single Lane Exit) • Wrong-Way Traffic Control for Diamond Interchanges (Single Lane Exit) <p>2) Flashing LEDs Around WW Sign and Alerts</p> <ul style="list-style-type: none"> • Single pilot site at one ramp in downtown Columbus (District 6, Neil Avenue) • Installed in September 2015 • Vehicle-activated flashing LEDs around border of WW sign • Alert to Transportation Management Center (TMC) and law enforcement • Two sets of detection plus a camera for verification: One at the bottom of the ramp and another at the top of the ramp. If a vehicle is detected at the first detection site, the LED signs will flash. If the vehicle is detected at the second detection site, the Ohio DOT Traffic Management Center and Columbus Police Department dispatchers are notified.
Evaluation Efforts/Results	<p>An evaluation is not planned due to the random nature of wrong-way crashes.</p> <ul style="list-style-type: none"> • Video captured by traffic cameras have been used to verify that the system has been effective in instances where violators have self-corrected and turned around after reaching the flashing signs.
Coordination	<p>ODOT plans to engage law enforcement in future efforts to help identify locations where wrong-way reports are occurring in order to target potential corridors for future improvements. See “Lessons Learned” section for additional information.</p>
Guidelines or Standards	<ul style="list-style-type: none"> • Ohio DOT created drawings for partial cloverleaf interchanges (single lane exit) and diamond interchanges (single lane exit). See the following pages for drawings. • Ramp improvements per these drawings are anticipated to be standard statewide in summer 2016 following inclusion in the Traffic Engineering Manual; 2 of 12 Districts have already implemented improvements.
Local/Public Response	<p>A local news story pointed out that Ohio DOT has implemented signing and pavement marking improvements: http://www.springfieldnewssun.com/news/news/transportation/wrong-way-crashes-often-deadly-hard-to-prevent/nk2m4/</p>
Lessons Learned	<p>Ohio continues to experience wrong-way fatalities and is working with law enforcement and looking at video from traffic cameras to determine entry points and trends of wrong-way drivers. Through this process ODOT hopes to identify potential corridors and implement additional detection with dynamic sign systems.</p>
Future Plans	<ul style="list-style-type: none"> • ODOT has standardized the process of upgrading ramps by developing a standard construction drawing for wrong-way traffic control at ramps. See the following page for this drawing. • ODOT is considering additional detection with dynamic sign systems and possibly selecting potential corridors for additional implementation, especially in urban areas.

Ohio DOT Wrong-Way Traffic Control Drawing (1 of 1)

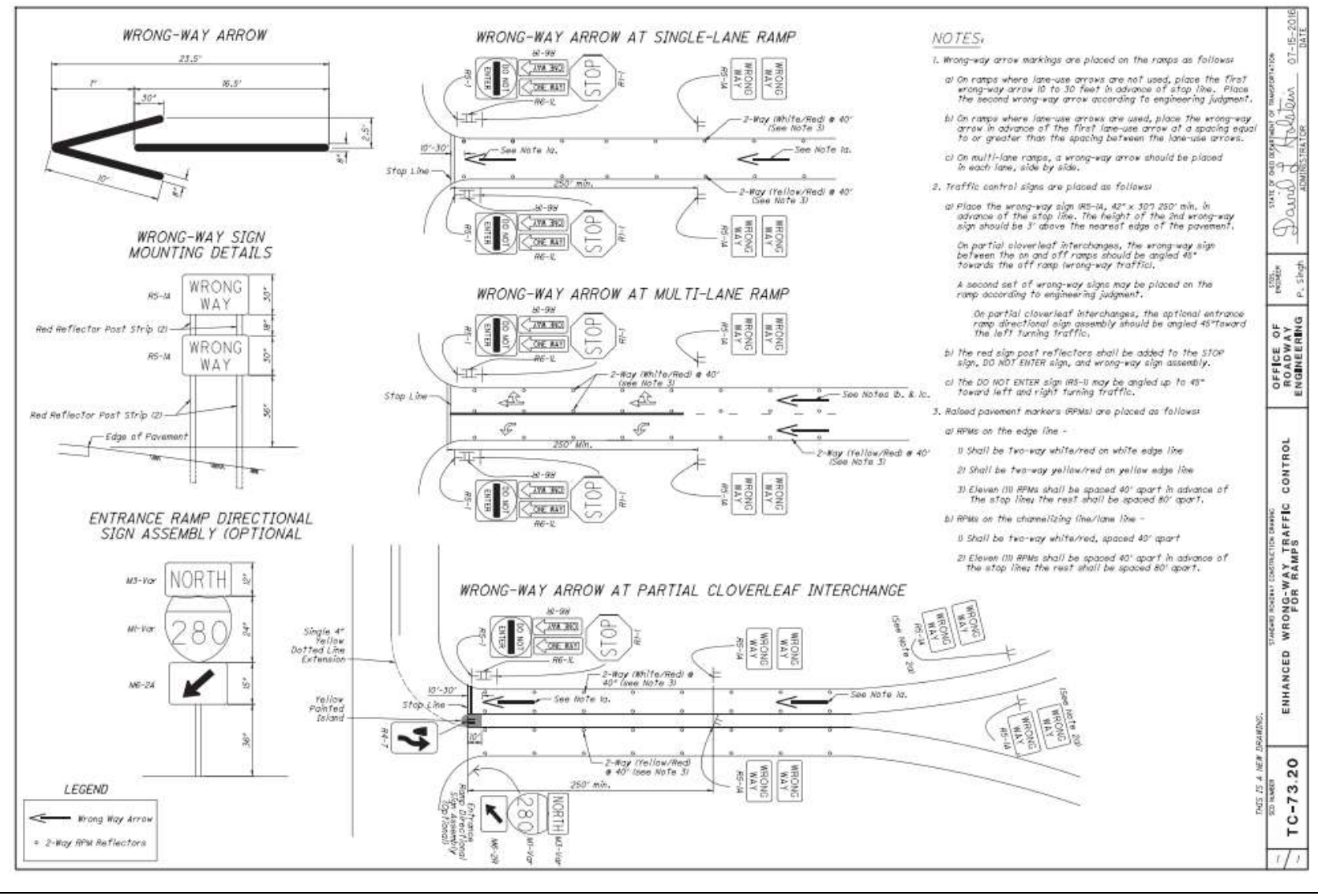

**“Countermeasures for Wrong Way Driving on Freeways”
Deployment Summary
Rhode Island Department of Transportation**

Agency	Rhode Island Department of Transportation (RI DOT)
Agency Contact	Daniel Waugh Email: daniel.waugh@dot.ri.gov Phone: (401) 222-2694, Ext. 4331
Information Source(s)	<ul style="list-style-type: none"> • Interview with Daniel Waugh on 6/9/16 • Interview with Daniel Waugh on 3/12/15 • Rhode Island Department of Transportation. <i>Wrong Way Crash Avoidance web page</i>. Retrieved March 1, 2015. www.dot.ri.gov/community/safety/wrong_way.php
Background	<p>In 2015, the Rhode Island Department of Transportation (RI DOT) began an initiative to upgrade signing and pavement markings and install detection/alert systems at high-risk sites to mitigate wrong-way driving. Every limited access off-ramp in the state (with the exception of freeway-to-freeway ramps) was reviewed. More than 200 ramps were selected for signing and pavement marking improvements, while an additional 24 sites were selected for implementation of vehicle detection with alerts to the driver and the Traffic Management Center (TMC).</p> <p>Detection/alert system deployments were modeled after similar detection/alert systems in San Antonio, TX. These 24 sites were selected by reviewing crash data, consulting with state police, and assessing ramp geometry.</p>
Deployment Location(s) and Number of Sites	<ul style="list-style-type: none"> • Signing and pavement marking improvements at over 200 ramps statewide • Flashing LED WRONG WAY (WW) signs at 24 ramps in metro areas, mostly near Providence, RI
Deployment Date	<ul style="list-style-type: none"> • Signing and Pavement Marking Improvements - Spring 2015 • Detection and Flashing Signs – May 1, 2015
Test/Pilot or Long-term	Long-term deployments
Countermeasure Types	<ol style="list-style-type: none"> 1) Signing and Pavement Marking Improvements 2) Flashing LED WW Signs; Alert to TMC and Oncoming Traffic
Description of Countermeasures	<p>1) Signing and Pavement Marking Improvements</p> <ul style="list-style-type: none"> • Over 200 ramps statewide • Ensure all ramps meet minimum MUTCD standards • Consider additional improvements: <ul style="list-style-type: none"> - Type 11 signs (most reflective available) - Low mounted signs (4 ft. mounting height) - Oversized signs (for dimensions, see “Rhode Island DOT Typical Details: Countermeasures for Wrong Way Traffic” on the following pages.) - Additional signs – one on each side of ramp

- Red reflective sign post reflectors
- “No Left Turn” signing on signal mast arms
- Replace traditional signal heads with straight arrow signal rather than traditional green ball signal, to discourage turning onto exit ramp
- Replace and re-mark arrows
- Pavement marking arrows with recessed delineators
- Lane line extensions to guide drivers onto entrance ramp



“No Left Turn” Signing on Signal Mast Arms
(Source: Rhode Island DOT)



Drawings/Details: See the following pages

- Typical details for signing and pavement marking configurations at ramps
- Pavement Marking Arrow with Recessed Delineators

2) Flashing LED WW Signs and Alert to TMC

- “Active” systems, triggered by vehicle detection (23 ramps)
 - Front facing radar activates the flashing LED sign.
 - If the vehicle continues to drive past the sign, rear facing radar confirms the wrong-way movement and triggers a camera to take 3 photos.
 - After camera verification, the system sends an alert with photos to the Traffic Management Center (TMC) and Dispatch
 - TMC operators verify the photos, then activate DMS to alert oncoming right-way drivers. The message posted to DMS is “WRONG WAY DRIVER USE CAUTION” as shown below.



DMS Message to Oncoming Right-Way Traffic
(Source: Rhode Island DOT)

- False calls have been reduced over the past year through troubleshooting with the manufacturer.
 - Attenuators placed over radar devices damp the radar and ensure large trucks traveling in the correct direction are not setting off radar.
 - Replacing the logic controller and reprogramming it with sequential logic has also reduced false calls.
 - Shields installed on the radar for side-by-side lanes have helped reduce “false flashing” on the signs resulting from detecting vehicles on adjacent ramps. This has helped prevent right-way drivers on the adjacent ramp from triggering a detection and seeing the sign flash.
- “Passive” system (1 ramp)
 - Blinks continuously at night (dusk to dawn)
- The 24 Flashing LED WW signs are installed in metro areas, mostly near Providence, RI
- To determine these sites, the agency looked at ramp geometry, crash data, and consulted with state police. Though the state police had no concrete data about where wrong-way drivers were entering the freeway, there was some knowledge about where related calls were coming from.

<p>Evaluation Efforts/Results</p>	<p>RI DOT has no formal plan to evaluate the deployments. Accurate “before” data does not exist; this data is difficult to determine because wrong-way driver entry points onto the freeway are not known. The agency will look for trends, comparing similar ramp types with those that have countermeasures deployed. Wrong-way fatalities will continue to be tracked.</p> <ul style="list-style-type: none"> • It is difficult to determine whether these improvements were the reason for any reduction in wrong-way events. However, RI DOT looked at wrong-way crashes and incidents (reports from drivers) one year before and one year after the system installation and report that wrong-way fatalities have been reduced. • Wrong-way driving has generated a significant amount of press; it is possible that an increased public awareness may have contributed to the reductions. • At least 49 wrong-way drivers detected on ramps were verified with the detection system and in some instances corrective action such as braking and turning around was observed. No crashes have occurred at locations where the systems are deployed.
<p>Coordination</p>	<p>TMC receives an alert that a wrong-way driver has been detected, then contacts state police. State police keep in contact with TMC operators, who verify and track the driver with cameras. There is an effort to reduce wrong-way events by increasing law enforcement patrols in targeted areas where drunk driving is more prevalent.</p>
<p>Guidelines or Standards</p>	<ul style="list-style-type: none"> • A systematic approach was taken to review interchanges and determine which ramps would undergo improvements. • Standard details were developed for wrong-way countermeasure ramp treatments. See the following pages for details.
<p>Local/Public Response</p>	<p>Received feedback from motorists due to an issue with sign placement on partial cloverleaf interchange ramps. In some cases, the WW signs placed at 45-degrees could be seen from the entrance ramp. Motorists traveling the correct direction on the entrance ramp were stopping and confused to see the sign. The placements were modified to reduce the likelihood of signs being seen by right-way drivers.</p>
<p>Lessons Learned</p>	<ul style="list-style-type: none"> • Regular maintenance and testing of the detection systems is required. Determine ownership and maintenance responsibilities within the DOT early in the deployment process. Currently, RI DOT is developing a test plan to determine protocols for closing ramps and testing the systems. • False calls from the detection systems have successfully been mitigated by working with the manufacturer to implement improvements.
<p>Future Plans</p>	<p>RI DOT will likely install additional flashing LED signs in 2018. RI DOT plans to use the past year’s data from the detection systems along with crash data to determine the next 25 locations for improvements, including where geometric improvements are needed.</p> <p>RI DOT is currently testing a GRIDSMART® camera at one intersection to detect wrong-way vehicles.</p>

Rhode Island DOT Typical Details: Countermeasures for Wrong Way Traffic (1 of 4)

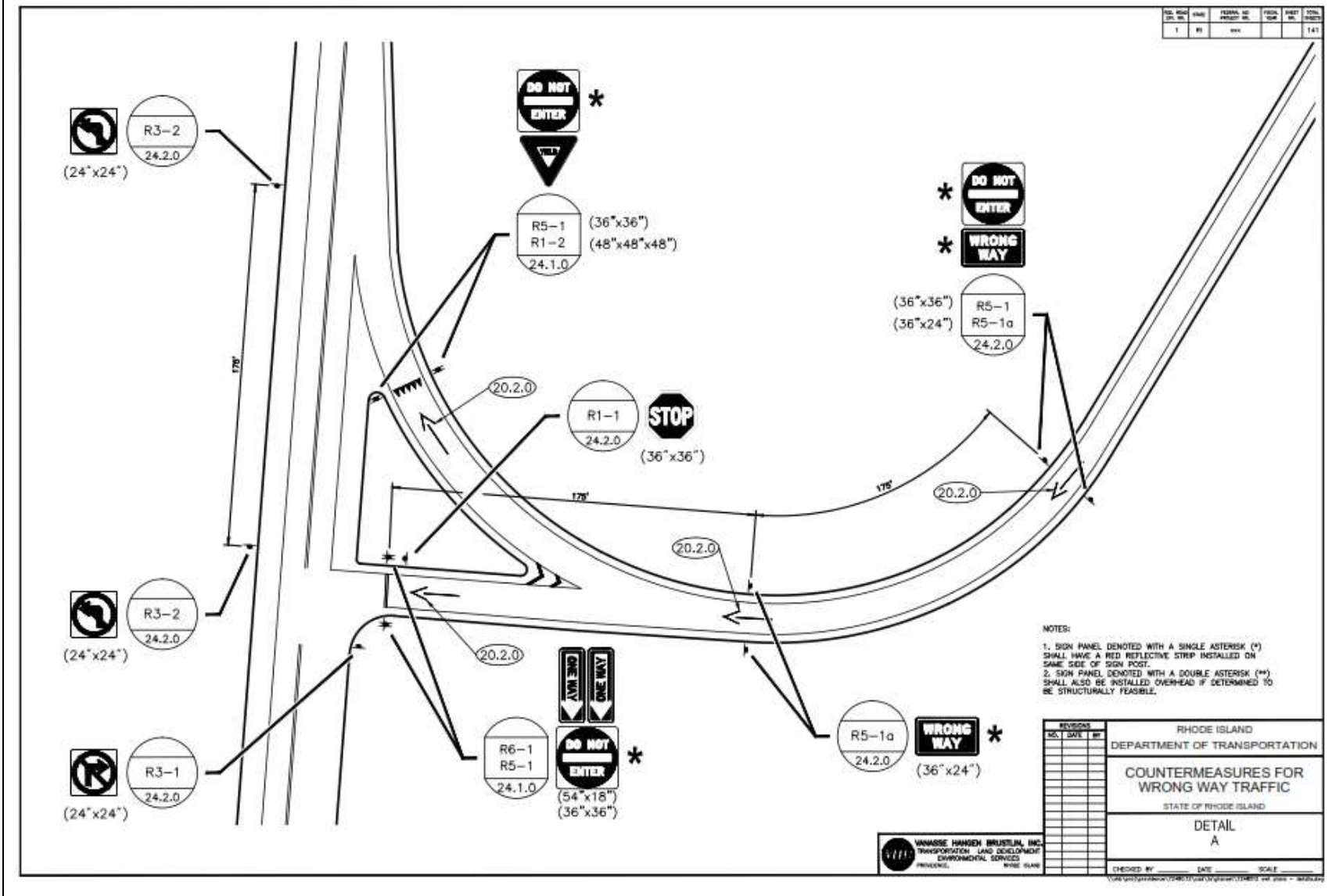

Rhode Island DOT Typical Details: Countermeasures for Wrong Way Traffic (2 of 4)

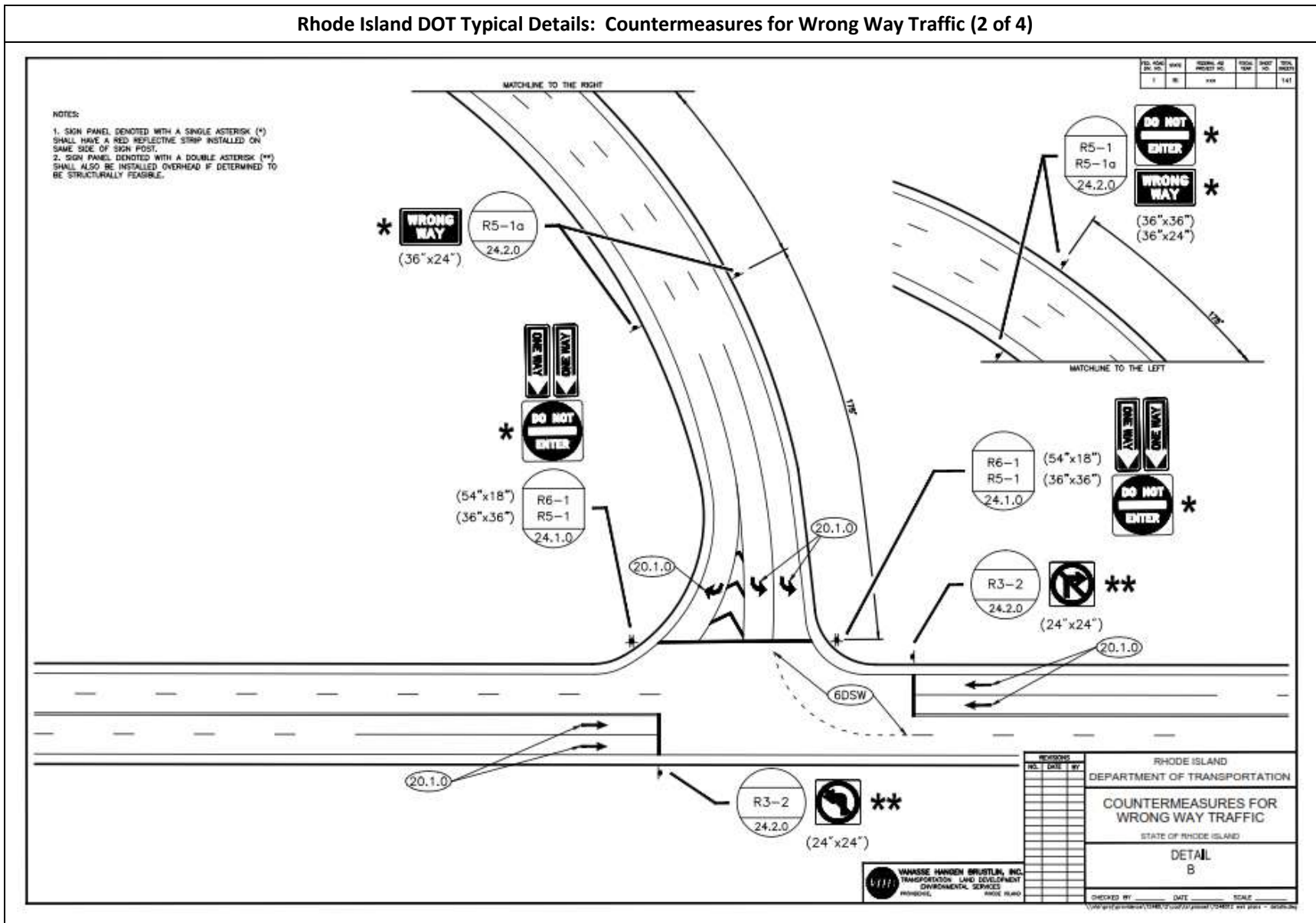

Rhode Island DOT Typical Details: Countermeasures for Wrong Way Traffic (4 of 4)

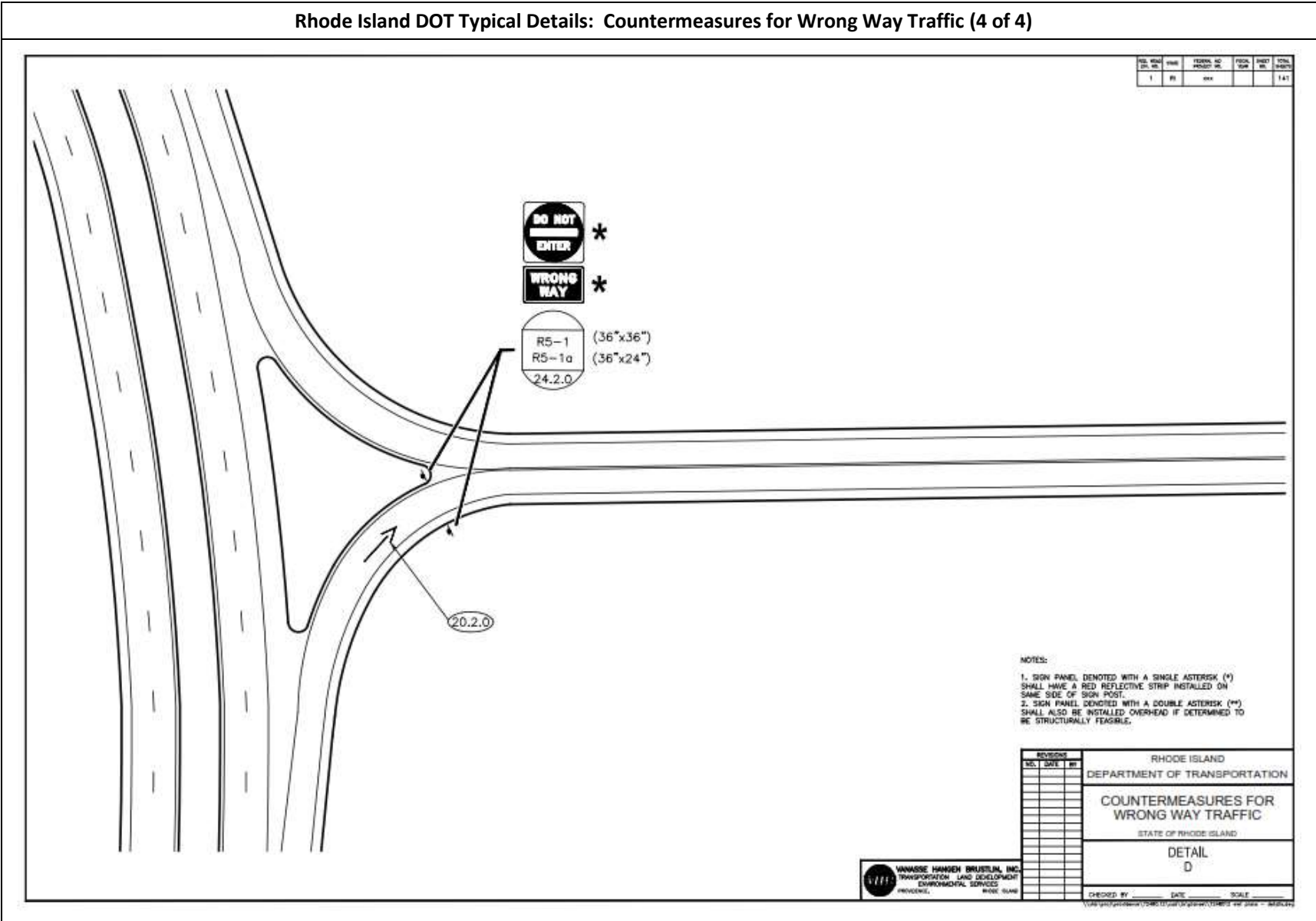

REV.	DATE	BY	CHKD.	TOTAL SHEETS
1				147

NOTES:
 1. SIGN PANEL DENOTED WITH A SINGLE ASTERISK (*) SHALL HAVE A RED REFLECTIVE STRIP INSTALLED ON SAME SIDE OF SIGN POST.
 2. SIGN PANEL DENOTED WITH A DOUBLE ASTERISK (**) SHALL ALSO BE INSTALLED OVERHEAD IF DETERMINED TO BE STRUCTURALLY FEASIBLE.

REVISIONS			RHODE ISLAND DEPARTMENT OF TRANSPORTATION	
NO.	DATE	BY		
			COUNTERMEASURES FOR WRONG WAY TRAFFIC	
			STATE OF RHODE ISLAND	
			DETAIL D	
			CHECKED BY _____	DATE _____ SCALE _____



Rhode Island DOT: Pavement Marking Arrow with Recessed Delineators (1 of 1)

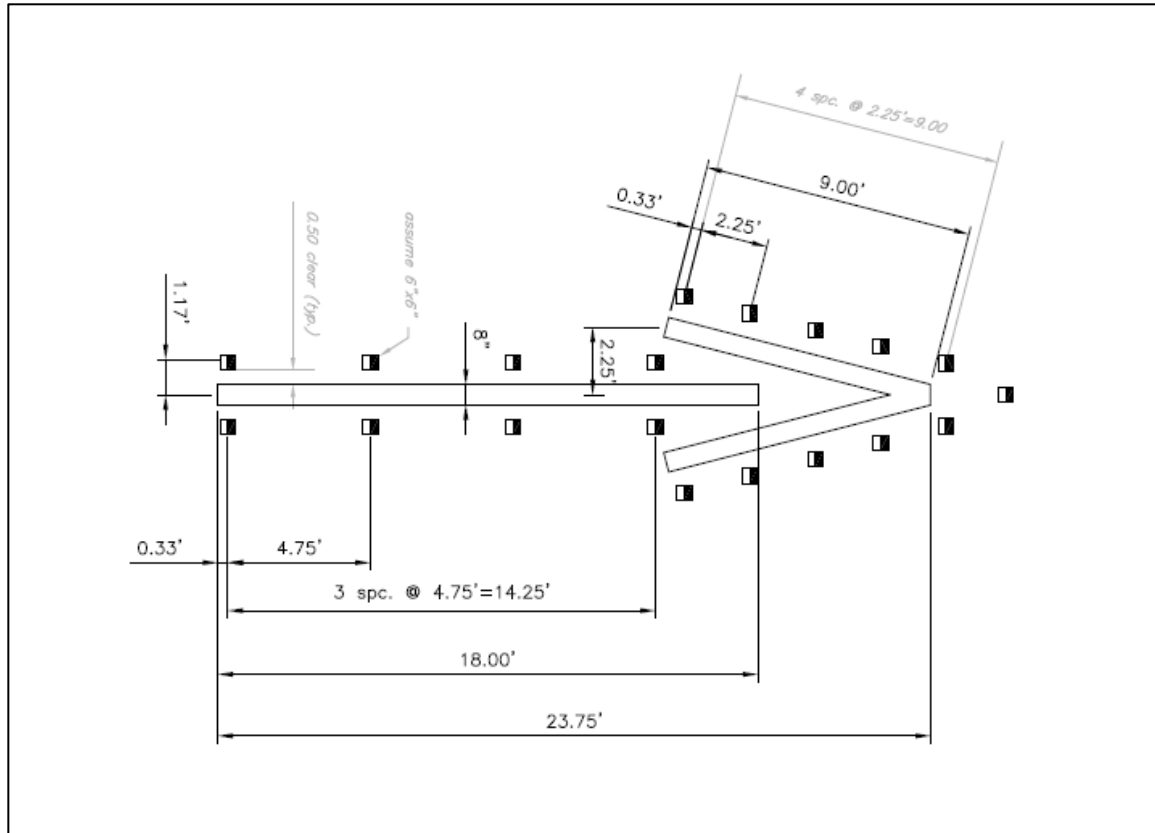

**“Countermeasures for Wrong Way Driving on Freeways”
Deployment Summary
Texas: Harris County Toll Road Authority**

Agency	Harris County Toll Road Authority (HCTRA)
Agency Contact	Captain Calvin Harvey Email: Calvin.Harvey@hctra.org Phone: (281) 584-7511
Information Sources	<ul style="list-style-type: none"> • Interview with Captain Calvin Harvey on 5/17/16 • Finley, Melisa D., et al. (2014). <i>Assessment of the Effectiveness of Wrong Way Driving Countermeasures and Mitigation Methods</i>. Texas A&M Transportation Institute. College Station, TX. http://d2dtl5nnlpr0r.cloudfront.net/tti.tamu.edu/documents/0-6769-1.pdf • Zhou, Huaguo, and Mahdi Pour Rouholamin. (2014b). <i>Proceedings of the 2013 National Wrong-Way Driving Summit</i>. Illinois Center for Transportation, University of Illinois at Urbana-Champaign. Urbana, IL. http://hdl.handle.net/2142/49045
Background	The Harris County Toll Road Authority (HCTRA) began deploying wrong-way vehicle detection and countermeasures in 2008. In 2016, HCTRA is replacing and upgrading its legacy equipment. Key aspects of this deployment include a strong focus on coordinated response efforts and adequate resources for law enforcement staff.
Deployment Location	Houston, Texas (Westpark Tollway)
Number of Sites	<ul style="list-style-type: none"> • Detection – 14 sites along mainline and exit ramps • LED-enhanced WRONG WAY (WW) Signs – approximately 20 ramps • In-pavement LED Lighting – 1 ramp
Deployment Dates	Initial deployment in 2008. System enhancements 2011-2016.
Test/Pilot or Long-term	Long-term deployment
Countermeasure Type(s)	<ol style="list-style-type: none"> 1) Detection with Alert to Incident Management Center (IMC) 2) Alert to Oncoming Right-Way Traffic 3) In-pavement LED Lighting (Will be phased out due to maintenance issues.) 4) LED-enhanced WRONG WAY (WW) Signs
Description of Countermeasures	<ol style="list-style-type: none"> 1) Detection at Ramps and Mainline with Alert to IMC <ul style="list-style-type: none"> • Initial installation included radar detection and in-pavement loop detectors along the mainline and at exit ramps <ul style="list-style-type: none"> – Puck loop sensors were more accurate with fewer false alarms; however, because they are installed in the pavement, they were determined to be too invasive to install and maintain system-wide. – In 2016, HCTRA is replacing the original sensors and installing double (redundant) high-definition radar at all locations.

- The number of false alarms increases during weather events such as rain and wind, but the overall false alarm rate is acceptable.
- The IMC receives detection alerts via an audible alarm.
- When a detection alarm is activated, several automated functions occur via the IMC's video management software system:
 - Nearby traffic cameras automatically pan toward detection site.
 - A GIS-based wrong-way vehicle detection map shows the vehicle's direction of travel to assist IMC operators with response efforts.
- IMC operators dispatch police, then utilizes the GIS map and traffic cameras to monitor the event and assist police with responses efforts.

2) Alert to Oncoming Right-Way Traffic

- Upon visual verification by IMC operators, a message on dynamic message signs (DMS) to warn oncoming right-way traffic.
- Message posted is: WARNING (red text) WRONG WAY DRIVER AHEAD ALL TRAFFIC MOVE TO SHOULDER AND STOP (amber text)



DMS Messages
(Source: Finley et al., 2014)

- HCTRA's ATMS software has been customized so operators only need to push one button to activate the DMS message. This saves time by eliminating the need for operators to log in to the system and enter the message.

3) In-pavement LED Lighting

- Installed at 1 exit ramp
- Continuously illuminated, day and night
- Will be phased out due to maintenance issues. Most self-correction occurs at flashing LED WW signs.



In-pavement LED Lighting at Exit Ramp
(Source: Provided by HCTRA)

	<p>4) LED-enhanced WRONG WAY (WW) Signs</p> <ul style="list-style-type: none"> • WW signs with blinking LEDs on sign border (blink continuously day and night) are installed at intersections with a higher rate of incidents. • Installed at all ramps on the Westpark Tollway. • Installed at exit ramps from managed (HOV/SOV toll) lanes on Katy Freeway.
<p>Evaluation Efforts/Results</p>	<p>A study conducted at the Texas A&M Transportation Institute in 2014 evaluated data from HCTRA for this deployment. Findings indicated that:</p> <ul style="list-style-type: none"> • Detection systems with camera verification and law enforcement response can successfully be used to detect, verify, and document wrong-way driving events. • The HCTRA detection system provides wrong-way driver entry points, a critical piece of information for helping practitioners further combat wrong-way driving. • Of 62 alerts received between January 2012 and December 2013, 86% of drivers self-corrected before reaching the mainline. (Finley et al., 2014) • Data collected and visually verified in 2015 showed that 28 of 40 (70%) wrong-way drivers detected by the system self-corrected. (Harvey, 2016)
<p>Coordination</p>	<p>HCTRA’s incident management group coordinates response efforts with law enforcement. All law enforcement vehicles are equipped with portable deflation devices. Law enforcement are advised to avoid driving in the wrong direction to chase vehicles. Rather, the responding vehicle drives in the correct direction, enters the freeway ahead of the wrong-way vehicle, and may use a portable tire deflation device to stop the vehicle.</p> <div data-bbox="1000 873 1446 1209" data-label="Image"> </div> <p style="text-align: center;">Portable Tire Deflation Device (Source: Zhou & Rouholamin, 2014b)</p>
<p>Guidelines or Standards</p>	<ul style="list-style-type: none"> • HCTRA has implemented standard procedures for response efforts when a wrong-way vehicle is detected (e.g. response protocol noted in “coordination” section). • Eventually, blinking LED WW signs will be standard at exit ramps across the tollway system.
<p>Local/Public Response</p>	<ul style="list-style-type: none"> • The media has done several stories on wrong-way crashes and countermeasures implemented. • When there is an event or crash, the public may also inquire about why the countermeasures are not implemented in other areas of Houston (i.e., in areas not under HCTRA’s jurisdiction). • There is a need to educate the public regarding appropriateness of certain countermeasures. HCTRA has received questions about why permanent pavement spikes are not used; these are not designed for higher speed environments.

<p>Lessons Learned</p>	<ul style="list-style-type: none"> • The detection and response protocols work very well, in part, because HCTRA adequate resources to dedicate law enforcement personnel to patrol the tollway system and respond accordingly. Other agencies may not have the resources to maintain a similar staffing level. • If unable to deploy a detection system, HCTRA recommends implementing lower-cost strategies such as striping and pavement marking improvements, and the LED-enhanced WW signs that blink continuously (detection not required).
<p>Future Plans</p>	<p>HCTRA is currently deploying LED-enhanced blinking WW signs on the Hardy Toll Road. HCTRA’s goal is to implement this countermeasure system-wide.</p>

“Countermeasures for Wrong Way Driving on Freeways” Deployment Summary

Texas Department of Transportation: San Antonio District

Agency	Texas Department of Transportation (TxDOT): San Antonio District
Agency Contact	John Gianotti Email: John.Gianotti@txdot.gov Phone: (210) 415-0688
Information Sources	<ul style="list-style-type: none"> • Interview with John Gianotti on 5/31/16 • Interview with John Gianotti on 12/4/14 • Gianotti, John. <i>Wrong Way Driver Project, TxDOT San Antonio District</i> [presentation slides]. TRB Wrong Way Driving webinar, April 20, 2016. Retrieved April 21, 2016. http://onlinepubs.trb.org/Onlinepubs/webinars/160420.pdf • Finley, Melisa, et al. (2016). <i>Conceptual Design of a Connected Vehicle Wrong-Way Driving Detection and Management System</i>. Texas A&M Transportation Institute. College Station, TX. http://d2dtl5nnlpr0r.cloudfront.net/tti.tamu.edu/documents/0-6867-1.pdf • Gianotti, John. San Antonio Wrong Way Driver Initiative [presentation slides]. 2015 TRB Annual Meeting, January 2015. Provided by John Gianotti. • KSAT 12 News. (Posted November 30, 2012). <i>Family nearly struck by wrong-way driver on I-35 at Loop 410</i>. Retrieved December 20, 2015. www.ksat.com/news/family-nearly-struck-by-wrong-way-driver-on-i-35-at-loop-410 • Texas Department of Transportation. The <i>San Antonio Wrong Way Driver Initiative web page</i>. Retrieved October 22, 2014. San Antonio, TX. www.transguide.dot.state.tx.us/sat/wwd/
Background	<ul style="list-style-type: none"> • The San Antonio Wrong Way Driver Initiative began in 2011 to address a growing issue of wrong-way driving in the San Antonio area. The San Antonio Wrong Way Driver Task Force, a multi-agency group, began tracking wrong-way driving occurrences and locations and devised a plan to implement countermeasures. • Research conducted by Texas DOT indicated that 72% of wrong-way driver events occurred at night (Gianotti, 2015 TRB Annual Meeting presentation). • U.S. Hwy 281 corridor had the highest number of reported wrong-way driving events in the San Antonio area and was selected to implement countermeasures.
Deployment Locations	San Antonio, Texas <ul style="list-style-type: none"> • U.S. Hwy 281 • I-10 and I-35
Number of Sites	<ul style="list-style-type: none"> • Enhanced Signing at Exit Ramps, with LED-Enhanced WRONG WAY (WW) Signs – 28 ramps • Detection at Exit Ramps with Alert to Traffic Management Center (TMC) – 16 ramps (Not active as of May 2016) • Mainlane Detection with Alert to Wrong-Way Driver, TMC, and Oncoming Traffic – 4 sites (2 sites on I-10 and 2 sites on I-35)

Deployment Dates	2012 - 2015
Test/Pilot or Long-term	Long-term deployments
Countermeasure Types	1) Enhanced Signing at Exit Ramps, including LED-Enhanced WW Signs 2) Detection at Exit Ramps with Alert to TMC (in place but not in use as of May 2016) 3) Mainlane Detection with Alert to Wrong-Way Driver, TMC, and Oncoming Traffic
Description of Countermeasures	<p>1) Enhanced Signing at Exit Ramps, including LED-Enhanced WW Signs</p> <ul style="list-style-type: none"> • Deployed at all exit ramps on U.S. Hwy 281: 15 miles, 28 exit ramps (NB and SB) • Additional static DO NOT ENTER (DNE) and WW signs beyond MUTCD minimums – one on each side of ramp (These additional signs were in place prior to the “Wrong-Way Driver Initiative” improvements that began being deployed in 2012) • Red reflective tape on sign posts (Not in place on U.S. Hwy 281. TxDOT is retaining original deployment configuration in order to analyze effectiveness.) • 2 additional flashing LED WW signs – one on each side of ramp. LEDs flash continuously at night and at low light levels. • If there is not enough room to implement all signs at a ramp, then install flashing WW signs in lieu of 2 standard WW signs. <div data-bbox="581 932 1305 1373" data-label="Diagram"> <p>The diagram illustrates the layout of exit ramp signing on U.S. Hwy 281. It shows an exit ramp curving to the right. On the left side of the ramp, there is a 'DO NOT ENTER' sign. On the right side, there are 'EXISTING' 'WRONG WAY' signs and 'NEW LED WW signs'. The highway lanes are labeled 'US 281 SBND' and 'US 281 NBND'. A street labeled 'JOSEPHINE ST.' is shown intersecting the highway. A north arrow is also present.</p> </div> <p style="text-align: center;">Typical Detail of Exit Ramp Signing - U.S. Hwy 281 (Source: Texas DOT)</p> <div data-bbox="829 1461 1102 1808" data-label="Image"> <p>A photograph showing a 'WRONG WAY' sign at night. The sign is illuminated with red flashing LEDs, making it highly visible against the dark background. The sign is mounted on a metal post.</p> </div> <p style="text-align: center;">Flashing LEDs on WW Sign (Source: Texas DOT)</p>

2) Detection at Exit Ramps with Alert to TMC

- Radar detection is deployed at 16 ramps on U.S. Hwy 281
- In place but not in use as of May 2016
- Upon detection, an alert is sent to the TransGuide TMC; TMC operators then alert the San Antonio Police Department (SAPD)
- Original radar technology sent several false alarms. TxDOT is considering multiple alternative options for detection, including a system that uses 2 radar detectors plus a camera to capture and confirm the wrong-way movement.

3) Mainlane Detection with Alerts



- High-definition radar detection devices are installed on overhead sign bridges along I-10 (2 systems) and I-35 (2 systems).
- Mainlane radar detection triggers the following:
 - Blank-out DMS displays “Wrong Way”
 - Flashing LED signs downstream attempt to catch driver’s attention
 - An alert is sent to the TransGuide TMC, to begin response efforts
 - TMC operators post a message on DMS to oncoming right-way traffic: “Wrong Way Driver Reported–Use Extreme Caution.” TxDOT’s San Antonio District plans to update the message content per results from a study completed by the Texas A&M Transportation Institute (Finley, et al., 2016). See figure below showing DMS messages.
 - Message is posted upon alert from the on-site detectors, before operators visually confirm the wrong-way vehicle. After the message is posted, operators use traffic cameras to locate the wrong-way vehicle.



Current Message Posted to Oncoming Right-Way Traffic
(Source: TxDOT)



DMS Messages to Oncoming Right-Way Traffic
Left Image: Recommended; Right Image: Alternative 15-character Message
(Source: Finley, et al., 2016)

	<div style="display: flex; justify-content: space-around; align-items: center;">   </div> <div style="display: flex; justify-content: space-around; margin-top: 10px;"> <p style="text-align: center;">Radar Detection on Mainlane Mounted to Sign Bridge <i>(Source: Texas DOT)</i></p> <p style="text-align: center;">LED Blank-out DMS <i>(Source: Texas DOT)</i></p> </div>
<p>Evaluation Efforts/Results</p>	<ul style="list-style-type: none"> • TxDOT is tracking the number of wrong-way driving events using TransGuide TMC logs and SAPD 911 logs. • Evaluation of the enhanced signing (including LED-enhanced WW signs) at ramps along U.S. Hwy 281 showed a 34.62% reduction in the average monthly rate of TransGuide wrong-way driving event logs from July 2012 to March 2016. Similar results were seen in SAPD logs. (Gianotti, April 2016 TRB Wrong Way Driving Webinar presentation).
<p>Coordination</p>	<ul style="list-style-type: none"> • San Antonio Wrong Way Task Force: <ul style="list-style-type: none"> - The San Antonio Wrong Way Task Force was initiated in 2011 to address the growing issue of wrong-way driving. Participating agencies include Texas DOT, San Antonio Police Department (SAPD), City of San Antonio Department of Public Works, Bexar County Sheriff’s Department, Federal Highway Administration, and Texas A&M University’s Texas Transportation Institute. - The Task Force met frequently initially, to coordinate on capabilities and issues and to conduct planning. It then began documenting and tracking number of wrong-way driving occurrences and location, and subsequently met less frequently as countermeasure deployments were implemented. - Texas DOT works closely with SAPD Dispatch when wrong-way events occur. • Education: <ul style="list-style-type: none"> - SAPD has worked with bar owners to make them aware of wrong-way driving issues near drinking establishments. • E-tone on Police Radio: <ul style="list-style-type: none"> - The San Antonio Police Department (SAPD) added “wrong-way driver” as one of the uses of an e-tone on police radio.

	<ul style="list-style-type: none"> • Lonestar Messages: <ul style="list-style-type: none"> - Wrong-way events are summarized and sent to a list of TxDOT safety/traffic staff. Messages include response efforts and updates. <div style="border: 1px solid black; padding: 10px; margin: 10px 0;"> <p style="text-align: center;">-----Original Message-----</p> <p style="text-align: center;">From: SAT_Lonestar@txdot.gov [mailto:SAT_Lonestar@txdot.gov]</p> <p style="text-align: center;">Sent: Wednesday, May 27, 2015 5:34 AM</p> <p style="text-align: center;">Subject: Lonestar Message</p> <p style="text-align: center;">UPDATE #1: IH 37 SOUTH IS STILL CLOSED FOR INVESTIGATION/CLEAN UP...UNKNOWN WHEN IH 37 WILL RE OPEN.....NO FATALITIES AS OF THIS UPDATE....VIA TRANS BUS WAS HIT HEAD ON BY WRONG WAY DRIVER.....//BL//</p> <p style="text-align: center;">MAJOR ACCIDENT: HIGHWAY CLOSED IH 37 SOUTHBOUND AT HOUSTON ST DUE TO POSSIBLE FATALITIES INVOLVING A WRONG WAY DRIVER...SAPD/SAFD ON THE SCENE....//BL//</p> <p style="text-align: center;">Sent from Lonestar user planmgr:TRF-ITS-WS22:920 Talk. Text. Crash.</p> <div style="text-align: center;">  </div> </div> <p style="text-align: center;">Example Lonestar Message (Source: TxDOT)</p>
<p>Guidelines or Standards</p>	<ul style="list-style-type: none"> • Some processes and standards are in place in the San Antonio District. For example, the District is installing flashing LED signs with new construction or when doing overlay work at applicable exit ramps. • San Antonio District has design/plan sheets and schematics for various countermeasure configurations, available upon request.
<p>Local/Public Response</p>	<ul style="list-style-type: none"> • TxDOT has not received a lot of feedback from the public, in general. • The following news story includes testimonial from a right-way driver who was grateful for the sign message indicating a wrong-way driver was reported: Family nearly struck by wrong-way driver on I-35 at Loop 410 (KSAT 12 News Video).

Lessons Learned	Recommend leveraging in-place high definition traffic detectors, such as those already placed in the mainlane, to include capability for wrong-way detection.
Future Plans	TxDOT San Antonio District continues to install new flashing LED signs with new construction or overlay work at applicable exit ramps on I-410, U.S. Hwy 90, and Loop 1604.

“Countermeasures for Wrong Way Driving on Freeways”

Deployment Summary

Washington State Department of Transportation

Agency	Washington State Department of Transportation
Agency Contact	Rick Mowlds Email: mowldsr@wsdot.wa.gov Phone: (360) 705-7988
Information Source	<ul style="list-style-type: none"> • Interview with Rick Mowlds on 6/8/16 • Interview with Rick Mowlds on 11/10/14
Background	Washington State DOT (WSDOT) noticed a series of wrong-way driving events occurring in 2010, prompting the agency to investigate further. WSDOT determined three types of interchanges for signing and pavement marking improvements: 1) partial cloverleaf ramps; 2) slip ramps; and 3) ramps opposite a two-way street.
Deployment Location	Statewide
Number of Sites	48 interchanges
Deployment Dates	2012-2013
Test/Pilot or Long-term	Long-term deployment
Countermeasure Type	Static Signing and Pavement Marking Improvements
Description of Countermeasures	<ul style="list-style-type: none"> • Low-mounted WRONG WAY signs (4 ft.) <ul style="list-style-type: none"> – WSDOT avoided placing low mounted signs in snow prone mountainous areas due to the potential for snow pileup or snow operations bending or breaking the sign post. • Ensure placement of Type 5 pavement marking arrows • Additional DO NOT ENTER (DNE) or ONE WAY signs at some ramp locations • Pavement marking extensions at side by side ramps
Evaluation Efforts/Results	WSDOT is tracking the number and locations of wrong-way driving events, upon notification from State Patrol. Each time a wrong-way event occurs WSDOT sends a team out to investigate.
Coordination	State Patrol notifies WSDOT when a wrong-way driving event occurs which enables to WSDOT to track occurrences, investigate events, and evaluate countermeasures.

<p>Guidelines or Standards</p>	<p>Statewide implementation of signing and pavement marking improvements at partial cloverleaf ramps, slip ramps, and ramps opposite a two-way street.</p> <p>WSDOT design details are provided on the following pages:</p> <ul style="list-style-type: none"> • Wrong Way Traffic Control for Partial Cloverleafs • Wrong Way Traffic Control for Partial Cloverleafs – Barrier or Curb Separation Between Ramps • Wrong Way Traffic Control for Partial Cloverleafs – Pavement Markings Only Separation Between Ramps • Wrong Way Traffic Control for Slip Exit Ramp • Wrong Way Traffic Control for Two-Way Street to Exit Ramp
<p>Local/Public Response</p>	<p>No feedback has been received from outside the agency.</p>
<p>Lessons Learned</p>	<p>All lessons are anecdotal. About 5 years ago, a high number of wrong-way movements were reported. In the past 2 years, wrong-way movements have dropped substantially. Eventually WSDOT will look at crash data as well to determine whether the issues still exist. WSDOT will then look at those sites specifically.</p>
<p>Future Plans</p>	<p>Nothing specific is planned. Program is in a monitoring stage.</p>

Wrong Way Traffic Control for Partial Cloverleaves

04/12/2012

(NOT TO SCALE)

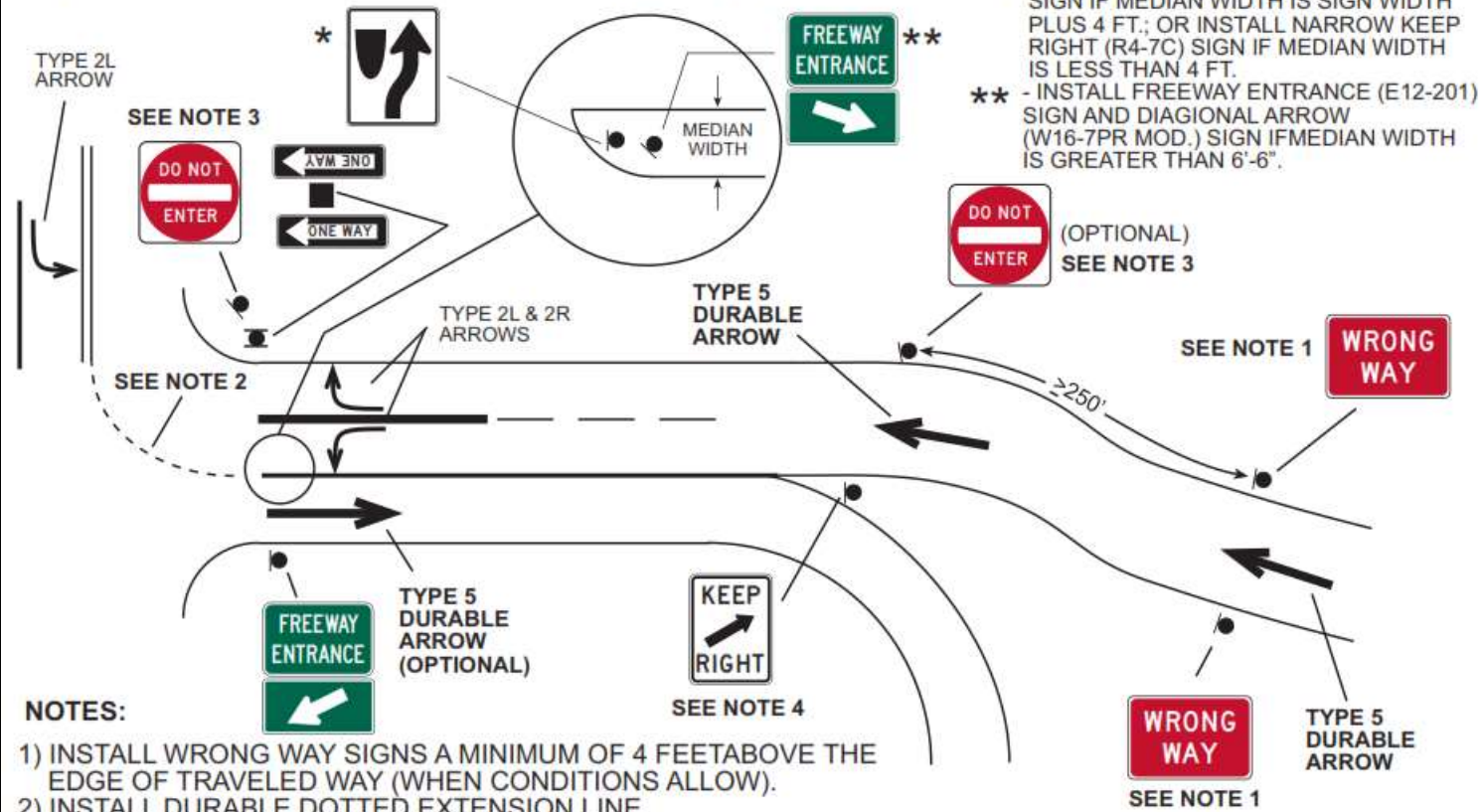

- * - INSTALL KEEP RIGHT SYMBOL (R4-7) SIGN IF MEDIAN WIDTH IS SIGN WIDTH PLUS 4 FT.; OR INSTALL NARROW KEEP RIGHT (R4-7C) SIGN IF MEDIAN WIDTH IS LESS THAN 4 FT.
- ** - INSTALL FREEWAY ENTRANCE (E12-201) SIGN AND DIAGONAL ARROW (W16-7PR MOD.) SIGN IF MEDIAN WIDTH IS GREATER THAN 6'-6".

NOTES:

- 1) INSTALL WRONG WAY SIGNS A MINIMUM OF 4 FEET ABOVE THE EDGE OF TRAVELED WAY (WHEN CONDITIONS ALLOW).
- 2) INSTALL DURABLE DOTTED EXTENSION LINE
- 3) DO NOT ENTER SIGNS MAY BE INSTALLED AT 4 FEET ABOVE THE EDGE OF TRAVELED WAY, IF THE LOWER HEIGHT DOES A CREATE SIGHT TRIANGLE ISSUE FOR RAMP TRAFFIC, AND/OR DOES NOT INTERFERE WITH PEDESTRIAN MOVEMENTS.
- 4) INSTALL KEEP RIGHT (R4-7B), IF MEDIAN FOR TWO-WAY RAMPS IS STRIPED ONLY.

SIGN TYPE	SIZE
DO NOT ENTER (R5-1)	48"X48"
WRONG WAY (R5-1A)	42"X30"
ONE WAY (R6-1L/R)	54"X18"

Wrong Way Traffic Control for Partial Cloverleafs Barrier or Curb Separation Between Ramps

06/21/2012

(NOT TO SCALE)

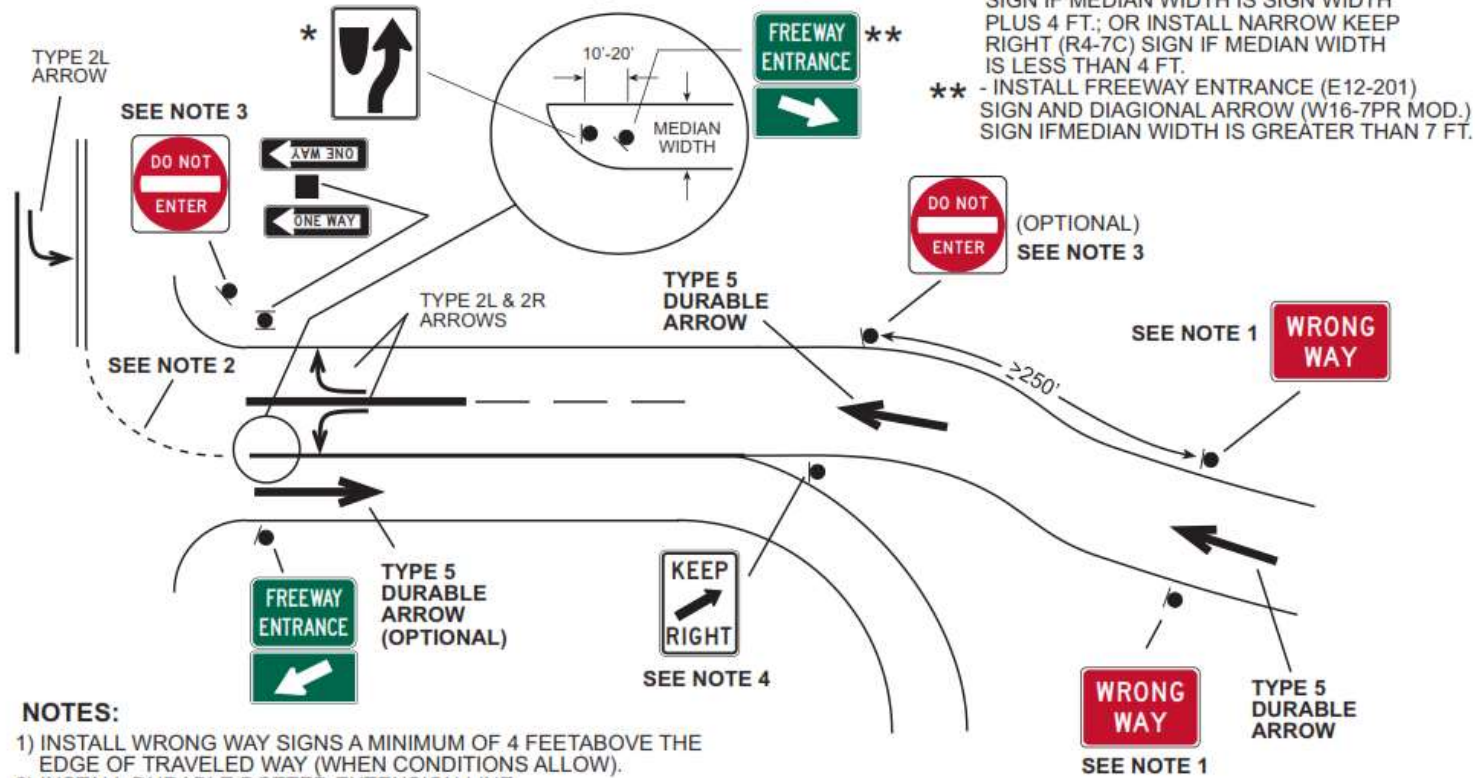

- * - INSTALL KEEP RIGHT SYMBOL (R4-7) SIGN IF MEDIAN WIDTH IS SIGN WIDTH PLUS 4 FT.; OR INSTALL NARROW KEEP RIGHT (R4-7C) SIGN IF MEDIAN WIDTH IS LESS THAN 4 FT.
- ** - INSTALL FREEWAY ENTRANCE (E12-201) SIGN AND DIAGONAL ARROW (W16-7PR MOD.) SIGN IF MEDIAN WIDTH IS GREATER THAN 7 FT.

NOTES:

- 1) INSTALL WRONG WAY SIGNS A MINIMUM OF 4 FEET ABOVE THE EDGE OF TRAVELED WAY (WHEN CONDITIONS ALLOW).
- 2) INSTALL DURABLE DOTTED EXTENSION LINE
- 3) DO NOT ENTER SIGNS MAY BE INSTALLED AT 4 FEET ABOVE THE EDGE OF TRAVELED WAY, IF THE LOWER HEIGHT DOES NOT CREATE A SIGHT TRIANGLE ISSUE FOR RAMP TRAFFIC, AND/OR DOES NOT INTERFERE WITH PEDESTRIAN MOVEMENTS.
- 4) INSTALL KEEP RIGHT (R4-7B), IF MEDIAN FOR TWO-WAY RAMPS IS STRIPED ONLY.

SIGN TYPE	SIZE
DO NOT ENTER (R5-1)	48"X48"
WRONG WAY (R5-1A)	42"X30"
ONE WAY (R6-1L/R)	54"X18"

Wrong Way Traffic Control for Partial Cloverleaves Pavement Markings Only Separation Between Ramps

06/21/2012

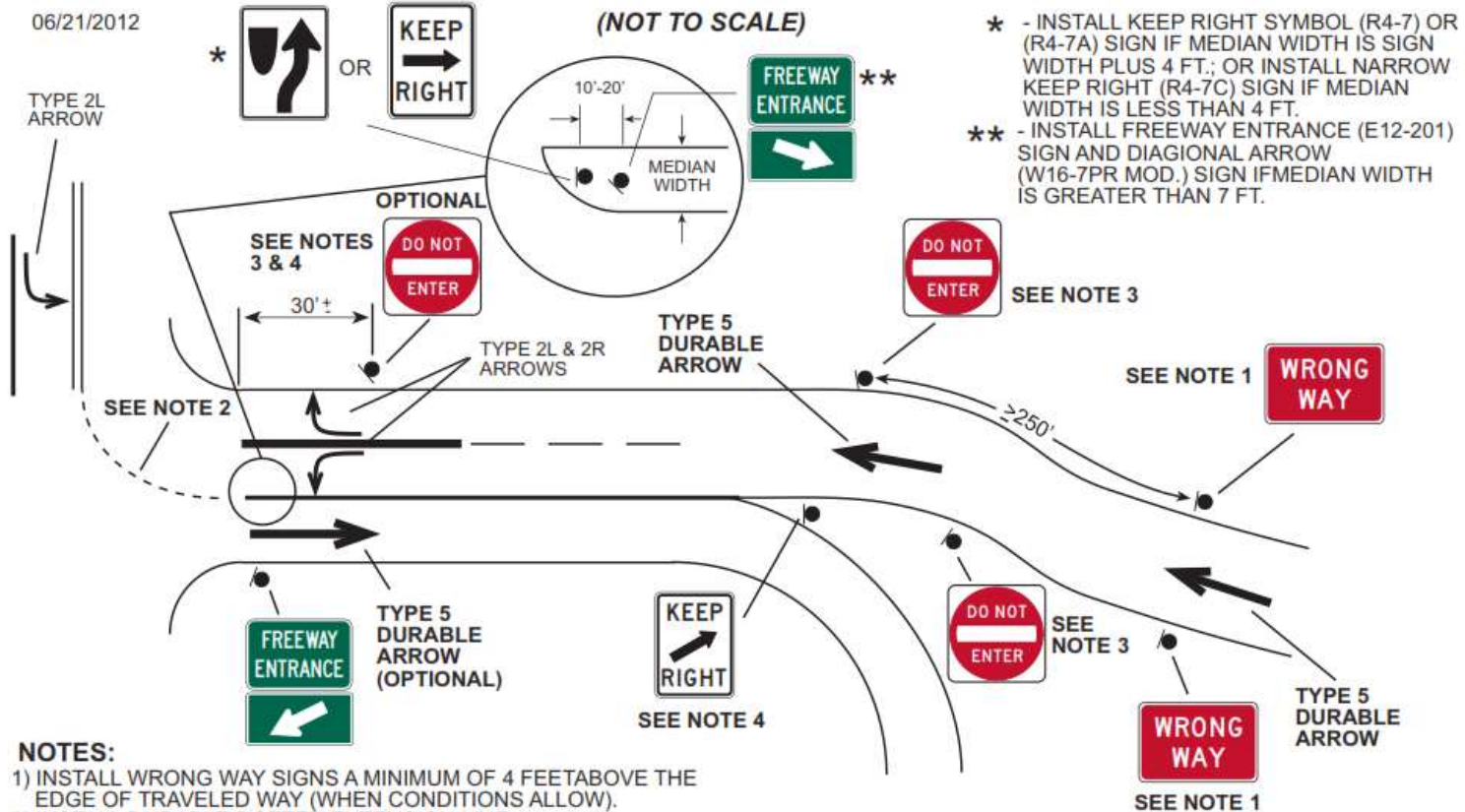

Wrong Way Traffic Control for Slip Exit Ramp

04/12/2012

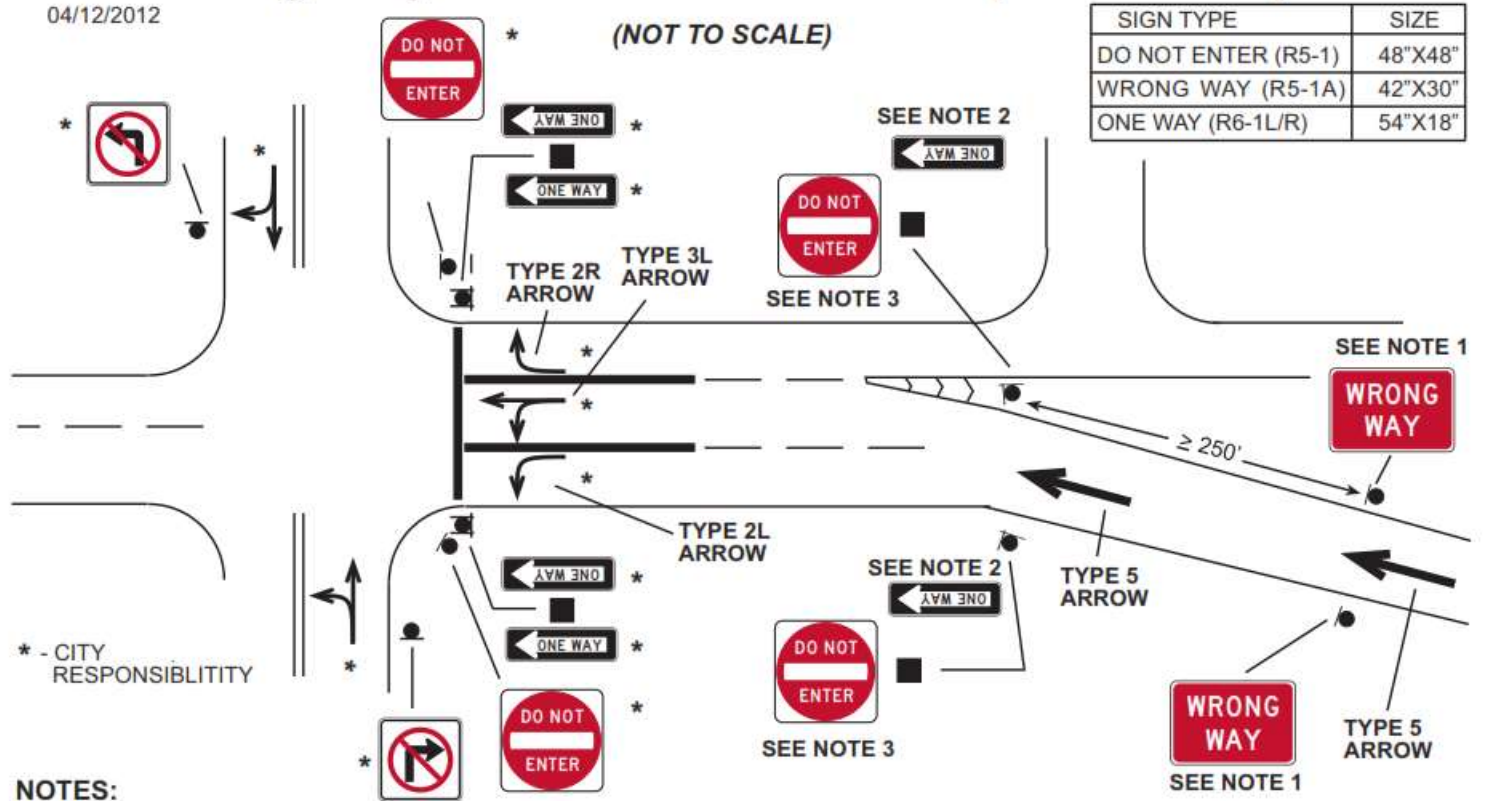

NOTES:

- 1) INSTALL WRONG WAY SIGNS A MINIMUM OF 4 FEET ABOVE THE EDGE OF TRAVELED WAY (WHEN CONDITIONS ALLOW).
- 2) INSTALL ONE WAY SIGNS AS SHOWN IF THERE IS AN EXISTING CROSS STREET OR DRIVEWAY NEAR THE EXIT GORE AREA.
- 3) DO NOT ENTER SIGNS MAY BE INSTALLED AT 4 FEET ABOVE THE EDGE OF TRAVELED WAY, IF THE LOWER HEIGHT DOES A CREATE SIGHT TRIANGLE ISSUE FOR RAMP TRAFFIC, AND/OR DOES NOT INTERFERE WITH PEDESTRIAN MOVEMENTS.

Wrong Way Traffic Control for Two-Way Street to Exit Ramp

04/12/2012

* - CITY RESPONSIBILITY

(NOT TO SCALE)

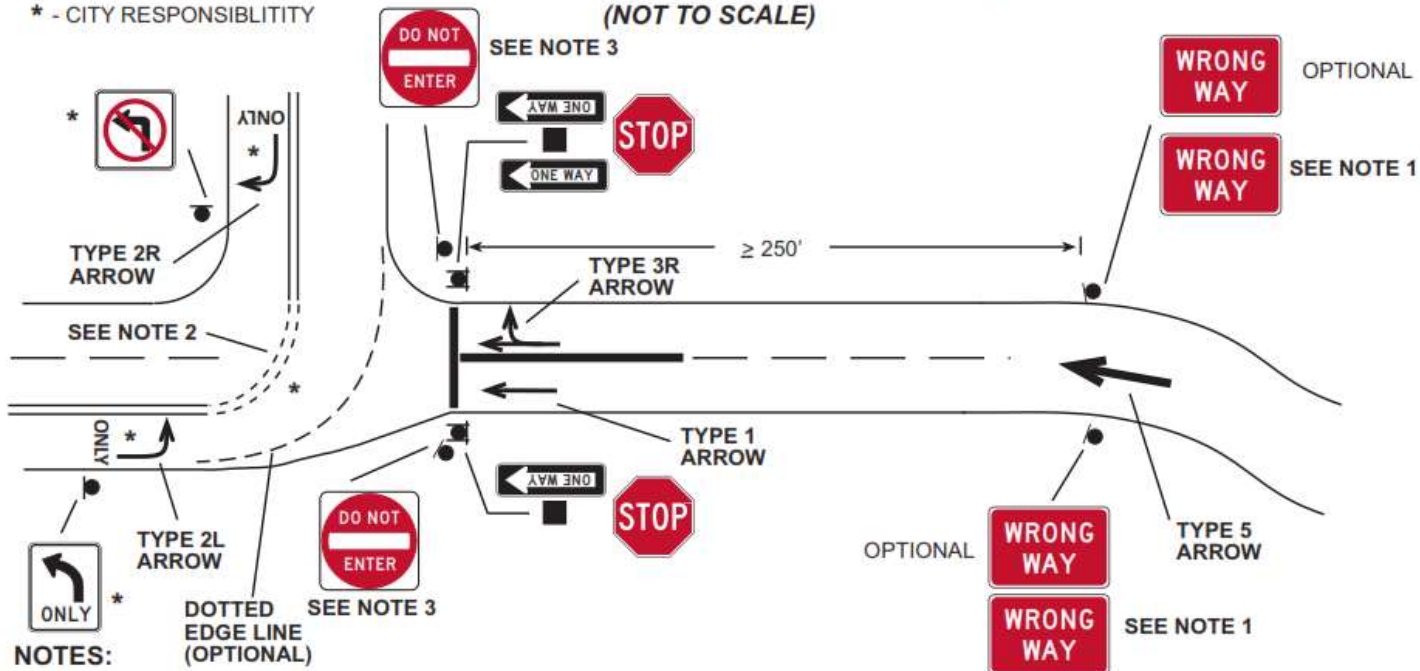

NOTES:

- 1) INSTALL WRONG WAY SIGNS A MINIMUM OF 4 FEET ABOVE THE EDGE OF TRAVELED WAY (WHEN CONDITIONS ALLOW); THE SECOND WRONG WAY SIGN IS OPTIONAL AND TO BE MOUNTED AT 7 FEET ABOVE THE EDGE OF TRAVELED WAY..
- 2) INSTALL DURABLE DOTTED LANE LINES
- 3) DO NOT ENTER SIGNS MAY BE INSTALLED AT 4 FEET ABOVE THE EDGE OF TRAVELED WAY, IF THE LOWER HEIGHT DOES A CREATE SIGHT TRIANGLE ISSUE FOR RAMP TRAFFIC, AND/OR DOES NOT INTERFERE WITH PEDESTRIAN MOVEMENTS.

SIGN TYPE	SIZE
DO NOT ENTER (R5-1)	48"X48"
WRONG WAY (R5-1A)	42"X30"
ONE WAY (R6-1L/R)	54"X18"

“Countermeasures for Wrong Way Driving on Freeways”

Deployment Summary

Wisconsin Department of Transportation

Agency	Wisconsin Department of Transportation (WisDOT)
Agency Contact	Stacey Pierce Email: Stacey.Pierce@dot.wi.gov Phone: (262) 548-5958
Information Sources	<ul style="list-style-type: none"> • Interview with Stacey Pierce on 1/30/15 • Interview with Stacey Pierce on 3/7/16
Background	<ul style="list-style-type: none"> • Wisconsin’s wrong-way fatality trends have been stable since 2004, but the number of related calls has increased, presumably due to more people having cell phones. • The Milwaukee urban area seems to have a higher number wrong-way driving occurrences than other areas of Wisconsin, possibly due to a higher population concentration and numerous ramps. A number of high visibility wrong-way crashes occurred in 2010 and 2011, prompting the Milwaukee County Sheriff’s Office to contact WisDOT about the issue. • The Milwaukee County Sheriff’s Office and the Wisconsin Department of Transportation (WisDOT) worked together to identify high risk locations. • WisDOT now works closely with the Sheriff’s Office to track the number of wrong-way reports per 911 calls received. When a 911 call is received, the Sheriff’s Office contacts the WisDOT Traffic Operations Center (TOC), at which time TOC operators assist with the response. Law enforcement is not able to intercept many wrong-way drivers, as they tend to enter and exit the freeway quickly.
Number of Sites & Deployment Locations	<ul style="list-style-type: none"> • Static Signing and Pavement Marking Improvements: 247 sites in the WisDOT Southeast Region • Detection with Alert to TOC and Milwaukee County Sheriff’s Office: 8 sites in Milwaukee County • LED-Enhanced WW Signs: 3 sites in Milwaukee County
Deployment Dates	Approximately 2013 -2015
Test/Pilot or Long-term	Long-term deployments
Types of Countermeasures	<ol style="list-style-type: none"> 1) Static Signing and Pavement Marking Improvements 2) Detection with Alert to Traffic Operations Center (TOC) and Milwaukee County Sheriff’s Office 3) LED-Enhanced WW Signs (Blink Continuously at Night)

Description of Countermeasures

1) Static Signage and Pavement Marking Improvements

- Approximately 247 sites, implemented over the past several years
- Additional signs - placed on both sides of ramp rather than one side as required
- WRONG WAY (WW) and DO NOT ENTER (DNE) signs on same post, with lower WW sign at 3 ft. mounting height, at ramp termini
- Added NO LEFT TURN and NO RIGHT TURN signs
- Added Freeway Entrance Signs at side by side ramps
- Red reflective tape in a few locations, especially at side by side ramps
- Skip line pavement markings to guide drivers onto the entrance ramp
- As construction projects occur in the future, adding additional turn arrows or wrong way arrows as needed if they are not currently in place



Additional WW and DNE Signs & Signs Mounted on Same Post
(Source: Wisconsin DOT)

2) Detection with Alert to TOC and Milwaukee County Sheriff's Office

- Deployed at 8 ramps in Milwaukee area; calibrations completed in 2013.
- System includes alert (email or text) and software interface with audible tone that sounds at the WisDOT TOC and Sheriff's Office.
- Two radar detection devices at all 8 locations. Cameras were added at a few ramps to verify detection and send static photos of the vehicle.
- Extensive CCTV camera system on freeways to track the wrong-way driver and intervene after an alert is received. TOC operators and Sheriff's Office are in constant communications during pursuit.
- Detection false call rate has improved dramatically since initial deployment. Side by side ramps were challenging due to detecting right way drivers on the adjacent ramp.
- In January 2015, a wrong-way vehicle entered the freeway at a ramp equipped with detection, but the vehicle was not detected and resulted in a fatal crash. The manufacturer indicated the vehicle may have been traveling too slowly to be detected. Prior to the fatal crash 7 wrong-way vehicle instances were detected and confirmed at this ramp site.

	<p>3) LED-Enhanced WW Signs (Blink Continuously at Night)</p> <ul style="list-style-type: none"> • In addition to detection/alert technology, 3 ramps also have solar powered LED-enhanced WW signs that blink continuously from dusk until dawn. 2 ramps were equipped with blinking signs in 2012; a 3rd was installed in 2015 at the site where the fatal crash entrance occurred. • Red LED lights are located around border of the WW sign. • Blinking LED WW signs placed on ramps near drinking establishments in the vicinity of Miller Park baseball stadium. • The blinking LED WW signs are typically placed halfway down the ramp with one sign on each side of the ramp. However, placement depends on each individual ramp configuration; need to position signs so they can't be seen by right-way drivers on the freeway (e.g. due to a curve approaching the ramp site).  <p style="text-align: center;">Blinking WRONG WAY Sign (Source: Wisconsin DOT)</p>
<p>Evaluation Efforts/Results</p>	<p>WisDOT has begun tracking data to assess the effectiveness of the countermeasures.</p> <p><u>Approach:</u></p> <ul style="list-style-type: none"> • WisDOT is tracking each instance when a wrong-way driver is reported, then logging events into a database with narration. • Within 1-2 hours after each event, a brief summary is sent out to a working group. A weekly report summarizes all wrong-way driver incidents for that week. • At the region, a spreadsheet is maintained to track details, such as where the wrong-way driver entered, where the wrong-way vehicle was reported/spotted, and whether a crash resulted. Each event is classified as “confirmed” or “unconfirmed.” Approximately 1/3 or more of the wrong-way events are confirmed. As crash reports are available, additional crash data (e.g. severity, fatalities, etc.) is also tracked if the event resulted in a crash. <p><u>Results:</u></p> <ul style="list-style-type: none"> • A detailed evaluation of the data has not yet been conducted. • Anecdotally, WisDOT has not seen a significant decrease in wrong-way driving events/crashes with increased static signing and pavement markings. WisDOT is still assessing whether or not to implement these countermeasures widely.
<p>Coordination</p>	<p>WisDOT is working closely with the Milwaukee County Sheriff’s office to log and track wrong-way driving events and implement countermeasures.</p>
<p>Guidelines or Standards</p>	<p>See the following pages for excerpts from the WisDOT Traffic Guidelines Manual, containing details for:</p> <ul style="list-style-type: none"> • LED’s (Blinker Signs) • Wrong-Way Prevention (signing and pavement markings)

Local/Public Response	WisDOT has not received much feedback from the public.
Lessons Learned	A lesson learned is to be careful when closing on-ramps that are immediately adjacent to off-ramps. In one instance, an on-ramp had been closed due to construction, and there seemed to be confusion late at night with impaired drivers. The driver in a 2015 fatal wrong-way crash had a blood alcohol content over 3 times the legal limit (.08), and the construction area was snow covered.
Future Plans	Detection and blinking WW signs are likely to be installed at 15-20 additional side-by-side ramps in 2016.



State of Wisconsin
Department of Transportation

Traffic Guidelines Manual

ORIGINATOR State Traffic Engineer		2-1-8
CHAPTER 2	Signing	
SECTION 1	Regulatory	
SUBJECT 8	LED's (Blinker Signs)	

A. Purpose

The 2009 MUTCD, [section 2A.07](#) provides standards and options for the usage of Light Emitting Diode (LED) units within the face of a sign and in the border of a sign to improve conspicuity and increase the legibility of sign legends and borders. This policy provides requirements and guidance on the proper use of the LED (commonly referred to as blinker) signs on state maintained highways. Per the MUTCD, these blinker signs *may* be used on STOP signs, Warning signs and other Regulatory signs such as speed limit sign or school signs. This policy provides guidance and requirements for usage on state maintained highways.

B. Background

The MUTCD, Wisconsin Supplement includes language in [Section 2A.07](#) which provides guidelines for the proper use of these devices. They are considered similar to flashing beacons in section [4L](#) of the MUTCD. The limiting guidelines under which they are considered in the Wisconsin Supplement are:

- Guideline 1: Demonstrated crash problem
- Guideline 2: Visibility restrictions
- Guideline 3: Unusual geometrics
- Guideline 4: Poor conspicuity – sign blending in with the environment

These 4 guidelines apply to all public highways and streets, including those not under state jurisdiction. The policy statements below pertain specifically to state maintained highways.

C. Definitions and MUTCD requirements (if LED's used)

1. LED's **shall** have a maximum diameter of ¼ inch and **shall** be the following colors based on the type of sign:
 - a. White or red, if used with STOP or YIELD signs.
 - b. White, if used with regulatory signs other than STOP or YIELD signs.
 - c. White or yellow, if used with warning signs.

2. If flashed, the LED units **shall** flash simultaneously at a rate of more than 50 and less than 60 times per minute.
3. The uniformity of the sign design **shall** be maintained without any decrease in visibility, legibility, or driver comprehension during either daytime or nighttime conditions.
4. A module of multiple LED units used as a closely-spaced, single light source **shall** only be used within the sign face for legends or symbols.

D. Policy

The usage of any illumination methods for traffic signs, including LED's, is strictly limited to situations with documented safety concerns.

1. Local authorities **shall not** be allowed to install LED units on State Maintained highways.
2. Blinker signs **shall** only be considered at existing locations. A conversion from a two to four way stop is also considered an existing location. New locations **shall not** be considered until such time as a minimum of one-year crash data, volume data and other traffic data is available for a traffic evaluation safety study **shall** be submitted to the State Safety Engineer for review.
3. For blinker STOP and STOP AHEAD signs, at a minimum, consider at intersections that meet both of the following criteria:
 - a. Crashes due to failure to stop (i.e. running the stop sign) not failure to yield the R/W (i.e. stopping and then proceeding)
 - b. At least 2 documented failures (crash reports) to stop in a most recent 12 month period or 3 documented failures to stop within the past five years.
4. Other countermeasures *should* be considered first, prior to installation of blinker STOP and STOP AHEAD signs, to address safety concerns such as:
 - a. Clearing vegetation
 - b. Double marking STOP AHEADS or STOP signs
 - c. Flags on signs
 - d. Rumble strips
 - e. Increasing sign sizes
 - f. Flashing Beacons
 - g. Others
5. Side-by-side ramps are common at partial cloverleaf interchanges where entrance and exit ramps operate directly adjacent to one another at the interchange ramp terminal. Geometric design techniques to discourage wrong way maneuvers *should* be considered at side-by-side ramps.

Where design constraints exist, blinker WRONG WAY signs *may* be utilized at side-by-side interchange ramps, provided there are documented wrong way movements noted by law enforcement or the Department. Blinker WRONG WAY signs **shall** not be used at locations other than side-by-side interchange ramps. WRONG WAY blinker signs shall only be used downstream of the ramp termini.

6. To maximize the effectiveness of the blinker WRONG WAY signs, vehicle actuated and time-of-day usage **shall** be considered by the Region. Some examples of time-of-day usage would include:

- Operation during periods when wrong way drivers are prevalent.
- Operation during periods of low visibility or darkness, which may include a photocell operation.

7. In order to avoid a proliferation of blinker signs, at this time they **shall** only be used for STOP, STOP AHEAD, and WRONG WAY signs (at side-by-side ramps). These are considered the more important of the regulatory and warning sign series. There is the longstanding concern that overuse of the blinker signs will diminish their effectiveness.

*There have been requests to utilize different types of blinker signs. To address these requests, the Bureau of Traffic Operations is in the process of coordinating the evaluation of different types of blinker signs, and the evaluation results will determine the potential expansion of use per statewide policy. Presently, blinker signs are currently being evaluated on chevron signs in the SE and SW Regions, where there is dynamic (vehicle actuated) system.

Any requests for additional blinker sign evaluations **shall** be approved by the Bureau of Traffic Operations.

8. Blinker STOP AHEAD signs **shall** be furnished and installed by WISDOT on State Highways based on the criteria noted above.

9. Do not install blinker STOP signs and STOP AHEAD signs on the same approach. If used, where there is a curve or hill approaching a STOP sign use blinker on STOP AHEAD sign rather than STOP sign.

10. Do not mix beacons and blinker signs with STOP and STOP AHEAD signs on the same approach.

A cost comparison analysis *should* be done to determine where beacons or blinker sign is more appropriate. Studies have not been performed to determine if one device is more appropriate than the other.



State of Wisconsin
Department of Transportation

Traffic Guidelines Manual

ORIGINATOR State Traffic Engineer		2-15-12
CHAPTER 2	Signs	
SECTION 15	Comprehensive Policies	
SUBJECT 12	Wrong-Way Prevention	

A. Purpose

Prevention of wrong-way movement is a concern wherever an entire roadway is dedicated to one-way traffic. Wrong-way prevention signing consists of the appropriate use and placement of Turn Prohibition signs, Keep Right signs, DO NOT ENTER signs, WRONG WAY signs, ONE WAY signs and Divided Highway Crossing signs.

The need for wrong-way prevention signing in any situation is determined by the complexity of the situation requiring positive guidance, and the consequence of error. The following guidance and details are intended to define the typical amount of signing for the various applications.

B. Applications

DIVIDED HIGHWAY WITH WIDE MEDIAN intersection with TWO-WAY CROSS STREET (See Figure 1)

This typical signing plan *should* be sufficient for most intersections of this type.

The Wisconsin Supplement to the MUTCD amends the 2009 FHWA MUTCD Section 2B.37 and Figure 2B-12 to allow the single installation of DO NOT ENTER and WRONG WAY SIGNS. Where the median width is 30 feet or greater, the signs *should* be installed on the median side.

DIVIDED HIGHWAY WITH NARROW MEDIAN intersection with TWO-WAY CROSS STREET (See Figure 2)

This typical signing plan *should* be sufficient for most intersections of this type. Additional needs *may* be met by installing additional signs as shown in 2009 Federal MUTCD Figure 2B-15.

The Wisconsin Supplement to the MUTCD amends the 2009 Federal MUTCD Section 2B.37 and Figure 2B-12 to allow the single installation of DO NOT ENTER and WRONG

WAY SIGNS. Where the median width is less than 30', the signs *should* be installed on the outer side.

DIVIDED HIGHWAY WITH WIDE MEDIAN intersection with INTERCHANGE RAMPS
(See Figure 3)

This typical signing plan *should* be sufficient for most intersections of this type. It combines the typical signing requirements from **Figure 1** with the Standards, Guidance and Options in the 2009 MUTCD Section 2B.41 and Figure 2B.18, except that the Turn Prohibition signs are designated optional. This is consistent with the last Option paragraph in the 2009 MUTCD Section 2B.18.

DIVIDED HIGHWAY WITH NARROW MEDIAN intersection with INTERCHANGE RAMPS
(See Figure 4)

This typical signing plan *should* be sufficient for most intersections of this type. It combines the typical signing requirements from **Figure 2** with the Standards, Guidance and Options in the 2009 MUTCD Section 2B.41 and Figure 2B.18, except that the Turn Prohibition signs are designated optional. This is consistent with the second to last Option paragraph in the 2009 MUTCD Section 2B.18.

TWO-WAY UNDIVIDED HIGHWAY intersection with INTERCHANGE RAMPS (See Figure 5)

This typical signing plan *should* be sufficient for most intersections of this type. It reflects the Standards, Guidance and Options in the 2009 MUTCD Section 2B.41 and Figure 2B.18, except that the Turn Prohibition signs are designated optional. This is consistent with the second to last Option paragraph in the 2009 MUTCD Section 2B.18.

TRANSITION FROM TWO-WAY UNDIVIDED HIGHWAY TO DIVIDED HIGHWAY (See Figure 6)

This typical signing plan *should* be sufficient to prevent wrong-way movements in these transition areas. TGM Subject 2-15-11 illustrates the overall signing and pavement marking requirements in greater detail.

DIVIDED HIGHWAY WITH INTERSECTING SIDEROAD (See Figures 7 and 8)

These typical signing plans should be sufficient for most side roads of these types. Additional needs may be met by installing additional signs as shown in the 2009 Federal MUTCD, Figure 2B-15.

The Wisconsin Supplement to the MUTCD amends the Federal MUTCD Section 2B.37 and Figure 2B-12 to allow for the single installation of the DO NOT ENTER and WRONG WAY signs. Where the median width is less than 30', the signs should be installed on the outer side.

DIVIDED HIGHWAY WITH NARROW OR WIDE MEDIAN DRIVEWAY (See Figures 9,

10 ,11, 12 and 13)

These typical signing plans should be sufficient for most driveways of these types. Additional needs may be met by installing additional signs as shown in the 2009 Federal MUTCD, Figure 2B-15.

The Wisconsin Supplement to the MUTCD amends the Federal MUTCD Section 2B.37 and Figure 2B-12 to allow for the single installation of the DO NOT ENTER and WRONG WAY signs. Where the median width is less than 30', the signs should be installed on the outer side.

ROUNDABOUTS (See Figure 14)

This typical signing plan should be sufficient for the prevention of wrong way movements on roundabouts with single and multiple approach lanes and interchange off-ramps.

DIVIDED HIGHWAY WITH SIGNALIZED WIDE MEDIAN INTERSECTION (See Figure 16)

This typical signing plan *should* be sufficient for most intersections of this type.

The Wisconsin Supplement to the MUTCD amends the 2009 Federal MUTCD Section 2B.37 and Figure 2B-12 to allow the single installation of DO NOT ENTER and WRONG WAY SIGNS. Where the median width is 30 feet or greater, the signs *should* be installed on the median side.

DIVIDED HIGHWAY WITH SIGNALIZED NARROW MEDIAN INTERSECTION (See Figure 17)

This typical signing plan *should* be sufficient for most intersections of this type. Additional needs *may* be met by installing additional signs as shown in 2009 Federal MUTCD Figure 2B-16.

The Wisconsin Supplement to the MUTCD amends the 2009 Federal MUTCD Section 2B.37 and Figure 2B-12 to allow the single installation of DO NOT ENTER and WRONG WAY SIGNS. Where the median width is less than 30', the signs *should* be installed on the outer side.

C. Policy

At approaches to multi-lane roadways with median widths less than 30', the R6-1 ONE WAY sign **shall** be installed at the near right installation above the STOP or YIELD sign. At approaches to multi-lane roadways with median widths 30' or greater, two R6-1 ONE WAY signs **shall** be installed back to back at the near right installation above the STOP or Yield sign. The R6-1 ONE WAY sign shall be used at "T" intersections with divided highways or above the roundabout directional arrow (R6-4b) sign.

At divided highways with wide medians that have a STOP or Yield sign in the median, a

R6-1 ONE WAY sign **shall** be installed back to back above the STOP or Yield sign (See Figure 15).

The R6-2 ONE WAY sign **shall** be used for all other locations on the STH system.

The DO NOT ENTER sign **shall** be installed where it does not obscure the outline or shape of STOP or YIELD signs. If space does not permit, it is permissible to trim the DO NOT ENTER sign into an octagon shape, however the preference is to install the DO NOT ENTER sign on a separate post, next to the STOP sign.

D. Guidelines

Short divided sections with low traffic volumes and a posted speed of 40 mph or less *may* not need the DO NOT ENTER and WRONG WAY signs.

An urban boulevard with frequent cross streets and median openings *should* not need repeated DO NOT ENTER and WRONG WAY signs.

A history of wrong way movements and/or related crashes *may* warrant further measures. If visibility of the far roadway from the side street or ramp is obscured by geometrics or cross section, additional ONE WAY signs *may* be necessary and positioned as shown in the 2009 MUTCD Figure 2B-15.

Highway lighting *may* be a solution to visibility problems, eliminating the need for extra signing.

Pavement marking arrows *may* be used to supplement signing and reinforce the wrong way prevention message, especially on exit ramps.

Freeway ramps *may* warrant additional signing and marking strategies to help prevent wrong way movements. The following strategies *may* be used at freeway ramp locations that have exhibited problems with wrong way drivers entering the freeway:

- Upsizing of DO NOT ENTER and WRONG WAY signs
- Stop bars and type 4 pavement marking arrows
- Dotted pavement marking line extensions through the intersection

The following strategies *may* be used in addition to the ones above or on their own. All of the following strategies are optional, and **shall** only be used at side by side ramp locations that have exhibited problems with wrong way drivers entering the freeway:

- Additional WRONG WAY signs mounted below the DO NOT ENTER signs at a 3 foot mounting height as measured vertically from the bottom of the sign to the top of the near edge of pavement.
- Reflective strips on WRONG WAY and DO NOT ENTER sign posts. These strips **shall** be 2 inches wide, composed of red Type H sheeting on 0.040 inch sheet aluminum, and **shall** run from the bottom of the sign to within 2 feet above the edge of pavement.
- A FREEWAY ENTRANCE sign placed at the entrance to the on ramp
- Dynamic (flashing) WRONG WAY signs

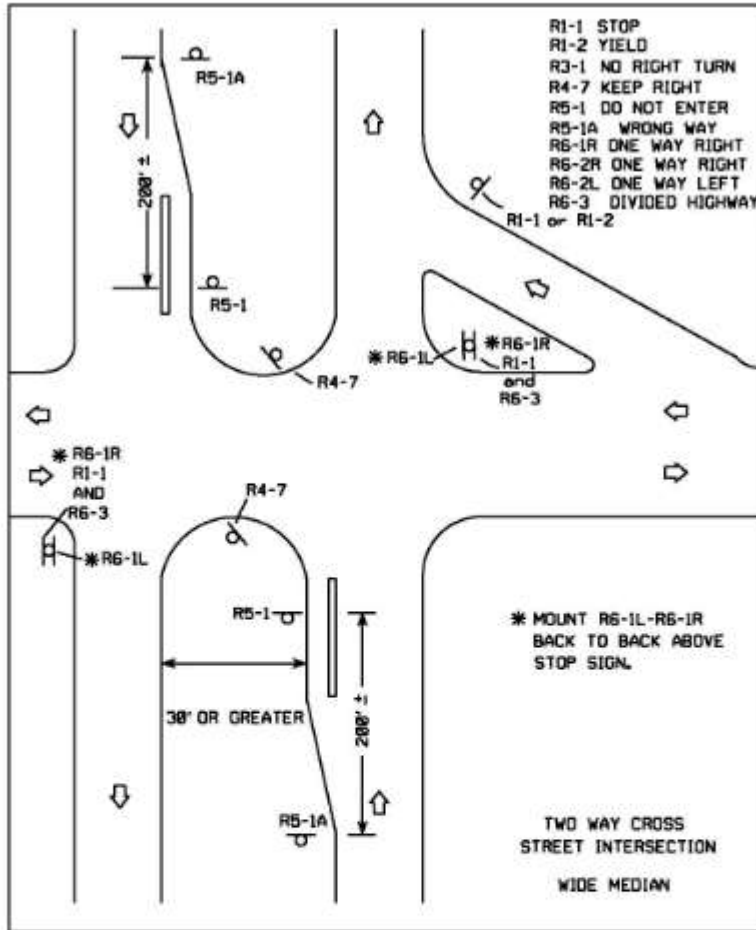

FIG. 1 WRONG WAY SIGNING RELATIVE TO DIVIDED HIGHWAY.

NOTE: SIGNING IS SHOWN AS TYPICAL SIGN PLACEMENT.
 FIELD CONDITIONS MAY DICTATE CHANGES IN
 SIGN PLACEMENT.

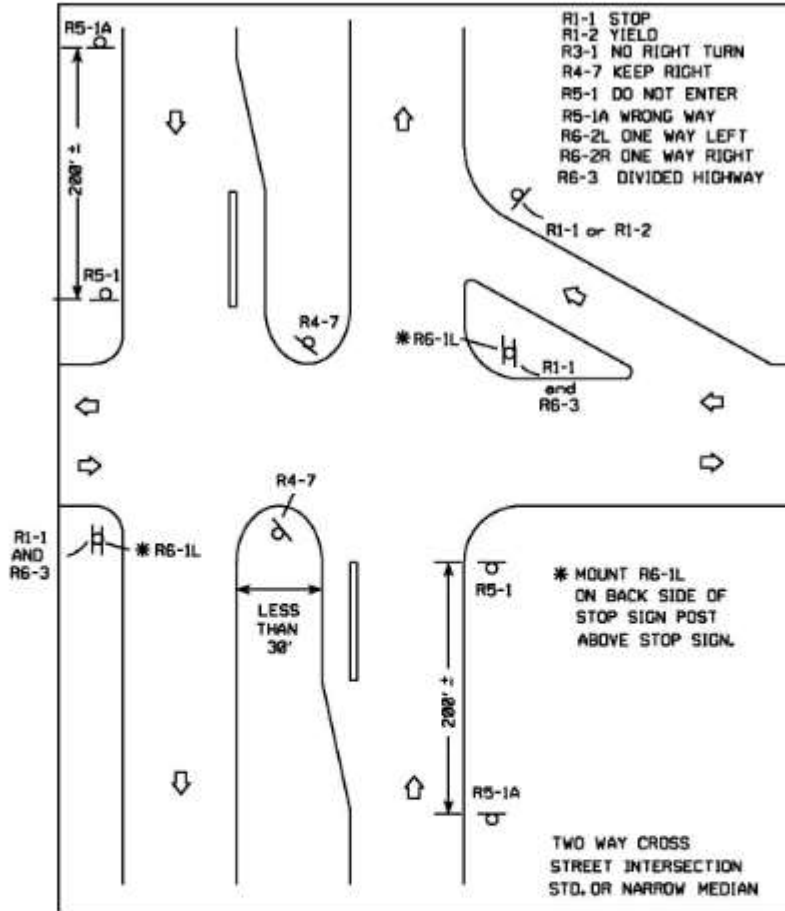

FIG. 2 WRONG WAY SIGNING RELATIVE TO DIVIDED HIGHWAY.

NOTE: SIGNING IS SHOWN AS TYPICAL SIGN PLACEMENT. FIELD CONDITIONS MAY DICTATE CHANGES IN SIGN PLACEMENT.

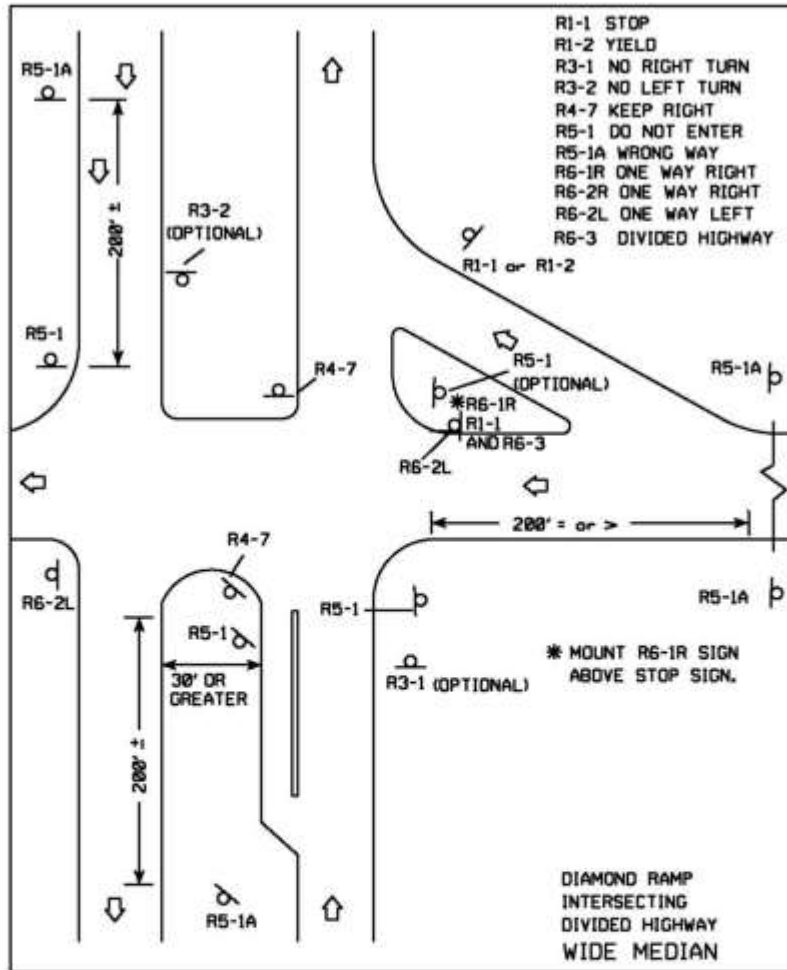

FIG. 3 WRONG WAY SIGNING RELATIVE TO RAMP.

NOTE: SIGNING IS SHOWN AS TYPICAL SIGN PLACEMENT.
 FIELD CONDITIONS MAY DICTATE CHANGES IN SIGN PLACEMENT.

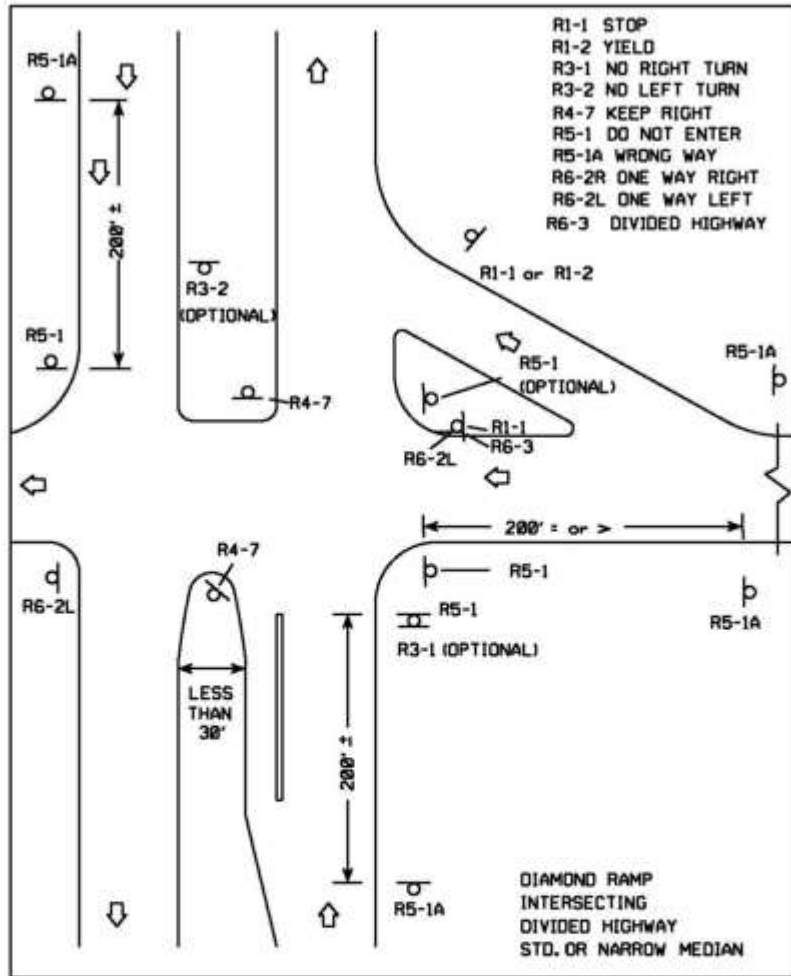

FIG. 4 WRONG WAY SIGNING RELATIVE TO RAMP.

NOTE: SIGNING IS SHOWN AS TYPICAL SIGN PLACEMENT.
 FIELD CONDITIONS MAY DICTATE CHANGES IN
 SIGN PLACEMENT.

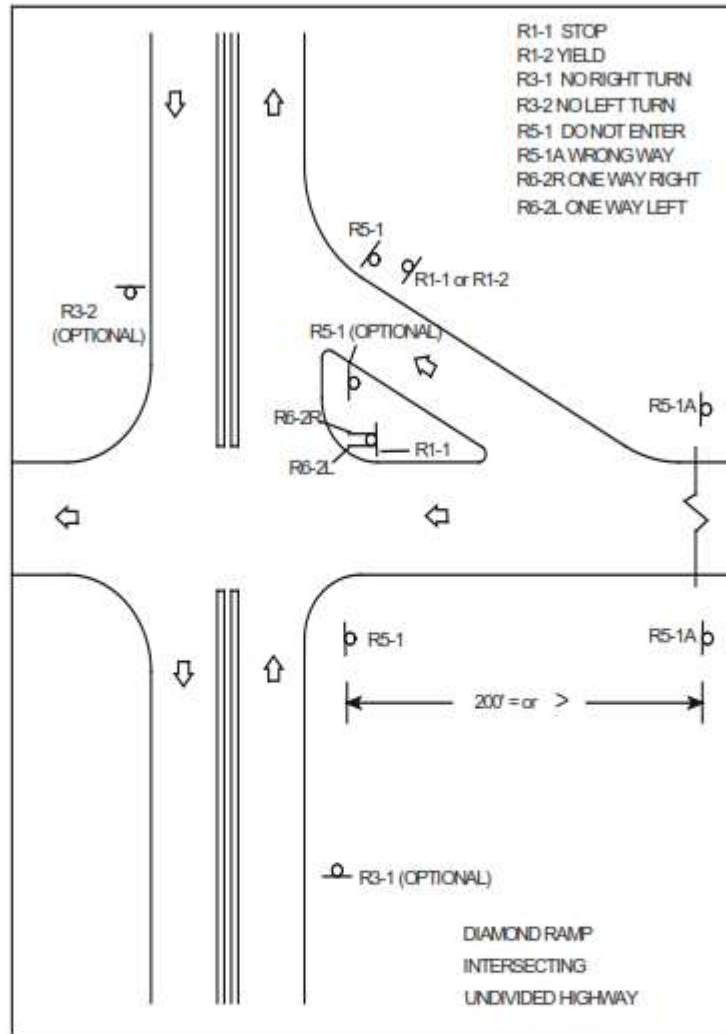

FIG. 5 WRONG WAY SIGNING RELATIVE TO RAMP.

NOTE: SIGNING IS SHOWN AS TYPICAL SIGN PLACEMENT.

FIELD CONDITIONS MAY DICTATE CHANGES IN
 SIGN PLACEMENT.

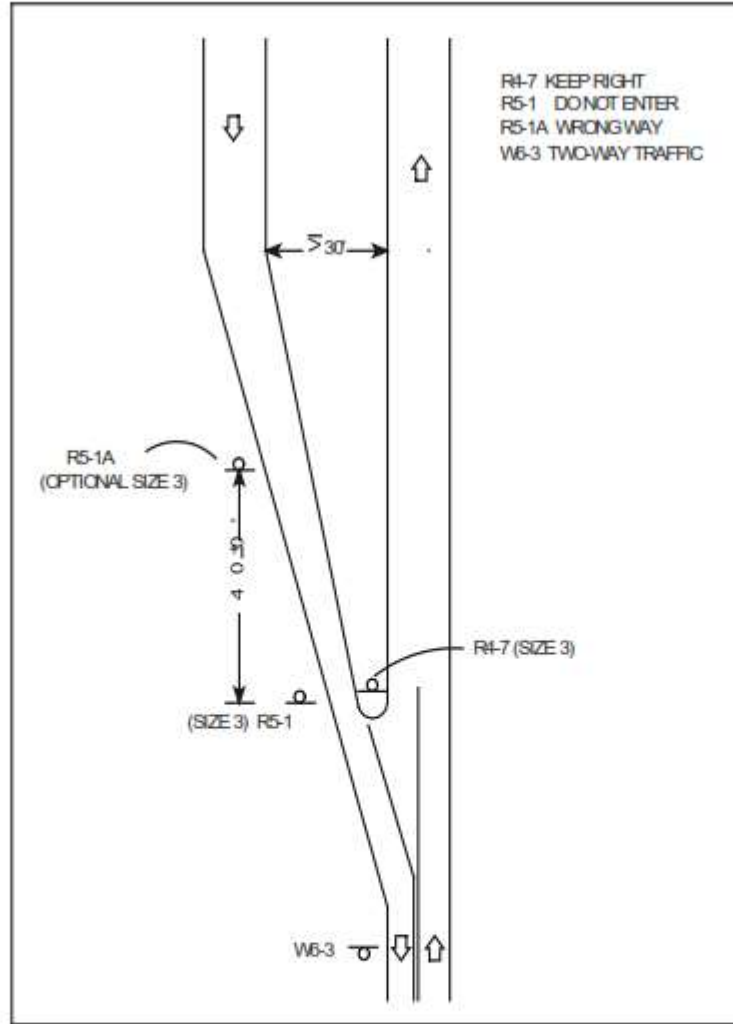

FIG. 6 TRANSITION FROM TWO-WAY UNDIVIDED HIGHWAY TO DIVIDED HIGHWAY

NOTE: SIGNING IS SHOWN AS TYPICAL SIGN PLACEMENT.
FIELD CONDITIONS MAY DICTATE CHANGES IN
SIGN PLACEMENT.

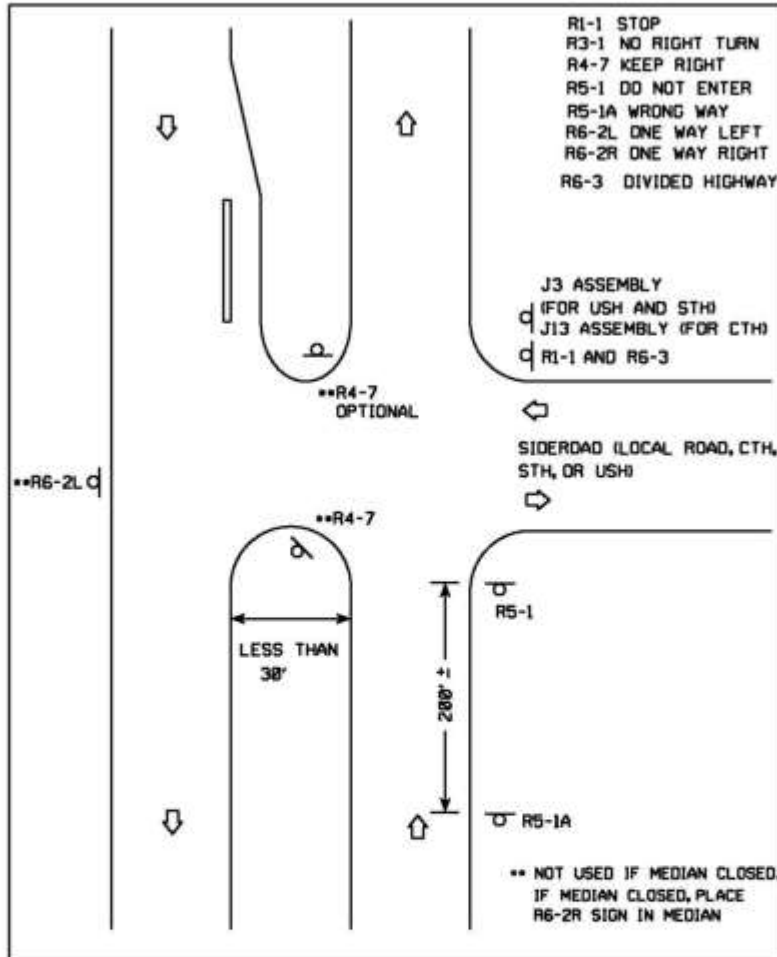

FIG. 7 WRONG WAY SIGNING RELATIVE TO DIVIDED HIGHWAY.

NOTE: SIGNING IS SHOWN AS TYPICAL SIGN PLACEMENT.
 FIELD CONDITIONS MAY DICTATE CHANGES IN
 SIGN PLACEMENT.

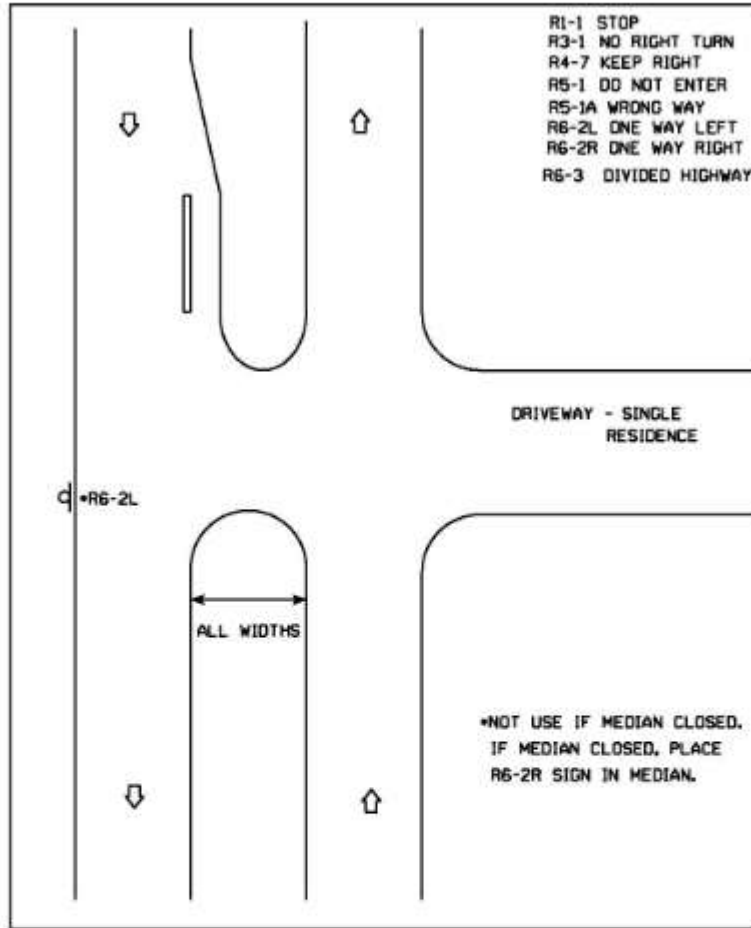

FIG. 9 WRONG WAY SIGNING RELATIVE TO DIVIDED HIGHWAY.

NOTE: SIGNING IS SHOWN AS TYPICAL SIGN PLACEMENT.
FIELD CONDITIONS MAY DICTATE CHANGES IN
SIGN PLACEMENT.

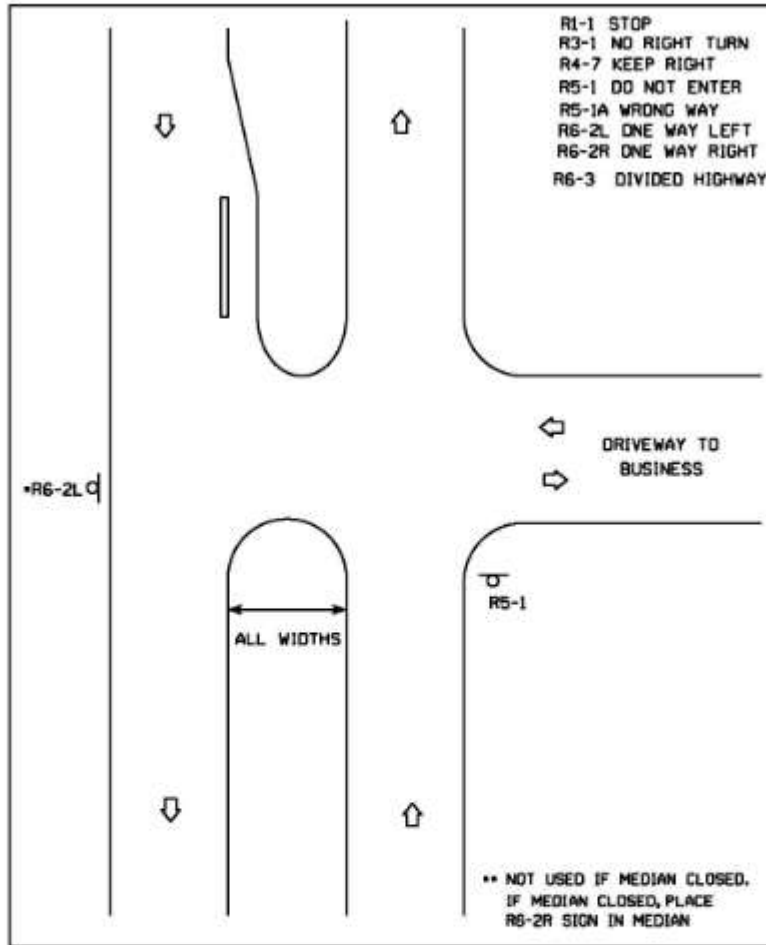

FIG. 10 WRONG WAY SIGNING RELATIVE TO DIVIDED HIGHWAY.

NOTE: SIGNING IS SHOWN AS TYPICAL SIGN PLACEMENT.
 FIELD CONDITIONS MAY DICTATE CHANGES IN
 SIGN PLACEMENT.

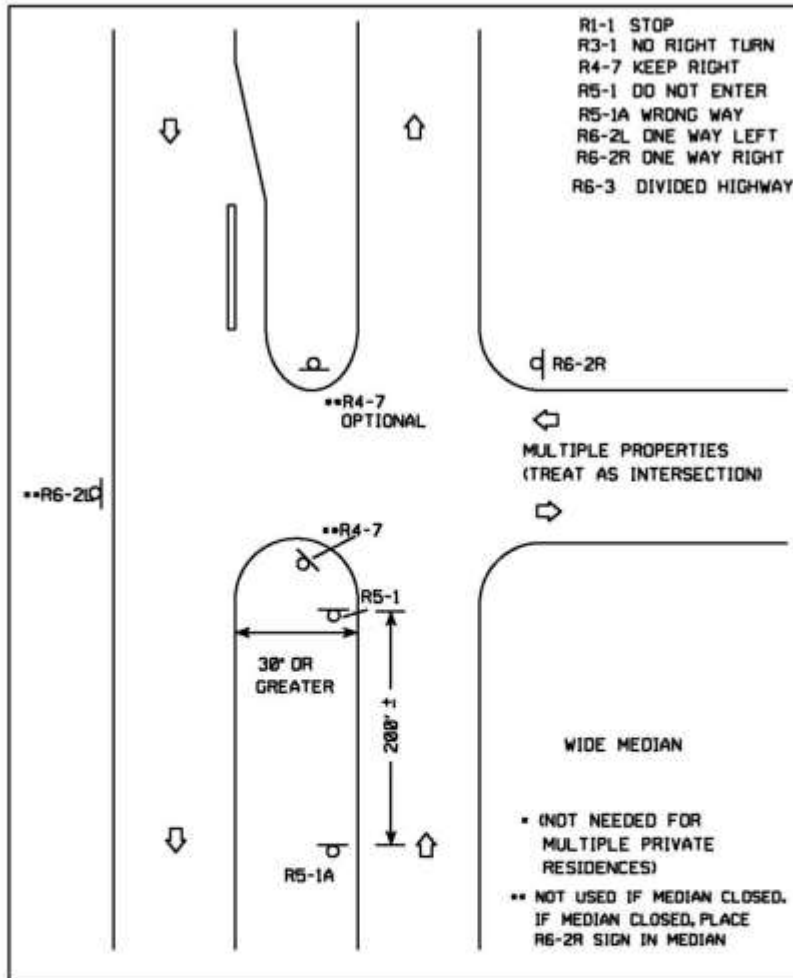

FIG. 11 WRONG WAY SIGNING RELATIVE TO DIVIDED HIGHWAY.

NOTE: SIGNING IS SHOWN AS TYPICAL SIGN PLACEMENT.
 FIELD CONDITIONS MAY DICTATE CHANGES IN
 SIGN PLACEMENT.

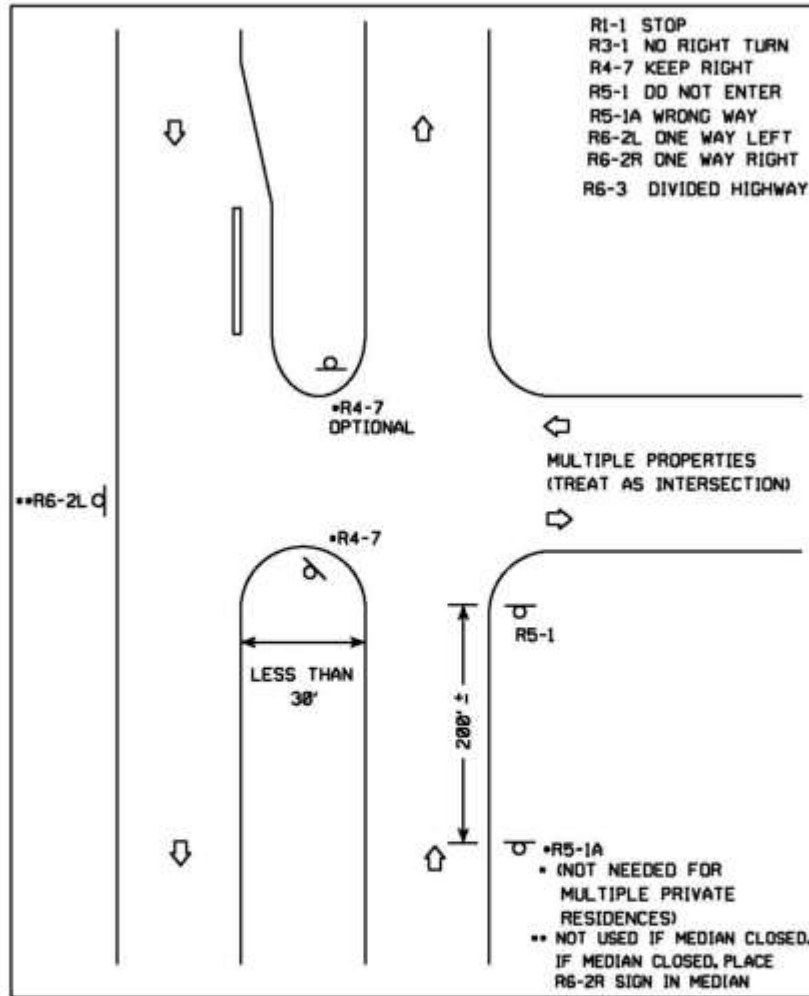

FIG. 12 WRONG WAY SIGNING RELATIVE TO DIVIDED HIGHWAY.

NOTE: SIGNING IS SHOWN AS TYPICAL SIGN PLACEMENT.
 FIELD CONDITIONS MAY DICTATE CHANGES IN
 SIGN PLACEMENT.

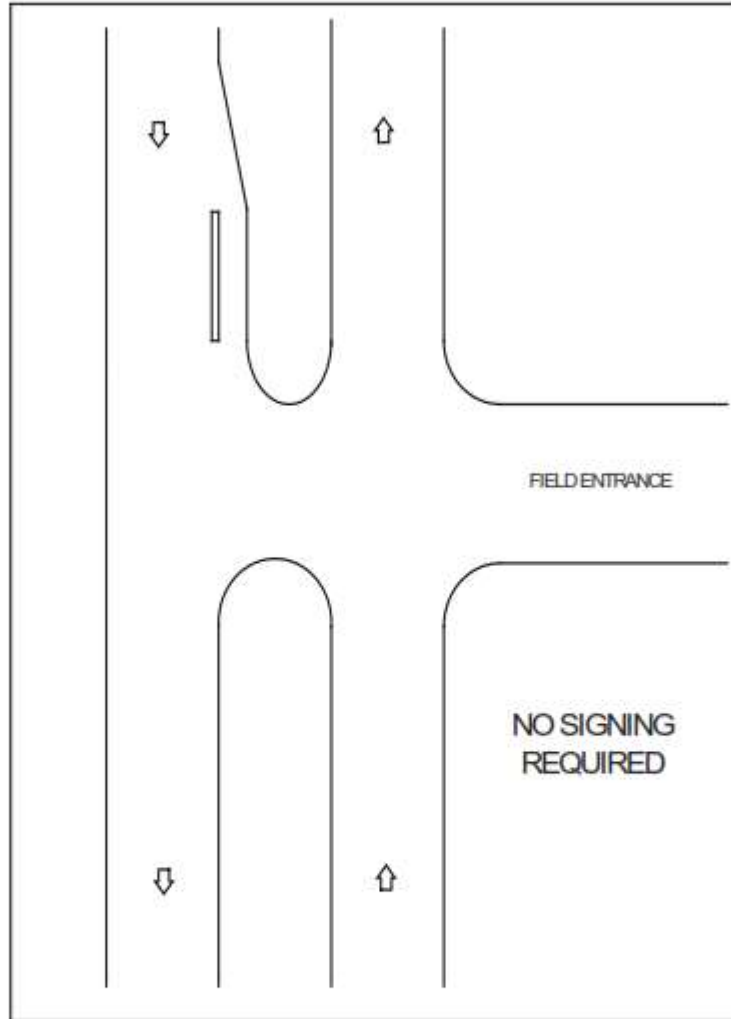

FIG. 13 WRONG WAY SIGNING RELATIVE TO DIVIDED HIGHWAY.

NOTE: SIGNING IS SHOWN AS TYPICAL SIGN PLACEMENT.
FIELD CONDITIONS MAY DICTATE CHANGES IN
SIGN PLACEMENT.

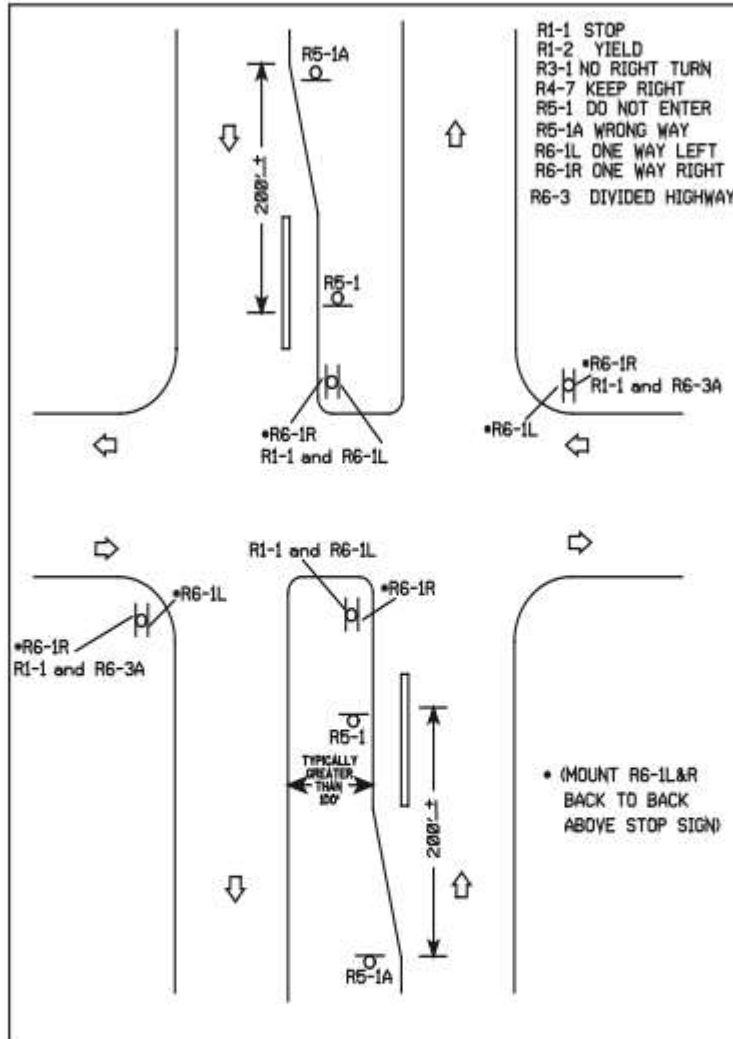

FIG. 15 WRONG WAY SIGNING RELATIVE TO DIVIDED HIGHWAY.

(WIDE MEDIAN WITH STOP OR YIELD SIGN IN MEDIAN)

NOTE: SIGNING IS SHOWN AS TYPICAL SIGN PLACEMENT.

FIELD CONDITIONS MAY DICTATE CHANGES IN
 SIGN PLACEMENT.

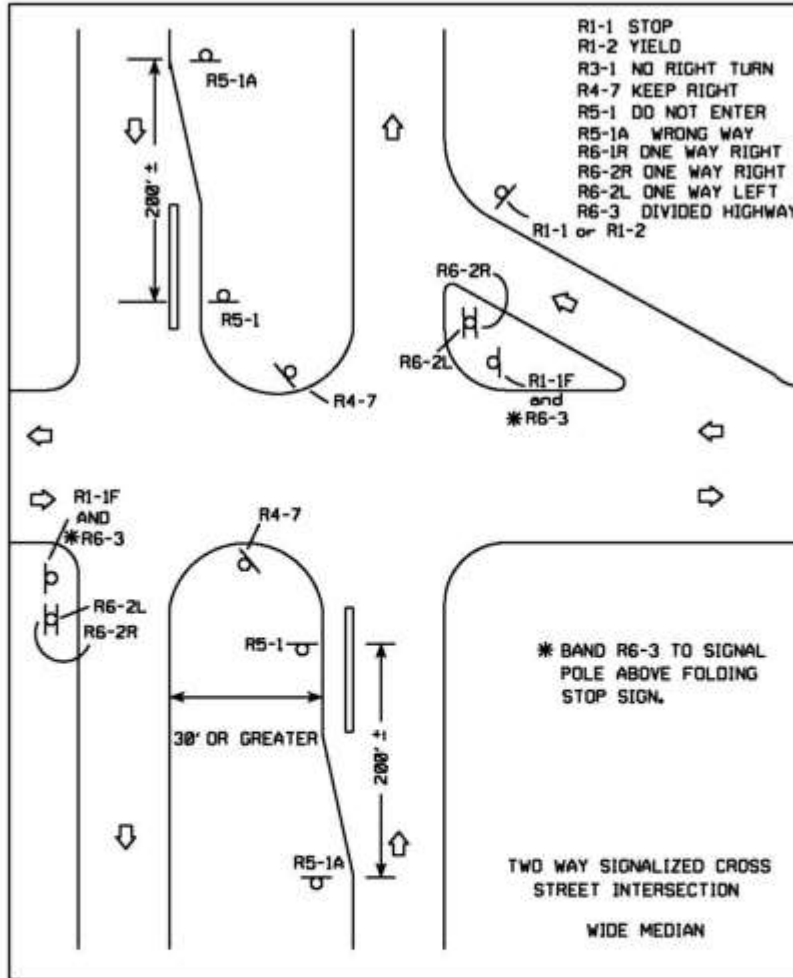

FIG. 16 WRONG WAY SIGNING RELATIVE TO DIVIDED HIGHWAY.

NOTE: SIGNING IS SHOWN AS TYPICAL SIGN PLACEMENT.
 FIELD CONDITIONS MAY DICTATE CHANGES IN
 SIGN PLACEMENT.

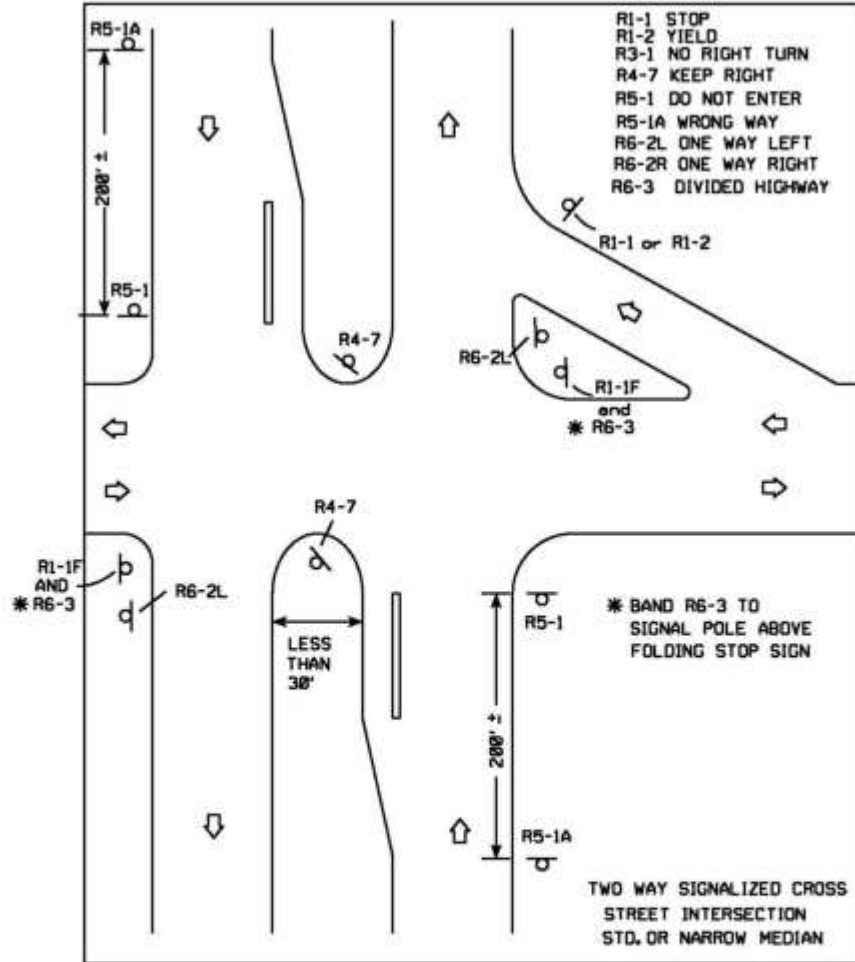

FIG. 17 WRONG WAY SIGNING RELATIVE TO DIVIDED HIGHWAY.

NOTE: SIGNING IS SHOWN AS TYPICAL SIGN PLACEMENT.
 FIELD CONDITIONS MAY DICTATE CHANGES IN
 SIGN PLACEMENT.

References

- Al-Deek, Haitham, John Rogers, Adrian Sandt, Ahmad Alomari, and Frank Consoli. (2013, May). *Wrong Way Driving Incidents on OOCEA Toll Road Network, Phase-1 Study: What is the Extent of this Problem?* Final Research Report. Department of Civil, Environmental, and Construction Engineering, University of Central Florida. Available from <http://ascelibrary.org/doi/abs/10.1061/9780784413586.032>
- Amoros, Rose. (2014, October 26). *Ask the DOT: Wrong-way project will help save lives*. Providence Journal. Providence, RI. Retrieved October 26, 2014 from <http://www.providencejournal.com/cars/ask-the-dot/20141026-ask-the-dot-wrong-way-project-will-help-save-lives.ece>
- Archer, Jeffrey. (2011, July). *Toyota Shows Off New Safety Features*. AutoTrader.com. Retrieved November 4, 2014. <http://www.autotrader.com/research/article/car-news/113024/toyota-shows-off-new-safety-features.jsp>
- Arizona Department of Transportation. (2014, June 25). *ADOT to test 'Wrong Way' sign changes, add reflective pavement arrows at several Phoenix-area freeway interchanges*. Retrieved January 2, 2014 from <http://azdot.gov/media/News/news-release/2014/06/25/adot-to-test-wrong-way-sign-changes-add-reflective-pavement-arrows-at-several-phoenix-area-freeway-interchanges>
- Baratian-Ghorghi, Fatemeh, Huaguo Zhou, and Jeffrey Shaw. (2014). *Overview of Wrong-Way Driving Fatal Crashes in the United States*. Institute of Transportation Engineers (ITE) Journal, 84(8), 41-47.
- Boot, Walter R., Neil Charness, Ainsley Mitchum, Nelson Roque, Cary Stothart, and Kimberly Barajas. (2015). *Driving Simulator studies of the Effectiveness of Countermeasures to Prevent Wrong-Way Crashes*. Florida Department of Transportation. Tallahassee, FL. www.dot.state.fl.us/research-center/Completed_Proj/Summary_TE/FDOT-BDV30-977-10-rpt.pdf
- Caltrans Division of Research, Innovation and System Information. (2015, October 2). *Wrong-Way Driving Prevention Methods*. www.dot.ca.gov/newtech/researchreports/preliminary_investigations/docs/wrong-way_driving_preliminary_investigation_10-02-15_-_with_appendices_final.pdf
- Cassidy, Megan. (2014, October 17). *Eastbound I-10 reopens after wrong-way crash*. The Arizona Republic. Phoenix, AZ. Retrieved January 2, 2014 from <http://www.azcentral.com/story/news/local/phoenix/2014/10/17/wreck-closes-i10-phoenix-abrk/17424839/>
- Connecticut Department of Transportation. (n.d.). *Wrong-Way Driving*. Retrieved October 26, 2014 from <http://www.ct.gov/dot/lib/dot/documents/dtrafficdesign/wrongwayinfo.pdf>
- Cooner, Scott. A, A. Scott Cothron, and Steven E. Ranft. (2004). *Countermeasures for Wrong-Way Movement on Freeways: Overview of Project Activities and Findings*. Texas Transportation Institute. College Station, TX. <http://d2dtl5nnlpr0r.cloudfront.net/tti.tamu.edu/documents/4128-1.pdf>
- Federal Highway Administration. (2016, May 20). *Wrong-Way Driving*. Retrieved from http://safety.fhwa.dot.gov/intersection/other_topics/wwd/
- Federal Highway Administration. (2013). *Wrong Way Driving Road Safety Audit Prompt List*. Office of Safety Publication No.: FHWA-SA-13-032. http://safety.fhwa.dot.gov/intersection/other_topics/wwd/wwdrsa/fhwasa13032.pdf

Finley, Melisa D., Steph P. Venglar, Vichika Iragavarapu, Jeffery D. Miles, Eun Sug Park, Scott A. Cooner, and Stephen E. Ranft. (2014). *Assessment of the Effectiveness of Wrong Way Driving Countermeasures and Mitigation Methods*. Texas A&M Transportation Institute. College Station, TX.

<http://d2dtl5nnlpr0r.cloudfront.net/tti.tamu.edu/documents/0-6769-1.pdf>

Finley, Melisa D., Kevin N. Balke, Rajat Rajbhandari, Susan T. Chrysler, Chiara Silvestri Dobrovolny, Nada D. Trout, Paul Avery, David Vickers, and Cameron Mott. (2016). *Conceptual Design of a Connected Vehicle Wrong-Way Driving Detection and Management System*. Texas A&M Transportation Institute. College Station, TX. <http://d2dtl5nnlpr0r.cloudfront.net/tti.tamu.edu/documents/0-6867-1.pdf>

Florida Department of Transportation. (2015). *Wrong Way Driving – Statewide Initiative*. District 7 Safety Summit. 13 January, 2015. Presentation.

www.tampabaytrafficsafety.com/SafetySummit/2015%20Resources/04%20%20D7%20Safety%20Summit%202015%20-%20Wrong%20Way%20Driving%20-%20Ponnaluri.pdf

Gaito, Allison and Kelly Sullivan. (2014, November 19). *Wrong-way driving technology set to be installed in RI*. WPRI Eyewitness News. Retrieved January 2, 2015 from <http://wpri.com/2014/11/19/wrong-way-driving-technology-set-to-be-installed-in-ri-nov14/>

Gianotti, John. (2015). *San Antonio Wrong Way Driver Initiative* [presentation slides]. 2015 TRB Annual Meeting. Received January 23, 2015 from John Gianotti, Texas Department of Transportation San Antonio District – TransGuide.

Gianotti, John. (2016). *Wrong Way Driver Project, TxDOT San Antonio District* [presentation slides]. TRB Wrong Way Driving webinar, April 20, 2016. Retrieved April 21, 2016 from <http://onlinepubs.trb.org/Onlinepubs/webinars/160420.pdf>

Homayouni, Bryan and Corey Quinn. (2016). *Wrong-Way Driving Detection and Prevention System: A Pilot Test Deployment* [presentation slides]. TRB Wrong Way Driving webinar, April 20, 2016. Retrieved April 21, 2016. <http://onlinepubs.trb.org/Onlinepubs/webinars/160420.pdf>

Huff, Chad. (2014, October). *Wrong-way vehicle detection pilot project underway on Turnpike roadways in South Florida*. Florida Department of Transportation. Fort Lauderdale, FL.

<http://www.floridasturnpike.com/PressReleases/2014/Wrong-way%20vehicle%20detection%20pilot%20project%20under%20way.pdf>

Kaminski Leduc, Janet L. (2008). *Wrong-Way Driving Countermeasures*. OLR Research Report 2008-R-0491. State of Connecticut General Assembly. Hartford, CT. <http://www.cga.ct.gov/2008/rpt/2008-r-0491.htm>.

Kittelson & Associates, Inc. (2015). *Statewide Wrong Way Crash Study Final Report*. Florida Department of Transportation. Tallahassee, Florida.

www.dot.state.fl.us/trafficoperations/PDF/Wrong%20Way%20Crash%20Study%20-%20Final%20Report-8-15.pdf

KSAT 12 News. (2012, November 30). *Family nearly struck by wrong-way driver on I-35 at Loop 410*. Retrieved December 20, 2015. www.ksat.com/news/family-nearly-struck-by-wrong-way-driver-on-i-35-at-loop-410

Johnson, Randy, and Calvin Harvey. (2013). *HCTRA Incident Management's Rapid Response & Rapid Removal* [PowerPoint presentation]. 2013 ITS Texas Annual Meeting. Houston, TX.

<http://itstexas.org/sites/itstexas.org/files/presentations/2013%20B%20HCTRA%20Incident%20Management%20&20Rapid%20Response%20&20Rapid%20Removal.pdf>

- Jones, Meg. (2012, October 9). *Milwaukee County launches effort to halt wrong-way drivers on freeways*. Milwaukee Journal Sentinel. Milwaukee, WI. Retrieved January 17, 2015 from <http://www.jsonline.com/news/milwaukee/milwaukee-county-launches-effort-to-halt-wrongway-drivers-4t75rpk-173358061.html>
- McCowan, Candace. (2014, March 21). *Florida DOT using 2 pilot programs to detect wrong-way drivers*. WFLA-TV News. Tampa, FL. Retrieved October 23, 2014 from <http://www.wfla.com/story/24787513/florida-dot-using-2-pilot-programs-to-detect-wrong-way-drivers>
- Michel, Lou. (2013, December 4) *High-tech sign seeks to prevent wrong-way drivers from entering Thruway*. Retrieved November 3, 2014. The Buffalo News. Buffalo, NY. <http://www.buffalonews.com/city-region/high-tech-sign-seeks-to-prevent-wrong-way-drivers-from-entering-thruway-20131204>
- Moler, Steve. (2002). *Stop. You're Going the Wrong Way!* Public Roads, 66(2). Federal Highway Administration, United States Department of Transportation. Washington, DC. Retrieved from <https://www.fhwa.dot.gov/publications/publicroads/02sep/06.cfm>
- Morena, David A. and Tracie J. Leix. (2012). *Where These Drivers Went Wrong*. Public Roads, 75(6), 33-41. Federal Highway Administration, United States Department of Transportation. Washington, DC. Retrieved from <http://www.fhwa.dot.gov/publications/publicroads/12mayjune/05.cfm>
- National Transportation Safety Board (NTSB). (2012). *Highway Special Investigation Report: Wrong-Way Driving*. Washington, DC. <http://www.nts.gov/safety/safety-studies/Documents/SIR1201.pdf>
- Neuman, Timothy R., John J. Nitzel, Nick Antonucci, Stee Nevill, and William Stein. (2008). *NCHRP Report 500: Guidance for the Implementation of the AASHTO Strategic Highway Safety Plan, Volume 2 0: A Guide for Reducing Head-On Crashes on Freeways*. Transportation Research Board. Washington, DC. http://onlinepubs.trb.org/onlinepubs/nchrp/nchrp_rpt_500v20.pdf
- New York State Governor's Press Office. (2013, December 4). *Governor Cuomo Announces First in the Nation 'Wrong-Way' LED Signs Placed On Thruway*. Albany, NY. <https://www.governor.ny.gov/press/12042013-wrong-way-led-signs-thruway>
- Nissan Motor Co., Ltd. (2010, October 25). *West NEXCO and Nissan Develop a Wrong-Way Alert Program*. Retrieved November 1, 2014 from http://www.nissan-global.com/EN/NEWS/2010/_STORY/101025-02-e.html
- North Texas Tollway Authority (NTTA). (2009). *Keeping NTTA Roadways Safe: Wrong-Way Driver Task Force Staff Analysis*. Plano, TX. <https://www.ntta.org/newsresources/safeinfo/wrongway/Documents/WWDAnalysisAUG2011.pdf>
- Ouyang, Yang. (2013). *Proceedings of the 2013 National Wrong-Way Driving Summit*. North Texas Tollway Authority's (NTTA) Wrong-Way Driving Program, Edwardsville, IL.
- Ozkul, Seckin, Pei-Sung Lin, and Chester H. Chandler. (2016). *Evaluation on Impact of Red RRFB Implementation at Freeway Off-Ramps on Driving Behaviors Along Adjacent Arterials* [Presentation slides]. Center for Urban Transportation Research. University of South Florida. https://www.floridasectionite.org/uploads/4/8/0/1/48016965/red_rrfbs_for_freeway_wwd_-_ozkul.pdf
- Ponnaluri, Raj and Fred Heery Sr. (2016). *Wrong-Way Driving Mitigation: A Holistic Approach in Florida, USA*. ITE Journal, 86(5), 43-47.
- Preisen, Linda and Dean Deeter. (2014). [*Next Generation Traffic Data and Incident Detection from Video*](#). Report Number ENT-2014-2. ENTERPRISE Pooled Fund Study TPF-5(231), Michigan Department of

Transportation (Administering State). Lansing, MI.

[http://www.enterprise.prog.org/Projects/2010 Present/nextgenerationvideo/ENT VideoAnalytics Report Sept2014 FINAL.pdf](http://www.enterprise.prog.org/Projects/2010%20Present/nextgenerationvideo/ENT%20VideoAnalytics%20Report%20Sept2014%20FINAL.pdf)

Provance, Jim. (2012, April 27). *Ohio senators urge tougher fines for wrong-way drivers*. The Toledo Blade. Toledo, OH. Retrieved January 17, 2015 from

<http://www.toledoblade.com/State/2012/04/27/Ohio-senators-urge-tougher-fines-for-wrong-way-drivers-1.html>

Rhode Island Department of Transportation. (n.d.). *Wrong Way Crash Avoidance* (web page). Retrieved March 1, 2015 from www.dot.ri.gov/community/safety/wrong_way.php

Roadway Safety Institute. (2016) *Directional Rumble Strips for Reducing Wrong-Way Driving Freeway Entries*. UTC Project Information. Retrieved May 17, 2016 from https://netfiles.umn.edu/users/andr0274/RSI%20UTC%20Project%20Information%20Forms/2015039_UTCForm_Luo.pdf

Simpson, Sarah. (2013). *Wrong-Way Vehicle Detection: Proof of Concept*. Final Report 697. Arizona Department of Transportation Research Center. Phoenix, AZ.

<http://ntl.bts.gov/lib/47000/47400/47414/AZ697.pdf>

Simpson, Sarah and Reza Karimvand. (2015). *Automatically Detecting Wrong-Way Drivers on the Highway System*. 2015 TRB 94th Annual Meeting Compendium of Papers. Paper #15-1299.

Transportation Research Board. Washington, DC.

Simpson, Sarah and Dave Bruggeman. (2015, November). *Detection and Warning Systems for Wrong-Way Driving*. SPR-741. Arizona Department of Transportation Research Center. Phoenix, AZ.

https://apps.azdot.gov/ADOTLibrary/publications/project_reports/PDF/az741.pdf

Skelos, Dean. (2012, January 23). *Senate passes legislation to create felony charges for wrong-way and reckless drivers*. New York State Senate website. Retrieved January 17, 2015 from

<http://www.nysenate.gov/press-release/senate-passes-legislation-create-felony-charges-wrong-way-and-reckless-drivers>

Smith, Rebecca. (2014, October 20). *Missouri DOT to Test New Method of Wrong-Way Accident Prevention*. St. Louis Public Radio. St. Louis, MO. Retrieved October 22, 2014 from

<http://news.stlpublicradio.org/post/modot-test-new-method-wrong-way-accident-prevention>

Szczesny, Joseph. (2013, February 6). *Daimler Debuts Alert System for Wrong-Way Drivers*. Retrieved November 1, 2014. The Detroit Bureau. Detroit, MI.

<http://www.thedetroitbureau.com/2013/02/daimler-debuts-alert-system-for-wrong-way-drivers/>

Texas Department of Transportation. (n.d.). *The San Antonio Wrong Way Driver Initiative* (web page). San Antonio, TX. Retrieved October 22, 2014 from www.transguide.dot.state.tx.us/sat/wwd/

Thurman, Terry. (2013). *Proceedings of the 2013 National Wrong-Way Driving Summit*. Law Enforcement Approach for Wrong-Way Detection and Correction, Edwardsville, IL.

Tobias, Pricilla. (2015). *Addressing Wrong Way Driving in Illinois* [PDF presentation slides]. Available from 2015 Transportation Research Board Annual Meeting Online. <http://amonline.trb.org/2015-subject-index>.

Willey, Jessica. (2011, January 6). *New system to catch wrong-way drivers*. ABC 13 Eyewitness News. Retrieved August 10, 2016 from <http://abc13.com/archive/7884311/>

Willey, Jessica. (2012, February 10). *Driver caught heading wrong way on Westpark Tollway*. Retrieved October 29, 2014. WPVI-TV Action News. Philadelphia, PA. <http://6abc.com/archive/8538185/>

Zhou, Huaguo and Albert Luo. *Directional Rumble Strips for Reducing Wrong-Way Driving Freeway Entries* [presentation slides]. Roadway Safety Institute. 2015 Transportation Research Conference. http://www.roadwaysafety.umn.edu/events/conference/2015/documents/07_zhou.pdf

Zhou, Huaguo, and Mahdi Pour Rouholamin. (2015). *Investigation of Contributing Factors Regarding Wrong-Way Driving on Freeways, Phase II*. Report # FHWA-ICT-15-016. Illinois Center for Transportation, University of Illinois at Urbana-Champaign. Urbana, IL. <http://hdl.handle.net/2142/88402>

Zhou, Huaguo, and Mahdi Pour Rouholamin. (2014a). *Guidelines for Reducing Wrong-Way Crashes on Freeways*. Report # FHWA-ICT-14-101. Illinois Center for Transportation, University of Illinois at Urbana-Champaign. Urbana, IL. <http://hdl.handle.net/2142/48998>

Zhou, Huaguo, and Mahdi Pour Rouholamin. (2014b). *Proceedings of the 2013 National Wrong-Way Driving Summit*. Illinois Center for Transportation, University of Illinois at Urbana-Champaign. Urbana, IL. <http://hdl.handle.net/2142/49045>

Zhou, Huaguo, Jiguang Zhao, Ryan Fries, Mostafa Reisi Gahrooei, Lin Wang, Brent Vaughn, Karzan Bahaaldin, and Balasubrahmanyam Ayyalasomayajula. (2012). *Investigation of Contributing Factors Regarding Wrong-Way Driving on Freeways*. Illinois Center for Transportation, University of Illinois at Urbana-Champaign. Urbana, IL. <http://cetrans.isg.siu.edu/WWD/FHWA-ICT-12-010.pdf>