



# **MASH TL-3 EVALUATION OF THE TxDOT TL-3 LOW-PROFILE BARRIER FOR HIGH SPEED APPLICATIONS**



Crash testing performed at:  
TTI Proving Ground  
3100 SH 47, Building 7091  
Bryan, TX 77807

**Test Report 0-6968-R1**

**Cooperative Research Program**

**TEXAS A&M TRANSPORTATION INSTITUTE**

**COLLEGE STATION, TEXAS**

**TEXAS DEPARTMENT OF TRANSPORTATION**

in cooperation with the  
Federal Highway Administration and the  
Texas Department of Transportation  
<http://tti.tamu.edu/documents/0-6968-R1.pdf>



1. Report No. FHWA/TX-18/0-6968-R1		2. Government Accession No.		3. Recipient's Catalog No.	
4. Title and Subtitle MASH TL-3 EVALUATION OF THE TXDOT TL-3 LOW-PROFILE BARRIER FOR HIGH SPEED APPLICATIONS				5. Report Date Published: September 2018	
				6. Performing Organization Code	
7. Author(s) Chiara Silvestri Dobrovolny, Shengyi Shi, Roger P. Bligh, Wanda L. Menges, and Darrell L. Kuhn				8. Performing Organization Report No. Report 0-6968-R1	
9. Performing Organization Name and Address Texas A&M Transportation Institute College Station, Texas 77843-3135				10. Work Unit No. (TRAIS)	
				11. Contract or Grant No. Project 0-6968	
12. Sponsoring Agency Name and Address Texas Department of Transportation Research and Technology Implementation Office 125 E. 11th Street Austin, Texas 78701-2483				13. Type of Report and Period Covered Technical Report: September 2017–May 2018	
				14. Sponsoring Agency Code	
15. Supplementary Notes Project performed in cooperation with the Texas Department of Transportation and the Federal Highway Administration. Project Title: Roadside Safety Device Analysis, Testing, and Evaluation Program URL: <a href="http://tti.tamu.edu/documents/0-6968-R1.pdf">http://tti.tamu.edu/documents/0-6968-R1.pdf</a>					
16. Abstract  <p>In response to the implementation requirements set forth by the Federal Highway Administration, the Texas Department of Transportation Bridge, Design, Maintenance, and Traffic Operations Divisions reviewed their standards for roadside safety devices and identified those devices that require testing and evaluation to assess <i>MASH</i> compliance. Under this phase of the project, the Low-Profile Concrete Barrier (LPCB-13) was evaluated. The objective of this project was to design a TL-3 low-profile barrier for high speed applications and assess its performance according to the safety-performance evaluation guidelines included in <i>MASH</i> for Test Level 3 (TL-3) longitudinal barriers. Based on the detailed computer model simulations results, researchers performed <i>MASH</i> full-scale crash tests on a low-profile portable concrete barrier system comprised of 26-inch tall, 30-ft long barrier segments with a T-shape profile. Based on constructability feedback, researchers modified the straight side of the barrier to a 1:18 slope, to allow for easiness of construction forming.</p> <p>The TL-3 Low-Profile Barrier performed acceptably as a <i>MASH</i> TL-3 longitudinal barrier.</p>					
17. Key Words Longitudinal Barriers, Portable Concrete Barriers, Temporary Concrete Barriers, Low-Profile Barriers, Work Zone Barriers, Crash Testing, Roadside Safety			18. Distribution Statement No restrictions. This document is available to the public through NTIS: National Technical Information Service Alexandria, Virginia <a href="http://www.ntis.gov">http://www.ntis.gov</a>		
19. Security Classif.(of this report) Unclassified		20. Security Classif.(of this page) Unclassified		21. No. of Pages 108	22. Price





***MASH TL-3 EVALUATION OF THE TxDOT  
TL-3 LOW-PROFILE BARRIER FOR HIGH SPEED APPLICATIONS***

by

Chiara Silvestri Dobrovolny, Ph.D.  
Associate Research Scientist  
Texas A&M Transportation Institute

Shengyi Shi  
Graduate Assistant  
Texas A&M Transportation Institute

Roger P. Bligh, Ph.D., P.E.  
Senior Research Engineer  
Texas A&M Transportation Institute

Wanda L. Menges  
Research Specialist  
Texas A&M Transportation Institute

and

Darrell L. Kuhn, P.E.  
Research Specialist  
Texas A&M Transportation Institute

Report 0-6968-R1

Project 0-6968

Project Title: Roadside Safety Device Analysis, Testing, and Evaluation Program

Performed in cooperation with the  
Texas Department of Transportation  
and the  
Federal Highway Administration

Published: September 2018

TEXAS A&M TRANSPORTATION INSTITUTE  
College Station, Texas 77843-3135



## **DISCLAIMER**

This research was performed in cooperation with the Texas Department of Transportation (TxDOT) and the Federal Highway Administration (FHWA). The contents of this report reflect the views of the authors, who are responsible for the facts and the accuracy of the data presented herein. The contents do not necessarily reflect the official view or policies of the FHWA or TxDOT. This report does not constitute a standard, specification, or regulation. The United States Government and the State of Texas do not endorse products or manufacturers. Trade or manufacturers' names appear herein solely because they are considered essential to the object of this report. This report is not intended for construction, bidding, or permit purposes. The engineer in charge of the project was Roger P. Bligh, P.E. #78550.

## **TTI PROVING GROUND DISCLAIMER**

The results of the crash testing reported herein apply only to the article being tested.

**THE TTI LAB SHALL NOT BE LIABLE FOR ANY INDIRECT, CONSEQUENTIAL, PUNITIVE, OR OTHER DAMAGES SUFFERED BY TEXAS DEPARTMENT OF TRANSPORTATION OR ANY OTHER PERSON OR ENTITY, WHETHER SUCH LIABILITY IS BASED, OR CLAIMED TO BE BASED, UPON ANY NEGLIGENT ACT, OMISSION, ERROR, CORRECTION OF ERROR, DELAY, OR BREACH OF AN OBLIGATION BY THE TTI LAB.**

## ACKNOWLEDGMENTS

This project was conducted in cooperation with TxDOT and FHWA. The project team would like to thank Mr. Wade Odell, P.E. (TxDOT Project Manager), Mr. Ken Mora, P.E., and Mr. Chris Lindsey, P.E., with the TxDOT Design Division, for their valuable assistance and input on this project. Their contributions were instrumental to the success of the project. Portions of this research were conducted with high performance research computing resources provided by Texas A&M University (<https://hprc.tamu.edu>).

## REPORT AUTHORIZATION

---

### REPORT REVIEWED BY:

DocuSigned by:  
*Glenn Schroeder*  
E692F9CB5047487...

---

Glenn Schroeder, Research Specialist  
Drafting & Reporting

DocuSigned by:  
*Gary Gerke*  
FBA2101E9F6B4B7...

---

Gary Gerke, Research Specialist  
Construction

DocuSigned by:  
*Scott Dobrovolny*  
1C613885787C44C...

---

Scott Dobrovolny, Research Specialist  
Mechanical Instrumentation

DocuSigned by:  
*Ken Reeves*  
60D556935596468...

---

Ken Reeves, Research Specialist  
Electronics Instrumentation

DocuSigned by:  
*Richard Badillo*  
0F51DA60AB144F9...

---

Richard Badillo, Research Specialist  
Photographic Instrumentation

DocuSigned by:  
*Wanda L. Menges*  
B92179622AF24FE...

---

Wanda L. Menges, Research Specialist  
Reporting & Deputy QM

DocuSigned by:  
*Darrell L. Kuhn*  
D4CC23E85D5B4E7...

---

Darrell L. Kuhn, P.E., Research Specialist  
Quality Manager

DocuSigned by:  
*Matt Robinson*  
EAA22BFA5BFD417...

---

Matthew N. Robinson, Research Specialist  
Test Facility Manager & Technical Manager

DocuSigned by:  
*Chiara Silvestri Dobrovolny*  
36EDAD98EFE94EC...

---

Chiara Silvestri Dobrovolny, Ph.D.  
Associate Research Scientist

---

# TABLE OF CONTENTS

	Page
<b>List of Figures</b> .....	vii
<b>List of Tables</b> .....	ix
<b>Chapter 1: Introduction</b> .....	<b>1</b>
1.1 Problem .....	1
1.2 Objective/Scope of Research .....	1
1.3 Literature Review.....	1
<b>Chapter 2: Concept Development and Engineering Evaluation</b> .....	<b>5</b>
2.1 Introduction.....	5
2.2 Height Selection.....	5
2.3 Barrier Conception Development .....	9
2.4 Preliminary Computer simulations .....	10
2.4.1 Simulations with 26-inch Barrier Height.....	12
2.4.2 Simulations with 24-Inch Barrier Height.....	14
2.4.3 Conclusions – Preliminary Simulations.....	16
2.5 Detailed Computer Simulations.....	18
2.5.1 Case 1 Detailed Simulation with Impact Tire Disengagement.....	19
2.5.2 Case 2 Detailed Simulation without Impact Tire Disengagement.....	20
2.6 Comparison between Case 1 and Case 2 .....	22
2.7 Conclusions – Detailed Model Simulations.....	26
<b>Chapter 3: TI-3 Low-Profile Barrier Details</b> .....	<b>27</b>
3.1 Test Article and Installation Details .....	27
3.2 Material Specifications .....	27
<b>Chapter 4: Test Requirements and Evaluation Criteria</b> .....	<b>31</b>
4.1 Crash Test Matrix .....	31
4.2 Evaluation Criteria.....	31
<b>Chapter 5: Test Conditions</b> .....	<b>33</b>
5.1 Test Facility .....	33
5.2 Vehicle Tow and Guidance System.....	33
5.3 Data Acquisition Systems .....	33
5.3.1 Vehicle Instrumentation and Data Processing .....	33
5.3.2 Anthropomorphic Dummy Instrumentation .....	34
5.3.3 Photographic Instrumentation and Data Processing .....	35
<b>Chapter 6: MASH Test 3-10 (Crash Test No. 469688-1-1)</b> .....	<b>37</b>
6.1 Test Designation and Actual Impact Conditions .....	37
6.2 Weather Conditions .....	37
6.3 Test Vehicle .....	37
6.4 Test Description .....	38
6.5 Damage to Test Installation .....	38
6.6 Damage to Test Vehicle.....	39
6.7 Occupant Risk Factors .....	40

## TABLE OF CONTENTS (CONTINUED)

	Page
<b>Chapter 7: MASH Test 3-11 (Crash Test No. 469688-1-2)</b> .....	<b>43</b>
7.1 Test Designation and Actual Impact Conditions .....	43
7.2 Weather Conditions .....	43
7.3 Test Vehicle .....	43
7.4 Test Description .....	44
7.5 Damage to Test Installation .....	44
7.6 Damage to Test Vehicle.....	46
7.7 Occupant Risk Factors .....	47
<b>Chapter 8: Summary and Conclusions</b> .....	<b>51</b>
8.1 Summary of Results .....	51
8.2 Conclusions.....	51
<b>Chapter 9: Implementation</b> .....	<b>55</b>
<b>References</b> .....	<b>57</b>
<b>Appendix A. Details of TL-3 Low-Profile Barrier</b> .....	<b>59</b>
<b>Appendix B. Supporting Certification Documents</b> .....	<b>65</b>
<b>Appendix C. MASH Test 3-10 (Crash Test No. 469688-1-1)</b> .....	<b>69</b>
C.1 Vehicle Properties and Information .....	69
C.2 Sequential Photographs.....	72
C.3 Vehicle Angular Displacement .....	75
C.4 Vehicle Accelerations .....	76
<b>Appendix D. MASH Test 3-11 (Crash Test No. 469688-1-2)</b> .....	<b>83</b>
D.1 Vehicle Properties and Information .....	83
D.2 Sequential Photographs.....	87
D.3 Vehicle Angular Displacement .....	90
D.4 Vehicle Accelerations .....	91

## LIST OF FIGURES

	Page
Figure 1.1. 20-Inch Tall Low-Profile Barrier.....	2
Figure 1.2. Roadside Application.....	4
Figure 1.3. Median Application. ....	4
Figure 2.1. Requirement of Vehicle Lens Mounting Height.....	6
Figure 2.2. Sight Obstruction (Median Barrier Application). ....	6
Figure 2.3. Sight Obstruction (Roadside Barrier Application). ....	7
Figure 2.4. Sight Obstruction for 24-Inch Tall Barrier. ....	7
Figure 2.5. Sight Obstruction for 26-Inch Tall Barrier. ....	8
Figure 2.6. Proposed Concepts for Low-Profile Barrier for TL-3 Applications. ....	10
Figure 2.7. Available <i>MASH</i> 2270P Pickup Truck FE Model [8].....	11
Figure 2.8. Vehicle Tire FE Model. ....	11
Figure 2.9. Roll Angle Comparison of 26-Inch Tall Barrier Concepts with Impact Tire Disengagement.....	12
Figure 2.10. Roll Angle Comparison of 26-Inch Tall Barriers without Impact Tire Disengagement.....	13
Figure 2.11. Range of Maximum Roll Angles for 26-Inch Tall Barrier Concepts. ....	14
Figure 2.12. Roll Angle Comparison of 24-Inch Tall Barrier Concepts with Impact Tire Disengagement.....	14
Figure 2.13. Roll Angle Comparison of 24-Inch Tall Barriers without Impact Tire Disengagement.....	15
Figure 2.14. Range of Maximum Roll Angles for 24-Inch Tall Barrier Concepts. ....	16
Figure 2.15. Detailed FE Model of 26-Inch Tall T-Shaped Low-Profile PCB Segment. ....	18
Figure 2.16. Detailed FE Model of Barrier Segments Connections.....	18
Figure 2.17. Angular Displacements for Tire Disengagement Detailed Simulation Case.....	19
Figure 2.18. Angular Displacements for No-Tire Disengagement Detailed Simulation Case.....	21
Figure 3.1. Overall Details of the TL-3 Low-Profile Barrier.....	28
Figure 3.2. TL-3 Low-Profile Barrier prior to Testing.....	29
Figure 6.1. TL-3 Low-Profile Barrier/Test Vehicle Geometrics for Test No. 469688-1-1.....	37
Figure 6.2. Test Vehicle before Test No. 469688-1-1.....	38
Figure 6.3. TL-3 Low-Profile Barrier after Test No. 469688-1-1.....	39
Figure 6.4. Test Vehicle after Test No. 469688-1-1. ....	40
Figure 6.5. Interior of Test Vehicle after Test No. 469688-1-1.....	40
Figure 6.6. Summary of Results for <i>MASH</i> Test 3-10 on the TL-3 Low-Profile Barrier. ....	42
Figure 7.1. TL-3 Low-Profile Barrier/Test Vehicle Geometrics for Test No. 469688-1-2.....	43
Figure 7.2. Test Vehicle before Test No. 469688-1-2.....	44
Figure 7.3. TL-3 Low-Profile Barrier after Test No. 469688-1-2.....	45
Figure 7.4. Damage at Joint 2-3 after Test No. 469688-1-2. ....	46
Figure 7.5. Test Vehicle after Test No. 469688-1-2. ....	47

## LIST OF FIGURES (CONTINUED)

		<b>Page</b>
Figure 7.6.	Interior of Test Vehicle for Test No. 469688-1-2.....	47
Figure 7.7.	Summary of Results for <i>MASH</i> Test 3-11 on the TL-3 Low-Profile Barrier. ....	49
Figure C.1.	Sequential Photographs for Test No. 469688-1-1 (Overhead and Gut Views).....	72
Figure C.2.	Sequential Photographs for Test No. 469688-1-1 (Rear View).....	74
Figure C.3.	Vehicle Angular Displacements for Test No. 469688-1-1. ....	75
Figure C.4.	Vehicle Longitudinal Accelerometer Trace for Test No. 469688-1-1 (Accelerometer Located at Center of Gravity). ....	76
Figure C.5.	Vehicle Lateral Accelerometer Trace for Test No. 469688-1-1 (Accelerometer Located at Center of Gravity). ....	77
Figure C.6.	Vehicle Vertical Accelerometer Trace for Test No. 469688-1-1 (Accelerometer Located at Center of Gravity). ....	78
Figure C.7.	Vehicle Longitudinal Accelerometer Trace for Test No. 469688-1-1 (Accelerometer Located Rear of Center of Gravity). ....	79
Figure C.8.	Vehicle Lateral Accelerometer Trace for Test No. 469688-1-1 (Accelerometer Located Rear of Center of Gravity). ....	80
Figure C.9.	Vehicle Vertical Accelerometer Trace for Test No. 469688-1-1 (Accelerometer Located Rear of Center of Gravity). ....	81
Figure D.1.	Sequential Photographs for Test No. 469688-1-2 (Overhead and Gut Views).....	87
Figure D.2.	Sequential Photographs for Test No. 469688-1-2 (Rear Angle View).....	89
Figure D.3.	Vehicle Angular Displacements for Test No. 469688-1-2. ....	90
Figure D.4.	Vehicle Longitudinal Accelerometer Trace for Test No. 469688-1-2 (Accelerometer Located at Center of Gravity). ....	91
Figure D.5.	Vehicle Lateral Accelerometer Trace for Test No. 469688-1-2 (Accelerometer Located at Center of Gravity). ....	92
Figure D.6.	Vehicle Vertical Accelerometer Trace for Test No. 469688-1-2 (Accelerometer Located at Center of Gravity). ....	93
Figure D.7.	Vehicle Longitudinal Accelerometer Trace for Test No. 469688-1-2 (Accelerometer Located Rear of Center of Gravity). ....	94
Figure D.8.	Vehicle Lateral Accelerometer Trace for Test No. 469688-1-2 (Accelerometer Located Rear of Center of Gravity). ....	95
Figure D.9.	Vehicle Vertical Accelerometer Trace for Test No. 469688-1-2 (Accelerometer Located Rear of Center of Gravity). ....	96



## LIST OF TABLES

	Page
Table 1.1. Summary of Previous TTI Low-Profile Barrier Crash Tests.....	3
Table 2.1. Sight Obstruction Experiment for 24 and 26-Inch Tall PCBs. ....	8
Table 2.2. Headlight Mounting Height of 10 Most-Sold Passenger Cars in U.S. in 2017.....	9
Table 2.3. Occupant Risk and Maximum Angular Displacements of Preliminary Simulations. ....	17
Table 2.4. Initial and Deflected Shape for Tire Disengagement Detailed Simulation Case.....	20
Table 2.5. Initial and Deflected Shape for No-Tire Disengagement Detailed Simulation Case. ....	22
Table 2.6. Comparison between Case 1 and Case 2. ....	23
Table 2.7. Sequential Images of Case 1 and Case 2 (Perpendicular View). ....	24
Table 2.8. Sequential images of Case 1 and Case 2 (Aerial View). ....	25
Table 4.1. Test Conditions and Evaluation Criteria Specified for <i>MASH</i> TL-3 Longitudinal Barriers. ....	31
Table 4.2. Evaluation Criteria Required for <i>MASH</i> TL-3 Longitudinal Barriers. ....	32
Table 6.1. Events during Test No. 469688-1-1.....	38
Table 6.2. Occupant Risk Factors for Test No. 469688-1-1. ....	41
Table 7.1. Events during Test No. 469688-1-2.....	44
Table 7.2. Occupant Risk Factors for Test No. 469688-1-2.....	48
Table 8.1. Performance Evaluation Summary for <i>MASH</i> Test 3-10 on TL-3 Low- Profile Barrier. ....	52
Table 8.2. Performance Evaluation Summary for <i>MASH</i> Test 3-11 on the TL-3 Low- Profile Barrier. ....	53
Table 8.3. Assessment Summary for <i>MASH</i> TL-3 Testing on TL-3 Low-Profile Barrier. ....	54
Table C.1. Vehicle Properties for Test No. 469688-1-1.....	69
Table C.2. Exterior Crush Measurements of Vehicle for Test No. 469688-1-1.....	69
Table C.3. Occupant Compartment Measurements of Vehicle for Test No. 469688-1-1.....	71
Table D.1. Vehicle Properties for Test No. 469688-1-2.....	83
Table D.2. Measurements of Vehicle Vertical CG for Test No. 469688-1-2.....	84
Table D.3. Exterior Crush Measurements of Vehicle for Test No. 469688-1-2.....	85
Table D.4. Occupant Compartment Measurements of Vehicle for Test No. 469688-1- 2.....	86



# CHAPTER 1: INTRODUCTION

## 1.1 PROBLEM

According to National Highway Traffic Safety Administration data from the Fatality Analysis Reporting System, 60 percent of all fatal crashes were single-vehicle crashes, and 71 percent of these fatal single-vehicle crashes were run-of-road crashes. Similarly, roadway departure crashes represent over 50 percent of fatalities on Texas roadways each year. Roadside safety devices shield motorists from roadside hazards such as non-traversable terrain and fixed objects, thereby reducing injuries and fatalities associated with roadway departure crashes. There is a need to develop new or improved roadside safety devices that accommodate various site conditions, placement locations, and a changing vehicle fleet to further enhance the safety of the motoring public. This project provides Texas Department of Transportation (TxDOT) with a mechanism to quickly and effectively address high priority issues related to roadside safety devices.

## 1.2 OBJECTIVE/SCOPE OF RESEARCH

The objective of this project was to design a TL-3 low-profile barrier for high speed applications and assess its performance according to the safety-performance evaluation guidelines included in American Association of State Highway and Transportation Officials (AASHTO) *Manual for Assessing Safety Hardware (MASH)* for Test Level 3 (TL-3) longitudinal barriers (1). The crash tests were performed in accordance with *MASH* TL-3. The test matrix for *MASH* TL-3 involves two tests: one with an 1100C vehicle and one with a 2270P vehicle, both impacting the barrier at a target impact speed of 62 mi/h and impact angle and 25°.

## 1.3 LITERATURE REVIEW\*

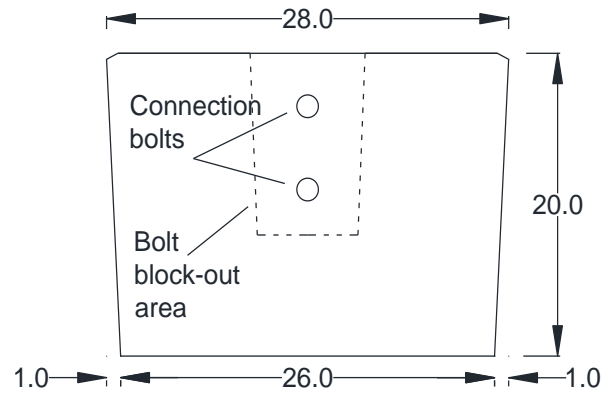
The use of conventional 32-inch tall portable concrete barriers (PCBs) can pose a sight distance problem in certain work zone locations, particularly at night. These 32-inch tall barriers can obstruct a driver's line of sight, making it difficult for a driver to detect oncoming vehicles approaching on the other side of the barrier. This is especially true for passenger cars due to the low elevation of a driver's sightline, and for nighttime situations when illumination at the site may not be sufficient to detect approaching vehicles. During these situations, identification of approaching passenger cars is hindered when their headlights are obstructed by a tall barrier. This situation makes it hazardous for a waiting vehicle to enter the mainstream traffic.

To address this sight-distance problem while still shielding errant vehicles from various work zone hazards, researchers at the Texas A&M Transportation Institute (TTI) developed a 20-inch tall low-profile PCB (Figure 1.1) for use in low-speed work zones (2). This 20-inch tall low-profile barrier was designed with a negative 1:20 vertical slope on the face, which reduces the vertical climb of the vehicle during an impact. The 20-ft long segments and connection tolerance allow the system to accommodate both vertical and horizontal roadway curvature. Full-

---

\* The opinions/interpretations identified/expressed in this section of the report are outside the scope of TTI Proving Ground's A2LA Accreditation.

scale crash tests demonstrated that the low-profile barrier is capable of redirecting vehicles impacting at speeds of 45 mi/h. Testing was conducted according to National Cooperative Highway Research Program (*NCHRP Report 230*) criteria (3). Based on a comprehensive review of the original testing conducted with the low-profile PCB segment, researchers have determined that the original test results were sufficient to be deemed compliant with the new *NCHRP Report 350* criteria. The 20-inch tall low-profile PCB was accepted for *NCHRP Report 350* TL-2 applications (4).



**Figure 1.1. 20-Inch Tall Low-Profile Barrier.**




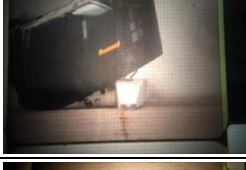




After the successful development of the 20-inch tall low-profile PCB, TTI researchers conducted several studies and full-scale crash tests to develop and evaluate low-profile barriers for high speed applications. Table 1.1 summarizes the crash tests completed at TTI from 1991 to 2007, some of them are unpublished. These barriers were tested in compliance with *NCHRP Report 230* or *NCHRP Report 350* (3, 4).

As reported in Table 1.1, TTI conducted a successful high-speed crash test on the 20-inch tall low-profile PCB. A 4500-lb large sedan (2043 kg) impacted the barrier at a speed of 61.1 mi/h and 24.9° and was successfully contained and redirected. The barrier received moderate damage at the impact connection and had a 7.0-inch lateral displacement.

In a subsequent high-speed (63.1 mi/h) impact with a 4400-lb (2000 kg) pickup truck, the 20-inch tall low-profile PCB contained the vehicle, but the vehicle subsequently rolled over on the traffic side of the barrier. TTI researchers conducted two additional high-speed pickup truck crash tests were performed for increased barrier heights of 22.6 inches and 25.4 inches. The negative slope profile was retained for the TL-3 low-profile PCB in both cases. At both heights, the pickup truck was contained and redirected but rolled over after exiting the barrier system.

To address the problem for high speed applications, TTI researchers applied modifications to the 20-inch tall low-profile PCB (5). Subsequently, researchers designed a steel rail retrofit attachment to be added on top of the existing 20-inch tall low-profile PCB. Two retrofit systems were designed and full-scale crash tested, to address roadside and median applications (Figures 1.2 and 1.3). The two retrofit systems performed acceptably and met the evaluation criteria for *NCHRP Report 350* test 3-11 in both the roadside barrier application and the median barrier application.

**Table 1.1. Summary of Previous TTI Low-Profile Barrier Crash Tests.**

Test Year	Test Criteria	Barrier Height (inches)	Test Vehicle	Impact Conditions		Picture	Result
				Speed (mi/h)	Angle (degrees)		
1991	<i>NCHRP Report 230</i>	20	2000P GMC Sierra 2500	44.4	26.1		Pass
1991	<i>NCHRP Report 230</i>	20	820C Honda Civic	45.7	23.1		Pass
1993	<i>NCHRP Report 230</i>	20	4500S large sedan	61.1	24.9		Pass
1995	<i>NCHRP Report 230</i>	20	2000P Chevrolet 2500	63.1	25.0		Fail
1996	<i>NCHRP Report 350</i>	22.6	2000P Chevrolet 2500	61.8	26.4		Fail
1996	<i>NCHRP Report 350</i>	25.4	2000P Chevrolet Cheyenne	62.0	26.7		Fail
2006	<i>NCHRP Report 350</i>	39 (includes 19-inch tall rail attachment)	2000P Chevrolet C2500	62.8	25.5		Pass
2007	<i>NCHRP Report 350</i>	39 (includes 19-inch tall rail attachment)	2000P Chevrolet C2500	62.0	26.1		Pass



**Figure 1.2. Roadside Application.**



**Figure 1.3. Median Application.**

## **CHAPTER 2: CONCEPT DEVELOPMENT AND ENGINEERING EVALUATION\***

### **2.1 INTRODUCTION**

The ability of a PCB to adequately contain and redirect an impacting vehicle is affected by various factors, including its height and profile. In order to offer proper vehicle containment and redirection, the barrier needs to be designed with an appropriate height. In fact, an impact against a barrier that is not designed to provide adequate minimum height can cause the impacting vehicle to either vault or roll over the barrier system. Even when designed to a minimum required height, a barrier needs to have a crashworthy profile, meaning that its impacted face geometry needs to be adequately designed to provide proper tire (and vehicle) interaction to maintain vehicle stability throughout the impact event. The need for a low-profile barrier is dictated by the desire for drivers to have clear visibility of approaching vehicles when entering the traffic stream from the other side of the barrier. In other words, a low-profile system needs to be adequately designed to allow for sufficient driver visibility, while maintaining crashworthiness.

### **2.2 HEIGHT SELECTION**

“Sight distance” is reported in the *A Policy on Geometric Design of Highways and Streets* as “... the distance along a roadway throughout which an object of specified height is continuously visible to the driver. This distance is dependent on the height of the driver’s eye above the road surface, the specified object height above the road surface, and the height and lateral position of sight obstructions within the driver’s line of sight. For all sight distance calculations for passenger vehicles, the height of the driver’s eye is considered 42 inches (3.5 ft) above the road surface” (6).

An unobstructed line-of-sight between the cross-traffic driver’s eye and the center of the headlight of the oncoming vehicle provides the boundary for acceptable barrier performance. To study the sight-distance problem, it is necessary to define the eye height of the driver, headlight heights, and other related geometric constraints.

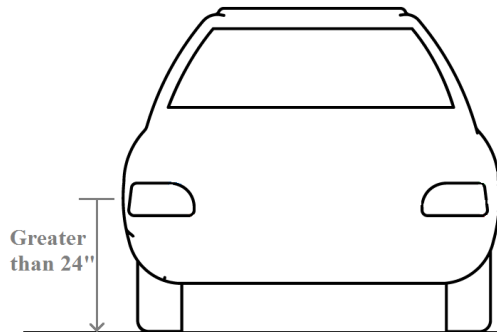
Federal Motor Vehicle Safety Standard 108 requires the center of the headlight lens be mounted no less than 24 inches above the road surface (7). Figure 2.1 illustrates the requirement of headlight mounting height.

In 1991, Guidry and Beason conducted a random survey of 100 vehicles to establish the range of typical headlight heights and found most cars at that time had headlight mounting heights between 24 and 28 inches (2). Simplified geometric analyses were conducted to study the sight-distance problem. It was found that the cross-traffic driver’s sight-distance is unlimited as long as the barrier height is less than 24 inches (minimum headlight mounting height) for constant slope and sag vertical curves. In the case of crest vertical curves, it was found that the

---

\* The opinions/interpretations identified/expressed in this section of the report are outside the scope of TTI Proving Ground’s A2LA Accreditation.

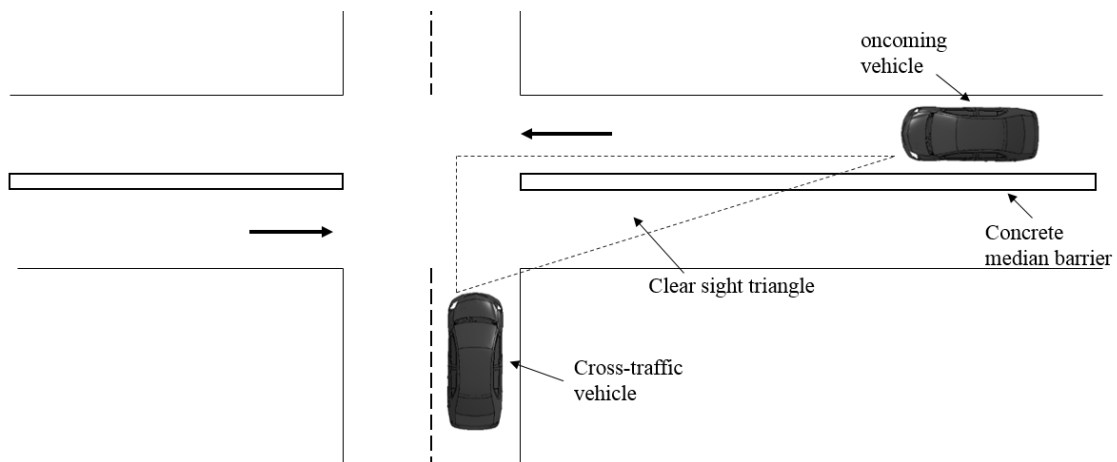
cross-traffic driver's sight-distance is significantly increased by using barrier heights of less than 24 inches.



**Figure 2.1. Requirement of Vehicle Lens Mounting Height.**

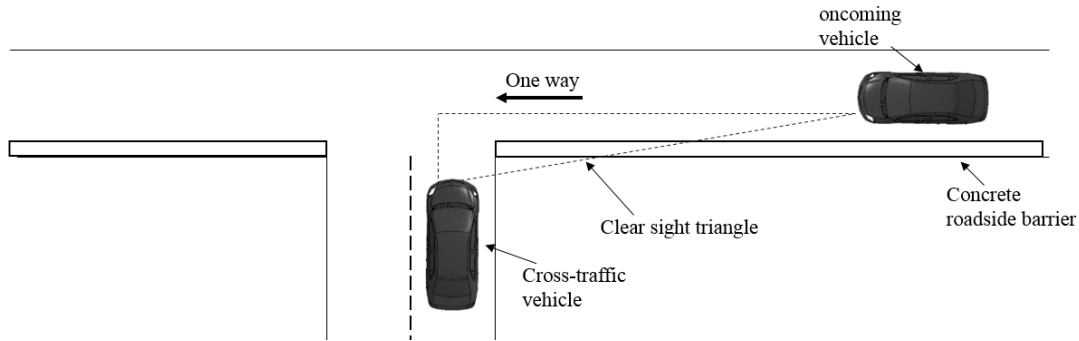
Barrier height is a critical dimension for the design of a roadside safety barrier. To date, no minimum barrier height for *MASH* TL-3 PCB applications has been investigated or determined. Barriers lower than 24 inches may not be able to contain and redirect an errant vehicle impacting at *MASH* TL-3 conditions. Heights of 24 and 26 inches were chosen as candidate barrier heights to be further investigated within this study.

Intersections can have issues with sight-distance obstruction. Each quadrant of an intersection should contain a triangular area free of obstructions that might block an approaching driver's view of potentially conflicting vehicles. Figures 2.2 and 2.3 illustrate the geometry of the sight obstruction problem of median and roadside barriers at intersections.



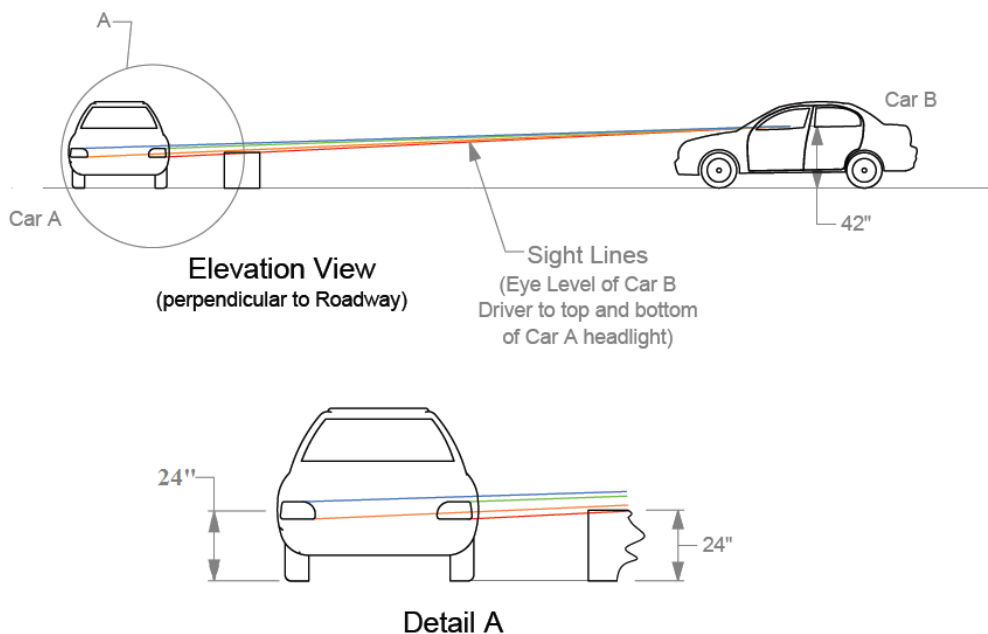
**Figure 2.2. Sight Obstruction (Median Barrier Application).**



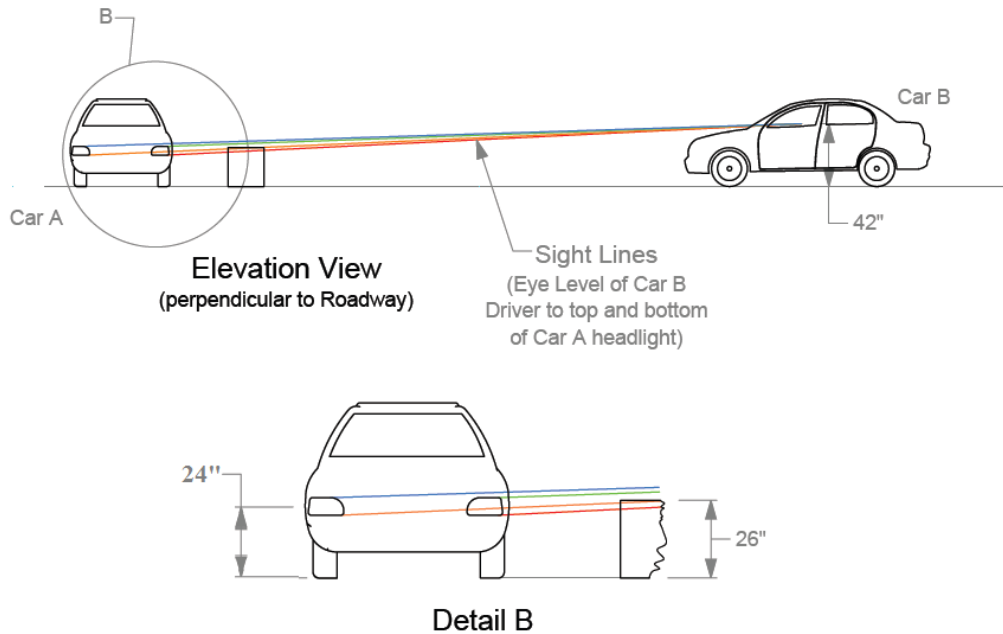


**Figure 2.3. Sight Obstruction (Roadside Barrier Application).**

A simplified experiment was conducted to check the sight distance obstruction problem of 24 and 26 inches tall barrier. The vehicle used in this experiment was a 2011 Kia Rio. A camera was placed at a distance of 600 ft from the vehicle. The camera was set 42 inches above the ground surface to represent driver's eye height. Two different lateral distances from the barrier to the camera were considered to replicate roadside and median barrier applications. The relative vehicle headlight mounting height was adjusted to be 24 inches. Figures 2.4 and 2.5 illustrate the geometric analyses for sight obstruction of 24-inch and 26-inch tall barriers. Table 2.1 shows zoomed in views of the experiments. Results from this analysis showed that a 24-inch tall barrier allowed vision of both headlights of an upcoming passenger car. While the upcoming vehicle's right headlight resulted in basically unobstructed by the barrier, the left headlight was just minimally obstructed. With the barrier height increased to 26 inches, a higher percentage of both headlights was obstructed. There was still sufficient visibility of both headlights to allow seeing the upcoming vehicle at nighttime (Table 2.1).



**Figure 2.4. Sight Obstruction for 24-Inch Tall Barrier.**



**Figure 2.5. Sight Obstruction for 26-Inch Tall Barrier.**

**Table 2.1. Sight Obstruction Experiment for 24- and 26-Inch Tall PCBs.**

Barrier Height (inch)	Lateral distance from barrier (ft)	
	18	30
24		
26		

It has been 25 years since the 20-inch tall low-profile TL-2 PCB was developed. With the auto industry continuing to innovate and adapt, researchers conducted a search on the best-sold passenger cars in the United States in 2017 (as listed in Table 2.2) (8). All of them have headlight mounting heights equal to or greater than 26 inches. Among them, only the Ford Fusion has the minimum headlight mounting height of 26 inches. These cars represent the most popular passenger cars on the road, and give evidence that a 26-inch tall concrete barrier should provide sufficient visibility for a driver to detect oncoming vehicles at a safe distance.

**Table 2.2. Headlight Mounting Height of 10 Most-Sold Passenger Cars in the United States in 2017.**

Type of vehicle	Headlight mounting height (inch)
Toyota Camry (L4) 4 door sedan	29
Honda Civic 4 door sedan	27
Toyota Corolla 4 door sedan	27
Accord (L4) 4 door sedan	27
Nissan Altima (L4) 4 door sedan Honda	27
Nissan Sentra 4 door sedan	28
Ford Fusion 4 door sedan	26
Hyundai Elantra 4 door sedan	27
Chevrolet Malibu 4 door sedan	28
Chevrolet Cruze 4 door sedan	27

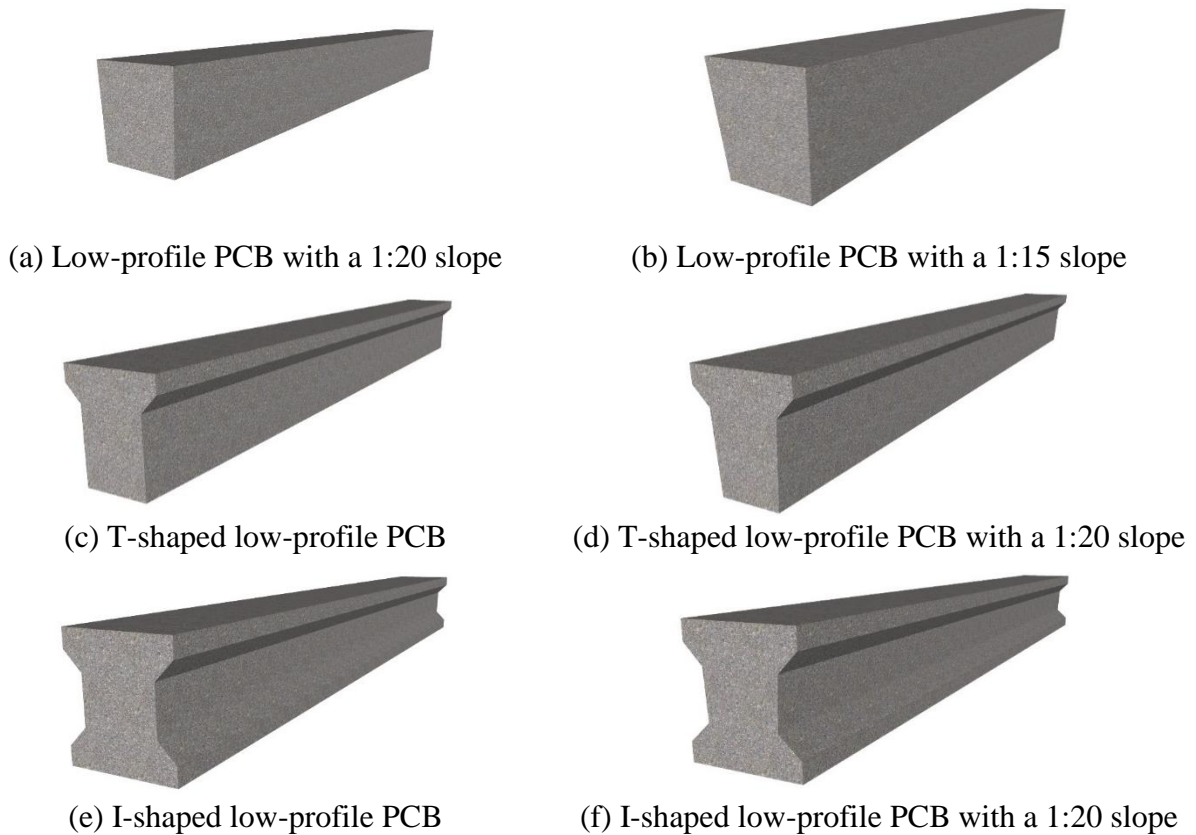
### 2.3 BARRIER CONCEPTION DEVELOPMENT

Several profile shapes were considered when developing the TL-3 barrier design for evaluation under *MASH* TL-3 testing conditions. Particular attention was given to developing a barrier profile that would limit vehicle climbing. Specifically, the TL-3 barrier profile concepts focused on keeping the impacting vehicle tires closer to ground level, thus limiting vehicle instability during the impact event.

Figure 2.6a shows a concept of a low-profile barrier with a negative angle slope. Based on the 20-inch tall low-profile, this concept increases the barrier height while keeping the 1:20 negative slope, since this negative slope was determined to be able to restrict the tendency for the impact side of the vehicle to rise. Figure 2.6b shows a low-profile barrier with a 1:15 slope. This steeper slope is a variation of the original low-profile barrier concept.

Figure 2.6c shows a concept of a T-shaped low-profile barrier. This concept can be considered as a vertical wall with a protruding beam at the top of the barrier. To further reduce the rise of the vehicle and assist with casting, a 1:20 negative slope is applied to the T-shaped low-profile barrier (Figure 2.6d).

Figures 2.6e and 2.6f show the concepts of an I-shape low-profile barrier and I-shaped low-profile barrier with a 1:20 negative slope, respectively. The I-shaped concept can be considered a variation of the T-shaped concept.



**Figure 2.6. Proposed Concepts for Low-Profile Barrier for TL-3 Applications.**

## 2.4 PRELIMINARY COMPUTER SIMULATIONS

Preliminary finite element computer simulations were performed to evaluate and compare the stability and impact performance of the proposed low-profile PCB concepts under *MASH* Test 3-11 conditions. Both 24- and 26-inch barrier heights were considered and modeled for each of the proposed concepts. For these preliminary computer simulations, the various barrier systems were modeled as free-standing 120-ft long concrete blocks, without simulating barrier segment lengths or connections. The intent was simply to investigate the vehicle interaction with the different barrier profiles. Simulations were performed with the non-linear finite element code LS-DYNA (9). No concrete failure options were included in the FE model. Therefore, the developed model does not have the ability to predict fracture or even spalling of concrete, which might happen during the full-scale crash test.

Test conditions of *MASH* Test 3-11 were replicated with a pickup truck model representing the *MASH* vehicle 2270P (Figure 2.7), impacting the PCB system at *MASH* TL-3 nominal conditions of 62 mi/h speed and 25° angle (10).

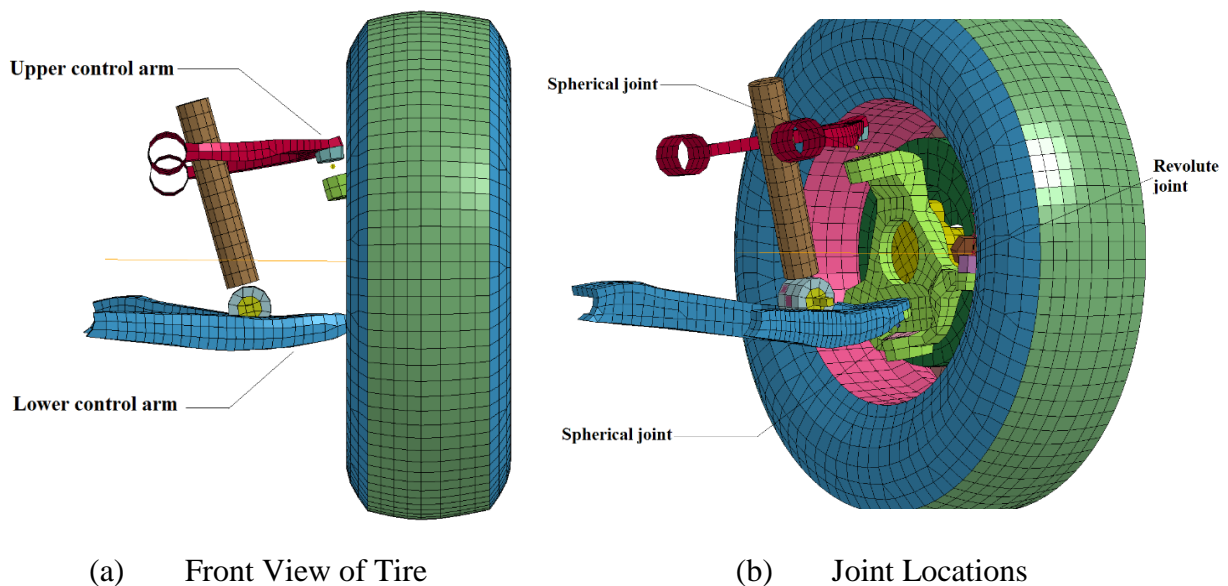


**Figure 2.7. Available MASH 2270P Pickup Truck FE Model (10).**

Each of the proposed barrier concepts and heights were evaluated under two different cases:

- (1) the vehicle's front impact tire was modeled with the ability to disengage from the suspension assembly to represent failure of the tire system commonly seen in full-scale testing.
- (2) the vehicle's front impact tire was not given the ability to disengage from the suspension system.

Under *MASH TL-3* pickup truck impact conditions, crash testing experience has shown that it is not uncommon for the front pickup truck impact tire to disengage (break away) from the suspension assembly. Figure 2.8a shows a front view of the impact tire and suspension assembly of the *MASH 2270P* pickup truck model. The suspension assembly is composed of upper and lower rotating control arms. Spherical joints connect the control arms to the knuckle of the tire assembly, and revolute joints connect the wheel to the chassis rail so that the wheel can rotate about the axes of the revolute joint. Figure 2.8b shows the location of those joints. To achieve the disengagement, a force-based failure option was applied within the joint card in LS-DYNA.



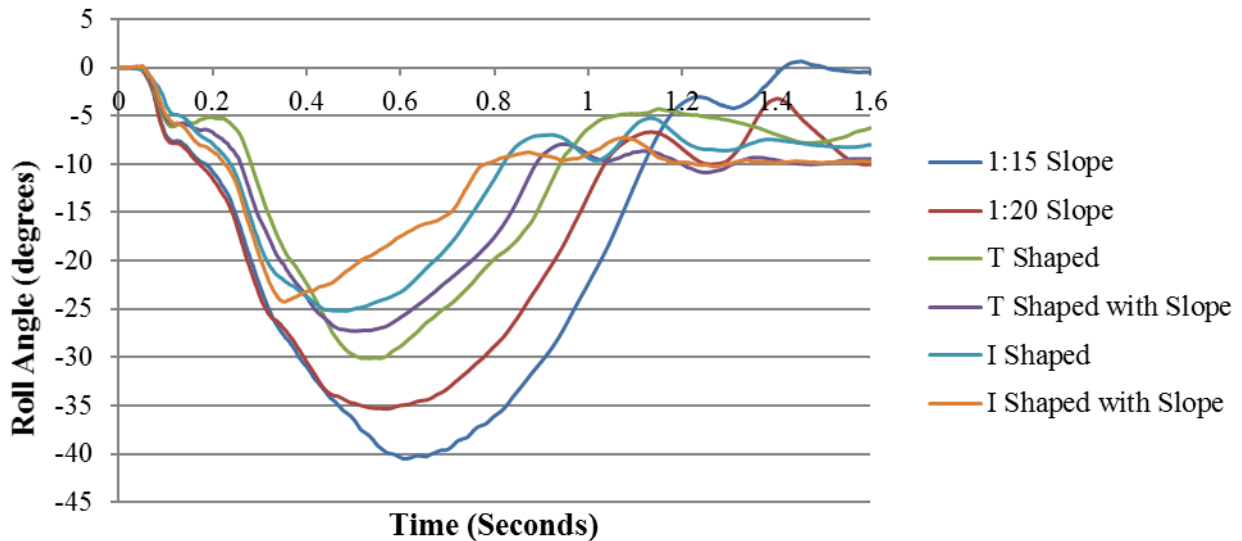
**Figure 2.8. Vehicle Tire Finite Element (FE) Model.**

Vehicle stability, occupant risk, and structural adequacy were evaluated and compared to *MASH* requirements. Vehicle angular displacements, also known as yaw, pitch, and roll angles, were used to evaluate the vehicle stability. *MASH* specifies that the maximum roll and pitch angles are not to exceed 75°. Occupant risk describes the risk of hazard to occupants. It is evaluated from the data collected by the accelerometer located at the vehicle center of gravity. Two factors are analyzed through the acceleration data: occupant impact velocity (OIV) and occupant ridedown acceleration (RDA). OIV is the relative velocity at which an unrestrained hypothetical occupant impacts the interior surface of the vehicle. RDA is the highest 10-msec average acceleration after time of occupant contact. *MASH* requires the OIV to be lower than 40 ft/s and RDA to be less than 20.49 g in the longitudinal and lateral directions. The structural adequacy of the system is determined by the barrier’s ability to contain and redirect the vehicle.

### 2.4.1 Simulations with 26-inch Barrier Height

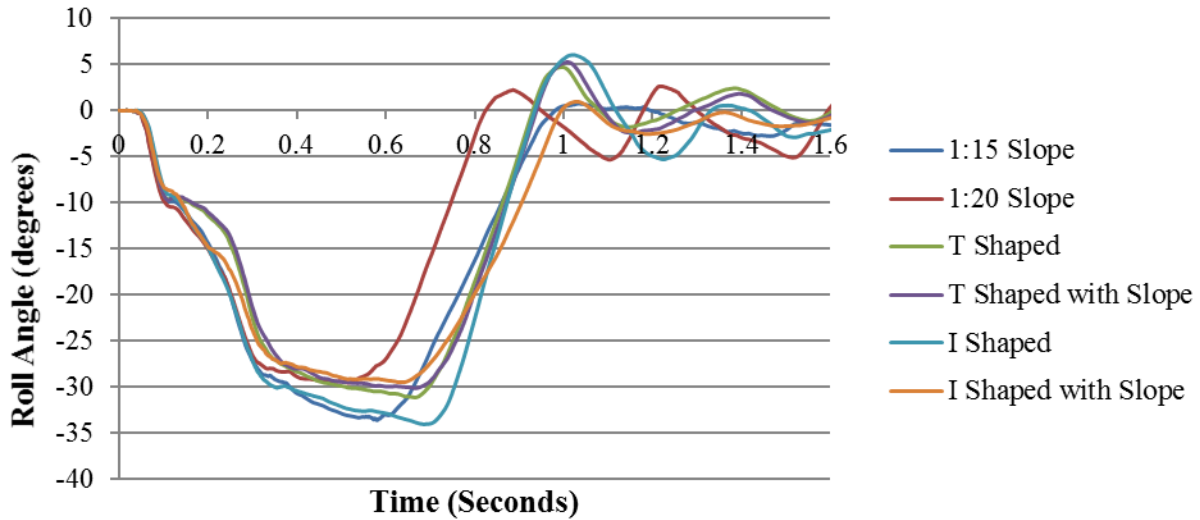
Simulations were conducted with the pickup truck vehicle impacting the PCB system at a speed of 62 mi/h and an impact angle of 25°. Impact location was at the one-third point of the 120-ft long, 26-inch tall concrete rigid block. Evaluated PCB systems included proposed PCB profile concepts of 1:15 negative slope, 1:20 negative slope, T-shaped, T-shaped with a 1:20 negative slope, I-shaped, and I-shaped with a 1:20 negative slope. For all the simulated cases, the 2270P vehicle was contained and redirected by the 26-inch tall PCB systems. Occupant risk indices for each of these simulations were all within *MASH* limits.

Figure 2.9 summarizes the vehicle roll angular displacements recorded during the impacts for those simulations that were modeled with impact tire disengagement. Figure 2.10 summarizes the vehicle roll angular displacements recorded during the impacts for those simulations that were modeled without impact tire disengagement.



**Figure 2.9. Roll Angle Comparison of 26-Inch Tall Barrier Concepts with Impact Tire Disengagement.**



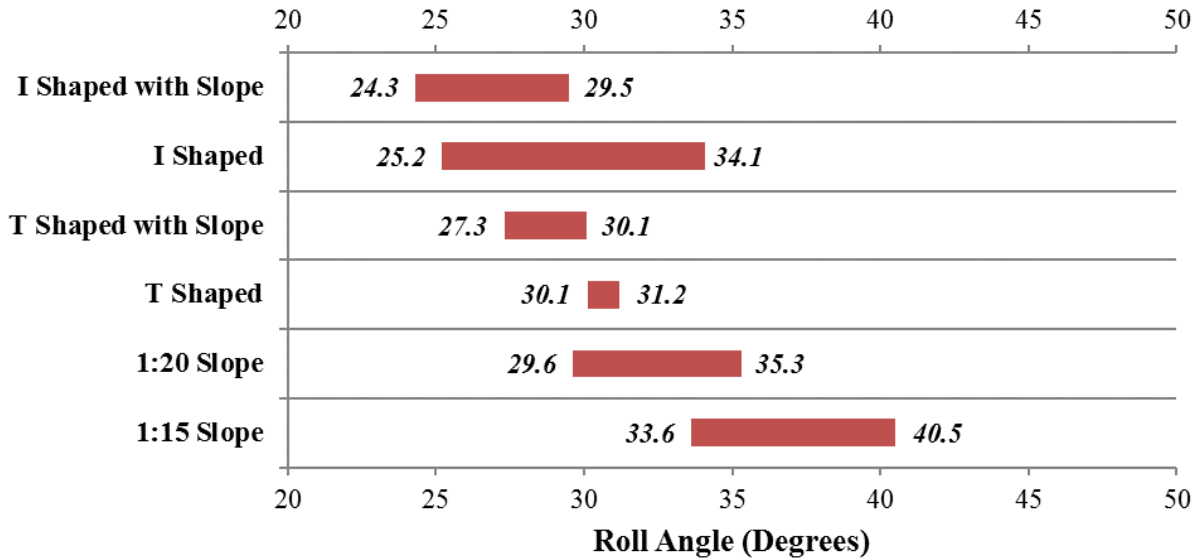


**Figure 2.10. Roll Angle Comparison of 26-Inch Tall Barriers without Impact Tire Disengagement.**

Preliminary simulations suggest that all the proposed barrier profiles would satisfy *MASH* stability criteria. The maximum vehicle roll angle ranges between roughly 25° and 40° when considering tire disengagement. When the tire disengagement option is not applied, the maximum vehicle roll angle has a tighter range (30° to 35°). It appears that the vehicle maintains a very similar roll behavior when impacting the two T-shaped profiles (with and without the negative slope), with and without tire disengagement (27° to 31°).

Figure 2.11 summarizes the maximum roll angle recorded in the preliminary simulations for the 26-inch tall barrier options. For each profile, maximum roll values from parametric simulations with and without tire disengagement are reported to establish an expected range of performance. Tire disengagement phenomena during a crash test cannot be easily predicted using existing vehicle models. Therefore, these two simulated cases—with and without tire disengagement—are intended to represent the extremes of vehicle tire behaviors that could potentially be experienced during a crash test. Therefore, when the simulations predict maximum roll angles of 27.3° and 30.1° for the two simulated extreme cases of impact against a T-shaped PCB with sloped sides, it would be expected that during the crash test the vehicle might experience a maximum roll angle within this range. However, the barrier modeling used in the preliminary simulations does not include actual barrier segment length and connections between segments.

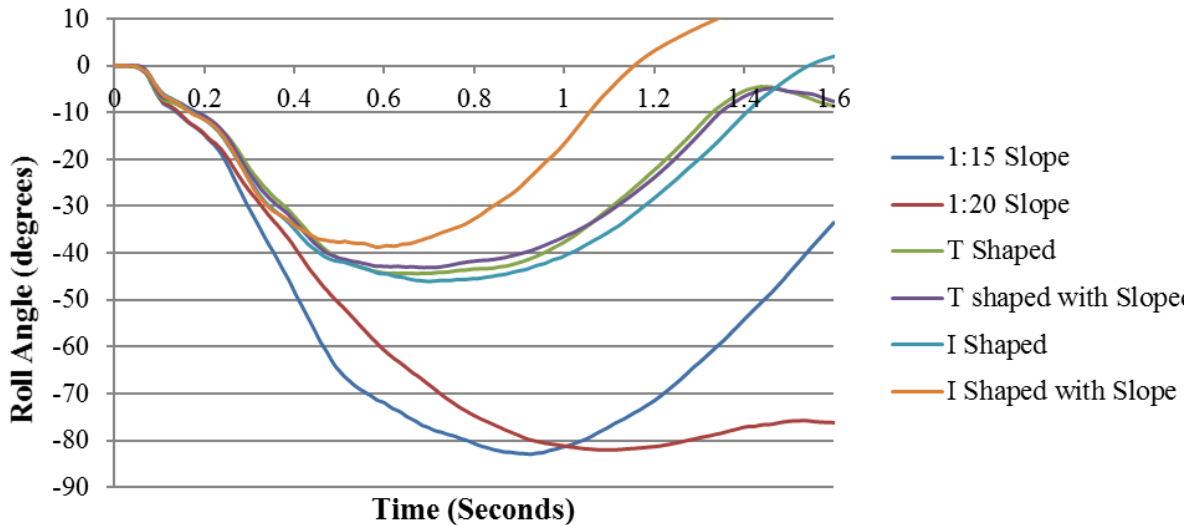
The conducted preliminary simulations on the 26-inch tall PCB systems suggest that a 26 inches height is adequate to contain and redirect the 2270P vehicle within the *MASH* stability criteria. Therefore, it was decided to explore barriers with a height of 24 inches.



**Figure 2.11. Range of Maximum Roll Angles for 26-Inch Tall Barrier Concepts.**

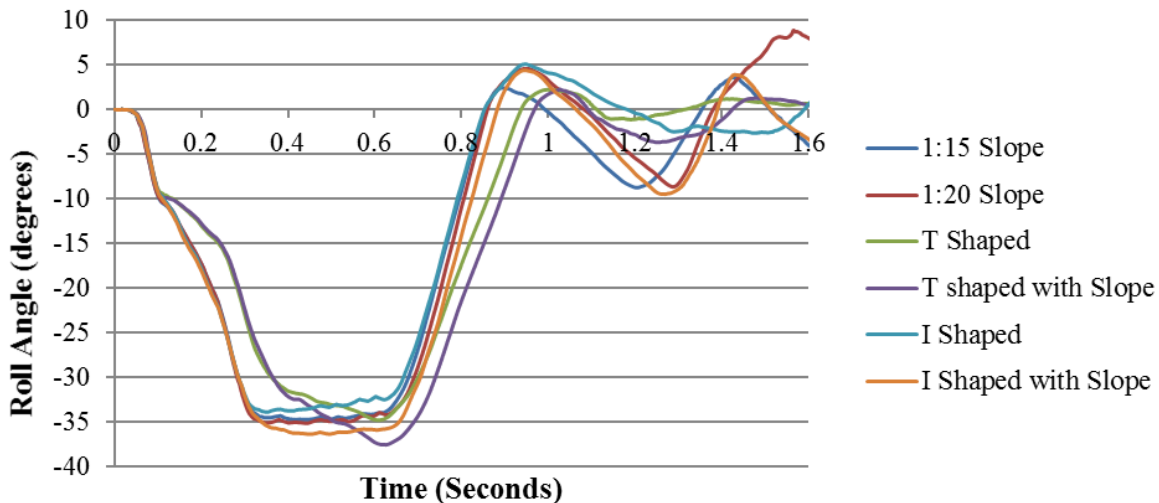
#### 2.4.2 Simulations with 24-Inch Barrier Height

Simulations were conducted with the pickup truck vehicle impacting the PCB system at a speed of 62 mi/h and an impact angle of 25°. Impact location was the one-third point of the 120-ft long, 24-inch tall concrete rigid block. Evaluated PCB systems included proposed PCB profile concepts of 1:15 negative slope, 1:20 negative slope, T-shaped, T-shaped with a 1:20 negative slope, I-shaped, I-shaped with a 1:20 negative slope. The 2270P vehicle was contained and redirected by all the 24-inch tall PCB systems. Figure 2.12 summarizes the vehicle roll angular displacements for the simulations modeled with impact tire disengagement. Figure 2.13 summarizes the vehicle roll angular displacements for the simulations modeled without impact tire disengagement.



**Figure 2.12. Roll Angle Comparison of 24-Inch Tall Barrier Concepts with Impact Tire Disengagement.**





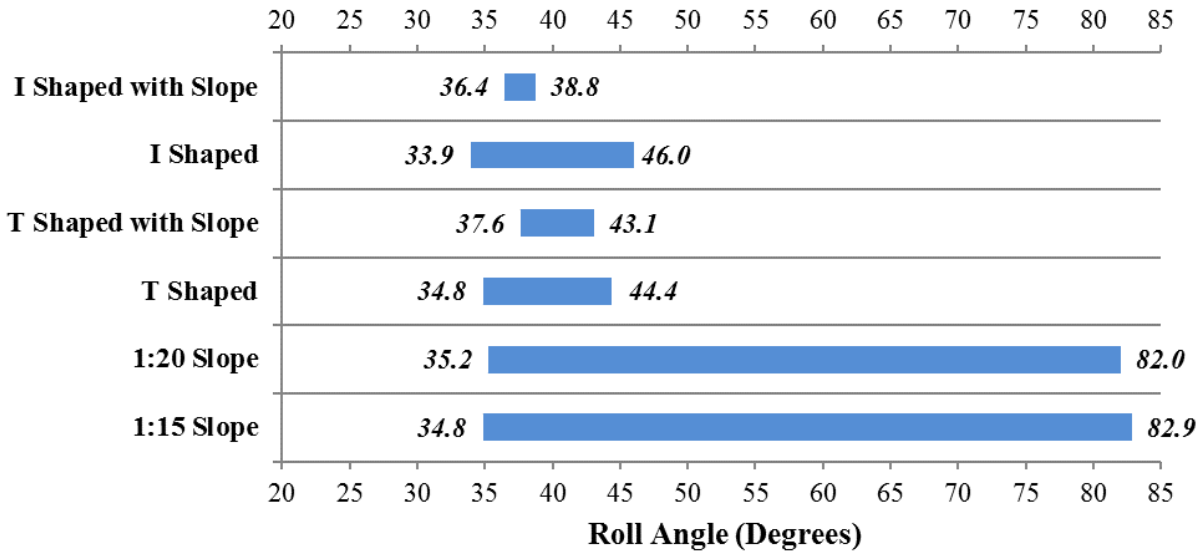
**Figure 2.13. Roll Angle Comparison of 24-Inch Tall Barriers without Impact Tire Disengagement.**

During the impact events against the 1:15 and 1:20 slope profiles (with impact tire disengagement), the 2270P vehicle was unstable and had unacceptable behavior. In both cases, the recorded maximum roll angular displacements were above the required *MASH* limits, failing the *MASH* requirements for vehicle stability. Figure 2.12 suggests that vehicle stability was acceptable during the impact events against the T-shaped and I-shaped low-profile PCBs with impact tire disengagement. For these cases, the vehicle roll angular displacement ranged between roughly 39° and 46°. When the tire disengagement option is not applied (Figure 2.13), the recorded maximum roll angular displacements were all below 38°.

Occupant risk indices for each of the simulations against 24-inch tall PCB systems were within *MASH* limits.

Figure 2.14 summarizes the maximum roll angular displacements recorded in the preliminary simulations for the 24-inch tall barrier options. For each profile, maximum roll values from the parametric simulations with and without tire disengagement are reported. Tire disengagement phenomena during a crash test cannot be easily predicted with current vehicle models. Therefore, these two simulated cases—with and without tire disengagement—are intended to represent the extremes that could potentially be experienced during a crash test. Therefore, when the simulations predict maximum roll angles of 37.6° and 43.1° for the two simulated cases for a T-shaped PCB with sloped sides, it would be expected that during the crash test the vehicle might experience a maximum roll angle within this range of angular displacements. However, the barrier modeling used in the preliminary simulations does not include actual barrier segment length and connections between segments.

The preliminary simulations conducted on the 24-inch tall PCB systems suggest that not all the proposed barrier profiles would be able to adequately contain and redirect the impacting 2270P vehicle within *MASH* stability criteria. For the case of the sloped profiles (1:15 and 1:20), the 2270P vehicle has a high probability of rollover.



**Figure 2.14. Range of Maximum Roll Angles for 24-Inch Tall Barrier Concepts.**

### 2.4.3 Conclusions – Preliminary Simulations

For all the 26-inch tall simulated profile concepts, the 2270P vehicle was contained and redirected by the impacted PCB systems.

For all the 24-inch tall simulated profile concepts, the 2270P vehicle was contained and redirected by the impacted PCB systems. During the impact events against the 1:15 and 1:20 slope profiles (with impact tire disengagement), the 2270P vehicle became unstable and exhibited unacceptable behavior. In both cases, the recorded maximum roll angular displacements were above the required *MASH* limits.

Table 2.3 summarizes the occupant risk and angular displacements recorded in the preliminary simulations. Recorded occupant risks for each of these simulations were within *MASH* limits.

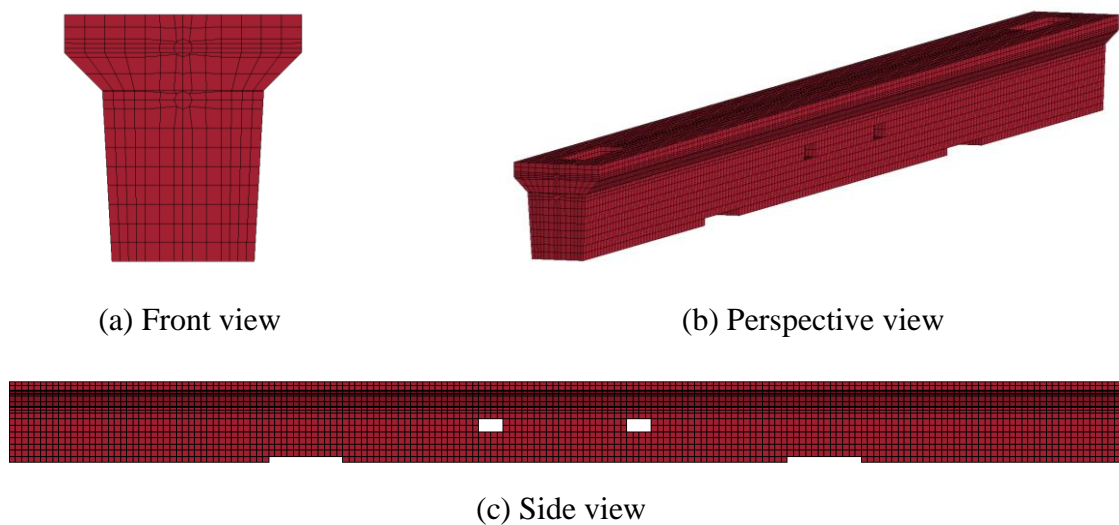
Based on these preliminary simulation results, researchers decided to further investigate the behavior of the 26-inch tall T-shaped low-profile PCB option, with consideration of specific barrier segment length and connections between the segments. A height of 26 inches rather than 24 inches should provide improved vehicle stability during the impact event. Researchers also concluded that the 26-inch T-shaped profile appeared to have demonstrated more consistent performance in cases with and without vehicle tire disengagement. There is no significant barrier performance improvement associated with sloping the sides of the T-shaped system. Therefore, researchers decided to conduct detailed computer modeling and simulations of *MASH* Test 3-11 impact conditions against a 26-inch tall T-shaped PCB profile with sloped sides. Based on constructability feedback, researchers included a 1:18 slope on the stem of the T-shaped barrier to accommodate construction forming.

**Table 2.3. Occupant Risk and Maximum Angular Displacements of Preliminary Simulations.**

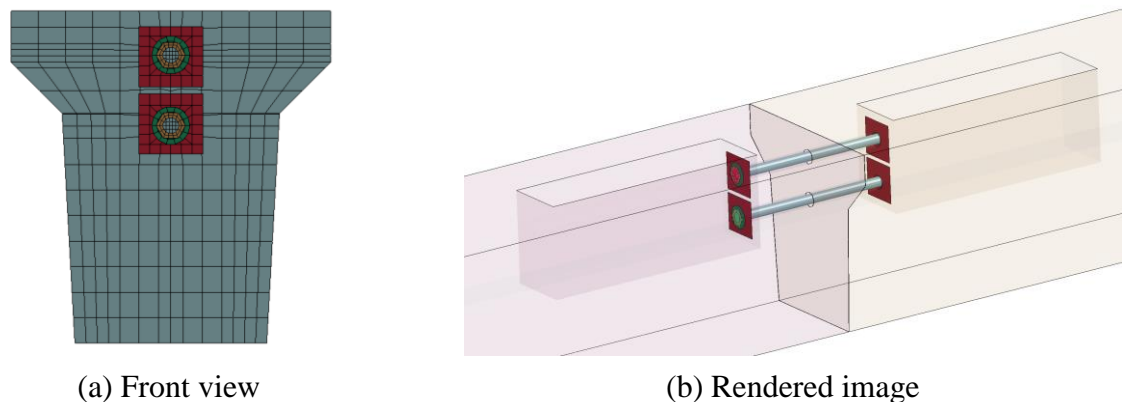
Name	Tire Disengagement	OIV (m/s)		RDA (g)		Roll	Pitch	Yaw
		Longitudinal	Lateral	Longitudinal	Lateral			
1:15 Slope 24"	With	14.1	24.9	-5.9	-12.6	-82.9	35.0	-40.9
	Without	14.1	20.0	11.0	-11.1	-34.8	24.2	-34.6
1:15 Slope 26"	With	20.7	20.3	-11.2	-11.5	-40.5	16.3	-35.2
	Without	16.7	24.3	-7.7	-12.0	-33.6	11.4	-33.4
1:20 Slope 24"	With	13.8	26.9	-5.7	-12.2	-82.0	18.6	-42.5
	Without	16.7	25.3	15.1	-14.8	-35.2	28.1	-35.4
1:20 Slope 26"	With	20.0	27.2	-10.2	-11.2	-35.3	18.3	-36.4
	Without	18.7	24.3	-8.2	-12.1	-29.6	15.2	-33.5
T-Shape 24"	With	19.0	22.6	-5.0	-11.5	-44.4	15.6	-37.5
	Without	20.3	20.7	-7.8	-11.0	-34.8	11.0	-33.9
T-Shape 26"	With	19.3	23.0	-7.6	-8.9	-30.1	9.8	-34.3
	Without	19.0	23.9	13.4	-14.0	-31.2	7.3	-34.3
T-Shape with Slope 24"	With	15.1	26.5	-6.5	-13.3	-43.1	16.1	-37.2
	Without	22.3	23.3	-9.0	-9.4	-37.6	9.2	-34.1
T-Shape with Slope 26"	With	14.1	25.3	-8.0	-9.9	-27.3	10.0	-36.3
	Without	20.7	25.3	-7.0	-15.7	-30.1	6.9	-34.1
I-Shape 24"	With	16.1	26.2	-5.4	-12.6	-46	23.3	-35.9
	Without	14.8	27.2	-10.4	-12.3	-33.9	27.5	-35.1
I-Shape 26"	With	13.4	26.9	5.8	-12.5	-25.2	10.9	-33.8
	Without	16.7	26.9	14.4	14.7	-34.1	12.3	-35.1
I-Shape with Slope 24"	With	16.4	23.3	-5.7	-13.9	-38.8	23.0	-34.5
	Without	16.4	22.3	10.5	-17.7	-36.4	25.2	-35.3
I-Shape with Slope 26"	With	17.4	26.6	-8.8	-13.1	-24.3	12.5	-38.0
	Without	14.8	22.6	-14.6	-20.0	-29.5	8.2	-34.3

## 2.5 DETAILED COMPUTER SIMULATIONS

The detailed FE model of the T-shaped low-profile PCB included barrier segment length, drainage scuppers, and segment connection details, such as steel rods, plate washers, washers, and nuts. The detailed PCB full system model is comprised of six 26-inch tall and 30-ft long barrier segments, for a total system length of 180 ft. The length of the barrier segment was discussed and approved by TxDOT based on horizontal curvature application needs. No concrete failure options were implemented in the detailed FE model. Therefore, the developed model does not have the ability to predict fracture or even spalling of concrete, which might be likely to be experienced during the full-scale crash test. Figure 2.15 shows the detailed FE model of a barrier segment. Figure 2.16 illustrates the modeled connection details between two barrier segments. The barrier system was modeled as free-standing.



**Figure 2.15. Detailed FE Model of 26-Inch Tall T-Shaped Low-Profile PCB Segment.**



**Figure 2.16. Detailed FE Model of Barrier Segments Connections.**

The 180-ft long, free-standing, low-profile PCB system was impacted by the 2270P vehicle at a speed of 62 mi/h and at an angle of 25°. Based on *MASH* requirements, the vehicle

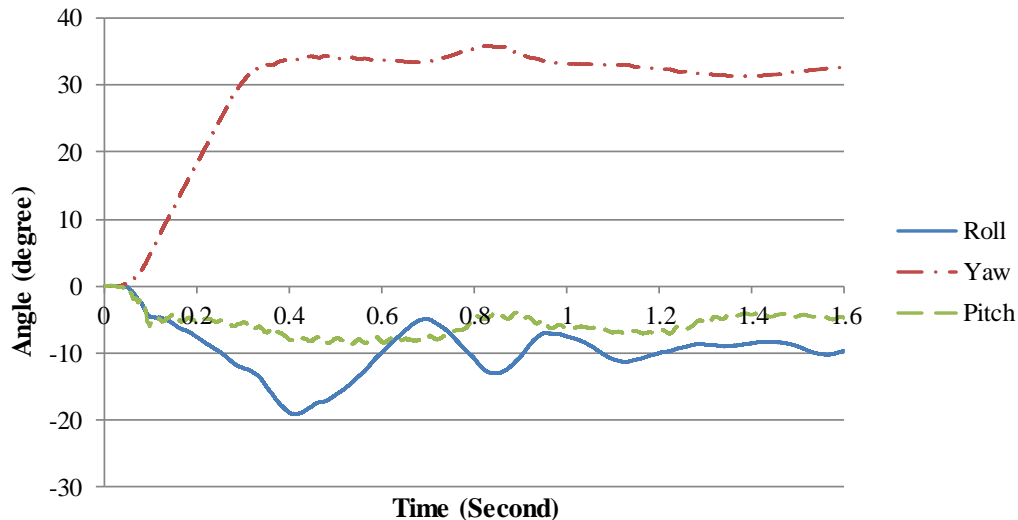
impacted the system 4.3-ft upstream of a connection at around one-third of the system length. Two simulation cases were conducted: with and without impact tire disengagement.

### 2.5.1 Case 1 Detailed Simulation with Impact Tire Disengagement

A force-based failure mechanism for front impact tire disengagement was applied for this simulation, giving the opportunity to the impacting front tire to detach from the vehicle (suspension assembly) if the tire forces exceeded the specified limits.

After 0.03 seconds from the initial impact of the pickup truck, the front impact tire began to disengage from the suspension. At 0.05 seconds, the vehicle began to redirect. The vehicle was traveling parallel with the barrier at 0.23 seconds, and the rear of the vehicle impacted the barrier at 0.25 seconds.

The modeled 2270P vehicle remained upright during and after the impact event. Figure 2.17 shows vehicle roll, pitch, and yaw angles throughout the impact event against the 26-inch tall low-profile PCB. Maximum roll, pitch, and yaw angles were  $-19.2^\circ$ ,  $-8.8^\circ$ , and  $35.9^\circ$ , respectively, which satisfied *MASH* stability criteria.

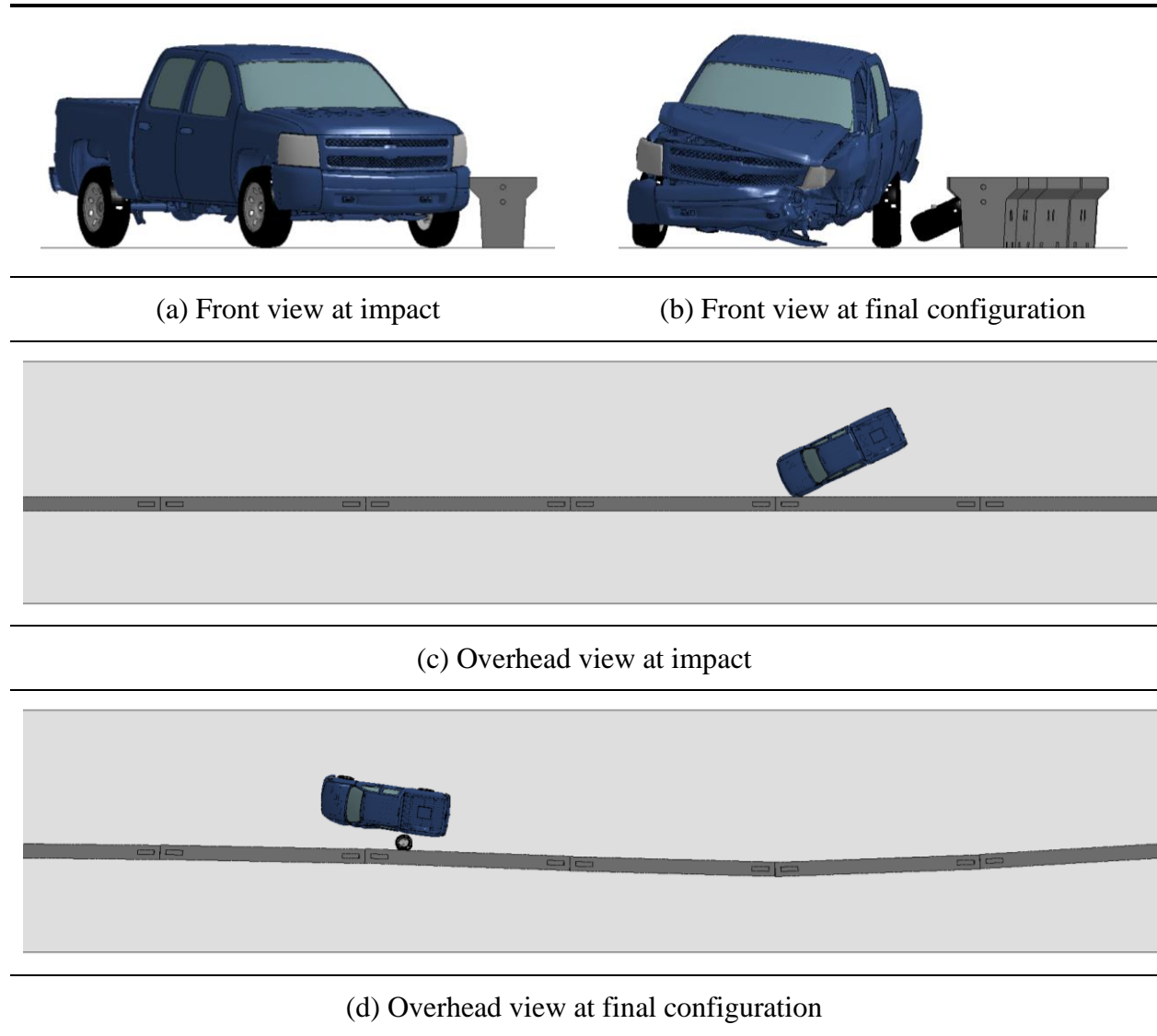


**Figure 2.17. Angular Displacements for Tire Disengagement Detailed Simulation Case.**

The Test Risk Assessment Program (TRAP) program was used to evaluate occupant risk factors based on the applicable *MASH* safety evaluation criteria. Data acquired from the accelerometer, located at the vehicle center of gravity, were digitized for evaluation of occupant risk. In the longitudinal direction, the OIV was 22.0 ft/s at 0.122 s, the highest 10-ms RDA was  $-5.0$  g from 0.139 to 0.149 s, and the maximum 50-ms average acceleration was  $-11.1$  g between 0.059 and 0.109 s. In the lateral direction, the OIV was  $-19.0$  ft/s at 0.122 s, the highest 10-ms RDA was 6.0 g from 0.312 to 0.322 s, and the maximum 50-ms average was 9.6 g between 0.045 and 0.095 s. These results were within the preferred limits of *MASH*. Furthermore, Theoretical Head Impact Velocity (THIV) was 28.4 ft/s at 0.117 s; Post-Impact Head Decelerations (PHD) was 6.0 g between 0.312 and 0.322 s; and Acceleration Severity Index (ASI) was 1.42 between 0.074 and 0.124 s.

Table 2.4 contains images of the barrier at the beginning of impact and at final configuration. A maximum barrier deflection of 29.8 inches (2.5 ft) was reached at approximately 0.60 s.

**Table 2.4. Initial and Deflected Shape for Tire Disengagement Detailed Simulation Case.**

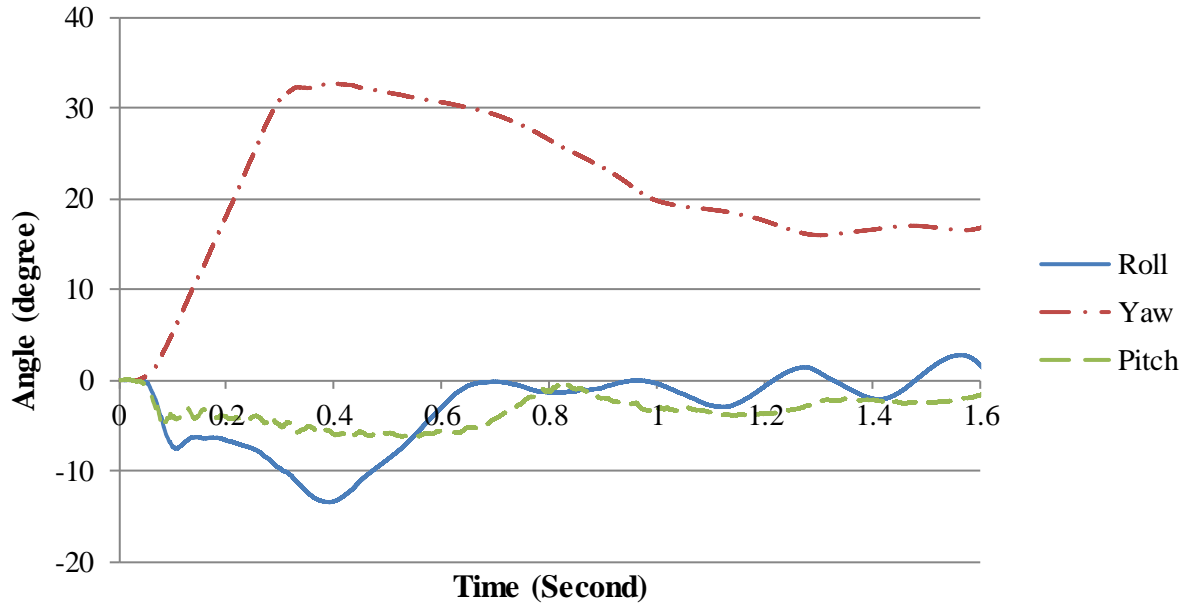


### 2.5.2 Case 2 Detailed Simulation without Impact Tire Disengagement

A second simulation type was conducted without application of the force-based failure mechanism for front impact tire disengagement.

At 0.06 s, the impacting vehicle began to redirect. The vehicle was traveling parallel with the barrier at 0.23 s, and the rear of the vehicle impacted the barrier at 0.25 s.

The modeled 2270P vehicle remained upright during and after the modeled collision event. Figure 2.18 shows vehicle roll, pitch, and yaw angles throughout the impact event against the 26-inch tall low-profile PCB. Maximum roll, pitch, and yaw angles were  $-13.5^\circ$ ,  $-6.3^\circ$ , and  $32.7^\circ$ , respectively, which met *MASH* stability criteria.



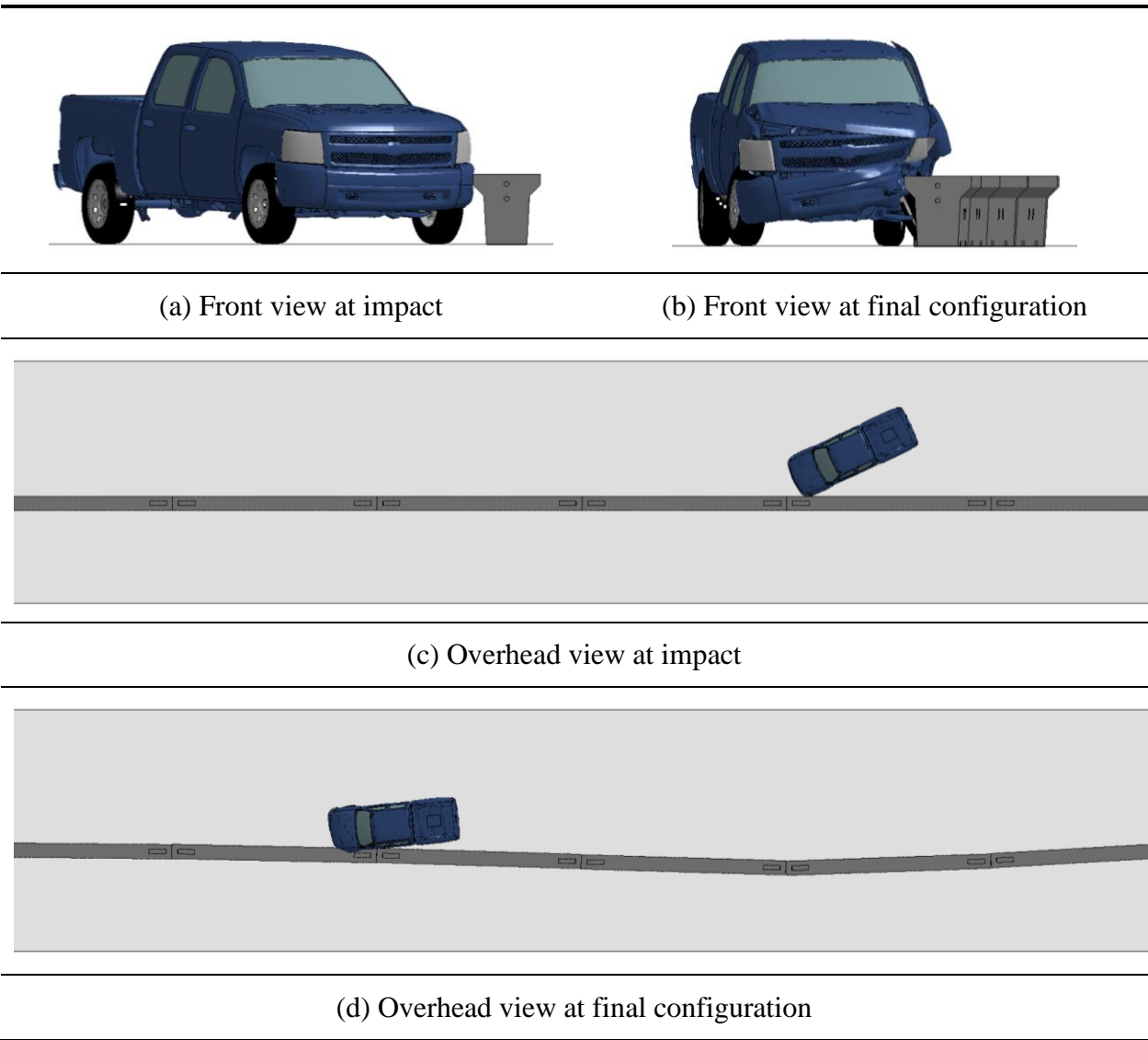
**Figure 2.18. Angular Displacements for No-Tire Disengagement Detailed Simulation Case.**

The TRAP program was used to evaluate occupant risk factors based on the applicable *MASH* safety evaluation criteria.

In the longitudinal direction, the OIV was 22.3 ft/s at 0.117 s, the highest 10-ms RDA was  $-6.0$  g from 0.134 to 0.144 s, and the maximum 50-ms average acceleration was  $-12.1$  g between 0.032 and 0.082 s. In the lateral direction, the OIV was  $-17.4$  ft/s at 0.117 s, the highest 10-ms RDA was 7.6 g from 0.304 to 0.314 s, and the maximum 50-ms average was 11.5 g between 0.034 and 0.084 s. These results were within the preferred limits in *MASH*. Additionally, THIV was 27.9 ft/s at 0.112 s; PHD was 7.9 g between 0.304 and 0.314 s; and ASI was 1.66 between 0.068 and 0.118 s.

Table 2.5 contains images of the barrier at the beginning of impact and at final configuration. A maximum barrier deflection of 29.4 inches (2.5 ft) was reached at approximately 0.61 s.

**Table 2.5. Initial and Deflected Shape for No-Tire Disengagement Detailed Simulation Case.**



**2.6 COMPARISON BETWEEN CASE 1 AND CASE 2**

Results of the two detailed FE simulations cases (Case 1: with impact tire disengagement; Case 2: without impact tire disengagement) were compared to determine the performance envelope of the 26-inch tall low-profile barrier. Table 2.6 compares the occupant risk values and maximum angular displacements. Table 2.7 and Table 2.8 show the sequential images of the two cases in front views and overhead views, respectively.

Occupant risk values are very similar between the two cases. The impact velocity increases slightly in the lateral direction (y-direction) for Case 1 (+1.6 ft/s). However, the predicted ridedown acceleration is reduced for Case 1 (there is a decrease of 1.0 g and 1.6 g in longitudinal and lateral direction, respectively). Case 1 has greater roll, pitch, and yaw angles



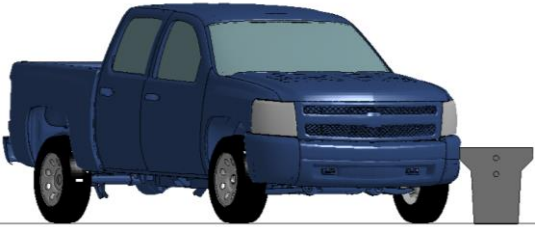
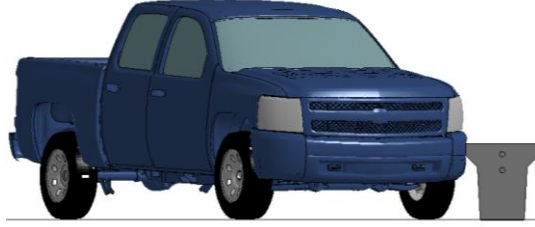
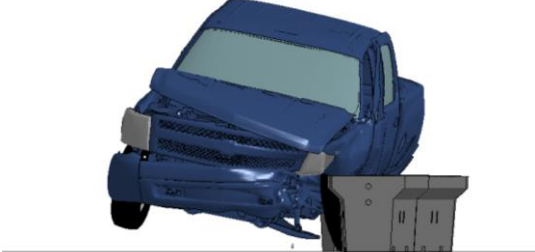
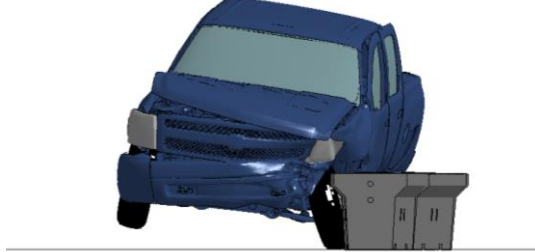
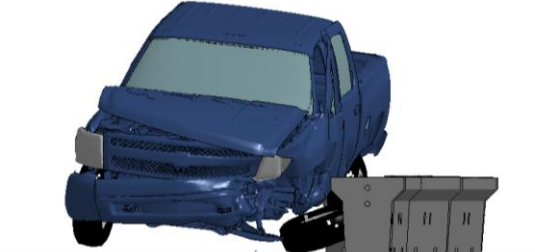
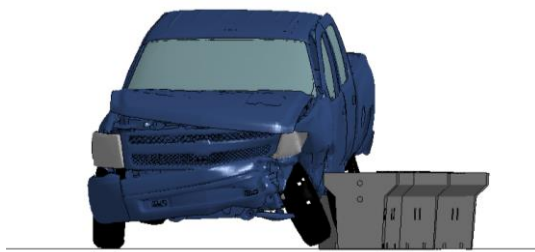
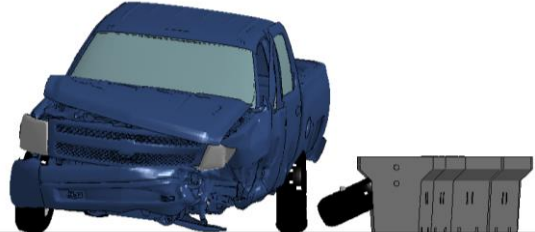
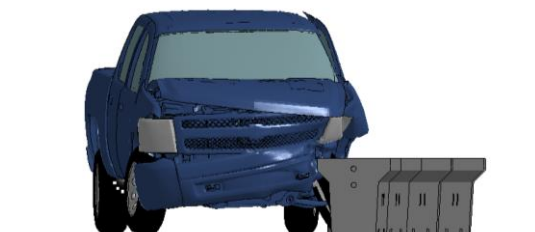
than Case 2. Comparing the sequential images of both simulations, tire disengagement has a tendency to increase the instability of the vehicle.

To summarize, the crashworthiness of the free-standing 26-inch tall low-profile PCB was evaluated through finite element computer simulations according to *MASH* test 3-11. Two different cases were considered. The vehicle in Case 1 with impact tire disengagement was less stable. Simulation results indicate that the 26-inch tall low-profile PCB maintained occupant risks well below the limiting values recommended in *MASH*.

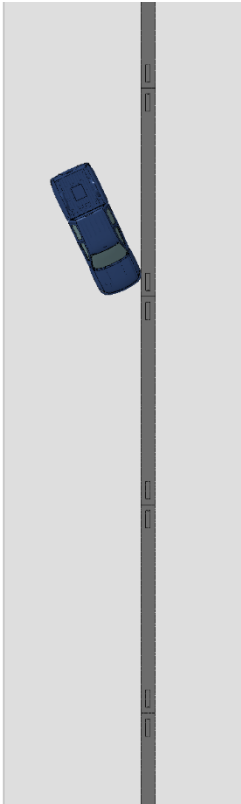
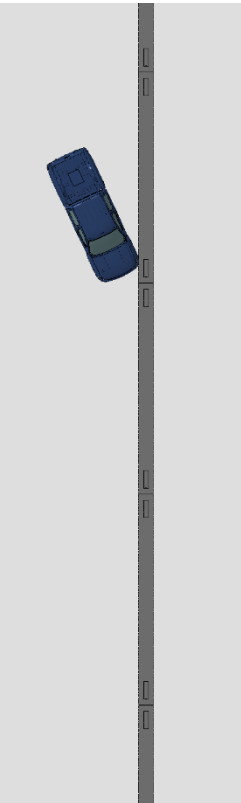


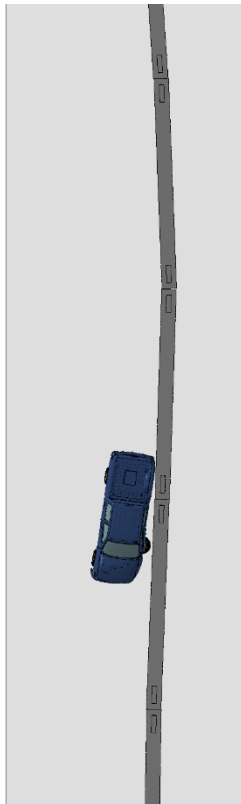
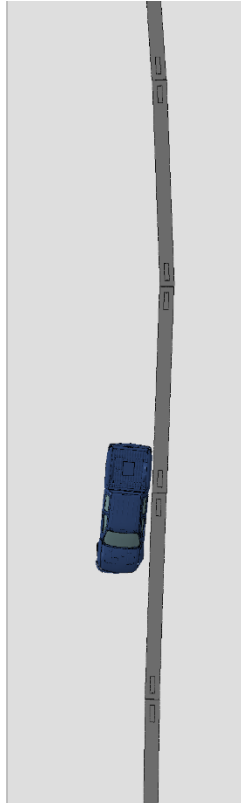
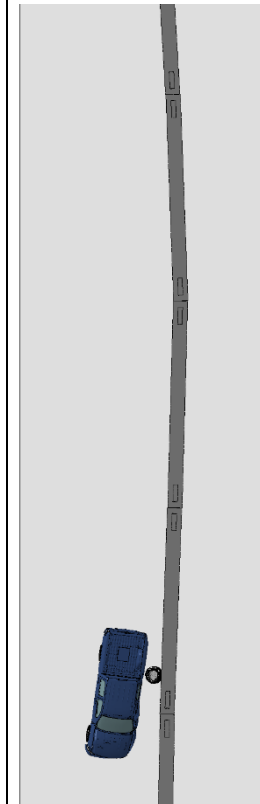
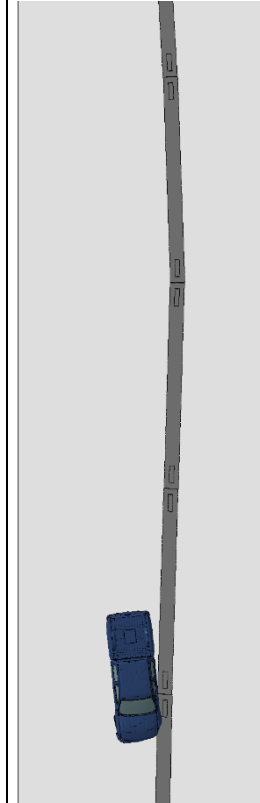
**Table 2.6. Comparison between Case 1 and Case 2.**

Occupant risk factors and maximum angular displacement		Case 1 With impact tire disengagement	Case 2 Without impact tire disengagement
Impact velocity (ft/s)	x-direction	22.0	22.3
	y-direction	-19.0	-17.4
Ridedown acceleration (g)	x-direction	-5.0	-6.0
	y-direction	6.0	7.6
Maximum angular displacement (degree)	Roll	-19.2	-13.5
	Pitch	-8.8	-6.3
	Yaw	35.9	32.7

**Table 2.7. Sequential Images of Case 1 and Case 2 (Perpendicular View).**

Time (sec)	Case 1 With impact tire disengagement	Case 2 Without impact tire disengagement
0.0		
0.3		
0.6		
1.0		

**Table 2.8. Sequential images of Case 1 and Case 2 (Aerial View).**

Time (sec)	Case 1 With impact tire disengagement	Case 2 Without impact tire disengagement
0.0		
0.3		
0.6		
1.0		

## 2.7 CONCLUSIONS – DETAILED MODEL SIMULATIONS

Based on the detailed computer model simulations results, researchers decided to perform a *MASH* full-scale crash test on a low-profile PCB system comprised of 26-inch tall and 30-ft long barrier segments with a T-shape profile. Based on constructability feedback, researchers included a 1:18 slope on the stem of the T-shaped barrier to accommodate construction forming.

Since concrete failure was not incorporated in the FE model, the model did not have the ability to predict fracture or spalling of concrete, which can happen during the full-scale crash test. If during the full-scale crash event significant concrete fracture and spalling occur at the ends of one or more barrier segments, barrier deflection could be higher than predicted in the FE simulation. A higher barrier deflection could also increase vehicle instability.

## **CHAPTER 3: TL-3 LOW-PROFILE BARRIER DETAILS**

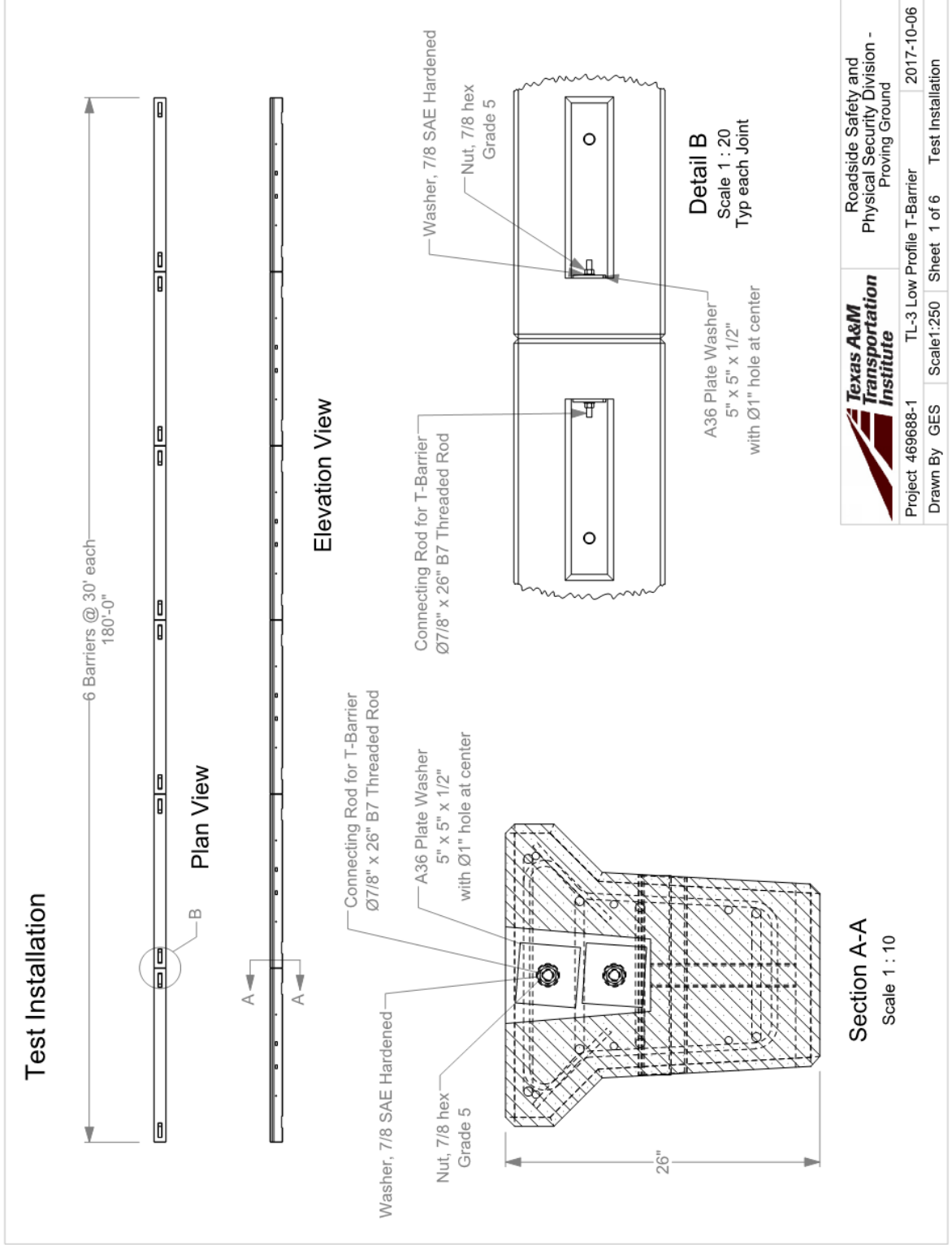
### **3.1 TEST ARTICLE AND INSTALLATION DETAILS**

The test installation consisted of six free-standing reinforced T-shaped concrete barriers, each 30 ft long, for a total length of 180 ft. Adjacent barriers were connected with two 26-inch long,  $\frac{7}{8}$ -inch diameter B7 threaded rods, along with plate washers, SAE hardened washers, and Grade 5 hex nuts. The barriers were 15 inches wide at bottom, 25 inches wide at top, and 26 inches tall.

Figure 3.1 presents overall information of the TL-3 Low-Profile Barrier, and Figure 3.2 provides photographs of the installation. Appendix A provides further details of the TL-3 Low-Profile Barrier.

### **3.2 MATERIAL SPECIFICATIONS**

Appendix B provides material certification documents for the materials used to install/construct the TL-3 Low-Profile Barrier.



T:\1-ProjectFiles\469688-TXDOT-1 Low Profile - Chiara\469688-1\Drafting, 469688-1-1469688-1 Drawing

	Roadside Safety and Physical Security Division - Proving Ground	2017-10-06
	Project 469688-1	TL-3 Low Profile T-Barrier
Drawn By	GES	Scale 1:250
Sheet	1 of 6	Test Installation

**Figure 3.1. Overall Details of the TL-3 Low-Profile Barrier.**



**Figure 3.2. TL-3 Low-Profile Barrier prior to Testing.**





## CHAPTER 4: TEST REQUIREMENTS AND EVALUATION CRITERIA

### 4.1 CRASH TEST MATRIX

Table 4.1 shows the test conditions and evaluation criteria for *MASH* TL-3 longitudinal barriers. *MASH* Test 3-10 involves an 1100C vehicle weighing 2420 lb  $\pm$ 55 lb impacting the critical impact point (CIP) of the barrier at a speed of 62.2 mi/h  $\pm$ 2.5 mi/h and an angle of 25°  $\pm$ 1.5°. *MASH* Test 3-11 involves a 2270P vehicle weighing 5000 lb  $\pm$ 110 lb impacting the CIP of the barrier at a speed of 62.2 mi/h  $\pm$ 2.5 mi/h and an angle of 25°  $\pm$ 1.5°. The target CIPs selected for the test were determined according to the information provided in *MASH* Section 2.3.2 and Figure 2.7. For *MASH* Test 3-10, CIP was 3.6 ft  $\pm$ 1 ft upstream of the joint between segments 2 and 3, and for *MASH* Test 3-11, CIP was 4.3 ft  $\pm$ 1 ft upstream of the joint between segments 2 and 3.

**Table 4.1. Test Conditions and Evaluation Criteria Specified for *MASH* TL-3 Longitudinal Barriers.**

Test Article	Test Designation	Test Vehicle	Impact Conditions		Evaluation Criteria
			Speed	Angle	
Longitudinal Barrier	3-10	1100C	62 mi/h	25	A, D, F, H, I
	3-11	2270P	62 mi/h	25	A, D, F, H, I

The crash tests and data analysis procedures were in accordance with guidelines presented in *MASH*. Chapter 4 presents brief descriptions of these procedures.

### 4.2 EVALUATION CRITERIA

The appropriate safety evaluation criteria from Tables 2-2A and 5-1A-B of *MASH* were used to evaluate the crash tests reported herein. The test conditions and evaluation criteria required for *MASH* TL-3 longitudinal barriers are listed in Table 4.1, and the substance of the evaluation criteria in Table 4.2. An evaluation of each of the crash test's results are presented in detail under the section Assessment of Test Results.

**Table 4.2. Evaluation Criteria Required for MASH TL-3 Longitudinal Barriers.**

<b>Evaluation Factors</b>	<b>Evaluation Criteria</b>
<b>Structural Adequacy</b>	<p>A. <i>Test article should contain and redirect the vehicle or bring the vehicle to a controlled stop; the vehicle should not penetrate, underride, or override the installation although controlled lateral deflection of the test article is acceptable.</i></p>
<b>Occupant Risk</b>	<p>D. <i>Detached elements, fragments, or other debris from the test article should not penetrate or show potential for penetrating the occupant compartment, or present undue hazard to other traffic, pedestrians, or personnel in a work zone.</i></p> <p><i>Deformations of, or intrusions into, the occupant compartment should not exceed limits set forth in Section 5.2.2 and Appendix E of MASH.</i></p>
	<p>F. <i>The vehicle should remain upright during and after collision. The maximum roll and pitch angles are not to exceed 75 degrees.</i></p>
	<p>H. <i>Occupant impact velocities (OIV) should satisfy the following limits: Preferred value of 30 ft/s, or maximum allowable value of 40 ft/s.</i></p>
	<p>I. <i>The occupant ridedown accelerations should satisfy the following limits: Preferred value of 15.0 g, or maximum allowable value of 20.49 g.</i></p>

## **CHAPTER 5: TEST CONDITIONS**

### **5.1 TEST FACILITY**

The full-scale crash tests reported herein were performed at TTI Proving Ground, an International Standards Organization 17025-accredited laboratory with American Association for Laboratory Accreditation Mechanical Testing Certificate 2821.01. The full-scale crash tests were performed according to TTI Proving Ground quality procedures, and according to the *MASH* guidelines and standards.

The test facilities of the TTI Proving Ground are located on the Texas A&M University RELLIS Campus, which consists of a 2000-acre complex of research and training facilities situated 10 miles northwest of the flagship campus of Texas A&M University. The site, formerly a United States Army Air Corps base, has large expanses of concrete runways and parking aprons well suited for experimental research and testing in the areas of vehicle performance and handling, vehicle-roadway interaction, durability and efficacy of highway pavements, and evaluation of roadside safety hardware and perimeter protective devices. The site selected for construction and testing of the barrier was along the surface of an out-of-service apron. The apron consists of an unreinforced jointed-concrete pavement in 12.5-ft × 15-ft blocks nominally 6 inches deep. The aprons were built in 1942, and the joints have some displacement, but are otherwise flat and level.

### **5.2 VEHICLE TOW AND GUIDANCE SYSTEM**

Each test vehicle was towed into the test installation using a steel cable guidance and reverse tow system. A steel cable for guiding the test vehicle was tensioned along the path, anchored at each end, and threaded through an attachment to the front wheel of the test vehicle. An additional steel cable was connected to the test vehicle, passed around a pulley near the impact point, through a pulley on the tow vehicle, and then anchored to the ground such that the tow vehicle moved away from the test site. A 2:1 speed ratio between the test and tow vehicle existed with this system. Just prior to impact with the installation, the test vehicle was released and ran unrestrained. Each vehicle remained freewheeling (i.e., no steering or braking inputs) until it cleared the immediate area of the test site (no sooner than 2 s after impact), after which the brakes were activated, if needed, to bring the test vehicle to a safe and controlled stop.

### **5.3 DATA ACQUISITION SYSTEMS**

#### **5.3.1 Vehicle Instrumentation and Data Processing**

Each test vehicle was instrumented with a self-contained, on-board data acquisition system. The signal conditioning and acquisition system is a 16-channel, Tiny Data Acquisition System (TDAS) Pro produced by Diversified Technical Systems, Inc. The accelerometers, which measure the x, y, and z axis of vehicle acceleration, are strain gauge type with linear millivolt output proportional to acceleration. Angular rate sensors, measuring vehicle roll, pitch, and yaw rates, are ultra-small, solid state units designed for crash test service. The TDAS Pro hardware

and software conform to the latest SAE J211, Instrumentation for Impact Test. Each of the 16 channels is capable of providing precision amplification, scaling, and filtering based on transducer specifications and calibrations. During the test, data are recorded from each channel at a rate of 10,000 values per second with a resolution of one part in 65,536. Once data are recorded, internal batteries back these up inside the unit should the primary battery cable be severed. Initial contact of the pressure switch on the vehicle bumper provides a time zero mark and initiates the recording process. After each test, the data are downloaded from the TDAS Pro unit into a laptop computer at the test site. The TRAP software then processes the raw data to produce detailed reports of the test results.

Each of the TDAS Pro units is returned to the factory annually for complete recalibration and all instrumentation used in the vehicle conforms to all specifications outlined by SAE J211. All accelerometers are calibrated annually by means of an ENDEVCO® 2901, precision primary vibration standard. This standard and its support instruments are checked annually and receive a National Institute of Standards Technology (NIST) traceable calibration. The rate transducers used in the data acquisition system receive a calibration via a Genisco Rate-of-Turn table. The subsystems of each data channel are also evaluated annually, using instruments with current NIST traceability, and the results are factored into the accuracy of the total data channel, per SAE J211. Calibrations and evaluations are also made any time data are suspect. Acceleration data are measured with an expanded uncertainty of  $\pm 1.7$  percent at a confidence factor of 95 percent ( $k=2$ ).

TRAP uses the data from the TDAS Pro to compute occupant/compartiment impact velocities, time of occupant/compartiment impact after vehicle impact, and the highest 10-millisecond (ms) average ridedown acceleration. TRAP calculates change in vehicle velocity at the end of a given impulse period. In addition, maximum average accelerations over 50-ms intervals in each of the three directions are computed. For reporting purposes, the data from the vehicle-mounted accelerometers are filtered with a 60-Hz low-pass digital filter, and acceleration versus time curves for the longitudinal, lateral, and vertical directions are plotted using TRAP.

TRAP uses the data from the yaw, pitch, and roll rate transducers to compute angular displacement in degrees at 0.0001-s intervals, then plots yaw, pitch, and roll versus time. These displacements are in reference to the vehicle-fixed coordinate system with the initial position and orientation of the vehicle-fixed coordinate systems being initial impact. Rate of rotation data is measured with an expanded uncertainty of  $\pm 0.7$  percent at a confidence factor of 95 percent ( $k=2$ ).

### **5.3.2 Anthropomorphic Dummy Instrumentation**

An Alderson Research Laboratories Hybrid II, 50th percentile male anthropomorphic dummy, restrained with lap and shoulder belts, was placed in the front seat on the impact side of the 1100C vehicle. The dummy was not instrumented.

According to *MASH*, use of a dummy in the 2270P vehicle is optional, and no dummy was used in the test.

### 5.3.3 Photographic Instrumentation and Data Processing

Photographic coverage of each test included three high-speed cameras:

- One overhead with a field of view perpendicular to the ground and directly over the impact point.
- One placed behind the installation at an angle.
- A third placed to have a field of view parallel to and aligned with the installation at the downstream end.

A flashbulb on each of the impacting vehicles was activated by a pressure-sensitive tape switch to indicate the instant of contact with the barrier. The flashbulb was visible from each camera. The video files from these digital high-speed cameras were analyzed to observe phenomena occurring during the collision and to obtain time-event, displacement, and angular data. A digital camera recorded and documented conditions of each test vehicle and the installation before and after the test.



## **CHAPTER 6: MASH TEST 3-10 (CRASH TEST NO. 469688-1-1)**

### **6.1 TEST DESIGNATION AND ACTUAL IMPACT CONDITIONS**

*MASH* Test 3-10 involves an 1100C vehicle weighing 2420 lb  $\pm$ 55 lb impacting the CIP of the barrier at a speed of 62 mi/h  $\pm$ 2.5 mi/h and an angle of 25°  $\pm$ 1.5°. The target CIP for *MASH* Test 3-10 on the TL-3 low-profile barrier was 3.6 ft  $\pm$ 1 ft upstream of the joint between segments 2 and 3.

The 2011 Kia Rio\* used in the test weighed 2588 lb, and the actual impact speed and angle were 63.4 mi/h and 24.9°, respectively. The actual impact point was 3.6 ft upstream of the joint between segments 2 and 3. Minimum target impact severity was 51 kip-ft, and actual IS was 62 kip-ft.

### **6.2 WEATHER CONDITIONS**

*MASH* Test 3-10 on the TL-3 low-profile barrier was performed on the morning of April 18, 2018. Weather conditions at the time of testing were as follows: wind speed: 6 mi/h; wind direction: 240° (vehicle was traveling in a northerly direction); temperature: 72°F; relative humidity: 83 percent.

### **6.3 TEST VEHICLE**

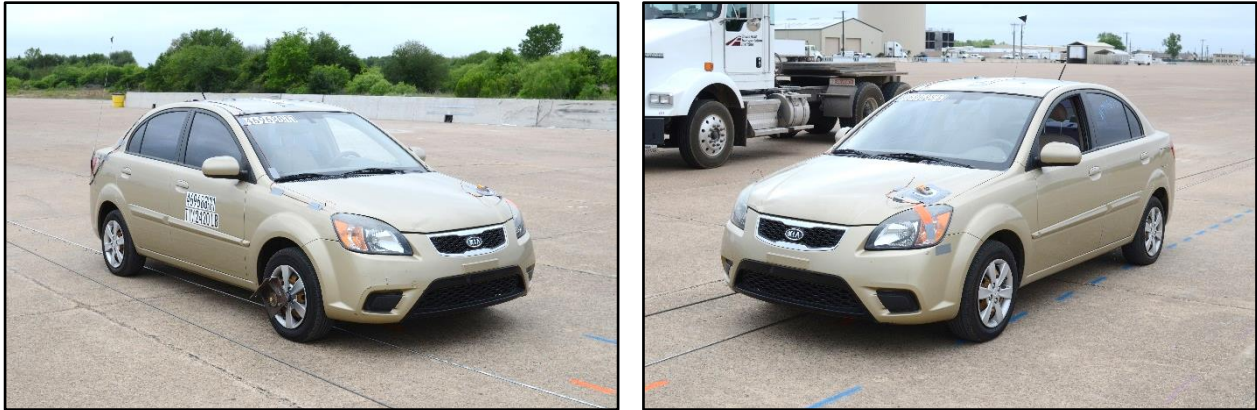
Figures 6.1 and 6.2 show the 2011 Kia Rio used for the crash test. The vehicle's test inertia weight was 2423 lb, and its gross static weight was 2588 lb. The height to the lower edge of the vehicle bumper was 7.75 inches, and height to the upper edge of the bumper was 21.5 inches. Tables C.1 and C.2 in Appendix C1 give additional dimensions and information on the vehicle. The vehicle was directed into the installation using a cable reverse tow and guidance system, and was released to be freewheeling and unrestrained just prior to impact.



**Figure 6.1. TL-3 Low-Profile Barrier/Test Vehicle Geometrics for Test No. 469688-1-1.**

---

\* An older model vehicle was used, based upon availability. An older model vehicle is permitted by AASHTO as long as it is otherwise *MASH* compliant. This vehicle meets the *MASH* dimensional specifications.



**Figure 6.2. Test Vehicle before Test No. 469688-1-1.**

#### 6.4 TEST DESCRIPTION

The test vehicle was traveling at an impact speed of 63.4 mi/h as it contacted the TL-3 low-profile barrier 3.6 ft upstream of the joint between segments 2 and 3, at an impact angle of 24.9°. Table 6.1 lists events that occurred during Test No. 469688-1-1. Figures C.1 and C.2 in Appendix C2 present sequential photographs during the test.

**Table 6.1. Events during Test No. 469688-1-1.**

<b>TIME (s)</b>	<b>EVENT</b>
0.000	Vehicle makes contact with barrier
0.028	Left front tire turned right by barrier impact
0.037	Vehicle begins to redirect
0.069	Right rear tire comes off the ground
0.204	Vehicle becomes parallel with barrier
0.245	Rear quarter panel of vehicle impacts barrier #3
0.340	Vehicle loses contact with barrier while traveling at 46.0 mi/h and 5.7°
0.436	Right rear tire makes contact with ground
1.410	Left front fender of vehicle makes contact with barrier again

For longitudinal barriers, it is desirable that the vehicle redirects and exits the barrier within the exit box criteria (not less than 32.8 ft downstream from loss of contact for cars and pickups). The 1100C vehicle exited within the exit box criteria defined in *MASH*. After loss of contact with the barrier, the vehicle yawed counterclockwise and came to rest 149 ft downstream of the impact and 2 inches toward traffic lanes.

#### 6.5 DAMAGE TO TEST INSTALLATION

Figure 6.3 shows the damage to the barrier. The upstream end of segment 1 was displaced 4.0 inches toward the traffic side, joint 1-2 was displaced 3.0 inches toward the field side, joint 2-3 was displaced 13.0 inches toward the field side, joint 3-4 was displaced 1.0 inch toward the field side, and the downstream end of segment 4 showed no movement. Working



width was 38.5 inches, and the height of maximum working width was 26.0 inches. Maximum dynamic deflection during the test was 13.2 inches, and maximum permanent deformation was 13.0 inches.



**Figure 6.3. TL-3 Low-Profile Barrier after Test No. 469688-1-1.**

## **6.6 DAMAGE TO TEST VEHICLE**

Figure 6.4 shows the damage sustained by the vehicle. The front bumper, left front fender, radiator and support, left front tire and wheel rim, left front strut and tower, left front and

rear doors, left rear rim, and rear bumper were damaged. The windshield sustained stress cracks in the left lower corner. Maximum exterior crush to the vehicle was 12.0 inches in the side plane at the left front corner at bumper height. Maximum occupant compartment deformation was 1.0 inch in the left kick panel area. Figure 6.5 shows the interior of the vehicle. Tables C.2 and C.3 in Appendix C1 provide exterior crush and occupant compartment measurements.



**Figure 6.4. Test Vehicle after Test No. 469688-1-1.**



**Figure 6.5. Interior of Test Vehicle after Test No. 469688-1-1.**

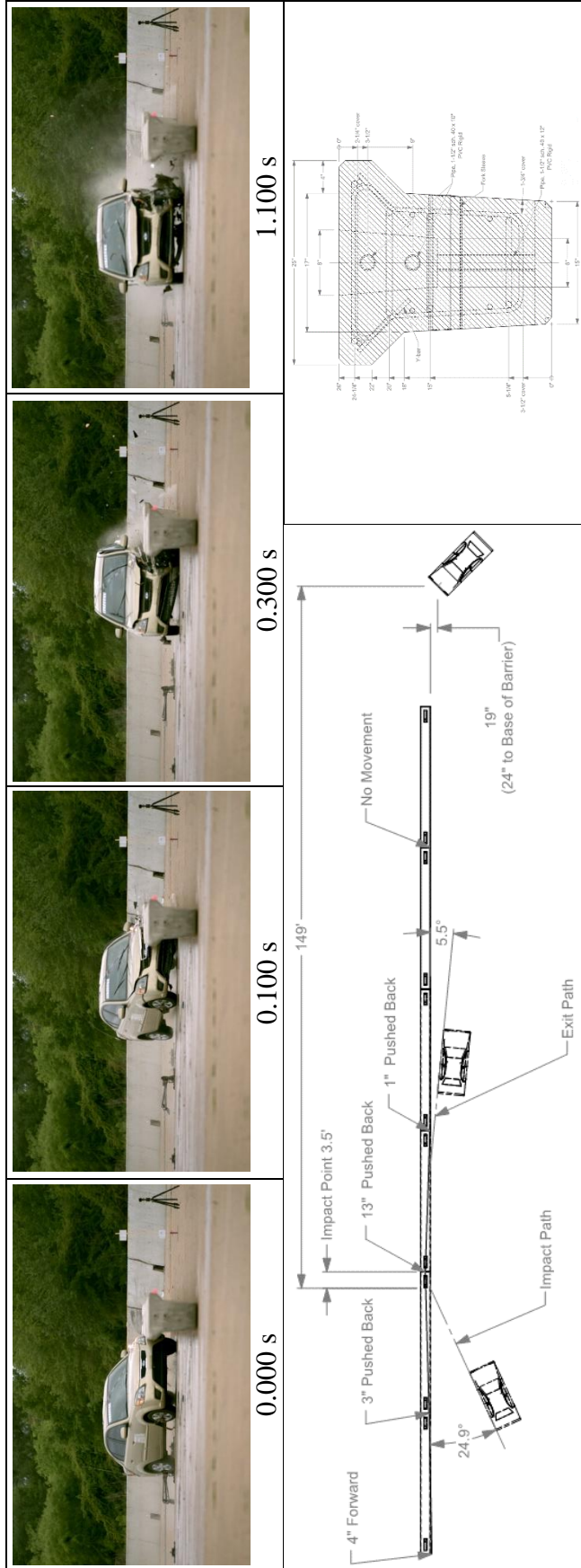
## **6.7 OCCUPANT RISK FACTORS**

Data from the accelerometer, located at the vehicle center of gravity, were digitized for evaluation of occupant risk and are shown in Table 6.2. Figure 6.6 summarizes these data and other pertinent information from the test. Figure C.3 in Appendix C3 shows the vehicle angular displacements, and Figures C.4 through C.9 in Appendix C4 show accelerations versus time traces.

**Table 6.2. Occupant Risk Factors for Test No. 469688-1-1.**

<b>Occupant Risk Factor</b>	<b>Value</b>	<b>Time</b>
<b>Impact Velocity</b> Longitudinal Lateral	<b>23.0 ft/s</b> <b>24.9 ft/s</b>	at 0.0829 s on left side of interior
<b>Ridedown Accelerations</b> Longitudinal Lateral	<b>4.7 g</b> <b>7.0 g</b>	1.4847–1.4947 s 0.22990.2399 s
<b>THIV</b>	<b>36.7 km/h</b> <b>10.2 m/s</b>	at 0.0804 s on left side of interior
<b>PHD</b>	<b>7.1 g</b>	0.2300–0.2400 s
<b>ASI</b>	<b>2.17</b>	0.0442–0.0942 s
<b>Maximum 50-ms Moving Average</b> Longitudinal Lateral Vertical	<b>-13.2 g</b> <b>14.8 g</b> <b>2.1 g</b>	0.0170–0.0670 s 0.0181–0.0681 s 0.0000–0.0500 s
<b>Maximum Roll, Pitch, and Yaw Angles</b> Roll Pitch Yaw	<b>4°</b> <b>7°</b> <b>31°</b>	0.0522 s 0.6417 s 0.4507 s





<b>General Information</b>		Texas A&M Transportation Institute (TTI)
Test Agency.....	MASH Test 3-10	
Test Standard Test No.....	469688-1-1	
TTI Test No.....	2018-04-18	
Test Date.....		
<b>Test Article</b>		
Type.....	Portable Concrete Barrier	
Name.....	TL-3 Low-Profile Barrier	
Installation Length.....	180 ft	
Material or Key Elements...	T-shaped concrete barrier 15 inches wide at base, 25 inches wide at top, 26 inches tall	
<b>Soil Type and Condition</b>		Placed on concrete surface, damp
<b>Test Vehicle</b>		
Type/Designation.....	1100C	
Make and Model.....	2011 Kia Rio	
Curb.....	2443 lb	
Test Inertial.....	2423 lb	
Dummy.....	165 lb	
Gross Static.....	2588 lb	
<b>Impact Conditions</b>		
Speed.....	63.4 mi/h	
Angle.....	24.9°	
Location/Orientation.....	3.6 ft upstream of joint 2&3	
<b>Exit Conditions</b>		
Speed.....	62 kip-ft	
Angle.....	46.0 mi/h	
<b>Occupant Risk Values</b>		
Longitudinal OIV.....	23.0 ft/s	
Lateral OIV.....	24.9 ft/s	
Longitudinal Ridedown.....	4.7 g	
Lateral Ridedown.....	7.0 g	
THIV.....	36.7 km/h	
PHD.....	7.1 g	
ASI.....	2.17 g	
Max. 0.050-s Average		
Longitudinal.....	-13.2 g	
Lateral.....	14.8 g	
Vertical.....	2.1 g	
<b>Impact Conditions</b>		
Speed.....	63.4 mi/h	
Angle.....	24.9°	
Location/Orientation.....	3.6 ft upstream of joint 2&3	
<b>Exit Conditions</b>		
Speed.....	62 kip-ft	
Angle.....	46.0 mi/h	
<b>Occupant Risk Values</b>		
Longitudinal OIV.....	23.0 ft/s	
Lateral OIV.....	24.9 ft/s	
Longitudinal Ridedown.....	4.7 g	
Lateral Ridedown.....	7.0 g	
THIV.....	36.7 km/h	
PHD.....	7.1 g	
ASI.....	2.17 g	
Max. 0.050-s Average		
Longitudinal.....	-13.2 g	
Lateral.....	14.8 g	
Vertical.....	2.1 g	
<b>Post-Impact Trajectory</b>		
Stopping Distance.....	149 ft downstream	
	2 ft toward traffic	
<b>Vehicle Stability</b>		
Maximum Roll Angle.....	4°	
Maximum Pitch Angle.....	7°	
Maximum Yaw Angle.....	31°	
Vehicle Snagging.....	No	
Vehicle Pocketing.....	No	
<b>Test Article Deflections</b>		
Dynamic.....	13.2 inches	
Permanent.....	13.0 inches	
Working Width.....	38.5 inches	
Height of Working Width.....	26.0 inches	
<b>Vehicle Damage</b>		
VDS.....	10-LFQ-5	
CDC.....	10FLEW3	
Max. Extorior Deformation.....	12 inches	
OCDI.....	LF0000000	
Max. Occupant Compartment Deformation.....	1.0 inches	

Figure 6.1. Summary of Results for MASH Test 3-10 on the TL-3 Low-Profile Barrier.

## **CHAPTER 7: MASH TEST 3-11 (CRASH TEST NO. 469688-1-2)**

### **7.1 TEST DESIGNATION AND ACTUAL IMPACT CONDITIONS**

*MASH* Test 3-11 involves a 2270P vehicle weighing 5000 lb  $\pm$ 110 lb impacting the CIP of the barrier at a speed of 62 mi/h  $\pm$ 2.5 mi/h and an angle of 25°  $\pm$ 1.5°. The target CIP for *MASH* Test 3-11 on the barrier was 4.3 ft  $\pm$ 1 ft upstream of the joint between segments 2 and 3.

The 2013 Dodge RAM 1500 pickup truck used in the test weighed 5012 lb, and the actual impact speed and angle were 62.4 mi/h and 24.5°, respectively. The actual impact point was 4.3 ft upstream of the joint between segments 2 and 3. Minimum target impact severity was 106 kip-ft, and actual IS was 112 kip-ft.

### **7.2 WEATHER CONDITIONS**

*MASH* Test 3-11 on the barrier was performed on the morning of April 16, 2018. Weather conditions at the time of testing were as follows: wind speed: 9 mi/h; wind direction: 190° (vehicle was traveling in a northerly direction); temperature: 71°F; relative humidity: 45 percent.

### **7.3 TEST VEHICLE**

Figures 7.1 and 7.2 show the 2013 Dodge RAM 1500 pickup truck used for the crash test. The vehicle's test inertia weight was 5012 lb, and its gross static weight was 5012 lb. The height to the lower edge of the vehicle bumper was 11.75 inches, and height to the upper edge of the bumper was 27.0 inches. The height to the vehicle's center of gravity was 29.0 inches. Tables D.1 and D.2 in Appendix D.1 give additional dimensions and information on the vehicle. The vehicle was directed into the installation using the cable reverse tow and guidance system, and was released to be freewheeling and unrestrained just prior to impact.



**Figure 7.1. TL-3 Low-Profile Barrier/Test Vehicle Geometrics for Test No. 469688-1-2.**



**Figure 7.2. Test Vehicle before Test No. 469688-1-2.**

#### **7.4 TEST DESCRIPTION**

The test vehicle was traveling at an impact speed of 62.4 mi/h as it contacted the TL-3 low-profile barrier 4.3 ft upstream of the joint between segments 2 and 3 at an impact angle of 24.5°. Table 7.1 lists events that occurred during Test No. 469688-1-2. Figures D.1 and D.2 in Appendix D.2 present sequential photographs during the test.

**Table 7.1. Events during Test No. 469688-1-2.**

<b>TIME (s)</b>	<b>EVENT</b>
0.000	Vehicle makes contact with barrier
0.070	Right front tire lifts off ground
0.072	Vehicle begins to redirect
0.089	Front left tire blows out
0.113	Right rear tire lifts off ground (body pitched and rolled)
0.281	Rear quarter panel of vehicle impacts barrier #3
0.245	Vehicle becomes parallel with barrier
0.493	Vehicle loses contact with barrier while traveling at 43.1 mi/h and 3.7°
1.018	Front left tire makes contact with ground
1.410	Left front fender of vehicle makes contact with barrier again

For longitudinal barriers, it is desirable that the vehicle redirects and exits the barrier within the exit box criteria (not less than 32.8 ft downstream from the loss of contact for cars and pickups). The 2270P vehicle exited within the exit box criteria defined in *MASH*. After loss of contact with the barrier, the vehicle yawed counterclockwise and came to rest 431 ft downstream of the impact and 81 ft toward the field side.

#### **7.5 DAMAGE TO TEST INSTALLATION**

Figure 7.3 shows the damage to the TL-3 low-profile barrier. The upstream end of segment 1 was displaced 8.5 inches toward the traffic side, and the downstream end was displaced 13.0 inches toward the field side. Joint 2-3 was displaced 25.0 inches toward the field



side, and joint 3-4 was displaced 12.0 inches toward the field side. No lateral movement was noted at the downstream end of segment 4. Working width was 50.6 inches, and the height of maximum working width was 26.0 inches. Maximum dynamic deflection during the test was 25.0 inches, and maximum permanent deformation was 25.0 inches.



**Figure 7.3. TL-3 Low-Profile Barrier after Test No. 469688-1-2.**



**Figure 7.4. Damage at Joint 2-3 after Test No. 469688-1-2.**

## **7.6 DAMAGE TO TEST VEHICLE**

Figure 7.4 shows the damage sustained by the vehicle. The front bumper, left frame rail, hood, grill, radiator and support, left front fender, left front tire and rim, left front upper and lower A-arms, left front upper and lower ball joints, front sway bar, tie rod ends, left front and rear doors, left rear cab corner, left rear exterior bed, left rear rim, and bumper were damaged. The windshield sustained a stress crack in the left lower corner radiating upward. Maximum exterior crush to the vehicle was 10.0 inches in the horizontal plane at the front bumper at bumper height. Maximum occupant compartment deformation was 2.0 inches in the driver side floor from the firewall to the driver seat. Figure 7.5 shows the interior of the vehicle. Tables D.3 and D.4 in Appendix D.1 provide exterior crush and occupant compartment measurements.





**Figure 7.5. Test Vehicle after Test No. 469688-1-2.**



Before Test

After Test

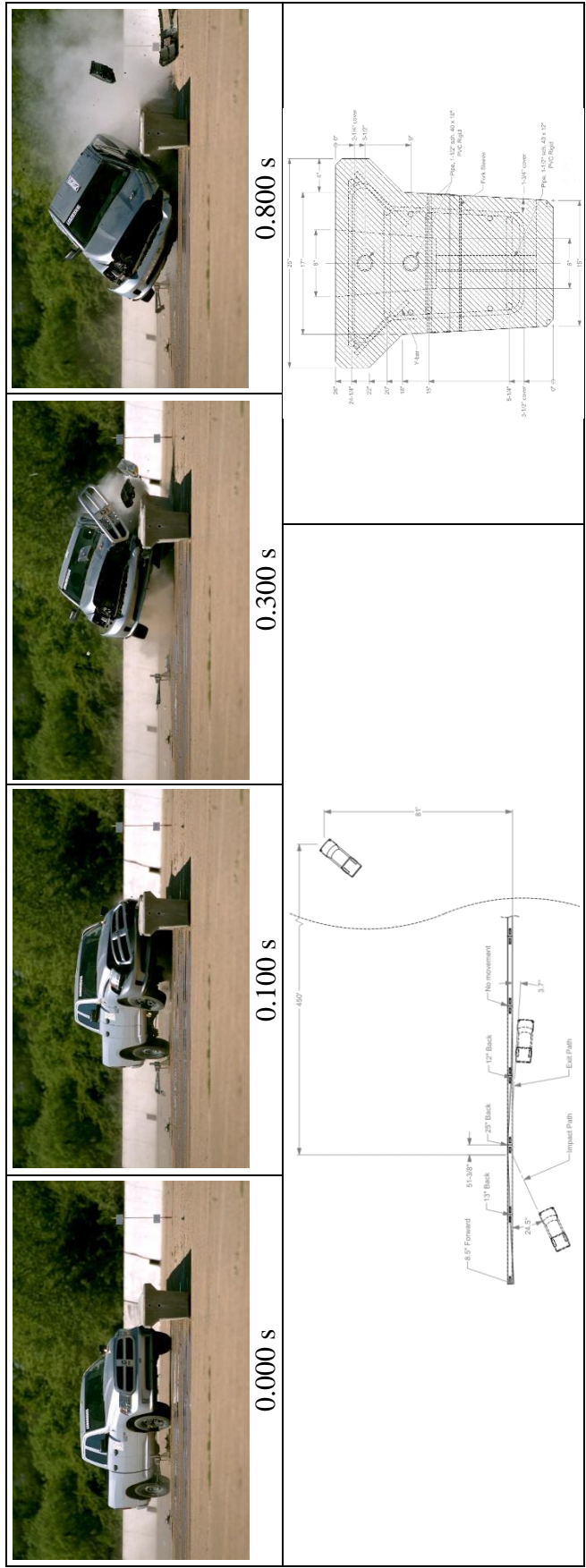
**Figure 7.6. Interior of Test Vehicle for Test No. 469688-1-2.**

## **7.7 OCCUPANT RISK FACTORS**

Data from the accelerometer, located at the vehicle center of gravity, were digitized for evaluation of occupant risk and are shown in Table 7.2. Figure 7.6 summarizes these data and other pertinent information from the test. Figure D.3 in Appendix D.3 shows the vehicle angular displacements, and Figures D.4 through D.9 in Appendix D.4 show accelerations versus time traces.

**Table 7.2. Occupant Risk Factors for Test No. 469688-1-2.**

<b>Occupant Risk Factor</b>	<b>Value</b>	<b>Time</b>
<b>Impact Velocity</b> Longitudinal Lateral	<b>19.4 ft/s</b> <b>20.7 ft/s</b>	at 0.1108 s on left side of interior
<b>Ridedown Accelerations</b> Longitudinal Lateral	<b>3.3 g</b> <b>6.5 g</b>	0.5916–0.6016 s 0.2787–0.2887 s
<b>THIV</b>	<b>32.5 km/h</b> <b>9.0 m/s</b>	at 0.1071 s on left side of interior
<b>PHD</b>	<b>6.9 g</b>	0.2786–0.2886 s
<b>ASI</b>	<b>1.55</b>	0.0582–0.1082 s
<b>Maximum 50-ms Moving Average</b> Longitudinal Lateral Vertical	<b>-9.4 g</b> <b>11.2 g</b> <b>-3.2 g</b>	0.0378–0.0878 s 0.0391–0.0891 s 0.0239–0.0739 s
<b>Maximum Roll, Pitch, and Yaw Angles</b> Roll Pitch Yaw	<b>40°</b> <b>10°</b> <b>36°</b>	0.6342 s 0.6911 s 0.7576 s



<b>General Information</b>		<b>Impact Conditions</b>		<b>Post-Impact Trajectory</b>	
Test Agency .....	Texas A&M Transportation Institute (TTI)	Speed .....	62.4 mi/h	Stopping Distance .....	431 ft downstream
Test Standard Test No. ....	MASH Test 3-11	Angle .....	24.5°		81 ft twd field side
TTI Test No. ....	469688-1-2	Location/Orientation .....	4.3 ft upstream of joint 2&3	<b>Vehicle Stability</b>	
Test Date .....	2018-04-16	<b>Exit Conditions</b>		Maximum Roll Angle .....	40°
<b>Test Article</b>		Speed .....	111.6 kip-ft	Maximum Pitch Angle .....	10°
Type .....	Portable Concrete Barrier	Angle .....	3.7°	Vehicle Snagging .....	No
Name .....	TL-3 Low-Profile Barrier	<b>Occupant Risk Values</b>		Vehicle Pocketing .....	No
Installation Length .....	180 ft	Longitudinal OIV .....	19.4 ft/s	<b>Test Article Deflections</b>	
Material or Key Elements ...	T-shaped concrete barrier 15 inches wide at base, 25 inches wide at top, 26 inches tall	Lateral OIV .....	20.7 ft/s	Dynamic .....	25.0 inches
<b>Soil Type and Condition</b> .....		Longitudinal Ridedown .....	3.3 g	Permanent .....	25.0 inches
	Placed on concrete surface, damp	Lateral Ridedown .....	6.5 g	Working Width .....	50.6 inches
<b>Test Vehicle</b>		THIV .....	32.5 km/h	Height of Working Width .....	26.0 inches
Type/Designation .....	2270P	PHD .....	6.9 g	<b>Vehicle Damage</b>	
Make and Model .....	2013 Dodge RAM Pickup	ASI .....	1.55	VDS .....	10-LFQ-5
Curb .....	5058 lb	Max. 0.050-s Average .....		CDC .....	10FLEW4
Test Inertial .....	5012 lb	Longitudinal .....	-9.4 g	Max. Extorior Deformation .....	10 inches
Dummy .....	No dummy	Lateral .....	11.2 g	OCDI .....	LF0010000
Gross Static .....	5058 lb	Vertical .....	-3.2 g	Max. Occupant Compartment Deformation .....	2.0 inches

Figure 7.2. Summary of Results for MASH Test 3-11 on the TL-3 Low-Profile Barrier.



## **CHAPTER 8: SUMMARY AND CONCLUSIONS**

### **8.1 SUMMARY OF RESULTS**

An assessment of each test based on the applicable safety evaluation criteria for *MASH* TL-3 longitudinal barrier is provided in Tables 8.1 and 8.2.

### **8.2 CONCLUSIONS**

Table 8.3 shows that the TL-3 Low-Profile Barrier performed acceptably as a *MASH* TL-3 longitudinal barrier.

**Table 8.1. Performance Evaluation Summary for MASH Test 3-10 on TL-3 Low-Profile Barrier.**

Test Agency: Texas A&M Transportation Institute

Test No.: 469688-1-1

Test Date: 2018-04-18

<b>MASH Test 3-10 Evaluation Criteria</b>	<b>Test Results</b>	<b>Assessment</b>
<p><b>Structural Adequacy</b></p> <p><i>A. Test article should contain and redirect the vehicle or bring the vehicle to a controlled stop; the vehicle should not penetrate, underride, or override the installation although controlled lateral deflection of the test article is acceptable.</i></p>	<p>The TL-3 low-profile barrier contained and redirected the 1100C vehicle. The vehicle did not penetrate, underride, or override the installation. Maximum dynamic deflection during the test was 13.2 inches.</p>	<p>Pass</p>
<p><b>Occupant Risk</b></p> <p><i>D. Detached elements, fragments, or other debris from the test article should not penetrate or show potential for penetrating the occupant compartment, or present an undue hazard to other traffic, pedestrians, or personnel in a work zone.</i></p> <p><i>Deformations of, or intrusions into, the occupant compartment should not exceed limits set forth in Section 5.3 and Appendix E of MASH.</i></p>	<p>No detached elements, fragments, or other debris were present to penetrate or show potential for penetrating the occupant compartment, or to present hazard to others in the area.</p> <p>Maximum occupant compartment deformation was 1.0 inches in the left kick panel area.</p>	<p>Pass</p>
<p><i>F. The vehicle should remain upright during and after collision. The maximum roll and pitch angles are not to exceed 75 degrees.</i></p>	<p>The 1100C vehicle remained upright during and after the collision event. Maximum roll and pitch angles were 4° and 7°, respectively.</p>	<p>Pass</p>
<p><i>H. Longitudinal and lateral occupant impact velocities should fall below the preferred value of 30 ft/s, or at least below the maximum allowable value of 40 ft/s.</i></p>	<p>Longitudinal OIV was 23.0 ft/s, and lateral OIV was 24.9 ft/s.</p>	<p>Pass</p>
<p><i>I. Longitudinal and lateral occupant ridedown accelerations should fall below the preferred value of 15.0 g, or at least below the maximum allowable value of 20.49 g.</i></p>	<p>Longitudinal RDA was 4.7 g, and lateral RDA was 7.0 g.</p>	<p>Pass</p>

**Table 8.2. Performance Evaluation Summary for MASH Test 3-11 on the TL-3 Low-Profile Barrier.**

Test Agency: Texas A&M Transportation Institute

Test No.: 469688-1-2

Test Date: 2018-04-16

<b>MASH Test 3-11 Evaluation Criteria</b>	<b>Test Results</b>	<b>Assessment</b>
<p><b>Structural Adequacy</b></p> <p><i>A. Test article should contain and redirect the vehicle or bring the vehicle to a controlled stop; the vehicle should not penetrate, underride, or override the installation although controlled lateral deflection of the test article is acceptable.</i></p>	<p>The TL-3 low-profile barrier contained and redirected the 2270IP vehicle. The vehicle did not penetrate, underride, or override the installation. Maximum dynamic deflection during the test was 25.0 inches.</p>	<p>Pass</p>
<p><b>Occupant Risk</b></p> <p><i>D. Detached elements, fragments, or other debris from the test article should not penetrate or show potential for penetrating the occupant compartment, or present an undue hazard to other traffic, pedestrians, or personnel in a work zone.</i></p> <p><i>F. Deformations of, or intrusions into, the occupant compartment should not exceed limits set forth in Section 5.3 and Appendix E of MASH.</i></p>	<p>No detached elements, fragments, or other debris were present to penetrate or show potential for penetrating the occupant compartment, or to present hazard to others in the area.</p> <p>Maximum occupant compartment deformation was 2.0 inches in the left side firewall area.</p>	<p>Pass</p>
<p><i>F. The vehicle should remain upright during and after collision. The maximum roll and pitch angles are not to exceed 75 degrees.</i></p>	<p>The 2270P vehicle remained upright during and after the collision event. Maximum roll and pitch angles were 40° and 10°, respectively.</p>	<p>Pass</p>
<p><i>H. Longitudinal and lateral occupant impact velocities should fall below the preferred value of 30 ft/s, or at least below the maximum allowable value of 40 ft/s.</i></p> <p><i>I. Longitudinal and lateral occupant ridedown accelerations should fall below the preferred value of 15.0 Gs, or at least below the maximum allowable value of 20.49 Gs.</i></p>	<p>Longitudinal OIV was 19.4 ft/s, and lateral OIV was 20.7 ft/s.</p> <p>Longitudinal RDA was 3.3 g, and lateral RDA was 6.5 g.</p>	<p>Pass</p>

**Table 8.3. Assessment Summary for *MASH* TL-3 Testing on TL-3 Low-Profile Barrier.**

<b>Evaluation Factors</b>	<b>Evaluation Criteria</b>	<b>Crash Test No. 469688-1-1</b>	<b>Crash Test No. 469688-1-2</b>
<b>Structural Adequacy</b>	A	S	S
<b>Occupant Risk</b>	D	S	S
	F	S	S
	H	S	S
	I	S	S
<b><i>MASH</i> Test No.</b>		<b><i>MASH</i> Test 3-10</b>	<b><i>MASH</i> Test 3-11</b>
<b>Pass/Fail</b>		Pass	Pass

Key: S = Satisfactory  
 U = Unsatisfactory



## **CHAPTER 9: IMPLEMENTATION\***

Two tests were performed to evaluate the newly developed TL-3 low profile barrier. They represent the required tests considered necessary to demonstrate *MASH* compliance of the device. The new TL-3 low profile barrier met *MASH* requirements and is considered *MASH* compliant and suitable for implementation at locations where a *MASH* TL-3 low profile barrier is needed and/or desired. Implementation of the 26-inch new TL-3 low profile barrier can be achieved by the Design Division through development of a new standard sheet based on details presented in Appendix A.

---

\* The opinions/interpretations identified/expressed in this section of the report are outside the scope of TTI Proving Ground's A2LA Accreditation.



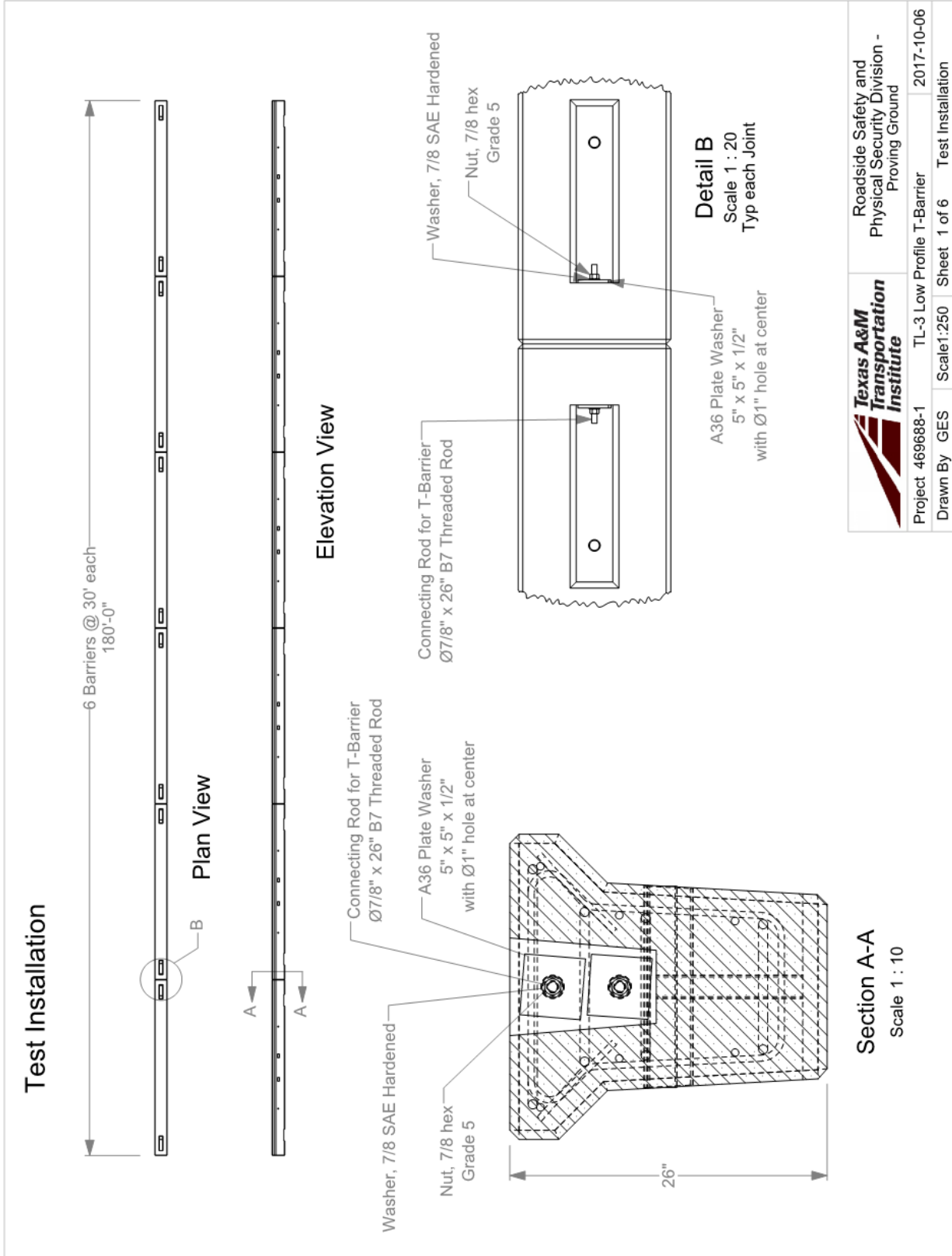
## REFERENCES

1. AASHTO. *Manual for Assessing Roadside Safety Hardware*. Second Edition, 2016, American Association of State Highway and Transportation Officials: Washington, DC.
2. Guidry, T.R. and W.L. Beason, *Development of a Low-Profile Portable Concrete Barrier*. Texas A&M Transportation Institute, College Station, TX, 1992.
3. Michie, J.D., “Recommended Procedures for the Safety Performance of Highway Appurtenances.” *National Cooperative Highway Research Program Report 230*, Transportation Research Board, National Research Council, Washington, DC, March 1981.
4. Ross, H.E., Sicking, D.L., Zimmer, R.A., and Michie, J.D., Recommended Procedures for Safety Performance Evaluation of Highway Features. *National Cooperative Highway Research Program Report 350*, Transportation Research Board, National Research Council, Washington, DC, 1993.
5. Klam, J. and W.L. Menges, *Low-Profile Barrier with Tl-3 Modification*. Texas A&M Transportation Institute, College Station, TX, 2010.
6. AASHTO. *Policy on Geometric Design of Highways and Streets*. American Association of State Highway and Transportation Officials, Washington, DC 1, no. 990 (2001): 158.
7. Standard, Federal Motor Vehicle Safety. "108." Lamps, reflective devices, and associated equipment (2004).
8. Leading cars in the U.S. 2017 | Statista. Retrieved from <https://www.statista.com/statistics/276419/best-selling-cars-in-the-united-states/>.
9. Hallquist J.O., “LS-DYNA Keyword User’s Manual, Version 971,” Livermore Software Technology Corporation, Livermore, CA, 2016.
10. National Crash Analysis Center (NCAC), Finite Element Vehicle Models: 2007 Chevy Silverado, George Washington University, VA, <http://www.ncac.gwu.edu/vml/models.html>, Accessed in April 2011.



# APPENDIX A. DETAILS OF TL-3 LOW-PROFILE BARRIER

T:\1-ProjectFiles\469688-TXDOT\1 Low Profile - Chiaral\469688-1\Drafting, 469688-1-1\469688-1 Drawing



**Texas A&M Transportation Institute**

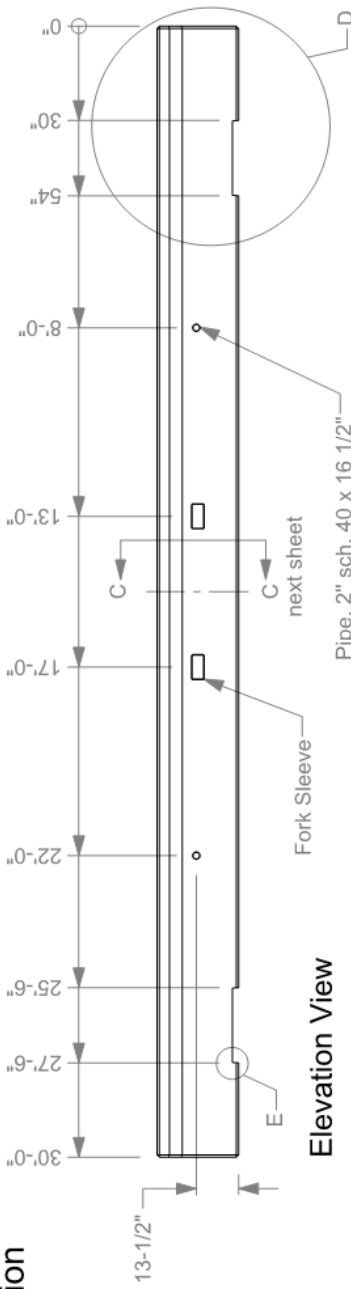
Roadside Safety and Physical Security Division - Proving Ground

Project 469688-1  
Scale 1:250  
Drawn By GES

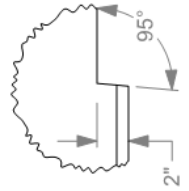
TL-3 Low Profile T-Barrier  
Sheet 1 of 6

2017-10-06  
Test Installation

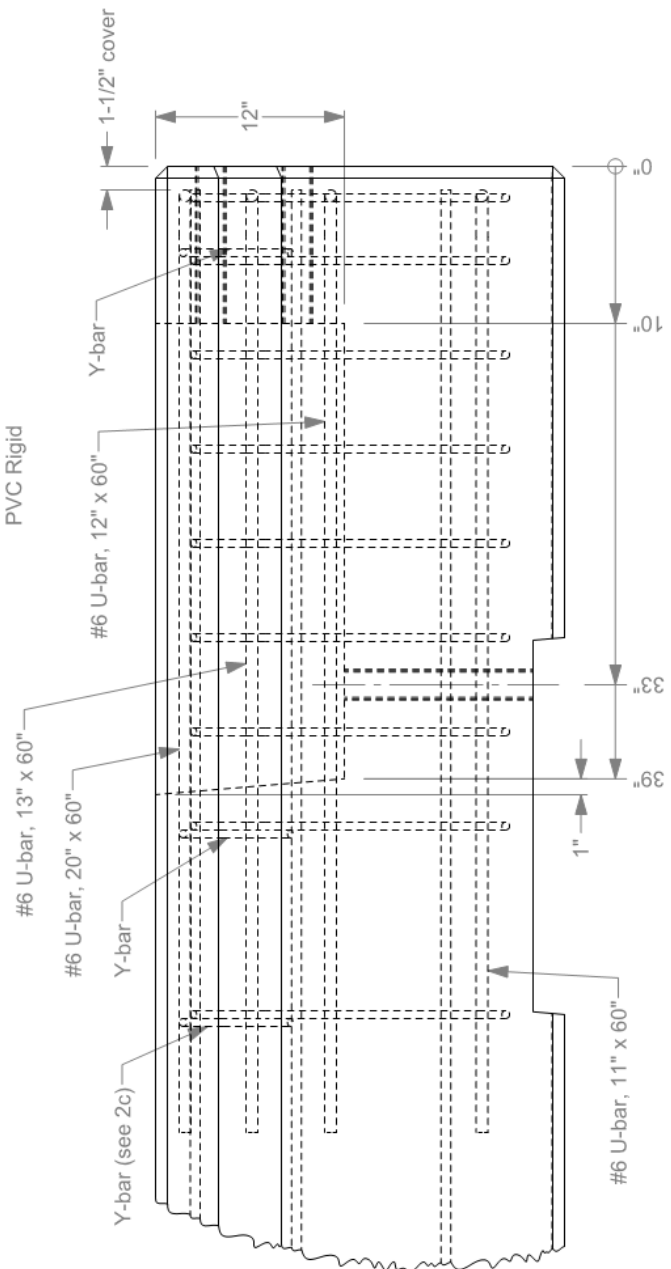
# T-Barrier - Elevation



## Elevation View



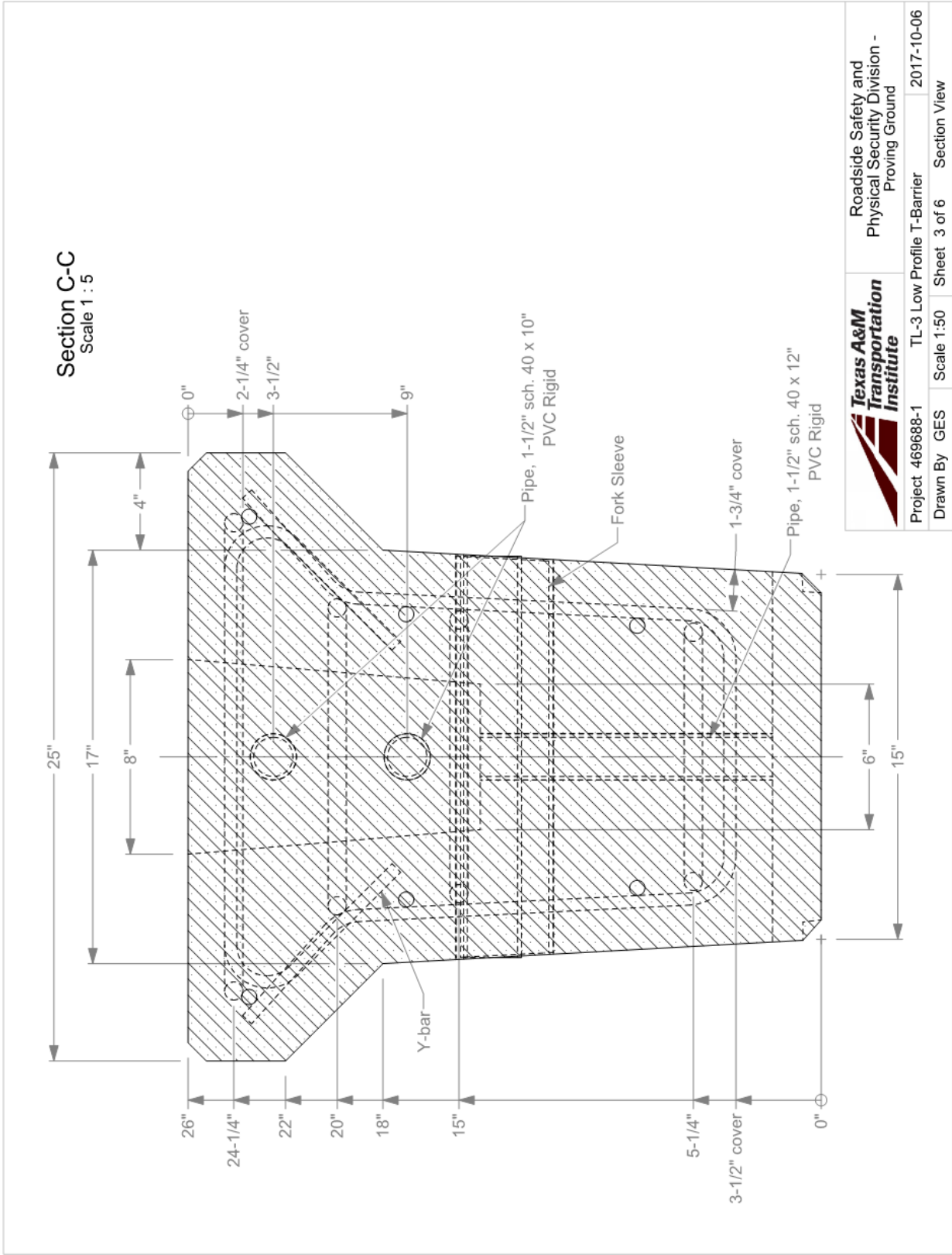
**Detail E**  
Scale 1 : 10



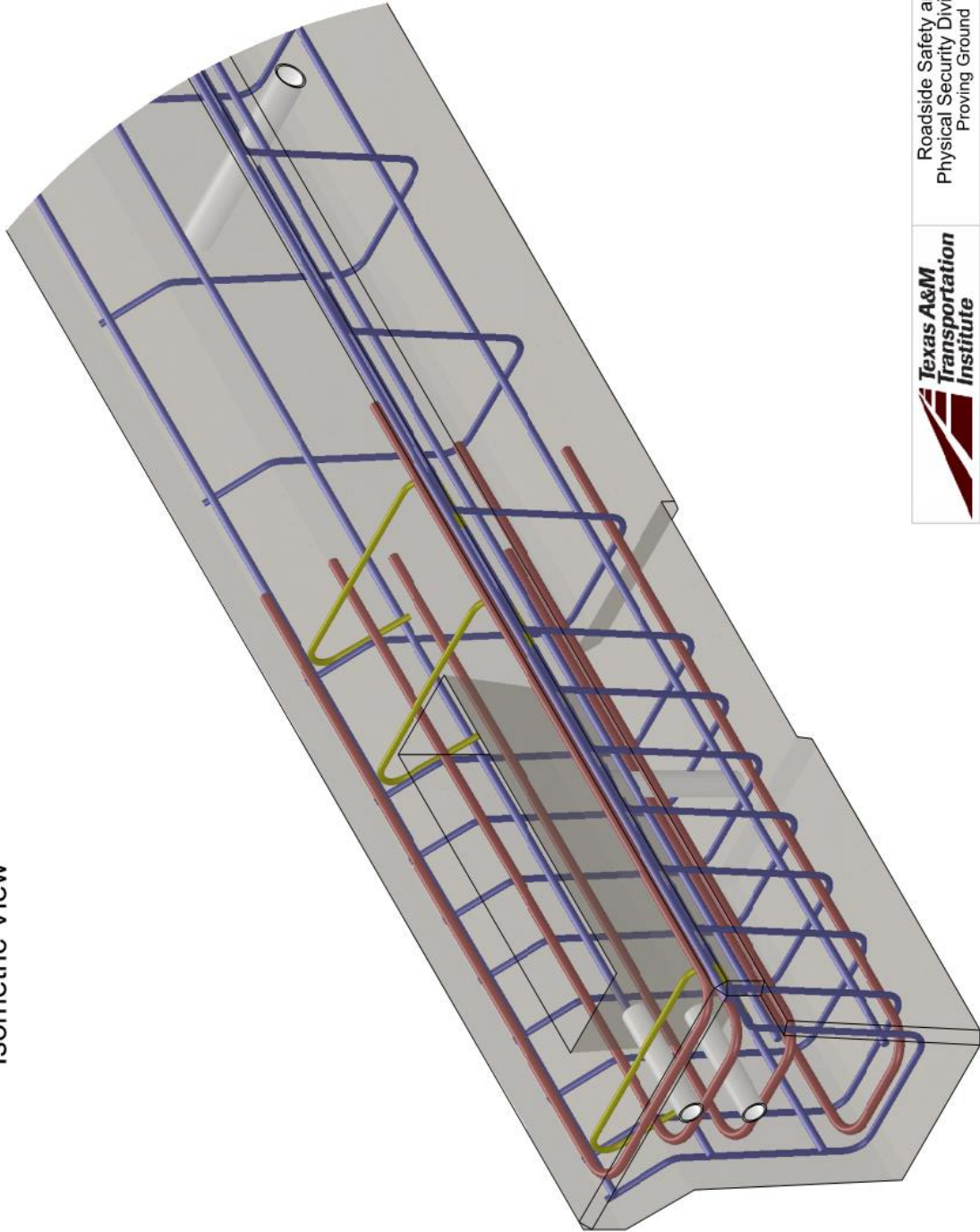
**Detail D**  
Scale 1 : 10  
Typ each end

- 2a. Concrete shall be TxDOT Class H (3600 psi). Chamfer exposed edges 3/4" as shown.
- 2b. Barrier is symmetric about centerlines.
- 2c. Place Y-bars beside welded wire stirrups as shown, three places.

	Roadside Safety and Physical Security Division - Proving Ground	
	Project 469688-1	2017-10-06
Drawn By GES	Scale 1:50	Sheet 2 of 6
TL-3 Low Profile T-Barrier		T-Barrier - Elevation



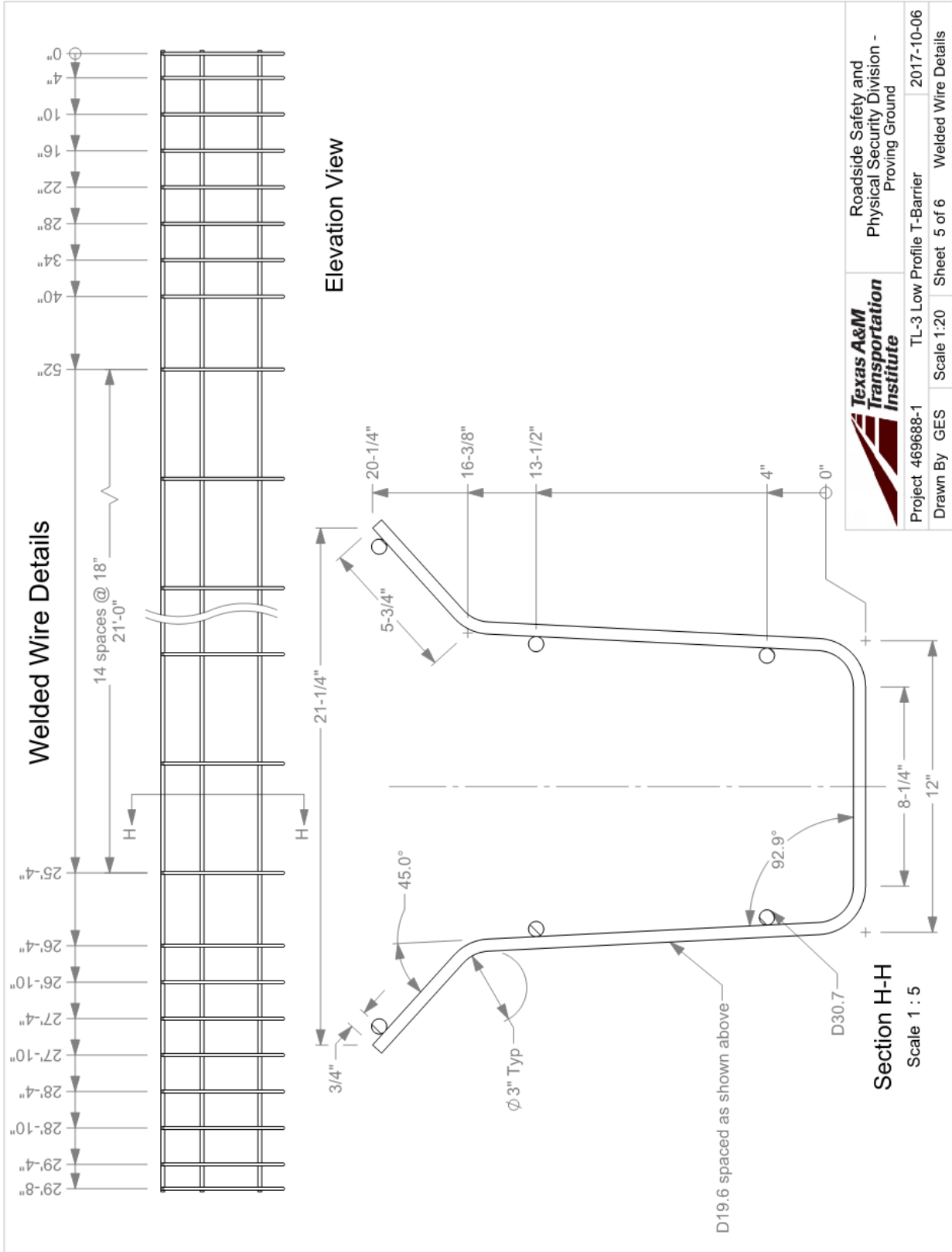
Isometric View

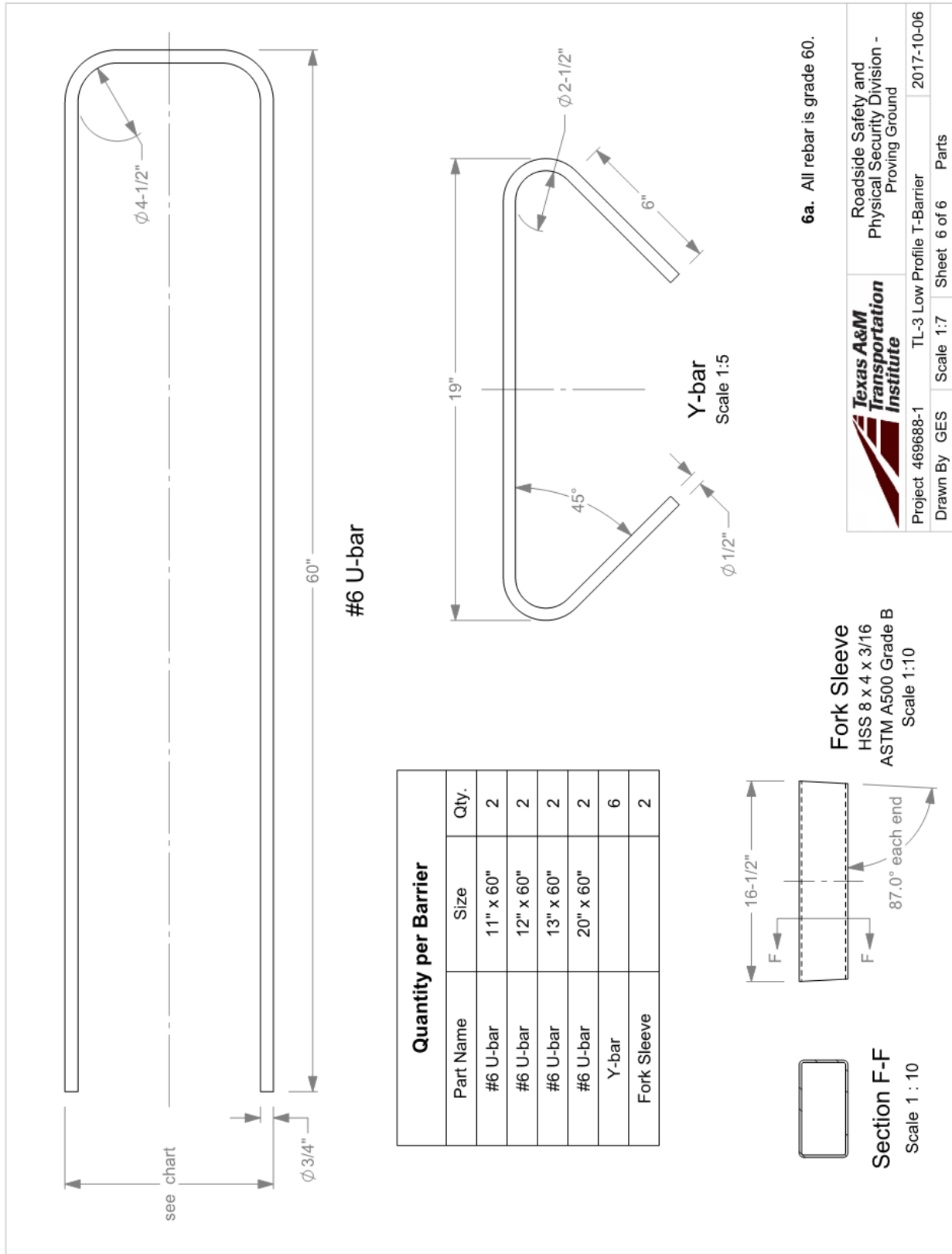


	Roadside Safety and Physical Security Division - Proving Ground	
Project 469688-1	TL-3 Low Profile T-Barrier	2017-10-06
Drawn By GES	Scale 1:50	Sheet 4 of 6
		Isometric View

T:\1-ProjectFiles\469688-TXDOT\1-Low Profile - Chiara\469688-1\Drafting, 469688-1-1\469688-1-Drawing








**Texas A&M Transportation Institute**

Roadside Safety and Physical Security Division - Proving Ground

Project 469688-1 TL-3 Low Profile T-Barrier 2017-10-06

Drawn By GES Scale 1:7 Sheet 6 of 6 Parts

**APPENDIX B. SUPPORTING CERTIFICATION DOCUMENTS**

 <p>Texas A&amp;M Transportation Institute          Proving Ground          3100 SH 47, Bldg 7091          Bryan, TX 77807          Texas A&amp;M University          College Station, TX 77843          Phone 979-845-6575</p>	<p><b>5.7.2 Concrete Break</b></p>	<p>Doc. No. QPF 5.7.2</p>	<p>Revision Date: 2012-09-17</p>
	<p>Revised by: G. E. Schroeder          Approved by: C. E. But</p>	<p>Revision: 5</p>	<p>Page: 1 of 1</p>

Project No.: 469688-1 Casting Date: 2018-3-12

Placement: \_\_\_\_\_ Mix Design P.S.I.: CLASS C

Printed name of Technician taking sample: GREG FRITZ

Signature of Technician taking sample: [Signature]

Printed name of Technician breaking sample: GREG FRITZ

Signature of Technician breaking sample: [Signature]

Truck No.	Batch Ticket	Yards
1		10
2		3

Break Date	Cylinder Age	Truck No.	Total Load (Pounds)	PSI Break	Average
<u>2018-4-13</u>	<u>32 days</u>	<u>1</u>	<u>190,000</u>	<u>6720</u>	
		<u>1</u>	<u>192,000</u>	<u>6790</u>	<u>6780</u>
		<u>1</u>	<u>193,000</u>	<u>6830</u>	
		<u>2</u>	<u>183,500</u>	<u>6490</u>	
		<u>2</u>	<u>169,000</u>	<u>5980</u>	<u>6245</u>
		<u>2</u>	<u>177,000</u>	<u>6260</u>	



Proving Ground  
3100 SH 47, Bldg 7091  
Bryan, TX 77807

Texas A&M University  
College Station, TX, 77843  
Phone 579-845-6375

**Quality Policy Form**

**5.7.2 Concrete Break**

Revised by: G. E. Schroeder  
Approved by: C. E. But

Doc. No.	QPF 5.7.2	Revision Date:	2012-09-17
Revision:	5	Page:	1 of 1

Project No.: 469688-1

Casting Date: 2018-3-27

Placement:

Mix Design P.S.I.: CLASS C

Truck No.	Batch Ticket	Yards
1		
2		

Printed name of Technician taking sample: GREG FRITZ  
 Signature of Technician taking sample: [Signature]  
 Printed name of Technician breaking sample: GREG FRITZ  
 Signature of Technician breaking sample: [Signature]

Break Date	Cylinder Age	Truck No.	Total Load (Pounds)	PSI Break	Average
2018-4-13	17 days	1	139,000	4915	
		1	141,000	4990	4815
		1	135,000	4775	
		2	146,500	5180	
		2	138,500	4900	4960
		2	135,500	4795	



**ZHEJIANG JUNYUE STANDARD PART CO.,LTD.**

**CERTIFIED MATERIAL TEST REPORT**

COMMODITY: STUD      SIZE: 7/8-9×144"      STANDARD: ASTM A193-06

Order No: B13120306      Q'TY: 3200 PCS)      HEAD MARKS: XL B7

LOT NO.: JY70317 778087      PART NO. 778087

一、CHEMICAL ELEMENTS (%)      HEAT NO: 6612040219      MATERIAL: B7/4140

CHEMICAL ELEMENT	C	Mn	Si	P	S	Cr	Mo
SPEC	0.37	0.65	0.15	max	max	0.75	0.15
	0.49	1.10	0.35	0.035	0.04	1.20	0.25
TEST REPORT	0.41	0.77	0.22	0.012	0.007	0.92	0.19

二、MACHINICAL PROPERTIES      BATCH NO 3P7051902      TEST NO: A193-06 B7

ITEM	TENSILE STRENGTH	YIELD STRENGTH	ELONGATION	REDUCE	TEMPERING	QUENCHING	HARDNESS
	min (Mpa)	min (Mpa)	min (%)	min (%)	min (°C)	(°C)	max (HRC)
STANDARD	860	724	16	50	593	820-880	35
TEST REPORT	933	810	18	56	640	860	29

三、TESTED SIZE

ITEM	LENGTH	MAJORDIA	GO	NO	MACROETCH	STRAIGHTNESS	ADD
STANDARD	3663.95	22.177	2A	2A		OK	
	3651.25	21.824			18.29		
TEST REPORT ①	3656.00	21.90	OK	OK	S2/R2/C2	OK	OK
②	3656.00	21.92	OK	OK		OK	
③	3657.00	21.95	OK	OK		OK	
④	3656.00	21.90	OK	OK		OK	
PCS: 4							

PARTS ARE MANUFACTURED AND TESTED IN ACCORDANCE WITH ASTM A193-06 B7

ALSO MEET THE REQUIREMENTS OF ASME SA-95 SECTION 2 IN YOUR MTR.

ALL TESTS IN ACCORDANCE WITH THE METHODS PRESCRIBED IN THE APPLICABLE ASTM

SPECIFICATION.WE CERTIFY THAT THIS DATA IS TRUE REPRESENTATION OF INFORMATION PROVIDED BY

THE MATERIAL SUPPLIES AND OUR TESTING LABORATORY.

**MADE IN CHINA**



QC: ZHANG GUANG  
ZHEJIANG JUNYUE STANDARD PART CO., LTD.  
QUALITY DEPARTMENT



# APPENDIX C. MASH TEST 3-10 (CRASH TEST NO. 469688-1-1)

## C.1 VEHICLE PROPERTIES AND INFORMATION

**Table C.1. Vehicle Properties for Test No. 469688-1-1.**

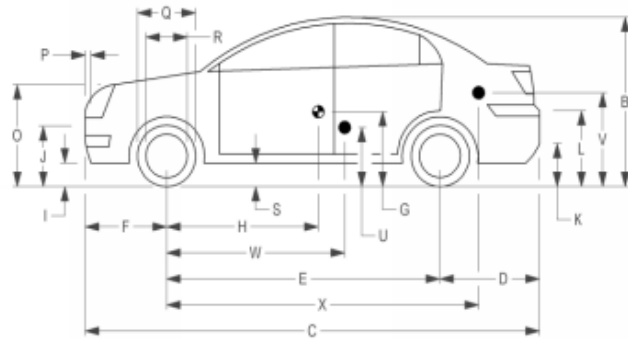
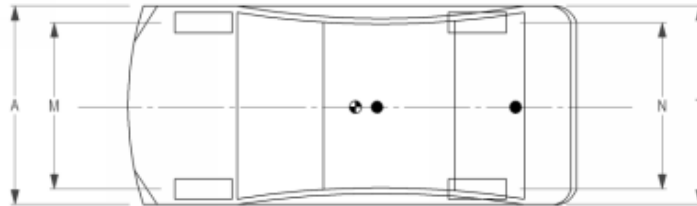
Date:	2018-04-18	Test No.:	469688-1-1	VIN No.:	KNADH4A31B6941853
Year:	2011	Make:	KIA	Model:	RIO
Tire Inflation Pressure:	32 PSI	Odometer:	140544	Tire Size:	185/65R14
Describe any damage to the vehicle prior to test:					

• Denotes accelerometer location.

NOTES:

Engine Type:	4 CYL
Engine CID:	1.6 L
Transmission Type:	<input checked="" type="checkbox"/> Auto or <input type="checkbox"/> Manual
	<input checked="" type="checkbox"/> FWD <input type="checkbox"/> RWD <input type="checkbox"/> 4WD
Optional Equipment:	NONE

Dummy Data:	
Type:	50 PERCENTILE
Mass:	165 LBS
Seat Position:	DRIVER SIDE



**Geometry:** inches

A	66.38	F	33.00	K	12.25	P	4.12	U	14.00
B	51.50	G		L	25.25	Q	22.50	V	19.00
C	165.75	H	35.70	M	57.75	R	15.50	W	35.70
D	34.00	I	7.75	N	57.70	S	8.25	X	70.25
E	98.75	J	21.50	O	28.25	T	66.20		
Wheel Center Ht Front	11.00			Wheel Center Ht Rear	11.00	W-H	0.00		

RANGE LIMIT: A = 65 ±3 inches; C = 168 ±8 inches; E = 98 ±5 inches; F = 35 ±4 inches; G = 39 ±4 inches; O = TOP OF RADIATOR SUPPORT (24 ±1 inches); M+N/2 = 56 ±2 inches; W-H < 2 inches or use MASH Paragraph A4.3.2

GVWR Ratings:	Mass: lb	Curb	Test Inertial	Gross Static
Front	1718	M <sub>front</sub> 1563	1547	1632
Back	1874	M <sub>rear</sub> 880	876	956
Total	3638	M <sub>Total</sub> 2443	2423	2588

Allowable TIM = 2420 lb ±55 lb | Allowable GSM = 2585 lb ± 55 lb

Mass Distribution:				
lb	LF: 780	RF: 767	LR: 422	RR: 454

**Table C.2. Exterior Crush Measurements of Vehicle for Test No. 469688-1-1.**

Date: **2018-04-18** Test No.: **469688-1-1** VIN No.: **KNADH4A31B6941853**  
 Year: **2011** Make: **KIA** Model: **RIO**

**VEHICLE CRUSH MEASUREMENT SHEET<sup>1</sup>**

Complete When Applicable	
End Damage	Side Damage
Undeformed end width <input style="width: 50px;" type="text"/> Corner shift: A1 <input style="width: 50px;" type="text"/> A2 <input style="width: 50px;" type="text"/> End shift at frame (CDC) (check one) < 4 inches <input style="width: 50px;" type="text"/> ≥ 4 inches <input style="width: 50px;" type="text"/>	Bowing: B1 <input style="width: 50px;" type="text"/> X1 <input style="width: 50px;" type="text"/> B2 <input style="width: 50px;" type="text"/> X2 <input style="width: 50px;" type="text"/> Bowing constant $\frac{X1 + X2}{2} = \text{  }$

Note: Measure C<sub>1</sub> to C<sub>6</sub> from Driver to Passenger Side in Front or Rear impacts – Rear to Front in Side Impacts.

Specific Impact Number	Plane* of C-Measurements	Direct Damage		Field L**	C <sub>1</sub>	C <sub>2</sub>	C <sub>3</sub>	C <sub>4</sub>	C <sub>5</sub>	C <sub>6</sub>	±D
		Width** (CDC)	Max*** Crush								
1	AT FT BUMPER	16	8	24	8	6	4	2	.5	0	-20
2	SAME	16	12	48	2	3	5	8	10.5	12	+60
	Units in inches ▼										

<sup>1</sup>Table taken from National Accident Sampling System (NASS).

\*Identify the plane at which the C-measurements are taken (e.g., at bumper, above bumper, at sill, above sill, at beltline, etc.) or label adjustments (e.g., free space).

Free space value is defined as the distance between the baseline and the original body contour taken at the individual C locations. This may include the following: bumper lead, bumper taper, side protrusion, side taper, etc. Record the value for each C-measurement and maximum crush.

\*\*Measure and document on the vehicle diagram the beginning or end of the direct damage width and field L (e.g., side damage with respect to undamaged axle).

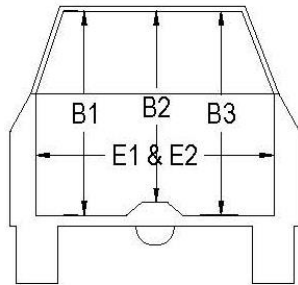
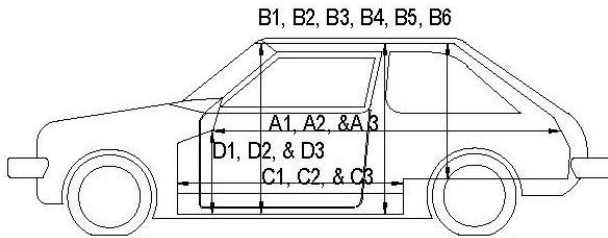
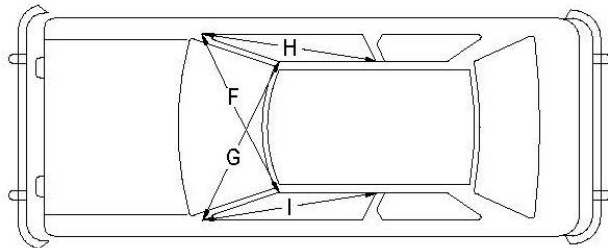
\*\*\*Measure and document on the vehicle diagram the location of the maximum crush.

Note: Use as many lines/columns as necessary to describe each damage profile.



**Table C.3. Occupant Compartment Measurements of Vehicle for Test No. 469688-1-1.**

Date: 2018-04-18 Test No.: 469688-1-1 VIN No.: KNADH4A31B6941853  
 Year: 2011 Make: KIA Model: RIO

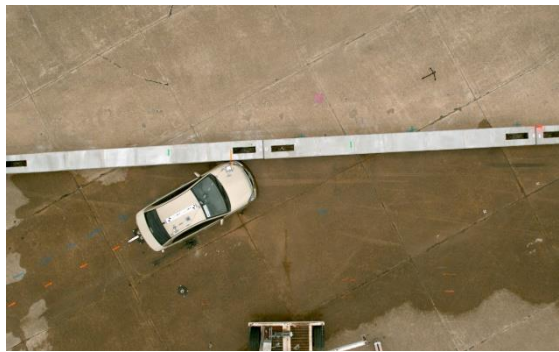


**OCCUPANT COMPARTMENT DEFORMATION MEASUREMENT**

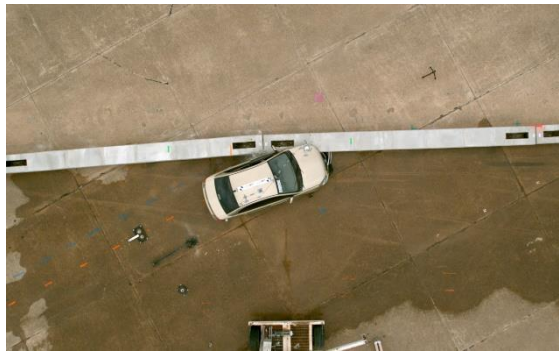
	Before	After	Differ.
	inches		
A1	67.50	67.50	0.00
A2	67.25	67.25	0.00
A3	67.75	67.75	0.00
B1	40.50	40.50	0.00
B2	39.00	39.00	0.00
B3	40.50	40.50	0.00
B4	36.25	36.25	0.00
B5	36.00	36.00	0.00
B6	36.25	36.25	0.00
C1	26.00	25.50	-0.50
C2	0.00	0.00	0.00
C3	26.00	26.00	0.00
D1	9.50	9.50	0.00
D2	0.00	0.00	0.00
D3	9.50	9.50	0.00
E1	51.50	53.00	+1.50
E2	51.00	52.25	+1.25
F	51.00	51.00	0.00
G	51.00	51.00	0.00
H	37.50	37.50	0.00
I	37.50	37.50	0.00
J*	51.00	50.00	-1.00

\*Lateral area across the cab from driver's side kickpanel to passenger's side kickpanel.

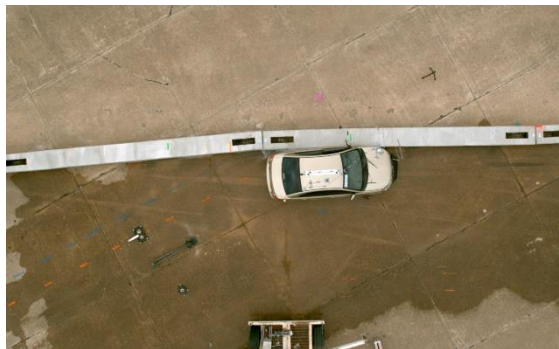
## C.2 SEQUENTIAL PHOTOGRAPHS



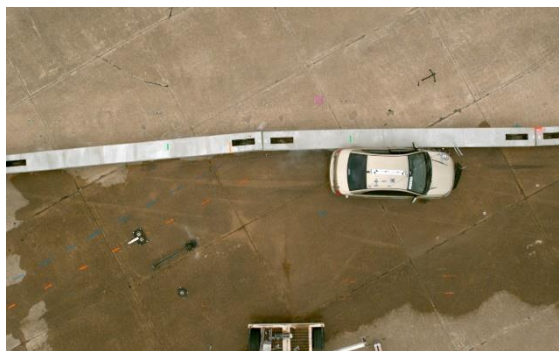
0.000 s



0.100 s



0.200 s



0.300 s



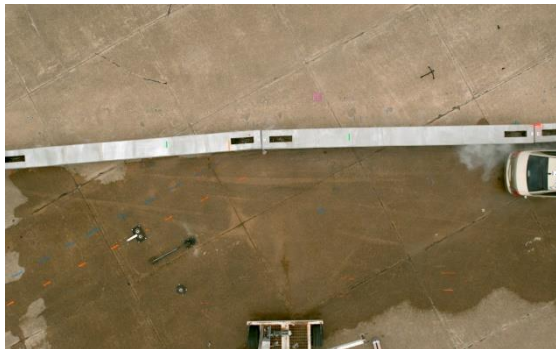
**Figure C.1. Sequential Photographs for Test No. 469688-1-1 (Overhead and Gut Views).**



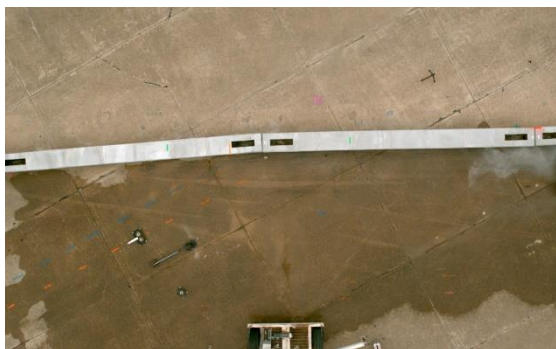
0.400 s



0.500 s



0.600 s



0.700 s



**Figure C.1. Sequential Photographs for Test No. 469688-1-1 (Overhead and Gut Views) (Continued).**





0.000 s



0.100 s



0.200 s



0.300 s



0.400 s



0.500 s



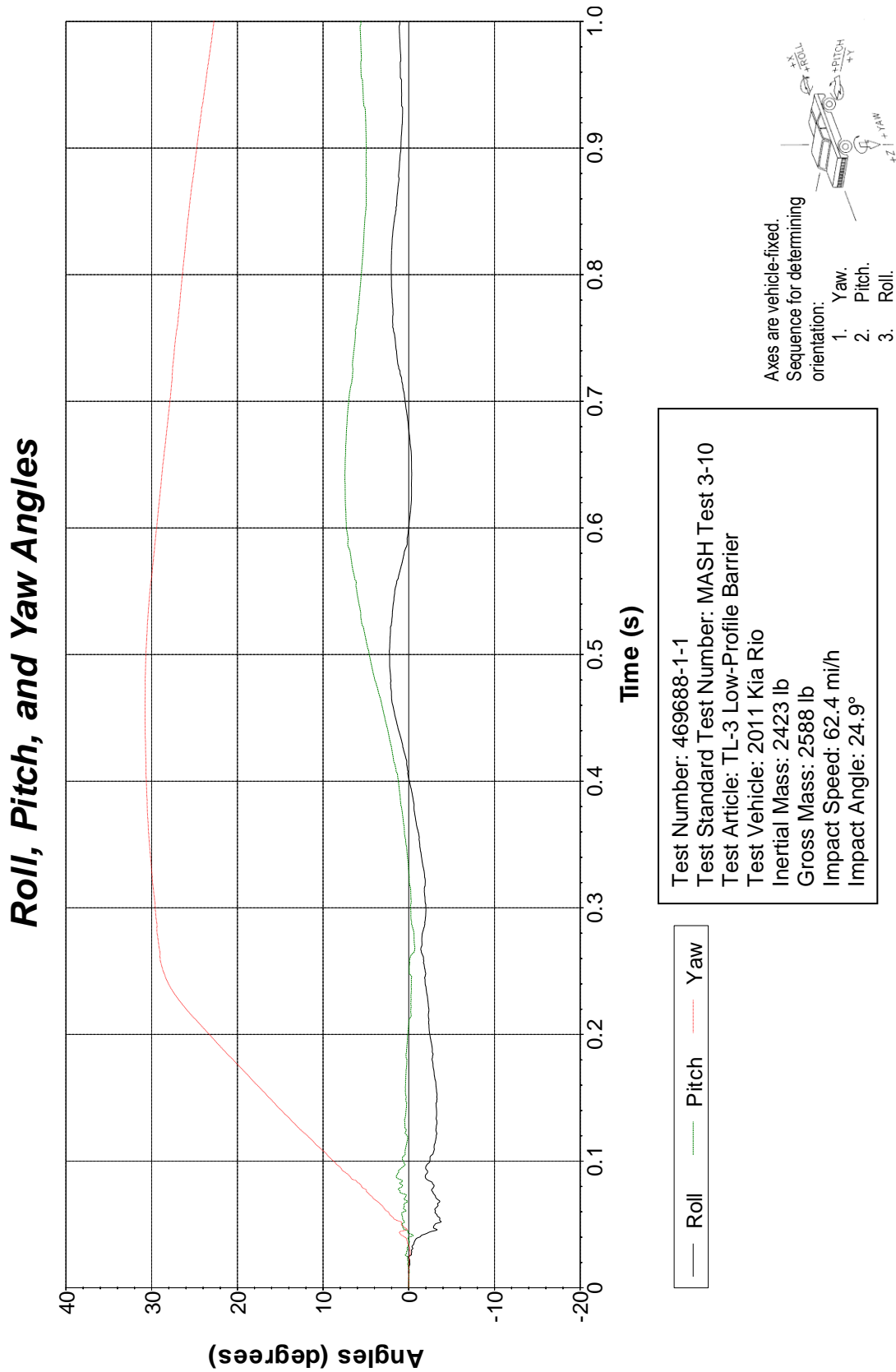
0.600 s



0.700 s

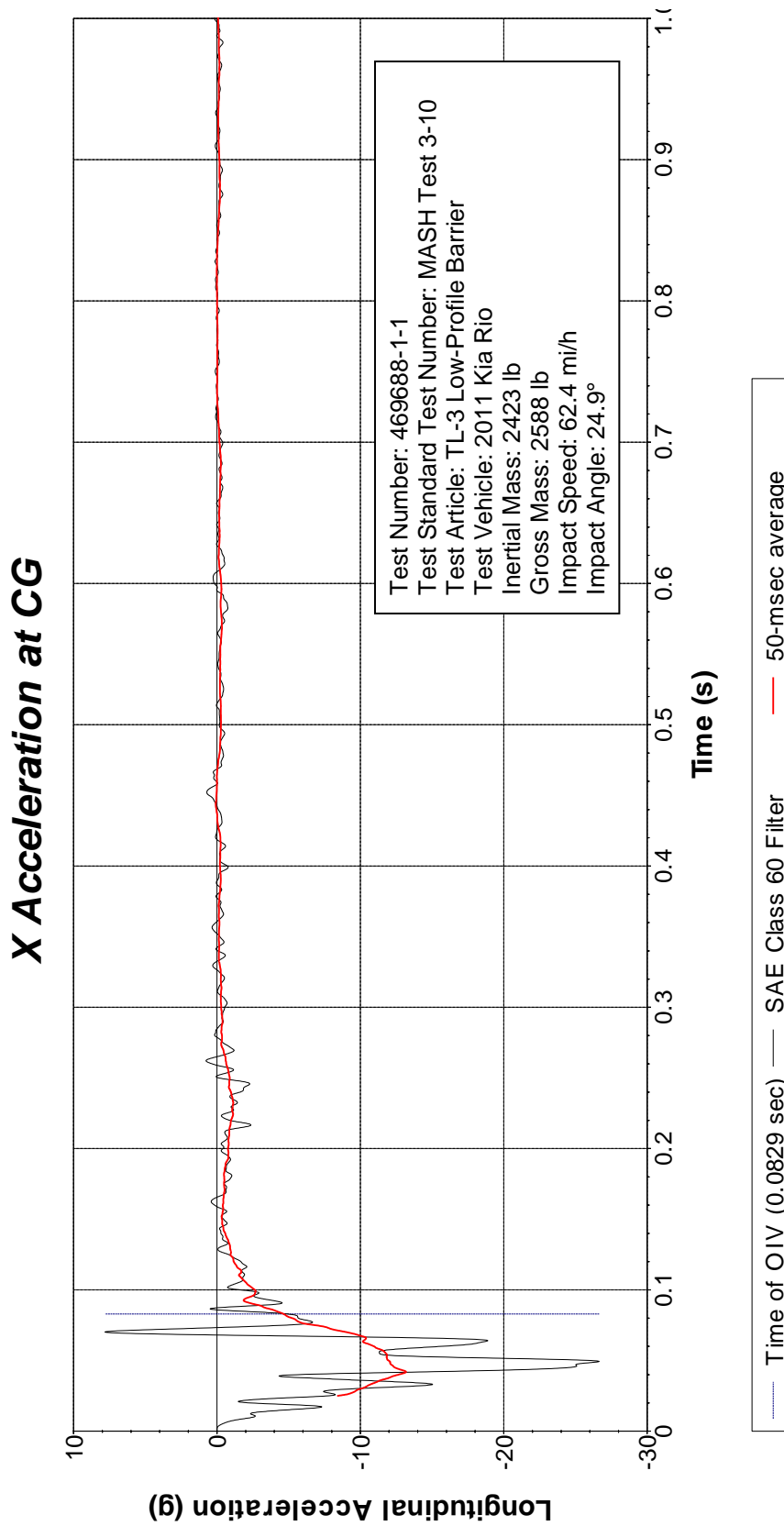
**Figure C.2. Sequential Photographs for Test No. 469688-1-1 (Rear View).**

### C.3 VEHICLE ANGULAR DISPLACEMENT



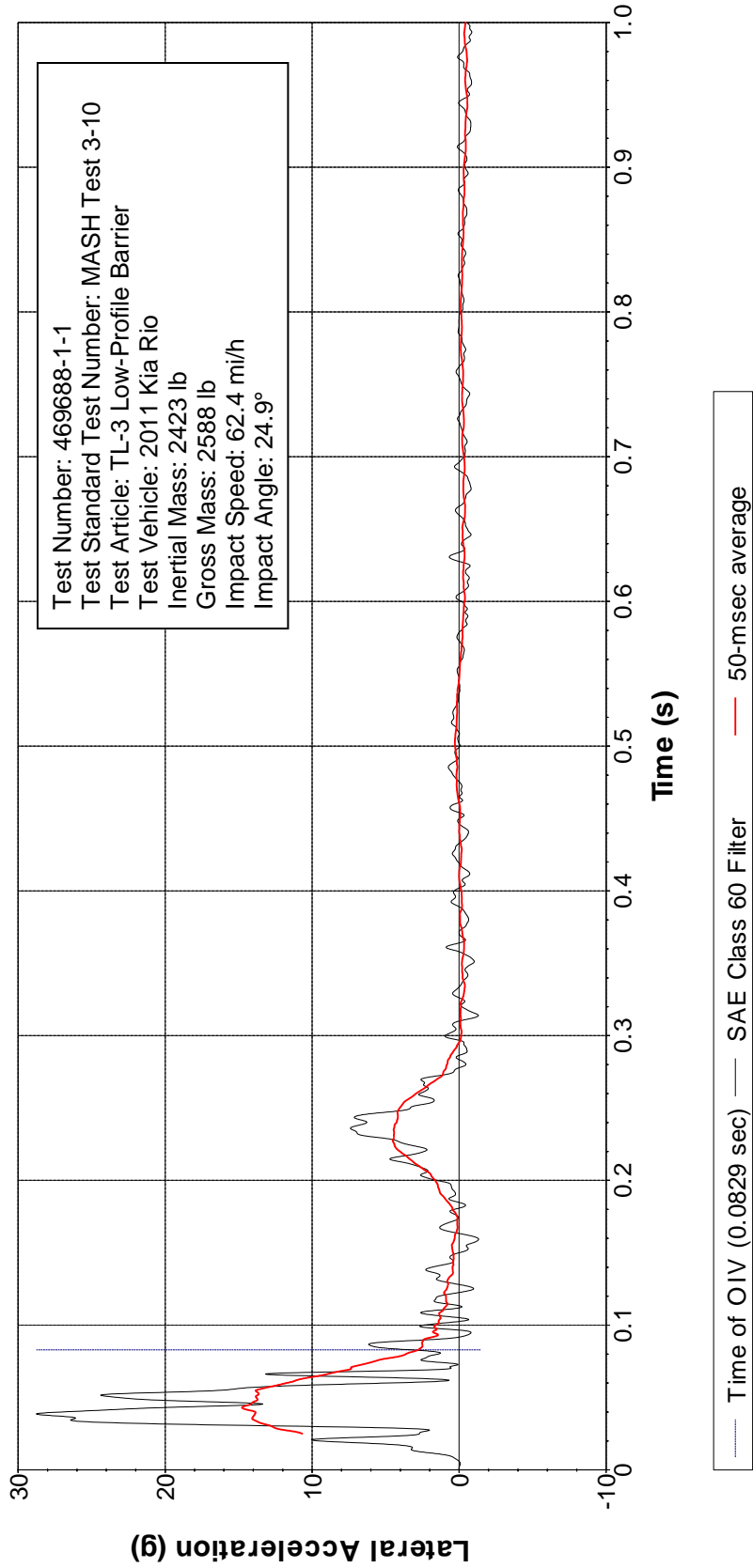
**Figure C.3. Vehicle Angular Displacements for Test No. 469688-1-1.**

## C.4 VEHICLE ACCELERATIONS



**Figure C.4. Vehicle Longitudinal Accelerometer Trace for Test No. 469688-1-1 (Accelerometer Located at Center of Gravity).**

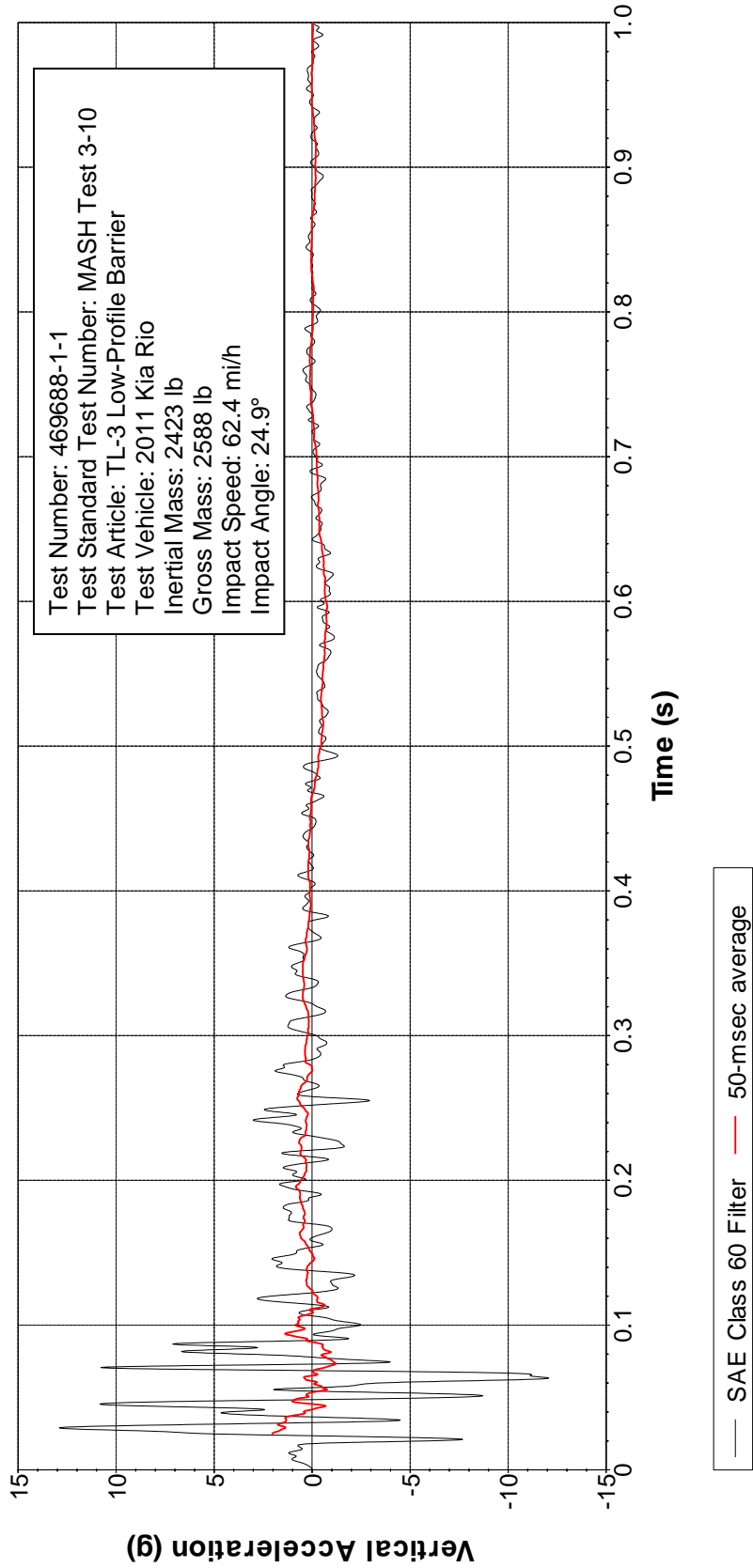
# Y Acceleration at CG



**Figure C.5. Vehicle Lateral Accelerometer Trace for Test No. 469688-1-1 (Accelerometer Located at Center of Gravity).**

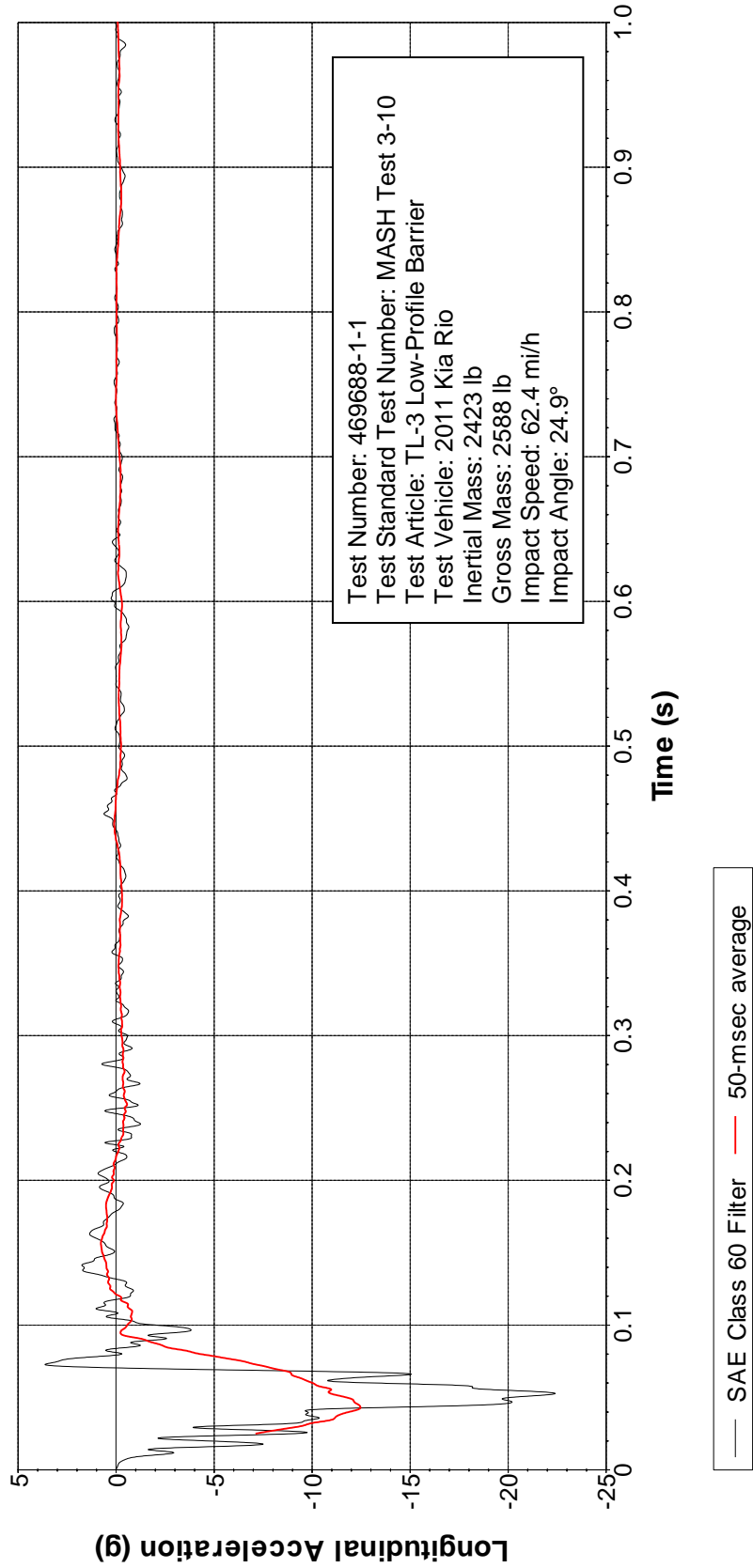


# Z Acceleration at CG



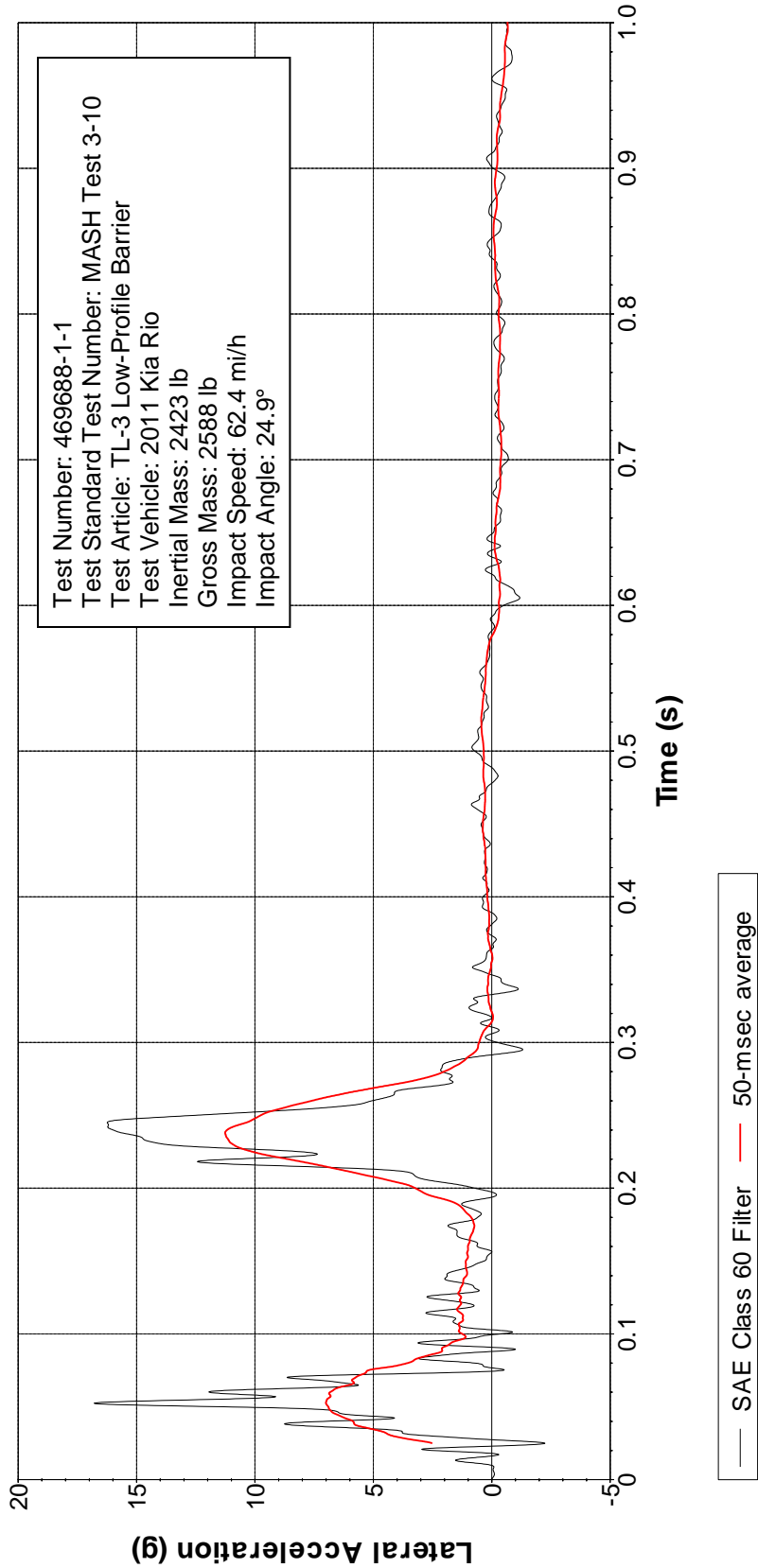
**Figure C.6. Vehicle Vertical Accelerometer Trace for Test No. 469688-1-1  
(Accelerometer Located at Center of Gravity).**

# X Acceleration Rear of CG



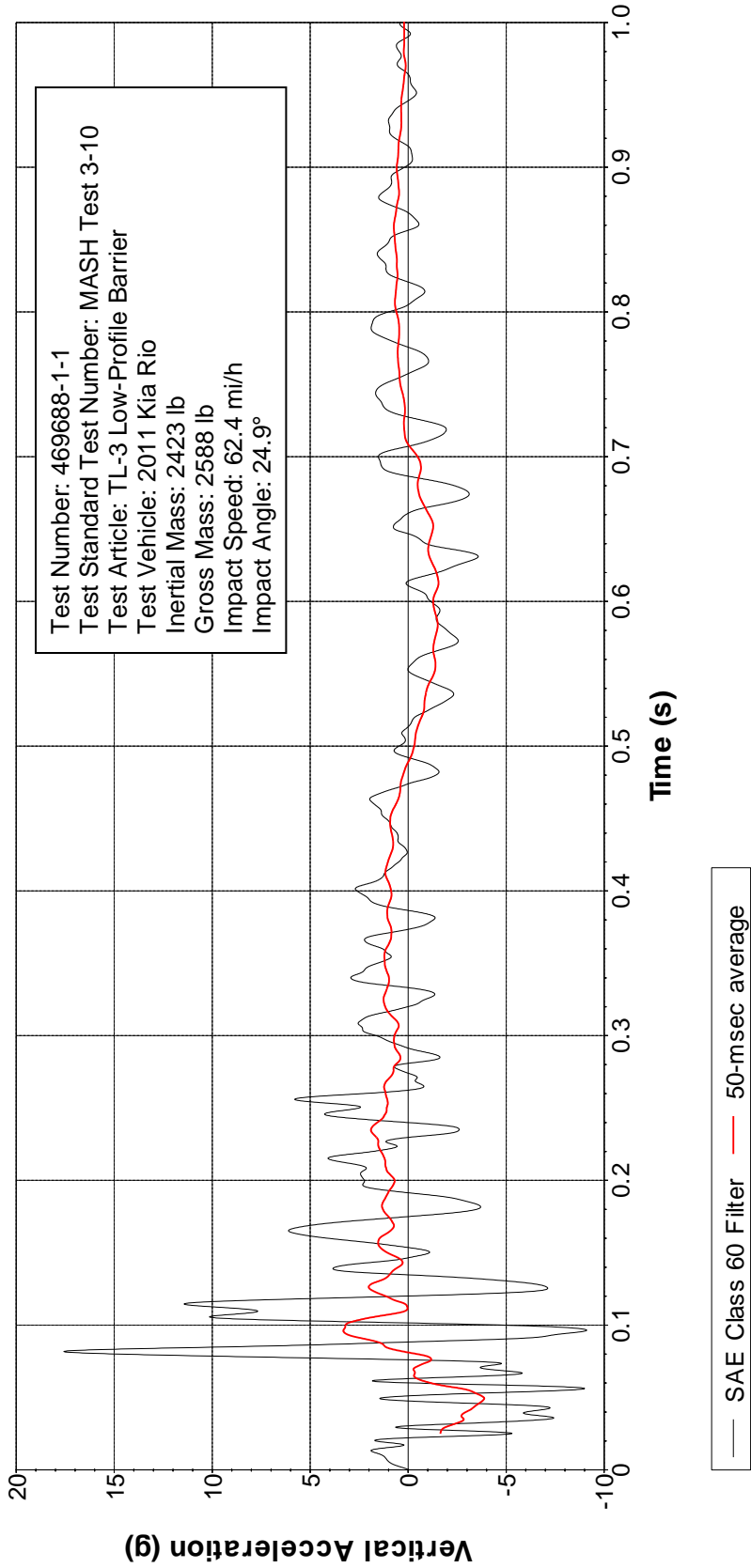
**Figure C.7. Vehicle Longitudinal Accelerometer Trace for Test No. 469688-1-1 (Accelerometer Located Rear of Center of Gravity).**

# Y Acceleration Rear of CG



**Figure C.8. Vehicle Lateral Accelerometer Trace for Test No. 469688-1-1 (Accelerometer Located Rear of Center of Gravity).**

# Z Acceleration Rear of CG



**Figure C.9. Vehicle Vertical Accelerometer Trace for Test No. 469688-1-1 (Accelerometer Located Rear of Center of Gravity).**



# APPENDIX D. MASH TEST 3-11 (CRASH TEST NO. 469688-1-2)

## D.1 VEHICLE PROPERTIES AND INFORMATION

**Table D.1. Vehicle Properties for Test No. 469688-1-2.**

Vehicle Inventory Number:		1306	
Date:	2018-4-16	Test No.:	469688-1-2
		VIN No.:	1C6RR6FTXDS556500
Year:	2013	Make:	DODGE
		Model:	RAM 1500
Tire Size:	265/70 R 17	Tire Inflation Pressure:	42 PSI
Tread Type:	HIGHWAY	Odometer:	177231
Note any damage to the vehicle prior to test:		NONE	

• Denotes accelerometer location.

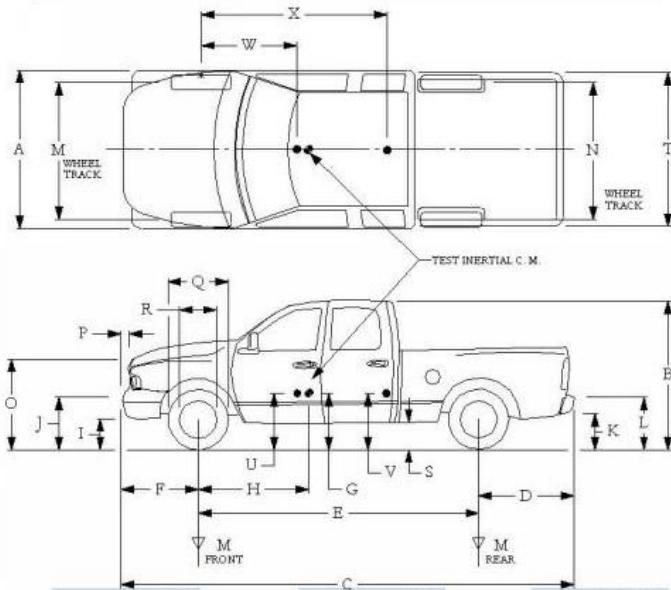
NOTES:

Engine Type: V-8  
 Engine CID: 5.7L

Transmission Type:  
 Auto or  Manual  
 FWD  RWD  4WD

Optional Equipment:  
 NONE

Dummy Data:  
 Type: NONE  
 Mass:  
 Seat Position:



Geometry:		inches			
A	78.50	F	40.00		
B	74.00	G	29.00		
C	227.50	H	61.08		
D	44.00	I	11.75		
E	140.50	J	27.00		
	Wheel Center Height Front	14.75	Wheel Well Clearance (Front)	6.00	
	Wheel Center Height Rear	14.75	Wheel Well Clearance (Rear)	9.25	
			Bottom Frame Height - Front	12.00	
			Bottom Frame Height - Rear	25.50	
K	20.00	P	3.00	U	27.75
L	30.00	Q	30.50	V	31.25
M	68.50	R	18.00	W	61.08
N	68.00	S	13.00	X	77.00
O	46.00	T	77.00		

RANGE LIMIT: A=78 ±2 inches; C=237 ±13 inches; E=148 ±12 inches; F=39 ±3 inches; G = > 28 inches; H = 63 ±4 inches; O=43 ±4 inches; M+N/2=67 ±1.5 inches

GVWR Ratings:	Mass: lb	Curb	Test Inertial	Gross Static
Front	3700	M <sub>front</sub>	2825	2833
Back	3900	M <sub>rear</sub>	2233	2179
Total	6700	M <sub>Total</sub>	5058	5012

(Allowable Range for TIM and GSM = 5000 lb ±110 lb)

Mass Distribution:	lb	LF:	RF:	LR:	RR:
		1403	1430	1100	1079

**Table D.2. Measurements of Vehicle Vertical CG for Test No. 469688-1-2.**

Vehicle Inventory Number: 1306

Date: 2018-4-16 Test No.: 469688-1-2 VIN: 1C6RR6FTXDS556500

Year: 2013 Make: DODGE Model: RAM 1500

Body Style: QUAD CAB Mileage: 177231

Engine: 4.7L V-8 Transmission: AUTO

Fuel Level: EMPTY Ballast: 171 LBS (440 lb max)

Tire Pressure: Front: 42 psi Rear: 42 psi Size: 265/70 R 17

Measured Vehicle Weights: (lb)			
LF:	<u>1403</u>	RF:	<u>1430</u>
Front Axle:		<u>2833</u>	
LR:	<u>1100</u>	RR:	<u>1079</u>
Rear Axle:		<u>2179</u>	
Left:	<u>2503</u>	Right:	<u>2509</u>
Total:		<u>5012</u>	
5000 ±110 lb allow ed			
Wheel Base:	<u>140.50</u> inches	Track: F:	<u>68.50</u> inches
148 ±12 inches allow ed		R:	<u>68.00</u> inches
Track = (F+R)/2 = 67 ±1.5 inches allow ed			
Center of Gravity, SAE J874 Suspension Method			
X:	<u>61.08</u> inches	Rear of Front Axle	(63 ±4 inches allow ed)
Y:	<u>0.04</u> inches	Left -	Right +
of Vehicle Centerline			
Z:	<u>29.00</u> inches	Above Ground	(minumum 28.0 inches allow ed)

Hood Height: 46.00 inches Front Bumper Height: 27.00 inches  
 43 ±4 inches allowed

Front Overhang: 40.00 inches Rear Bumper Height: 30.00 inches  
 39 ±3 inches allowed

Overall Length: 227.50 inches  
 237 ±13 inches allowed

Test Conductor(s): SCD



**Table D.3. Exterior Crush Measurements of Vehicle for Test No. 469688-1-2.**

Vehicle Inventory Number: 1306

Date: 2018-4-16 Test No.: 469688-1-2 VIN No.: 1C6RR6FTXDS556500

Year: 2013 Make: DODGE Model: RAM 1500

**VEHICLE CRUSH MEASUREMENT SHEET<sup>1</sup>**

Complete When Applicable	
End Damage	Side Damage
Undeformed end width <input style="width: 50px;" type="text"/>	Bowing: B1 <input style="width: 30px;" type="text"/> X1 <input style="width: 30px;" type="text"/>
Corner shift: A1 <input style="width: 50px;" type="text"/>	B2 <input style="width: 30px;" type="text"/> X2 <input style="width: 30px;" type="text"/>
A2 <input style="width: 50px;" type="text"/>	
End shift at frame (CDC)	Bowing constant
(check one)	$\frac{X1 + X2}{2} = $ <input style="width: 50px;" type="text"/>
< 4 inches <input style="width: 50px;" type="text"/>	
≥ 4 inches <input style="width: 50px;" type="text"/>	

Note: Measure C<sub>1</sub> to C<sub>6</sub> from Driver to Passenger Side in Front or Rear impacts – Rear to Front in Side Impacts.

Specific Impact Number	Plane* of C-Measurements	Direct Damage		Field L**	C <sub>1</sub>	C <sub>2</sub>	C <sub>3</sub>	C <sub>4</sub>	C <sub>5</sub>	C <sub>6</sub>	±D
		Width** (CDC)	Max*** Crush								
1	AT FT BUMPER	20	10	44	10	8	6	2	1	0	-20
2	SAME	20	10	60	1	3			8	10	+75
	inches ▼										

<sup>1</sup>Table taken from National Accident Sampling System (NASS).

\*Identify the plane at which the C-measurements are taken (e.g., at bumper, above bumper, at sill, above sill, at beltline, etc.) or label adjustments (e.g., free space).

Free space value is defined as the distance between the baseline and the original body contour taken at the individual C locations. This may include the following: bumper lead, bumper taper, side protrusion, side taper, etc. Record the value for each C-measurement and maximum crush.

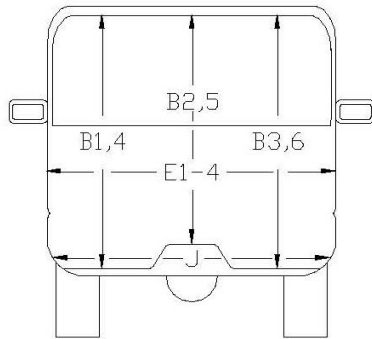
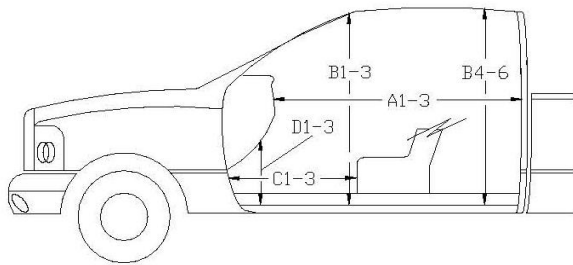
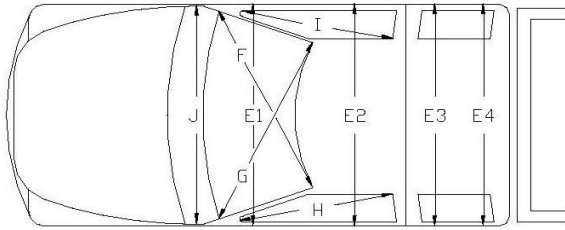
\*\*Measure and document on the vehicle diagram the beginning or end of the direct damage width and field L (e.g., side damage with respect to undamaged axle).

\*\*\*Measure and document on the vehicle diagram the location of the maximum crush.

Note: Use as many lines/columns as necessary to describe each damage profile.

**Table D.4. Occupant Compartment Measurements of Vehicle for Test No. 469688-1-2.**

Date: 2018-4-16 Test No.: 469688-1-2 VIN No.: 1C6RR6FTXDS556500  
 Year: 2013 Make: DODGE Model: RAM 1500



**OCCUPANT COMPARTMENT DEFORMATION MEASUREMENT**

	Before	After inches	Differ.
A1	65.00	65.00	0.00
A2	63.00	63.00	0.00
A3	65.50	65.50	0.00
B1	45.00	45.00	0.00
B2	38.00	38.00	0.00
B3	45.00	45.00	0.00
B4	39.50	39.50	0.00
B5	43.00	43.00	0.00
B6	39.50	39.50	0.00
C1	26.00	24.00	-2.00
C2	0.00	0.00	0.00
C3	26.00	26.00	0.00
D1	11.00	11.00	0.00
D2	0.00	0.00	0.00
D3	11.50	11.50	0.00
E1	58.50	59.00	0.50
E2	63.50	64.00	0.50
E3	63.50	63.75	0.25
E4	63.50	63.50	0.00
F	59.00	59.00	0.00
G	59.00	59.00	0.00
H	37.50	37.50	0.00
I	37.50	37.50	0.00
J*	25.00	24.50	-0.50

\*Lateral area across the cab from driver's side kickpanel to passenger's side kickpanel.

## D.2 SEQUENTIAL PHOTOGRAPHS



0.000 s



0.100 s



0.200 s



0.300 s



**Figure D.1. Sequential Photographs for Test No. 469688-1-2 (Overhead and Gut Views).**





0.400 s



0.500 s



0.600 s



0.700 s



**Figure D.1. Sequential Photographs for Test No. 469688-1-2 (Overhead and Gut Views) (Continued).**



0.000 s



0.100 s



0.200 s



0.300 s

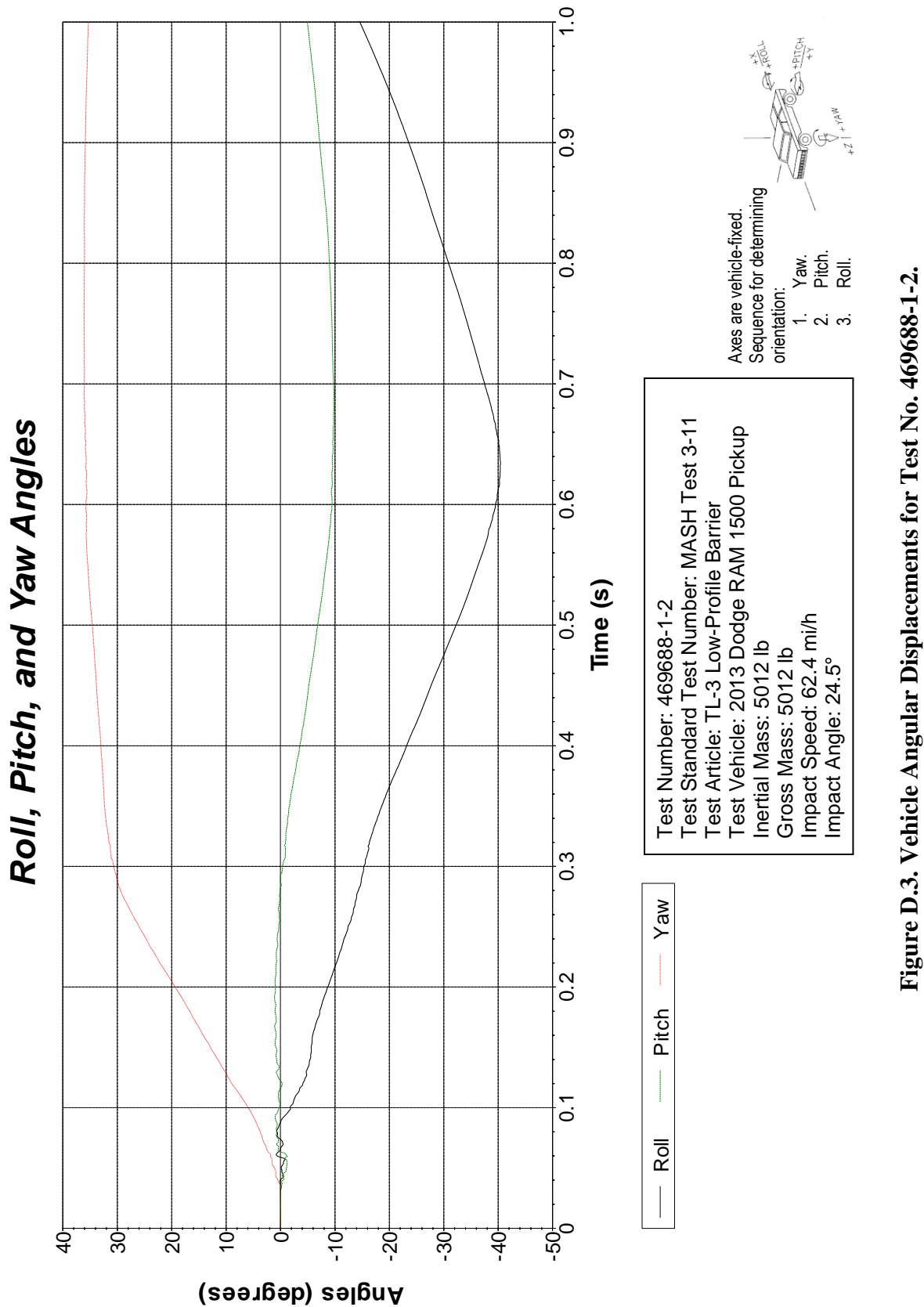


0.400 s

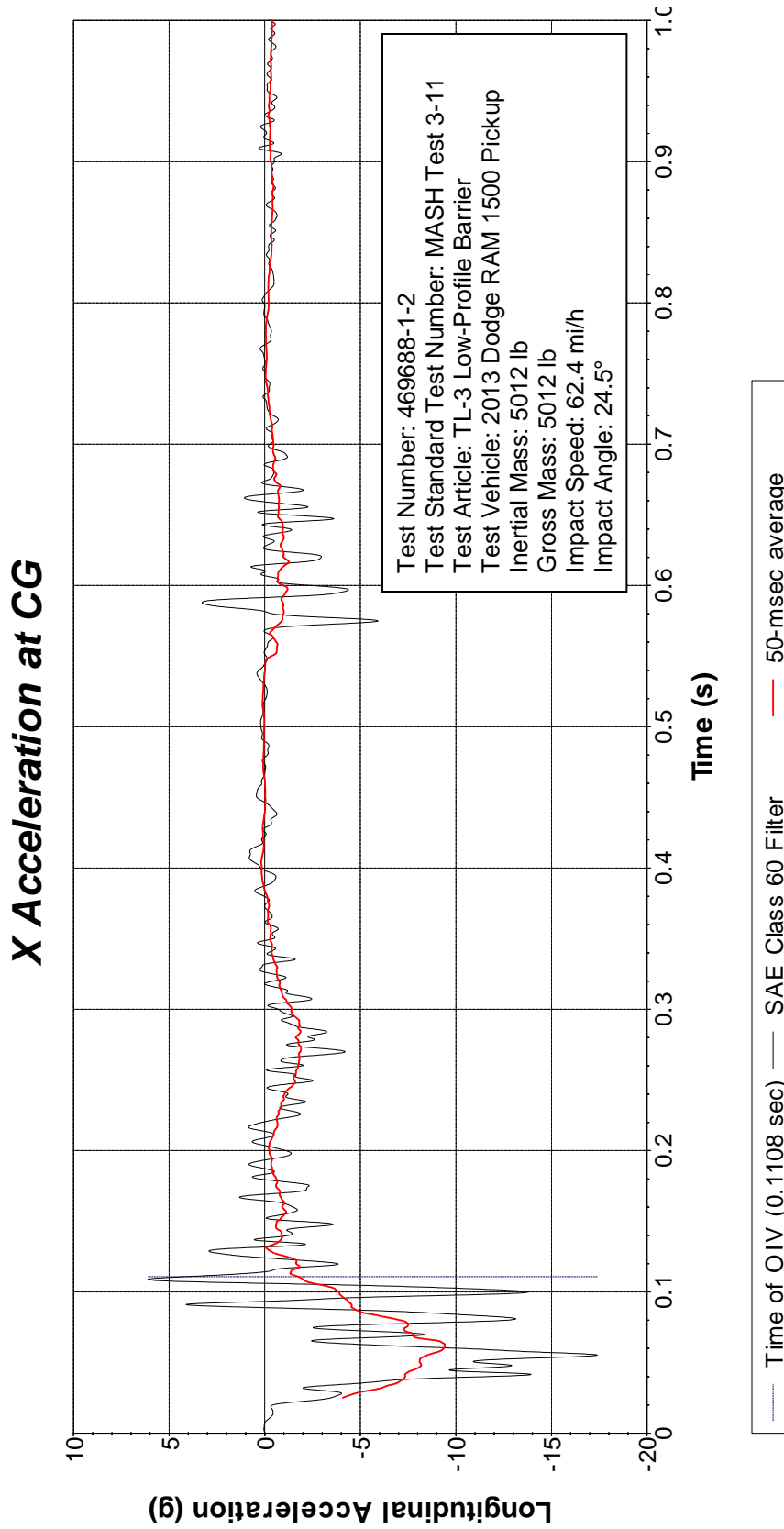
Out of View

**Figure D.2. Sequential Photographs for Test No. 469688-1-2 (Rear Angle View).**

### D.3 VEHICLE ANGULAR DISPLACEMENT



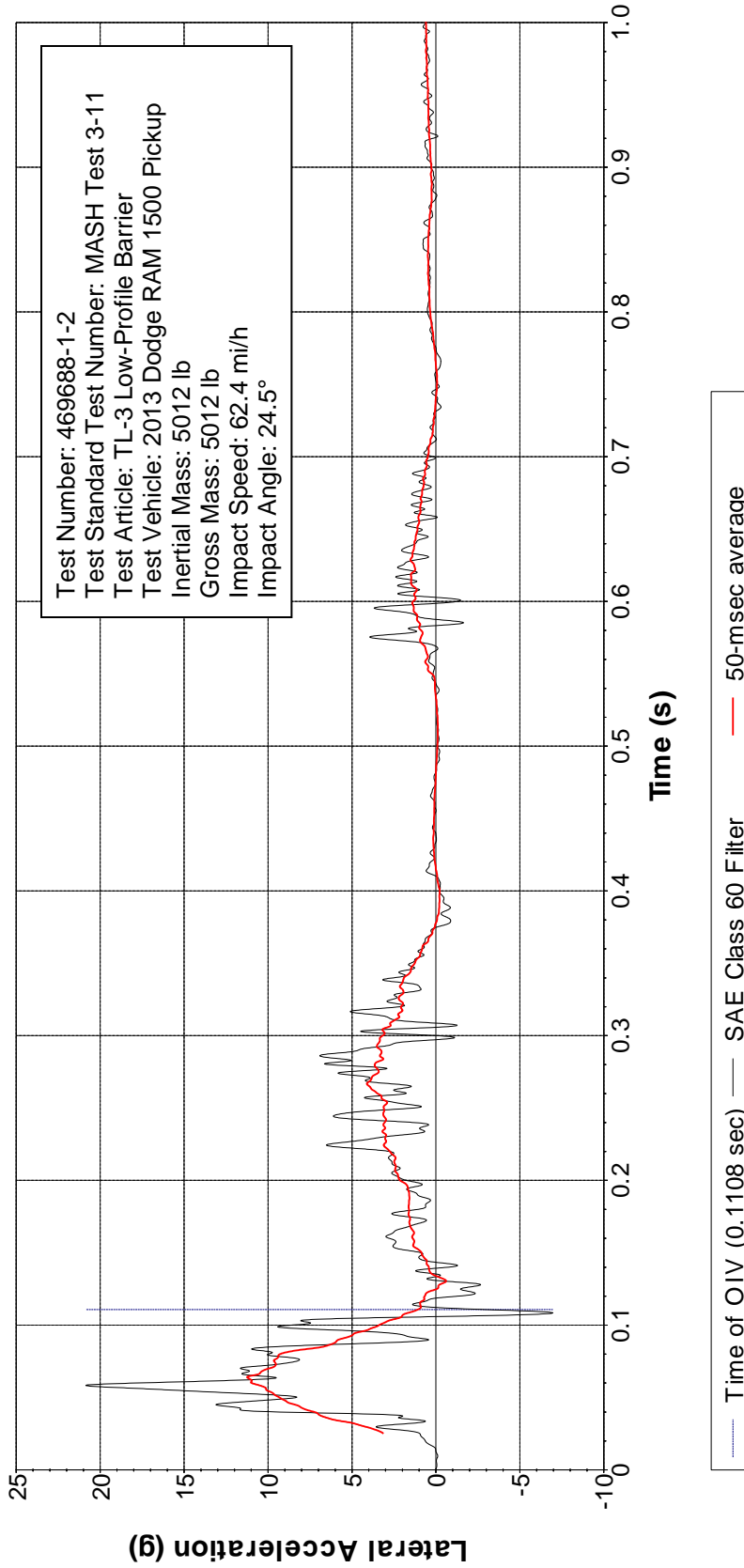
**D.4 VEHICLE ACCELERATIONS**



**Figure D.4. Vehicle Longitudinal Accelerometer Trace for Test No. 469688-1-2  
(Accelerometer Located at Center of Gravity).**

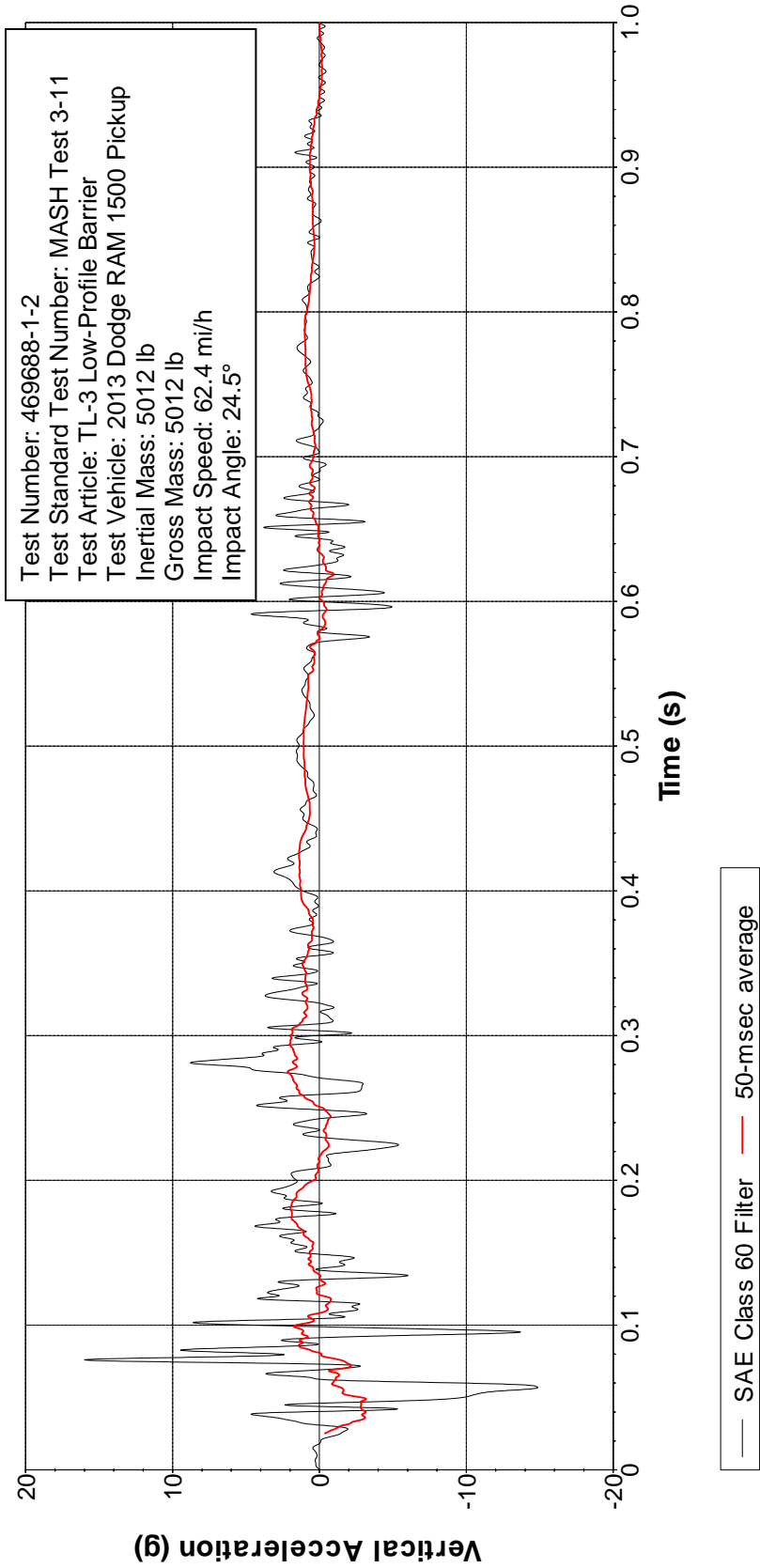


# Y Acceleration at CG



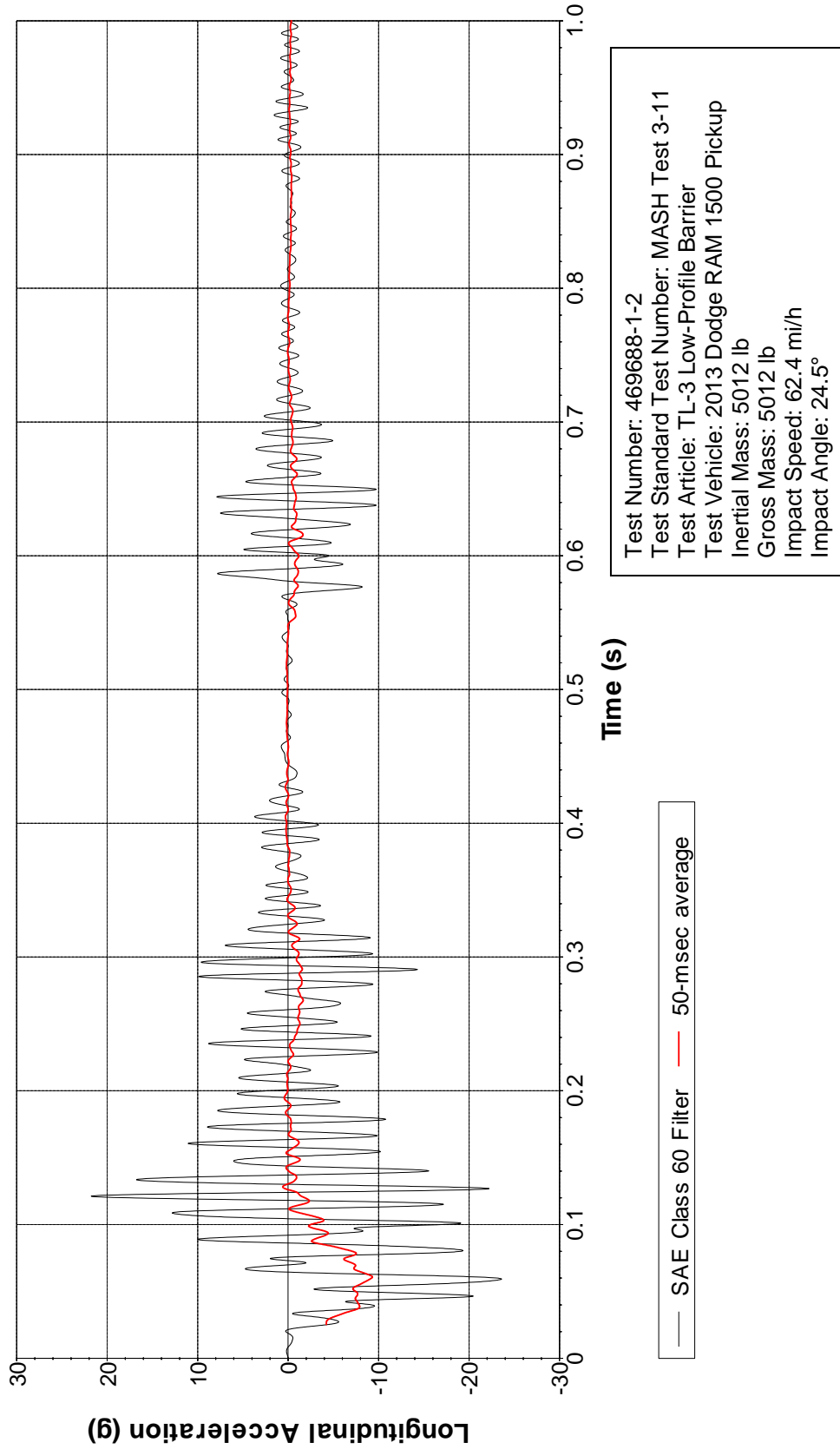
**Figure D.5. Vehicle Lateral Accelerometer Trace for Test No. 469688-1-2 (Accelerometer Located at Center of Gravity).**

# Z Acceleration at CG



**Figure D.6. Vehicle Vertical Accelerometer Trace for Test No. 469688-1-2  
(Accelerometer Located at Center of Gravity).**

# X Acceleration Rear of CG



**Figure D.7. Vehicle Longitudinal Accelerometer Trace for Test No. 469688-1-2 (Accelerometer Located Rear of Center of Gravity).**

# Y Acceleration Rear of CG

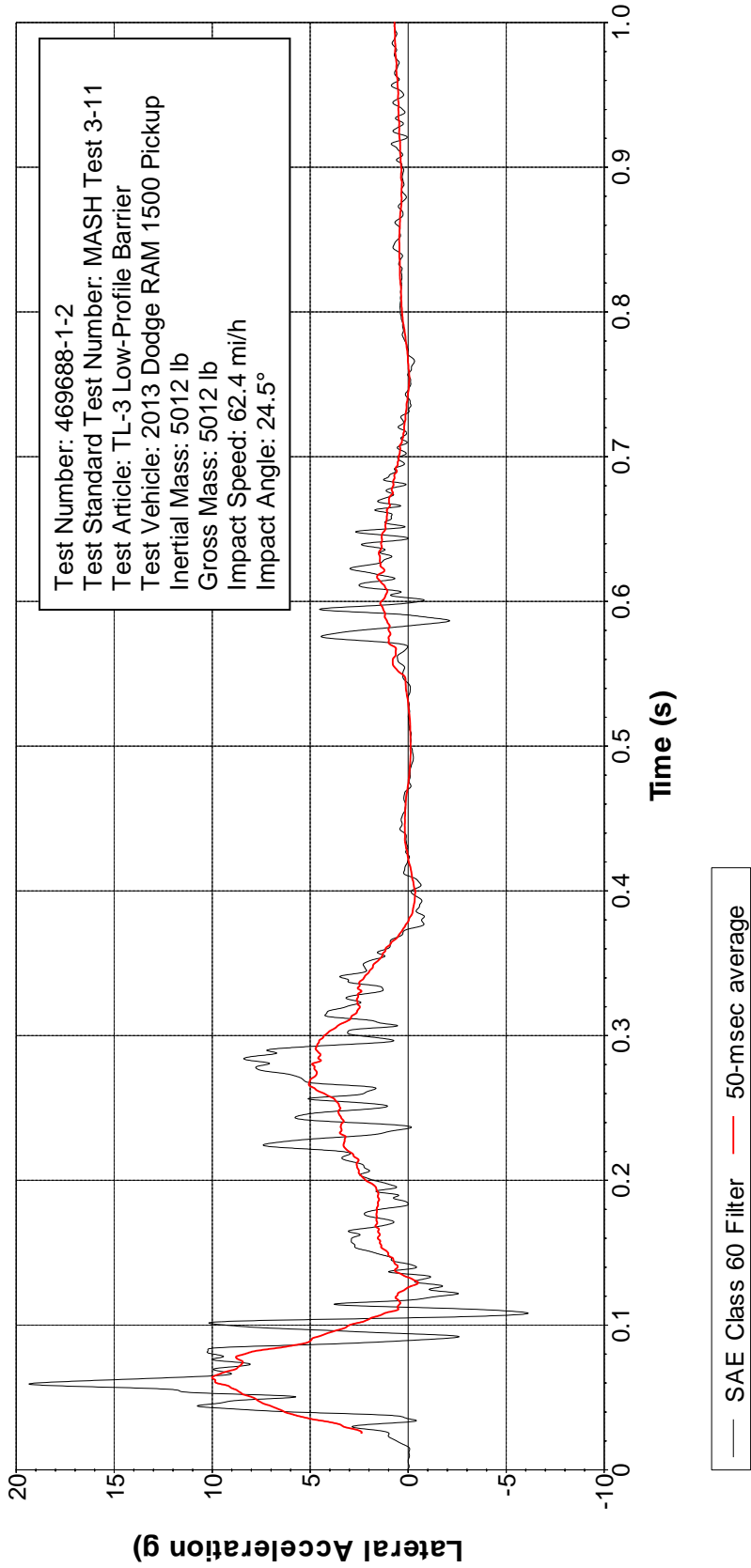
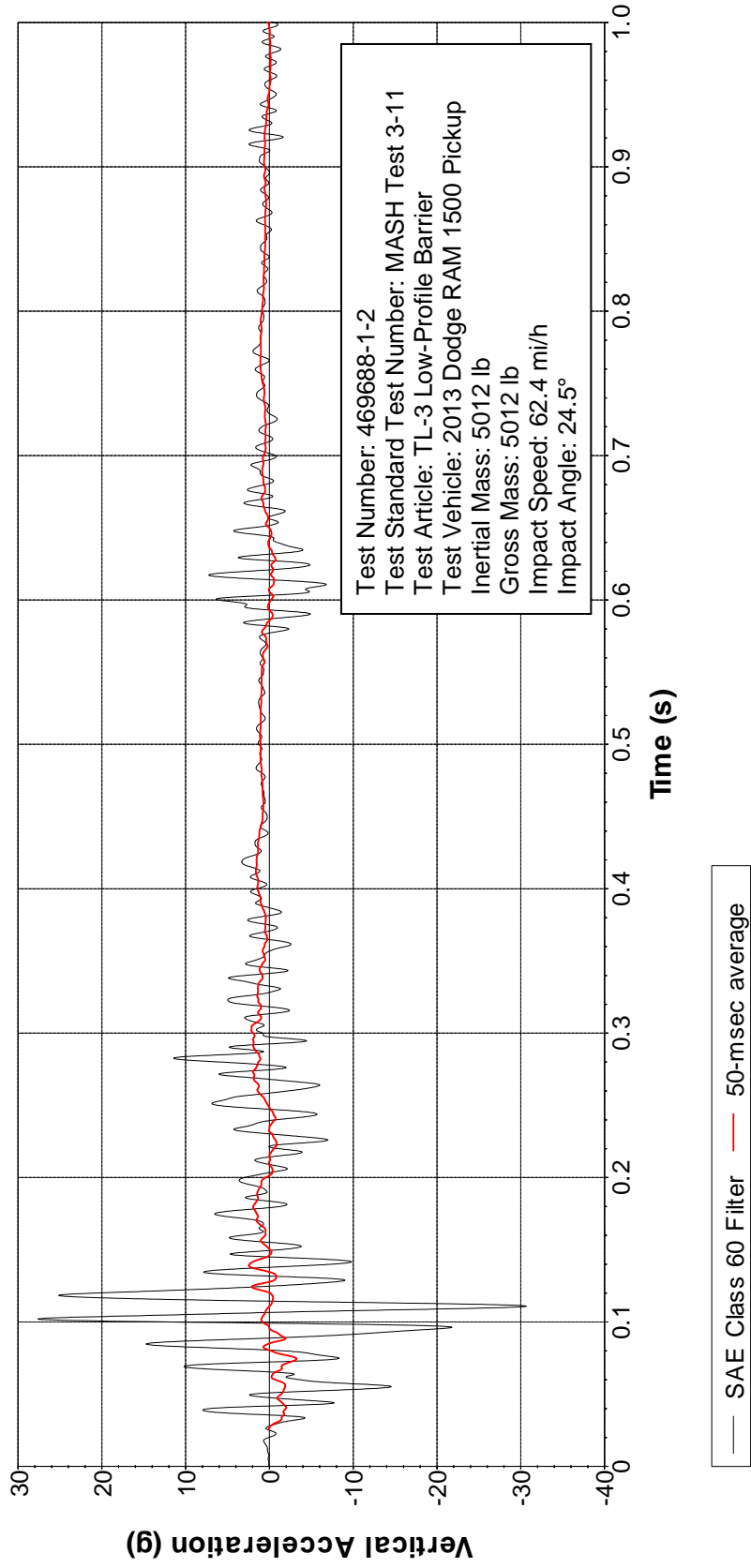


Figure D.8. Vehicle Lateral Accelerometer Trace for Test No. 469688-1-2 (Accelerometer Located Rear of Center of Gravity).

# Z Acceleration Rear of CG



**Figure D.9. Vehicle Vertical Accelerometer Trace for Test No. 469688-1-2 (Accelerometer Located Rear of Center of Gravity).**