



U.S. Department  
of Transportation  
**National Highway  
Traffic Safety  
Administration**



---

DOT HS 811 024

September 2008

# **On-Road Study of Drivers' Use of Rearview Video Systems (ORSDURVS)**

## **DISCLAIMER**

This publication is distributed by the U.S. Department of Transportation, National Highway Traffic Safety Administration, in the interest of information exchange. The opinions, findings, and conclusions expressed in this publication are those of the author(s) and not necessarily those of the Department of Transportation or the National Highway Traffic Safety Administration. The United States Government assumes no liability for its contents or use thereof. If trade or manufacturers' names or products are mentioned, it is because they are considered essential to the object of the publication and should not be construed as an endorsement. The United States Government does not endorse products or manufacturers.

### Technical Report Documentation Page

1. Report No. DOT HS 811 024	2. Government Accession No.	3. Recipient's Catalog No.	
4. Title and Subtitle  On-Road Study of Drivers' Use of Rearview Video Systems (ORS DURVS)		5. Report Date September 2008	
		6. Performing Organization Code NHTSA/NVS-312	
7. Author(s) Elizabeth N. Mazzae and Frank Barickman, National Highway Traffic Safety Administration; G. H. Scott Baldwin and Thomas Ranney, Transportation Research Center Inc.		8. Performing Organization Report No.	
9. Performing Organization Name and Address National Highway Traffic Safety Administration Vehicle Research and Test Center P.O. Box 37 East Liberty, OH 43319		10. Work Unit No. (TRAIS)	
		11. Contract or Grant No.	
12. Sponsoring Agency Name and Address National Highway Traffic Safety Administration 1200 New Jersey Ave., S.E. Washington, D.C. 20590		13. Type of Report and Period Covered Final Report	
		14. Sponsoring Agency Code	
15. Supplementary Notes The authors thank Heath Albrecht, Adam Andrella, Christopher Boday, Jodi Clark, Thomas Gerlach, Ed Parmer, and Scott Vasko of TRC; Steve Wilson of SSI; and John Martin of The Ohio State University for their technical support in performing this research.			
16. Abstract <p>Driver's use of rearview video (RV) systems was observed during staged and naturalistic backing maneuvers to determine whether drivers look at the RV display during backing and whether use of the system affects backing behavior. The 37 test participants aged 25 to 60 years were comprised of 12 drivers of RV equipped vehicles, 13 drivers of vehicles equipped with an RV system and a rear parking sensor system (RPS), and 12 drivers of vehicles having no backing aid. All participants had driven and owned a 2007 Honda Odyssey minivan as their primary vehicle for at least 6 months. Participants were told that the purpose of the study was to assess how drivers learn to use the features and functions of a new vehicle.</p> <p>Participants visited the sponsor's research lab to have unobtrusive video and other data recording equipment installed in their personal vehicles and take a brief test drive. Participants then drove their vehicles for a period of 4 weeks in their normal daily activities while backing maneuvers were recorded. At the end of the 4 weeks, participants returned to the research lab to have the recording equipment removed. Participants took a 2nd test drive, identical to the first, except that when backing out of the garage bay at the end of the drive, an unexpected obstacle appeared behind the vehicle.</p> <p>Drivers with RV made 13 to 14 percent of glances to the RV video screen during initial phases of backing in the staged maneuvers, independent of system presence, drivers spent over 25 percent of backing time looking over their right shoulder in the staged backing maneuvers. Only participants with an RV system who looked at the RV display more than once during the maneuver avoided a crash. Results showed that RV system presence was associated with a statistically significant 28 percent reduction in crashes compared with the unexpected obstacle participants without a system. All 12 participants in the "no system" condition crashed. More participants in the 'RV &amp; RPS' condition crashed (85 percent) than did in the RV condition (58 percent). Substantial benefits of the presence of an RPS system were not seen in the staged obstacle event. Only 5 of 13 participants in the "RV &amp; RPS" condition received RPS warning indicating the presence of a rear obstacle. Of those 5 participants, 4 crashed.</p> <p>In naturalistic backing maneuvers, the 37 participants made 6145 backing maneuvers. None of the 6145 naturalistic backing events resulted in a significant collision. There were several minor collisions during routine backing with, for example, trash cans and other vehicles. Approximately 61 percent of backing events involved no concurrent driver activity. In real-world backing situations, drivers with RV systems spent 8 to 12 percent of the backing time looking at the RV display. On average, drivers made less than one glance to the console or RV display location when no video display was present, versus 2.17 glances when only the RV system was present and 1.65 glances with RV plus RPS. Overall, drivers looked at least once at the RV display on approximately 65 percent of backing events and looked more than once at RV on approximately 40 percent of backing events.</p> <p>Overall, results of this study revealed that drivers look at rearview video displays during backing maneuvers at least some of the time. Approximately 14 percent of glances in baseline and obstacle events and 10 percent of glances in naturalistic backing maneuvers went to the RV display. In addition, there was no evidence to support the hypothesis that driver's backing behavior (i.e. speed and acceleration) was influenced by the presence of absence of an RV system in either the staged obstacle event or the naturalistic backing maneuvers. Drivers' average backing speed in naturalistic backing maneuvers was 2.26 miles per hour.</p>			
17. Key Words		18. Distribution Statement Document is available to the public from the National Technical Information Service Springfield, VA 22161	
19. Security Classif. (of this report) Unclassified	20. Security Classif. (of this page) Unclassified	21. No. of Pages 139	22. Price

## TABLE OF CONTENTS

<b>TABLE OF CONTENTS</b> .....	<b>i</b>
<b>LIST OF FIGURES</b> .....	<b>iii</b>
<b>LIST OF TABLES</b> .....	<b>v</b>
<b>EXECUTIVE SUMMARY</b> .....	<b>vii</b>
<b>1.0 INTRODUCTION</b> .....	<b>1</b>
1.1 Background.....	1
1.2 Related Research .....	2
1.3 Current Study Objectives .....	3
<b>2.0 VEHICLE SELECTION</b> .....	<b>5</b>
2.1 Performance of 2007 Honda Odyssey Parking Sensor System.....	11
2.1.1 Odyssey RPS Performance in Detecting Stationary Objects .....	11
2.1.2 Sensor Detection Zone Area Repeatability Tests with Stationary Objects .....	14
2.1.3 Odyssey RPS Performance in Detecting Dynamic Objects.....	18
<b>3.0 METHOD</b> .....	<b>21</b>
3.1 Experimental Design.....	21
3.2 Participant Recruitment.....	21
3.3 Participants .....	22
3.4 Ruse .....	22
3.5 Data Acquisition and Instrumentation .....	22
<b>4.0 PROCEDURE</b> .....	<b>25</b>
4.1 Initial Meeting.....	25
4.2 Naturalistic Driving Period.....	26
4.3 Final Meeting and Surprise Obstacle Event.....	26
4.3.1 Details of the Obstacle Event Scenario .....	27
4.4 Data Reduction Method .....	31
<b>5.0 RESULTS: NATURALISTIC DRIVING</b> .....	<b>33</b>
5.1 Characteristics of Naturalistic Driving .....	33
5.2 Characteristics of Naturalistic Backing Maneuvers .....	34
5.3 Naturalistic Backing Crashes .....	37
5.4 Eye Glance Behavior During Naturalistic Backing Events .....	38
5.4.1 Eye Glance Behavior During Backing as a Function of Environmental Conditions.....	42
5.5 Drivers' Activities During Naturalistic Backing Events.....	50
5.6 RPS Use .....	52
<b>6.0 RESULTS: INITIAL 'BASELINE EVENT' AND FINAL 'OBSTACLE EVENT' ....</b>	<b>53</b>
6.1 Backing Behavior During Baseline and Obstacle Events.....	53
6.2 Obstacle Event Outcome Results .....	55

6.3 Eye Glance Behavior During Baseline and Obstacle Events .....	59
<b>7.0 QUESTIONNAIRE RESULTS.....</b>	<b>65</b>
<b>8.0 DISCUSSION.....</b>	<b>72</b>
8.1 Rearview Video System Display Response Time .....	72
8.2 Why Was RV (only) Associated with Fewer Crashes Than RV & RPS? .....	73
8.3 Impact of Rearview Video Use on Likelihood of Backover Crash Avoidance... 74	
8.4 Caveats.....	74
8.5 What is “Good” Driver Glance Behavior During Backing?.....	75
<b>9.0 SUMMARY and CONCLUSIONS.....</b>	<b>76</b>
<b>10.0 REFERENCES.....</b>	<b>79</b>
<b>11.0 APPENDICES.....</b>	<b>80</b>
11.1 Appendix A: Results for Performance Testing of the 2007 Honda Odyssey’s Parking Sensor System – Front Sensors.....	80
11.2 Appendix B: Participant Information Summary .....	81
11.3 Appendix C: Vehicle Condition Check Sheet.....	91
11.4 Appendix D: Participant Debrief Form .....	92
11.5 Appendix E: Participant Questionnaire With Results (No System) .....	93
11.6 Appendix F: Participant Questionnaire With Results (Rearview Video Only) 95	
11.7 Appendix G: Participant Questionnaire With Results (Rearview Video and Rear Parking Sensors) .....	104
11.8 Appendix H: Details of Mechanisms Used in Presenting the Obstacle Event.... .....	122

## LIST OF FIGURES

Figure 1.	Percent Crashes by System Condition for the Staged Obstacle Event .....	viii
Figure 2.	Number of Glances Per Naturalistic Backing Maneuver Trial to the Rearview Video Display or Center Console Area (For the 'No System' Condition) .....	x
Figure 3.	Rearview Video System Visual Display of the 2007 Honda Odyssey.....	6
Figure 4.	Field of View of the 2007 Honda Odyssey Rearview Video System for a 29.4 Inch-Tall Object .....	7
Figure 5.	Rear Field of View for the 2007 Honda Odyssey with 60-Inch-Tall Driver Viewing a 29.4 Inch-Tall Object.....	8
Figure 6.	Rear Field of View for the 2007 Honda Odyssey with 70-Inch-Tall Driver Viewing a 29.4 Inch-Tall Object.....	9
Figure 7.	Photo of Warning Message from Odyssey Parking Sensor System.....	10
Figure 8.	Image of the Locations of the Four Rear Parking System Sensors.....	11
Figure 9.	2007 Honda Odyssey RPS Detection Results for the 18-Inch-Tall Traffic Cone.....	12
Figure 10.	2007 Honda Odyssey RPS Detection Results for the 36-Inch-Tall Traffic Cone .....	13
Figure 11.	2007 Honda Odyssey RPS Detection Results for the 1-Year-Old ATD ...	13
Figure 12.	2007 Honda Odyssey RPS Detection Results for the 3-Year-Old ATD ...	14
Figure 13.	Repeatability Test Results for the 2007 Odyssey RPS Detecting a 28-Inch-Tall Traffic Cone .....	15
Figure 14.	Repeatability Test Results for the 2007 Odyssey RPS Detecting a 40-Inch-Tall PVC Pole .....	16
Figure 15.	Repeatability Test Results for the 2007 Honda Odyssey RPS Detecting an Adult Male .....	17
Figure 16.	Illustration of How Test Objects Were Towed Behind the Test Vehicle ...	18
Figure 17.	Numbered Walking Paths for "Adult Waking Diagonally" Trials .....	20
Figure 18.	Two-Dimensional Image of a Child Used in the Surprise Obstacle Event	28
Figure 19.	Photograph of the Obstacle at the Beginning of Surprise Obstacle Event	29
Figure 20.	Photograph of the Obstacle at the End of Surprise Obstacle Event .....	30
Figure 21.	Locations of the Subject Vehicle, Obstacle, and Surrounding Objects During the Staged Backing Maneuver .....	31
Figure 22.	Mean Percentage of Glances by Glance Location and System Condition	39
Figure 23.	Mean Number of Glances Per Backing Maneuver by Glance Location and System Condition .....	40
Figure 24.	Mean Total Glance time by Glance Location and System Condition .....	41
Figure 25.	Mean Glance Duration by Glance Location and System Condition .....	41
Figure 26.	Mean Percentage of Glance Time by Location and System Condition ...	42
Figure 27.	Percentage Glance Time by Eye Glance Location and Maneuver Length... ..	43
Figure 28.	Percentage Glance Time by Location and Visibility .....	44
Figure 29.	Percentage Glance Time by Starting Location and Glance Location.....	44
Figure 30.	Percent Glance Time by Starting Location and System Condition.....	45
Figure 31.	Percent Glance Time by Visibility: No System .....	47

Figure 32.	Percent Glance Time by Backing Maneuver Length and System Condition .....	49
Figure 33.	Mean Time ( $\pm$ SD) Between Shifting into Reverse Gear and the Beginning of Rearward Motion (Baseline and Obstacle Events) .....	53
Figure 34.	Mean Backing Speed ( $\pm$ SD) by System Condition (Baseline and Obstacle Events) .....	54
Figure 35.	Mean Maximum Backing Speed ( $\pm$ SD) by System Condition (Baseline and Obstacle Events) .....	54
Figure 36.	Maximum Backing Acceleration ( $\pm$ SD) by System (Baseline and Obstacle Events) .....	55
Figure 37.	Percent Crashes by System Condition for the Staged Obstacle Event....	56
Figure 38.	Summary of Participants' Glances to the Rearview Video System During the Obstacle Event .....	57
Figure 39.	Obstacle Event Crashes as a Function of Rearview Video Glances.....	58
Figure 40.	Mean Number of Glances Per Trial by Glance Location and System (Baseline and Obstacle Events) .....	62
Figure 41.	Mean Percentage of Glances by Glance Location and System Condition (Baseline and Obstacle Events) .....	63
Figure 42.	Mean Glance Duration by Glance Location and System Condition (Baseline and Obstacle Events) .....	63
Figure 43.	Mean Percentage of Total Glance Time by Glance Location and System Condition (Baseline and Obstacle Events) .....	64
Figure 44.	Graphic Used to Assess in Which Areas Participants Thought a Small Child Standing Behind Their Vehicle Could Be Seen in the RV Display.....	69
Figure 45.	Summary of Questionnaire Responses Indicating in Which Areas a Small Standing Child Would Be Detected by the RPS .....	70
Figure 46.	PSS Front Sensors' Detection Results for the Various Traffic Cones, a 40-inch-Tall PVC Pole, and an Adult Male.....	80
Figure 47.	Backing Plate for Cutout .....	122
Figure 48.	Complete Cutout Assembly .....	123
Figure 49.	Anchor Points .....	124
Figure 50.	Piston and Electric Air Valve Assembly .....	125

## LIST OF TABLES

Table 1.	System Conditions and Numbers of Test Participants .....	vii
Table 2.	Availability of Vehicles Equipped with Parking Aid Systems and Rearview Video Systems in the U.S. (2005/2006 Model Year) .....	5
Table 3.	Maximum Detection Range as a Function of Test Object Speed .....	19
Table 4.	Data Channels.....	23
Table 5.	Characteristics of the Participants' Naturalistic Driving .....	33
Table 6.	Characteristics of the Participants Naturalistic Driving By System Condition .....	34
Table 7.	Characteristics of the 6145 Recorded Backing Maneuver Events.....	34
Table 8.	Distribution of Time Between Shift to Reverse and Beginning of Backing by Backing System Condition (Naturalistic Backing Events) .....	35
Table 9.	Mean Maximum Backing Speed by System Condition (Naturalistic Backing Events) .....	36
Table 10.	Quantiles of Overall Distribution of Maximum Backing Speed (from 6037 Naturalistic Backing Events).....	36
Table 11.	Extreme Values of Maximum Backing Speed (from 6037 Naturalistic Backing Events).....	37
Table 12.	Descriptive Statistics for Backing Maneuver Characteristics by Maneuver Starting Location.....	37
Table 13.	Naturalistic Crashes Observed .....	38
Table 14.	Number of Glances to the RV Display Per Backing Maneuver by System Condition .....	39
Table 15.	Descriptive Characteristics of Naturalistic Backing Maneuvers by Maneuver Length.....	43
Table 16.	Drivers' Activities During Backing Events .....	50
Table 17.	Summary of Observed Instances of Multiple Activities During Backing ...	51
Table 18.	Drivers' Primary Activity By System Condition.....	52
Table 19.	Mean Maximum Backing Speed by System Condition (Baseline and Obstacle Events) .....	55
Table 20.	Staged Obstacle Event Outcomes.....	56
Table 21.	Hypothetical Staged Obstacle Event Outcomes .....	59
Table 22.	Obstacle Event Outcomes as a Function of RPS Detection .....	59
Table 23.	Summary of Participants' Glances to the Rearview Video System During the Baseline and Obstacle Events.....	60
Table 24.	Number of Glances to the Console/RV Display by System and Baseline or Event Trial .....	61
Table 25.	Number of Glances to the Console/RV Display by RV Presence and Baseline or Event Trial .....	61
Table 26.	Questionnaire Responses Regarding Where Drivers Look to Determine Whether the Area Behind Their Vehicle is Clear Prior to Backing .....	65
Table 27.	Percent Responses Regarding Why "No System" Participants Did Not Choose To Purchase a Backing Aid System .....	66
Table 28.	Participant Responses Regarding Whether They Would Like Their Next New Vehicle to be Equipped With a Backing Aid System (by System Condition).....	66



Table 29.	How Did Participants Learn to Use Their RV or RPS .....	66
Table 30.	How Well Does Your Vehicle's RPS (N=13) and RV (N=12) Work in the Following Weather Conditions? .....	67
Table 31.	Summary of Participant Responses to the Question, "How Easy is Your (System) To Use When Backing Out of a Driveway? .....	68
Table 32.	Summary of Questionnaire Responses Indicating in Which Areas (in Figure 44) a Small Standing Child Could Be Seen in the RV Display.....	68
Table 33.	RV Display Measured Response Time (s) .....	72

## EXECUTIVE SUMMARY

A backover crash involves a vehicle moving in reverse striking a person, frequently a young child. Over the past 15 years, NHTSA has studied rear object detection systems for heavy trucks, medium straight trucks, and passenger vehicles and evaluated their performance in detecting people. As recently as 2007, NHTSA research found that sensor-based systems perform poorly and unreliably in detecting people, particularly children.

The advent of rearview video systems gave drivers a means to see the area directly behind the vehicle without reliability issues or object detection performance issues in most conditions. However, we are aware of no research to date that has examined drivers' use of rearview video systems in a naturalistic setting to assess drivers' ability to integrate this information source into their everyday backing behavior in real-world conditions.

Research was conducted to examine drivers' use of rearview video systems during backing maneuvers. The main purposes of the study were to 1) determine whether drivers look at the rearview video display during backing maneuvers and 2) determine whether use of the system affects backing performance (i.e., obstacle avoidance success).

An experiment was conducted to observe the driving behavior of drivers aged 25 to 60 years in both laboratory-staged and naturalistic backing maneuvers. The 37 test participants were comprised of 12 drivers of a vehicle equipped with a rearview video (RV) system, 13 drivers of vehicles equipped with an RV system and a rear parking sensor system (RPS), and 12 drivers of vehicles having no backing maneuver aid, as summarized in Table 1. All participants drove a 2007 Honda Odyssey minivan as their primary vehicle and had owned the vehicle for at least 6 months prior to study participation. Participants were told that the purpose of the study was to assess how drivers learn to use the features and functions of a new vehicle.

Table 1. System Conditions and Numbers of Test Participants

System	Number of Test Participants
No System	12
Rearview Video (RV) Only	12
Rearview Video and Rear Parking Sensors (RV & RPS)	13

The Odyssey's RV system had a center dashboard-mounted video display. The Odyssey's RPS had four rear bumper-mounted ultrasonic sensors and warned the driver of obstacles using a visual alert presented under the speedometer and an auditory alert.

At the start of their participation, drivers visited the sponsor's research lab to consent to study participation and have an unobtrusive data recording system installed in their

personal vehicles. Installed equipment included five video cameras, a video recorder, and a data acquisition system which controlled the recording of driving events. During this visit, participants took a test drive in an instrumented vehicle that was essentially identical to their own. At the end of the test drive, participants backed out of a garage bay without incident. Participants then drove their personal vehicles for a period of 4 weeks in their normal daily activities while backing maneuvers were recorded by the installed recording equipment. At the end of the 4 weeks, participants returned to the research lab to have the recording equipment removed from their vehicle. Participants took a second test drive, identical to that driven in their first visit except that when backing out of the garage bay at the end of the drive an unexpected obstacle appeared behind the vehicle. The obstacle was a rigid photo image of a small child. Participants' responses to this obstacle event were recorded.

### ***Staged Obstacle Event Results***

The rearview video system examined in this study improved detection and avoidance of a crash with a simulated stationary object in the experimental trials. Overall, the RV system presence was associated with a 28 percent reduction in crashes with the unexpected obstacle presented at the end of the second test drive (i.e., 7 out of 25 participants with RV did not crash). Since it was essentially impossible to directly see the obstacle without an RV system, 100 percent of participants in the 'no system' condition crashed, as shown below in Figure 1. Participants with an RV system experienced significantly fewer crashes than those without a system. More participants in the 'RV & RPS' condition crashed (85 percent) than did participants in the RV condition (58 percent); however, this difference was not statistically significant.

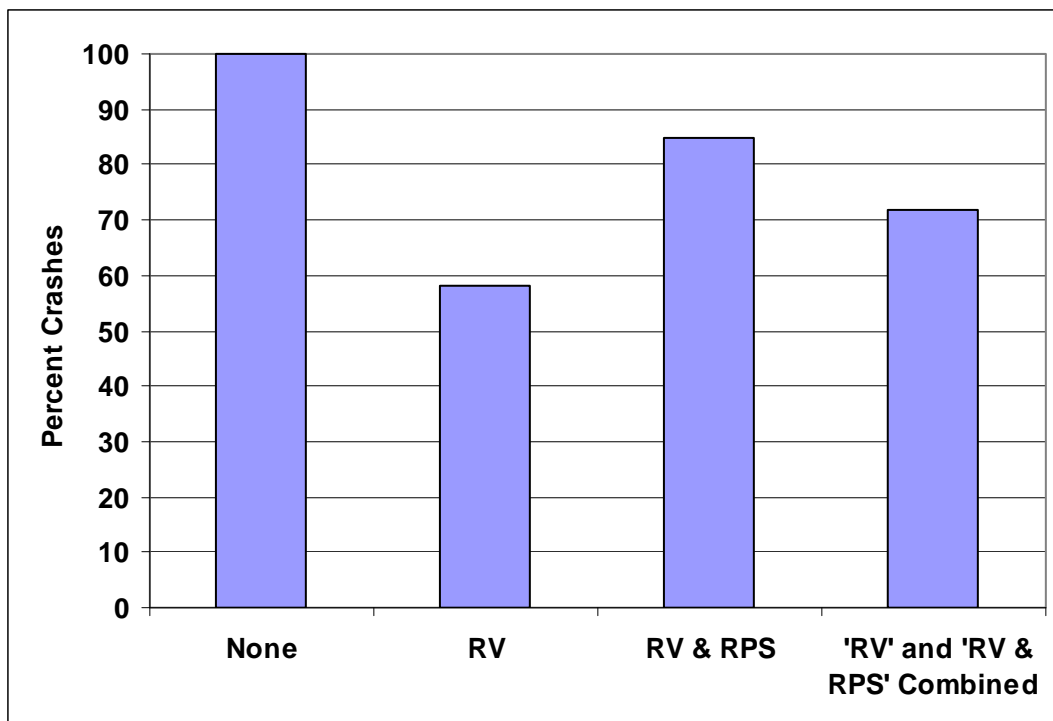

Figure 1. Percent Crashes by System Condition for the Staged Obstacle Event

Only participants with an RV system who looked at the RV display more than once during the backing maneuver avoided a crash. Two participants with an RV system who looked at the display more than once and still crashed were likely unable to see the obstacle in the RV display due to a delay in the RV image appearance. A brief examination of the timing of presentation of the RV image in that vehicle showed a 6.44 second delay between the time the driver shifted into reverse until the time the RV image appeared when reversing soon after starting the vehicle.

Drivers varied in their use of the RV system during the staged baseline and event trials. Specifically, among drivers with an RV system, 16 of 25 participants (64 percent) made at least one glance to the RV during the staged event trials. When both baseline and event trials were considered, the percentage of glance time directed at the RV display varied between 0 and 81 percent of the first 12 seconds of backing. Drivers with RV made 13 to 14 percent of glances to the RV video display during initial phases of backing. Without an RV system, drivers could not see obstacle in the staged obstacle event. Independent of system presence, drivers spent over 25 percent of backing time looking over their right shoulder in the staged backing maneuvers.

There are several possible reasons why the RV systems did not have a bigger benefit in the obstacle event trials. These include the delay associated with the appearance of the image in the RV display, the inappropriate timing of the drivers' looks to the RV system, their failure to make multiple glances at the RV display, and the possibility that drivers had strong expectations that no such event would occur in the research setting, which may have led them to become less vigilant than in real-world backing.

Substantial benefits associated with the presence of an RPS system on the vehicle were not seen in the staged obstacle event. Only 5 of 13 participants in the 'RV & RPS' condition received RPS warnings indicating the presence of an obstacle behind the vehicle. Of those 5 participants, 4 crashed.

### ***Naturalistic Backing Results***

In the naturalistic portion of this study, among 37 participants, each of whom participated for 28 days for a total of 42,982 miles, there were 6145 backing maneuvers. A typical backing event took approximately 10 seconds and covered 34 feet. Twenty-two percent of backing maneuvers involved multiple backing components, in which backing motion was separated by a period of stopped time, for example when a driver backed to the end of a driveway, stopped to wait for traffic then continued backing into the street. The results of naturalistic data collection reveal that on average drivers made approximately 1.14 backing maneuvers per trip; average trip length was slightly less than 9 miles.

None of the 6145 naturalistic backing events resulted in a significant collision. There were several minor collisions during routine backing with, for example, trash cans and other vehicles.

There is no evidence to support the hypothesis that drivers' backing behavior (i.e. speed and acceleration) was influenced by the presence or absence of an RV system.

Drivers' average backing speed in naturalistic backing maneuvers was 2.26 miles per hour; the average maximum speed was 3.64 miles per hour.

Glance behavior during backing appears to be robust and relatively invariant over different environmental conditions. In real-world backing situations, drivers with RV systems spent 8 to 12 percent of the backing time looking at the location of the RV display. Drivers with no system spent about 3 percent of their backing time looking at the center console area. Ignoring the possible effects of differential exposure, the differences between these values (5 to 9 percent) constitute one estimate of the percentage of backing time devoted to looking at the rearview video display. Furthermore, this result suggests that in addition to the routine preparatory tasks involving the console (radio, HVAC) drivers regularly look at the RV system while backing. Drivers with no RV system do not devote more glance time to the rear view mirror.

Overall, drivers looked at least once at the RV display on approximately 65 percent of backing events and looked more than once at the RV display on approximately 40 percent of backing events. Figure 2 highlights that, on average, drivers made less than one ( $M=0.81$ ) glance per trial to the console/video display location when no video display was present (e.g., to look at the vehicle clock), versus 2.17 (RV) and 1.89 glances (RV & RPS) when the RV system was present. Data suggest that participants in the RV & RPS condition made no glances per trial to the RV display more often than those in the 'RV only' condition. The data also suggest that participants in the RV & RPS condition made four or more glances per trial to the RV display less often than those in the 'RV only' condition. This trend of more participants with 'RV only' looking at the RV display than those with RV & RPS may indicate that participants in the RV & RPS condition were relying on the sensors to alert them of an obstacle. However, differences in the particular backing situations between driver groups (i.e., differential exposure) or individual differences in backing habits between groups may have contributed to this difference.

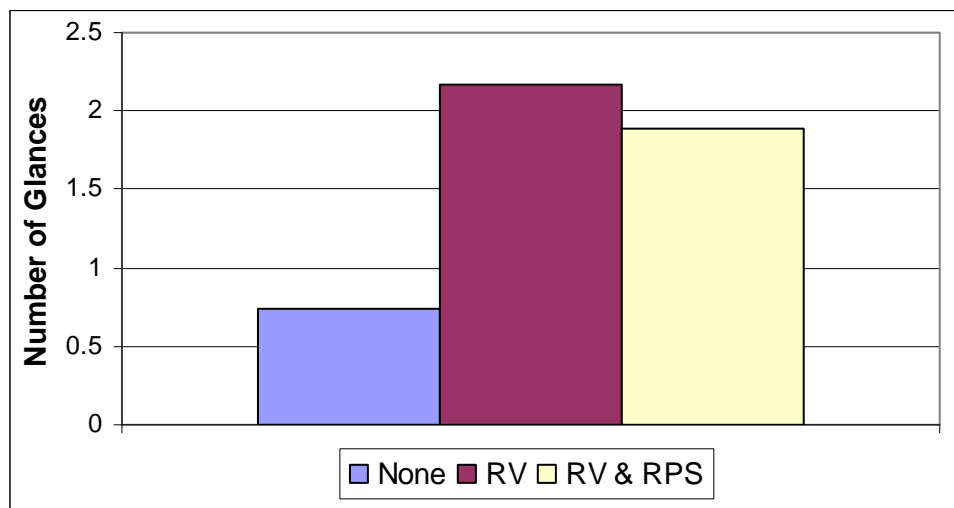

Figure 2. Number of Glances Per Naturalistic Backing Maneuver Trial to the Rearview Video Display or Center Console Area (For the 'No System' Condition)

Approximately 61 percent of backing events involved no concurrent driver activity. Among the remaining 39 percent of backing events, concurrent activities included activation of garage door remote (13 percent), talking with passenger (13 percent), using cell phone (3 percent) and securing seat belt (3 percent), among others. In 508 backing events (approximately 10 percent of the subset for which driver activity was recorded), drivers were engaged in multiple concurrent activities while backing.

The specific patterns of driver glance behavior and visual sampling of the center dashboard-mounted rearview video display may not be similar to those that would be observed in drivers using an RV display mounted in the center rearview mirror. Additional research would be required to determine whether rates of drivers' glances to the RV display seen in this study would be similar with a display in the rearview mirror.

### ***Conclusions***

Overall, results of this study revealed that drivers look at rearview video displays during backing maneuvers at least some of the time. Approximately 14 percent of glances in baseline and obstacle events and 10 percent of glances in naturalistic backing maneuvers were to the rearview video display. While this evidence of drivers' use of the rearview video systems is encouraging, it should be noted that due to the wide range of directions and speeds in which an obstacle might approach the area behind a vehicle and the timing in which a driver may choose to glance at the rearview video display, a rearview video system cannot be expected to prevent all backing crashes.

While rearview video systems offer the driver a useful tool for detecting rear obstacles, some guidance may be necessary to educate drivers as to the most effective way to incorporate this new visual information source into their glance behavior during backing maneuvers. Encouraging drivers to make more than one glance to the RV display during backing maneuvers, and to glance at the display throughout the maneuver rather than just at the beginning, may increase the benefits attainable with these systems.

## 1.0 INTRODUCTION

A backover crash is one in which a vehicle moving in reverse strikes a person. Tragically, the victims of these crashes are typically young children.

The size of the backover safety problem can only be roughly estimated because many of the backover crashes that occur on private property are not recorded in State or Federal crash databases, which focus on crashes occurring in traffic-ways. Supplementing NHTSA crash records with death certificate reports, backover crashes involving all vehicle types are estimated to cause at least 183 fatalities annually [1]. In addition, between 6,700 and 7,419 injuries per year result from pedestrian backovers [1]. A substantial portion of these injuries are minor.

### 1.1 Background

In 2006, in response to Section 10304 of the Safe, Accountable, Flexible, Efficient Transportation Equity Act: A Legacy for Users (SAFETEA-LU), the National Highway Traffic Safety Administration (NHTSA) published both a report to Congress about backover crashes [1] and an assessment of methods for reducing the incidence of injury, death, and property damage caused by collisions of backing passenger vehicles [2]. This second report documented the results of an assessment of available backover avoidance technologies for their ability to detect a variety of objects, including small children.

Eight sensor-based parking aid systems were examined to measure a variety of aspects of their object detection performance. Measurements included static field of view, static field of view repeatability, and dynamic detection range for a variety of test objects, including small children. An examination of three rear video and two auxiliary mirror systems was also conducted, which involved measurement of field of view and displayed image quality.

Test results revealed that sensor-based systems generally exhibited poor ability to detect pedestrians, particularly children, located behind the vehicle. Sensor-based systems' performance in detecting children was inconsistent, unreliable, and in nearly all cases quite limited in range. However, the rearview video systems examined were found to accurately display images of pedestrians or obstacles behind the vehicle.

While rearview video systems can display objects behind a vehicle, unless coupled with electronic proximity sensors, they cannot alert the driver to the presence of a rear obstacle. Thus, rearview video systems alone are passive and require the driver to take the initiative to look at the video display, perceive any pedestrian or obstacle present, and respond correctly. Without knowing whether drivers will make effective use of rearview video systems, it is not possible to estimate the benefits such a system may provide. The true efficacy of rearview video systems cannot be known without assessing whether drivers effectively incorporate the information into their visual scanning patterns. Thus, the current research seeks to investigate whether drivers will actively use rearview video systems when making backing maneuvers.

NHTSA also examined rear cross-view mirrors as part of a separate NHTSA study [3] that examined commercially-available rear object detection systems intended for use on medium straight trucks. For this study, NHTSA tested three sensor-based rear object detection systems, one rear object detection system that combined sensors with rearview video, one rearview video (only) rear object detection system and one rear cross-view mirror. Overall, the quality of the rear cross-view mirror image was found to be insufficient to allow drivers to resolve small objects behind the step van (or other vehicles of this length). It was found to be very hard to impossible to see small children over much of the blind zone behind the vehicle. Larger children and adults were visible, although there the combination of high distortion plus significant minification may reduce detection likelihood in certain portions of the blind zone. Weather effects, such as water droplets or ice on the mirror surface, will obscure the view of images in the rear cross-view mirror. People or objects behind a vehicle may not be sufficiently visible in the mirror in conditions of darkness. Overall, this study reported that rear cross-view mirrors are not a very effective means of allowing a driver to see behind a vehicle. Additionally, NHTSA has concerns that drivers may not use the mirrors effectively.

## **1.2 Related Research**

Two prior studies by General Motors (GM) examined driver performance while using rear parking aids that included an ultrasonic rear park assist system (URPA) and a rear video (RV) system [4,5,6].

The 2003 study [4] examined driver backing performance with an ultrasonic rear park assist (URPA), rear video (RV), URPA with RV, or no aid. The focus of the study was on parking behaviors; therefore participants performed a number of parking trials. Participants were asked to perform five parking tasks with each of the four levels of parking aid. The four parking aid systems were presented using a 2002 Cadillac Escalade. Seventy-two percent of participants drove an SUV, truck or van as their primary vehicle, while 19 percent reported their secondary vehicle was an SUV, truck or van. Prior to performing the trials, the use of the parking aid systems was explained to the participant. After all parking trials had been completed, an unexpected obstacle scenario was presented to examine obstacle avoidance performance differences that could result from the presence or absence of the parking aid systems [4]. Overall, 23 of 29 (83 percent) participants crashed into the obstacle (pylon). Of 5 participants who did not strike the obstacle, only 3 of them avoided it by viewing it in the video display. The paper states that, of the five participants who did not hit the obstacle: “three saw the obstacle using the RV (two in the RV condition, one in the URPA with RV condition), one saw the obstacle in their mirror (in the URPA with RV condition), and one saw the obstacle out the back window (in the RV condition).” However, the authors report that glance behavior during the parking tasks indicated that drivers were using both the URPA and RV systems when available.

The 2004 study [5] examined the effectiveness of backing warnings and showed low effectiveness for the warnings tested. Driver performance during backing maneuvers was examined in an open parking lot using two instrumented vehicles, both equipped



with prototype backing warning systems. All participants were trained on the integrated parking assist capability of the warning system, while a portion was provided specific training on the backing warning functionality. A surprise obstacle event was presented with the assistance of a distraction task involving a small video screen adjacent to the rear window. For drivers who received warnings from the system, only 13 percent avoided hitting the obstacle. Many drivers who experienced the warning (68 percent) demonstrated precautionary behaviors in response to the warning (e.g., covering the brake pedal). Participants reported that they did not expect there to be an obstacle present during the surprise obstacle maneuver. Many participants reported searching for an obstacle after receiving the warning, but since they “didn’t see anything” they continued to back. The authors noted that these observations suggest that expectancy is a powerful determinant, guiding driver perception and behavior. Many drivers appeared to want direct sensory confirmation of obstacle presence before initiating avoidance behaviors [6].

These studies used drivers who were unfamiliar with the use of the parking aid systems tested. Furthermore, participants drove “test vehicles” which were not necessarily the same make model as a vehicle they drove on a regular basis. Therefore, it cannot be determined whether lack of familiarity with the systems or the test vehicle contributed to the poor parking aid system effectiveness in the unexpected obstacle scenario.

### **1.3 Current Study Objectives**

Research was conducted to examine drivers’ use of rearview video systems during backing maneuvers. The main purpose of the study was to 1) determine whether drivers look at the rearview video display prior to and/or during backing and 2) determine whether use of the system affects backing performance (i.e., obstacle avoidance success). The following research questions were addressed:

1. How do drivers “use” the system?:
  - Do drivers of vehicles equipped with rearview video systems look at the video display during backing to gain information about the environment behind the vehicle?
  - Do drivers of vehicles equipped with rearview video systems glance at the mirrors and over their shoulder less than drivers without such a system?
  - Are glances made to the side and center rearview mirrors during a backing maneuver shorter in duration and/or fewer in frequency when using a rearview video system than when not using such a system?
  - Do drivers of vehicles equipped with rearview video systems look at the video before they initiate rearward motion of the vehicle?
  - Do drivers of vehicles equipped with rearview video systems and backing sensors look at the video display less often during backing than do drivers with rearview video only?
2. What effect do systems have on drivers’ behavior and performance during backing maneuvers?:

- Do drivers of vehicles equipped with rearview video systems experience fewer collisions with rear obstacles?
- Do drivers of vehicles equipped with a backing aid system perform backing maneuvers differently than drivers of vehicles without such equipment?

## 2.0 VEHICLE SELECTION

A single vehicle make/model was used in this study to prevent confounding of study results due to the differing physical characteristics of multiple vehicles. To select a vehicle with features relevant to this research, an early 2006 report [7] containing inventories of available in-vehicle technologies were reviewed to identify vehicles equipped with original equipment backing systems. Table 2, taken from the Early Adopters Survey Results Report [8], shows the availability of rearview video and sensor-based backing systems on recent model year vehicles.

Table 2. Availability of Vehicles Equipped with Parking Aid Systems and Rearview Video Systems in the U.S. (2005/2006 Model Year)

<b>System</b>	<b>Vehicle Manufacturer</b>	<b>Model Lines with System as Optional Equipment</b>	<b>Model Lines with Feature as Standard Equipment</b>
Backing aid only	21	82	22
Rearview video system only	0	8	2
Backing aid and rearview video system	10	10	2

This study required a 2007 model year vehicle that could be obtained with a factory-installed rearview video system alone or augmented by a factory-installed backing aid system. The vehicles that fit this description included models such as the Honda Odyssey, Acura TL and MDX, and Porsche Cayenne. Based on this list of vehicles, the model having the highest sales, the Honda Odyssey, was chosen for use in this study.

The rearview video system of the 2007 Honda Odyssey operates whenever the vehicle is in reverse (R) gear and the ignition switch is in the "on" position. The camera was located to the right side of the rear license plate. The visual display for the system was located at the top center of the dashboard. Figure 3 contains a photograph of the rearview camera system's visual display showing a grid of 1 foot squares. Figure 4 contains a graphical representation of the field of view of the vehicle's rearview camera. For comparison purposes, Figures 5 and 6 present the rear field of view (from the side mirrors rearward) for the Odyssey using only direct glances and mirrors for a 60-inch-tall driver and a 70-inch-tall driver.



Figure 3. Rearview Video System Visual Display of the 2007 Honda Odyssey

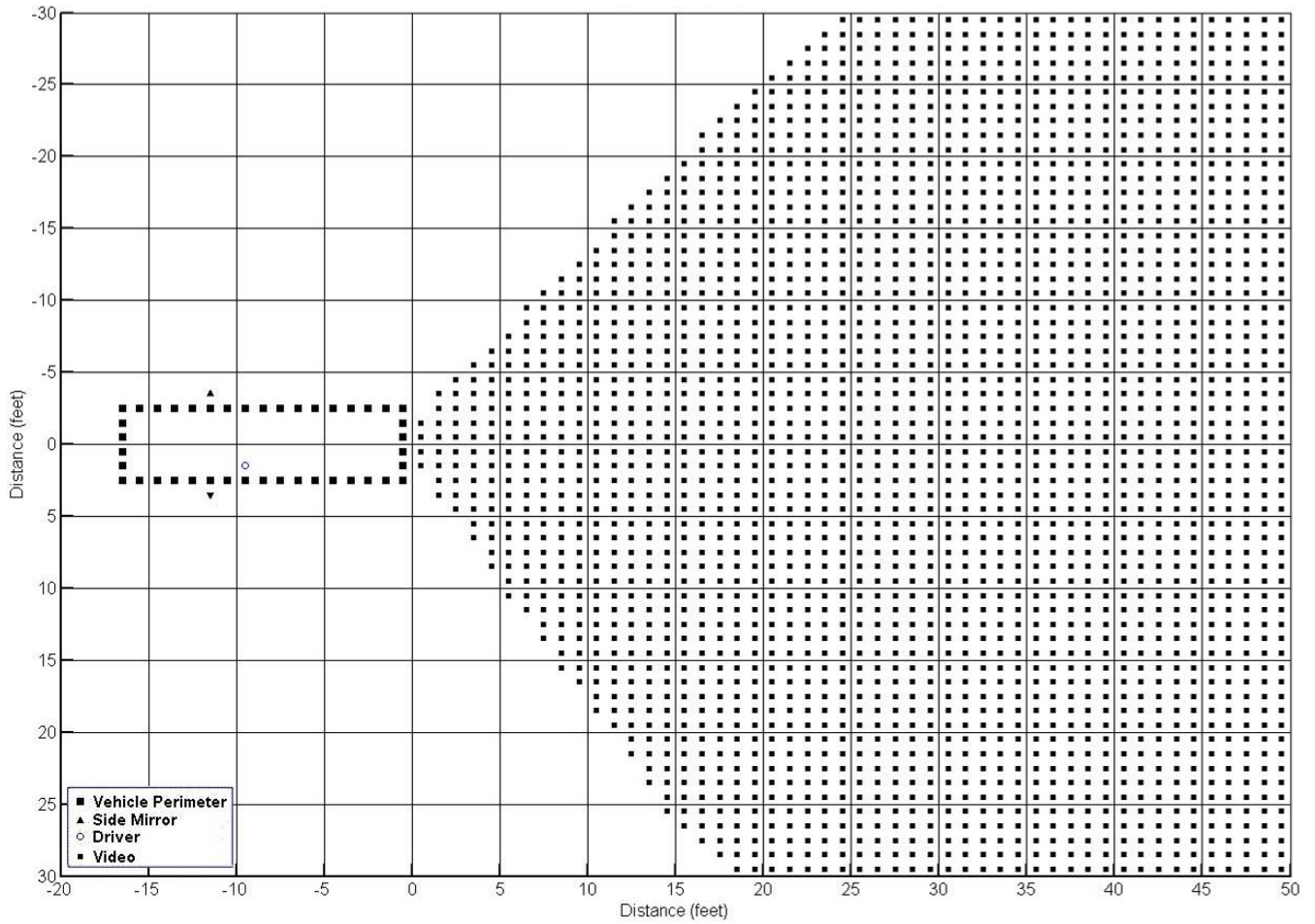

Figure 4. Field of View of the 2007 Honda Odyssey Rearview Video System for a 29.4 Inch-Tall Object

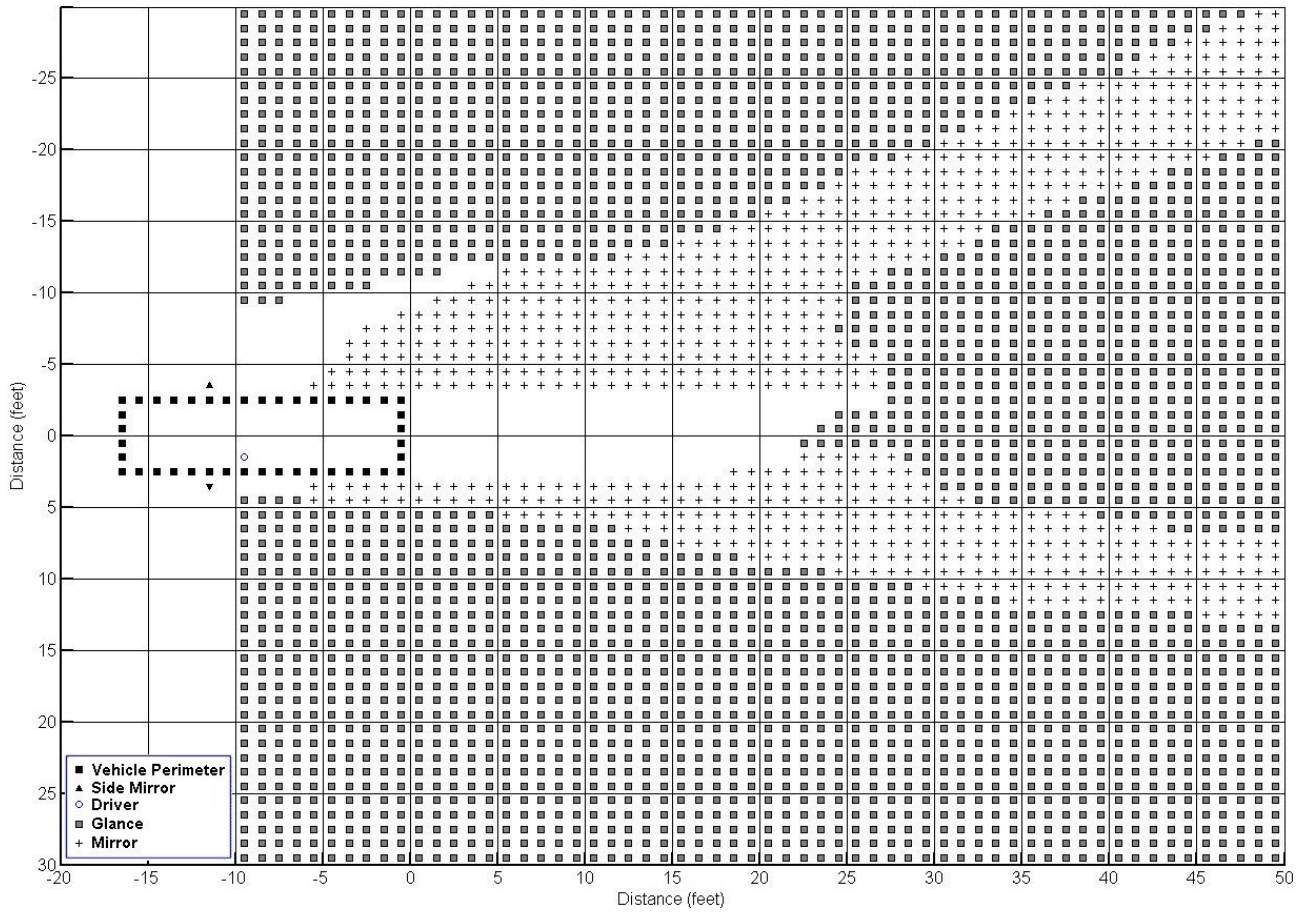

Figure 5. Rear Field of View for the 2007 Honda Odyssey with 60-Inch-Tall Driver Viewing a 29.4 Inch-Tall Object

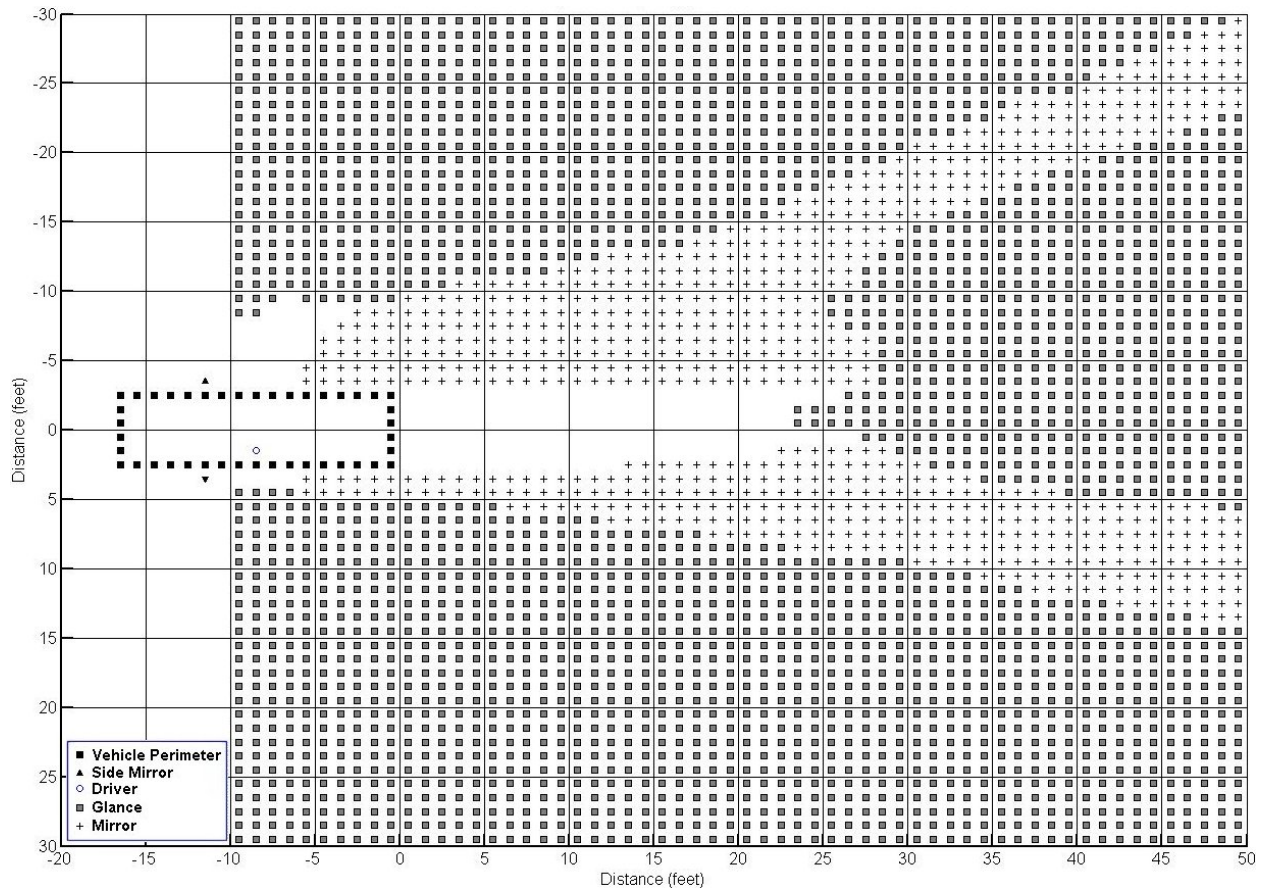

Figure 6. Rear Field of View for the 2007 Honda Odyssey with 70-Inch-Tall Driver Viewing a 29.4 Inch-Tall Object

The Odyssey's factory-equipped backing system was referred to as a "Parking Sensor System" (PSS). Note that, for the purposes of this report, the rear sensor portion of the system is referred to as the "Rear Parking System," or "RPS." The vehicle's owner's manual stated that the system "lets you know the approximate distance between your vehicle and most rear obstacles while you are parking" [9]. The system alerts the driver to the presence of a rear obstacle using "a beeper" and "system messages on the multi-information display" [9]. Figure 7 shows an image of a warning message from the Parking Sensor System. The manual further states that "All obstacles may not always be sensed. Even when the system is on, you should look for obstacles near your vehicle to make sure it is safe to park." The Parking Sensor System could be activated and deactivated via a button on the dashboard.



Figure 7. Photo of Warning Message from Odyssey Parking Sensor System

The vehicle's owner's manual [9] stated that the Parking Sensor System had two front corner sensors (20 in. range), two rear corner sensors (20 in. range), and a rear center sensor (70 in. range). However, the Odyssey "Touring" model vehicle acquired for use as a test drive vehicle for this study had two rear corner sensors and two rear center sensors, as shown in Figure 8. According to the vehicle's owner's manual [9], the "rear center sensor works only when the shift level is in reverse (R), and the vehicle speed is less than 5 mph (8 km/h)." The manual also stated that the "corner sensors work only when the shift lever is in any position other than P and the vehicle speed is less than 5 mph (8 km/h). The system alerts the driver to the presence of a nearby obstacle using a visual indicator presented on the multi-information display. The visual alert consists of an icon representing an overhead view of a car with a polygon adjacent to the location of the sensor that detected the obstacle. The system uses three different beep frequencies to indicate the range of the obstacle detected ("short beeps" for 16-20 in., "very short beeps" for 12-16 in., or "continuous beep" for 12 in. or less).

Two 2007 Honda Odyssey minivans were obtained for use as the test vehicles to be driven during the initial and final test drives. These vehicles helped expedite the test procedure by allowing for the participant's vehicle to have instrumentation installed or removed at the same time as the test drive was being conducted. A Touring trim level Odyssey equipped with "Honda Satellite-Linked Navigation System with voice recognition and rearview camera" was used as the test drive vehicle for participants owning vehicles equipped with rearview video (only) and rearview video plus parking sensors. An Odyssey LX was used as the test drive vehicle for participants whose personal vehicle was not equipped with a rearview video system or rear parking sensors.



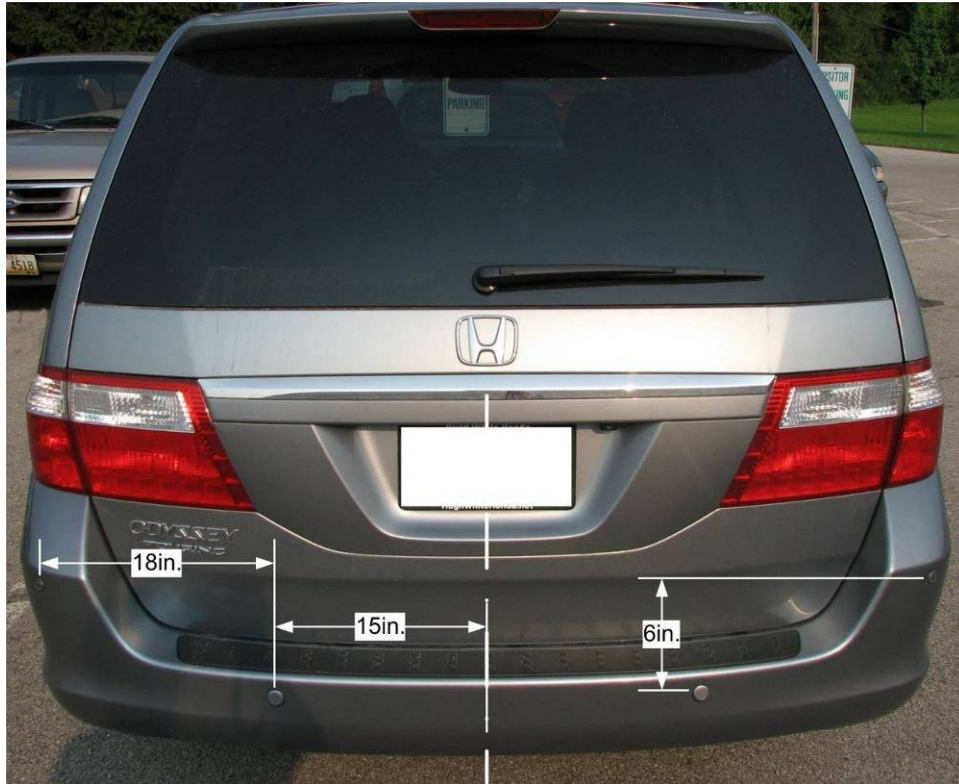

Figure 8. Image of the Locations of the Four Rear Parking System Sensors

## 2.1 Performance of 2007 Honda Odyssey Parking Sensor System

Hardware testing was performed to characterize the performance of the 2007 Honda Odyssey's Rear Parking Sensors (RPS) portion of the Parking Sensor System (PSS). Tests measured the ability of the system's rear sensors to detect stationary and moving targets including an adult male, various sizes of traffic cones, two anthropomorphic test devices (ATD) representing a 1-year-old and 3-year-old child, an ISO-specified PVC pole, and a plastic traffic curb. A detailed description of the methods used can be found in the NHTSA report, "Experimental Evaluation of the Performance of Available Backover Prevention Technologies" [2]. Selected results of testing of the current vehicle are presented in this section. Brief testing of the PSS's front parking sensors was also performed and results are presented in Appendix A.

### 2.1.1 Odyssey RPS Performance in Detecting Stationary Objects

For stationary object testing, trials were conducted to determine whether or not a particular test object was detected in a location on the test grid and what approximate level of warning was provided by the system. A system's response was considered an "inconsistent warning" if the system produced a sporadic or occasional visual or auditory alert in response to the object's presence. Each graph of detection results shows an overhead view of the test grid with the vehicle's rear bumper (not to scale) at the bottom of the graph positioned at the 0 longitudinal point on the grid.

The RPS was found to be unable to detect short objects behind the vehicle, including a 12-inch-tall traffic cone, plastic parking curb, and an adult male lying on the ground. An 18-inch-tall traffic cone was detectable in the range of 1 to 4 feet from the vehicle's rear bumper, however due to the height of the object and the shape of the sensor detection "beams," it could not be detected within the first 12 inches as shown in Figure 9. The detection results for a 36-inch-tall traffic cone shown in Figure 10 indicate that this object, twice as tall as the aforementioned one, showed only slightly better detectability and still was generally invisible to the sensors within a 12-inch range. The 1-year-old ATD with its 29.4-inch height was detectable within a 12-inch range in each outer one-third of the bumper span, but was invisible in that range within 1 foot to either side of the vehicle's centerline. Figure 11 also shows that the 1-year-old ATD was only detected consistently out to a distance of 4 feet. The 3-year old ATD, which was 37.2 inches in height, was detected over a slightly broader area (up to 1 ft in either lateral direction) and 1 foot further in range than was the 1-year old ATD (see Figure 12).

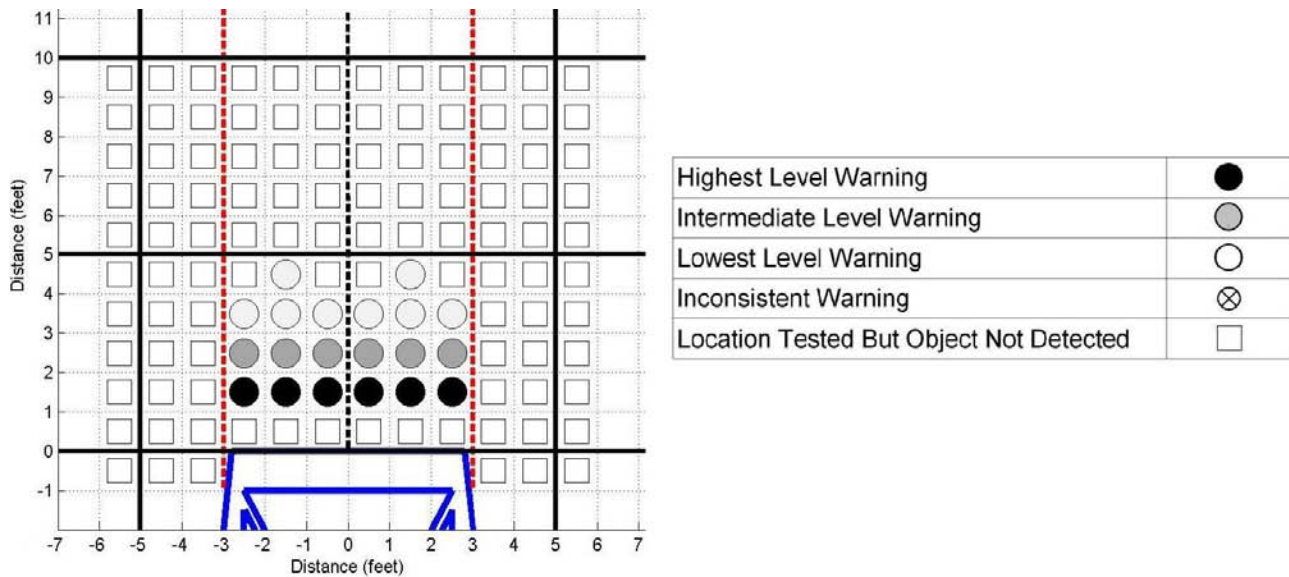

Figure 9. 2007 Honda Odyssey RPS Detection Results for the 18-Inch-Tall Traffic Cone

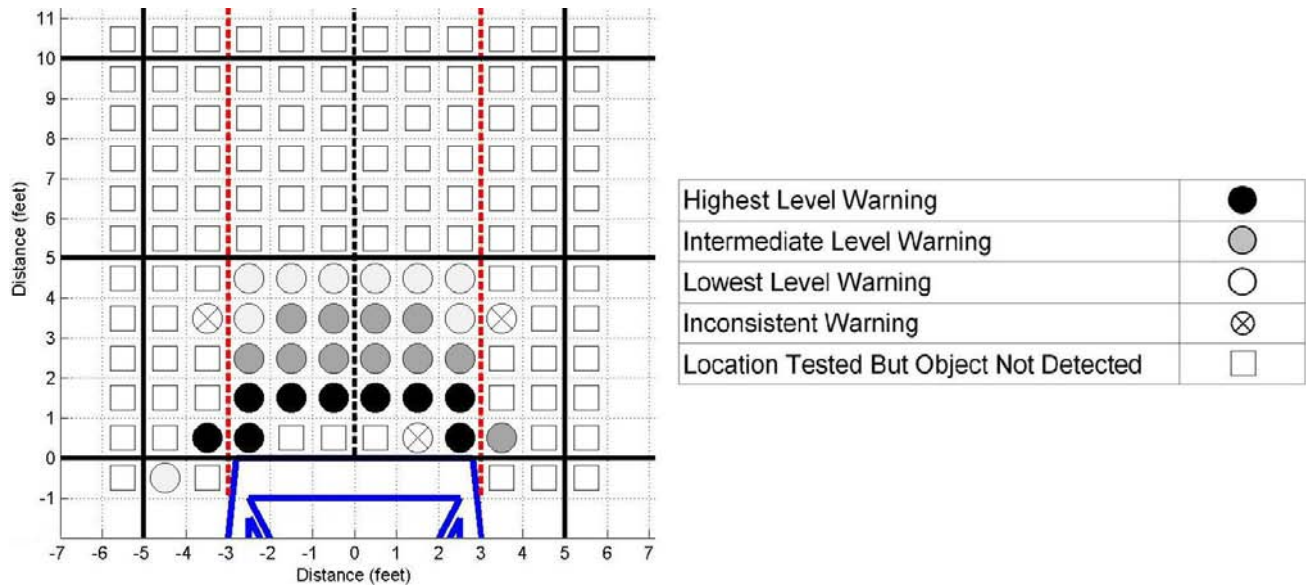

Figure 10. 2007 Honda Odyssey RPS Detection Results for the 36-Inch-Tall Traffic Cone

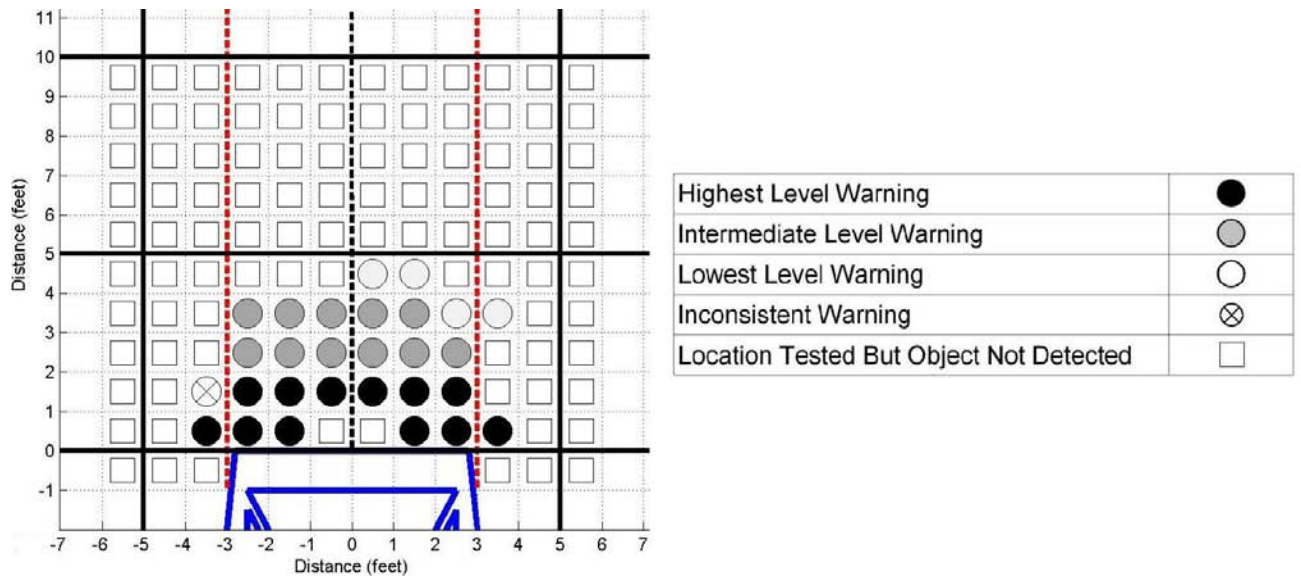

Figure 11. 2007 Honda Odyssey RPS Detection Results for the 1-Year-Old ATD

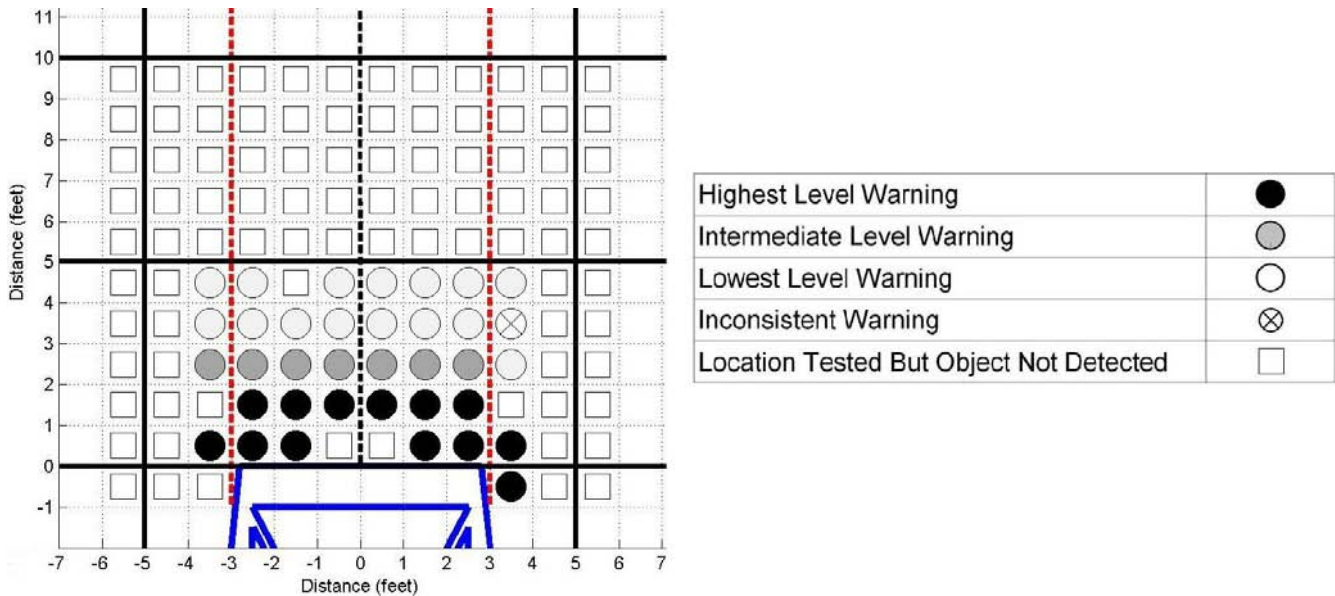

Figure 12. 2007 Honda Odyssey RPS Detection Results for the 3-Year-Old ATD

### 2.1.2 Sensor Detection Zone Area Repeatability Tests with Stationary Objects

Providing consistent, accurate object detection performance is important to ensure the detection of critical objects and to ensure that the driver will trust and therefore use and respond to the system. To assess repeatability, additional trials of static sensor system detection zone measurements were conducted with a subset of test objects to capture day-to-day variability in the detection performance of sensor systems. The degree of variability noted in these tests was whether or not an object was detected in a particular location (i.e., differences in level of warning provided were not noted) on a particular day. Systems' performance in detecting objects was measured on each of 3 consecutive days. The procedure used was the same as that used in the other static sensor system detection zone measurements. Objects used in these tests included the 28-inch cone, 40-inch-tall PVC pole, and an adult male human.

Figures 13 through 15 show the static detection zone repeatability test results. Each figure contains three graphs, one for each day in which the test was run. Each graph shows an overhead view of the test grid with the vehicle's rear bumper positioned at the bottom of the graph at the 0 longitudinal point on the grid.

Results for the 28-inch-tall traffic cone were fairly similar in each repetition, with variability concentrated in the far extent of the system's range between 4 and 5 feet. Detection results for the 40-inch-tall PVC pole were very consistent across the three repetitions, with each test showing a detection range of 5 feet. Results for detection of the adult male show consistent detection to a range of 5 feet and sporadic detection within the range of 5 to 6 feet. The far left and right edges of the detection zone also showed variable detection of the adult male, as shown in Figure 15. Overall, the variability seen in these repeatability results is consistent with that of similar, previously tested systems [2].

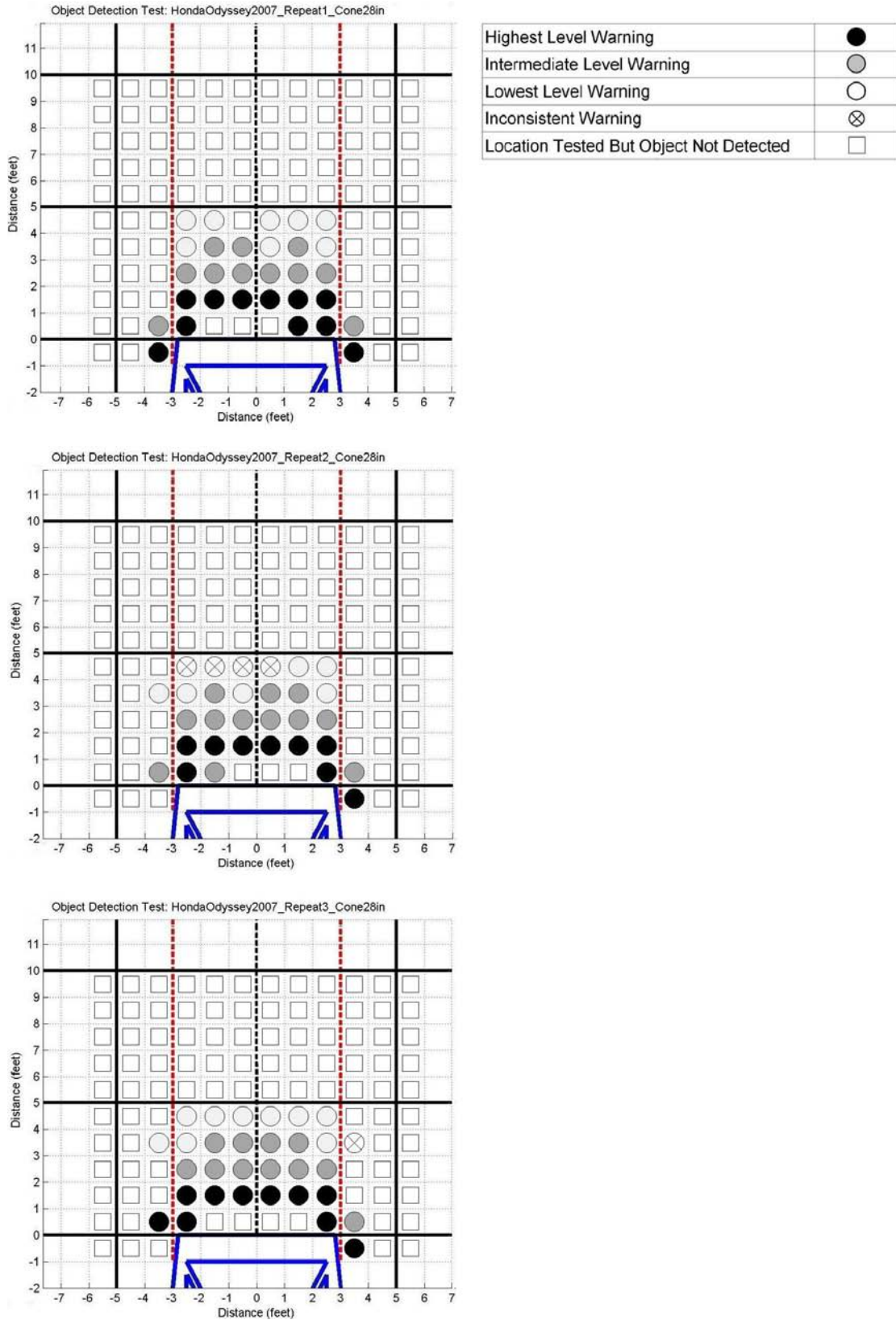

Figure 13. Repeatability Test Results for the 2007 Odyssey RPS Detecting a 28-Inch-Tall Traffic Cone

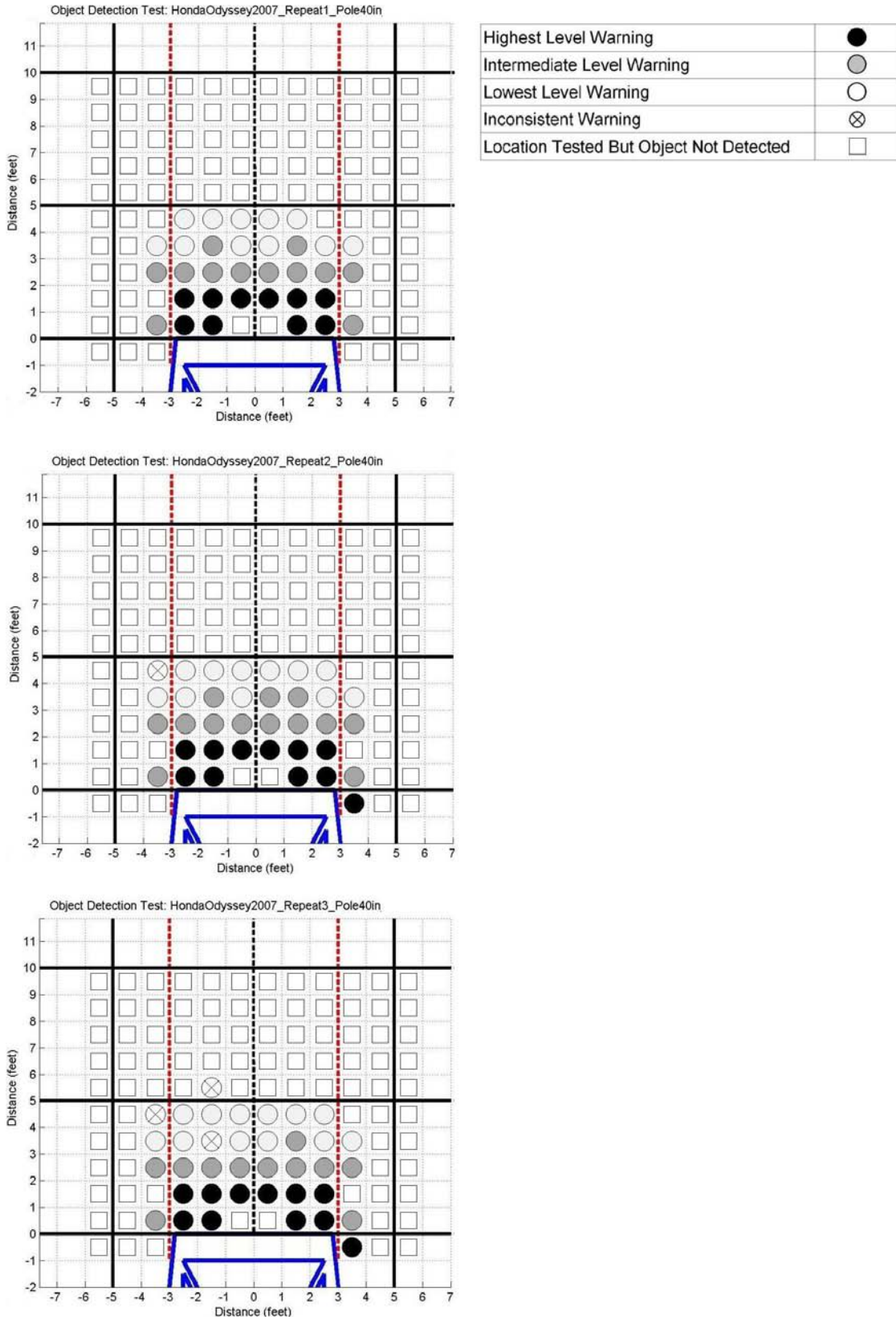

Figure 14. Repeatability Test Results for the 2007 Odyssey RPS Detecting a 40-Inch-Tall PVC Pole

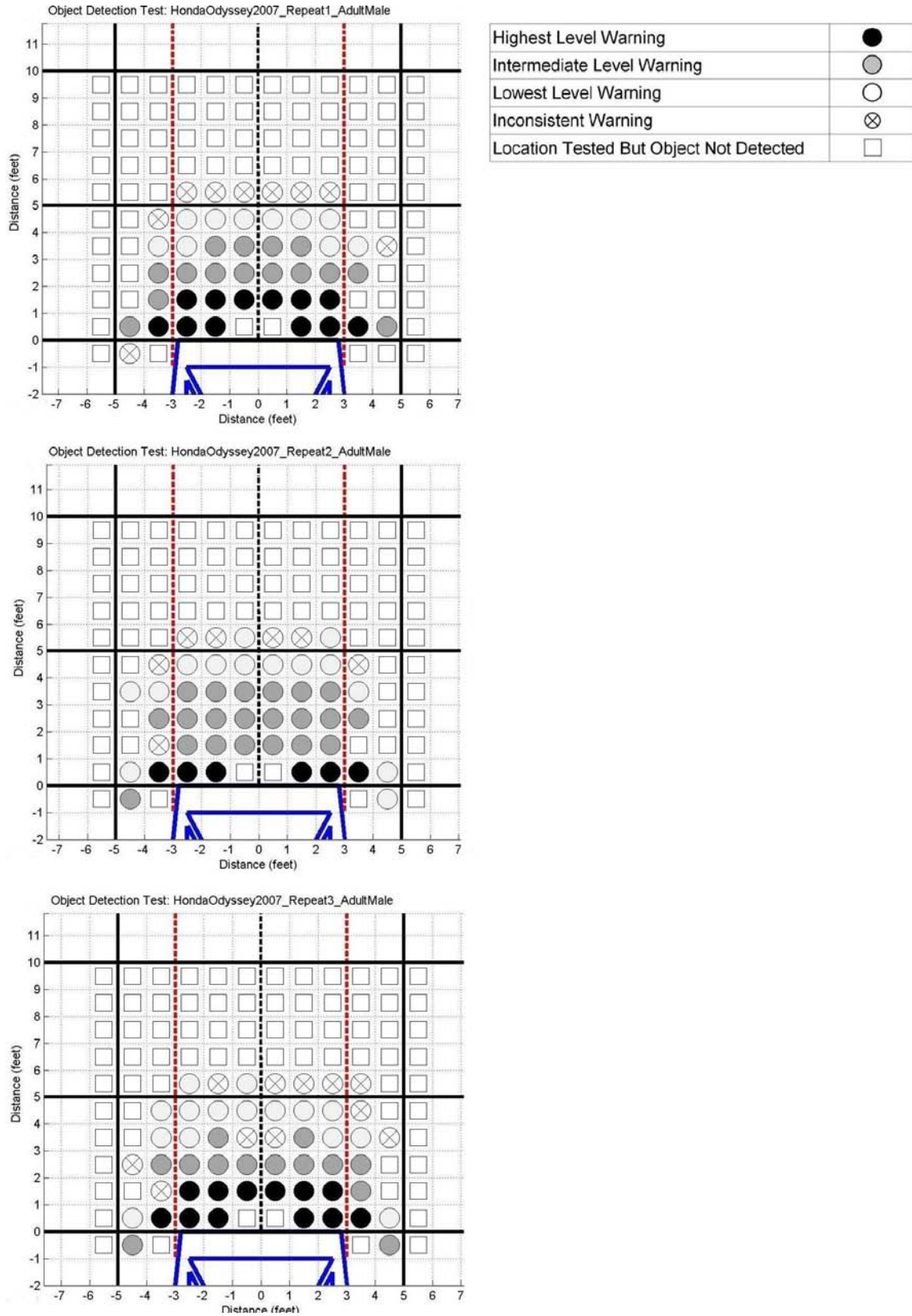

Figure 15. Repeatability Test Results for the 2007 Honda Odyssey RPS Detecting an Adult Male

### 2.1.3 Odyssey RPS Performance in Detecting Dynamic Objects

RPS performance in detecting objects moving behind the vehicle was measured using several test objects that were towed laterally (parallel to the vehicle's bumper) to determine the maximum range at which they were detected. Figure 16 illustrates the way in which test objects were moved during this test. The object was first moved behind the vehicle at a range of 1 foot from the rear bumper and, if successfully detected, the object was moved 1 foot further from the rear bumper. Table 3 presents results for the maximum range at which the dynamic objects were detected by the RPS. The maximum distance from the bumper at which any object was detected was 6 feet.

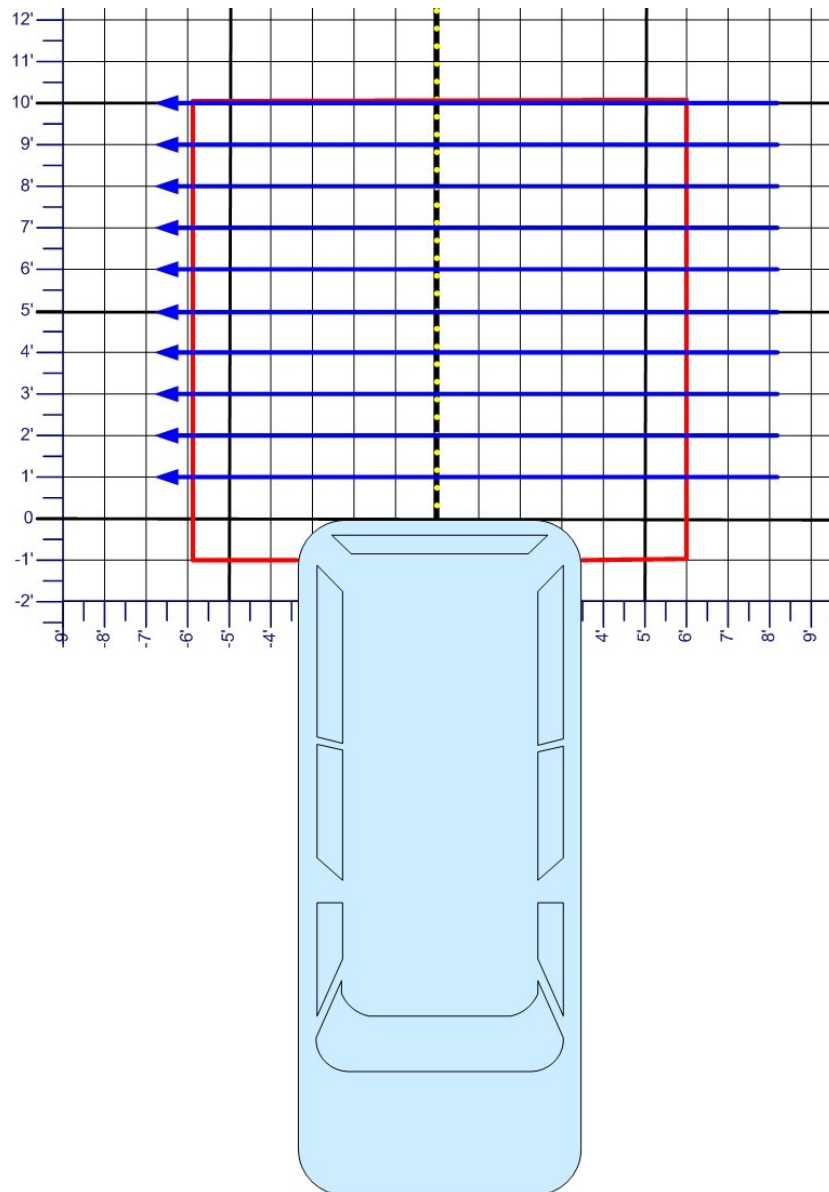

Figure 16. Illustration of How Test Objects Were Towed Behind the Test Vehicle



Table 3. Maximum Detection Range as a Function of Test Object Speed

TEST OBJECT	TEST OBJECT SPEED (mph)	MAXIMUM DETECTION RANGE (ft)
40-inch PVC pole (as per ISO 17386)	2	5
	3	5
CRABI 12-month-old ATD*	2	4
	3	3
Hybrid III 3-year-old ATD	2	4
	3	4
Cozy coupe (toy car)	2	6
	3	6
Adult, male human (height 6 ft 2.75 in., weight 183 lbs)	Comfortable walking speed	5

\*Note: Referred to in this report as "1-year-old ATD."

RPS performance was also tested in a variety of scenarios using a walking adult male. The Odyssey RPS was able to detect an adult male walking laterally behind the vehicle out to a range of 5 ft. An adult male walking a longitudinal path toward the rear of the vehicle was successfully detected along paths located 1 to 3 ft to either side of the vehicle's centerline. However, an adult male walking toward the rear of the vehicle at the vehicle's centerline was not detected.

Dynamic RPS performance trials were conducted with the adult walking diagonally with respect to the rear bumper (i.e., at a 45 degree angle), as shown in Figure 17. In this figure, the rear bumper of the system-equipped test vehicle (not to scale) is shown at the bottom of the figure with the walking paths behind it indicated with arrows and labeled with numbers. The subject performed two trials for each path, one walking toward the vehicle and one walking away from it. In these trials, nearly every path that crossed within a 5-foot longitudinal range of the area directly behind the vehicle was detected. Paths 7 through 13, which intersected the far corners of the system's detection zone, went undetected.

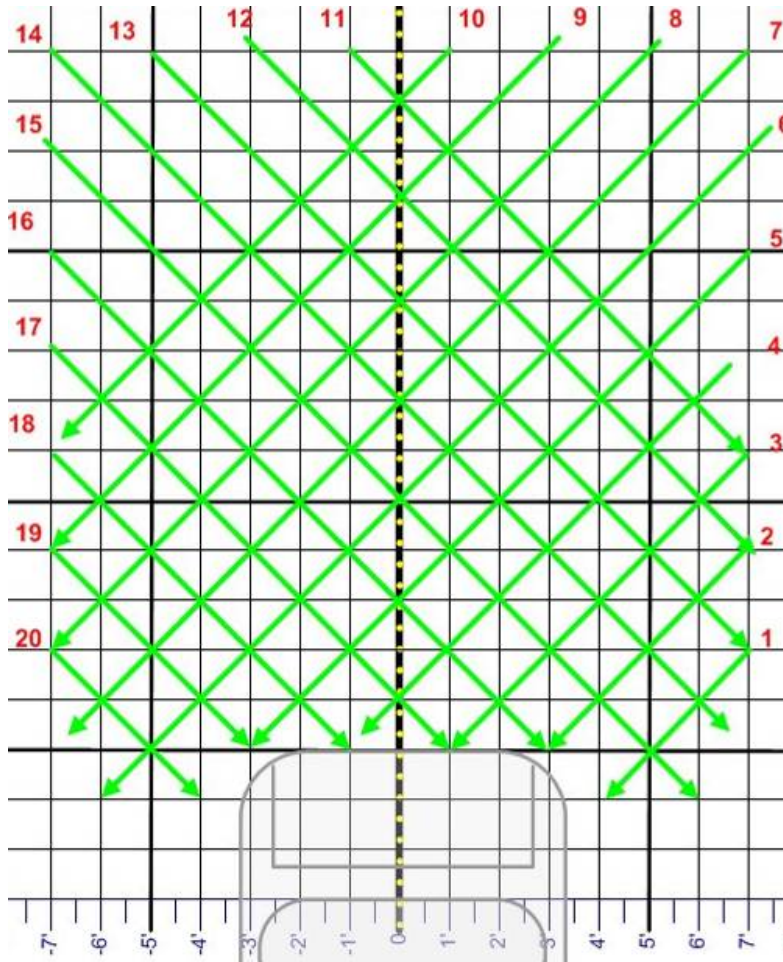

Figure 17. Numbered Walking Paths for “Adult Waking Diagonally” Trials

Note: Each square in the grid had the dimensions of 1 foot by 1 foot.

## **3.0 METHOD**

In order to answer the research questions, the driving behavior of drivers of rearview video system equipped vehicles was compared to that of drivers without such a system. To determine whether the addition of backing sensors might enhance any benefits achievable through the use of a rearview video system, a third condition was tested that included rear object detection sensors in addition to rearview video. A total of twelve participants participated in each system condition. Participants were observed driving their own vehicles in a naturalistic setting for 4 weeks followed by presentation of a controlled backing crash avoidance scenario. Additional details of the method follow.

### **3.1 Experimental Design**

The experiment used a between-subjects design with a single independent variable, "system," referring to the type of backing aid present on the vehicle. The variable had three levels: no system, rearview video (RV) system, and rearview video system plus backing sensors (RV & RPS). To control variability, all three treatment levels were presented using the same vehicle model.

Dependent variables included measures such as the number and duration of glances to the rearview video display, side and center rearview mirrors, and glances over the shoulder during backing maneuvers. Additional measures included vehicle backing speed, and collision avoidance success. The method by which these dependent measures were acquired is detailed in the following section.

### **3.2 Participant Recruitment**

Persons owning 2007 Honda Odyssey minivans were sought out for participation. The State of Ohio Bureau of Motor Vehicles was contacted to obtain the names and addresses of persons who registered a vehicle having a Vehicle Identification Number (VIN) corresponding to that of a 2007 Honda Odyssey. Mailings were sent to these owners asking about the equipment present on their minivans and inviting them to participate in the study. The mailings included a response form with several questions about the person's vehicle, driving habits, and availability to participate. Persons who submitted a completed response form and met the study criteria listed were contacted by phone to explain additional details about the study and acquire additional information to use in evaluating their suitability for participation. The following points constituted the main criteria for participation:

- Between 25 and 60 years of age
- No health problems that could negatively impact driving performance
- Make 2 or more trips per day in the subject vehicle
- Agree to be the only driver of the subject vehicle during the 4-week study period
- Agree to drive to NHTSA's Vehicle Research and Test Center (VRTC) to have instrumentation installed and later removed from the subject vehicle

- Agree to accommodate data retrieval visits as frequently as once per week
- Agree to perform two brief test drives
- Consent to release of video and engineering data for research, scientific, and outreach purposes

### **3.3 Participants**

Participants were 37 Ohioans who owned 2007 Honda Odyssey minivans and had driven them as their primary vehicle for at least 6 months. Participants' ages ranged from 25 to 60 years ( $M=40.0$ ,  $SD=8.3$ ). On average, participants had owned their Odysseys 260.7 days ( $SD=63.0$ ) at the time they began participation in the study. The average odometer reading at the time study participation began was 11,610.4 miles ( $SD=4734.0$ ). Participants were paid \$800 for completing participation in the study, plus 50 cents per mile, up to a total of \$200, for mileage driven between their residence and VRTC for the initial and final meetings.

Recruitment preference was given to persons who reported making a minimum of 2-5 trips per day in the subject vehicle and who stated that they drove with one or more children in the vehicle "sometimes" or "always."

### **3.4 Ruse**

During recruitment, prospective participants were told that the purpose of the study was to determine how people become familiar with and learn to take advantage of the features of new vehicles. By observing people driving in real-world situations, we would hope to better understand driver behavior and estimate the degree of safety that newer vehicles may provide. Prospective participants were asked about the features of their vehicle (e.g., radio, navigation, rear seat DVD) and whether their vehicle was equipped with a rearview video system. To minimize any possible influence on their backing behavior due to knowledge of the study's focus, prospective participants were asked a number of other questions about their vehicle so they would not be alerted to the focus of the study.

### **3.5 Data Acquisition and Instrumentation**

A data acquisition system (DAS) capable of collecting data within less than 5 seconds after the vehicle was powered on was developed for this study. The DAS was programmed to record data during all backing maneuvers. To ensure that all backing maneuvers were recorded, the DAS was primed to record data each time the vehicle's doors were unlocked using the key fob, one of the vehicle's doors was opened, or the key was placed in the ignition. After one of these events, the system began recording data automatically as soon as the power up sequence was complete. Data would continue to be recorded until it was triggered to stop recording through timeout settings. The DAS was triggered to stop recording data (but remain powered on) if the vehicle's transmission had not been placed into reverse gear within 3 minutes of the time when data recording began. If the transmission was placed into reverse gear, the DAS would

begin recording data. Following any backing maneuver, data recording was triggered to cease 10 seconds after the transmission had been placed into a gear other than reverse. The DAS turned off when the vehicle's engine was turned off.

Instrumentation included video cameras, digital video recording equipment, an embedded DAS, wiring, and a GPS antenna mounted on the roof of the vehicle. Wiring was used to access CAN bus signals and transmit desired data to the DAS. Video and sensor data were transmitted to an embedded DAS. The DAS stored data files to a Secure Digital (SD) card. Table 4 lists the data channels that were recorded to acquire the needed dependent measures.

Table 4. Data Channels

Data	Acquisition Method / Equipment
Video image of driver's face to determine glance location (to rearview video display, mirrors, over the shoulder)	Camera (full resolution)
Video images of areas surrounding vehicle (Environmental conditions in which backing occurs)	Cameras; 1 rear, 1 each side (quad multiplexed; ¼ resolution)
Backing sensor warnings (record each backing maneuver)	Parking System module
Info that triggers data collection start (driver's door open, key insertion, ignition)	B-CAN Bus
Transmission gear selection	F-CAN Bus
Brake applications	F-CAN Bus
Throttle percent displacement	F-CAN Bus
Vehicle speed	F-CAN Bus, GPS
Headlights (on or off)	B-CAN Bus
Turn signal (left, right)	F-CAN Bus
Vehicle location (latitude, longitude, heading; use to determine path)	GPS or derive from video data
Time of day	GPS or real-time computer clock
Odometer (per trip if possible)	Derive from CAN Bus
Vehicle longitudinal acceleration	Derive from speed
Collisions	Derive from video data

Video cameras were installed in unobtrusive locations. A camera mounted to the rear license plate frame recorded the scene behind the vehicle. Cameras mounted to the vehicle's undercarriage just aft of each front wheel recorded the scene on either side of the vehicle. Lastly, a video camera positioned above the center rearview mirror focused on the driver's face to facilitate collection of eye glance data. As part of the ruse, a fifth camera was mounted above the center rearview mirror facing forward to prevent test participants from realizing the focus was on what was behind the vehicle. Initially, video data were recorded using small digital video recorders. Due to a high malfunction rate in those devices, they were replaced with mini-DV digital video tape recorders.

Vehicles equipped with parking sensor systems were instrumented such that their parking sensor system status (e.g., which sensor is detecting something, if any) was recorded during backing maneuvers. To acquire data indicating the status of the parking system, the parking system module located under the dashboard required wires soldered to it for transmission of bus data to the DAS. To make installation of this

connection faster (and not modify a participant's equipment long-term), the parking system module of the participant's vehicle was replaced for the duration of the study with an identical module that had soldered connections on it to allow for access of the signal data.

## **4.0 PROCEDURE**

The 36 participants were divided into three groups of 12 drivers. The three groups of participants were run sequentially. Each set of 12 drivers contained a balanced number of each treatment condition. Due to an incident where one driver lost use of her rear parking sensors during the course of the study, a 37th participant was run in order to ensure the treatment conditions were balanced.

The procedure had three main components: an initial meeting, 4 weeks of naturalistic driving, and a final meeting. Both the initial and final meetings were held at NHTSA's Vehicle Research and Test Center (VRTC) located on the Transportation Research Center Inc. (TRC) proving ground. These meetings and the procedural aspects of the 4 weeks of naturalistic driving are described in detail below.

### **4.1 Initial Meeting**

The first component involved the participants attending an "initial meeting" at which they completed consent paperwork, received instructions and allowed instrumentation to be installed in their vehicles. The participants also made a short test drive in a vehicle with identical features as their own.

Each participant attended an initial meeting, which lasted between 2 and 3 hours. Upon arrival at VRTC, the participant was asked to read the Participant Information Summary, which described the experiment and set forth the terms of participation (Appendix B). Participants also read a Confidential Information form (TRC P&P153) for visitors to the TRC proving ground, which describes TRC's policy for safeguarding proprietary information. After all questions were answered, the participant signed the documents, thereby giving informed consent to participate in the study and have the instrumentation installed in his or her personal vehicle. No individuals declined to participate.

The participant was then escorted outside to the parking lot where a technician was inspecting the pre-existing condition of the participant's vehicle, by completing the Vehicle Condition Check Sheet (Appendix C). While the technician was inspecting the participant's vehicle, the experimenter documented the current vehicle mileage and the mileage it took to get from the participant's residence to VRTC (used for payment purposes). The experimenter also showed the participant the location of the cameras and other equipment by using VRTC's identical experimental vehicle as an example. In addition, the experimenter provided verbal tips for preventing damage to the equipment when washing the car.

After the participant reviewed the condition of the vehicle with the technician and signed the Vehicle Condition Check Sheet to complete the vehicle inspection, the technician drove the participant's vehicle to the garage for the installation of instrumentation. The experimenter and the participant went inside to discuss the test drive and guidelines for driving on the 7.5-mile oval test track. During this time, the participant was offered the opportunity to ask more questions and take a break if needed, before going on the actual test drive.

The test drive was used both to occupy the participants while waiting for their vehicle to be instrumented, as well as to give the opportunity to present an obstacle avoidance event at the final meeting. The test drive also helped support the primary experimental ruse of recording the participant's driving behavior in the new vehicle under a variety of conditions. The participant was asked to enter the test vehicle, adjust the mirrors and controls to their comfort level, and to wear the seatbelt at all times. The test drive consisted of a tour of selected TRC facilities in which the experimenter gave directions. In order to help establish the ruse for the surprise event, the test drive consisted of a mix of rural road, residential, parking lot, and test track (interstate speeds) driving. At the completion of the test drive, the participant was asked to drive the vehicle into a garage bay at VRTC so a technician could offload the data collected during the test drive. In actuality, this data offloading step was another ruse used to set up the conditions for an obstacle avoidance event that would occur at the end of the final meeting's test drive. The participant was instructed to drive the vehicle into the garage bay and park with the left front wheel on a yellow wheel stop mat. The mat was used to obtain a consistent location of the test vehicle to ensure that the initial position of the vehicle prior to the obstacle event at the final meeting was the same for all participants. Once the vehicle was stopped, the technician closed the garage door and commenced with data offloading while the participant and experimenter waited in the car.

After the technician offloaded the data and raised the garage door, the participant drove the vehicle to the front parking lot and returned to the conference room with the experimenter to wait on the completion of the installation of instrumentation into their vehicle. When the technician returned the vehicle, the participant was escorted to the parking lot and given an opportunity to review the vehicle and instrumentation before departing for the 4 weeks of participation.

## **4.2 Naturalistic Driving Period**

During the four weeks of naturalistic driving, a technician was dispatched weekly to retrieve data from each test vehicle, at a place and time convenient for the participant. The procedure of offloading data and checking instrumentation typically took up to 1 hour. To retrieve the data, the technician would obtain the vehicle keys from the participant, and then get into the vehicle to offload the engineering data to a laptop computer and change the miniDV tape in the video recorder and SD card that held other data. While offloading data, the technician would inspect the system and check the cameras to ensure everything was still working properly. If a problem was detected, the technician would exchange the malfunctioning component with a properly functioning replacement and make any necessary repairs. Once the data retrieval was complete, the technician would return the vehicle keys to the participant and confirm a date and time for the next data retrieval or final meeting.

## **4.3 Final Meeting and Surprise Obstacle Event**

The final meeting followed a format similar to the initial meeting. This time when the participant arrived, however, the first step was the vehicle inspection since the informed consent and confidential information paperwork were already covered during the initial



meeting. The current vehicle mileage was documented during the inspection, such that the total mileage driven for the 4 weeks could be calculated. Once the Vehicle Condition Check Sheet was completed as in the initial meeting, the technician took the vehicle to the garage again, this time for instrumentation to be removed from the vehicle.

The participant was given an opportunity for a break, and then followed the same test drive procedures as in the initial meeting. Once in the test vehicle, participants were again encouraged to adjust the mirrors and controls to their comfort level and to wear the seatbelt at all times. The test drive consisted of a tour in which the experimenter gave the same directions as in the initial meeting.

At the end of the test drive, the participant was instructed to drive the vehicle into the garage bay and park with the left front wheel on a yellow wheel stop mat. Once the vehicle was parked inside, the garage door was closed. A technician opened the rear hatch of the vehicle and appeared to connect a laptop to the data acquisition system and copy data, while the experimenter and participant sat inside the vehicle. During the apparent data download process, another member of the research staff was outside setting up the obstacle (see Appendix H for a description of the obstacle event mechanics). When the obstacle was ready for the event, the technician copying the data from the vehicle was signaled that the obstacle setup was complete. He then closed the rear door of the vehicle and raised the garage door.

At that time, the participant was told that it was time to return to the conference room for debriefing and to await the completion of the vehicle instrumentation removal from their vehicle. The experimenter instructed the participant to back out of the garage and then drive the vehicle to the front parking lot so the vehicle could be parked. However, this time the obstacle event was triggered as the vehicle backed out of the garage. After the event was complete, the participant drove the vehicle to the front parking lot and returned to the conference room.

Participants were then informed of the surprise event details using a Debrief form (Appendix D), and were given a questionnaire to complete. The questionnaire was adapted from that used for another NHTSA study investigating early adopters' use of sensor-based backing aid systems and rearview video cameras [8]. Three versions of the questionnaire were used to address the different system conditions (no system, RV only, or RV and rear parking sensors) (Appendices E, F, and G). Each participant completed the questionnaire version that corresponded to their vehicle's equipment. Once the questionnaire was complete, the participant was given payment for participation.

#### 4.3.1 Details of the Obstacle Event Scenario

The obstacle event involved a two-dimensional, life-size image of a small child popping up behind the test vehicle while the participant was backing out of a garage at the end of the final meeting test drive. The image consisted of a full-color photo of a 36-inch-tall toddler. The photo was printed on a corrugated plastic substrate (see Figure 18). The 36-inch height corresponded approximately to the height of a 2.5 year old child.



Figure 18. Two-Dimensional Image of a Child Used in the Surprise Obstacle Event

The photo obstacle was located along the centerline of the vehicle to prevent it from being seen by a driver using the side rearview mirrors. Originally, a wheeled obstacle towed laterally into the area behind the vehicle was planned. However, an object that moved into the rear blind zone on a lateral path could be seen in the side mirror, making it difficult to know whether the subject had seen the obstacle using the rearview video or the mirror. While a backing scenario involving a centered, stationary object may not be representative of all the different types of real world backover crash scenarios, it allowed for the clear determination of whether visual detections of the obstacle were attributable to rearview video system use.

The distance of 14 feet between the bumper of the vehicle and the obstacle at the start of the staged backing maneuver was selected for a few reasons. At average backing speeds (based on baseline (initial meeting) event backing speed data from the first 12 participants), this distance would give the participant approximately 5 to 7 seconds to visually detect the obstacle before the rear bumper would contact it. This distance also placed the obstacle within the blind spot area of average-height drivers. The obstacle could not be seen with mirrors or over the shoulder glances by a properly belted driver

of average or below average height. As a result, participants had to use the rearview video system in order to detect the presence of the obstacle. While this situation put the participants in the “no system” category at an obvious disadvantage, it also allowed for clear determination of whether visual detections of the obstacle were attributable to rearview video system use.

When the participant drove the vehicle into the garage, the obstacle was not present. After the participant had driven the van into the garage and the door was closed behind them, the object was set up. The back side of the obstacle was painted with textured paint to mimic the appearance of asphalt pavement (see Figure 19). With the rigid photograph laid flat in a face-down (child image side) orientation, its presence was concealed. Once the obstacle was in its face-down position and ready for the event, the staff member conducting the data download was notified that all was clear for the event. The garage door was then opened and the participant was told to back out so they could return the vehicle to its designated parking space in the parking lot outside. The obstacle was not present at the beginning of the maneuver. After the vehicle traveled 3 feet in reverse, it contacted a switch in the pavement that triggered the obstacle to swiftly move into an upright position, as shown in Figure 20. This delayed presentation was intended to mimic the scenario of child running into the blind zone after the vehicle has started backing. It also facilitated observation of whether drivers would look at the RV screen multiple times during a backing maneuver, rather than only once at the start of the maneuver.

The method used to cause the obstacle to pop up into a vertical position in a controlled manner is described in detail in Appendix H.



Figure 19. Photograph of the Obstacle at the Beginning of Surprise Obstacle Event



Figure 20. Photograph of the Obstacle at the End of Surprise Obstacle Event

Figure 21 shows the location of the vehicle at the beginning of the event, features of the surrounding area, and the location of the obstacle. Two dark red colored vehicles were positioned outside the garage bay entrance on either side. A white step van was also positioned outside the garage bay door in line with its opening, to provide a consistent visual field behind the backing vehicle.

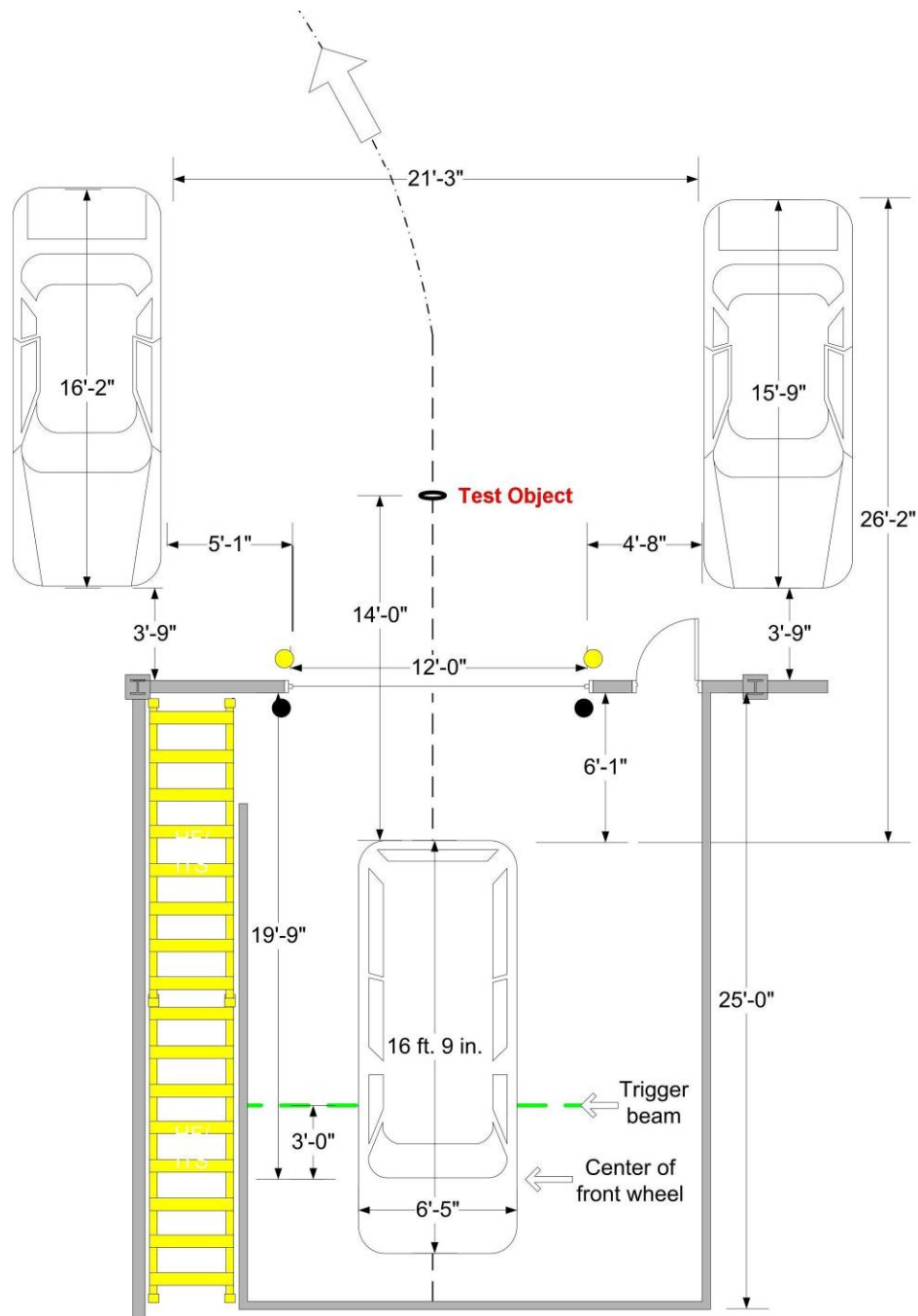

Figure 21. Locations of the Subject Vehicle, Obstacle, and Surrounding Objects During the Staged Backing Maneuver

#### 4.4 Data Reduction Method

Characteristics of eye glance behavior and details of the conditions of naturalistic backing maneuvers were determined through manual video data reduction. Vehicle-based engineering data channels recorded by the DAS were validated and then processed using Matlab to extract metrics of interest. Naturalistic video data files for

particular backing maneuvers were matched to their corresponding engineering data files using software.

Data were reduced and analyzed to provide quantitative and qualitative measures of drivers' backing behavior (e.g., glance patterns) and performance (i.e., avoiding a crash), as well as their use of the rearview video system (when present). Information about the conditions in which drivers perform backing maneuvers and how the conditions may affect mirror or system use was obtained.

## 5.0 RESULTS: NATURALISTIC DRIVING

While more than 6000 naturalistic backing maneuvers were recorded in this study, they were made by only 37 people. This is a relatively small sample size. Each maneuver an individual participant made was not an independent data point. Due to the statistical problems associated with using multiple events from the same person, the use of summary measures, such as the mean number of glances to system per backing event, was deemed the most appropriate method in which to compare conditions.

### 5.1 Characteristics of Naturalistic Driving

The 37 participants in this study drove 42,982 miles during 5219 trips. On average, each participant drove 1235.4 miles (SD=534.2). Miles driven per day during study participation, 44.1 miles on average, was similar to that driven prior to the study, 45.3 miles per day (based on mileage at the start of participation and time of ownership). A total of 6145 naturalistic backing events were recorded for the 37 drivers. This equates to an average of 166 backing maneuvers per driver. Table 5 summarizes additional characteristics of participants' naturalistic driving and Table 6 breaks down these same results by system condition.

Table 5. Characteristics of the Participants' Naturalistic Driving

Variable	N	Mean	Standard Deviation	Minimum	Maximum
Trips	37	141.05	52.53	31.00	272.00
Mean Backing Maneuvers per Trip	37	1.14	0.20	0.61	1.60
Mean Distance per Trip (mi)	37	8.89	4.45	2.78	24.04
Backing Maneuvers	37	163.11	68.16	19.00	318.00
Sum Miles	37	1161.69	573.59	270.75	3414.03
Mean Backing Maneuvers per Mile	37	0.16	0.08	0.06	0.38

Table 6. Characteristics of the Participants Naturalistic Driving By System Condition

System	Variable	N	Mean	Standard Deviation	Minimum	Maximum
None	Trips	12	116.83	48.56	31.00	210.00
	Mean Backing Maneuvers per Trip	12	1.04	0.20	0.61	1.35
	Mean Distance per Trip (mi)	12	10.14	3.97	4.30	18.10
	Backing Maneuvers	12	124.00	56.29	19.00	223.00
	Sum Miles	12	1127.71	519.86	270.75	2042.78
	Mean Backing Maneuvers per Mile	12	0.12	0.06	0.07	0.26
RV	Trips	12	150.17	61.63	64.00	272.00
	Mean Backing Maneuvers per Trip	12	1.12	0.07	1.03	1.28
	Mean Distance per Trip (mi)	12	8.33	3.95	2.78	15.62
	Backing Maneuvers	12	167.92	72.16	76.00	318.00
	Sum Miles	12	1153.71	513.54	294.19	1914.95
	Mean Backing Maneuvers per Mile	12	0.17	0.09	0.07	0.38
RV & RPS	Trips	13	155.00	41.87	111.00	228.00
	Mean Backing Maneuvers per Trip	13	1.26	0.23	0.79	1.60
	Mean Distance per Trip (mi)	13	8.25	5.31	4.17	24.04
	Backing Maneuvers	13	194.77	60.17	88.00	286.00
	Sum Miles	13	1200.42	703.34	653.04	3414.03
	Mean Backing Maneuvers per Mile	13	0.19	0.08	0.06	0.30

## 5.2 Characteristics of Naturalistic Backing Maneuvers

Table 7 summarizes the characteristics of the naturalistic backing maneuver events. Of the 6,145 recorded backing maneuvers observed during this study, 72 percent had durations of 5 to 20 seconds. A large majority of backing maneuvers, 78 percent, involved only one reverse movement. The other 22 percent of backing maneuvers involved multiple reverse movements, e.g., the driver brought the vehicle to a stop during the backing maneuver or engaged in parallel parking.

Average backing speed during the naturalistic maneuvers, 2.26 mph, was essentially identical to that observed in the staged baseline and obstacle events. Maximum backing speed was correlated with backing time ( $r=.77$ ) and backing distance ( $r=.73$ ).

Table 7. Characteristics of the 6145 Recorded Backing Maneuver Events

Variable	Mean	Standard Deviation
Distance (ft)	33.97	25.96
Time Backing (s)	10.08	6.44
Average Backing Speed (mph)	2.26	0.89
Maximum Backing Speed (mph)	3.64	1.51
Maximum Lateral Acceleration (g)	0.08	0.04
Maximum Long Acceleration (g)	0.09	0.04
Number Reverse Movements	1.34	0.81



The time between when the drivers shifted into reverse and the vehicle began moving backwards was noted for naturalistic backing maneuvers that had an interpretable time value (38 percent of maneuvers). The data summarized in Table 8 indicate a trend that agrees with the baseline/obstacle event finding. The time between shifting and rearward movement was longer for drivers with RV and RV & RPS than for drivers with no system. The longer time intervals between shifting into reverse and rearward motion for drivers with a rearview video system may be attributable to a delay in the appearance of the RV image that was typical for the specific make/model of test vehicle used in this study. Separate testing found this delay to have an average duration of 6.44 seconds when reversing immediately after vehicle ignition (the delay was shorter when backing after the vehicle had been running for a period of time). This RV display delay issue is discussed further in Section 8.1.

Table 8. Distribution of Time Between Shift to Reverse and Beginning of Backing by Backing System Condition (Naturalistic Backing Events)

Quantile	None (576)	RV (862)	RV & RPS (948)
100% Max	25.77	29.44	31.56
99%	17.51	17.07	21.62
95%	9.81	10.07	10.21
90%	6.33	7.11	7.09
75% Q3	3.28	4.08	4.28
50% Median	2.09	2.39	2.58
25% Q1	1.58	1.69	1.73
10%	1.21	1.36	1.35
5%	1.03	1.15	1.16
1%	0.94	0.82	1.00
0% Min	0.42	0.62	0.76

Table 9 presents mean maximum backing speeds for naturalistic backing events. The overall mean value for maximum backing speed was 3.7 mph, which was consistent with the baseline and event trials.

With respect to the interpretation of this trend, one hypothesis from the outset was that drivers with RV systems might choose to back faster than drivers without such systems. The lack of consistency between the 'RV' and 'RV & RPS' system conditions and the fact that the mean for the 'None' system condition is between these two extremes suggests that such an overall effect does not exist. However, no statistical testing was performed. Moreover, the discrepancy between the 'RV' and 'RV & RPS' means is likely to be an artifact of the fact that different subjects were involved and that they drove in different situations. This variance added noise to all comparisons made across systems.

Table 9. Mean Maximum Backing Speed by System Condition (Naturalistic Backing Events)

	<b>N</b>	<b>Mean Maximum Backing Speed (mph)</b>	<b>Standard Deviation</b>
None	1489	3.7069275	1.4144236
RV	2016	3.9878938	1.5622352
RV & RPS	2532	3.4505742	1.3884731

Table 10 summarizes the quantiles for the overall distribution of maximum backing speed (from 6037 naturalistic backing events). Maximum and minimum values are shown along with some other percentile values. Table 11 shows the extreme values of maximum backing speed for naturalistic backing maneuvers, with the absolute fastest speed being of particular interest. These values represent observed values of maximum backing speed from individual backing maneuvers. These data show that only a few backing segments had maximum speeds greater than 10 mph. While the distribution of maximum backing speed was not strictly normal (since zero is boundary they were positively skewed), they were not bimodal. Thus, they did not reveal an obvious split between parking spaces and garages or short versus long backs. Table 12 provides descriptive statistics for backing maneuver duration, average and maximum backing speed, and backing distance for driveway, garage, and parking space backing maneuvers.

Table 10. Quantiles of Overall Distribution of Maximum Backing Speed (from 6037 Naturalistic Backing Events)

<b>Quantiles (Definition 5)</b>	
<b>Quantile</b>	<b>Estimate</b>
<b>100% Max</b>	14.291
<b>99%</b>	7.542
<b>95%</b>	6.275
<b>90%</b>	5.633
<b>75% Q3</b>	4.649
<b>50% Median</b>	3.532
<b>25% Q1</b>	2.581
<b>10%</b>	1.899
<b>5%</b>	1.572
<b>1%</b>	1.160
<b>0% Min</b>	1.001

Table 11. Extreme Values of Maximum Backing Speed (from 6037 Naturalistic Backing Events)

Extreme Observations	
Lowest	Highest
1.001	10.979
1.010	12.545
1.013	13.414
1.013	13.684
1.015	14.291

Table 12. Descriptive Statistics for Backing Maneuver Characteristics by Maneuver Starting Location

Starting Location	N	Variable	N	Mean	Std Dev	Minimum	Maximum
Driveway	1303	Backing Duration (s)	1287	10.8659	5.6975	0.32	48.92
		Average Backing Speed (mph)	1287	2.7450	0.8609	0.71	8.359
		Maximum Backing Speed (mph)	1287	4.3643	1.3321	1.024	10.665
		Distance Backed (ft)	1287	44.0675	27.1696	0.344	372.473
Garage	1154	Backing Duration (s)	1138	16.6410	6.4863	1.42	42.86
		Average Backing Speed (mph)	1138	2.4573	0.7923	0.796	5.487
		Maximum Backing Speed (mph)	1138	4.5140	1.4804	1.015	8.934
		Distance Backed (ft)	1138	58.6050	25.5014	1.918	144.77
Parking Space	2198	Backing Duration (s)	2170	7.5454	3.1119	0.36	52.81
		Average Backing Speed (mph)	2170	2.0253	0.6568	0.756	5.495
		Maximum Backing Speed (mph)	2170	3.0935	1.02858	1.01	7.181
		Distance Backed (ft)	2170	21.3259	9.0866	0.421	255.693

### 5.3 Naturalistic Backing Crashes

A small number of minor crashes were observed during the naturalistic portion of this study. These incidents and their conditions are summarized in Table 13. Five drivers were involved in a total of 6 collisions. Ironically, 5 of the 6 incidents involved drivers whose vehicles were equipped with an RV system and 4 of those 5 also were equipped with a RPS. The obstacles involved in these incidents were likely to be visible in an RV system display.

Table 13. Naturalistic Crashes Observed

Subject Number	System Condition	Situation	Description
1	RV & RPS	Backing out of driveway	Struck trash can
8	RV & RPS	Parking	Backed into a vehicle while parking
8	RV & RPS	Unknown	Struck unknown object while backing in a gravel lot
15	None	Backing out of driveway	Struck trash can; poodle on lap
24	RV & RPS	Parking	Backed into a vehicle while parking
28	RV	Parking	Struck wheeled cooler while backing out of parking space

#### 5.4 Eye Glance Behavior During Naturalistic Backing Events

This section presents data describing eye glance data during naturalistic backing maneuvers with a focus on reporting drivers' use of (i.e., glances to) rearview video systems. Glance locations noted for these data were as follows:

- Over left shoulder (Left Shoulder)
- Out left window or at left mirror (Left)
- Instrument panel
- Forward (out windshield)
- Rearview mirror
- RV display or center console (console/video)
- Out right window or at right mirror
- Over right shoulder
- Other

The driver was considered to be looking at the noted location if their eyes were determined to be focused on that location, regardless of their body orientation.

In the figures presented in this section, the 'other' glance category represents a significant portion of the glances. Typically, these glances represent non-driving-related behavior, for example when a driver looks down to the passenger seat, to the floor, or to his or her lap. For the most part, they do occur during the backing maneuver and thus give a rough estimation of the percentage of time devoted to potentially distracting activities during backing.

During naturalistic driving, an average of 10 percent of glances was to the RV display. Individual drivers' percentages of glances to the RV display varied between 2 percent and 26 percent. These data along with glance percentages for other glance locations are shown in Figure 22.

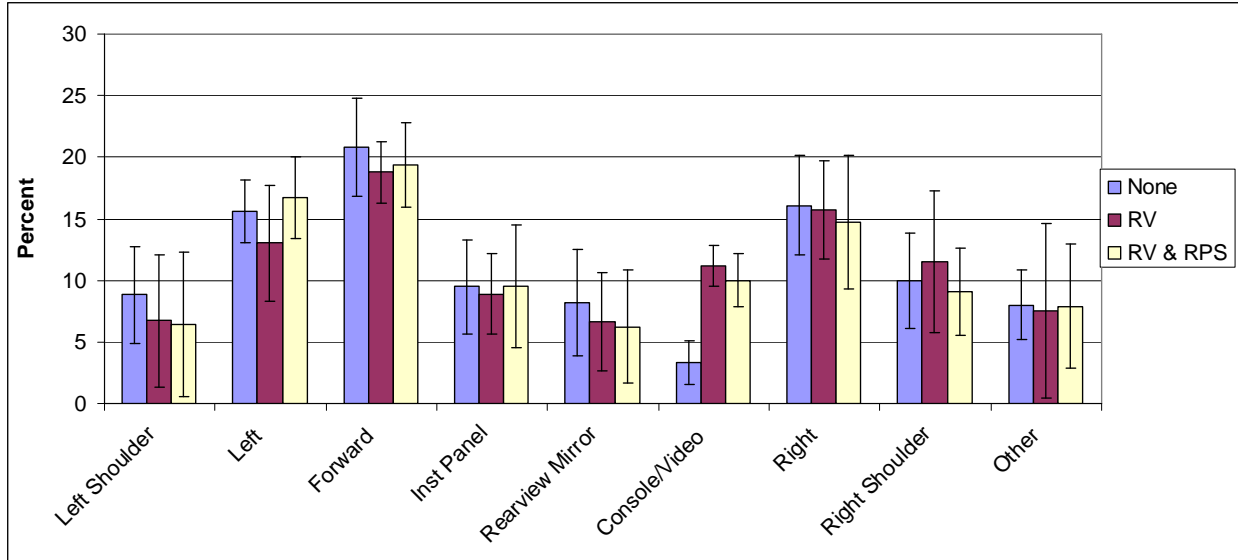

Figure 22. Mean Percentage of Glances by Glance Location and System Condition  
 Note: Based on 1 value per subject.

Overall, drivers looked at least once at the RV display on approximately 65 percent of backing events and looked more than once at RV on approximately 40 percent of backing events. Table 14 summarizes the number of glances to the RV display per naturalistic backing maneuver by system condition. These data show that participants in the RV & RPS condition made no glances per trial to the RV display more often than those in the ‘RV only’ condition. The data also show that participants in the RV & RPS condition made four or more glances per trial to the RV display less often than those in the ‘RV only’ condition. This trend of more participants with ‘RV only’ looking at the RV display than those with RV & RPS may indicate that participants in the RV & RPS condition were relying on the sensors to alert them of an obstacle. However, differences in the particular backing situations between driver groups (i.e., differential exposure) or individual differences in backing habits between groups may have contributed to this difference.

Table 14. Number of Glances to the RV Display Per Backing Maneuver by System Condition

	0	1	2	3	4+	Total
RV	274 (32.85%)	197 (23.62%)	125 (14.99%)	74 (8.87%)	164 (19.66%)	834 100
RV & RPS	389 (38.98%)	219 (21.94%)	152 (15.23%)	95 (9.52%)	143 (14.33%)	999 100
Total	663 (36.19%)	416 (22.71%)	277 (15.12%)	169 (9.22%)	307 (16.76%)	1832 100

The following figures illustrate glance behavior data from naturalistic backing events. These figures include data for all glances except the very first segments of video data files before the subject begins to focus on the driving task. In essence, they all show

increased glance activity to the console/rear video area when a rear video system is available. For example, Figure 23 shows that on average, drivers made less than one ( $M = 0.81$ ) glance to the console/video location when no video (System = None) display is present, versus 2.17 (RV) and 1.89 glances (RV & RPS) when the RV systems are present. In this and the following figures, there also is a trend toward slightly more use of the rearview mirror when no backing system is present. This difference is not nearly as large, however as the differences in glance behavior to the console/video area, suggesting that drivers do not simply trade console/video glances for rearview mirror glances.

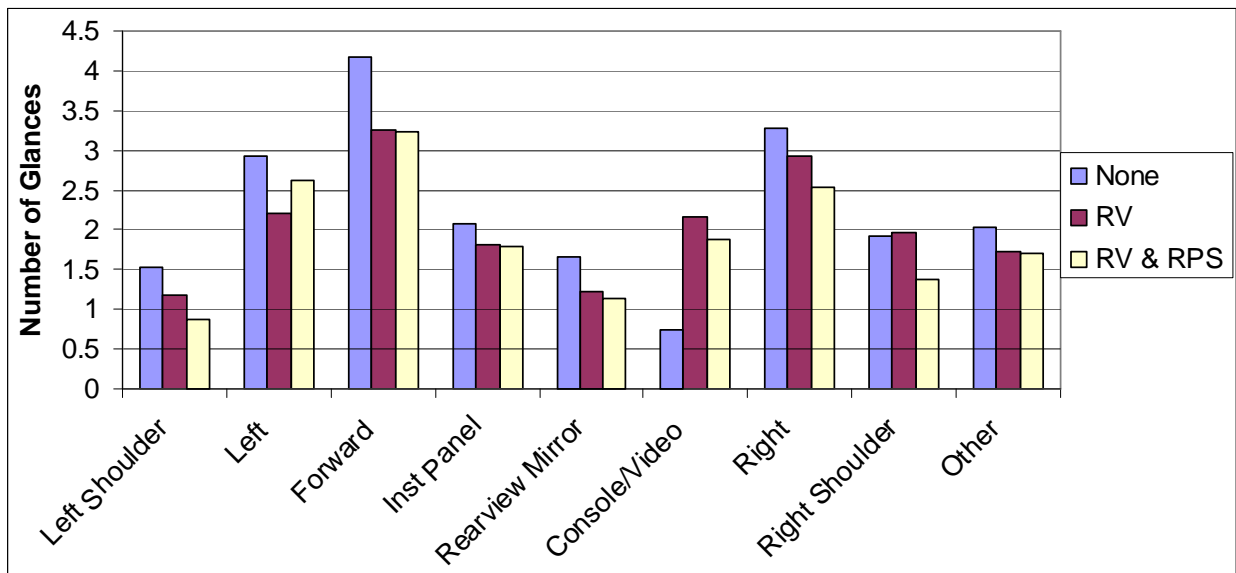

Figure 23. Mean Number of Glances Per Backing Maneuver by Glance Location and System Condition

A similar pattern is evident for Figure 24 that shows the total glance time by location and backing system. While drivers with no system looked at the console/video area for less than one second ( $M = 0.90$ ), drivers with other systems looked on average for 2.89 and 1.84 seconds, respectively.

With all of these comparisons, it must be noted that because different drivers were included in each backing system group, comparisons are based on differential exposure. Despite these differences in exposure, it appears that the tendency to look more often and for more time at the console/video area supports the conclusion that drivers make regular use of these systems.

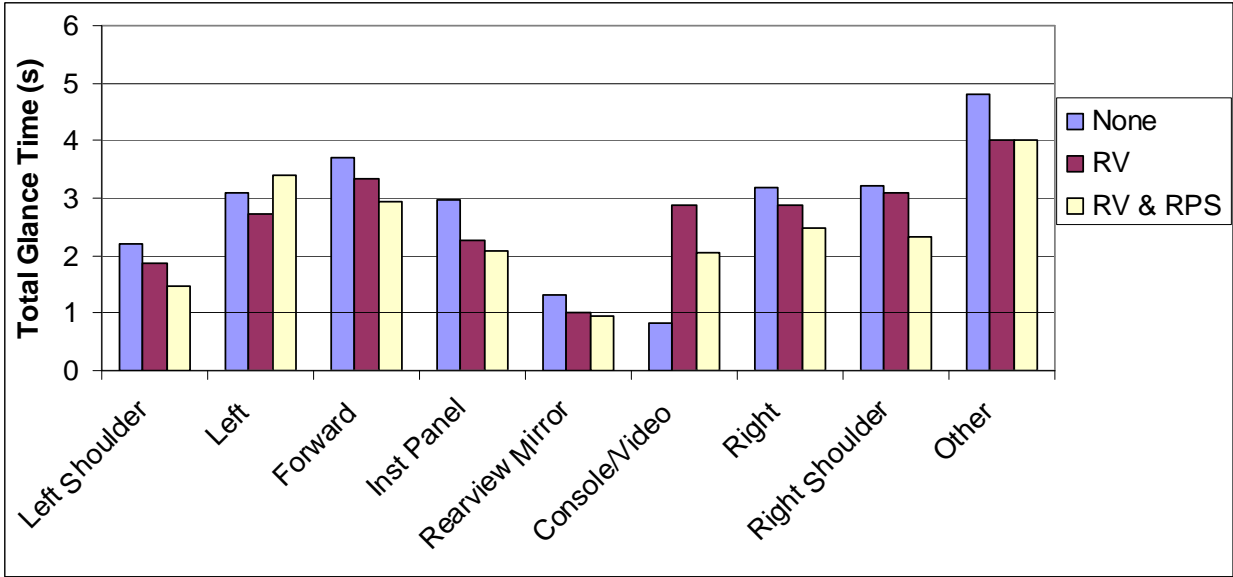

Figure 24. Mean Total Glance time by Glance Location and System Condition

Figure 25 shows that drivers' glances to the console/video area were on average considerably longer for participants in the RV and RV & RPS conditions than for those in the "no system" condition. Noteworthy also is the observation that the mean durations of drivers' glances to other locations do not appear to differ as much as the durations to the console/video area.

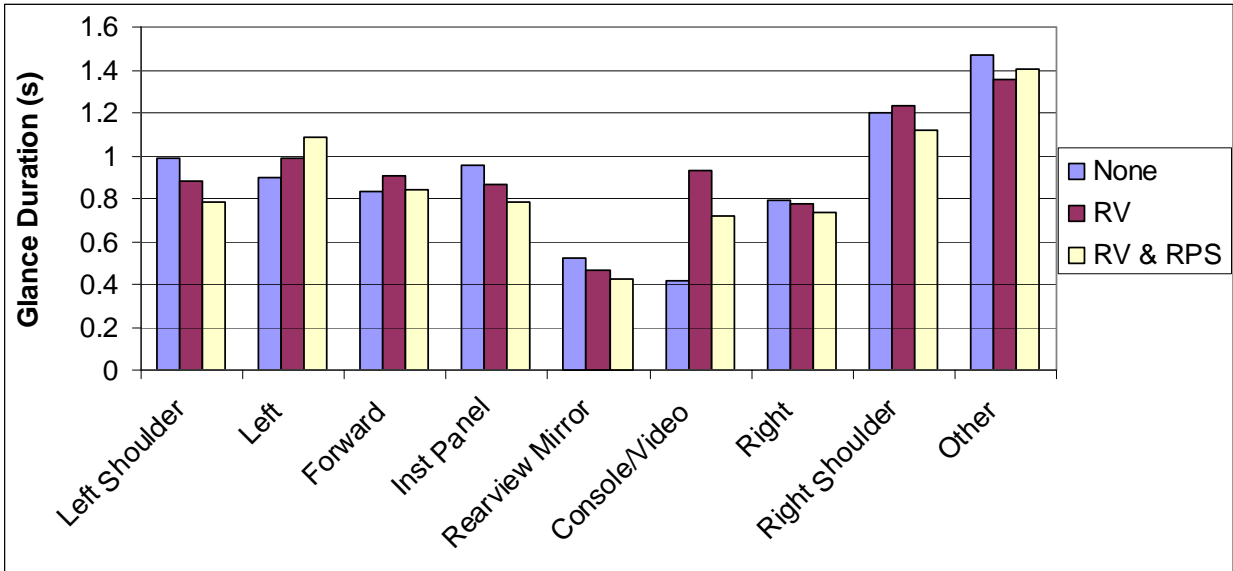

Figure 25. Mean Glance Duration by Glance Location and System Condition

Figure 26 illustrates the same data in terms of the percentage of glance time directed to each of the locations. Drivers with no system devoted 3.3 percent of the recorded

glance time to looking at the console/video, while those with RV and RV & RPS systems devoted 11.6 and 7.5 percent, respectively, to this area. Percentages of glances to other areas remain more consistent and this is remarkable given the wide variety of backing situations and possible differences between these situations by backing system group. The results suggest that glance behavior during backing is relatively consistent across backing situations.

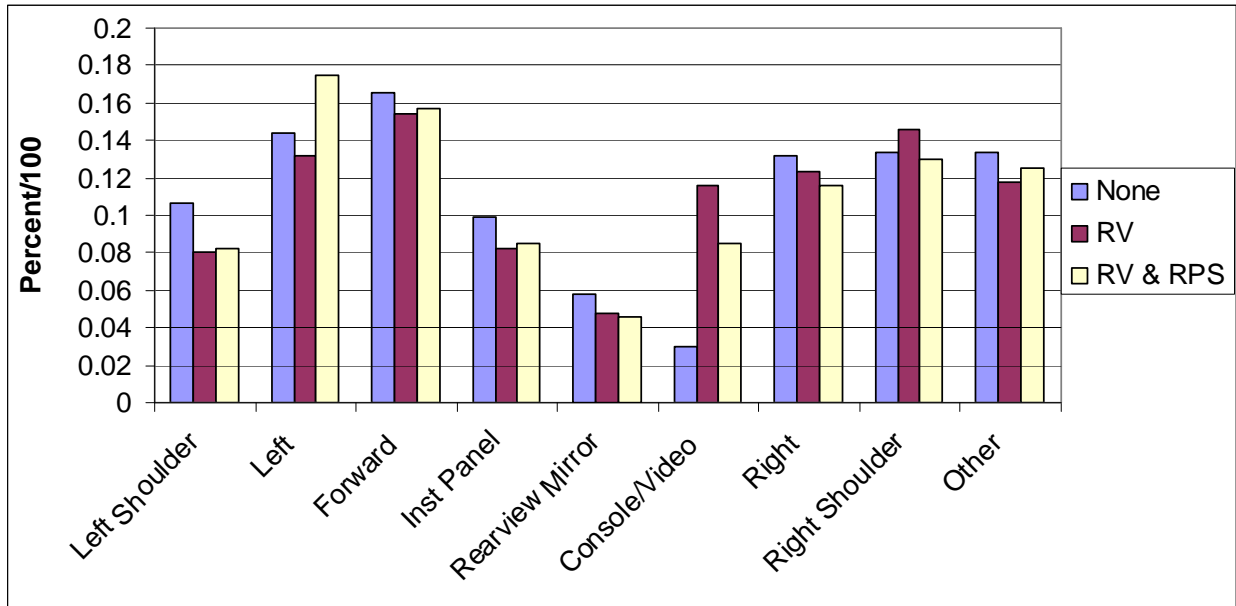

Figure 26. Mean Percentage of Glance Time by Location and System Condition

#### 5.4.1 Eye Glance Behavior During Backing as a Function of Environmental Conditions

Starting location provides one classification of backing situations. The first level of characterization of backing maneuvers was based on maneuver length. The following table provides descriptive characteristics for the set of backing events separated into Long versus Short backing maneuver length categories. No strict criterion was used for this categorization. As is evident from the ranges of values, there is overlap in the two categories. Longer backs were indeed longer in duration and in distance, on average. They were associated with higher average and maximum backing speeds. Figure 27 illustrates percent eye glance time by eye glance location and maneuver length.



Table 15. Descriptive Characteristics of Naturalistic Backing Maneuvers by Maneuver Length

Backing Distance	N Obs	Variable	N	Mean	Std Dev	Minimum	Maximum
Long	1417	Backing Duration (s)	1415	15.3465	6.1853	2.23	52.81
		Average Backing Speed (mph)	1415	2.7405	0.9289	0.847	9.868
		Maximum Backing Speed (mph)	1415	4.6735	1.4237	1.059	14.291
		Distance Backed (ft)	1415	59.1853	27.3475	4.009	372.473
Short	3941	Backing Duration (s)	3846	8.3300	4.8539	0.32	42.86
		Average Backing Speed (mph)	3846	2.1456	0.7677	0.71	7.013
		Maximum Backing Speed (mph)	3846	3.3773	1.3145	1.01	12.545
		Distance Backed (ft)	3846	26.0564	18.1645	0.344	190.239

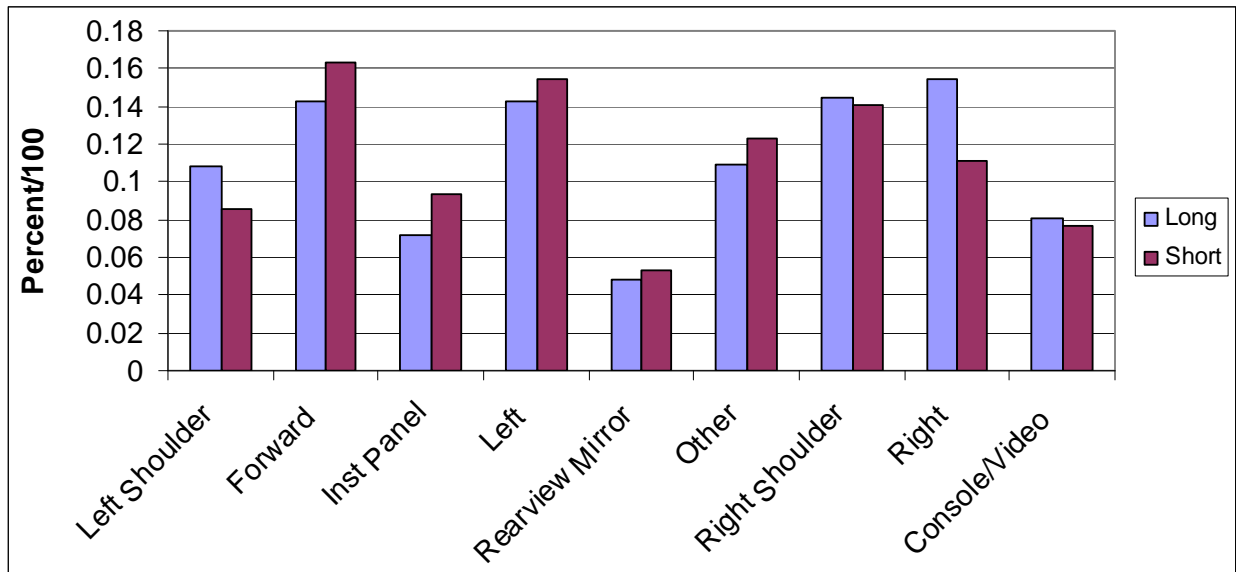

Figure 27. Percentage Glance Time by Eye Glance Location and Maneuver Length

Naturalistic backing maneuvers were also characterized by the degree of visibility surrounding the vehicle at the time of the maneuver. If the area was clear of visual obstructions and it was possible to see vehicles and other objects coming from a variety of directions, then the visibility was characterized as being “open.” If the area around the vehicle was surrounded by trees, buildings, or other objects that obstructed visibility, then the visibility was characterized as “closed.” Figure 28 illustrates results for percent glance time by eye glance location and visibility.

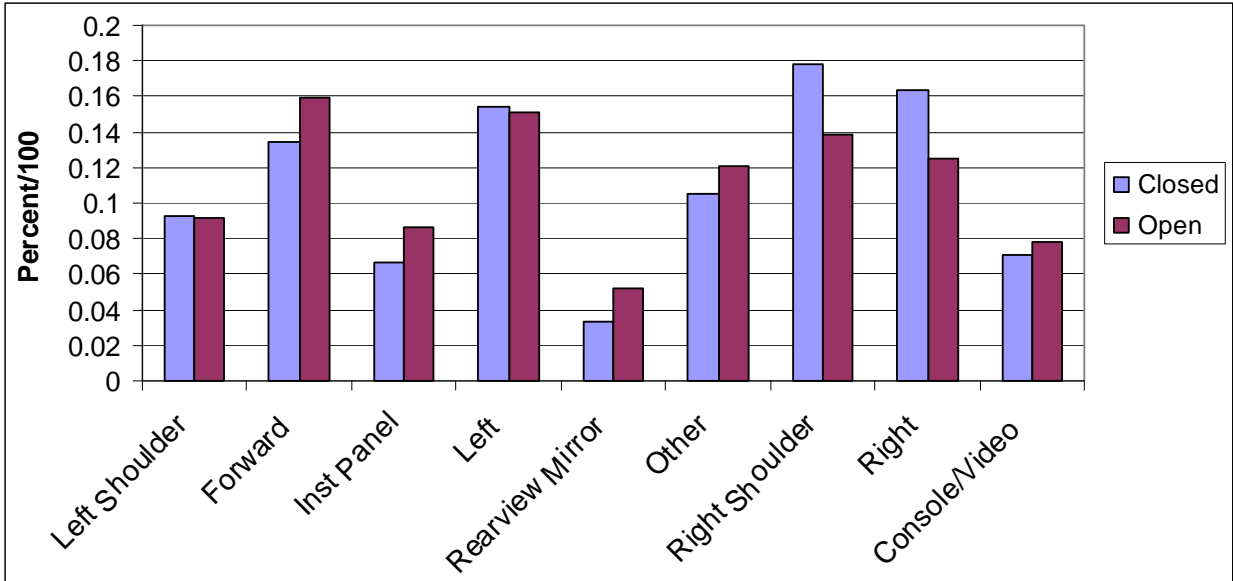

Figure 28. Percentage Glance Time by Location and Visibility

All naturalistic backing maneuvers were classified as starting from a garage, driveway, parking space, or other. Figure 29 presents results for percent glance time by eye glance location and backing maneuver starting location.

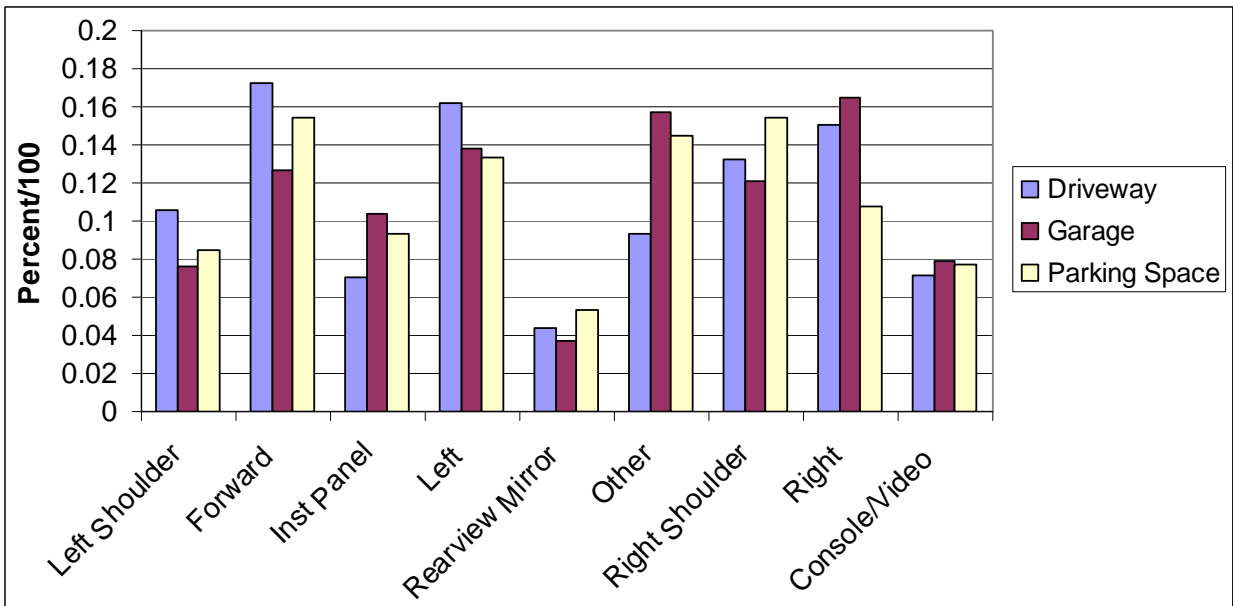

Figure 29. Percentage Glance Time by Starting Location and Glance Location

Figure 30 shows percentages of glance time to each location as a function of the starting location and system condition. These figures represent within-subject comparisons.

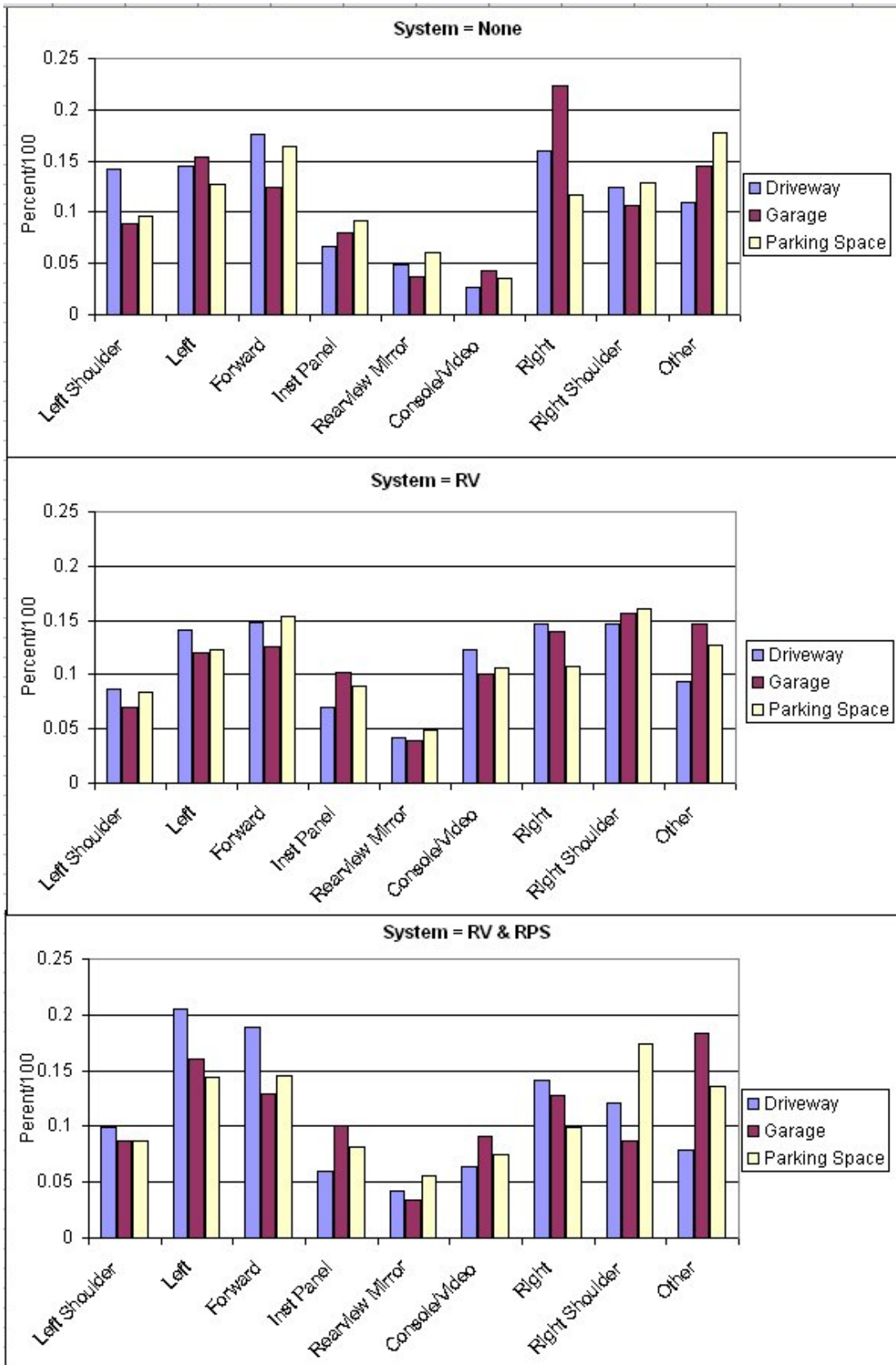

Figure 30. Percent Glance Time by Starting Location and System Condition

The second environmental variable considered was the visibility surrounding the vehicle at the time of the back, which was coded either as Closed (e.g., narrow driveway) or Open (e.g., parking lot). Figure 31 presents comparisons by system condition. The data show that drivers in the “no system” condition made greater adaptations to their glance behavior based on the quality of visibility surrounding their vehicle. For example, “no system” condition participants show bigger differences in the percent of time spent glancing to the right, and right shoulder and less over the left shoulder in closed conditions versus open conditions. Also for closed conditions, drivers with no RV system also appear to glance over their right shoulders approximately 7 percent more than those with ‘RV only’ and approximately 12 percent more than those with RV & RPS. Drivers in the RV & RPS condition looked over their left shoulders in closed conditions approximately 9 percent more than those with RV or no system. Overall, differences between system conditions appeared smaller for open conditions. The data show comparatively low usage of the center rearview mirror for all system conditions regardless of the surrounding visibility.

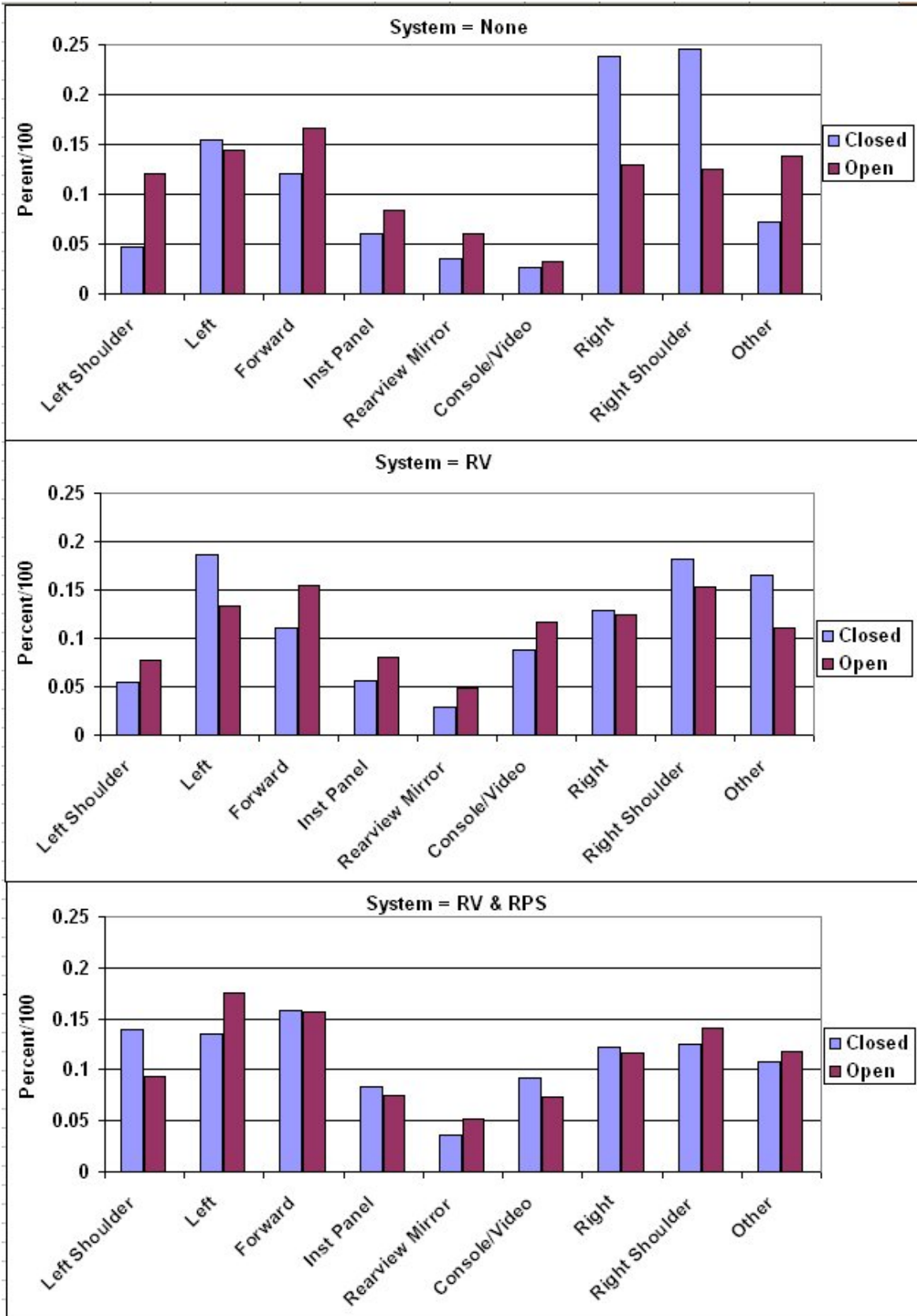

Figure 31. Percent Glance Time by Visibility: No System

The third environmental coding classification was the distance driven in the backing maneuver, or backing maneuver length. Maneuvers were coded as “long” or “short.” Figure 32 examines whether there were any differences in percentage of time spent looking at different locations for long versus short backing maneuvers as a function of system condition. Long maneuvers appear to correspond to more time spent glancing over the left shoulder and to the right, particularly for the no system and RV & RPS conditions. As with the prior analyses, these data show comparatively low usage of the center rearview mirror for all system conditions regardless of maneuver length.

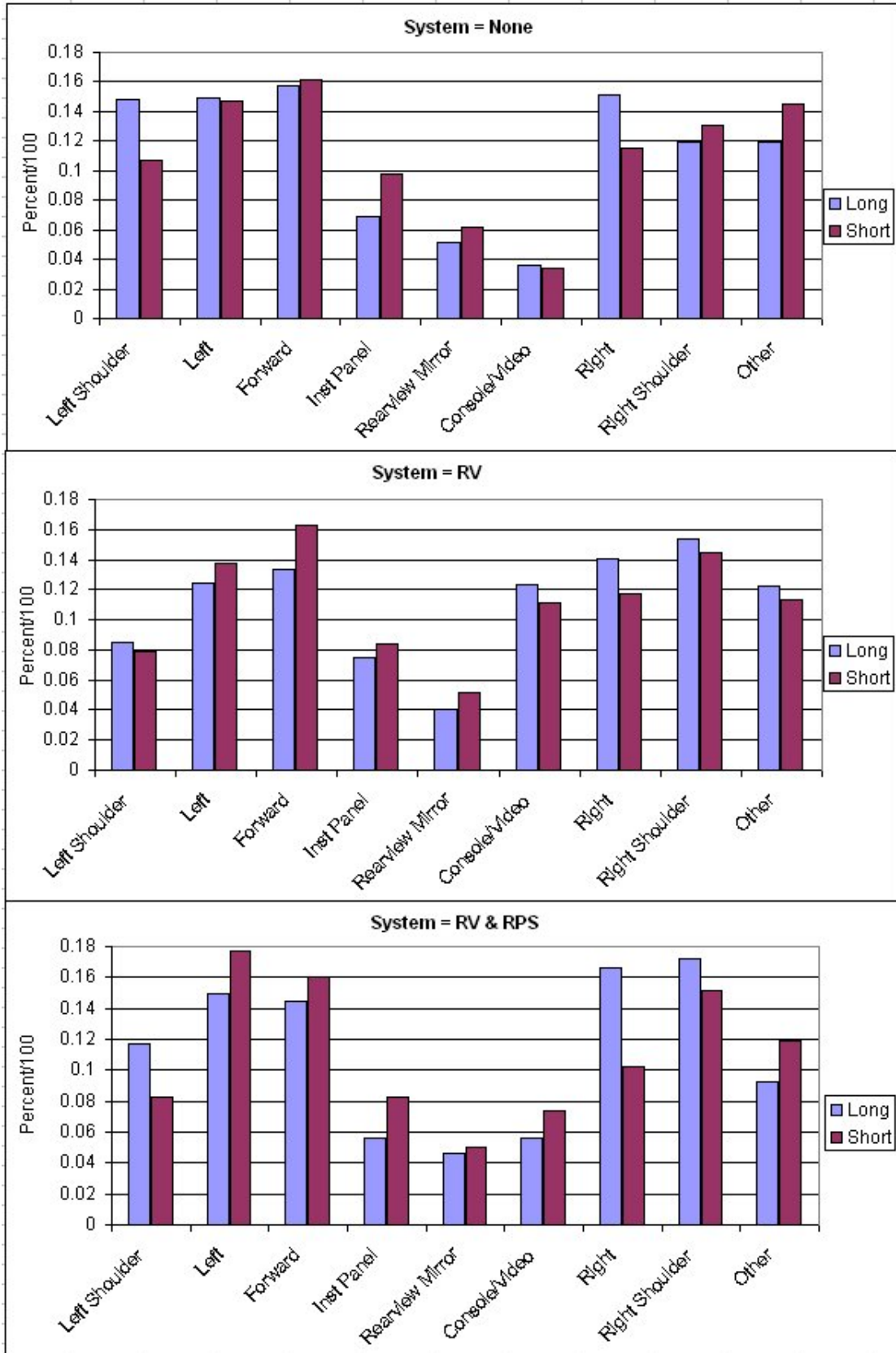

Figure 32. Percent Glance Time by Backing Maneuver Length and System Condition

## 5.5 Drivers' Activities During Naturalistic Backing Events

This section provides descriptive statistics on activities performed by drivers during naturalistic backing maneuvers. Table 16 lists the activities observed during 5076 of the 6145 naturalistic backing maneuvers that were able to be coded (i.e., video data files were available for review). The frequency with which these activities were observed was noted. If the driver performed multiple activities during a backing maneuver, each activity was noted.

Overall, 61 percent of backing maneuvers involved the driver maneuvering the vehicle without performing any additional activities. The two most frequent activities during backing were pushing a garage door remote (13.36 percent) and talking to a passenger (12.77 percent).

Table 16. Drivers' Activities During Backing Events

Activity	Frequency	Percent
None Just Backing	3115	61.37
Pushing Garage Remote	673	13.26
Talking With Passenger	648	12.77
Other	239	4.71
Using Cell Phone	157	3.09
Securing Seat Belt	133	2.62
Touching Passenger Or Dog	69	1.36
Unknown	42	0.83
Total	5076	100.00

Table 17 highlights observed instances of multiple activities during backing. The most common combination of identified activities was pushing a garage door remote while talking with a passenger.



Table 17. Summary of Observed Instances of Multiple Activities During Backing

First Recorded Driver Activity	Second Recorded Driver Activity	Count	Percent
Using Cell Phone	Other	4	0.7874
Using Cell Phone	Pushing Garage Remote	20	3.937
Using Cell Phone	Securing Seat Belt	3	0.5906
Other	Pushing Garage Remote	24	4.7244
Other	Securing Seat Belt	1	0.1969
Other	Touching Passenger Or Dog	3	0.5906
Other	Talking With Passenger	21	4.1339
Pushing Garage Remote	Using Cell Phone	1	0.1969
Pushing Garage Remote	Other	77	15.1575
Pushing Garage Remote	Securing Seat Belt	15	2.9528
Pushing Garage Remote	Touching Passenger Or Dog	14	2.7559
Pushing Garage Remote	Talking With Passenger	74	14.5669
Securing Seat Belt	Using Cell Phone	2	0.3937
Securing Seat Belt	Other	16	3.1496
Securing Seat Belt	Pushing Garage Remote	59	11.6142
Securing Seat Belt	Touching Passenger Or Dog	2	0.3937
Securing Seat Belt	Talking With Passenger	18	3.5433
Touching Passenger Or Dog	Other	4	0.7874
Touching Passenger Or Dog	Pushing Garage Remote	10	1.9685
Touching Passenger Or Dog	Talking With Passenger	3	0.5906
Talking With Passenger	Other	49	9.6457
Talking With Passenger	Pushing Garage Remote	84	16.5354
Talking With Passenger	Securing Seat Belt	2	0.3937
Talking With Passenger	Touching Passenger Or Dog	2	0.3937
		508	100

Table 18 summarizes driver activities during backing as a function of system condition. The data show that drivers in the RV & RPS condition were slightly less likely to engage in any other activity while backing. Conducting statistical testing to demonstrate that participants in the RV & RPS condition were less likely to engage in secondary activities while backing is inappropriate because of the multiple backing events included for each driver in the analyses. Statistical testing would assume that all backing events were from different drivers. This could overstate the findings because these data represent multiple instances of the tendencies of the small sample of drivers used in the study. Nevertheless, it is fair to say without statistical backing that the RV & RPS drivers were more likely not to engage in secondary activities while backing than drivers with other systems and that the RV drivers were less likely than drivers with no system to engage in secondary activities while backing.

Table 18. Drivers' Primary Activity By System Condition

Driver Activity	System			Total
	None	RV	RV & RPS	
<b>Frequency</b>				
<b>Column Percent</b>				
<b>None Just Backing</b>	656 51.69	905 60.01	1554 67.59	3115 61.37
<b>Pushing Garage Remote</b>	223 17.57	217 14.39	233 10.13	673 13.26
<b>Talking With Passenger</b>	185 14.58	191 12.67	272 11.83	648 12.77
<b>Other</b>	72 5.67	69 4.58	98 4.26	239 4.71
<b>Using Cell Phone</b>	29 2.29	38 2.52	90 3.91	157 3.09
<b>Securing Seat Belt</b>	28 2.21	60 3.98	45 1.96	133 2.62
<b>Touching Passenger Or Dog</b>	41 3.23	21 1.39	7 0.3	69 1.36
<b>Unknown</b>	35 2.76	7 0.46	0 0	42 0.83
<b>Total</b>	1269	1508	2299	5076 100

## 5.6 RPS Use

During the course of the experiment, five participants made unsolicited comments to members of the research staff about turning off the RPS on their vehicle. One person reported that he just did not use it. Another person stated that she did not know that the button had to be pushed for the RPS to work (the vehicle was equipped with a button for turning off the RPS). Three participants stated that they frequently turned the RPS off when driving through a restaurant drive-through lane due to nuisance alarms (i.e., audible notifications of the presence of vehicles that the driver is already aware of). Lastly, a sixth participant was observed having the RPS on their vehicle switched off during their initial meeting visit. When this participant returned for their final meeting visit, the RPS was observed to be switched on. In summary, half of the participants in the RV & RPS system condition stated or were observed to have turned the RPS on their vehicle off at least some of the time.

## 6.0 RESULTS: INITIAL 'BASELINE EVENT' AND FINAL 'OBSTACLE EVENT'

This section presents results for the backing maneuvers occurring at the end of participants' initial and final test drives. The backing maneuver occurring at the end of the final test drive involved presentation of an unexpected obstacle and therefore is at times referred to here as the "obstacle event." The initial test drive backing maneuver is also referred to as the "baseline event."

### 6.1 Backing Behavior During Baseline and Obstacle Events

In an effort to assess how quickly drivers initiate a backing maneuver, the time between when the drivers shifted into reverse and the vehicle began moving backwards was noted for the baseline and obstacle events. Figure 33 illustrates these times as a function of system condition. Analysis results showed no significant difference due to system condition or trial (baseline versus obstacle event). However, the somewhat longer times seen for the RV and RV & RPS conditions may indicate that drivers were waiting for the RV display image to appear.

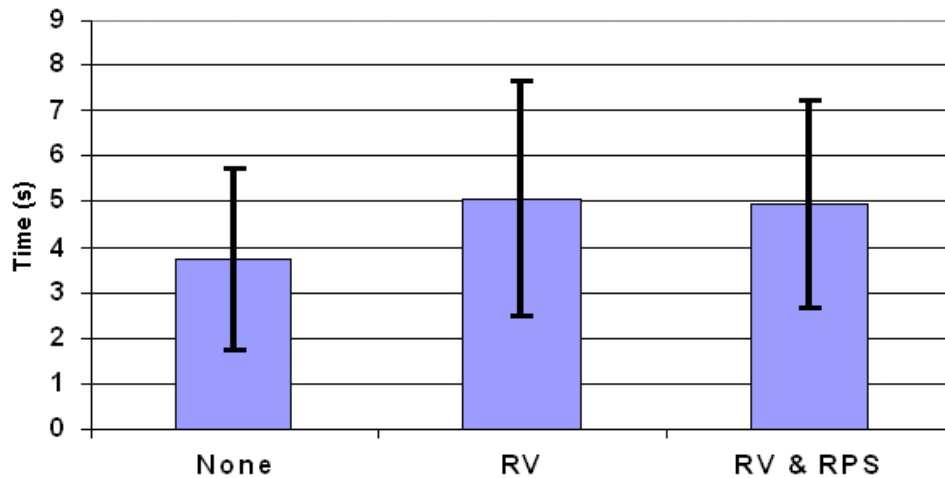

Figure 33. Mean Time ( $\pm$ SD) Between Shifting into Reverse Gear and the Beginning of Rearward Motion (Baseline and Obstacle Events)

Mean backing speed during the baseline and obstacle events was also determined. Figure 34 illustrates mean backing speeds for baseline trials and all obstacle event trials in which the driver did not see the obstacle and stop. Overall mean backing speed in these staged events was 2.25 mph. No significant difference between system condition or trial (baseline versus obstacle event) was observed.

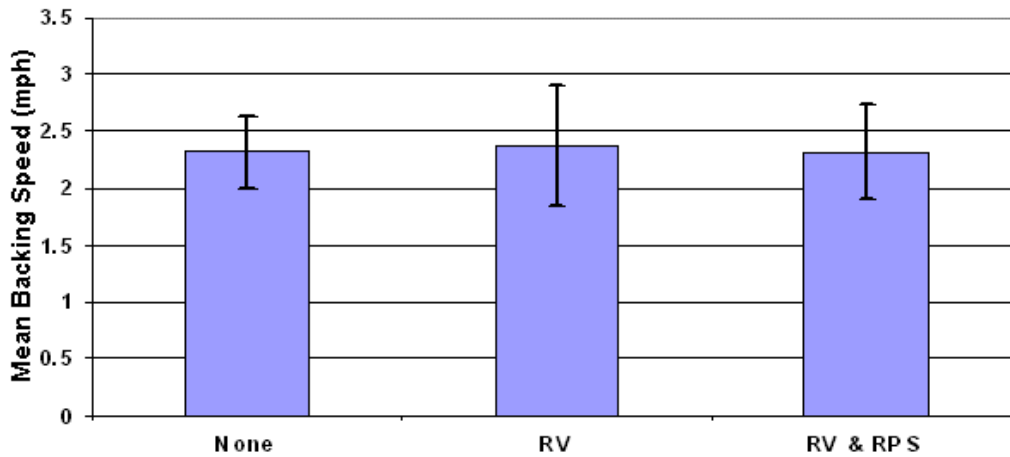

Figure 34. Mean Backing Speed ( $\pm$ SD) by System Condition (Baseline and Obstacle Events)

Figure 35 and Table 19 present mean maximum backing speeds for the baseline and event trials. Trials in which the participant stopped the vehicle in the middle of the maneuver were removed from these data. The mean maximum backing speed mean of 3.7 mph is fairly constant across systems.

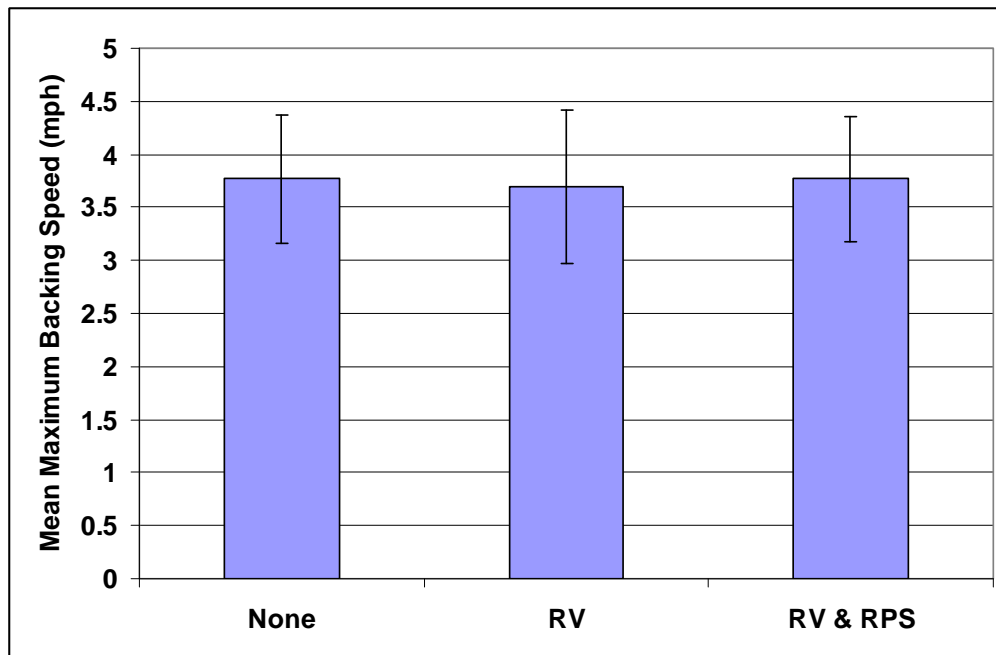

Figure 35. Mean Maximum Backing Speed ( $\pm$ SD) by System Condition (Baseline and Obstacle Events)

Table 19. Mean Maximum Backing Speed by System Condition (Baseline and Obstacle Events)

System	Mean Maximum Backing Speed (mph)	Std Dev
None	3.7683478	0.6027962
RV	3.7020556	0.7232739
RV & RPS	3.7695238	0.5924636

Figure 362 presents means for the maximum acceleration during the baseline and obstacle event backing maneuvers. Maximum acceleration did not differ significantly as a function of system condition.

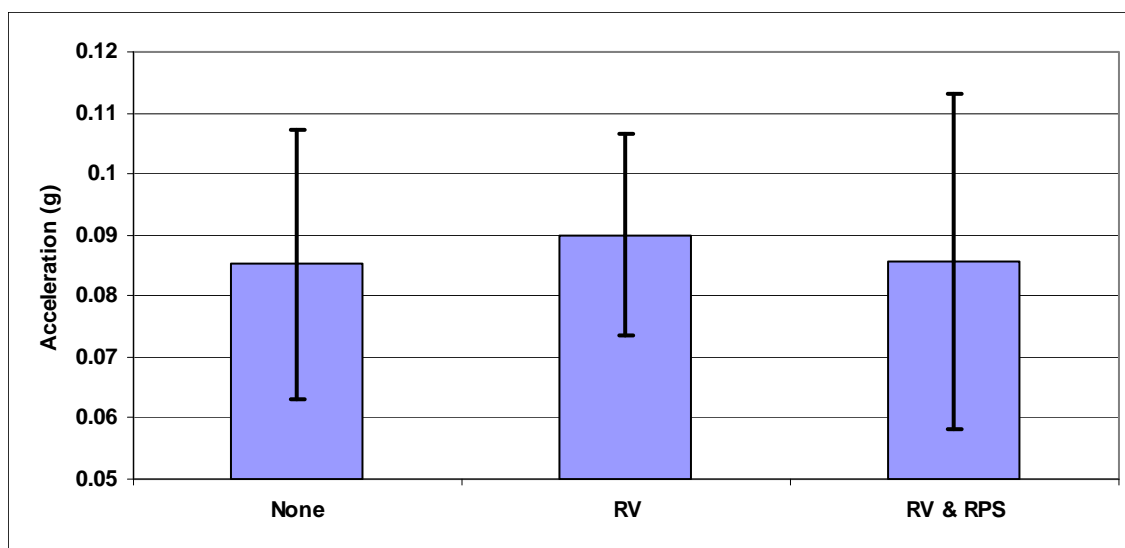

Figure 36. Maximum Backing Acceleration ( $\pm$ SD) by System (Baseline and Obstacle Events)

## 6.2 Obstacle Event Outcome Results

Results for the outcomes of the staged obstacle scenario are presented in Table 20. Overall, 81 percent of participants crashed in this staged scenario. Combining the results for participants with 'RV only' with results of those with RV & RPS shows that a total of 72 percent of participants with RV crashed, as seen in Figure 37. Participants with RV crashed significantly less than those without RV ( $\chi^2(2)=6.95$ ,  $p=.03$ ). The difference between the percent of crashes for participants with 'RV only' and RV & RPS, while seemingly large, was not significant ( $\chi^2(1)=2.13$ ,  $p=.14$ ). However, it was found that if, hypothetically, the sample size was doubled with the same outcomes, then the difference between those two conditions would become statistically significant.

Table 20. Staged Obstacle Event Outcomes

System	N	Number that Crashed	Percent Crashed
No system	12	12	100%
RV only	12	7	58%
RV & RPS	13	11	85%
Total	37	30	81%

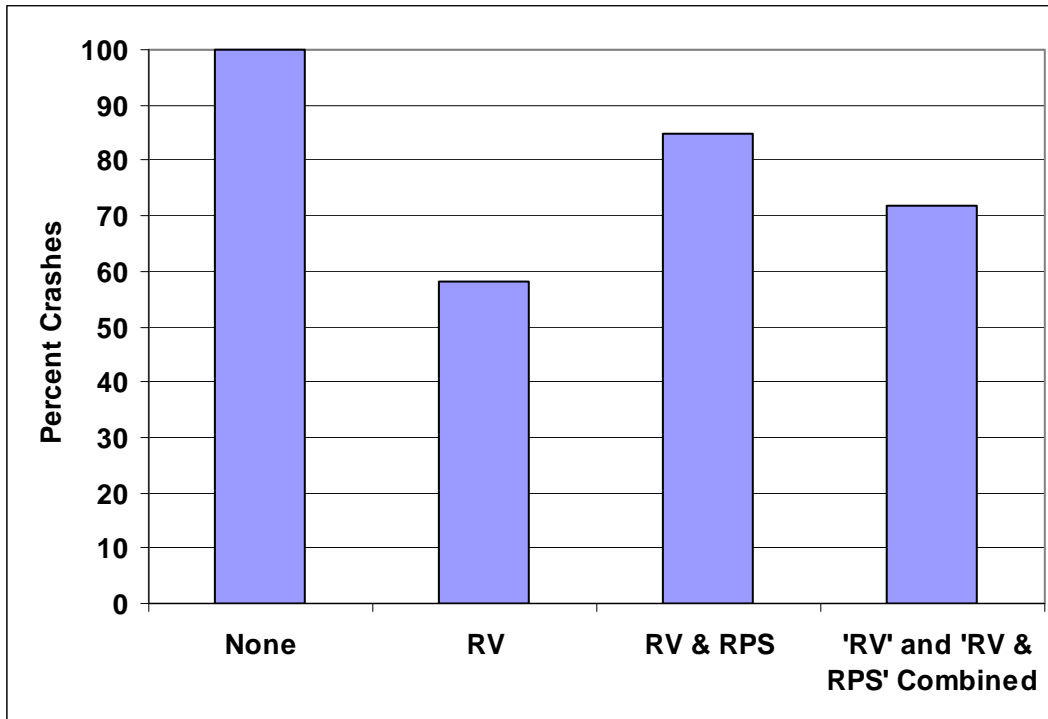

Figure 37. Percent Crashes by System Condition for the Staged Obstacle Event

Data illustrated in Figure 38 indicate whether participants driving a vehicle equipped with RV actually looked at the RV display during the obstacle event scenario. Overall, 16 of 25 participants (64 percent) glanced at the RV display during the obstacle event backing maneuver. Trends in these data suggest that participants with 'RV only' glanced at the RV display slightly more than those in the 'RV & RPS' condition.

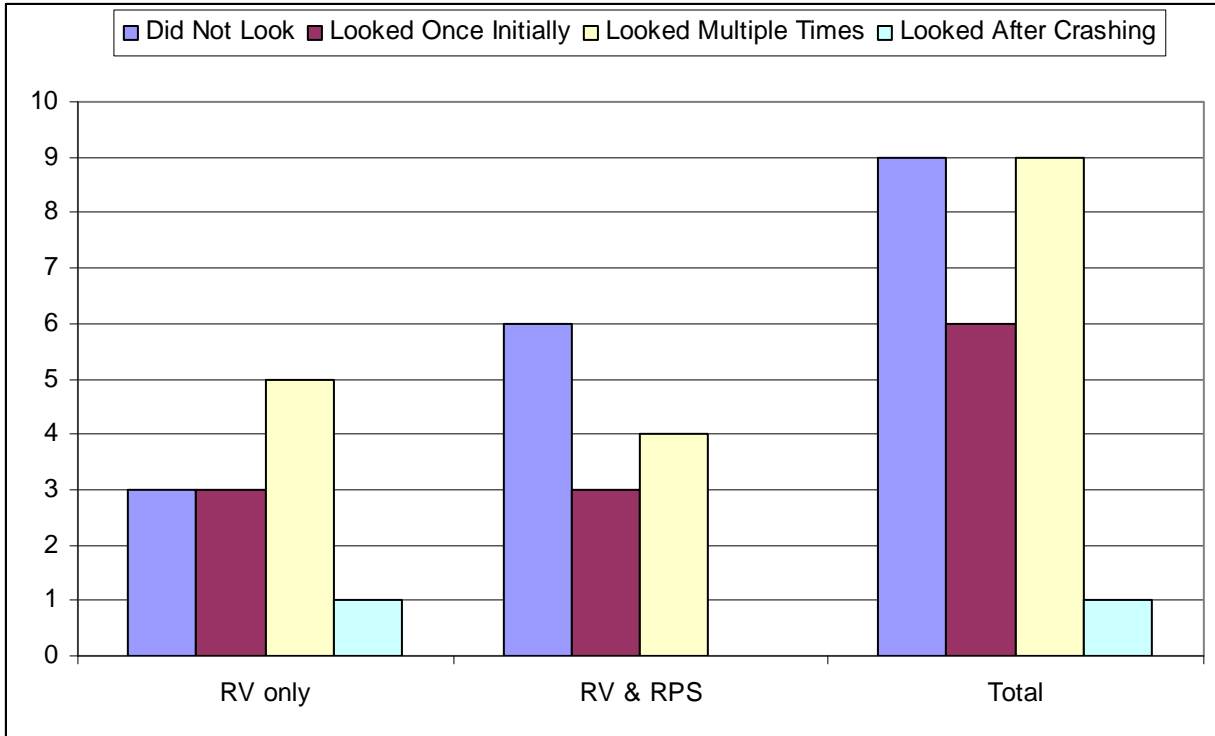

Figure 38. Summary of Participants' Glances to the Rearview Video System During the Obstacle Event

Data presented in Figure 39 show that participants who glanced at the RV display multiple times during the backing maneuver tended to avoid a crash more often than those who glanced only once initially or not at all. All participants who failed to look at the RV display, or who looked once at the beginning of the maneuver but never looked again, crashed, since the obstacle was not present until the vehicle had moved 3 feet rearward.

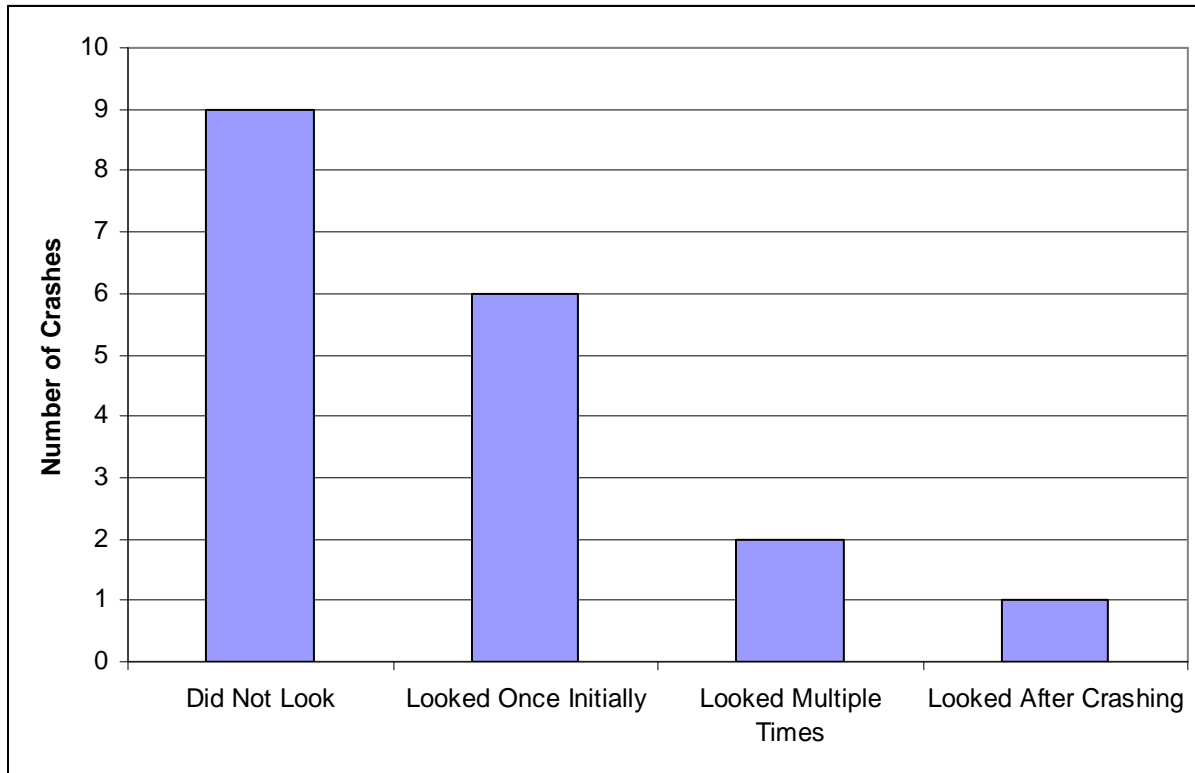

Figure 39. Obstacle Event Crashes as a Function of Rearview Video Glances

Crashes involving participants who made multiple glances to the RV display may be attributable to a delay in the appearance of the RV image that was typical for the specific make/model of test vehicle used in this study. As noted previously, separate testing found this delay to have an average duration of 6.44 seconds when reversing immediately after vehicle ignition (the delay was shorter when backing after the vehicle had been running for a period of time). This RV display delay issue is discussed further in Section 8.1.

Table 21 presents hypothetical results showing what the outcomes might have been a) had the obstacle been present at the start of the maneuver and b) had the RV display delay been less than 1 second in duration. These hypothetical results were determined through review of participants' sequences of glances during the obstacle event in consideration with the timing of the appearance of the RV image. The figures in Table 21 assume that if the driver had glanced at the RV display at the start of the maneuver, then the driver would have successfully identified the presence of the obstacle through that RV display glance.



Table 21. Hypothetical Staged Obstacle Event Outcomes

System	N	Number that Crashed	Hypothetical Number/Percent That May Have Crashed Had...		
			The Obstacle Been Present at the Start of the Maneuver	The RV Display Delay Been < 1 Second in Duration	Both Occurred
No system	12	12	12 (100%)	12 (100%)	12 (100%)
RV only	12	7	5 (41.7%)	7 (58.3%)	5 (41.7%)
RV & RPS	13	11	8 (61.5%)	9 (69.2%)	6 (46.1%)
Total	37	30	25 (67.6%)	28 (75.7%)	23 (62.2%)

Table 22 highlights obstacle event outcome (i.e., crash) results as a function of whether or not the RPS detected the obstacle. Four out of five, or 80 percent, of the cases in which the RPS detected the obstacle and provided a visual and audible warning alert the participant still crashed. Of the four who received RPS warnings and crashed, one driver did not look at the RV display, one driver looked once initially (before the obstacle was present), and two looked more than once but the RV image had not displayed yet (due to RV display delay). It should be noted that, while the RV display exhibited a delay in appearance of the video image, the RPS worked independently and did not exhibit a similar delay.

Table 22. Obstacle Event Outcomes as a Function of RPS Detection

System	N	Detected Object	Did Not Detect Object
RV & RPS	13	5 (38.5%)	8 (61.5%)
Number That Crashed	11	4	7

The one person who did not receive a RPS warning alert in the obstacle event and did not crash had observed the obstacle in the RV display and was able to stop without striking it. The RPS appeared to be unable to detect the obstacle if it was located at the centerline of the vehicle. Thus, those participants who backed out of the garage on an off-center path were the ones who tended to receive RPS warning alerts. This observation agrees with RPS detection performance results presented in Section 2.1.

### 6.3 Eye Glance Behavior During Baseline and Obstacle Events

This section presents results for eye glance behavior observed during baseline and obstacle events. Glance locations noted for these data were as follows:

- Over left shoulder (Left Shoulder)
- Out left window or at left mirror (Left)
- Instrument panel
- Forward (out windshield)
- Rearview mirror
- RV display or center console (console/video)
- Out right window or at right mirror

- Over right shoulder
- Other

The driver was considered to be looking at the noted location if their eyes were determined to be focused on that location, regardless of their body orientation.

Data presented in Table 23 summarize glances to the RV display for baseline and obstacle events. Note that data are from the first 12 seconds of backing (after car began to move as judged visually). Note further that these data may include more than 12 seconds of glance behavior. This would occur when the driver began backing while in the middle of a glance. In these situations, the entire glance duration was included. These data have an N of 46 because they represent two trials for each of the 25 participants with a rearview video system in their vehicle (12 who had 'RV only' and 13 who had 'RV & RPS'), minus two participants for which eye glance data was not available due to problems with data recording equipment.

Table 23. Summary of Participants' Glances to the Rearview Video System During the Baseline and Obstacle Events

<b>Dependent Variable</b>	<b>N</b>	<b>Mean</b>	<b>Std Dev</b>	<b>Min</b>	<b>Max</b>
Number of Glances to RV	46	1.41	1.45	0.00	6.00
Total Number of Glances	46	10.50	3.28	4.00	18.00
Percentage of Glances to RV	46	14.00	13.00	0.00	50.00
Percentage of Time Viewing RV	46	15.00	19.00	0.00	81.00
Total Glance Time (s)	46	11.74	1.53	5.77	14.44

On average, drivers made 10.50 distinct glances during a backing event that lasted 11.74 seconds. Of these glances, 1.41 were to the RV display. This value ranged between 0 and 6.0. The percentage of time spent looking at the RV display was 15 percent (SD=19, range 0 to 81). Drivers with RV made 13 to 14 percent of glances to the RV display during initial phases of backing.

With respect to individual drivers, one subject (S2) viewed the RV display for 63 percent and 81 percent of the two experimental backing trials, although the latter number is undoubtedly inflated by the fact that the object was seen in the rear video. Thus the baseline trials may be better representations of uneventful backing. Following the highest value for proportion of time spent viewing the RV display, the next highest values were: 40 percent (S37), 37 percent (S7), and 27 percent (S34).

The following table presents the number of subjects for each combination of Trial (baseline or event), System (None, RV, RV & RPS), and Glance category (0, 1, or 2+).

Table 24. Number of Glances to the Console/RV Display by System and Baseline or Event Trial

	System	Glances to Console/Video			Total subjects
		0	1	2+	
Baseline	None	10	1	0	11
	RV	5	3	4	12
	RV& RPS	2	5	4	11
Event	None	11	1	0	12
	RV	3	4	4	11
	RV & RPS	4	4	4	12

If the two systems with RV are combined the results shown in Table 25 are obtained.

Table 25. Number of Glances to the Console/RV Display by RV Presence and Baseline or Event Trial

	System	Glances to Console/Video			Total subjects
		0	1	2+	
Baseline	None	10	1	0	11
	RV combined	7	8	8	23
Event	None	11	1	0	12
	RV combined	7	8	8	23

Thus, for both baseline and event trials, 16 of 23 (70 percent) of the subjects looked at least once at the console/video area. The corresponding values for baseline trials were 1 out of 11 (9 percent) and 1 out of 12 (8 percent).

These data are remarkably consistent in the aggregate, however when the glance behavior of each subject was considered, it became apparent that there was some inconsistency in individual subjects' glance behavior between baseline and event conditions. Specifically:

- 6 subjects were consistent between baseline and event trials in the specific number (1 or 2+) of recorded glances to the console/video
- 3 subjects were consistent in not glancing at console/video across trials
- 4 subjects were consistent in devoting some glances to the console/video, but the number differed between baseline and event trials.
- 8 subjects were not consistent; each of these had one or more glances on one condition but none in the other condition
- (4 subjects had eye glance data from only one of the two conditions.)

These data can be summarized in several ways:

1. For the event trials, 70 percent (16 of 23) of drivers looked at least once at the video display. The corresponding percentage for the baseline trials was also 70 percent.

2. When we consider drivers' behavior on both trials together, we find that 18 (86 percent of the 21 drivers for which both sets of glance data were available) drivers looked at the console/video area on at least one of the two trials (10 on both, 8 on one or the other), while 3 drivers looked on neither trial.
3. When we consider only consistency of behavior across the two trials, we find that 13 drivers were consistent in their behavior (10 in looking, 3 in not looking) while 8 were inconsistent in their behavior (looked on one trial but not the other).

Figure 40 shows the mean number of glances per backing trial (baseline and obstacle events) for the first 12 seconds of backing by glance location and system condition. The start of backing was determined visually (i.e., manual review of video-recorded data) for baseline and obstacle event trials. Overall, drivers with no system made slightly more glances per maneuver ( $M=11.9$ ,  $SD=3.4$ ), compared to those drivers with RV ( $M=9.9$ ,  $SD=3.4$ ) and RV & RPS ( $M=9.5$ ,  $SD=5.0$ ) systems. Relative to those with RV systems, drivers with no RV system made more glances over the left shoulder, forward, left, and right. Drivers with no RV system did not look more frequently at the rear view mirror. Drivers with RV made 13-14 percent of glances to the RV display during the initial phases of backing (see Figure 39).

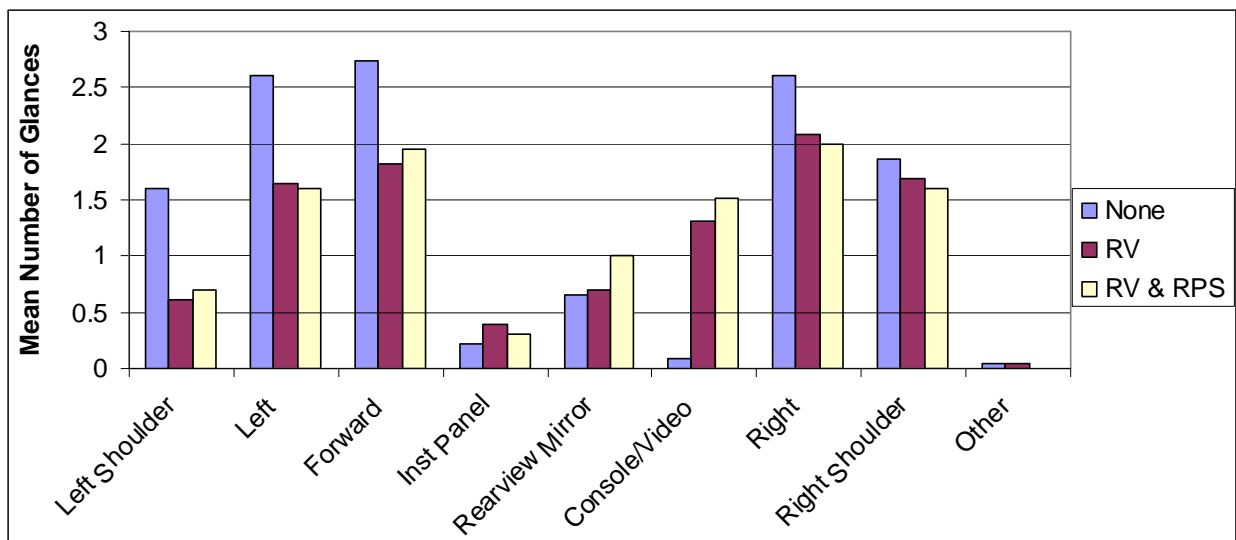

Figure 40. Mean Number of Glances Per Trial by Glance Location and System (Baseline and Obstacle Events)

Summary data for glance frequency and mean percentage of glances by location (see Figure 41) reveal similar patterns. Drivers glanced predominantly forward, left, or right during backing. Drivers with no RV system glanced more often over their left shoulders. Drivers with RV systems directed almost 15 percent of glances during the first 12 seconds of backing to the RV system display. These data show an extremely low percentage of glances to console/video among drivers in the “no system” condition, which differs from naturalistic findings (presented in Section 5.0) and probably reflects

the fact that the drivers had no need to look at the console (e.g., for radio or HVAC) while backing out of the garage in the staged obstacle event scenario.

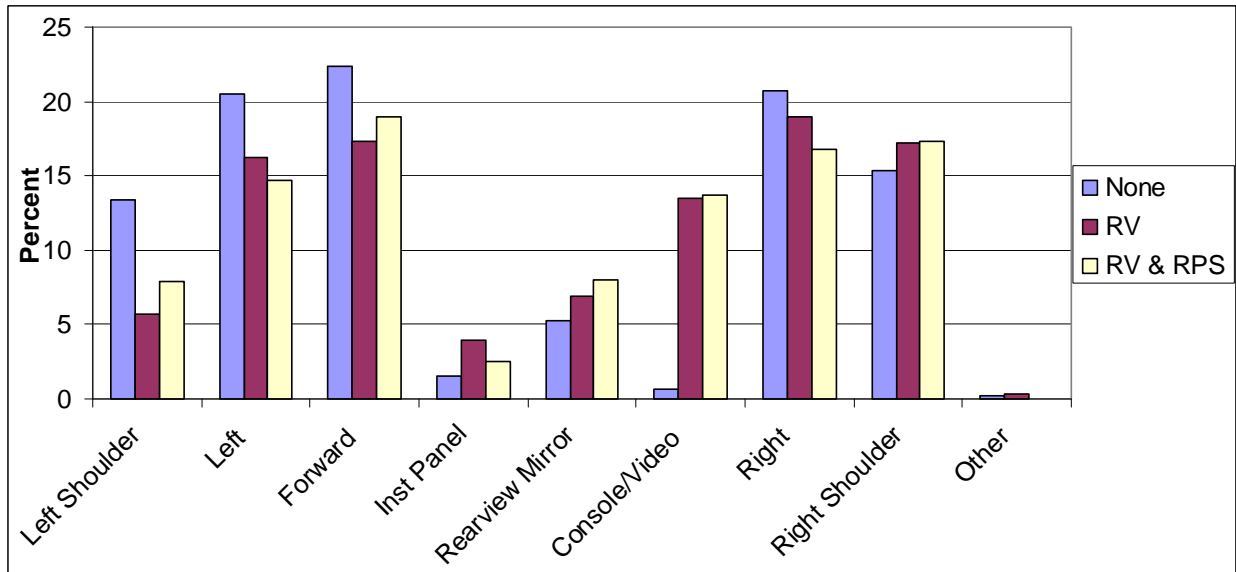

Figure 41. Mean Percentage of Glances by Glance Location and System Condition (Baseline and Obstacle Events)

Figure 42 presents eye glance durations by glance location and system condition for baseline and obstacle events. Mean durations were computed first by subject. For drivers with no RV system, results indicate slightly shorter glances to the console/video and slightly longer glances to the rearview mirror. Glances over the right shoulder were slightly shorter for those in the no system condition.

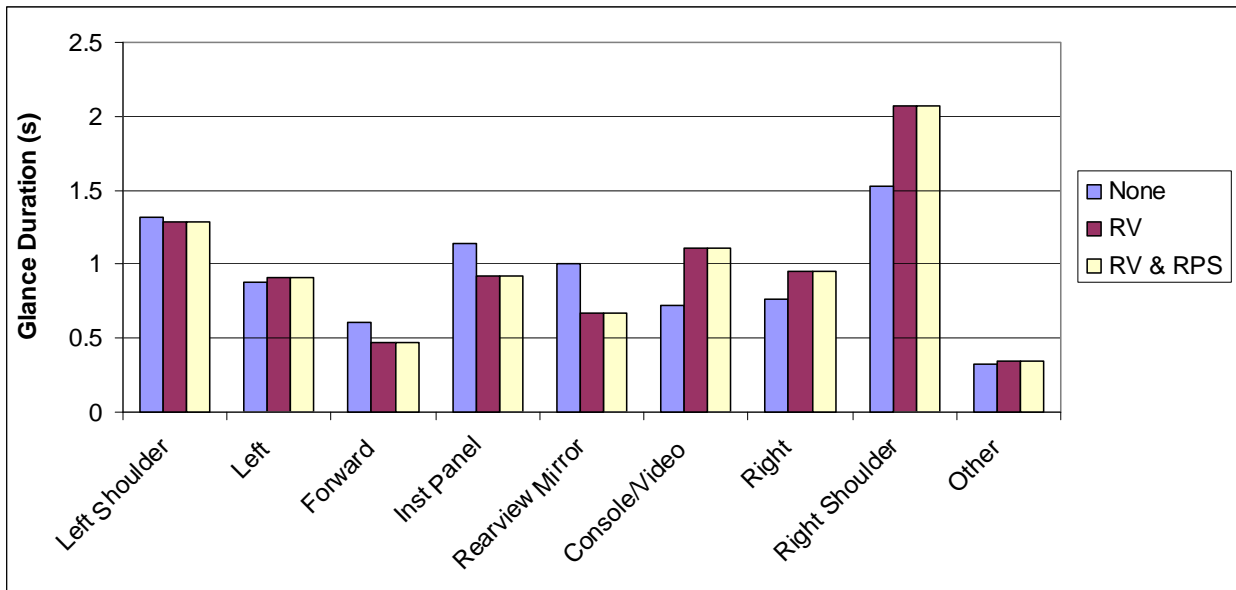

Figure 42. Mean Glance Duration by Glance Location and System Condition (Baseline and Obstacle Events)

Figure 43 illustrates the mean percentage of total glance time by glance location and system condition for the baseline and obstacle events. Independent of system presence, drivers spent over 25 percent of backing time looking over their right shoulder and 15 percent of time looking toward the right mirror or window.

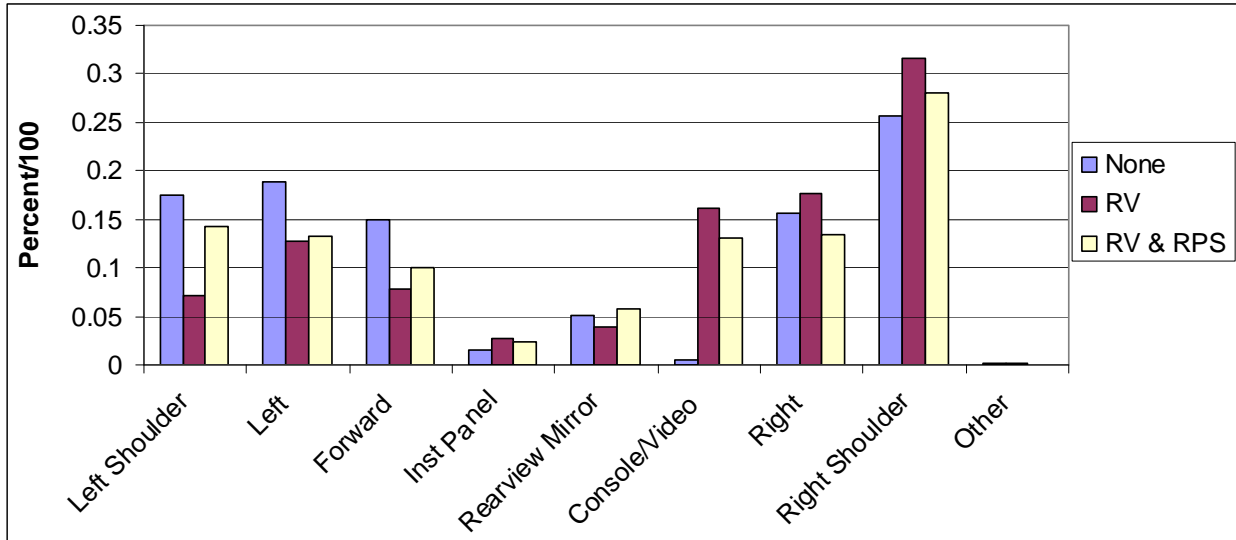

Figure 43. Mean Percentage of Total Glance Time by Glance Location and System Condition (Baseline and Obstacle Events)

## 7.0 QUESTIONNAIRE RESULTS

This section presents summaries of selected questionnaire items. A full set of questionnaire responses is provided in Appendices E through G.

Immediately after experiencing the obstacle event, participants were asked to complete a questionnaire tailored to their system condition. The first question asked whether the participants had anticipated the obstacle event, i.e., were they genuinely surprised. All participants in all system conditions reported that they did not anticipate the obstacle event.

Participants' responses regarding where they look primarily to determine whether the area behind the vehicle is clear when backing, showed a fairly equal distribution of reported glances to the side mirrors, center rearview mirror, over their shoulders, and at the rearview video display (when present). However, as shown in Table 26, only 3 of 13 (23 percent) drivers of vehicles with a RPS system stated that they used RPS information.

Table 26. Questionnaire Responses Regarding Where Drivers Look to Determine Whether the Area Behind Their Vehicle is Clear Prior to Backing

Glance Location	No System (12)	RV (12)	RV & RPS (13)
At the side mirrors	75%	66.67%	61.5%
At the center rearview mirror	75%	83.33%	76.9%
Over my shoulder	91.67%	91.67%	92.3%
At the rearview video display		83.33%	61.5%
At the backing aid display			23.1%

Note: Multiple responses to this question were allowed.

One participant in the 'RV only' condition and three participants in the 'RV & RPS' condition stated that they rarely or never look at the rearview video display when backing. Five of thirteen participants with RV & RPS stated that they rarely or never look at the backing aid display when backing.

When asked why their vehicle did not have an RV or RPS system, a majority of participants in the "no system" condition gave three responses. Thirty-three percent said that it never occurred to them to look for an RV system and 58 percent responded similarly in regard to a RPS. A third of participants reported that the RV or RPS was packaged with options that they were not interested in purchasing. Nearly 42 percent of participants in the "no system" condition reported that an RV system was not an option on their vehicle, while 25 percent reported that a RPS was not an option. (Note that since RV & RPS were available for their vehicle, this indicates a lack of awareness of these systems.) Table 27 presents a complete summary of responses.

Table 27. Percent Responses Regarding Why “No System” Participants Did Not Choose To Purchase a Backing Aid System

Response Choices	RV	RPS
It never occurred to me to look for one when I was buying the vehicle	33.3%	58.3%
It was not an option on my vehicle	41.7%	25.0%
I thought the (system) would be a nuisance or distraction	8.3%	0%
I wouldn't trust the (system)	8.3%	0%
I don't need a (system) because I have good backing skills	8.3%	8.3%
The (system) was not worth the extra cost	8.3%	16.7%
The (system) was only available with other options that I didn't want	33.3%	33.3%
I was not the person who purchased or made the decision to purchase this vehicle	0%	0%
No response	0%	8.3%

As noted in Table 28, all 12 participants in the RV system condition reported that they would want RV on their next vehicle. Twelve of 13 RV & RPS participants reported that they would be repeat customers of a RPS. Two-thirds of participants in the “no system” group reported that they did not know if they would like an RV or RPS system on their next vehicle.

Table 28. Participant Responses Regarding Whether They Would Like Their Next New Vehicle to be Equipped With a Backing Aid System (by System Condition)

Response	System Condition:	No System		RV	RV & RPS	
	Would you Want:	RV	RPS	RV	RV	RPS
Yes		33.3%	33.3%	100%	76.9%	92.3%
No		0%	0%	0%	7.7%	0%
Don't Know		66.7%	66.7%	0%	15.4%	7.7%

Table 29 summarizes the responses of participants in the RV and RV & RPS groups regarding how they learned to use their RV and RPS systems, as appropriate.

Table 29. How Did Participants Learn to Use Their RV or RPS

System Condition	RV	RV & RPS	
How Did the Participant Learn To Use...	RV	RV	RPS
Instructions from the dealership, such as a video, brochure, or demonstration	50.0%	38.5%	30.8%
Vehicle owner's manual	8.3%	30.8%	23.1%
Help from a friend or relative	16.7%	7.7%	15.4%
Information on the Internet	0%	0%	7.7%
On-road experience and practice (trial and error)	83.3%	84.6%	76.9%
I have not yet learned how to use the system	0%	0%	0%



When asked whether there was anything difficult about learning to use an RV system, 4 participants in the RV system condition reported that it was difficult to judge the distance between the vehicle and an object behind it and 7 reported that it was easy to judge distances. Five participants in the RV & RPS condition reported varied difficulties in learning to use their systems including ignoring the audible warning tones, difficulty incorporating use of the aid into their normal backing behavior, and difficulty in judging distances.

Two of 12 participants in the RV condition and 2 of 13 participants in the RV & RPS condition reported that at some point in the prior 2 weeks they had made a backing maneuver using only the RV system. Conversely, one participant in the RV condition and five in the RV & RPS condition reported via questionnaire response that she “rarely or never look(ed) at (her) system.” It is interesting to note that this participant who reported not looking at her system crashed in the staged obstacle event scenario, but had no crashes during her recorded period of naturalistic driving.

When asked about how well their vehicle’s RV or RV & RPS work in certain weather conditions, 23 percent of participants in the RV condition reported that their system does not work well in darkness. One commented that it doesn’t work well when the camera is dirty. Table 30 provides a complete summary of responses regarding participants’ perceptions of RV and RPS performance in difference environmental conditions.

Table 30. How Well Does Your Vehicle’s RPS (N=13) and RV (N=12) Work in the Following Weather Conditions?

Response	Darkness		Fog		Cold Temperatures		Rain		Snow		Bright Sun	
	RV	RV & RPS	RV	RV & RPS	RV	RV & RPS	RV	RV & RPS	RV	RV & RPS	RV	RV & RPS
Not at All	0%	0%	0%	0%	0%	0%	0%	0%	0%	0%	8.3%	0%
Poorly	0%	23.1%	25%	7.7%	8.3%	0%	16.7%	15.4%	8.3%	15.4%	25%	15.4%
Fairly Well	66.7%	38.5%	16.7%	30.8%	8.3%	30.8%	50%	76.9%	25%	30.8%	33.3%	38.5%
Perfectly	25%	23.1%	0%	7.7%	50%	38.5%	25%	0%	8.3%	7.7%	41.7%	30.8%
Don't Know	8.3%	15.4%	58.3%	53.9%	33.3%	30.8%	8.3%	7.69%	58.3%	46.2%	0%	7.7%

Question 16 of the ‘RV & RPS’ questionnaire sought to determine whether participants had any misconceptions about the utility of the rearview video and rear parking sensor systems. One misconception identified was the belief of ten of thirteen participants that the RPS would be operational when backing at a speed of 10 mph (ultrasonic systems are typically not operational above 3 mph). Six participants did not realize that an RPS cannot detect a child located under the rear bumper and four participants thought that the system would detect a child in that location poorly. Nine participants optimistically thought that their RPS would detect a narrow sign post behind their vehicle at least fairly well.

Given that backover crashes frequently happen in driveways, participants were asked how easy their RV or RV & RPS are to use when backing out of a driveway. Table 31 summarizes these responses. Three participants in the RV & RPS system condition felt that their vehicle's equipment was difficult to use in this situation. Specifics regarding what these participants found difficult about using the system were not obtained.

Table 31. Summary of Participant Responses to the Question, "How Easy is Your (System) To Use When Backing Out of a Driveway?"

Response	RV	RV & RPS
Very easy to use	58.3%	38.5%
Somewhat easy to use	25.0%	38.5%
Somewhat difficult to use	16.7%	0%
Very difficult to use	0%	23.1%
Don't Know	0%	0%

Participants in the RV and RV & RPS conditions were presented with a schematic (see Figure 44) of a vehicle with defined areas behind it, labeled "A" through "Q", and asked in which of these areas a small standing child could be seen in the RV display. Table 32 summarizes the percentages of participants who chose each area as a place where such a child would be visible. Using data presented earlier in Section 2, the difference between which areas participants believe they would be able to see in the RV display and what they actually would be able to see are compared. In Table 29, areas in which a small standing child would not be visible in the RV display are presented with dark shading. Lightly shaded areas indicate locations in which a small standing child may not be visible in the RV display. As was shown in Figure 4, the 2007 Honda Odyssey RV system's camera appears to have a range of approximately 100 degrees. This visible range, leaves approximately 40 degrees on each side of the vehicle that are not visible in the RV display. These invisible areas coincide with areas A, B, J, K, and most of C, I, L, and N in Figure 44.

Table 32. Summary of Questionnaire Responses Indicating in Which Areas (in Figure 44) a Small Standing Child Could Be Seen in the RV Display

Response	RV	RV & RPS
A	0%	7.69%
B	8.33%	38.46%
C	50.00%	69.23%
D	66.67%	92.31%
E	75.00%	84.62%
F	91.67%	92.31%
G	75.00%	84.62%
H	66.67%	92.31%
I	50.00%	69.23%
J	25.00%	38.46%
K	0	7.69%

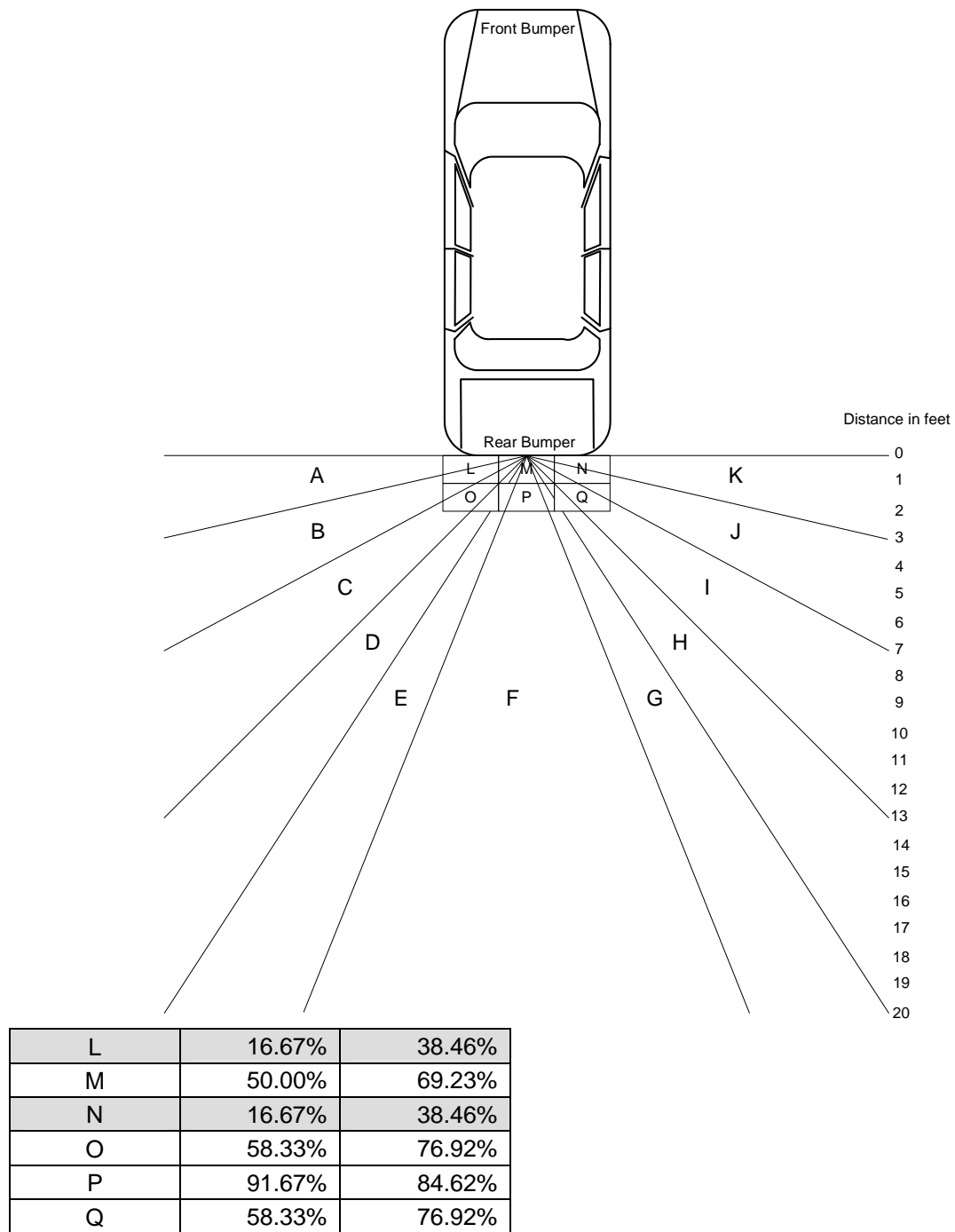

Figure 44. Graphic Used to Assess in Which Areas Participants Thought a Small Child Standing Behind Their Vehicle Could Be Seen in the RV Display

Participants in the RV & RPS condition were presented with another schematic (see Figure 45) of a vehicle with defined rectangular areas behind it and asked in which of these areas a small standing child would be detected by the RPS. Figure 45 contains the illustration provided in the questionnaire with summarized data overlaid on it to highlight the percentages of participants who chose each area as a place where such a

child would be detectable by the RPS. Shaded areas indicate locations in which RPS detection performance testing (summarized previously in Section 2.0) showed the system to be unable to detect objects. Based on these responses, it seems that participants in this study overestimated the detection range capabilities of the RPS on their vehicles. There was not one location where all 13 participants unanimously agreed a standing child would be detected, with the most detectable area being in the one to three foot range of the area straight back from the vehicle's bumper.

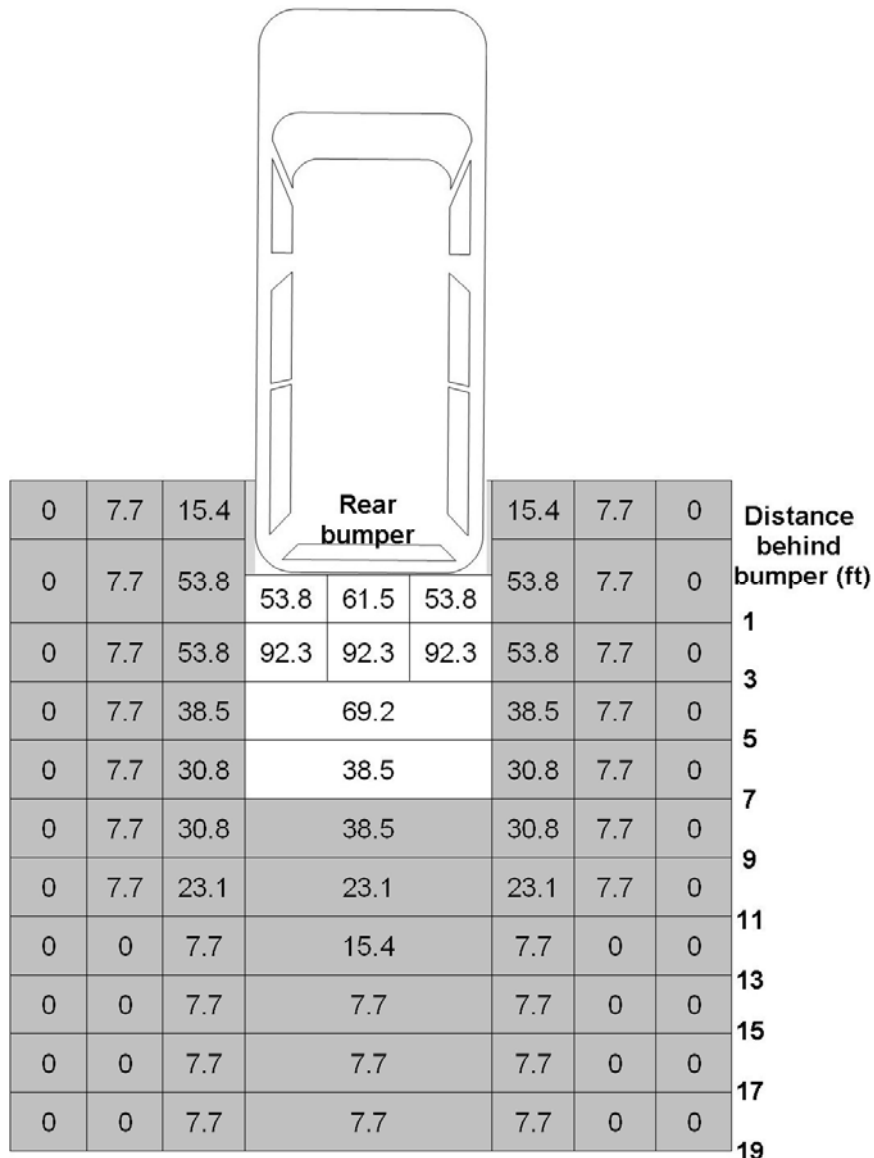

Figure 45. Summary of Questionnaire Responses Indicating in Which Areas a Small Standing Child Would Be Detected by the RPS

When asked whether having an RV system made them safer drivers, 8 of 12 participants in the RV condition responded 'yes', while the other 4 reported that it made

no difference. Seven of 13 participants in the RV & RPS system condition reported that having the system made them a safer driver, while 6 reported that it made no difference.

When asked whether or not they think there is anything about their vehicle's system that could be improved, 8 of the 12 participants in the RV condition responded, 'Yes'. Some of their recommendations included provision of a distance indication, quicker appearance of the RV image after shifting into reverse, a wider angle of view, elimination of sun glare, and improved image quality in rain. One RV participant also stated that the RV system needs a way to make it easier to determine if the vehicle is going straight or not.

Participants in the RV & RPS condition were asked whether they thought improvements were warranted for their vehicles' RV and RPS features. Eight of 13 participants in the RV & RPS condition thought improvements were warranted including use of a different sound for backing versus parking, use of different sounds for side versus rear, provision of a distance indication, elimination of the RV image appearance delay after shifting into reverse, and relocation the RPS visual warning display so the driver can see it when looking backwards over their shoulder. One participant in the RV & RPS condition suggested that the system have more sensors and no camera. Lastly, one participant in the RV & RPS condition suggested that the manufacturer provide a way to temporarily turn off the sensors, apparently not realizing that such a switch is provided.

## 8.0 DISCUSSION

### 8.1 Rearview Video System Display Response Time

The time it takes for the rearview video image to appear on the system's visual display once the transmission has been shifted into reverse gear may affect drivers' use of a rearview video system. The rearview video image response time was measured for the study vehicle (2007 Honda Odyssey) and two additional vehicles equipped with rearview video systems: a 2007 Cadillac Escalade and a 2005 Infiniti FX35.

Rearview video system display timing was recorded using a tripod-mounted digital video camera pointed at the video screen and the gear shift control. Timing information was extracted by watching the recorded video files using a software program allowing frame-by-frame video analysis with accuracy to 1/30 of a second. Video frames in which the gear shift control was placed into park and in which the rearview video image appeared were marked. The marked times were written to a text file, which was opened in a spreadsheet program. The response time was calculated by subtracting the time the car was shifted into reverse gear from the time that the rearview image appeared. This calculation was made for two cases: one in which the car was just started, and a second in which the car had been running for some time before the transmission was shifted into reverse. Table 33 summarizes these data.

Table 33. RV Display Measured Response Time (s)

Time from shifting into reverse gear until the RV image appears	2007 Honda Odyssey Touring	2007 Cadillac Escalade	2005 Infiniti FX35
Car just started	6.44	1.81	0.45
Car already running	0.81	1.99	0.45

The case that corresponds to that which participants experienced in the staged, unexpected obstacle event is that of the Honda Odyssey in which the car has just been started before shifting into reverse gear. As shown in Table 31, this response time was the longest of the test conditions. Shorter RV image response time would make the view behind the vehicle available to the driver for a larger portion of the maneuver duration.

For the Odyssey, the authors believe that the RV image delay after vehicle ignition is due to the manufacturer's priority scheme for the display, namely giving initialization priority to the navigation system over the RV system. Two of the three vehicles examined exhibited RV image response times of less than 2 seconds, demonstrating that quick presentation of the RV image is technologically possible. Given the busy nature of peoples' lives in this day and age and the emphasis on safety, giving priority to the RV image would be a more sensible option.

## 8.2 Why Was RV (only) Associated with Fewer Crashes Than RV & RPS?

Results of the staged obstacle event in this study found that 58 percent of participants with RV crashed and 85 percent of participants in the RV & RPS condition crashed. This result is counterintuitive if you assume that having two driver assistance systems for backing is better than one. However, not all drivers in the RV & RPS condition received warnings from the RPS during the obstacle event. As stated in Section 6.2, the RPS appeared to be unable to detect the obstacle if it was located at the centerline of the vehicle. Thus, those participants who backed out of the garage on an off-center path were the ones who tended to receive RPS warning alerts. This observation agrees with RPS detection performance results presented in Section 2.1.

Participants in the 'RV & RPS' system condition seemed to glance at the RV display less often. On average, drivers made less than one ( $M=0.81$ ) glance to the center console area (e.g., to look at the vehicle's clock) when no video display was present, versus 2.17 (RV) and 1.65 glances (RV & RPS) when the RV system was present. Data suggest that participants in the RV & RPS condition made no glances at all per trial to the RV display more often than those in the 'RV only' condition. The data also suggest that participants in the RV & RPS condition made four or more glances per trial to the RV display less often than those in the 'RV only' condition. This trend of more participants with 'RV only' looking at the RV display than those with RV & RPS may indicate that participants in the RV & RPS condition were relying on the sensors to alert them of an obstacle. However, differences in the particular backing situations between driver groups (i.e., differential exposure) or individual differences in backing habits between groups may have contributed to this difference.

Even if an RPS provides a visual or audible warning of a rear obstacle, drivers may not look at the visual alert or heed an audible one. The RPS visual alert in the specific vehicle used in this study was located under the speedometer. This location is not one that drivers tend to check while backing. Drivers of vehicle equipped with RV & RPS in this make model had two new visual sources of information to check during backing: the center dashboard-mounted RV display and the RPS alert under the speedometer. An RV display with integrated warnings would avoid the situation of divided attention between multiple displays (RV and visual alert). Alternatively, presenting a warning alert in another location that a driver typically checks when backing (e.g., right C-pillar) should be more beneficial.

In a 2005 study by Llaneras et al., nearly three quarters of drivers hit a toy coupe obstacle that was presented despite being given warnings by a RPS system. In the current study, 80 percent of drivers that received RPS warnings still collided with the obstacle. Therefore, the obstacle event crash results of the current study also support Llaneras' statement that "none of the interface warning conditions reliably induced avoidance braking under the surprise event condition." The combined results of these studies may suggest that intervention by a collision avoidance system may be necessary in order to achieve a significant reduction in backing crashes.

### **8.3 Impact of Rearview Video Use on Likelihood of Backover Crash Avoidance**

The likelihood that a backover crash scenario could be mitigated by use of a rearview video system depends on several conditions, most notably the location and movement (or path) of the obstacle. A review of NHTSA Special Crash Investigation (SCI) not-in-traffic crashes shows that for the 66 percent of cases in which the location of the child was determinable, 24 percent (10 of 42 cases; 9 stationary, 1 running toward a car from the rear) of them involved a child behind the car and 43 percent (18 of 42 cases) involved a child approaching the area behind the car from the left or right. Considering that drivers in the backing maneuver obstacle event reported on here made only 1.41 glances on average to the RV display during a backing maneuver, the case in which the victim is stationary behind the vehicle would seem to provide the best opportunity for mitigation via rearview video system. A child moving into the area behind the vehicle may not be present in the RV system's field of view at the time that the driver looks at the RV display.

In this study, 15 of 25 (60 percent) participants with an RV (including RV & RPS condition participants) glanced at the RV display at least once during the obstacle event. If it is assumed that a driver would successfully identify the presence of a stationary or longitudinally moving child behind the vehicle, then it can be asserted that 60 percent of the 10 relevant SCI crashes, or 21.4 percent (6 of 28), may have been avoidable through the use of an RV system.

In naturalistic backing maneuvers observed in this study, drivers with RV looked more than once at the RV display in approximately 40 percent of maneuvers and looked at least once in approximately 65 percent of maneuvers. If, based on the above mentioned SCI data, 35.7 percent (10 of 28) of crash scenarios involve a stationary victim behind the vehicle, effectiveness can be estimated to be 14.3 percent ( $.357 \times .40 \times 100$ ) if more than one RV glance is required to detect object or 23.2 percent ( $.357 \times .65 \times 100$ ) if just one RV glance will result in object detection. Based on SCI data and both obstacle event and naturalistic data from the current study, overall effectiveness of RV (only) is anticipated to be around 20 percent.

A vehicle equipped with an RPS could have the ability to detect a rear obstacle and alert the driver to the presence of the object, eliciting a look by the driver to the RV display. However, RPS's tested to date by NHTSA have exhibited poor performance in detecting children and general unreliability in a variety of test conditions.

### **8.4 Caveats**

This study examined a set of people driving a single vehicle model, a minivan. Participants may not have exhibited same glance behavior as they would in a vehicle of a different type or size.

The particular rearview video system in the vehicle chosen for use in this study had a center dashboard-mounted display. Some model year 2008 vehicles come equipped with a rearview video display located in the center rearview mirror. It is unknown whether the glance behavior observed with a center dashboard-mounted display would



be similar to that of drivers in a vehicle equipped with the RV display in the center rearview mirror.

### **8.5 What is “Good” Driver Glance Behavior During Backing?**

Examining the extent to which drivers look at a rearview video system during backing maneuvers to assess whether drivers are using the systems sufficiently invites the question, “what should drivers’ glance behavior be like during backing?”. Drivers’ glance behavior should vary according to the backing situation. Different driving environments, traffic conditions, degrees of pedestrian presence, and vehicle configurations all can warrant different eye glance behavior. The following statements highlight some aspects of “good” glance behavior during backing maneuvers might be like:

1. When a rearview video system is present on the vehicle, drivers should not begin backing until the RV display image becomes visible and they have looked at the image.
2. Drivers should also look at the RV display periodically during backing. One glance immediately before, or at the beginning of, backing is not enough.
3. Drivers should look more frequently at the RV display if they are in a busy area or if they hear noise that might suggest movement behind the vehicle.
4. Drivers should look more frequently at the video screen if they think they see a moving object in one of the mirrors.
5. Drivers should not use the RV display to avoid looking in other locations. They should look to both sides and in all mirrors in addition to their use of the RV system.
6. Drivers should be aware of the approximate size of blind zone behind their vehicle as well as limitations in lateral visibility for their specific vehicle(s).
7. Drivers of vehicles equipped with rear parking sensor systems should not rely on alerts from that system to indicate the presence of people, particularly children, behind the vehicle. The driver must actively look out the vehicle’s windows and in the mirrors to aid in the detection of pedestrians.

## 9.0 SUMMARY AND CONCLUSIONS

Results of this study revealed that drivers look at rearview video displays during backing maneuvers at least some of the time. This study found that approximately 14 percent of glances in baseline and obstacle events and 10 percent of glances in naturalistic backing maneuvers were to the rearview video display. The timing and frequency of their glances to the RV display has a noticeable impact on the likelihood of rear obstacle detection. Making single or multiple glances to the RV display at the start of the maneuver do not ensure that the path behind the vehicle will remain clear for the entire backing maneuver.

Drivers varied in their use of the RV system during the staged baseline and event trials. Specifically, among drivers with an RV system, 16 of 25 participants (64 percent) made at least one glance to the RV during the staged event trials. When both baseline and event trials were considered, the percentage of glance time directed at the RV display varied between 0 and 81 percent of the first 12 seconds of backing. The staged obstacle event scenario was designed such that without an RV system drivers could not see obstacle.

The rearview video system examined in this study improved detection and avoidance of a crash with a simulated stationary object in the experimental trials. Overall, the RV system presence was associated with a 28 percent reduction in crashes. The addition of RPS had no additional benefit; in fact, although statistically not significant, participants in the RV & RPS system condition crashed more often than those in the 'RV only' system condition. For reasons that are not completely understood, the RPS on the specific vehicle used in the study only detected the obstacle in 38 percent of obstacle event trials involving participants in the RV & RPS system condition.

There are several possible reasons why the RV systems did not have a bigger benefit in the obstacle event trials. These include the delay associated with the appearance of the image in the RV display, the inappropriate timing of the drivers' looks to the RV display, their failure to make multiple glances, and the possibility that drivers had strong expectations that no such event would occur in the research setting, which may have led them to become less vigilant than in real-world backing.

The presence of an RV system has no apparent effect on drivers' backing behavior (e.g., speed, acceleration) in the baseline and obstacle event trials. There was a statistically non-significant tendency for drivers of vehicles with RV systems to wait longer after shifting into reverse before starting to back. This may be related to drivers' waiting for the rearview video image to appear, however there is no direct evidence to support this conclusion.

In the naturalistic portion of this study, among 37 participants, each of whom participated for 28 days for a total of 42,982 miles, there were 6145 backing maneuvers. A typical backing event took approximately 10 seconds and covered 34 feet. Drivers' average backing speed was 2.26 miles per hour; the average maximum speed was 3.64 miles per hour. Twenty-two percent of backing maneuvers involved multiple backing

components, in which backing motion was separated by a period of stopped time, for example when a driver backed to the end of a driveway, stopped to wait for traffic then continued backing into the street. The results of naturalistic data collection reveal that on average drivers made approximately 1.14 backing maneuvers per trip; average trip length was slightly less than 9 miles.

None of the 6145 naturalistic backing events resulted in a significant collision. There were several minor collisions during routine backing with, for example, trash cans and other vehicles.

There is no evidence to support the hypothesis that drivers' backing behavior (i.e. speed and acceleration) was influenced by the presence or absence of an RV system. Mean backing speeds across all system conditions was approximately 2.25 mph in both staged and naturalistic backing maneuvers in this study.

Glance behavior during backing appears to be robust and relatively invariant over different environmental conditions. In real-world backing situations, drivers with RV systems spent 8 to 12 percent of the backing time looking at the location of the RV display. Drivers with no system spent about 3 percent of their backing time looking at the console/video. Ignoring the possible effects of differential exposure, the differences between these values (5 to 9 percent) constitute one estimate of the percentage of backing time devoted to looking at the rearview video display. Furthermore, this result suggests that in addition to the routine preparatory tasks involving the console (radio, HVAC) drivers regularly look at the RV system while backing. Drivers with no RV system do not devote more glance time to the rear view mirror.

While the evidence of drivers' use of the rearview video systems obtained in this study is encouraging, it should be noted that due to the wide range of directions and speeds in which an obstacle might approach the area behind a vehicle and the timing in which a driver may choose to glance at the rearview video display, a rearview video system cannot be expected to prevent all backing crashes.

Approximately 61 percent of backing events involved no concurrent driver activity. Among the remaining 39 percent of backing events, concurrent activities included activation of garage door remote (13 percent), talking with passenger (13 percent), using cell phone (3 percent) and securing seat belt (3 percent), among others. In 508 backing events (approximately 10 percent of the subset for which driver activity was recorded), drivers were engaged in multiple concurrent activities while backing.

The specific patterns of drivers' eye glance behavior and visual sampling of the center dashboard-mounted rearview video display may not be similar to those that would be observed in drivers using an RV display mounted in the center rearview mirror. Additional research would be required to determine whether rates of drivers' glances to the RV display seen in this study would be similar with a display in the rearview mirror.

While rearview video systems offer the driver a useful tool for detecting rear obstacles, some guidance may be necessary to educate drivers as to the most effective way to

incorporate this new visual information source into their glance behavior during backing maneuvers. Encouraging drivers to make more than once glance to the RV display during backing maneuvers, and to glance at the display throughout the maneuver rather than just at the beginning, may increase the benefits attainable with these systems.

## 10.0 REFERENCES

- [1] National Highway Traffic Safety Administration (2006). Vehicle Backover Avoidance Technology Study (Report to Congress).
- [2] Mazzae, E. N. and Garrott, W. R. (2006). Experimental Evaluation of the Performance of Available Backover Prevention Technologies." National Highway Traffic Safety Administration, DOT HS 810 634; September, 2006.
- [3] Mazzae, E. N. and Garrott, W. R. Experimental Evaluation of the Performance of Available Backover Prevention Technologies for Medium Straight Trucks, DOT HS 810 865; November, 2007.
- [4] McLaughlin, S.B., Hankey, J. M., Green, C. A., and Kiefer, R. J. (2003). Driver Performance Evaluation of Two Rear Parking Aids. 2003 Enhanced Safety of Vehicles Conference, Paper 522.
- [5] Llaneras, RE, Green, CA, Chundrik, W, Altan, OD, and Singer, JP (2005). Design and Evaluation of a Prototype Rear Obstacle Detection and Driver Warning System. Human Factors, Vol. 47, No. 1, Spring 2005. Human Factors and Ergonomics Society.
- [6] Green, C. A. and Deering, R. K. (2006). Driver Performance Research Regarding Systems for Use While Backing. SAE International, Paper No. 2006-01-1982.
- [7] Llaneras E. & Neurauter L. (2005). Early Adopters Safety-Related Driving With Advanced Technologies. 2005 Inventory of In-vehicle Devices & Interface Characteristics. (Task Order 10 under Project DTNH22-99-D-07005).
- [8] Jenness, J. W., Lerner N. D., Mazor S., Osberg J. S., and Tefft B. C. (2007). Use of Advanced In-Vehicle Technology by Young and Older Early Adopters. Survey Results on Sensor-Based Backing Aid Systems and Rear-View Video Cameras. National Highway Traffic Safety Administration, DOT HS 810 828.
- [9] Honda (2006). 2007 Odyssey Owner's Manual.

## 11.0 APPENDICES

### 11.1 Appendix A: Results for Performance Testing of the 2007 Honda Odyssey's Parking Sensor System – Front Sensors

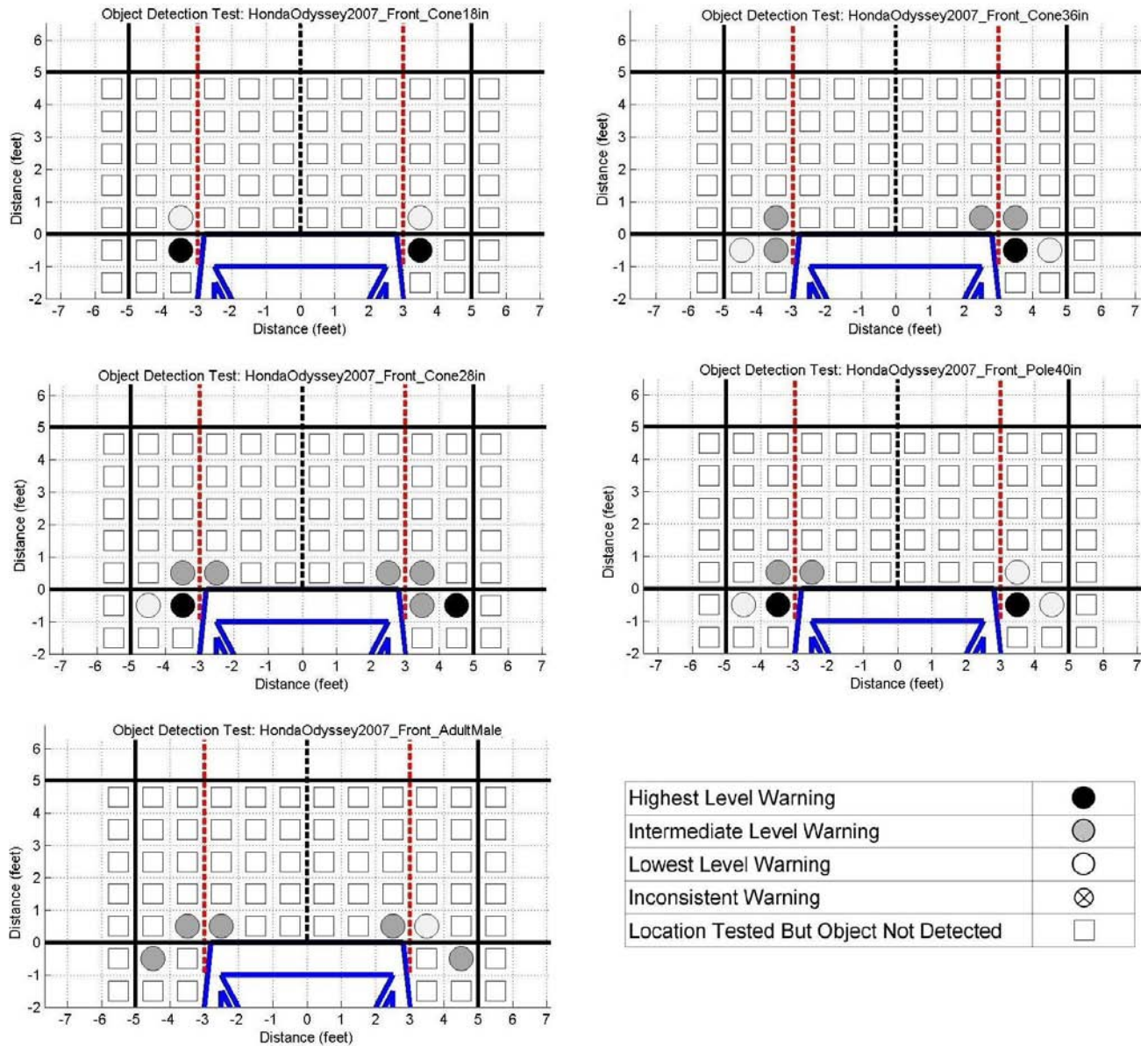

Figure 46. PSS Front Sensors' Detection Results for the Various Traffic Cones, a 40-inch-Tall PVC Pole, and an Adult Male

## 11.2 Appendix B: Participant Information Summary

## **PARTICIPANT INFORMED CONSENT AND CONFIDENTIAL INFORMATION FORM**

**STUDY TITLE:** Driving Behavior in New Vehicles

**STUDY DOCTOR:** Elizabeth N. Mazzae, M.S.E.

**STUDY SITE:** NHTSA Vehicle Research and Test Center (VRTC)  
10820 SR 347  
East Liberty, OH 43319

**TELEPHONE:** 800-262-8309  
937-666-4511

**SPONSOR:** National Highway Traffic Safety Administration

You are being asked to participate in a research study. Your participation in this research is strictly voluntary, meaning that you may or may not choose to take part. To decide whether or not you want to be part of this research, you should understand the study risks and benefits in order to make an informed decision. This process is known as informed consent. This consent form describes the purpose, procedures, possible benefits and risks of the study. This form also explains how your information will be used and who may see it. You are being asked to take part in this study because the study investigator feels that you meet the qualifications of the study.

The study investigator or staff will answer any questions you may have about this form or about the study. Please read this document carefully and do not hesitate to ask anything about this information. This form may contain words that you do not understand. Please ask the investigator or staff to explain the words or information that you do not understand. After reading the consent form, if you would like to participate, you will be asked to sign and date this consent form. You may have a copy of this form to review at your leisure and keep for your records.

This study is being conducted by the U. S. Department of Transportation's National Highway Traffic Safety Administration (NHTSA).

### **STUDY PURPOSE**

This research study is being conducted to assess how drivers learn to use the features and functions of a new vehicle. By learning more about how people become familiar with and learn to take advantage of their vehicle's features, we hope to better understand driver behavior and estimate the degree of safety that newer vehicles may provide.

### **STUDY REQUIREMENTS**

You are being asked to participate in this research study because you:

- Are 25-60 years of age
- Have a valid, unrestricted U.S. driver's license (except for restrictions concerning corrective



- eyewear)
- Have a minimum of 2 years driving experience
- Drive at least 7,000 miles per year
- Are in general good health
- Are the primary driver of a 2007 Honda Odyssey and drive it as your primary source of transportation
- Agree to be the sole driver of the 2007 Honda Odyssey for the duration of your participation

## NUMBER OF STUDY SITES AND STUDY PARTICIPANTS

This study will take place at one research site (NHTSA's Vehicle Research and Test Center, VRTC) and will include up to 39 participants.

## STUDY PROCEDURES

Before participating in this research study, you will be asked to read this Participant Informed Consent Form. After all of your questions have been answered, you will be asked to sign this form to show that you voluntarily consent to participate in this research study.

### Summary of Study Procedures:

Your participation in this study will last for about 4 weeks. There are three phases involved in this study:

- an initial meeting with test drive
- a 4-week period of monitored driving
- a final meeting with test drive

Details regarding these three phases follow:

### Initial Meeting

- You will be asked to review and sign this consent form.
- Your vehicle will be inspected for any pre-existing damage by a member of the research staff. You will be asked to sign a form acknowledging the current condition of your vehicle.
- Technicians will install electronic recording equipment in your vehicle. It will take approximately 2 hours to install the equipment in your vehicle.
- While the recording equipment is being installed, you and a member of the research study staff will go for a brief test drive. A member of the research staff will be with you in the vehicle at all times, and will give you detailed instructions during the test drive. During the test drive, you will be asked to perform various basic driving maneuvers, such as changing lanes, turning, and backing. The test drive will take place on specific driving courses and on two-lane private access roads on the grounds of the Transportation Research Center.
- Your vehicle will be returned to you and the locations of any visible instrumentation or wiring will be pointed out for your information.

#### 4 Weeks of Monitored Driving

- You will drive your own vehicle as you normally would for a period of approximately 4 weeks. During this time, your driving behavior will be recorded using special sensors and a video recorder. (Please see the following section regarding “4 Weeks of Monitored Driving” below for additional details).
- A technician will check your vehicle approximately once per week during the 4-week period to determine the remaining available data storage capacity and add additional storage media as needed.

#### Final meeting

- A member of the study staff will give you detailed instructions and accompany you on a brief test drive. You will be asked to perform various basic driving maneuvers during the test drive.
- Electronic recording equipment will be removed from your vehicle.
  - You will be presented with additional information regarding this study.
  - You will complete a brief questionnaire regarding your driving experiences.
  - Your vehicle will be returned to you in the same condition as in the first meeting.

#### **Test Drives**

During your participation, you will be asked to complete two “test drives” that involve driving a vehicle equipped with special recording instruments. You will drive on private access roads, a 7.5-mile oval test track, and parking lots located on the grounds of the Transportation Research Center (TRC) in East Liberty, Ohio. The instrumented vehicle will be of the same make and model as your vehicle, but may have a different trim level. The instrumented vehicle is equipped with sensors to record information on your steering, braking, and gas pedal use. A video camera pointed at the driver’s face will record eye glance locations. The camera and sensors are located so that they will not affect your driving. The information collected by these sensors is recorded so that it can be analyzed at a later time.

You will be given instructions on the rules and procedures before driving on the TRC test track and other driving areas at TRC. You will be required to wear a seat belt at all times while driving. Although a member of the study staff will be with you at all times, he or she is not able to ensure complete safety. Therefore, it is important to remember that you, as the driver, are in control of the vehicle and you must be the final judge as to when to complete the tasks during this study.

#### **4 Weeks of Monitored Driving**

The monitored driving will involve 4 weeks of driving your own vehicle as you normally would, while allowing your driving behavior to be recorded. The study investigator may request that you permit a technician to access your vehicle approximately once a week during the 4 week period to check the condition of installed instrumentation and data recording capacity. Arrangements for these meetings will be made at your convenience.

Your vehicle will be equipped with video and electronic monitoring equipment that we will install for the 4 week period. This equipment should not be in your way. A data collection system including

up to 5 small, digital video cameras, video and data recording equipment, and associated wiring will be installed in your vehicle to record data that will document your driving. A camera that will record your eye glances will be placed securely inside the vehicle above your center rearview mirror. Up to four video cameras will be placed securely on the exterior of the vehicle: one under the vehicle just behind each front tire and one or two attached to the rear license plate mounting bracket. All cameras will be attached to your vehicle using existing bolt holes or temporary, non-damaging adhesive. A GPS antenna will be magnetically attached to the roof of your vehicle. A rugged box containing data recording equipment will be placed securely in the rear cargo area of the vehicle. Interior vehicle trim panels may be removed temporarily to allow wires to be run beneath them. Your vehicle's electrical system will be used to power data collection equipment while the vehicle is running, but should not noticeably impact your vehicle's performance or battery voltage. All installed equipment will be temporarily, yet securely attached to your vehicle to prevent the equipment from moving in the event of a crash. No permanent changes will be made to your vehicle. In the unlikely event that your vehicle is damaged during equipment installation or removal, you will be compensated for the reasonable cost of vehicle repair.

## **NEW INFORMATION**

No changes to procedures are anticipated to occur during this study. However, any new information developed during testing that may affect your willingness to participate will be provided to you.

## **RISKS**

During the test drives, participants will be subject to all risks and uncertainties normally associated with driving on the TRC test track, TRC access roads (two-lane rural roads), and in parking lots. A number of controls have been put in place to reduce the risk of crashing. Specifically, test track traffic is generally light and travels in one direction only. The test track access is controlled. Data collection will be conducted only in daylight conditions. In the event of bad weather, your test drive may be delayed until conditions for driving improve. The experimental vehicle is equipped with a kill switch, which can be activated by the study staff to initiate full braking in an emergency situation. For these reasons, the risks are considered to be less than might be expected when performing comparable driving tasks while traveling on a controlled access freeway under light to moderate traffic conditions.

While driving your vehicle on public roads, you will be subject to all risks and uncertainties normally associated with your daily driving routine.

You will not be asked to perform any unsafe acts. There are no known physical or psychological risks associated with participation in this study beyond those described above.

## **BENEFITS**

There is no personal benefit to you from participating in this study. You are not expected to receive direct benefit from your participation in this research study.

The research study will provide data on driver behavior and performance that may be used by researchers to develop recommendations or standards for increasing vehicle and driving safety.

## **ALTERNATIVES**

This study is for research purposes only. Your alternative is to not participate.

## **CONDITIONS OF PARTICIPATION, WITHDRAWAL, AND TERMINATION**

Participation in this research is voluntary. By consenting to your participation, you agree to allow instrumentation to be installed in and later removed from your vehicle. You agree that you will drive the vehicle on a regular basis and that you will not let another person drive the vehicle during the 4-week monitored driving period. You agree to permit a member of the research staff to access your vehicle approximately once per week to ensure that the in-vehicle data collection system has sufficient data storage capacity to record the entire 4 week period of monitored driving.

During test drives on TRC property, you agree to operate the research vehicle in accordance with all instructions provided by the study staff. If you fail to follow instructions, or behave in a dangerous manner, you may be terminated from the study.

You may withdraw your consent and discontinue your participation without penalty at any time. If you decide to withdraw from the research study, you should notify the study investigator. In addition, you agree to make your vehicle available for the removal of government-owned data recording equipment should you withdraw from the study early.

## **COSTS TO YOU**

Other than the time you contribute, there will be no costs to you.

## **COMPENSATION**

You will receive \$800.00 if you complete the study. If you do not complete the entire study, you will be paid a pro-rated portion of this amount. In addition, you will be compensated 50 cents per mile (up to a maximum of \$200.00) for driving from your residence to our facility to attend the required initial and final meetings. In the event that severe weather causes a delay in your initial or final test drive completion, you will receive \$25.00 per hour for up to 2 hours spent at the research facility in excess of 3 hours. Therefore, you may receive up to a total of \$1,100.00 for participating in this study.

## **COMPENSATION FOR RESEARCH RELATED INJURY**

The contractor assisting with the conduct of this study, TRC, will maintain insurance to cover you in the event of a crash occurring in a government-owned research vehicle on TRC facilities. This insurance covers injuries to yourself up to a limit of \$10,000.00. You may contact your insurance company to check on additional coverage. Coverage is also provided for injuries to others, including the driver and any passengers of other vehicles involved in the crash, as well as damages resulting from any crashes occurring during your participation in this study, up to a \$1,000,000 limit. Except to the extent covered by such insurance policy, neither the TRC nor NHTSA will be responsible for your actions during this study nor will they indemnify you or otherwise compensate you for any problems arising out of your actions or the normal risks associated with driving. However, you will not be liable for loss or damage to the vehicle instrumentation, the government-owned research vehicle, or other equipment during your

participation unless there is gross negligence on your part.

If you are injured in a crash while on TRC facilities, emergency personnel will be dispatched to treat you. The nearest hospital is about 15 miles away.

If you are injured while driving your vehicle off-site during your participation in the study, either you or your insurance company will be responsible for the costs associated with your medical treatment and your vehicle repairs.

## **USE OF INFORMATION COLLECTED**

In the course of this study, the following data will be collected:

- Engineering data (such as the information recorded by the study vehicle sensors)
- Video data (such as the information recorded by the video cameras)

### **Information NHTSA may release:**

- The engineering data collected and recorded in this study will include measures of driving behavior and performance. These data will be analyzed along with data gathered from other participants to characterize driver behavior and performance. NHTSA may publicly release the data in reports or other publications or media for scientific, educational, research, or outreach purposes.
- The video data recorded in this study includes your video-recorded likeness. Video data will be used to assess your driving performance. NHTSA may publicly release video image data (in continuous video or still formats), either separately or in association with the appropriate engineering data for scientific, educational, research, or outreach purposes.
- 

### **Information NHTSA may not release:**

- Any release of engineering data or video data will not include release of your name. However, in the event of court action, NHTSA may not be able to prevent release of your name or other personal identifying information. NHTSA will not release any information collected regarding your health and driving record.

## **QUESTIONS**

Any questions you have about the study can be answered by Elizabeth N. Mazzae, M.S.E. or the study staff by calling 1-800-262-8309 or 937-666-4511.

If you have any questions regarding your rights as a research subject, you may contact Sally P. Green, M.D., Chairman of Sterling Institutional Review Board, 6300 Powers Ferry Road, Suite 600-351, Atlanta, Georgia 30339 (mailing address) at telephone number 1-888-636-1062 (toll free).

## INFORMED CONSENT

By signing the informed consent statement contained in this document, you agree that participation is voluntary and you accept all terms of this agreement. Also by signing the informed consent statement, you agree to operate the study vehicle in accordance with all instructions provided by the study staff. You may withdraw your consent and discontinue your participation in the study at any time without penalty.

NHTSA will retain a signed copy of this Informed Consent form. A copy of this form will also be provided to you.

I do not give up any of my legal rights by signing this form.

### Informed Consent Statement:

I certify that:

- I have a valid, U.S. driver's license.
- I am the primary driver of the following vehicle: 2007 Honda Odyssey.
- All personal and vehicle information as well as information regarding my normal daily driving habits provided by me to NHTSA, and/or the Transportation Research Center (TRC) employees associated with this study during the pre-participation phone interview and the introductory briefing was true and accurate to the best of my knowledge.
- I have been informed about the study in which I am about to participate.
- I have been told how much time and compensation is involved.
- I have been told that the purpose of this study is to examine how drivers learn about the features and functions of a new vehicle.
- I agree to operate the research vehicle in accordance with all instructions provided to me by the study staff.

I have been told that:

- The study involves a period of electronically recorded observation of my driving my own vehicle over public and other roads and locations and that the risk of injury is identical to that which I would normally experience in my typical daily driving.
- The study involves a period of observation of my driving a government-owned vehicle on the TRC test courses and private roads, and that the risk of injury due to a motor vehicle collision is less than in real world driving due to the closed environment and safety precautions which include an on-board experimenter ready to intervene if necessary.

- For scientific, educational, research, or outreach purposes, video images of my driving which will contain views of my face may be used or disclosed by NHTSA, but my name and any health data or driving record information will not be used or disclosed by NHTSA.
- My participation is voluntary and I may refuse to participate or withdraw my consent and stop taking part at any time without penalty or loss of benefits to which I may be entitled.
- I have the right to ask questions at any time and I may contact the study investigator, Elizabeth Mazzae, or the study staff at 937-666-4511 or 800-262-8309 for information about the study and my rights.

I have been given adequate time to read this informed consent form. I hereby consent to take part in this research study.

I, \_\_\_\_\_, voluntarily consent to participate.  
(Printed Name of Participant)

\_\_\_\_\_  
Signature of Participant

\_\_\_\_\_  
Date

\_\_\_\_\_  
Signature of Person Obtaining Consent

\_\_\_\_\_  
Date

## INFORMATION DISCLOSURE

By signing the information disclosure statement below, you agree that NHTSA and its authorized contractors and agents will have the right to use the engineering data and the video data collected during your participation for scientific, educational, research, or outreach purposes. This includes wide distribution or publication of your likeness in video or still photo format. Neither NHTSA nor its authorized contractors or agents shall release your name. You have been told that, in the event of court action, NHTSA may not be able to prevent release of names or other personal identifying information. NHTSA will not release any information collected regarding your health and driving record, either by questionnaire or medical examination. Your permission to disclose this information will not expire on a specific date.

### Information Disclosure Statement:

I, \_\_\_\_\_, grant permission to the National Highway Traffic Safety Administration (NHTSA) to use, publish, or otherwise distribute NHTSA engineering data and NHTSA video image data of my likeness (including continuous video and still photo formats) collected in this study, either separately or in association with the appropriate engineering data for scientific, educational, research, or outreach purposes. I have been informed that such use may involve widespread distribution to the public and may involve distribution of my likeness in video or still photo formats, but will not result in release of my name or other identifying personal information by NHTSA or its authorized contractors or agents. I have been told that my permission to disclose this information will not expire on a specific date.

---

Signature of Participant

---

Date



### 11.3 Appendix C: Vehicle Condition Check Sheet

#### Driving Study

#### Vehicle Condition Check Sheet

This form is used to document the condition of your vehicle before and after data recording equipment is installed or removed from your vehicle by the research staff. A member of the research staff will look over your vehicle and indicate on this form any damage observed. Your signature at the bottom of this form will document your acknowledgement that the damage was pre-existing and not caused during the process of installation or removal of data recording equipment by the research staff. In the unlikely event that scratches or other damage to your vehicle occur during the installation or removal of data recording equipment, VRTC will pay for the cost of repairs performed at a manufacturer's dealership service facility.

**Research Staff:** Using the drawing below, indicate the locations of any damage using an "S" for scratches and "D" for dents.) Fill in the VIN below.

VIN: \_\_\_\_\_

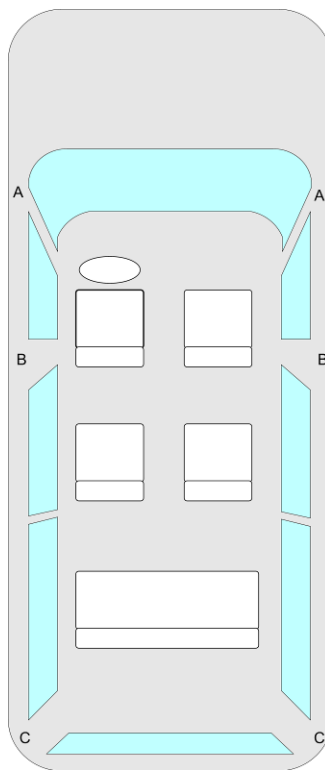

I acknowledge that the description of my vehicle's condition as noted on this form is accurate.

\_\_\_\_\_  
Print Name

\_\_\_\_\_  
Signature

\_\_\_\_\_  
Date

## 11.4 Appendix D: Participant Debrief Form

### Debrief

"We are very sorry but we staged this event and deliberately caused an object to be behind you. There were no real people in the way. We did this because part of our research is to observe where people look while they are driving, including when backing.

Did you have any idea that this would happen? \_\_\_ Yes \_\_\_ No

The reason we didn't tell you that this would happen ahead of time is that we wanted to observe your natural reaction. I hope you will understand why we deliberately misled you. Also, I hope you can appreciate that the kind of event you just experienced is similar to real situations that occasionally occur in everyday driving.

This type of surprise won't happen again. And, since we are testing at least through the end of the year, we would be grateful if you did not discuss this surprise event experience with anyone until after our research is completed.

We can now walk back to the conference room, where we have some questionnaires for you to complete. Then, we can take care of payment information while we wait for your vehicle to get de-instrumented."

## 11.5 Appendix E: Participant Questionnaire With Results (No System)

The tabulated questionnaire results for the 12 participants in the no video or sensor condition are incorporated below. Counts show the number of participants who selected a particular response to a question. Some questions required participants to choose one best response, while other questions allowed the participants to choose multiple responses. In order to better understand the results, the response percentages for both types of questions are based upon the total number of participants (12), not the total count of responses. If a participant didn't respond to a question, it is accounted for in the table.

<b>Q1. During your final test drive, did you anticipate the obstacle behind the vehicle during the backing maneuver? (circle one)</b>		
<b>Response</b>	<b>Count</b>	<b>Percentage</b>
Yes	0	0
No	12	100
Don't Know	0	0

<b>Q2. Where do you usually look to determine whether the area behind the vehicle is clear when backing? (Check all that apply)</b>		
<b>Response</b>	<b>Count</b>	<b>Percentage</b>
At the side mirrors	9	75
At the center rearview mirror	9	75
Over my shoulder	11	91.67

<b>Q3. A <u>backing aid system</u> helps the driver back up by providing sounds, lights or symbols when the vehicle is near an obstacle. Your vehicle does not have a system like this. Why not? (check boxes for all that apply)</b>		
<b>Response</b>	<b>Count</b>	<b>Percentage</b>
It never occurred to me to look for one when I was buying the vehicle	4	33.33
It was not an option on my vehicle	5	41.67
I thought it would be a nuisance or distraction	1	8.33
I wouldn't trust the backing aid system to give me warnings when I need them	1	8.33
I don't need a backing aid system because I have good backing skills	1	8.33
The backing aid was not worth the extra cost	1	8.33
The backing aid was only available with other options that I didn't want	4	33.33
I was not the person who purchased or made the decision to purchase this	0	0

<b>Q4. If you purchased this same model vehicle again would you want a backing aid system? (circle one)</b>		
<b>Response</b>	<b>Count</b>	<b>Percentage</b>
Yes	4	33.33
No	0	0
Don't Know	8	66.67

**Q5. A rearview video camera system shows the driver the area behind the vehicle when you are backing on a screen inside the vehicle. Your vehicle does not have a rearview video camera system like this. Why not? (check boxes for all that apply)**

<b>Response</b>	<b>Count</b>	<b>Percentage</b>
It never occurred to me to look for one when I was buying the vehicle	7	58.33
The rearview camera was not an option on my vehicle	3	25
I thought the rearview camera would be a nuisance or distraction	0	0
I wouldn't trust the rearview camera	0	0
I don't need a rearview camera because I have good backing skills	1	8.33
The rearview camera was not worth the extra cost	2	16.67
The rearview camera was only available with other options I didn't want	4	33.33
I was not the person who purchased or made the decision to purchase this vehicle	0	0
<i>No Response (Blank)</i>	1	8.33

**Q6. If you purchased this same model vehicle again would you want a rearview video camera system? (circle one)**

<b>Response</b>	<b>Count</b>	<b>Percentage</b>
Yes	4	33.33
No	0	0
Don't Know	8	66.67

## 11.6 Appendix F: Participant Questionnaire With Results (Rearview Video Only)

The tabulated questionnaire results for the 12 participants in the video only (no sensors) condition are incorporated below. Counts show the number of participants who selected a particular response to a question. Some questions required participants to choose one best response, while other questions allowed the participants to choose multiple responses. In order to better understand the results, the response percentages for both types of questions are based upon the total number of participants (12), not the total count of responses. If a participant didn't respond to a question, it is accounted for in the table. Questions with open-ended responses or comments are categorized when possible.

<b>Q1. During your final test drive, did you anticipate the obstacle behind the vehicle during the backing maneuver? (circle one)</b>		
<b>Response</b>	<b>Count</b>	<b>Percentage</b>
Yes	0	0
No	12	100
Don't Know	0	0

<b>Q2. Where do you usually look to determine whether the area behind the vehicle is clear when backing? (Check all that apply)</b>		
<b>Response</b>	<b>Count</b>	<b>Percentage</b>
At the side mirrors	8	66.67
At the center rearview mirror	10	83.33
Over my shoulder	11	91.67
At the rearview video display	10	83.33

<b>Q3. A rearview video camera displays the area behind the vehicle when you are backing on a screen inside the vehicle. Your vehicle is equipped with this type of system. If you purchased this same model vehicle again would you want a rearview camera? (circle one)</b>		
<b>Response</b>	<b>Count</b>	<b>Percentage</b>
Yes	12	100
No	0	0
Don't Know	0	0

<b>Q4. How did you learn to use your vehicle's rearview camera? (check all boxes that apply)</b>		
<b>Response</b>	<b>Count</b>	<b>Percentage</b>
Instructions from the dealership, such as a video, brochure, or demonstration	6	50
Vehicle owner's manual	1	8.33
Help from a friend or relative	2	16.67
Information on the Internet	0	0
On-road experience and practice (trial and error)	10	83.33
I have not yet learned how to use the rearview camera	0	0

<b>Q5. How easy was it to learn how to use your vehicle's rearview camera to judge the distance to</b>		
--------------------------------------------------------------------------------------------------------	--	--

<b>objects behind your vehicle? (choose one)</b>		
<b>Response</b>	<b>Count</b>	<b>Percentage</b>
Very easy to learn	1	8.33
Somewhat easy to learn	7	58.33
Somewhat difficult to learn	2	16.67
Very difficult to learn	2	16.67
I have not tried to learn how to use the rearview camera	0	0
I do not want to learn how to use the rearview camera	0	0

<b>Q6. Was there anything especially difficult to learn about your vehicle's rearview camera? (circle one)</b>		
<b>Response</b>	<b>Count</b>	<b>Percentage</b>
Yes	5	41.67
No	7	58.33
<b><i>If yes, please explain.</i></b>		
<i>Difficulty in judging distances using rearview camera</i>	4	33.33
<i>Difficulty backing in straight line over long distances when using only the rearview camera</i>	1	8.33

<b>Q7. Are you aware of any warnings or limitations about your vehicle's rearview camera? (circle one)</b>		
<b>Response</b>	<b>Count</b>	<b>Percentage</b>
Yes	2	16.67
No	8	66.67
<i>Both 'Yes' and 'No' Circled</i>	2	16.67
<b><i>If yes, please explain.</i></b>		
<i>Learning curve, judging distances (Yes response)</i>	1	8.33
<i>Distortion due to type of lens on camera (Yes response)</i>	1	8.33
<i>There are areas that can not be seen by camera (Yes and No response)</i>	1	8.33
<i>Not being able to see anything when backing toward the sun (Yes and No response)</i>	1	8.33

<b>Q8. In the last two weeks, did you ever use just the camera when backing without checking the mirrors or turning to look out the rear window? (circle one)</b>		
<b>Response</b>	<b>Count</b>	<b>Percentage</b>
Yes	2	16.67
No	10	83.33

<b>Q9. Which of the following best describes how much you normally pay attention to the rearview camera when backing? (choose one)</b>		
<b>Response</b>	<b>Count</b>	<b>Percentage</b>
I rarely or never look at it	1	8.33
I usually just take a quick glance at the camera screen to determine if I can back up	5	41.67
I share my attention about equally between the rearview camera screen and my mirrors or glances over my shoulder	6	50
I pay attention to the rearview camera screen more than to my mirrors and glances over my shoulder	0	0
I usually back up the vehicle using only the camera. I don't feel that I need to check mirrors or look out the rear windows	0	0

<b>Q10. Imagine that your vehicle's rearview camera broke down. How would your driving behavior change if you could not use your vehicle's rearview camera anymore? (check boxes for all that apply)</b>		
<b>Response</b>	<b>Count</b>	<b>Percentage</b>
I would back up much more slowly	4	33.33
I would avoid parking in places where I would have to back up	0	0
I would not try to fit into tight parking spaces	3	25
I would rely more on my mirrors and/or glances over my shoulder to see what's behind my vehicle	8	66.67
My driving behavior would not change	3	25
Other ( <i>specify</i> ):	2	16.67
<i>More apt to get out and check behind vehicle</i>	1	8.33
<i>Nothing specified (blank)</i>	1	8.33

<b>Q11. How well does your vehicle's rearview camera work in the following weather conditions? (choose one response for each row)</b>		
<b>Q11A. Darkness.</b>		
<b>Response</b>	<b>Count</b>	<b>Percentage</b>
Not at All	0	0
Poorly	0	0
Fairly Well	8	66.67
Perfectly	3	25
Don't Know	1	8.33
<b>Q11B. Fog.</b>		
<b>Response</b>	<b>Count</b>	<b>Percentage</b>
Not at All	0	0
Poorly	3	25
Fairly Well	2	16.67
Perfectly	0	0
Don't Know	7	58.33

<b>Q11C. Cold temperatures.</b>		
<b>Response</b>	<b>Count</b>	<b>Percentage</b>
Not at All	0	0
Poorly	1	8.33
Fairly Well	1	8.33
Perfectly	6	50
Don't Know	4	33.33
<b>Q11D. Rain.</b>		
<b>Response</b>	<b>Count</b>	<b>Percentage</b>
Not at All	0	0
Poorly	2	16.67
Fairly Well	6	50
Perfectly	3	25
Don't Know	1	8.33
<b>Q11E. Snow.</b>		
<b>Response</b>	<b>Count</b>	<b>Percentage</b>
Not at All	0	0
Poorly	1	8.33
Fairly Well	3	25
Perfectly	1	8.33
Don't Know	7	58.33
<b>Q11F. Bright sun (1 participant gave 2 responses).</b>		
<b>Response</b>	<b>Count</b>	<b>Percentage</b>
Not at All	1	8.33
Poorly	3	25
Fairly Well	4	33.33
Perfectly	5	41.67
Don't Know	0	0



<b>Q11 Part 2. Are there any other conditions when your vehicle's rearview camera does not work well? Explain.</b>		
When camera is dirty	1	8.33
Video takes time to brighten up when car is put in reverse if screen is initially dark due to navigation system being off	1	8.33

<b>Q12. Overall, how easy is the rearview camera to use when backing out of a driveway? (circle one)</b>		
<b>Response</b>	<b>Count</b>	<b>Percentage</b>
Very easy to use	7	58.33
Somewhat easy to use	3	25
Somewhat difficult to use	2	16.67
Very difficult to use	0	0
Don't know	0	0

<b>Q13. How has your usage of the rearview camera changed since you first got the vehicle? (circle one) If it changed, then why?</b>		
<b>Response</b>	<b>Count</b>	<b>Percentage</b>
I use it more now than I did in the beginning	4	33.33
I use it less now than I did in the beginning	0	0
My usage has stayed about the same	8	66.67
<b><i>If you use it more now than in the beginning, then why?</i></b>		
<i>More comfortable after proven reliability</i>	1	8.33
<i>Gotten used to it over time</i>	2	16.67
<i>Helps when backing out of a driveway on a hill</i>	1	8.33

<b>Q14. Please indicate how much you agree or disagree with the following statements. (choose one response for each row)</b>		
<b>Q14A. The rearview camera screen is in a location where it is easy to see when I am backing.</b>		
<b>Response</b>	<b>Count</b>	<b>Percentage</b>
Strongly Disagree	0	0
Disagree	0	0
Neutral	1	8.33
Agree	5	41.67
Strongly Agree	6	50
<b>Q14B. I am more confident in my backing abilities when I use the rearview camera.</b>		
<b>Response</b>	<b>Count</b>	<b>Percentage</b>
Strongly Disagree	1	8.33
Disagree	1	8.33
Neutral	2	16.67
Agree	3	25
Strongly Agree	5	41.67
<b>Q14C. I am more willing to park in small or difficult parking spaces when I use the rearview camera.</b>		
<b>Response</b>	<b>Count</b>	<b>Percentage</b>
Strongly Disagree	1	8.33
Disagree	2	16.67
Neutral	2	16.67
Agree	6	50
Strongly Agree	1	8.33
<b>Q14D. It's easy to tell how close I am to an obstacle by looking at the rearview camera display.</b>		
<b>Response</b>	<b>Count</b>	<b>Percentage</b>
Strongly Disagree	2	16.67
Disagree	1	8.33
Neutral	3	25
Agree	5	41.67
Strongly Agree	1	8.33
<b>Q14E. The rearview camera does not show the entire area behind the vehicle that I need to see when backing, in other words, there is a blind spot.</b>		
<b>Response</b>	<b>Count</b>	<b>Percentage</b>
Strongly Disagree	1	8.33
Disagree	5	41.67
Neutral	4	33.33
Agree	1	8.33
Strongly Agree	1	8.33
<b>Q14F. The rearview camera display gets blurry or hard to see if I am moving.</b>		
<b>Response</b>	<b>Count</b>	<b>Percentage</b>
Strongly Disagree	1	8.33
Disagree	7	58.33

Neutral	4	33.33
Agree	0	0
Strongly Agree	0	0

**Q14G. The rearview camera gets dirty and makes obstacles hard to see.**

Response	Count	Percentage
Strongly Disagree	1	8.33
Disagree	6	50
Neutral	4	33.33
Agree	0	0
Strongly Agree	1	8.33

**Q14H. Sun glare on the video display makes it hard for me to see objects or people.**

Response	Count	Percentage
Strongly Disagree	0	0
Disagree	4	33.33
Neutral	4	33.33
Agree	2	16.67
Strongly Agree	2	16.67

**Q14I. It's hard to distinguish something or someone who may be in a shadow area behind my vehicle (Image contrast level is poor in camera).**

Response	Count	Percentage
Strongly Disagree	0	0
Disagree	5	41.67
Neutral	5	41.67
Agree	2	16.67
Strongly Agree	0	0

**Q14J. My risk of hitting somebody while backing is lower with the rearview camera than without it.**

Response	Count	Percentage
Strongly Disagree	0	0
Disagree	2	16.67
Neutral	0	0
Agree	3	25
Strongly Agree	7	58.33

**Q15. Suppose that the diagram below shows an overhead view of your vehicle and areas labeled “A” – “Q”. Based on your experience, please circle the letters for all areas where your rearview camera would show you obstacles such as a small child *standing* behind the vehicle.**

Response Areas	Count	Percentage
A	0	0
B	1	8.33
C	6	50
D	8	66.67
E	9	75
F	11	91.67
G	9	75
H	8	66.67
I	6	50
J	3	25
K	0	0
L	2	16.67
M	6	50
N	2	16.67
O	7	58.33
P	11	91.67
Q	7	58.33

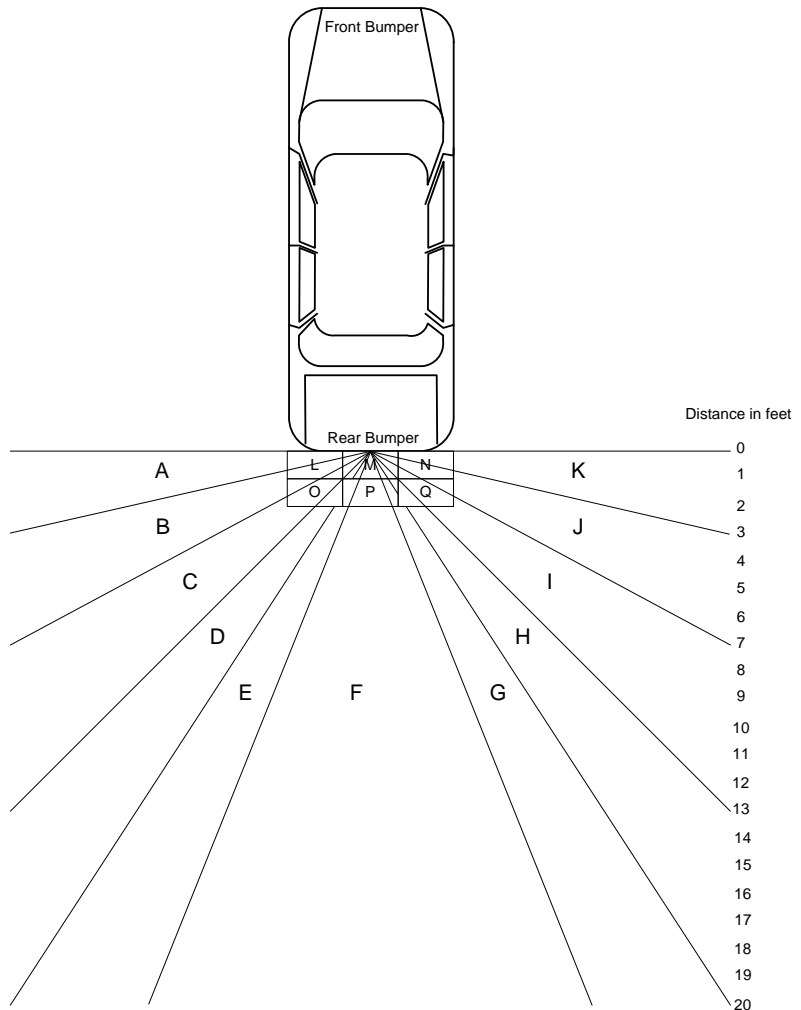

<b>Q16. Have you ever unintentionally backed into something or had a “close call” since you started driving this vehicle? (circle one)</b>		
Response	Count	Percentage
Yes	3	25
No	9	75
<b><i>If yes, were you using the camera at the time? Please describe the situation.</i></b>		
<i>Backing out of parking space at mall, lady yelled when came too close</i>	1	8.33
<i>Backing out of driveway, used camera early, but hit garbage can when looking over shoulder at the time of collision</i>	1	8.33
<i>Hit mailbox at end of driveway, roads snow covered, camera lens dirty from road grime</i>	1	8.33

<b>Q17. Does using the rearview camera create any new driving problems or safety concerns for you? (circle one)</b>		
<b>Response</b>	<b>Count</b>	<b>Percentage</b>
Yes	1	8.33
No	11	91.67
<b><i>If yes, please explain.</i></b>		
<i>Hard to focus on driving while looking at the camera</i>	1	8.33

<b>Q18. Overall, does having the rearview camera make you a safer driver? (circle one)</b>		
<b>Response</b>	<b>Count</b>	<b>Percentage</b>
Safer	8	66.67
Neither more nor less safe	4	33.33
Less safe	0	0

<b>Q19. Since you have owned this vehicle, have you driven <u>another vehicle without a backing aid system or rearview video system</u> and backed into something or had a “close call” because you expected the vehicle to give you a warning or display the obstacle on the video screen? (circle one)</b>		
<b>Response</b>	<b>Count</b>	<b>Percentage</b>
Yes	0	0
No	12	100

<b>Q20. Is there anything about the rearview camera that you think should be improved? (circle one)</b>		
<b>Response</b>	<b>Count</b>	<b>Percentage</b>
Yes	8	66.67
No	4	33.33
<b><i>If yes, please explain.</i></b>		
<i>Thoughts on improvements: include some kind of distance markers; have the video come on quicker; create a wider angle of view; eliminate sun glare; improve the determinability of the distance to an object; prevent disorientation; improve field of view; find a way for it to see better in the rain; and make it so it would be easier to determine if one is going straight or not.</i>		

<b>Q21. In general, do you believe that car manufacturers are doing enough to design their vehicles to accommodate an aging population? (circle one)</b>		
<b>Response</b>	<b>Count</b>	<b>Percentage</b>
Yes	10	83.33
No	2	16.67
<b><i>If you answered “no” then what more do you believe could be done? Explain.</i></b>		
<i>Could be more universal symbols and more standard location of controls and switches</i>	1	8.33
<i>No explanation (blank)</i>	1	8.33

## 11.7 Appendix G: Participant Questionnaire With Results (Rearview Video and Rear Parking Sensors)

The tabulated questionnaire results for the 13 participants in the video plus sensors condition are incorporated below. Counts show the number of participants who selected a particular response to a question. Some questions required participants to choose one best response, while other questions allowed the participants to choose multiple responses. In order to better understand the results, the response percentages for both types of questions are based upon the total number of participants (13), not the total count of responses. If a participant didn't respond to a question, it is accounted for in the table. Questions with open-ended responses or comments are categorized when possible.

<b>Q1. During your final test drive, did you anticipate the obstacle behind the vehicle during the backing maneuver? (circle one)</b>		
<b>Response</b>	<b>Count</b>	<b>Percentage</b>
Yes	0	0
No	13	100
Don't Know	0	0

<b>Q2. Where do you usually look to determine whether the area behind the vehicle is clear when backing? (Check all that apply)</b>		
<b>Response</b>	<b>Count</b>	<b>Percentage</b>
At the side mirrors	8	61.54
At the center rearview mirror	10	76.92
Over my shoulder	12	92.31
At the rearview video display	8	61.54
At the backing aid display	3	23.08

<b>Q3. A <u>backing aid system</u> helps the driver back up by providing sounds, lights or symbols when the vehicle is near an obstacle. Your vehicle is equipped with this type of system. If you purchased this same model vehicle again would you want the backing aid system? (circle one)</b>		
<b>Response</b>	<b>Count</b>	<b>Percentage</b>
Yes	12	92.31
No	0	0
Don't Know	1	7.69

<b>Q4. A <u>rearview video camera</u> shows the driver the area behind the vehicle when you are backing on a screen inside the vehicle. Your vehicle is equipped with this type of system. If you purchased this same model vehicle again would you want a rearview camera? (circle one)</b>		
<b>Response</b>	<b>Count</b>	<b>Percentage</b>
Yes	10	76.92
No	1	7.69
Don't Know	2	15.38

<b>Q5. How did you learn to use your vehicle's backing aid system? (check all that apply)</b>		
<b>Response</b>	<b>Count</b>	<b>Percentage</b>
Instructions from the dealership, such as a video, brochure, or demonstration	4	30.77
Vehicle owner's manual	3	23.08
Help from a friend or relative	2	15.38
Information on the Internet	1	7.69
On-road experience and practice (trial and error)	10	76.92
I have not yet learned how to use the backing aid	0	0

<b>Q6. How did you learn to use your vehicle's rearview camera? (check all that apply)</b>		
<b>Response</b>	<b>Count</b>	<b>Percentage</b>
Instructions from the dealership, such as a video, brochure, or demonstration	5	38.46
Vehicle owner's manual	4	30.77
Help from a friend or relative	1	7.69
Information on the Internet	0	0
On-road experience and practice (trial and error)	11	84.62
I have not yet learned how to use the rearview camera	0	0

<b>Q7. Are you aware of any warnings or limitations about your vehicle's rearview camera? (circle one)</b>		
<b>Response</b>	<b>Count</b>	<b>Percentage</b>
Yes	5	38.46
No	8	61.54
<b><i>If yes, please explain.</i></b>		
<i>Distance appears distorted</i>	1	7.69
<i>System doesn't come on immediately</i>	1	7.69
<i>Limited field of view</i>	1	7.69
<i>Objects are closer than they appear when looking at video</i>	2	15.38

<b>Q8. How easy was it to learn how to use your vehicle's backing aid and rearview camera together to judge the distance to objects behind your vehicle? (circle one)</b>		
<b>Response</b>	<b>Count</b>	<b>Percentage</b>
Very easy to learn	3	23.08
Somewhat easy to learn	6	46.15
Somewhat difficult to learn	1	7.69
Very difficult to learn	0	0
I have not tried to learn how to use the backing aid	3	23.08
I do not want to learn how to use the backing aid	1	7.69

<b>Q9. Were there things that were especially difficult to learn about your vehicle's backing aid system and/or rearview camera? (circle one)</b>		
<b>Response</b>	<b>Count</b>	<b>Percentage</b>
Yes	5	38.46
No	8	61.54
<b><i>If yes, please explain.</i></b>		
<i>Tends to ignore sounds since a user cannot tell the difference when the sounds go off when parking and backing</i>	1	7.69
<i>Find it hard to break a 25 year behavior or pattern</i>	1	7.69
<i>Find it hard to watch camera and more comfortable to look over the shoulder when backing up</i>	1	7.69
<i>Distance is not easy to judge</i>	2	15.38

<b>Q10. Are you aware of any warnings or limitations about your vehicle's backing aid system? (circle one)</b>		
<b>Response</b>	<b>Count</b>	<b>Percentage</b>
Yes	3	23.08
No	9	69.23
No Response (Blank)	1	7.69
<b><i>If yes, please explain.</i></b>		
<i>False alarms of the sensors (in environments such as: sides of a garage, drive-thru windows, and driveways having a slope)</i>	3	23.08

<b>Q11. In the last two weeks, did you ever use just the backing aid system and/or rearview camera when backing without checking the mirrors or turning to look out the rear window? (circle one)</b>		
<b>Response</b>	<b>Count</b>	<b>Percentage</b>
Yes	2	15.38
No	11	84.62

<b>Q12. Which of the following best describes how much you normally pay attention to the backing aid system display when backing? (circle one)</b>		
<b>Response</b>	<b>Count</b>	<b>Percentage</b>
I rarely or never look at it	5	38.46
I usually just take a quick glance at the display to determine if I can back up	5	38.46
I share my attention about equally between the display and my mirrors or glances over my shoulder	3	23.08
I pay attention to the rearview camera screen more than to my mirrors and glances over my shoulder	0	0
I usually back up the vehicle using only the camera. I don't feel that I need to check mirrors or look out the rear windows	0	0



<b>Q13. Which of the following best describes how much you normally pay attention to the rearview camera when backing? (circle one)</b>		
<b>Response</b>	<b>Count</b>	<b>Percentage</b>
I rarely or never look at it	3	23.08
I usually just take a quick glance at the camera screen to determine if I can back up	5	38.46
I share my attention about equally between the rearview camera screen and my mirrors or glances over my shoulder	5	38.46
I pay attention to the rearview camera screen more than to my mirrors and glances over my shoulder	1	7.69
I usually back up the vehicle using only the camera. I don't feel that I need to check mirrors or look out the rear windows	0	0

<b>Q14. Imagine that your vehicle's backing aid system and rearview camera broke down. How would your driving behavior change if you could not use these systems anymore? (check boxes for all that apply)</b>		
<b>Response</b>	<b>Count</b>	<b>Percentage</b>
I would back up much more slowly	6	46.15
I would avoid parking places where I would have to back up	1	7.69
I would not try to fit into tight parking spaces	1	7.69
I would rely more on my mirrors and/or glances over my shoulder to see what is behind my vehicle	8	61.54
My driving behavior would not change	3	23.08
Other ( <i>specify</i> )	0	0

<b>Q15. How well does your vehicle's backing aid system and rearview camera work in the following weather conditions? (choose one response for each row)</b>		
<b>Q15A. Darkness.</b>		
<b>Response</b>	<b>Count</b>	<b>Percentage</b>
Not at All	0	0
Poorly	3	23.08
Fairly Well	5	38.46
Perfectly	3	23.08
Don't Know	2	15.38

<b>Q15B. Fog.</b>		
<b>Response</b>	<b>Count</b>	<b>Percentage</b>
Not at All	0	0
Poorly	1	7.69
Fairly Well	4	30.77
Perfectly	1	7.69
Don't Know	7	53.85
<b>Q15C. Cold temperatures.</b>		
<b>Response</b>	<b>Count</b>	<b>Percentage</b>
Not at All	0	0
Poorly	0	0
Fairly Well	4	30.77
Perfectly	5	38.46
Don't Know	4	30.77
<b>Q15D. Rain.</b>		
<b>Response</b>	<b>Count</b>	<b>Percentage</b>
Not at All	0	0
Poorly	2	15.38
Fairly Well	10	76.92
Perfectly	0	0
Don't Know	1	7.69
<b>Q15E. Snow.</b>		
<b>Response</b>	<b>Count</b>	<b>Percentage</b>
Not at All	0	0
Poorly	2	15.38
Fairly Well	4	30.77
Perfectly	1	7.69
Don't Know	6	46.15

<b>Q15F. Bright sun</b> (1 participant commented instead of circling a response).		
<b>Response</b>	<b>Count</b>	<b>Percentage</b>
Not at All	0	0
Poorly	2	15.38
Fairly Well	5	38.46
Perfectly	4	30.77
Don't Know	1	7.69
<i>Comment: hard to see image in the bright sun, but the sensors still work under such conditions</i>	1	7.69
<b>Q15 Part 2. Are there any other conditions where your vehicle's backing aid system or rearview camera does not work well? Explain.</b>		
<i>When camera lens is dirty</i>	1	7.69
<i>Glare on the screen</i>	1	7.69
<i>See above comment in 'Bright sun' section (Q15F)</i>		

<b>Q16. Please rate how well the backing aid and rearview camera would assist you to avoid colliding under the following circumstances.</b> (choose one response for each row)		
<b>Q16A. You are slowly backing out of a driveway into the street. There is a car that you can't see approaching on the street as you begin to back into its path.</b>		
<b>Response</b>	<b>Count</b>	<b>Percentage</b>
Not at All	1	7.69
Poorly	7	53.85
Fairly Well	3	23.08
Perfectly	1	7.69
Don't Know	1	7.69
<b>Q16B. You are backing quickly down a long driveway, going about 10 mph. There is a bicycle behind the vehicle that you didn't see.</b>		
<b>Response</b>	<b>Count</b>	<b>Percentage</b>
Not at All	0	0
Poorly	2	15.38
Fairly Well	8	61.54
Perfectly	2	15.38
Don't Know	1	7.69

<b>Q16C. You begin to back out of a garage and there is a child immediately under the rear bumper.</b>		
<b>Response</b>	<b>Count</b>	<b>Percentage</b>
Not at All	4	30.77
Poorly	4	30.77
Fairly Well	5	38.46
Perfectly	1	7.69
Don't Know	0	0
<b>Q16D. You are slowly backing out of a parking space and there is a pedestrian standing 10 feet behind your rear bumper.</b>		
<b>Response</b>	<b>Count</b>	<b>Percentage</b>
Not at All	0	0
Poorly	3	23.08
Fairly Well	5	38.46
Perfectly	5	38.46
Don't Know	0	0
<b>Q16E. You are backing up to a narrow sign post.</b>		
<b>Response</b>	<b>Count</b>	<b>Percentage</b>
Not at All	0	0
Poorly	2	15.38
Fairly Well	5	38.46
Perfectly	4	30.77
Don't Know	2	15.38
<b>Q16F. You are backing into a parallel parking space. The space is tight and you have to back very close to the car behind you.</b>		
<b>Response</b>	<b>Count</b>	<b>Percentage</b>
Not at All	0	0
Poorly	3	23.08
Fairly Well	7	53.85
Perfectly	3	23.08
Don't Know	0	0

<b>Q17. Overall, how easy are the backing aid system and rearview camera to use when backing out of a driveway? (circle one)</b>		
<b>Response</b>	<b>Count</b>	<b>Percentage</b>
Very easy to use	5	38.46
Somewhat easy to use	5	38.46
Somewhat difficult to use	0	0
Very difficult to use	3	23.08
Don't Know	0	0

<b>Q18. Your vehicle's backing aid system has both lights/symbols, sounds, and a rearview camera display. Which do you rely on more? (circle one)</b>		
<b>Response</b>	<b>Count</b>	<b>Percentage</b>
I rely on the lights/symbols more than the sounds	0	0
I rely on the sounds more than the lights/symbols	3	23.08
I rely on the rearview video display more than the lights/symbols or sounds	2	15.38
I rely on the sounds more than the rearview video display	2	15.38
I rely on the lights/symbols and sounds about equally	1	7.69
I rely on the rearview video display and sounds about equally	3	23.08
I rely on the rearview video display and lights/symbols and sounds about equally	0	0
I don't rely on the systems, I just use my mirrors or look over my shoulder	5	38.46

<b>Q19. Have you ever unintentionally backed into something or had a "close call" since you started driving this vehicle? (circle one)</b>		
<b>Response</b>	<b>Count</b>	<b>Percentage</b>
Yes	4	30.77
No	9	69.23
<b><i>If yes, please describe the situation.</i></b>		
<i>Almost hit light post when backing into parking space</i>	1	7.69
<i>Situation with toy balls behind the back tires</i>	1	7.69
<i>Close calls with trash cans in the driveway</i>	1	7.69
<i>Got too close to another vehicle when backing into parking spot and had to readjust</i>	1	7.69

<b>Q20. Since you have owned this vehicle, have you driven <u>another vehicle without a backing aid system or rearview video system</u> and backed into something or had a "close call" because you expected the vehicle to give you a warning or display the obstacle on the video screen? (circle one)</b>		
<b>Response</b>	<b>Count</b>	<b>Percentage</b>
Yes	0	0
No	13	100

<b>Q21. Have you ever received an unexpected warning when backing because you didn't know what was behind your vehicle? (circle one)</b>		
<b>Response</b>	<b>Count</b>	<b>Percentage</b>
Yes (*one person forgot to respond, but answered subsequent questions as if 'yes' was the response)	9*	69.23
No	4	30.77
<b>If yes, then how did you react the last time this happened?</b>		
I got out of the vehicle and checked for obstacles	5	38.46
I stopped immediately and checked my mirrors and/or looked out the rear window before continuing to back up	3	23.08
I slowed down and looked for the obstacle before stopping	0	0
I ignored the warning because I was sure that no obstacle was behind me	1	7.69
<b>If yes, what was the reason for the last unexpected warning?</b>		
It was nothing that I could identify	1	7.69
It was another vehicle	1	7.69
It was a person	1	7.69
It was a pole, post, or tree	1	7.69
It was a curb	1	7.69
It was some other object on the ground	4	30.77

<b>Q22. Does using the backing aid system and rearview camera create any new driving problems or safety concerns for you? (circle one)</b>		
<b>Response</b>	<b>Count</b>	<b>Percentage</b>
Yes	5	38.46
No	8	61.54
<b>If yes, please explain.</b>		
More sounds causes more checking	1	7.69
It messes up the rear distance concept	1	7.69
Relying more on the camera and not the side mirrors or over the shoulder	1	7.69
Sounds are distracting and overly cautious (especially when parallel parking)	1	7.69
Would be harder to back up if one totally relied on the backing aid system and rearview camera	1	7.69

<b>Q23. Please indicate how much you agree or disagree with the following statements. (choose one response for each row)</b>		
<b>Q23A. It's easy to hear the sounds made by the backing aid system.</b>		
<b>Response</b>	<b>Count</b>	<b>Percentage</b>
Strongly Disagree	1	7.69
Disagree	2	15.38
Neutral	0	0
Agree	0	0
Strongly Agree	10	76.92
Not Applicable	0	0
<b>Q23B. It's easy to see the lights/symbols on the backing aid system.</b>		
<b>Response</b>	<b>Count</b>	<b>Percentage</b>
Strongly Disagree	1	7.69
Disagree	3	23.08
Neutral	4	30.77
Agree	3	23.08
Strongly Agree	0	0
Not Applicable	2	15.38

<b>Q23C. It's easy to see rear obstacles in the rearview video system display.</b>		
<b>Response</b>	<b>Count</b>	<b>Percentage</b>
Strongly Disagree	1	7.69
Disagree	0	0
Neutral	2	15.38
Agree	10	76.92
Strongly Agree	0	0
Not Applicable	0	0
<b>Q23D. When I use the backing aid, I use my mirrors less often than I would if I did not have the backing aid.</b>		
<b>Response</b>	<b>Count</b>	<b>Percentage</b>
Strongly Disagree	4	30.77
Disagree	5	38.46
Neutral	0	0
Agree	3	23.08
Strongly Agree	1	7.69
Not Applicable	0	0
<b>Q23E. When I use the backing aid, I look over my shoulder less often than I would if I did not have the backing aid.</b>		
<b>Response</b>	<b>Count</b>	<b>Percentage</b>
Strongly Disagree	4	30.77
Disagree	3	23.08
Neutral	1	7.69
Agree	4	30.77
Strongly Agree	1	7.69
Not Applicable	0	0

<b>Q23F. I am more confident in my ability to detect pedestrians when I use the backing aid.</b>		
<b>Response</b>	<b>Count</b>	<b>Percentage</b>
Strongly Disagree	0	0
Disagree	2	15.38
Neutral	4	30.77
Agree	6	46.15
Strongly Agree	1	7.69
Not Applicable	0	0
<b>Q23G. I am more willing to park in small or difficult parking spaces when I use the backing aid.</b>		
<b>Response</b>	<b>Count</b>	<b>Percentage</b>
Strongly Disagree	2	15.38
Disagree	4	30.77
Neutral	5	38.46
Agree	2	15.38
Strongly Agree	0	0
Not Applicable	0	0
<b>Q23H. The backing aid gives me a good idea of my distance from an obstacle.</b>		
<b>Response</b>	<b>Count</b>	<b>Percentage</b>
Strongly Disagree	2	15.38
Disagree	2	15.38
Neutral	1	7.69
Agree	8	61.54
Strongly Agree	0	0
Not Applicable	0	0



<b>Q23I. The backing aid gives alerts with enough time to avoid hitting an obstacle.</b>		
<b>Response</b>	<b>Count</b>	<b>Percentage</b>
Strongly Disagree	1	7.69
Disagree	1	7.69
Neutral	3	23.08
Agree	7	53.85
Strongly Agree	1	7.69
Not Applicable	0	0
<b>Q23J. The backing aid gives too many false warnings when I am not in danger of hitting anything.</b>		
<b>Response</b>	<b>Count</b>	<b>Percentage</b>
Strongly Disagree	0	0
Disagree	6	46.15
Neutral	1	7.69
Agree	5	38.46
Strongly Agree	1	7.69
Not Applicable	0	0
<b>Q23K. The backing aid fails to warn me about an obstacle when it should have.</b>		
<b>Response</b>	<b>Count</b>	<b>Percentage</b>
Strongly Disagree	1	7.69
Disagree	8	61.54
Neutral	4	30.77
Agree	0	0
Strongly Agree	0	0
Not Applicable	0	0

<b>Q24. Please indicate how much you agree or disagree with the following statements. (choose one)</b>		
<b>Q24A. The rearview camera screen is in a location where it is easy to see when I am backing.</b>		
<b>Response</b>	<b>Count</b>	<b>Percentage</b>
Strongly Disagree	2	15.38
Disagree	0	0
Neutral	2	15.38
Agree	6	46.15
Strongly Agree	3	23.08
<b>Q24B. I am more confident in my backing abilities when I use the rearview camera.</b>		
<b>Response</b>	<b>Count</b>	<b>Percentage</b>
Strongly Disagree	3	23.08
Disagree	1	7.69
Neutral	1	7.69
Agree	4	30.77
Strongly Agree	4	30.77
<b>Q24C. I am more willing to park in small or difficult parking spaces when I use the rearview camera.</b>		
<b>Response</b>	<b>Count</b>	<b>Percentage</b>
Strongly Disagree	3	23.08
Disagree	3	23.08
Neutral	3	23.08
Agree	4	30.77
Strongly Agree	0	0
<b>Q24D. It's easy to tell how close I am to an obstacle by looking at the rearview camera display.</b>		
<b>Response</b>	<b>Count</b>	<b>Percentage</b>
Strongly Disagree	4	30.77
Disagree	2	15.38
Neutral	3	23.08
Agree	4	30.77
Strongly Agree	0	0

<b>Q24E. The rearview camera does not show the entire area behind the vehicle that I need to see when backing, in other words, there is a blind spot.</b>		
<b>Response</b>	<b>Count</b>	<b>Percentage</b>
Strongly Disagree	0	0
Disagree	5	38.46
Neutral	1	7.69
Agree	6	46.15
Strongly Agree	1	7.69
<b>Q24F. The rearview camera display gets blurry or hard to see if I am moving.</b>		
<b>Response</b>	<b>Count</b>	<b>Percentage</b>
Strongly Disagree	2	15.38
Disagree	6	46.15
Neutral	4	30.77
Agree	1	7.69
Strongly Agree	0	0
<b>Q24G. The rearview camera gets dirty and makes obstacles hard to see.</b>		
<b>Response</b>	<b>Count</b>	<b>Percentage</b>
Strongly Disagree	2	15.38
Disagree	6	46.15
Neutral	2	15.38
Agree	2	15.38
Strongly Agree	1	7.69
<b>Q24H. Sun glare on the video display makes it hard for me to see objects or people.</b>		
<b>Response</b>	<b>Count</b>	<b>Percentage</b>
Strongly Disagree	0	0
Disagree	2	15.38
Neutral	2	15.38
Agree	6	46.15
Strongly Agree	3	23.08
<b>Q24I. It's hard to distinguish something or someone who may be in a shadow area behind my vehicle (Image contrast level is poor in camera).</b>		
<b>Response</b>	<b>Count</b>	<b>Percentage</b>
Strongly Disagree	0	0
Disagree	3	23.08
Neutral	6	46.15
Agree	3	23.08
Strongly Agree	1	7.69
<b>Q24J. My risk of hitting somebody while backing is lower with the rearview camera than without it.</b>		
<b>Response</b>	<b>Count</b>	<b>Percentage</b>
Strongly Disagree	0	0
Disagree	1	7.69
Neutral	3	23.08
Agree	6	46.15
Strongly Agree	3	23.08

**Q25. Suppose that the diagram below shows an overhead view of your vehicle and areas labeled “A” – “Q”. Based on your experience, please circle the letters for all areas where your rearview camera would show you obstacles such as a small child standing behind the vehicle.**

Response Areas	Count	Percentage
A	1	7.69
B	5	38.46
C	9	69.23
D	12	92.31
E	11	84.62
F	12	92.31
G	11	84.62
H	12	92.31
I	9	69.23
J	5	38.46
K	1	7.69
L	5	38.46
M	9	69.23
N	5	38.46
O	10	76.92
P	11	84.62
Q	10	76.92

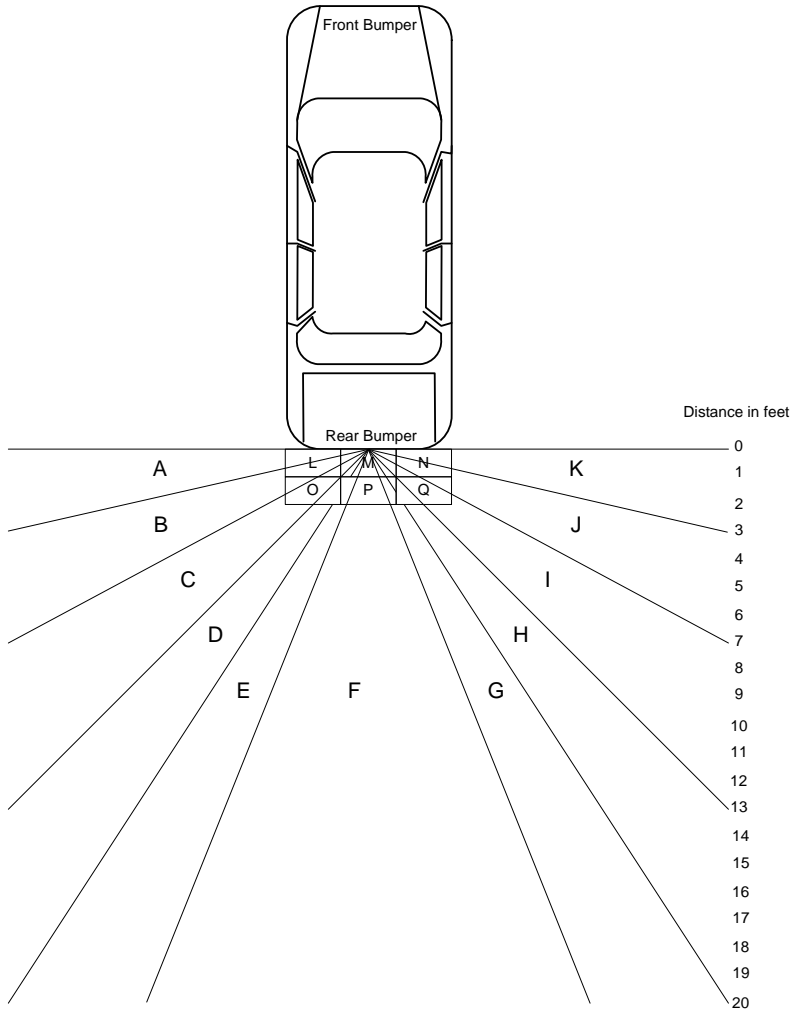

**Q26. Suppose that the diagram below shows an overhead view of your vehicle. Based on your experience, write an "X" in all rectangles where you think your backing aid system would detect a small, *standing* child and give you a warning.**

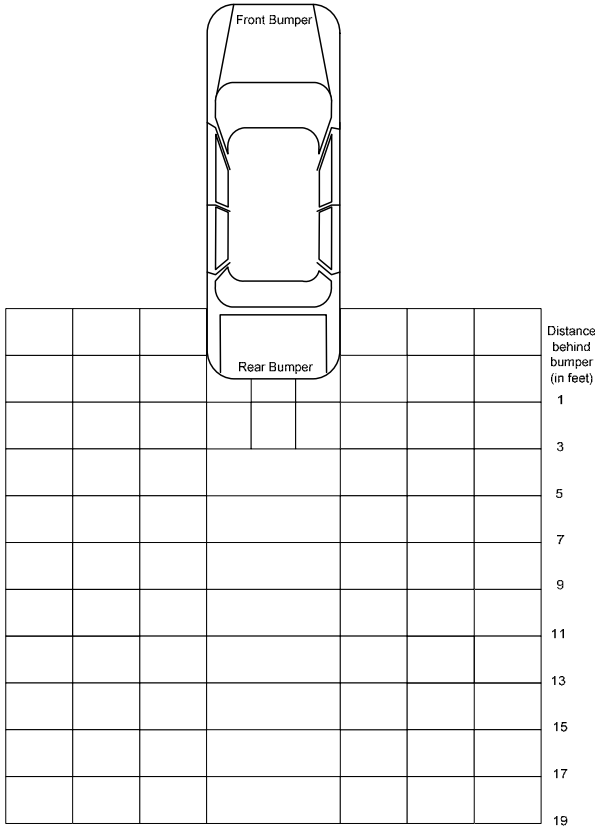

**Count:**

0	1	2	Bumper			2	1	0
0	1	7	7	8	7	7	1	0
0	1	7	12	12	12	7	1	0
0	1	5	9			5	1	0
0	1	4	5			4	1	0
0	1	4	5			4	1	0
0	1	3	3			3	1	0
0	0	1	2			1	0	0
0	0	1	1			1	0	0
0	0	1	1			1	0	0
0	0	1	1			1	0	0

**Percentages:**

0	7.7	15.4	Bumper			15.4	7.7	0
0	7.7	53.8	53.8	61.5	53.8	53.8	7.7	0
0	7.7	53.8	92.3	92.3	92.3	53.8	7.7	0
0	7.7	38.5	69.2			38.5	7.7	0
0	7.7	30.8	38.5			30.8	7.7	0
0	7.7	30.8	38.5			30.8	7.7	0
0	7.7	23.1	23.1			23.1	7.7	0
0	0	7.7	15.4			7.7	0	0
0	0	7.7	7.7			7.7	0	0
0	0	7.7	7.7			7.7	0	0
0	0	7.7	7.7			7.7	0	0

<b>Q27. How has your reliance on the backing aid and rearview video systems changed since you first got the vehicle? (circle one) <i>If it changed, then why?</i></b>		
<b>Response</b>	<b>Count</b>	<b>Percentage</b>
I rely on it more now than I did in the beginning	8	61.54
I rely on it less now than I did in the beginning	1	7.69
My reliance has stayed about the same	4	30.77
<b><i>If you rely on it more now than in the beginning, then why?</i></b>		
<i>It makes a noise</i>	1	7.69
<i>I rely on the camera due to blind spots when looking over the shoulder</i>	1	7.69
<i>Gotten used to having it – use the camera more and ignore the sensors more</i>	1	7.69
<i>After learning about the distance over time</i>	1	7.69
<i>No Response (Blank)</i>	4	30.77
<b><i>If you rely on it less now than in the beginning, then why?</i></b>		
<i>No Response (Blank)</i>	1	7.69

<b>Q28. Overall, does having the backing aid make you a safer driver? (circle one)</b>		
<b>Response</b>	<b>Count</b>	<b>Percentage</b>
Yes, safer	7	53.85
Neither more nor less safe	6	46.15
No, less safe	0	0

<b>Q29. Does using the backing aid and/or rearview video system create any new driving problems or safety concerns for you? (circle one)</b>		
<b>Response</b>	<b>Count</b>	<b>Percentage</b>
Yes	5	38.46
No	8	61.54
<b><i>If yes, please explain.</i></b>		
<i>They create a need to look closer</i>	1	7.69
<i>The beep is distracting</i>	1	7.69
<i>There are false alarms with backing aid, like at a drive-thru window</i>	1	7.69
<i>One relies on the sensors to the point of not checking the mirrors</i>	1	7.69
<i>If one uses it and looks over the shoulder then one is more likely to run into something</i>	1	7.69

<b>Q30. Is there anything about the way that the backing aid and/or rearview video system works that you think should be improved? (circle one)</b>		
<b>Response</b>	<b>Count</b>	<b>Percentage</b>
Yes	8	61.54
No	5	38.46
<b><i>If yes, please explain.</i></b>		
<i>A different sound for backing / parking would be helpful – become immune to warning sound when parking</i>	1	7.69
<i>Need different beeping sounds for the side versus the rear</i>	1	7.69
<i>Consider more sensors and no camera</i>	1	7.69
<i>Provide a better judge of distance</i>	1	7.69
<i>There's a time lapse when the video comes on</i>	1	7.69
<i>Directly behind the vehicle is undetected by the backing aid</i>	1	7.69
<i>Have a way to temporarily turn off the sensor</i>	1	7.69
<i>Have it behind the person so it can be seen when one is turned around to back up</i>	1	7.69

<b>Q31. In general, do you believe that car manufacturers are doing enough to design vehicles to accommodate an aging population? (circle one)</b>		
<b>Response</b>	<b>Count</b>	<b>Percentage</b>
Yes	11	84.62
No	2	15.38
<b><i>If you answered "no" then what more do you believe could be done?</i></b>		
<i>It would be good to have seats that turned toward the door, and that a lift device might also be good</i>	1	7.69
<i>There is always more that can be done</i>	1	7.69

## 11.8 Appendix H: Details of Mechanisms Used in Presenting the Obstacle Event

The obstacle event involved a two-dimensional, life-size image of a child popping up behind the test vehicle while the participant was backing out of a garage at the end of the second test drive. The image consisted of a full-color photo a 36-inch-tall toddler. The photo was printed on a corrugated plastic substrate (see Figure 16). The 36-inch-height corresponded approximately to the height of a 2.5 year old child.

A 6 inch by 12 inch piece of sheet metal was attached to the back side of the photo sheet using tape. The plate was positioned on the lower portion of the cutout so the edge extended slightly outside of the child's right leg. A 6-inch length of metal hinge was attached with screws to the bottom of the metal plate to form the fulcrum. Two holes were drilled through the plate and child cutout for attachment of a spring and tether. Figure 38 shows the locations of the spring eye bolt and tether holes.

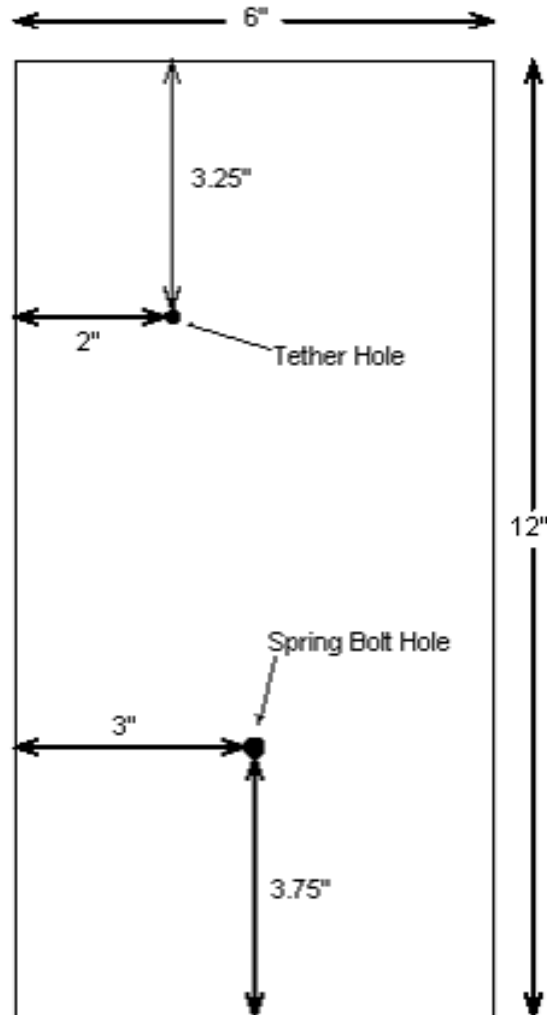

Figure 47. Backing Plate for Cutout



The dimensions of the spring were 5/16 inch x 16-1/8 inches x 0.047 inch (Century Spring Corporation part number CS-3). The spring was attached to an eye bolt using a thick zip tie. Additional cable ties were fastened to the remaining eye bolt space in order to keep the spring attachment point near the middle part of the bolt eye.

The tether was a two-piece construction. The first piece was a loop made from a 2.5 inch long piece of 50 pound test monofilament line and a wire cable stop. The cable stop was crimped to the two ends of the 50 pound test line to create a loop 1" in length when the loop was pinched lengthwise. The loop was then pushed through the tether hole from the backing plate side until the cable stop contacted the plate and the loop protruded from front side of the child cutout.

The second piece of the tether was constructed of a length of 17 pound test monofilament with a size 5 barrel swivel attached to each end. The barrel swivels had clips that allow for quick connect/disconnect. The length of this 17 pound test tether piece measured 13.25" from tip to tip of the barrel swivels. One swivel clip was attached to the 50 pound test loop, while the other clip was eventually attached to a pavement anchor.

At this point in construction, the entire back side of this assembly was coated with gray textured spray paint in order to allow the cutout to blend in with asphalt pavement when laid flat prior to it being triggered into an upright position. Figure 39 shows the back side of a completed assembly.

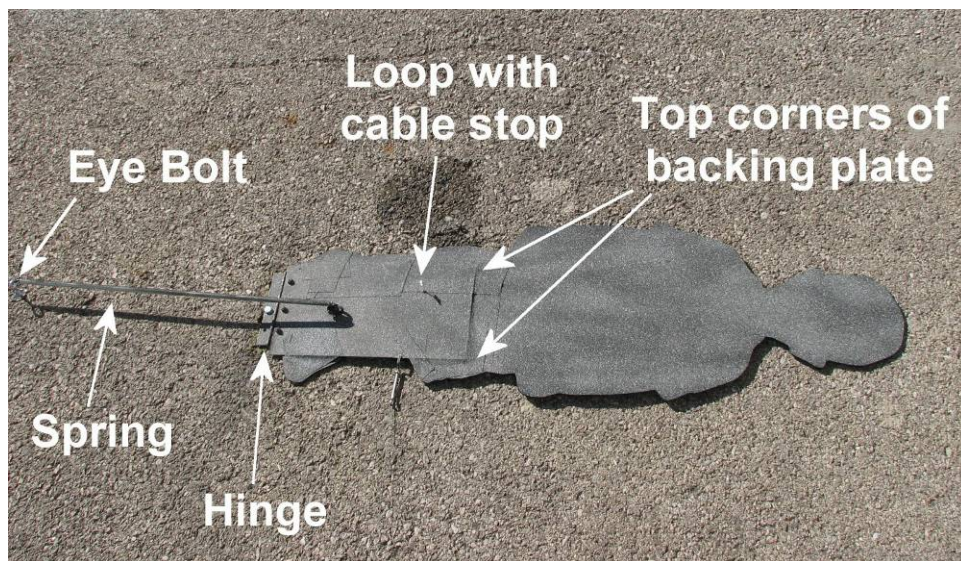

Figure 48. Complete Cutout Assembly

### Attachment to Pavement

The assembly was placed face down and the hinge was attached to the pavement using two lag bolts (the insert part of the lags remain permanently fixed in the pavement). A third lag was inserted into the pavement 17 inches back from the hinge to accept a

3/16" eye bolt that was used to anchor the spring. Two small sheet metal type eye screws were screwed directly into the pavement on either side of the cutout. The screw on the cutout's left side was used as the anchor point for the tether. The position of the eye was not critical as long as it did not interfere with the cutout laying flat and the tether allows the cutout to stand fully upright when extended. The screw on the cutout's right side was used to hold a cotter pin in place. The cotter pin held the assembly down with the spring stretched taught. The ends of the cotter pin were bent to prevent it from hanging up on pavement irregularities and to accommodate for the thickness of the assembly. Figure 40 shows the anchor points used.

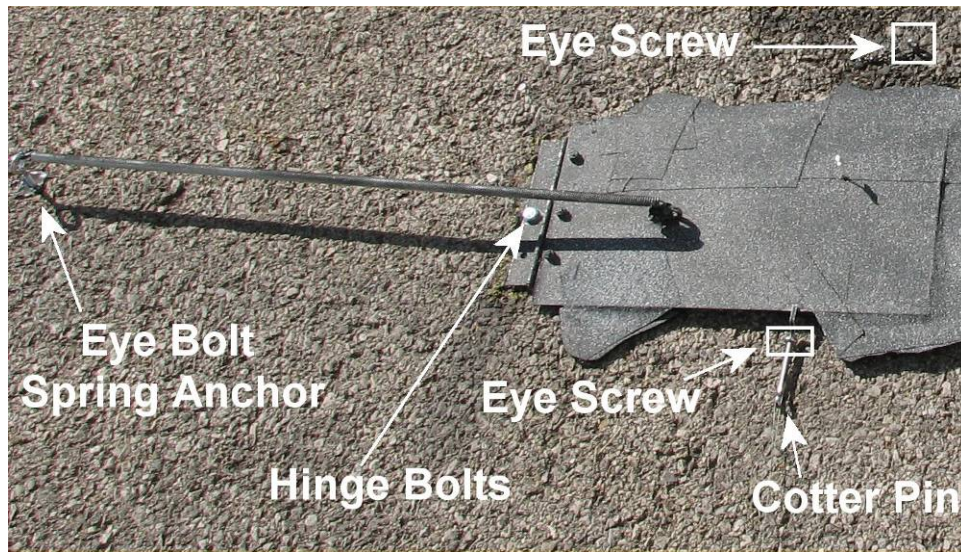

Figure 49. Anchor Points

The assembly raised to an upright position when the cotter pin was pulled due to spring tension and the tether stop. The cotter pin was attached via a 50 pound test braided low-stretch line to a Bimba model 091-RP air piston. The piston was connected to a Skinner Electric Valves 12V, 1000 psi valve and an air source. The piston and valve were mounted to a metal plate that was held in place with a 50 pound weight placed on top of the plate (see Figure 41).

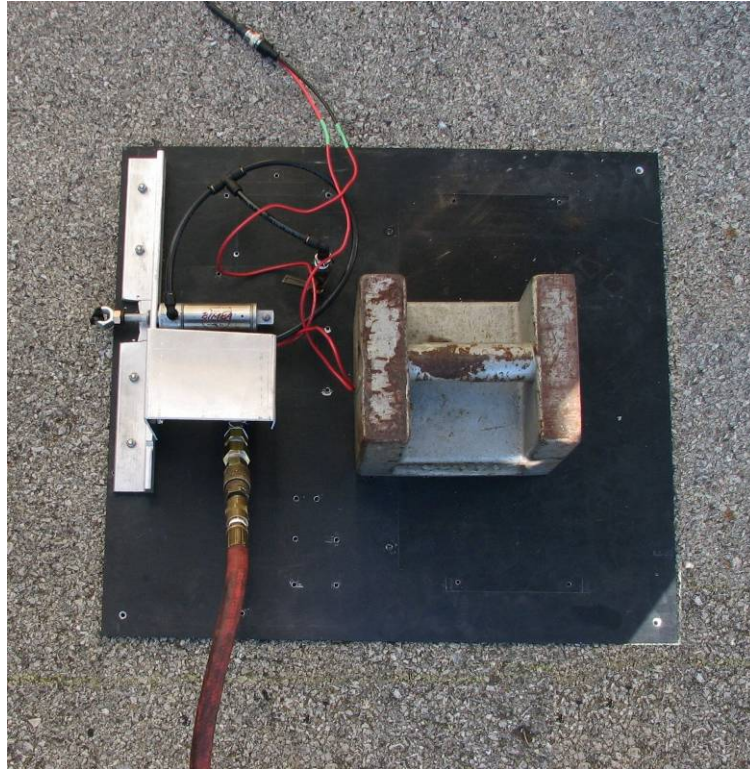

Figure 50. Piston and Electric Air Valve Assembly

A 12V battery was used to activate the valve which in turn makes the piston move its full stroke, thus pulling the cotter pin. An NPD7050 field effect transistor was used to turn on the 12V battery/electric valve circuit. This transistor was turned on from a signal received from a garage door beam sensor ([www.northwestern1.com/beam\\_detector.htm](http://www.northwestern1.com/beam_detector.htm)).

The garage door sensor was installed on the garage floor, behind the front wheel stop mat so that the vehicle's front wheels break the garage door sensor beam when backing up. The breaking of the beam triggered the NPD7050 transistor. The garage door sensor had its own power supply which was connected to a hidden toggle switch. Thus, the beam could be turned off until the garage door was open and any technicians were clear of the beam, eliminating any false triggers by persons walking through the beam before the event began.

DOT HS 811 024  
September 2008



U.S. Department  
of Transportation  
**National Highway  
Traffic Safety  
Administration**

