

Technologies for Safe & Efficient Transportation

THE NATIONAL USDOT UNIVERSITY
TRANSPORTATION CENTER FOR SAFETY

Carnegie Mellon University

UNIVERSITY of PENNSYLVANIA

Towards a Viable Autonomous Driving Research Platform

FINAL RESEARCH REPORT

Junqing Wei, Jarrod M. Snider, Junsung
Kim, John M. Dolan, Raj Rajkumar and
Bakhtiar Litkouhi

Contract No. DTRT-13-GUTC-26

DISCLAIMER

The contents of this report reflect the views of the authors, who are responsible for the facts and the accuracy of the information presented herein. This document is disseminated under the sponsorship of the U.S. Department of Transportation's University Transportation Centers Program, in the interest of information exchange. The U.S. Government assumes no liability for the contents or use thereof.

Towards a Viable Autonomous Driving Research Platform

Junqing Wei, Jarrod M. Snider, Junsung Kim, John M. Dolan, Raj Rajkumar and Bakhtiar Litkouhi

Abstract— We present an autonomous driving research vehicle with minimal appearance modifications that is capable of a wide range of autonomous and intelligent behaviors, including smooth and comfortable trajectory generation and following; lane keeping and lane changing; intersection handling with or without V2I and V2V; and pedestrian, bicyclist, and workzone detection. Safety and reliability features include a fault-tolerant computing system; smooth and intuitive autonomous-manual switching; and the ability to fully disengage and power down the drive-by-wire and computing system upon E-stop. The vehicle has been tested extensively on both a closed test field and public roads.

I. INTRODUCTION

Imagining autonomous passenger cars in mass production has been difficult for many years. Reliability, safety, cost, appearance and social acceptance are only a few of the legitimate concerns. Advances in state-of-the-art software and sensing have afforded great improvements in reliability and safe operation of autonomous vehicles in real-world conditions. As autonomous driving technologies make the transition from laboratories to the real world, so must the vehicle platforms used to test and develop them. The next generation of intelligent research platforms must reinforce reliability and safety through hardware design and systems integration. Additionally, future research platforms have a great opportunity to demonstrate that autonomous cars can be cost-effective and user-friendly while maintaining an appealing appearance. Social acceptance of autonomous vehicles will continue to be a challenge. However, demonstrating production viability and consumer-oriented features, as well as vehicle intelligence, is an important step towards this technology becoming a commercial product.

This paper presents a research vehicle platform developed at Carnegie Mellon University to conduct autonomous driving research (Figure 1). The platform is designed to meet the requirements of general autonomous driving while simultaneously addressing some of the above-mentioned reliability, safety and appearance imperatives.

1) *Autonomous driving platforms*: Beginning in the late 1980s, multiple autonomous driving experimental platforms have been built. Capabilities of such vehicles have greatly increased, from only lane centering to being able to deal



Fig. 1: The CMU autonomous vehicle research platform in road test

with simple driving scenarios, including distance keeping, lane changing and intersection handling [14], [6], [3], [12].

The NAVLAB project at Carnegie Mellon University (CMU) has built a series of experimental platforms since the 1990s which are able to run autonomously on freeways [13], but they can only drive within a single lane.

In 2005-2007, the DARPA Grand Challenge and Urban Challenge provided researchers a practical scenario in which to test the latest sensors, computer technologies and artificial intelligence algorithms [16], [15]. 35 self-driving vehicle platforms built by teams from both industry and academia were in the semifinal competition. However, these cars were heavily modified, so that it was difficult and unsafe to drive them even in manual mode on public roads. They also made significant use of expensive, non-automotive-grade sensors.

In 2011, Google released its autonomous driving platform [10]. The main sensors are radars and a rotational multi-beam laser scanner installed on a customized roof-rack. The autonomous driving system has logged over 300,000 miles on public roads. However, it needs a high-resolution 3D map acquired by driving the route in advance, and its strong dependency on a single non-automotive-grade sensor for localization and perception significantly reduces its likelihood of deployment.

The VisLab vehicle from Parma University crossed Europe and Asia autonomously in 2010 [2]. Vision technology is heavily used in this system and shows great potential. Another Parma University vehicle, BRAiVE, has improved sensor integration and user interface design [7]. However, the vehicle will not work as well in extreme weather conditions due to its high dependency on cameras and the lack of automotive radar sensors.

2) *Advanced Driving Assist System (ADAS)*: Adaptive cruise control is one of the more widely used autonomous driving assist systems in production. In recent years, lane

This work was supported by NSF & GM

Junqing Wei, Jarrod M. Snider and Junsung Kim are with the Department of Electrical and Computer Engineering, Carnegie Mellon University, Pittsburgh, PA 15213, USA junqingw, jmsnider, junsungk@cmu.edu

John M. Dolan and Raj Rajkumar are with the faculty of the Department of Electrical and Computer Engineering and Robotics Institute, Carnegie Mellon University, Pittsburgh, PA 15213, USA

Bakhtiar Litkouhi is with the General Motor R&D, Warren, MI 48090-0955, USA

centering / lane keeping assist technology has also been developed to enhance freeway driving safety. A few prototype freeway single-lane autonomous driving platforms integrating these basic modules have been released by auto manufacturers [6], [17]. Though these platforms show potential to improve the driver's experience and safety, they can only perform single-lane autonomy, and in limited scenarios. Human supervision is always needed so that people can take over when the system encounters scenarios it cannot handle.

3) *Human Machine Interface*: Compared with autonomy *per se*, not much research has been done on the Human Machine Interface (HMI) for autonomous vehicles. For most DARPA Grand Challenge and Urban Challenge vehicles, the user interface was mainly an emergency stop button [16], [15]. In the Google and BMW connectedDrive projects, the operator interfaces are more user-friendly, which usually include a laptop computer for loading the map and starting the program [10]. In general, these autonomous driving system user interfaces are designed for developers, rather than customers, of the autonomous driving system. Autonomous vehicle researchers from the University of Parma and CMU proposed designs for a multi-level collaborative cooperation system for future autonomous vehicles [5], [19]. However, neither of these designs has been fully integrated into an autonomous car and user-tested.

II. ACTUATION SYSTEM FOR DRIVE-BY-WIRE

CMU's autonomous driving research platform is based on a Cadillac SRX. The stock car is not equipped with by-wire controls for operation. Therefore, several mechanical and electrical modifications were necessary to enable computer control of the required inputs that operate the vehicle. In order to support a full range of completely autonomous features, actuation and/or electronic control of the brake, throttle, steering, transmission shifting and secondary controls were implemented. This section provides a brief overview of each implementation.

A. Brake Actuation

The stock hydraulic brake assist system found in the SRX does not allow appropriate electronic control of braking for full-range autonomy. Actuation of the stock brake pedal assembly is achieved using an electric motor. The motor commutation is achieved via feedback from integrated Hall effect sensors and an internal incremental encoder. The incremental encoder provides feedback for braking rate control. The stock brake pedal position and fluid pressure sensors, as well as an auxiliary absolute angle sensor on the motor output, provide feedback for position control of the brake pedal. All feedback sensors are fused to produce optimal estimates of the braking system state and to provide redundancy/fault tolerance.

B. Throttle Actuation

Enabling computer control of the throttle does not require an additional actuator, since the throttle body of the stock SRX is already controlled electronically. The stock configuration uses accelerator pedal position sensors to generate

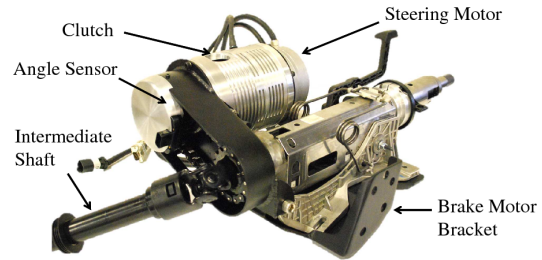

Fig. 2: Modified Steering Column

input signals to the throttle body control module (throttle-by-wire). The modification that allows a computer to control the throttle simply simulates the pedal position sensors. A custom circuit board allows seamless switching between the pedal and computer inputs depending on the state of the Auto/Manual switch.

C. Steering Actuation

The stock vehicle uses a hydraulic power steering assist system without electronic control, so the steering column was modified to allow computer-controlled actuation of the steering system. The steering column modification is shown in Figure 2. Actuation of the steering system is achieved using an electric motor. The 3-phase motor commutation is achieved via feedback from the motor's internal incremental encoder, the stock steering wheel angle sensor and an auxiliary absolute angle sensor on the motor output.

An electromagnetic clutch serves as the mechanical interface between the steering actuator and the intermediate shaft of the steering system. The addition of the clutch provides two main features. First, it allows the steering wheel to be completely disengaged when the vehicle is switched to Manual mode. Second, it is sized such that the driver can easily override the steering actuation for manual takeover from Auto mode.

D. Gear Selection Actuation

Actuation of the transmission gear selector is achieved using an electric motor and linear actuator. The actuator is mechanically connected in line with the stock gear selector cable. The linear actuation is achieved by a coarse-pitch ball screw to allow the actuator to be back-driven with little force when not energized. The design keeps the original gear selector lever intact and operational for manual operation. A stock lever position sensor, as well as an auxiliary absolute linear position sensor on the actuator, provides feedback for position control of the transmission selector.

E. Secondary controls

A variety of secondary controls are electrically modified to allow for computer control of turn signals, hazard lights, dim/bright headlights, door locks, ignition, and the horn. A custom circuit board is used to manipulate the signals of the secondary controls that are input into the body control module. The design allows for parallel operation of the controls by both computer and driver. The electrical configuration defaults to the stock version when the car is placed into Manual mode.

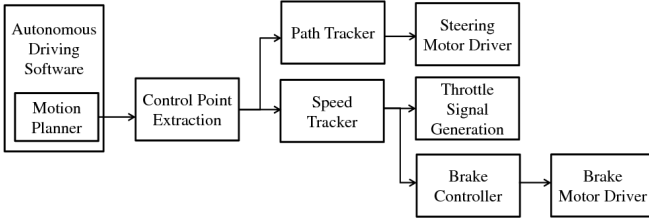

Fig. 3: Block diagram of the Drive-by-Wire hierarchical trajectory tracking controller

III. OVERVIEW OF DRIVE-BY-WIRE SYSTEM CONTROL

Desired trajectories for the next 5-10 seconds are generated by the motion planning at 10Hz in the software system, including both the velocity and path information. The role of the Drive-by-Wire (DBW) system is to track the trajectory. The DBW-level controller is implemented in a dSPACE MicroAutoBox, which runs at 100Hz. A hierarchical controller is implemented to control the actuators to operate the autonomous vehicle to track the designated path, as shown in Figure 3.

The control point extraction module projects the vehicle's current pose onto the desired trajectory and outputs information for the controller, including cross-track error Δd , heading error Δh , desired curvature k , desired curvature rate dk and desired velocity $v_{desired}$. The velocity tracker consists of two Proportional-Integral (PI) controller outputs, the desired brake position and throttle percentage, which respectively minimize the error between current and desired vehicle velocities $v_{desired}$. The desired brake position is converted by a brake motor controller into the instantaneous motor current command using a PI controller. A logic module switches between the brake and throttle with hysteresis to avoid operating them at the same time.

For the path tracking, a vehicle-kinematic-model-based controller is built to perform accurate lateral control when the vehicle is at low speed. It works very well even on very sharp corners (e.g. U-turns). This controller is also used to execute trajectories when the car moves in reverse.

In addition to the low-speed path controller, another controller is being implemented for high-speed path tracking with vehicle dynamics taken into account. It considers the side-drift of the vehicle and is able to control the car well in moderate-curvature turns. Both controllers output the steering wheel velocity. Smoothly merging these two controllers allows the lateral tracking error to be limited to within 30cm even for sharp turns and high-speed driving. The steering velocity command is then sent to the driver of the steering motor.

IV. POWER SYSTEM

The autonomous vehicle actuation system usually needs more power than the stock vehicle electrical system can generate. Therefore, an auxiliary power system is installed in addition to the stock vehicle battery system, as shown in Figure 4. A high-output alternator is installed to replace the stock alternator. A dedicated battery with a battery isolator is connected to the alternator. The isolation device prevents the

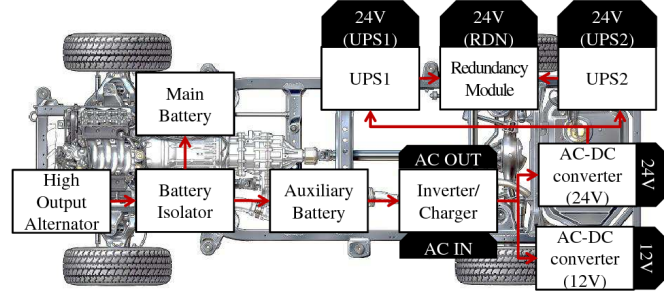

Fig. 4: The power system design of the autonomous vehicle

risk of the auxiliary system affecting the stock car electrical system.

To generate a stable DC voltage, the power from the alternator is first inverted to AC, then converted back to DC. All of the AC power comes from an inverter/charger device. When the engine of the car is on, the device will invert the current from the alternator to AC. When the car stays in the garage with shore power plugged in, it works as a charger to charge the auxiliary battery and also directly route the AC power to the converters.

From the AC bus, two converters are installed to generate 12V (1000W peak) and 24V (1500W peak), respectively. Also, parts of the 24V bus are backed up, as shown in Figure 4. To support different voltages, maximum current, and redundancy requirements of the auxiliary autonomous driving system, six independent power busses are created, as shown in Table I.

Table I shows that the safety-critical DBW that controls the steering, brake and throttle is fully backed up on the 24V bus. Two 24V Uninterrupted Power Supply (UPS) UPS with 7.2AH capacity and 20A peak current are used to meet the requirements for peak current of the motor. In addition, a redundancy module merging the two backed up 24V busses ensures that even if one of the UPSs fails, the main controller of the DBW system will still be alive. The backed-up DBW subsystem ensures that even if the 24V converter fails, the auxiliary system can still keep the vehicle on the road for over 10 minutes while performing behaviors like notifying the human driver and trying to safely approach an emergency parking zone.

All of these power electronic devices are also equipped with a digital diagnostic port. Their health status is real-time-monitored by the autonomous driving system computer.

To install and better conceal the power electronic devices,

TABLE I: Power-bus Connection Diagram

Power Bus	Devices
12V	Computer system, Sensors, Localization system, Network devices
24V	CAN Gateways, RTK bridge
24V(UPS1)	Steering motor, Gear shifter
24V(UPS2)	Brake motor
24V(RDN)	dSPACE, Motor Controllers, Auto/Manual Switching
AC	Developer's laptop

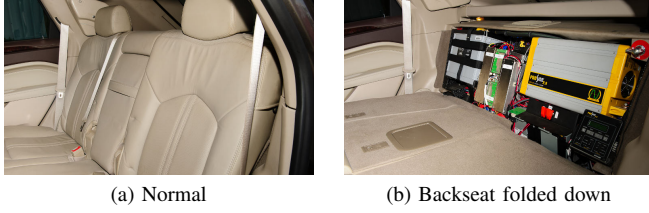

Fig. 5: The implementation of designed power system with consideration of space constraints, cooling and accessibility for debugging

a separation wall is built 6 inches behind the vehicle’s rear seat. As shown in Figure 5, all power system components are housed in this concealed space and cooled by the cold air routed from the outlet for the rear seats. Without major modification to the vehicle, an isolated and backed-up power system is integrated into the stock vehicle.

V. PERCEPTION SYSTEM

A. Localization system

High-performance localization is of great importance for fully autonomous driving. In the DARPA Urban Challenge, the Tartan Racing team proposed a pose filtering mechanism that combines the output of global localization and local lane marker features together [16]. Based on the pose filtering approach, a hybrid system consisting of both global and local localization was implemented. The global localization system focuses on determining the vehicle’s absolute coordinates on the earth. GPS antennas, wheel speed sensors, IMU and additional cellular-transmitted RTK correction data are fused by a GPS pose estimator as shown in Figure 6. This system is able to localize the vehicle with an error as small as 1.5cm RMS when the cellular network is available and the GPS antenna can receive good signals. When the satellites’ signals become unavailable for a short period of time, the IMU is still able to keep the localization error relatively small ($< 1.0m$) for a few minutes using dead reckoning.

The meter-level error from the global localization system is usually not good enough for the car to keep in the center of a lane autonomously. An additional few meters of error can be expected from the geo-information system’s map. Therefore, a local localization system is implemented to compensate the error by using lane marking and road shape features to estimate the lateral and longitudinal distances

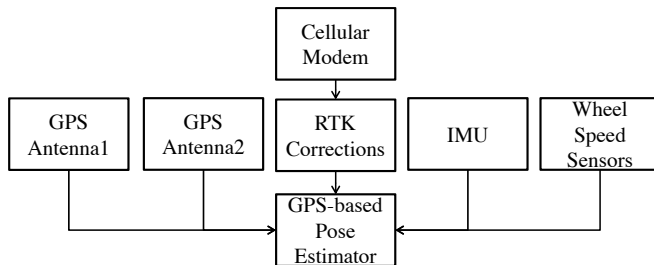

Fig. 6: The design of the autonomous vehicle global localization system

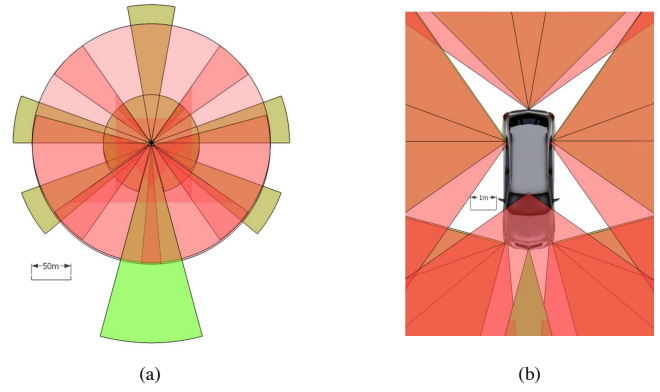

Fig. 7: Perception system coverage with all sensors integrated. a) Maximum ranges b) Sensor Field-of-View (FoV) and coverage close to the car

between the vehicle and the lane center from the map. This information is fused with the output of the global localization to provide a higher-accuracy estimate of the vehicle pose. More importantly, the pose generated by this mechanism has an accurate relative position between the vehicle and the road, which enables the car to drive correctly in the middle of the road.

B. Environmental Perception System

In autonomous driving, vehicles need to make decisions based on the perception of the surrounding environment, including static and dynamic obstacles. The perception system performance will greatly affect the system’s overall ability and robustness. There are three main types of sensors used by autonomous vehicle platforms: radar, LIDAR and cameras. Radar has been widely used in automotive applications for decades. It has the ability to detect obstacles’ positions and speeds directly. However, radar outputs are usually not informative enough to estimate obstacle shape.

In the DARPA Challenges in 2005 and 2007, LIDAR sensors showed great potential for automotive applications. The data provided by LIDAR are usually a cloud of 3D points dense enough for the shape of cars, pedestrians, curbs, undrivable areas and more information to be extracted. However, LIDAR’s cost, sensing range, robustness to weather conditions and velocity measurement accuracy are not as good as radar’s. Cameras are the most cost-effective sensor for automotive applications. Camera data are very

TABLE II: Installed Sensors’ Specifications

Sensor Type	Number	FoV (°)	MaxRange(m) / Resolution	Update Rate(Hz)
LIDAR	6	85–110	200	50
Radar1	1	12 – 30	250	12.5
Radar2	5	20(near) 18(far)	60(near) 175(far)	20
Video Camera	1	30	1360x1024	30
FLIR Camera	1	36	640x480	24

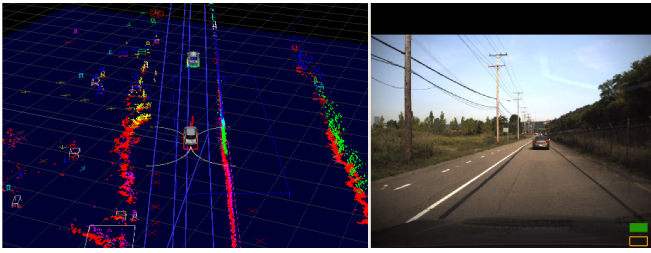

Fig. 8: Data visualization of the integrated LIDARs, radars and camera

informative, especially for detecting lane markings, signs and traffic lights with texture and color features. However, false-positive and recognition failure rates are much higher for vision than for LIDAR and radar.

Based on the features of these three sensor types, a hybrid perception system was designed to fuse the sensor data, exploiting their strengths and mutually compensating for their weaknesses. Table II shows the sensors used by the SRX and their main specifications.

As shown in Figure 7(a), there are multiple LIDAR and radar sensors installed, giving the vehicle 360-degree coverage around the car. Based on this design, any obstacle within 200 meters will be covered by at least one type of sensor. Obstacles within 60 meters will be detected by at least two different types of sensors. This configuration maximizes the sensor's ability at long range. It also provides redundancy for obstacles close to the car, which are usually more important for the autonomous vehicle's decision making. The LIDAR & radar can also compensate for each other's shortcomings and minimize sensing failures for obstacles within 60 meters.

Figure 7(a) shows how multiple LIDARs and Radars are installed in pairs around the car, allowing them to see obstacles from the same point of view. This makes the LIDAR & radar data more consistent with each other and leads to higher perception performance. Cameras with vision-based recognition are used to assist the LIDAR/radar fusion system and also provide traffic light detection, work zone detection and help other assistance features.

In an autonomous vehicle sensor layout, blind spots can hardly be avoided. The blind spots for this platform are shown in Figure 7(b). Because of the integration of multiple wide-FOV sensors surrounding the car, the blind spots are small enough that no vehicle can be overlooked. Assisted by the tracking algorithm of the perception system, the actual effect of the blind spots can be further reduced.

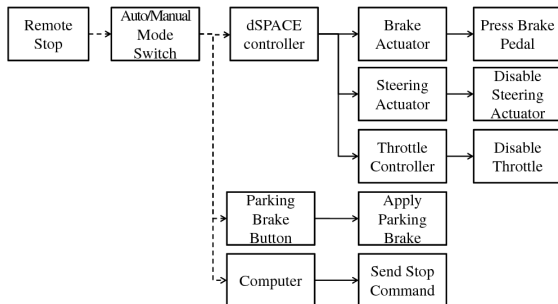

Fig. 9: Remote stop mechanism of the platform

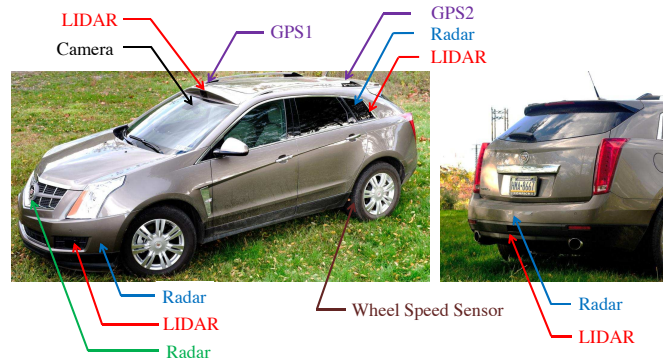

Fig. 10: Sensor installation

C. Vehicular Communication as a Sensor

Autonomous vehicles require various sensors such as LIDAR, radar, cameras, etc. to understand their surroundings; however, such sensors can be easily obstructed by nearby obstacles, preventing long-range detection. This can be improved by using sensor data from other vehicles equipped with a vehicular communication device. Our platform uses a DSRC (Dedicated Short-Range Communications) [8] modem to communicate with other similarly equipped vehicles. It can also talk to any infrastructure equipped with a DSRC capability. As a proof-of-concept implementation, our platform can retrieve detailed traffic light information via DSRC from DSRC-equipped traffic lights.

D. Sensor installation

For both safety and appearance reasons, the perception system should be well concealed and integrated into the vehicle. Therefore, the described platform avoids additional exterior sensor mounting racks, which greatly change the look and aerodynamics of the car.

The final sensor installation is shown in Figure 10. It shows that even with 15 sensors installed on the vehicle, the appearance and driving performance of the vehicle are not much influenced. Compared with previous research vehicle platforms, which have larger-scale and non-automotive-grade sensors on top of the car, the proposed sensor configuration and installation options are more practical for future volume-produced autonomous vehicles. A typical data acquisition result of the LIDAR, radar and camera is shown in Figure 8.

VI. SAFETY SYSTEM

The vehicle platform hardware is equipped with a three-layer safety system: remote stop, auto/manual switch and emergency stop. The remote stop is used when there is no one in the car. Virtual valet is one target application, wherein the vehicle drops off users and then drives away to find a parking spot. As shown in Figure 9, when the remote stop is activated, the vehicle will disable both steering and throttle controllers, press the brake pedal and also apply the parking brake. This ensures that even if one braking mechanism fails, the car can still be commanded to stop.

The second layer is the auto/manual switching mechanism, shown in Figure 11. The most important feature of the

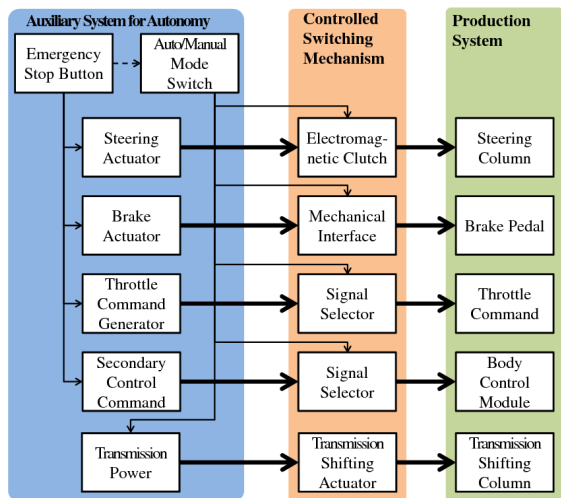

Fig. 11: Switching mechanism between autonomous mode and manual driving mode

switching module is that when the vehicle is in manual mode, the additional actuators are isolated from the stock vehicle through clutch, brake releasing and signal selection relays. Therefore, by disengaging the whole auxiliary system, the vehicle will become an unmodified car. The physical disengagement greatly improves driving safety when the platform is in manual mode.

The third layer, the emergency stop system, is designed to disable the auxiliary autonomous driving system entirely. The AC power from the inverter/converter is shut off by pressing the emergency stop button on the dashboard of the car, easily accessible. The backed-up power for the DBW system is also disconnected. This makes the vehicle platform return directly to manual mode, which is the nominal state. The three-layer safety subsystem is fully integrated and tested in the vehicle.

VII. COMPUTING PLATFORM

A. Computer Configurations

The hardware components of the SRX have been carefully chosen to satisfy the following requirements: (i) the temperature of the computing hardware must remain under its maximum operating temperature even inside its small and closed space; (ii) the computing hardware must offer enough computation resources to support complicated intelligent algorithms; and (iii) the vehicle must tolerate a single point of failure of the computing system.

Since one of our high-level requirements is that the automated vehicle should look as *normal* as possible, we decided

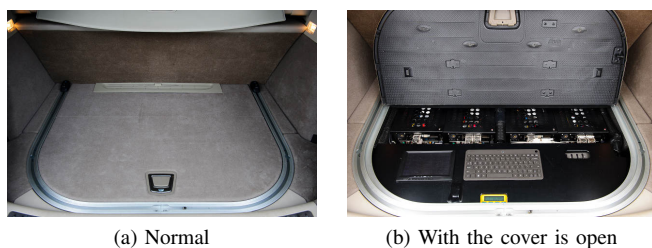

Fig. 12: Computing hardware components are hidden in the spare tire compartment.

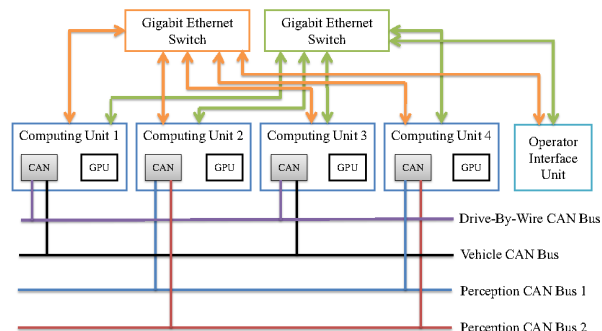

Fig. 13: Abstracted computing hardware architecture

to use small-scale-factor computers, which can be installed underneath the carpet in the trunk area. Four Intel® Core™2 Extreme Processor QX9300s with mini-ITX motherboards are deployed in a custom chassis. Each motherboard is also equipped with a CUDA-compatible GPU, NVIDIA GT530, having 96 cores for accelerating computations. We also have a separate operator interface computing unit equipped with an Intel® Atom™ Processor D525 to run a user application controlling the vehicle via an in-dash touch-screen interface. A tube extended from the car air conditioning system is directly attached to the custom chassis and pumps cold air into the computers.

B. Fault-tolerance Features

The ultimate goal of autonomous vehicle research is to achieve convenient and safe everyday autonomous driving. Therefore, it cannot be assumed that there will be a trained engineer taking over when the autonomous system fails. A single point of failure should not lead to an unsafe state of the vehicle. As a result, we enable the system to switch into (i) a fail-operational mode on the failure of a critical subsystem to bring the vehicle to a safe state and stopping, or (ii) a limp-home mode on tolerable failures.

To achieve these goals, making the vehicle computing platform fault-tolerant is essential. With this in mind, we selected the hardware such that each compute unit has the same hardware combination. Then, we can migrate the running algorithms on the vehicle from a given compute unit to other units in the case of failure, and it is easier for us to predict their timing characteristics due to the identical hardware. Network failure is also considered. To increase the reliability, we have deployed two Gigabit Ethernet switches for compute units to have two isolated networks. If one switch fails, the other switch should be able to operate so that the car can be driven to a safe place and stopped for maintenance. The same philosophy is adopted in the configuration of the three CANbuses [4] on the vehicle. The described abstracted computing hardware architecture is depicted in Figure 13.

C. Software System

The software infrastructure for the SRX has been extended from the Tartan Racing Urban Challenge System (TRUCS) [11], which was designed to support the perception, behavior, planning, and other artificial intelligence

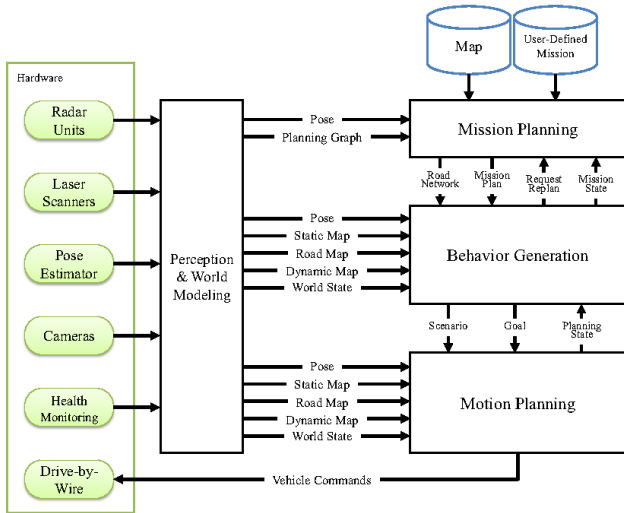

Fig. 14: Software architecture of the autonomous vehicle

components of an autonomous vehicle by providing an operator interface, inter-process communications system, process launching and management system, data logging system, configuration system, and task framework libraries. As mentioned in Section VII, adding fault tolerance to the computing platform is one of our main requirements, and its carefully chosen hardware should also be supported by a custom software framework. To meet the requirements described above, we have developed a layer which supports a range of configurable task-level fault-tolerant schemes such as hot standby, cold standby and adaptive graceful degradation with consideration of sensors and actuators on autonomous vehicles [9].

On top of the software infrastructure described above, perception, behavior and planning algorithms will run. The perception subsystem fuses data from multiple sensors and provides a composite model of the world to the other subsystems. The behavior subsystem makes decisions to execute the output of the mission planner, which finds the optimal route to the next destination given the road network. The motion planning subsystem avoids static and dynamic obstacles. The abstracted software architecture is illustrated in Figure 14.

VIII. USER INTERFACE

The user interface has greater importance in an autonomous vehicle than in normal cars. In autonomous driving, both human and car have a certain level of intelligence and are able to make decisions based on their own understandings of the driving scenario. Therefore, without smooth communication between them, the human driver/passenger may easily feel uncomfortable or even panicked. The user interface should provide the human operator the ability to cooperate with the car at four levels.

- 1) Mission level: Users should be able to input their destinations and select a preferred route;
- 2) Behavior level: Users should be able to adjust the autonomous driving preference (e.g. the preferred lane). The vehicle should generate notification or confirmation requests when it wants to perform certain behaviors like circumventions or U-turns. For the above two levels, a 7-inch touch screen integrated in the front



(a) Car Interior

(b) Center Console

Fig. 15: User Interface

dash of the vehicle (Figure 15b) is used as the main interface for the mission level, behavior-level communication and health status supervision. The vehicle's audio system is used for indication and notification.

- 3) Execution level: A safe switching mechanism allows the human driver to take over when desired. The auto/manual switching button described in Section VI allows the user to switch between autonomous mode and manual mode by physically engaging or disengaging the auxiliary autonomous driving system.
- 4) Remote Access level: The vehicle should be accessible remotely for autonomous-parking and passenger pickup applications. A smart phone interface is implemented for such applications.

The vehicle is also equipped with a developer interface, including a dedicated diagnostic panel for the computing cluster shown in Figure 13, a special diagnostic widget on the main touch screen and two additional monitoring displays on the backs of the front-seat headrests (Figure 15a). These devices enable developers to perform debugging more efficiently.

IX. AUTONOMOUS VEHICLE INTELLIGENCE

Based on the software framework developed by the Tartan Racing team of the DARPA Urban Challenge 2007, a variety of autonomous vehicle behaviors allow the car to deal with different kinds of driving scenarios.

1) *Mission planning*: The vehicle is able to automatically generate a route from the user's current location to his desired destination. There can be penalties for low speed limit, number of traffic light / stop signs, number of lane changes, etc. to find the path with the soonest estimated time of arrival. After the destination is chosen, autonomous driving can be enabled by pushing the auto/manual switch button.

2) *On-road driving*: On the road, the vehicle is able to perform lane-keeping and distance-keeping to slower traffic. It can perform a lane change if the vehicle needs to merge into another lane to exit the road or if the neighboring lane is faster [18]. The autonomous vehicle is also able to avoid on-road obstacles by either stopping if the road is blocked or circumventing if permitted, as shown in Figure 16.

3) *Work zone behavior*: The autonomous vehicle can detect work zones. It notifies the human driver to be ready to take over and also slows down to the work zone speed limit. The vehicle can also follow a shifted or alternate lane indicated by the work zone channelizers.

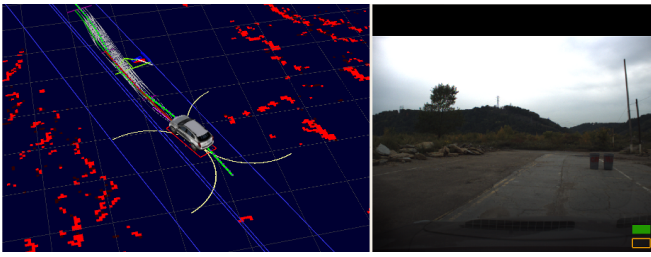

Fig. 16: The autonomous vehicle slows down and drives around obstacles on the road

4) *Pedestrian & Bicyclist Handling*: The vehicle is able to detect and stop for pedestrians crossing the road. If there is a bicyclist in front of the car, it will keep a safe distance and look for a safe opportunity to perform a lane change or circumvent.

5) *Intersections Handling*: The vehicle is able to traverse intersections with both stop signs and traffic lights. For instance, for a four-way-stop intersection, it can estimate precedence and decide when it is its turn to proceed, as shown in Figure 17. For a traffic light-controlled intersection, the vehicle will follow the rules to stop on red and go on green.

6) *Intersection Traversal using Vehicular Networks*: The vehicle is capable of communicating with other vehicles using DSRC, and it can cross an intersection with minimal stopping in two different ways: 1) using V2I (Vehicle-To-Infrastructure) or 2) V2V (Vehicle-To-Vehicle) communication. Our vehicle uses V2I communication to cross an intersection governed by a traffic light equipped with DSRC and V2V communication to cross a four-way-stop intersection. This can provide higher traffic throughput and shorter delay [1].

X. SUMMARY AND FUTURE WORK

A new, highly integrated autonomous vehicle has been developed and tested in a closed test field and public road for over a year. Experiments show that the platform design proposed in this paper is robust and easy for developers and end-users to operate. The vehicle is equipped with redundant sensors and has the ability to perform everyday driving while maintaining an appealing appearance. The system also has reliability and fault-tolerance features.

Future work includes improving the vehicle's intelligence. The vehicle should better understand surrounding vehicles' intentions / movements to perform socially cooperative behavior. The on-road planner will also be improved to perform more like skillful, socially aware human drivers for better social acceptance. Multiple fault-tolerance modes will be tested in the vehicle to ensure the car can still function even if one or more components fails. Along with these developments, more intensive road tests in different driving situations will be performed to analyze the vehicle's driving performance statistically.

REFERENCES

[1] R. Azimi, G. Bhatia, R. Rajkumar, and P. Mudalige. Intersection management using vehicular networks. In *SAE World Congress*, 2012.



Fig. 17: The autonomous vehicle stops at a four-way-stop intersection, and waits for its turn to move

- [2] M. Bertozzi, L. Bombini, A. Broggi, M. Buzzoni, E. Cardarelli, S. Cattani, P. Cerri, A. Coati, S. Debatisti, A. Falzoni, et al. Viac: An out of ordinary experiment. In *Intelligent Vehicles Symposium (IV)*, 2011 IEEE, pages 175–180. IEEE, 2011.
- [3] BMW ConnectedDrive. Take Over Please! http://www.bmw.com/com/en/insights/technology/connecteddrive/2010/future_lab/index.html#/1/4 as of Oct 5, 2012.
- [4] Bosch. *CAN Specification version 2.0*. Bosch, 1991.
- [5] M. Cellario. Human-centered intelligent vehicles: Toward multimodal interface integration. *Intelligent Systems, IEEE*, 16(4):78–81, 2001.
- [6] GM Press. Self-Driving Car in Cadillac's Future. http://media.gm.com/media/us/en/cadillac/news.detail.html/content/Pages/news/us/en/2012/Apr/0420_cadillac.html as of Oct 5, 2012.
- [7] P. Grisleri and I. Fedriga. The brave autonomous ground vehicle platform. In *Intelligent Autonomous Vehicles*, volume 7, pages 497–502, 2010.
- [8] J. Kenney. Dedicated Short-Range Communications (DSRC) Standards in the United States. *Proceedings of the IEEE*, 99(7):1162 – 1182, july 2011.
- [9] J. Kim, G. Bhatia, R. R. Rajkumar, and M. Jochim. SAFER: System-level Architecture for Failure Evasion in Real-time Applications. In *Proc. of the 33rd IEEE Real-Time Systems Symposium (RTSS)*, 2012.
- [10] J. Markoff. Google cars drive themselves, in traffic. *The New York Times*, 10:A1, 2010.
- [11] M. McNaughton, C. R. Baker, T. Galatali, B. Salesky, C. Urmson, and J. Ziegler. Software infrastructure for an autonomous ground vehicle. *Journal of Aerospace Computing, Information, and Communication*, 5(1):491 – 505, December 2008.
- [12] S. Pinkow. Continental Tests Highly-Automated Driving. http://www.conti-online.com/generator/www/com/en/continental/pressportal/themes/press_releases/3_automotive_group/chassis_safety/press_releases/pr_2012_03_23_automated_driving_en.html as of Oct 5, 2012.
- [13] D. Pomerleau. Alvin: An autonomous land vehicle in a neural network. In D. Touretzky, editor, *Advances in Neural Information Processing Systems 1*. Morgan Kaufmann, 1989.
- [14] S. Thrun. What we're driving at. <http://googleblog.blogspot.com/2010/10/what-were-driving-at.html> as of Oct 5, 2012.
- [15] S. Thrun, M. Montemerlo, H. Dahlkamp, D. Stavens, A. Aron, J. Diebel, P. Fong, J. Gale, M. Halpenny, G. Hoffmann, et al. Stanley: The robot that won the darpa grand challenge. *The 2005 DARPA Grand Challenge*, pages 1–43, 2007.
- [16] C. Urmson, J. Anhalt, D. Bagnell, C. Baker, R. Bittner, M. Clark, J. Dolan, D. Duggins, et al. Autonomous driving in urban environments: Boss and the urban challenge. *Journal of Field Robotics Special Issue on the 2007 DARPA Urban Challenge, Part 1*, 25(1):425–466, June 2008.
- [17] V. Vijayenthiran. Volkswagen Shows Off Self-Driving Auto Pilot Technology For Cars. MotorAuthority, 2011.
- [18] J. Wei, J. Dolan, and B. Litkouhi. A prediction-and cost function-based algorithm for robust autonomous freeway driving. In *Intelligent Vehicles Symposium (IV)*, 2010 IEEE, pages 512–517. IEEE, 2010.
- [19] J. Wei and J. M. Dolan. A multi-level collaborative driving framework for autonomous vehicles. In *The 18th IEEE International Symposium on Robot and Human Interactive Communication*, pages 40–45, September 2009.