

1. REPORT NUMBER CA18-2663	2. GOVERNMENT ASSOCIATION NUMBER	3. RECIPIENT'S CATALOG NUMBER
4. TITLE AND SUBTITLE Development and Field Testing of An Integrated Dynamic Transit Operation System (IDTO)		5. REPORT DATE August 2018
7. AUTHOR(S) Huadong Meng, Dachuan Li, Lu Li, Eric Kim, Justin Picar, Yun Xiang and Wei-Bin Zhang		6. PERFORMING ORGANIZATION CODE
9. PERFORMING ORGANIZATION NAME AND ADDRESS California PATH Program, University of California at Berkeley 1357 46th St., Richmond, CA 94804		8. PERFORMING ORGANIZATION REPORT NO. UCB-ITS-PRR-2018-01
12. SPONSORING AGENCY AND ADDRESS California Department of Transportation Division of Research and Innovation and System Information P.O. Box 942873, MS 83 Sacramento, CA 94273-0001		10. WORK UNIT NUMBER
		11. CONTRACT OR GRANT NUMBER
		13. TYPE OF REPORT AND PERIOD COVERED Final Report June 2015 – May 2018
		14. SPONSORING AGENCY CODE
15. SUPPLEMENTARY NOTES		

16. ABSTRACT

This report documents the research efforts to the design and development of an Integrated Dynamic Transit Operation System for suburban transit operations. The key concepts and operational scenarios for IDTO are specified based on the system requirements, and the IDTO system architecture is designed as an information system, along with the key functional components. An IDTO system is intended to enable T-CONNECT, T-DISP and D-RIDE services and real-time transit information for transit operations and travelers. Under this project, a prototype IDTO system has been implemented and tested. The IDTO prototype system which includes the IDTO server, a dispatch interface and a traveler mobile app has been field tested and demonstrated with respect to a number of Tri-Delta Transit bus routes and BART routes connecting at identified points, with a special focus on the implementation and test of T-COONNET application. Data collected from the field operational test has been analyzed to obtain the key findings in terms of system performance, benefits and impacts of IDTO operations. The test results indicate that IDTO can effectively detect trip delays, reduce travel time and meet passengers' needs in real-time.

17. KEY WORDS Integrated Dynamic Transit Operations, suburban transit, multimodal transit	18. DISTRIBUTION STATEMENT No restrictions. This document is available to the public through the National Technical Information Service, Springfield, VA 22161
19. SECURITY CLASSIFICATION (of this report) Unclassified	20. NUMBER OF PAGES 99
	21. COST OF REPORT CHARGED N/A

Development and Field Testing of An Integrated Dynamic Transit Operation System (IDTO)

Version 2.0

June 2018

Prepared by:

**California Partners for Advanced Transportation Technology (PATH),
University of California at Berkeley**

Prepared for:

**Tri Delta Transit
California Department of Transportation
Contra Costa Transportation Authority**

Authors:

Huadong Meng,

Dachuan Li,

Lu Li,

Eric Kim,

Justin Picar,

Yun Xiang,

Wei-Bin Zhang

Disclaimer Statement

This document is disseminated in the interest of information exchange. The contents of this report reflect the views of the authors, who are responsible for the facts and accuracy of the data presented herein. The contents do not necessarily reflect the official views or policies of the State of California or the Federal Highway Administration. This publication does not constitute a standard, specification, or regulation. This report does not constitute an endorsement by the California Department of Transportation (Caltrans) and Federal Transit Administration of any product described herein.

For individuals with sensory disabilities, this document is available in braille, large print, audiocassette, or compact disk. To obtain a copy of this document in one of these alternate formats, please contact: the California Department of Transportation, Division of Research Innovation, and Systems Information, MS-83, P.O. Box 942873, Sacramento, CA 94273-0001.

Executive Summary

Transit agencies in suburban regions in California and the U.S. are facing enormous challenges to improve transit operation efficiency and to provide cost-effective operations, due to the fact that the traveling populations are distributed in large geographic regions. Therefore, transit agencies must assign a limited number of vehicles on routes to ensure geographic coverages, resulting in long headways between vehicles and long waiting time for travelers. This significantly discourages choices to take public transit.

The Integrated Dynamic Transit Operations system is intended to enable enhanced connectivity, reduced travel time and improved transit operations by providing transit connection protection (T-CONNECT), dynamic dispatch (T-DISP) and dynamic ride-sharing (D-RIDE) applications. The T-CONNECT application intends to improve the successful transfer between multiple transit modes (BART-bus, car-bus) and between different bus routes of an individual agency, by extending wait time of outbound buses at transfer stops to meet with connecting passengers. The T-DISP aims at dynamically adjusting transit routes and stops to be responsive to travelers' demand and traffic conditions. The D-RIDE intends to facilitate first-mile and last-mile shared riders by arranging shared rides in real-time. The phase one effort of IDTO project focuses on the framework design and functional definition of the IDTO prototype, and the development of a preliminary IDTO prototype, with special attention to the T-CONNECT functionality.

The IDTO Phase One effort can be summarized as follows: The concept of operations (ConOps) and conceptual design are specified based on the definition of sponsors' requirements, and the IDTO system architecture is designed. Based on the system design, we developed an IDTO system architecture that includes the essential functional components, including the IDTO server, a dispatch interface and an IDTO mobile app for passengers.

The IDTO server hosts transit database and transit data management, the decision support planner and the notification planner, using the cloud computing services provided by AWS. The IDTO server receives input from the travelers' mobile devices, executes the IDTO primary logic using the static and real-time transit data, and pushes notification messages regarding real-time trip updates. The dispatch interface is the primary interface located at the transit dispatch center for the operation personnel, which enables dispatchers to receive and process IDTO requests from the IDTO server. The processing results are then sent back to the IDTO server. The IDTO mobile application runs on the travelers' mobile devices and acts as the interface between the passengers and IDTO system. It enables the users to input travel information of routes and transfer stops, and to receive downstream push notifications about real-time service and personalized trip update information.

An IDTO prototype with the focus on T-Connect application has been developed and implemented based on the ConOps and system design. The system components were tested separately and

then integrated into the IDTO prototype. The field operational test (FOT) was conducted during the period from July 25th to August 11th, 2017. For the Phase One effort, the demonstration and field testing focused on the T-CONNECT application which was implemented on selected routes (380w, 383ccw, 388w 300w, 390e and 391e) operated by TDT and Pittsburg/Bay Point BART at two major connection points (Antioch Park & Ride, Pittsburg/Bay Point BART station). The data collected during FOT and historical operation data were analyzed to evaluate the performance of the IDTO prototype, as well as the impact of IDTO operations.

Benefits and impacts of IDTO are evaluated in terms of connection needs detection, correspondence with passengers' needs, trip time savings and the improvement on the connection success rate, using the data collected from the FOT. The evaluation shows that the IDTO prototype can correctly identify 85.5% of all trip delays involving connection failures during the FOT, and the precision of T-CONNECT requests of IDTO prototype reaches 72.3%, indicating that the IDTO prototype system can effectively detect trip delays and submit T-CONNECT requests to hold the connecting bus. Due to the vehicle holding service provided by the IDTO T-CONNECT function, the passengers' waiting time decreases by 23.78 minutes and 30.71 minutes on average as a result of connections being successfully protected, for bus-bus and BART-bus scenarios respectively. The success rate of connections can be increased from 80.21% to 97.12% by implementing T-CONNECT. In addition, FOT results indicate that the IDTO system-submitted T-CONNECT request matches the passengers' manual connection protection requests well, indicating that the IDTO prototype is able to fulfill passengers' actual needs for requesting connection protection services, where T-Connect requests can be automatically submitted without passengers' interventions.

The promising results of the FOT indicate that the IDTO prototype with the T-CONNECT application has demonstrated the potential to improve connectivity, reduce travel time and enable efficient and cost-effective transit operations. The project further recommends that a fully-functional IDTO prototype needs to be developed and implemented in order to further investigate the benefits of T-CONNECT, T-DISP and D-RIDE applications and the impacts of the IDTO operations in the real operation settings.

Table of Contents

ACRONYMS AND DEFINITIONS	XI
1 INTRODUCTION.....	12
1.1 OVERVIEW OF THIS RESEARCH PROJECT ON IDTO	12
1.2 REPORT OVERVIEW.....	13
2 CURRENT STATUS OF SUBURBAN TRANSIT OPERATIONS.....	15
2.1 COMMUTE PROFILE WITHIN THE DEMONSTRATION SITE REGION	15
2.2 OVERVIEW OF TRANSIT OPERATION AT TRI DELTA TRANSIT	15
2.3 COMPARISONS WITH PREVIOUS DEVELOPMENTS OF DYNAMIC TRANSIT OPERATION.....	18
3 IDTO CONCEPT OF OPERATION.....	20
3.1 IDTO GOAL	20
3.2 PRIMARY FUNCTIONALITIES OF IDTO	20
3.3 IDTO KEY CONCEPTS	21
3.4 CONCEPTUAL ARCHITECTURE	22
3.5 OPERATIONAL SCENARIOS.....	23
3.5.1 <i>Scenario 1: Dynamic Connection Protection (T-CONNECT)</i>	23
3.5.2 <i>Scenario 2: Dynamic Dispatching (T-DISP)</i>	26
3.5.3 <i>Scenario 3: Dynamic Ridesharing (D-RIDE)</i>	26
4 DEVELOPMENT OF IDTO PROTOTYPE	28
4.1 ASSUMPTIONS AND CONSTRAINTS OF IDTO	28
4.2 PHYSICAL ARCHITECTURE	29
4.3 ACTIVITY SEQUENCE OF OPERATIONAL SCENARIOS	33
4.3.1 <i>Activity Sequence 1: Connection Protection (T-CONNECT)</i>	33
4.3.2 <i>Activity Sequence 2: Dynamic Dispatching (T-DISP)</i>	34
4.3.3 <i>Activity Sequence 3: Dynamic Ridesharing (D-RIDE)</i>	35
4.4 DEVELOPMENT OF IDTO SERVER	35
4.4.1 <i>IDTO Database and Transit Data Management</i>	35
4.4.2 <i>IDTO Decision Support Planner</i>	41
4.4.3 <i>IDTO Notification Manager and Notification Pushing</i>	42
4.5 DEVELOPMENT OF DISPATCHER INTERFACE	43
4.5.1 <i>Dispatcher Interface Frame</i>	43
4.5.2 <i>Dispatcher Interface Operational Logistics</i>	46
4.6 DEVELOPMENT OF IDTO MOBILE APPLICATION.....	47
4.6.1 <i>IDTO Mobile Application Interface Frame</i>	47
4.6.2 <i>IDTO Mobile Application Interface Operational Logistics</i>	50
4.6.3 <i>IDTO Push-notifications</i>	54
5 FIELD OPERATIONAL TEST	57
5.1 ANALYSIS OF THE CONNECTION ACTIVITIES	57

5.1.1	<i>Analysis of the boarding/alighting activities</i>	57
5.1.2	<i>Analysis of the connections between bus routes</i>	60
5.1.3	<i>Analysis of the connection of selected trips</i>	68
5.1.4	<i>Analysis of the distribution of the arrival time</i>	72
5.1.5	<i>Conclusions</i>	76
5.2	FIELD OPERATIONAL TEST DESIGN	76
5.3	FIELD OPERATIONAL TEST DATA COLLECTION AND LOGGING	79
5.4	COLLECTION OF HISTORIC OPERATIONAL TEST DATA	82
5.5	DATA PROCESSING	83
5.6	SYSTEM EVALUATION AND SUMMARY OF BENEFITS	84
5.6.1	<i>Evaluation Criteria and Methodology</i>	84
5.6.2	<i>Capability of Trip Delay Detection</i>	85
5.6.3	<i>Correspondence with Manual Connection Protection Requests</i>	91
5.6.4	<i>Savings on Passengers' Trip Time</i>	94
5.6.5	<i>Improvement on the Success Rate of Connections</i>	95
6	CONCLUSIONS AND RECOMMENDATIONS	97
6.1	SUMMARY OF DEVELOPMENT	97
6.2	SUMMARY OF BENEFITS AND IMPROVEMENTS	97
6.3	RECOMMENDATIONS	98

List of Figures

Figure 1. Transit Service Map of Proposed Demonstration Site: a) Bus Transit Map of Proposed Demonstration Site; b) Rail Transit Map of Proposed Demonstration Site.....	16
Figure 2. Typical Midweek Freeway Conditions: a) at 8:00 am b) at 5:30 pm	17
Figure 3. IDTO Conceptual Architecture.....	23
Figure 4. Passenger boarding/alighting at Hillcrest Park & Ride station	26
Figure 5. IDTO System Architecture	32
Figure 6. Sequence Diagram of Scenario 1: T-CONNECT.....	37
Figure 7. Sequence Diagram of Scenario 2(a) Route Deviation to Avoid Congestion	38
Figure 8. Sequence Diagram of Scenario 2(b) Route Deviation to Pick Up Passenger	39
Figure 9. IDTO Database and Transit Data Management.....	40
Figure 10. Decision Support Planner Flowchart	42
Figure 11. GCM mechanism	43
Figure 12. IDTO Dispatcher Interface	45
Figure 13. Interactions on the Dispatcher Interface	46
Figure 14. Activity Graph of Dispatcher Interface	48
Figure 15. Mobile App Interface.....	49
Figure 16. Interactions on the Mobile App Interface	50
Figure 17. Mobile App registration and login page	51
Figure 18. Activity Graph of Input Trip Information.....	52
Figure 19. IDTO Mobile App T-CONNECT Components.....	53
Figure 20. IDTO mobile notifications.....	55
Figure 21. Activity Graph of register and subscribe a trip.....	56
Figure 22 Hillcrest P & R and BART Central Platform station	57
Figure 23. Pittsburg/Bay Point BART station	58
Figure 24. Hillcrest P&R station.....	59
Figure 25. Information of bus routes that visit Hillcrest Park & Ride station.....	64
Figure 26. 380W connect to 300W (trip 1087) at Hillcrest Park & Ride station.....	69
Figure 27. Connection success rate of T-CONNECT of 380W to 300W (trip 1087) at Hillcrest P & R	69
Figure 28. 380W connect to 300W (trip 1090) at Hillcrest P & R station	70
Figure 29. Connection success rate of T-CONNECT of 380W to 300W (trip 1090) at Hillcrest P & R	71
Figure 30. 388W connect to 300W (trip 1087) at Hillcrest P & R.....	72
Figure 31. Connection success rate of T-CONNECT of 388W to 300W (trip 1087) at Hillcrest P& R	72
Figure 32. Demonstration Connection points (BART Central Platform and Antioch P&R).....	77
Figure 33. Workflow of T-Connect demonstration	82
Figure 34. Definitions of connection sensitivity and request precision	86

Figure 35. a) Connection sensitivity of T-Connect requests; b) Request precision of T-Connect requests.....	88
Figure 36. a) Connection sensitivity and b) request precision of T-Connect requests involving bus No. 380w	89
Figure 37. a) Connection sensitivity and b) request precision of T-Connect requests involving bus No. 388w	90
Figure 38. a) Connection sensitivity and b) request precision of T-Connect requests involving bus No. 383ccw.....	91
Figure 39. Parallel testing flow of T-CONNECT.....	93
Figure 40. Definition of connection success rate	96

List of Tables

Table 1. Previous and Current IDTO Development Status	19
Table 2. IDTO Operational Scenarios.....	23
Table 3. Major Connections of Tri-Delta Transit	25
Table 4. Tables in the Transit Database	41
Table 5. Total passenger boarding/alighting on stations from historical data.....	57
Table 6. Routes which have hourly passenger boarding/alighting larger than 5 at Bart station ..	59
Table 7. Routes which have hourly boarding/alighting larger than 5 at Hillcrest P&R station	60
Table 8. Top 10 bus stations with the most bus routes from historical data for half-year	61
Table 9. Bus routes information at Hillcrest Park & Ride station	62
Table 10. Actual connections of bus routes at Hillcrest Park & Ride station from historical data	66
Table 11. Connections of bus routes at Hillcrest Park & Ride station from historical data.....	66
Table 12. Potential connections to 300W from 383 at Hillcrest Park & Ride station from historical data	67
Table 13. Potential connectivity of 388E from 300E at Hillcrest Park & Ride station from historical data	68
Table 14. Potential connectivity of 388E from 391E at Hillcrest Park & Ride station from historical data	68
Table 15. Total trip time of passenger transferring from 380W to 300W.....	70
Table 16. Total trip time of passenger transferring from 380W to 300W with/without T-CONNECT.....	70
Table 17. Averaged delay of the time of arrivals.....	75
Table 18. IDTO demonstration trips and connection points	77
Table 19. Operational Sequence for the T-CONNECT demonstration.....	79
Table 20. Schema of T-CONNECT request/service log	80
Table 21. Schema of AVL data	81
Table 22. APC data schema	83
Table 23. T-CONNECT Statistics.....	87
Table 24. Matching Rate with Manual Connection Protection Requests.....	92
Table 25. Success rate of connections	96

Acronyms and Definitions

APC	Automated Passenger Counting
AVL	Automatic Vehicle Location
BART	San Francisco Bay Area Rapid Transit
Caltrans	California Department of Transportation
ConOps	Concept of Operations
CPUC	California Public Utilities Commission
D-RIDE	Dynamic Ridesharing
FOT	Field Operational Test
FTA	Federal Transit Administration
GPS	Global Positioning System
DTO	Dynamic Transit Operation
IDTO	Integrated Dynamic Transit Operation
ITS	Intelligent Transportation System
O-D	Origin-Destination
PATH	California Partners for Advanced Transportation Technology
PeMs	Caltrans Performance Measurement System
T-CONNECT	Connection Protection
T-DISP	Dynamic Dispatching

1 Introduction

Transit agencies in suburban regions in California and in the United States face enormous challenges for delivering cost effective operations due to the fact that traveling populations are distributed in large geographic areas. Transit operations in suburban California and in the U.S. have been a business-as-usual for many years. Operators typically assign a limited number of buses on the maximum number of routes possible in order to offer wide geographic coverage. As a result, the headway of each bus route is long (i.e., 20 to 30 minutes or often longer) and many passengers need transfers among such routes in order to reach their destinations. Consequently, travel using transit takes much longer than the driving alternative. The longer travel time significantly discourages choices to take transit. Transit agencies need tools to be able to innovate transit operations.

Integrated Dynamic Connection Operation (IDTO) applications are expected to have great potential to support the transit dispatcher center in adjusting transit routing to pick up passengers not on regular routes (Dynamic Dispatch or T-DISP), to extend wait time at bus stops to meet with connecting passengers (Connection Protection or T-CONNECT), and to facilitate first-mile and last-mile shared riders (Dynamic Rideshare or D-RIDE). This will occur in real-time in order to offer connectivity, faster travel time, and more convenient and higher service quality to the traveling public. Therefore, IDTO can offer significantly reduced travel time and improve connectivity for a greater number of travelers, change travel demand which in turn will help congestion relief, run a more cost-effective operation, and create positive changes in inter-organizational cooperation. IDTO represents a significant innovation of transit operations and may potentially change the way in which transit services are operated in suburban American cities. While IDTO applications have long been desired, the deployment of IDTO cannot be easily realized until GPS and communication systems are widely applied in the transit industry. Therefore, it is of vital importance to develop a fully functional IDTO prototype system by leveraging a combination of innovative methodologies and data collected from connected travelers, vehicles and infrastructure, and to investigate the benefits and impacts of IDTO operations

1.1 Overview of this Research Project on IDTO

The objective of this research project is to develop a prototype Integrated Dynamic Transit Operation (IDTO) prototype system that enables T-DISP, T-CONNECT and D-RIDE services as well as real-time information for transit operations and travelers. This prototype IDTO was tested and demonstrated with limited scale at Tri Delta Transit

agency in this phase of the project. A rich set of data was collected from the field testing to evaluate the benefits and impacts and IDTO.

Under the sponsorship of Caltrans, California PATH, Tri Delta Transit, and the Contra Costa Transportation Authority have been devoting efforts investigating the benefits of IDTO. This study conducted a case study of IDTO applications for a number of bus routes in a typical suburban transit operation. As a part of USDOT's Dynamic Mobility Program, a prototype IDTO system with T-CONNECT function was developed and field tested.

In the development of this project, a combination of innovative real-time data capture, data management, transit decision-making and real-time transit information notification methodologies and tools were used to enable improved dynamic transit applications.

Field-operational testing was conducted on bus routes and multiple transfer stops within Tri Delta Transit service areas that connecting regional transit rail (BART), with special focus on the T-CONNECT applications. The IDTO prototype was integrated with the Tri-Delta Transit dispatching operations during the two-weeks period. The testing scenarios included both bus-bus and transit rail-bus connections. A rich set of operational data was collected from both the IDTO prototype and the Tri-Delta Transit operational facility. An assessment of the technical and performance issues related to the field testing was conducted after the testing period.

The results have shown that IDTO provides improved level of service to passengers and supports enhanced transit operations by enabling travelers to interact with transit systems on trip options and real-time needs. T-Connect can significantly improve connections between transit routes, thus offering substantial reduction of travel time for transfer passengers; T-DISP and D-RIDE combined can offer travelers with connectivity and convenience, thus they have potential to attract choice riders.

The results in better passenger service and improved transit operations will expand the horizon for public transit management, offering the opportunity to both improve service level and facilitate better operational and planning decisions. The promising results indicate that additional test sites including bus stops, routes and connecting points within the transit agency should be further implemented and tested in full scale in the next phase.

1.2 Report Overview

This document is built upon the previously submitted concept of operations (ConOps), concept design and system requirement documents, and summarizes the development of prototype IDTO system, the field operational testing design, as well as key findings from the IDTO project.

The remainder of this document is organized as follows: Section 2 summarizes the current status of suburban transit operations; Section 3 provides the IDTO concept of operations; Section 4 summarizes the development of the IDTO prototype system; Section 5 describes the field operational testing and key findings related to the IDTO field operational testing.

2 Current Status of Suburban Transit Operations

2.1 Commute Profile within the Demonstration Site Region

This IDTO project focuses on the suburban region of Contra Costa County. 82% of all Contra Costa County commuters travel by car (64% drive alone and 18% carpool) and 15% use public transportation; the average one-way commute time is 35 minutes for an average commute distance of 22 miles. Although the commute patterns vary among the regions of East and Central Contra Costa and Tri-Valley, there are several common characteristics:

- 45% of Tri Delta Transit customers are frequent users who ride a bus 5+ days per week¹. Of those frequent users, many are “transit dependent” (i.e., lacking access to a car).
- 40% Tri Delta Transit need to make at least one transfer during their trip.
- 10% of all Tri Delta Transit trips transferring to/from BART account for the most frequent inter-system transfers.

2.2 Overview of Transit Operation at Tri Delta Transit

The demonstration site of the IDTO is in the Eastern Area of Contra Costa County in the San Francisco Bay Area, including the communities of Bay Point, Pittsburg, Antioch, Oakley, Brentwood, Discovery Bay and Byron (see Figure 1.a) Tri Delta Transit, also known as Eastern Contra Costa Transit Authority (ECCTA), is the local public transit transportation provider for the proposed demonstration site with a population of about 280,000 residents in the 225 square miles of Eastern Contra Costa County. Tri Delta owns a total of 96 revenue vehicles, including 67 fixed-route buses, 23 Dial-a-Ride buses and 6 med-vans. All buses are wheelchair accessible. Tri Delta Transit operates 13 weekday local bus routes (including express route 300) and four local bus routes on weekends and holidays to serve more than 650 bus stops, and door-to-door bus service (Dial-a-Ride) for senior citizens and people with disabilities. Tri Delta Transit provides nearly 10,000 rides per day on fixed-route service and over 300 rides per day on Dial-a-Ride.

In addition to serving patrons who travel within the service area, Tri Delta Transit provides transit connection service to adjacent areas and other public transit transportation providers to move travelers to other regions in the San Francisco Bay Area (see Figure 1 b). Tri Delta Transit local buses connect to the Bay Area Rapid Transit (BART) system at

¹ Tri Delta Transit. 2012 Passenger Survey Report.

Pittsburg/Bay Point and Concord, Amtrak Capitol Corridor trains at Martinez, and with transit agencies County Connection at shared bus stops.

Tri Delta Transit operates along State Highway 4 corridor, which suffers recurrent congestions during the peak periods. The Caltrans Performance Measurement System (PeMS) collects loop detector data and estimates real-time traffic conditions. In addition, a number of FasTrak readers are installed along the major freeways to collect point-to-point travel time. The archived loop data and point-to-point detector data are being used to forecast driving times for about 90% of the Bay Area freeway network². Real-time traffic conditions, incidents, and travel time forecasts are currently available to the public through '511 SF Bay' Web APIs³. Figures 2 a) and Figure 2 b) illustrate typical midweek (Tuesday to Thursday) morning and afternoon peak freeway conditions.

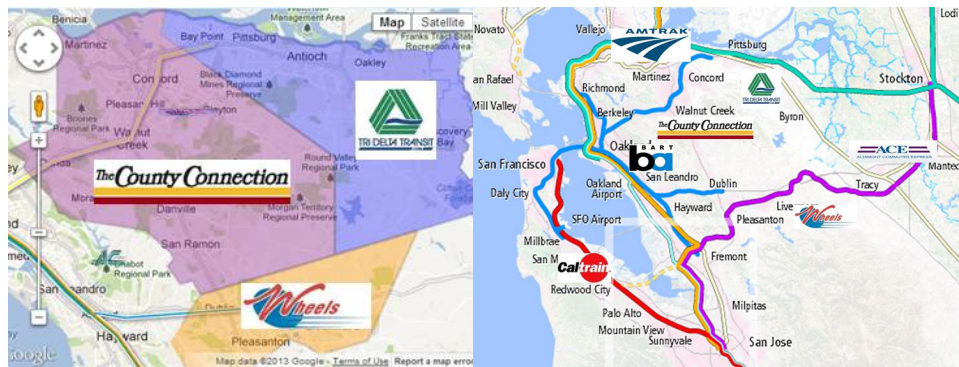

a) b)
 Figure 1. Transit Service Map of Proposed Demonstration Site; a) Bus Transit Map of Proposed Demonstration Site; b) Rail Transit Map of Proposed Demonstration Site

² <http://www.mtc.ca.gov/news/transactions/ta02-0307/predict-a-trip.htm>

³ <http://511.org/developer-resources.asp>

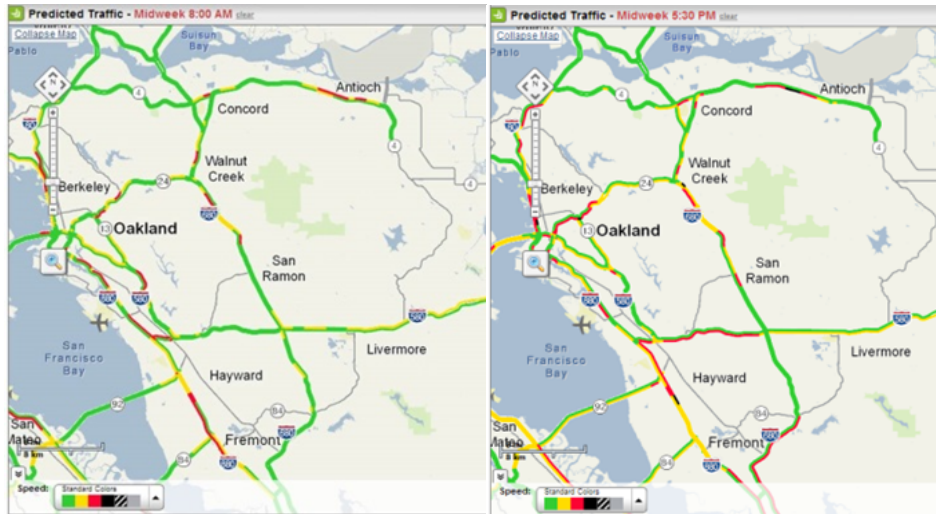

a) b)
 Figure 2. Typical Midweek Freeway Conditions: a) at 8:00 am b) at 5:30 pm

Tri Delta Transit is equipped with a transit management system developed by Connexionz. The transit management system is capable of providing real-time bus AVL/APC data⁴ and predicted arrival time data. However, Tri Delta Transit management system does not have an onboard data terminal. The communication between a bus operator and the dispatch center (including holding bus requests) is via voice over radio. Real-time bus arrival information has become available on the Internet and through mobile applications.

There are four Park-N-Ride lots within the Tri Delta Transit service area that offer free parking and connections to BART and Tri Delta Transit, namely, the future BART Station at Hillcrest in Antioch (with 312 parking spaces), the Brentwood Park-N-Ride (with 78 parking spaces), the Pittsburg Park-N-Ride (with 125 parking spaces), and the Discovery Bay Park-N-Ride (with 41 parking spaces). Most of the Park-N-Ride lots are not being fully utilized. Parking is also available at BART Stations at Pittsburg/Bay Point and Concord, however they are usually filled before 8 AM. Tri Delta Transit service honors free inter-agency transfers among the connecting transit agencies at shared bus stops and offer reduced fares for transferring from BART.

Tri Delta Transit has already deployed operations of connection protection in response to phone calls from passengers. Bus operators also hold the buses at BART station based on train arrival indication lights. Tri Delta Transit buses also perform route deviation for congestion avoidance. Bus operators report to dispatch about the congestion, and dispatch assigns the detour route.

⁴ Currently APC is not provided in real-time

2.3 Comparisons with Previous Developments of Dynamic Transit Operation

Dynamic Transit Operation (DTO) is a desirable public transportation mode which has been implemented for few paratransit services but has not been deployed for regular transit service routes in the United States. United State Department of Transportation sponsored field operation tests of IDTO between 2013 and 2014 in Ohio and Florida, respectively. Only Connection protection has been tested in the full-scale transit operation environment. Because of the 1-minute maximum holding time limitation, the success rates for connection protection were low. In addition, since the services have to be initiated by the passengers' requests for the above IDTO prototypes, only one request was received from the passenger during the demonstration. Therefore, it is difficult to investigate the effectiveness and impacts of the IDTO system due to the limited amount of FOT data.

In contrast, the IDTO project efforts summarized in this report focus on multimodal transit including both bus-bus and BART-bus connections, and the system is designed to detect trip delays and submit T-CONNECT requests automatically when connection protection conditions are met, without requiring any passengers' intervention. In addition, the field operational testing data was collected, and a comprehensive analysis was conducted to

evaluate the performance of the IDTO prototype and impacts of implementing T-CONNECT. Table 1 provides a summary of these field operational tests.

IDTO Applications	Columbus, OH	Orlando, FL	Contra Costa, CA
T CONNECT	<p>Agencies:</p> <ul style="list-style-type: none"> Central Ohio Transit Authority (COTA) Fixed-Bus-Routes OSU Campus Area Bus System (CABS) Free On-Campus bus service <p>Scenarios:</p> <ul style="list-style-type: none"> T-CONNECT on selected COTA routes (transfer within COTA) and at selected OSU campus locations (CABS to COTA transfer) 	<p>Agencies:</p> <ul style="list-style-type: none"> Central Florida Regional Transportation Authority (LYNX) UCF on-campus shuttle service SunRail – commuter rail, 31 miles with 12 station <p>Scenarios:</p> <ul style="list-style-type: none"> T-CONNECT on selected LYNX routes (transfer within LYNX), at selected UCF campus (UCF shuttle to LYNX transfer), and potentially at selected SunRail stations (SunRail to LYNX transfer) 	<p>Agencies:</p> <ul style="list-style-type: none"> Contra Costa Transportation Authority(CCTA) Tri-Delta Transit (TDT) bus service Bay Area Rapid Transit (BART) rail system <p>Scenarios:</p> <ul style="list-style-type: none"> T-CONNECT for bus-bus connections on selected TDT routes, at selected connection points T-CONNECT for rail-bus connections on selected TDT routes and BART line, at selected connection points
T DISP	OSU TaxiCABS (demand responsive shuttle service for faculty and staff)	LYNX FlexBus (demand responsive station-to-station service)	<ul style="list-style-type: none"> T-DISP potentially at selected TDT routes
Demo/Service period	<ul style="list-style-type: none"> Service started in late-May, 2014 	<ul style="list-style-type: none"> Demonstration began on April, 2014 	<ul style="list-style-type: none"> Demonstration from July to August, 2017

Table 1. Previous and Current IDTO Development Status

3 IDTO Concept of Operation

3.1 IDTO Goal

The goal of implementing IDTO is twofold:

- From travelers' perspective, the goal of IDTO is to enable transit to become a viable transportation option that helps people effortlessly transfer from one mode of travel (car, bus, train, etc.) to another for the fastest and most environmentally-friendly trip and makes multiple-modal travel truly possible.

- From transit agencies' perspectives, IDTO is to promptly respond to travelers' needs in a cost-effective manner thereby attracting more transit riders, reducing the transit operation costs, and enabling public transit to assume a greater role in the overall solution to reduce transportation congestion, increase safety, and improve air quality.

3.2 Primary functionalities of IDTO

The primary functions that the IDTO system are supposed to ultimately achieve as follows:

- **Real-time trip information** enables passengers to receive “personalized” real-time trip information about transit vehicle arrivals at their origin and destination stop on their planned travel route and the ability to ‘interact’ with transit by requesting timely transit services.
- **T-CONNECT** application is intended to improve the successful transfer between mode (from car to bus, train to bus) and between different bus routes of an individual agency.
- **T-DISP** application is intended to dynamically adjust transit routes and stops to be responsive to travelers' demand and traffic conditions. T-DISP may involve:
 - Deviating from the route to avoid traffic congestion (can be detected by real-time traffic conditions and incident information).
 - Deviating from the route to pick up passengers who are either having difficulty gaining access to the transit stop, or the passengers prefer to be picked up at familiar and/or alternative locations.
- **D-RIDE** acts as a service to arrange shared rides in real-time between origin and transit stops, as well as between transit stops and destination, and it offers the potential to reduce the number of transit vehicles used for personal travel, leading to significant environmental and economic benefits.

For the phase one effort, the investigation focuses mainly on the development and implementation T-CONNECT function, and the design and specification of T-DISP and D-

RIDE functions. The complete development and testing of T-DISP and D-RIDE will be conducted in future phase.

3.3 IDTO Key Concepts

IDTO is implemented through dynamic operations supporting tools for automatic connection protection, route deviation decision making and dynamic ride sharing following a set of predesigned operation rules. IDTO dynamic operation advisories can be provided through an on-board driver communication terminal via transit data communication and management system. IDTO is intended to require minimum involvement of the dispatcher center except for cases exceeding the pre-configured rules. In the demonstration of the first phase, since direct data communication terminal has not been integrated, the IDTO dynamic operation advisories are currently communicated to the bus operators by dispatchers through voice radio communication. (The in-vehicle communication terminal will be implemented in the next phase of the IDO project, thus most of the dispatch involvement will no longer be necessary).

IDTO functions should be transparent to travelers in an on-demand manner, but with a condition that a bus may or may not be available. A traveler would input the trip (bus or BART trip) he/she is currently taking (or automatically set to the user's current location using the Smartphone GPS), the trip he/she would like to transfer to, and the transfer points (e.g., bus stop or BART station, etc.). The IDTO system, taking into consideration the real-time transit and traffic condition information, will register the traveler's trip information and connection requests. Once the traveler has confirmed the connection information, the IDTO system will track the user throughout the planned trip and will request IDTO operation (e.g. connection protection request) according to the current condition of the system. IDTO will provide real-time update of IDTO service status to the traveler and require confirmation when needed.

When a traveler's trip originates from a region served by dynamic transit service, a service request is placed by the IDTO system. T-DISP evaluates the condition of the in-route transit vehicles and designates an available transit bus to deviate from its routes when necessary to pick up the passenger who made the request.

The IDTO system will keep an update on the status of the traveler and the corresponding trains/buses, and when needed, automatically place T-CONNECT requests for connection protections. The traveler will be informed of updates or status changes, preferably through notifications on the traveler's mobile device.

After the passenger reaches his/her destination stop, but still is distance away from his/her final destination, D-RIDE will evaluate available ridesharing options that are

desired by the traveler and match this traveler with a potential ride provider (The D-RIDE function was not designed or developed in this phase of the IDTO project, and the development will be in the next research phase).

As a traveler can change his/her options during a planned trip, new trip information will be registered in the IDTO system for the traveler based on the traveler's preference, and the IDTO system will continue to assist the traveler throughout the newly planned trip.

3.4 Conceptual Architecture

The following conceptual architecture has been conceptualized for the development of the IDTO prototype under this project, as depicted in Figure 3. The IDTO system consists of the following key functional elements:

- Mobile interface that enables travelers to input trip information and receive real-time trip information and notifications as described in the typical use case.
- An IDTO server that hosts Decision Support (DS) tools, Primary Planners (PP) and Notification Manager (NM). The DC tools interact with travelers to take O/D inputs, calculate travel choices, present the choices to the traveler, take traveler's confirmation and submit specific requests to the IDTO PP tools when this request involves transit buses. The responsibility of the PP tool is to evaluate the feasible strategies (i.e., T-DISP or T-CONNECT) that will accommodate the request from the travelers. Once a feasible T-DISP and T-CONNECT strategy is found, it will be submitted to transit dispatchers for confirmation and execution. The NM pushes real time trip update information and notifications when there are important changes and decisions on the traveler's current trip.
- IDTO dispatch interfaces located at the transit operation center which enable transit operation staff to receive requests from the IDTO server and to communicate with bus drivers either through voice or via in-vehicle communication terminals through transit management system to advise drivers to implement connection protection or dynamic deviation operations.

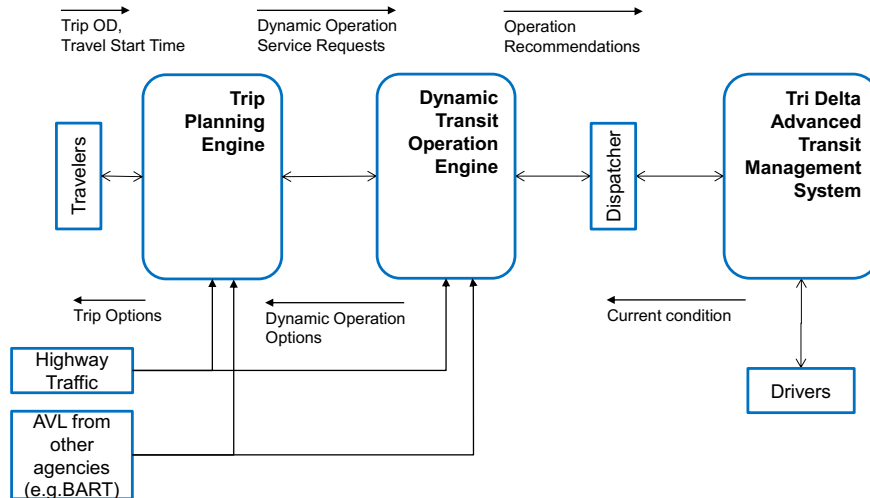

Figure 3. IDTO Conceptual Architecture

3.5 Operational Scenarios

A suite of IDTO scenarios to be implemented at Tri Delta Transit covers all three dynamic transit operations, as summarized in Table 2. A multimodal real-time traveler information system will be integrated with the dynamic transit operation to offer maximum benefit to travelers. (In the first phase, this project mainly focused on the development and implementation of T-CONNECT applications, and the application to the T-CONNECT scenarios are demonstrated in the field operational testing)

Application	Scenarios
T-CONNECT	Train-to-bus connection protection at BART stations
	Bus-to-bus connection protection at key transfer points
T-DISP	Route deviation to avoid congestion (fixed-route)
	Route deviation to pick up passengers (fixed-route)
D-RIDE	Bus-to-ridesharing service

Table 2. IDTO Operational Scenarios

Additional details of the dynamic operation scenarios will be provided in the following subsections.

3.5.1 Scenario 1: Dynamic Connection Protection (T-CONNECT)

IDTO T-CONNECT helps travelers to make connections at major meeting points by holding one bus up to a predetermined period to wait for the arrival of passengers from another

arriving bus or BART, in cases that the arriving bus or BART is behind the schedule. An IDTO traveler can obtain the T-CONNECT service through automatic delay detection and connection protection request of the IDTO server or directly requesting on a connection bus via mobile interface.

- Scenario 1(a) T-Connect request triggering using trip information
 - 1) Passengers use the IDTO mobile app to input trip information and initiate a trip.
 - 2) IDTO system tracks traveler's trip activities and determines that he/she is on a service bus or BART train X.
 - 3) IDTO system detects that bus/train X will be behind the schedule, and the connecting bus Y will depart from the transfer stop before bus/train X arrives, after evaluating the impacts of the connection prediction, advises bus Y to wait at the transfer station.
 - 4) IDTO system confirms bus holding activity with the passenger through their IDTO mobile app.

- Scenario 1(b) T-Connect request triggering using connecting bus information
 - 1) Passengers use the IDTO app to initiate a holding request for bus Y while traveling on bus/train X.
 - 2) IDTO system tracks traveler's trip activities and determines that he/she is on a service bus/train X.
 - 3) IDTO system determines the connecting bus Y will depart from the transfer stop before bus/train X arrives and, after evaluating the impacts of the connection prediction, advises bus Y to wait at the transfer station.
 - 4) IDTO system confirms bus holding activity with the requesting passenger through their IDTO mobile app.

There are a total of 11 routes operated by Tri Delta Transit that connect with BART and/or Park-N-Ride Lots. Tri Delta Transit has identified the following fixed-routes and key transfer points between Tri Delta Transit routes that can be included in the T-CONNECT applications to be tested in this phase of the project, as summarized in Table 3.

According to the operation statistics of Tri-Delta Transit, Antioch Park & Ride (Hillcrest Park & Ride) station is the major connection point of bus routes 300, 380, 383 and 388 for bus-bus transfer, and Pittsburg/Bay Point BART station for BART-bus transfer, and a large number of passengers commute via the related bus routes/BART during peak hours on weekdays (Figure 4). In addition, express route 300 connects Pittsburg/Bay Point BART with Antioch Park-N-Ride lot via state highway 4 without any stop in between these end points. This route carries one half of all boarding numbers at this Park-N-Ride lot. These two connection stations and related bus routes/BART are selected for the demonstration and field operational testing in the first phase of this project.

Route	Major Connections	Peak Frequency	Off Peak Frequency	Span of Service
TDT 200 (Weekday)	Pittsburg/Bay Point BART Martinez Amtrak	60 -75 min	60 min	6:42 AM -7:10 PM
TDT 201 (Weekday)	Pittsburg/Bay Point BART Concord BART	30 min	60 min	6:09 AM – 7:33 PM
TDT 300 (Weekday)	Pittsburg/Bay Point BART Antioch Park-N-Ride Brentwood Park-N-Ride	20 min	30 min	4:12 AM – 10:00 PM
TDT 380 (Weekday)	Pittsburg/Bay Point BART Los Medanos College Antioch Park-N-Ride	30 min	50 min	3:14 AM – 11:31 PM
TDT 387 (Weekday)	Pittsburg/Bay Point BART Pittsburg Park-N-Ride Los Medanos College	60 min	60 min	4:48 AM – 9:18 PM
TDT 388 (Weekday)	Pittsburg/Bay Point BART Antioch Park-N-Ride Los Medanos College Antioch Park-N-Ride	30 min	60 min	5:06 AM – 11:28 PM
TDT 390 (Weekday)	Pittsburg/Bay Point BART Antioch Park-N-Ride	30 min	n. a.	3:50 AM – 7:28 PM 4:13 PM – 8:28 PM
TDT 391 (Weekday)	Pittsburg/Bay Point BART Pittsburg Park-N-Ride Los Medanos College Antioch Park-N-Ride Brentwood Park-N-Ride	30 min	60 min	4:03 AM – 1:14 AM
TDT 392 (Weekend)	Pittsburg/Bay Point BART Pittsburg Park-N-Ride Los Medanos College Brentwood Park-N-Ride	60 min	60 min	5:23 AM – 1:28 AM
TDT 393 (Weekend)	Pittsburg/Bay Point BART Los Medanos College Antioch Park-N-Ride Brentwood Park-N-Ride	60 min	60 min	5:23 AM – 1:19 AM
TDT 394 (Weekend)	Pittsburg/Bay Point BART Los Medanos College Antioch Park-N-Ride	60 min	60 min	5:22 AM – 1:49 AM

Table 3. Major Connections of Tri-Delta Transit

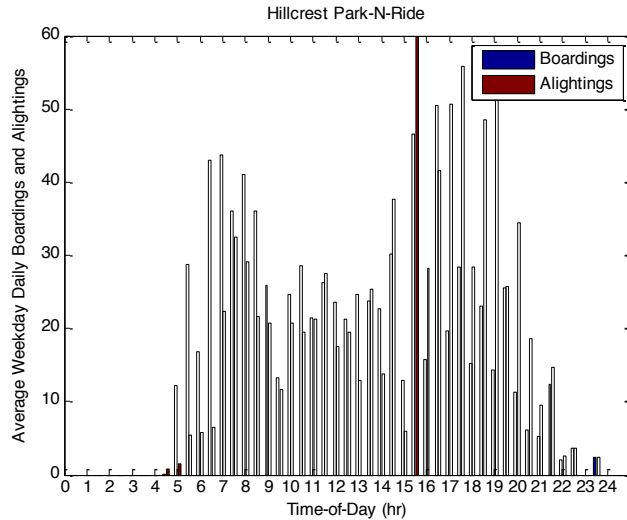

Figure 4. Passenger boarding/alighting at Hillcrest Park & Ride station

3.5.2 Scenario 2: Dynamic Dispatching (T-DISP)

In the areas or regions where dynamic transit services are designated, IDTO is able to dispatch buses to meet with passengers or drop off passengers at predetermined pickup locations (marked with T-DISP station signs). In addition, the IDTO can evaluate the current traffic conditions and provide advice on bus detours to avoid congestion regions.

- 1) The passenger uses the IDOT mobile app to request transit service in the proximity of a designated IDTO T-DISP stop.
- 2) The information of the passenger's request is communicated with the IDTO system.
- 3) IDTO evaluates the current operating condition and designates a near-by bus on the route the passenger requested to pick up at the stop.
- 4) IDTO system communicates with the dispatch center through the IDTO operation interface.
- 5) The dispatch center communicates with the designated bus driver to instruct route deviation.
- 6) The bus driver confirms the pickup.
- 7) The dispatcher center responds to the requesting passenger with a confirmation and estimated time of arrival through IDTO mobile app.
- 8) The bus operator makes route deviation and picks up passenger.

3.5.3 Scenario 3: Dynamic Ridesharing (D-RIDE)

IDTO D-RIDE will incorporate an existing ridesharing application (e.g. Uber and Lyft). The detailed design and information flow will be materialized in conjunction with the ridesharing application developer. The IDTO D-RIDE function enables the passenger to

submit his/her ridesharing request to the Server, which in turn forward the request to the ridesharing application, and then passenger arranges the ridesharing directly with the ridesharing service provider. Potential use cases of the D-RIDE scenarios are as follows:

- 1) While on transit, the passenger uses the IDTO mobile app to check the availability of connecting service.
- 2) IDTO system provides the options of transit and ridesharing.
- 3) The passenger selects ridesharing option. IDTO informs the passenger to establish the ridesharing appointment through ridesharing service app, and the IDTO service for this trip ends.
- 4) The passenger makes ridesharing appointment through ridesharing service app.

Note: The operational scenarios specified here are just preliminary design for the current phase, and the detailed operational workflow will be further specified based on the coordination with ride-sharing providers in the next research phase.

4 Development of IDTO Prototype

4.1 Assumptions and Constraints of IDTO

In the development of the IDTO prototype, all IDTO functions were built on the existing ITS applications including AVL, transit operational data, real-time transit data, and the Tri-Delta dispatch system. The following assumptions and constraints have been taken into consideration for the IDTO prototype development:

(1) The IDTO prototype interfaces with transit management system, through which real-time transit operation information can be directly input to IDTO system with minimum delays (<1 sec);

(2) All IDTO functions are based on the transit operational data including routes, stops, and schedules. The IDTO prototype accesses the above operational data through standard GTFS format data files which are updated in a fixed period or whenever changes are made to the operational routines.

(3) For the demonstration of the first phase, T-CONNECT function was implemented at two major connection points (Pittsburg/Bay Point BART station and Antioch Park-n-Ride TDT station), and connection protection was applied to the transfers from TDT route 380, 383, 388 to 300, and those from Pittsburg/Bay Point bound BART trains to TDT bus route 300, 390 and 391.

(4) For the Phase One effort, the D-RIDE and T-DISP functionalities were not developed and the related research focuses on the definition of functions and preliminary design. D-RIDE is designed upon an existing ridesharing application. The future arrangement with the ridesharing provider will be facilitated by CCTA. The effort was made to operational procedure design of the D-RIDE application at this phase of the project. T-DISP is designed for selected transit routes at this phase of the project, and the design task is focused on the scenario design and operational procedure.

(5) Interface with the dispatcher center responded to recommendations generated by the IDTO system when predetermined conditions are met.

(6) The lack of on-board driver information terminal presents a constraint for IDTO. The transit dispatcher center may experience increased workload in respond to the dynamic operation recommendations by the IDTO system. It is a natural progression for Tri Delta Transit to upgrade its transit management system with driver information terminals when the level of dynamic operation increases.

4.2 Physical Architecture

The overall IDTO physical architecture is illustrated in **Error! Reference source not found.** and the development of IDTO prototype is based on this architecture. The primary components of the IDTO system include:

- **IDTO Mobile Interface** provides the capability for travelers to input their travel needs (e.g., trip information, request a service for T-CONNECT, T-DISP, or D-RIDE, acquire transit information and status of IDTO service request), and to receive trip status notifications.
- **IDTO Server** hosts Data Collection and Management, the Travel Choice Tool, the Decision Support Tool (Decision Support Planner), and the Notification Manager.
 - The Data Collection and Management module is responsible for acquiring transit information from the Transit Management Centers (Tri Delta Transit and BART management system), acquiring real-time travel time information on SR 4 and vehicle locations through AVL system, and managing the data in the transit database which provides access to the Travel Choice Tool and Decision Support Tool. Collected transit information data include routes, stops and schedule in the form of GTFS (General Transit Feed Specification) feed, and real-time update (schedule adherence and vehicle location) in the form of GTFS real-time feed.
 - The Travel Choice Tool interacts with travelers to take their travel information and to provide response that meets travelers' needs.
 - In the case of planning a trip, the Travel Choice Tool takes the inputs of trip origin, destination, preferred mode of travel, and expected departure or arrival time, gets trip plans through Google Map (or through the ridesharing service when the traveler is interested in D-RIDE), presents the plans to the traveler, and takes traveler's trip confirmation. When the confirmed trip involves a transfer at a T-CONNECT point, the Travel Choice Tool submits a T-CONNECT service request to the Decision Support Tool and generates notifications to inform the traveler that he/she will receive status update regarding connect protection.
 - In the case of requesting a T-CONNECT or T-DISP service, the 'Travel Choice Tool' takes the inputs of route, stop (or desired pick up location), and expected arrival time, submits the service request to the 'Decision Support Tool', and notifies the traveler on receiving

an IDTO service status update.

- In the case of acquiring real-time transit information, the 'Travel Choice Tool' takes inputs of route and stop, acquires arrival time from the 'Data Collection', and presents the arrival time to the traveler.
- The 'Decision Support Tool' monitors the status of active T-CONNECT and T-DISP-PP service requests, transit real-time updates, and travel time difference between traveling on SR 4 and predesigned detour routes, and evaluates the feasible T-CONNECT and T-DISP strategies that will accommodate the requests from the travelers. Once a feasible T-CONNECT and T-DISP strategy is found, it will be submitted to transit dispatchers (through the 'IDTO Interface') for confirmation and execution. The confirmed T-CONNECT and T-DISP-PP strategy will be sent to the requested travelers (through the 'Notification Manager') to inform them the status of their IDTO service requests.
- The 'Notification Manager' is responsible to manage the interaction with travelers using Google Cloud Messaging (GCM), to provide trip status update and to respond to travelers' inquiring of their IDTO service requests. All notifications are pushed by the Notification Manager to the passenger's mobile apps
- **IDTO Dispatch Interface** is located at the TDT operation center (dispatch center) that enables transit operation staff to receive T-CONNECT and T-DISP requests from the IDTO Server and to communicate with bus drivers through voice to advise drivers to implement connection protection or dynamic detour operation.

IDTO functions were built upon on existing advanced communications technologies and ITS applications. The physical components that are external to the IDTO prototype are shown on the left column in Figure 5, including:

- Transit Management Centers (i.e., Tri Delta Transit and BART) that provide transit information on routes, stops, schedule, fare, as well as real-time update of vehicle location and schedule adherence;
- Google Map that provides regional trip-planning service based on real-time transit and traffic conditions. (Tri Delta Transit and BART are providing GTFS and GTFS-realtime feeds to Google Map. Google Map also utilizes various data sources [e.g. Google Map users as vehicle probes] for estimating real-time

traffic conditions);

- Google Cloud Messaging (GCM) that provides two-way mobile messaging service between developer-run servers and mobile clients (GCM is free and supports both Android and iOS); and
- Ridesharing service provided by an existing ridesharing application.

The IDTO architecture was designed and the internal/external interfaces were defined at the first phase of this project. The IDTO server and the function modules (Data Collection and Management, Travel Choice Tool, Decision Support Tool (Primary Planner), Notification Manager) running on it were developed with special focus on the T-CONNECT functions, and the IDTO dispatch interface and mobile interface were developed with components related T-CONNECT and T-DISP functions. As the first phase focused on the investigation and testing of T-CONNECT application, the T-CONNECT related functions were fully implemented on the IDTO server, the dispatch interface and the mobile interface. The full implementation of T-DISP and D-RIDE functions will be conducted in the next phase, based on the architecture design, interface definitions and the operational procedures specified in this document.

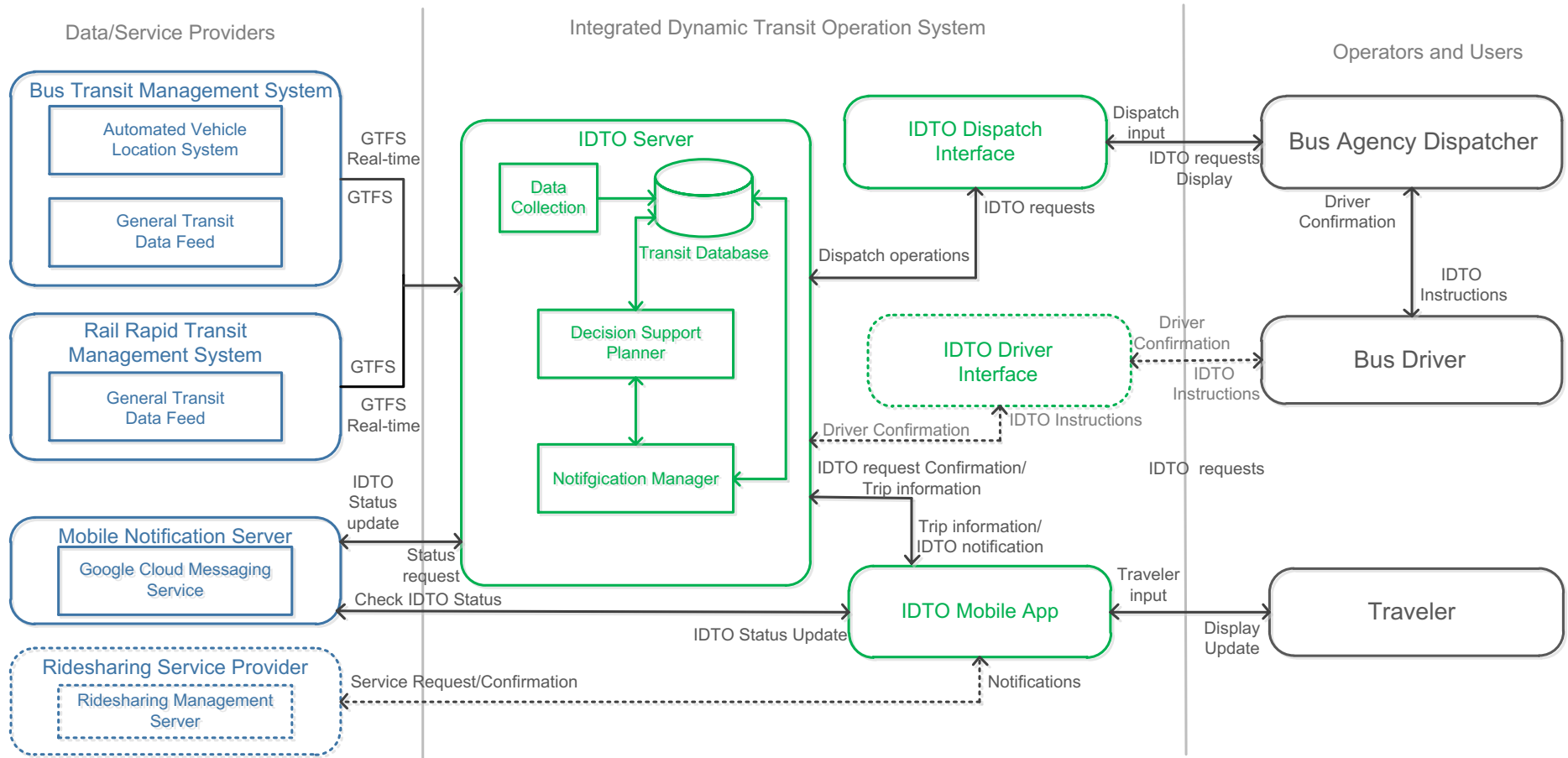

Figure 5. IDTO System Architecture⁵

⁵ The blocks with dashed borders represent components that are not implemented in the current phase of the IDTO project. The dispatcher will no longer need to communicate with drivers to get the confirmation if the IDTO Driver Interface is implemented in the vehicles.

4.3 Activity Sequence of Operational Scenarios

The activity sequences of operational scenarios follow the scenarios definitions specified in Section 3.5.

4.3.1 Activity Sequence 1: Connection Protection (T-CONNECT)

IDTO T-CONNECT helps travelers to make connections at major meeting points by holding up one bus for a predetermined period to wait for the arrival of passengers from another arriving bus/BART train in the cases the arriving bus/BART train is behind schedule. At the first phase of this project, the development and implementation focused on the scenario where the passenger submits the trip information and the IDTO system detects trip delay and automatically initiate T-CONNECT service.

Typical use case: Passenger A uses the IDTO Mobile App to input the information of a trip which involves connection from one bus route/BART train to another bus route by selecting the inbound bus route number/BART, the outbound bus route number and the connection point. Passenger A is provided with several trip options. He selects the inbound/outbound trips and connection stop and confirms the trip information. Passenger A is informed that his trip is under connection protection and during his trip he will receive push notifications on the status update of the connection protection. John starts his trip.

Alternative: Passenger A can use the saved 'Pre-stored trips' information containing inbound/outbound trip and connection points to skip inputting the connection points and section of trip options.

While riding on the first transit segment of his trip (e.g. BART train), Passenger A received a push notification informing him that his bus is behind the schedule and he can have the opportunity for the connection protection. Passenger A confirms that he needs the connection protection. The T-CONNECT request is then sent to the TDT dispatch center and displayed via dispatch interface and the dispatcher confirms the connection protection after communicating with the bus driver. Passenger A in turn receives a confirmation notification that the connection bus will wait for him to make the transfer.

Alternative: IDTO was not able to hold the connection bus. Passenger receives a push notification informing him that he is going to miss the connection and the arrival time of the next bus.

Passenger A boards the connection bus and receives a notification to confirm whether the connection was made. This ends the connection protection event.

The sequence diagram of this scenario is illustrated in Figure 6.

4.3.2 Activity Sequence 2: Dynamic Dispatching (T-DISP)

As specified in subsection 3.5.2, IDTO T-DISP dynamically adjusts transit routes and stops to be responsive to passengers' demand and traffic conditions.

- Activity Sequence 2(a) Route Deviation to Avoid Congestion

Typical use case: The IDTO Decision Support Tool keeps monitoring the travel time difference between traveling on SR 4 and predesigned detour routes. When the travel time on SR 4 exceeds the travel time on a detour route by a pre-determined threshold, the IDTO Decision Supporting Tool submits the recommended detour route to the dispatch center for approval and execution. The sequence diagram of this scenario is illustrated in Figure 7.

- Activity Sequence 2(b) Route Deviation to Pick Up Passengers

In the areas or regions where dynamic transit services are designated, IDTO dispatches buses to meet with passengers at predetermined pickup locations (marked with T-DISP-PP stop signs).

Typical use case: Passenger B's home is closer to a T-DISP-PP stop than the regular bus stops. Passenger B uses the IDTO mobile app to request a pick-up service by inputting the T-DISP-PP stop, route, and the expected pick up time. Passenger B is informed that his pick-up request has been registered and he will receive push notifications on the status update of the pick-up request.

The IDTO Decision Support Tool evaluates the current operating condition and status of active IDTO requests, and finds it is possible to detour a near-by bus to pick up Passenger B. Passenger B receives a push notification informing him that he can be picked up at the T-DISP-PP stop and the expected arrival time of the bus. Passenger B confirms the pick-up service, which is then communicated with the dispatch center and the bus driver to execute the route deviation to pick up Passenger B. Passenger B shows the T-DISP-PP service confirmation screen to the bus driver when he boards the bus. This ends the T-DISP-PP event.

Alternative 1: The IDTO Decision Support Tool was not able to find a feasible bus to make the route deviation to pick up Passenger B around Passenger B's expected pick-up time, but it is possible to arrange the pick-up service X minutes after Passenger B's expected pick-up time. Passenger B receives a push notification informing him that he

can be picked up later than his expected time. Passenger B confirms the pick-up service and the rest processes are the same as the typical use case.

Alternative 2: The IDTO Decision Support Tool was not able to find a feasible bus to make the route deviation to pick up Passenger B. Passenger B receives a push notification informing him that his request cannot be fulfilled and providing him the arrival time of the bus at a near-by regular stop. Passenger B walks to the regular stop to wait for his bus. The T-DISP-PP request is removed from the IDTO Decision Support Tool.

The sequence diagram of this scenario is illustrated in Figure 8.

4.3.3 Activity Sequence 3: Dynamic Ridesharing (D-RIDE)

IDTO D-RIDE is designed to incorporate an existing ridesharing application. As stated in previous sections, the detailed operational scenarios data flow D-RIDE will not be defined in the current phase. The detailed design and information flow will be materialized in conjunction with the existing ridesharing application in the future research phase.

4.4 Development of IDTO Server

4.4.1 IDTO Database and Transit Data Management

As described in section 4.2, Data Collection and Management Module is hosted by the IDTO server and provides the key functions related to transit data: static transit data acquisition and importing, real-time transit data acquisition importing as well as transit data management. The architecture of the data collection and management module is depicted in Figure 9.

Static Data Acquisition and Importing module imports transit information data include routes, stops and schedule in the form of GTFS (General Transit Feed Specification) feed, parses the GTFS file and import the static transit data into the corresponding data field in the IDTO transit database (Transit Data Management).

Real-time Data Acquisition and Importing Module imports real-time transit information from two data sources: the real-time GTFS feed and transit data from AVL. The real-time GTDS feed provides information about the live arrival / departures times for vehicles traveling along trips for the various transit agencies (i.e. BART and TDT), and the AVL provides real-time locations and trip information of each vehicle run by TDT. This module parses the GTFS real-time file and AVL data and imports the real-time transit data into the corresponding data field in the IDTO transit database (Transit Data Management).

Transit Data Management (IDTO transit database) utilizes a SQL-based relational database which organizes and manages transit data in various Tables. It enables IDTO function modules (Decision Support Planner and Notification Manager) to access transit data via SQL commands, and IDTO maintenance personnel can also manually manage

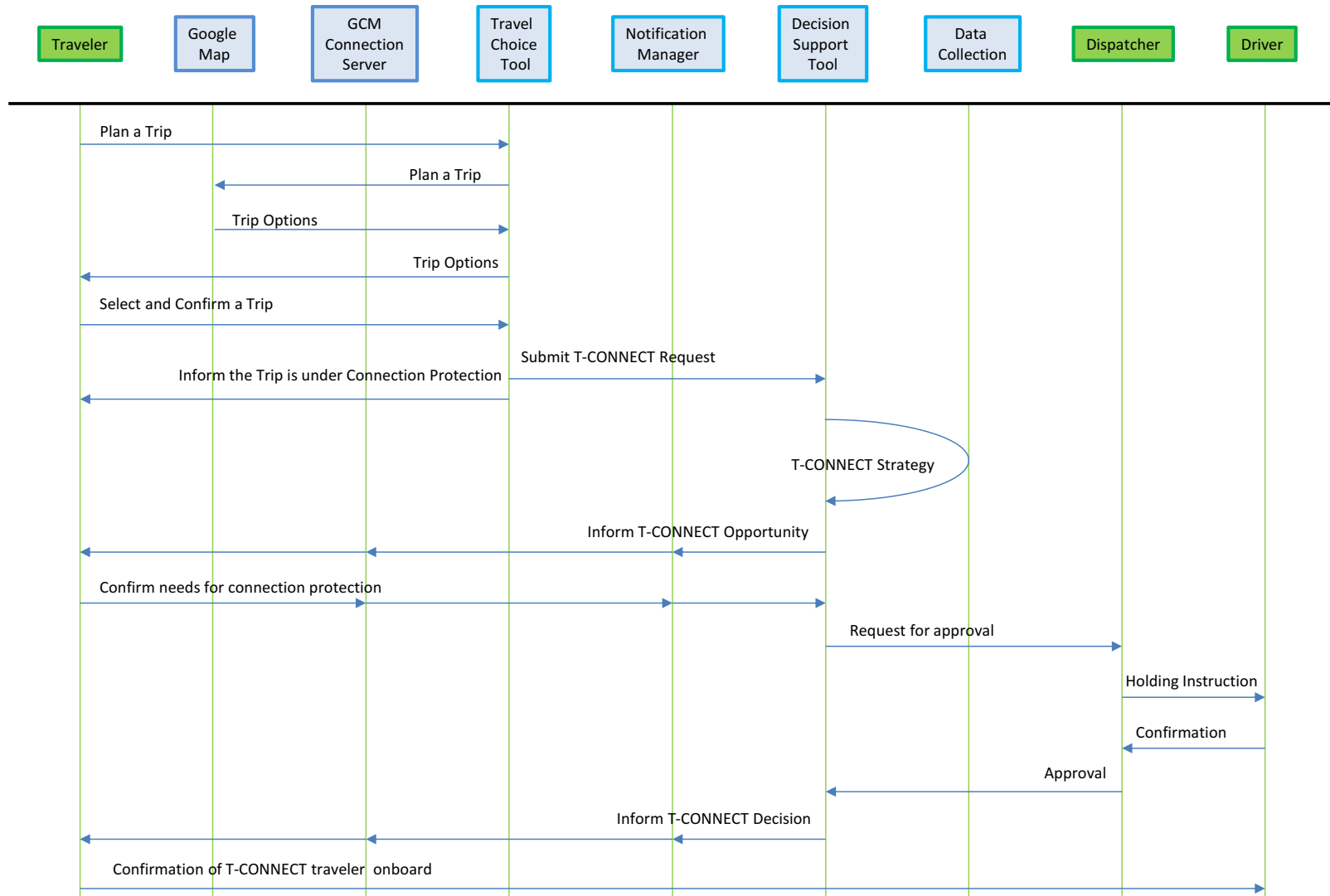

Figure 6. Sequence Diagram of Scenario 1: T-CONNECT

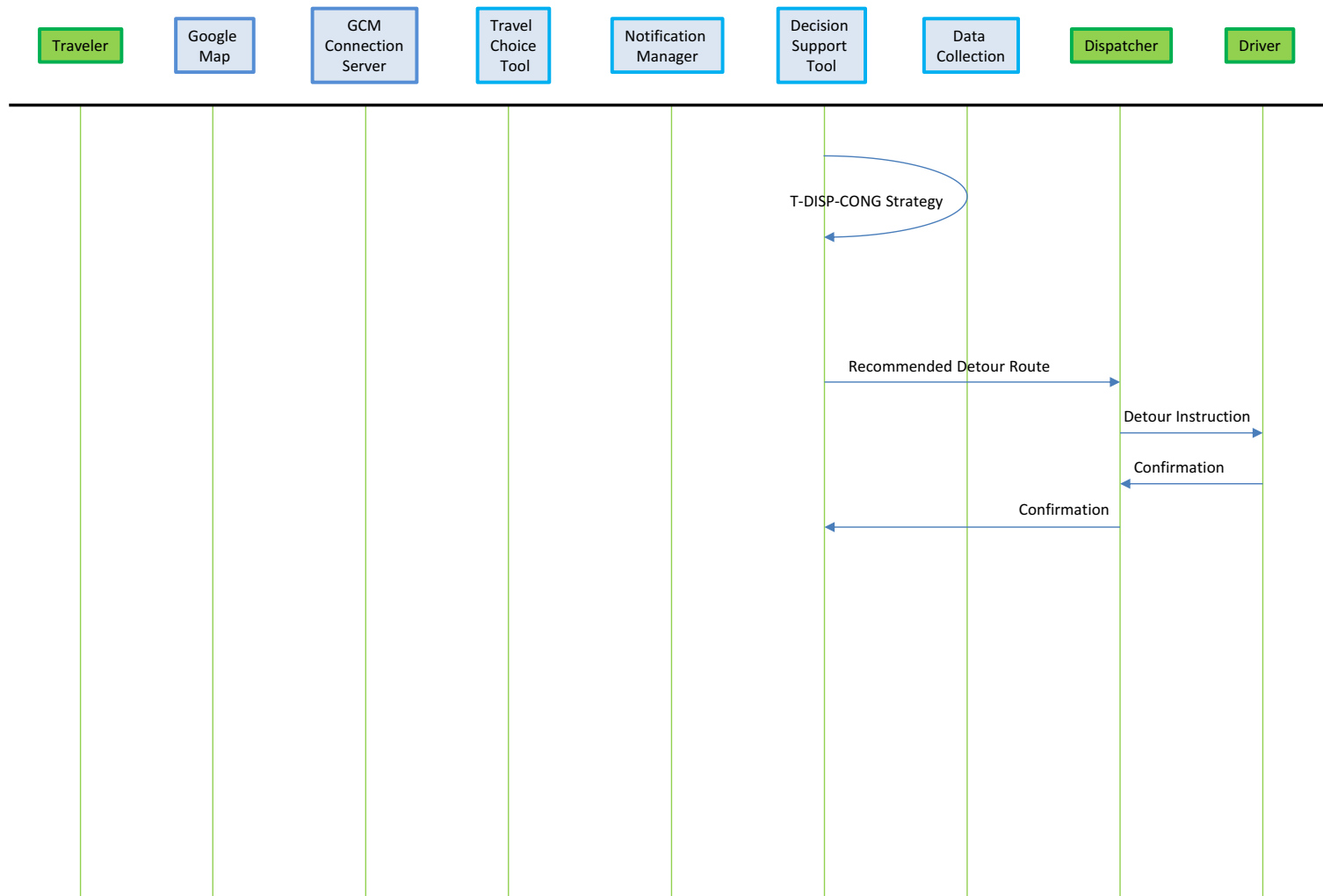

Figure 7. Sequence Diagram of Scenario 2(a) Route Deviation to Avoid Congestion

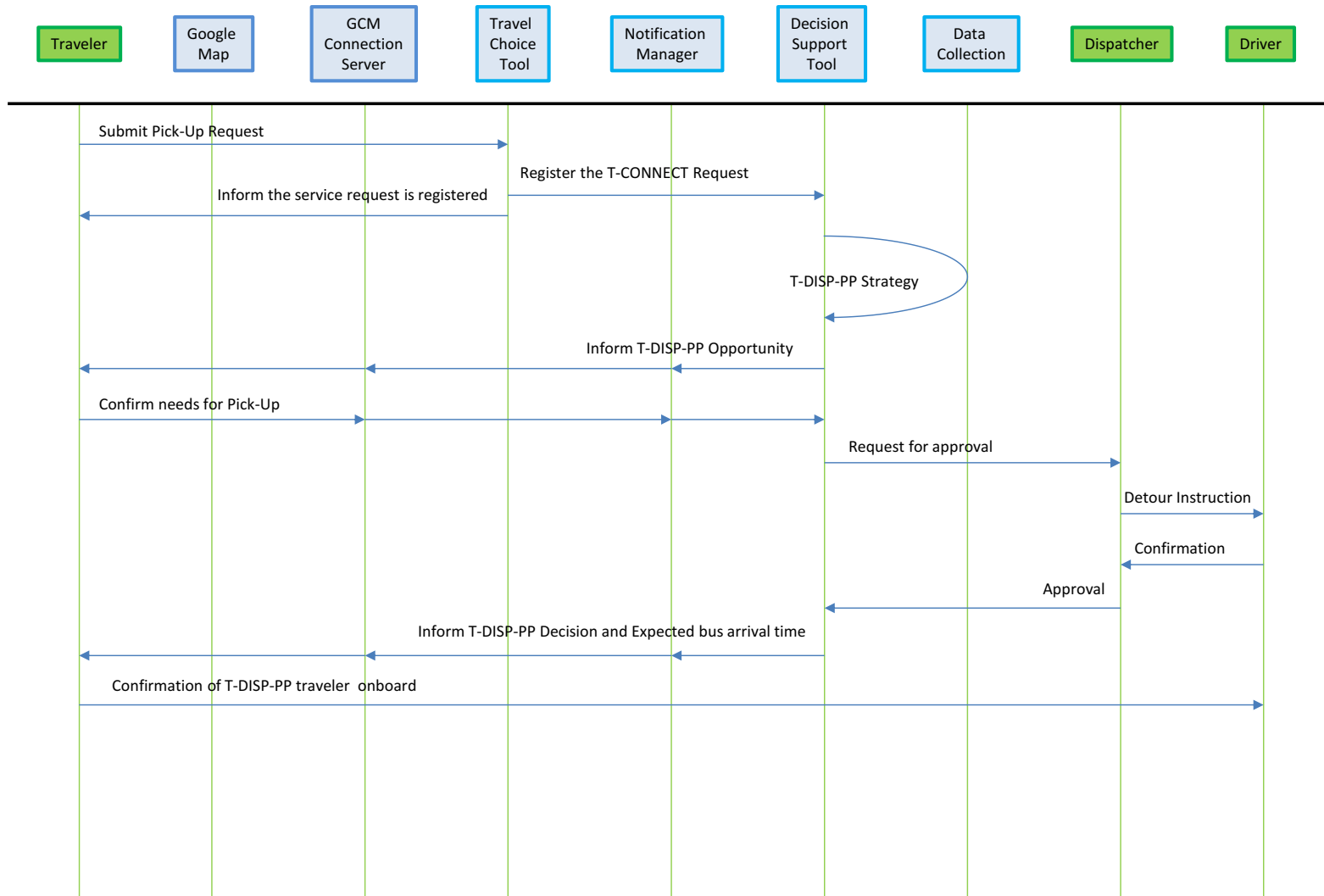

Figure 8. Sequence Diagram of Scenario 2(b) Route Deviation to Pick Up Passenger

transit data using SQL commands as well. The diagram of IDTO database and management is illustrated in Figure 9. The schema of the IDTO database is depicted in Table 4.

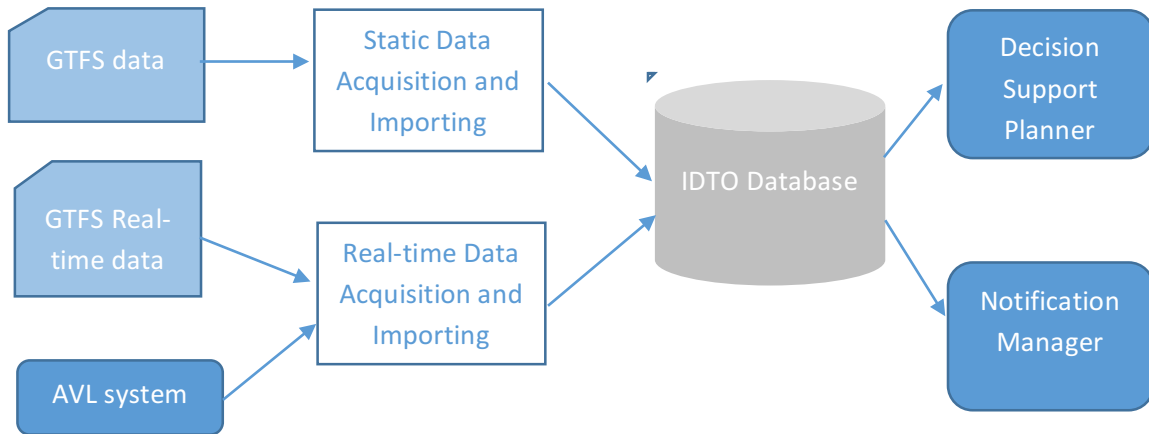

Figure 9. IDTO Database and Transit Data Management

Table Name	Category	Data Specification
agency	Static	Information for the various transit agencies tracked in the IDTO database
Routes	Static	Information for the different routes in an agency's network
Stops	Static	Information for the different stops in an agency's network
Route_stop_seq	Static	Information about the sequences of stops along each route in an agency's network
RunPattern	Static	Information about the service patterns for a route in an agency's network
Schedules	Static	Information for the arrival / departure times for vehicles on each trip for a certain route tracked in the IDTO database
Route_point_seq	Static	Information about the different points in an agency's network and how vehicles travel to them
Points	Static	Information about different points in an agency's network
Transfers	Static	Information about intra- and inter-transfers for the various transit agencies

gps_fixs	Static	Information about the live location of vehicles for the various transit agencies
Transit_ETA	Dynamic	Information about the live arrival / departures times for vehicles traveling along trips for the various transit agencies
TConnect_2	Dynamic	Real-time information of all T-CONNECT service of connection protection-enabled trips on the current day

Table 4. Tables in the Transit Database

4.4.2 IDTO Decision Support Planner

The IDTO decision support planner provides the core functions of T-CONNECT and T-DISP. As stated at the beginning of Section 4, the first phase of this project focuses on the development of cloud-server based architecture with special focus on the functions related to IDTO application:

- The IDTO decision support planner takes the passenger’s input of trip information (inbound trip, connecting trip and transfer stops) from the IDTO mobile app.
- The passenger is matched with a specific trip in operation by tracking the passenger’s GPS location from the passenger’s mobile app and the real-time AVL GPS coordinates of vehicles read from the Transit Database.
- The IDTO decision support planner monitors the estimated time-of-arrival (ETA) of the bus or BART with the passenger and detects possible delay of the vehicle based on the ETA.
- The IDTO decision support planner initiates T-CONNECT request once it detects bus or BART delays, and sends T-CONNECT request information (route number of the bus requested to hold, transfer stops the bus is requested to hold at, scheduled time of departure, minutes the bus is requested to hold) to the dispatch interface.
- After the dispatcher communicates with the vehicle driver and processes the T-CONNECT requests (the request is either approved or rejected), the IDTO decision support planner updates the status of the T-CONNECT service in the Transit Database.

The IDTO decision planner is developed using PHP language and hosted on Amazon EC2 Server, and both IDTO decision support planner and (MySQL database) resides inside Amazon EC2 instance. The flowchart of the IDTO decision planner main process is depicted in Figure 10.

4.4.3 IDTO Notification Manager and Notification Pushing

The IDTO notification manager is responsible for pushing notification messages to the passenger’s mobile app once the status of IDTO service is updated. It monitors the status of each IDTO request hosted in the transit database and generates contents of notification messages once the status is changed by the IDTO decision support planner. The notification message is then pushed to the passenger’s mobile app and displays on the cellphone. The upstream information input by the passenger is also sent back to the notification manager, which in turn parses the information and updates the corresponding record in the Transit Database (details of the contents of push-notification messages will be specified in Section 4.6).

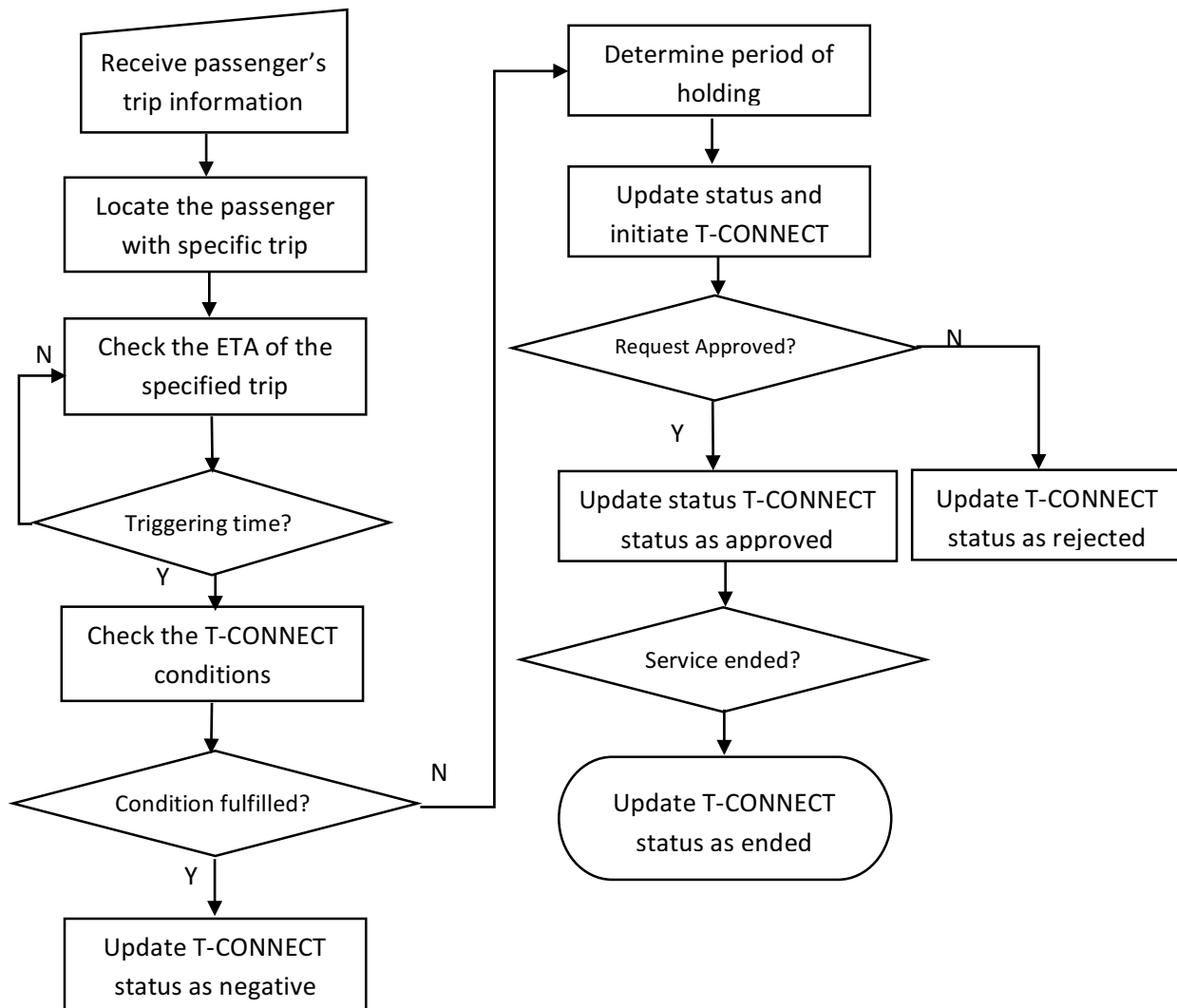

Figure 10. Decision Support Planner Flowchart

The IDTO notification-pushing mechanism in this project is developed utilizing Google Cloud Messaging (GCM) service, which enables timely delivery of personalized trip status

update to IDTO travelers and timely response to travelers’ status inquiring (through push notification). GCM architecture is illustrated in **Error! Reference source not found.**. The developer-run server (i.e. the ‘IDTO Notification Manager’) can send downstream push notifications to the client (i.e. the ‘IDTO Mobile Interface’) and receive upstream push notifications sent from the client, through the GCM Connection Server. Push notifications through GCM will overcome battery drain problem when the client does not know when a new update is available on the IDTO Server and keeps polling status update from the server. The basic procedure of the GCM push notification is as follows (For the IDTO system, the client is the IDTO mobile app, and the server is the IDTO notification manager):

1. Client sends an activation request to GCM server by subscribing to IDTO service using web application
2. GCM server sends Registration Token back to client
3. Client sends its Registration Token to Amazon EC2 Server to store
4. When Amazon EC2 Server needs to send downstream notification to clients, it fetches Registration Token from its database and sends a request to GCM server with Registration Tokens
5. GCM server sends downstream notification to clients.

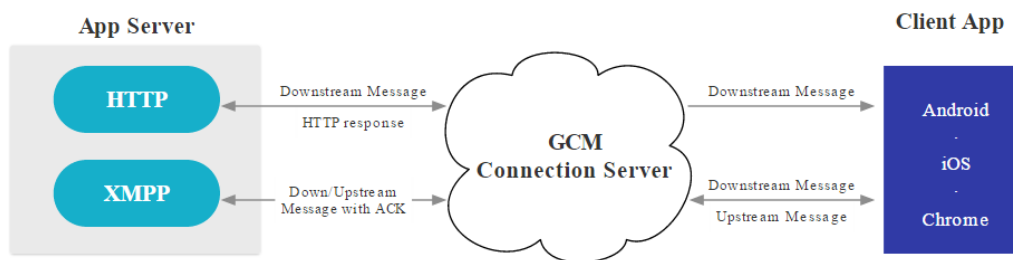

Figure 11. GCM mechanism

4.5 Development of Dispatcher Interface

4.5.1 Dispatcher Interface Frame

The Dispatcher interface is located at TDT operation (dispatch) center and functions as the primary interface of IDTO system to the dispatch personnel. It displays information of current T-CONNECT requests and allows the dispatch personnel to process the T-CONNECT requests (Approve/Reject), monitor the status of in-process requests and view historical T-CONNECT requests. The layout of IDTO Dispatcher Interface is depicted in Figure 12. The components of the IDTO interface include:

Active T-CONNECT requests bar All Active requests (for which dispatch has not yet taken action) appear at the top of the page, with the most urgent request (Current request) at

the top and less urgent requests following in order of their urgency. The information displayed includes: 1) The route number of the bus requested to hold; 2) The scheduled time of departure; 3) The station where the bus is requested to hold at; and 4) The minutes the bus is requested to hold. The approve and reject buttons are displayed to allow the dispatcher to take actions on the requests based on the drivers' response.



Display toggles allow the dispatcher to enable/disable display of in-process and historical requests.



In-process T-CONNECT service bar shows the information of all active T-CONNECT requests requiring dispatcher's attention, for which dispatcher has already approved but the connection protection service is not yet completed. Once the service ends, the records are no longer displayed and the corresponding information is shown in the historical requests zone (described below).



Historical requests zone displays the information of all terminated T-CONNECT services, which are either requests rejected by the dispatcher or the completed T-CONNECT services. The status of the request is also displayed (with check mark or cross mark).

IDTO Dispatch Center [Dispatch Feed](#) [Instructions](#) [About](#)

Active T-CONNECT request bar

 **Bus 300 WestBound**
Scheduled to depart at 05:28 is requested to hold at Hillcrest Park & Ride for an additional 2 minutes  

 **Bus 300 WestBound**
Scheduled to depart at 05:28 is requested to hold at Hillcrest Park & Ride for an additional 2 minutes  

 **Bus 300 WestBound**
Scheduled to depart at 05:28 is requested to hold at Hillcrest Park & Ride for an additional 2 minutes  

Toggles

Display in-process requests? Yes No Display expired requests? Yes No

 **Bus 300 WestBound**
Scheduled to depart at 05:26 is requested to hold at Hillcrest Park & Ride for an additional 3 minutes **In-Process**

 **Bus 300 WestBound**
Scheduled to depart at 05:26 is requested to hold at Hillcrest Park & Ride for an additional 3 minutes **In-Process**

Historical request zone

 **Bus 80 WestBound**
Scheduled to depart at 05:24 is requested to hold at Dolores Vitae for an additional 2 minutes Expired

 **Bus 80 WestBound**
Scheduled to depart at 05:24 is requested to hold at Dolores Vitae for an additional 2 minutes Expired

Figure 12. IDTO Dispatcher Interface

4.5.2 Dispatcher Interface Operational Logistics

The interactions of dispatcher with the IDTO Dispatcher interface are depicted in Figure 13. The IDTO Dispatcher interface is a web-page based application, which allows the dispatcher to complete the interactions on the web-page via a standard web browser.

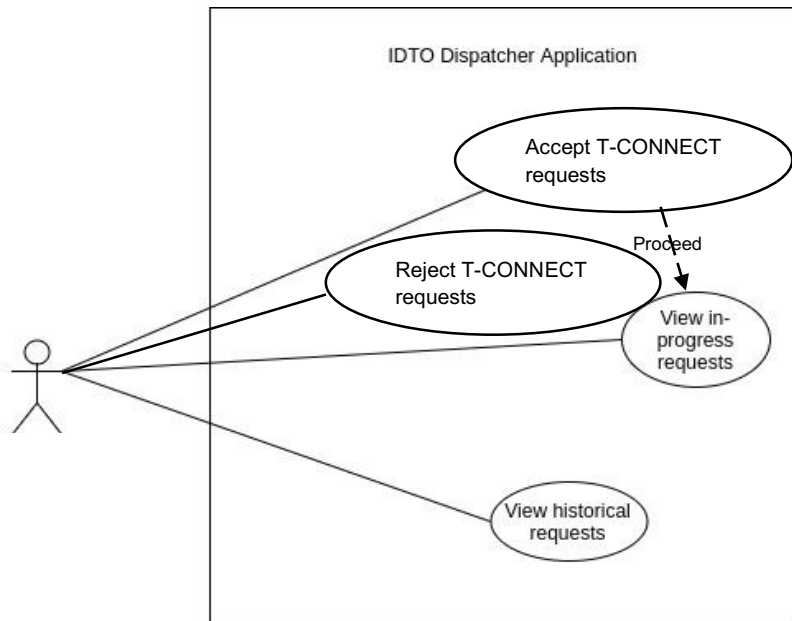

Figure 13. Interactions on the Dispatcher Interface

The operations of the Dispatcher are illustrated in Figure 14. For the phase one effort, the primary operation of the dispatcher's interaction with the Dispatcher Interface is to Approve or Reject T-CONNECT Requests. These activities are described below.

- Check Active T-CONNECT Requests
 - The application displays the active request on the screen, with bus route number, location, and holding period information. The dispatcher checks the information and determines with which vehicle to communicate.
- Process T-CONNECT Request
 - Approve:
 - The dispatcher communicates with the bus driver and approves the T-CONNECT request by pressing the approve button (with check mark)
 - The record of the request is moved from current request bar region to in-process service bar, showing the connection protection service is in progress.
 - Reject:

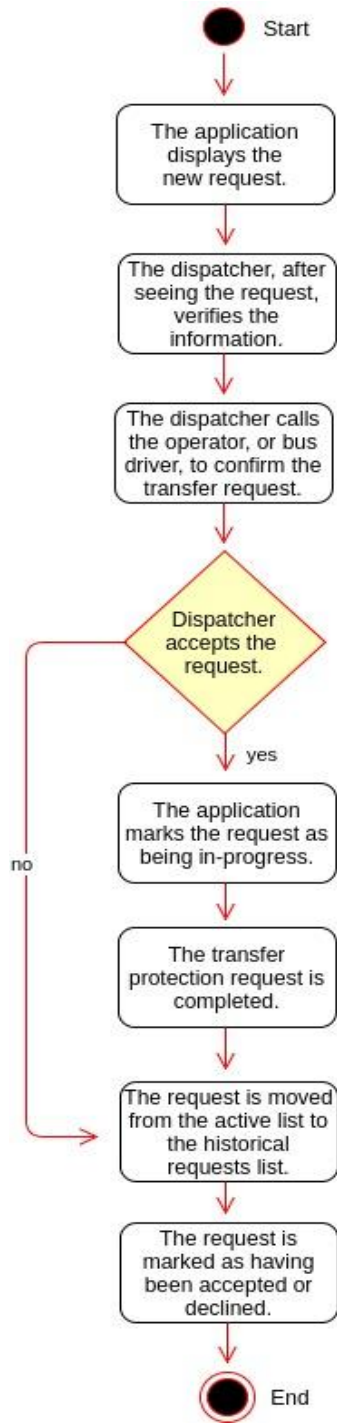

Figure 14. Activity Graph of Dispatcher Interface

Components of the IDTO Mobile App Interface include:

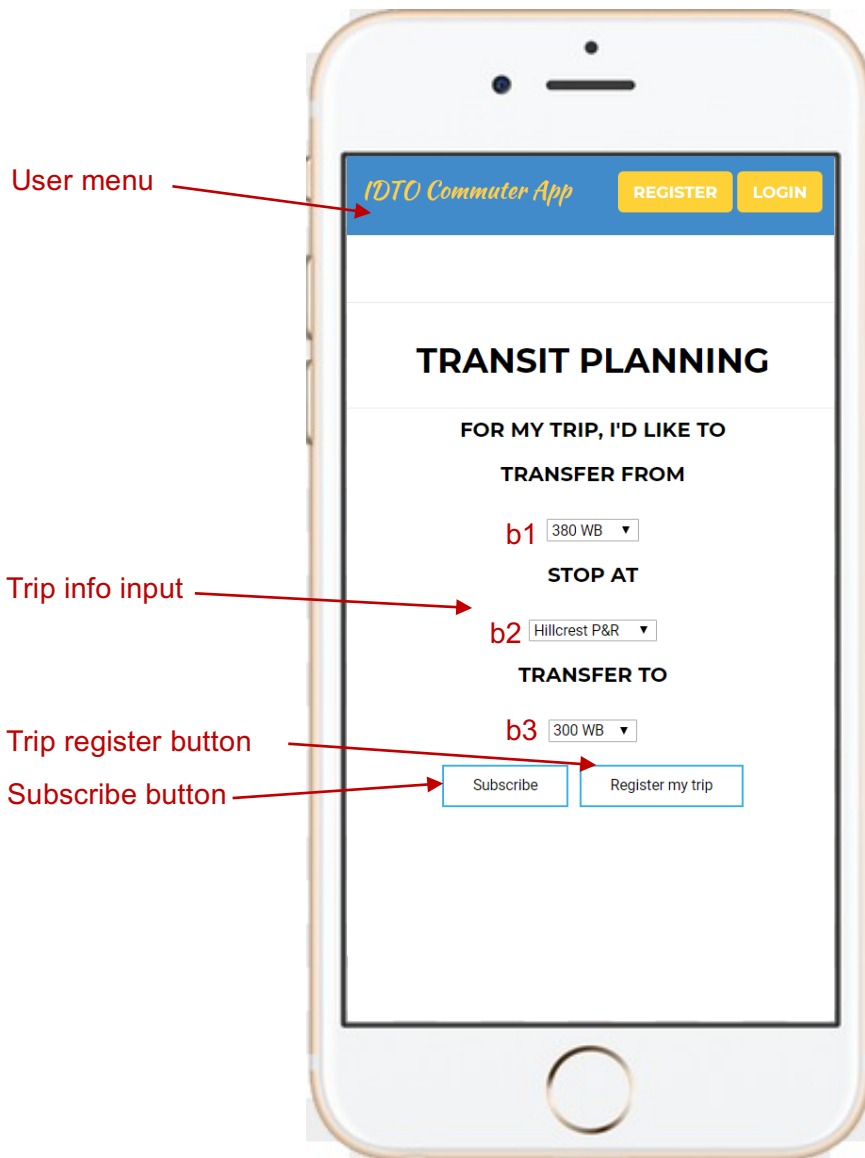

Figure 15. Mobile App Interface

User menu allows the passenger to register an IDTO passenger account or login using an existing account.

Trip info input enables the passenger to input trip information using the drop-down components. The trip info includes: 1) Bus route number (or BART) the passenger is currently on; 2) The connection point where the passenger will make the transfer; 3) Bus route number the passenger would like to transfer to.

Trip register button is used by the passenger to register his/her trip for uploading the trip information.

Subscribe button takes the passenger's confirmation on connection protection service.

4.6.2 IDTO Mobile Application Interface Operational Logistics

The passenger's interactions with the IDTO Mobile App Interface are depicted in Figure 16. As described in section 4.6.1, the IDTO Mobile App is developed as a standard web application and all interactions can be made via the web-page on the passenger's mobile device.

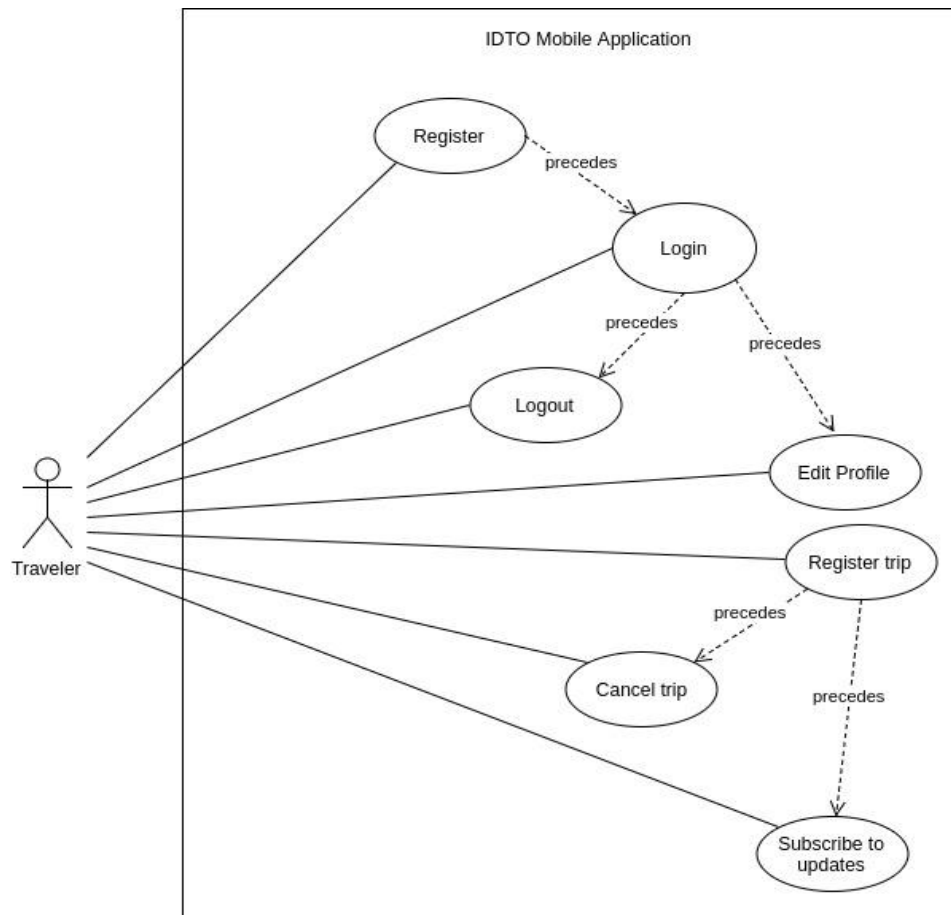

Figure 16. Interactions on the Mobile App Interface

4.6.2.1 Register/login

The passenger can register a personal IDTO account using their email address and user name:

- The passenger presses the 'registration' button displayed in the user menu, and the registration form is displayed. The passenger enters name, email, username and password, and then presses the registration button (Figure 17).
- The IDTO Mobile App validates the information and creates an account for the passenger (Figure 17).

The passenger can login using an existing account:

- The passenger presses 'login' button displayed in the user menu, and a login form is presented. The passenger then enters pre-created username and password
- The IDTO Mobile App validates the inputted username and password.

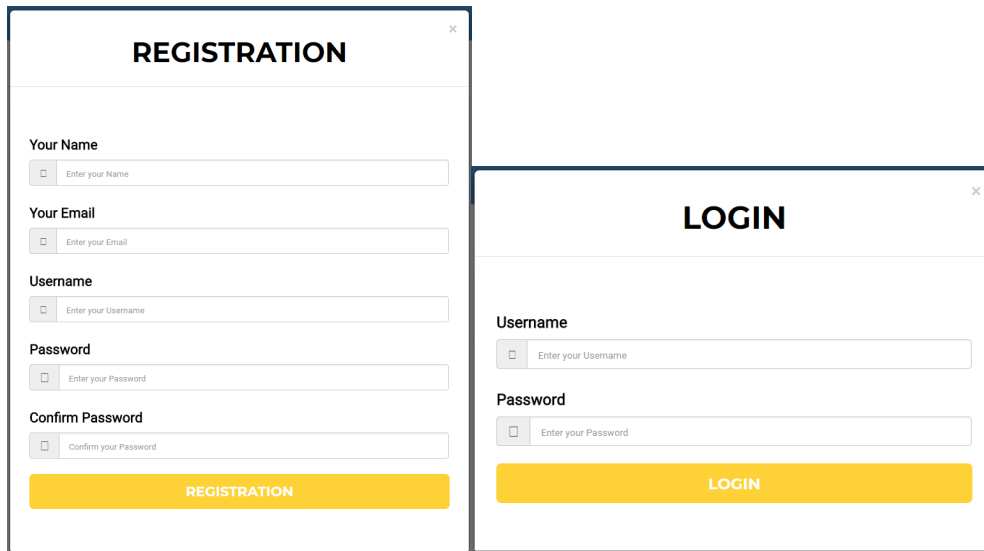

Figure 17. Mobile App registration and login page

4.6.2.2 Input trip information

The operations of inputting trip information are illustrated in Figure 18.

- The trip input components b1, b2, and b3 are presented as drop-down for the passenger to select from possible trips and stops (Figure 15). They correspond to the current transit agency and route the passenger is on (b1), the intended transfer stop between transit trips(b2), and the transit route the passenger intends to transfer to(b3).
- The passenger presses the drop-down menus, and then the drop-down menus become populated with the possible corresponding choices (trips with connection protection service).
- The passenger presses 'Transfer From' drop-down menu (b1), the possible agencies (TDT bus/BART) and routes are listed in the menu (Figure 19a).
- The passenger selects the route he/she is currently on (or BART train).
- The passenger presses 'Stop at' drop-down menu (b2), the possible connection points are listed in the menu (Figure 19b).
- The passenger selects the stop where he/she intends to make the transfer.
- The passenger presses 'Transfer To' drop-down menu (b3), the possible bus routes are listed in the menu (Figure 19c).
- The passenger selects the route to which he/she intends to transfer.

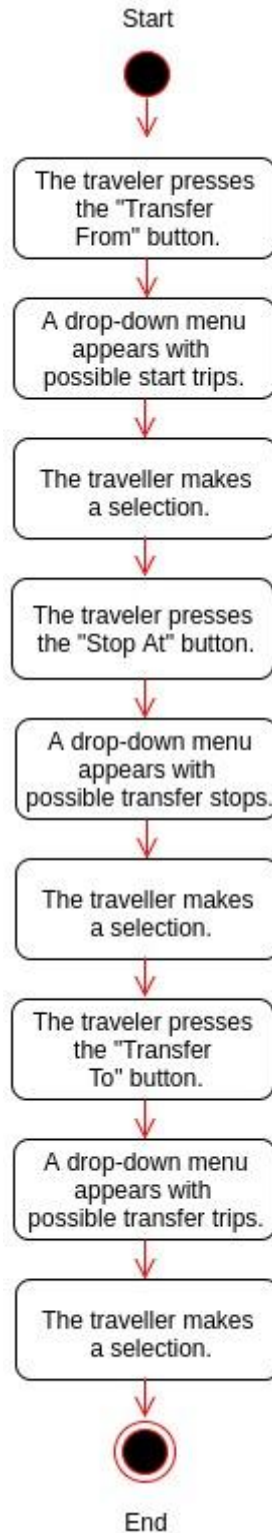

Figure 18. Activity Graph of Input Trip Information

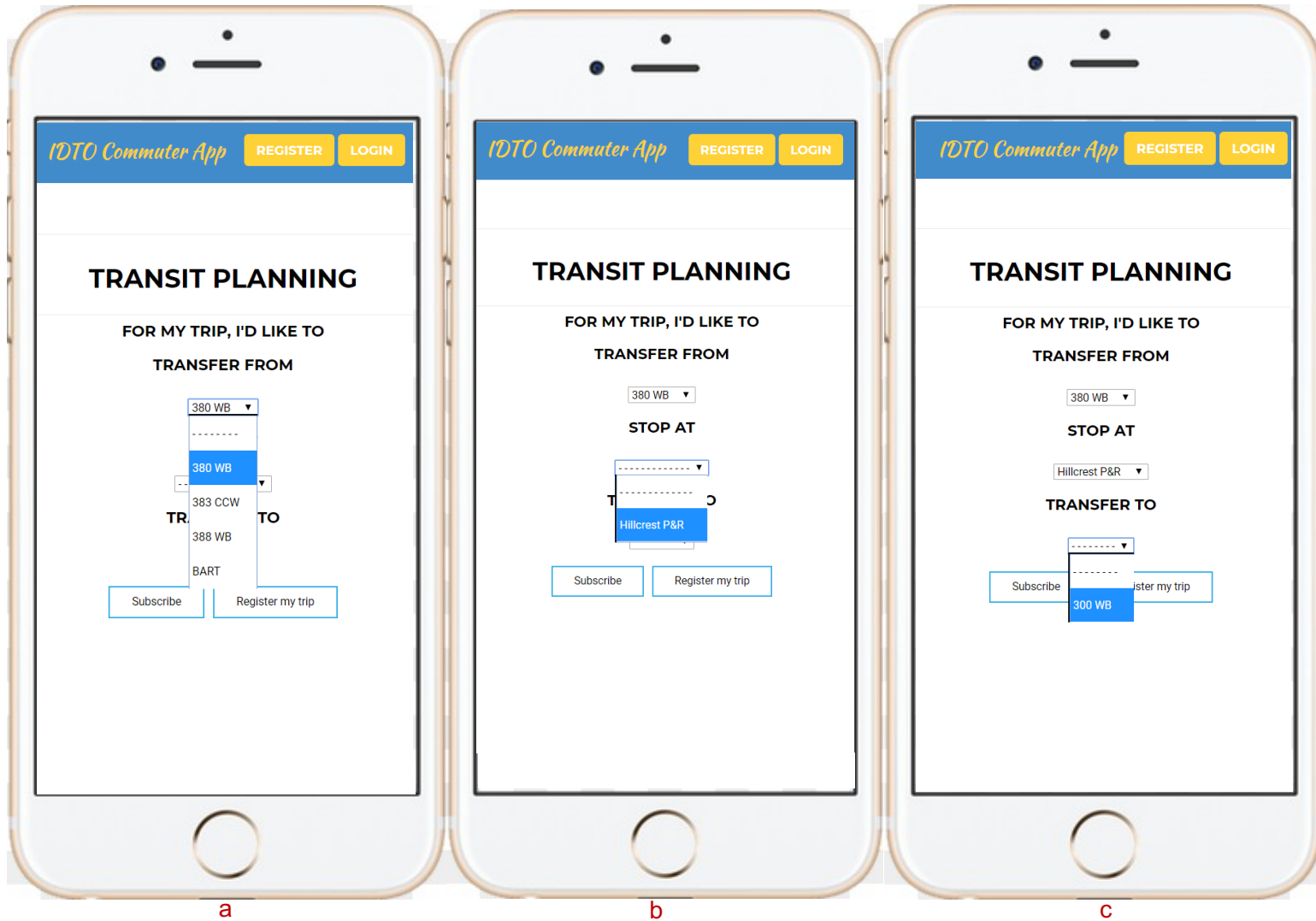

Figure 19. IDTO Mobile App T-CONNECT Components

4.6.2.3 Register and subscribe a trip

The operations of trip registration and subscription/cancellation are depicted in Figure 21.

- Registering and Confirming a Trip
 - After the passenger inputs trip information, he/she clicks the “Register my trip” button to confirm trip selections.
 - The Mobile App displays a notification to indicate that the inputted trip was successfully registered, and that the passenger will receive trip status updates.
 - The passenger then clicks the “Subscribe” button. The Mobile App then displays a notification informing that the IDTO system has subscribed the trip information for connection protection services.
- Cancel a Trip
 - After registering a trip, the label of trip registration button turns from ‘Register my trip’ into ‘Cancel my trip’, a passenger can choose to cancel the trip by pressing this button.

4.6.3 IDTO Push-notifications

While the passenger is on the trip after subscribing the information, the IDTO Mobile App receives and displays real-time notifications pushed by the IDTO server. The current prototype receives notifications when the status of trips changes or decisions are made on the IDTO service. The mobile app receives the following notifications (Figure 20):

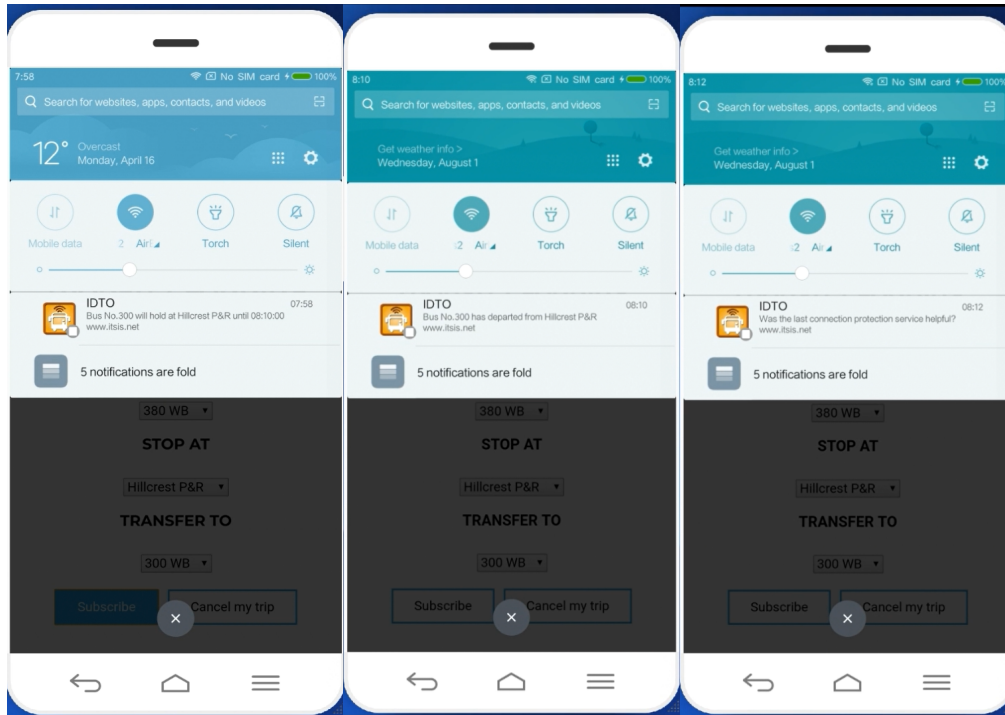

Figure 20. IDTO mobile notifications

- Status of the inbound trip (whether the inbound trip is delayed)
- T-CONNECT service decisions (Approval/rejection of connection protection services)
- Status of the outbound vehicle (whether the outbound vehicle has departed from the connecting stop)
- Survey on the T-CONNECT services (whether the T-CONNECT service has been successfully provided)

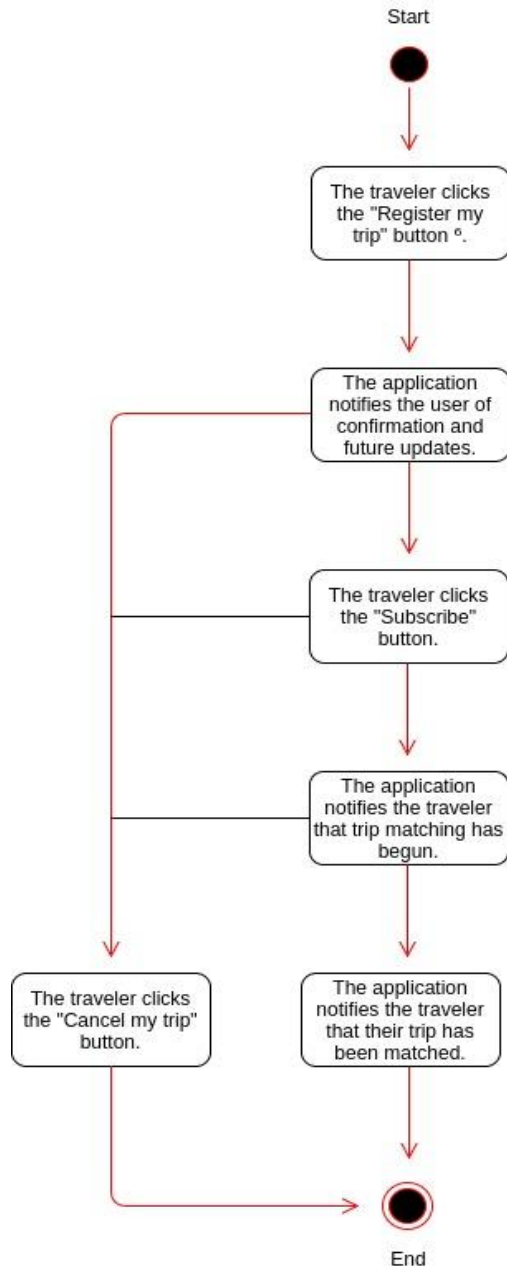

Figure 21. Activity Graph of register and subscribe a trip

5 Field Operational Test

5.1 Analysis of the connection activities

5.1.1 Analysis of the boarding/alighting activities

The historical APC data is analyzed to identify the bus stops with top boarding/alighting activities so that the IDTO can be implemented on the identified stops. Table 5 lists the top 10 stations with top boarding/alighting activities in the Tri-Delta Transit service region. Among these stations, the top 1 is the Pittsburg/Bay Point Bart station located in the west, and the No.2 on top is the Hillcrest Park & Ride station, as shown in Figure 22.

Stop ID	Stop Name	Boarding	Alighting
00818889	BART CENTRAL PLATFORM	184077	193518
00817754	HILLCREST PARK & RIDE	93751	89861
00811425	BRENTWOOD PARK N RIDE	21924	18841
00812113	EAST LELAND RD & LOVERIDGE R	14579	16052
00810019	WILBUR AVE & CAVALLO RD	13926	347
00812987	DELTA FAIR BLVD & KAISER	13231	11401
00819444	EAST LELAND RD & LAKEVIEW CI	12611	16194
00819073	EAST LELAND RD & LAKEVIEW CI	11669	9434
00812925	EAST LELAND RD & LOVERIDGE R	11016	10275
00810639	MAIN ST & CHARLES WY	10371	3582
00812052	DELTA FAIR BLVD & SOMERSVILL	9148	13464

Table 5. Total passenger boarding/alighting on stations from historical data



Figure 22 Hillcrest P & R and BART Central Platform station

Further analysis is conducted on an hourly basis for each bus station. The results are as follows:

1) Pittsburg Bay Point BART station

As shown in Figure 23, there are 12 routes that visit or terminate at Pittsburg/Bay Point BART station. Table 6 shows the routes which have hourly boarding/alighting numbers larger than 5 at the Pittsburg/Bay Point BART station.



Figure 23. Pittsburg/Bay Point BART station

	Boarding	alighting
3: 00-4: 00	[391 388]	[391 390 300]
4: 00-5: 00	[300 200 390]	[391 387 390 300 389 393]
5: 00-6: 00	[391 388 200]	[391 390 300 388 201 390 380 392 393]
6: 00-7: 00	[387 391 387 388 200 389]	[391 391 390 300 201 390 380 392 393]
7: 00-8: 00	[391 388 200 394 392 393]	[387 300 201 389 380 392 393]
8: 00-9: 00	[391 200 380 392 393]	[391 387 300 388 201 200 380 394 392 393]
9: 00-10: 00	[391 388 201 200 389 380 392 393]	[387 391 387 380 394 392 393]
10: 00-11: 00	[387 300 388 201 380 393]	[391 200 380 394 394 393]
11: 00-12: 00	[387 391 300 388 200 380 393]	[387 201 389 393]
12: 00-13: 00	[387 300 201 380 394 392 393]	[391 388 200 389 380 393]

14: 00-15: 00	[391 387 390 300 388 201 390 380 394 392 393]	[387 391 388 200 394]
16: 00-17: 00	[387 391 390 300 388 390 380 394 392 393]	[300 200 393 393]
18: 00-19: 00	[387 391 300 389 380 392 393]	[391]
20: 00-21: 00	[388 392 393]	[391 393]

Table 6. Routes which have hourly passenger boarding/alighting larger than 5 at Bart station

2) Hillcrest Park & Ride

As shown in Figure 24, there are 13 routes that visit Hillcrest P&R station. Table 7 shows the routes which have hourly alighting/boarding numbers larger than 5 at this stop.

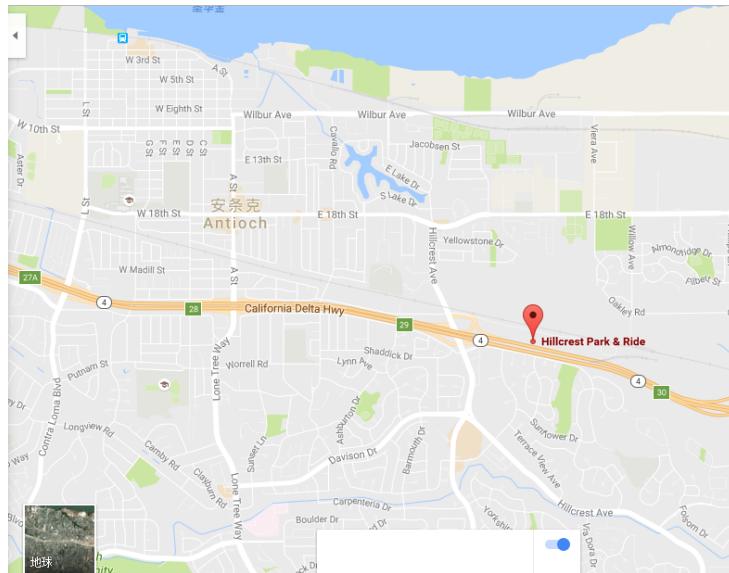

Figure 24. Hillcrest P&R station

	boarding	alighting
7: 00-8: 00	[391 300]	[388]
8: 00-9: 00	[391 383 300]	[385]
9: 00-10: 00	[391 300]	[385]
10: 00-11: 00		
11: 00-12: 00		
12: 00-13: 00	[383 300 395 392]	[391]
13: 00-14: 00		
14: 00-15: 00		
15: 00-16: 00		
16: 00-17: 00	[391 385]	[300]
17: 00-18: 00	[391]	[300 393]
18: 00-19: 00	[394]	[395]
19: 00-20: 00		
20: 00-21: 00	[380 395 393]	[300 394 393]

Table 7. Routes which have hourly boarding/alighting larger than 5 at Hillcrest P&R station

5.1.2 Analysis of the connections between bus routes

According to the operational data from Tri-Delta Transit, there are totally 618 bus stops in the Tri-Delta Transit service region, among which 400 bus stops are visited by more than or equal to 2 bus routes. The connections between different bus routes occur at these stops and the stops with large number of connection activities can be identified for FOT purposes. Table 8 shows the top 10 bus stop with the most bus route visits.

Bus stop		Bus route visits											
817754	HILLCREST PARK & RIDE	391	383	385	390	300	388	380	379	394	395	392	393
818889	BART CENTRAL PLATFORM	391	387	300	388	201	200	389	390	380	394	392	393
812483	WEST LELAND RD & OAK HILLS D	391	388	201	390	380	389	387	394	392	393		

819266	BAILEY RD & MAYLARD ST	391	201	380	389	387	394	392	393				
814259	BAILEY RD & MAYLARD ST	387	391	201	389	380	394	392	393				
819444	EAST LELAND RD & LAKEVIEW CI	391	388	380	387	394	392	393					
812939	EAST LELAND RD & GLADSTONSE D	391	388	380	387	394	392	393					
812113	EAST LELAND RD & LOVERIDGE R	387	391	380	388	394	392	393					
812109	EAST LELAND RD & COMMERCE PL	387	391	388	380	394	392	393					
819073	EAST LELAND RD & LAKEVIEW CI	387	391	388	380	394	392	393					
817380	HILLCREST AVE & EAST TREGALL	383	385	388	390	380	379	392					
817398	HILLCREST AVE & LARKSPUR DR	388	390	380	385	392	379	383					
812505	BAILEY RD & CANAL RD	201	380	389	387	394	392	393					
812431	BAILEY RD & CANAL RD	389	201	380	387	394	392	393					
819087	BAILEY RD & PLACER DR	389	380	387	201	394	392	393					
812514	BAILEY RD & MARY ANN	389	380	387	201	394	392	393					

Table 8. Top 10 bus stations with the most bus routes from historical data for half-year

Based on the above analysis, the Hillcrest P & R stop is a key connecting stop as it has the most bus route visits with a large number of passenger boarding/alighting. Therefore, the Hillcrest P & R is taken as an example for further analysis of connection activities.

There are totally 13 bus routes stop by Hillcrest Park & Ride stops on weekdays, and details of the related bus routes are listed in Table 9 and Figure 25.

Bus route	Starting stop	End stop	Operational Directions	Time of first visit Hillcrest	Time of last visit Hillcrest
300	Brentwood Park & Ride	Pittsburg BART	Westbound	4:36A	8:03P
300	Pittsburg BART	Brentwood Park & Ride	Eastbound	6:42A	9:21P

379	Hillcrest Park & Ride	Kaiser	Eastbound	7:21A	7:21A
379	Kaiser	Hillcrest Park & Ride	Westbound	3:05P	3:26P
380	Antioch	Pittsburg BART	Westbound	3:14A	9:06P
380	Pittsburg BART	Antioch	Eastbound	4:27A	11:27P
383	Hillcrest Park & Ride	Hillcrest Park & Ride	Loop	7:12A	4:25P
385	Hillcrest Park & Ride	Brentwood Park & Ride	Eastbound	6:38A	6:25P
388	Kaiser	Pittsburg BART	Westbound	5:25A	8:27P
388	Pittsburg BART	Kaiser	Eastbound	6:40A	11:05P
390	Hillcrest Park & Ride	Pittsburg BART	Westbound	3:50A	7:06A
391	Brentwood Park & Ride	Pittsburg BART	Westbound	4:45A	11:18P
391	Pittsburg BART	Brentwood Park & Ride	Eastbound	6:20A	12:34A

Table 9. Bus routes information at Hillcrest Park & Ride station

300 Eastbound



300 Westbound

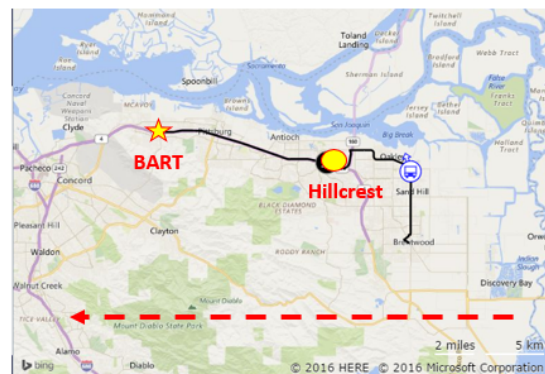

300	Brentwood Park & Ride	Pittsburg BART	Westbound	4:36A	8:03P	weekday
300	Pittsburg BART	Brentwood Park & Ride	Eastbound	6:42A	9:21P	weekday

380 Eastbound

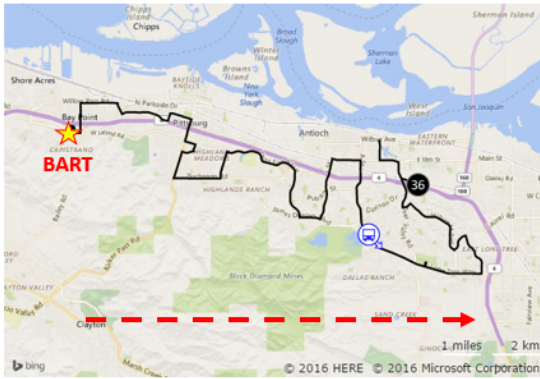

380 Westbound



380	Antioch	Pittsburg BART	Westbound	3:14A	9:06P	weekday
380	Pittsburg BART	Antioch	Eastbound	4:27A	11:27P	weekday

388 Eastbound

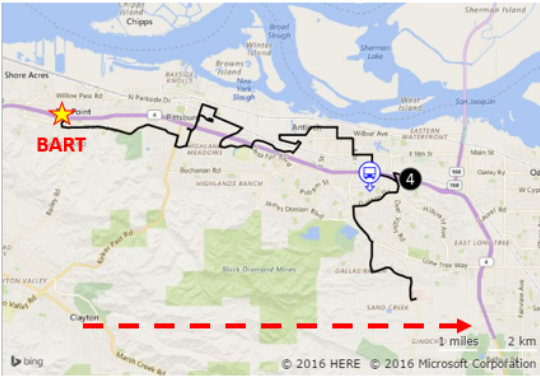

388 Westbound



388	Kaiser	Pittsburg BART	Westbound	5:25A	8:27P	weekday
388	Pittsburg BART	Kaiser	Eastbound	6:40A	11:05P	weekday

391 Eastbound

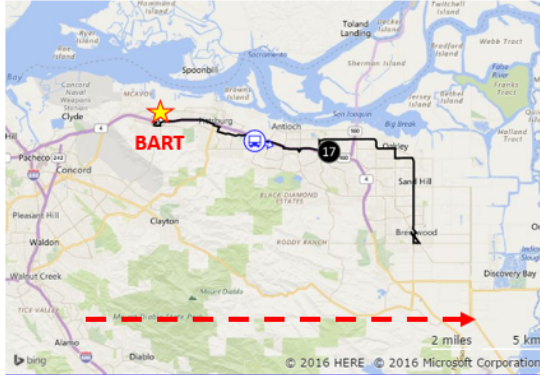

391 Westbound



391	Brentwood Park & Ride	Pittsburg BART	Westbound	4:45A	11:18P	weekday
391	Pittsburg BART	Brentwood Park & Ride	Eastbound	6:20A	00:34A	weekday

385 Eastbound

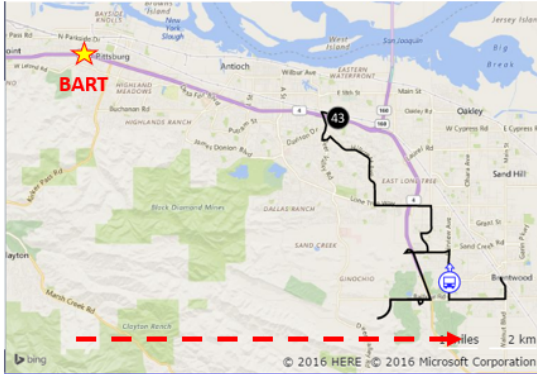

383 Loop

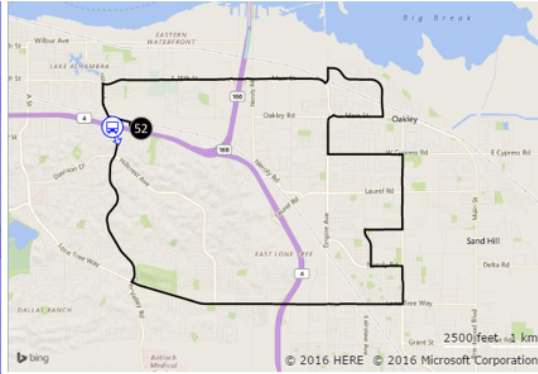

385	Hillcrest Park & Ride	Brentwood Park & Ride	Eastbound	6:38A	6:25P	weekday
383	Hillcrest Park & Ride	Hillcrest Park & Ride	Loop	7:12A	4:25P	weekday

379 Eastbound

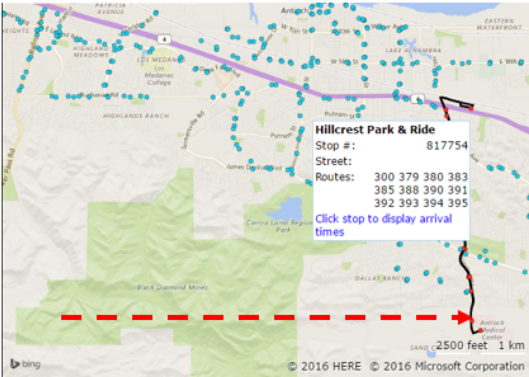

379 Westbound

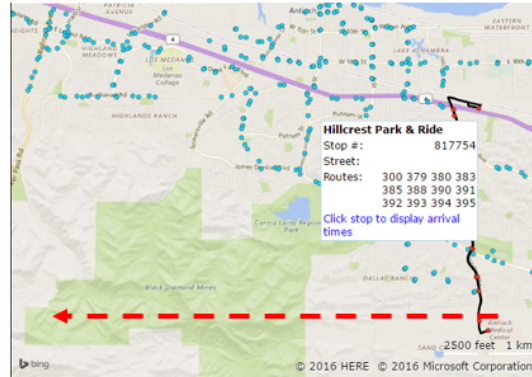

379	Hillcrest Park & Ride	Kaiser	Eastbound	7:21A	7:21A	weekday
379	Kaiser	Hillcrest Park & Ride	Westbound	3:05P	3:26P	weekday

390 Westbound

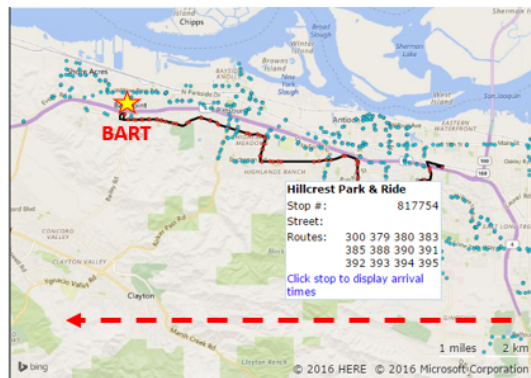

390	Hillcrest Park & Ride	Pittsburg BART	Westbound	3:50A	7:06A	weekday
-----	-----------------------	----------------	-----------	-------	-------	---------

Figure 25. Information of bus routes that visit Hillcrest Park & Ride station

The analysis of connection activities at the Hillcrest P & R stop is conducted based on the information of bus routes listed above, and the concept of bus connections is defined in two ways: the schedule-based connections and operational data-based connections.

The schedule-based connection between two bus routes is defined as the transfer from the inbound bus to the outbound bus at the specified stop, when meeting the following condition:

$$0 \leq (\text{scheduled time of departure of outbound route} - \text{scheduled time of arrival of inbound route}) \leq n \text{ mins}$$

While the operational data-based connection is defined as the actual transfer activities where the actual arrival/departure times meet the following conditions:

$$0 \leq (\text{actual time of departure of outbound route} - \text{actual time of arrival of inbound route}) \leq n \text{ mins}$$

1) Analysis of the current actual connections

The actual operational data-based connections of all bus routes at Hillcrest Park & Ride stop are derived by setting the time of connection n as 5 mins, using the operational data recorded during the six-month period. Table 10 shows the results of bus-bus connection with the largest number of connections of 665 (300E connect to 380E) in 6-months.



	300E	300W	379	380E	380W	383	385E	388E	388W	390W	391E	391W
300E	0	228	27	665	1	190	229	536	4	9	371	51
300W	213	0	8	660	1	206	302	460	1	81	592	4
379	22	10	0	25	0	10	16	24	2	0	28	1
380E	460	673	27	0	1	383	453	648	5	57	771	50
380W	2	0	0	0	0	1	0	1	0	0	0	0
383	125	210	10	469	1	52	32	297	228	1	5	121
385E	385	257	22	500	1	328	0	513	2	10	288	44
388E	494	402	29	644	1	291	438	0	6	48	552	21
388W	8	2	2	2	0	1	5	5	0	0	5	2

390W	4	80	1	87	0	5	10	25	0	0	91	11
391E	317	627	23	781	2	154	344	585	6	71	0	48
391W	43	5	0	59	0	19	29	37	1	11	47	0

Table 10. Actual connections of bus routes at Hillcrest Park & Ride station from historical data

2) Analysis of the potential connections

We consider the potential connections to analyze the potential benefits of implementing T-CONNECT, using the recorded operational data. The time of connections is now set to be -5 mins, which means the departure of outbound buses is within 5 mins earlier than the arrival of inbound buses. Those cases can still be considered as a successful connection since T-CONNECT can be implemented to hold the outbound bus. The potential connection is defined as transfer that meet the following condition:

$$5 \text{ mins} \leq \text{time of departure of outbound bus} - \text{time of arrival of inbound bus} < 0 \text{ mins}$$



	300E	300W	379	380E	380W	383	385E	388E	388W	390W	391E	391W
300E	0	376	9	515	0	194	253	419	4	1	504	41
300W	170	0	9	509	0	134	257	285	2	55	532	16
379	24	17	0	35	0	6	26	29	1	1	20	6
380E	448	738	24	0	0	401	418	559	2	92	958	77
380W	2	1	0	1	0	0	0	1	0	0	3	0
383	152	207	12	391	1	27	89	204	0	3	250	17
385E	296	231	19	489	0	226	0	347	9	7	372	39
388E	380	420	17	779	1	220	292	0	5	17	511	26
388W	5	1	0	6	0	0	1	3	0	0	12	1
390W	6	48	4	63	0	3	16	49	0	0	55	6
391E	342	425	25	640	1	132	363	670	4	91	0	31
391W	43	10	0	48	0	25	20	27	2	5	48	0

Table 11. Connections of bus routes at Hillcrest Park & Ride station from historical data

As shown in the Table 11, the number of connections can be significantly increased if the T-CONNECT is implemented, as a large portion of failed transfers can be turned into successful connections.

3) Analysis of selected bus-bus transfer pairs

- 383L to 300W:

The time of connection n is set to be -5 mins, and Table 12 shows that the current number of actual connections from 383 to 300 is 206. The analysis results show that the number of successful connections can be maximally increased by 134 if T-CONNECT is implemented.



300W	Number of connections from 383	Increase of Connections
Current	206	0
1 mins added to the depart time	231	25
2 mins added to the depart time	255	49
3 mins added to the depart time	283	77
4 mins added to the depart time	312	106
5 mins added to the depart time	340	134

Table 12. Potential connections to 300W from 383 at Hillcrest Park & Ride station from historical data

- 300E connect to 388E:

The time of connection n is set to be -5 mins, and Table 13 shows that the current number of actual connections from 300E to 388E is 114. The analysis results show that the number of successful connections can be maximally increased by 135 if T-CONNECT is implemented.



388E	Number of connections from 300E	Increase of Connections
Current	114	0
1 mins added to the depart time	143	29
2 mins added to the depart time	172	58
3 mins added to the depart time	201	87

4 mins added to the depart time	228	114
5 mins added to the depart time	249	135

Table 13. Potential connectivity of 388E from 300E at Hillcrest Park & Ride station from historical data

- 391E connect to 388E:

The time of connection n is set to be -5 mins, and **Error! Reference source not found. 14** shows that the current number of actual connections from 391E to 388E is 331. The analysis results show that the number of successful connections can be maximally increased by 235 if T-CONNECT is implemented.



388E	Number of connections from 391E	Increase of Connections
Current	96	0
1 mins added to the depart time	128	32
2 mins added to the depart time	162	66
3 mins added to the depart time	219	123
4 mins added to the depart time	264	168
5 mins added to the depart time	331	235

Table 14. Potential connectivity of 388E from 391E at Hillcrest Park & Ride station from historical data

5.1.3 Analysis of the connection of selected trips

In this subsection, the historical record of selected connecting trips at Hillcrest P&R stop is analyzed to further evaluate the current connection status and potential improvement on the connection success rate by implementing T-CONNECT. The identified connecting trips are: 1) 5:19 pm 380W- 5:21 pm 300W, 2) 5:49 pm 380W- 5:54 pm 300W and 3) 5:25 pm 388W – 5:26 pm 300W.

- 1) 380W (5:19pm) - 300W (5:21pm)

Trip ID: 1087

Connection stop: HILLCREST PARK & RIDE

Period: 2016-02-22 to 2016-08-26

According to the data log, there are 88 valid records in total, and 79 real time connections. Figure 26 shows the time interval between the two connecting bus routes (the gap between departure time of 300W and the arrival time of 380W).

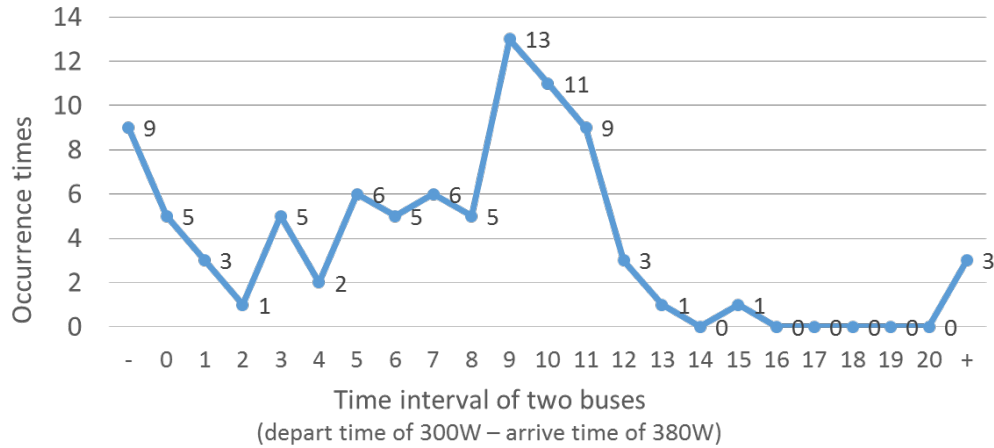

Figure 26. 380W connect to 300W (trip 1087) at Hillcrest Park & Ride station

Figure 27 depicts the potential success rate of connections and estimated savings on the passengers’ travel time under the circumstances that T-CONNECT is implemented.

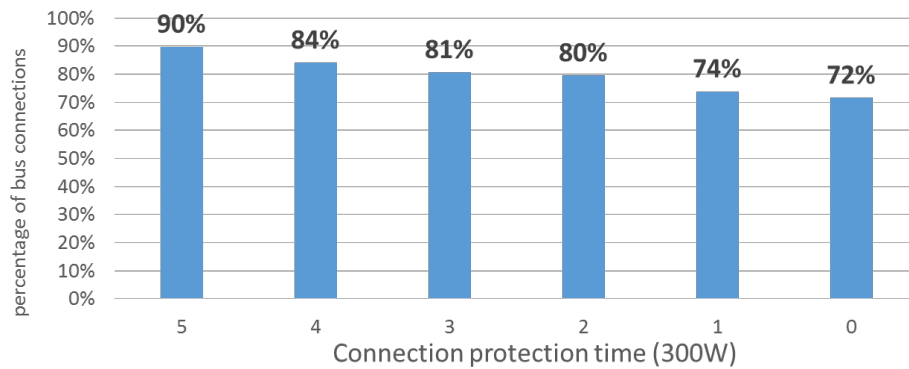

Figure 27. Connection success rate of T-CONNECT of 380W to 300W (trip 1087) at Hillcrest P & R

The current bus holding period of TDT in operation is 5 mins. Therefore, the whole travel time for the passenger transfer from 380W to 300W will be 32mins, as listed in Table 15, where the transfer time occupies 22% of the whole trip time. However, based on historical data, if T-CONNECT is implemented on this trip, the average travel time will be 27.6 mins, and the time savings are 4.4 mins (14%) per trip, as shown in Table 15. According to Table 15, considering that the statistical value of time per passenger is \$ 12.5 per hour, the passengers total travel time savings are up to approximately 2 hours per day, and 480 hours per year if T-CONNECT is implemented.

	Antioch	HILLCREST PARK & RIDE	Pittsburg BART	Total time (per trip)
	380 Westbound	Transfer	300 Westbound	
Without T-CONNECT	10 mins	7 mins	15 mins	32 mins
With T-CONNECT	10 mins	2 mins	15 mins	27.6 mins

Table 15. Total trip time of passenger transferring from 380W to 300W

	Passengers from Hillcrest to Bart who wait on 300 at Hillcrest	Passengers from Antioch to Bart transfer at Hillcrest (380 to 300)
Number of passengers	25	1
Travel time without T-CONNECT	20	32
Travel time with T-CONNECT	15.6	27.6

Table 16. Total trip time of passenger transferring from 380W to 300W with/without T-CONNECT

2) 380W (5:49pm) - 300W (5:54pm)

Trip ID: 1090

Connection stop: HILLCREST PARK & RIDE

Period: 2016-02-22 to 2016-08-26

According to the data log, there are 95 valid records in total, and 71 real time connections. Figure 28 shows the time interval between the two connecting bus routes (the gap between departure time of 300W and the arrival time of 380W).

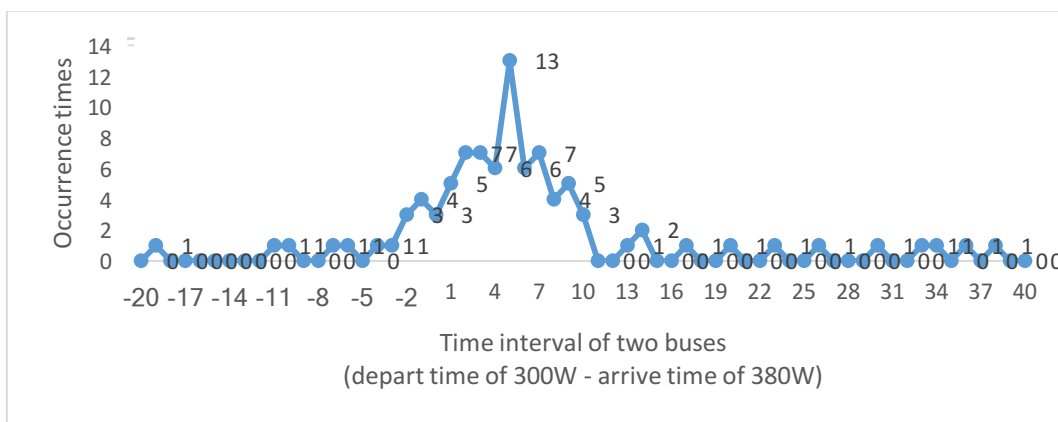

Figure 28. 380W connect to 300W (trip 1090) at Hillcrest P & R station

Figure 29 depicts the potential success rate of connections and estimated savings on the passengers' travel time under the circumstances that T-CONNECT is implemented.

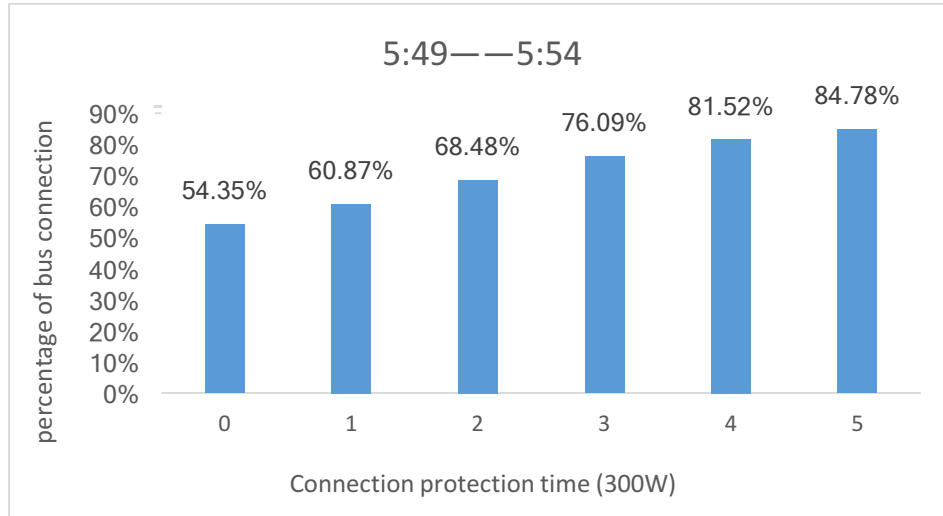

Figure 29. Connection success rate of T-CONNECT of 380W to 300W (trip 1090) at Hillcrest P & R

3) 388W (5:25pm) - 300W (5:26pm)

Trip ID: 1087

Bus stop: HILLCREST PARK & RIDE

Period: 2016-02-22 to 2016-08-26

According to the data log, there are 88 valid records in total, and 71 real time connections. Figure 30 depicts the time interval between the two connecting bus routes (the gap between departure time of 300W and the arrival time of 388W). Figure 31 depicts the potential success rate of connections and estimated savings on the passengers' travel time under the circumstances that T-CONNECT is implemented.

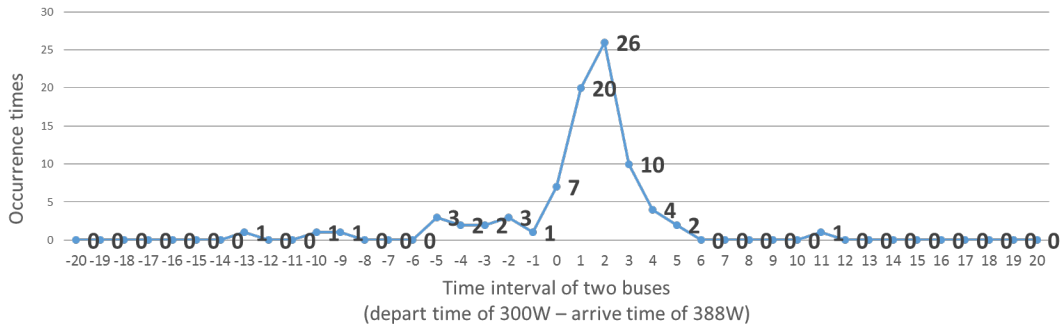

Figure 30. 388W connect to 300W (trip 1087) at Hillcrest P & R

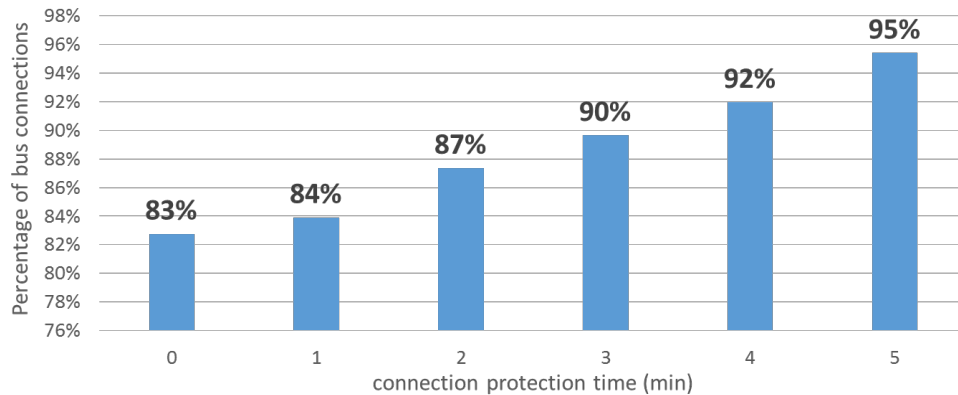

Figure 31. Connection success rate of T-CONNECT of 388W to 300W (trip 1087) at Hillcrest P & R

Assume that all passengers alighting from 388W at 5:25pm would transfer to 300W. (4.3 on average). The time savings are approximately 500 mins per year (which is equivalent to a cost of \$102) if T-CONNECT is implemented on 300W. The estimation is conducted on the following basis:

- The passenger load on 300W is 25 at Hillcrest P&R, and the passengers onboard would have to wait for additional 0.4min on average due to holding, which are 2483 mins per year.
- An additional 124 passengers can successfully make the transfer per year, who are supposed to wait an additional 24mins for the next scheduled 300W if the 388 is behind schedule and T-CONNECT is not implemented. Therefore, 2972 mins could be saved by implementing T-CONNECT.
- Therefore, the trip time savings for a year are: $2972 - 2483 = 489$ mins.

5.1.4 Analysis of the distribution of the arrival time

The average delay of the time of arrival of major TDT bus routes at Hillcrest P&R stop are listed in Table 17.

Trip ID	Average delay (min)	Trip ID	Average delay (min)	Trip ID	Average delay (min)	Trip ID	Average delay (min)	Trip ID	Average delay (min)
300		380		388		383		391	
1094	0.90	1006	7.50	908	1.54	1043	4.15	1239	1.63
956	0.42	1274	(2.53)	899	10.18	893	2.09	945	2.85
1101	5.67	1003	4.72	1228	(1.44)	36	8.36	1024	7.43
963	4.29	1271	5.02	1096	8.02	37	4.72	902	4.83
1062	0.08	1254	2.28	1070	7.25	1219	1.72	1288	(0.37)
966	4.96	1001	3.43	925	(0.71)	122	1.10	943	4.91
1071	2.62	919	2.87	1241	2.22	1218	3.17	1287	3.46
970	3.92	1013	2.75	1075	6.37	1220	9.27	944	5.79
1086	3.08	1270	2.52	909	1.77			953	4.55
1113	(0.21)	1004	1.67	375	6.25			942	11.98
1033	(3.46)	358	7.65	1224	0.98			951	(1.20)
1055	3.78	254	0.78	19	3.00			1286	9.35
Trip ID	Average delay (min)	Trip ID	Average delay (min)	Trip ID	Average delay (min)	Trip ID	Average delay (min)	Trip ID	Average delay (min)
300		380		388		383		391	
978	(1.00)	916	4.39	907	2.58			946	0.43
1112	(0.90)	997	3.31	1066	5.43			952	4.25
1044	(0.04)	1009	4.83	1093	3.10			1280	(3.86)

1351	(0.25)	319	5.11	912	0.67			1022	(2.89)
957	(2.23)	1272	3.51	922	2.25			1243	2.54
1090	3.38	242	0.82	1091	1.58			1242	2.25
955	2.45	999	3.72	1246	4.85			1284	3.94
959	3.29	353	3.87	898	3.81			950	4.71
1087	1.04	1277	(0.70)	1095	2.05			1232	1.20
1015	3.78	1255	1.93	938	7.95			3489	2.97
1017	1.01	1077	0.24	372	3.03			263	2.94
960	2.98	1085	3.77	911	1.54			947	0.11
1035	1.03	920	6.79	1245	4.03			1281	1.31
Trip ID	Average delay (min)	Trip ID	Average delay (min)	Trip ID	Average delay (min)	Trip ID	Average delay (min)	Trip ID	Average delay (min)
300		380		388		383		391	
1029	3.88	1275	(0.56)	1263	1.63			1023	(1.04)
				897	3.42			941	6.51
				1069	5.86			265	3.78
				900	2.15			269	8.70
				1264	3.88			1289	7.25
				1019	5.60			1283	2.04
				923	10.18			940	5.51
				374	4.40			1282	3.09

				910	0.59			939	1.86
				1016	6.08			272	5.04
				231	2.63			395	0.32
				373	5.78			954	7.22
				22	3.38			268	9.83
Trip ID	Average delay (min)	Trip ID	Average delay (min)	Trip ID	Average delay (min)	Trip ID	Average delay (min)	Trip ID	Average delay (min)
300		380		388		383		391	
				924	2.55			1285	2.54
				1067	12.13			1290	6.42
				926	2.45			387	13.61
				1073	16.70			347	7.42
				927	4.51			416	0.91

Table 17. Averaged delay of the time of arrivals

As shown in Table 17, there is non-zero delay on the time of arrival at the Hillcrest P&R for most trips of TDT, with a maximum delay of 16.7 minutes. The delay of time of arrival of the inbound bus may cause connections failure to the passengers who intend to transfer to a connecting bus at Hillcrest. Particularly, the delay may affect a larger number of passengers during peak hours. Therefore, this analysis reveals the necessity of the implementation of T-CONNECT due to the frequent delay of bus routes.

5.1.5 Conclusions

In this subsection, the historical operation data from APC have been analyzed to summarize the overall passenger boarding/alighting activities, the distribution of bus arrival time and connections between bus routes. The analysis results reveal a typical travel pattern of commuters, where a large number of passengers make transfers (bus-bus and bus-BART) at two major connecting points (i.e. Hillcrest P&R stop and Pittsburg/Bay Point station) during the peak hours. Therefore, the two identified connection stops can be used as candidate connection points for further evaluation in the FOT and corresponding bus routes and trips can be identified accordingly for the demonstration of T-CONNECT.

In addition, the analysis of the historical data in this subsection reveals that delay on the arrival time is quite common in actual operations, which may result in potential connection failure. Based on predefined assumptions, further analysis reveals that the T-CONNECT has great potential to increase successful connections and improve the overall success rate of transfer. Therefore, the results indicate that it is necessary to implement the T-CONNECT in actual operations and evaluate the consequential benefits in FOT.

5.2 Field Operational Test Design

To demonstrate the effectiveness of the IDTO prototype developed in this project and to evaluate the performance of the IDTO applications of Phase One, an IDTO prototype was implemented in limited scale at Tri-Delta Transit agency, and a field operational test was conducted and from July 25th to August 11th, 2017. For the Phase One effort, the demonstration and field testing focused on the T-CONNECT application on selected routes operated by TDT and at key connection points between buses and BART.

As analyzed in section 5.1, the TDT express route 300W connects Pittsburg/Bay Point BART with Antioch Park-N-Ride (Hillcrest Park-N-Ride) lot via state highway 4 without any stop in between these end points. Route 300 carries one half of all boarding numbers at this Park-N-Ride lot, this indicates a large number of passengers take rides to Antioch Park-N-Ride lot and transferred to bus route 300W to get to the Pittsburg/Bay Point BART during morning peak-hours. This also makes Antioch Park-N-Ride a major connection

point for TDT bus routes operating in morning peak (Figure 23). Therefore, a number of trips of route 380WB, 383CCW and 388W connecting 300W at Park-N-Ride during morning peak hours are identified to be included in the field testing of the IDTO prototype. (listed in Table 4)

Naturally, the trend of commuting in the evening peak hours is opposite to that in the morning peak hours, where most of the commuters transfer from BART trains to buses at BART station. As a result, TDT bus trips (300EB, 390EB and 391EB) that connect with BART at the Pittsburg/Bay Point central BART platform station (Figure 32) have been selected for the demonstration of T-CONNECT application for BART-bus connections (Table 18).



Figure 32. Demonstration Connection points (BART Central Platform and Antioch P&R)

Based on the analysis in subsection 5.1, the IDTO T-CONNECT function was implemented on the selected connecting trips and connection points listed in Table 4. A group of testing personnel from both PATH and TDT were identified to test the IDTO mobile App. The testing personnel were supposed to get onboard an identified bus and input and register a set of trip information containing the arriving trip, the downstream trip and connecting point from the below list, using the IDTO Mobile App on their own mobile device. The IDTO server receives all registered trips and keeps monitoring the ETA of the arriving trip and submits T-CONNECT requests if the conditions for connection protection are met.

Operational period	Arriving trip	Downstream trip	Connection Point	Connection stop id
AM	TDT 380WB	TDT 300WB	Antioch Park-N-Ride	817754
AM	TDT 383CCW	TDT 300WB	Antioch Park-N-Ride	817754
AM	TDT 388WB	TDT 300WB	Antioch Park-N-Ride	817754
PM	Pittsburg/Bay Point BART	TDT 300EB	BART Central Platform	818889
PM	Pittsburg/Bay Point BART	TDT 390EB	BART Central Platform	818889
PM	Pittsburg/Bay Point BART	TDT 391EB	BART Central Platform	818889

Table 18. IDTO demonstration trips and connection points

The Dispatch interface is implemented on a tablet device with touch-screen, which is installed in the dispatch room of Tri-Delta Transit. The dispatch interface displays all active T-CONNECT requests and enables the dispatcher to operate on the requests (Approve/Reject) after communicating with bus drivers. The maximum waiting time for T-Connect is limited to 5 minutes to avoid creating delays to passengers already onboard the downstream bus. The mobile app testing personnel can then receive notifications regarding the dispatch decisions on T-CONNECT request on their mobile devices. Once the testing personnel’s trip fulfills connection protection conditions and the T-CONNECT service is initiated, the notifications of the T-CONNECT status can be received on the testing personnel’s mobile devices.

An example of the operational sequence of the T-CONNECT scenario is described in Table 19, and the corresponding workflow of IDTO system is illustrated in Figure 33.

Time	Passenger	IDTO Server	Dispatch Center	Bus Driver
10:01	O/D Input, trip information registration			
	Confirm Trip to subscribe notification service	Receive and store (to Transit database) information of planned trip (*)		
		Get ETA of 380 at “Antioch P & R”, 10:17 for example		
10:14		<3 min. before arrival> Detects the 300 will arrive at Antioch P & R 2min behind schedule Update “event_state” in the transit database		
			Receive new T-CONNECT request on the dispatch interface	
10:15			Ask driver to hold until 10:20 via radio	
				Approve/Reject

				connection protection
			Press “Approve” or “Reject” button	
		Update “event_state” and push the first notification		
	Receive the first notification push: “Upon your request, the Bus 300 will wait at Antioch P&R until 10:20am.” or “Bus 300 is unable to hold at Antioch P&R”			
10:20				Finish waiting and pull
10:21		<1 min. after departure> Update “event_state” and push the second notification		
	Receive the second push notification: “The bus 300 on your trip has left from Antioch P&R.”			
10:22	Receive the third notification with: “Was the connection protection service successful? Y/N”			
		Update “event_state”		

Table 19. Operational Sequence for the T-CONNECT demonstration

5.3 Field Operational Test Data Collection and Logging

The analysis of the performance of IDTO prototype and benefits and improvements of implementation of IDTO is based on the data collected during the FOT. Therefore, during the demonstration, two categories of data are collected and logged: T-CONNECT request/service records and the AVL data.

The T-CONNECT requests/service data contains all details of each T-CONNECT request and the corresponding service status. A table (named 'Tconnect_log') is created in the MySQL database for logging the T-CONNECT requests during the FOT phase, and the IDTO server automatically insert T-CONNECT requests into the Tconnect_log table at the end of operations of each day. Details of the T-CONNECT request/service log is listed in Table 20.

Data field	Data type	Data Specification
Record_id	varchar	Id for each record, with the date at which the T-CONNECT request is submitted
This_route_agency	int	Transit agency of the incoming trip (TDT/BART)
This_route_id	varchar	The route id of the incoming trip (route number/BART)
This_route_arr_stop	int	Id of the stop at which the incoming trip arrives
This_trip_id	int	Trip id number of the incoming trip
Next_route_agency	int	Transit agency of the downstream trip (TDT/BART)
Next_route_id	varchar	Route id of the downstream trip (route number/BART)
Next_route_dep_stop	int	Id of the stop from which the downstream trip departs
Next_trip_id	int	Trip id number of the downstream trip
Requested_holding_time	int	Number of minutes the downstream trip is requested to hold for
Event_req_time	time	The time when the T-CONNECT requests is submitted
Event_state	var	Status of the T-CONNECT request/service

Table 20. Schema of T-CONNECT request/service log

In addition, the vehicle location data from AVL feed is also logged to support the analysis of T-CONNECT request accuracy (which will be described in section 5.5.2). The AVL data feed are read by the route number of the vehicle at a fixed interval (1min), and all data is

logged in data files at the end of each operation day during the FOT phase. Data obtained from AVL system are listed Table 21.

Data field	Data Specification
vehicle_id	ID of each vehicle in operation
trip_id	ID of each trip corresponded with the vehicle
route_number	TDT route number
dir	Operation directions (e.g. Estbound/Wstbound)
next_stop	ID of the downstream stop
lat	Latitude of the vehicle
lon	Longitude of the vehicle
time	timestamp at which the record is updated at the AVL
timestamp	time at which the record is updated at the data source

Table 21. Schema of AVL data

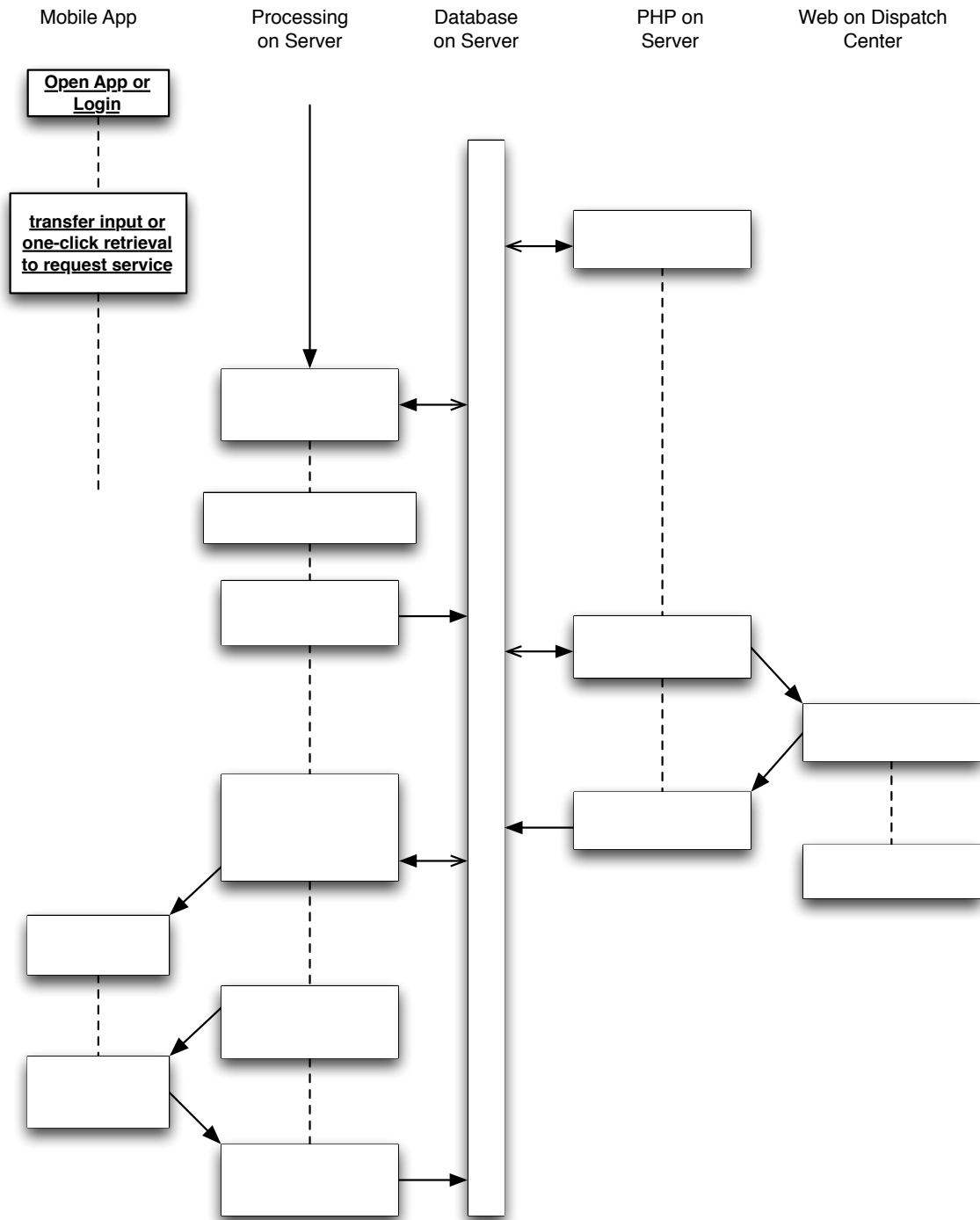

Figure 33. Workflow of T-Connect demonstration

5.4 Collection of Historic Operational Test Data

The improvement of the agency's operations and passengers' transit is an important aspect of the evaluation criteria. This can be evaluated by comparing the operational statistics collected during FOT phase with the historical data collected before

implementing the IDTO system. To achieve this objective, the historical APC (Automatic Passenger counting) data from the TDT transit management system has been collected. The APC data contains the number of passengers’ boarding and alighting from each vehicle by stops and is recorded in data files. Details of the APC data are listed in Table 8.

Data Field	Data Specification
ID	Bus stop id
Date	Date (MM/DD/YY) of record
Route	Bus route number
Arrive	Time of arrivals (hh/mm/ss)
Depart	Time of departure from the specified stop
On	Number of passenger boarding at specified stop
Off	Number of passenger alighting at specified stop
Load	Number of passenger load at the moment of departure
SchD	Scheduled time of departure
TripID	Trip ID of the vehicle
DOC DCC	Recorded count of door open and close

Table 22. APC data schema

5.5 Data Processing

The FOT data and historical operational data specified in section 5.2 and 5.3 were processed to support further analysis and system evaluation. Steps for processing the data are as follows:

- AVL data processing: A program is developed to read and parse the AVL data file recorded during the FOT phase, and it determines the time-of-arrival and time-of-departure of the specified vehicle at the specified stop (Antioch P&R for this phase) by comparing the GPS location of the vehicle with that of the stop. The above results are then inserted into the MySQL database on the IDTO server.

- APC data processing: The APC data are processed by another program which reads and parses APC data files, and determines the number of transfers between connecting vehicles at specified stop (Antioch P&R for this phase).

5.6 System Evaluation and Summary of Benefits

5.6.1 Evaluation Criteria and Methodology

The benefits and improvement brought by implementing the IDTO system were evaluated by analyzing the operational data collected during the FOT phase and the historical operational data. To achieve this object, a series of evaluation criteria are defined, and the corresponding data is processed to determine those criteria:

- **Capability of trip delay detection** indicates the capability of the IDTO prototype to detect trip delays and submit T-CONNECT requests. This criteria is evaluated based on the T-CONNECT records and the AVL data recorded during the FOT phase. As described in section 5.4, the AVL data are processed to extract the time-of-arrival of each trip, and these results are then compared with the ETA recorded in the T-CONNECT log so that the correctness of T-CONNECT requests is determined.
- **Correspondence with manual connection protection requests** represents the extent to which the IDTO system can replace the conventional connection protection requests manually made by the passengers and drivers via phone calls. During the FOT at this phase, the passengers' phone calls for bus-holding are recorded at the dispatch center, and these records are matched with the logged T-CONNECT requests triggered during the FOT to determine the correspondence.
- **Savings on passenger's trip time** is used to indicate how the implementation of T-CONNECT benefits the passenger in making transfers. As passengers on delayed trips do not necessarily have to wait for the next trip on schedule due to connection protections, the savings on the trips time are estimated by comparing the passenger's trip time with and without the implementation of IDTO T-CONNECT functions.
- **Improvement on the success rate of connections** is used to evaluate how the IDTO T-CONNECT functionality can improve the overall connection success rate, which is defined as the ratio of successful connections among all connections. The connection success rate by implementing the T-CONNECT is compared with that without implementing T-CONNECT to summarize the improvement brought by IDTO.

Details of the evaluation results are summarized in the following subsections.

5.6.2 Capability of Trip Delay Detection

As described in Section 5.1, the T-Connect application of the IDTO prototype is designed to detect delays of incoming trips in real-time, and it automatically triggers and displays connection protection requests (T-Connect requests) for further operations. Therefore, one of the critical performance measures of the IDTO prototype is the system's capability to correctly detect trip delays that may result in connection failure and trigger connection protection requests.

The trip delay detection of the IDTO prototype can be considered as a binary classification application (to detect whether a trip is delayed or not) of which the typical performance evaluation metrics include the **connection sensitivity** and the **request precision**. The true positive rate is the proportion of positive target instances that are correctly identified as positive class among all positive instances, while the accuracy is the fraction of positive instances among the identified positive class. In this section, we apply these two metrics to the IDTO T-CONNECT scenario and evaluate the IDTO prototype using the data record from FOT.

For the IDTO case, the **connection sensitivity** is defined as follows:

$$TPR = \frac{N_{TP}}{N_p} \times 100\% = \frac{N_{TP}}{(N_{TP} + N_{FN})} \times 100\%$$

Where:

TPR – connection sensitivity of connection protections (during the field operational test period)

N_{TP} - Number of delayed connections that are correctly detected by the IDTO system (True positive instances)

N_{FN} - Number of delayed connections that are incorrectly identified as on-schedule by the IDTO system (False negative instances)

N_p - Total number of delayed connections that need connection protection, and apparently:

$$N_p = (N_{TP} + N_{FN})$$

As shown in the above definition, TPR indicate the capability of the IDTO prototype on correctly identifying connection protection requirements. N_p denote all connections that are actually delayed and need holding service, and N_p can be determined by extracting the actual time of arrival at specified transfer stop (Antioch Park & Ride in this case) using the recorded GPS data. N_{TP} and N_{FN} can be extracted from the logged T-CONNECT instances during the FOT phase.

The **request precision** of connection protections is defined as follows:

$$\rho = \frac{N_{TP}}{N_T} \times 100\% = \frac{N_{TP}}{(N_{TP} + N_{FP})} \times 100\%$$

Where:

ρ – Request precision of connection protection requests (during the field operational test period)

N_{TP} -Number of correct T-Connect requests

N_T -Total number of T-Connect requests triggered by the IDTO prototype, and apparently:

$$N_T = N_{TP} + N_{FP}$$

where N_{FP} is the number of incorrect T-Connect requests triggered by IDTO prototype.

Therefore, TPR indicates the extent to which the IDTO T-Connect function can detect connections that need protections, and ρ denotes the percentage of correct connection protection requests among the total number of requests triggered by the IDTO prototype within a specified period (i.e. the field operational test period in this report). The is depicted in Figure 34. N_T can be extracted from the data records of the field operational test period. Correct T-Connect requests are detected events where the incoming trip is actually delayed and can cause connection failure. In this report, the T-Connect requests are examined using the GPS coordinates of vehicles recorded from the AVL system. The GPS coordinates of each incoming trip are checked first to find the moment (timestamp) when the vehicle arrivals at a specified bus stop (Hillcrest Park & Ride in the field operational test), and the extracted timestamp of arrival is then compared with the scheduled time of arrival (STA) to determine if the trip is actually delayed.

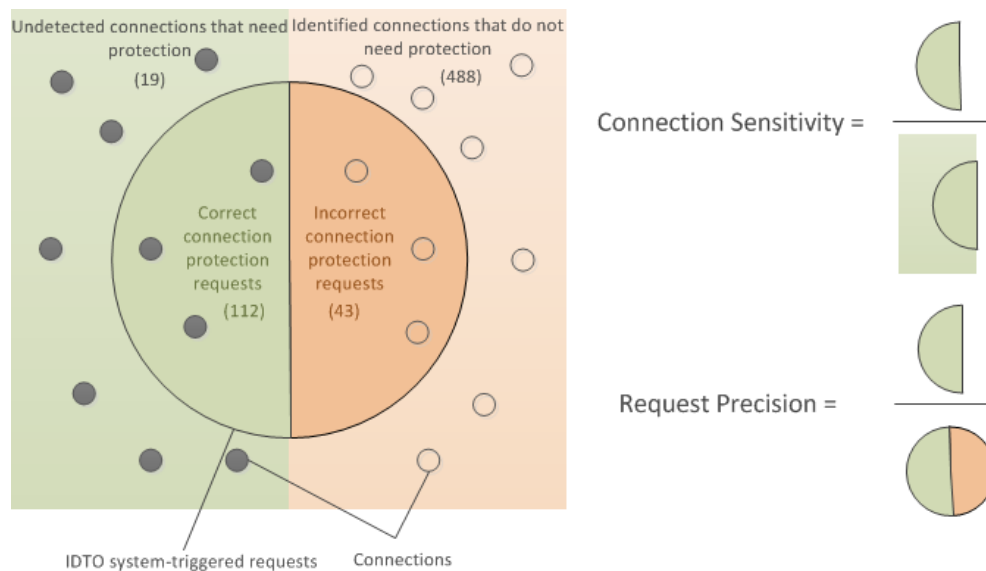

Figure 34. Definitions of connection sensitivity and request precision

The statistics of connections during the FOT phase is summarized in Table 23. The database recorded a total number of **662** connections, among which **155** are identified by the IDTO prototype as delayed connections and holding requests are triggered. By analyzing the actual time-of-arrival of the vehicles using the recorded GPS locations, **131** connections are recognized as ‘real’ delayed connections (the corresponding incoming trips are indeed behind schedule) that required holding service.

The criteria defined in this subsection is then calculated using the above statistics. The connection sensitivity and request precision of T-CONNECT function of the field operational test period are depicted in Figure 35 a) and Figure 35 b), respectively. The TPR and accuracy of each incoming bus route (380W, 383CCW and 388W, note that their connecting trip is 300W) involved in the FOT phase are also illustrated in the figure.

As can be seen from the figure, the overall connection sensitivity and request precision of T-Connect requests during the test period is **85.5%** and **72.26%** (A total number of 155 T-Connect requests are triggered, among which 112 requests are true positive instances, and 131 are delayed connections that need protection), respectively.

	Connection protection requests of IDTO	Normal connections identified by IDTO	Total	Precision of requests
Connections in need of protection	112	19	131	85.5%
Normal Connections	43	488	531	
Total	155	507	662	
Connection sensitivity	72.26%			

Table 23. T-CONNECT Statistics

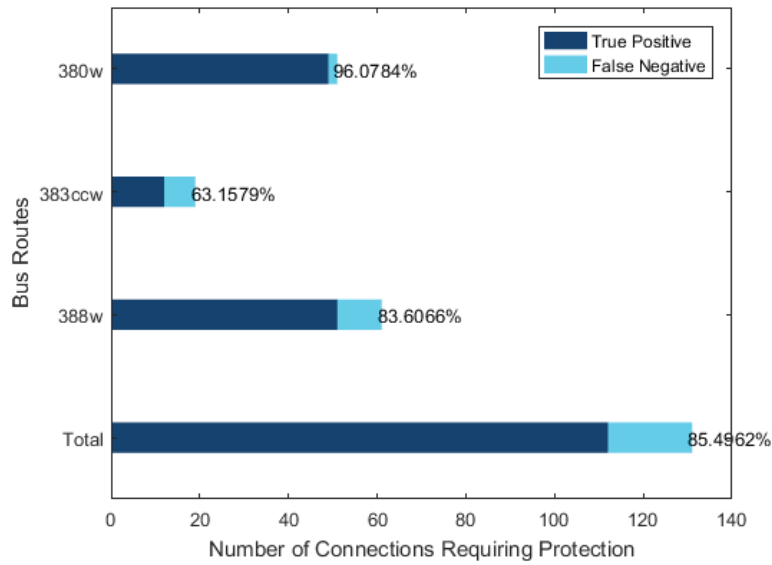

a)

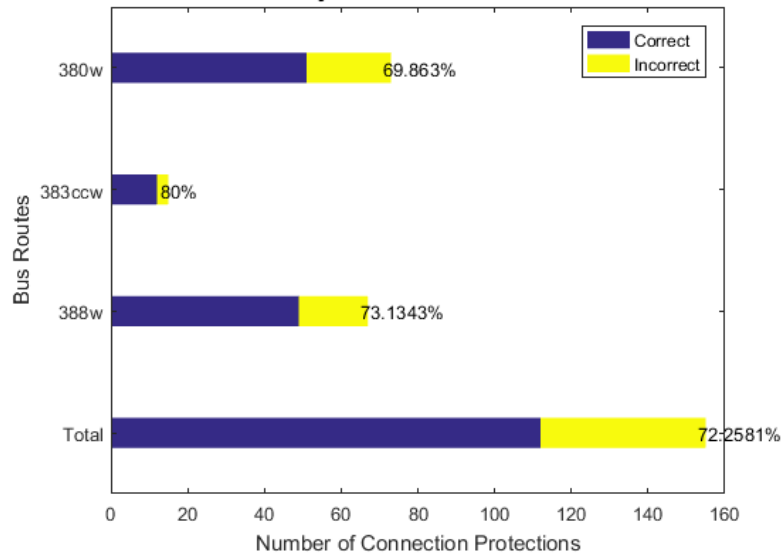

b)

Figure 35. a) Connection sensitivity of T-Connect requests; b) Request precision of T-Connect requests

These metrics were further analyzed by categorizing the T-Connect requests according to the bus route numbers (380w, 383ccw and 388w) of the incoming trips (Figure 35a), as well as the trips on the timetable (Figure 36b, Figure 37b and Figure 38b).

As shown in the figures, the overall connection sensitivity and request precision of bus No. 380w are 96.1% and 69.86%, respectively, and most of T-Connect requests occurred during the morning and evening peak hours (Figure 35b). Among all the selected trips of bus No. 380w, the highest connection sensitivity and request precision reaches 100%, while the lowest accuracy is 27.27% during the morning peak hours.

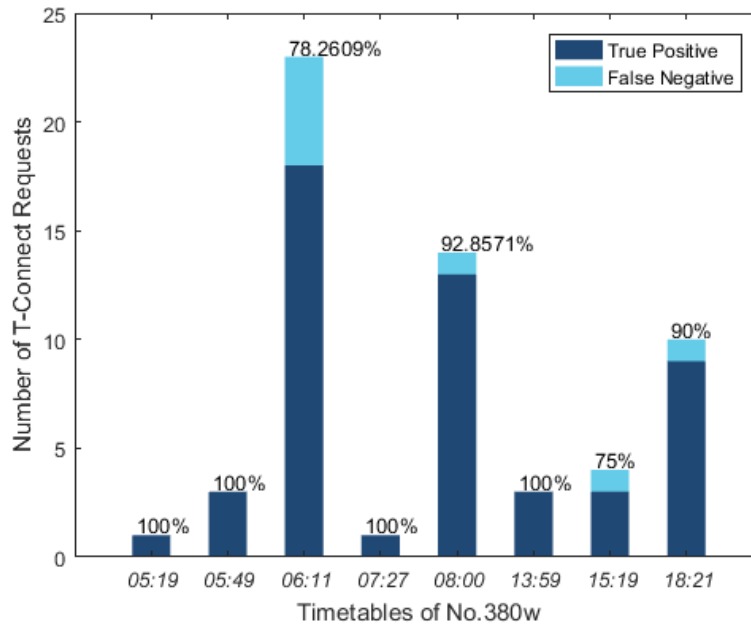

a)

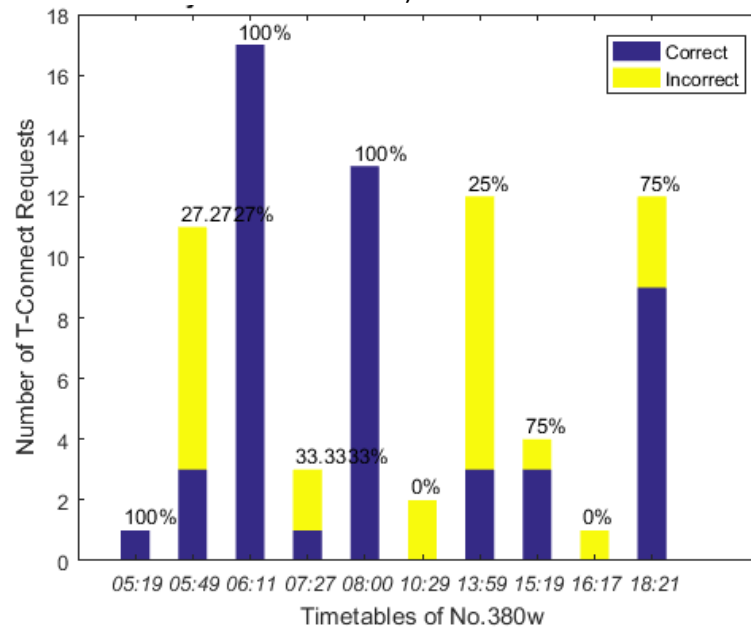

b)

Figure 36. a) Connection sensitivity and b) request precision of T-Connect requests involving bus No. 380w

Figure 37 and Figure 38 depicts the T-Connect connection sensitivity and request precision of bus route No. 388w and 383ccw, respectively. Similar to bus No. 380w, most of connection protection events occurred during morning peak hours for the trips of bus No. 388w. The overall connection sensitivity and request precision accuracy of 388w trips are 83.6% and 73.13%, and the highest TPR and T-Connect accuracy for the trips of bus No. 388w are also 100%, while the lowest accuracy is 10% (6:25).

The connection sensitivity and request precision indicate that the IDTO prototype system can effectively detect trip delays and trigger T-Connect requests to hold the connecting vehicles. This allows the passengers on the delayed bus to make the connections even if the trip is delayed. However, as the detection of trip delay is currently based on the estimation of time of arrivals from the AVL system (ETA), the T-Connect connection sensitivity and request precision are significantly affected by the accuracy of ETA of the AVL system. In some extreme cases, the T-Connect accuracy is lower than 50% (e.g., trip 5:49, 7:27 of No.380w and trip 6:25 of No. 388w) and is even 0% due to inaccurate predictions of ETA from the AVL system. This issue may be solved by improving the approaches for predicting the ETA, which will be an important aspect of study in the next research phase of IDTO.

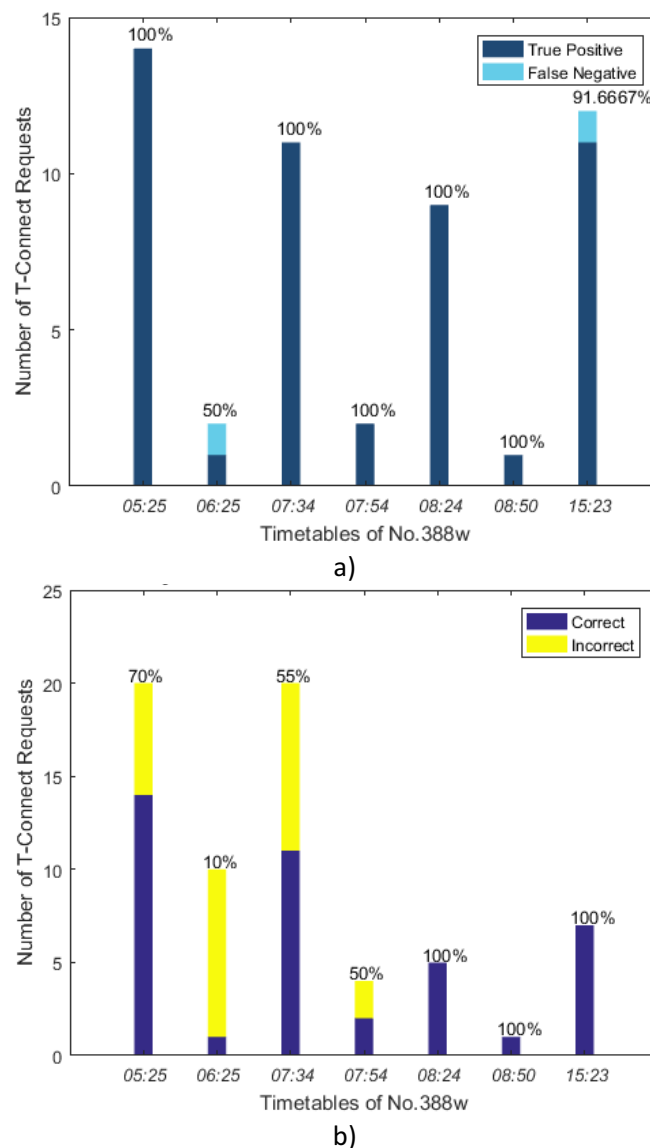
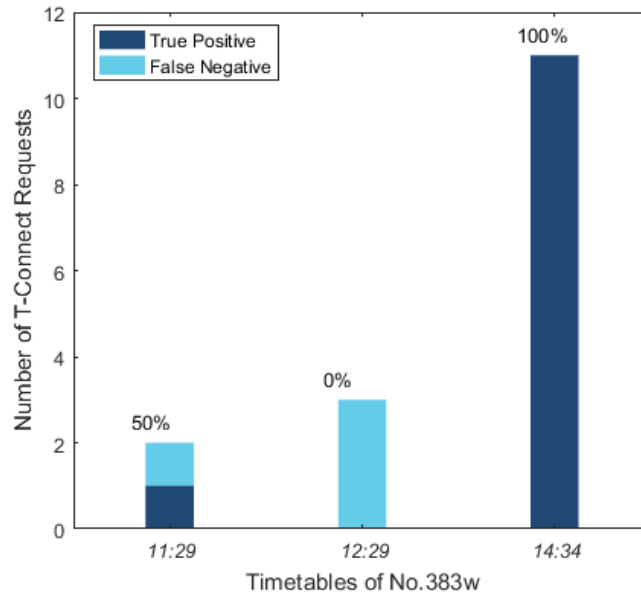
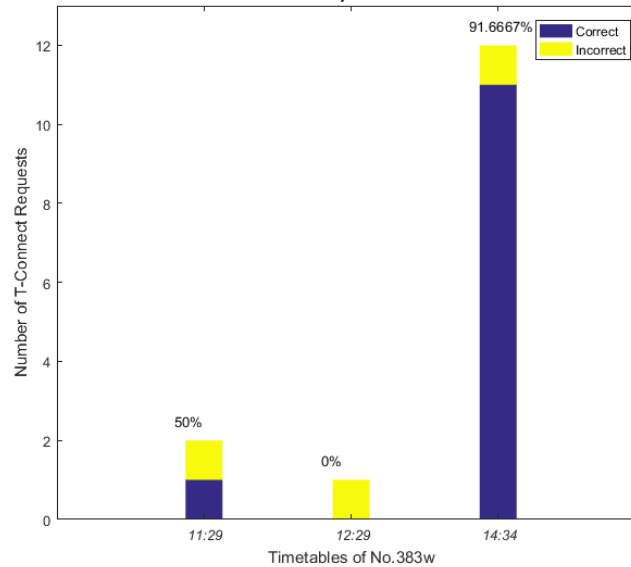

Figure 37. a) Connection sensitivity and b) request precision of T-Connect requests involving bus No. 388w



a)



b)

Figure 38. a) Connection sensitivity and b) request precision of T-Connect requests involving bus No. 383ccw

5.6.3 Correspondence with Manual Connection Protection Requests

For the FOT of the IDTO prototype, a parallel testing procedure is proposed and applied to the evaluation of T-CONNECT functions. For conventional operations without the implementation of T-Connect applications, the passengers or vehicle drivers have to submit connection requests to the dispatch center by making phone calls or via driver-dispatcher/driver-driver communication channels. For the parallel testing procedure, in order to evaluate how the IDTO T-Connect application addresses passengers' needs for connection protections when trip delay occurs, the manual connection protection requests made by the passengers and drivers are also recorded as most passengers are

not involved in the FOT. The system-triggered T-Connect requests are then compared with the manual connection protection requests to determine how they are matched.

In this report, the **replacement rate (matching rate) of manual connection protection requests** are used to evaluate how the system-triggered T-Connect requests match the manual request. The definition of replacement rate is as follows:

$$R = N_r / N_m$$

where:

R – replacement rate (matching rate) of manual connection protection requests

N_r – Number of system-triggered T-Connect requests that can be matched with manually-submitted connection protection requests

N_m – Total number of connection protection requests submitted by the passengers and drivers.

As discussed in the field operational testing design subsection, a total number of 77 transfer trip pairs are selected for the field operational testing, so N_m denotes only the total number of manual protection requests among the selected trip pairs. Therefore N_r denotes the matched T-Connect requests among N_m .

The following statistics are obtained by analyzing the IDTO prototype data log (which contains all the information of T-Connect events during the testing period) and the dispatch operations log (which contains the information of connection protection requests made by drivers and passengers):

ITEM	Number of matched T Connect requests (N_m)	Total number of manual connection protection requests for selected (N_r)	Total number of manual connection protection requests(N_t)
Statistics	7	10	37

Table 24. Matching Rate with Manual Connection Protection Requests

As can be seen from Table 24, among all recorded manual connection protection requests (**37** in total), **10** requests involve transfers that fall into the selected transfer trip pairs. **7** of the manual connection protection requests can be matched with the T-Connect requests triggered by IDTO prototype, which means the requests are made by passengers/drivers because the trips are delayed, and those trip delays are also detected by IDTO prototype and T-Connect requests are automatically triggered at the same time.

An example of the parallel T-CONNECT demonstration is depicted in Figure 38. All the data shown in the figure is extracted from the IDTO data log and manual connection protection request records. For this recorded case, a passenger was on a BART train which was scheduled to arrive at Pittsburg/Bay Point BART station at 7:32PM, and he intended to transfer to TDT bus 390EB scheduled to depart at 7:41PM. The IDTO predicted the time-of-arrival of the train and submitted connection protection request at 7:35PM as it detected delayed arrival of the BART train. The train actually arrived at 7:39, which is 7 mins behind the schedule, and the passenger made a phone call to the dispatch center and requested to hold the bus 390EB.

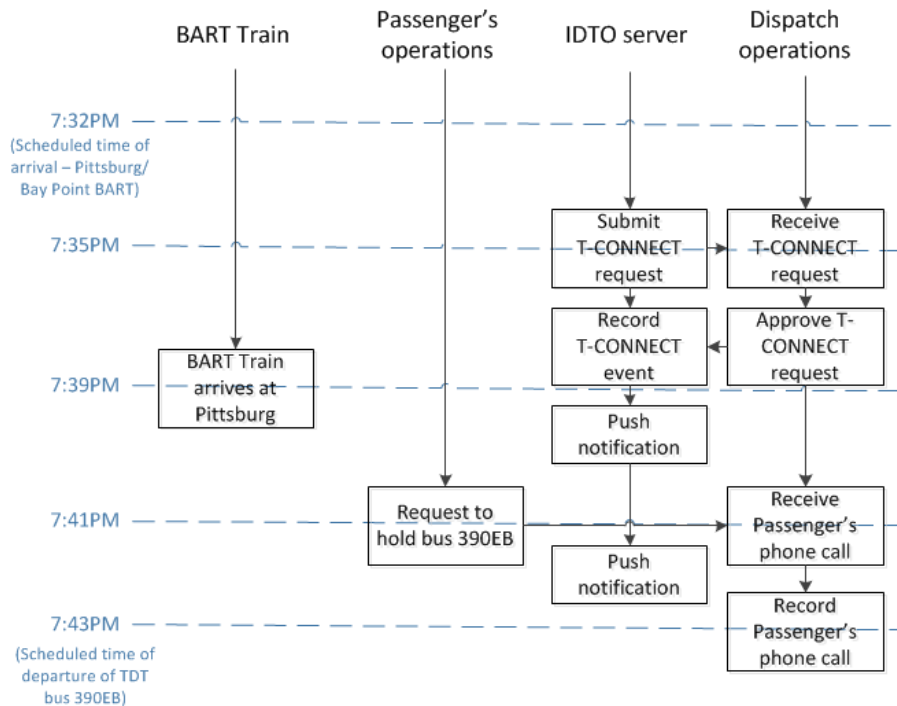

Figure 39. Parallel testing flow of T-CONNECT

There are several primary factors that may affect the matching rate of manual connection requests. The biggest factor is the difference in passenger traffic during different hours of day. For trips in off-peak hours, the number of commuters is much smaller than that on trips in peak hours. In that case, it is possible that no passenger/driver make connection protection requests even the trip is actually delayed. In addition, some of the holding requests are made directly between vehicle drivers via radio channels, and there will be no records at the dispatcher side in that case. This is the reason that only 10 manual requests fall into selected transfer pairs.

The matching rate of manual connection protection requests indicates that the IDTO prototype is able to fulfil passengers' actual needs for requesting connection protection

requests, and automatically submit T-Connect requests without the passengers' operations. This capability can be further evaluated via fully deployment of the T-Connect applications during the second research phase of IDTO.

5.6.4 Savings on Passengers' Trip Time

One of objective of implementing the IDTO system is to save passenger's travel time by providing connection protection services (T-Connect service). For instance, a connection trip can be requested to hold due to the delayed incoming trip, so the passengers can successfully make the transfer and do not have to wait for the next scheduled trip. Therefore, this reduces the waiting time of the passengers who board downstream. In order to evaluate the statistics on trip time saving brought by the IDTO T-Connect application, we divide the connections in the demonstration into two groups: bus-bus and BART-bus, and define the averaged trip time saving criteria. We then utilize the criteria to analyze the data record from the field testing and summarize the findings.

The definition of the averaged trip time saving is as follows:

$$\bar{t}_s = \frac{\sum_i n_i t_i}{N_c}$$

where:

n_i - number of connections for trip i that request connection protection service by IDTO system.

t_i - trip time saving of connection i brought by the IDTO connection protection service, and t_i is calculated by $t_i = ST_k^i - ST_{k-1}^i$, where ST_{k-1}^i is the $(k-1)$ th schedule on the timetable of trip i at the specified connection point, and thus ST_k^i is the next schedule of ST_{k-1}^i . Therefore, t_i indicates that the passenger can save the trip time t_i because he/she can board the vehicle at ST_{k-1}^i rather than waiting for the next one scheduled at ST_k^i due to the connection protection service provided by IDTO.

N_c - total number of connections that request connection protection service, therefore:

$$N_c = \sum_i n_i$$

\bar{t}_s - the overall averaged trip time savings. As shown in the above definition, \bar{t}_s is actually the weighted averaged trip time savings and the weight depends on the frequency of requesting connection protections for each connection trips.

Based on the above definition, we analyze the recorded T-CONNECT data of the field testing period and the results are presented as follows:

During the FOT phase, 16.67% of the bus-bus connections (52 connections out of a total number of 312) were identified by the IDTO system as involving trip delay and were provided with connection protection service. The passengers' trip time (waiting time) decreased by 23.78 mins on average due to connection protection. In the cases of BART-bus connections, 114 out of 612 connections (18.62%) required bus-holding service which resulted in a decrease of 30.71 min (averaged) of passengers' trip time. The results demonstrate that the implementation of the IDTO system can significantly reduce passengers' waiting time during transfer by providing vehicle holding service(T-CONNECT). This also indicates the IDTO system has great potential in reducing the total trip time and improving passengers' travel experience if fully-deployed.

5.6.5 Improvement on the Success Rate of Connections

As discussed in Section 5.2, one of the important criteria to assess the benefits brought by implementing the T-CONNECT is the improvement on the overall success rate of connections. While the analysis in subsection 5.1 is based on the historical operation data, the actual FOT data is used for analysis in this subsection.

The success rate of connections is defined as the ratio of successful connections (the discrepancy between the arrival time of inbound trip and departure time of the connecting trip is equal to or larger than the required time for transfer) among all connections (Figure 40). A connection is considered as unsuccessful if the discrepancy between the inbound trip and connecting trip does not meet connection time requirements (1min for bus-bus connections, and 5mins for bus-BART transfer) and T-CONNECT is not implemented. Based on the above hypothesis, we analyze the data of bus-bus connections recorded during the FOT and extract the statistics of successful and unsuccessful connections. As shown in Table 25, there are 662 connections in total during the FOT phase, among which 531 connections would be successful without implementing T-CONNECT (the success rate is 80.21%), and the number of successful connections is 643 as potential connection failures can be identified and connection protection service is provided if T-CONNECT is implemented (the success rate is 97.13%). Therefore, the success rate of connections can be increased from 80.21% to 97.12% by implementing T-CONNECT. Therefore, it can be concluded that the IDTO has the potential of improving the success rate of connections and ensuring transfer in the cases the inbound trip is delayed.

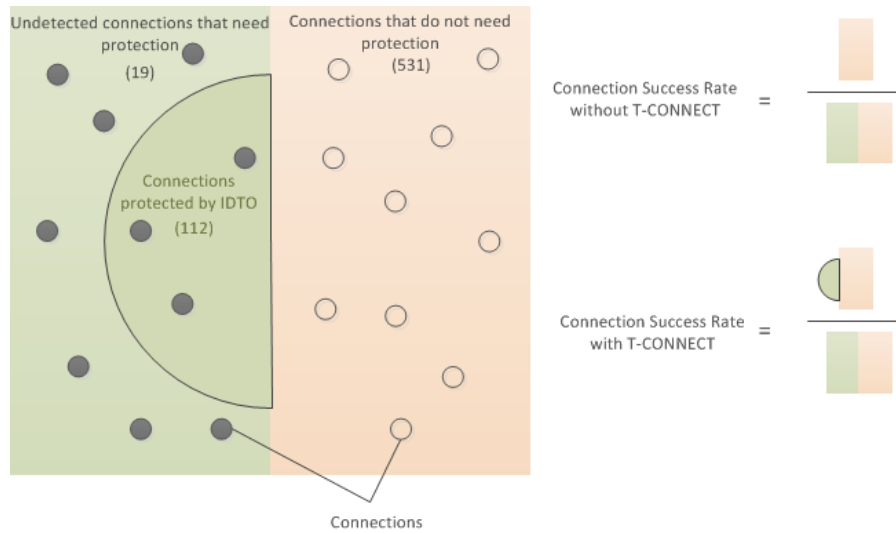

Figure 40. Definition of connection success rate

	Connection success	Connection failure	Success rate of connections
Without T-CONNECT	531	131	80.21%
With T-CONNECT	643	19	97.13%

Table 25. Success rate of connections

6 Conclusions and Recommendations

6.1 Summary of development

The IDTO project aims at developing a fully functional Integrated Dynamic Transit Operation (IDTO) prototype system that enables T-CONNECT and T-DISP services as well as real-time information for transit operations and travelers. An IDTO system architecture with all functional components and interfaces is designed based on the design and development requirements, and the operational scenarios and corresponding sequences are also defined. Under the Phase One project, an IDTO prototype is developed with special focus on the T-CONNECT functions. The IDTO prototype includes the full-functional IDTO server, the IDTO Dispatch Interface, and the IDTO Mobile App.

The developed IDTO prototype was tested and demonstrated on selected bus routes of Tri Delta Transit agency at two major connection points (Antioch P&R, Pittsburg/Bay Point BART station) during the FOT period between July 25th and August 11th, 2017. Both bus-bus and BART-bus connection scenarios were tested for the IDTO functions. The developed IDTO Mobile App was tested on real trips of TDT bus routes. The T-CONNECT connection protection services are carried out by the operations of dispatchers using the developed Dispatch Interface installed in the Tri Delta Transit dispatch center. The FOT collects a rich set of data to evaluate the benefits and impacts and IDTO.

6.2 Summary of benefits and improvements

A thorough analysis including FOT data analytical evaluation and discussion with transit stakeholders and operation staff was conducted to evaluate the improvements and benefits. The key findings are summarized as follows:

- (1) The IDTO prototype can correctly identify 85.5% of all trip delays during the FOT, and the precision of T-CONNECT requests of IDTO prototype reaches 72.3%, indicating that the IDTO prototype system can effectively detect trip delays and submit T-Connect requests to hold the connecting bus. This allows the passengers on the delayed trip to make the connections more easily.
- (2) The FOT results show that the T-CONNECT submitted by the IDTO system requests match well with the passengers' phone requests for connection protection, indicating that the IDTO prototype is able to fulfill passengers' actual needs for requesting connection protection services. An IDTO that automatically submit T-Connect requests without requiring the passengers' operations can bring pleasant travel experience to riders.

- (3) Due to the vehicle holding service provided by the IDTO T-CONNECT function, the passengers' waiting time decreases by 23.78mins and 30.71mins on average for bus-bus and BART-bus connections, respectively.
- (4) The FOT statistics indicate that the success rate of connections can be increased from 80.21% to 97.13% by implementing the IDTO T-CONNECT application.

The analysis of FOT results demonstrates that IDTO provides an improved level of service to passengers and supports enhanced transit operations by enabling travelers to interact with transit systems on their real-time connection needs. The better passenger service delivered by IDTO will expand the horizon for public transit management, offering the opportunity to improve the transit service level and to facilitate better operational decisions. Dynamic transit operation also offers significant benefits to travelers with improved convenience and reduced travel time. The quality trip experience for transit travel offered by dynamic transit operation has a great potential to attract more transit riders.

6.3 Recommendations

- (1) The promising results from the first phase FOT and the areas of improvements needed the project team recommends to further extend the current prototype into a deployable system that implements the full IDTO operation strategies for additional test sites that include bus stops, routes and connecting points within the transit agency in the following phase.
- (2) The implementation of IDTO prototype demonstrates that it is possible to enable improved dynamic transit applications by using a combination of innovative real-time data capture and data management methodologies. Therefore, it is suggested that more innovative technologies such as stand-alone mobile applications and in-vehicle driver information terminals should be introduced in the next phase.
- (3) As most of the IDTO functions rely on the predictions of ETA, the effectiveness of the IDTO is significantly affected by the accuracy of ETA predictions currently provided by the AVL system. It is observed during the demonstration that a large portion of invalid T-CONNECT requests was caused by occasional inaccurate ETA predictions. This can be improved by utilizing more advanced approaches for predicting the ETA, which should be investigated in the next research phase of IDTO.
- (4) The lack of onboard driver information terminal presents a constraint for IDTO. The transit dispatcher center experienced increased workload in responding to the dynamic operation recommendations by the IDTO system. It is a natural

progression for Tri Delta Transit to upgrade its transit management system with driver information terminals when the level of dynamic operation increases in the following phase.

- (5) A thorough analysis has been conducted during the first phase to evaluate how connection protection can provide benefits at Hillcrest Park & Ride bus stop of Tri Delta Transit. By adjusting the scheduled time of the connecting bus routes to meet the main bus Route 300, the waiting time for transfer passengers can be significantly reduced. The study shows that a large number of schedules can be adjusted, resulting in a considerable benefit for all passengers. Our study has concluded that adjustments and optimization of scheduled departure times and running time must be conducted in order to gain a higher success rate of connection protections and the overall efficiency and effectiveness of transit operation.
- (6) The current fixed holding time also limits the improvement on passenger's transit experience as it may not fulfill the dynamic conditions of passengers' needs. The determination of holding period should also achieve a trade-off between the waiting time of the boarding passengers and passengers already onboard. It is suggested that a mechanism for determining the dynamic holding time should be developed by incorporating both operational conditions and passengers' dynamic needs.
- (7) The demonstration and evaluation in the first research phase are all based on the current schedules and route maps of TDT. As the Pittsburg/Bay Point BART line has been extended east to the Antioch station which coincides with the current Hillcrest Park & Ride TDT bus stop, the route maps and schedules of TDT will be adjusted to accommodate the changes on the passengers' travel pattern and commute needs. As a result, the future research and development of IDTO system should take the changes on trip schedules and route maps into account. The full deployment of IDTO system should be able to satisfy dynamic connection needs.