

# Motorcycle Crash Data Analysis to Support Development of a Retrofit Concrete Barrier System for Freeway Ramps

JULY 2019 | Final Report



## **Disclaimer**

*The contents of this report reflect the views of the authors, who are responsible for the facts and the accuracy of the information presented herein. This document is disseminated in the interest of information exchange. The report is funded, partially or entirely, by a grant from the U.S. Department of Transportation's University Transportation Centers Program. However, the U.S. Government assumes no liability for the contents or use thereof.*

## TECHNICAL REPORT DOCUMENTATION PAGE

1. Report No. TTI-Student-04	2. Government Accession No.	3. Recipient's Catalog No.	
4. Title and Subtitle Motorcycle Crash Data Analysis to Support Development of a Retrofit Concrete Barrier System for Freeway Ramps		5. Report Date July 2019	
		6. Performing Organization Code:	
7. Author(s) Jonathan Wilson <a href="#">Heather Sulaica</a> <a href="#">Chiara Silvestri Dobrovolny</a> <a href="#">Marcie Perez</a>		8. Performing Organization Report No. Report TTI-Student-04	
		10. Work Unit No.	
9. Performing Organization Name and Address: Safe-D National UTC Texas A&M Transportation Institute		11. Contract or Grant No. 69A3551747115/Project TTI-Student-04	
		13. Type of Report and Period Final Research Report	
12. Sponsoring Agency Name and Address Office of the Secretary of Transportation (OST) U.S. Department of Transportation (US DOT) State of Texas		14. Sponsoring Agency Code	
		15. Supplementary Notes This project was funded by the Safety through Disruption (Safe-D) National University Transportation Center, a grant from the U.S. Department of Transportation – Office of the Assistant Secretary for Research and Technology, University Transportation Centers Program, and, in part, with general revenue funds from the State of Texas.	
16. Abstract This project was intended to review the most relevant national and international studies, as well as protocols and standards that were developed to support motorcycle safety on roadways. In addition, crash data analysis was conducted to identify relevant factors involved with motorcycle accidents where the bike has impacted roadside safety barriers on flyovers/connectors or on curves. This crash data review was developed in support of an existing research project sponsored by the Texas Department of Transportation, which aims at identifying and testing retrofit options for existing concrete barriers to contain errant motorcycle occupants during an impact event.			
17. Key Words Motorcycle Safety, Impact, Curves, Flyover, Connectors, Standards, Protocols, Testing		18. Distribution Statement No restrictions. This document is available to the public through the <a href="#">Safe-D National UTC website</a> , as well as the following repositories: <a href="#">VTechWorks</a> , <a href="#">The National Transportation Library</a> , <a href="#">The Transportation Library</a> , <a href="#">Volpe National Transportation Systems Center</a> , <a href="#">Federal Highway Administration Research Library</a> , and the <a href="#">National Technical Reports Library</a> .	
19. Security Classif. (of this report) Unclassified	20. Security Classif. (of this page) Unclassified	21. No. of Pages 76	22. Price \$0

## Abstract

*This project was intended to review the most relevant national and international studies, as well as protocols and standards that were developed to support motorcycle safety on roadways. In addition, crash data analysis was conducted to identify relevant factors involved with motorcycle accidents where the bike has impacted roadside safety barriers on flyovers/connectors or on curves. This crash data review was developed in support of an existing research project sponsored by the Texas Department of Transportation, which aims at identifying and testing retrofit options for existing concrete barriers to contain errant motorcycle occupants during an impact event.*

## Acknowledgements

*This project was funded by the Safety through Disruption (Safe-D) National University Transportation Center, a grant from the U.S. Department of Transportation – Office of the Assistant Secretary for Research and Technology, University Transportation Centers Program, and, in part, with general revenue funds from the State of Texas.*

# Table of Contents

---

<b>DISCLAIMER .....</b>	<b>0</b>
<b>LIST OF FIGURES .....</b>	<b>V</b>
<b>LIST OF TABLES .....</b>	<b>VII</b>
<b>INTRODUCTION .....</b>	<b>1</b>
<b>BACKGROUND .....</b>	<b>1</b>
<b>Literature Review .....</b>	<b>1</b>
Roadside Safety Barrier Retrofits for Motorcycle Safety .....	1
<b>METHODS .....</b>	<b>3</b>
<b>Motorcycle Crash Data Analysis .....</b>	<b>3</b>
Crash Data Analysis for Flyovers/Connectors .....	4
Crash Data Analysis for Curves .....	9
<b>CONCLUSIONS AND RECOMMENDATIONS .....</b>	<b>19</b>
<b>ADDITIONAL PRODUCTS.....</b>	<b>20</b>
Education and Workforce Development Products .....	20
Technology Transfer Products .....	20
Data Products.....	20
<b>REFERENCES.....</b>	<b>21</b>
<b>APPENDIX A1 .....</b>	<b>24</b>
<b>APPENDIX A2 .....</b>	<b>29</b>
Motorcycle Crash Testing Literature Sample.....	29
Motorbiking on Safe Roads .....	35

Three Infrastructure Improvements to Reduce Motorcycle Casualties .....	37
<b>APPENDIX A3 .....</b>	<b>41</b>
Motorcycle Crash Testing Literature Sample.....	41
Traffic Safety Facts for Motorcycles (U.S. DOT, 2015) .....	42
Infrastructure Countermeasures to Mitigate Motorcyclist Crashes in Europe .....	44
Leading Practices for Motorcyclist Safety.....	44
Motorcycle Crash Causation Study .....	45
Motorcycle Road Safety Audit Case Studies .....	45
<b>APPENDIX A4 .....</b>	<b>47</b>
Motorcycle Full-Scale Testing Protocols and Standards.....	47
L.I.E.R. Procedure (France).....	47
UNE-135900 Protocol (Spain or Spanish Standard).....	48
EN 1317-8 Technical Specification .....	49
ISO 13232 International Standards .....	55
BASt Homologation Procedure .....	56
Australian/New Zealand Standard (AS/NZS 3845:2015).....	56
Dummy Types Employed in Motorcycle Crash Testing.....	58
Technical Specification EN 1317-8 – Dummy .....	58
ISO 13232 International Standard – Dummy .....	59
Injury Criteria and Biofidelity .....	60
<b>APPENDIX B.....</b>	<b>61</b>
Descriptions of Crashes and their Respective Google Earth Images of the Roadside Barriers Hit in Flyover/Connector Cases .....	61
<b>APPENDIX C.....</b>	<b>73</b>

# List of Figures

---

Figure 1. Chart. All KA on flyovers/connectors for various roadway types. .... 5

Figure 2. Chart. Type of road traveled before first harmful event resulting in KA (flyovers/connectors). .... 5

Figure 3. Chart. All KA on flyovers/connectors for various roadway sections..... 5

Figure 4. Chart. All KA on flyovers/connectors for various road base materials. .... 6

Figure 5. Chart. All KA on flyovers/connectors for various road surfaces. .... 7

Figure 6. Chart. Distribution of all harmful objects struck resulting in KA on flyovers/connectors. .... 7

Figure 7. Chart. All KA for flyovers/connectors with various median widths..... 8

Figure 8. Chart. Variation of contributing factors resulting in KA on flyovers/connectors. .... 9

Figure 9. Chart. All KA on curves for various road alignment configurations. .... 10

Figure 10. Chart. All KA on curves for various roadway functional classifications..... 11

Figure 11. Chart. All fatal and incapacitating injuries for various curve types. .... 11

Figure 12. Chart. All KA on curves for various weather conditions. .... 12

Figure 13. Chart. All KA on curves for various lighting conditions. .... 12

Figure 14. Chart. All KA on curves for various road base materials..... 13

Figure 15. Chart. All KA on curves for various road surface types. .... 13

Figure 16. Chart. All KA on curves for harmful events. .... 14

Figure 17. Chart. All KA on curves for objects struck. .... 15

Figure 18. Chart. Distribution of fatalities for different speed limits. .... 15

Figure 19. Chart. Distribution of incapacitations for different speed limits. .... 16

Figure 20. Chart. Various primary contributing factors resulting in KA on curves. .... 17

Figure 21. Chart. Distribution of secondary contributing factors and possible contributing factors for KA on curves where the primary contributing factor was “Under the influence.” ..... 17

Figure 22. Chart. Distribution of secondary contributing factors and possible contributing factors for KA on curves where the primary contributing factor was “Faulty/unsafe maneuvering.” ..... 18

Figure 23. Chart. Distribution of secondary contributing factors and possible contributing factors for KA on curves where the primary contributing factor was “Involved excessive speed.” ..... 18

Figure 24. Chart. Distribution of secondary contributing factors and possible contributing factors for KA on curves where the primary contributing factor was “Other (explain in narrative), not reported.” ..... 19

Figure 25. Chart. Number of KA victims of different age groups on curves. .... 19

Figure 26. Metal beam standard guardrail designs – INRETS (Quincy et al., 1988)..... 29

Figure 27. Motorcycle trolley (Nieboer et al., 1993)..... 32

Figure 28. Motorcycle trolley including dummy support frame (Nieboer et al., 1993). .... 33

Figure 29. Test sled in inclined position with motorcycle and dummy (Peldschus et al., 2007). 34

Figure 30. Test sled in upright position with motorcycle and dummy (Peldschus et al., 2007)... 35

Figure 31. Concrete barrier and motorcycle type used in full-scale motorcycle crash testing (Adamson et al., 2002)..... 41

Figure 32. Motorcycle tow system (Adamson et al., 2002)..... 42

Figure 33. EN 1317-8 Technical Specification Force and Moment Criteria..... 53

Figure 34. ISO 13232-2 requires seven impact configurations between the MC and OV (ISO 13232, 1996). .... 56

Figure 35. Frangible shoulder for Hybrid III dummy (Peldschus et al., 2007). .... 60



# List of Tables

---

Table 1. Devices for Retrofitting Roadside Barriers for Motorcycle Safety ..... 24

Table 2. Dummy Test Results from Quincy et al. (1988) Tests – INRETS ..... 29

Table 3. Impact Configurations and Details from Berg et al. (2005) ..... 30

Table 4. Load Impact Data of the Inclined Test (Peldschus et al., 2007) ..... 34

Table 5. Load Impact Data of the Upright Test (Peldschus et al., 2007)..... 35

Table 6. Infrastructure Elements Influencing Likelihood Risk Factors for Vehicles and Motorcycles (Milling et al., 2016) ..... 38

Table 7. Methods to Mitigate Crash Severity (Milling et al., 2016)..... 39

Table 8. Impact Configurations and Details from Adamson et al. (2002)..... 42

Table 9. L.I.E.R. Test Impact Configurations (Page and Bloch, 2010)..... 48

Table 10. UNE-135900 Standard Test Impact Configurations (Page and Bloch, 2010)..... 50

Table 11. EN 1317-8 Technical Specification Test Impact Configurations ..... 52

Table 12. EN 1317-8 Technical Specification Severity Levels ..... 53

Table 13. EN 1317-8 Technical Specification: Determination of Wd..... 54

Table 14. OV Contact Point Relative Tolerances for the Seven Required Impact Configurations Described in ISO 13232-2 (1996)..... 57

Table 15. Category Recommendations. Roadside Barriers (Stock et al., 2001; Bambach and Grzebieta, 2014)..... 73

Table 16. Category Recommendations. Surface/Pavement (Stock et al., 2001; Nabors et al., 2016). ..... 74

Table 17. Category Recommendations. Road Design/Visibility (Stock et al., 2001; Nabors et al., 2016). ..... 74

Table 18. Category Recommendations. Signage/Delineation (Stock et al., 2001; Nabors et al., 2016). ..... 75

# Introduction

---

This project was intended to review the most relevant national and international studies, as well as protocols and standards that were developed to support motorcycle safety on roadways. In addition, crash data analysis was conducted to identify relevant factors involved with motorcycle accidents where the bike has impacted roadside safety barriers on flyovers/connectors or on curves. This crash data review was developed in support of an existing research project sponsored by the Texas Department of Transportation (TxDOT), which aims at identifying and testing retrofit options for existing concrete barriers to contain errant motorcycle occupants during an impact event.

## Background

---

### Literature Review

The literature review investigated the current knowledge on motorcycle crashes, multiple-vehicle accidents, and contributing factors (with a focus on contributing factors related to road infrastructure).

- A summary of the motorcycle devices used to retrofit roadside barriers for motorcycle safety can be found in Appendix A1.
- A review of the literature on motorcycle crashes into barriers and vehicles, as well as mitigation measures, outside the U.S. can be found in Appendix A2.
- A review of the literature on motorcycle crashes and mitigation measures inside the U.S. can be found in Appendix A3.
- A summary of the literature on the crash standards and protocols for motorcycles can be found in Appendix A4.

### Roadside Safety Barrier Retrofits for Motorcycle Safety

This section summarizes motorcycle safety recommendations, including good practices and retrofit systems used across the world, based upon the key projects reviewed in the literature. The summaries are divided into four categories: roadside barriers, surface/pavement, road design/visibility, and signage/delineation. An illustrated guide to these recommendations can be found in Appendix C.

Recommendations for roadside barriers (Stock et al., 2001; Bambach and Grzebieta, 2014):

- “Mitigate roadside risk and underrun protection on crash barriers.”
- “Mitigate roadside risk along the outside of bends: earth walls.”
- “Equip crash barriers with underrun protection in bends.”
- “Make obstacles in the roadside area or shoulder safer.”

- “Concrete Barriers are much safer for motorcyclists than W-beam post-and-rail systems.”
- “Flexible rub-rail systems attached to steel W-beam barriers provide the best protection for motorcyclists in sliding collisions with roadside barriers.”
- “Guidance systems made of flexible materials: flexible bollards.”

Recommendations for surface/pavement (Stock et al., 2001; Nabors et al., 2016):

- “Improve road surfaces and pot holes.”
- “Full resurfacing instead of patchwork repairs”
- “Surface friction: The wearing course should provide an appropriate level of surface friction in wet and dry conditions.”
- “Surface condition: The road surface should be smooth, consistent and predictable.”
- “Repair pavement where potholes, debris, longitudinal cracks, vertical displacement, and reduced friction are apparent.”
- “Implement a program to install Safety Edge<sup>SM</sup> and/or pavement edge striping along the Parkway roadside, particularly along curves or areas where data suggests motorcycles run off the road.”
- “Exploring opportunities to apply Advanced Pavement Markings specific to motorcyclists within the travel lanes to provide warning of conditions that may be particularly challenging to motorcyclists, such as ‘slow’ at the entrance to curves.”
- “Re-grading roadsides and removing hazards to eliminate the need for guardrail.”
- “Paving shoulders on the inside of curves, especially gravel shoulders as motorcyclists may try to steer away from these to avoid debris”

Recommendations for road design/invisibility (Stock et al., 2001; Nabors et al., 2016):

- “Create stopping zones before especially dangerous intersections and junctions.”
- “Sight distance: Clear visibility over a crest, through a curve, and adequate sight lines between motorcyclists and other objects.”
- “Overtaking provisions: Frequent, safe and legal passing opportunities”
- “Intersection sight distance: Sight lines between all road users on the through road and side road should be available.”
- “Road alignment: Readable and consistent horizontal geometry”
- Cross-section: Lanes should be wide enough to provide width for safe riding path selection.
- “Intersection type, control and turn provisions: Intersections have different risks for motorcycles, these are dependent on type.”
- “Roadside hazards: The clear zone should be hazard free.”
- “Remove vegetation to improve sight distance.”
- “Evaluate super elevation of curve though a ball bank test. If inconsistent with adjacent curves, provide motorcycle-specific warning.”

- “Limit parking near intersections, driveways, and crosswalks to help improve visibility of entering vehicles and approaching vehicles.”

Recommendations for signage/delineation (Stock et al., 2001; Nabors et al., 2016):

- “Double-line centre markings”
- “Influence road behavior in sections with reduced visibility by installing traffic signs.”
- “Continuous centre lines in bends”
- “Replace traffic guidance signs in bends with flexible bollards.”
- “Guidance systems made of flexible materials: flexible bollards (...) instead of rigid road markings & signs”
- “Intersection location: Intersections should be clearly identified through signage or pavement markings.”
- Use curve markers on crash barriers.
- Use rumble strips to warn of accident black spots.
- “Provide additional intersection/driveway delineation and warning.”
- “Provide additional curve delineation and intersection warning through use of warning signs indicating the location of intersections. Consider motorcycle specific signage.”
- “Provide consistency in the corridor through pavement markings or raised pavement markers that define travel lanes.”
- “Restrict left turns from driveways and entrances, only permitting them in certain designated locations. Use signage, pavement markings, and physical barriers to restrict left turns.”
- “Continuing dash marks through gaps in the centerline or edge line markings, to help keep motorcyclists from losing visual focus of the roadway”
- “Enhancing awareness of other complex situations that may overload an operator of a motorcycle”
- “Installing delineation devices per the MUTCD on the full length of guardrail to improve nighttime conspicuity”

## Methods

---

### Motorcycle Crash Data Analysis

A crash data analysis study was conducted through the Texas Crash Records Information System (CRIS) database. The researchers then refined the search by looking at motorcycle crashes only. It was decided to further refine the study by only concentrating on motorcycle crashes that were one-motor-vehicle (OMV) crashes, where the person who suffered a fatal or incapacitating injury was the one operating the motorcycle. By looking at a smaller number of cases, we considered the specific narratives case by case. It was our decision to consider the specific places on the map where the crashes on flyovers/connectors occurred and to provide images of the type of roadside barrier that was struck. This was conducted only on the flyovers/connectors since there were over

600 cases on the curves. We felt that if further research into the crash narratives for curves was needed, that it would not be a problem to do so.

### **Crash Data Analysis for Flyovers/Connectors**

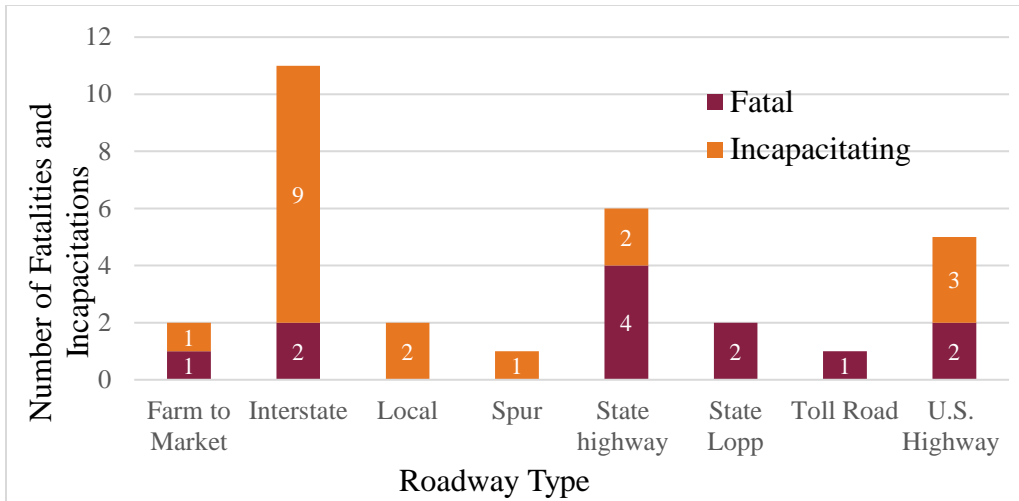
A crash data analysis was performed that primarily focused on fatal and incapacitating motorcycle injuries in Texas that happened on flyovers/connectors from 2014 to 2016. The scope of this study considered the distribution of injuries incurred to riders that struck roadside safety barriers such as concrete barriers. Many more variables were studied, including human characteristics, environmental conditions, road configurations, and surface layouts; however, these human factors were not used in the analysis. For both the analysis done on flyovers/connectors and on curves, only OMV accidents were looked at where the driver of the motorcycle was the one that received the injury.

The distribution of fatal and incapacitating injuries that happened in Texas from 2014 to 2016 for flyovers/connectors shows that 40% of these injuries were fatal and 60% were incapacitating.

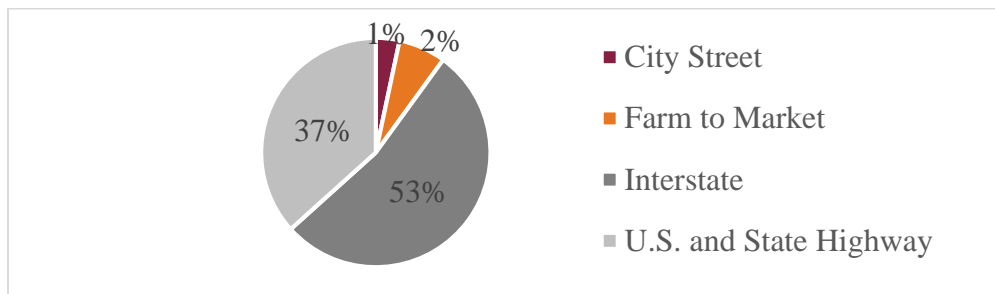
When looking at different roadway types, the highest number of incidents happened on interstates, followed by accidents occurring on state highways. This is shown below in Figure 1.

The roadway types shown along the x-axis in Figure 1 can be further classified into four main roadway categories: city, street, Farm to Market, interstate, and U.S. & state highways. The distribution of fatal and incapacitating (KA) injuries within the four roadway categories can be viewed in Figure 2 below.

Similarly, different sections of roadway were recorded. Even though all 30 of the fatal and incapacitating cases occurred on flyovers/connectors, only 22 were reported to be flyovers/connectors by the officer. Various other roadway sections where these accidents occurred were on exits/off-ramps and in the main/proper lane, with four and three total KA, respectively. All fatal and incapacitating injuries on flyovers/connectors for various roadway sections can be seen in Figure 3 below.

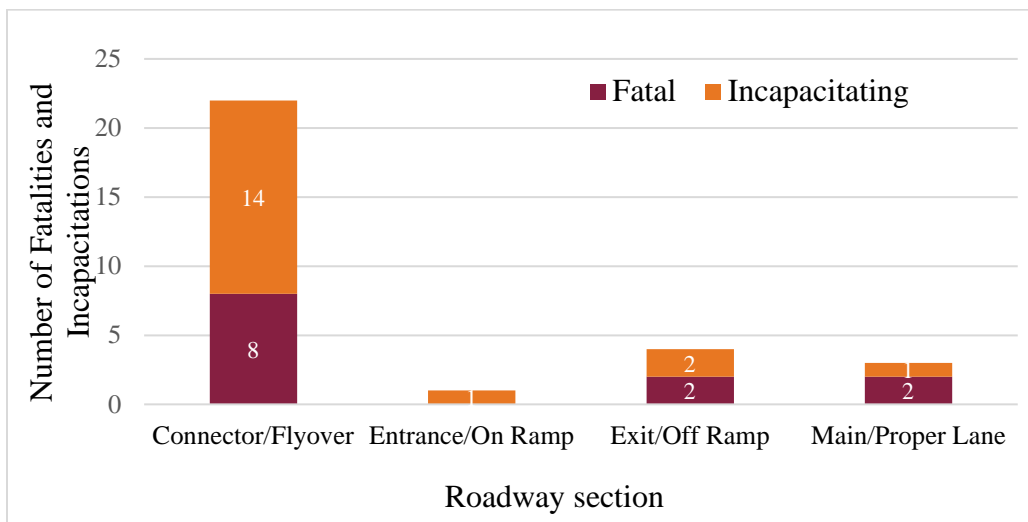


**Figure 1. Chart. All KA on flyovers/connectors for various roadway types.**



**Figure 2. Chart. Type of road traveled before first harmful event resulting in KA (flyovers/connectors).**

Two of the 30 cases happened at intersections. These cases are explained in detail in the crash narratives, which can be viewed in Appendix B. The distribution of occurrences at intersections was 7%.



**Figure 3. Chart. All KA on flyovers/connectors for various roadway sections.**

### Road Materials and Conditions for Fatal and Incapacitating Injuries on Flyovers/Connectors

Road materials and configurations were considered in order to better understand the conditions of the road surface at the time of the crash. Seven of the thirty cases contained no information on the road base type or road surface type; however, an analysis was still conducted to see the distribution of injuries in cases where road configuration was recorded. Figure 4 shows the different road base types and the number of both fatal and incapacitating injuries recorded for each base type.

Three base types, Flex Base (Granular), Stabilized Earth or Flex (Granular), and Concrete had the highest numbers of fatalities or incapacitating injuries. The same number of people sustained fatal injuries on Stabilized Earth as Flex Base; however, Flex Base proved to have more incapacitating injuries.

The road surface type analysis is shown in Figure 5 below. The maximum number of fatalities and incapacitating injuries happened on High Type Rigid road surfaces. The road surface type that was recorded to have the second highest number of fatalities was High Type Flexible, with three fatalities.

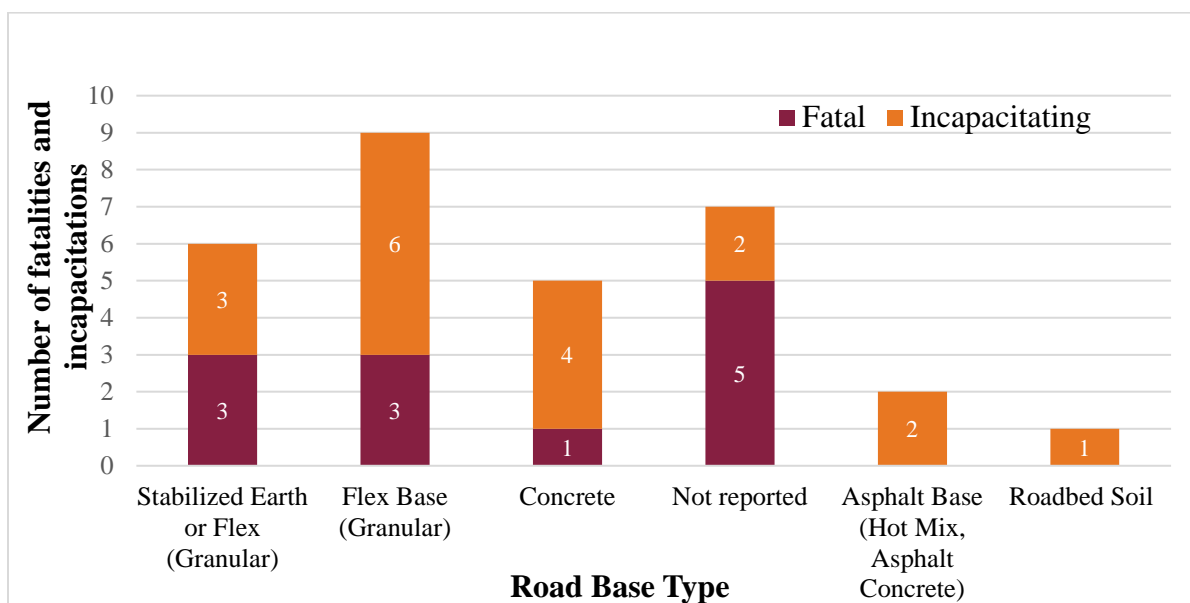


Figure 4. Chart. All KA on flyovers/connectors for various road base materials.

### Harmful Objects Struck Resulting in KA on Flyovers/Connectors

Figure 6 breaks down the different objects that were struck by motorcyclists in the 30 fatal and incapacitating cases. For cases where no object was struck, many times the bike was overturned, so Figure 6 also shows the number of fatal and incapacitating injuries received by motorcyclists overturning their motorcycle.

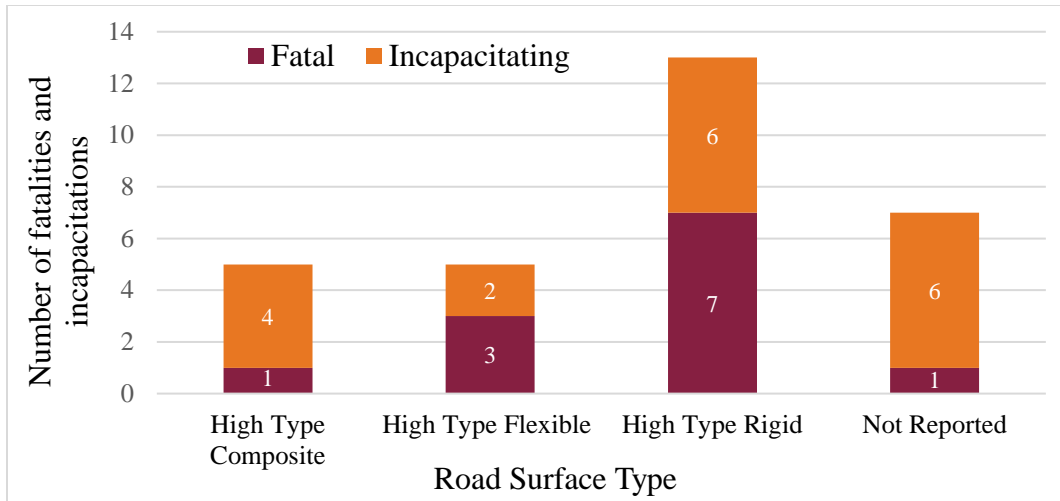


Figure 5. Chart. All KA on flyovers/connectors for various road surfaces.

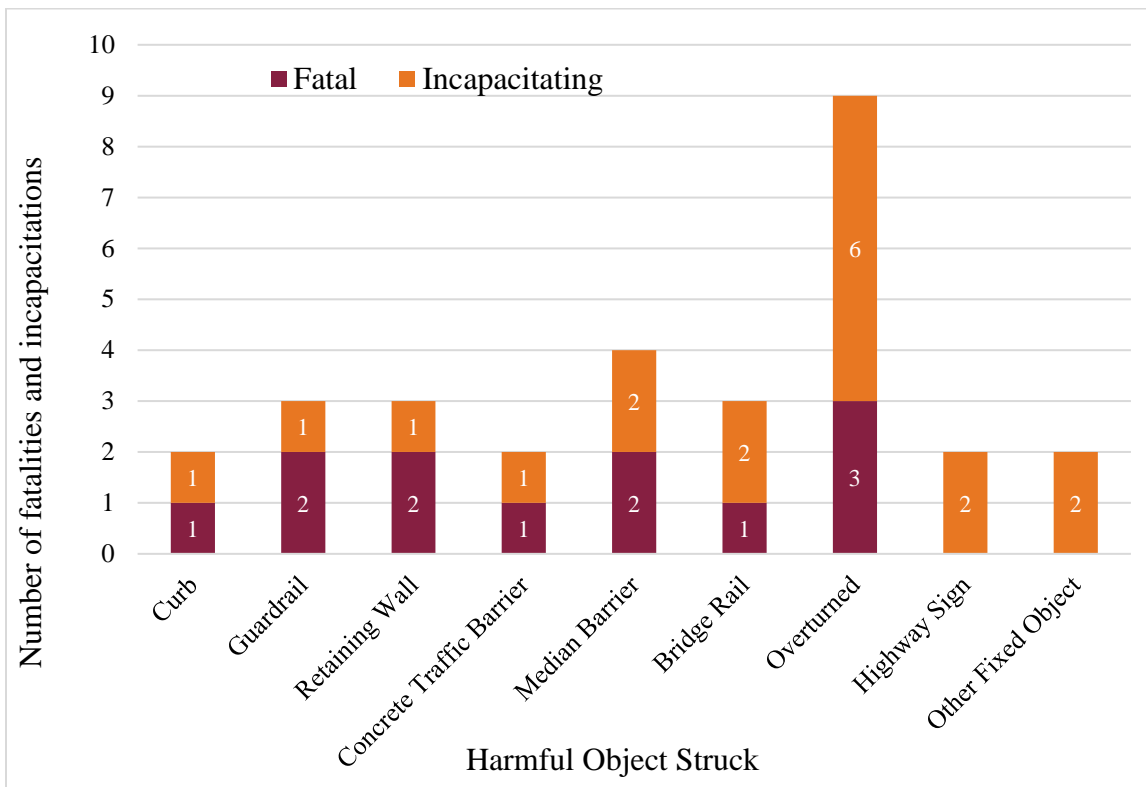
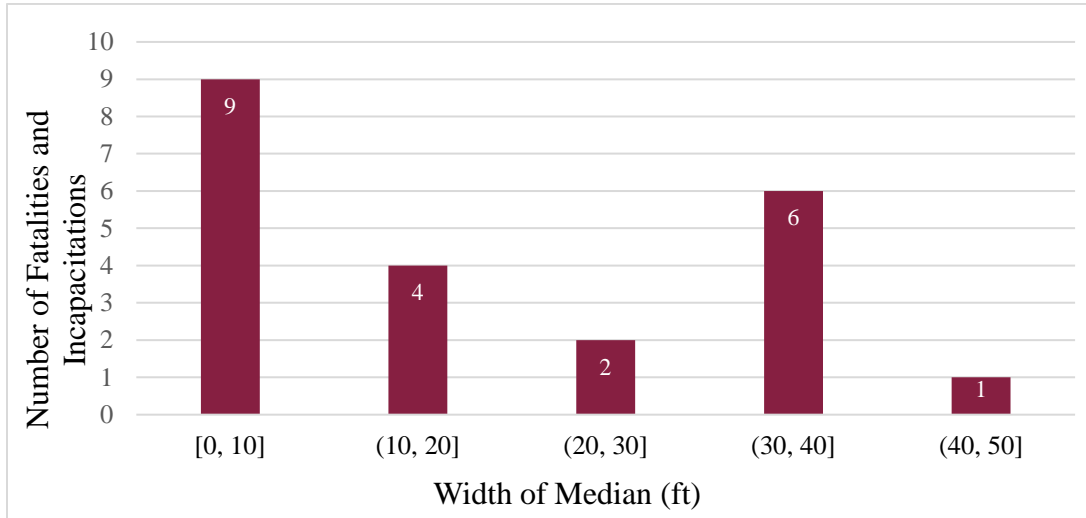


Figure 6. Chart. Distribution of all harmful objects struck resulting in KA on flyovers/connectors.

Figure 6 demonstrates that many riders involved in a crash on a flyover/connector either struck some type of roadside safety barrier or overturned their bike. On many of these flyovers and connectors, the “median width,” or the distance between where the lane ends and the barrier starts, was found to play some role in the distribution of injuries. Figure 7 shows the number of fatal and incapacitating injuries for different median widths. The highest number of incidences was nine when the median width was between 0 and 10 feet. The next most frequent range of median widths that resulted in either fatal or incapacitating injuries was much larger at 30 to 40 feet. Six KA



incidences occurred in the 30- to 40-foot range. Both of these instances could possibly point to a higher risk to riders when the median width is not at an optimal distance away from the rider. Due to the small sample size of KA on flyovers/connectors (only 30 cases), it is difficult to draw this assumption.

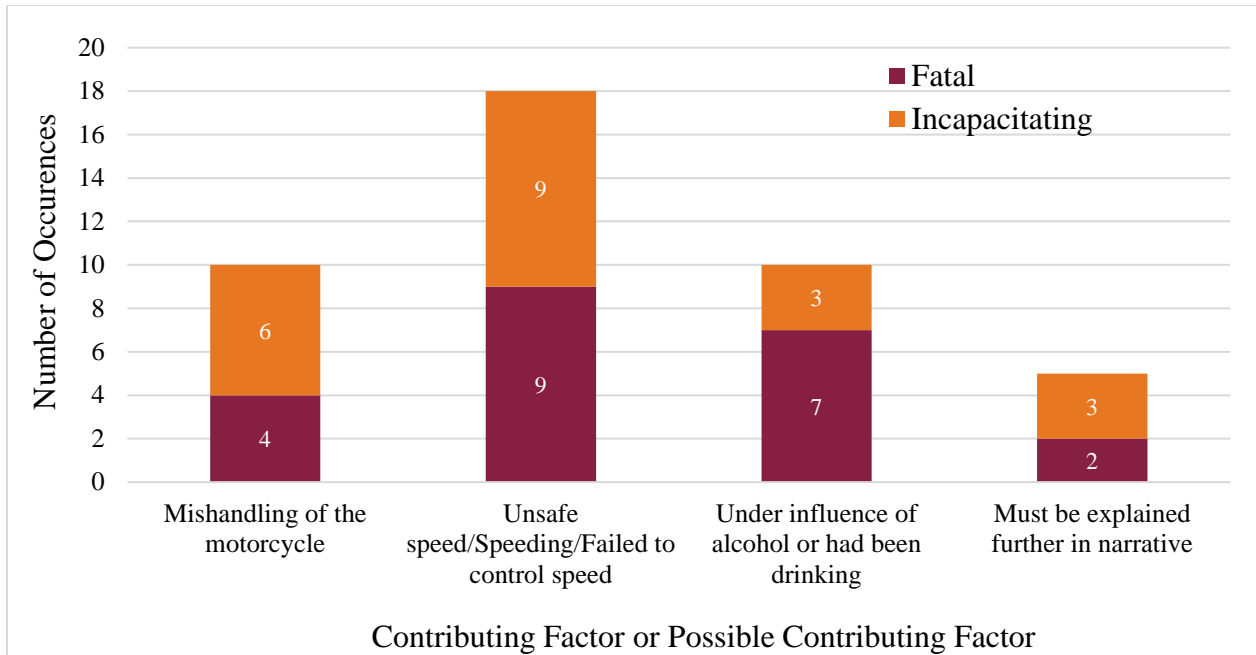


**Figure 7. Chart. All KA for flyovers/connectors with various median widths.**

### Possible Contributing Factors to Fatal and Incapacitating Injuries on Flyovers/Connectors

For almost all fatal and incapacitating cases, the officer reporting on the scene records primary contributing factors as well as possible contributing factors. To find a relationship between the primary contributing factors and the possible contributing factors, we found it effective to first group the different contributing factors into similar categories. For example, all factors involving alcohol or drugs were grouped together to look at the total number of occurrences of impairment.

Figure 8 shows the breakdown of fatal and incapacitating injuries for the different categories of contributing or possible contributing factors. Different categories could have been created to analyze the data, but the ones that were felt to be the most effective were “Mishandling of the motorcycle,” “Unsafe speed/Speeding/Failed to control speed,” “Under influence of alcohol or drugs,” and “Needs to be explained further in narrative.”



**Figure 8. Chart. Variation of contributing factors resulting in KA on flyovers/connectors.**

Figure 8 provides insight into the actions and decisions leading up to the time of the crash. It can be seen that nine of the fatal cases on flyovers/connectors had a contributing factor or possible contributing factor that involved excessive speed. The next most fatal contributing factor, with seven cases, was riders under the influence of alcohol, drugs, or a combination of both. Also, there was a larger percentage of incapacitating injuries when riders were considered to have mishandled the bike in some way, either when under the influence or not.

### Crash Data Analysis for Curves

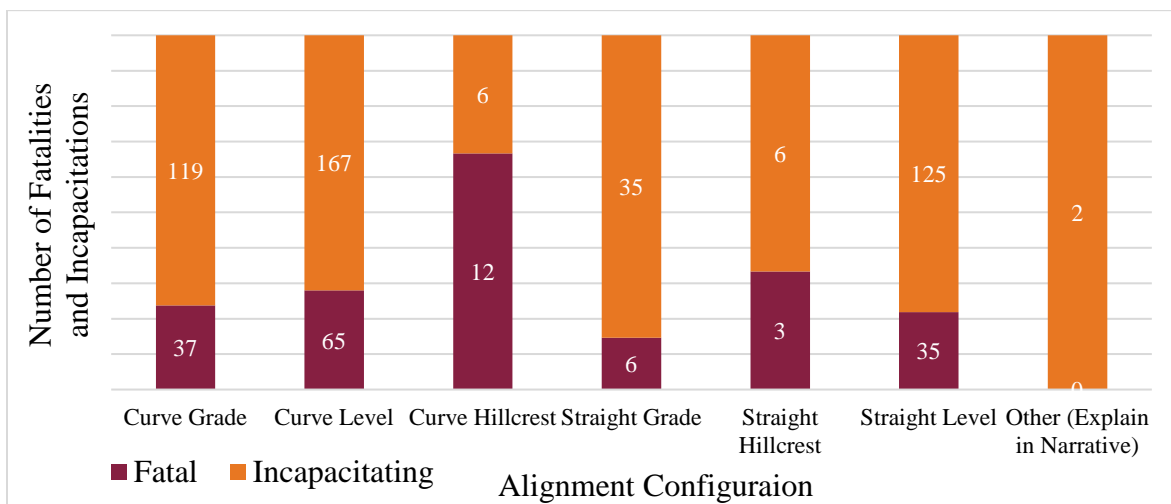
This part of the study and analysis was primarily focused on fatal and incapacitating motorcycle injuries in Texas that happened on curves from 2014 to 2016. The scope of the study was to look into the distribution of injuries incurred to riders who struck roadside safety barriers such as concrete barriers, guardrails, etc. However, many more variables were examined, such as human characteristics, environmental conditions, road configurations, and surface layouts. Although looking into human contributing factors and other environmental factors was not the primary focus of the study, the patterns indicated by the data are interesting and may prove to be useful. For both the analysis done on flyovers/connectors and on curves, only OMV accidents were looked at where the driver of the motorcycle was the one that received the injury. Since the total number of fatal and incapacitating injury cases that happened on curves was much larger than the number of fatal and incapacitating injuries on flyovers/connectors, the sample size for the analysis of curves is bigger, which creates a more realistic distribution.

According to the data, incapacitating injuries on curves decreased from 181 cases in 2014 to 162 cases in 2015. However, from 2015 to 2016 the number of incapacitations on curves stayed almost constant, decreasing by only three cases. Fatal crashes decreased from 61 in 2014 to 58 in 2015 to

54 in 2016. In terms of the overall distribution, of fatal and incapacitating injuries that happened on curves in Texas from 2014 to 2016, it was found that 26% of the injuries received were fatal and 74% of the injuries were incapacitating.

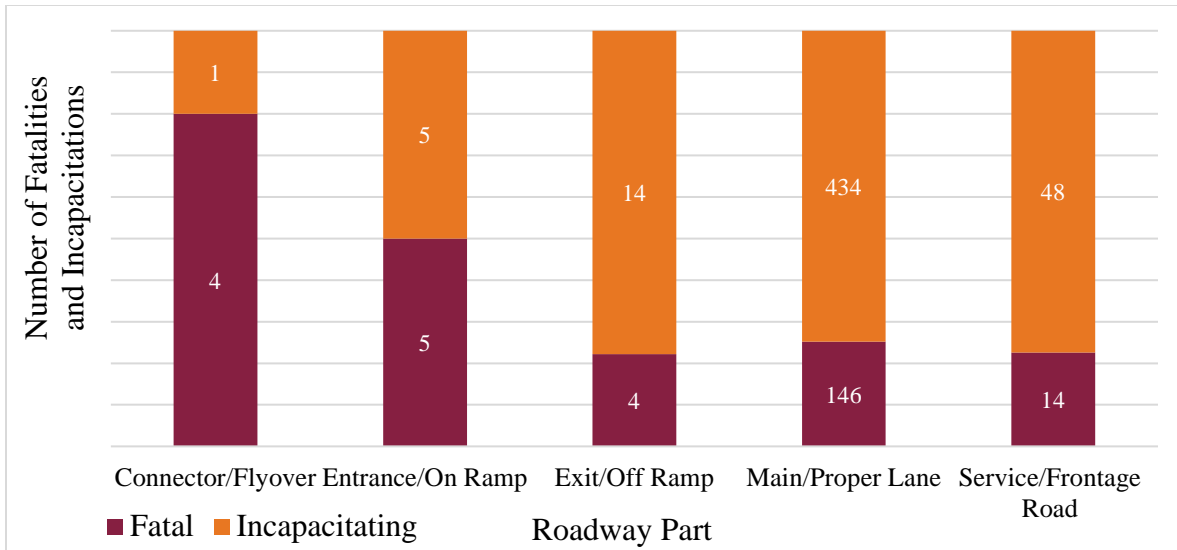
Thirty-five percent of the accidents on curves happened on U.S. and state highways, 18% on an interstate, and 47% on Farm to Market roads. Such a high percentage of occurrences happening on Farm to Market roads raises questions as to why so many people are suffering fatal and incapacitating injuries on these roadways.

Road alignment configuration, which is defined by TxDOT as “the geometric characteristics of the roadway at the crash site,” was recorded for each fatal and incapacitating case. The distribution of injuries for different configurations can be seen below in Figure 9.



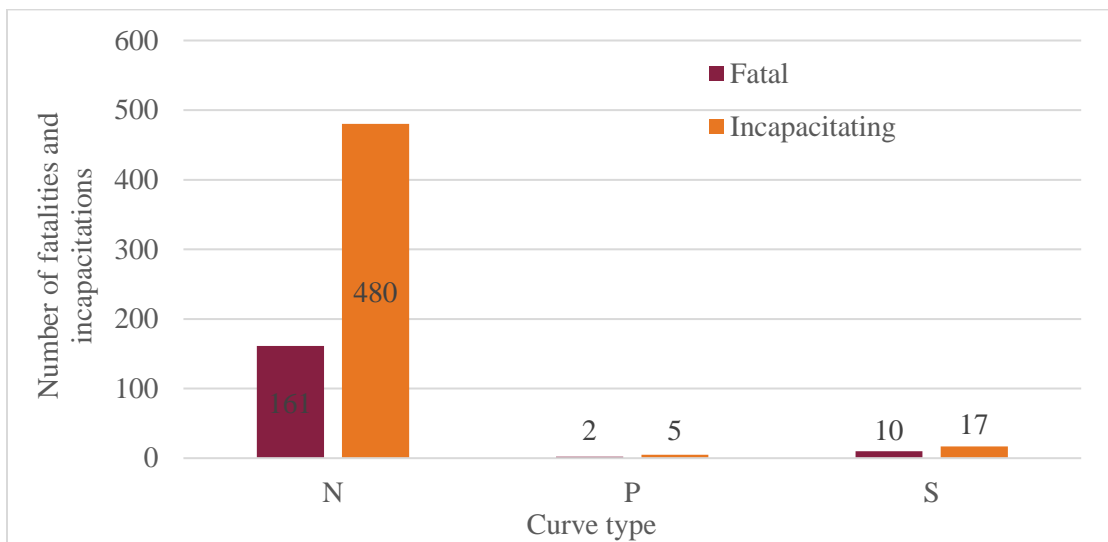
**Figure 9. Chart. All KA on curves for various road alignment configurations.**

The fatal and incapacitating injury cases happening on curves can be further categorized based on roadway functional classifications. As seen in Figure 10, the majority of fatal and incapacitating injuries occurred in the main/proper lane. The category with the next highest number of fatal and incapacitating injuries was Service/Frontage Road. Very small numbers were recorded on roadways classified as both curves and flyovers/connectors.



**Figure 10. Chart. All KA on curves for various roadway functional classifications.**

Each curve that was involved in these fatal and incapacitating cases can have different configurations, attributes, alignments, and properties. There are currently three types of curves that are used in Texas and recorded by officers when they conduct crash reports at the scene of the incident. These curve types as defined by TxDot are either type N, P, or S. The vast majority of injuries that happened on curves occurred on curves that were type N; small numbers were recorded for type S curves. The distribution of fatal and incapacitating injuries for different curve types can be seen in Figure 11.



**Figure 11. Chart. All fatal and incapacitating injuries for various curve types.**

All of the figures up to this point have focused on various aspects of the roadways, such as road type, alignment configuration, and roadway section type. Figure 12 and Figure 13, on the other hand, illustrate various environmental and lighting conditions. Figure 12 shows the distribution of fatal and incapacitating injuries in different weather conditions such as clear, cloudy, foggy, rainy,

and severe crosswinds. The most frequently recorded weather condition at the time of the accident for fatal cases (131) and incapacitating cases (367) was “clear.” The next most significantly recorded weather condition was “cloudy,” with 76 incapacitating cases and 20 fatal cases.

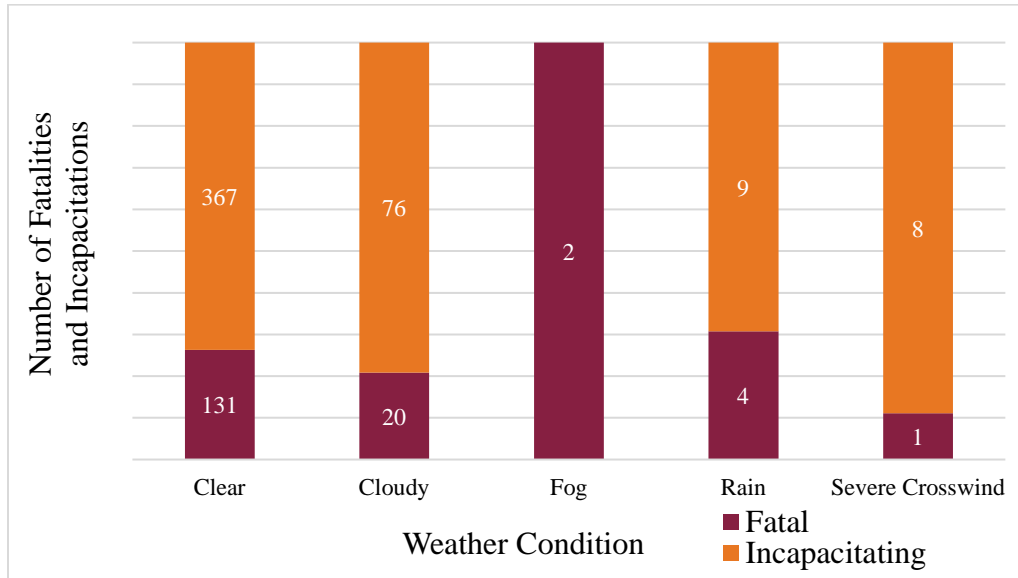


Figure 12. Chart. All KA on curves for various weather conditions.

Figure 13 represents different lighting conditions that were present at the time of the crash. The most frequently recorded lighting condition that resulted in an incapacitating injury was daylight. The Daylight condition also had the highest number of fatal injuries. A large number of motorcyclists suffered injuries during times that were considered to be Dark, Not Lighted.

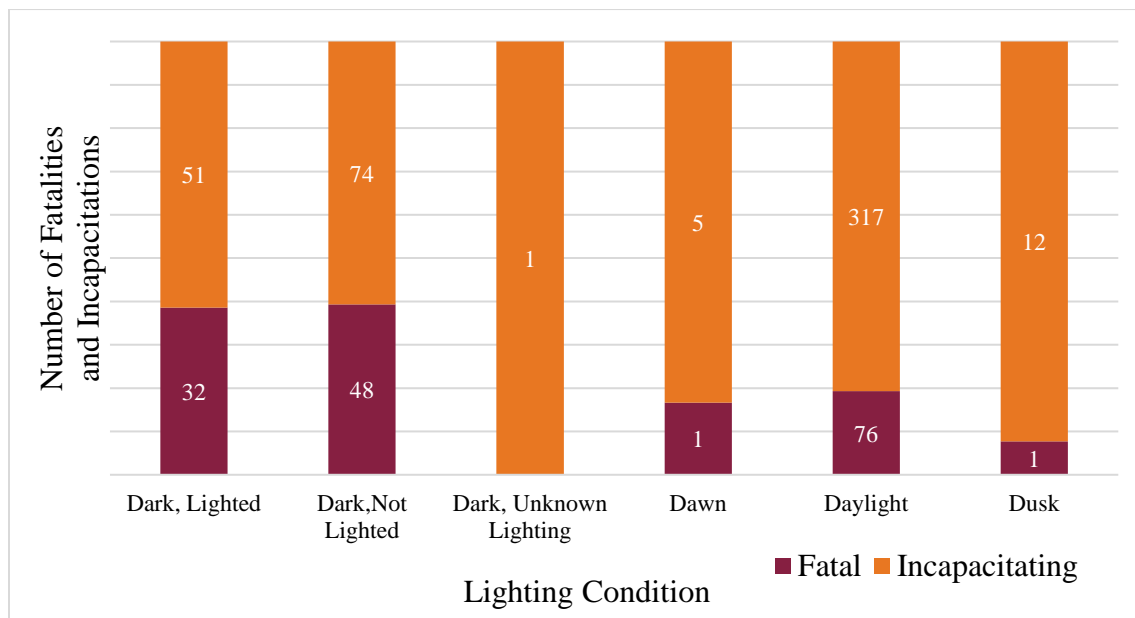


Figure 13. Chart. All KA on curves for various lighting conditions.

Physical features of the road, such as road base type and road surface type, were also analyzed. Figure 14 shows that the most dangerous road base type was Flex Base Granular, with 323 incapacitating cases and 90 fatal cases. The next most significantly dangerous base type for motorcyclists was Stabilized Earth or Flex Granular, which had 67 incapacitations and 36 fatalities. Figure 15 shows that the two road surface types that produced the most incapacitating injuries were High Type Flexible and Low Type Bituminous Surface-Treated, both with 170 cases each. High Type Flexible was the road surface type that had the highest number of fatalities.

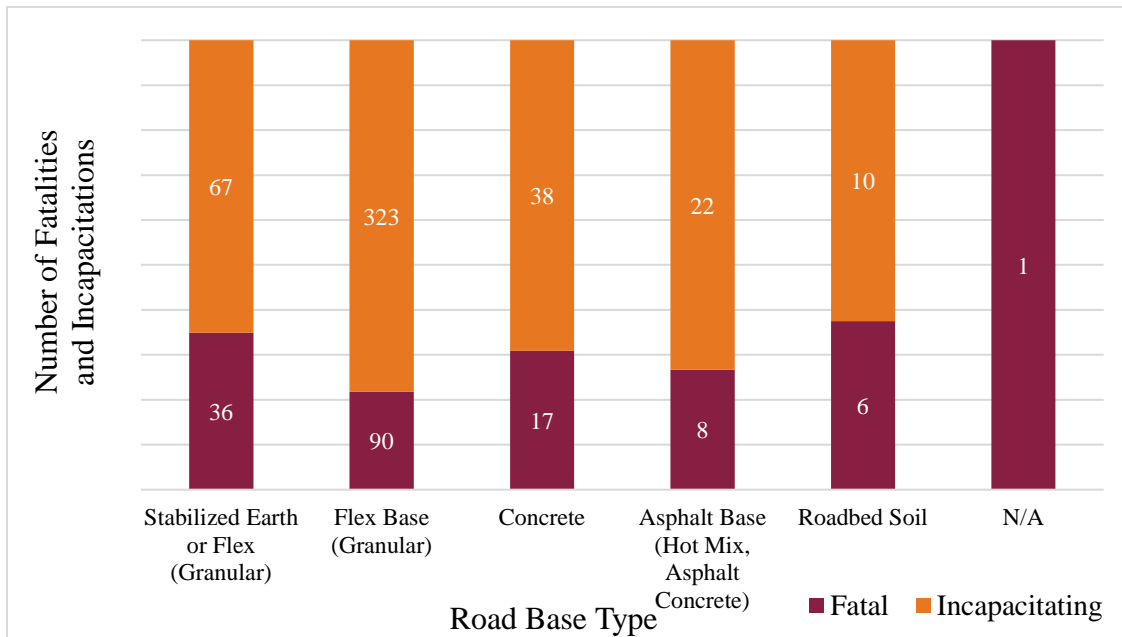


Figure 14. Chart. All KA on curves for various road base materials.

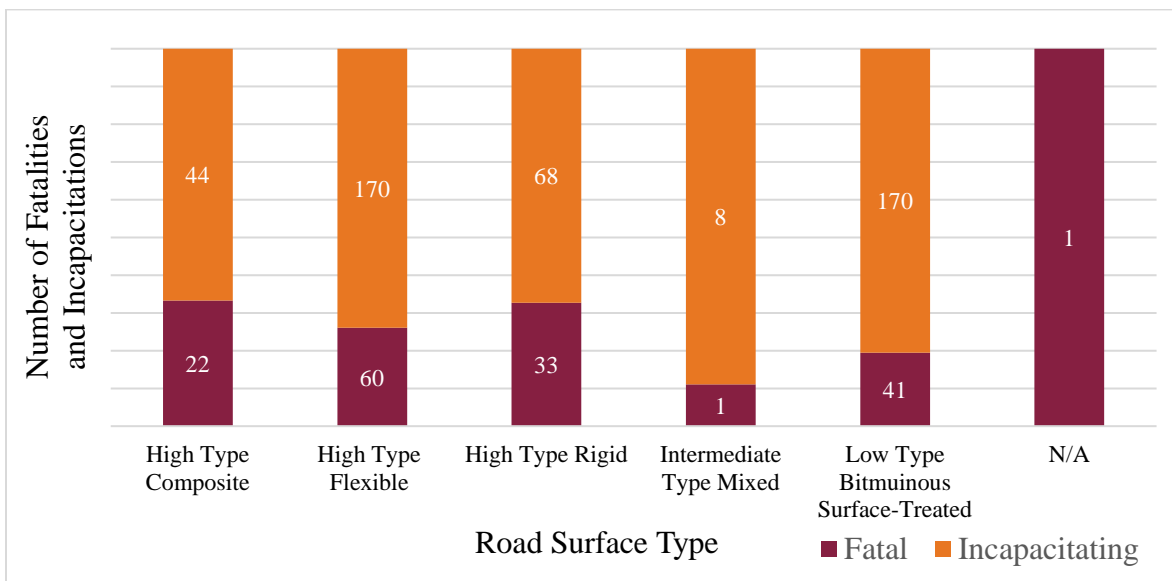
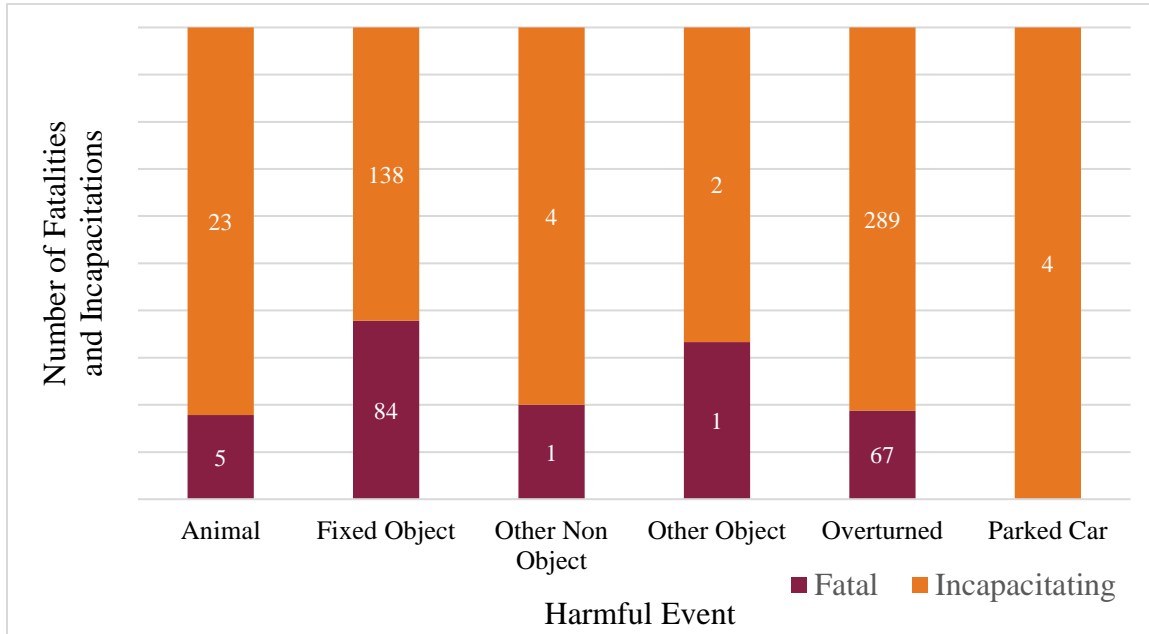


Figure 15. Chart. All KA on curves for various road surface types.

The next section focuses on the nature of the collision and includes aspects such as harmful events, objects struck, and speed limits. For all 675 fatal or incapacitating cases that happened on curves in Texas, the first injury- or damage-producing event was recorded and is represented in Figure 16.



**Figure 16. Chart. All KA on curves for harmful events.**

Similar to flyovers/connectors, the two most common harmful events were collisions with fixed objects and the overturning of the rider’s motorcycle. Out of the 675 cases, 356 of them were classified as overturned. Of these 356, 67 were fatal and 289 were incapacitating. For riders that collided with a fixed object, there were 138 incapacitating cases and 84 fatal cases. Thus, riders on curves who collide with a fixed object are much more likely to be killed. A small number of crashes were caused by animals on the road, with 23 incapacitating cases and 5 fatal cases. Figure 17 further breaks down the different fixed objects that were struck and other roadside objects that caused injuries.

Figure 17 provides details on exactly what the motorcycle struck, whether it was some type of roadside barrier system, a natural embankment, or a sign, etc. As previously stated, a large number of motorcyclists overturned and a large number of them hit fixed objects. Median barriers were the most hit object, with 32 incapacitations and 16 fatalities. There were also small numbers recorded for fences, guardrails, signs, and curbs. Figure 18 and Figure 19 show the distribution of crashes that occurred in areas of different posted speed limits. Figure 18 shows the distribution of fatalities, and Figure 19 shows the incapacitations. Note that the speed ranges represent the posted speed limits, not necessarily the speed of the motorcycle at the time of the crash.

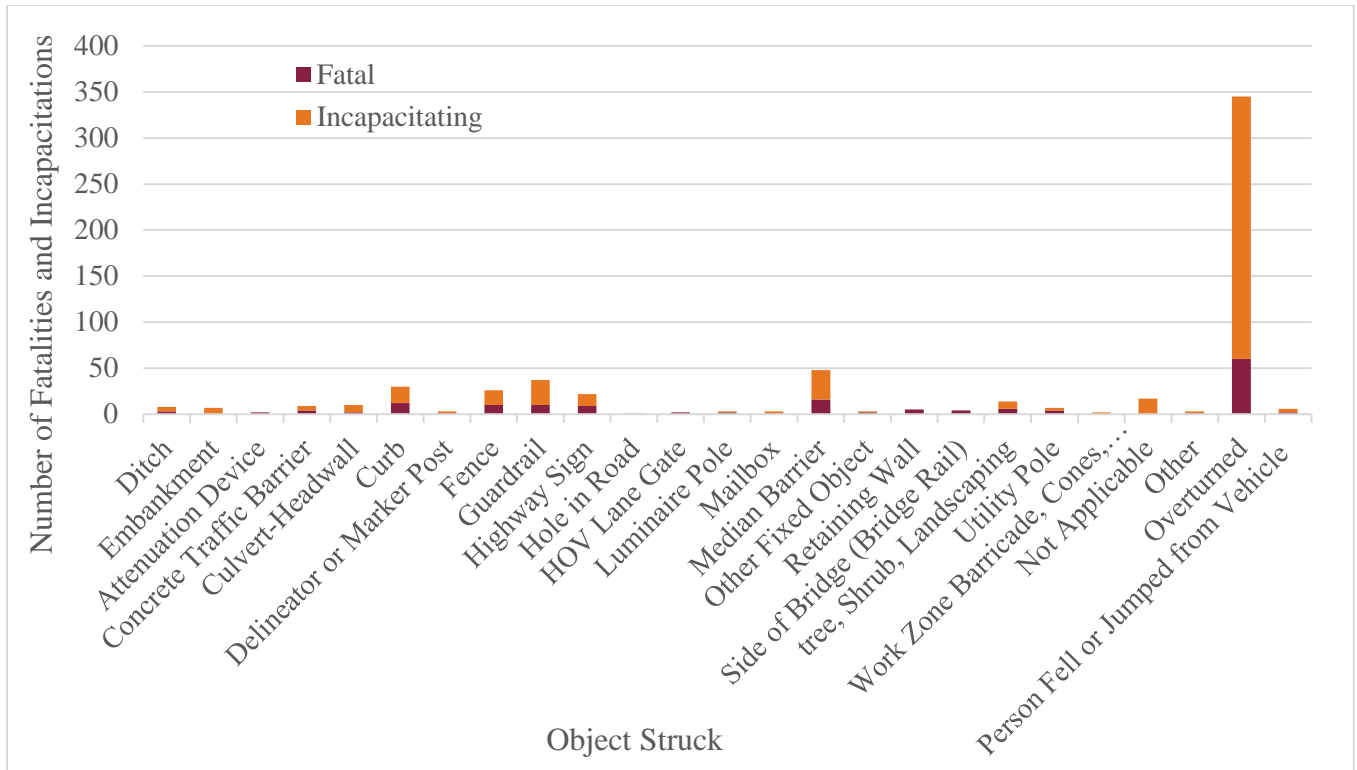


Figure 17. Chart. All KA on curves for objects struck.

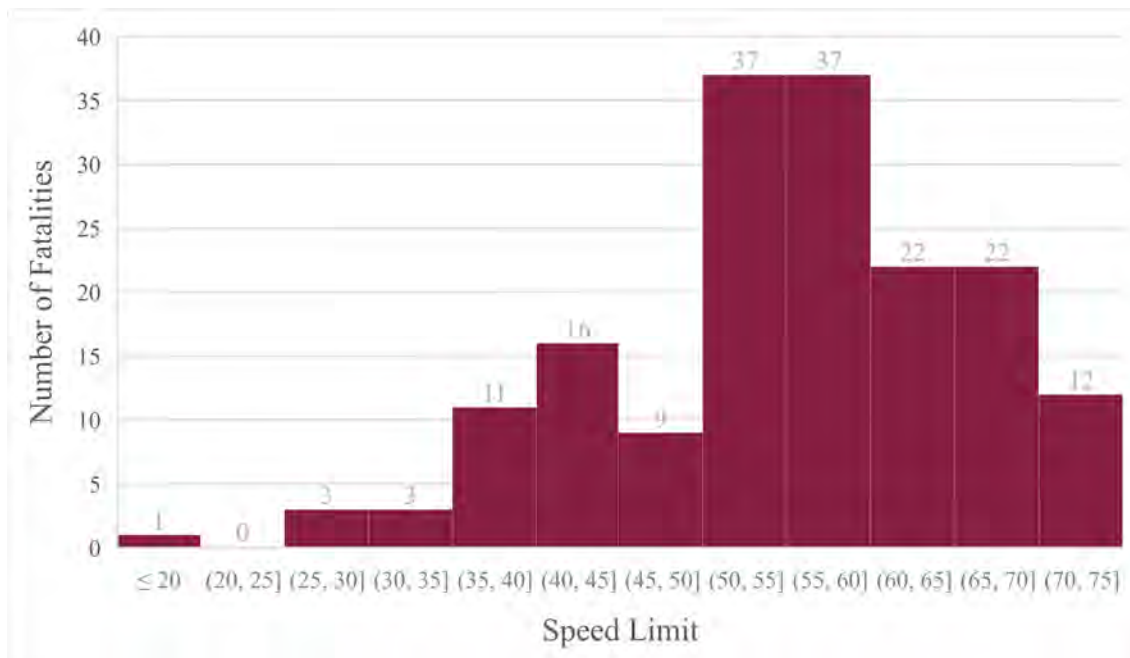
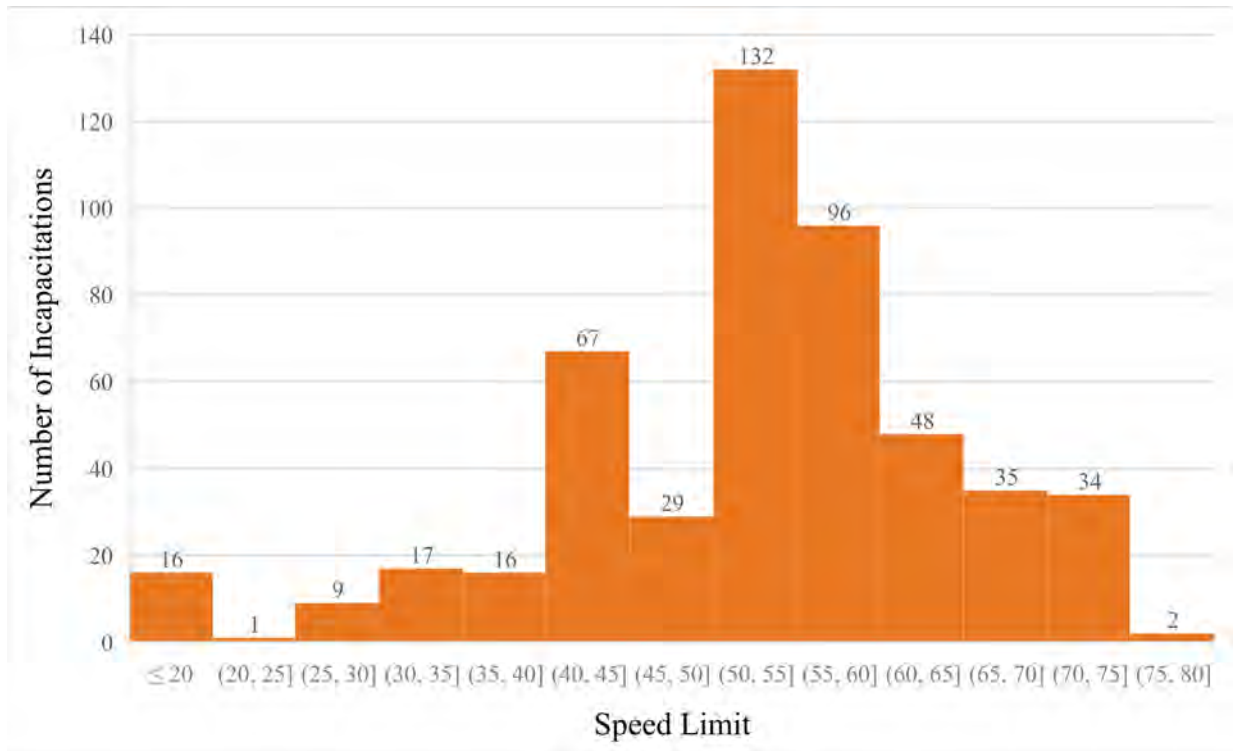


Figure 18. Chart. Distribution of fatalities for different speed limits.





**Figure 19. Chart. Distribution of incapacitations for different speed limits.**

The next analysis examined the various primary contributing factors that were recorded by the police officer on scene. There were numerous contributing factors, and some were similar enough to be easily categorized. Five categories were created that cover all of the various contributing factors: “Was under the influence,” “Involved excessive speed,” “Mishandling of the motorcycle,” “External distraction,” and “Other (explain in narrative).” Figure 20 shows the counts of the primary contributing factors.

For many of the cases where the officer reported a primary contributing factor, one or two possible contributing factors were also reported. These secondary contributing factors were then classified in the same way as the primary contributing factors. The next four graphs show the distribution of secondary contributing factors for different primary contributing factors. For example, in Figure 21 the primary contributing factor was “Under the influence” and possible secondary contributing factors are shown along the x-axis. The y-axis represents the number of times that each category was identified as a possible contributing factor. This was conducted for each category of primary contributing factor to see all of the possible combinations of correlations between the different factors (Figures 22 to 25).

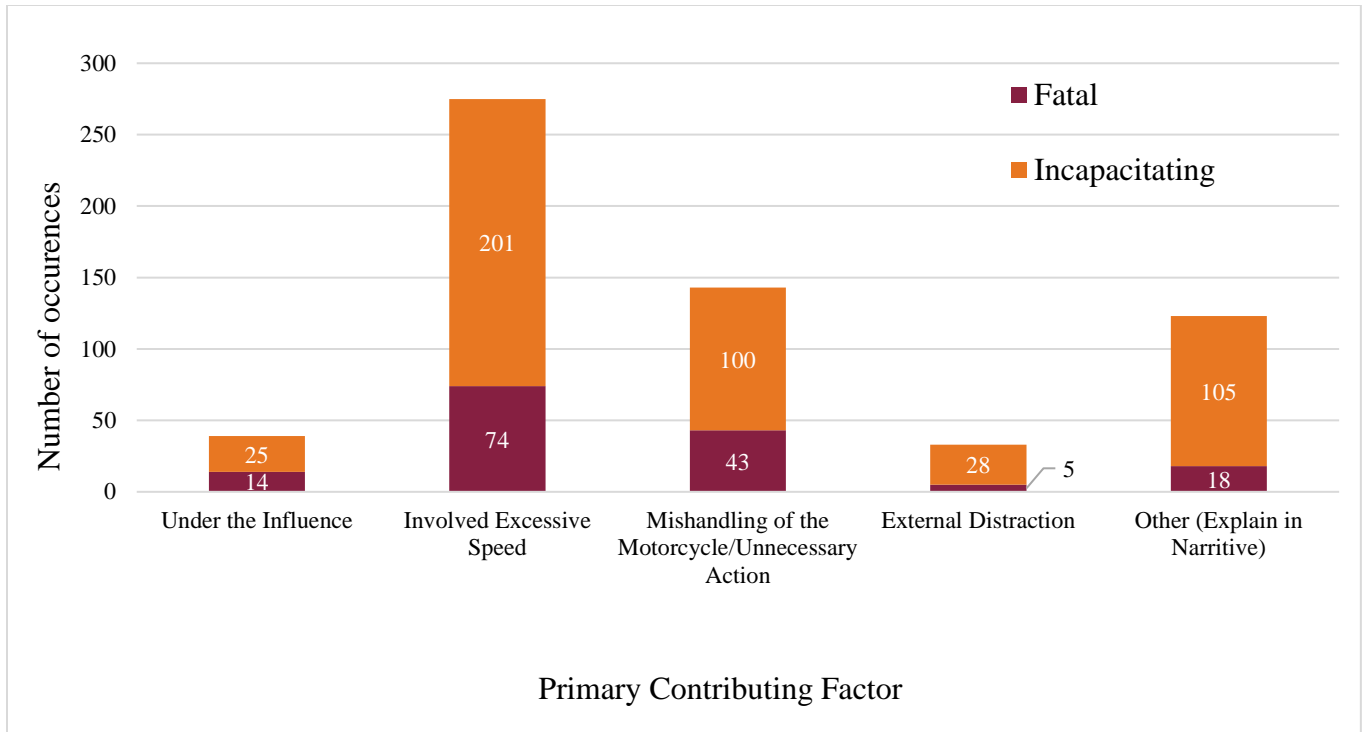


Figure 20. Chart. Various primary contributing factors resulting in KA on curves.

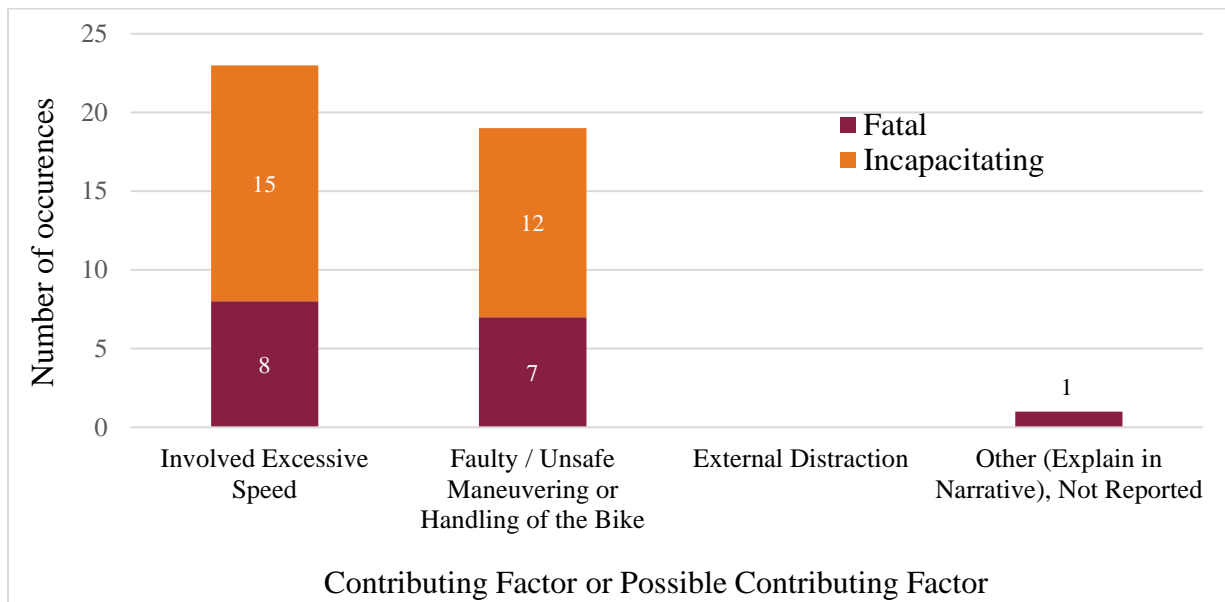
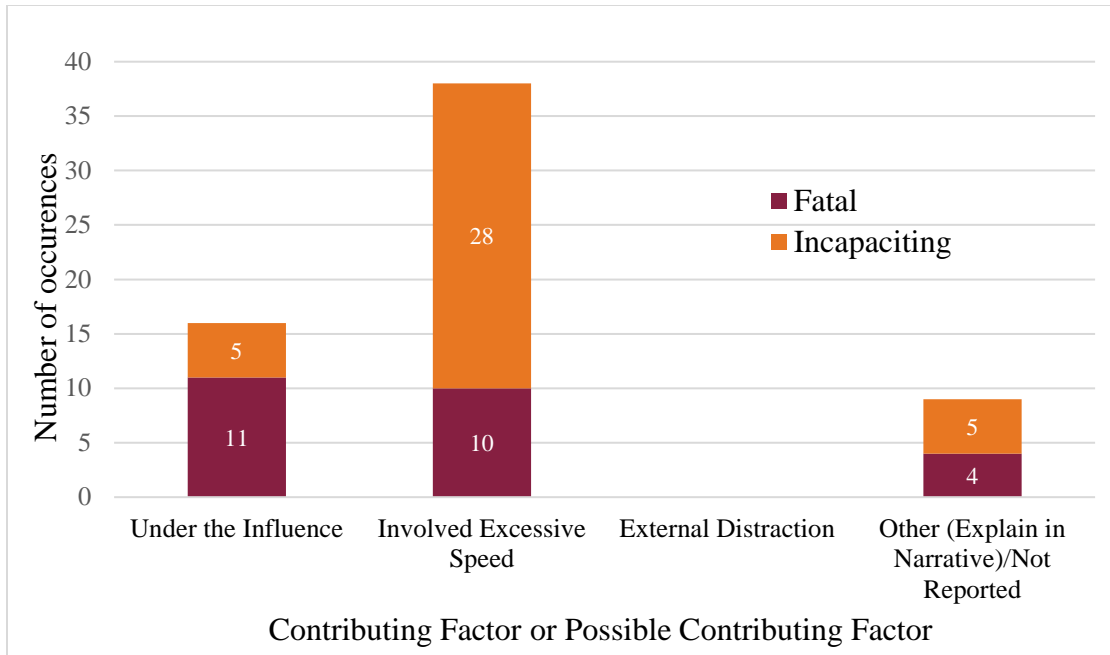
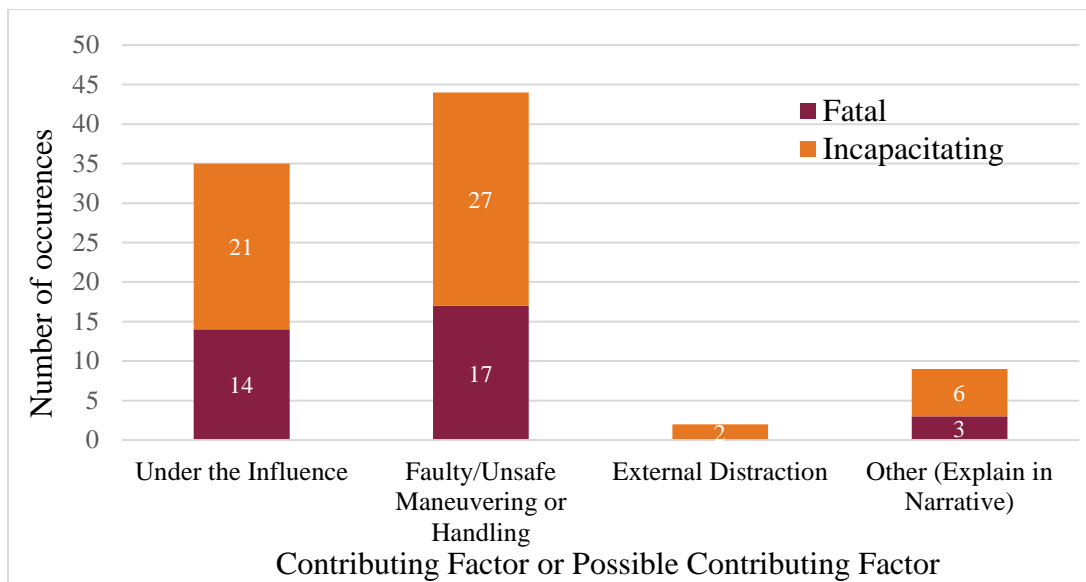


Figure 21. Chart. Distribution of secondary contributing factors and possible contributing factors for KA on curves where the primary contributing factor was “Under the influence.”

From these figures it can be seen that quite often when speeding was a primary contributing factor or possible contributing factor then alcohol was also involved. Similarly, when “Under the influence” was the primary contributing factor, excessive speed was also commonly identified as a possible contributing factor.



**Figure 22. Chart. Distribution of secondary contributing factors and possible contributing factors for KA on curves where the primary contributing factor was “Faulty/unsafe maneuvering.”**



**Figure 23. Chart. Distribution of secondary contributing factors and possible contributing factors for KA on curves where the primary contributing factor was “Involved excessive speed.”**

Lastly, the age of each driver was plotted in a histogram to examine the crash distribution by age (Figure 25). The maximums were found to occur from age 25 to 30 and from age 50 to 60.

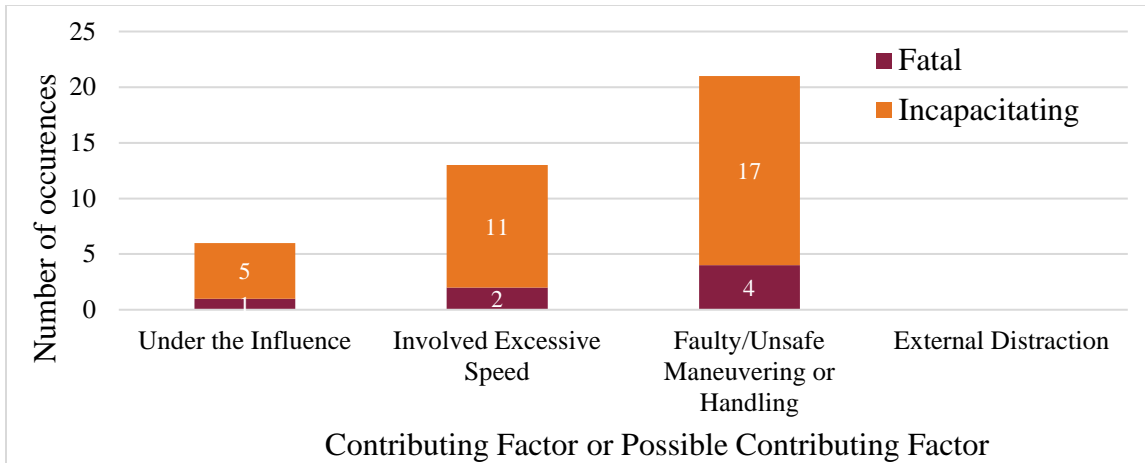


Figure 24. Chart. Distribution of secondary contributing factors and possible contributing factors for KA on curves where the primary contributing factor was “Other (explain in narrative), not reported.”

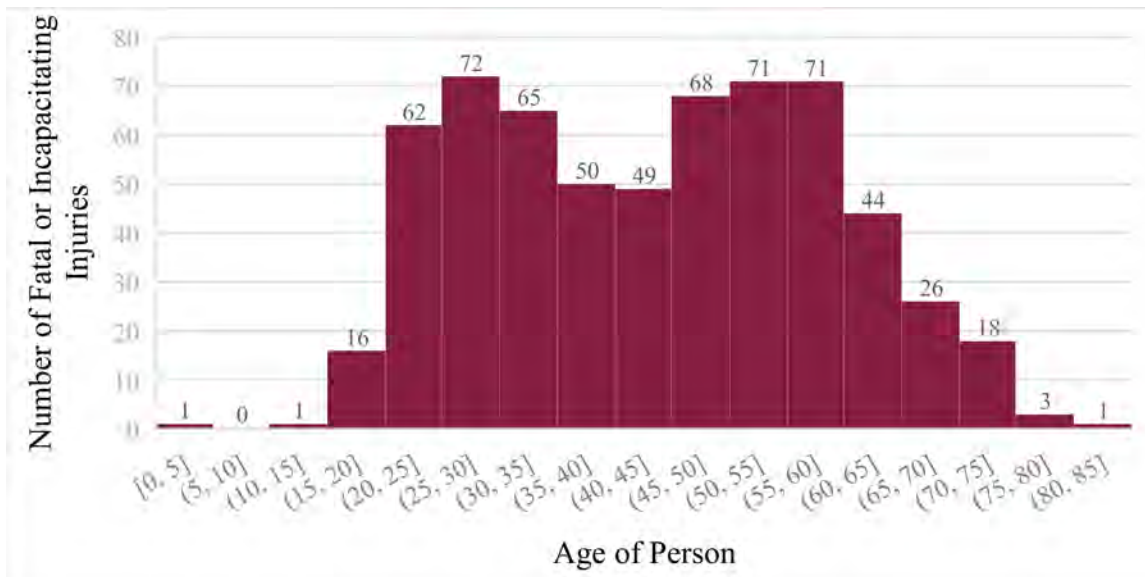


Figure 25. Chart. Number of KA victims of different age groups on curves.

## Conclusions and Recommendations

The international literature review conducted through this project revealed that the U.S. is still far behind other countries in the area of motorcycle safety when considering the impact of motorcycles against roadside safety barriers. While other countries have developed standards and/or national protocols to guide the design and evaluation of more-forgiving roadside safety systems during motorcycle impacts, very little has been done in the U.S. to address this critical issue. In addition, efforts to improve motorcycle safety can be directed not only to roadside barriers, but also to signage, visibility, delineation, and pavement.

Crash data analysis was conducted to identify relevant factors involved in motorcycle crashes impacting roadside safety barriers on flyovers/connectors or on curves. This crash data review was developed in support of an existing research project that aims to identify and test retrofit options for existing concrete barriers to contain errant motorcyclists during an impact event. The current crash data analysis primarily focused on fatal and incapacitating motorcycle injuries in Texas that happened on flyovers/connectors from 2014 to 2016. The scope of this study considered the distribution of injuries incurred to riders who struck roadside safety barriers such as concrete barriers. Although there could be a variety of factors related to these incapacitating injuries (including human characteristics, environmental conditions, road configurations, surface layouts, etc.), it appears evident that retrofit options for existing roadside safety systems are necessary to (1) contain the errant motorcycle user after impact, and (2) to reduce injury severity for the rider during the impact event.

Future research and testing studies are recommended to address the need for retrofitting these existing concrete barriers to properly provide containment options and reduction of riders' impact severity during impact events.

## Additional Products

---

The Education and Workforce Development (EWD) and Technology Transfer (T2) products created as part of this project can be downloaded from the Safe-D website [here](#). The final project dataset is located on the [Safe-D Dataverse](#).

### Education and Workforce Development Products

Undergraduate students at TTI were involved for the completion of this student project. Both students successfully graduated from the Civil and Aerospace Engineering Departments.

### Technology Transfer Products

Technology transfer products developed as a part of this project are listed below.

- A presentation related to the results obtained in this project is being prepared for submission to the 2020 Transportation Research Board (TRB) Annual Meeting for consideration for presentation and publication.
- Researchers are preparing a PowerPoint presentation based on the results of the research.

### Data Products

The raw crash data from the CRIS database used for this project was uploaded to the Safe-D Dataverse and can be accessed at:

<https://dataverse.vtti.vt.edu/dataset.xhtml?persistentId=doi:10.15787/VTTI/GCERVA>

## References

---

Adamson, K. S., P. Alexander, E. L. Robinson, G. M. Johnson, C. I. Burkhead, J. McManus, G. C. Anderson, R. Aronberg, J. R. Kinney, and D. W. Sallmann. Seventeen Motorcycle Crash Tests into Vehicles and a Barrier. SAE Technical Paper Series 2002-01-0551. SAE 2002 World Congress, Detroit, Michigan, USA, 2002.

AENOR. Standard UNE 135900:2005, 2005.

AENOR. Standard UNE 135900:2008rev.01, 2008.

Bambach, M., and R. Grzebieta. Motorcycle Crashes into Roadside Barriers Stage 4: Protecting Motorcyclists in Collisions with Roadside Barriers. Transport and Road Safety (TARS) Research Report, The University of New South Wales, New South Wales, Australia, 2014.

Berg, F. A., P. Rucker, M. Gartner, J. Konig, R. H. Grzebieta, and R. Zou. Motorcycle Impacts into Roadside Barriers – Real-World Accident Studies, Crash Tests and Simulations Carried Out in Germany and Australia. 19th International Technical Conference on the Enhanced Safety of Vehicles, Washington D.C., USA, 2005.

EN 1317-2. Road Restraint Systems - Part 2: Performance Classes, Impact Test Acceptance Criteria and Test Methods for Safety Barriers Including Vehicle Parapets. European Standard, European Committee for Standardization, Brussels, Belgium, 2010.

EN 1317-8. Road Restraint Systems - Part 8: Motorcycle Road Restraint Systems which Reduce the Impact Severity of Motorcyclist Collisions with Safety Barriers. Technical Specification, Final Draft for CEN/TS 1317-8, European Committee for Standardization, Brussels, Belgium, 2011.

FEMA. Final Report of the Motorcyclists & Crash Barriers Project. Federation of European Motorcyclist's Associations, 2010. [http://www.fema-online.eu/uploads/documents/guardrails/Motorcyclists\\_and\\_crash\\_barriers.pdf](http://www.fema-online.eu/uploads/documents/guardrails/Motorcyclists_and_crash_barriers.pdf). Accessed April 1, 2012.

ISO. Motorcycles-Test and Analysis Procedures for Research Evaluation of Rider Crash Protection Devices Fitted to Motorcycles. ISO 13232. International Organization for Standardization, Geneva, Switzerland, 1996.

L.I.E.R. Protocol: Motorcyclist Safety Evaluation Regarding Safety Barriers, 1998.

MAG. Vehicle Restraint Systems Safety Fences Crash Barriers Motorcyclists. Version 1:4. Motorcycle Action Group, Rugby, UK, 2005.

Milling, D., J. Affum, L. Chong, and S. Taylor. Infrastructure Improvements to Reduce Motorcycle Casualties. Austroads Research Report AP-R515-16. Austroads Ltd, Sydney, Australia, 2016.

Nabors, D., E. Goughnour, and J. Soika. Motorcycle Road Safety Audit Case Studies. Roadside Safety Audits (RSAs), Federal Highway Administration, Vanasse Hangen Brustlin, Inc., Vienna, VA, USA, 2016.

Nicol, D. A., D. W. Heuer, S. T. Chrysler, J. S. Baron, M. J. Blosscock, K. A. Cota, D. D. Paul, N. J. Garber, J. W. Kolb, M. McGrath, M. Moreland, and C. H. Tan. Infrastructure Countermeasures to Mitigate Motorcycle Crashes in Europe. International Technology Scanning Program, Stafford, VA, USA, 2012.

Nieboer J. J., J. Wismans, A. C. M. Versmissen, M. T. P. van Slagmaat, I. Kurawaki, and N. Ohara. Motorcycle Crash Test Modelling. *Proceedings of 37th Stapp Car Crash Conference*, pp. 273-288, SAE paper 933133, San Antonio, CA, USA, 1993.

Page, M., and J. Bloch. Evaluation Procedures of Motorcyclist Protection Devices. *Europeanroads Review*, ERR 16, 16th IRF World Meeting Sharing the Road, 2010.

Peldschus, S., E. Schuller, J. Koenig, M. Gaertner, D. García, and A. Mansilla. Technical Bases for the Development of a Test Standard for Impacts of Powered Two-Wheelers on Roadside Barriers. *Proceedings of the 20<sup>th</sup> International Conference on the Enhanced Safety of Vehicles Conference*, Lyon, France, 2007.

Quincy R., D. Vulin, and B. Mounier. Motorcycle Impacts with Guardrail. *Institute National de Recherche sur les Transports et leur Securite*, INRETS, France, 1988.

Rogers, N .M. Further Evaluation of Motorcycle Leg Protectors as Proposed in the UK Draft Specification. *Proceedings of the Thirteenth International Technical Conference on Experimental Safety Vehicles*, Paris, France, 1991.

Rogers, N. M., and J. W. Zellner. An Overall Evaluation of UKDS Motorcyclist Leg Protectors Based on ISO 13232. 16th International Technical Conference on the Enhanced Safety of Vehicles (ESV), Paper Number 98-S 10-0-13, Windsor, Ontario, Canada, 1998.

Shaffer, R. G., D. W. Heuer, F. D. Bents, J. A. Foglietta III, D. C. Wieder, M. J. Jordan, and P. Tiwari. Scan 09-04 Leading Practices for Motorcyclist Safety. Arora and Associates, P.C., Lawrenceville, NJ, USA, 2001.

Stock, R., J. Follman, R. Frieling, A. Kuschefski, D. Lippard, H. Nikolaus, M. Lenzen, A. Heuber, and T. Ritz. Motorbiking On Safe Roads, Practical Guidelines. Allgemeiner Deutscher Automobil-Club e.V. München, Deutschland, 2001.

Tan, C. H. *FHWA Motorcycle Crash Causation Study*. Federal Highway Administration, USA, 2017.

United States Department of Transportation. *Traffic Safety Facts* [Data file]. Available from the National Highway Traffic Safety Administration, 2015.

Zellner, J. W., K. D. Wiley, N. L. Broen, and J. A. Newman. A Standardized Motorcyclist Impact Dummy for Protective Device Research. 15th International Technical Conference on the Enhanced Safety of Vehicles, Melbourne, Australia, 1996.




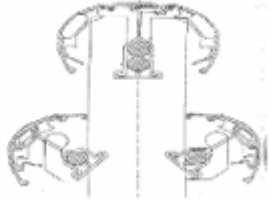
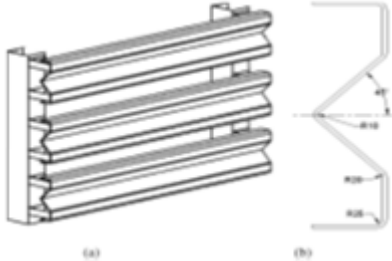
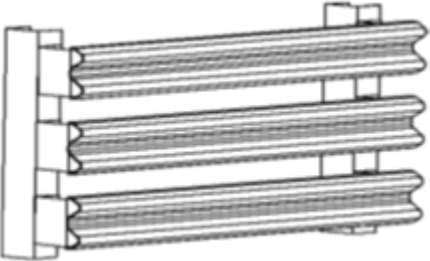
# Appendix A1

The chart below is a summary of devices used to retrofit roadside barrier for motorcycle safety.

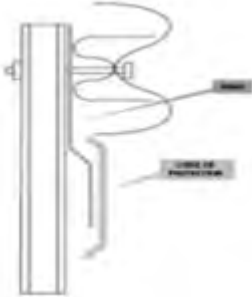




**Table 1. Devices for Retrofitting Roadside Barriers for Motorcycle Safety**

Device	Description	Picture
Punctual Energy Absorbers		
Punctual Energy Absorbers (Other)	Used tires on metal barrier posts with the purpose of protecting the impacting rider from the sharp edges of the post.	
Plastrail	Soft plastic fence covering barrier posts sold by Sodilor (France).	
Metal Shield	Metal Plate sold by SEC-Envel (France).	
Motorail	Built-in secondary fail sold by Solosar (France).	






**Table 1. Devices for Retrofitting Roadside Barriers for Motorcycle Safety (Continued)**

Device	Description	Picture
Mototub	Similar approach as “Plastrail”. But comprising 70% recycled material, sold by Sodirel (France).	
Cable Cover	Cable cover for wire rope safety fence, invented by Mr. Johansson (Sweden).	
V-Beam Guardrail System	V-beam guardrail system is made up of three V-profile rails	
Modified W-Beam Guardrail System for the Control Purpose	W-beam system with one made of PP and the AISI 1020 steel. There is no change in standard dimensions (M617-11 standard) for W-beam.	




**Table 1. Devices for Retrofitting Roadside Barriers for Motorcycle Safety (Continued)**

Device	Description	Picture
<p>W-beam guardrail equipped with lower motorcycle barrier</p>	<p>Shields bodies sliding on the pavement from the posts</p>	
<p>System Euskirchen Plus guardrail</p>	<p>Barrier was designed that includes a cap along the top to prevent upper-body injuries from sliding along the top of the rail.</p>	
<p>Spanish guardrail</p>	<p>Conforming Barrier</p>	
<p>Motorcycle Specific Guardrail</p>	<p>These guardrail systems feature a solid, flat beam across the bottom, manufactured in either metal or by a series of horizontally-run polyurethane tubes. The purpose of the lower beam is to prevent the motorcyclist from striking the vertical guardrail post while sliding across the road surface following a crash.</p>	
<p>Reflective White and Red Sheeting</p>	<p>Reflective white and red sheeting is applied to the top of motorcycle guardrail in a curve.</p>	

**Table 1. Devices for Retrofitting Roadside Barriers for Motorcycle Safety (Continued)**

Device	Description	Picture
Flexible Rub Rail	Flexible rub-rail systems attached to steel W-beam barriers provide the best protection for motorcyclists in sliding collisions with roadside barriers.	
Flexible bollards	Guidance systems made of flexible materials: flexible bollards	
Underrun Protection in bends	Equip crash barriers with underrun protection in bends	
Earth Walls		
Motorcycle Specific Guardrail		

**Table 1. Devices for Retrofitting Roadside Barriers for Motorcycle Safety (Continued)**

Device	Description	Picture
High Visibility Nose		
Biker-Mate Crash Cushion		
Blue System Protection		

## Appendix A2

### Motorcycle Crash Testing Literature Sample

Past accident investigations have shown that head injuries are the most numerous and severe after impact against a barrier post, and that the impact often happens after the motorcycle slides along the ground. In 1988, at INRETS (France), Quincy et al. (1988) developed two designs to reduce the aggressiveness of a metal beam standard guardrail. With the first design, a lower beam was added near the ground to prevent post impact and an upper beam was added to the existing guardrail. With the second design, the upper beam was removed and the lower beam stiffness was reduced to make the fitting easier (Figure 26).

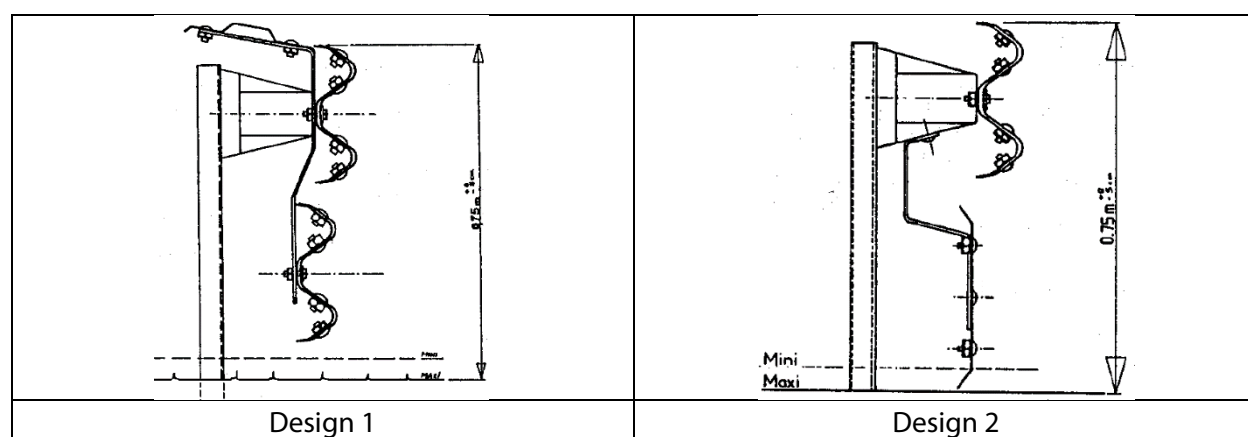


Figure 26. Metal beam standard guardrail designs – INRETS (Quincy et al., 1988).

In their test configuration, the dummy was placed on a platform, lying on its back with its head forward. Just before impact, the platform was stopped and after 6.6 ft (2 m) sliding on the pavement the dummy impacted the barrier. Three tests were conducted: two with the first design and one with the second design. Impact speed was 34.2 mph (55 km/h) and impact angles were  $32^\circ$  for the first design and  $30^\circ$  for the second design. A comparative test on a concrete median barrier was also performed. Table 2 reports the dummy test results.

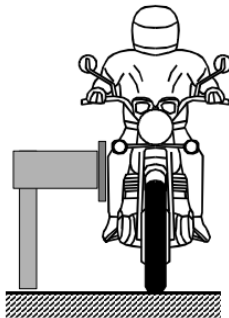
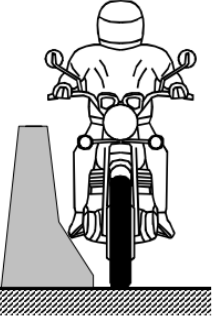
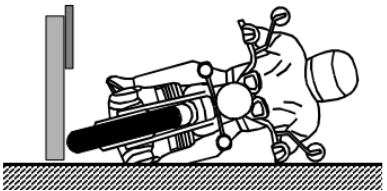
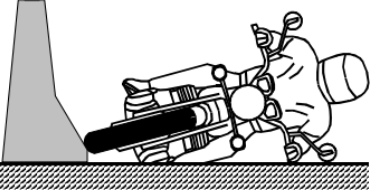
Table 2. Dummy Test Results from Quincy et al. (1988) Tests – INRETS

Test No.	Device	Impact Speed (km/h)	Angle	Head Acceleration	
				at 3 ms (g)	Head Injury Criterion (HIC)
504	G2R/1	55	32	66	325
506	G2R/1	55	32	40	175
566	G2R/2	54.5	30	80	365
505	Concrete Barrier	55	30	110	110

DEKRA Automobil GmbH (Germany) and Monash University (Australia) conducted a joint study on motorcycle impacts into roadside barriers (Berg et al., 2005). The scope of this study was to have a better understanding of real-world motorcycle-barrier accident configurations. Evaluation of 57 real-world accident studies showed that in 51% of those cases the motorcycle impacted the roadside barrier while driving in an upright position. In 45% of the impacts, the motorcycle struck the barrier after sliding on its side on the road surface. Finally, 4% of the crashes involved the motorcycle impacting the barrier driving in an inclined position.

Findings from the real-world crash investigations suggested conducting full-scale crash tests with two different impact scenarios: the motorcycle impacting the barrier while being driven in an upright position and the motorcycle striking the barrier while skidding on its side. Two different barrier types were considered for each impact configuration: a steel guardrail and a concrete barrier. Full-scale crash tests were conducted with a motorcycle pre-crash speed of 37.3 mph (60 km/h). Impact angles were 12° and 25° for the motorcycle impacting in an upright position and motorcycle skidding on its side, respectively. The road surface was wet. A summary of the test configurations is provided in Table 3.

**Table 3. Impact Configurations and Details from Berg et al. (2005)**

Impact Configuration		Impact Speed	Impact Angle
		60 km/h 37.3 mi/h	12°
Test 1. Upward Driving Condition – Steel Guard Rail	Test 2. Upward Driving Condition – Concrete Barrier		
		60 km/h 37.3 mi/h	25°
Test 3. Motorcycle Skidding on Side – Steel Guard Rail	Test 4. Motorcycle Skidding on Side Concrete Barrier		

A Kawasaki ER 5 Twister motorcycle was used in each test. The motorcycle’s mass was approximately 397 lb (180 kg) and reached 600 lb (272 kg) with the dummy sitting on it. A Hybrid

III dummy (50<sup>th</sup>-percentile male, hip the same as for a “standing Anthropomorphic Test Device (ATD)”) was chosen to represent the motorcycle rider. The dummy was wearing standard protective clothing. Dummy loads were measured for the head (HIC,  $a_{3ms}$ ), the chest ( $a_{3ms}$ ), the pelvis ( $a_{3ms}$ ) and the femur ( $F_{left}$ ,  $F_{right}$ ). Loads were collected for “primary” impact into the guardrail and “secondary” impact onto the road surface.

In the upward driving condition test against the guardrail, although dummy loads did not indicate a high-level injury risk, the rider would have suffered severe injuries due to aggressive contacts and snagging with some of the barrier’s stiff parts and open profiles. In the upward driving condition test against the concrete barrier, the dummy flew over the top of the barrier and landed on the opposite side of the roadside protection system. The concrete barrier increased the risk of being deflected into the oncoming traffic and, with respect to the steel guardrail, it dissipated lower kinetic energy via deformation.

In the configuration with the motorcycle skidding on its side against the steel guardrail, the motorcycle impacted a sigma post at 29.2 mph (47 km/h), was stopped, and remained stuck underneath the guardrail, while the dummy separated from the motorcycle and collided with a sigma post. Dummy loads indicated very high head values, above the biomechanical limits. Also, the dummy’s left shoulder joint was broken. In the configuration with the motorcycle skidding on its side against the concrete barrier, both motorcycle and dummy decelerations were not as rapid as observed in the same configuration against the steel guardrail. Dummy head loads were above the corresponding biomechanical limits.

Following the full-scale crash tests results, Berg et al. (2005) decided to modify the steel guardrail system to provide a better protection for impacting motorcyclists. They designed a system consisting of sigma posts and a closed box-shaped profile at the top. An underrun protection board was additionally mounted near the ground to prevent direct impact onto the post and rider movement underneath the barrier. Two additional full-scale crash tests were run with the motorcycle and dummy impacting the modified steel guardrail at 37.3 mph (60 km/h), a 12° angle, with an upright position, and with the motorcycle sliding into the barrier.

For a motorcycle rider impacting the modified system, the risk of injury decreased. In fact, the additional underrun protection board eliminated the risk of the impacting dummy snagging and absorbed kinetic energy as a result of its deformation after impact.

Berg et al. (2005), however, still questioned the biofidelity of the dummy Hybrid III in predicting all injury risks a human might be exposed to after an impact against a roadside barrier and after any subsequent impacts onto the road surface.

Nieboer et al. (1993) performed several motorcycle-to-barrier crash tests and two motorcycle-to-passenger car tests at the laboratories of the TNO Crash-Safety Research Center in The Netherlands. The scope of these tests was to acquire data for the implementation and validation of a MADYMO motorcycle model. In a second stage of this study, the MADYMO motorcycle model

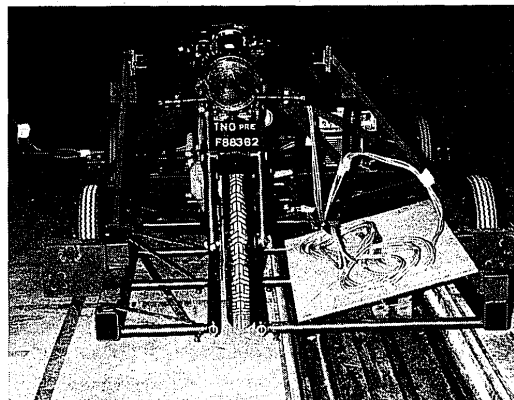


was extended with a rider and passenger car model to assess its performance in real-life crash situations.

A YAMAHA SRX-600 motorcycle model and a 50<sup>th</sup>-percentile Part 572 dummy with a pedestrian (standing) pelvis and pedestrian legs and feet were used. No helmet was applied to the dummy. The dummy was equipped with triaxial accelerometers in the head, chest, pelvis, left knee, and right knee. Uniaxial accelerometers in the longitudinal direction were applied in the feet.

A special trolley (Figure 27) was designed to guide the motorcycle and the dummy prior to impact. The motorcycle was supported at the handlebar and at the upper spring-damper element attachment points. It was pushed forward at its rear axle. The motorcycle was connected to the trolley with a pneumatic lock during the acceleration phase, in case an emergency stop was required. During the tests, the trolley was stopped 18 ft (5.5 m) in front of the barrier by means of crumple tubes, allowing the motorcycle to impact the barrier in an upright position.

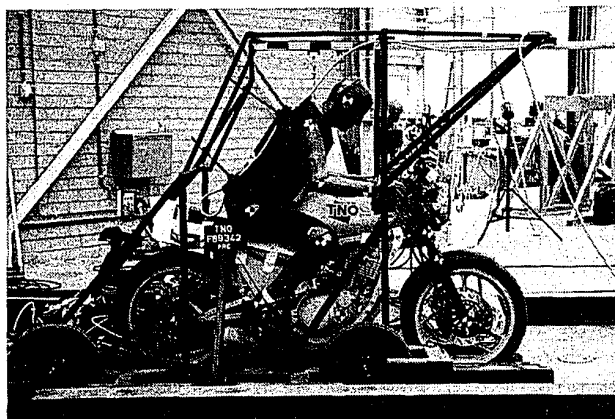
Three different test conditions were considered: 20 mph (32.2 km/h) at 90°, 30 mph (48.3 km/h) at 90°, and 37 mph (59.5 km/h) at approximately 67°.



**Figure 27. Motorcycle trolley (Nieboer et al., 1993).**

Two additional full-scale crash tests were performed in which the motorcycle with rider ran into a Mazda 323 passenger car. The first crash test involved a moving passenger car (20 mph [32.2 km/h]) and a moving motorcycle with rider (20 mph [32.2 km/h]) colliding into each other at an angle of 45°. The second crash test condition involved a motorcycle with rider impacting at 30 mph (48.3 km/h) against a stationary passenger car at an angle of 90°.

To support the dummy during the pre-release phase, the trolley was extended with a frame (Figure 28). Prior to impact, the dummy was prevented from sliding backwards by two supports, one at the pelvis and one at the shoulder height. The neck bracket of the dummy was also connected to a rail with a steel cable and a sliding mechanism, holding the dummy in the correct position after the motorcycle released from the trolley.



**Figure 28. Motorcycle trolley including dummy support frame (Nieboer et al., 1993).**

Peldschus et al. (2007) performed two different motorcycle-into-barrier crash tests by order of the German Federal Highway Research Institute. The purpose of the project was to design a safety barrier that could easily be adapted to existing barriers in Germany that would be more motorcycle friendly. The tests were performed with two different configurations of the motorcycle and dummy. Extensive data analysis was conducted on the nature of motorcyclist crashes into barriers. Several databases were available, including the GIDAS data of 2002, the DEKRA database, and the data of the COST 327 project. Analysis considered impact velocities for accidents, angle of impact between road tangent and velocity vector, and sustained injuries during accidents. A Motorcyclist Anthropometric Test Device (MATD) dummy was used for two different crash tests. The two different configurations were suitable to represent the impact conditions found in the data analysis.

One configuration consisted of the motorcycle and rider being inclined so they would crash into the barrier in a sliding position on the ground.

Figure 29 shows the test sled used for this inclined crash test. The device allows for an inclination of  $45^\circ$ , which creates the tumble and sliding of the motorcycle and dummy.

The first configuration for the crash test set the impact angle of the motorcycle and dummy with the guardrail at  $25^\circ$ . The initial velocity of the motorcycle leaving the sled was 60 km/h. The test dummy was equipped with several measurement channels in the neck, chest, head, pelvis, tibias, and femurs. These channels were used to measure the rotational acceleration, force, and moment upon impact. Different resulting loads from the first configuration crash test are shown in Table 4.

The data were separated into primary and secondary data to distinguish the difference between contact with the safety system and loads that are caused by the fall on the ground. This separation was necessary due to impact of the head on the ground, which caused a high peak in the acceleration data.



Figure 29. Test sled in inclined position with motorcycle and dummy (Peldschus et al., 2007).

Table 4. Load Impact Data of the Inclined Test (Peldschus et al., 2007)

	limit	primary	%**	secondary	%**
<b>Head</b>					
a res 3ms	80 g	33,2	42	101	127
HIC 36 ms	1000	69,0	7	584	58
<b>Neck</b>					
M b y	57 Nm	11,5	20	18	31
F <sub>X</sub> max	3100 N	175,8	6	243	8
F <sub>Z</sub> max	4000 N	31,6	1	1283	32
<b>Chest</b>					
a res 3ms	60 g	11	19	9	16
<b>Pelvis</b>					
a res 3ms	60 g	12	20	14	24
<b>Femur</b>					
F <sub>Z</sub> right max	9070 N	-2764	30	776	9
F <sub>Z</sub> left max	9070 N	401	4	-774	9

\*: neg. values = compression, pos. values = tension

\*\* : % of the limit

The second impact configuration was an upright position of the dummy and the motorcycle. The test sled used for this configuration was similar to the one used for the inclined sled except there was no attachment to put the motorcycle in an inclined position. Figure 30 shows the test sled used for the upright impact configuration. The motorcycle and dummy impacted the guardrail at an angle of 12° instead of the 25° as in the inclined crash test. The initial velocity of 60 km/h was the same.



**Figure 30. Test sled in upright position with motorcycle and dummy (Peldschus et al., 2007).**

Similar to the first crash test, the test dummy was equipped with several measurement channels that would analyze the rotational accelerations upon impact of the different parts of the body. The measurement channels covered several parts of the body, including the head, neck, chest, pelvis, femurs, and tibias. The head, chest, and pelvis channels measured rotational acceleration, while the neck and femur channels measured moment and force loads. Table 5 shows the recorded loads during the crash impact for the upright position. The primary data are specific to when the dummy impacted the guardrail, while the secondary data are specific to measured loads when the dummy hit the ground.

**Table 5. Load Impact Data of the Upright Test (Peldschus et al., 2007)**

	limit	primary	%	secondary	%
<b>Head</b>					
a <sub>res 3ms</sub>	80 g	10	<b>13</b>	84	<b>106</b>
HIC <sub>36 ms</sub>	1000	5	<b>1</b>	383	<b>38</b>
<b>Neck</b>					
M <sub>b y</sub>	57 Nm	26	<b>45</b>	56	<b>98</b>
F <sub>x max</sub>	3100 N	144	<b>5</b>	317	<b>10</b>
F <sub>z max</sub>	4000 N	391	<b>10</b>	3406	<b>85</b>
<b>Chest</b>					
a <sub>res 3ms</sub>	60 g	13	<b>21</b>	51	<b>85</b>
<b>Pelvis</b>					
a <sub>res 3ms</sub>	60 g	18	<b>30</b>	12	<b>20</b>
<b>Femur</b>					
F <sub>z right max</sub>	9070 N	-6744	<b>74</b>	-590	<b>7</b>
F <sub>z left max</sub>	9070 N	-2960	<b>33</b>	-815	<b>9</b>

\*: neg. values = compression, pos. values = tension

\*\* : % of the limit

## Motorbiking on Safe Roads

A report by Stock et al. (2011), *Motorbiking on Safe Roads*, sought to call attention to and address hazards to motorcyclists. Stock et al. (2011) first examined the differences between maneuvering a motorbike and a motor vehicle. Next, certain physical features and flaws in roadway surfaces

were looked at. It was found that longitudinal lane ruts and road patches pose great risks to riders because of the high probability of causing a motorcycle to go off track. Sometimes in rural areas it can be very difficult for motorcyclists to anticipate upcoming bends in the road when agricultural products, such as corn fields, protrude closer to the road. The highest risk to riders when they crash is colliding with a fixed object, such as a roadway safety systems and signage.

The report includes images depicting poor road quality and safety alerts around bends and curves. Many of these images present hazards such as damaged pavement, low visibility, lack of underrun protection, longitudinal ruts, and unsafe roadway surface conditions. The need to prevent collisions between motorbike riders and roadside obstacles is emphasized, as roadways have always been designed to accommodate car collisions. The layout and overall profile of a bend or roadway section that is considered to be a hotspot was found to be the reason for critical numbers of accidents. Multiple recommendations are made for how to better treat the roads and roadsides for motorcyclists and also how to better manage crossings and junctions.

Stock et al. (2011) also analyzed motorcycle accidents in different areas of Germany. Some of the significant findings were that in 2008 nearly one in seven people killed in a roadway accident were motorcyclists. Also 10% of accidents that resulted in injuries involved motorcycles. Inexperienced riders were found to experience much higher injury and fatality ratings, which the report mentions could be due to lack of experience on how to maneuver curves and other difficult road layouts. Some of the primary reasons that were found to contribute to such high numbers of motorcycle accidents were incorrect right-of-way maneuvering and driving error while navigating corners. It was felt that many of these riders did not possess proper riding and handling skills, which led to the high number of accidents and faulty maneuvers.

The authors suggest that a good alternative to guardrails in some bends is an earth berm. Earth berms are thought to be more forgiving by preventing riders from impacting any sharp or blunt objects. The importance of widening shoulders is also made clear, especially shoulders around bends. Clear specifications are stated on how to implement the most effective reinforced shoulder. A reinforced shoulder will accommodate a motorcyclist better than an unadjusted standard shoulder. It was shown how implementation of safe railing systems can make bends in the road less threatening to motorcyclists for a few specific roadway sections that were known to pose a high risk to riders if they were to crash into them.

It was found that Germany was the second most popular motorcyclist nation behind Italy. The authors identified three areas for advancing road infrastructure safety: man, machine, and road. By investing in infrastructure and more advanced engineering systems, there is a greater chance for long-term sustainability. One of the most important countermeasures is to increase the awareness of road authorities at all levels, such as road planners, road builders, construction authorities, etc. In order for these recommendations and implementations to be realized, they will need to be brought forward to the proper authorities and agencies.

Six main points were presented depicting how to move forward with motorcyclist safety. The first point is to increase awareness among experts, work groups, and political decision makers. Next is to urge critical authorities to make their MVMot guidelines “state of the art.” The authors’ subsequent points were to analyze and discuss accident causes, figures, and facts; to detect and repair road damage; inform and train road users; and lastly to focus implementation of road construction and traffic engineering measures for improved road safety. Furthermore, 10 recommendations were made and proposed as 10 crucial principles that should be followed.

### Three Infrastructure Improvements to Reduce Motorcycle Casualties

The Australian/New Zealand report, *AP-R515-16 Infrastructure Improvements to Reduce Motorcycle Casualties* (Milling et al., 2016), represents a critical progression in the area of motorcyclist safety with respect to roadside barriers and other roadside infrastructure.

This report summarizes the technical findings of a two-year study identifying effective infrastructure improvements for reducing motorcycle crash risk and severity based on how riders perceive, respond, and react to infrastructure. The research in this study included a literature review, crash analysis, the identification of road infrastructure elements as crash factors, the identification of effective mitigation measures and their likely safety benefit, and consultations with stakeholders.

In Australia, motorcycle fatalities occurred most frequently on curves (39%), intersections (38%), and straight roadways (23%). Crossfall, curve radius, grade, approach speed, and non-predictable geometry were identified as contributing factors to motorcycle crashes. While the road environment may not be the direct cause of the crash, roadside hazards and roadside conditions accounted for 75% of single-vehicle collisions. Some of the most commonly struck objects included trees (24%–31%), fences/safety barriers (10%–12%), street lights or traffic light poles (9%), and drainage and drain pipes (5%). Common road-related factors that contribute to motorcycle fatalities were poor surface grip, road surface hazards, poor or lack of consistent delineation, and unsealed shoulders. Some suggestions for possible remediation of these factors included consistent, well-located skid resistant pavement surfaces and markings, improved delineation especially on curves, provision of motorcycle-friendly barriers, advance stop lines at intersections with filtering lanes for motorcycles to reach the front of traffic, and anti-lock braking systems that may help the motorcycle maintain traction with the road and mitigate the risk of crashing due to rider inexperience, poor road surface, or weather conditions.

For the crash analysis, any crashes that occurred during Monday through Friday but excluding holidays were defined as commuting periods, and crashes that occurred on Saturday, Sunday, or on a public holiday were defined as recreational period crashes. The majority of motorcycle crashes occurred during the commuting period, but there was a higher proportion of motorcycle-only crashes during the recreational period. Recreational periods had a higher proportion of crashes occurring on curves, while commuting periods had a higher percentage of crashes occurring on straights and intersections. The commuting period witnessed a high proportion of crashes

occurring on curves with an open view, compared to curves with obstructed views, but the recreational period had a higher proportion of crashes occurring on obscured view curves. Ninety-two to ninety-nine percent of motorcycle crashes at intersections, occurred at T-junctions, followed by cross roads, then roundabouts.

According to many specific roadside safety audits undertaken by the ARRB Group, infrastructure elements can influence the likelihood and severity of a crash (Milling et al., 2016). Some infrastructure elements that contribute to crashes include poor sight lines, signage, and delineation that can reduce road readability, rutting, and surface deformations. Location, size, and type of roadside object can also affect crash severity. Because motorcycles are comparatively complex to operate compared to motor vehicles, the number of attributes that contribute to motorcycle crash severity is significantly higher than for passenger vehicles. Some attributes that contribute to motorcycle crash likelihood are curvature, quality of curve, visibility, road condition, skid resistance, and intersection type. Attributes contributing to greater crash severity include driver-side object, passenger-side object, and intersection type.

**Table 6. Infrastructure Elements Influencing Likelihood Risk Factors for Vehicles and Motorcycles (Milling et al., 2016)**

Elements	Description	Likelihood risk Factors (rural and urban)		Differences between vehicle and motorcycle risk factors
Curvature	Moderate curvature	1.8	2	0.2
	Sharp curve	3.5	3.8	0.3
	Very sharp	6	6.5	0.5
Quality of curve	Poor	1.25	1.4	0.15
Road Condition	Medium	1.2	1.25	0.05
	Poor	1.4	1.5	0.1
Skid resistance/grip	Sealed – medium	1.4	1.6	0.2
	Sealed – poor	2	2.5	0.5
	Unsealed – adequate	3	4	2
	Unsealed - poor	5.5	7.5	2.0
Intersection type	Roundabout	15	30	15
	3-leg (unsignalized) driver-side turn lane	13	17	4
	3-leg (unsignalized) no driver-side turn lane	16	20	4
	3-leg (signalized) no driver-side turn lane	12	14	2
	4-leg (unsignalized) no driver-side turn lane	23	26	3
	4-leg (signalized) no driver-side turn lane	15	16	1
Intersection quality	Readability of layout, approach signage, delineation and line marking	0	1	1

A road with a greater number of curves is inherently more likely to have a greater crash likelihood for all vehicles, but will affect motorcycles at a higher proportion because of their unique handling characteristics. Crash likelihood also increases as lane width and shoulder width decrease. Clear signage and warning information displayed in advance to the rider greatly affect crash likelihood and severity. Key infrastructure elements that are catered to reducing the risk of motorcycle crashes

are not currently conveyed in publications and are therefore not yet in consideration among practitioners. Several treatments to mitigate crash severity can be put in place as displayed in the chart below.

**Table 7. Methods to Mitigate Crash Severity (Milling et al., 2016)**

Control Method	Issue	Safe System pillar			
		Safe roads	Safe speeds	Safe people	Safe vehicles
Elimination Remove the hazard from the road and traffic environment	Roadside object – tree	Remove tree to provide a clear zone			
	Poor surface texture	Resurface the road			
	Sharp horizontal curve	Realignment of road			
	Right turn crashes at signalized intersection	Grade separation			
Substitution Replace one hazard with another, less severe and more controllable hazard	Roadside object – tree	Install safety barrier			
	Poor surface texture	High surface friction treatment, re-instate the surface friction			
	Reduce crash risk on curves	Improve horizontal sight distance			
	Right turn crashes at signalized intersection	Provide a dedicated right turn phase and right turn lane			
Engineering control – isolation Apply design modifications to minimize road user interaction with the hazard	Roadside object – tree	Provide a wider shoulder to allow for recovery			
	Poor surface texture	Repair localized surface texture defect			
	Reduce crash risk on curves	Proved wider lanes and shoulder on curve			
	Right turn crashes at signalized intersection	Right turn lane, sight lanes			
Administrative control Provide warning/advice to seek appropriate behavior	Roadside object – tree	Install warning signs	Reduce posted speed		
	Poor surface texture	Install warning signs	Reduce posted speed		
	Reduce crash risk on curves	Improve delineation and signage on curve	Reduce posted speed		
	Right turn crashes at signalized intersection	Ensure intersection has good delineation and advanced warning signage	Reduce posted speed		
Personal protective equipment Use equipment to protect road users from death/injury	Roadside object – tree			Helmets	ESC, ABS etc.
	Poor surface texture			Rider training	ESC, ABS etc.
	Reduce crash risk on curves			Rider training and education	ESC, ABS etc.
	Right turn crashes at signalized intersection			High visibility clothing	ESC, ABS etc.

According to the report, when considering motorcycle safety the following measures should be considered:



- Motorcyclists should be recognized as a unique road user group that has specific needs with regard to road infrastructure.
- The likelihood of a crash occurring and its likely severity are both important considerations; however, with more focus on treating road infrastructure elements that affect crash likelihood, further crash reductions can be achieved.
- It is perhaps more economical to treat road infrastructure elements that effect the likelihood of a crash occurring. Greater reductions in fatal or serious injury crashes (FSIs) may be achieved through a targeted focus on reducing the likelihood of a crash occurring as well as reducing the severity of a crash.
- As the proposed mitigation measures are road-infrastructure-based treatments, over time they can be integrated into existing practice and therefore existing funding.
- Motorcycle crash risk should be proactively identified and a remedial action program developed through motorcycle-focused network safety assessments or road safety audits.

## Appendix A3

### Motorcycle Crash Testing Literature Sample

Adamson et al. (2002) conducted 17 staged motorcycle crash tests at the World Reconstruction Exposition 2000 (WREX2000), with the scope of evaluating the post-impact characteristics of a heavy motorcycle involved in collisions with stationary targets.

Four-cylinder, air-cooled Kawasaki 1000 police motorcycles, weighing between 546 lb (248 kg) and 633 lb (287 kg), were employed in the full-scale crash tests. Seven crash tests were conducted against an 11,080-lb concrete target block (120-in wide, 39-in high, and 24-in thick) (Figure 31). Ten crash tests were conducted against two 1989 Ford Thunderbirds. Crash impact speeds ranged from 10 mph (16.1 km/h) to 49 mph (78.9 km/h) and the impact angle was 90°.

The WREX2000 was held in College Station, Texas, and the test area chosen was the TTI facility. The Roadside Safety & Physical Security Division at TTI had an active role in conducting the full-scale crash tests, offering its knowledge and manpower to develop the motorcycle tow system and to set up, conduct, and analyze the crash tests.



**Figure 31. Concrete barrier and motorcycle type used in full-scale motorcycle crash testing (Adamson et al., 2002).**

The motorcycle tow system pictured in Figure 32 consisted of a 2-in × 2-in steel tubing boom protruding from a fixture welded to a trailer. Inserted into the steel tubing was a wooden 2 × 2 square bar, which extended out 3 ft (0.9 m). The top of the motorcycle's fork was then connected to the wooden bar with the use of adjustable straps to provide enough tension to support the motorcycle upright. The motorcycles were manually stabilized until they were moving at a sufficient speed to remain upright while in motion. The motorcycles were towed to the target by a Ford Expedition vehicle, and were released by fracture of the wooden bar during the early phase of the collision. The tow arrangement allowed impacts extending up to about 8.5 ft (2.6 m) from the near end of the target vehicle.

Car damage photographs, motorcycle crush measurements, and car crush measurements were collected to provide a useful database for future reconstruction of motorcycle collisions.



Figure 32. Motorcycle tow system (Adamson et al., 2002).

Table 8 summarizes the impact test configurations and conditions for the motorcycle full-scale crash tests performed.

Table 8. Impact Configurations and Details from Adamson et al. (2002)

M/C No.	Target	Impact Location and comments	Speed mph
1	Block	Vertical face	42
2	Block	Vertical face (M/C leaning left 30 deg at impact)	10
3	Block	Vertical face	31
4	Block	Vertical face	20
5	Block	Vertical face	24
6	Block	Vertical face	21
7	Block	Vertical face	35
8	Car (M)	Body between B-post and LR wheel well	46
9	Car (M)	Body LR, between wheel well and bumper	39
10	Car (M)	Rear bumper, 17 inches left of right end	34
11	Car (M)	Right side, between front wheel well and door	25
12	Car (M)	Right front wheel	30
13	Car (M)	Right door, center	42
14	Car (M)	Front bumper, 6 inches right of centerline	30
15	Car(S)	No target impact	-
16	Car(S)	Right front fender between wheel well and bumper	41
17	Car(S)	No target impact	-
18	Car(S)	Front bumper, right of center	45
19	Car(S)	Body left rear fender, between wheel well and bumper	49

### Traffic Safety Facts for Motorcycles (U.S. DOT, 2015)

This U.S. DOT study (2015) on fatal motorcycle crashes is based on data received from the Fatality Analysis Reporting System (FARS), along with the General Estimates System (GES) in the United States. Some of the most important findings are listed below.

One key finding from the study was that 4,976 motorcyclists were killed in 2015, which was an increase of 8% from 2014. Another general finding was that approximately 88,000 motorcyclists received injuries in 2015, which was 3% less than the previous year. An interesting aspect of this study was that passenger injuries were recorded as accurately as driver injuries, which allows the analysis of passenger risk to be calculated. Through this method, it was found that out of the 4,976 motorcyclists that were killed, 6% of them were passengers. This study also looked into vehicle miles traveled (VMT) and found that in 2015 a fatality involving a passenger car was 29 times less frequent than a motorcyclist fatality. According to the report, the number of people being killed in motorcycle accidents has been slightly decreasing since 2008. However, when looking at the number of registered vehicles, the fatality rate for a motorcyclist was six times that for an occupant of a passenger car.

The study also looked into many environmental characteristics and human factors that affected or influenced motorcycle accidents. A few key points regarding environmental and human factors from the study were:

- Fifty-five percent of the motorcycle fatalities occurred in urban areas compared to 45% in rural areas.
- Sixty-seven percent occurred at non-intersection locations compared to 33% at intersections.
- Fifty-seven percent occurred during daylight compared to 38% in the dark, 4% during dusk, and 1% during dawn.
- Ninety-seven percent occurred in cloudy/clear conditions compared to 2% in the rain and 1% in other conditions.

In regard to the configuration of crash involvement, it was found that the most harmful event for 2,761 (54%) of the 5,076 motorcycles involved in fatal crashes was a collision with a motor vehicle in transport. Also, it was found that in two-vehicle crashes, 74% of the cases were considered “frontal collisions” and a mere 7% were considered “struck in the rear.” A significant leading cause of fatalities for motorcyclists was found to be collisions with fixed objects (24%). Thirty-three percent of all motorcycle riders involved in fatal crashes were speeding.

In 2015, of 4,684 motorcycle riders killed in motor vehicle traffic crashes, 1,285 (27%) were alcohol impaired (blood alcohol concentration [BAC] of .08 g/dL or higher). Additionally, there were 337 (7%) fatally injured motorcycle riders who had lower alcohol levels (BACs of .01 to .07 g/dL).

Helmets are estimated to be 37% effective in preventing fatal injuries to motorcycle riders and 41% for motorcycle passengers.

## Infrastructure Countermeasures to Mitigate Motorcyclist Crashes in Europe

A study by Nicol et al. (2012) involved a team of 12 transportation engineers assessing and evaluating infrastructure improvements, maintenance practices, and traffic operation strategies to enhance motorcyclist safety in the countries of Belgium, England, France, Germany, and Norway. The types of infrastructure safety improvements used were those that improved safety for all vehicle classes.

In both Europe and the United States motorcycle ridership is increasing. The fatalities in each country are consistently around 15% to 20%. The team of engineers observed some roadside and median barriers specially designed for motorcycle safety, but no conclusive data were available on their effectiveness.

For findings and recommendations, the team concluded that agencies in Europe are working closely with motorcycle groups to address the safety problems associated with motorcycles. Several European countries have developed standards and guidelines specifically targeted at motorcycle safety, yet no single infrastructure change was identified to reduce motorcycle injury. New barrier systems, though, are currently being tested and evaluated for effectiveness. A long-term goal that the research team felt should be achieved is that United States agencies should establish goals to reduce motorcycle injuries through roadway design, operations, and maintenance practices. Promoting motorcycle awareness and developing a motorcycle research agenda are some ways these goals can be accomplished.

## Leading Practices for Motorcyclist Safety

Shaffer et al. (2011) documents the results of meetings between a small team of transportation professionals and motorcycle rider advocacy groups from different states and an expert on infrastructure manufacturing for motorcyclist safety. The decision by the research team to choose these experts from different states was a comprehensive decision. They looked into which states were considered the most proactive toward motorcyclist safety, and also states with a high number of popular riding events. The states that the team decided to focus on were Florida, Maryland, and Wisconsin. The team also had a large number of organizations and other states that it worked closely with and consulted with during the research process.

The main purpose of this study was to improve the planning and organization of infrastructure advancements for motorcyclists. The team feels that by creating more motorcyclist safety advocacy groups within states there will be an increased awareness of the need for more motorcyclist safety devices across the U.S. This will then create a positive influence to address mutual concerns that have been observed in states with large numbers of advocacy groups. Some of the primary concerns and areas of focus with regard to infrastructure improvements are signage and lineage of roads, maintenance of roadway systems, and the design of infrastructure systems that take motorcyclists into greater account.

The report discusses some of the primary concerns related to infrastructure issues and has some recommendations for mitigation approaches to drainage, shoulders, traffic control devices, communication of upcoming road conditions, pavement and surface conditions, and curves and roundabouts.

Strong emphasis is put on popular motorcycle rallies in different states and the need for government agencies and advocacy groups to be fluent and cohesive at the time of the gathering in order to provide a safe and orderly experience. Both Florida, South Dakota, and Wisconsin have recorded very large numbers in attendance at their annual bike rallies, which is why both states were looked at in greater depth to understand the dynamic of the situation in those states. Another primary focus of this study was to understand the data acquisition processes each state uses for vehicle crashes and motorcycle crashes. Due to differences in crash reporting, there is some inconsistency from state to state in the processes undertaken. It was recorded that most states experienced difficulty when considering VMT, which is necessary when calculating risk factors involved in these traffic accidents.

Further recommendations and implementation plans were developed to reflect previously successful cases from different organizations across different states. The plan to make these recommendations known is to conduct outreach to federal, state, and local agencies. A few of the recommendations that were made are the need to create Motorcycle Safety Coalitions (MSCs), communicate roadway condition information, improve data collection methods, and share successful strategies with other states to increase common effectiveness. Suggested implementation steps include conducting outreach to critical national organizations, developing official guidelines, and encouraging states to create MSCs.

## **Motorcycle Crash Causation Study**

The Federal Highway Administration (FHWA), with Oklahoma State University and the Southern Plains Transportation Center, recently conducted the most extensive data collection on motorcycle crash causation in the United States in over 30 years (Tan, 2017). The data that were collected come from 351 crash investigations and 702 control rider interviews. The study involved partnerships with motorcycle safety advocates and stakeholders at the federal, state, and local levels. The goal of the data analysis is to offer a one-of-a-kind perspective into the role of different crash causation factors. These perspectives will allow for effective countermeasures to be put in place according to the new recommendations.

Some general findings from the report are that in 2009, the number of motorcycle rider fatalities was more than twice the number recorded in 1997. Alongside this statistic, a 27% decrease in the number of passenger car and light truck fatalities was also observed in the same time period.

## **Motorcycle Road Safety Audit Case Studies**

Nabors et al. (2016) conducted safety audit case studies to better understand different conditions that influence the overall safety of motorcyclists. The objectives of the study were to look into

road safety issues and find the locations with the greatest opportunities for improvement. This document is a compilation of three different Road Safety Audits (RSAs) that took place between 2012 and 2014, each of which focus on various roadside facilities. This project was funded by FHWA to show how using RSAs can improve motorcyclist safety.

The study found that from 2003 to 2008 there was a 43% increase in motorcyclist fatalities and injuries nationally. From 2008 to 2009, there was a significant decrease in both fatalities and injuries of motorcyclists. However, from 2009 to 2012 the increasing trend returned for both fatalities and injuries to motorcyclists. In 2012, motorcycles composed just 3% of all registered vehicles in the United States, yet the number of fatalities of motorcyclists was 15% of the total vehicle fatalities. An interesting finding in this report relates all motor vehicle accidents over the year. In 1997, 1 in every 20 motor vehicle fatalities occurred on a motorcycle. In 2014, 1 out of 7 motor vehicle accidents took place on a motorcycle. This clearly shows an increasing risk through the years to motorcycle riders and drivers. Human factors and characteristics examined included age, rider experience, purpose of travel, and frequency of bike usage. Of the fatal motorcycle crashes in 2012, 27% were found to have a BAC of at least .08 g/dL at the time the crash occurred. In many cases there were trends between the type of motorcycle that was involved and the severity of the crash.

# Appendix A4

---

## Motorcycle Full-Scale Testing Protocols and Standards

To ensure a comprehensive picture of the relevant research, the research team conducted a literature search and reviewed both the domestic and international literature on crash testing motorcycles and motorcyclists into barrier systems. To date, much of the motorcycle/barrier crash testing that has been done has been performed in Europe and Australia. Consequently, compared to the U.S., other parts of the world have been more progressive in terms of the development of barrier safety features to accommodate motorcyclists.

Specific attention was given to identifying any protocols and research pertaining to the testing of barriers using upright motorcyclists. It was also found that in some countries it was considered slightly more important to conduct crash tests that account for motorcyclists sliding before impacting the barrier. A significant percentage of this body of work involves sliding rather than upright motorcyclists. Although not directly relevant to upright motorcyclist testing, these references may be useful in establishing certain aspects of the testing and evaluation criteria that were developed under this project. Details on the following international procedures can be found below.

- L.I.E.R. Procedure (France)
- UNE-135900 Protocol (Spain or Spanish Standard)
- EN 1317-8 Technical Specification
- ISO 13232 International Standards
- BASt Homologation Procedure
- Australian/New Zealand Standard (AS/NZS 3845:2015)

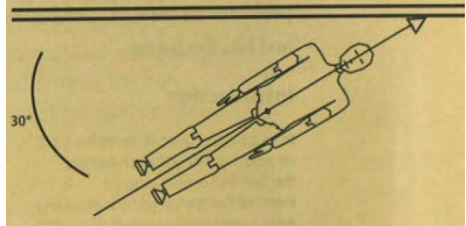
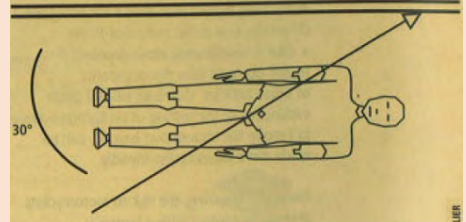
### L.I.E.R. Procedure (France)

In 1998, the L.I.E.R. (Laboratoire d'essais INRETS Equipment de la Route) laboratory in France developed a dynamic test procedure for motorcyclist protection systems for safety barriers in collaboration with INRETS (the French National Institute for Research on Transport and Safety) and the French national road authority (L.I.E.R., 1998).

As depicted in Table 9, the L.I.E.R. procedure involves two tests and consists of launching an anthropomorphic test device (ATD) into the protection system sliding on the ground on its back at an impact speed of 37.3 mph (60 km/h). In the first test, the dummy is aligned with its launch path and impacts the test item head first at 30 degrees to the test item axis. In the second test, the impact conditions remain unchanged, but the dummy is parallel to the test item. The impact point is at approximately the halfway point of the system tested and opposite a stiff element (barrier post). The complete system (safety barrier with included motorcyclist protection system) must also be subjected to full-scale vehicle crash tests according to European Standard EN 1317 part 2 (EN 1317-2).



Table 9. L.I.E.R. Test Impact Configurations (Page and Bloch, 2010)

Impact Configuration	Impact Speed	Impact Angle
<p><b>Test 1. Dummy aligned with launch path</b></p> 	<p>60 km/h 37.3 mi/h</p>	<p>30°</p>
<p><b>Test 2. Dummy parallel to the test item</b></p> 	<p>60 km/h 37.3 mi/h</p>	<p>30°</p>

The dummy wears standard motorcyclist clothing and a standard motorcycle helmet. The ATD used in the L.I.E.R. procedure is a standard dummy model developed for automotive crash testing applications. Several changes, however, are necessary to adapt the dummy to the impact configuration. Sensors are applied to the occipital condyles (head-neck point) of the dummy to measure head acceleration, forces, and moments and compare them to several biomechanical acceptance criteria. In addition, in order for the system to be approved, the dummy must not pass through the system nor remain trapped in it. Since the approval of the test protocol, any motorcyclist protection systems in use on the French road network must be first successfully tested according to this procedure.

**UNE-135900 Protocol (Spain or Spanish Standard)**

In 2003, the Spanish ministry of public works launched a research project to further develop the L.I.E.R. basic test configuration. In 2005, this study resulted in the Spanish national standard, UNE-135900 (AENOR, 2005). In 2008, a revision of the UNE-135900 standard included an additional test speed of 70 km/h (AENOR, 2008). Some of the main differences from the L.I.E.R. protocol are:

- Dummy oriented at 30 degrees to the test item (head first) for both impacts (37.3 mph);
- Second impact performed between two posts rather than opposite a post;
- Additional biomechanical acceptance criteria specified;
- Two distinct performance classes determined based on biomechanical measurements.

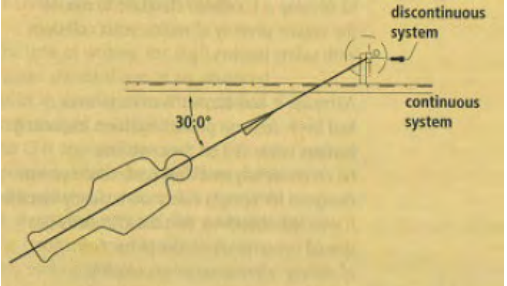
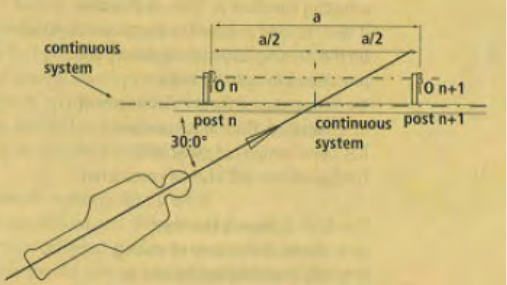
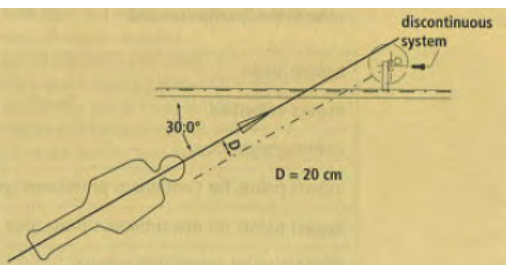
Discontinuous protection systems are also taken into account (protective device fitted locally around the post), which are tested with the post-centered test and with a specific head-first test with the impact point offset with respect to the post (see Table 10).

### **EN 1317-8 Technical Specification**

In 2008, the CEN Technical Committee on Road Equipment (TC 226) agreed on a resolution to develop a European standard for the reduction of the impact severity of a motorcycle collision with safety barriers. The proposal was to define an additional part of the EN 1317 standard which would be primarily intended for the testing of motorcyclist protection systems to be added on to barriers. In 2009, the Spanish protocol was put forward to TC 226 to consider for adoption throughout Europe as the definitive standard EN 1317-8. In 2011, the TC 226 committee decided to accept it as a Technical Specification (EN 1317-8). However, countries with less experience with this particular type of testing felt uncomfortable with it, hence it was decided to adopt it as an interim solution. Thus, it is not obligatory for any country to adopt this standard until its use is required by a national regulation. Each individual country has the option of installing barriers that they believe to be safer without subjecting them to testing—but in this case, the country, or rather the National Road Authority, would be responsible for this decision.

At that time, no commercially available protection systems designed for upright riders were clearly identified. Therefore, CEN decided to concentrate its activities on the protection of sliding riders in order to complete a testing standard as soon as possible, and only afterwards would other rider configurations (upright position) be considered.

Table 10. UNE-135900 Standard Test Impact Configurations (Page and Bloch, 2010)

Impact Configuration	Impact Speed	Impact Angle
<p><b>Test 1. Dummy aligned with launch path – Post centered</b></p> 	<p>60 km/h 37.3 mi/h</p>	<p>30°</p>
<p><b>Test 2. Dummy aligned with launch path – Mid-Span</b></p> 	<p>60 km/h 37.3 mi/h</p>	<p>30°</p>
<p><b>Test 3. Dummy aligned with launch path – Post Offset</b></p> 	<p>70 km/h 43.5 mi/h</p>	<p>30°</p>

The full-scale impact test consists of launching an ATD at a given speed against a barrier with a motorcycle protection system (MPS). The ATD slides on its back and should not be restrained, guided, or propelled by any force external to it at the point of impact. Three approach paths are defined (Table 11). However, if the test laboratory judges that the impact point identified in the Technical Specification is not representative of the most severe testing conditions for the considered test, the point of impact can be changed accordingly. The ATD should be aligned with the 30-degree approach path.

The ATD used for the tests should be a modified Hybrid III 50<sup>th</sup>-percentile male ATD with the following modifications:

- Substitution of original pelvis and lumbar spine by the pelvis reference 78051-60P and the lumbar spine reference 78051-66P and their accessories to allow the ATD to adopt an upright position;

- Modification of both original shoulders to provide for repeatable collapse during testing, contrary to the standard Hybrid III shoulder, which exhibits unrepeatable modes of failure;
- Installation of a foam neck shield on the neck to ensure adjustment of the chin strap buckle.

The ATD shall be equipped with a motorcycle helmet with a polycarbonate shell, complying with the requirements set out in Regulation 22 of ECE/TRANS/505. The ATD should wear a long-sleeved cotton tee-shirt, a leather, one-piece motorcycle suit conforming to EN 1621-1, leather gloves, and leather boots. The total test ATD mass, including instrumentation, helmet, and clothing, shall be  $193 \pm 5.5$  lb ( $87.5 \pm 2.5$  kg).

The performance of the MPS is determined by two performance classes:

- The speed class, determined by the impact speed of the tests;
- The severity level, determined by the level of the biomechanical indices obtained from the ATD instrumentation during the test (Table 12 and Figure 33).

All necessary measurements to evaluate the biomechanical indices are to be carried out in compliance with ISO 6487.

The acceptance criteria of the impact test are the following:

- **MPS:** There shall be no complete rupture of any longitudinal element of the test item.
- **ATD:** The ATD shall not remain trapped in the test item. No limb, or part of a limb, nor the head or neck of the ATD shall become totally detached from the ATD following impact (except for the detachment of the upper extremity due to rupture of the frangible screws in the shoulder assembly) (Table 13).

Table 11. EN 1317-8 Technical Specification Test Impact Configurations

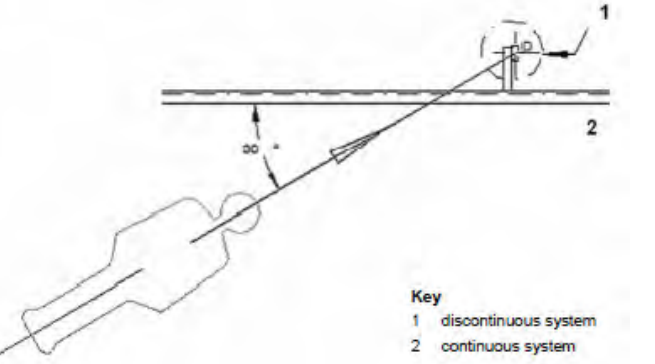
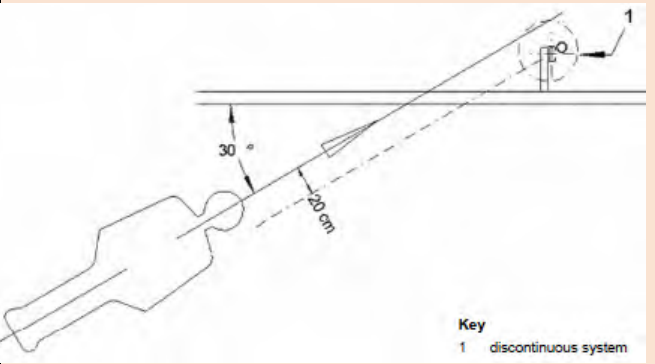
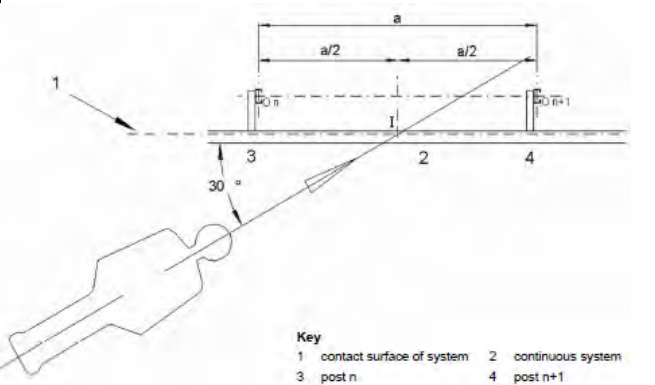
	Impact Configuration	Impact Speed	Impact Angle
<p><b>Test 1.</b> <b>Launch</b> <b>Configuration 1:</b> <b>Post-Centered</b> <b>Impact</b></p>		<p>60 km/h 37.3 mi/h</p> <p>or</p> <p>70 km/h 43.5 mi/h</p>	<p>30°</p>
<p><b>Test 2.</b> <b>Launch</b> <b>Configuration 2:</b> <b>Post-Offset Impact</b></p>		<p>60 km/h 37.3 mi/h</p> <p>or</p> <p>70 km/h 43.5 mi/h</p>	<p>30°</p>
<p><b>Test 3.</b> <b>Launch</b> <b>Configuration 3:</b> <b>Mid-Span Impact</b></p>		<p>60 km/h 37.3 mi/h</p> <p>or</p> <p>70 km/h 43.5 mi/h</p>	<p>30°</p>

Table 12. EN 1317-8 Technical Specification Severity Levels

Severity Level	Maximum Admissible Values						
	Head	Neck					
		$F_x$ (N)	$F_{z\text{ten}}$ (N)	$F_{z\text{comp}}$ (N)	$M_{Ocx}$ (Nm)	$M_{Ocy\text{ext}}$ (Nm)	$M_{Ocy\text{flex}}$ (Nm)
	HIC <sub>36</sub>						
I	650	Table 1.5(a)	Table 1.5(b)	Table 1.5(c)	134	42	190
II	1,000	Table 1.5(d)	Table 1.5(e)	Table 1.5(f)	134	57	190

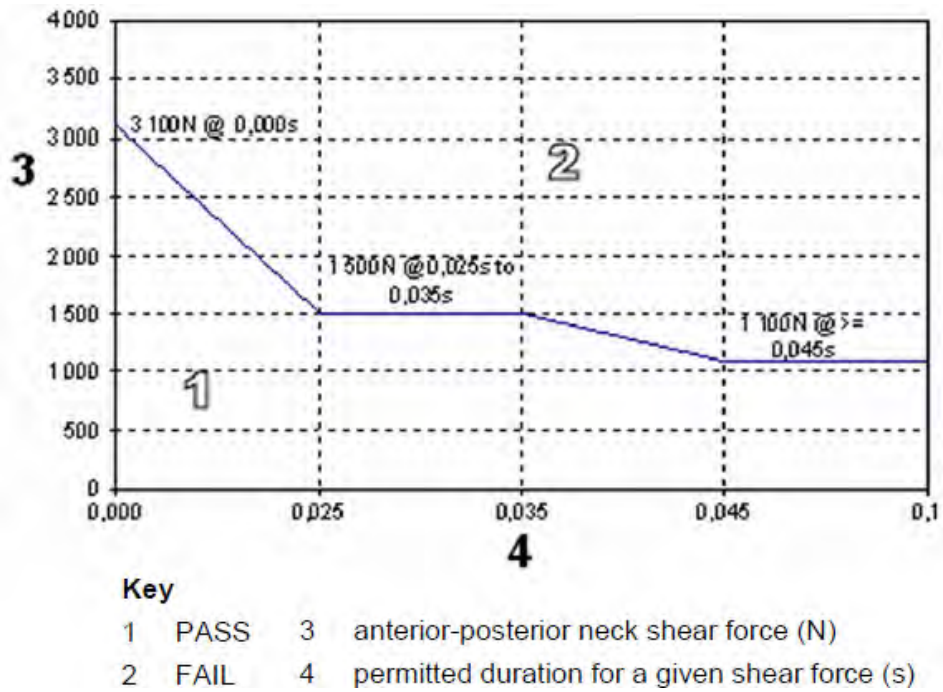
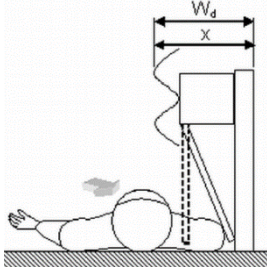
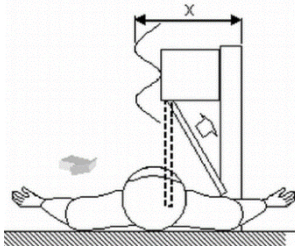
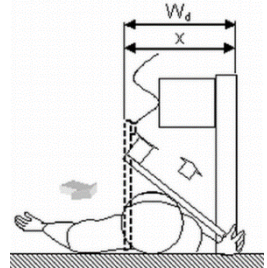
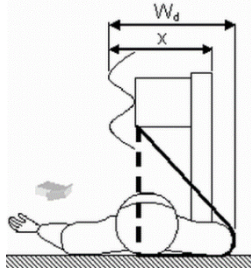
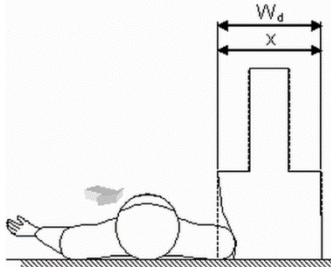


Figure 33. EN 1317-8 Technical Specification Force and Moment Criteria

Table 13. EN 1317-8 Technical Specification: Determination of  $W_d$

	
<p>(a) Example: barrier + MPS No protrusions rearward of complete system</p>	<p>(b) Example: barrier + MPS Arm protrudes rearward of complete system</p>
<p>-&gt; ACCEPTABLE PERFORMANCE</p>	<p>-&gt; SYSTEM FAILS TEST</p>
	
<p>(c) Example: barrier + MPS Hand protrudes rearward of complete system but is not trapped in system after test</p>	<p>(d) Example: barrier + flexible MPS ATD contained by MPS and MPS protrudes behind barrier</p>
<p>-&gt; ACCEPTABLE PERFORMANCE</p>	<p>-&gt; ACCEPTABLE PERFORMANCE</p>
<p><math>W_d</math> determined by rearmost part of system</p>	<p><math>W_d</math> determined by rearmost part of deformed MPS</p>
	
<p>(e) Integrated MPS or MPS on modular or wall-type barrier No protrusions rearward of complete system</p>	
<p>-&gt; ACCEPTABLE PERFORMANCE</p>	
<p><math>W_d</math> determined by rearmost part of system</p>	
<p>*<math>W_d</math> = Dummy Working Width</p>	

### **ISO 13232 International Standards**

In 1996, the International Organization for Standardization (ISO) appointed a group of motorcycle safety experts to develop guidelines to cover all aspects of the conduct of physical crash-testing of a motorcycle impacting against a vehicle (ISO 13232, 1996). ISO 13232 consists of eight parts under the general title “Motorcycles - Test and Analysis Procedures for Research Evaluation of Rider Crash Protective Devices Fitted to Motorcycles”:

- Part 1: Definitions, symbols and general considerations
- Part 2: Definition of impact conditions in relation to accident data
- Part 3: Motorcyclist anthropometric impact dummy
- Part 4: Variables to be measured, instrumentation and measurement procedures
- Part 5: Injury indices and risk/benefit analysis
- Part 6: Full-scale impact test procedures
- Part 7: Standardized procedures for performing computer simulations of motorcycle impact tests
- Part 8: Documentation and reports

Because motorcycle testing is not required by federal regulation, there is not a legal requirement for crash laboratories to comply with the ISO motorcycle crashing standard when developing a motorcycle crash test. ISO 13232-2 requires seven impact configurations between the motorcycle (MC) and the opposing vehicle (OV), which are illustrated in Figure 34 and summarized in Table 14.

The basis dummy recommended by the ISO for motorcycle crash-testing is a Hybrid III 50<sup>th</sup>-percentile male dummy. The ATD needs to have sit/stand construction, standard non-sliding knees and head/neck assembly compatible with either a three- or a six-axis upper neck load cell. In addition, certain modifications are required, and those include a sit/stand pelvis, modified elbow bushing, frangible upper-leg components, and leg retaining cables (Zellner et al., 1996).



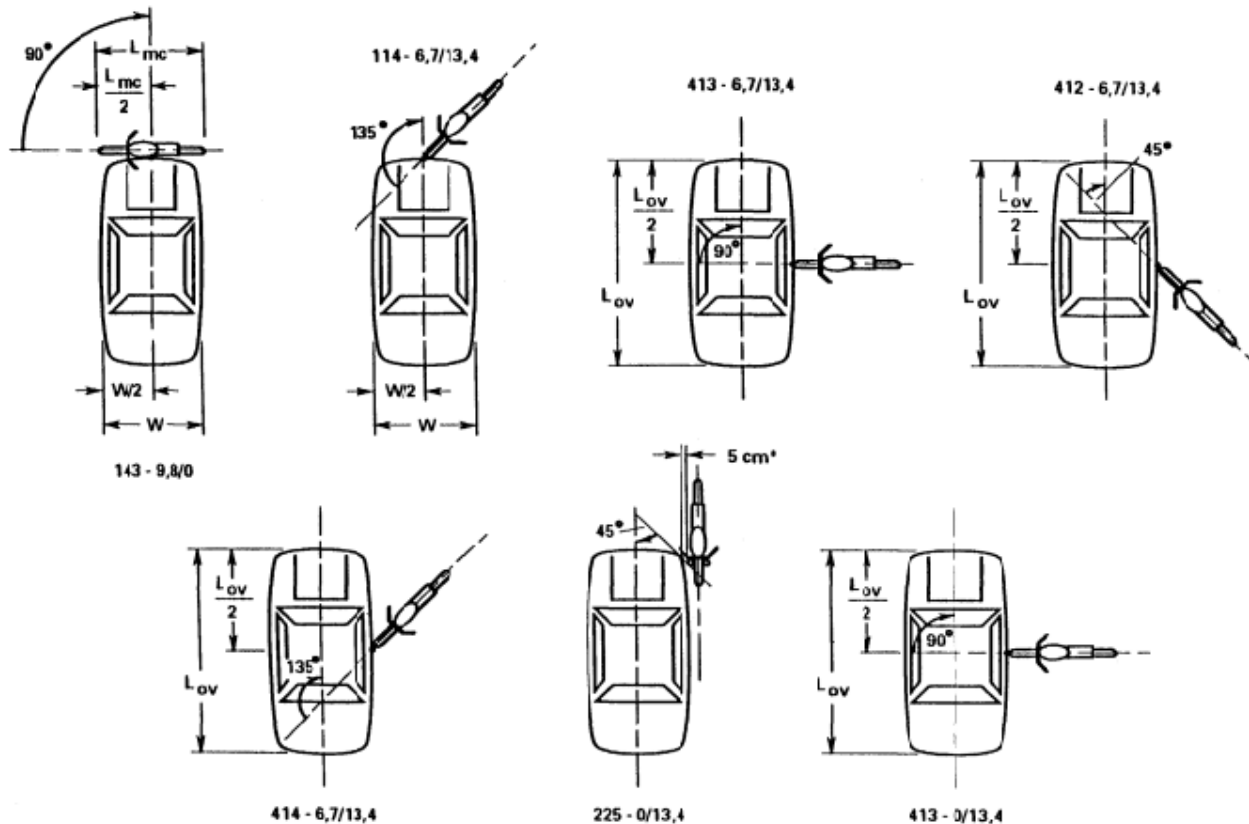


Figure 34. ISO 13232-2 requires seven impact configurations between the MC and OV (ISO 13232, 1996).

Note here that Figure 34 involves collisions between motorcycles and vehicles, which offers alternative insight since some studies only look at motorcycle collisions with barriers.

### BASt Homologation Procedure

In Germany, BASt has defined a homologation procedure for an impact protector (FEMA, 2010). The procedure evaluates the deceleration against the barrier protector during impact, which should not exceed 60 g peak value, and 40 g over a 3-ms interval. The report states there are two classes of devices: class 1, which is tested with an impact speed of 12.4 mph (20 km/h), and class 2, which is tested with an impact speed of 21.7 mph (35 km/h). No more details regarding the two classes of devices or, in general, the method procedure are reported.

### Australian/New Zealand Standard (AS/NZS 3845:2015)

Created in 2015, the AS/NZS 3845:2015 standard is composed of two parts. The first part (AS/NZS 3845.1:2015) addresses requirements for permanent and temporary safety barrier systems, including longitudinal road safety barriers, terminals, crash cushions, interfaces including transitions, and longitudinal barrier gates. Part 2 defines the requirements for permanent and temporary road safety devices such as bollards, pedestrian fences and channelizers, truck or trailer mounted attenuators, and sign support structures and poles. An important note is that the AS/NZS 3845 series of standards, including the publications and findings done by Austroad regarding road

design and safety barrier assessment processes, support and line up with one another. The difference between the Austroad guides and this series of standards is that the Austroad guides describe the road and roadside configurations that identify where road safety barriers may need to be installed, including the location of these barriers, whereas the standards set out requirements for road safety barrier systems.

**Table 14. OV Contact Point Relative Tolerances for the Seven Required Impact Configurations Described in ISO 13232-2 (1996)**

OV contact location	Relative heading angle (deg)	OV/MC speeds (m/s)	OV/MC speeds (mph)
<b>Front</b>	90	9.8 / 0	22 / 0
<b>Front</b>	135	6.7 / 13.4	15 / 30
<b>Front Corner</b>	<b>180</b>	<b>0 / 13.4</b>	<b>0 / 30</b>
<b>Side</b>	<b>90</b>	<b>0 / 13.4</b>	<b>0 / 30</b>
<b>Side</b>	135	6.7 / 13.4	15 / 30
<b>Side</b>	90	6.7 / 13.4	15 / 30
<b>Side</b>	45	6.7 / 13.4	15 / 30

This standard presents three other standards that are commonly accepted, but the difference is that previous standards only require the testing of HIC, and the AS/NZS standard suggests that additional thorax compression criterion testing be conducted since in many cases riders suffered critical injuries to the thorax region. This study reports that about half of motorcyclists fall from the bike and slide into the roadside safety barrier, and approximately half crash into the barrier in an upright position on the bike. Of those that crash in the upright position on the bike, about half of them suffered serious thorax related injuries according to Australian coronial files. Other countries have also started to adopt this thorax compression criterion along with other various criterion extensions such as realistic shoulders and pelvises, which is discussed later. It is pointed out that previous standards, such as the Spanish standard, L.I.E.R. testing protocol, and EN 1317 part 8, involved a test dummy sliding into the barrier at 60 km/h at an approach angle of 30 degrees. According to the AS/NZS standard, many motorcyclists impact roadside barriers in an upright position, which is not accounted for in previous studies. This, in turn, makes the barriers that are suggested in other standards outdated and less effective at reducing the severity of impacts of motorcyclists in the upright position. In addition, since the fitting of MPS devices around critical posts and beams can prove less effective at withstanding car collisions, these newly retrofitted devices must be crash tested with cars. It is suggested that efforts should be made to understand the risk of riders who come in contact with the top of a barrier after colliding with it in an upright position.

## Dummy Types Employed in Motorcycle Crash Testing

Based on the literature review conducted, different ATDs have been used and/or modified worldwide to perform crash tests involving motorcycle-related crashes. As Zellner et al. (1996) explain, the use of ATDs in motorcycle impact research has involved a wide range of dummies adapted from the automotive and aviation fields:

- An early anthropomorphic manikin;
- Alderson CG-50 dummy and parachutist dummies;
- 50<sup>th</sup>-percentile male anthropomorphic dummy;
- Modified Ito 3DGM-AM50-70 standing dummy;
- OPAT 50<sup>th</sup>-percentile male manikin;
- Combined Hybrid II and Hybrid III standing dummy (Rogers, 1991).

In Berg et al. (2005), the motorcycle rider was represented by a Hybrid III dummy (50<sup>th</sup>-percentile male, hip the same as for a “standing ATD”). To evaluate the injury risk of the rider, dummy loads were measured for the head (HIC,  $a_{3ms}$ ), the chest ( $a_{3ms}$ ), the pelvis ( $a_{3ms}$ ), and the femur ( $F_{left}$ ,  $F_{right}$ ) corresponding to the moment of first “primary” impact into the guardrail and the “secondary” impact onto the road surface.

In Nieboer et al. (1993), a 50<sup>th</sup>-percentile Part 572 dummy with a pedestrian (standing) pelvis and pedestrian legs and feet was used. No helmet was applied to the dummy. The dummy was equipped with triaxial accelerometers in the head, chest, pelvis, left knee, and right knee. Uniaxial accelerometers in the longitudinal direction were applied in the dummy feet.

ATD characteristics and/or main modifications required for motorcycle tests according to existing Technical Specification EN 1317-8 and International Standard ISO 13232 are summarized below.

### Technical Specification EN 1317-8 – Dummy

According to the technical specification EN 1317-8, the ATD used for these tests shall be a modified Hybrid III 50<sup>th</sup>-percentile male ATD, which should incorporate the following modifications (EN 1317-8, 2011):

1. The original Hybrid III 50<sup>th</sup>-percentile male pelvis and lumbar spine should be modified by the pelvis reference 78051-60P and by the lumbar spine reference 78051-66P and their accessories to allow the ATD to adopt an upright position;
2. Both original shoulders should be modified to provide for repeatable collapse (standard Hybrid III shoulder exhibits unrepeatable modes of failure);
3. A foam neck shield should be installed on the neck to ensure adjustment of the chin strap buckle.

The ATD shall be equipped with an integral type, production motorcycle helmet weighing 2.9 lb  $\pm$  0.11 lb (1.3 kg  $\pm$  0.05 kg) and with a polycarbonate shell. The helmet used shall comply with the

requirements set out in Regulation 22 of ECE/TRANS/505. Additional requirements on type and use of helmet are explained in Annex C, E, and F of Technical Specification EN 1317-8.

The ATD should wear a long-sleeved cotton tee-shirt under a leather, one-piece motorcycle suit (or two-piece suit if the two pieces are joined together) conforming to EN 1621-1, leather gloves, and leather boots. The leather suit shall not be fitted with any additional protection devices (e.g., back supports or neck restraints) to avoid influence in the behavior of the ATD and to avoid restriction of limb movement. EN 1317-8 requires a total test ATD mass, including instrumentation, helmet, shirt, suit, gloves, and boots, of  $193 \text{ lb} \pm 5.5 \text{ lb}$  ( $87.5 \text{ kg} \pm 2.5 \text{ kg}$ ).

The ATD's upper neck should be equipped with a six-channel load cell especially designed to be fitted to the Hybrid III, in order to measure force and moments at the neck. These forces and moments shall be recorded as follows:

- $F_x$  and  $F_y$  with a CAC of 8 kN and a Channel Frequency Class (CFC) of 1,000;
- $F_z$  with a CAC of 13 kN and a CFC of 1,000;
- $M_x$ ,  $M_y$ , and  $M_z$  with a CAC of 280 N m and a CFC of 600.

For the transfer of moments measured by the neck load cell to the occipital condyle, both the forces and moments shall have a CFC of 600. All necessary measurements to evaluate the biomechanical indices shall be carried out with measurement systems compliant with ISO 6487.

### ISO 13232 International Standard – Dummy

A specialized crash-test dummy for motorcycle crash testing has been developed by ISO 13232 (Zellner et al., 1996; ISO 13232, 1996). The basis dummy recommended by ISO for motorcycle crash-testing is a Hybrid III 50<sup>th</sup>-percentile male dummy with sit/stand construction, standard non-sliding knees, and head/neck assembly compatible with either a three- or a six-axis upper neck load cell. To transform the Hybrid III dummy into an ISO 13232 motorcyclist dummy, certain modifications are required. Some of these modifications and related explanations are reported below:

1. **Motorcycle dummy thorax components.** A slightly modified chest skin and a modified straight lumbar spine are required to provide an upright seating position on a motorcycle and to assure the Hybrid III's center of gravity and mass.
2. **Sit/stand pelvis.** It is a requirement that the Hybrid III sit/stand characteristics remain unchanged.
3. **Modified elbow bushing.** This modification allows for proper positioning of the elbow/arm of the ATD while in an upright seating position on the motorcycle to guarantee realistic torso motion and realistic forces in the arms.
4. **Motorcyclist dummy hand components.** Deformable aluminum wires are needed to allow the dummy to “grasp” the handlebars, providing realistic dummy-to-handlebar force properties.

5. **Motorcyclist dummy upper-leg components.** The rigid metal leg bones of the Hybrid III are modified with upper-leg components, including frangible femur and tibia bones with human-like stiffness and strength, to achieve human-like impact force levels up to fracture.
6. **Motorcyclist dummy frangible knee assembly.** This is included to measure knee ligament injuries in lateral bending and monitor torsion relative to the tibia. A failure of an internal shear pin is interpreted as an injury of the respective knee ligament. The assembly allows also for measuring the forces between the lower and upper legs.
7. **Leg retaining cables.** These are included to prevent the loss of the dummy legs in the case of frangible bone fracture.

### Injury Criteria and Biofidelity

Further analyses of full-scale crash tests can identify potential improvements in injury criteria. Dummy's upper extremities can easily get caught in the top part of the barrier, and the lower extremities can get jammed between the barrier and the motorcycle. In the sliding configuration test, the shoulder and arm contact the barrier post through the lower rail. This contact can cause the thorax to be highly loaded during such an impact. Therefore, in a test configuration of sliding barrier contact, injury criteria for a lateral thorax loading should be included.

In order to improve biofidelity, as part of the dummy modification it was proposed that a frangible shoulder be used. The Hybrid dummy was primarily designed for frontal impact tests, which may cause the lateral loading measurements to possibly be misleading. This is due to the dummy not being biofidelic in lateral loading. A shoulder fracture was reported many times during L.I.E.R. crash tests, which was caused by its inability to handle the strong load requirements of lateral tests.

**Error! Reference source not found.** depicts the frangible shoulder used to improve the biofidelity. The frangible shoulder is designed to replicate a human clavicle.



Figure 35. Frangible shoulder for Hybrid III dummy (Peldschus et al., 2007).

## Appendix B

### Descriptions of Crashes and their Respective Google Earth Images of the Roadside Barriers Hit in Flyover/Connector Cases

**Note:** The descriptions provided below for the type of railing struck in the crashes on flyovers/connectors are in no particular order. This work was conducted to get an idea of exactly the type and configuration of railings/protective barriers that were struck by motorcyclists that crashed. Please keep in mind that the following was done out of curiosity and no specific conclusions were formed.



**Crash Narrative 1:** Driver drifted into left lane and hit the concrete railing; incapacitated.

**Crash Narrative 2:** Driver hit guardrail and flew over bridge; incapacitated (no image available).



**Crash Narrative 3:** Driver crashed into guardrail on sharp, left-handed curve; fatal.



**Crash Narrative 4:** Driver hit curb line wall and flew over bridge; fatal.



**Crash Narrative 5:** Three-foot concrete wall; driver flew over bridge; intoxicated (BAC of .23); fatal.



**Crash Narrative 6:** Driver was traveling at 65 mph and lost control; incapacitating.

**Crash Narrative 7:** Driver lost control and hit guardrail; incapacitating (no picture available).





**Crash Narrative 8:** Unexpected S-turn; driver crashed into guardrail; intoxicated; fatal.



**Crash Narrative 9:** Intoxicated driver failed to drive in single lane and struck guardrail after failing to negotiate turn; incapacitating.



**Crash Narrative 10:** Driver failed to control speed and hit curb while negotiating turn; incapacitating.



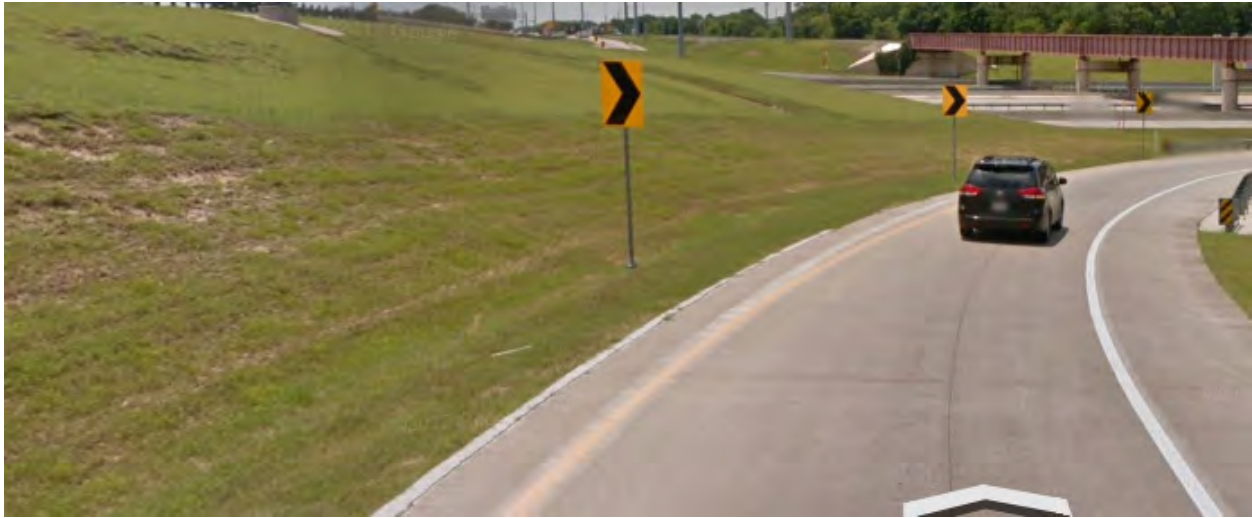
**Crash Narrative 11:** Driver lost traction on the road and fell over; incapacitating.



**Crash Narrative 12:** Two motorcycles crashed into already parked vehicles on the side of the road after traveling at unsafe speeds; fatal.



**Crash Narrative 13:** Driver was fleeing police and lost control; incapacitating.



**Crash Narrative 14:** Driver lost control while running from the police and skidded on the roadway until hitting the dirt off the shoulder; incapacitating.



**Crash Narrative 15:** Intoxicated driver failed to drive in single lane and struck barrier, flipping over, and then was run over by a car; fatal.



**Crash Narrative 16:** Driver collided with left cement lane after losing control on curve; incapacitating.



**Crash Narrative 17:** The back end of the motorcycle came loose and the driver lost control, crashing into the stop sign; incapacitating.



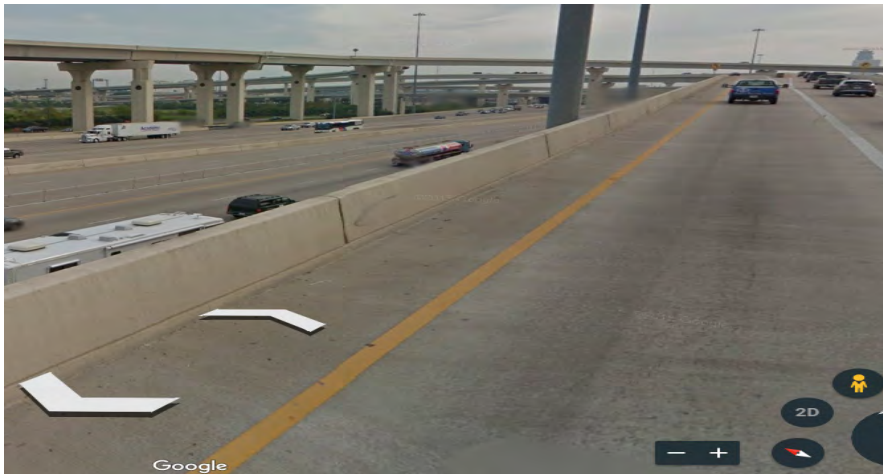
**Crash Narrative 18:** Motorcycle drove straight into guardrail and cartwheeled three times until hitting construction barrels; fatal.



**Crash Narrative 19:** Front wheel of motorcycle started wobbling and driver hit curb and struck a sign; incapacitating.



**Crash Narrative 20:** Driver lost control of motorcycle on curve, causing crash; incapacitating.



**Crash Narrative 21:** Driver failed to drive in single lane and struck barrier wall, which caused the driver to go over the barrier wall and fall onto the service area below; incapacitating.

**Crash Narrative 22:** Driver failed to control speed and lost control of motorcycle. Driver was thrown and came to rest several feet away from motorcycle; fatal (no picture available).



**Crash Narrative 23:** Driver blacked out and struck barrels; incapacitating.



**Crash Narrative 24:** Driver crashed into retaining wall and was ejected off motorcycle and flew over retaining wall; fatal.

**Crash Narrative 25:** Driver lost control and then hit and bounced off the wall. The driver then slid across the lane, ran into a curb and railing, and came to a stop; not wearing helmet; incapacitating (no picture available).





**Crash Narrative 26:** Driver failed to drive in a single lane and crashed into retaining wall. Driver was ejected from motorcycle and fell 40 ft; fatal.






**Crash Narrative 27:** Driver hit a curb at a high rate of speed and then hit a stop sign and came to rest in the intersection of the eastbound and westbound connector road; incapacitating (no picture available).

# Appendix C

**Table 15. Category Recommendations. Roadside Barriers (Stock et al., 2001; Bambach and Grzebieta, 2014).**

<p>"Mitigate roadside risk and underrun protection on crash barriers"</p> 	<p>"Mitigate roadside risk along the outside of bends: earth walls"</p> 	<p>"Equip crash barriers with underrun protection in bends"</p> 
<p>"Make obstacles in the roadside area or shoulder safer"</p> 	<p>"(...) Concrete Barriers are much safer for motorcyclists than W-beam post-and-rail systems"</p> 	<p>"Flexible rub-rail systems attached to steel W-beam barriers provide the best protection for motorcyclists in sliding collisions with roadside barriers."</p> 
<p>"Guidance systems made of flexible materials: flexible bollards"</p> 		

**Table 16. Category Recommendations. Surface/Pavement (Stock et al., 2001; Nabors et al., 2016).**

<p>"Improve road surfaces and pot holes"</p> 	<p>"Full resurfacing instead of patchwork repairs"</p> 	<p>"Surface Friction: The wearing course should provide an appropriate level of surface friction in wet and dry conditions"</p> 
<p>"Surface Condition: The road surface should be smooth, consistent and predictable"</p> 	<p>"Repair pavement where potholes, debris, longitudinal cracks, vertical displacement, and reduced friction are apparent."</p> 	<p>"Implement a program to install Safety EdgeSM and/or pavement edge striping along the Parkway roadside, particularly along curves or areas where data suggests motorcycles run off the road."</p> 
<p>"Exploring opportunities to apply Advanced Pavement Markings specific to motorcyclists within the travel lanes to provide warning of conditions that may be particularly challenging to motorcyclists, such as "slow" at the entrance to curves."</p> 	<p>"Re-grading roadsides and removing hazards to eliminate the need for guardrail."</p> 	<p>"Paving shoulders on the inside of curves, especially gravel shoulders as motorcyclists may try to steer away from these to avoid debris"</p> 

**Table 17. Category Recommendations. Road Design/Visibility (Stock et al., 2001; Nabors et al., 2016).**



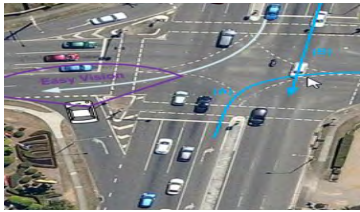
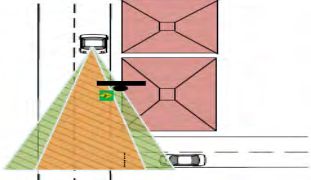





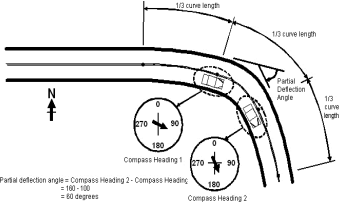

<p>"Create stopping zones before especially dangerous intersections and junctions"</p> 	<p>"Sight Distance: Clear visibility over a crest, through a curve, and adequate sight lines between motorcyclists and other objects"</p> 	<p>"Overtaking Provisions: Frequent, safe and legal passing opportunities"</p> 
<p>"Intersection sight distance: Sight lines between all road users on the through road and side road should be available."</p> 	<p>"Road alignment: Readable and consistent horizontal geometry"</p> 	<p>Cross-Section: Lanes should be wide enough to provide width for safe riding path selection.</p> 
<p>"Intersection type, control and turn provisions: intersections have different risks for motorcycles, these are dependent on type."</p> 	<p>"Roadside hazards: the clear zone should be hazard free."</p> 	<p>"Remove vegetation to improve sight distance"</p> 
<p>"Evaluate super elevation of curve though a ball bank test. If inconsistent with adjacent curves, provide motorcycle-specific warning."</p> 	<p>"Limit parking near intersections, driveways, and crosswalks to help improve visibility of entering vehicles and approaching vehicles."</p> 	

Table 18. Category Recommendations. Signage/Delineation (Stock et al., 2001; Nabors et al., 2016).

<p>"Double-line centre markings"</p> 	<p>"Influence road behavior in sections with reduced visibility by installing traffic signs"</p> 	<p>"Continuous centre lines in bends"</p> 
<p>"Replace traffic guidance signs in bends with flexible bollards"</p> 	<p>"Guidance systems made of flexible materials: flexible bollards (...) instead of rigid road markings &amp; signs"</p> 	<p>"Intersection location: Intersections should be clearly identified through signage or pavement markings."</p> 
<p>Use curve markers on crash barriers.</p> 	<p>Use rumble strips to warn of accident black spots.</p> 	<p>"Provide additional intersection/driveway delineation and warning."</p> 
<p>"Provide additional curve delineation and intersection warning through use of warning signs indicating the location of intersections. Consider motorcycle specific signage"</p> 	<p>"Provide consistency in the corridor through pavement markings or raised pavement markers that define travel lanes."</p> 	<p>"Restrict left turns from driveways and entrances, only permitting them in certain designated locations. Use signage, pavement markings, and physical barriers to restrict left turns."</p> 
<p>"Continuing dash marks through gaps in the centerline or edge line markings, to help keep motorcyclists from losing visual focus of the roadway."</p> 	<p>"Enhancing awareness of other complex situations that may overload an operator of a motorcycle"</p> 	<p>"Installing delineation devices per the MUTCD on the full length of guardrail to improve nighttime conspicuity"</p> 