

# LOW WATER STREAM CROSSINGS: DESIGN AND CONSTRUCTION RECOMMENDATIONS

FINAL REPORT

Sponsored by  
the Iowa Department of Transportation  
and the Iowa Highway Research Board  
CTRE Project 01-78  
Iowa DOT Project TR-453

DECEMBER 2001



*Center for Transportation  
Research and Education*

Department of Civil and Construction Engineering

IOWA STATE UNIVERSITY



## **ABSTRACT**

Most counties have bridges that are no longer adequate, and are faced with large capital expenditure for replacement structures of the same size. In this regard, low water stream crossings (LWSCs) can provide an acceptable, low cost alternative to bridges and culverts on low volume and reduced maintenance level roads. In addition to providing a low cost option for stream crossings, LWSCs have been designed to have the additional benefit of streambed stabilization.

Considerable information on the current status of LWSCs in Iowa, along with insight of needs for design assistance, was gained from a survey of county engineers that was conducted as part of this research (Appendix A). Copies of responses and analysis are included in Appendix B.

This document provides guidelines for the design of LWSCs. There are three common types of LWSCs: unvented ford, vented ford with pipes, and low water bridges. Selection among these depends on stream geometry, discharge, importance of road, and budget availability. To minimize exposure to tort liability, local agencies using low water stream crossings should consider adopting reasonable selection and design criteria and certainly provide adequate warning of these structures to road users. The design recommendations included in this report for LWSCs provide guidelines and suggestions for local agency reference. Several design examples of design calculations are included in Appendix E.

---

The opinions, findings, and conclusions expressed in this publication are those of the authors and not necessarily those of the Iowa Department of Transportation.

CTRE's mission is to develop and implement innovative methods, materials, and technologies for improving transportation efficiency, safety, and reliability while improving the learning environment of students, faculty, and staff in transportation-related fields.

# **LOW WATER STREAM CROSSINGS: DESIGN AND CONSTRUCTION RECOMMENDATIONS**

## **FINAL REPORT**

### **Principal Investigator**

R. A. Lohnes

Professor of Civil and Construction Engineering, Iowa State University

### **Co-Principal Investigators**

R. R. Gu

Associate Professor of Civil and Construction Engineering, Iowa State University

T. McDonald

Safety Circuit Rider, Center for Transportation Research and Education, Iowa State University

### **Research Assistant**

M. K. Jha

Department of Civil and Construction Engineering, Iowa State University

Preparation of this report was financed in part  
through funds provided by the Iowa Department of Transportation  
through its research management agreement with the  
Center for Transportation Research and Education.

CTRE Project 01-78

Iowa DOT Project TR-453

### **Center for Transportation Research and Education**

**Iowa State University**

ISU Research Park

2901 South Loop Drive, Suite 3100

Ames, Iowa 50010-8632

Telephone: 515-294-8103

Fax: 515-294-0467

[www.ctre.iastate.edu/](http://www.ctre.iastate.edu/)

**DECEMBER 2001**

## TABLE OF CONTENTS

1 INTRODUCTION.....	1
2 SELECTION OF LWSC SITE AND STRUCTURE .....	4
2.1 Data collection .....	4
2.2 Site selection criteria .....	7
2.3 LWSC selection.....	7
2.3.1 Unvented ford.....	8
2.3.2 Vented ford.....	8
2.3.3 Low water bridge.....	8
3 LWSC DESIGN.....	9
3.1 Design considerations.....	9
3.2 Design of fords.....	10
3.2.1 Unvented ford.....	10
3.2.2 Vented ford.....	13
3.2.3 Low water bridge.....	14
4 LWSC CONSTRUCTION .....	19
4.1 Unvented ford.....	19
4.2 Vented ford .....	20
4.2.1 Streambed preparation .....	20
4.2.2 Installation of pipes.....	20
4.2.3 Riding surface considerations .....	21
4.2.4 Erosion protection of structure side and core material .....	21
4.2.5 Erosion protection of streambed.....	22
4.3 Low water bridge.....	23
5 TRAFFIC CONTROLS.....	24
5.1 Recommended signing.....	24
5.1.1 Flood Area Ahead sign .....	24
5.1.2 Impassable During High Water sign.....	24
5.1.3 Do Not Enter When Flooded sign .....	25
5.2 Other suggestions .....	25
6 LEGAL CONSIDERATIONS.....	27
7 REFERENCES .....	28
8 ACKNOWLEDGEMENTS.....	29
APPENDIX A: 2001 SURVEY ON THE USE OF LOW WATER STREAM CROSSINGS.....	30
APPENDIX B: SUMMARY OF SURVEY RESPONSES .....	32
LWSCs in service (Question 1) .....	33
Experience with LWSCs design and construction (Question 2).....	34

Preferences on LWSC types (Question 3).....	35
Legal experience with LWSCs (Question 4).....	35
Suggestions on the use of LWSCs (Question 5).....	35
Benefit from a LWSCs manual (Question 6).....	36
Suggestion of topics for manual (Question 7).....	37
Support for LWSCs applications in Iowa counties if manual were available (Question 8).....	38
APPENDIX C: MANNING’S ROUGHNESS COEFFICIENT ( $N$ ) FOR NATURAL STREAM CHANNELS.....	39
APPENDIX D: DESIGN OF A VENTED FORD—SIZE AND NUMBER OF PIPES.....	40
D.1 Design Curves ( $D$ vs. $Q_{vent}$ ).....	40
D.2 HEC-5 charts.....	41
D.3 Computer program—CulvertMaster.....	42
APPENDIX E: DESIGN EXAMPLES.....	44
E.1 Example One.....	44
E.2 Example Two.....	45
E.3 Example Three.....	45
E.4 Example Four.....	47
E.5 Example Five.....	48
E.6 Example Six.....	49

## 1 INTRODUCTION

There is an increasing need for replacement of many old, unsafe bridges on low volume roads. Most counties have bridges that are no longer adequate, and are faced with large capital expenditure for replacement structures of the same size. In this regard, low water stream crossings (LWSCs) can provide an acceptable, low cost alternative to bridges and culverts on low volume and reduced maintenance level roads.

A LWSC is a structure that provides reasonable access as a stream crossing but will be flooded periodically and therefore closed to traffic. These structures are relatively inexpensive and particularly suitable for low volume roads, across streams with periodically dry beds, or streams where the normal depth of flow is relatively low. In addition to providing a low cost option for stream crossings, LWSC have been designed to have the additional benefit of streambed stabilization.

This document provides guidelines for the design of LWSCs and is a synthesis and summary of previous studies reports from Iowa State University, Federal Highway Administration reports and common practices of Iowa county engineers. Results of the research on LWSCs including a survey of the county engineers, suggestions from an advisory group, field trip observations and the ideas of individual engineers provided valuable input for the design recommendations and are included in Appendix A and Appendix B. In an attempt to make this report “user friendly” most theoretical analyses and experimental results are omitted, but can be found in references cited in this document.

There are three common types of LWSCs: unvented ford, vented ford with pipes, and low water bridges. Selection among these depends on stream geometry, discharge, importance of road, and budget availability. Experience suggests that a normal low water bridge may cost about \$40,000 to \$50,000, whereas a vented ford may be constructed for \$15,000 to \$20,000. A brief description of different types of LWSC is given as follows:

- 1) An unvented ford (no pipes) is a structure that crosses streams that are dry most of the year or where normal streamflow is less than 6 inches in depth (Figure 1). Unvented fords can be placed to conform with the streambed or the crossing elevation can be raised up to 4 ft above the streambed. The grades of the roadway approaches are shaped to provide a smooth transition with acceptable slopes of less than 10%. The crossing may be constructed of crushed stone, riprap, precast concrete slabs, or other suitable material.



Figure 1. Unvented ford.

- 2) A vented ford is a LWSC that has pipe(s) under the crossing that accommodate low flows without overtopping the road (Figure 2). High water will periodically flow over the crossing. Approaches are designed to provide acceptable grades of less than 10% by shaping the roadway or adjusting the elevation of the crossing. The pipe(s) or culverts may be embedded in earth fill, aggregate, riprap, or portland cement concrete.



Figure 2 Vented ford in Tama County, Iowa.

- 3) A low water bridge is a flat-slab bridge deck (Figure 3) constructed at about the elevation of the adjacent stream banks, with the smooth cross section designed to allow high water to flow over the bridge surface without damaging the structure.



Figure 3 Low water bridge in Benton County, Iowa.

This report summarizes a simplified approach for LWSC selection and design. Figure 4 is a flowchart showing a process for LWSC design and construction.

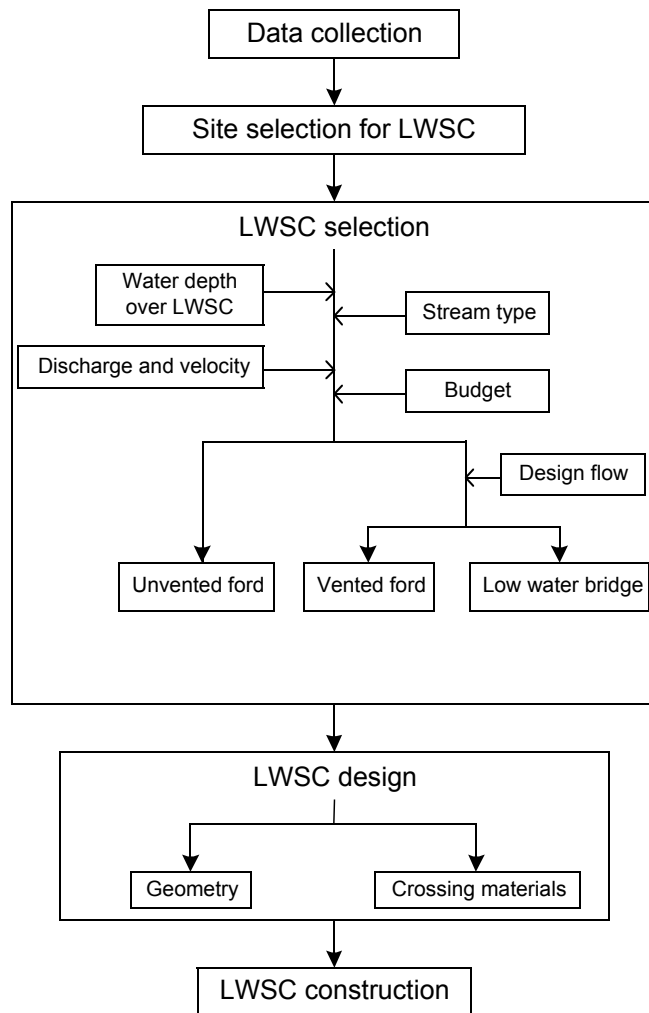

Figure 4 Flow chart for LWSC design and construction.



## 2 SELECTION OF LWSC SITE AND STRUCTURE

### 2.1 Data collection

When a LWSC structure is considered, other options, such as replacing the existing structure and closing the road, should also be reviewed for the site and feasibility assessed. Following is a list of data that may be used in determining potential sites as well as geometric design and material selection for low water stream crossings:

- 1) Type of stream:
  - Perennial*: water flows in the stream at least 90% of the time in a well-defined channel.
  - Intermittent*: flow generally occurs only during the wet season (50% of the time or less).
  - Ephemeral*: flow generally occurs for a short time after extreme storms. The channel is usually not well defined.
- 2) Type of road: paved, gravel, or dirt (Area Service Level A, B, or C).
- 3) Use of road: dwellings, recreation, farm access, school, mail route, alternate available access, etc.
- 4) Channel geometry: width, depth, side slope, and longitudinal slope.
- 5) Manning's roughness coefficient ( $n$ ) (see Appendix C).
- 6) Roadway geometry: width, approach grades, and height of roadway above streambed.
- 7) Drainage area: drainage area can be determined by measuring watershed area on USGS topographic maps or by consulting Bulletin No. 7 (Larimer, 1957).
- 8) Historical daily discharges at the site for the development of a flow-duration curve.
- 9) Level of access desired or tolerable time out of service.
- 10) Design flow for the acceptable closing duration per year is determined from the flow-duration curve at a gaged site or flow-duration-area equations at ungaged sites.

A flow-duration curve indicates the percent of time, within a certain period, in which given rates of flow were equaled or exceeded. The curve is prepared by arranging the daily discharges collected in the past. Flow-duration information for daily flows collected at all the gaging stations in Iowa can be found in Lara (1979). The road and LWSC is closed when a design discharge,  $Q_e$ , is equaled or exceeded and results in LWSC overtopping. The acceptable closing percent of time per year ( $e$ ) can be called as the design exceedence probability. For example, a 2% exceedence probability means the crossing will be closed, on the average, for 2% time of a year, i.e. 7 days in the year, because the design discharge,  $Q_{2\%}$ , is equaled or exceeded and the crossing structure is overtopped during that time period.

Flow-duration information at ungaged sites in Iowa can be found in Rossmiller et al. (1984). Flow-duration-area equations for ungaged streams were developed from flow data at gaged sites by dividing Iowa into three different hydrological regions (Figure 5). The equations are presented and plotted as the flow-duration-area curves in this report (Figures 6, 7, and 8). The hydrologic region of the site is identified from Figure 5. The design discharge,  $Q_e$ , at an ungaged site with a drainage area of  $A$  for a selected exceedence probability,  $e$ , is determined from corresponding flow-duration-area curves (Figures 6-8).

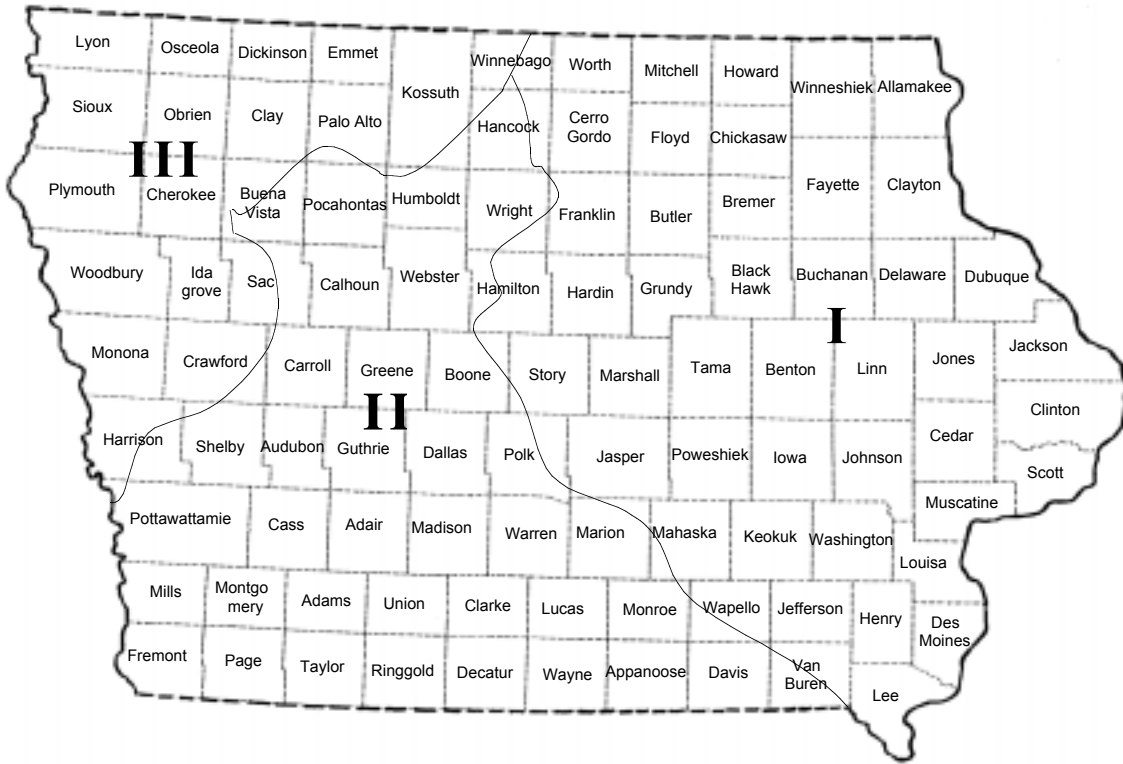

Figure 5 Hydrologic regions of Iowa for discharge estimation.

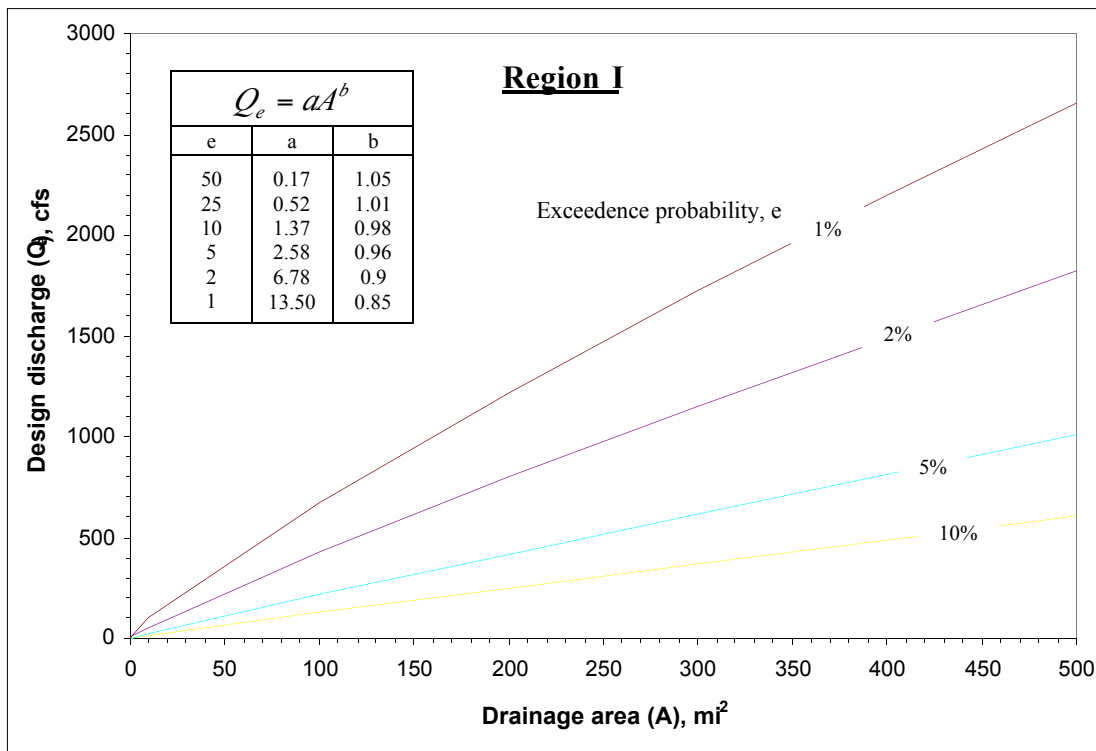

Figure 6 Discharge estimation for Region I.

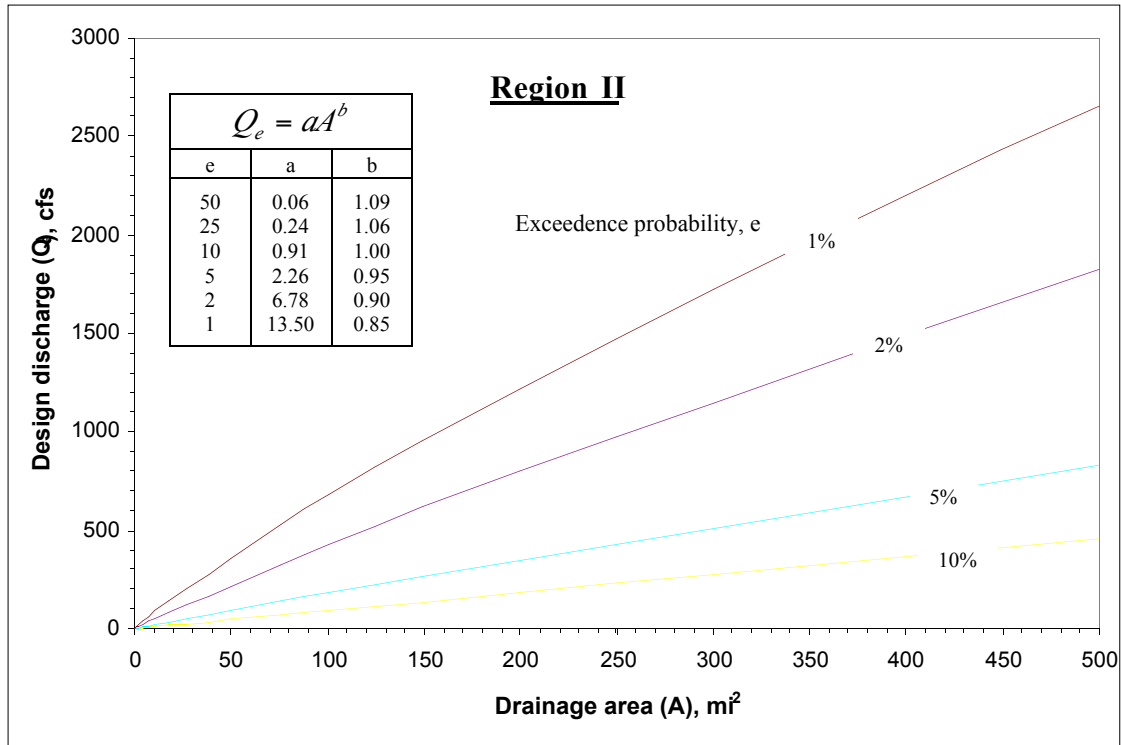

Figure 7 Discharge estimation for Region II.

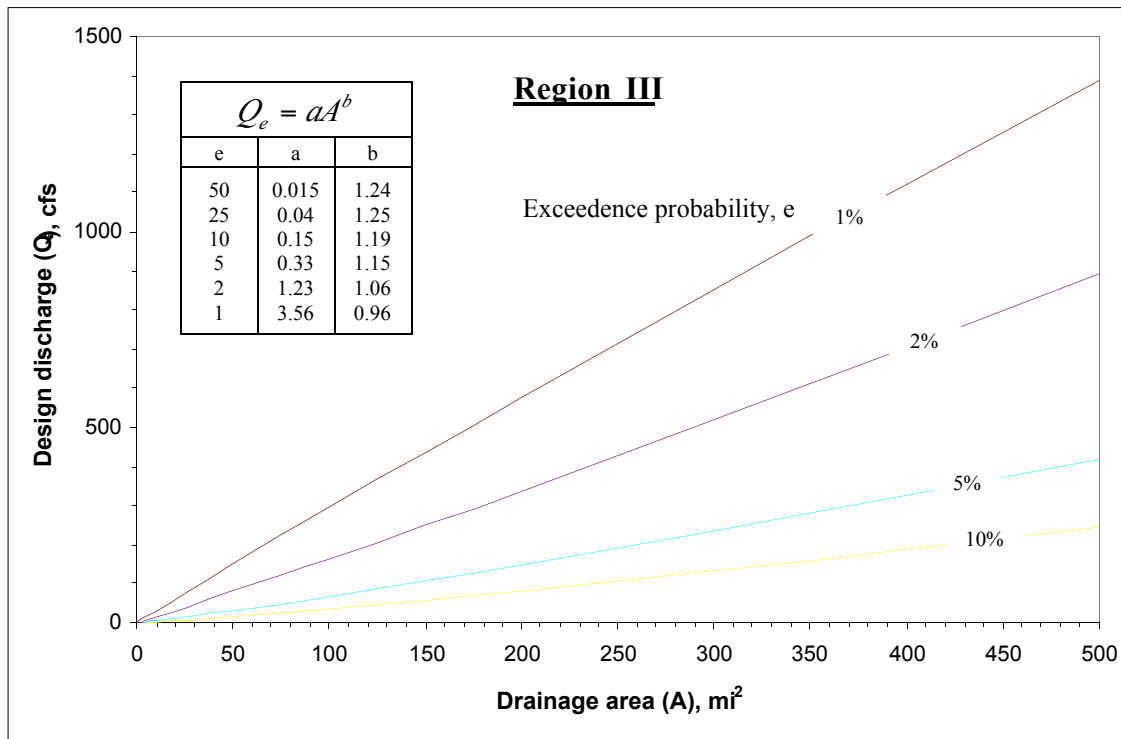

Figure 8 Discharge estimation for Region III.

## 2.2 Site selection criteria

The following criteria should be considered when selecting a site for a LWSC:

- 1) A LWSC is recommended only on Area Service B and C level roads: unpaved or primitive roads, field access roads, roads with no inhabited dwellings, low traffic volume roads, and roads with alternate routes available during flooding.
- 2) Stream channel should be stable. If evidence of aggradation, degradation, or lateral migration is present at the proposed location the site may not be desirable. However, these issues should be considered in the LWSC design.
- 3) Approach grades to the LWSC structure should be less than 10%.
- 4) Height between road approach and LWSC surface should be less than 12 ft.
- 5) Cost comparison analysis with bridges or culverts should indicate considerable savings.
- 6) A LWSC should not be constructed along roads where a future increase in traffic is expected due to economic, social and other changes.

Specific guidelines are suggested in Table 1, which are based on an opinion survey in 40 states (Motayed et al., 1982).

Table 1 Site selection factors for LWSC (Motayed et al., 1982).

<u>Criteria</u>	<u>Most favorable for LWSC</u>	<u>Least favorable for LWSC</u>
Average daily traffic (ADT)	Less than 5 vehicles	200 vehicles
Average annual flooding	Less than 2 times per year	10 times per year
Average duration of traffic interruption per occurrence	Less than 24 hours	3 days
Extra travel time for alternate route	Less than 1 hour	2 hours
Possibility of danger to human life	Less than 1 in 1 billion with extra warning systems	1 in 100,000
Property damage	None	One million dollars
Frequency of using LWSC as an emergency route	None	Once per month

## 2.3 LWSC selection

Generally, for selecting LWSC type (unvented, vented, or low water bridge), the cross-sectional and longitudinal geometry of the stream, magnitude of discharge/flow velocity, importance (classification) of road, traffic volume and alternate access should be considered. For example, if the road is relatively important, a low water bridge might be appropriate regardless the size of the stream. Other factors, such as traffic volume and alternate access may also be considered. Following are some guidelines.

### 2.3.1 Unvented ford

Unvented fords are best suited for intermittent or ephemeral streams, or over the wide shallow perennial streams where the velocity is low. For a perennial stream, it is necessary to determine the depth of flow associated with design discharge,  $Q_e$ . The probable water depth can be determined either by site observation over a long period (at least a year or preferably 5 years), or by conducting hydrological and hydraulic analysis as described in Section 3.2.1.1.

The maximum allowable depth of flow over LWSCs is 6 inches (Looschen and Coy, 1982; Motayed et al., 1983). An unvented ford is acceptable only if the probable water depth over the ford is less than or equal to 6 inches during the desirable period of year. If the calculated depth of flow over the ford exceeds 6 inches, then a ford constructed above the channel bottom or a vented ford should be considered. A raised ford reduces the overtop flow depth if the upstream flow is sub-critical as is the case in most natural streams. However, when the natural flow is supercritical, a raised ford will cause an increase in flow depth over it. The design is described in Section 3.2.1.2.

### 2.3.2 Vented ford

Vented fords should be considered where the depth of flow is calculated to exceed 6 inches for the desirable period over a raised unvented ford. The flow over the top of the LWSC can be decreased to a depth less than 6 inches by adding pipe(s) to accommodate low flows. The design of the pipes or vents is described in Section 3.2.2. Figure 9(a) shows the crossing profile of a vented ford, where  $HW$  is the depth of headwater,  $P$  is the height of the ford above the channel bottom,  $H$  is the upstream head,  $h$  is water depth over the ford (ft), and  $D$  is the diameter of pipe or the height of vent.

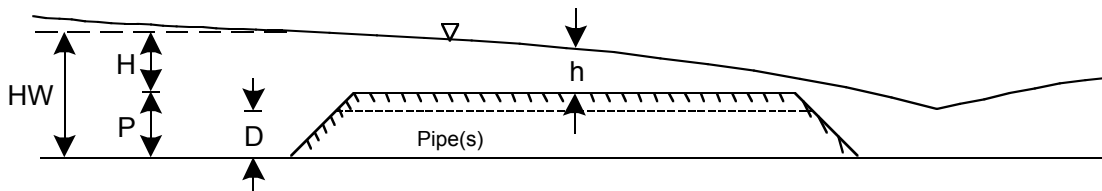

Figure 9(a) Crossing profile of a vented ford.

### 2.3.3 Low water bridge

Low water bridges are an acceptable alternative where higher streamflows,  $Q_e$ , exceed the capacity of a vented ford. Low water bridges also may be considered if the watershed has a high potential for debris that might clog the pipes in a vented ford. If the channel cross section is environmentally sensitive to an obstruction, a low water bridge is a possible option. Finally, a low water bridge should be considered if the average daily traffic (ADT) exceeds 5 vehicles per day (Motayed et al., 1983). Two possible structural designs are described in Section 3.2.3.

### 3 LWSC DESIGN

#### 3.1 Design considerations

Based on field trips, meetings with field engineers, survey results, and literature review (Rossmiller et al., 1984; Looschen and Coy, 1982; Motayed et al., 1983), a list of important design considerations for a LWSC has been developed, as shown in Table 2.

Table 2 Design constraints for LWSC design and construction.

Considerations	Criteria
Channel cross section	Should not be altered
Overtopping flow depth	Less than or equal to 6 inches
Vertical curve at dip (approach grades)	Less than 10%
Stream bank height	Less than 12 ft
Orientation of structure	Straight, avoid skew
Approach distance	750 ft minimum sight distance for warning signs
Height of crossing above streambed	Less than 4 ft
Erosion from flows overtopping crossing	Elevation difference between crossing and streambed kept to minimum. LWSC surface material extended in both directions away from structure. Downstream slope 4:1 or milder.
Core material protection	Provide cutoff walls and sidewalls
Stream bank protection	Establish vegetation

Attempts should be made to minimize the disturbance to the stream due to LWSC construction; however, if natural stream sediments are unstable foundation materials, the sediments should be replaced, compacted or otherwise stabilized.

## 3.2 Design of fords

### 3.2.1 Unvented ford

Unvented fords are constructed of various materials including riprap or crushed rock, gabions, portland cement concrete, and precast concrete panels. Section 3.2.1.3 provides guidelines for crushed rock and riprap selection.

Table 3 Design considerations for unvented ford.

Considerations	Criteria
Precast concrete panels	Should include a proper filter to prevent piping and consequent undermining of the crossing.
Erosion protection	End walls and/or gabion protection may be desirable; wide, sloped shoulders downstream may be helpful
Markers	Provide markers to help drivers spot the limits of the roadway when flooded

#### 3.2.1.1 Ford on channel bottom

If the unvented ford is to be placed on stream bottom with minimum disturbance to channel cross section, Manning's equation combined with the continuity equation can be used in this form, assuming a rectangular cross section:

$$Q_e = \frac{1.486}{n} \frac{(wH)^{5/3}}{(w+2H)^{2/3}} S^{1/2} \quad (1)$$

where  $Q_e$  is the design discharge from hydrologic analysis (Section 2.1) in cfs,  $n$  is the roughness from Appendix C,  $S$  is the channel slope in ft/ft,  $w$  is the channel width and  $H$  is the depth of flow associated with  $Q_e$ . Both width and depth are in feet. Given  $Q_e$ ,  $w$ , and  $S$ , the depth of flow,  $H$ , can be determined from Equation (1) by trial and error. For very wide channels, i.e. when

$$w/H \geq 10 \quad (2)$$

Equation (1) can be simplified to

$$H = \left( \frac{nQ_e}{1.486wS^{1/2}} \right)^{3/5} \quad (3)$$

The computed  $H$  value can then be compared with the allowable maximum flow depth of 6 inches to determine if an unvented ford would be an acceptable option.

### 3.2.1.2 Raised unvented ford

Calculating the depth of flow across a raised ford,  $h$  as shown in Figure 9(b), can be accomplished with an empirical equation for a broad crested weir (Rossmiller et al., 1984) as follows:

$$H = 0.389 Q_e^{0.599} L^{-0.493} \quad (4)$$

and 
$$h = 0.6H \quad (5)$$

Combining Equations (4) and (5),

$$h = 0.233 Q_e^{0.599} L^{-0.493} \quad (6)$$

where  $L$  is the length of LWSC normal to flow (ft), and  $Q_e$  is design discharge from hydrological analysis (cfs). Equation (6) can be used to calculate the depth of water over the raised ford for a given design discharge and length of LWSC, normal to flow.  $P$  is the height of raised ford above streambed. According to laboratory experiments conducted by Rossmiller et al. (1984),  $P$  does not significantly affect the discharge-depth relation, i.e., Equation (4). Therefore,  $P$  is a flexible design parameter. However, the ford height should not exceed 4 ft in order to meet the requirement for fish passage as recommended by the Iowa Department of Natural Resources. A range of 2 to 4 ft is recommended for  $P$ .

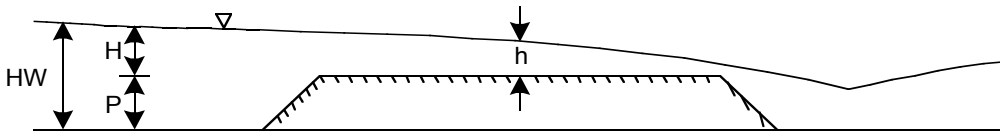

Figure 9(b) Crossing profile of an unvented ford.

The calculated  $h$  value can then be compared with the acceptable flow depth of 6 inches.

### 3.2.1.3 Material selection

The design of an unvented ford should include careful selection of materials for the crossing. Riprap, gabion, and reinforcement concrete are the most commonly used materials.

**Riprap or crushed rock:** There are three basic types of riprap: dumped, hand-placed, and grouted. The dumped or hand-placed stones constitute a protective lining made up of more than one layer of stones resting on the foundation soil or bedding layer. Dumped riprap is the best in terms of less labor cost, less material cost, and least vulnerable to impact damage (Berg, 1980). Block shaped rather than elongated shaped rocks, with sharp rather than smooth edges provide better interlocking and stability (Keown et al., 1977). Generally, stones with a length to width ratio less than 3 are preferred. Detailed discussion of riprap shape and durability are found elsewhere (Voegelé, 1997).

In the construction of an unvented ford using riprap or crushed rock, the recommended average size of rock depends on the flow velocity and the threshold velocity to erode the material. A variety of procedures for selecting acceptable riprap size are available (Rice et al., 1996; Voegelé, 1997). For simplicity, only one method will be suggested here. A relationship (Isbash, 1936) between median riprap size ( $D_{50}$ ) and streamflow velocity ( $v$ ) is



presented in Figure 10. A factor of safety of 2 provides a conservative lower rock size. The minimum value of  $D_{50}$  is arbitrarily limited to 3 inches.

Mean velocity of streamflow can be calculated from Manning's equation:

$$v = \frac{1.46}{n} R^{2/3} S^{1/2} \quad (7)$$

where  $v$  is velocity of streamflow (ft/s);  
 $n$  is Manning's roughness coefficient (see Appendix C);  
 $R$  is hydraulic radius (ft),  $R = a/p$  where  $a$  is cross-sectional area of flow (ft<sup>2</sup>) and  $p$  is wetted perimeter of channel (ft). For very wide channels,  $R =$  flow depth of river; and  
 $S$  is slope of streambed (ft/ft), which can be calculated from topographic map or field survey.

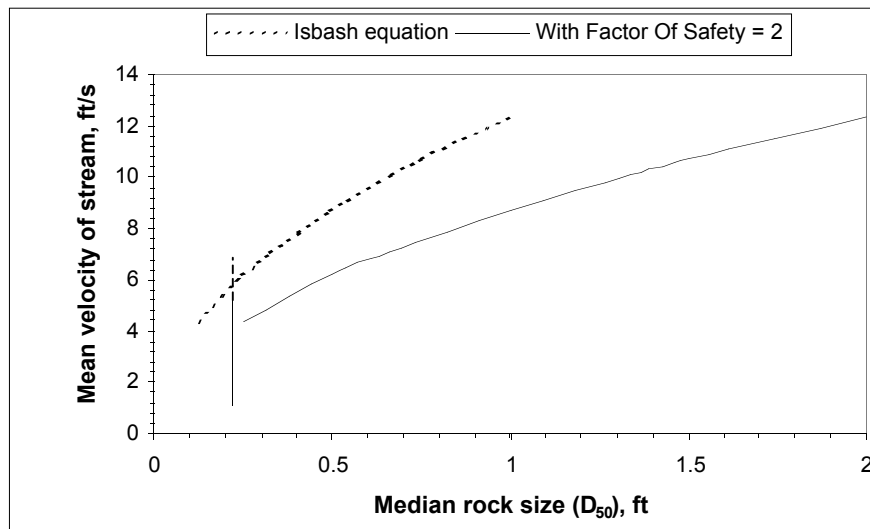

Figure 10 Crushed stone size for unvented ford.

Use Equation (7) to calculate velocity for bank-full depth with the ford placed on the streambed. For a raised ford the cross-sectional area,  $a$ , is based on the length of the ford (channel width) and the difference between the bank height and the roadway elevation. Then, with velocity from Equation (7) and Figure 10, determine the median rock size.

**Gabions:** Gabions are steel wire fabric baskets filled with stones, providing a mass so heavy that water cannot displace them. The advantages of gabions are: they are flexible, thus making them less prone to failure from settlement or undermining; they fill up with silt quickly and allow the establishment of natural vegetation giving a more aesthetically pleasing look; and are 20% to 30% cheaper than concrete. However, they are labor intensive and a suitable filter material is required to prevent scouring of the underlying soil. Suitable rocks of size 4 to 8 inches are generally acceptable.

**Portland Cement Concrete:** Cast-in-place or precast concrete is the most expensive material for a LWSC. Cast-in-place crossings are difficult to construct in flowing streams and precast panels may offer construction advantages. Concrete may be the most durable material and requires the least maintenance; however, adequate protection for scour around the structure must be provided. Additionally, sufficient thickness and/or reinforcing should be provided to prevent differential settlement.

In the construction of an unvented ford, precast panels can be placed directly on the streambed. The following design details are recommended based on local agency experience:

- Thickness = 8 inches
- Length and width: 6 ft × 16 ft (vary according to the stream size)
- Reinforcement: number 5 bars at 12 inch centers
- Panels tied together with 5/8 inch steel cable
- Side gaps: filled with 3 to 5 inch crushed stones

### 3.2.2 Vented ford

Vented fords offer more flexibility and range of use than unvented crossings.

Table 4 Design considerations for vented ford.

Considerations	Criteria
Depth of cover above pipes	Minimum 1 ft recommended.
Exit velocity of pipes (vents)	Limit exit velocity of the flow not to exceed 10 ft/s. Exit velocity, $V_e = Q_{vent}/(\text{flow area of pipe})$ .
Pipes	Pipes should be anchored in the ground; both ends beveled or mitered to reduce debris accumulation. Minimum size 1-ft diameter.
Guard rails	Guard rails are not recommended to avoid catching debris and floating materials during a flood.
High streamflow	Road surface is raised above streambed to accommodate the flow.
Streambed erosion protection	Riprap placed upstream and downstream to reduce the scour in erodible channel.

The design of a vented ford is similar to that of a culvert. Available design tools include culvert hydraulics and flow equations (Normann et al., 1985), HEC-5 charts (Herr and Bossy 1965; Normann et al., 1985), a computer model CulvertMaster program (Haestad Methods 1999), and culvert design procedures developed by Gupta (1995). Culvert flow equations and HEC-5 charts are recommended in this report (Appendix D).

A vented ford is designed to have a flow capacity of  $Q_{vent}$ :

$$Q_{vent} = Q_e - Q_{top} \quad (8)$$

where,  $Q_e$  is the total design flow from hydrological analysis, and  $Q_{top}$  is the flow over the ford. Overtopping can be 0 to 6 inches (i.e.,  $h = 0$  to 0.5 ft). As shown in Figure 9(a),  $H$  is upstream

head;  $P$  is height of ford above streambed;  $D$  is diameter of pipe or height of vent; and  $h$  is water depth at the middle of crossing.

Flow over the ford can be calculated from rearranging Equation (4),

$$Q_{top} = 4.83 L^{0.823} H^{1.67} \quad (9)$$

Considering  $H = h/0.6$  and assuming a maximum allowable water depth ( $h$ ) of 0.5 ft over the ford,  $H$  becomes 0.833 ft and Equation (9) can be rearranged as

$$Q_{top} = 3.538 L^{0.823} \quad (10)$$

After discharge through the vent ( $Q_{vent}$ ) is determined from Equation (8), the number and size of pipes is selected. Single pipe may be considered first. If a computed trial size is larger than the design height of LWSC or availability of pipe size, multiple culverts should be used. The design discharge flowing through each pipe is equal to the total discharge through the vent divided by the number of pipes. The pipe diameter is determined for the design discharge with the design curve ( $D$  vs.  $Q_{vent}$ ) shown in Figure 11. This curve was developed from the culvert hydraulics and flow equations as described in Appendix D. Alternately the HEC-5 chart (Figure D.1 in Appendix D) can be used to determine pipe diameter for the design discharge.

Pipe exit flow velocity should not exceed 10 ft/s for scour control and channel protection. Exit velocity is computed by

$$V_e = Q_{vent}/(\pi D^2/4) \quad (11)$$

Similar to unvented fords, crossing materials for vented fords can be compacted earth, riprap, gabion, and reinforced concrete. See Section 3.2.1 for details.

### 3.2.3 Low water bridge

Low water bridges can be used with higher streamflows and traffic volumes.

Table 5 Design considerations for low water bridges.

Considerations	Criteria
Surface	Decks must be heavy to withstand drag, uplift and lateral forces due to overflow and upstream water; upstream and downstream edges should be rounded
Height of piers	To reduce the risk of overturning, the height of piers should be limited to approximately 10 ft

In this report, two typical designs are provided: simple supported slab design (Motayed et al., 1982) and beam-in-slab bridge design (Klaiber et al., 1997). Selection of the specific design depends on site factors and budget availability; however, simple supported slab design is limited to an approximate 30-ft span length. For continuous slab design, see *Structural Engineering Handbook* by Gaylord and Gaylord (1979).

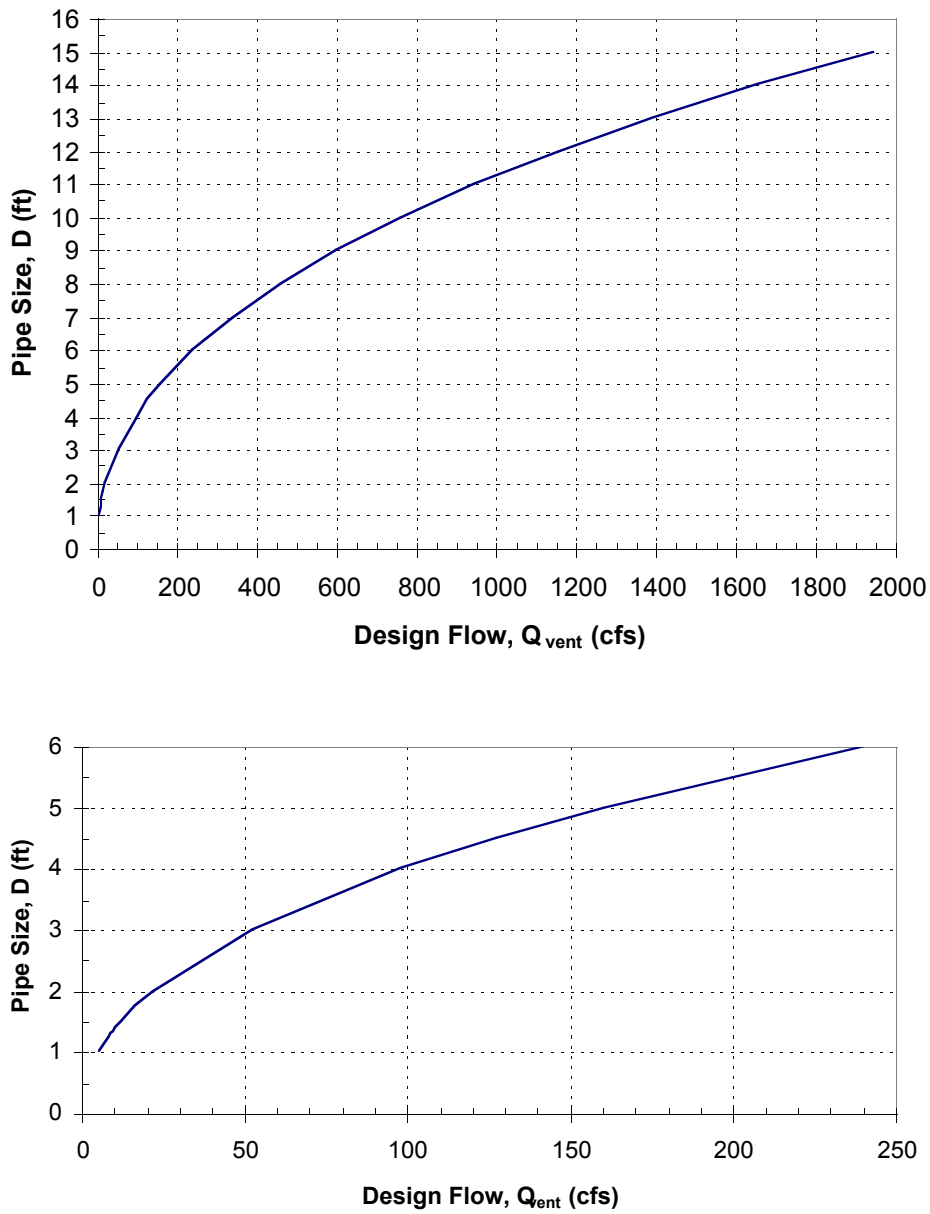

Figure 11 Typical design curves for vented fords using CMP with mitred entrance and under inlet control (barrel slope  $\leq 0.02$ , use Equation D.1 for different types).

*Simple supported slab design.* Table 6 provides the recommended slab thickness for a given bridge span, and corresponding positions of the bottom bars  $S_1$  and  $S_2$  and top bars  $S_3$  and  $S_4$ . Detail A and Detail B in Figure 12 are the design sketches for slab thickness less than 16 inches and more than 16 inches, respectively.

Table 6 Reinforcement bars for simple span slab bridge (Motayed et al., 1983).

Bridge span (ft)	Slab thickness (inch)	Size and spacing (inch) of bottom bars		Size and spacing (inch) of top bars	
		S1	S2	S3	S4
10	11.0	# 8 @ 8.5	# 6 @ 12	# 5 @ 17.0	# 4 @ 12
12	12.0	# 8 @ 8.0	# 6 @ 12	# 5 @ 16.0	# 4 @ 12
14	12.5	# 8 @ 7.0	# 6 @ 12	# 5 @ 12.0	# 4 @ 12
16	13.5	# 9 @ 8.0	# 6 @ 12	# 5 @ 16.0	# 4 @ 12
18	14.5	# 9 @ 7.5	# 6 @ 12	# 5 @ 15.0	# 4 @ 12
20	15.0	# 9 @ 7.0	# 6 @ 12	# 5 @ 14.0	# 4 @ 12
22	16.0	#10 @ 8.5	# 7 @ 15	# 5 @ 17.0	# 4 @ 15
24	17.0	#10 @ 8.0	# 7 @ 15	# 5 @ 16.0	# 4 @ 15
26	18.0	#10 @ 7.0	# 7 @ 15	# 5 @ 14.0	# 4 @ 15
28	19.5	#11 @ 8.5	# 7 @ 15	# 5 @ 17.0	# 4 @ 15
30	21.0	#11 @ 7.5	# 7 @ 15	# 5 @ 15.0	# 4 @ 15

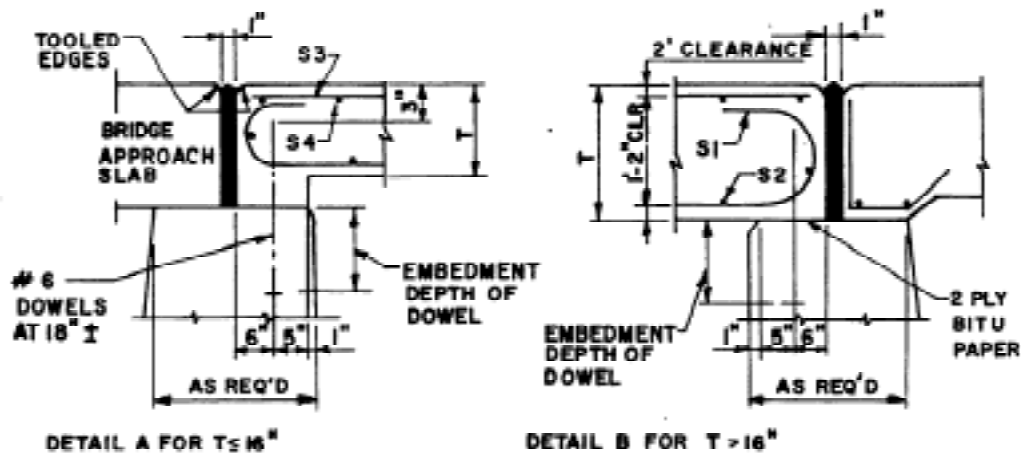

Figure 12 Typical section of slab bridge at abutments.

*Beam-in-slab bridge design.* This design can be used for spans between 20 and 50 ft (Figure 13) and consists of a series of W shape steel beams generally W 12×79 spaced 2 ft center to center. The exterior beam is either a channel section (generally C 12×30) of the same height as the W sections, or another W section. The channel section provides some streamlining of water flow around the edge of the bridge. Plywood 5/8 or 3/4 inches thick is placed between the adjacent beams as a bottom form. The plywood is cut to a width of 18 inches so that when

concrete is placed, it is in contact with the surface of the bottom flange. After the formwork has deteriorated, bearing will still exist between the concrete and steel (Figure 13(b)). Concrete is poured flush with the top flange of the beams. Width of the structure should be increased by 5 ft beyond the roadway on each side of structure to provide additional traffic width.

For abutments, typically nine steel piles are driven on 4 ft centers. As shown in the Figure 14(a), wing walls of the desired height are connected with reinforcement to each of the abutments. Reinforcement bars (Figure 14(b)) are provided for connection of the superstructure to the abutment.

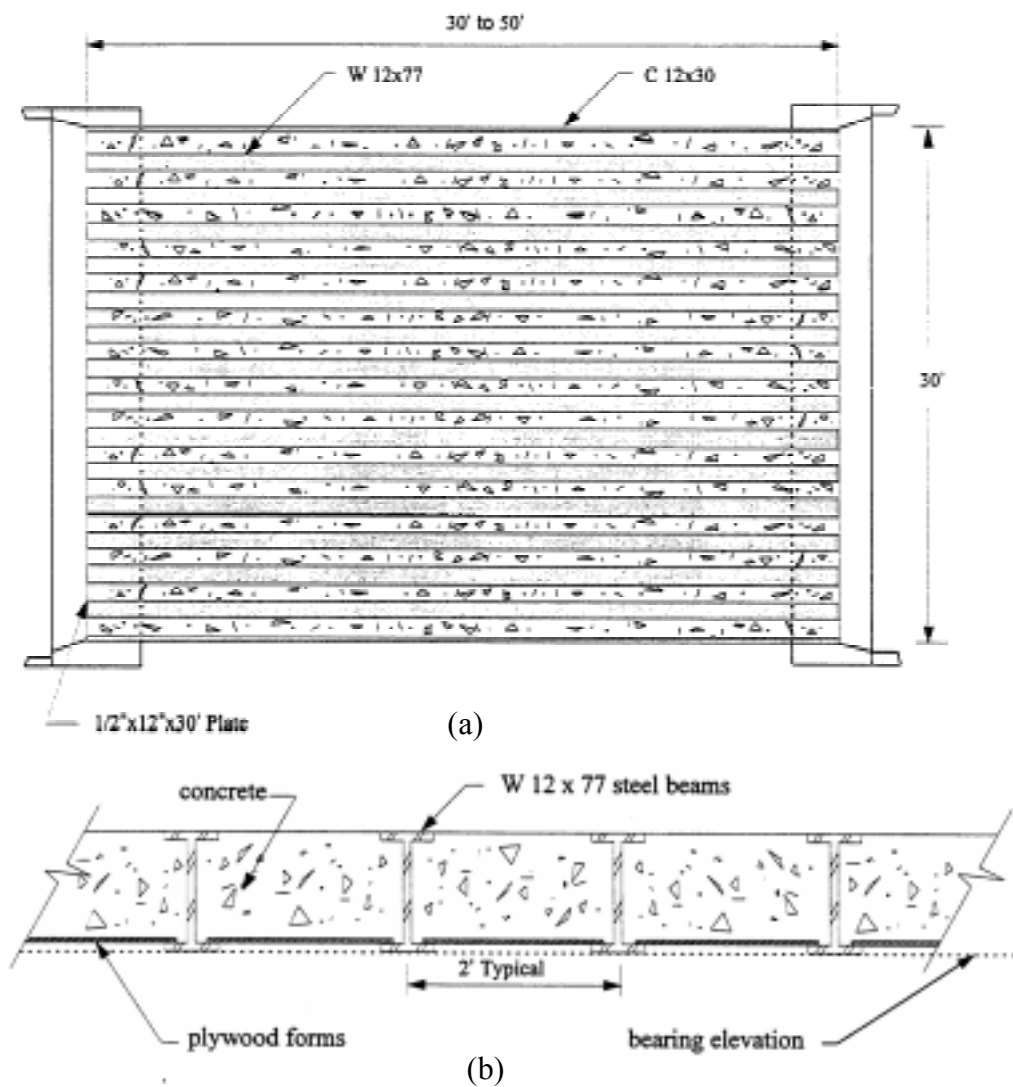

Figure 13 Beam-in-slab bridge.

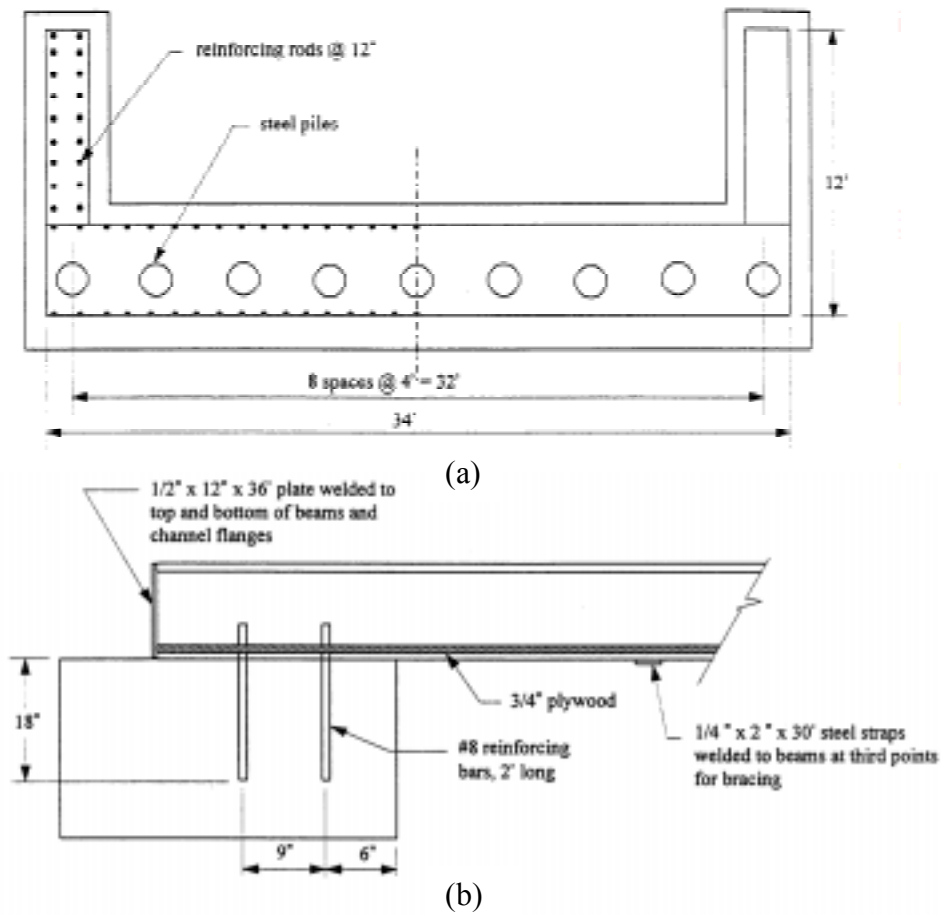

Figure 14 Beam-in-slab: abutment details.

## 4 LWSC CONSTRUCTION

### 4.1 Unvented ford

Figure 15 shows three types of unvented fords. Case (a) is applicable when the streambed is stable, such as bedrock or coarse gravel. Case (b) is appropriate for erodible streambed material. This type of unvented ford allows for some stream scour with minimal impact on the crossing roadway. During a flood event, the ford is not washed out and to restore use only removal of deposited material on the crossing is needed. The crossing material may be rock, coarse gravel, or precast concrete panels; however, in any case, a stable tractive surface should result.

If the stream has high banks, that require lowering of approach grades or if the depth of normal flow exceeds 6 inches, it may be necessary to raise the LWSC above the streambed as shown in Case (c). In this case, protection of fill material must be provided. An encasement of the core material, including surface and sidewalls, may be necessary if the core material is erodible. Moreover, sidewalls and cutoff walls may be necessary to reduce scour and washout in an erodible stream. The design of sidewalls and cutoff walls could be similar to the vented fords (see Section 4.2).

In all cases, end treatment with boulders, rubble, riprap, gabions, etc. is recommended to protect the edge of the crossing. This modification will reduce scour and undermining on the downstream side and may be beneficial on the upstream side as well.

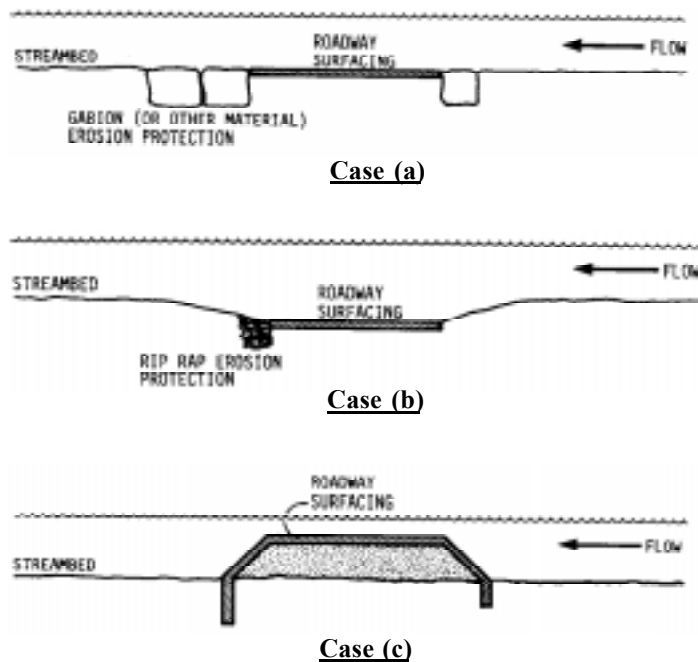

Figure 15 Typical unvented fords.



## 4.2 Vented ford

Figure 16 shows a typical vented ford with six components: core material, pipes, driving surface, sidewalls and cutoff walls, upstream and downstream erosion protection, and approaches.

### 4.2.1 Streambed preparation

For both vented and unvented designs, proper preparation of the crossing base is recommended. This can be accomplished by

- Stabilizing the streambed with crushed stone, riprap, or rubble
- Removing silt and replacing with suitable material
- Compacting base and core to reduce future settlement, especially if the crossing will be paved

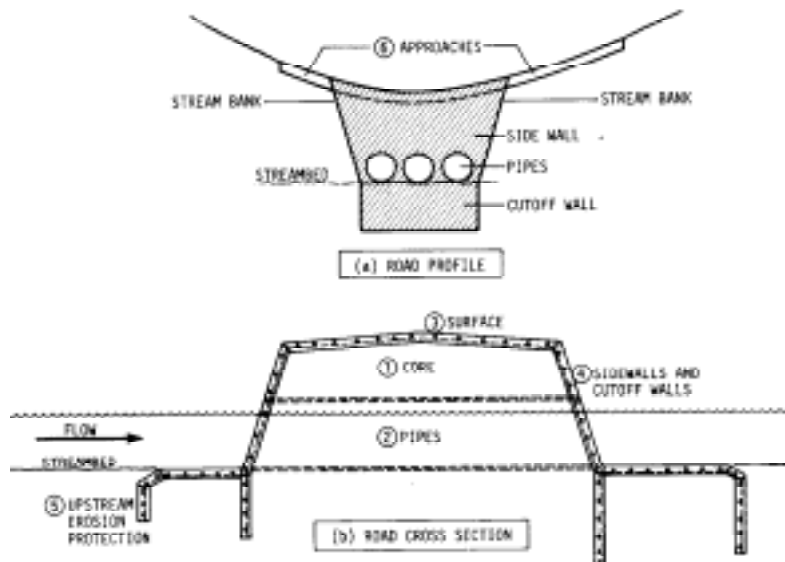

Figure 16 Typical vented ford.

### 4.2.2 Installation of pipes

Corrugated metal, plastic and precast concrete pipes are commonly used. The details of assembling and placing are dependent on the normal practices for the material selected. For smoother hydraulic operation, and to reduce the potential of clogging, both ends, but particularly the inlet should be beveled to fit the sidewall slope. Pipe(s) can also be offset from the stream channel to reduce debris accumulation at the inlet. Diaphragms can be used to reduce seepage and piping. Some designs utilize one or more cables anchored to upstream piling and tied to the pipe or diaphragms to hold the pipe in place in case of washout of the core material (Figure 17).

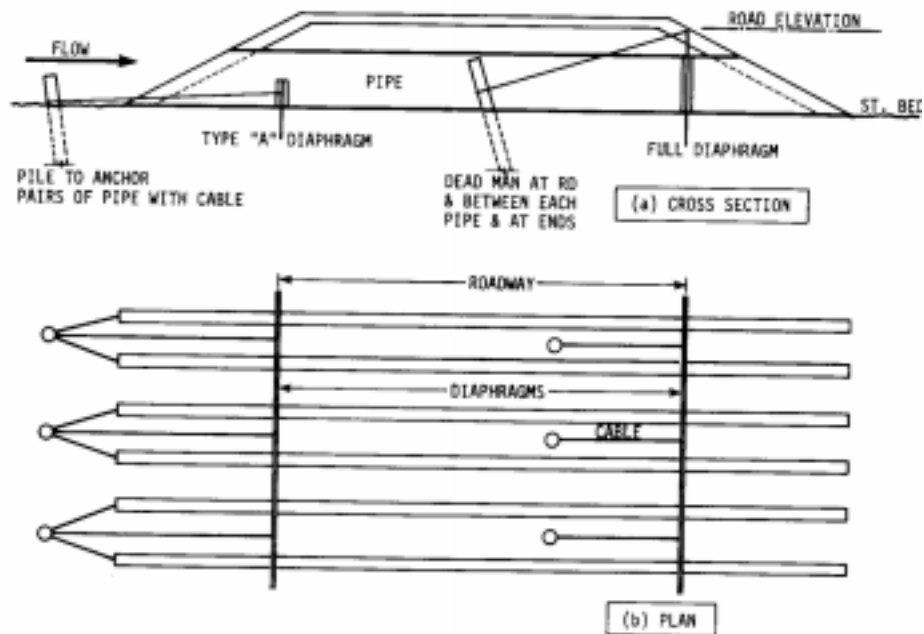

Figure 17 Cable anchor to tie the pipes in vented ford.

#### 4.2.3 Riding surface considerations

- The surface material normally will consist of gravel, rubble, or portland cement concrete.
- If concrete is used, a coarse texture will increase traction following overtopping and possible siltation on the surface.
  - A crown will ensure cross drainage and avoid ponding on the surface. Surfaces other than the rigid type should have a steeper crown.
  - If curbs, markers, or other edge identifying elements are used, care should be taken that the surface will drain completely after overtopping and that the shape is self-cleaning. Any projection above the surface may collect debris however. Some roadway surfaces will require maintenance after overtopping.

#### 4.2.4 Erosion protection of structure side and core material

The function of sidewalls (crossing foreslopes) is to protect the edges of the structure and prevent erosion of the core material. Although 2:1 foreslopes can be used, a minimum slope of 4:1 is suggested for safety reasons and to improve the self-cleaning aspects and flow in the pipes. A vertical sidewall is not recommended. If the sidewalls are constructed of concrete, joints should be sealed to reduce intrusion of streamflow. If riprap is used, the size should be selected and placed to minimize openings and subsequent abrasion of the core material. Geotextiles also may be appropriate in this application. If the sidewalls can not be tied into bedrock or a firm foundation of non-erodible material, cutoff walls may be necessary to protect against scouring. If cutoff walls are required, they normally would be used both upstream and downstream. Cutoff

walls can be concrete, rubble, or sheet piling. The construction details of typical sidewall and cutoff wall are shown in Figure 18.

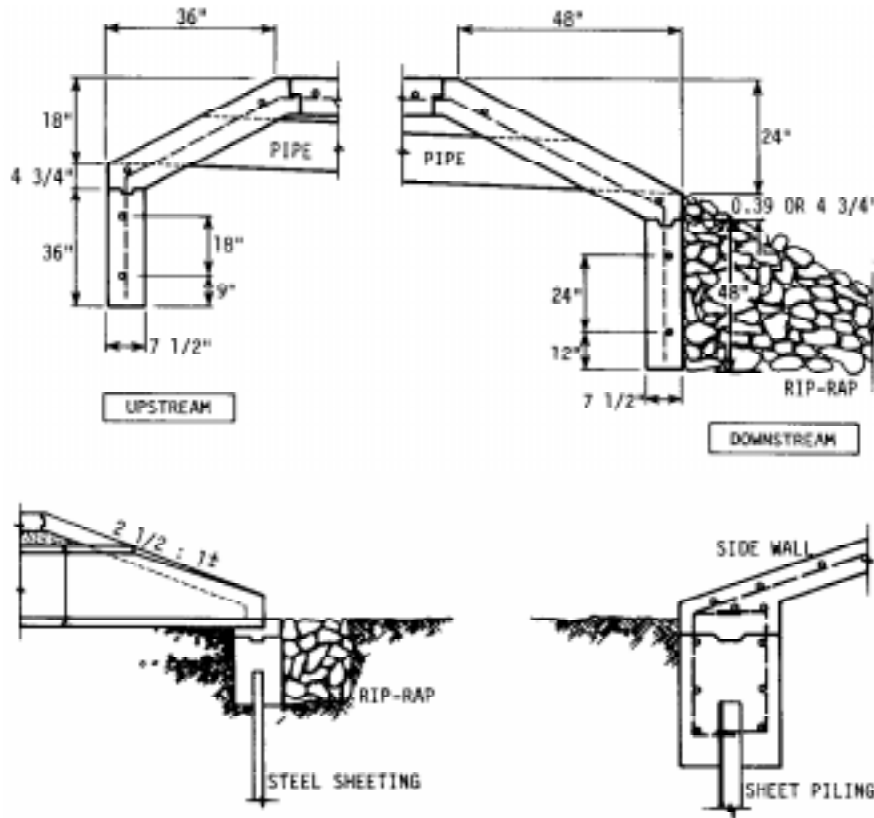

Figure 18 Typical sidewall and cutoff walls.

#### 4.2.5 Erosion protection of streambed

Streambed protection extending upstream and downstream may be used to control scour in erodible channels. This practice will reduce the potential for turbulent flows to create scour pools with subsequent undermining of the structure. Protection may be constructed of concrete, riprap, gabions or rubble (Figure 19), which will move any scour hole further downstream, preventing undermining of the roadway and culverts.

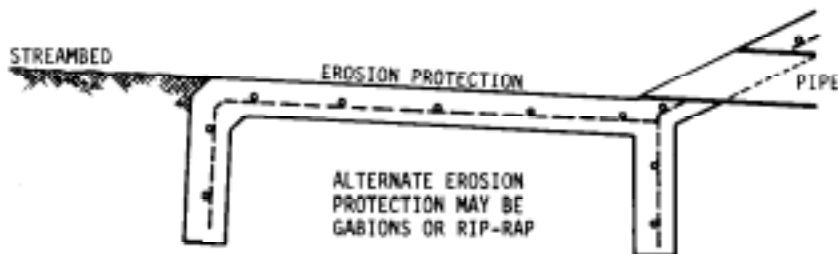

Figure 19 Typical streambed erosion protection (downstream).

### **4.3 Low water bridge**

A low water bridge usually consists of four components: foundation (footing or pile), substructure (piers and abutments), superstructure (reinforced concrete slabs; steel or concrete beams), and approaches (Motayed et al., 1982).

Footings may be used when hard rock or non-erodible soil is at shallow depths. Piles should be used in all other situations

Piers and abutments require streamlining to reduce resistance to the streamflow. The abutment should not project excessively into the stream to avoid constricting the flow path and possible scouring. Piers should be well anchored to the foundation. Upstream edge of the pier should be rounded so accumulation of debris is minimized. For smaller low bridges, various types of piling have been used as piers to reduce construction cost. Piles are found particularly suitable and economical for weak soil such as silt.

The deck slab should be well anchored to the substructure to prevent displacement by flood water. Upstream and downstream edges of the deck slab should be smoothly rounded to enhance the efficiency of flow over the slab during overtopping.

## 5 TRAFFIC CONTROLS

### 5.1 Recommended signing

To adequately advise road users of low water stream crossings, recommended signing was developed in a research study by R. L. Carstens et al. of Iowa State University in 1981. Following is a description of recommended signing.

#### 5.1.1 Flood Area Ahead sign

The Flood Area Ahead sign is a diamond-shaped warning sign and is yellow with black lettering and border. The standard size is 30 inches by 30 inches. This sign would usually be installed about 750 ft in advance of the low water crossing or at the last turnaround location for vehicles, whichever is greater. If the location of the low water crossing is not readily visible from approximately 1,000 ft, use of a supplemental distance advisory plate mounted below the Flood Area Ahead sign may be considered. An advisory speed plate may also be considered if the recommended crossing speed is less than the speed limit established by law or regulation for the approach roadway. If an advisory distance plate is used with the Flood Area Ahead sign, a speed advisory plate can be mounted under the next sign, Impassable During High Water. Neither supplemental plate should be used alone.



#### 5.1.2 Impassable During High Water sign

The Impassable During High Water sign is diamond-shaped and yellow with black lettering and border. The standard size is 30 inches by 30 inches. This sign is normally installed about 450 ft in advance of the low water crossing.



### *5.1.3 Do Not Enter When Flooded sign*

The Do Not Enter When Flooded sign consists of a 24-inch by 30-inch rectangular sign with black lettering and border on a white background. Since this is a regulatory sign, installation and enforcement requires an appropriate resolution by the board of supervisors or city council. This sign should be installed about 200 ft from the actual low water crossing.



## **5.2 Other suggestions**

In addition to these recommended signs, the following suggestions should be considered in establishing low water crossings:

- Use only on low volume, unpaved roads.
- Do not use on roads that serve occupied dwellings where no alternate emergency access is available.
- Perform timely maintenance of signs and roadway, particularly after flooding.

The following illustration shows a suggested typical layout for signing of a low water crossing in Iowa. Additional information can be obtained from the Iowa DOT Office of Local Systems.

Typical Signing of Low Water Stream Crossing (LWSC)

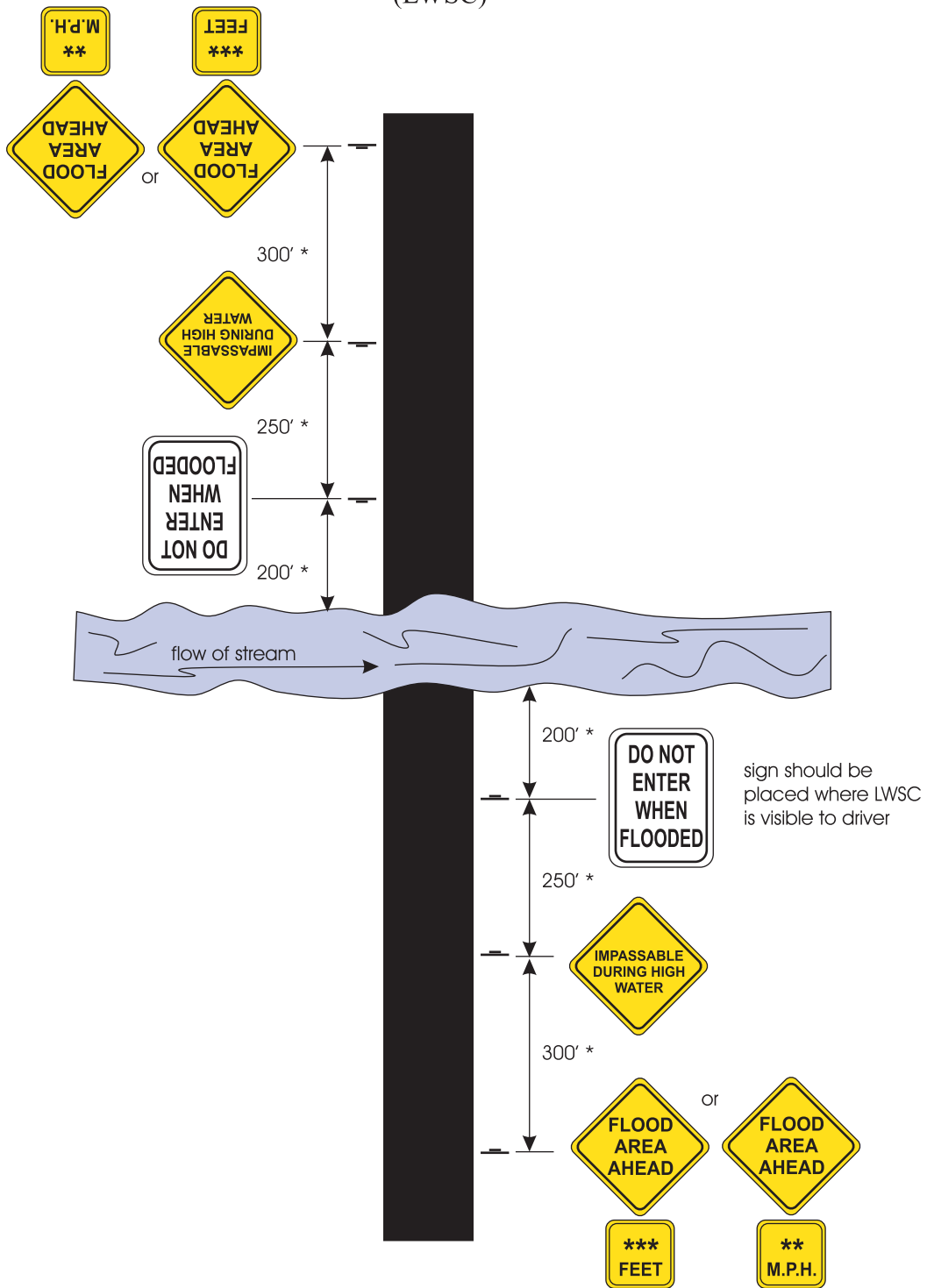

\* Nominal distance (other distance may be used if engineering study indicates).

Figure 20 Typical signing of LWSC.

## 6 LEGAL CONSIDERATIONS

Potential liability for actions and inactions is always a major concern for local agencies, especially county engineers. Low water stream crossings may raise particular interest since design criteria do not conform with Iowa Department of Transportation standards for bridges and culverts. The Code of Iowa in Section 309.79 seems to imply that all bridges and culverts comply with standards specifications furnished to local agencies by the department. Section 309.74 states that culverts shall allow a minimum clear roadway width of 20 ft and bridge width of 16 ft. LWSCs can easily be designed to comply with Section 309.74 but Section 309.79 seems more problematic.

However, the Code further allows considerable flexibility to boards of supervisors and county engineers to carry out responsibilities for the secondary road system. Section 309.57, area service classification, establishes authority for Boards to establish reduced maintenance levels for certain roads under their jurisdiction. Further, it has long been recognized that local agencies must prioritize available funding to best meet the needs of public transportation. Low water stream crossings, designed, constructed, and maintained to reasonable guidelines would seem to meet these responsibilities.

A 1981 research report by R. L. Carstens, et al. (1981), *Liability and Traffic Control Considerations for Low Water Stream Crossings*, studied the legal implications in the use of LWSCs and concluded that, with adequate warning of the existence of such a structure, the potential for accidents and subsequent tort claims may actually be decreased by LWSCs over deficient and obsolete bridges. A description of recommended traffic control signing is included in this report (Section 5).

The survey of county engineers undertaken as part of this research project indicated the existence of over 225 LWSCs in Iowa, some for approximately 20 years or more. In addition, only three counties advised of tort claims relating to LWSCs. Of these, two counties were found not at fault for crashes that occurred at existing crossings. The third claim was filed alleging a right of way issue not directly relating to the LWSC and the county settled out of court. Based on this history, it would seem that potential liability from the use of LWSCs is not extensive in Iowa.

To minimize exposure to tort liability, local agencies using low water stream crossings should consider adopting reasonable selection and design criteria and certainly provide adequate warning of these structures to road users. The design recommendations included in this report for LWSCs provide guidelines and suggestions for local agency reference.



## 7 REFERENCES

- Berg, B.M. *Shoreline Erosion on Selected Artificial Lakes in Iowa*. M.S. Thesis, Department of Civil Engineering, Iowa State University, Ames, 1980.
- Carstens, R.L., et al. *Liability and Traffic Control Considerations for Low Water Stream Crossings*. Department of Civil and Construction Engineering, Iowa State University, Ames, 1981.
- Gaylord, E.H., and C.N. Gaylord. *Structural Engineering Handbook*. 2nd ed. McGraw-Hill Book Co., New York, 1979.
- Gupta, R.S. *Hydrology and Hydraulic Systems*. 2nd ed. Waveland Press, Inc., Prospect Heights, Illinois, 2001.
- Haestad Methods. *Computer Applications in Hydraulic Engineering*. Third Edition, Haestad Methods, Inc., Haestad Methods Press, 1999.
- Herr, L.A., and H.G. Bossy. *Hydraulic Charts for the Selection of Highway Culverts*. Hydraulic Engineering Circulation No. 5, GPO, Washington, D.C., 1965.
- Isbash, S.V. *Construction of Dams by Depositing Rock in Flowing Water*. Proc. Second Congress on Small Dams, Washington, D.C., pp. 123-136, 1936.
- Keown, M.P., N.R. Oswalt, and E.B. Perry. *Literature Survey and Preliminary Evaluation of Streambank Protection*. WES Report RE-H-77-9, Army Engineer Waterways Experiment Station, Vicksburg, 1977.
- Klaiber, F.W., T.J. Wipf, J.R. Reid, and M.J. Peterson. *Investigation of Two Bridge Alternatives for Low Volume Roads*. Iowa Department of Transportation, Project No. HR-382, 1997.
- Lara, O.G. Annual and Seasonal Low-flow Characteristics of Iowa Streams. Iowa DNR Bulletin No. 13, U.S. Geological Survey, Iowa City, 1979.
- Larimer, O.J. *Drainage Areas of Iowa Streams*. Iowa Highway Research Board Bulletin No. 7, U.S. Geological Survey, Iowa City, 1957.
- Looschen, M., and D.D. Coy. *Hydrologic and Hydraulic Considerations for Low Water Crossings*. Office of Bridge Design, Iowa Department of Transportation, 1982.
- Motayed, A.K., F.M. Chang, and D.K. Mukherjee. *Design Guide: Low Water Stream Crossing*. Federal Highway Administration Report No. FHWA/RD-82/164, U.S. Department of Transportation, 1982.
- Motayed, A.K., F.M. Chang, and D.K. Mukherjee. *Design and Construction of Low Water Stream Crossings*. Federal Highway Administration Report No. FHWA/RD-83/015, U.S. Department of Transportation, 1983.
- Normann J.M., R.J. Houghtalen, and W.J. Johnston. Hydraulic Design of Highway Culverts. US Dept. of Transportation Report No. FHWA-IP-85-15, Hydraulic Design Series No. 5, 1985.
- Rossmiller, R.L., R.A. Lohnes, S.L. Ring, J.M. Phillips, B.C. Barrett. *Design Manual for Low Water Stream Crossings*. Iowa Department of Transportation, Project No. HR-247, 1984.
- Rice, C.E., K.M. Robinson, K.C. Kadavy. Rock riprap for grade control, North American Water and Environmental Congress, American Society of Civil Engineers, 1996.
- U.S. Department of Transportation. *Design charts for Open-Channel Flow*. Federal Highway Administration, Washington, D.C.
- Voegele, D.M. The evaluation of riprap and low-cost grade control structures in western Iowa, Unpublished M.S. Thesis, Iowa State University, Ames, 1997.

## 8 ACKNOWLEDGEMENTS

The authors gratefully acknowledge the following county engineers who generously provided valuable information based on their first hand experience with LWSCs. The advisory committee consisted of Gary Bishop, Todde Folkerts, Tom Goff, John Goode, Mike Olson, and Tom Stoner. Meetings during field trips with Gerry Petermeier, Lyle Brehm, Mike Olson, Dan Ahart, and Myron Parizek provided additional useful insights.

### List of Additional Contacts

Dennis Osipowicz, Lee County Engineer

Steve Parks, Davis County

Danny Waid, Howard County Engineer

Christy Van Buskirk, Keokuk County Engineer

Keith Kruger, National Park Service, Omaha, Nebraska

Peter Bolander, USDA Forest Service, Oregon

Terry Jorgenson, South Dakota Department of Transportation

Amir Sortani, Nevada Department of Transportation

Richard Lusardy, Wilson's Creek Park, Missouri

Gary Sullivan, Wilson's Creek National Park, Missouri

LeRoy Bergmann, Iowa Department of Transportation

Curtis Monk, Federal Highway Administration, Ames

## APPENDIX A: 2001 SURVEY ON THE USE OF LOW WATER STREAM CROSSINGS

1. Does your county have any low water stream crossings (LWSCs) in service?
  - Yes
  - If yes*, how many on the following:  
 service level roads A? \_\_\_\_\_ B? \_\_\_\_\_ C? \_\_\_\_\_  
 aggregate-surfaced roads? \_\_\_\_\_  
 other roads? \_\_\_\_\_
  - No (if no, please skip to question 6)
  
2. Has your county constructed any LWSCs under your supervision?
  - Yes
  - No
  - If yes*,
    - a. Were your LWSCs constructed
      - by contract?
      - in-house?
    - b. What did you use as design standards?
      - Existing references (please list source)
      - In-house design (describe or provide copy)
    - c. Do you consider drainage area and/or streambed gradient in your design?
 

Drainage area	Streambed gradient
<input type="checkbox"/> Yes	<input type="checkbox"/> Yes
<input type="checkbox"/> No	<input type="checkbox"/> No
  
3. What type of LWSC do you prefer?  
 (please rank in order of preference)
  - \_\_\_\_\_ With pipe/s
  - \_\_\_\_\_ Without pipe
  - \_\_\_\_\_ Beam in slab
  - \_\_\_\_\_ Other, please describe
  
4. Has your county ever been involved in a tort liability claim or lawsuit over the use of LWSCs?
  - Yes
  - No
  - If yes*, may we contact you for more information about liability claims?
    - Yes
    - No
  - Name, Phone: \_\_\_\_\_
  
5. In your experience with LWSCs, are there any practices/situations you would recommend others to avoid?

6. Would you benefit from an easy-to-use design manual for LWSCs?  
 Yes  
 No
7. What topics would you recommend for such a manual?
8. If you had access to a user-friendly manual, would you be more likely to specify LWSCs as low cost substitutes for bridges and/or culverts under appropriate and applicable conditions?  
 Yes  
 No
9. May we contact you for more information about your experiences with LWSCs?  
 Yes  
 No  
Name, Phone: \_\_\_\_\_

---

Please return the completed survey by **May 15, 2001**.

## APPENDIX B: SUMMARY OF SURVEY RESPONSES

A survey was conducted of Iowa county engineers on the use of and experience with low water stream crossings (LWSCs). The purpose of this survey was to collect information about existing LWSCs, along with needs and recommendations of potential manual users. This information was very useful in the preparation of an easy-to-use manual on LWSCs. A survey consisting of nine questions was sent to every county in Iowa (Appendix A). The survey questions were basically objective; however, few questions included an opportunity for the respondents to describe experiences on the use of LWSCs. Figure B.1 shows the participation of Iowa counties in the survey. Of the 99 counties, 70 responded and 5 of were anonymous.

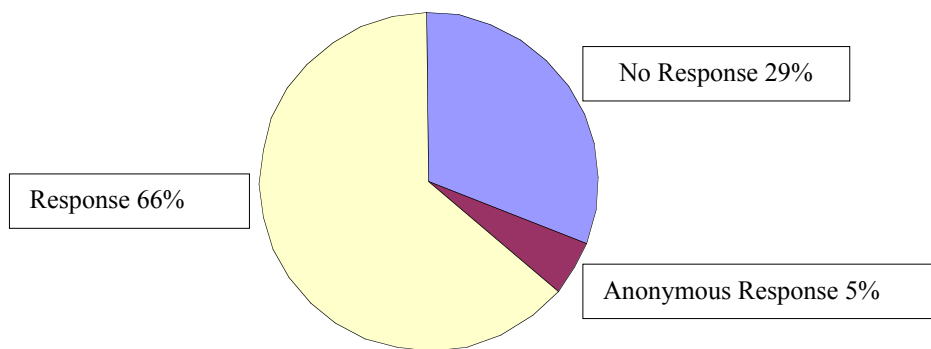

Figure B.1 Survey responses.

Analysis of survey responses are divided into three categories:

1. Total responses;
2. Responses having LWSCs in county; and
3. Responses having experience with LWSCs design and construction.

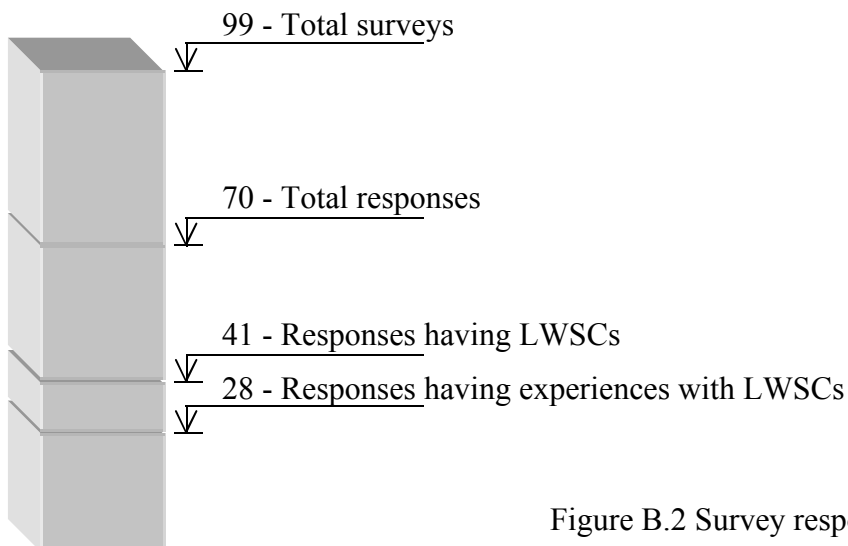

Figure B.2 Survey responses.

Figure B.2 presents an overall summary of survey responses. Among 70 responses, 41 have LWSCs in their counties, but only 28 engineers indicated having experience with the design and construction. The results and discussion are therefore presented in these three categories.

### LWSCs in service (Question 1)

More than 226 LWSCs are found in 36 counties (Figure B.3). This estimate is quite close to the result from a survey conducted in 1984, where a total of 220 LWSCs in 42 counties was indicated (Rossmiller et al., 1984). Most of LWSCs are found located in Service Level B roads. Considering the earlier results, it is possible that many more LWSCs exist than were indicated by the current survey.

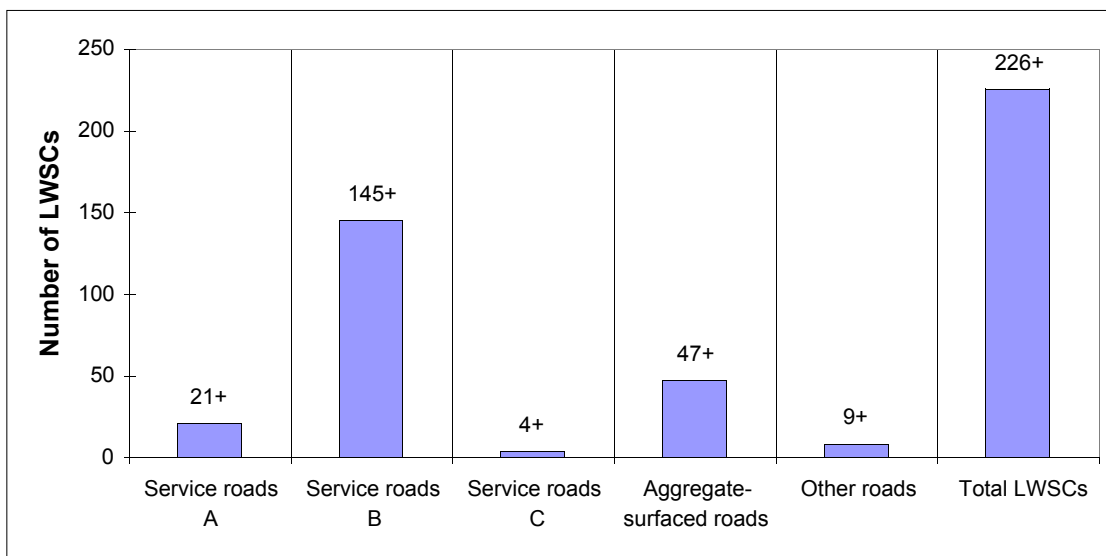

Figure B.3 Number of LWSCs on different types of roads (Question 1).

## Experience with LWSCs design and construction (Question 2)

Only 28 of 70 responding county engineers indicated having experience with design and construction of LWSCs. Figure B.4 presents a summary of practices. More than 80% use either drainage area and streambed gradient or both in the design of LWSCs. Nearly 20%, who do not consider these factors, use other standards. Most responding counties use in-house developed standards and local staff in the design and construction of LWSCs. Approximately 32% rely on existing references for design criteria.

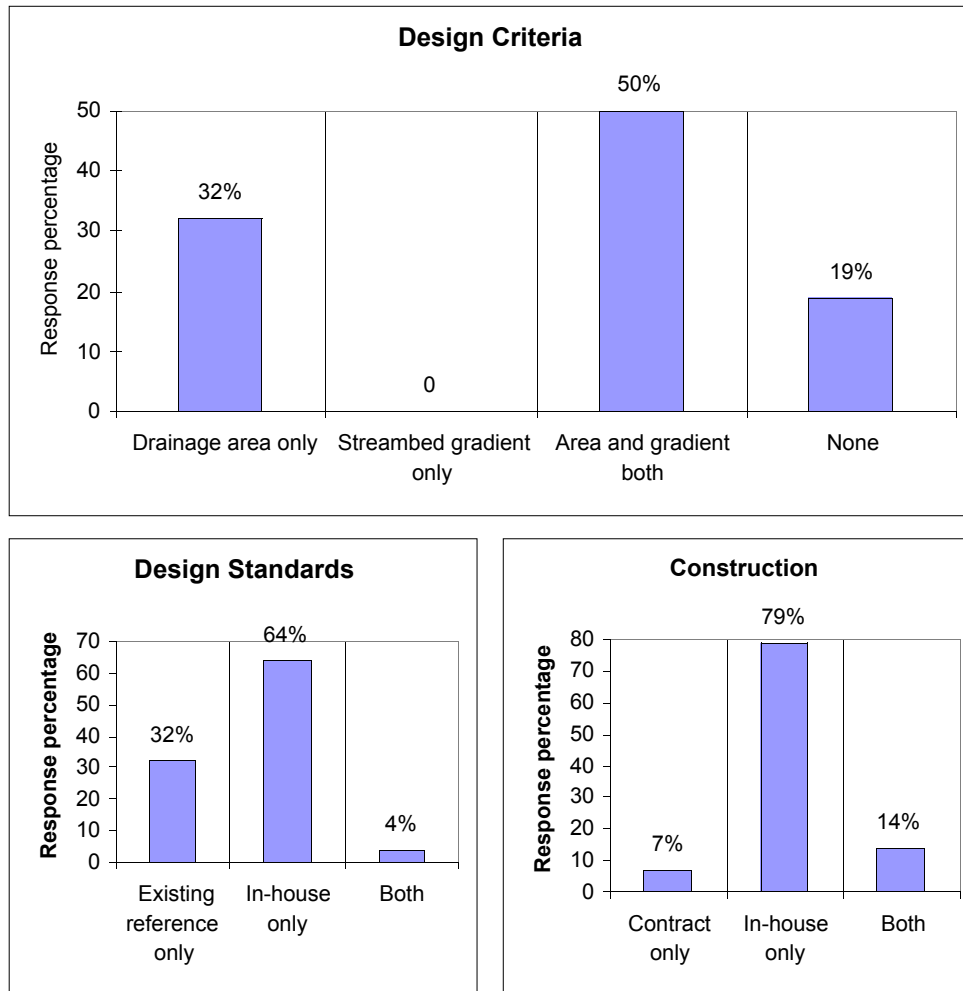

Figure B.4 Design criteria, design standards, and construction method used in the construction of LWSCs (Question 2).

### Preferences on LWSCtypes (Question 3)

Preferred type of LWSCs found that vented (piped) crossings are most popular (Figure B.5).

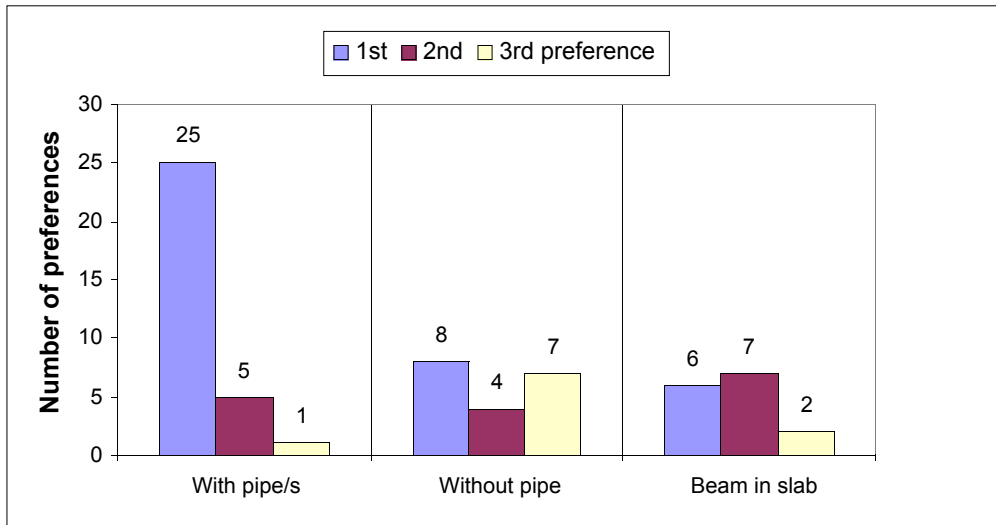

Figure B.5 Preferences on several types of LWSCs (Question 3).

### Legal experience with LWSCs (Question 4)

Only three responding counties indicated experiencing tort liability claims with the use of LWSCs: Howard, Keokuk, and Jefferson. Further discussion on this topic can be found in the liability section of this report.

### Suggestions on the use of LWSCs (Question 5)

Many responding counties related experiences with LWSCs and made recommendations. The main points are summarized below:

1. Avoid LWSCs:
  - With small diameter pipes; clogging problem.
  - In deep channels; approaches washing out.
  - At crossings with skew angles above 10-15 degrees; scouring problem.
  - On loess soils; instability.
  - In dead end roads with residences at end.
2. LWSC suitable locations:
  - With pipe/s: Small streams with defined channel and good fit with approaches



- Without pipe: Low roads near river prone to flooding
  - Beam in slab: Deeper channel and large drainage area
  - On very low traffic roads and where land access is necessary
  - In ephemeral streams
  - On Class C roads due to liability concerns
  - Road alignment should allow for a straight entry
3. Additional considerations:
- Gradual crossing slope into and out of the stream.
  - Use of design storm to base hydraulics on (at least 5 years frequency event).
  - Protection of side slopes.
  - Undulations in roads due to LWSCs construction.
  - Posting of traffic signs and signals at positions well ahead of crossing.
  - Make area 200-300 ft either side of Class B roads.

### Benefit from a LWSCs manual (Question 6)

Figure B.6 displays the interest of Iowa counties in a design manual for LWSCs. Forty-seven counties are interested, of which 29 have experience with LWSCs. Several counties not having LWSCs are not interested in a manual. Note that the availability of an improved, complete, and easy-to-use manual could influence additional use.

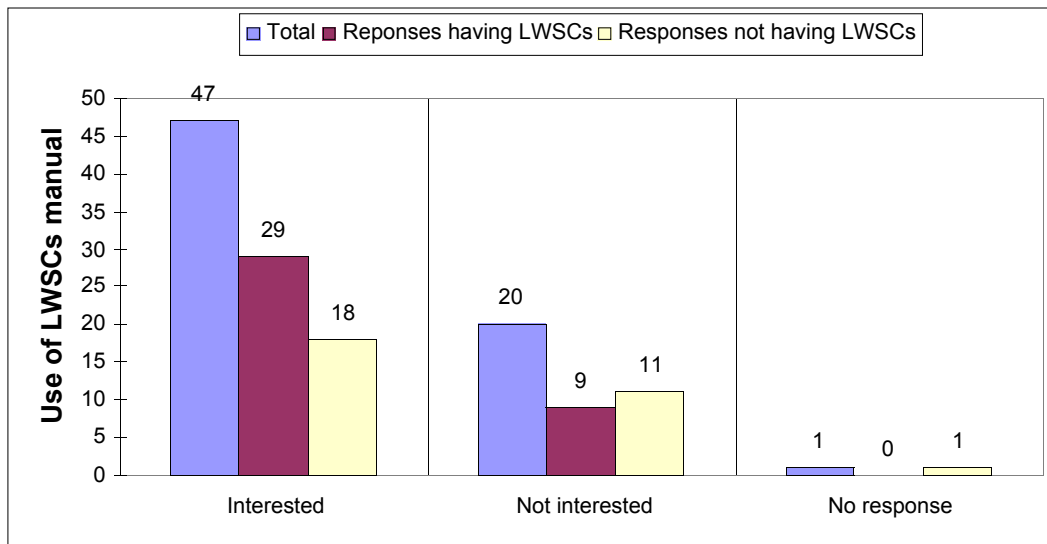

Figure B.6 Support for the use of LWSCs manual (Question 6).

### Suggestion of topics for manual (Question 7)

More than half of the respondents suggested topics for a design manual. Table B.1 lists these under several categories. This information provides good insight for useful manual contents. Liability concerns were found to be of equal importance with design considerations.

Table B.1 Discussion topics suggested for LWSCs manual (Question 7).

<u>Category</u>	<u>Topics</u>
Liabilities	<ol style="list-style-type: none"> <li>1. Thorough discussion of associated liabilities</li> <li>2. How LWSCs compromise public safety?</li> <li>3. Example of a legal case concerning LWSC</li> </ol>
Design	<ol style="list-style-type: none"> <li>1. Construction procedures</li> <li>2. Structural design details: <ul style="list-style-type: none"> <li>• Paving requirements</li> <li>• Riprap size</li> <li>• Fore slope recommendations</li> <li>• Depth of sheet wall</li> <li>• Side slope protection (shotcrete, matting, vegetation, etc.)</li> <li>• Geometric of crossings</li> <li>• Materials</li> </ul> </li> <li>3. Maintenance considerations</li> <li>4. ADT design guidelines</li> </ol>
Design criteria	<ol style="list-style-type: none"> <li>1. Best circumstances to use LWSCs based on <ul style="list-style-type: none"> <li>• Drainage area</li> <li>• Slope</li> <li>• Approach heights</li> <li>• Channel shapes</li> <li>• Regions</li> <li>• Level of service, road type</li> </ul> </li> <li>2. Application of LWSCs in winter</li> <li>3. When to change roadway grade?</li> <li>4. When to use LWSCs instead of others like ADT, etc.?</li> </ol>
Signing	Proper and legal signing
Miscellaneous	<ol style="list-style-type: none"> <li>1. What backwater effects are created?</li> <li>2. Benefit-cost information compared to culverts and bridges.</li> </ol>

### Support for LWSCs applications in Iowa counties if manual were available (Question 8)

More than 70% of respondents would consider LWSC structures as low-cost substitutes for bridges and/or culverts under appropriate and applicable conditions (Figure B.7). Uninterested counties having no experience with LWSCs structures may be motivated to consider this option if an easy to use manual were provided.

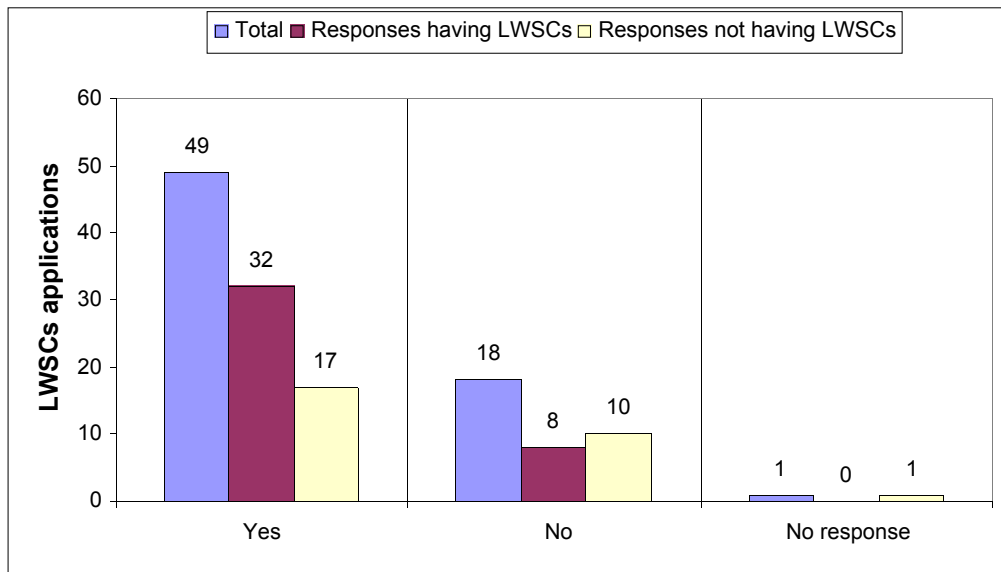

Figure B.7 Support for LWSCs applications (Question 8).

**APPENDIX C: MANNING'S ROUGHNESS COEFFICIENTS FOR NATURAL  
STREAM CHANNELS**

1. Fairly regular section:	
a. Some grass and weeds, little or no brush	0.03 - 0.035
b. Dense growth of weeds, depth of flow materially greater than weed height	0.035 - 0.05
c. Some weeds, light brush on banks	0.035 - 0.05
d. Some weeds, heavy brush on banks	0.05 - 0.07
e. Some weeds, dense willows on banks	0.06 - 0.08
f. For trees within channel, with branches submerged at high stage, increase all above values by	0.01 - 0.02
2. Irregular section, with pools, slight channel meander; increase values given above about	0.01 - 0.02
3. Mountain streams, no vegetation in channel, banks usually steep, trees and brush along banks submerged at high stage:	
a. Bottom of gravel, cobbles, and few boulders	0.04 - 0.05
b. Bottom of cobbles, with large boulders	0.05 - 0.07

Source: U.S. Department of Transportation

## APPENDIX D DESIGN OF A VENTED FORD—SIZE AND NUMBER OF PIPES

### D.1 Design Curves ( $D$ vs. $Q_{vent}$ )

A design curve ( $D$  vs.  $Q_{vent}$ ) is derived from culvert hydraulics and flow equations (Herr and Bossy, 1965; Normann et al., 1985, Haestad Methods, 1999; Gupta, 2001), which are divided into two categories: inlet control and outlet control. Inlet control means that the discharge capacity is controlled at the entrance by headwater depth (HW) and entrance geometry, including barrel shape and cross-sectional area, and the type of inlet edges. Under the inlet control assumption, culvert barrel friction and other minor losses can be neglected. In contrast, barrel friction is the predominant head loss in outlet control situation. The tail water condition has an important effect on the culvert with outlet control flow. The practical significance of inlet control is that flow capacity of a culvert can be increased by improving entrance condition. The improved flow condition by treating the entrance under inlet control is an advantage over outlet control.

The entrance of a culvert can be above the water or submerged. When the inlet is submerged, the pipe is partially full under inlet control while the barrel is completely full under outlet control. This implies that a larger size is required for a culvert that is operating under inlet control as compared with outlet control.

Determination of number and size of pipes in a vented ford design is a trial and error process. In general, it is first assumed that the flow is governed by inlet control and then the design is checked for outlet control. In LWSC designs, a vented ford is allowed to have an overtopping flow depth of 0.5 ft in maximum and the inlet is submerged. When the inlet of a culvert is submerged, a larger size is required under inlet control. Therefore, the design of a vented ford with a submerged entrance for inlet control flow does not need to be checked for outlet control.

Once the conditions of a vented ford are specified or selected, a design curve ( $D$  vs.  $Q_{vent}$ ) can be derived from culvert hydraulics and corresponding flow equation. The flow equation for submerged entrance under inlet control is

$$\frac{HW}{D} = c \left[ \frac{Q_{vent}}{A_b D^{0.5}} \right]^2 + Y + f_s S_o \quad (D.1)$$

where  $HW$  is headwater depth (ft),  $D$  is culvert barrel size (ft),  $Q_{vent}$  is design discharge calculated by Equation (8) ( $\text{ft}^3/\text{s}$ , i.e. cfs),  $A_b$  = full cross-sectional area of the culvert barrel ( $\text{ft}^2$ ),  $Y$  and  $c$  are inlet constants,  $S_o$  is culvert barrel slope, and  $f_s$  is slope correction factor that is equal to 0.7 for mitered inlet and -0.5 for other inlets. The sensitivity of design size ( $D$ ) to the slope ( $S_o$ ) was analyzed using Equation (D.1) during the development of this report. The results indicated that the maximum difference in design size is less than 5% for barrel slopes ranging from 0.2 to 0.0002 under a design discharge from 0 to 2000  $\text{ft}^3/\text{s}$ .  $D$  is not sensitive to  $S_o$  when  $S_o$  is less than 0.02.

For a vented ford with corrugated metal pipes (CMP) with 0.5-ft overtopping flow depth, 1-ft cover above the pipe, and mitered inlet, Equation (D.1) can be employed to develop a design curve. The area ( $A_b$ ) of a circular pipe is equal to  $A_b = \pi D^2/4$ . The inlet constants  $Y$  and  $c$  are

0.75 and 0.0463, respectively, for CMP culverts with a mitered entrance (Herr and Bossy, 1965; Normann et al., 1985; Haestad Methods, 1999). The headwater is equal to  $D$  plus pipe cover (1 ft) and overtopping flow depth at the entrance ( $0.5 \text{ ft}/0.6 = 0.83 \text{ ft}$ ). Equation (D.1) can be rewritten as

$$Q_{vent} = 3.65 D^{2.5} \left( \frac{1.83}{D} + 0.25 - 0.7 S_o \right)^{1/2} \quad (\text{D.2})$$

The design curve ( $D$  vs.  $Q_{vent}$ ) shown in Figure 11 is obtained by plotting Equation (D.2) for the conditions specified above and a pipe slope of 0.02 or less.

## D.2 HEC-5 charts

Existing HEC-5 charts (Herr and Bossy, 1965; Normann et al., 1985) may also be used for vented ford design. The monographs were developed from the culvert hydraulics and flow equations described above (Section D.1) for various types and conditions, including flow controls (inlet or outlet), barrel shapes, barrel materials, and inlet treatments, etc.

To use the charts for a vented ford design, design flow through the vent ( $Q_{vent}$ ) is first determined from Equation (8) and a chart is then selected for specific inlet submergence, flow control, barrel shape and material, and inlet treatment, etc. Following steps are taken in the design:

- 1) Assume a size ( $D_a$ ) of the vent (pipe diameter or box width). As a reference for the first trial, use  $D_a = 2(Q_{vent}/20)^{1/2}$
- 2) Calculate the allowable headwater depth  $HW = H + P$ , where  $H = h/0.6 = 0.833$  if  $h$  is designed as 0.5 ft (Figure 9(a)). Calculation of  $P$  requires consideration of cover depth above pipes. If a pipe cover depth of 1 ft is used,  $P = D_a + 1$ . Then,  $HW = 1.833 + D_a$
- 3) On the monograph as shown in Figure D.1, which is for a submerged inlet, corrugated metal pipes and inlet control flow, connect the point of  $D_a$  value to that of the given discharge ( $Q_{vent}$ ) and extend the line to read the ratio  $HW/D_c$  value on scale (2) for mitered (beveled) entrance, where  $D_a$  is the assumed pipe size and  $D_c$  is the calculated pipe size. Charts for other types of vents with different flow control, barrel shape, pipe material, and entrance treatment are provided in Herr and Bossy (1965) and Normann et al. (1985).
- 4) Compute  $D_c$  using  $HW$  calculated in step (2) and ratio  $HW/D_c$  determined in step (3),  
 $D_c = HW / (HW/D_c)$
- 5) If the computed size,  $D_c$ , is not equal or close enough to that originally assumed,  $D_a$ , repeat the procedure by assuming a new  $D_a$ . If  $D_c > D_a$ , assume a smaller  $D_a$  and if  $D_c < D_a$  use a greater  $D_a$  for the next trial.
- 6) If any trial size is too large in dimension because of limited height of LWSC or availability of pipe size, multiple culverts may be used by dividing the discharge equally between the

numbers of barrels used. Raising the LWSC height or the use of pipe arch and box culverts with width greater than height can also be considered.

- 7) If the selected design size is too small (less than 12 inches), the recommended minimum size should be used.

### **D.3 Computerprogram – CulvertMaster**

This commercial computer model was developed by Haestad Methods (1999) and is based on the culvert hydraulics and flow equations (Herr and Bossy, 1965; Normann et al., 1985; Haestad Methods 1999) described above (Section D.1). As a convenient design tool, the model provides quick culvert calculations and detailed analyses. The computer program can be purchased through the internet at [www.haestat.com](http://www.haestat.com).

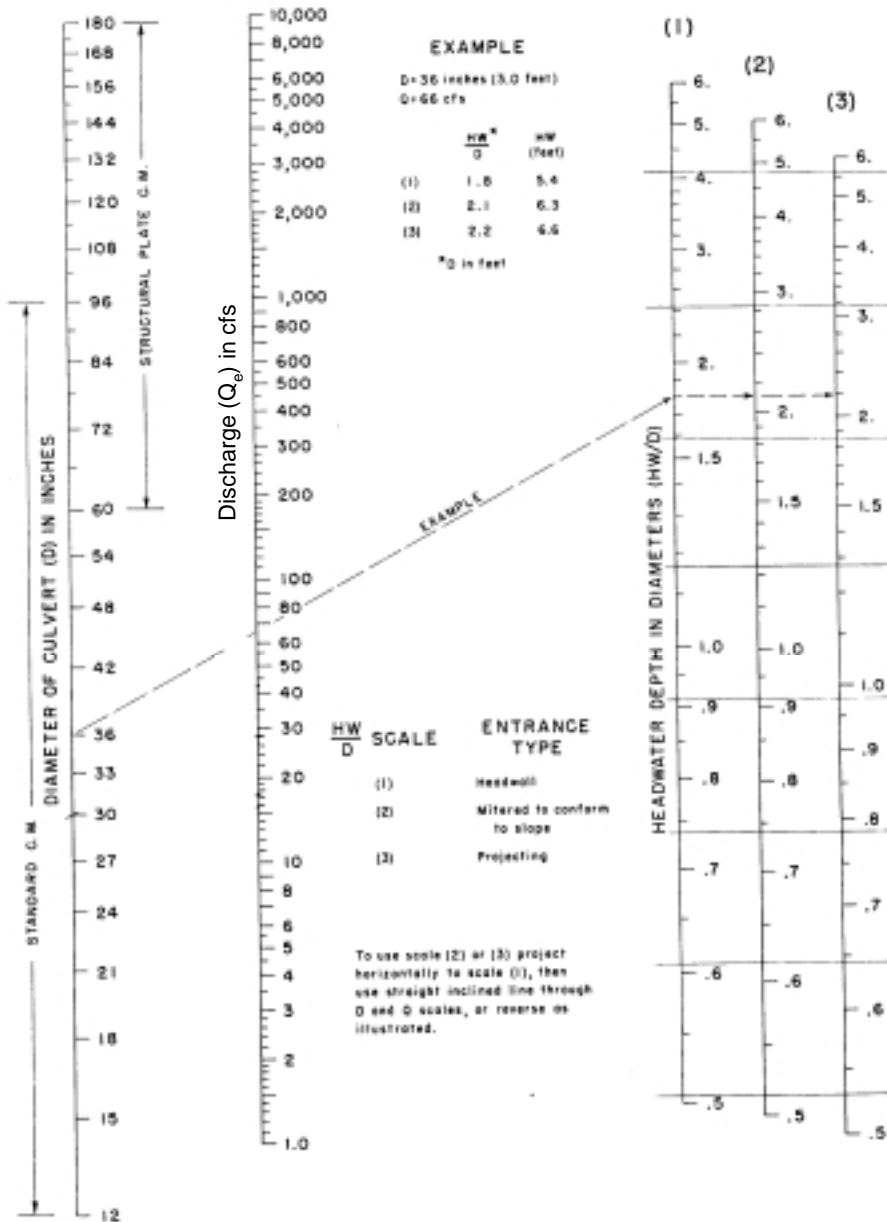

Figure D.1 Headwater depth for C.M. pipe culverts with inlet control—Chart #5 of HEC-5 charts in Herr and Bossy (1965).

Note: Figure D.1 is valid only for submerged inlet, corrugated metal pipes and inlet control flow. Charts for other types of vents with different flow control, barrel shape, pipe material, and entrance treatment are provided in Herr and Bossy (1965) and Normann et al. (1985).



## APPENDIX E: DESIGN EXAMPLES

General design criteria listed below are used in these design examples. Where different criteria are used, these are specified in each individual example.

For all fords:

Allowable flow depth over LWSC:	$h = 0.5$ ft
Acceptable percent of time closed:	$e = 2\%$

For unvented fords:

Maximum height of LWSC above streambed:	$P \leq 4$ ft
---	---------------

For vented fords:

Minimum pipe size:	1 ft
Above-pipe cover:	1 ft

### E.1 Example One

#### Data

LWSC site:	Shelby County, Region II
Drainage area (Larimer, 1957):	$A = 5.02$ mile <sup>2</sup>
Stream slope:	$S = 0.0013$
Streambed roughness:	$n = 0.04$
Stream width:	$w = 20$ ft

#### Criteria

Acceptable percent of time closed:  $e = 10\%$

#### Design

1. Design discharge. For 10% allowable closing time, the design discharge is determined from the equation in Figure 7:

$$Q_e = 4.57 \text{ cfs}$$

2. Unvented ford on channel bottom ( $h = H$ ), using Equation (3):

$$H = \left( \frac{nQ_e}{1.486wS^{1/2}} \right)^{3/5} = 0.35 \text{ ft}$$

This simplified equation is valid since  $w/H = 20/0.35 = 57$ , which is greater than 10 (see Section 3.2.1.1 and Equation (2)). Flow depth,  $h = 0.35$  ft, is less than design requirement ( $\leq 0.5$  ft). Therefore, a ford on the channel bottom is acceptable.

## E.2 Example Two

### Data

LWSC site:	Shelby County, Region II
Drainage area (Larimer, 1957):	$A = 6.32 \text{ mile}^2$
Stream slope:	$S = 0.0060$
Streambed roughness:	$n = 0.04$
Stream width:	$w = 20 \text{ ft}$

### Design

1. Design discharge for a 2% exceedence probability. The design discharge is determined from the equation in Figure 7:

$$Q_e = 35.63 \text{ cfs}$$

2. Unvented ford on channel bottom ( $h = H$ ), using Equation (3):

$$H = \left( \frac{nQ_e}{1.486wS^{1/2}} \right)^{3/5} = 0.75 \text{ ft}$$

This simplified equation is valid since  $w/H = 20/0.75 = 27$  which is greater than 10. Flow depth,  $h = 0.75 \text{ ft}$ , is greater than design requirement ( $\leq 0.5 \text{ ft}$ ). Therefore, a ford on the channel bottom is not acceptable.

3. Raised unvented ford ( $L = 20 \text{ ft}$ ,  $P = 2\text{-}4 \text{ ft}$ ), using Equation (6):

$$h = 0.233 Q_e^{0.599} L^{-0.493} = 0.45 \text{ ft, less than } 0.5 \text{ ft, acceptable.}$$

## E.3 Example Three

### Data

LWSC site:	Located in Region II of Iowa
Drainage area:	$A = 40 \text{ mile}^2$
Stream slope:	$S = 0.0019$
Streambed roughness:	$n = 0.04$
Stream width:	$w = 50 \text{ ft}$

### Design

1. Design discharge. For 2% allowable closing time, the design discharge can be determined from the equation in Figure 7,  $Q_e = 6.78A^{0.9}$ :

$$Q_e = 188 \text{ cfs}$$

2. Unvented ford on channel bottom ( $h = H$ ), using Equation (3):

$$H = \left( \frac{nQ_e}{1.486wS^{1/2}} \right)^{3/5} = 1.658 \text{ ft}$$

This simplified equation is valid since  $w/H = 50/1.658 = 30$ , which is greater than 10. Flow depth,  $h = 1.658$  ft, is greater than design requirement ( $\leq 0.5$  ft). Therefore, a ford on the channel bottom is not acceptable.

3. Raised unvented ford ( $L = 50$  ft,  $P = 2$ -4 ft), using Equation (6):

$$h = 0.233 Q_e^{0.599} L^{-0.493} = 0.8 \text{ ft, greater than 0.5 ft, not acceptable.}$$

4. Vented ford (corrugated metal pipe with inlet control and mitered entrance):

$$Q_{top} = 3.538 L^{0.823} = 88 \text{ cfs} \quad \text{Equation (10)}$$

$$Q_{vent} = Q_e - Q_{top} = 188 - 88 = 100 \text{ cfs} \quad \text{Equation (8)}$$

a. Using a design curve (see Section D.1). The required pipe size can be obtained from the design curves shown in Figure 11. Recommended pipe diameters are 4 ft if a single pipe is used ( $Q_{vent} = 100$  cfs), 3 ft each for two pipes ( $Q_{vent} = 50$  cfs), 2 ft for five pipes ( $Q_{vent} = 20$  cfs), and 1.5 ft for ten pipes ( $Q_{vent} = 10$  cfs).

b. Using HEC-5 charts (see Section D.2 and Figure D.1)

For a single pipe,  $Q_{vent} = 100$  cfs. Use  $D_a = 2(Q_{vent}/20)^{1/2} = 4.5$  ft as a reference trial.

$D_a$ (ft)	$D_a$ (in)	$P$ (ft)	HW (ft)	$HW/D_c$	$D_c$ (ft)	$ D_c - D_a /D_a$
3.5	42	4.5	5.33	2.43	2.19	0.373
<b>4</b>	<b>48</b>	<b>5</b>	<b>5.83</b>	<b>1.5</b>	<b>3.94</b>	<b>0.015</b>
4.5	54	5.5	6.33	1.02	6.20	0.378

Select 4 ft as the design size.

For two pipes,  $Q_{vent} = 50$  cfs. Use  $D_a = 2(Q_{vent}/20)^{1/2} = 3.2$  ft as a reference trial.

$D_a$ (ft)	$D_a$ (in)	$P$ (ft)	HW (ft)	$HW/D_c$	$D_c$ (ft)	$ D_c - D_a /D_a$
2.5	30	3.5	4.58	3.2	1.43	0.428
<b>3</b>	<b>36</b>	<b>4</b>	<b>4.83</b>	<b>1.6</b>	<b>3.0</b>	<b>0.0</b>
3.5	42	4.5	5.33	0.98	5.4	0.54

Select 3 ft as the design size and use two pipes.

For five pipes,  $Q_{vent} = 20$  cfs. Use  $D_a = 2(Q_{vent}/20)^{1/2} = 2.0$  ft as a reference trial.

$D_a$ (ft)	$D_a$ (in)	$P$ (ft)	$HW$ (ft)	$HW/D_c$	$D_c$ (ft)	$ D_c - D_a /D_a$
1.75	21	2.75	3.58	3.3	1.09	0.38
<b>2</b>	<b>24</b>	<b>3</b>	<b>3.83</b>	<b>1.93</b>	<b>1.98</b>	<b>0.0078</b>
2.25	27	3.25	4.08	1.27	3.21	0.43

Select 2 ft as the design size and use five pipes.

For ten pipes,  $Q_{vent} = 10$  cfs. Use  $D_a = 2(Q_{vent}/20)^{1/2} = 1.4$  ft as a reference trial.

$D_a$ (ft)	$D_a$ (in)	$P$ (ft)	$HW$ (ft)	$HW/D_c$	$D_c$ (ft)	$ D_c - D_a /D_a$
1.25	15	2.25	3.08	4.8	0.64	0.488
<b>1.5</b>	<b>18</b>	<b>2.5</b>	<b>3.33</b>	<b>2.1</b>	<b>1.59</b>	<b>0.06</b>
1.75	21	2.75	3.58	1.2	2.98	0.70

Select 1.5 ft as the design size and use ten pipes.

In summary, this vented ford would require one 4-ft pipe, two 3-ft pipes, five 2-ft pipes, or ten 1.5-ft pipes.

5. Pipe exit velocity, using Equation (11):

$$V_e = Q/(3.1417 D^2/4)$$

Computed exit velocities are 9.1, 7.1, 6.4, and 5.7 ft/s for one pipe (4 ft), two pipes (3 ft), five pipes (2 ft) and ten pipes (1.5 ft), respectively, all less than the 10 ft/s limit to prevent scour of channel.

#### E.4 Example Four

##### Data

LWSC site:	Benton County, Region I
Drainage area:	$A = 150 \text{ mile}^2$
Stream slope:	$S = 0.0015$
Streambed roughness:	$n = 0.04$
Stream width:	$w = 80 \text{ ft}$

##### Design

1. Design discharge for a 2% exceedence probability. The design discharge is determined from the equation in Figure 6:

$$Q_e = 616.19 \text{ cfs}$$

2. Unvented ford on channel bottom ( $h = H$ ), using Equation (3):

$$H = \left( \frac{nQ_e}{1.486wS^{1/2}} \right)^{3/5} = 2.74 \text{ ft}$$

This simplified equation is valid since  $w/H = 80/2.74 = 29$ , which is greater than 10. Flow depth,  $h = 2.74$  ft, is greater than design requirement ( $\leq 0.5$  ft). Therefore, a ford on the channel bottom is not acceptable.

3. Raised unvented ford ( $L = 80$  ft,  $P = 2\text{-}4$  ft), using Equation (6):

$$h = 0.233 Q_e^{0.599} L^{-0.493} = 1.26 \text{ ft, greater than 0.5 ft, not acceptable.}$$

4. Vented ford (corrugated metal pipe with inlet control and mitered entrance)

$$Q_{top} = 3.538 L^{0.823} = 130.32 \text{ cfs} \quad \text{Equation (10)}$$

$$Q_{vent} = Q_e - Q_{top} = 616.19 - 130.32 = 485.87 \text{ cfs} \quad \text{Equation (8)}$$

The required pipe size can be obtained from the design curves shown in Figure 11 or HEC-5 charts. Recommended pipe diameters are 8.5 ft if a single pipe is used ( $Q_{vent} = 486$  cfs), 6 ft each for two pipes ( $Q_{vent} = 243$  cfs), 4 ft for five pipes ( $Q_{vent} = 97.2$  cfs), and 3 ft for ten pipes ( $Q_{vent} = 48.6$  cfs). A low water bridge might be considered here.

5. Pipe exit velocity, using Equation (11):

$$V_e = 8.5 \text{ ft/s meets the requirement (10 ft/s).}$$

## E.5 Example Five

### Data

LWSC site:	Harrison County, Region II
Drainage area:	$A = 10.60 \text{ mile}^2$
Stream slope:	$S = 0.0023$
Streambed roughness:	$n = 0.04$
Stream width:	$w = 10 \text{ ft}$

### Design

1. Design discharge for 2% exceedence probability. The design discharge is determined from the equation in Figure 7:

$$Q_e = 56.76 \text{ cfs}$$

2. Unvented ford on channel bottom ( $h = H$ ), using Equation (3):

Flow depth,  $h = 2.0$  ft, is greater than design requirement ( $\leq 0.5$  ft). Therefore, a ford on the channel bottom is not acceptable.

3. Raised unvented ford ( $L = 10$  ft,  $P = 2\text{-}4$  ft), using Equation (6):

$$h = 0.233 Q_e^{0.599} L^{-0.493} = 0.84 \text{ ft, greater than } 0.5 \text{ ft, not acceptable.}$$

4. Vented ford (corrugated metal pipe with inlet control and mitered entrance)

$$Q_{top} = 3.538 L^{0.823} = 23.54 \text{ cfs} \quad \text{Equation (10)}$$

$$Q_{vent} = Q_e - Q_{top} = 56.76 - 23.54 = 33.22 \text{ cfs} \quad \text{Equation (8)}$$

The required pipe size can be obtained from the design curves (Figure 11) or HEC-5 charts. Recommended pipe diameters are 2.25 ft if a single pipe is used and 1.75 ft for two pipes.

5. Exit velocity (8.3 f/s) is acceptable, using Equation (11).

## E.6 Example Six

### Data

LWSC site:	Key Creek, Harrison County
Drainage area:	$A = 30.4 \text{ mile}^2$
Stream slope:	$S = 0.012$
Streambed roughness:	$n = 0.04$
Stream width:	$w = 30 \text{ ft}$

### Criteria

Above-pipe cover:	2 ft
-------------------	------

### Design

1. Design discharge for 2% exceedence probability. The design discharge is determined from the equation in Figure 7:

$$Q_e = 146.49 \text{ cfs}$$

2. Unvented ford on channel bottom ( $h = H$ ), using Equation (3):

Flow depth,  $h = 1.56$  ft, is greater than design requirement ( $\leq 0.5$  ft). Therefore, a ford on the channel bottom is not acceptable.

3. Raised unvented ford ( $L = 30$  ft,  $P = 2-4$  ft), using Equation (6):

$$h = 0.233 Q_e^{0.599} L^{-0.493} = 0.86 \text{ ft, greater than 0.5 ft, not acceptable.}$$

4. Vented ford (corrugated metal pipe with inlet control and mitered entrance)

$$Q_{top} = 3.538 L^{0.823} = 58.13 \text{ cfs} \quad \text{Equation (10)}$$

$$Q_{vent} = Q_e - Q_{top} = 146.49 - 58.16 = 88.36 \text{ cfs} \quad \text{Equation (8)}$$

The required pipe size is obtained from Equation (D.2) or HEC-5 charts. With a cover of 2 ft above the pipe, Equation (D.2) is modified to

$$Q_{vent} = 3.65 D^{2.5} \left( \frac{2.83}{D} + 0.25 - 0.7 S_o \right)^{1/2}$$

Substituting  $S_o = 0.012$  and  $Q_{vent} = 88.36$  and solving for  $D$ , the required pipe diameter is obtained as 3.5 ft. If using two pipes, the size would be 2.5 ft each. For three pipes, the design diameter is 2 ft each. The above equation could be plotted and used as a design curve for vented fords with a pipe cover of 2 ft.

5. Exit velocity (9.1 f/s) is acceptable, using Equation (11).