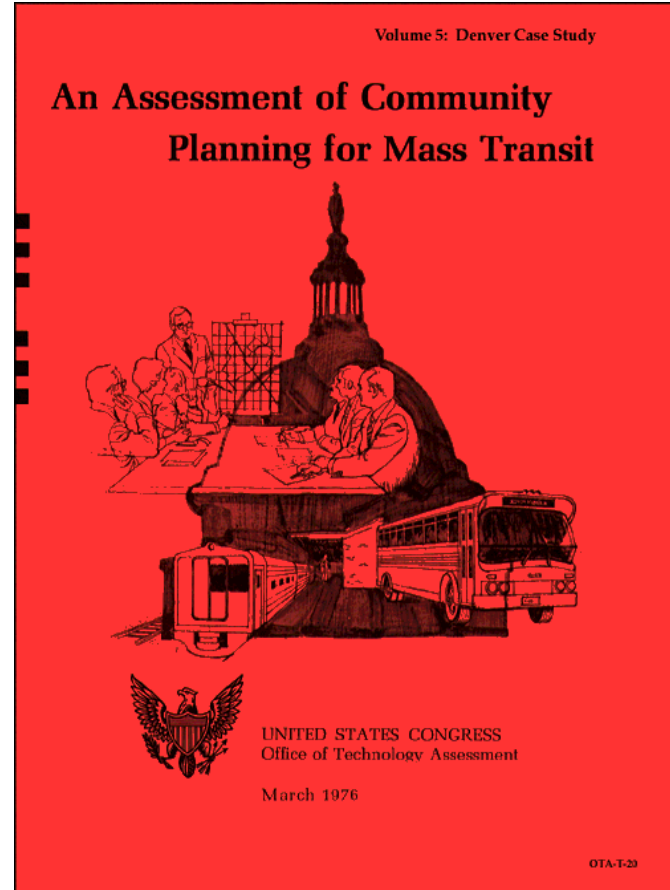


*Assessment of Community Planning for  
Mass Transit: Volume 5—Denver Case  
Study*

February 1976

NTIS order #PB-253683



# OFFICE OF TECHNOLOGY ASSESSMENT

## DIRECTOR'S OFFICE

Emilio Q. Daddario, Director

Daniel V. De Simone, Deputy *Director*

## URBAN MASS TRANSIT ADVISORY PANEL

George Krambles, *Chairman*, Chicago Transit Authority

Walter J. Bierwagen

*Amalgamated Transit Union*

Robert A. Burco

Oregon DOT

Jeanne J. Fox

*Joint Center for*

*Political Studies*

Lawrence A. Goldmuntz

*Economics and Science Planning*

Dorn McGrath

*George Washington University*

Bernard M. Oliver

Hewlett-Packard Corporation

Simon Reich

*Gibbs and Hill*

Thomas C. Sutherland, Jr.

*Princeton University*

Frederick P. Salvucci

Massachusetts DOT

Stewart F. Taylor

*Sanders and Thomas, Inc.*

## OTA TRANSPORTATION PROGRAM STAFF

Gretchen S. Kolsrud, *Program Manager*

Mary E. Ames

V. Rodger Digilio

Thomas E. Hirsch, 111

Larry L. Jenney

Bev Johnson

Teri Miles

## CONTRACTORS

Skidmore, Owings and Merrill

System Design Concepts, Inc.

# PREFACE

This report on urban transportation planning in the Denver, Colorado metropolitan area is one of nine case studies undertaken by the Office of Technology Assessment to provide an information base for an overall assessment of community planning for mass transit.

The findings of the overall study are reported in the summary document, *An Assessment of Community Planning /or Mass Transit*, which forms the first volume of this series. The assessment was performed at the request of the Committee on Appropriations of the U.S Senate, on behalf of its Transportation Subcommittee.

The study was directed by the Office of Technology Assessment's Transportation Program Staff with guidance and review provided by the OTA Urban Mass Transit Advisory Panel. The firms of Skidmore, Owings and Merrill and System Design Concepts, Inc., were contractors for the study. This assessment is a joint effort, identifying different possible points of view but not necessarily reflecting the opinion of any individual.

# INTRODUCTION

This report assesses how one of nine major United States metropolitan areas made its decisions about the development or modernization of rail transit.

The assessment of the nine cities attempts to identify the factors that help communities, facing critical technological choices, make wise decisions that are consistent with local and national goals for transit. The study investigates the following issues:

- . Are there major barriers to communication and cooperation among governmental agencies involved in transit planning and operating? Do these barriers interfere with making sound decisions?
- Do transit decisions reflect the combined interests of all major public groups, including citizen organizations, trade unions, the business community, and others?
- Does the planning process provide enough information about the advantages and disadvantages of alternative courses of action to provide a solid basis for making decisions?
- Does the availability or lack of financing, or the conditions under which financing has been provided, unnecessarily limit the range of options that are considered?

The ultimate purpose of the work has been to cast light on those prospective changes in national transit policy and administrative programs which might improve, in different ways and to different extents, the way communities plan mass transit systems. The nine cities were selected to represent the full range of issues that arise at different stages in the overall process of planning and developing a transit system.

San Francisco, for example, has the first regional rail system built in decades, while Denver is planning an automated system, and voters in Seattle have twice said “no” to rail transit funding proposals.

The assessment of transit planning in each of the nine metropolitan areas has been an inquiry into an evolving social process. Consequently, the study results more closely resemble historical analysis than classical technology assessment.

This study employs a set of evaluation guidelines to orient the investigation in the nine metropolitan areas and to provide the basis for comparative judgments about them. The guidelines were derived from issues identified during preliminary visits to the metropolitan areas, a review of Federal requirements for transit planning, and an investigation via the literature into the state-of-the-art in the field.

The evaluation guidelines cover major topics which were investigated during the case assessment process. They deal with the character of the institutional arrangements and the conduct of the technical planning process.

## GUIDELINES FOR ASSESSMENT: INSTITUTIONAL CONTEXT

Some of the most significant influences on transit planning are exerted by the organizations responsible for conducting the planning and making the decisions. Three guidelines were used to evaluate the institutional arrangements in the nine metropolitan areas:

- Agencies responsible for various aspects of transit decisionmaking should cooperate effectively in a clearly designated “forum”.
- The participants in this forum should have properly designated decisionmaking authority, and the public should have formal channels for holding decisionmakers accountable for their actions.
- Citizens should participate in the transit planning process from its beginning and should have open lines of communication with decisionmakers.

## **GUIDELINES FOR ASSESSMENT: TECHNICAL PLANNING PROCESS**

The technical planning process provides the information that public officials and their constituents draw upon in making plans and decisions. Four guidelines were used to assess the technical planning process in the nine metropolitan areas:

- Broad, explicit goals and objectives should guide technical planning and decision-making.
- A range of realistic alternative solutions should be developed.
- The evaluation of these alternatives should give balanced consideration to a full range of goals and objectives.
- A practical and flexible plan for financing and implementation should be developed.

During visits to each of the nine metropolitan areas, the study team interviewed the principal representative of the transportation planning

institution and other main participants in the local planning process. The visits were supplemented by interviews with UMTA officials in Washington. Pertinent documents—official plans, reports, studies, and other material—were reviewed in each case.

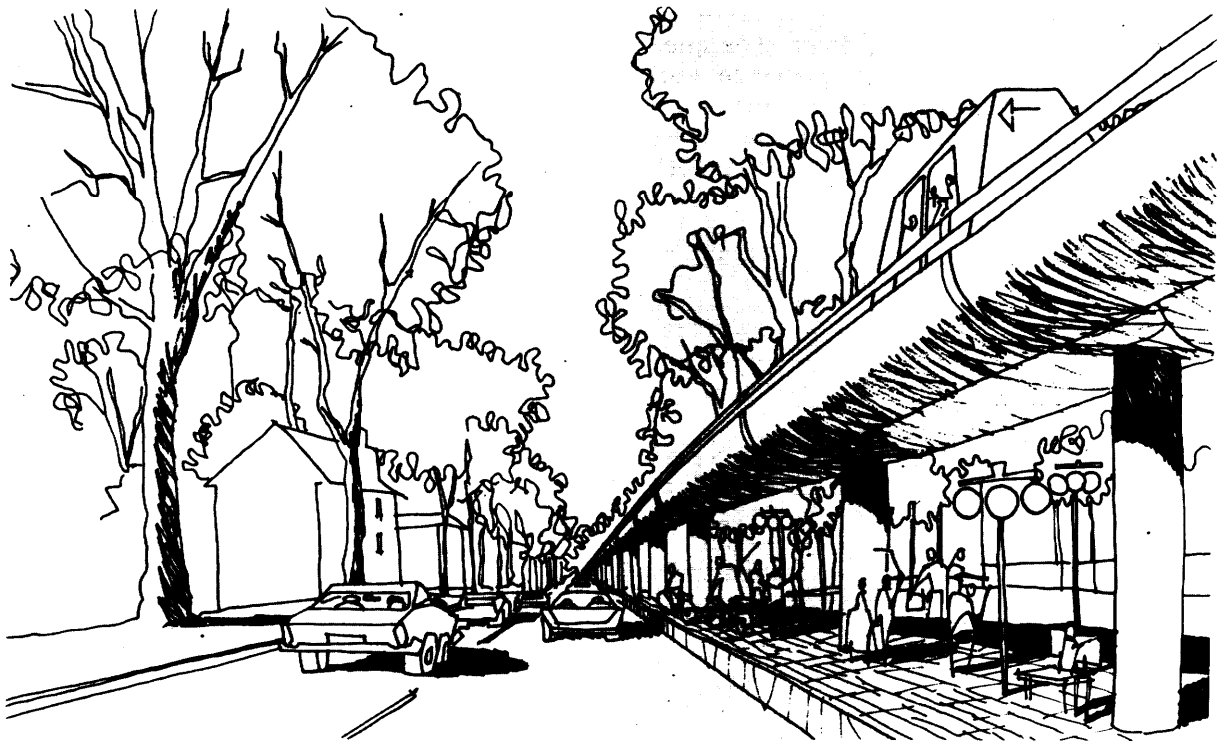
The information thus collected was used in compiling a history of the transit planning process in each case area, organized around key decisions such as the decision to study transit, the selection of a particular transit system, and public ratification of the decision to pay for and build the system. The main political, institutional, financial and technical characteristics affecting the conduct of the planning process were then assessed in light of the evaluation guidelines.

The same set of guidelines used in assessing each case metropolitan area was employed in making a generalized evaluation of the metropolitan experience. The results of the generalized evaluation are summarized in the report, *An Assessment of Community Planning for Mass Transit: Summary Report*, issued by the Office of Technology Assessment in February 1976.

# CONTENTS

SUMMARY AND HIGHLIGHTS . . . . .	1
METROPOLITAN SETTING . . . . .	3
General Characteristics . . . . .	3
Existing Transportation System . . . . .	3
Transportation Planning Institutions . . . . .	6
CRITICAL HISTORY OF TRANSIT PLANNING AND DECISIONMAKING . . . . .	9
Decision to Study Transit . . . . .	9
Decision to Approve a Transit Financing Plan in1973 . . . . .	10
Selection of the ART System . . . . .	15
CHRONOLOGY OF THE TRANSIT PLANNING PROCESS . . . .	19
ASSESSMENT OF THE PLANNING AND DECISIONMAKING PROCESS . . . . .	21
Institutional Context . . . . .	21
Technical Planning Process . . . . .	23
SUMMARY CASE ASSESSMENT . . . . .	34

# Summary and Highlights



Artist's sketch of the personal rapid transit system proposed for Denver in 1973

- It was not until 1971 that serious planning for a modern rapid transit system began in Denver.
- Transit planners in Denver capitalized upon environmental concerns, especially growing air pollution and suburban sprawl, to help generate enthusiasm and acceptance for their transit proposals.
- Land use, highway, and transit plans in the Denver area are well coordinated, and the agencies responsible for these plans are reasonably successful in working together through a formal contractual agreement. The highway and transit agencies have the authority and usually the money to implement their plans, while the land use planning agency has little or no implementation authority.
- The current Denver regional land use plan was developed in 1972 in conjunction with the transit plan and reflects the environmental concern of the citizens by directing growth away from environmentally unsuitable areas. The proposed transit plans for Denver have been presented as contributing to implementation of the land use plan.
- In 1973 voters in Denver adopted a financing plan for a rapid transportation program. Although no technology was specifically identified, public discussion before the election prominently featured personal rapid transit. In addition, UMTA's placement of a PRT demonstration project in Denver and the views of the Regional Transportation District's ex-

ecutive director and senior consultants contributed to the climate of opinion favoring PRT.

- In 1974 UMTA insisted upon an alternatives analysis before funding of the system would be considered. The alternative analysis was completed in April 1975 and recommended an Automated Regional Transit (ART) system, which uses less advanced technology than PRT.

This system was approved by all of the regional transportation and planning authorities in June 1975.

- The most recent alternatives analysis illustrates the difficulties in providing complete information about a full range of transit alternatives when local official and public support for a particular option is expressed from the beginning.



# Metropolitan Setting

## GENERAL CHARACTERISTICS

Denver, the largest city between Kansas City and the west coast, is a wholesale, service, manufacturing, research, and governmental center for a large portion of the plains and mountain States. It is the capital and principal city of the State of Colorado.

In the decade between 1960 and 1970 Denver was among the 10 fastest growing metropolitan areas in the United States. During this period the population of the Denver region grew by more than a third to over 1.2 million. In 1970 Denver ranked twenty-seventh in SMSA population.

Between 1960 and 1970 over half of the population growth represented net migration as families were drawn by economic opportunities and by Denver's clean attractive environment. Most of the new arrivals settled in the suburban ring, which grew at a much faster pace than Denver itself in spite of annexations (see Figure 2). The change in work trip distribution between 1960 and 1970 reflects the greater growth in the suburbs. The percentage of work trips beginning and ending in the suburban ring increased from 25 percent to 34 percent of total areawide work trips over the decade (see Figure 3).

The relatively high rate of growth in the low-density suburbs and the fast growth of suburban employment centers has contributed to the decline in the use of transit in the Denver metropolitan area and increased reliance upon the automobile. In 1970, 89 percent of residents of Denver suburbs and 80 percent of city residents drove to work. Only 2 percent of suburbanites and 8 percent of city residents rode transit; regionwide, 4.2 percent of work trips used transit. These percentages are lowest of the nine cities studied in this report. Even in Los Angeles, 5 percent of all SMSA work trips and 9.2 percent of work trips originating in Los Angeles City used transits

<sup>1</sup> See Figure 1, pages 12 and 13.

<sup>2</sup> Denver is a city-count jurisdiction that operates as a single unit of government called the City and County of Denver.

<sup>3</sup> American Institute of Planners and Motor Vehicle Manufacturers of the U. S., Inc., *Urban Transportation Fact Book*, 1974.

## EXISTING TRANSPORTATION SYSTEM

The extensive low-density pattern of development in the Denver area has been well suited to automobile transportation, which almost totally dominates travel in the region. Denver has one of the highest automobile ownership rates in the Nation (with 1.46 autos per household), and 20 times more work trips were taken by automobile than transit in 1970.

Denver has an extensive grid of major arterial streets that is supplemented by two major interstate routes and their spurs. Interstate 70 passes through Denver just north of the CBD going east to west. North-south routes are I-25, which passes just west of downtown, and I-225, which runs east of the city. Denver does not yet have a circumferential highway. However, I-470, planned for a corridor south and west of the city, would complete a loop. This highway is currently the subject of a dispute between the Colorado State Highway Commission, which has directed the road to be built, and the Governor, who, supported by many environmentalists, opposes the highway.

The existing highway network services the auto traffic in the area so adequately that traffic is free flowing except in a few locations even at the height of the rush hour. However, the reliance upon the automobile has contributed to a severe increase in air pollution, and Denver now ranks among the six cities in the United States with the worst air quality problems. 4

Public transportation is provided by about 350 diesel buses on 987 miles of one-way routes oriented toward the central business districts. Between 1960 and 1970 transit ridership decreased by 60 percent as the privately owned Denver Tramway System raised fares from 25 cents to 40 cents and cut service in an attempt to stay solvent. Since the public takeover in 1971, fares have been

<sup>4</sup> *RTD Transit Development Program 1975-80*, March 1975, p. 2-4.

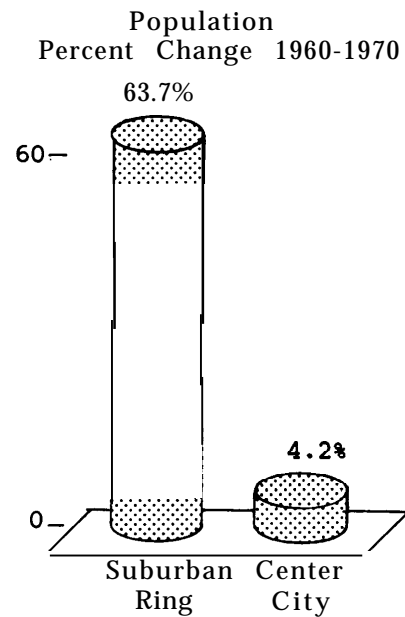
<sup>5</sup> As of January 1, 1975, however, since then RTD has expanded its service by acquiring additional bus operations in the area, and by expanding its bus fleet.

LAND AREA

(in square miles)	1960	1970
Suburban Ring	3,592.0	3,564.8
Center City	68.0	95.2

POPULATION

	<u>Suburban Ring</u>	<u>Center City</u>
1960	435,496	493,887
1970	712,851	514,678



DENSITY

(population/square mile)

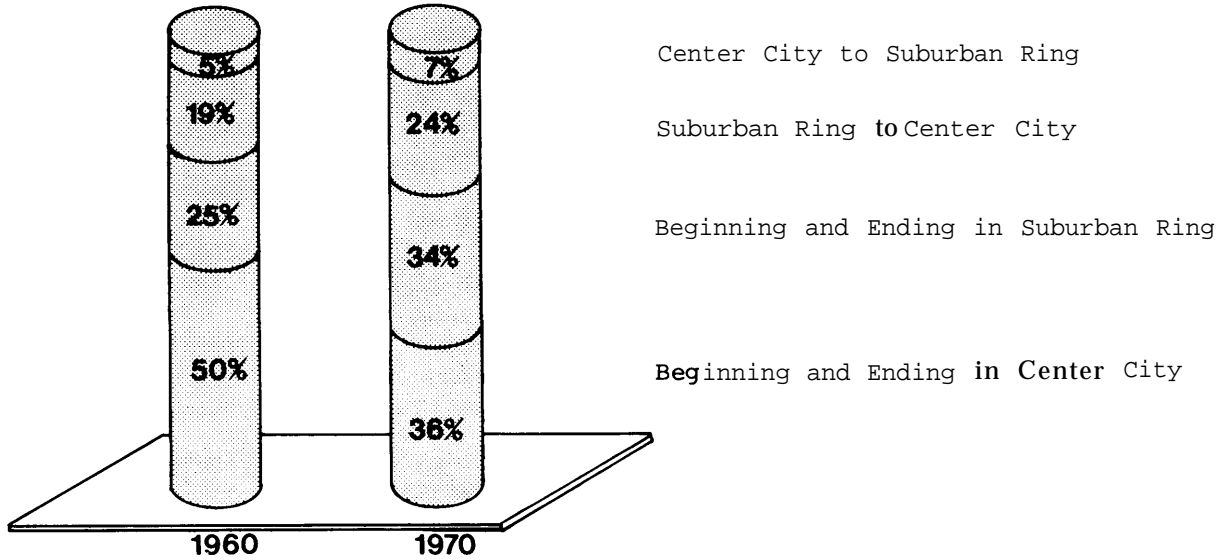
	<u>Suburban Ring</u>	<u>Center City</u>
1960	121	7,263
1970	200	5,4061

**FIGURE 2: DENVER METROPOLITAN AREA CHARACTERISTICS**

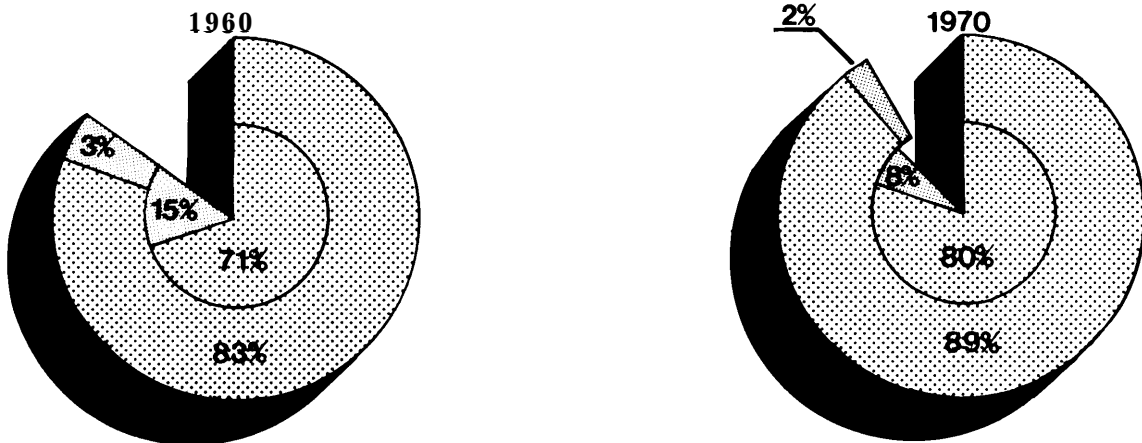
The change in Denver City's density reflects the **annexation** of 27 miles into the city between 1960-1970.

A Standard Metropolitan Statistical Area (SMSA) includes a center city (or cities), usually with a population of at least 50,000, plus adjacent counties or other political divisions that are economically and socially integrated with the central area.

**WORK TRIP DISTRIBUTION**

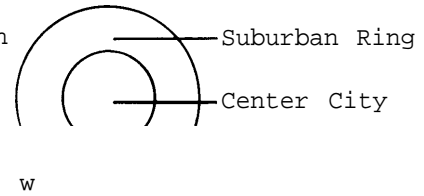


**WORK TRIP MODE**



Employed Residents Using Public Transportation  
 Employed Residents Using Autos

Remaining workers either walked to work, stayed at home, or did not report mode.



**FIGURE 3: DENVER SMSA TRAVEL CHARACTERISTICS**

Source: Urban Transportation FactBook, American Institute of Planners and the Motor Vehicle Manufacturers Association of the U.S., Inc., 1974.

A Standard Metropolitan Statistical Area (SMSA) includes a center city (or cities), usually with a population of at least 50,000, plus adjacent counties or other political divisions that are economically and socially integrated with the central area.

lowered to 35 cents during the peak and 25 cents in the offpeak, service has been increased (including the expansion of intrasuburban routes), and ridership has risen more than 50 percent to over 24 million passengers in 1974 (see Figure 4). Most of the bus service is now owned and operated by the Regional Transportation District (RTD), which coordinates service throughout the Denver-Boulder area.

The fixed guideway system planned for the Denver area is not scheduled to be under construction until early 1978, and is not scheduled to begin initial revenue operations until 1981. In the meantime, RTD is planning extensive upgrading of bus service in the area.

## TRANSPORTATION PLANNING INSTITUTIONS

The organizational framework for transportation planning in the Denver area is distinguished by the strong contractual arrangement between the three regional and State agencies most concerned with transportation, which have joined to form the Joint Regional Planning Program (JRPP). The three agencies represented in JRPP are the Regional Transportation District (RTD), which is responsible for transit planning, construction, and operation; the Colorado Division of Highways (CDH), which has similar responsibilities for highways; and the Denver Regional Council of Governments (DRCOG), which is responsible for land use planning in the Denver area.

TABLE I.—Federally Recognized Regional Agencies

Designation	Agency
A-95	Denver Regional Council of Governments
MPO	Joint Regional Planning Program

### Joint Regional Planning Program (JRPP)

JRPP was established in early 1971 when RTD, CDH, and DRCOG joined together to coordinate transportation and land use planning in the Denver region. JRPP has been designated by Federal

transportation agencies to coordinate transportation planning and programming for the region. b

As established in a recent internal reorganization process, the decisionmaking body within JRPP is a collective regional directorate comprised of the executive directors of RTD, DRCOG, and CDH. The three executives are required to reach unanimous agreement on any action or policy recommendation. Their recommendations are presented to the DRCOG, which is empowered to act on behalf of JRPP for planning and management. In this role DRCOG can approve (or reject) a recommendation from the collective regional director but cannot modify the recommendation in any way unless the regional directorate approves.

The reorganization plan provided JRPP with a citizens' advisory committee composed of the DRCOG Citizens' Advisory Committee, the Steering Committee of the RTD Citizen Action Committee, and other citizens selected by the regional directorate. The citizens' committee is instructed to set up meetings between the regional director body and the public," in addition to other duties.

### Regional Transportation District (RTD)

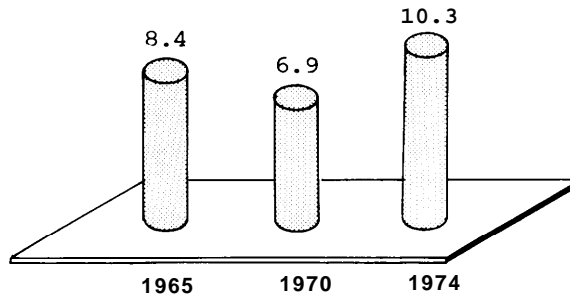
RTD is responsible for both long- and short-range transit planning (subject to JRPP approval), for operating most of the transit systems in the Denver area, and for implementing long- and short-range plans. RTD's area of jurisdiction includes the City and County of Denver, Boulder, Douglas, and Jefferson counties, and western portions of Adams and Arapahoe counties (see Figure 1). RTD is governed by a 21-member board of directors. Directives from the board are carried out by RTD's staff, which is headed by an executive director.

---

◦ The Urban Mass Transportation Administration and the Federal Highway Administration require Governors to designate a Metropolitan Planning Organization (MPO) in each area to carry out the "continuing, comprehensive transportation planning process. . . carried out cooperatively . . ." (the "3-C" process) mandated by the Federal-Aid Highway Act of 1962 and the Urban Mass Transportation Assistance Act of 1974. According to joint UMTA-FHWA regulations published in September 1975, MPO's must prepare or endorse (1) a long-range general transportation plan, including a separate plan for improvements in management of the existing transportation system; (2) an annually updated list of specific projects, called the Transportation Improvement Program (TIP), to implement portions of the long-range plan; and (3) a multi-year planning prospectus supplemented by annual unified planning work programs.

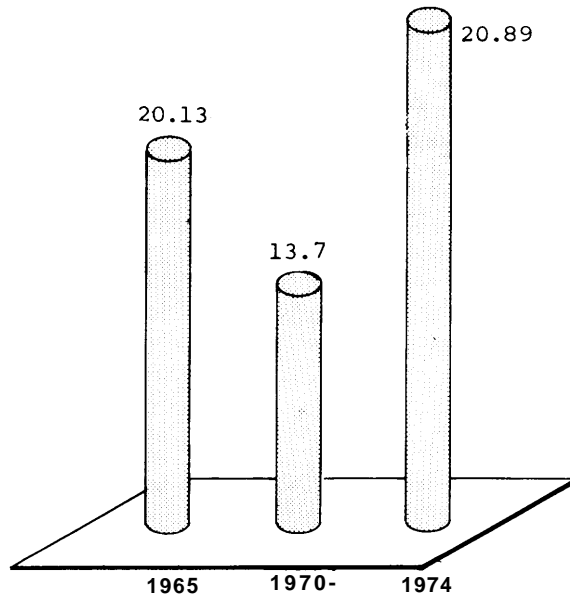
VEHICLE MILES OPERATED  
(millions of miles)

Peak Year= 1974 (10.3 million miles)  
Low Year= 1970 (6.9 million miles)



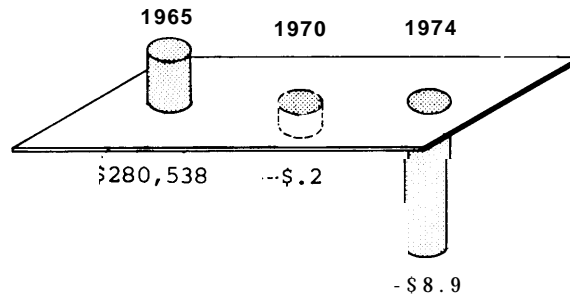
REVENUE PASSENGERS  
(millions of passengers)

Peak Year= 1974 (20.9 million riders)  
Low Year= 1970 (13.7 million riders)



NET OPERATING REVENUE  
(millions of dollars)

Peak Year= 1965 (\$280,538)  
Low Year= 1974 (-\$8,863,147)



**FIGURE 4: DENVER TRANSIT OPERATIONS, 1965- 1974**

No data on Denver transit operations was reported in 1972.

Source: American Public Transit Association records for the Denver Tramway Corporation and the Regional Transportation District.

A Standard Metropolitan Statistical Area (SMSA) includes a center city (or cities) , usually with a population of at least 50,000, plus adjacent counties or other political divisions that are economically and socially integrated with the central area.

Besides fares and Federal grants, RTD has three major sources of funds: (1) a one-half mill property tax for planning, (2) a two mill property tax to cover operating deficits, and (3) a one-half cent sales tax for operations, capital construction, equipment, and debt repayment.

#### **Colorado Division of Highways (CDH)**

CDH is a State agency directly under the Colorado State Highway Commission, a semi-independent commission appointed by the Governor. CDH is responsible for planning (subject to JRPP approval in the Denver area), location, design, construction, and maintenance of State highways.

#### **Denver Regional Council of Governments (DRCOG)**

DRCOG is the weakest of the three agencies represented in the JRPP. DRCOG has no independent funding authority and has no power to implement either land use or transportation plans. It is, however, the A-95 agency and thus must review and approve urban area plans.

---

<sup>7</sup> Circular A-95 of the Federal Office of Management and Budget requires one agency in each region to be empowered to review all proposals for Federal funds from agencies in that region. Circular A-95 replaced Circular A-82, which was created to implement Section 204 of the Demonstration Cities and Metropolitan Development Act of 1966 (42 U.S.C. 3301).

DRCOG is responsible for compiling land use and transportation information and developing and evaluating land use and transportation models. DRCOG also is directed to identify natural and manmade physical characteristics influencing regional development, to identify and project requirements for community facilities and services, and to prepare land development criteria and standards. While in theory DRCOG has responsibility for land use planning in the Denver region, most of the actions required to implement land use plans are taken by local governments or private developers, over which DRCOG has little control.

DRCOG'S jurisdiction extends over an area that includes the City and County of Denver, and Jefferson, Adams, Arapahoe, Boulder, Douglas, Gilpin, and Clear Creek counties. Most counties and cities within the area delegate representatives to the DRCOG board of directors. A staff carries out the policy directives of the board.

#### **City and County of Denver**

The City and County of Denver functions as a jurisdictional unit. Through its City Planning Department Denver has participated in many of the transportation studies in the Denver region, including several studies designed to encourage continued downtown growth. Since RTD was created, Denver City, which is well represented on the RTD board, has tended to participate in transit planning within that forum.

# Critical History of Transit Planning and Decisionmaking

Ten years ago few people thought Denver needed a fixed guideway transit system. Most residents of Denver's low-density urbanized area could travel easily by automobile. Since then, however, worsening air pollution and other impacts of growth have sharpened concern for environmental quality among the residents of the area and, in turn, aroused interest in fixed-guideway transit.

While popular support for mass transit was growing, several factors encouraged the development of automated transit for Denver. Increasing bus system deficits inspired a search for a more efficient approach to transit operations. UMTA'S Center City Transportation Project in 1970 suggested a PRT link for downtown Denver, thus ins talling the PRT concept as a popular favorite. The relocation of many advanced technology companies to the Denver area provided a reservoir of experts with skills and interest in new technology. This was the context that shaped transit planning in Denver.

The following history covers the decision making process in Denver from its beginnings in regional highway-oriented studies through the recent system selection decision. The discussion is organized around three key decision periods: (1) the decision to study transit that was implicit in the establishment of a regional transit planning and operating authority; (2) the decision to approve a transit financing plan in 1973; and (3) the period of reevaluation leading to the decision to select an automated rapid transit system in 1975,

## DECISION TO STUDY TRANSIT

Until the late 1960's Denver was strictly a highway-oriented city. Support for transit grew out of an interest in environmental protection and control of future growth that swept the region (and the rest of the Nation) at the turn of the decade. In short order the environmentalists had joined forces with city officials, civic groups, and businessmen

concerned about financial difficulties of the city's bus company to negotiate the establishment of a powerful regional transit authority that could plan improvements in the area's transit service.

Transportation planning in the Denver metropolitan area began in the early 1940's with origin-destination studies performed by the Colorado Division of Highways (CDH). In 1957, the U.S. Bureau of Public Roads provided funds that allowed CDH to sponsor the first Denver Metropolitan Area Transportation Study (DMATS). DMATS was jointly carried out by CDH, the Inter-County Regional Planning Commission (the predecessor of DRCOG), and the City and County of Denver. Financed primarily by Federal highway and HUD 701 funds, DMATS concentrated on planning a highway network. The study forecast that a maximum of only 4 percent of total trips in Denver would use public transportation.

In the late 1960's the highway orientation of DMATS alarmed many citizens who felt that additional highways might turn Denver into a Los Angeles-type spread city. Transit was viewed as a tool for shaping a more desirable urban form. Environmental organizations, concerned citizen groups, and the Metropolitan League of Women Voters therefore began to promote transit.

During the same period, the Denver Tramway Corporation, the principal transit operator in the region, was encountering increasingly difficult financial circumstances. The Denver Chamber of Commerce set up a transportation committee to investigate remedies to these fiscal problems.

Both the citizen groups and the businessmen advocated the creation of an independent regional transit agency with taxing authority to plan, construct, and operate transit facilities in the Denver metropolitan area. They were joined by officials from the City and County of Denver in lobbyin<sub>g</sub> the Colorado State Legislature to create such an agency.



Environmental concerns—including auto-created smog—were a major factor behind public support for a new transit system in Denver

In 1969, the Center City Transportation Project began discussing a proposal to build a PRT system from the Denver's Mile High Stadium to the CBD.<sup>8</sup> This system would allow CBD commuters to park at the stadium and ride the PRT downtown. The recommendation for PRT rather than a more conventional transit technology was significant. PRT was popular in Denver from the beginning of public attention to transit needs. Both UMTA and the transit industry considered PRT a promising new system. While no particular technology was promoted at that time, PRT was generally assumed to be the only transit system suitable for Denver's low-density land use patterns,

These various developments and pressures persuaded State legislators to stand behind Denver's transit initiatives. In 1969 the Colorado State Legislature established the Regional Transportation District (RTD). RTD was mandated to develop a transit plan and hold a financing referendum for it within 5 years. After gaining voter approval, RTD could construct and operate the transit system.

<sup>8</sup> Arthur D. Little, Skidmore, Owings & Merrill et al., *Denver, Center City Transportation Project*, Washington, D. C., 1971.

## DECISION TO APPROVE A TRANSIT FINANCING PLAN IN 1973

RTD's planners worked in a climate in which a majority of Denver's residents were solidly in favor of PRT. A carefully integrated land use and transportation planning effort with continuous involvement of citizens and local officials had no trouble in reaching a consensus to recommend a long-range plan for a PRT system and a complementary early action bus improvement program. The proposal won public support in the September 1973 referendum as voters approved a one-half cent sales tax authority for RTD.

When it was created in 1969, RTD actively sought to coordinate land use and transportation planning. The consultant RTD hired to prepare a long-range transit development plan in 1971 was an interdisciplinary team. The joint venture of Development Research Associates (DRA) and Wallace, McHarg, Roberts and Todd (WMRT) was chosen from among 13 bidders. The winning team's three-step planning process proposed to (1) survey the goals and desires of the community; (2) forecast



a land use plan acceptable to the citizens and public agencies in the area; and (3) then design a transportation package tailored to implement the land use plan. Kaiser Engineers was later added to the team.

An integrated planning approach was being institutionalized in the Denver region at that time. In 1971 RTD had entered into an agreement with the Denver Regional Council of Governments (DRCOG) and the Colorado Department of Highways (CDH) to establish the Joint Regional Planning Program (JRPP). The JRPP was structured to coordinate land use planning, highway planning, and public transportation planning. Within that framework the three agencies cooperated in assembling data for the first phase of the DRA-WMRT study. DRCOG supervised and coordinated the demographic projections. Local governments also contributed data to the plan.

In spring 1972 DRA-WMRT completed its Phase I report, *A CorIcept*. The study surveyed the ecological and social composition of the region and included a development plan and preliminary transportation data. Seven county profiles in separate documents supplemented the report. It was adopted by all three agencies—RTD on February 1973, CDH in August 1973, and DRCOG in December 1973.

The development plan relied heavily upon environmental factors in determining the best locations for future growth. Hazards to development, such as poor soil and drainage conditions and steeply sloping topography, were identified along with ecologically fragile or valuable areas—watersheds, rare wildlife habitat, and the like. Environmentally advantageous sites for new development were located. The plan proposed that much of the new growth be sited in already developed areas so that suburban sprawl would be curtailed. According to this policy of encouraging more concentrated development, Denver City was forecast to gain 90,000 inhabitants by the year 2000, whereas trend projections expected only 50,000 new residents. A series of activity centers were identified where high density growth would be located and urban services concentrated. g

The strong environmental influence in the land use plan was consistent with prevailing opinion of the citizens and leaders in Denver at the time. RTD

---

<sup>g</sup> The activity centers are shown on Figure 5, Denver Recommended Transit System, page 14.

had been created in 1969 under the influence of a number of individual environmentalists. But by 1972 environmentalism had taken hold among the general public. That year, as RTD's land use plan was released, fears about uncontrolled growth led area voters to refuse to host the 1976 Winter Olympics.

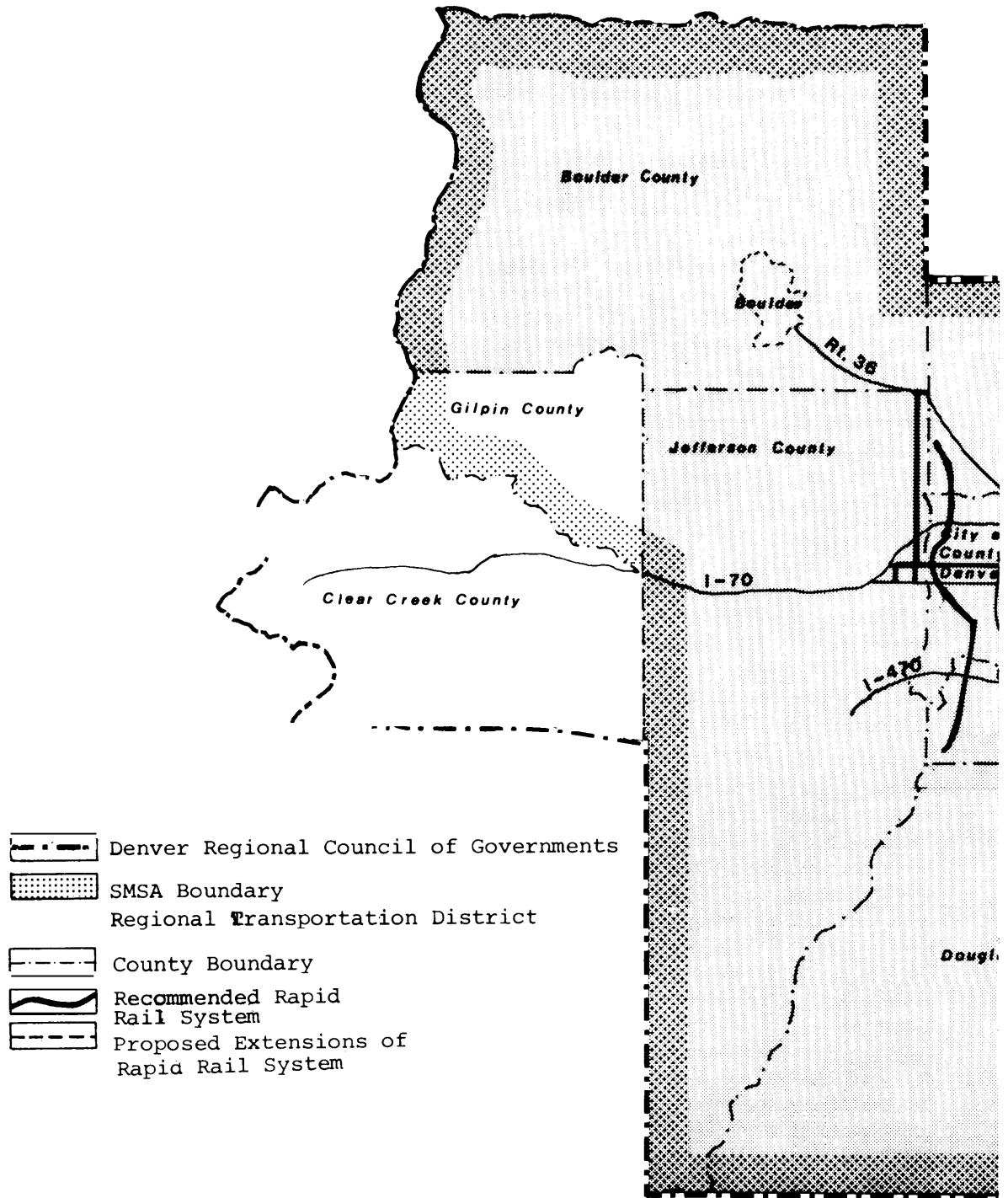
DRA/WMRT incorporated these popular concerns into its transit and land use plans. In 1971 RTD established Citizen Action Committees (CAC). CAC'S included many of the same people who, out of interest in relating transit and land use policy, had helped create RTD. They worked closely with the DRA-WMRT team as it surveyed the goals and desires of the community and developed a land use plan.

In June 1973 DRA-WMRT published its final report, *Phase 11: A Public Transportation Plan*. The plan called for a 98-mile personal rapid transit-type system supplemented by a bus feeder system and included an "early action plan" for immediate bus improvements. The transit system would utilize 12-passenger unattended vehicles that a patron could summon to a station and direct to his destination like a horizontal elevator. Such a "personalized" system appeared to be highly competitive with the private automobile. The report projected an appealingly low operating cost for the proposed system—lower than for a similar level of bus service.

The PRT concept was endorsed by the three agencies in JRPP in spite of the apparent risk inherent in an unproven technology. The reasons for its acceptance can be found in the series of events that had unfolded since RTD was created.

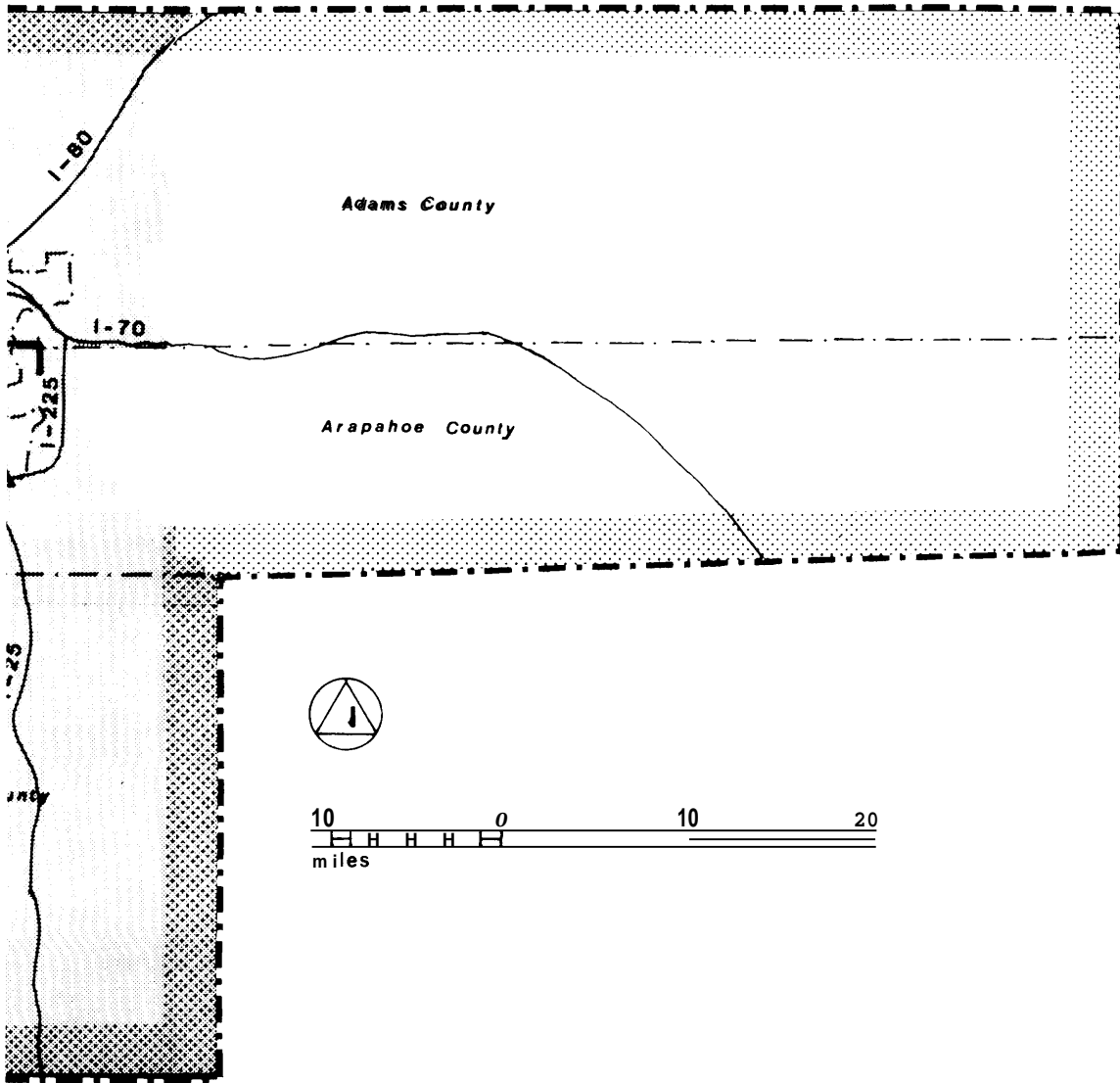
First, while RTD was being organized, another PRT project was proposed for Denver. (The first proposed PRT had been the Center City Transportation Project CBD shuttle.) The new proposal was UMTA'S "Demo B" project, which would provide for construction and operation of a demonstration PRT system. In 1972 Dr. Robert Hemmes, Assistant Administrator for UMTA'S Research and Development program, announced that Denver would be the site for the "Demo B."

Meanwhile RTD hired an executive director, Harry Parrish, who was interested in PRT. RTD's consulting team included Bill Eager, a planner who had previously worked for Boeing, which was developing its own PRT technology. Eager helped shape RTD's "family of vehicles" concept, which

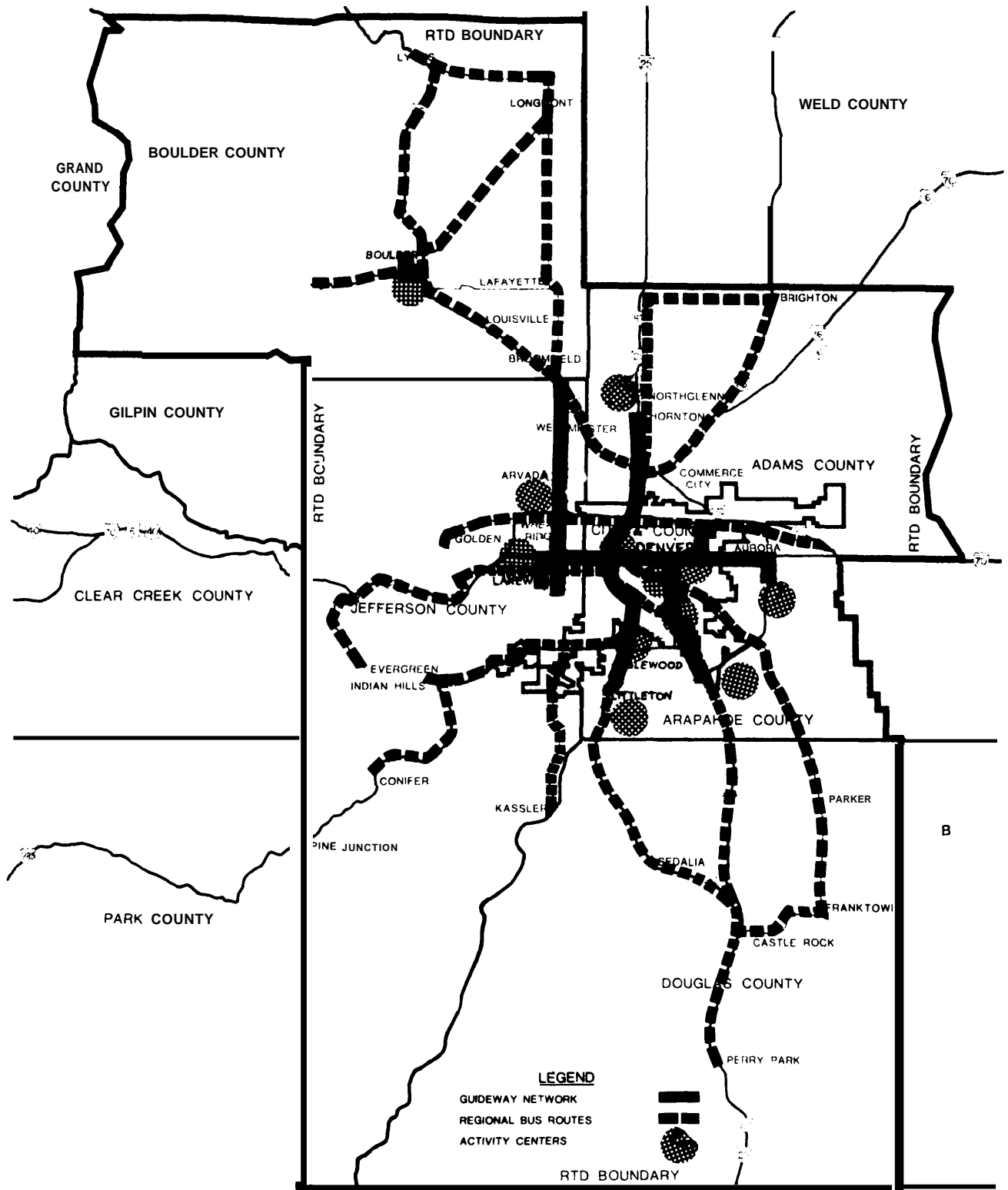


**FIGURE 1: DENVER METROPOLITAN AREA**

A Standard Metropolitan Statistical Area (SMSA) includes cities), usually with a population of at least 50,000, plus other political divisions that are economically and socially integrated with the central area.



Inter city (or adjacent counties) integrated



**FIGURE 5: DENVER- RECOMMENDED TRANSIT SYSTEM**

Source: Regional Transportation District, Long Range Transit Development  
 Analysis: Transit Concept Comparison, April 1975.

called for use of new technologies where appropriate.

During the same period a conference on PRT in the Denver area generated considerable enthusiasm about new-technology transportation systems. An additional factor favoring PRT was the movement to Denver of several advanced-technology research and development firms, including Martin Marietta Aerospace and Transportation Technology, Inc., whose enthusiasm for developing new technologies may have added to the atmosphere in favor of new technology in Denver.

PRT also looked appealing for practical reasons. In April 1971 Denver took over bus transit operations from the local operators. The public agency incurred growing deficits that totaled nearly \$4 million by the end of 1973. The large deficit tended to make capital-intensive systems such as PRT more attractive than conventional bus and nonautomated rail transit. Theoretically, automated systems cost less to operate principally because of lesser labor costs per passenger. Another reason behind popular enthusiasm for improved transit was a gasoline shortage in the Denver area in 1973.<sup>10</sup>

After publication of its Phase I and II reports, RTD assembled a campaign to cement the public support behind the PRT plan and a financing plan to implement it. Before the referendum, RTD drafted and gained approval for legislation that substituted a sales tax increase for the general property tax contemplated in the original RTD legislation. The one-half cent sales tax was expected to generate \$1.5 billion (including the Federal share) to implement the RTD plan, if the financing plan was approved in referendum. At the same time the legislature acted to permit a second referendum if voters rejected the RTD plan during the first trip to the polls.

RTD's strategy for promoting the plan to the public included surveys, media advertisements, campaign mailings, special fund-raising committees, and speaking tours. During the campaign citizen advisory committees actively promoted the RTD plan by holding informational meetings and distributing literature.

The election was scheduled for September 1973, although RTD could have waited as much as a year

<sup>10</sup> The gasoline shortage in the Denver area occurred prior to the nationwide fuel shortages of fall and winter 1973-74.

longer. The referendum was timed to take advantage of popular support for the efforts to address environmental issues in Denver, which had been expressed in the decision to reject the 1976 Olympics sponsorship.

Technically, the issue before the voters at referendum was RTD's request to levy the one-half cent sales tax. However, the tax was linked closely to a promotional campaign for the PRTs system. The RTD literature made direct reference to PRT, and a few weeks before the vote several firms displayed their PRT vehicles in Denver. In addition, the RTD board promised to consult the people again if the transit system finally selected was substantially different from PRT. The campaign strategy was successful, and on September 7, 1973, 57 percent of Denver region voters registered approval.

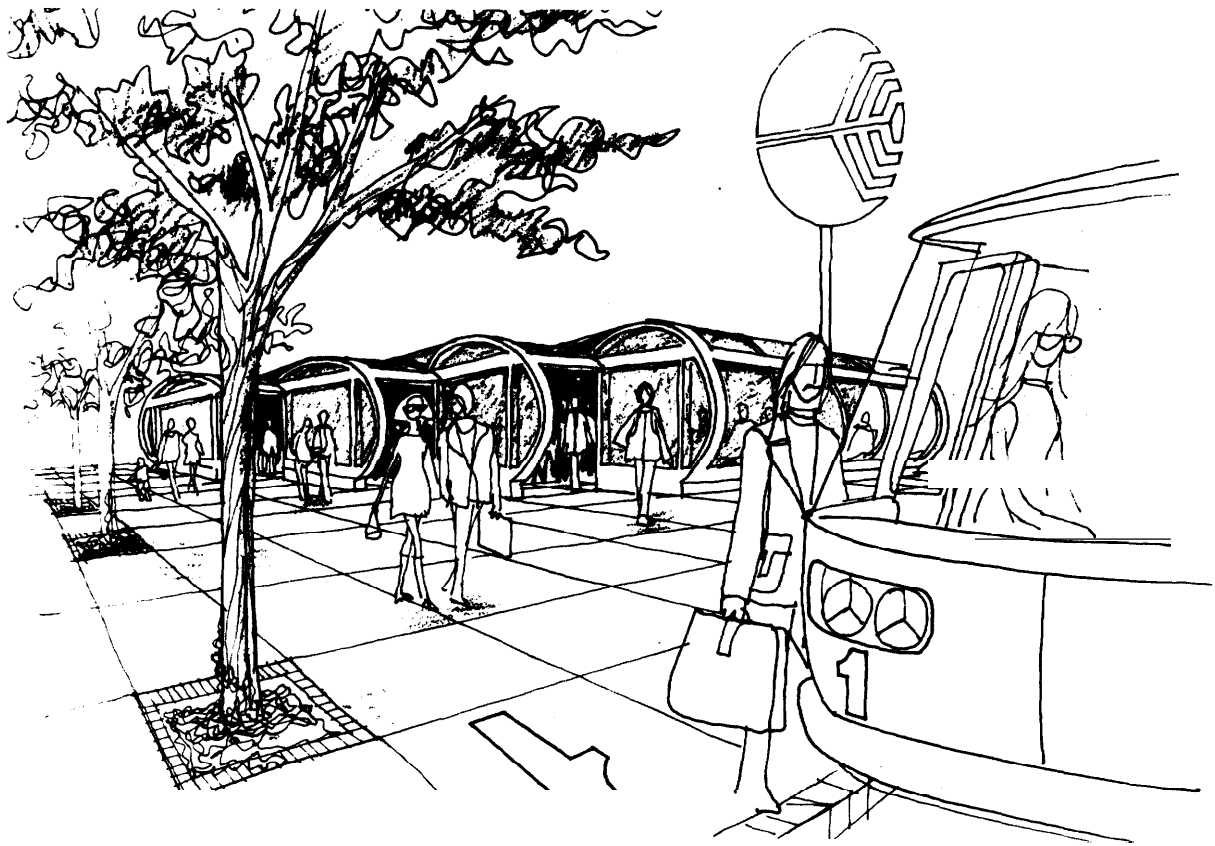
## SELECTION OF THE ART SYSTEM

After the referendum vote, RTD's progress toward implementing the transit proposal temporarily reversed. UMTA required RTD to evaluate a full range of alternatives to the PRT concept before proceeding with preliminary design. RTD carried out an alternatives analysis and produced a plan which, although the PRT concept is considerably modified, nevertheless enjoys broad-based popular support.

UMTA began backing away from its early enthusiasm for the Denver PRT proposal in 1974. Embarrassing cost overruns in the demonstration project in Morgantown, W. Va. had cast doubt on the financial and technical feasibility of a PRT system similar to the one proposed in Denver. In addition, the Airtrans System at the Dallas-Fort Worth Airport—like Morgantown's PRT, a technological predecessor of the proposed Denver system—was not performing up to specifications.

At the same time these projects were running into difficulties, UMTA began to realize that it could not meet all the requests for Federal assistance from cities across the country with large fixed-guideway systems in planning or preplanning stages.

When RTD asked for a study grant to continue work on the PRT-type system approved in 1973, UMTA responded with a new requirement for a complete evaluation of alternatives. UMTA implied informally that its funding levels would be geared to the most cost-effective alternative. After the



The transit system proposed in 1973 linked personal rapid transit lines with feeder bus service

referendum RTD had taken steps to select a consultant to refine the PRT plan, prepare an UMTA capital grant application, and ultimately to do final design and manage construction of the entire system. UMTA'S insistent request for an alternatives analysis resulted in the addition of this task to the work program. However, the candidates for the consultant job had already submitted their proposals—and had undergone a round of interviews—by this time,

RTD selected a consultant team headed by TRW, Inc. with participation of architects Gruen Associates, engineers Ralph M. Parsons & Co., and DeLeuw, Cather & Co. The consultants were hired to function as the “system management contractor,” a title that implied the predominance of the construction-phase responsibilities.

The findings were reported in April 1975. 11 They included recommendations for an 80-mile

11 RTD, *Public Transportation Alternatives, Report and Recommendations to the Board of Directors from the Staff of the Regional Transportation District*, April 1975, p. 5.

automated fixed-guideway system—referred to as the Automated Rapid Transit system (ART)—supplemented by expanded bus service (see Figure 5). The proposed ART system employs a much simpler and, it was hoped, less expensive technology than the PRT system proposed in 1973. The ART system would use automated or semiautomated vehicles that would be mass produced. The specially designed vehicles of the earlier plan were ruled out.

The system would serve all 12 of the activity centers identified by the 1972 Phase I plan and would be implemented in stages up to the year 2000. The initial 30-passenger vehicle probably would be replaced with larger vehicles as demand increased. The first segment of the ART system, approximately 28 miles long, would run north and south from Denver's CBD to serve three other activity centers.

Most of the first segment follows expressways and railroads and therefore would cause little (if any) disruption of residential communities. RTD

was sensitive to neighborhood opposition because it found (as did many other cities) that people who support a plan in the abstract often become concerned if transit facilities threaten to disrupt their own neighborhoods.

In the period following the 1973 referendum—but before the reevaluation got underway—citizens in the east side of Denver had begun to oppose PRT alignments routed through their area that did not follow railroad rights-of-way. In addition, citizen groups in the South Colorado and East Colfax corridors objected to having an elevated PRT guideway in their neighborhoods.

To avoid such criticisms, the ART plan promises to implement segments of the transit system only as the demand arises and to give priority to those segments that are acceptable to the residents of neighborhoods they affect. In the meantime the other corridors would be provided with improved bus service—ranging from local buses to exclusive

bus lanes as circumstances warrant.

JRPP adopted the ART plan on June 19, 1975. It has thus been officially approved by the three agencies participating in JRPP: the Denver Regional Council of Governments, the Colorado Department of Highways, and, of course, RTD. The plan has been well received by local governments, other regional agencies, and the public, and continued support is expected.

Despite widespread support for the plan, issues have been raised concerning two aspects of the alternatives analysis: the procedures used for formal citizen and public agency participation, and some of the procedures and the assumptions used in the alternatives evaluation itself.

RTD, however, has fulfilled its obligation to do an analysis of alternatives, and the ball is once again in UMTA'S court. UMTA plans to comment on RTD's alternatives analysis by November 1975.

# Chronology of the Transit Planning Process

- 1957 The Denver Metropolitan Area Transportation Study (DMATS) commenced. The highway orientation of this study helped generate interest in transit and in controlling growth.
- 1969 Effective July 1, the Regional Transportation District (RTD) was created by the State legislature and given authority to develop a transit plan.
- 1970 In September the UMTA-funded Center City Transportation Project released its final report recommending a PRT system between the downtown and Mile High Stadium.
- 1971 In April the City and County of Denver took over ownership and operations of the financially ailing Denver Tramways Corporation.
- In April the Regional Transportation District (RTD), the Colorado Department of Highways (CDH), and the Denver Regional Council of Governments (DRCOG) entered into an agreement to create JRPP, giving it the power to approve and coordinate transportation and land use planning in the Denver region.
- RTD hired Development Research Associates and Wallace, McHarg, Roberts & Todd (DRA-WMRT) to develop complementary land use and transportation "concept" plans ("Phase I") that would provide the groundwork for designing a transit plan.
- Later in the year RTD contracted DRA-WMRT and Kaiser Engineers to develop a public transportation plan ("Phase II").
- 1972 In May the DRA-WMRT plan *Phase 1: A Concept* was released. The land use concept identified regional growth centers, and the transportation concept called for a range of service levels. The plan was adopted by RTD in February 1973, by CDH in August 1973, and by DRCOG in December 1973.
- In October UMTA announced it would locate the "Demo B" demonstration project in Denver. Funds were designated for the first mile of a 5-mile PRT system. The project was later moved to Broom field, a Denver suburb.
- In November Denver area voters rejected funding for the 1976 Winter Olympics and forced the Olympics to seek a site elsewhere.
- 1973 In June the Phase 11 report, *A Public Transportation Plan*, was issued. It called for a 98-mile personal rapid transit type of system for Denver supplemented by an early action bus program.
- In September Denver area voters approved a one-half cent sales tax levy to support RTD and to pay for construction and operation of transit systems.
- 1974 In February RTD began negotiations with consultants to perform preliminary engineering work on the approved PRT system and prepare an UMTA capital grant application. In the midst of the consultant selection process, UMTA requested an analysis of alternative transit systems. Subsequently RTD selected a consulting group, led by TRW, Inc., to conduct the alternatives analysis.
- In July RTD acquired the Denver transit system from the City and County of Denver.
- 1975 In April RTD released its *Transit Concept Comparison* report recommending an 80-mile automated rapid transit system supplemented by express bus.
- In May public hearings were held on the ART proposal.
- In June JRPP approved the ART plan.
- In July UMTA began its evaluation of the alternatives analysis study.



# Assessment of the Planning and Decisionmaking Process

## INSTITUTIONAL CONTEXT

The institutional structure for transportation planning in Denver is relatively clearly articulated. The three major participating agencies cooperate in a single forum in which responsibilities are reasonably well defined. However, while collaboration is encouraged, institutional rivalries stand in the way of genuine integration between transit planning and other planning efforts. An active program for citizen participation has led to enthusiastic public support for transit proposals.

### Forum for Decisionmaking

The responsibility for transit decisionmaking is firmly lodged in the Regional Transportation District (RTD), although some decisions must be executed through the Joint Regional Planning Program (JRPP). Under the JRPP umbrella, transit policies can be coordinated with highway and land use planning. The JRPP structure allows the three participating agencies to cooperate effectively. However, the nature of the decisionmaking procedure with JRPP encourages compromise among the three participating agencies, while their unequal political clout has led to competition over which agency should make which decisions.

RTD, created by the State Legislature in 1969, is the only organization in the Denver region with the authority to plan, implement, and operate transit service. RTD joined with the Colorado Department of Highways (CDH) and the Denver Regional Council of Governments (DRCOG) to create JRPP. A governing board was established consisting of the combined boards of the three agencies. This structure proved to be cumbersome and time consuming, and a board consisting of the executives of each agency was substituted for it. Operating procedures that were adopted require the board to reach unanimous agreement on all policy matters. As the designated Metropolitan Planning Organization (MPO), JRPP is the recipient of all assistance from the U.S. Department of Transportation, and the JRPP board must approve funding requests and distribution among the three agencies.

The JRPP forum has encouraged cooperation among the three participating agencies, and staffs of these agencies have established close working relationships. However, the structure of the JRPP board has set the stage for decisionmaking that is characterized by negotiation and compromise.

Evidence of concessions by one agency to another in JRPP are difficult to document. However, some features of the recent ART plan reflect compromise between RTD and CDH. None of the busway alternatives tested in that study recommended using any portion of the highway system that was needed to carry congestion-free automobile traffic. In addition, the recommended alternative did not affect CDH'S plans for construction of new highways. Although CDH has not endorsed the technical planning process that produced the ART proposal, the agency nevertheless has officially approved the transit plan. One CDH official stated the agency felt able to approve ART because the highway programs would remain intact.

Thus, although JRPP provides opportunities for cooperative planning, the participating agencies have tended to guard their independent autonomy. DRCOG is weakest of the three JRPP agencies primarily because it lacks a steady source of funding. Nevertheless, DRCOG has taken several initiatives to strengthen its hand. DRCOG, not JRPP, is the regional A-95 review agency. Using this status as leverage, DRCOG recently renewed its request to the Governor to transfer the MPO designation to DRCOG from JRPP. As MPO, DRCOG would become the lead agency in JRPP. To date, RTD, understandably interested in protecting its autonomy, has been able to head off the change.

RTD also has lobbied against several attempts in the Colorado legislature during recent years to improve regional planning coordination by creating an urban service authority for the Denver area. The proposed regional agency would have had a number of broad powers, including control of transportation as well as more traditional urban services, such as water and sewers. If such an agency existed, RTD would become one of several departments within it.

The State of Colorado has no continuing involvement in transit planning in the Denver area other than through CDH. Occasional acts by the legislature, of course—such as creation of RTD—have been influential. In addition, the Governor's recent involvement in curtailing highway development sets a precedent for high-level State participation in some aspects of transit planning. A move to create a State department of transportation during the 1975 legislative session was unsuccessful. RTD was one of the opponents of this proposal.

#### Accountability of Decisionmakers

Most of Denver's transit decisions are reached in a process that offers a relatively high degree of public accountability. RTD, which bears the responsibility for the bulk of decisionmaking, has a board that is structured to respond to the will of elected officials. However, to the extent that decisions are reached in the JRPP forum, accountability is reduced.

Most of RTD's 21-person board is appointed by the officials of the participating jurisdictions. The mayor of Denver appoints 10 delegates. Boulder, Jefferson, Arapahoe, and Adams Counties each appoint two board members, and Douglas County names one. Within each county the appointees are subject to confirmation by a majority of the municipalities in that county, a procedure that adds a special degree of public responsiveness. The remaining two board members are appointed by the other 19 to represent the region at large.

As explained, transportation programming decisions involving Federal funds are reached in the JRPP forum. In this context RTD must gain approval from DRCOG and CDH for its proposals. To an extent that varies with the nature of particular decisions, therefore, the structure of these two organizations affects the accountability of transit decisionmakers in Denver. The DRCOG board of directors is made up of one representative from each city and each county in the region with the exception of Denver, which has two representatives. CDH, a State agency, is further removed from the public.

#### Public Involvement

Denver citizens have been a guiding force behind the development of the region's transit plan. Pressure from civic activists and environmentalists helped set the stage for creation of RTD. Later, they helped shape the transportation "concept" and

complementary land use plan that led to design of the PRT proposal in 1973. RTD's program for public involvement continued through the recent ART study, although there is controversy over whether the public had adequate opportunity to participate in the analysis of alternatives required by UMTA in 1974.

RTD's first Citizen Advisory Committees (CAC) were organized in 1969 by many of the same individuals who had campaigned for RTD. The original CAC'S were organized around council districts and provided citizen input into the land use and transportation concepts developed by RTD and its consultants. The CAC'S were major contributors to the establishment of goals and identification of activity centers. They worked closely with the consultant personnel. Later, the CAC'S actively supported RTD in preparing for the referendum by distributing literature and holding informational meetings. DRCOG'S own CAC'S also contributed to aspects of the transit planning effort. In all, the citizen participation program during the early phases of RTD planning was admirably progressive.

After the 1973 referendum the CAC'S were reorganized to correspond to the PRT corridors for the purpose of recommending guideway alignments. RTD presented alternative alignments to the CAC'S and asked citizens to rank alignments in order of preference. Some CAC'S could not agree on an acceptable alignment and others ranked only one alternative as acceptable. In several cases the alternatives selected by the CAC'S generated less ridership or cost considerably more than the alignments favored by RTD planners. In these cases the relationship between RTD and the CAC'S deteriorated as the citizens and planners adopted conflicting positions. However, in general, the citizen involvement program was considered a good effort.

At the time of the alternatives analysis, RTA began by restructuring CAC'S once again, assimilating the small units that had been organized around PRT corridors into larger groups. This restructuring was a logical step, since planning had shifted away from selection of alignments at the neighborhood level and back to system-level concerns. Nevertheless, the change tended to dilute the strength of old CAC'S. In at least one case, the difficulties were compounded because the change in structure was announced without consulting the old CAC leaders. The old East Colfax CAC was

combined with other groups and its members required to work under the leadership of strangers. RTD attempted to resolve the tension that developed subsequently between the old East Colfax people and the new CAC leader but was only partially successful.

Citizen leaders have complained that RTD's presentations to new CAC'S were not designed to elicit direct citizen input into evaluation and selection of alternatives. All RTD's technical reports were made available to the public, and citizens attempting to contribute were not rebuffed. But evidence indicates that RTD did more to obtain ratification of a particular alternative than to involve citizens in the examination of a full range of alternatives. Gary Robertson, RTD's Community Liaison Officer, stated that the citizens never voted on alternatives. Don Bain, former head of the East Colfax CAC, said that his group was asked to comment on alternatives on only one occasion, at which time the RTD staff requested support for its findings that the ART system was the best alternative. Some responsible regional officials also expressed displeasure at not having played any role in the technical planning work.

Following publication of Transit Concept *Comparison* in April 1975, which presented the findings of the alternatives analysis and recommended an 80-mile automated regional system, the public was given a period of about a month to register comments before the plan was officially adopted. Some students of the Denver planning process have questioned whether this period was too short to allow for substantive modifications to be made, although there is no evidence of public conflict in this particular case that would have required additional time and study to resolve.

In spite of the criticisms of RTD's approach to citizen involvement during the alternatives analysis, the plan that evolved has won acceptance from most groups. Criticism has been stemmed by the promise that no transit route will be constructed through unreceptive neighborhoods. Under these conditions the Denver public generally supports the ART plan.

## TECHNICAL PLANNING PROCESS

The decisions by leaders and citizens of Denver to choose fixed-guideway transit have followed logically from the technical information provided

by RTD. However, the process has been criticized for failing to provide accurate information on a full range of alternatives.

### Goals and Objectives

Transit planning in Denver began with an elaborate and comprehensive goal-setting process based on a strong community participation program that has received widespread notice and praise. In keeping with current planning theory, the set of goals and objectives that evolved was intended for use in evaluating alternative plans. Many of the goals were employed for this purpose, although due to difficulties inherent in their broad-ranging character, other goals were ignored or used less effectively.

June 1970 RTD adopted several goals and objectives to guide the transportation planning process. First on the list was the objective of providing "maximum feasible integration of public transportation planning with comprehensive land use planning."<sup>12</sup> This general goal has been cast in various forms over the .5-year period of transit planning. Most recently it surfaced in the April 1975 ART study in this phase: "A basic goal served by planning for the future is the preservation and enhancement of the quality of life, commonly expressed as preservation of the natural environment, improvement of cultural opportunities, and control of growth."<sup>13</sup>

This basic goal had to be refined to produce the objectives that could guide selection of a transit plan. One of the first tasks RTD's consultants undertook in 1971 was to assemble all the goals and objectives that had been drawn up by local jurisdictions. Community meetings throughout the region generated additional goals and a sense of priority ordering among them. Both land use and transportation objectives were articulated. In January 1972 the RTD board approved a regional transportation concept reported in Phase 1: *A Concept* and containing the following points:

- A transportation system must be designed to serve present needs and meet current transportation problems.

<sup>12</sup> The other goals for transportation planning that appeared on the June 1970 list dealt with the desirability of (1) achieving a regional perspective, (2) protecting and enhancing the environment, (3) involving citizens in an informed decision making process, (4) utilizing existing transportation systems, and (5) coordinating with other agencies.

<sup>13</sup> RTD *Transit Concept Comparison*, April 1975, pp 1-5

- Development should be directed away from areas that the ecological inventory identified for protection.
- Uncontrolled or minimally controlled suburban sprawl is detrimental to the region.
- The transportation system should reflect a family of technologies, each designed to best meet specific needs.
- A transportation system should be designed over a period of time to meet changing needs of the district.

Once the “concept” 14 had been identified, the consultant during the second phase of planning set

14 This transportation concept was defined as “a synthesis of regional transportation objectives.” The report summarized these objectives into a list of “three important functions for the regional transportation system:

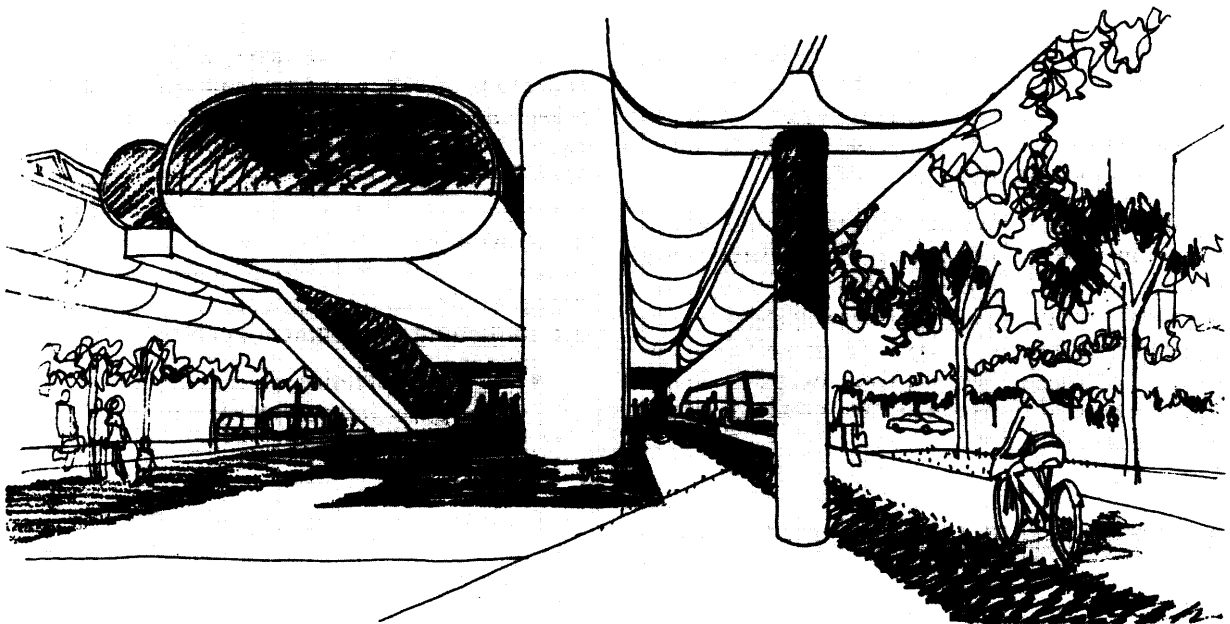
- “to alleviate immediate and growing transportation problems—congestion, pollution, and lack of adequate opportunity for mobility-deficient riders.
- “to reinforce and organize development of existing urban areas.
- “to serve and encourage development in new regional patterns as directed by local and State legislative policies.”

(RTD, A Public Transportation Plan for *Colorado's Regional Transportation District*, Technical Report 1—Preliminary System Design, June 1973.)

out to transform it into a specific system. The alternative systems were measured against a set of service quality criteria, but they also had to honor a wide range of economic, social, environmental, and ecological goals.

Like its Phase 11 predecessor, the evaluation process for the ART study also took regional goals and community concerns into account. The regional goals were extrapolated from the Year 2000 Land Use Plan that was developed during the first phase of the transit planning effort and adopted by JRPP in 1973. The regional goals were summarized as: (1) directing growth to designated areas; (2) providing a high degree of accessibility to employment, activity centers, and other attractions; and (3) supporting national energy programs. Citizen concerns were solicited during some 250 community and CAC meetings in 1974. The “community values” identified during these sessions dealt with mobility issues; the desire to minimize relocation, disruption, and other adverse effects in neighborhoods; enhancement of the environment; esthetic concerns; and the wish to minimize cost. 15

15 The Consultant also built traditional transportation planning factors into the evaluation process: the operational effectiveness of the alternatives, their relative financial feasibility, and the comparative economic viability. This last issue responded to UMTA'S interest in cost-effectiveness analysis.



In this sketch, an elevated station on the personal rapid transit system proposed in 1973 collects passengers arriving by bus, bicycle, and automobile

The consultant had mixed success in translating these goals into workable evaluation criteria. The ability of alternatives to meet goals for mobility, for example, would be tested by counting the number of disadvantaged persons each alternative would bring within 40 minutes of employment and activity centers. Other goals were not so amenable to quantification, although they were employed in the evaluation process, as described in the next section.

### Development and Evaluation of Alternatives

Over the past 3 years, RTD conducted two technical studies to evaluate alternative transit systems and recommend a system that would best serve Denver's needs. The first study took only a cursory look at alternatives before recommending a PRT system. The second study was more thorough but did not put all the technical issues to rest. This section discusses both studies but focuses on the second, more recent study.

The first study was prepared by consultants Development Research Associates and Wallace, McHarg, Roberts & Todd with Kaiser Engineers. Published in June 1973, the study recommended a PRT transit system for the Denver region. The 400-page, three-volume technical report entitled *A Public Transportation Plan for Colorado's Regional Transportation District* limits the discussion of alternatives evaluation to eight pages.

Three alternatives were considered in the 1973 study: (1) the PRT system, (2) an all-bus system, and (3) a conventional rapid transit system. The analysis of alternatives was conducted in three cycles. Cycle 1 compared all-bus against an all-fixed-guideway system. (No feeder bus systems were considered.) The all-fixed-guideway solution was rejected because the ridership generated in low-density areas would not justify the high cost of constructing guideways. It was concluded that an all-bus and a combination bus-and-fixed-guideway system merited further analysis.

Cycle 2 compared the all-bus alternative with a nonspecified fixed-guideway and feeder bus combination. The all-bus alternative was rejected for two reasons. The report found that (1) the all-bus system would cost more in the long run due to higher operating costs and (2) that "with the possible exception of the busways, the potential influence of a bus system on development is highly

questionable . . ."<sup>16</sup> Neither of these reasons for rejecting the all-bus alternative is fully justified in the report. The all-bus alternative assumed standard transit buses of no more than 50 seats; larger articulated or double-decker buses that might reduce operating costs per passenger were not considered. In addition, the analysis notes that a bus system probably would not influence development without proving that any other transit systems would be more effective in doing so.

The third cycle in the alternatives analysis compared conventional rail transit with a PRT system. The conventional system was rejected for several reasons. One reason was that it would not be able to carry the projected passenger demand. Actually, the conventional rapid transit system hypothesized in the analysis had the same on-line passenger capacity as the PRT system, although this fact was not reported in the analysis. Furthermore, the conventional system was defined in a way that its capacity was less than a third of the capacity typically estimated for a double-tracked rapid rail system.<sup>17</sup>

This "conventional" rapid transit system was compared with an advanced personal rapid transit system. The PRT vehicles were assumed to hold 12 passengers, attain speeds of 40 miles per hour, have off-track stations, operate "on demand" (if necessary), and achieve headways of 7.5 seconds.<sup>18</sup> At that time, no operating PRT systems could achieve 7.5 second headways and "on demand" operational capability.<sup>19</sup> The study offers no

<sup>16</sup> RTD, *A Public Transportation Plan for Colorado Regional Transit District, Technical Report I: Preliminary System Design*, June 1973, p. 23

<sup>17</sup> The conventional rail system was defined to have 90-second headways, maximum speeds of 50 to 75 mph., on-line stations, and a maximum of three cars per train with 48 passengers per car. These assumptions result in a maximum one-way line capacity of 5,760 passengers per hour. The capacity of most existing rapid transit cars is at least 70 passengers seated with an additional .50 or more standing. The train size of three cars also is very unusual. Normally, rapid transit cars are operated in semi-permanently coupled pairs, making train sizes usually two, four, six, or eight cars. In most other cities, it has been assumed that a double-tracked rapid rail system could handle an excess of 20,000 one-way passengers per hour.

<sup>18</sup> The use of the term "PRT" in Denver at that time does not coincide with current usage. A June 1975 definition that appeared in the Office of Technology Assessment's *Automated Guideway Transit* stated that a PRT system would include 3-second headways and vehicles that could carry up to six passengers.

<sup>19</sup> The state-of-the-art of PRT is advancing. Although no system now has both on-demand service and T. S.-second headways, some claim to have achieved one or the other.

evidence that such systems could be operating in the near future.

Another reason given for rejecting the conventional rapid transit system was that it would cost more than the PRT system. Since there is no experience in either construction or operation of the kind of PRT system described in the study, the relatively low cost figures have been questioned. Indeed, one member of the consulting team advocated including a large contingency factor in the cost estimate to allow for unexpected cost overruns on the untested technology. This was not done.

The second alternatives analysis was performed at the request of UMTA. It was carried out by RTD's System Management Contractor, a consultant team headed by TRW, Inc. and including Gruen Associates, Deleuw Cather & Company, and Ralph M. Parsons and Company. An 80-mile automated rapid transit (ART) system was recommended in the final report, entitled *Transit Concept Comparison*, which was released in April 1975.<sup>20</sup>

At the time that RTD/TRW was conducting the alternatives analysis, UMTA was in the process of preparing new guidelines for evaluation of capital grant applications. The study was designed to conform to the new guidelines, to the extent that UMTA had developed them as the study got underway. Although the RTD/TRW alternatives analysis had been completed, final guidelines for UMTA'S capital grant application evaluation have not yet been developed. Thus, this alternative analysis is not only the first of its kind, but it was conducted without the benefit of final UMTA guidelines.<sup>21</sup>

Several characteristics of the analysis are regarded as steps forward in the practice of transit planning. First, the RTD/TRW analysis assumed that fares would increase at only 3 percent per year while costs would increase at 6 percent to 8 percent annually. Most past financial analyses assumed that fares and costs would increase at the same rate. RTD's conservative approach is more realistic, given current economic trends.

---

<sup>20</sup> ART is the term used in Denver for a group rapid transit system (CRT), as defined by the Office of Technology Assessment in *Automated Guideway Travel*, June 1975.

<sup>21</sup> Draft guidelines were published in the August 1, 1975, *Federal Register* (pp. 32546-7) under the title "Proposed Policy for Major Urban Mass Transportation Investments."

Another strength of RTD's alternatives analysis was that instead of using the highways planned for the year 2000, RTD considered only existing highways plus those to which full funding had been committed. This approach eliminated several major expressways that are planned for construction by the year 2000, according to the official plan. Public opposition to the construction of new freeways in Denver is considered likely to delay completion of the major highways for which funds have not been committed, and assuming their completion would have given a distorted picture of regional travel needs.

The third and most significant strength of RTD's analysis is associated with the relationship between transit and land use change. Most transit studies have assumed that transit itself will have a significant effect on land use. RTD, however, assumed that a fixed-guideway system will not necessarily shape land use that would encourage transit use unless those patterns are reinforced through other governmental actions. RTD has stated that Denver's transit system will be implemented. "... where responsible local officials are receptive to early development of the transit infrastructure, as evidenced by their adoption of policies which complement the provision of rapid transit in a corridor."<sup>22</sup>

If RTD demands the "policies" to be backed by effective programs of incentives and/or controls, and if the promise of transit service can be used in this way to put genuinely coordinated and comprehensive urban area plans into effect, Denver will have made a significant advance in planning practice.

Despite these contributions to the state-of-the-art, however, the alternatives analysis has been the source of controversy within professional transit planning circles. To a great extent, the debate turns on questions of approach and value. Some disagreements center on the contention that the analysis did not produce adequate information about the full range of feasible alternatives.

The following discussion examines the RTD/TRW alternatives analysis in detail, paying special attention to four areas of disagreement: (1) elimination of low-capital alternatives, (2) exten-

---

<sup>22</sup> RTD, *Public Transportation Alternatives: Report and Recommendations to the Board of Directors from the Staff of the Regional Transportation District*, April 1975, p. 5.

siveness of the fixed-guideway system, (3) patronage estimates, and (4) economic analysis.

### 1. Elimination of Low-Capital Alternatives

One issue involves the analysis of low-capital alternatives. Critics suggest the RTD/TRW report does not provide all the information helpful in determining whether a high-capital system would be worth the extra cost required to provide a higher level of transit service.

Denver has defined the alternatives analysis as involving essentially a choice between a fixed-guideway system and buses in mixed traffic. The issue, as described in the *Transit Concept Comparison*, is whether an expensive fixed-guideway system can be economically justified in a moderately large city, or whether a buses-in-mixed-traffic system would be more suitable. The question becomes one of ratio of benefits to costs. An improved bus system may cost in the neighborhood of \$200 million and generate several times that figure in benefits, but this level of benefits would be small compared to the benefits generated by a fixed-guideway system that would cost several billion dollars.

The alternatives analysis developed the theme of the fixed-guideway versus bus. Denver examined seven alternatives, including five fixed-guideway options:

- *Baseline bus*, assuming operation of buses in mixed traffic at the same level of service as the existing bus system;
- *Expanded bus*, which would increase baseline bus operations by 48 percent;
- *Advanced Bus*, with 70 miles of bus operating on exclusive busways;
- *Light rail*, operating on 79 miles of fixed guideways;
- *Conventional rapid rail*, operating on 46 miles of fixed guideway;
- *Automated rapid transit*, operating on 80 miles of fixed guideway; and
- *Demand-responsive transit*, operating on 93 miles of fixed guideway.

The expanded and the baseline bus systems are the only low-capital alternatives described in the *Transit Concept Comparison*. All of the fixed-guideway

systems include extensive fixed-guideway systems covering several corridors.

The expanded bus system was eliminated from further consideration early in the *Transit Concept Comparison*.<sup>23</sup> In Chapter III, "The Issue," RTD summarized its position on the low-capital expanded bus system:

On balance, an expanded bus system is economically a desirable investment but cannot meet either the national or regional goals for transportation investment. In order to provide the improved transit mobility and accessibility necessary to support these goals, transit alternatives with higher levels of service and resulting higher capital costs must be examined.

Thus, on the grounds that it would not provide sufficient transit service, RTD eliminated the expanded bus alternative. It was not mentioned in the remaining seven chapters of the report, or in the *Economic Analysis Report*, which provided technical backup for the economic analysis.

One point of information useful in deciding what level of transit service is appropriate to an area is the marginal cost—or total extra cost—required to achieve a higher level of service. The marginal cost would represent the difference in capital plus operating costs between a system that would provide the desired service level and a less expensive system providing a lower level of service, such as a buses-in-mixed-traffic system or a small fixed-guideway system. RTD has not provided this information in any of its reports.

However, from the data supplied in the *Transit Concept Comparison* and the *Economic Analysis Report*, it is possible to calculate roughly the marginal capital costs of achieving the increased level of service desired by RTD above the level of service provided by the expanded bus alternative. The expanded bus system will require \$247 million (1974 dollars) in capital costs by the year 2000 and offer a level of transit service that would attract 5 percent of all of person trips in the Denver region. The Automated Rapid Transit system, the alternative eventually selected by RTD will have a capital cost of \$1,488 million (1974 dollars) by the year 2000 and is

<sup>23</sup> The baseline bus was not eliminated but was kept to provide a point of reference for the systems that were evaluated. It was not an alternative for improving transit service but was the "do-nothing" alternative.

predicted to handle 7.5 percent of all daily Denver area person trips.

Thus, the Denver region would pay \$247 million in capital costs in order to provide an expanded bus transit system that would carry 5 percent of the total daily person trips in the region. In order to increase the percentage of trips taken on transit to 7.5 percent the Denver region would have to pay additional capital costs of \$1,241 million (1974 dollars) by the year 2000 to pay for the ART system. RTD has decided that the extra cost is justified in order to increase the level of transit service so that an additional 2.5 percent of all area trips will be taken on transit. The report states the justification to be the benefits from "improved transit mobility and accessibility."<sup>24</sup> The comparison would have been aided if these benefits had been assigned dollar values or other measures.

In evaluating marginal costs, one must also take into account a comparison of the operating costs of the two systems. In the year 2000, the ART system will carry 495,000 daily passengers at an annual operating cost of \$57 million. The expanded bus system will carry 341,000 daily passengers at an annual operating cost of \$50.8 million. Assuming the same cost per passenger, the annual operating cost of using the expanded bus system to carry the number of passengers that the ART is projected to carry (an additional 154 million passengers) would be \$73.9 million. Under these assumptions, the ART system would cost about \$15.9 million less per year to operate than the bus system. Over the 40-year life of the ART system, this would amount to a savings of \$165.3 million when discounted at 10 percent<sup>25</sup> or \$334.5 million when discounted at 4 percent.<sup>26</sup> However, these savings would not alter the fact that the ART system would cost considerably more to provide the higher service level desired.

The need for marginal cost information has become more widely recognized since the publication of UMTA'S proposed policy governing technical planning, which calls for identifying the most cost-effective alternative, or the one that meets planning objectives at the lowest cost.

## 2. The Extensiveness of the System

The methodology used in the RTD/TRW analysis to determine the length of the fixed-guideway system required for the Denver area is unconventional. The systemwide approach taken, in combination with a decision not to examine any fixed-guideway system under 45 miles in length, has not provided information that would be useful in determining either the optimum length of the system or the segment of the system that should be built and put into operation first.

The accepted practice for determining the length of a fixed-guideway system is to examine the demand for transit service in each subarea or corridor in order to determine where sufficient demand exists to justify a fixed-guideway system. UMTA'S proposed policy on major urban mass transportation investments calls for this kind of subarea approach when it states, "The plans should include specific transit elements tailored to the level demands and service requirements of the specific corridors and neighborhoods they serve."<sup>27</sup> However, instead of doing a corridor-by-corridor analysis, the RTD/TRW analysis examined the effect of varying lengths of fixed-guideways on the whole area.

RTD takes the position that, whereas a subarea approach would result in the appropriate transit mode for each corridor, the combination of corridor transit systems may not be the best transit system for the urban area as a whole.<sup>28</sup> (In practice, transit studies using the subarea approach have simultaneously considered the systemwide implications of corridor alternatives and thus have been able to study systems using the same technology in several corridors.)

One of the disadvantages of the RTD/TRW approach is that it provides little data that would be useful in determining how to stage implementation of the plan. In order to meet the requirements in UMTA'S proposed policy for building the system in stages, it would be necessary to know how each section of the system functions independently.

Data on ridership generated by systems under 45 miles in length also would have been useful in determining the optimum system length, but

<sup>24</sup> *Transit Concept Comparison*, p. 3-3.

<sup>25</sup> The rate recommended by the Office of Management and Budget.

<sup>26</sup> The rate used by RTD/TRW.

<sup>27</sup> *Ibid.*

<sup>28</sup> John Gaudette, Executive Assistant to the Director of RTD, in a telephone interview with System Design Concepts, Inc.



RTD/TRW elected not to examine shorter alternatives. Examination of patronage estimates indicates that the reason for the 45-mile minimum is not intuitively clear. The 45-mile fixed-guideway system was shown to carry 236,000 daily riders. Two of three 60-mile fixed-guideway systems would have carried fewer riders (232,000 and 235,000 per day), although probably because they occupied less favorable corridors; while the third system tested would have produced only 5,000 additional patrons. Since the addition of 15 miles to the 45-mile system generated so little additional patronage, it would have been appropriate to test smaller fixed-guideway systems of 30, 20, 10, and even 5 miles to determine the length of the shortest fixed-guideway system that could generate a significant portion of the 230,000 or so daily line-haul riders projected to use the longer systems.

### 3. Patronage Estimates

Patronage estimates for the year 2000 were developed for each of the six alternatives and were later used to determine the benefits of each of the fixed-guideway systems. The patronage estimates were developed using trip generation, trip distribution, and modal split models that represent the state-of-the-art in modeling. However, the data manipulated by these models yielded transit patronage estimates that have been criticized as being unrealistically high.

At the current time, the percentage of the total trips in the Denver region taken on transit is less than 3 percent. The model predicts that in the year 2000 the baseline bus system, which would provide the same level of service (i.e. an increase in service proportionate to the increase in population growth), would attract proportionally more riders, or 3.4 percent of the total daily trips in the region. The expanded bus system, which represents a 48 percent increase in bus miles above the baseline bus system, is projected to generate an increase in patronage of 54 percent (equal to a total of 5 percent of all daily trips in the region). These increases in ridership are very difficult to explain under normal conditions.<sup>29</sup> In other transit studies, the existing bus system is usually assumed to serve

the best transit markets, and thus expanded service is assumed to serve areas that generate proportionally fewer transit users. Thus, an increase in the transit service of 48 percent would normally be expected to generate ridership increases of less than 48 percent. RTD's figures do not bear out this logic.

The RTD/TRW reports did not explain what might have led to their apparently high patronage estimates. RTD subsequently has said that the greater-than-expected ridership increases in the expanded bus system would be generated through improvements in the bus operations, although this explanation does not account for good performance of the baseline bus system.

One reason for the high patronage estimates may be that unrealistic assumptions were made for future parking charges. The average parking costs for a work trip into the Denver CBD in 1971 were assumed to be \$2, and these costs were expected to increase to \$3.90 by the year 2000. The \$2 figure appears high in view of the report that in January 1970 parking charges in downtown Denver exceeded \$2 in less than seven square blocks, and most of the CBD had charges of much less than \$2. so

The assumptions about parking charges greatly influenced the modal split figures developed by the RTD. The patronage model used an implied time-cost tradeoff for vehicle work trips of \$1.78 per hour.<sup>31</sup> In other words, if all other factors are equal, RTD assumed that a person would be willing to spend somewhat over an hour on the bus in order to avoid driving his car and incur a \$2 parking charge. This assumption, which greatly influenced the modal split developed by RTD, does not seem valid on the basis of past experience.

### 4. Economic Analysis of Alternatives

The analysis of alternatives resulted in the finding that the Automated Rapid Transit System (ART) was not only cost-effective but provided other community benefits such as reduced air pollution, increased mobility for the disadvantaged, and the diversion of more auto riders to transit. The part of the analysis to which RTD/TRW devoted the most attention was the determination

---

<sup>29</sup> Such increases would be conceivable under gas shortage conditions. However, the model would reflect a gas shortage in increased auto operating costs. Since RTD's model projected operating costs at normal levels, it seems that the high patronage increases do not assume gas shortages

---

<sup>30</sup> A.D. Little, et al., Center City Transportation project, September 1970, p. 45.

<sup>31</sup> RTD, SMC (Systems Management Consultant), *Multi-Modal Patronage Model*, May 30, 1975, p. 6-5.

of the most cost-effective system by comparing benefit-cost ratios. Aspects of the benefit-cost analysis have been questioned by some of the study's reviewers.

The benefits quantified for the evaluation of alternatives are all related to the savings incurred due to the diversion of auto trips to transit. These benefits include: (1) savings in private and commercial vehicle operating costs due to fewer total trips and increased operating efficiency for those vehicles remaining on less crowded highways; (2) decreases in accidents on the less crowded and therefore safer highways; and (3) construction and operating costs for highways and parking spaces avoided due to the decrease in demand for highways.

The first two categories of benefits are commonly taken into account in transit benefit-cost analyses. The third category is unusual and has been handled in such a way that benefits are claimed that have already been counted once before under the first category.

The normal procedure is to count as a benefit the decrease in demand for highways in the form of decreased congestion and elimination of some auto trips. RTD/TRW did this under the first category—but the analysis then double counted this decrease in demand for highways by counting as an additional benefit the construction costs saved when unneeded highways were not built. Furthermore, these were hypothetical highways: they were not included in Denver's year 2000 highway plan and are unlikely to be built regardless of the future of the transit system.

The analysis that double counted benefits in this fashion used what RTD termed a cost-avoided approach. It did not take into account the dollar value of time saved due to the reduction in travel time on less congested highways. RTD also calculated benefits in this second fashion, which it called the value-of-time approach (see Table 2). Because the total benefits under the value-of-time approach exceeded the total under the cost-avoided approach, RTD/TRW opted to use the latter total in making its system selection decision because it appeared to be more conservative. In fact, if the benefits had not been double counted, the benefit-cost ratio developed under the cost-avoided approach would have been *even* smaller and the value-of-time approach would have seemed much more attractive. However, the calculation of the \$722.5 million benefit from the value-of-time

savings also has been questioned by several authorities as being excessively high.

RTD/TRW estimated the value of time at \$6.88 per hour, and assumed that any time savings incurred on trips would be valued by the individual at his full pay. Critiques of this evaluation of time-saving benefits focus on: (1) the calculation of the hourly rate, and (2) the application of a value-of-time only to work trips.

The hourly rate used by RTD is higher than would be justified by Bureau of the Census statistics. Page 5-11 of the *Economic Analysis Report* states that the median family income for the Denver-Boulder SMSA in 1974 was estimated at \$13,750, or \$6.88 per hour. This calculation assumes that there is only one wage earner per family. In fact, according to the Bureau of the Census, there were 304,456 families in the Denver SMSA in 1970 and 525,744 people in the work force or about 1.7 workers per family. If the same relationship holds true in 1974, dividing the median family income by the number of workers per family (1.7) indicates an average hourly wage per worker of \$4.05 compared to the RTD figure of \$6.88.<sup>32</sup>

The RTD/TRW study assigned the value of \$6.88 for work trips only. No time value was assigned to nonwork trips. Because of the difficulty of determining time values for the variety of trips for nonwork purposes, values-of-time for these trips usually are much less than for work trips. However, RTD mistakenly implies that increased benefits would accrue if it had assigned time value to nonwork trips. Page 5-40 of the *Economic Analysis Report* states, "The Denver analysis excluded nonwork trips . . . and therefore is basically conservative." An examination of the data in the *Patronage Results for the Analysis of Transit Alternatives for Regional Transportation District* indicates that this is not true. As can be seen in Table 3, the average speed of all trips (automobile and transit) is higher with the ART system in operation than it is for the baseline bus system, thus generating travel time savings for the ART. The table also shows that total nonwork trips travel at a slower speed with ART than with the baseline bus system. If a value-of-time had been applied to these trips, the ART system would have incurred additional costs in the form of increased travel time for nonwork trips.

<sup>32</sup> Elsewhere in the study, RTD used a much smaller rate of \$1.78 per hour in figuring the time-cost tradeoff in its determination of the modal split.

TABLE 2.—Art Concept Relative Present Values of the Benefit-Cost Analysis

	At 4.0 Percent Discount Rate	
	Cost-Avoided Approach	Value-of-Time Approach
<b>Benefits</b>		
<b>Capital Costs Avoided</b>		
Highway .....	393.3	—
Parking .....	15.2	—
<b>Operating Costs Avoided</b>		
Highway .....	38.1	—
Parking .....	6.1	—
Value of Time .....	—	722.5
Autos—Peak Hour .....	733.5	733.5
Autos—Off Peak Hour .....	693.2	693.2
Commercial Vehicles .....	57.0	57.0
Accidents .....	23.0	23.0
Value of Time .....	126.5	126.5
<b>Total Present Value of Benefits</b> .....	<b>2085.9</b>	<b>2355.7</b>
<b>COSTS</b>		
<b>Transit System</b>		
<b>Capital Costs</b>		
Line Haul .....	1209.1	1209.1
CDL .....	-13.6	-13.6
<b>Operating Costs</b>		
Line Haul .....	378.0	378.0
CDL .....	-84.5	-84.5
<b>Total Present Value of Costs</b> .....	<b>1489.0</b>	<b>1489.0</b>
<b>Benefit/Cost Ratio</b> .....	<b>1.401</b>	<b>1.582</b>
<b>Net Present Value</b> .....	<b>596.9</b>	<b>866.7</b>
<b>Internal Rate of Return</b> .....	<b>7.04</b>	<b>8.25</b>

Source: RTD, *Economic Analysis Report 96264-9036-OO*, May 23, 1975, pp. 5-12

TABLE 3.—Average Speed of Total Work and Nonwork Trips for the Baseline Bus System and Art System

Trip Type	Average Speed in MPH	
	Baseline Bus	ART System
Work .....	20.0	20.6
Nonwork .....	18.2	18.1
Total .....	18.8	18.9

Note: Work trips are 22.9 percent of total trips.

Source: RTD, *Patronage Results for the Analysis of Transit Alternatives for the Regional Transportation District May 9, 1975*, pp.46 and 56,

On the cost side of the ledger, two factors in the benefit-cost analysis do not seem to have been adequately justified. First, no debt service costs are included in the cost of the system. Since RTD will

be floating bonds to pay for its share of the construction of this system, it will incur a cost for debt service that should be included.

Second, for all of the fixed-guideway systems, the same contingency factor of 30 percent was used. This figure is reasonable for normal construction work, considering the uncertainty of the current economic situation. Most engineering estimates include a contingency factor of about 20 percent. However, the assumption of the same contingency factor for each fixed-guideway system disregards the fact that the options are at different levels of technological development. It can be assumed that the cost of the advanced bus system, the light rail system, and the conventional rapid transit system can be reasonably well predicted, since the construction industry has had a great deal of experience building these systems. In these cases a 30 percent contingency factor is adequate. The

automated rapid transit system and the demand-responsive transit system, on the other hand, are not yet in standard production or in operation in an ordinary urban setting. Thus, it should be assumed that there will be additional startup costs that cannot be predicted as well as they could be for other systems that have been well tested and for which production methods have been developed. RTD has included greater "preoperation, testing, training and maintenance" costs for the automated systems but these additional costs were \$10 million. A greater contingency factor for the automated system would have been justified.

Benefit-cost analyses generally assume that future costs and benefits are worth less than current costs and benefits. Thus, a cost that will not be incurred until 10 years from now would be assigned a lesser value than a cost to be incurred this year. For the purpose of calculating the value of future costs and benefits, an analytical tool known as the "discount rate" has been devised to discount future costs and benefits so that they are expressed in values comparable to today's values. Thus, future benefits must be greater than today's costs in order to justify the expenditure of resources at this time.

The Office of Management and Budget (OMB) in its Circular A-94, "Discount Rates to be Used in Evaluating Time Distributed Costs and Benefits," recommends a 10 percent discount rate for all government projects except those involving post offices and water resources management. JJ OMB has directed UMTA to apply this rate 10 transit projects. However, the RTD/TRW analysis used a discount rate of 4 percent. RTD/TRW justified using its lower figure on the grounds that, after 6 percent to 8 percent was added to its discount rate to account for inflation, its figure would be very close to OMB'S figure. In other words, once an inflation rate of 6 percent to 8 percent was added to its 4 percent discount rate, its discount rate would be 10 percent to 12 percent, nearly equivalent to OMB'S 10 percent recommended rate. However, this is not a valid claim, since OMB'S 10 percent figure is applied to values from which inflation has been eliminated. OMB Circular A-94 states that, "all estimates of the costs and benefits for each year of the planning period should be made in constant dollars, i.e., in terms of the general purchasing power of the dollar at the time of the decision."

<sup>33</sup> Of file of Management and Budget, Circular A-94 (revised), March 27, 1972.

In the past, transit benefit-cost analyses have not adhered to the 10 percent discount rate recommended by OMB. No effort was made at the Federal level to get them to do so until UMTA and OMB began to develop the recently formulated policy of requiring cost-effectiveness analysis. However, although most have used figures lower than OMB'S 10 percent, their average is in the neighborhood of 6 percent, considerably higher than RTD's 4 percent discount rate.

The use of the low 4 percent discount rate tends to exaggerate the value of future benefits. For example, the net present value of \$1 in benefits 20 years from now is less than 14 cents when discounted at 10 percent. The value of this same dollar of benefits 20 years from now when discounted at only 4 percent is about 46 cents. In the case of most major transportation investments, costs need not be discounted over as many years as benefits, because they are incurred in the early years of the life of the project. In contrast, benefits, which normally accrue after the construction costs have been incurred, are stretched out for years into the future and thus are discounted for many more years than are to the capital costs. A low discount rate tends to justify an expensive investment by preserving the value of future benefits; a high rate makes it extremely difficult to justify expensive investments in terms of their long-term benefits because those benefits tend to be reduced to insignificance by years of repeated discounting.

After the costs and benefits have been discounted, they are compared in a ratio known as the benefit-cost ratio. In the case of the ART system, using benefits and costs discounted at 4 percent, the ratio of benefits to costs was 1.4 to 1. The benefit-cost ratio of the improved bus system was 4.85 to 1. If a discount rate of 10 percent had been used in this benefit-cost analysis, the discounted cost of ART would have exceeded the benefits, and the project would be assumed to be unjustified economically.

The benefits used in the benefit-cost analysis do not include all of the benefits that can be credited to the system. The *Transit Concept Comparison* cites several additional benefits accruing to the ART system. These additional benefits include improved air quality, improved transit safety, and savings in government expenditures due to more economical land use patterns, all of which are assumed to follow the construction and operation of the ART. The savings in governmental expenditures for infrastructural development such as sewers and roads that would accompany the implementation of

the year 2000 Denver land use plan have been quantified and added to the benefits of the ART system. These benefits raise the ART's benefit-cost ratio to 4.87 to 1.

The Transit *Concept Comparison* presents no evidence that the transit system alone will be responsible for the changes in land use patterns that would allow savings in government expenditures for infrastructure. RTD has expressly recognized this fact by proposing to give priority to implementing its transit plan in communities that have adopted complementary land use policies. However, the additional benefits in land development savings do not subtract any cost that might be required to put these land use policies into effect.

In conclusion, the RTD/TRW alternatives analysis contributed to the state-of-the-art in several important ways. It established precedents for a realistic assessment of fare and cost increases and for using only existing highways and those with full funding commitments behind them in calculating transit patronage. (The questionable assumptions about future highway construction were confined to the benefit-cost part of the analysis.) The Denver study's most important contribution is its stated intention to offer transit service as an incentive for implementation of desired land use patterns. Most other urban areas could benefit greatly from the Denver example in this regard. A number of other lessons for future transit planning are provided by Denver's technical process~ ,

- Calculation of marginal costs can aid in accurately determining the comparative costs of providing different levels of service.
- Testing smaller systems may be necessary to determine optimal system length.
- Using a subarea approach for evaluating different systems is more likely to identify the type of transit service best suited for individual corridors and the most appropriate schedule for staging construction of system increments.
- A low discount rate tends to exaggerate future transit benefits.

Professional planners familiar with Denver's alternatives evaluation have raised questions about the validity and reliability of the assumptions and procedures used. To the extent that the process did not provide complete, accurate information about a

full range of feasible alternatives, it illustrates the difficulty of accomplishing this ideal in a metropolitan area where, with few exceptions, there was solid support from public officials and private citizens for a specific transit system. Few forces were pushing for a thorough analysis of alternative transit improvements in Denver when, to meet a requirement imposed by UMTA, the ART study was begun. In the view of most Denver residents, the time for alternatives analysis had passed. The Denver experience suggests the need for UMTA to develop explicit guidelines for conduct of alternatives analysis that specify evaluation procedures and to apply these guidelines from the beginning of the transit planning process.

### Financing and Implementation

RTD is one of the few transit agencies in the country with no major money problems. RTD has sources of revenue which it has not tapped yet and last year had a \$17 million surplus. The fact that RTD has an assured source of local money probably contributes to its eagerness to build a transit system.

RTD can raise revenue from a 1/2 cent sales tax and a 2-1/2 mil property tax. The sales tax can be used to back bond sales of up to \$425 million to pay the local share of new system costs. The \$425 million local share will generate a total of approximately \$2 billion when the 80 percent Federal share is added.

A \$2 billion limit on transit system cost will affect the type of transit system the region can afford. Washington's largely underground 98-mile system will cost at least \$4.5 billion. If Denver is to construct an 80-mile system, at-grade and elevated structures will have to be used almost exclusively.

RTD has stated that the construction of the ART system will require an 80 percent Federal share. At the same time, however, it is not clear whether the Federal share is forthcoming. (Table 4 shows Federal aid to Denver transit from 1962 through May 1975.)

TABLE 4.—Federal Assistance to Denver Transit Programs From F.Y. 1962 to May 31, 1975

Type of Assistance	Federal Share	Total Costs
Capital Grants . . . . .	\$20,737,000	\$34,054,000
Technical Studies . . . . .	2,017,000	3,807,000
Total . . . . .	\$22,754,000	\$37,861,000

Source: Urban Mass Transportation Administration.

# Summary Case Assessment

The purpose of this section is to summarize the nature of the transit planning and decisionmaking process in the Denver region in light of the guidelines listed in the Introduction. The summary, therefore, is divided into two parts: (1) Assessment of the Institutional Context, and (2) Assessment of the Technical Planning Process.

## 1. ASSESSMENT OF THE INSTITUTIONAL CONTEXT

- **Forum for Decisionmaking.**—The responsibility for transit decisionmaking is firmly lodged in the Regional Transportation District (RTD), although some decisions must be executed through the Joint Regional Transportation Program (JRPP). Under the JRPP umbrella, transit policies can be coordinated with highway and land use planning and the staffs of the three participating agencies (RTD, Colorado Department of Highways, and the Denver Regional Council of Governments) have established successful working relationships. However, the nature of the decisionmaking procedure within JRPP encourages compromise among the three agencies, while their unequal political clout had led to competition over where decisionmaking should take place.
- **Accountability of Decisionmakers.**—RTD, which is directly responsible for the bulk of transportation decisionmaking in the Denver region, is accountable to the public through a board appointed by elected officials. To the extent that decisions are reached in the JRPP forum, accountability is reduced.
- **Public Involvement.**—The public has been influential throughout the goal-setting,

alignment selection, and initial system selection periods of transit planning in Denver, acting through RTD's citizen action committees and, in 1973, at the polls. RTD minimized the public role during the recent study of alternatives, although the chosen system met with widespread public approval.

## 2. ASSESSMENT OF THE TECHNICAL PLANNING PROCESS

- **Goals and Objectives.**—RTD established a comprehensive set of goals in a broadly participatory process and has used many of these goals in evaluating alternative systems.
- **Development and Evaluation of Alternatives.**—Denver's latest alternatives analysis makes several contributions to the state-of-the-art, most importantly in its stress on the need for coordinated government policies to shape land use to encourage use of transit. Questions raised about the quality and completeness of the technical information have identified additional, more specific lessons for future transit planners. The fact that Denver officials and residents had registered approval of a specific system before UMTA required a detailed analysis of alternatives points to the difficulty of directing equal attention to all options under such circumstances.
- **Financing and Implementation.**—RTD enjoys a steady source of local share financing and in 1974 had a \$17 million surplus. However, the system RTD selected to construct will require an 80 percent Federal share.