



U.S. Department  
of Transportation  
**Federal Railroad  
Administration**

Office of Research,  
Development and Technology  
Washington, DC 20590

---

## Acoustical Warning Device for Locomotive Horns



#### NOTICE

This document is disseminated under the sponsorship of the Department of Transportation in the interest of information exchange. The United States Government assumes no liability for its contents or use thereof. Any opinions, findings and conclusions, or recommendations expressed in this material do not necessarily reflect the views or policies of the United States Government, nor does mention of trade names, commercial products, or organizations imply endorsement by the United States Government. The United States Government assumes no liability for the content or use of the material contained in this document.

#### NOTICE

The United States Government does not endorse products or manufacturers. Trade or manufacturers' names appear herein solely because they are considered essential to the objective of this report.

**REPORT DOCUMENTATION PAGE**Form Approved OMB  
No. 0704-0188

The public reporting burden for this collection of information is estimated to average 1 hour per response, including the time for reviewing instructions, searching existing data sources, gathering and maintaining the data needed, and completing and reviewing the collection of information. Send comments regarding this burden estimate or any other aspect of this collection of information, including suggestions for reducing the burden, to Department of Defense, Washington Headquarters Services, Directorate for Information Operations and Reports (0704-0188), 1215 Jefferson Davis Highway, Suite 1204, Arlington, VA 22202-4302. Respondents should be aware that notwithstanding any other provision of law, no person shall be subject to any penalty for failing to comply with a collection of information if it does not display a currently valid OMB control number.

**PLEASE DO NOT RETURN YOUR FORM TO THE ABOVE ADDRESS.**

<b>1. REPORT DATE (DD-MM-YYYY)</b> February 2022		<b>2. REPORT TYPE</b> Technical Report		<b>3. DATES COVERED (From - To)</b> June 2016	
<b>4. TITLE AND SUBTITLE</b> Acoustical Warning Device for Locomotive Horns				<b>5a. CONTRACT NUMBER</b> DTFR53-12-D-00003L Task Order 0013	
				<b>5b. GRANT NUMBER</b>	
				<b>5c. PROGRAM ELEMENT NUMBER</b>	
<b>6. AUTHOR(S)</b> Tom Campbell <a href="tel:0000-0003-4228-9685">0000-0003-4228-9685</a> *, Basant K. Parida <a href="tel:0000-0003-1070-7475">0000-0003-1070-7475</a> * and Jason C. Ross**				<b>5d. PROJECT NUMBER</b>	
				<b>5e. TASK NUMBER</b>	
				<b>5f. WORK UNIT NUMBER</b>	
<b>7. PERFORMING ORGANIZATION NAME(S) AND ADDRESS(ES)</b> *QinetiQ North America 350 Second Avenue Waltham, MA 02451-1196				<b>8. PERFORMING ORGANIZATION REPORT NUMBER</b>	
				**Vanasse Hangen Brustlin, Inc. 101 Walnut Street, PO Box 9151 Watertown, MA 02471	
<b>9. SPONSORING/MONITORING AGENCY NAME(S) AND ADDRESS(ES)</b> U.S. Department of Transportation Federal Railroad Administration Office of Railroad Policy and Development Office of Research, Development and Technology Washington, DC 20590				<b>10. SPONSOR/MONITOR'S ACRONYM(S)</b>	
				<b>11. SPONSOR/MONITOR'S REPORT NUMBER(S)</b> DOT/FRA/ORD-22/08	
<b>12. DISTRIBUTION/AVAILABILITY STATEMENT</b> This document is available to the public through the FRA <a href="#">website</a> .					
<b>13. SUPPLEMENTARY NOTES</b> COR: John Punwani/Tarek Omar					
<b>14. ABSTRACT</b> This report summarizes the research and development of a variable directivity Acoustic Warning Device (AWD) used as a locomotive horn. A Global Positioning System (GPS) was developed to control an arrangement of directional loudspeakers. Loudspeakers are arranged on the locomotive so that sound is directed forward when the horn is initially sounded 1/4 mile from a grade crossing. Other loudspeakers are sounded approaching a crossing to direct sound more to the wayside. This approach reduces wayside noise and maintains horn detectability. The work took place at the Transportation Technology Center (TTC) with wayside sound levels comparing well to predicted patterns.					
<b>15. SUBJECT TERMS</b> Acoustic Warning Device, AWD, air horn, variable directivity, grade crossing, sound beam steering, speaker array, locomotive, detectability, noise reduction					
<b>16. SECURITY CLASSIFICATION OF:</b>			<b>17. LIMITATION OF ABSTRACT</b>	<b>18. NUMBER OF PAGES</b> 83	<b>19a. NAME OF RESPONSIBLE PERSON</b>
<b>a. REPORT</b>	<b>b. ABSTRACT</b>	<b>c. THIS PAGE</b>			<b>19b. TELEPHONE NUMBER (Include area code)</b>

Standard Form 298 (Rev. 8/98)  
Prescribed by ANSI Std. Z39.18

# METRIC/ENGLISH CONVERSION FACTORS

## ENGLISH TO METRIC

### LENGTH (APPROXIMATE)

1 inch (in) = 2.5 centimeters (cm)  
 1 foot (ft) = 30 centimeters (cm)  
 1 yard (yd) = 0.9 meter (m)  
 1 mile (mi) = 1.6 kilometers (km)

### AREA (APPROXIMATE)

1 square inch (sq in, in<sup>2</sup>) = 6.5 square centimeters (cm<sup>2</sup>)  
 1 square foot (sq ft, ft<sup>2</sup>) = 0.09 square meter (m<sup>2</sup>)  
 1 square yard (sq yd, yd<sup>2</sup>) = 0.8 square meter (m<sup>2</sup>)  
 1 square mile (sq mi, mi<sup>2</sup>) = 2.6 square kilometers (km<sup>2</sup>)  
 1 acre = 0.4 hectare (he) = 4,000 square meters (m<sup>2</sup>)

### MASS - WEIGHT (APPROXIMATE)

1 ounce (oz) = 28 grams (gm)  
 1 pound (lb) = 0.45 kilogram (kg)  
 1 short ton = 2,000 pounds (lb) = 0.9 tonne (t)

### VOLUME (APPROXIMATE)

1 teaspoon (tsp) = 5 milliliters (ml)  
 1 tablespoon (tbsp) = 15 milliliters (ml)  
 1 fluid ounce (fl oz) = 30 milliliters (ml)  
 1 cup (c) = 0.24 liter (l)  
 1 pint (pt) = 0.47 liter (l)  
 1 quart (qt) = 0.96 liter (l)  
 1 gallon (gal) = 3.8 liters (l)  
 1 cubic foot (cu ft, ft<sup>3</sup>) = 0.03 cubic meter (m<sup>3</sup>)  
 1 cubic yard (cu yd, yd<sup>3</sup>) = 0.76 cubic meter (m<sup>3</sup>)

### TEMPERATURE (EXACT)

$$[(x-32)(5/9)]^{\circ}\text{F} = y^{\circ}\text{C}$$

## METRIC TO ENGLISH

### LENGTH (APPROXIMATE)

1 millimeter (mm) = 0.04 inch (in)  
 1 centimeter (cm) = 0.4 inch (in)  
 1 meter (m) = 3.3 feet (ft)  
 1 meter (m) = 1.1 yards (yd)  
 1 kilometer (km) = 0.6 mile (mi)

### AREA (APPROXIMATE)

1 square centimeter (cm<sup>2</sup>) = 0.16 square inch (sq in, in<sup>2</sup>)  
 1 square meter (m<sup>2</sup>) = 1.2 square yards (sq yd, yd<sup>2</sup>)  
 1 square kilometer (km<sup>2</sup>) = 0.4 square mile (sq mi, mi<sup>2</sup>)  
 10,000 square meters (m<sup>2</sup>) = 1 hectare (ha) = 2.5 acres

### MASS - WEIGHT (APPROXIMATE)

1 gram (gm) = 0.036 ounce (oz)  
 1 kilogram (kg) = 2.2 pounds (lb)  
 1 tonne (t) = 1,000 kilograms (kg)  
 = 1.1 short tons

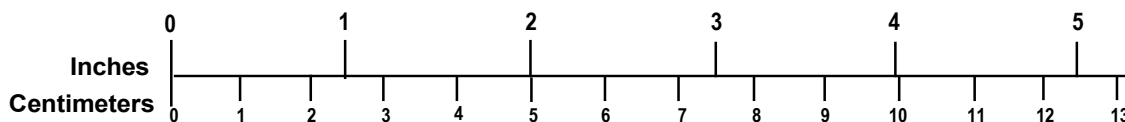
### VOLUME (APPROXIMATE)

1 milliliter (ml) = 0.03 fluid ounce (fl oz)  
 1 liter (l) = 2.1 pints (pt)  
 1 liter (l) = 1.06 quarts (qt)  
 1 liter (l) = 0.26 gallon (gal)  
 1 cubic meter (m<sup>3</sup>) = 36 cubic feet (cu ft, ft<sup>3</sup>)  
 1 cubic meter (m<sup>3</sup>) = 1.3 cubic yards (cu yd, yd<sup>3</sup>)

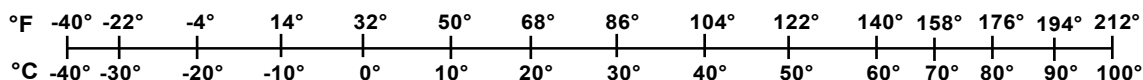
### TEMPERATURE (EXACT)

$$[(9/5)y + 32]^{\circ}\text{C} = x^{\circ}\text{F}$$

## QUICK INCH - CENTIMETER LENGTH CONVERSION



## QUICK FAHRENHEIT - CELSIUS TEMPERATURE CONVERSION



For more exact and or other conversion factors, see NIST Miscellaneous Publication 286, Units of Weights and Measures. Price \$2.50 SD Catalog No. C13 10286

Updated 6/17/98

# Contents

---

Executive Summary .....	1
1. Introduction .....	3
1.1 Background .....	3
1.2 Objectives .....	6
1.3 Overall Approach .....	7
1.4 Scope .....	8
1.5 Organization of the Report .....	8
2. AWD Speaker Selection.....	9
3. Assessment of Environmental Noise Impact for Horn Geometries and Mounting Location .....	13
4. AWD System Design .....	17
4.1 AWD Development with Community RMG-200A Speakers.....	17
4.2 AWD System Description.....	17
4.3 AWD Speaker Sound Sequence and Control .....	20
5. AWD Static and Dynamic Testing at TTCI .....	24
5.1 AWD Test System Description .....	24
5.2 AWD System Installation and Static Testing.....	30
5.3 AWD System Dynamic Testing on TTCI Track.....	35
5.4 Results of AWD and Air-Horn Static Testing.....	38
5.5 Dynamic Testing and Evaluation of AWD .....	46
6. Conclusion.....	62
7. References .....	64
Appendix A. Raw Static and Dynamic Test Data.....	65

## Illustrations

---

Figure 1. Critical Distance and Horn Angle Geometry .....	5
Figure 2. Critical Horn Angle Versus Train Location .....	6
Figure 3. Locomotive Dimension Limits.....	11
Figure 4. Noise Contours of a Traditional Horn.....	13
Figure 5. Ideal AWD Goal with Variable Directivity Sound Pattern Without Reduction in Sound Forward of the Locomotive Past the Grade Crossing.....	14
Figure 6. Noise Contours in Ldn for a Five-Element AWD Traversing from 1/4 Mile to the Grade Crossing.....	15
Figure 7. Ideal Directivity Patterns for Equal Sound Distribution on a Grade Crossing Road ....	16
Figure 8. RMG-200A Speaker Dimensional Details .....	18
Figure 9. RMG-200A Loudspeaker Included Beamwidth Variation in Horizontal and Vertical Planes .....	19
Figure 10. Specified Frequency Response of RMG-200A Horn.....	19
Figure 11. Major Components Constituting the AWD System .....	20
Figure 12. Schematic Representation of Three Sets of AWD Speaker Activation Sequence Near a Grade Crossing.....	21
Figure 13. AWD Sounding Pattern Algorithm for Different Speed of the Locomotive.....	22
Figure 14. An Ideal AWD’s Ldn Contours with Optimized Forward Emission Control.....	23
Figure 15. TTCI RTT Track 3 .....	24
Figure 16. AWD System Schematic .....	25
Figure 17. Horn Sounding Pattern Algorithm (Train Speed vs. Time) .....	27
Figure 18. Horn Sounding Pattern (Train Speed vs. Location) .....	28
Figure 19. AWD Audio Control System Setup .....	28
Figure 20. AWD Audio Control System Running (Demo Mode) – Approaching Sounding.....	29
Figure 21. AWD Audio Control System Running (Demo Mode) – During Sounding .....	29
Figure 22. Optimized Mounting Angles for All Six Speakers of AWD System Per Test Plan....	30
Figure 23. Two AWD Speakers Located at $\pm 15$ Degrees Above the K5LA Air-pressure Horn..	31
Figure 24. Top View of AWD System Six Speakers Installed on TTCI’s DOTX4113 Locomotive .....	31
Figure 25. Side View of F40 PH—DOTX4113 Locomotive with Fully Installed AWD System	32
Figure 26. Sound Measurement with 15 Feet High Pole Right in Front of Locomotive.....	32
Figure 27. Sound Level Measurement at 100 Feet Behind the Locomotive .....	33

Figure 28. Sound Meter Positions for Stationary Locomotive Horn and AWD Sound Measurement.....	33
Figure 29. Static Locomotive Horn and AWD Directivity Measurement at 0 Degree Location .	34
Figure 30. SLMs on Tripods Setup for Stationary Locomotive Horn/AWD Directivity Survey.....	34
Figure 31. Test Locomotive Near Simulated Grade Crossing Location on TTCI Tangent Track ...	37
Figure 32. DOTX4113 Locomotive at Simulated Grade Crossing.....	37
Figure 33. View of Simulated Grade Crossing from SLM Location 500 Feet from Track.....	38
Figure 34. AWD Directivity Pattern of $\pm 15$ Degree Forward Facing Speakers at 100 Feet from Locomotive with Approximately 15-dBA Sound Reduction Wayside for Horn Sounding at 1/4 Mile.....	39
Figure 35. AWD Directivity Pattern of $\pm 35$ Degree Loudspeakers 100 Feet from Locomotive..	40
Figure 36. AWD Directivity Pattern of $\pm 75$ Degree Loudspeakers 100 Feet from Locomotive Representative of Sound Pattern with Locomotive at Grade Crossing.....	40
Figure 37. Combined Directivity Pattern of AWD $\pm 15$ and $\pm 35$ Degree Loudspeakers at 100 Feet from Locomotive .....	41
Figure 38. Combined Directivity Pattern of AWD $\pm 35$ and $\pm 75$ Degree Loudspeakers at 100 Feet from Locomotive .....	41
Figure 39. Combined Directivity Pattern of All Six Speakers of AWD System.....	42
Figure 40. Comparative Directivity Patterns of All Three Sets of AWD Speakers .....	42
Figure 41. Comparative Directivity Patterns of AWD Speaker Combined Emissions .....	43
Figure 42. Nathan K5LA and $\pm 15$ Degree AWD Loudspeakers Mounted on the DOTX4113 Locomotive .....	44
Figure 43. Cab Roof Mounted K5LA Air Horn Directivity Pattern on DOTX4113.....	45
Figure 44. Directivity Pattern of Center-mounted K5LA Air Horn on SD70ACe #4223 .....	45
Figure 45. Comparative Directivity Plot of Cab-mounted and Center-mounted Air Horns.....	46
Figure 46. Sound Meter Locations for Dynamic Tests.....	46
Figure 47. Sound Weighting Scales Compared to Sound Source Frequency Range.....	47
Figure 48. Exterior Sound Level at Grade Crossing 50 Feet from Track with Train at 40 mph for Comparably Scaled Systems.....	49
Figure 49. Detectability (d-prime) at Grade Crossing 50 Feet from Track with Train at 40 mph for Comparably Scaled Systems .....	49
Figure 50. Exterior Sound Level at Grade Crossing 50 Feet from Track with Train at 60 mph for Comparably Scaled Systems.....	50

Figure 51. Detectability (d-prime) at Grade Crossing 50 Feet from Track with Train at 60 mph for Comparably Scaled Systems .....	50
Figure 52. Exterior Sound Level at Grade Crossing 50 Feet from Track with Train at 75 mph for Comparably Scaled Systems.....	51
Figure 53. Detectability (d-prime) at Grade Crossing 50 Feet from Track with Train at 75 mph for Comparably Scaled Systems .....	51
Figure 54. Exterior Sound Level at Grade Crossing 500 Feet from Track with Train at 40 mph for Comparably Scaled Systems .....	53
Figure 55. Detectability (d-prime) at Grade Crossing 500 Feet from Track with Train at 40 mph for Comparably Scaled Systems .....	53
Figure 56. Exterior Sound Level at Grade Crossing 500 Feet from Track with Train at 60 mph for Comparably Scaled Systems .....	54
Figure 57. Detectability (d-prime) at Grade Crossing 500 Feet from Track with Train at 60 mph for Comparably Scaled Systems .....	54
Figure 58. Exterior Sound Level at Grade Crossing 500 Feet from Track with Train at 75 mph for Comparably Scaled Systems .....	55
Figure 59. Detectability (d-prime) at the Grade Crossing 500 Feet from Track with Train at 75 mph for Comparably Scaled Systems .....	55
Figure 60. Analytical d-prime Estimates for K5LA, Center Mounted on a GP40 Locomotive ...	56
Figure 61. Sound Level at 500 Feet from Track, 1,000 Feet Before Crossing with Train at 40 mph with Comparably Scaled Systems.....	57
Figure 62. Sound Level at 500 Feet from Track, 1,000 Feet Before Crossing with Train at 60 mph with Comparably Scaled Systems.....	58
Figure 63. Sound Level at 500 Feet from Track, 1,000 Feet Before Crossing with Train at 75 mph with Comparably Scaled Systems.....	58
Figure 64. Comparison of Measured and Predicted AWD Sound Patterns at 1,100 feet from the Crossing .....	59
Figure 65. Comparison of Measured and Modeled AWD Sound Patterns at 900 feet from Crossing .....	60
Figure 66. Comparison of Measured and Modeled AWD Sound Patterns at 645 feet from Crossing .....	60
Figure 67. Comparison of Measured and Modeled AWD Sound Patterns at 300 feet from Crossing .....	61
Figure 68. Comparison of Measured and Modeled AWD Sound Patterns at 0 feet Through the Crossing .....	61



## Tables

---

Table 1. Comparison of COTS Loudspeaker Systems .....	9
Table 2. Horn Mounting Heights on Locomotives .....	11
Table 3. Speaker Sound Levels Approaching the Crossing.....	21
Table 4. Dynamic Test Matrix for AWD and Air-Horn Performance Evaluation .....	36
Table 5. Dynamic Test Data at Grade Crossing and Trackside for AWD and Air Horn Scaled to 110 dBA System .....	48
Table 6. Comparison of K5LA Polar SLMs .....	56

## Executive Summary

---

The Federal Railroad Administration (FRA) sponsored a project with QinetiQ North America (QNA) and Vanasse Hangen Brustlin (VHB) to develop a variable directivity Acoustic Warning Device (AWD) system for train locomotives that consists of an array of loudspeakers. The goal of this project was to reduce noise levels wayside, while still matching or exceeding detectability along a crossing roadway. The AWD speakers were mounted with an optimized configuration and tested on a Transportation Technology Center, Inc. (TTCI) locomotive. The open air performance was successfully evaluated for detectability at a grade crossing, at critical distances along the crossing roadway, and at wayside locations to assess noise reduction.

The program used commercial off-the-shelf (COTS) directional loudspeakers to demonstrate the capability to control the directivity of the train horn sound. Several loudspeaker options were explored at various price levels. Given the price sensitivity of implementing a multi-speaker system on locomotives, the RMG-200A loudspeakers by Community Professional Loudspeakers were used. The RMG-200A system acoustic simulations using acoustic coverage maps revealed that by using a 6-unit array, it should be possible to develop both narrow and directive sound beams to progressively cover a wide area of interest over the frequency range of nearly 400 Hz to 8 KHz. Standard train air pressure horns typically have tones as low as 311 Hz. It was found that loudspeakers that develop sounds below 400 Hz were significantly more costly.

Standard air pressure horns were characterized and recorded for playback through the loudspeakers. Analysis with the RMG-200A loudspeakers showed that a six speaker system was needed to meet FRA sound level requirements for train horns when used in pairs. Loudspeakers are arranged in pairs at three orientations of  $\pm 15$ ,  $\pm 35$ , and  $\pm 75$  degrees. The  $\pm 15$  degree speakers are sounded first at 1/4 mile from the crossing, with the 35 and 75 degree loudspeakers sound as the train approaches the crossing. At the crossing only the 75 degree loudspeakers are sounded.

On June 2016, the research team conducted testing at the Transportation Technology Center (TTC) with the AWD speakers mounted on a TTCI locomotive. A Global Positioning System (GPS)-integrated AWD control system consisted of a GPS sensor and proprietary software resident in a laptop and located within the cab along with the power amplifier for the speakers. During the dynamic test, the control system autonomously started activating the AWD at 1/4 mile marker, then regulated the sound output of individual speakers through preprogrammed gain controls that steered an initial narrow sound beam to progressively cover wider angles as the locomotive approached and covered the grade crossing.

The AWD test at TTCI was conducted on a long tangent track segment of Railroad Test Track #3 which offered relatively flat trackside terrain that was necessary for ease of acoustic measurements at a simulated grade crossing. Sound level meters (SLM) were mounted on tripods and repeatedly positioned 100 feet away from the AWD/horn location on the stationary test locomotive along an 1,800-circular arc to measure the sound levels of both the AWD and the standard air horn for the comparison of their directivity in a polar plot.

In dynamic testing, the SLMs were positioned at 50 and 500 feet to one side of the track along the simulated crossing. To evaluate the detectability of the variable directivity AWD as the locomotive traveled at different constant speeds toward crossing the standard long-long-short-long sound pattern of a train horn was sounded starting at 1/4 mile before the grade crossing.

Another SLM was located at 500 feet to the right of the track at 1,000 feet before the crossing with a view to measure the trackside noise level normally experienced by the trackside residents.

The locomotive was moved at 40, 60 and 75 mph constant speeds over the designated section of the tangent track repeatedly, while sounding both the AWD and the standard air horn starting at 1/4 mile from the simulated crossing. The SLMs recorded the incident sound levels for each run of the locomotive. Post-test analysis of the results indicated that, the AWD system indeed demonstrated the beneficial effects of variable directivity with the locomotive approaching the grade crossing and the wayside noise levels measured for the AWD was noticeably less compared to that of the standard omnidirectional air horn.

The detectability of the AWD system at the simulated grade crossing was somewhat lower than that of the existing K5LA air horn. This was consistent with the sound levels developed by the respective horn systems. The K5LA sound levels were measured at 114 dBA at 100 feet and the AWD system was 96 dBA. The AWD sound level is within the FRA requirements for train horns. The current state of the art in loudspeaker design is challenged to produce equivalent sound levels to air pressure horns at reasonable costs.

Both the air pressure and AWD horn results were scaled to a 110-dBA equivalent sound level to compare the basic directivity and detectability of the two systems. The detectability of the AWD horn was 3 dB greater than the K5LA air horn at 500 feet from the crossing along the roadway. Wayside sound exposure levels were 2 dB to 5 dB less with the AWD horn than the K5LA horn when measured 500 feet from the tracks and 1,000 feet from the crossing in the direction of the approaching train.

# 1. Introduction

---

According to the Federal Railroad Administration's (FRA) Office of Railroad Safety analysis data in 2015, there were over 837 incidents that resulted in over 91 fatalities and 471 non-fatal injuries at highway-rail grade crossings [1]. Based on FRA's estimate, by the end of 2014, there were 209,308 railroad crossings and approximately 129,326 (62%) of them intersected with public roads. Only 36 percent of public crossings nationwide have gates and private crossings, and often do not have any safety protection devices.

A significant part of the reported accidents in 2015 pertain to collisions between trains and road vehicles at passively controlled grade crossings, where the vehicle drivers did not receive effective early warning of an approaching train [2]. It is also estimated that over 9 million people in the United States may be impacted by the noise produced by the locomotive horns and up to 4.6 million of those may be seriously impacted [3]. The National Academy of Engineering (NAE) Committee on Technology for a Quieter America indicated that the public would benefit if the train horn was more directional and had recommended that research and development be undertaken by FRA to better understand the beneficial effects of directional horns, including the safety at grade crossings which would ultimately benefit the public [4]. QinetiQ North America (QNA) addressed the concern of the NAE as part of this FRA sponsored research and development program.

The standard locomotive air-pressure horn develops nearly omnidirectional sound patterns and it is difficult to make them directional. High capacity directional loudspeaker systems, in lieu of the train air-pressure horn, would permit the imparting of directivity to such a system. QNA working in collaboration with Vanasse Hangen Brustlin, Inc. (VHB) developed an Acoustical Warning Device (AWD) prototype system through research and laboratory testing that is intended to maximize the safety at grade crossings, while at the same time minimizing the environmental noise pollution along both sides of the railway tracks, especially near the grade crossings. Depending on the mounting position of the AWD speaker system on the locomotive, it can also potentially reduce the noise exposure of the crew inside the locomotive cab as well.

## 1.1 Background

The railroads and FRA are well aware of the benefits and problems associated with the mandatory requirement of sounding locomotive horns at a quarter mile before all highway-rail grade crossings. The standard air-pressure horns of locomotives are omnidirectional and consequently create adverse noise impact on a large population of trackside residents near grade crossings.

In the late 1980s, in response to many petitions made by the public, Florida State Law imposed a night time train whistle ban on railroads at highway rail grade crossings equipped with gates and flashing lights on the Florida East Coast Railway (FEC) between 10PM and 6AM, which resulted in a sharp increase in collision between trains and road vehicles. After 1 year, FRA conducted a detailed study that compared the number of collisions before and after the implementation of the Florida Whistle Ban. The results of the study clearly identified a 195 percent increase in train-vehicle collisions during the ban hours at hornless gated grade crossings [5]. There was not a similar increase in collisions during the time period that horns were sounded. FRA then issued Emergency Order 15, which overturned Florida's ban and required

trains to resume sounding their horns. Subsequent review clearly indicated that the collision rates at those grade crossings returned to the old level prior to the imposition of the whistle ban, thus justifying the importance of sounding the train horn at highway-rail grade crossings. FRA later permitted imposition of ‘silence zones’ only in very limited grade crossings based on the merit of the individual petitions of aggrieved communities.

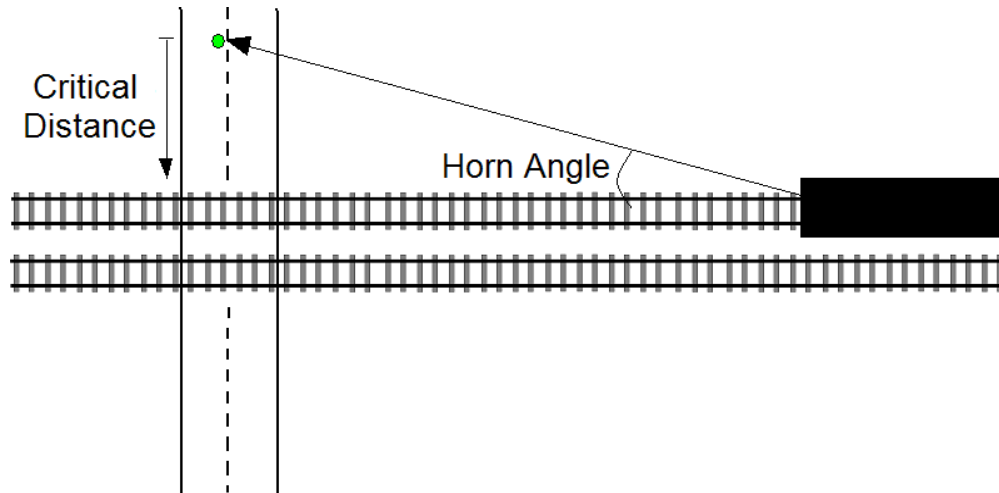
In the late 1990s, Volpe National Transportation Systems Center (Volpe) carried out extensive research to assess and quantify the sound pressure level (SPL) required inside various automobiles approaching a grade crossing for the detectability of an approaching train [6]. Volpe’s research resulted in the definition of a detectability parameter, which is commonly referred to in the literature as “d-prime.” Their study recognized that while approaching a highway-rail grade crossing a motorist listening to the car radio or loud music, with the windows shut, may not be in a position to detect an approaching train horn sufficiently in advance to safely stop the car before the crossing.

### **1.1.1 Train Horn Directivity**

Train horns must generate an audible warning signal which can be detected by railway workers and trespassers in the railroad right-of-way, and pedestrians and motorists on crossing roads.

Warning railway workers, trespassers and pedestrians requires having a sufficient signal generated forward of the locomotive. Since pedestrians travel at a relatively low speed, there is not a need to generate sound very far to the side of the tracks. Motorists, on the other hand, may be traveling at high speeds and train horns must generate sufficient signals further away from the tracks. Specifically, motorists approaching a grade crossing must notice a train approaching, react to the situation, initiate the stopping of their vehicle and then stop the vehicle according to the dynamic properties of its motion.

The critical distance from the crossing that a motorist must notice a train to stop before the tracks must be calculated. Further, the train audible warning signal must be noticeable for the entire segment of road between this critical position and the train tracks. [Figure 1](#) shows the computation of the critical positions using a similar methodology to that in prior studies and is based on the vehicle speed, the motorist reaction time, the minimum stopping distance of the vehicle assuming it is traveling on wet pavement, and the critical track zone and the vehicle length.



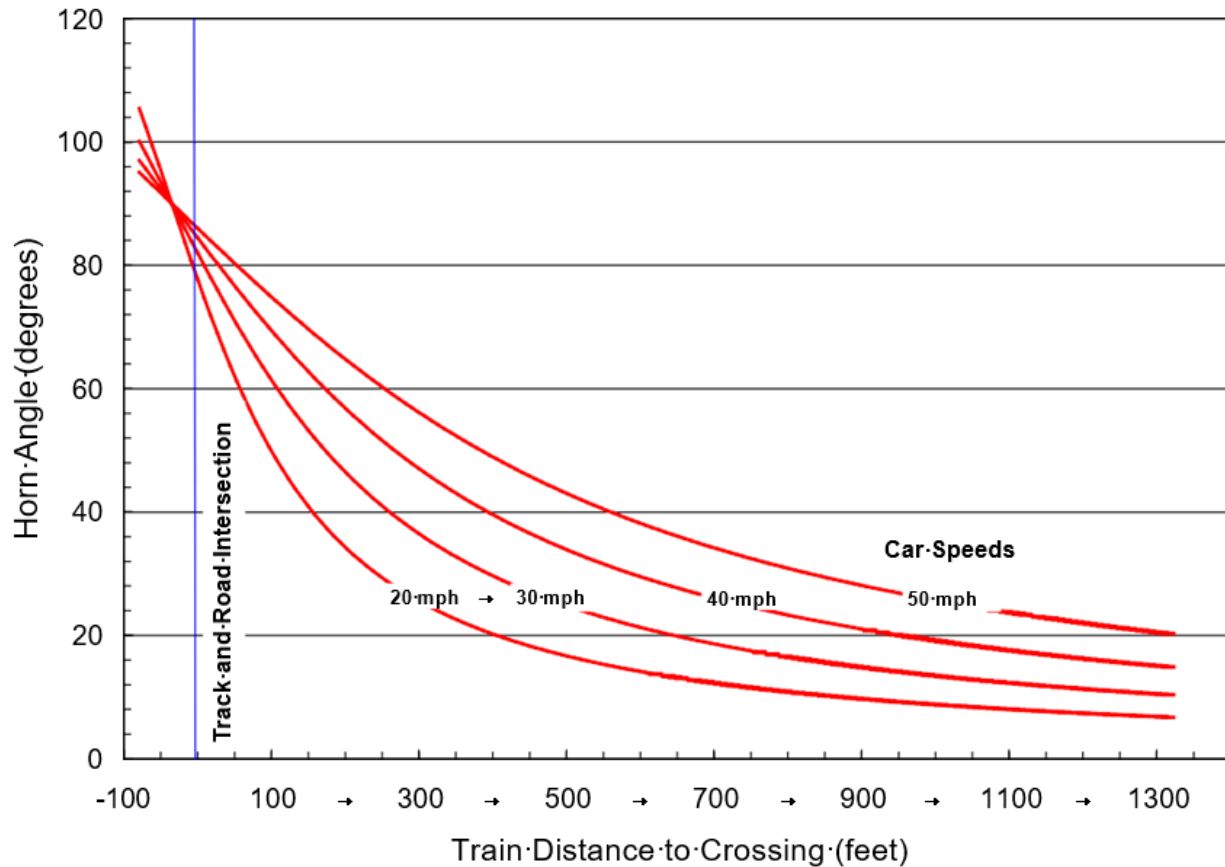
**Figure 1. Critical Distance and Horn Angle Geometry**

The critical distance for the driver to notice the train horn is computed as follows:

$$D_{cr} = V_m^2 (m/s) / 20(f \pm g) + CTZ (m) + Vehicle Length (m) + V_m(m/s) * Driver Reaction Time,$$

where  $V_m$  is the vehicle velocity in meters per second,  $f$  is the skidding friction coefficient and  $g$  is the pavement grade. Assuming a driver reaction time of 2.5 seconds, no grade, a coefficient of friction from 0.31 to 0.35 depending on vehicle speed, a critical track zone (CTZ) of 9.14 m and a vehicle length of 5.8 m, the critical positions are 160, 248, 360, and 499 feet for vehicle speeds of 20, 30, 40, and 50 mph, respectively.

The angles that a train horn must cover to provide sufficient signal to these critical positions vary according to the train position. At 1/4-mile from the crossing, the angles are minimized and when the first locomotive is entirely through the crossing, the angles are maximized. Figure 2 shows these critical angles for vehicle speed of 20, 30, 40, and 50 mph. This assumes the horn is mounted in the center of the long hood approximately 30 feet back from the front of the locomotive. This figure shows that the narrowest angle that must be maintained (at 1/4 mile from the crossing) is 14 degrees (0 degrees +/- 7 degrees) for cars traveling at 20 mph. The maximum angle that must be maintained (near the crossing) is 210 degrees for cars traveling at 20 mph. Except when the locomotive passes through the crossing, the greatest angles must be maintained for cars traveling at 50 mph and thus the analysis of environmental benefit is based on the directivity needed for cars at 50 mph. Even though the angle needed when the locomotive is going through the crossing is greatest for cars at 20 mph, the distance associated with this position is significantly less than the distance for cars traveling at 50 mph.



**Figure 2. Critical Horn Angle Versus Train Location  
(For crossing vehicles at 20, 30, 40, and 50 mph)**

The AWD system must then be designed to always provide sufficient sound levels along the crossing roadway out to the critical stopping distance to maximize the probability of detection within the vehicle approaching the crossing. At the same time, the AWD system must minimize the sound levels to wayside and behind the locomotive. This is done by using a narrow sound beamwidth at 1/4 mile out from the crossing and widening that beamwidth as the train approaches the crossing.

## 1.2 Objectives

The major objectives of the current phase of the program were to develop the AWD prototype system and conduct testing at the Transportation Technology Center (TTCI) to confirm the system performance. Loudspeaker performance is a limiting factor in the AWD system performance. The program did not include development of specialized loudspeakers, but instead relied on commercial off-the-shelf (COTS) loudspeakers. Loudspeaker selection was based on minimizing cost while achieving the highest sound level output and lowest frequency output. Geometric constraints with roof mounted speakers were a major consideration as was cost. It was the program goal to achieve as close to an economically viable system as was practical using COTS components.

The goal of the program was to match as close as possible the detectability of a Nathan K5LA horn at the critical stopping distance of a crossing vehicle for all train positions from the start of the horn sounding. At the same time, the AWD system was designed to minimize wayside noise along that same train passing distance.

### **1.3 Overall Approach**

The program based the AWD system performance on that of the Nathan K5LA horn calibrated to 110 A-weighting (dBA) SPL at 100 feet forward of the locomotive. This is a common horn used on freight locomotives. This condition is the maximum allowed according to the FRA specifications in Title 49 Code of Federal Regulations (CFR) Parts 222 and 229 which allow sound levels from 96 dBA to 110 dBA at that 100 ft. forward position. As a minimum, the AWD system needed to achieve at least the minimum sound level allowed. It was assumed that technology development with loudspeaker drivers and horns could achieve equivalence to air-pressure horns under a separate effort at affordable prices.

Loudspeakers were selected that achieved directionality at a reasonable cost. Recordings of K5LA air horns were taken to use for playback through AWD system speakers. A sufficiently long time sample was needed to smoothly reproduce sounds over the full extent of sounding a long-long-short-long (LLSL) horn pattern. Loudspeaker selection was modified to comply with locomotive height and tunnel clearances for mounted loudspeakers. The RMG-200A speaker manufactured by Community Professional Loudspeakers was found to be a good candidate for constituting the AWD system.

Acoustic simulations were conducted using the candidate loudspeaker to achieve the required 96 dBA to 110 dBA sound levels per the FRA requirements. For sound levels not defined by the regulations, the acoustic simulations attempted to closely match the sound levels achieved by a K5LA horn calibrated to 110 dBA at that specific location. Essentially, the design attempted to always have a 110 dBA in the direction of the critical stopping distance for an approaching 50 mph vehicle at every critical angle as the train approached the crossing. That optimized system was achieved with six RMG-200A loudspeakers positioned in pairs at  $\pm 15$ ,  $\pm 35$ , and  $\pm 75$  degrees from the locomotive axis.

The AWD system was designed to be controlled both manually by the engineer and through automatic Global Positioning System (GPS) control of the system. Given that grade crossing GPS coordinates are known, a GPS sensor on the locomotive can calculate distance and speed of the train to automatically start the AWD horn and control the speakers to achieve the variable sound pattern. The engineer can override the system to manually sound the horn if needed.

The AWD system components were evaluated on moving vehicles to ensure proper operation of the automatic controls with the GPS. Loudspeaker performance was evaluated in a sound booth to ensure proper sequencing of the speakers and to ensure appropriate sound levels. The entire system was then evaluated at the TTC. The AWD system was mounted on a TTCI locomotive and several runs were made at speeds from 40 to 70 mph. Measurements of the wayside noise levels, sound levels at the grade crossing and sound patterns around the locomotive were made and correlated to acoustic simulation predictions.



## 1.4 Scope

This report summarizes the research and development and the variable directivity AWD used as a locomotive horn. A GPS driven control system was developed to control an arrangement of directional loudspeakers. Loudspeakers are arranged on the locomotive so that sound is directed only forward when the horn is initially sounded 1/4 mile from a grade crossing. Other loudspeakers are sounded approaching a crossing to direct sound more to the wayside. This approach reduces wayside noise and maintains horn detectability. This system was tested at the TTCI with wayside sound levels comparing well to predicted patterns.

## 1.5 Organization of the Report

This report is organized into the following sections. [Section 2](#) provides a review of the acoustic performance data, including the directivity pattern of RMG-200A speakers, manufactured by the Community Professional Loudspeakers. [Section 3](#) describes the AWD control system optimization and its performance evaluation along with an integrated GPS sensor through laboratory simulations, and also describes the assessment of the AWD performance requirements for improved detectability of an approaching train at a highway- rail grade crossing. [Section 4](#) describes the loudspeaker selection. [Section 5](#) describes the development of a prototype AWD system and its field performance evaluation while mounted on a TTCI locomotive running at three constant speeds on TTCI tracks. It also contains the presentation of all test results including a comparison of exterior A-weighted sound levels and d-prime detectability of the air horn as well as the AWD. [Section 6](#) summarizes the results and presents the conclusions and next steps. [Appendix A](#) contains static and dynamic test data from TTCI.

## 2. AWD Speaker Selection

---

The investigators evaluated the effectiveness of using existing train horn signatures based on the need to produce adequate amplitude and directivity control with the AWD electronic acoustic sources. It is important that the AWD horn signature be clearly recognized as that of a train, have a similar level of detectability and create a similar sense of urgency for motorists, trespassers, and railroad workers to keep away from the right of way as soon as they hear the horn sound.

The AWD uses digital recordings of actual air-pressure train horns (Nathan K5LA) when reproducing the horn sound. The frequency content of the horn signature affects the device cost. For the directive AWD to generate directive low-frequency sound, it typically must have a long wave guide with a large area, a powerful amplifier, strong magnet, multiple acoustic elements making it costly to produce. To evolve a low-cost solution, it was considered important to go for a COTS electronic speaker system capable of delivering as close to the standard air-pressure horn sound as possible.

A standard Nathan K-5-LA train horn generates primary tones at 311, 370, 415, 494 and 622 Hz (D<sup>#</sup><sub>4</sub>, F<sup>#</sup> G<sup>#</sup><sub>4</sub>, B<sub>4</sub> and D<sup>#</sup><sub>5</sub>) and their harmonics. Depending on the specific physical characteristics of a K5LA horn, these primary tones may vary in frequency range by several Hertz. This standard horn signature has significant acoustic energy between 300 Hz to 10 KHz. The primary challenge in using electronic acoustic sources rather than air-pressure horns is the ability to reproduce the low-frequency content. The Community Professional Loudspeakers RMG-200A speaker, as well as other similar high-amplitude horn speakers, are often less efficient in the low frequency range (i.e., below 500 Hz) and are designed for best efficiency in the mid-range frequencies between 500 and 2,000 Hz.

Many high power COTS electronic speakers were reviewed as shown in [Table 1](#) and a reasonably priced RMG-200A speaker with built-in M200 acoustic driver manufactured by the Community Professional Loudspeakers was selected for its performance evaluation in an optimized configuration of multiple speakers.

**Table 1. Comparison of COTS Loudspeaker Systems**

Manufacturer	Model No.	Dimension (in) (H xW xD)	Speaker Type	Frequency Range	Output / Max. SPL (1 m)	Bandwidth to 6 d-prime detectability (dB) (Horizontal [degrees])	Remarks
JBL Professional	VRX92 8-LA	9 x 16.5x10.5	Two-way Line Array	70 Hz–20 kHz (-10 dB)	122 dB SPL	100	Neodymium compression driver
JBL Professional	VTX V25-II-CS	16.3x48.2x24.2	High Performance Dual Array	35 Hz–18 kHz	141 dB SPL(LF) 149 dB SPL(HF)	90	Dual Neodymium Magnet used

Manufacturer	Model No.	Dimension (in) (H xW xD)	Speaker Type	Frequency Range	Output / Max. SPL (1 m)	Bandwidth to 6 d-prime detectability (dB) (Horizontal [degrees])	Remarks
JBL - VerTec Series	VT4887 A	11x31x 16.3	Compact High Directivity	55 Hz–22 kHz (-10dB)	97 dB (LF); 103 dB (HF)	100	Continuous Power Rating – Line Element
SoundTube Entertainment/ MSE Audio	LA880i	40.87x7.91x 11.99	Line Array Column Loudspeaker	55 Hz–20 kHz (-10dB)	116 dB (1m)	120	Makes use of Woofer, Midrange and Tweeter
Martin Audio Ltd.	CDD 12	22.5x14.2x13.8	Compact Coaxial Differential Dispersion System	62 Hz–20 kHz (+/-3 dB) -10 dB@50 Hz	122 dB continuous; 128 dB (peak)	110	Compression driver; Indoor applications
IML Corp	Sound-commander- SC5600	24x10x22	Long Range Acoustic Hailing System	400 Hz–8 kHz	146 dB @ 1m RMS/154 dB (Peak)	15	Max. effective range 2 km;
Community Professional Loudspeakers	RMG-200A	9.75x17.63x 25	Horn/driver voice range horn system	400 Hz–8 kHz / 500 Hz–4 kHz (+/-3.5 dB)	134 dB SPL / 141 dB SPL (Peak)	50 (40 Vertical)	IEC529 IP65W environmental rating

Figure 3 shows the maximum allowable locomotive height of 16 ft. 3 in. as defined by AAR-M 2008. Table 2 shows various freight locomotives and the potential horn mounting heights. The most severe height restriction appears to be the SD70MAC with a cab mounted available height of 7.5 in. and a center mounted available height restriction of 11 in. An emphasis on loudspeakers being less than 11 in. high is being used as a guideline in selection. By comparison, the Nathan K5LA is 9.94 in. high when mounted. The selected RMG-200A specifications conform to this specification.

A more powerful loudspeaker, the Sound Commander SC5600 by IML Corp, is a more powerful speaker with the potential to match the maximum FRA requirement. A follow on effort may include this speaker as an option.

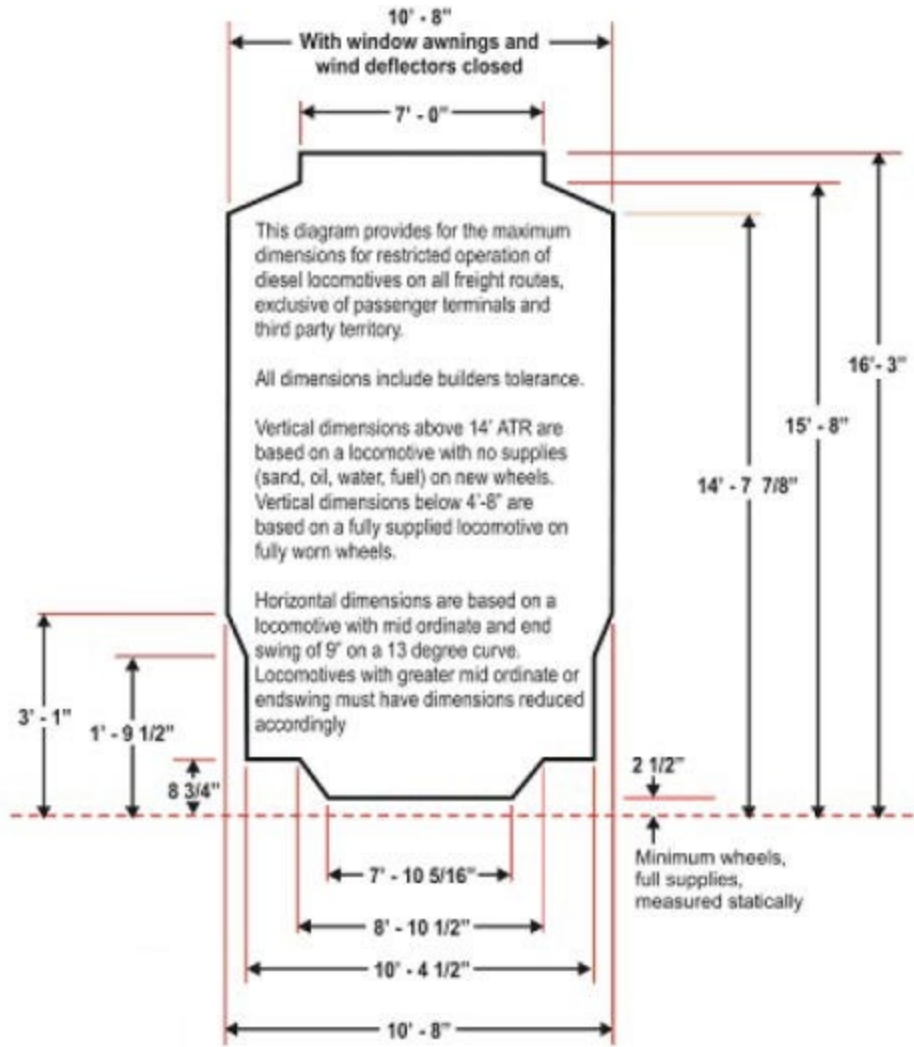


Fig. 2.1 Freight locomotive Plate L

Figure 3. Locomotive Dimension Limits

Table 2. Horn Mounting Heights on Locomotives

Locomotive	Cab Mount Height, feet	Center Hood Height, feet	Available Speaker Height, in. (max/low)
GP50	14' 7 1/2"		19' 1/2"
GP39-2	14' 6"		21"
SD40-2	14' 8 3/4"		18 1/4"
SD90MAC	15' 5"	14' 7"	10"/20"

<b>Locomotive</b>	<b>Cab Mount Height, feet</b>	<b>Center Hood Height, feet</b>	<b>Available Speaker Height, in. (max/low)</b>
SD70MAC	15' 7 1/2"	15' 4"	7 1/2"/11"
AC6000CW	15' 2"	14' 7 1/4"	13"/19 3/4"
AC4400C	15' 5"	14' 3"	10"/24"
DASH 9-44CW	15' 5"	14' 3"	10"/24"
DASH 8-40CW	15' 4"	14' 2"	11"/25"

### 3. Assessment of Environmental Noise Impact for Horn Geometries and Mounting Location

The number of acoustic sources, their mounting location and individual amplitude are important factors that would affect the overall directivity pattern of the AWD and the resulting environmental and occupational noise exposure.

The noise emissions of a traditional train horn include substantial noise transmitted beyond the grade crossing location relative to the train's direction of travel as shown in Figure 4. This is an inherent aspect of the nearly omnidirectional emissions of air-pressure horns and the requirement to sound the horn until the lead locomotive has covered the crossing. In Figure 4 the noise contours represent the day-night average sound level (Ldn) which is the average noise level over a 24-hour period assuming one train per hour, day and night, in one-way traffic. Sound propagated beyond the crossing, however, is of no benefit to motorists on the cross-road and is therefore an adverse environmental impact that should be minimized.

The figure highlights the 65 dBA Ldn value. This is the maximum acceptable level per the US Department of Housing and Urban Development (HUD) noise standard found in 24 CFR Part 51 Subpart B. Values above this are deemed unacceptable. The figure indicates that approximately 0.125 square mile of wayside area is exposed to unacceptably high sound level exposures according to HUD standards at each grade crossing. This figure assumes frequent trains at every hour and may not represent actual train schedules, but produces a useful comparison between horn systems.

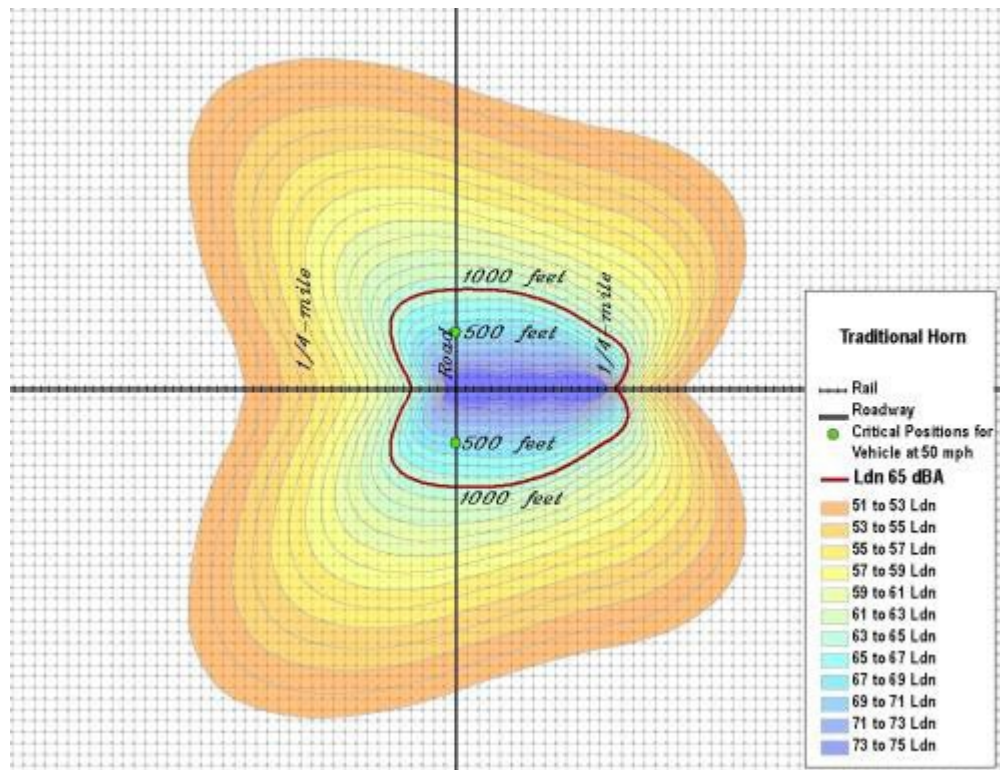
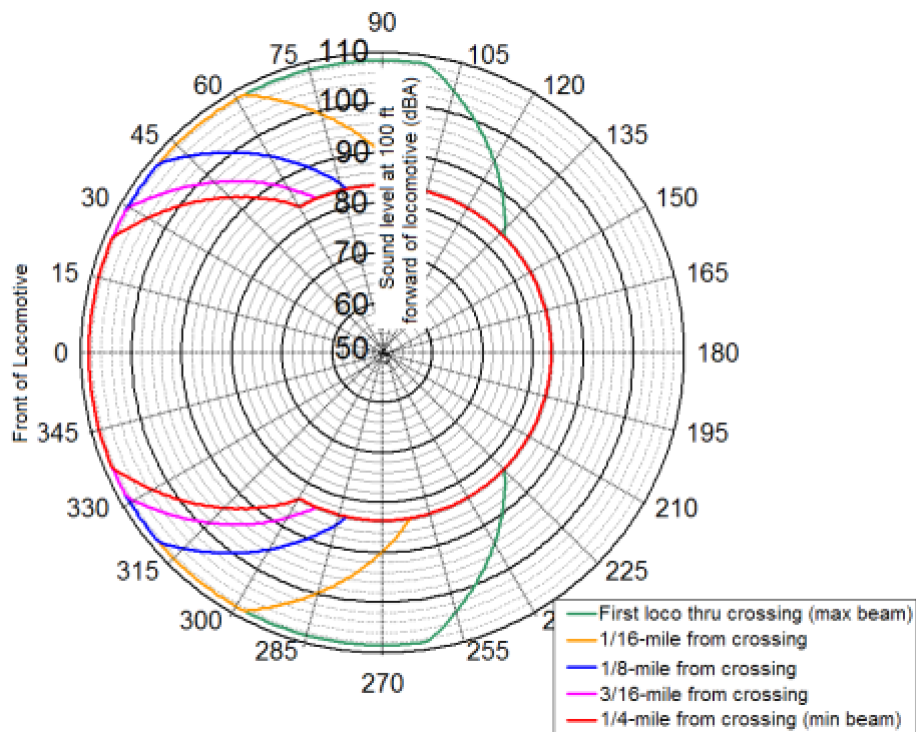


Figure 4. Noise Contours of a Traditional Horn

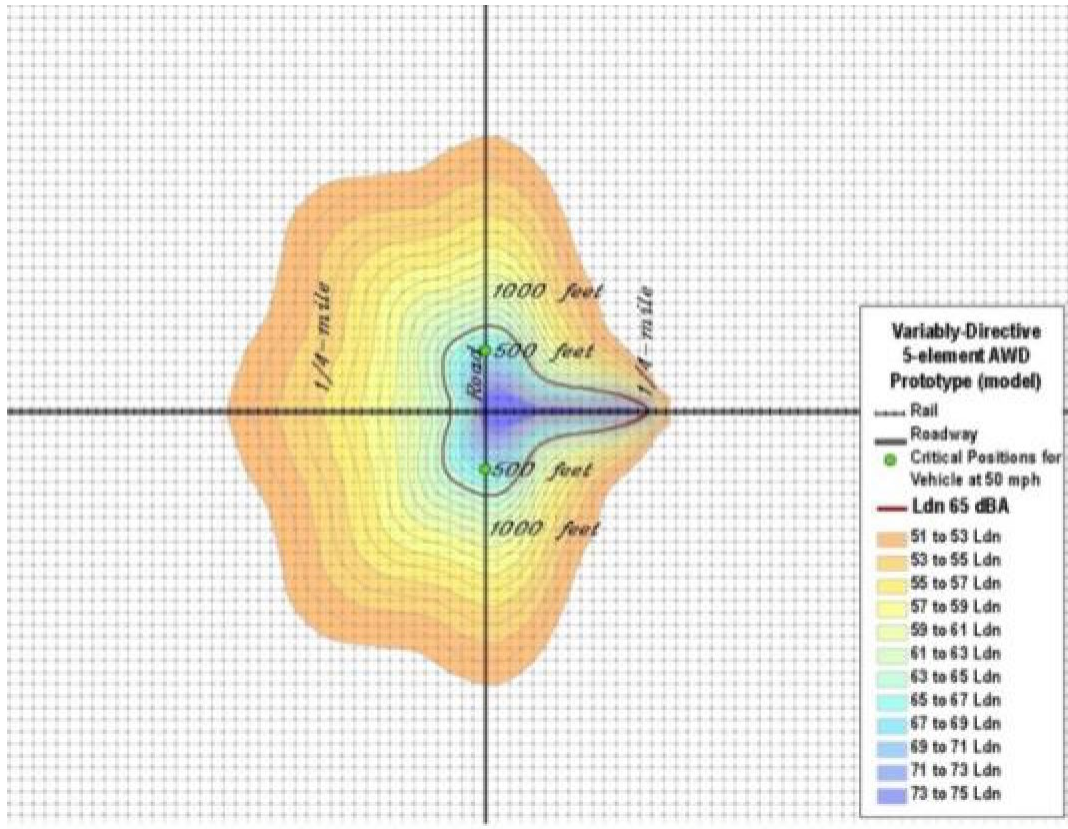
Figure 5 shows the ideal directivity pattern goals. Ideally, the sound levels would be 110 dBA from the critical stopping distance along the roadway to the track centerline. As the train approaches the crossing, the horn angle increases to the maximum of 105 degrees from the train axis at the point the locomotive is fully past the crossing. It was also determined that to minimize occupational noise exposure to the locomotive crew while providing the greatest amplitude forward of the locomotive, all the acoustic sources should be mounted on top of the locomotive cab unless there is any physical constraint for their mounting. If the AWD is center-mounted on a locomotive, it will increase the noise exposure level of the locomotive crew and likely reduce the maximum dBA level in front of the locomotive because of the partial obstruction caused by the cab to the sound wave propagation from the forward-facing speakers of the AWD. This is expected to further reduce the detectability of an approaching train to the motorists traveling along the grade crossing road.

The resulting environmental noise impact of the AWD with original directivity pattern goals, shown in Figure 6 as Ldn contours, also exhibited substantial noise exposure on the far side of the crossing. The area that is exposed to Ldn levels above 65 dBA has been reduced to 0.048 square miles, which is approximately a 60 percent reduction in high sound level exposure area.

Greater reductions are possible by eliminating the forward sound once the locomotive is past the crossing.



**Figure 5. Ideal AWD Goal with Variable Directivity Sound Pattern Without Reduction in Sound Forward of the Locomotive Past the Grade Crossing**



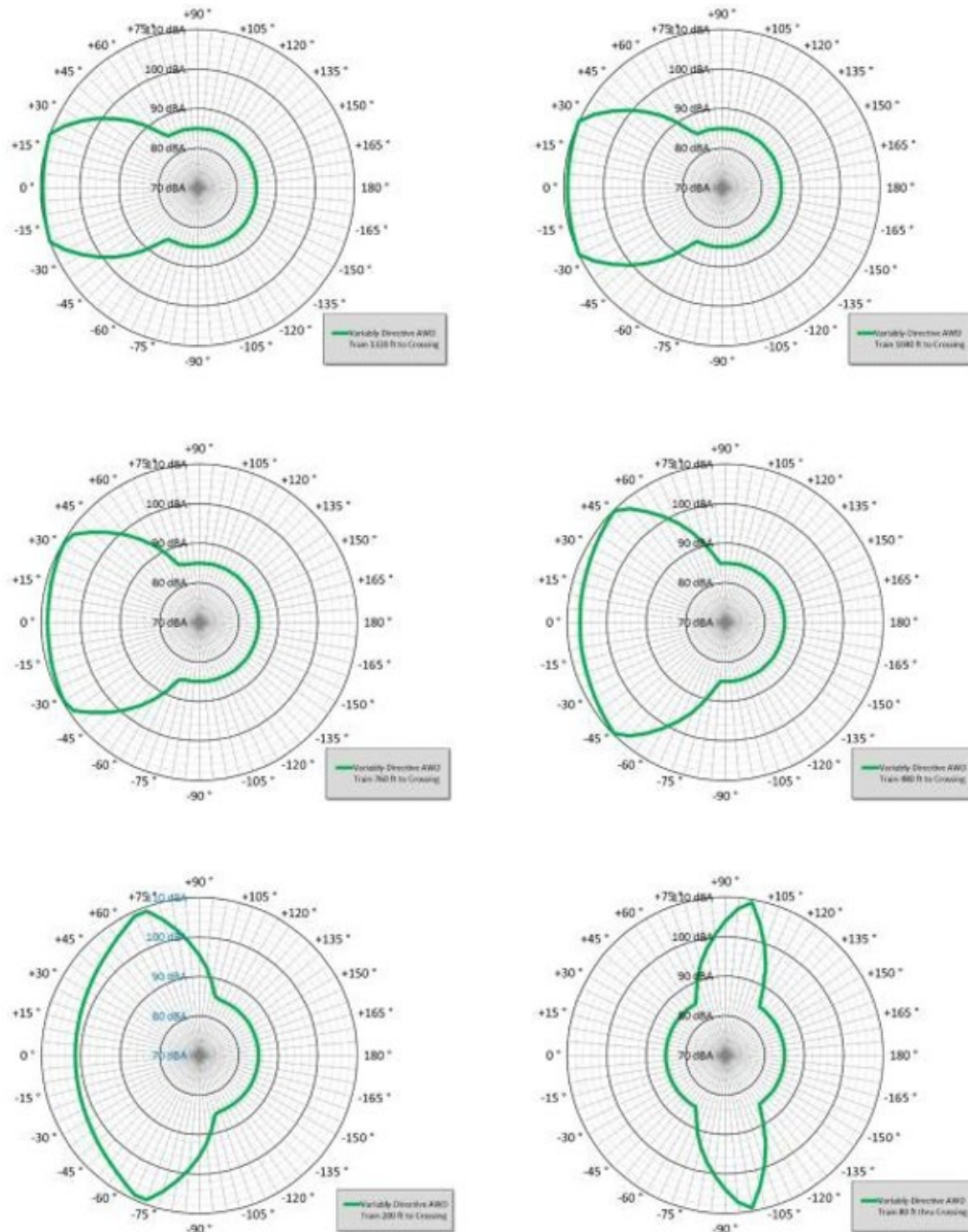
**Figure 6. Noise Contours in Ldn for a Five-Element AWD Traversing from 1/4 Mile to the Grade Crossing**

The program targeted the 500-ft. distance along the roadway as the critical location for drivers to notice an approaching train’s horn. This provides the critical stopping distance for a 50 mph vehicle. According to this methodology, should a driver only detect the train horn at a distance less than 500 feet from the crossing, it is not likely to stop before the crossing. Distances less than 500 feet are critical for slower moving vehicles. So, the entire distance from 500 feet either side of the crossing along the roadway must develop sufficient train horn sound levels to be detectable by a driver.

The next level of AWD horn optimization reduces the forward sound levels as the locomotive is at the crossing as shown in Figure 7. The angles at the various locomotive distance from the crossing reflects the straight line to the 500-ft. point along the roadway. So, at 1/4 mile (1,320 ft.) the horn angle to maintain the needed sound level is 21 degrees either side of the train. At the bottom of the figure, the sound pattern begins to decrease sound levels as the locomotive passes the crossing. This will reduce noise levels further than shown in Figure 6. Since there is not a significant difference in the distance from the train to all locations 500 feet on either side of the cross-road, the amplitude of this front lobe of sound is relatively equal. As the train gets closer to the crossing, for example at 480 feet, the acoustic beam-width that is needed to cover the critical points on road is 1,000 (+/- 50 degrees). However, since the distance from the train to the rail-road crossing is closer than the distance from the train to 500 feet down the road to the “critical points,” the amplitude of sound across the front lobe is not equal. In fact, the sound generated directly forward of the locomotive can be 3 dB lower than the edges of the beam and still provide



equal amplitude along the roadway. As the train gets even closer to the crossing, for example at 200 feet, the sound generated directly forward of the locomotive can be approximately 10 dB lower than the edges of the beam. Finally, as the locomotive enters the crossing and continues past it, the AWD can reproduce sound only through the side-facing (i.e.,  $\leq \pm 90^\circ$ ) speakers to focus it down the roadway. At this location, the AWD is essentially acting like an on-board wayside horn that focuses sound just down the roadway.



**Figure 7. Ideal Directivity Patterns for Equal Sound Distribution on a Grade Crossing Road**

## 4. AWD System Design

---

### 4.1 AWD Development with Community RMG-200A Speakers

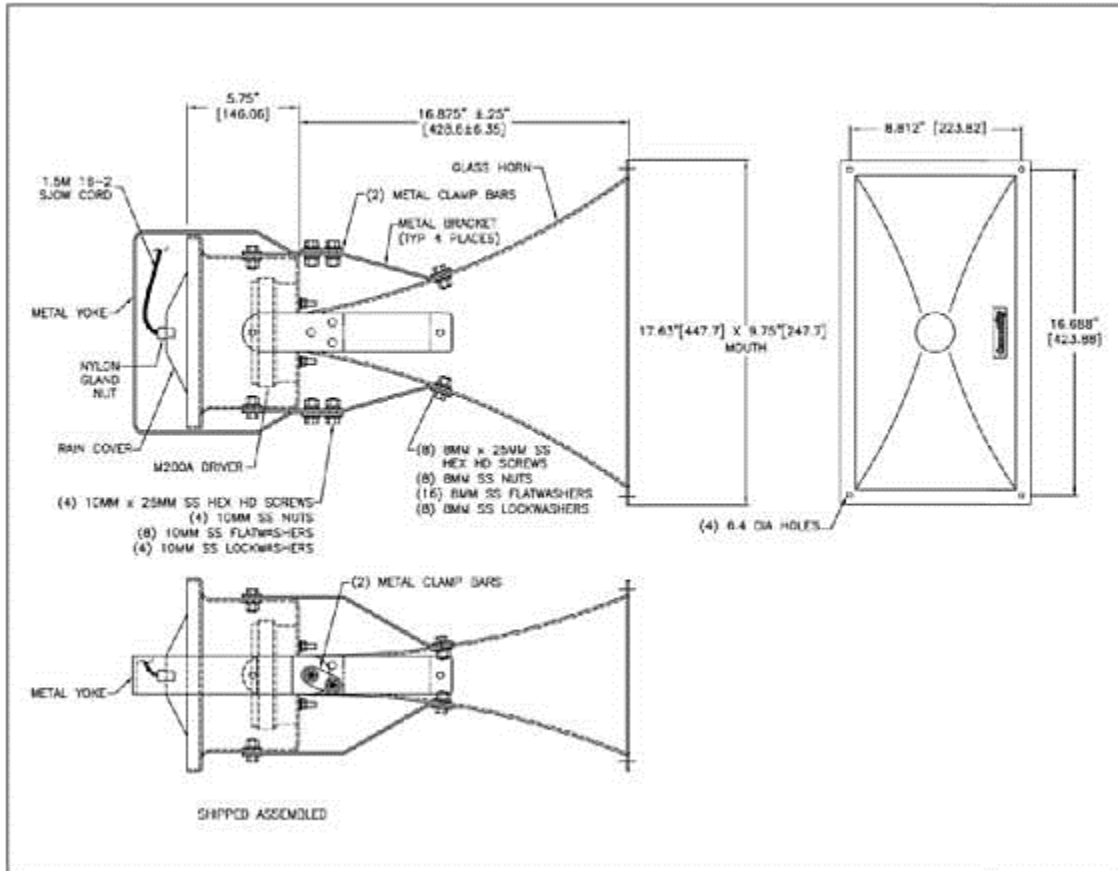
One of the prerequisites for use of a speaker system as a locomotive horn is its compliance with the FRA regulations cited in 49 CFR Parts 222 and 229 [7]. These include both geometric size limitations as well as output sound amplitude limitations at 100 feet forward of the locomotive. The peak sound level at 100 feet in front of the locomotive should not be less than 96 dBA and not greater than 110 dBA. To determine height restrictions for loudspeakers, the allowable height of a locomotive is compared to the potential mounting height.

### 4.2 AWD System Description

The selected COTS electronic loudspeaker with an acceptable directivity is RMG-200A which was originally designed as a voice-range horn system. It is a complete horn/driver system that is designed to provide focused, high output sound projection with predictable performance and exceptional long term durability in outdoor applications. The horn portion of the assembly is a handcrafted one-piece waveguide, precision molded in hand-laminated, fiber-reinforced fiberglass for optimum performance. With substantial fiber reinforced plastic (FRP) layering and integral throat and driver flange construction, the horn is built to withstand substantial torque loads. The inherent strength and rigidity of the FRP construction enhances sonic efficiency by preventing sound energy loss as well as offering inherently weatherproof fabrication.

The compression driver is a high output high sensitivity loudspeaker that is configured with the diaphragm facing forward, isolating the voice coil and magnetic structure from the environment. The one-piece nonmetallic diaphragm/suspension offers exceptional resistance to the effects of humidity, dust, and corrosive atmospheres. The large area, low compression phase plug loading and large magnet structure exhibits extremely low distortion at high output while maintaining high efficiency and low power compression. Its environmental performance conforms to the IEC529 IP65W rating with a minimum five-degree downward aiming angle.

Figure 8 shows the RMG-200A speaker dimensional details. Its specified geometric dimensions are as follows: height: 9.75 in; width: 17.63 in (front) / 10.5 in (rear); depth: 25 in.



**Figure 8. RMG-200A Speaker Dimensional Details**

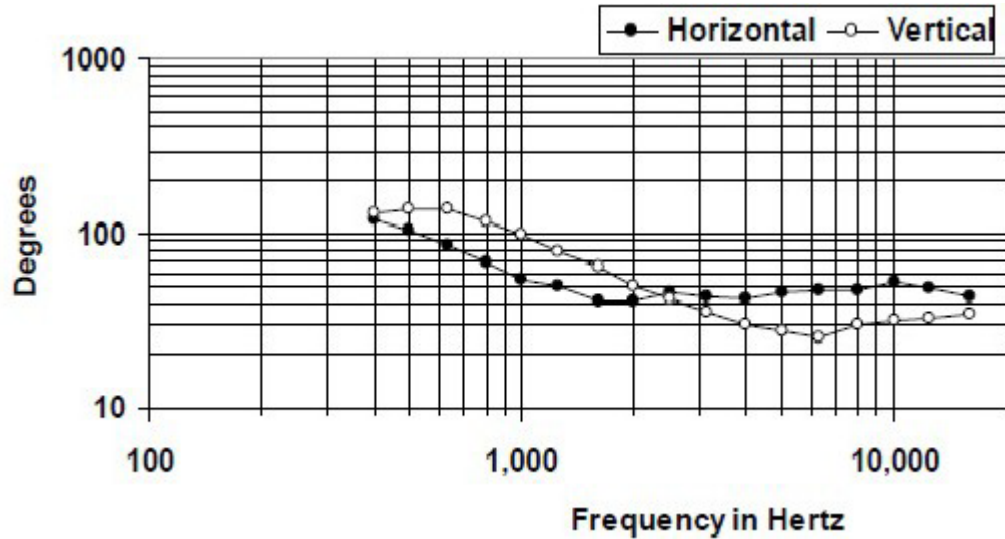
It features a 2-inch throat exit M200 driver. Its operating frequency range is 400 Hz to 8 kHz / 500 Hz to 4 kHz (+/-3.5 dB). The maximum input ratings: 75 W continuous, and 120 W program. A 100 W to 140 W power amplifier is recommended. The maximum output power is 134 dB SPL / 141 dB SPL (peak).

The RMG-200A beamwidth variations with frequency in both horizontal and vertical planes are shown in [Figure 9](#) and its frequency response is shown in [Figure 10](#). The frequency response is tailored for voice applications of loudspeakers. An ideal train horn loudspeaker would have greater sound output at the lower frequencies. The relatively narrow directivity of the sound beam emitted by the RMG-200A is ideal to minimize the trackside noise impact.

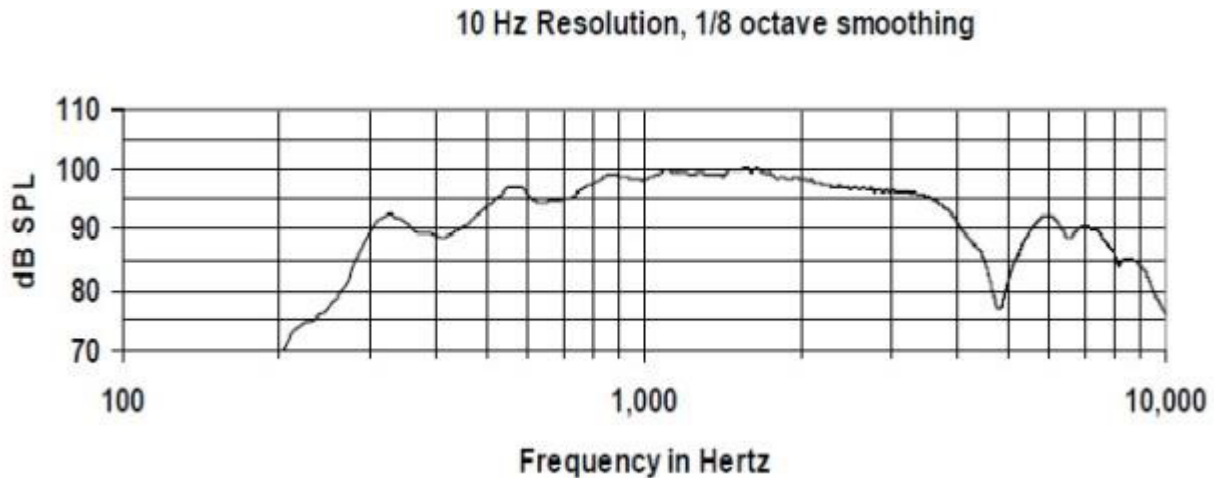
However, the narrow beamwidth also means that several loudspeakers are need for full area coverage. This is the basic trade-off of the AWD concept. Highly directive loudspeakers enable control of the overall sound beamwidth. But the directivity also means that several speakers are needed to cover the range of from directly ahead of the locomotive at 0 degrees to about 100 degrees as the locomotive passes through the crossing. The current program demonstrated viability of the concept. However, there is still a need to optimize the performance and cost of each loudspeaker and the entire loudspeaker array to provide a cost effective solution for the railroad industry.

The required number of speaker units and their mounting orientations on a locomotive are determined through acoustic modeling and in the laboratory. Based on simulation results, six

RMG-200A units were selected and their mounting orientations were symmetric about the locomotive moving axis and these were set at  $\pm 15$ ,  $\pm 35$ , and  $\pm 75$  degrees.



**Figure 9. RMG-200A Loudspeaker Included Beamwidth Variation in Horizontal and Vertical Planes**



**Figure 10. Specified Frequency Response of RMG-200A Horn**

For effective performance of the AWD system on a locomotive meeting the dual objectives of good detectability of an approaching train at the grade crossing while minimizing the trackside noise exposure to the abutters, it was found necessary to activate the three sets of RMG-200A speakers sequentially starting at 1/4 mile as the locomotive approached the crossing at a constant speed. To accurately determine the locomotive position from the crossing, it was necessary to use a GPS unit and integrate it with the AWD control system that permitted the automatic activation of all three sets of speakers according to the predefined horn sounding algorithm, which depends on the speed of the locomotive. All the major components constituting the AWD system such as the RMG-200A speakers, audio amplifier, a rugged tablet or a laptop containing

the AWD control system software, GPS sensor unit, power supply module, and a manual override push button, etc. are shown in Figure 11. The AWD used for the laboratory testing and for the performance evaluation on a test locomotive consisted of six units of RMG-200A integrated driver and speaker, but for the sake of clarity, only two speakers are shown in Figure 11.



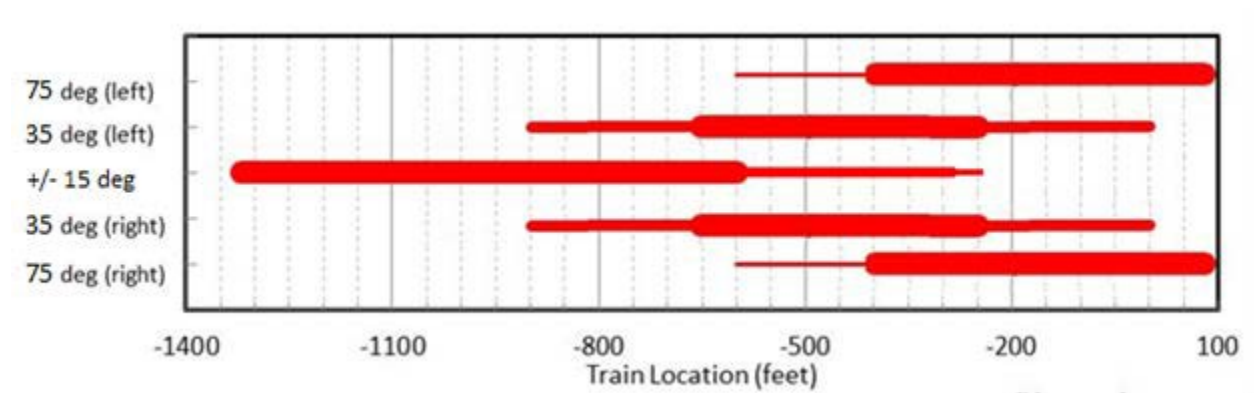
**Figure 11. Major Components Constituting the AWD System**

### **4.3 AWD Speaker Sound Sequence and Control**

The relatively narrow directivity of the RMG-200A speaker of the Community Professional Loudspeakers is a desirable attribute for directing the sound energy to a smaller segment directly in front of the speaker. This was advantageous for use at greater distances from the grade crossing while cutting down on the side lobes to minimize the noise impact on trackside residents. However, as the locomotive gets closer to the grade crossing, there is the need to provide a far wider sound beam to cover the critical points on either side of the track so as to offer adequate warning to the traveling motorists to stop their vehicles safely before the crossing. To meet these conflicting requirements near grade crossings, the AWD required the use of 3 sets of speakers or a total of 6 speakers symmetrically mounted on a locomotive cab roof about its longitudinal axis with optimal orientation to cover the entire frontal arc of 1,800 and slightly beyond. According to the FRA regulation, the train horn needs to be sounded until the lead locomotive of a train completely covers the grade crossing, which amounts to a sound coverage angle of almost 2,000 to cover the 2 critical points on either side of a cross road.

These considerations lead to the concept of sequential activation of all three sets of AWD speakers as the locomotive started sounding the horn from 1/4 mile up to the grade crossing. At the 1/4 mile marker, a narrow sound beam of 42 degree wide is required to cover the two critical points on the cross road and the activation of  $\pm 15$  degree speakers adequately delivered the AWD sound to the critical points. As the locomotive moves up to 900 feet from the crossing, the

AWD control system with the help of GPS would activate another two  $\pm 35$  degree speakers which along with the front facing two speakers cover the entire frontal arc up to the critical points on the cross road. The AWD speakers' activation pattern is schematically shown in Figure 12 with the speaker out levels shown in Table 3.



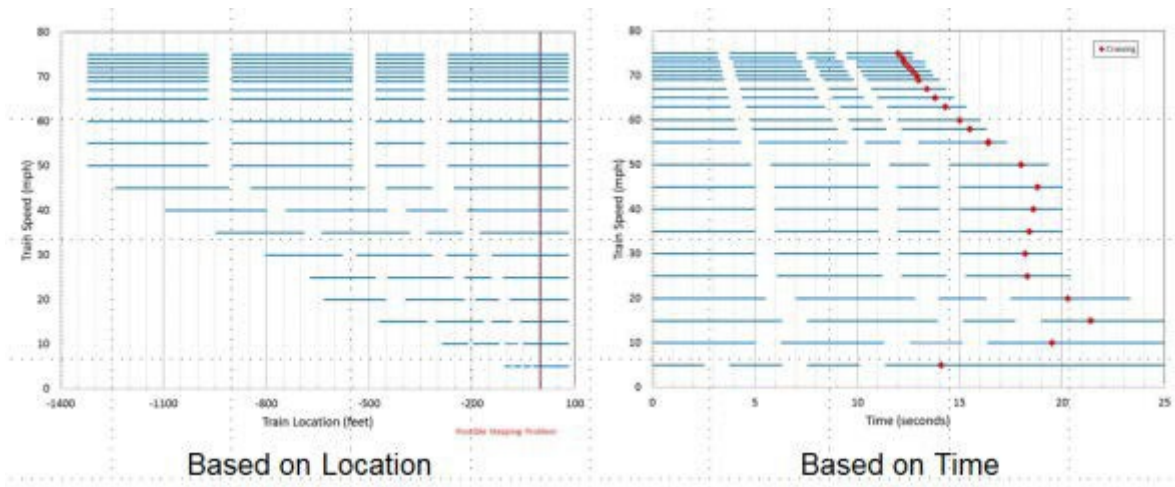
**Figure 12. Schematic Representation of Three Sets of AWD Speaker Activation Sequence Near a Grade Crossing**

**Table 3. Speaker Sound Levels Approaching the Crossing**

Distance to crossing, feet	$\pm 15$ -degree speakers, dBA at 1 meter	$\pm 35$ -degree speakers, dBA at 1 meter	$\pm 75$ -degree speakers, dBA at 1 meter
1,320	134	—	—
900		124	—
650		134	—
600	134		0
400			134
300	124		
250	0	134	
0 (at crossing)	—	0	
-90	—	—	134

When the locomotive reaches 600 feet from the crossing, the third set of side-facing speakers ( $\pm 75$  degrees) is activated with fine gain control by the AWD control system and the first set of front-facing speakers are turned down to minimize further frontal sound intensity. As the locomotive reaches 200 feet from the crossing, the second set of  $\pm 35$  degree speakers is turned off. Upon completely covering the grade crossing, the last set of side facing speakers is turned off. All the above AWD system operations were achieved with the help of an AWD GPS control system design and implementation along with an integrated GPS sensor. In compliance with the Federal Acquisition Regulation (FAR), the AWD horn sounding pattern was designed to reproduce the classical LLSL sound starting at 1,320 feet from crossing and lasting until the lead

locomotive completely covers the grade crossing, but not exceeding 25 seconds depending on the speed. A representation of the horn sounding pattern algorithm for different speeds is schematically shown in Figure 13, both based on the locomotive location from the grade crossing and also based on time.



**Figure 13. AWD Sounding Pattern Algorithm for Different Speed of the Locomotive**

The simulation results expressed as an ideally configured AWD’s Ldn contours along with optimized forward emission control is shown in Figure 14. In this figure, the 24 hour day-night average Ldn 65 dBA contour is prominently marked starting at 1/4 mile and covering the two critical points (500 feet from track on either side) on the highway at the grade crossing. It also clearly shows the benefit of optimized forward sound emission control through sequential activation and deactivation of the three sets of speakers which drastically reduces the noise level on the far side of the grade crossing. The resulting area affected by the 65 dBA Ldn has been reduced to 0.022 square mile, or an 80 percent reduction from the 0.125 square mile estimated for the standard air pressure horn.

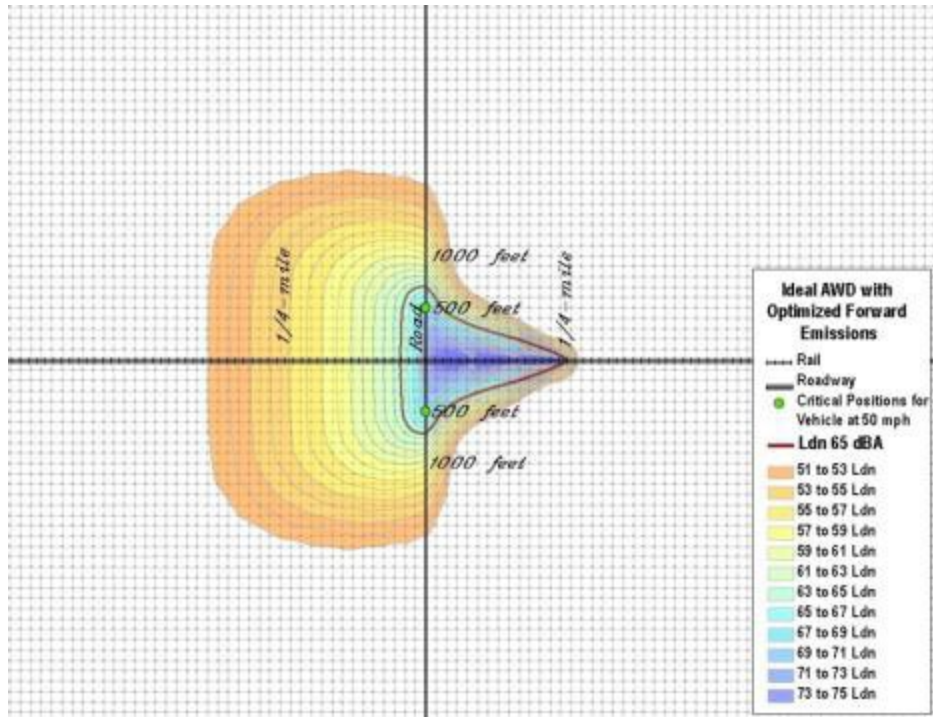


Figure 14. An Ideal AWD's Ldn Contours with Optimized Forward Emission Control



## 5. AWD Static and Dynamic Testing at TTCI

---

The AWD system consisting of a set of six RMG-200A speakers, a 4-channel Crown ITech 4-3500 HD amplifier, a laptop-based MATLAB AWD control system and a GPS unit. Researchers conducted static and dynamic testing at TTCI in Pueblo, CO, with the test system mounted on a F-40 PH locomotive (DOTX4113). TTCI's Railroad Test Track (RTT) # 3 as in [Figure 15](#) was used for the AWD testing over a stretch of tangent track during June 6–8, 2016.

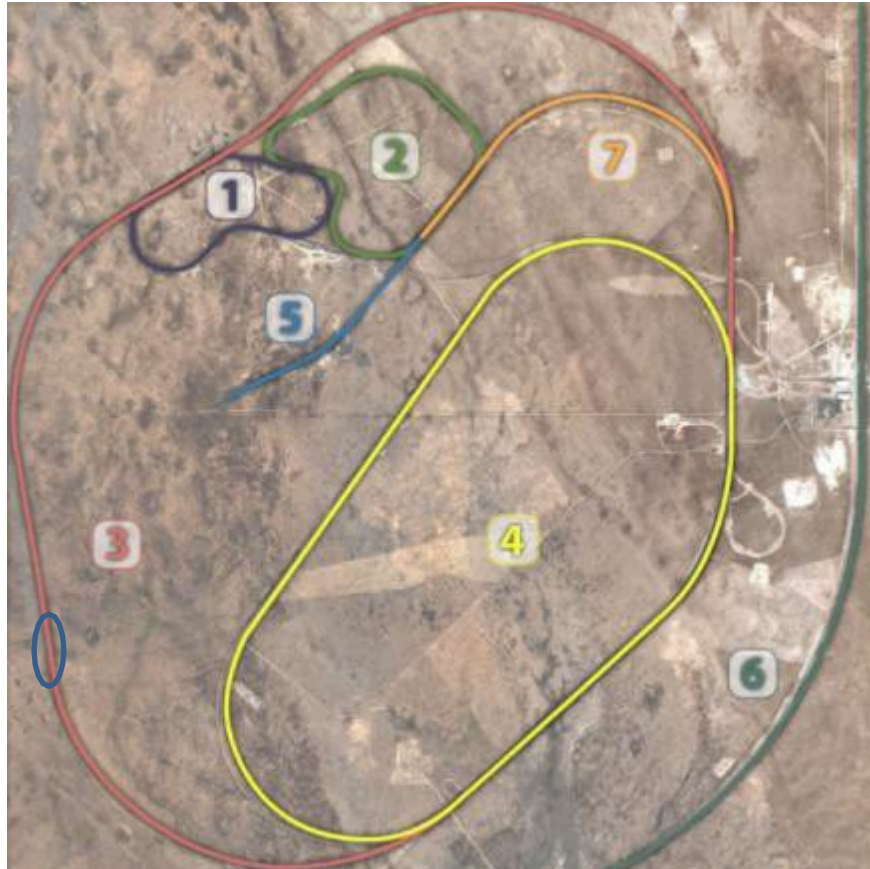
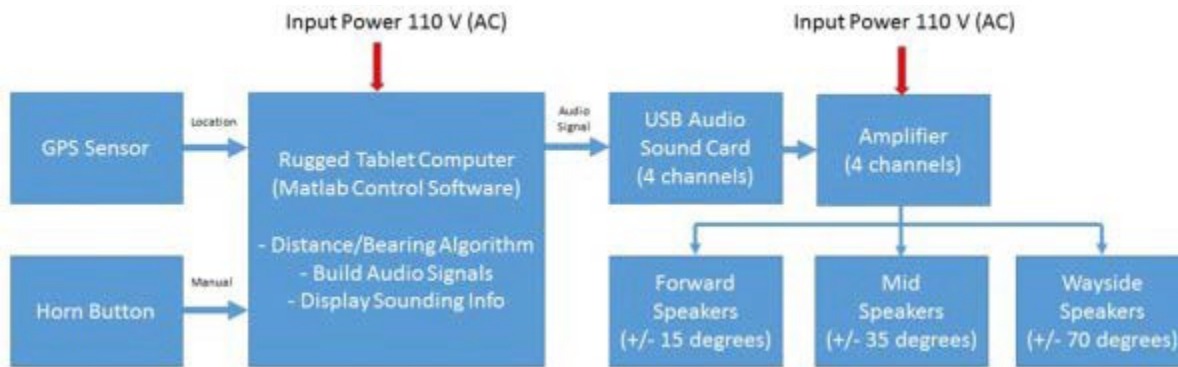


Figure 15. TTCI RTT Track 3

### 5.1 AWD Test System Description

The AWD system used in the static and dynamic tests at TTCI was a GPS controlled system that was driven through MATLAB control software on a rugged tablet computer ([Figure 16](#)). Although not used in the testing, the system was designed with a manual override using an input button to manually sound the AWD loudspeakers if needed. The computer uses the GPS position to determine train speed and distance from the grade crossing. A Universal Serial Bus (USB) audio sound card drives a 4-channel amplifier. Only three channels are used, one for each of the three pairs of loudspeakers in the system.



**Figure 16. AWD System Schematic**

The AWD system includes the following components:

- GPS Sensor – A Garmin GPS 18x 5 Hz sensor collects position data five times per second which is subsequently analyzed to determine train location, speed and bearing relative to grade crossing locations. This sensor is a WAAS-enabled receiver that provides positional accuracy typically less than 3 meters. The operating temperature of the sensor ranges from -22 °F to 176 °F. Power consumption of the sensor is relatively low at approximately 100 mA at 5 volts.
- Rugged Tablet – A Panasonic FZ-G1 rugged tablet collects data from the GPS sensor and MATLAB software runs the AWD control system.
- Horn Button – An automation button is connected to a serial input on the rugged tablet. The button is used to manually sound the horn.
- USB Sound Cards – Two Edirol UA-1A 2-channel USB audio cards are connected to the rugged tablet. These sound cards output audio signals with 16-bit resolution at up to 44.1 kHz sample rate. Audio signals of the train horn generated by the MATLAB control system software are output via the respective channels of the sound cards.
- Audio Amplifier – A Crown I-Tech 4x3500HD sends the amplified audio signals from the sound cards to the AWD speakers. This amplifier provides up to 1,900 watts RMS per channel for signals between 20 and 20k Hz. This amplifier has substantially greater power available than that required for the AWD speakers; however, the amplifier includes two important audio processing features including voltage and peak limiting (i.e., to not overpower the speakers) and equalization to limit the low-frequency audio signal (below 400 Hz) from reaching the speakers and potentially damaging them.
- AWD Speakers – Six Community RMG-200 complete horn/driver speakers output the horn signals. The horns are made of a fiberglass material and perforated sheet metal screens were mounted in front of the horn opening to stop debris from entering the speaker while on the train. These speakers have an operating range from 400 Hz to 8 kHz with maximum input rating of 75 watts. The maximum output of each speaker is 134 dB SPL at 3 meters. The nominal (6 dB down) directivity of these speakers is 50 degrees in the horizontal plane and 40 degrees in the vertical plane included angles. Each speaker weighs approximately 21 pounds and is nominally 10 inches tall, 18 inches wide and 25 inches deep. The speakers are positioned on the side to limit height above the locomotive.

The AWD audio control system completes the following processes:

- Scan and connect serial connections are automatically
- Read GPS locations every 200 ms
- Calculate distance and bearing to all crossings in database to determine distance to closest crossing location and time sounds will start
- Calculate a sounding pattern (LLSL) in real-time based on train speed and distance from crossing
- Build an acoustic waveform in 200 ms portions which modifies amplitude of all six channels and adds pauses to create long-long-short-long. This algorithm is adaptive so that as the train speed changes, the long-long-short-long pattern is updated to ensure that the horn sounding continues until the first locomotive is through the crossing and that there are no additional gaps in the sounding pattern.
- Allows a manual playback and button connection for manual playback of the horn signal
- Displays the train location relative to the crossing, the long-long-short-long sounding pattern, the train speed, distance to crossing, horns that are currently sounding, time remaining and system status
- Outputs acoustic signal through audio sound cards
  - Sound cards are connected to the AWD amplifier system for playback through the acoustic sources
- Writes a diagnostic data file of all variables (every 200 ms) such as; GPS data, system values and central processing unit (CPU) processing times
  - Diagnostic files/filenames automatically generated each hour
  - Plots diagnostic data
- Optionally loads GPS data National Marine Electronics Association (NMEA) files into Google Earth/ArcGIS to display path
- GPS demo files run tests on various train operations

The AWD audio control system has also been tested on a moving vehicle to collect realistic time-varying GPS data. The actual GPS data can then be modified to replicate unique train operations. The modified GPS data can be read back into the system to test different operating conditions such as long-term operation, trains that accelerate or decelerate through the crossing, trains that stop before the crossing, etc.

Figure 17 and Figure 18 present the horn sounding pattern algorithm that the control system uses. The horn sounding must be ideally 15 to 20 seconds long, and no longer than 25 seconds including a LLSL pattern.

Figure 19 shows the AWD audio control system setup. Before starting the system, the program allows for the diagnostic file folder to be specified, selection and review of the crossing database, connection and testing to the GPS sensor and the horn sounding button, selection of the horn signature to be played back, and selection and testing of the audio sound cards.

Figure 20 and Figure 21 show the audio control system during operation. The nearest crossing, if any within 3,000 feet, the train speed and the time for the horn to automatically start sounding are displayed. Additional diagnostic information including the distance and bearing to the nearest crossing, the date and time and the number of milliseconds the system is taking to process (i.e., read the GPS data, find the nearest crossing, run through the sounding pattern algorithm, develop the acoustic waveform, output the waveform and display data) are displayed. These figures show how each acoustic source will be sounded as a function of train location. The red LLSL pattern is dynamic and changes according to train speed and location. The blue vertical marker moves across the screen as the train approaches and departs the crossing.

Tests of the AWD audio control system indicate that the system is robust and can be run for extended periods of time.

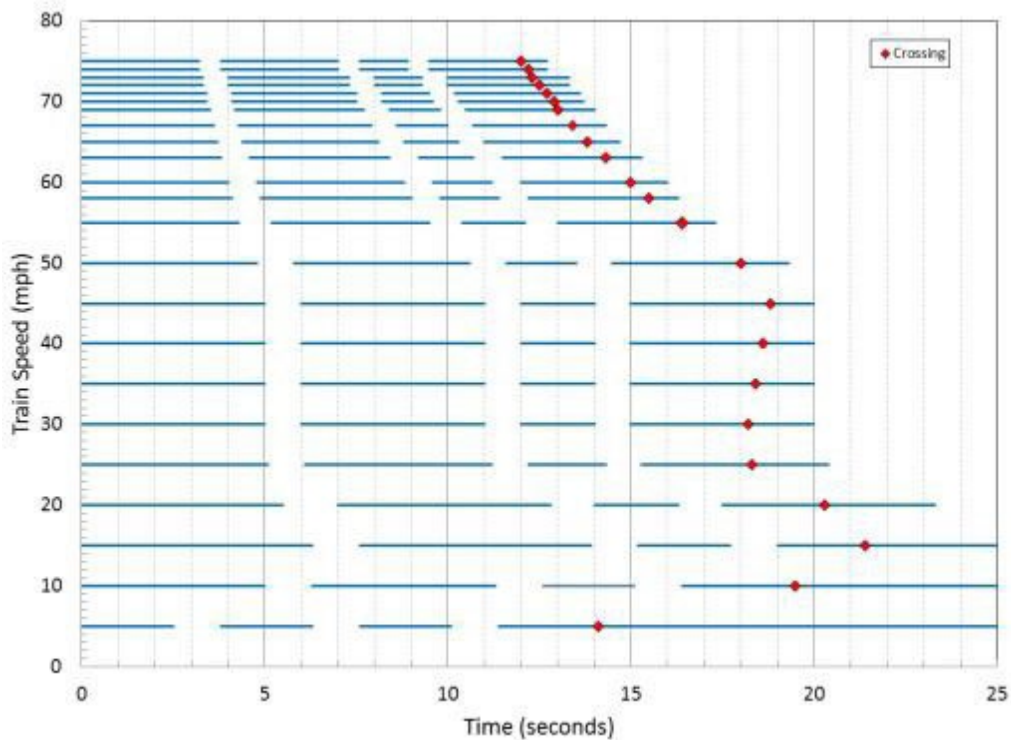


Figure 17. Horn Sounding Pattern Algorithm (Train Speed vs. Time)

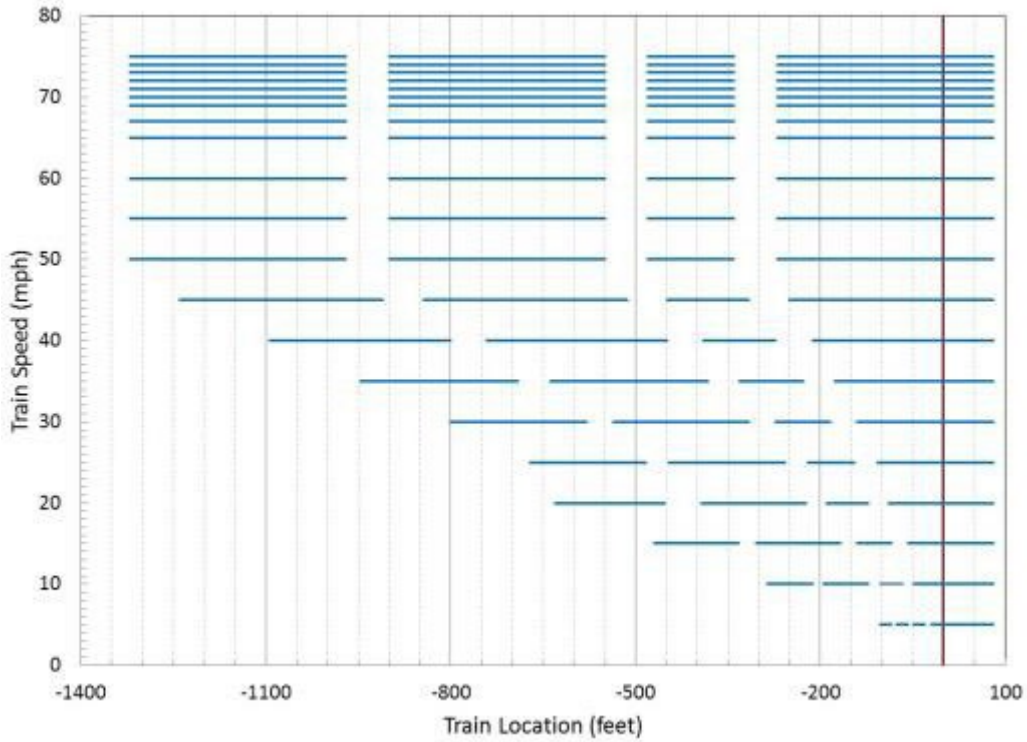


Figure 18. Horn Sounding Pattern (Train Speed vs. Location)

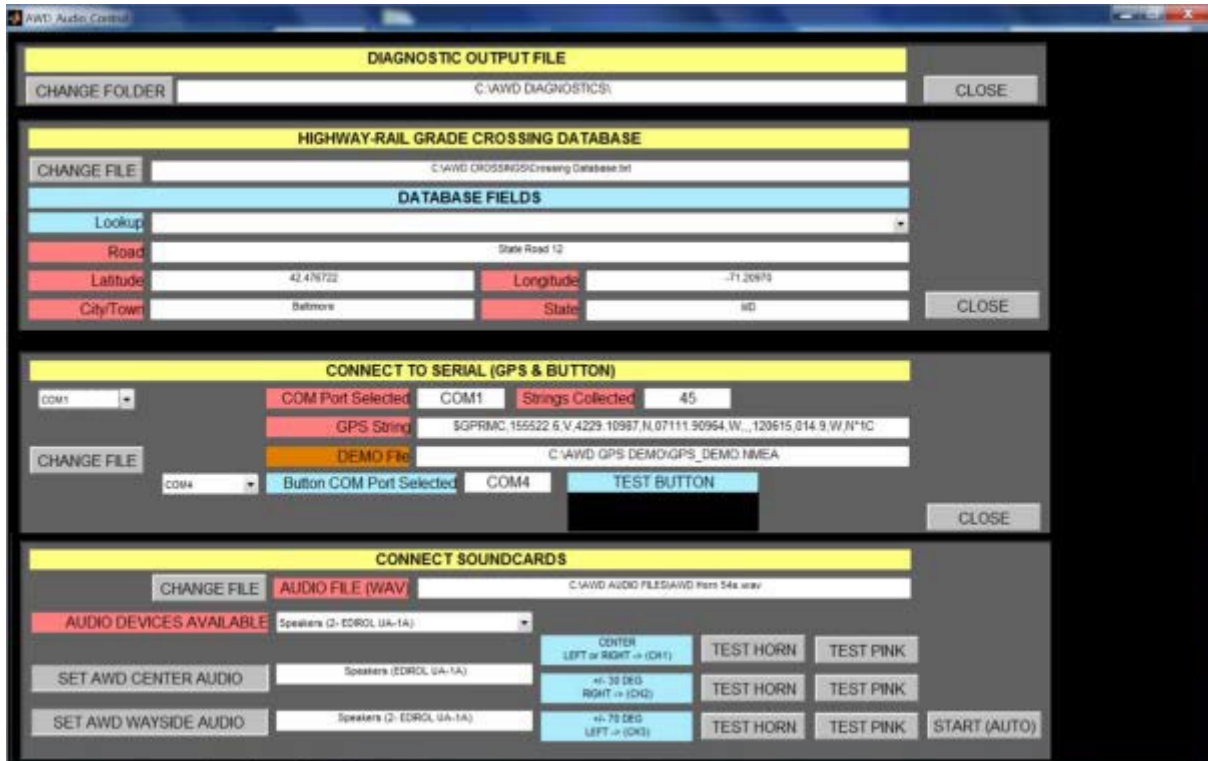


Figure 19. AWD Audio Control System Setup



Figure 20. AWD Audio Control System Running (Demo Mode) – Approaching Sounding

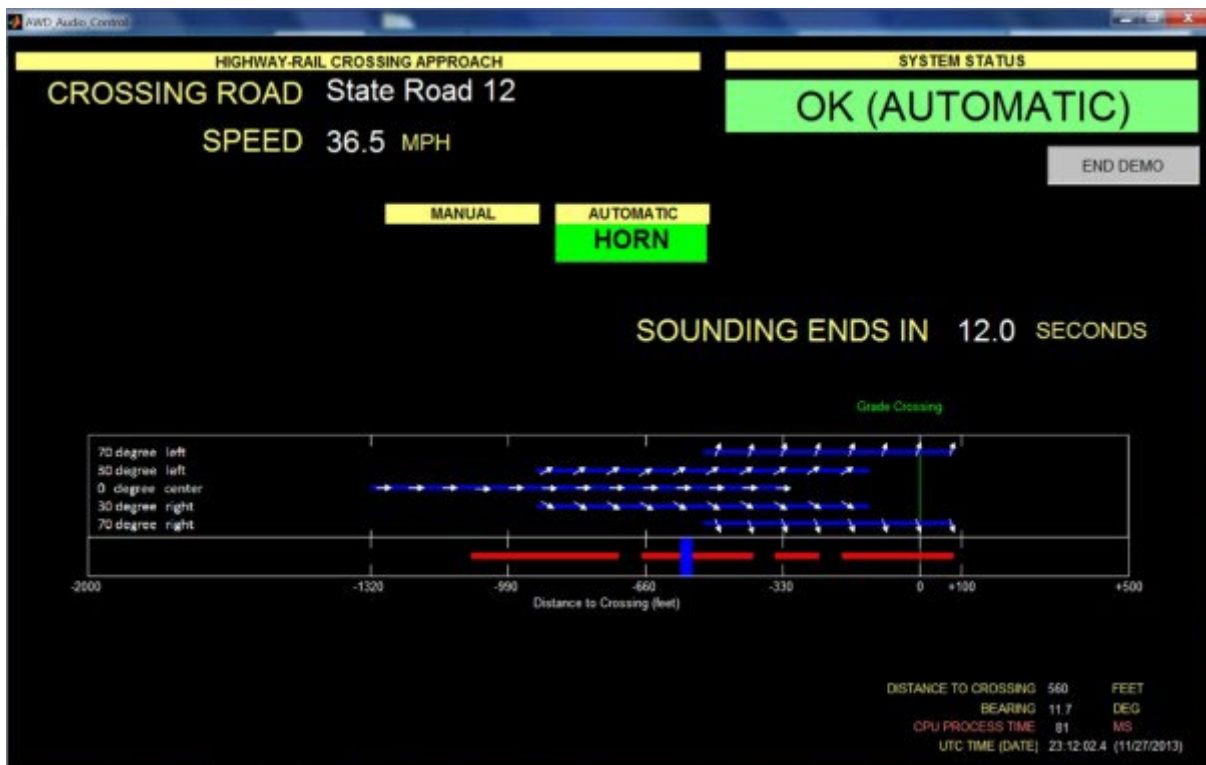
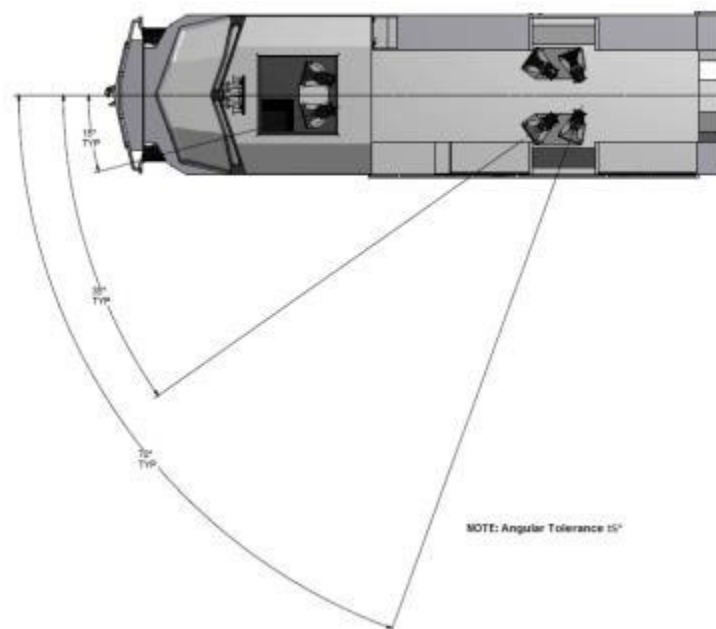


Figure 21. AWD Audio Control System Running (Demo Mode) – During Sounding

## 5.2 AWD System Installation and Static Testing

Following the review of QNA's AWD test plan, TTCI agreed to use one of their F40PH locomotives (DOTX4113) for testing. It is fitted with a conventional Nathan K5LA air-pressure horn with all 5-chimes facing forward of the locomotive and mounted along the center line at front end of the cab roof. Prior to the conduct of the test, TTCI technicians carried out the mounting of six RMG-200A speakers on the roof of the locomotive according to their optimized orientations provided in QNA's test plan as shown in Figure 22. The two front-facing speakers mounted at  $\pm 15$  degrees with respect to the longitudinal axis of locomotive were positioned above the existing K5LA air pressure horn for an obstruction-free delivery of AWD sound as shown in Figure 23. The other two sets of side-facing RMG-200A speakers were mounted on two steel plates at  $\pm 35$  and  $\pm 75$  degrees a short distance behind the first set of front-facing speakers. Figure 24 shows a top view of all six speakers mounted on the roof of the locomotive and Figure 25 shows the side view of the locomotive fitted with the AWD system near the test track following completion of the installation. The GPS sensor unit was also attached to the cab roof and the AWD control system that was operated from a laptop as well as the Crown 4-channel I-tech 4-3500 HD amplifier were located within the cab space for ease of operation by the test engineer during the locomotive test run.

The next step involved the measurement of the maximum sound output level as well as the directivity of the AWD system mounted on a static locomotive under unobstructed open air condition and also that of the standard 5-chime air-pressure horn under identical conditions at 100 feet away from and 360 degrees surrounding the locomotive. The sound output level measurement was carried out by holding a microphone mounted atop a 15 feet high pole just in front of the locomotive as shown in Figure 26. This method was used to measure the sound amplitude of both air-pressure horn and AWD system. A similar measurement was taken at 100 feet in front of the locomotive (at 0 degrees) and at 100 feet behind the locomotive (at 180 degrees) as shown in Figure 27.



**Figure 22. Optimized Mounting Angles for All Six Speakers of AWD System Per Test Plan**



**Figure 23. Two AWD Speakers Located at  $\pm 15$  Degrees Above the K5LA Air-pressure Horn**



**Figure 24. Top View of AWD System Six Speakers Installed on TTCI's DOTX4113 Locomotive**





**Figure 25. Side View of F40 PH—DOTX4113 Locomotive with Fully Installed AWD System**

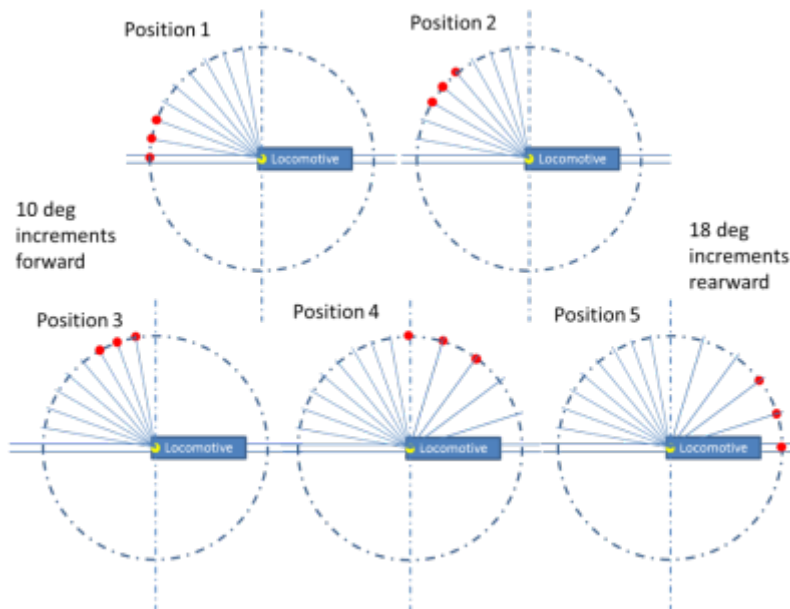


**Figure 26. Sound Measurement with 15 Feet High Pole Right in Front of Locomotive**



**Figure 27. Sound Level Measurement at 100 Feet Behind the Locomotive**

For measuring the sound directivity pattern at 100 feet from the front of locomotive, a 180 degree arc was considered at 100 feet radius starting from the track center line in front of the locomotive to the track center line at the rear of the locomotive. The front segment of the arc up to 90 degrees was marked at 10 degree intervals and the rear segment of the arc was marked at 18-degree intervals as shown in Figure 28.



**Figure 28. Sound Meter Positions for Stationary Locomotive Horn and AWD Sound Measurement**

For the measurement of train horn sound level (dBA) surrounding the stationary locomotive DOTX4113, it was considered adequate to carry out the measurement at discrete points along the symmetrical right half starting at 0 degrees from the forward middle of the track as shown in Figure 29. At the marked points along the 100 feet radius arc, 3 sound level meters (SLM) mounted on tripod stands were placed sequentially from position 1 through position 5 as shown in Figure 30.



**Figure 29. Static Locomotive Horn and AWD Directivity Measurement at 0 Degree Location**



**Figure 30. SLMs on Tripods Setup for Stationary Locomotive Horn/AWD Directivity Survey**

At each position with 3 SLMs set on tripods covering three consecutive marked locations on the 100 feet radius arc, first the AWD-horn was sounded briefly with the LLSL pattern and next the air horn (K5LA) was sounded repeating the same pattern. After covering all the 15 marked points on the 100 feet radius arc and recording the sound levels in the 3 SLMs, the data were stored for later analysis and the test preparation was made to carry out the dynamic test at the selected simulated grade crossing location on the TTCI RTT test track.

### **5.3 AWD System Dynamic Testing on TTCI Track**

The main objective of the dynamic test was to evaluate the performance of the prototype AWD system installed on a locomotive as compared to acoustic models. This test was conducted over a long stretch of tangent track at TTCI RTT #3 on completion of the static sound measurement test. In the absence of a pre-existing grade crossing on this track, it was necessary to consider a simulated grade crossing and the sound level measurements made to the right side of the track at predefined distances from the track and, by symmetry, the measured dB levels were deemed to be identical at corresponding points on the left side of the track on the simulated cross road. The view down the tangent track from the simulated grade crossing is shown in [Figure 31](#) with DOTX4113 approximately a 1/4 mile distance, and a view of DOTX4113 at the simulated grade crossing is shown in [Figure 32](#).

For the evaluation of the detectability of an approaching train, it was necessary to measure the sound levels at predefined locations along the simulated crossroad with the help of tripod mounted SLM as the locomotive fitted with the AWD system and the K5LA traditional horn traveled at different constant speeds along the tangent track. During the dynamic test, 1 SLM was positioned at 50 feet from the track centerline to the right of the track along the simulated cross road. Another SLM was positioned at 500 feet from the track centerline also on the right side of the track along the simulated crossroad. For the assessment of the train horn noise impact on trackside residents assumed to be living along the railroad corridor, another SLM was positioned at 500 feet from the track 1,000 feet before the grade crossing. [Figure 33](#) shows a view of the simulated grade crossing from the SLM location 500 feet away from the track with the locomotive present near the grade crossing.

#### **5.3.1 Test Procedure**

The GPS AWD control system was programmed to automatically sound the train horn in LLSL sequence starting at 1/4 mile from the grade crossing and ending with the locomotive occupying the grade crossing. The duration of the AWD/air-horn sounding depended on the constant approach speed of the locomotive near the grade crossing in a specific run. During the dynamic test, the locomotive accelerated to a constant speed before reaching the 1/4 mile point. It maintained constant speed through the grade crossing and then decelerated. The locomotive was then reversed to the starting point to begin the subsequent test run. In all, 12 test runs were conducted including repeat runs for both AWD and the air horn at each of the 3 selected speeds as summarized in the AWD and air-horn dynamic test matrix in [Table 4](#).

**Table 4. Dynamic Test Matrix for AWD and Air-Horn Performance Evaluation**

<b>Test No.</b>	<b>Horn Type</b>	<b>Speed (mph)</b>
1	AWD	40
2	AWD	40
3	Air Horn	40
4	Air Horn	40
5	AWD	60
6	AWD	60
7	Air Horn	60
8	Air Horn	60
9	AWD	75
10	AWD	75
11	Air Horn	75
12	Air Horn	75

The test engineer on-board the locomotive ensured that during each run of the locomotive the sounding of the AWD/air-horn was initiated autonomously by the GPS-integrated AWD control system at the 1/4 mile marker and that the six speakers of the AWD system were activated in the right sequence as designed for an optimum performance. On completion of the dynamic test, all the recorded data in 3 SLM were saved for later analysis and the deployed AWD system components were retrieved from the test locomotive.



**Figure 31. Test Locomotive Near Simulated Grade Crossing Location on TTCI Tangent Track**



**Figure 32. DOTX4113 Locomotive at Simulated Grade Crossing**



**Figure 33. View of Simulated Grade Crossing from SLM Location 500 Feet from Track**

## **5.4 Results of AWD and Air-Horn Static Testing**

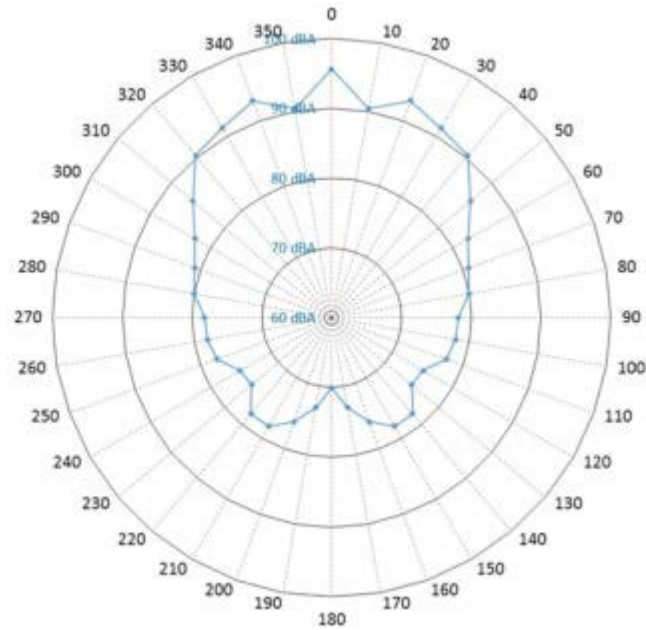
Following the completion of the AWD system field testing at TTCI, all the recorded test data were analyzed both for the six-speaker AWD and the K5LA air horn mounted on the TTCI test locomotive. The results of the static test data are presented here as polar plots displaying the amplitude of the measured sound expressed as dBA SPL as well as the directivity patterns of both the horns sounded during the survey surrounding the locomotive.

### **5.4.1 AWD System Directivity Pattern**

The AWD system consists of six units of RMG-200A electronic loudspeakers. They are optimized to offer the best variable directivity pattern at a highway–rail grade crossing with three pairs of speakers mounted on the locomotive roof at orientations of  $\pm 15$ ,  $\pm 35$ , and  $\pm 75$  degrees from the track axis as in [Figure 24](#).

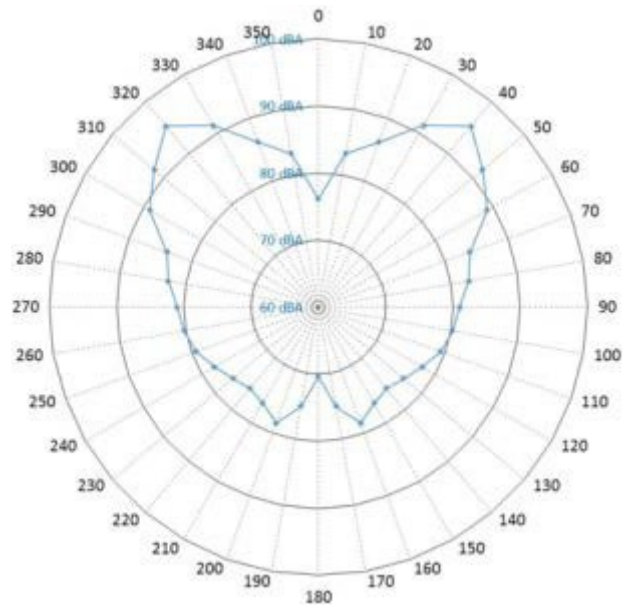
Sound measurements were taken for each pair of loudspeakers and for groups of adjacent pairs of loudspeakers. The sound measurements were also taken for all loudspeakers sounding. [Figure 34](#) through [Figure 36](#) shows the directivity patterns of  $\pm 15$ ,  $\pm 35$ , and  $\pm 75$  degrees loudspeaker pairs respectively. The figures show the measured sound levels at 100 feet from the locomotive

with SLM positioned about 5 feet high. The 0 and 180-degree measurement was 5 feet above the tracks and the remaining measurements are at grade level, approximately 5 feet lower. Figure 34 shows the AWD sound directivity pattern generated by activating the  $\pm 15$  degrees forward facing loudspeakers. This set of speakers are the first to be activated at 1/4 mile from the grade crossing with very little noise emission wayside. Both the  $\pm 35$  and  $\pm 75$  degree loudspeakers show the intended directive patterns.

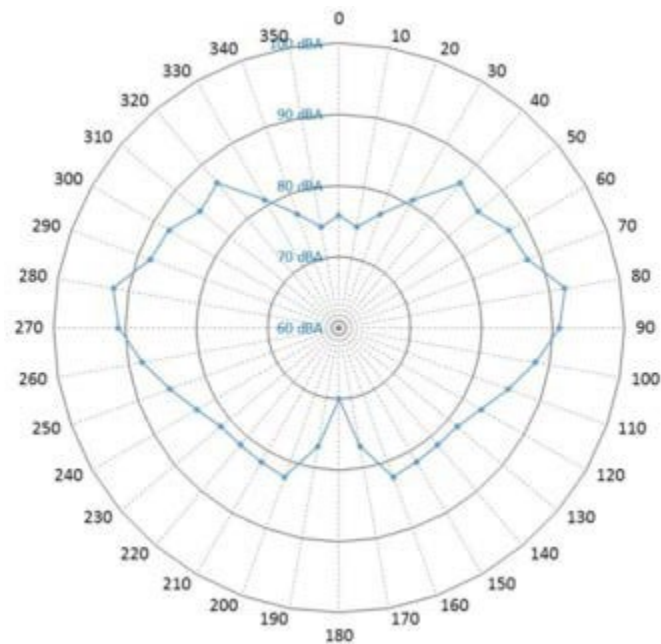


**Figure 34. AWD Directivity Pattern of  $\pm 15$  Degree Forward Facing Speakers at 100 Feet from Locomotive with Approximately 15-dBA Sound Reduction Wayside for Horn Sounding at 1/4 Mile**



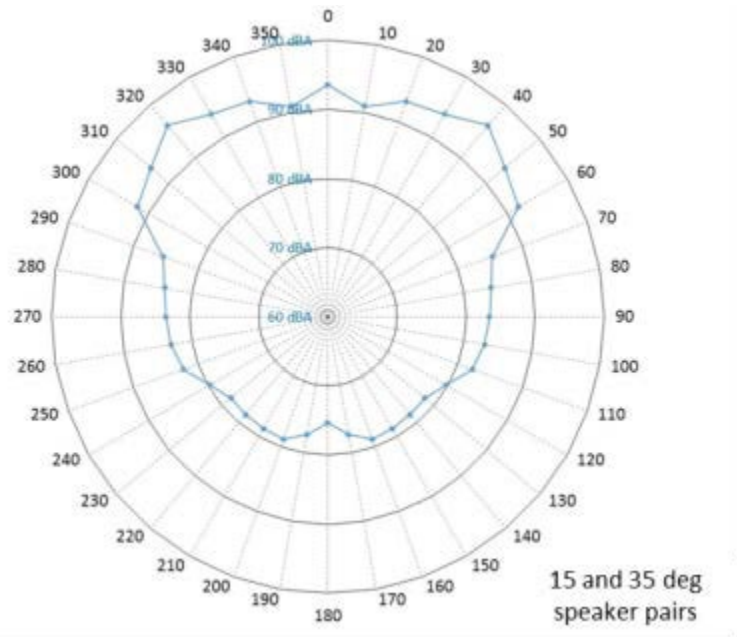


**Figure 35. AWD Directivity Pattern of  $\pm 35$  Degree Loudspeakers 100 Feet from Locomotive**

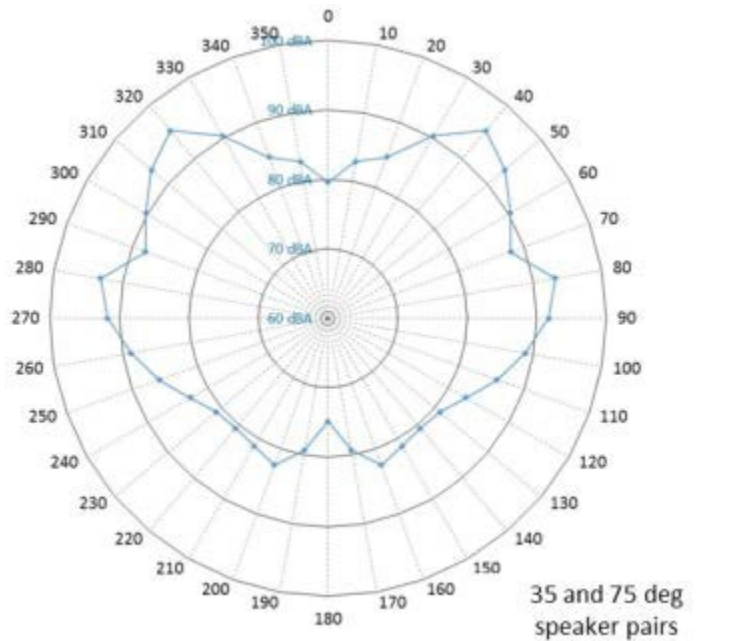


**Figure 36. AWD Directivity Pattern of  $\pm 75$  Degree Loudspeakers 100 Feet from Locomotive Representative of Sound Pattern with Locomotive at Grade Crossing**

The combined effect of simultaneously activating the  $\pm 15$  and  $\pm 35$  degree speakers is shown in [Figure 37](#). This plot shows the additive effect of the two loudspeaker pairs. Similarly, the combined  $\pm 35$  and  $\pm 75$  degree loudspeaker pair directivity is found in [Figure 38](#). The individual peaks at  $\pm 35$  and  $\pm 75$  degrees are enhanced by one or two dB by the other pair. The sound levels between the peak lobes show increased intensity combining the two sets of loudspeakers.



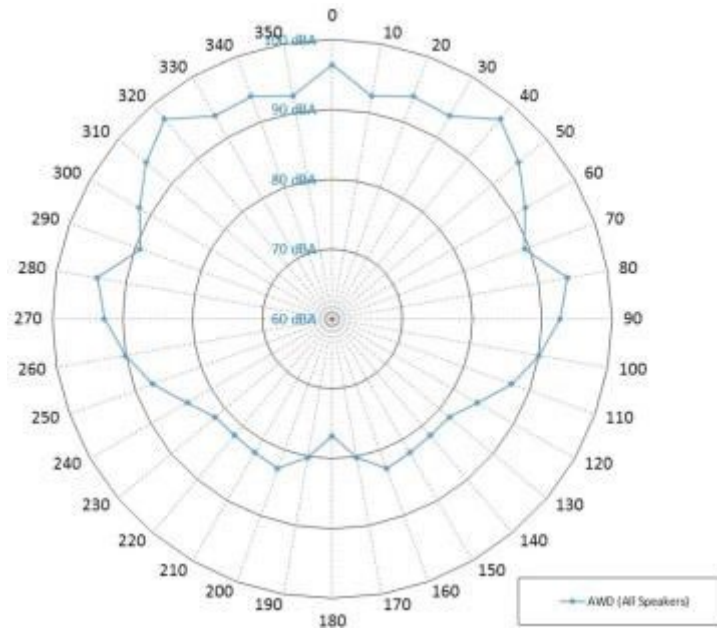
**Figure 37. Combined Directivity Pattern of AWD  $\pm 15$  and  $\pm 35$  Degree Loudspeakers at 100 Feet from Locomotive**



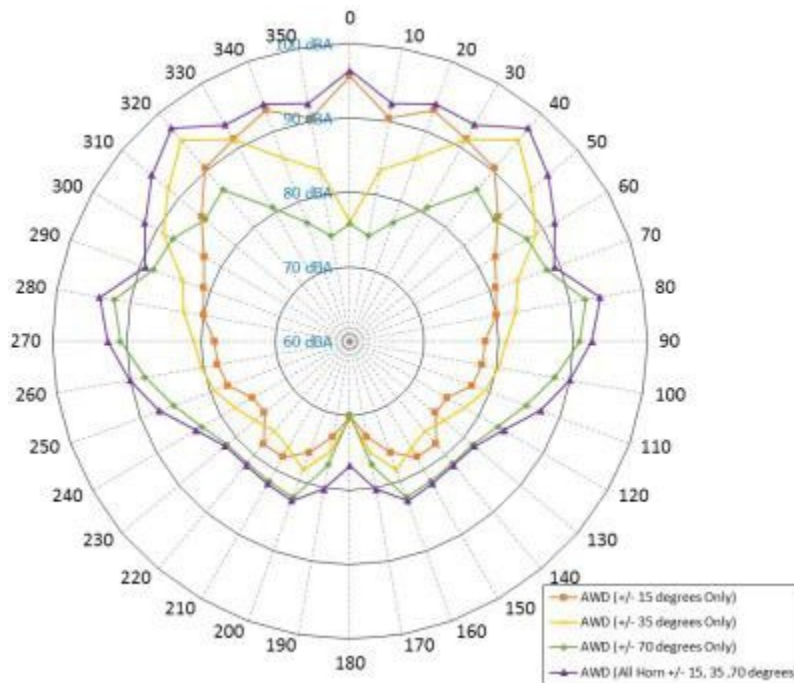
**Figure 38. Combined Directivity Pattern of AWD  $\pm 35$  and  $\pm 75$  Degree Loudspeakers at 100 Feet from Locomotive**

The combined effect off all six loudspeakers is found in [Figure 39](#) and the comparison to the individual loudspeakers pairs is shown in [Figure 40](#). In the actual use of the six loudspeaker system, loudspeakers are never on at 100 percent volume simultaneously. The plot does show

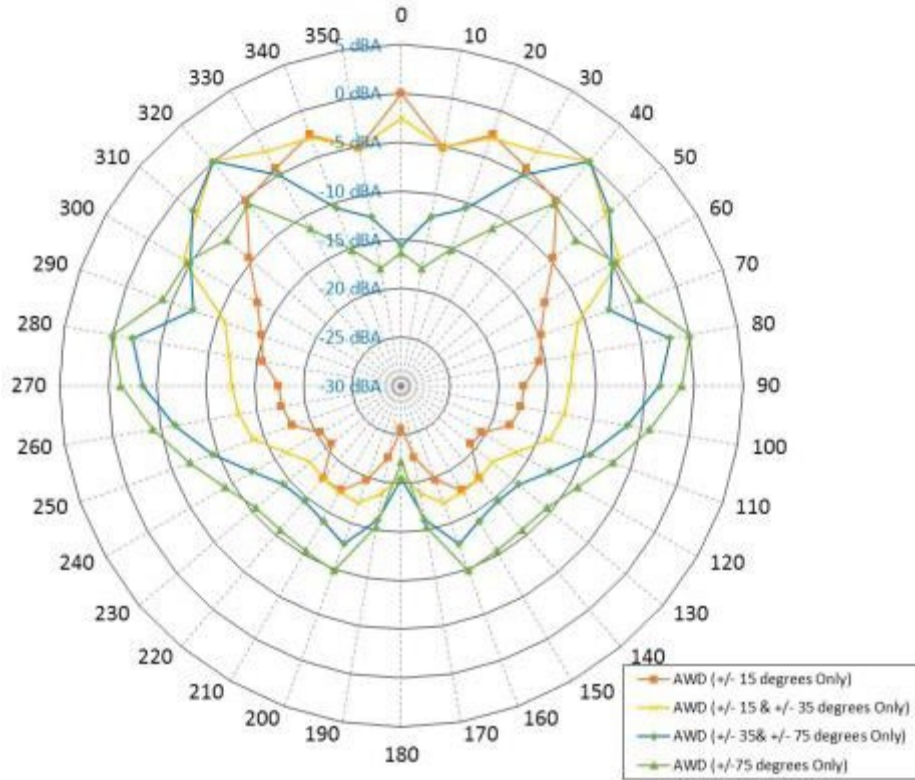
that the sum of the six loudspeakers begins to approach the general directivity of standard air horns found in [Figure 39](#) through [Figure 41](#).



**Figure 39. Combined Directivity Pattern of All Six Speakers of AWD System**



**Figure 40. Comparative Directivity Patterns of All Three Sets of AWD Speakers**



**Figure 41. Comparative Directivity Patterns of AWD Speaker Combined Emissions**

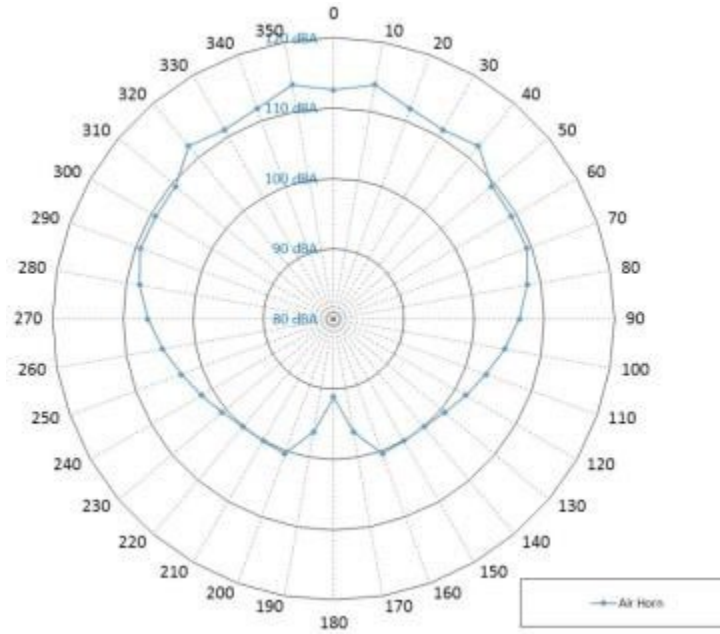
#### **5.4.2 Standard Nathan K5LA Air Horn Directivity Pattern**

TTCI provided a F40PH (DOTX4113) locomotive fitted with a Nathan K5LA air horn with all five chimes facing forward as seen in [Figure 42](#). As a part of the static test, the directivity pattern of this K5LA air horn was made at 100 feet radius arc covering 180 degrees and it was assumed to be symmetric about the longitudinal axis of the locomotive since the air horn was centrally mounted at the front end of the cab roof. [Figure 43](#) shows the directivity pattern of the K5LA horn. The measurements are made on a 5 feet high stand. Sound amplitude is significantly masked by the locomotive from mid locomotive and back to the rear.

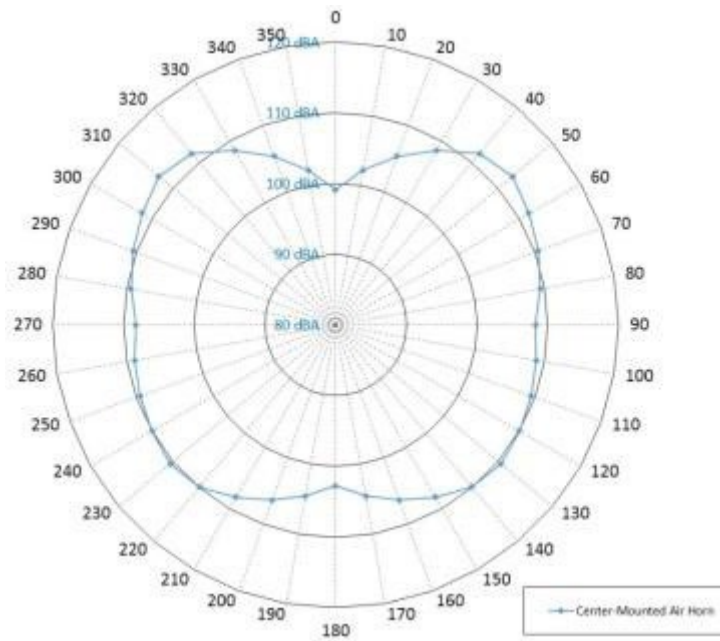


**Figure 42. Nathan K5LA and  $\pm 15$  Degree AWD Loudspeakers Mounted on the DOTX4113 Locomotive**

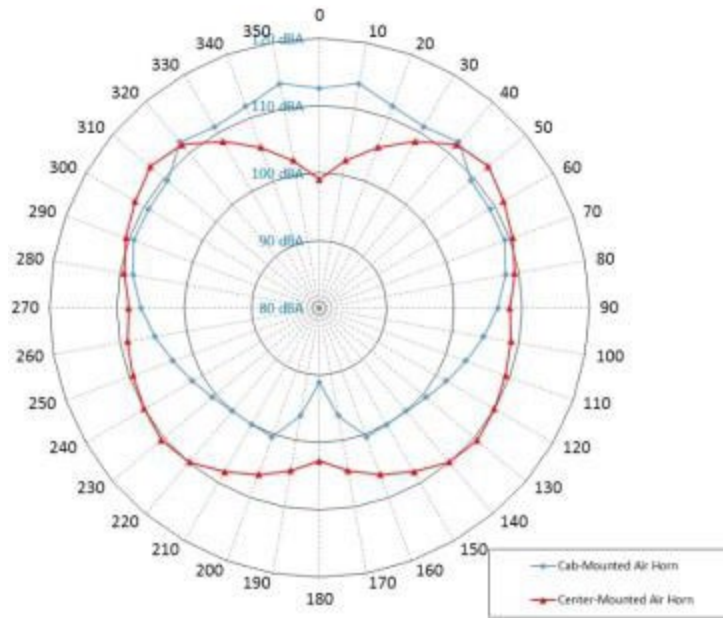
The corresponding directivity pattern for another five-chime air pressure horn with four chimes facing forward and one chime facing rearward, which was center-mounted on an SD70ACe locomotive #4223 is shown in [Figure 44](#). Because of the frontal obstruction to sound propagation caused by the cab roof in this case, both side lobes attain higher amplitudes compared to the front and rear portions and the directivity patterns resembles the wings of a butterfly. [Figure 45](#) shows a comparative directivity plot of a cab-roof-mounted and a center mounted air-pressure horn, although with a slightly different air-chime configuration.



**Figure 43. Cab Roof Mounted K5LA Air Horn Directivity Pattern on DOTX4113**



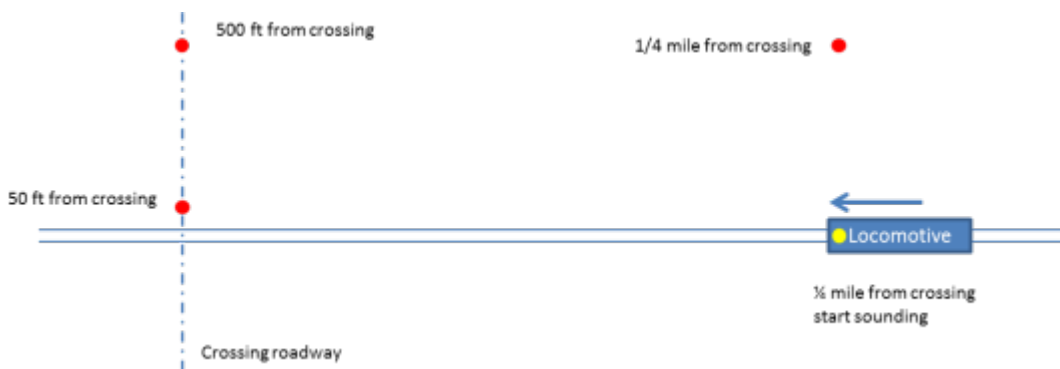
**Figure 44. Directivity Pattern of Center-mounted K5LA Air Horn on SD70ACe #4223**



**Figure 45. Comparative Directivity Plot of Cab-mounted and Center-mounted Air Horns**

### 5.5 Dynamic Testing and Evaluation of AWD

On completion of the static measurement of the characteristics of both the air horn and the AWD, the test locomotive was operated at three different constant speeds between a simulated grade crossing and 1/4 mile from it while acoustic measurements were made with 3 SLM as shown in Figure 46.



**Figure 46. Sound Meter Locations for Dynamic Tests**

#### 5.5.1 AWD Detectability at Grade Crossing

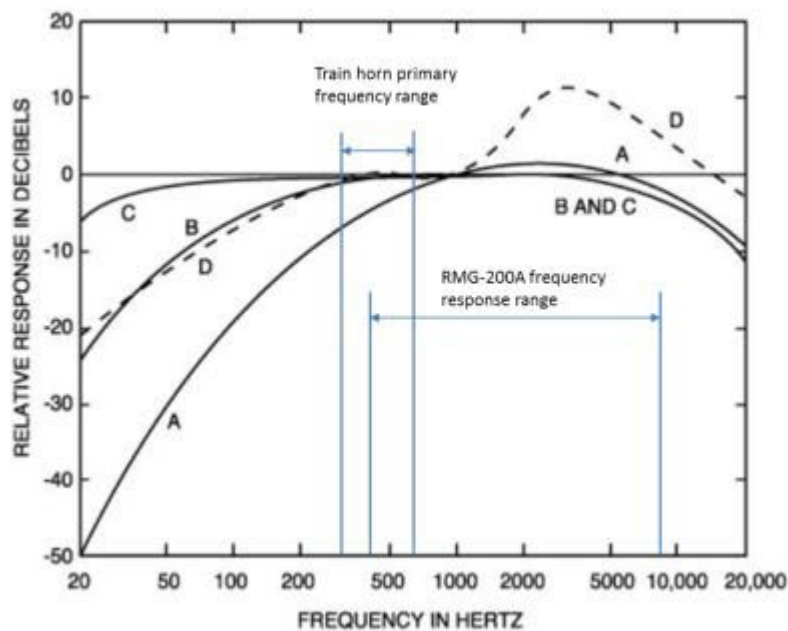
The dynamic tests were conducted for three different constant speed runs (40, 60, and 75 mph). Three SLMs were located according to Figure 46. The SLM at the 1/4 mile location was to assess the wayside noise levels. The SLMs at the simulated crossing road were to assess detectability and the level of noise attenuation.

In Table 5, four events are shown corresponding to each of the three constant speeds the locomotive was operated with during the dynamic test. At each constant speed, the AWD was

sounded once representing event 1 and a repeat run was made with AWD sounding to represent event 2. Similarly, the air horn was sounded once representing event 3 and a repeat run was made with air horn sounding to represent event 4.

The summary of the reduced AWD dynamic test data is presented in [Table 5](#). The sound level recordings were made with three tripod-mounted SLMs located at three different locations as indicated in the table and the reduced data are presented as d-prime Dose, SEL Dose, and Lmax at each location. The sound exposure level (SEL) of the A-weighted sound gives the same sound energy as the entire sound event in a 1-second window. This is a convenient measure to compare different events of different durations and sound levels. The d-prime Dose is similar to the SEL except the d-prime detectability value is integrated over the event duration and an equivalent 1-second d-prime is developed. The Lmax is the maximum A-weighted SPL of the event.

The test results all use A-weighted sound levels as the most relevant scale to compare to the response of human hearing. It is noted that the train horn primary frequencies are in the lower range, as in [Figure 47](#). The capability of the selected RMG-200A speakers truncates at 400 Hz. It may be informative to consider a C-weighted comparison to assess other effects of the sound on the listener at a future date.



**Figure 47. Sound Weighting Scales Compared to Sound Source Frequency Range**

[Table 5](#) represents the measured data from the TTCI tests and scales both the AWD and K5LA results to a consistent 110 dBA at 100 feet. It has been discussed earlier that the particular loudspeaker selected (RMG-200A) is not optimized for train horn use and was designed primarily to the project voice as a loudspeaker. As a result, the sound levels produced by the RMG-200A do not match that of the K5LA on the DOTX4113 locomotive. Additionally, the K5LA used in the tests was calibrated above the FRA regulations. So to conduct a reasonable comparison of the test results and show how much detectability and noise are influenced by the horn designs, the two system results were scaled to the same 110 dBA. The same delta dBA that produces the 110 dBA at 100 feet was used in all polar directions of the results. So, if K5LA



were 3 dBA higher than the 110 dBA goal, all polar directions of the K5LA were reduced by 3 dBA as well.

The overall goal of the program is to show that an AWD system can match the detectability of the K5LA at the critical stopping distance along the roadway and at the same time reduces wayside noise exposure. The results of Table 5 show that at the critical stopping distance of 500 feet from the grade crossing, the AWD speaker system produced about 3 dBA greater d-prime detectability and 6 dBA greater max sound levels relative to the K5LA. This is primarily due to the effort to maximize the sound levels at this critical location. Also, at the distant sound meter location 500 feet from the tracks and 1,000 feet from the crossing, the AWD SEL levels are reduced from 2 to 5 dBA and the maximum sound levels are reduced from 5 to 8 dBA, depending on locomotive speed. The AWD system performs about 2 dBA worse than the K5LA closer to the tracks at 50 feet.

**Table 5. Dynamic Test Data at Grade Crossing and Trackside for AWD and Air Horn Scaled to 110 dBA System**

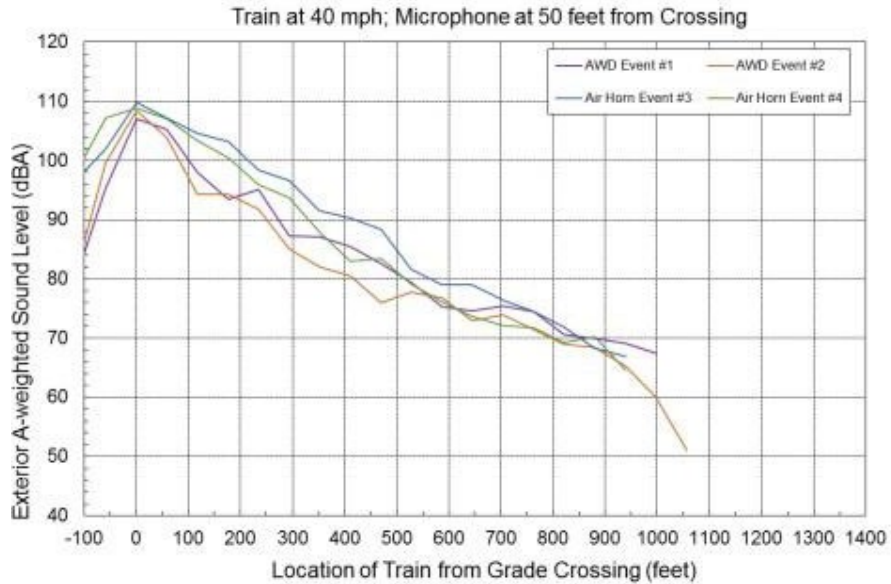
Horn	Event	Speed-(mph)	50-feet-from-Crossing			500-feet-from-Crossing			500-feet-from-Tracks,1,000-feet-from-Crossing		
			d-prime-Dose	SEL-Dose	Lmax	d-prime-Dose	SEL-Dose	Lmax	d-prime-Dose	SEL-Dose	Lmax
AWD	1	40	80.5	110.1	107.0	65.6	96.8	89.3	57.1	85.8	77.7
AWD	2	40	80.7	110.5	108.4	65.9	97.3	92.4	58.2	87.3	76.6
Air-Horn	3	40	87.4	113.8	109.8	61.6	90.0	84.7	63.7	91.3	85.6
Air-Horn	4	40	87.2	113.6	108.9	63.4	92.7	84.3	62.9	91.1	84.5
		<b>Avg-AWD</b>	80.6	110.3	107.7	65.8	97.0	90.9	57.7	86.5	77.1
		<b>Avg-Horn</b>	87.3	113.7	109.3	62.5	91.3	84.5	63.3	91.2	85.0
		<b>AWD--Horn</b>	-6.7	-3.4	-1.6	3.3	5.7	6.4	-5.6	-4.7	-7.9
AWD	1	60	79.4	108.6	107.6	64.2	95.6	91.4	58.8	87.0	78.4
AWD	2	60	79.8	109.2	107.6	66.6	98.0	93.5	57.8	86.5	79.3
Air-Horn	3	60	85.7	111.9	109.0	64.2	92.8	87.3	60.7	88.6	84.7
Air-Horn	4	60	85.5	111.8	108.8	61.1	90.2	84.6	59.8	88.1	83.1
		<b>Avg-AWD</b>	79.6	108.9	107.6	65.4	96.8	92.5	58.3	86.8	78.8
		<b>Avg-Horn</b>	85.6	111.9	108.9	62.7	91.5	86.0	60.3	88.4	83.9
		<b>AWD--Horn</b>	-6.0	-3.0	-1.3	2.7	5.3	6.5	-2.0	-1.6	-5.1
AWD	1	75	81.3	110.7	107.6	62.5	93.2	88.1	57.3	85.2	79.0
AWD	2	75	79.1	107.9	104.8	64.0	95.2	91.8	60.4	88.6	81.0
Air-Horn	3	75	84.6	110.6	107.9	61.5	90.5	86.2	62.0	90.4	86.1
Air-Horn	4	75	84.7	110.9	108.5	58.6	87.1	80.9	62.2	90.3	85.2
		<b>Avg-AWD</b>	80.2	109.3	106.2	63.3	94.2	89.9	58.8	86.9	80.0
		<b>Avg-Horn</b>	84.7	110.8	108.2	60.0	88.8	83.5	62.1	90.3	85.6
		<b>AWD--Horn</b>	-4.5	-1.5	-2.0	3.2	5.4	6.4	-3.3	-3.5	-5.6

### 5.5.1.1 Detectability at 50 Feet from the Tracks

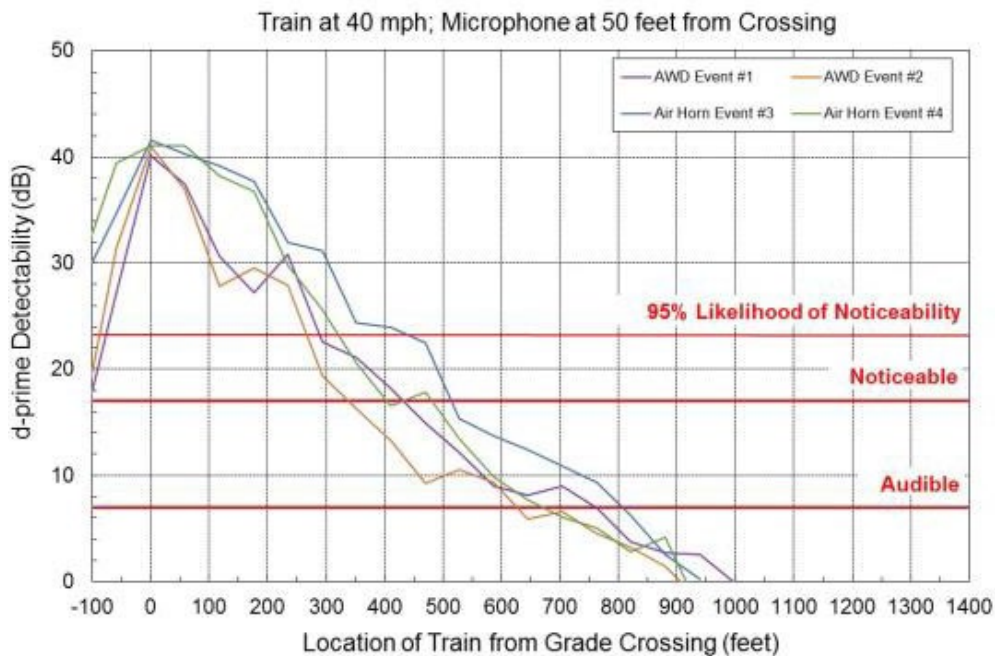
With the microphone located 50 feet from the track at the grade crossing and the locomotive running at a constant speed of 40 mph, the variation of exterior A-weighted sound level versus the location of the locomotive in feet from the grade crossing is shown in Figure 48 for all four events as described above. The corresponding d-prime detectability (dB) graphs for all four events are shown in Figure 49. It is observed that at 40 mph, both the air horn and the AWD are audible from 600–800 feet from the grade crossing. However, the range for 95% Likelihood of Noticeability drops to as low as 260–400 feet with the air horn showing a slightly better performance than the AWD.

For the case of the locomotive running at 60 mph, the exterior A-weighted sound level variation with locomotive distance from grade crossing and the corresponding d-prime detectability variation with locomotive distance are shown in Figure 50 and Figure 51 respectively. These

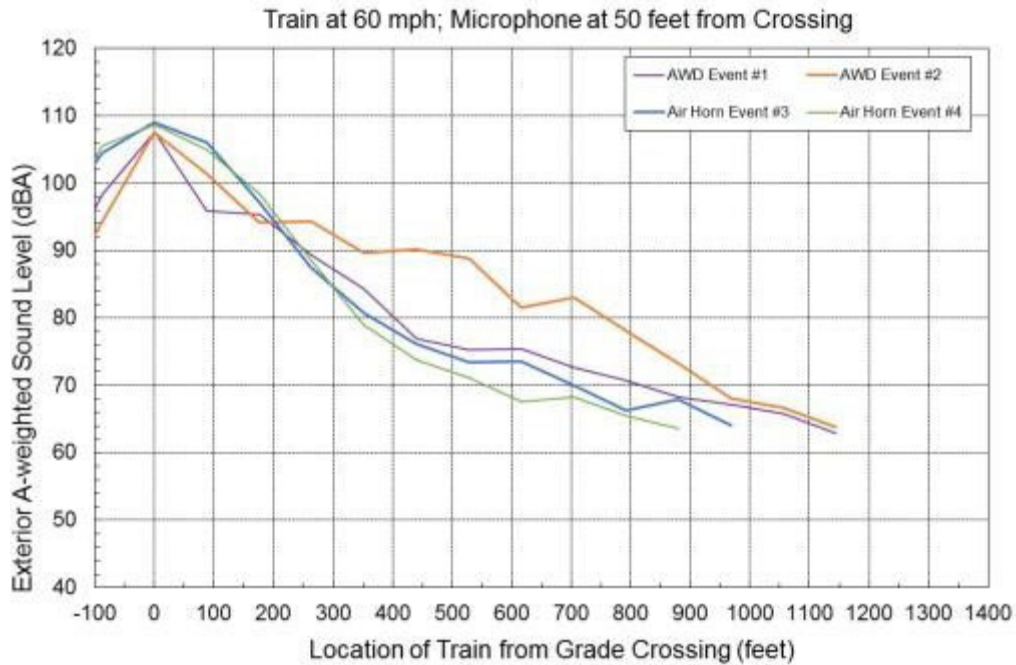
figures exhibit a better performance of AWD over the air horn for the 95% Likelihood of Noticeability of an approaching train. Similar variations of the exterior sound level (dBA) and d-prime detectability for the case of the test locomotive running at 75 mph are shown in Figure 52 and Figure 53 respectively. Again, the AWD performance is seen to be better over the air horn due to the sequential activation of the six AWD speakers resulting in variable directivity.



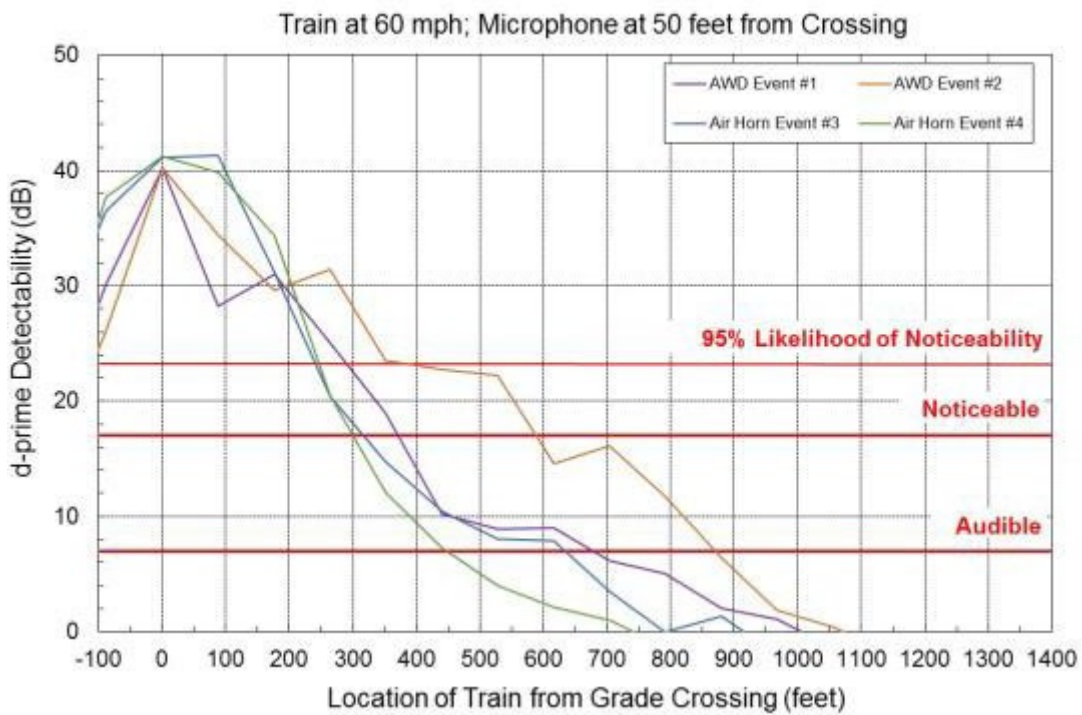
**Figure 48. Exterior Sound Level at Grade Crossing 50 Feet from Track with Train at 40 mph for Comparably Scaled Systems**



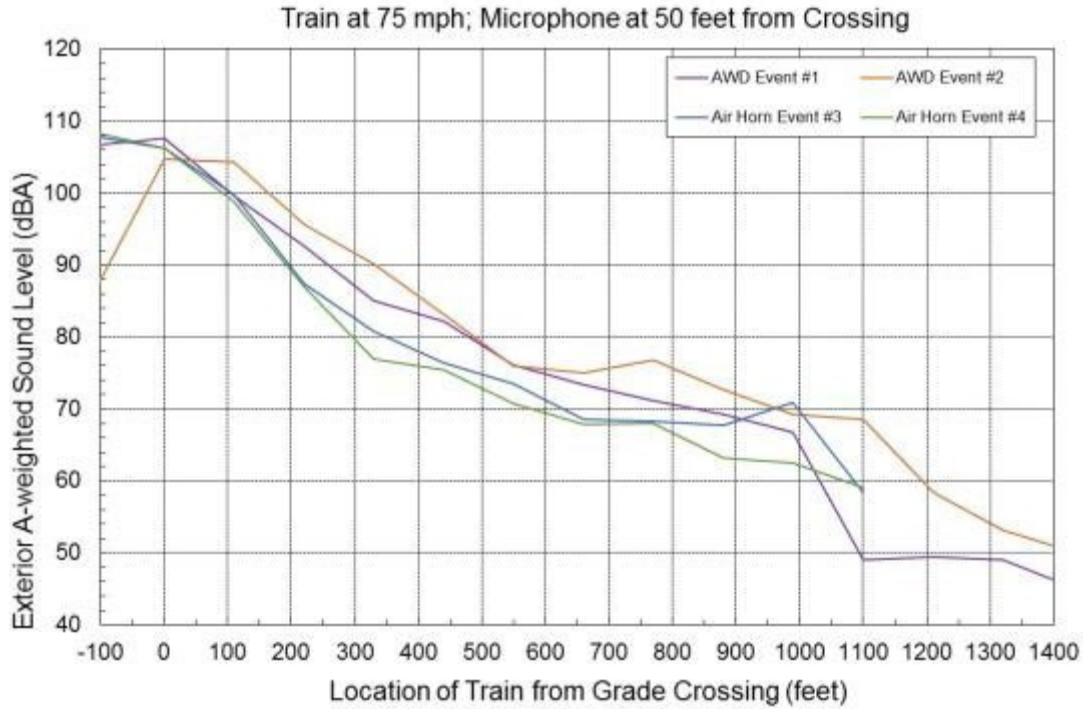
**Figure 49. Detectability (d-prime) at Grade Crossing 50 Feet from Track with Train at 40 mph for Comparably Scaled Systems**



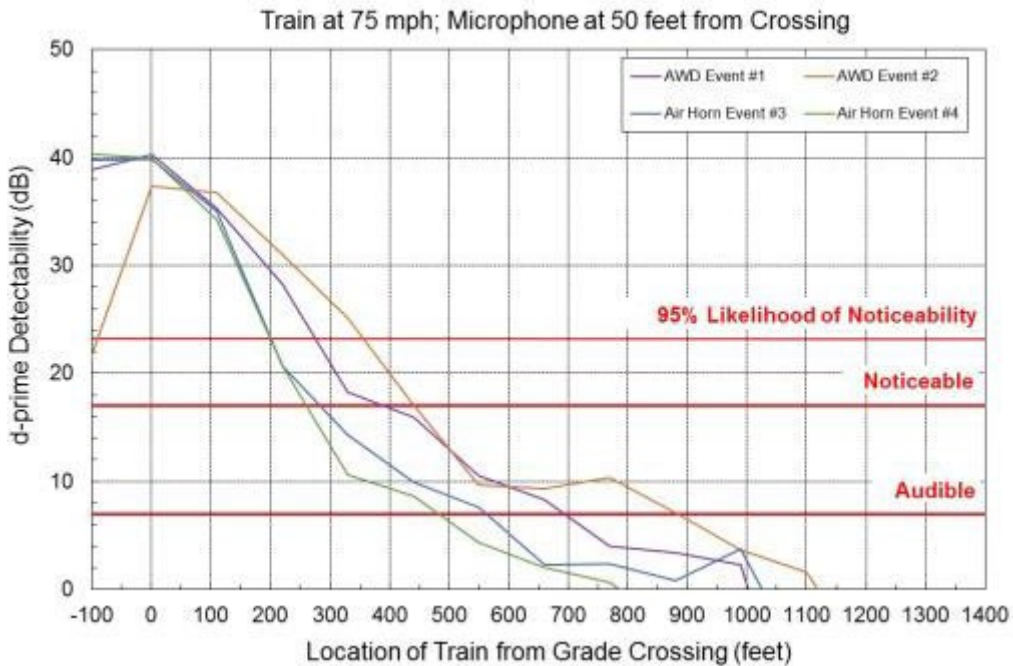
**Figure 50. Exterior Sound Level at Grade Crossing 50 Feet from Track with Train at 60 mph for Comparably Scaled Systems**



**Figure 51. Detectability (d-prime) at Grade Crossing 50 Feet from Track with Train at 60 mph for Comparably Scaled Systems**



**Figure 52. Exterior Sound Level at Grade Crossing 50 Feet from Track with Train at 75 mph for Comparably Scaled Systems**



**Figure 53. Detectability (d-prime) at Grade Crossing 50 Feet from Track with Train at 75 mph for Comparably Scaled Systems**

### 5.5.1.2 Detectability at the Critical Distance on the Road 500 Feet Away from Track

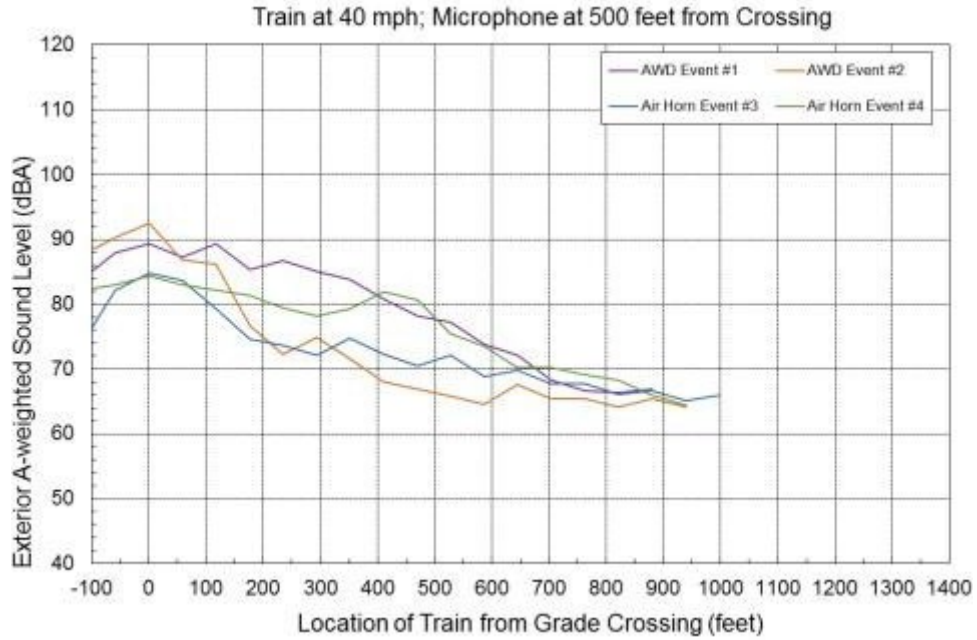
The location along the roadway of 500 feet from the tracks represents the critical stopping distance for a 50-mph vehicle upon noticing a train horn. The critical stopping distance allows for a 2.5 second reaction time prior to applying the brakes as discussed earlier. The sound levels measured at this location for 40, 60 and 75 mph locomotive runs are found in [Figure 54](#), [Figure 56](#), and [Figure 58](#) respectively. Similarly, the d-prime detectability of the sounds for the same locomotive speeds is found in [Figure 55](#), [Figure 57](#), and [Figure 59](#) respectively.

The results were comparable across the locomotive speeds. The AWD system produced higher SPLs with the locomotive from 300 to 400 feet in to the crossing. Both the AWD and K5LA produced comparable sound levels further out then the 400-ft. range. Generally, both systems were audible to a vehicle driver from about 400 feet and in to the crossing and noticeable from 200 feet and in. These noticeability and d-prime values are significantly less than predicted using standard attenuation from previously measured K5LA values.

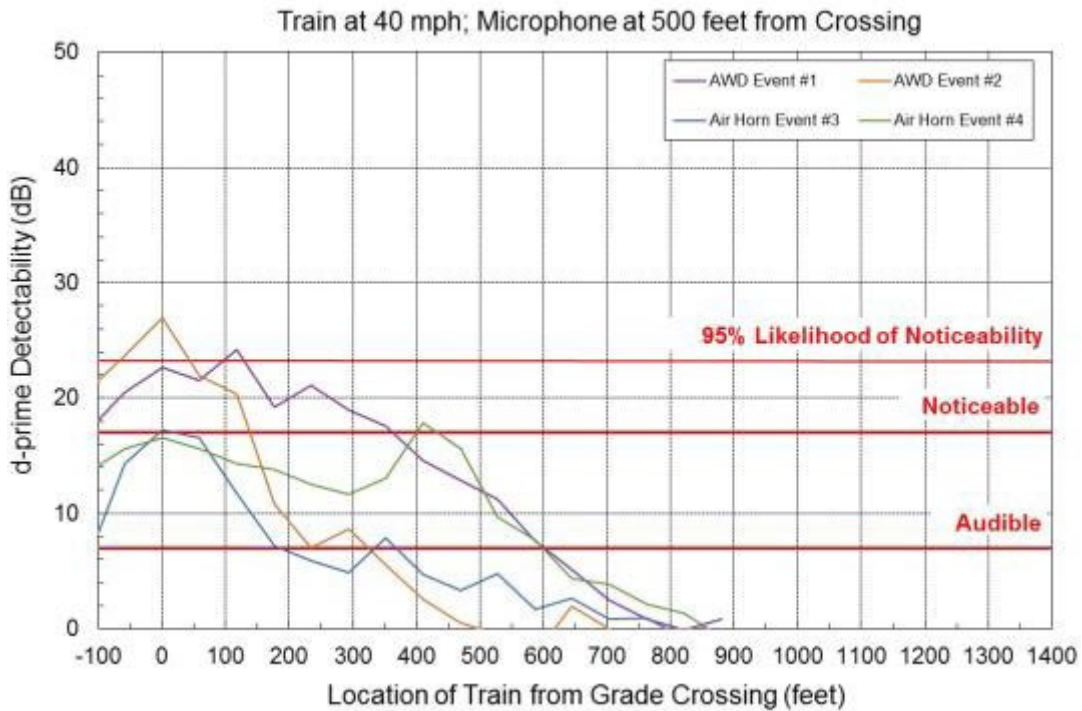
Two different limits are used in characterizing the detection of noise sources; the limit of “audibility” is considered to be the lowest level that a human with normal hearing can detect a source when purposely listening for the source and “noticeability” is considered to be the lowest level that a human can detect a source when not awaiting or expecting an event to occur.

The metric used to measure the detectability of a noise source is called “d-prime.” The d-prime metric reported in this study is 10 times the logarithm of the sum of the squared individual d-primes in all 1/3-octave bands between 160 and 10,000 Hz. The limit of audibility used in this analysis is a d-prime value of 7, the limit of noticeability is a d-prime value of 17 and the limit of a 95% Likelihood of Noticeability is a d-prime value of 23.3 for a passive grade-crossing. A passive grade-crossing is where there are no crossing bells or gates.

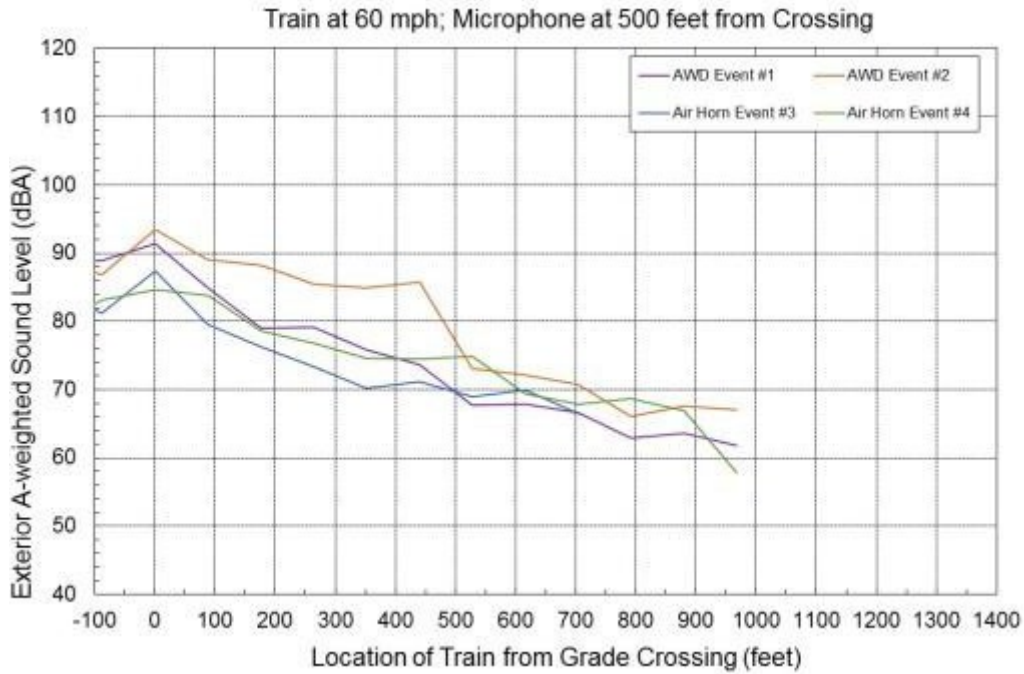
A previous study measured the polar sound levels of a K5LA that was center mounted on a GP40 locomotive and estimated the d-prime values as shown in [Figure 60](#). The figure estimated that at the critical stopping distance location for vehicles from 20 to 50 mph, that K5LA would be noticeable from as far away as 1,000 feet from the grade crossing. The detectability developed on this program was through measured values at the critical stopping distance. Previous detectability predictions were based on static polar measurements of sound levels and analytical estimates of sound attenuation to a vehicle at that critical stopping distance. The difference between detectability found between [Figure 59](#) and [Figure 60](#) is the dynamics of the locomotive motion as well as actual ground effect factors. Scaling of the measured K5LA sound levels, as in [Table 6](#), to 110 dBA may have some influence on the detectability from 500 feet in to the crossing, but has no appreciable effect for detectability with the train further away from the crossing. Wind during the test was only nominal at less than 15 mph. Literature stated that wind gradients from a moving locomotive that may cause sound to refract upwards, reducing sound levels down field. There is a need for more research to better understand this effect. It appears to the case that neither a K5LA nor an AWD system may be noticeable at the critical stopping distance for a 50 mph vehicle approaching the grade crossing.



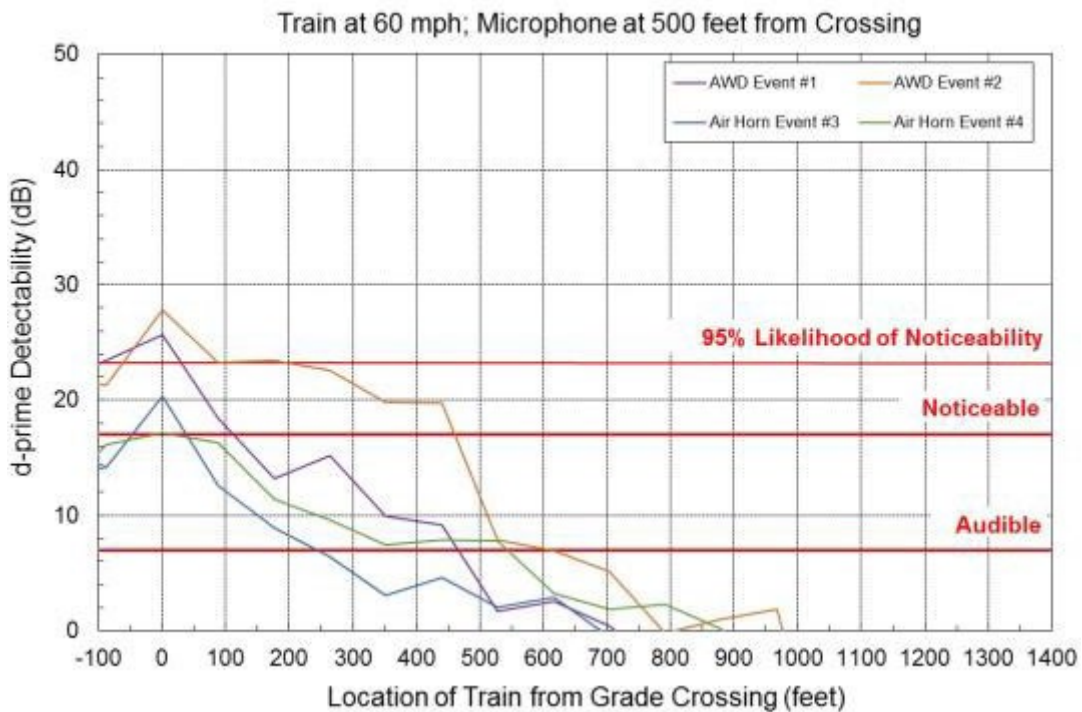
**Figure 54. Exterior Sound Level at Grade Crossing 500 Feet from Track with Train at 40 mph for Comparably Scaled Systems**



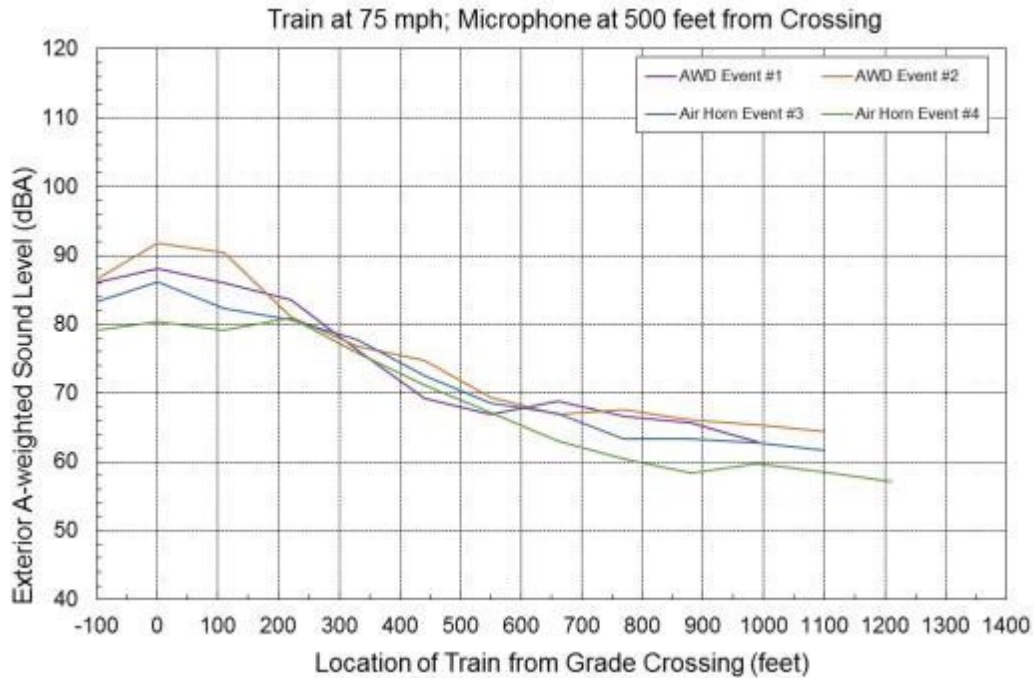
**Figure 55. Detectability (d-prime) at Grade Crossing 500 Feet from Track with Train at 40 mph for Comparably Scaled Systems**



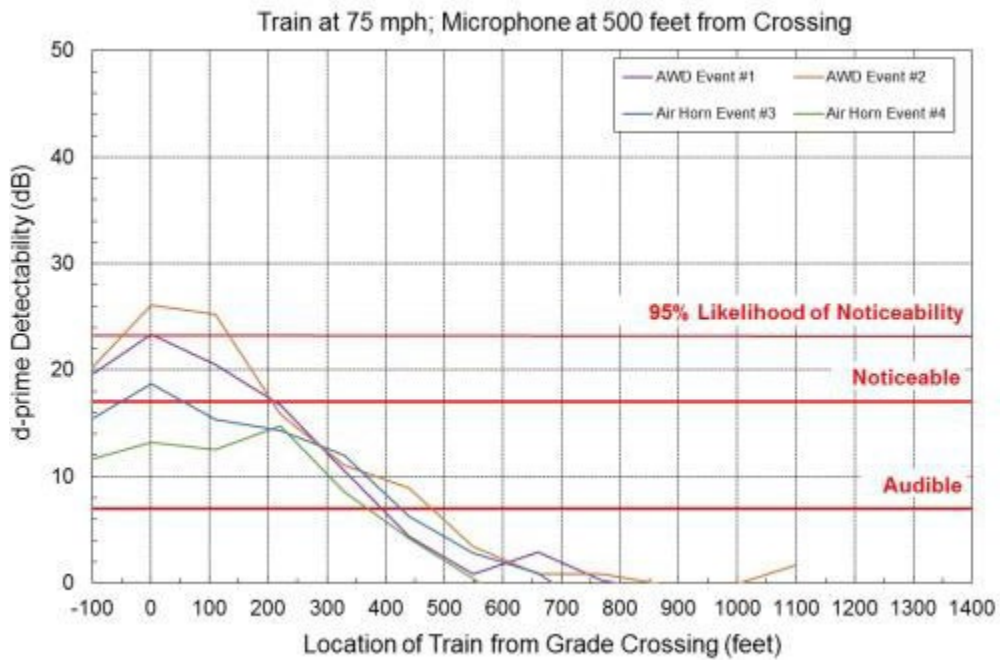
**Figure 56. Exterior Sound Level at Grade Crossing 500 Feet from Track with Train at 60 mph for Comparably Scaled Systems**



**Figure 57. Detectability (d-prime) at Grade Crossing 500 Feet from Track with Train at 60 mph for Comparably Scaled Systems**

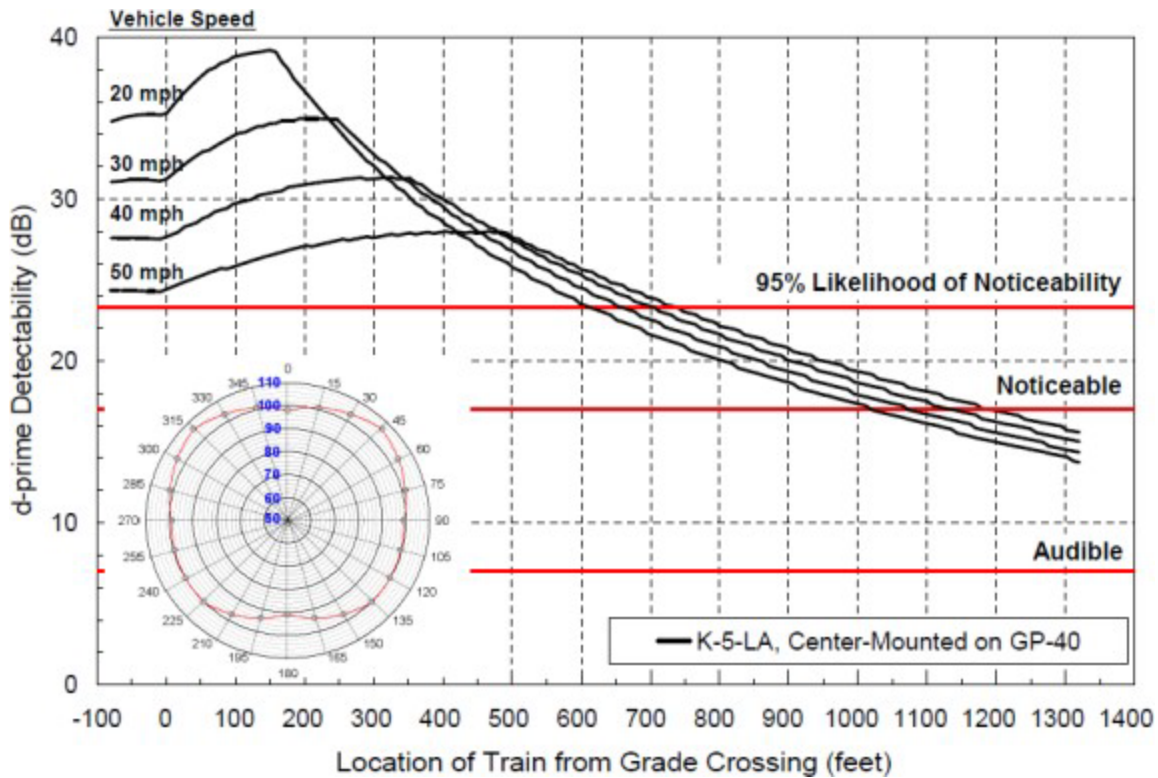


**Figure 58. Exterior Sound Level at Grade Crossing 500 Feet from Track with Train at 75 mph for Comparably Scaled Systems**



**Figure 59. Detectability (d-prime) at the Grade Crossing 500 Feet from Track with Train at 75 mph for Comparably Scaled Systems**





**Figure 60. Analytical d-prime Estimates for K5LA, Center Mounted on a GP40 Locomotive**

**Table 6. Comparison of K5LA Polar SLMs**

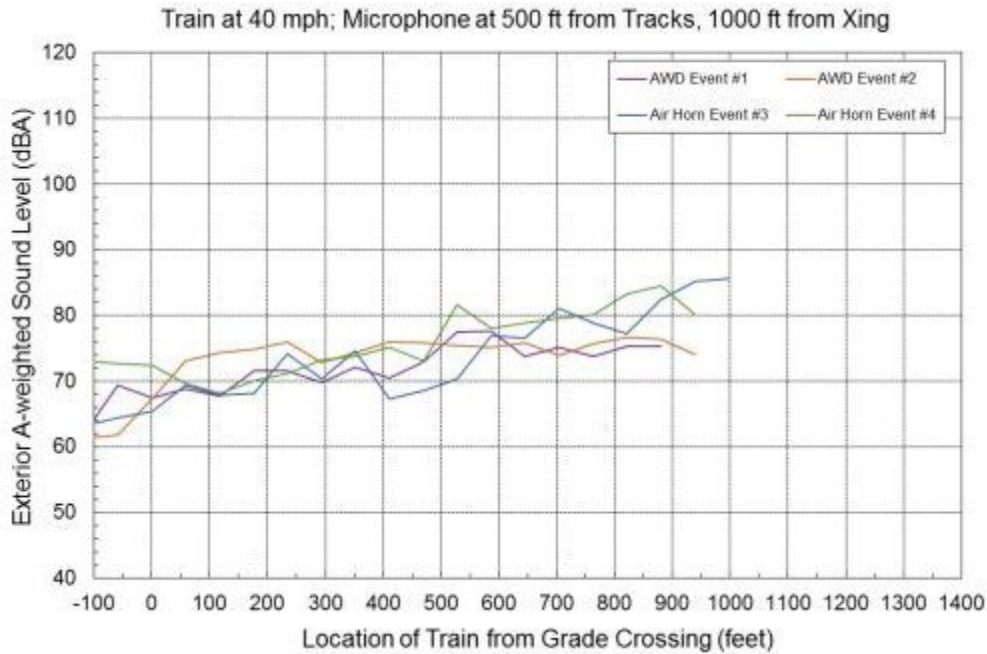
	Early study GP40 center-mounted	Current study FP40 cab mounted	
Polar Angle, deg	Measured, dBA	Measured, dBA	Scaled, dBA
0	98	113	110
30	103	111	108
45	106	102	99
60	104	99	96
75	102	98	95

### 5.5.2 AWD and Air Horn Performance for Tracksideside Acoustic Noise Reduction

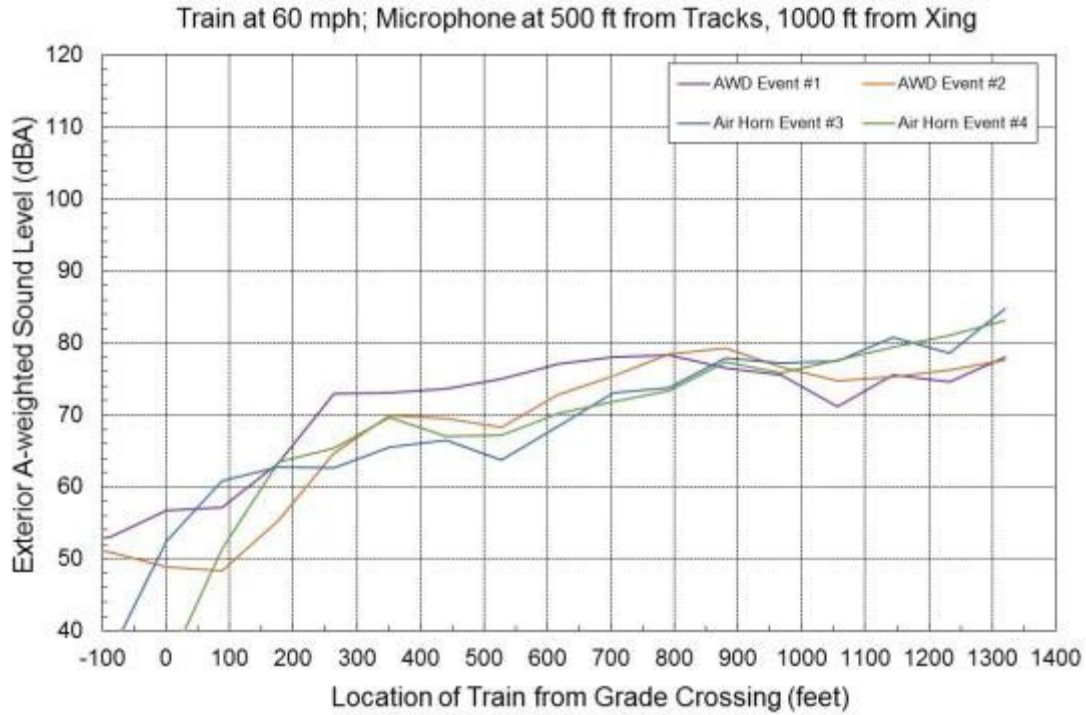
In addition to the detectability of the approaching train along the highway at a grade crossing, it is desirable to have the sound beam directed away from the tracksideside to minimize the noise exposure of tracksideside residents and concentrate on the cross road up to the critical stopping distance, which is 500 feet from track for a motorist traveling at 50 mph. The variable directivity pattern of a horn is important to meet these dual objectives. During the dynamic tests, a tripod-mounted SLM was placed 500 feet away from the track 1,000 feet before the grade crossing. The

recorded sound measurement data were reduced and presented as exterior A-weighted sound level versus location of the locomotive from the grade crossing in feet. Figure 61 shows the reduced data plots showing sound levels in dBA for two AWD events and two air horn events for the case of locomotive traveling at 40 mph. The repeat run of the locomotive at a given constant speed while sounding the AWD represents event #2 and a repeat run of the locomotive at the same speed while sounding the air horn is represented as event #4. Similar data plotted for the case of locomotive traveling at 60 and 75 mph are shown in Figure 62 and Figure 63 respectively. The AWD horn sounds are consistently 5 dBA lower than the K5LA for horns sounding at 1/4 mile to the 1,000 ft. point. The sounds are equivalent when the locomotive is from the crossing out to 1,000 feet.

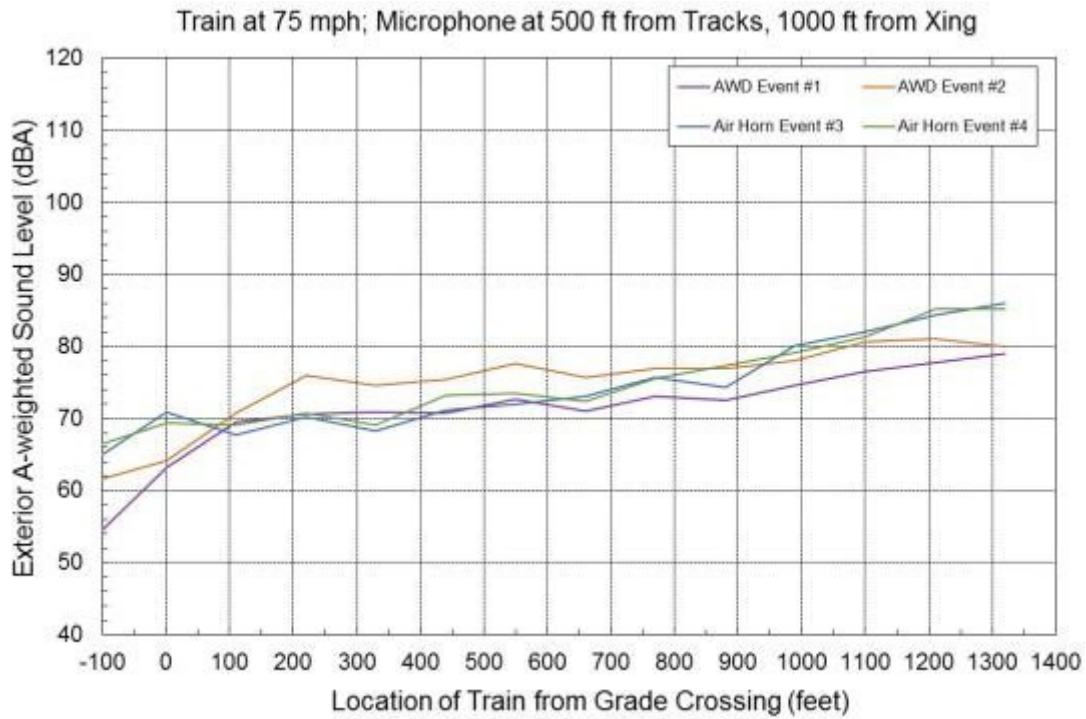
Predictions of overall noise levels were made analytically in Figure 4 and Figure 6. At the test location of 500 feet away from the tracks and 1,000 feet from the crossing, we find that the Ldn goes from 67 dBA for the K5LA to 53 dBA for the ideal AWD as found in these two figures. This is a 14 dBA reduction at this location. It has been determined that the actual AWD reduction in SEL is in the range of 5 dBA rather than the analytical prediction of 14 dBA. Although this is a dramatic improvement, it is less than predicted for an ideal horn.



**Figure 61. Sound Level at 500 Feet from Track 1,000 Feet Before Crossing with Train at 40 mph with Comparably Scaled Systems**



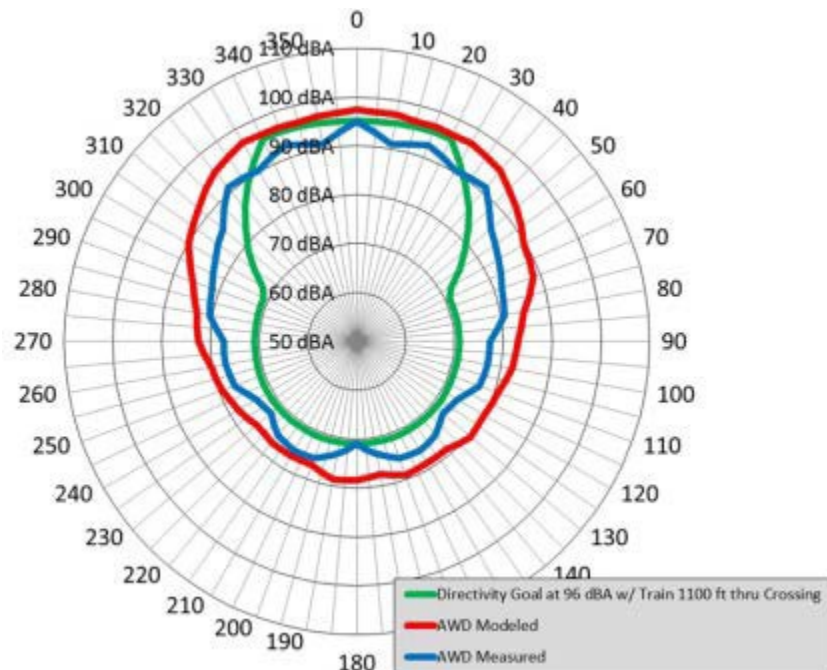
**Figure 62. Sound Level at 500 Feet from Track, 1,000 Feet Before Crossing with Train at 60 mph with Comparably Scaled Systems**



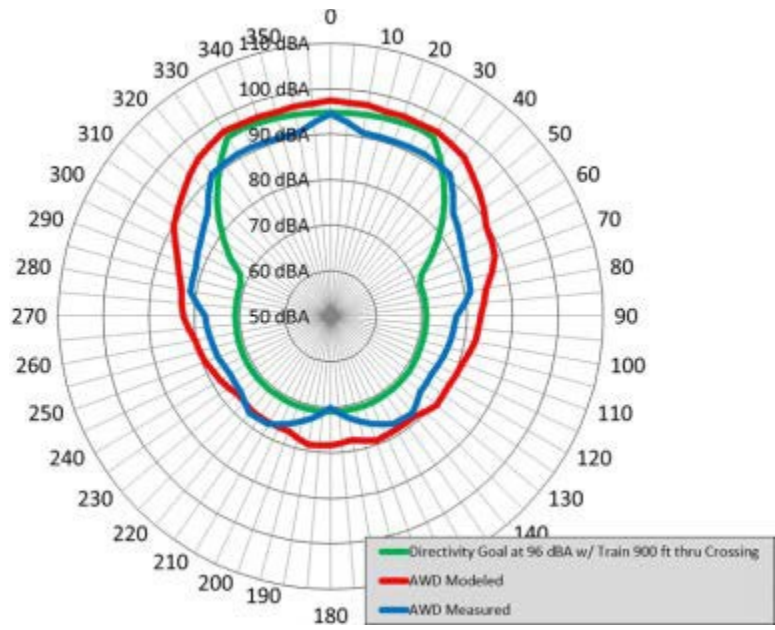
**Figure 63. Sound Level at 500 Feet from Track, 1,000 Feet Before Crossing with Train at 75 mph with Comparably Scaled Systems**

Although wayside sound levels were reduced with AWD as compared to the air-pressure K5LA horn, the reduction was less than predicted for an ideal AWD. Figure 64 through Figure 68 shows the comparison of the ideal AWD, defined as the 96-dB directivity goal in the figure, with the measured and modeled AWD sound patterns at 1,100, 900, 645, 300, and 0 feet from the crossing respectively. The ideal AWD curves are generated without concern for the specifics of the speakers. The modeled AWD curves are those modeled based on the six speakers used in this test. The measured AWD curves were those measured at TTCI for the six speaker system. It can be seen that the measured AWD system produces significantly more wayside noise than the ideal directivity goals for the system. As the AWD system is refined with more appropriate loudspeakers and speaker sound sequencing, the closer it will come to achieving the ideal wayside noise reduction.

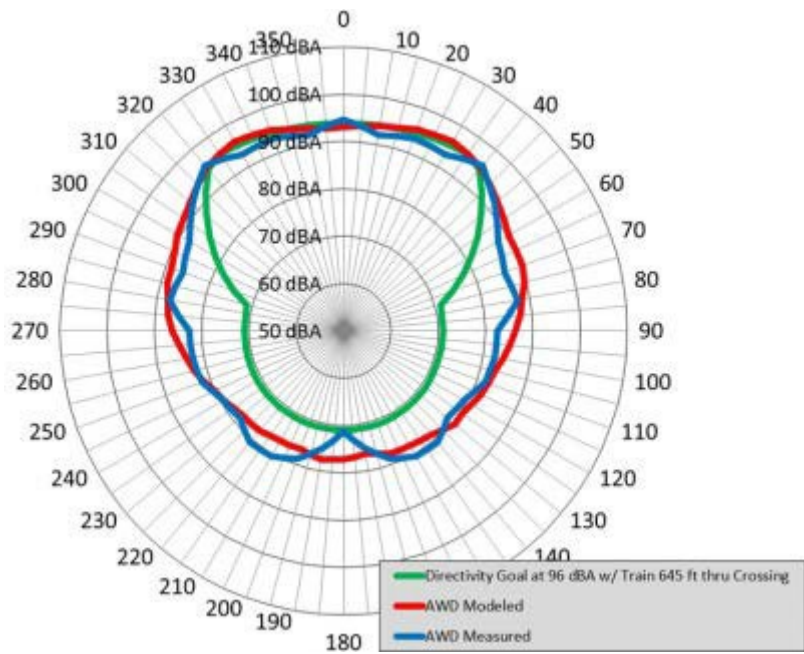
The ideal AWD system produces the maximum sound levels at the crossing roadway, and then decays rapidly at direction angle greater than those that produce maximum sound at the critical point on the roadway. The actual fielded system was limited in the number of speakers and the narrowness of their individual beamwidth. Several more speakers with very narrow beamwidth and high output sound levels can approach the AWD ideal system.



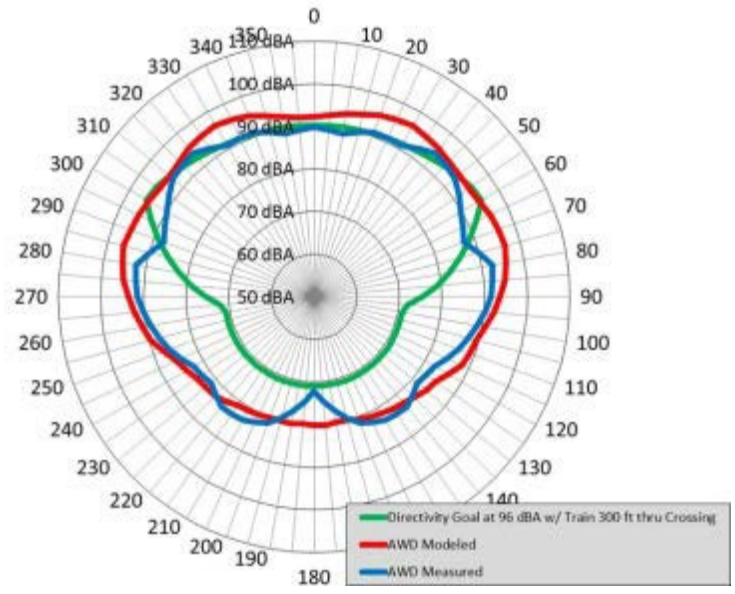
**Figure 64. Comparison of Measured and Predicted AWD Sound Patterns at 1,100 feet from the Crossing**



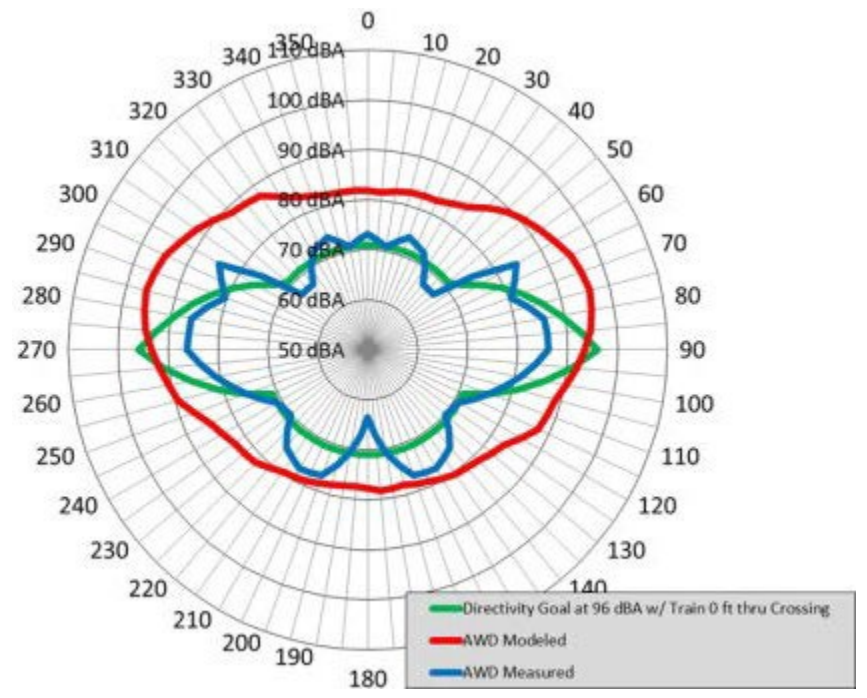
**Figure 65. Comparison of Measured and Modeled AWD Sound Patterns at 900 feet from Crossing**



**Figure 66. Comparison of Measured and Modeled AWD Sound Patterns at 645 feet from Crossing**



**Figure 67. Comparison of Measured and Modeled AWD Sound Patterns at 300 feet from Crossing**



**Figure 68. Comparison of Measured and Modeled AWD Sound Patterns at 0 feet Through the Crossing**

## 6. Conclusion

---

The primary objectives of this phase of research, development and testing were to assemble and dynamically test an AWD system for detectability and wayside noise reduction. A six-speaker system was developed using relatively low cost RMG-200A speakers from Community Professional Loudspeakers. The speakers are directional with a horizontal coverage angle of 50 degrees. They also offer good performance down to 400 Hz. Although they were developed for voice transmission, they were effective functioning as a train horn. Air pressure horns, like the Nathan K5LA, have lower tones down to 311 Hz. These lower tones were missing, but the higher harmonics were effectively captured. A K5LA was recorded and that recording was played back through the speakers to produce the AWD sounds.

Variable directivity for an AWD system was achieved with three pairs of speakers oriented at  $\pm 15$ ,  $\pm 35$ , and  $\pm 75$  degrees from the locomotive axis. The  $\pm 15$ -degree speakers are sounded initially at the 1/4 mile point to minimize wayside noise. The other speakers are activated closer to the grade crossing until only the  $\pm 75$  degree speakers are used at and past the grade crossing.

A GPS driven control system was developed that automatically adjusted the speakers sequencing as a function of distance from the grade crossing and train speed. The control system always developed the LLSL sound pattern and ensured a maximum sound time of 25 seconds. This control system worked very effectively in dynamic tests at TTCI. The system also has a manual override should the engineer wish to modify the automatic sound sequence for any reason.

Sound pattern directivity was measured statically with the AWD system mounted on a TTCI FP40 locomotive (DOTX4113). Directivity was also measured for a K5LA mounted on an SD70ACe at TTCI. The cab mounted K5LA on the FP40 had nearly omnidirectional sound pattern going from 114 dBA forward to 106 dBA at 90 degrees, 100 dBA at 160 degrees, and 91 dBA at 180 degrees. The SD70ACe horn was center mounted in the recessed hood. The forward sound level was 99 dBA at 0 degrees, 113 dBA at 50 degrees, 110 dBA at 140 degrees, and 103 dBA at 180 degrees. The SD70ACe mount develops more wayside noise when center mounted in the recess since the sound levels must be increased to develop sounds forward to adequate levels. The recess inhibits forward sound propagation.

Dynamic testing of the AWD system showed that only 96 dBA were produced forward. This is within FRA regulations, but is less than that of the K5LA. This limitation is due to the capability of the specific speakers selected. Improved speakers can produce equivalent sound levels to a K5LA. To make useful comparisons between both the K5LA and AWD horns, the results of both were scaled to 110 dBA at 100 feet forward of the locomotive.

The scaled results of the AWD and K5LA system were compared. The AWD provided a consistent 3 dB improvement in detectability at the critical stopping distance of 500 feet from the crossing for an approaching 50 mph vehicle. Wayside measurements also showed a 2 to 5 dB reduction in the SELs for the AWD system compared to the K5LA.

Detectability, as defined by d-prime, was predicted for the K5LA using measured sound levels around the locomotive at 100 feet. The sound was then calculated for the critical stopping distance of vehicles traveling at speeds from 20 to 50 mph. The sound attenuation in that calculation included the spherical sound projection and atmospheric attenuation. The results predicted greater than a 95 percent likelihood of the horn being noticed by a driver not listening for the horn. Actual test measurements in dynamic testing at locomotive speeds of 40, 60, and 75

mph showed much lower detectability for the K5LA on the RTT track at TICI. The measured sound levels were used to calculate d-prime using the same methodology as earlier. In the measured case, the detectability was appreciably lower than estimated. The K5LA was audible at 500 feet from the crossing as opposed to 95 percent likely to be detected. Closer to the crossing, the sound levels were noticeable but were not at the 95 percent noticeable level.

Lower measured sound levels in dynamic testing relative to prediction indicate other factors are at work attenuating the sound. Calculations did not assume ground effect, which might have been a factor. Also, some literature has shown that the wind gradients created by moving trains can refract the sound levels and redirect them vertically. Both of these effects could explain the lower detectability found in this study at the critical stopping distances for approaching vehicles. This finding indicates that more work should be done to better understand train horn sound propagation from moving trains to maintain adequate detectability for approaching vehicles.

The report includes the scaled values for the AWD and K5LA systems. The actual measurements are included in [Appendix A](#).



## 7. References

---

1. Office of Safety Analysis. (2015). [Accident Trends – Summary Statistics](#). Washington, DC: Federal Railroad Administration.
2. Federal Railroad Administration, [Office of Safety Analysis Database](#).
3. “[Use of Locomotive Horns at Highway-Rail Grade Crossings](#).” (December 2013). Interim Final Rule, Final Environmental Impact Statement. Washington, DC: U.S. Department of Transportation, Federal Railroad Administration.
4. Maling, G. C. (2010). “Technology for Quieter America.” Washington, DC: National Academy of Engineering, Committee on Technology for a Quieter America.
5. Federal Railroad Administration. (1995). [Florida’s Train Whistle Ban](#). Washington, DC: U.S. Department of Transportation, Office of Railroad Safety.
6. Rapoza, A. S., & Fleming, G. G. (2002). [Determination of a Sound Level for Railroad Horn Regulatory Compliance](#). Technical Report No. DOT/FRA/ORD-03/28. Washington, DC: U.S. Department of Transportation, Federal Railroad Administration.
7. Electronic Code of Federal Regulations. [Title 49 CFR Part 222–Use of Locomotive Horns at Public Highway-Rail Grade Crossings](#). [49 CFR Part 229–Railroad Locomotive Safety Standards](#). Washington, DC: Federal Railroad Administration.
8. Ross, J. C., Johnson, T. M., Parida, B. K., & Zaouk, A. K. (2021). “Feasibility of a Train Horn with Optimized Directivity: Environmental and Occupational Noise Benefit of an Ideal Train Horn.” Technical Report No. DOT/FRA/ORD-21/XX. Washington, DC: U.S. Department of Transportation, Federal Railroad Administration.
9. Ross, J. C., Parida, B. K., Zaouk, A. K., Nash, G. S., & Punwani, S. K. (2012). Feasibility of a Variable-Directivity Locomotive Horn.” Paper No. JRC2012-74086. Proceedings from *2012 Joint Rail Conference*, Philadelphia, PA, pg. 653–662.
10. Campbell, T., Parida, B. K., & Ross, J. C. (2020). “[Acoustical Warning Devices as Emergency Warning Signals \(EWS\) Phase 3: Performance Evaluation on a Locomotive](#).” Technical Report No. DOT/FRA/ORD-21/25. Washington, DC: U.S. Department of Transportation, Federal Railroad Administration.

## Appendix A. Raw Static and Dynamic Test Data

---

### A.1 Measured Directivity of the AWD and the Air Horn at TTCI

In Figures A1 through A2, the directivity patterns of the cab-roof mounted air horn on a F40PH locomotive # 4113 and that of the center-mounted K5LA air horn on an SD70ACe locomotive # 4223 are plotted based on the measured values in dBA. The corresponding directivity patterns of all three pairs of AWD speakers separately and in combinations representing their activation sequences are also plotted.

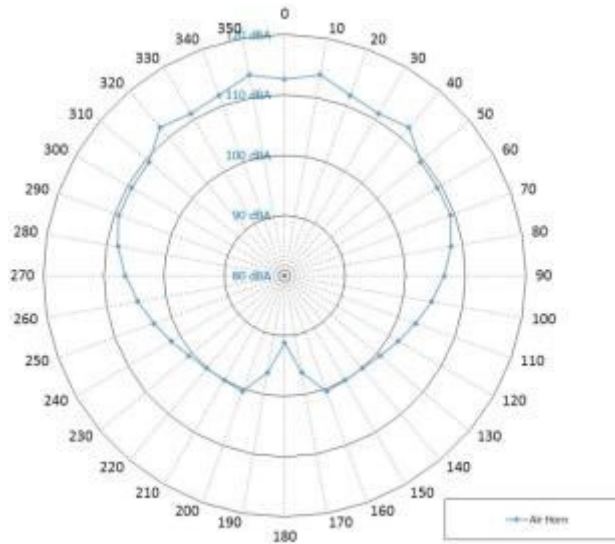


Figure A1. Cab-Roof Mounted Air Horn Directivity Pattern

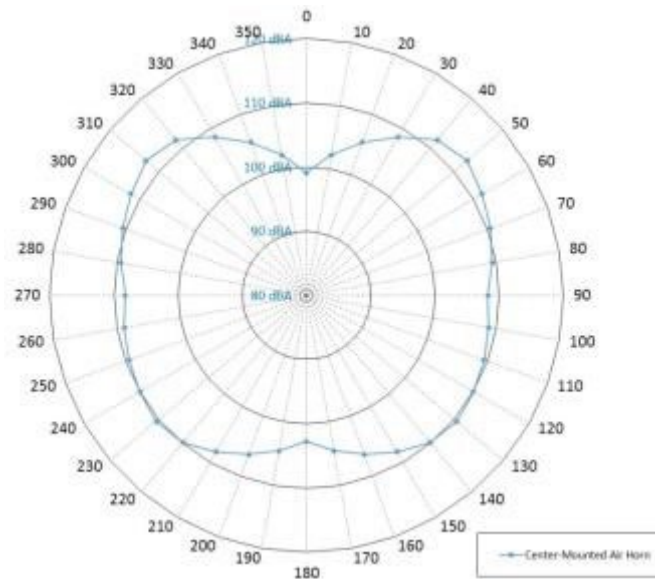
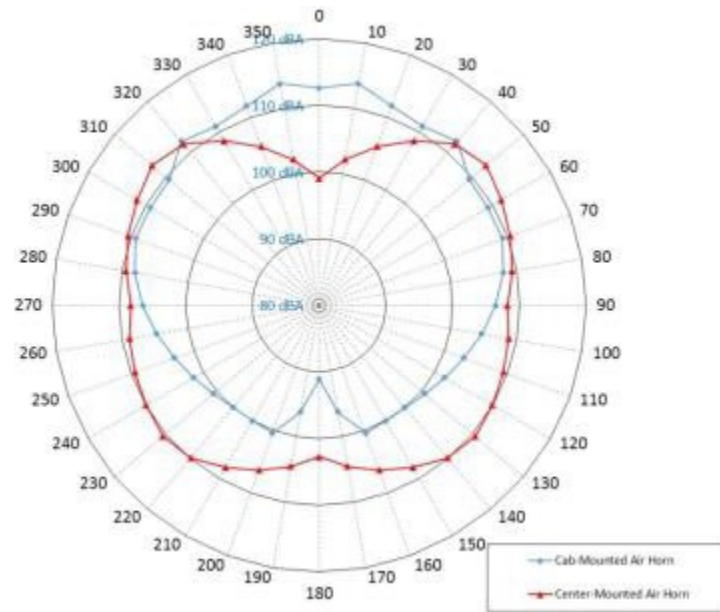
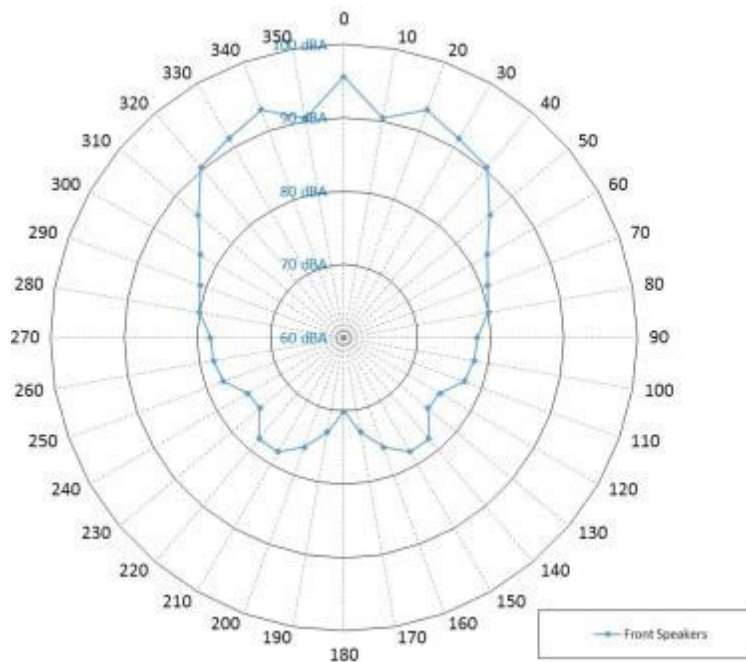


Figure A2. Center-Mounted Air Horn Directivity Pattern

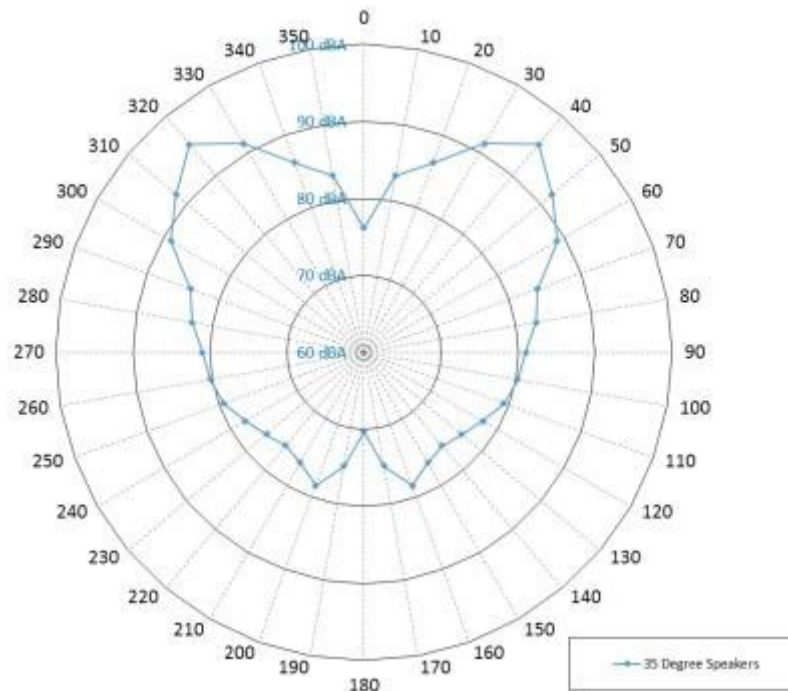
Figure A3 shows the distinctive variation in the directivity patterns between the cab-roof mounted air horn and the center mounted air horn having its four chimes facing forward and one chime facing to the rear. Clearly, the center-mounted air horn will have a relatively lower frontal directivity and a greater trackside noise impact, especially to the rear half.



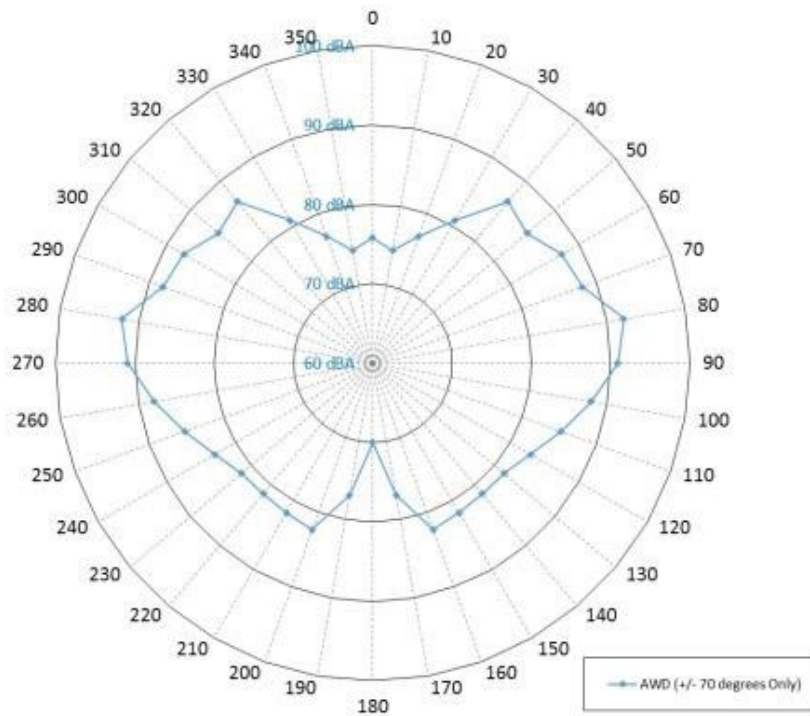
**Figure A3. Comparison of Directivity Patterns of Cab-Roof and Center-Mounted Air Horns**



**Figure A4. Directivity of AWD  $\pm 15$  Degree Speakers**



**Figure A5. Directivity of AWD ±35 Degree Speakers**



**Figure A6. Directivity of AWD ±75 Degree Speakers**

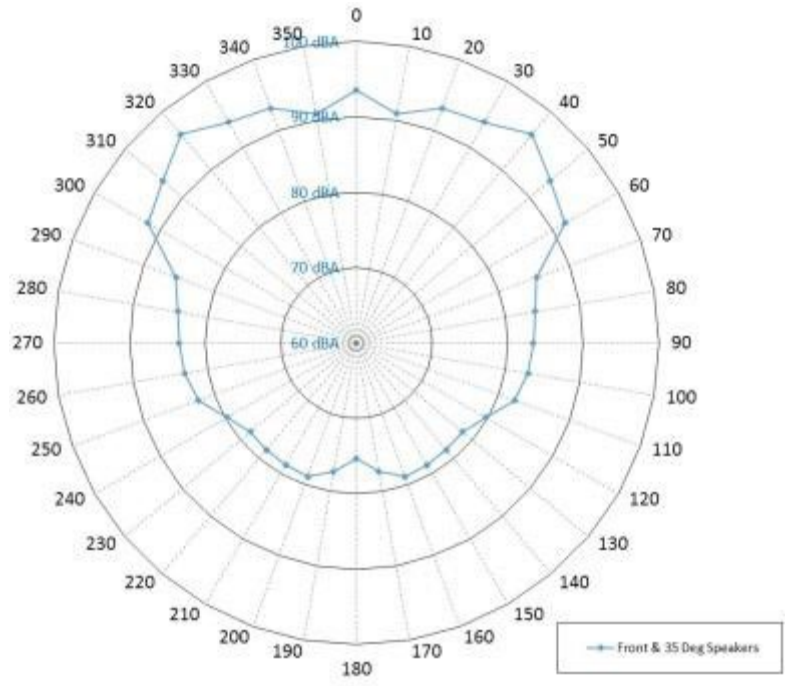


Figure A7. Directivity of AWD ±15 and ±35 Degree Speakers

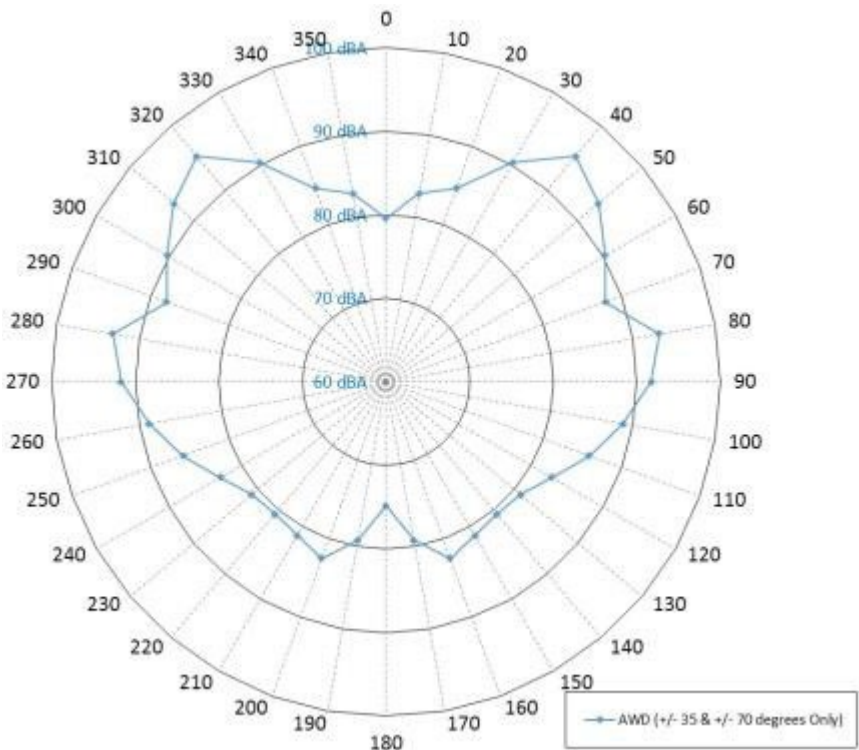
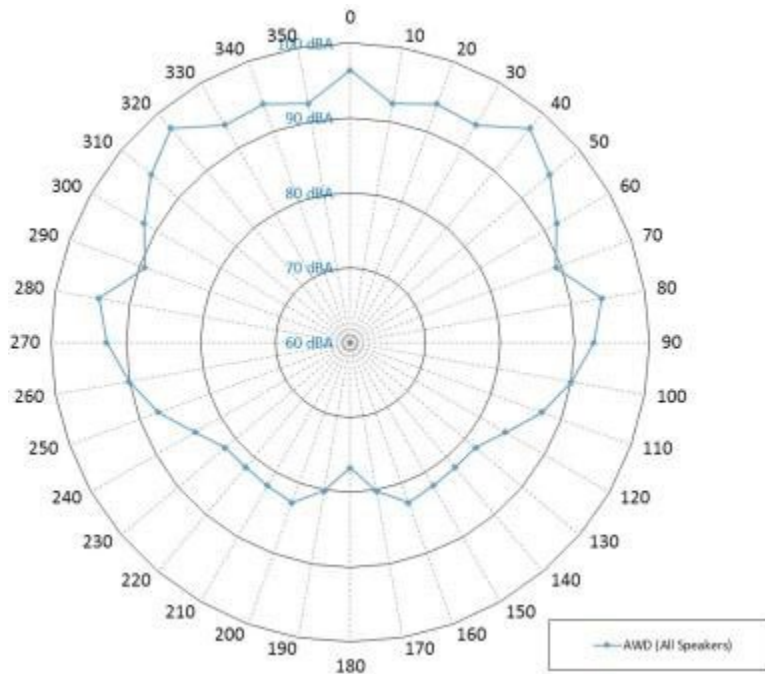
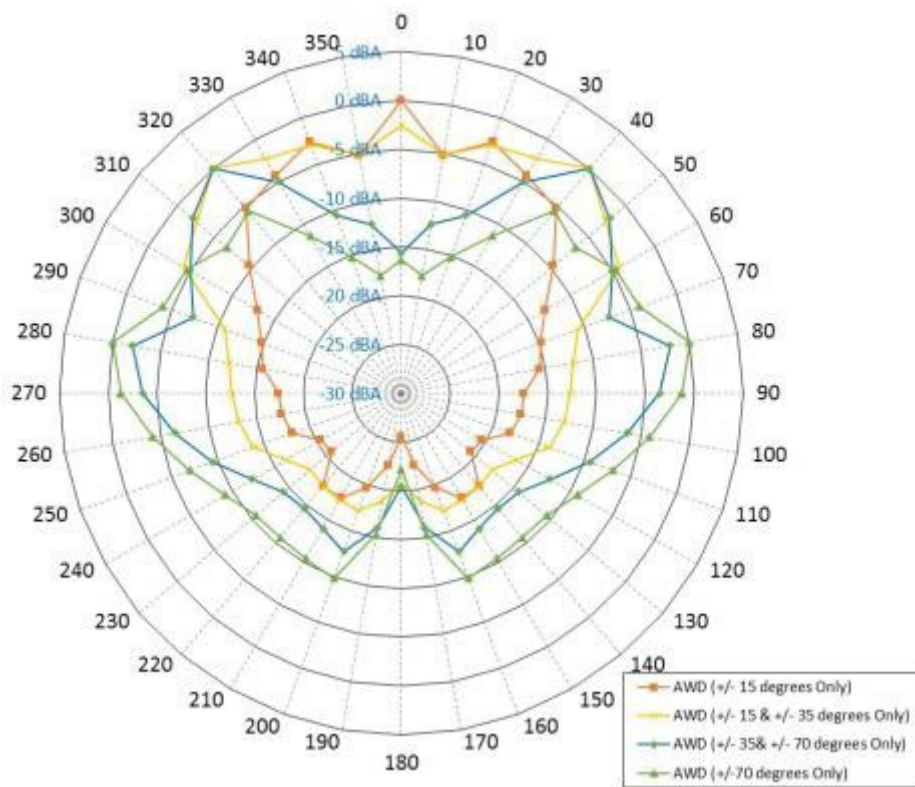


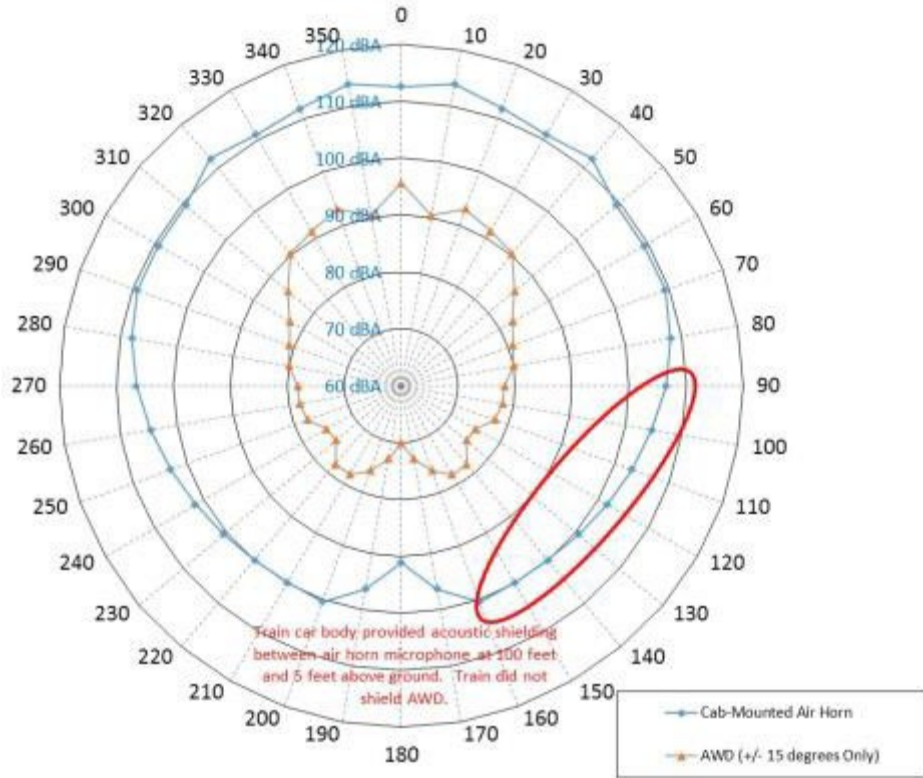
Figure A8. Directivity of AWD ±35 and ±75 Degree Speakers



**Figure A9. Directivity Pattern of All Speakers of AWD**



**Figure A10. Directivity Patterns (showing relative amplitudes) of Various Speaker Combinations of AWD**



**Figure A11. Comparison of Directivity Patterns and Amplitude of Cab-Mounted Air Horn of DOTX4113 Locomotive and AWD  $\pm 15$  Degree Speakers Only**

The comparison between the directivity patterns of a cab-roof mounted air horn and that of the two forward facing ( $\pm 15$  degree) speakers of the AWD shown in Figure A11 is quite remarkable on many counts. The directivity pattern boundary of the air horn far exceeds the AWD boundary along the entire 360 degrees, which would imply that the air horn is nearly omni-directional with very little directivity. It would have an adverse noise impact on the residents residing along the railroad corridor. In comparison, the directivity pattern of the two forward facing AWD speakers is very much acceptable with an elongated front lobe and shrinking side and rear lobes.

However, the measured amplitude levels (dBA) for both the air horn and the AWD appear to be unsatisfactory. While the air horn maximum amplitude is on the higher side at around 114 dBA, the AWD maximum amplitude is found to be in the range of 95 dBA. For practical applications, it will be desirable to use AWD speaker system with similar or better directivity with higher amplitude close to 110 dBA.

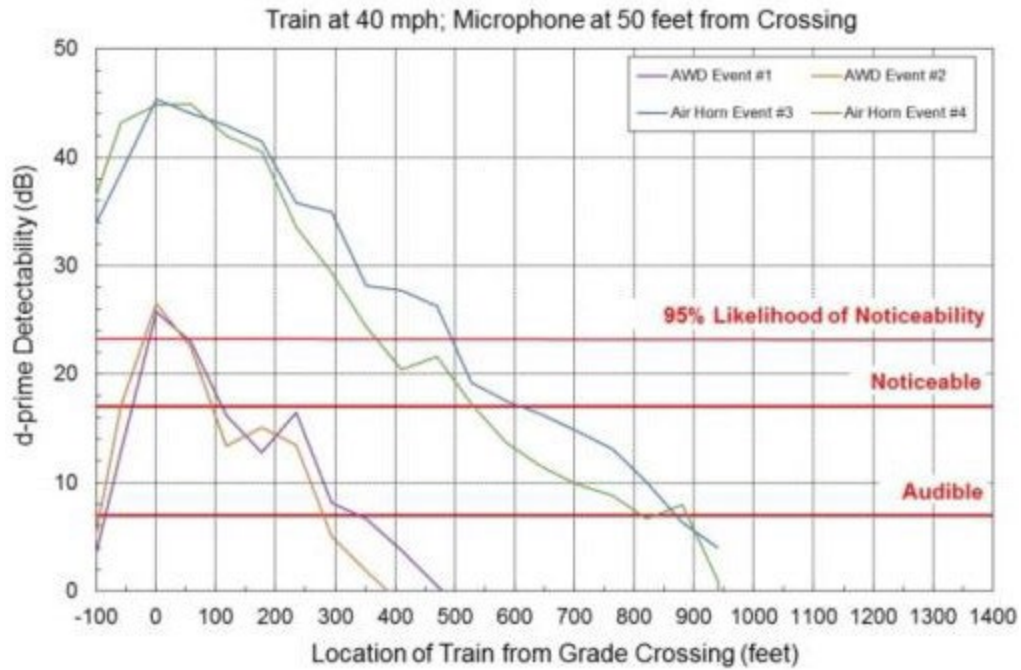
## A.2 Measured Detectability of the AWD and Air Horn from Test at TTCI

Table A1. AWD and Air Horn Performance Evaluation at Three Locomotive Speeds

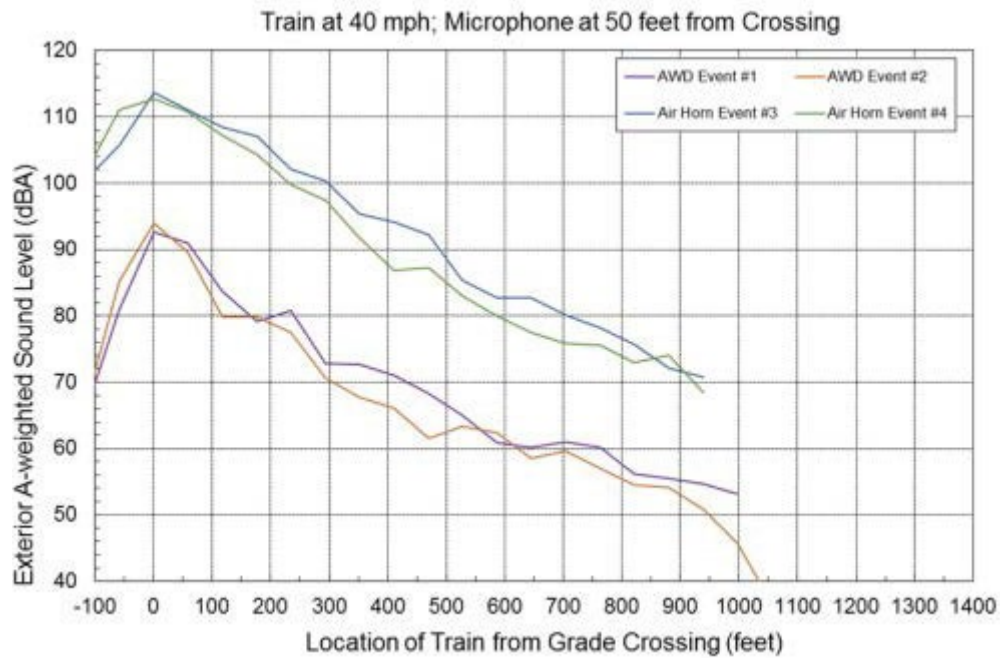
Horn	Event	Speed (mph)	50 feet from Crossing			500 feet from Crossing			500 ft from Tracks, 1000 ft from Crc		
			d-prime Dose	SEL Dose	Lmax	d-prime Dose	SEL Dose	Lmax	d-prime Dose	SEL Dose	Lmax
AWD	1	40	66.1	95.7	92.6	51.2	82.4	74.9	42.7	71.4	63.3
AWD	2	40	66.3	96.1	94.0	51.5	82.9	78.0	43.8	72.9	62.2
Air Horn	3	40	91.2	117.6	113.6	65.4	93.8	88.5	67.5	95.1	89.4
Air Horn	4	40	91.0	117.4	112.7	67.2	96.5	88.1	66.7	94.9	88.3
		<b>Avg AWD</b>	66.2	95.9	93.3	51.4	82.6	76.5	43.3	72.1	62.7
		<b>Avg Horn</b>	91.1	117.5	113.1	66.3	95.1	88.3	67.1	95.0	88.8
		<b>AWD - Horn</b>	<b>-24.9</b>	<b>-21.6</b>	<b>-19.8</b>	<b>-14.9</b>	<b>-12.5</b>	<b>-11.8</b>	<b>-23.8</b>	<b>-22.9</b>	<b>-26.1</b>
AWD	1	60	65.0	94.2	93.2	49.8	81.2	77.0	44.4	72.6	64.0
AWD	2	60	65.4	94.8	93.2	52.2	83.6	79.1	43.4	72.1	64.9
Air Horn	3	60	89.5	115.7	112.8	68.0	96.6	91.1	64.5	92.4	88.5
Air Horn	4	60	89.3	115.6	112.6	64.9	94.0	88.4	63.6	91.9	86.9
		<b>Avg AWD</b>	65.2	94.5	93.2	51.0	82.4	78.1	43.9	72.4	64.4
		<b>Avg Horn</b>	89.4	115.7	112.7	66.5	95.3	89.8	64.1	92.2	87.7
		<b>AWD - Horn</b>	<b>-24.2</b>	<b>-21.2</b>	<b>-19.5</b>	<b>-15.5</b>	<b>-12.9</b>	<b>-11.7</b>	<b>-20.2</b>	<b>-19.8</b>	<b>-23.3</b>
AWD	1	75	66.9	96.3	93.2	48.1	78.8	73.7	42.9	70.8	64.6
AWD	2	75	64.7	93.5	90.4	49.6	80.8	77.4	46.0	74.2	66.6
Air Horn	3	75	88.4	114.4	111.7	65.3	94.3	90.0	65.8	94.2	89.9
Air Horn	4	75	88.5	114.7	112.3	62.4	90.9	84.7	66.0	94.1	89.0
		<b>Avg AWD</b>	65.8	94.9	91.8	48.9	79.8	75.5	44.4	72.5	65.6
		<b>Avg Horn</b>	88.5	114.6	112.0	63.8	92.6	87.3	65.9	94.1	89.4
		<b>AWD - Horn</b>	<b>-22.7</b>	<b>-19.7</b>	<b>-20.2</b>	<b>-15.0</b>	<b>-12.8</b>	<b>-11.8</b>	<b>-21.5</b>	<b>-21.7</b>	<b>-23.8</b>

In Figures A12 through A15, the exterior A-weighted sound level (dBA) and the d-prime detectability data for both cab-roof mounted air horn and the AWD are presented. Also, three lines representing the d-prime detectability (dB) required for the horn to be “Audible,” “Noticeable,” and “95% Likelihood of Noticeability” are marked in these figures. However, it is to be noted that the measured air horn max amplitude was about 114 dBA at 100 feet in front of the locomotive and the corresponding AWD maximum amplitude was about 96 dBA.





**Figure A12. D-prime Detectability at 50 Feet from Crossing with Locomotive Speed at 40 mph**



**Figure A13. Exterior Sound Level (dBA) at 50 Feet from Crossing with Locomotive Speed at 40 mph**

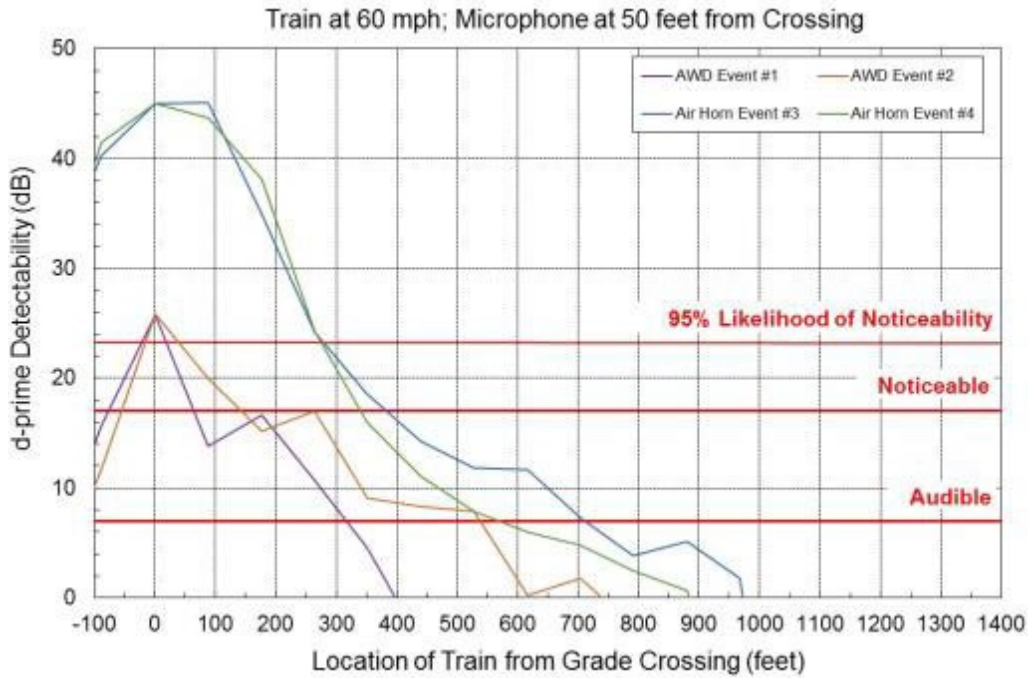


Figure A14. D-prime Detectability at 50 Feet from Crossing with Locomotive Speed at 60 mph

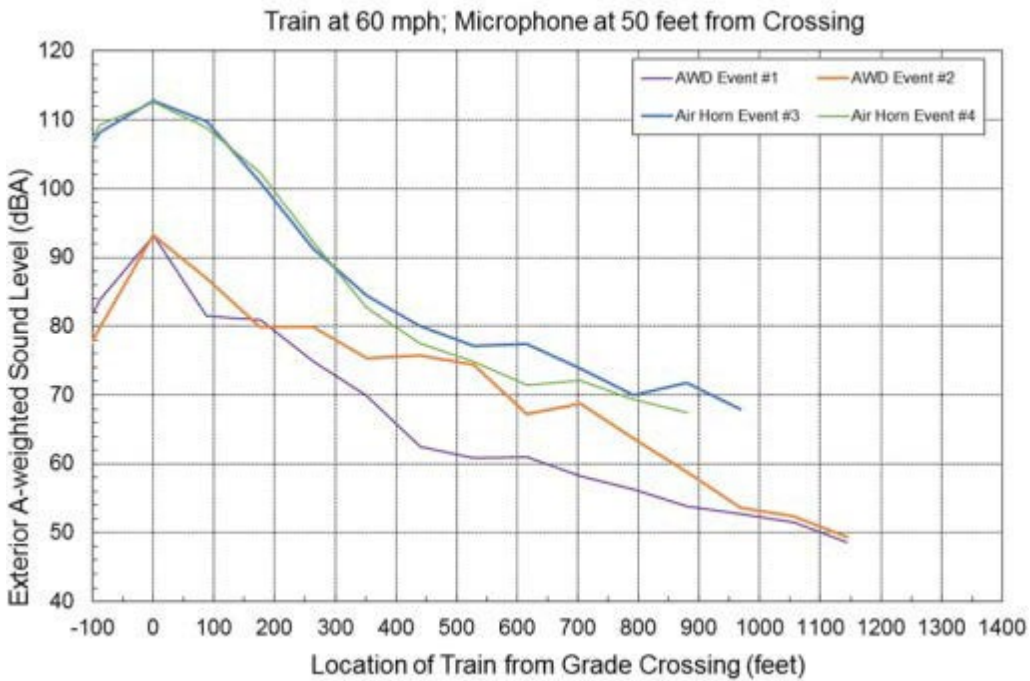


Figure A15. Exterior Sound Level (dBA) at 50 Feet from Crossing with Locomotive Speed at 60 mph

## Abbreviations and Acronyms

---

<b>ACRONYMS</b>	<b>EXPLANATION</b>
AWD	Acoustic Warning Device
AAR	American Association of Railroads
dBA	A-Weighted Decibel Sound Level
CPU	Central Processing Unit
CFR	Code of Federal Regulations
COTS	Commercial Off-The-Shelf
CTZ	Critical Track Zone
Ldn	Day-Night Average Sound Level
HUD	Department of Housing and Urban Development
FRA	Federal Railroad Administration
FRP	Fiber Reinforced Plastic
FEC	Florida East Coast Railway
GPS	Global Positioning System
Hz	Hertz
LLSL	Long-Long-Short-Long
Lmax	Maximum Sound Level
NAE	National Academy of Engineering
QNA	QinetiQ North America
RTT	Railroad Test Track
RMS	Root Mean Square
SEL	Sound Exposure Level
SLM	Sound Level Meter
TTC	Transportation Technology Center
TTCI	Transportation Technology Center, Inc.
HUD	US Department of Housing and Urban Development
USB	Universal Serial Bus
VHB	Vanasse Hangen Brustlin, Inc.
Volpe	Volpe National Transportation Systems Center
WAAS	Wide Area Augmentation System