



Public Roads

Spring 1994

RECEIVED
MAY 11 1994
U.S. DEPT. OF TRANSPORTATION
LIBRARY SERVICE BRANCH

RECEIVED
MAY 11 1994
U.S. DEPT. OF TRANSPORTATION
LIBRARY SERVICE BRANCH



U.S. Department
of Transportation
Federal Highway
Administration

Public Roads

Spring 1994 Vol. 57, No. 4

COVER:

Jenny Lake Road was reconstructed as part of the road improvement project at Grand Teton National Park in Wyoming. The old Jenny Lake Road was a one-way loop, but the northern portion of the road was rebuilt as a two-way road to accommodate the increasing traffic of picnickers, hikers, and other visitors to the park.

Articles

Texas High-Strength Concrete Bridge Project by <i>Mary Lou Ralls and Ramon Carrasquillo</i>	1
The Impact of Highway Infrastructure on Economic Performance by <i>Theresa M. Smith</i>	8
Automatic Weather Station Installed at Turner-Fairbank Highway Research Center by <i>Aramis Lopez</i>	15
An Automatic Warning System to Prevent Truck Rollover on Curved Ramps by <i>Hugh W. McGee and Rodney R. Strickland</i>	17
FHWA Assistance to Russia by <i>Bert Schacknies</i>	23
Using Finite Element Analysis in Designing Roadside Hardware by <i>Malcolm Ray</i>	28
National Crash Analysis Center by <i>Azim Eskandarian, Nabih E. Bedewi, and Leonard Meczowski</i>	32

Departments

Along the Road	36
Recent Publications	42
New Research	45
Technology Applications	46

Information

U.S. Department of Transportation

Federico Peña, *Secretary*

Federal Highway Administration

Rodney E. Slater, *Administrator*

Office of Research and Development

John A. Clements, *Associate Administrator*

Anne N. Barsanti, *Managing Editor*

Robert V. Bryant, *Editor*

Kevin C. Kerdash, *Associate Editor*

Nita Congress, *Contributing Editor*

Publication Board

R.E. Slater, F.B. Francois, T.B. Deen, H. Bernstein

Editorial Board

E.D. Carlson, J.A. Clements, G.J. Jeff, D.C. Judycki,

A.R. Kane, G.S. Moore, G.L. Reagle, D.S. Gendell,

R.J. Betsold, R.J. Kreklau

NOTICE

The United States Government does not endorse products or manufacturers. Trade or manufacturers' names appear herein solely because they are considered essential to the object of an article.

Public Roads (ISSN 0033-3735; USPS 516-690) is published quarterly by the Office of Research and Development, Federal Highway Administration (FHWA), 400 Seventh Street SW, Washington, DC 20590. Second class postage paid at Washington, DC, and additional mailing offices.

POSTMASTER: Send address changes to *Public Roads*, HRD-10, FHWA, 6300 Georgetown Pike, McLean, VA 22101-2296.

Public Roads is sold by the Superintendent of Documents, U.S. Government Printing Office, Washington, DC 20402, for \$7.50 per year (\$1.90 additional for foreign mailing) or \$2.50 per single copy (\$0.63 additional for foreign mailing). Check or money order should be made payable and sent directly to New Orders, Superintendent of Documents, P.O. Box 371954, Pittsburgh, PA 15250-7954. Subscriptions are available for one-year periods.

The Secretary of Transportation has determined that the publication of this periodical is necessary in the transaction of the public business required by law of this Department.

All articles are advisory or informational in nature and should not be construed as having regulatory effect.

Articles written by private individuals contain the personal views of the author and do not necessarily reflect those of FHWA.

All photographs are provided by FHWA unless otherwise credited.

Contents of this publication may be reprinted. Mention of source is requested.

TEXAS

HIGH-STRENGTH CONCRETE BRIDGE PROJECT

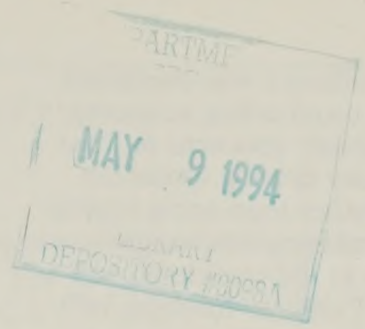

by Mary Lou Ralls and
Ramon Carrasquillo

Introduction

High-strength concrete is one of the most significant new materials available to federal, state, and local highway agencies to rehabilitate the nation's crumbling infrastructure. High-strength concrete, as defined in this article, has a specified design strength of 55.2 megapascals (8,000 pounds per square inch) or greater. With its improved impermeability, durability, and accelerated strength gain over normal-strength concrete, high-strength concrete should enhance performance and be an ideal material to assist with the widespread problem of deteriorating bridge structures.

In addition to its better long-term performance, the use of high-strength concrete allows either longer spans with fewer support locations or fewer beams for a given span length. This results in savings due to reduced fabrication, transportation, and erection costs, as well as reduced substructure requirements because of the lighter superstructure. The net result should be comparable, if not decreased, costs relative to conventional construction.

This article describes the design and construction details for Louetta Road Overpass, two adjacent bridges on State Highway 249 in Houston, Texas. These structures showcase the use of high-strength concrete and are the first bridges in the United States to fully use high-strength concrete in all aspects of design and construction. Several innovations make

these structures unique in the use of high-strength concrete. They are also the first in the United States to use 15.24-millimeter (0.6-inch-) diameter, prestressed strands in a pretensioned concrete application and on a 50-mm (1.97-in) grid spacing.

A number of differences exist between the Louetta bridges and the Braker Lane Bridge, built in Austin, Texas, in 1990. The Braker Lane Bridge is a conventional prestressed concrete beam bridge except that its I-shaped beams have a design strength of 66.2 MPa (9,600 lbf/in²). Actual concrete

strengths ranged from 75.8 MPa (11,000 lbf/in²) to 96.5 MPa (14,000 lbf/in²) at 28 days.

The Louetta Road Overpass structures, which were let to contract in February 1994, are simple-span, pretensioned concrete beams with composite precast/cast-in-place concrete decks using construction materials that incorporate the latest technology. All components of these structures are being built with high-strength concrete. The beams are pretensioned concrete U-beams—a recent, Texas Department of Transportation (TxDOT) development in

Other High-Strength Concrete Bridges*

1980	Red River Cable-Stayed Bridge Guangxi, China	60 MPa (8,700 lbf/in ²)
1985	East Huntington Cable-Stayed Bridge East Huntington, W.Va.	55 MPa (8,000 lbf/in ²)
1986	Annacis Cable-Stayed Bridge Vancouver, British Columbia, Canada	55 MPa (8,000 lbf/in ²)
1989	Joigny Bridge Joigny, France	60 MPa (8,700 lbf/in ²)
1990	Braker Lane Bridge Austin, Texas	66 MPa (9,600 lbf/in ²)
1990	Liangshui River Bridge Beijing-Tianjin Highway, China	60 MPa (8,700 lbf/in ²)
1993	Normandie Bridge Normandie, France	60 MPa (8,700 lbf/in ²)
1993	Portneuf Bridge Quebec, Canada	60 MPa (8,700 lbf/in ²)

*Several other bridges have used some high-strength concrete; however, these are the only commonly known high-strength concrete bridges.

which aesthetics was combined with the usual safety, economy, and durability concerns to form the primary driving forces for design. Rather than using typical prestressed concrete design strengths in the traditional 34.5- to 41.4-MPa (5,000- to 6,000-lbf/in²) range, the beams in these structures fully use concrete strengths in the 69- to 89.6-MPa (10,000- to 13,000-lbf/in²) range.

The high-strength beams combine with a high-strength concrete deck in one of the structures to obtain a totally high-strength concrete superstructure. The superstructures are supported on high-strength concrete, post-tensioned pier segments—another new application for conventional bridge construction. This culminates in the first bridge structures in the United States to fully use high-strength concrete in combination with aesthetics and economy in a total package that adds up to long-term high performance at costs that are anticipated to be competitive with conventional structures. It is expected that information developed from this project will assist in the design of high-performance, economical structures throughout the country in the near future and for years to come.

The Cooperative Agreement

In July 1993, a cooperative agreement was initiated between the Federal Highway Administration (FHWA) and TxDOT, in conjunction with the Center for Transportation Research (CTR) at The University of Texas at Austin, to conduct research in the design and construction of extra-high-strength concrete bridges. The agreement involves the Louetta Road Overpass with specified design strengths in the 69- to 89.6-MPa (10,000- to 13,000-lbf/in²) range for pretensioned beams and 69 MPa (10,000 lbf/in²) for post-tensioned substructures. This research project is the first phase of a larger, overall effort to design and construct bridges with specified strengths in the 103.4- to 117.2-MPa (15,000- to 17,000-lbf/in²) range. The emphasis is to collect data on all aspects of high-strength

concrete bridge construction to lay the groundwork for designing and constructing extra-high-strength concrete bridges with minimum variation from conventional bridge-building techniques. A cooperative agreement is also anticipated between FHWA and TxDOT to develop and present technology transfer materials in conjunction with the Louetta Road Overpass design and construction effort.

Louetta Structures

The existing S.H. 249 is a four-lane, at-grade, asphalt-surfaced road that is classified as a major rural/urban arterial. After reconstruction, the thoroughfare, known as the Aggie Freeway, will be a controlled-access, six- to eight-lane, divided freeway with access ramps to and from frontage roads

and with a number of mainlane overpasses, including Louetta Road. The 1992 average daily traffic count for S.H. 249 was 32,700 vehicles, of which 5.8 percent—approximately 1,900 vehicles—were trucks. A minimum average daily traffic count of 144,200 vehicles is projected for the year 2022, again with 5.8 percent—8,400 vehicles—projected to be trucks. The construction phasing allows the project to proceed with minimum

inconvenience to motorists.

The sequence of work was modified to allow construction of the Louetta Road Overpass structures at the beginning of this project. Construction is, therefore, anticipated to start in the spring of 1994 and to be completed in the fall of 1994. According to the current plan, the structures will be opened to traffic in 1995.

Figure 1 shows a plan view of the Louetta structures. Each three-span unit consists of a 37-m (121.5-ft) span, a 41.3-m (135.5-ft) span, and a 40.8-m (134.0-ft) span, each with a varying roadway width. These

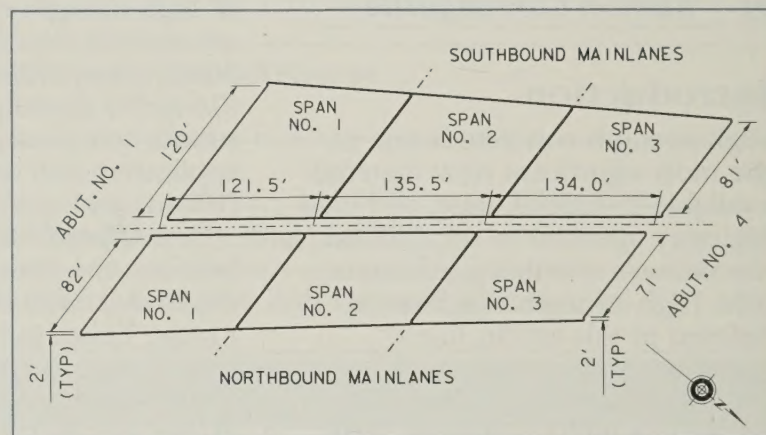

Figure 1—Plan view of Louetta Road Overpass.

lengths are longer than the maximum spans used in typical U-beam bridges, which have wide beam spacings that limit the span lengths to approximately 35.1 m (115 ft).

Thus, the Louetta bridges are an ideal application for high-strength concrete. The longer span lengths combine with wider spacing of the U beams to provide a more structurally efficient, aesthetic, streamlined appearance than could be achieved with typical

Table 1—Average Beam Spacings and Concrete Strengths

Category	Unit	Southbound	Northbound
Ave. Beam Spacing ~ Span #1	ft	15.8	13.0
Avg. Beam Spacing ~ Span #2	ft	13.7	12.4
Avg. Beam Spacing ~ Span #3	ft	11.7	11.7
f'ci ~ U-Beams [3 designs]	psi	6,900 to 8,800	6,900 to 8,800
f'c ~ U-Beams [3 designs]	psi	9,800 to 13,100	9,800 to 13,100
f'c ~ Post-Tensioned Piers	psi	10,000	10,000

1 ft = 0.3048 m

1 psi (lbf/in²) = 6.89 kPa

design concrete strengths of less than 55.2 MPa (8,000 lbf/in²). Six U-beams span the southbound lanes, and five U-beams span the more narrow northbound lanes. The average beam spacings vary from 3.57 to 4.82 m (11.7 to 15.8 ft), as shown in table 1. This results in clear spacings of 1.13 to 2.38 m (3.7 to 7.8 ft) between beams.

Also shown in table 1 are the specified design concrete strengths. The U-beams are designed for three concrete mixes, with design release strengths from 47.6 to 60.7 MPa (6,900 to 8,800 lbf/in²) and with specified 56-day design strengths from 67.6 to 90.3 MPa (9,800 to 13,100 lbf/in²). The post-tensioned concrete pier segments are designed for 69-MPa (10,000-lbf/in²), specified 28-day strength. The design strengths for the U-beams were specified at 56 days, the project standard for high-strength concrete. The standard is 56 days, compared to the 28-day standard for normal-strength concrete, to account for the appreciable strength gain with time that occurs in high-strength concrete after 28 days. The post-tensioned concrete segments, however, were specified at 28 days because preliminary results from the 69-MPa (10,000-lbf/in²) mix designs indicated the strength could be achieved in 28 days.

The U-Beam

The Louetta structures were designed using a new beam shape recently developed by TxDOT. Dubbed the "U-beam," this beam is a pretensioned concrete, open-top, trapezoidal-shaped beam that was developed as an economical, aesthetic alternative to I-shaped beams. Structures designed with U-beams typically require only one-half to two-thirds as many beams as structures designed with I-beams.

A reduction in both number of beams per span and number of visual horizontal breaklines per beam contributes to the streamlined appearance of the U-beam bridge. This can be seen in figure 2, which shows that seven American Association of State Highway and Transportation Officials (AASHTO) Type IV beams—1372-mm (54-in.) deep

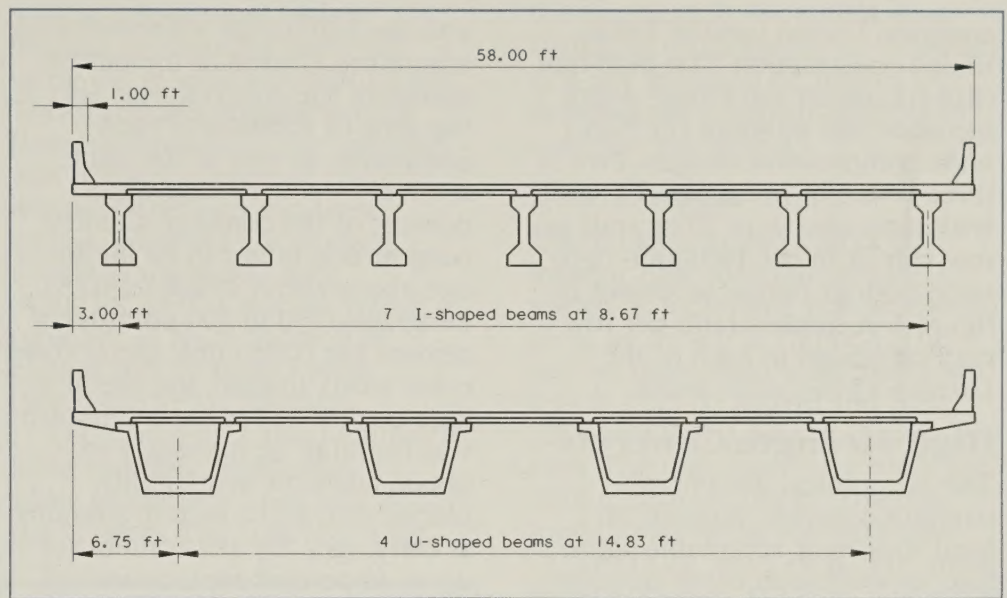

Figure 2—Comparison of Texas standard, 16.6-m- (56-ft-) wide roadway cross section with AASHTO type IV beams and with U54 beams.

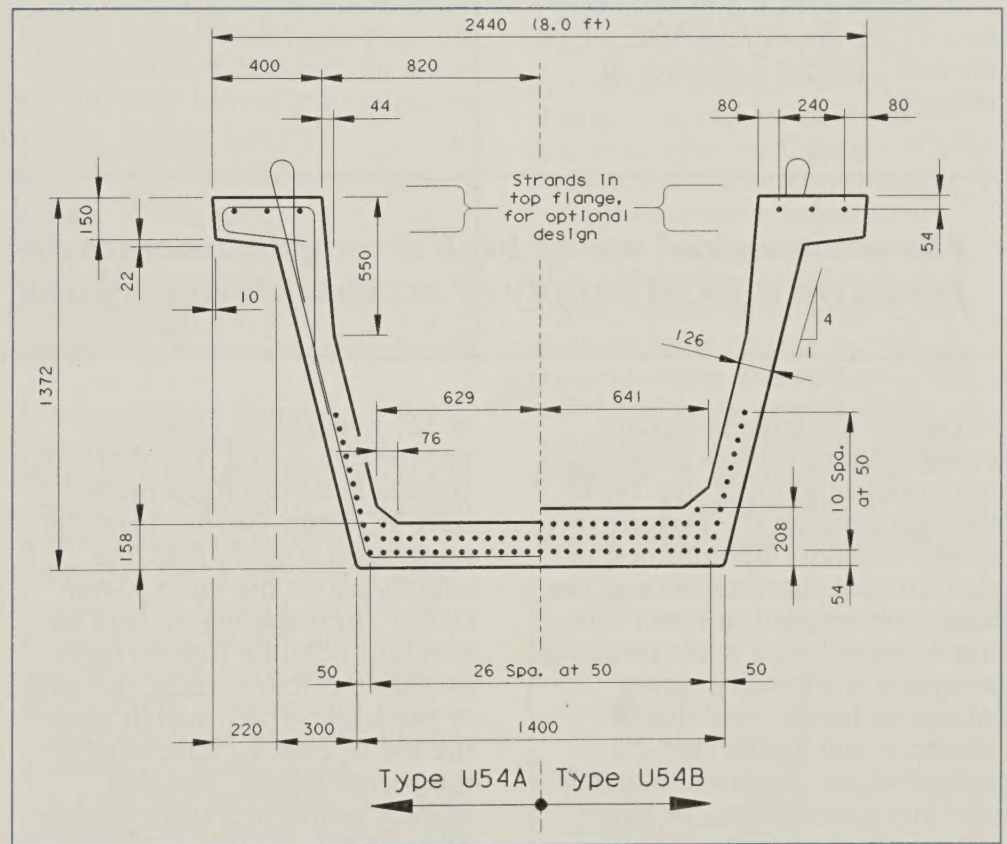

Figure 3—Cross section and prestressed strand patterns of U54 beams. (Note: Dimensions are shown in millimeters; 1 mm = 0.0394 in.)

prestressed concrete I-beams—on a typical 17.1-m- (56-ft-) wide roadway can be replaced with four 1372-mm (54-in) U-beams, called U54 beams. The Louetta bridges, designed with high-strength concrete U54 beams, will have a similar decrease in the number of beams.

The U-beam was developed in metric dimensions, anticipating the

requirement that all federally funded construction projects be specified in metric (SI) units, effective September 1996. Figure 3 shows the cross-sectional dimensions and pretensioned strand locations for the U54 beam. This beam is 1372 mm (54-in) in depth, thus allowing its use as an alternative to the 1372-mm (54-in) AASHTO Type IV beam, the most

common I-beam used in Texas bridge construction. The 2440-mm (8.01-ft) overall top flange width includes two 400-mm- (15.75-in-) wide compression flanges. Two or three layers of prestressed strands, with a maximum of 27 strands per row, can fit in the 1400-mm- (5-ft-) wide bottom flange, as shown in figure 3. A single strand per row may be placed in each of the 126-mm- (5-in-) wide webs.

High-Strength Concrete

The economical use of high-strength concrete depends on a local supply of acceptable aggregate, as well as on other considerations, such as quality of available cement, admixture compatibility, and availability of mineral admixtures. Because this structure is in a no-freeze area, it was not necessary to use air entrainment, which normally carries a sacrifice in strength.

and the high-range water-reducing admixture. Critical to the performance of the concrete was also the time of addition of each admixture, as well as the minimum allowable mixing-water content of the concrete. Cement content was found to be ineffective above about 294.84 to 317.52 kilograms (650 to 700 pounds) of cement per 0.765 cubic meter (one cubic yard). Instead, the use of a high-quality ASTM Class C fly ash was found to be necessary to obtain adequate workability, placeability, and concrete strength at early ages. Fly ash contents of up to 40-percent replacement of the cement were evaluated.

Use of 15.24-mm- (0.6-in-) Diameter Strand

To take full advantage of high-strength concrete, a higher prestress force is required than can typically be achieved with the use

allowed full use of concrete strengths greater than 69 MPa (10,000 lbf/in²) in the U-beam designs. The benefit of this combination quickly became apparent in designing the U-beams for the Louetta structures. The interior beams in the 37-m (121.5-ft) span of the northbound mainlanes were the only beams that could be designed with 12.7-mm- (0.5-in-) diameter prestressed strands. All other beams required 15.24-mm- (0.6-in-) diameter strands in combination with the high-strength concrete to meet design criteria.

Use of the larger 195.5 kN (43,950 pounds force) per strand on a 50-mm (1.97-in) grid spacing raised concerns about stress concentrations and possible concrete splitting in the end regions of the beams and about development length requirements. To get field data and to verify adequate performance, two full-scale U-beam specimens were cast in September 1993. The beams were instrumented with mechanical gauge points on the outside surfaces of the webs along the beam length to measure concrete strains at release of prestress. No end splitting due to prestress force was seen, and preliminary results from strain measurements indicate adequate transfer length. The release was gradual (multistrand release), as required by TxDOT for bridge projects.

Also of concern is the development length of 15.24-mm- (0.6-in-) diameter strand. Two rectangular beams, 355.6 mm (14 in) wide and 1,066.8 mm (42 in) deep, were cast in December 1993. Each was pretensioned with one layer of six 15.24-mm- (0.6-in-) diameter strands on a 50.8-mm (2-in) grid spacing at 50.8 mm (2 in) up from the bottom fiber. These beams will be tested to failure at the CTR laboratory to obtain development-length measurements.

Beam Design

The beam designs have different concrete design parameters due to the use of high-strength concrete. The allowable tension coefficients were increased from 7.5 to 10 for release and from 6 to 8 for final to be consistent with previous experimental studies of

The economical use of high-strength concrete depends on a local supply of acceptable aggregate.

One of the most important considerations for this project was the understanding of the role of the aggregate on the performance of the concrete. Optimization of the physical characteristics of the aggregate resulted in lower mixing-water demand while retaining adequate workability, higher strengths, higher modulus of elasticity, and higher flexural strengths. For the same materials and mix proportions, the aggregate resulted in up to 24.1-MPa (3,500-lbf/in²) strength difference and up to 20-percent difference in modulus of elasticity. Of great importance to optimizing the flexural strength of the concrete were the surface characteristics, size, and composition of the aggregate, as well as the amount used in the concrete.

The strength-gain characteristics of the concrete were greatly influenced by the type and dosage rate of retarding admixture, as well as by the compatibility between the retarding admixture

of 12.7-mm- (0.5-in-) diameter prestressing strand. Therefore, the Louetta Road Overpass beams have 15.24-mm- (0.6-in-) diameter prestressed strands. Also, the strands are on the same 50-mm (1.97-in) grid spacing as used for standard 12.7-mm- (0.5-in-) diameter strands to maximize the effect of the larger strand and to allow the use of existing hardware at the precast plants. This grid spacing results in a clear spacing between strands that is less than currently allowed in AASHTO standard specifications. Although FHWA has a moratorium on the use of 15.24-mm- (0.6-in-) diameter strands for pretensioned applications a special approval was requested and received from FHWA based on results from tests conducted on this project indicating no problems with the strand configuration.

A 42-percent increase in prestress results from using the 15.24-mm- (0.6-in-) diameter strand. This increase in prestress force

high-strength concrete. Modulus of rupture tests conducted on the mix designs used in the field tests indicate an allowable tension coefficient at release of 9.6.

The modulus of elasticity used in design was 41,370 MPa (6 million lbf/in²) at seven days. An average modulus of elasticity of 45,507 MPa (6.6 million lbf/in²) at seven days was obtained in the field tests.

Concrete Mix Proportioning

When proportioning high-strength concrete, emphasis must be placed

well as a 33-percent higher flexural strength, as indicated using the modulus-of-rupture test. This increased demand on the flexural capacity of the concrete was needed to prevent cracking at release. Other specifications include concrete compressive strengths up to 60.7 MPa (8,800 lbf/in²) at release, which is typically 18 to 24 hours after casting and up to 90.3 MPa (13,100 lbf/in²) at 56 days.

The concrete is also required to have excellent workability to allow placement from one web of the U-beam. The concrete must

the concrete. It is evident that future advancements in construction are going to be highly dependent on advancements in concrete technology.

Pier Design

The Louetta substructures at interior bent locations are designed as individual post-tensioned piers, as shown in figure 4. The hollow core column segments are 0.99 m (3.25 ft) square and have 228.6-mm (9-in) daps at the corners. The two transverse walls are 101.6 mm (4 in) thick. The two longitudinal walls are 190.5 mm (7.5 in) thick, with each containing three 34.93-mm- (1.375-in-) diameter post-tensioned bars. The post-tensioned bars are designed for a wobble coefficient of 0.0, an anchorage set of 159 mm (0.0625 in), a maximum average bar stress after anchoring of 70-percent guaranteed ultimate tensile strength, and allowable final concrete stress coefficients of 3 for tension and 0.4 for compression.

This innovative substructure was selected for several reasons. First, the bridges are classified as highly visible, and therefore, an aesthetic substructure as well as superstructure was required. The individual piers, devoid of the conventional connecting cap, are perceived by many as more aesthetic. Second, relatively thin-walled, hollow post-tensioned

FRESH CONCRETE

Slump after high-range water reducer (HRWR):	177.8 to 241.3 mm (7.0 to 9.5 in)
Concrete temperature:	35.6° to 38.9° C (96° to 102° F)
Unit weight:	66.77 to 69.67 kg/m ³ (147.2 to 153.6 lb/ft ³ [pcf])

HARDENED CONCRETE

Compressive strength at 40 hours:	56.677 to 66.054 MPa (8,220 to 9,580 lbf/in ²)
Compressive strength at 56 days:	90.118 to 110.32 MPa (13,070 to 16,000 lbf/in ²)
Modulus of elasticity at 7 days:	41,370 to 48,270 MPa (6 to 7 million lbf/in ²)

on the interaction among the components used in making the concrete, as well as the quality and characteristics of each component. Materials selection should be based on the following four considerations:

- Contribution to the workability, placeability, and finishability of the fresh concrete.
- Effect on the mixing-water demand of the fresh concrete for adequate workability.
- Effect on the mortar-aggregate tensile bond strength within the hardened concrete.
- Contribution of the material to any special specification or performance requirements of the concrete, such as durability, modulus of elasticity, or flexural strength.

The special requirements for the Louetta U-beams include a high modulus of elasticity, 41,370-MPa (6-million lbf/in²) minimum at early ages to control deflections, as

flow across a 1400-mm- (4.59-ft-) wide bottom flange without segregation, passing two layers of strands in a 158-mm (6.22-in) depth or three layers of strands in a 208-mm (8.19-in) depth, and then flow into the bottom portion of the far web, at which time concrete is placed in the far web to fill the entire cross section.

No silica fume was used in any of the mixes in this study.

A field trial batch program was conducted to evaluate eight of the mixes that had been developed in the laboratory. The results from the trial batch program are detailed below. No accelerated curing was used in the field tests.

In summary, use of high-strength concrete depends greatly on the optimization and engineering of the concrete and its components. For high-strength concrete construction, compressive strength, flexural strength, modulus of elasticity, creep, and shrinkage need to be predictable performance characteristics of

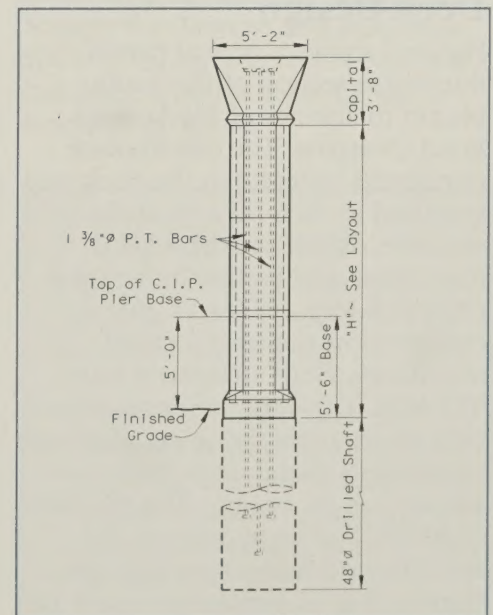

Figure 4—Typical post-tensioned pier at interior bent locations.

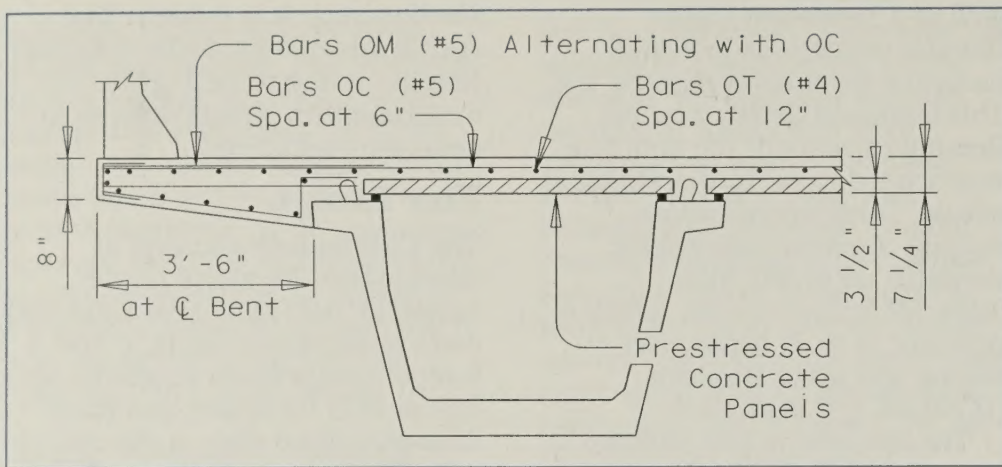

Figure 5—Typical cross section of the southbound Louetta Road structure, showing deck reinforcement.

concrete pier segments were required to fully use the high concrete strength in design and to also have a practical and economical construction method. In addition, the use of precast hollow pier segments allows the introduction of architectural creativity in future designs. Third, the time savings inherent with precast concrete construction should result in a reduction in costs. Immediately upon completion of the pier construction, the U-beams may be erected and deck construction begun. This saves a significant amount of construction time since the substructure does not require the usual seven-day minimum to obtain design concrete strengths.

Deck Design

Figure 5 shows a typical partial transverse section of the southbound mainlanes of the Louetta Road Overpass. The cast-in-place reinforced concrete in the deck was specified as 55.16-MPa (8,000-lbf/in²) concrete on the southbound mainlanes and as the Texas standard 27.6-MPa (4,000-lbf/in²) concrete on the northbound mainlanes. Both structures have 55.2-MPa (8,000-lbf/in²) prestressed concrete panels specified, although permanent metal deck forms are allowed as an option. The 55.2-MPa (8,000-lbf/in²) concrete on the southbound mainlanes was specified so that observations could be made to determine whether the increased cost and complexities of placing and curing the higher strength concrete are justified

by an increase in long-term performance.

The deck was designed for main reinforcement perpendicular to traffic, the standard method used in Texas. The transverse No. 5 bars at 152.4-mm (6-in) spacings were doubled on the overhang. This allowed a 2.29-m (7.5-ft) overhang from centerline of outside U-beam to edge of slab, compared to the 2.06-m (6.75-ft) overhang used in standard U-beam bridge design. The wider overhangs contribute to a more aesthetic overall appearance.

A perspective of the completed southbound mainlanes is shown in figure 6, and an artist's rendering of both structures is shown in figure 7.

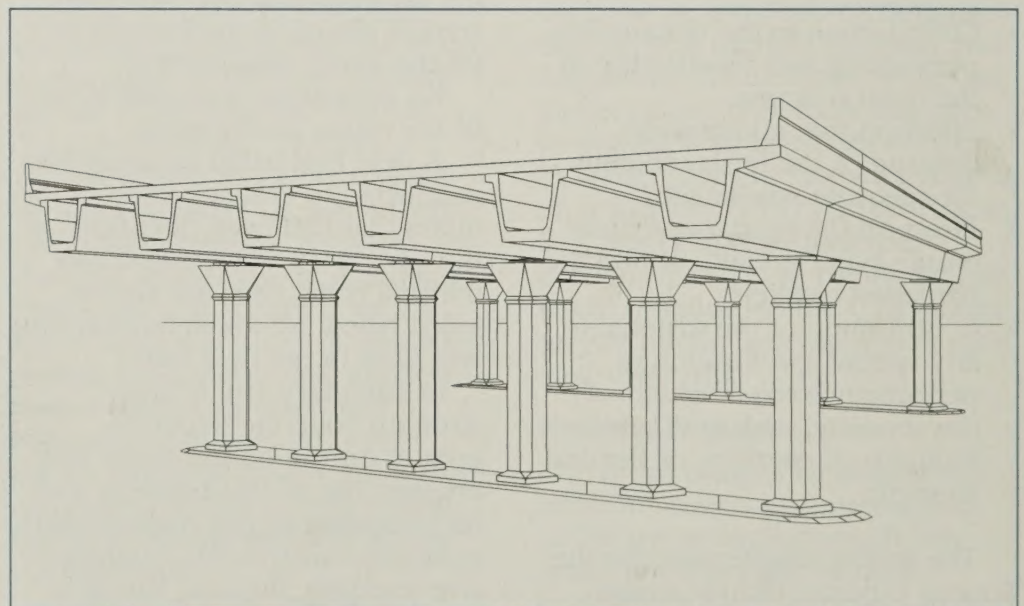

Figure 6—Perspective of the completed southbound mainlanes.

Quality Control/Quality Assurance Program

Most important to the successful completion of a high-strength concrete project is the establishment of a comprehensive Quality Control/Quality Assurance (QC/QA) program. Furthermore, if the QC/QA program is to work as intended, it must be developed with the full cooperation and approval of all the parties involved in the construction process, including FHWA, the state DOT, and the general contractor and its subcontractors, such as the testing laboratory and the concrete supplier.

Developing and implementing the QC/QA program will be a dynamic process requiring continuous updating through regularly scheduled meetings to accommodate test results and findings during actual construction. The QC/QA program should cover all aspects of the concreting process at the construction site—from materials selection to concrete production, curing, testing, placement, troubleshooting, and performance evaluation. This program should include some of the more traditional aspects of quality control, such as frequency of testing, sampling, size of test specimens, testing machines, sample preparation, and others, as well as strict, fresh concrete temperature controls, limits on

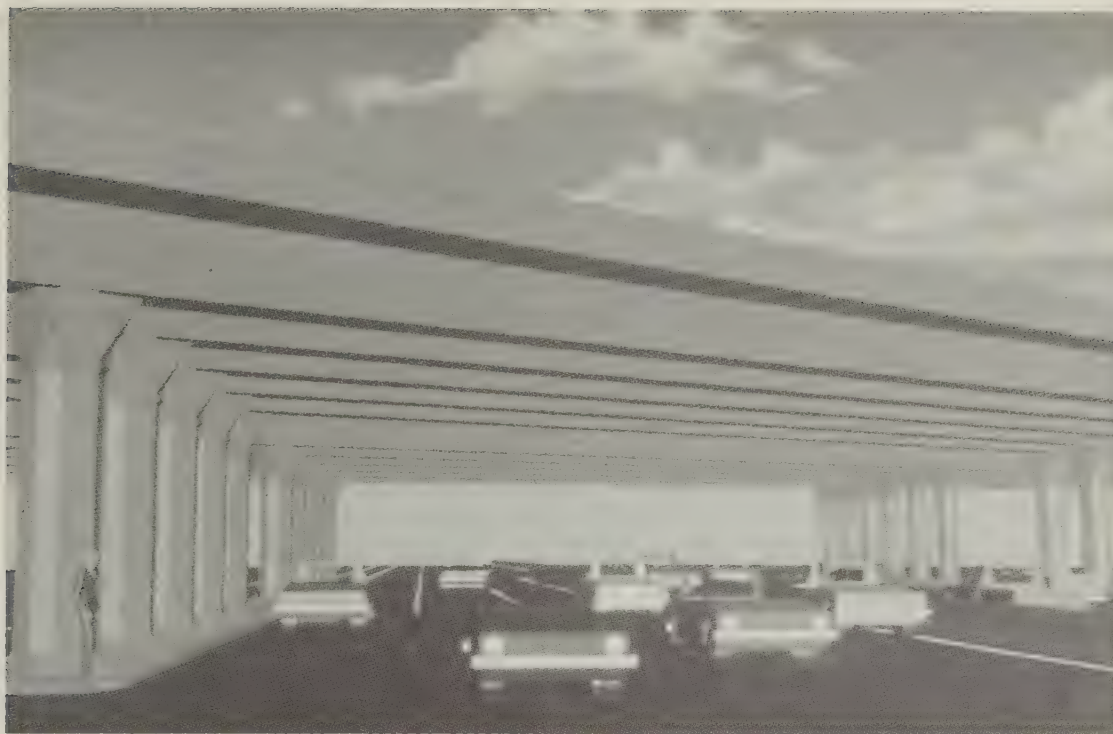

Figure 7—Artist's rendering of the Louetta Road Overpass structures.

temperature rise due to cementitious hydration, vibration, surface temperature at time of formwork removal, etc.

Key elements to the QC/QA program are the awareness of the parties involved of the purpose of each of the elements of the QC/QA program and their commitment to communicate and cooperate in the resolution of any concerns. The Louetta project will be an opportunity for all individual parties to contribute to the overall QC/QA plan and ensure the success of this challenging and unique bridge project.

Technology Transfer Efforts

Efforts are underway to document all aspects of the Louetta Road Overpass high-strength concrete project. Videotapes and slides have been taken of the two castings of research beams done at the precast plant and are planned for the preconstruction and subsequent meetings, the U-beam and pier segment fabrication, the bridge construction, and any loading or monitoring of the completed structures.

The videotapes with script will be edited into a 10- to 15-minute production that documents the entire project. The slides are being used in presentations at various

technical conferences and meetings around the country.

Ongoing efforts include development of brochures on the initial and final phases of this high-strength concrete project and development of two or three multiday workshops on high-strength concrete to be held around the country, including one planned for Houston during bridge construction.

Conclusion

The Louetta Road Overpass structures are the first in the United States to fully use high-strength concrete in all aspects of design and construction. They are also the first in the United States to use 15.24-mm- (0.6-in-) diameter strands in a pretensioned concrete application and on a 50-mm (1.97-in) grid spacing. This project lays the groundwork for designing and constructing extra-high-strength concrete bridges with minimum variation from conventional bridge-building techniques.

The benefits of high-strength concrete to the transportation system are being identified, documented, and verified in this project. Methods for optimizing all aspects of design and construction are being developed, and specifications and construction documents for future high-strength concrete

projects are being formulated. Results from this project should assist the engineering and construction professions in consistently producing high-strength, high-performance, prestressed concrete bridges and to do so at competitive costs.

Mary Lou Ralls, P.E., is a supervising design engineer in the Bridge Section of the Design Division of the Texas Department of Transportation. She is technical chair of the Louetta research project and has been coordinator for the development of the U-beam. She received a bachelor of science degree in civil engineering and a master of science degree in engineering from The

University of Texas at Austin, and she is a registered professional engineer in the state of Texas.

Ramon Carrasquillo, Ph.D., P.E., is a professor of civil engineering at The University of Texas at Austin. He also serves as the associate director of the Center for Aggregate Research and coordinator of the Construction Materials Graduate Program. He is very active in professional organizations such as the American Concrete Institute and the American Society for Testing and Materials. Since 1976, high-strength concrete has been a major topic of his research program.

Future Research

Future FHWA-sponsored, concrete-related research will focus on developing:

- Higher strength concrete.
- Durable frost-resistant concrete for cold environments.
- Higher load-carrying capacity strands to reduce steel congestion.
- Evolving technical details for handling and connecting these higher capacity members.

The Impact of Highway Infrastructure on Economic Performance

by Theresa M. Smith

Introduction

In the United States, the importance of transportation facilities to the nation's economic strength and efficiency is generally accepted. A fundamental requirement of manufacturers is to distribute their products to appropriate markets quickly and inexpensively; people must be able to get to work and to conduct business. And as illustrated by recent disasters—flooding along the Mississippi and Missouri rivers and the Northridge earthquake in California—any significant disruption in the movement of goods or people economically impacts a great number of businesses and huge population groups. This recognized link between transportation and economic development continues to justify significant public expenditures in transportation systems at the local, state, and federal levels. Nevertheless, many of the intuitive relationships are not analytically established.

Although evaluations of relatively localized user costs and benefits of investments in transportation projects are possible, it is difficult to quantitatively link such investments to national or regional growth, economic development, industry or national productivity, growth in economic welfare, or the nation's competitiveness in the international market.

The Clinton administration recognizes the importance of transportation infrastructure investment to revitalize the economy and to enhance U.S. global competitiveness. That's why one of the U.S. Department of Transportation's (DOT) strategic goals is to get the economy

going and create new jobs by making strategic transportation investments.

The Intermodal Surface Transportation Efficiency Act (ISTEA) of 1991 has given us the tools to improve transportation—to channel innovative thinking, to harness technology, to strengthen old partnerships and build new ones.

These new partnerships blend business, labor, government, and the environmental and educational communities into a united force for economic growth and job creation.

In support of these efforts, the Federal Highway Administration (FHWA) is building on a priority research area, established in 1989,

Table 1—Studies of the Relationship Between Highway Transportation and Productivity

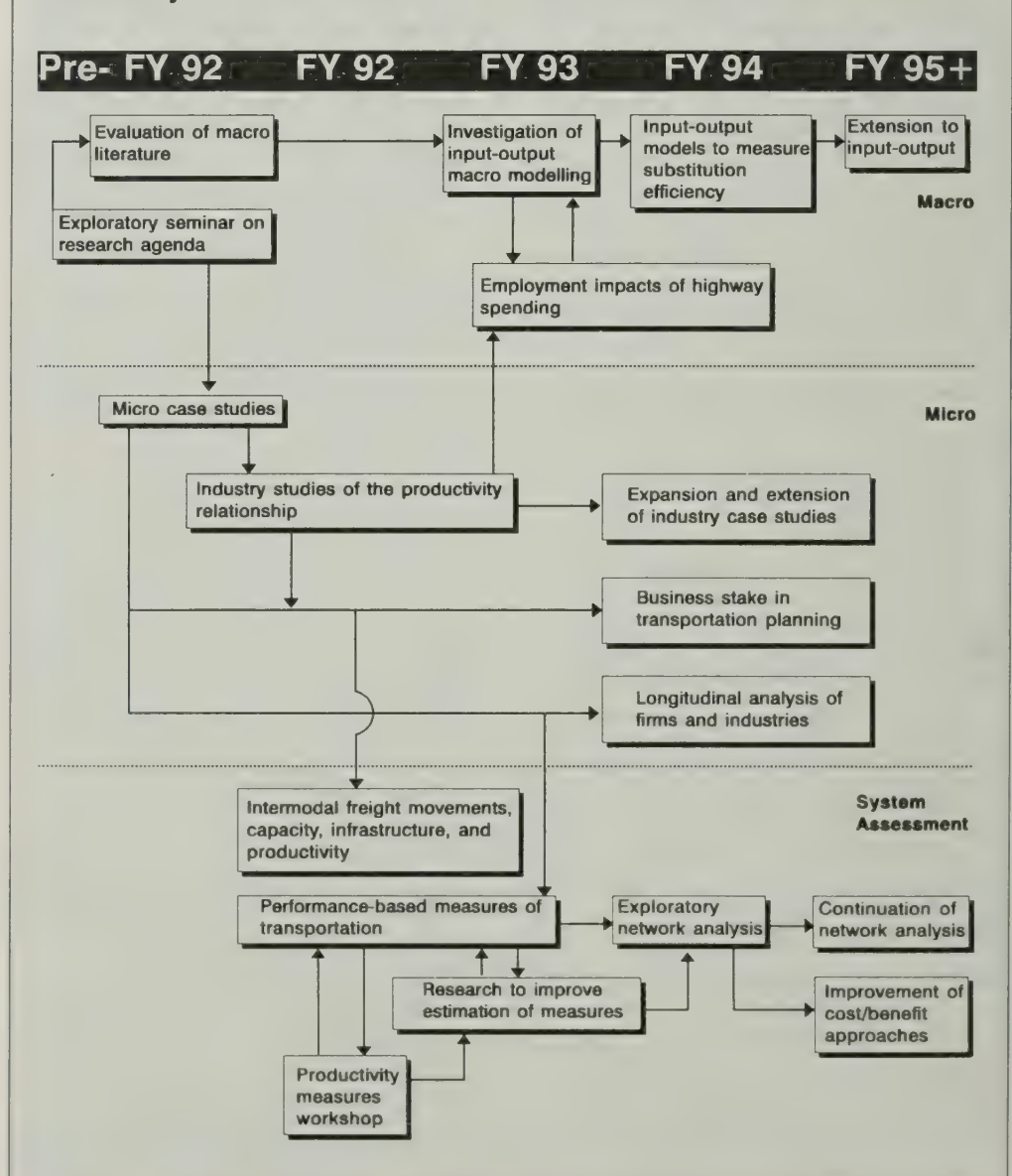

which examines the linkage between investment in highways and bridges and the nation's capacity to sustain economic performance and growth. In this research, the FHWA is acting as an intelligent consumer—studying all relevant data including previous, related research.

The purpose of this article is to explain the FHWA research agenda—"Interrelationships Between Transportation Infrastructure Investment and Productivity"—and to offer a summary of research from this program. (1)

This research will clarify, as quantitatively as possible, both the short- and long-term influences of highway infrastructure investment and service on the economy to make possible more informed decision making and to respond to the productivity slowdowns. The research program seeks to answer the question: How do changes in highway investment or service translate to private productivity?

Research Approaches

Three approaches are used in this research. The first approach, macroeconomic analysis, investigates national and state-level linkages between infrastructure capital stock or investment and economic growth and productivity, using econometric methodologies such as the production function. The second dimension, microeconomic industry analysis, explores the connection between individual industries or firms and transportation infrastructure through analysis of logistics relationships. A third perspective, highway system assessment, examines service, network, and system characteristics to determine whether a causal relationship exists.

Together the three dimensions will incorporate leading analytical perspectives to assess the contribution to economic performance and growth of systems, corridors, and projects as reflected in investment programs at local, state, regional, and national levels. Several methodologies and analysis levels are explored to locate the best way to understand the relationship between highway infrastructure and economic vitality. These

approaches are only a starting point for a thorough analysis.

FHWA began investigating this issue in fiscal year 1990. Table 1 shows several projects are ongoing and others are scheduled for fiscal year 1994.

Summaries of specific research projects are presented according to the approach undertaken. Collateral studies with the National Cooperative Highway Research Program (NCHRP) at the American Association of State Highway and Transportation Officials (AASHTO) are also included. The goal is to promote an objective and useful understanding of the significance of highway investment and service at the global, national, state, local, and industry levels. While results of individual studies show mixed results, they are presented to emphasize the difficulty of answering the question of how highway infrastructure is related to economic performance.

Background

The study of productivity and economic growth has always been an important issue. However, interest in the sources of such activity rises in times of recession such as we experienced in the early 1990s. U.S. productivity growth has been lower in this decade than in the past. At the same time, the United States has experienced lower productivity growth than other industrialized nations. While several measures reflect the health of the economy, it is difficult to ascertain which measure is the best, since slightly dissimilar objectives are captured in different measures. While one measure may imply a healthy economy, another may show tremendous cause for concern.

Growth implies a healthy, expanding, flourishing economy—an economy where output is continually expanding. Productivity is the ratio of outputs to inputs. Increases in productivity typically means more output is produced with the same amount of input. Productivity for a specific input can be measured separately. For example, labor productivity measures how much output increases for a particular amount

Table 2—Potential Causes of Productivity Slowdowns

- Changes in the composition of the labor force.
- Changes in the growth rate of private capital stock and its flow of services.
- An increase in energy prices.
- Declining investment in private research and development.
- Diversion of capital resources to pollution abatement and government worker safety regulations.
- Mismeasurement of output.
- Shift to a service-oriented economy.
- Declining investment in public infrastructure.

of labor input. Individual productivity can be measured by the amount of product or service produced per hour.

While some economists suggest that growth is not always a panacea, many in the United States are concerned that without continued productivity growth, our standard of living will not continue to rise. Indeed, without productivity growth, the only way for our incomes as a whole to increase would be through a redistribution of the current level of wealth.

In light of this, one might ask: What causes increases in productivity? or What causes declines in productivity? To answer the first question, increases in productivity result from increases in technology or innovation, increases in labor skills or education, and growth in the quality or quantity of capital stock. However, there is much disagreement over the second question. Table 2 shows several possibilities.

One hypothesis postulates that declines in the quantity and quality of public capital infrastructure investment led to the current slowdown in productivity. Indeed, investment in infrastructure as a percentage of gross domestic product has fallen from

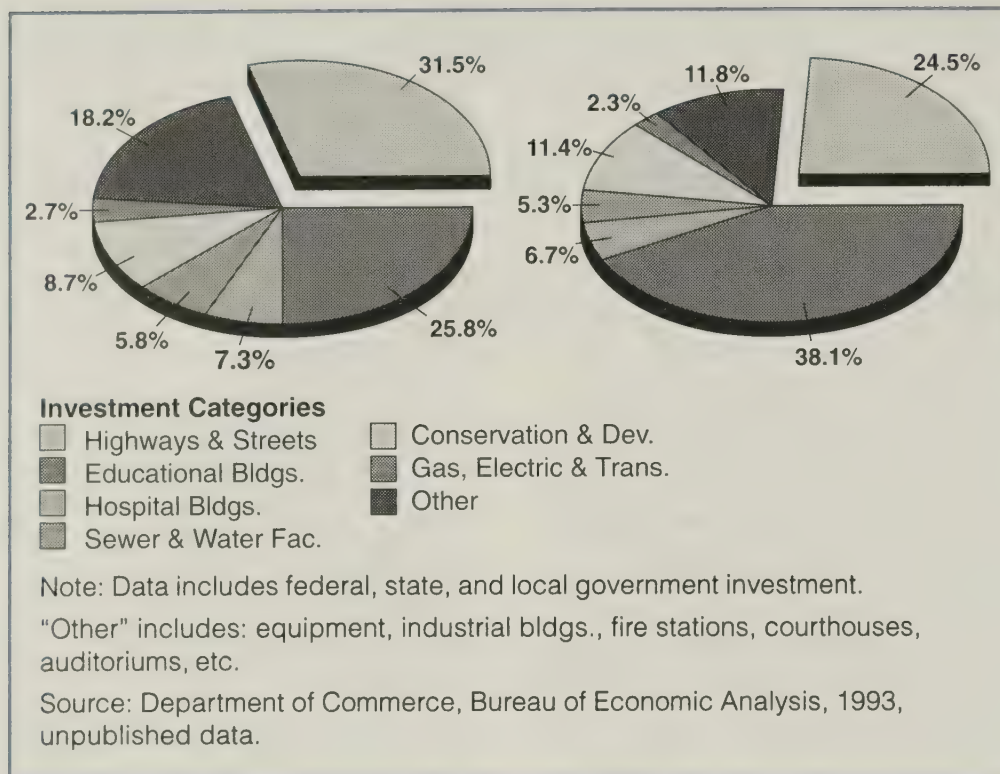

Figure 1—Public infrastructure investment (percentage breakdown by investment category).

3.4 percent in 1970 to 25 percent in 1992. Figure 1 shows the decrease in investment in highways as a portion of all infrastructure investment from 1970 to 1992. While analysts first addressed this question in terms of percentages—investigating how investment in infrastructure has changed over the years—this sort of investigation cannot prove a causal relationship. Indeed, such efforts are highly criticized because they neglect several other issues and offer no statistical proof of a linkage. To understand the causal relationships between infrastructure investment and productivity, one must perform a thorough regression analysis—a statistical process of estimating a causal relationship between an assumed known constant (e.g., highway capital stock) and a random variable (e.g., output growth).

Several objectives exist and infrastructure's effectiveness in promoting change in each of these areas varies tremendously. In practice, the U.S. transportation objective has focused on mobility and an intuitive sense of the benefits to connectivity rather than specific distributional or economic growth objectives.

Economist David Lewis differentiates areas of economic activity where "the influence of infrastructure investment is verifiable" into distributional and growth categories. Infrastructure investment may cause distributional effects on the structure of employment, personal income, regional output and income, and sectorial output and income. Likewise, infrastructure investment can yield growth in economic output, productivity, employment, and economic welfare. (2)

The Macroeconometric Approach

Studies often use national, state, or metropolitan area data in a production function to estimate the magnitude of the causal relationship between the inputs—labor,

$$\text{Output} = \text{function of (labor + private capital + public capital) + error term}$$

private capital, and public capital—and the output.

This perspective follows the structure and logic of early efforts by economists David Aschauer and Alicia Munnell. They found an enormous role for public capital

infrastructure, specifically highways, in output growth. A wide range of elasticities are found in the literature. These efforts address impacts of transportation investment or capital stock on economy-wide output growth. While studies to explore this magnitude have been commonplace in the history of economics, previously, public capital was not included as a production factor. (3,4,5)

Several journal articles have been published that explore the possibility of a causal relationship from public capital infrastructure or specific portions of public capital infrastructure—such as highways, water and sewer systems—or education to economic productivity. Other studies investigate the question of complementarity or substitutability between public and private capital.

Sensitivity testing of national-level macro studies

The FHWA study "Highways and Macroeconomic Productivity, Phase I" was completed in January 1992. This project critically evaluated the hypotheses and conclusions of frequently cited macroeconometric analyses concerning the relative magnitude of effects of public and private capital investment on economic growth. (6)

Michael Nienhaus at the Volpe National Transportation Systems Center pursued replication and sensitivity testing of Aschauer's and Munnell's production function results using national aggregate time series data. Aschauer and Munnell's results are frequently criticized because of the unbelievably large size of the coefficients. Many economists suggest that the results do not indicate causation between public capital and output growth; rather they suggest that

the results may arise from simple correlation or that output growth may be causing a rise in public capital investment. (3,4)

Although Nienhaus duplicated key results of the Aschauer and Munnell studies, slight changes to

the data and mixing of the data sets led to sensitive results. While Aschauer and Munnell's analyses served as ground-breaking introductions to an important issue, their results are not strong enough to justify the conclusions; other levels of analysis are needed.

State-level econometric analyses

As part of the macroeconomic approach in FHWA's research program, state-level production functions have also been investigated to address the question of a proper scale—national, statewide, regional, or industry—for analysis. Indeed, many researchers postulate that the magnitude of the linkage varies according to the scale of analysis. While a relationship is intuitive, the question remains: Is the relationship so strong that it surpasses the role of private capital? or Do the public good benefits, in combination with output effects, outweigh the effects of public capital? Research on state-level analysis has investigated whether a linkage exists between transportation infrastructure and productivity. The research has also tried to reconcile the various methodologies, choose an appropriate functional form for analysis, and deal with problems of measurement error.

In the FHWA study "Highways and Macroeconomic Productivity: Phase II," Therese McGuire investigated state-level relationships using pooled cross-section, time series data on gross state product as output and the following inputs: private capital stock for structures and equipment; public capital stock, including educational buildings and highway capital as separate categories; and labor, either nonagricultural or total labor. (7)

of the public capital components included. Estimates indicated that for a 1-percent increase in highway capital stock, gross state product—the output measure—will increase by 0.121 to 0.127 percent. Overall, McGuire concluded that public capital has a small but significant, positive impact on productivity.

Capital stock and investment data

Consistent with the macro dimension of the FHWA research

and waterways. These improvements to the data will help answer the question: Do results of the above studies differ due to differences in the data or insufficient historical data? (8)

The Industry Studies Approach

In 1990, the FHWA and AASHTO through NCHRP began a set of six industry case studies to identify firm-specific relationships between transportation—specifically highways—and productivity. Each

Estimates indicated that for a 1-percent increase in highway capital stock, gross state product—the output measure—will increase by 0.121 to 0.127 percent. Overall, McGuire concluded that public capital has a small but significant, positive impact on productivity.

agenda, an AASHTO project "Macroeconomic Analyses of the Linkages Between Transportation Investments and Economic Performance" addressed the problem of limited data. This project generated two industry-specific, state-level private capital stock, time-series data bases using the U.S. Bureau of Economic Analysis (BEA) national figures on employment and output as allocators. Two state-level highway stock data bases were generated using national-level FHWA and U.S. Bureau of the Census (Census) data for highway investment and distributed to the state level using a variety of allocators such as employment. These two highway capital data bases are in

effort used a different methodology; however, the main emphasis was on a logistics-style analysis. By collecting new data from firms in particular industries, these studies have tried to identify the mechanisms through which highway investment is converted into increased private sector productivity at the microeconomic or industry level. This dimension of the FHWA research agenda asks questions such as: How does the effect of public capital vary among firms and modes of transportation? What is the overall impact of transportation service on specific industries such as bulk agricultural products, heavy materials, or light-weight and high-value products? How can changing logistical needs and truck size and weight policies affect transportation's economic performance?

These two studies, FHWA's "Industries Studies of the Relationship Between Highway Transportation and Productivity" and AASHTO's "Measuring the Relationship Between Freight Transportation Services and Industry Productivity," have tried to measure "direct" costs such as those

Gross State Product = function of (state labor + state private capital + state public capital) + error term

Results indicated a positive and statistically significant role for public capital in determining output.

When McGuire tested highways separately from public capital, highways had the strongest effect

in addition to the national-level BEA data base used by other researchers. Additional state-level data used Census investment data for six types of infrastructure, including four transportation categories: highways, mass transit, airports,



Current studies are looking at the relationship between traffic congestion and productivity.

associated with travel time, vehicle maintenance, fuel use, and safety, as well as “indirect” benefits such as innovation in design and operation of production and distribution systems, which influence productivity. (9,10) For example, transportation improvements allow firms to design more productive processes based on lower-cost, reliable freight transportation. Improvements to the system also may increase the range of territory from which firms can gather inputs or seek markets. As final consumers, the public benefits through a wider array of goods and services which can be offered at lower costs.

By identifying industry benefits and costs which are not usually quantified—such as transit time reduction, reliability of arrival time, inventory reductions, decreased product damage rates, and decreased freight costs—we will better understand the linkages between highway infrastructure investment and economic performance.

Efforts to measure the indirect economic benefits of the highway

network to industry indicate, as expected, that cost and logistics savings would not be possible without a reliable highway system. Indeed, the FHWA study’s preliminary estimates indicate that in the first year, a 6.6 percent rate of return accrues to the manufacturing sector as a whole, due to highway investment. Results for the economy as a whole may be even higher, when other sectors of the economy are incorporated into the analysis. Results for specific sectors of the economy will be additive; therefore, the rate of return for the total economy may be considerably larger. These results are preliminary, and additional industrial studies will offer further detail on this issue.

The Highway Service and Performance Assessment Approach

Projects using FHWA’s highway system assessment approach focus more directly on the efficiency and productivity of the services provided through the use of highway facilities, rather than

either their asset value or investment expenditures for highways over time. This approach studies the highway system and its connectivity as seen in its unique network aspects, public utility aspects, pervasiveness, extensiveness, and maturity. This approach takes advantage of FHWA’s existing data bases describing highway capital expenditures, highway facilities, and highway system performance. Changing industrial transportation demand impacts and the effects on the highway system are also considered. A national approach captures spillover benefits of the network. This perspective addresses the following questions: How do impacts of transportation spending vary by the type of expenditure? What are the effects of networks and of connectivity? How do congestion, capacity, and highway performance measures affect highway system or economy-wide productivity?

The FHWA study “Performance-Based Measures of the Transportation Productivity Linkage” focuses

on the importance of highway density and network connectivity—both interstate and intrastate—to economic growth. Using data on highway performance and conditions, the study assessed measures for operating characteristics, physical conditions, and safety in relation to economic vitality. (11)

This study uses correlation analysis to assess whether a coincident relationship exists between random variables—performance and condition measures—and economic output. This is opposed to regression analysis, which estimates a causal relationship between an assumed known constant—highway capital stock—and a random variable—output growth. Early results of cross-section, time-series correlations for the 48 contiguous states in the United States over two time periods 1985-88 and 1980-88 complement the macroeconomic findings of production and

similar; however, causality cannot be implied from simple correlation analysis. We are not yet certain what network analysis measures to pursue or how to incorporate this element into the economic analysis. However, this study indicates that performance measures of the highway system may provide additional insight into the economic linkages between networks and productivity.

Future Research

FHWA's fiscal year 1994 research agenda "Interrelationships Between Highway Infrastructure and Productivity" plans several approaches.

The FHWA research from the macroeconomic perspective has moved away from production and cost function analyses towards other methodologies at the national level, such as input-output analysis. A new effort explores input-output models to

current efforts by the FHWA and the NCHRP. Other efforts will explore the availability of additional firm-level data.

To better understand the linkage of highways to economic performance, network and service characteristics of the highway system will be explored further. Specifically, spatial economics and location theory will be used to investigate the highway system network attributes. Other efforts will consider how these research products can be incorporated at both program and project levels. Cost-benefit analysis, one example of such a methodology, can contribute to project evaluation and selection, but applications at a national level remain inadequate.

Issues of Structural Change

Bruce McDowell and Bruce Bell identify several structural transformations underway throughout the world: changes in production processes and in the structure of the industrial sector, shifts in the location of various economic activities, and the increasing importance of the service sector in the economy. (12) Economist Randall Eberts also identifies increased international competition as a potential cause of restructuring in America. (13) These changes may alter our demands for infrastructure in the future. For example, will the development of advanced telecommunications capabilities serve as a complement or substitute to transportation infrastructure?

Other changes that will affect the U.S. future transportation outlook include a shift toward intermodalism, increased responsiveness to customer needs, more attention to performance measures, accountability, efficiency, and cost-effectiveness.

Conclusion

This article has presented a discussion of FHWA research from the "Interrelationships Between Transportation Infrastructure Investment and Productivity" priority initiative. The research program pursues three unique dimensions to address several questions about the linkage



Network and service characteristics must be explored further to better understand the linkage of highways to economic performance.

cost functions. They show positive correlations between highway infrastructure measures and the level and growth rate of gross state product (i.e., income) per labor force member.

The study identified several similar positive relationships and similar trends. The study indicated that pavement quality (PSR) has a positive relationship with income growth. The trends for urban interstate congestion and gross domestic product (GDP) are

explain the production and consumption impacts of technological improvements of highway transportation. Other projects have begun to extend in-house research and model-building efforts to assess the employment effects of highway spending.

The FHWA microeconomic industry analysis approach continues to examine and develop a variety of methodologies at the industrial level. Continued logistics-style analysis will expand the

between highways and the economy. While the projects within these approaches are unique, they offer several levels of analysis and divergent methodologies to achieve a full complement of answers to questions such as: How do highways promote employment, income, output, or economic growth? Are public and private capital substitutes or complements? Are industries affected differently by transportation infrastructure? How does the quality or performance of highway infrastructure effect economic vitality? How can we enhance highway system efficiency and productivity?

We will use the information from this research to enhance the productivity and efficiency of the highway system and to respond to structural changes in the economy.

Further study of the relationship between infrastructure investment and productivity growth is needed to develop strategic infrastructure investment policies that will provide policy guidance at the program level and to determine tradeoffs to maximize economic vitality.

In the past, the U.S. transportation objective focused mainly on mobility and connectivity. While early research on the linkage served as a ground-breaking introduction, it has taken time to learn the right questions to ask. We are just now beginning to get some results, especially in the industry studies, and we anticipate developments in the network analysis and the macro input-output modeling efforts.

The benefits from our highway system cross all levels of society and are exhibited in several ways. The industry studies indicate that evolving management forms and logistic cost-savings would not be possible without our expansive highway system. For example, a lower-cost, efficient, reliable highway network allows transportation consumers to redesign production processes and access more markets, thereby providing a wider array of goods and services at lower costs. Reductions in logistic costs will continue to offer consumers and producers extraordinary benefits. It is our hope that

this research agenda will provide an overall estimate of the level and process by which these economic benefits become a reality. By improving our understanding of this linkage process, we can begin to offer more direction on how to support continued economic benefits to the economy as a whole from the transportation network. Without this increase in economic productivity, we cannot expect our standard of living to rise or even be maintained.

References

(1) *Assessing the Relationship Between Transportation Infrastructure and Productivity*, Searching for Solutions: A Policy Discussion Series, Federal Highway Administration, Publication No. FHWA-PL-92-022 Washington, D.C., August 1992.

(2) David Lewis. "Objectives and Decision Criteria for Infrastructure Investment: A Summary of Research Findings of Project 2-17 of the National Cooperative Highway Research Program," American Association of State Highway and Transportation Officials, Washington, D.C., 1993.

(3) David A. Aschauer. "Is Public Expenditure Productive?" *Journal of Monetary Economics*, Volume 23, pp. 177-200, 1989.

(4) Alicia Munnell. "Why Has Productivity Growth Declined? Productivity and Public Investment," *New England Economic Review*, January/February 1990, pp. 3-22.

(5) Alicia Munnell. "How Does Public Infrastructure Affect Regional Economic Performance?" *Is There a Shortfall in Public Capital Investment?* Federal Reserve Bank, pp. 69-194, 1990.

(6) "Highways and Macroeconomic Productivity: Phase I," Federal Highway Administration, Washington, D.C., 1991. (Unpublished)

(7) "Highways and Macroeconomic Productivity: Phase II," Federal Highway Administration, Washington, D.C., 1992. (Unpublished)

(8) Michael Bell and Therese McGuire. "Macroeconomic Analyses of the Linkages Between Transportation Investments and

Economic Performance," National Cooperative Highway Research Program Project 2-17(3), American Association of State Highway Transportation Officials, Washington, D.C., 1994.

(9) "Industries Studies of the Relationship Between Highway Transportation and Productivity," Federal Highway Administration, Washington, D.C., 1993. (Unpublished)

(10) David Lewis and Daniel Brod. "Measuring the Relationship Between Freight Transportation Services and Industry Productivity," National Cooperative Highway Research Program Project 2-17(4), Federal Highway Administration and the American Association of State Highway Transportation Officials, Washington, D.C., 1993.

(11) "Performance-Based Measures of the Transportation-Productivity Linkage: Technical Memorandum on Phase I," Federal Highway Administration, Washington, D.C., 1993. (Unpublished)

(12) Bruce McDowell and Michael Bell. "The Value of Infrastructure to America," U.S. Army Corps of Engineers, Washington, D.C., 1991. (Unpublished)

(13) Randall W. Eberts. "An Assessment of the Linkage Between Public Infrastructure and Economic Development," Final Report, National Council on Public Works Improvement, Washington, D.C., 1986.

Theresa M. Smith is an economist in the Industry and Economic Analysis Branch of the Transportation Studies Division of FHWA. She is a member of Transportation Research Board's Transportation and Economic Development Committee, the American Economic Association, and the Western Economic Association. For more than three years, she has worked principally on analyzing the linkage between transportation infrastructure investment and economic productivity. She is currently the contract manager on "The Contribution of Transportation to Aggregate and Sectoral Efficiency." She holds a master's degree in economics from the University of North Carolina at Chapel Hill.

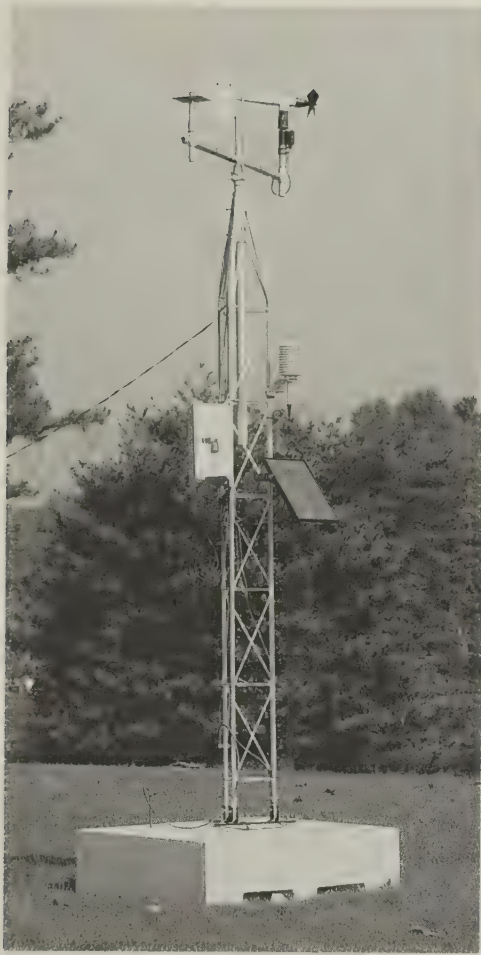

Automatic Weather Station Installed at Turner-Fairbank Highway Research Center

by Aramis Lopez

The automatic weather station provides useful data for pavement studies and design.

A state-of-the-art automatic weather station (AWS) was installed at the Federal Highway Administration's Turner-Fairbank Highway Research Center (TFHRC) in McLean, Va., on July 26, 1993.

The data collected by AWS include air temperature, precipitation, wind speed and direction, relative humidity, and incoming solar radiation. The data will be used with other pavement-related data to develop improved pavement design and performance prediction models.

The installation was a cooperative effort by TFHRC's Pavements Division and the Long-Term Pavement Performance Division (LTPP). The AWS is currently located at a temporary site and will later become part of the expanded Accelerated Loading Facility now under reconstruction at TFHRC. Presently, the AWS is being evaluated by the LTPP Division for possible use at the LTPP's Specific

Pavement Studies (SPS) project sites.

As part of the LTPP program, an extensive climatic data base is being developed for more than 2,000 test sections monitored under the program. For the most part, the data base is being developed using data from the National Climatic Data Center and Canadian weather stations. However, onsite AWSs are planned to collect site-specific weather data for the test sections that are newly constructed under the Structural Factors for Flexible Pavements (SPS-1), the Structural Factors for Rigid Pavements (SPS-2), and the Environmental Effects in the Absence of Heavy Loads (SPS-8) experiments.

AWS selected for the pilot evaluation at TFHRC is a tower-mounted system. The 3-meter- (10-foot-) high tilt-tower holds the temperature, relative humidity, and wind instruments, plus the data-logging, power supply, and

data storage modules. A separate pole assembly is used for mounting the rain gauge. Once the concrete pedestals have been constructed, AWS can be installed and fenced at a site within four hours, using only light tools.

AWS is powered by a 12-volt power pack trickle-charged by a solar panel. In the northern, freeze areas, an external power source for heating the rain gauge is required.

The weather data will be sampled every three seconds and recorded at intervals of 60 minutes. Data will be stored in solid-state data modules that will be retrieved every two or three months from the project site. The accumulated data can be downloaded to a laptop PC computer using an RS232 interface cable or a DC112 telephone modem. The modem enables communication between a computer with a modem and the data processor over a public telephone network.

A cellular telephone package is also available, and a customized version of the data acquisition software has been developed for pavement applications.

AWS is undergoing pilot testing at TFHRC for several months. The maintenance needs are being evaluated and ruggedness testing is being performed. Based on the final evaluation results, AWS will be installed at future SPS-1, SPS-2, and SPS-8 project sites. In addition, AWS, as configured and with the customized software, will be available for installation at any future pavement test section location.

Aramis Lopez is a team leader in the Long-Term Pavement Performance Division at the Turner-Fairbank Highway Research Center. He has worked for FHWA for 16 years. Previously, he was an engineer with the Puerto Rico Department of Transportation. He has a bachelor's degree in civil engineering from the University of Puerto Rico at Mayaguez.

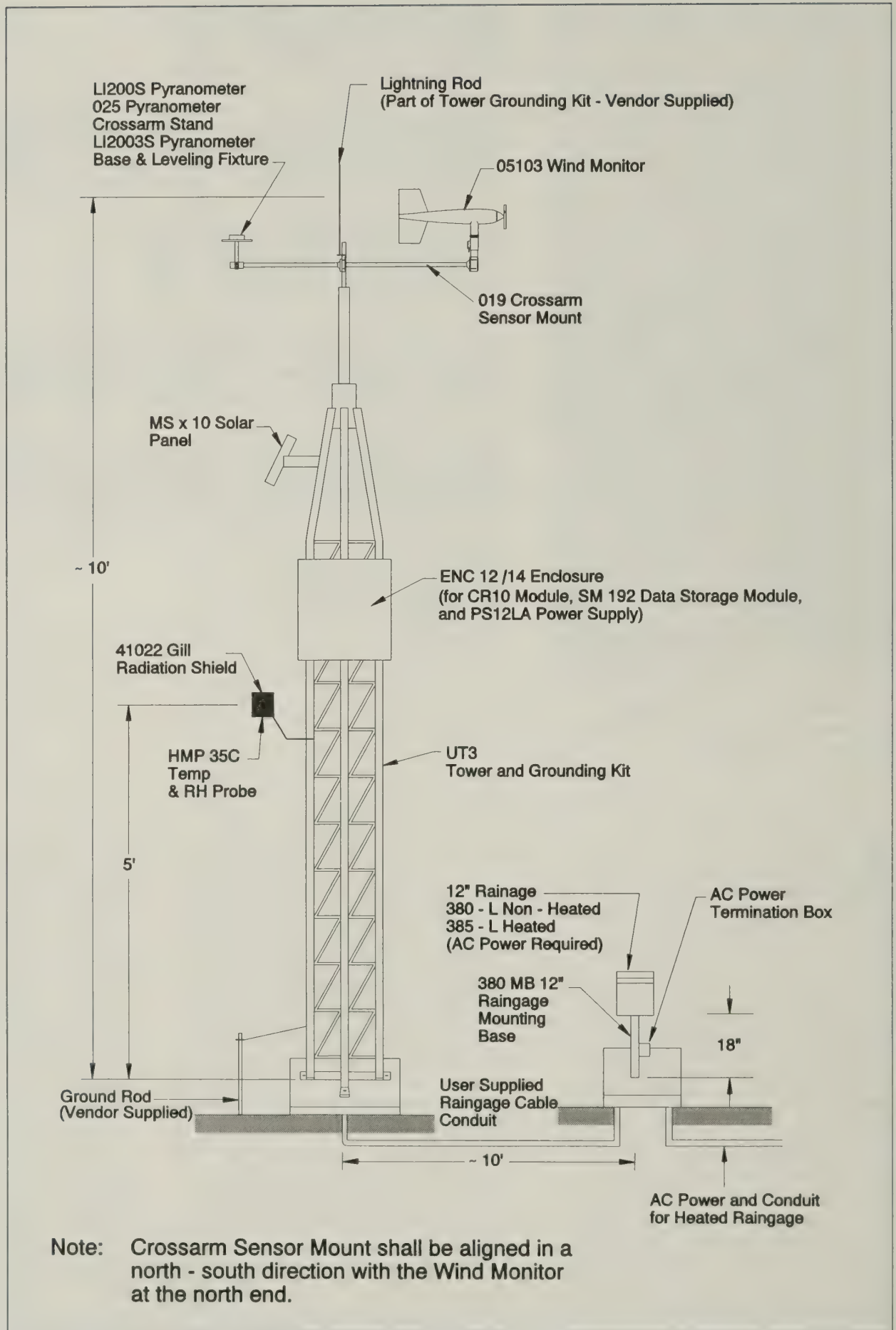

Figure 1—Schematic of the completed weather station.

An Automatic

Warning System

to Prevent

Truck Rollover

on Curved Ramps



by Hugh W. McGee and
Rodney R. Strickland

Example of a static warning sign and an activated warning sign used together.

Introduction

Truck accidents on urban freeways occur more frequently at interchanges—particularly on curved exit ramps—than at any other location. In fact, trucks overturning on exit ramps at interstate interchanges account for five out of every 100 fatal truck accidents. (1) Truck rollover accidents can be very costly, especially in urban areas, because these accidents usually result in fatalities and injuries, vehicle and roadway damage, and traffic delays. Losses are even greater when trucks carrying combustible or hazardous cargo are involved.

One way to prevent—or at least reduce—truck rollover accidents on curved exit ramps would be to install an automatic warning system on these ramps to help truck drivers take preventive action. The system warns drivers when the truck, based on its load conditions and speed, would roll over if its speed were not reduced.

“Feasibility of an Automatic Truck Warning System,” a Federal Highway Administration (FHWA) study, looked at the details of creating and implementing such an automated warning system. The study team developed system requirements, prepared design plans and specifications, identified available system hardware and software, and installed a prototype truck warning system at selected ramps on the Capital Beltway in Maryland and Virginia. The team then assessed the costs and benefits of the system. These research activities and assessments are summarized in this article.

The Rollover Process

As a truck travels through a curved ramp, its speed and the ramp's curvature and super-elevation cause a level of lateral acceleration on the truck. For each truck and loading condition, there is a maximum value of lateral acceleration beyond which it will

roll over. This level of acceleration is called the rollover threshold (RT). The University of Michigan's Transportation Research Institute (UMTRI) has developed rollover threshold values for various trucks and loading conditions using static and dynamic tests. (2, 3) These values are shown in table 1. UMTRI also has defined the maximum lateral acceleration a truck with a given rollover threshold can sustain:





$$^2y_{\max} = \frac{RT - SM}{1.15}$$

where SM is a safety margin value and 1.15 is a factor accounting for additional lateral acceleration due to steering fluctuations during the turn. (3)

Truck Rollover Occurrence on Capital Beltway Ramps

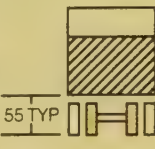
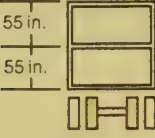
The present study involved 41 interchanges on the Capital Beltway in Virginia and Maryland. Ramp locations at which truck rollovers occurred were identified from accident data, including police reports, provided by the

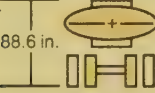
Table 1—Rollover Thresholds for Example Vehicles and Loading Conditions

Case	Configuration	Weight (lbs) GVW	Payload CG Height (in)	Pullover Threshold (g's)
A. "BASELINE"	 Full Gross, Medium-Density Freight (34 lb/ft ³)	80,000	83.5	0.34
B.	 "Typical" LTL Freight Load	73,000	95.0	0.28
C. "HIGH-CG"	 Full Gross, Full Cube, Homogeneous Freight (18.7 lb/ft ³)	80,000	105.0	0.24
D.	 Full Gross Gasoline Tanker	80,000	88.6	0.32
E.	 Cryogenic Tanker (He ₂ and H ₂)	80,000	100.0	0.26
		1 lb = 0.454 kg 1 in = 0.0254 m 1 lb/ft ³ = 16.01 kg/m ³		

Virginia and Maryland Departments of Transportation. Truck rollover accidents are a relatively rare event here: Only five of the 14 Virginia ramps had two rollovers for a four-year period, and only one ramp of 27 in Maryland had more than one rollover in a five-year period. This interchange in Maryland experienced a total of 15 rollovers with six on one specific ramp. The interchange was recently redone; consequently, the high rollover ramp is no longer a truck rollover problem site.

Alternative Concepts of a Truck Warning System

Ideally, an automatic truck warning system would detect a truck's weight and center of gravity sufficiently in advance of a curved ramp, "know" the curvature and superelevation of the ramp, and

warn the truck driver to reduce speed to a level below the vehicle's rollover threshold speed. Given this general functional requirement, the study team postulated at least two detection/warning system concepts.

The first concept is an *inroad detection-warning system* that depends on an "intelligent highway." In this system, a detector or detectors placed in or along the road identifies the truck and its relevant parameters—speed, weight—and a warning device—an activated sign and/or flashing beacon—is positioned in advance of the curved ramp. A controller receives the signal from the detector(s), processes the information according to an algorithm that determines if the truck's speed may cause a rollover, and transmits a signal to activate the warning device if the truck's

speed is equal to or greater than the rollover threshold speed.

The second concept is an *invehicle detection/warning system* that depends on an "intelligent vehicle." At the start of each trip, the driver enters into an onboard computer information on the vehicle configuration—number of trailers, trailer type—cargo type and weight, and load distribution. The truck's speed is continuously monitored from a sensor on the tractor's drive axle, and the sensor's data is processed through the onboard computer. At each curved ramp or ramp with a history of rollover accidents or with a degree of curvature and superelevation that have been found to be associated with truck rollover, a transponder transmits the ramp geometrics data—ramp radius and superelevation—to the truck. This radio signal is processed in the onboard computer. If a rollover is possible, an alarm signal or recorded message warns the driver to reduce speed.

Several factors make this latter concept highly appealing. The system determines the possibility of rollover from precise, accurate information about the truck's configuration, cargo type, weight, and speed. It provides information to the truck driver through invehicle displays as opposed to via an external device that might go undetected. Also, the ease and low cost of transponder installation allows agencies to install the system at most ramps.

However, this system is not currently available. Therefore, the study team focused on the inroad detection/warning system.

Inroad Detection/Warning System Design Requirements

An inroad detection/warning system would include detector hardware, a controller for processing the electronic data, and a warning system. The requirements identified by the study team for each of these components are discussed below.

Detection system

For an inroad detection/warning system to operate effectively, it should capture certain vehicle



The sensor can detect trucks above or below a threshold height.

parameters as a minimum—vehicle type, such as truck or nontruck; speed and deceleration profile; and weight. Ideally, it should also be able to detect the truck's center of gravity; however, this is not possible for an inroad detection system. These parameters can be determined using various roadway detection systems.

- Vehicle type identification.

Trucks can be identified and classified using either an inductive loop, a piezoelectric sensor, or a combination of the two systems coupled with a controller to process the electrical charges. When trucks pass over these sensors embedded in the pavement, they establish a vehicle charge or voltage profile which is then matched with existing FHWA data base profiles to classify vehicle type correctly.

Because tanker trucks have a lower rollover threshold than box trailer trucks of the same



Truck speed can be determined using a pair of embedded inductive loop detectors or piezo sensors.

weight (see table 1), the system must be able to distinguish between these. Since tanker trucks are typically lower than box trailer trucks, a vehicle height sensor can be used for making this distinction. Commercially available height detectors use a microwave-based radar beam as an "electric eye"

to detect a vehicle within the beam angle. By adjusting the height of the detector above the pavement and properly angling the beam, this device can be used to detect trucks above or below a threshold height. Tanker trucks are typically 3.4 meters (11 feet) or lower; this height should be established as

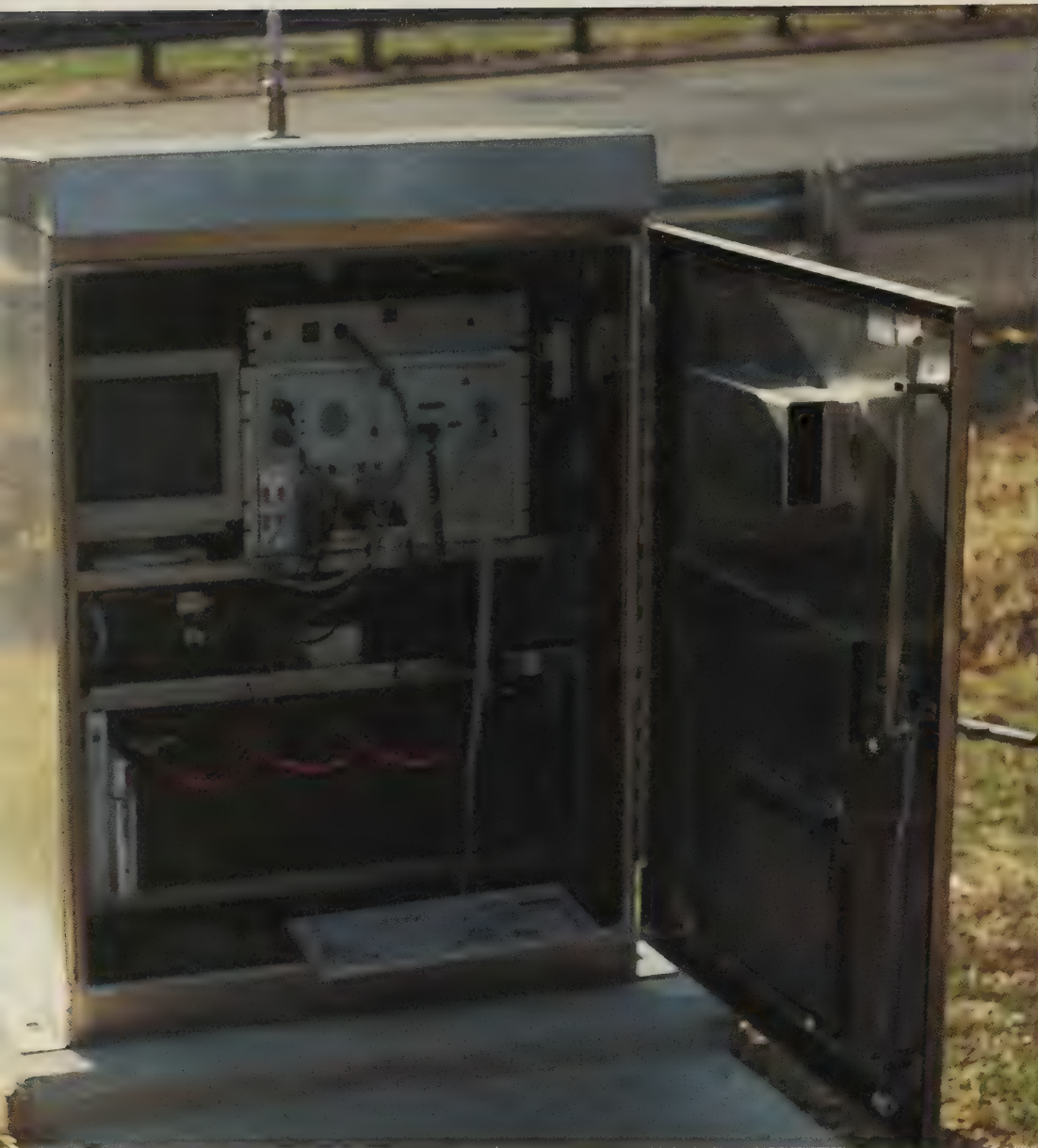

The electronic controller processes the inputs from the sensors and sends the signal to activate the warning device.

the threshold value for distinguishing between a box trailer and tanker truck.

- **Truck speed detection.**

The speed at which a truck is traveling at a specific point on a ramp is the most important variable in determining its rollover potential. Therefore, accurate and reliable truck speed detection must be a prime feature of the system. If the truck speed is detected too early, the assumptions regarding the truck's speed profile, based on truck deceleration rates, may not be accurate. On the other hand, if speed is detected too close to the curve, activation of a warning sign may not serve as

a sufficient warning. Therefore, sensors for detecting truck speed must be placed carefully and appropriately.

The speed of a vehicle can be determined using a pair of either embedded inductive loop detectors or piezo sensors. A controller is needed to process the electrical charges and determine the speed. Thus, the same detector hardware used for truck classification can, when properly arranged, also be used to determine the truck's speed.

Another desirable system feature would be its ability to determine the truck deceleration profile. Although a truck may

be traveling faster than the calculated rollover threshold speed at a point upstream of the curved section, it may be decelerating at a certain rate that would bring it below the critical speed by the time it reaches the point of curvature. A speed deceleration profile can be determined by installing two-point speed detection systems.

- **Vehicle weight measurement.**

The weight of a truck—a useful indirect variable in determining the truck's rollover threshold—can be obtained by using commercially available weigh-in-motion (WIM) systems. These weight systems use a combination of inductive loop and piezo sensors to provide electrical charges to a controller that is programmed to calculate vehicle weight. Some WIM systems can measure truck weight at an accuracy of 2 percent of the true weight for trucks traveling up to 103 kilometers/hour (70 miles/hour).

Controller

An electronic controller is needed to accept the electrical inputs from the detection, process the charges according to a prescribed logic for identifying a truck that is exceeding the rollover threshold, and send a signal to activate the warning device. The controller should be housed in a cabinet; its electricity should be drawn from the nearest existing source. The system should have a built-in capability to test each of the components and the system as a whole. Maintenance personnel could access this feature through switches provided in the controller.

Warning device

The following two alternative devices are suggested to warn the driver:

- **Option 1—static warning sign with yellow beacons.** This sign would consist of a standard static truck rollover warning sign, flashing yellow beacons that would be activated by the controller if the system detects a potential rollover, and

a supplemental message explaining the flashing beacon.

- Option 2—static warning sign with supplemental message. This sign would consist of a static truck rollover warning sign as in option 1 but without the flashing beacons. Instead, the sign would have a supplemental fiber-optic sign carrying the message “TRUCKS REDUCE SPEED.” This message would appear only if a truck is at or exceeding the rollover threshold speed.

A major drawback of the first option is its potential for tort liability. The device only warns a driver when it detects a potential rollover. Consequently, if the system fails to detect a potential rollover and that vehicle does roll over, the agency could be held liable for not providing the expected warning. Under the second option, however, the driver is not expecting the sign to activate unless the driver regularly drives the route and has “tested” the system. Thus, if the system fails to detect a potential rollover and does not activate the sign, the driver still receives the standard warning from the static sign.

System Design and Operation

Upon selecting and determining the components of the inroad detection/warning system, the study team next selected sites for system design and development. In consultation with Virginia and Maryland transportation representatives, three ramp sites were selected for preparation,



A speeding truck activates the warning sign.



A slower truck does not activate the sign.

installation, and evaluation. Two of the sites were dual-lane exits so the system was designed for both lanes.

In the system, detection stations 1 and 2, which are loop-piezo-piezo configurations, provide weight, vehicle classification, and vehicle speed data to the programmable controller. If the vehicle is classified as a truck, the two weights are compared and the heavier weight used. Also, at station 2, a height detector determines if the truck is less than 3.4 m (11 ft); if so, it is classified as a tanker truck. A rollover threshold value is assigned

to the truck based on its weight and tanker/nontanker classification, using the data programmed into the controller.

Data from all stations are recorded and retained in the controller for a specified period. The data can be downloaded to a microcomputer at the controller site or transferred to a microcomputer in a central office over a communication link.

System Costs and Benefits

Based on plans, specifications, and cost estimates prepared for three

installations on the Capital Beltway, the study team found that system costs at a single-lane ramp would be nearly \$100,000 and for a dual ramp about \$160,000. These costs include engineering design, materials, installation, and annual maintenance and operations costs. The final estimated system cost did not include controller modification cost by the manufacturer, since this was a one-time cost for the three sites. It is assumed that if the system is installed at a significant number of locations, the modification costs would be amortized.

The benefits from this automatic warning system are a reduction in truck rollover accidents and in the associated costs. These costs are the dollar values assigned to the fatalities, injuries, vehicle property damage and cargo loss, possible damage to the highway facility and appurtenances, motorist delays, and traffic control and clean-up caused by the accident.

Truck accidents are costly, especially if hazardous cargo is involved. The study of truck accidents on urban freeways determined that the average total cost of a truck accident is \$13,274. (4) An analysis of truck accidents on the Capital Beltway established a cost per accident. (5) These costs were \$1,200,000 per fatality, \$13,650 per injury, and \$2,425 for property damage. Using these costs and applying the observed distribution of accidents and accident severity on the Beltway for 1986-87, a value of \$15,470 per truck accident was developed. This value did not include delay or clean-up costs. It is likely that both of these

estimated accident values—\$13,274 and \$15,470—are less than the actual average costs of a truck rollover accident. A more likely average estimate is \$20,000, with a significant probability that such an accident will result in a fatality.

Conclusion: Cost-Effectiveness Analysis

One way to assess the cost-effectiveness of an automatic truck warning system is to establish how many accidents would have to be eliminated by the system to make it pay for itself. Table 2 provides the results of this analysis. Increments of total accident costs ranging from the estimated average costs of \$20,000 to \$1,000,000 are listed with the number of accidents that would have to be eliminated by a one- or two-lane system.

Obviously, the cost-effectiveness of this system is very much dependent on whether it prevents a high-cost rollover accident—an event that is relatively rare. There were 12 rollover accidents at seven ramps in Virginia over a four-year period. Linear extrapolation of this frequency rate reveals that there could be an average of 4.25 accidents per ramp for those seven ramps in a 10-year period. It thus appears from this simplistic, but reasonable, analysis that an effective automatic truck warning system could be cost-effective if applied at ramps with a history of truck rollover accidents of at least once every five years.

References

(1) *The Effect of Truck Size and Weight on Accident Experience*

and *Traffic Operations*, Publication No. FHWA-RD-80-137, Federal Highway Administration, Washington, D.C., July 1981.

(2) *Impact of Specific Geometric Features on Truck Operations and Safety at Interchanges*, Publication No. FHWA-RD-86-057, Federal Highway Administration, Washington, D.C., August 1986.

(3) P.L. Olson, P.S. Fancher, Z. Bareket, D.S. Gattle, T. Aoki, T. Sato, E.C. Traube, and L.S. Pettis. *An Evaluation of Freeway Ramp Speed Advisory Signs for Trucks*. Report No. UMTR1-91-40, University of Michigan Transportation Research Institute, October 1991.

(4) B.L. Bowman and H.S. Lum. "Examination of Truck Accidents on Urban Freeways," *ITE Journal*, October 1990, pp. 21-26.

(5) *Washington Bypass Study: Technical Memorandum No. 3, Traffic*, Bellomo-McGee Inc., Vienna, Va., April 1990.

For more detailed information about the FHWA study "Feasibility of an Automatic Truck Warning System," contact:

Howard H. Bissell
Information and Behavioral
Systems Division
Office of Safety and Traffic
Operations R&D
Federal Highway Administration
6300 Georgetown Pike
McLean, VA 22101-2296
Phone: (703) 285-2428
Fax: (703) 285-2379

Hugh W. McGee, P.E., is a principal of Bellomo-McGee, Inc. (BMI), a transportation and traffic engineering firm located in Vienna, Va. Dr. McGee has been involved in highway and traffic engineering research for 23 years and has conducted numerous projects for the Federal Highway Administration. Dr. McGee holds a bachelor's degree, master's degree, and doctorate in civil engineering from Pennsylvania State University.

Rodney R. Strickland is an electrical engineering technician at BMI. In this capacity, he provides technical support in the area of signal, lighting, and communications design. Mr. Strickland has a bachelor's degree in engineering technology from Purdue University.

Table 2—Required Rollover Accident Reduction for System Cost-Effectiveness

All Accident Costs (\$)	No. of Rollover Accidents	
	1-Lane System @ \$109,000*	2-Lane System @ \$172,000*
20,000	5.45	8.60
50,000	2.18	3.44
100,000	1.09	1.72
500,000	0.22	0.34
1,000,000	0.11	0.17

*Installation costs plus \$1,000 per year for 10 years for maintenance

FHWA Assistance to Russia

by Bert Schacknies



One of the most well-known sites in Moscow is Red Square with St. Basil's Church (left) and the Kremlin.

Background

The United States government has been standing behind the reformist platform of the Russian government since August 1991. The U.S. Congress has provided the legislative authorization for the Department of State (DOS) and other government agencies to assist in the reform process in Russia. The "Freedom for Russia Act," which authorizes DOS to provide assistance to the Commonwealth of Independent States (CIS), also includes a provision to provide support for the CIS transport sector. However, independent of the DOS foreign assistance authority, the Department of Transportation (DOT) has authority to provide technical assistance throughout the developing world under provision 6003 of the Intermodal Surface Transportation Efficiency Act (ISTEA) of 1991. DOT is cooperating with DOS and the Trade and Development

Agency to help Russia evolve toward a free-market economy and to promote the resulting opportunities for the export of goods and services by the U.S. private sector.

Russia's transportation system—specifically its highways—were built without using competitive procurement procedures, modern construction techniques, or rigorous quality control measures. They were also constructed with little consideration of changing consumer demands, market-based energy costs, or efficiency. Up to 70 percent of all freight is moved by rail, including much of the short-haul freight typically carried by truck in Western Europe and the United States.

With the development of a private sector and the privatization of local trucking enterprises, freight is shifting from the slow-moving and increasingly expensive rail carriers to the highways.

Also, the number of privately owned vehicles on the roadways is increasing. Russia's road system, already crumbling in many areas, will be pushed to the breaking point under this increase in vehicular traffic, if massive rehabilitation and repair work do not begin soon.

The Federal Highway Administration's (FHWA) expertise and experience is expected to be most useful to the Russians. Over the past 60 years, FHWA, through its Office of International Programs, has contributed to the road programs of more than 70 countries. Not only does FHWA share practical information about building roads; it also serves as a model of a federalist agency as Russia decentralizes its Soviet-era bureaucracy.

FHWA Cooperation with the World Bank

FHWA is currently providing technical assistance in support of

This building houses the Russian Federal Highway Department's Project Implementation Unit, which will supervise the Russian effort in the \$340-million program of the World Bank to rehabilitate and maintain Russian roads.



This church in the Trinity-St. Sergius Monastery in Zagorsk is about 160 kilometers (100 miles) from Moscow.



ConExpo '93 in Las Vegas was one of the stops on the spring 1993 observational study tour for Russian highway officials.

the Russian Federal Highway Department's (FHD) institutional reform measures. Through an unprecedented, cooperative effort with the World Bank, staff from FHWA's Offices of Policy, International Programs, and Program Development traveled to Russia with various World Bank missions to assist in preparing the scope of a project loan for road rehabilitation and maintenance in Russia. FHWA contributed to the Project Appraisal Report and also prepared a separate report that assessed the structure and process of decision making at the federal, provincial, and municipal levels of the Russian road transportation sector.

FHWA is co-financing the technical assistance component of the \$340-million project and has committed \$5 million worth of staff resources over a four-year period to its Russian counterpart, FHD. Several FHWA experts, including a highway engineer and a financial manager, will be working in Moscow to advise the FHD Project Implementation Unit (PIU).

Although several foreign governments offered to advise the PIU, FHD preferred FHWA largely because of the American experience in sustaining a decentralized—federal, state, municipal—transportation system with stable funding sources.

Technical Assistance and Institutional Reform Through “Twinning”

FHWA plans to establish “twinning” relationships at the federal, state, and local levels of government and to encourage U.S. highway-related industry and professional associations to develop twinning arrangements with Russian counterparts. Twinning focuses on organizational and manpower development efforts. The twinning plans include the following proposed pairs:

- FHWA with FHD.
- U.S. state highway agencies with the highway agencies of Russian autonomous republics and oblasts (a Russian territorial division, roughly comparable to a state in the United States).
- U.S. industry organizations—such as the American Road and Transportation Builders Association (ARTBA), American Consulting Engineers Council (ACEC), Construction Industry Manufacturers Association (CIMA), National Asphalt Pavement Association (NAPA), and others—with yet-to-be-established Russian counterparts.
- U.S. professional associations—such as the American Association of State Highway and Transportation Officials (AASHTO), the Transportation Research Board (TRB), and the American Society of Civil Engineers (ASCE)—with Russian counterparts, which are in various stages of formation. A



During his trip to the United States in November 1993, Russian Minister of Transportation Vitali Efimov (right) met with Congressman Norman Mineta (left), chairman of the House Public Works and Transportation Committee.



FHWA Administrator Rodney E. Slater (left) and his Russian hosts visit a paving project in St. Petersburg.

Russian version of AASHTO was established in June 1993 by 24 oblasts and other regions. The director of the Moscow Regional Highway Department became the principal founder after visiting AASHTO in Washington during an FHWA-sponsored observational study tour through the United States in the spring of 1993.

Observational Study Tours

Meetings of Russians and Americans in relevant work areas ranging from engineering to law making have facilitated better communication, understanding, and cooperation by both sides.

During a three-week observational study tour for eight senior Russian highway officials from March 20 through April 8, 1993, the Russian officials spoke informally with their U.S. counterparts and gained a more concrete understanding of the interaction

between the private and public sectors in the United States and among the public sector entities at the federal, state, and local levels. The FHWA-sponsored tour included visits to a number of professional organizations. Additionally, the Russians conferred with representatives of private companies, industry associations, and governmental agencies in New York, Las Vegas, San Diego, Los Angeles, San Francisco, Minneapolis/St. Paul, Baltimore, Atlanta, and Washington, D.C.

The Russian officials were pleased by the strong interest expressed by U.S. business representatives in exploring investment opportunities in Russia. They were convinced, after attending a state-of-the-art technology exhibit at ConExpo in Las Vegas, that the United States has a significant competitive advantage over European equipment manufacturers. Also, they concluded that the U.S. experience in federal, state, and local government relations would be an appropriate model for their country.

The positive results of the tour were important for American businessmen and contractors, as the United States is only one of many countries interested in establishing strong commercial ties in Russia by exerting an early influence on the reform process



John Cutrell (in purple coat), director of FHWA's Office of International Programs, observes some road work in St. Petersburg.



This is a section of the main highway between Moscow and Minsk.

within the transportation sector.

Subsequent FHWA-sponsored tours will continue a broad approach to familiarize the first-time visitors with America's federal structures. However, for repeat visitors from Russia, the focus will narrow and emphasize indepth coverage of specific aspects of transportation-related structures and the decision-making process to support the Russians' institutional reform agenda. Largely as a result of the first FHWA-sponsored study tour and the formation of RADOR, the Russian version of AASHTO, the Russian highway group has contracted with a commercial tour organizer to bring more than 60 officials per year to the United States.

Personnel Exchanges and Training

In November 1993, seven employees from the FHWA Federal Lands Highway Program traveled to Moscow to appraise the FHD's road design capabilities and verify the availability of data for the preparation of contract documents for two of the World Bank's Highway Rehabilitation and Maintenance Projects. These projects were subsequently designed in the Federal Lands Eastern Division in Sterling, Va., with four Russian engineers, who came to the United States for six weeks in January and February 1994. Because the Russians are not yet experienced in competitive bidding procedures, the projects

are considered a "training exercise" leading to the preparation of tender packages for local and international competitive bidding. Most of the subsequent design work will be undertaken by foreign and Russian engineering firms to be retained by the FHD/PIU under the World Bank's international competitive procurement procedures.

Congressional Visit to Russia

When the Russian participants in the observational study tour met in the spring of 1992 with Congressman Norman Mineta (D-Calif.), chairman of the House Public Works and Transportation Committee, Mineta's then Russian counterpart, Gennady Alekseev, invited Mineta to visit Russia. Mineta accepted and asked FHWA to prepare and participate in a congressional oversight visit.

Congressman Mineta, seven of his committee members, FHWA Administrator Rodney E. Slater, and Office of International Programs Director John D. Cutrell

were in Russia from Aug. 22 through Sept. 1, 1993, and met with high-ranking officials. The congressional delegation held meetings with U.S. Ambassador Thomas Pickering; the ministers of foreign affairs, economy and international affairs, and transport; representatives of the regional and municipal governments in Moscow and St. Petersburg; and their legislative counterparts in the Russian Parliament. The visit also included contacts with U.S. corporations—such as 3M, Caterpillar, and Paccar/Kenworth Trucks—that have significant interests and investments in Russia.

The ambassador and American businessmen presented first-hand reports about conditions in Russia. The ambassador explained the status of the Russian government's privatization efforts and the role of the U.S. Agency for International Development (AID). He also said that, despite the Russian government's ability to obtain international credits, the majority of the capital for road rehabilitation and maintenance must still come from private investors. The businessmen reported that it is still somewhat difficult to do business in Russia and amplified the need for institutional reform.

High-ranking officials in the Russian government expressed a strong willingness to model their government on the American experience. Congressman Mineta discussed the importance of transportation in a free-market economy and the significance of Russian-American private sector cooperation.

Initiatives to Develop the Private Sector

FHWA's direct interaction with Russian colleagues will help guide their policy formulation and standard-setting processes. This will ultimately open the Russian market to U.S. products and services. It will also help strengthen the Russian desire to import American—rather than European or Asian—technology. The equipment-procurement requirements of the capital investment projects of multilateral finance institutions and private banks are only now being formulated, and FHWA's involvement will ensure that U.S. companies receive timely notification of opportunities.

The principal sources of U.S. funding for multimodal transportation feasibility studies in Russia are AID and the U.S. Trade and

Development Agency. Several U.S. transportation companies are active in Russia, including CSX Sealand, involved in railroad and port access improvements; Cummins Engine, working with a diesel engine plant at Kamaz; and Kenworth Trucks and Caterpillar, which are part of a U.S.-Russian joint venture to manufacture a new truck for Russia. The World Bank is also concerned with urban transportation and the upgrading of the bus fleets. These projects are only a few of many projects covering all modes of transportation.

Summary

As the world's economies become increasingly interconnected, transportation networks will be even more important for continuing growth. The availability of adequate surface transportation infrastructure and services will be an essential precondition for any other capital investment in production facilities, for the efficient distribution of goods and services in the Russian market, and for the mobility of the Russian people. On the American side, early involvement in the Russian reform process will not only shore up the foundations of an emerging democracy but will also contribute positively to the export of U.S. transportation-related products and services. In the end, by helping to build roads for a new free-market economy, we all stand to benefit.

Bert Schacknies, Ph.D., is an international programs officer at the FHWA's Office of International Programs. He has been to Russia on various fact-finding and project-appraisal missions. Prior to joining DOT in 1991, he served for six years with the U.S. Agency for International Development in the Middle East. He has also worked for six years as a transport economist with the Federal Railroad Administration and for nine years as an urban and regional planner in Baltimore, Md. He has a doctorate in international development from the University of Pittsburgh and a master's in city planning from the University of Cincinnati.



The number of private vehicles in Moscow is increasing.

Using Finite Element Analysis in Designing Roadside Hardware

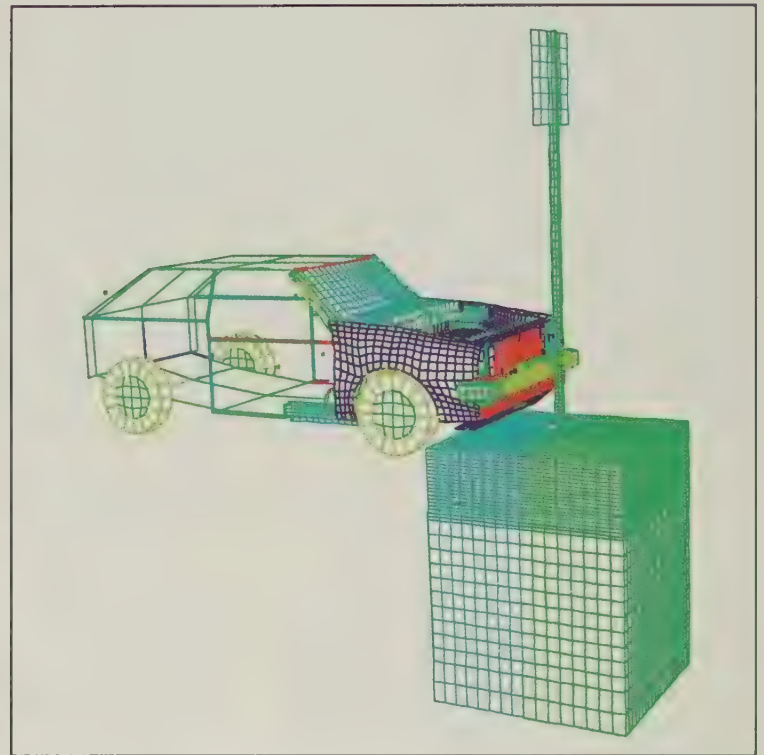

Figure 1—Photograph and corresponding finite element model of the pre-collision with a sign post.

by Malcolm Ray

Over the past several decades, the finite element method has become a popular technique in civil engineering for predicting the response of structures and materials; however, until recently it was rarely used in the design of roadside hardware such as guardrails, bridge rails, and sign supports.

In the finite element method, complex structures are divided into a large number of small elements whose stress-strain relationships are more easily approximated. Software programs then enforce the conditions of dynamic equilibrium and the boundary conditions on each of the thousands of elements. This allows the analyst to determine

the displacements and stress associated with each element.

Roadside hardware is subjected to large impacting forces, applied very rapidly, which often results in the failure of the hardware. Such structures undergo large deformations, and nonlinear changes in material and geometric properties make it difficult to predict barrier response. Until the early 1980s, nonlinear finite element analysis techniques that would address these impact problems were not available for non-defense applications.

Beginning in the late 1970s, the Lawrence Livermore National Laboratory (LLNL) developed DYNA3D, an explicit, nonlinear finite element program, to solve explosion, blast, and high-velocity

impact problems. (1) The analytical tools for solving impact problems evolved throughout the 1980s, but they required highly specialized analysts and super-computer processing power. Even with the most advanced super computers of the day, many relatively simple analyses would take days or even weeks to perform. Such computing resources were not available to roadside safety researchers. However, rapid improvement in the performance and cost of scientific workstations in the past several years and the civilian conversion of defense technologies have made nonlinear finite element analysis a feasible tool for evaluating and designing roadside hardware.

The Federal Highway Administration (FHWA) is the leader in using nonlinear finite element technology on motor vehicle collision problems. Researchers from FHWA, the National Highway Traffic Safety Administration (NHTSA), and LLNL are working together to develop common tools and techniques for crashworthiness research using analytical techniques such as nonlinear finite elements. These collaborators are

sharing detailed finite element models of vehicles, anthropometric dummies, and roadside barriers to not only solve problems but to improve the capabilities of these analytical tools.

At FHWA, nonlinear finite element simulations are being integrated into the roadside hardware design-test-evaluate cycle. Figure 1 shows a photograph taken from a recent crash test at FHWA's Federal Outdoor

Impact Laboratory and a similar finite element model of the same physical conditions. An 820-kilogram vehicle struck a 55-kilogram/meter flange-channel sign post at 9 meters/second. The 13,000-element vehicle model allows the analyst and designer to examine the collision sequence in much greater detail than is possible

with a full-scale crash test as illustrated in figure 2. The state of stress of any vehicle or barrier component can be examined in detail to determine the actual failure mechanisms involved in the collision.

Vehicle and post deformations, shown in figures 3 and 4, can be compared to the tested articles to gain confidence in the fidelity of the simulation model. A full-scale crash test would only show that the post tore along its center, whereas the finite element simulation can be used to show the initiation of the tear, how the crack propagates, and the stress and strain levels when failure occurs. The tear shown in the simulation plot in figure 4 can clearly be seen in the accompanying photograph. The simulation plot shows the levels of plastic strain experienced by the post as well as the regions where the strains were high enough to cause failure. Contoured plots of stress and strains in various vehicle and barrier components, as shown in figure 4, yield useful information about how materials deform and ultimately fail in collision events. The acceleration responses can also be compared as is shown in figure 5.

If the response of a finite element model is acceptable in

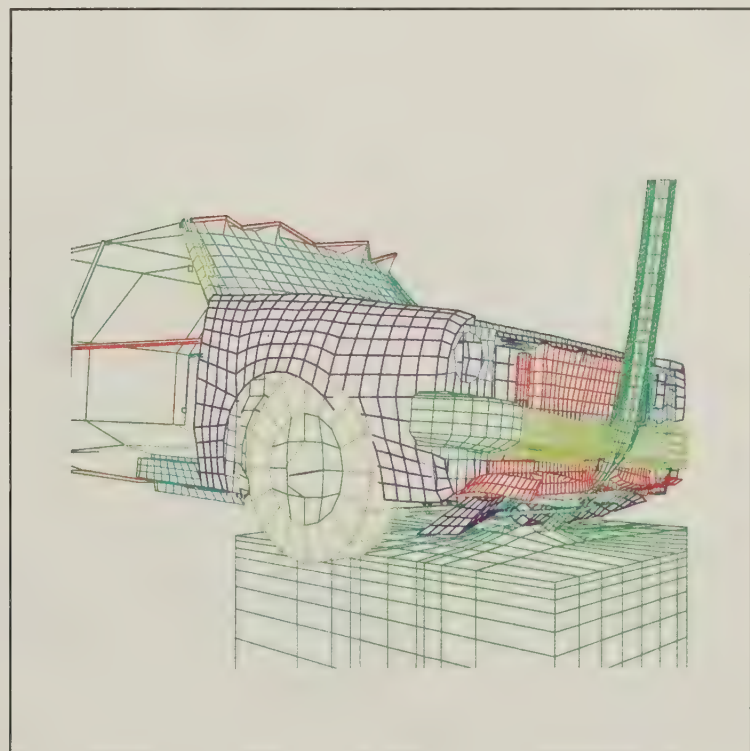
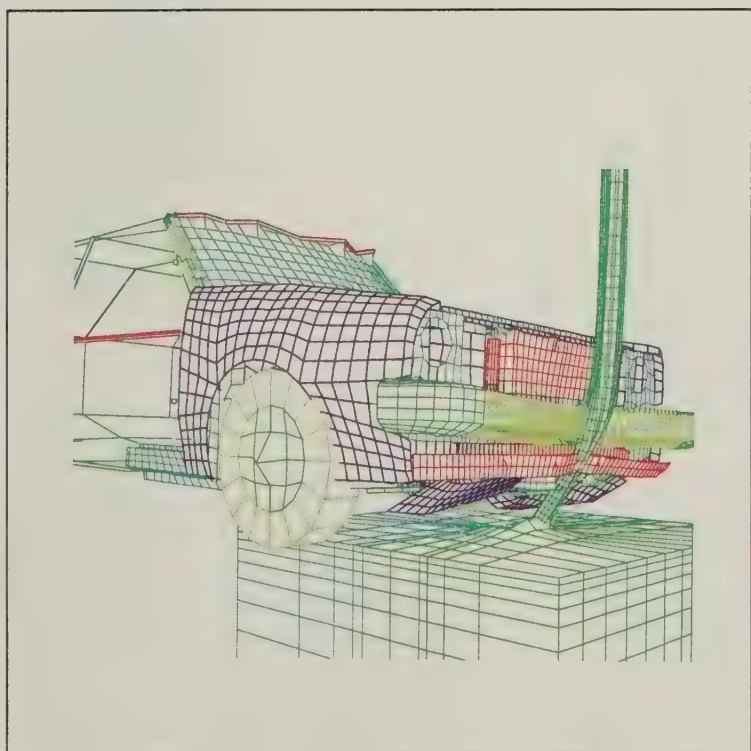
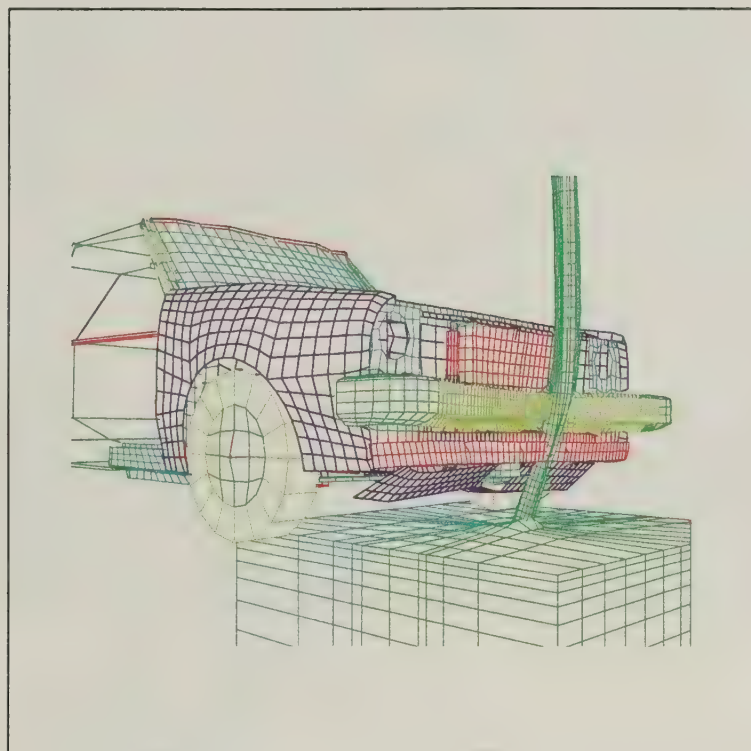

Figure 2—Sequential view of finite element simulation.

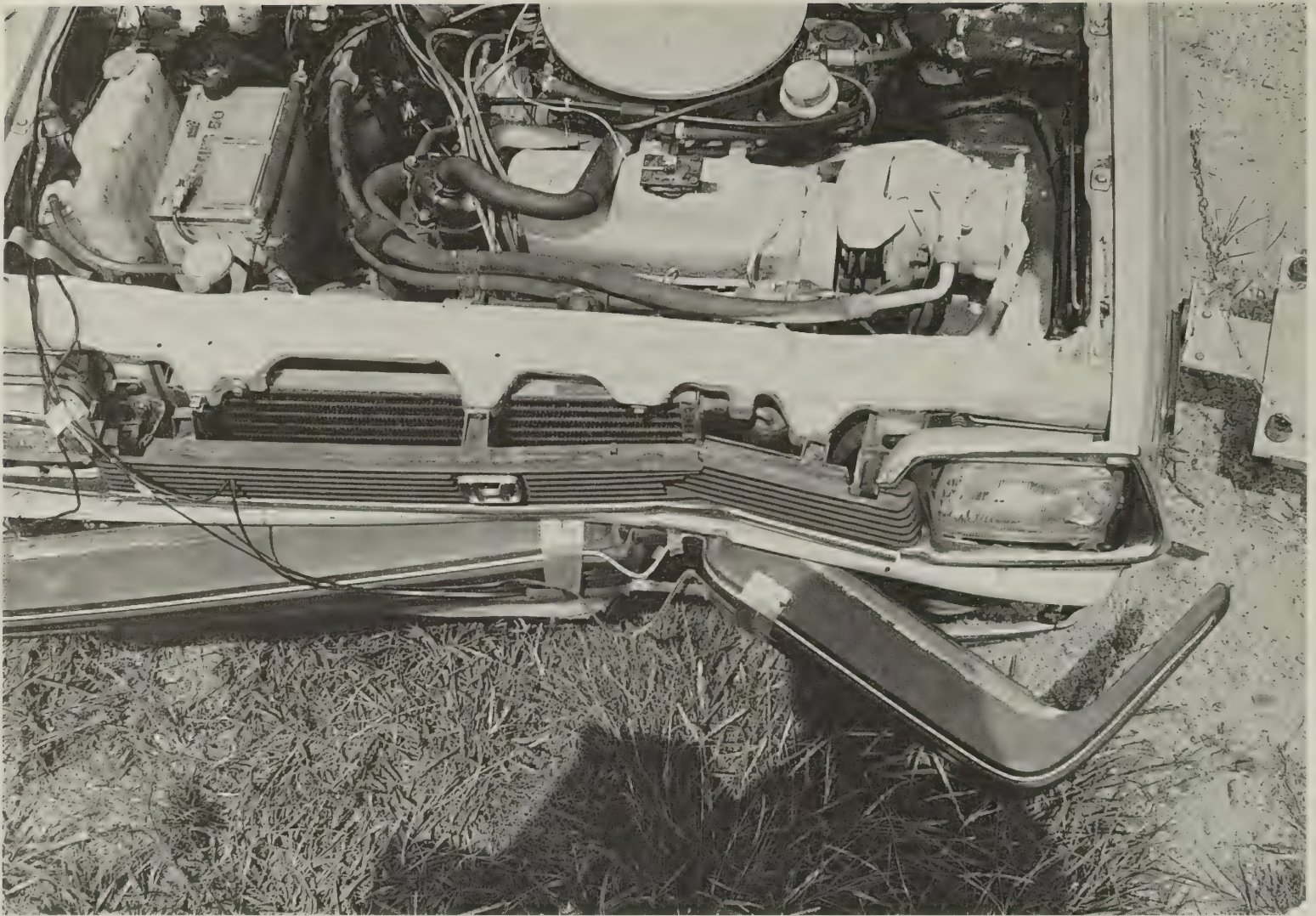
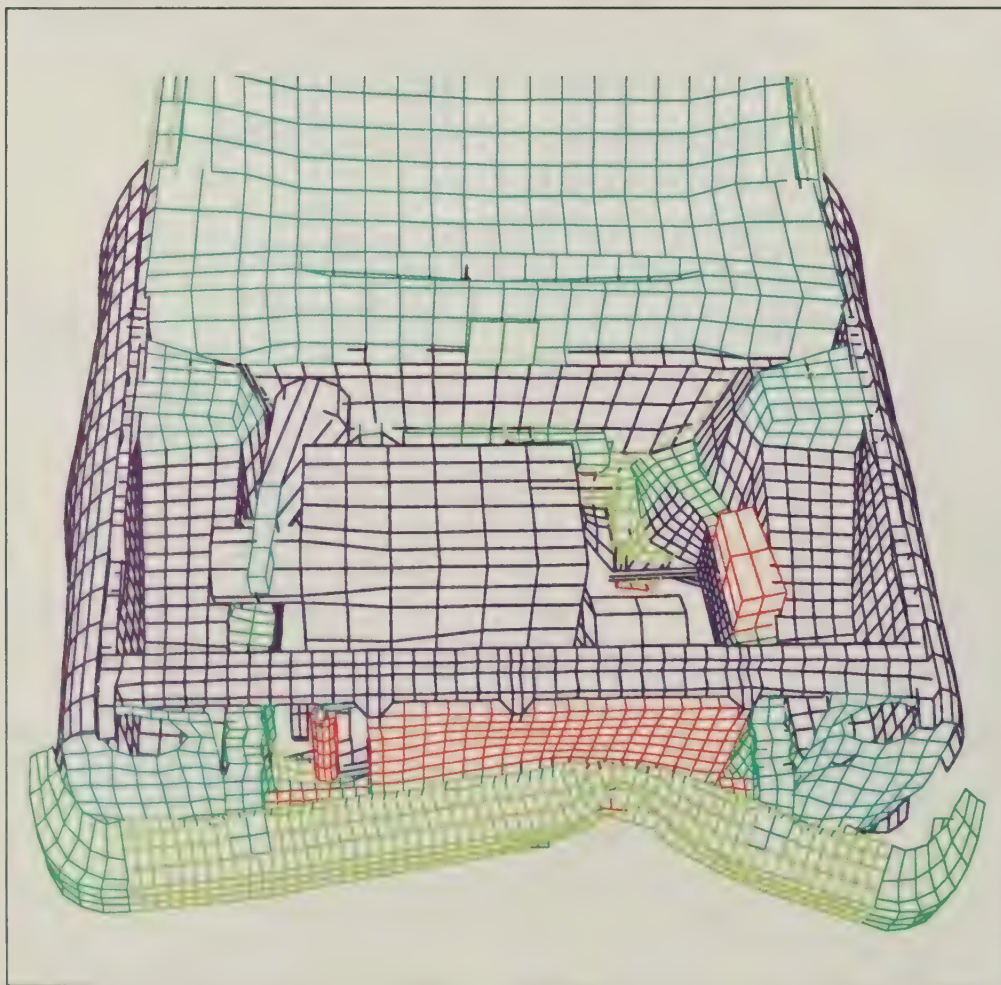

Figure 3—Vehicle damage shown from a crash test and from a finite element simulation.



comparison with full-scale tests, the designer can use the model to learn detailed information about the barrier that is not available in a full-scale test. For example, knowing the stresses and strains in a particular component is crucial for correctly sizing the member. A simulation will provide the required information directly, whereas the full-scale test could never provide this information.

While there are numerous benefits to using nonlinear finite element simulations, good correlation between simulations and tests requires well-understood, validated, and often complex models. While the plots in figure 5 are reasonably similar, improvement is still needed before the models can be used with confidence. This vehicle model is being carefully validated to ensure that the model



changed other fields in engineering. These techniques have great potential as a design tool for improving the effectiveness of roadside safety hardware.

Reference

(1) R. G. Whirley and J. O. Halquist. *DYNA3D: A Nonlinear, Explicit, Three-Dimensional Finite Element Code for Solid and Structural Mechanics—User Manual*, Publication No. UCRL-MA-107254, Lawrence Livermore National Laboratory, Livermore, Calif., May 1991.

Malcolm Ray, Ph.D., P.E., is a senior engineer/analyst for Advanced Engineering and Planning Corporation, Inc. (AEPSCO). Since 1993, he has been working as a lead analyst in the AEPSCO Support Services contract to the FHWA's Turner-Fairbank Highway Research Center in McLean, Va. He has more than a decade of experience in roadside safety research, including crash testing hardware, simulating collision events, and formulating test and evaluation criteria and design. He received his doctorate in civil engineering from Vanderbilt University.

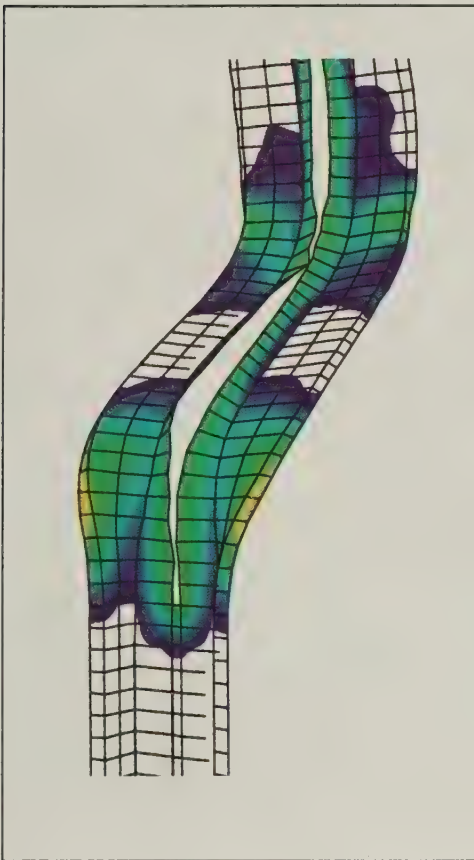

Figure 4—Deformation of a post from a crash test and from a finite element simulation.

where proper understanding of the nonlinear dynamics of the impact is crucial. These persistent problems must be viewed in new, more analytically rigorous ways. Nonlinear finite element analysis is a technique that has drastically

response is a good predictor of actual vehicle kinematics.

In the past, roadside hardware was designed using intuition and basic engineering principles—the only tools available at the time. A host of highly effective roadside hardware systems were developed, tested, and installed using these basic techniques. The roadside safety problems that have remained unsolved, however, are those that have resisted solution for decades. These are problems

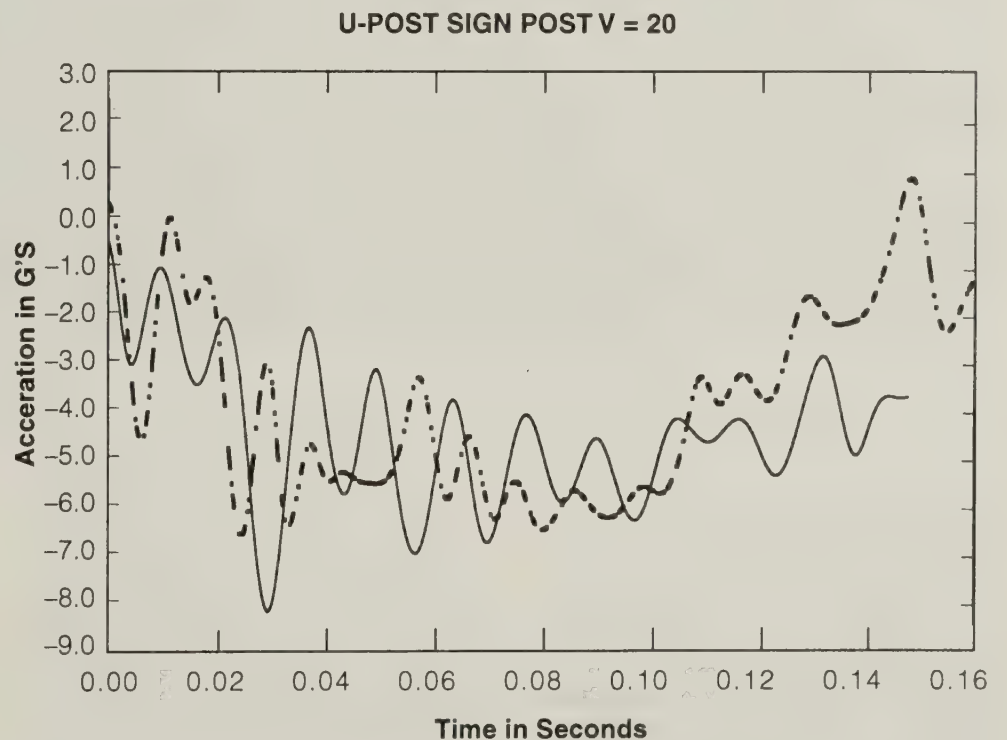

Figure 5—Comparison of accelerations at the center of gravity from a simulation (solid line) and a crash test (broken line).

National Crash Analysis Center

*by Azim Eskandarian,
Nabib E. Bedewi, and
Leonard Meczowski*



NCAC is located on The George Washington University—Virginia Campus in Ashburn, Va.

Introduction

The National Crash Analysis Center (NCAC) is a research and resource center for transportation safety studies on vehicles and highways. NCAC was established at The George Washington (GW) University—Virginia Campus in Ashburn, Va., on Oct. 1, 1992, through a contract from the U.S. Department of Transportation

(DOT) and contributions from GW's School of Engineering and Applied Science. Both the Federal Highway Administration's (FHWA) Office of Safety and Traffic Operations Research & Development and the National Highway Traffic Safety Administration's (NHTSA) Office of Crashworthiness Research fund the center.

NCAC has two main goals:

- To conduct research to assist government researchers in resolving transportation safety issues.
- To combine FHWA and NHTSA crash-test films and documentation collected over the past two decades into a single national library.

The Center also provides an environment for national and international visiting scholars to conduct research using the data and facilities and to interact with the NCAC research team.

NCAC researchers use highway-use data, on-the-road crash data, vehicle crash-test data, and models of vehicles and occupants as resources. In addition, the center maintains, improves, and applies vehicle and occupant computer models developed by FHWA and NHTSA and conducts research in the development of new computer simulation models. A unique feature of the center is that researchers can combine and use all available resources.

The NCAC library provides a national resource for crash-test reports and films, current computer models used by FHWA and NHTSA, and access to accident data bases such as the Fatal Accident Reporting System (FARS), the National Accident Sampling System (NASS), and the General Estimating System. The library currently has more than 14,000 crash-test films, along with the accompanying test report (if such a report is available).

NCAC Activities and Services

NCAC houses, maintains, and makes available to the public vehicle and highway crash-test films, data, and documentation that has been compiled over the past two decades by DOT. NCAC also has access to various accident reports and data bases. In addition, several computer models and software for modeling of vehicles, dummies, occupants, and highway objects are maintained and used for research at NCAC. NCAC provides an extraordinary setting

in which to conduct integrated research that considers all facets of a highway transportation safety problem. Ultimately, these research findings contribute to the design of safer highways and vehicles.

The following is a summary of NCAC activities and services:

- Research on modeling and computer simulation of vehicles



Researchers at NCAC have access to videotapes and films, reports, data bases, computer models, and software enabling them to conduct integrated research that considers all facets of a highway safety problem.

- and roadside objects for impact analysis.
- Research on comparison of computer models and test data.
- Research on biomechanics computer simulation and analysis of human injury due to impact.
- Research on highway safety issues using crash-test films, on-the-road crash statistics, and vehicle crash-test data.
- Research, investigation, and traffic injury studies and effectiveness analyses on safety improvements.
- Validation and engineering data services for existing and new programs.
- Maintenance and improvement of available vehicle and roadside-object computer models.
- Operation, maintenance, and

support for the Crash Analysis Information System (CAIS).

- Maintenance and support services for the Crash Test Information System (CTIS).
- Response to user inquiries on computer programs.
- Response to user inquiries on crash-film resources.
- Development and support of the International Visiting Scholars Program.

Vehicle and Highway Safety Research

The main goal of NCAC is to use its available resources to resolve transportation safety issues. FHWA's Office of Safety and Traffic Operations Research & Development is primarily concerned with the crash analysis and testing for highway design safety and roadside objects, NHTSA's Office of Crashworthiness Research focuses on regulations for safer vehicles and occupant protection.

Research at NCAC focuses on both aspects of the safety problem and combines the findings from both roadside objects and vehicle/occupant analyses. Research at NCAC starts with reviewing the accident data from various data bases and statistical analyses of injury patterns, frequencies, and severity to identify and characterize the impact problems for further investigation. The specific problems, tasks, and objectives are defined jointly with FHWA and NHTSA.

The research philosophy at NCAC is to look at the overall safety issue, use the available resources to identify and characterize the problem, use the most appropriate methods and tools or a combination of them to analyze the problem, and ultimately, recommend solutions or approaches that will enhance the

safety of occupants and reduce harm. Another aspect of the research at NCAC is to evaluate the current methods of transportation safety analysis and make improvements as research progresses, rather than relying on the existing tools.

The research activities at NCAC are divided into two major groups under two directors working with the principal investigator: (1) simulation and modeling research and (2) biomechanics and safety research. A basic theme for research is selected after the actual accident and test data are reviewed and several tasks are identified under that theme. The two research wings of the center then join forces and closely coordinate their work to solve the problem. Identification and sufficient characterization of the problem from accident records and statistical data analysis concerning various crash frequencies and severity and occupant casualties are a major part of the research activities.

Another major area of concentration in safety research at NCAC is the application, development, and enhancement of simulation tools and methods. Special-purpose simulation programs, rigid-body dynamics programs, and finite element structural codes are developed or used to model various aspects of vehicle crashes. These include modeling vehicle and occupant motion, vehicle-roadside object impact, dynamic and impact response of various highway objects, vehicle components, restraint systems, dummies, occupants, and biomechanics simulation. Finite element and multibody dynamics programs used extensively by the research team include DYNA3D, NIKE3D, PATRAN, HVOSM, GUARD, NARD, among others.

Recent Research Theme

The currently identified research theme is "analysis of vehicle impacts with narrow objects." Efforts are expanded in:

- Data base analysis and identification.
- Analysis of safety issues (eg, intrusions, types of bodily injury).



NCAC has an extensive film library.

- Modeling, simulation, validation, and evaluation.

Currently, the simulation research at NCAC is concentrated on finite element modeling. The codes primarily used for this purpose are DYNA3D and NIKE3D software. DYNA3D is a nonlinear, explicit dynamics finite element analysis code suited for high-impact rate and large deformation problems. DYNA3D is widely used by researchers in the field, the automobile industry, and both FHWA and NHTSA to model vehicle impact problems. NIKE3D is an implicit finite element code with similar characteristics. Both the public

domain and commercial versions of these codes are currently undergoing further improvement.

Research Topics

NCAC is currently conducting research concerning:

- Finite element analysis and evaluation of the performance of 4-lb/ft, U-post channel sign support using crash-test data.
- Cost/benefit analysis on testing and simulation of vehicles and roadside objects.
- Three-dimensional finite element modeling of the human surrogate head using DYNA3D.
- Modeling of lower limb injuries



Program (TRD/Docket), Office of Crashworthiness Research (OCR), and the compliance films. Furthermore, accident study data files from several hospitals, including Jackson Memorial's Ryder Trauma Center and Children's Hospital, are maintained by the NCAC library. The reports of several DOT committees on safety research will also be cataloged and shelved in

university's rich tradition and its bold future in graduate engineering education and research. GW's School of Engineering and Applied Science currently houses several high-caliber research laboratories at the Virginia Campus and offers 11 masters and doctoral programs, including one in transportation safety that will commence in fall 1994. The transportation safety

The main goal of NCAC is to use its available resources to resolve transportation safety issues.

the NCAC library.

Several specialized simulations developed during the past two decades by DOT, including NARD, GUARD, HVOSM, GRAPHx, BARRIERIV, and PORCHE, are maintained at the NCAC library.

These resources are available to NCAC's scientists, DOT researchers and engineers, and the public. The NCAC library provides these resources to the public under certain rules and government-approved cost schedules.

NCAC also provides services for public viewing of crash-test films on VCRs and 16-mm film projectors, reviewing of printed crash-test reports and documents on paper and microfiche, and viewing of test pictures and slides. A public viewing and projection room equipped with the necessary audiovisual equipment is dedicated to these services. Arrangements to use these facilities may be made by contacting the NCAC library. During regular business hours, visits to the NCAC library can be arranged by appointment or walk-in.

GW-Virginia Campus

GW-Virginia Campus provides an ideal setting for this unique center. Dedicated to the study of advanced technology and management techniques, this campus is located near Washington, D.C., eight kilometers (five miles) north of Dulles International Airport in one of America's most dynamic high-tech regions. GW's Virginia Campus reflects both the

program is offered by the Civil, Mechanical, and Environmental Engineering (CMEE) Department and covers a range of courses in mathematics, systems modeling and simulation, solid mechanics, biomechanics, structural dynamics, and so forth. This program provides a solid background that enables students to pursue their scholarly research in the transportation field. It is expected that state and federal highway safety engineers, accident investigation and insurance institute engineers, and investigators in the field of forensic engineering, among others, will be candidates for graduate study in this program. Graduate students will interact with GW's faculty and use the resources available at NCAC.

Dr. Azim Eskandarian is an associate research professor at GW-Virginia Campus, and he is the director of simulation and modeling research at NCAC.

Dr. Nabih E. Bedewi is the director and principal investigator of NCAC.

Leonard Meczkowski is a highway safety specialist in FHWA's Office of Safety and Traffic Operations Research and Development. He is FHWA's contracting officer's technical representative (COTR) assigned to oversee the operations of the NCAC.

in vehicle crashes: human ankle and foot.

- Research on development of general protocols for finite element interfaces and pre- and post-processing.
- Analysis of injury patterns and severity in support of Jackson Memorial Hospital's Ryder Trauma Center.
- Statistical data analysis of recent field accident records concerning crash frequency and severity and also occupant casualties in the collision of vehicles with narrow objects.

NCAC Film Library Services

The NCAC film library includes the collections of FHWA's Roadside Safety Library (RSL), NHTSA's New Vehicle Assessment

"Along the Road" is a hodgepodge of items of general interest to the highway community. But this is more than a miscellaneous section; "Along the Road" is the place to look for information about current and upcoming activities, developments, and trends. This information comes from Federal Highway Administration sources unless otherwise indicated. Your suggestions and input are welcome. Let's meet along the road.

FHWA Sends \$45 Million for Earthquake Repair

In January, the Federal Highway Administration provided California with an initial allocation of \$15 million, followed by an additional \$30 million, in emergency relief funds for repair of federal-aid highways damaged by the Northridge earthquake. Preliminary indications are that, while some major failures occurred in structures such as bridge columns, the majority of bridges in the area performed acceptably with hinge restrainers, a seismic retrofit application, accomplishing their task.

Lansing Trolley Is Dedicated

The Lansing Trolley, a part of the Lansing (Mich.) Area Mobility Project, was dedicated on Jan. 24 by Lansing Mayor Hollister, Congressman Carr, and Governor Engler. The project was funded to demonstrate methods of enhancing safety and economic development by improving traffic flow, transit service, and pedestrian safety between Lansing and Meridian Township.

Murrow Bridge Is Outstanding Engineering Achievement

The new Interstate 90, Lacey V. Murrow floating bridge in Washington state was selected by the National Society of Professional Engineers as one of the ten most outstanding engineering achievements for 1993. The award is based on resourcefulness in planning and in the solution of design problems, contribution to the well-being of people and communities, use of new materials and methods, and innovations in construction.

Radar Detectors Are Banned in Interstate Buses and Trucks

The ban on radar detectors in buses and trucks operating in interstate commerce went into effect on Jan. 20. The prohibition applies to vehicles with a gross vehicle weight rating of 10,001 pounds (4,536.45 kilograms) or more, vehicles designed to carry 16 or more persons, and any vehicle transporting hazardous materials. The rule also affects intrastate truck and bus drivers operating in states that have adopted the Federal Motor Carrier Safety Regulations. The federal ban on detectors does not affect passenger cars or any other vehicles. Enforcement of the ban will largely be in the hands of the individual states. During the first 60 days of the ban, FHWA conducted an information and education program for carriers and drivers.



The Lacey V. Murrow Bridge in Washington state was recognized as an outstanding engineering achievement. The new bridge, shown on the left, opened to traffic on September 12, 1993. The floating portion of the bridge is two kilometers (6,600 feet) long.

Rensselaer Establishes Center for Infrastructure and Transportation Studies

Rensselaer Polytechnic Institute (RPI) in Troy, N.Y., established the Center for Infrastructure and Transportation Studies. When the National Research Foundation designates the RPI center as the nation's 19th official engineering research center, RPI will receive from \$2 million to \$3 million annually for five years to conduct research projects. The center will work with government in three ways: providing education and training to transportation engineers and project managers, developing and sharing cutting-edge technologies, and conducting research in the areas of tractor-trailer dynamics, bridge construction, computer methods for intermodal cooperation and coordination, highway maintenance, and earthquake engineering.

North Carolina Proposes a Global Transpark

Global Transpark, proposed at the airport complex in Kinston, N.C., is a high-technology industrial park and

all-purpose transportation hub that would provide a seamless flow of goods. Finished products and components would be shipped by rail, highway, and air to factories built along the runway. Factories and suppliers would be linked electronically. Cargo would be handled by computer-controlled conveyor belts and unmanned shuttles. The cost of the first phase is estimated at \$159 million. The cost of infrastructure improvements for roadways and a railroad spur is \$15.5 million. Overall cost for this complex could be as high as \$450 million; total funding sources are not yet known.

EPA May Sanction Three States

The EPA published a notice of proposed rulemaking (NPRM) in the *Federal Register* on Jan. 24, 1994, that proposes sanctions against California, Illinois, and Indiana for failure to meet the Clean Air Act requirements for inspection and maintenance programs. According to the NPRM, "discretionary" sanctions will take effect on May 15 if the requirements are not met. Highway sanctions would be imposed on a statewide basis and 2:1 offset sanctions would be imposed in the states' nonattainment areas.

AASHTO and FHWA Sponsor a National Metric Conference

The American Association of State Highway and Transportation Officials (AASHTO) and FHWA jointly sponsored a National Metric Conference, hosted by the North Carolina Department of Transportation (DOT) on Jan. 31 through Feb. 3 in Research Triangle Park, N.C. (Raleigh-Durham area). The primary purpose was to provide an opportunity to share metric implementation ideas and techniques among state highway agencies, FHWA, and others.

Nebraska and California Use Electronic Billing

The Nebraska Department of Roads submitted a bill on Dec. 28, 1993, and the FHWA division office approved the bill electronically on the same day. This was the first "in production" use of this system in Nebraska; all future bills will be submitted and approved this way. FHWA's California Division office graduated from "test mode" to full production on Jan. 5, 1994, and electronically approved approximately \$100 million in California DOT (Caltrans) bills between Jan. 5 and 11.

Smart Cars Are Here

Oldsmobile announced on Jan. 4 that they would offer a \$2,000 optional invehicle navigation system in 1994 Oldsmobile 88 LSS vehicles. Reportedly, the navigation system will be available first on the West Coast later this model year. The navigation unit gets its positioning information from both a Global Positioning System receiver and gyroscopic/odometer sensors. The navigation system will provide directions to one's destination via turn arrows and a moving map. It will also contain "yellow pages" for location information. Zexel

of Sunnyvale, Calif., supplies the navigation system. The map is provided by Navigation Technologies also of Sunnyvale. This is not an autonomous navigation system; therefore, it does not use current traffic flow information to develop the best route to one's destination.

Florida Uses Scrap Tire Rubber

Effective Jan. 1, Florida DOT requires the use of ground scrap tire rubber in all projects involving asphalt cement pavements. The scrap tire rubber is required in both the dense and open-graded friction courses and in the asphalt-rubber membrane interlayer. The friction courses historically represent more than 15 percent of the total tonnage of asphaltic concrete awarded by FDOT each year. The use of rubber in asphalt was recently showcased to FDOT construction personnel and contractors in three demonstration projects in the state.

Earthquake Shakes Western Wyoming

An earthquake, measuring 4.7 on the Richter scale, occurred near Jackson, Wyo., on Dec. 28. It was felt almost 200 miles away in Rock Springs, Wyo. An earthquake of lesser intensity had been recorded in the same area on Nov. 26, 1993. The Wyoming Transportation Department (WTD) is checking the bridges in the areas that could have been affected by the latest earthquake; no damage has been reported so far. WTD recently developed procedures for the preliminary seismic screening of all bridges, and WTD plans to screen their bridges in the near future.

Bicycle Racks May Be on Buses

An effort is underway in Salt Lake City to determine if the public supports bicycle racks on buses to improve air quality. If the public is supportive, a request may be submitted to FHWA to transfer Congestion Mitigation-Air Quality (CMAQ) funds to the Federal Transit Administration for the project.

Group Reviews Electronic Toll Collection Communications Requirements

On Jan. 11, FHWA, IVHS America, state representatives, and toll authorities met to enhance electronic toll collection communications compatibility. They reviewed a preliminary set of common requirements. The consensus from this meeting will be presented to the industry at large and to the standard-setting community for consideration as a formal Intelligent Vehicle-Highway Systems (IVHS) industry standard for automated vehicle identification.

TRB Meeting Focuses on IVHS

IVHS was a major topic at the annual meeting of the Transportation Research Board on Jan. 10-13. At the annual meeting, about 20 sessions were held on various IVHS subjects, and about the same number of committees discussed IVHS-related topics. At one session,

FHWA Administrator Rodney E. Slater presented a "National IVHS Status Report."

Pennsylvania Wants to Buy I-80

Robert A. Gleason Jr., Pennsylvania Turnpike commissioner, announced on Nov. 22 that he would like to buy I-80 from the federal government and turn it into a toll road. Commissioner Gleason believes that, with the turnpike's ability to sell bonds and maintain its system, an I-80 toll road could be a revenue source to fund future north-south extensions. He sees more toll roads in the future because the state can no longer afford to maintain the public roads and because he believes that the development of the toll road system is the most important factor to boost the Pennsylvania economy.

Philadelphia Loses Wheelchair Ramps Case

The 3rd Circuit Court of Appeals in Philadelphia ruled in November that the city of Philadelphia must install wheelchair ramps on the curbs of all streets resurfaced since January 1992. This ruling upheld a lower court decision in a suit, brought by a dozen disabled people, to force the city to abide by the Americans with Disabilities Act. The city argued that resurfaced streets did not count for ADA purposes as an alteration because curbs are not modified when a street is resurfaced. However, the court decided that resurfacing work is substantial enough to require the modification of the curbs.

Mississippi Collects \$5.2 Million in Fines from Truckers

During its first year in operation, the Mississippi DOT's Law Enforcement Unit weighed more than 7,000 trucks and issued more than 8,262 citations to vehicles in non-compliance with weight and size laws. The total revenue in fines, permit and tag fees, and fuel tax for these violations was \$5.2 million.

FHWA Adopts AASHTO Policy for Geometric Design

In November, FHWA adopted, as an interim policy for the geometric design of projects on the National Highway System, a 1993 AASHTO publication titled "Interim Selected Metric Values for Geometric Design, an Addendum to a Policy on Geometric Design of Highways and Streets, 1990."

Kentucky Has First Automated Weigh Station on I-75

Recently, participants in a meeting of federal and state officials involved in the Advantage I-75 commercial vehicle project toured the Scott County, Ky, weigh station. This station is the first of 22 stations in the United States along I-75 and eight stations in Canada along Route 401 to be equipped with the Hughes Automatic Vehicle-to-Roadside Communications System. About 200 trucks from six carriers are taking part in the initial testing of

the Advantage I-75 system at this station. Participating trucks in compliance with regulations will not have to stop at the weigh station for weighing and inspection of credentials.

FHWA Supports IVHS Awareness

IVHS America, in contract with the FHWA, is implementing a series of outreach activities to promote public education and general awareness of IVHS. The initial meetings focus on state, regional, and local public officials. One of the first efforts was at a meeting of the Urban Consortium, a forum for large city and county officials, in Orlando, Fla., in December; this meeting was organized with the assistance of Public Technologies Inc., the research arm of the National League of Cities, the National Association of Counties, and the International City Managers Association. Also in December, there was a workshop for representatives of metropolitan planning organizations.

Signal Manufacturers Meet to Set Standard

On Dec. 9, the Steering Committee of the Signal Manufacturers Symposium met to discuss progress in developing a communication standard/protocol to permit communication among all brands of traffic signal controllers. A protocol will greatly enhance the application of IVHS technologies to the problems of traffic congestion in metropolitan areas and along major corridors. This is another public-private partnership effort supported by FHWA to advance IVHS deployment.

U.S. DOT Agencies Support CTIPS

The Comprehensive Transportation Information and Planning System (CTIPS) is being developed by AASHTO and the states to share transportation information from existing federal and state data bases. On Nov. 19, FHWA hosted meetings for other appropriate U.S. DOT agencies—Federal Transit Administration, National Highway Traffic Safety Administration, and Bureau of Transportation Statistics—to discuss with representatives of the CTIPS Steering Committee the multimodal information currently available on CTIPS and ways to improve the system for the DOT agencies and their customers. Each agency agreed to identify additional data for CTIPS and to attend a CTIPS Steering Committee meeting in January 1994.

New York Holds Workshop to Promote Partnering

The New York State DOT (NYSDOT) recently held a workshop to develop a formal partnering agreement among the participants in the \$35-million rehabilitation of the Bruckner Expressway Viaduct (I-278) in the Bronx. The workshop was also used to develop a statewide partnering policy. Workshop participants represented NYSDOT, New York City DOT, FHWA, the prime contractor, the construction inspection consultant, and the construction support consultant. Although

the I-278 project is New York's eighth with a partnering agreement, it is the state's first major federal-aid project with a partnering agreement; by next year, 52 transportation projects in New York are anticipated to involve partnering.

Oregon Completes Study of Seismic Retrofit Needs

The Oregon DOT recently completed a study of its 2,545 bridges to determine the seismic retrofit needs. The study concluded that it is necessary to retrofit nearly 2,000 bridges at a total cost of \$800 million. ODOT is assessing its options since the entire bridge program has been averaging only \$44 million annually. Only 51 bridges have been retrofitted.

Alaska Begins Its First Entirely Metric Project

In December, Alaska opened bids on its first project designed in metric units only (rather than dual units). The project includes the grading and paving of a 9.7-kilometer, two-lane road in Haines, Alaska.

IVHS Architecture Development Program Has First Progress Review

The four IVHS architecture development contractor teams individually presented their early architecture concepts—"missions definitions"—to the U.S. DOT program management group in mid-November. These teams are defining, developing, and evaluating alternative architectural concepts for a nationwide, integrated IVHS program. This was the first progress review of the program and the first time the teams officially revealed their developmental approaches. It was clear that FHWA achieved its goal of identifying a wide range of concepts by sponsoring competing approaches.

Minnesota Goes After Fuel Tax Evaders

In November, the Minnesota Department of Revenue filed its first complaint against an oil company for fuel tax evasion. The firm is charged with selling fuel without a license and failure to pay the state gasoline tax. FHWA allocated funds to the state to increase efforts to curb motor fuel tax evasion.

TRB Releases Report on Native American Transportation Issues

Transportation Research Board (TRB) released the final conference report on "Exploring Solutions to Native American Transportation Issues and Economic Development Problems" in November 1993. The report discusses Native American transportation-related provisions of the Intermodal Surface Transportation Efficiency Act of 1991 (ISTEA) and a broad range of other Native American transportation issues. The tribes are establishing an Intertribal Transportation Association. "Transportation and Indian Affairs: Forging New Partnerships" was the subject of a session at the TRB annual meeting in January 1994.



Frank Francois, executive director of AASHTO, makes a presentation to the inaugural U.S. Hot Mix Asphalt Conference held in Atlanta on Nov. 17-19. More than 370 asphalt paving experts, from 38 states and six foreign countries and representing the public and private sectors, participated in the two-day symposium. The keynote address was delivered by FHWA Executive Director E. Dean Carlson.

FHWA Is Testing Self-Managed Work Team Concept

FHWA's Wisconsin Division is the pilot organization to test self-managed work teams. Recently, the division presented for approval a formal plan for the second phase of the test: designing, implementing, and evaluating an alternative performance management system that is appropriate to support personal performance in a team-oriented environment.

Butterfly Stops Freeway Project in Michigan

The proposed U.S. Route 31 freeway project in Berrien County, Mich., has been held up for two years because an endangered species of butterfly is located on the proposed right of way. For the past two years, FHWA has been in informal consultation with the U.S. Fish and Wildlife Service. On Oct. 28, 1993, "formal consultation" under section 7 of the Endangered Species Act

was requested. Several project design changes are being proposed to lessen any effects to the butterfly. In addition, FHWA and the Michigan DOT are prepared to assist the Fish and Wildlife Service in the management and recovery of the butterfly at this location.

Doug Bernard Retires from FHWA

Douglas A. Bernard, director of FHWA's Office of Technology Applications (OTA), retired on Jan. 3 after 31 years with the agency. He plans to continue his work in technology transfer in the private sector. As director of OTA, he led a program that included technology assessment and deployment of highway technology, product implementation of the Strategic Highway Research Program (SHRP), and technology transfer to rural and small urban transportation agencies and to Native American tribal governments through the Local Technical Assistance Program. To many, Bernard was "Mr. T2" because of his significant involvement and accomplishments in technology transfer over the past 20 years. In the 1970s, he was one of the early leaders in aggressively promoting the recycling of asphalt pavements. Throughout his career, he received numerous awards, including the FHWA Administrator's Award, the Dwight David Eisenhower Centennial Coin Award, and the FHWA Unusually Outstanding Performance Award. From industry, he was recognized by *Engineering News Record*, National Asphalt Pavement Association, American Concrete Pavement Association, Asphalt Rubber Producers Group, and Asphalt Recycling and Reclaiming Association. In addition, he was elected as chairman of the board of the Washington, D.C., "Road Gang" in 1990.

FHWA Selects IVHS Research Centers of Excellence

On Oct. 7, FHWA Administrator Rodney E. Slater announced the selection of three universities to establish and operate IVHS research centers of excellence to aggressively develop and implement activities that advance the state of the art in IVHS. The centers are located at Virginia Polytechnic Institute and State University, the University of Michigan, and the Texas Transportation Institute at Texas A&M University. Each university will receive up to \$1 million per year for two to five years to assess IVHS technology, perform basic and applied research, and serve as partners in IVHS operational testing. Funding will be provided on an 80-percent federal share basis. The universities were selected based on a competitive technical review of applications.

Fifteen States Are Testing Anti-Icing Techniques

FHWA is funding a study to carefully examine selected processes for preventing the formation of a strong bond between frozen precipitation and the pavement surface. This winter and next, highway agencies in 15 states—California, Colorado, Iowa, Kansas, Maryland,



Doug Bernard, on the right, receives a Distinguished Career Service Award from FHWA Executive Director E. Dean Carlson for Bernard's 31 years of service to FHWA. Bernard retired from FHWA on Jan. 3, 1994.

Massachusetts, Minnesota, Missouri, Nevada, New Hampshire, New York, Ohio, Oregon, Washington, and Wisconsin—will test and evaluate anti-icing strategies and techniques to determine which have the greatest potential for success over a range of topographic, climatic, and traffic conditions. This FHWA study is a continuation, with some modifications, of a SHRP project. A final report of the study and a manual for an anti-icing program are due in the summer of 1995.

ASCE Offers Technical Assistance in Wake of California Quake

The American Society of Civil Engineers (ASCE) offered California officials the Society's full technical support to help the state recover from the Northridge earthquake. ASCE has emergency disaster response teams of expert civil engineers to provide assistance to state and local authorities in conducting damage assessments and safety inspections. ASCE civil engineers throughout California remain on alert to inspect the public works infrastructure, including water treatment plants, water pipelines, gas pipelines, roadways, and geotechnical engineering. More than 100 volunteer engineers made hazard inspections after the San Francisco earthquake in 1989, and an ASCE official predicted that a much larger number of volunteer engineers will be needed this time because of the vast damage.

—American Society of Civil Engineers

Civil Engineering R&D Investment Is Lagging

Spending for research and development (R&D) by the U.S. civil engineering community lags far behind other major U.S. industries, according to a recent study sponsored by the Civil Engineering Research Foundation (CERF) and the National Science Foundation. As a

result, the design and construction industry has not derived as many technological advances through R&D as other industries, even though it is the largest manufacturing sector of the U.S. economy and accounts for about 8 percent of the gross national product. The civil engineering community as a whole invests only 0.5 percent of its total revenue, as compared to an "all-industry" composite level of investment of 3.4 percent for 1990 according to *Business Week*. Among the study's major findings:

- A lack of national strategy and direction for R&D by the design and construction industry restricts the effectiveness of limited R&D resources; barriers to implementing new technology provide a disincentive for R&D.
- Nearly 28 percent of all design and construction firms reporting some level of civil engineering-related R&D are not able to quantify this activity; if those firms that do not perform any R&D are included, the percentage of firms not having a line item for R&D activities rises to 74.1 percent. This lack of record-keeping makes it difficult to evaluate the effectiveness of R&D investments.
- The federal government funded 62.9 percent of all civil engineering-related R&D performed in 1992.

Survey findings are documented in a new CERF report entitled *A Nationwide Survey of Civil Engineering-Related R&D* (Report No. 93-5006). The report concludes with specific recommendations addressed to each sector—federal government, industry, academia, state, and nonprofit—and to the community as a whole aimed at improving the interaction and coordination between sectors to maximize the effectiveness of limited R&D resources.

—Civil Engineering Research Foundation

Reduced Median Width Leads to More Crashes

Reducing the width of median strips between divided highways to add more lanes and to save money will lead to more crashes, injuries, and deaths, according to an FHWA-funded study conducted by the University of North Carolina Highway Safety Research Center. Wider lanes provided the most protection against head-on collisions—usually the most deadly—but also reduced the number of multivehicle, single-vehicle, and rollover crashes. Over an increasing range of median widths from zero to 110 feet (33.5 meters), the rates of serious-injury, all-injury, and property-damage-only crashes declined as much as 15-fold. Using the Illinois model, reducing an existing 64-ft (19.5-m) median to 40 ft (12 m) would result in a 23-percent increase in the total crash rate. Medians wider than 80 ft (24 m) did not show continuing declines in crash rates. The center used data from the Highway Safety Information System, a multistate data base on motor vehicle crashes, road characteristics, and traffic volume, to compare the median widths of Utah and Illinois highways with computerized accident data from those states. Utah and Illinois were the

only two states with enough reliable information to conduct the analysis, according to researchers.

—UNC Highway Safety Research Center

Advanced Composite Cables for Waterfront Structures Will Be Demonstrated

The U.S. Army Construction Engineering Research Laboratories, the South Dakota School of Mines and Technology, and several industry partners have joined in a project to demonstrate the corrosion resistance of advanced composite prestressing cables in waterfront structures. Measures, such as epoxy coatings and cathodic protection, to prevent the corrosion of steel reinforcing cables exposed to ocean waters have not been cost-effective. Currently, maintenance of waterfront structures costs the U.S. military and civilian communities nearly \$2 billion annually. Fiberglass- and carbon fiber-reinforced composite cables are very strong and do not corrode; therefore, they provide a promising alternative to steel to significantly reduce maintenance costs and increase the useful life of a structure. Use of these new materials will require minimal change in commercial production equipment and training.

—U.S. Army Construction Engineering Research Laboratories

Taiwan Is Site of Major International Conference

The eighth conference of the Road Engineering Association of Asia and Australasia (REAAA) will be held in Taipei, Taiwan, on April 17-21, 1995. At the last REAAA conference in Singapore in 1992, nearly 1,000 participants from more than 20 countries engaged in this forum for information exchange among road engineering professionals. The theme of the 8th REAAA conference is "Roads for Future Development." The conference will focus on the following topics: road planning, design, construction, maintenance and infrastructure management; mass transit use of roads; traffic management; parking systems; road safety; vehicle standards and regulations; IVHS and its applications; road financing issues; and environmental impacts of road projects. The official language of the conference is English. Abstracts for proposed papers and presentations are due on Feb. 15, 1994. REAAA maintains close contacts with the International Road Federation and the Permanent International Association of Road Congresses. For more information, contact:

The Executive Secretary
8th REAAA Conference
Organizing Committee
c/o THI Consultants Inc.
P.O. Box 96-1021
Taipei, Taiwan, R.O.C.
Tel. & Fax: 886-2-7024642

—8th REAAA Conference Organizing Committee

RECENT PUBLICATIONS

The following are brief descriptions of selected publications recently published by the Federal Highway Administration, Office of Research and Development (R&D). The Office of Engineering and Highway Operations R&D includes the Structures Division, Pavements Division, Materials Division, and Long-Term Pavement Performance Division. The Office of Safety and Traffic Operations R&D includes the Intelligent Vehicle-Highway Systems Research Division, Design Concepts Research Division, and Information and Behavioral Systems Division. All publications are available from the National Technical Information Service (NTIS). In some cases, limited copies of publications are available from the R&T Report Center.

When ordering from NTIS, include NTIS' PB number (or publication number) and the publication title. Address requests to:

**National Technical Information Service
5285 Port Royal Road
Springfield, Virginia 22161**

Requests for items available from the R&T Report Center should be addressed to:

**Federal Highway Administration
R&T Report Center, HRD-11
6300 Georgetown Pike
McLean, Virginia 22101-2296
Telephone: (703) 285-2144**

An Integrated Model of the Climatic Effects on Pavements

Publication No. FHWA-RD-90-033

by Office of Engineering and Highway Operations R&D

The integrated model described in this report combines and modifies three separate models of climatic effects on pavements: the Climatic-Materials-Structures Model developed at the University of Illinois, the Infiltration and Drainage Model developed by the Texas Transportation Institute, and the Frost Heave and Thaw Settlement Model developed by the U.S. Army Cold Regions Research and Engineering Laboratory.

Within this integrated model, the weather patterns of rainfall, temperature, solar radiation, cloud cover, wind speed, and snowfall are simulated throughout an entire year. The patterns of temperature and rainfall may be set by the user to be as mild or as severe as desired. The program computes the pore water pressure, temperature, frost and thaw depth, frost heave, and layer materials elastic modulus with time. The computations are made in accordance with a numerical model of coupled heat and moisture flow in a medium with small volume changes. The third appendix includes a complete users guide to the Integrated Model Program.

The program is intended for use on an IBM-compatible, 286- or 386-level microcomputer. Thirty-year climatic data files for 15 cities representing nine climatic regions in the United States make the weather data input simple, or if desired, different elements of weather data that are peculiar to a specific site may be used.

The NTIS number for this publication is PB94-121043; the cost is \$44.50 for a paper copy or \$17.50 for the report on microfiche.

Trade-Off Between Delineation and Lighting on Freeway Interchanges: Investigation of Transient Visual Adaptation

Publication No. FHWA-RD-91-041

by Office of Safety and Traffic Operations R&D

The objective was to determine the extent that transient visual adaptation (TVA) affects drivers' detection of targets along partially lighted freeway interchanges. The study expanded a preliminary task on TVA described in publication FHWA-RD-88-223. Twenty-five subjects drove 10 trials on an entrance and an exit ramp. Lighting was manipulated to provide trials in darkness and with one through four luminaires lighted along each ramp. The same drivers returned for a second session of 10 trials, after refractors were replaced with sharp cut-off luminaires (low glare). The drivers pressed a button on a hand-held switch when they detected the 0.178-m by 0.178-m (7-in by 7-in) gray targets placed on the shoulder at 106.75 m (350 ft) or 144.88 m (475 ft) downstream of the final ramp luminaire. The vehicle computer recorded distances between subjects and targets at the instant of detection. Significantly shorter detection distances were obtained in the lighted conditions than in darkness. Significant differences in mean detection distance as a function of luminaire number were not observed except for four conventional luminaires with the target at 144.88 m. This was significant compared to one, two, or three luminaires. There was no significant difference between conventional and sharp cut-off luminaires.

The NTIS number for this publication is PB94-118429; the cost is \$17.50 for a paper copy or \$9 for the report on microfiche.

Guide Design Specification for Bridge Temporary Works

Publication No. FHWA-RD-93-032

by Office of Engineering and Highway Operations R&D

This guide design specification was developed for use by state agencies to update their existing standard specifications for falsework, formwork, and related temporary construction. The guide specification was prepared in a format similar to the American Association of State Highway and Transportation Officials (AASHTO) Standard Specifications for Highway Bridge Structures.

This guide design specification is the result of a

Federal Highway Administration (FHWA) temporary works research program established in 1989 after the collapse of the Route 198 bridge over the Baltimore/Washington Parkway. This report is one of a series produced under this program. The other reports are: FHWA-RD-91-062, *Synthesis of Falsework, Formwork, and Scaffolding for Highway Bridge Construction*; FHWA-RD-93-031, *Guide Standard Specification for Bridge Temporary Works*; FHWA-RD-93-033, *Certification Program for Bridge Temporary Works*; and FHWA-RD-93-034, *Construction Handbook for Bridge Temporary Works*.

The NTIS number for this publication is PB94-118445; the cost is \$19.50 for a paper copy or \$9 for the report on microfiche.

Construction Handbook for Bridge Temporary Works

Publication No. FHWA-RD-93-034

by Office of Engineering and Highway Operations R&D

This handbook was developed for use by contractors and construction engineers involved in bridge construction on federal-aid highway projects. The content is construction-oriented and contains chapters on falsework, formwork, and temporary retaining structures. For the purposes of this handbook, temporary retaining structure refers to both earth-retaining structures and cofferdams.

This handbook is a result of the FHWA temporary works research program mentioned in the previous item.

The NTIS number for this publication is PB94-120367; the cost is \$27 for a paper copy or \$12.50 for the report on microfiche.

Condition of Prestressed Concrete Bridge Components Technology Review and Field Surveys

Publication No. FHWA-RD-93-037

by Office of Engineering and Highway Operations R&D

This report describes the results of a technology review and field condition surveys carried out in the area of prestressed concrete (PS/C) bridge components. Both pretensioned and post-tensioned systems are included. The technology review indicates that most prestressed concrete bridges, when properly designed and constructed, can perform adequately even in severe environments. Only a limited number of structural failures attributed to corrosion of prestressed elements have been documented. Field surveys were conducted on 12 bridges in severe environments, including both marine exposure and exposure to deicing agents. Direct exposure to marine spray or runoff of deicing solutions represents the exposure most likely to lead to premature corrosion and failure of prestressed systems. When elements can be protected or shielded from such exposure, the corrosion-free life of PS/C bridge members

can be greatly extended. Care must be exercised in selection and application of rehabilitation measures in such environments, as the severity of exposure may impact adversely on the expected life and performance of such repairs.

The NTIS number for this publication is PB94-120250; the cost is \$36.50 for a paper copy or \$17.50 for the report on microfiche.

Structural Effects of Epoxy Coating Disbondment

Publication No. FHWA-RD-93-055

by Office of Engineering and Highway Operations R&D

This short-term study was conducted in response to questions about the structural effects of the loss of epoxy coating adhesion. The study was conducted at the Turner-Fairbank Highway Research Center from September 1992 to December 1992 and consisted of three phases. Phase 1 induced disbondment between the epoxy coating by means of an electrochemical process. This resulted in epoxy-coated rebar with a significant degree of disbondment (between 20 and 30 percent). In phase 2, experiments were conducted to test the effects of this degree of disbondment on the flexural capacity of reinforced concrete slabs. Three sets of identical, reinforced concrete slabs were fabricated. The control slabs were fabricated with plain (uncoated) bars and untreated epoxy-coated bars. The test slabs were fabricated with the disbonded epoxy-coated bars. The slabs were then tested to failure in positive and negative moment. Phase 3 tested the effects of disbondment on pull-out resistance.

The results of the flexural tests indicated essentially no difference in the negative moment capacities and some small differences in the positive moment capacities between the three test groups. The differences were not considered large enough to constitute a structural safety problem. There were measurable differences between the results of pull-out tests conducted with plain bars, untreated epoxy-coated bars, and disbonded epoxy-coated bars. The pull-out resistance of the test specimens with disbonded bars was still within the specified acceptable limits.

The conclusion from this study is that a 20- to 30-percent degree of disbondment between the epoxy coating and its steel substrate for bars used as the main flexural reinforcement of a one-way slab does not compromise the slab's flexural capacity.

The NTIS number for this publication is PB94-133626; the cost is \$19.50 for a paper copy or \$9 for the report on microfiche.

Minimum Retroreflectivity Requirements for Traffic Signs

Publication No. FHWA-RD-93-077

by Office of Safety and Traffic Operations R&D

This study establishes minimum retroreflectivity requirements for traffic signs. Previously, national guidelines regarding the nighttime visibility of signs were limited to the stipulation in the *Manual on Uniform Traffic Control Devices for Streets and Highways* (MUTCD) that all warning and regulatory signs be illuminated or reflective to show the same color and shape by day or night. There were no objective measures to determine when a sign has reached the end of its service life and needs to be replaced.

Given the wide range of visual, cognitive, and psychomotor capabilities of the driving population and the complexity of the relationships between the driver, vehicle, sign, and roadway, a mathematical modeling approach was selected. The model determines the distance at which a driver needs to see a sign, uses this distance to determine the luminance required, and then calculates the coefficient of retroreflection at standard measurement angles. This model is called the Computer Analysis of Retroreflectance of Traffic Signs (CARTS).

CARTS was executed for each sign in the MUTCD at various vehicle speeds, sign sizes, and sign placements. The results are summarized and presented in a format that can be implemented by practitioners. Retroreflectivity values are given for yellow warning signs, orange warning signs, white-on-red regulatory signs, white regulatory signs, and white-on-green guide signs.

The NTIS number for this publication is PB94-124682; the cost is \$19.50 for a paper copy or \$9 for the report on microfiche

Nationally Coordinated Program of Highway Research, Development, and Technology: Annual Progress Report Fiscal Year 1993.

Publication No. FHWA-RD-93-163

by Office of Research and Development Operations and Support

This progress report gives an overview of research and technology transfer being conducted under the Nationally Coordinated Program (NCP) of Highway Research, Development, and Technology (RD&T) from October

1, 1992, through September 30, 1993. The NCP is organized into categories, programs, and projects. The NCP categories covered in this report are: A. Highway Safety, B. Traffic Operations/Intelligent Vehicle-Highway Systems, C. Pavements, D. Structures, E. Materials and Operations, F. Policy, G. Motor Carrier Transportation, J. Planning, K. Environment, L. Right of Way, and M. Advanced Research.

This report highlights the high priority areas to show the research emphasis of the NCP. Each NCP program has a program manager within the FHWA headquarters (Washington, D.C., and the Turner-Fairbank Highway Research Center in McLean, Va.). The program manager coordinates the federal staff and contract activities with the State Planning and Research (SP&R) Program and the National Cooperative Highway Research Program (NCHRP), and the manager networks with other groups, including the American Association of State Highway and Transportation Officials' Standing Committee on Research. This report covers research on all categories, RD&T transfer activities funded by the states, as well as other government and special programs.

This report is available without charge from the R&T Report Center.

TFHRC Achievement Report—1993

Publication No. FHWA-RD-93-172

by Office of Research and Development Operations and Support

This 1993 report is the 17th in a series of annual reports highlighting the achievements of the Turner-Fairbank Highway Research Center. TFHRC is operated by the Federal Highway Administration's Office of the Associate Administrator for Research and Development. This report covers the period from October 1, 1992, to September 30, 1993.

This report is available without charge from the R&T Report Center.

NEW RESEARCH

The following new research studies reported by the Federal Highway Administration's (FHWA) Office of Research and Development are sponsored in whole or in part with federal highway funds. For further details on a particular study, please contact Richard Richter, (703) 285-2134.

NCP Category A—Highway Safety

A.3: Highway Safety Information Management

Title: Improving Traffic Safety Analysis Using GSI

Objective: To conduct a cooperative research effort to develop a proposal to improve traffic safety analysis using geographic information systems (GSI).

Contractor: North Carolina Department of Transportation

Expected Completion Date: October 1995

Estimated Cost: \$201,700

NCP Category B—Traffic Operations/ Intelligent Vehicle-Highway Systems

B.1: Advanced Traffic Management Systems

Title: Integration of Traffic Operations and Traffic Data Collections

Objective: To establish a process and methodology for the integrated collection of traffic data. This research is

expected to result in increased awareness of organizational objectives and increased cooperation between traffic engineering/operations staff and the traffic data collection efforts of the transportation planning programs at both the state and local levels.

Contractor: Georgia and Washington state DOTs

Expected Completion Date: Open

Estimated Cost: \$195,000

NCP Category E—Materials and Operations

E.3: Geotechnology

Title: Standard Reference Soils and Testing Program '94 Overlays

Objective: To conduct a comprehensive interlaboratory testing program to obtain reliable estimates of precision (reproducibility and repeatability) for 12 selected ASTM test methods for soils. To accomplish this requires the production of four uniform standard soils to conduct these tests and future check tests. An interlaboratory testing program involving an estimated 20 voluntary laboratories distributed across the United States will conduct the 12 test methods on the four standard soils. These results will be used to develop reliable precision statements for each method; the statements are necessary to improve cost effectiveness in design and construction programs.

Contractor: National Science Foundation

Expected Completion Date: June 1996

Estimated Cost: \$108,000

TECHNOLOGY APPLICATIONS

The following are brief descriptions of selected items that have been completed recently by state and federal highway units in cooperation with the Office of Technology Applications and the Office of Research and Development, Federal Highway Administration. Some items by others are included when they are of special interest to highway agencies. All publications are available from the National Technical Information Service (NTIS). In some cases, limited copies of publications are available from the R&T Report Center.

When ordering from NTIS, include NTIS' PB number (or publication number) and the publication title. Address requests to:

**National Technical Information Service
5285 Port Royal Road
Springfield, Virginia 22161**

Requests for items available from the R&T Report Center should be addressed to:

**Federal Highway Administration
R&T Report Center, HRD-11
6300 Georgetown Pike
McLean, Virginia 22101-2296
Telephone: (703) 285-2144**

Highway/Utility Guide

Publication No. FHWA-SA-93-049

This guide assembles, under one cover, state-of-the-art knowledge about practices employed to address the full array of issues that can arise from highway and utility facilities sharing common right of way. It provides useful information relevant to joint-use issues, a historical perspective, and good current practices. Issues addressed in the guide include: planning and coordination, design permits, information management and mapping, notification procedures, legal, safety, construction, maintenance, reimbursement, and others.

The NTIS number for this publication is PB94-114436; the cost is \$44.50 for a paper copy or \$17.50 for the report on microfiche.

Pier Scour Equations Used in the People's Republic of China: Review and Summary

Publication No. FHWA-SA-93-076

The focus of this report is on the development of equations based on hydraulic model studies and a considerable amount of field data from China and other countries. Results calculated from the equations are in reasonable agreement with field data. The report is based on a recent research paper by Gao and Xu for improving the equations used in Chinese highway and railway engineering for more than 20 years.

The NTIS number for this publication is PB94-122892; the cost is \$19.50 for a paper copy or \$9 for the report on microfiche.

Along with the quarterly Public Roads Read the *Transporter*

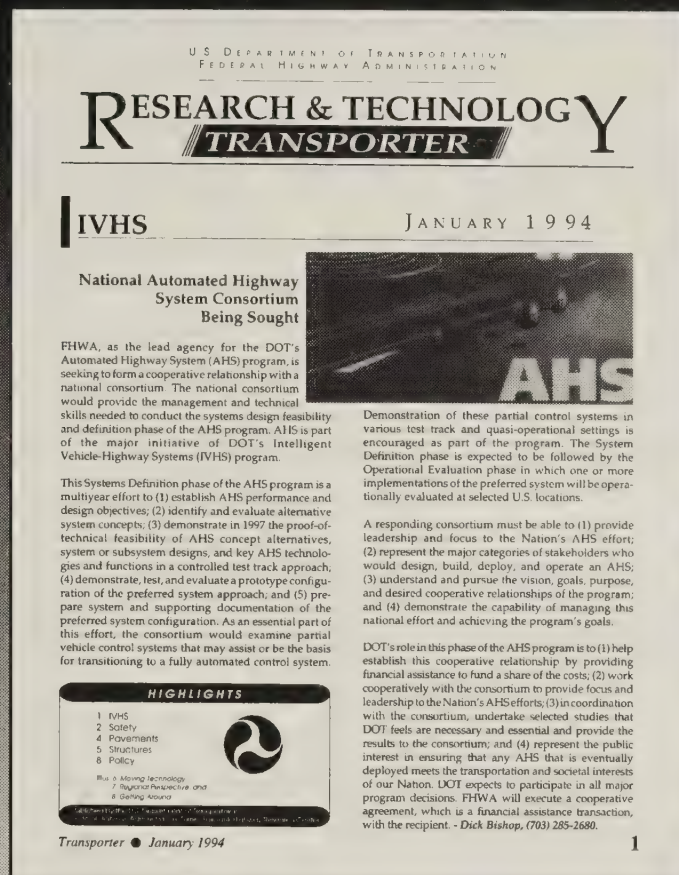

It's the ideal vehicle for bringing you monthly developments in FHWA's research and technology program activities — free.

Join our mailing list for this free monthly publication by sending your name and address to:

Editor, Research & Technology Transporter
Federal Highway Administration, HRD-10
Turner-Fairbank Highway Research Center
6300 Georgetown Pike
McLean, VA 22101-2296

Once on the list, you won't miss a single issue.

Contents of Volume 57

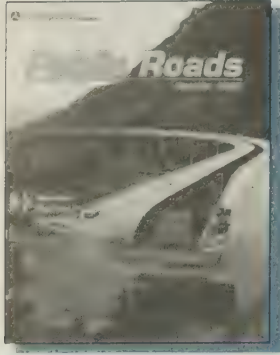

No. 1, Summer 1993

<i>Public Roads</i> —75 Years and Going Strong by Robert V. Bryant	1
A Close Look at Road Surfaces by Rudolph R. Hegmon	4
Highway, Bridge, and Transit Conditions and Performance Adapted from 1993 Biennial Report to Congress	8
H-3: The Island Interstate by Craig Sanders	16
A New Approach to Public-Private Cooperation in Transportation Research by Daniel S. Metzger	22
Side Impacts: The Highway Perspective by Jerry A. Reagan	28

No. 2, Autumn 1993

A Peaceful Campaign of Progress and Reform: The Federal Highway Administration at 100 by Richard F. Weingroff	1
New Era in FHWA Leadership by Ronald A. Zeitz	14
National Geotechnical Experimentation Sites by Albert F. DiMillio and Geraldine C. Prince	17
The Pacific Rim TransTech Conference by William Zaccagnino	23
Changeable Message Signs: Avoiding the Design and Procurement Pitfalls by Pamela P. Marston	27

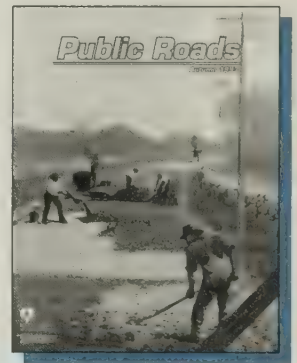

No. 3, Winter 1994

The National Highway System Adapted from a speech by Rodney E. Slater	1
Applied Research and Technology: New Guidelines for Accelerating the Use of Innovative Technology by the Highway Industry by Richard A. McComb and Daniel F. Larson	5
Highway Innovative Technology Evaluation Center by Louis Colucci and Robert Bryant	9
Modeling of Geotextiles and Other Membranes in the Prevention of Reflection Cracking in Asphaltic Resurfacing by Luis F. DaSilva and Juan A. Confré	12
HYSIM: the Next Best Thing to Being on the Road by Elizabeth Alicandri	19
FHWA's Implementation Plan for SHRP Products by Charles J. Churilla	24
Environmental Research: Helping Highways Improve the Quality of Life by Ginny Finch	30
Looking for a Few Good Ideas by K. Thirumalai	32
The National Quality Initiative by Donald Tuggle	33

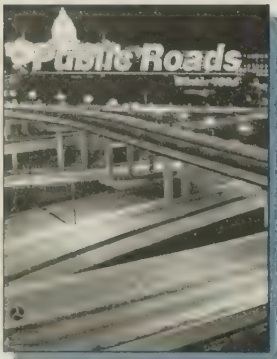

Texas High-Strength Concrete Bridge Project
by Mary Lou Ralls and Ramon Carrasquillo 1

The Impact of Highway Infrastructure on Economic Performance
by Theresa M. Smith 8

Automatic Weather Station Installed at Turner-Fairbank Highway Research Center
by Aramis Lopez 15

An Automatic Warning System to Prevent Truck Rollover on Curved Ramps
by Hugh W. McGee and Rodney R. Strickland 17

FHWA Assistance to Russia
by Bert Schacknies 23

Using Finite Element Analysis in Designing Roadside Hardware
by Malcolm Ray 28

National Crash Analysis Center
by Azim Eskandarian, Nabih E. Bedewi, and Leonard Meczkowski 32



List of Authors
(and issue and page references)

Elizabeth Alicandri 3/p.19

Nabih E. Bedewi 4/p.32

Robert V. Bryant 1/p.1, 3/p.9

Ramon Carrasquillo 4/p.1

Charles J. Churilla 3/p.24

Louis Colucci 3/p.9

Juan A. Confré 3/p.12

Luis F. DaSilva 3/p.12

Albert F. DiMillio 2/p.17

Azim Eskandarian 4/p.32

Ginny Finch 3/p.30

Rudolph R. Hegmon 1/p.4

Daniel F. Larson 3/p.5

Aramis Lopez 4/p.15

Pamela P. Marston 2/p.27

Richard A. McComb 3/p.5

Hugh W. McGee 4/p.17

Leonard Meczkowski 4/p.32

Daniel S. Metzger 1/p.22

Geraldine C. Prince 2/p.17

Mary Lou Ralls 4/p.1

Malcolm Ray 4/p.28

Jerry A. Reagan 1/p.28

Craig Sanders 1/p.16

Bert Schacknies 4/p.23

Rodney E. Slater 3/p.1

Theresa M. Smith 4/p.8

Rodney R. Strickland 4/p.17

K. Thirumalai 3/p.32

Donald Tuggle 3/p.33

Richard F. Weingroff 2/p.1

William Zaccagnino 2/p.23

Ronald A. Zeitz 2/p.14

Statement of Ownership, Management and Circulation
(Required by 39 U.S.C. 3685)

1A Title of Publication Public Roads		1B PUBLICATION NO	2 Date of Filing February 1, 1994
3 Frequency of Issue Quarterly		3A No. of Issues Published Annually Four	3B Annual Subscription Price 7.50/yr (domestic) 9.40/yr (foreign)
4 Complete Mailing Address of Known Office of Publication (Street, City, County, State and ZIP + 4 Code) (Not printers) Federal Highway Administration 400 7th St. S.W., Washington, DC 20590			
5 Complete Mailing Address of the Headquarters of General Business Offices of the Publisher (Not printer) Same as item 4			
6 Full Names and Complete Mailing Address of Publisher, Editor, and Managing Editor (This item MUST NOT be blank)			
Publisher (Name and Complete Mailing Address) Same as item 4			
Editor (Name and Complete Mailing Address) Robert V. Bryant Federal Highway Administration, HRD-10 6300 Georgetown Pike, McLean, VA 22101-2296			
Managing Editor (Name and Complete Mailing Address) Anne N. Barsanti Federal Highway Administration, HRD-10 6300 Georgetown Pike, McLean, VA 22101-2296			
7 Owner (If owned by a corporation, its name and address must be stated and also immediately thereunder the names and addresses of stockholders owning or holding 1 percent or more of total amount of stock. If not owned by a corporation, the names and addresses of the individual owners must be given. If owned by a partnership or other unincorporated firm, its name and address, as well as that of each individual must be given. If the publication is published by a nonprofit organization, its name and address must be stated.) (Item must be completed.)			
Full Name U.S. Department of Transportation		Complete Mailing Address 400 7th St. S.W., Washington, DC 20590	
8 Known Bondholders, Mortgagees, and Other Security Holders Owning or Holding 1 Percent or More of Total Amount of Bonds, Mortgages or Other Securities (If there are none, so state)			
Full Name N/A U.S. Government Publication		Complete Mailing Address	
9 For Completion by Nonprofit Organizations Authorized to Mail at Special Rates (DMJ Section 424.12 only) The purpose, function, and nonprofit status of this organization and the exempt status for Federal income tax purposes (Check one)			
(1) <input checked="" type="checkbox"/> Has Not Changed During Preceding 12 Months			
(2) <input type="checkbox"/> Has Changed During Preceding 12 Months (If changed, publisher must submit explanation of change with this statement.)			
10 Extent and Nature of Circulation (See instructions on reverse side)		Average No. Copies Each Issue During Preceding 12 Months	Actual No. Copies of Single Issue Published Nearest to Filing Date
A Total No. Copies (Net Press Run)		5143	5500
B Paid and/or Requested Circulation		0	0
1 Sales through dealers and carriers, street vendors and counter sales			
2 Mail Subscription (Paid and/or requested)		850	850
C Total Paid and/or Requested Circulation (Sum of 10B1 and 10B2)		850	850
D Free Distribution by Mail, Carrier or Other Means (Samples, Complimentary, and Other Free Copies)		4061	4435
E Total Distribution (Sum of C and D)		4911	5285
F Copies Not Distributed		232	215
1 Office use, left over, unaccounted, spoiled after printing			
2 Return from News Agents		0	0
G TOTAL (Sum of E, F1 and 2—should equal net press run shown in A)		5143	5500
11 I certify that the statements made by me above are correct and complete		Signature and Title of Editor, Publisher, Business Manager, or Owner <i>Anne N. Barsanti</i> Anne N. Barsanti, Managing Editor	

PS Form 3526, January 1991 (See instructions on reverse)

U.S. Department
of Transportation

**Federal Highway
Administration**

400 Seventh St., SW
Washington, DC 20590

Official Business
Penalty for Private Use \$300

SECOND CLASS MAIL
Postage and Fees Paid
Federal Highway Administration
ISSN No. 0033-3735
USPS No. 516-690

in this issue

Texas High-Strength Concrete Bridge Project

The Impact of Highway Infrastructure on Economic Performance

Automatic Weather Station Installed at
Turner-Fairbank Highway Research Center

An Automatic Warning System to Prevent Truck
Rollover on Curved Ramps

FHWA Assistance to Russia

Using Finite Element Analysis in Designing Roadside
Hardware

National Crash Analysis Center





DOT LIBRARY



00181255