

Detecting Driver Drowsiness with Multi-Sensor Data Fusion Combined with Machine Learning

Hovannes Kulhandjian



Mineta Transportation Institute

Founded in 1991, the Mineta Transportation Institute (MTI), an organized research and training unit in partnership with the Lucas College and Graduate School of Business at San José State University (SJSU), increases mobility for all by improving the safety, efficiency, accessibility, and convenience of our nation's transportation system. Through research, education, workforce development, and technology transfer, we help create a connected world. MTI leads the [Mineta Consortium for Transportation Mobility](#) (MCTM) funded by the U.S. Department of Transportation and the [California State University Transportation Consortium](#) (CSUTC) funded by the State of California through Senate Bill 1. MTI focuses on three primary responsibilities:

Research

MTI conducts multi-disciplinary research focused on surface transportation that contributes to effective decision making. Research areas include: active transportation; planning and policy; security and counterterrorism; sustainable transportation and land use; transit and passenger rail; transportation engineering; transportation finance; transportation technology; and workforce and labor. MTI research publications undergo expert peer review to ensure the quality of the research.

Education and Workforce

To ensure the efficient movement of people and products, we must prepare a new cohort of transportation professionals who are ready to lead a more diverse, inclusive, and equitable transportation industry. To help achieve this, MTI sponsors a suite of workforce development and education opportunities. The Institute supports educational programs offered by the Lucas Graduate School of Business: a

Master of Science in Transportation Management, plus graduate certificates that include High-Speed and Intercity Rail Management and Transportation Security Management. These flexible programs offer live online classes so that working transportation professionals can pursue an advanced degree regardless of their location.

Information and Technology Transfer

MTI utilizes a diverse array of dissemination methods and media to ensure research results reach those responsible for managing change. These methods include publication, seminars, workshops, websites, social media, webinars, and other technology transfer mechanisms. Additionally, MTI promotes the availability of completed research to professional organizations and works to integrate the research findings into the graduate education program. MTI's extensive collection of transportation-related publications is integrated into San José State University's world-class Martin Luther King, Jr. Library.

Disclaimer

The contents of this report reflect the views of the authors, who are responsible for the facts and accuracy of the information presented herein. This document is disseminated in the interest of information exchange. MTT's research is funded, partially or entirely, by grants from the California Department of Transportation, the California State University Office of the Chancellor, the U.S. Department of Homeland Security, and the U.S. Department of Transportation, who assume no liability for the contents or use thereof. This report does not constitute a standard specification, design standard, or regulation.

Report 21-25

Detecting Driver Drowsiness with Multi-Sensor Data Fusion Combined with Machine Learning

Hovannes Kulhandjian

September 2021

A publication of the
Mineta Transportation Institute
Created by Congress in 1991

College of Business
San José State University
San José, CA 95192-0219

TECHNICAL REPORT DOCUMENTATION PAGE

1. Report No. 21-25	2. Government Accession No.	3. Recipient's Catalog No.	
4. Title and Subtitle Detecting Driver Drowsiness with Multi-Sensor Data Fusion Combined with Machine Learning		5. Report Date September 2021	
		6. Performing Organization Code	
7. Authors Hovannes Kulhandjian: 0000-0002-8983-6757		8. Performing Organization Report CA-MTI-2015	
9. Performing Organization Name and Address Mineta Transportation Institute College of Business San José State University San José, CA 95192-0219		10. Work Unit No.	
		11. Contract or Grant No. ZSB12017-SJAUX	
12. Sponsoring Agency Name and Address State of California SB1 2017/2018 Trustees of the California State University Sponsored Programs Administration 401 Golden Shore, 5th Floor Long Beach, CA 90802		13. Type of Report and Period Covered	
		14. Sponsoring Agency Code	
15. Supplemental Notes			
16. Abstract <p>According to the National Highway Traffic Safety Administration, in 2017 drowsy driving resulted in 50,000 injuries across 91,000 police-reported accidents, as well as almost 800 deaths. Through the application of visual and radar sensors combined with machine learning, this research developed a drowsy driver detection system aimed to prevent potentially fatal accidents. The working prototype of Advanced Driver Assistance Systems can be installed in present-day vehicles to detect drowsy drivers with over 95% accuracy. It integrates two types of visual surveillance to examine the driver for signs of drowsiness. A camera is used to monitor the driver's eyes, mouth and head movement in order to recognize when a discrepancy occurs in the driver's eye blinking pattern, yawning incidence, and/or head drop, thereby signaling that the driver may be experiencing fatigue or drowsiness. The micro-Doppler sensor in the system allows the driver's head movement to be captured at all times. Through data fusion and deep learning, the system quickly analyzes and classifies a driver's behavior under various conditions in real-time monitoring. This research could be implemented to reduce drowsy driving, thereby, making the roads safer for everyone and ultimately saving lives.</p>			
17. Key Words Intelligent Transportation Systems (ITS), Drowsy Driver Detection, Applied Machine Learning, Accident Prevention, Advanced Driver Assistance systems (ADAS)		18. Distribution Statement No restrictions. This document is available to the public through The National Technical Information Service, Springfield, VA 22161.	
19. Security Classif. (of this report) Unclassified	20. Security Classif. (of this page) Unclassified	21. No. of Pages 34	22. Price

Copyright © 2021
by **Mineta Transportation Institute**

All rights reserved.

DOI: 10.31979/mti.2021.2015

Mineta Transportation Institute
College of Business
San José State University
San José, CA 95192-0219

Tel: (408) 924-7560
Fax: (408) 924-7565
Email: mineta-institute@sjsu.edu

transweb.sjsu.edu/research/2015

ACKNOWLEDGMENTS

This study was supported by both the CSU Transportation Consortium and the Fresno State Transportation Institute. Any opinions, findings, conclusions, and recommendations expressed in this material are those of the author and do not necessarily reflect the views of these institutes. The author would like to thank his student assistant, Nicolas Martinez, an undergraduate student who graduated from the Electrical and Computer Engineering department at California State University, Fresno for working on this interesting research project and implementing and testing the final proposed prototype. The author would also like to thank Editing Press for editorial services, as well as MTI staff.

CONTENTS

Acknowledgments	iv
List of Figures.....	vi
Executive Summary	1
1. Introduction.....	3
2. System Overview.....	5
2.1. System Design	5
2.2. Deep Convolutional Neural Network Design.....	6
2.3. Micro-Doppler Radar	10
3. Driver Drowsiness Detection using a Webcam	11
3.1. Blink Detection.....	11
3.2. Yawn Detection	12
4. Driver Drowsiness Detection using Micro-Doppler Radar.....	14
4.1. Micro-Doppler Radar Setup	14
4.2. Experimental Results on Head Drop Detection	15
5. Prototype Experimentations.....	17
5.1. Camera System	17
5.2. Micro-Doppler System	18
5.3. Testbed Experimentation in a Vehicle.....	19
6. Conclusion.....	21
Abbreviations and Acronyms	22
Bibliography	23
About the Author	25

LIST OF FIGURES

Figure 1. Block Diagram of the Drowsy Driver Detection System	6
Figure 2. Convolutional Neural Network Architecture for the Video Image Input.....	7
Figure 3. Convolutional Neural Network Architecture for the Spectrogram Image Input	7
Figure 4. Max Pooling Principle	8
Figure 5. Sample Images of Driver’s Mouth Open and Closed Along with Face Detection	9
Figure 6. Machine Learning Model Conversion Process.....	10
Figure 7. Accuracy and Loss Training Results for Blink Detection Model.....	12
Figure 8. Accuracy and Loss Training Results for Yawn Detection Model.....	13
Figure 9. Amplifier Circuit Schematic for Micro-Doppler sensor	14
Figure 10. Micro-Doppler Spectrogram of a Head Drop	15
Figure 11. Micro-Doppler Spectrogram of No Head Drop.....	15
Figure 12. Micro-Doppler DCNN Training Result.....	16
Figure 13. System Hardwar Layout.....	17
Figure 14. Touchscreen Display for User Interface.....	18
Figure 15. Micro-Doppler Data Collection and Processing Unit	19
Figure 16. System Setup in a Vehicle	19
Figure 17. Live Demonstration of the Drowsy Driver Detection System in a Vehicle.....	20

Executive Summary

Driving while drowsy is one of the most prevalent causes of motor vehicle accidents. Driver drowsiness is reported to be responsible for 1–2% of all motor vehicle accidents (Owens et al, 2018), however, other studies reveal that the number of reported accidents is considered to be conservative. Although the effects of drowsiness and fatigue are often compared to the impairment caused by drinking alcohol, the evidence of drowsiness in the event of a crash are unreliable and often go unseen. “Drowsiness is similar to alcohol in how it compromises driving ability by reducing alertness and attentiveness, delaying reaction times, and hindering decision-making skills,” said Dr. Nathaniel Watson, spokesperson for the American Academy of Sleep Medicine. “Drowsy driving is deadly, but it can be prevented” (American Academy of Sleep Medicine, 2015). A research brief by the American Automobile Association (AAA) Foundation for Traffic Safety, states that standard police reports cannot be used as the sole source of data in estimating the number of crashes involving driver drowsiness due to two main reasons: firstly, the presence of drowsiness after a crash may be entirely absent given what the driver(s) have just endured. Secondly, drivers involved in motor vehicle crashes are hesitant to admit to their drowsy state. In an effort to determine the prevalence of drowsy driving, the AAA Foundation for Traffic Safety obtained naturalistic driving data by placing video cameras in 3,593 subject’s vehicles for roughly a three year period. A total of 701 police reportable crashes were recorded. The results demonstrated that the percentage of crashes where drowsiness was involved was between 10.6–10.8% (Owens et al., 2018), as opposed to the NHTSA’s estimated 1.4% (NHTSA, 2017). To understand how underreported driver drowsiness is, we can apply the two percentages (i.e., 10.6–10.8%) to the total number of reported crashes for 2018. In doing so, the resulting values are to be considered generous given the absence of unreported occurrences where driver drowsiness may have been involved. The NHTSA estimates that in 2018, there were 6.73 million police-reported crashes in the United States (National Center for Statistics and Analysis, 2018). Applying the NHTSA’s estimated total percentage of driver drowsiness crashes to the total number of accidents reported in 2018 results in approximately 94,000 cases, while applying the more probable percentage determined by the AAA results in over 700,000 cases. An astounding 700% increase in the number of crashes where driver drowsiness may have played a role, but failed to be reported. Drowsy driving is defined by the American Academy of Sleep Medicine as the moment at which a person who is operating a motor vehicle becomes too tired to remain alert and as a result may have slow reaction times, reduced vigilance, and impaired thinking (American Academy of Sleep Medicine, 2015). There are many symptoms of drowsiness and fatigue one must be aware of when thinking about operating a motor vehicle. The signs include: yawning, inability to keep your eyes open, nodding off, inability to remember driving the last few miles, and drifting into other lanes or onto the shoulder (American Academy of Sleep Medicine, 2015).

In this research, we provide a reliable solution to address the issue of driver drowsiness. Our driver drowsiness detection system uses image data recorded by a webcam and signatures returned from a micro-Doppler radar, combined with deep learning, to classify the state of alertness of the driver. In order to determine a driver's level of alertness, facial images sent from the webcam will serve as the input to the Deep Convolution Neural Network (DCNN) algorithm. The DCNN classifies the state of the driver's eyes, mouth, and head position. Through these classifications, patterns resembling symptoms of drowsiness can be detected and then used to alert the driver when they are or may become drowsy. The micro-Doppler sensor is also used to track the motion of the driver's head; since nodding off is a common symptom of drowsiness. The sensory data from the micro-Doppler also serves as input to a second DCNN architecture that will classify the driver as drowsy, and alert them promptly. A vibration of the steering wheel is used to alert the driver when the system detects the driver is about to doze off.

1. Introduction

According to the National Highway Traffic Safety Administration (NHTSA) 91,000 police-reported crashes involved drowsy drivers in 2017 alone. These crashes led to an estimated 50,000 people injured and claimed 795 lives. However, these numbers are underestimated, and up to 6,000 fatal crashes each year may be caused by drowsy drivers (Klauer 2006, Tefft 2014, Institute of Medicine, 2014). According to a study conducted by the Centers for Disease Control and Prevention (CDC), 1 in 25 drivers surveyed reported that they had fallen asleep while driving in the past 30 days (CDC, 2021). Studies have shown that not having enough sleep, hence being drowsy, can impair drivers' abilities the same way as drinking too much alcohol. "Drowsy drivers put themselves and others at risk through a slower reaction time and the inability to pay attention," said California Highway Patrol (CHP) Commissioner Warren Stanley at a press release (California Highway Patrol, Press Release, 2019). He went on and added, "[a] sleepy driver can be just as impaired or dangerous as one under the influence of alcohol or drugs". In addition, at that same press release, California Department of Transportation (Caltrans) Director Toks Omishakin said, "[i]n a state the size of California, long drives between cities are common. Without enough rest, all of us may feel drowsy behind the wheel". According to the California Office of Traffic Safety, the main signs of driver fatigue are yawning, blinking frequently, as well as daydreaming (California Office of Traffic Safety, Drowsy Driving, 2021). Drowsiness impairs mental alertness, making it difficult to drive safely and increasing the risk of human error, which can lead to fatalities and injuries. It has also been shown to slow reaction time, decrease memory, and impair judgment. Due to long hours behind the wheel in monotonous driving conditions, truck drivers are particularly prone to drowsy driving accidents (Barr et al., 2005).

One possible solution is to enable the vehicle to detect drowsiness or discrepancies in the driver's behavior and alert the user when this occurs. The research on detecting drowsy drivers and alerting them is still in its infancy. The Intelligent Transportation System (ITS) are paving new research directions on this subject matter. ITS has been leading the revolutionary ideas on improving the transportation system, ranging from autonomous driving to using smart traffic light controller through visible light communications (Kulhandjian, California State Transportation Consortium, Project No. 1911, 2020). Several methods have been explored to detect driver drowsiness with the intention to alert them (Saini 2014, Stork 2015, Lee 2008). To the best of our knowledge, no prior research work has explored or experimented with the idea of using data fusion (DF) from multiple sensors (i.e., video camera with night vision capabilities and micro-Doppler radar) combined with machine learning (ML) to create a drowsy driver detection and alerting mechanism. Therefore, we believe that this research exploration could lead to new Artificial Intelligent-based application tools for drivers that could potentially save lives. In this research study we explore the state-of-the-art ML techniques combined with DF to achieve this objective. The goal for this research is to maximize the detection accuracy of drowsy driving and alert drivers by effectively data fusing the

information gathered from a video camera with night vision capabilities and micro-Doppler radar along with the use a trained Deep Convolutional Neural Network (DCNN) system to classify and identify drowsy driving features in real-time. Using this valuable multi-dimensional data, the DCNN system could make intelligent inferences about driver behavior and alert drowsy drivers to prevent them from falling asleep and having or causing a fatal accident. The proposed system can be installed in a smart vehicle that can provide a real-time drowsy driving alerting mechanism by vibrating the steering wheel and displaying a message on a monitor/dashboard (e.g., “Stay Awake to Stay Alive”, “Coffee Time”, etc.) to warn the driver not to fall asleep and recommend they pull over to have some rest. The proposed system can be used both during the day and at night, using the combination of video camera with night vision capabilities and micro-Doppler radar sensor.

2. System Overview

2.1 System Design

This system is designed to inform a driver of their state of alertness. The system utilizes machine learning, combined with a web camera, and a micro-Doppler sensor, to make an accurate assessment of the driver's current state. The camera is responsible for capturing sample images of the driver's face. The camera is strategically placed so that it captures a clear image of the driver's head, eyes, and mouth. Once the driver's face is detected, the eyes and mouth are cropped automatically by running a computer script and formatted to serve as the input to their respective deep convolutional neural network models that will be used to train them. The micro-Doppler is used to detect driver's head dropping while in a drowsy state. The deep convolutional neural networks algorithm, after being trained with the labeled trained images, will make predictions corresponding to the driver's behaviors captured in the sample images. The predictions made are then used to detect blinks, head movements, and yawning. The deep convolutional neural networks algorithm are run on a Raspberry Pi paired with a Coral USB Accelerator used to reduce inference times, which is real-time processing time. The detections are made continuously over a sample period of sixty seconds. Once each sample period has elapsed, the cumulative detections of blinks, head drops, and yawns are used to assess the driver's state of alertness. The models predictions and the number of detections captured are displayed to the driver through the touch screen display in real-time. If the driver is determined to be drowsy, a signal is sent to a vibration motor connected to the steering wheel of the vehicle. The vibration of the steering wheel alerts the driver and deters them from dozing off.

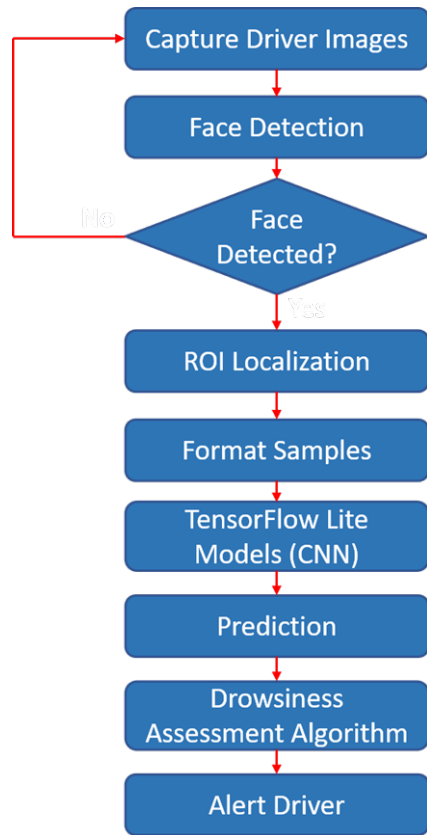

Figure 1. Block Diagram of the Drowsy Driver Detection System.

Figure 1 shows an overview of how the complete system operates. The camera first captures images of the driver and then runs the face detection algorithm, in case a face is detected it runs the region of interest localization algorithm to detect the eyes and the mouth. Once a face is detected, the system automatically crops and formats the images of the eyes and the month, which is used as an input for the DCNN algorithm. TensorFlow Lite, an open source deep learning framework for on-device inference, is used for training the DCNN. Once the images are fed into the machine learning model it will provide predictions that includes for example whether the eyes are closed or open, the number of blinks, whether the mouth is open or closed, if the person is yawning or not, etc. All the predictions are fed into the drowsiness assessment algorithm, which makes use of a data fusion algorithm by combining all the predictions in order to make a judgement on the status of the driver, i.e., whether the driver is about to doze off or not. In case the driver is about to doze off, an alert is sent to the vibration motor located on the steering wheel to alert the driver.

2.2 Deep Convolutional Neural Network Design

There are several algorithms used to detect eye blinking, such as: local binary patterns, scale invariant feature transform, speed up robust features, Eigenfaces, and Fishersfaces. However, this project will focus on more recently developed blink detection methods using deep learning. Deep

learning is a branch of machine learning in artificial intelligence. Deep learning algorithms use artificial neural networks that replicate the functionality of a brain. It is made up of layers of artificial nodes that carry raw input data through each layer to the final output layer. These neural networks are powerful in decision making, and are able to learn from unstructured data. A deep convolutional neural network (DCNN) model is created in this project, as DCNN are most common for image classification. The architecture of the DCNN algorithm implemented in this project is shown in Figures 2 and 3, for the video image input and micro-Doppler spectrogram image input, respectively.

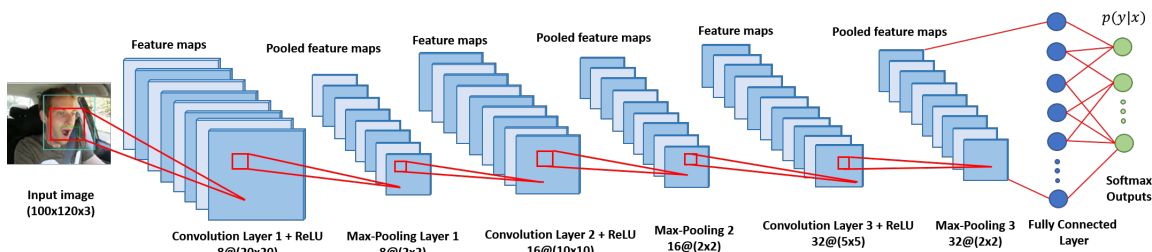

Figure 2. Convolutional Neural Network Architecture for the Video Image Input

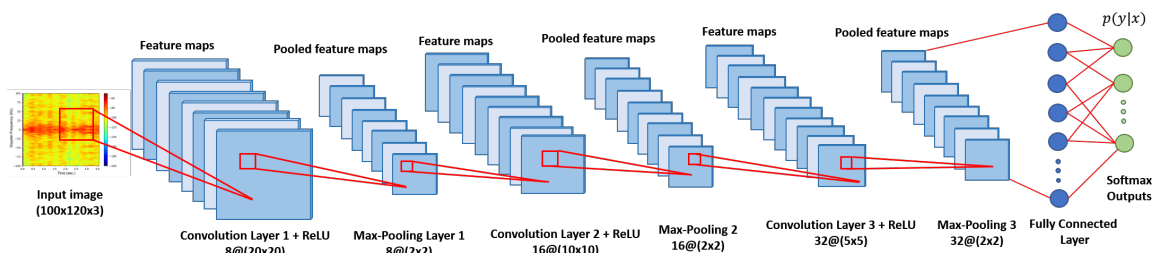

Figure 3. Convolutional Neural Network Architecture for the Spectrogram Image Input

The captured video and spectrogram images are first cropped to 100×120 pixel RGB images. The input images then undergo feature extraction, by first being processed by the convolution layer consisting of 8 convolution filters of size 20×20 . The output from the convolution layer goes through the rectified linear unit (ReLU) function, followed by the pooling layer which employs max pooling process of 2×2 matrices. This process is repeated several times to create the output and train the machine with inherent features of the image. The output of the pooling layer is then fed into a second convolution layer consisting of 16 convolution filters of size 110×10 . Similarly, after passing the output through the ReLU function it undergoes the pooling layer, with max pooling size of 2×2 matrices. Finally, it is passed through a third round convolution layer, consisting of 32 convolution filters of size 5×5 , after which it is again processed by the ReLU function

and the pooling layer with max pooling size of 2×2 matrices. The max pooling concept is demonstrated in Figure 4.

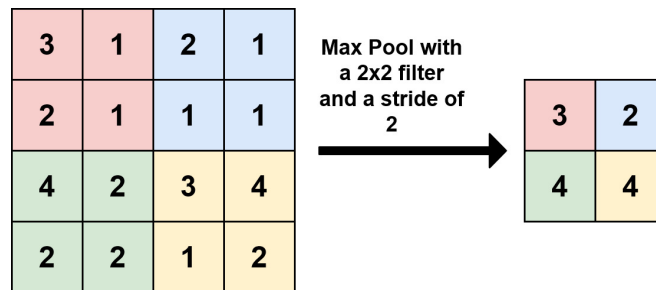

Figure 4. Max Pooling Principle

The stride is the sliding window operation, which is used in the convolution layer, and in the max pooling operation, in which case the stride is 2 (Kulhandjian et al., ACM WUWNNet, 2019). Suppose $n \times n$ convolutions are performed, the stride represents the movement by S elements with every step. If the stride is defined as 1, that means the convolution layer will move with sliding window of 1 pixel and move every third pixel by skipping the second pixel. Max pooling, shown in Figure 4, is a down sampling process where the maximum value is selected from each view (Kulhandjian et al., IEEE GLOBECOM, 2019). Since the video and spectrogram images contain sharp edges, max pooling instead of average pooling is used to extract the most important features such as edges. The classifier network consists of a fully connected layer comprised of 100 hidden nodes, which produce a Softmax output that in turn is used for classifying the driver's status. The output layer of the DCNN represents the probability distribution containing the probabilities that each class is assigned in accordance to the input images. Once the driver's face has been detected, the Raspberry Pi will perform one of two operations. If the eyes are closed for a certain amount of time, then the driver will be alerted. If the eyes are not closed or do not show signs of drowsiness, then the camera will continue to capture images until the eyes are closed for a certain amount of time.

Figure 5 shows sample images of drivers' mouths open and closed, as well as face detection that is performed by the DCNN algorithm.

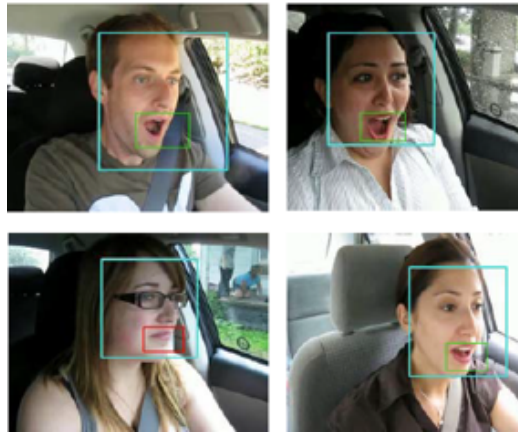

Figure 5. Sample Images of Driver's Mouth Open and Closed Along with Face Detection

In order to obtain reliable results regarding the systems capabilities for capturing rapid changes in biometric data, the DCNN model was converted into a model capable of running on the Raspberry Pi coupled with the Coral USB Accelerator. The model conversion process is shown in Figure 6, in which the model must be compiled to run on the Edge Tensor Processing Unit (TPU), which is an Artificial Intelligence (AI) accelerator application-specific integrated circuit (ASIC) developed by Google, specifically for neural network machine learning, particularly using Google's own TensorFlow software.

First, the TensorFlow model is converted into a TensorFlow Lite model. TensorFlow Lite models are scaled down in size, in terms of data representation, and they produce faster inference times. TensorFlow Lite allows for models to run efficiently on low-power devices with limited memory resources. The converted parameters of the Tensorflow Lite model are represented using 32-bit floating point numbers, however, the Edge TPU requires 8-bit fixed point numbers. The 8-bit fixed point numbers can be obtained from the next step of the conversion process, which is post-training quantization. The method of post-training quantization used was called full integer quantization. Full integer quantization scales the model down by an additional four times, and speeds up inferencing times by a factor of three. The last step in the model conversion process is done to compile the quantized TensorFlow Lite model using the Edge TPU compiler. In this project, multiple models were compiled to further increase the model performance.

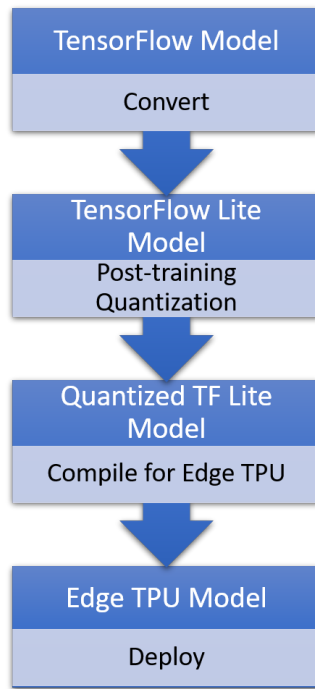

Figure 6. Machine Learning Model Conversion Process.

2.3 Micro-Doppler Radar

The secondary measure includes the use of a micro-Doppler sensor, MH-ET Live HB100 operating at 10.5GHz frequency. The micro-Doppler sensor is used to detect any sudden head movements that could indicate drowsy driving. The microwave sensor uses the data from the captured motion and produces an output that is an analog voltage between 0 to 5 volts. The analog output is then converted into a digital voltage, with the help of an analog-to-digital (ADC) converter (ADC), ADS1115 16-bit. Additional details of the micro-Doppler radar system is discussed in **Section 4**.

3. Driver Drowsiness Detection Using Webcam

3.1 Blink Detection

The dataset used for the blink detection model was a combination of the Closed Eyes in the Wild (CEW) dataset (Song et al., 2014) and our own collected images. The CEW dataset consisted of over 2400 subjects with different ethnic backgrounds, various age groups and genders as well as with and without glasses. The images were captured with both open and closed eyes. The image dimensions were 100x100 pixels, therefore, localization of the eyes in each image was done in advance to train the DCNN model. Since every image was of the same dimension, the cropping of the eyes was automated using a Python program. The eye-blinking model was trained to handle input images of 100x75 pixels. The resizing of each image was done to take advantage of the increase in the pixel data. In doing so, a portion of the images from the CEW dataset suffered distortion and blurriness, which posed a potential imbalance in the continuity of the dataset, hence they were removed. After curating the dataset, the deep convolutional neural network was trained. A validation accuracy of 91.8% was achieved as shown in Figure 7. Examining the validation graph, accuracy begins to plateau after nine epochs of training, indicating that the model has reached its peak performance. One epoch is when the entire training data set is passed forward and backward through the neural network once. Since the training data set is often limited, in practice multiple epochs are utilized to allow the learning algorithm to run until the error from the model is sufficiently minimized. The validation accuracy represents the accuracy the model can practically achieve when new samples are input to the model. The loss metric of the attained model describes how well the model is responding to training after each iteration. The loss is used to optimize the model so that the accuracy of the next prediction can be improved. Ideally, the loss will continue to decrease as training continues.

In order to detect the blinking pattern of a driver, one must first be able to detect a single blink. A blink in its basic routine starts with an open eye, transitions to a closed eye, and then back again to an open eye. The neural network functions on the assumption of simultaneous eye opening and eye closure because that is the basis of its training. As such, the eye-blinking model only detects the current state of the driver's eyes, open or closed. It is the rapid succession of the blinking routine that allows for the detection of a single blink. The blink detection algorithm will first wait for the neural network to detect an open eye, and then for the detection of a closed eye. Once a closed eye is detected, the driver's eyes may either return to their open state, signaling a blink, or remain closed, indicating a possibility of drowsiness. The blink detection algorithm will continuously count the number of consecutive frames the driver's eyes are classified as closed. The algorithm utilizes a threshold value of 7 frames. Seven consecutive frames was found to be ideal, due to the variable frame rate of the system at run time. The system fluctuated between 16-20 fps (frames per second). Thus, seven frames was chosen due to the length of the average blink being

one-third of a second, therefore, one-third of an average of 18 fps is 6 frames, and therefore 7 frames is ideal selection for the threshold.

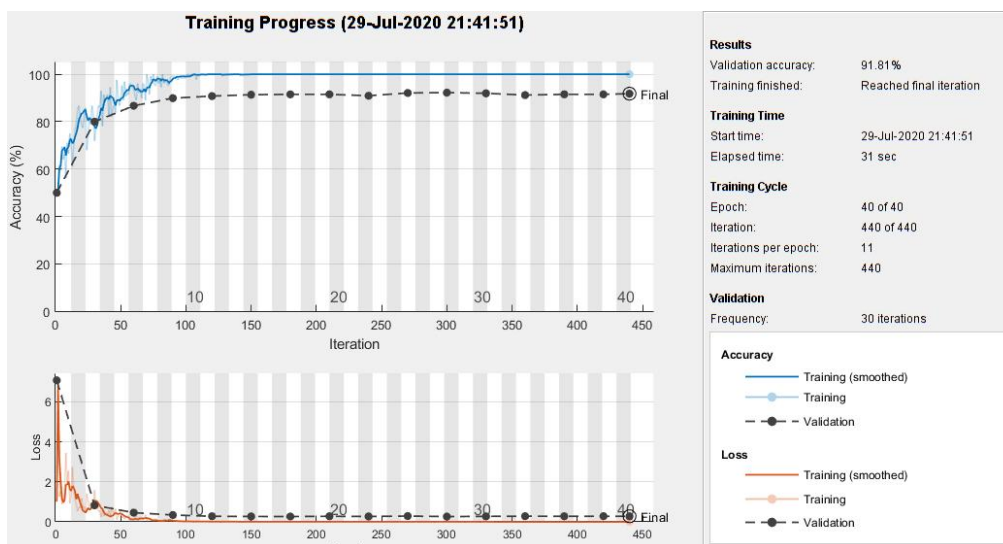

Figure 7. Accuracy and Loss Training Results for Blink Detection Model.

3.2 Yawn Detection

In this section, we present the results of the trained model for yawn detection. The dataset used to train the yawning model was from IEEE DataPort YAWDD: Yawning Detection Dataset (Abtahi et al, 2014), which contains a combination of yawn, no yawn and an unknown class in addition to our own collected images of those three categories. The dataset consisted of 1728 images composed of 576 images of each type of classification. The metrics used to interpret the performance of the DCNN training are measured by accuracy and loss. The model accuracy is shown in Figure 8. When training a DCNN, a common issue that occurs is over-fitting. Over-fitting is when the model learns from the training data well, but when tested with the testing data, the model is less capable of making accurate predictions. The validation accuracy begins to plateau after nine epochs of training, indicating that the model has reached its peak performance. Overall, a validation accuracy of 95.1% was achieved for yawn detection, as shown in Figure 8. Ten epochs were used in the DCNN training process with 19 iterations per epoch.

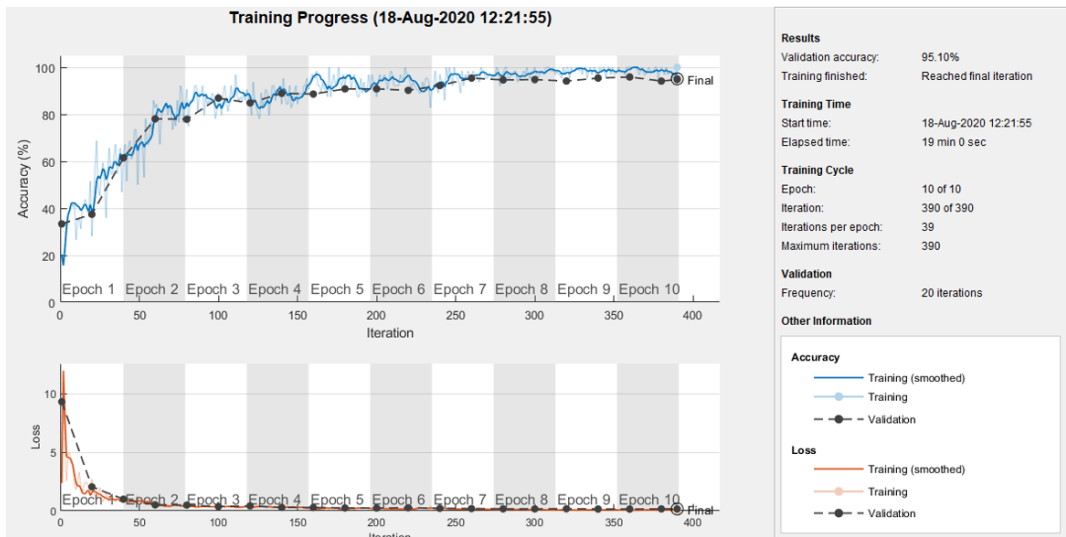

Figure 8. Accuracy and Loss Training Results for Yawn Detection Model.

4. Drowsiness Detection Using Micro-Doppler Radar

4.1 Micro-Doppler Radar Setup

The micro-Doppler radar sensor HB100 transmits a sinusoidal waveform at the frequency 10.5GHz and the reflected waveforms are collected by the radar. The reflected radar signals are first amplified using the amplifier circuit, shown in Figure 9. After which the voltages are passed through an ADC converter to enable processing of the radar data in the digital domain in a computer, in this case a Raspberry Pi 4 model B was used as the processing unit.

The received signals from the micro-Doppler radar were further converted into spectrograms, which are a visual representation of the spectrum of frequencies of a signal as it varies with time. The spectrogram images are used as an input image in training the DCNN architecture discussed in Section 2.2 and are shown in Figure 3.

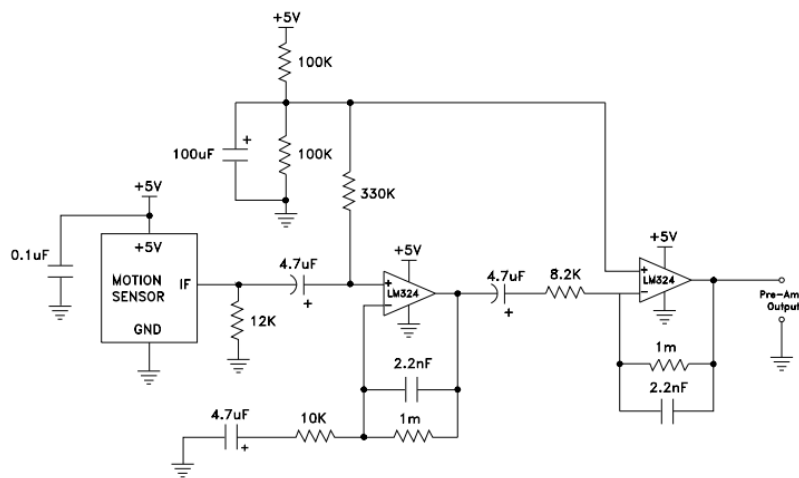

Figure 9. Amplifier Circuit Schematic for Micro-Doppler Sensor

Figures 10 and 11 show sample images of driver's with head drop and with no head drop, as captured by the micro-Doppler sensor in a form of a spectrogram, to predict the driver's status. The vertical axis represents Doppler frequency variations in Hertz, while the horizontal axis denotes time in seconds. Greater head motion (head drops) are depicted toward the red end of the heat map (as shown in Figure 10), while minimal head motion (normal state) is indicated toward the blue end of the scale (as shown in Figure 11).

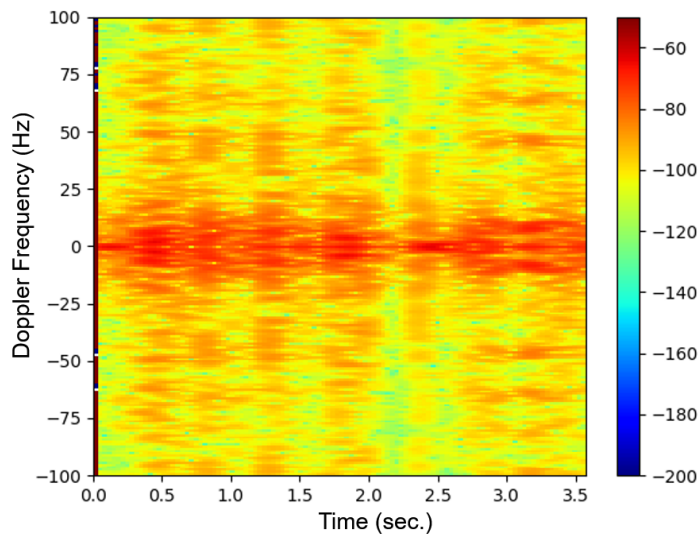

Figure 10. Micro-Doppler Spectrogram of a Head Drop.

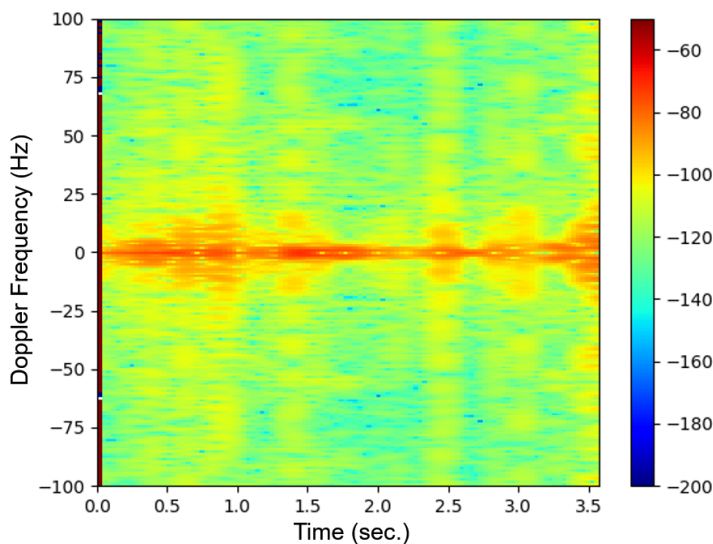

Figure 11. Micro-Doppler Spectrogram of No Head Drop.

4.2 Experimental Results on Head Drop Detection

Using the micro-Doppler radar, experiments were conducted to train the DCNN with spectrogram images fed into the network to predict the driver’s head status. Two hundred spectrogram images classified as Head Drop and No Head Drop were used. 80% of these images were used to initially train the DCNN algorithm, and the remaining 20% were used to validate the DCNN algorithm. Figure 12 demonstrates the results of the trained DCNN algorithm. A validation accuracy of 92.11% was achieved. To further improve the accuracy, additional data sets need to be

collected from different sources. The micro-Doppler radar prediction results, along with the camera predictions, can be used to successfully detect a drowsy driver in a vehicle.

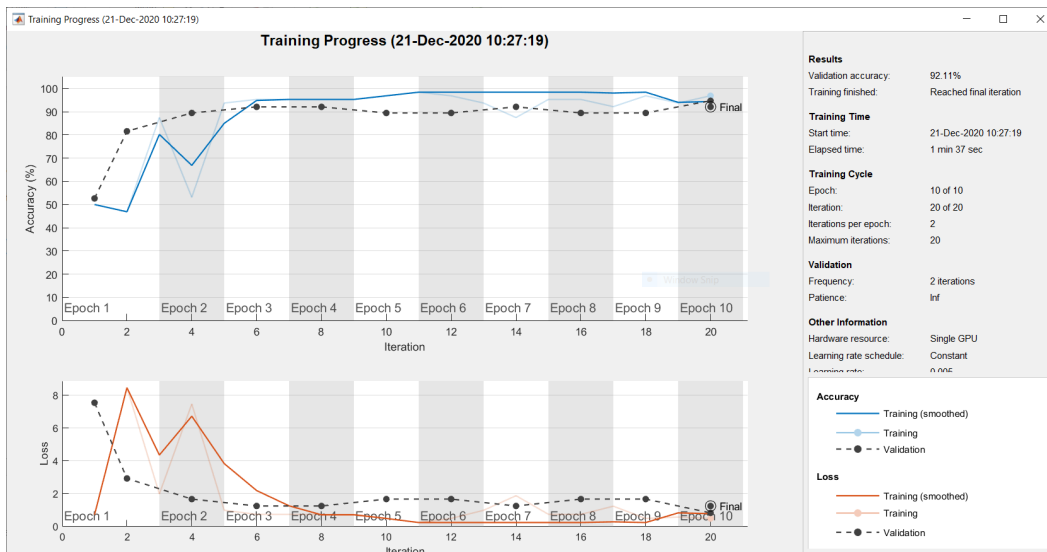

Figure 12. Micro-Doppler DCNN Training Result

5. Prototype Experimentation

In this section, we evaluate the performance of the proposed drowsy driver detection scheme. The developed system was tested in a vehicle.

5.1 Camera System

The experimental setup is shown in Figures 13. The Google Coral USB Accelerator used in the project adds an Edge TPU coprocessor to the system, enabling high-speed machine learning inferencing on a wide range of systems, simply by connecting it to a USB port. This on-device ML processing reduces latency, increases data privacy, and removes the need for a constant internet connection.

The Raspberry Pi 4 B is used for processing real-time data with the machine learning model. Some of the key features include a high-performance 64-bit quad-core processor, dual-display support at resolutions up to 4K via a pair of micro-HDMI ports, hardware video decoding at up to 4Kp60, up to 4GB of RAM (random access memory), dual-band 2.4/5.0 GHz wireless LAN, Bluetooth 5.0, Gigabit Ethernet and USB 3.0.

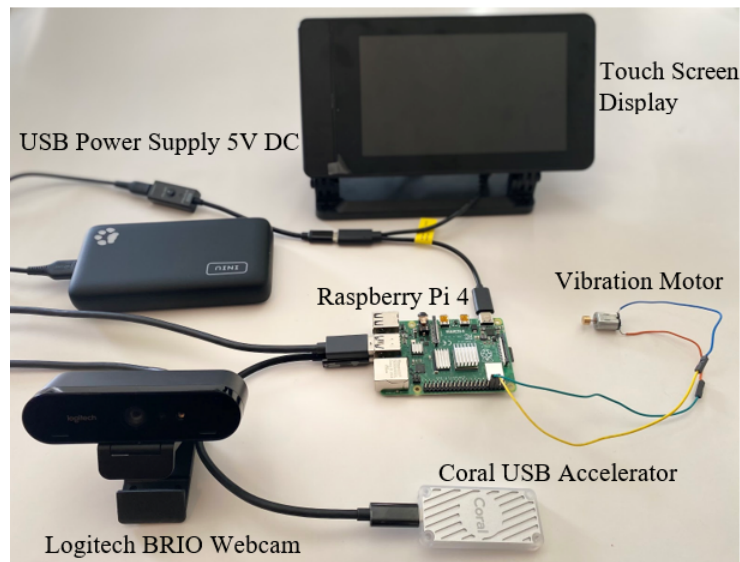

Figure 13. System Hardware Layout.

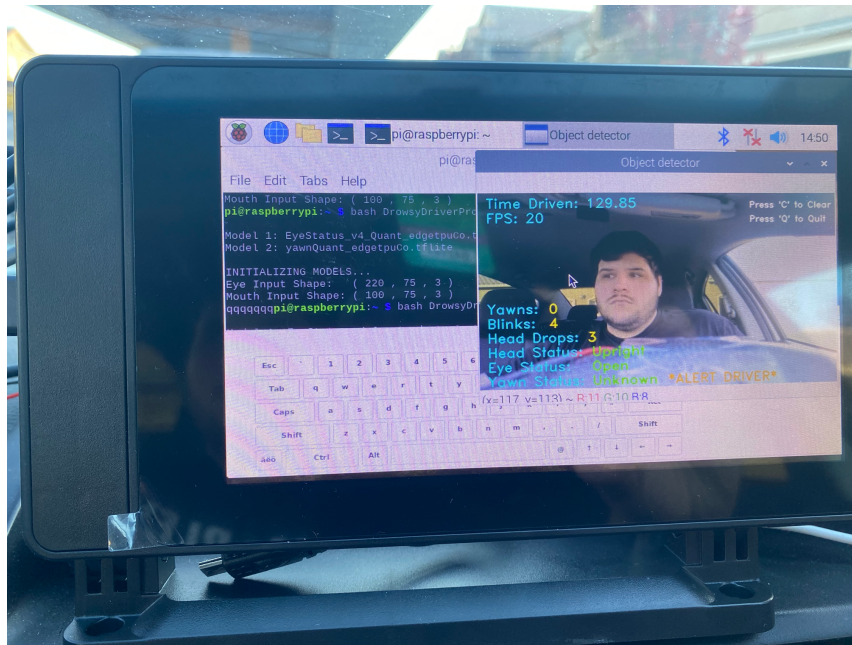

Figure 14. Touchscreen Display for User Interface.

Figure 14 shows the touch screen display attached to the car dashboard, which provides real-time information to the driver on the status of the driver and the system. It displays the number of blinks that are detected, whether the driver has yawned within a specific period of time, and the driver head status. In addition, it has a warning message (blinking red and activating the motor on the steering wheel) in case it detects the driver is about to doze off.

5.2 Micro-Doppler System

The micro-Doppler sensor, along with the additional circuits, shown in Figure 15, was used to collect the driver's status in a form of spectrogram data for the DCNN algorithm training and testing purposes. During experimentation the radar system was located about 50 cm from the driver on the dashboard. The collected data is first converted to spectrogram to be used by the DCNN as an input image. Sample spectrogram images for head drop and no head drop are shown in Figures 10 and 11, respectively.

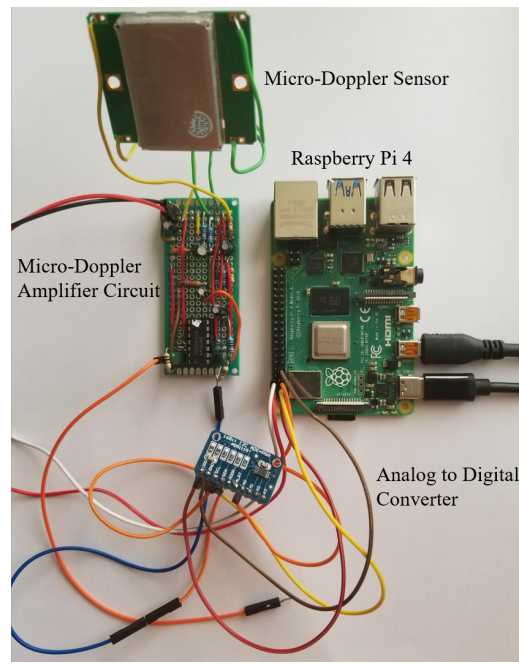

Figure 15. Micro-Doppler Data Collection and Processing Unit.

5.3 Testbed Experimentation in a Vehicle

The drowsy driver system was deployed in a vehicle, as shown in Figure 16. A motor was attached to the steering wheel, to alert the driver as soon as it detects the driver is about to doze off.



Figure 16. System Setup in a Vehicle.

A live demonstration was performed in a vehicle in a parking lot to detect the driver's drowsy status (Figure 17). Overall, the developed system did perform quite well. Over 95% accuracy was achieved in detecting a drowsy driver condition.



Figure 17. Live Demonstration of the Drowsy Driver Detection System in a Vehicle.

6. Conclusion

In this research project, a drowsy driver detection scheme that can be used for intelligent transportation systems (ITSs), using multi-sensor data collection paired with machine learning is implemented and experimentally tested. The system is composed of a webcam and a micro-Doppler radar for data collection and training. After training of the machine learning models, the system is deployed for real-time experiment in a vehicle. Overall, the system can count the number of blinks performed within a minute, number of yawns, and detect head drops, to evaluate if the driver is drowsy or not. Evaluation of drowsiness is done through looking at 3 factors, the blink results, yawn results, and the head drop results. The eye blinks and the yawns were captured with the camera while the head drops were detected using the micro-Doppler radar. The experimental results reveal the system can detect the status of a drowsy driver with an average accuracy slightly above 95%. We believe this on-board system, that monitors driver's state in real-time, will have real value as a safety measure in the future development of ITS.

Abbreviations and Acronyms

NHTSA	National Highway Traffic Safety Administration
ADAS	Advanced Driver Assistance Systems
AAA	American Automobile Association
DCNN	Deep Convolution Neural Network
CDC	Centers for Disease Control and Prevention
CHP	California Highway Patrol
Caltrans	California Department of Transportation
ITS	Intelligent Transportation System
ReLU	Rectified Linear Unit
TPU	Tensor Processing Unit
AI	Artificial Intelligence
ASIC	Accelerator Application-Specific Integrated Circuit
ADC	Analog-To-Digital Converter
CEW	Closed Eyes in the Wild
RAM	Random Access Memory

Bibliography

- Abtahi, S., Omidyeganeh, M., Shirmohammadi, S., & Hariri, B. (2014). "YawDD: A Yawning Detection Dataset", Proc. ACM Multimedia Systems, Singapore, March 19–21, pp. 24–28. DOI: 10.1145/2557642.2563678. Available online: <https://iee-dataport.org/open-access/yawdd-yawning-detection-dataset>
- American Academy of Sleep Medicine. (2015). "Drowsy Driving." <http://sleepeducation.org/sleep-topics/drowsy-driving>
- Barr, L., Howarth, H., Popkin, S., & Carroll, R. J. (2005). "A review and evaluation of emerging driver fatigue detection measures and technologies." *National Transportation Systems Center*, Cambridge. US Department of Transportation, Washington.
- California Highway Patrol. Press Release, November 1, 2019. Accessed March 19, 2021. <https://www.chp.ca.gov/PressReleases/Pages/HIGHWAY-SAFETY-PARTNERS-SAY-STAY-AWAKE-TO-STAY-ALIVE.aspx>
- California Office of Traffic Safety. "Drowsy Driving." Accessed March 19, 2021. <https://www.ots.ca.gov/media-and-research/campaigns/drowsy-driving/>
- Centers for Disease Control and Prevention (CDC). "Drowsy Driving: Asleep at the Wheel." Accessed March 19, 2021. <https://www.cdc.gov/sleep/features/drowsy-driving.html>
- Institute of Medicine. (2006). *Sleep Disorders and Sleep Deprivation: An Unmet Public Health Problem*. Washington, DC: The National Academies Press.
- Klauer, S. G., Dingus, T. A., Neale, V. L., Sudweek, J. D., & Ramsey, D. J. (2006). "The Impact of Driver Inattention on Near-Crash/Crash Risk: An Analysis Using the 100-Car Naturalistic Study Data." Springfield, VA.
- Kulhandjian, H., Ramachandran, N., Kulhandjian, M., & C D'Amours, C. (October 2019) "Human Activity Classification in Underwater Using Sonar and Deep Learning." In *Proc. of ACM Conference on Underwater Networks and Systems (WUWNet)*. Atlanta, GA, USA.
- Kulhandjian, H., Sharma, P., Kulhandjian, M. & D'Amours, C. (December 2019). "Sign Language Gesture Recognition using Doppler Radar and Deep Learning." In *Proc. of IEEE GLOBECOM Workshop on Machine Learning for Wireless Communications*. Waikoloa, HI, USA.
- Kulhandjian, H. (August 2020). "A Visible Light Communications Framework for Intelligent Transportation Systems," in *California State Transportation Consortium, Project No. 1911*, 1–36,

- Lee, D., Oh, S., Heo, S., & Hahn, M. (December 2008). "Drowsy driving detection based on the driver's head movement using infrared sensors." In *IEEE Second International Symposium on Universal Communication*, 231–236.
- National Center for Statistics and Analysis. (2020). "Police-Reported Motor Vehicle Traffic Crashes in 2018." *Traffic Safety Facts Research Note*. Report No. DOT HS 812 860, National Highway Traffic Safety Administration. <https://crashstats.nhtsa.dot.gov/Api/Public/ViewPublication/812860>
- National Highway Traffic Safety Administration (NHTSA), United States. "Drowsy Driving." Accessed March 19, 2021. <https://www.nhtsa.gov/risky-driving/drowsy-driving>.
- NHTSA. (March 2016). "Drowsy Driving Research and Program Plan." *U.S. Department of Transportation's National Highway Traffic Safety Administration*. Accessed March 19, 2021. https://www.nhtsa.gov/sites/nhtsa.dot.gov/files/drowsydriving_strategicplan_030316.pdf
- NHTSA. (2017). "Traffic safety facts 2015."
- Owens, J., Dingus, T., Guo, F., Fang, Y., Perez, M., McClafferty, J. & Tefft, B. (2018). "Prevalence of drowsy-driving crashes: Estimates from a large-scale naturalistic driving study."
- Saini, V. & Saini, R. (2014). "Driver drowsiness detection system and techniques: a review." *International Journal of Computer Science and Information Technologies*, 5(3), 4245–4249.
- Song, F., Tan, X. Liu, X. & Chen, S. (2014). "Eyes Closeness Detection from Still Images with Multi-scale Histograms of Principal Oriented Gradients." *Pattern Recognition*.
- Stork, M., Skála, J., Weissar, P., Holota, R. & Kubík, Z. (September 2015). "Various Approaches to Driver Fatigue Detection: A Review." In *IEEE International Conference on Applied Electronics (AE)*, 239–244.
- Tefft, B. C. (2014). *Prevalence of Motor Vehicle Crashes Involving Drowsy Drivers, United States, 2009–2013*. Washington, DC: AAA Foundation for Traffic Safety.

About the Author

Hovannes Kulhandjian

Dr. Hovannes Kulhandjian is an Associate Professor in the Department of Electrical and Computer Engineering at California State University, Fresno (Fresno State). He joined Fresno State in Fall 2015 as a tenure-track faculty member. Prior to that, he was an Associate Research Engineer in the Department of Electrical and Computer Engineering at Northeastern University. He received his B.S. degree in Electronics Engineering with high honors from the American University in Cairo (AUC) in 2008, and his M.S. and Ph.D. degrees in Electrical Engineering from the State University of New York at Buffalo in 2010 and 2014, respectively. His current research interests are in applied machine learning, wireless communications, and networking, with applications to underwater and visible light communications and networking geared towards Intelligent Transportation Systems (ITS).

Dr. Kulhandjian has received three research grants from Fresno State Transportation Institute (FSTI) and he also received the Claude C. Laval III Award for Commercialization of Research, Innovation and Creativity 2021 as well as the Claude C. Laval Award for Innovative Technology and Research 2020 at Fresno State. In April 2021, as a PI he received a grant from the Department of Defense (DOD) Research and Education Program for Historically Black Colleges and Universities and Minority-Serving Institutions (HBCU/MI) Equipment/Instrumentation, to establish a "Secure Communications and Embedded Systems Laboratory at California State University, Fresno".

Dr. Kulhandjian is an active member of the Association for Computing Machinery (ACM) and the Institute of Electrical and Electronics Engineers (IEEE). He is a Senior Member of IEEE. He is serving as a guest editor for Journal of Sensor and Actuator Networks (JSAN) - Special Issue on Advances in Intelligent Transportation Systems (ITS). He has also served as a Guest Editor for IEEE Access Special Section Journal, Session Co-Chair for IEEE UComms'20 Conference, Session Chair for ACM WUWNet'19 Conference, Publicity Co-Chair for IEEE BlackSeaCom'21 Conference. He also serves as a member of the Technical Program Committee (TCP) for ACM and IEEE Conferences such as GLOBECOM 2021, WD 2021, WTS 2021, WD 2018, ICC 2018, WUWNet 2018, and VTC Fall 2017. He is a recipient of the Outstanding Reviewer Award from ELSEVIER Ad Hoc Networks and ELSEVIER Computer Networks.

MTI FOUNDER

Hon. Norman Y. Mineta

MTI BOARD OF TRUSTEES

Founder, Honorable Norman Mineta*
Secretary (ret.),
US Department of Transportation

**Chair,
Will Kempton**
Retired Transportation Executive

**Vice Chair,
Jeff Morales**
Managing Principal
InfraStrategies, LLC

**Executive Director,
Karen Philbrick, PhD***
Mineta Transportation Institute
San José State University

Winsome Bowen
Vice President, Project Development
Strategy
WSP

David Castagnetti
Co-Founder
Mehlman Castagnetti Rosen &
Thomas

Maria Cino
Vice President, America & U.S.
Government Relations
Hewlett-Packard Enterprise

Grace Crunican**
Owner
Crunican LLC

Donna DeMartino
Managing Director
Los Angeles-San Diego-San Luis
Obispo Rail Corridor Agency

John Flaherty
Senior Fellow
Silicon Valley American Leadership
Forum

William Flynn *
President & CEO
Amtrak

Rose Guilbault
Board Member
Peninsula Corridor Joint Power
Board

Ian Jefferies*
President & CEO
Association of American Railroads

Diane Woodend Jones
Principal & Chair of Board
Lea & Elliott, Inc.

David S. Kim*
Secretary
California State Transportation
Agency (CALSTA)

Therese McMillan
Executive Director
Metropolitan Transportation
Commission (MTC)

Abbas Mohaddes
President & COO
Econolite Group Inc.

Stephen Morrissey
Vice President – Regulatory and
Policy
United Airlines

Dan Moshavi, PhD*
Dean
Lucas College and Graduate School
of Business, San José State
University

Toks Omishakin*
Director
California Department of
Transportation (Caltrans)

Takayoshi Oshima
Chairman & CEO
Allied Telesis, Inc.

Greg Regan
President
Transportation Trades Department,
AFL-CIO

Paul Skoutelas*
President & CEO
American Public Transportation
Association (APTA)

Kimberly Slaughter
CEO
Systra USA

Beverley Swaim-Staley
President
Union Station Redevelopment
Corporation

Jim Tymon*
Executive Director
American Association of State
Highway and Transportation
Officials (AASHTO)

* = Ex-Officio

** = Past Chair, Board of Trustees

Directors

Karen Philbrick, PhD
Executive Director

Hilary Nixon, PhD
Deputy Executive Director

Asha Weinstein Agrawal, PhD
Education Director
National Transportation Finance Center Director

Brian Michael Jenkins National Transportation
Security Center Director

