



Selecting a Preventive Maintenance Treatment for Flexible Pavements

PUBLICATION NO. FHWA-IF-00-027

AUGUST 2000



U.S. Department of Transportation
Federal Highway Administration

Office of Asset Management
HIAM-20
400 7th Street, SW
Washington, DC 20590



Foundation for Pavement Preservation

2025 M Street, NW
Suite 800
Washington, DC 20036
<http://fp2.org>

REPRODUCED BY:
U.S. Department of Commerce
National Technical Information Service
Springfield, Virginia 22161



Technical Report Documentation Page

1. Report No. FHWA-IF-00-027		2. Government Accession No.		3. Recipient's Catalog No.	
4. Title and Subtitle Selecting a Preventive Maintenance Treatment for Flexible Pavements				5. Report Date 08-07-2000	
				6. Performing Organization Code	
7. Author(s) R. Gary Hicks, Stephen B. Seeds, and David G. Peshkin				8. Performing Organization Report No.	
9. Performing Organization Name and Address Foundation for Pavement Preservation 2025 M. ST., NW, Suite 800 Washington, D.C. 20036				10. Work Unit No. (TRAIS)	
				11. Contract or Grant No.	
				13. Type of Report and Period Covered	
12. Sponsoring Agency Name and Address Foundation for Pavement Preservation Office of Asset Management/FHWA 2025 M. ST., NW, Suite 800 400 Seventh St., SW Washington, D.C. 20036 Washington, D.C. 20590				14. Sponsoring Agency Code	
15. Supplementary Notes This report was funded by the Foundation for Pavement Preservation (FPP). Technical oversight was provided by the following individuals: Bill Ballou, FPP; Jim Chehovits, Crafc0; Randy Iwasaki, Caltrans; Dennis Jackson, Retired (WSDOT); Mark Ishee, Ergon; Jim Moulthrop, Koch; Dick Nelson, Valentine Construction; Jim Sorenson, FHWA; and Jim Stevenson, Montana DOT.					
16. Abstract This report is a continuation of research and efforts to promote the principals of pavement preservation by the Foundation for Pavement Preservation. The objectives of this study are to: <ol style="list-style-type: none"> 1. Review existing practices related to selecting appropriate preventive maintenance strategies. 2. Develop a framework for the selection of the most appropriate preventive maintenance treatments. 3. Prepare a summary report (and slide presentation) which documents the findings. <p>The review of selected current practices is presented in Appendices A and B. This framework for selecting the most appropriate maintenance and rehabilitation treatments is discussed in Chapters 2, 3, and 4. The slide presentation, which provides an overview of this report, is found in Appendix C. The slide presentation is also available as a PowerPoint file on the FPP web site at http://fp2.org.</p>					
17. Key Words Preventive preservation, pavement maintenance, pavement maintenance treatment selection, optimal timing, cost effectiveness, asphalt concrete pavement.			18. Distribution Statement No restrictions. This document is available to the public through the National Technical Information Services, 5285 Port Royal Road, Springfield, VA 22161		
19. Security Classif. (of this report) Unclassified		20. Security Classif. (of this page) Unclassified		21. No. of Pages	22. Price

METRIC (SI*) CONVERSION FACTORS

APPROXIMATE CONVERSIONS TO SI UNITS				APPROXIMATE CONVERSIONS TO SI UNITS			
Symbol	When You Know	Multiply By	To Find	Symbol	When You Know	Multiply By	To Find
LENGTH				LENGTH			
in	inches	2.54	centimeters	cm	mm	0.039	inches
ft	feet	0.3048	meters	m	m	3.28	feet
yd	yards	0.914	meters	m	yd	1.09	yards
mi	miles	1.61	kilometers	km	km	0.621	miles
AREA				AREA			
in ²	square inches	6.452	centimeters squared	cm ²	mm ²	0.0018	square inches
ft ²	square feet	0.0929	meters squared	m ²	m ²	10.764	square feet
yd ²	square yards	0.836	meters squared	m ²	yd ²	0.39	square meters
mi ²	square miles	2.59	kilometers squared	km ²	ha	2.59	acres
ac	acres	0.396	hectares	ha			
MASS (weight)				MASS (weight)			
oz	ounces	28.35	grams	g	g	0.0353	ounces
lb	pounds	0.454	kilograms	kg	kg	2.205	pounds
T	short tons (2000 lb)	0.907	megagrams	Mg	Mg	1.103	short tons
VOLUME				VOLUME			
fl oz	fluid ounces	29.57	milliliters	mL	mL	0.034	fluid ounces
gal	gallons	3.785	liters	L	L	0.264	gallons
ft ³	cubic feet	0.0328	meters cubed	m ³	m ³	35.315	cubic feet
yd ³	cubic yards	0.765	meters cubed	m ³	m ³	1.308	cubic yards

Note: Volumes greater than 1000 L shall be shown in m³.

TEMPERATURE (exact)

°F	°C
Fahrenheit temperature	Celsius temperature
5/9 (after subtracting 32)	temperature

TEMPERATURE (exact)

°C	°F
Celsius temperature	Fahrenheit temperature
9/5 (then add 32)	temperature

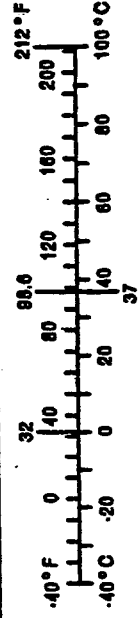

These factors conform to the requirement of FHWA Order 5190.1A.

*SI is the symbol for the International System of Measurements

ABSTRACT

Maintenance engineers have been applying treatments to both flexible and rigid pavements for as long as such pavements have existed. The types and application of various treatments for both corrective and preventive maintenance have been the subject of research studies over a number of years, and many publications have reported these findings. Recently, the Federal Highway Administration (FHWA) has initiated an effort to encourage DOTs (state and local) to begin, or extend, the practice of preventive maintenance, since there simply is not enough money available to continue the types of maintenance currently employed.

This report specifically addresses flexible pavement preventive maintenance, including the types of pavements that are candidates for preventive maintenance, the available treatments, where and when they should be used, their cost effectiveness, the factors to be considered in selecting the appropriate treatment strategy, and a methodology to determine the most effective treatment for a particular pavement.

KEY WORDS

Preventive preservation, pavement maintenance, pavement maintenance treatment selection, optimal timing, cost effectiveness, asphalt concrete pavements

***PROTECTED UNDER INTERNATIONAL COPYRIGHT
ALL RIGHTS RESERVED
NATIONAL TECHNICAL INFORMATION SERVICE
U.S. DEPARTMENT OF COMMERCE***

GLOSSARY OF TERMS

Annual Costs – Any costs associated with the annual maintenance and repair of the facility.

Cape Seal – A surface treatment that involves the application of a slurry seal to a newly constructed surface treatment or chip seal. Cape seals are used to provide a dense, waterproof surface with improved skid resistance.

Chip Seal – A surface treatment in which a pavement surface is sprayed with asphalt (generally emulsified) and then immediately covered with aggregate and rolled. Chip seals are used primarily to seal the surface of a pavement with non load-associated cracks and to improve surface friction, although they also are commonly used as a wearing course on low volume roads.

Cold In-Place Recycling (CIR) – A process in which a portion of an existing bituminous pavement is pulverized or milled, the reclaimed material is mixed with new binder and, in some instances, virgin aggregates. The resultant blend is placed as a base for a subsequent overlay. Emulsified asphalt is especially suited for cold in-place recycling. Although not necessarily required, a softening agent may be used along with the emulsified asphalt.

Cold Milling – A process of removing pavement material from the surface of the pavement either to prepare the surface (by removing rutting and surface irregularities) to receive overlays, to restore pavement cross slopes and profile, or even to re-establish the pavement's surface friction characteristics.

Corrective Maintenance – Maintenance performed once a deficiency occurs in the pavement; i.e., loss of friction, moderate to severe rutting, extensive cracking or raveling.

Crack Filling – The placement of materials into non-working cracks to substantially reduce infiltration of water and to reinforce the adjacent pavement. Working cracks are defined as those that experience significant horizontal movements, generally greater than about 2 mm (0.1 in.). Crack filling should be distinguished from crack sealing.

Crack Sealing – A maintenance procedure that involves placement of specialized materials into working cracks using unique configurations to reduce the intrusion of incompressibles into the crack and to prevent intrusion of water into the underlying pavement layers. Working cracks are defined as those that experience significant horizontal movements, generally greater than about 2 mm (0.1 in.).

Dense-Graded Asphalt Overlay – An overlay course consisting of a mix of asphalt cement and a well graded (also called dense-graded) aggregate. A well graded aggregate is uniformly distributed throughout the full range of sieve sizes.

Discount Rate – The rate of interest reflecting the investor’s time value of money, used to determine discount factors for converting benefits and costs occurring at different times to a baseline date. Discount rates can incorporate an inflation rate, depending on whether real discount rates or nominal discount rates are used.

Emulsified Asphalt – An emulsion of asphalt cement and water, which contains a small amount of an emulsifying agent. Emulsified asphalt droplets, which are suspended in water, may be either the anionic (negative charge) or cationic (positive charge) type, depending upon the emulsifying agent.

Equivalent Uniform Annual Cost (EUAC) – The net present value of all discounted cost and benefits of an alternative as if they were to occur uniformly throughout the analysis period. Net Present Value (NPV) is the discounted monetary value of expected benefits (i.e., benefits minus costs).

Fog Seal – A light application of slow setting asphalt emulsion diluted with water. It is used to renew old asphalt surfaces and to seal small cracks and surface voids.

Heater Scarification – A form of hot in-place recycling in which the surface of the old pavement is heated, scarified with a set of scarifying teeth, mixed with a recycling agent, and then leveled and compacted.

Hot In-Place Recycling (HIR) – A process which consists of softening the existing asphalt surface with heat, mechanically removing the surface material, mixing the material with a recycling agent, adding (if required) virgin asphalt and aggregate to the material, and then replacing the material back on the pavement.

Hot Mix Asphalt (HMA) – High quality, thoroughly controlled hot mixture of asphalt cement and well graded, high quality aggregate thoroughly compacted into a uniform dense mass.

Inflation Rate – The rate of increase in the general price levels, caused usually by an increase in the volume of money and credit relative to available goods. The inflation rate is also reflective of the rate of decline in the general purchasing power of a currency.

Initial Costs – All costs associated with the initial design and construction of a facility, placement of a treatment, or any other activity with a cost component.

International Roughness Index (IRI) – A ratio of the accumulated suspension motion to the distance traveled obtained from a mathematical model of a standard quarter car traversing a measured profile at a speed of 80 km/h (50 mph). Expressed in units of meters per kilometer (inches per mile), the IRI summarizes the longitudinal surface profile in the wheel-path.

Reproduced from
best available copy. 

Life Cycle Costing – An economic assessment of an item, system, or facility and competing design alternatives considering all significant costs of ownership over the economic life, expressed in terms of equivalent dollars.

Microsurfacing – A mixture of polymer modified asphalt emulsion, mineral aggregate, mineral filler, water, and other additives, properly proportioned, mixed and spread on a paved surface.

Net Present Value – The present value of future expenditures or costs discounted using an appropriate interest rate.

Nominal Dollars – Dollars of purchasing power in which actual prices are stated, including inflation or deflation. Hence, nominal dollars are dollars whose purchasing power fluctuates over time.

Open-Graded Friction Course (OGFC) – An overlay course consisting of a mix of asphalt cement and open-graded (also called uniformly graded) aggregate. An open-graded aggregate consists of particles of predominantly a single size.

Pavement Preservation – The sum of all activities undertaken to provide and maintain serviceable roadways. This includes corrective maintenance and preventive maintenance, as well as minor rehabilitation projects.

Pavement Preventive Maintenance – Planned strategy of cost-effective treatments to an existing roadway system and its appurtenances that preserves the system, retards future deterioration, and maintains or improves the functional condition of the system (without increasing the structural capacity).

Pavement Reconstruction – Construction of the equivalent of a new pavement structure which usually involves complete removal and replacement of the existing pavement structure including new and/or recycled materials.

Pavement Rehabilitation – Work undertaken to extend the service life of an existing pavement. This includes the restoration, placing an overlay, and/or other work required to return an existing roadway to a condition of structural and functional adequacy.

Pavement Serviceability Index (PSI) – A subjective rating of the pavement condition made by a group of individuals riding over the pavement.

Periodic Costs – Costs associated with rehabilitation activities that must be applied periodically over the life of the facility.

Present Worth Method – Economic method that requires conversion of costs and benefits by discounting all present and future costs to a single point in time, usually at or around the time of the first expenditure.

Real Dollars – Dollars of uniform purchasing power exclusive of general inflation or deflation. Real dollars have a constant purchasing power over time.

Recycling Agents – Organic materials with chemical and physical characteristics selected to address binder deficiencies and to restore aged asphalt material to desired specifications.

Rejuvenating Agent – Similar to recycling agents in material composition, these products are added to existing aged or oxidized HMA pavements in order to restore flexibility and retard cracking.

Rubberized Asphalt Chip Seal – A variation on conventional chip seals in which the asphalt binder is replaced with a blend of ground tire rubber (or latex rubber) and asphalt cement to enhance the elasticity and adhesion characteristics of the binder. Commonly used in conjunction with an overlay to retard reflection cracking.

Salvage Value – The remaining worth of the pavement at the end of the analysis period. There are generally two components of salvage value: residual value, the net value from recycling the pavement, and serviceable life, the remaining life of the pavement at the end of the analysis period.

Sand Seal – An application of asphalt material covered with fine aggregate. It may be used to improve the skid resistance of slippery pavements and to seal against air and water intrusion.

Sandwich Seal – A surface treatment that consists of application of a large aggregate, followed by a spray of asphalt emulsion that is in turn covered with an application of smaller aggregate. Sandwich seals are used to seal the surface and improve skid resistance.

Scrub Seal – Application of a polymer modified asphalt to the pavement surface followed by the broom scrubbing of the asphalt into cracks and voids, then the application of an even coat of sand or small aggregate, and finally a second brooming of the aggregate and asphalt mixture. This seal is then rolled with a pneumatic tire roller.

Slurry Seal – A mixture of slow setting emulsified asphalt, well graded fine aggregate, mineral filler, and water. It is used to fill cracks and seal areas of old pavements, to restore a uniform surface texture, to seal the surface to prevent moisture and air intrusion into the pavement, and to provide skid resistance.

Stone Mastic Asphalt Overlay – An overlay course consisting of a mix of asphalt cement, stabilizer material, mineral filler, and gap-graded aggregate. The gap-graded aggregate is similar to an open-graded material but is not quite as open.

Surface Texture – The characteristics of the pavement surface that contribute to both surface friction and noise.

User Costs – Costs incurred by highway users traveling on the facility and the excess costs incurred by those who cannot use the facility because of either agency or self-imposed detour requirements. User costs typically are comprised of vehicle operating costs (VOC), accident costs, and user delay costs.

TABLE OF CONTENTS

	<u>Page</u>
1.0 Introduction	1
1.1 Background	1
1.2 Objectives of Study	1
2.0 Establishing a Preventive Maintenance Program	5
2.1 Elements of a Preventive Maintenance Program.....	5
2.2 Preventive Maintenance Treatments	6
3.0 Framework for Treatment Selection and Timing	10
3.1 Tools for Treatment Selection.....	10
3.1.1 Decision Trees.....	12
3.1.2 Decision Matrices.....	15
3.1.3 Benefits and Limitations of Decision Trees/Matrices	19
3.2 Optimum Timing of Maintenance Treatments.....	19
4.0 Analysis to Determine the Most Effective Treatment.....	26
4.1 Cost Effectiveness Evaluation Techniques	26
4.2 Use of Decision Matrices	26
4.3 Example Decision Matrix.....	28
4.3.1 Customer Satisfaction Rating Factors	30
4.3.2 Performance and Constructability Rating Factors.....	30
4.3.3 Computation of Ranking	30
5.0 Conclusions and Recommendations.....	37
5.1 Conclusions	37
5.2 Recommendations	37
6.0 References Cited.....	38

7.0 References Reviewed but Not Cited40

Appendices

- A Summary of Organizations Surveyed
- B Examples of Decision Trees/Matrices Currently in Use
- C Slide Presentation on Treatment Selection

1.0 INTRODUCTION

1.1 Background

According to recent figures reported by the Federal Highway Administration, the condition of highway pavements on the National Highway System in the United States is such that the cost to maintain the system at existing condition levels is nearly \$50 billion annually (1). However, the United States currently spends only about \$25 billion per year, and the estimated cost to bring the entire system up from its current level to a “good” level is \$200 billion. Judging from this, it is clear that the system cannot continue to operate with traditional approaches to pavement management at the maintenance level and that the pavement preservation strategies employed at the various levels of DOTs (i.e., state, county, and city) need to be restructured.

Pavement management systems (PMS) generally include a subsystem for pavement maintenance which may contain models to determine the most cost effective treatment (2, 3). These are generally based on pavement type, condition, and other important factors. It is critical, however, that the proper maintenance treatment be placed at the right time for the pavement to function as designed and for the maintenance program to be cost effective. A limitation of many PMS systems is their inability to comprehensively analyze individual projects and determine the proper timing and cost of treatment.

Two types of pavement maintenance are generally recognized (Figure 1.1): preventive and corrective (or reactive). Preventive maintenance is used to arrest minor deterioration, retard progressive failures, and reduce the need for corrective maintenance. It is performed before the pavement shows significant distress to provide a more uniform performing pavement system. Corrective maintenance is performed after a deficiency occurs in the pavement; i.e., loss of friction, moderate to severe rutting, or extensive cracking. Although there are many different definitions for these terms, these are the ones used in this report.

Although each type of maintenance is needed in a comprehensive pavement preservation program, the emphasis should be placed on preventing a pavement from reaching the condition where corrective maintenance is required, since the cost associated with this approach can be substantial (4). This situation is often depicted as shown in Figure 1.2, which compares different treatments at different times. What is really needed is a determination of the cost effectiveness of the preventive maintenance (PM) approach compared with standard practices of rehabilitation when the pavement wears out (see Figure 1.3).

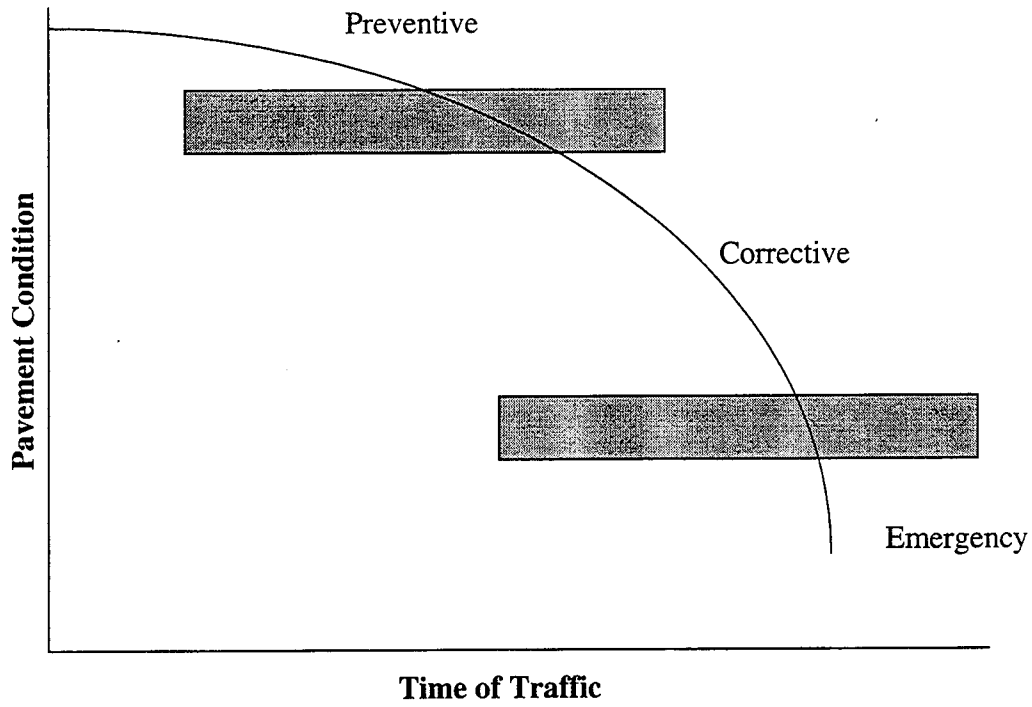

Figure 1.1. Categories of Pavement Maintenance (1)

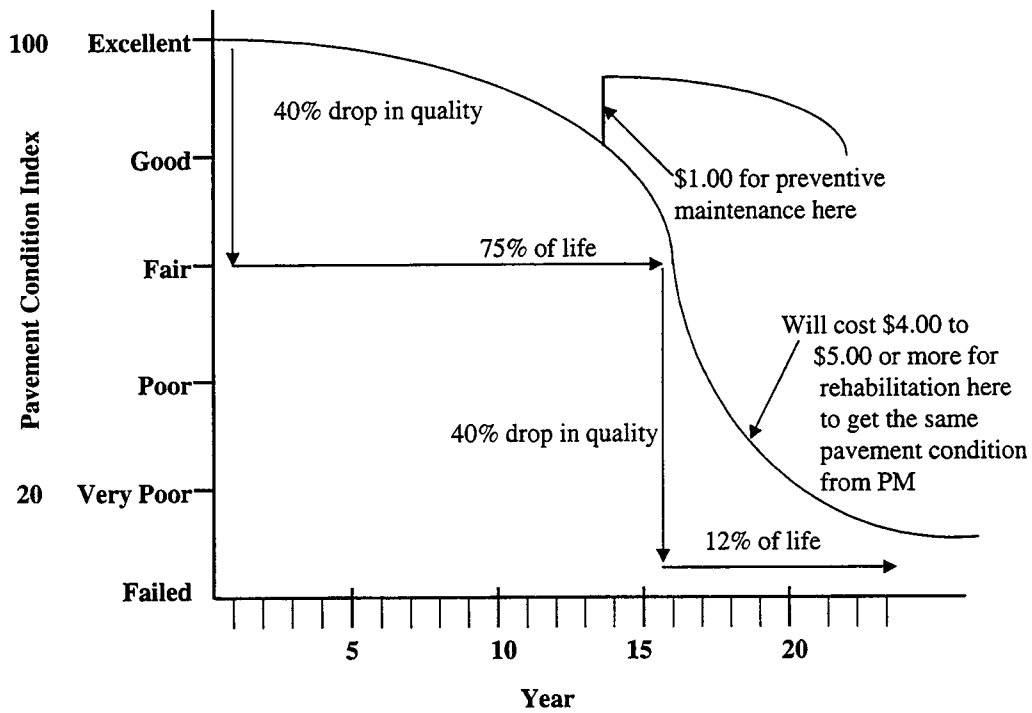
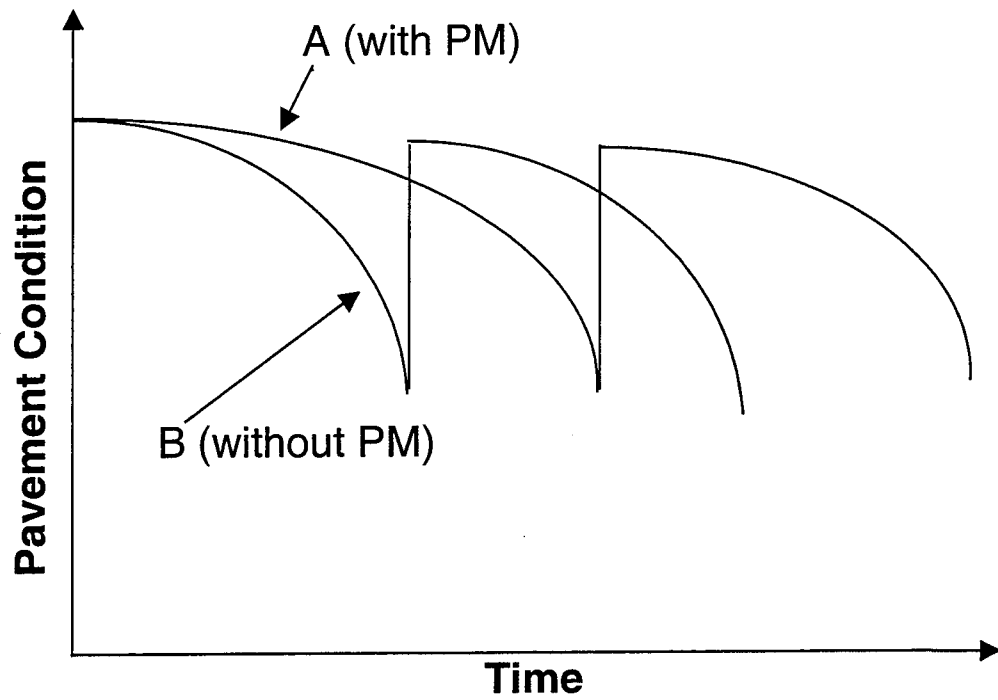
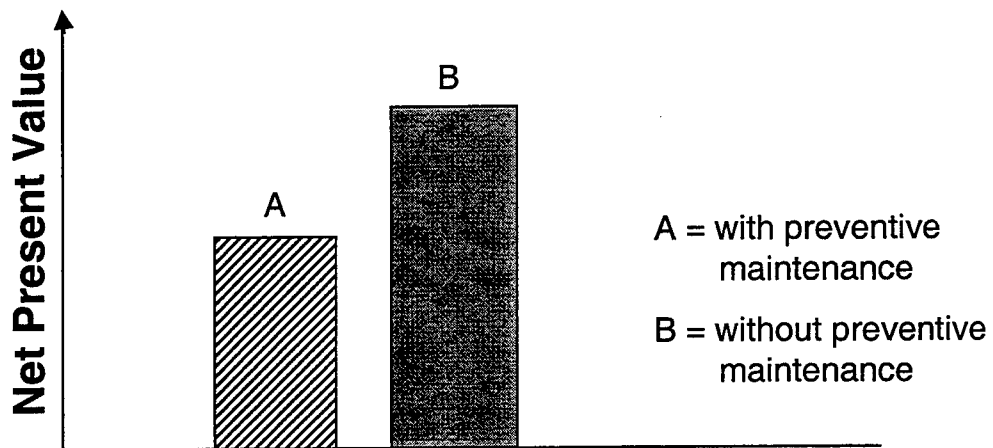

Figure 1.2. Typical Variation in Pavement Conditions as a Function of Time (modified after reference 4)



a) Deterioration curves for pavements with and without preventive maintenance (PM)



b) Net present value (NPV) of alternates

Figure 1.3. Cost Effectiveness of Various Pavement Maintenance Strategies Over Analysis Period

1.2 Objectives of Study

The objectives of this study are to:

1. Review existing practices related to selecting appropriate preventive maintenance strategies.
2. Develop a framework for the selection of the most appropriate preventive maintenance treatments.
3. Prepare a summary report (and slide presentation) which documents the findings.

The review of selected current practices is presented in Appendices A and B. The framework for selecting the most appropriate maintenance and rehabilitation treatments is discussed in Chapters 2, 3 and 4. The slide presentation, which provides an overview of this report, is found in Appendix C.

2.0 ESTABLISHING A PAVEMENT PRESERVATION PROGRAM

There are a number of technical components of a successful pavement preservation program, but they must first be preceded by two non-technical ones. They include: 1) top management commitment to the program within the agency, and 2) a comprehensive education effort aimed at the customer. If these two features are not embedded in the program, it is not likely to be successful. Of course, commitment from top management is always essential in any endeavor, but if an agency is not currently operating in a preventive mode, the changes required are as much “mind set” as they are operational. In addition, performing maintenance activities on pavements that are considered by the customer (the traveling public and taxpayers) to be in “good” condition will often bring criticism. Agency management must be able to articulate the concepts of system preservation and the use of preventive maintenance treatments to address the criticism, which means that the public, the customer, must be informed of the goals and objectives of this approach.

2.1 Elements of a Pavement Preservation Program

The following elements should be considered when developing a pavement preservation program:

1. **Establish program guidelines.** These guidelines become the instrument to express the overall strategies and goals of the preservation program by providing policy on such features as safety and environmental issues, and identifying a program coordinator. The technical elements of the program, such as what system will be used to determine needs, must also be included. Finally, a system to measure progress in relation to the stated goals of the program needs to be identified. An example of a typical program guideline is given in a report by Galehouse (5).
2. **Determine maintenance needs.** A system to determine the existing condition of the pavement network under the jurisdiction of the agency is an essential component of the management program. Pavement management systems (PMS) currently in use by agencies have this component, but they vary widely in their approach and sophistication. Generally, a condition survey is conducted on segments of existing pavements and various distress features are noted. This survey, conducted by trained individuals or with automated vehicles, may be supplemented by destructive sampling (i.e., cores and/or slabs) or nondestructive testing means (i.e., friction trailer, falling weight deflectometer, and profilometer/roughness meter). It should be emphasized that the traditional PMS distresses generally indicate failure conditions and do not provide early indicators for preservation.

An analysis of this data, along with information such as project location, average daily traffic, percent trucks, traffic projections, and environmental conditions (high and low temperature, freeze-thaw cycles, precipitation) provides an inventory of

data that can be factored into creating pavement segments appropriate for preservation, rehabilitation, or reconstruction. Segments (or pavements) requiring immediate maintenance or rehabilitation would not generally be good candidates for pavement preservation.

3. **Provide a framework for treatment selection.** It is important that the maintenance treatment selected is the proper one for the type and levels of distress, the climate, and the level of service expected for the project. (This topic is discussed later.)
4. **Develop analysis procedures to determine the most effective treatment.** A number of procedures exist to determine the cost effectiveness of maintenance treatments (6, 7). These are based on several approaches and vary from simple to complex. A simplified approach, which is based on the decision tree or matrix process, is presented later in this paper.
5. **Include a feedback mechanism to determine program effectiveness.** This is a management process to assess how the program is working in relation to the established goals. It becomes a tool to help adjust factors that need to be changed because of program modifications. The feedback should include both individual pavement performance and overall system performance.

Figure 2.1 is a flowchart showing the relationship among the various elements of a pavement preservation program. It should be emphasized that top management needs to be involved in steps 1 and 5 above to ensure a successful program.

2.2 Preventive Maintenance Treatments

There are a number of preventive maintenance treatments for flexible pavements. A comprehensive discussion of each treatment may be found in the *Basic Asphalt Emulsion Manual* (8), including the conditions in which each can be effective, and the pavement distress(es) which each is intended to address. The timing the various treatments are applied determines whether they are preventive or corrective maintenance treatments. The most common types of distress in flexible pavements include:

- Rutting.
- Cracking (i.e., fatigue, shrinkage, and thermal).
- Bleeding.
- Roughness (due to one or several of the above).
- Weathering
- Raveling

Table 2.1 provides possible maintenance treatments matched to various distress types. The causes of these distresses are not discussed, but can be found in work by Roberts et al. (9), or elsewhere. If the distresses identified in the pavement condition survey are related to structural

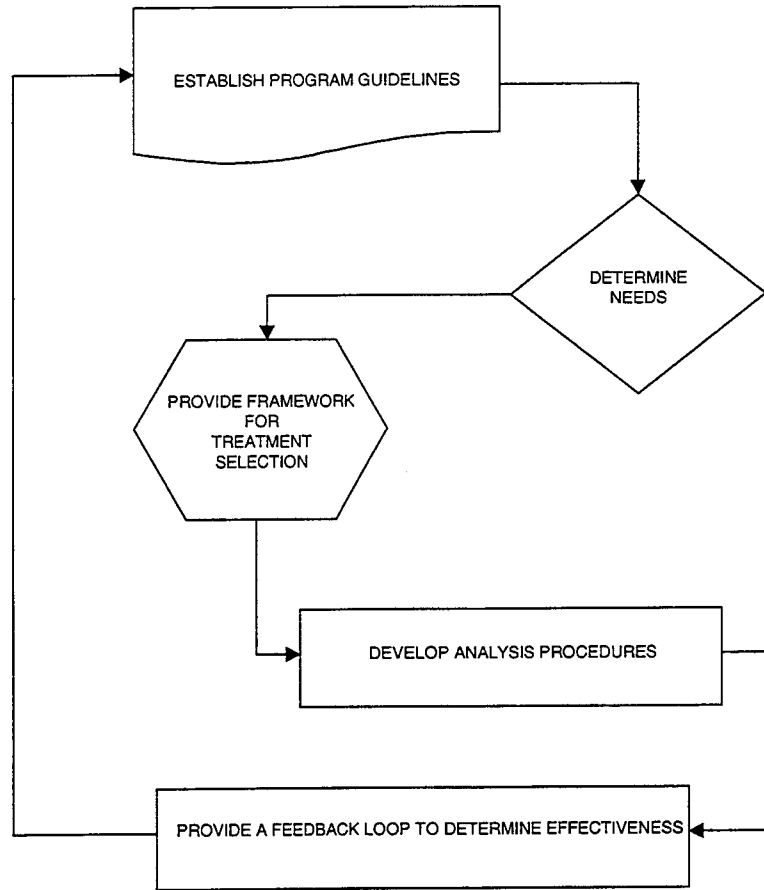

Figure 2.1. Elements of a Pavement Preservation Program

Table 2.1. Possible Preventive Maintenance Treatments for Various Distress Types

Pavement Distress	Crack Sealing	Fog Seal	Microsurfacing	Slurry Seal	Cape Seal	Chip Seal	Thin HMA Overlay	Mill or Grind ^a
Roughness								
Nonstability Related			X		X		X	X
Stability Related							X	
Rutting			X				X	X
Fatigue Cracking ^b		X	X	X	X	X	X	
Longitudinal and Transverse Cracking	X		X	X	X	X	X	
Bleeding			X			X		X
Raveling		X	X	X	X	X		

Key: X = appropriate strategy

^aThis is a corrective maintenance technique

^bFor low severity only; preventive maintenance is not applicable for medium to high severity fatigue cracking

deficiencies, the pavement is most likely not a candidate for a preventive maintenance treatment and should be programmed for rehabilitation or reconstruction. The different types of maintenance treatments considered in this report include:

1. **Crack Sealing.** This treatment is used to prevent water and debris from entering cracks in the pavement. The treatment might include routing to clean the entire crack and to create a reservoir to hold the sealant.
2. **Fog Seal.** An application of diluted emulsion (normally 1 to 1) to enrich the pavement surface and hinder raveling and oxidation. This is considered a temporary application.
3. **Chip Seal.** This treatment is used to waterproof the surface, seal small cracks, and improve friction. Although typically used on low volume roads and streets, it can also be used on high volume highways and expressways.
4. **Thin Cold Mix Seals.** These treatments include slurry seals, cape seals, and microsurfacing which are used on all types of facilities to fill cracks, improve friction, and improve ride quality.
5. **Thin Overlays.** These include dense-, open-, and gap-graded mixes (as well as surface recycling) that are used to improve ride quality, provide surface drainage and friction, and correct surface irregularities. They are generally 37 mm in thickness.

Table 2.2 summarizes typical unit costs and expected lives for various treatments. These values (which are based on the authors' experiences) will vary depending on the project location, quantities placed, and environmental conditions.

Table 2.2. Typical Unit Costs and Expected Life of Typical Pavement Maintenance Treatments

Treatment	Cost/m ²	Cost/yd ²	Expected Life of Treatment		
			Min.	Average	Max.
Crack Treatment ^a	0.60	\$0.50	2	3	5
Fog Seals ^b	0.54	\$0.45	2	3	4
Slurry Seals ^c	1.08	\$0.90	3	5	7
Microsurfacing ^d	1.50	\$1.25	3	7	9
Chip Seals ^e	1.02	\$0.85	3	5	7
Thin Hot-Mix Overlay ^f	2.09	\$1.75	2	7	12
Thin Cold-Mix Overlay ^f	1.50	\$1.25	2	5	10

Notes:

^a Assumes typical crack density of 0.25 yd / yd²

^b 0.2 l/m² (0.05 g/yd²) of a 1:1 dilution of CSS emulsion and water

^c 7 kg/m² of ISSA Type II slurry

^d 14 kg/m² of ISSA Type II microsurfacing

^e 15 kg/m²

^f 30 to 44 mm/m²

Note: The costs would be expected to vary with size and/or location of job. The expected lives would also vary depending on the traffic and environmental conditions.

3.0 FRAMEWORK FOR TREATMENT SELECTION AND TIMING

Pavement treatments applied after initial construction are employed to either preserve (maintain) the life of the original pavement or, in the case of rehabilitation, extend it. Figure 3.1 provides an early classification for the variety of different treatments typically used by highway agencies (10). Many of the treatments fall under the maintenance category (both preventive and corrective), while all others fall under the rehabilitation category.

Many agencies and organizations (see Appendices A and B) have also developed decision tools for selecting the appropriate maintenance or rehabilitation strategy for a given pavement condition. This chapter presents the use of decision trees and matrices as well as an approach for selecting optimal timing for each of the treatments. The emphasis is on maintenance treatments (preventive treatments, in particular); however, it is important to point out that the focus of most highway agencies, thus far, has been more on rehabilitation.

3.1 Tools for Treatment Selection

According to resource materials available from the Federal Highway Administration that deal with pavement management (2, 3), there are a number of indicators used by highway agencies as a basis for identifying an appropriate maintenance or rehabilitation treatment to address a given state of pavement deterioration. The two most common simple tools are referred to as *decision trees* and *decision matrices*. Both depend upon certain rules and criteria set forth by the agency based upon past experience and represent a practical aid in the treatment timing selection process. The general types of data that are considered in the development of these tools include:

- Pavement surface type and/or construction history.
- An indication of the functional classification and/or traffic level.
- At least one type of condition index, including distress and/or roughness.
- More specific information about the type of deterioration present, either in terms of an amount of load-related deterioration or the presence of a particular distress type.
- Geometrics, in order to indicate whether pavement widening or shoulder repair should also be required.
- Environmental conditions in which the treatment is to be used.

The primary advantage of these tools is that they reflect the decision processes normally used by the agency. Other advantages include: 1) the flexibility to modify both the decision criteria and the associated treatments, 2) the capability to generate consistent recommendations,

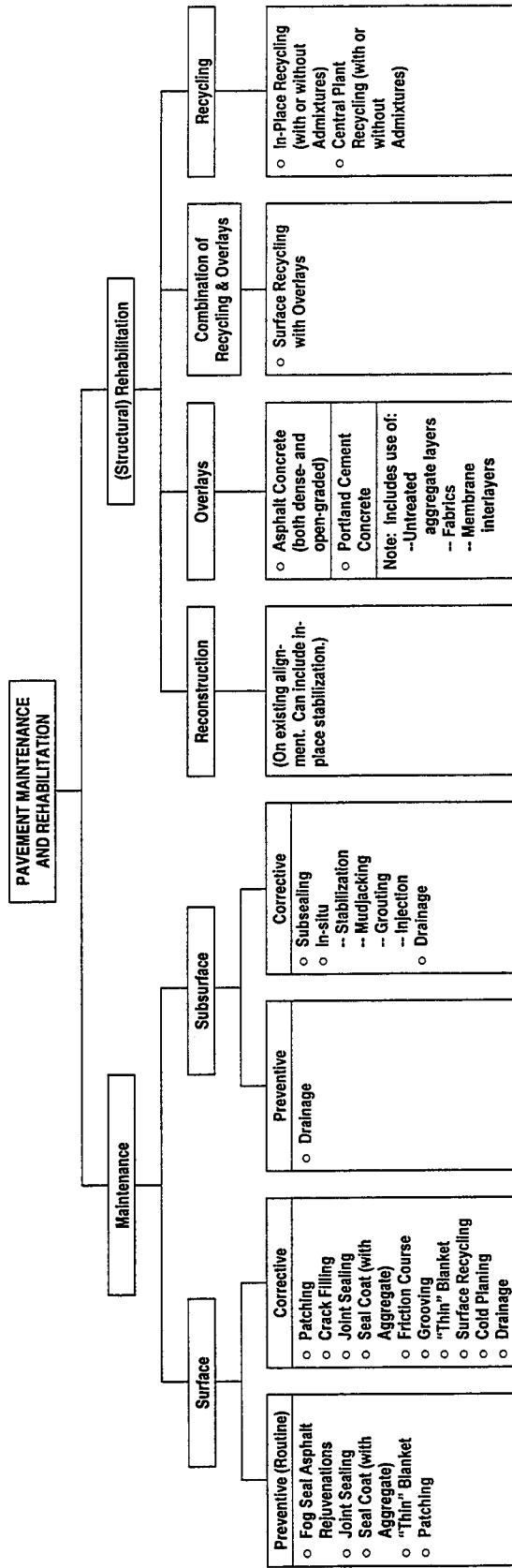

Figure 3.1. Pavement Maintenance and Rehabilitation Considerations (10)

and 3) the relative ease with which the selection process can be explained and programmed. Both tools can be used effectively in the selection/identification of suitable preventive maintenance treatments as well as routine preservation and rehabilitation options.

The primary disadvantage of these tools is that they are generally only designed to focus attention on the one (or two) treatments that have worked well in the past. Unfortunately, they tend to ignore or overlook new/improved treatments that may be more effective. Furthermore, it should be noted that the use of decision trees and matrices, by themselves, does not ensure the selection of the optimum or most cost effective treatment. Generally, a more sophisticated process involving the consideration of cost and timing is required to achieve optimization.

3.1.1 Decision Trees

As the terminology implies, decision trees incorporate a set of criteria for identifying a particular treatment through the use of “branches.” Each branch represents a specific set of conditions (in terms of factors such as pavement type, distress type and level, traffic volume, and functional classification) that ultimately leads to the identification of a particular treatment.

Figure 3.2 provides an example of a relatively straightforward maintenance and rehabilitation decision tree using only a few treatments to illustrate the concept. In this example (intended for demonstration purposes only), five criteria are used as the basis for treatment selection. It should be noted, however, that inherent in a simplified decision tree of this type are certain environmental conditions and traffic levels which influenced the original determination of the recommended treatments. Accordingly, users should exercise caution in applying any decision tree for conditions that are outside the basis for its development. Examples of more comprehensive maintenance and rehabilitation decision trees, which include additional treatments, are included in Appendix B.

Many decision trees use distress criteria of a composite nature to further simplify the selection process. The Pavement Condition Index (PCI) is an example of one of these composite distress indices. The problem with decision trees based on a composite distress index is that the treatments do not always appropriately address the actual distress conditions, particularly at the higher levels of deterioration associated with pavement rehabilitation. The criteria shown in the decision tree of Figure 3.2 may be interpreted as follows:

1. **Structural Deterioration.** If little or no structural deterioration exists, the associated treatments are directed at maintaining the functional performance and preserving the intended life of the original pavement. This is the optimum timing for applying preservation treatments. If structural deterioration (in the form of fatigue cracking or rutting) does exist, then the associated treatments are directed more at improving the structural performance; i.e., retarding the rate of structural deterioration and extending the intended life of the original pavement.

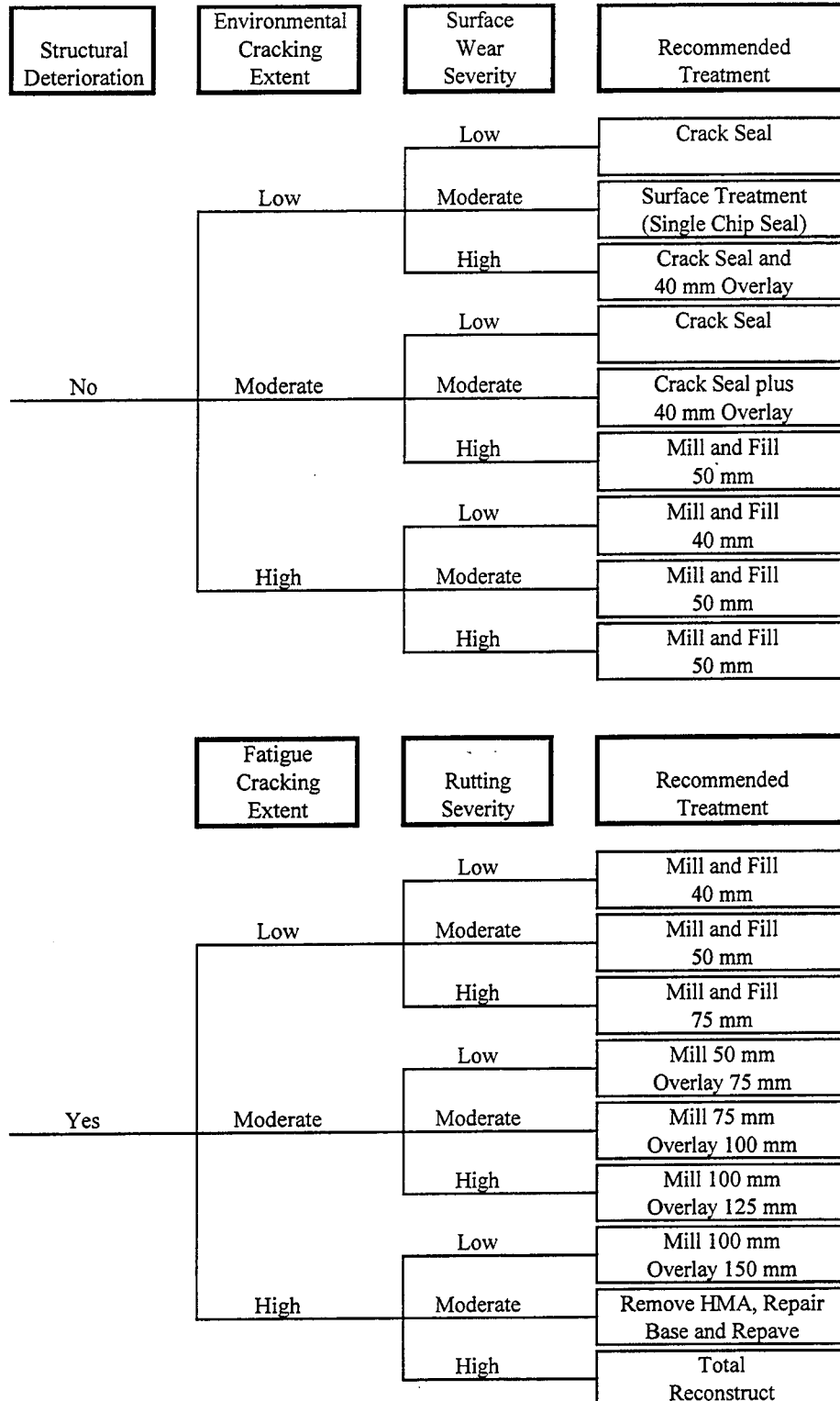

Figure 3.2. Simplified Maintenance and Rehabilitation Decision Tree for Asphalt Pavements (for demonstration purpose only)

2. **Environmental Cracking.** This refers to the transverse, longitudinal, and block cracking that develop in an asphalt pavement as it ages and undergoes the thermal stresses associated with daily temperature cycles. Treatments for this type of distress are intended to prevent moisture intrusion and retard the rate of crack deterioration that occurs at the pavement surface. The extent levels, in this case, are defined as follows:
- Low – The amount of cracking is so slight that there is little question as to the feasibility of crack sealing.
 - Moderate – The cracking has achieved a level where sealing alone may not be cost effective.
 - High – The extent of cracking is so great that crack sealing would definitely not be cost effective and some other remedial work is required.
3. **Surface Wear.** This refers to the pavement deterioration that takes place at the asphalt pavement surface (i.e., within the top 20 mm), primarily as a result of tire wear (e.g., polishing) and material degradation (e.g., raveling). Treatments for surface wear remove and/or cover up the worn surface. The severity levels, in this case, are defined as follows:
- Low – Surface texture and frictional resistance are minimally affected.
 - Moderate – Surface texture and frictional resistance are significantly affected. The potential for wet weather accidents is increased.
 - High – Surface texture and frictional resistance are heavily affected. The probability of wet weather accidents is near (or above) the unacceptable level.
4. **Fatigue Cracking.** Wheelpath cracking associated with the cumulative effects of wheel loads is a clear indication of structural deterioration and loss of load carrying capacity in a pavement. Accordingly, rehabilitation strategies tend to focus on removal and replacement of significant amounts of the HMA surface layer and, in some cases, base course. The extent levels are defined as follows:
- Low – Less than one percent of the wheelpath area exhibits load-associated cracking, which may start as single longitudinal cracks.
 - Moderate – At least 1 and up to 10 percent of the wheelpath area exhibit cracking, likely in an interconnected pattern. The rate of crack progression is increasing.
 - High – Ten percent or more of the wheelpath area exhibits load-associated cracking. Rapid progression to 100 percent of the wheelpath area is likely.

5. **Rutting.** This type of permanent deformation can take place in any one or more of the pavement layers. If the HMA surface layer is of poor quality (either because of poor mix design or improper construction), rutting can be confined to the top 50 to 70 mm of the pavement. If the structural design is inadequate or the pavement is overloaded, rutting can take place in the underlying pavement layers and natural subgrade soil. Generally, pavement rehabilitation strategies are targeted at replacing the deteriorated/deformed layers. The treatments recommended in Figure 3.2 are based on the assumption that the rutting is confined to the HMA surface layer. The three rut severity levels are defined as follows:

- Low – Rut depth is less than 6 mm. Problems with hydroplaning and wet weather accidents are unlikely.
- Moderate – Rut depth is in the range of 7 to 12 mm. Inadequate cross slope can lead to hydroplaning and wet weather accidents.
- High – Rut depth is greater than 13 mm. The potential for hydroplaning and wet weather accidents is significantly increased.

Again, Figure 3.2 is an example of how an agency (or organization) may develop their own decision tree.

Figure 3.3 provides another example of relatively simple decision trees developed by Hicks, et al. (11) which are geared towards preventive maintenance treatments. These decision trees independently address pavement roughness, rutting, cracking, and raveling/weathering, respectively. In Figure 3.3(a), the decision criteria include type of roughness and average daily traffic (ADT) level. In Figure 3.3(b), the criteria include the cause of rutting and ADT level. In Figure 3.3(c), the criteria include the type of cracking and ADT level. Finally, in Figure 3.3(d), the decision criteria for treatment include structural condition (ability to carry heavy traffic) and ADT. Another example of a decision tree for preventive maintenance has been developed by Michigan DOT (12) and is presented in Figure 3.4. Decision trees have also been developed at Westrack (13) and by the states of New York (14) and Minnesota (15). These can be found in Appendix B.

3.1.2 Decision Matrices

Decision matrices are very similar to decision trees in the sense that each relies on a set of rules or criteria to arrive at an appropriate maintenance or rehabilitation treatment. The major difference is that decision trees provide a more systematic and graphical approach to the selection process. The fact that decision matrices are tabular, however, makes them capable of storing more information in a smaller space.

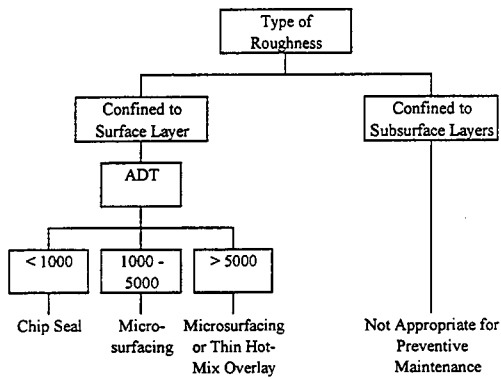

a) Decision tree for roughness.

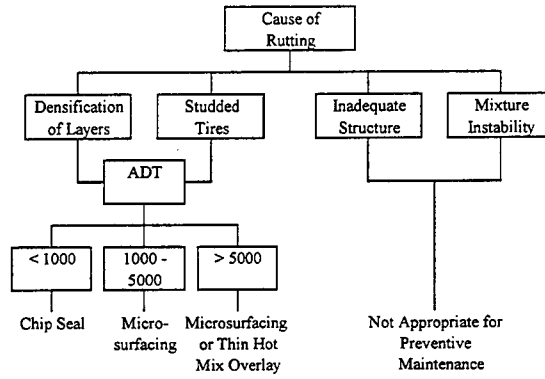

b) Decision tree for rutting.

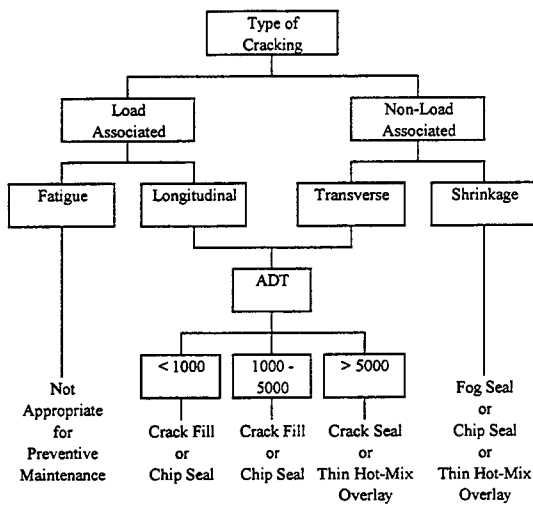

c) Decision tree for cracking.

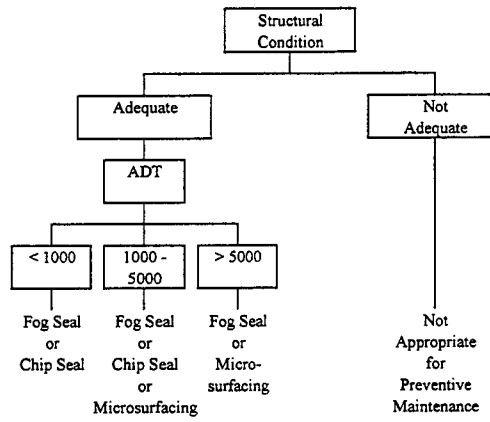

d) Decision tree for raveling and weathering.

Figure 3.3. Example Decision Trees for Preventive Maintenance Considering Roughness, Rutting, Cracking, and Raveling/Weathering (11)

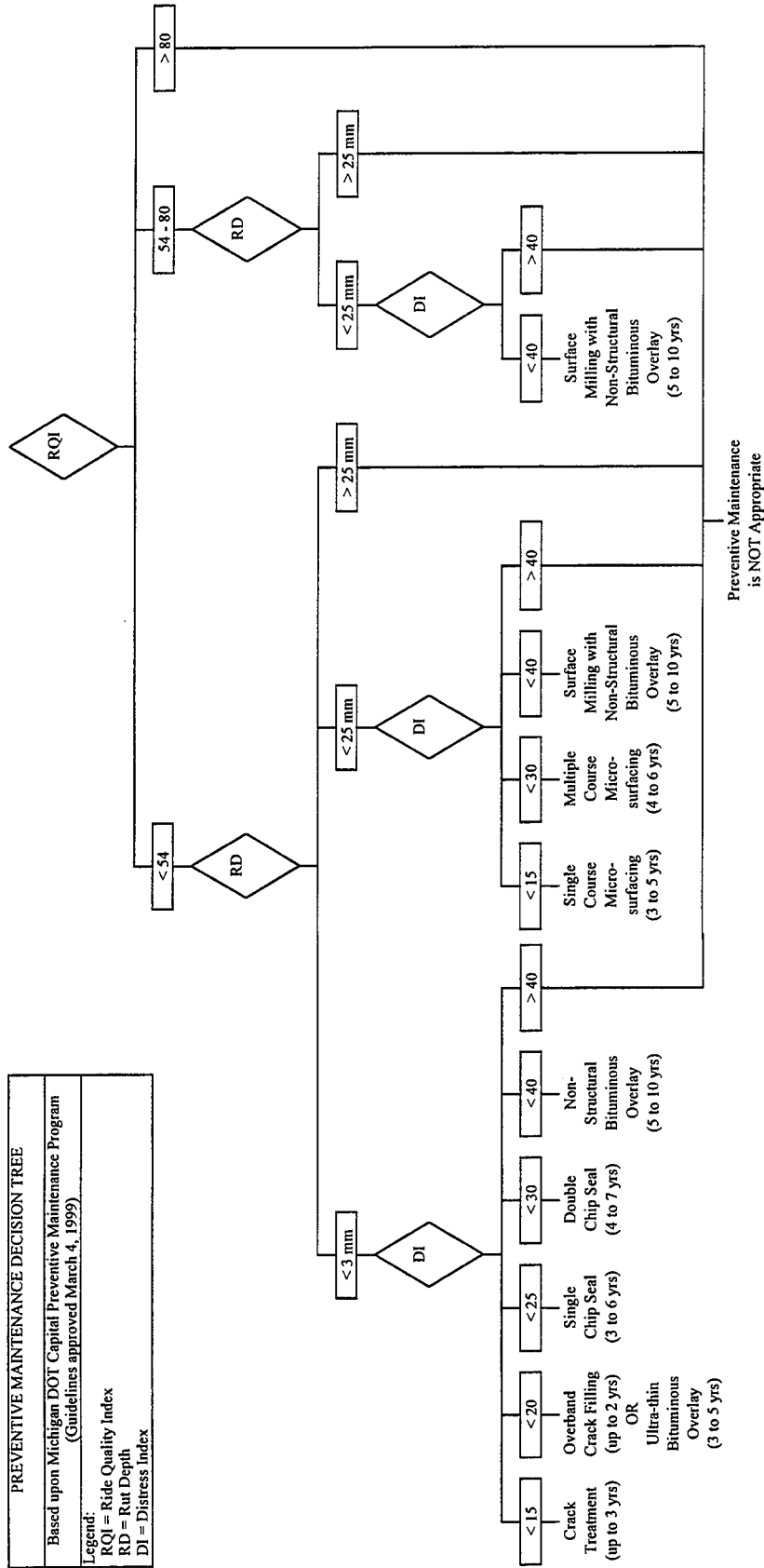

Figure 3.4. Preventive Maintenance Decision Tree Based on Criteria Provided by Michigan DOT (12)

In a study for FHWA that summarizes preventive maintenance treatments and their effectiveness, Zaniewski and Mamlouk (1) offer a relatively simple decision matrix for preventive maintenance treatments. This matrix, shown in Table 3.1, relates type of distress to potential actions. Although this table does not specifically mention recycling, the thin cold or hot mix overlays could contain recycled materials.

Table 3.2 provides an example of a more sophisticated decision matrix that was constructed from the thoughts and experiences of a number of engineers who toured the SHRP SPS-3 and 4 test sections in the Southern Region of the U.S. (16). It represents the combined opinions on the most appropriate preventive maintenance treatment for a specific set of project conditions by knowledgeable people. What the opinions suggest is that numerous factors affect the selection of the appropriate maintenance treatment, including:

- Type and extent of distress.
- Climate.
- Cost of treatment.
- Availability of qualified contractors.
- Time of year of placement.
- Facility downtime.
- Traffic loading.
- Existing pavement type.
- Expected life.
- Availability of quality materials.
- Pavement noise.
- Surface friction.

In order to begin the process of selecting the most cost effective preventive maintenance treatment, an understanding of the performance features of each of the potential treatments, considering the above factors and others that might be relevant on a specific project, must be catalogued by an agency. In fact, depending on the size and extent of the agency jurisdiction, the factors will likely change from geographical region to region. Examples of other decision matrices from agencies such as California, Ohio, the U.S. Forest Service, the Asphalt Institute, the U.S. Army Corps of Engineers, and others are given in Appendix B (17-24).

3.1.3 Benefits and Limitations of Decision Trees/Matrices

Table 3.3 summarizes the primary benefits and limitations of using these tools. The reader must be aware of not only the benefits, but also the stated limitations. Generally, deterministic decision trees are not a good idea (i.e., when someone identifies a set of conditions, including type and extent of distress, traffic, and environmental conditions, and then picks a treatment). The preferred way is to identify the conditions, identify feasible alternates (usually three to four are enough), evaluate the cost effectiveness of each alternate, and select the optimum treatment based on minimization of costs or maximization of benefits. This approach is discussed in more detail in Chapter 4.

Table 3.1. Flexible Pavement Distresses and Candidate Preventive Maintenance Treatments (1)

Category of Distress	Type of Distress	Potential Actions
Cracking	Fatigue Cracking	Not a candidate for preventive maintenance
	Block Cracking (low to moderate)	Thin cold treatment, chip seal, thin hot-mix overlay
	Edge Cracking	Crack treatment
	Longitudinal Cracking	Crack treatment
	Reflection Cracking at Joints	Crack treatment
	Transverse Cracking	Crack treatment
Patching and Potholes	Patch/Patch Deterioration	Extensively patched pavements are not good candidates for preventive maintenance
	Potholes	Pothole pavements are not good candidates for preventive maintenance
Surface Defects	Rutting – Densification of Pavement	Fill ruts with microsurfacing or strip chip seal, then thin cold treatment or chip seal
	Rutting – Unstable Asphalt Concrete	Preventive maintenance can not repair problem
	Shoving	Unstable pavement, not a candidate for preventive maintenance
	Bleeding	Sand seal, chip seal, microsurfacing
	Polished Aggregate	Thin cold treatment, chip seal, thin hot-mix overlay
	Raveling	Fog seal, thin cold treatment, chip seal, thin hot-mix overlay

Table 3.3. Benefits/Limitations of Using Decision Trees/Matrices

a) Benefits
<ul style="list-style-type: none">• Makes use of existing experience• Works well for local conditions• Good as a project-level tool
b) Limitations
<ul style="list-style-type: none">• Not always transferable from agency to agency• Limits innovation or use of new treatments• Hard to incorporate all factors which are important (e.g., competing projects, functional classification, remaining life)• Difficult to develop matrix that can incorporate multiple pavement distress types (i.e., does not always address the actual distress conditions)• Does not include more comprehensive evaluation of various feasible alternatives and LCC analysis to determine most cost effective strategy• Not good for network evaluation

3.2 Optimum Timing of Maintenance Treatments

Another critical element of an effective preventive maintenance program is determining the time to place the selected treatment. Some agencies have developed protocols that trigger a treatment based upon the condition of the pavement as determined by a combination of a condition survey and nondestructive testing. Many types of condition surveys are currently in use and they can provide meaningful information upon which to make a decision on the placement of the treatment. The use of a condition survey, coupled with nondestructive testing (if desired), provides a rational approach to determine which pavements in a network need a treatment *and* when the treatment should be placed. Figure 3.5 is an example of the type of decision process that an agency can adopt to determine the timing of a treatment for specific projects (25). Using the output of a pavement condition survey (regardless of the system used) on a scale of 1-100, threshold limits can be developed to define when a treatment type should be placed. Of course, the concept of preventive maintenance is to place an economical treatment early in the life of the pavement to preserve the pavement condition and possibly extend the pavement life. For example, the province of Ontario selects from a list of various maintenance treatments for freeways depending on the pavement structure (Table 3.4).

Another approach is shown in Figures 3.6 to 3.8 (26) using an annual cost approach. Figure 3.6 shows that the longer maintenance is delayed the more it will cost to repair the pavement. Alternatively, if a pavement is maintained too soon (similar to painting your house more frequently than needed), you spend money unnecessarily. The annual cost of premature maintenance (or rehabilitation) is illustrated in Figure 3.7. As shown, early maintenance results in higher annual costs. When the costs of delayed maintenance vs. those of early maintenance are superimposed (as shown in Figure 3.8), one can determine optimum timing to fix pavements. Generally, the optimum time for applying the various treatments is as follows:

<u>Treatment</u>	<u>Years</u>
Fog Seals	1-3
Crack Seals	2-4
Chip Seals	5-7
Slurry Seals	5-7
Thin Overlays (including surface recycling)	5-10

The actual timing for the various treatments may vary depending on traffic level and environment. Each agency is encouraged to develop their own optimal timing for maintenance treatments to minimize life-cycle costs.

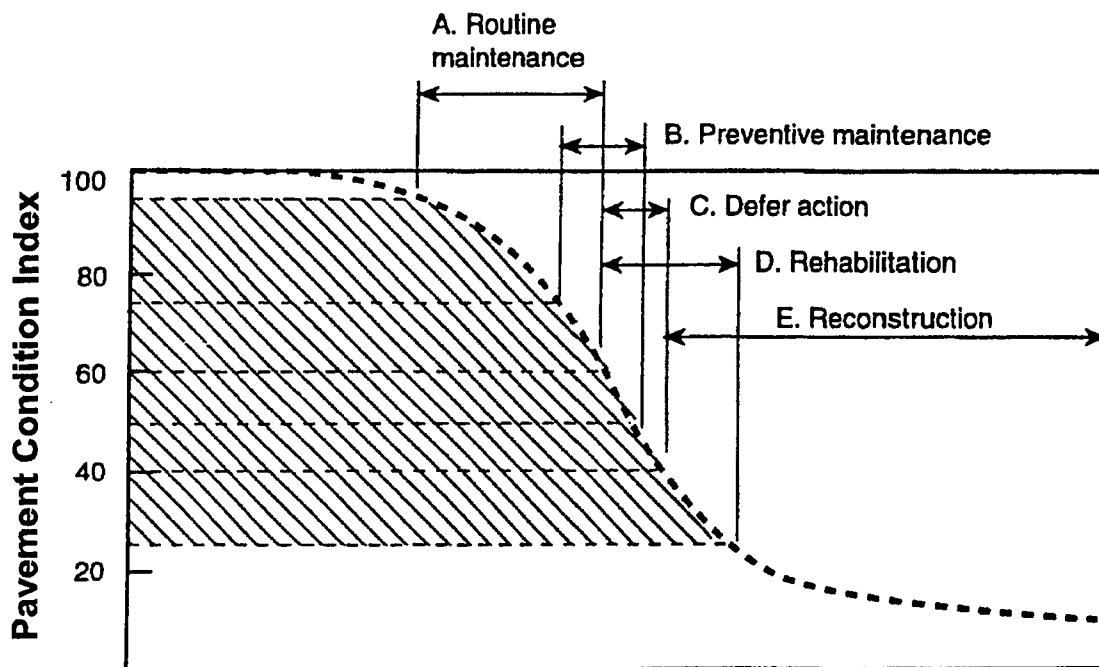

Figure 3.5. Conceptual Relationship for Timing of Various Maintenance and Rehabilitation Treatments (25)

Table 3.4. Preventive Maintenance Strategies Used by the Province of Ontario on Freeways (6)

Scheme	Design Life (yrs)	Year of Treatment	Maintenance Treatment
Scheme A Concrete	20	10	Reseal 10% of all joints
		15	Reseal 20% of all joints
		20	REHABILITATION
	25	10	Reseal 10% of all joints
		15	Reseal 20% of all joints
		20	Reseal 20% of all joints
		25	REHABILITATION
Scheme B Composite	18	3	Rout and seal 70% of transverse joints
		7	Rout and seal 30% of transverse joints and 30% of longitudinal joints
		11	Rout and seal 70% of longitudinal joints
		15	Reseal 30% of sealed cracks
		18	REHABILITATION
		21	Rout and seal 70% of transverse joints
		25	Rout and seal 30% of transverse joints and 30% of longitudinal joints
	29	Rout and seal 70% of longitudinal joints	
Scheme C Full Depth	15	3	Rout and seal 250 m of transverse cracks and 250 m centerline cracks
		7	Rout and seal 250 m of centerline and 520 m of transverse cracking
		11	Mill 25 mm and patch with 25 mm OFC (5%)
		15	REHABILITATION
		18	Rout and seal 250 m of transverse cracks and 250 m centerline cracks
		22	Rout and seal 250 m of centerline and 520 m of transverse cracking
	27	REHABILITATION	
Scheme D Deep Strength	15	3	Rout and seal 250 m of transverse cracks and 750 m centerline cracks
		7	Rout and seal 250 m of centerline and 520 m of transverse cracking
		11	Mill 25 mm and patch with 25 mm OFC (5%)
		15	REHABILITATION
		18	Rout and seal 250 m of transverse cracks and 750 m centerline cracks
		22	Rout and seal 250 m of centerline and 520 m of transverse cracking
	27	REHABILITATION	

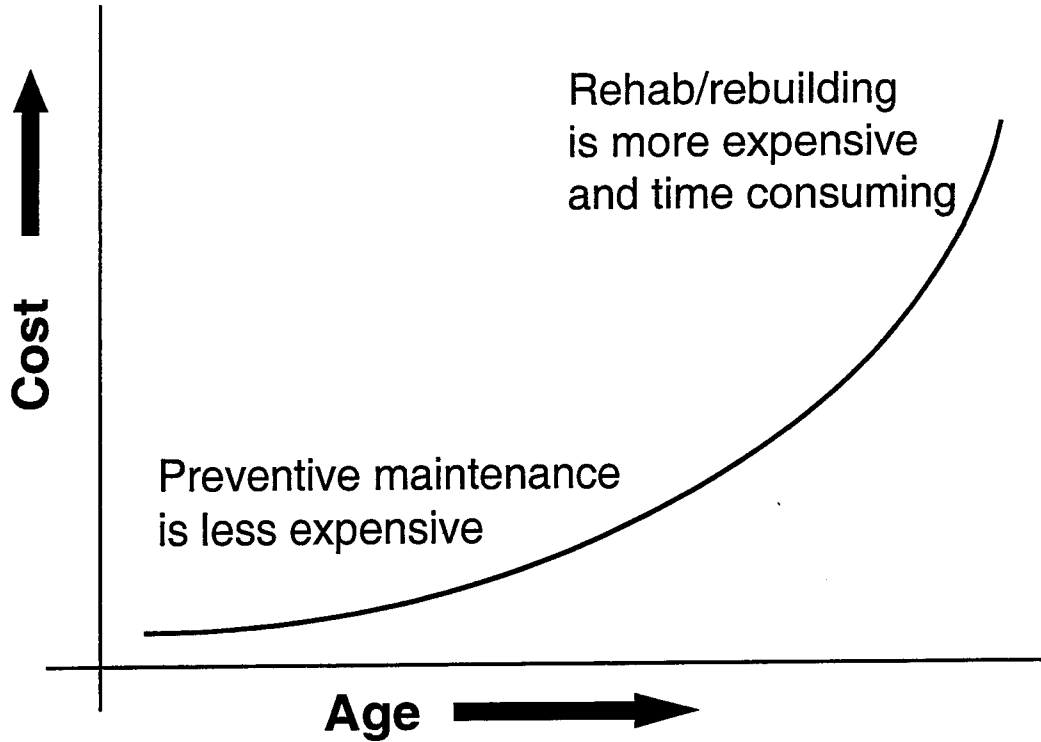

Figure 3.6. Cost of Maintenance or Rehabilitation as a Function of Age (26)

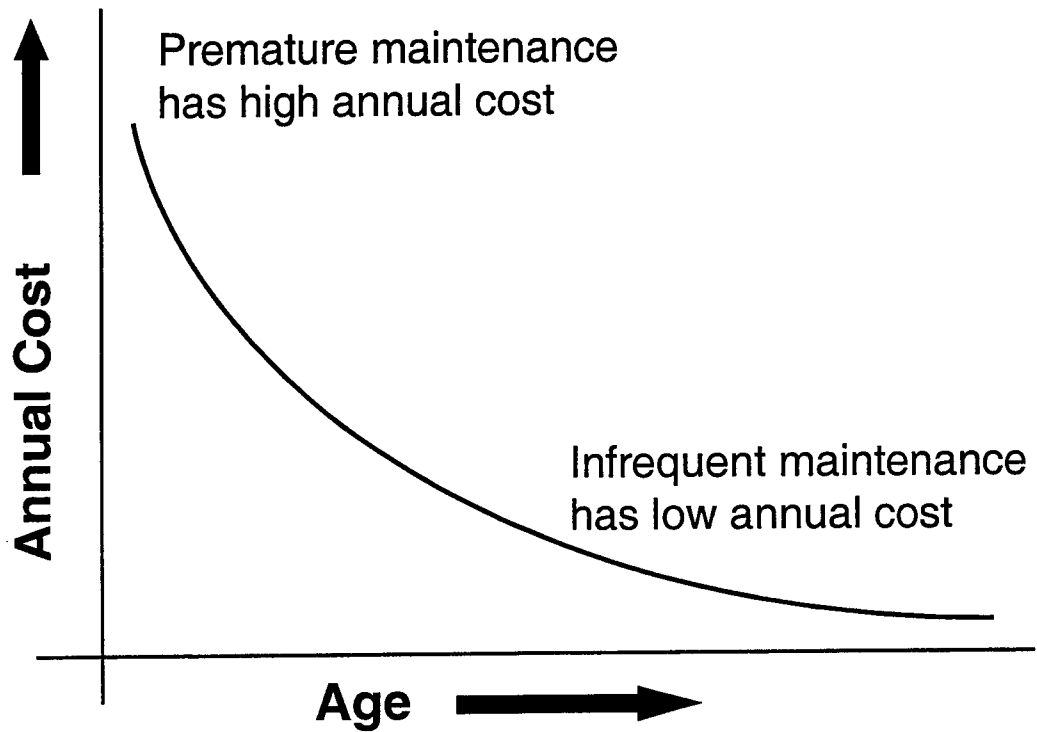

Figure 3.7. Annual Maintenance (or Rehabilitation) Cost as a Function of Age (26)

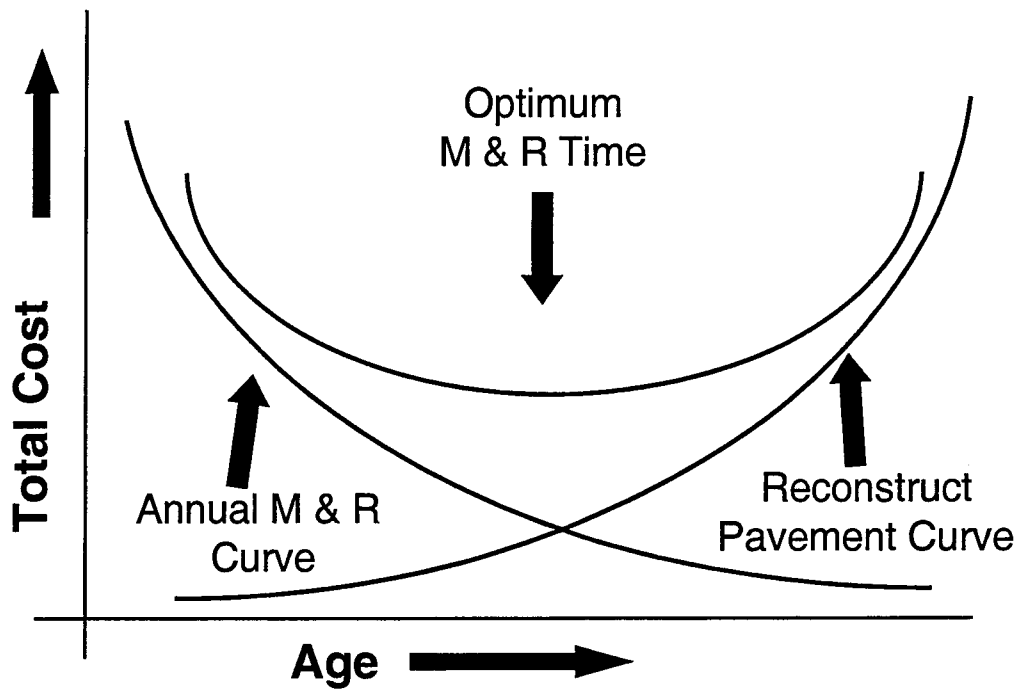

Figure 3.8. Optimum Time to Fix Pavements (26)

4.0 ANALYSIS TO DETERMINE THE MOST COST EFFECTIVE TREATMENT

Typical unit cost and expected life values for various preventive maintenance treatments were presented in Table 2.2. Since these are more or less nationwide averages, similar cost and life data need to be accumulated by an agency to reflect local conditions. (Note, many agencies track costs on their internet sites.) It may be difficult to analyze costs from bid results if a number of items of work are grouped under one bid item, i.e., if the cost for a chip seal includes preparatory patching and crack sealing or traffic control. On the other hand, if all projects contain the same items under chip seals, the costs may be relative and can be analyzed. Once this has been accomplished, the cost data can be used to determine the cost effectiveness of each treatment to be considered. This section of the report presents a framework to determine the most cost effective PM treatment.

4.1 Cost Effectiveness Evaluation Techniques

A number of approaches for determining cost effectiveness exist (8) and some can be very complex. Some of the more common ones are identified in Table 4.1. The Equivalent Annual Cost method (EAC) (3) is recommended, since it is relatively straightforward and can be used in additional calculations that will be discussed later. The equation for EAC is as follows:

$$\text{Equivalent Annual Cost (EAC)} = \frac{\text{unit cost}}{\text{expected life of treatment, years}} \quad (1)$$

As an example of computing EAC, using the values from Table 2.2 for fog seals, the EAC would be the unit cost, \$0.45/yd² divided by the expected life of 3.5 years, as shown in Equation 2.

$$\text{EAC for Fog Seal} = \frac{\$0.45}{3.5} = \approx \$0.13 \quad (2)$$

Additional examples for the other treatments are provided in Table 4.2.

4.2 Developing Decision Matrices

It was previously noted that a number of factors can affect the decision of selecting the most appropriate preventive maintenance treatment. A decision matrix provides a useful mechanism to introduce the effects of several variables in the selection process. Decision matrices can have several forms, are not new, and have been developed by others in a number of business areas, including transportation. Once the various treatments have been identified and the appropriate EACs have been computed, decision matrixes can be prepared for a project. The preparation of a decision matrix should include the following steps (27):

Table 4.1. Common Cost Effectiveness Analysis Methods (4)

Method	Requirements	Output
Life-Cycle Costing	<ul style="list-style-type: none"> • Interest rates • Inflation • Analysis period • Unit cost for treatment • Estimated life of treatment 	Computation of the Equivalent Uniform Annual Cost (EUAC) for each proposed treatment and selection of lowest cost
Cost-Effectiveness Analysis	<ul style="list-style-type: none"> • Pavement performance curve 	Area under the pavement performance curve is equivalent to effectiveness
Equivalent Annual Cost	<ul style="list-style-type: none"> • Cost of equipment, workers, and materials per day 	Unit cost per expected life of treatment
Longevity Cost Index	<ul style="list-style-type: none"> • Treatment unit cost • Present value of unit cost over life of treatment • Traffic loading • Life of the treatment 	Relates present value of cost of treatment to life and traffic

Table 4.2. Examples of Cost Effectiveness of Various PM Treatments (27)

Treatment	Life of Treatment ^a	Equivalent Annual Cost
Fog Seal	3.5	\$0.13
Slurry Seal	5	\$0.18
Microsurfacing	6	\$0.21
Chip Seals	5	\$0.17
Thin Hot-Mix Overlay	7	\$0.25

^aTypical life of maintenance treatment for this example

1. Select the potential treatments with their attendant EACs.
2. Identify specific attributes that are important for the project, i.e., minimal lane closures, high traffic volumes require night work, and so on. These attributes should be consistent throughout the evaluation process.
3. Develop weighting (or rating) factors that can be determined for each condition, if desired, i.e., lane closures are more important than noise, noise is more important than time of year of construction, etc. For a specific project, these attributes need to be consistent for each treatment so as not to bias the selection. The sum of all factors must equal 100 percent.
4. Rate the importance of each attribute for each potential treatment (scoring factor), i.e., the length of time of traffic disruption for a chip seal will differ from a thin hot mix asphalt overlay. For example, each treatment could be rated from 1-5, with 5 being most important and 1 being the least important for a given treatment. The scoring factors would be assigned by the individual agency.
5. Compute the scores for each treatment, then select the treatment with the highest score as the best alternative.

A typical decision matrix following this process is noted in Figure 4.1 and is aligned with the following example. This particular matrix has a linear format.

4.3 Example Decision Matrix

Assume that an agency has developed guidelines that indicate that for each project a Pavement Condition Index (PCI) will be determined from a condition survey and that a preservation treatment will be programmed if the PCI falls between two arbitrary values. For example, Agency A has determined that if the PCI on a portion of the network is less than 75 but greater than 60, a preventive treatment is appropriate. Additionally, if the PCI is greater than 75, no treatment is required. If the value is less than 60, a corrective maintenance activity is scheduled. For this example, assume the PCI is 70, that the cracking is low to moderate, the surface condition (such as bird baths, dips, and other minor surface irregularities) is variable but not excessive, but the ride quality is marginal. The agency inventory data indicates that the projected traffic for the next 5 years will be less than 5,000 ADT. Following agency guidelines, it can be determined that for these conditions, four possible treatments could be considered, including thin HMA overlay, slurry seal, chip seal, and microsurfacing. The project is two lanes in a suburban location near a strip shopping area and the desired life is at least 7 years.

Several project features need to be considered in the evaluation including those important to the customer and those important to the agency. The specific project attributes used in the example are discussed below:

RATING FACTOR		SCORING FACTOR	RATING FACTOR	TOTAL SCORE
PERFORMANCE EVALUATION ATTRIBUTES				
%	Expected Life	_____	×	_____ = _____
%	Seasonal Effects	_____	×	_____ = _____
%	Pavement Structure Influence	_____	×	_____ = _____
%	Influence of Existing Pavement Condition	_____	×	_____ = _____
CONSTRUCTABILITY ATTRIBUTES				
%	Cost Effectiveness (EAC)	_____	×	_____ = _____
%	Availability of Quality Contractors	_____	×	_____ = _____
%	Availability of Quality Materials	_____	×	_____ = _____
%	Weather Limits	_____	×	_____ = _____
CUSTOMER SATISFACTION ATTRIBUTES				
%	Traffic Disruption	_____	×	_____ = _____
%	Noise	_____	×	_____ = _____
%	Surface Friction	_____	×	_____ = _____
$\Sigma = 100$ %				
RATING FACTOR: PERCENT OF IMPACT ON TREATMENT DECISION (total must = 100%) SCORING FACTOR: 5 = Very important 4 = Important 3 = Some importance 2 = Little importance 1 = Not important				

Figure 4.1. Treatment Selection Analysis Worksheet (Modified after Reference 27)

1. **Performance and Constructability Attribute Rating and Scoring Factors.** There are a number of factors to consider in the selection process and some of these are referred to as performance and constructability factors such as expected life, availability of qualified contractors, and availability of local materials. For any given project, the number and types of factors will vary. For this example, the performance and constructability attributes chosen are shown in Table 4.3, items 1 through 8. For each of the treatments to be evaluated, a numerical score from 1 to 5 can be assigned to each attribute that will account for differences between treatments for a particular desired characteristic. For example, the treatment with the longest life might have a rating of 5 while other treatments would be less; or the treatment with the least cost would be rated 5 and the rest something less. Considering EAC only will always skew the decision to the lowest cost product. For this example, the scoring factors noted in Table 4.3 could be assigned for the treatments under consideration. **It should be emphasized that these scores would likely vary from agency to agency.**

2. **Customer Satisfaction Attributes Rating and Scoring Factors.** The primary objectives for the agency, on this project, are to provide customer satisfaction by constructing a quiet riding surface with adequate friction resistance that can be placed so that traffic can be returned quickly with minimal disruption to the businesses located along the route. As a result of these concerns, the agency chooses the following three attributes and ranks them accordingly:

- Traffic disruption
- Surface friction
- Noise

It should be noted that these attributes probably will change from project to project and the ratings, or impact of each factor, may change as well. Figure 4.2 shows the attributes chosen for this example and the associated agency selected rating factors.

For each treatment, the performance, constructability, and customer satisfaction attributes are assigned an initial rating which can be adjusted further according to importance. The sum of all the rating factors for all attributes for each project should equal 100 percent.

The factors are computed and the final score is derived for each treatment. The alternate with the highest score is selected as the most effective treatment. Using the above data sets as input, the total effective ranking for each potential treatment can be calculated as shown in Figures 4.2 through 4.5. The summary of each treatment analyzed for the example project is shown in Table 4.4. **It must be emphasized that each agency must determine the EAC, effectiveness of maintenance treatments, the expected life for each treatment, and the weighting factors, because they will vary based on local conditions. The examples shown above are illustrative only and should not be used; they should be developed by each agency.**

Table 4.3. Examples of Performance and Constructability Scoring Factors

Item	Attribute	Thin HMA	Slurry Seal	Chip Seal	Microsurfacing
1	Expected Life ^a	4	2	3	4
2	Seasonal Effects ^b	3	3	2	3
3	Pavement Structure ^c	4	2	3	3
4	Existing Conditions ^d	3	1	4	2
5	Cost Effectiveness ^e	3	5	5	4
6	Qualified Contractor ^f	4	3	4	3
7	Quality Materials ^g	3	2	3	2
8	Weather Limits ^h	2	4	3	4
9	Traffic Disruption ⁱ	2	4	1	5
10	Noise ^j	5	4	1	3
11	Surface Friction ^k	4	4	5	4

^aWhich treatment will provide the longest life? (5 = longest; 1 = shortest)

^bAre the treatments affected by seasonal changes? (5 = little; 1 = a great deal)

^cWill the existing pavement structure influence the selection? (5 = little; 1 = a great deal)

^dWill the treatment type be influenced by the condition of the pavement? (5 = little; 1 = a great deal)

^eFrom Table 4.2, Average Unit Costs and Expected Life (5 = most cost effective; 1 = least cost effective)

^fAvailability and quality history (5 = very qualified; 1 = least qualified)

^gAre quality materials available to construct the project? (5 = yes; 1 = no)

^hRestrictions on time of the year for placement (5 = no restrictions; 1 = considerable restrictions)

ⁱIs traffic disruption an issue? (5 = not at all; 1 = a great deal)

^jIs noise an issue? (5 = not at all; 1 = a great deal)

^kIs surface friction important? (5 = no; 1 = yes)

Table 4.4 Total Ranking for Example Project

Treatment	Total Score
Thin HMA Overlay	3.20
Slurry Seal	3.20
Chip Seal	2.90
Microsurfacing	3.65

RATING FACTOR		SCORING FACTOR	RATING FACTOR	TOTAL SCORE
PERFORMANCE EVALUATION ATTRIBUTES				
15 %	Expected Life	4	\times 0.15	= 0.60
10 %	Seasonal Effects	3	\times 0.10	= 0.30
5 %	Pavement Structure Influence	4	\times 0.05	= 0.20
5 %	Influence of Existing Pavement Condition	3	\times 0.05	= 0.15
CONSTRUCTABILITY ATTRIBUTES				
10 %	Cost Effectiveness (EAC)	3	\times 0.10	= 0.30
5 %	Availability of Quality Contractors	4	\times 0.05	= 0.20
10 %	Availability of Quality Materials	3	\times 0.10	= 0.30
5 %	Weather Limits	2	\times 0.05	= 0.10
CUSTOMER SATISFACTION ATTRIBUTES				
20 %	Traffic Disruption	2	\times 0.20	= 0.40
5 %	Noise	5	\times 0.05	= 0.25
10 %	Surface Friction	4	\times 0.10	= 0.40
$\Sigma = 100$ %			$\Sigma =$	3.20
<p>RATING FACTOR: PERCENT OF IMPACT ON TREATMENT DECISION (total must = 100%)</p> <p>SCORING FACTOR: 5 = Very important 4 = Important 3 = Some importance 2 = Little importance 1 = Not important</p>				

Figure 4.2. Treatment Selection Analysis Worksheet for Thin HMA

RATING FACTOR		SCORING FACTOR		RATING FACTOR	TOTAL SCORE
PERFORMANCE EVALUATION ATTRIBUTES					
15 %	Expected Life	2	×	0.15	= 0.30
10 %	Seasonal Effects	3	×	0.10	= 0.30
5 %	Pavement Structure Influence	2	×	0.05	= 0.10
5 %	Influence of Existing Pavement Condition	1	×	0.05	= 0.05
CONSTRUCTABILITY ATTRIBUTES					
10 %	Cost Effectiveness (EAC)	5	×	0.10	= 0.50
5 %	Availability of Quality Contractors	3	×	0.05	= 0.15
10 %	Availability of Quality Materials	2	×	0.10	= 0.20
5 %	Weather Limits	4	×	0.05	= 0.20
CUSTOMER SATISFACTION ATTRIBUTES					
20 %	Traffic Disruption	4	×	0.20	= 0.80
5 %	Noise	4	×	0.05	= 0.20
10 %	Surface Friction	4	×	0.10	= 0.40
∑ = 100 %				∑ =	3.20
RATING FACTOR: PERCENT OF IMPACT ON TREATMENT DECISION (total must = 100%) SCORING FACTOR: 5 = Very important 4 = Important 3 = Some importance 2 = Little importance 1 = Not important					

Figure 4.3. Treatment Selection Analysis Worksheet for Slurry Seal

RATING FACTOR		SCORING FACTOR		RATING FACTOR	TOTAL SCORE
PERFORMANCE EVALUATION ATTRIBUTES					
15 %	Expected Life	3	×	0.15	= 0.45
10 %	Seasonal Effects	2	×	0.10	= 0.20
5 %	Pavement Structure Influence	3	×	0.05	= 0.15
5 %	Influence of Existing Pavement Condition	4	×	0.05	= 0.20
CONSTRUCTABILITY ATTRIBUTES					
10 %	Cost Effectiveness (EAC)	5	×	0.10	= 0.50
5 %	Availability of Quality Contractors	4	×	0.05	= 0.20
10 %	Availability of Quality Materials	3	×	0.10	= 0.30
5 %	Weather Limits	3	×	0.05	= 0.15
CUSTOMER SATISFACTION ATTRIBUTES					
20 %	Traffic Disruption	1	×	0.20	= 0.20
5 %	Noise	1	×	0.05	= 0.05
10 %	Surface Friction	5	×	0.10	= 0.50
∑ = 100 %				∑ =	2.90
RATING FACTOR: PERCENT OF IMPACT ON TREATMENT DECISION (total must = 100%) SCORING FACTOR: 5 = Very important 4 = Important 3 = Some importance 2 = Little importance 1 = Not important					

Figure 4.4. Treatment Selection Analysis Worksheet for Chip Seal

RATING FACTOR		SCORING FACTOR		RATING FACTOR		TOTAL SCORE
PERFORMANCE EVALUATION ATTRIBUTES						
15 %	Expected Life	4	×	0.15	=	0.60
10 %	Seasonal Effects	3	×	0.10	=	0.30
5 %	Pavement Structure Influence	3	×	0.05	=	0.15
5 %	Influence of Existing Pavement Condition	2	×	0.05	=	0.10
CONSTRUCTABILITY ATTRIBUTES						
10 %	Cost Effectiveness (EAC)	4	×	0.10	=	0.40
5 %	Availability of Quality Contractors	3	×	0.05	=	0.15
10 %	Availability of Quality Materials	2	×	0.10	=	0.20
5 %	Weather Limits	4	×	0.05	=	0.20
CUSTOMER SATISFACTION ATTRIBUTES						
20 %	Traffic Disruption	5	×	0.20	=	1.00
5 %	Noise	3	×	0.05	=	0.15
10 %	Surface Friction	4	×	0.10	=	0.40
∑ = 100 %				∑ =		3.65
RATING FACTOR: PERCENT OF IMPACT ON TREATMENT DECISION (total must = 100%) SCORING FACTOR: 5 = Very important 4 = Important 3 = Some importance 2 = Little importance 1 = Not important						

Figure 4.5. Treatment Selection Analysis Worksheet for Microsurfacing

From this analysis, microsurfacing would be the selected treatment. A particular point to note is that the fewer the number of variables considered, the greater the effect a single variable will have in the selection process. Objectivity in assigning rating factors will also affect the outcome of the analysis. This approach demands that the process of selecting an effective preventive maintenance treatment must be properly engineered to insure that the most effective treatment is chosen. It is not a haphazard exercise.

5.0 CONCLUSIONS AND RECOMMENDATIONS

5.1 Conclusions

Maintenance engineers apply many different maintenance treatments to flexible pavements. The selection process used to determine these treatments is becoming increasingly important because of the limited funds that agencies have available and the growing backlog of needs.

A framework for determining the most effective pavement preventive maintenance treatment for a flexible pavement is presented in this paper. Although simplistic, the process provides a logical approach that can be used by agencies, large or small. Each agency must recognize the type and cause of existing pavement distresses before evaluating available treatments and the other factors that will influence the decision making process. Although cost must be considered, it should not always be the overriding factor in deciding which treatment to use. Engineering judgment, as it should, plays an important role in the overall process.

5.2 Recommendations

Work is needed to develop appropriate decision trees by each agency. The use of these decision trees can (and need to) be built into the agency's PMS process and result in cost effective preventive maintenance solutions. Concepts presented in this report lay the ground work and fully support the need for a Pavement Preservation Program with dedicated funds. Agencies can provide the traveling public a higher level of service at reduced overall costs by making the correct decision to "apply the right treatment, to the right road at the right time."

6.0 REFERENCES CITED

1. Zaniewski, J.P., and M.S. Mamlouk. *Pavement Maintenance Effectiveness Preventive Maintenance Treatments Participants Handbook*. FHWA -SA-96-127, Federal Highway Administration, 1996.
2. *Pavement Management Systems*. Participant's Manual, Federal Highway Administration, National Highway Institute, Washington, DC, 1998.
3. *Pavement Management Analysis, Multi-Year Prioritization*. Demonstration Project No. 108, Publication No. FHWA-SA-97-071, Federal Highway Administration, National Highway Institute, Washington, DC, 1997.
4. O'Brien, L.G. *Evolution and Benefits of Preventive Maintenance Strategies*. NCHRP Synthesis 153, Transportation Research Board, December 1989, 69 pp.
5. Galehouse, L. *Michigan Department of Transportation Highway Preventive Maintenance Program Manual*. Michigan DOT, Lansing, MI, 1996, 21 pp.
6. Geoffroy, D.N. *Cost-Effective Preventive Pavement Maintenance*. NCHRP Synthesis 223, Transportation Research Board, 1996, 103 pp.
7. Peterson, D.E. *Pavement Management Practices*. NCHRP Synthesis 135, Transportation Research Board, November, 1987, 139 pp.
8. *A Basic Asphalt Emulsion Manual*, Manual Series No. 19, Third Edition. The Asphalt Institute and the Asphalt Emulsion Manufacturer's Association, 1997.
9. Roberts, F.L., P.K. Kandahl, E.R. Brown, D. Lee, and T.W. Kennedy. *Hot Mix Asphalt Materials, Mixture Design, and Construction*, Second Edition. NAPA Education Foundation, Lanham, MD, 1996.
10. Monismith, C.L. *Pavement Management: Proceedings of National Workshop*. FHWA-TS-82-203, Federal Highway Administration, June 1981, 74 pp.
11. Hicks, R.G., K. Dunn, and J.S. Moulthrop. Framework for Selecting Effective Preventive Maintenance Treatments for Flexible Pavements. In *Transportation Research Record 1597*, Washington, DC, 1997.
12. Michigan DOT. *Capital Preventive Maintenance Program – Guidelines*. March 4, 1999.

13. *Accelerated Field Test of Performance-Related Specifications for Hot-Mix Asphalt Construction*. NCHRP Project No. 9-20 (in progress), National Cooperative Highway Research Program, Transportation Research Board, National Research Council, Washington, DC, 1998.
14. New York State DOT. *Pavement Rehabilitation Manual – Volume II: Treatment Selection*. NYDOT, Materials Bureau, May 1993.
15. Personal communication with Roger C. Olson, Minnesota Road Research Section, August 4, 1999.
16. Southern Region SPS Tour, October, 1995. Brent Rauhut Engineering, Austin, TX.
17. Hunt, Elizabeth. *Asphalt Pavement Maintenance and Rehabilitation Selection Guide*. Department of Civil Engineering, Oregon State University, June 1991.
18. The Asphalt Institute. *Asphalt Overlays for Highway and Street Rehabilitation*. MS-17, June 1983.
19. Jahren, Charles K., Kenneth L. Bergeson, A. Al-Hammadi, S. Celik, and G. Lau. *Thin Maintenance Surfaces: Phase One Report*. Center for Transportation Research and Education, Iowa State University, April 1999.
20. Shober, Stephen F. and David A. Friedrichs. *A Pavement Preservation Strategy*. Presented at the 1998 annual meeting of Transportation Research Board, 1997.
21. New York State DOT. *Pavement Rehabilitation Manual – Volume III: Preventive Maintenance Treatments and Selection*. NYDOT Materials Bureau, June 1999.
22. American Society of Testing and Materials. *Standard Test Method for Airport Condition Index Surveys*. D5340-93, Volume 0.403, 1998.
23. Moulthrop, J., T. Thomas, B. Ballou, and H. King. Choose the Right Tool for the Distress. In *Asphalt Contractor*, September 1999, pp. 8-12.
24. Haas, Ralph, W.R. Hudson, and John Zaniewski. *Modern Pavement Management*. Krieger Publishing Co., 1994.
25. *Hot and Cold Mixing Paving: Principles and Practices*. Cornell Local Roads Program Report 95-4, 1995.
26. Hicks, R.G. and Dennis Jackson. Benefits of Pavement Maintenance – An Update. 1998 Western Pavement Maintenance Forum, Sacramento, CA, January 1998.

27. Hicks, R.G., J.S. Moulthrop, and J. Daleiden. Selecting a Preventive Maintenance Treatment for Flexible Pavements. In *Transportation Research Record 1680*, Transportation Research Board, 1999, pp. 1-12.

7.0 REFERENCES REVIEWED BUT NOT CITED

1. Way, George B., John F. Eisenberg, and James P. Delton. *Arizona's Pavement Management System Summary and Development of Arizona's Operational Pavement Management System*. Arizona DOT, Report No. FHWA/AZ-82/169/2, January 1982.
2. Ritchie, S.G., C. Yeh, J.P. Mahoney, and N.C. Jackson. Development of an Expert System for Pavement Rehabilitation Decision Making. In *Transportation Research Report 1070*, Transportation Research Board, 1986.
3. *Road Surface Management for Local Governments*, Participant's Manual, Course No. 13246, Federal Highway Administration, National Highway Institute, Washington, DC, 1990.
4. NAPA. *Pavement Preparation Prior to Overlaying with HMA*. Q1P Series 116, 1990.
5. Ross, T., S. Vetzi, S. Shuler, G. McKeen, and V. Shaefer. *A Pavement Rehabilitation Expert System (PARES) for Preliminary Design*. FHWA-HPR-NM, -88-08, New Mexico State Highway and Transportation Department, July 1990.
6. Geoffrey, Donald N. and John J. Shuton. Network-Level Pavement Management in New York State: A Goal Oriented Approach. In *Transportation Research Report 1344*, Transportation Research Board, 1992.
7. Roads and Traffic Authority. *Guidelines for Rehabilitation of Flexible Pavements*. Australia, 1993.
8. Al-Mansour, A.I. and K.C. Sinha. Economic Analysis of Effectiveness of Pavement Preventive Maintenance. In *Transportation Research Record 1442*, Transportation Research Board, 1994.
9. The Asphalt Institute. *Asphalt in Pavement Maintenance*. MS-16, 3rd Edition.
10. Stampley, Bryon E., B. Miller, R.E. Smith, and T. Scullion. *Pavement Management Information System Concepts, Equations and Analyses Models*. TTI Report 7-1989, Texas A & M University, August 1995.
11. Zimmerman, K.A. *Pavement Management Methodologies to Select Projects and Recommended Preservation Treatments*. NCHRP Synthesis 222, Transportation Research Board, 1997.
12. Denehey, Edward J. Implementing New York State DOT's Pavement Preventive Maintenance Program. In *Transportation Research Record 1597*, Transportation Research Board, 1997.

13. *Techniques for Pavement Rehabilitation*, Reference Manual (Sixth Edition), Course No. 13108, Publication No. FHWA HI-98-033, Federal Highway Administration, National Highway Institute, Washington, DC, August 1998.
14. Galehouse, Larry. Innovative Concepts for Preventive Maintenance. In *Transportation Research Record 1627*, Transportation Research Board, 1998.
15. Bureau of Maintenance and Operations. *Bituminous and Cement Concrete Pavement Treatment Strategies, Material Quality, and Cost Calculations and Indices*. Pennsylvania Department of Transportation, December 1998.
16. Davies, Robert M. and Jim Sorenson. Pavement Preservation: Preserving the Investment in Our Highways. Draft *Public Roads* Article, November 10, 1999.

APPENDIX A
Summary of Organizations Surveyed

Table A.1. State Highway/Provincial Agencies

State	Contacts	Status
a) Western USA		
Arizona	George Way/Larry Scofield	Received information from PMS
California	Larry Orcutt/Paul Elliott	Received decision matrix
Montana	Bill Vischer	Embedded in TRDI PMS
New Mexico	Gordon McKeen	Received research report, "A Pavement Rehab Expert System for Preliminary Design"
Oregon	Jeff Gower	Received – embedded in TRDI PMS
Washington	Linda Pierce	Nothing formal available
b) Central USA		
Iowa	F. Todey	Received ISU report titled "Thin Maintenance Surfaces"
Kansas	Andrew Gisi	Embedded in PMS
Michigan	Larry Galehouse	Received copy of PM program guidelines
Minnesota	Roger Olsen/Jim Lilly	Received the 1999 decision trees
Texas	Ken Fults/Roger Smith	Received a copy of TTI report "Pavement Management Information System, Concepts, Equations, and Analysis"
Wisconsin	Steve Shober/David Friedrichs	Received two papers
c) Eastern USA		
Georgia	Wouter Gulden	GIT is currently working on a project
New York	Ed Denehy/Ed Fahrenkopf	Provided several reports
Ohio	Bob McQuiston	ODOT is currently updating their process
Pennsylvania	Danny Dawood	Embedded in PMS
Virginia	Andrew Bailey	Nothing Available

Table A.1. State Highway/Provincial Agencies (continued)

d) Canadian Provinces		
Province	Contact	Status
British Columbia	Shawn Landers	Provided decision trees
Ontario	Tom Kazmierowski	Currently developing decision trees
e) Toll Authorities		
	Contact	Status
New Jersey Turnpike	Tom Wilson 732-247-0900 x 5266	Nothing available
Pennsylvania Turnpike	Gene Matson 717-939-9551 x 3502	Nothing available
Port Authority (New York & New Jersey)	Cas Bognacki 201-216-2964	Nothing available

Table A.2. Local Agencies

Agency	Contact	Status
APWA	Peter King	Received several reports
NACE	Tony Giancola	Received NACE manual
Benton County, Oregon	James Blair	Received NACE/APWA reports
Marion County, Oregon	Mike Rypka	Embedded in PMS
City of Vancouver, Washington	Bill Whitcomb	Working on decision trees
Clark County, Washington	David Shepard	Embedded in PMS

Table A.3. Federal Agencies

Agency	Contact	Status
FHWA – Direct Federal	Brad Nietzke	Nothing available
USFS – Region 6	Pete Bolander	Provided two reports
USACE	David Pittman/Al Bush	Provided decision trees
USAF	Jim Greene	Similar to USACE

Table A.4. International Organizations

Agency	Contact	Status
AAPA	Ray Farelley/Dave Mangan	Provided two reports
EAPA	Max von Devivere/Charlotte Berg	Nothing available
Sabita	P. Myburgh/R. Vos	Received Manual #16
ISAP	Steve Brown	Nothing available

Table A.5. Industry Groups – USA

Organization	Contact	Status
AEMA	Mike Krissoff/Neal Guiles	Nothing available
ARRA	Mike Krissoff/John Rathbun	Received report
ISSA	John Fiegel/Bill Ballou	Nothing available
NAPA	Dale Decker	Nothing available, but Q1P-116 may help
TAI	Ed Miller/J. Hensley	Suggested MS-16 and 17 and IS-169
Crafco	Jim Chehovits	Received several papers on crack sealants

APPENDIX B
Examples of Decision Trees/Matrices Currently in Use

INTRODUCTION

This appendix presents a selection of decision trees and/or matrices used by selected agencies. As indicated in the body of the report, most of the early decision trees/matrices were developed for pavement rehabilitation and were included in some form of pavement management system. Later efforts have focussed more on maintenance treatments. Regardless, this appendix provides the reader with a number of examples which could be modified for his/her intended use.

a) Typical Decision Trees

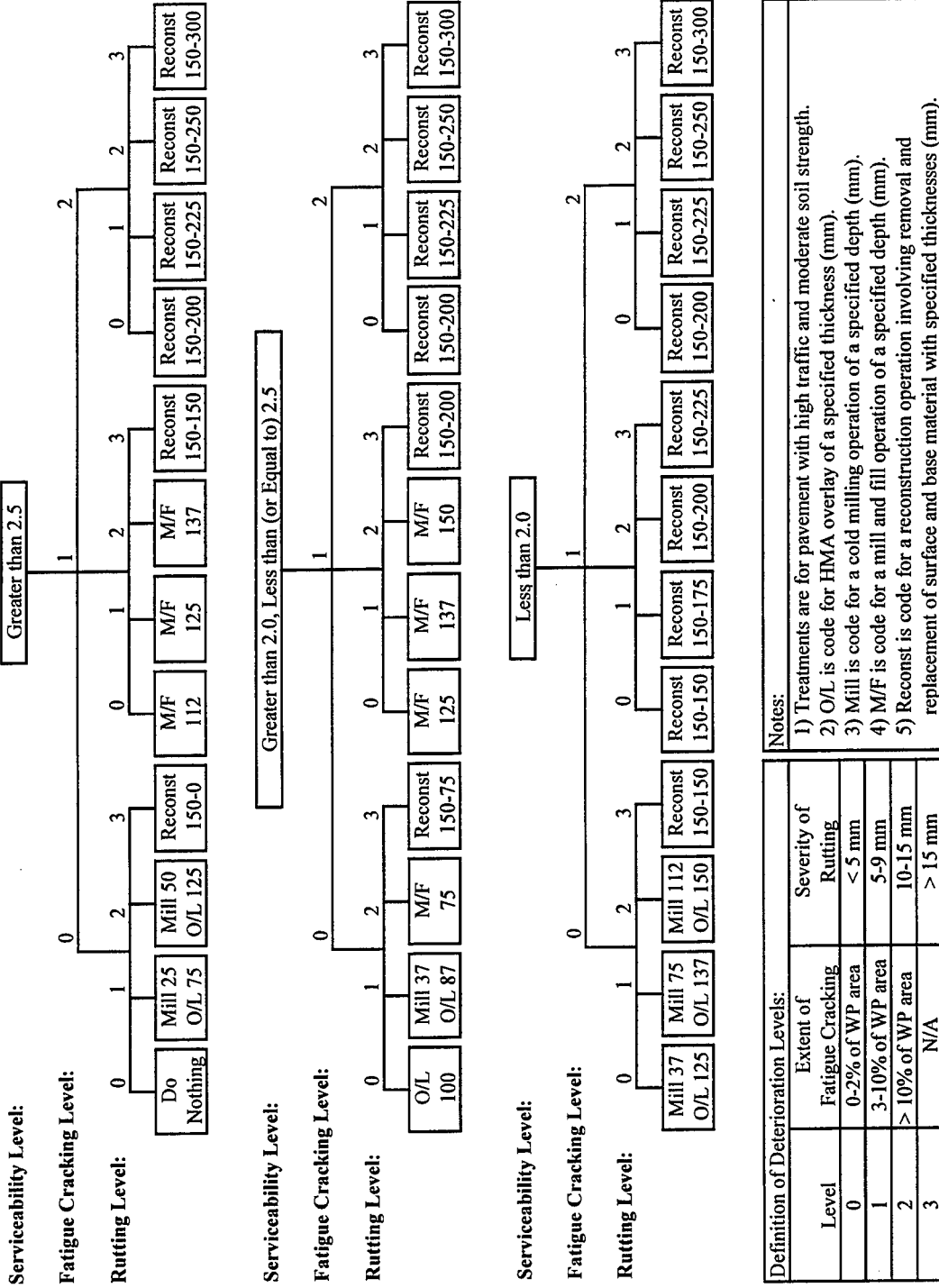

Figure B.1. Preliminary Pavement Rehabilitation Decision Tree Selected for Incorporation into the Prototype Performance-Related Specification for HMA Pavement Construction Being Developed Under NCHRP Project 9-20 (13)

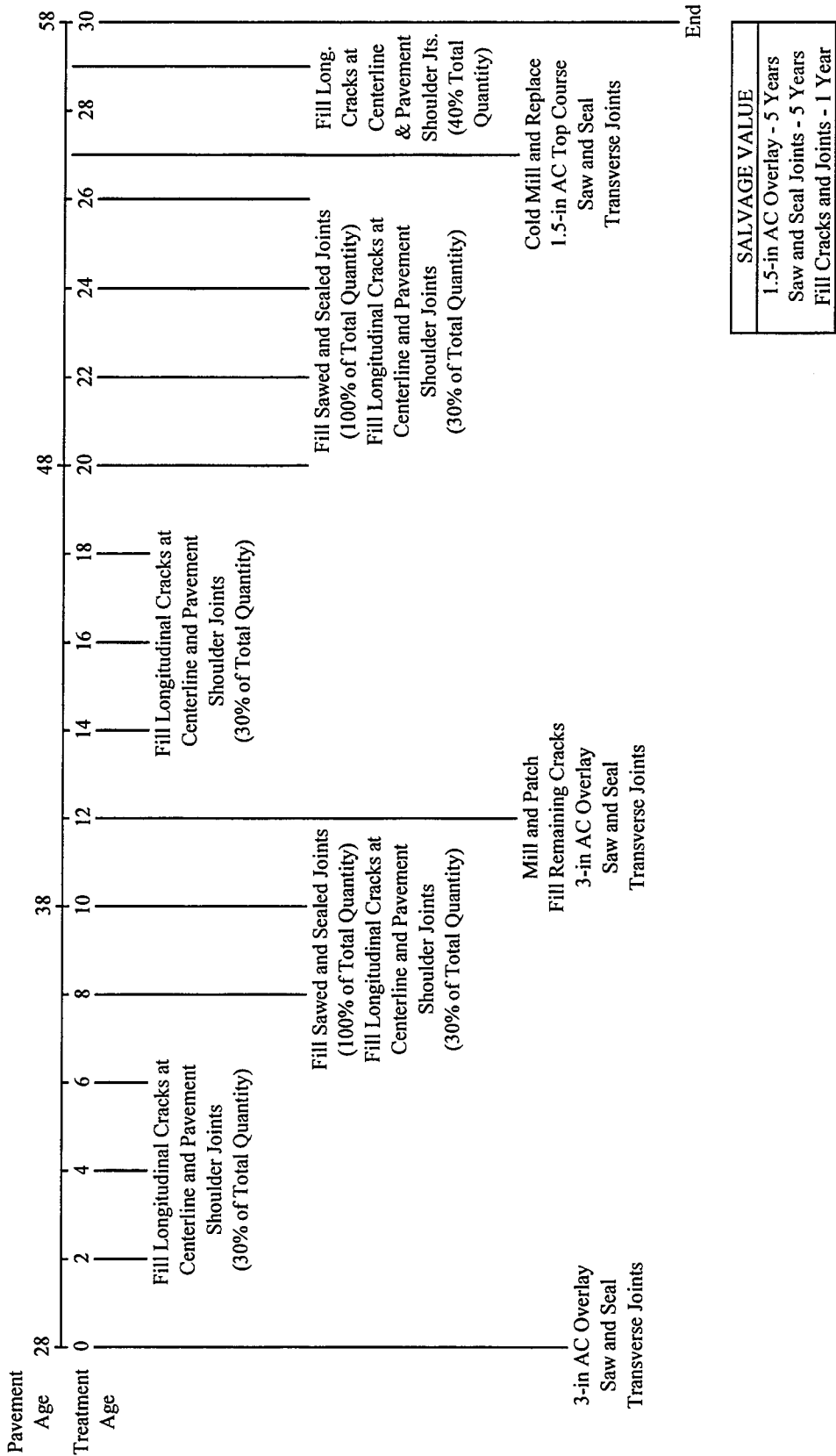

Figure B.2. Example of a Preventive Maintenance Strategy Provided to Designers by NYSDOT (14)

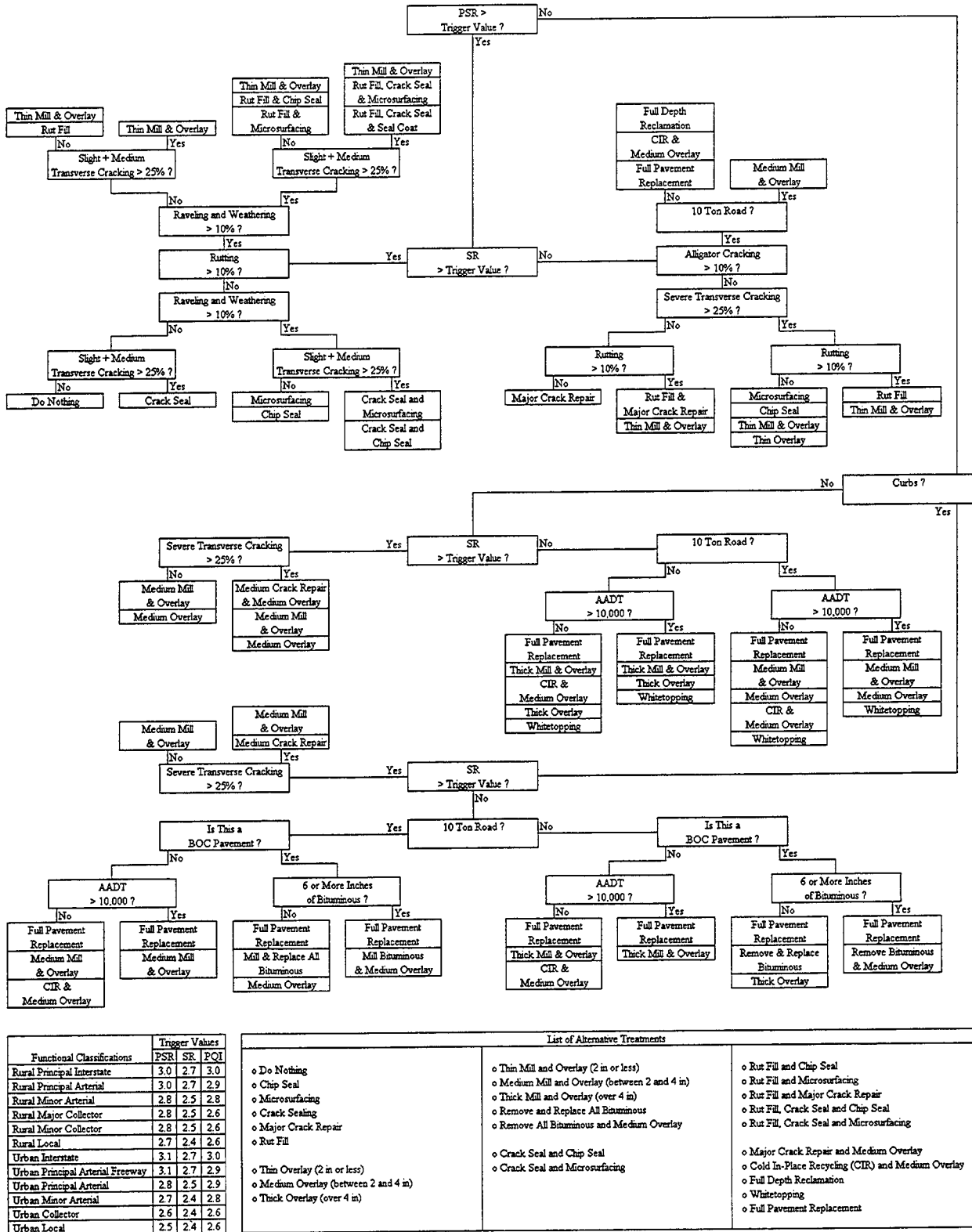

Figure B.3. Network Level Decision Tree for Bituminous Pavements – Minnesota DOT (15)

b) Typical Decision Matrices

Table B.2. Pavement Preventive Maintenance Techniques – Asphalt Pavement Surfaces (Ohio DOT)

Preventive Maintenance Technique	Reasons for Use						Traffic Volume		Average Thickness	Application Rate			Average Cost ¹	
	Friction	Raveling	Rutting	Seal Minor Cracks	Aging & Oxidation	Keep Out Water	Low	High		Asphalt	Aggregate	Mix	Weight or Area	Lane Mile
Crack Sealing						✓	X	X					\$0.60-\$1.00 per lb	\$1,000-\$4,000
Fog Seal		✓		✓	✓		X			0.10-0.15 Gal/sy			\$0.20-\$0.25 per sy	\$1,400-\$1,700
Slurry Seal		✓		✓	✓		X		1/8"-1/4"	0.15-0.20 Gal/sy	6-15 #/sy		\$0.70-\$0.95 per sy	\$5,000-\$7,000
Microsurfacing	✓	✓	✓	✓	✓		X	X	1/2"-1 1/2" Ruts & 1/4 Surface		22-26 #/sy to 50 #/sy		\$1.25-\$2.00 per sy	\$8,500-\$14,000
Sand Seal				✓	✓	✓	X		3/4"-1"				\$30-\$35 per ton	\$8,500-\$13,500
Rubber Sand Seal				✓	✓	✓	X	X	3/4"-1"				\$35-\$45 per ton	\$10,000-\$15,000
Chip Seal	✓	✓		✓	✓	✓	X		1/4"	0.30-0.35 Gal/sy	#8/#9 LS 15-25#/sy		\$0.80-\$1.10 per sy	\$5,500-\$7,500
Double Chip Seal	✓	✓		✓	✓	✓	X		1/2"	0.35 Gal/sy	#8/#9 LS 25-40#/sy		\$1.25-\$1.75 per sy	\$8,500-\$12,000
Open Graded Friction Course	✓						X	X	3/4"				\$30-\$40 per ton	\$8,500-\$11,500
Rubber OGFC	✓							X	3/4"				\$35-\$45 per ton	\$10,000-\$13,000
Thin Hot Mix Asphalt Overlay	✓	✓	✓	✓	✓	✓	X	X	1"-1 1/2"				\$30-\$35 per ton	\$7,000-\$15,000
Cold in Place Recycling		✓	✓	✓	✓		X		Scarify 1"-4"				\$15-\$25 per ton	\$6,000-\$8,000
Hot in Place Recycling			✓	✓	✓			X	Scarify 1"-1 1/2"	0.10 Gal/sy			\$2.00-\$2.20 per sy	\$14,000-\$15,500

¹ 1997 Statewide average unit bid prices ODOT projects

Note: These treatments should only be used on structurally sound pavements.

Table B.3. Pavement Maintenance and Rehabilitation Alternatives (17)

Distress Types	Primary Cause	Basic Routine Maintenance				Major Routine Maintenance						Rehabilitation			Other	
		Crack Seal	Skin Patch	Partial Patch	Deep Patch	Fog Seal	Rejuvenator	Single Chip Seal	Double Chip Seal	Slurry Seal	Thin Overlay ¹	Thick Overlay ¹	Cold Recycling	Reconstruction ²	Return to Aggregate ²	
Alligator Cracking	Load	L ⁴			M,H ³				L ⁴			X	X	X		
Block Cracking	Environment ⁵	L,M					L	L,M	L,M			X		X		
Distortions ⁷	Environment or Materials		M,H	M	M,H ³						X ⁶	X	X	X		
Longitudinal & Transverse Cracking	Environment ⁵	L,M		M	H		L	L,M	L,M			X			X	
Patch Deterioration ⁸	Other				H							X	X	X	X	
Rutting/Depressions ⁷	Load		M,H		M,H							X	X	X	X	
Weathering/Raveling	Environment					L,M	L	M,H	M,H	L,M,H	X	X	X	X	X	

Notes: L = Low Severity Distress; M = Medium Severity Distress; H = High Severity Distress; X = Possible Alternative

1 = Deflection testing required for overlay designs

2 = If distress is extensive enough

3 = Patching with a geotextile is recommended for areas requiring additional subgrade support

4 = Temporary repair

5 = High severity distress is load related

6 = Over planed surface

7 = Low severity distress does not require basic routine maintenance

8 = Low or medium severity distresses do not require basic routine maintenance

Table B.4. Some Alternatives in Pavement Maintenance and Rehabilitation (18)

Problem	Possible Cause				Maintenance ¹				Rehabilitation ²					
	Structural Failure	Mix Composition	Temperature or Moisture Changes	Construction	Patching & Routine Maintenance	Fog Seal	Surface Treatment	Slurry Seal	Surface Recycling	Thin Overlay	Open-Graded Surface	Structural Overlay	Structural Recycling	Reconstruction ³
Alligator Cracking	X				X ⁴		X ⁵	X ⁵				X	X	X
Edge Joint Cracks	X		X	X	X									
Reflection Cracks					X		X ⁵	X ⁵			X ⁶	X	X	
Shrinkage Cracking		X	X				X	X	X		X ⁶	X	X	
Slippage Cracks				X	X									
Rutting	X	X		X					X	X ⁷		X	X	X
Corrugation	X	X		X					X	X ⁸		X	X	X
Depressions	X			X	X								X	X
Upheaval			X		X								X	X
Potholes	X		X	X	X							X		
Raveling		X		X		X ⁵		X		X				
Flushing Asphalt		X		X					X					
Polished Aggregate		X	X				X		X					
Loss of Cover Aggregate		X		X			X		X					

Notes: 1 = Refer to Asphalt in Pavement Maintenance (MS-16), The Asphalt Institute, for details

2 = When cracking exceeds 40 percent of the surface area of the pavement

3 = If problem is extensive enough

4 = Deep patch-permanent repair

5 = Temporary repair

6 = When accompanied by surface recycling

7 = When rutting is minor

8 = Over planed surface

Table B.5. Recommended Maintenance Strategies for Various Distress Types and Usage
(19)

	Seal Coat	Slurry Seal	Microsurfacing
Traffic			
ADT < 2000	R	R	R
2000 > ADT < 5000	M ^a	M ^a	R
ADT > 5000	NR	NR	R
Bleeding	R	R	R
Rutting	NR	R	R
Raveling	R	R	R
Cracking			
Few tight cracks	R	R	R
Extensive cracking	R	NR	NR
Improving Friction	Yes	Yes	Yes ^b
Snow Plow Damage	Most susceptible	Moderately susceptible	Least susceptible

R = Recommended

NR = Not recommended

M = Marginal

^aThere is a greater likelihood of success when used in lower speed traffic

^bMicrosurfacing reportedly retains high friction for a longer period of time

Table B.6. Pavement Distress Types and Their Alternative Treatments and Service Lives, Wisconsin DOT (20)

Distress Type	Distress Severity	Treatment Number and Type ⁽¹⁾												
		0	1	2	3	4	5	6	7	8	9	10	11	12
		Do Nothing	Spot Repair	Seal Coat	Crack Filling	Cold Recycle	Rut Fill	Surface Mill	Thin Overlay	Thick Overlay	Partial Mill and Overlay	Full Depth Mill/Overlay	Reconstruct	Micro Surface
Flushing/ Bleeding	Moderate	N/A	RL ⁽²⁾	RL ⁽³⁾										
	Severe							RL	RL		10-12			RL
Non-Structural Cracking	Minor	N/A	3-5		3-5									
	Moderate		3-5		3-5				6-9		8-10			
	Severe									8-12	8-10	12-15	FL	
Insufficient Structure	Minor		RL ⁽²⁾			5-8 ⁽⁴⁾	2-6		4-8					2-6 ⁽⁵⁾
	Moderate						2-6		4-8	8-12		12-15	FL	2-6 ⁽⁵⁾
	Severe									8-12		12-15	FL	
Bad Ride	Minor	N/A	RL ⁽⁶⁾					RL						
	Moderate							RL	8-10		10-12			
	Severe							RL		12-15	10-12			
Unstable Base and Subgrade	Minor		RL ⁽²⁾				2-6		4-8					2-6
	Moderate					5-8 ⁽⁴⁾	2-6		4-8	8-12		12-15		
	Severe									8-12	10-12	12-15	FL	
Unstable Mix	Minor						2-6				6-10	8-12		5-8
	Moderate											8-12	FL	
	Severe											8-12	FL	
Aged Pavement	Minor		4-8 ⁽⁷⁾	3-6			2-6							
	Moderate					5-10 ⁽⁸⁾	2-6		6-10	8-12	8-12			
	Severe									8-12	8-12	12-15	FL	
Surface Raveling	Minor	N/A												
	Moderate			3-6										
	Severe								8-12					

Notes: ⁽¹⁾ Numbers in cells indicate the expected range in life (in years) of an alternative treatment; RL = remaining life and FL = full life.

⁽²⁾ Executed on pavement lengths of 50 ft or less. Consists of light sanding, seal coat, milling or thin overlay.

⁽³⁾ Use reduced oil content in seal coat.

⁽⁴⁾ Only on low emphasis routes; usually followed by a seal coat.

⁽⁵⁾ Use multiple passes to build up surface.

⁽⁶⁾ Spot repairs may include skip grinding.

⁽⁷⁾ Spot repairs may include edge wedging, thin overlay and thick overlay.

⁽⁸⁾ With or without mixing grade emulsion added.

Table B.7. Alternative Preventive Maintenance Treatments and Their Conditions for Use by New York State DOT (21)

Pavement Maintenance Treatment	Conditions for Use					
	Traffic Criteria		Maximum Pavement Distress Criteria*			
	AADT	Trucks	Cracking Severity	Raveling Severity	Rutting Severity	Drop-Off Severity
Single Course Surface Treatment	Less Than 2000	Low - Moderate	Low	Low	Low	---
Quick-Set Slurry	Low Volume	Low - Moderate	Low	Low	Low	---
Micro-Surfacing	No Restriction	No Restriction	Low	Low	Medium	---
Paver Placed Surface Treatment	No Restriction	No Restriction	Low	Low	Medium	---
Hot-Mix Asphalt Overlay (40 mm)	No Restriction	No Restriction	Low	Infrequent	Medium	Medium
Cold Milling with Non-Structural HMA Inlay	No Restriction	No Restriction	Low to Medium	Medium	Medium	Medium
CIPR with Non-Structural HMA Inlay	Less Than 4000	Less Than 10%	Medium	High	High	High

*Note: All treatments (with the exception of CIPR with Non-Structural HMA Inlay) assume infrequent corrugations, settlements, heaves or slippage cracks.

Table B.8. Maintenance, Repair, and Major Repair Alternatives for Flexible Airfield Pavements, USACOE (22)

Distress Type	Maintenance					Repair							Major Repair						
	Seal Minor Cracks Holes	Repair Pot-Holes	Partial-Depth Patching	Apply Reluctant materials ¹	Seal Major Cracks	Full-Depth Patching	Micro-Surfacing	Slurry Seal ²	Thin AC Overlays ³	Surface Milling	Grooving	Porous Friction Course	Repair Drainage Facilities ⁴	Surface Recycling	AC Structural Overlay ³	PCC Structural Overlay	Remove Existing Surface and Reconstruct	Hot Recycle	Cold Recycle
Alligator cracking	L	M,H	M			M,H	L	L				L,M,H		M,H	M,H	H			
Bleeding									A					A		A		A	
Block cracking	L,M			L	M,H		L							M	M,H		M,H	M,H	
Corrugation			L,M			L,M,H	L,M	M,H	L,M							M,H			
Depression			L,M,H			M,H	L	M,H				L,M,H				H			
Jet blast				A		A	A	A											
Reflection cracking	L,M				M,H		L,M								M,H				H
Longitudinal and transverse cracking	L,M				M,H		L,M								M,H				H
Oil spillage			A			A		A	A					A		A		A	
Patching	L,M		M		M	M,H								M,H		H		H	
Polished aggregate							A	A	A	A	A			A					
Raveling/weathering		M,H		L,M		M	L,M	M,H	M					M,H		H		M,H	
Rutting			L,M			L,M,H	L							M,H		H		M,H	
Shoving			L			L,M			L,M							M,H		M,H	
Slippage cracking	A		A		A	A								A		A		A	
Swell			L,M			M,H			L,M			L,M,H				H			

Note: L = low severity level; M = medium severity level; H = high severity level; A = no severity levels for this distress.

¹ Not to be used on high speed areas due to increased skid potential.

² Not to be used on heavy traffic areas.

³ Patch distressed areas prior to overlay.

⁴ Drainage facilities to be repaired as needed.

Table B.9. Maintenance, Repair, and Major Repair Alternatives for Rigid Airfield Pavements, USACOE (22)

Distress Type	Maintenance					Repair							Major Repair				
	Seal Minor Cracks	Joint Seal	Partial Patch	Epoxy Patch	Seal Major Cracks	Full-Depth Patch	Under Sealing	Slab Grinding	Surface Milling	AC Overlay	PCC Overlay	Slab Replacement	Crack & Seal with AC Structural Overlay	AC Overlay w/ Geotextile	Repair/Install Surface/Subsurface Drainage System ¹	PCC Recycling	Remove Existing PCC and Reconstruct
Blowup			L,M			M,H						H					
Corner break	L			M,H	M,H	M,H						H					
Longitudinal/Transverse/Diagonal cracking	L,M				M,H				H		H	H	M,H	H	L,M,H	H	H
D cracking	L		M,H		M,H	H						H				H	H
Joint seal damage		M,H															
Patching (small) <5 ft ²	L,M		M	L,M	M,H	M,H					H						
Patching/utility cut	L,M		M	L,M	M,H	M,H					H						H
Popouts ²				A					A	A							
Pumping	A	A			A		A								A		
Scaling/map cracking			M,H				M,H			M,H							
Fault/settlement		L,M				M,H	L,M	M,H							L,M,H		
Shattered slab	L				L,M					M,H		M,H			L,M,H	H	H
Shrinkage crack ³																	
Spalling (joints)		L	L,M		M,H												
Spalling (corner)		L,M	L,M		M,H	M,H											

Note: L = low severity level; M = medium severity level; H = high severity level; A = no severity levels for this distress.

¹ Drainage facilities to be repaired as needed.

² Popouts normally do not require maintenance.

³ Shrinkage cracks normally do not require maintenance.

Table B.10. Guidelines for Pavement Treatment Selection (23)

Pavement Conditions	Parameters	Fog Seal	Crack Seal	Sand Seal	Chip Seal	Polymer Chip	Slurry Seal	Microsurfacing	Ultra Thin Bonded	Recycle Overlay	Cold-in-Place Recycling	Thin Overlay
Traffic (ADT/lane)	< 1000	yes	yes	yes	yes	yes	yes	yes	yes	yes	yes	yes
	1000-4000	yes	yes	yes	yes	yes	yes	yes	yes	maybe	yes	yes
Ruts	> 4000	maybe	yes	no	yes	yes	yes	yes	yes	maybe	yes	yes
	< 3/8 in. (9.5 mm)	yes	maybe	yes	maybe	maybe	yes	yes	yes	yes	yes	yes
Cracking (Fatigue)	3/8-1 in. (9.5-25 mm)	no	no	no	no	no	no	maybe	no	yes	yes	yes
	> 1 in. (25 mm)	no	no	no	no	no	no	maybe	no	maybe	yes	yes
Cracking (Longitudinal)	low	maybe	yes	yes	yes	yes	yes	yes	yes	yes	yes	yes
	moderate	no	maybe	maybe	yes	maybe	yes	maybe	maybe	maybe	yes	yes
Cracking (Transverse)	high	no	no	no	no	no	no	no	no	maybe	yes	yes
	low	maybe	yes	yes	yes	yes	yes	yes	yes	yes	yes	yes
Surface Condition	moderate	no	yes	maybe	yes	maybe	yes	maybe	maybe	maybe	yes	yes
	high	no	maybe	no	no	no	maybe	no	no	no	yes	maybe
Ravelling	dry	yes	no	yes	yes	yes	yes	yes	yes	yes	yes	yes
	flushing	no	no	maybe	yes	yes	no	yes	yes	yes	yes	yes
Potholes	bleeding	no	no	no	maybe	yes	yes	yes	yes	yes	yes	yes
	variable	maybe	no	maybe	yes	yes	yes	yes	yes	yes	yes	yes
Texture	PCC	no	maybe	yes	yes	yes	yes	yes	yes	maybe	no	yes
	low	yes	no	yes	yes	yes	yes	yes	yes	yes	yes	yes
Ride	moderate	maybe	no	yes	yes	yes	yes	yes	yes	yes	yes	yes
	high	maybe	no	yes	yes	yes	maybe	yes	yes	yes	yes	yes
Rural	poor	no	no	no	no	no	no	maybe	yes	yes	yes	yes
	minimal turning	yes	yes	yes	yes	yes	no	yes	yes	yes	yes	yes
Urban	maximum turning	yes	yes	maybe	yes	yes	yes	yes	yes	yes	yes	yes
	poor	no	no	no	no	no	no	no	no	no	no	no
Snow Plow Usage	high	yes	yes	yes	yes	yes	yes	yes	yes	yes	yes	yes
	low	no	no	yes	yes	yes	yes	yes	yes	yes	yes	yes
Initial Cost Concern	low	yes	yes	yes	yes	yes	yes	yes	yes	yes	yes	yes
	high	yes	maybe	yes	yes	maybe	maybe	no	yes	yes	yes	yes
Life Cost Concern	low	yes	yes	yes	yes	maybe	maybe	no	no	yes	maybe	maybe
	high	maybe	yes	yes	yes	maybe	yes	yes	maybe	yes	yes	maybe
Local Construction Quality	low	no	maybe	no	no	maybe	no	yes	yes	yes	yes	maybe
	high	yes	yes	yes	yes	maybe	no	yes	yes	maybe	no	maybe
User-Delay Cost Concern	low	maybe	maybe	maybe	maybe	maybe	maybe	yes	yes	maybe	yes	yes
	high	maybe	maybe	maybe	maybe	maybe	maybe	yes	yes	maybe	maybe	maybe

Notes: These are very broad assumptions: assessment of a given road should take precedence. Recommendations in top chart assume good quality design and construction. Multipliers from the bottom chart should be used. This information is meant to be fed into a decision matrix.

Table B.11. Matrix Form of Decision Tree for Treatment Selection (24)

Distress	Combinations of Distress (Read Vertically)															
	N	N	N	N	N	N	N	N	Y	Y	Y	Y	Y	Y	Y	Y
PSI < 4.0	N	N	N	N	N	N	N	N	Y	Y	Y	Y	Y	Y	Y	Y
Major Cracking	N	N	N	N	Y	Y	Y	Y								
Rutting > 30%	Y	N	N	N												
Raveling > 30%		Y	N	N												
Bleeding > 30%			Y	N												
Alligator Cracking > 30%					N	N	N	Y								
Edge Cracking > 30%					N	N	Y									
Long. Cracking > 30%					N	Y										
Excess Crown									Y	N	N					
AADT > 5000										N	Y	N	Y	N	Y	Y
Alligator Crack Major												N	N	Y	Y	Y
Feasible	3	1	1	3	3	3	3	3	4	1	2	2	3	2	3	3
Rehabilitation	4	5	8	4	5	4	6	6	10	4	9	4	9	4	9	9
Options	6	7	12	5	7	6	9	11		10	11	5	11	6	11	11
	11	12				9	11					9		10		
						10						10				

Notes: Y = Specified condition is met
N = Specified condition is not met

Rehabilitation Codes:

1) 1-in overlay	7) Plane and 1-in overlay
2) 2-in overlay	8) Plane and 2-in overlay
3) 3-in overlay	9) Plane and 3-in overlay
4) Mill 1 in and chip seal	10) Reconstruct: 2-in AC and 4-in base
5) Recycle and 1-in overlay	11) Reconstruct: 2-in AC and 6-in base
6) Recycle and 2-in overlay	12) Chip seal

Source: Haas et al., 1994

Table B.12. Decision Table for Maintenance Treatments on Interstate and Primary Highways from Montana Department of Transportation – PMS

Ride	SCI	Maintenance Treatment
> 73		Do Nothing
60 - 73	> 60	Thin Overlay
	<= 60	Thin Overlay_SR
< 60		Reactive Maintenance

ACI	AGE	SCI	Maintenance Treatment
> 90			Do Nothing
81 - 90	> 6		Crack Seal and Seal & Cover
	<= 6		Crack Seal
66 - 80		> 60	Thin Overlay
		<= 60	Thin Overlay_SR
< 66			Reactive Maintenance

MCI	AGE	SCI	Maintenance Treatment
> 94	> 12		Do Nothing
	7 - 12		Crack Seal and Seal & Cover
	< 7		Do Nothing
71 - 94	> 6		Crack Seal and Seal & Cover
	<= 6		Crack Seal
56 - 70		> 60	Thin Overlay
		<= 60	Thin Overlay_SR
< 56			Reactive Maintenance

Rut	Ride	SCI	Maintenance Treatment
> 52			Do Nothing
41 - 52	> 60	> 60	Maintenance Rut Fill
		<= 60	Reactive Maintenance
	<= 60		Reactive Maintenance
< 41			Reactive Maintenance

APPENDIX C
Slide Presentation on Treatment Selection

SELECTING A PREVENTIVE MAINTENANCE TREATMENT FOR FLEXIBLE PAVEMENTS

prepared by
Dr. R. Gary Hicks, P.E.
Stephen B. Seeds, P.E.

and
David G. Peshkin, P.E.
 for

Foundation for Pavement Preservation
 Washington, DC
 May 2000

Presentation Outline

- Background and Objectives
- Establishing a Preventive Maintenance Program
- Framework for Treatment Selection and Timing
- Analysis to Determine the Most Effective Treatment
- Summary

Background

- Pavement Management Systems
 - Most Agencies have one
 - Usually contain maintenance component
- Limitations
 - Models to determine cost effective treatment
 - Most don't contain proper treatment timing

Background (continued)

- Types of Pavement Maintenance
 - Preventive (Proactive)
 - Arrest light deterioration
 - Retard progressive failures
 - Reduce need for corrective maintenance
 - "Right" treatment at the "right" time!
 - Corrective (Reactive)
 - After deficiency occurs
 - More expensive
 - Emergency

Typical Variation of Pavement of Pavement Condition as a Function of Time

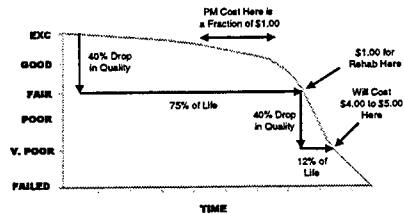

Study Objectives

- Review existing practices related to selection of appropriate PM strategies
- Develop a framework for selection of the most appropriate PM treatments
- Prepare Summary Report

Establishing a Preventive Maintenance Program

- Number of Technical Components BUT!
- Two most important are non-technical
 - Agency Top Management Commitment
 - Customer Education Program

Elements of a Preventive Maintenance Program



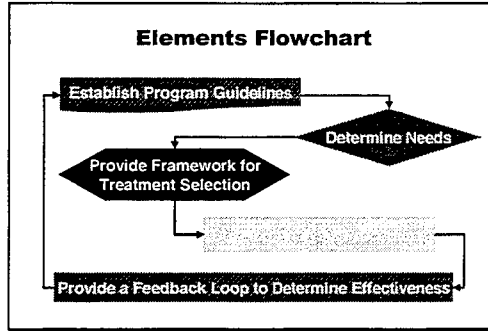

- 1. Establish Program Guidelines**
- "Policy Manual"
 - Contains overall strategies and goals
 - Safety issues
 - Environmental issues
 - Program coordinator named
 - Technical elements
 - Feedback loop

- 2. Determine Maintenance Needs**
- Condition Survey
 - Trained observers
 - Automated vehicles
 - Non-destructive testing (FWD, Friction)
 - Cores, slabs
 - Project data
 - Location, ADT, % trucks, environment, etc.

- 3. Framework for Treatment Selection**
- The "right" treatment at the "right" time on the "right" project
 - Amen!

- 4. Develop Analysis Procedures for the Most Effective Treatment**
- A number of procedures for determining cost effectiveness exist and should be used
 - Cost should be part of the decision process but not the only consideration
 - Use of decision trees is a viable method

- 5. Feedback Mechanism**
- Generally a weakness in many management processes
 - "The boss doesn't want to hear bad news" syndrome
 - Need to know how the system is working
 - A tool to adjust the program when needed

- Preventive Maintenance Treatments**
- Can be effective if used under proper conditions to address distress
 - Types of Flexible Pavement distress include:
 - Rutting
 - Cracking (fatigue, shrinkage, thermal, etc.)
 - Bleeding
 - Raveling
 - Weathering
 - Roughness

Crack Sealing

Used to prevent water and incompressibles from entering the pavement
 Cracks are often routed
 Sealants are only effective for a few years

Fog Seal

- Application of diluted emulsion to enrich the surface
- Primarily used to address raveling, oxidation, and seal minor surface cracks
- Expected life not greater than 3 to 4 years

Chip Seal

- Used to waterproof the surface, seal small cracks and improve surface friction
- Normally used on low-volume roadways, but have been used on high-volume facilities

Thin Cold-Mix Seal

- Treatments include slurry seals, micro-surfacing and cape seals
- Used to fill cracks, increase frictional resistance and improve ride quality

Thin Hot-Mix Overlay

- Treatments include dense-, open and gap-graded mixes
- Used to improve ride quality, increase frictional resistance and correct surface irregularities

Typical Unit Costs and Expected Lives

Treatment	Unit Cost (\$/SY)	Expected Life (years)
Crack Treatments	1.00	1 - 3
Fog Seals	0.45	2 - 4
Slurry Seals	0.90	3 - 7
Microsurfacing	1.25	3 - 9
Chip Seals	0.85	3 - 7
Thin HM Overlay	1.75	2 - 12

Framework for Treatment Selection and Timing

- Data/criteria used for developing tools
- Decision tools for treatment selection
 - Decision Trees
 - Decision Matrices
- Benefits/limitations of decision tools
- Optimum timing of treatments

Data/Criteria Considered in Developing Tools

- Pavement type and construction history
- Functional classification or traffic level
- Pavement condition index
- Specific type of deterioration present
- Geometric issues
- Environmental conditions
- Unit costs
- Expected life

Other Potential Criteria

- Availability of qualified contractors
- Availability of materials
- Time (of year) of construction
- Pavement noise
- Facility downtime
- Surface friction

Example Decision Matrix

- Assumptions
 - Project PCI is 70
 - Cracking low to moderate
 - Surface condition variable
 - Ride quality marginal
 - Projected traffic, 5 years, less than 5K ADT
 - Two lanes, suburban, feeder to strip shopping center
 - Desired life is 7 years

Example Decision Matrix (continued)

- Attributes
 - Performance
 - Constructability
 - Customer satisfaction

Treatment Analysis Worksheet

RATING FACTOR	SCORING FACTOR	RATING FACTOR	TOTAL SCORE
PERFORMANCE EVALUATION ATTRIBUTES			
1. Expected Life	1	4	4
2. Annual Miles	1	3	3
3. Proposed Street Section	1	3	3
4. Mileage of Existing Pavement Condition	1	3	3
CONSTRUCTABILITY ATTRIBUTES			
5. Cost Efficiency (CAC)	1	4	4
6. Availability of Quality Contractors	1	4	4
7. Availability of Quality Materials	1	4	4
8. Worker Loads	1	4	4
CUSTOMER SATISFACTION ATTRIBUTES			
9. Traffic Disruption	1	4	4
10. Noise	1	4	4
11. Safety Hazards	1	4	4
Σ = 36 %			
RATING FACTOR: PERCENT OF IMPACT ON TREATMENT CHOICE (See Note 1, Item 1)			
SCORING FACTOR: 1 = No Impact			
2 = Slight			
3 = Moderate			
4 = Severe			

Example Scoring Factors

Treatment	Expected Life	Annual Miles	Proposed Street Section	Mileage of Existing Pavement Condition	Cost Efficiency (CAC)	Availability of Quality Contractors	Availability of Quality Materials	Worker Loads	Traffic Disruption	Noise	Safety Hazards
Thin HMA Overlay	2	1	3	3	2	2	2	2	2	2	2
Slurry Seal	4	2	3	3	2	2	2	2	2	2	2
Chip Seal	3	1	4	3	2	2	2	2	2	2	2
Microsurfacing	2	1	4	3	2	2	2	2	2	2	2

Total Ranking for Project

Treatment	Total Score
Thin HMA Overlay	3.20
Slurry Seal	3.15
Chip Seal	2.90
Microsurfacing	3.60

Example Decision Matrix

- Rating factors
 - or any i en ro ect t e number an ty es of factors ill ary
 - oul be e alo e for eac a ency t e same as t e C factor
 - actors can be el t e to account for differences bet een treatments for t e same c aracteristic

Computing Rankings

- Factors are computed and scores for each treatment are derived
- Treatment with highest score is considered the most effective treatment for the specific project

Summary

- Preventive maintenance is the only effective way to manage pavements
- Simple, logical process for determining the most effective treatment for a specific pavement has been presented
- Recognizing the type and cause of pavement distress is fundamental to the approach

Summary (continued)

- **Agencies must develop cost and life data for various maintenance treatments**
- **A number of factors must be accounted for in determining the most effective treatment**
- **Cost needs to be considered but must not be the only consideration**
- **Good engineering principles should guide the selection of the treatment**

