

**AIP**  
**AERONAUTICAL INFORMATION PUBLICATION**  
**UNITED STATES OF AMERICA**



PB99-124372

**FIFTEENTH EDITION**

**28 JANUARY 1999**

**CONSULT NOTAM FOR LATEST INFORMATION**

**DEPARTMENT OF TRANSPORTATION**  
**FEDERAL AVIATION ADMINISTRATION**

REPRODUCED BY: **NTIS**  
U.S. Department of Commerce  
National Technical Information Service  
Springfield, Virginia 22161



**AIP**  
**AERONAUTICAL INFORMATION PUBLICATION**  
**UNITED STATES OF AMERICA**

**PART 1**  
**GENERAL (GEN)**

PROTECTED UNDER INTERNATIONAL COPYRIGHT  
ALL RIGHTS RESERVED.  
NATIONAL TECHNICAL INFORMATION SERVICE  
U.S. DEPARTMENT OF COMMERCE



## PART 1 - GENERAL (GEN)

### GEN 0.

#### GEN 0.1 PREFACE

##### 1. Name of the publishing authority

The United States of America Aeronautical Information Publication (AIP) is published by the authority of the Federal Aviation Administration.

##### 2. Applicable ICAO documents

The AIP is prepared in accordance with the Standards and Recommended Practices (SARP) of Annex 15 to the Convention on International Civil Aviation and the Aeronautical Information Services Manual (ICAO Doc 8126). Charts contained in the AIP are produced in accordance with Annex 4 to the Convention on International Civil Aviation and the Aeronautical Chart Manual (ICAO Doc 8697). Differences from ICAO Standards, Recommended Practices and Procedures are given in subsection GEN 1.7.

##### 3. The AIP structure and established regular amendment interval

###### 3.1 The AIP structure

The AIP is made up of three Parts; General (GEN), En Route (ENR), and Aerodromes (AD); each divided into sections and subsections as applicable, containing various types of information subjects.

###### 3.1.1 Part 1 - General (GEN)

Part 1 consists of five sections containing information as briefly described hereafter:

a) *GEN 0.* - Preface; Record of AIP Amendments; Checklist of AIP Pages; and Table of Contents to Part 1.

b) *GEN 1. National Regulations and Requirements* - Designated Authorities; Entry, Transit, and Departure of Aircraft; Entry, Transit, and Departure of Passengers and Crew; Entry, Transit, and Departure of Cargo; Aircraft Instruments, Equipment, and Flight Documents; Summary of National Regulations and International Agreements/Conventions; and Differences from ICAO Standards, Recommended Practices, and Procedures.

c) *GEN 2. Tables and Codes* - Measuring System, Time System, Aircraft Markings; Abbreviations Used

in AIS Publications; Chart Symbols; Location Indicators; List of Radio Navigation Aids; Conversion Tables; and Sunrise/Sunset Tables.

d) *GEN 3. Services* - Aeronautical Information Services; Aeronautical Charts; Air Traffic Services; Communication Services; Meteorological Services; and Search and Rescue.

e) *GEN 4. Charges for Aerodromes/Heliports and Air Navigation Services* - Fees and Charges; and Air Navigation Facility Charges.

###### 3.1.2 Part 2 - En Route (ENR)

Part 2 consists of six sections containing information as briefly described hereafter:

a) *ENR 0.* - Checklist of AIP Pages; and the Table of Contents to Part 2.

b) *ENR 1. General Rules and Procedures* - General Rules; Visual Flight Rules; Instrument Flight Rules; ATS Airspace Classification; Holding, Approach, and Departure Procedures; Radar Services and Procedures; Altimeter Setting Procedures; Flight Planning; Interception of Civil Aircraft; Medical Facts for Pilots; and Safety, Hazard and Accident Reports.

c) *ENR 2. Air Traffic Services Airspace.*

d) *ENR 3. ATS routes* - Area Navigation Routes; and Other Routes.

e) *ENR 4. Radio Navigation Aids/Systems* - Radio Navigation Aids - En Route; and Special Navigation Systems.

f) *ENR 5. Navigation Warnings* - Prohibited, Restricted, and Other Areas; Military Exercise and Training Areas; Bird Migration and Areas with Sensitive Fauna; and Potential Flight Hazards.

###### 3.1.3 Part 3 - Aerodromes (AD)

Part 3 consists of three sections containing information as briefly described hereafter:

a) *AD 0.* - Checklist of AIP Pages; and Table of Contents to Part 3.

b) *AD 1. Aerodromes - Introduction - Aerodrome Availability.*

c) *AD 2. Aerodromes - Listing of Aerodromes.*

### 3.2 Regular amendment interval

Regular amendments to the AIP will be issued every 6 months on the dates listed in the following table:

<b>Publication Schedule</b>		
<i>New Edition or Amendment</i>	<i>Cutoff Date for Submission</i>	<i>Effective Date of Publication</i>
Amendment 1	1/28/99	7/15/99
Amendment 2	7/15/99	2/24/00
Amendment 3	2/24/00	8/10/00
Sixteenth Edition	8/10/00	1/25/01

### 4. Service to contact in case of detected AIP errors or omissions

In the compilation of the AIP, care has been taken to ensure that the information contained therein is accurate

and complete. Any errors and omissions which may be detected, as well as any correspondence concerning the Aeronautical Information Publication, should be referred to:

Federal Aviation Administration Air Traffic Publications, ATA-10 800 Independence Avenue, S.W. Washington DC 20591 USA
------------------------------------------------------------------------------------------------------------------------------------

### 5. Subscription Information

The AIP is offered for sale on a subscription basis from:

Superintendent of Documents  
U.S. Government Printing Office  
P.O. Box 371954  
Pittsburgh, PA 15250-7954

Telephone (202) 512-1800

The AIP may ordered via the internet at:  
[http://www.access.gpo.gov/su\\_docs/](http://www.access.gpo.gov/su_docs/)

- GEN 0.2 RECORD OF AIP AMENDMENTS - Not applicable
- GEN 0.3 RECORD OF AIP SUPPLEMENTS - Not applicable
- GEN 0.4 CHECKLIST OF AIP PAGES - Not applicable
- GEN 0.5 LIST OF HAND AMENDMENTS TO THE AIP - Not applicable

## GEN 0.6 TABLE OF CONTENTS TO PART 1

	<i>Page</i>
<b>GEN 1. NATIONAL REGULATIONS AND REQUIREMENTS</b>	
GEN 1.1 Designated Authorities .....	GEN 1.1-1
GEN 1.2 Entry, Transit, and Departure of Aircraft .....	GEN 1.2-1
GEN 1.3 Entry, Transit, and Departure of Passengers and Crew .....	GEN 1.3-1
GEN 1.4 Entry, Transit, and Departure of Cargo .....	GEN 1.4-1
GEN 1.5 Aircraft Instruments, Equipment, and Flight Documents .....	GEN 1.5-1
GEN 1.6 Summary of National Regulations and International Agreements/Conventions .....	GEN 1.6-1
GEN 1.7 Differences From ICAO Standards, Recommended Practices and Procedures .....	GEN 1.7-1
<b>GEN 2. TABLES AND CODES</b>	
GEN 2.1 Measuring System, Time System, Aircraft Markings .....	GEN 2.1-1
GEN 2.2 Abbreviations Used in AIS Publications .....	GEN 2.2-1
GEN 2.3 Chart Symbols .....	GEN 2.3-1
GEN 2.4 Location Indicators .....	GEN 2.4-1
GEN 2.5 List of Radio Navigation Aids .....	GEN 2.5-1
GEN 2.6 Conversion Tables .....	GEN 2.6-1
GEN 2.7 Sunrise/Sunset Tables .....	GEN 2.7-1
<b>GEN 3. SERVICES</b>	
GEN 3.1 Aeronautical Information Services .....	GEN 3.1-1
GEN 3.2 Aeronautical Charts .....	GEN 3.2-1
GEN 3.3 Air Traffic Services .....	GEN 3.3-1
GEN 3.4 Communication Service .....	GEN 3.4-1
GEN 3.5 Meteorological Services .....	GEN 3.5-1
GEN 3.6 Search and Rescue .....	GEN 3.6-1
<b>GEN 4. CHARGES FOR AERODROMES/HELIPORTS AND AIR NAVIGATION SERVICES</b>	
GEN 4.1 Fees and Charges .....	GEN 4.1-1
GEN 4.2 Air Navigation Facility Charges .....	GEN 4.2-1





# GEN 1. NATIONAL REGULATIONS AND REQUIREMENTS

## GEN 1.1 Designated Authorities

### 1. Introduction

1.1 The requirements for entry and departure of aircraft engaged in international flights and the standard procedure for clearance of these aircraft at all international airports are given for the information and guidance of operators conducting international flights. The information contained in this section does not replace, amend or change in any manner, the current regulations of the designated authorities, listed below, which are of concern to international air travel.

### 2. Designated Authorities

2.1 The postal, telex and telegraphic addresses of the designated authorities concerned with the entry, transit and departures of international air travel are as follows:

<b>Customs:</b>
<i>Postal Address:</i> Department of the Treasury U.S. Customs Service 1300 Pennsylvania Ave., NW Washington, DC 20229
<i>Telephone:</i> 202-927-6724
<i>Commercial Telegraphic Address:</i> None

<b>Immigrations:</b>
<i>Postal Address:</i> Department of Justice Immigration and Naturalization Service 425 I Street, NW Washington, D.C. 20001
<i>Telephone:</i> 202-514-2000
<i>Telex:</i> None
<i>Commercial Telegraphic Address:</i> None

<b>Health:</b>
<i>Postal Address:</i> Center for Disease Control Quarantine Division Atlanta, Georgia 30333
<i>Telephone:</i> 404-639-3311
<i>Fax:</i> 404-639-2599
<i>Commercial Telegraphic Address:</i> None

<b>Agriculture Quarantine:</b>
<i>Postal Address:</i> Department of Agriculture Animal and Plant Health Inspection Service 4700 River Road, Unit 38 Riverdale, MD 20737
<i>Telephone:</i> 301-734-7799
<i>Fax:</i> 301-734-3222
<i>Commercial Telegraphic Address:</i> None

<b>Regulations Governing Air Carriers:</b>
<i>Postal Address:</i> Department of Transportation Office of The Secretary Office of International Aviation 400 7th St. SW Washington, D.C. 20590
<i>Telephone:</i> 202-366-2423
<i>Fax:</i> 202-366-3694
<i>Commercial Telegraphic Address:</i> (MARAD WASH) Attention Office of International Aviation X-40

<b>Regulations Governing Export of Aircraft and Commodities:</b>
<i>Postal Address:</i> Department of Commerce Bureau of Export Administration 14th and Constitution Ave., NW Washington, D.C. 20230
<i>Telephone:</i> 202-482-3881
<i>Fax:</i> 202-482-3322
<i>Commercial Telegraphic Address:</i> None

<b>Regulations Governing Firearms (Import):</b>
<i>Postal Address:</i> Department of the Treasury Internal Revenue Service Director of Alcohol, Tobacco and Firearms Division 650 Massachusetts Avenue, NW Washington, D.C. 20226
<i>Telephone:</i> 202-927-7777
<i>Fax:</i> 202-927-7862
<i>Commercial Telegraphic Address:</i> None

<b>Regulations Governing Military Type Hardware (Export):</b>
<i>Postal Address:</i> Department of State Defense Trade Center 1701 North Fort Myers Drive Rosslyn, Virginia 22209
<i>Telephone:</i> 703-875-6650
<i>Fax:</i> 703-875-5663
<i>Commercial Telegraphic Address:</i> None

### 3. Applicable ICAO Documents

**3.1** National regulations and practices concerning facilitation of international air transport are being carried out at all international airports as far as possible in accordance with the provisions set forth in the Standards and Recommended Practices of Annex 9 to the Convention on International Civil Aviation. Differences from certain Annex 9 provisions exist only in those cases where it has not yet been possible to amend national legislation accordingly. Continuous efforts are being made to eliminate these differences.

### 4. Customs Offices Service/Area Port Directors

**4.1** Address all correspondence to the Service/Area Port Director of Customs at the following locations:

Location	Address
Anchorage	605 W Fourth Avenue Anchorage, AK 99501
Atlanta	700 Doug Davis Drive Atlanta, GA 30354
Baltimore	40 S Gay Street Baltimore, MD 21202
Baton Rouge	5353 Essen Lane Baton Rouge, LA 70809
Blaine	9901 Pacific Highway Blaine, WA 98230
Boston	10 Causeway Street, Suite 603 Boston, MA 22220
Buffalo	111 W Huron Street Buffalo, NY 14202
Calais	1 Main Street Calais, ME 46190
Calexico	P.O. Box 632 Calexico, CA 92231
Champlain	198 W Service Road Champlain, NY 12919
Charleston	200 E Bay Street Charleston, SC 29401
Charlotte	1901 Cross Beam Drive Charlotte, NC 28217
Charlotte/ Amalie	Main Post Office - Sugar Estate St. Thomas, USVI 00801
Chicago	610 S Canal Street Chicago, IL 60607
Christiansted	1B La Grande Princess, P.O. Box 249 Christiansted, St. Croix, USVI 00820
Cleveland	6747 Engle Road Middleburg Heights, OH 44130
Dallas/ Ft. Worth	P.O. Box 619050 DFW Airport, TX 75261
Denver	4735 Oakland Street Denver, CO 80239
Derby Line	Interstate 91 Derby Line, VT 58300
Detroit	477 Michigan Avenue, Suite 200 Detroit, MI 48226

Douglas	First Street & Pan American Avenue Douglas, AZ 85607
Duluth	515 W First Street Duluth, MN 55801
El Paso	797 S Saragosa Road El Paso, TX 79907
Grand Rapids	Kent County Airport Grand Rapids, MI 49512
Great Falls	300 Second Avenue South Great Falls, MT 59405
Greenville/ Spartanburg	150-A W Phillips Road Greer, SC 29650
Harrisburg	Harrisburg International Airport, Building 135 Middletown, PA 17057
Hartford	135 High Street Hartford, CT 61030
Highgate Springs	RR 2 Box 170 Swanton, VT 54880
Honolulu	335 Merchant Street Honolulu, HI 96813
Houlton	RR 3 Box 5300 Houlton, ME 47300
Houston/ Galveston	2350 N Sam Houston Parkway East, Suite 1000 Houston, TX 77032
Jacksonville	2831 Talleyrand Avenue Jacksonville, FL 32206
Kansas City	2701 Rockcreek Parkway, Suite 202 N Kansas City, MO 64116
Laredo/ Colombia	P.O. Box 3130 Laredo, TX 78044
Los Angeles/ Airport Area	11099 S La Cienega Boulevard Los Angeles, CA 90045
Los Angeles/ Long Beach Seaport Area	300 S. Ferry Street Terminal Island, CA 90731
Louisville	601 W Broadway Louisville, KY 40202
Miami Airport	6601 W 25th Street Miami FL 33102
Miami Seaport	1500 Port Boulevard Miami, FL 33132
Milwaukee	6269 Ace Industries Drive Cudahy, WI 53110
Minneapolis	330 Second Avenue South, Suite 560 Minneapolis, MN 55401
Mobile	150 N Royal Street, Room 3004 Mobile, AL 36602
Nashville	P.O. Box 270008 Nashville, TN 37227
New Orleans	423 Canal Street New Orleans, LA 70130
New York	6 World Trade Center New York, NY 10048
New York/ JFK Area	Building 77 Jamaica, NY 11430
New York/ Newark Area	1210 Corbin Street Elizabeth, NJ 07201
Nogales	9 N Grand Avenue Nogales, AZ 85621

Norfolk	200 Granby Street, Suite 839 Norfolk, VA 23510
Ogdensburg	127 N Water Street Ogdensburg, NY 13669
Orlando	5390 Bear Road Orlando, FL 32827
Oroville	Rt 1 Box 130 Oroville, WA 98844
Otay Mesa	9777 Via De La Amistad San Diego, CA 92173
Pembina	122 W Stutsman Pembina, ND 58271
Philadelphia	Second and Chestnut Streets Philadelphia, PA 19106
Phoenix	1315 S 27th Street Phoenix, AZ 85034
Port Huron	526 Water Street Port Huron, MI 48060
Portland, ME	312 Fore Street Portland, ME 04101
Portland, OR	P.O. Box 55580 Portland, OR 97238-5580
Providence	49 Pavilion Avenue Providence, RI 02905
Raleigh/ Durham	120 Southcenter Court, Suite 500 Morrisville, NC 27560
Richmond	4501 Williamsburg Road, Suite G Richmond, VA 23231
San Antonio	9800 Airport Boulevard, Suite 1103 San Antonio, TX 78216
San Francisco	555 Battery Street San Francisco, CA 94126
San Juan	#1 La Puntilla San Juan, PR 00901
San Luis	P.O. Box H San Luis, AZ 85349
San Ysidro	720 E San Ysidro Boulevard San Ysidro, CA 92173
Sault Ste Marie	International Bridge Plaza Sault Ste Marie, MI 49783
Savannah	One East Bay Street Savannah, GA 31401
Seattle	1000 Second Avenue, Suite 2100 Seattle, WA 98104
St. Albans	P.O. Box 1490 St. Albans, VT 05478
St. Louis	4477 Woodson Road St. Louis, MO 63134
Syracuse	4034 S Service Road N Syracuse, NY 13212
Tacoma	2202 Port of Tacoma Road Tacoma, WA 98421
Tampa	1624 E 7th Avenue, Suite 101 Tampa, FL 33605
Tucson	7150 S Tucson Boulevard Tucson, AZ 85706

Washington, DC	P.O. Box 17423 Washington, DC 20041
Wilmington, NC	One Virginia Avenue Wilmington, NC 28401

## 5. Customs Management Centers

5.1 Address all correspondence to the Customs Management Centers Directors at the following locations:

Arizona	4740 North Oracle Road, Suite 310 Tucson, AZ 85705
Caribbean Area	#1 La Puntilla Street, Room 203 San Juan, PR 00901
East Great Lakes	4455 Genesee Street Buffalo, NY 14225
East Texas	2323 S Shepard Street, Suite 1200 Houston, TX 77019
Gulf	423 Canal Street, Room 337 New Orleans, LA 70130
Mid America	610 S Canal Street, Suite 900 Chicago, IL 60607
Mid Atlantic	103 S Gay Street, Suite 208 Baltimore, MD 21202
Mid Pacific	33 New Montgomery Street, Suite 1601 San Francisco, CA 94105
New York	6 World Trade Center, Room 716 New York, NY 10048
North Atlantic	10 Causeway Street, Room 801 Boston, MA 02222
North Florida	1624 E Seventh Avenue, Suite 301 Tampa, FL 33605
North Pacific	8337 NE Alderwood Road, Room 200 Mailing Address: P.O. Box 55700 Portland, OR 97238-5700
Northwest Great Plains	1000 Second Avenue, Suite 2200 Seattle, WA 98104
South Atlantic	1691 Phoenix Boulevard, Suite 270 College Park, GA 30349
South Florida	909 SE First Avenue, Suite 980 Miami, FL 33131
South Pacific	One World Trade Center P.O. Box 32639 Long Beach, CA 90815
South Texas	P.O. Box 3130, Building #2 Lincoln-Juarez Bridge Laredo, TX 78044
Southern California	610 W Ash Street, Suite 1200 San Diego, CA 92101
West Great Lakes	613 Abbott Street, 3rd Floor Detroit, MI 48226
West Texas/ New Mexico	9400 Viscount Boulevard, Suite 104 El Paso, TX 79925

## 6. Customs Headquarters

6.1 Address all correspondence to:  
Commissioner of Customs  
1300 Pennsylvania Avenue, N.W.  
Washington, D.C. 20229.



## GEN 1.2 Entry, Transit, and Departure of Aircraft

### 1. General

**1.1** All flights into or over the territories of the U.S. and landing in such territories shall be carried out in accordance with the regulations of the U.S. regarding civil aviation.

**1.2** Aircraft landing in or departing from the territories of the U.S. must first land at, or finally depart from, an international airport (see AD-2) except as may be otherwise noted in this section.

**1.3** All aircraft entering the U.S. must land at a designated international airport of entry unless prior approval to land at a landing rights or other airport has been obtained from U.S. Customs. The terms "international airport of entry" refers to any airport designated by the Secretary of the Treasury or the Commissioner of Customs as a port of entry for civil aircraft arriving in the U.S. from any place outside thereof and for cargo carried on such aircraft. (Note: Frequently the word "international" is included in the name of an airport for other than Customs purposes, in which case it has no special Customs meaning.) The term "landing rights airport" refers to an airport of entry at which permission to land must be granted by the appropriate Customs officer with acknowledgement of the Immigration and Naturalization Service, the Public Health Service, and the Animal and Plant Health Inspection Service of the Department of Agriculture. Such landing rights are required before an aircraft may land at an airport which has not been designated for Customs purposes as an international airport of entry. In the case of scheduled aircraft, such permission shall be obtained from the Service/Area Director of Customs of the Port (see GEN 1.1 paragraph 4) where the first landing will occur. In all other cases, including private aircraft, landing permission may be obtained from the Port Director of Customs (see GEN 1.1) or the Customs officer in charge of the port of entry or Customs station nearest the intended place of landing. All persons entering the U.S. must be inspected for U.S. Customs, Immigration and Public Health purposes.

**1.4** Subject to the observance of the applicable rules, conditions, and limitations of the Federal Aviation Regulations and the Department of Transportation (DOT)/Office of the Secretary of Transportation (OST), Office of International Aviation, as described below, foreign civil aircraft registered and manufactured in any foreign

country which is a member of the International Civil Aviation Organization (ICAO) may be navigated in the U.S. Foreign civil aircraft manufactured in a country which at the time of manufacture was not a member of ICAO may be navigated in the U.S. if the country has notified ICAO that the aircraft meets the standards described in the Chicago Convention or if a notice has been filed with the DOT/OST, Office of International Aviation, through diplomatic channels, that the aircraft meets the standards described in the Chicago Convention.

**1.5** Aircraft registered under the laws of foreign countries, not members of the ICAO, may be navigated in U.S. territory only when authorized by the DOT/OST, Office of International Aviation.

**1.6** All foreign civil aircraft operated to, from, or within the U.S. must carry on board effective certificates of registration and air worthiness issued by the country of registry. Also, each member of the flight crew must carry a valid airman certificate or license authorizing that member to perform their assigned functions in the aircraft.

**1.7** Transportation of firearms by aircraft passengers: Regulations of the Alcohol, Tobacco and Firearms Division of the Internal Revenue Service make it unlawful for any person knowingly to deliver or cause to be delivered to any common or contract carrier for transportation or shipment in interstate or foreign commerce, to persons other than licensed importers, licensed manufacturers, licensed dealers, or licensed collectors, any package or other container in which there is any firearm or ammunition without written notice to the carrier that such firearm or ammunition is being transported or shipped; except that any passenger who owns or legally possesses a firearm or ammunition being transported aboard any common or contract carrier for movement with the passenger in interstate or foreign commerce may deliver said firearm or ammunition into the custody of the pilot, captain, conductor or operator of such common or contract carrier for the duration of the trip.

### 1.8 Miscellaneous Information

**1.8.1** Commercial air transport operators in the U.S. must adhere to Annex 6 - Operation of Aircraft with the proviso that aircraft which have no operators' local representative available to them will be required to carry a

fixed fuel reserve of not less than 45 minutes at the approved fuel consumption rate plus a variable reserve equivalent to 15% of the fuel required from departure to destination and to an alternate if an alternate is required; or where the reserve calculated in accordance with the above exceeds two hours at the approved fuel consumption rate - two hours reserve fuel.

## 2. Scheduled Common Carriage Flights

### 2.1 General

**2.1.1** Generally, when an operator of an aircraft advertises its transportation services to the general public or particular classes or segments of the public for compensation or hire, it is a common carrier. In turn, the transportation service the operator performs is considered to be in common carriage. The scheduled flights into, from and landing in the territory of the U.S. for purposes of loading or unloading passengers, cargo and mail (revenue flights), must first obtain from the U.S. DOT/OST, Office of International Aviation (X-40), a foreign air carrier permit. Applications for common carrier authority must be filed with X-40. If X-40, with the President's approval, determines that the carrier is fit, willing, and able to perform the service it proposes and that the service is in the public interest, X-40 shall issue the carrier a foreign air carrier permit, subject to the disapproval of the President of the U.S.

**2.1.2** The scheduled flights in transit across the territory of the U.S. or landing for reasons other than for the purpose of loading and unloading of passengers, cargo or mail (nonrevenue flights), which are registered in a State which is a party to the International Air Services Transit Agreement, shall submit a notice of transit to X-40. The notice of transit must be submitted at least 15 days prior to the flight and must include:

a) name, country of organization and nationality (including the nationality of all ownership interests) of the operator;

b) name of the country in which the aircraft to be used in the service is registered;

c) a full description of the proposed operations including the type of operations (passenger, property, mail, or combination), date of commencement, duration and frequency of flights, and routing (including each terminal and intermediate point that will be served);

d) copies of advertising of the flights, if advertised in the U.S.

**2.1.3** If the notice is timely filed, the flights may be operated in the absence of a contrary notification from X-40.

**2.1.4** Scheduled flights in transit across the territory of the U.S. or landing for reasons other than for the purpose of loading and unloading of passengers, cargo or mail (nonrevenue flights), which are registered in a State which is not a party to the International Air Services Transit Agreement, must obtain prior permission from X-40 at least 15 days prior to the flight. All permission requests must include the same information as requested in paragraph 2.1.2. (See also paragraph 1.5). The carrier may not transit U.S. territory unless and until it receives a foreign aircraft permit to do so from X-40.

**2.1.5** The permission to transit U.S. territory as described above also includes the right to make stops in the U.S. for technical purposes (for example, refueling and servicing of the aircraft) as long as the stopover does not exceed 24 hours. Stopovers which do exceed 24 hours are permitted only in those cases where a transfer of passengers, property or mail to another aircraft is necessary for the safety of the aircraft, passengers, property, or crew. Stopovers for the pleasure or convenience of passengers are not included in the transit authority.

### 2.2 Documentary Requirements for Clearance of Aircraft

**2.2.1** The undermentioned documents must be submitted to U.S. authorities for clearance on entry and departure of aircraft. All documents listed below must follow the ICAO standard format as set forth in the relevant appendixes to Annex 9, and are acceptable only when furnished in English.

#### 2.2.2 Aircraft Documents Required (Arrival and Departure)

Required by:	General Declaration:	*Passenger Manifest:	Cargo Manifest:
Customs Agriculture	1	0	1
Plant and Quarantine	1	0	1
Immigrations	1	0	1
Public Health	1	0	0
Total	4	0	3
*See paragraph 2.4 in GEN 1.3			

## 2.3 Public Health Measures Applied to Aircraft

**2.3.1** At airports without Public Health Service Quarantine staff, the Customs, Immigration or Agriculture Officer present will represent the Public Health Service.

**2.3.2** No public health measures are required to be carried out with respect to aircraft entering U.S. territory except that disinfection of an aircraft may be required if it has left a foreign area that is infected with insect-borne communicable disease and the aircraft is suspected of harboring insects of public health importance. Disinfection is defined as: "The operation in which measures are taken to kill the insect vectors of human disease present in carriers and containers."

**2.3.3** Disinfection shall be the responsibility of the air carrier and shall be subject to monitoring by the Director of the Public Health Service.

**2.3.4** Disinfection of the aircraft shall be accomplished immediately after landing and blocking. The cargo compartment shall be disinfected before the mail, baggage, and other cargo are discharged and the rest of the aircraft shall be disinfected after passengers and crew deplane.

**2.3.5** Disinfection shall be performed with an approved insecticide in accordance with the manufacturer's instructions. The current list of approved insecticides and sources may be obtained from the Division of Quarantine, Center for Prevention Services, Centers for Disease Control, Atlanta, GA 30333.

**2.3.6** All food and potable water taken on board an aircraft at any airport and intended for human consumption thereon shall be obtained from sources approved in accordance with Title 21, Code of Federal Regulations, Parts 1240 and 1250.

**2.3.7** Aircraft inbound or outbound on an international flight shall not discharge over the U.S. any excrement or waste water or other polluting materials. Arriving aircraft shall discharge such matter only at servicing areas approved under regulations cited in paragraph 2.3.6 above.

**2.3.8** Aircraft on an international voyage, which are in traffic between U.S. airports, shall be subject to inspection when there occurs on board, among passengers or crew, any death, or any ill person, or when illness is suspected to be caused by insanitary conditions.

## 3. Nonscheduled Noncommon Carriage Flights

### 3.1 General

**3.1.1** Nonscheduled, noncommon carriage flights are transportation services for remuneration or hire that are not offered to the general public.

**3.1.2** Nonscheduled flights in transit across the territory of the U.S. or landing for reasons other than the purposes of loading and unloading passengers, cargo or mail (nonrevenue flights) which are registered in a State which is a member of the International Civil Aviation Organization (ICAO) may do so without the necessity of obtaining prior permission, provided passengers are not permitted to leave the airport during stopover or provided that each stopover does not exceed 24 hours. Stopovers which do exceed 24 hours are permitted only in those cases where a transfer of passengers, property or mail to another aircraft is necessary for the safety of the aircraft, passengers, property, or crew. Stopovers for the pleasure or convenience of passengers are not included in the transit authority.

**3.1.3** Nonscheduled flights landing in the territory of the U.S. for reasons of loading or unloading passengers, cargo or mail (revenue flights), must obtain prior permission from the DOT/OST, Office of International Aviation (X-40), at least 15 days prior to the flight. All permission requests must include:

- a) name and address of applicant;
- b) aircraft make, model, and registration or identification marks;
- c) country in which the aircraft is registered;
- d) name and address of registered owner of aircraft;
- e) type of flight(s) (passenger, cargo, or agricultural or industrial operation);
- f) purpose of flight(s);
- g) date of the flight(s);
- h) routing of the flight(s);
- i) number of flights;
- j) name of charterer;
- k) charter price.

**3.1.4** Applications should be made on DOT/OST, Office of International Aviation Form 4509; however, if time does not permit, applications by telegram will be accepted as long as they include the information described above. Telegraphic applications must include a prepaid voucher sufficient to allow a sixty word reply.

The permit must be carried aboard the aircraft during flight over U.S. territory.

### **3.2 The following commercial air operations require preflight authorization from X-40:**

**3.2.1** Agricultural and industrial operations which include, but are not limited to, such services as crop dusting, pest control, pipeline patrols, mapping, surveying, banner towing or skywriting.

**3.2.2** Occasional and infrequent planeload charter flights carrying persons or property to and/or from the U.S. The number of these flights that may be performed is limited to six in any calendar year. Foreign civil aircraft are not permitted to transport persons or property or mail for compensation or hire between points wholly within the U.S.

**3.2.3** Continuing cargo operations for one or more contractors. Applicants may be authorized to serve up to 10 different contractors in a 12-month period; however, authorization may be granted only if it is clear that the service is not in common carriage and the carrier and contractor enter into a contract which provides for (a) continuing cargo operations for a period of at least 6 months; (b) an absolute or minimum number of flights or volume of cargo to be transported; and (c) a guarantee by the contractor to the carrier to pay for the minimum number of flights to be performed or volume of cargo to be transported whether or not he uses the capacity. Continuing cargo operations wholly within the U.S. cannot be authorized.

**3.2.4** Persons wishing to operate foreign civil aircraft from, to, or within the U.S. other than as described in this Section may request permission to perform those services by filing an application with X-40. The application should include the information described above in this section. Permission to perform these services may be granted if X-40 finds that the service is consistent with applicable law and is in the interest of the public of the U.S.

**3.2.5** Nonscheduled flights in transit across the territory of the U.S. or landing with or without purposes of loading and unloading passengers, cargo or mail (revenue or nonrevenue flights) which are registered in a State which is not a member of the International Civil Aviation Organization (ICAO) must obtain prior permission from X-40 at least 15 days prior to the flight. All permission requests must include the same information as requested in paragraph 3.1.3. (See also paragraph 1.5).

### **3.3 Documentary Requirements for Clearance of Aircraft**

**3.3.1** Same requirements as for scheduled flights; in addition, Customs Form 178 must be filled out for all private aircraft arrivals.

## **4. Private flights**

### **4.1 Procedures**

**4.1.1** If an operator intends to carry out a private flight in transit across the territory of the U.S. without landing, he may do so without the necessity of obtaining prior permission.

**4.1.2** If an operator intends to carry out a private flight in transit across the territory of the U.S. with intermediate landing, the operator must provide advance notice of arrival to U.S. Customs officials at or nearest the first intended landing. Custom officials, upon notification, will notify the necessary Immigration, Public Health and Agriculture officials. Advance notice must be received in sufficient time to enable the officials designated to inspect the aircraft to reach the place of landing before the arrival of the aircraft. At least one hour advance notice is required for this purpose during regular business hours. More advance notice may be required during other times (see Aerodrome Section).

**4.1.3** Notification of arrival must include:

- a) Type of aircraft and registration number;
- b) Name of aircraft commander;
- c) Number of alien passengers;
- d) Number of U.S. citizen passengers;
- e) Place of last foreign departure;
- f) Estimated time and location of crossing U.S. border/coastline;
- g) Name of intended U.S. airport of first landing (designated airport);
- h) Estimated time of arrival.

**4.1.4** Private aircraft arriving from Canada or Mexico may request that advance notice of arrival to Customs officers be included in the flight plan to be transmitted to a Federal Aviation Administration (FAA) facility which is filed in those countries if destined to an airport in the U.S. where flight notification advise custom (ADCUS) service is available. An ADCUS message in the remarks section of the plan consists of the word ADCUS followed by the pilots name and the number of persons on board (POB) with a notation of the number of non-U.S. citizens (i.e.; ADCUS John Doe 5 POB 2



NON). This notification may be provided through FAA; however, this entails the relaying of information and is not as timely or reliable as direct communication. It is recommended that if possible, pilots attempt to communicate directly with Customs by telephone or other means to insure that an officer will be available at the time requested. It is the ultimate responsibility of the pilot to insure Customs is properly notified, and the failure to do so may subject the pilot to penalty action. At those airports where ADCUS service is available, the FAA will forward the ADCUS information to the Customs official on duty. At a landing rights airport such notices will then be treated as an application for permission to land. A flight plan notice must be filed sufficiently before the estimated time of arrival of the flight to permit Customs to make a determination as to whether or not to grant the requested landing rights.

**4.1.5** Aircraft may use the following method of notifying Customs when departing from a country or remote area where a pre-departure flight plan cannot be filed or an advise Customs (ADCUS) message cannot be included in a pre-departure flight plan: Call the nearest enroute domestic or international FAA flight service station as soon as it is estimated that radio communications can be established and file a VFR or DVFR flight plan and include as the last item the ADCUS information. The station with which such a flight plan is filed will forward it to the appropriate FAA station who will notify the Customs office responsible for the destination airport.

**4.1.6** If the pilot fails to include "advise Customs" in the radioed flight plan, it will be assumed that the pilot has made other arrangements and FAA will not advise Customs.

**4.1.7** FAA assumes no responsibility for any delays in advising Customs if the flight plan is given to FAA too late for delivery to Customs before arrival of the aircraft. *It is still the pilot's responsibility to give timely notice even though a flight plan is given to FAA.* FAA cannot relay an "advise Customs" flight plan if the pilot indicates a destination airport where flight service notice to Customs is NOT available. When dependable facilities for giving timely notice of arrival are not available, a landing shall be made at a place where the necessary facilities do exist before coming into any area from any place outside the U.S.

**4.1.8** All private aircraft arriving in the U.S. via (a) the U.S./Mexican border or the Pacific Coast from a foreign place in the Western Hemisphere south of 33 degrees

north latitude or (b) the Gulf of Mexico and Atlantic Coasts from a foreign place in the Western Hemisphere south of 30 degrees north latitude, from any place in Mexico, or from the U.S. Virgin Islands, shall furnish a notice of intended arrival to the Customs service at the *nearest* designated airport, listed in paragraph 6, to the point of first border or coastline crossing. They must land at this airport for inspection, unless they have an overflight exemption, see paragraph 4.5. Landing rights must be obtained from Customs to land at designated airports that are *not* also approved as international airports. The requirement to furnish an advance notice of intended arrival shall not apply to private aircraft departing from Puerto Rico and conducting their flights under instrument flight rules (IFR) until crossing the U.S. coastline or proceeding north of 30 degrees north latitude prior to crossing the coastline. The notice must be furnished at least one hour before crossing the U.S. coastline or border. The notice may be furnished directly to Customs by telephone, radio, or other means, or may be furnished by means of an ADCUS message in the flight plan through the FAA to Customs. The FAA will accept these notices up to 23 hours in advance.

**4.1.9** A one-hour advance notice of coastline or border penetration (but not landing) is required of private aircraft arriving in the continental U.S. from Puerto Rico that are *not* conducting their flight on an IFR flight plan and those private aircraft that have flown beyond the inner boundary of the Air Defense Identification Zone (ADIZ) south of 30 degrees north latitude on the Atlantic Coast, beyond the inner boundary of the Gulf Coast ADIZ, south of the U.S./Mexican border, or beyond the inner boundary of the Pacific Coast ADIZ south of 33 degrees north latitude *which have not landed in a foreign place.* This notice requirement may be satisfied by either filing a flight plan with the FAA and placing ADCUS in the remarks section of the flight plan or by contacting Customs directly at least one hour prior to the inbound crossing of the U.S. border or coastline.

## 4.2 Notice to Customs

**4.2.1** The notice to Customs required by paragraph 4.1.9 of this section shall include the following:

- a) Aircraft registration number;
- b) Name of aircraft commander;
- c) Number of U.S. citizen passengers;
- d) Number of alien passengers;
- e) Place of last departure;

f) Estimated time and location of crossing U.S. border/coastline;

g) Name of U.S. airport of first landing (one of the designated airports listed in paragraph 6 of this section, unless an exemption has been granted in accordance with paragraph 4.5 of this section);

h) Estimated time of arrival.

### 4.3. Landing Requirement

**4.3.1** Private aircraft that are coming from a foreign place are required to furnish a notice of intended arrival in compliance with paragraphs 4.1.9 and 4.2 of this section and must land for Customs processing at the nearest designated airport to the border or coastline crossing point as listed in paragraph 6 of this section, unless exempted from this requirement in accordance with paragraph 4.5 of this section. In addition to the requirements of this paragraph, private aircraft commanders must comply with all other landing and notice of arrival requirements. This landing requirement shall not apply to private aircraft that have not landed in a foreign place or are arriving directly from Puerto Rico.

### 4.4 Private Aircraft Defined

**4.4.1** For the purpose of this section, "private aircraft" means any civil aircraft not being used to transport persons or property for compensation or hire. The term "person transported for compensation or hire" means a person who would not be transported unless there was some payment or other consideration, including monetary or services rendered, by or for the person and who is not connected with the operation of the aircraft or its navigation, ownership, or business. An aircraft will be presumed to not be carrying persons or merchandise for hire, and thus will be a private aircraft for Customs purposes, when the aircraft is transporting only the aircraft owner's employees, invited guests, or the aircraft owner's own property. This presumption may be overcome by evidence that the employees, "guests," or property are being transported for compensation or other consideration. If an aircraft is used by a group of individuals, one of whom is the pilot making the flight for his own convenience, and all persons aboard the aircraft including the pilot contribute equally toward payment of the expense of operating the aircraft owned or rented by them, the aircraft would be considered private.

### 4.5 Exemption from the Landing Requirement

**4.5.1** The owner or aircraft commander of a private aircraft required to furnish a notice of intended arrival in compliance with paragraph 4.1.9 of this section may re-

quest an exemption from the landing requirement specified in paragraph 4.3 of this section. If approved, the applicant is bound to comply with all other requirements, including operating at or above 12,500 feet mean sea level, providing advance notice of penetration to U.S. Customs at least one hour in advance of crossing the border or coastline, furnishing advance notice of arrival at the first intended airport of landing, etc. The request should be addressed to the Port Director of U.S. Customs having jurisdiction over the airport to be utilized most frequently when arriving from points south of the U.S. Requests for exemptions can be for either a single specific flight or term (one year) approval. Applications for a single overflight exemption must be received at least 15 days in advance of the intended date of arrival; for term exemption, at least 30 days in advance.

**4.5.2** Air charters or taxi service cannot be granted an unqualified term exemption since they cannot reasonably comply with the requirements of a term application, namely, comprehensive details of the passengers they will transport in the course of one year. By submitting all other details, air charters/taxis will accrue the benefit of "conditional" approval. This approval is called conditional because the operator must receive the concurrence of the Port Director prior to each trip. Concurrence will be based upon factors such as the foreign point of departure to the U.S. and the passengers being transported. The benefit realized by the charter/taxi operator is that the time constraints listed above for timely submission of single overflight exemptions can be drastically reduced. Local Customs Ports will establish minimum time frames in accordance with their own requirements.

**4.5.3** Required elements of any overflight exemption include the following:

- a) Aircraft registration number and serial number.
- b) Identification information for the aircraft (make, model, color scheme, and type, such as turboprop, etc.).
- c) A statement that the aircraft is equipped with a functioning mode C (altitude reporting) transponder which will be in use during the overflight.
- d) A statement that the aircraft is capable of flying above 12,500 feet and that it will be operated at such an altitude when utilizing the overflight exemption unless ordered to fly at a lower altitude by FAA air traffic controllers.
- e) Names, home addresses, social security numbers (optional), and dates of birth of owners of the aircraft. (If the aircraft is being operated under a lease, the name

and address of the lessee, in addition to that of the owner.)

f) Names, home addresses, social security numbers (optional), dates of birth, and any FAA certificate numbers of all crew members that the applicant wishes to have approved. Individual applications from each crew member must also be attached and should take the form of a signed letter from the crew member in question. The applicant must verify the accuracy of the information provided by the crew member to the best of the applicants ability. The application must contain a statement to this effect.

g) Names, home addresses, social security numbers (optional), and dates of birth of usual and potential passengers to the greatest extent possible. An approved passenger must be on board to utilize the overflight exemption.

h) Description of usual or anticipated cargo or baggage.

i) Description of the company's usual business activity, if the aircraft is company owned.

j) Name of intended airport(s) of first landing in the U.S. (The overflight exemption will only be valid to fly to airports preapproved by Customs).

k) Foreign place(s) from which the flight(s) will originate.

l) Reason for the request of overflight exemption.

**4.5.3.1** Information should be as complete and accurate as possible and should be specific rather than general. The following points will assist in preparing an acceptable application:

a) Include all potential crew members who might be present on the aircraft during the term of the desired exemption. In order for overflight exemptions to remain valid, all crew members on a flight must have been listed on your application.

b) Provide as many identifiers as possible for all crew and passengers. Social security numbers, passport numbers, aircraft pilot license numbers, etc., will contribute greatly to expediting background investigations.

c) Describe the type of business the corporation is engaged in. If the corporation that owns the aircraft is merely an air transportation service for the benefit of an affiliated company, please provide details.

d) List the foreign cities and countries the aircraft will visit. It is to your advantage to describe the nature of your business in each location, or to indicate that certain destinations are vacation/entertainment locations.

e) The reason for overflight exemption requests should be as tangible and concretely stated as possible. Estimate the costs incurred by making an extra landing at a "designated airport" (fuel, wear on aircraft components, landing fees, additional time/distance).

f) Provide an estimate of the number of nautical flying miles which will be saved on an annual basis if the exemption is granted.

g) Companies involved in air ambulance-type operations may be granted a single overflight exemption when emergency situations arise, as well as in the case of nonemergency transport for individuals seeking medical treatment. Both U.S. and foreign registered aircraft will be eligible for the special exemption. The applicant must provide all the necessary information normally required for an overflight exemption. Customs should be notified at least 24 hours prior to departure. If this cannot be accomplished, Customs will allow receipt of the overflight exemption application up to departure time, as well as in flight through a flight service station.

**4.5.4** Applicants should be aware that the processing of term applications requires time for all background reports to be prepared for the deciding official. Incomplete applications will not be processed, and the applicant will be notified of the specific additional information that must be supplied. Should an application for overflight be denied at the district level, an appeal process is available. Letters of denial will include the name and address of the Service/Area Director of Customs responsible for the district office that denied your application. You may petition the Service/Area Director for reconsideration of your request.

## **5. Public Health Measures Applied to Aircraft**

**5.1** Same requirements as for scheduled flights.

**6. Airports Designated as Entry Points for Aircraft Arriving from Mexico and Other Foreign Countries in the Western Hemisphere South of 30 Degrees North Latitude.**

LOCATION	AIRPORT NAME
<b>ARIZONA</b>	
Douglas	Bisbee-Douglas International
Douglas	Douglas Municipal
Nogales	Nogales International
Tucson	Tucson International
Yuma	Yuma International
<b>CALIFORNIA</b>	
Calexico	Calexico International
San Diego	Brown Field
<b>FLORIDA</b>	
Fort Lauderdale	Fort Lauderdale Executive
Fort Lauderdale	Fort Lauderdale-Hollywood International
Key West	Key West International
Miami	Miami International
Miami	Opa-Locka
Miami	Tamiami
West Palm Beach	Palm Beach International
Fort Pierce	St. Lucie County
Tampa	Tampa International
<b>LOUISIANA</b>	
New Orleans	New Orleans Lakefront
New Orleans	New Orleans International (Moissant Field)
<b>NEW MEXICO</b>	
Santa Teresa	Santa Teresa
<b>NORTH CAROLINA</b>	
Wilmington	New Hanover County
<b>TEXAS</b>	
Beaumont	Jefferson County
Brownsville	Brownsville International
Corpus Christi	Corpus Christi International
Del Rio	Del Rio International
Eagle Pass	Eagle Pass Municipal
El Paso	El Paso International
Houston	William P. Hobby
Laredo	Laredo International
McAllen	Miller International
Presidio	Presidio-Lely International

**7. Entry and Clearance - Cuba**

7.1 Aircraft arriving from or departing for Cuba must land at or depart from Miami International Airport. Upon arrival, the pilot will present a manifest of all passengers on board to an officer of the U.S. Immigration and Naturalization Service or to a Customs officer acting as an Immigration officer. No passenger arriving from Cuba by aircraft will be released by Customs, nor will the aircraft be cleared or permitted to depart before the passenger is released by an Immigration officer or a Customs officer acting on behalf of that agency.

7.2 Aircraft proceeding to Cuba are required to have a validated license issued by the Department of Commerce or a license issued by the Department of State.

7.3 These special requirements do not apply to aircraft arriving from or departing to the U.S. Naval Base at Guantanamo Bay. Aircraft from this base must meet the same requirements as aircraft arriving from other Caribbean nations.

## GEN 1.3 Entry, Transit, and Departure of Passengers and Crew

### 1. Customs Requirements

**1.1** Incoming passengers are required to complete a customs declaration. All baggage or articles belonging to the disembarking passengers are subject to customs inspection. Permission of the Customs officer is required prior to discharging any merchandise or baggage not previously cleared by Customs or prior to permitting passengers or persons employed on the aircraft not cleared by Customs to depart unless such removal or departure is necessary for the purpose of safety or the preservation of life or property. In case of an emergency or forced landing, Customs, Immigration, Public Health and Agriculture officials must be notified immediately.

**1.2** No departure formalities are required upon departure for embarking passengers.

**1.3** Any aircraft departing from the U.S. on a business or pleasure flight to unauthorized destinations (see GEN 1.4 paragraphs 3.3 and 3.4) or aircraft carrying passengers or merchandise for hire, or which will take on board or discharge passengers anywhere outside the U.S., is required to obtain clearance at the customs port of entry at or nearest the last place of take-off from the U.S.

**1.4** A private aircraft departing from the U.S. on a business or pleasure flight to an authorized destination, is not required to present a departure manifest or have a U.S. Customs clearance of any type, although modified, military-type, privately owned aircraft are subject to certain restrictions (see GEN 1.4 paragraph 5.8) under the regulations of the Office of Munitions Control of the Department of State.

### 2. Immigration Requirements

**2.1** Aircraft operators are required to present all persons for U.S. immigration inspection. Aliens must comply with all provisions of current immigration laws and regulations. Aliens who are lawfully domiciled residents of the U.S., must, with certain exceptions not generally applicable here, present their valid alien registration cards (Form I-151) issued by the Immigration Office. U.S. citizens must be able to satisfy inspectors of their citizenship and should, therefore, carry with them sufficient identification.

**2.2** Valid passports and visas are required for all alien passengers arriving and departing on the same or

through flights or transferring to another flight at the same or a nearby airport. The visa requirement may be exempted for passengers in direct transit with a layover period of up to eight hours who are passengers on scheduled air carriers which are signatory to a previously approved transit agreement with the Immigration and Naturalization Service.

**2.3** An alien passenger entering the U.S. for the purpose of immigration must hold a valid passport and an immigration visa, the latter being issued at U.S. Consulates abroad. Temporary visitors must be in possession of a valid passport and visa.

**2.4** Flight crew members must be in possession of a valid passport and visa regardless of length of stay unless the crew members are exempted through previous agreement. (See paragraph 2.2).

### 2.5 Arrival and Departure Manifests

**2.5.1** Neither arrival nor departure manifests containing information on all passengers are required in the U.S. However, the U.S. Immigration and Naturalization Service does require the completion and submission to immigration officials, of an arrival/departure card for each nonresident alien entering the U.S., regardless of length of stay.

### 2.6 Arriving Flights

**2.6.1** The captain or agent of every aircraft (other than private) arriving in the U.S. from a foreign place or from an outlying possession of the U.S. is responsible for and must ensure that an arrival/departure card (Form I-94) is prepared by each nonresident alien passenger and is presented to the immigration officer at the port of arrival. The I-94 card, however, is not required for the citizens of Canada and the French islands of St. Pierre and Miquelon, near Newfoundland. In addition, an arrival/departure card is not required for an arriving, direct transit passenger at a U.S. port from which the passenger will depart directly to a foreign place or an outlying possession of the U.S. on the same flight, provided that a listing which includes the number of such direct transit passengers is provided or that the number of such passengers are noted on the U.S. Customs Service Form 7507 or on the International Civil Aviation Organization's General Declaration and such passengers remain, during ground time, in a separate area under the direction and control of the Customs Service.

**2.6.2** Captains of private aircraft not engaged in the carriage of persons or cargo for hire (nonrevenue flights) are not required to present arrival-departure cards (Form I-94). This, however, does not relieve a nonresident alien passenger from the responsibility of completing and submitting a Form I-94 to immigration officials when required. Most alien passengers must execute and present Form I-94 (revised March 1, 1986). Prior editions may not be used. Form I-94 must be completed by all persons except U.S. citizens, returning resident aliens, aliens with immigrant visas, and Canadians visiting or in transit. Mexican nationals in possession of Immigration Form I-86 or Form I-586 are exempt from Form I-94 reporting requirements when their itinerary is limited to California, Arizona, New Mexico, or Texas and will not exceed 72 hours in duration. This exemption does not apply when travel will exceed 25 miles from the international border between Mexico and the U.S. Travel to Nevada by Mexican nationals is exempted for periods of less than 30 days. Mexican nationals proceeding to destinations more than 25 miles from the border in these states will have to obtain a visitor's permit I-444 when arriving in the U.S. Mexican nationals presenting official or diplomatic passports and destined to the U.S. for purposes other than permanent assignment are exempted from Form I-94 reporting requirements.

**2.6.3** Completion of the arrival-departure cards (Form I-94) must be as follows:

a) Alien passengers on temporary visit in the U.S. must complete all items of Form I-94 in duplicate, one copy of which is attached to the passport for surrender to immigration officials upon departure.

b) Alien passengers in direct transit, when required to complete Form I-94, are to insert the symbol TRWOV on the line headed "Passenger Boarded At" and need not complete items 3, 8 and 9. Form I-94 is to be completed in single copy only.

c) When the Form I-94 is required by individuals entering the U.S. by private aircraft it should indicate PRIVATE in block #7-Airline and Flight Number. They do not need to complete block #9-City Where You Boarded. All other items on the form are self-explanatory and should be completed prior to actual arrival in the U.S.

**2.6.4** When inspection of an arriving passenger is deferred at the request of the air carrier to another port of debarkation, the required forms relating to any such passenger shall be returned, together with a Form I-92,

when the Form I-94 procedure is used, for presentation by the captain, master, or agent at the port where inspection is to be conducted.

## **2.7 Departing Flights**

**2.7.1** The captain or agent of every aircraft (other than private) departing from the U.S. for a foreign place or an outlying possession of the U.S. is responsible for and must ensure that all alien passengers on board (except for citizens of Canada and the French islands of St. Pierre and Miqueion, near Newfoundland), surrender to the immigration officer at the port of departure, prior to departure, the passport copy of the arrival/departure card (Form I-94) which was completed upon arrival in the U.S. Aircraft departing on regularly scheduled flights from the U.S., however, may collect the cards and defer their presentation, along with either the Bureau of Customs Form 7507 or the ICAO General Declaration, containing the listing of alien direct transit passengers for whom the arrival/departure card was not prepared upon arrival.

**2.7.2** Private aircraft owners are responsible for the proper completion and submission of Form I-94 for all crew and passengers affected by the reporting requirement. Departure documents should be annotated on the reverse of the document to indicate Port of Departure and Date of Departure. Following Carrier, print the word PRIVATE. In the space provided for Flight Number/Ship Name, print the aircraft's tail number. Departure documents should be submitted to a U.S. Immigration or U.S. Customs inspector at the time of departure from the U.S. or mailed to the Appalachian Computer Service address in London, KY. Aircraft owners are responsible for the submission of all I-94 Departure Records upon departure to a foreign destination.

**2.7.3** Resident aliens of the U.S. who will be traveling abroad under a foreign passport must ensure that their Alien Registration Card, Form 151, is available for presentation to gain re-entry into the U.S. upon completion of trip.

## **2.8 Currency Reporting Requirements**

**2.8.1** There is no limitation in terms of the total amount of monetary instruments which may be brought into or taken out of the U.S., nor is it illegal to do so. However, if you transport or cause to be transported (including by mail or other means), more than \$10,000 in monetary instruments on any occasion into or out of the U.S., or if you receive more than that amount, you must file a report (Customs Form 4790) with U.S. Customs (Currency and Foreign Transactions Reporting Act, 31 U.S.C. 1101, et seq.). Monetary instruments include U.S. or

foreign coin in current circulation, currency, traveler's checks, money orders, and negotiable instruments or investment securities in bearer form. Failure to comply can result in civil and criminal penalties.

### 3. Public Health Requirements

**3.1** Disembarking passengers are not required to present a vaccination certificate except when coming directly from an area infected with cholera, yellow fever or smallpox. Smallpox vaccination is necessary only if, within the 14 days before arrival, the traveler has been in a country reporting smallpox.

**3.2** The pilot in command of an aircraft destined for a U.S. airport must report immediately to the Quarantine Station at or nearest the airport at which the aircraft will arrive, the occurrence, on board, of any death or any ill

person among passengers or crew. Ill person is defined as:

a) Temperature of 100 degrees Fahrenheit (38 degrees Celsius) or greater accompanied by rash, glandular swelling, or jaundice, or which has persisted for more than 48 hours; or

b) Diarrhea, defined as the occurrence in a 24-hour period of three or more loose stools or of a greater than normal (for the person) amount of loose stools.

**3.3** The pilot in command is responsible for detaining the aircraft and persons and things arriving thereon and keeping them free from unauthorized contact pending release when required by Sections 71.31, 71.46, 71.62, 71.63, and 71.102 of the Foreign Quarantine Regulations of the Public Health Service (Part 71, Title 42, Code of Federal Regulations).





## GEN 1.4 Entry, Transit, and Departure of Cargo

### 1. Requirements Concerning Cargo and Other Articles

**1.1** Customs entry and clearance of cargo and unaccompanied baggage destined for points within U.S. territory must be completed at the first international airport of entry.

**1.2** Transshipment of cargo and other articles must be dealt with at the first international airport of entry according to related regulations. All aircraft entering the U.S. or arriving any place in the U.S. from any other place in the U.S. carrying residue foreign cargo shall not depart from the place of landing without receiving permission from the Customs officer.

### 2. Agricultural Quarantine Requirements

**2.1** The U.S. Department of Agriculture, Plant Protection and Quarantine Division (PPQ), has strict requirements regarding the entry, handling and disposition of garbage and galley refuse on all flights arriving from any foreign country, except Canada (7 CFR Parts 94 and 330). A list of sanitary international airports approved by PPQ can be secured from any PPQ office at major airports (see Aerodrome Section).

**2.2** Meat, meat products, milk, live birds, poultry or other domestic farm animals can only enter the U.S. under certain conditions from certain countries under the regulations of the PPQ.

**2.3** No insects or other plant pests shall knowingly be transported into the U.S. If the pilot of any aircraft has reason to believe any flying or crawling insects are aboard his aircraft, such information should be relayed to the nearest PPQ office or inspector when landing.

**2.4** Permits are required to bring most fruits, vegetables, plants, seeds, etc., into the U.S. from foreign countries. A guide to restricted or prohibited products can be secured from any PPQ office.

**2.5** Dogs, cats, monkeys psittacine birds (parrot family), turtles, shipments of disease organisms and vectors, and dead bodies are subject to entry restrictions prescribed in the Foreign Quarantine Regulations of the Public Health Service (42 CFR Part 71, Subject J).

### 3. Exportation of Aircraft, Cargo and Other Articles

**3.1** All U.S. and foreign registered aircraft departing the U.S. for a foreign destination on a temporary sojourn must have export authorization. The two types of export authorization are a license exception (AVS) and a license. Detailed information on both the license exception and the license can be obtained from:

The U. S. Department of Commerce  
Bureau of Export Administration  
Exporter Counseling Division  
Washington, DC 20230  
Telephone: (202) 482-4811  
Facsimile: (202) 482-3617

**3.2** A license exception (AVS) is an authorization to export the aircraft if certain criteria are satisfied. This exception does not require an application nor will there be an issuance of a license document prior to the flight.

**REFERENCE-**  
15 CFR SECTION 740.15

**3.3** License exception AVS authorizes an operating civil aircraft of foreign registry that has been in the U.S. on a temporary sojourn to depart from the U.S. under its own power for any destination, provided that:

a) No sale or transfer of operational control of the aircraft to nationals of Cuba, Iran, Iraq, Libya, North Korea, Sudan, or Syria has occurred while in the U.S.;

b) The aircraft is not departing for the purpose of sale or transfer of operational control to nationals of Cuba, Iran, Iraq, Libya, North Korea, Sudan, or Syria; and

c) It does not carry from the U.S. any item for which an export license is required and has not been granted by the U.S. Government.

**3.4** License exception AVS authorizes a civil aircraft of U.S. registry operating under an Air Carrier Operating Certificate, Commercial Operating Certificate, or Air Taxi Operating Certificate issued by the Federal Aviation Administration or conducting flights under operating specifications approved by the Federal Aviation Administration pursuant to 14 CFR Part 129 of the regulations of the Federal Aviation Administration, may depart from the U.S. under its own power for any destination provided that:

a) The aircraft does not depart for the purpose of sale, lease or other disposition of operational control of the aircraft or its equipment, parts, accessories, or

components to a foreign country or any national thereof;

b) The aircraft's U.S. registration will not be changed while abroad;

c) The aircraft is not to be used in any foreign military activity while abroad; and

d) The aircraft does not carry from the U.S. any item for which a license is required and has not been granted by the U.S. Government.

**3.5** License exception AVS authorizes any other operating civil aircraft of U.S. registry to depart from the U.S. under its own power for any destination, except to Cuba, Iran, Iraq, Sudan, Syria, Libya, and North Korea (flights to these destinations require a license), provided that:

a) The aircraft does not depart for the purpose of sale, lease or other disposition of operational control of the aircraft, or its equipment, parts, accessories, or components to a foreign country or national thereof;

b) The aircraft's U.S. registration will not be changed while abroad;

c) The aircraft is not to be used in any foreign military activity while abroad;

d) The aircraft does not carry from the U.S. any item for which an export license is required and has not been granted by the U.S. Government; and

e) The aircraft will be operated while abroad by a U.S. licensed pilot, except that during domestic flights within a foreign country, the aircraft may be operated by a pilot currently licensed by that foreign country.

**3.6** A license authorizes the departure of the aircraft within the special limitations set forth in the license document. It is issued only on the basis of a formal application requesting the issuance of a license prior to the flight.

**3.7** Once it has been determined that an export license is required, an application for the license should be submitted to the Bureau of Export Administration, U.S. Department of Commerce. An application consists of Form BXA-748P (multipurpose application). This form and information on the application process can be obtained free of charge from either the U.S. Department of Commerce in Washington or any of its District Offices. (See paragraph 4.)

**3.8** Applications for validated licenses by non-U.S. citizens require that the applicant appoint an agent

subject to U.S. jurisdiction to act in his behalf. If an emergency situation necessitates the expedition of the application process, contact the Counseling Division Staff of the Bureau of Export Administration (telephone 202-482-4811) or any Department of Commerce District Office for assistance.

**4. Department of Commerce District Office Locations:**

State	City
Alabama	Birmingham
Alaska	Anchorage
Arizona	Phoenix
California	Los Angeles
California	San Francisco
Colorado	Denver
Connecticut	Hartford
Florida	Miami
Georgia	Atlanta
Georgia	Savannah
Hawaii	Honolulu
Illinois	Chicago
Indiana	Indianapolis
Iowa	Des Moines
Louisiana	New Orleans
Maryland	Baltimore
Massachusetts	Boston
Michigan	Detroit
Minnesota	Minneapolis
Missouri	St. Louis
Nebraska	Omaha
Nevada	Reno
New Jersey	Newark
New Mexico	Albuquerque
New York	Buffalo
New York	New York
North Carolina	Greensboro
Ohio	Cincinnati
Ohio	Cleveland
Oregon	Portland
Pennsylvania	Philadelphia
Pennsylvania	Pittsburgh
Puerto Rico	San Juan
South Carolina	Columbia
Tennessee	Memphis
Texas	Dallas
Texas	Houston

State	City
Utah	Salt Lake City
Washington	Seattle
West Virginia	Charleston
Wisconsin	Milwaukee
Wyoming	Cheyenne

## 5. Regulations Concerning Civil Movement of Arms, Ammunition and Military Type Aircraft

**5.1** Importation of military type aircraft and the carriage or importation of firearms or ammunition are regulated by the U.S. Department of the Treasury, Division of Alcohol, Tobacco and Firearms.

**5.2** A permit must be obtained from the Alcohol, Tobacco and Firearms Division for the importation of certain military type aircraft regardless of demilitarization. Aircraft that are exempt from permits are specifically listed in the regulations on Importation of Arms, Ammunition and Implements of War (26 CFR Part 180).

**5.3** A permit must be obtained from the Alcohol, Tobacco and Firearms Division for the importation of firearms and ammunition for commercial transactions.

**5.4** Transportation or shipment of firearms or ammunition in interstate or foreign commerce to persons other than licensed importers, licensed manufacturers, licensed dealers or licensed collectors, without written notice to the carrier that such firearms or ammunition is being transported or shipped is unlawful.

**5.5** Any passenger who owns or legally possesses a firearm or ammunition being transported aboard any common or contract carrier for movement with the passenger must deliver said firearm or ammunition into the custody of the pilot, captain, conductor or operator of such common or contract carrier for the duration of the trip.

**5.6** Applications for permits should be made on Form 6 (Firearms), preferably 30 days in advance of importation. Form IRS-4522, International Import Certificate, may also be required by the exporting country and should accompany applications on Form 6 (Firearms) when necessary.

**5.7** Exportation of military type aircraft are regulated by the U.S. Department of State, Office of Munitions Control.

**5.8** A license must be obtained from the Office of Munitions Control, Department of State, for the exportation from the U. S. of certain military type aircraft regardless of demilitarization. Aircraft that are exempt from licenses are specifically listed in the regulations on International Traffic in Arms (22 CFR Part 121). Applications for licenses are made as follows:

a) For permanent export, on Form DSP-5. Apply at least 30, preferable 60, days in advance. A Form DSP-63a may also be required from the importing country.

b) For temporary export, on Form DSP-73. Apply at least 10 days in advance.



## GEN 1.5 Aircraft Instruments, Equipment, and Flight Documents

### 1. General

1.1 Commercial air transport aircraft operating in the U.S. airspace must adhere to the provisions of Annex 6,

Operation of Aircraft, Part One, Chapter Six (Airplane Instruments, Equipment and Flight Documents) and Chapter Seven (Airplane Communications and Navigation Equipment).



## GEN 1.6 Summary of National Regulations and International Agreements/Conventions

### 1. Summary of National Regulations

**1.1** Air regulations for the U.S. and areas under its jurisdiction are published in Title 14 of the U.S. Code of Federal Regulations Parts 1-199, entitled the Federal Aviation Administration, Department of Transportation. These regulations are also referred to as the Federal Aviation Regulations (FAR). It is essential that persons engaged in air operations in the U.S. airspace be acquainted with the relevant regulations. Copies of the 14 CFR parts may be purchased from the:

Superintendent of Documents  
Attn: New Orders  
P.O.Box 371954  
Pittsburgh, PA 15250-7954  
Telephone: 202-512-1800

The Code of Federal Regulations is available electronically at [www.access.gpo.gov/nara/index.html](http://www.access.gpo.gov/nara/index.html).

**1.2** The following is a partial list of Federal Aviation Regulations and their respective subject matter:

14 CFR Part No.	Title
1	Definitions and abbreviations
11	General rulemaking procedures
13	Investigative and enforcement procedures
21	Certification procedures for products and parts
23	Airworthiness standards: normal, utility, acrobatic, and commuter category airplanes
25	Airworthiness standards: transport category airplanes
27	Airworthiness standards: normal category rotorcraft
29	Airworthiness Standards: transport category rotorcraft
31	Airworthiness standards: manned free balloons
33	Airworthiness standards: aircraft engines
35	Airworthiness standards: propellers
36	Noise standards: aircraft type and airworthiness certification
39	Airworthiness directives
43	Maintenance, preventive maintenance, rebuilding, and alteration
45	Identification and registration marking
47	Aircraft registration
49	Recording of aircraft titles and security documents

14 CFR Part No.	Title
61	Certification: Pilots and flight instructors
63	Certification: Flight crewmembers other than pilots
65	Certification: Airmen other than flight crewmembers
67	Medical standards and certification
71	Designation of Class A, B, C, D, and E airspace areas; airways; routes; and reporting points
73	Special use airspace
77	Objects affecting navigable airspace
91	General operating and flight rules
93	Special air traffic rules and airport traffic patterns
95	IFR altitudes
97	Standard instrument approach procedures
99	Security control of air traffic
101	Moored balloons, kites, unmanned rockets and unmanned free balloons
103	Ultralight vehicles
105	Parachute jumping
107	Airport security
108	Airplane operator security
109	Indirect air carrier security
119	Certification: Air carriers and commercial operators
121	Operating requirements: Domestic, flag, and supplemental operations
125	Certification and operations: Airplanes having a seating capacity of 20 or more passengers or a maximum payload capacity of 6,000 pounds or more
129	Operations: Foreign air carriers and foreign operations of U.S. registered aircraft engaged in common carriage
133	Rotorcraft external load operations
135	Operating requirements: Commuter and on-demand operations
137	Agricultural aircraft operations
139	Certification and operations: Land airports serving certain air carriers
141	Pilot schools
142	Training centers
145	Repair stations
147	Aviation maintenance technician schools
150	Airport noise compatibility planning
151	Federal aid to airports
152	Airport aid program
155	Release of airport property from surplus property disposal restrictions
156	State block grant pilot program

14 CFR Part No.	Title
157	Notice of construction, alteration, activation, and deactivation of airports
158	Passenger facility charges (PFC's)
161	Notice and approval of airport noise and access restrictions
169	Expenditure of Federal funds for nonmilitary airports or air navigation facilities thereon
170	Establishment and discontinuance criteria for air traffic control services and navigational facilities

14 CFR Part No.	Title
171	Non-Federal navigation facilities
183	Representatives of the Administrator
185	Testimony by employees and production of records in legal proceedings, and service of legal process and pleadings
187	Fees
189	Use of Federal Aviation Administration communications system
191	Protection of sensitive security information
198	Aviation insurance



## GEN 1.7 Differences From ICAO Standards, Recommended Practices and Procedures

NOTE - See GEN 1.6 for the availability of Title 14 of the U.S. Code of Federal Regulations Parts 1-199 which contain the Federal Aviation Regulations.

<b>ANNEX 1 - PERSONNEL LICENSING</b>	
<b>Chapter 1</b>	<b>Definitions and General Rules Concerning Licences</b>
1.2.5.2, 1.2.5.2.1	Persons performing airline transport pilot duties must be medically examined at 6-month intervals, regardless of age or type of aircraft.
1.2.5.2, 1.2.5.2.2	Persons performing air traffic control tower duties must be medically examined at 12-month intervals, regardless of age.
<b>Chapter 2</b>	<b>Licences and Ratings for Pilots</b>
2.1.3.2 b)	Class ratings are required for all grades of certificates.
2.1.4.1, 2.1.4.1.1	Not applied to copilots.
2.1.5.2 b)	Not applied to copilots.
2.1.9	An applicant for an airline transport pilot certificate with an airplane rating may credit toward the total flight time requirement all flight time served as copilot in airplanes required to have more than one pilot by their approved aircraft flight manual or airworthiness certificate. Flight time served as copilot of an airplane performing the duties and functions of a pilot-in-command under the supervision of a pilot-in-command may be credited towards the 250 hours of pilot-in-command flight time required for an airline transport pilot certificate with an airplane rating (if the aircraft or the operating rule requires a copilot).
2.3.1.3.1	If the applicant has satisfactorily completed an approved training course, 35 hours of flight time are required.
2.5.1.5.1	There is no requirement for an applicant to demonstrate skills in a multi-engine airplane required to be operated with a copilot. Skill demonstration may be performed in a single-engine aircraft or in a small multi-engine aircraft requiring only one pilot. A certificate may be issued with single-engine land or sea class rating, as appropriate.
2.9.1.3.1.1	Two-hundred hours in helicopters, of which 75 hours must be as pilot-in-command.
2.12.1.5	Glider pilots are not required to hold medical certificates. However a person shall not act as pilot in command, or in any other capacity as a required flight crewmember, while that person knows or has reason to know of any medical condition that would make the person unable to operate the aircraft in a safe manner.
2.13.1.3.1	Ten hours of flight training in balloons that includes at least 6 training flights.
2.13.1.3.3	There is no night requirement.
2.13.1.5	Free balloon pilots are not required to hold medical certificates. However a person shall not act as pilot in command, or in any other capacity as a required flight crewmember, while that person knows or has reason to know of any medical condition that would make the person unable to operate the aircraft in a safe manner.
<b>Chapter 3</b>	<b>Licences for Flight Crew Members Other Than Licences for Pilots</b>
3.3.1.1	Flight engineers must be at least 21 years of age.
<b>Chapter 4</b>	<b>Licences and Ratings for Personnel Other Than Flight Crew Members</b>
4.2.1.3 a)	U.S. regulations only require 30 months of the appropriate prior experience, not 48 months.
4.4.1.1	To be eligible for an air traffic control tower operator certificate, a person must be at least 18 years of age.

4.4.1.3	Each applicant for a facility rating at any air traffic control tower must have satisfactorily served as an air traffic control tower operator at that control tower without a facility rating for at least 6 months, or as an air traffic control tower operator with a facility rating at a different control tower for at least 6 months before the date he/she applies for the rating. However, an applicant who is a member of an Armed Force of the U.S. meets these requirements if he/she has satisfactorily served as an air traffic control tower operator for at least 6 months.
4.4.1.4	No person may act as an air traffic control tower operator in connection with civil aircraft unless he/she holds at least a second class medical certificate. Exception to this is an individual employed by the Federal Aviation Administration or on active duty with the Department of the Air Force, Army, Navy, or Coast Guard.
4.5.2.2.1 b) 1)	Six months.
4.5.2.2.1 b) 2)	Six months.
4.5.2.2.1 b) 3)	The U.S. does not specify a minimum number of precision approaches to be completed prior to receiving a rating.
4.5.2.2.1 c)	The U.S. does not specify a minimum number of precision approaches to be completed prior to receiving a rating.
4.6.1.1	The applicant must be at least 23 years of age.
4.6.1.2	The U.S. requires applicants to pass a written test.
<b>Chapter 6</b>	<b>Medical Provisions for Licencing</b>
6.3.2.5.1	Except for duties requiring an airline transport pilot certificate, electrocardiography is not required. For duties requiring an airline transport pilot certificate, an applicant who has passed his/her 35th birthday, but not the 40th birthday, must submit an electrocardiogram on the first examination after the 35th birthday and annually after the 40th birthday.
6.3.2.8.1	No radiography required.
6.3.2.23	Pregnancy does not prohibit the issue of a medical certificate.
6.3.3.3	Applicants who must wear correcting lenses will not require testing for refractive error. A flight crew member is not required to have a spare set of suitable correcting lenses available.
6.4.2.5.1	No electrocardiography required.
6.4.2.8.1	No radiography required.
6.4.2.22	Pregnancy does not prohibit the issue of a medical certificate.

ANNEX 2 - RULES OF THE AIR	
Chapter 1	Definitions
Aerodrome control tower	In the U.S., an "aerodrome control facility" is referred to as a "tower" or "airport traffic control tower"; "aerodrome control" is referred to as "airport traffic control service."
Airborne collision avoidance	The U.S. uses "traffic alert collision avoidance system (TCAS)." TCAS is an airborne collision avoidance system based on radar beacon signals and operates independent of ground-based equipment. TCAS-I generates traffic advisories only. TCAS-II generates traffic advisories and resolution (collision avoidance) advisories in the vertical plane.
Air-taxiing	The U.S. uses "hover taxi" for this maneuver above 100 feet above ground level (AGL) and "air taxi" below 100 feet AGL.
Area control service	The U.S. does not use the term "area control service" to indicate controlled flight in controlled areas.
Area control centre	The U.S. equivalent facility for an Area Control Centre (ACC) is an Air Route Traffic Control Center (ARTCC).
ATS route	In U.S. domestic airspace, the term "ATS route" is not used. Routes in the U.S. include VOR airways, jet routes, substitute routes, and off-airway routes. The U.S. also uses instrument departure procedures (DP's) and standard terminal arrivals (STAR's).
Controlled airspace	The U.S. terms for controlled airspace have different parameters than for ICAO.
Danger area	The term "danger area" is not used within the U.S. or any of its possessions or territories.
Estimated off-block time	The U.S. uses the term "estimated departure time" for domestic operations.
Flight information centre	The U.S. does not operate flight information centers (FIC's). In the U.S., the services provided by FIC's are performed by air traffic control (ATC) facilities, automated flight service stations (AFSS's), and rescue coordination centers (RCC's).
Instrument meteorological conditions	The U.S. air traffic service units use the phrase "IFR conditions."
Level	The U.S. uses "altitude" or "flight level" rather than "level" and "cruising altitude" rather than "cruising level." The term "level" is not used to mean "height," "altitude," or "flight level."
Movement area	In the U.S., the term "movement area" means "the runways, taxiways, and other areas of an airport/heliport which are utilized for taxiing, hover taxiing, air-taxiing, take-off and landing of aircraft, exclusive of loading ramps and parking areas. At those airport/heliports with a tower, specific approval for entry onto the movement area must be obtained from ATC."  The U.S. does not use an all-inclusive term to denote the movement area plus loading ramps and parking areas of an airport, nor does the U.S. use the term "maneuvering area" in any related context.
Repetitive flight plan (RPL)	The U.S. uses the term "stored flight plan" for domestic operations.
Terminal control area	In the U.S., "terminal control area" has been replaced by "Class B airspace/area." Standard IFR services are provided to IFR aircraft operating in Class B airspace.
Total estimated elapsed time	The U.S. uses "estimated time en route" for domestic operations.
Transition altitude	In U.S. domestic airspace, "transition altitude," "layer" and "level" are not used; however, in the U.S., flight levels begin at FL 180 where the reference datum of 29.92 inches of mercury is used as the constant atmospheric pressure. Below FL 180, altitudes are based on barometric pressure readings. QNH and QFE altimeter settings are not provided in domestic U.S. airspace.
Visual meteorological conditions	The U.S. air traffic service units use the phrase "VFR conditions."

<b>Chapter 2</b>	<b>Applicability of the Rules of the Air</b>
2.2	See difference under "Movement area."
2.5	Except in an emergency, no pilot of a civil aircraft may allow a person who appears to be intoxicated or who demonstrates by manner or physical indications that the individual is under the influence of drugs (except a medical patient under proper care) to be carried in that aircraft.
<b>Chapter 3</b>	<b>General Rules</b>
3.1.8	In addition, aircraft shall not be flown in formation flight when passengers are carried for hire.
3.2 Note	See difference under "Movement area."
3.2.2.6.1	See difference under "Movement area."
3.2.3.2 d)	The U.S. national regulations do not require aircraft on the movement area of an airport, whose engines are running, to display lights which indicate that fact from sunset to sunrise.
3.2.5	Unless otherwise authorized or required by ATC, no person may operate an aircraft within a Class B, C or D surface area except for the purpose of landing at, or taking off from, an airport within that area. In addition, in the case of a helicopter approaching to land, avoid the flow of fixed-wing aircraft. In addition, no person may, within a Class B, C or D surface area operate an aircraft to, from, or on an airport having a control tower operated by the U.S. unless two-way radio communications are maintained between that aircraft and the control tower.
3.3.1.2	In the U.S., ATC flight plans are not required for VFR flight in Class C, D or E airspace.
3.3.1.2.1 d)	Requirements pertaining to filing flight plans for flights operating across U.S. borders and for identification purposes are described in 14 CFR Part 91 (Section 91.84) and Part 99.
3.3.1.2.2	The U.S. requires that domestic flight plans be submitted at least 30 minutes before departure. For international flights, the U.S. recommends that they be transmitted so that they are received by ATC authorities in each Flight Information Region (FIR) to be entered, at least 2 hours prior to entry, unless otherwise provided in that State's requirements.
3.6.1	Air traffic control clearances are not needed for VFR flight in U.S. Class C, D or E airspace.
3.6.2.4	When meteorological conditions fall below the minimum specified for en route VFR flights, the pilot of the aircraft shall not continue his/her flight in such conditions, except in emergency, beyond the extent necessary to return to his/her departure point or to the nearest suitable landing point.
3.6.5.2.2	In the event of two-way communications failure in the U.S., ATC service is predicated on pilot compliance with the provisions of 14 CFR Part 91 (Section 91.185). If the failure occurs in IMC, or if VFR cannot be complied with, each pilot is to continue the flight according to the following: <u>Route</u> a) By the route assigned in the last ATC clearance received; b) If being radar vectored, by the direct route from the point of failure to the fix, route, or airway specified in the vector clearance; c) In the absence of an assigned route, by the route that ATC has advised may be expected in a further clearance; or d) In the absence of an assigned route or a route that ATC has advised may be expected in a further clearance, by the route filed in the flight plan.  <u>Altitude</u> - At the <b>HIGHEST</b> of the following altitudes or flight levels <b>FOR THE ROUTE SEGMENT BEING FLOWN</b> : a) The altitude or flight level assigned in the last ATC clearance received; b) The minimum altitude/flight level as prescribed for IFR operations; or c) The altitude or flight level ATC has advised may be expected in a further clearance.

**Basic VFR Weather Minimums**

Airspace	Flight Visibility	Distance from Clouds
Class A .....	Not Applicable	Not Applicable
Class B .....	3 statute miles	Clear of Clouds
Class C .....	3 statute miles	500 feet below 1,000 feet above 2,000 feet horizontal
Class D .....	3 statute miles	500 feet below 1,000 feet above 2,000 feet horizontal
Class E Less than 10,000 feet MSL .....	3 statute miles	500 feet below 1,000 feet above 2,000 feet horizontal
At or above 10,000 feet MSL .....	5 statute miles	1,000 feet below 1,000 feet above 1 statute mile horizontal
Class G 1,200 feet or less above the surface (regardless of MSL altitude). Day, except as provided in Section 91.155(b) .....	1 statute mile	Clear of clouds
Night, except as provided in Section 91.155(b) .....	3 statute miles	500 feet below 1,000 feet above 2,000 feet horizontal
More than 1,200 feet above the surface but less than 10,000 feet MSL. Day .....	1 statute mile	500 feet below 1,000 feet above 2,000 feet horizontal
Night .....	3 statute miles	500 feet below 1,000 feet above 2,000 feet horizontal
More than 1,200 feet above the surface and at or above 10,000 feet MSL. ....	5 statute miles	1,000 feet below 1,000 feet above 1 statute mile horizontal

Chapter 4	Visual Flight Rules
4.1 and Table 4-1	There is no Class F airspace in the U.S. Basic VFR weather minimums are listed in the table above.
4.1 a)	Except as otherwise authorized by the appropriate air traffic control unit for special VFR flights within Class B, C, D or E surface areas, no person may operate an aircraft under VFR when the flight visibility is less, or at a distance from clouds that is less than that prescribed for the corresponding altitude and class of airspace in the table above.
4.1 b)	<b>Class G Airspace:</b> Notwithstanding the provisions of paragraph a) of this section, the following operations may be conducted in Class G airspace below 1,200 feet above the surface: 1) <b>Helicopter.</b> A helicopter may be operated clear of clouds if operated at a speed that allows the pilot adequate opportunity to see any air traffic or obstruction in time to avoid collision. 2) <b>Airplane.</b> When the visibility is less than 3 statute miles but not less than 1 statute mile during night hours, an airplane may be operated clear of clouds if operated in an airport traffic pattern within one-half mile of the runway.
4.1 c)	Except as provided in 4.2, no person may operate an aircraft under VFR within the lateral boundaries of the surface areas of Class B, Class C, Class D or Class E airspace designated for an airport when the ceiling is less than 1,000 feet.

4.1 d)	<p>Except as provided in 4.2, no person may take-off or land an aircraft, or enter the traffic pattern area of an airport under VFR, within the lateral boundaries of the surface area of Class B, Class C, Class D or Class E airspace designed for an airport :</p> <ol style="list-style-type: none"> <li>1) unless ground visibility at that airport is at least 3 statute miles; or</li> <li>2) if ground visibility is not reported at that airport, unless flight visibility during landing or takeoff, or while operating in the traffic pattern is at least 3 statute miles.</li> </ol>
4.2	<p>In the U.S., no person may operate an aircraft beneath the ceiling under VFR within the lateral boundaries of controlled airspace designated to the surface for an airport when the ceiling is less than 1,000 feet. No person may take-off or land an aircraft (other than a helicopter) under special VFR (SVFR) unless ground visibility is at least 1 statute mile or if ground visibility is not reported, unless flight visibility is at least 1 statute mile.</p>
4.2 a)	<p>When an appropriate ATC clearance has been received, the special weather minimums in this section apply to the operation of an aircraft in a Class B, C, D or E surface area under VFR.</p> <ol style="list-style-type: none"> <li>1) No person may operate an aircraft in a Class B, C, D or E surface area under VFR except clear of clouds;</li> <li>2) No person may operate an aircraft (other than a helicopter) in a Class B, C, D or E surface area under VFR unless flight visibility is at least 1 statute mile;</li> <li>3) No person may take-off or land an aircraft (other than a helicopter) at any airport in a Class B, C, D or E surface area under VFR: <ol style="list-style-type: none"> <li>a) unless ground visibility at that airport is at least 1 statute mile; or</li> <li>b) if ground visibility is not reported at that airport, unless flight visibility during landing or take-off is at least 1 statute mile.</li> </ol> </li> </ol>
4.3	<p>The U.S. does not prohibit VFR flight between sunset and sunrise.</p>
4.4	<p>In the U.S., VFR flight is not permitted within Class A airspace designated in 14 CFR Part 71 unless otherwise authorized by ATC.</p> <p>In the U.S., an ATC clearance is needed for VFR flight only in Class B airspace area.</p>
4.6	<p>In addition: anywhere, an altitude allowing, if a power unit fails, an emergency landing without due hazard to persons or property on the surface.</p>
4.7	<p>In addition, grid tracks are not used to determine cruising altitudes in polar areas. True tracks are used to determine cruising levels above FL 230 in the area north of Alaska bounded by the true North Pole to 72°00'00"N, 141°00'00"W; to 72°00'00"N, 158°00'00"W; to 68°00'00"N, 168°58'23"W; to point of beginning. The U.S. has named this area the Anchorage Arctic CTA/FIR for national reference purposes.</p>
4.8	<p>In U.S. Class C and D airspace/areas, an ATC clearance is not required for VFR flights.</p>
<b>Chapter 5</b>	<b>Instrument Flight Rules</b>
5.1.2	<p>In the U.S., minimum altitudes for IFR flights are 2,000 feet above the highest obstacle within a horizontal distance of 4 nautical miles from the course to be flown in mountainous terrain and 1,000 feet above the highest obstacle within a horizontal distance of 4 nautical miles from the course to be flown in non-mountainous terrain.</p>
5.2.2	<p>See difference under paragraph 4.7.</p>
5.3.1	<p>See difference under paragraph 4.7.</p>

<p><b>Further differences which exist by virtue of the fact that the Annex contains no comparable standards for the U.S. national regulations.</b></p>	<p>1) The regulations covering the selection and use of alternate airports in respect to ceiling and visibility minima, require that:</p> <p>Unless otherwise authorized by the FAA Administrator, no person may include an alternate airport in an IFR flight plan unless current weather forecasts indicate that, at the estimated time of arrival at the alternate airport, the ceiling and visibility at that airport will be at or above the alternate airport weather minima.</p>
	<p>2) Operation under IFR in Class A, B, C, D or E airspace malfunction reports:</p> <p>a) The pilot-in-command of each aircraft operated in Class A, B, C, D or E airspace under IFR shall report as soon as practical to ATC any malfunctions of navigational, approach, or communication equipment occurring in flight.</p> <p>b) In each report the pilot-in-command shall include:</p> <ol style="list-style-type: none"> <li>1) aircraft identification;</li> <li>2) equipment affected;</li> <li>3) degree to which the capability of the pilot to operate under IFR in the ATC system is impaired; and</li> <li>4) nature and extent of assistance desired from ATC.</li> </ol>
	<p>3) When an aircraft has been cleared to maintain "VFR conditions on top," the pilot is responsible to fly at an appropriate VFR altitude, comply with VFR visibility and distance from cloud criteria, and to be vigilant so as to see and avoid other aircraft.</p>
	<p>4) Aircraft speed:</p> <p>a) Unless otherwise authorized by the FAA Administrator, no person may operate an aircraft below 10,000 feet MSL at an indicated airspeed of more than 250 kt (288 m.p.h.).</p> <p>b) Unless otherwise authorized or required by ATC, no person may operate an aircraft within Class B, C or D surface area at an indicated airspeed of more than 200 kt (230 m.p.h.). This paragraph 4 b) does not apply to operations within Class B airspace. Such operations shall comply with paragraph 4 a) of this section.</p> <p>c) No person may operate an aircraft in the airspace underlying Class B airspace, or in a VFR corridor designated through Class B airspace, at an indicated airspeed of more than 200 kt (230 m.p.h.).</p> <p>d) If the minimum safe airspeed for any operation is greater than the maximum speed prescribed in this section, the aircraft may be operated at that minimum speed.</p>
	<p>5) Operating rules and pilot and equipment requirements for flight in Class B airspace.</p> <p>a) Operating rules. No person may operate an aircraft within Class B airspace except in compliance with the following rules:</p> <ol style="list-style-type: none"> <li>1) No person may operate an aircraft within Class B airspace unless that person has received an appropriate authorization from ATC prior to operation of that aircraft in that area.</li> <li>2) Unless otherwise authorized by ATC, each person operating a large turbine engine-powered airplane to or from a primary airport shall operate at or above the designated floors while within the lateral limits of the Class B airspace.</li> <li>3) Any person conducting pilot training operations at an airport within Class B airspace shall comply with any procedures established by ATC for such operations in Class B airspace.</li> </ol> <p>b) Pilot requirements. No person may take off or land a civil aircraft at an airport within Class B airspace or operate a civil aircraft within Class B airspace unless:</p> <ol style="list-style-type: none"> <li>1) The pilot-in-command holds at least a private pilot certificate; or</li> <li>2) The aircraft is operated by a student pilot who has met the requirements (14 CFR Part 61 (Section 61.95)).</li> </ol> <p>c) Communications and navigation requirements. Unless otherwise authorized by ATC, no person may operate an aircraft within Class B airspace unless that aircraft is equipped with:</p> <ol style="list-style-type: none"> <li>1) For <b>IFR</b> operations, an operable VOR or TACAN receiver, and</li> <li>2) For <b>all</b> operations, an operable two-way radio capable of communications with ATC on appropriate frequencies for that Class B airspace.</li> </ol> <p>d) Transponder requirements. No person may operate an aircraft in Class B airspace unless the aircraft is equipped with the applicable operating transponder and automatic altitude reporting equipment.</p>

	<p>6) Operating rules and pilot and equipment requirements for operating in Class C airspace.</p> <p>a) General. For the purpose of this section, the primary airport is the airport designated in 14 CFR Part 71, for which the Class C airspace is designated. A satellite airport is any other airport within the Class C airspace.</p> <p>b) Deviations. An operator may deviate from any provisions of this section under the provisions of an ATC authorization issued by the ATC facility giving jurisdiction of the Class C airspace. ATC may authorize a deviation on a continuing basis or for an individual flight, as appropriate.</p> <p>c) Arrivals and overflights. No person may operate an aircraft in Class C airspace unless two-way radio communication is established with the ATC facility having jurisdiction over the Class C airspace prior to entering that area and is thereafter maintained with the ATC facility having jurisdiction over the Class C airspace while within that area.</p> <p>d) Departures. No person may operate an aircraft within Class C airspace except as follows:</p> <p>1) From the primary airport or satellite airport with an operating control tower, unless two-way radio communication is established and maintained with the control tower, and thereafter as instructed by ATC while operating in the Class C airspace.</p> <p>2) From a satellite airport without an operating control tower, unless two-way radio communication is established as soon as practical after departing and thereafter maintained with the ATC facility having jurisdiction over the Class C airspace.</p> <p>e) Traffic patterns. No person may take off or land an aircraft at a satellite airport within Class C airspace except in compliance with FAA arrival and departure traffic patterns.</p> <p>f) Equipment requirements. Unless otherwise authorized by the ATC facility having jurisdiction over the Class C airspace, no person may operate an aircraft within Class C airspace unless that aircraft is equipped with the applicable equipment specified in 14 CFR Part 91 (Section 91.215).</p> <p>7) Except for persons operating gliders below the floor of Class A airspace, no person may operate an aircraft in Class B, C, D or E airspace of the 48 contiguous States and the District of Columbia above 10,000 feet MSL, excluding that airspace at and below 2,500 feet AGL, unless that aircraft is equipped with an operable radar beacon transponder having at least a Mode 3/A 4096-code capability, replying to Mode 3/A interrogation with the code specified by ATC, and automatic altitude reporting equipment having a Mode C capability that automatically replies to Mode C interrogations by transmitting pressure altitude information in 100-foot increments.</p> <p>8) Compliance with ATC clearances and instructions:</p> <p>a) When an ATC clearance has been obtained, no pilot-in-command may deviate from that clearance, except in an emergency, unless an amended clearance is obtained. A pilot-in-command may cancel an IFR flight plan if that pilot is operating in VFR weather conditions outside of Class A airspace. If a pilot is uncertain of the meaning of an ATC clearance, the pilot shall immediately request clarification from ATC.</p> <p>b) Except in an emergency, no person may operate an aircraft contrary to an ATC instruction in an area in which ATC is exercised.</p> <p>c) Each pilot-in-command who, in an emergency, deviates from an ATC clearance or instruction shall notify ATC of that deviation as soon as possible.</p> <p>d) Each pilot-in-command who is given priority by ATC in an emergency shall submit a detailed report of that emergency within 48 hours to the manager of that ATC facility, if requested by ATC.</p> <p>e) Unless otherwise authorized by ATC, no person operating an aircraft may operate that aircraft according to any clearance or instruction that has been issued to the pilot of another aircraft for radar ATC purposes.</p>
<b>Appendix 1</b>	<b>Signals</b>
4.1.1	<p>The flashing white signal to aircraft in flight, meaning “land at this aerodrome and proceed to apron” is not used in the United States.</p> <p>In addition, the alternating red and green signal to aircraft on the ground or in flight means exercise extreme caution.</p>



<b>PANS - RAC - DOC 4444</b>	
There are several substantive differences between the U.S. procedures and those of ICAO, in addition to some minor variations in detail which are not considered significant. These differences are the result of initiatives and/or refinements which the U.S. has effected in the interest of improving the safety and efficiency of air traffic services.	
<b>Part I</b>	<b>Definitions</b>
Airborne collision avoidance system	The U.S. uses traffic alert and collision avoidance system (TCAS).
AIRMET information	In the U.S., AIRMET stands for Airman's Meteorological Information which is in-flight weather advisories issued only to amend the area forecast concerning weather phenomena which are of operational interest to all aircraft and potentially hazardous to aircraft having limited capability because of lack of equipment, instrumentation, or pilot qualifications. AIRMET's concern weather of less severity than that covered by SIGMET's or convective SIGMET's. AIRMET's cover moderate icing, moderate turbulence, sustained winds of 30 kt or more at the surface, widespread areas of ceilings less than 1,000 feet and/or visibility less than 3 miles, and extensive mountain obscurement.
Air-report	The U.S. does not normally use the term "air-report." Pilot weather reports (PIREP's), position, and operational reports are used. PIREP's include reports of strong frontal activity, squall lines, thunderstorms, light to severe icing, windshear and turbulence (including clear air turbulence) of moderate or greater intensity, volcanic eruptions and volcanic ash clouds, and other conditions pertinent to flight safety. They may include information on ceilings, visibility, thunderstorms, icing of light degree or greater, windshear and its effect on airspeed, or volcanic ash clouds, but do not usually include air temperature.
Air-taxiing	In the U.S., the term "hover taxi" is sometimes used to indicate the ICAO term "air-taxiing." Additionally, in the U.S., air taxi is used to indicate certain commercial aircraft operations. For those operations, usually a special call sign is used, or the prefix "Tango" is added to the aircraft call sign.
ALERFA	The U.S. does not use the code words ALERFA, DETRESFA, and INCERFA to designate an alert phase, a distress phase, or an uncertainty phase in domestic airspace. The U.S. uses information request (INREQ) and alert notice (ALNOT) in domestic airspace.
Area control service	The U.S. does not use the term "area control service" to indicate controlled flight in controlled areas.
ATS route	In U.S. domestic airspace, the term "ATS route" is not used. Routes in the U.S. include VOR airways, jet routes, substitute routes, off-airway routes, RNAV routes and colored airways. The U.S. also uses instrument departure procedures (DP's) and standard terminal arrivals (STAR's).
Automatic dependent surveillance (ADS)	The U.S. has not yet published ATS procedures for the use of Automatic Dependent Surveillance (ADS).
Control zone	The U.S. uses "surface area" in place of the ICAO term "control zone." Surface area is defined as the airspace contained by the lateral boundary of the Class B, C, D or E airspace designated for an airport that begins at the surface and extends upward.
Cruising level	The U.S. uses the term "cruising altitude."
DETRESFA	See ALERFA.
Flight information centre	In the U.S., the services provided by flight information centers (FIC's) are conducted by air traffic control (ATC) facilities, automated flight service stations (AFSS's), and rescue coordination centers (RCC's).
Glide path	The U.S. uses "glideslope" rather than "glide path" although the terms are sometimes interchangeable. For the U.S., a glideslope provides vertical guidance for aircraft during approach and landing.
Holding point	The U.S. uses "holding fix" rather than "holding point."
Holding procedure	In the U.S., a hold procedure is also used during ground operations to keep aircraft within a specified area or at a specified point while awaiting further clearance from air traffic control.
INCERFA	See ALERFA.
Level	The U.S. uses "altitude" or "flight level" rather than "level."

Movement area	In the U.S., the "movement area" is equivalent to the ICAO "maneuvering area" which does not include parking areas.
Slush	In the U.S., "slush" is not used as a weather phenomena.
Taxi-holding position	In the U.S., "taxi into position and hold" means taxi onto the departure runway in take-off position and hold while the ICAO "taxi-holding position" or "taxi-holding point" is a designated position that provides adequate clearance from a runway.
Terminal control area	In the U.S., the term "terminal control area" has been replaced by "Class B airspace." Standard IFR services should be provided to IFR aircraft operating in Class B airspace.
Track	The U.S. uses the term "course" instead of "track."
Transition altitude, transition layer, and transition level	In U.S. domestic airspace, transition altitude, layer, and level are not used. U.S. flight levels begin at FL 180 where a barometric altimeter setting of 29.92 inches of mercury is used as the constant atmospheric pressure. Below FL 180, altitudes are based on barometric pressure readings.
Visual approach	In the U.S., aircrews may execute visual approaches when the pilot has either the airport or the preceding aircraft in sight and is instructed to follow it.
<b>Part II</b>	<b>General Provisions</b>
4.1	In the U.S., flight information and alerting services are provided by ATC facilities, AFSS's, and RCC's.
8, 8.4	The U.S. uses a flight plan format different from the ICAO model discussed in Appendix 2. The U.S. ATS facilities will transmit ICAO repetitive flight plans (RPL's) even though a different format is used for stored flight plans.
9.3	ATS units are not required to advise a pilot who has canceled an IFR flight plan that IMC conditions are likely to be encountered along the route of flight; however, if a pilot informs a controller of a desire to change from IFR to VFR, the controller will request that the pilot contact the appropriate AFSS.
10.2.2	Standard IFR services should be provided to IFR aircraft operating in Class B airspace. U.S. Class B airspace includes a speed restriction of 250 kt indicated airspeed or less.
10.2.3	U.S. ATS controllers do not normally include clearance for transonic acceleration in their ATC clearances.
12.1.1, 12.1.1.1, 12.2	In U.S. domestic airspace, transition altitude, layer, and level are not used. U.S. flight levels begin at FL 180 where a barometric altimeter setting of 29.92 inches of mercury is used as the constant atmospheric pressure. Below FL 180, altitudes are based on barometric pressure readings. QNH and QFE altimeter settings are not provided in domestic U.S. airspace.
13.1	In the U.S., the word "heavy" is used in all communications with or about heavy jet aircraft in the terminal environment. In the en route environment, "heavy" is used in all communications with or about heavy jet aircraft with a terminal facility, when the en route center is providing approach control service, when the separation from a following aircraft may become less than five miles by approved procedure, and when issuing traffic advisories.
14.3, 14.4	The U.S. has not yet published ATS procedures for the use of Automatic Dependent Surveillance (ADS).
15.1, 15.2, 15.3, 15.4, 15.5, 15.6, 16	The U.S. does not normally use the term "air-report." Pilot weather reports (PIREP's), position, and operational reports are used. PIREP's include reports of strong frontal activity, squall lines, thunderstorms, light to severe icing, windshear and turbulence (including clear air turbulence) of moderate or greater intensity, volcanic eruptions and volcanic ash clouds, and other conditions pertinent to flight safety. They may include information on ceilings, visibility, thunderstorms, icing of light degree or greater, windshear and its effect on airspeed, or volcanic ash clouds, but do not usually include air temperature.
18	The U.S. has procedures for a duplicate aircraft identification watch and notification to airline operators but does not publish national procedures for on-the-spot temporary changes to aircraft call signs in accordance with ICAO guidelines.
19	The U.S. uses traffic alert and collision avoidance system (TCAS). U.S. controllers are not to issue control instructions that are contrary to the TCAS resolution advisory (RA) procedure that a crew member advises is being executed.
<b>Part III</b>	<b>Area Control Service</b>
	Remark: The U.S. does not use the term "area control service" to indicate controlled flight in controlled areas.

1.1	In U.S. airspace, only conflict resolution (not separation) is provided between IFR and VFR operations. Separation is provided between IFR and Special VFR (SVFR) aircraft only within the lateral boundaries of Class B, C, D or E control zones (the U.S. term is surface areas) below 10,000 feet MSL.
8	The U.S. uses the term "course" instead of "track." "Reciprocal" courses are sometimes referred to as "opposite" courses. The wording of the definitions for U.S. <i>same</i> , <i>crossing</i> , or <i>opposite/reciprocal</i> courses differs from the ICAO worded definitions, but the intent appears to be the same.
8.2.1.1, 8.3.1.1.1	The U.S. uses 22 kt instead of 20 kt and 44 kt instead of 40 kt.
8.4.1	The U.S. does not conduct direct pilot-controller high frequency (HF) communications. The U.S. is establishing direct pilot-controller data link communications where HF is currently being used.
14.1	In U.S. Class A and B airspace, separation is provided for all aircraft. In U.S. Class C airspace, separation is provided between IFR and SVFR aircraft; conflict resolution is provided between IFR and VFR operations.
17.3	In the U.S., if the communications failure occurs in IFR conditions, or if VFR cannot be complied with, each pilot shall continue the flight according to the following requirements:  <u>Route</u> <ul style="list-style-type: none"> <li>a) By the route assigned in the last ATC clearance received;</li> <li>b) If being radar vectored, by the direct route from the point of failure to the fix, route, or airway specified in the vector clearance;</li> <li>c) In the absence of an assigned route, by the route that ATC has advised may be expected in a further clearance; or</li> <li>d) In the absence of an assigned route or a route that ATC has advised may be expected in a further clearance, by the route filed in the flight plan.</li> </ul> <u>Altitude</u> - At the highest of the following altitudes or flight levels for the route segment being flown: <ul style="list-style-type: none"> <li>a) The altitude or flight level assigned in the last ATC clearance received;</li> <li>b) The minimum altitude as prescribed in 14 CFR Part 91 (Section 91.121(c)) for IFR operations;</li> </ul> or <ul style="list-style-type: none"> <li>c) The altitude or flight level ATC has advised may be expected in a further clearance.</li> </ul>
<b>Part IV</b>	<b>Approach Control Service</b>
9	In the U.S., aircrews may execute visual approaches when the pilot has either the airport or the preceding aircraft in sight and is instructed to follow it. A contact approach is one wherein an aircraft on an IFR flight plan, having an air traffic control authorization, operating clear of clouds with at least 1 mile flight visibility and a reasonable expectation of continuing to the destination airport by visual reference in those conditions, may deviate from the instrument approach procedure and proceed to the destination airport by visual reference to the surface. This approach will only be authorized when requested by the pilot and the reported ground visibility at the destination airport is at least 1 statute mile.
15	Except where a "runway use" program is in effect, in the U.S. the runway used will be the one most nearly aligned with the wind when 5 kt or more, or the "calm wind" runway when less than 5 kt unless use of another runway will be operationally advantageous or is requested by a pilot.
<b>Part V</b>	<b>Aerodrome Control Service</b>
2.2	When neither communications nor radar contact can be established for 30 minutes (or prior, if appropriate), U.S. controllers will consider an aircraft overdue and will initiate overdue aircraft procedures including reporting to the ARTCC or AFSS.
6.1.2	In the U.S., airport lighting is not used for en route navigation.
10.3	In the U.S., "taxi into position and hold" means taxi onto the departure runway in takeoff position and hold while the ICAO "taxi-holding position" or "taxi-holding point" is a designated position that provides adequate clearance from a runway.
10.5, 10.5.1	In the U.S., the term "hover taxi" is sometimes used to indicate the ICAO term "air-taxiing." In the U.S., air-taxiing is the preferred method for helicopter movements on airports provided ground operations/conditions permit.

11.2.1	In the U.S., for movements of other than aircraft traffic (i.e., vehicles, equipment, and personnel), steady green means cleared to cross, proceed, go; flashing green is not applicable; flashing white means return to starting point on airport; and alternating red and green means a general warning signal to exercise extreme caution.
11.2.2	U.S. controllers do not normally flash runway or taxiway lights.
15.1, 15.2	In the U.S., landing clearance to a succeeding aircraft in a landing sequence need not be withheld if the controller observes the positions of the aircraft and determines that prescribed runway separation will exist when the aircraft crosses the landing threshold. Controllers issue traffic information to the succeeding aircraft if it has not previously been reported.
16	ICAO aircraft wake turbulence categories (heavy, medium, light) and FAA weight classes (heavy, large, small) differ. Also, for landing aircraft, wake turbulence separation is defined differently. The U.S. makes special provisions for any aircraft landing behind a B-757 (4 miles for a large aircraft behind or 5 miles for a small aircraft behind).
17.2, 17.3	Normally in the U.S., ground visibility must be 1 statute mile or better for Special VFR (SVFR) operations. There may be exceptions for helicopters, scheduled air carrier operations, flight visibility of 1 statute mile or better, emergencies and special authorizations outlined in a letter of agreement.
<b>Part VI</b>	<b>Radar Services</b>
7.4.4.1	See Part V, Aerodrome Control Service, 16.
7.6	U.S. ATIS units do not accept aircraft speeds in metric terms nor do they use the term "minimum clean speed." The U.S. does use phrases such as "maintain maximum forward speed" or "maintain slowest practical speed."
9.3.5, 9.3.6	The U.S. normally uses "glideslope" rather than "glide path" although they are sometimes interchangeable. For the U.S., a glideslope provides vertical guidance for aircraft during approach and landing.
<b>Part VII</b>	<b>Flight Information Service and Alerting Service</b>
1.3.2	See Part II, General, 15.1.
1.3.7	The U.S. does not have special procedures for the transmission of information to supersonic aircraft.
1.4.1, 1.4.2, 1.4.3	Class F airspace is not used in the U.S. Traffic advisories are provided in Class C airspace and, workload permitting, in Class D, Class E, and Class G airspace.
2.1.2, 2.1.3, 2.2.1	The U.S. does not use "operations normal" or "QRU" messages. U.S. controllers are not normally familiar with the term "uncertainty phase."
<b>Part VIII</b>	<b>Co-ordination</b>
3.2.10	See Part II, General, 14.3.
3.3.1.1, 3.3.2.1	Except for a VFR aircraft practicing an instrument approach, an IFR approach clearance in the U.S. automatically authorizes the aircraft to execute the missed approach procedure depicted for the instrument approach being flown. No additional coordination is normally needed between the approach and en route controllers. Once an aircraft commences a missed approach, it may be radar vectored.
<b>Part IX</b>	<b>Air Traffic Services Messages</b>
1.3	The existing U.S. ATIS automation system does not process logical acknowledgment messages (LAM's).
4.2.2.2.1	See Part II, General, 8.
4.2.3.1, 4.2.3.6, 4.2.4, 4.2.5.1, 4.2.5.4	See 1.3, above.
4.2.5.5	See Part II, General, 15.1.
4.3.1.2.1	In the U.S., traffic information messages include the position of the traffic (aircraft concerned).
4.3.2.2.1, 4.3.2.3.5	U.S. controllers do not use the term "CAVOK." However, the ceiling/sky condition, visibility, and obstructions to vision may be omitted if the ceiling is above 5,000 feet and the visibility is more than 5 miles.
4.3.2.2.1, 4.3.2.3.2, 4.3.2.3.3	U.S. controllers do not give wind speed, visibility, or RVR/RVV values in metric terms. RVR values are given in 100- or 200-foot increments while RVV values are given in 1/4-mile increments.

4.3.2.3.1	In the U.S., the criteria for a variable wind is wind speed greater than 6 kt and direction varies by 60 degrees or more. If the wind is $\geq 1$ kt but $\leq 6$ kt, the wind direction may be replaced by "VRB" followed by the speed or reported as observed. "VRB" would be spoken as "wind variable at <speed>."
4.3.2.3.4.1	For weather phenomena, the U.S. uses "ice crystals" instead of "diamond dust" and does not use the term "dust devils."
4.3.2.3.4.2	Additionally, the U.S. uses "supercooled" (or freezing) and "partial" as descriptors for weather phenomena.
4.3.2.3.5	In the U.S., CLR is used at automated stations for SKC when no clouds below 12,000 feet are reported. SCT indicates cloud coverage between 3-4 oktas; FEW indicates cloud coverage $>0$ but $\leq 2$ oktas.
4.3.2.3.6	In the U.S., since the Celsius scale is not as finely graduated as the Fahrenheit scale, the hourly temperature and dew point to the nearest tenth of a degree will be encoded in the additive data section of METAR remarks.
4.3.2.3.7	In the U.S., an "A" precedes the altimeter which is given in inches of mercury.
<b>Part X</b>	<b>Phraseologies</b>
2.3	In the U.S., "proceed" or "hold" may be used for aircraft or equipment/vehicle/personnel operations, while "taxi" and "cleared" should only be used as appropriate for aircraft instructions.
2.4 2.7	In the U.S., conditional clearances are not usually issued. However, traffic that may affect the clearance is usually issued to the aircraft with the clearance. Restricted clearances may also be issued.
2.5, 2.6, 2.7, 2.8	In the U.S., pilots may acknowledge some clearances, instructions, or other information by using "wilco," "roger," "affirmative," or other words or remarks. If the pilot reads back information, the controller should ensure the readback is correct or make corrections as appropriate.
2.8, 3.1.1 3.1.2	The U.S. uses "altitude" or "flight level" rather than "level"; and "cruising altitude" rather than "cruising level." The term "level" is not used to mean "height," "altitude," or "flight level" in the U.S. The U.S. sometimes uses "altitude" to mean "altitude" or "flight level."
3.1.1, 3.1.2	U.S. ATS units do not normally accept aircraft speeds or altitudes in metric terms nor do they use the term "minimum clean speed." The U.S. does not use the term "level" in lieu of "flight level" or "altitude." The U.S. also uses the phrases "maintain the highest/lowest practical speed" and "increase or reduce to a specified speed or by a specified number of knots."
3.1.2	See Part VII, Flight Information Service and Alerting Service, 1.3.7. Also, the term "step climb" is not used in the U.S. The word "immediately" is used only when expeditious compliance is required to avoid an imminent situation. Instead of "maintain own separation and VMC 'from,' 'above,' or 'below' . . .," U.S. controllers say "maintain visual separation 'from' that traffic." For TCAS resolution advisories in the U.S., pilots would advise "clear of conflict, returning to . . ."
3.1.4	See Part II, General, 18.
3.1.6	See Part IX, ATS Messages, 4.3.2.2.1.
3.1.6	See Part II, General, 12.1.
3.3.1	Instead of "track," U.S. controllers would advise pilots to "fly a (degree) bearing/azimuth from/to (fix) until (time)" or "until reaching (fix or altitude)," and if required, "before proceeding on course."
3.4.7	See Part II, General, 12.1.
3.4.8	See Part V, Aerodrome Control Service, 10.3. Also, U.S. controllers do not use the term "backtrack."
3.4.11	U.S. controllers do not say "line up" or "wait." Clearance to enter runway and await take-off clearance is stated "taxi into position and hold."
3.4.13	See 3.3.1, above.
3.4.14	See Part II, General, 12.1.
4.1.1	U.S. controllers do not use the phrases "identified" or "not identified [position]" to replace "radar contact [position]."
4.1.3	U.S. controllers do not say "closing [slowly (or quickly)] [from the left (or from the right)]" nor "heading is good" nor "rate of descent is good" nor do they give "(number) meters left (or right) of course or too high or too low." In case of elevation failure, U.S. controllers advise "no glidepath information available . . . ." instead of "elevation element unserviceable . . . ."
4.1.6	See 3.1.1, above.

4.1.10	U.S. controllers say “radar service terminated” not “radar control terminated.” U.S. controllers do not say “will shortly lose identification” or “identification lost.”
4.2.1	U.S. controllers would use “airport” rather than “field.”
4.2.2	In the U.S., pilots are not told “you will intercept (radio aid or track) (distance) from (significant point or touchdown).” Neither are pilots informed “closing from left (or right) [report established]” nor “this turn will take you through (aid) [reason]” nor “taking you through (aid) [reason].” Also, see 3.1.1, above.
4.2.3	U.S. ATS units use “course” rather than “track.”
4.2.4.1	U.S. controllers say “this will be a P-A-R/surveillance approach to runway (number) or airport/runway (number) or airport/heliport.” U.S. controllers do not say “approach completed . . .” U.S. controllers say “your missed approach procedure is (missed approach procedure)” and, if needed, “execute missed approach.”
4.2.4.2	For PAR approaches, U.S. controllers say “begin descent” and for surveillance approaches, U.S. controllers say “descend to your minimum descent altitude.”
4.2.4.4	The wheels down check is only done by U.S. military ATS units; the phraseology is “check wheels down” for military tower controllers and “wheels should be down” for military ATS radar units.
4.2.4.5	Although U.S. controllers say “go around,” they do not say “continue visually or go around.” In that case, they would say “if runway, approach/runway lights, not in sight, execute missed approach” or “if not visual, (advise you) execute missed approach.” Also, see 4.2.4.1, above.
4.2.5.1	See 4.2.4.1, above.
4.2.5.3	See Part VI, Radar Services, 9.3.5 and 4.1.3, above.
4.2.5.4	See 4.1.3 and 4.2.4.2, above.
4.2.5.7	See 4.2.4.1, above.
4.2.5.8	See 4.2.4.5, above.
4.3.3	When a transponder appears inoperative or malfunctioning, U.S. controllers would instruct “. . . reset transponder, squawk” or “. . . your transponder appears inoperative/malfunctioning, reset, squawk . . .”
4.3.6, 4.3.8	U.S. controllers do not say “squawk Charlie.” U.S. controllers may ask a pilot to “ident” or “squawk standby” or “squawk low/normal” or “squawk MAYDAY on 7700” or “squawk altitude.”
4.3.9	For aircraft above FL 180, U.S. controllers would say, “confirm using two niner niner two as your altimeter setting, verify altitude” or “stop altitude squawk” “stop altitude squawk; altitude differs by (number) feet.” U.S. controllers would not say “stop squawk Charlie.”
4.3.10	See 4.3.6, above.
4.3.11, 4.3.12	See 4.3.9, above.
4.3.13	U.S. controllers would say “verify at (altitude)” and/or “verify assigned altitude.”
<b>Appendix 1</b>	<b>Instructions for Air-reporting by Voice Communications</b>
AIREP Form of Air-report	See Part II, General, 15.1.
<b>Appendix 2</b>	<b>Flight Plan</b>
	See Part II, General, 8.
2.2 (Item 15)	U.S. ATS units do not accept cruising speeds nor filed altitudes/flight levels in metric terms. The U.S. accepts filed Mach Number expressed as M followed by 3 figures.
2.2 (Item 18)	The U.S. requires filed FIR boundary designators and accumulated estimated elapsed times to such points or FIR boundaries in the sequence and form as prescribed in 2.2, Item 18 of Doc 4444, Appendix 2.
<b>Appendix 3</b>	<b>ATS Messages</b>
1.1.1	See Part IX, ATS Messages, 1.3.
1.6.2	See Part X, Phraseologies, 2.8.

1.8.1 (Field Type 3), (Field Type 15), and (Field Type 18).	See Part IX, ATS Messages. 1.3. See Appendix 2, Flight Plan, 2.2 (Item 15) and 2.2 (Item 18).
2.1, 2.4.5, 2.5	See Part IX, ATS Messages 1.3.
<b>Attachment B</b>	<b>This section now appears in the Air Traffic Services Planning Manual (Doc 9426).</b>
3.2 (Item 15)	See Appendix 2, Flight Plan, 2.2 (Item 15).
3.2 (Item 18)	See Appendix 2, Flight Plan, 2.2 (Item 18).





<b>ANNEX 3 - METEOROLOGICAL SERVICE FOR INTERNATIONAL AIR NAVIGATION</b>	
<b>Chapter 3</b>	<b>World Area Forecast System and Meteorological Offices</b>
3.2.1 b), c)	The capability to comply continues to be developed.
<b>Chapter 4</b>	<b>Meteorological Observations and Reports</b>
4.3.1 c)*	The U.S. does not prepare SPECI for changes in air temperature.
4.3.3 a)*	Practices require SPECI for wind shift when wind direction changes by 45 degrees or more in less than 15 minutes and the wind speed is 10 knots or more throughout the wind shift.
4.3.3 b)*	Practices do not require SPECI for increases of mean surface wind speed.
4.3.3 c)*	Practices require SPECI for squall, where squall is defined as a strong wind characterized by a sudden onset in which the wind speed increases at least 16 knots and is sustained at least 22 knots or more for at least 1 minute.
4.3.3 d)*	Practices do not require SPECI for wind direction changes based on local criteria.
4.3.3 f)*	SPECI are not prepared for the equivalents in feet of 150, 350, or 600 meters. U.S. military stations may not report a SPECI based on RVR.
4.3.3 g)*	Practices do not require SPECI for the onset, cessation, or change in intensity of: <ul style="list-style-type: none"> <li>- freezing fog;</li> <li>- moderate or heavy precipitation (including showers thereof);</li> <li>- low drifting dust, sand or snow;</li> <li>- blowing dust, sand or snow (including snowstorm);</li> <li>- duststorm; or</li> <li>- sandstorm.</li> </ul>
4.3.3 h)*, j)*	Practices do not require SPECI when the height of the lowest BKN or OVC cloud layer or vertical visibility changes to or passes 100 feet (30 meters) unless an approach minimum exists.
4.5.6*, 4.5.9 a)*	Practices use 6-knot criterion for average wind speed to report variable wind direction in METAR and SPECI.
4.5.9 b)*	Practices define wind gust as rapid fluctuations in wind speed with a variation of 10 knots or more between peaks and lulls. Wind speed data for the most recent 10 minutes is examined and a gust, the maximum instantaneous wind speed during that 10-minute period, is reported if the definition above is met during that period.
4.6.5*	Practice is to report prevailing visibility. Prevailing visibility is defined as the visibility that is considered representative of visibility conditions at the station (automated observation), or the greatest distance seen throughout at least half the horizon circle, not necessarily continuous (manual observation).
4.7.14*	RVR values, reported in feet (FT), are based on light setting 5 (highest available) for the designated instrument runway. RVR tendency is not reported.
4.8.2*	The following weather elements are augmented manually at designated automated stations observation sites: FC, TS, GR, GS, and VA. At selected airports, additional present weather elements may be provided.  With the exception of volcanic ash, present weather is reported when prevailing visibility is less than 7 statute miles or considered operationally significant. Volcanic ash is always reported when observed.
4.8.4*	The practice is to not report the following weather phenomena at unstaffed stations in METAR or SPECI: DZ, PL, IC, SG, GR, GS, SA, DU, FU, VA, PY, PO, SQ, FC, DS, and SS.
4.8.5*	The practice is to not report the following characteristics of present weather phenomena in METAR or SPECI: SH, DR, MI, BC, and PR at unstaffed stations.
4.8.6*	The practice with respect to the proximity indicator VC is between 5 to 10 statute miles from the point of observation with the exception of precipitation for which the VC indicates > 0 to 10 statute miles from the point of observation.
4.9.5*	The U.S. reports only up to 3 layers at automated sites and up to 6 layers at manual sites. Cloud layer amounts are a summation of layers at or below a given level, utilizing cumulative cloud amount. In addition, at automated sites which are unstaffed, cloud layers about 12,000 feet are not reported. At staffed automated sites, clouds above 12,000 feet may be augmented.

4.13.1*	Practices require the inclusion of a modifier field to designate AUTO for totally "automated" observations (no human augmentation) or COR for corrected observations between the date and time of the report and the surface wind direction and speed.
4.13.2	The U.S. does not use the term CAVOK in meteorological reports.
<b>Chapter 6</b>	<b>Forecasts</b>
6.2.5 b)*	Change groups and amendment criteria below 1/2 statute mile (800 meters) are not used.
6.2.5 d)*	The 100 foot (30 meter) change group and amendment criterion is not used.
6.2.17*	Forecast visibility increments used consist of 1/4 mile from 0 (zero) to 1 mile; 1/2 mile from 1 to 2 miles; and 1 mile above 2 miles.
6.2.18*	Practices require the forecast of non-convective low-level wind shear within 2,000 feet of the ground in the Optional Group.
6.2.19*	The U.S. does not use CAVOK and NSC in meteorological forecasts.
6.3*, 6.4*	Landing and takeoff forecasts are provided by the TAF.
6.5*	Upper winds and upper-air temperatures are not included in area forecasts.
6.6.2, 6.6.3	Area forecasts are issued three times a day in the U.S., with the exception of Alaska and Hawaii where they are issued four times a day. They are valid for a 12-hour period beginning 1 hour after issuance and have an 18-hour outlook.
<b>Chapter 7</b>	<b>SIGMET and AIRMET Information, Aerodrome Warnings and Wind Shear Warnings</b>
7.3.1	The U.S. does not include cloud amount or type in AIRMET.
9.6.1, 9.6.3	The U.S. does not report ISOL, OCNL or FREQ in accordance with the guidance on the use of the terms given in Attachment F.
*Indicates ICAO Recommended Practice	

<b>ANNEX 4 - AERONAUTICAL CHARTS</b>	
<b>Chapter 1</b>	<b>Definitions</b>
Air taxiway	The U.S. does not depict defined surfaces for air-taxiing of helicopters.
Danger area	The term "danger area" will not be used in reference to areas within the U.S. or in any of its possessions or territories.
Final approach and take-off area (FATO)	The U.S. does not depict final approach and take-off areas (FATO's).
Helicopter stand	The U.S. does not use this term.
Prohibited area Restricted area	<p>The U.S. will employ the terms "prohibited area" and "restricted area" substantially in accordance with the definitions established and, additionally, will use the following terms:</p> <p>"Alert area." Airspace which may contain a high volume of pilot training activities or an unusual type of aerial activity, neither of which is hazardous to aircraft.</p> <p>"Controlled firing area." Airspace wherein activities are conducted under conditions so controlled as to eliminate the hazards to nonparticipating aircraft and to ensure the safety of persons and property on the ground.</p> <p>"Warning area." Airspace which may contain hazards to nonparticipating aircraft in international airspace.</p> <p>"Maneuvering area." This term is not used by the U.S.</p> <p>"Military operations area (MOA)." An MOA is an airspace assignment of defined vertical and lateral dimensions established outside Class A airspace to separate/segregate certain military activities from IFR traffic and to identify for VFR traffic where these activities are conducted.</p> <p>"Movement area." Movement area is defined by the U.S. as the runways, taxiways, and other areas of an airport which are utilized for taxiing, take-off, and landing of aircraft, exclusive of loading ramp and parking areas.</p>
Touchdown and lift-off area (TLOF)	The U.S. does not use this term.
<b>Chapter 2</b>	<b>General Specifications</b>
2.1	The titles of charts produced by the U.S. are not those provided for in Annex 4.
2.2.1	The marginal note layouts, in some cases, differ from those set forth in Appendices 1, 5, and 6.
2.4.1	Visibility distances are expressed in statute miles and fractions thereof.
2.4.4	Conversion scale (meters/feet) is not shown on Radio Navigation Charts.
<b>Chapter 3</b>	<b>Aerodrome Obstacle Chart - ICAO Type A (Operating Limitations)</b>
3.1	The U.S. produces an Airport Obstruction Chart which covers the basic requirements called for by Aerodrome Obstruction Chart - ICAO Type A.
<b>Chapter 4</b>	<b>Aerodrome Obstacle Chart - ICAO Type B</b>
4.1	The U.S. produces an Airport Obstruction Chart which covers the basic requirements called for by Aerodrome Obstruction Chart - ICAO Type B.
<b>Chapter 5</b>	<b>Aerodrome Obstacle Chart - ICAO Type C</b>
5.8.1	The navigation grid on U.S. Aircraft Position Chart 3097 comprises lines parallel to 54° West Meridian and the navigation grid on U.S. Aircraft Position Chart 3096 comprises lines parallel to 92° West Meridian. These changes to the ICAO Standard were made to provide navigation grid lines vertical to a great circle projection base.
<b>Chapter 6</b>	<b>Precision Approach Terrain Chart - ICAO</b>
6.9.1.1	Only outbound magnetic bearings from VOR facilities and inbound magnetic bearings to low/medium frequency radio navigation facilities are shown.

<b>Chapter 7</b>	<b>En Route Chart - ICAO</b>
7.9.3.1.1 1) and 5)	The U.S. depicts geographic positions in degrees and minutes to the hundredth of a degree.
<b>Chapter 8</b>	<b>Area Chart - ICAO</b>
8.9.3.1.1 1) and 6)	The U.S. depicts geographic positions in degrees and minutes to the hundredth of a degree.
<b>Chapter 9</b>	<b>Standard Departure Chart - Instrument (SID) - ICAO</b>
9.3.1	Charts covering continental U.S. between latitudes 24° and 52° North are based on standard parallels at 33° and 45° and between latitudes 52° and 72° North on standard parallels at 55° and 65°.
9.4.1	The U.S. uses a sheet numbering system which differs from the index in Appendix 7.
9.8.3.2*	The elevation of the highest point on any sheet is not always cleared of hypsometric tinting.
9.9.3.1.1 2d) and 3)	The U.S. depicts geographic positions in degrees and minutes to the hundredth of a degree.
9.10.1	Heliports are not shown.
<b>Chapter 10</b>	<b>Standard Arrival Chart - Instrument (STAR) - ICAO</b>
10.8.3.2*	The elevation of the highest point on any sheet is not always cleared of hypsometric tinting.
10.9.3.1.1 2d) and 3)	The U.S. depicts geographic positions in degrees and minutes to the hundredth of a degree.
<b>Chapter 11</b>	<b>Instrument Approach Chart - ICAO</b>
11.10.4.3	The U.S. does not depict geographic position of the final approach fix.
<b>Chapter 12</b>	<b>Visual Approach Chart - ICAO</b>
12.2.1	Stopways are not indicated.
12.5.5.2.1	The datum (MSL) is stated in the Instrument Approach Chart legend, not on the chart.
12.6.2	Runway threshold elevations are not shown.
<b>Chapter 13</b>	<b>Aerodrome/Heliport Chart - ICAO</b>
13.6.1.d Surface type for heliports.	The U.S. does not show "type of surface for heliports."
13.6.2 Elevated helidecks, etc.	The U.S. does not show "surface level, elevated or helidecks."
<b>Chapter 14</b>	<b>Aerodrome Ground Movement Chart - ICAO</b>
14.6.1 c)	The U.S. does not depict geographic positions of aircraft stands.
14.6.1 f)	The U.S. does not depict taxiway centerline points.
<b>Appendix 2</b>	<b>ICAO Chart Symbols</b>
No. 21	Tidal flats are shown in brown stipple over the blue open water tint.
No. 45	Rocks awash are shown by a six-armed symbol as adopted by the International Hydrographic Bureau.
No. 54, 61	Spaces between sides of bridge and road or railroad symbols are filled solid.
No. 70	Oil or gas fields are shown with an oil well derrick symbol.
No. 77	Ruins are shown by a solid square, properly annotated.
No. 94	The runway surface indicator (letter H) and the lighting indicator (letter L) are not normally used on high altitude Radio Navigation Charts. Only those airports with a minimum of 5,000 feet hard-surfaced runways are shown.  The letter H is not used on low altitude Radio Navigation Charts. All airports depicted have hard-surfaced runways, excepting that where the letter "S" follows the runway length, the runway surface is soft.  On Visual Navigation Charts of the 1:500 000 scale, a miniature runway layout depiction indicates airports with hard-surfaced runways at least 1,500 feet long.

No. 110	Aerodrome traffic zones are termed "SURFACE AREAS" in U.S. usage. These are all of standard dimensions. Limits are not shown, but airports at which SURFACE AREAS have been established are indicated by a color-coded airport symbol.
No. 113	Limits of advisory areas are shown on Radio Navigation Charts with a crenellated line. This depiction is indicated in the legend as the border of an Air Route Traffic Control Center (ARTCC).
No. 116	The nomenclature "non-compulsory" is used instead of "on request" for appropriate position reporting points.
No. 127	Isogonic lines are shown on Radio Navigation Charts only as short sections of continuous lines extending inward from the neat lines.
*Indicates ICAO Recommended Practice.	



**ANNEX 5 - UNITS OF MEASUREMENT TO BE USED IN AIR-GROUND COMMUNICATIONS**

*General Statement:* Most of the individual SI quantities and measurement units listed in the Annex are not commonly used in routine international air operations. Although most U.S. national standards and practices do not specifically utilize the SI units, the SI units of measurement are acceptable and not prohibited from use by U.S. regulations. Under the present operational practices, these differences are not significant and are identified in U.S. Aeronautical Information and Technical Publications.

In accordance with Article 38 of the Convention, the U.S. wishes to file the enclosed Notice of Differences to Annex 5, Fourth Edition, as amended by Amendment 13. Only those differences recognized as necessary for the safety or regularity of international air navigation and required for day-to-day operations in U.S. airspace are listed separately in this notification. In addition, we do not support the establishment of dates for planning purpose for termination of the use of bar, knot, nautical mile, and foot. (Chapter 4, Table 4-1) Until sufficient operational analysis identifies and resolves the safety issues, the establishment of termination dates for use of the bar, knot, nautical mile, and foot is unacceptable.

Reference: Table 3-4, Chapter 3, Annex 5, Fourth Edition, as Amended by Amendment 13.

**Chapter 3.3 (Table 3-4)**

Ref. No.	Quantity	Unit (SI)	Differences as of 5 January 1988
1.4	distance (short)	meter	foot
1.12	runway length	meter	foot
1.13	runway visual range	meter	foot
1.15	time	hour and minute, the day of 24 hours beginning at midnight UTC	Time may be given in local time
1.16	visibility	kilometer	statute mile and fraction
2.12	mass (weight)	kilogram	pound (lb)
3.2	altimeter setting	hectopascal	inches of mercury
6.7	temperature	°C	C° except Fahrenheit used for surface air and dew point temperature
10.1	absorbed dose	Gy	rd
10.2	absorbed dose rate	Gy/s	rd/s
10.4	dose equivalent	Sv	rem
10.5	radiation exposure	C/kg	R
10.6	exposure rate	C/kg·s	R/s

All non-SI alternative units listed in this table will continue to be utilized where permitted.  
(1.1, 1.3, 1.5, 1.7, 4.1, 4.7, 4.15, 4.16)





<b>ANNEX 6 - OPERATION OF AIRCRAFT</b>	
<b>PART I</b>	
<b>Chapter 1</b>	<b>Definitions</b>
Aerodrome operating minima	This term is not used in the U.S.
Category I (Cat I) operation	For a Category I operation, the U.S. requires a decision height (DH) of not less than 200 feet and either visibility of not less than 1/2 mile or a runway visual range of 2,400 feet (RVR 1,800 feet with operative touchdown zone and runway centerline lights).
Category II (Cat II) operation	The U.S. requires that Category II provide approaches to minima of less than 200 feet decision height/2,400 runway visual range to as low as 100 feet decision height/1,200 feet runway visual range.
Category IIIA (Cat IIIA) operation	U.S. criteria are the same as those adopted in Part 1 of Annex 6. However, the runway visual range is expressed as not less than 700 feet (200 meters).
Category IIIB (Cat IIIB) operation	U.S. criteria are the same as those adopted in Part 1 of Annex 6. However, the runway visual range is expressed as less than 700 feet (200 meters) but not less than 150 feet (50 meters).
Cruising level	The term "cruising altitude" is used in lieu of "cruising level" in U.S. ATC phraseology.
Decision height	Although not identical, the U.S. definition of decision height is not substantially different.
General aviation operation	<p>General aviation is defined as all civil aviation operations other than scheduled air transportation and nonscheduled air transport operations for remuneration or hire. The classification of general aviation flying by powered aircraft is, as follows:</p> <p>Instructional flying. Use of an aircraft for purposes of flight instruction with an instructor. The flights may be performed by aero-clubs, flying schools, fixed-base operators, or commercial operators.</p> <p>Business flying. Use of an aircraft to carry personnel and/or property to meet the transport needs of officials of a business, firm, company, or corporation. These flights may be performed by a commercial pilot or by a private pilot.</p> <p>Pleasure flying. Use of an aircraft for personal or recreational purpose not associated with a business or profession.</p> <p>Aerial work. Use of an aircraft for activities such as: (1) crop dusting, chemical or fertilizer spraying, seed dissemination, prevention of frost formation, insect fighting, animal herding, or (2) aerial photography, patrol and surveillance, prospecting, construction, advertising, medical relief, and rescue work.</p> <p>Other flying. All flights by pilots for maintaining their flight proficiency should also be included under this heading as well as all general aviation flights that cannot be included in the above four categories.</p>
Instrument meteorological conditions (IMC)	<p>The U.S. difference, as stated in the Supplement to Annex 2, 5th Edition, dated February 1967 as amended by Amendment 1 is as follows:</p> <p>It will be impracticable to implement the terms "instrument meteorological conditions" and "visual meteorological conditions," abbreviated as "IMC" and "VMC" as they appear in Chapter 1, Definitions, and within the other paragraphs of the Annex where they appear.</p>
Visual meteorological conditions (VMC)	<p>Use of the terms "IFR conditions" and "VFR conditions" rather than "instrument meteorological conditions" and "visual meteorological conditions" will have no effect with respect to the safety of air navigation. The terms "IFR conditions" and "VFR conditions" have been in effect in the U.S. for many years and are well known to all pilots and providers of the various aeronautical services. Therefore, a change from the present phraseology to the new phraseology would, in so far as the U.S. is concerned, impose a change which is not justified from the standpoint of improvement of the overall aviation procedures and practices.</p> <p>U.S. Federal Aviation Regulations specify the use of the phrases "IFR conditions" and "VFR conditions."</p>

Maximum mass	The U.S. Federal Aviation Regulations state “weight” rather than “mass.”
Obstacle clearance limit (OCL)	This term is not used in the U.S. Federal Aviation Regulations.
Pressure altitude	Although not identical, the U.S. definition of pressure altitude is not substantially different.
Synthetic flight trainer: flight simulator, flight procedures trainer, basic instrument flight trainer	The U.S. does not have a regulatory definition of these terms; however, the terms are in common usage in the U.S. and have a meaning that is similar to the ICAO definition.
<b>Chapter 4</b>	<b>Flight Operations</b>
4.3.1 d)	The U.S. Federal Aviation Regulations state “weight” rather than “mass.”
4.3.7.2	When refueling with passengers embarking, on board, or disembarking an airplane, two-way communication is not required between the ground crew supervising the refueling and the qualified personnel on board the airplane. The U.S. refueling safety procedures which meet the intent of this Standard are contained in each operator’s approved operating manual.
4.3.8.2	U.S. regulations require descent within 4 minutes to 14,000 feet rather than 13,000 feet (620 hPa).
4.4.4.4	U.S. regulations require all occupants of seats equipped with combined safety belts and shoulder harnesses to be properly secured during take-offs and landings and still be able to properly perform their assigned duties.
4.4.9.2	The U.S. Federal Aviation Administration (FAA) develops standard flight operational noise abatement procedures for each airplane type. Alternative flight operational noise procedures are also developed by the FAA for certain airports that have unique noise situations.
<b>Chapter 5</b>	<b>Aeroplane Performance Operating Limitations</b>
5.2.6, 5.2.7 a), b), c), d)	The U.S. Federal Aviation Regulations state “weight” rather than “mass.”
5.2.8.1	U.S. regulations do not require that account be taken of the loss, if any, of runway length due to alignment of the airplane prior to take-off in determining the length of the runway available.
<b>Chapter 6</b>	<b>Aeroplane Instruments, Equipment and Flight Documents</b>
6.2.4.2	The U.S. Federal Aviation Regulations express lengths in feet and inches.
6.3	<p>a) Large airplanes that have a U.S. original type certificate issued on or before 30 September 1969, which are certificated for operations above 25,000 feet altitude or are turbine-engine powered must have one or more flight data recorders that record data from which time, altitude, airspeed, vertical acceleration, heading and the time of each radio transmission either to or from air traffic control (ATC) can be determined.</p> <p>b) Large airplanes that have a U.S. original type certificate issued after 30 September 1969, which are certificated for operations above 25,000 feet altitude or are turbine-engined powered must have one or more flight data recorders that record data from which the following information may be determined: time, altitude, airspeed, vertical acceleration, heading, time of each radio transmission either to or from ATC, pitch attitude, roll attitude, sideslip angle or lateral acceleration, pitch trim position, control column or pitch control surface position, control wheel or lateral control surface position, rudder pedal or yaw control surface position, thrust of each engine, position of each thrust reverser, trailing edge flap or cockpit flap control position and leading edge flap or cockpit flap control position.</p>
6.3.1.1	Pursuant with above paragraph a), recorders do not record engine power, configuration, or operation. Pursuant with paragraph b), recorders do not record operation.
6.3.1.2	Pursuant with above paragraph a), recorders do not record engine power or configuration of lift and drag devices.

6.3.5.1	The U.S. does not require such equipage for all aircraft which meet this weight criterion. U.S. regulations (14 CFR 135.152) only require that multi-engine, turbine-powered airplanes or rotorcraft with 10-19 seats that are brought onto the U.S. register after 11 October 1991, be equipped with the flight data recorder specified in this standard.
6.4	Although the U.S. does provide air traffic control services to aircraft operating under VFR, it does not specifically provide for en route "controlled VFR flights" in the ICAO context. The U.S. does not, therefore, have specific requirements or regulations regarding airman certification or aircraft minimum equipment for "controlled VFR flights."
6.5.1 a), c)	The U.S. Federal Aviation Regulations do not require all seaplanes for all flights to be equipped with: a) equipment for making the sound signals prescribed in the International Regulations for Preventing Collisions at Sea; or b) one sea anchor (drogue).
6.5.3.1	The U.S. defines extended over water operations for aircraft other than helicopters as an operation over water at a horizontal distance of more than 50 nautical miles from the nearest shoreline.
6.7.5	U.S. regulations require that oxygen dispensing units capable of being automatically presented to the passengers and cabin attendants (before the cabin pressure altitude exceeds 15,000 feet) be installed, in all transport category aircraft approved to operate <u>above 30,000 feet</u> , type certificated on or after 1 September 1977.
6.9.2	The U.S. Federal Aviation Regulations state "weight" and express weight in pounds.
6.12	The U.S. Federal Aviation Regulations do not require airplanes operated above 15,000 meters (49,000 feet) to carry equipment to measure and indicate continuously the dose rate of total cosmic radiation being received and the cumulative dose on each flight.
6.15.1, 6.15.2	The U.S. Federal Aviation Regulations state "weight" and express weight in pounds.
6.17.1	The U.S. only requires one automatic-type, emergency locator transmitter in operable condition that meets the requirement of TSO-C91. However, installations of emergency locator transmitters which occur after 21 June 1995 must meet the requirements of TSO-C91A.
6.17.2	Emergency locator transmitters are not required for: turbojet-powered aircraft, aircraft while engaged in scheduled flights by scheduled air carriers, or aircraft while used to show compliance with regulators or crew training.
6.18.1	U.S. regulations do not require such airplanes to be equipped with an airborne collision avoidance system (ACAS II). U.S. regulations only require equipage with TCAS II which is not equivalent to ACAS II.
6.18.2	U.S. regulations do not require such airplanes to be equipped with an airborne collision avoidance system (ACAS II). U.S. regulations only require equipage with TCAS I.
6.19	U.S. regulations do not require that all airplanes be equipped with pressure-altitude reporting transponders. The U.S. requirement for pressure altitude reporting transponders depends on the specific airspace in which airplanes fly.
<b>Chapter 8</b>	<b>Aeroplane Maintenance</b>
8.1.3	U.S. regulations do not require persons who sign maintenance releases to be licensed strictly in accordance with the provisions of Annex 1. U.S. requirements do not include knowledge of human performance/limitations or entries on the license such as specific aircraft model and avionic systems or components (or under broad categories).
8.7.5.4	There is no comparable requirement in U.S. regulations for training in knowledge and skills related to human performance.
8.7.6.2	U.S. regulations require that records of work shall be retained until the work is repeated, superseded by other work or for one year after the work is performed.
8.8.2	The U.S. does not require records to be maintained after the end of the operating life of the unit.

<b>Chapter 9</b>	<b>Aeroplane Flight Crew</b>
9.5	The U.S. Federal Aviation Regulations do not require a flight crew member to have a spare set of suitable lenses readily available when exercising the privileges of a license for which he was assessed as fit subject to suitable correcting lenses being worn. However, the U.S. practice is to require extra correcting lenses when a flight crew member's defective visual acuity necessitates a limitation; i.e., worse than 20/100 uncorrected distance visual acuity.
<b>Chapter 11</b>	<b>Manuals, Logs and Records</b>
11.1.11	a) Operators may conduct operations without an approved minimum equipment (MEL) list provided all instruments and equipment are fully operable. b) The U.S. prohibits operations to be conducted solely under the provisions of a master minimum equipment list (MMEL). Each operator must develop its own MEL, based on the MMEL, which includes operational procedures. When approved, the MEL may be used only by the individual operator.
<b>PART II</b>	
General	The U.S. does not accept any provision of Annexes 2, 6, 10 or 11 or any other Annex as a Standard or Recommended Practice as applicable to State aircraft. In accordance with Article 3(a) of the Convention of International Civil Aviation, the Convention and its Annexes are not applicable to State aircraft. In so far as any provisions of Annexes 2, 6, 10 or 11 address the operation or control of State aircraft, the U.S. considers such provisions to be in the nature of a special recommendation of the Council, advisory only, and not requiring the filing of differences under Article 38 of the Convention.
<b>Chapter 1</b>	<b>Definitions</b>
Category I (Cat I) operation	For a Category I operation, the U.S. requires a decision height (DH) of not less than 200 feet and either visibility of not less than 1/2 mile or a runway visual range of 2,400 feet (RVR 1,800 feet with operative touchdown zone and runway centerline lights).
Category II (Cat II) operation	The U.S. requires that Category II provide approaches to minima of less than 200 feet DH/2,400 runway visual range to as low as 100 feet DH/1,200 runway visual range.
Category IIIA (Cat IIIA) operation	U.S. criteria are the same as those adopted in Part 1 of Annex 6. However, the runway visual range is expressed as not less than 700 feet (200 meters).
Category IIIB (Cat IIIB) operation	U.S. criteria are the same as those adopted in Part 1 of Annex 6. However, the runway visual range is expressed as less than 700 feet (200 meters), but not less than 150 feet (50 meters).
Minimum descent altitude (MDA) or minimum descent height (MDH)	The U.S. does not use MDH (or height above airport) as an altitude or height in a nonprecision approach or circling approach below which descent must not be made without the required visual reference.
<b>Chapter 3</b>	<b>General</b>
3.5	The pilot-in-command is not required to have available on board the airplane essential information concerning search and rescue services.
<b>Chapter 4</b>	<b>Flight Preparation and In-Flight Procedures</b>
4.3	Except as provided for in 14 CFR 91.519 for large and turbine-powered, multi-engine airplanes, the pilot-in-command is not required to ensure that crew members and passengers are familiar with the location and use of emergency exits, life jackets, oxygen dispensing equipment, or other emergency equipment provided for individual use.
4.6.2.1	A destination alternate airport is not required when the weather at the airport of intended landing is forecast to have a ceiling of at least 2,000 feet and a visibility of at least 3 miles. In addition, standard alternate airport minima are prescribed as follows: 600-foot ceiling and 2 miles visibility are prescribed for precision approaches, and 800-foot ceiling and 2 miles visibility for nonprecision approaches.
4.6.2.2 b)	The forecast period for the destination alternate airport is from 1 hour before to 1 hour after the estimated time of arrival. In addition, the minima for ceiling/visibility at the airport of intended landings are 2,000 feet and 3 miles; that is, when at least such minima exist, no alternate airport is required.

4.6.3	A flight is permitted to continue towards the airport of intended landing when the latest available meteorological information indicates that conditions at that airport will, at the expected time of arrival, be at or below the specified airport meteorological minima.
4.9	The pilot-in-command is not required to ensure that all persons on board the aircraft during an emergency are instructed in emergency procedures.
4.14 b)	The pilot-in-command is not required to discontinue a flight at the nearest suitable airport when flight crew members' capacity to perform functions is significantly reduced by impairment of faculties from causes such as fatigue, sickness or lack of oxygen.
4.18.1, 4.18.2	The recommendation concerning aircraft refueling with passengers on board is not addressed in U.S. regulations. U.S. experience has not demonstrated a need for such regulation.
<b>Chapter 6</b>	<b>Aeroplane Instruments and Equipment</b>
6.1.3.1.1	All airplanes on all flights are not required to be equipped with an accessible first aid kit, portable fire extinguishers, seat or berth for each person, current and suitable air navigation charts, or spare electrical fuses. However, spare fuses are required on all airplanes operated at night or under instrument flight rules.  In addition, general aviation aircraft presently are not required to carry on board either procedures, as prescribed in Annex 2, for pilots-in-command of intercepted aircraft or visual signals for use by intercepting and intercepted aircraft. (See ENR 1.12, Interception of Civil Aircraft National Security and Interception Procedures.)
6.1.3.1.2	All airplanes on all flights are not required to be equipped with ground/air signal codes for search and rescue purposes.
6.2.1 b), c)	An accurate time piece and a sensitive pressure altimeter are not required for VFR flight.
6.3.1 a), b), c), and d)	The U.S. does not require all seaplanes on all flights to be equipped with the items listed in subparagraphs a), b), c), and d).
6.3.2	Single-engine airplanes flying over water are not required to be equipped with life jackets or equivalent individual flotation devices when the airplane is operated more than 50 nautical miles from land suitable for an emergency landing.
6.3.3 a)	Only large and turbine-powered, multi-engine airplanes are required to carry life preservers or an approved flotation means for each occupant of an airplane on a flight over water more than 50 nautical miles from the nearest shore.
6.3.3 b)	Only large and turbine-powered, multi-engine airplanes on flights over water for more than 30 minutes flying time or 100 nautical miles from the nearest shore are required to have life rafts and pyrotechnic signaling devices.
6.4	Not all airplanes on flights over land areas designated as areas in which search and rescue would be especially difficult are specifically required to be equipped with signaling devices or life-saving equipment.
6.5	All airplanes on high altitude flights, both pressurized and unpressurized, are required to carry oxygen for the crew and passengers.
6.6 f), h), and i)	All airplanes when operated in accordance with the instrument flight rules or when the airplane cannot be maintained in a desired altitude without reference to one or more flight instruments are not required to be equipped with: -- an outside air temperature indicator; -- an airspeed indicating system with a means of preventing malfunctioning due to condensation or icing; or -- a rate of climb and descent indicator.

6.7 a), c), d), e) and f)	All airplanes operated at night are not required to be equipped with: -- a turn and bank indicator; -- an attitude indicator (artificial horizon); -- a heading indicator (directional gyroscope); -- a means of indicating whether the supply of power to the gyroscope instruments is adequate; -- a sensitive pressure altimeter; -- a means of indicating the outside air temperature; -- a timepiece with a sweep second hand; -- an airspeed indicating system with a means of preventing malfunctioning due to either condensation or icing; -- a rate-of-climb and descent indicator; -- a landing light; -- illumination for flight instruments and equipment; -- lights in passenger compartments; or -- an electric torch for each crewmember station.
6.9	The U.S. does not require general aviation aircraft to be equipped with ground proximity warning systems.
6.10.3.1 and Recommendation 6.10.3.2	The requirement for U.S. general aviation airplanes to be equipped with flight data recorders (FDR's) is based on passenger and engine configurations. Specifically, FDR's are required for U.S. civil registered multiengine, turbine-powered airplanes having a passenger seating configuration of 10 passengers or more, excluding any pilot seats.
6.10.4.1 and Recommendation 6.10.4.2	The requirement for U.S. general aviation airplanes to be equipped with cockpit voice recorders (CVR's) is based on passenger, crew, and engine configurations. Specifically, CVR's are required for U.S. civil registered multiengine, turbine-powered airplanes having a passenger seating configuration of six passengers or more, and for which two pilots are required by type certification.
6.10.7.2	U.S. regulations do not require that flight recorders be deactivated upon completion of flight time following an accident or incident, or prohibit their reactivation before their disposition is determined. U.S. regulations require that such recorders be operated continuously from the use of checklist before the flight to completion of the final checklist at the end of the flight (14 CFR 91.609(d) and (g)).
6.12.1	Emergency locator transmitters are not required for: turbojet-powered aircraft while operated in scheduled flights by scheduled air carriers; training operations within a 50-nautical mile radius of the airport from which the flight began; flight operations incident to design and testing; flight operations of new aircraft incident to manufacture, preparation, and delivery; agricultural aircraft operations; aircraft certificated for research and development purposes; operations showing compliance with regulations, crew training, exhibition, air racing, or market surveys; or aircraft equipped to carry not more than one person.
Recommendation 6.14	U.S. regulations do not require that flight crew members communicate through boom or throat microphones below the transition level/altitude.
<b>Chapter 7</b>	<b>Aeroplane Communication and Navigation Equipment</b>
7.1.1	All airplanes operated at night are not required to have radio communications equipment capable of conducting two-way communications with aeronautical stations.
7.1.2	When more than one radio communications equipment unit is required, it is not required that each unit be independent of the other or others.
7.1.4	Except when operating under instrument flight rules, airplanes operated on extended flights over water or on flights over underdeveloped land are not required to have radio communications equipment capable of conducting two-way communications at any time during flight with aeronautical stations.
7.1.5	The U.S. does not base its requirement for radio communications equipment in general aviation aircraft on the criteria included in ICAO Annex 6, Part II (Chapters 6 and 7); for example, all night operations, operations over land areas in which search and rescue would be especially difficult, etc. Instead, U.S. requirements for such equipment is based upon the type of airspace with which the aircraft is to be involved; that is, use of controlled airspace such as terminal control areas (Class B Airspace), airport radar service areas, and positive control areas (Class A Airspace). Thus, U.S. requirements do not depend on such ICAO factors as time of day of the operation or the nature of the land over which the operation is to be conducted. Where such equipment is required by U.S. regulations, the aeronautical emergency frequency of 121.5 MHz is automatically available to all such radio-equipped aircraft since the VHF communications frequency range encompasses the emergency frequency of 121.5 MHz.

7.2.4	An airplane is not required to be provided with navigation equipment to ensure that, in the event of the failure of one item of equipment at any stage of the flight, the remaining equipment will enable the airplane to proceed in accordance with 7.2.1.
<b>Chapter 8</b>	<b>Aeroplane Maintenance</b>
8.3.2	The U.S. does not require records to be maintained after the end of the operating life of the unit.
<b>PART III</b>	
<b>SECTION I</b>	
General	The U.S. does not accept any provision of Annexes 2, 6, 10, or 11 or any other Annex as a Standard or Recommended Practice as applicable to State aircraft. In accordance with Article 3(a) of the Convention of International Civil Aviation, the Convention and its Annexes are not applicable to State aircraft. In so far as any provisions of Annexes 2, 6, 10 or 11 address the operation or control of State aircraft, the U.S. considers such provisions to be in the nature of a special recommendation of the Council, advisory only, and not requiring the filing of differences under Article 38 of the Convention.
<b>Chapter 1</b>	<b>Definitions</b>
Minimum descent altitude (MDA) or minimum descent height (MDH)	The U.S. does not use MDH (or height above airport) as an altitude or height in a non-precision approach or circling approach below which descent must not be made without the required visual reference.
Performance Class 1 helicopter	The U.S. does not have performance class designations for helicopters.
Performance Class 2 helicopter	The U.S. does not have performance class designations for helicopters.
Performance Class 3 helicopter	The U.S. does not have performance class designations for helicopters.
<b>SECTION II - International Commercial Air Transport</b>	
2.2.11	The U.S. regulations require that helicopters flown over water in passenger-carrying operations must simply be equipped with flotation devices.
2.3.4.1 b)	The U.S. has no requirement that a point of no return (PNR) be determined.
2.3.4.3	The U.S. has no related requirement for the use of on-shore versus off-shore alternate heliports.
2.3.6.2 b)	The requirement for fuel reserves for VFR operations is 20 minutes at normal cruise speed.
2.3.6.3.1	There is no U.S. requirement for maintenance of a specific altitude above a destination. In addition, the U.S. requirement is based on normal cruise speed, not holding speed, and provides for a single, 30-minute reserve.
2.3.6.3.2	There is no requirement for maintenance of a specific altitude above an alternate. In addition, the requirement is based on normal cruise speed, no holding speed, and provides for a single, 30-minute reserve.
2.3.6.3.3	The U.S. has no related requirement. If the destination weather so requires, an alternate must be specified and a 30-minute fuel reserve carried.
<b>Chapter 3</b>	<b>Helicopter Performance Operating Limitations</b>
3.1.1	The U.S. has no related performance class requirements.
<b>Chapter 4</b>	<b>Helicopter Instruments, Equipment and Flight Documents</b>
4.3.3.1 and Recommendation 4.3.3.2	The U.S. requires that multi-engine, turbine-powered rotorcraft having a passenger seating configuration of 20 or more seats be equipped with one or more flight recorders. In addition, multi-engine, turbine-powered rotorcraft, brought onto the U.S. register after 1 October 1991 having a passenger seating configuration of 10 to 19 seats must have one or more flight recorders.

4.3.5	The U.S. requires cockpit voice recorders in all multi-engine, turbine-powered rotorcraft having a passenger seating configuration of 20 or more seats and in all multi-engine, turbine-powered rotorcraft having a passenger seating configuration of six or more and for which two pilots are required by certification or operating rules.
4.5.1	U.S. regulations require that helicopters flown over water in passenger-carrying operations must simply be equipped with flotation devices.
4.5.2.1	Life rafts and pyrotechnic signaling devices are only required for extended over-water operations; that is, with respect to helicopters, an operation over water at a horizontal distance of more than 50 nautical miles from the nearest shoreline and more than 50 nautical miles from an off-shore heliport structure.
4.7 (all)	The U.S. does not require rotorcraft to carry emergency locator transmitters.
4.11.1 c)	The U.S. requires only one landing light for operations conducted at night for hire.
4.15	U.S. regulations do not require that all helicopters be equipped with pressure-altitude reporting transponders. The U.S. requirement for pressure-altitude reporting transponders depends on the specific airspace in which helicopters fly.
<b>Chapter 6</b>	<b>Helicopter Maintenance</b>
6.3	There is no comparable requirement in U.S. regulations for training in knowledge and skills related to human performance.
<b>Chapter 7</b>	<b>Helicopter Flight Crew</b>
7.4.1	Recency of experience need not be in the same type of helicopter.
7.4.2	Recency of experience need not be in the same type of helicopter.
7.4.3.3	There is no U.S. equivalent for nonscheduled, commercial helicopter operations.
7.5	The U.S. has no related requirement.
<b>Chapter 11</b>	<b>Security</b>
11.1	The U.S. has no related requirement.
<b>SECTION III - International General Aviation</b>	
<b>Chapter 2</b>	<b>Flight Operations</b>
2.3.1 b), c), d), and e	The U.S. has no related requirement.
2.3.2	The U.S. has no related requirement.
2.6.2.1	A destination alternate heliport is not required when the weather at the heliport of intended landing is forecast to have a ceiling of at least 2,000 feet and a visibility of at least 3 miles. In addition, standard alternate heliport minima are prescribed as follows: 600-foot ceiling and 2 miles visibility are prescribed for precision approaches, and 800-foot ceiling and 2 miles visibility for non-precision approaches.
2.6.2.2	The forecast period for the destination heliport is from 1 hour before to 1 hour after the estimated time of arrival. In addition, the minima for ceiling/visibility at the heliport of intended landing are 2,000 feet and 3 miles; that is, when at least such minima exist, no alternate heliport is required.
2.7.1 b)	The U.S. has no related requirement.
2.7.2	The U.S. has no requirement for one engine inoperative performance capability.
2.8.2b)	The U.S. requirement for fuel reserves for VFR operations is 20 minutes at normal cruise speed.
2.8.3.1	There is no U.S. requirement for maintenance of a specific altitude above the destination. In addition, the requirement is based on normal cruise speed, not holding speed, and provides for a single 30-minute reserve.
2.8.3.2	There is no U.S. requirement for maintenance of a specific altitude above the alternate. In addition, the requirement is based on normal cruise speed, not holding speed, and provides for a single 30-minute reserve.
2.8.3.3	The U.S. has no related requirement. If the destination weather so requires, an alternate must be specified and a 30-minute fuel reserve carried.
2.8.4 d)	The U.S. has no related requirement.
2.9.1	The U.S. oxygen supply requirement applies to crew members at altitudes between 12,500 and 14,000 feet. For passengers, the requirement applies above 15,000 feet.



2.10	The U.S. requirement for flight crew members applies at altitudes above 14,000 feet.
2.11	The pilot-in-command is not required to ensure that all persons on board the aircraft during an emergency are instructed in emergency procedures.
2.14 b)	The U.S. has no related requirement.
2.17	The U.S. has no related requirement.
2.18	The recommendations concerning aircraft refueling with passengers on board are not addressed in U.S. regulations. U.S. experience has not demonstrated a need for such regulation.
2.19	The U.S. has no related requirement.
<b>Chapter 3</b>	<b>Helicopter Performance Operating Limitations</b>
3.3	The U.S. does not have performance class designations for helicopters.
3.4	The U.S. does not have performance class designations for helicopters.
<b>Chapter 4</b>	<b>Helicopter Instruments, Equipment and Flight Documents</b>
4.1.3.1	The U.S. does not require general aviation helicopters to be equipped with a first aid kit or portable fire extinguishers, or to have procedures for pilots-in-command of intercepted aircraft or a list of visual signals for use by intercepting and intercepted aircraft. Spare fuses are not required for day VFR operations.
4.1.3.2	The U.S. has no related requirement.
4.1.3.3	The U.S. requires rotorcraft manufactured after 16 September 1992 to be equipped with a safety belt and shoulder harness for each occupant's seat.
4.1.4.1	The U.S. has no related requirement.
4.1.4.2	The U.S. has no related requirement.
4.2.1	An accurate time piece is not required for VFR flight. In addition, a non-sensitive pressure altimeter is required.
4.3.1	The U.S. has no related requirement.
4.3.2.1	Approved flotation gear and at least one pyrotechnic signaling device are required for aircraft operating for hire over water and beyond a power-off gliding distance from shore.
4.3.2.3	The U.S. has no related requirement.
4.3.2.6	The U.S. has no related requirement.
4.4	The U.S. has no related requirement.
4.6 f)	Only one attitude indicator (artificial horizon) is required.
4.7.1	Landing lights and electric torches are not required for all night operations.
4.9.3.1 and Recommendation 4.9.3.2	The requirement for U.S. general aviation helicopters to be equipped with flight data recorders (FDR's) is based on passenger and engine configurations. Specifically, FDR's are required for U.S. civil registered multiengine, turbine-powered rotorcraft having a passenger seating configuration of 10 passengers or more, excluding any pilot seats.
4.9.4.1 and Recommendation 4.9.4.2	The requirement for U.S. general aviation helicopters to be equipped with cockpit voice recorders (CVR's) is based on passenger, crew, and engine configurations. Specifically, CVR's are required for U.S. civil registered multiengine, turbine-powered rotorcraft having a passenger seating configuration of six passengers or more, and for which two pilots are required by type certification.
4.9.7.2	U.S. regulations do not require that flight recorders be deactivated upon completion of flight time following an accident or incident, or prohibit their reactivation before their disposition is determined. U.S. regulations require that such recorders be operated continuously from the use of checklist before the flight to completion of the final checklist at the end of the flight (14 CFR 91.609 (d) and (g)).
4.10	Emergency locator transmitters are not required for rotorcraft.
4.12	U.S. regulations do not require that flight crew members communicate through boom or throat microphones below the transition level/altitude.
<b>Chapter 5</b>	<b>Helicopter Communication and Navigation Equipment</b>
5.2.2	The U.S. has no minimum navigation equipment requirement for VFR flights.



ANNEX 7 - AIRCRAFT NATIONALITY AND REGISTRATION MARKS	
3.3.1 and 4.2.1	The marks on wing surfaces are not required.
3.2.5 and Section 8	Identification plates are not required on unmanned, free balloons.
4.2.2	The minimum height of marks on small (12,500 lb or less), fixed-wing aircraft is 3 inches when none of the following exceeds 180 knots true airspeed: (1) design cruising speed; (2) maximum operating limit speed; (3) maximum structural cruising speed; and (4) if none of the foregoing speeds have been determined for the aircraft, the speed shown to be the maximum cruising speed of the aircraft.
Section 6	A centralized registry of unmanned free balloons is not maintained. Operators are required to furnish the nearest ATC facility with a prelaunch notice containing information on the date, time, and location of release, and the type of balloon. This information is not maintained for any specified period of time.



<b>ANNEX 8 - AIRWORTHINESS OF AIRCRAFT</b>	
<b>PART I Definitions</b>	
Performance Class 1, 2 and 3 helicopters.	Large helicopters (heavier than 6,000 lb) are classified as either Category A or B on the basis of weight, passenger-carrying capacity, and auxiliary systems as well as performance capabilities. There is no classification scheme for all other helicopters (6,000 lb or less).
Standard atmosphere	The U.S. uses the U.S. Standard Atmosphere, 1962. This standard contains a sea-level molecular weight ( $M_0$ ) of 28.9644 kg (kg-mol) <sup>-1</sup> .
<b>PART II Administration</b>	
4.2.3	The U.S. does not generally issue Airworthiness Directives for non-type certificated aircraft. This includes foreign aircraft that are U.S.-registered, but operate under experimental, rather than standard airworthiness certificates.
4.2.7	At this time, the U.S. does not require that the continuing structural integrity program contain specific information concerning corrosion prevention and control.
<b>PART III Aeroplanes</b>	
<b>Chapter 1</b>	<b>General</b>
1.1.3	The U.S. certifies certain airplanes at weights in excess of 5,700 kg (12,566 lb) that will not fully meet the ICAO Airworthiness Standards of Part III. The Airworthiness Certificate of airplanes that do not meet ICAO Standards will be endorsed as follows: "This airplane at weights in excess of 5,700 kg does not meet the airworthiness requirements of ICAO, as prescribed by Annex 8 to the Convention on International Civil Aviation."
1.5.1	The U.S. also uses service experience and equivalent safety findings as a basis for finding compliance with the appropriate airworthiness requirements.
2.2.3	This ICAO provision requires performance data to be scheduled for ranges of gradient of the landing surface for landplanes and ranges of water surface conditions, water density, and current strength for seaplanes. For landplanes, the U.S. requires the landing distance to be determined only on a level runway. For seaplanes, the U.S. requires the landing distance on water to be determined only on smooth water. Operational take-off and landing distance margins are applied where appropriate by U.S. operational regulations and guidance.
<b>PART IV Helicopters</b>	
<b>Chapter 1</b>	<b>General</b>
1.2.2 Note 1	The U.S. does not allow the weight and center of gravity limitations to vary as a function of altitude or phase of flight (take-off, cruise, landing, etc.).
<b>Chapter 2</b>	<b>Flight</b>
2.2.1 and 2.2.2	As stated in the difference with respect to the definitions of classes of helicopters in Part I, U.S. classifications are based on other factors as well as performance.
2.2.3.1 through 2.2.3.1.4	For Category B helicopters, only take-off distance is required to be included in the performance data while take-off distance, path, and rejected take-off distance information is required for Category A helicopters. There are no comparable requirements for helicopters weighing less than 6,000 lb.
2.2.3.2	En route performance is based solely on climb performance for both engines operating and one engine inoperative situations (Categories A and B). There is no comparable requirement for helicopters weighing less than 6,000 lb.
2.2.3.3.1	The landing decision point (LDP) is required for Category A helicopters only.
<b>Chapter 4</b>	<b>Design and Construction</b>
4.1.6 e)	The U.S. does not provide criteria relative to fire protection/prevention for interior furnishing materials replaced during major refurbishment. The fire protection levied is dependent on the original certification basis.
<b>Chapter 7</b>	<b>Instruments and Equipment</b>
7.4.2	Minimum acceptable intensities are prescribed for navigation lights and anti-collision lights; i.e., no reduction below these levels is possible.



<b>ANNEX 9 - FACILITATION</b>	
*The list of differences include Guam, Puerto Rico and the U.S. Virgin Islands. The status of implementation of Annex 9 in Guam with respect to public health quarantine is not covered in the list of differences.	
<b>Chapter 2</b>	<b>Entry and Departure of Aircraft</b>
2.3	Written crew baggage declaration is required in certain circumstances, and a special Embarkation/Disembarkation Card is required for most alien crew members.
2.4	A General Declaration for all inbound and for outbound flights with commercial cargo are required. However, the General Declaration outbound flights with commercial cargo shall not be required if the declaratory statement is made on the air cargo manifest. No declaration is required for outbound flights without commercial cargo if Customs clearance is obtained by telephone.
Remarks	19 CFR 122
2.4.1	Each crew member must be listed showing surname, given name, and middle initial.
2.4.4	The signing or stamping of the General Declaration protects the carrier by serving as proof of clearance.
2.5	The crew list is required by statute.
2.7	There is a statutory requirement for the Cargo Manifest.
2.8	In order to combat illicit drug smuggling, the U.S. requires the additional following information: the shipper's and the consignee's name and address, the type of air waybills, weight, and number of house air waybills. The manifest submitted in electronic form may become legally acceptable in the future. However, until the compliance rate for the automated manifest is acceptable, the U.S. must be able to require the written form of the manifest.
Remarks	19 CFR 122.48
2.9	Nature of goods information is required.
2.10	Stores list required in all cases but may be recorded on General Declaration in lieu of a separate list.
2.17	A cargo manifest is required except for merchandise, baggage and stores arriving from and departing for a foreign country on the same through flight. "All articles on board which must be licensed by the Secretary of State shall be listed on the cargo manifest." "Company mail shall be listed on the cargo manifest."
2.18	Traveling general declaration and manifest, crew purchases and stores list as well as a permit to proceed are required under various conditions when aircraft arrive in the U.S. from a foreign area with cargo shown on the manifest to be traveling to other airports in the U.S. or to foreign areas.
2.21	There is a statutory requirement that such changes can only be made prior to or at the time of formal entry of the aircraft.
2.25	The U.S. does not support the use of insecticides in aircraft with passengers present. Pesticides registered for such use should not be inhaled. In effect, the passenger safety issue has precluded the use of such insecticides in the presence of passengers since 1979.
2.35	Advance notice is required of the number of citizens and aliens on board (non-scheduled flights only).
2.40	A copy of the contract for remuneration or hire is required to be a part of the application in the case of non-common carrier operations.
2.41	Single inspection is accorded certain aircraft not by size of aircraft but rather by type of operation. Loads (cargo) of an agricultural nature require inspection by a plant or animal quarantine inspector.
2.41c	Fees are charged for services provided in connection with the arrival of private aircraft (nonscheduled aircraft).
<b>Chapter 3</b>	<b>Entry and Departure of Persons and Their Baggage</b>
3.3	Medical reports are required in some cases.
Remarks	8 CFR 212.7 and INA 234
3.4	Documents such as visas with certain security devices serve as identity documents.
3.4.1	The U.S. has not standardized the personal identification data included in all national passports to conform with the recommendation in Doc 9303.
3.5.6	U.S. passport fees exceed the cost of the operation.
3.5.7	U.S. allows separate passports for minor dependents under the age of 16 entering the U.S. with a parent or legal guardian.

3.7	The U.S. has a pilot program that allows nationals of certain countries which meet certain criteria to seek admission to the U.S. without a visa for up to 90 days as a visitor for pleasure or business.
Remarks	22 CFR 41.112(d) INA 212(d)(4), INA 238, 8 CFR 214.2(c) INA 217
	The law permits visa waivers for aliens from contiguous countries and adjacent islands or in emergency cases. Visas are also waived for admissible aliens arriving on a carrier which is signatory to an agreement assuring immediate transit of its passengers provided they have a travel document or documents establishing identity, nationality, and ability to enter some country other than the U.S.
3.8	The U.S. charges a fee for visas.
3.8.3	Duration of stay is determined at port of entry.
Remarks	INA 217
3.8.4	A visitor to the U.S. cannot enter without documentation.
Remarks	INA 212(a) (26)
3.8.5	Under U.S. law, the duration of stay is determined by the Immigration Authorities at the port of entry and thus cannot be shown on the visa at the time of issuance.
3.10	Embarkation/Disembarkation Card does not conform to Appendix 4 in some particulars.
3.10.1	The operator is responsible for passengers' presentation of completed embarkation/disembarkation cards.
Remarks	8 CFR 299.3
3.10.2	Embarkation/Disembarkation cards may be purchased from the U.S. Government, Superintendent of Documents.
Remarks	8 CFR 299.3
3.14.2	The U.S. fully supports the electronic Advance Passenger Information (API) systems. However, the WCO/IATA Guideline is too restrictive and does not conform to the advancements in the PAXLIST EDIFACT international standard.
3.15	U.S. Federal Inspection Services' officials see individuals more than once.
3.16	Written baggage declarations by crew members are required in some instances.
3.17.1	The U.S. uses a multiple channel system rather than the dual channel clearance system.
3.23, 3.23.1	Statute requires a valid visa and passport of all foreign crew members.
3.24, 3.24.1, 3.25, 3.25.1, 3.25.2, 3.25.3	Crew members, except those eligible under Visa Waiver Pilot Program guidelines, are required to have valid passports and valid visas to enter the U.S.
Remarks	INA 212(a) (26), INA 252 and 253, 8 CFR 214.1(a), 8 CFR 252.1(c)
3.26, 3.27, 3.28, 3.29	Passports and visas are required for crew and non-U.S. nationals to enter the U.S.
3.33	Does not apply to landing card.
3.35	Law requires that the alien shall be returned to the place whence he came. Interpretation of this provision requires that he be returned to the place where he began his journey and not only to the point where he boarded the last-used carrier.
3.35.1	Law requires that certain aliens be deported from the U.S. at the expense of the transportation line which brought them to the U.S.
3.36	Statute provides for a fine if a passenger is not in possession of proper documents.
3.39.3	NOTE: The U.S. considers security for individuals in airline custody to be the carrier's responsibility.
3.40.2	Annex 9 recommends that fines and penalties be mitigated if an alien with a document deficiency is eventually admitted to the country of destination.
3.43	Operator can be held responsible for some detention costs.
<b>Chapter 4</b>	<b>Entry and Departure of Cargo and Other Articles</b>
4.20	The Goods Declaration as defined by the Kyoto Convention serves as the fundamental Customs document rather than the commercial invoice.



4.40	Aircraft equipment and parts, certified for use in civil aircraft, may be entered duty-free by any nation entitled to most-favored nation tariff treatment. Security equipment and parts, unless certified for use in the aircraft, are not included.
4.41	Customs currently penalizes the exporting carrier for late filing of Shipper's Export Declarations (SEDs) and inaccuracies on bills of lading with respect to the SEDs.
4.42	Regulations require entry of such items, most of which are dutiable by law.
4.44	Certain items in this category are dutiable by law.
4.48	Carriers are required to submit new documentation to explain the circumstances under which cargo manifest is not unladen. No penalty is imposed if the carrier properly reports this condition.
4.50	The procedures for adding, deleting, or correcting manifest items require filing a separate document.
4.55	The U.S. requires a transportation in-bond entry or a special manifest bonded movement for this type of movement.
<b>Chapter 5</b>	<b>Traffic Passing Through the Territory of a Contracting State</b>
5.1	Such traffic must be inspected at airports where passengers are required to disembark from the aircraft and no suitable sterile area is available.
5.2	Passports and visas are waived for admissible aliens arriving on a carrier which is signatory to an agreement assuring immediate transit of its passengers provided they have a travel document or documents establishing identity, nationality, and ability to enter some country other than the U.S.
5.3	Such traffic must be inspected at airports where no suitable sterile area is available.
5.4	Passports and visas are waived for admissible aliens arriving on a carrier which is signatory to an agreement assuring immediate transit of its passengers provided they have a travel document or documents establishing identity, nationality, and ability to enter some country other than the U.S.
5.4.1	Passengers will not be required to obtain and present visas if they will be departing from the U.S. within 8 hours of arrival or on the first flight thereafter departing for their destination.
5.8	Examination of transit traffic is required by law. Transit passengers without visas are allowed one stop-over between the port of arrival and their foreign destination.
5.9	Passports and visas are required generally for transit passengers who are remaining in the U.S. beyond 8 hours or beyond the first available flight to their foreign destinations.
<b>Chapter 6</b>	<b>International Airports - Facilities and Services for Traffic</b>
6.3.1	Procedures involving scheduling committees raise a number of anti-trust problems under U.S. law.
6.33	Sterile physical facilities shall be provided, and in-transit passengers within those areas shall be subject to immigration inspection at any time.
Remarks	OI 214.2(c)
6.34	The U.S. inspects crew and passengers in transit.
6.36	The U.S. inspects crew and passengers in transit.
6.56	Operators of aircraft are statutorily required to pay overtime charges for federal inspections conducted outside normal scheduled hours of operation. This requirement places aircraft operators in a less favorable position than operators of highway vehicles and ferries who are statutorily exempt from such charges.
<b>Chapter 8</b>	<b>Other Facilitation Provisions</b>
8.1	Separate bonds are required.
8.3.2	Visas are issued by the Department of State and are not issued at ports of entry.



<b>ANNEX 10 - VOLUME I - AERONAUTICAL TELECOMMUNICATIONS</b>	
<b>PART I</b>	
<b>Chapter 3</b>	
3.1.4.1 3.1.4.2 3.1.4.3	The U.S. does not require such equipage for aircraft.
3.1.7.3.1 c)	When necessary to achieve coverage to the edges of the localizer course, the U.S. authorizes coverage over a greater distance than that specified in 3.1.7.3.1 c); i.e., up to 1,200 meters (4,000 feet) along the localizer course centerline.
3.3.8.1 3.3.8.2 3.3.8.3	The U.S. does not require such equipage for aircraft.
<b>PART II</b>	
<b>Chapter 4</b>	
4.1.5.2	In the U.S., the shortage of communications channels, compared with the total operational requirement, has resulted in the geographical separation between facilities working on the same frequency being considerably less (up to 50 percent reduction) than the Standard defined for such separation.
<b>ANNEX 10 - VOLUME II - AERONAUTICAL TELECOMMUNICATIONS</b>	
<b>Chapter 3</b>	
3.3.2	Class B traffic, including reservation messages pertaining to flights scheduled to depart within 72 hours, shall not be acceptable for transmission over U.S. Government operated AFTN circuits, except in those cases where it has been determined by the U.S. that adequate non-government facilities are not available.
<b>Chapter 4</b>	
4.4.2	In the Caribbean Region, U.S. industry-operated AFTN terminals will continue to accept messages in both ICAO and non-ICAO formats. The U.S. now accepts only messages in ICAO format from other states, including the Caribbean Region.
<b>Chapter 5</b>	
5.2.1.3.1.1	The U.S. will use the term "hundred" in stating altitude numbers by radiotelephone. Whole hundreds will be spoken as follows: 400 - "Four hundred" 4,500 - "Four thousand five hundred"
5.2.1.3.1.2	The U.S. will use the term "point" in lieu of "decimal" in stating frequencies: 126.55 MHz - "One two six point five five" 8,828.5 MHz - "Eight eight two eight point five"
5.2.1.6.1	Air route traffic control centers will use "center" rather than "control" in their radiotelephone identification. Example: "Washington Center"  Approach control service units will use "approach control" or "departure control" rather than "approach" in their radiotelephone identification. Example: "Washington Approach Control" or "Washington Departure Control" Aerodrome control towers will use "ground control" or "clearance delivery" rather than "tower" in their radiotelephone identification, where appropriate, to identify ground control services. Example: "Washington Ground Control" or "Washington Clearance Delivery"
5.2.1.6 5.2.1.6.2.1.1 5.2.1.6.2.2.1	U.S. procedures allow abbreviation of only Type a) call signs and limit abbreviation to not less than <b>three</b> characters following the first character of the registration marking or the manufacturer of the aircraft. Also, the U.S. does not use call signs comprised of aircraft operating agency telephony designators in combination with aircraft registration markings (Type b).
Remarks	To facilitate understanding, examples (5.2.1.6) should follow rather than precede corresponding provisions which govern them (5.2.1.6.2.1.1 and 5.2.1.6.2.2.1).
5.2.2.1.1.1 5.2.2.1.1.2	The U.S. Federal Aviation Regulations do not require that a continuous airborne guard on VHF121.5 MHz be maintained.

<b>ANNEX 10 - VOLUME III - AERONAUTICAL TELECOMMUNICATIONS</b>	
<b>PART I</b>	
4.2.1.2 4.2.1.3	In the U.S., AMSS terminals <u>shall have</u> the capability of operating in the frequency bands 1544-1559 MHz and 1645.5-1660.5 MHz bands. (NOTE: Use of the band 1544-1545/1645.5-1646.5 MHz by the mobile satellite service is limited to distress and safety.)
<b>PART II</b>	
2.3.3.1 2.3.3.2 2.3.3.3	The U.S. does not require such equipage for aircraft.
<b>ANNEX 10 - VOLUME IV - AERONAUTICAL TELECOMMUNICATIONS</b>	
4.3.2.2.2 4.3.2.2.2.2 4.3.2.2.2.2.2 4.3.2.2.2.2.3	TCAS II Version 6.04A Enhanced Interference Limiting Algorithms won't comply with these sections of the standards and recommended practices (SARP's). See remark below.
4.3.5.1	TCAS II Version 6.04A Enhanced won't comply because it has a 3-second coordination delay. See remark below.
4.3.5.3	TCAS II Version 6.04A Enhanced does not comply since the section implies a requirement for reversals in some instances in encounters between two TCAS II-equipped aircraft. See remark below.
4.3.5.4	TCAS II Version 6.04A Enhanced does not comply since the section explicitly requires reversal of coordinated resolution advisories (RA's) under some circumstances. See remark below.
4.3.5.5	TCAS II Version 6.04A Enhanced does not comply since it contains a dormancy requirement, does not have 5-second targets, and only has surveillance of $\pm 3,000$ feet in altitude. See remark below.
4.3.8.4.2.2.1 4.3.8.4.2.2.1.1 4.3.8.4.2.2.1.3 4.3.8.4.2.2.1.4 4.3.8.4.2.2.1.5 4.3.8.4.2.2.1.6 4.3.8.4.2.2.16.1 4.3.8.4.2.2.1.6.2 4.3.8.4.2.2.1.6.3	TCAS II Version 6.04A Enhanced has different RA Report formats in DF = 20, 21 replies. See remark below.
4.3.8.4.2.2.2 4.3.8.4.2.2.3	TCAS Version 6.04 Enhanced has different Data Link Capability format in DF = 20, 21 replies. See remark below.
4.3.8.4.2.3.4 4.3.8.4.2.3.4.1 4.3.8.4.2.3.4.2 4.3.8.4.2.3.4.3 4.3.8.4.2.3.4.4 4.3.8.4.2.3.4.5 4.3.8.4.2.3.4.6	TCAS II Version 6.04A Enhanced RA does not meet the Broadcast format specified in these sections. See remark below.
4.3.8.4.2.4.2.1 4.3.8.4.2.4.2.3 4.3.8.4.2.4.2.4	TCAS II Version 6.04A Enhanced has a different Coordination Reply format in DF = 16 replies. See remark below.
Remark	The U.S. does not require TCAS II Version 7 (ACAS II) equipage in its National Airspace System.

<b>ANNEX 11 - AIR TRAFFIC SERVICES</b>	
<b>Chapter 1</b>	<b>Definitions</b>
Air-taxiing	U.S. uses "hover taxi" for this maneuver above 100 feet above ground level (AGL) and "air taxi" below 100 feet AGL.
Airborne collision avoidance	The U.S. uses "traffic alert collision avoidance system (TCAS)." TCAS is an airborne collision avoidance system based on radar beacon signals and operates independent of ground-based equipment. TCAS-I generates traffic advisories only. TCAS-II generates traffic advisories and resolution (collision avoidance) advisories in the vertical plane.
<b>Chapter 2</b>	<b>General</b>
2.6	The Class F airspace is not used in the designation of U.S. airspace.
2.9 2.11 Appendix 1 Appendix 2	Converting the present U.S. system for identifying ATS routes and significant points to conform to the provisions of amended paragraphs 2.9 - 2.9.2, 2.11 - 2.11.3, Appendix 1 and Appendix 2 is an effort of considerable magnitude and complexity. The U.S. has an ongoing program to accomplish the conversion, but it is estimated that a period of 2 to 5 years will be required for full compliance.
<b>Chapter 3</b>	<b>Air Traffic Control Service</b>
3.3.3 Exception Clause	Clearances may be issued to conduct flight in VFR conditions without a pilot request if the clearance would result in noise abatement benefits or when a pilot conducts a practice instrument approach.
<b>Chapter 4</b>	<b>Flight Information Service</b>
4.2.2 b)	No provision is made for the issuance of collision hazard information to flights operating in Class G airspace.
4.3.4.4 h) 4.3.4.8	The U.S. requires that the current altimeter setting be included in the ATIS broadcast. Information contained in a current ATIS broadcast, the receipt of which has been acknowledged by an aircraft, is not included in a directed transmission to the aircraft unless requested by the pilot.
4.3.5 4.3.6 4.3.7	The order in which information is listed in ATIS broadcast messages is not mandated and certain elements are regarded as optional.
<b>Appendix 1</b>	<b>Principles Governing the Identification of RNP Types and the Identification of ATS Routes Other Than Standard Departure and Arrival Routes</b>
	See 2.9, above.
2.2.1	Routes designated to serve aircraft operating from 18,000 MSL up to and including FL 450 are referred to as "jet routes" and are designated with the letter "J" followed by a number of up to three digits.
<b>Appendix 2</b>	<b>Principles Governing the Establishment and Identification of Significant Points</b>
	See 2.9, above.
2.1	The U.S. will not comply with this guidance in naming the Missed Approach Point (MAP) located at the landing threshold.
<b>Appendix 4</b>	<b>ATS Airspace Classifications</b>
	It should be noted that the term "Class B airspace" as used in the U.S. is more restrictive than that specified by ICAO. Flights within Class B Airspace in the U.S. must be operated in accord with the provisions of 14 CFR Part 91 (Section 91.90).
	Speed restrictions do not necessarily apply to aircraft operating beyond 12 NM from the coast line within the U.S. Flight Information Region, in offshore Class E airspace below 10,000 feet MSL. However, in airspace underlying a Class B airspace area designated for an airport, or in a VFR corridor designated through such a Class B airspace area, pilots are expected to comply with the 200 knot speed limit specified in 14 CFR Part 91 (sections 91.117(c) and 91.703). This difference will allow airspeed adjustments exceeding 250 knots, thereby improving air traffic services, enhancing safety and expediting air traffic movement.



**ANNEX 12 - SEARCH AND RESCUE**

There are no reportable differences between U.S. regulations and the Standards and Recommended Practices contained in this Annex.





**ANNEX 13 - AIRCRAFT ACCIDENT INVESTIGATION**

<b>Chapter 5</b>	<b>Investigation</b>
5.12	<p>The full exchange of information is vital to effective accident investigation and prevention. The U.S. supports, in principle, measures that are intended to facilitate the development and sharing of information. The laws of the U.S. require the determination and public reporting of the facts, circumstances, and probable cause of every civil aviation accident. This requirement does not confine the public disclosure of such information to an accident investigation. However, the laws of the U.S. do provide some protection against public dissemination of certain information of a medical or private nature. Also, U.S. law prohibits the disclosure of cockpit voice recordings to the public and limits the disclosure of cockpit voice recording transcript to that specific information which is deemed pertinent and relevant by the investigative authority. However, U.S. Courts can order the disclosure of the foregoing information for other than accident investigation purposes. The standard for determining access to this information does not consider the adverse domestic or international effects on investigations that might result from such access.</p>
5.25 h)	<p>Investigative procedures observed by the U.S. allow full participation in all progress and investigation planning meetings; however, deliberations related to analysis, findings, probable causes, and safety recommendations are restricted to the investigative authority and its staff. However, participation in these areas is extended through timely written submissions, as specified in paragraph 5.25 i).</p>
5.26 b)	<p>The U.S. supports, in principle, the privacy of the State conducting the investigation regarding the progress and the findings of that investigation. However, the laws of the U.S. facilitate the public disclosure of information held by U.S. government agencies and U.S. commercial business. The standard for determining public access to information requested from a U.S. government agency or a commercial business does not consider or require the expressed consent of the State conducting the investigation.</p>
<b>Chapter 6</b>	<b>Reporting</b>
6.13	<p>The U.S. supports the principle of not circulating, publishing, or providing access to a draft report or any part thereof unless such a report or document has already been published or released by the State which conducted the investigation. However, the laws of the U.S. facilitate the public disclosure of information held by government agencies and commercial business. The U.S. government may not be able to restrict public access to a draft report or any part thereof on behalf of the State conducting the investigation. The standard for determining public access to information requested from a U.S. government agency or a commercial business does not consider or require the expressed consent of the State conducting an investigation.</p>



<b>ANNEX 14 - AERODROMES</b>	
<b>VOLUME 1 - AERODROME DESIGN AND OPERATIONS</b>	
<b>Chapter 1</b>	<b>General</b>
1.2.1	<p>Airports in the U.S. are for the most part owned and operated by local governments and quasi-government organizations formed to operate transportation facilities. The Federal Government provides air traffic control, operates and maintains NAVAIDS, provides financial assistance for airport development, certifies major airports and issues standards and guidance for airport planning, design and operational safety.</p> <p>There is general conformance with the Standards and Recommended Practices of Annex 14, Volume I. At airports with scheduled passenger service using aircraft having more than nine seats, compliance with standards is enforced through regulation and certification. At other airports, compliance is achieved through the agreements with individual airports under which Federal development funds were granted; or, through voluntary actions.</p>
1.3.1 1.3.2 1.3.3 1.3.4	<p>In the U.S., the Airport Reference Code is a two-component indicator relating the standards used in the airport's design to a combination of dimensional and operating characteristics of the largest aircraft expected to use the airport. The first element, Aircraft Approach Category, corresponds to the ICAO PANS-OPS approach speed groupings. The second, Airplane Design Group, corresponds to the wing-span groupings of code element 2 of the Annex 14, Aerodrome Reference Code. See below:</p>

**Airport Reference Code (ARC)**

Aircraft Approach Category	Approximate Annex 14 Code Number
A	1
B	2
C	3
D	4
E	-
Airplane Design Group	Corresponding Annex 14 Code Letter
I	A
II	B
III	C
IV	D
V	E
VI	F (proposed)

*EXAMPLE: AIRPORT DESIGNED FOR B747-400 ARC D-V.*

<b>Chapter 2</b>	<b>Aerodrome Data</b>
2.2.1	The airport reference point is recomputed when the ultimate planned development of the airport is changed.
2.9.6 2.9.7	Minimum friction values have not been established to indicate that runways are "slippery when wet." However, U.S. guidance recommends that pavements be maintained to the same levels indicated in the ICAO Airport Services Manual.
2.11.3	If inoperative fire fighting apparatus cannot be replaced immediately, a NOTAM must be issued. If the apparatus is not restored to service within 48 hours, operations shall be limited to those compatible with the lower index corresponding to operative apparatus.
2.12 e)	Where the original VASI is still installed, the threshold crossing height is reported as the center of the on-course signal, not the top of the red signal from the downwind bar.

<b>Chapter 3</b>	<b>Physical Characteristics</b>
3.1.2*	The crosswind component is based on the ARC: 10.5 kt for AI and BI; 13 kt for AII and BII; 16 kt for AIII, BIII and CI through DIII; 20 kts for AIV through DVI.
3.1.9*	Runway widths (in meters) used in design are shown in the table below:

**Width of Runway in Meters**

Aircraft Approach Category	Airplane Design Group					
	I	II	III	IV	V	VI
A	18 <sup>1</sup>	23 <sup>1</sup>	--	--	45	60
B	18 <sup>1</sup>	23 <sup>1</sup>	--	--	45	60
C	30	30	30 <sup>2</sup>	45	45	60
D	30	30	30 <sup>2</sup>	45	45	60

<sup>1</sup>The width of a precision (lower than 3/4 statute mile approach visibility minimums) runway is 23 meters for a runway which is to accommodate only small (less than 5,700 kg) airplanes and 30 meters for runways accommodating larger airplanes.

<sup>2</sup>For airplanes with a maximum certificated take-off mass greater than 68,000 kg, the standard runway width is 45 meters.

3.1.12*	Longitudinal runway slopes of up to 1.5 percent are permitted for aircraft approach categories C and D except for the first and last quarter of the runway where the maximum slope is 0.8 percent.
3.1.18*	Minimum and maximum transverse runway slopes are based on aircraft approach categories as follows: For categories A and B 1.0 - 2.0 percent C and D 1.0 - 1.5 percent
3.2.2	The U.S. does not require that the minimum combined runway and shoulder widths equal 60 meters. The widths of shoulders are determined independently.
3.2.3*	The transverse slope on the innermost portion of the shoulder can be as high as 5 percent.
3.3.3 3.3.4* 3.3.5*	A strip width of 120 meters is used for code 3 and 4 runways for precision, non-precision and non-instrumented operations. For code 1 and 2 precision runways, the width is 120 meters. For non-precision/visual runways, widths vary from 37.5 meters up to 120 meters.
3.3.9*	Airports used exclusively by small aircraft (U.S. Airplane Design Group I) may be graded to distances as little as 18 meters from the runway centerline.
3.3.14*	The maximum transverse slope of the graded portion of the strip can be 3 percent for aircraft approach categories C and D and 5 percent for aircraft approach categories A and B.
3.3.15*	The U.S. does not have standards for the maximum transverse grade on portions of the runway strip falling beyond the area that is normally graded.
3.3.17*	Runways designed for use by smaller aircraft under non-instrument conditions may be graded to distances as little as 18 meters from the runway centerline (U.S. Airplane Design Groups I and II).
3.4.2*	For certain code 1 runways, the runway end safety areas may be only 72 meters.
3.7.1* 3.7.2*	The U.S. does not provide Standards or Recommended Practices for radio altimeter operating areas.
3.8.3*	The U.S. specifies a 6 meter clearance for Design Group VI airplanes.
3.8.4*	The taxiway width for Design Group VI airplanes is 30 meters.
3.8.5*	The U.S. also permits designing taxiway turns and intersections using the judgmental oversteering method.
3.8.7*	Minimum separations between runway and taxiway centerlines, and minimum separations between taxiways and taxilanes and between taxiway/taxilanes and fixed/moveable objects are shown in the tables that follow. Generally, U.S. separations are larger for non-instrumented runways, and smaller for instrumented runways, than the Annex. Values are also provided for aircraft with wingspans up to 80 meters.

**Minimum Separations Between Runway Centerline and Parallel Taxiway/Taxilane Centerline**

Operation	Aircraft Approach Category	Airplane Design Group						
		I <sup>1</sup>	I	II	III	IV	V	VI
Visual runways and runways with not lower than 3/4 statute mile (1,200 meters) approach visibility minimums	A and B	150 feet 45 meters	225 feet 67.5 meters	240 feet 72 meters	300 feet 90 meters	400 feet 120 meters	--	--
Runways with lower than 3/4 statute mile (1,200 meters) approach visibility minimums	A and B	200 feet 60 meters	250 feet 75 meters	300 feet 90 meters	350 feet 105 meters	400 feet 120 meters	--	--
Visual runways and runways with not lower than 3/4 statute mile (1,200 meters) approach visibility minimums	C and D	--	300 feet 90 meters	300 feet 90 meters	400 feet 120 meters	400 feet 120 meters	400 <sup>2</sup> feet 120 <sup>2</sup> meters	600 feet 180 meters
Runways with lower than 3/4 statute mile (1,200 meters) approach visibility minimums	C and D	--	400 feet 120 meters	400 feet 120 meters	400 feet 120 meters	400 feet 120 meters	400 <sup>2</sup> feet 120 <sup>2</sup> meters	600 feet 180 meters

<sup>1</sup>These dimensional standards pertain to facilities for small airplanes exclusively.

<sup>2</sup>Corrections are made for altitude: 120 meters separation for airports at or below 410 meters; 135 meters for altitudes between 410 meters and 2,000 meters; and, 150 meters for altitudes above 2,000 meters.

**Minimum Taxiway and Taxilane Separations:**

	Airplane Design Group					
	I	II	III	IV	V	VI
Taxiway centerline to parallel taxiway/taxilane centerline	69 feet 21 meters	105 feet 32 meters	152 feet 46.5 meters	215 feet 65.5 meters	267 feet 81 meters	324 feet 99 meters
Fixed or movable object	44.5 feet 13.5 meters	65.5 feet 20 meters	93 feet 28.5 meters	129.5 feet 39.5 meters	160 feet 48 meters	193 feet 59 meters
Taxilane centerline to parallel taxilane centerline	64 feet 19.5 meters	97 feet 29.5 meters	140 feet 42.5 meters	198 feet 60 meters	245 feet 74.5 meters	298 feet 91 meters
Fixed or movable object	39.5 feet 12 meters	57.5 feet 17.5 meters	81 feet 24.5 meters	112.5 feet 34 meters	138 feet 42 meters	167 feet 51 meters

3.8.10*	Line-of-sight standards for taxiways are not provided in U.S. practice, but there is a requirement that the sight distance along a runway from an intersecting taxiway must be sufficient to allow a taxiing aircraft to safely enter or cross the runway.
3.8.11*	Transverse slopes of taxiways are based on aircraft approach categories. For categories C and D, slopes are 1.0-1.5 percent; for A and B, 1.0-2.0 percent.
3.11.5	The runway centerline to taxi-holding position separation for code 1 is 38 meters for non-precision operations and 53 meters for precision. Code 3 and 4 precision operations require a separation of 75 meters, except for "wide bodies," which require 85 meters.

**Dimensions and Slopes for Protective Areas and Surfaces**

	Precision Approach	Non-precision Instrument Approach			Visual Runway	
	All runways	All runways <sup>a</sup>	Runways other than utility <sup>b</sup>	Utility runways <sup>d</sup>	Runways other than utility	Utility runways
Width of inner edge	305 meters	305 meters	152 meters	152 meters	152 meters	76 meters <sup>c</sup>
Divergency (each side)	15 percent	15 percent	15 percent	15 percent	10 percent	10 percent
Final width	4,877 meters	1,219 meters	1,067 meters <sup>c</sup>	610 meters	475 meters <sup>c</sup>	381 meters <sup>c</sup>
Length	15,240 meters	3,048 meters <sup>c</sup>	3,048 meters <sup>c</sup>	1,524 meters <sup>c</sup>	1,524 meters <sup>c</sup>	1,524 meters <sup>c</sup>
Slope: inner 3,049 meters	2 percent	2.94 percent <sup>c</sup>	2.94 percent <sup>c</sup>	5 percent <sup>c</sup>	5 percent <sup>c</sup>	5 percent <sup>c</sup>
Slope: beyond 3,048 meters	2.5 percent <sup>c</sup>					

<sup>a</sup>With visibility minimum as low as 1.2 km; <sup>b</sup>with visibility minimum greater than 1.2 km; <sup>c</sup>criteria less demanding than Annex 14 Table 4-1 dimensions and slopes. <sup>d</sup>Utility runways are intended to serve propeller-driven aircraft having a maximum take-off mass of 5,570 kg.

Chapter 4	Obstacle Restriction and Removal
4.1	Obstacle limitation surfaces similar to those described in 4.1-4.20 are found in 14 CFR Part 77.
4.1.21	A balked landing surface is not used.
4.1.25	The U.S. does not establish take-off climb obstacle limitation areas and surface, <i>per se</i> , but does specify protective surfaces for each end of the runway based on the type of approach procedures available or planned. The dimensions and slopes for these surfaces and areas are listed in the table above.
4.2	The dimensions and slopes of U.S. approach areas and surfaces are set forth in the above table. Aviation regulations do not prohibit construction of fixed objects above the surfaces described in these sections.
Chapter 5	Visual Aids for Navigation
5.2.1.7*	The U.S. does not require unpaved taxiways to be marked.
5.2.2.2*	The U.S. does not require a runway designator marking for unpaved runways.
5.2.2.4	Zeros are not used to precede single-digit runway markings. An optional configuration of the numeral 1 is available to designate a runway 1 and to prevent confusion with the runway centerline.
5.2.4.2* 5.2.4.3*	Threshold markings are not required, but sometimes provided, for non-instrument runways that do not serve international operations.
5.2.4.5	The current U.S. standard for threshold designation is eight stripes, except that more than eight stripes may be used on runways wider than 45 meters. After 1 January 2008, the U.S. standard will comply with Annex 14.
5.2.4.6	The width and spacing of threshold stripes will comply with Annex 14 after 1 January 2008.
5.2.4.10	When a threshold is temporarily displaced, there is no requirement that runway or taxiway edge markings, prior to the displaced threshold, be obscured. These markings are removed only if the area is unsuitable for the movement of aircraft.
5.2.5.2 5.2.5.3*	Aiming point markings are required on precision instrument runways and code 3 and 4 runways used by jet aircraft.
5.2.5.4	The aiming point marking commences 306 meters from the threshold at all runways.
5.2.6.3	The U.S. pattern for touchdown zone markings, when installed on both runway ends, is only applicable to runways longer than 4,990 feet. On shorter runways, the three pair of markings closest to the runway midpoint are eliminated.
5.2.6.4	The U.S. standard places the aiming point marking 306 meters from the threshold where it replaces one of the pair of three stripe threshold markings. The 306 meters location is used regardless of runway length.
5.2.6.5*	Touchdown zone markings are not required at a non-precision approach runway, though they may be provided.
5.2.7.4*	Runway side stripe markings on a non-instrument runway may have an over-all width of 0.3 meter.

5.2.8.3	Taxiway centerline markings are never installed longitudinally on a runway even if the runway is part of a standard taxi route.
5.2.9.5*	The term "ILS" is used instead of CAT I, CAT II, CAT III.
5.2.11.4 5.2.11.5* 5.2.11.6*	Check-point markings are provided, but the circle is 3 meters in diameter, and the directional line may be of varying width and length. The color is the yellow used for taxiway markings.
5.2.12	Standards for aircraft stand markings are not provided.
5.2.13.1*	Apron safety lines are not required although many airports have installed them.
5.2.14.1	The U.S. does not have standards for holding position markings on roadways that cross runways. Local traffic control practices are used.
5.3.1.1 5.3.1.2*	The U.S. does not have regulations to prevent the establishment of non-aviation ground lights that might interfere with airport operations.
5.3.1.3 5.3.1.4	New approach lighting installations will meet the frangibility requirements. Some existing non-frangible systems may not be replaced before 1 January 2005.
5.3.2.1* 5.3.2.2* 5.3.2.3*	There is no requirement for an airport to have emergency runway lighting available if it does not have a secondary power source. Some airports do have these systems, and there is an FAA specification for these lights.
5.3.3.1 5.3.3.3	Only airports served by aircraft having more than 30 seats are required to have a beacon, though they are available at many others.
5.3.3.6	Although the present U.S. standard for beacons calls for 24-30 flashes per minute, some older beacons may have flash rates as low as 12 flashes per minute.
5.3.3.8	Coded identification beacons are not required and are not commonly installed. Typically, airport beacons conforming to 5.3.3.6 are installed at locations served by aircraft having more than 30 seats.
5.3.4.1	While the U.S. has installed an approach light system conforming to the specifications in 5.3.4.10 through 5.3.4.19, it also provides for a lower cost system consisting of medium intensity approach lighting and sequenced flashing lights (MALSF) at some locations.
5.3.4.2	In addition to the system described in 5.3.4.1, a system consisting of omnidirectional strobe lights (ODALS) located at 90 meters intervals extending out to 450 meters from the runway threshold is used at some locations.
5.3.4.10 through 5.3.4.19	The U.S. standard for a precision approach category I lighting system is a medium intensity approach lighting system with runway alignment indicator lights (MALSR). This system consists of 3 meters barrettes at 60 meters intervals out to 420 meters from the threshold and sequenced flashing lights at 60 meters intervals from 480 meters to 900 meters. A crossbar 20 meters in length is provided 300 meters from the threshold. The total length of this system is dependent upon the ILS glide path angle. For angles 2.75° and higher, the length is 720 meters.
5.3.4.16 5.3.4.31	The capacitor discharge lights can be switched on or off when the steady-burning lights of the approach lighting system are operating. However, they cannot be operated when the other lights are not in operation.
5.3.4.20	The U.S. standard for a precision approach category II and III lighting system has a total length dependent upon the ILS glide path angle. For angles 2.75° and higher, the length is 720 meters.
5.3.5.1 5.3.5.3 5.3.5.4	Visual approach slope indicator systems are not required for all runways used by turbojets except runways involved with land and hold short operations that do not have an electronic glideslope system.
5.3.5.2	In addition to PAPI and APAPI systems, VASI and AVASI type systems remain in service at U.S. airports with commercial service. Smaller general aviation airports may have various other approach slope indicators including tri-color and pulsating visual approach slope indicators.
5.3.5.27	The U.S. standard for PAPI allows for the distance between the edge of the runway and the first light unit to be reduced to 9 meters for code 1 runways used by nonjet aircraft.
5.3.5.42	The PAPI obstacle protection surface used is as follows: The surface begins 90 meters in front of the PAPI system (toward the threshold) and proceeds outward into the approach zone at an angle 1 degree less than the aiming angle of the third light unit from the runway. The surface flares 10 degrees on either side of the extended runway centerline and extends 4 statute miles from its point of origin.
5.3.8.4	The U.S. permits the use of omnidirectional runway threshold identification lights.

5.3.13.2	<p>The U.S. does not require the lateral spacing of touchdown zone lights to be equal to that of touchdown zone marking when runways are less than 45 meters wide.</p> <p>The lateral distance between the markings is 22 meters when installed on runways with a width of 45 meters or greater. The distance is proportionately smaller for narrower runways. The lateral distance between touchdown zone lights is nominally 22 meters but may be reduced to 20 meters to avoid construction problems.</p>														
5.3.14	The U.S. has no provision for stopway lights.														
5.3.15.1 5.3.15.2*	Taxiway centerline lights are required only below 183 meters RVR on designated taxi routes. However, they are generally recommended whenever a taxiing problem exists.														
5.3.15.3 8.2.3	Taxiway centerline lights are not provided on runways forming part of a standard taxi route even for low visibility operations. Under these conditions, the taxi path is coincident with the runway centerline, and the runway lights are illuminated.														
5.3.15.5	Taxiway centerline lights on exit taxiways presently are green. However, the new U.S. standard which is scheduled to be published by 1 January 98 will comply with the alternating green/yellow standard of Annex 14.														
5.3.15.7*	The U.S. permits an offset of up to 60 cm.														
5.3.16.2 8.2.3	Taxiway edge lights are not provided on runways forming part of a standard taxi route.														
5.3.17.1 5.3.17.2* 5.3.17.3 5.3.17.4* 5.3.17.5*	Stop bars are required only for runway visual range conditions less than a value of 183 meters at taxiway/runway intersections where the taxiway is lighted during low visibility operations. Once installed, controlled stop bars are operated at RVR conditions less than a value of 350 meters.														
5.3.17.6	Elevated stop bar lights are normally installed longitudinally in line with taxiway edge lights. Where edge lights are not installed, the stop bar lights are installed not more than 3 meters from the taxiway edge.														
5.3.17.9	The beamspread of elevated stop bar lights differs from the in-pavement lights. The inner isocandela curve for the elevated lights is $\pm 7$ horizontal and $\pm 4$ vertical.														
5.3.17.12	The U.S. standard for stop bars, which are switchable in groups, does not require the taxiway centerline lights beyond the stop bars to be extinguished when the stop bars are illuminated. The taxiway centerline lights which extend beyond selectively switchable stop bars are grouped into two segments of approximately 45 meters each. A sensor at the end of the first segment re-illuminates the stop bar and extinguishes the first segment of centerline lights. A sensor at the end of the second segment extinguishes that segment of centerline lights.														
5.3.18.1*	Taxiway intersection lights are also used at other hold locations on taxiways such as low visibility holding points.														
5.3.18.2	<p>Taxiway intersection lights are collocated with the taxiway intersection marking. The marking is located at the following distances from the centerline of the intersecting taxiway:</p> <table border="1" style="margin-left: 40px;"> <thead> <tr> <th>Airplane Design Group</th> <th>Distance</th> </tr> </thead> <tbody> <tr> <td>I</td> <td>13.5 meters</td> </tr> <tr> <td>II</td> <td>20 meters</td> </tr> <tr> <td>III</td> <td>28.5 meters</td> </tr> <tr> <td>IV</td> <td>39 meters</td> </tr> <tr> <td>V</td> <td>48.5 meters</td> </tr> <tr> <td>VI</td> <td>59 meters</td> </tr> </tbody> </table>	Airplane Design Group	Distance	I	13.5 meters	II	20 meters	III	28.5 meters	IV	39 meters	V	48.5 meters	VI	59 meters
Airplane Design Group	Distance														
I	13.5 meters														
II	20 meters														
III	28.5 meters														
IV	39 meters														
V	48.5 meters														
VI	59 meters														
5.3.19.1 5.3.19.2*	Runway guard lights are required only for runway visual range conditions less than a value of 350 meters.														
5.3.19.4 5.3.19.5	Runway guard lights are placed at the same distance from the runway centerline as the aircraft holding distance, or within a few feet of this location.														
5.3.19.12	The new U.S. standard for in-pavement runway guard lights complies with Annex 14. However, there may be some existing systems that do not flash alternately.														



5.3.20.4*	The U.S. does not set aviation standards for flood lighting aprons.
5.3.21	The U.S. does not provide standards for visual docking guidance systems. U.S. manufacturers of these devices generally adhere to ICAO SARPS.
5.3.23.1	The U.S. does not have a requirement for providing roadholding position lights during RVR conditions less than a value of 350 meters.
5.4.1.2	Signs are often installed a few centimeters taller than specified in Annex 14, Volume 1, Table 5-4.
5.4.1.5	Sign inscriptions are slightly larger, and margins around the sign slightly smaller, than indicated in Annex 14, Volume 1, Appendix 4.
5.4.1.6	The sign luminance requirements are not as high as specified in Appendix 4. The U.S. does not specify a nighttime color requirement in terms of chromaticity.
5.4.2.2 5.4.2.4 5.4.2.9 5.4.2.14 5.4.2.16	All signs used to denote precision approach holding positions have the legend "ILS."
5.4.2.6	U.S. practice uses the NO ENTRY sign to prohibit entry by aircraft only.
5.4.2.8 5.4.2.10	The second mandatory instruction sign is usually not installed unless added guidance is necessary.
5.4.2.15	Signs for holding aircraft and vehicles from entering areas where they would infringe on obstacle limitation surfaces or interfere with NAVAIDS are inscribed with the <i>designator of the approach</i> , followed by the letters "APCH"; for example, "15-APCH."
5.4.3.13 5.4.3.15	U.S. practice is to install signs about 3 to 5 meters closer to the taxiway/runway (See Annex 14, Table 5-4).
5.4.3.16	The U.S. does not have standards for the location of runway exit signs.
5.4.3.24	A yellow border is used on all location signs, regardless of whether they are stand-alone or collocated with other signs.
5.4.3.26	U.S. practice is to use Pattern A on runway vacated signs, except that Pattern B is used to indicate that an ILS critical area has been cleared.
5.4.3.30*	The U.S. does not have standards for signs used to indicate a series of taxi-holding positions on the same taxiway.
5.4.4.4*	The inscription, "VOR Check Course," is placed on the sign in addition to the VOR and DME data.
5.4.5.1*	The U.S. does not have requirements for airport identification signs, though they are usually installed.
5.4.6.1*	Standards are not provided for signs used to identify aircraft stands.
5.4.7.2	The distance from the edge of road to the road-holding position sign conforms to local highway practice.
5.5.2.2* 5.5.7.1*	Boundary markers may be used to denote the edges of an unpaved runway.
5.5.3	There is no provision for stopway edge markers.
<b>Chapter 6</b>	<b>Visual Aids for Denoting Obstacles</b>
6.1	Recommended practices for marking and lighting obstacles are found in FAA Advisory Circular 70/7460-1J, Obstruction Marking and Lighting.
6.2.3*	The maximum dimension of the rectangles in a checkered pattern is 6 meters on a side.
6.3.21* 6.3.22*	The effective intensity, for daylight-luminance background, of Type A high-intensity obstacle lights is 270,000 cd ± 25 percent.  The effective intensity, for daylight-luminance background, of Type B high-intensity obstacle lights is 140,000 cd ± 25 percent.
<b>Chapter 7</b>	<b>Visual Aids for Denoting Restricted Use Areas</b>
7.1.2*	A "closed" marking is not used with partially closed runways. See 5.2.4.10, above.

7.1.4	Crosses with shapes similar to figure 7.1, illustration b) are used to indicate closed runways and taxiways.  The cross for denoting a closed runway is yellow.
7.1.5	In the U.S. when a runway is permanently closed, only the threshold marking, runway designation marking, and touchdown zone marking need be obliterated. Permanently closed taxiways need not have the markings obliterated.
7.1.7	The U.S. does not require unserviceability lights across the entrance to a closed runway or taxiway when it is intersected by a night-use runway or taxiway.
7.4.4	Flashing yellow lights are used as unserviceability lights. The intensity is such as to be adequate to delineate a hazardous area.
<b>Chapter 8</b>	<b>Equipment and Installations</b>
8.1.5* 8.1.6* 8.1.7 8.1.8	A secondary power supply for non-precision instrument and non-instrument approach runways is not required, nor is it required for all precision approach runways.  The U.S. does not provide secondary power specifically for take-off operations below 550 meters RVR.
8.2.1	There is no requirement in the U.S. to interleave lights as described in the Aerodrome Design Manual, Part 5.
8.2.3	See 5.3.15.3 and 5.3.16.2
8.7.2* 8.7.3 8.7.4*	Glide slope facilities and certain other installations located within the runway strip, or which penetrate obstacle limitation surfaces, may not be frangibly mounted.
8.9.7*	A surface movement surveillance system is recommended for operations from 350 meters RVR down to 183 meters. Below 183 meters RVR, a surface movement radar or alternative technology is generally required.
<b>Chapter 9</b>	<b>Emergency and Other Services</b>
9.1.1	Emergency plans such as those specified in this section are required only at airports serving scheduled air carriers using aircraft having more than 30 seats. These airports are certificated under 14 CFR Part 139. In practice, other airports also prepare emergency plans.
9.1.12	Full-scale airport emergency exercises are conducted at intervals, not to exceed three years, at airports with scheduled passenger service using aircraft with more than 30 seats.
9.2.1	Rescue and fire fighting equipment and services such as those specified in this section are required only at airports serving scheduled air carriers in aircraft having more than 30 seats. Such airports generally equate to ICAO categories 4 through 9.  Other airports have varying degrees of services and equipment.
9.2.3*	There is no plan to eliminate, after 1 January 2005, the current practice of permitting a reduction of one category in the index when the largest aircraft has fewer than an average of five scheduled departures a day.
9.2.4 9.2.5	The level of protection at U.S. airports is derived from the length of the largest aircraft serving the airport similar to the Annex's procedure, except that maximum fuselage width is not used.  U.S. indices A-E are close equivalents of the Annex's categories 5-9. The U.S. does not have an equivalent to category 10.

**Fire Extinguishing Agents and Equipment**

Index	Aircraft length		Total minimum quantities of extinguishing agents		Minimum trucks	Discharge rate <sup>1</sup>
	More than	Not more than	Dry chemical	Water for protein foam		
A		27 meters	225 kg	0	1	See below
B	27 meters	38 meters	225 kg	5,700 L	1	See below
C	38 meters	48 meters	225 kg	5,700 L	2	See below
D	48 meters	60 meters	225 kg	5,700 L	3	See below
E	60 meters		225 kg	11,400 L	3	See below

<sup>1</sup>Truck size  
1,900 L but less than 7,600  
7,600 L or greater

Discharge rate  
at least 1,900 L per minute but not more than 3,800 L per minute  
at least 2,280 L per minute but not more than 4,560 L per minute

9.2.10	The required firefighting equipment and agents by index are shown in the table above.  The substitution equivalencies between complementary agents and foam meeting performance level A are also used for protein and fluoroprotein foam. Equivalencies for foam meeting performance level B are used only for aqueous film forming foams.
9.2.18*	There is no specific requirement to provide rescue equipment as distinguished from firefighting equipment.
9.2.19*	At least one apparatus must arrive and apply foam within 3 minutes with all other required vehicles arriving within 4 minutes.  Response time is measured from the alarm at the equipment's customary assigned post to the commencement of the application of foam at the mid-point of the farthest runway.
9.2.29*	For ICAO category 6 (U.S. index B), the U.S. allows one vehicle.
9.4.4	At the present time, there is no requirement to perform tests using a continuous friction measuring device with self-wetting features. Some U.S. airports own these devices, while others use less formal methods to monitor build-up of rubber deposits and the deterioration of friction characteristics.
9.4.15	The standard grade for temporary ramps is 15 feet longitudinal per 1 inch of height (0.56 percent slope) maximum, regardless of overlay depth.
9.4.19	There is no U.S. standard for declaring a light unserviceable if it is out of alignment or if its intensity is less than 50 percent of its specified value.

\*Indicates ICAO Recommended Practice



<b>ANNEX 14 - AERODROMES</b>	
<b>VOLUME II - HELIPORTS</b>	
<b>Chapter 1</b>	<b>Definitions</b>
Declared distances	The U.S. does not use declared distances (take-off distance available, rejected take-off distance available, or landing distance available) in designing heliports.
Final approach and take-off area (FATO)	The U.S. "take-off and landing area" is comparable to the ICAO FATO, and the U.S. "FATO" is more comparable to the ICAO TLOF. The U.S. definition for the FATO stops with "the take-off manoeuvre is commenced." This difference in definition reflects a variation in concept. The rejected take-off distance is an operational computation and is not required as part of the design.
Helicopter stand	The U.S. does not use the term "helicopter stand." Instead, the U.S. considers paved or unpaved aprons, helipads, and helidecks, all as helicopter parking areas; i.e., helicopter stands.
Safety area	The U.S. considers the safety area to be part of the take-off and landing area which surrounds the FATO and does not call for or define a separate safety area.
Touchdown and lift-off area (TLOF)	The U.S. differs in the definition by considering helipads and helidecks to be FATO. The U.S. does not define the load bearing area on which the helicopter may touch down or lift-off as a TLOF.
<b>Chapter 2</b>	<b>Heliport Data</b>
2.1 d)	The U.S. does not measure or report a safety area as a separate feature of a heliport.
2.2	The U.S. does not "declare" distances for heliports.
<b>Chapter 3</b>	<b>Physical Characteristics</b>
3.1.2	The U.S. does not distinguish between single-engine and multi-engine helicopters for the purposes of heliport design standards. Neither does the U.S. design or classify heliports on the basis of helicopter performance. The U.S. FATO dimensions are at least equal to the rotor diameter of the design single rotor helicopter and the area must be capable of providing ground effect. The U.S. does not have alternative design standards for water FATOs, elevated heliports, or helidecks.
3.1.3	The U.S. has a single gradient standard; i.e., 5 percent, except in fueling areas where the limit is 2 percent, which is applicable for all portions of heliports.
3.1.6 3.1.7* 3.1.8*	The U.S. does not require or provide criteria for clearways in its design standards. It does encourage ownership and clearing of the land underlying the innermost portion of the approach out to where the approach surface is 10.5 meters above the level of the take-off surface.
3.1.14 to 3.1.21	Safety areas are considered part of the take-off and landing area (or primary surface) in U.S. heliport design. The take-off and landing area of the U.S. design criteria, based on 2 rotor diameters, provides for the ICAO safety area; however, the surface does not have to be continuous with the FATO or be load bearing.
3.1.22	Taxiway widths are twice the undercarriage width of the design helicopter.
3.1.23	The U.S. requires 1.25 rotor diameters plus 2 meters of separation between helicopter ground taxiways.
3.1.24	The U.S. gradient standard for taxiways is a maximum of 5 percent.
3.1.32*	The U.S. sets no gradient standards for air taxiways.
3.1.33	The U.S. requires 1.5 rotor diameters of separation between hover or air taxiways.
3.1.34	The U.S. standards for air taxiways and air transit routes are combined as the standards for hover taxiways noted in paragraphs 3.1.23, 3.1.24 and 3.1.33.
3.1.35	The U.S. sets no maximum turning angle or minimum radius of turn on hover taxiways.
3.1.36	The U.S. gradient standard for aprons is a maximum of 5 percent except in fueling areas where it is 2 percent.
3.1.37	The U.S. criterion for object clearances is 1/3 rotor diameter or 3 meters, whichever is greater.
3.1.38	The U.S. standard for helipads (comparable to helicopter stands) is 1.5 times the undercarriage length or width, whichever is greater.
3.1.39	The U.S. standard for separation between FATO center and the centerline of the runway is 120 meters.
3.2.2	The U.S. does not apply either a performance related or an alternative design standard for elevated heliport facilities.

3.2.5 to 3.2.10	The U.S. does not use safety areas in its heliport design.
3.3 3.4	In the U.S., shipboard and relocatable off-shore helicopter “helideck” facilities are under the purview of the U.S. Coast Guard and utilize the International Maritime Organization (IMO) code. Fixed off-shore helideck facilities are under the purview of the Department of Interior based on their document 351DM2. Coastal water helideck facilities are under the purview of the individual affected States.
<b>Chapter 4</b>	<b>Obstacle Restriction and Removal</b>
4.1.1	The U.S. approach surface starts at the edge of the take-off and landing area.
4.1.2 a)	The U.S. approach surface width adjacent to the heliport take-off and landing area is a minimum of 2 rotor diameters.
4.1.2 b) 2)	The U.S. precision instrument approach surface flares from a width of 2 rotor diameters to a width of 1,800 meters at the 7,500 meters outer end. The U.S. does not use a note similar to the one that follows 4.1.4, as it does not differentiate between helicopter requirements on the basis of operational performance.
4.1.5	The outer limit of the U.S. transitional surfaces adjacent to the take-off and landing area is 76 meters from the centerline of the VFR approach/departure surfaces. The transitional surface width decreases to zero at a point 1,220 meters from the take-off and landing area. It does not terminate at an inner horizontal surface or at a predetermined height.
4.1.6	The U.S. transitional surfaces have a fixed width, 76 meters less the width of the take-off and landing area, from the approach centerline for visual operations and an outwardly flaring width to 450 meters for precision instrument operations. The U.S. does not use an inner horizontal surface nor terminate the transitional surfaces at a fixed/predetermined height.
4.1.7 b)	Since the U.S. includes the safety area in the take-off and landing area, the comparable elevation is at the elevation of the FATO.
4.1.9 through 4.1.20	The U.S. does not use the inner horizontal surface, the conical surface, or take-off climb surface described in these paragraphs or the note following paragraph 4.1.20 for heliport design.
4.1.21 through 4.1.25	The U.S. does not have alternative criteria for floating or fixed-in-place helidecks.
4.2	The U.S. has no requirement for a note similar to the one following the heading “Obstacle limitation requirements.”
4.2.1	The U.S. criteria does not require a take-off climb surface or a conical obstacle limitation surface to establish a precision instrument approach procedure.
4.2.2	The U.S. criteria does not require a take-off climb surface or a conical obstacle limitation surface to establish a non-precision instrument approach procedure.
4.2.3	The U.S. criteria does not require a take-off climb obstacle limitation surface to establish a non-instrument approach procedure.
4.2.4*	The U.S. has no requirement for protective surfaces such as an inner horizontal surface or a conical surface.
4.2.5	The U.S. does not have tables for heliport design comparable to the ICAO Tables 4-1 to 4-4.
4.2.6	The U.S. subscribes to the intent of this paragraph to limit object heights in the heliport protective surfaces but uses fewer surfaces with different dimensions for those surfaces.
4.2.7*	The U.S. subscribes to the intent of this paragraph but uses different dimensional surfaces.
4.2.8	The U.S. criterion requires that a heliport have at least one approach and departure route and encourages multiple approaches separated by arcs of 90 to 180 degrees.
4.2.9*	The U.S. has no requirement that a heliport’s approach surfaces provide 95 percent usability.
4.2.10	Since the U.S. does not differentiate between surface level and elevated heliports, the comments to paragraphs 4.2.1 through 4.2.5 above apply.
4.2.11	The U.S. has no requirement for a take-off climb surface. It does require at least one approach/departure surface and encourages that there be as many approaches as is practical separated by arcs of 90 to 180 degrees.
4.2.12 through 4.2.22	Since the U.S. does not have alternative design criteria for helidecks or shipboard heliports, there are no comparable U.S. protective surface requirements.

Tables 4-1, 4-2, 4-3, 4-4	The U.S. does not have tables comparable to the ICAO Tables 4-1 to 4-4.
<b>Chapter 5</b>	<b>Visual Aids</b>
5.2.1	The U.S. does not have criteria for markings to be used in defining winching areas.
5.2.3.3	The U.S. maximum mass markings are specified in 1,000 pound units rather than tonnes or kilograms.
5.2.4.3	The U.S. criterion requires FATO markers but is not specific on the number or spacing between markers.
5.2.4.4	The U.S. criteria for FATO markers is not dimensionally specific.
5.2.6	The U.S. does not require, or have criteria for, marking an aiming point.
5.2.7.1	The U.S. does not require specific criteria for marking floating or off-shore fixed-in-place helicopter or helideck facilities.
5.2.8	The U.S. does not require marking the touchdown area.
5.2.9	The U.S. does not have criteria for heliport name markings.
5.2.10	The U.S. does not have a requirement to mark helideck obstacle-free sectors.
5.2.12.2	The U.S. criterion places the air taxiway markers along the edges of the routes rather than on the centerline.
5.2.12.3	The U.S. criterion for air taxiway markers does not specify the viewing area or height to width ratio.
5.3.2.3	The U.S. heliport beacon flashes white-green-yellow colors rather than a series of timed flashes.
5.3.2.5*	The U.S. criteria is not specific on the light intensity of the flash.
5.3.3.3	The U.S. criterion specifies a 300 meters approach light system configuration. The light bars are spaced at 30 meters intervals. The first two bars of the configuration are single lights, the next two bars are two lights, then two bars with three lights, then two bars with four lights, and finally two bars with five lights.
5.3.3.4	The U.S. approach light system uses aimed PAR-56 lights.
5.3.3.6	The U.S. heliport approach light system does not contain flashing lights.
5.3.5.2 a)	The U.S. requires an odd number of lights, but not less than three lights per side.
5.3.5.2 b)	The U.S. requires a minimum of eight lights for a circular FATO and does not specify the distance between lights.
5.3.5.4*	The U.S. criteria does not specify light distribution.
5.3.6	The U.S. does not have specific criteria for aiming point lights.
5.3.8	The U.S. does not have standards for winching area lighting.
<b>Chapter 6</b>	<b>Heliport Services</b>
6.1*	The U.S. requirements for rescue and fire fighting services at certificated heliports are found in 14 CFR Part 139. Criteria for other heliports are established by the National Fire Protection Association (NFPA) pamphlets 403 or 418, or in regulations of local fire departments.
*Indicates ICAO Recommended Practice	





<b>ANNEX 15 - AERONAUTICAL INFORMATION SERVICES</b>	
<b>Chapter 2</b>	<b>Definitions</b>
Danger area	“Danger area” is not used in reference to areas within the U.S. or in any of its possessions or territories.
Integrated Aeronautical Information Package	The U.S. does not produce the entire information package.
Maneuvering area	This term is not used by the U.S.
Movement area	The runways, taxiways, and other areas of an airport/heliport which are utilized for taxiing/hover-taxiing, air-taxiing, takeoff, and landing of aircraft, exclusive of loading ramps and parking areas. At those airports/heliports with a tower, specific approval for entry onto the movement area must be obtained from ATC.
Prohibited area Restricted area	The terms “prohibited area” and “restricted area” will be employed substantially in accordance with the definitions established. Additionally, the following terms will be used: Alert area. Airspace which may contain a high volume of pilot training activities or an unusual type of aerial activity, neither of which is hazardous to aircraft. Alert areas are depicted on aeronautical charts for the information of nonparticipating pilots. All activities within an alert area are conducted in accordance with Federal Aviation Regulations, and pilots of participating aircraft as well as pilots transiting the area are equally responsible for collision avoidance. Controlled firing area. Airspace wherein activities are conducted under conditions so controlled as to eliminate hazards to nonparticipating aircraft and to ensure the safety of persons and property on the ground. Warning area. Airspace which may contain hazards to nonparticipating aircraft in international airspace. Military operations area (MOA). An airspace assignment of defined vertical and lateral dimensions established outside Class A airspace to separate/segregate certain military activities from IFR traffic and to identify for VFR traffic where these activities are conducted.
<b>Chapter 4</b>	<b>Aeronautical Information Publications (AIP)</b>
4.2.8 4.3.4	The U.S. does not publish an aeronautical information regulation and control (AIRAC).
4.4 4.5	The U.S. does not issue AIP supplements. Corrections or changes from the latest amendments to the AIP are carried as NOTAMs.
<b>Chapter 5</b>	<b>NOTAM</b>
5.1.1.2	The U.S. does not routinely issue “trigger NOTAMs” referencing published material when an AIP amendment is issued.
5.2.1	The current U.S. system numbers international NOTAMs consecutively by the location in the A field. The U.S. routinely issues over 70,000 outgoing international NOTAMs each year. Only series A is used for international distribution. This precludes numbering the NOTAMs by the originator.
5.2.3	The U.S. periodically issues multipart NOTAMs which are transmitted as multiple telecommunication messages. The nature of the NOTAM material is such that it will not always fit in one message.
5.2.8.1	The monthly checklist of NOTAMs does not specifically reference printed publications, such as AIP amendments.
5.2.8.3	A monthly printed plain language summary of NOTAMs in force is not issued. The International NOTAM publication, issued biweekly, is not inclusive of all U.S. international NOTAMs.
5.3.2	The U.S. does not use the System NOTAM format at this time. The format used is based on the previous ICAO Class I format. See notes on Appendix 6 for details.
<b>Chapter 6</b>	<b>Aeronautical Information Regulation and Control (AIRAC)</b>
	See 4.2.8.
<b>Chapter 8</b>	<b>Pre-Flight and Post-Flight Information</b>
8.1.2.1 f)	NOTAMs relating to bird hazards are relayed as local NOTAM information and are not disseminated internationally. The information is available from the local flight service station during preflight briefing.

<b>Appendix 1</b>	<b>Contents of Aeronautical Information Publication (AIP)</b>
GEN 2.7	The U.S. does not publish sunrise/sunset tables in the AIP.
GEN 3.1.3 4)	The U.S. does not publish pre-flight information bulletins (PIBs).
<b>Appendix 2</b>	<b>SNOWTAM Format</b>
	The U.S. does not use the SNOWTAM for issuance of winter weather information. Snow conditions are reported using our current international NOTAM format (Class I).
<b>Appendix 3</b>	<b>ASHTAM Format</b>
1.3	ASHTAM information will continue to be distributed as an International NOTAM.
2.1	The heading will not be entered as stated.
3	ASHTAM information will be distributed in U.S. International NOTAM format.
<b>Appendix 6</b>	<b>NOTAM Format</b>
	The U.S. is not prepared to transition to the System NOTAM format. NOTAMs are processed in the previous ICAO Class I format.
1.2 General	Multiple conditions, for a single location, may be reported in a NOTAM.
2 NOTAM numbering	The U.S. numbers NOTAMs consecutively by location, not by country of origin. Due to the volume of international NOTAMs generated by the U.S., the current U.S. numbering scheme is expected to continue.
3 Qualifiers	The current software will not accept the Item Q) qualifiers line.
5 Item B)	Item B) is currently issued as an eight digit date-time group.  The U.S. also uses the initials "WIE" (with immediate effect) for NOTAMs that take effect immediately upon issuance.  The U.S. does not include an Item B) in NOTAMCs. The assumption is that all cancellations take effect immediately when issued. While this date-time group could be added to NOTAMCs, the U.S. position is that it is unnecessary.
6 Item C)	Item C), like item B), is currently issued as an eight digit date-time group.  The U.S. also uses the initials "UFN" (until further notice) for NOTAMs that have an uncertain duration.
8 Item E)	U.S. NOTAMs do not contain Item E) information for NOTAMCs.  Remark: Item E) contains the NOTAM Code (Q-code) in addition to plain language and ICAO abbreviations.



<b>ANNEX 16 - ENVIRONMENTAL PROTECTION</b>	
<b>VOLUME I - AIRCRAFT NOISE</b>	
Reference: Part 36 of Title 14 of the United States Code of Federal Regulations	
<b>Chapter 1</b>	
1.7	Each person who applies for a type certificate for an airplane covered by 14 CFR Part 36, irrespective of the date of application for the type certificate, must show compliance with Part 36.
<b>Chapter 2</b>	
2.1.1	For type design change applications made after 14 August 1989, if an airplane is a Stage 3 airplane prior to a change in type design, it must remain a Stage 3 airplane after the change in type design regardless of whether Stage 3 compliance was required before the change in type design.
2.3.1 a)	Sideline noise is measured along a line 450 meters from and parallel to the extended runway centerline for two- and three-engine aircraft; for four-engine aircraft, the sideline distance is 0.35 NM.
2.4.2	Noise level limits for Stage 2 derivative aircraft depend upon whether the engine by-pass ratio is less than two. If it is, the Stage 2 limits apply. Otherwise, the limits are the Stage 3 limits plus 3 dB or the Stage 2 value, whichever is lower.
2.4.2.2 b)	Take-off noise limits for three-engine, Stage 2 derivative airplanes with a by-pass ratio equal to or greater than 2 are 107 EPNdB for maximum weights of 385,000 kg (850,000 lb) or more, reduced by 4 dB per halving of the weight down to 92 EPNdB for maximum weights of 28,700 kg (63,177 lb) or less. Aircraft with a by-pass ratio less than 2 only need meet the Stage 2 limits.
2.5.1	Trade-off sum of excesses not greater than 3 EPNdB and no excess greater than 2 EPNdB.
2.6.1.1	For airplanes that do not have turbo-jet engines with a by-pass ratio of 2 or more, the following apply: a) four-engine airplanes - 214 meters (700 feet); b) all other airplanes - 305 meters (1,000 feet). For all airplanes that have turbo-jet engines with a by-pass ratio of 2 or more, the following apply: a) four-engine airplanes - 210 meters (689 feet); b) three-engine airplanes - 260 meters (853 feet); c) airplanes with fewer than three engines - 305 meters (1,000 feet). The power may not be reduced below that which will provide level flight for an engine inoperative or that will maintain a climb gradient of at least 4 percent, whichever is greater.
<b>Chapter 3</b>	
3.1.1	For type design change applications made after 14 August 1989, if an airplane is a Stage 3 airplane prior to a change in type design, it must remain a Stage 3 airplane after the change in type design regardless of whether Stage 3 compliance was required before the change in type design.
3.3.1 a) 2)	The U.S. has no equivalent provision in 14 CFR Part 36.
3.3.2.2	A minimum of two microphones symmetrically positioned about the test flight track must be used to define the maximum sideline noise. This maximum noise may be assumed to occur where the aircraft reaches 305 meters (1,000 feet). 14 CFR Part 36 does not require symmetrical measurements to be made at each and every point for propeller-driven airplane sideline noise determination.
3.6.2.1 c)	Under 14 CFR Part 36, during each test take-off, simultaneous measurements should be made at the sideline noise measuring stations on each side of the runway and also at the take-off noise measuring station. If test site conditions make it impractical to simultaneously measure take-off and sideline noise, and if each of the other sideline measurement requirements is met, independent measurements may be made of the sideline noise under simulated flight path techniques. If the reference flight path includes a power cutback before the maximum possible sideline noise level is developed, the reduced sideline noise level, which is the maximum value developed by the simulated flight path technique, must be the certificated sideline noise value.
3.6.2.1 d)	14 CFR Part 36 specifies the day speeds and the acoustic reference speed to be the minimum approved value of $V_2 + 10$ kt, or the all-engines operating speed at 35 feet (for turbine-engine powered airplanes) or 50 feet (for reciprocating-engine powered airplanes), whichever speed is greater as determined under the regulations constituting the type certification basis of the airplane. The test must be conducted at the test day speeds $\pm 3$ kt.

3.7.4	<p>If a take-off test series is conducted at weights other than the maximum take-off weight for which noise certification is requested:</p> <ul style="list-style-type: none"> <li>a) at least one take-off test must be at or above that maximum weight;</li> <li>b) each take-off test weight must be within +5 or -10 percent of the maximum weight.</li> </ul> <p>If an approach test series is conducted at weights other than the maximum landing weight for which certification is requested:</p> <ul style="list-style-type: none"> <li>a) at least one approach test must be conducted at or above that maximum weight;</li> <li>b) each test weight must exceed 90 percent of the maximum landing weight.</li> </ul> <p>Total EPNL adjustment for variations in approach flight path from the reference flight path and for any difference between test engine thrust or power and reference engine thrust or power must not exceed 2 EPNdB.</p>
<b>Chapter 5</b>	
5.1.1	Applies to all large transport category aircraft (as they do to all subsonic turbo-jet aircraft regardless of category). Commuter category aircraft, propeller-driven airplanes below 8,640 kg (19,000 lb) are subject to 14 CFR Part 36, Appendix F or to Appendix G, depending upon the date of completion of the noise certification tests.
<b>Chapter 6</b>	
6.1.1	Applies to new, all propeller-driven airplane types below 19,000 lb (8,640 kg.) in the normal, commuter, utility, acrobatic, transport, or restricted categories for which the noise certification tests are completed before 22 December 1988.
<b>Chapter 8</b>	
General	<p>14 CFR Part 36 (Section 36.1 (h)) defines Stage 1 and Stage 2 noise levels and Stage 1 and Stage 2 helicopters. These definitions parallel those used in 14 CFR Part 36 for turbo-jets and are used primarily to simplify the acoustical change provisions in Section 36.11.</p> <p>14 CFR Part 36 (Section 36.805(c)) provides for certain derived versions of helicopters for which there are no civil prototypes to be certificated above the noise level limits.</p>
8.1.1 a)	Applicable to new helicopter types for which application for an original type certificate was made on or after 6 March 1988.
8.1.1 b)	Applicable only to "acoustical changes" for which application for an amended or supplemental type certificate was made on or after 6 March 1988.
8.4	14 CFR Part 36 Appendix H specifies a slightly different rate of allowable maximum noise levels as a function of helicopter mass. The difference can lead to a difference in the calculated maximum noise limits of 0.1 EPNdB under certain roundoff condition.
8.6.3.1 b)	Does not include the $V_{NE}$ speeds.
8.7	14 CFR Part 36 Appendix H does not permit certain negative corrections. Annex 16 has no equivalent provision.
8.7.4	<p>EPNL correction must be less than 2.0 EPNdB for any combination of lateral deviation, height, approach angle and, in the case of flyover, thrust or power.</p> <p>Corrections to the measured data are required if the tests were conducted below the reference weight.</p> <p>Corrections to the measured data are required if the tests were conducted at other than reference engine power.</p>
8.7.5	The rotor speed must be maintained within one percent of the normal operating RPM during the take-off procedure.
8.7.8	The helicopter shall fly within $\pm 10^\circ$ from the zenith for approach and take-off, but within $\pm 5^\circ$ from the zenith for horizontal flyover.
<b>Chapter 10</b>	
General	Exception from acoustical change rule given for aircraft with flight time prior to 1 January 1955 and land configured aircraft reconfigured with floats or skis.
10.1.1	Applies to new, amended, or supplemental type certificates for propeller-driven airplanes not exceeding 8,640 kg (19,000 lb) for which noise certification tests have not been completed before 22 December 1988.
10.4	The maximum noise level is a constant 73 dBA up to 600 kg (1,320 lb). Above that weight, the limit increases at the rate of 1 dBA/75kg (1 dBA/165 lb) up to 85 dBA at 1,500 kg (3,300 lb) after which it is constant up to and including 8,640 kg (19,000 lb).

10.5.2, second phase, d)	For variable-pitch propellers, the definition of engine power is different in the second segment of the reference path. Maximum continuous installed power instead of maximum power is used.
<b>Chapter 11</b>	
11.1	14 CFR Part 36 Appendix J was effective 11 September 1992 and applies to those helicopters for which application for a type certificate was made on or after 6 March 1986.
11.4	14 CFR Part 36 Appendix J specifies a slightly different rate of allowable maximum noise levels as a function of helicopter mass. The difference can lead to a difference in the calculated maximum noise limits of 0.1 EPNdB under certain roundoff condition.
11.6	14 CFR Part 36 Appendix J prescribes a $\pm 15$ meter limitation on the allowed vertical deviation about the reference flight path. Annex 16 has no equivalent provision.
<b>PART V</b>	
General	No comparable provision exists in U.S. Federal Regulations. Any local airport proprietor may propose noise abatement operating procedures to the FAA which reviews them for safety and appropriateness.
<b>Appendix 1</b>	
General	Sections 3, 8, and 9 of Appendix 1 which contain the technical specifications for equipment, measurement and analysis and data correction for Chapter 2 aircraft and their derivatives differ in many important aspects from the corresponding requirements in Appendix 2 which has been updated several times. 14 CFR Part 36 updates have generally paralleled those of Appendix 2 of Annex 16. These updated requirements are applicable in the U.S. to both Stage 2 and Stage 3 aircraft and their derivatives.
2.2.1	A minimum of two microphones symmetrically positioned about the test flight track must be used to define the maximum sideline noise. This maximum noise may be assumed to occur where the aircraft reaches 305 meters (1,000 feet), except for four-engine, Stage 2 aircraft for which 439 meters (1,440 feet) may be used.
2.2.2	No obstructions in the cone defined by the axis normal to the ground and the half-angle $80^\circ$ from the axis.
2.2.3 c)	Relative humidity and ambient temperature over the sound path between the aircraft and 10 meters above the ground at the noise measuring site is such that the sound attenuation in the 8 kHz one-third octave band is not greater than 12 dB/100 meters and the relative humidity is between 20 and 95 percent. However, if the dew point and dry bulb temperature used for obtaining relative humidity are measured with a device which is accurate to within one-half a degree Celsius, the sound attenuation rate shall not exceed 14 dB/100 meters in the 8 kHz one-third octave band.
2.2.3 d)	Test site average wind not above 12 kt and average cross-wind component not above 7 kt.
2.3.4	The aircraft position along the flight path is related to the recorded noise 10 dB downpoints.
2.3.5	At least one take-off test must be a maximum take-off weight and the test weight must be within +5 or -10 percent of maximum certificated take-off weight.
<b>Appendix 2</b>	
2.2.1	A minimum of two symmetrically placed microphones must be used to define the maximum sideline noise at the point where the aircraft reaches 305 meters.
2.2.2	When a multiple layering calculation is required, the atmosphere between the airplane and the ground shall be divided into layers. These layers are not required to be of equal depth, and the maximum layer depth must be 100 meters.
2.2.2 b)	14 CFR Part 36 specifies that the lower limit of the temperature test window is 36 degrees Fahrenheit (2.2 degrees Celsius). Annex 16 provides 10 degrees Celsius as the lower limit for the temperature test window. 14 CFR Part 36 does not specify that the airport facility used to obtain meteorological condition measurements be within 2,000 meters of the measurement site.
2.2.2 c)	14 CFR Part 36 imposes a limit of 14 dB/100 meters in the 8 kHz one-third octave band when the temperature and dew point are measured with a device which is accurate to within one-half a degree Celsius.

2.2.3	14 CFR Part 36 requires that the limitations on the temperature and relative humidity test window must apply over the whole noise propagation path between a point 10 meters above the ground and the helicopter. Annex 16 specifies that the limitations on the temperature and relative humidity test window apply only at a point 10 meters above the ground.  14 CFR Part 36 requires that corrections for sound attenuation must be based on the average of temperature and relative humidity readings at 10 meters and the helicopter. Annex 16 implies that the corrections for sound absorption are based on the temperature and relative humidity measured at 10 meters only.
3.2.6	No equivalent requirement.
3.4.5	For each detector/integrator the response to a sudden onset or interruption of a constant sinusoidal signal at the respective one-third octave band center frequency must be measured at sampling times 0.5, 1.0, 1.5, and 2.0 seconds after the onset or interruption. The rising responses must be the following amounts before the steady-state level: 0.5 seconds: $4.0 \pm 1.0$ dB 1.0 seconds: $1.75 \pm 0.75$ dB 1.5 seconds: $1.0 \pm 0.5$ dB 2.0 seconds: $0.6 \pm 0.5$ dB
3.4.5 (Note 1)	No equivalent provision in 14 CFR Part 36.
3.5.2	No equivalent requirement.
5.4	14 CFR Part 36 requires that the difference between airspeed and groundspeed shall not exceed 10 kt between the 10 dB down time period.
8.4.2	14 CFR Part 36 specifies a value of -10 in the adjustment for duration correction. Annex 16 specifies a value of -7.5.
9.1.2, 9.1.3	14 CFR Part 36 always requires use of the integrated procedure if the corrected take-off or approach noise level is within 1.0 dB of the applicable noise limit.
<b>Appendix 6</b>	
4.4.1	The microphone performance, not its dimensions, is specified. The microphone must be mounted 1.2 meters (4 feet) above ground level. A windscreen must be employed when the wind speed is in excess of 9 km/h (5 kt).
5.2.2 a)	Reference conditions are different. Noise data outside the applicable range must be corrected to 77 degrees F and 70 percent humidity.
5.2.2 c)	There is no equivalent provision in 14 CFR Part 36. Fixed-pitch propeller-driven airplanes have a special provision. If the propeller is fixed-pitch and the test power is not within 5 percent of reference power, a helical tip Mach number correction is required.
<b>ANNEX 16 - ENVIRONMENTAL PROTECTION</b>	
<b>VOLUME II - AIRCRAFT ENGINE EMISSIONS</b>	
<b>Chapter 1</b>	
	The U.S. currently has regulations prohibiting intentional fuel venting from turbojet, turbofan and turbo-prop aircraft, but we do not now have a regulation preventing the intentional fuel venting from helicopter engines.





**ANNEX 17 - SECURITY - SAFEGUARDING INTERNATIONAL CIVIL AVIATION AGAINST ACTS OF UNLAWFUL INTERFERENCE**

There are no reportable differences between U.S. regulations and the Standards and Recommended Practices contained in this Annex.



**ANNEX 18 - THE SAFE TRANSPORT OF DANGEROUS GOODS BY AIR**

Adopted by the ICAO Council 6/26/81

Effective Date: 1/1/83

Applicability Date: 1/1/84

(Note: Differences are to be filed with ICAO by 6/1/83).



<b>PANS - OPS - 8168/611</b>	
<b>VOLUME 1</b>	
<b>PART IV</b>	
1.2.1	The airspeeds contained in ENR 1.5 shall be used in U.S. <b>CONTROLLED AIRSPACE.</b>



**PAN - ABC - DOC 8400**

Differences between abbreviations used in U.S. AIP, International NOTAMs Class I and Class II, and Notices to Airmen Publication and ICAO PANS - ABC are listed in GEN 2-2. For other U.S. listings of abbreviations (contractions) for general use, air traffic control, and National Weather Service (NWS), which differ in some respects, see U.S. publication Contractions Handbook (DOT/FAA Order 7340.1). In addition, various U.S. publications contain abbreviations of terms used therein, particularly those unique to that publication.





## GEN 2. TABLES AND CODES

### GEN 2.1 Measuring System, Time System and Aircraft Markings

#### 1. Units of Measurement

**1.1** The following table identifies the units of measurement that have been selected for use in messages transmitted by all U.S. aeronautical stations, in the U.S. AIP, NOTAM dissemination, and other publications.

#### 2. Time System

**2.1** Coordinated Universal Time (UTC) is used in the Air Traffic and Communication services provided and in most documents published by the Aeronautical Information Services.

**2.2** When local mean time is used, it will be so indicated as local standard time (LST). See GEN 2.1-2

for a depiction of the standard time zones within the continental U.S.

#### 3. Geodetic Reference Datum

**3.1** All published geographic coordinates indicating latitude and longitude are expressed in terms of the World Geodetic System - 1984 (WGS-84) geodetic reference datum.

#### 4. Nationality and Registration Marks

**4.1** The nationality mark for the aircraft registered in the U.S. is the letter N, followed by a series of numbers or a series of numbers and letters.

For Measurements of:	Units used:
Distance used in navigation, position reporting, etc. - generally in excess of 2 to 3 nautical miles	Nautical miles and tenths
Relatively short distances such as those relating to aerodrome (e.g., runway lengths)	Feet
Altitudes, elevations and heights	Feet
Horizontal speed, including wind speed	Knots
Vertical speed	Feet per minute
Wind direction for landing and taking off	Degrees magnetic
Wind direction except for landing and taking off	Degrees true
Visibility, including runway visual	Statute miles or feet
Altimeter Setting	Inches of mercury
Temperature	Degrees Fahrenheit
Weight	Pounds
Time	Hours and minutes, the day of 24 hours beginning at midnight Coordinated Universal Time

# STANDARD TIME ZONES OF THE CONTINENTAL UNITED STATES

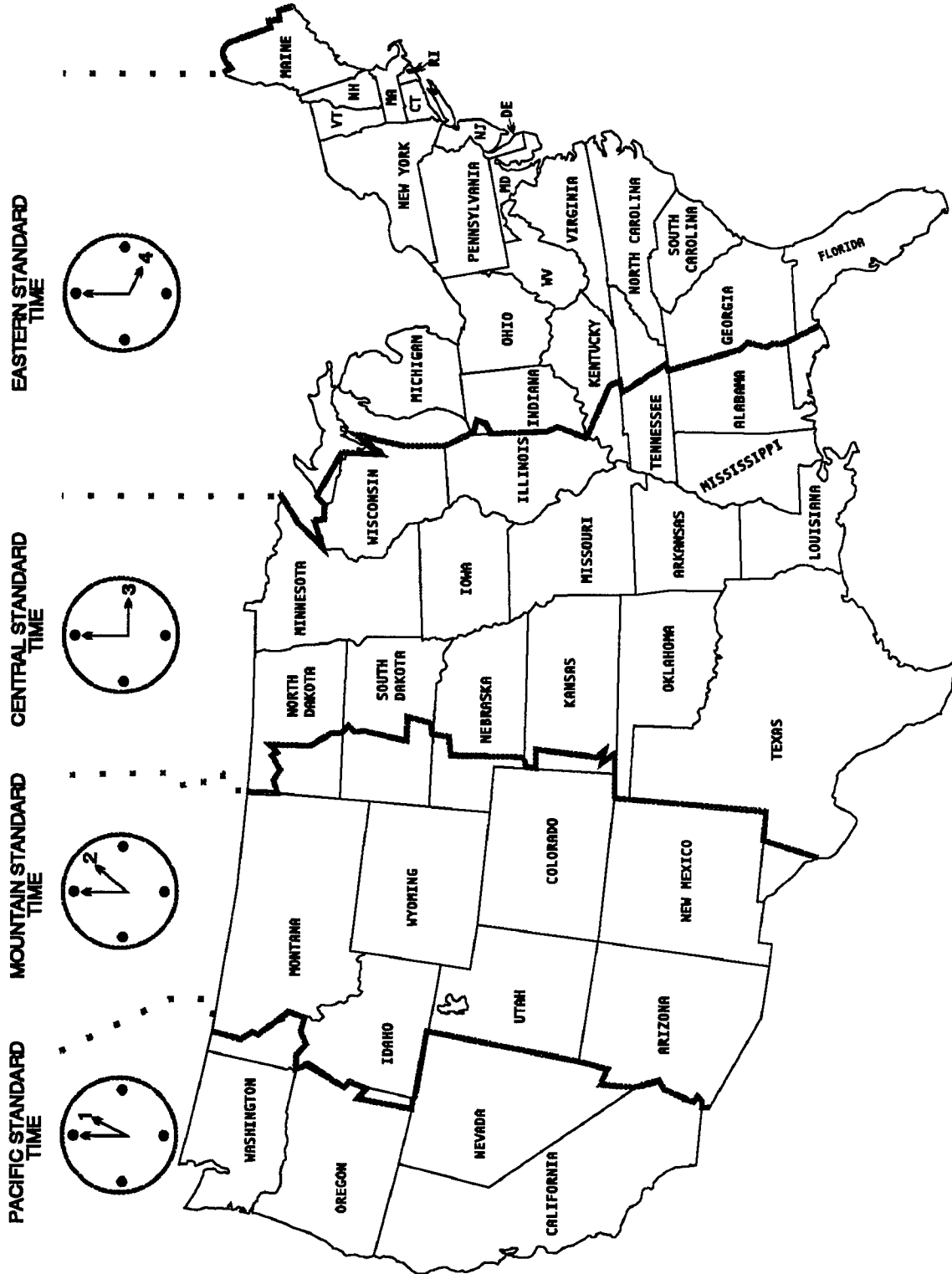

## GEN 2.2 Abbreviations Used In AIS Publications

NOTE - An "s" may be added for plural. ICAO indicates ICAO usage.

A	
/	and
AAS	airport advisory service
A/C	approach control
ICAO:	AAP - approach control; AC - altocumulus
ACFT	aircraft
ACR	air carrier
ADF	automatic direction finder
AER	approach end runway
AFT	after
AGL	above ground level
AIM	Aeronautical Information Manual
ALS	approach light system
ALSF-1	standard 2400' high-intensity approach lighting system with sequenced flashers (Category I configuration)
ALSF-2	standard 2400' high-intensity approach lighting system with sequenced flashers (Category II configuration)
ALSTG	altimeter setting
ALT	altitude
ALTM	altimeter
ALTN	alternate
AMDT	amendment
ICAO:	AMD - amendment
APCH	approach
APCHG	approaching
APRX	approximate
APV	approve or approved or approval
ARPT	airport
ICAO:	AD - aerodrome
ARR	arrive or arrival
ARSR	air route surveillance radar
ARTCC	air route traffic control center
ASDE	airport surface detection equipment
ASPH	asphalt
ASR	airport surveillance radar
ATCT	air traffic control tower
ATIS	automatic terminal information service

AVBL	available
AWY	airway
B	
BC	back course
BCN	beacon
BCST	broadcast
BLDG	building
BRG	bearing
BTN	between
BYD	beyond
C	
CAT	category
ICAO:	CAT - clear air turbulence
CFR	Code of Federal Regulations
CFR	crash fire rescue
CLNC	clearance
ICAO:	CLR - clear/cleared to/clearance
CLSD	close or closed or closing
CMSND	commissioned
CNTR	center
CNTRLN	centerline
ICAO:	cl - centerline
COMLO	compass locator
CONST	construction
CPTY	capacity
CRS	course
CTC	contact
ICAO:	CTR - control zone
D	
ICAO:	D - danger area
ICAO:	D - downward (tendency in RVR during previous 10 minutes)
DALGT	daylight
DCMSND	decommissioned
DDT	runway weight bearing capacity for aircraft with double dual-tandem type landing gear
DEGS	degrees
ICAO:	C - degrees Celsius (Centigrade) F - degrees Fahrenheit
DEP	depart; departure

ICAO:	DEP - depart/departure/departure message
DF	direction finder
ICAO:	DF - I am connecting you to the station you request
DH	decision height
DME	UHF standard (TACAN compatible distance measuring equipment)
ICAO:	DME - distance meaning equipment
DSPLCD	displaced
DSTC	distance
ICAO:	DIST - distance
DT	runway weight bearing capacity for aircraft with dual-tandem type landing gear
DURG	during
ICAO:	DRG - during
DVFR	defense visual flight rule
DW	runway weight bearing capacity for aircraft with dual-wheel type landing gear
<b>E</b>	
E	east
ICAO:	E - east/east longitude
EFAS	en route flight advisory service
ELEV	elevation
EMERG	emergency
EQUIP	equipment
ICAO:	EQPT - equipment
ETA	estimated time of arrival
ETE	estimated time en route
EXCP	except
ICAO:	EXC-except
EXTD	extend or extended
<b>F</b>	
FAF	final approach fix
FAR	Federal Aviation Regulation
FDC	flight data center
FI/P	flight information (permanent)
FI/T	flight information (temporary)
FL	flight level
FM	fan marker
FM	from
ICAO:	FM - from; FM - from (followed by time weather change is forecast to begin)
FREQ	frequency

FRQ	frequent
FSS	flight service station
FT	feet
<b>G</b>	
GOVT	government
GP	glide path
ICAO:	GP - glide path
GS	glide slope
ICAO:	GS - ground speed; GS - small hail and/or snow pellets
GWT	gross weight
<b>H</b>	
HAA	height above airport
HAT	height above touchdown
ICAO:	HGT - height/height above
HIRL	High intensity runway lights
HOL	holiday
HWY	highway
<b>I</b>	
IAF	initial approach fix
IAP	instrument approach procedure
ICAO:	INA - initial approach
IDENT	identification
ICAO:	ID - identifier/identification/identify
IF	intermediate fix
ICAO:	IF - intermediate approach fix
IFR	instrument flight rules
IFSS	international flight service station
ILS	instrument landing system
INFO	information
INOP	inoperative
INT	intersection
INTL	international
INTST	intensity
ISMLS	interim standard microwave landing system
<b>J</b>	
J-bar	jet runway barrier
<b>K</b>	
KHZ	kilohertz
<b>L</b>	
L	left (used only to designate rwys; e.g., rwy 12L)
ICAO:	L - left/runway identification/locator
LAT	latitude

LB	pounds (weight)
LCTD	located
LDA	localizer type directional aid
ICAO:	LDA - landing distance available LLZ - localizer
LDIN	lead-in lighting system
LGTD	lighted
LMM	compass locator at ILS middle marker
LNDG	landing
ICAO:	LDG - landing
LOC	localizer
ICAO:	LOC-localizer or locally or location or located
LOM	compass locator at ILS outer marker
LONG	longitude
LRCO	limited remote communications outlet
<b>M</b>	
MAA	maximum authorized altitude
MAG	magnetic
MAINT	maintain, maintenance
ICAO:	MNTN - maintain; MAINT - maintenance
MALS	medium intensity approach light system
MALSR	medium intensity approach light system with runway alignment indicator lights
MAP	missed approach point
ICAO:	MAP - aeronautical maps and charts
MAX	maximum
MCA	minimum crossing altitude
MDA	minimum descent altitude
MEA	minimum en route IFR altitude
MHZ	megahertz
MIN	minimum or minute
MIRL	medium intensity runway edge lights
MLS	microwave landing system
MM	middle marker ILS
MOCA	minimum obstruction clearance altitude
MRA	minimum reception altitude
MSA	minimum safe altitude
MSL	mean sea level
MUNI	municipal
<b>N</b>	
N	north

NA	not authorized
NATL	national
NAVAID	navigational aid
NDB	nondirectional radio beacon
NM	nautical mile(s)
NOPT	no procedure turn required
NR	number
<b>O</b>	
OBSTN	obstruction
ODALS	omnidirectional approach lighting system
OM	outer marker ILS
OPER	operate
OPN	operation
ICAO:	OPR - operator/operate/operative/operating/ operational
ORIG	original
OTS	out of service
OVRN	overrun
<b>P</b>	
PAR	precision approach radar
PAT	pattern
PCN	pavement classification number
PERMLY	permanently
POB	persons on board
PPR	prior permission required
PROC	procedure
<b>Q</b>	
QUAD	quadrant
<b>R</b>	
R	right (used only to designate rwys; e.g., rwy 19R)
ICAO:	R - received (acknowledgement of receipt)/red/restricted area (followed by identification)/right (runway iden- tification)
RADAR	radio detection and ranging
RAPCON	radar approach control (USAF)
RCAG	remote communications air/ground
RCLS	runway centerline lights system
ICAO:	RCL - runway centerline
RCO	remote communications outlet
RCV	receive
RCVG	receiving

REIL	runway end identifier lights
REQ	request
RNAV	area navigation
RRP	runway reference point
RSTRD	restricted
RTS	returned to service
RVR	runway visual range
RVRM	runway visual range midpoint
RVRR	runway visual range rollout
RVRT	runway visual range touchdown
RVV	runway visibility values
RWY	runway
ICAO:	RWY-runway
<b>S</b>	
S	runway weight bearing capacity for aircraft with single-wheel type landing gear
S	south
ICAO:	S - south/south latitude
SDF	simplified directional facility
SEC	second
SFC	surface
SFL	sequenced flashing lights
SI	straight-in approach
ICAO:	STA - straight-in approach
SM	statute mile(s)
SR	sunrise
SS	sunset
ICAO:	SS - sandstorm
SSALF	simplified short approach lighting system with sequenced flashers
SSALR	simplified short approach lighting system with runway alignment indicator lights
SSALS	simplified short approach lighting system
STOL	short take-off and landing runway
ICAO:	STOL - short takeoff and landing
SVC	service
ICAO:	SVC - service message
<b>T</b>	
T	true (after a bearing)
ICAO:	T - temperature
TAC	terminal area chart
TACAN	UHF navigational facility - omnidirectional course and distance information

ICAO:	TACAN - VHF tactical navigational aid
TAS	true air speed
ICAO:	TMA - TERMINAL CONTROL AREA
TCH	threshold crossing height
TFC	traffic
THR	threshold
THRU	through
ICAO:	THRU - through/I am connecting you to another switchboard
TKOF	take-off
TEMPRLY	temporarily
TMPRY	temporary/temporarily
ICAO:	TEMPO - Temporary/temporarily
TPA	traffic pattern altitude
TRACON	terminal radar approach control
TRML	terminal
TRSA	terminal radar service area
TSNT	transient
TWEB	transcribed weather broadcast
TWR	tower
TWY	taxiway
<b>U</b>	
UAVBL	unavailable
UHF	ultra high frequency
UNLGTD	unlighted
UNMON	unmonitored
UNSKED	unscheduled
UNUSBL	unusable
ICAO:	U/S - unserviceable
<b>V</b>	
VASI	visual approach slope indicator
VCNTY	vicinity
VDP	visual descent point
VFR	visual flight rules
VHF	very high frequency
VOR	VHF omni-directional radio range
VORTAC	Combined VOR and TACAN system (collocated)
VOT	a VOR Receiver testing facility
VSBY	visibility
ICAO:	VIS - visibility
<b>W</b>	
W	west
WEA	weather

ICAO:	WX - weather
WKDAY	weekday
WKEND	weekend
WPT	waypoint
WS	Weather Service
WT	weight
<b>Z</b>	
Z	Coordinated Universal Time
ICAO:	UTC - Coordinated Universal Time





## GEN 2.3 Chart Symbols

Aeronautical chart symbols are published in the Chart Users Guide published by the National Ocean Service. Copies are available at the following address:

NOAA Distribution Branch, N/CG33  
National Ocean Service  
Riverdale, MD 20737-1199.



## **GEN 2.4 Location Indicators**

Location identifiers authorized by the Federal Aviation Administration, Department of the Navy, and Transport Canada and U.S. airspace fixes and procedure codes are

published in FAA Order 7350.6, Location Identifiers. This publication may be purchased as a subscription from the U.S. Government Printing Office.



## **GEN 2.5 List of Radio Navigation Aids**

A listing of navigation aids is not available. See individual aeronautical charts for specific information.



### GEN 2.6 Conversion Tables

ft/M										
ft	0	1	2	3	4	5	6	7	8	9
0	0	0.30	0.61	0.91	1.22	1.52	1.83	2.13	2.44	2.74
10	3.05	3.35	3.66	3.96	4.27	4.57	4.88	5.18	5.49	5.79
20	6.10	6.40	6.71	7.01	7.32	7.62	7.92	8.23	8.53	8.84
30	9.14	9.45	9.75	10.06	10.36	10.67	10.97	11.28	11.58	11.89
40	12.19	12.50	12.80	13.11	13.41	13.72	14.02	14.33	14.73	14.94
50	15.24	15.54	15.85	16.15	16.46	16.76	17.07	17.37	17.68	17.98
60	18.29	18.59	18.90	19.20	19.51	19.81	20.12	20.42	20.73	21.03
70	21.34	21.64	21.95	22.25	22.56	22.86	23.16	23.47	23.77	24.08
80	24.38	24.69	24.99	25.30	25.60	25.91	26.21	26.52	26.82	27.13
90	27.43	27.74	28.04	28.35	28.65	28.96	29.26	29.57	29.87	30.18
	0	10	20	30	40	50	60	70	80	90
100	30.48	33.53	36.58	39.62	42.67	45.72	48.77	51.82	54.86	57.91
200	60.96	64.01	67.06	70.10	73.15	76.20	79.25	82.30	85.34	88.39
300	91.44	94.49	97.54	100.53	103.63	106.68	109.73	112.78	115.82	118.87
400	121.92	124.97	128.02	131.06	134.11	137.16	140.21	143.26	146.30	149.35
500	152.40	155.45	158.50	161.54	164.59	167.64	170.69	173.74	176.78	179.83
600	182.88	185.93	188.98	192.02	195.07	198.12	201.17	204.22	207.26	210.31
700	213.36	216.41	219.46	222.50	225.55	228.60	231.65	234.70	237.74	240.79
800	243.84	246.89	249.94	252.98	256.03	259.09	262.13	265.18	268.22	271.27
900	274.32	277.37	280.42	283.42	286.51	289.56	292.61	295.66	298.70	301.75
	0	100	200	300	400	500	600	700	800	900
1000	304.80	335.28	365.76	396.24	426.72	457.20	487.68	518.16	548.64	579.12
2000	609.60	640.08	670.56	701.04	731.52	762.00	792.48	822.96	853.44	883.92
3000	914.40	944.88	975.36	1005.8	1036.3	1066.8	1097.3	1127.8	1158.2	1188.7
4000	1219.2	1249.7	1280.2	1310.6	1341.6	1371.6	1402.1	1432.6	1463.0	1493.5
5000	1524.0	1554.5	1585.0	1615.4	1645.9	1676.4	1706.9	1737.4	1767.8	1798.3
6000	1828.8	1859.3	1889.8	1920.2	1950.7	1981.2	2011.7	2042.2	2072.6	2103.1
7000	2133.6	2164.1	2194.6	2225.0	2255.5	2286.0	2316.5	2347.0	2377.4	2407.9
8000	2438.4	2468.9	2499.4	2529.8	2560.3	2590.8	2621.3	2651.8	2682.2	2712.7
9000	2743.2	2773.7	2804.2	2834.6	2865.1	2895.6	2926.1	2956.6	2987.0	3017.5
	0	1000	2000	3000	4000	5000	6000	7000	8000	9000
10000	3048.0	3352.8	3657.6	3962.4	4267.2	4572.0	4876.8	5181.6	5486.4	5791.2
20000	6096.0	6400.8	6705.6	7010.4	7315.2	7620.0	7924.8	8229.6	8534.4	8839.2
30000	9144.0	9448.8	9753.6	10058	10363	10668	10937	11278	11582	11887
40000	12192	12497	12802	13106	13411	13716	14021	14326	14630	14935
50000	15240	15545	15850	16154	16459	16764	17069	17374	17678	17983

M/ft										
M	0	1	2	3	4	5	6	7	8	9
0	0	3.28	6.56	9.84	13.12	16.40	19.68	22.97	26.25	29.53
10	32.81	36.09	39.37	42.65	45.93	49.21	52.49	55.77	59.05	62.34
20	65.62	68.90	72.18	75.46	78.74	82.02	85.30	88.58	91.86	95.14
30	98.42	101.70	104.99	108.27	111.55	114.83	118.11	121.39	124.67	127.95
40	131.23	134.51	137.79	141.07	144.36	147.64	150.92	154.20	157.48	160.76
50	164.04	167.32	170.60	173.88	177.16	180.44	183.72	187.01	190.29	193.57
60	196.85	200.13	203.41	206.69	209.97	213.25	216.53	219.81	223.09	226.38
70	229.66	232.94	236.22	239.50	242.78	246.06	249.34	252.62	255.90	259.18
80	262.46	265.74	269.03	272.31	275.59	278.87	282.15	285.43	288.71	291.99
90	295.27	298.55	301.83	305.11	308.40	311.68	314.96	318.24	321.52	324.80
	0	10	20	30	40	50	60	70	80	90
100	328.08	360.89	393.70	426.50	459.31	492.12	524.93	557.74	590.54	623.35
200	656.16	688.97	721.78	754.58	787.39	820.20	853.01	885.82	918.62	951.43
300	984.24	1017.0	1049.9	1082.7	1115.5	1148.3	1181.1	1213.9	1246.7	1279.5
400	1312.3	1345.1	1377.9	1410.7	1443.6	1476.4	1509.2	1542.0	1574.8	1607.6
500	1640.4	1673.2	1706.0	1738.8	1771.6	1804.4	1837.2	1870.1	1902.9	1935.7
600	1968.5	2001.3	2034.1	2066.9	2099.7	2132.5	2165.3	2198.1	2230.9	2263.8
700	2296.6	2329.4	2362.2	2395.0	2427.8	2460.6	2493.4	2526.2	2559.0	2591.8
800	2624.6	2657.4	2690.3	2723.1	2755.9	2788.7	2821.5	2854.3	2887.1	2919.9
900	2952.7	2985.5	3018.3	3051.1	3084.0	3116.8	3149.6	3182.4	3215.2	3248.0
	0	100	200	300	400	500	600	700	800	900
1000	3280.8	3608.0	3937.0	4265.0	4593.1	4921.2	5249.3	5577.4	5905.4	6233.5
2000	6561.6	6889.7	7217.8	7545.8	7873.9	8202.0	8530.1	8858.2	9186.2	9514.3
3000	9842.4	10170	10499	10827	11155	11483	11811	12139	12467	12795
4000	13123	13451	13779	14107	14436	14764	15092	15420	15748	16076
5000	16404	16732	17060	17388	17716	18044	18372	18701	19029	19357
6000	19685	20013	20341	20669	20997	21325	21653	21981	22309	22638
7000	22966	23294	23622	23950	24278	24606	24934	25262	25590	25918
8000	26246	26574	26903	27231	27559	27887	28215	28543	28871	29199
9000	29527	29855	30183	30511	30840	31168	31496	31824	32152	32480



<b>INTERNATIONAL NAUTICAL MILES TO STATUTE MILES</b>										
1 nautical mile = 6,076.10 feet or 1,852 meters 1 statute mile = 5,280 feet or 1,609.35 meters										
NM	0	1	2	3	4	5	6	7	8	9
0	0.000	1.151	2.302	3.452	4.603	5.754	6.905	8.055	9.206	10.357
10	11.508	12.659	13.809	14.960	16.111	17.262	18.412	19.563	20.714	21.865
20	23.016	24.166	25.317	26.468	27.619	28.769	29.920	31.071	32.222	33.373
30	34.523	35.674	36.825	37.976	39.126	40.277	41.428	42.579	43.730	44.880
40	46.031	47.182	48.333	49.483	50.634	51.785	52.936	54.087	55.237	56.388
50	57.539	58.690	59.840	60.991	62.142	63.293	64.444	65.594	66.745	67.896
60	69.047	70.197	71.348	72.499	73.650	74.801	75.951	77.102	78.253	79.404
70	80.554	81.705	82.856	84.007	85.158	86.308	87.459	88.610	89.761	90.911
80	92.062	93.213	94.364	95.515	96.665	97.816	98.967	100.118	101.268	102.419
90	103.570	104.721	105.871	107.022	108.173	109.324	110.475	111.625	112.776	113.927

<b>STATUTE MILES TO INTERNATIONAL NAUTICAL MILES</b>										
SM	0	1	2	3	4	5	6	7	8	9
0	0.000	0.869	1.738	2.607	3.476	4.345	5.214	6.083	6.952	7.821
10	8.690	9.559	10.428	11.297	12.166	13.035	13.904	14.773	15.642	16.511
20	17.380	18.249	19.118	19.986	20.855	21.724	22.593	23.462	24.331	25.200
30	26.069	26.938	27.807	28.676	29.545	30.414	31.283	32.152	33.021	33.890
40	34.759	35.628	36.497	37.366	38.235	39.104	39.973	40.842	41.711	42.580
50	43.449	44.318	45.187	46.056	46.925	47.794	48.663	49.532	50.401	51.270
60	52.139	53.008	53.877	54.746	55.615	56.484	57.353	58.222	59.091	59.959
70	60.828	61.697	62.566	63.435	64.304	65.173	66.042	66.911	67.780	68.649
80	69.518	70.387	71.256	72.125	72.994	73.863	74.732	75.601	76.470	77.339
90	78.208	79.077	79.946	80.815	81.684	82.553	83.422	84.291	85.160	86.029

CONVERSION TABLE - NM/ft										
NM	0	1	2	3	4	5	6	7	8	9
0	0	607	1215	1822	2430	3037	3645	4252	4860	5467
1	6075	6682	7289	7897	8504	9112	9719	10327	10934	11542
2	12149	12757	13364	13971	14579	15186	15794	16401	17009	17616
3	18224	18831	19439	20046	20653	21261	21868	22476	23083	23691
4	24298	24906	25513	26121	26728	27335	27943	28550	29158	29765
5	30373	30980	31588	32195	32803	33410	34017	34625	35232	35840
6	36447	37055	37662	38270	38877	39485	40092	40700	41307	41914
7	42522	43129	43737	44344	44952	45559	46167	46774	47382	47989
8	48596	49204	49811	50419	51026	51634	52241	52849	53456	54064
9	54671	55278	55886	56493	57101	57708	58316	58923	59531	60138

CONVERSION TABLE - ft/NM										
ft	0	1	2	3	4	5	6	7	8	9
0	0	0.016	0.033	0.049	0.066	0.082	0.099	0.115	0.132	0.148
1000	0.165	0.181	0.197	0.214	0.230	0.247	0.263	0.280	0.296	0.313
2000	0.329	0.346	0.362	0.379	0.395	0.411	0.428	0.444	0.461	0.477
3000	0.494	0.510	0.527	0.543	0.560	0.576	0.593	0.609	0.625	0.642
4000	0.658	0.675	0.691	0.708	0.724	0.741	0.757	0.774	0.790	0.806
5000	0.823	0.839	0.856	0.872	0.889	0.905	0.922	0.938	0.955	0.971
6000	0.988	1.004	1.020	1.037	1.053	1.070	1.086	1.103	1.119	1.136
7000	1.152	1.169	1.185	1.202	1.218	1.234	1.251	1.267	1.284	1.300
8000	1.317	1.333	1.350	1.366	1.383	1.399	1.416	1.432	1.448	1.465
9000	1.481	1.498	1.514	1.531	1.547	1.564	1.580	1.597	1.613	1.629
	0	1000	2000	3000	4000	5000	6000	7000	8000	9000
10000	1.646	1.811	1.975	2.140	2.304	2.469	2.634	2.798	2.963	3.127
20000	3.292	3.457	3.621	3.786	3.950	4.115	4.280	4.444	4.609	4.773
30000	4.938	5.103	5.267	5.432	5.596	5.761	5.926	6.090	6.255	6.419
40000	6.584	6.749	6.913	7.078	7.242	7.407	7.572	7.736	7.901	8.065
50000	8.230	8.395	8.559	8.724	8.888	9.053	9.218	9.382	9.547	9.711

MB/INS						°C/°F					
MB	INS	MB	INS	MB	INS	°C	°F	°C	°F	°C	°F
948	27.99	982	29.00	1016	30.00	-60	-76.0	-15	15	30	86.0
949	28.02	983	29.03	1017	30.03	-59	-74.2	-14	6.8	31	87.8
950	28.05	984	29.06	1018	30.06	-58	-72.4	-13	8.6	32	89.6
951	28.08	985	29.09	1019	30.09	-57	-70.6	-12	10.4	33	91.4
952	28.11	986	29.12	1020	30.12	-56	-68.8	-11	12.2	34	93.2
953	28.14	987	29.15	1021	30.15	-55	-67.0	-10	14.0	35	95.0
954	28.17	988	29.18	1022	30.18	-54	-65.2	-9	15.8	36	96.8
955	28.20	989	29.21	1023	30.21	-53	-63.4	-8	17.6	37	98.6
956	28.23	990	29.23	1024	30.24	-52	-61.6	-7	19.4	38	100.4
957	28.26	991	29.26	1025	30.27	-51	-59.8	-6	21.2	39	102.2
958	28.29	992	29.29	1026	30.30	-50	-58.0	-5	23.0	40	104.0
959	28.32	993	29.32	1027	30.33	-49	-56.2	-4	24.8	42	105.8
960	28.35	994	29.35	1028	30.36	-48	-54.4	-3	26.6	42	107.6
961	28.38	995	29.38	1029	30.39	-47	-52.6	-2	28.4	43	109.4
962	28.41	996	29.41	1030	30.42	-46	-50.8	-1	30.2	44	111.2
963	28.44	997	29.44	1031	30.45	-45	-49.0	0	32.0	45	113.0
964	28.47	998	29.47	1032	30.47	-44	-47.2	1	33.8	46	114.8
965	28.50	999	29.50	1033	30.50	-43	-45.4	2	35.6	47	116.6
966	28.53	1000	29.53	1034	30.53	-42	-43.6	3	37.4	48	118.4
967	28.56	1001	29.56	1035	30.56	-41	-41.8	4	39.2	49	120.2
968	28.59	1002	29.59	1036	30.59	-40	-40.0	5	41.0	50	122.0
969	28.61	1003	29.62	1037	30.62	-39	-38.2	6	42.8	51	123.8
970	28.64	1004	29.65	1038	30.65	-38	-36.4	7	44.6	52	125.6
971	28.67	1005	29.68	1039	30.68	-37	-34.6	8	46.4	53	127.4
972	28.70	1006	29.71	1040	30.71	-36	-32.8	9	48.2	54	129.2
973	28.73	1007	29.74	1041	30.74	-35	-31.0	10	50.0	55	131.0
974	28.76	1008	29.77	1042	30.77	-34	-29.2	11	51.8	56	132.8
975	28.79	1009	29.80	1043	30.80	-33	-27.4	12	53.6	57	134.6
976	28.82	1010	29.83	1044	30.83	-32	-25.6	13	55.4	58	136.4
977	28.85	1011	29.86	1045	30.86	-31	-23.8	14	57.2	59	138.2
978	28.88	1012	29.88	1046	30.89	-30	-22.0	15	59.0	60	140.0
979	28.91	1013	29.91	1047	30.92	-29	-20.2	16	60.8	61	141.8
980	28.94	1014	29.94	1048	30.95	-28	-18.4	17	62.6	62	143.6
981	28.97	1015	29.97	1049	30.98	-27	-16.6	18	64.4	63	145.4
				1050	31.01	-26	-14.8	19	66.2	64	147.2
						-24	-11.2	21	69.8	66	150.8
						-23	-9.4	22	71.6	67	152.6
						-22	-7.6	23	73.4	68	154.4
						-21	-5.8	24	75.2	69	156.2
						-20	-4.0	25	77.0	70	158.0
						-19	-2.2	26	78.7		
						-18	-0.4	27	80.6		
						-17	1.4	28	82.4		
						-16	3.2	29	84.2		

litres/imperial gallons						litres/U.S. gallons					
L	IMP	L	IMP	L	IMP	L	U.S.	L	U.S.	L	U.S.
1	.22	41	9.02	81	17.82	1	.26	41	10.83	81	21.40
3	.66	43	9.46	83	18.26	3	.79	43	11.36	83	21.93
4	.88	44	9.68	84	18.48	4	1.06	44	11.63	84	22.19
5	1.10	45	9.90	85	18.70	5	1.32	45	11.89	85	22.46
6	1.32	46	10.12	86	18.92	6	1.59	46	12.15	86	22.72
7	1.54	47	10.34	87	19.14	7	1.85	47	12.42	87	22.99
8	1.76	48	10.56	88	19.36	8	2.11	48	12.68	88	22.35
9	1.98	49	10.78	89	19.58	9	2.38	49	12.95	89	23.51
10	2.20	50	11.00	90	19.80	10	2.64	50	13.21	90	23.78
11	2.42	51	11.22	91	20.02	11	2.91	51	13.47	91	24.04
12	2.64	52	11.44	92	20.24	12	3.17	52	13.74	92	24.31
13	2.86	53	11.66	93	20.46	13	3.44	53	14.00	93	24.57
14	3.08	54	11.88	94	20.68	14	3.70	54	14.27	94	24.84
15	3.30	55	12.10	95	20.90	15	3.96	55	14.53	95	25.10
16	3.52	56	12.32	96	21.12	16	4.23	56	14.80	96	25.36
17	3.74	57	12.54	97	21.34	17	4.49	57	15.06	97	25.63
18	3.86	58	12.76	98	21.56	18	4.76	58	15.32	98	25.89
19	4.18	59	12.98	99	21.78	19	5.02	59	15.59	99	26.16
20	4.40	60	13.20	100	22.00	20	5.28	60	15.85	100	26.42
21	4.62	61	13.42	200	44.00	21	5.55	61	16.12	200	52.84
22	4.84	62	13.64	300	66.00	22	5.81	62	16.38	300	79.26
23	5.06	63	13.86	400	88.00	23	6.08	63	16.65	400	105.68
24	5.28	64	14.08	500	110.00	24	6.34	64	16.91	500	132.10
25	5.50	65	14.30	600	132.00	25	6.61	65	17.17	600	158.52
26	5.72	66	14.52	700	154.00	26	6.87	66	17.44	700	184.94
27	5.94	67	14.74	800	176.00	27	7.13	67	17.70	800	211.36
28	6.16	68	14.96	900	198.00	28	7.40	68	17.97	900	237.78
29	6.38	69	15.18	1000	220.00	29	7.66	69	18.23	1000	264.2
30	6.60	70	15.40	2000	440.00	30	7.93	70	18.49	2000	528.4
31	6.82	71	15.62	3000	660.00	31	8.19	71	18.76	3000	792.6
32	7.04	72	15.84	4000	880.00	32	8.45	72	19.02	4000	1056.8
33	7.26	73	16.06	5000	1100.00	33	8.72	73	19.29	5000	1321.0
34	7.48	74	16.28	6000	1320.00	34	8.98	74	19.55	6000	1585.2
35	7.70	75	16.50	7000	1540.00	35	9.25	75	19.82	7000	1849.4
36	7.92	76	16.72	8000	1760.00	36	9.51	76	20.08	8000	2113.6
37	8.14	77	16.94	9000	1980.00	37	9.78	77	20.34	9000	2377.8
38	8.36	78	17.16	10000	2200.00	38	10.04	78	20.61	10000	2642.0
39	8.58	79	17.38			39	10.30	79	20.87		
40	8.80	80	17.60			40	10.57	80	21.14		

Kg/lb											
kg	lb	kg	lb	kg	lb	kg	lb	kg	lb	kg	lb
1	2.20	28	61.73	52	114.64	76	167.55	100	220.5	16000	35273.6
2	4.41	29	63.93	53	116.84	77	169.75	200	440.9	17000	37478.2
3	6.61	30	6.14	54	119.05	78	171.96	300	661.4	18000	39682.2
4	8.82	31	68.34	55	121.25	79	174.16	400	881.8	19000	41887.4
5	11.02	32	70.55	56	123.46	80	176.37	500	1102.3	20000	44092.0
6	13.23	33	72.75	57	125.66	81	178.57	600	1322.8	21000	46296.6
7	15.43	34	74.96	58	127.87	82	180.78	700	1543.2	22000	48501.2
8	17.64	35	77.16	59	130.07	83	182.98	800	1763.7	23000	50705.8
9	19.84	36	79.37	60	132.28	84	185.19	900	1984.1	24000	52910.4
10	22.05	37	81.57	61	134.48	85	187.39	1000	2204.6	25000	55115.0
11	24.25	38	83.78	62	136.69	86	189.60	2000	4409.2	26000	57319.6
12	26.46	39	85.98	63	138.98	87	191.80	3000	6613.8	27000	59524.2
13	28.66	40	88.18	64	141.09	88	194.01	4000	8818.4	28000	61728.8
14	30.86	41	90.39	65	143.30	89	196.21	5000	11023.0	29000	63933.5
15	33.07	42	92.59	66	145.50	90	198.41	6000	13227.6	30000	66138.0
16	35.27	43	94.80	67	147.71	91	200.62	7000	15432.2	35000	77161.0
17	37.48	44	97.00	68	149.91	92	202.82	8000	17636.8	40000	88184.0
18	39.68	45	99.21	69	152.12	93	205.03	9000	19841.4	45000	99207.0
19	41.89	46	101.41	70	154.32	94	207.23	10000	22046.0	50000	110230.0
20	44.09	47	103.62	71	156.53	95	209.44	11000	24250.6	60000	132276.0
21	46.30	48	105.82	72	158.73	96	211.64	12000	26455.2	70000	154322.0
22	48.50	49	108.03	73	160.94	97	213.85	13000	28659.8	80000	176368.0
23	50.71	50	110.23	74	163.14	98	216.05	14000	30864.4	90000	198414.0
24	52.91	51	112.44	75	165.35	99	218.26	15000	33069.0	100000	220460.0
25	55.12										
26	57.32										
27	59.52										



---

## **GEN 2.7 Sunrise/Sunset Tables**

The U.S. does not publish sunrise/sunset tables.





## GEN 3. SERVICES

### GEN 3.1 Aeronautical Information Services

#### 1. Aeronautical Information Service

**1.1** The United States Aeronautical Information Service is the National Flight Data Center, which forms a part of the Air Traffic Airspace Management of the Federal Aviation Administration.

Postal Address:  
Federal Aviation Administration  
National Flight Data Center (ATA-110)  
800 Independence Avenue, SW.  
Washington, D.C. 20591  
Telephone: 202-267-9311  
Telex: 892-562  
Commercial Telegraphic Address: FAA WASH  
AFTN Address: KRWAYAYX

**1.2** The United States NOTAM office is located at the following address:

Postal Address:  
Federal Aviation Administration  
U.S. NOTAM Office, ATO-282  
Air Traffic Control System Command Center  
13600 EDS Drive  
Herndon, VA 20171-3225  
Telephone: 703-904-4557  
Facsimile: 703-904-4437  
Telex: 892-562  
AFTN Address (Administrative): KDCAVNYX  
AFTN (NOTAM): KDZZNAXX

#### 2. Area of Responsibility of AIS

The National Flight Data Center is responsible for the collection, validation and dissemination of aeronautical information for the United States and areas under its jurisdiction for air traffic control purposes.

#### 3. Aeronautical Publications

##### 3.1 United States AIP

The AIP, issued in one volume, is the basic aeronautical information document published for international use. It contains information of a lasting character, with interim updates published in various other publications. The AIP is available in English only and is maintained on a current basis by a 6-month amendment service.

##### 3.2 NOTAM Publication

NOTAM information is published in booklet form every 28 days, entitled Notices to Airmen. This booklet disseminates aeronautical information of operational significance concerning airspace, procedures and information concerning the status of both international and domestic airports and navigational aids.

##### 3.3 Aeronautical Information Circulars

These circulars, called Advisory Circulars, contain information of general or technical interest relating to administrative or aviation matters which are inappropriate to either the AIP or the NOTAM. Advisory Circulars are available in English only. A checklist of outstanding circulars is issued annually.

##### 3.4 En route Aeronautical Charts, En Route Supplements, Approach Procedure Charts, Regional Airport/Facility Directories

These publications, available in English only, contain specific information on airspace, airports, navigational aids, and flight procedures applicable to the regional areas of the United States and the territories and airspace under its jurisdiction. These publications are available by subscription only.

#### 4. Distribution of Publications

**4.1** The AIP subscriptions, including amendments, are made available to foreign aeronautical authorities on a reciprocal basis through the Federal Aviation Administration, ATA-10, 800 Independence Avenue, SW., Washington, D.C. 20591 upon request. Address corrections and changes in distribution to foreign aeronautical authorities are also accomplished through this office. See information in paragraph 1.2 for published NOTAM's.

**4.2** Private paying subscriptions must be obtained for each separate AIP document from the:

Superintendent of Documents  
U.S. Government Printing Office  
P. O. Box 371954  
Pittsburgh, PA 15250-7954  
Telephone: 202-512-1800  
Internet: [http://www.access.gpo.gov/su\\_docs](http://www.access.gpo.gov/su_docs)

**4.3** Advisory Circulars are available, upon request, from the:

U.S. Department of Transportation  
Subsequent Distribution Office  
Ardmore East Business Center  
3341 Q 75th Avenue  
Landover, MD 20785

**4.4** All domestic chart and chart products as well as Defense Mapping Agency world-wide products are available upon subscription from the:

NOAA Distribution Branch, N/CG33  
National Ocean Service  
Riverdale, Maryland 20737-1199  
Telephone: 800-638-8972

## 5. NOTAM Service

### 5.1 NOTAM Publication (Postal Distribution)

NOTAM publication distribution, by means of the Notices to Airmen publication, is in booklet form which contains a recapitulation of pertinent or permanent information of concern to airspace, facilities, services and procedures which are of interest to both international and domestic civil aviation users. The information contained will eventually be published in either the U.S. AIP or in other publications for domestic use, as applicable. The Notices to Airmen publication will also contain information regarding temporary changes or unscheduled interruptions to flight procedures and navigational aids or airport services, the duration of which is expected to last seven or more days. Distribution of the Notices to Airmen publication parallels NOTAM Class I and AIP distribution.

### 5.2 NOTAM Class I (Telecommunication Distribution)

**5.2.1.** NOTAM Class I distribution is used mainly for the notification of temporary information of timely significance such as unforeseen changes in services, facilities, airspace utilization or any other emergency. Distribution is via telecommunications through the International NOTAM Office of the National Flight Data Center, in accordance with the following classifications:

**a) International NOTAM:** NOTAM containing full information on all airports, facilities and flight procedures available for use by international civil aviation. NOTAM's are given selected distribution to adjacent or appropriate International NOTAM Offices which require their exchange.

**b) International Airspace NOTAM:** NOTAM containing short term information pertaining to potentially hazardous international and domestic airspace utilization which is of concern to international flights. NOTAM's are given selected distribution to adjacent or appropriate International NOTAM Offices which require their exchange.

**c) International Airspace NOTAM:** NOTAM containing permanent changes-en route airway structure/ aeronautical service and information of a general nature. NOTAM's are given selected distribution to adjacent or appropriate International NOTAM Offices which require their exchange.

**d) International OMEGA and LORAN Facilities** status of the OMEGA or LORAN Navigational Aid Facilities. NOTAM's are given selected distribution to adjacent or appropriate International NOTAM Offices which require their exchange.

**e) Domestic NOTAM:** NOTAM containing information of concern to aircraft other than those engaged in international civil aviation. Distribution is to local or national users only. (See ENR 1.10)

**5.2.2** Each NOTAM is assigned a four digit serial number which is followed by the location indicator for which the series is applicable. The serial numbers start with number 0001 at 0000 UTC on 1 July of each year. Each serial number is preceded by a letter:

#### 5.2.2.1 A for NOTAM classification "1"

*NOTE.—*  
NOTAM NUMBER ONE FOR THE YEAR 1984 FOR THE NEW YORK, JOHN F. KENNEDY INTERNATIONAL AIRPORT WOULD READ A0001/84 KJFK. ALL NOTAM'S ISSUED WILL BE PRECEDED BY AN "A."

#### 5.2.2.2 B for NOTAM classification "2"

(Airspace): the identifier of the affected air traffic control center/FIR will be used.

*NOTE.—*  
NOTAM NUMBER ONE FOR THE YEAR 1984 FOR THE OAKLAND ARTCC/FIR (PACIFIC OCEAN AREA) WOULD READ A0001/84 KZOA.

**5.2.2.3 C** for NOTAM classification "3" (Permanent Airspace): The KFDC identifier will be used for data of permanent airway/aeronautical services and of a general nature that are transmitted as NOTAM's and are given selected distribution to adjacent or appropriate International NOTAM Offices which require their exchange.

*NOTE.—*  
NOTAM NUMBER ONE FOR THE YEAR 1984 FOR KFDC IS A0001/84 KFDC.

**5.2.2.4 D** for NOTAM classification "4" (OMEGA/LORAN facilities): The KNMH will be used for OMEGA/LORAN information that is transmitted to all

NOTAM Offices that exchange information with the U.S. International NOTAM Office.

**NOTE.**—  
NOTAM number one for the year 1984 concerning the status of OMEGA Station Norway would read A0001/84 KNMH.

**5.2.2.5 E** for NOTAM classification “5” (domestic):  
No application (see ENR 1.10).

**5.3** Each NOTAM is provided with an identification letter adjoining the end of the word NOTAM meaning:

- a) NOTAMN: NOTAM containing new information;
- b) NOTAMC: NOTAM cancelling a previous NOTAM indicated;
- c) NOTAMR: NOTAM replacing a previous NOTAM indicated.

**5.4** A checklist of NOTAM’s currently in force for each international NOTAM classification is issued each month over the Aeronautical Fixed Telecommunications Network (AFTN) to each International NOTAM office which exchanges International NOTAM’s with the U.S. International NOTAM Office.

**5.5** NOTAM Class I information is exchanged between the U.S. International NOTAM Office and the following International NOTAM Offices:

COUNTRY	CITY
AFGHANISTAN	KABUL
ALBANIA	ROME
ALGERIA	ALGIERS
ANGOLA	LUANDA
ARGENTINA	BUENOS AIRES
AUSTRALIA	SIDNEY
AUSTRIA	VIENNA
AZORES	SANTO MARIA
BAHAMAS	NASSAU
BAHRAIN	BAHRAIN
BANGLADESH	DHAKA (DACCA)
BELGIUM	BRUSSELS
BERMUDA	BERMUDA
BOLIVIA	LA PAZ
BOSNIA	ZAGREB
BRAZIL	RIO DE JANEIRO
BULGARIA	SOFIA
CAMBODIA	PHNOM-PEHN
CANADA	OTTAWA
CAPE VERDE ISLANDS	AMILCAR CABRAL
CHILE	SANTIAGO
CHINA	BEIJING
CHINA (FORMOSA)	TAIPEI

COLOMBIA	BOGOTA
CONGO	BRAZZAVILLE
CROATIA	ZAGREB
CUBA	HAVANA
<b>COUNTRY</b>	<b>CITY</b>
CYPRUS	NICOSIA
CZECH REPUBLIC	PRAGUE
DENMARK	COPENHAGEN
DOMINICAN REPUBLIC	SANTO DOMINGO
ECUADOR	GUAYAQUIL
ENGLAND	LONDON
ESTONIA	TALLINN
ETHIOPIA	ADDIS ABABA
EYGPT	CAIRO
FIJI	NANDI
FINLAND	HELSINKI
FRANCE	PARIS
FRENCH GUIANA	MARTINIQUE
FRENCH POLYNESIA	TAHITI
GERMANY (WEST)	FRANKFURT
GHANA	ACCRA
GREECE	ATHENS
GREENLAND	SONDRE STROMFJORD
GUYANA	GEORGETOWN
HAITI	PORT-AU-PRINCE
HONDURAS	TEQUICIGALPA
HONG KONG	HONG KONG
HUNGARY	BUDAPEST
ICELAND	REYKJAVIK
INDIA	BOMBAY
INDIA	CALCUTTA
INDIA	DELHI
INDIA	MADRAS
INDONESIA	JAKARTA
IRAN	TEHRAN (NOT AVBL)
IRELAND	SHANNON
ISRAEL	TEL AVIV
ITALY	ROME
JAMAICA	KINGSTON
JAPAN	TOKYO
JORDAN	AMMAN
KENYA	NAIROBI
KOREA (SOUTH)	SEOUL
KUWAIT	KUWAIT
LATVIA	MOSCOW
LEBANON	BEIRUT
LIBERIA	ROBERTS
LIBYA	TRIPOLI
MALAYSIA	KUALA LUMPUR
MALTA	LUQA
MAURITIUS	PLAISANCE

MAYNMAR	RANGOON
MEXICO	MEXICO CITY
MOROCCO	CASABLANCA
MOZAMBIQUE	MAPUTO
<b>COUNTRY</b>	<b>CITY</b>
NAMIBIA	JOHANNESBURG
NAURU ISLAND	NAURU
NETHERLANDS	AMSTERDAM
NETHERLANDS AN-TILLES	CURACAO
NEW GUINEA	PORT MOSEBY
NEW ZEALAND	AUCKLAND
NIGERIA	LAGOS
NORWAY	OSLO
OMAN	MUSCAT
PAKISTAN	KARACHI
PANAMA	TOCUMEN
PARAGUAY	ASUNCION
PERU	LIMA
PHILLIPINES	MANILLA
POLAND	WARSAW
PORTUGAL	LISBON
ROMANIA	BUCHAREST
RUSSIA	MOSCOW
SAMOA	FALEOLA
SAUDI ARABIA	JEDDAH
SENEGAL	DAKAR
SEYCHELLES	MAHE
SINGAPORE	SINGAPORE
SLOVAKIA	BRATISLAVA
SOLOMON ISLANDS	HONIARA
SOUTH AFRICA	JOHANNESBURG
SPAIN	MADRID
SRI LANKA	COLOMBO
SUDAN	KHARTOUM
SURINAME	PARAMARIBO
SWEDEN	STOCKHOLM
SWITZERLAND	ZURICH
SYRIA	DAMASCUS
TANZANIA	DAR-ES-SALAAM
THAILAND	BANKOK
TRINIDAD	PORT OF SPAIN
TUNISIA	TUNIS
TURKEY	ANKARA
URUGUAY	MONTEVIDEO
VIET NAM	HO CHI MINH CITY

VENEZUELA	CARACAS
YEMEN	ADEN
<b>COUNTRY</b>	<b>CITY</b>
YUGOSLAVIA	BELGRADE
ZAIRE	KINSHASA
ZAMBIA	LUSAKA
ZIMBABWE	HARARE

**6. Pre-Flight Information Service at Aerodromes Available to International Flights**

**6.1** Pre-Flight Information Units in the U.S. are either FAA operated Flight Service Stations (FSS) or National Weather Service operated Weather Service Offices (WS).

**6.2** Flight Service Stations (FSS's) are air traffic facilities which provide pilot briefings, en route communications and VFR search and rescue services, assist lost aircraft and aircraft in emergency situations, relay ATC clearances, originate Notices to Airmen, broadcast aviation weather and National Airspace System (NAS) information, receive and process IFR flight plans, and monitor NAVAID's. In addition, at selected locations FSS's provide En Route Flight Advisory Service (Flight Watch), take weather observations, issue airport advisories, and advise the U.S. Customs and Immigration Services of transborder flights.

**6.3** Supplemental Weather Service Locations (SWSL's) are airport facilities staffed with contract personnel who take weather observations and provide current local weather to pilots via telephone or radio. All other services are provided by the parent FSS.

**6.4** Flight Service Station (FSS) locations, services and telephone information are available in the U.S. Airport/Facility Directory, Supplement Alaska and Pacific Chart Supplement.

**6.5** Flight Service Station, Pre-Flight information service coverage is designed primarily to provide service within a 500-mile area of the Flight Service Station. All Flight Service Stations, nevertheless, do have telecommunications access to all of the weather and NOTAM information available, on an as needed basis, for preflight briefing to international locations with which the U.S. International NOTAM office exchanges information.

## GEN 3.2 Aeronautical Charts

### 1. General

**1.1 Civil aeronautical charts for the U.S. and its territories, and possessions** are produced by the National Ocean Service (NOS), which is a part of the National Oceanic and Atmospheric Administration (NOAA). Aeronautical data is furnished by the FAA.

### 2. Obtaining Aeronautical Charts

**2.1** Most charts and publications described in this Chapter can be obtained by subscription or one-time sales from:

NOAA Distribution Division, N/ACC3  
National Ocean Service  
Riverdale, MD 20737-1199  
Telephone: 1-800-638-8972 (Toll free within U.S.)  
301-436-8301/6990  
301-436-6829 (FAX)

**2.2** Public sales of charts and publications are also available through a network of NOAA/NOS chart agents primarily located at or near major civil airports. A listing of products and agents is printed in the free NOS catalog, *Aeronautical Charts and Related Products*. (NOS Stock No. ACATSET). A free quarterly bulletin, *Dates of Latest Editions, VFR Aeronautical Charts* (NOS Stock No. 5318), is also available from NOS.

### 3. Selected Charts and Products Available

VFR Navigation Charts  
IFR Navigation Charts  
Planning Charts  
Supplementary Charts and Publications  
Digital Products

### 4. General Description of Each Chart Series

#### 4.1 VFR Navigation Charts

**4.1.1 Sectional Aeronautical Charts:** Sectional Charts are designed for visual navigation of slow to medium speed aircraft. The topographic information consists of contour lines, shaded relief, drainage patterns, and an extensive selection of visual checkpoints and landmarks used for flight under VFR. Cultural features include cities and towns, roads, railroads, and other distinct landmarks. The aeronautical information includes visual and radio aids to navigation, airports, controlled airspace, special-use airspace, obstructions, and related

data. Scale 1 inch = 6.86nm/1:500,000. 60 x 20 inches folded to 5 x 10 inches. Revised semiannually, except most Alaskan charts are revised annually.  
(See FIG 3.2-1 and FIG 3.2-11.)

**4.1.2 VFR Terminal Area Charts (TAC):** TAC's depict the airspace designated as Class B airspace. While similar to sectional charts, TAC's have more detail because the scale is larger. The TAC should be used by pilots intending to operate to or from airfields within or near Class B or Class C airspace. Areas with TAC coverage are indicated by a • on the Sectional Chart indexes. Scale 1 inch = 3.43nm/1:250,000. Charts are revised semiannually, except Puerto Rico-Virgin Islands which is revised annually.  
(See FIG 3.2-1 and FIG 3.2-11.)

**4.1.3 World Aeronautical Charts (WAC):** WAC's cover land areas for navigation by moderate speed aircraft operating at high altitudes. Included are city tints, principal roads, railroads, distinctive landmarks, drainage patterns, and relief. Aeronautical information includes visual and radio aids to navigation, airports, airways, special-use airspace, and obstructions. Because of a smaller scale, WAC's do not show as much detail as sectional or TAC's, and therefore are not recommended for exclusive use by pilots of low speed, low altitude aircraft. Scale 1 inch = 13.7nm/1:1,000,000. 60 x 20 inches folded to 5 x 10 inches. WAC's are revised annually, except for a few in Alaska and the Caribbean, which are revised biennially.  
(See FIG 3.2-12 and FIG 3.2-13.)

**4.1.4 U.S. Gulf Coast VFR Aeronautical Chart:** The Gulf Coast Chart is designed primarily for helicopter operation in the Gulf of Mexico area. Information depicted includes offshore mineral leasing areas and blocks, oil drilling platforms, and high density helicopter activity areas. Scale 1 inch = 13.7nm/1:1,000,000. 55 x 27 inches folded to 5 x 10 inches. Revised annually.

**4.1.5 Grand Canyon VFR Aeronautical Chart:** Covers the Grand Canyon National Park area and is designed to promote aviation safety, flight free zones, and facilitate VFR navigation in this popular area. The chart contains aeronautical information for general aviation VFR pilots on one side and commercial VFR air tour operators on the other side.

Sectional and VFR Terminal Area Charts for the Conterminous U.S., Hawaii, Puerto Rico, and Virgin Islands

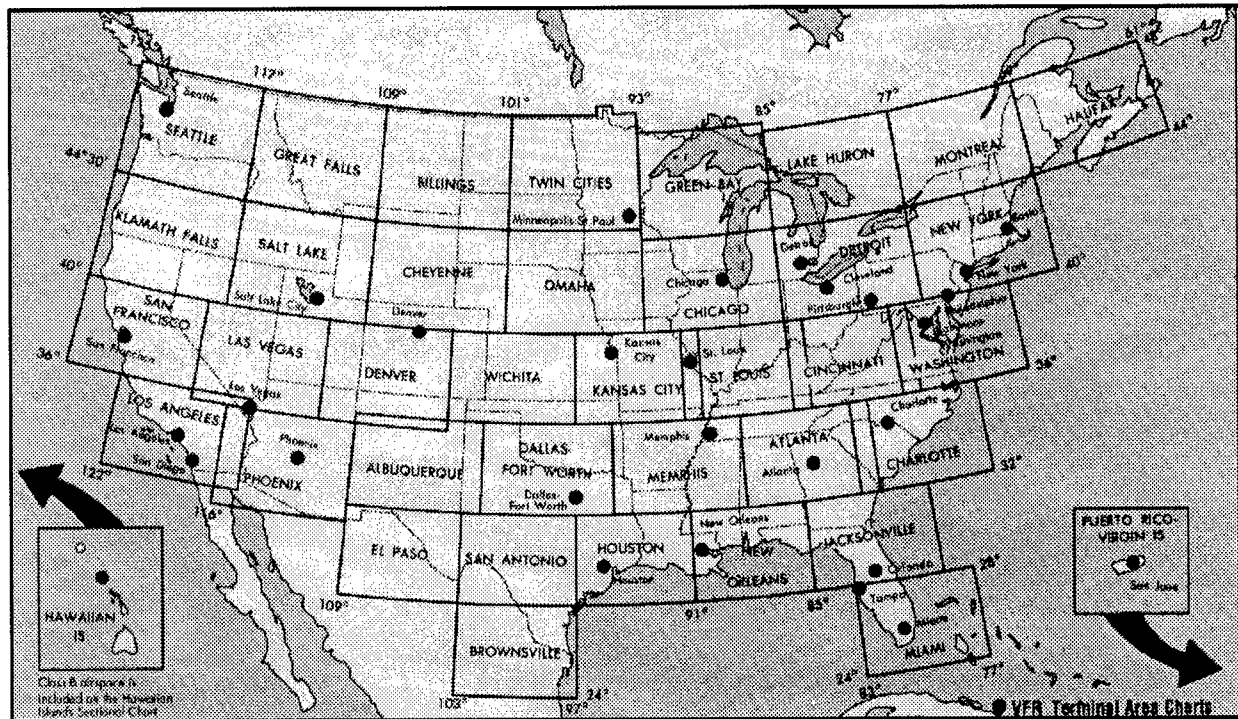

FIG 3.2-1

**4.1.6 Helicopter Route Charts:** A three-color chart series which shows current aeronautical information useful to helicopter pilots navigating in areas with high concentrations of helicopter activity. Information depicted includes helicopter routes, four classes of heliports with associated frequency and lighting capabilities, NAVAID's, and obstructions. In addition, pictorial symbols, roads, and easily identified geographical features are portrayed. Helicopter charts have a longer life span than other chart products and may be current for several years. All new editions of these charts are printed on a durable plastic material. Helicopter Route Charts are updated as requested by the FAA. Scale 1 inch = 1.71nm/1:125,000. 34 x 30 inches folded to 5 x 10 inches.

**4.2 IFR Navigation Charts**

**4.2.1 IFR En Route Low Altitude Charts (Conterminous U.S. and Alaska):** En route low altitude charts provide aeronautical information for navigation under IFR conditions below 18,000 feet MSL. This four-color chart series includes airways; limits of controlled

airspace; VHF NAVAID's with frequency, identification, channel, geographic coordinates; airports with terminal air/ground communications; minimum en route and obstruction clearance altitudes; airway distances; reporting points; special use airspace; and military training routes. Scales vary from 1 inch = 5nm to 1 inch = 20nm. 50 x 20 inches folded to 5 x 10 inches. Charts revised every 56 days. *Area charts* show congested terminal areas at a large scale. They are included with subscriptions to any conterminous U.S. Set Low (Full set, East or West sets). (See FIG 3.2-2 and FIG 3.2-4.)

**4.2.2 IFR En Route High Altitude Charts (Conterminous U.S. and Alaska):** En route high altitude charts are designed for navigation at or above 18,000 feet MSL. This four-color chart series includes the jet route structure; VHF NAVAID's with frequency, identification, channel, geographic coordinates; selected airports; reporting points. Scales vary from 1 inch = 45nm to 1 inch = 18nm. 55 x 20 inches folded to 5 x 10 inches. Revised every 56 days. (See FIG 3.2-3 and FIG 3.2-5.)

**En Route Low Altitude Instrument Charts for the Conterminous U.S. (Includes Area Charts)**

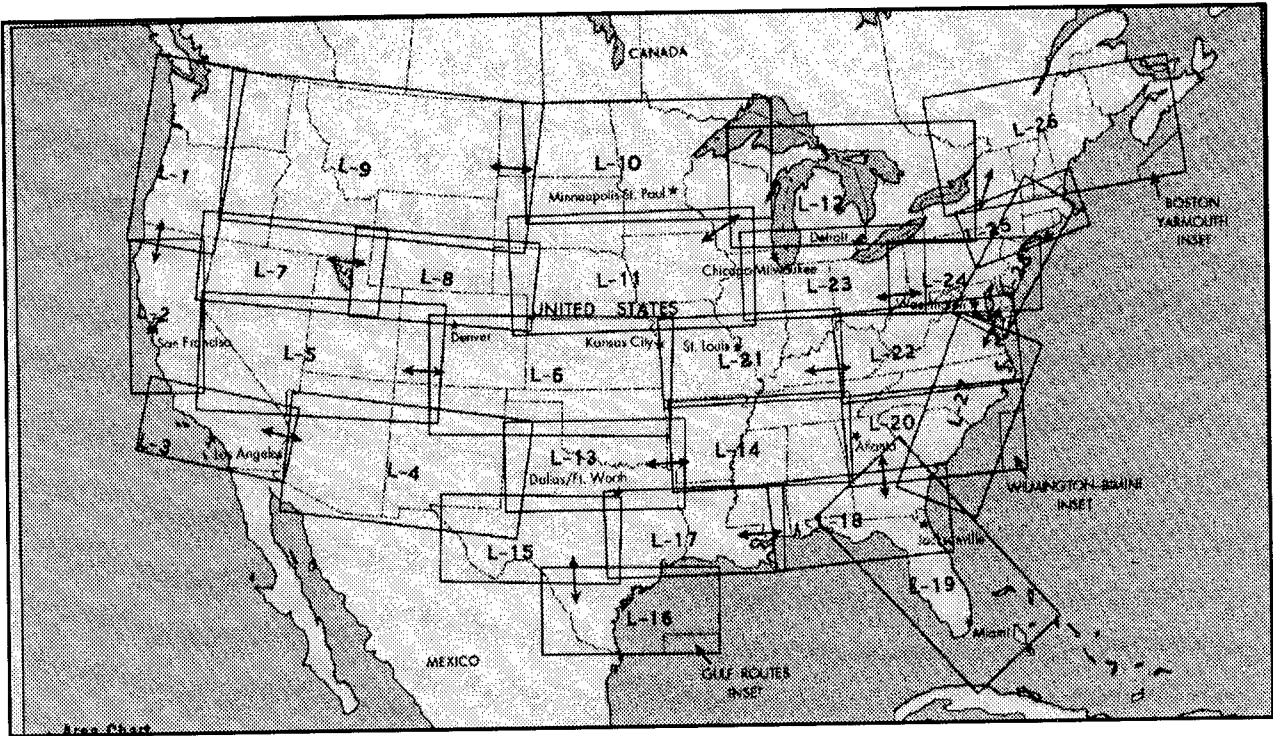

FIG 3.2-2

**En Route High Altitude Charts for the Conterminous U.S.**

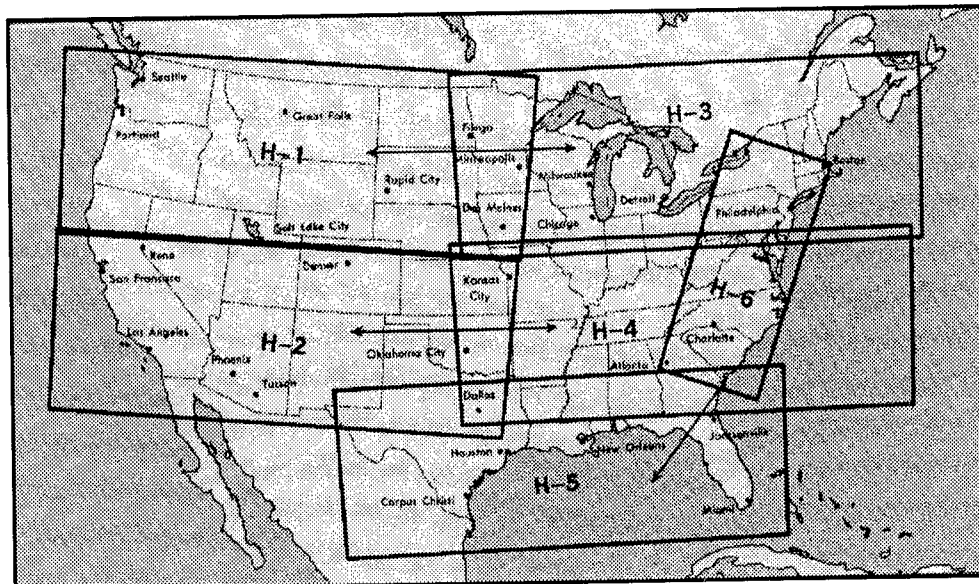

FIG 3.2-3

Alaska En Route Low Altitude Chart

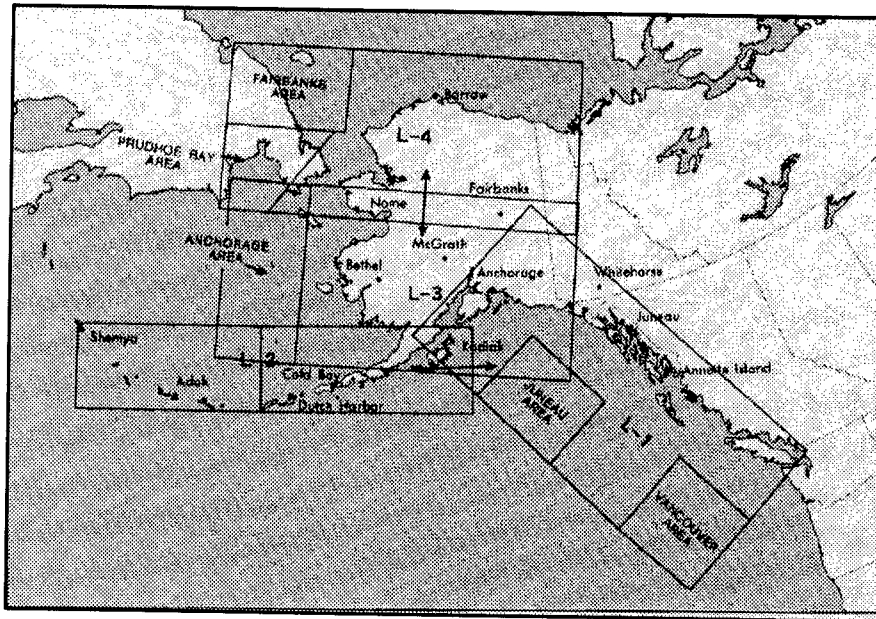

FIG 3.2-4

Alaskan En Route High Altitude Chart

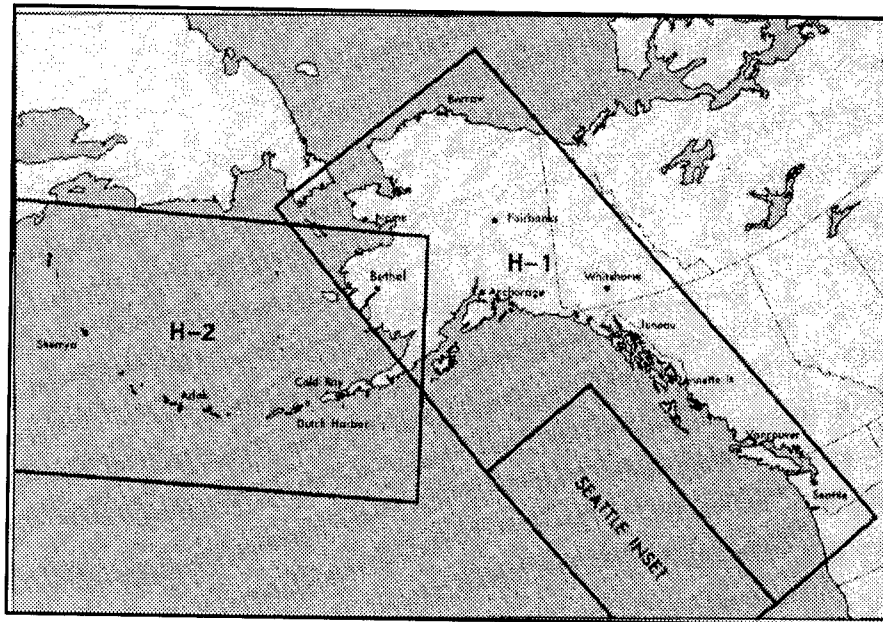

FIG 3.2-5

**4.2.3 U.S. Terminal Procedures Publication (TPP):** TPP's are published in 20 loose-leaf or perfect bound volumes covering the conterminous U.S., Puerto Rico and the Virgin Islands. A Change Notice is published at the midpoint between revisions in bound volume format. (See FIG 3.2-10.) The TPP's include:

**4.2.3.1 Instrument Approach Procedure (IAP) Charts:** IAP charts portray the aeronautical data that is required to execute instrument approaches to airports. Each chart depicts the IAP, all related navigation data, communications information, and an airport sketch. Each procedure is designated for use with a specific electronic navigational aid, such as ILS, VOR, NDB, RNAV, etc.



**4.2.3.2 Instrument Departure Procedure (DP) Charts:** DP charts are designed to expedite clearance delivery and to facilitate transition between takeoff and en route operations. They furnish pilots' departure routing clearance information in graphic and textual form.

**4.2.3.3 Standard Terminal Arrival (STAR) Charts:** STAR charts are designed to expedite ATC arrival procedures and to facilitate transition between en route and instrument approach operations. They depict pre-planned IFR ATC arrival procedures in graphic and textual form. Each STAR procedure is presented as a separate chart and may serve either a single airport or more than one airport in a given geographic area.

**4.2.3.4 Airport Diagrams:** Full page airport diagrams are designed to assist in the movement of ground traffic at locations with complex runway/taxiway configurations and provide information for updating geodetic position navigational systems aboard aircraft.

**4.2.4 Alaska Terminal Procedures Publication:** This publication contains all terminal flight procedures for civil and military aviation in Alaska. Included are IAP charts, DP charts, STAR charts, airport diagrams, radar minimums, and supplementary support data such as IFR alternate minimums, take-off minimums, rate of descent tables, rate of climb tables and inoperative components tables. Volume is 5-3/8 x 8-1/4 inch top bound. Publication revised every 56 days with provisions for a Terminal Change Notice, as required.

### 4.3 Planning Charts

**4.3.1 U.S. IFR/VFR Low Altitude Planning Chart:** This chart is designed for preflight and en route flight planning for IFR/VFR flights. Depiction includes low altitude airways and mileage, NAVAID's, airports, special use airspace, cities, times zones, major drainage, a directory of airports with their airspace classification, and a mileage table showing great circle distances between major airports. Scale 1 inch = 47nm/1:3,400,000. Chart revised annually, and is available either folded or unfolded for wall mounting. (See FIG 3.2-6.)

**4.3.2 Gulf of Mexico and Caribbean Planning Chart:** This is a VFR planning chart on the reverse side of the *Puerto Rico - Virgin Islands VFR Terminal Area Chart*. Information shown includes mileage between airports of entry, a selection of special use airspace and a directory of airports with their available services. Scale 1 inch = 85nm/1:6,192,178. 60 x 20 inches folded

to 5 x 10 inches. The chart is revised annually. (See FIG 3.2-6.)

### Planning Charts

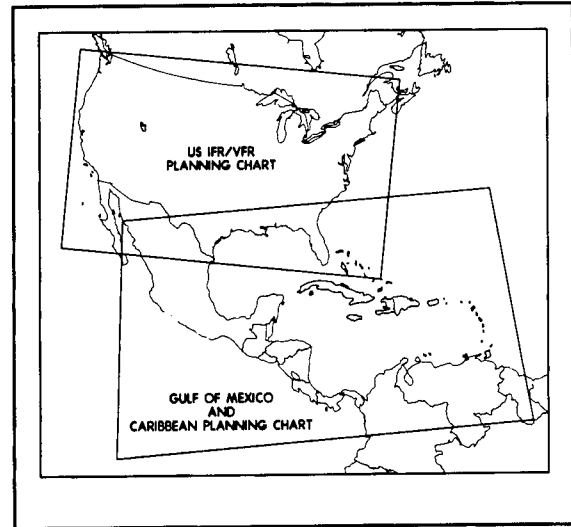

FIG 3.2-6

**4.3.3 Charted VFR Flyway Planning Charts:** This chart is printed on the reverse side of selected TAC charts. The coverage is the same as the associated TAC. Flyway planning charts depict flight paths and altitudes recommended for use to bypass high traffic areas. Ground references are provided as a guide for visual orientation. Flyway planning charts are designed for use in conjunction with TAC's and sectional charts and are not to be used for navigation. Chart scale 1 inch = 3.43nm/1:250,000.

### 4.4 Supplementary Charts and Publications

**4.4.1 Airport/Facility Directory (AFD):** This 7-volume booklet series contains data on airports, seaplane bases, heliports, NAVAID's, communications data, weather data sources, airspace, special notices, and operational procedures. Coverage includes the conterminous United States, Puerto Rico, and the Virgin Islands. The AFD shows data that cannot be readily depicted in graphic form; e.g. airport hours of operations, types of fuel available, runway widths, lighting codes, etc. The chart bulletin section of the AFD also provides a means for pilots to update visual charts between edition dates. (AFD is published every 56 days while sectional and Terminal Area Charts are generally revised every six months). Volumes are side-bound 5-3/8 x 8-1/4 inches. (See FIG 3.2-7.)

Airport/Facility Directory Geographic Areas

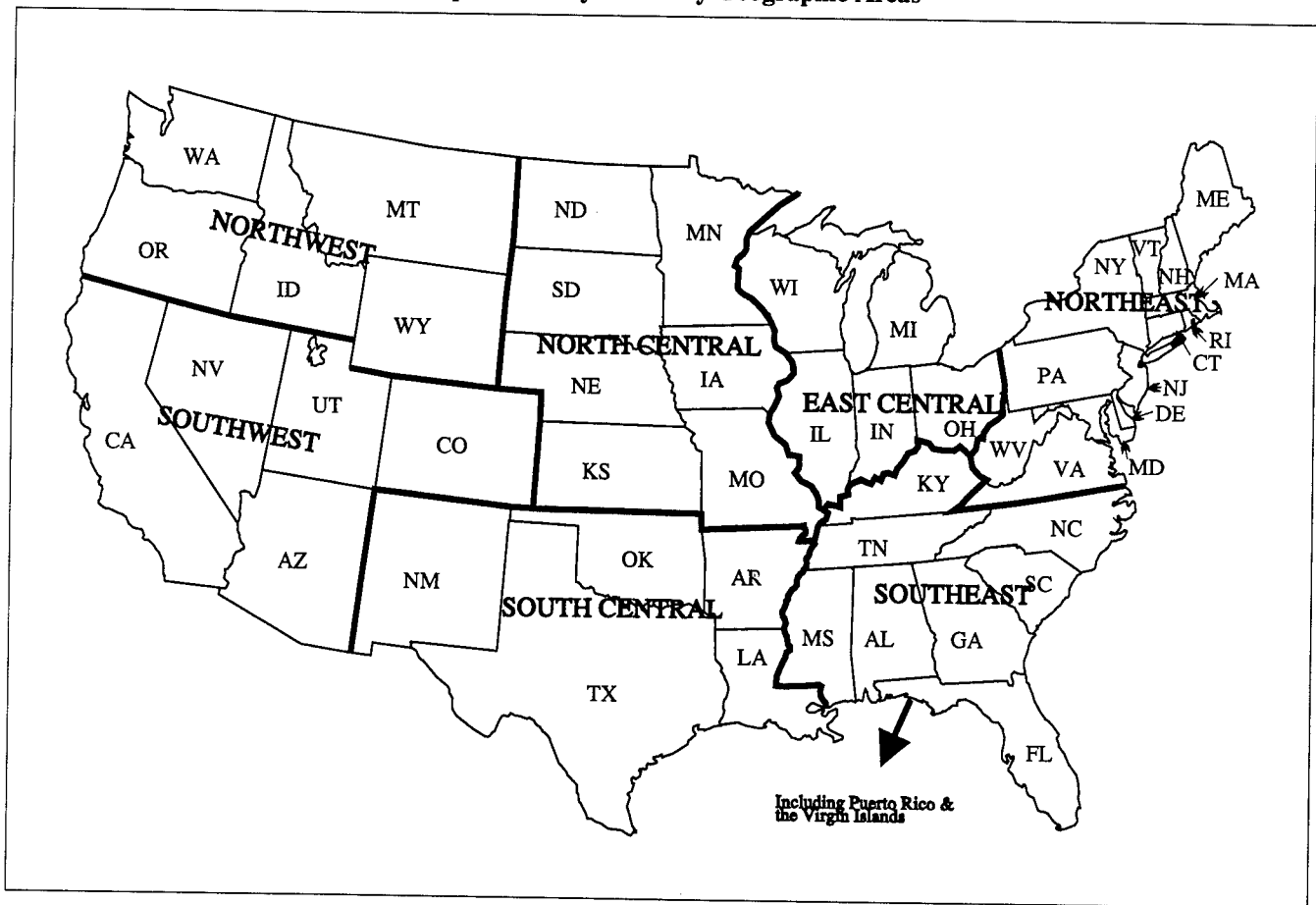

FIG 3.2-7

**4.4.2 Supplement Alaska:** This is a civil/military flight information publication issued by NOAA every 56 days. It is a single volume booklet designed for use with appropriate IFR or VFR charts. The Supplement Alaska contains an airport/facility directory, airport sketches, communications data, weather data sources, airspace, listing of navigational facilities, and special notices and procedures. Volume is side-bound 5-3/8 x 8-1/4 inches.

**4.4.3 Chart Supplement Pacific:** This supplement is designed for use with appropriate VFR or IFR en route charts. Included in this one-volume booklet are the airport/facility directory, communications data, weather data sources, airspace, navigational facilities, special notices, and Pacific area procedures. IAP charts, DP charts, STAR charts, airport diagrams, radar minimums, and supporting data for the Hawaiian and Pacific Islands are included. The manual is published every 56 days. Volume is side-bound 5-3/8 x 8-1/4 inches.

**4.4.4 North Pacific Route Charts:** These charts are designed for FAA controllers to monitor transoceanic flights. They show established intercontinental air

routes, including reporting points with geographic positions. Composite Chart: scale 1 inch = 164nm/1:12,000,000. 48 x 41-1/2 inches. Area Charts: scale 1 inch = 95.9nm/1:7,000,000. 52 x 40-1/2 inches. All charts are shipped unfolded. Charts are revised every 56 days.

(See FIG 3.2-8.)

**4.4.5 North Atlantic Route Chart:** Designed for FAA controllers to monitor transatlantic flights, this 5-color chart shows oceanic control areas, coastal navigation aids, oceanic reporting points, and NAVAID geographic coordinates. Full Size Chart: scale 1 inch = 113.1nm/1:8,250,000. Chart is shipped flat only. Half Size Chart: scale 1 inch = 150.8nm/1:11,000,000. Chart is 29-3/4 x 20-1/2 inches, shipped folded to 5 x 10 inches only. Chart are revised every 56 days.

(See FIG 3.2-9.)

### North Pacific Oceanic Route Charts

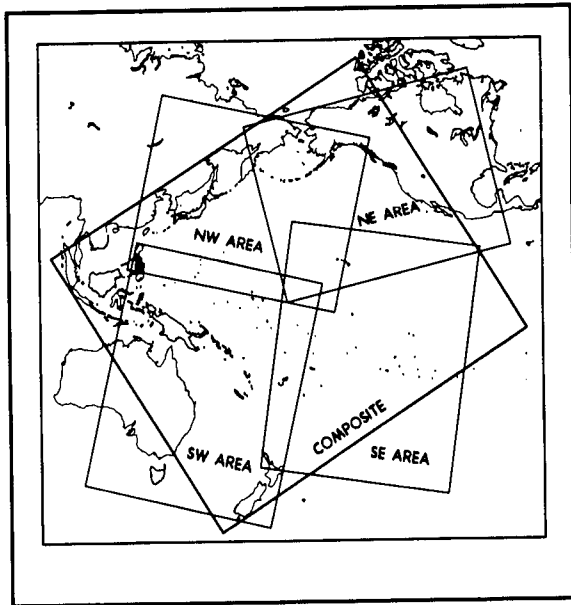

FIG 3.2-8

### North Atlantic Route Chart

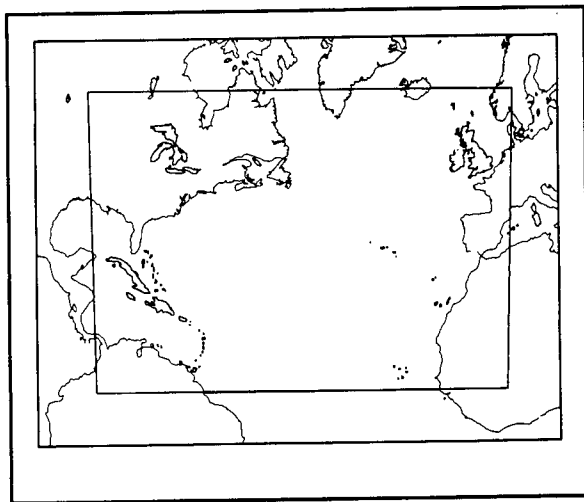

FIG 3.2-9

**4.4.6. Airport Obstruction Charts (OC):** The OC is a 1:12,000 scale graphic depicting FAR Part 77, *Objects Affecting Navigable Airspace* surfaces, a representation of objects that penetrate these surfaces, aircraft movement and apron areas, navigational aids, prominent airport buildings, and a selection of roads and other planimetric detail in the airport vicinity. Also included are tabulations of runway and other operational data.

**4.4.7. NOAA Aeronautical Chart User's Guide:** A booklet designed to be used as a teaching aid and reference document. It describes the substantial amount of information provided on NOAA's aeronautical charts and publications. It includes explanations and illustrations of chart terms and symbols organized by chart type.

### 4.5 Digital Products

**4.5.1 The NAVAID Digital Data File:** This file contains a current listing of NAVAID's that is compatible with the National Airspace System. Updated every 56 days, the file contains all NAVAID's including ILS and its components, in the U.S., Puerto Rico, and the Virgin Islands plus bordering facilities in Canada, Mexico, and the Atlantic and Pacific areas. The file is available by subscription only, on 3.5-inch, 1.4 megabyte diskette.

**4.5.2. The Digital Obstacle File:** This file describes all obstacles of interest to aviation users in the U.S., with limited coverage of the Pacific, Caribbean, Canada, and Mexico. The obstacles are assigned unique numerical identifiers, accuracy codes, and listed in order of ascending latitude within each state or area. The file is updated every 56 days. File is available on 3.5-inch, 1.4 megabyte diskettes.

**4.5.3. The Digital Aeronautical Chart Supplement (DACS):** The DACS is a subset of the data NOAA provides to FAA controllers every 56 days. It reflects digitally what is shown on the en route high and low charts. The DACS is designed to be used with aeronautical charts for flight planning purposes only. It should not be used as a substitute for a chart. The DACS is available on two 3.5-inch diskettes, compressed format. The supplement is divided into nine individual sections.

- Section 1: High altitude airways, conterminous U.S.
- Section 2: Low altitude airways, conterminous U.S.
- Section 3: Selected instrument approach procedure  
NAVAID and fix data
- Section 4: Military training routes
- Section 5: Alaska, Hawaii, Puerto Rico, Bahamas and  
selected oceanic routes
- Section 6: STAR's - Standard Terminal Arrivals
- Section 7: DP's - Instrument Departure Procedure
- Section 8: Preferred IFR routes (low and high altitude)
- Section 9: Air route and airport surveillance radar  
facilities

U.S. Terminal Publication Volumes

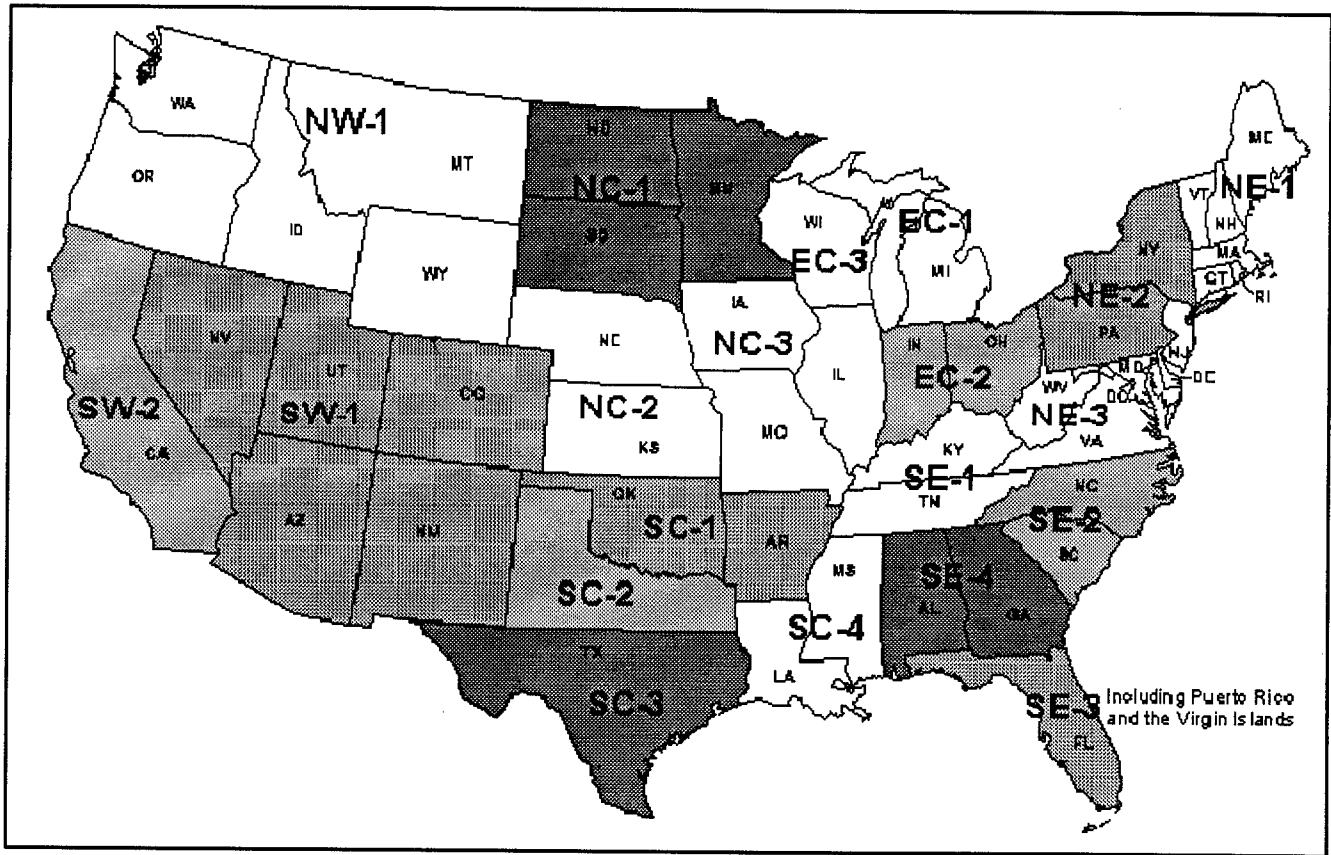

FIG 3.2-10

Sectional and VFR Terminal Area Charts for Alaska

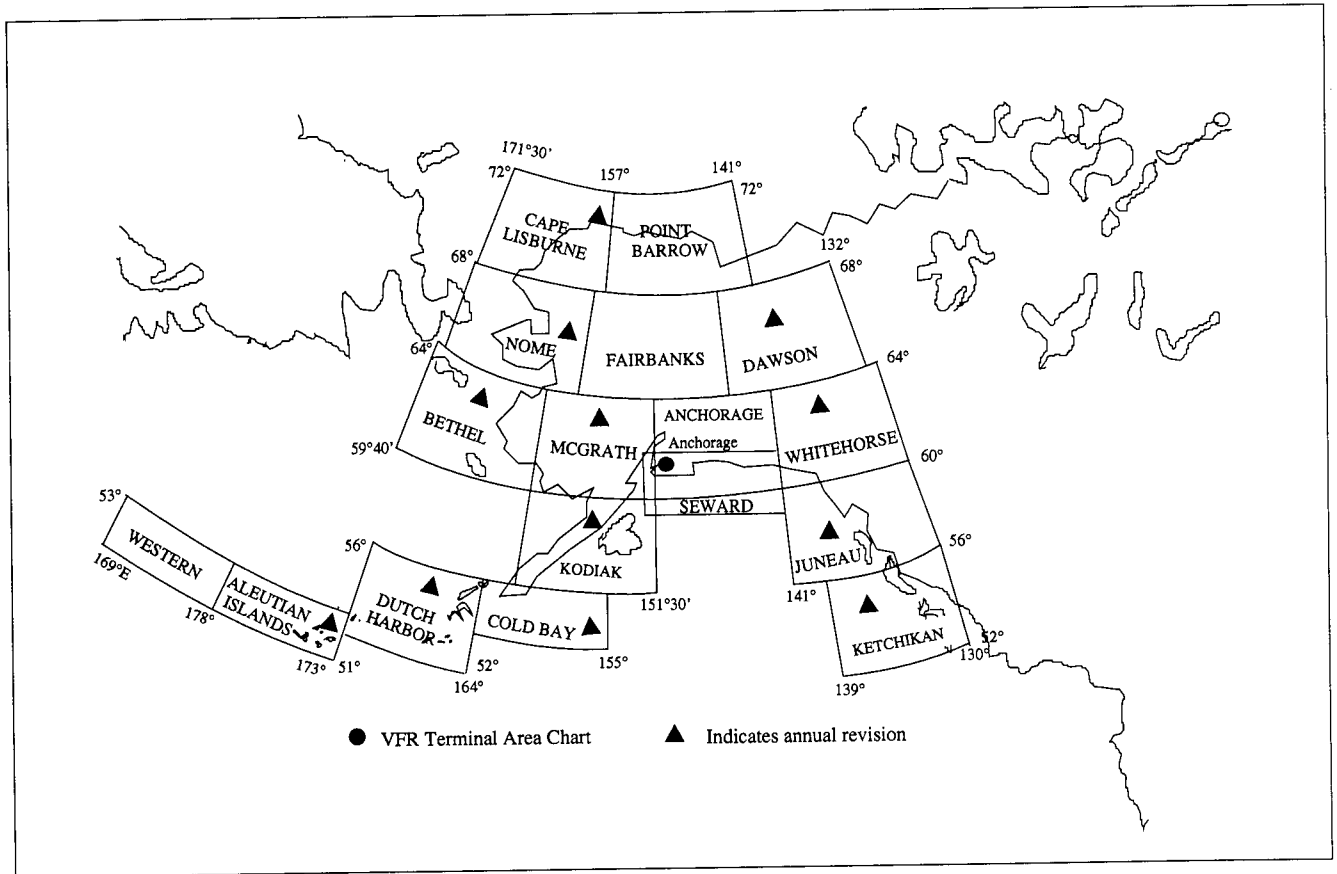

FIG 3.2-11

World Aeronautical Charts for Alaska

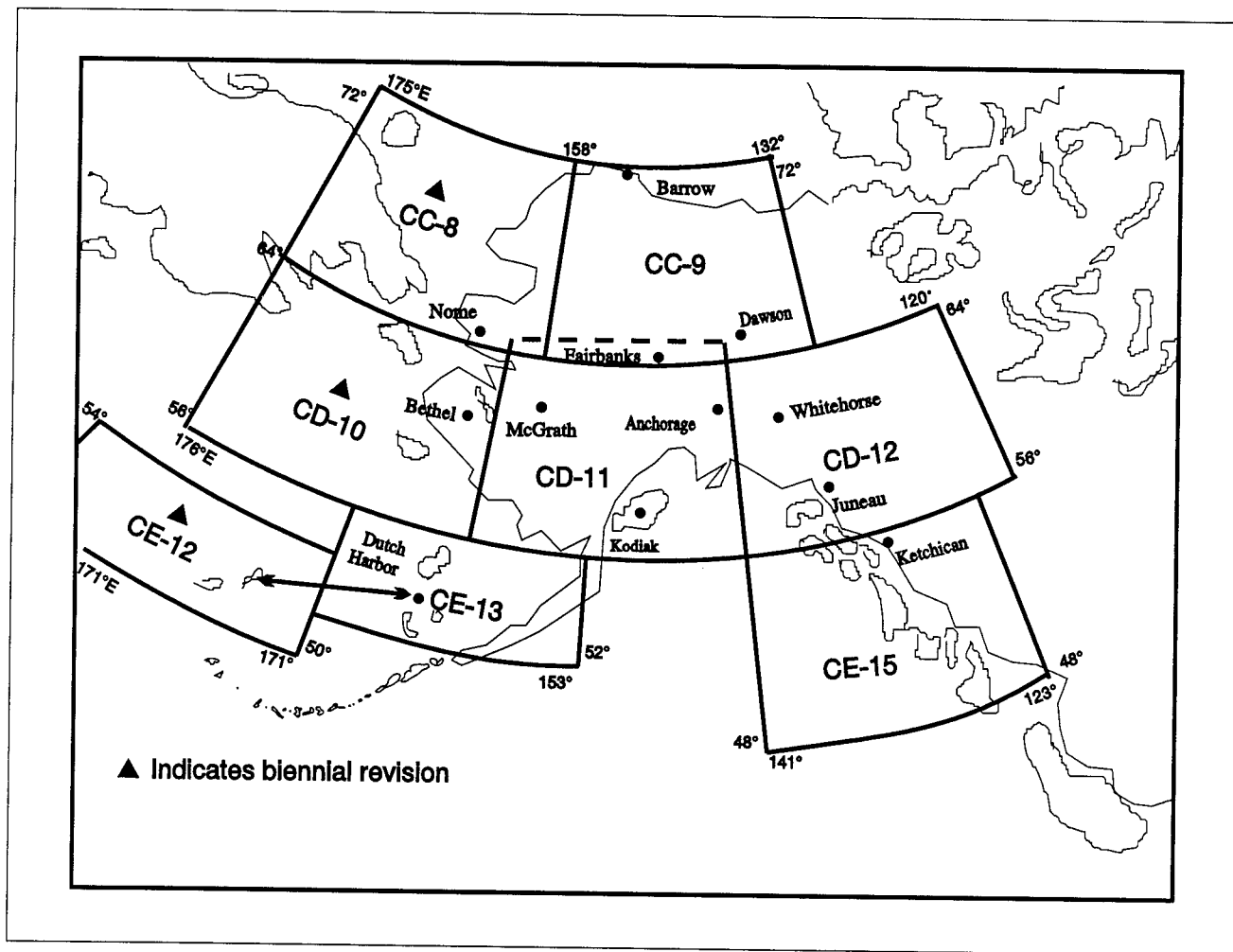

FIG 3.2-12

**World Aeronautical Charts for the Conterminous U.S.  
Mexico, and the Caribbean Areas**

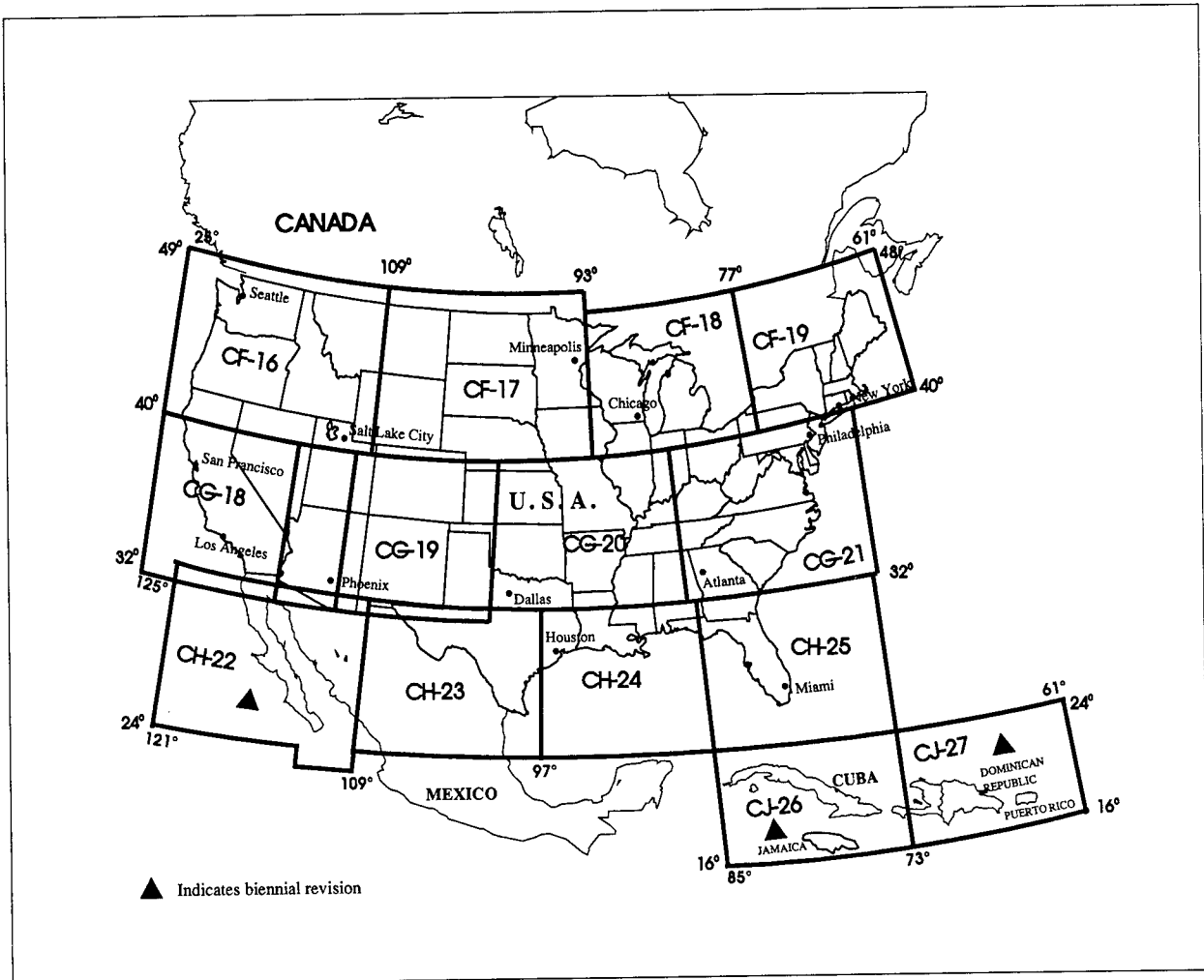

FIG 3.2-13

**5. National Imagery and Mapping Agency (NIMA) Products**

**5.1 How to Order NIMA Products:** A National Ocean Service (NOS) catalog of *NIMA Public Sale Aeronautical Charts and Publications* (NOS Stock No. DMAACATSET), is available from the NOAA Distribution Division. The catalog describes available charts and publications primarily covering areas outside the U.S. A free quarterly bulletin, *Dates of Latest Editions - NIMA Aeronautical Charts and Publications* (NOS Stock No. DADOLE), is also available from NOS.

**5.1.1 Flight Information Publication (FLIP) Planning Documents**

- General Planning (GP)
- Area Planning

**Area Planning - Special Use Airspace - Planning Charts**

**5.1.2 FLIP En Route Charts and Chart Supplements**

- Pacific, Australasia, and Antarctica
- United States - IFR and VFR Supplements
- Flight Information Handbook
- Caribbean and South America - Low Altitude
- Caribbean and South America - High Altitude
- Europe, North Africa, and Middle East - Low Altitude
- Europe, North Africa, and Middle East - High Altitude
- Africa
- Eastern Europe and Asia
- Area Arrival Charts

**5.1.3. FLIP Instrument Approach Procedures (IAP's)**

Africa  
Canada and North Atlantic  
Caribbean and South America  
Eastern Europe and Asia  
Europe, North Africa, and Middle East  
Pacific, Australasia, and Antarctica  
VFR Arrival/Departure Routes - Europe and Korea  
United States

**5.1.4. Miscellaneous DOD Charts and Products**

Aeronautical Chart Updating Manual (CHUM)  
DOD Weather Plotting Charts (WPC)  
Tactical Pilotage Charts (TPC)

Operational Navigation Charts (ONC)  
Global Navigation and Planning Charts (GNC)  
Global LORAN-C Navigation Charts (GLCC)  
LORAN-C Coastal Navigation Charts (LCNC)  
Jet Navigation Charts (JNC) and Universal Jet  
Navigation Charts (JNU)  
Jet Navigation Charts (JNCA)  
Aerospace Planning Charts (ASC)  
Oceanic Planning Charts (OPC)  
Joint Operations Graphics - Air (JOG-A)  
Standard Index Charts (SIC)  
Universal Plotting Sheet (VP-OS)  
Sight Reduction Tables for Air Navigation (PUB249)  
Plotting Sheets (VP-30)  
Dial-Up Electronic CHUM



## GEN 3.3 Air Traffic Services

### 1. Responsible Authority

The authority responsible for the overall administration of air traffic services provided for civil aviation in the U.S. and its territories, possessions and international airspace under its jurisdiction is the Associate Administrator for Air Traffic Services, acting under the authority of the Federal Aviation Administration (FAA).

<i>Postal Address:</i> Director Air Traffic Operations Program (ATO-1) Federal Aviation Administration 800 Independence Ave., SW Washington, D.C. 20591 U.S.A.
<i>Telephone:</i> 202-267-9155
<i>Telex:</i> 892-562
<i>Commercial Telegraphic Address:</i> FAA WSH
<i>AFTN Address:</i> KDCAYAYX

### 2. Area of Responsibility

Air traffic services as indicated in the following paragraphs are provided for the entire territory of the conterminous U.S., Alaska, Hawaii, Puerto Rico and the U.S. Virgin Islands, and the Panama Canal Zone, as well as the international airspace in oceanic areas under the jurisdiction of the U.S. which lies within the ICAO Caribbean (CAR), North Atlantic (NAT), North American (NAM) and Pacific (PAC) regions.

### 3. Air Traffic Services

**3.1** With the exception of terminal control services at certain civil aerodromes and military aerodromes, air traffic service in the U.S. is provided by the Air Traffic Operations Program, FAA, Department of Transportation (DOT), U.S. Government.

**3.2** Air Traffic control is exercised within the area of responsibility of the U.S.:

**3.2.1** On all airways;

**3.2.2** In Class B, C, D and E Airspace; and

**3.2.3** Within the Class A airspace whose vertical extent is from 18,000 feet to and including FL 600 throughout most of the conterminous U.S. and, in Alaska, from 18,000 feet to and including FL 600 but not including the airspace less than 1,500 feet above the surface of the earth and the Alaskan Peninsula west of longitude 160° 00" West. (A complete description of Class A airspace

is contained in the Code of Federal Regulations (CFR), Title 14, part 71.)

**3.3** Air traffic control and alerting services are provided by various air traffic control (ATC) units and are described in ENR 1.1.

**3.4** Radar service is an integral part of the air traffic system. A description of radar services and procedures is provided in ENR 1.6.

**3.5** The description of airspace designated for air traffic services is found in ENR 1.4.

**3.6** Procedural data and descriptions are found in ENR 1.5.

**3.7** Numerous restricted and prohibited areas are established within U.S. territory. These areas, none of which interfere with normal air traffic, are explained in ENR 5.1. Activation of areas subject to intermittent activity is notified in advance by a Notice to Airmen (NOTAM), giving reference to the area by its identification.

**3.8** In general, the air traffic rules and procedures in force and the organization of the air traffic services are in conformity with ICAO Standards, Recommended Practices and Procedures. Differences between the national and international rules and procedures are given in GEN 1.7. The regional supplementary procedures and altimeter setting procedures are reproduced in full with an indication wherein there is a difference.

**3.9** Coordination between the operator and air traffic services is effected in accordance with 2.11 of Annex II, and 2.1.1.4 and 2.1.2.5 of Part VIII of the PANS-RAC (DOC 4444-RAC/501).

**3.10** Minimum flight altitudes on the ATS routes as listed in ENR 1.4 have been determined so as to ensure at least 1,000 feet vertical clearance above the highest obstacle within 4 nautical miles (NM) on each side of the centerline of the route. However, where the regular divergence (4.5 degrees) of the navigational aid signal in combination with the distance between the navigational aids could result in the aircraft being more than 4 NM on either side of the centerline, the 4 NM protection limit is increased by the extent to which the divergence is more than 4 NM from the centerline.

**3.11 Pilot Visits to Air Traffic Facilities.** Pilots are encouraged to visit air traffic facilities (Airport Traffic Control Towers (ATCT's), Air Route Traffic Control Centers (ARTCC's), and Flight Service Stations

(FSS's)) and familiarize themselves with the ATC system. On rare occasions, facilities may not be able to approve a visit because of workload or other reasons. Pilots should contact the facility prior to the visit and advise of the number of persons in the group, the time and date of the proposed visit, and the primary interest of the group. With this information available, the facility can prepare an itinerary and have someone available to guide the group through the facility.

### 3.12 Operation Take-off and Operation Raincheck:

Operation Take-off is a program that educates pilots in how best to utilize the FSS modernization efforts and services available in Automated Flight Service Stations (AFSS), as stated in FAA Order 7230.17. Operation Raincheck is a program designed to familiarize pilots with the ATC system, its functions, responsibilities and benefits.

## 4. En Route Procedures

### 4.1 Air Route Traffic Control Center (ARTCC)

An ARTCC is a facility established to provide air traffic control service to aircraft operating on instrument flight rule (IFR) flight plans within CONTROLLED AIRSPACE and principally during the en route phase of flight. When equipment capabilities and controller workload permit, certain advisory/assistance services may be provided to visual flight rule (VFR) aircraft.

### 4.2 ARTCC Communications

#### 4.2.1 Direct Communications, Controllers and Pilots

a) ARTCC's are capable of direct communications with IFR air traffic on certain frequencies. Maximum communications coverage is possible through the use of Remote Center Air/Ground (RCAG) sites comprised of very high frequency (VHF) and ultra high frequency (UHF) transmitters and receivers. These sites are located throughout the United States. Although they may be several hundred miles away from the ARTCC, they are remoted to the various centers by land lines or microwave links. As IFR operations are expedited through the use of direct communications, pilots are requested to use these frequencies strictly for communications pertinent to the control of IFR aircraft. Flight plan filing, en route weather, weather forecasts, and similar data should be requested through Flight Service Stations, company radio, or appropriate military facilities capable of performing these services.

b) An ARTCC is divided into sectors. Each sector is handled by one or a team of controllers and has its own sector discrete frequency. As a flight progresses from

one sector to another, the pilot is requested to change to the appropriate sector discrete frequency.

#### 4.2.2 ATC Frequency Change Procedures

a) The following phraseology will be used by controllers to effect a frequency change:

**EXAMPLE.—**

*(AIRCRAFT IDENTIFICATION) CONTACT (FACILITY NAME OR LOCATION NAME AND TERMINAL FUNCTION) (FREQUENCY) AT (TIME, FIX, OR ALTITUDE).*

**NOTE.—**

*PILOTS ARE EXPECTED TO MAINTAIN A LISTENING WATCH ON THE TRANSFERRING CONTROLLER'S FREQUENCY UNTIL THE TIME, FIX, OR ALTITUDE SPECIFIED. ATC WILL OMIT FREQUENCY CHANGE RESTRICTIONS WHENEVER PILOT COMPLIANCE IS EXPECTED UPON RECEIPT.*

b) The following phraseology should be utilized by pilots for establishing contact with the designated facility:

1) When operating in a radar environment:

— On initial contact, the pilot should inform the controller of the aircraft's assigned altitude preceded by the words "level," or "climbing to," or "descending to," as appropriate; and the aircraft's present vacating altitude, if applicable.

**EXAMPLE.—**

*[ ] (NAME) CENTER, (AIRCRAFT IDENTIFICATION), LEVEL (ALTITUDE OR FLIGHT LEVEL).*

*[ / ] (NAME) CENTER, (AIRCRAFT IDENTIFICATION), LEAVING (EXACT ALTITUDE OR FLIGHT LEVEL), CLIMBING TO OR DESCENDING TO (ALTITUDE OR FLIGHT LEVEL).*

**NOTE.—**

*EXACT ALTITUDE OR FLIGHT LEVEL MEANS TO THE NEAREST 100 FOOT INCREMENT. EXACT ALTITUDE OR FLIGHT LEVEL REPORTS ON INITIAL CONTACT PROVIDE ATC WITH INFORMATION REQUIRED PRIOR TO USING MODE C ALTITUDE INFORMATION FOR SEPARATION PURPOSES.*

2) When operating in a nonradar environment:

— On initial contact, the pilot should inform the controller of the aircraft's present position, altitude and time estimate for the next reporting point.

**EXAMPLE.—**

*(NAME) CENTER, (AIRCRAFT IDENTIFICATION), (POSITION), (ALTITUDE), ESTIMATING (REPORTING POINT) AT (TIME).*

— After initial contact, when a position report will be made, the pilot should give the controller a complete position report.

**EXAMPLE.—**

*(NAME) CENTER, (AIRCRAFT IDENTIFICATION), (POSITION), (TIME), (ALTITUDE), (TYPE OF FLIGHT PLAN), (ETA AND NAME OF NEXT REPORTING POINT), (THE NAME OF THE NEXT SUCCEEDING REPORTING POINT), AND (REMARKS).*

**REFERENCE—**

*AIP, POSITION REPORTING, PARAGRAPH 6.*

c) At times controllers will ask pilots to verify the fact that they are at a particular altitude. The phraseology used will be: “VERIFY AT (altitude).” In climbing/descending situations, controllers may ask pilots to “VERIFY ASSIGNED ALTITUDE AS (altitude).” Pilots should confirm that they are at the altitude stated by the controller or that the assigned altitude is correct as stated. If this is not the case, they should inform the controller of the actual altitude being maintained or the different assigned altitude.

**CAUTION.—**  
*PILOTS SHOULD NOT TAKE ACTION TO CHANGE THEIR ACTUAL ALTITUDE OR DIFFERENT ASSIGNED ALTITUDE TO THAT STATED IN THE CONTROLLER'S VERIFICATION REQUEST UNLESS THE CONTROLLER SPECIFICALLY AUTHORIZES A CHANGE.*

**4.2.3 ARTCC Radio Frequency Outage:** ARTCC's normally have at least one back-up radio receiver and transmitter system for each frequency which can usually be pressed into service quickly with little or no disruption of ATC service. Occasionally, technical problems may cause a delay but switchover seldom takes more than 60 seconds. When it appears that the outage will not be quickly remedied, the ARTCC will usually request a nearby aircraft, if there is one, to switch to the affected frequency to broadcast communications instructions. It is important, therefore, that the pilot wait at least one minute before deciding that the ARTCC has actually experienced a radio frequency failure. When such an outage does occur, the pilot should, if workload and equipment capability permit, maintain a listening watch on the affected frequency while attempting to comply with the recommended communications procedures which follow.

a) If two-way communications cannot be established with the ARTCC after changing frequencies, a pilot should attempt to recontact the transferring controller for the assignment of an alternative frequency or other instructions.

b) When an ARTCC radio frequency failure occurs after two-way communications have been established, the pilot should attempt to reestablish contact with the center on any other known ARTCC frequency, preferably that of the next responsible sector when practicable, and ask for instructions. However, when the next normal frequency change along the route is known to involve another ATC facility, the pilot should contact that facility, if feasible, for instructions. If communications cannot be reestablished by either method, the pilot is expected to request communications instructions from the FSS appropriate to the route of flight.

**NOTE.—**  
*THE EXCHANGE OF INFORMATION BETWEEN AN AIRCRAFT AND AN ARTCC THROUGH AN FSS IS QUICKER THAN RELAY VIA COMPANY RADIO BECAUSE THE FSS HAS DIRECT INTERPHONE LINES TO THE RESPONSIBLE ARTCC SECTOR. ACCORDINGLY, WHEN CIRCUMSTANCES DICTATE A CHOICE BETWEEN THE TWO, DURING AN ARTCC FREQUENCY OUTAGE, RELAY VIA FSS RADIO IS RECOMMENDED.*

## 5. Radio Communications Failure

Pilots of IFR flights experiencing two-way radio failure are expected to adhere to the procedures prescribed in GEN 3.4 paragraph 12.

**REFERENCE—**  
*14 CFR SECTION 91.185*

## 6. Position Reporting

**6.1** The safety and effectiveness of traffic control depends to a large extent on accurate position reporting. In order to provide the proper separation and expedite aircraft movements, ATC must be able to make accurate estimates of the progress of every aircraft operating on an IFR flight plan.

### 6.2 Position Identification

**6.2.1** When a position report is to be made passing a VOR radio facility, the time reported should be the time at which the first complete reversal of the “to/from” indicator is accomplished.

**6.2.2** When a position report is made passing a facility by means of an airborne automatic direction finder (ADF), the time reported should be the time at which the indicator makes a complete reversal.



**6.2.3** When an aural or light-panel indication is used to determine the time passing a reporting point, such as a fan marker, Z marker, cone of silence or intersection of range courses, the time should be noted when the signal is first received and again when it ceases. The mean of these two times should then be taken as the actual time over the fix.

**6.2.4** If a position is given with respect to distance and direction from a reporting point, the distance and direction should be computed as accurately as possible.

**6.2.5** Except for terminal transition purposes, position reports or navigation with reference to aids not established for use in the structure in which flight is being conducted will not normally be required by ATC.

### 6.3. Position Reporting Points

Federal Aviation Regulations require pilots to maintain a listening watch on the appropriate frequency and, unless operating under the provisions of subparagraph 6.4, to furnish position reports passing certain reporting

points. Reporting points are indicated by symbols on en route charts. The designated compulsory reporting point symbol is the solid triangle ; the "on request" reporting point symbol is the open triangle . Reports passing an "on request" reporting point are only necessary when requested by ATC.

## 6.4 Position Reporting Requirements

**6.4.1 Flights Along Airways or Routes:** A position report is required by all flights regardless of altitude, including those operating in accordance with an ATC clearance specifying "VFR ON TOP," over each designated compulsory reporting point along the route being flown.

**6.4.2 Flight Along a Direct Route:** Regardless of the altitude or flight level being flown, including flights operating in accordance with an ATC clearance specifying "VFR ON TOP," pilots shall report over each reporting point used in the flight plan to define the route of flight.

**6.4.3 Flights in a Radar Environment:** When informed by ATC that their aircraft are in "RADAR CONTACT," PILOTS SHOULD DISCONTINUE POSITION REPORTS OVER DESIGNATED REPORTING POINTS. They should resume normal position reporting when ATC advises "RADAR CONTACT LOST" or "RADAR SERVICE TERMINATED."

**NOTE.—**

ATC WILL INFORM PILOTS THAT THEY ARE IN "RADAR CONTACT"

(A) WHEN THEIR AIRCRAFT IS INITIALLY IDENTIFIED IN THE ATC SYSTEM; AND

(B) WHEN RADAR IDENTIFICATION IS REESTABLISHED AFTER RADAR SERVICE HAS BEEN TERMINATED OR RADAR CONTACT HAS BEEN LOST.

SUBSEQUENT TO BEING ADVISED THAT THE CONTROLLER HAS ESTABLISHED RADAR CONTACT, THIS FACT WILL NOT BE REPEATED TO THE PILOT WHEN HANDED OFF TO ANOTHER CONTROLLER. AT TIMES, THE AIRCRAFT IDENTITY WILL BE CONFIRMED BY THE RECEIVING CONTROLLER; HOWEVER, THIS SHOULD NOT BE CONSTRUED TO MEAN THAT RADAR CONTACT HAS BEEN LOST. THE IDENTITY OF TRANSPONDER-EQUIPPED AIRCRAFT WILL BE CONFIRMED BY ASKING THE PILOT TO "IDENT, SQUAWK STANDBY," OR TO CHANGE CODES. AIRCRAFT WITHOUT TRANSPONDERS WILL BE ADVISED OF THEIR POSITION TO ADVISE THE CONTROLLER IF IN DISAGREEMENT WITH THE POSITION GIVEN. IF THE PILOT CANNOT CONFIRM THE ACCURACY OF THE POSITION GIVEN BECAUSE OF NOT BEING TUNED TO THE NAVAID REFERENCED BY THE CONTROLLER, THE PILOT SHOULD ASK FOR ANOTHER RADAR POSITION RELATIVE TO THE TUNED IN NAVAID.

## 6.5 Position Report Items

Position reports should include the following items:

- a) Identification;
- b) Position;

c) Time;

d) Altitude or flight level (Include actual altitude or flight level when operating on a clearance specifying "VFR ON TOP.");

e) Type of flight plan (not required in IFR position reports made directly to ARTCC's or approach control);

f) ETA and name of next reporting point;

g) The name only of the next succeeding reporting point along the route of flight; and

h) Pertinent remarks.

## 7. Additional Reports

The following reports should be made to ATC or FSS facilities without a specific request:

### 7.1 At all times, report:

a) When vacating any previously assigned altitude/flight level for a newly assigned altitude/flight level;

b) When an altitude change will be made if operating on a clearance specifying "VFR ON TOP";

c) When unable to climb/descend at a rate of at least 500 feet per minute;

d) When approach has been missed. (Request clearance for specific action; i.e., to alternative airport, another approach, etc.);

e) Change in the average true airspeed (at cruising altitude) when it varies by 5 percent or 10 knots (whichever is greater) from that filed in the flight plan;

f) The time and altitude/flight level reaching a hold-in fix or point to which cleared;

g) When leaving any assigned holding fix or point;

**NOTE.—**

THE REPORTS IN SUBPARAGRAPHS F AND G MAY BE OMITTED BY PILOTS OF AIRCRAFT INVOLVED IN INSTRUMENT TRAINING AT MILITARY AREA FACILITIES WHEN RADAR SERVICE IS BEING PROVIDED.

h) Any loss, in controlled airspace, of VOR, TACAN, ADF, low frequency navigation receiver capability, complete or partial loss of ILS receiver capability or impairment of air/ground communications capability. Reports should include aircraft identification, equipment affected, degree to which the capability to operate under IFR in the ATC system is impaired, and the nature and extent of assistance desired from ATC; and

i) Any information relating to the safety of flight.

**NOTE.—**  
*OTHER EQUIPMENT INSTALLED IN AN AIRCRAFT MAY EFFECTIVELY IMPAIR SAFETY AND/OR THE ABILITY TO OPERATE UNDER IFR. IF SUCH EQUIPMENT; E.G., AIRBORNE WEATHER RADAR MALFUNCTIONS AND IN THE PILOT'S JUDGMENT EITHER SAFETY OR IFR CAPABILITIES ARE AFFECTED, REPORTS SHOULD BE MADE AS ABOVE.*

## 7.2 When not in radar contact, report:

a) When leaving the final approach fix inbound on final approach (nonprecision approach) or when leaving the outer marker or fix used in lieu of the outer marker inbound on final approach (precision approach); or

b) A corrected estimate at any time it becomes apparent that an estimate as previously submitted is in error in excess of 3 minutes.

7.3 Pilots encountering weather conditions which have not been forecast, or hazardous condition which have been forecast, are expected to forward a report of such weather to ATC.

## 8. Quota Flow Control

8.1 Quota Flow Control is designed to balance the ATC system demand with system capacity.

8.2 ARTCC's will hold the optimum number of aircraft that their primary and secondary holding fixes will safely accommodate without imposing undue limitations on the control of other traffic operating within the ARTCC's airspace. This is based on user requirement to continue operating to a terminal regardless of the acceptance rate at that terminal. When staffing, equipment or severe weather will inhibit the number of aircraft the arrival ARTCC may safely hold, a reduction may be necessary.

8.3 When an ARTCC is holding the optimum number of aircraft, the adjacent ARTCC's will be issued quotas concerning aircraft which can be cleared into the impacted ARTCC's airspace. When the adjacent center's demand exceeds the quota, aircraft will be held in the adjacent ARTCC's airspace until they can be permitted to proceed.

8.4 The size of the hourly quota will be based initially on the projected acceptance rate and thereafter on the actual landing and diversion totals. Once quotas have been imposed, departures in the arrival and adjacent ARTCC's area to the affected airport may be assigned ground delay, if necessary, to limit airborne holding to ATC capacity. However, when a forecast of improved acceptance rate appears reliable, in the opinion of the arrival ARTCC, additional above-quota flights may be approved based on the expectation that by the time these

additional above-quota flights become an operational factor in the affected area, the system will be able to absorb them without undue difficulty.

8.5 Long distance flights, which originate beyond the adjacent ARTCC area, will normally be permitted to proceed to a point just short of the arrival ARTCC boundary where a delay, at least equal to the delays (ground/airborne) being encountered, will be assigned.

8.6 ARTCC's imposing ground delays make efforts to advise the users when lengthy delays are a prospect to preclude unnecessary boarding and subsequent unloading prior to actual takeoff due to lengthy unanticipated ground delays. Users should advise the ARTCC through FSS or operation offices when there is any significant change in the proposed departure time so as to permit more efficient flow control planning. Airborne aircraft holding in the adjacent ARTCC airspace generally receive more benefit than ground delayed aircraft when increases unexpectedly develop in the quota number because the reaction time is less. For this reason, whenever operationally feasible, adjacent ARTCC's may offer airborne delay within their areas instead of ground delay.

8.7 Flights originating beyond the adjacent ARTCC areas may not have sufficient fuel to absorb the total anticipated delay while airborne. Accordingly, the concerned adjacent ARTCC may permit these flights to land in its area while retaining previously accumulated delay for the purpose of quota priority. When the amount of air traffic backlogging in an adjacent ARTCC area is approaching the saturation point, additional en route traffic will be subject to prior approval.

8.8 Generally, movement of arrival aircraft into the impacted airport terminal area will be made on the basis that those flights with the most accumulated delay, either ground, airborne, or a combination of both, normally receive priority over other traffic. This applies only to delays encountered because of the situation at the airport of intended landing.

8.9 Pilots/operators are advised to check for flow control advisories which are transmitted to FSS's, to selected airline dispatch offices and ARTCC's.

## 9. Advisory and Air Traffic Information Services

### 9.1 Approach Control Service for VFR Arriving Aircraft

9.1.1 Numerous approach control facilities have established programs for arriving VFR aircraft to contact approach control for landing information. This information includes: wind, runway, and altimeter setting at the

airport of intended landing. This information may be omitted if contained in the ATIS broadcast and the pilot states the appropriate ATIS code.

**NOTE.—**

*PILOT USE OF "HAVE NUMBERS" DOES NOT INDICATE RECEIPT OF THE ATIS BROADCAST. IN ADDITION, THE CONTROLLER WILL PROVIDE TRAFFIC ADVISORIES ON A WORKLOAD PERMITTING BASIS.*

**9.1.2** Such information will be furnished upon initial contact with the concerned approach control facility. The pilot will be requested to change to the tower frequency at a predetermined time or point, to receive further landing information.

**9.1.3** Where available, use of this procedure will not hinder the operation of VFR flights by requiring excessive spacing between aircraft or devious routing. Radio contact points will be based on time or distance rather than on landmarks.

**9.1.4** Compliance with this procedure is not mandatory but pilot participation is encouraged. (See ENR 1.6 paragraph 11 Terminal Radar Programs for VFR Aircraft.)

**NOTE.—**

*APPROACH CONTROL SERVICES FOR VFR AIRCRAFT ARE NORMALLY DEPENDENT ON AIR TRAFFIC CONTROL RADAR. THESE SERVICES ARE NOT AVAILABLE DURING PERIODS OF A RADAR OUTAGE. APPROACH CONTROL SERVICES FOR VFR AIRCRAFT ARE LIMITED WHEN CENTER RADAR ARTS PRESENTATION/PROCESSING (CENRAP) IS IN USE.*

## **9.2 Traffic Advisory Practices at Airports Without Operating Control Towers**

### **9.2.1 Airport Operations Without An Operating Control Tower**

**9.2.1.1** There is no substitute for alertness while in the vicinity of an airport. It is essential that pilots be alert and look for other traffic and exchange traffic information when approaching or departing an airport without an operating control tower. This is of particular importance since other aircraft may not have communication capability or, in some cases, pilots may not communicate their presence or intentions when operating into or out of such airports. To achieve the greatest degree of safety, it is essential that all radio-equipped aircraft transmit/receive on a common frequency identified for the purpose of airport advisories.

**9.2.1.2** An airport may have a full or part-time tower or FSS located on the airport, a full or part-time UNICOM station or no aeronautical station at all. There are three ways for pilots to communicate their intention and obtain airport/traffic information when operating at an airport that does not have an operating tower: by

communicating with an FSS, a UNICOM operator, or by making a self-announce broadcast.

### **9.2.2 Communicating on a Common Frequency**

**9.2.2.1** The key to communicating at an airport without an operating control tower is selection of the correct common frequency. The acronym, CTAF, which stands for common traffic advisory frequency, is synonymous with this program. A CTAF is a frequency designated for the purpose of carrying out airport advisory practices while operating to or from an airport without an operating control tower. The CTAF may be a UNICOM, MULTICOM, FSS, or tower frequency and is identified in appropriate aeronautical publications.

**9.2.2.2** The CTAF frequency for a particular airport is contained in the Airport/Facility Directory (A/FD), Alaska Supplement, Alaska Terminal Publication, Instrument Approach Procedure Charts, and Instrument Departure Procedure (DP) charts. Also, the CTAF frequency can be obtained by contacting any FSS. Use of the appropriate CTAF, combined with a visual alertness and application of the following recommended good operating practices, will enhance safety of flight into and out of all uncontrolled airports.

### **9.2.3 Recommended Traffic Advisory Practices**

**9.2.3.1** Pilots of inbound aircraft should monitor and communicate on the designated CTAF from 10 miles to landing. Pilots of departing aircraft should monitor/communicate on the appropriate frequency from start-up, during taxi, and until 10 miles from the airport unless the Code of Federal Regulations (CFR) or local procedures require otherwise.

**9.2.3.2** Pilots of aircraft conducting other than arriving or departing operations at altitudes normally used by arriving and departing aircraft should monitor/communicate on the appropriate frequency while within 10 miles of the airport unless required to do otherwise by the CFR or local procedures. Such operations include parachute jumping/dropping (see ENR 5.1, paragraph 12), en route, practicing maneuvers, etc.

### **9.2.4 Local Airport Advisory Service Provided by a FSS.**

**9.2.4.1** Local airport advisory (LAA) is a service provided at selected locations by an FSS physically located on an airport which does not have a control tower or where the tower is operated on a part-time basis. The CTAF for FSS's which provide this service will be disseminated in appropriate aeronautical publications.

**9.2.4.2** In communicating with a CTAF FSS, establish 2-way communications before transmitting outbound

or inbound intentions or information. An inbound aircraft should report approximately 10 miles from the airport, reporting altitude and aircraft type, location relative to the airport, state whether landing or overflight, and request airport advisory. Departing aircraft should state the aircraft type, full identification number, type of flight planned, i.e., VFR or IFR and the planned destination or direction of flight. Report before taxiing and before taxiing onto the runway for departure. If communications with a UNICOM are necessary after initial report to FSS, return to FSS frequency for traffic update.

a) Inbound

**EXAMPLE.—**  
VERO BEACH RADIO, CENTURIAN SIX NINER DELTA DELTA IS TEN MILES SOUTH, TWO THOUSAND, LANDING VERO BEACH. REQUEST AIRPORT ADVISORY.

b) Outbound

**EXAMPLE.—**  
VERO BEACH RADIO, CENTURIAN SIX NINER DELTA DELTA, READY TO TAXI, VFR, DEPARTING TO THE SOUTHWEST. REQUEST AIRPORT ADVISORY.

**9.2.4.3** A CTAF FSS provides wind direction and velocity, favored or designated runway, altimeter setting, known traffic, notices to airmen, airport taxi routes, airport traffic pattern information, and instrument approach procedures. These elements are varied so as to best serve the current traffic situation. Some airport managers have specified that under certain wind or other conditions designated runways be used. Pilots should advise the FSS of the runway they intend to use.

**CAUTION.—**  
ALL AIRCRAFT IN THE VICINITY OF AN AIRPORT MAY NOT BE IN COMMUNICATION WITH THE FSS.

**9.2.5 Information Provided by Aeronautical Advisory Stations (UNICOM)**

**9.2.5.1** UNICOM is a nongovernment air/ground radio communication station which may provide airport information at public use airports where there is no tower or FSS.

**9.2.5.2** On pilot request, UNICOM stations may provide pilots with weather information, wind direction, the recommended runway, or other necessary information. If the UNICOM frequency is designated as the CTAF, it will be identified in appropriate aeronautical publications.

**9.2.5.3 Unavailability of Information from FSS or UNICOM:** Should LAA by an FSS or Aeronautical Advisory Station UNICOM be unavailable, wind and weather information may be obtainable from nearby

controlled airports via Automatic Terminal Information Service (ATIS) or Automated Weather Observing System (AWOS) frequency.

**9.2.6 Self-Announce Position and/or Intentions**

**9.2.6.1** “Self-announce” is a procedure whereby pilots broadcast their position or intended flight activity or ground operation on the designated CTAF. This procedure is used primarily at airports which do not have an FSS on the airport. The self-announce procedure should also be used if a pilot is unable to communicate with the FSS on the designated CTAF.

**9.2.6.2** If an airport has a tower which is temporarily closed or operated on a part-time basis, and there is no FSS on the airport or the FSS is closed, use the CTAF to self-announce your position or intentions.

**9.2.6.3** Where there is no tower, FSS, or UNICOM station on the airport, use MULTICOM frequency 122.9 for self-announce procedures. Such airports will be identified in appropriate aeronautical information publications.

**9.2.6.4 Practice Approaches.** Pilots conducting practice instrument approaches should be particularly alert for other aircraft that may be departing in the opposite direction. When conducting any practice approach, regardless of its direction relative to other airport operations, pilots should make announcements on the CTAF as follows:

a) Departing the final approach fix, inbound (nonprecision approach) or departing the outer marker or fix used in lieu of the outer marker, inbound (precision approach);

b) Established on the final approach segment or immediately upon being released by ATC;

c) Upon completion or termination of the approach; and

d) Upon executing the missed approach procedure.

**9.2.6.5** Departing aircraft should always be alert for arrival aircraft coming from the opposite direction.

**9.2.6.6 Recommended Self-Announce Phraseologies:** It should be noted that aircraft operating to or from another nearby airport may be making self-announce broadcasts on the same UNICOM or MULTICOM frequency. To help identify one airport from another, the airport name should be spoken at the beginning and end of each self-announce transmission.

a) Inbound

**EXAMPLE.—**

STRAWN TRAFFIC, APACHE TWO TWO FIVE ZULU, (POSITION), (ALTITUDE), (DESCENDING) OR ENTERING DOWNWIND/BASE/FINAL (AS APPROPRIATE) RUNWAY ONE SEVEN FULL STOP/TOUCH-AND-GO, STRAWN.

STRAWN TRAFFIC APACHE TWO TWO FIVE ZULU CLEAR OF RUNWAY ONE SEVEN STRAWN.

**b) Outbound**

**EXAMPLE.—**

STRAWN TRAFFIC, QUEEN AIR SEVEN ONE FIVE FIVE BRAVO (LOCATION ON AIRPORT) TAXIING TO RUNWAY TWO SIX STRAWN.

STRAWN TRAFFIC, QUEEN AIR SEVEN ONE FIVE FIVE BRAVO DEPARTING RUNWAY TWO SIX. "DEPARTING THE PATTERN TO THE (DIRECTION), CLIMBING TO (ALTITUDE) STRAWN."

**c) Practice Instrument Approach**

**EXAMPLE.—**

STRAWN TRAFFIC, CESSNA TWO ONE FOUR THREE QUEBEC (POSITION FROM AIRPORT) INBOUND DESCENDING THROUGH (ALTITUDE) PRACTICE (NAME OF APPROACH) APPROACH RUNWAY THREE FIVE STRAWN.

STRAWN TRAFFIC, CESSNA TWO ONE FOUR THREE QUEBEC PRACTICE (TYPE) APPROACH COMPLETED OR TERMINATED RUNWAY THREE FIVE STRAWN.

**9.2.7 UNICOM Communication Procedures**

**9.2.7.1** In communicating with a UNICOM station, the following practices will help reduce frequency congestion, facilitate a better understanding of pilot intentions, help identify the location of aircraft in the traffic pattern, and enhance safety of flight:

- a) Select the correct UNICOM frequency;
- b) State the identification of the UNICOM station you are calling in each transmission;
- c) Speak slowly and distinctly;
- d) Report approximately 10 miles from the airport, reporting altitude, and state your aircraft type, aircraft identification, location relative to the airport, state whether landing or overflight, and request wind information and runway in use;
- e) Report on downwind, base and final approach; and
- f) Report leaving the runway.

**9.2.7.2 Recommended UNICOM Phraseologies:**

**a) Inbound.**

**EXAMPLE.—**

FREDERICK UNICOM CESSNA EIGHT ZERO ONE TANGO FOXTROT 10 MILES SOUTHEAST DESCENDING THROUGH (ALTITUDE) LANDING FREDERICK, REQUEST WIND AND RUNWAY INFORMATION

**FREDERICK.**

FREDERICK TRAFFIC CESSNA EIGHT ZERO ONE TANGO FOXTROT ENTERING DOWNWIND/BASE/FINAL (AS APPROPRIATE) FOR RUNWAY ONE NINER FULL STOP/TOUCH-AND-GO FREDERICK.

FREDERICK TRAFFIC CESSNA EIGHT ZERO ONE TANGO FOXTROT CLEAR OF RUNWAY ONE NINER FREDERICK.

**b) Outbound**

**EXAMPLE.—**

FREDERICK UNICOM CESSNA EIGHT ZERO ONE TANGO FOXTROT (LOCATION ON AIRPORT) TAXIING TO RUNWAY ONE NINE, REQUEST WIND AND TRAFFIC INFORMATION FREDERICK.

FREDERICK TRAFFIC CESSNA EIGHT ZERO ONE TANGO FOXTROT DEPARTING RUNWAY ONE NINE. "REMAINING IN THE PATTERN" OR "DEPARTING THE PATTERN TO THE (DIRECTION) (AS APPROPRIATE)" FREDERICK.

**9.3 IFR Approaches/Ground Vehicle Operations**

**9.3.1 IFR Approaches:** When operating in accordance with an IFR clearance and ATC approves a change to the advisory frequency, make an expeditious change to the CTAF and employ the recommended traffic advisory procedures.

**9.3.2 Ground Vehicle Operation:** Airport ground vehicles equipped with radios should monitor the CTAF frequency when operating on the airport movement area and remain clear of runways/taxiways being used by aircraft. Radio transmissions from ground vehicles should be confined to safety-related matters.

**9.3.3 Radio Control of Airport Lighting Systems:** Whenever possible, the CTAF will be used to control airport lighting systems at airports without operating control towers. This eliminates the need for pilots to change frequencies to turn the lights on and allows a continuous listening watch on a single frequency. The CTAF is published on the instrument approach chart and in other appropriate aeronautical information publications. For further details concerning radio controlled lights, see Advisory Circular 150/5340.27.

**9.4 Designated UNICOM/MULTICOM Frequencies**

**9.4.1 Communications Between Aircraft**

**CAUTION.—**

THE FEDERAL COMMUNICATIONS COMMISSION (FCC) MAY REQUIRE AN AIRCRAFT STATION LICENSE FOR CERTAIN TYPES OF AIRCRAFT TRANSMITTERS AND OR CERTAIN TYPES OF FLIGHT OPERATIONS. PILOTS AND AIRCRAFT OWNERS OR AIRCRAFT OPERATORS MUST REVIEW THE CURRENT FCC REQUIREMENTS TO ENSURE COMPLIANCE WITH APPLICABLE FCC AND FAA REGULATIONS.



**Summary of Recommended Communication Procedures**

	FACILITY AT AIRPORT	FREQUENCY USE	COMMUNICATION/BROADCAST PROCEDURES		
			OUTBOUND	INBOUND	PRACTICE INSTRUMENT APPROACH
1.	UNICOM (No Tower or FSS)	Communicate with UNICOM station on published CTAF frequency (122.7; 122.8; 122.725; 122.975; or 123.0). If unable to contact UNICOM station, use self-announce procedures on CTAF.	Before taxiing and before taxiing onto the runway for departure.	10 miles out; entering downwind, base, and final; leaving the runway.	
2.	No Tower, FSS, or UNICOM	Self-announce on MULTICOM frequency 122.9.	Before taxiing and before taxiing onto the runway for departure.	10 miles out; entering downwind, base, and final; leaving the runway.	Departing final approach fix (name) or on final approach segment inbound.
3.	No Tower in operation, FSS open	Communicate with FSS on CTAF frequency.	Before taxiing and before taxiing onto the runway for departure.	10 miles out; entering downwind, base, and final; leaving the runway.	Approach completed/terminated.
4.	FSS closed (No Tower)	Self-announce on CTAF.	Before taxiing and before taxiing onto the runway for departure.	10 miles out; entering downwind, base, and final; leaving the runway.	
5.	Tower or FSS not in operation	Self-announce on CTAF.	Before taxiing and before taxiing onto the runway for departure.	10 miles out; entering downwind, base, and final; leaving the runway.	

TBL 3.3-1

**9.4.2 Frequency Use**

**9.4.2.1** TBL 3.3-2 depicts UNICOM and MULTICOM frequency uses as designated by the FCC.

**NOTE.—**

☐ IN SOME AREAS OF THE COUNTRY, FREQUENCY INTERFERENCE MAY BE ENCOUNTERED FROM NEARBY AIRPORTS USING THE SAME UNICOM FREQUENCY. WHERE THERE IS A PROBLEM, UNICOM OPERATORS ARE ENCOURAGED TO DEVELOP A "LEAST INTERFERENCE" FREQUENCY ASSIGNMENT PLAN FOR AIRPORTS CONCERNED USING THE FREQUENCIES DESIGNATED FOR AIRPORTS WITHOUT OPERATING CONTROL TOWERS. UNICOM LICENSEES ARE ENCOURAGED TO APPLY FOR UNICOM 25 kHz SPACED CHANNEL FREQUENCIES. DUE TO THE EXTREMELY LIMITED NUMBER OF FREQUENCIES WITH 50 kHz CHANNEL SPACING, 25 kHz CHANNEL SPACING SHOULD BE IMPLEMENTED. UNICOM LICENSEES MAY THEN REQUEST FCC TO ASSIGN FREQUENCIES IN ACCORDANCE WITH THE PLAN, WHICH FCC WILL REVIEW AND CONSIDER FOR APPROVAL.

☐ WIND DIRECTION AND RUNWAY INFORMATION MAY NOT BE AVAILABLE ON UNICOM FREQUENCY 122.950.

**UNICOM/MULTICOM Frequency Usage**

USE	FREQUENCY
Airports without an operating control tower.	122.700
	122.725
	122.800
	122.975
	123.000
	123.050
(MULTICOM FREQUENCY) Activities of a temporary, seasonal, emergency nature or search and rescue, as well as, airports with no tower, FSS, or UNICOM.	122.900
(MULTICOM FREQUENCY) Forestry management and fire suppression, fish and game management and protection, and environmental monitoring and protection.	122.925
Airports with a control tower or FSS on airport.	122.950

TBL 3.3-2

**9.4.2.2** TBL 3.3-3 depicts other frequency uses as designated by the FCC.

**Other Frequency Usage Designated by FCC**

USE	FREQUENCY
Air-to-air communications & private airports (not open to the public).	122.750 122.850
Air-to-air communications (general aviation helicopters).	123.025
Aviation instruction, Glider, Hot Air Balloon (not to be used for advisory service).	123.300 123.500

TBL 3.3-3

**9.5 Use of UNICOM for ATC purposes**

UNICOM service may be used for air traffic control purposes, only under the following circumstances:

- a) Revision to proposed departure time.
- b) Takeoff, arrival, or flight plan cancellation time.
- c) ATC clearance, provided arrangements are made between the ATC facility and the UNICOM licensee to handle such messages.

**9.6 Automatic Terminal Information Service (ATIS)**

**9.6.1** ATIS is the continuous broadcast of recorded non-control information in selected high activity terminal areas. Its purpose is to improve controller effectiveness and to relieve frequency congestion by automating the repetitive transmission of essential but routine information. The information is continuously broadcast over a discrete VHF radio frequency or the voice portion of a local NAVAID. ATIS transmissions on a discrete VHF radio frequency are engineered to be receivable to a maximum of 60 NM from the ATIS site and a maximum altitude of 25,000 feet AGL. At most locations, ATIS signals may be received on the surface of the airport, but local conditions may limit the maximum ATIS reception distance and/or altitude. Pilots are urged to cooperate in the ATIS program as it relieves frequency congestion on approach control, ground control, and local control frequencies. The Airport/Facility Directory indicates airports for which ATIS is provided.

**9.6.2** ATIS information includes the time of the latest weather sequence, ceiling, visibility, obstructions to visibility, temperature, dew point (if available), wind direction (magnetic), and velocity, altimeter, other pertinent remarks, instrument approach and runway in use. The ceiling/sky condition, visibility, and obstructions to vision may be omitted from the ATIS broadcast if the ceiling is above 5,000 feet and the visibility is more than

5 miles. The departure runway will only be given if different from the landing runway except at locations having a separate ATIS for departure. The broadcast may include the appropriate frequency and instructions for VFR arrivals to make initial contact with approach control. Pilots of aircraft arriving or departing the terminal area can receive the continuous ATIS broadcast at times when cockpit duties are least pressing and listen to as many repeats as desired. ATIS broadcast shall be updated upon the receipt of any official hourly and special weather. A new recording will also be made when there is a change in other pertinent data such as runway change, instrument approach in use, etc.

**SAMPLE BROADCAST.—**

*DULLES INTERNATIONAL INFORMATION SIERRA. 1300ZULU WEATHER. MEASURED CEILING THREE THOUSAND OVERCAST. VISIBILITY THREE, SMOKE. TEMPERATURE SIX EIGHT. WIND THREE FIVE ZERO AT EIGHT. ALTIMETER TWO NINER NINER TWO. ILS RUNWAY ONE RIGHT APPROACH IN USE. LANDING RUNWAY ONE RIGHT AND LEFT. DEPARTURE RUNWAY THREE ZERO. ARMEL VORTAC OUT OF SERVICE. ADVISE YOU HAVE SIERRA.*

**9.6.3** Pilots should listen to ATIS broadcasts whenever ATIS is in operation.

**9.6.4** Pilots should notify controllers on initial contact that they have received the ATIS broadcast by repeating the alphabetical code word appended to the broadcast.

**EXAMPLE.—**

*"INFORMATION SIERRA RECEIVED."*

**9.6.5** When the pilot acknowledges receipt of the ATIS broadcast, controllers may omit those items contained on the broadcast if they are current. Rapidly changing conditions will be issued by ATC and the ATIS will contain words as follows:

**EXAMPLE.—**

*"LATEST CEILING/VISIBILITY/ALTIMETER/WIND/(OTHER CONDITIONS) WILL BE ISSUED BY APPROACH CONTROL/TOWER."*

**NOTE.—**

*THE ABSENCE OF A SKY CONDITION/CEILING AND/OR VISIBILITY ON ATIS INDICATES A SKY CONDITION/CEILING OF 5,000 FEET OR ABOVE AND VISIBILITY OF 5 MILES OR MORE. A REMARK MAY BE MADE ON THE BROADCAST, "THE WEATHER IS BETTER THAN 5,000 AND 5," OR THE EXISTING WEATHER MAY BE BROADCAST.*

**9.6.6** Controllers will issue pertinent information to pilots who do not acknowledge receipt of a broadcast or who acknowledge receipt of a broadcast which is not current.

**9.6.7** To serve frequency-limited aircraft, FSS's are equipped to transmit on the omnirange frequency at most en route VOR's used as ATIS voice outlets. Such communication interrupts the ATIS broadcast. Pilots of aircraft equipped to receive on other FSS frequencies are encouraged to do so in order that these override transmissions may be kept to an absolute minimum.

**9.6.8** While it is a good operating practice for pilots to make use of the ATIS broadcast where it is available, some pilots use the phrase “Have Numbers” in communications with the control tower. Use of this phrase means that the pilot has received wind, runway and altimeter information ONLY and the tower does not have to repeat this information. It does not indicate receipt of the ATIS broadcast and should never be used for this purpose.

## **9.7 Airport Reservations Operations and Procedures**

**9.7.1** The FAA operates the Computerized Voice Reservation System (CVRS) which is used to make arrival and/or departure reservations at airports designated by 14 CFR Part 93, Subpart K as high density traffic airports (HDTA). The system may also be used to make arrival and/or departure reservations at airports which are part of a Special Traffic Management Program (STMP). Some STMP’s may require users to contact the controlling ARTCC to make reservations, while others will use the CVRS to make reservations. Pilots should check current NOTAM’s to determine airports included in a special traffic management program and reservations procedures.

### **9.7.2 High Density Traffic Airports (HDTA)**

**9.7.2.1** The FAA, by 14 CFR Part 93, Subpart K, as amended, has designated the John F. Kennedy (JFK), LaGuardia (LGA), Chicago O’Hare (ORD), Washington National (DCA), and Newark (EWR) Airports as high density airports and has prescribed air traffic rules and requirements for operating aircraft to and from these airports. (The quota for EWR has been suspended indefinitely.) Reservations for JFK are required between 3:00 p.m. and 7:59 p.m. local time. Reservations at ORD are required between 6:45 a.m. and 9:15 p.m. local time. Reservations for LGA and DCA are required between 6:00 a.m. and 11:59 p.m. local time. Helicopter operations are excluded from the requirement for a reservation.

*NOTE.—  
TIME PERIODS FOR ORD ARE IN 30-MINUTE INCREMENTS.*

**9.7.2.2** The FAA has established an Airport Reservations Office (ARO) to receive and process all IFR requests for operations at the designated HDTA’s. This office monitors operation of the high density rule and allots reservations on a “first-come-first-served” basis determined by the time the request is received at the reservation office. Standby lists are not maintained. The ARO utilizes the CVRS to make all reservations. Users may access the computer system using a touch tone

telephone, rotary dial telephone, or a personal computer equipped with a modem. Requests for IFR reservations will be accepted starting 48 hours prior to the proposed time of operation at the affected airport. For example, a request for an 11:00 a.m. reservation on a Thursday will be accepted beginning at 11:00 a.m. on the preceding Tuesday. An exception to the 48-hour limitation is made for weekends to recognize normal business hours. Consequently, a reservation request for an IFR operation on Monday would be accepted on the previous Thursday, starting at the proposed hour of operation. Similarly, requests for IFR operations on Tuesday would be accepted on the previous Friday, starting at the proposed hour of operation. For example, a request for an 11:00 a.m. reservation on Tuesday would be accepted beginning at 11:00 a.m. on Friday. Another exception to the 48-hour time limit is made for users who make both an arrival and departure reservation provided they both fall on the same calendar day and they are both made during the same phone call. For example, a reservation request for an 11:00 a.m. arrival on Friday and a 4:00 p.m. departure on Friday may be made beginning at 11:00 a.m. Wednesday.

**9.7.2.3** A maximum of two transactions per phone call will be accepted.

**9.7.2.4** The ARO will not provide scheduling according to planned departure/arrival time. Assignments will be made on an hourly or 30-minute basis; e.g., an approved reservation for 1300 covers an operation any time between 1300 and 1359 and an approved reservation for 0845 at O’Hare covers an operation between 0845 and 0914.

**9.7.2.5** An approved reservation does not constitute a warranty against traffic delays nor does it guarantee arrival and/or departure within such allocated hours. Also, a reservation does not constitute an ATC clearance.

**9.7.2.6** The filing of a request for an IFR reservation does not constitute the filing of an IFR flight plan as required by regulation. The IFR flight plan should be filed only after the reservation is obtained and should be filed through normal channels. The ARO is not equipped to accept or process IFR flight plans.

## **9.7.3 IFR Reservations**

**9.7.3.1** If operating IFR, an IFR reservation is required prior to takeoff for any operation to or from a high density airport. Users may obtain IFR reservations in either of two ways. They may file their request with the nearest FSS by any available means or call the ARO’s interactive computer system via touch-tone telephone,

rotary dial telephone, or personal computer modem. The telephone numbers for the ARO computer are: Using touch-tone or rotary phone: 1-800-875-9694. For Personal Computer and Modem: 1-800-875-9759.

**9.7.3.2** Users may contact the ARO at 703-904-4452 if they have a problem making a reservation or have a question concerning the HDTA regulations. (Being unable to make a reservation due to the fact that all the slots have been allocated is not considered as having a problem making a reservation.)

**9.7.3.3** When filing a request for an IFR reservation, the pilot should be prepared to provide the following information:

- a) Name(s) of high density traffic airport(s) for which the pilot wishes reservation(s);
- b) Date(s) and hour(s) (UTC) of proposed operation(s); and
- c) Aircraft identification/tail number(s).

**9.7.3.4** Should the requested time not be available, the user will be offered the closest time before or after the requested time. If an alternate time is accepted, this will be considered as an assigned allocation unless subsequently cancelled by the user.

**9.7.3.5** Users are encouraged to advise the ARO whenever they need to change their reservation or to cancel their IFR reservation when it is known that the reservation will not be used. For other than scheduled air carriers/commuters, a cancellation should be made directly to the ARO computer system or an FSS.

**9.7.3.6** The following information should be available when cancelling a reservation:

- a) Aircraft identification/tail number;
- b) Airport for which the reservation was made;
- c) Date and Time (UTC) of the reservation; and
- d) Reservation number.

**9.7.3.7** To ensure retention of a reservation, a pilot holding an IFR arrival reservation must retain IFR status until in contact with the terminal ATC facility.

**9.7.3.8** Reservations are required when filing one of the HDTA's as an alternate airport. Pilots are encouraged to file airports other than the high density as alternate airports.

## **9.7.4 Additional IFR Reservations**

**9.7.4.1** If favorable conditions in the system and at the HDTA indicate a significant delay is not likely in the short term, the ARO may coordinate with the HDTA tower to determine that additional IFR reservations may be accommodated for a specific time period. This is an additional IFR reservation as described in 14 CFR Part 93. If additional IFR reservations can be accommodated, they are administered by the ARO under the procedures described above.

**9.7.4.2** An operator of an IFR unscheduled operation may take off or land an aircraft without regard to the maximum allocation if a reservation is obtained from ATC in accordance with the procedures above. A reservation is granted for an additional IFR operation only if it can be accommodated by ATC without significant additional delay to operations already allocated. The granting of an additional IFR reservation is contingent upon dynamic, short-term traffic and weather conditions. Generally, availability of additional reservations will not be known more than 8 hours in advance of the current time. If available, IFR additional reservations will be granted on a first-come-first-served basis.

**9.7.4.3** An operator who has been unable to obtain a reservation under the normal 48-hour in advance procedure may find they are able to obtain a reservation on the scheduled day of operation when additional reservations can be authorized.

## **9.7.5 Visual Flight Rules (VFR) Reservations**

**9.7.5.1** The operator of a VFR unscheduled operation may take off or land an aircraft under VFR at an HDTA if a departure or arrival reservation is obtained from the FAA ATC facility serving the HDTA.

**9.7.5.2** Under 14 CFR Part 93, a VFR operation is considered to be an additional operation. VFR additional operations may be granted by ATC if they can be accommodated without significant delay to operations already allocated. In addition, the reported ceiling at the HDTA must be at least 1,000 feet and the reported ground visibility at least 3 miles.

**9.7.5.3** Each HDTA lies within Class B airspace. A clearance from ATC to enter the airspace or depart the airport under VFR constitutes an approval for a VFR additional reservation.

**9.7.5.4** Any time a HDTA is not authorizing VFR operations, a NOTAM to that effect will be issued by the controlling ATC facility and a recording placed on the ATIS. This information can be obtained from any FSS or by referring to the HDTA teletype weather report.

The code "VNA" at the end of the weather report indicates VFR arrival reservations are not authorized. The indication will not be made when IFR weather conditions exist.

**9.7.5.5** The requirements for obtaining reservations pursuant to 14 CFR Part 93, Subpart K, are mandatory. Failure to operate in accordance with FAA regulations may be grounds for enforcement action.

### **9.7.6 Special Traffic Management Programs (STMP)**

**9.7.6.1** Special procedures may be established when a location requires special traffic handling to accommodate above normal traffic demand (e.g., the Indianapolis 500, Super Bowl, etc.) or reduced airport capacity (e.g., airport runway/taxiway closures for airport construction). The special procedures may remain in effect until the problem has been resolved or until local traffic management procedures can handle the situation and a need for special handling no longer exists.

**9.7.6.2** CVRS may be used to allocate the reservations during a STMP. If CVRS is being used, the toll-free telephone numbers will be advertised by NOTAM. Be sure to check current NOTAM's to determine what airports are included in a STMP, days and times reservations are required, time limits for reservations requests, and who to contact for reservations.

### **9.7.7 Making HDTA/STMP Reservations Using the CVRS**

**9.7.7.1** Computer Modem Users: A personal computer (PC) may be used to make reservations on the CVRS. Equipment required is a computer with a modem capable of a 300 to 9600 baud rate and a communications software program. There are several communications software programs available from many computer stores. The type program required is one which is used to connect with a bulletin board system (BBS). The CVRS modem data is transmitted using no parity, 8 data bits, and 1 stop bit (N,8,1). Be sure your computer software is set to these parameters.

**9.7.7.2** When your computer connects with CVRS, you will be presented with a screen that will ask you to log on. If this is the first time you have logged onto the

CVRS, you will be asked for your name, the city you are calling from, and a password. (Be sure to record your password for future use). CVRS uses your name and password to save your computer "set-up" so that the next time you call you will have the same display. After you have logged on, everything you need to do involving a reservation is menu driven. There are also several files you can download which explain CVRS operations in greater detail.

**9.7.7.3** Telephone users: When using the telephone to make a reservation, you are prompted for input of information about what you wish to do. All input is accomplished using the keypad or rotary dial on the telephone. The only problem with a telephone is that most keys have a letter and number associated with them. When the system asks for a date or time, it is expecting an input of numbers. A problem arises when entering a tail number. The system does not detect if you are entering a letter (alpha character) or a number. Therefore, when entering a tail number two keys are used to represent each letter or number. When entering a number, precede the number you wish by the number 0 (zero) i.e. 01, 02, 03, 04, ... If you wish to enter a letter, first press the key on which the letter appears and then press 1, 2, or 3, depending upon whether the letter you desire is the first, second, or third letter on that key. For example to enter the letter "N" first press the "6" key because "N" is on that key, then press the "2" key because the letter "N" is the second letter on the "6" key. Since there are no keys for the letters "Q" and "Z" CVRS pretends they are on the number "1" key. Therefore, to enter the letter "Q" press 11 and to enter the letter "Z" press 12.

**NOTE.—**

USERS ARE REMINDED TO ENTER THE "N" CHARACTER WITH THEIR TAIL NUMBERS. (SEE TBL 3.3-5 HELPFUL KEY ENTRIES).

<b>CODES FOR TAIL NUMBER INPUT ONLY</b>			
A-21	J-51	S-73	1-01
B-22	K-52	T-81	2-02
C-23	L-53	U-82	3-03
D-31	M-61	V-83	4-04
E-32	N-62	W-91	5-05
F-33	O-63	X-92	6-06
G-11	P-71	Y-93	7-07
H-42	Q-11	Z-12	8-08
I-43	R-72	0-00	9-09

TBL 3.3-4

### Helpful Key Entries

#	After entering a tail number, depressing the "pound key" (#) twice will indicate the end of the tail number.
*2	Will take the user back to the start of the process.
*3	Will repeat the tail number used in a previous reservation.
*5	Will repeat the previous question.
*8	Tutorial Mode: In the tutorial mode each prompt for input includes a more detailed description of what is expected as input. *8 is a toggle on/off switch. If you are in tutorial mode and enter *8, you will return to the normal mode.
*0	Expert Mode: In the expert mode, each prompt for input is brief with little or no explanation. Expert mode is also on/off toggle.

TBL 3.3-5

## 9.8 Operations at Uncontrolled Airports with Automated Surface Observing System (ASOS)/Automated Weather Observation System (AWOS)

**9.8.1** Many airports throughout the National Airspace System are equipped with either ASOS or AWOS. At most airports with an operating control tower or human observer, the weather will be available to you in a METAR hourly or special observation format on the Automatic Terminal Information Service (ATIS) or directly transmitted from the controller/observer.

**9.8.2** At uncontrolled airports that are equipped with ASOS/AWOS with ground-to-air broadcast capability, the one-minute updated airport weather should be available to you within approximately 25 NM of the airport below 10,000 feet. The frequency for the weather broadcast will be published on sectional charts and in the Airport/Facility Directory. Some part-time towered airports may also broadcast the automated weather on their ATIS frequency during the hours that the tower is closed.

**9.8.3** Controllers issue SVFR or IFR clearances based on pilot request, known traffic and reported weather; i.e., METAR/SPECI observations, when they are available. Pilots have access to more current weather at uncontrolled ASOS/AWOS airports than do the controllers who may be located several miles away. Controllers will rely on the pilot to determine the current airport weather from the ASOS/AWOS. All aircraft arriving or departing an ASOS/AWOS equipped uncontrolled airport should monitor the airport weather frequency to ascertain the status of the airspace. Pilots in Class E airspace must be alert for changing weather conditions which may effect the status of the airspace from IFR/VFR. If ATC service is required for IFR/SVFR approach/departure or requested for VFR service, the pilot should advise the controller that he/she has received the one-minute weather and state his/her intentions.

**EXAMPLE.—**

*"I HAVE THE (AIRPORT) ONE-MINUTE WEATHER, REQUEST AN ILS RUNWAY 14 APPROACH."*

**REFERENCE—**

*SECTION GEN 3.5, PARAGRAPH 7, WEATHER OBSERVING PROGRAMS.*

## GEN 3.4 Communication Service

### 1. Responsible Authority

1.1 The authority responsible for the administration of communications services in the U.S. is the Federal Aviation Administration, Communication, Navigation, Surveillance, and Infrastructure.

*Postal Address:*

Federal Aviation Administration  
Communication, Navigation, Surveillance, and  
Infrastructure (ARN-1 )  
400 7th Street, SW  
Washington, D.C. 20590

*AFTN Address:* KDCAYAYX

*Commercial Telegraphic Address:*  
ACIVAIR Washington DC

*Telex:* 892-562

### 2. Area of Responsibility

2.1 Communications services are available on a continuous basis without charge to the user. The Air Traffic Services Division is responsible for the establishment of the operational requirements of the U.S. communications system. Responsibility for the day to day operation of these services resides with the local air traffic facility. Enquiries or complaints regarding any communications services or facilities should be referred to the relevant air traffic facility or to the Federal Aviation Administration, Air Traffic Operations Services, as appropriate.

### 3. Types of Services

#### 3.1 Radio Navigation Service

3.1.1 Various types of air navigation aids are in use today, each serving a special purpose. These aids have varied owners and operators, namely: the Federal Aviation Administration, the military services, private organizations; and individual states and foreign governments. The Federal Aviation Administration has the statutory authority to establish, operate, and maintain air navigation facilities and to prescribe standards for the operation of any of these aids which are used by both civil and military aircraft for instrument flight in federally controlled airspace. These aids are tabulated in the Airport/Facility Directory by State.

3.1.2 The following types of Radio Navigation Aids are provided in the U.S.:

- a) VHF Direction-Finding (VHF-DF)
- b) LF Non-Directional Beacon (NDB)
- c) VHF Omni-Directional Radio Range (VOR)
- d) Distance Measuring Equipment (DME)
- e) Tactical Air Navigation (TACAN)
- f) Instrument Landing System (ILS)
- g) Final Approach Simplified Directional Facility (SDF)
- h) Precision Approach Radar (PAR) at certain military aerodromes
- i) LORAN
- j) Global Positioning System (GPS)

#### 3.1.3 NAVAID Service Volumes

3.1.3.1 Most air navigation radio aids which provide positive course guidance have a designated standard service volume (SSV). The SSV defines the reception limits of unrestricted NAVAID's which are usable for random/unpublished route navigation.

3.1.3.2 A NAVAID will be classified as restricted if it does not conform to flight inspection signal strength and course quality standards throughout the published SSV. However, the NAVAID should not be considered usable at altitudes below that which could be flown while operating under random route IFR conditions; even though these altitudes may lie within the designated SSV.

*NOTE.—*  
*REFER TO FEDERAL AVIATION REGULATIONS (14 CFR SECTION 91.177) FOR MINIMUM ALTITUDES FOR IFR OPERATIONS. SERVICE VOLUME RESTRICTIONS ARE FIRST PUBLISHED IN THE NOTICES TO AIRMAN (NOTAM) AND THEN WITH THE ALPHABETICAL LISTING OF THE NAVAIDS IN THE AIRPORT/FACILITY DIRECTORY.*

3.1.3.3 Standard service volume limitations do not apply to published IFR routes or procedures.

#### 3.1.3.4 VOR/DME/TACAN Standard Service Volumes (SSV)

a) SSV's are graphically shown in FIG 3.4-1, FIG 3.4-2, FIG 3.4-3, FIG 3.4-4, and FIG 3.4-5. The SSV of a station is indicated by using the class designator as a prefix to the station type designation.

*EXAMPLE.—*  
*TVOR, LDME, AND HVORTAC.*

b) Within 25 NM, the bottom of the T service volume is defined by the curve in FIG 3.4-4. Within 40 NM, the

bottoms of the L and H service volumes are defined by the curve in FIG 3.4-5.

**3.1.3.5 Nondirectional Radio Beacon (NDB)**

a) NDB's are classified according to their intended use.

b) The ranges of NDB service volumes are shown in TBL 3.4-2. The distances (radius) are the same at all altitudes.

**3.1.4 NAVAID's with Voice**

**3.1.4.1** Voice equipped en route radio navigational aids are under the operational control of either an FAA AFSS or an approach control facility. The voice communication is available on some facilities. The HIWAS broadcast capability on selected VOR sites is in the process of being implemented throughout the conterminous United States and does not provide voice communication. The availability of two-way voice communication and HIWAS is indicated in the Airport/Facility Directory and aeronautical charts.

**Standard Low Altitude Service Volume**  
(See FIG 3.4-5 for altitudes below 1,000 feet.)

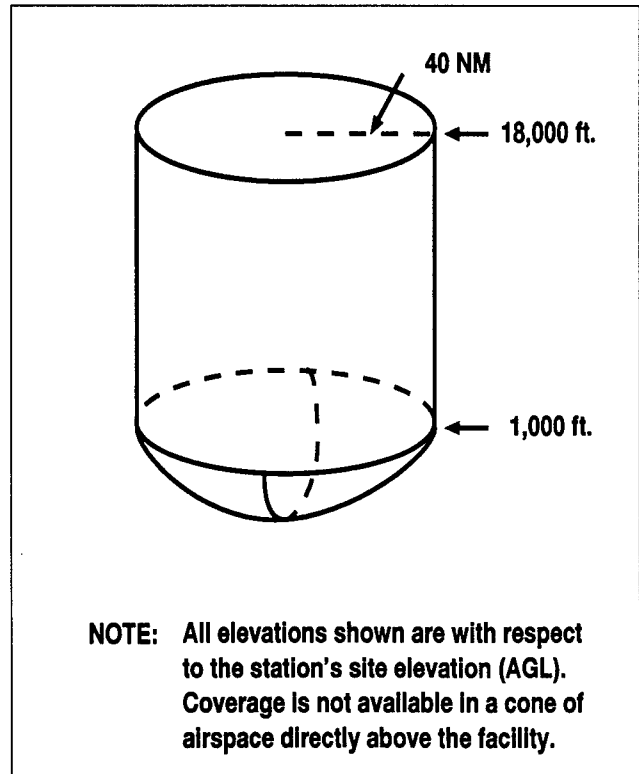

FIG 3.4-2

**Standard High Altitude Service Volume**  
(See FIG 3.4-5 for altitudes below 1,000 feet.)

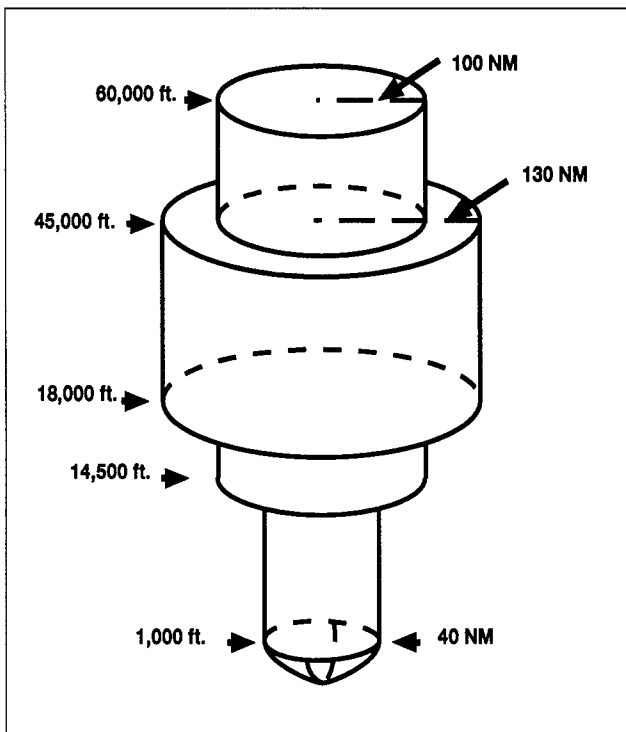

FIG 3.4-1

**Standard Terminal Service Volume**  
(See FIG 3.4-4 for altitudes below 1,000 feet)

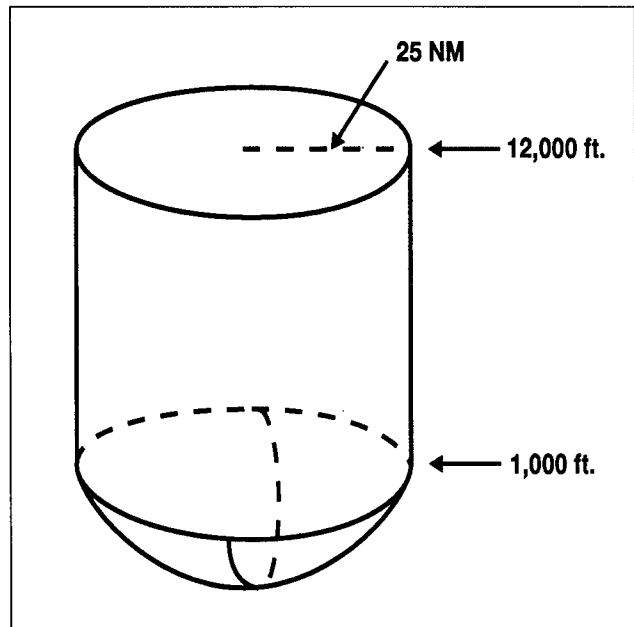

FIG 3.4-3



**3.1.4.2** Unless otherwise noted on the chart, all radio navigation aids operate continuously except during shutdowns for maintenance. Hours of operation of facilities not operating continuously are annotated on charts and in the Airport/Facility Directory.

**3.2 Mobile Service**

**3.2.1** The aeronautical stations (Airport Traffic Control Towers, Air Route Traffic Control Centers and Flight Service Stations) maintain a continuous watch on their assigned frequencies during the published hours of service unless otherwise notified. An aircraft should normally communicate with the air-ground control radio station which exercises control in the area in which it is flying. Aircraft should maintain continuous watch on the appropriate frequency of the control station and should not abandon watch, except in an emergency, without informing the control radio station.

**3.2.2** Flight Service Stations (FSS's) are allocated frequencies for different functions. For Airport Advisory Service, the pilot should contact the FSS on 123.6 MHz. Individual assigned FSS frequencies are listed in Airport/Facility Directory under the FSS entry. If you are in doubt as to what frequency to use to contact an FSS, transmit on 122.1 MHz and advise the FSS of the frequency on which you are receiving.

**3.3 Fixed Service**

**3.3.1** Messages to be transmitted over the Aeronautical Fixed Service are accepted only if they satisfy the requirements of:

- a) ICAO Annex 10, Vol. II, Chapter 3, paragraph 3.3,
- b) Are prepared in the form specified in Annex 10, and

c) The text of an individual message does not exceed 200 groups.

**3.3.2** General aircraft operating messages, Class B traffic, including reservation messages pertaining to flights scheduled to depart within 72 hours, shall not be acceptable for transmission over U.S. government operated telecommunications circuits except in those cases where it has been determined by the U.S. that adequate non-government facilities are not available.

**3.4 Broadcast Service**

**3.4.1** The following meteorological broadcasts are available for the use of aircraft in flight:

- a) LF Transcribed Weather Broadcast (TWEB)
- b) Sub-Area Meteorological Broadcast (Volmet)
- c) VHF RTF Meteorological Broadcasts

**3.4.2** Full details of broadcast service are given in GEN 3.5.

**3.4.3** All broadcast services to aircraft are provided in the English language only.

**4. Aeronautical Fixed Services**

**4.1 General**

**4.1.1** All U.S. ATC facilities have the ability to communicate with all other ATS facilities via either telephone or other domestic telecommunications systems. Circuit diagrams depicting these connections are not available for this publication due to the number of ATS facilities available in the U.S.

**VOR/DME/TACAN Standard Service Volumes**

<i>SSV Class Designator</i>	<i>Altitude and Range Boundaries</i>
T (Terminal) .....	From 1,000 feet above ground level (AGL) up to and including 12,000 feet AGL at radial distances out to 25 NM.
L (Low Altitude) .....	From 1,000 feet AGL up to and including 18,000 feet AGL at radial distances out to 40 NM.
H (High Altitude) .....	From 1,000 feet AGL up to and including 14,500 feet AGL at radial distances out to 40 NM. From 14,500 AGL up to and including 60,000 feet at radial distances out to 100 NM. From 18,000 feet AGL up to and including 45,000 feet AGL at radial distances out to 130 NM.

TBL 3.4-1

**NDB Service Volumes**

<i>Class</i>	<i>Distance (Radius)</i>
Compass Locator	15 NM
MH	25 NM
H	50 NM*
HH	75 NM

*\* Service ranges of individual facilities may be less than 50 nautical miles (NM). Restrictions to service volumes are first published as a Notice to Airmen and then with the alphabetical listing of the NAVAID in the A/FD.*

TBL 3.4-2

**Service Volume Lower Edge  
Terminal**

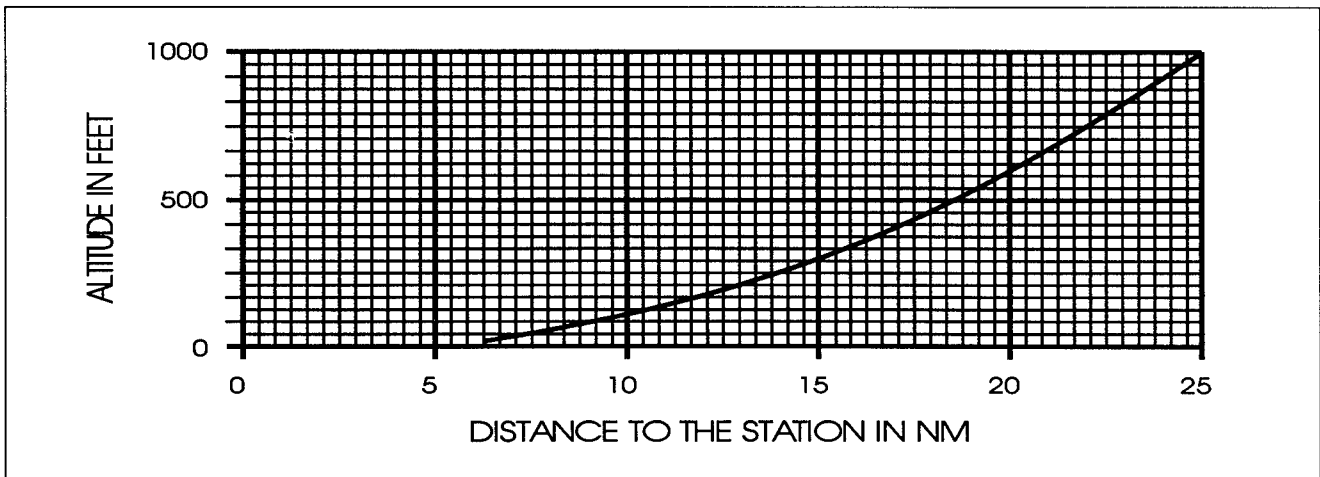

FIG 3.4-4

**Service Volume Lower Edge  
Standard High and Low**

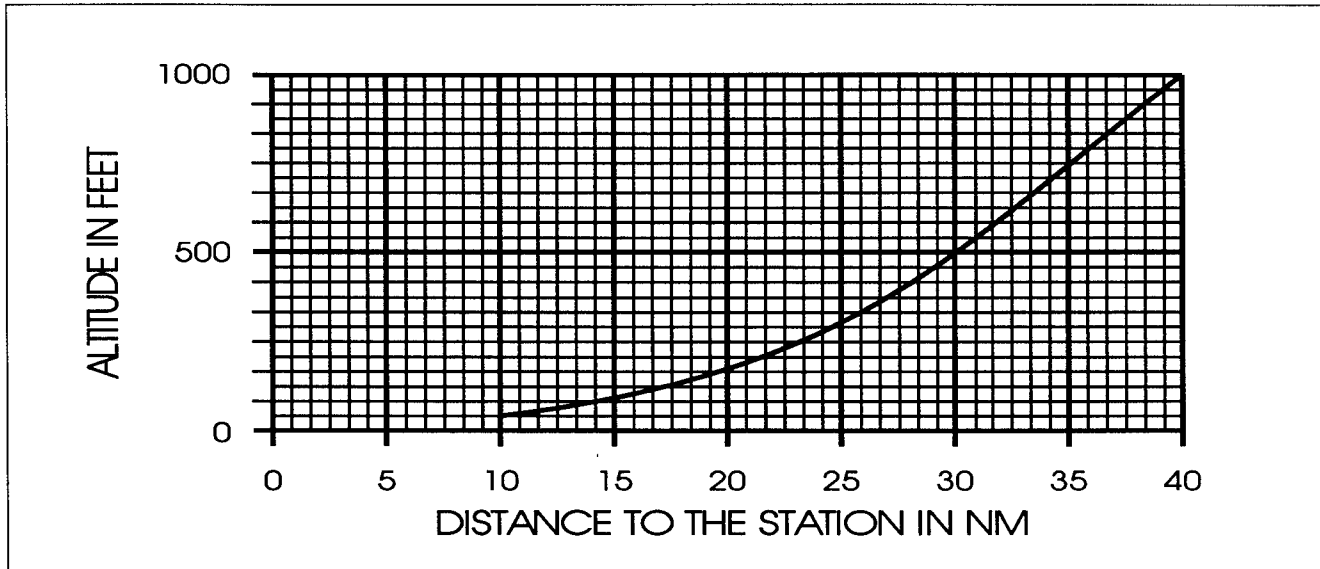

FIG 3.4-5

## 4.2 The Domestic Telecommunications Network

**4.2.1** The U.S. Domestic telecommunications network is an automated system operating through the National Airspace Data Interchange Network (NADIN) in Atlanta, GA, and Salt Lake City, NV. All Flight Service Stations (FSS) and Air Route Traffic Control Centers (ARTCC) connect through the NATCOM. All FSS and ARTCC facilities have both transmit and receive capabilities.

**4.2.2** Airport Air Traffic Control Towers (ATCT) and Approach Control (A/C) Facilities do not connect with this system. Messages originating from or destined to these facilities are relayed through the associated FSS. Associated FSS's for these facilities are listed in the Airport/Facility Directory.

**4.2.3** Airport administrative offices, airport managers or airport administrative officials do not normally connect with the domestic telecommunications network. Urgent messages destined to these facilities must be forwarded to the associated FSS for relay or the message must be sent through commercial telegraphic systems.

## 4.3 The International Message Network (Aeronautical Fixed Telecommunications Network-AFTN)

**4.3.1** AFTN messages originating from outside the U.S. domestic telecommunications system must be prepared in accordance with ICAO procedures. All incoming messages are received by NADIN and relayed to the addressed facility through automated procedures. The automated system will interpret the international address group and automatically forward the message via the domestic system to the addressee. For example, a message addressed KIKKYFYX will be accepted by AFTN and relayed to IKK (Kankakee FSS). The Kankakee FSS will manually relay this message to the intended recipient when necessary. Intended recipients are to be addressed in the first line of the message text.

**4.3.2** All international flight plans entering the U.S. system must adhere to ICAO format. These flight plans are to be forwarded, via AFTN, to each affected, U.S. controlled, Flight Information Region (FIR) or Air Route Traffic Control Center (ARTCC) outside the continental U.S. (e.g., Miami FIR, San Juan, P.R. ARTCC) or the first FIR/ARTCC for flights entering the continental U.S. (e.g., New York FIR/ARTCC). If the flight plan content is acceptable, it is entered into the ARTCC system and is forwarded, automatically, via ARTCC computer, to all subsequently affected domestic ARTCC's. Flight plans which cannot be processed are rejected at the point of entry into the U.S. system and

the originator is queried. Format adherence, once the flight plan is in the ARTCC system, is assured since each of the ARTCC's are automated facilities. Each subsequent ARTCC computer, however, will process incoming flight plans according to the requested routing. Flight plans can be rejected by any ARTCC due to errors in routing. Rejected flight plans, regardless of reason or point of rejection, are held in suspense until the needed clarification is received by the ARTCC facility.

## 4.4 Radio Communications Phraseology And Techniques

### 4.4.1 General

**4.4.1.1** Radio communications are a critical link in the ATC system. The link can be a strong bond between pilot and controller - or it can be broken with surprising speed and disastrous results. Discussion herein provides basic procedures for new pilots and also highlights safe operating concepts for all pilots.

**4.4.1.2** The single, most important thought in pilot-controller communications is understanding. It is essential, therefore, that pilots acknowledge each radio communication with ATC by using the appropriate aircraft call sign. Brevity is important, and contacts should be kept as brief as possible, but the controller must know what you want to do before he can properly carry out his control duties. And you, the pilot, must know exactly what he wants you to do. Since concise phraseology may not always be adequate, use whatever words are necessary to get your message across. Pilots are to maintain vigilance in monitoring air traffic control radio communications frequencies for potential traffic conflicts with their aircraft especially when operating on an active runway and/or when conducting a final approach to landing.

**4.4.1.3** All pilots will find the Pilot/Controller Glossary very helpful in learning what certain words or phrases mean. Good phraseology enhances safety and is the mark of a professional pilot. Jargon, chatter and "CB" slang have no place in ATC communications. The Pilot/Controller Glossary is the same glossary used in the ATC controller's handbook. We recommend that it be studied and reviewed from time to time to sharpen your communication skills.

### 4.4.2 Radio Technique

**4.4.2.1** Listen before you transmit. Many times you can get the information you want through ATIS or by monitoring the frequency. Except for a few situations where some frequency overlap occurs, if you hear someone

else talking, the keying of your transmitter will be futile and you will probably jam their receivers causing them to repeat their call. If you have just changed frequency, pause for your receiver to tune, listen and make sure the frequency is clear.

**4.4.2.2** Think before keying your transmitter. Know what you want to say and if it is lengthy; e.g., a flight plan or IFR position report, jot it down. (But do not lock your head in the cockpit.)

**4.4.2.3** The microphone should be very close to your lips and after pressing the mike button, a slight pause may be necessary to be sure the first word is transmitted. Speak in a normal conversational tone.

**4.4.2.4** When you release the button, wait a few seconds before calling again. The controller or FSS specialist may be jotting down your number, looking for your flight plan, transmitting on a different frequency, or selecting his transmitter to your frequency.

**4.4.2.5** Be alert to the sounds or lack of sounds in your receiver. Check your volume, recheck your frequency and make sure that your microphone is not stuck in the transmit position. Frequency blockage can, and has, occurred for extended periods of time due to unintentional transmitter operation. This type of interference is commonly referred to as a "stuck mike," and controllers may refer to it in this manner when attempting to assign an alternate frequency. If the assigned frequency is completely blocked by this type of interference, use the procedures described in paragraph 12.

**4.4.2.6** Be sure that you are within the performance range of your radio equipment and the ground station equipment. Remote radio sites do not always transmit and receive on all of a facilities' available frequencies, particularly with regard to VOR sites where you can hear but not reach a ground station's receiver. Remember that higher altitude increases the range of VHF "line of sight" communications.

### 4.4.3 Aircraft Call Signs

**4.4.3.1** Improper use of call signs can result in pilots executing a clearance intended for another aircraft. Call signs should never be abbreviated on an initial contact or at any time when other aircraft call signs have similar numbers/sounds or identical letters/numbers, (e.g., Cessna 6132F, Cessna 1622F, Baron 123F, Cherokee 7732F, etc.).

*EXAMPLE.—*  
AS AN EXAMPLE, ASSUME THAT A CONTROLLER ISSUES AN APPROACH CLEARANCE TO AN AIRCRAFT AT THE BOTTOM OF A HOLDING STACK AND AN AIRCRAFT WITH A SIMILAR CALL SIGN

*(AT THE TOP OF THE STACK) ACKNOWLEDGES THE CLEARANCE WITH THE LAST TWO OR THREE NUMBERS OF HIS CALL SIGN. IF THE AIRCRAFT AT THE BOTTOM OF THE STACK DID NOT HEAR THE CLEARANCE AND INTERVENE, FLIGHT SAFETY WOULD BE AFFECTED, AND THERE WOULD BE NO REASON FOR EITHER THE CONTROLLER OR PILOT TO SUSPECT THAT ANYTHING IS WRONG. THIS KIND OF "HUMAN FACTORS" ERROR CAN STRIKE SWIFTLY AND IS EXTREMELY DIFFICULT TO RECTIFY.*

**4.4.3.2** Pilots, therefore, must be certain that aircraft identification is complete and clearly identified before taking action on an ATC clearance. ATC specialists will not abbreviate call signs of air carrier or other civil aircraft having authorized call signs. ATC specialists may initiate abbreviated call signs of other aircraft by using the prefix and the last three digits/letters of the aircraft identification after communications are established. The pilot may use the abbreviated call sign in subsequent contacts with the ATC specialist. When aware of similar/identical call signs, ATC specialists will take action to minimize errors by emphasizing certain numbers/letters, by repeating the entire call sign, repeating the prefix, or by asking pilots to use a different call sign temporarily. Pilots should use the phrase "Verify clearance for (your complete call sign)" if doubt exists concerning proper identity.

**4.4.3.3** Civil aircraft pilots should state the aircraft type, model or manufacturer's name followed by the digits/letters of the registration number. When the aircraft manufacturer's name or model is stated, the prefix "N" is dropped.

*EXAMPLE.—*  
"BONANZA SIX FIVE FIVE GOLF," "DOUGLAS ONE ONE ZERO," "BREEZY SIX ONE THREE ROMEO EXPERIMENTAL" (OMIT "EXPERIMENTAL" AFTER INITIAL CONTACT).

**4.4.3.4** Air Taxi or other commercial operators not having FAA authorized call signs should prefix their normal identification with the phonetic word "Tango." For example, Tango Aztec Two Four Six Four Alpha.

**4.4.3.5** Air carriers and commuter air carriers having FAA authorized call signs should identify themselves by stating the complete call sign, using group form for the numbers.

*EXAMPLE.—*  
UNITED TWENTY-FIVE, MIDWEST COMMUTER SEVEN ELEVEN.

**4.4.3.6** Military aircraft use a variety of systems including serial numbers, word call signs and combinations of letters/numbers. Examples include Army Copter 48931, Air Force 61782, REACH 31792, Pat 157, Air-Evac 17652, Navy Golf Alpha Kilo 21, Marine 4 Charlie 36, etc.

**4.4.3.7 Air Ambulance Flights.** Because of the priority afforded air ambulance flights in the ATC system, extreme discretion is necessary when using the term

“LIFEGUARD.” It is only intended for those missions of an urgent medical nature and to be utilized only for that portion of the flight requiring expeditious handling. When requested by the pilot, necessary notification to expedite ground handling of patients, etc., is provided by ATC; however, when possible, this information should be passed in advance through non-ATC communications systems.

a) Civilian air ambulance flights responding to medical emergencies (first call to an accident scene, carrying patients, organ donors, organs, or other urgently needed lifesaving medical material) will be expedited by ATC when necessary. When expeditious handling is necessary, add the word “LIFEGUARD” in the remarks section of the flight plan. In radio communications, use the call sign “LIFEGUARD” followed by the aircraft registration letters/numbers.

b) Similar provisions have been made for the use of “Air-Evac” and “Med-Evac” by military air ambulance flights, except that these military flights will receive priority only when specifically requested.

**EXAMPLE.—**  
LIFEGUARD TWO SIX FOUR SIX.

c) Air carrier and air taxi flights responding to medical emergencies will also be expedited by ATC when necessary. The nature of these medical emergency flights usually concerns the transportation of urgently needed lifesaving medical materials or vital organs. IT IS IMPERATIVE THAT THE COMPANY/PILOT DETERMINE, BY THE NATURE/URGENCY OF THE SPECIFIC MEDICAL CARGO, IF PRIORITY ATC ASSISTANCE IS REQUIRED. Pilots shall ensure that the word “LIFEGUARD” is included in the remarks section of the flight plan and use the call sign “LIFEGUARD” followed by the company name and flight number, for all transmissions when expeditious handling is required. It is important for ATC to be aware of “LIFEGUARD” status, and it is the pilot’s responsibility to ensure that this information is provided to ATC.

**EXAMPLE.—**  
LIFEGUARD DELTA THIRTY-SEVEN.

**4.4.3.8 Student Pilots Radio Identification.** The FAA desires to help the student pilot in acquiring sufficient practical experience in the environment in which he will be required to operate. To receive additional assistance while operating in areas of concentrated air traffic, a student pilot need only identify himself as a student pilot during his initial call to an FAA radio facility. For instance, “Dayton Tower, this is Fleetwing 1234, Student Pilot.” This special identification will alert

FAA air traffic control personnel and enable them to provide the student pilot with such extra assistance and consideration as he may need. This procedure is not mandatory.

#### 4.4.4 Description of Interchange or Leased Aircraft

**4.4.4.1** Controllers issue traffic information based on familiarity with airline equipment and color/markings. When an air carrier dispatches a flight using another company’s equipment and the pilot does not advise the terminal ATC facility, the possible confusion in aircraft identification can compromise safety.

**4.4.4.2** Pilots flying an “interchange” or “leased” aircraft not bearing the colors/markings of the company operating the aircraft should inform the terminal ATC facility on first contact the name of the operating company and trip number, followed by the company name as displayed on the aircraft, and aircraft type.

**EXAMPLE.—**  
AIR CAL 311, UNITED (INTERCHANGE/LEASE), BOEING 727.

#### 4.4.5 Ground Station Call Signs

**4.4.5.1** Pilots, when calling a ground station, should begin with the name of the facility being called followed by the type of the facility being called, as indicated in the following examples.

##### Calling a Ground Station

<i>Facility</i>	<i>Call Sign</i>
Airport UNICOM	“Shannon UNICOM”
FAA Flight Service Station	“Chicago Radio”
FAA Flight Service Station (En Route Flight Advisory Service (Weather))	“Seattle Flight Watch”
Airport Traffic Control Tower	“Augusta Tower”
Clearance Delivery Position (IFR)	“Dallas Clearance Delivery”
Ground Control Position in Tower	“Miami Ground”
Radar or Nonradar Approach Control Position	“Oklahoma City Approach”
Radar Departure Control Position	“St. Louis Departure”
FAA Air Route Traffic Control Center	“Washington Center”

TBL 3.4-3

#### 4.5 Radio Communications Phraseology

##### 4.5.1 Phonetic Alphabet

**4.5.1.1** The International Civil Aviation Organization (ICAO) phonetic alphabet is used by FAA personnel when communications conditions are such that the information cannot be readily received without their use. Air traffic control facilities may also request pilots to use phonetic letter equivalents when aircraft with

similar sounding identifications are receiving communications on the same frequency. Pilots should use the phonetic alphabet when identifying their aircraft during initial contact with air traffic control facilities. Additionally, use the phonetic equivalents for single letters and to spell out groups of letters or difficult words during adverse communications conditions.

Character	Morse Code	Telephony	Phonic (Pronunciation)
A	•—	Alfa	(AL-FAH)
B	—•••	Bravo	(BRAH-VOH)
C	—•—•	Charlie	(CHAR-LEE) or (SHAR-LEE)
D	—••	Delta	(DELL-TAH)
E	•	Echo	(ECK-OH)
F	••—•	Foxtrot	(FOKS-TROT)
G	—•—•	Golf	(GOLF)
H	••••	Hotel	(HOH-TEL)
I	••	India	(IN-DEE-AH)
J	•—•••	Juliett	(JEW-LEE-ETT)
K	—•—	Kilo	(KEY-LOH)
L	•—••	Lima	(LEE-MAH)
M	—•—	Mike	(MIKE)
N	—•	November	(NO-VEM-BER)
O	—•••	Oscar	(OSS-CAH)
P	•—••	Papa	(PAH-PAH)
Q	—••—	Quebec	(KEH-BECK)
R	•—•	Romeo	(ROW-ME-OH)
S	•••	Sierra	(SEE-AIR-RAH)
T	—••	Tango	(TANG-GO)
U	••—	Uniform	(YOU-NEE-FORM) or (OO-NEE-FORM)
V	•••—	Victor	(VIK-TAH)
W	•—•—	Whiskey	(WISS-KEY)
X	—••—	Xray	(ECKS-RAY)
Y	—•—•	Yankee	(YANG-KEY)
Z	—•••	Zulu	(ZOO-LOO)
1	•—••••	One	(WUN)
2	••—•••	Two	(TOO)
3	•••—••	Three	(TREE)
4	••••—	Four	(FOW-ER)
5	•••••	Five	(FIFE)
6	—••••	Six	(SIX)
7	—••••	Seven	(SEV-EN)
8	—•••••	Eight	(AIT)
9	—•••••	Nine	(NIN-ER)
0	—•••••	Zero	(ZEE-RO)

TBL 3.4-4

### 4.5.2 Figures

4.5.2.1 Figures indicating hundreds and thousands in round numbers, as for ceiling heights, and upper wind levels up to 9,900, shall be spoken in accordance with the following:

EXAMPLE.—

- ① 500 ..... FIVE HUNDRED
- ② 4,500 ..... FOUR THOUSAND FIVE HUNDRED

4.5.2.2 Numbers above 9,900 shall be spoken by separating the digits preceding the word “thousand.”

EXAMPLE.—

- ① 10,000 ..... ONE ZERO THOUSAND
- ② 13,500 ..... ONE THREE THOUSAND FIVE HUNDRED

4.5.2.3 Transmit airway or jet route numbers as follows:

EXAMPLE.—

- ① V12 ..... VICTOR TWELVE
- ② J533 ..... J FIVE THIRTY THREE

4.5.2.4 All other numbers shall be transmitted by pronouncing each digit.

EXAMPLE.—

- 10 ..... ONE ZERO

4.5.2.5 When a radio frequency contains a decimal point, the decimal point is spoken as “Point.”

EXAMPLE.—

- 122.1 ..... ONE TWO TWO POINT ONE

NOTE.— ICAO PROCEDURES REQUIRE THE DECIMAL POINT BE SPOKEN AS “DECIMAL.” THE FAA WILL HONOR SUCH USAGE BY MILITARY AIRCRAFT AND ALL OTHER AIRCRAFT REQUIRED TO USE ICAO PROCEDURES.

### 4.5.3 Altitudes and Flight Levels

4.5.3.1 Up to but not including 18,000’ MSL, by stating the separate digits of the thousands, plus the hundreds.

EXAMPLE.—

- ① 12,000 ..... ONE TWO THOUSAND
- ② 12,500 ..... ONE TWO THOUSAND FIVE HUNDRED

4.5.3.2 At and above 18,000’ MSL (FL 180) by stating the words “flight level” followed by the separated digits of the flight level.

EXAMPLE.—

- ① 190 ..... FLIGHT LEVEL ONE NINER ZERO
- ② 275 ..... FLIGHT LEVEL TWO SEVEN FIVE

### 4.5.4 Directions

4.5.4.1 The three digits of a magnetic course, bearing, heading or wind direction, should always be magnetic. The word “true” must be added when it applies.

EXAMPLE.—

- ① (Magnetic course) 005 .... ZERO ZERO FIVE
- ② (True course) 050 ..... ZERO FIVE ZERO TRUE
- ③ (Magnetic bearing) 360 ... THREE SIX ZERO
- ④ (Magnetic heading) 100 ... HEADING ONE ZERO ZERO
- ⑤ (Wind direction) 220 ..... WIND TWO TWO ZERO

**4.5.5 Speeds**

**4.5.5.1** The separate digits of the speed are to be followed by the word “KNOTS” except that controllers may omit the word “KNOTS” when using speed adjustment procedures (e.g., “REDUCE/INCREASE SPEED TO TWO FIVE ZERO”).

**EXAMPLE.—**  
(Speed) 250 ..... TWO FIVE ZERO KNOTS  
(Speed) 190 ..... ONE NINER ZERO KNOTS

**4.5.5.2** The separate digits of the mach number are to be preceded by the word “MACH.”

**EXAMPLE.—**  
(Mach number) 1.5 ..... MACH ONE POINT FIVE  
(Mach number) 0.64 ..... MACH POINT SIX FOUR  
(Mach number) 0.7 ..... MACH POINT SEVEN

**4.5.6 Time**

**4.5.6.1** FAA uses Coordinated Universal Time (UTC) for all operations. The word “local” or the time zone equivalent shall be used to denote local when local time is given during radio and telephone communications. The term “ZULU” may be used to denote UTC.

**EXAMPLE.—**  
0920 UTC ..... ZERO NINER TWO ZERO,  
ZERO ONE TWO ZERO PACIFIC OR LOCAL,  
OR ONE TWENTY AM

**4.5.6.2** To convert from Standard Time to UTC:

**Standard Time to Coordinated Universal Time**

Eastern Standard Time	.....	Add 5 hours
Central Standard Time	.....	Add 6 hours
Mountain Standard Time	.....	Add 7 hours
Pacific Standard Time	.....	Add 8 hours
Alaska Standard Time	.....	Add 9 hours
Hawaii Standard Time	.....	Add 10 hours

TBL 3.4-5

**NOTE.—**  
FOR DAYLIGHT TIME, SUBTRACT 1 HOUR.

**4.5.6.3** A reference may be made to local daylight or standard time utilizing the 24-hour clock system. The hour is indicated by the first two figures and the minutes by the last two figures.

**EXAMPLE.—**  
0000 ..... ZERO ZERO ZERO ZERO  
0920 ..... ZERO NINER TWO ZERO

**4.5.6.4** Time may be stated in minutes only (two figures) in radio telephone communications when no misunderstanding is likely to occur.

**4.5.6.5** Current time in use at a station is stated in the nearest quarter minute in order that pilots may use this information for time checks. Fractions of a quarter minute or more, but less than eight seconds more, are stated as the preceding quarter minute; fractions of a quarter

minute of eight seconds or more are stated as the succeeding quarter minute.

**EXAMPLE.—**  
0929:05 ..... TIME, ZERO NINER TWO NINER  
0929:10 ..... TIME, ZERO NINER TWO NINER AND ONE-QUARTER

**4.5.7 Communications With Tower When Aircraft Transmitter/Receiver or Both Are Inoperative**

**4.5.7.1 Arriving Aircraft**

**a) Receiver Inoperative:** If you have reason to believe your receiver is inoperative, remain outside or above Class D airspace until the direction and flow of traffic has been determined; then, advise the tower of your type aircraft, position, altitude, intention to land, and request that you be controlled with light signals. When you are approximately 3 to 5 miles from the airport, advise the tower of your position and join the airport traffic pattern. From this point on, watch the tower for light signals. Thereafter, if a complete pattern is made, transmit your position when downwind and/or turning base leg.

**b) Transmitter Inoperative:** Remain outside or above Class D airspace until the direction and flow of traffic has been determined, then join the airport traffic pattern. Monitor the primary local control frequency as depicted on sectional charts for landing or traffic information, and look for a light signal which may be addressed to your aircraft. During hours of daylight, acknowledge tower transmissions or light signals by rocking your wings. At night, acknowledge by blinking the landing or navigational lights.

**NOTE.—**  
TO ACKNOWLEDGE TOWER TRANSMISSIONS DURING DAYLIGHT HOURS, HOVERING HELICOPTERS WILL TURN IN THE DIRECTION OF THE CONTROLLING FACILITY AND FLASH THE LANDING LIGHT. WHILE IN FLIGHT, HELICOPTERS SHOULD SHOW THEIR ACKNOWLEDGMENT OF RECEIVING A TRANSMISSION BY MAKING SHALLOW BANKS IN OPPOSITE DIRECTIONS. AT NIGHT, HELICOPTERS WILL ACKNOWLEDGE RECEIPT OF TRANSMISSIONS BY FLASHING EITHER THE LANDING OR THE SEARCH LIGHT.

**c) Transmitter and Receiver Inoperative:** Remain outside or above Class D airspace until the direction and flow of traffic has been determined, then join the airport traffic pattern and maintain visual contact with tower to receive light signals.

**4.5.7.2 Departing Aircraft:** If you experience radio failure prior to leaving the parking area, make every effort to have the equipment repaired. If you are unable to have the malfunction repaired, call the tower by telephone and request authorization to depart without two-way radio communications. If tower authorization is granted, you will be given departure information and requested to monitor the tower frequency or watch for

light signals, as appropriate. During daylight hours, acknowledge tower transmissions or light signals by moving the ailerons or rudder. At night, acknowledge by blinking the landing or navigation lights. If radio malfunction occurs after departing the parking area, watch the tower for light signals or monitor tower frequency.

#### 4.5.8 Contact Procedures

##### 4.5.8.1 Initial Contact

a) The terms “initial contact” or “initial call up” mean the first radio call you make to a given facility, or the first call to a different controller/FSS specialist within a facility. Use the following format:

- 1) Name of facility being called;
- 2) Your full aircraft identification as filed in the flight plan or as discussed under aircraft call signs;
- 3) Type of message to follow or your request if it is short; and
- 4) The word “Over,” if required.

*EXAMPLE.—*  
“NEW YORK RADIO, MOONEY THREE ONE ONE ECHO.” “COLUMBIA GROUND CONTROL, CESSNA THREE ONE SIX ZERO FOXTROT, IFR MEMPHIS.”

*EXAMPLE.—*  
“MIAMI CENTER BARON FIVE SIX THREE HOTEL, REQUEST VFR TRAFFIC ADVISORIES.”

b) Many FSS’s are equipped with remote communications outlets and can transmit on the same frequency at more than one location. The frequencies available at specific locations are indicated on charts above FSS communications boxes. To enable the specialist to utilize the correct transmitter, advise the location and frequency on which you expect a reply.

*EXAMPLE.—*  
ST. LOUIS FSS CAN TRANSMIT ON FREQUENCY 122.3 AT EITHER FARMINGTON, MO, OR DECATUR, IL. IF YOU ARE IN THE VICINITY OF DECATUR, YOUR CALLUP SHOULD BE “SAINT LOUIS RADIO, PIPER SIX NINER SIX YANKEE, RECEIVING DECATUR ONE TWO TWO POINT THREE.”

c) If radio reception is reasonably assured, inclusion of your request, your position or altitude, the phrase “Have numbers” or “Information Charlie received” (for ATIS) in the initial contact helps decrease radio frequency congestion. Use discretion and do not overload the controller with information he does not need. When you do not get a response from the ground station, recheck your radios or use another transmitter and keep the next contact short.

*EXAMPLE.—*  
“ATLANTA CENTER, DUKE FOUR ONE ROMEO, REQUEST VFR TRAFFIC ADVISORIES, TWENTY NORTHWEST ROME, SEVEN THOUSAND FIVE HUNDRED, OVER.”

#### 4.5.9 Initial Contact When Your Transmitting and Receiving Frequencies Are Different

4.5.9.1 If you are attempting to establish contact with a ground station and you are receiving on a different frequency than that transmitted, indicate the VOR name or the frequency on which you expect a reply. Most FSS’s and control facilities can transmit on several VOR stations in the area. Use the appropriate FSS call sign as indicated on charts.

*EXAMPLE.—*  
NEW YORK FSS TRANSMITS ON THE KENNEDY, DEER PARK AND CALVERTON VORTACS. IF YOU ARE IN THE CALVERTON AREA, YOUR CALLUP SHOULD BE “NEW YORK RADIO, CESSNA THREE ONE SIX ZERO FOXTROT, RECEIVING RIVERHEAD VOR, OVER.”

4.5.9.2 If the chart indicates FSS frequencies above the VORTAC or in FSS communications boxes, transmit or receive on those frequencies nearest your location.

4.5.9.3 When unable to establish contact and you wish to call any ground station, use the phrase “any radio (tower) (station), give Cessna Three One Six Zero Foxtrot a call on (frequency) or (VOR).” If an emergency exists or you need assistance, so state.

4.5.10 **Subsequent Contacts and Responses to Call Up From a Ground Facility:** Use the same format as used for initial contact except you should state your message or request with the call up in one transmission. The ground station name and the word “Over” may be omitted if the message requires an obvious reply and there is no possibility for misunderstandings. You should acknowledge all callups or clearances unless the controller of FSS specialist advises otherwise. There are some occasions when the controller must issue time-critical instructions to other aircraft and he may be in a position to observe your response, either visually or on radar. If the situation demands your response, take appropriate action or immediately advise the facility of any problem. Acknowledge with your aircraft identification, either at the beginning or at the end of your transmission, and one of the words “Wilco, Roger, Affirmative, Negative” or other appropriate remarks; e.g., “Piper Two One Four Lima, Roger.” If you have been receiving services such as VFR traffic advisories and you are leaving the area or changing frequencies, advise the ATC facility and terminate contact.



## 4.6 Acknowledgement of Frequency Changes

**4.6.1** When advised by ATC to change frequencies, acknowledge the instruction. If you select the new frequency without an acknowledgement, the controller's workload is increased because he has no way of knowing whether you received the instruction or have had radio communications failure.

**4.6.2** At times, a controller/specialist may be working a sector with multiple frequency assignments. In order to eliminate unnecessary verbiage and to free the controller/specialist for higher priority transmissions, the controller/specialist may request the pilot "(Identification), change to my frequency 123.4." This phrase should alert the pilot that he is only changing frequencies, not controller/specialist, and that initial call-up phraseology may be abbreviated.

*EXAMPLE.—*  
"UNITED TWO TWENTY-TWO ON ONE TWO THREE POINT FOUR"  
OR "ONE TWO THREE POINT FOUR, UNITED TWO TWENTY-TWO."

**4.6.3 Compliance with Frequency Changes.** When instructed by ATC to change frequencies, select the new frequency as soon as possible unless instructed to make the change at a specific time, fix, or altitude. A delay in making the change could result in an untimely receipt of important information. If you are instructed to make the frequency change at a specific time, fix, or altitude, monitor the frequency you are on until reaching the specified time, fix, or altitudes unless instructed otherwise by ATC.

## 5. Communications for VFR Flights

**5.1** FSS's are allocated frequencies for different functions; for example, 122.0 MHz is assigned as the En Route Flight Advisory Service frequency at selected FSS's. In addition, certain FSS's provide Local Airport Advisory on 123.6 MHz. Frequencies are listed in the Airport/Facility Directory. If you are in doubt as to what frequency to use, 122.2 MHz is assigned to the majority of FSS's as a common en route simplex frequency.

*NOTE.—*  
IN ORDER TO EXPEDITE COMMUNICATIONS, STATE THE FREQUENCY BEING USED AND THE AIRCRAFT LOCATION DURING INITIAL CALL-UP.

*EXAMPLE.—*  
"DAYTON RADIO, THIS IS N12345 ON 122.2 MHz OVER SPRING-FIELD VOR, OVER."

**5.1.1** Certain VOR voice channels are being utilized for recorded broadcasts; i.e., ATIS, HIWAS, etc. These services and appropriate frequencies are listed in the Airport/Facility Directory. On VFR flights, pilots are urged to monitor these frequencies. When in contact

with a control facility, notify the controller if you plan to leave the frequency to monitor these broadcasts.

## 5.2 Hazardous Area Reporting Service

**5.2.1** Selected FSS's provide flight monitoring where regularly traveled VFR routes cross large bodies of water, swamps, and mountains, for the purpose of expeditiously alerting Search and Rescue facilities when required.

**5.2.1.1** When requesting the service either in person, by telephone or by radio, pilots should be prepared to give the following information: type of aircraft, altitude, indicated airspeed, present position, route of flight, heading.

**5.2.1.2** Radio contacts are desired at least every 10 minutes. If contact is lost for more than 15 minutes, Search and Rescue will be alerted. Pilots are responsible for cancelling their request for service when they are outside the service area boundary. Pilots experiencing two-way radio failure are expected to land as soon as practicable and cancel their request for the service. FIG 3.4-6 includes the areas and the FSS facilities involved in this program.

## 5.2.2 Long Island Sound Reporting Service (LIRS)

**5.2.2.1** The New York and Bridgeport AFSS's provide Long Island Sound Reporting service on request for aircraft traversing Long Island Sound.

**5.2.2.2** When requesting the service, pilots should ask for SOUND REPORTING SERVICE and should be prepared to provide the following appropriate information:

- a) Type and color of aircraft;
- b) The specific route and altitude across the sound including the shore crossing point;
- c) The overwater crossing time;
- d) Number of persons on board; and
- e) True air speed.

**5.2.2.3** Radio contacts are desired at least every 10 minutes; however, for flights of shorter duration, a mid-sound report is requested. If contact is lost for more than 15 minutes, Search and Rescue will be alerted. Pilots are responsible for cancelling their request for the Long Island Sound Reporting Service when outside the service area boundary. Aircraft experiencing radio failure will be expected to land as soon as practicable and cancel their request for the service.

5.2.2.4 Communications: Primary communications - pilot transmits 122.1 MHz and listens on the VOR frequency.

NEW YORK AFSS	
Hampton RCO	T122.6/R122.6 MHz
Calverton VORTAC	T117.2 MHz
Kennedy VORTAC	T115.9/R122.1 MHz
BRIDGEPORT AFSS	
Madison VORTAC	T110.4/R122.1 MHz
Groton VOR	T111.8/R122.1 MHz
Bridgeport VOR	T108.8/R122.1 MHz

TBL 3.4-6

### 5.2.3 Block Island Reporting Service (BIRS)

5.2.3.1 Within the Long Island Reporting Service, the New York FSS/IFSS also provides an additional service for aircraft operating between Montauk Point and Block Island. When requesting this service, pilots should ask for BLOCK ISLAND REPORTING SERVICE and should be prepared to provide the same flight information as that required for the Long Island Sound Reporting Service.

### Hazardous Area Reporting Service

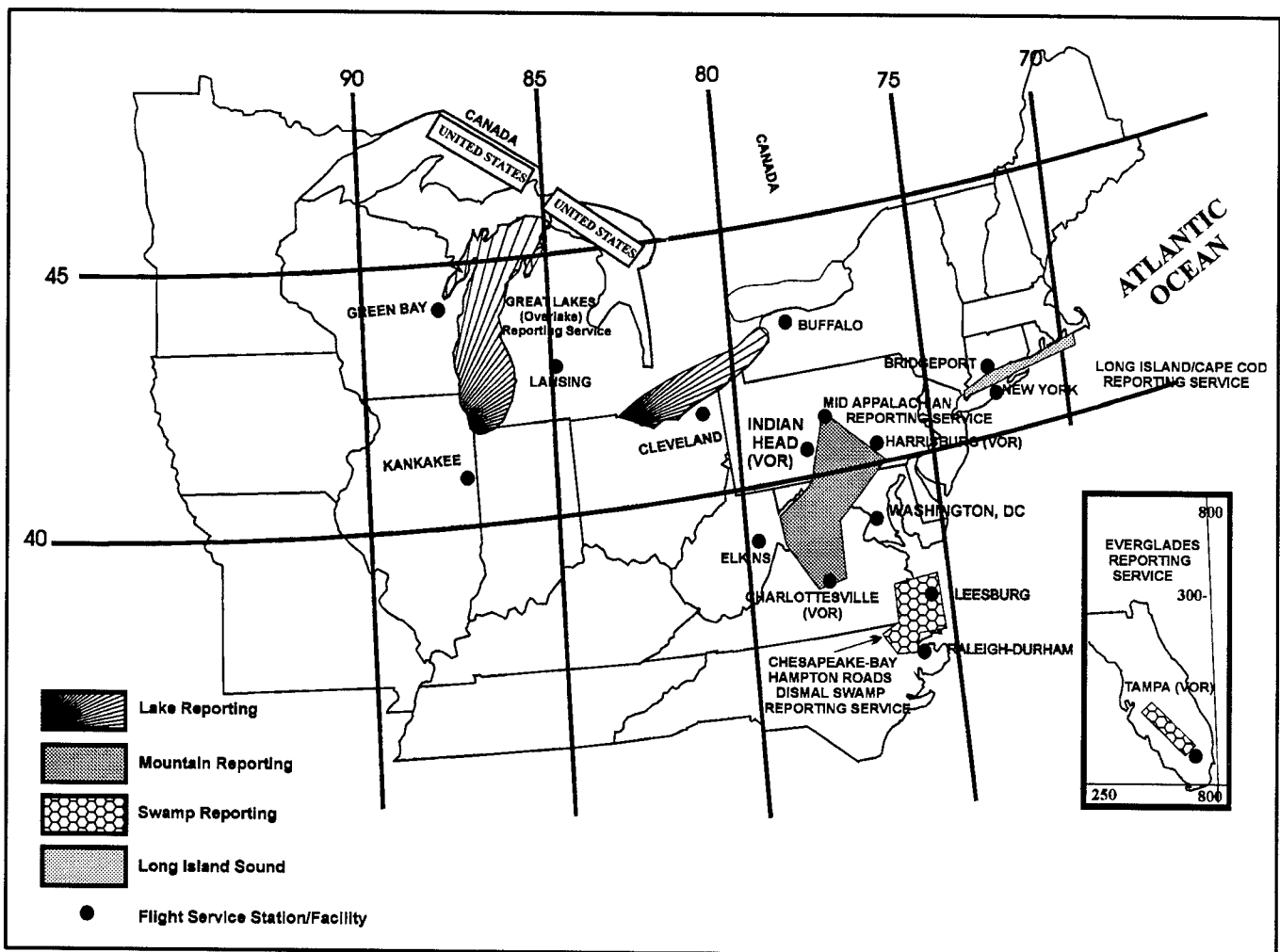

FIG 3.4-6

**5.2.3.2** A minimum of three position reports are mandatory for this service. These are: 1. Report leaving Montauk Point or Block Island. 2. Midway report. 3. Report when over Montauk Point or Block Island at which time the pilot cancels the overwater service.

**5.2.3.3 Communications:** Pilots are to transmit and receive on 122.6 MHz.

**5.2.3.4** Pilots are advised that 122.6 MHz is a remote receiver located at the Hampton VORTAC site and designed to provide radio coverage between Hampton and Block Island. Flights proceeding beyond Block Island may contact the Bridgeport AFSS by transmitting on 122.1 MHz and listing on Groton VOR (TMU) frequency 111.8 MHz.

#### **5.2.4 Cape Cod and Islands Radar Overwater Flight Following**

**5.2.4.1** In addition to normal VFR radar advisory service, traffic permitting, Otis Approach Control provides a radar overwater flight following service for aircraft traversing the Cape Code and adjacent island area. Pilots desiring this service may contact Cape RAPCON on 118.2 MHz.

**5.2.4.2** Pilots requesting this service should be prepared to give the following information: type and color of aircraft, altitude, position and heading, route of flight, and true airspeed.

**5.2.4.3** For best radar coverage, pilots are encouraged to fly at 1,500 feet MSL or above.

**5.2.4.4** Pilots are responsible for cancelling their request for overwater flight following when they are over the mainland and/or outside the service area boundary.

#### **5.2.5 Lake Reporting Service**

**5.2.5.1** Cleveland and Lansing AFSS's provide Lake Reporting Service on request for aircraft traversing the western half of Lake Erie. Green Bay, Kankakee, Lansing, and Terre Haute AFSS's provide Lake Reporting Service on request for aircraft traversing Lake Michigan.

a) When requesting the service, pilots should ask for LAKE REPORTING SERVICE.

b) Pilots not on a VFR flight plan should be prepared to provide all information that is normally provided for a complete VFR flight plan.

c) Pilots already on a VFR flight plan should be prepared to provide the following information:

1) Aircraft or flight identification.

2) Type of aircraft.

3) Near-shore crossing point or last fix before crossing.

4) Proposed time over near-shore crossing point or last fix before crossing.

5) Proposed altitude.

6) Proposed route of flight.

7) Estimated time over water.

8) Next landing point.

9) AFSS/FSS having complete VFR flight plan information.

d) Radio contacts must not exceed 10 minutes when pilots fly at an altitude that affords continuous communications. If radio contact is lost for more than 15 minutes (5 minutes after a scheduled reporting time), Search and Rescue (SAR) will be alerted.

**5.2.5.2** The estimated time for crossing the far shore will be the scheduled reporting time for aircraft that fly at an altitude that does not afford continuous communication coverage while crossing the lake. If radio contact is not established within 5 minutes of that time, SAR will be alerted.

**5.2.5.3** Pilots are responsible for canceling their request for Lake Reporting Service when outside the service area boundary. Aircraft experiencing radio failure will be expected to land as soon as practicable and cancel their Lake Reporting Service flight plan.

**5.2.5.4 Communications:** Primary communications - Pilots should communicate with the following facilities on the indicated frequencies:

##### **1) Cleveland AFSS Controls:**

(a) Cleveland RCO (FSS transmits and receives on 122.35 or 122.55 MHz).

(b) Sandusky VOR (FSS transmits on 109.2 and receives on 122.1 MHz).

##### **2) Green Bay AFSS Controls:**

(a) Escanaba VORTAC (FSS transmits on 110.8 and receives on 122.1 MHz).

(b) Green Bay RCO (FSS transmits and receives on 122.55 MHz).

(c) Manistique RCO (FSS transmits and receives on 122.25 MHz).

(d) Manitowoc VOR (FSS transmits on 111.0 and receives on 122.1 MHz).

(e) Menominee VOR (FSS transmits on 109.6 and receives on 122.1 MHz).

(f) Milwaukee RCO (FSS transmits and receives on 122.65 MHz).

(g) Falls VOR (FSS transmits on 110.0 and receives on 122.1 MHz).

### 3) Kankakee AFSS Controls:

(a) Northbrook VORTAC (FSS transmits on 113.0 and receives on 122.1 MHz).

(b) Chicago Heights VORTAC (FSS transmits on 114.2 and receives on 122.1 MHz).

(c) Meigs RCO (FSS transmits and receives on 122.15 MHz).

### 4) Lansing AFSS Controls:

(a) **Lake Erie:** Detroit City RCO (FSS transmits and receives on 122.55 MHz).

#### (b) **Lake Michigan:**

(1) Keeler VORTAC (FSS transmits on 116.6 and receives on 122.1 MHz).

(2) Ludington RCO (FSS transmits and receives on 122.45 MHz).

(3) Manistee VORTAC (FSS transmits on 111.4 and receives on 122.1 MHz).

(4) Muskegon RCO (FSS transmits and receives on 122.5 MHz).

(5) Pellston RCO (FSS transmits and receives on 122.3 MHz).

(6) Pullman VORTAC (FSS transmits on 112.1 and receives on 122.1 MHz).

(7) Traverse City RCO (FSS transmits and receives on 122.65 MHz).

5) **Terre Haute AFSS Controls:** South Bend RCO's (FSS transmits and receives on 123.65/primary and 122.6/secondary MHz).

## 6. Over-water Flights Radio Procedure

6.1 Pilots should remember that there is a need to continuously guard the VHF emergency frequency 121.5 MHz when on long over-water flights, except when communications on other VHF channels, equipment limitations, or cockpit duties prevent simultaneous guarding of two channels. Guarding of 121.5 MHz is particularly critical when operating in proximity to

flight information region (FIR) boundaries; for example, operations on Route R220 between Anchorage and Tokyo, since it serves to facilitate communications with regard to aircraft which may experience in-flight emergencies, communications, or navigational difficulties. (Reference ICAO Annex 10, Vol II Paras. 5.2.2.1.1.1 and 5.2.2.1.1.2.)

## 7. Radio Communications and Navigation Facilities

7.1 A complete listing of air traffic radio communications facilities and frequencies and radio navigation facilities and frequencies are contained in the Airport/Facility Directory. Similar information for the Pacific and Alaskan areas is contained in the Pacific and Alaskan Supplements (See GEN 3.2).

## 8. U.S. Aeronautical Telecommunications Services

8.1 The following services are available for aircraft engaged in international or overseas flight.

8.2 The aeronautical voice communication stations listed are available to and utilized by the U.S. Federal Aviation Administration Air Traffic Control Centers for air traffic control purposes.

8.3 The frequencies in use will depend upon the time of day or night and conditions which affect radio wave propagation. Voice communications handled on a single channel simplex basis (i.e., with the aircraft and the ground station using the same frequency for transmission and reception) unless otherwise noted in remarks.

8.4 The stations will remain on continuous watch for aircraft within their communications areas and, when practicable will transfer this watch to another station when the aircraft reaches the limit of the communications area.

8.5 Stations listed below which are designated "FAA" are operated by the U.S. Federal Aviation Administration. Stations designated "ARINC" are operated by Aeronautical Radio, Incorporated, 2551 Riva Road, Annapolis, MD 21401. Contact Air/Ground Operations at 410-266-4430, E:Mail AGOPS@arinc.com or cable HDQXGXA. (See TBL 3.4-8.)

8.6 All users of the North Atlantic HF MWARA services should consult International NOTAMS and ICAO Regional Supplementary Procedures, Document 7030, for current procedures concerning the operational use of the North Atlantic HF families. At present, procedures for the distribution of HF communications traffic in the North Atlantic are:

a) All aircraft registered in the hemisphere west of 30W should use family alpha on the southern routes and family bravo on the central and northern routes. (Southern routes are those which enter the New York, San Juan and Santa Maria FIR's. The central and northern routes comprise all others).

b) All aircraft registered in the hemisphere east of 30W should use family alpha on the southern routes and family charlie on the central and northern routes.

c) All aircraft should use family alpha on the southern route and family delta on the central and northern routes while outside the organized track system (OTS).

d) Aircraft registered in Australia will use families designated to aircraft registered east of 30W.

**8.7 Aircraft operating in the Anchorage Arctic CTA/FIR beyond line of sight range of remote control VHF air/ground facilities operated from the Anchorage ACC, shall maintain communications with Cambridge Bay radio and a listening or SELCAL watch on HF**

frequencies of the North Atlantic D (NAT D) network (2971 kHz, 4675 kHz, 8891 kHz and 11279 kHz). Additionally, and in view of reported marginal reception of the Honolulu Pacific Volmet broadcasts in that and adjacent Canadian airspace, Cambridge Bay radio can provide Anchorage and Fairbanks surface observations and terminal forecasts to flight crews on request.

**9. Selective Calling System (SELCAL) Facilities Available**

**9.1** The SELCAL is a communication system which permits the selective calling of individual aircraft over radio-telephone channels from the ground station to properly equipped aircraft, so as to eliminate the need for the flight crew to constantly monitor the frequency in use.

Location	Operator	HF	VHF
New York	ARINC	X	X
San Francisco	ARINC	X	X

TBL 3.4-7

STATION AND OPERATING AGENCY	RADIO CALL	TRANSMITTING FREQUENCIES	REMARKS
HONOLULU (FAA)	Honolulu Radio	122.6 122.2 #121.5 MHz	#Emergency. Frequency 122.1 also available for receiving only.
	Volmet	2863 6679 8828 13282 kHz	Broadcasts at H+00-05 and H+30-35; Aerodrome Forecasts, Honolulu, Hilo, Agana, Honolulu. SIGMET. Hourly Report, Honolulu, Hilo, Kahu-lui, Agana, Honolulu.
			Broadcasts at H+05-10 and H+35-40; Hourly Reports, San Francisco, Los Angeles, Seattle, Portland, Sacramento, Ontario, Las Vegas. SIGMET. Aerodrome Forecasts, San Francisco, Seattle, Los Angeles.
			Broadcasts at H+25-30 and H+55-60; Hourly Reports, Anchorage, El-mendorf, Fairbanks, Cold Bay, King Salmon, Vancouver. SIGMET. Aero-drome Forecasts, Anchorage, Fairbanks, Cold Bay, Vancouver.
MIAMI (FAA)	Miami Radio	126.7 118.4 126.9 122.2 122.4 122.75 123.65 127.9 MHz	Local and Short Range.
		#121.5 MHz	#Emergency.
NEW YORK (FAA)	New York Ra-dio (Volmet)	3485* 6604 10051 13270* kHz	*3485 Volmet broadcasts from 1 hour after sunset to 1 hour before sunrise.
			*13270 Volmet broadcasts from 1 hour before sunrise to 1 hour after sun-set.
			Broadcasts at H+00-05; Aerodrome Forecasts, Detroit, Chicago, Cleve-land. Hourly Reports, Detroit, Chicago, Cleveland, Niagara Falls, Milwau-kee, Indianapolis.
			Broadcasts at H+05-10; SIGMET, (Oceanic-New York). Aerodrome Forecasts, Bangor, Pittsburgh, Charlotte. Hourly Reports, Bangor, Pitts-burgh, Windsor Locks, St. Louis, Charlotte, Minneapolis.
			Broadcasts at H+10-15; Aerodrome Forecasts, New York, Newark, Bos-ton. Hourly reports, New York, Newark, Boston, Baltimore, Philadelphia, Washington.
			Broadcasts at H+15-20; SIGMET (Oceanic-Miami/San Juan). Aerodrome Forecasts, Bermuda, Miami, Atlanta. Hourly Reports, Bermuda, Miami, Nassau, Freeport, Tampa, West Palm Beach, Atlanta.

STATION AND OPERATING AGENCY	RADIO CALL	TRANSMITTING FREQUENCIES	REMARKS
			Broadcasts at H+30-35; Aerodrome Forecasts, Niagara Falls, Milwaukee, Indianapolis. Hourly Reports Detroit, Chicago, Cleveland, Niagara Falls, Milwaukee, Indianapolis.
			Broadcasts at H+35-40; SIGMET (Oceanic-New York). Aerodrome Forecasts, Windsor Locks, St. Louis. Hourly Reports, Bangor, Pittsburgh, Windsor Locks, St. Louis, Charlotte, Minneapolis.
			Broadcasts at H+40-45; Aerodrome Forecasts, Baltimore, Philadelphia, Washington. Hourly Reports, New York, Newark, Boston, Baltimore, Philadelphia, Washington.
			Broadcasts at H+45-50; SIGMET (Oceanic-Miami/San Juan). Aerodrome Forecasts, Nassau, Freeport. Hourly Reports, Bermuda, Miami, Nassau, Freeport, Tampa, West Palm Beach, Atlanta.
NEW YORK (ARINC)	New York	3016 5598 8906 13306 17946 kHz	North Atlantic Family A Network.
		2962 6628 8825 11309 13354 kHz	North Atlantic Family E Network.
		2887 5550 6577 8918 11396 13297 kHz	Caribbean Family A Network.
		3455 5520 6586 8846 11330 17907 kHz	Caribbean Family B Network.
		3494 6640 8933 11342 13330 17925 kHz	Long Distance Operations Control (LDOC) Service (phone-patch). Communications are limited to operational control matters only. Public correspondence (personal messages) to/from crew or passengers can not be accepted.
		129.90 MHz	Extended range VHF. Coverage area includes Canadian Maritime Provinces, and oceanic routes to Bermuda and the Caribbean, from Boston, New York and Washington areas to approximately 250 nautical miles from the east coast.
		130.7 MHz	Extended range VHF. Full period service is provided within most of the Gulf of Mexico. Also on routes between Miami and San Juan to a distance of approximately 250 nautical miles from the Florida coast and within approximately 250 nautical miles of San Juan. Dial-up stations are provided when within approximately 250 nautical miles of Nassau and Grand Turk Islands. To operate these, click mike (3) three times and wait one minute for station to dial a New York operator.
			Note: Due to the distances involved, signal levels received by aircraft communicating with New York ARINC in the Gulf of Mexico on frequency 130.700 MHz will be weaker than normally encountered in VHF communications. Most aircraft usually have the squelch setup to communicate where signal levels are much higher and to totally eliminate background noise for the flight crew. In order to increase the range and maximize the coverage area, aircraft are asked to utilize the following squelch settings on their VHF radios while monitoring or communicating with New York ARINC. On aircraft with an OPEN/CLOSE squelch switch, the squelch should be set to the OPEN position while communicating or after being SELCAL'ed. Aircraft with an adjustable system should first set their squelch to fully open position and then adjust to where the noise is reduced or just closed. This will allow the weakest signals to be heard. Utilizing this procedure will increase the background noise heard by the flight crew but will allow communications at a much greater range.
	New York ARINC	436623*	Aircraft operating within the New York Oceanic FIR.
			*Note: This satellite Voice Air/Ground calling number is available to call ARINC and will be recognized and converted by all Ground Earth Station (GES) service providers to the appropriate Public Service Telephone Network (PTSN) or direct dial number for this communications center.

STATION AND OPERATING AGENCY	RADIO CALL	TRANSMITTING FREQUENCIES	REMARKS
SAN FRANCISCO (ARINC)	San Francisco	3413 5574 8843 10057 13354 17904 kHz	Central East Pacific One Network.
		2869 5547 6673 11282 13288 kHz	Central East Pacific Two Network.
		2998 4666 6532 8903 11384 13300 17904 21985 kHz	Central West Pacific Network.
		3467 5643 8867 13261 17904 kHz	South Pacific Network.
		2932 5628 5667 6655 8915 8951 10048 11330 13273 13339 17946 21925 kHz	North Pacific Network
		3013 6640 11342 13348 17925 21964	Long Distance Operations Control (LDOC) Service (phone-patch). Communications are limited to operational control matters only. Public correspondence (personal messages) to/from crew or passengers cannot be accepted.
		131.95 MHz	Extended range VHF. Coverage area includes area surrounding the Hawaiian Islands and along the tracks from HNL to the mainland. Coverage extends out approximately 250 NM from Hawaii and from the West coast.
		129.40 MHz	For en route communications for aircraft operating on Seattle/Anchorage/Routes.
	San Francisco ARINC	436625*	Aircraft operating within the Oakland and Anchorage Oceanic FIR's.
			*Note: This satellite Voice Air/Ground calling number is available to call ARINC and will be recognized and converted by all Ground Earth Station (GES) service providers to the appropriate Public Service Telephone Network (PTSN) or direct dial number for this communications center.
OAKLAND (FAA)	Oakland Radio	122.5 122.2 #121.5 MHz	#Emergency.
SAN JUAN P.R. (FAA)	San Juan Radio	#121.5 122.2 126.7 123.65 #243.0 255.4 114.0 113.5 108.2 108.6 109.0 110.6 MHz	Unscheduled broadcasts H+00, H+15, H+30 and H+45 as appropriate, for Weather and Military Activity Advisories, on 110.6, 109.0, 108.6, 108.2, 113.5, and 114.0 MHz. #Emergency. For frequencies 114.0, 113.5, 108.2 and 109.0 MHz use 122.1 MHz for transmissions to San Juan Radio. For frequency 108.6 use 123.6 MHz.

TBL 3.4-8

### 10. Special North Atlantic, Caribbean and Pacific Area Communications

**10.1** VHF air-to-air frequencies enable aircraft engaged on flights over remote and oceanic areas out of range of VHF ground stations to exchange necessary operational information and to facilitate the resolution of operational problems.

**10.2** Frequencies have been designated as follows:

Area	Frequency
North Atlantic	131.80 MHz
Caribbean	130.55 MHz
Pacific	128.95 MHz

TBL 3.4-9

### 11. Distress and Urgency Communications

**11.1** A pilot who encounters a distress or urgency condition can obtain assistance simply by contacting the air traffic facility or other agency in whose area of responsibility the aircraft is operating, stating the nature of the difficulty, pilot's intentions and assistance desired. Distress and urgency communications procedures are prescribed by the International Civil Aviation Organization (ICAO), however, and have decided advantages over the informal procedure described above.

**11.2** Distress and urgency communications procedures discussed in the following paragraphs relate to the use of air ground voice communications.

**11.3** The initial communication, and if considered necessary, any subsequent transmissions by an aircraft in distress should begin with the signal MAYDAY, preferably repeated three times. The signal PAN-PAN should be used in the same manner for an urgency condition.

**11.4** Distress communications have absolute priority over all other communications, and the word MAYDAY commands radio silence on the frequency in use. Urgency communications have priority over all other communications except distress, and the word PAN-PAN warns other stations not to interfere with urgency transmissions.

**11.5** Normally, the station addressed will be the air traffic facility or other agency providing air traffic services, on the frequency in use at the time. If the pilot is not communicating and receiving services, the station to be called will normally be the air traffic facility or other agency in whose area of responsibility the aircraft is operating, on the appropriate assigned frequency. If the station addressed does not respond, or if time or the situation dictates, the distress or urgency message may be broadcast, or a collect call may be used, addressing "Any Station (Tower) (Radio) (Radar)."

**11.6** The station addressed should immediately acknowledge a distress or urgency message, provide assistance, coordinate and direct the activities of assisting facilities, and alert the appropriate Search and Rescue coordinator if warranted. Responsibility will be transferred to another station only if better handling will result.

**11.7** All other stations, aircraft and ground, will continue to listen until it is evident that assistance is being provided. If any station becomes aware that the station being called either has not received a distress or urgency message, or cannot communicate with the aircraft in difficulty, it will attempt to contact the aircraft and provide assistance.

**11.8** Although the frequency in use or other frequencies assigned by ATC are preferable, the following emergency frequencies can be used for distress or urgency communications, if necessary or desirable:

**11.9 121.5 MHz and 243.0 MHz:** Both have a range generally limited to line of sight. 121.5 MHz is guarded by direction finding stations and some military and civil aircraft. 243.0 MHz is guarded by military aircraft. Both 121.5 MHz and 243.0 MHz are guarded by military towers, most civil towers, flight service stations, and radar facilities. Normally ARTCC emergency frequency capability does not extend to radar coverage

limits. If an ARTCC does not respond when called on 121.5 MHz or 243.0 MHz, call the nearest tower or flight service station.

**11.10 2182 kHz:** The range is generally less than 300 miles for the average aircraft installation. It can be used to request assistance from stations in the maritime service. 2182 kHz is guarded by major radio stations serving Coast Guard Rescue Coordination Centers, and Coast Guard units along the sea coasts of the U.S. and shores of the Great Lakes. The call "Coast Guard" will alert all Coast Guard Radio Stations within range. 2182 kHz is also guarded by most commercial coast stations and some ships and boats.

## **12. Two-Way Radio Communications Failure**

**12.1** It is virtually impossible to provide regulations and procedures applicable to all possible situations associated with two-way radio communications failure. During two-way radio communications failure when confronted by a situation not covered in the regulation, pilots are expected to exercise good judgment in whatever action they elect to take. Should the situation so dictate, they should not be reluctant to use the emergency action contained in 14 CFR Section 91.3(b).

**12.2** Whether two-way communications failure constitutes an emergency depends on the circumstances, and in any event is a determination made by the pilot. 14 CFR Section 91.3 authorizes a pilot to deviate from any rule to the extent required to meet an emergency.

**12.3** In the event of two-way radio communications failure, ATC service will be provided on the basis that the pilot is operating in accordance with 14 CFR Section 91.185. A pilot experiencing two-way communications failure should (unless emergency authority is exercised) comply with 14 CFR Section 91.185 as indicated below.

**12.4** Unless otherwise authorized by ATC, each pilot who has two-way radio communications failure when operating under IFR shall comply with the following conditions:

a) If the failure occurs in VFR conditions, or if VFR conditions are encountered after the failure, each pilot shall continue the flight under VFR and land as soon as practicable. This procedure also applies when two-way radio failure occurs while operating in Class A Airspace. The primary objective of this provision in 14 CFR Section 91.185 is to preclude extended IFR operations in the air traffic control system in VFR weather conditions. Pilots should recognize that operation under these conditions may unnecessarily as well as



adversely affect other users of the airspace, since ATC may be required to reroute or delay other users in order to protect the failure aircraft. However, it is not intended that the requirement to "land as soon as practicable" be construed to mean "as soon as possible." The pilot retains his prerogative of exercising his best judgment and is not required to land at an unauthorized airport, at an airport unsuitable for the type of aircraft flown, or to land only minutes short of his destination.

b) If the failure occurs in IFR conditions, or if VFR conditions cannot be complied with, each pilot shall continue the flight according to the following requirements.

### 12.5 Route requirements:

a) By the route assigned in the last ATC clearance received;

b) If being radar vectored, by the direct route from the point of radio failure to the fix, route, or airway specified in the vector clearance;

c) In the absence of an assigned route, by the route that ATC has advised may be expected in a further clearance; or

d) In the absence of an assigned route or a route that ATC has advised may be expected in a further clearance, by the route filed in the flight plan.

**12.6 Altitude requirements.** At the HIGHEST of the following altitudes or flight levels FOR THE ROUTE SEGMENT BEING FLOWN:

a) The altitude or flight level assigned in the last ATC clearance received;

b) The minimum altitude (converted, if appropriate, to minimum flight level as prescribed in 14 CFR Section 91.121(c)) for IFR operations; or

c) The altitude or flight level ATC has advised may be expected in a further clearance.

**NOTE.—**  
THE INTENT OF THE RULE IS THAT A PILOT WHO HAS EXPERIENCED TWO-WAY RADIO FAILURE SHOULD SELECT THE APPROPRIATE ALTITUDE FOR THE PARTICULAR ROUTE SEGMENT BEING FLOWN AND MAKE THE NECESSARY ALTITUDE ADJUSTMENTS FOR SUBSEQUENT ROUTE SEGMENTS. IF THE PILOT RECEIVED AN "EXPECT FURTHER CLEARANCE" CONTAINING A HIGHER ALTITUDE TO EXPECT AT A SPECIFIED TIME OR FIX, HE/SHE SHOULD MAINTAIN THE HIGHEST OF THE FOLLOWING ALTITUDES UNTIL THAT TIME/FIX: (1) HIS/HER LAST ASSIGNED ALTITUDE, OR (2) THE MINIMUM ALTITUDE/FLIGHT LEVEL FOR IFR OPERATIONS.

UPON REACHING THE TIME/FIX SPECIFIED, THE PILOT SHOULD COMMENCE HIS/HER CLIMB TO THE ALTITUDE HE/SHE WAS ADVISED TO EXPECT. IF THE RADIO FAILURE OCCURS AFTER THE

TIME/FIX SPECIFIED, THE ALTITUDE TO BE EXPECTED IS NOT APPLICABLE AND THE PILOT SHOULD MAINTAIN AN ALTITUDE CONSISTENT WITH 1 OR 2 ABOVE.

IF THE PILOT RECEIVES AN "EXPECT FURTHER CLEARANCE" CONTAINING A LOWER ALTITUDE, THE PILOT SHOULD MAINTAIN THE HIGHEST OF 1 OR 2 ABOVE UNTIL THAT TIME/FIX SPECIFIED IN PARAGRAPH 12.7.

**EXAMPLE.—**

① A PILOT EXPERIENCING TWO-WAY RADIO FAILURE AT AN ASSIGNED ALTITUDE OF 7,000 FEET IS CLEARED ALONG A DIRECT ROUTE WHICH WILL REQUIRE A CLIMB TO A MINIMUM IFR ALTITUDE OF 9,000 FEET, SHOULD CLIMB TO REACH 9,000 FEET AT THE TIME OR PLACE WHERE IT BECOMES NECESSARY (SEE 14 CFR SECTION 91.177(B)). LATER WHILE PROCEEDING ALONG AN AIRWAY WITH AN MEA OF 5,000 FEET, THE PILOT WOULD DESCEND TO 7,000 FEET (THE LAST ASSIGNED ALTITUDE), BECAUSE THAT ALTITUDE IS HIGHER THAN THE MEA.

② A PILOT EXPERIENCING TWO-WAY RADIO FAILURE WHILE BEING PROGRESSIVELY DESCENDED TO LOWER ALTITUDES TO BEGIN AN APPROACH IS ASSIGNED 2,700 FEET UNTIL CROSSING THE VOR AND THEN CLEARED FOR THE APPROACH. THE MOCA ALONG THE AIRWAY IS 2,700 FEET AND MEA IS 4,000 FEET. THE AIRCRAFT IS WITHIN 22 NM OF THE VOR. THE PILOT SHOULD REMAIN AT 2,700 FEET UNTIL CROSSING THE VOR BECAUSE THAT ALTITUDE IS THE MINIMUM IFR ALTITUDE FOR THE ROUTE SEGMENT BEING FLOWN.

③ THE MEA BETWEEN A AND B - 5,000 FEET. THE MEA BETWEEN B AND C - 5,000 FEET. THE MEA BETWEEN C AND D - 11,000 FEET. THE MEA BETWEEN D AND E - 7,000 FEET. A PILOT HAD BEEN CLEARED VIA A, B, C, D, TO E. WHILE FLYING BETWEEN A AND B THE ASSIGNED ALTITUDE WAS 6,000 FEET AND THE PILOT WAS TOLD TO EXPECT A CLEARANCE TO 8,000 FEET AT B. PRIOR TO RECEIVING THE HIGHER ALTITUDE ASSIGNMENT, THE PILOT EXPERIENCED TWO-WAY FAILURE. THE PILOT WOULD MAINTAIN 6,000 TO B, THEN CLIMB TO 8,000 FEET (THE ALTITUDE THE PILOT WAS ADVISED TO EXPECT.) THE PILOT WOULD MAINTAIN 8,000 FEET, THEN CLIMB TO 11,000 AT C, OR PRIOR TO C IF NECESSARY TO COMPLY WITH AN MCA AT C. 14 CFR SECTION 91.177(B). UPON REACHING D, THE PILOT WOULD DESCEND TO 8,000 FEET (EVEN THOUGH THE MEA WAS 7,000 FEET), AS 8,000 WAS THE HIGHEST OF THE ALTITUDE SITUATIONS STATED IN THE RULE 14 CFR SECTION 91.185.

### 12.7 Leave Clearance Limit

a) When the clearance limit is a fix from which an approach begins, commence descent or descent and approach as close as possible to the expect further clearance time if one has been received, or if one has not been received, as close as possible to the estimated time of arrival as calculated from the filed or amended (with ATC) estimated time en route.

b) If the clearance limit is not a fix from which an approach begins, leave the clearance limit at the expect further clearance time if one has been received, or if none has been received, upon arrival over the clearance limit, and proceed to a fix from which an approach begins and commence descent or descent and approach as close as possible to the estimated time of arrival as calculated from the filed or amended (with ATC) estimated time en route.

### 13. Transponder Operation During Two-Way Communications Failure

**13.1** If an aircraft with a coded radar beacon transponder experiences a loss of two-way radio capability, the pilot should adjust the transponder to reply on Mode 3/A, Code 7600.

**13.2** The pilot should understand that the aircraft may not be in an area of radar coverage.

### 14. Reestablishing Radio Contact

**14.1** In addition to monitoring the NAVAID voice feature, the pilot should attempt to reestablish communications by attempting contact:

a) on the previously assigned frequency

b) with an FSS or ARINC.

**14.2** If communications are established with an FSS or ARINC, the pilot should advise the aircraft's position, altitude, last assigned frequency and then request further clearance from the controlling facility. The preceding does not preclude the use of 121.5 MHz. There is no priority on which action should be attempted first. If the capability exists, do all at the same time.

*NOTE.—*

*AERONAUTICAL RADIO INCORPORATED (ARINC) IS A COMMERCIAL COMMUNICATIONS CORPORATION WHICH DESIGNS, CONSTRUCTS, OPERATES, LEASES OR OTHERWISE ENGAGES IN RADIO ACTIVITIES SERVING THE AVIATION COMMUNITY. ARINC HAS THE CAPABILITY OF RELAYING INFORMATION TO/FROM ATC FACILITIES THROUGHOUT THE COUNTRY.*

## GEN 3.5 Meteorological Services

### 1. Meteorological Authority

**1.1** The meteorological services for civil aviation are prepared by the National Oceanic and Atmospheric Administration (NOAA) of the U.S. Department of Commerce.

<p><i>Postal Address:</i> National Weather Service National Oceanic and Atmospheric Administration Department of Commerce 1325 East West Highway Silver Spring, Maryland 20910</p>
<p><i>Telephone:</i> 301-713-1726</p>
<p><i>Telex:</i> None</p>
<p><i>Commercial Telegraphic Address:</i> METEO WASHINGTON DC</p>

### 1.2 Meteorological Offices

#### 1.2.1 FAA Flight Service Stations

**1.2.1.1** A complete listing of FAA Flight Service Stations and their telephone numbers is contained in the Airport/Facility Directory. Additionally, communications data and en route services provided by FAA Flight Service Stations are contained in the same publication. Similar information for the Pacific and Alaskan areas is contained in the Pacific and Alaskan Supplements. (See GEN 3.2.)

### 1.3 Climatological Summaries

**1.3.1** Requests for copies of climatological summaries are made available through the:

<p>National Climatic Data Center Department of Commerce National Oceanic and Atmospheric Administration Environmental Data Services Branch Federal Building Asheville, North Carolina 28801</p>
---------------------------------------------------------------------------------------------------------------------------------------------------------------------------------------------------------------------

## 2. Area of Responsibility

**2.1** The National Weather Service (NWS) is responsible for providing meteorological services for the 50 states of the U.S., its external territories, and possessions.

**2.2 International Flight Documentation Sites.** Airports listed below are designated as international flight documentation sites.

Location	Airport Name	Indicator
Anchorage, AK	Anchorage International	PANC
Atlanta, GA	William B. Hartsfield International	KATL
Baltimore, MD	Baltimore-Washington International	KBWI
Boston, MA	General Edward Lawrence Logan International	KBOS
Charlotte, NC	Charlotte/Douglas International	KCLT
Chicago, IL	O'Hare International	KORD
Cincinnati, OH	Cincinnati/Northern Kentucky International	KCVG
Dallas-Ft. Worth, TX	Dallas-Ft. Worth International	KDFW
Detroit, MI	Detroit Metropolitan Wayne County	KDTW
Fairbanks, AK	Fairbanks International	PAFA
Guam	Guam/Agana Naval Air Station	NOCD AGANA
Hartford, CT	Bradley International	KBDL
Houston, TX	George Bush Intercontinental/Houston	KIAH
Kahului, HI	Kahului	PHOG
Las Vegas, NV	McCarran International	KLAS
Los Angeles, CA	Los Angeles International	KLAX
Miami, FL	Miami International	KMIA
Minneapolis, MN	Minneapolis-St. Paul International (Wold-Chamberlain)	KMSP
New Orleans, LA	New Orleans International (Moisant Field)	KMSY
New York, NY	John F. Kennedy International	KJFK
Newark, NJ	Newark International	KEWR
Orlando, FL	Orlando International	KMCO
Pago Pago, American Samoa	Pago Pago International	NSTU
Philadelphia, PA	Philadelphia International	KPHL
Pittsburgh, PA	Pittsburgh International	KPIT
Portland, OR	Portland International	KPDX
Raleigh-Durham, NC	Raleigh-Durham International	KRDU
San Francisco, CA	San Francisco International	KSFO
San Juan, PR	Luis Munoz Marin International	TJSJ
Seattle, WA	Seattle-Tacoma International	KSEA
Tampa, FL	Tampa International	KTPA
Washington, DC	Washington Dulles International	KIAD

**2.2.1** Climatological information, basically in the form of climatological summaries, is available at all designated international airports in the U.S.

**2.2.2** Flight documentation is provided in the form of copies of facsimile charts, copies of teletype-writer forecasts, and airport forecast decode sheets. Flight documentation materials are available at all destination regular airport meteorological stations. English is the language used for all U.S. flight documentation. Briefings can be provided either in person or received by telephone at all airport meteorological offices.

**2.2.3** All airport forecasts (TAF) prepared for U.S. international airports cover the following validity periods: 00-24 UTC, 06-06 UTC, 12-12 UTC and 18-18 UTC. At the present time, specific landing forecasts are not made for any U.S. airport. The portion of the airport's TAF valid closest to the time of landing is used in lieu of a landing forecast.

**2.2.4** Supplementary information available at U.S. meteorological airport offices includes extended weather and severe weather outlooks, pilot reports, runway braking action reports (during the winter), relative humidity, times of sunrise and sunset, surface and upper air analyses, radar echo charts, and forecasts of maximum and minimum surface temperatures.

**2.2.5** All meteorological offices shown as taking routine aviation observations also take unscheduled special aviation observations when meteorological conditions warrant.

### **3. Types of Service Provided**

#### **3.1 Area Forecast Charts (Facsimile Form)**

**3.1.1** The U.S. has one Area Forecast Center, the National Center for Environmental Predictions (NCEP), located in Suitland, Maryland. The NCEP prepares current weather, significant weather, forecast weather, constant pressure, and tropopause-vertical wind shear charts for the U.S., the Caribbean and Northern South America, the North Atlantic, and the North Pacific areas. The NCEP also prepares a constant pressure and tropopause-vertical wind shear chart for Canada.

#### **3.2 Local and Regional Aviation Forecasts (printed form)**

**3.2.1** Numerous forecasts and weather advisories are prepared which serve local and regional areas of the U.S. These forecasts are generally prepared by the NWS

on a scheduled basis or, as in the case of severe weather advisories, as needed. These forecasts are Area Forecast (FA), Airport Forecast (TAF), Severe Weather Forecast (WW), Hurricane Advisories (WT), Winds and Temperature Aloft Forecast (FD), Simplified Surface Analyses (AS), 12- and 24-Hour Prognoses (FS), and flight advisory notices, such as SIGMET's (WS), AIRMET's (WA), Center Weather Advisories (CWA), and Radar Weather Reports (SD).

### **3.3 Preflight Briefing Services**

**3.3.1** Preflight briefing services and flight documentation is provided through the FAA's Automated Flight Service Stations (AFSS).

### **3.4 National Weather Service Aviation Products**

**3.4.1** Weather service to aviation is a joint effort of the NWS, the FAA, the military weather services, and other aviation oriented groups and individuals. The NWS maintains an extensive surface, upper air, and radar weather observing program and a nationwide aviation weather forecasting service. The majority of pilot weather briefings are provided by FAA personnel at Flight Service Stations (AFSS/FSS). Surface weather observations are taken by the NWS and NWS certified FAA, contract, and supplemental observers and by automated observing systems. (See paragraph 7, Weather Observing Programs.)

**3.4.2** Weather element values may be expressed by using different measurement systems depending on several factors including the user of the weather products; i.e., the general public, aviation interests, international services, or a combination of these users. FIG 3.5-1 provides conversion tables for the weather elements that will be most often encountered by pilots.

### **3.5 FAA Weather Services**

**3.5.1** The FAA maintains a nationwide network of AFSS's/FSS's to serve the weather needs of pilots. In addition, NWS meteorologists are assigned to all Air Route Traffic Control Centers (ARTCC's) as part the Center Weather Service Unit (CWSU). They provide advisory service and short-term forecasts (nowcasts) to support the needs of the FAA and other users of the national airspace system.

Weather Elements Conversion Tables

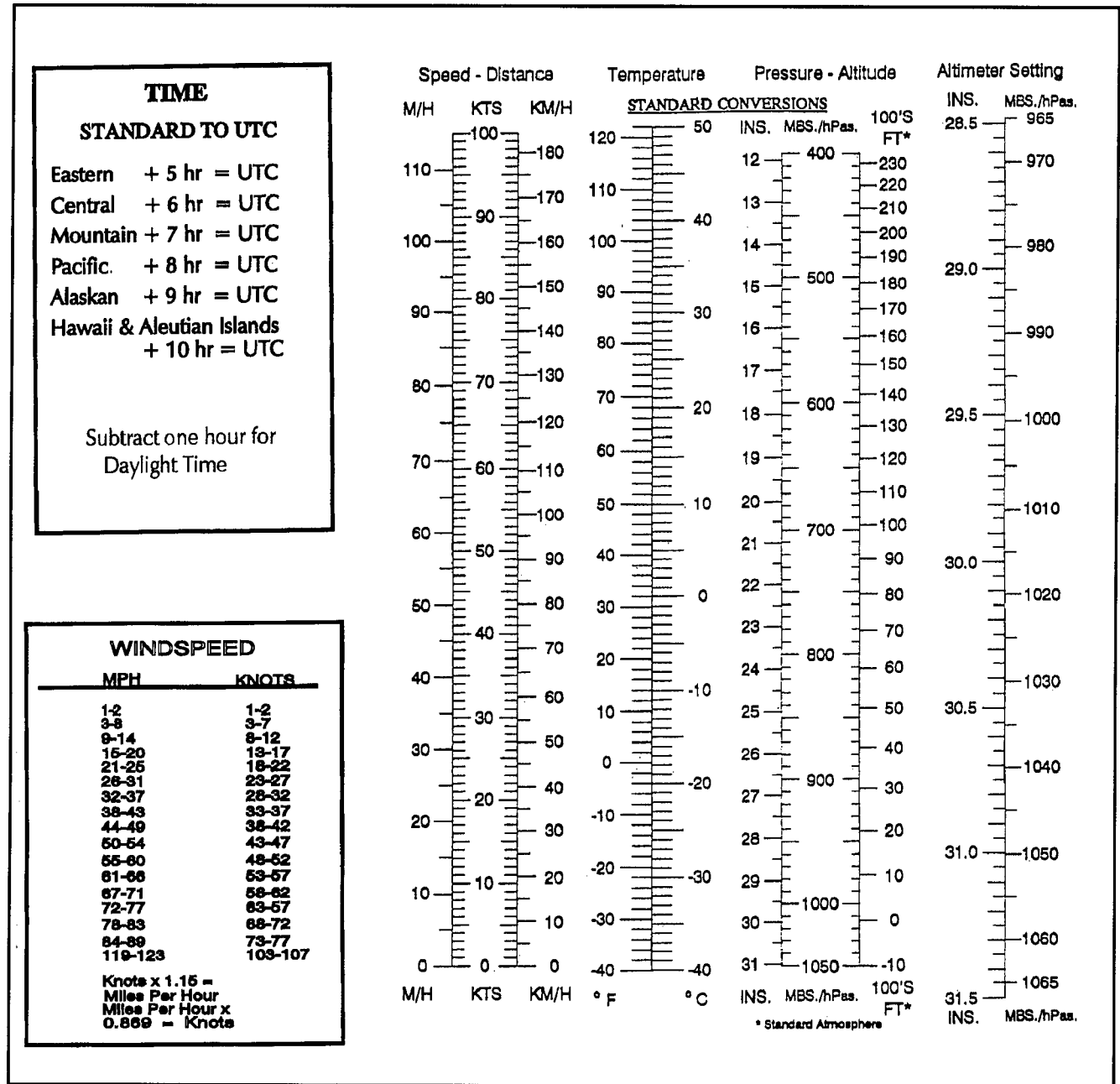

FIG 3.5-1

3.5.2 The primary source of preflight weather briefings is an individual briefing obtained from a briefer at the AFSS/FSS. These briefings, which are tailored to your specific flight, are available 24 hours a day through the use of toll free lines (INWATS). Numbers for these services can be found in the Airport/Facility Directory under "FAA and NWS Telephone Numbers" section.

They are also listed in the U.S. Government section of your local telephone directory under Department of Transportation, Federal Aviation Administration or Department of Commerce, National Weather Service. See paragraph 3.6 for the types of preflight briefings available and the types of information contained in each.

### 3.5.3 Other sources of weather information

**3.5.3.1** Continuously updated recorded weather information for short or local flights is available through the Transcribed Weather Broadcast (TWEB), telephone access to the TWEB (TEL-TWEB), and the Telephone Information Briefing Service (TIBS). Separate paragraphs in this section give additional information about these services.

**3.5.3.2** Weather and aeronautical information is also available from numerous private industry sources on an individual or contract pay basis. Information on how to obtain this service should be available from local pilot organizations.

**3.5.3.3** The Direct User Access System (DUATS) can be accessed by U.S. certified pilots with a current medical certificate toll-free via personal computer. Pilots can receive alpha-numeric preflight weather data and file domestic VFR and IFR flight plans. The following are the contract DUATS vendors:

GTE Information Federal Systems 15000 Conference Center Drive Chantilly, VA 22021-3808
Computer Modem Access Number-For filing flight plans and obtaining weather briefings: 1-800-767-9989
For customer service: 1-800-345-3828

Data Transformation Corporation 108-D Greentree Road Turnersville, NJ 08012
Computer Modem Access Number-For filing flight plans and obtaining weather briefings: 1-800-245-3828
For customer service: 1-800-243-3828

**3.5.4** In-flight weather information is available from any AFSS/FSS within radio range. The common frequency for all AFSS's is 122.2. Discrete frequencies for individual stations are listed in the Airport/Facility Directory. See paragraph 6 for information on broadcasts. En route Flight Advisory Service (EFAS) is provided to serve the non-routine weather needs of pilots in flight. See paragraph 3.7 for details on this service.

### 3.6. Preflight Briefing

**3.6.1** Flight Service Stations are the primary source of obtaining preflight briefings and in-flight weather information. Flight Service Specialists are qualified and certificated by the NWS as Pilot Weather Briefers. They are not authorized to make original forecasts, but are authorized to translate and interpret available forecasts (TAF) and reports (METAR/SPECI) directly into terms describing the weather conditions which you can expect along your flight route and at your destination. Available aviation weather reports and forecasts are displayed at each AFSS/FSS. Some of the larger AFSS's/FSS's provide a separate display for pilot use. Pilots should feel free to use these self-briefing displays where available, or to ask for a briefing or for assistance from the specialist on duty. Three basic types of preflight briefings are available: Standard Briefing, Abbreviated Briefing, and Outlook Briefing. You should specify to the briefer the type of briefing you want, along with appropriate background information. This will enable the briefer to tailor the information to your intended flight. The following paragraphs describe the types of briefings available and the information provided in each.

**3.6.2 Standard Briefing:** You should request a Standard Briefing any time you are planning a flight and you have not received a previous briefing or have not received preliminary information through mass dissemination media such as TWEB. The briefer will automatically provide the following information in the sequence listed, except as noted, when it is applicable to your proposed flight.

**3.6.2.1 Adverse Conditions:** significant meteorological and aeronautical information that might influence the pilot to alter the proposed flight; e.g., hazardous weather conditions, runway closures, NAVAID outages.

**3.6.2.2 VFR Flight Not Recommended:** When VFR flight is proposed and sky conditions or visibilities are present or forecast, surface or aloft, that in the briefer's judgment would make flight under visual flight rules doubtful, the briefer will describe the conditions, affected locations, and use the phrase "VFR flight not recommended." This recommendation is advisory in nature. The final decision as to whether the flight can be conducted safely rests solely with the pilot.

**3.6.2.3 Synopsis:** a brief statement describing the type, location, and movement of weather systems and/or air masses which might affect the proposed flight.

**NOTE.—**

*THE FIRST 3 ELEMENTS OF A STANDARD BRIEFING MAY BE COMBINED IN ANY ORDER WHEN THE BRIEFER BELIEVES IT WILL HELP TO DESCRIBE CONDITIONS MORE CLEARLY.*

**3.6.2.4 Current Conditions:** Reported weather conditions applicable to the flight will be summarized from all available sources; e.g., METAR's, PIREP's, RAREP's. This element may be omitted if the proposed time of departure is beyond two hours, unless the information is specifically requested by the pilot.

**3.6.2.5 En Route Forecast:** En route conditions forecast for the proposed route are summarized in logical order; i.e., departure-climbout, en route, and descent.

**3.6.2.6 Destination Forecast:** the destination forecast (TAF) for the planned estimated time of arrival (ETA). Any significant changes within 1 hour before and after the planned arrival are included.

**3.6.2.7 Winds Aloft:** Forecast winds aloft for the proposed route will be provided using degrees of the compass. The briefer will interpolate wind directions and speeds between levels and stations as necessary to provide expected conditions at planned altitudes.

**3.6.2.8 Notices to Airmen (NOTAM's)**

a) Available NOTAM (D) information pertinent to the proposed flight.

b) Available NOTAM (L) information pertinent to the departure and/or local area, and pertinent FDC NOTAMs.

**NOTE.—**

*NOTAM INFORMATION MAY BE COMBINED WITH CURRENT CONDITIONS WHEN THE BRIEFER BELIEVES IT IS LOGICAL TO DO SO.*

**NOTE.—**

*NOTAM (D) INFORMATION AND FLIGHT DATA CENTER NOTAMS WHICH HAVE BEEN PUBLISHED IN THE NOTICES TO AIRMEN PUBLICATION ARE NOT INCLUDED IN PILOT BRIEFINGS UNLESS A REVIEW OF THIS PUBLICATION IS SPECIFICALLY REQUESTED BY THE PILOT. FOR COMPLETE FLIGHT INFORMATION YOU ARE URGED TO REVIEW BOTH THE NOTICES TO AIRMEN PUBLICATION AND THE AIRPORT/FACILITY DIRECTORY IN ADDITION TO OBTAINING A BRIEFING.*

**3.6.2.9 Air Traffic Control (ATC) Delays:** any known ATC delays and flow control advisories which might affect the proposed flight.

**3.6.2.10 Pilots may obtain the following from Flight Service Station briefers upon request:**

a) Information on military training routes (MTR) and military operations area (MOA) activity within the

flight plan area and a 100 NM extension around the flight plan area.

**NOTE.—**

*PILOTS ARE ENCOURAGED TO REQUEST UPDATED INFORMATION FROM EN ROUTE FSS's.*

b) A review of the Notices to Airmen publication for pertinent NOTAM's and Special Notices.

c) Approximate density altitude data.

d) Information regarding such items as air traffic services and rules, customs/immigration procedures, ADIZ rules, and search and rescue.

e) LORAN-C NOTAM's, available military NOTAM's, runway friction measurement value NOTAM's.

f) GPS RAIM availability for 1 hour before to 1 hour after ETA, or a time specified by the pilot.

g) Other assistance as required.

**3.6.3 Abbreviated Briefing:** Request an Abbreviated Briefing when you need information to supplement mass disseminated data, to update a previous briefing, or when you need only one or two specific items. Provide the briefer with appropriate background information, the time you received the previous information, and/or the specific items needed. You should indicate the source of the information already received so that the briefer can limit the briefing to the information that you have not received, and/or appreciable changes in meteorological/aeronautical conditions since your previous briefing. To the extent possible, the briefer will provide the information in the sequence shown for a Standard Briefing. If you request only one or two specific items, the briefer will advise you if adverse conditions are present or forecast. Adverse conditions contain both meteorological and aeronautical information. Details on these conditions will be provided at your request.

**3.6.4 Outlook Briefing:** You should request an Outlook Briefing whenever your proposed time of departure is 6 or more hours from the time of the briefing. The briefer will provide available forecast data applicable to the proposed flight. This type of briefing is provided for planning purposes only. You should obtain a Standard or Abbreviated Briefing prior to departure in order to obtain such items as adverse conditions, current conditions, updated forecasts, winds aloft, and NOTAM's.

**3.6.5 In-flight Briefing:** You are encouraged to obtain your preflight briefing by telephone or in person before departure. In those cases where you need to obtain a preflight briefing or an update to a previous briefing by

radio, you should contact the nearest AFSS/FSS to obtain this information. After communications have been established, advise the specialist of the type briefing you require and provide appropriate background information. You will be provided information as specified in the above paragraphs, depending upon the type briefing requested. In addition, the specialist will recommend shifting to the flight watch frequency when conditions along the intended route indicate that it would be advantageous for you to do so.

**3.6.6** Following any briefing, feel free to ask for any information that you or the briefer may have missed. It helps to save your questions until the briefing has been completed. This way the briefer is able to present the information in a logical sequence and lessens the chance of important items being overlooked.

### 3.7 En Route Flight Advisory Service (EFAS)

**3.7.1** EFAS is a service specifically designed to provide en route aircraft with timely and meaningful weather advisories pertinent to the type of flight intended, route of flight, and altitude. In conjunction with this service, EFAS is also a central collection and distribution point for pilot-reported weather information. EFAS is provided by specially trained specialists in selected AFSS's/FSS's controlling multiple remote communications outlets covering a large geographical area and is normally available throughout the conterminous U.S. and Puerto Rico from 6 a.m. to 10 p.m. EFAS provides communications capabilities for aircraft flying at 5,000 feet AGL to 17,500 feet MSL on a common frequency of 122.0 MHz. Discrete EFAS frequencies have been established to ensure communications coverage from 18,000 through 45,000 MSL serving in each specific ARTCC area. These discrete frequencies may be used below 18,000 feet when coverage permits reliable communication.

*NOTE.—*  
*WHEN AN EFAS OUTLET IS LOCATED IN A TIME ZONE DIFFERENT FROM THE ZONE IN WHICH THE FLIGHT WATCH CONTROL STATION IS LOCATED, THE AVAILABILITY OF SERVICE MAY BE PLUS OR MINUS 1 HOUR FROM THE NORMAL OPERATING HOURS.*

**3.7.2** Contact flight watch by using the name of the ARTCC facility serving the area of your location, followed by your aircraft identification and the name of the nearest VOR to your position. The specialist needs to know this approximate location to select the most appropriate outlet for communications coverage.

*EXAMPLE.—*  
*CLEVELAND FLIGHT WATCH, CESSNA ONE THREE FOUR TWO KILO, MANSFIELD V-O-R, OVER.*

**3.7.3** Charts depicting the location of the flight watch control stations (parent facility) and the outlets they use are contained in the Airport/Facility Directory. If you do not know in which flight watch area you are flying, initiate contact by using the words "FLIGHT WATCH," your aircraft identification, and the name of the nearest VOR. The facility will respond using the name of the flight watch facility.

*EXAMPLE.—*  
*FLIGHT WATCH, CESSNA ONE TWO THREE FOUR KILO, MANSFIELD V-O-R, OVER.*

**3.7.4** The AFSS's/FSS's which have implemented En Route Flight Advisory Service are listed in the Airport/Facility Directory.

**3.7.5** EFAS is not intended to be used for filing or closing flight plans, position reporting, getting complete preflight briefings, or obtaining random weather reports and forecasts. En route flight advisories are tailored to the phase of flight that begins after climb-out and ends with descent to land. Immediate destination weather and terminal airport forecasts will be provided on request. Pilots requesting information not within the scope of flight watch will be advised of the appropriate AFSS/FSS frequency to contact to obtain the information. Pilot participation is essential to the success of EFAS by providing a continuous exchange of information on weather, winds, turbulence, flight visibility, icing or other hazardous conditions between pilots and flight watch specialists. Pilots are encouraged to report good weather as well as bad, and to confirm both expected conditions and unexpected conditions to EFAS facilities.

### 3.8 In-Flight Weather Advisories

**3.8.1** The NWS issues in-flight weather advisories designated as Severe Weather Forecast Alerts (AWW), Convective SIGMET's (WST), SIGMET's (WS), Center Weather Advisories (CWA) and AIRMET's (WA). In-flight advisories serve to notify en route pilots of the possibility of encountering hazardous flying conditions which may not have been forecast at the time of the preflight briefing. Whether or not the condition described is potentially hazardous to a particular flight is for the pilot and/or aircraft dispatcher to evaluate on the basis of experience and the operational limits of the aircraft. In-flight weather advisories in the contiguous United States are described and plotted using VOR's as reference points. In Alaska and Hawaii, advisories are described and plotted using either geographic references or latitude/longitude coordinates.



**3.8.2 Severe Weather Forecast Alerts (AWW)** are preliminary messages issued in order to alert users that a Severe Weather Watch Bulletin (WW) is being issued. These messages define areas of possible severe thunderstorms or tornado activity. The messages are unscheduled and issued by the Aviation Weather Center at Kansas City, Missouri. Each AWW is numbered sequentially beginning 1 January of each year.

**EXAMPLE.—**

*MKC AWW 161755  
WW 279 SEVERE TSTM NY PA NY  
161830Z-170000Z  
AXIS..70 STATUTE MILES EITHER SIDE OF LINE..10W MSS TO 20E  
ABE..AVIATION COORDS..60NM EITHER SIDE/60NW SLK - 35W  
EWR..HAIL SURFACE AND ALOFT..2 INCHES. SURFACE WIND  
GUSTS..65 KNOTS. MAX TOPS TO 540. MEAN WIND VECTOR 19020.  
REPLACES WW 278..OH PA NY.*

**3.8.3 Status reports** are issued as needed on severe weather watch bulletins to show progress of storms and to delineate areas no longer under the threat of severe storm activity. Cancellation bulletins are issued when it becomes evident that no severe weather will develop or that storms have subsided and are no longer severe.

**3.8.4 Convective SIGMET's (WST's)** in the conterminous U.S. concern only thunderstorms and related phenomena (tornadoes, heavy precipitation, hail, and high surface winds) over the conterminous U.S. and imply the associated occurrence of turbulence, icing, and convective low level wind shear. Individual WSTs for each day are numbered sequentially (00-1-99), beginning at 00Z. The affected geographic area is contained in the number; i.e., the first WST issued each day in the Eastern U.S. is CONVECTIVE SIGMET 1E, the second is CONVECTIVE SIGMET 2E, and so forth. WSTs are issued on a scheduled basis, hourly at 55 minutes past the hour (H+55), and are valid for 2 hours or until superseded by the next hourly update.

**3.8.5 WST's** are issued for the following phenomena:

- a) Tornadoes;
- b) Lines of thunderstorms;
- c) Embedded thunderstorms;
- d) Thunderstorms that are greater than or equal to thunderstorm intensity level 4 with an area coverage of  $\frac{4}{10}$  (40 percent) or more; and
- e) Hail greater than or equal to  $\frac{3}{4}$  inches in diameter and/or winds gusting to 50 knots or greater.

**NOTE.—**

*SINCE THUNDERSTORMS ARE THE REASON FOR ISSUING THE WST, SEVERE OR GREATER TURBULENCE, SEVERE ICING, AND LOW-LEVEL WIND SHEAR (GUST FRONTS, DOWNBURSTS,*

*MICROBURSTS) ARE IMPLIED AND WILL NOT BE SPECIFIED IN THE ADVISORY.*

**3.8.6 Convective SIGMET Bulletins:**

**3.8.6.1** Three Convective SIGMET bulletins, each covering a specified geographic area, are issued. These areas are the Eastern (E), Central (C), and Western (W) U.S. These bulletins are issued on a scheduled basis, hourly at 55 minutes past the hour (H+55), and they are issued as special bulletins on an unscheduled basis. The boundaries that separate the eastern from the central, and the central from the western U.S. are 87 and 107 degrees west, respectively.

**3.8.6.2** Each of the Convective SIGMET bulletins will be:

- a) Made up of one or more individually numbered Convective SIGMET's; and
- b) Valid for 2 hours or until superseded by the next hourly issuance.

**3.8.6.3** On an hourly basis, an outlook is made for each of the three Convective SIGMET regions. The outlook for a particular region is appended to the Convective SIGMET bulletin for the same region. The convective outlook is also appended to special Convective SIGMET's. The outlook is reviewed each hour and revised when necessary. The outlook is a forecast and a meteorological discussion for thunderstorm systems that are expected to require Convective SIGMET issuances during a time period 2-6 hours into the future. Furthermore, an outlook will always be made for each of the three regions, even if it is a negative statement.

**3.8.7** SIGMET's within the conterminous U.S. are issued by the Aviation Weather Center for the following hazardous weather phenomena:

- a) Severe, extreme turbulence or clear air turbulence (CAT) not associated with thunderstorms;
- b) Severe icing not associated with thunderstorms; and
- c) Widespread duststorms, sandstorms, or volcanic ash lowering surface and/or in-flight visibilities to less than 3 miles.

**3.8.8** Volcanic eruption SIGMET's are identified by an alphanumeric designator which consists of an alphabetic identifier and issuance number. The first time an advisory is issued for a phenomenon associated with a particular weather system, it will be given the next alphabetic designator in the series and will be numbered as the first for that designator. Subsequent advisories will retain the same alphabetic designator until the

phenomenon ends. In the conterminous U.S., this means that a phenomenon that is assigned an alphabetic designator in one area will retain that designator as it moves within the area or into one or more other areas. Issuances for the same phenomenon will be sequentially numbered, using the same alphabetic designator until the phenomenon no longer exists. Alphabetic designators NOVEMBER through YANKEE, except SIERRA, TANGO and ZULU, are only used for SIGMET's, while designators SIERRA, TANGO and ZULU are used for AIRMET's.

**3.8.9 Center Weather Advisory (CWA):** The CWA is an unscheduled in-flight, flow control, air traffic, and air crew advisory. By nature of its short lead time, the CWA is not a flight planning product. It is generally a "nowcast" for conditions beginning within the next 2 hours. CWA's will be issued:

- a) As a supplement to an existing SIGMET, Convective SIGMET, AIRMET, or Area Forecast (FA);
- b) When an In-flight Advisory has not been issued, but observed or expected weather conditions meet SIGMET/AIRMET criteria based upon current pilot reports and reinforced by other sources of information about existing meteorological conditions; and
- c) When observed or developing weather conditions do not meet SIGMET, Convective SIGMET, or AIRMET criteria; e.g., in terms of intensity or area coverage, but current pilot reports or other weather information sources indicate that existing or anticipated meteorological phenomena will adversely affect the safe flow of air traffic within the ARTCC's area of responsibility.

**3.8.10 AIRMET's (WA)** may be of significance to any pilot or aircraft operator and are issued for all domestic airspace. They are of particular concern to operators and pilots of aircraft sensitive to the phenomena described and to pilots without instrument ratings and are issued by the Aviation Weather Center for the following weather phenomena which are potentially hazardous to aircraft:

- a) Moderate icing;
- b) Moderate turbulence;
- c) Sustained winds of 30 knots or more at the surface;
- d) Widespread areas of ceilings less than 1,000 feet and/or visibility less than 3 miles; and
- e) Extensive mountain obscurement.

**3.8.11 AIRMET's** are issued on a scheduled basis every 6 hours, with unscheduled amendments issued as required. AIRMET's have fixed alphanumeric designator with ZULU for icing and freezing level data, TANGO for turbulence, strong surface winds, and wind shear, and SIERRA for instrument flight rules and mountain obscuration.

#### 4. Categorical Outlooks

**4.1 Categorical outlook terms** describing general ceiling and visibility conditions for advance planning purposes are used only in area forecasts. They are defined as follows:

- a) LIFR (Low IFR) - Ceiling less than 500 feet and/or visibility less than 1 mile;
- b) IFR - Ceiling 500 to less than 1,000 feet and/or visibility 1 to less than 3 miles;
- c) MVFR (Marginal VFR)- Ceiling 1,000 or 3,000 feet and/or visibility 3 to 5 miles inclusive; and
- d) VFR - Ceiling greater than 3,000 feet and visibility greater than 5 miles; includes sky clear.

**4.2** The cause of LIFR, IFR, or MVFR is indicated by either ceiling or visibility restrictions or both. The contraction "CIG" and/or weather and obstruction to vision symbols are used. If winds or gusts of 25 knots or greater are forecast for the outlook period, the word "WIND" is also included for all categories, including VFR.

*EXAMPLE.—*  
*LIFR CIG-LOW IFR DUE TO LOW CEILING.*

*IFR FG-IFR DUE TO VISIBILITY RESTRICTED BY FOG.*

*MVFR CIG HZ FU-MARGINAL VFR DUE BOTH TO CEILING AND TO VISIBILITY RESTRICTED BY HAZE AND SMOKE.*

*IFR CIG RA WIND-IFR DUE BOTH TO LOW CEILING AND TO VISIBILITY RESTRICTED BY RAIN: WIND EXPECTED TO BE 25 KNOTS OR GREATER.*

#### 5. Telephone Information Briefing Service (TIBS)

TIBS, provided by automated flight service stations (AFSS's) is a continuous recording of meteorological and aeronautical information, available by telephone. Each AFSS provides at least four route and/or area briefings. In addition, airspace procedures and special announcements (if applicable) concerning aviation interests are also available. Depending upon user demand, other items may be provided; i.e., METAR observations, terminal airport forecasts, winds aloft, and temperatures aloft forecasts.

## 6. In-Flight Weather Broadcasts

**6.1 Weather Advisory Broadcasts:** ARTCC's broadcast a Severe Weather Forecast Alert (AWW), Convective SIGMET, or CWA alert once on all frequencies, except emergency, when any part of the area described is within 150 miles of the airspace under their jurisdiction. These broadcasts contain SIGMET or CWA identification and a brief description of the weather activity and general area affected.

**EXAMPLE.—**  
*ATTENTION ALL AIRCRAFT, SIGMET DELTA THREE. FROM MYTON TO TUBA CITY TO MILFORD. SEVERE TURBULENCE AND SEVERE CLEAR ICING BELOW ONE ZERO THOUSAND FEET. EXPECTED TO CONTINUE BEYOND ZERO THREE ZERO ZERO ZULU.*

**EXAMPLE.—**  
*ATTENTION ALL AIRCRAFT, CONVECTIVE SIGMET TWO SEVEN EASTERN. FROM THE VICINITY OF ELMIRA TO PHILLIPSBURG. SCATTERED EMBEDDED THUNDERSTORMS MOVING EAST AT ONE ZERO KNOTS. A FEW INTENSE LEVEL FIVE CELLS, MAXIMUM TOPS FOUR FIVE ZERO.*

**EXAMPLE.—**  
*ATTENTION ALL AIRCRAFT, KANSAS CITY CENTER WEATHER ADVISORY ONE ZERO THREE. NUMEROUS REPORTS OF MODERATE TO SEVERE ICING FROM EIGHT TO NINER THOUSAND FEET IN A THREE ZERO MILE RADIUS OF ST. LOUIS. LIGHT OR NEGATIVE ICING REPORTED FROM FOUR THOUSAND TO ONE TWO THOUSAND FEET REMAINDER OF KANSAS CITY CENTER AREA.*

**NOTE.—**  
*TERMINAL CONTROL FACILITIES HAVE THE OPTION TO LIMIT THE AWW, CONVECTIVE SIGMET, SIGMET, OR CWA BROADCAST AS FOLLOWS: LOCAL CONTROL AND APPROACH CONTROL POSITIONS MAY OPT TO BROADCAST SIGMET OR CWA ALERTS ONLY WHEN ANY PART OF THE AREA DESCRIBED IS WITHIN 50 MILES OF THE AIRSPACE UNDER THEIR JURISDICTION.*

**6.2 Hazardous In-Flight Weather Advisory Service (HIWAS):** This is a continuous broadcast of in-flight weather advisories including summarized AWW's, SIGMET's, Convective SIGMET's, CWA's, AIRMET's, and urgent PIREP's. HIWAS has been adopted as a national program and will be implemented throughout the conterminous U.S. as resources permit. In those areas where HIWAS is commissioned, ARTCC, Terminal ATC, and AFSS/FSS facilities have discontinued the broadcast of in-flight advisories. HIWAS is an additional source of hazardous weather information which makes these data available on a continuous basis. It is not, however, a replacement for preflight or in-flight briefings or real-time weather updates from Flight Watch (EFAS). As HIWAS is implemented in individual center areas, the commissioning will be advertised in the Notices to Airmen publication.

a) Where HIWAS has been implemented, a HIWAS alert will be broadcast on all except emergency frequencies once upon receipt by ARTCC and terminal facilities which will include an alert announcement, frequency instruction, number, and type of advisory

updated; e.g., AWW, SIGMET, Convective SIGMET, or CWA.

**EXAMPLE.—**  
*ATTENTION ALL AIRCRAFT, HAZARDOUS WEATHER INFORMATION (SIGMET, CONVECTIVE SIGMET, AIRMET, URGENT PILOT WEATHER REPORT (UUA), OR CENTER WEATHER ADVISORY (CWA)), (NUMBER OR NUMBERS) FOR (GEOGRAPHICAL AREA) AVAILABLE ON HIWAS, FLIGHT WATCH, OR FLIGHT SERVICE FREQUENCIES.*

b) In HIWAS ARTCC areas, AFSS's/FSS's will broadcast a HIWAS update announcement once on all except emergency frequencies upon completion of recording an update to the HIWAS broadcast. Included in the broadcast will be the type of advisory update; e.g., AWW, SIGMET, Convective SIGMET, or CWA.

**EXAMPLE.—**  
*ATTENTION ALL AIRCRAFT, HAZARDOUS WEATHER INFORMATION FOR (GEOGRAPHICAL AREA) AVAILABLE FROM FLIGHT WATCH OR FLIGHT SERVICE.*

c) HIWAS availability is shown on IFR En Route Low Altitude Charts and VFR Sectional Charts. The symbol depiction is identified in the chart legend.

## 7. Weather Observing Programs

**7.1 Manual Observations:** Aviation Routine Weather Reports (METAR) are taken at more than 600 locations in the United States. With only a few exceptions, these stations are located at airport sites and most are staffed by FAA or NWS personnel who manually observe, perform calculations, and enter the observation into the distribution system. The format and coding of these observations are contained in FIG 3.5-18.

### 7.2 Automated Weather Observing System (AWOS)

**7.2.1 Automated weather reporting systems** are increasingly being installed at airports. These systems consist of various sensors, a processor, a computer-generated voice subsystem, and a transmitter to broadcast local, minute-by-minute weather data directly to the pilot.

**NOTE.—**  
*WHEN THE BAROMETRIC PRESSURE EXCEEDS 31.00 INCHES HQ., SEE SECTION ENR 1.7 FOR THE ALTIMETER SETTING PROCEDURES.*

**7.2.2** The AWOS observations will include the prefix "AUTO" to indicate that the data are derived from an automated system. Some AWOS locations will be augmented by certified observers who will provide weather and obstruction to vision information in the remarks of the report when the reported visibility is less than 3 miles. These sites, along with the hours of augmentation, are published in the Airport/Facility Directory. Augmentation is identified in the observation as "OBSERVER WEATHER." The AWOS wind speed, direction and gusts, temperature, dew point, and altimeter setting are exactly the same as for manual observations.

The AWOS will also report density altitude when it exceeds the field elevation by more than 1,000 feet. The reported visibility is derived from a sensor near the touchdown of the primary instrument runway. The visibility sensor output is converted to a visibility value using a 10-minute harmonic average. The reported sky condition/ceiling is derived from the ceilometer located next to the visibility sensor. The AWOS algorithm integrates the last 30 minutes of ceilometer data to derive cloud layers and heights. This output may also differ from the observer sky condition in that the AWOS is totally dependent upon the cloud advection over the sensor site.

**7.2.3** Referred to as AWOS, these real-time systems are operationally classified into four basic levels:

- a) AWOS-A: only reports altimeter setting;
- b) AWOS-1: usually reports altimeter setting, wind data, temperature, dew point, and density altitude;
- c) AWOS-2 provides the information provided by AWOS-1, plus visibility; and
- d) AWOS-3 provides the information provided by AWOS-2, plus cloud/ceiling data.

**7.2.4** The information is transmitted over a discrete VHF radio frequency or the voice portion of a local NAVAID. AWOS transmissions on a discrete VHF radio frequency are engineered to be receivable to a maximum of 25 NM from the AWOS site and a maximum altitude of 10,000 feet AGL. At many locations, AWOS signals may be received on the surface of the airport, but local conditions may limit the maximum AWOS reception distance and/or altitude. The system transmits a 20- to 30-second weather message updated each minute. Pilots should monitor the designated frequency for the automated weather broadcast. A description of the broadcast is contained in paragraph 7.3. There is no two-way communication capability. Most AWOS sites also have a dial-up capability so that the minute-by-minute weather messages can be accessed via telephone.

**7.2.5** AWOS information (system level, frequency, phone number) concerning specific locations is published, as the systems become operational, in the Airport/Facility Directory and, where applicable, on published Instrument Approach Procedure (IAP) charts. Selected individual systems may be incorporated into nationwide data collection and dissemination networks in the future.

**7.3 Automated Weather Observing System (AWOS) Broadcasts:** Computer-generated voice is used in AWOS to automate the broadcast of the minute-by-minute weather observations. In addition, some systems are configured to permit the addition of an operator-generated voice message; e.g., weather remarks, following the automated parameters. The phraseology used generally follows that used for other weather broadcasts. Following are explanations and examples of the exceptions.

**7.3.1 Location and Time:** The location/name and the phrase "AUTOMATED WEATHER OBSERVATION" followed by the time are announced.

a) If the airport's specific location is included in the airport's name, the airport's name is announced.

*EXAMPLE.—*  
"BREMERTON NATIONAL AIRPORT AUTOMATED WEATHER OBSERVATION ONE FOUR FIVE SIX ZULU."

"RAVENSWOOD JACKSON COUNTY AIRPORT AUTOMATED WEATHER OBSERVATION ONE FOUR FIVE SIX ZULU."

b) If the airport's specific location is not included in the airport's name, the location is announced followed by the airport's name.

*EXAMPLE.—*  
"SAULT STE MARIE, CHIPPEWA COUNTY INTERNATIONAL AIRPORT AUTOMATED WEATHER OBSERVATION."

"SANDUSKY, COWLEY FIELD AUTOMATED WEATHER OBSERVATION."

c) The word "TEST" is added following "OBSERVATION" when the system is not in commissioned status.

*EXAMPLE.—*  
"BREMERTON NATIONAL AIRPORT AUTOMATED WEATHER OBSERVATION TEST ONE FOUR FIVE SIX ZULU."

d) The phrase "TEMPORARILY INOPERATIVE" is added when the system is inoperative.

*EXAMPLE.—*  
"BREMERTON NATIONAL AIRPORT AUTOMATED WEATHER OBSERVING SYSTEM TEMPORARILY INOPERATIVE."

### 7.3.2 Ceiling and Sky Cover

a) Ceiling is announced as either "CEILING" or "INDEFINITE CEILING." The phrases "MEASURED CEILING" and "ESTIMATED CEILING" are not used. With the exception of indefinite ceilings, all automated ceiling heights are measured.

*EXAMPLE.—*  
"BREMERTON NATIONAL AIRPORT AUTOMATED WEATHER OBSERVATION ONE FOUR FIVE SIX ZULU, CEILING TWO THOUSAND OVERCAST."

"BREMERTON NATIONAL AIRPORT AUTOMATED WEATHER OBSERVATION ONE FOUR FIVE SIX ZULU, INDEFINITE CEILING TWO HUNDRED."

b) The word "CLEAR" is not used in AWOS due to limitations in the height ranges of the sensors. No clouds detected is announced as, "No clouds below XXX" or, in newer systems as, "Clear below XXX" (where XXX is the range limit of the sensor).

*EXAMPLE.—*  
"NO CLOUDS BELOW ONE TWO THOUSAND."

"CLEAR BELOW ONE TWO THOUSAND."

c) A sensor for determining ceiling and sky cover is not included in some AWOS. In these systems, ceiling and sky cover are not announced. "SKY CONDITION MISSING" is announced only if the system is configured with a ceilometer, and the ceiling and sky cover information is not available.

### 7.3.3 Visibility

a) The lowest reportable visibility value in AWOS is "less than 1/4." It is announced as "VISIBILITY LESS THAN ONE QUARTER."

b) A sensor for determining visibility is not included in some AWOSs. In these systems, visibility is not announced. "VISIBILITY MISSING" is announced only if the system is configured with a visibility sensor and visibility information is not available.

**7.3.4 Weather.** In the future, some AWOS's are to be configured to determine the occurrence of precipitation. However, the type and intensity may not always be determined. In these systems, the word "PRECIPITATION" will be announced if precipitation is occurring, but the type and intensity are not determined.

**7.3.5 Remarks:** If remarks are included in the observation, the word "REMARKS" is announced following the altimeter setting. Remarks are announced in the following order of priority:

a) Automated "remarks":

- 1) Variable visibility; and
- 2) Density altitude.

b) Manual input remarks: Manual input remarks are prefaced with the phrase "OBSERVER WEATHER." As a general rule the manual remarks are limited to:

- 1) Type and intensity of precipitation;
- 2) Thunderstorms, intensity (if applicable), and direction; and
- 3) Obstructions to vision when the visibility is less than 7 miles.

*EXAMPLE.—*  
"REMARKS...DENSITY ALTITUDE, TWO THOUSAND FIVE HUNDRED...VISIBILITY VARIABLE BETWEEN ONE AND TWO...WIND DIRECTION VARIABLE BETWEEN TWO FOUR ZERO AND THREE ONE ZERO...OBSERVED WEATHER...THUNDERSTORM MODERATE RAIN SHOWERS AND MIST...THUNDERSTORM OVERHEAD."

c) If an automated parameter is "missing" and no manual input for that parameter is available, the parameter is announced as "MISSING." For example, a report with the dew point "missing," and no manual input available, would be announced as follows:

*EXAMPLE.—*  
"CEILING ONE THOUSAND OVERCAST, VISIBILITY THREE, PRECIPITATION, TEMPERATURE THREE ZERO, DEW POINT MISSING, WIND CALM, ALTIMETER THREE ZERO ZERO ONE."

d) "REMARKS" are announced in the following order of priority:

1) Automated "REMARKS";

- Variable visibility; and
- Density altitude.

2) Manual Input "REMARKS." As a general rule, the remarks are announced in the same order as the parameters appear in the basic text of the observation.

*EXAMPLE.—*  
"REMARKS, DENSITY ALTITUDE, TWO THOUSAND FIVE HUNDRED, VISIBILITY VARIABLE BETWEEN ONE AND TWO, WIND DIRECTION VARIABLE BETWEEN TWO FOUR ZERO AND THREE ONE ZERO, OBSERVER CEILING ESTIMATED TWO THOUSAND BROKEN, OBSERVER TEMPERATURE TWO, DEW POINT MINUS FIVE."

## 7.4 Automated Surface Observation System (ASOS)

**7.4.1** The ASOS is the primary surface weather observing system of the United States. The program to install and operate up to 1,700 systems throughout the United States is a joint effort of the NWS, the FAA, and the Department of Defense. ASOS is designed to support aviation operations and weather forecast activities. The ASOS will provide continuous minute-by-minute observations and perform the basic observing functions necessary to generate a METAR and other aviation weather information. The information is transmitted over a discrete VHF radio frequency or the voice portion of a local NAVAID. ASOS transmissions on a discrete VHF radio frequency are engineered to be receivable to a maximum of 25 NM from the ASOS site and a maximum altitude of 10,000 feet AGL. At many locations, ASOS signals may be received on the surface of the airport, but local conditions may limit the maximum reception distance and/or altitude. While the automated system and the human may differ in their methods of data collection and interpretation, both produce an observation quite similar in form and content. For the "objective" elements such as pressure, ambient temperature, dew point temperature, wind, and precipitation

accumulation, both the automated system and the observer use a fixed location and time-averaging technique. The quantitative differences between the observer and the automated observation of these elements are negligible. For the "subjective" elements, however, observers use a fixed-time, spatial-averaging technique to describe the visual elements (sky condition, visibility and present weather), while the automated systems use a fixed-location, time-averaging technique. Although this is a fundamental change, the manual and automated techniques yield remarkably similar results within the limits of their respective capabilities. (See FIG 3.5-19 and FIG 3.5-20.)

**7.4.2 System Description:**

- a) The ASOS at each airport location consists of four main components:
  - 1) Individual weather sensors;
  - 2) Data collection package(s) (DCP);
  - 3) The acquisition control unit; and
  - 4) Peripherals and displays.
- b) The ASOS sensors perform the basic function of data acquisition. They continuously sample and measure the ambient environment, derive raw sensor data, and make them available to the collocated DCP.

**7.4.3 Every ASOS will contain the following basic set of sensors:**

- a) Cloud height indicator (one or possibly three);
- b) Visibility sensor (one or possibly three);
- c) Precipitation identification sensor;
- d) Freezing rain sensor;
- e) Pressure sensors (two sensors at small airports; three sensors at large airports);
- f) Ambient temperature/dew point temperature sensor;
- g) Anemometer (wind direction and speed sensor); and
- h) Rainfall accumulation sensor.

**7.4.4 The ASOS data outlets include:**

- a) Those necessary for on-site airport users;
- b) National communications networks; and
- c) Computer-generated voice (available through FAA radio broadcast to pilots and dial-in telephone line).

**7.5** A comparison of weather observing programs and the elements observed by each are in TBL 3.5-1.

**Weather Observing Programs**

Element Reported	AWOS-A	AWOS-1	AWOS-2	AWOS-3	ASOS	MANUAL
Altimeter	X	X	X	X	X	X
Wind		X	X	X	X	X
Temperature/Dew point		X	X	X	X	X
Density altitude		X	X	X	X	
Visibility			X	X	X	X
Clouds/Ceiling				X	X	X
Precipitation					X	X
Remarks					X	X

TBL 3.5-1

**7.6 Service Standards.** During 1995, a government/industry team worked to comprehensively reassess the requirements for surface observations at the nation's airports. That work resulted in agreement on a set of service standards and the FAA and NWS ASOS sites to which the standards would apply. The term "Service Standards" refers to the level of detail in the weather observation. The service standards consist of four different levels of service (A, B, C, and D) as described below. Specific observational elements included in each service level are listed in TBL 3.5-2.

a) Service Level D defines the minimum acceptable level of service. It is a completely automated service in which the ASOS observation will constitute the entire observation; i.e., no additional weather information is added by a human observer. This service is referred to as a stand alone D site.

b) Service Level C is a service in which the human observer, usually an air traffic controller, augments or adds information to the automated observation. Service Level C also includes backup of ASOS elements in the event of an ASOS malfunction or an unrepresentative ASOS report. In backup, the human observer inserts the correct or missing value for the automated ASOS ele-

ments. This service is provided by air traffic controllers under the Limited Aviation Weather Reporting Station (LAWRS) process, FSS and NWS observers, and, at selected sites, Non-Federal Observation Program observers.

Two categories of airports require detail beyond Service Level C in order to enhance air traffic control efficiency and increase system capacity. Services at these airports are typically provided by contract weather observers, NWS observers, and, at some locations, FSS observers.

c) Service Level B is a service in which weather observations consist of all elements provided under Service Level C, plus augmentation of additional data beyond the capability of the ASOS. This category of airports includes smaller hubs or airports special in other ways that have worse than average bad weather operations for thunderstorms and/or freezing/frozen precipitation, and/or that are remote airports.

d) Service Level A, the highest and most demanding category, includes all the data reported in Service Standard B, plus additional requirements as specified. Service Level A covers major aviation hubs and/or high volume traffic airports with average or worse weather.

## WEATHER OBSERVATION SERVICE STANDARDS

<b>SERVICE LEVEL A</b>	
<p>Service Level A consists of all the elements of service levels B, C and D plus the elements listed to the right, if observed.</p>	<p>10-minute longline RVR at predated sites or additional visibility increments of <math>\frac{1}{8}</math>, <math>\frac{1}{16}</math>, and 0</p> <p>Sector visibility</p> <p>Variable sky condition</p> <p>Cloud layers above 12,000 feet and cloud types</p> <p>Widespread dust, sand, and other obscurations</p> <p>Volcanic eruptions</p>
<b>SERVICE LEVEL B</b>	
<p>Service Level B consists of all the elements of service levels C and D plus the elements listed to the right, if observed.</p>	<p>Longline RVR at predated sites (may be instantaneous readout)</p> <p>Freezing drizzle versus freezing rain</p> <p>Ice pellets</p> <p>Snow depth &amp; snow increasing rapidly remarks</p> <p>Thunderstorm and lightning location remarks</p> <p>Observed significant weather not at the station remarks</p>
<b>SERVICE LEVEL C</b>	
<p>Service Level C consists of all the elements of Service Level D plus augmentation and backup by a human observer or an air traffic control specialist on location nearby. Backup consists of inserting the correct value if the system malfunctions or is unrepresentative. Augmentation consists of adding the elements listed to the right, if observed. During hours that the observing facility is closed, the site reverts to Service Level D.</p>	<p>Thunderstorms</p> <p>Tornadoes</p> <p>Hail</p> <p>Virga</p> <p>Volcanic ash</p> <p>Tower visibility</p> <p>Operationally significant remarks as deemed appropriate by the observer</p>
<b>SERVICE LEVEL D</b>	
<p>This level of service consists of an ASOS continually measuring the atmosphere at a point near the runway. The ASOS senses and measures the weather parameters listed to the right.</p>	<p>Wind</p> <p>Visibility</p> <p>Precipitation/Obstruction to vision</p> <p>Cloud height</p> <p>Sky cover</p> <p>Temperature</p> <p>Dew point</p> <p>Altimeter</p>



## 8. Weather Radar Services

**8.1** The National Weather Service operates a network of radar sites for detecting coverage, intensity, and movement of precipitation. The network is supplemented by FAA and DOD radar sites in the western sections of the country. Local warning radars augment the network by operating on an as needed basis to support warning and forecast programs.

**8.2** Scheduled radar observations are taken hourly and transmitted in alpha-numeric format on weather telecommunications circuits for flight planning purposes. Under certain conditions special radar reports are issued in addition to the hourly transmittals. Data contained in the reports is also collected by the National Meteorological Center and used to prepare hourly national radar summary charts for dissemination on facsimile circuits.

**8.3** All En route Flight Advisory Service facilities and many Automated Flight Service Stations have equipment to directly access the radar displays from the individual weather radar sites. Specialists at these locations are trained to interpret the display for pilot briefing and in-flight advisory services. The Center Weather Service Units located in the ARTCC's also have access to weather radar displays and provide support to all air traffic facilities within their center's area.

**8.4** A clear radar display (no echoes) does not mean that there is no significant weather within the coverage of the radar site. Clouds and fog are not detected by the radar. However, when echoes are present, turbulence can be implied by the intensity of the precipitation, and icing is implied by the presence of the precipitation at temperatures at or below zero degrees Celsius. Used in conjunction with other weather products, radar provides invaluable information for weather avoidance and flight planning.

**8.5** Additional information on weather radar products and services can be found in FAA Advisory Circular 00-45, "Aviation Weather Services." Also, see Pilot/Controller Glossary, Radar Weather Echo Intensity Levels, and paragraph 25, Thunderstorms. (See Airport/Facility Directory charts, NWS Upper Air Observing Stations and Weather Network for the location of specific radar sites.)

## 9. ATC In-flight Weather Avoidance Assistance

### 9.1 ATC Radar Weather Display

a) Areas of weather clutter are radar echoes from rain or moisture. Radars cannot detect turbulence. The determination of the intensity of the weather displayed

is based on its precipitation density. Generally, the turbulence associated with a very heavy rate of rainfall will normally be significantly more severe than any associated with a very light rainfall rate.

b) ARTCC's use narrowband radar which provides the controller with two distinct levels of weather intensity by assigning radar display symbols for specific precipitation densities measured by the narrowband system.

### 9.2 Weather Avoidance Assistance

a) To the extent possible, controllers will issue pertinent information of weather or chaff areas and assist pilots in avoiding such areas if requested. Pilots should respond to a weather advisory by either acknowledging the advisory or by acknowledging the advisory and requesting an alternative course of action as follows:

1) Request to deviate off course by stating the number of miles and the direction of the requested deviation. In this case, when the requested deviation is approved the pilot is expected to provide his own navigation, to maintain the altitude assigned by ATC, and to remain within the specified mileage of his original course;

2) Request a new route to avoid the affected area;

3) Request a change of altitude; and

4) Request radar vectors around the affected areas.

b) For obvious reasons of safety, an IFR pilot must not deviate from the course or altitude/flight level without a proper ATC clearance. When weather conditions encountered are so severe that an immediate deviation is determined to be necessary and time will not permit approval by ATC, the pilot's emergency authority may be exercised.

c) When the pilot requests clearance for a route deviation or for an ATC radar vector, the controller must evaluate the air traffic picture in the affected area and coordinate with other controllers (if ATC jurisdictional boundaries may be crossed) before replying to the request.

d) It should be remembered that the controller's primary function is to provide safe separation between aircraft. Any additional service, such as weather avoidance assistance, can only be provided to the extent that it does not derogate the primary function. It is also worth noting that the separation workload is generally greater than normal when weather disrupts the usual flow of traffic. ATC radar limitations and frequency congestion may also be factors in limiting the controller's capability to provide additional service.

e) It is very important that the request for deviation or radar vector be forwarded to ATC as far in advance as possible. Delay in submitting it may delay or even preclude ATC approval or require that additional restrictions be placed on the clearance. Insofar as possible, the following information should be furnished to ATC when requesting clearance to detour around weather activity:

- 1) Proposed point where detour will commence;
- 2) Proposed route and extent of detour (direction and distance);
- 3) Point where original route will be resumed;
- 4) Flight conditions (IFR or VFR);
- 5) Any further deviation that may become necessary as the flight progresses; and
- 6) Advise if the aircraft is equipped with functioning airborne radar.

f) To a large degree, the assistance that might be rendered by ATC will depend upon the weather information available to controllers. Due to the extremely transitory nature of severe weather situations, the controller's weather information may be of only limited value if based on weather observed on radar only. Frequent updates by pilots giving specific information as to the area affected, altitudes, intensity, and nature of the severe weather can be of considerable value. Such reports are relayed by radio or phone to other pilots and controllers, and they also receive widespread teletype-writer dissemination.

g) Obtaining IFR clearance or an ATC radar vector to circumnavigate severe weather can often be accommodated more readily in the en route areas away from terminals because there is usually less congestion and, therefore, greater freedom of action. In terminal areas, the problem is more acute because of traffic density, ATC coordination requirements, complex departure and arrival routes, and adjacent airports. As a consequence, controllers are less likely to be able to accommodate all requests for weather detours in a terminal area or be in a position to volunteer such routes to the pilot. Nevertheless, pilots should not hesitate to advise controllers of any observed severe weather and should specifically advise controllers if they desire circumnavigation of observed weather.

### 9.3 ATC Severe Weather Avoidance Plans

9.3.1 Air Route Traffic Control Centers and some Terminal Radar Control facilities utilize plans for severe weather avoidance within their control areas. Aviation-oriented meteorologists provide weather information. Preplanned alternate route packages developed by the facilities are used in conjunction with flow restrictions to ensure a more orderly flow of traffic during periods of severe or adverse weather conditions.

9.3.2 During these periods, pilots may expect to receive alternative route clearances. These routes are predicated upon the forecasts of the meteorologist and coordination between the Air Traffic Control System Command Center and the other centers. The routes are utilized as necessary in order to allow as many aircraft as possible to operate in any given area, and frequently they will deviate from the normal preferred routes. With user cooperation, this plan may significantly reduce delays.

### 9.4 Procedures for Weather Deviations and Other Contingencies in Oceanic Controlled Airspace:

9.4.1 When the pilot initiates communications with ATC, rapid response may be obtained by stating "WEATHER DEVIATION REQUIRED" to indicate priority is desired on the frequency and for ATC response.

9.4.2 The pilot still retains the option of initiating the communications using the urgency call "PAN-PAN" three times to alert all listening parties of a special handling condition which will receive ATC priority for issuance of a clearance or assistance.

#### 9.4.3 ATC will:

- a) Approve the deviation, or
- b) Provide vertical separation and then approve the deviation, or
- c) If ATC is unable to establish vertical separation, ATC shall advise the pilot that standard separation cannot be applied; provide essential traffic information for all affected aircraft, to the extent practicable; and if possible, suggest a course of action. ATC may suggest that the pilot climb or descend to a contingency altitude (1,000 feet above or below that assigned if operating above FL 290; 500 feet above or below that assigned if operating at or below FL 290).

**PHRASEOLOGY-**  
*STANDARD SEPARATION NOT AVAILABLE; DEVIATE AT PILOT'S DISCRETION; SUGGEST CLIMB (or descent) TO (appropriate altitude); TRAFFIC (position and altitude); REPORT DEVIATION COMPLETE.*

**9.4.4** The pilot will follow the ATC advisory altitude when approximately 10 NM from track as well as execute the procedures detailed in paragraph 9.4.5.

**9.4.5** If contact cannot be established or a revised ATC clearance or advisory is not available and deviation from track is required, the pilot shall take the following actions:

a) If possible, deviate away from an organized track or route system.

b) Broadcast aircraft position and intentions on the frequency in use, as well as on frequency 121.5 MHz at suitable intervals stating: flight identification (operator call sign), flight level, track code or ATS route designator, and extent of deviation expected.

c) Watch for conflicting traffic both visually and by reference to the Traffic Alert and Collision Avoidance System (TCAS), if equipped.

d) Turn on aircraft exterior lights.

e) Deviations of less than 10 NM or operations within COMPOSITE (NOPAC and CEPAC) Airspace, should REMAIN at ASSIGNED altitude. Otherwise, when the aircraft is approximately 10 NM from track, initiate an altitude change based upon the following criteria:

Route Centerline/Track	Deviations >10 NM	Altitude Change
EAST 000 - 179°M	LEFT RIGHT	DESCEND 500 FEET CLIMB 500 FEET
WEST 180-359°M	LEFT RIGHT	CLIMB 500 FEET DESCEND 500 FEET
<i>Pilot Memory Slogan: "East right up, West right down."</i>		

TBL 3.5-3

f) When returning to track, be at the assigned flight level when the aircraft is within approximately 10 NM of centerline.

g) If contact was not established prior to deviating, continue to attempt to contact ATC to obtain a clearance. If contact was established, continue to keep ATC advised of intentions and obtain essential traffic information.

## 10. Notifications Required From Operators

**10.1** Preflight briefing and flight documentation services provided by AFSS's do not require prior notification.

**10.2** Preflight briefing and flight documentation services provided by a National Weather Service Office (or contract office) are available upon request for long-range international flights for which meteorological data packages are prepared for the pilot-in-command. Briefing times should be coordinated between the local representative and the local meteorological office.

**10.3** Flight Service Stations do not normally have the capability to prepare meteorological data packages for a preflight briefing.

## 11. Weather Observing Systems and Operating Procedures

For surface wind readings, most meteorological reporting stations have a direct reading, 3-cup anemometer wind system for which a 1-minute mean wind speed and direction (based on true north) is taken. Some stations also have a continuous wind speed recorder which is used in determining the gustiness of the wind.

## 12. Runway Visual Range (RVR)

There are currently two configurations of the RVR, commonly identified as Taskers and New Generation RVR. The Taskers use transmissometer technology. The New Generation RVRs use forward scatter technology and are currently being deployed to replace the existing Taskers.

**12.1** RVR values are measured by transmissometers mounted on 14-foot towers along the runway. A full RVR system consists of:

- a) A transmissometer projector and related items;
- b) A transmissometer receiver (detector) and related items;
- c) An analogue recorder;
- d) A signal data converter and related items; and
- e) A remote digital or remote display programmer.

**12.2** The transmissometer projector and receiver are mounted on towers 250 feet apart. A known intensity of light is emitted from the projector and is measured by the receiver. Any obscuring matter, such as rain, snow, dust, fog, haze, or smoke, reduces the light intensity arriving at the receiver. The resultant intensity measurement is then converted to an RVR value by the signal data converter. These values are displayed by readout equipment in the associated air traffic facility and updated approximately once every minute for controller issuance to pilots.

**12.3** The signal data converter receives information on the high-intensity runway edge light setting in use (step 3, 4, or 5), transmission values from the transmissometer, and the sensing of day or night conditions. From the three data sources, the system will compute appropriate RVR values.

**12.4** An RVR transmissometer established on a 250-foot baseline provides digital readouts to a minimum of 600 feet, which are displayed in 200-foot increments to 3,000 feet and in 500-foot increments from 3,000 feet to a maximum value of 6,000 feet.

**12.5** RVR values for Category IIIa operations extend down to 700-foot RVR; however, only 600 and 800 feet are reportable RVR increments. The 800 RVR reportable value covers a range of 701 feet to 900 feet and is therefore a valid minimum indication of Category IIIa operations.

**12.6** Approach categories with the corresponding minimum RVR values are listed in TBL 3.5-4.

**Approach Category/Minimum RVR Table**

Category	Visibility (RVR)
Non-precision	2,400 feet
Category I	1,800 feet
Category II	1,200 feet
Category IIIa	700 feet
Category IIIb	150 feet
Category IIIc	0 feet

TBL 3.5-4

**12.7** Ten-minute maximum and minimum RVR values for the designated RVR runway are reported in the body of the aviation weather report when the prevailing visibility is less than 1 mile and/or the RVR is 6,000 feet or less. ATCT's report RVR when the prevailing visibility is 1 mile or less and/or the RVR is 6,000 feet or less.

**12.8** Details on the requirements for the operational use of RVR are contained in FAA Advisory Circular 97-1, "Runway Visual Range (RVR)." Pilots are responsible for compliance with minimums prescribed for their class of operations in appropriate Federal Aviation Regulations and/or operations specifications.

**12.8.1** RVR values are also measured by forward scatter meters mounted on 14-foot frangible fiberglass poles. A full RVR system consists of:

- a) Forward scatter meter with a transmitter, receiver and associated items;
- b) A runway light intensity monitor (RLIM);

- c) An ambient light sensor (ALS);
- d) A data processor unit (DPU); and
- e) A controller display (CD).

**12.8.2** The forward scatter meter is mounted on a 14-foot frangible pole. Infrared light is emitted from the transmitter and received by the receiver. Any obscuring matter such as rain, snow, dust, fog, haze or smoke increases the amount of scattered light reaching the receiver. The resulting measurement along with inputs from the runway light intensity monitor and the ambient light sensor are forwarded to the DPU which calculates the proper RVR value. The RVR values are displayed locally and remotely on controller displays.

**12.8.3** The runway light intensity monitors both the runway edge and centerline light step settings (steps 1 through 5). Centerline light step settings are used for CAT IIIb operations. Edge light step settings are used for CAT I, II, and IIIa operations.

**12.8.4** New Generation RVR's can measure and display RVR values down to the lowest limits of Category IIIb operations (150 foot RVR). RVR values are displayed in 100-foot increments and are reported as follows:

- a) 100-foot increments for products below 800 feet.
- b) 200-foot increments for products between 800 feet and 3,000 feet.
- c) 500-foot increments for products between 3,000 feet and 6,500 feet.
- d) 25-meter increments for products below 150 meters.
- e) 50-meter increments for products between 150 meters and 800 meters.
- f) 100-meter increments for products between 800 meters and 1,200 meters.
- g) 200-meter increments for products between 1,200 meters and 2,000 meters.

**13. Reporting of Cloud Heights**

**13.1** Ceiling, by definition in Federal Aviation Regulations, and as used in Aviation Weather Reports and Forecasts, is the height above ground (or water) level of the lowest layer of clouds or obscuring phenomenon that is reported as "broken," "overcast," or "the vertical visibility into an obscuration." For example, an aerodrome forecast which reads "BKN030" refers to heights above ground level (AGL). An area forecast which reads "BKN030" states that the height is above mean sea level (MSL). See FIG 3.5-18 for the Key to

Routine Aviation Weather Reports and Forecasts for the definition of “broken,” “overcast,” and “obscuration.”

**13.2** Information on cloud base height is obtained by use of ceilometers (rotating or fixed beam), ceiling lights, ceiling balloons, pilot reports, and observer estimations. The systems in use by most reporting stations are either the observer estimation or the rotating beam ceilometer.

**13.3** Pilots usually report height values above mean sea level, since they determine heights by the altimeter. This is taken into account when disseminating and otherwise applying information received from pilots. (“Ceiling” heights are always above ground level.) In reports disseminated as pilot reports, height references are given the same as received from pilots; that is, above mean sea level.

**13.4** In area forecasts or In-flight Advisories, ceilings are denoted by the contraction “CIG” when used with sky cover symbols as in “LWRG TO CIG OVC005,” or the contraction “AGL” after the forecast cloud height value. When the cloud base is given in height above mean sea level, it is so indicated by the contraction “MSL” or “ASL” following the height value. The heights of cloud tops, freezing level, icing, and turbulence are always given in heights above mean sea level (ASL or MSL).

#### **14. Reporting Prevailing Visibility**

**14.1** Surface (horizontal) visibility is reported in METAR reports in terms of statute miles and increments thereof; e.g.,  $\frac{1}{16}$ ,  $\frac{1}{8}$ ,  $\frac{3}{16}$ ,  $\frac{1}{4}$ ,  $\frac{5}{16}$ ,  $\frac{3}{8}$ ,  $\frac{1}{2}$ ,  $\frac{5}{8}$ ,  $\frac{3}{4}$ ,  $\frac{7}{8}$ , 1,  $1\frac{1}{8}$ , etc. (Visibility reported by an unaugmented automated site is reported differently than in a manual report; i.e.,  $M\frac{1}{4}$ ,  $\frac{1}{4}$ ,  $\frac{1}{2}$ ,  $\frac{3}{4}$ , 1,  $1\frac{1}{4}$ ,  $1\frac{1}{2}$ ,  $1\frac{3}{4}$ , 2,  $2\frac{1}{2}$ , 3, 4, 5, etc.) Visibility is determined through the ability to see and identify preselected and prominent objects at a known distance from the usual point of observation. Visibilities which are determined to be less than 7 miles identify the obscuring atmospheric condition; e.g., fog, haze, smoke, or combinations thereof.

**14.2** Prevailing visibility is the greatest visibility equalled or exceeded throughout at least one-half the horizon circle, not necessarily contiguous. Segments of the horizon circle which may have a significantly different visibility may be reported in the remarks section of the weather report; i.e., the southeastern quadrant of the horizon circle may be determined to be 2 miles in mist while the remaining quadrants are determined to be 3 miles in mist.

**14.3** When the prevailing visibility at the usual point of observation, or at the tower level, is less than 4 miles, certificated tower personnel will take visibility observations in addition to those taken at the usual point of observation. The lower of these two values will be used as the prevailing visibility for aircraft operations.

#### **15. Estimating Intensity of Rain and Ice Pellets**

##### **15.1 RAIN:**

**a) Light:** From scattered drops that, regardless of duration, do not completely wet an exposed surface up to a condition where individual drops are easily seen.

**b) Moderate:** Individual drops are not clearly identifiable; spray is observable just above pavements and other hard surfaces.

**c) Heavy:** Rain seemingly falls in sheets; individual drops are not identifiable; heavy spray to a height of several inches is observed over hard surfaces.

##### **15.2 ICE PELLETS:**

**a) Light:** Scattered pellets that do not completely cover an exposed surface regardless of duration. Visibility is not affected.

**b) Moderate:** Slow accumulation on the ground. Visibility is reduced by ice pellets to less than 7 statute miles.

**c) Heavy:** Rapid accumulation on the ground. Visibility is reduced by ice pellets to less than 3 statute miles.

#### **16. Estimating the Intensity of Snow or Drizzle (Based on Visibility)**

**16.1 Light:** Visibility more than  $\frac{1}{2}$  statute mile.

**16.2 Moderate:** Visibility from more than  $\frac{1}{4}$  statute mile to  $\frac{1}{2}$  statute mile.

**16.3 Heavy:** Visibility  $\frac{1}{4}$  statute mile or less.

## 17. Pilot Weather Reports (PIREP's)

**17.1** FAA air traffic facilities are required to solicit PIREP's when the following conditions are reported or forecast: ceilings at or below 5,000 feet, visibility at or below 5 miles (surface or aloft), thunderstorms and related phenomena, icing of a light degree or greater, turbulence of a moderate degree or greater, wind shear, and reported or forecast volcanic ash clouds.

**17.2** Pilots are urged to cooperate and promptly volunteer reports of these conditions and other atmospheric data, such as cloud bases, tops and layers, flight visibility, precipitation, visibility restrictions (haze, smoke, and dust), wind at altitude, and temperature aloft.

**17.3** PIREP's should be given to the ground facility with which communications are established; i.e., EFAS, AFSS/FSS, ARTCC, or terminal ATC. Radio call "FLIGHT WATCH," which serves as a collection point for the exchange of PIREP's with en route aircraft, is one of the primary duties of EFAS facilities.

**17.4** If pilots do not make PIREP's by radio, it is helpful if, upon landing, they report to the nearest AFSS/FSS or Weather Forecast Office the in-flight conditions which they encountered. Some of the uses made of the reports are:

a) The ATCT uses the reports to expedite the flow of air traffic in the vicinity of the field and for hazardous weather avoidance procedures;

b) The AFSS/FSS uses the reports to brief other pilots, to provide in-flight advisories and weather avoidance information to en route aircraft;

c) The ARTCC uses the reports to expedite the flow of en route traffic, to determine most favorable altitudes, and to issue hazardous weather information within the center's area;

d) The NWS uses the reports to verify or amend conditions contained in aviation forecasts and advisories. In some cases, pilot reports of hazardous

conditions are the triggering mechanism for the issuance of advisories.

e) The NWS, other government organizations, the military, and private industry groups use PIREP's for research activities in the study of meteorological phenomena; and

f) All air traffic facilities and the NWS forward the reports received from pilots into the weather distribution system to assure the information is made available to all pilots and other interested parties.

**17.5** The FAA, NWS, and other organizations that enter PIREP's into the weather reporting system use the format listed in TBL 3.5-5. Items 1 through 6 are included in all transmitted PIREP's along with one or more of items 7 through 13. Although the PIREP should be as complete and concise as possible, pilots should not be overly concerned with strict format or phraseology. The important thing is that the information is relayed so other pilots may benefit from your observation. If a portion of the report needs clarification, the ground station will request the information.

**17.6** Completed PIREP's will be transmitted to weather circuits as in the following examples:

**EXAMPLE.—**

*KCMH UA/OV APE 230010/TM 1516/FL085/TP BE20/SK BKN065/WX FV03SM HZ FU/TA 20/TB LGT.*

*TRANSLATION: ONE ZERO MILES SOUTHWEST OF APPLETON VOR; TIME 1516 UTC; ALTITUDE EIGHT THOUSAND FIVE HUNDRED; AIRCRAFT TYPE BE20; BASE OF THE BROKEN CLOUD LAYER IS SIX THOUSAND FIVE HUNDRED; FLIGHT VISIBILITY 3 MILES WITH HAZE AND SMOKE; AIR TEMPERATURE 20 DEGREES CELSIUS; LIGHT TURBULENCE.*

**EXAMPLE.—**

*KCRW UA/OV KBKW 360015-KCRW/TM 1815/FL120/TP BE99/SK IMC/WX RA-/TA -08/WV 290030/TB LGT-MDT/IC LGT RIME/IRM MDT MXD ICG DURGC KROA NWBND FL080-100 1750z.*

*TRANSLATION: FROM 15 MILES NORTH OF BECKLEY VOR TO CHARLESTON VOR; TIME 1815 UTC; ALTITUDE 12,000 FEET; TYPE AIRCRAFT BE-99; IN CLOUDS; RAIN; TEMPERATURE MINUS 8 CELSIUS; WIND 290 DEGREES TRUE AT 30 KNOTS; LIGHT TO MODERATE TURBULENCE; LIGHT RIME ICING; ENCOUNTERED MODERATE MIXED ICING DURING CLIMB NORTHWESTBOUND FROM ROANOKE, VIRGINIA, BETWEEN 8,000 AND 10,000 FEET AT 1750 UTC.*

**PIREP ELEMENT CODE CHART**

	PIREP ELEMENT	PIREP CODE	CONTENTS
1.	3-letter station identifier	XXX	Nearest weather reporting location to the reported phenomenon
2.	Report type	UA or UUA	Routine or urgent PIREP
3.	Location	/OV	In relation to a VOR
4.	Time	/TM	Coordinated Universal Time
5.	Altitude	/FL	Essential for turbulence and icing reports
6.	Type aircraft	/TP	Essential for turbulence and icing reports
7.	Sky cover	/SK	Cloud height and coverage (sky clear, few, scattered, broken, or overcast)
8.	Weather	/WX	Flight visibility, precipitation, restrictions to visibility, etc.
9.	Temperature	/TA	Degrees Celsius
10.	Wind	/WV	Direction in degrees true north and speed in knots
11.	Turbulence	/TB	See paragraph 20
12.	Icing	/IC	See paragraph 19
13.	Remarks	/RM	For reporting elements not included or to clarify previously reported items

TBL 3.5-5

**18. Mandatory MET Points**

**18.1** Within the ICAO CAR/SAM Regions and within the U.S. area of responsibility, several mandatory MET reporting points have been established. These points are located within the Houston, Miami, and San Juan Flight Information Regions (FIR). These points have been established for flights between the South American and Caribbean Regions and Europe, Canada and the U.S.

**18.2 Mandatory MET Reporting Points Within the Houston FIR**

POINT	FOR FLIGHTS BETWEEN
ABBOT	Acapulco and Montreal, New York, Toronto, Mexico City and New Orleans.
ALARD	New Orleans and Belize, Guatemala, San Pedro Sula, Mexico City and Miami, Tampa.
ARGUS	Toronto and Guadalajara, Mexico City, New Orleans and Mexico City.
SWORD	Dallas-Fort Worth, New Orleans, Chicago and Cancun, Cozumel, and Central America.

**18.3 Mandatory MET Reporting Points Within the Miami FIR**

POINT	FOR FLIGHTS BETWEEN
Grand Turk	New York and Aruba, Curacao, Kingston, Miami and Belem, St. Thomas, Rio de Janeiro, San Paulo, St. Croix, Kingston and Bermuda.
GRATX	Madrid and Miami, Havana.
MAPYL	New York and Guayaquil, Montego Bay, Panama, Lima, Atlanta and San Juan.
RESIN	New Orleans and San Juan.
SLAPP	New York and Aruba, Curacao, Kingston, Port-au-Prince, Bermuda and Freeport, Nassau, New York and Barranquilla, Bogota, Santo Domingo, Washington and Santo Domingo, Atlanta and San Juan.

**18.4 Mandatory MET Reporting Points Within the San Juan FIR**

POINT	FOR FLIGHTS BETWEEN
GRANN	Toronto and Barbados, New York and Fort de France. At intersection of routes A321, A523, G432.
KRAFT	San Juan and Buenos Aires, Caracas, St. Thomas, St. Croix, St. Maarten, San Juan, Kingston and Bermuda.
PISAX	New York and Barbados, Fort de France, Bermuda and Antigua, Barbados.

### 19. PIREP's Relating to Airframe Icing

**19.1** The effects of ice accretion on aircraft are: cumulative-thrust is reduced, drag increases, lift lessens, weight increases. The results are an increase in stall speed and a deterioration of aircraft performance. In extreme cases, 2 to 3 inches of ice can form on the leading edge of the airfoil in less than 5 minutes. It takes but 1/2 inch of ice to reduce the lifting power of some aircraft by 50 percent and to increase the frictional drag by an equal percentage.

**19.2** A pilot can expect icing when flying in visible precipitation, such as rain or cloud droplets, and the temperature is between +02 and -10 degrees Celsius. When icing is detected, a pilot should do one of two things (particularly if the aircraft is not equipped with deicing equipment). The pilot should get out of the area of precipitation or go to an altitude where the temperature is above freezing. This "warmer" altitude may not always be a lower altitude. Proper preflight action includes obtaining information on the freezing level and the above-freezing levels in precipitation areas. Report the icing to an ATC or FSS facility, and if operating IFR, request new routing or altitude if icing will be a hazard. Be sure to give the type of aircraft to ATC when reporting icing. TBL 3.5-6 describes how to report icing conditions.

### 20. PIREP's Relating to Turbulence

**20.1** When encountering turbulence, pilots are urgently requested to report such conditions to ATC as soon as practicable. PIREP's relating to turbulence should state:

- a) Aircraft location;
- b) Time of occurrence in UTC;
- c) Turbulence intensity;
- d) Whether the turbulence occurred in or near clouds;
- e) Aircraft altitude, or flight level;
- f) Type of aircraft; and
- g) Duration of turbulence.

**EXAMPLE.—**  
OVER OMAHA, 1232 Z, MODERATE TURBULENCE IN CLOUDS AT FLIGHT LEVEL THREE ONE ZERO, BOEING 707.

**EXAMPLE.—**  
FROM FIVE ZERO MILES SOUTH OF ALBUQUERQUE TO THREE ZERO MILES NORTH OF PHOENIX, 1250 Z, OCCASIONAL MODERATE CHOP AT FLIGHT LEVEL THREE THREE ZERO, DC8.

**20.2** Duration and classification of intensity should be made using the Turbulence Reporting Criteria Table. See TBL 3.5-7.

### 21. Wind Shear PIREP's

**21.1** Because unexpected changes in wind speed and direction can be hazardous to aircraft operations at low altitudes on approach to and departing from airports, pilots are urged to promptly volunteer reports to controllers of wind shear conditions they encounter. An advance warning of this information will assist other pilots in avoiding or coping with a wind shear on approach or departure.

INTENSITY	ICE ACCUMULATION
Trace	Ice becomes perceptible. Rate of accumulation slightly greater than rate of sublimation. It is not hazardous even though deicing/anti-icing equipment is not utilized unless encountered for an extended period of time (over 1 hour).
Light	The rate of accumulation may create a problem if flight is prolonged in this environment (over 1 hour). Occasional use of deicing/anti-icing equipment removes/prevents accumulation. It does not present a problem if the deicing/anti-icing equipment is used.
Moderate	The rate of accumulation is such that even short encounters become potentially hazardous and use of deicing/anti-icing equipment or diversion is necessary.
Severe	The rate of accumulation is such that deicing/anti-icing equipment fails to reduce or control the hazard. Immediate diversion is necessary.
Pilot Report: Aircraft Identification, Location, Time (UTC), Intensity of Type <sup>1</sup> , Altitude/FL, Aircraft Type, Indicated Air Speed (IAS), and Outside Air Temperature (OAT) <sup>2</sup> .	
<sup>1</sup> Rime or Clear Ice: Rime ice is a rough, milky, opaque ice formed by the instantaneous freezing of small supercooled water droplets. Clear ice is a glossy, clear, or translucent ice formed by the relatively slow freezing of large supercooled water droplets.	
<sup>2</sup> The Outside Air Temperature (OAT) should be requested by the AFSS/FSS or ATC if not included in the PIREP.	

TBL 3.5-6



**Turbulence Reporting Criteria Table**

Intensity	Aircraft Reaction	Reaction inside Aircraft	Reporting Term-Definition
Light	Turbulence that momentarily causes slight, erratic changes in altitude and/or attitude (pitch, roll, yaw). Report as <b>Light Turbulence</b> ; <sup>1</sup> or Turbulence that causes slight, rapid and somewhat rhythmic bumpiness without appreciable changes in altitude or attitude. Report as <b>Light Chop</b> .	Occupants may feel a slight strain against seat belts or shoulder straps. Unsecured objects may be displaced slightly. Food service may be conducted, and little or no difficulty is encountered in walking.	Occasional—Less than 1/3 of the time Intermittent—1/3 to 2/3 Continuous—More than 2/3
Moderate	Turbulence that is similar to Light Turbulence but of greater intensity. Changes in altitude and/or attitude occur, but the aircraft remains in positive control at all times. It usually causes variations in indicated airspeed. Report as <b>Moderate Turbulence</b> ; <sup>1</sup> or Turbulence that is similar to Light Chop but of greater intensity. It causes rapid bumps or jolts without appreciable changes in aircraft altitude or attitude. Report as <b>Moderate Chop</b> . <sup>1</sup>	Occupants feel definite strains against seat belts or shoulder straps. Unsecured objects are dislodged. Food service and walking are difficult.	<b>NOTE</b> 1. Pilots should report location(s), time (UTC), intensity, whether in or near clouds, altitude, type of aircraft and, when applicable, duration of turbulence. 2. Duration may be based on time between two locations or over a single location. All locations should be readily identifiable.
Severe	Turbulence that causes large, abrupt changes in altitude and/or attitude. It usually causes large variations in indicated airspeed. Aircraft may be momentarily out of control. Report as <b>Severe Turbulence</b> . <sup>1</sup>	Occupants are forced violently against seat belts or shoulder straps. Unsecured objects are tossed about. Food service and walking are impossible.	<b>EXAMPLES:</b> a. Over Omaha, 1232Z, Moderate Turbulence, in cloud, Flight Level 310, B707. b. From 50 miles south of Albuquerque to 30 miles north of Phoenix, 1210Z to 1250Z, occasional Moderate Chop, Flight Level 330, DC8.
Extreme	Turbulence in which the aircraft is violently tossed about and is practically impossible to control. It may cause structural damage. Report as <b>Extreme Turbulence</b> . <sup>1</sup>		

<sup>1</sup> High level turbulence (normally above 15,000 feet ASL) not associated with cumuliform cloudiness, including thunderstorms, should be reported as clear air turbulence (CAT) preceded by the appropriate intensity, or light or moderate chop.

TBL 3.5-7

**21.2** When describing conditions, the use of the terms “negative” or “positive” wind shear should be avoided. PIREP’s of negative wind shear on final, intended to describe loss of airspeed and lift, have been interpreted to mean that no wind shear was encountered. The recommended method for wind shear reporting is to state the loss/gain of airspeed and the altitude(s) at which it was encountered.

**EXAMPLE.—**  
“DENVER TOWER, CESSNA 1234 ENCOUNTERED WIND SHEAR, LOSS OF 20 KNOTS AT 400 FEET.”

“TULSA TOWER, AMERICAN 721 ENCOUNTERED WIND SHEAR ON FINAL, GAINED 25 KNOTS BETWEEN 600 AND 400 FEET FOLLOWED BY LOSS OF 40 KNOTS BETWEEN 400 FEET AND SURFACE.”

Pilots who are not able to report wind shear in these specific terms are encouraged to make reports in terms of the effect upon their aircraft.

**EXAMPLE.—**  
“MIAMI TOWER, GULFSTREAM 403 CHARLIE ENCOUNTERED AN ABRUPT WIND SHEAR AT 800 FEET ON FINAL, MAX THRUST REQUIRED.”

Pilots using Inertial Navigation Systems should report the wind and altitude both above and below the shear layer.

**22. Clear Air Turbulence (CAT) PIREP’s**

Clear air turbulence (CAT) has become a very serious operational factor to flight operations at all levels and especially to jet traffic flying in excess of 15,000 feet. The best available information on this phenomenon must come from pilots via the PIREP procedures. All pilots encountering CAT conditions are urgently requested to report time, location, and intensity (light, moderate, severe, or extreme) of the element to the FAA facility with which they are maintaining radio contact. If time and conditions permit, elements should be reported according to the standards for other PIREP’s and position reports. See TBL 3.5-7, Turbulence Reporting Criteria Table.

**23. Microbursts**

**23.1** Relatively recent meteorological studies have confirmed the existence of microburst phenomena. Microbursts are small-scale intense downdrafts which, on

reaching the surface, spread outward in all directions from the downdraft center. This causes the presence of both vertical and horizontal wind shears that can be extremely hazardous to all types and categories of aircraft, especially at low altitudes. Due to their small size, short life-span, and the fact that they can occur over areas without surface precipitation, microbursts are not easily detectable using conventional weather radar or wind shear alert systems.

**23.2** Parent clouds producing microburst activity can be any of the low or middle layer convective cloud types. Note however, that microbursts commonly occur within the heavy rain portion of thunderstorms, and in much weaker, benign-appearing convective cells that have little or no precipitation reaching the ground.

**23.3** The life cycle of a microburst as it descends in a convective rain shaft is seen in FIG 3.5-2. An important consideration for pilots is the fact that the microburst intensifies for about 5 minutes after it strikes the ground.

**23.4 Characteristics of microbursts include:**

**a) Size.** The microburst downdraft is typically less than 1 mile in diameter as it descends from the cloud base to about 1,000-3,000 feet above the ground. In the transition zone near the ground, the downdraft changes

to a horizontal outflow that can extend to approximately 2 1/2 miles in diameter.

**b) Intensity.** The downdrafts can be as strong as 6,000 feet per minute. Horizontal winds near the surface can be as strong as 45 knots resulting in a 90-knot shear (headwind to tailwind change for a traversing aircraft) across the microburst. These strong horizontal winds occur within a few hundred feet of the ground.

**c) Visual Signs.** Microbursts can be found almost anywhere that there is convective activity. They may be embedded in heavy rain associated with a thunderstorm or in light rain in benign-appearing virga. When there is little or no precipitation at the surface accompanying the microburst, a ring of blowing dust may be the only visual clue of its existence.

**d) Duration.** An individual microburst will seldom last longer than 15 minutes from the time it strikes the ground until dissipation. The horizontal winds continue to increase during the first 5 minutes with the maximum intensity winds lasting approximately 2-4 minutes. Sometimes microbursts are concentrated into a line structure and, under these conditions, activity may continue for as long as 1 hour. Once microburst activity starts, multiple microbursts in the same general area are not uncommon and should be expected.

Evolution of a Microburst

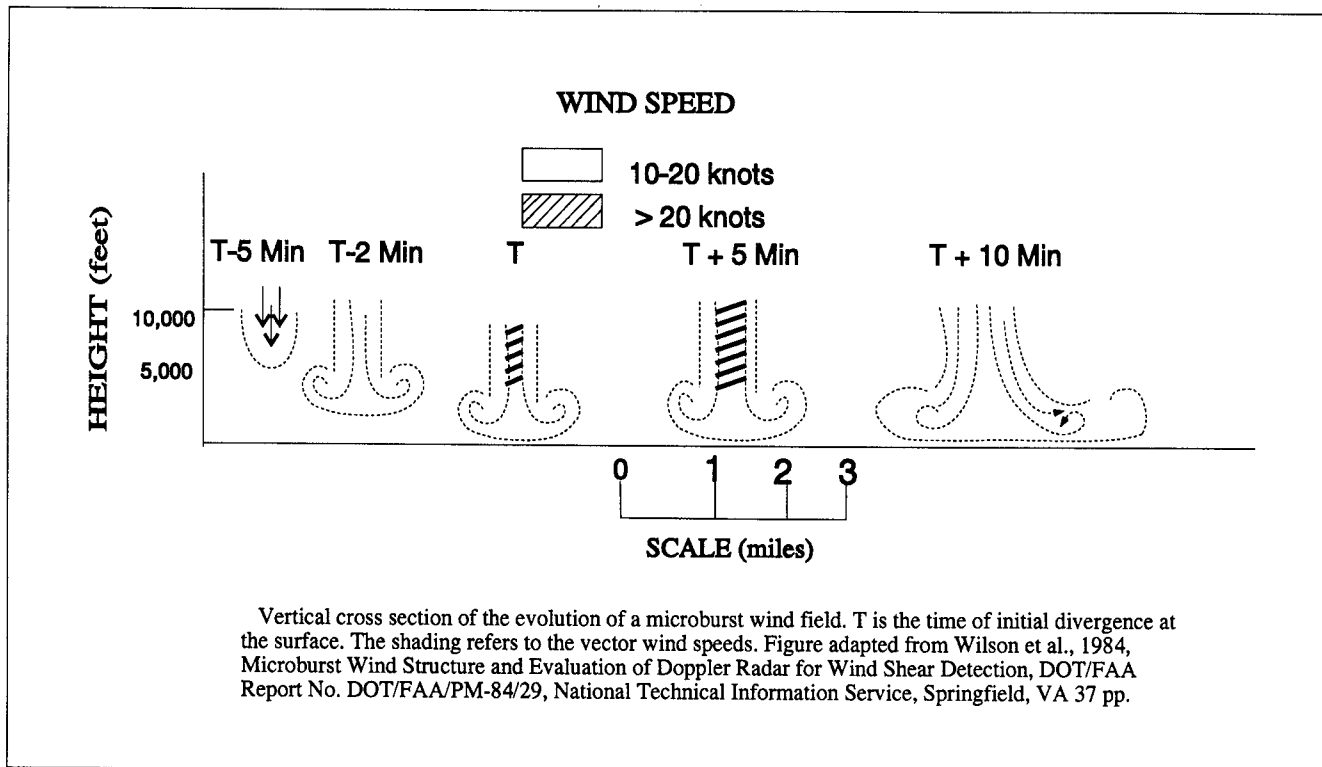

FIG 3.5-2

### Microburst Encounter During Takeoff

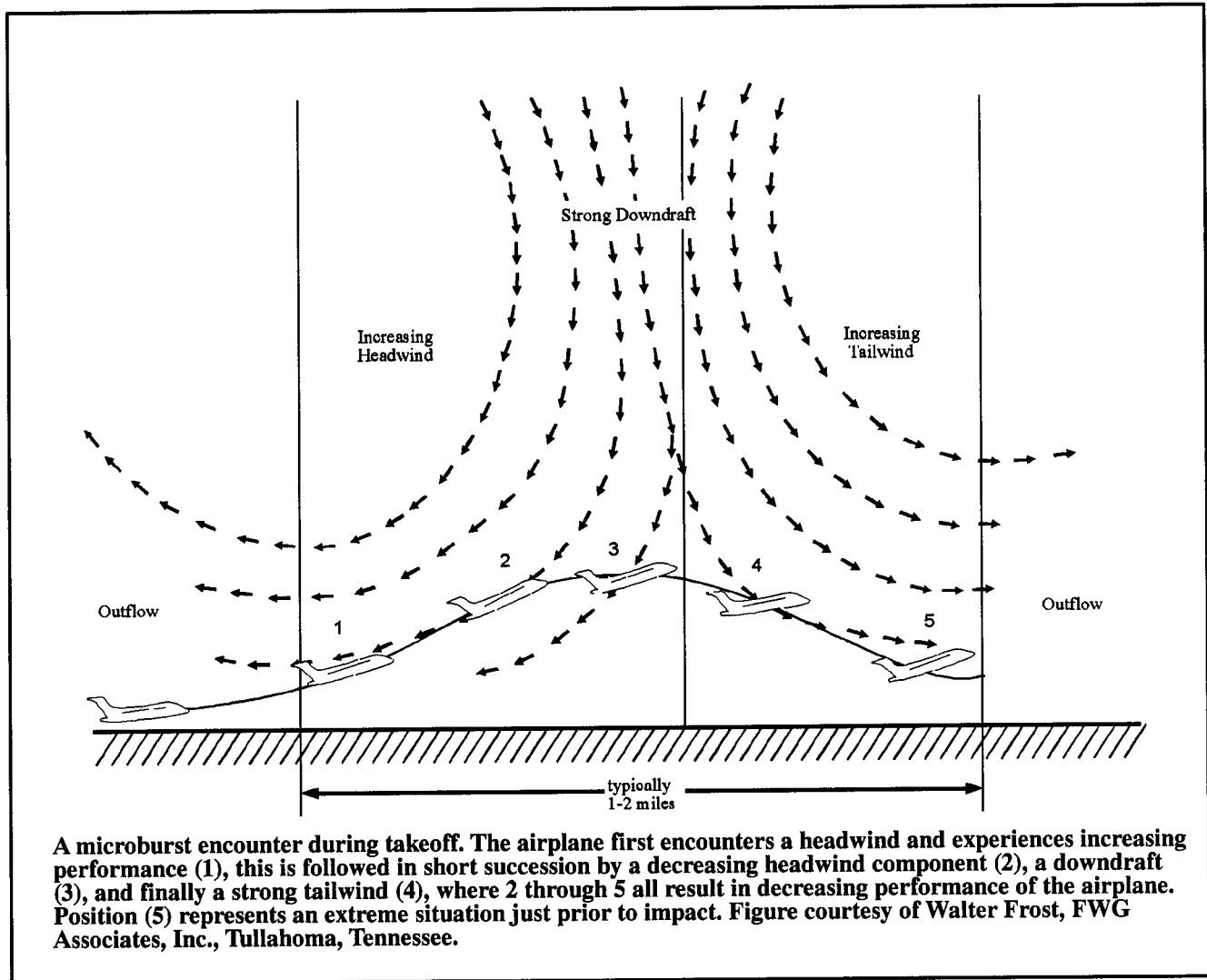

FIG 3.5-3

**23.5** Microburst wind shear may create a severe hazard for aircraft within 1,000 feet of the ground, particularly during the approach to landing and landing and take-off phases. The impact of a microburst on aircraft which have the unfortunate experience of penetrating one is characterized in FIG 3.5-3. The aircraft may encounter a headwind (performance increasing), followed by a downdraft and a tailwind (both performance decreasing), possibly resulting in terrain impact.

#### 23.6 Detection of Microbursts, Wind Shear, and Gust Fronts

##### a) FAA's Integrated Wind Shear Detection Plan

1) The FAA currently employs an integrated plan for wind shear detection that will significantly improve both the safety and capacity of the majority of the airports currently served by the air carriers. This plan

integrates several programs, such as the Integrated Terminal Weather System (ITWS), Terminal Doppler Weather Radar (TDWR), Weather System Processor (WSP), and Low Level Wind Shear Alert Systems (LLWAS) into a single strategic concept that significantly improves the aviation weather information in the terminal area. (See FIG 3.5-4.)

2) The wind shear/microburst information and warnings are displayed on the ribbon display terminal (RBDT) located in the tower cabs. They are identical (and standardized) to those in the LLWAS, TDWR and WSP systems, and designed so that the controller does not need to interpret the data, but simply read the displayed information to the pilot. The RBDT's are constantly monitored by the controller to ensure the rapid and timely dissemination of any hazardous event(s) to the pilot.

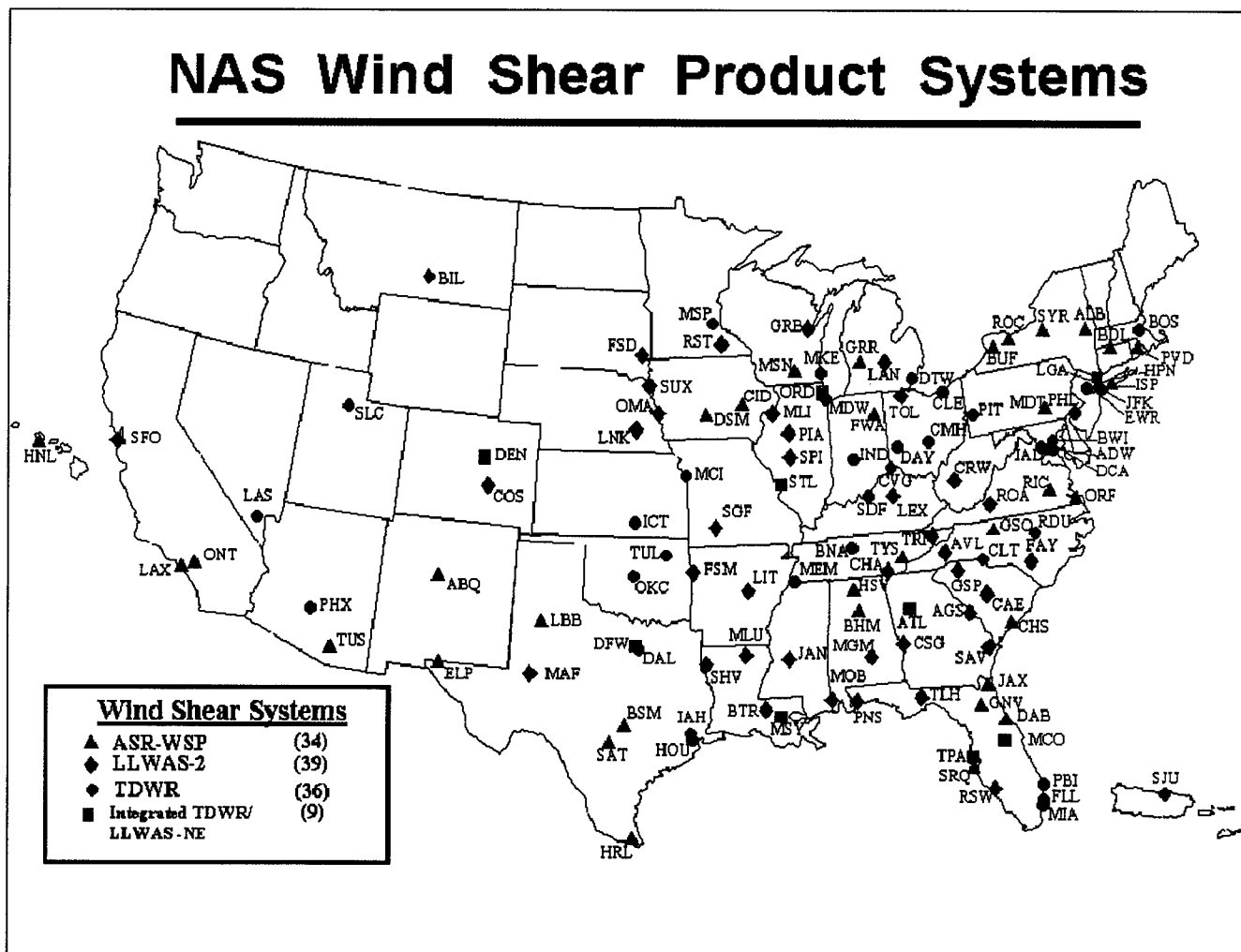

FIG 3.5-4

3) The early detection of a wind shear/microburst event, and the subsequent warning(s) issued to an aircraft on approach or departure, will alert the pilot/crew to the potential of, and to be prepared for, a situation that could become very dangerous! Without these warnings, the aircraft may NOT be able to climb out of or safely transition the event, resulting in a catastrophe. The air carriers, working with the FAA, have developed specialized training programs using their simulators to train and prepare their pilots on the demanding aircraft procedures required to escape these very dangerous wind shear and/or microburst encounters.

**b) Low Level Wind Shear Alert System (LLWAS)**

1) The LLWAS provides wind data and software processes to detect the presence of hazardous wind shear and microbursts in the vicinity of an airport. Wind sensors, mounted on poles sometimes as high as 150 feet, are (ideally) located 2,000 - 3,500 feet, but not

more than 5,000 feet, from the centerline of the runway. (See FIG 3.5-5.)

2) The LLWAS was fielded in 1988 at 110 airports across the nation. Many of these systems have been replaced by new terminal doppler weather radar (TDWR) and weather systems processor (WSP) technology. Eventually all LLWAS systems will be phased out; however, 39 airports will be upgraded to the LLWAS-NE (Network Expansion) system, which employs the very latest software and sensor technology. The new LLWAS-NE systems will not only provide the controller with wind shear warnings and alerts, including wind shear/microburst detection at the centerfield wind sensor location, but will also provide the location of the hazards relative to the airport runway(s). It will also have the flexibility and capability to grow with the airport as new runways are built. As many as 32 sensors, strategically located around the airport and in relationship to its runway configuration, can be accommodated by the LLWAS-NE network.

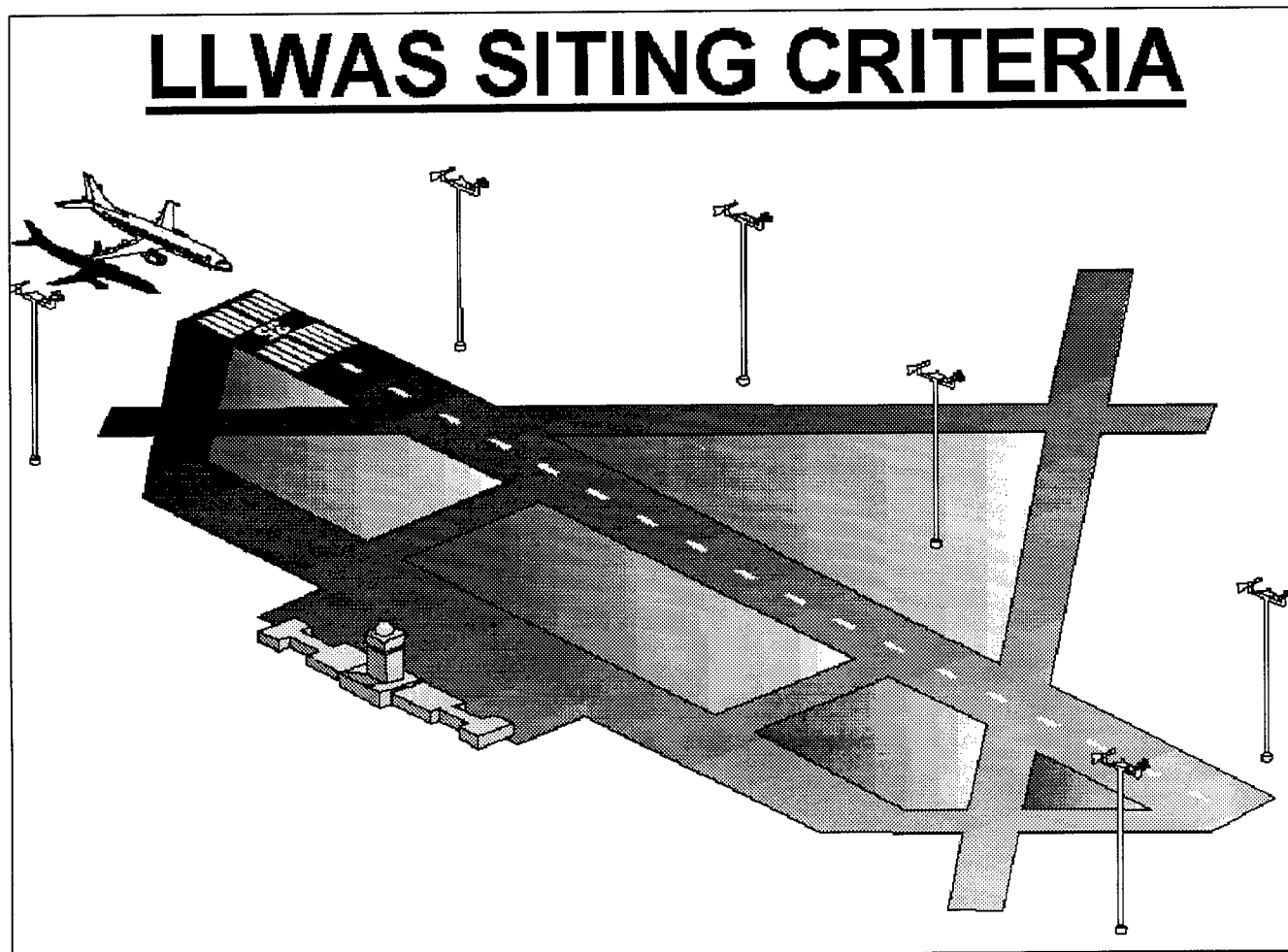

FIG 3.5-5

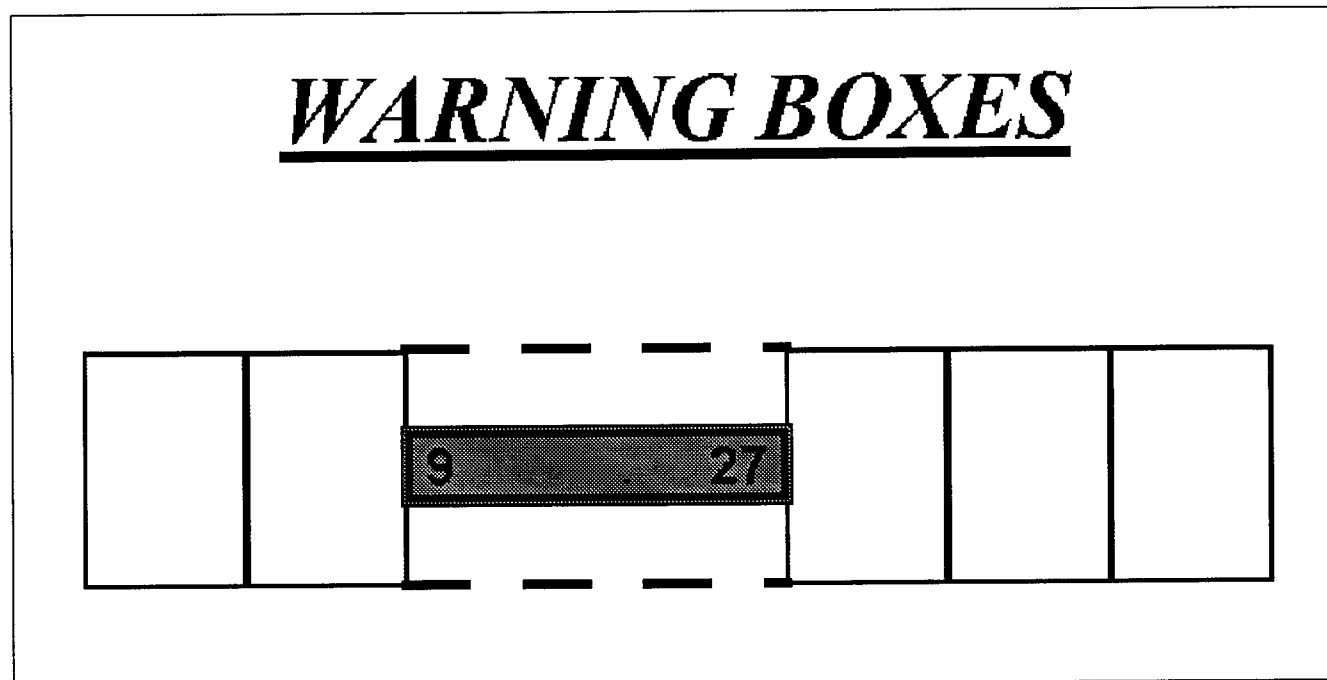

FIG 3.5-6

### c) Terminal Doppler Weather Radar (TDWR)

1) TDWR's are being deployed at 45 locations across the United States. Optimum locations for TDWR's are 8 to 12 miles from the airport proper, and designed to look at the airspace around and over the airport to detect microbursts, gust fronts, wind shifts, and precipitation intensities. TDWR products advise the controller of wind shear and microburst events impacting all runways and the areas  $\frac{1}{2}$  mile on either side of the extended centerline of the runways and to a distance of 3 miles on final approach and 2 miles on departure. FIG 3.5-6 is a theoretical view of the runway and the warning boxes that the software uses to determine the location(s) of wind shear or microbursts. These warnings are displayed (as depicted in the examples in subparagraph e) on the ribbon display terminal located in the tower cabs.

2) It is very important to understand what TDWR DOES NOT DO:

It **DOES NOT** warn of wind shear outside of the alert boxes (on the arrival and departure ends of the runways);

It **DOES NOT** detect wind shear that is NOT a microburst or a gust front;

It **DOES NOT** detect gusty or cross wind conditions; and

It **DOES NOT** detect turbulence.

However, research and development is continuing on these systems. Future improvements may include such areas as storm motion (movement), improved gust front detection, storm growth and decay, microburst prediction, and turbulence detection.

3) TDWR also provides a geographical situation display (GSD) for supervisors and traffic management specialists for planning purposes. The GSD displays (in color) 6 levels of weather (precipitation), gust fronts and predicted storm movement(s). See FIG 3.5-7 for a sample display. This data is used by the tower supervisor(s), traffic management specialists, and controllers to plan for runway changes and arrival/departure route changes in order to reduce aircraft delays and increase airport capacity.

### d) Weather Systems Processor (WSP)

1) The WSP provides the controller, supervisor, traffic management specialist, and ultimately the pilot, with the same products as the terminal doppler weather

radar at a fraction of the cost. This is accomplished by utilizing new technologies to access the weather channel capabilities of the existing ASR-9 radar located on or near the airport, thus eliminating the requirements for a separate radar location, land acquisition, support facilities, and the associated communication landlines and expenses.

2) The WSP utilizes the same RBDT display as the TDWR and LLWAS, and, like the TDWR, has a GSD for planning purposes by supervisors, traffic management specialists, and controllers. The WSP GSD emulates the TDWR display; i.e., it also depicts 6 levels of precipitation, gust fronts and predicted storm movement, and like the TDWR, GSD is used to plan for runway changes and arrival/departure route changes in order to reduce aircraft delays and to increase airport capacity.

3) This system is currently under development and is operating in a developmental test status at the Albuquerque, New Mexico, airport. When fielded, the WSP is expected to be installed at 34 airports across the nation, substantially increasing the safety of flying.

### e) Operational Aspects of LLWAS, TDWR, and WSP

To demonstrate how this data is used by both the controller and the pilot, 3 ribbon display examples and their explanations are presented:

#### 1) MICROBURST ALERTS

*EXAMPLE.—*  
*THIS IS WHAT THE CONTROLLER SEES ON HIS/HER RIBBON DISPLAY IN THE TOWER CAB.*

27A MBA 35K- 2MF 250 20

*NOTE.—*  
*(SEE FIG 3.5-8 TO SEE HOW THE TDWR/WSP DETERMINES THE MICROBURST LOCATION).*

This is what the controller will say when issuing the alert.

*PHRASEOLOGY.—*  
*RUNWAY 27 ARRIVAL, MICROBURST ALERT, 35 KT LOSS 2 MILE FINAL, THRESHOLD WINDS 250 AT 20.*

In plain language, the controller is telling the pilot that on approach to runway 27, there is a microburst alert on the approach lane to the runway, and to anticipate or expect a 35-knot loss of airspeed at approximately 2 miles out on final approach (where the aircraft will first encounter the phenomena). With that information, the aircrew is forewarned, and should be prepared to apply wind shear/microburst escape procedures should they decide to continue the approach. Additionally, the

surface winds at the airport for landing runway 27 are reported as 250 degrees at 20 knots.

**NOTE.—**  
THRESHOLD WIND IS AT PILOT'S REQUEST OR AS DEEMED APPROPRIATE BY THE CONTROLLER.

## 2) WIND SHEAR ALERTS

**EXAMPLE.—**  
THIS IS WHAT THE CONTROLLER SEES ON HIS/HER RIBBON DISPLAY IN THE TOWER CAB.

27A WSA 20K- 3MF 200 15
-------------------------

**NOTE.—**  
(SEE FIG 3.5-9 TO SEE HOW THE TDWR/WSP DETERMINES THE WIND SHEAR LOCATION).

This is what the controller will say when issuing the alert.

**PHRASEOLOGY-**  
RUNWAY 27 ARRIVAL, WIND SHEAR ALERT, 20 KT LOSS 3 MILE FINAL, THRESHOLD WINDS 200 AT 15.

In plain language, the controller is advising the aircraft arriving on runway 27 that at 3 miles out the pilot should expect to encounter a wind shear condition that will decrease airspeed by 20 knots and possibly the aircraft will encounter turbulence. Additionally, the airport surface winds for landing runway 27 are reported as 200 degrees at 15 knots.

**NOTE.—**  
THRESHOLD WIND IS AT PILOT'S REQUEST OR AS DEEMED APPROPRIATE BY THE CONTROLLER.

## 3) MULTIPLE WIND SHEAR ALERTS

**EXAMPLE.—**  
THIS IS WHAT THE CONTROLLER SEES ON HIS/HER RIBBON DISPLAY IN THE TOWER CAB.

27A WSA 20K+ RWY 250 20
27D WSA 20K+ RWY 250 20

**NOTE.—**  
(SEE FIG 3.5-10 TO SEE HOW THE TDWR/WSP DETERMINES THE GUST FRONT/WIND SHEAR LOCATION).

This is what the controller will say when issuing the alert.

**PHRASEOLOGY-**  
MULTIPLE WIND SHEAR ALERTS.  
RUNWAY 27 ARRIVAL, WIND SHEAR ALERT, 20 KT GAIN ON RUNWAY;  
RUNWAY 27 DEPARTURE, WIND SHEAR ALERT, 20 KT GAIN ON RUNWAY, WINDS 250 AT 20.

**EXAMPLE.—**  
IN THIS EXAMPLE, THE CONTROLLER IS ADVISING ARRIVING AND DEPARTING AIRCRAFT THAT THEY COULD ENCOUNTER A WIND SHEAR CONDITION RIGHT ON THE RUNWAY DUE TO A GUST FRONT (SIGNIFICANT CHANGE OF WIND DIRECTION) WITH THE POSSIBILITY OF A 20 KNOT GAIN IN AIRSPEED ASSOCIATED WITH THE GUST FRONT. ADDITIONALLY, THE AIRPORT SURFACE WINDS (FOR THE RUNWAY IN USE) ARE REPORTED AS 250 DEGREES AT 20 KNOTS.

## f) The Terminal Weather Information For Pilots System (TWIP)

1) With the increase in the quantity and quality of terminal weather information available through TDWR, the next step is to provide this information directly to pilots rather than relying on voice communications from ATC. The National Airspace System has long been in need of a means of delivering terminal weather information to the cockpit more efficiently in terms of both speed and accuracy to enhance pilot awareness of weather hazards and to reduce air traffic controller workload. With the TWIP capability, terminal weather information, both alphanumerically and graphically, is now available directly to the cockpit on a test basis at 9 locations.

2) TWIP products are generated using weather data from the TDWR or the Integrated Terminal Weather System (ITWS) testbed. TWIP products are generated and stored in the form of text and character graphic messages. Software has been developed to allow TDWR or ITWS to format the data and send the TWIP products to a database resident at Aeronautical Radio, Inc. (ARINC). These products can then be accessed by pilots using the ARINC Aircraft Communications Addressing and Reporting System (ACARS) data link services. Airline dispatchers can also access this database and send messages to specific aircraft whenever wind shear activity begins or ends at an airport.

3) TWIP products include descriptions and character graphics of microburst alerts, wind shear alerts, significant precipitation, convective activity within 30 NM surrounding the terminal area, and expected weather that will impact airport operations. During inclement weather; i.e., whenever a pre-determined level of precipitation or wind shear is detected within 15 miles of the terminal area, TWIP products are updated once each minute for text messages and once every 5 minutes for character graphic messages. During good weather (below the pre-determined precipitation or wind shear parameters) each message is updated every 10 minutes. These products are intended to improve the situational awareness of the pilot/flight crew, and to aid in flight planning prior to arriving or departing the terminal area. It is important to understand that, in the context of TWIP, the pre-determined levels for inclement versus good weather has nothing to do with the criteria for VFR/MVFR/IFR/LIFR; it only deals with precipitation, wind shears, and microbursts.

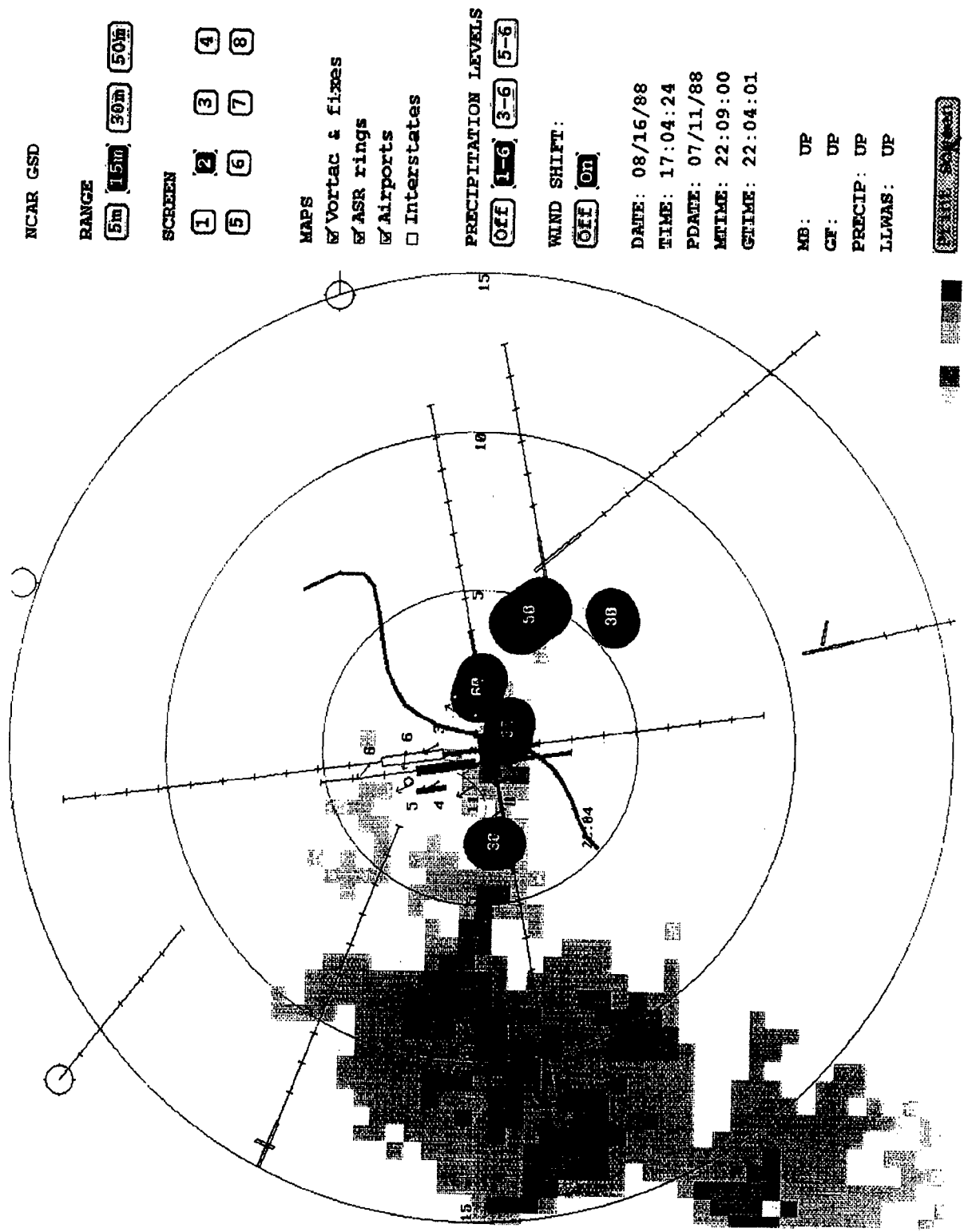

FIG 3.5-7



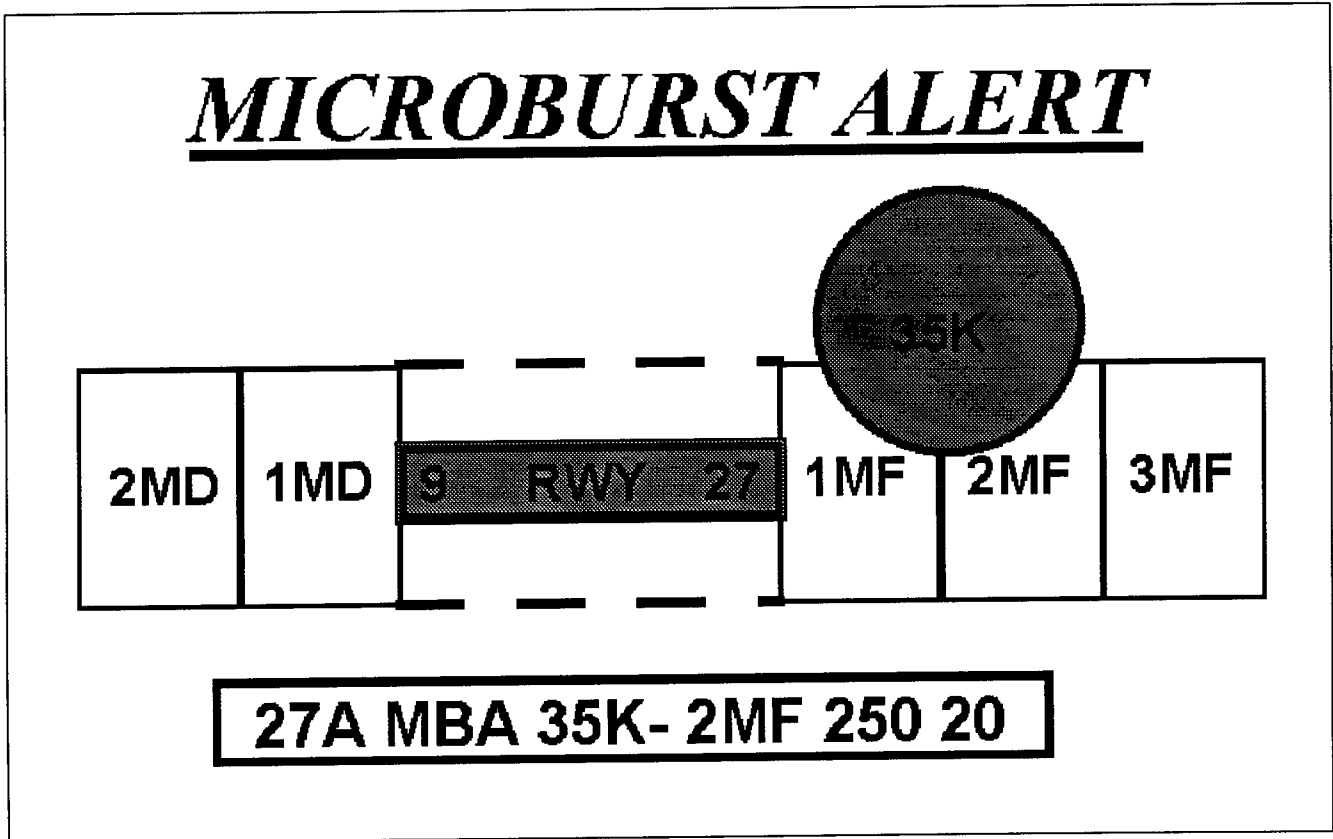

FIG 3.5-8

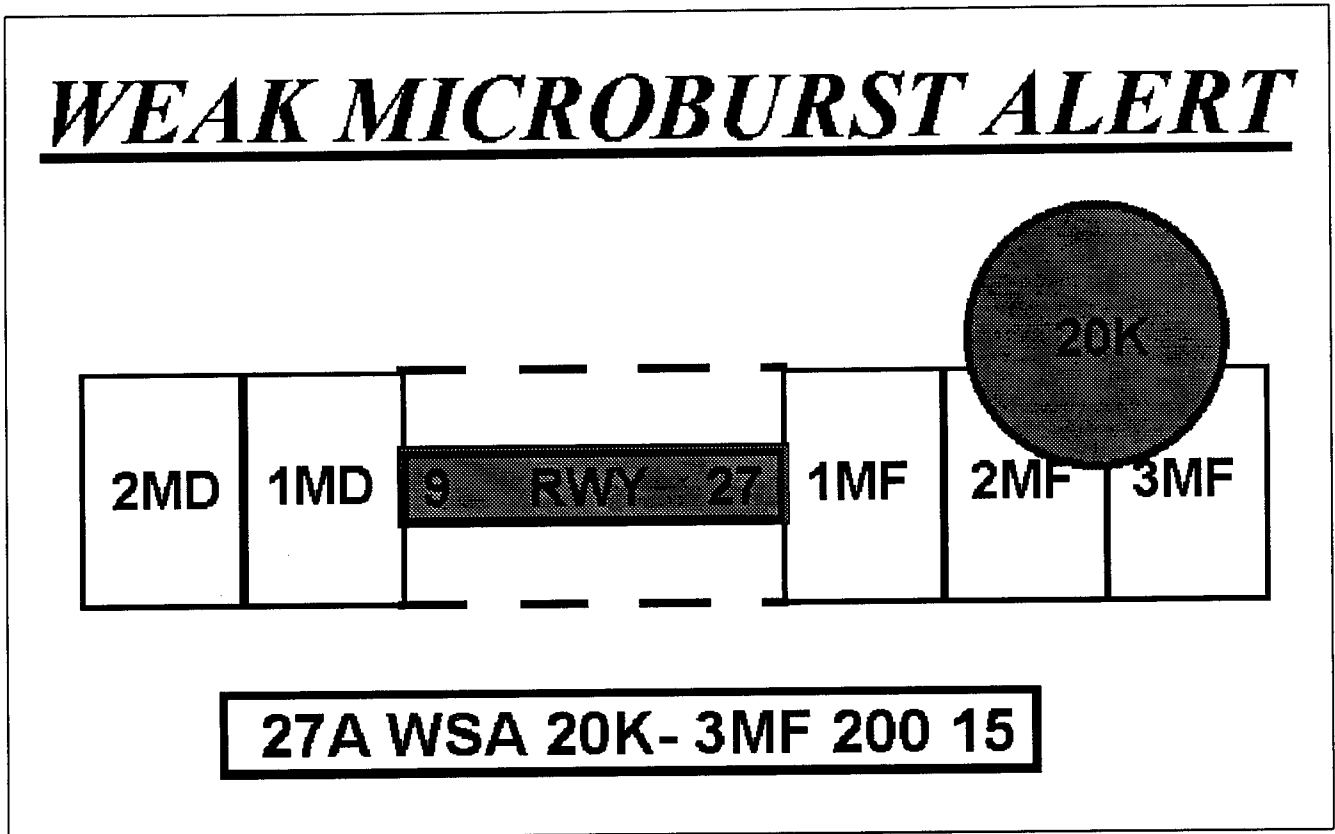

FIG 3.5-9

# GUST FRONT ALERT

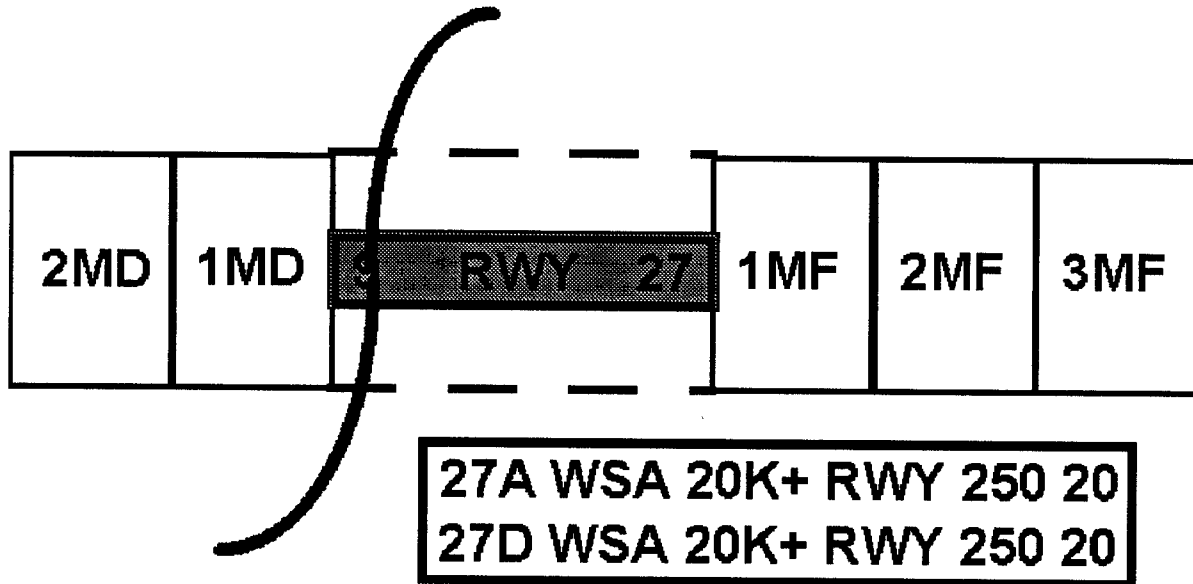

FIG 3.5-10

## 24. PIREP's Relating to Volcanic Ash Activity

**24.1** Volcanic eruptions which send ash into the upper atmosphere occur somewhere around the world several times each year. Flying into a volcanic ash cloud can be exceedingly dangerous. At least two B747s have lost all power in all four engines after such an encounter. Regardless of the type aircraft, some damage is almost certain to ensue after an encounter with a volcanic ash cloud.

**24.2** While some volcanoes in the United States are monitored, many in remote areas are not. These unmonitored volcanoes may erupt without prior warning to the aviation community. A pilot observing a volcanic eruption who has not had previous notification of it may be the only witness to the eruption. Pilots are strongly encouraged to transmit a PIREP regarding volcanic eruptions and any observed volcanic ash clouds.

**24.3** Pilots should submit PIREP's regarding volcanic activity using the Volcanic Activity Reporting form (VAR) as illustrated in FIG 3.5-24. (If a VAR form is

not immediately available, relay enough information to identify the position and type of volcanic activity.)

**24.4** Pilots should verbally transmit the data required in items 1 through 8 of the VAR as soon as possible. The data required in items 9 through 16 of the VAR should be relayed after landing, if possible.

## 25. Thunderstorms

**25.1** Turbulence, hail, rain, snow, lightning, sustained updrafts and downdrafts, and icing conditions are all present in thunderstorms. While there is some evidence that maximum turbulence exists at the middle level of a thunderstorm, recent studies show little variation of turbulence intensity with altitude.

**25.2** There is no useful correlation between the external visual appearance of thunderstorms and the severity or amount of turbulence or hail within them. Also, the visible thunderstorm cloud is only a portion of a turbulent system whose updrafts and downdrafts often extend far beyond the visible storm cloud. Severe turbulence can be expected up to 20 miles from severe thunderstorms. This distance decreases to about 10 miles in less severe

storms. These turbulent areas may appear as a well-defined echo on weather radar.

**25.3** Weather radar, airborne or ground-based, will normally reflect the areas of moderate to heavy precipitation. (Radar does not detect turbulence.) The frequency and severity of turbulence generally increases with the areas of highest liquid water content of the storm. **NO FLIGHT PATH THROUGH AN AREA OF STRONG OR VERY STRONG RADAR ECHOES SEPARATED BY 20-30 MILES OR LESS MAY BE CONSIDERED FREE OF SEVERE TURBULENCE.**

**25.4** Turbulence beneath a thunderstorm should not be minimized. This is especially true when the relative humidity is low in any layer between the surface and 15,000 feet. Then the lower altitudes may be characterized by strong out-flowing winds and severe turbulence.

**25.5** The probability of lightning strikes occurring to aircraft is greatest when operating at altitudes where temperatures are between -5 C and +5 C. Lightning can strike aircraft flying in the clear in the vicinity of a thunderstorm.

**25.6** National Weather Service radar systems are able to objectively determine radar weather echo intensity levels by use of Video Integrator Processor (VIP) equipment. The thunderstorm intensity levels are on a scale of one to six.

**EXAMPLE.—**  
**ALERT PROVIDED BY AN ATC FACILITY TO AN AIRCRAFT:**

*(AIRCRAFT IDENTIFICATION), LEVEL FIVE INTENSE WEATHER ECHO BETWEEN TEN O'CLOCK AND TWO O'CLOCK, ONE ZERO MILES, MOVING EAST AT TWO ZERO KNOTS, TOPS FLIGHT LEVEL THREE NINER ZERO.*

**EXAMPLE.—**  
**ALERT PROVIDED BY A FLIGHT SERVICE STATION:**

*(AIRCRAFT IDENTIFICATION), LEVEL FIVE INTENSE WEATHER ECHO, TWO ZERO MILES WEST OF THE ATLANTA V-O-R, TWO FIVE MILES WIDE, MOVING EAST AT TWO ZERO KNOTS, TOPS FLIGHT LEVEL THREE NINER ZERO.*

## 26. Thunderstorm Flying

**26.1** Above all, remember this: never regard any thunderstorm lightly, even when radar observers report the echoes are of light intensity. Avoiding thunderstorms is the best policy. Following are some Do's and Don'ts of thunderstorm avoidance:

a) Don't land or takeoff in the face of an approaching thunderstorm. A sudden gust front of low-level turbulence could cause loss of control;

b) Don't attempt to fly under a thunderstorm even if you can see through to the other side. Turbulence and wind shear under the storm could be disastrous;

c) Don't fly without airborne radar into a cloud mass containing scattered embedded thunderstorms. Scattered thunderstorms not embedded usually can be visually circumnavigated;

d) Don't trust the visual appearance to be a reliable indicator of the turbulence inside a thunderstorm;

e) Do avoid by at least 20 miles any thunderstorm identified as severe or giving an intense radar echo. This is especially true under the anvil of a large cumulonimbus;

f) Do clear the top of a known or suspected severe thunderstorm by at least 1,000 feet altitude for each 10 knots of wind speed at the cloud top. However, the altitude capability of most aircraft make it unlikely that the aircraft will be able to clear the storm top;

g) Do circumnavigate the entire area if the area has 6/10 thunderstorm coverage;

h) Do remember that vivid and frequent lightning indicates the probability of a severe thunderstorm; and

i) Do regard as extremely hazardous any thunderstorm with tops 35,000 feet or higher whether the top is visually sighted or determined by radar.

**26.2** If you cannot avoid penetrating a thunderstorm, before entering the storm, you should do the following:

a) Tighten your safety belt, put on your shoulder harness if you have one, and secure all loose objects;

b) Plan and hold your course to take you through the storm in a minimum time;

c) To avoid the most critical icing, establish a penetration altitude below the freezing level or above the level of -15 C;

d) Verify that pitot heat is on and turn on carburetor heat or jet engine anti-ice. Icing can be rapid at any altitude and cause almost instantaneous power failure and/or loss of airspeed indication;

e) Establish power settings for turbulence penetration airspeed recommended in your aircraft manual;

f) Turn up cockpit lights to highest intensity to lessen danger of temporary blindness from lightning;

g) If using automatic pilot, disengage altitude hold mode and speed hold mode. The automatic altitude and speed controls will increase maneuvers of the aircraft thus increasing structural stresses; and

h) If using airborne radar, tilt the antenna up and down occasionally. This will permit you to detect other thunderstorm activity at altitudes other than the one being flown.

**26.3** Following are some Do's and Don'ts during the thunderstorm penetration:

a) Do keep your eyes on your instruments. Looking outside the cockpit can increase danger of temporary blindness from lightning;

b) Don't change power settings; maintain settings for the recommended turbulence penetration airspeed;

c) Do maintain constant attitude; let the aircraft "ride the waves." Maneuvers in trying to maintain constant altitude increase stress on the aircraft; and

d) Don't turn back once you are in the thunderstorm. A straight course through the storm most likely will get you out of the hazards more quickly. In addition, turning maneuvers increase stress on the aircraft.

## **27. Wake Turbulence**

### **27.1 General**

**27.1.1** Every aircraft generates a wake while in flight. Initially, when pilots encountered this wake in flight, the disturbance was attributed to "prop wash." It is known, however, that this disturbance is caused by a pair of counterrotating vortices trailing from the wing tips. The vortices from larger aircraft pose problems to encountering aircraft. For instance, the wake of these aircraft can impose rolling moments exceeding the roll control authority of the encountering aircraft. Further, turbulence generated within the vortices can damage aircraft components and equipment if encountered at close range. The pilot must learn to envision the loca-

tion of the vortex wake generated by larger (transport category) aircraft and adjust the flight path accordingly.

**27.1.2** During ground operations and during takeoff, jet engine blast (thrust stream turbulence) can cause damage and upsets if encountered at close range. Exhaust velocity versus distance studies at various thrust levels have shown a need for light aircraft to maintain an adequate separation behind large turbojet aircraft. Pilots of larger aircraft should be particularly careful to consider the effects of their "jet blast" on other aircraft, vehicles, and maintenance equipment during ground operations.

### **27.2 Vortex Generation**

Lift is generated by the creation of a pressure differential over the wing surface. The lowest pressure occurs over the upper wing surface and the highest pressure under the wing. This pressure differential triggers the roll up of the airflow aft of the wing resulting in swirling air masses trailing downstream of the wing tips. After the roll up is completed, the wake consists of two counter rotating cylindrical vortices. Most of the energy is within a few feet of the center of each vortex, but pilots should avoid a region within about 100 feet of the vortex core. (See FIG 3.5-11.)

### **27.3 Vortex Strength**

**27.3.1** The strength of the vortex is governed by the weight, speed, and shape of the wing of the generating aircraft. The vortex characteristics of any given aircraft can also be changed by extension of flaps or other wing configuring devices as well as by change in speed. However, as the basic factor is weight the vortex strength increases proportionately. Peak vortex tangential speeds up to almost 300 feet per second have been recorded. The greatest vortex strength occurs when the generating aircraft is HEAVY, CLEAN, and SLOW.

### 27.3.2 Induced Roll

a) In rare instances, a wake encounter could cause in-flight structural damage of catastrophic proportions. However, the usual hazard is associated with induced rolling moments which can exceed the roll control authority of the encountering aircraft. In flight experiments, aircraft have been intentionally flown directly up trailing vortex cores of larger aircraft. It was shown that the capability of an aircraft to counteract the roll imposed by the wake vortex primarily depends on the wing span and counter-control responsiveness of the encountering aircraft.

b) Counter-control is usually effective and induced roll minimal in cases where the wing span and ailerons of the encountering aircraft extend beyond the rotational flow field of the vortex. It is more difficult for aircraft with short wing span (relative to the generating aircraft) to counter the imposed roll induced by vortex flow. Pilots of short-span aircraft, even of the high-performance type, must be especially alert to vortex encounters. (See FIG 3.5-12.)

c) The wake of larger aircraft requires the respect of all pilots.

### 27.4 Vortex Behavior

27.4.1 Trailing vortices have certain behavioral characteristics which can help a pilot visualize the wake location and thereby take avoidance precautions.

a) Vortices are generated from the moment aircraft leave the ground, since trailing vortices are a by-product of wing lift. Prior to takeoff or touchdown pilots should note the rotation or touchdown point of the preceding aircraft. (See FIG 3.5-13.)

Wake Vortex Generation

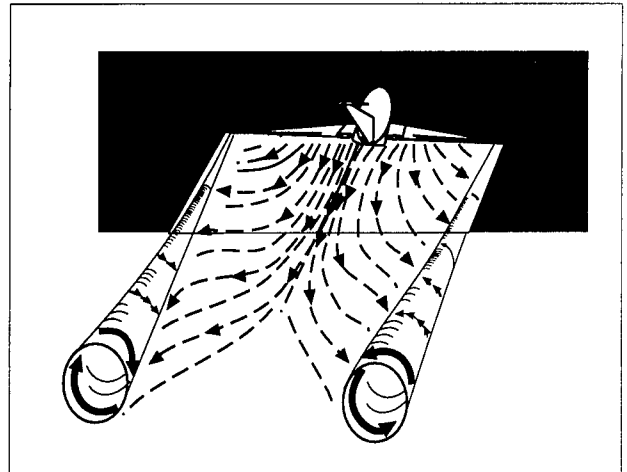

FIG 3.5-11

Wake Encounter Counter Control

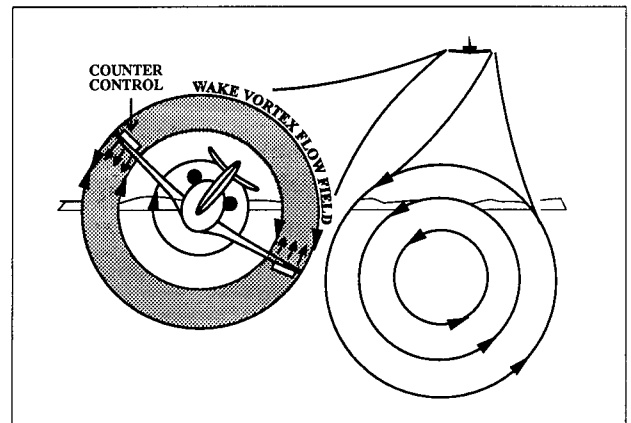

FIG 3.5-12

Wake Ends/Wake Begins

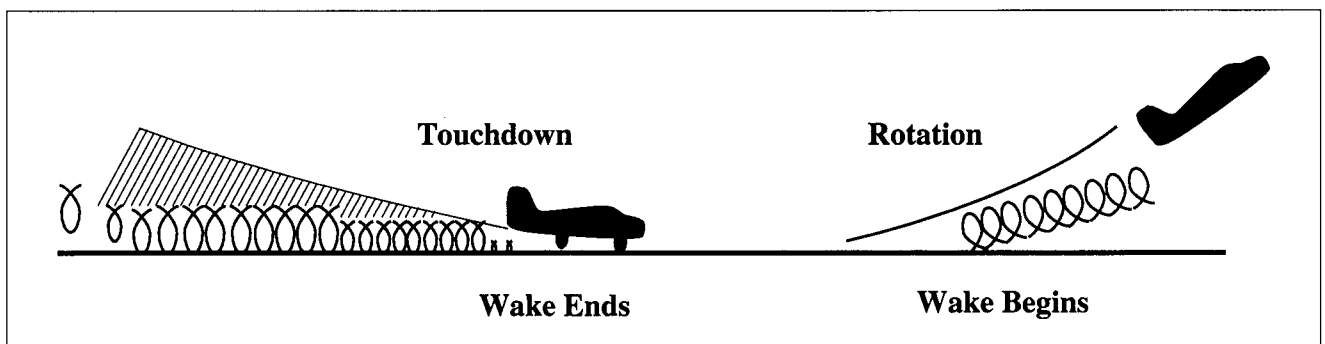

FIG 3.5-13

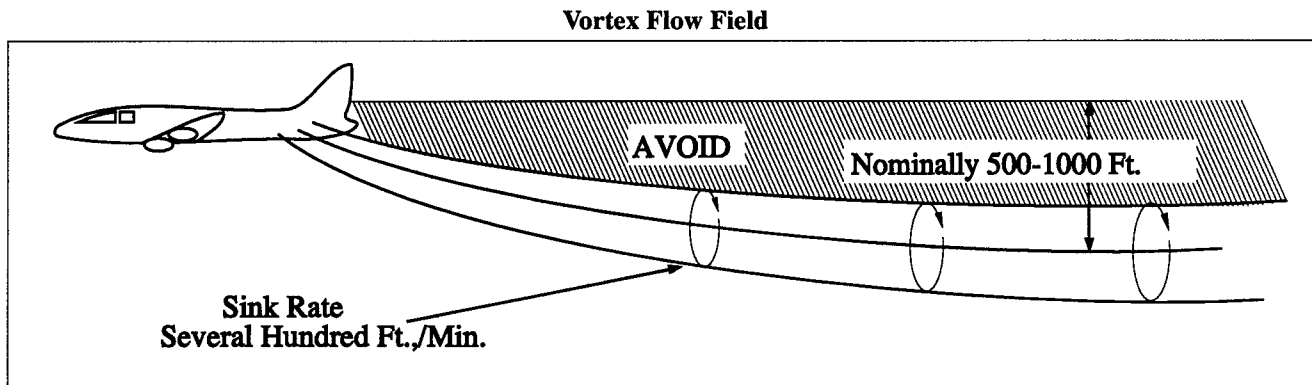

FIG 3.5-14

b) The vortex circulation is outward, upward and around the wing tips when viewed from either ahead or behind the aircraft. Tests with large aircraft have shown that the vortices remain spaced a bit less than a wing span apart, drifting with the wind, at altitudes greater than a wing span from the ground. In view of this, if persistent vortex turbulence is encountered, a slight change of altitude and lateral position (preferably upwind) will provide a flight path clear of the turbulence.

c) Flight tests have shown that the vortices from larger (transport category) aircraft sink at a rate of several hundred feet per minute, slowing their descent

and diminishing in strength with time and distance behind the generating aircraft. Atmospheric turbulence hastens breakup. Pilots should fly at or above the preceding aircraft's flight path, altering course as necessary to avoid the area behind and below the generating aircraft. However, vertical separation of 1,000 feet may be considered safe. (See FIG 3.5-14.)

d) When the vortices of larger aircraft sink close to the ground (within 100 to 200 feet), they tend to move laterally over the ground at a speed of 2 or 3 knots. (See FIG 3.5-15.)

Vortex Movement Near Ground - No Wind

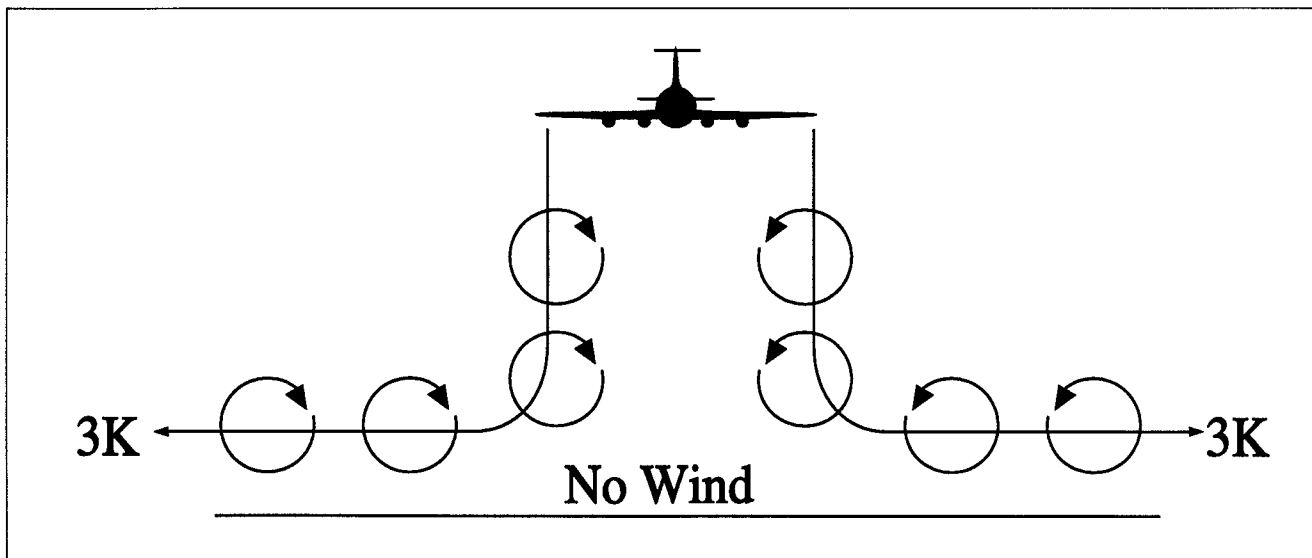

FIG 3.5-15

Vortex Movement Near Ground - with Cross Winds

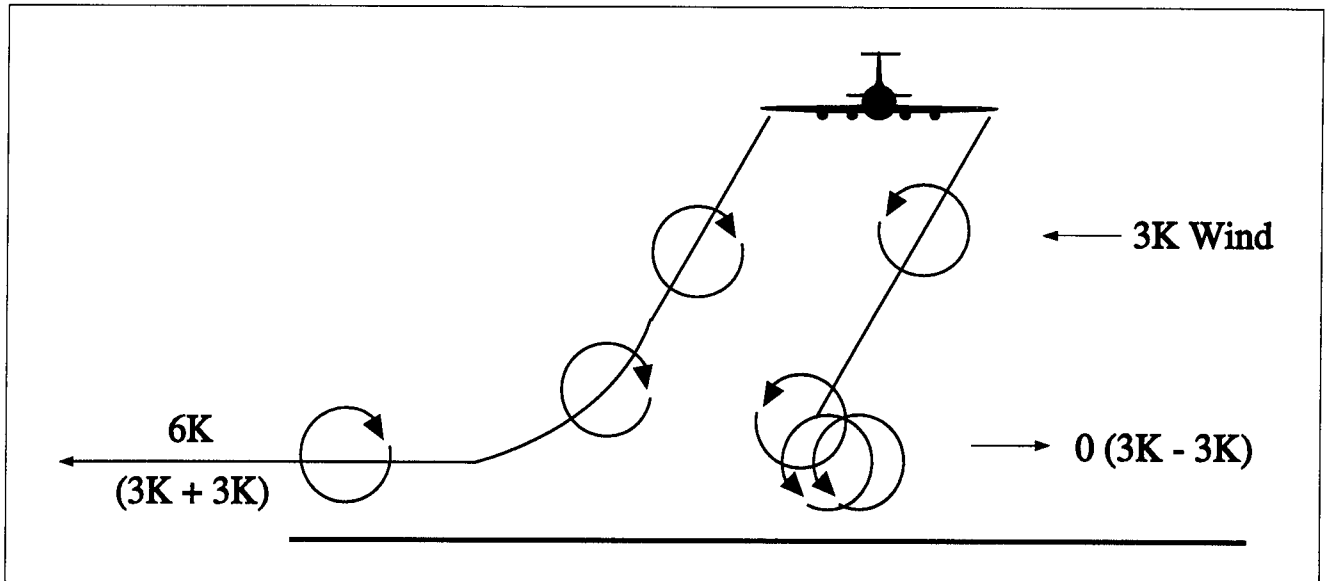

FIG 3.5-16

Vortex Movement in Ground Effect  
Tailwind

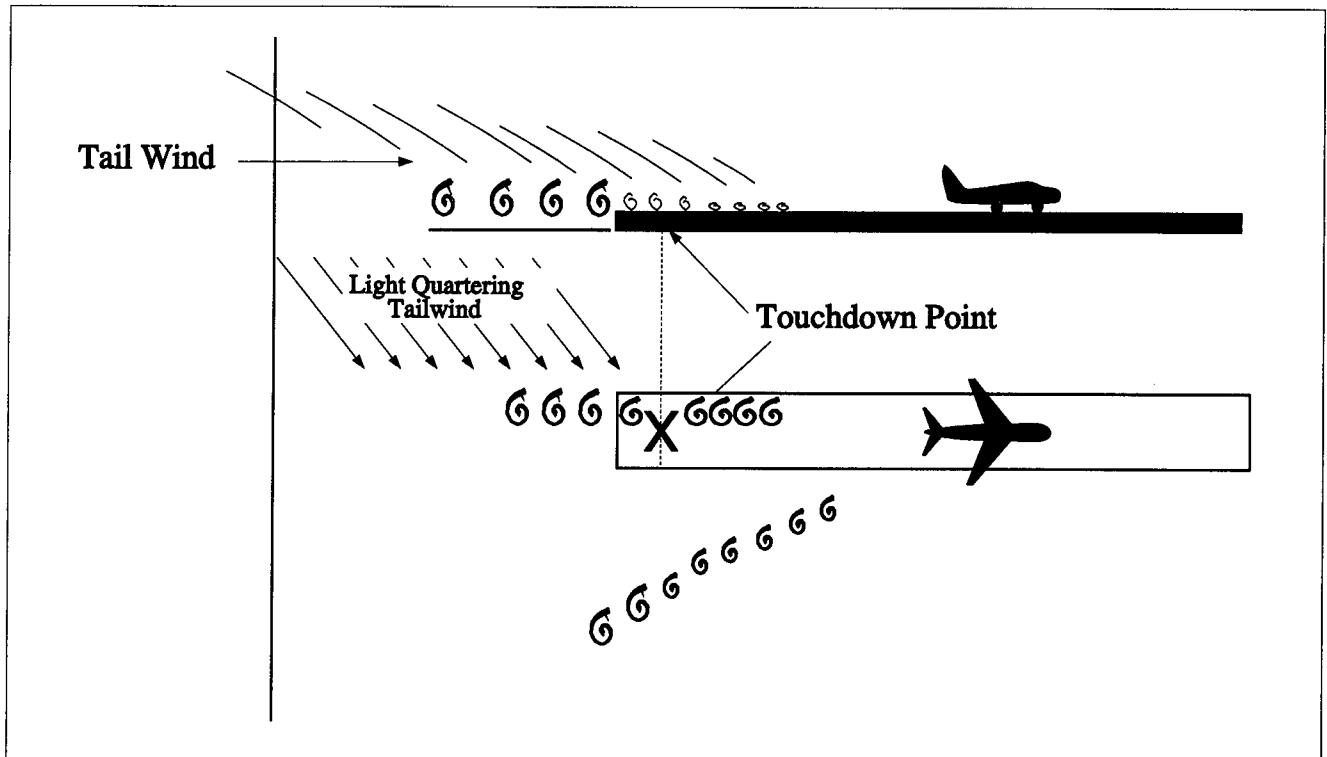

FIG 3.5-17

27.4.2 A crosswind will decrease the lateral movement of the upwind vortex and increase the movement of the downwind vortex. Thus a light wind with a cross-runway component of 1 to 5 knots could result in the upwind vortex remaining in the touchdown zone for a period of time and hasten the drift of the downwind vortex toward another runway. (See FIG 3.5-16.) Similarly, a

tailwind condition can move the vortices of the preceding aircraft forward into the touchdown zone. THE LIGHT QUARTERING TAILWIND REQUIRES MAXIMUM CAUTION. Pilots should be alert to larger aircraft upwind from their approach and takeoff flight paths. (See FIG 3.5-17.)

## 27.5 Operations Problem Areas

**27.5.1** A wake encounter can be catastrophic. In 1972 at Fort Worth, Texas, a DC-9 got too close to a DC-10 (two miles back), rolled, caught a wingtip, and cart-wheeled coming to rest in an inverted position on the runway. All aboard were killed. Serious and even fatal general aviation accidents induced by wake vortices are not uncommon. However, a wake encounter is not necessarily hazardous. It can be one or more jolts with varying severity depending upon the direction of the encounter, weight of the generating aircraft, size of the encountering aircraft, distance from the generating aircraft, and point of vortex encounter. The probability of induced roll increases when the encountering aircraft's heading is generally aligned with the flight path of the generating aircraft.

**27.5.2** AVOID THE AREA BELOW AND BEHIND THE GENERATING AIRCRAFT, ESPECIALLY AT LOW ALTITUDE WHERE EVEN A MOMENTARY WAKE ENCOUNTER COULD BE HAZARDOUS. This is not easy to do. Some accidents have occurred even though the pilot of the trailing aircraft had carefully noted that the aircraft in front was at a considerably lower altitude. Unfortunately, this does not ensure that the flight path of the lead aircraft will be below that of the trailing aircraft.

**27.5.3** Pilots should be particularly alert in calm wind conditions and situations where the vortices could:

- a) Remain in the touchdown area;
- b) Drift from aircraft operating on a nearby runway;
- c) Sink into the takeoff or landing path from a crossing runway;
- d) Sink into the traffic pattern from other airport operations; and
- e) Sink into the flight path of VFR aircraft operating on the hemispheric altitude 500 feet below.

**27.5.4** Pilots of all aircraft should visualize the location of the vortex trail behind larger aircraft and use proper vortex avoidance procedures to achieve safe operation. It is equally important that pilots of larger aircraft plan or adjust their flight paths to minimize vortex exposure to other aircraft.

## 27.6 Vortex Avoidance Procedures

**27.6.1** Under certain conditions, airport traffic controllers apply procedures for separating IFR aircraft. The

controllers will also provide to VFR aircraft, with whom they are in communication and which in the tower's opinion may be adversely affected by wake turbulence from a larger aircraft, the position, altitude and direction of flight of larger aircraft followed by the phrase "CAUTION - WAKE TURBULENCE." WHETHER OR NOT A WARNING HAS BEEN GIVEN, HOWEVER, THE PILOT IS EXPECTED TO ADJUST HIS OR HER OPERATIONS AND FLIGHT PATH AS NECESSARY TO PRECLUDE SERIOUS WAKE ENCOUNTERS.

**27.6.2** The following vortex avoidance procedures are recommended for the various situations:

**a) Landing behind a larger aircraft - same runway:** Stay at or above the larger aircraft's final approach flight path - note its touchdown point - land beyond it;

**b) Landing behind a larger aircraft - when a parallel runway is closer than 2,500 feet:** Consider possible drift to your runway. Stay at or above the larger aircraft's final approach flight path - note its touchdown point;

**c) Landing behind a larger aircraft - crossing runway:** Cross above the larger aircraft's flight path;

**d) Landing behind a departing larger aircraft - same runway:** Note the larger aircraft's rotation point - land well prior to rotation point;

**e) Landing behind a departing larger aircraft - crossing runway:** Note the larger aircraft's rotation point - if past the intersection - continue the approach - land prior to the intersection. If larger aircraft rotates prior to the intersection, avoid flight below the larger aircraft's flight path. Abandon the approach unless a landing is ensured well before reaching the intersection;

**f) Departing behind a larger aircraft:** Note the larger aircraft's rotation point - rotate prior to larger aircraft's rotation point - continue climb above the larger aircraft's climb path until turning clear of the larger aircraft's wake. Avoid subsequent headings which will cross below and behind a larger aircraft. Be alert for any critical takeoff situation which could lead to a vortex encounter;

**g) Intersection takeoffs - same runway:** Be alert to adjacent larger aircraft operations, particularly upwind of your runway. If intersection takeoff clearance is received, avoid subsequent headings which will cross below a larger aircraft's path;



**h) Departing or landing after a larger aircraft executing a low approach, missed approach or touch-and-go landing:** Because vortices settle and move laterally near the ground, the vortex hazard may exist along the runway and in your flight path after a larger aircraft has executed a low approach, missed approach or a touch-and-go landing, particular in light quartering wind conditions. You should ensure that an interval of at least 2 minutes has elapsed before your takeoff or landing; and

**i) En route VFR (thousand-foot altitude plus 500 feet):** Avoid flight below and behind a large aircraft's path. If a larger aircraft is observed above on the same track (meeting or overtaking) adjust your position laterally, preferably upwind.

## 27.7 Helicopters

In a slow hover-taxi or stationary hover near the surface, helicopter main rotor(s) generate downwash producing high velocity outwash vortices to a distance approximately three times the diameter of the rotor. When rotor downwash hits the surface, the resulting outwash vortices have behavioral characteristics similar to wing tip vortices produced by fixed-wing aircraft. However, the vortex circulation is outward, upward, around, and away from the main rotor(s) in all directions. Pilots of small aircraft should avoid operating within three rotor diameters of any helicopter in a slow hover-taxi or stationary hover. In forward flight, departing or landing helicopters produce a pair of strong, high-speed trailing vortices similar to wing tip vortices of larger fixed-wing aircraft. Pilots of small aircraft should use caution when operating behind or crossing behind landing and departing helicopters.

## 27.8 Pilot Responsibility

**27.8.1** Government and industry groups are making concerted efforts to minimize or eliminate the hazards of trailing vortices. However, the flight disciplines necessary to ensure vortex avoidance during VFR operations must be exercised by the pilot. Vortex visualization and avoidance procedures should be exercised by the pilot using the same degree of concern as in collision avoidance.

**27.8.2** Wake turbulence may be encountered by aircraft in flight as well as when operating on the airport movement area.

**27.8.3** Pilots are reminded that in operations conducted behind all aircraft, acceptance of instructions from ATC in the following situations is an acknowledgment that

the pilot will ensure safe takeoff and landing intervals and accepts the responsibility of providing his own wake turbulence separation:

- a) Traffic information;
- b) Instructions to follow an aircraft; and
- c) The acceptance of a visual approach clearance.

**27.8.4** For operations conducted behind heavy aircraft, ATC will specify the word "heavy" when this information is known. Pilots of heavy aircraft should always use the word "heavy" in radio communications.

**27.8.5** Heavy and large jet aircraft operators should use the following procedures during an approach to landing. These procedures establish a dependable baseline from which pilots of in-trail, lighter aircraft may reasonably expect to make effective flight path adjustments to avoid serious wake vortex turbulence.

a) Pilots of aircraft that produce strong wake vortices should make every attempt to fly on the established glidepath, not above it; or, if glidepath guidance is not available, to fly as closely as possible to a "3-1" glidepath, not above it.

**EXAMPLE.—**  
FLY 3,000 FEET AT 10 MILES FROM TOUCHDOWN, 1,500 FEET AT 5 MILES, 1,200 FEET AT 4 MILES, AND SO ON TO TOUCHDOWN.

b) Pilots of aircraft that produce strong wake vortices should fly as closely as possible to the approach course centerline or to the extended centerline of the runway of intended landing as appropriate to conditions.

**27.8.6** Pilots operating lighter aircraft on visual approaches in-trail to aircraft producing strong wake vortices should use the following procedures to assist in avoiding wake turbulence. These procedures apply only to those aircraft that are on visual approaches.

a) Pilots of lighter aircraft should fly on or above the glidepath. Glidepath reference may be furnished by an ILS, by a visual approach slope system, by other ground-based approach slope guidance systems, or by other means. In the absence of visible glidepath guidance, pilots may very nearly duplicate a 3-degree glide slope by adhering to the "3 to 1" glidepath principle.

**EXAMPLE.—**  
FLY 3,000 FEET AT 10 MILES FROM TOUCHDOWN, 1,500 FEET AT 5 MILES, 1,200 FEET AT 4 MILES, AND SO ON TO TOUCHDOWN.

b) If the pilot of the lighter following aircraft has visual contact with the preceding heavier aircraft and also with the runway, the pilot may further adjust for possible wake vortex turbulence by the following practices:

1) Pick a point of landing no less than 1,000 feet from the arrival end of the runway;

2) Establish a line-of-sight to that landing point that is above and in front of the heavier preceding aircraft;

3) When possible, note the point of landing of the heavier preceding aircraft and adjust point of intended landing as necessary;

**EXAMPLE.—**  
A PUFF OF SMOKE MAY APPEAR AT THE 1,000-FOOT MARKINGS OF THE RUNWAY, SHOWING THAT TOUCHDOWN WAS AT THAT POINT; THEREFORE, ADJUST POINT OF INTENDED LANDING TO THE 1,500-FOOT MARKINGS.

4) Maintain the line-of-sight to the point of intended landing above and ahead of the heavier preceding aircraft; maintain it to touchdown; and

5) Land beyond the point of landing of the preceding heavier aircraft.

**27.8.7** During visual approaches pilots may ask ATC for updates on separation and groundspeed with respect to heavier preceding aircraft, especially when there is any question of safe separation from wake turbulence.

## 27.9 Air Traffic Wake Turbulence Separations

**27.9.1** Because of the possible effects of wake turbulence, controllers are required to apply no less than specified minimum separation for aircraft operating behind a heavy jet and, in certain instances, behind large nonheavy aircraft; i.e., B757 aircraft.

a) Separation is applied to aircraft operating directly behind a heavy and/or B757 jet at the same altitude or less than 1,000 feet below:

- 1) Heavy jet behind heavy jet-4 miles;
- 2) Large/heavy behind B757 - 4 miles;
- 3) Small behind B757-5 miles; and
- 4) Small/large aircraft behind heavy jet - 5 miles.

b) Also, separation, measured at the time the preceding aircraft is over the landing threshold, is provided to small aircraft:

- 1) Small aircraft landing behind heavy jet - 6 miles;
- 2) Small aircraft landing behind B757 - 5 miles; and
- 3) Small aircraft landing behind large aircraft - 4 miles.

**NOTE.—**  
AIRCRAFT CLASSES ARE LISTED IN THE PILOT/CONTROLLER GLOSSARY IN THE AERONAUTICAL INFORMATION MANUAL.

c) Additionally, appropriate time or distance intervals are provided to departing aircraft. Two minutes or the appropriate 4 or 5 mile radar separation when takeoff behind a heavy/B757 jet will be:

- 1) From the same threshold;
- 2) On a crossing runway and projected flight paths will cross; and
- 3) From the threshold of a parallel runway when staggered ahead of that of the adjacent runway by less than 500 feet and when the runways are separated by less than 2,500 feet.

**NOTE.—**  
CONTROLLERS MAY NOT REDUCE OR WAIVE THESE INTERVALS.

**27.9.2** A 3-minute interval will be provided for a small aircraft taking off:

- a) From an intersection on the same runway (same or opposite direction) behind a departing large aircraft; or
- b) In the opposite direction on the same runway behind a large aircraft takeoff or low/missed approach.

**NOTE.—**  
THIS 3-MINUTE INTERVAL MAY BE WAIVED UPON SPECIFIC PILOT REQUEST.

**27.9.3** A 3-minute interval will be provided for all aircraft taking off when the operations are as described in paragraph 27.9.2 above, the preceding aircraft is a heavy and/or a B757 jet, and the operations are on either the same runway or parallel runways separated by less than 2,500 feet. Controllers may not reduce or waive this interval.

**27.9.4** Pilots may request additional separation; i.e., 2 minutes instead of 4 or 5 miles for wake turbulence avoidance. This request should be made as soon as practical on ground control and at least before taxiing onto the runway.

**NOTE.—**  
FEDERAL AVIATION ADMINISTRATION REGULATIONS STATE: "THE PILOT IN COMMAND OF AN AIRCRAFT IS DIRECTLY RESPONSIBLE FOR AND IS THE FINAL AUTHORITY AS TO THE OPERATION OF THAT AIRCRAFT."

**27.9.5** Controllers may anticipate separation and need not withhold a takeoff clearance for an aircraft departing behind a large/heavy aircraft if there is reasonable assurance the required separation will exist when the departing aircraft starts takeoff roll.

## 28. International Civil Aviation Organization (ICAO) Weather Formats

**28.1** The United States uses the ICAO world standard for aviation weather reporting and forecasting. The utilization of terminal forecasts affirms U.S. commitment to a single global format for aviation weather. The World Meteorological Organization's (WMO) publication No. 782, "Aerodrome Reports and Forecasts," contains the base METAR and TAF code as adopted by the WMO member countries.

**28.2** Although the METAR code is adopted worldwide, each country is allowed to make modifications or exceptions to the code for use in their particular country; e.g., the U.S. will continue to use statute miles for visibility, feet for RVR values, knots for wind speed, inches of mercury for altimetry, and will continue reporting prevailing visibility rather than lowest sector visibility. A METAR report contains the following sequence of elements in the following order:

- a) Type of report;
- b) ICAO station identifier;
- c) Date and time of report;
- d) Modifier (as required);
- e) Wind;
- f) Visibility;
- g) Runway Visual Range (RVR);
- h) Weather phenomena;
- i) Sky conditions;
- j) Temperature/Dew point group;
- k) Altimeter; and
- l) Remarks (RMK).

**28.3** The following paragraphs describe the elements in a METAR report.

**a) Type of Report:** There are two types of reports:

- 1) The METAR, an aviation routine weather report; and
- 2) The SPECI, a nonroutine (special) aviation weather report.

The type of report (METAR or SPECI) will always appear as the lead element of the report.

**b) ICAO Station Identifier:** The METAR code uses ICAO 4-letter station identifiers. In the contiguous 48

states, the 3-letter domestic station identifier is prefixed with a "K"; i.e., the domestic identifier for Seattle is SEA while the ICAO identifier is KSEA. For Alaska, all station identifiers start with "PA"; for Hawaii, all station identifiers start with "PH." The identifier for the eastern Caribbean is "T" followed by the individual country's letter; i.e., Puerto Rico is "TJ." For a complete worldwide listing see ICAO Document 7910, "Location Indicators."

**c) Date and Time of Report:** The date and time the observation is taken are transmitted as a six-digit date/time group appended with Z to denote Coordinated Universal Time (UTC). The first two digits are the date followed with two digits for hour and two digits for minutes.

**EXAMPLE.—**

172345Z (THE 17TH DAY OF THE MONTH AT 2345Z)

**d) Modifier (As Required):** "AUTO" identifies a METAR/SPECI report as an automated weather report with no human intervention. If "AUTO" is shown in the body of the report, the type of sensor equipment used at the station will be encoded in the remarks section of the report. The absence of "AUTO" indicates that a report was made manually by an observer or that an automated report had human augmentation/backup. The modifier "COR" indicates a corrected report that is sent out to replace an earlier report with an error.

**NOTE.—**

THERE ARE TWO TYPES OF AUTOMATED STATIONS, AO1 FOR AUTOMATED WEATHER REPORTING STATIONS WITHOUT A PRECIPITATION DISCRIMINATOR, AND AO2 FOR AUTOMATED STATIONS WITH A PRECIPITATION DISCRIMINATOR. (A PRECIPITATION DISCRIMINATOR CAN DETERMINE THE DIFFERENCE BETWEEN LIQUID AND FROZEN/FREEZING PRECIPITATION). THIS INFORMATION APPEARS IN THE REMARKS SECTION OF AN AUTOMATED REPORT.

**e) Wind:** The wind is reported as a five digit group (six digits if speed is over 99 knots). The first three digits are the direction from which the wind is blowing, in tens of degrees referenced to true north, or "VRB" if the direction is variable. The next two digits is the wind speed in knots, or if over 99 knots, the next three digits. If the wind is gusty, it is reported as a "G" after the speed followed by the highest gust reported. The abbreviation "KT" is appended to denote the use of knots for wind speed.

**EXAMPLE.—**

13008KT - WIND FROM 130 DEGREES AT 8 KNOTS

08032G45KT - WIND FROM 080 DEGREES AT 32 KNOTS WITH GUSTS TO 45 KNOTS

VRB04KT - WIND VARIABLE IN DIRECTION AT 4 KNOTS

00000KT - WIND CALM

210103G130KT - WIND FROM 210 DEGREES AT 103 KNOTS WITH GUSTS TO 130 KNOTS

IF THE WIND DIRECTION IS VARIABLE BY 60 DEGREES OR MORE AND THE SPEED IS GREATER THAN 6 KNOTS, A VARIABLE GROUP CONSISTING OF THE EXTREMES OF THE WIND DIRECTION SEPARATED BY A "V" WILL FOLLOW THE PREVAILING WIND GROUP.

32012G22KT 280V350

**1) Peak Wind:** Whenever the peak wind exceeds 25 knots, "PK WND" will be included in Remarks; e.g., PK WND 280045/1955 "Peak wind two eight zero at four five occurred at one niner five five." If the hour can be inferred from the report time, only the minutes will be appended; e.g., PK WND 34050/38 "Peak wind three four zero at five zero occurred at three eight past the hour."

**2) Wind shift:** Whenever a wind shift occurs, "WSHFT" will be included in remarks followed by the time the wind shift began; e.g., WSHFT 30 FROPA "Wind shift at three zero due to frontal passage."

**f) Visibility:** Prevailing visibility is reported in statute miles with "SM" appended to it.

EXAMPLE.—

7SM ..... SEVEN STATUTE MILES  
15SM ..... FIFTEEN STATUTE MILES  
1/2SM ..... ONE-HALF STATUTE MILE

**1) Tower/surface visibility:** If either tower or surface visibility is below 4 statute miles, the lesser of the 2 will be reported in the body of the report; the greater will be reported in remarks.

**2) Automated visibility:** Automated visibility stations will show visibility less than 1/4 statute mile as "M1/4SM" and visibility 10 miles or greater as "10SM."

**3) Variable visibility:** Variable visibility is shown in remarks when rapid increase or decrease by 1/2 statute mile or more and the average prevailing visibility is less than 3 statute miles; e.g., VIS 1V2 means "visibility variable between 1 and 2 statute miles."

**4) Sector visibility:** Sector visibility is shown in remarks when it differs from the prevailing visibility, and either the prevailing or sector visibility is less than 3 statute miles.

EXAMPLE.—

VIS N2 ..... VISIBILITY NORTH TWO

**g) Runway Visual Range (when reported):** "R" identifies the group followed by the runway heading (and parallel runway designator, if needed) "/" and the

visual range in feet (meters in other countries) followed with "FT." ("Feet" is not spoken.)

**1) Variability Values:** When RVR varies by more than on reportable value, the lowest and highest values are shown with "V" between them.

**2) Maximum/Minimum Range:** "P" indicates an observed RVR is above the maximum value for this system (spoken as "more than"). "M" indicates an observed RVR is below the minimum value which can be determined by the system (spoken as "less than").

EXAMPLE.—

R32L/1200FT - RUNWAY THREE TWO LEFT R-V-R ONE THOUSAND TWO HUNDRED

R27R/M1000V4000FT - RUNWAY TWO SEVEN RIGHT R-V-R VARIABLE FROM LESS THAN ONE THOUSAND TO FOUR THOUSAND.

**h) Weather Phenomena:** In METAR, weather is reported in the format:

Intensity / Proximity / Descriptor / Precipitation / Obstruction to Visibility / Other

NOTE.—

THE "/" ABOVE AND IN THE FOLLOWING DESCRIPTIONS (EXCEPT AS THE SEPARATOR BETWEEN THE TEMPERATURE AND DEW POINT) ARE FOR SEPARATION PURPOSES IN THIS PUBLICATION AND DO NOT APPEAR IN THE ACTUAL METARS.

**1) Intensity:** applies only to the first type of precipitation reported. A "-" denotes light, no symbol denotes moderate, and a "+" denotes heavy.

**2) Proximity:** applies to and is reported only for weather occurring in the vicinity of the airport (between 5 and 10 miles of the point(s) of observation). It is denoted by the letters "VC." (Intensity and "VC" will not appear together in the weather group.)

**3) Descriptor:** these eight descriptors apply to the precipitation or obstructions to visibility:

TS	thunderstorm
DR	low drifting
SH	showers
MI	shallow
FZ	freezing
BC	patches
BL	blowing
PR	partial

NOTE.—

ALTHOUGH "TS" AND "SH" ARE USED WITH PRECIPITATION AND MAY BE PRECEDED WITH AN INTENSITY SYMBOL, THE INTENSITY STILL APPLIES TO THE PRECIPITATION NOT THE DESCRIPTOR.

**4) Precipitation:** There are nine types of precipitation in the METAR code:

RA	rain
DZ	drizzle
SN	snow
GR	hail ( $\frac{1}{4}$ " or greater)
GS	small hail/snow pellets
PL	ice pellets
SG	snow grains
IC	ice crystals
UP	unknown precipitation (automated stations only)

**EXAMPLE.—**

TSRA	thunderstorm with moderate rain
+SN	heavy snow
-RA FG	light rain and fog
BRHZ	mist and haze (visibility $\frac{5}{8}$ mile or greater)
FZDZ	freezing drizzle
VCSH	rain shower in the vicinity
+SHRASNPL	heavy rain showers, snow, ice pellets (Intensity indicator refers to the predominant rain.)

**5) Obstructions to visibility:** Obscurations are any phenomena in the atmosphere, other than precipitation, that reduce horizontal visibility. There are eight types of obscuration phenomena in the METAR code:

FG	fog (visibility less than $\frac{5}{8}$ mile)
HZ	haze
FU	smoke
PY	spray
BR	mist (visibility $\frac{5}{8}$ -6 miles)
SA	sand
DU	dust
VA	volcanic ash

**NOTE.—**

FOG (FG) IS OBSERVED OR FORECAST ONLY WHEN THE VISIBILITY IS LESS THAN  $\frac{5}{8}$  MILE. OTHERWISE, MIST (BR) IS OBSERVED OR FORECAST.

**6) Other:** There are five categories of other weather phenomena which are reported when they occur:

SQ	squall
SS	sandstorm
DS	duststorm
PO	dust/sand whirls
FC	funnel cloud
+FC	tornado/waterspout

**i) Sky Condition:** In METAR, sky condition is reported in the format:

Amount / Height / (Type) or Indefinite Ceiling / Height

**1) Amount:** The amount of sky cover is reported in eighths of sky cover, using contractions:

SKC	clear (no clouds)
FEW	$>\frac{0}{8}$ to $\frac{2}{8}$ cloud cover
SCT	scattered ( $\frac{3}{8}$ to $\frac{4}{8}$ cloud cover)
BKN	broken ( $\frac{5}{8}$ to $\frac{7}{8}$ cloud cover)
OVC	overcast ( $\frac{8}{8}$ cloud cover)
CB	cumulonimbus when present
TCU	towering cumulus when present

**NOTE.—**

[1] "SKC" WILL BE REPORTED AT MANUAL STATIONS. "CLR" WILL BE USED AT AUTOMATED STATIONS WHEN NO CLOUDS BELOW 12,000 FEET ARE REPORTED.

[2] A CEILING LAYER IS NOT DESIGNATED IN THE METAR CODE. FOR AVIATION PURPOSES, THE CEILING IS THE LOWEST BROKEN OR OVERCAST LAYER, OR VERTICAL VISIBILITY INTO OBSCURATION. ALSO, THERE IS NO PROVISION FOR REPORTING THIN LAYERS IN THE METAR CODE. WHEN CLOUDS ARE THIN, THAT LAYER SHALL BE REPORTED AS IF IT WERE OPAQUE.

**2) Height:** Cloud bases are reported with three digits in hundreds of feet. (Clouds above 12,000 feet cannot be reported by an automated station.)

**3) Type:** If towering cumulus clouds (TCU) or cumulonimbus clouds (CB) are present, they are reported after the height which represents their base.

**EXAMPLE.—**

SCT025TCU BKN080 BKN250 - "TWO THOUSAND FIVE HUNDRED SCATTERED TOWERING CUMULUS, CEILING EIGHT THOUSAND BROKEN, TWO FIVE THOUSAND BROKEN."

SCT008 OVC012CB - "EIGHT HUNDRED SCATTERED CEILING ONE THOUSAND TWO HUNDRED OVERCAST CUMULONIMBUS CLOUDS."

**4) Vertical Visibility (indefinite ceiling height):**

The height into an indefinite ceiling is preceded by "VV" and followed by three digits indicating the vertical visibility in hundreds of feet. This layer indicates total obscuration.

*EXAMPLE.—*  
*<sup>1</sup>/<sub>8</sub>SMFG VV006 - VISIBILITY ONE EIGHTH, FOG, INDEFINITE CEILING SIX HUNDRED.*

**5) Obscurations:** are reported when the sky is partially obscured by a ground-based phenomena by indicating the amount of obscuration as FEW, SCT, BKN followed by three zeros (000). In remarks, the obscuring phenomenon precedes the amount of obscuration and three zeros.

*EXAMPLE.—*  
*BKN000 (IN BODY) - "SKY PARTIALLY OBSCURED."*

*FU BKN000 (IN REMARKS) - "SMOKE OBSCURING FIVE- TO SEVEN-EIGHTHS OF THE SKY."*

**6) When sky conditions include a layer aloft other than clouds, such as smoke or haze, the type of phenomena, sky cover and height are shown in remarks.**

*EXAMPLE.—*  
*BKN020 (IN BODY) - "CEILING TWO THOUSAND BROKEN."*  
*RMK FU BKN020 - "BROKEN LAYER OF SMOKE ALOFT, BASED AT TWO THOUSAND."*

**7) Variable ceiling.** When a ceiling is below three thousand and is variable, the remark "CIG" will be shown followed with the lowest and highest ceiling heights separated by a "V."

*EXAMPLE.—*  
*CIG 005V010 - "CEILING VARIABLE BETWEEN FIVE HUNDRED AND ONE THOUSAND."*

**8) Second site sensor.** When an automated station uses meteorological discontinuity sensors, remarks will be shown to identify site specific sky conditions which differ and are lower than conditions reported in the body.

*EXAMPLE.—*  
*CIG 020 RY11 - "CEILING TWO THOUSAND AT RUNWAY ONE ONE."*

**9) Variable cloud layer.** When a layer is varying in sky cover, remarks will show the variability range. If there is more than one cloud layer, the variable layer will be identified by including the layer height.

*EXAMPLE.—*  
*SCT V BKN - "SCATTERED LAYER VARIABLE TO BROKEN."*

*BKN025 V OVC - "BROKEN LAYER AT TWO THOUSAND FIVE HUNDRED VARIABLE TO OVERCAST."*

**10) Significant clouds.** When significant clouds are observed, they are shown in remarks, along with the specified information as shown below:

— Cumulonimbus (CB), or Cumulonimbus Mammatus (CBMAM), distance (if known), direction from the station, and direction of movement, if known. If the clouds are beyond 10 miles from the airport, DSNT will indicate distance.

*EXAMPLE.—*  
*CB W MOVE - "CUMULONIMBUS WEST MOVING EAST."*

*CBMAM DSNT S - "CUMULONIMBUS MAMMATUS DISTANT SOUTH."*

— Towering Cumulus (TCU), location, (if known), or direction from the station.

*EXAMPLE.—*  
*TCU OHD - "TOWERING CUMULUS OVERHEAD."*

*TCU W - "TOWERING CUMULUS WEST."*

— Altocumulus Castellanus (ACC), Stratocumulus Standing Lenticular (SCSL), Altocumulus Standing Lenticular (ACSL), Cirrocumulus Standing Lenticular (CCSL) or rotor clouds, describing the clouds (if needed) and the direction from the station.

ACC W	"ALTOCUMULUS CASTELLANUS WEST"
ACSL SW-S	"STANDING LENTICULAR ALTOCUMULUS SOUTHWEST THROUGH SOUTH"
APRNT ROTOR CLD S	"APPARENT ROTOR CLOUD SOUTH"
CCSL OVR E	"STANDING LENTICULAR CIRROCUMULUS OVER THE EAST"

**j) Temperature/Dew Point:** Temperature and dew point are reported in two, two-digit groups in degrees Celsius, separated by a solidus (/). Temperatures below zero are prefixed with an "M." If the temperature is available but the dew point is missing, the temperature is shown followed by a solidus. If the temperature is missing, the group is omitted from the report.

*EXAMPLE.—*  
*15/08 ..... "TEMPERATURE ONE FIVE, DEW POINT 8"*  
*00/M02 ..... "TEMPERATURE ZERO, DEW POINT MINUS 2"*  
*M05/ ..... "TEMPERATURE MINUS FIVE, DEW POINT MISSING"*

**k) Altimeter:** Altimeter settings are reported in a four-digit format in inches of mercury prefixed with an "A" to denote the units of pressure.

*EXAMPLE.—*  
*A2995 ..... "ALTIMETER TWO NINER NINER FIVE"*

**l) Remarks:** Remarks will be included in all observations, when appropriate. The contraction "RMK" denotes the start of the remarks section of a METAR report.

Location of a phenomena within 5 statute miles of the point of observation will be reported as at the station.

Phenomena between 5 and 10 statute miles will be reported in the vicinity, "VC." Phenomena beyond 10 statute miles will be shown as distant, "DSNT." Distances are in statute miles except for automated lightning remarks which are in nautical miles. Movement of clouds or weather will be indicated by the direction toward which the phenomena is moving.

There are two categories of remarks: Automated, Manual, and Plain Language; and Additive and Automated Maintenance Data.

**1) Automated, Manual, and Plain Language Remarks:**

This group of remarks may be generated from either manual or automated weather reporting stations and generally elaborates on parameters reported in the body of the report. Plain language remarks are only provided by manual stations.

1) Volcanic Eruptions
2) Tornado, Funnel Cloud, Waterspout
3) Type of Automated Station (AO1 or AO2)
4) Peak Wind
5) Wind Shift
6) Tower or Surface Visibility
7) Variable Prevailing Visibility
8) Sector Visibility
9) Visibility at Second Location
10) Dispatch Visual Range
11) Lightning (freq) LTG (type) (loc)
12) Beginning/Ending Time of Precipitation
13) Beginning/Ending Time of Thunderstorms
14) Thunderstorm Location; Movement Direction
15) Hailstone Size
16) Virga
17) Variable Ceiling
18) Obscurations
19) Variable Sky Condition
20) Significant Cloud Types
21) Ceiling Height at Second Location
22) Pressure Rising or Falling Rapidly
23) Sea-Level Pressure
24) Aircraft Mishap (not transmitted)
25) No SPECI Reports Taken
26) Snow Increasing Rapidly
27) Other Significant Information

**2) Additive and Automated Maintenance Data Remarks:**

1) Hourly Precipitation
2) Precipitation Amount
3) 24-Hour Precipitation
4) Snow Depth on Ground
5) Water Equivalent of Snow on Ground
6) Cloud Types
7) Duration of Sunshine
8) Hourly Temperature and Dew Point (Tenths)
9) 6-Hour Maximum Temperature
10) 6-Hour Minimum Temperature
11) 24-Hour Maximum/Minimum Temperatures
12) Pressure Tendency
13) Sensor Status:
WINO
ZRANO
SNO
VRNO
PNO
VISNO

**EXAMPLE.—**  
**METAR REPORT AND EXPLANATION:**

METAR KSFO 041453Z AUTO VRB02KT 3SM BR CLR 15/12 A3012  
RMK AO2

METAR	Type of report (aviation routine weather report)
KSFO	Station identifier (San Francisco, CA)
041453Z	Date/Time (4th day of month; time 1453 UTC)
AUTO	Fully automated; no human intervention
VRB02KT	Wind (wind variable at two)
3SM	Visibility (visibility three statute miles)
BR	Visibility obscured by mist
CLR	No clouds below one two thousand
15/12	Temperature one five; dew point one two
A3012	Altimeter three zero one two
RMK	Remarks
AO2	This automated station has a weather discriminator (for precipitation).

**EXAMPLE.—**  
**METAR REPORT AND EXPLANATION:**

METAR KBNA 281250Z 33018KT 290V360 1/2SM R31/2700FT SN BLSN FG VV008 00/M03 A2991 RMK RAE42SNB42

METAR	Aviation routine weather report
KBNA	Nashville, TN
281250Z	28th day of month; time 1250 UTC
(no modifier)	This is a manually generated report, due to the absence of "AUTO" and "AO1 or AO2" in remarks.
33018KT	Wind three three zero at one eight
290V360	Wind variable between two nine zero and three six zero
1/2SM	Visibility one half statute mile
R31/2700FT	Runway three one RVR two thousand seven hundred feet
SN	Moderate snow
BLSN FG	Visibility obscured by blowing snow and fog
VV008	Indefinite ceiling eight hundred
00/M03	Temperature zero; dew point minus three
A2991	Altimeter two niner niner one
RMK	Remarks
RAE36	Rain ended at three six
SNB42	Snow began at four two

**EXAMPLE.—**  
**SPECI REPORT AND EXPLANATION:**

SPECI KCVG 152224Z 28024G36KT 3/4SM +TSRA BKN008 OVC020CB 28/23 A3000 RMK TSRAB24 TS W MOV E.

SPECI	Nonroutine aviation special weather report
KCVG	Cincinnati, OH
152224Z	15th day of month; time 2224 UTC
(no modifier)	This is a manually generated report due to the absence of "AUTO" and "AO1 or AO2" in remarks.
28024G36KT	Wind two eight zero at two four gusts three six
3/4SM	Visibility three fourths statute mile
+TSRA	Thunderstorms, heavy rain
BKN008	Ceiling eight hundred broken
OVC020CB	Two thousand overcast cumulonimbus clouds
28/23	Temperature two eight; dew point two three
A3000	Altimeter three zero zero zero
RMK	Remarks
TSRAB24	Thunderstorm and rain began at two four
TS W MOV E	Thunderstorm west moving east



**28.4 Aerodrome Forecast (TAF):** A concise statement of the expected meteorological conditions at an airport during a specified period (usually 24 hours). TAF's use the same codes as METAR weather reports. They are scheduled four times daily for 24-hour periods beginning at 0000Z, 0600Z, 1200Z, and 1800Z. TAF's are issued in the following format:

Type of Report / ICAO Station Identifier / Date and Time of Origin / Valid Period Date and Time / Forecast Meteorological Conditions

*NOTE.—*  
THE "I" ABOVE AND IN THE FOLLOWING DESCRIPTIONS ARE FOR SEPARATION PURPOSES IN THIS PUBLICATION AND DO NOT APPEAR IN THE ACTUAL TAF's.

#### 28.4.1 Explanation of TAF elements:

**a) Type of report:** There are two types of TAF issuances, a routine forecast issuance (TAF) and an amended forecast (TAF AMD). An amended TAF is issued when the current TAF no longer adequately describes the on-going weather or the forecaster feels the TAF is not representative of the current or expected weather. Corrected (COR) or delayed (RTD) TAF's are identified only in the communications header which precedes the actual forecasts.

**b) ICAO Station Identifier:** The TAF code uses ICAO 4-letter location identifiers as described in the METAR section.

**c) Date and Time of Origin:** This element is the date and time the forecast is actually prepared. The format is a two-digit date and four-digit time followed, without a space, by the letter "Z."

**d) Valid Period Date and Time:** The UTC valid period of the forecast is a two-digit date followed by the two-digit beginning hour and two-digit ending hour. In the case of an amended forecast, or a forecast which is corrected or delayed, the valid period may be for less than 24 hours. Where an airport or terminal operates on a part-time basis (less than 24 hours/day), the TAF's issued for those locations will have the abbreviated statement "NIL AMD SKED AFT (closing time) Z" added to the end of the forecasts. For the TAF's issued while these locations are closed, the word "NIL" will appear in place of the forecast text. A delayed (RTD) forecast will then be issued for these locations after two complete observations are received.

**e) Forecast Meteorological Conditions:** This is the body of the TAF. The basic format is:

Wind / Visibility / Weather / Sky Condition / Optional Data (Wind Shear)

The wind, visibility, and sky condition elements are always included in the initial time group of the forecast. Weather is included only if significant to aviation. If a significant, lasting change in any of the elements is expected during the valid period, a new time period with the changes is included. It should be noted that with the exception of an "FM" group, the new time period will include only those elements which are expected to change; i.e., if a lowering of the visibility is expected but the wind is expected to remain the same, the new time period reflecting the lower visibility would not include a forecast wind. The forecast wind would remain the same as in the previous time period.

Any temporary conditions expected during a specific time period are included with that time period. The following describes the elements in the above format.

**1) Wind:** This five (or six) digit group includes the expected wind direction (first 3 digits) and speed (last 2 digits or 3 digits if 100 knots or greater). The contraction "KT" follows to denote the units of wind speed. Wind gusts are noted by the letter "G" appended to the wind speed followed by the highest expected gust.

*NOTE.—*  
A VARIABLE WIND DIRECTION IS NOTED BY "VRB" WHERE THE THREE DIGIT DIRECTION USUALLY APPEARS. A CALM WIND (3 KNOTS OR LESS) IS FORECAST AS "0000KT."

*EXAMPLE.—*  
18010KT - WIND ONE EIGHT ZERO AT ONE ZERO (WIND IS BLOWING FROM 180 AT 10 KNOTS).

35012G20KT - WIND THREE FIVE ZERO AT ONE TWO GUST TWO ZERO

**2) Visibility:** The expected prevailing visibility up to and including 6 miles is forecast in statute miles, including fractions of miles, followed by "SM" to note the units of measure. Expected visibilities greater than 6 miles are forecast as P6SM (Plus six statute miles).

*EXAMPLE.—*  
1/2SM ..... VISIBILITY ONE-HALF  
4SM ..... VISIBILITY FOUR  
P6SM ..... VISIBILITY MORE THAN SIX

**3) Weather:** The expected weather phenomena is coded in TAF reports using the same format, qualifiers, and phenomena contractions as METAR reports (except UP).

Obscurations to vision will be forecast whenever the prevailing visibility is forecast to be 6 statute miles or less.

If no significant weather is expected to occur during a specific time period in the forecast, the weather group is omitted for that time period. If, after a time period in which significant weather has been forecast, a change to a forecast of no significant weather occurs, the contraction NSW (no significant weather) will appear as the weather group in the new time period. (NSW is included only in becoming (BECMG) or temporary (TEMPO) groups.)

**4) Sky Condition:** TAF sky condition forecasts use the METAR format described in the METAR section. Cumulonimbus clouds (CB) are the only cloud type forecast in TAF's.

When clear skies are forecast, the contraction "SKC" will always be used. The contraction "CLR" is never used in the aerodrome forecast (TAF).

When the sky is obscured due to a surface-based phenomenon, vertical visibility (VV) into the obscuration is forecast. The format for vertical visibility is "VV" followed by a three-digit height in hundreds of feet.

*NOTE.—*  
AS IN METAR, CEILING LAYERS ARE NOT DESIGNATED IN THE TAF CODE. FOR AVIATION PURPOSES, THE CEILING IS THE LOWEST BROKEN OR OVERCAST LAYER OR VERTICAL VISIBILITY INTO A COMPLETE OBSCURATION.

SKC	"SKY CLEAR"
SCT005 BKN025CB	"FIVE HUNDRED SCATTERED, CEILING TWO THOUSAND FIVE HUNDRED BROKEN CUMULONIMBUS CLOUDS"
VV008	"INDEFINITE CEILING EIGHT HUNDRED"

**5) Optional Data (Wind Shear):** Wind Shear is the forecast of non-convective, low-level winds (up to 2,000 feet). The forecast includes the letters "WS" followed by the height of the wind shear, the wind direction and wind speed at the indicated height and the ending letters "KT" (knots). Height is given in hundreds of feet (AGL) up to and including 2,000 feet. Wind shear is encoded with the contraction "WS" followed

by a three-digit height, slant character "/" and winds at the height indicated in the same format as surface winds. Then wind shear element is omitted if not expected to occur.

WS010/18040KT	"LOW LEVEL WIND SHEAR AT ONE THOUSAND, WIND ONE EIGHT ZERO AT FOUR ZERO"
---------------	--------------------------------------------------------------------------

**28.5 Probability Forecast:** the probability or chance of thunderstorms or other precipitation events occurring, along with associated weather conditions (wind, visibility, and sky conditions).

The PROB30 group is used when the occurrence of thunderstorms or precipitation is 30-39 percent and the PROB40 group is used when the occurrence of thunderstorms or precipitation is 40-49 percent. This is followed by a four-digit group giving the beginning hour and ending hour of the time period during which the thunderstorms or precipitation are expected.

*NOTE.—*  
NEITHER PROB30 NOR PROB40 WILL BE SHOWN DURING THE FIRST SIX HOURS OF A FORECAST.

*EXAMPLE.—*  
PROB40 2102 1/2SM +TSRA - "CHANCE BETWEEN 2100Z AND 0200Z OF VISIBILITY ONE-HALF THUNDERSTORM, HEAVY RAIN."

PROB30 1014 1SM RASN - "CHANCE BETWEEN 1000Z AND 1400Z OF VISIBILITY ONE RAIN AND SNOW."

**28.6 Forecast Change Indicators:** The following change indicators are used when either a rapid, gradual, or temporary change is expected in some or all of the forecast meteorological conditions. Each change indicator marks a time group within the TAF report.

**a) From (FM) group:** is used when a rapid change, usually occurring in less than one hour, in prevailing conditions is expected. Typically, a rapid change of prevailing conditions to more or less a completely new set of prevailing conditions is associated with a synoptic feature passing through the terminal area (cold or warm frontal passage). Appended to the "FM" indicator is the four-digit hour and minute the change is expected to begin and continues until the next change group or until the end of the current forecast.

An "FM" group marks the beginning of a new line in a TAF report (indented 5 spaces). Each "FM" group contains all the required elements—wind, visibility, weather, and sky condition. Weather is omitted in "FM" groups when it is not significant to aviation. FM groups do not include the contraction NSW.

*EXAMPLE.—*  
FM0100 14010KT P6SM SKC - "AFTER 0100Z, WIND ONE FOUR ZERO AT ONE ZERO, VISIBILITY MORE THAN SIX, SKY CLEAR"

**b) Becoming (BECMG) group:** The becoming group is used when a gradual change in conditions is expected over a longer time period, usually two hours. The time period when the change is expected is a four-digit group with the beginning hour and ending hour of the change period which follows the BECMG indicator. The gradual change will occur at an unspecified time within this time period. Only the changing forecast meteorological conditions are included in BECMG groups. The omitted conditions are carried over from the previous time group.

**EXAMPLE.—**

*OVC012 BECMG 1416 BKN020 - "CEILING ONE THOUSAND TWO HUNDRED OVERCAST. THEN A GRADUAL CHANGE TO CEILING TWO THOUSAND BROKEN BETWEEN 1400Z AND 1600Z."*

**c) Temporary (TEMPO) group:** The TEMPO group is used for any conditions in wind, visibility,

weather, or sky condition which are expected to last for generally less than an hour at a time (occasional), and are expected to occur during less than half the time period. The TEMPO indicator is followed by a four-digit group giving the beginning hour and ending hour of the time period during which the temporary conditions are expected. Only the changing forecast meteorological conditions are included in TEMPO groups. The omitted conditions are carried over from the previous time group.

**EXAMPLE.—**

*[T] SCT030 TEMPO 1923 BKN030 - "THREE THOUSAND SCATTERED WITH OCCASIONAL CEILINGS THREE THOUSAND BROKEN BETWEEN 1900Z AND 2300Z"*

*[Z] 4SM HZ TEMPO 0006 2SM BR HZ - "VISIBILITY FOUR IN HAZE WITH OCCASIONAL VISIBILITY TWO IN MIST AND HAZE BETWEEN 0000Z AND 0600Z"*

Key to Aviation Routine Weather Report (METAR) and Aerodrome Forecasts (TAF)

KEY TO AERODROME FORECAST (TAF) and AVIATION ROUTINE WEATHER REPORT (METAR)	
<p><b>Forecast</b></p> <p>WS01031022KT</p> <p>FM1930</p> <p>TEMPO 2022</p> <p>PROB40 0407</p> <p>BECMG 1315</p>	<p><b>Report</b></p> <p>RMK SLP045 T01820159</p>
<p><b>Forecast</b></p> <p>FM1930</p> <p>TEMPO 2022</p> <p>PROB40 0407</p> <p>BECMG 1315</p>	<p><b>Explanation</b></p> <p>In U.S. TAF, non-convective low-level (≤2,000 ft) Wind Shear, 3-digit height (hundreds of ft); "7"; 3-digit wind direction and 2-3 digit wind speed above the indicated height, and unit, <u>KT</u></p> <p>In METAR, ReMark indicator &amp; remarks. For example: Sea-Level Pressure in hectopascals &amp; tenths, as shown: 1004.5 hPa; Temp/ dew-point in tenths °C, as shown: temp. 18.2°C, dew-point 15.9°C</p> <p>FM and 2-digit hour and 2-digit minute beginning time: indicates significant change. Each FM starts on new line, indented 5 spaces.</p> <p>TEMPO: changes expected for &lt; 1 hour and in total, &lt; half of 2-digit hour beginning and 2-digit hour ending time period</p> <p>PROB40 and 2-digit percent (30 or 40): probable condition during 2-digit hour beginning and 2-digit hour ending time period</p> <p>BECMG: change expected during 2-digit hour beginning and 2-digit hour ending time period</p>
<p><b>Forecast</b></p> <p>FM1930</p> <p>TEMPO 2022</p> <p>PROB40 0407</p> <p>BECMG 1315</p>	<p><b>Table of Significant Present, Forecast and Recent Weather - Grouped in categories and used in the order listed below; or as needed in TAF, No Significant Weather.</b></p> <p><b>QUALIFIER</b></p> <p>Intensity or Proximity "no sign" Moderate + Heavy - Light VC Vicinity: but not at aerodrome; in U.S. METAR, between 5 and 10SM of the point(s) of observation; in U.S. TAF, 5 to 10SM from center of runway complex (elsewhere within 8000m)</p> <p><b>Descriptor</b></p> <p>MI Shallow BC Patches PR Partial TS Thunderstorm BL Blowing SH Showers DR Drifting FZ Freezing</p> <p><b>WEATHER PHENOMENA</b></p> <p>Precipitation RA Rain SN Snow SG Snow grains DZ Drizzle PE Ice pellets GR Hall GS Small hail/snow pellets IC Ice crystals UP Unknown precipitation in automated observations</p> <p><b>Obscuration</b> BR Mist (&gt;5/8SM) FG Fog (&lt;5/8SM) FU Smoke VA Volcanic ash SA Sand HZ Haze PY Spray DU Widespread dust</p> <p><b>Other</b> SQ Squall SS Sandstorm DS Duststorm PO Well developed FC Funnel cloud +FC tornado/waterspout dust/sand whirls</p> <p>Explanations in parentheses ( ) indicate different worldwide practices. - Ceiling is not specified; defined as the lowest broken or overcast layer, or the vertical visibility. - NWS TAFs exclude turbulence, icing &amp; temperature forecasts; NWS METARs exclude trend forecasts - Although not used in US, Ceiling And Visibility OK replaces visibility, weather and clouds in visibility &gt; 10 km; no cloud below 5000 ft (1500 m) or below the highest minimum sector altitude, whichever is greater and no CB; and no precipitation. TS, DS, SS, MIFG, DRDU, DRSA or DRSN. March 1996 UNITED STATES DEPARTMENT OF COMMERCE NOAA/PA 96052 National Oceanic and Atmospheric Administration—National Weather Service</p>
<p><b>Forecast</b></p> <p>TAF KPIT 091730Z 091818 15005KT 5SM HZ FEW020 WS01031022KT FM1930 30015G25KT 3SM SHRA OVC015 TEMPO 2022 1/2SM +TSRA OVC008CB FM0100 27008KT 5SM SHRA BKN020 OVC040 PROB40 0407 1SM -RA BR FM1015 18005KT 6SM -SHRA OVC020 BECMG 1315 P6SM NSW SKC</p> <p><b>Report</b></p> <p>METAR KPIT 091955Z 091818 22015G25KT 3/4SM R28L/2600FT TSRA OVC010CB 18/16 A2992 RMK SLP045 T01820159</p>	<p><b>Explanation</b></p> <p>Message type: TAF-routine or TAF AMD-amended forecast, METAR; hourly, SPECI-special or TESTM-non-commissioned ASOS report</p> <p>ICAO location indicator</p> <p>issuance time: ALL times in UTC "Z", 2-digit date, 4-digit time</p> <p>Valid period: 2-digit date, 2-digit beginning, 2-digit ending times</p> <p>In U.S. METAR: CORrected obs; or AUTOMated obs for automated report with no human intervention; omitted when observer logs on</p> <p>Wind: 3 digit true-north direction, nearest 10 degrees (or Var[Dir][Dir]; next 2-3 digits for speed and unit, <u>KT</u> (KMH or MPS); as needed, Gust and maximum speed, 00000KT for calm; for METAR, if direction varies 60 degrees or more, Variability appended, e.g. 180V250</p> <p>Prevailing visibility: in U.S., Statute Miles &amp; fractions; above 6 miles in TAF Plus6SM. (Or, 4-digit minimum visibility in meters and as required, lowest value with direction)</p> <p>Runway Visual Range: R; 2-digit runway designator, Left, Center, or Flight as needed; "7"; Minus or Plus in U.S., 4-digit value, Feet in U.S., (usually meters elsewhere); 4-digit value Variability 4-digit value (and tendency) Down, Up or No change)</p> <p>Significant present, forecast and recent weather: see table (on back)</p> <p>Cloud amount, height and type: SKY Clear 0/8, FEW 5-0/8-2/8, SCoTered 3/8-4/8, BroKen 5/8-7/8, OverCast 8/8; 3-digit height in hundreds of ft; Towering CUmulus or CUmulonimBus in METAR; in TAF, only CB. Vertical Visibility for obscured sky and height "VV004". More than 1 layer may be reported or forecast. In automated METAR reports only, CLearB for "clear below 12,000 feet"</p> <p>Temperature: degrees Celsius; first 2 digits, temperature "7" last 2 digits, dew-point temperature; Minus for below zero, e.g., M06</p> <p>Altimeter setting: indicator and 4 digits; in U.S., A-inches and hundredths; Q-hectopascals, e.g., Q1013)</p>
<p><b>Forecast</b></p> <p>TAF</p> <p>KPIT 091730Z 091818</p> <p>15005KT</p> <p>5SM</p> <p>HZ</p> <p>FEW020</p>	<p><b>Report</b></p> <p>METAR</p> <p>KPIT 091955Z</p> <p>COR</p> <p>22015G25KT</p> <p>3/4SM</p> <p>R28L/2600FT</p> <p>TSRA</p> <p>OVC010CB</p> <p>18/16</p> <p>A2992</p>

FIG 3.5-18

## **29. Meteorological Broadcasts (ATIS, VHF and LF)**

### **29.1 Continuous Transcribed Weather Broadcasts (TWEB)**

Weather broadcasts are made continuously over selected navigational aids. These broadcasts contain the general weather forecasts and winds up to 12,000 feet within a 250-mile radius of the radio. In some cases the forecasts are for route of flight rather than the general area. They also broadcast pilot reports, radar reports and hourly weather reports of selected locations within a 400-mile radius of the broadcast station.

### **29.2 Automatic Terminal Information Service (ATIS) Broadcasts**

These broadcasts are made continuously and include as weather information only the ceiling, visibility, wind and altimeter setting of the aerodrome at which they are located.

### **29.3 Scheduled Weather Broadcasts (SWB)**

Scheduled broadcasts are made only in Alaska at 15 minutes past the hour over en route navigational aids not used for TWEB or ATIS. These broadcasts contain hourly weather reports of selected locations within 150 miles of the station and weather advisories, pilot

weather reports, radar weather reports, and notices to airmen (NOTAM).

### **29.4 Navigational Aids Providing Broadcast Services**

A compilation of navigational aids over which weather broadcasts are transmitted is not available for this publication. Complete information concerning all navigational aids providing this service is contained in the Airport/Facility directory. Similar information for the Pacific and Alaskan areas is contained in the Pacific and Alaska Supplements.

### **29.5 Hazardous In-flight Weather Advisory Service (HIWAS)**

A 24-hour continuous broadcast of hazardous in-flight weather is available on selected navigational outlets. Broadcasts include: severe weather forecast alerts (AWW), airman's meteorological information (AIRMET), significant meteorological information (SIGMET), convective SIGMET (WST), urgent pilot weather reports (UUA), hazardous portions of the domestic area forecasts (FA), and center weather advisories (CWA). HIWAS broadcast outlets are identified on en route/sectional charts and in airport facility directories. For further details, contact your nearest FSS.

METEOROLOGICAL BROADCASTS (VOLMET)							
Name	Call Sign	Frequency	Broadcast	Form	Contents	Emission	Remarks
Honolulu	Honolulu Radio	2863, 6679, 8828, 13282 kHz	H00-05 and H30-35	Forecasts	PHNL Honolulu PHTO Hilo PGUM Guam	Voice	Plain language English
				SIGMET	Oakland FIR		
				Hourly Reports	PHNL Honolulu PHTO Hilo PHOG Kahului PGUM Guam		
			E05-10 and E35-40	Hourly Reports	KSFO San Francisco KSEA Seattle KLAX Los Angeles KPDX Portland KSMF Sacramento KONT Ontario KLAS Las Vegas		
				SIGMET	Oakland FIR		
				Aerodrome Forecasts	KSFO San Francisco KSEA Seattle KLAX Los Angeles		
			E25-30 and E55-00	Hourly Reports	PANC Anchorage PAED ElmendorfAFB PAFA Fairbanks PACD Cold Bay PAKN King Salmon CYVR Vancouver		
				SIGMET	Oakland FIR		
				Forecasts	PANC Anchorage PAFA Fairbanks PACD Cold Bay CYVR Vancouver		
New York	New York Radio	3485, 6604, 10051, 13270 kHz	H00-05	Aerodrome Forecasts	KDTW Detroit KCLE Cleveland KCVG Cincinnati	Voice	Plain language English
				Hourly Reports	KDTW Detroit KCLE Cleveland KCVG Cincinnati KIND Indianapolis KPIT Pittsburgh		
			H05-10	SIGMET	Oceanic - New York FIR		
				Aerodrome Forecasts	KBGR Bangor KBDL Windsor Locks KCLT Charlotte		
				Hourly Reports	KBGR Bangor KBDL Windsor Locks KORF Norfolk KCLT Charlotte		
			H10-15	Aerodrome Forecasts	KJFK New York KEWR Newark KBOS Boston		
				Hourly Reports	KJFK New York KEWR Newark KBOS Boston KBAL Baltimore KIAD Washington		

METEOROLOGICAL BROADCASTS (VOLMET) - continued							
Name	Call Sign	Frequency	Broadcast	Form	Contents	Emission	Remarks
			H15-20	SIGMET	Oceanic - Miami FIR/ San Juan FIR		
				Aerodrome Forecasts	MXKF Bermuda KMIA Miami KATL Atlanta		
				Hourly Reports	MXKF Bermuda KMIA Miami MYNN Nassau KMCO Orlando KATL Atlanta		
			H30-35	Aerodrome Forecasts	KORD Chicago KMKE Milwaukee KMSP Minneapolis		
				Hourly Reports	KORD Chicago KMKE Milwaukee KMSP Minneapolis KDTW Detroit KBOS Boston		
			E35-40	SIGMET	Oceanic - New York FIR		
				Aerodrome Forecasts	KIND Indianapolis KSTL St. Louis KPIT Pittsburgh		
				Hourly Reports	KIND Indianapolis KSTL St. Louis KPIT Pittsburgh KACY Atlantic City		
			E40-45	Aerodrome Forecasts	KBAL Baltimore KPHL Philadelphia KIAD Washington		
				Hourly Reports	KBAL Baltimore KPHL Philadelphia KIAD Washington KJFK New York KEWR Newark		
			E45-50	SIGMET	Oceanic - Miami FIR/ San Juan FIR		
				Aerodrome Forecasts	MYNN Nassau KMCO Orlando		
				Hourly Reports	MXKF Bermuda KMIA Miami MYNN Nassau KMCO Orlando KATL Atlanta KTPA Tampa KPBI West Palm Beach		
All stations operate on A3 emission H24.							
All broadcasts are made 24 hours daily, seven days a week.							

Key to Decode an ASOS (METAR) Observation (Front)

KEY TO DECODE AN ASOS (METAR) OBSERVATION

METAR KABC 121755Z AUTO 21016G24KT 180V240 1SM R11/P6000FT -RA BR BKN015 OVC025 06/04 A2990  
 RMK AO2 PK WND 20032/25 WSHFT 1715 VIS 3/4V1 1/2 VIS 3/4 RWY11 RAB07 CIG 013V017 CIG 017 RWY11 PRESFR  
 SLP125 P0003 60009 T00640036 10066 21012 58033 TSNO \$

<b>TYPE OF REPORT</b>	METAR: hourly (scheduled) report; SPECI: special (unscheduled) report.	METAR
<b>STATION IDENTIFIER</b>	Four alphabetic characters; ICAO location identifier.	KABC
<b>DATE/TIME</b>	All dates and times in UTC using a 24-hour clock; two-digit date and four-digit time; always appended with <u>Z</u> to indicate UTC.	121755Z
<b>REPORT MODIFIER</b>	Fully automated report, no human intervention; removed when observer signed-on.	AUTO
<b>WIND DIRECTION AND SPEED</b>	Direction in tens of degrees from true north (first three digits); next two digits: speed in whole knots; as needed Gusts (character) followed by maximum observed speed; always appended with <u>KT</u> to indicate knots; 0000 <u>KT</u> for calm; if direction varies by 60° or more a <u>Variable</u> wind direction group is reported.	21016G24KT 180V240
<b>VISIBILITY</b>	Prevailing visibility in statute miles and fractions (space between whole miles and fractions); always appended with <u>SM</u> to indicate statute miles; values <1/4 reported as M1/4.	1SM
<b>RUNWAY VISUAL RANGE</b>	10-minute RVR value in hundreds of feet; reported if prevailing visibility is ≤ one mile or RVR ≤ 6000 feet; always appended with <u>FT</u> to indicate feet; value prefixed with <u>M</u> or <u>P</u> to indicate value is lower or higher than the reportable RVR value.	R11/P6000FT
<b>WEATHER PHENOMENA</b>	RA: liquid precipitation that does not freeze; SN: frozen precipitation other than hail; UP: precipitation of unknown type; intensity prefixed to precipitation: light (-), moderate (no sign), heavy (+); FG: fog; FZFG: freezing fog (temperature below 0°C); BR: mist; HZ: haze; SQ: squall; maximum of three groups reported; augmented by observer: FC (funnel cloud/tornado/waterspout); TS (thunderstorm); GR (hail); GS (small hail; <1/4 inch); FZRA (intensity; freezing rain); VA (volcanic ash).	-RA BR
<b>SKY CONDITION</b>	Cloud amount and height: CLR (no clouds detected below 12000 feet); FEW (few); SCT (scattered); BKN (broken); OVC (overcast); followed by 3-digit height in hundreds of feet; or vertical visibility ( <u>VV</u> ) followed by height for indefinite ceiling.	BKN015 OVC025
<b>TEMPERATURE/DEW POINT</b>	Each is reported in whole degrees Celsius using two digits; values are separated by a solidus; sub-zero values are prefixed with an <u>M</u> (minus).	06/04
<b>ALTIMETER</b>	Altimeter always prefixed with an <u>A</u> indicating inches of mercury; reported using four digits: tens, units, tenths, and hundredths.	A2990

FIG 3.5-19



Key to Decode an ASOS (METAR) Observation (Back)

REMARKS IDENTIFIER: RMK		RMK
<b>TORNADIC ACTIVITY:</b> Augmented; report should include TORNADO, FUNNEL CLOUD, or WATERSPOUT, time begin/end, location, movement; e.g., TORNADO B25 N MOV E.		AO2
<b>TYPE OF AUTOMATED STATION:</b> AO2; automated station with precipitation discriminator.		PK WND 20032/25 WSHFT 1715
<b>PEAK WIND:</b> PK WND dddd(f)/(hh)mm; direction in tens of degrees, speed in whole knots, and time.		
<b>WIND SHIFT:</b> WSHFT (hh)mm		
<b>TOWER OR SURFACE VISIBILITY:</b> TWR VIS vvvvv; visibility reported by tower personnel, e.g., TWR VIS 2; SFC VIS vvvvv; visibility reported by ASOS, e.g., SFC VIS 2.		VIS 3/4V1 1/2 VIS 3/4 Rwy11
<b>VARIABLE PREVAILING VISIBILITY:</b> VIS $v_n v_a v_v v_v v_v$ ; reported if prevailing visibility is < 3 miles and variable.		RAB07
<b>VISIBILITY AT SECOND LOCATION:</b> VIS vvvvv [LOC]; reported if different than the reported prevailing visibility in body of report.		CIG 013V017 CIG 017 Rwy11
<b>LIGHTNING:</b> [FREQ] LTG [LOC]; when detected the frequency and location is reported, e.g., FRQ LTG NE.		PRESFR
<b>BEGINNING AND ENDING OF PRECIPITATION AND THUNDERSTORMS:</b> w'B(hh)mmE(hh)mm		SLP125
<b>VIRGA:</b> Augmented; precipitation not reaching the ground, e.g., VIRGA.		P0003
<b>VARIABLE CEILING HEIGHT:</b> CIG $h_n h_a h_n V h_n h_n$ ; reported if ceiling in body of report is < 3000 feet and variable.		60009
<b>CEILING HEIGHT AT SECOND LOCATION:</b> CIG hht [LOC]; Ceiling height reported if secondary ceilmeter site is different than the ceiling height in the body of the report.		T00640036
<b>PRESSURE RISING OR FALLING RAPIDLY:</b> PRESRR or PRESFR; pressure rising or falling rapidly at time of observation.		10066
<b>SEA-LEVEL PRESSURE:</b> SLPppp; tens, units, and tenths of SLP in hPa.		21012
<b>HOURLY PRECIPITATION AMOUNT:</b> Prrr; in .01 inches since last METAR; a trace is P0000.		58033
<b>3- AND 6-HOUR PRECIPITATION AMOUNT:</b> 6RRRR; precipitation amount in .01 inches for past 6 hours reported in 00, 06, 12, and 18 UTC observations and for past 3 hours in 03, 09, 15, and 21 UTC observations; a trace is 60000.		TSNO
<b>24-HOUR PRECIPITATION AMOUNT:</b> 7R <sub>3</sub> R <sub>6</sub> R <sub>12</sub> R <sub>24</sub> ; precipitation amount in .01 inches for past 24 hours reported in 12 UTC observation, e.g., 70015.		\$
<b>HOURLY TEMPERATURE AND DEW POINT:</b> Ts <sub>n</sub> T <sub>1</sub> T <sub>1</sub> T <sub>1</sub> T <sub>1</sub> T <sub>1</sub> T <sub>1</sub> ; tenths of degree Celsius; s <sub>n</sub> : 1 if temperature below 0°C and 0 if temperature 0°C or higher.		
<b>6-HOUR MAXIMUM TEMPERATURE:</b> 1s <sub>n</sub> T <sub>1</sub> T <sub>1</sub> ; tenths of degree Celsius; 00, 06, 12, 18 UTC; s <sub>n</sub> : 1 if temperature below 0°C and 0 if temperature 0°C or higher.		
<b>6-HOUR MINIMUM TEMPERATURE:</b> 2s <sub>n</sub> T <sub>1</sub> T <sub>1</sub> ; tenths of degree Celsius; 00, 06, 12, 18 UTC; s <sub>n</sub> : 1 if temperature below 0°C and 0 if temperature 0°C or higher.		
<b>24-HOUR MAXIMUM AND MINIMUM TEMPERATURE:</b> 4s <sub>n</sub> T <sub>1</sub> T <sub>1</sub> T <sub>1</sub> T <sub>1</sub> T <sub>1</sub> T <sub>1</sub> ; tenths of degree Celsius; reported at midnight local standard time; 1 if temperature below 0°C and 0 if temperature 0°C or higher, e.g., 400461006.		
<b>PRESSURE TENDENCY:</b> 5app; the character (a) and change in pressure (ppp); tenths of hPa) the past 3 hours.		
<b>SENSOR STATUS INDICATORS:</b> RVRNO: RVR missing; PWINO: precipitation identifier information not available; PNO: precipitation amount not available; FZRANO: freezing rain information not available; TSNO: thunderstorm information not available; VISNO [LOC]: visibility at secondary location not available, e.g., VISNO Rwy06; CHINO [LOC]: (cloud-height-indicator) sky condition at secondary location not available, e.g., CHINO Rwy06.		
<b>MAINTENANCE CHECK INDICATOR:</b> Maintenance needed on the system.		

METAR/AZ328-96

U.S. DEPARTMENT OF COMMERCE - NATIONAL OCEANIC AND ATMOSPHERIC ADMINISTRATION - National Weather Service - Observing Systems Branch, 1325 East-West Highway, Silver Spring, Maryland 20910

If an element or phenomena does not occur, is missing, or cannot be observed, the corresponding group and space are omitted (body and/or remarks) from that particular report, except for Sea-Level Pressure (SLPppp). SLPNO shall be reported in a METAR when the SLP is not available.

FIG 3.5-20

NEXRAD Coverage

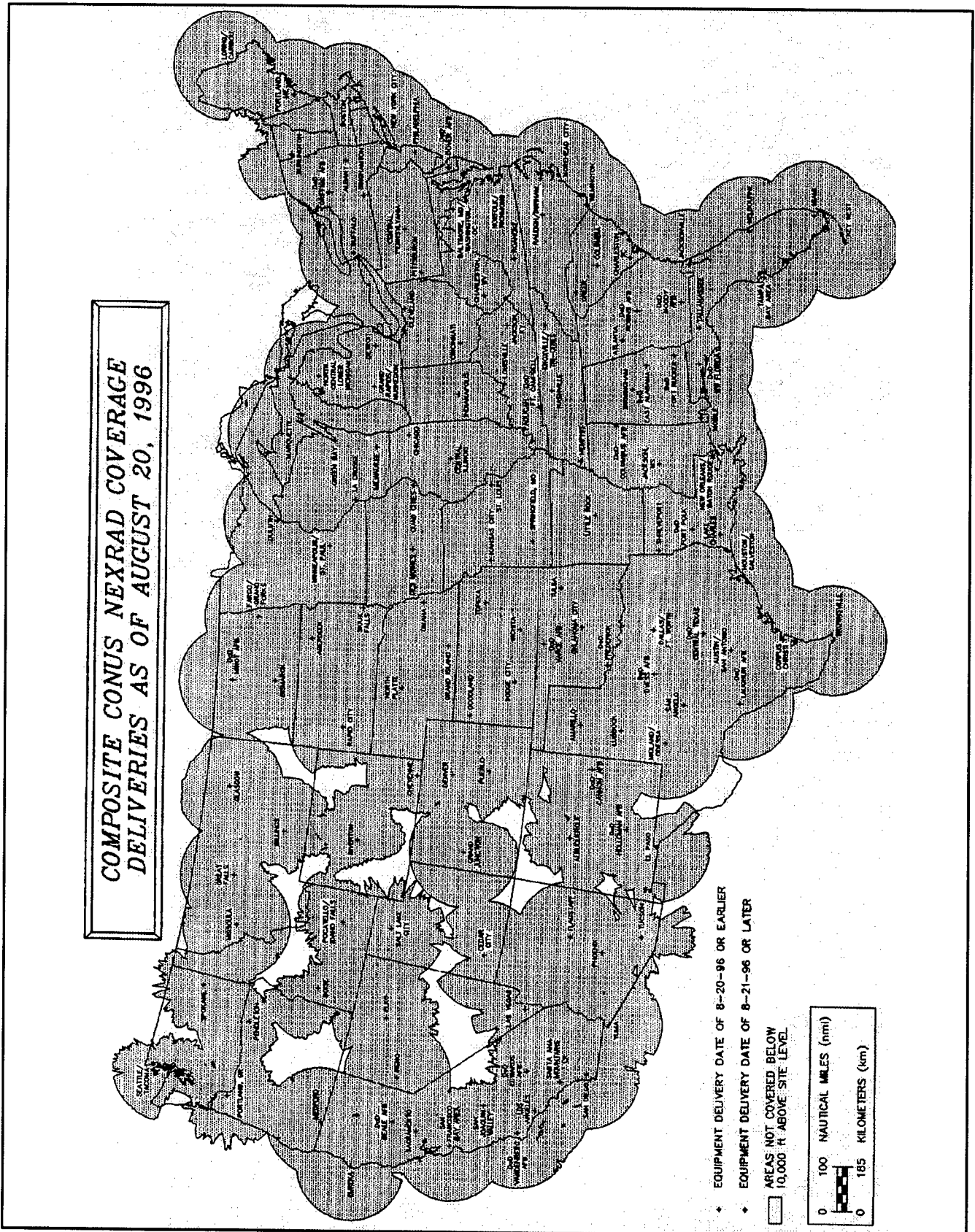

FIG 3.5-21

### NEXRAD Coverage

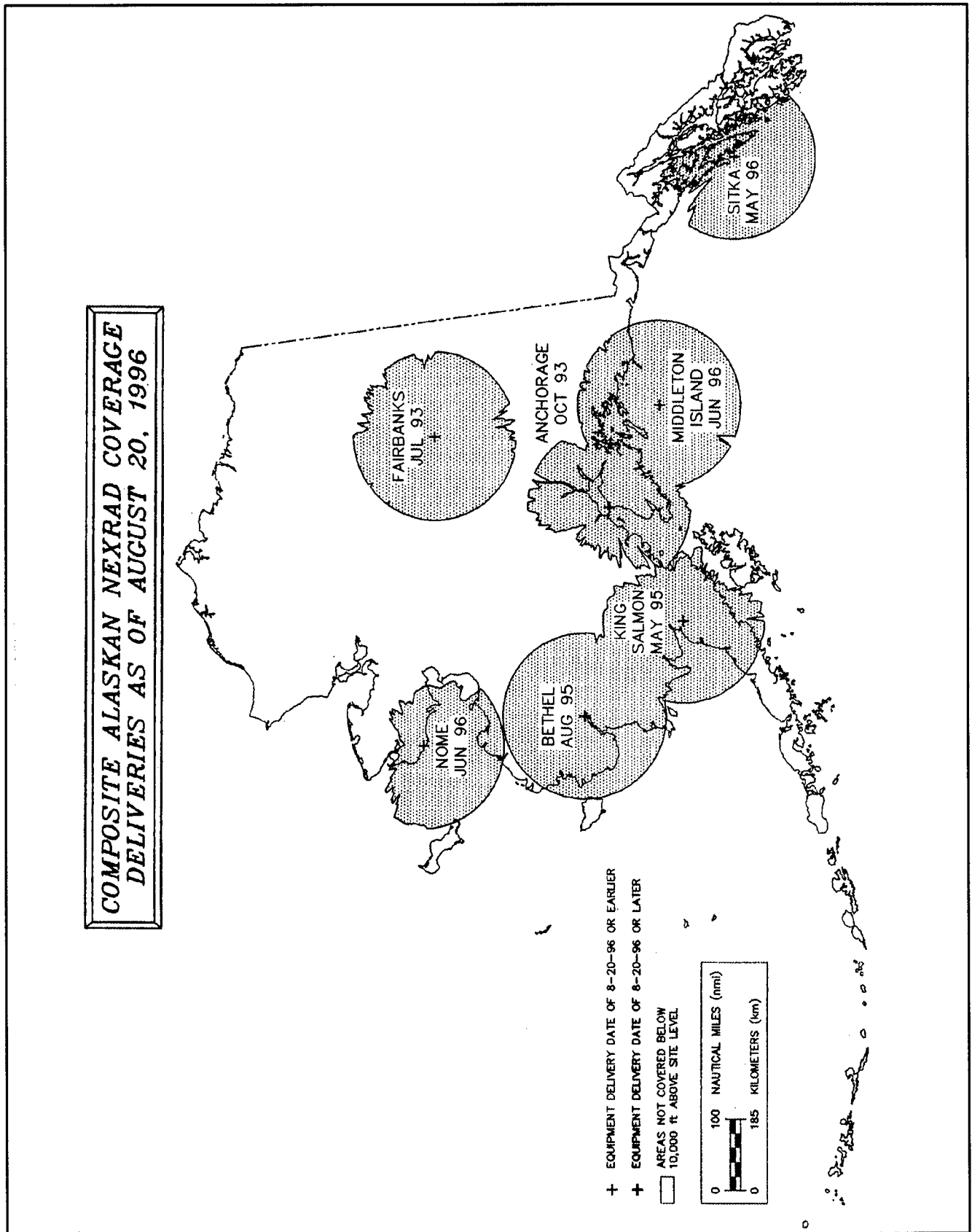

FIG 3.5-22

NEXRAD Coverage

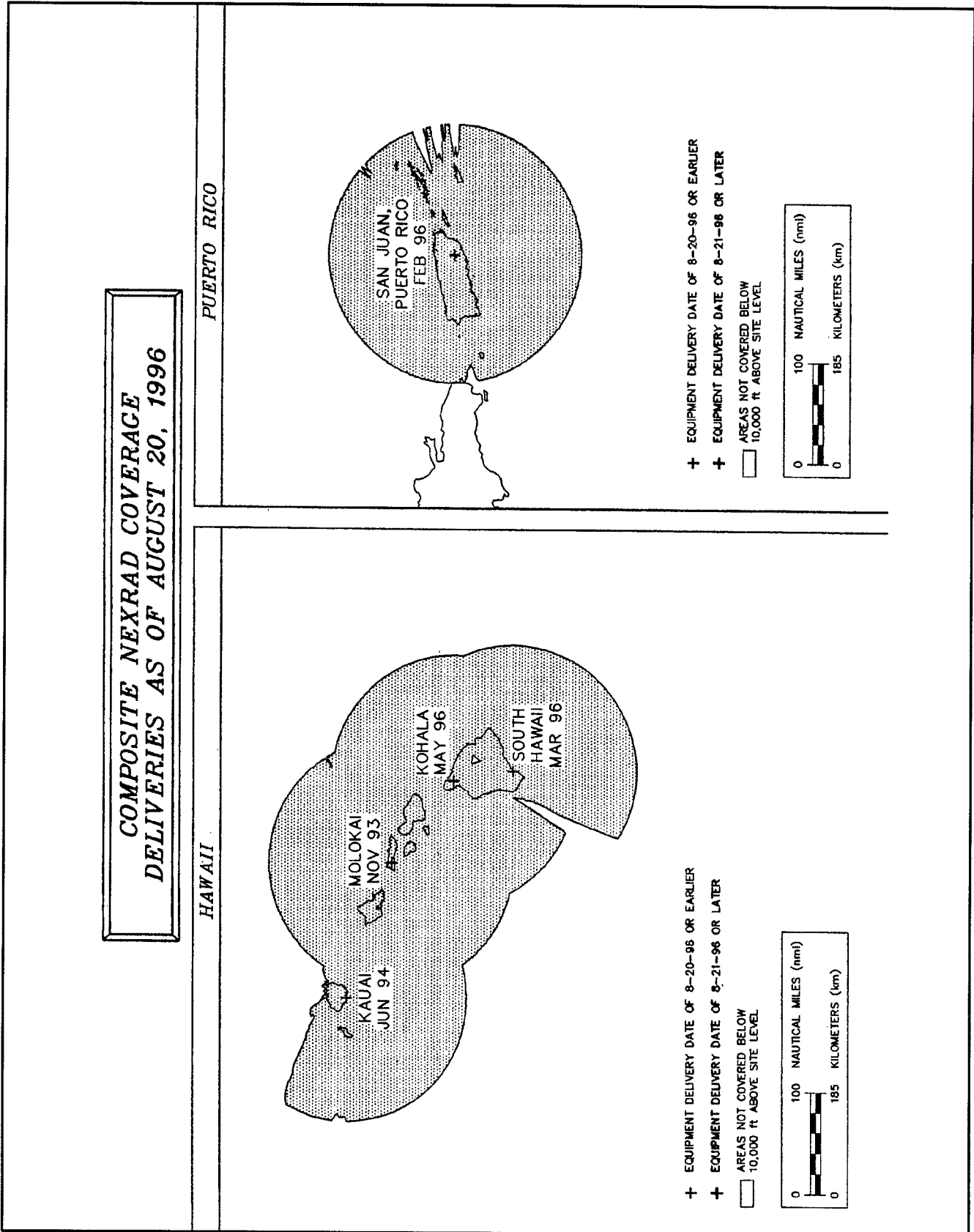

FIG 3.5-23

## Volcanic Activity Reporting Form (VAR)

Date \_\_\_\_\_

SECTION 1 - Transmit to ATC via radio	1. Aircraft Identification			
	2. Position			
	3. Time (UTC)			
	4. Flight level or altitude			
	5. Position/location of volcanic activity or ash cloud			
	6. Air temperature			
	7. Wind			
	8. Supplementary Information  (Brief description of activity including vertical and lateral extent of the ash cloud, horizontal movement, rate of growth, etc., as available.)			
<b>Mark the appropriate box(s)</b>				
SECTION 2 - Complete and forward as directed	9. <i>Density of ash cloud</i>	<input type="checkbox"/> wispy	<input type="checkbox"/> moderately dense	<input type="checkbox"/> very dense
	10. <i>Color of ash</i>	<input type="checkbox"/> white <input type="checkbox"/> black	<input type="checkbox"/> light gray	<input type="checkbox"/> dark gray
	11. <i>Eruption</i>	<input type="checkbox"/> continuous	<input type="checkbox"/> intermittent	<input type="checkbox"/> not visible
	12. <i>Position of activity</i>	<input type="checkbox"/> summit <input type="checkbox"/> multiple	<input type="checkbox"/> side <input type="checkbox"/> not observed	<input type="checkbox"/> single
	13. <i>Other observed features of eruption</i>	<input type="checkbox"/> lightning <input type="checkbox"/> ash fallout	<input type="checkbox"/> glow <input type="checkbox"/> mushroom cloud	<input type="checkbox"/> large rocks <input type="checkbox"/> none
	14. <i>Effect on aircraft</i>	<input type="checkbox"/> communications <input type="checkbox"/> pitot static <input type="checkbox"/> none	<input type="checkbox"/> navigation system <input type="checkbox"/> windscreen	<input type="checkbox"/> engines <input type="checkbox"/> other windows
	15. <i>Other effects</i>	<input type="checkbox"/> turbulence <input type="checkbox"/> ash deposits	<input type="checkbox"/> St. Elmo's fire	<input type="checkbox"/> fumes
16. <i>Other information deemed useful</i>				

**Forward completed form via mail to:**  
Global Volcanism Program  
NHB-119  
Smithsonian Institution  
Washington, DC 20560

**Or Fax to:**  
Global Volcanism Program  
(202) 357-2476

FIG 3.5-24



## GEN 3.6 Search and Rescue

### 1 Responsible Authority

**1.1** The Search and Rescue (SAR) service in the United States and its area of jurisdiction is organized in accordance with the Standards and Recommended Practices of ICAO Annex 12 by the Federal Aviation Administration with the collaboration of the United States Coast Guard and the United States Air Force. The Coast Guard and the Air Force are the responsible SAR authorities and have the responsibility for making the necessary facilities available. Postal and telegraphic addresses for the Federal Aviation Administration are given on page GEN 3.1-1. The appropriate addresses for Coast Guard and Air Force offices are:

<b>(A) Air Force</b>
<i>Postal Address:</i> Inland SAR Coordinator Commander ARRS USAF RCC Langley AFB, VA.
<i>Telegraphic Address:</i> None.
<i>Telex:</i> None.
<i>Telephone:</i> 1-800-851-3051, Commercial: 804-764-8112, Base Operator: 804-764-1110, (ask for extension 48112) or Defense Switching Network: 574-8112.

<b>(B) Coast Guard</b>
<i>Postal Address:</i> United States Coast Guard Search and Rescue Division (GOSR/73) 400 7th Street, S.W. Washington, D.C. 20590
<i>Telegraphic Address:</i> None.
<i>Telex:</i> 89 2427

### 2. Types of Service

**2.1** Details of the Rescue Coordination Centers (RCC's) and related rescue units are given in this section. In addition, various elements of state and local police organizations are available for search and rescue missions when required. The aeronautical, maritime and public telecommunication services are available to the search and rescue organizations.

**2.2** Aircraft, both land and amphibious based, are used, as well as land and seagoing vessels, when required, and

carry survival equipment. Airborne survival equipment, capable of being dropped, consists of inflatable rubber dinghies equipped with medical supplies, emergency rations and survival radio equipment. Aircraft and marine craft are equipped to communicate on 121.5, 123.1, 243.0, 500 kHz, 2182 kHz, and 8364 kHz. Ground rescue teams are equipped to communicate on 121.5 MHz, 500 kHz, and 8364 kHz. SAR aircraft and marine craft are equipped with direction finding equipment and radar.

### 3. SAR Agreements

**3.1** Bilateral agreements exist between the U.S. and the following neighboring States of the NAM region: Canada and Mexico.

**3.1.1** There are two agreements with Canada. One provides for public aircraft of either country which are engaged in air search and rescue operations to enter or leave either country without being subjected to immigration or customs formalities normally required. The other permits vessels and wrecking appliances of either country to render aid and assistance on specified border waters and on the shores and in the waters of the other country along the Atlantic and Pacific Coasts within a distance of 30 miles from the international boundary on those coasts. A post operations report is required.

**3.1.2** The agreement with Mexico applies to territorial waters and shores of each country within 200 miles of the border on the Gulf Coast and within 270 miles of the border on the Pacific Coast. It permits the vessels and aircraft of either country to proceed to the assistance of a distressed vessel or aircraft of their own registry upon notification of entry and of departure of the applicable waters and shores.

**3.2** In situations not falling under the above agreements, requests from States to participate in a SAR operation within the United States for aircraft of their own registry may be addressed to the nearest RCC. The RCC would reply, and issue appropriate instructions.

### 4. General Conditions of Availability

**4.1** The SAR service and facilities in the U.S. are available to the neighboring States within the NAM, NAT, CAR, PAC Regions upon request to the appropriate RCC at all times when they are not engaged in search and rescue activity in their home territory. All facilities are specialized in SAR techniques and functions.

## 5. Applicable ICAO Documents

Annex 12	Search and Rescue
Annex 13	Aircraft Accident Inquiry
Doc 7030	Regional Supplementary Procedures for Alerting and Search and Rescue Services applicable to the NAM, NAT, CAR, PAC Regions.

## 6. Differences From ICAO Standards, Recommended Practices and Procedures

Differences from ICAO Standards, Recommended Practices and Procedures are listed in GEN 1.7.

## 7. Emergency Locator Transmitters

### 7.1. General

**7.1.1** Emergency Locator Transmitters (ELT's) are required for most general aviation airplanes (reference: 14 CFR Part 91.207). ELT's of various types have been developed as a means of locating downed aircraft. These electronic, battery operated transmitters emit a distinctive downward swept audio tone on 121.5 MHz and/or 243.0 MHz. If "armed" and when subject to crash generated forces, they are designed to automatically activate and continuously emit these signals. The transmitters will operate continuously for at least 48 hours over a wide temperature range. A properly installed and maintained ELT can expedite search and rescue operations and save lives. Approved ELT's include both 121.5 MHz and 406 MHz models.

### 7.2 ELT Testing

**7.2.1** ELT's should be tested in accordance with the manufacturer's instructions, preferably in a shielded or screened room to prevent the broadcast of signals which could trigger a false alert. When this cannot be done, aircraft operational testing is authorized on 121.5 MHz and 243.0 MHz as follows:

- a) Tests should be conducted only during the first 5 minutes after any hour. If operational tests must be made outside of this time-frame, they should be coordinated with the nearest FAA control tower (ATCT) or flight service station (FSS).
- b) Tests should be no longer than 3 audible sweeps.
- c) If the antenna is removable, a dummy load should be substituted during test procedures.
- d) Airborne tests are not authorized.

## 7.3 False Alarms

**7.3.1** Caution should be exercised to prevent the inadvertent activation of ELT's in the air or while they are being handled on the ground. Accidental or unauthorized activation will generate an emergency signal that cannot be distinguished from the real thing, leading to expensive and frustrating searches. A false ELT signal could also interfere with genuine emergency transmissions and hinder or prevent the timely location of crash sites. Frequent false alarms could also result in complacency and decrease the vigorous reaction that must be attached to all ELT signals. Numerous cases of inadvertent activation have occurred as a result of aerobatics, hard landings, movement by ground crews and aircraft and aircraft maintenances. These false alarms can be minimized by monitoring 121.5 MHz and/or 243.0 MHz as follows:

- a) Inflight when a receiver is available.
- b) Prior to engine shut-down at the end of each flight.
- c) When the ELT is handled during installation or maintenance.
- d) When maintenance is being performed in the vicinity of the ELT.
- e) When the aircraft is moved by a ground crew.
- f) If an ELT signal is heard, turn off the ELT to determine if it is transmitting. If it has been activated, maintenance might be required before the unit is returned to the "ARMED" position.

### 7.4 ELT Reporting Procedures

**7.4.1** Pilots are encouraged to monitor 121.5 MHz and/or 243.0 MHz while in flight to assist in identifying possible emergency ELT transmissions. On receiving a signal from an ELT report the following information to the nearest FAA facility:

- a) Your position at time the signal was first heard.
- b) Your position at time the signal was last heard.
- c) Your position at maximum signal strength.
- d) Flight altitude and frequency on which the emergency signal was heard. (121.5/243.0)

**NOTE.—**  
IF POSSIBLE, POSITIONS SHOULD BE GIVEN RELATIVE TO A NAVIGATION AID. IF THE AIRCRAFT HAS HOMING EQUIPMENT, PROVIDE THE BEARING TO THE EMERGENCY SIGNAL WITH EACH REPORTED POSITION.



## 8. National Search and Rescue Plan

**8.1** By federal interagency agreement, the National Search and Rescue Plan provides for the effective use of all available facilities in all types of SAR missions. These facilities include aircraft, vessels, pararescue and ground rescue teams, and emergency radio fixing. Under the Plan, the U.S. Coast Guard is responsible for the coordination of SAR in the Maritime Region, and the U.S. Air Force is responsible in the Inland Region. To carry out these responsibilities, the Coast Guard and the Air Force have established RCC's to direct SAR activities within their regions. For aircraft emergencies, distress and urgency information normally will be passed to the appropriate RCC through an air route traffic control center (ARTCC) or flight service station (FSS).

### 8.2 Coast Guard Rescue Coordination Centers

Coast Guard Rescue Coordination Centers	
Boston, MA 617-223-8555	Long Beach, CA 213-590-2225 310-499-5380
New York, NY 212-668-7055	San Francisco, CA 415-437-3700
Portsmouth, VA 804-398-6231	Seattle, WA 206-553-5886
Miami, FL 305-536-5611	Juneau, AK 907-463-2000
New Orleans, LA 504-589-6225	Honolulu, HI 808-541-2500
Cleveland, OH 216-522-3984	San Juan, Puerto Rico 809-729-6770
St. Louis, MO 314-262-3706	

TBL 3.6-1

**8.3** Coast Guard Rescue Coordination Centers are served by major radio stations which guard 2182 kHz (VOICE). In addition, Coast Guard units along the sea-coasts of the United States and shores of the Great Lakes guard 2182 kHz. The call "COAST GUARD" will alert all Coast Guard Radio Stations within range. 2182 kHz is also guarded by most commercial coast stations and some ships and boats.

### 8.4 Air Force Rescue Coordination Centers

Air Force Rescue Coordination Center	
<i>Langley AFB, Virginia</i>	<i>Phone</i>
Commercial	804-764-8112
WATS	800-851-3051
DSN	574-8112

TBL 3.6-2

### Air Command Rescue Coordination Center Alaska

Alaskan Air Command Rescue Coordination Center	
<i>Fort Richardson, 11th RCC, Alaska</i>	<i>Phone</i>
Commercial	907-428-7230 or 800-420-7230
DSN	317-384-6726

TBL 3.6-3

### 8.5 Joint Rescue Coordination Center Hawaii

Honolulu Joint Rescue Coordination Center	
<i>HQ 14th CG District Honolulu</i>	<i>Phone</i>
Commercial	808-541-2500
DSN	448-0301

TBL 3.6-4

## 9. Procedures and Signals for Aircraft in Emergency

### 9.1 Search and Rescue

**9.1.1** Search and Rescue is a life-saving service provided through the combined efforts of the federal agencies signatory to the National SAR Plan, and the agencies responsible for SAR within each State. Operational resources are provided by the U.S. Coast Guard, Department of Defense components, the Civil Air Patrol, the Coast Guard Auxiliary, state, county and local law enforcement and other public safety agencies, and private volunteer organizations. Services include search for missing aircraft, survival aid, rescue, and emergency medical help for the occupants after an accident site is located.

### 9.2 Emergency and Overdue Aircraft

**9.2.1** ARTCC's and FSS's will alert the SAR system when information is received from any source that an aircraft is in difficulty, overdue, or missing.

**9.2.2** Radar facilities providing radar flight following or advisories consider the loss of radar and radios, without service termination notice, to be a possible emergency. Pilots receiving VFR services from radar facilities should be aware that SAR may be initiated under these circumstances.

**9.2.3** A filed flight plan in the most timely and effective indicator that an aircraft is overdue. Flight plan information is invaluable to SAR forces for search planning and executing search efforts. Prior to departure on every flight, local or otherwise, someone at the departure point should be advised of your destination

and the route of flight if other than direct. Search efforts are often wasted and rescue is often delayed because of pilots who thoughtlessly take off without telling anyone where they are going. File a flight plan for your safety.

**9.2.4** According to the National Search and Rescue Plan, "The life expectancy of an injured survivor decreases as much as 80 percent during the first 24 hours, while the chances of survival of uninjured survivors rapidly diminishes after the first 3 days."

**9.2.5** An Air Force Review of 325 SAR missions conducted during a 23-month period revealed that "Time works against people who experience a distress but are not on a flight plan, since 36 hours normally pass before family concern initiates an (alert)."

### **9.3 VFR Search and Rescue Protection**

**9.3.1** To receive this valuable protection, file a VFR or DVFR Flight Plan with an FAA FSS. For maximum protection, file only to the point of first intended landing, and refile for each leg to final destination. When a lengthy flight plan is filed, with several stops en route and an ETE to final destination, a mishap could occur on any leg, and unless other information is received, it is probable that no one would start looking for you until 30 minutes after your ETA at your final destination.

**9.3.2** If you land at a location other than the intended destination, report the landing to the nearest FAA FSS and advise them of your original destination.

**9.3.3** If you land en route and are delayed more than 30 minutes, report this information to the nearest FSS and give them your original destination.

**9.3.4** If your ETE changes by 30 minutes or more, report a new ETA to the nearest FSS and give them your original destination. Remember that if you fail to respond within one-half hour after your ETA at final destination, a search will be started to locate you.

**9.3.5** It is important that you **CLOSE YOUR FLIGHT PLAN IMMEDIATELY AFTER ARRIVAL AT YOUR FINAL DESTINATION WITH THE FSS DESIGNATED WHEN YOUR FLIGHT PLAN WAS FILED.** The pilot is responsible for closure of a VFR or DVFR flight plan; they are not closed automatically. This will prevent needless search efforts.

**9.3.6** The rapidity of rescue on land or water will depend on how accurately your position may be determined. If a flight plan has been followed and your position is on course, rescue will be expedited.

### **9.4 Survival Equipment**

**9.4.1** For flight over uninhabited land areas, it is wise to take suitable survival equipment depending on type of climate and terrain.

**9.4.2** If forced landing occurs at sea, chances for survival are governed by degree of crew proficiency in emergency procedures and by effectiveness of water survival equipment.

### **9.5 Body Signal Illustrations:**

**9.5.1** If you are forced down and are able to attract the attention of the pilot of a rescue airplane, the body signals illustrated on the pages following can be used to transmit messages to the pilot circling over your location.

**9.5.2** Stand in the open when you make the signals.

**9.5.3** Be sure the background, as seen from the air, is not confusing.

**9.5.4** Go through the motions slowly and repeat each signal until you are positive that the pilot understands you.

### **9.6 Observance of a Downed Aircraft**

**9.6.1** Determine if the crash is marked with yellow cross; if so, the crash has already been reported and identified.

**9.6.2** Determine, if possible, the type and number of the aircraft and whether there is evidence of survivors.

**9.6.3** Fix, as accurately as possible, the exact location of the crash.

**9.6.4** If circumstances permit, orbit the scene to guide in other assisting units or until relieved by another aircraft.

**9.6.5** Transmit information to the nearest FAA or other appropriate radio facility.

**9.6.6** Immediately after landing, make a complete report to nearest FAA, Air Force, or Coast Guard installation. The report may be made by long distance collect telephone.

**Ground-Air Visual Code for Use by Survivors**

NO.	MESSAGE	CODE SYMBOL
1	Require assistance	V
2	Require medical assistance	X
3	No or Negative	N
4	Yes or Affirmative	Y
5	Proceeding in this direction	↑

**IF IN DOUBT, USE INTERNATIONAL SYMBOL    S O S**

**INSTRUCTIONS**

1. Lay out symbols by using strips of fabric or parachutes, pieces of wood, stones, or any available material.
2. Provide as much color contrast as possible between material used for symbols and background against which symbols are exposed.
3. Symbols should be at least 10 feet high or larger. Care should be taken to lay out symbols exactly as shown.
4. In addition to using symbols, every effort is to be made to attract attention by means of radio, flares, smoke, or other available means.
5. On snow covered ground, signals can be made by dragging, shoveling or tramping. Depressed areas forming symbols will appear black from the air.
6. Pilot should acknowledge message by rocking wings from side to side.

FIG 3.6-1

**Ground-Air Visual Code for use by Ground Search Parties**

NO.	MESSAGE	CODE SYMBOL
1	Operation completed.	LLL
2	We have found all personnel.	LL
3	We have found only some personnel.	+
4	We are not able to continue. Returning to base.	XX
5	Have divided into two groups. Each proceeding in direction indicated.	↔
6	Information received that aircraft is in this direction.	→ →
7	Nothing found. Will continue search.	NN

Note: These visual signals have been accepted for international use and appear in Annex 12 to the Convention on International Civil Aviation.

FIG 3.6-2

**Urgent Medical Assistance**

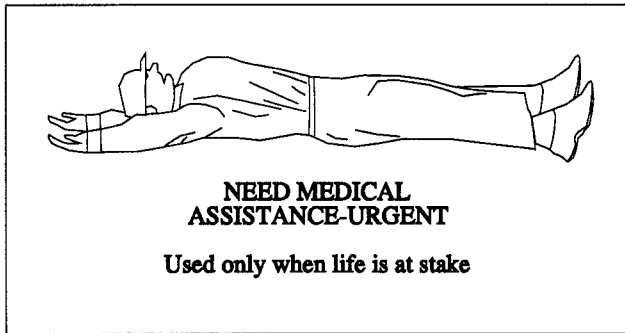

FIG 3.6-3

**Short Delay**

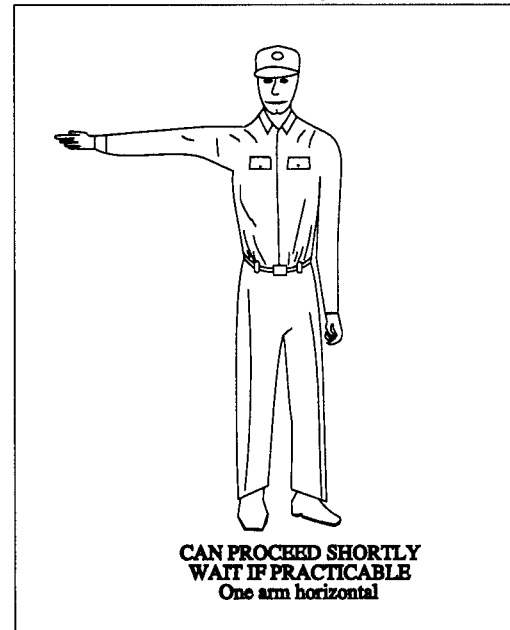

FIG 3.6-5

**All OK**

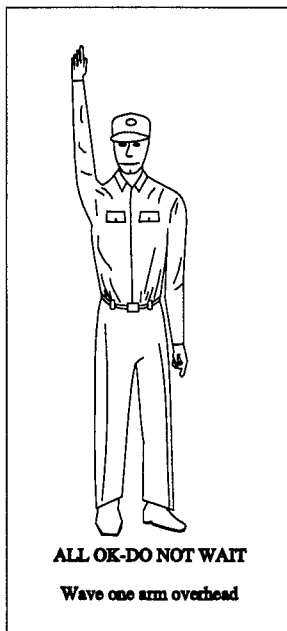

FIG 3.6-4

**Long Delay**

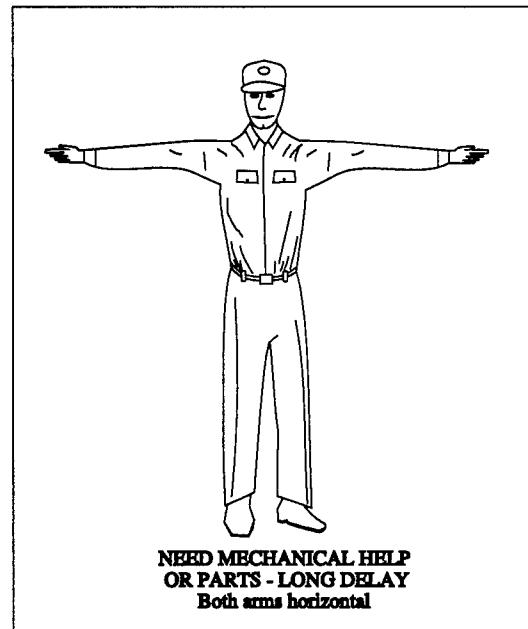

FIG 3.6-6

**Drop Message**

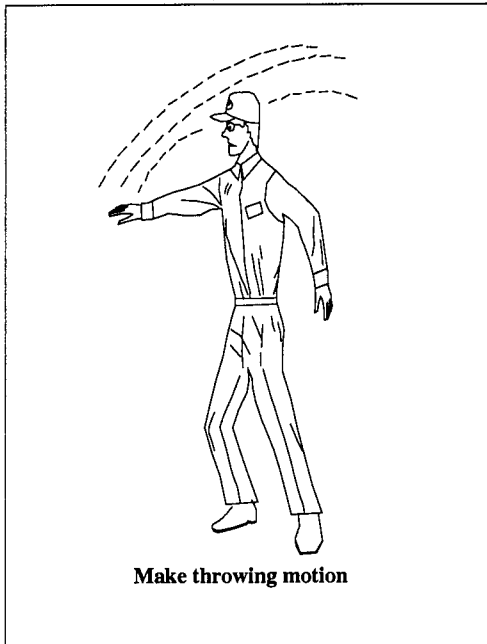

FIG 3.6-7

**Do Not Land Here**

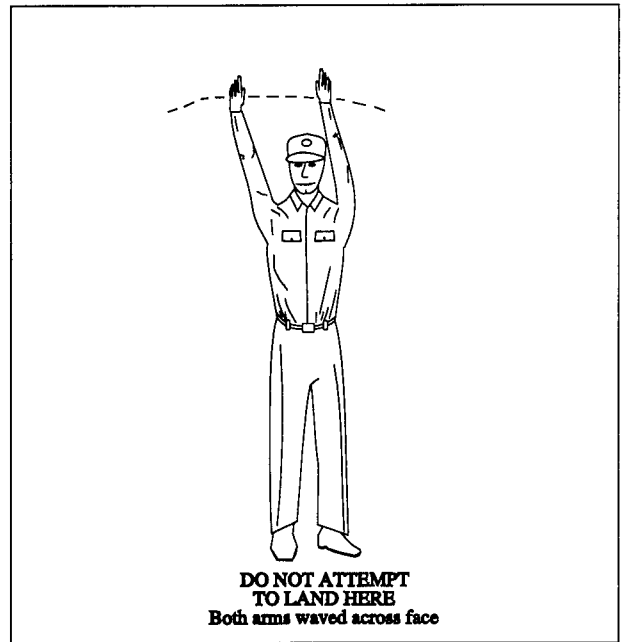

FIG 3.6-9

**Receiver Operates**

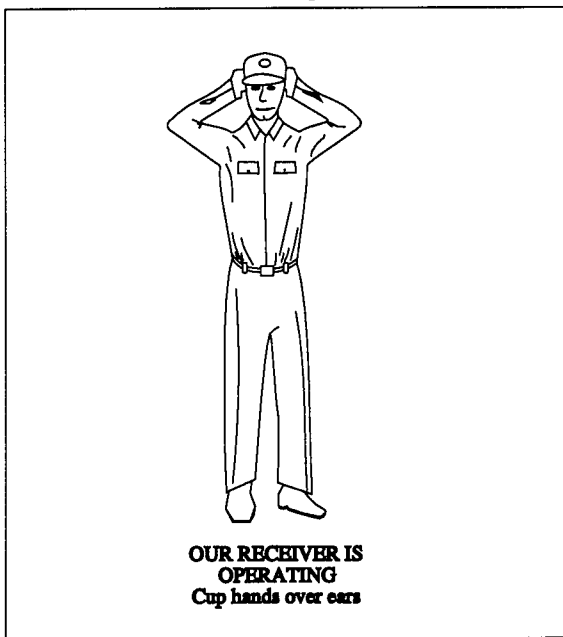

FIG 3.6-8

**Land Here**

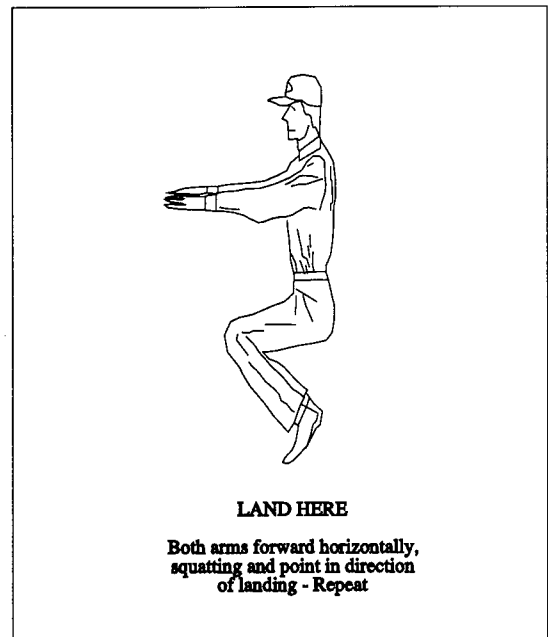

FIG 3.6-10

**Negative (Ground)**

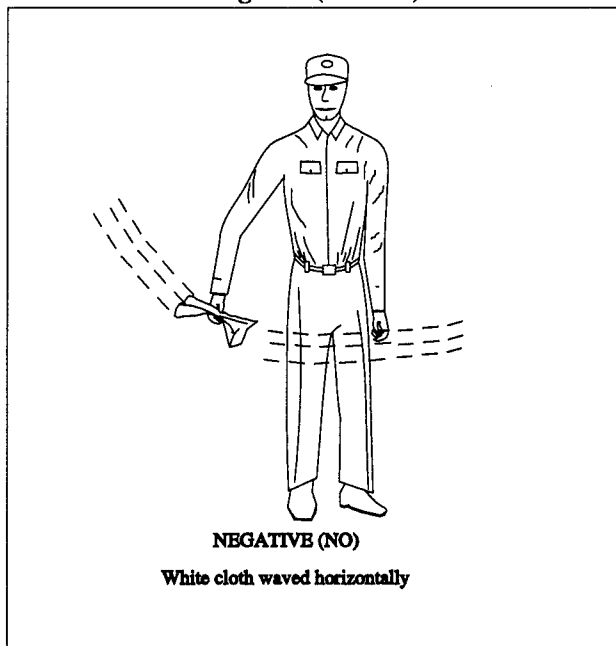

FIG 3.6-11

**Pick Us Up**

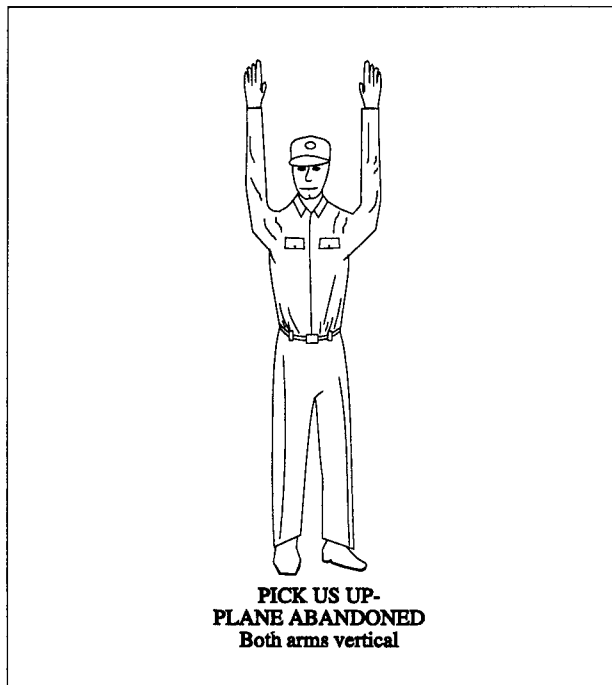

FIG 3.6-13

**Affirmative (Ground)**

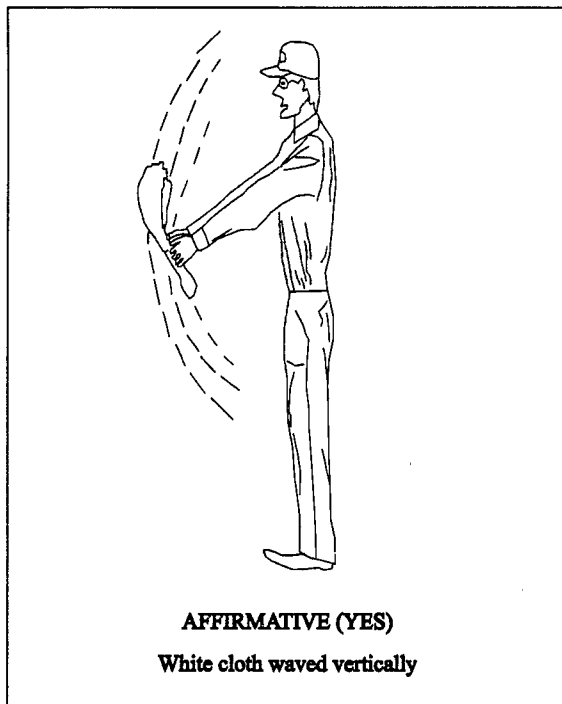

FIG 3.6-12

**Affirmative (Aircraft)**

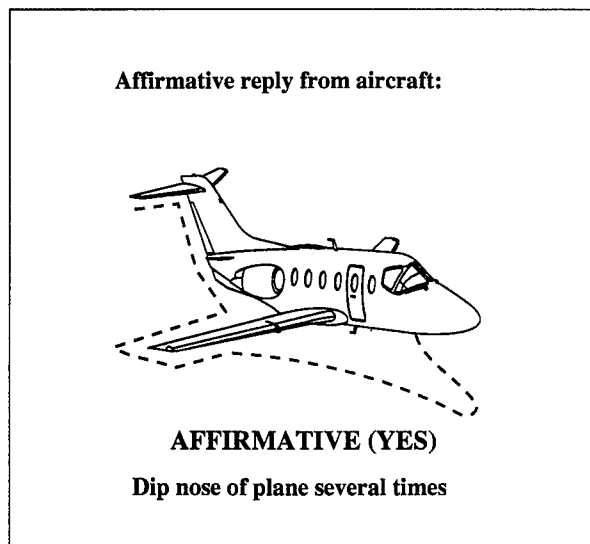

FIG 3.6-14

**Negative (Aircraft)**

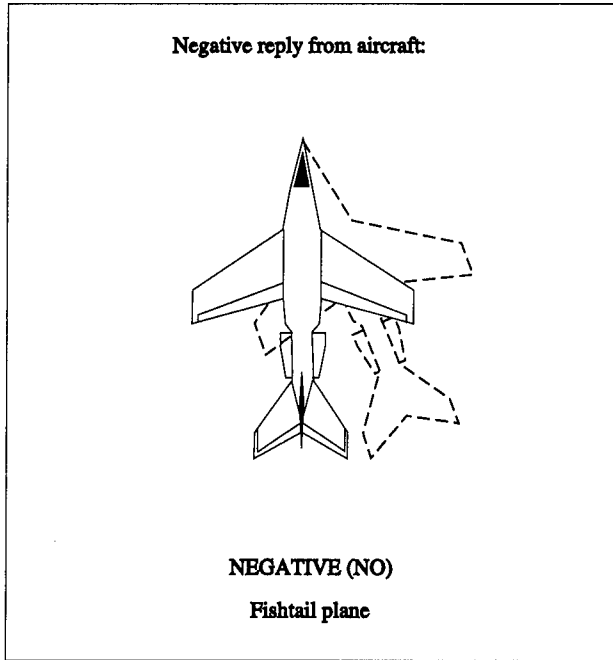
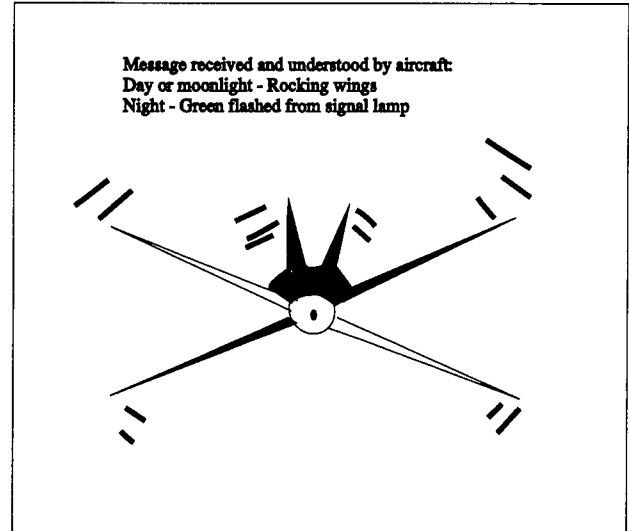
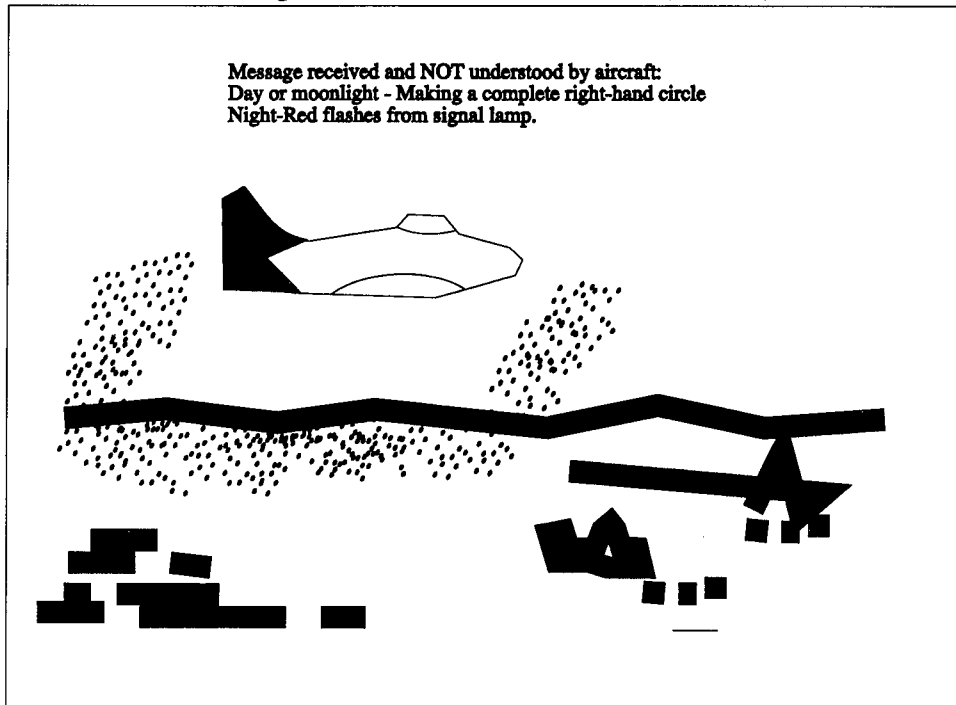

FIG 3.6-15

**Message received and understood (Aircraft)**



**Message received and NOT understood (Aircraft)**



## 10. Pilot Responsibility and Authority

**10.1** The pilot in command of an aircraft is directly responsible for, and is the final authority as to the operation of that aircraft. In an emergency requiring immediate action, the pilot in command may deviate from any rule in Title 14 of the Code of Federal Regulations (CFR), part 91, subpart A, General, and subpart B, Flight Rules, to the extent required to meet that emergency (14 CFR Section 91.3(b)).

**10.2** If the emergency authority of 14 CFR Section 91.3(b) is used to deviate from the provisions of an air traffic control clearance, the pilot in command must notify ATC as soon as possible and obtain an amended clearance (14 CFR Section 91.123(c)).

**10.3** Unless deviation is necessary under the emergency authority of 14 CFR Section 91.3, pilots of IFR flights experiencing two-way radio communications failure are expected to adhere to the procedures prescribed under "IFR operations; two-way radio communications failure." (14 CFR Section 91.185)

## 11. Distress and Urgency Communications

**11.1** A pilot who encounters a distress or urgency condition can obtain assistance simply by contacting the air traffic facility or other agency in whose area of responsibility the aircraft is operating, stating the nature of the difficulty, pilot's intentions and assistance desired. Distress and urgency communications procedures prescribed by the International Civil Aviation Organization (ICAO), however, have decided advantages over the informal procedure described above.

**11.2** Distress and urgency communications procedures discussed in the following paragraphs relate to the use of air-ground voice communications.

**11.3** The initial communication, and if considered necessary, any subsequent transmissions by an aircraft in distress should begin with the signal MAYDAY, preferably repeated three times. The signal PAN-PAN should be used in the same manner for an urgency condition.

**11.4** Distress communications have absolute priority over all other communications, and the word MAYDAY commands radio silence on the frequency in use. Urgency communications have priority over all other communications except distress, and the word PAN-PAN warns other stations not to interfere with urgency transmissions.

**11.5** Normally, the station addressed will be the air traffic facility or other agency providing air traffic services

on the frequency in use at the time. If the pilot is not communicating and receiving services, the station to be called will normally be the air traffic facility or other agency in whose area of responsibility the aircraft is operating on the appropriate assigned frequency. If the station addressed does not respond, or if time or the situation dictates, the distress or urgency message may be broadcast, or a collect call may be used, addressing "Any Station (Tower) (Radio) (Radar)."

**11.6** The station addressed should immediately acknowledge a distress or urgency message, provide assistance, coordinate and direct the activities of assisting facilities, and alert the appropriate search and rescue coordinator if warranted. Responsibility will be transferred to another station only if better handling will result.

**11.7** All other stations, aircraft and ground, will continue to listen until it is evident that assistance is being provided. If any station becomes aware that the station being called either has not received a distress or urgency message, or cannot communicate with the aircraft in difficulty, it will attempt to contact the aircraft and provide assistance.

**11.8** Although the frequency in use or other frequencies assigned by ATC are preferable, the following emergency frequencies can be used for distress or urgency communications, if necessary or desirable:

a) 121.5 MHz and 243.0 MHz - Both have a range generally limited to line of sight. 121.5 MHz is guarded by direction finding stations and some military and civil aircraft. 243.0 MHz is guarded by military aircraft. Both 121.5 MHz and 243.0 MHz are guarded by military towers, most civil towers, flight service stations, and radar facilities. Normally ARTCC emergency frequency capability does not extend to radar coverage limits. If an ARTCC does not respond when called on 121.5 MHz or 243.0 MHz, call the nearest tower or flight service station.

b) 2182 kHz - The range is generally less than 300 miles for the average aircraft installation. It can be used to request assistance from stations in the maritime service. 2182 kHz is guarded by major radio stations serving Coast Guard Rescue Coordination Centers, and Coast Guard units along the sea coasts of the U.S. and shores of the Great Lakes. The call "Coast Guard" will alert all Coast Guard Radio Stations within range. 2182 kHz is also guarded by most commercial coast stations and some ships and boats.



## 12. Emergency Condition - Request Assistance Immediately

**12.1** Pilots do not hesitate to declare an emergency when they are faced with distress conditions such as fire, mechanical failure, or structural damage. However, some are reluctant to report an urgency condition when they encounter situations which may not be immediately perilous, but are potentially catastrophic. An aircraft is in at least an urgency condition the moment the pilot becomes doubtful about position, fuel endurance, weather, or any other condition that could adversely affect flight safety. This is the time to ask for help, not after the situation has developed into a distress condition.

**12.2** Pilots who become apprehensive for their safety for any reason should request assistance immediately. Ready and willing help is available in the form of radio, radar, direction finding stations and other aircraft. Delay has caused accidents and cost lives. Safety is not a luxury. Take action.

## 13. Obtaining Emergency Assistance

**13.1** A pilot in any distress or urgency condition should immediately take the following action, not necessarily in the order listed, to obtain assistance:

a) Climb, if possible, for improved communications and better radar and direction finding detection. However, it must be understood that unauthorized climb or descent under IFR conditions within CONTROLLED AIRSPACE is prohibited, except as permitted by 14 CFR Section 91.3(b).

b) If equipped with a radar beacon transponder (civil) or IFF/SIF (military):

1) Continue squawking assigned Mode A/3 discrete code/VFR code and Mode C altitude encoding when in radio contact with an air traffic facility or other agency providing air traffic services, unless instructed to do otherwise.

2) If unable to immediately establish communications with an air traffic facility/agency, squawk Mode A/3, Code 7700/Emergency and Mode C.

3) Transmit a distress or urgency message consisting of as many as necessary of the following elements, preferably in the order listed:

(a) If distress, MAYDAY, MAYDAY, MAYDAY; if urgency, PAN-PAN, PAN-PAN, PAN-PAN.

(b) Name of station addressed.

- (c) Aircraft identification and type.
- (d) Nature of distress or urgency.
- (e) Weather.
- (f) Pilots intentions and request.
- (g) Present position, and heading; or if lost, last known position, time, and heading since that position.
- (h) Altitude or flight level.
- (i) Fuel remaining in minutes.
- (j) Number of people on board.
- (k) Any other useful information.

c) After establishing radio contact, comply with advice and instructions received. Cooperate. Do not hesitate to ask questions or clarify instructions when you do not understand or if you cannot comply with clearances. Assist the ground station to control communications on the frequency in use. Silence interfering radio stations. Do not change frequency or change to another ground station unless absolutely necessary. If you do, advise the ground station of the new frequency and station name prior to the change, transmitting in the blind if necessary. If two-way communications cannot be established on the frequency, return immediately to the frequency or station where two-way communications last existed.

d) When in a distress condition with bailout, crash landing or ditching imminent, take the following additional actions to assist search and rescue units:

1) Time and circumstances permitting, transmit as many as necessary of the message elements in subparagraph 13.1b)3) and any of the following you think might be helpful:

- (a) ELT status.
- (b) Visible landmarks.
- (c) Aircraft color.
- (d) Number of persons on board.
- (e) Emergency equipment on board.

2) Actuate your ELT if the installation permits.

3) For bailout, and for crash landing or ditching if risk of fire is not a consideration, set your radio for continuous transmission.

4) If it becomes necessary to ditch, make every effort to ditch near a surface vessel. If time permits, an FAA facility should be able to get the position of the nearest commercial or Coast Guard vessel from a Coast Guard Rescue Coordination Center.

**13.2** After a crash landing unless you have good reason to believe that you will not be located by search aircraft or ground teams, it is best to remain with your aircraft and prepare means for signalling search aircraft.

#### **14. Radar Service for VFR Aircraft in Difficulty**

**14.1** Radar equipped air traffic control facilities can provide radar assistance and navigation service (vectors) to VFR aircraft in difficulty when the pilot can talk with the controller, and the aircraft is within radar coverage. Pilots should clearly understand that authorization to proceed in accordance with such radar navigational assistance does not constitute authorization for the pilot to violate Federal Aviation Regulations. In effect, assistance is provided on the basis that navigational guidance information is advisory in nature, and the responsibility for flying the aircraft safely remains with the pilot.

**14.2** Experience has shown that many pilots who are not qualified for instrument flight cannot maintain control of their aircraft when they encounter clouds or other reduced visibility conditions. In many cases, the controller will not know whether flight into instrument conditions will result from his instructions. To avoid possible hazards resulting from being vectored into IFR conditions, a pilot in difficulty should keep the controller advised of the weather conditions in which he is operating and the weather along the course ahead, and observe the following:

a) If a course of action is available which will permit flight and a safe landing in VFR weather conditions, noninstrument rated pilots should choose the VFR condition rather than requesting a vector or approach that will take them into IFR weather conditions; or

b) If continued flight in VFR conditions is not possible, the noninstrument rated pilot should so advise the controller and indicating the lack of an instrument rating, declare a distress condition.

c) If the pilot is instrument rated and current, and the aircraft is instrument equipped, the pilot should so indicate by requesting an IFR flight clearance. Assistance will then be provided on the basis that the aircraft can operate safely in IFR weather conditions.

1) When a distress or urgency condition is encountered, the pilot of an aircraft with a coded radar beacon transponder, who desires to alert a ground radar facility, should squawk Mode 3/A, Code 7700/Emergency and

Mode C altitude reporting and then immediately establish communications with the air traffic control facility.

2) Radar facilities are equipped so that Code 7700 normally triggers an alarm or special indicator at all control positions. Pilots should understand that they might not be within a radar coverage area. Therefore, they should continue squawking Code 7700 and establish radio communications as soon as possible.

#### **15. Direction Finding Instrument Approach Procedure**

**15.1** Direction finding (DF) equipment has long been used to locate lost aircraft and to guide aircraft to areas of good weather or to airports; and now at most DF equipped airports, DF instrument approaches may be given to aircraft in emergency.

**15.2** Experience has shown that a majority of actual emergencies requiring DF assistance involve pilots with a minimum of flight experience. With this in mind, DF approach procedures provide maximum flight stability in the approach by utilizing small turns, and descents in a wings level attitude. The DF specialist will give the pilot headings to fly and tell the pilot when to begin descent.

**15.3** DF instrument approach procedures are for emergency use only and will not be given to IFR weather conditions unless the pilot has declared an emergency.

**15.4** To become familiar with the procedures and other benefits of DF, pilots are urged to request practice guidance and approaches in VFR weather conditions. DF specialists welcome the practice and, workload permitting, will honor such requests.

#### **16. Intercept and Escort**

**16.1** The concept of airborne intercept and escort is based on the SAR aircraft establishing visual and/or electronic contact with an aircraft in difficulty, providing inflight assistance, and escorting it to a safe landing. If bailout, crash landing or ditching becomes necessary, SAR operations can be conducted without delay. For most incidents, particularly those occurring at night and/or during instrument flight conditions, the availability of intercept and escort services will depend on the proximity of SAR units with suitable aircraft on alert for immediate dispatch. In limited circumstances, other aircraft flying in the vicinity of an aircraft in difficulty can provide these services.

**16.2** If specifically requested by a pilot in difficulty or if a distress condition is declared, SAR coordinators

will take steps to intercept and escort an aircraft. Steps may be initiated for intercept and escort if an urgency condition is declared and unusual circumstances make such action advisable.

**16.3** It is the pilot's prerogative to refuse intercept and escort services. Escort services will normally be provided to the nearest adequate airport. Should the pilot receiving escort services continue on to another location after reaching a safe airport, or decide not to divert to the nearest safe airport, the escort aircraft is not obligated to continue and further escort is discretionary. The decision will depend on the circumstances of the individual incident.

## 17. Visual Emergency Signals

*NOTE.—*  
*SEE FIG 3.6-1 THROUGH FIG 3.6-17.*

## 18. Ditching Procedures

**18.1** In order to select a proper ditching course for an aircraft, a basic knowledge of sea evaluation and other factors involved is required. Selection of the ditching heading may well determine the difference between survival and disaster. (See FIG 3.6-18, FIG 3.6-19, FIG 3.6-20, and FIG 3.6-21).

### 18.2 Common Oceanographic Terminology:

**a) Sea.** The condition of the surface that is the result of both waves and swells.

**b) Wave (or Chop).** The condition of the surface caused by local winds.

**c) Swell.** The condition of the surface which has been caused by a distant disturbance.

**d) Swell Face.** The side of the swell toward the observer. The backside is the side away from the observer. These definitions apply regardless of the direction of swell movement.

**e) Primary Swell.** The swell system having the greatest height from trough to crest.

**f) Secondary Swells.** Those swell systems of less height than the primary swell.

**g) Fetch.** The distance the waves have been driven by a wind blowing in a constant direction, without obstruction.

**h) Swell Period.** The time interval between the passage of two successive crests at the same spot in the water, measured in seconds.

**i) Swell Velocity.** The velocity with which the swell advances with relation to a fixed reference point, measured in knots. There is little movement of water in the horizontal direction. Swells move primarily in a vertical motion, similar to the motion observed when shaking out a carpet.

**j) Swell Direction.** The direction from which a swell is moving. This direction is not necessarily the result of the wind present at the scene. The swell encountered may be moving into or across the local wind. Swells, once set in motion, tend to maintain their original direction for as long as they continue in deep water, regardless of changes in wind direction.

**k) Swell Height.** The height between crest and trough, measured in feet. The vast majority of ocean swells are lower than 12 to 15 feet, and swells over 25 feet are not common at any spot on the oceans. Successive swells may differ considerably in height.

### 18.3 Swells

18.3.1 It is extremely dangerous to land into the wind without regard to sea conditions. The swell system, or systems, must be taken into consideration.

Single Swell (15 knot wind)

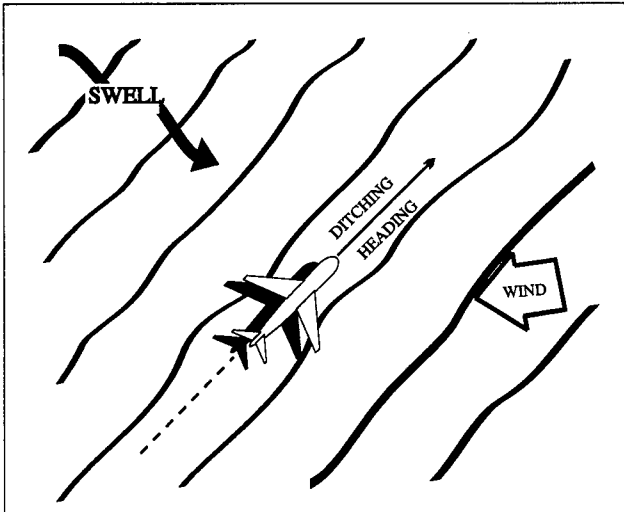

FIG 3.6-18

Double Swell (15 knot wind)

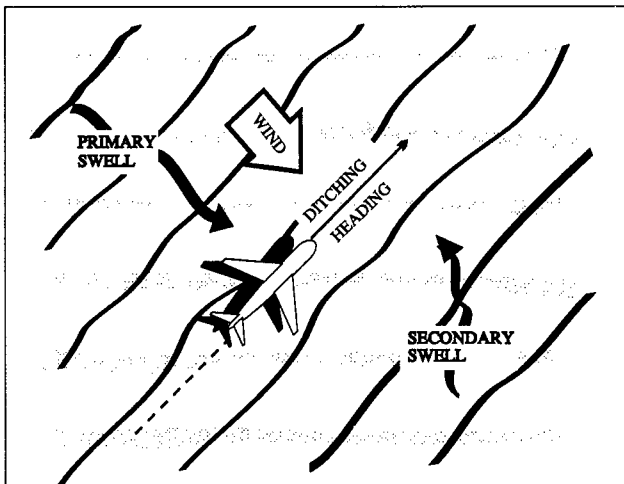

FIG 3.6-19

Double Swell (30 knot wind)

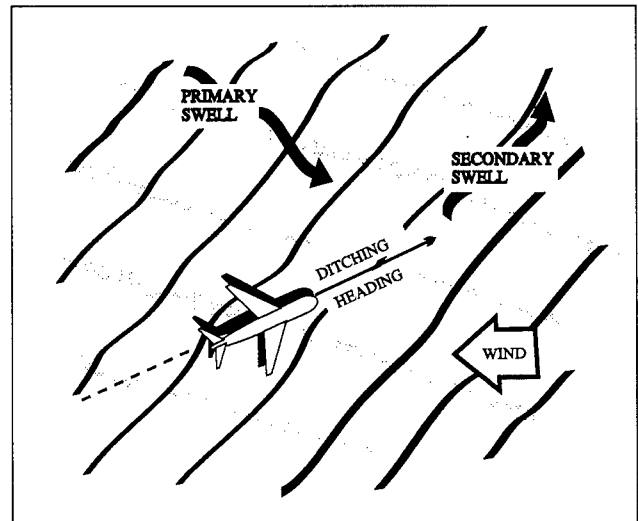

FIG 3.6-20

(50 knot wind)

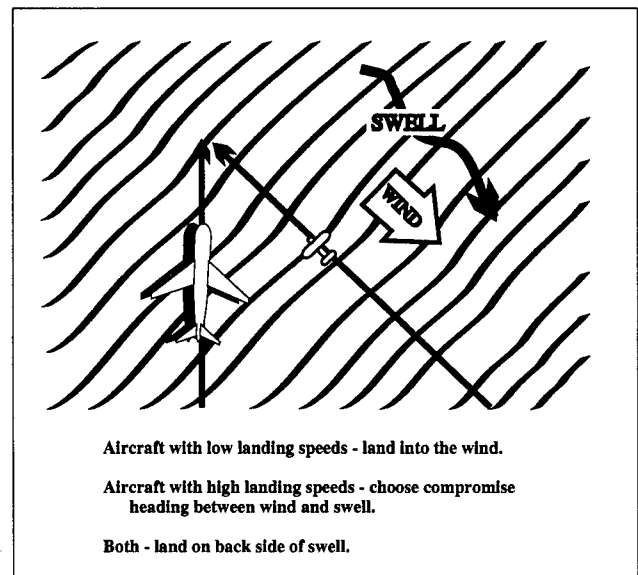

FIG 3.6-21

### Wind-Swell-Ditch Heading

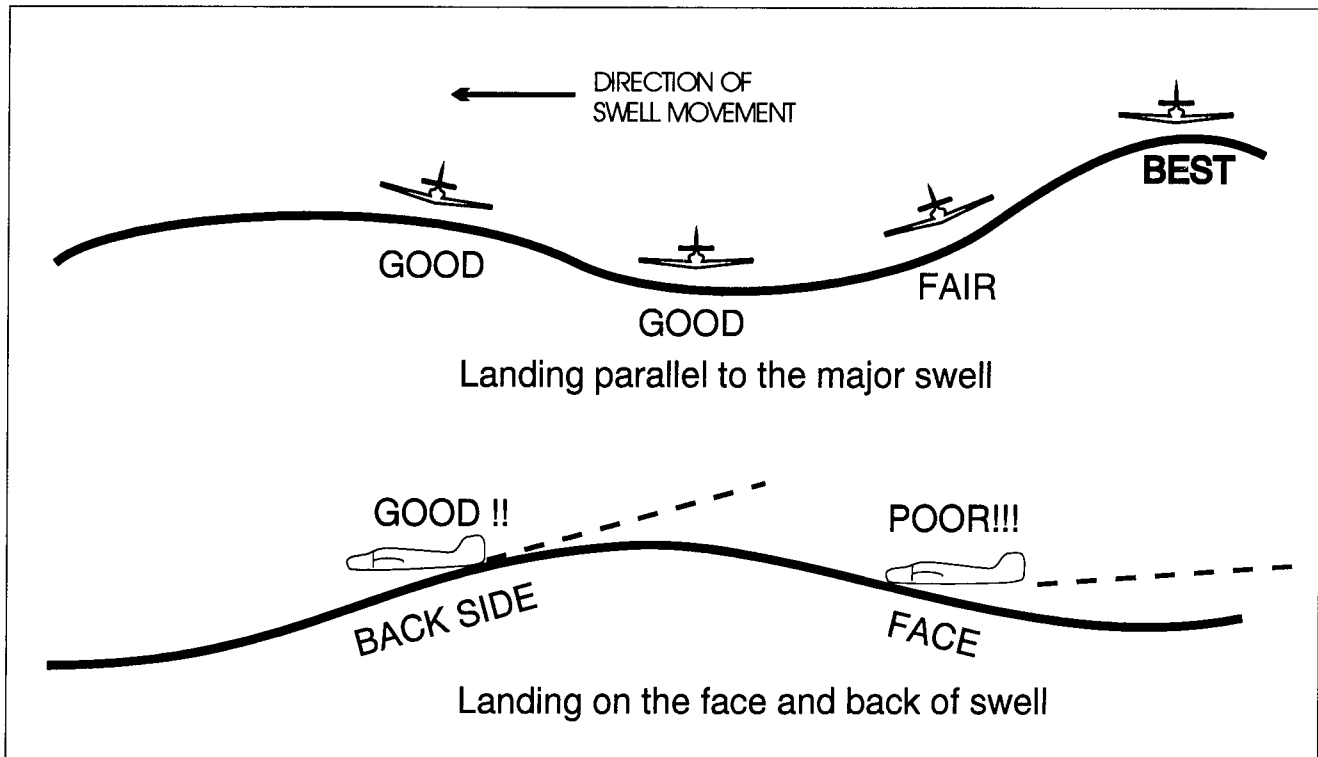

FIG 3.6-22

**18.3.2** In ditching parallel to the swell, it makes little difference whether touchdown is on top of the crest or in the trough. It is preferable, if possible, to land on the top or back side of the swell. After determining which heading (and its reciprocal) will parallel the swell, select the heading with the most into the wind component.

**18.3.3** If only one swell system exists, the problem is relatively simple - even with a high, fast system. Unfortunately, most cases involve two or more systems running in different directions. With many systems present, the sea presents a confused appearance. One of the most difficult situations occurs when two swell systems are at right angles. For example, if one system is 8 feet high, and the other 3 feet, a landing parallel to the primary system, and down swell on the secondary system is indicated. If both systems are of equal height, a compromise may be advisable - selecting an intermediate heading at 45 degrees down swell to both systems. When landing down a secondary swell, attempt to touch down on the back side, not on the face of the swell. Remember one axiom - **AVOID THE FACE OF A SWELL.**

**18.3.4** If the swell system is formidable, it is considered advisable, in landplanes, to accept more crosswind in order to avoid landing directly into the swell.

**18.3.5** The secondary swell system is often from the same direction as the wind. Here, the landing may be made parallel to the primary system, with the wind and secondary system at an angle. There is a choice of two headings paralleling the primary system. One heading is downwind and down the secondary swell; and the other is into the wind and into the secondary swell. The choice of heading will depend on the velocity of the wind versus the velocity and height of the secondary swell.

### 18.4 Wind

**18.4.1** The simplest method of estimating the wind direction and velocity is to examine the wind streaks on the water. These appear as long streaks up and down wind. Some persons may have difficulty determining wind direction after seeing the streaks in the water. Whitecaps fall forward with the wind but are overrun by the waves thus producing the illusion that the foam is sliding backward. Knowing this, and by observing the direction of the streaks, the wind direction is easily determined. Wind velocity can be accurately estimated by noting the appearance of the whitecaps, foam and wind streaks.

## 18.5 Preditching Preparation

**18.5.1** A successful aircraft ditching is dependent on three primary factors. In order of importance they are:

- a) Sea conditions and wind;
- b) Type of aircraft; and
- c) Skill and technique of pilot.

**18.5.2** The behavior of the aircraft on making contact with the water will vary within wide limits according to the state of the sea. If landed parallel to a single swell system, the behavior of the aircraft may approximate that to be expected on a smooth sea. If landed into a heavy swell or into a confused sea, the deceleration forces may be extremely great - resulting in breaking up of the aircraft. Within certain limits, the pilot is able to minimize these forces by proper sea evaluation and selection of ditching heading.

**18.5.3** When on final approach the pilot should look ahead and observe the surface of the sea. There may be shadows and whitecaps - signs of large seas. Shadows and whitecaps close together indicate that the seas are short and rough. Touchdown in these areas is to be avoided. Select and touchdown in any area (only about 500 feet is needed) where the shadows and whitecaps are not so numerous.

**18.5.4** Touchdown should be at the lowest speed and rate of descent which permit safe handling and optimum nose up attitude on impact. Once first impact has been made there is often little the pilot can do to control a landplane.

## 18.6 Ditching

**18.6.1** Once preditching preparations are completed, the pilot should turn to the ditching heading and commence letdown. The aircraft should be flown low over the water, and slowed down until ten knots or so above stall. At this point, additional power should be used to overcome the increased drag caused by the noseup attitude. When a smooth stretch of water appears ahead, cut power, and touchdown at the best recommended speed as fully stalled as possible. By cutting power when approaching a relatively smooth area, the pilot will prevent overshooting and will touchdown with less chance of planing off into a second uncontrolled landing. Most experienced seaplane pilots prefer to make contact with the water in a semi-stalled attitude, cutting power as the tail makes contact. This technique eliminates the chance of misjudging altitude with a resultant heavy drop in a fully stalled condition. Care must be taken not

to drop in a fully stalled condition. Care must be taken not to drop the aircraft from too high altitude, or to balloon due to excessive speed. The altitude above water depends on the aircraft. Over glassy smooth water, or at night without sufficient light, it is very easy for even the most experienced pilots to misjudge altitude by 50 feet or more. Under such conditions, carry enough power to maintain 9° to 12° noseup attitude, and 10° to 20° over stalling speed until contact is made with the water. The proper use of power on the approach is of great importance. If power is available on one side only, a little power should be used to flatten the approach; however, the engine should not be used to such an extent that the aircraft cannot be turned against the good engines right down to the stall with a margin of rudder movement available. When near the stall, sudden application of excessive unbalanced power may result in loss of directional control. If power is available on one side only, a slightly higher than normal glide approach speed should be used. This will insure good control and some margin of speed after leveling off without excessive use of power. The use of power in ditching is so important that when it is certain that the coast cannot be reached, the pilot should, if possible, ditch before fuel is exhausted. The use of power in a night or instrument ditching is far more essential than under daylight contact conditions.

**18.6.2** If no power is available, a greater than normal approach speed should be used down to the flare-out. This speed margin will allow the glide to be broken early and more gradually, thereby giving the pilot time and distance to feel for the surface - decreasing the possibility of stalling high or flying into the water. When landing parallel to a swell system, little difference is noted between landing on top of a crest or in the trough. If the wings of the aircraft are trimmed to the surface of the sea rather than the horizon, there is little need to worry about a wing hitting a swell crest. The actual slope of a swell is very gradual. If forced to land into a swell, touchdown should be made just after passage of the crest. If contact is made on the face of the swell, the aircraft may be swamped or thrown violently into the air, dropping heavily into the next swell. If control surfaces remain intact, the pilot should attempt to maintain the proper nose attitude by rapid and positive use of the controls.

## 18.7 After Touchdown

**18.7.1** In most cases drift caused by crosswind can be ignored; the forces acting on the aircraft after touchdown are of such magnitude that drift will be only a secondary consideration. If the aircraft is under good

control, the “crab” may be kicked out with rudder just prior to touchdown. This is more important with high wing aircraft, for they are laterally unstable on the water in a crosswind, and may roll to the side in ditching.

**NOTE.—**  
THIS INFORMATION HAS BEEN EXTRACTED FROM THE PUBLICATION “AIRCRAFT EMERGENCY PROCEDURES OVER WATER.”

## 19. Fuel Dumping

**19.1** Should it become necessary to dump fuel, the pilot should immediately advise ATC. Upon receipt of advice that an aircraft will dump fuel, ATC will broadcast or cause to be broadcast immediately and every 3 minutes thereafter on appropriate ATC, FSS and airline company radio frequencies the following:

**EXAMPLE.—**  
ATTENTION ALL AIRCRAFT-FUEL DUMPING IN PROGRESS-OVER (LOCATION) AT (ALTITUDE) BY (TYPE AIRCRAFT) (FLIGHT DIRECTION).

**19.2** Upon receipt of such a broadcast, pilots of aircraft affected, which are not on IFR flight plans or special VFR clearances, should clear the area specified in the advisory. Aircraft on IFR flight plans or special VFR clearances will be provided specific separation by ATC. At the termination of the fuel dumping operation, pilots should advise ATC. Upon receipt of such information, ATC will issue, on appropriate frequencies, the following:

**EXAMPLE.—**  
ATTENTION ALL AIRCRAFT-FUEL DUMPING BY- (TYPE AIRCRAFT) TERMINATED.

## 20. Special Emergency (Air Piracy)

**20.1** A special emergency is a condition of air piracy, or other hostile act by a person(s) aboard an aircraft, which threatens the safety of the aircraft or its passengers.

**20.2** The pilot of an aircraft reporting a special emergency condition should:

a) If circumstances permit, apply distress or urgency radio - telephony procedures. Include the details of the special emergency; or

b) If circumstances do not permit the use of prescribed distress or urgency procedures, transmit:

1) On the air-ground frequency in use at the time;

2) As many as possible of the following elements spoken distinctly and in the following order:

—Name of the station addressed (time and circumstances permitting);

—The identification of the aircraft and present position; and

—The nature of the special emergency condition and pilot intentions (circumstances permitting).

—If unable to provide this information, use code words and/or transponder setting for indicated meanings as follows:

<i>Spoken Words</i>
TRANSPONDER SEVEN FIVE ZERO ZERO
<i>Meaning</i>
Am being hijacked/forced to a new destination
<i>Transponder Setting</i>
Mode 3/A, Code 7500

**NOTE.—**  
CODE 7500 WILL NEVER BE ASSIGNED BY ATC WITHOUT PRIOR NOTIFICATION FROM THE PILOT THAT THE AIRCRAFT IS BEING SUBJECTED TO UNLAWFUL INTERFERENCE. THE PILOT SHOULD REFUSE THE ASSIGNMENT OF THIS CODE IN ANY OTHER SITUATION AND INFORM THE CONTROLLER ACCORDINGLY. CODE 7500 WILL TRIGGER THE SPECIAL EMERGENCY INDICATOR IN ALL RADAR ATC FACILITIES.

**20.3** Air traffic controllers will acknowledge and confirm receipt of transponder Code 7500 by asking the pilot to verify it. If the aircraft is not being subjected to unlawful interference, the pilot should respond to the query by broadcasting in the clear that the aircraft is not being subjected to unlawful interference. Upon receipt of this information, the controller will request the pilot to verify the code selection depicted in the code selector windows in the transponder control panel and change the code to the appropriate setting. If the pilot replies in the affirmative or does not reply, the controller will not ask further questions but will flight follow, respond to pilot requests and notify appropriate authorities.

**20.4** If it is possible to do so without jeopardizing the safety of the flight, the pilot of a hijacked U.S. passenger aircraft, after departing from the cleared routing over which the aircraft was operating, will attempt to do one or more of the following things insofar as circumstances may permit:

a) Maintain a true airspeed of no more than 400 knots and, preferably, an altitude of between 10,000 and 25,000 feet; and

b) Fly a course toward the destination which the hijacker has announced.

**20.5** If these procedures result in either radio contact or air intercept, the pilot will attempt to comply with any instructions received which may direct him to an appropriate landing field.

**21. FAA K-9 Explosives Detection Team Program**

**21.1** The FAA's Office of Civil Aviation Security Operations manages the FAA K-9 Explosives Detection Team Program, which was established in 1972. Through a unique agreement with law enforcement agencies and airport authorities, the FAA has strategically placed FAA-certified K-9 teams (a team is one handler and one dog) at airports throughout the country. If a bomb threat is received while an aircraft is in flight, the aircraft can be directed to an airport with this capability.

**21.2** The FAA provides initial and refresher training for all handlers, provides single purpose explosive detector dogs, and requires that each team is annually evaluated in five areas for FAA certification: aircraft (wide body and narrow body), vehicles, terminal, freight, (cargo), and luggage. If you desire this service, notify your company or an FAA air traffic control facility.

**21.3 FAA Sponsored Explosives Detection Dog/Handler Team Locations**

Airport Symbol	Location
ATL	Atlanta, Georgia
BHM	Birmingham, Alabama
BOS	Boston, Massachusetts
BUF	Buffalo, New York
CLT	Charlotte, North Carolina
ORD	Chicago, Illinois
CVG	Cincinnati, Ohio
DFW	Dallas, Texas
DEN	Denver, Colorado

Airport Symbol	Location
DTW	Detroit, Michigan
IAH	Houston, Texas
JAX	Jacksonville, Florida
MCI	Kansas City, Missouri
LAX	Los Angeles, California
MEM	Memphis, Tennessee
MIA	Miami, Florida
MKE	Milwaukee, Wisconsin
MSY	New Orleans, Louisiana
MCO	Orlando, Florida
PHX	Phoenix, Arizona
PIT	Pittsburgh, Pennsylvania
PDX	Portland, Oregon
SLC	Salt Lake City, Utah
SFO	San Francisco, California
SJU	San Juan, Puerto Rico
SEA	Seattle, Washington
STL	St. Louis, Missouri
TUS	Tucson, Arizona
TUL	Tulsa, Oklahoma

TBL 3.6-5

**21.4** If due to weather or other considerations an aircraft with a suspected hidden explosive problem were to land or intended to land at an airport other than those listed above, it is recommended they call the FAA's Washington Operations Center (telephone 202-267-3333, if appropriate) or have an air traffic facility with which you can communicate contact the above center requesting assistance.



## GEN 4. CHARGES FOR AERODROMES/HELIPORTS AND AIR NAVIGATION SERVICES

### GEN 4.1 Fees and Charges

#### 1. General

**1.1** Charges for services and facilities vary from aerodrome to aerodrome, and information concerning such charges may be obtained at the aerodromes. Unless alternative arrangements have been made, all charges for the use of the aerodrome, such as landing fees, passenger service charges, cargo charges, storage charges, and the like, are payable on demand or before the aircraft departs the aerodrome. All such charges are established by and payable to the various administrative authorities of the various aerodromes.

**1.2** A private aircraft will be charged a processing fee of \$25 once every calendar year. This will be charged the first time the aircraft arrives from a foreign place in the calendar year or may be paid in advance. This fee is charged to the aircraft, not the pilot, and the receipt should be kept with the aircraft.

**1.3** Commercial aircraft operators will be charged a processing fee of \$5 per paying passenger for each arrival from foreign to the U.S. This fee will not be charged for passengers arriving from Canada, Mexico, and certain nearby Caribbean countries.

#### 2. Charges for Inspection Services

**2.1** Generally speaking, free service is provided at airports during regular business hours (usually 8 a.m. to 5 p.m.), Monday through Saturday, and from 8 a.m. to 5 p.m. on Sundays and national holidays. However, tours of duty at airports are based on the need for services and are altered at some ports to coincide with schedule changes and peak workloads.

**2.2** Overtime charges may be imposed, in certain cases, for Immigration and Naturalization Services and Public Health Service quarantine inspection of aircraft whose operations are not covered by published schedules. Information concerning such charges may be obtained from the Immigration and Naturalization Office and the Public Health Service Medical Officer in Charge at, or nearest, the intended place of landing.

#### 3. Penalties for Violations

**3.1** Since the law provides for substantial penalties for violations of the Customs regulations, aircraft operators and pilots should make every effort to comply with them.

**3.2** A \$5,000 penalty will be assessed for common violations such as:

- a) Failure to report arrival.
- b) Failure to obtain landing rights.
- c) Failure to provide advance notice of arrival.
- d) Failure to provide penetration report on southern border.
- e) Departing without permission of discharging passengers or cargo without permission.

**REFERENCE-**  
19 CFR 122.161.

**NOTE.—**

*[7] IMPORTATION OF CONTRABAND, INCLUDING AGRICULTURAL MATERIALS, OR UNDECLARED MERCHANDISE CAN RESULT IN PENALTY ACTION AND SEIZURE OF AIRCRAFT, WHICH VARIES ACCORDING TO THE NATURE OF THE VIOLATION AND PERTINENT PROVISION OF LAW.*

**NOTE.—**

*[2] THE ABOVE PENALTIES ARE DOUBLE TO \$10,000 FOR A SECOND OFFENSE. SEIZURE OF AIRCRAFT MAY OCCUR AT ANY TIME DEPENDING UPON THE CIRCUMSTANCES BEHIND THE VIOLATION.*

**NOTE.—**

*[3] IF A PENALTY IS INCURRED, APPLICATION MAY BE MADE TO THE CUSTOMS OFFICER IN CHARGE FOR A REDUCTION IN AMOUNT OR CANCELLATION, GIVING THE GROUNDS UPON WHICH RELIEF IS BELIEVED TO BE JUSTIFIED. IF THE OPERATOR OR PILOT DESIRES TO PETITION FURTHER FOR RELIEF OF THE PENALTY, HE MAY APPEAL TO THE APPROPRIATE DISTRICT DIRECTOR OF CUSTOMS. IF STILL FURTHER REVIEW OF THE PENALTY IS DESIRED, WRITTEN APPEAL MAY BE MADE TO THE PROPER REGIONAL COMMISSIONER OF CUSTOMS AND, IN SOME CASES, TO CUSTOMS HEADQUARTERS.*

**3.3** Any person violating any provision of the Public Health Service regulations shall be subject to a fine of not more than \$1,000 or to imprisonment for not more than 1 year, or both, as provided in section 368 of the Public Health Service Act (42 U.S.C. 271).



## **GEN 4.2 Air Navigation Facility Charges**

The Federal Aviation Administration does not charge for the use of Federal air navigation facilities or telecommunications services.



**AIP**  
**AERONAUTICAL INFORMATION PUBLICATION**  
**UNITED STATES OF AMERICA**

**PART 2**  
**EN ROUTE (ENR)**



- ENR 0.1 PREFACE - Not applicable
- ENR 0.2 RECORD OF AIP AMENDMENTS - Not applicable
- ENR 0.3 RECORD OF AIP SUPPLEMENTS - Not applicable
- ENR 0.4 CHECKLIST OF AIP PAGES - Not applicable
- ENR 0.5 LIST OF HAND AMENDMENTS TO THE AIP - Not applicable

## ENR 0.6 TABLE OF CONTENTS TO PART 2

	<i>Page</i>
<b>ENR 1. GENERAL RULES AND PROCEDURES</b>	
ENR 1.1 General Rules .....	ENR 1.1-1
ENR 1.2 Visual Flight Rules .....	ENR 1.2-1
ENR 1.3 Instrument Flight Rules .....	ENR 1.3-1
ENR 1.4 ATS Airspace Classification .....	ENR 1.4-1
ENR 1.5 Holding, Approach, and Departure Procedures .....	ENR 1.5-1
ENR 1.6 Radar Services and Procedures .....	ENR 1.6-1
ENR 1.7 Altimeter Setting Procedures .....	ENR 1.7-1
ENR 1.8 [Reserved] .....	ENR 1.8-1
ENR 1.9 [Reserved] .....	ENR 1.9-1
ENR 1.10 Flight Planning (Restriction, Limitation or Advisory Information) .....	ENR 1.10-1
ENR 1.11 [Reserved] .....	ENR 1.11-1
ENR 1.12 Interception of Civil Aircraft, National Security and Interception Procedures .....	ENR 1.12-1
ENR 1.13 [Reserved] .....	ENR 1.13-1
ENR 1.14 [Reserved] .....	ENR 1.14-1
ENR 1.15 Medical Facts for Pilots .....	ENR 1.15-1
ENR 1.16 Safety, Hazard and Accident Reports .....	ENR 1.16-1
<b>ENR 2. AIR TRAFFIC SERVICES AIRSPACE .....</b>	<b>ENR 2-1</b>
<b>ENR 3. ATS ROUTES</b>	
ENR 3.1 [Reserved] .....	ENR 3.1-1
ENR 3.2 [Reserved] .....	ENR 3.2-1
ENR 3.3 Area Navigation (RNAV) Routes .....	ENR 3.3-1
ENR 3.4 [Reserved] .....	ENR 3.4-1
ENR 3.5 Other Routes .....	ENR 3.5-1
<b>ENR 4. RADIO NAVIGATION AIDS/SYSTEMS</b>	
ENR 4.1 Radio Navigation Aids - En Route .....	ENR 4.1-1
ENR 4.2 Special Navigation Systems .....	ENR 4.2-1
<b>ENR 5. NAVIGATION WARNINGS</b>	
ENR 5.1 Prohibited, Restricted and Other Areas .....	ENR 5.1-1
ENR 5.2 Military Exercise and Training Areas .....	ENR 5.2-1
ENR 5.3 [Reserved] .....	ENR 5.3-1
ENR 5.4 [Reserved] .....	ENR 5.4-1
ENR 5.5 [Reserved] .....	ENR 5.5-1
ENR 5.6 Bird Migration and Areas with Sensitive Fauna .....	ENR 5.6-1
ENR 5.7 Potential Flight Hazards .....	ENR 5.7-1





# ENR 1. GENERAL RULES AND PROCEDURES

## ENR 1.1 General Rules

### 1. Differences Between National and International Rules and Procedures

**1.1** The air traffic rules and procedures applicable to air traffic in U.S. Class A, B, C, D and E airspace conform with Annexes 2 and 11 to the Convention on International Civil Aviation and to those portions applicable to aircraft in the Procedures for Air Navigation Services - Rules of the Air and Air Traffic Services (Doc 4444 - RAC/501/10) and to the Regional Supplementary Procedures (DOC 7030) applicable to the NAM, NAT, CAR and PAC Regions, except as noted in the cases below. All differences have been registered with the International Civil Aviation Organization.

#### 1.1.1 Annex 3 - Rules of the Air

*NOTE.—*  
*SEE GEN 1.7.*

#### 1.1.2 Annex 11 - Air Traffic Services

*NOTE.—*  
*SEE GEN 1.7.*

#### 1.1.3 Procedures for Air Navigation Services - Rules of the Air (DOC 4444) and Air Traffic Services (RAC/501/10)

*NOTE.—*  
*SEE GEN 1.7.*

#### 1.1.4 Regional Supplementary Procedures (Doc 7030)

*NOTE.—*  
*SEE GEN 1.7.*

### 2. Airport Operations

#### 2.1 General

**2.1.1** Increased traffic congestion, aircraft in climb and descent attitudes, and pilots preoccupation with cockpit duties are some factors that increase the hazardous accident potential near the airport. The situation is further compounded when the weather is marginal; that is, just meeting VFR requirements. Pilots must be particularly alert when operating in the vicinity of an airport. This section defines some rules, practices, and procedures that pilots should be familiar with, and adhere to, for safe airport operations.

**2.1.2** Each airport operator regularly serving scheduled air carriers has put into use security measures designed to prevent or deter unauthorized persons from having

access to "Air Operations Area." The "Air Operations Area" means any area of the airport used or intended to be used for landing, takeoff, or surface maneuvering of aircraft. Pilots are encouraged to obtain airport security instructions by posted signs or radio communication.

### 3. Visual Indicators at Airports Without an Operating Control Tower

**3.1** At those airports without an operating control tower, a segmented circle visual indicator system, if installed, is designed to provide traffic pattern information. The segmented circle system consists of the following components:

**a) The segmented circle:** Located in a position affording maximum visibility to pilots in the air and on the ground and providing a centralized location for other elements of the system.

**b) The wind direction indicator:** A wind cone, wind sock, or wind tee installed near the operational runway to indicate wind direction. The large end of the wind cone/wind sock points into the wind as does the large end (cross bar) of the wind tee. In lieu of a tetrahedron and where a wind sock or wind cone is collocated with a wind tee, the wind tee may be manually aligned with the runway in use to indicate landing direction. These signaling devices may be located in the center of the segmented circle and may be lighted for night use. Pilots are cautioned against using a tetrahedron to indicate wind direction.

**c) The landing direction indicator:** A tetrahedron is installed when conditions at the airport warrant its use. It may be used to indicate the direction of landings and takeoffs. A tetrahedron may be located at the center of a segmented circle and may be lighted for night operations. The small end of the tetrahedron points in the direction of landing. Pilots are cautioned against using a tetrahedron for any purpose other than as an indicator of landing direction. Further, pilots should use extreme caution when making runway selection by use of a tetrahedron in very light or calm wind conditions as the tetrahedron may not be aligned with the designated calm-wind runway. At airports with control towers, the tetrahedron should only be referenced when the control tower is not in operation. Tower instructions supersede tetrahedron indications.

**d) Landing strip indicators:** Installed in pairs as shown in the segmented circle diagram, and used to show the alignment of landing strips.

**e) Traffic pattern indicators:** Arranged in pairs in conjunction with landing strip indicators and used to indicate the direction of turns when there is a variation from the normal left traffic pattern. If there is no segmented circle installed at the airport, traffic pattern indicators may be installed on or near the end of the runway.

**3.2** Preparatory to landing at an airport without a control tower, or when the control tower is not in operation, the pilot should concern himself with the indicator for the approach end of the runway to be used. When approaching for landing, all turns must be made to the left unless a traffic pattern indicator indicates that turns should be made to the right. If the pilot will mentally enlarge the indicator for the runway to be used, the base and final approach legs of the traffic pattern to be flown immediately become apparent. Similar treatment of the indicator at the departure end of the runway will clearly indicate the direction of turn after takeoff.

**3.3** When two or more aircraft are approaching an airport for the purpose of landing, the aircraft at the lower altitude has the right of way, but it shall not take advantage of this rule to cut in front of another which is on final approach to land, or to overtake that aircraft (14 CFR Part 91.113(g)).

#### 4. Airports With an Operating Control Tower

**4.1** Towers have been established to provide for a safe, orderly, and expeditious flow of traffic on and in the vicinity of an airport. When the responsibility has been so delegated, towers also provide for the separation of IFR aircraft in the terminal areas (Approach Control).

**4.2** When operating at an airport where traffic control is being exercised by a control tower, pilots are required to maintain two-way radio contact with the tower while operating within the Class B, Class C, and Class D surface area unless the tower authorizes otherwise. Initial callup should be made about 15 miles from the airport. Unless there is a good reason to leave the tower frequency before exiting the Class B, Class C, and Class D surface area, it is a good operating practice to remain on the tower frequency for the purpose of receiving traffic information. In the interest of reducing tower frequency congestion, pilots are reminded that it is not necessary to request permission to leave the tower frequency once outside of Class B, Class C, and Class D surface area. Not all airports with an operating control tower will have Class D airspace. These airports do not have

weather reporting which is a requirement for surface-based controlled airspace, previously known as a control zone. The controlled airspace over these airports will normally begin at 700 feet or 1,200 feet above ground level and can be determined from the visual aeronautical charts. Pilots are expected to use good operating practices and communicate with the control tower as described in this section.

**4.3** When necessary, the tower controller will issue clearances or other information for aircraft to generally follow the desired flight path (traffic pattern) when flying in the Class D airspace, and the proper taxi routes when operating on the ground. If not otherwise authorized or directed by the tower, pilots approach to land in an airplane must circle the airport to the left, and pilots approaching to land in a helicopter must avoid the flow of fixed-wing traffic. However, an appropriate clearance must be received from the tower before landing.

**4.4** The following terminology for the various components of a traffic pattern has been adopted as standard for use by control towers and pilots:

- a) **Upwind leg:** A flight path parallel to the landing runway in the direction of landing.
- b) **Crosswind leg:** A flight path at right angles to the landing runway off its takeoff end.
- c) **Downwind leg:** A flight path parallel to the landing runway in the opposite direction of landing.
- d) **Base leg:** A flight path at right angles to the landing runway off its approach end and extending from the downwind leg to the intersection of the extended runway centerline.
- e) **Final approach:** A flight path in the direction of landing along the extended runway centerline from the base leg to the runway.

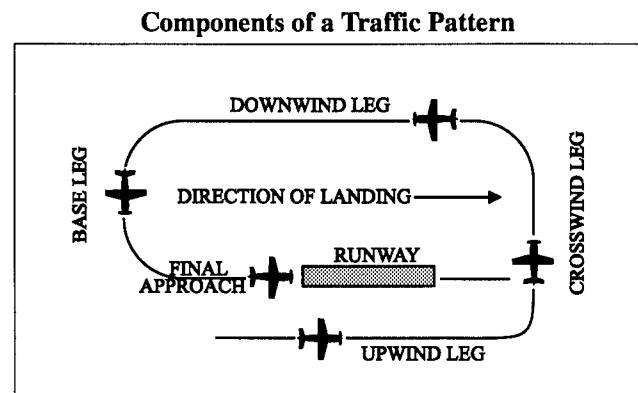

FIG 1.1-1

**NOTE.—**

FIG 1.1-1 IS INTENDED ONLY TO ILLUSTRATE TERMINOLOGY USED IN IDENTIFYING VARIOUS COMPONENTS OF A TRAFFIC PATTERN. IT SHOULD NOT BE USED AS A REFERENCE OR GUIDE ON HOW TO ENTER A TRAFFIC PATTERN.

**4.5** Many towers are equipped with a tower radar display. The radar uses are intended to enhance the effectiveness and efficiency of the local control, or tower, position. They are not intended to provide radar services or benefits to pilots except as they may accrue through a more efficient tower operation. The four basic uses are:

**a) To determine an aircraft's exact location:** This is accomplished by radar identifying the VFR aircraft through any of the techniques available to a radar position; such as, having the aircraft ident. Once identified, the aircraft's position and spatial relationship to other aircraft can be quickly determined, and standard instructions regarding VFR operation in the aircraft traffic area will be issued. Once initial radar identification of a VFR aircraft has been established and the appropriate instructions have been issued, radar monitoring may be discontinued. The reason being that the local controller's primary means of surveillance in VFR conditions is usually scanning the airport and local area.

**b) To provide radar traffic advisories:** Radar traffic advisories may be provided to the extent that the local controller is able to monitor the radar display. Local control has primary control responsibilities to the aircraft operating on the runways which will normally supersede radar monitoring duties.

**c) To provide a direction or suggested heading:** The local controller may provide pilots flying VFR with generalized instructions which will facilitate operations; e.g., "PROCEED SOUTHWEST BOUND, ENTER A RIGHT DOWNWIND RUNWAY THREE ZERO;" or provide a suggested heading to establish radar identification or as an advisory aid to navigation; e.g., "SUGGESTED HEADING TWO TWO ZERO, FOR RADAR IDENTIFICATION." In both cases, the instructions are advisory aids to the pilot flying VFR and are not radar vectors. PILOTS HAVE COMPLETE DISCRETION REGARDING ACCEPTANCE OF THE SUGGESTED HEADING OR DIRECTION AND HAVE SOLE RESPONSIBILITY FOR SEEING AND AVOIDING OTHER AIRCRAFT.

**d) To provide information and instructions to aircraft operating within Class D airspace:** In an example of this situation, the local controller would use the radar to advise a pilot on an extended downwind when to turn base leg.

**NOTE.—**

THE ABOVE TOWER RADAR APPLICATIONS ARE INTENDED TO AUGMENT THE STANDARD FUNCTIONS OF THE LOCAL CONTROL POSITION. THERE IS NO CONTROLLER REQUIREMENT TO MAINTAIN CONSTANT RADAR IDENTIFICATION AND, IN FACT, SUCH A REQUIREMENT COULD COMPROMISE THE LOCAL CONTROLLER'S ABILITY TO VISUALLY SCAN THE AIRPORT AND LOCAL AREA TO MEET FAA RESPONSIBILITIES TO THE AIRCRAFT OPERATING ON THE RUNWAYS AND WITHIN CLASS D AIRSPACE. NORMALLY, PILOTS WILL NOT BE ADVISED OF BEING IN RADAR CONTACT SINCE THAT CONTINUED STATUS CANNOT BE GUARANTEED AND SINCE THE PURPOSE OF THE RADAR IDENTIFICATION IS NOT TO ESTABLISH A LINK FOR THE PROVISION OF RADAR SERVICES.

**4.6** A few of the radar-equipped towers are authorized to use the radar to ensure separation between aircraft in specific situations, while still others may function as limited radar approach controls. The various radar uses are strictly a function of FAA operational need. The facilities may be indistinguishable to pilots since they are all referred to as tower and no publication lists the degree of radar use. THEREFORE, WHEN IN COMMUNICATION WITH A TOWER CONTROLLER WHO MAY HAVE RADAR AVAILABLE, DO NOT ASSUME THAT CONSTANT RADAR MONITORING AND COMPLETE ATC RADAR SERVICES ARE BEING PROVIDED.

## 5. Ground Control Frequencies

**5.1** The majority of ground control frequencies are in the 121.6-121.9 MHz bandwidth. Ground control frequencies are provided to eliminate frequency congestion on the tower (local control) frequency and are limited to communications between the tower and aircraft on the ground and between the tower and utility vehicles on the airport, provide a clear VHF channel for arriving and departing aircraft. They are used for issuance of taxi information, clearances, and other necessary contacts between the tower and aircraft or other vehicles operated on the airport. A pilot who has just landed should not change from the tower frequency to the ground control frequency until directed to do so by the controller. Normally, only one ground control frequency is assigned at an airport; however, at locations where the amount of traffic so warrants, a second ground control frequency and/or another frequency designated as a clearance delivery frequency may be assigned.

**5.2** A controller may omit the ground or local frequency if the controller believes the pilot knows which frequency is in use. If the ground control frequency is in the 121 MHz bandwidth, the controller may omit the numbers preceding the decimal point; e.g., 121.7, "CONTACT GROUND POINT SEVEN." However, if any doubt exists as to what frequency is in use, the pilot should

promptly request the controller to provide that information.

**5.3** Controllers will normally avoid issuing a radio frequency change to helicopters, known to be single-piloted, which are hovering, air taxiing, or flying near the ground. At times, it may be necessary for pilots to alert ATC regarding single pilot operations to minimize delay of essential ATC communications. Whenever possible, ATC instructions will be relayed through the frequency being monitored until a frequency change can be accomplished. You must promptly advise ATC if you are unable to comply with a frequency change. Also, you should advise ATC if you must land to accomplish the frequency change unless it is clear the landing; e.g., on a taxiway or in a helicopter operating area, will have no impact on other air traffic.

**6. Traffic Control Light Signals**

**6.1** The following procedures are used by airport traffic control towers in the control of aircraft, ground vehicles, equipment, and personnel not equipped with radio. These same procedures will be used to control aircraft, ground vehicles, equipment, and personnel equipped with radio if radio contact cannot be established. Airport traffic control personnel use a directive traffic control signal which emits an intense narrow beam of a selected color (either red, white, or green) when controlling traffic by light signals.

**6.2** Although the traffic signal light offers the advantage that some control may be exercised over nonradio-

equipped aircraft, pilots should be cognizant of the disadvantages which are:

a) The pilot may not be looking at the control tower at the time a signal is directed toward him; and

b) The directions transmitted by a light signal are very limited since only approval of a pilot's anticipated actions may be transmitted. No supplement or explanatory information may be transmitted except by the use of the "General Warning Signal" which advises the pilot to be on the alert.

**6.3** Between sunset and sunrise, a pilot wishing to attract the attention of the control tower should turn on a landing light and taxi the aircraft into a position, clear of the active runway, so that light is visible to the tower. The landing light should remain on until appropriate signals are received from the tower.

**7. Traffic Patterns**

**7.1** At most airports and military air bases, traffic pattern altitudes for propeller driven aircraft generally extend from 600 feet to as high as 1,500 feet above the ground. Also traffic pattern altitudes for military turbojet aircraft sometimes extend up to 2,500 feet above the ground. Therefore, pilots of en route aircraft should be constantly on the alert for other aircraft in traffic patterns and avoid these areas whenever possible. Traffic pattern altitudes should be maintained unless otherwise required by the applicable distance from cloud criteria (14 CFR Section 91.155.) (See FIG 1.1-2 and FIG 1.1-3.)

**Air Traffic Control Tower Light Gun Signals**

<i>COLOR AND TYPE OF SIGNAL</i>	<i>MEANING</i>		
	<i>MOVEMENT OF VEHICLES, EQUIPMENT AND PERSONNEL</i>	<i>AIRCRAFT ON THE GROUND</i>	<i>AIRCRAFT IN FLIGHT</i>
Steady green	Cleared to cross, proceed or go	Cleared for takeoff	Cleared to land
Flashing green	Not applicable	Cleared for taxi	Return for landing (to be followed by steady green at the proper time)
Steady red	STOP	STOP	Give way to other aircraft and continue circling
Flashing red	Clear the taxiway/runway	Taxi clear of the runway in use	Airport unsafe, do not land
Flashing white	Return to starting point on airport	Return to starting point on airport	Not applicable
Alternating red and green	Exercise extreme caution	Exercise extreme caution	Exercise extreme caution

TBL 1.1-1

**Traffic Pattern Operations  
Single Runway**

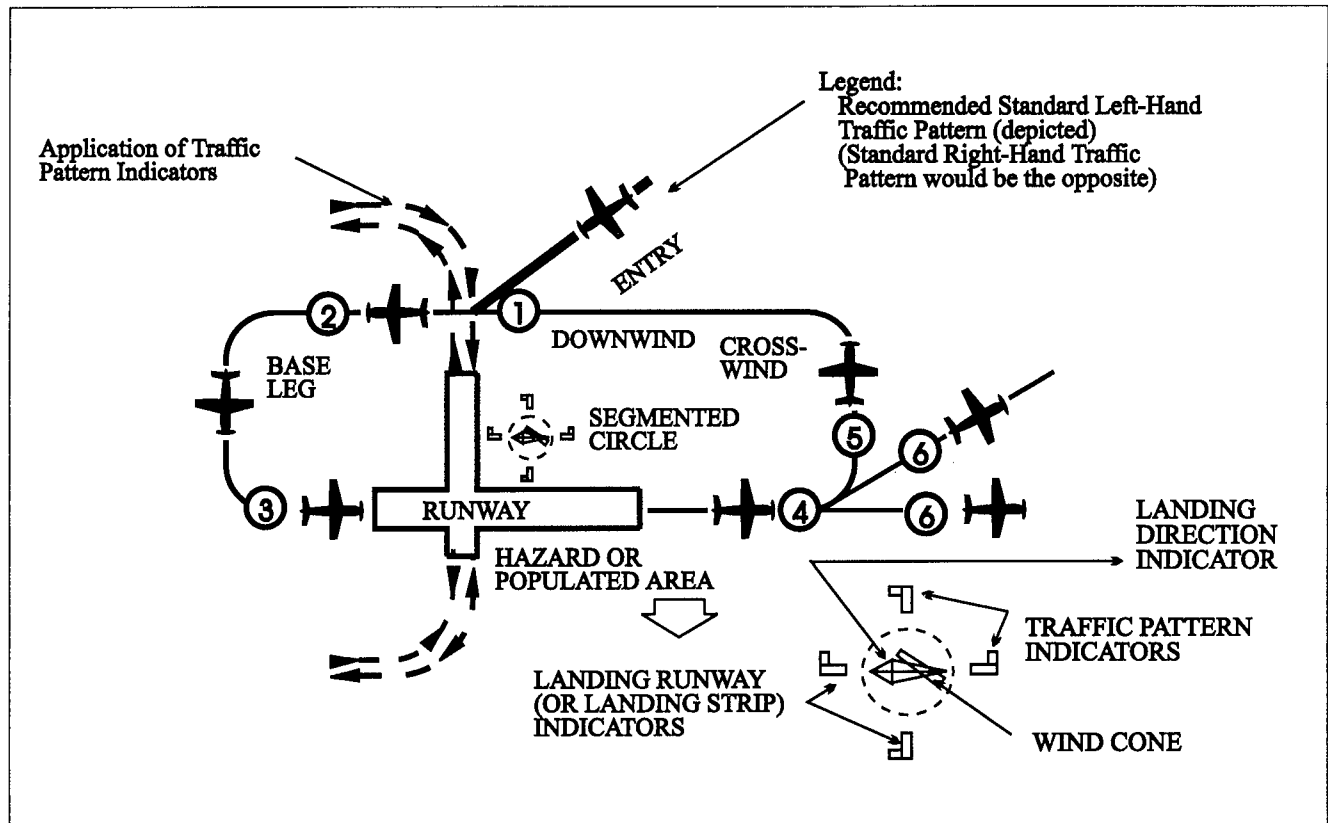

\* FIG 1.1-2 See Key to Traffic Pattern Operations under FIG 1.1-3.

**7.2 Unexpected Maneuvers in the Airport Traffic Pattern**

**7.2.2** There have been several incidents in the vicinity of controlled airports that were caused primarily by aircraft executing unexpected maneuvers. ATC service is based upon observed or known traffic and airport conditions. Controllers establish the sequence of arriving and departing aircraft by requiring them to adjust flight as necessary to achieve proper spacing. These adjustments can only be based on observed traffic, accurate pilot reports, and anticipated aircraft maneuvers. Pilots are expected to cooperate so as to preclude disruption of traffic flow or creation of conflicting patterns. The pilot in command of an aircraft is directly responsible for and is the final authority as to the operation of that aircraft.

**7.2.3** On occasion it may be necessary for pilots to maneuver their aircraft to maintain spacing with the traffic they have been sequenced to follow. The controller can anticipate minor maneuvering such as shallow "S" turns. The controller cannot, however, anticipate a major maneuver such as a 360-degree turn. If a pilot makes a 360-degree turn after obtaining a landing se-

quence, the result is usually a gap in the landing interval and more importantly it causes a chain reaction which may result in a conflict with following traffic and interruption of the sequence established by the tower or approach controller. Should a pilot decide to make maneuvering turns to maintain spacing behind a preceding aircraft, the pilot should always advise the controller if at all possible. Except when requested by the controller or in emergency situations, a 360-degree turn should never be executed in the traffic pattern or when receiving radar service without first advising the controller.

**8. Use of Runways/Declared Distances**

**8.1** Runways are identified by numbers which indicate the nearest 10-degree increment of the azimuth of the runway centerline. For example, where the magnetic azimuth is 183 degrees, the runway designation would be 18; for a magnetic azimuth of 87 degrees, the runway designation would be 9. For a magnetic azimuth ending in the number 5, such as 185, the runway designation could be either 18 or 19. Wind direction issued by the tower is also magnetic and wind velocity is in knots.

**Traffic Pattern Operations  
Parallel Runways**

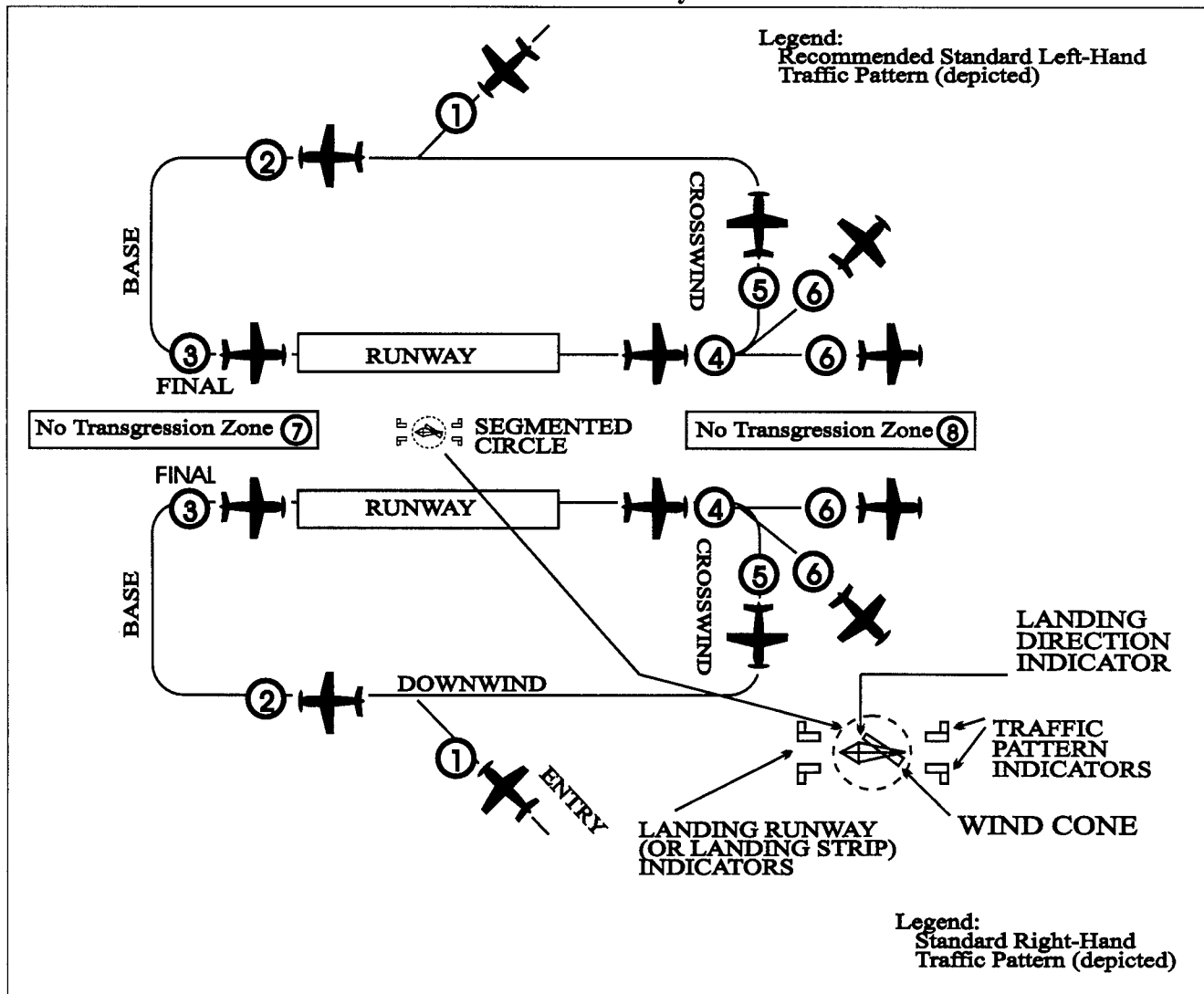

FIG 1.1-3 See Key to Traffic Pattern Operations below.

**EXAMPLE.—**

**KEY TO TRAFFIC PATTERN OPERATIONS**

- ① ENTER PATTERN IN LEVEL FLIGHT, ABEAM THE MIDPOINT OF THE RUNWAY, AT PATTERN ALTITUDE. (1,000' AGL IS RECOMMENDED PATTERN ALTITUDE UNLESS ESTABLISHED OTHERWISE.)
- ② MAINTAIN PATTERN ALTITUDE UNTIL ABEAM APPROACH END OF THE LANDING RUNWAY ON DOWNWIND LEG.
- ③ COMPLETE TURN TO FINAL AT LEAST  $\frac{1}{4}$  MILE FROM THE RUNWAY.
- ④ CONTINUE STRAIGHT AHEAD UNTIL BEYOND DEPARTURE END OF RUNWAY.

- ⑤ IF REMAINING IN THE TRAFFIC PATTERN, COMMENCE TURN TO CROSSWIND LEG BEYOND THE DEPARTURE END OF THE RUNWAY WITHIN 300 FEET OF PATTERN ALTITUDE.
- ⑥ IF DEPARTING THE TRAFFIC PATTERN, CONTINUE STRAIGHT OUT, OR EXIT WITH A 45 DEGREE TURN (TO THE LEFT WHEN IN A LEFT-HAND TRAFFIC PATTERN; TO THE RIGHT WHEN IN A RIGHT-HAND TRAFFIC PATTERN) BEYOND THE DEPARTURE END OF THE RUNWAY, AFTER REACHING PATTERN ALTITUDE.
- ⑦ DO NOT OVERSHOOT FINAL OR CONTINUE ON A TRACK WHICH WILL PENETRATE THE FINAL APPROACH OF THE PARALLEL RUNWAY.
- ⑧ DO NOT CONTINUE ON A TRACK WHICH WILL PENETRATE THE DEPARTURE PATH OF THE PARALLEL RUNWAY.

**8.2** Airport proprietors are responsible for taking the lead in local aviation noise control. Accordingly, they may propose specific noise abatement plans to the FAA. If approved, these plans are applied in the form of Formal or Informal Runway Use Programs for noise abatement purposes.

**8.3** At airports where no runway use program is established, ATC clearance may specify:

a) The runway most nearly aligned with the wind when it is five knots or more;

b) The “calm wind” runway when wind is less than five knots; or

c) Another runway if operationally advantageous.

*NOTE.—*  
*IT IS NOT NECESSARY FOR A CONTROLLER TO SPECIFICALLY INQUIRE IF THE PILOT WILL USE A SPECIFIC RUNWAY OR TO OFFER THE PILOT A CHOICE OF RUNWAYS. IF A PILOT PREFERS TO USE A DIFFERENT RUNWAY THAN THAT SPECIFIED OR THE ONE MOST NEARLY ALIGNED WITH THE WIND, THE PILOT IS EXPECTED TO INFORM ATC ACCORDINGLY.*

**8.4** At airports where a runway use program is established, ATC will assign runways deemed to have the least noise impact. If in the interest of safety a runway different than that specified is preferred, the pilot is expedited to advise ATC accordingly. ATC will honor such requests and advise pilots when the requested runway is noise sensitive. When use of a runway other than the one assigned is requested, pilot cooperation is encouraged to preclude disruption of traffic flows or creation of conflicting patterns.

**8.5** At some airports, the airport proprietor may declare that sections of a runway at one or both ends are not available for landing or takeoff. For these airports, the declared distance of runway length available for a particular operation is published in the Airport/Facility Directory. These distances are calculated by adding to the full length of paved runway any applicable clearway or stopway and subtracting from that sum the sections of the runway unsuitable for satisfying the required takeoff run, takeoff, accelerate/stop, or landing distance.

## **9. Low Level Wind Shear Alert System (LLWAS) and Terminal Doppler Weather Radar (TDWR)**

**9.1** LLWAS and TDWR are systems designed to provide pilots with information on hazardous wind shear and microburst activity in the vicinity of an airport. Not all airports will have this capability, but more than half of the towered airports will have the capability to provide some level of alert.

a) At airports equipped with LLWAS, controllers are provided with gust front wind shear information. Controllers will provide this information to pilots by giving the pilot the centerfield wind followed by the boundary wind.

*EXAMPLE.—*  
*WIND SHEAR ALERT, CENTERFIELD WIND 230 AT 8, SOUTH BOUNDARY WIND 170 AT 20.*

*NOTE.—*  
*THE LLWAS IS DESIGNED TO DETECT LOW LEVEL WIND SHEAR CONDITIONS AROUND THE PERIPHERY OF AN AIRPORT. IT DOES NOT DETECT WIND SHEAR BEYOND THAT LIMITATION.*

b) Airports equipped with LLWAS “network expansion,” LLWAS systems integrated with TDWR and TDWR systems provide the capability of detecting microburst alerts and wind shear alerts. Controllers will issue the appropriate wind shear alerts or microburst alerts. In some of these systems controllers also have the ability to issue wind information oriented to the threshold or departure end of the runway.

*EXAMPLE.—*  
*RUNWAY 17 ARRIVAL MICROBURST ALERT, 40 KNOT LOSS 3 MILE FINAL.*

*NOTE.—*  
*REFERENCE GEN 3.5, PARAGRAPH 23, MICROBURSTS.*

c) An airport equipped with the LLWAS is so indicated in the Airport/Facility Directory under Weather Data Sources for that particular airport.

## **10. Braking Action Reports and Advisories**

**10.1** When available, ATC furnishes pilots the quality of braking action received from pilots or airport management. The quality of braking action is described by the terms “good,” “fair,” “poor,” and “nil,” or a combination of these terms. When pilots report the quality of braking action by using the terms noted above, they should use descriptive terms that are easily understood, such as, “braking action poor the first/last half of the runway,” together with the particular type of aircraft.

**10.2** For NOTAM purposes, braking action reports are classified according to the most critical term (“fair,” “poor,” or “nil”) used and issued as a NOTAM(D).

**10.3** When tower controllers have received runway braking action reports which include the terms “poor” or “nil” or whenever weather conditions are conducive to deteriorating or rapidly changing runway braking conditions, the tower will include on the ATIS broadcast the statement. “BRAKING ACTION ADVISORIES ARE IN EFFECT.”

**10.4** During the time that Braking Action Advisories are in effect, ATC will issue the latest braking action report for the runway in use to each arriving and departing

aircraft. Pilots should be prepared for deteriorating braking conditions and should request current runway condition information if not volunteered by controllers. Pilots should also be prepared to provide a descriptive runway condition report to controllers after landing.

## 11. Runway Friction Reports and Advisories

**11.1** Friction is defined as the ratio of the tangential force needed to maintain uniform relative motion between two contacting surfaces (aircraft tires to the pavement surface) to the perpendicular force holding them in contact (distributed aircraft weight to the aircraft tire area). Simply stated, friction quantifies slipperiness of pavement surfaces.

**11.2** The Greek letter MU (pronounced "myew"), is used to designate a friction value representing runway surface conditions.

**11.3** MU (friction) values range from 0 to 100 where zero is the lowest friction value and 100 is the maximum friction value obtainable. For frozen contaminants on runway surfaces, a MU value of 40 or less is the level when the aircraft braking performance starts to deteriorate and directional control begins to be less responsive. The lower the MU value, the less effective braking performance becomes and the more difficult directional control becomes.

**11.4** At airports with friction measuring devices, airport management should conduct friction measurements on runways covered with compacted snow and/or ice.

a) Numerical readings may be obtained by using any FAA approved friction measuring device. It is not necessary to designate the type of friction measuring device since they provide essentially the same numerical reading when the values are 40 or less.

b) When the MU value for any one-third zone of an active runway is 40 or less, a report should be given to ATC by airport management for dissemination to pilots. The report will identify the runway, the time of measurement, MU values for each zone, and the contaminant conditions; e.g., wet snow, dry snow, slush, deicing chemicals, etc. Measurements for each one-third zone will be given in the direction of takeoff and landing on the runway. A report should also be given when MU values rise above 40 in all zones of a runway previously reporting a MU below 40.

c) Airport management should initiate a NOTAM(D) when the friction measuring device is out of service.

d) When MU reports are provided by airport management, the ATC facility providing approach control or local airport advisory will provide the report to any pilot upon request.

e) Pilots should use MU information with other knowledge including aircraft performance characteristics, type, and weight, previous experience, wind conditions, and aircraft tire type (i.e., bias ply vs. radial constructed) to determine runway suitability.

f) No correlation has been established between MU values and the descriptive terms "good," "fair," "poor," and "nil" used in braking action reports.

## 12. Communications Prior to Departure

### 12.1 Nontower Controlled Airports

**12.1.1** At airports not served by a FSS located on the airport, the pilot in command should broadcast his intentions on the prescribed frequency prior to aircraft movement and departure.

**12.1.2** At airports served by a FSS located on the airport, the pilot in command should obtain airport advisory service prior to aircraft movement and departure.

**12.1.3** Aircraft departing on an IFR clearance must obtain the clearance prior to departure via telephone, the appropriate FSS, or via direct communications with the ATC facility issuing the clearance as appropriate. An IFR clearance does not relieve the pilot from the communication stated above prior to aircraft movement and departure.

### 12.2 Tower Controlled Airports

**12.2.1** Pilots of departing aircraft should communicate with the control tower on the appropriate ground control/clearance delivery frequency prior to starting engines to receive engine start time, taxi, and/or clearance information. Unless otherwise advised by the tower, remain on the frequency during taxiing and run up, then change to local control frequency when ready to request takeoff clearance.

*NOTE.—  
REFER TO AUTOMATIC TERMINAL INFORMATION SERVICE (ATIS)  
FOR CONTINUOUS BROADCAST OF TERMINAL INFORMATION.*

## 13. Gate Holding Due to Departure Delays

**13.1** Pilots should contact ground control/clearance delivery prior to starting engines as gate hold procedures will be in effect whenever departure delays exceed or are anticipated to exceed 15 minutes. The sequence for departure will be maintained in accordance with initial call up unless modified by flow control restrictions. Pilots should monitor the ground



control/clearance delivery frequency for engine startup advisories or new proposed start time if the delay changes.

**13.2** The tower controller will consider that pilots of turbine-powered aircraft are ready for takeoff when they reach the runway/warm-up block unless advised otherwise.

#### 14. Taxiing

**14.3 General:** Approval must be obtained prior to moving an aircraft or vehicle onto the movement area during the hours an airport traffic control tower is in operation.

a) Always state your position on the airport when calling the tower for taxi instructions.

b) The movement area is normally described in local bulletins issued by the airport manager or control tower. These bulletins may be found in FSS's, fixed base operators offices, air carrier offices, and operations offices.

c) The control tower also issues bulletins describing areas where they cannot provide airport traffic control service due to nonvisibility or other reasons.

d) A clearance must be obtained prior to taxiing on a runway, taking off, or landing during the hours an airport traffic control tower is in operation.

e) When ATC clears an aircraft to "taxi to" an assigned takeoff runway, the absence of holding instructions authorizes the aircraft to "cross" all runways which the taxi route intersects except the assigned takeoff runway. It does not include authorization to "taxi onto" or "cross" the assigned takeoff runway at any point. In order to preclude misunderstandings in radio communications, ATC will not use the word "cleared" in conjunction with authorization for aircraft to taxi.

f) In the absence of holding instructions, a clearance to "taxi to" any point other than an assigned takeoff runway is a clearance to cross all runways that intersect the taxi route to that point.

g) ATC will first specify the runway, issue taxi instructions, and then state any required hold short instructions, when authorizing an aircraft to taxi for departure. This does not authorize the aircraft to "enter" or "cross" the assigned departure runway at any point. **AIR TRAFFIC CONTROLLERS ARE REQUIRED TO OBTAIN FROM THE PILOT A READBACK OF ALL RUNWAY HOLD SHORT INSTRUCTIONS.**

h) Pilots should always read back the runway assignment when taxi instructions are received from the

controller. Controllers are required to confirm the runway hold-short assignment when they issue taxi instructions

**14.4** ATC clearances or instructions pertaining to taxiing are predicated on known traffic and known physical airport conditions. Therefore, it is important that pilots clearly understand the clearance or instruction. Although an ATC clearance is issued for taxiing purposes, when operating in accordance with the Federal Regulations, it is the responsibility of the pilot to avoid collision with other aircraft. Since "the pilot in command of an aircraft is directly responsible for, and is the final authority as to, the operation of that aircraft" the pilot should obtain clarification of any clearance or instruction which is not understood.

a) Good operating practice dictates that pilots acknowledge all runway crossing, hold short, or takeoff clearances unless there is some misunderstanding, at which time the pilot should query the controller until the clearance is understood. **AIR TRAFFIC CONTROLLERS ARE REQUIRED TO OBTAIN FROM THE PILOT A READBACK OF ALL RUNWAY HOLD SHORT INSTRUCTIONS.** Pilots operating a single pilot aircraft should monitor only assigned ATC communications after being cleared onto the active runway for departure. Single pilot aircraft should not monitor other than ATC communications until flight from Class D airspace is completed. This same procedure should be practiced from after receipt of the clearance for landing until the landing and taxi activities are complete. Proper effective scanning for other aircraft, surface vehicles, or other objects should be continuously exercised in all cases.

b) If the pilot is unfamiliar with the airport or for any reason confusion exists as to the correct taxi routing, a request may be made for progressive taxi instructions which include step-by-step routing directions. Progressive instructions may also be issued if the controller deems it necessary due to traffic or field conditions; i.e., construction or closed taxiways.

**14.5** At those airports where the United States Government operates the control tower and ATC has authorized noncompliance with the requirement for two-way radio communications while operating within Class D airspace, or at those airports where the United States Government does not operate the control tower and radio communications cannot be established, pilots shall obtain a clearance by visual light signal prior to taxiing on a runway and prior to takeoff and landing.

**14.6** The following phraseologies and procedures are used in radio-telephone communications with aeronautical ground stations.

**a) Request for taxi instructions prior to departure:** State your aircraft identification, location, type of operation planned (VFR or IFR), and the point of first intended landing.

**EXAMPLE.—**

AIRCRAFT: "WASHINGTON GROUND, BEECHCRAFT ONE THREE ONE FIVE NINER AT HANGAR EIGHT, READY TO TAXI, IFR TO CHICAGO."

TOWER: "BEECHCRAFT ONE THREE ONE FIVE NINER, WASHINGTON GROUND, TAXI TO RUNWAY THREE SIX, WIND ZERO THREE ZERO AT TWO FIVE, ALTIMETER THREE ZERO ZERO FOUR,"

OR

TOWER: "BEECHCRAFT ONE THREE ONE FIVE NINER, WASHINGTON GROUND, RUNWAY TWO SEVEN, TAXI VIA TAXIWAYS CHARLIE AND DELTA, HOLD SHORT OF RUNWAY THREE THREE LEFT."

AIRCRAFT: "BEECHCRAFT ONE THREE ONE FIVE NINER, HOLD SHORT OF RUNWAY THREE THREE LEFT."

**b) Receipt of air traffic control clearance:** Air route traffic control clearances are relayed to pilots by airport traffic controllers in the following manner:

**EXAMPLE.—**

TOWER: "BEECHCRAFT ONE THREE ONE FIVE NINER, CLEARED TO THE CHICAGO MIDWAY AIRPORT VIA VICTOR EIGHT, MAINTAIN EIGHT THOUSAND."

AIRCRAFT: "BEECHCRAFT ONE THREE ONE FIVE NINER, CLEARED TO THE CHICAGO MIDWAY AIRPORT VIA VICTOR EIGHT, MAINTAIN EIGHT THOUSAND."

**NOTE.—**

NORMALLY, AN ATC IFR CLEARANCE IS RELAYED TO A PILOT BY THE GROUND CONTROLLER. AT BUSY LOCATIONS, HOWEVER, PILOTS MAY BE INSTRUCTED BY THE GROUND CONTROLLER TO "CONTACT CLEARANCE DELIVERY" ON A FREQUENCY DESIGNATED FOR THIS PURPOSE. NO SURVEILLANCE OR CONTROL OVER THE MOVEMENT OF TRAFFIC IS EXERCISED BY THIS POSITION OF OPERATION. (SEE PARAGRAPH 27 ATC CLEARANCES/SEPARATIONS-PILOT/CONTROLLER ROLES AND RESPONSIBILITIES.)

**c) Request for taxi instructions after landing:** State your aircraft identification, location, and that you request taxi instructions.

**EXAMPLE.—**

AIRCRAFT: "DULLES GROUND, BEECHCRAFT ONE FOUR TWO SIX ONE CLEARING RUNWAY ONE RIGHT ON TAXIWAY ECHO THREE, REQUEST CLEARANCE TO PAGE."

TOWER: "BEECHCRAFT ONE FOUR TWO SIX ONE, DULLES GROUND, TAXI TO PAGE VIA TAXIWAYS ECHO THREE, ECHO ONE, AND ECHO NINER."

or

AIRCRAFT: "ORLANDO GROUND, BEECHCRAFT ONE FOUR TWO

SIX ONE CLEARING RUNWAY ONE EIGHT LEFT AT TAXIWAY BRAVO THREE, REQUEST CLEARANCE TO PAGE."

TOWER: "BEECHCRAFT ONE FOUR TWO SIX ONE, ORLANDO GROUND, HOLD SHORT OF RUNWAY ONE EIGHT RIGHT."

AIRCRAFT: "BEECHCRAFT ONE FOUR TWO SIX ONE, HOLD SHORT OF RUNWAY ONE EIGHT RIGHT."

## 15. Taxi During Low Visibility

**15.1** Pilots and aircraft operators should be constantly aware that during certain low visibility conditions the movement of aircraft and vehicles on airports may not be visible to the tower controller. This may prevent visual confirmation of an aircraft's adherence to taxi instructions. Pilots should, therefore, exercise extreme vigilance and proceed cautiously under such conditions.

**15.2** Of vital importance is the need for pilots to notify the controller when difficulties are encountered or at the first indication of becoming disoriented. Pilots should proceed with extreme caution when taxiing toward the sun. When vision difficulties are encountered pilots should immediately inform the controller.

**15.3** Advisory Circular 120-57, Surface Movement Guidance and Control System, commonly known as SMGCS (pronounced "SMIGS") requires a low visibility taxi plan for any airport which has takeoff or landing operations in less than 1,200 feet runway visual range (RVR) visibility conditions. These plans, which affect aircrew and vehicle operators, may incorporate additional lighting, markings, and procedures to control airport surface traffic. They will be addressed at two levels: operations less than 1,200 feet RVR to 600 feet RVR and operations less than 600 feet RVR.

## 16. Intersection Takeoffs

**16.1** In order to enhance airport capacities, reduce taxiing distances, minimize departure delays, and provide for more efficient movement of air traffic, controllers may initiate intersection takeoffs as well as approve them when the pilot requests. If for ANY reason a pilot prefers to use a different intersection or the full length of the runway or desires to obtain the distance between the intersection and the runway end, THE PILOT IS EXPECTED TO INFORM ATC ACCORDINGLY.

**16.2** An aircraft is expected to taxi to (but not onto) the end of the assigned runway unless prior approval for an intersection departure is received from ground control.

**16.3** Pilots should state their position on the airport when calling the tower for takeoff from a runway intersection.

**EXAMPLE.—**  
CLEVELAND TOWER, APACHE THREE SEVEN TWO TWO PAPA, AT THE INTERSECTION OF TAXIWAY OSCAR AND RUNWAY TWO THREE RIGHT, READY FOR DEPARTURE.

**16.4** Controllers are required to separate small aircraft (12,500 pounds or less maximum certificated takeoff weight) departing (same or opposite direction) from an intersection behind a large nonheavy aircraft on the same runway by ensuring that at least a 3-minute interval exists between the time the preceding large aircraft has taken off and the succeeding small aircraft begins takeoff roll. To inform the pilot of the required 3-minute hold, the controller will state, "Hold for wake turbulence." If after considering wake turbulence hazards, the pilot feels that a lesser time interval is appropriate, the pilot may request a waiver to the 3-minute interval. Pilots must initiate such a request by stating, "Request waiver to 3-minute interval," or by making a similar statement. Controllers may then issue a takeoff clearance if other traffic permits, since the pilot has accepted the responsibility for wake turbulence separation.

**16.5** The 3-minute interval is not required when the intersection is 500 feet or less from the departure point of the preceding aircraft and both aircraft are taking off in the same direction. Controllers may permit the small aircraft to alter course after takeoff to avoid the flight path of the preceding departure.

**16.6** The 3-minute interval is mandatory behind a heavy aircraft in all cases.

### 17. VFR Flights in Terminal Areas

**17.1** Use reasonable restraint in exercising the prerogative of VFR flight, especially in terminal areas. The weather minimums and distances from clouds are minimums. Giving yourself a greater margin in specific instances is just good judgment.

**a) Approach Area:** Conducting a VFR operation in Class D and E Airspace when the official visibility is 3 or 4 miles is not prohibited, but good judgment would dictate that you keep out of the approach area.

**b) Reduced Visibility:** It has always been recognized that precipitation reduces forward visibility. Consequently, although again it may be perfectly legal to cancel your IFR flight plan at any time you can proceed VFR, it is good practice, when precipitation is occurring, to continue IFR operation into a terminal area until you are reasonably close to your destination.

**c) Simulated Instrument Flights:** In conducting simulated instrument flights, be sure that the weather is good enough to compensate for the restricted visibility

of the safety pilot and your greater concentration on your flight instruments. Give yourself a little greater margin when your flight plan lies in or near a busy airway or close to an airport.

### 18. Low Approach

**18.1** A low approach (sometimes referred to as a low pass) is the go-around maneuver following approach. Instead of landing or making a touch-and-go, a pilot may wish to go around (low approach) in order to expedite a particular operation—a series of practice instrument approaches is an example of such an operation. Unless otherwise authorized by ATC, the low approach should be made straight ahead with no turns or climb made until the pilot has made a thorough visual check for other aircraft in the area.

**18.2** When operating within Class D airspace, a pilot intending to make a low approach should contact the tower for approval. This request should be made prior to starting the final approach.

**18.3** When operating to an airport within Class E airspace, a pilot intending to make a low approach should, prior to leaving the final approach fix inbound (nonprecision approach) or the outer marker or fix used in lieu of the outer marker inbound (precision approach), so advise the FSS, UNICOM, or make a broadcast as appropriate.

### 19. Practice Instrument Approaches

**19.1** Various air traffic incidents required adoption of measures to achieve more organized and controlled operations where practice instrument approaches are conducted. Practice instrument approaches are considered to be instrument approaches made by either a VFR aircraft not on an IFR flight plan or an aircraft on an IFR flight plan. To achieve this and thereby enhance air safety, it is Air Traffic Operations policy to provide for separation of such operations at locations where approach control facilities are located and, as resources permit, at certain other locations served by ARTCC's or approach control facilities. Pilot requests to practice instrument approaches may be approved by ATC subject to traffic and workload conditions. Pilots should anticipate that in some instances the controller may find it necessary to deny approval or withdraw previous approval when traffic conditions warrant. It must be clearly understood, however, that even though the controller may be providing separation, pilots on VFR flight plans are required to comply with basic visual flight rules (14 CFR Section 91.155). Application of ATC procedures or any action taken by the controller to

avoid traffic conflicts does not relieve IFR and VFR pilots of their responsibility to see and avoid other traffic while operating in VFR conditions (14 CFR Section 91.113). In addition to the normal IFR separation minimums (which includes visual separation) during VFR conditions, 500 feet vertical separation may be applied between VFR aircraft and between a VFR aircraft and an IFR aircraft. Pilots not on IFR flight plans desiring practice instrument approaches should always state "practice" when making requests to ATC. Controllers will instruct VFR aircraft requesting an instrument approach to maintain VFR. This is to preclude misunderstandings between the pilot and controller as to the status of the aircraft. If the pilot wishes to proceed in accordance with instrument flight rules, he must specifically request and obtain an IFR clearance.

**19.2** Before practicing an instrument approach, pilots should inform the approach control facility or the tower of the type of practice approach they desire to make and how they intend to terminate it; i.e., full-stop landing, touch-and-go, or missed/low approach maneuver. This information may be furnished progressively when conducting a series of approaches. Pilots on an IFR flight plan, who have made a series of instrument approaches to full stop landings, should inform ATC when they make their final landing. The controller will control flights practicing instrument approaches so as to ensure that they do not disrupt the flow of arriving and departing itinerant IFR or VFR aircraft. The priority afforded itinerant aircraft over practice instrument approaches is not intended to be so rigidly applied that it causes a grossly inefficient application of services. A minimum delay to itinerant traffic may be appropriate to allow an aircraft practicing an approach to complete that approach.

*NOTE.—  
A CLEARANCE TO LAND MEANS THAT APPROPRIATE SEPARATION ON THE LANDING RUNWAY WILL BE ENSURED. A LANDING CLEARANCE DOES NOT RELIEVE THE PILOT FROM COMPLIANCE WITH ANY PREVIOUSLY ISSUED RESTRICTION.*

**19.3** At airports without a tower, pilots wishing to make practice instrument approaches should notify the facility having control jurisdiction of the desired approach as indicated on the approach chart. All approach control facilities and ARTCC's are required to publish a Letter to Airmen depicting those airports where they provide standard separation to both VFR and IFR aircraft conducting practice instrument approaches.

**19.4** The controller will provide approved separation between both VFR and IFR aircraft when authorization

is granted to make practice approaches to airports where an approach control facility is located and to certain other airports served by approach control or an ARTCC. Controller responsibility for separation of VFR aircraft begins at the point where the approach clearance becomes effective or when the aircraft enters Class B or TRSA airspace whichever comes first.

**19.5** VFR aircraft practicing instrument approaches are not automatically authorized to execute the missed approach procedure. This authorization must be specifically requested by the pilot and approved by the controller. Separation will not be provided unless the missed approach has been approved by ATC.

**19.6** Except in an emergency, aircraft cleared to practice instrument approaches must not deviate from the approved procedure until cleared to do so by the controller.

**19.7** At radar approach control locations when a full approach procedure (procedure turn, etc.) cannot be approved, pilots should expect to be vectored to a final approach course for a practice instrument approach which is compatible with the general direction of traffic at that airport.

**19.8** When granting approval for a practice instrument approach, the controller will usually ask the pilot to report to the tower prior to or over the final approach fix inbound (nonprecision approaches) or over the outer marker or fix used in lieu of the outer marker inbound (precision approaches).

**19.9** When authorization is granted to conduct practice instrument approaches to an airport with a tower but where approved standard separation is not provided to aircraft conducting practice instrument approaches, the tower will approve the practice approach, instruct the aircraft to maintain VFR and issue traffic information, as required.

**19.10** When an aircraft notifies a FSS providing Airport Advisory Service of intent to conduct a practice instrument approach and if separation will be provided, you will be instructed to contact the appropriate facility on a specified frequency prior to initiating the approach. At airports where separation is not provided, the FSS will acknowledge the message and issue known traffic information but will neither approve or disapprove the approach.

**19.11** Pilots conducting practice instrument approaches should be particularly alert for other aircraft operating in the local traffic pattern or in proximity to the airport.

## 20. Option Approach

**20.1** The “Cleared for the Option” procedure will permit an instructor pilot/flight examiner/pilot the option to make a touch-and-go, low approach, missed approach, stop-and-go, or full stop landing. This procedure can be very beneficial in a training situation in that neither the student pilot nor examinee would know what maneuver would be accomplished. The pilot should make a request for this procedure passing the final approach fix inbound on an instrument approach or entering downwind for a VFR traffic pattern. The advantages of this procedure as a training aid are that it enables an instructor/examiner to obtain the reaction of a trainee/examinee under changing conditions, the pilot would not have to discontinue an approach in the middle of the procedure due to student error or pilot proficiency requirements, and finally it allows more flexibility and economy in training programs. This procedure will only be used at those locations with an operational control tower and will be subject to ATC approval/disapproval.

## 21. Communications Release of IFR Aircraft Landing at an Airport Without an Operating Control Tower

**21.1** Aircraft operating on an IFR flight plan, landing at an airport without an operating control tower will be advised to change to the airport advisory frequency when direct communications with ATC is no longer required.

## 22. Pilot Responsibilities When Conducting Land and Hold Short Operations (LAHSO)

**22.1** LAHSO is an acronym for “Land And Hold Short Operations.” These operations include landing and holding short of an intersecting runway, an intersecting taxiway, or some other designated point on a runway other than an intersecting runway or taxiway. (See FIG 1.1-4, FIG 1.1-5, FIG 1.1-6.)

### 22.2 Pilot Responsibilities and Basic Procedures:

a) LAHSO is an air traffic control procedure that requires pilot participation to balance the needs for increased airport capacity and system efficiency, consistent with safety. This procedure can be done safely **provided** pilots and controllers are knowledgeable and understand their responsibilities. The following paragraphs outline specific pilot/operator responsibilities when conducting LAHSO.

b) At controlled airports, air traffic may clear a pilot to land and hold short. Pilots may accept such a clearance provided that the pilot-in-command determines

that the aircraft can safely land and stop within the Available Landing Distance (ALD). ALD data are published in the special notices section of the Airport/Facility Directory (A/FD) and in the U.S. Terminal Procedures Publications. Controllers will also provide ALD data upon request. Student pilots or pilots not familiar with LAHSO should **not** participate in the program.

### Land and Hold Short of an Intersecting Runway

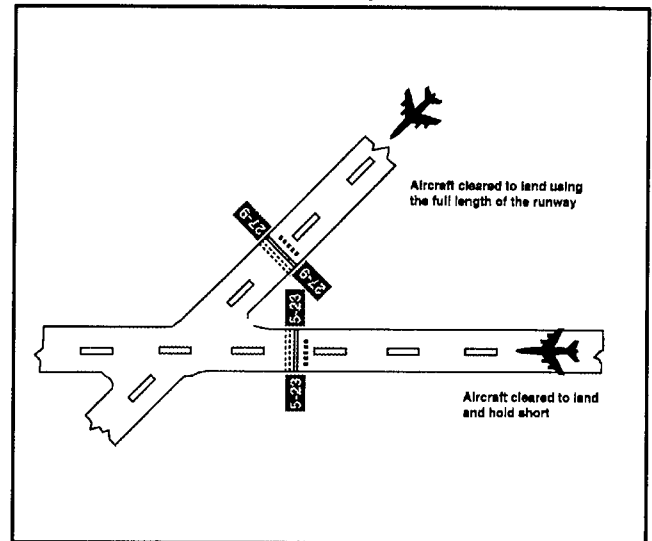

FIG 1.1-4

### Land and Hold Short of an Intersecting Taxiway

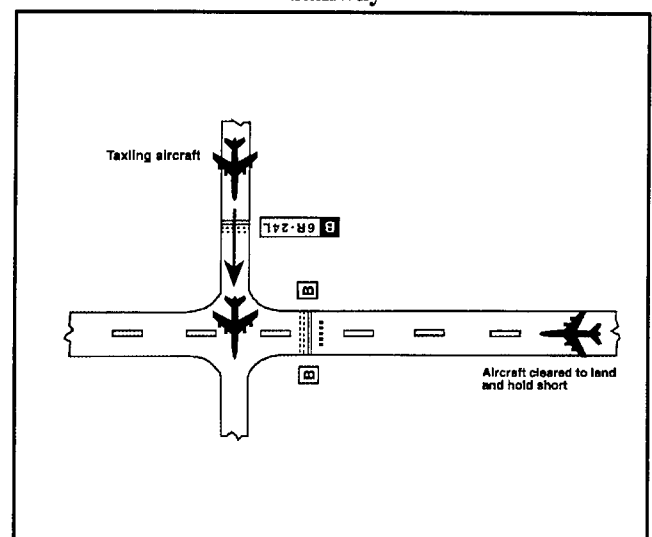

FIG 1.1-5

**EXAMPLE.—**  
FIG 1.1-6 - HOLDING SHORT AT A DESIGNATED POINT MAY BE REQUIRED TO AVOID CONFLICTS WITH THE RUNWAY SAFETY AREA/FLIGHT PATH OF A NEARBY RUNWAY.

**NOTE.—**  
EACH FIGURE SHOWS THE APPROXIMATE LOCATION OF LAHSO MARKINGS, SIGNAGE, AND IN-PAVEMENT LIGHTING WHEN INSTALLED.

REFERENCE-  
AIP, PART 3 - AERODROMES.

**Land and Hold Short of a Designated Point on a Runway Other Than an Intersecting Runway or Taxiway**

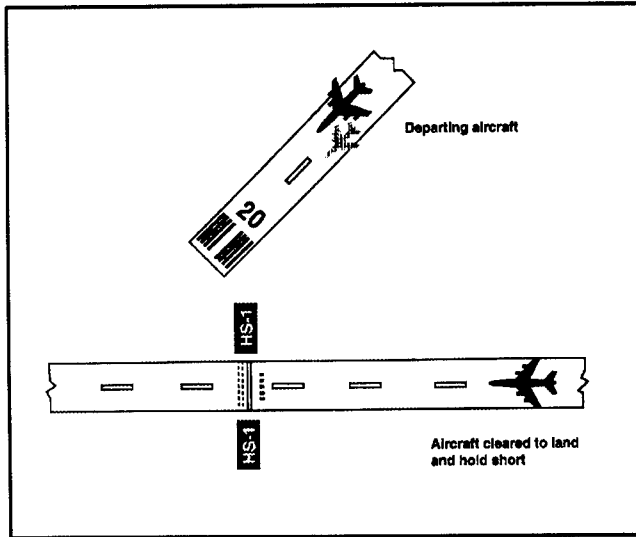

FIG 1.1-6

c) The pilot-in-command has the final authority to accept or decline any land and hold short clearance. The safety and operation of the aircraft remain the responsibility of the pilot. Pilots are expected to decline a LAHSO clearance if they determine it will compromise safety.

d) To conduct LAHSO, pilots should become familiar with all available information concerning LAHSO at their destination airport. Pilots should have, *readily available*, the published ALD and runway slope information for all LAHSO runway combinations at each airport of intended landing. Additionally, knowledge about landing performance data permits the pilot to *readily* determine that the ALD for the assigned runway is sufficient for safe LAHSO. As part of a pilot's preflight planning process, pilots should determine if their destination airport has LAHSO. If so, their preflight planning process should include an assessment of which LAHSO combinations would work for them given their aircraft's required landing distance. Good pilot decision-making is knowing in advance whether one can accept a LAHSO clearance if offered.

e) For those airplanes flown with two crewmembers, effective **intra-cockpit** communication between cockpit crewmembers is also critical. There have been several instances where the pilot working the radios accepted a LAHSO clearance but then simply forgot to tell the pilot flying the aircraft.

f) If, for any reason, such as difficulty in discerning the location of a LAHSO intersection, wind conditions, aircraft condition, etc., the pilot elects to request to land on the full length of the runway, to land on another runway, or to decline LAHSO, a pilot is expected to promptly inform air traffic, ideally even before the clearance is issued. A LAHSO clearance, once accepted, must be adhered to, just as any other ATC clearance, unless an amended clearance is obtained or an emergency occurs. A LAHSO clearance does not preclude a rejected landing.

g) A pilot who accepts a LAHSO clearance should land and exit the runway at the first convenient taxiway (unless directed otherwise) before reaching the hold short point. Otherwise, the pilot must stop and hold at the hold short point. If a rejected landing becomes necessary after accepting a LAHSO clearance, the pilot should maintain safe separation from other aircraft or vehicles, and should promptly notify the controller.

h) Controllers need a full read back of all LAHSO clearances. Pilots should read back their LAHSO clearance and include the words, "HOLD SHORT OF (RUNWAY / TAXIWAY / OR POINT)" in their acknowledgment of all LAHSO clearances. In order to reduce frequency congestion, pilots are encouraged to read back the LAHSO clearance without prompting. Don't make the controller have to ask for a read back!

### 22.3 LAHSO Situational Awareness

a) Situational awareness is **vital** to the success of LAHSO. Situational awareness starts with having current airport information in the cockpit, readily accessible to the pilot. (An airport diagram assists pilots in identifying their location on the airport, thus reducing requests for "progressive taxi instructions" from controllers.)

b) Situational awareness includes effective pilot-controller radio communication. ATC expects pilots to specifically acknowledge and read back all LAHSO clearances as follows:

**EXAMPLE.—**

ATC: "(AIRCRAFT ID) CLEARED TO LAND RUNWAY SIX RIGHT, HOLD SHORT OF TAXIWAY BRAVO FOR CROSSING TRAFFIC (TYPE AIRCRAFT)."

AIRCRAFT: "(AIRCRAFT ID), WILCO, CLEARED TO LAND RUNWAY SIX RIGHT TO HOLD SHORT OF TAXIWAY BRAVO."

ATC: "(AIRCRAFT ID) CROSS RUNWAY SIX RIGHT AT TAXIWAY BRAVO, LANDING AIRCRAFT WILL HOLD SHORT."

AIRCRAFT: "(AIRCRAFT ID), WILCO, CROSS RUNWAY SIX RIGHT AT BRAVO, LANDING TRAFFIC (TYPE AIRCRAFT) TO HOLD."

c) Situational awareness also includes a thorough understanding of the airport markings, signage, and lighting associated with LAHSO. These visual aids consist of a three-part system of **yellow hold-short markings, red and white signage** and, in certain cases, **in-pavement lighting**. Visual aids assist the pilot in determining where to hold short. FIG 1.1-4, FIG 1.1-5, FIG 1.1-6 depict how these markings, signage, and lighting combinations will appear once installed. Pilots are cautioned that not all airports conducting LAHSO have installed any or all of the above markings, signage, or lighting.

d) Pilots should only receive a LAHSO clearance when there is a minimum ceiling of 1,000 feet and 3 statute miles visibility. The intent of having "basic" VFR weather conditions is to allow pilots to maintain visual contact with other aircraft and ground vehicle operations. Pilots should consider the effects of prevailing inflight visibility (such as landing into the sun) and how it may affect overall situational awareness. Additionally, surface vehicles and aircraft being taxied by maintenance personnel may also be participating in LAHSO, especially in those operations that involve crossing an active runway.

### 23. Exiting the Runway after Landing

23.1 The following procedures should be followed after landing and reaching taxi speed.

a) Exit the runway without delay at the first available taxiway or on a taxiway as instructed by ATC. Pilots shall not exit the landing runway onto another runway unless authorized by ATC. At airports with an operating control tower, pilots should not stop or reverse course on the runway without first obtaining ATC approval.

b) Taxi clear of the runway unless otherwise directed by ATC. In the absence of ATC instructions, the pilot is expected to taxi clear of the landing runway even if that requires the aircraft to protrude into or cross another taxiway, runway, or ramp area. This does not authorize an aircraft to cross a subsequent taxiway/runway/ramp after clearing the landing runway.

**NOTE.—**  
*THE TOWER WILL ISSUE THE PILOT INSTRUCTIONS WHICH WILL NORMALLY PERMIT THE AIRCRAFT TO ENTER ANOTHER TAXIWAY, RUNWAY, OR RAMP AREA WHEN REQUIRED TO TAXI CLEAR OF THE RUNWAY.*

c) Stop the aircraft after clearing the runway if instructions have not been received from ATC.

d) Immediately change to ground control frequency when advised by the tower and obtain a taxi clearance.

**NOTE.—**  
*[1] THE TOWER WILL ISSUE INSTRUCTIONS REQUIRED TO RESOLVE ANY POTENTIAL CONFLICTIONS WITH OTHER GROUND TRAFFIC PRIOR TO ADVISING THE PILOT TO CONTACT GROUND CONTROL.*

*[2] A CLEARANCE FROM ATC TO TAXI TO THE RAMP AUTHORIZES THE AIRCRAFT TO CROSS ALL RUNWAYS AND TAXIWAY INTERSECTIONS. PILOTS NOT FAMILIAR WITH THE TAXI ROUTE SHOULD REQUEST SPECIFIC TAXI INSTRUCTIONS FROM ATC.*

### 24. Hand Signals

Signalman Directs Towing

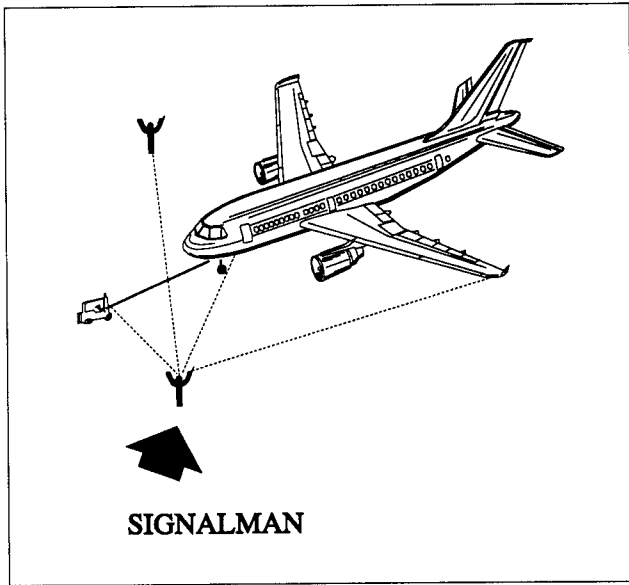

FIG 1.1-7

Signalman's Position

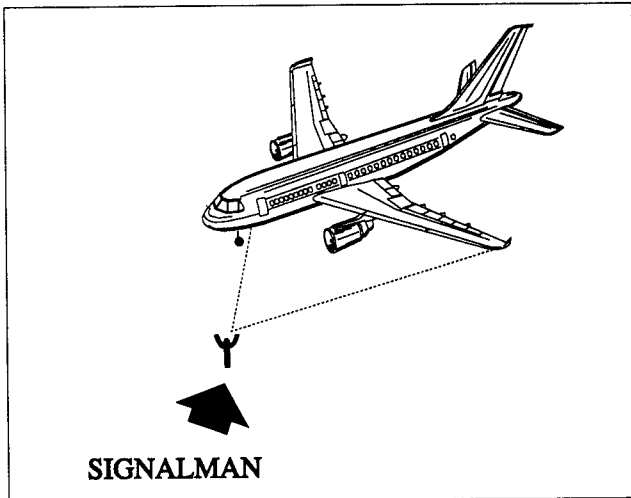

FIG 1.1-8

Flagman Directs Pilot

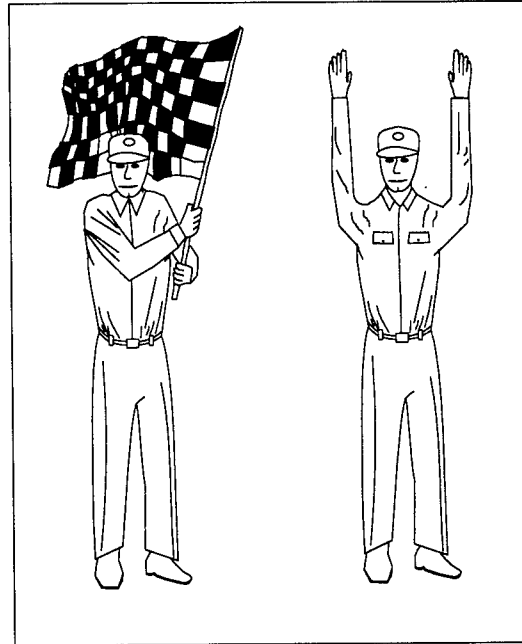

FIG 1.1-9

All Clear  
(O.K.)

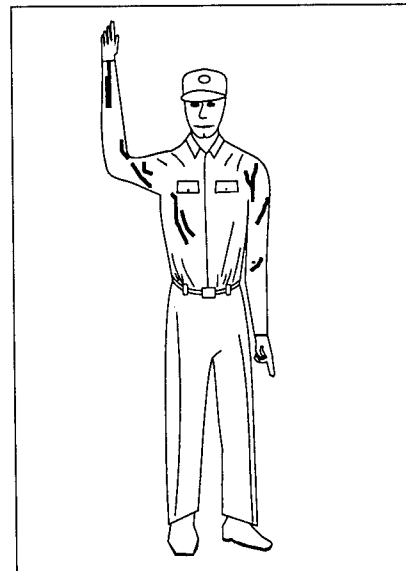

FIG 1.1-10



**Start Engine**

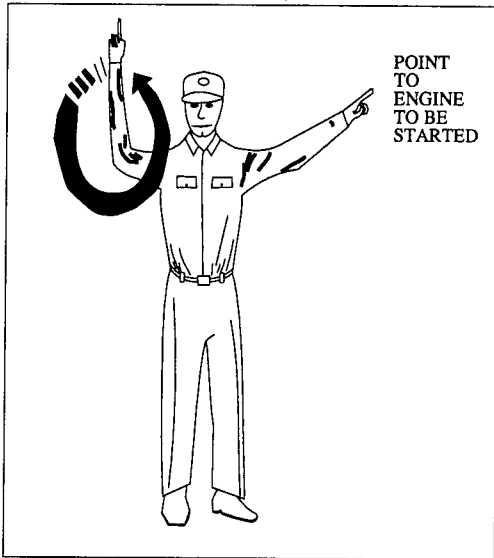

FIG 1.1-11

**Come Ahead**

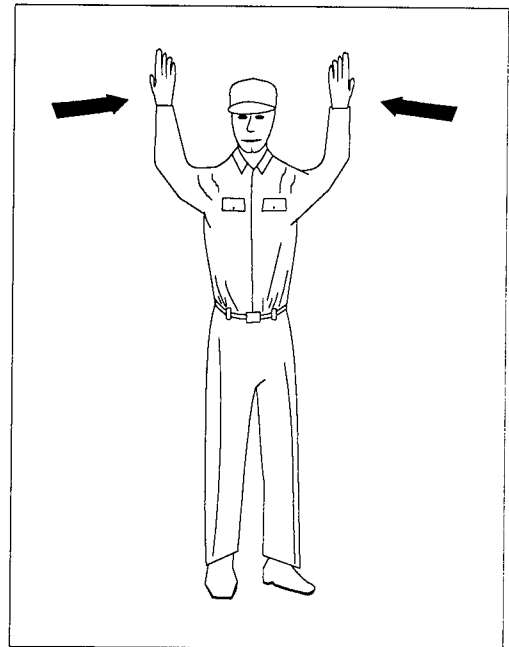

FIG 1.1-13

**Pull Chocks**

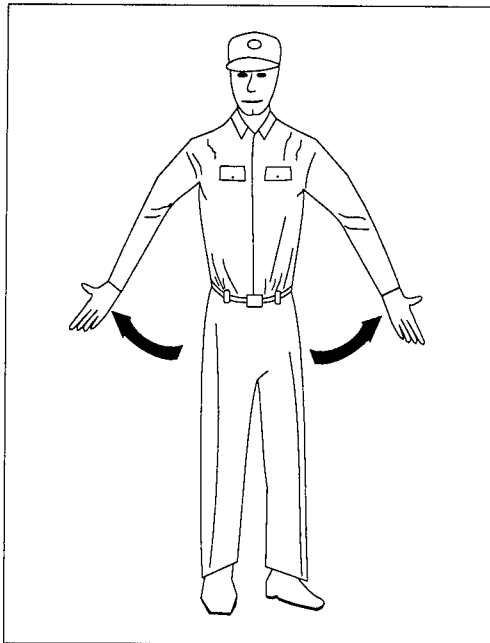

FIG 1.1-12

**Left Turn**

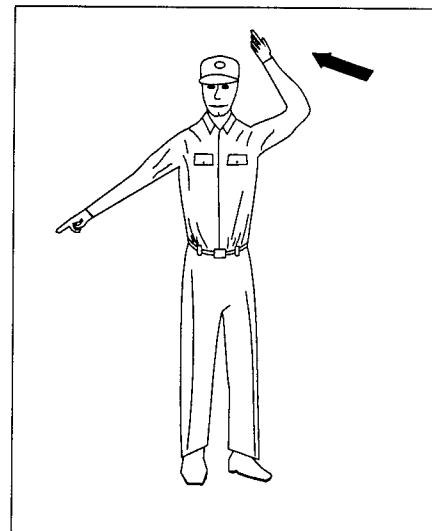

FIG 1.1-14

**Right Turn**

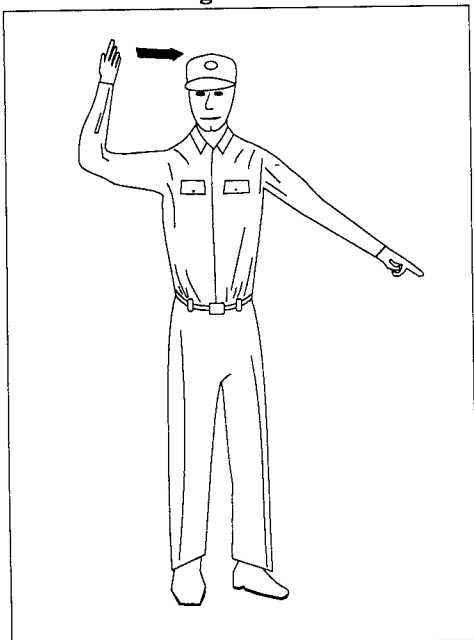

FIG 1.1-15

**Stop**

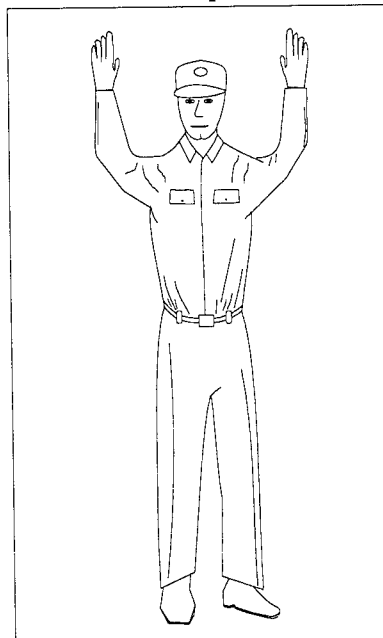

FIG 1.1-17

**Slow Down**

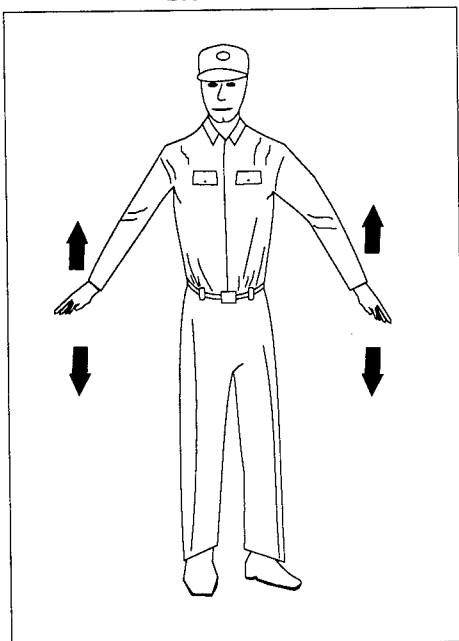

FIG 1.1-16

**Insert Chocks**

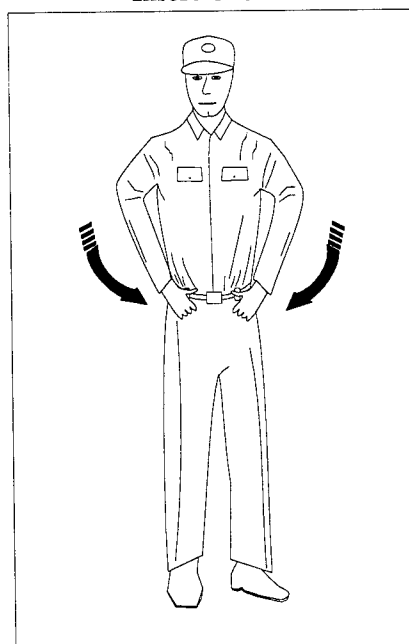

FIG 1.1-18

**Cut Engines**

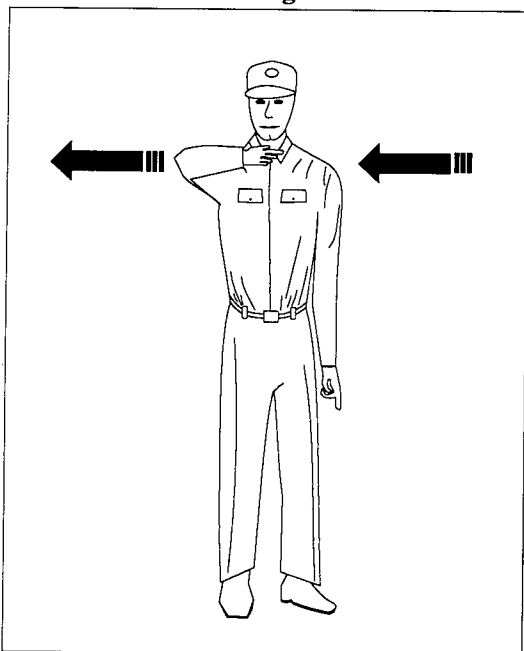

FIG 1.1-19

**Emergency Stop**

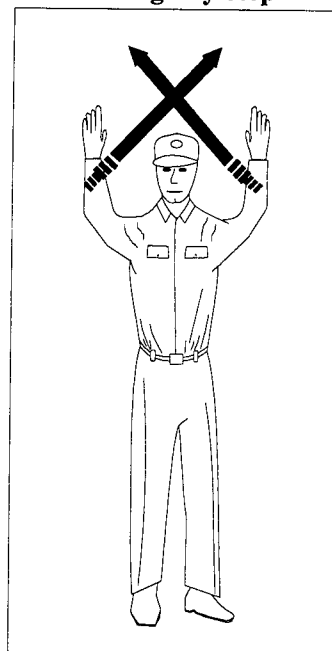

FIG 1.1-21

**Night Operation**

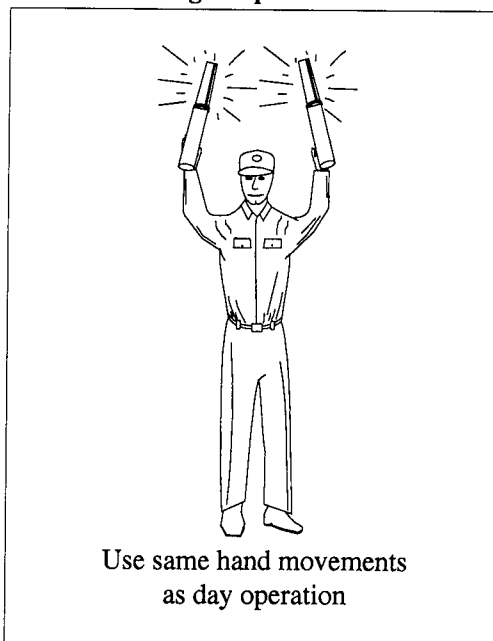

FIG 1.1-20

## 25. Use of Aircraft Lights

**25.1** Aircraft position lights are required to be lighted on aircraft operated on the surface and in flight from sunset to sunrise. In addition, aircraft equipped with an anti-collision light system are required to be operated during all types of operations (day and night) except when the pilot-in-command determines that the anti-collision lights should be turned off when their light output during adverse meteorological conditions would constitute a hazard to safety (14 CFR Section 91.209). Supplementary strobe lights should be turned off on the ground when they adversely affect ground personnel or other pilots, and in flight when there are adverse reflection from clouds.

**25.2** An aircraft anti-collision light system can use one or more rotating beacons and/or strobe lights, be colored either red or white, and have different (higher than minimum) intensities when compared to other aircraft. Many aircraft have both a rotating beacon and a strobe light system.

**25.3** The FAA has a voluntary pilot safety program, *Operation Lights On*, to enhance the see-and-avoid concept. Pilots are encouraged to turn on their landing lights during takeoff; i.e., either after takeoff clearance has been received or when beginning takeoff roll. Pilots are further encouraged to turn on their landing lights when operating below 10,000 feet, day or night, especially when operating within 10 miles of any airport or in conditions of reduced visibility and in areas where flocks of birds may be expected; i.e., coastal areas, lake areas, around refuse dumps, etc. Although turning on aircraft lights does enhance the see-and-avoid concept, pilots should not become complacent about keeping a sharp lookout for other aircraft. Not all aircraft are equipped with lights, and some pilots may not have their lights turned on. Aircraft manufacturers' recommendations for operation of landing lights and electrical systems should be observed.

**25.4** Prop and jet blast forces generated by large aircraft have overturned or damaged several smaller aircraft taxiing behind them. To avoid similar results and in the interest of preventing upsets and injuries to ground personnel from such forces, the FAA recommends that air carriers and commercial operators turn on their rotating beacons anytime their aircraft engines are in operation. General aviation pilots using rotating beacon-equipped aircraft are also encouraged to participate in this program which is designed to alert others to the potential hazard. Since this is a voluntary program, exercise cau-

tion and do not rely solely on the rotating beacon as an indication that aircraft engines are in operation.

**25.5** At the sole discretion of the pilot in command, if aircraft equipment permits, at least one landing light may be turned on when holding in position on the runway. This increases the conspicuity of the holding aircraft to aircraft approaching to land, aircraft taxiing, and/or aircraft crossing the runway. When appropriate, or cleared for takeoff, pilots should turn on all remaining exterior lights. Pilots should be aware of and respect any operating limitations on aircraft systems or other limitations, and the effect of landing lights to other aircraft in the immediate vicinity.

## 26. Flight Inspection/"Flight Check" Aircraft in Terminal Areas

**26.1** "Flight Check" is a call sign used to alert pilots and air traffic controllers when an FAA aircraft is engaged in flight inspection/certification of NAVAID's and flight procedures. Flight check aircraft fly pre-planned high/low altitude flight patterns such as grids, orbits, DME arcs, and tracks, including low passes along the full length of the runway to verify NAVAID performance. In most instances, these flight checks are being automatically recorded and/or flown in an automated mode.

**26.2** Pilots should be especially watchful and avoid the flight paths of any aircraft using the call sign "Flight Check" or "Flight Check Recorded." The latter call sign; e.g. "Flight Check 47 Recorded," indicates that automated flight inspections are in progress in terminal areas. These flights will normally receive special handling from ATC. Pilot patience and cooperation in allowing uninterrupted recordings can significantly help expedite flight inspections, minimize costly, repetitive runs, and reduce the burden on the U.S. taxpayer.

## 27. ATC Clearances/Separations

### 27.1 Clearance

**27.1.1** A clearance issued by ATC is predicated on known traffic and known physical airport conditions. An ATC clearance means an authorization by ATC, for the purpose of preventing collision between known aircraft, for an aircraft to proceed under specified conditions within Classes A, B, C, D and E airspace. IT IS NOT AUTHORIZATION FOR A PILOT TO DEVIATE FROM ANY RULE, REGULATION OR MINIMUM ALTITUDE NOR TO CONDUCT UNSAFE OPERATION OF THE AIRCRAFT.

**27.1.2** 14 CFR Section 91.3(a) states: "The pilot in command of an aircraft is directly responsible for, and

is the final authority as to, the operation of that aircraft.” If ATC issues a clearance that would cause a pilot to deviate from a rule or regulation, or in the pilot’s opinion, would place the aircraft in jeopardy, **IT IS THE PILOT’S RESPONSIBILITY TO REQUEST AN AMENDED CLEARANCE.** Similarly, if a pilot prefers to follow a different course of action, such as make a 360-degree turn for spacing to follow traffic when established in a landing or spacing to follow traffic when established in a landing or approach sequence, land on a different runway, takeoff from a different intersection, takeoff from the threshold instead of an intersection or delay operation, **THE PILOT IS EXPECTED TO INFORM ATC ACCORDINGLY.** When the pilot requests a different course of action, however, the pilot is expected to cooperate so as to preclude the disruption of the traffic flow or the creation of conflicting patterns. The pilot is also expected to use the appropriate aircraft call sign to acknowledge all ATC clearances, frequency changes, or advisory information.

**27.1.3** Each pilot who deviates from an ATC clearance in response to a traffic alert and collision avoidance system resolution advisory shall notify ATC of that deviation as soon as possible.

**27.1.4** When weather conditions permit, during the time an IFR flight is operating, it is the direct responsibility of the pilot to avoid other aircraft since VFR flights may be operating in the same area without the knowledge of ATC, and traffic clearances provide standard separation only between IFR flights.

## **27.2 Clearance Prefix**

A clearance, information, or request for information originated by an ATC facility and relayed to the pilot through an air/ground communication station will be prefixed by “ATC CLEARS,” “ATC ADVISES,” or “ATC REQUESTS.”

## **27.3 Clearance Items**

An ATC clearance normally contains the following:

**a) Clearance Limit:** The traffic clearance issued prior to departure will normally authorize flight to the airport of intended landing. Under certain conditions at some locations, a short-range clearance procedure is utilized whereby a clearance is issued to a fix within or just outside the terminal area and pilots are advised of the frequency on which they will receive the long-range clearance direct from the center controller.

**b) Departure Procedure:** Headings to fly and altitude restrictions may be issued to separate a departure from other air traffic in the terminal area. Where the volume of traffic warrants, instrument departure procedures (DP’s) have been developed. (See ENR 1.5.)

### **c) Route of Flight:**

1) Clearances are normally issued for the altitude/flight level and route filed by the pilot. However, due to traffic conditions, it is frequently necessary for ATC to specify an altitude/flight level or route different from that requested by the pilot. In addition, flow patterns have been established in certain congested areas, or between congested areas, whereby traffic capacity is increased by routing all traffic on preferred routes. Information on these flow patterns is available in offices where preflight briefing is furnished or where flight plans are accepted.

2) When required, air traffic clearances include data to assist pilots in identifying radio reporting points. It is the responsibility of a pilot to notify ATC immediately if the radio equipment cannot receive the type of signals the pilot must utilize to comply with the clearance.

### **d) Altitude Data:**

1) The altitude/flight level instructions in an ATC clearance normally require that a pilot “MAINTAIN” the altitude/flight level to which the flight will operate when in Classes A, B, C, D and E airspace. Altitude/flight level changes while en route should be requested prior to the time the change is desired.

2) When possible, if the altitude assigned is different than that requested by the pilot, ATC will inform an aircraft when to expect climb or descent clearance or to request altitude change from another facility. If this has not been received prior to crossing the boundary of the ATC facility’s area and assignment at a different flight level is still desired, the pilot should reinitiate the request with the next facility.

3) The term “CRUISE” may be used instead of “MAINTAIN” to assign a block of airspace, to a pilot, from the minimum IFR altitude up to and including the altitude specified in the cruise clearance. The pilot may level off at any intermediate altitude within this block of airspace. Climb/descent within the block is to be made at the discretion of the pilot. However, once the pilot starts descent and verbally reports leaving an altitude in the block, the pilot may not return to that altitude without additional ATC clearance.

### e) Holding Instructions:

1) Whenever an aircraft is cleared to a fix other than the destination airport and delay is expected, it is the responsibility of the ATC controller to issue complete holding instructions (unless the pattern is charted), an EFC time, and a best estimate of any additional en route/terminal delay.

2) If the holding pattern is charted and the controller doesn't issue complete holding instructions, the pilot is expected to hold as depicted on the appropriate chart. When the pattern is charted, the controller may omit all holding instructions except the charted holding direction and the statement "AS PUBLISHED;" e.g., "HOLD EAST AS PUBLISHED." Controllers shall always issue complete holding instructions when pilots request them.

**NOTE.—**  
ONLY THOSE HOLDING PATTERNS DEPICTED ON U.S. GOVERNMENT OR COMMERCIALY PRODUCED CHARTS WHICH MEET FAA REQUIREMENTS SHOULD BE USED.

3) If no holding pattern is charted and holding instructions have not been issued, the pilot should ask ATC for holding instructions prior to reaching the fix. This procedure will eliminate the possibility of an aircraft entering a holding pattern other than that desired by ATC. If unable to obtain holding instructions prior to reaching the fix (due to frequency congestion, stuck microphones, etc.), hold in a standard pattern on the course on which you approached the fix and request further clearance as soon as possible. In this event, the altitude/flight level of the aircraft at the clearance limit will be protected so that separation will be provided as required.

4) When an aircraft is 3 minutes or less from a clearance limit and a clearance beyond the fix has not been received, the pilot is expected to start a speed reduction so that the aircraft will cross the fix, initially, at or below the maximum holding airspeed.

5) When no delay is expected, the controller should issue a clearance beyond the fix as soon as possible and, whenever possible, at least 5 minutes before the aircraft reaches the clearance limit.

6) Pilots should report to ATC the time and altitude/flight level at which the aircraft reaches the clearance limit and report leaving the clearance limit.

**NOTE.—**  
IN THE EVENT OF TWO-WAY COMMUNICATIONS FAILURE, PILOTS ARE REQUIRED TO COMPLY WITH 14 CFR SECTION 91.185.

### 27.4 Amended Clearances

**27.4.1** Amendments to the initial clearance will be issued at any time an air traffic controller deems such action necessary to avoid possible conflict between aircraft. Clearances will require that a flight "hold" or change altitude prior to reaching the point where standard separation from other IFR traffic would no longer exist.

**NOTE.—**  
SOME PILOTS HAVE QUESTIONED THIS ACTION AND REQUESTED "TRAFFIC INFORMATION" AND WERE AT A LOSS WHEN THE REPLY INDICATED "NO TRAFFIC REPORTED." IN SUCH CASES THE CONTROLLER HAS TAKEN ACTION TO PREVENT A TRAFFIC CONFLICTION WHICH WOULD HAVE OCCURRED AT A DISTANT POINT.

**27.4.2** A pilot may wish an explanation of the handling of the flight at the time of occurrence; however, controllers are not able to take time from their immediate control duties, nor can they afford to overload the ATC communications channels to furnish explanations. Pilots may obtain an explanation by directing a letter or telephone call to the chief controller of the facility involved.

**27.4.3** Pilots have the privilege of requesting a different clearance from that which has been issued by ATC if they feel that they have information which would make another course of action more practicable or if aircraft equipment limitations or company procedures forbid compliance with the clearance issued.

**27.4.4** Pilots should pay particular attention to the clearance and not assume that the route and altitude/flight level are the same as requested in the flight plan. It is suggested that pilots make a written report of clearances at the time they are received, and verify, by a repeat back, any portions that are complex or about which a doubt exists. It will be the responsibility of each pilot to accept or refuse the clearance issued.

### 27.5 Special VFR Clearance

**27.5.1** An ATC clearance must be obtained *prior* to operating within a Class B, Class C, Class D and Class E surface area when the weather is less than that required for VFR flight. A VFR pilot may request and be given a clearance to enter, leave or operate within most Class D and Class E surface areas and some Class B and Class C surface areas in special VFR conditions, traffic permitting, and providing such flight will not delay IFR operations. All special VFR flights must remain clear of clouds. The visibility requirements for Special VFR aircraft (other than helicopters) are:

a) At least one statute mile flight visibility for operations within Classes B, C, D and E surface areas;

b) At least one statute mile ground visibility if taking off or landing. If ground visibility is not reported at that airport, the flight visibility must be at least one statute mile; and

c) The restrictions in (a and (b do not apply to helicopters. Helicopters must remain clear of clouds and may operate in Classes B, C, D and E surface areas with less than one statute mile visibility.

**27.5.2** When a control tower is located within a Class B, Class C and Class D surface area, requests for clearances should be to the tower. If no tower is located within the surface area, a clearance may be obtained from the nearest tower, FSS or ARTCC.

**27.5.3** It is not necessary to file a complete flight plan with the request for clearance, but pilots should state their intentions in sufficient detail to permit ATC to fit their flight into the traffic flow. The clearance will not contain a specific altitude as the pilot must remain clear of clouds. The controller may require the pilot to fly at or below a certain altitude due to other traffic, but the altitude specified will permit flight at or above the minimum safe altitude. In addition, at radar locations, flight may be vectored if necessary for control purposes or on pilot request.

**NOTE.—**  
*THE PILOT IS RESPONSIBLE FOR OBSTACLE OR TERRAIN CLEARANCE (REFERENCE 14 CFR SECTION 91.119).*

**27.5.4** Special VFR clearances are effective within Classes B, C, D and E surface areas only. ATC does not provide separation after an aircraft leaves Class D surface area on a special VFR clearance.

**27.5.5** Special VFR operations by fixed-wing aircraft are prohibited in some Classes B and C surface areas due to the volume of IFR traffic. A list of these Classes B and C surface areas is contained in 14 CFR Part 91, Appendix D, Section 3 and also depicted on Sectional Aeronautical Charts.

**27.5.6** ATC provides separation between special VFR flights and between them and other IFR flights.

**27.5.7** Special VFR operations by fixed-wing aircraft are prohibited between sunset and sunrise unless the pilot is instrument rated and the aircraft is equipped for IFR flight.

**27.5.8** Pilots arriving or departing an uncontrolled airport that has automated weather broadcast capability (ASOS/AWOS) should monitor the broadcast frequency, advise the controller that they have the “one-minute weather” and state intentions prior to operating within the Class B, Class C, Class D or Class E surface areas.

**NOTE.—**

*ONE-MINUTE WEATHER IS THE MOST RECENT ONE MINUTE UPDATED WEATHER BROADCAST RECEIVED BY A PILOT FROM AN UNCONTROLLED AIRPORT ASOS/AWOS.*

## 28. Pilot Responsibilities Upon Clearance Issuance

**28.1 Record ATC Clearance:** When conducting an IFR operation, make a written record of your ATC clearance. The specified conditions which are a part of your air traffic clearance may be somewhat different from those included in your flight plan. Additionally, ATC may find it necessary to ADD conditions, such as a particular departure route. The very fact that ATC specifies different or additional conditions means that other aircraft are involved in the traffic situation.

**28.2 ATC Clearance/Instruction Readback:** Pilots of airborne aircraft should read back those parts of the ATC clearances/instructions containing altitude assignments or vectors, as a means of mutual verification. The readback of the “numbers” serves as a double check between pilots and controllers, and such, it is an invaluable aid in reducing the kinds of communications errors that occur when a number is either “misheard” or is incorrect.

a) Include the aircraft identification in all readbacks and acknowledgments. This aids controllers in determining that the correct aircraft received the clearance or instruction. The requirement to include aircraft identification in all readbacks and acknowledgments becomes more important as frequency congestion increases and when aircraft with similar call signs are on the same frequency.

**EXAMPLE.—**  
*“CLIMBING TO FLIGHT LEVEL THREE THREE ZERO, UNITED TWELVE” OR “NOVEMBER FIVE CHARLIE TANGO, ROGER, CLEARED TO LAND”*

b) Read back altitudes, altitude restrictions, and vectors in the same sequence as they are given in the clearance/instruction.

c) Altitudes contained in charted procedures such as DP's, instrument approaches, etc., should not be read back unless they are specifically stated by the controller.

**28.3** It is the responsibility of the pilot to accept or refuse the clearance issued.

## 29. IFR Clearance VFR-On-Top

**29.1** A pilot on an IFR flight plan operating in VFR weather conditions, may request VFR-on-top in lieu of an assigned altitude. This would permit pilots to select an altitude or flight level of their choice (subject to any ATC restrictions).

**29.2** Pilots desiring to climb through a cloud, haze, smoke, or other meteorological formation and then either cancel their IFR flight plan or operate VFR-on-top may request a climb to VFR-on-top. The ATC authorization shall contain either a top report or a statement that no top report is available, and a request to report reaching VFR-on-top. Additionally, the ATC authorization may contain a clearance limit, routing and an alternative clearance if VFR-on-top is not reached by a specified altitude.

**29.3** A pilot on an IFR flight plan operating in VFR conditions may request to climb/descend in VFR conditions.

**29.4** ATC may not authorize VFR-on-top/VFR conditions operations unless the pilot requests the VFR operation or a clearance to operate in VFR conditions will result in noise abatement benefits where part of the IFR departure route does not conform to an FAA approved noise abatement route or altitude.

**29.5** When operating in VFR conditions with an ATC authorization to “maintain VFR-on-top” or “maintain VFR conditions,” pilots on IFR flight plans must:

a) Fly at the appropriate VFR altitude as prescribed in 14 CFR Section 91.159.

b) Comply with the VFR visibility and distance from cloud criteria in 14 CFR Section 91.155 (Basic VFR Weather Minimums).

*NOTE.— SEE AIP, GEN 1.7, ANNEX 2, FOR A TABLE SHOWING BASIC VFR WEATHER MINIMUMS.*

c) Comply with instrument flight rules that are applicable to this flight; i.e., minimum IFR altitude, position reporting, radio communications, course to be flown, adherence to ATC clearance, etc. Pilots should advise ATC prior to any altitude change to insure the exchange of accurate traffic information.

**29.6** ATC authorization to “maintain VFR-on-top” is not intended to restrict pilots so that they must operate only above an obscuring meteorological formation (layer). Instead, it permits operation above, below, between layers or in areas where there is no meteorological obscuration. It is imperative that clearance to operate “VFR-on-top/VFR conditions” does not imply cancellation of the IFR flight plan.

**29.7** Pilots operating VFR-on-top/VFR conditions may receive traffic information from ATC on other pertinent IFR or VFR aircraft. However, aircraft operating in Class B or Class C airspace and TRSA's shall be separated as required by FAA Order 7110.65.

*NOTE.—  
WHEN OPERATING IN VFR WEATHER CONDITIONS, IT IS THE PILOT'S RESPONSIBILITY TO BE VIGILANT SO AS TO SEE AND AVOID OTHER AIRCRAFT.*

### **30. VFR/IFR Flights**

A pilot departing VFR, either intending to or needing to obtain an IFR clearance en route, must be aware of the position of the aircraft and the relative terrain/obstructions. When accepting a clearance below the minimum en route altitude (MEA)/minimum IFR altitude (MIA)/minimum vector altitude (MVA)/off route obstruction clearance altitude (OROCA), pilots are responsible for their own terrain/obstruction clearance until reaching the MEA/MIA/MVA/OROCA. If the pilots are unable to maintain terrain/obstruction clearance, the controller should be advised and pilots should state their intentions.

*NOTE.—  
OROCA IS AN OFF ROUTE ALTITUDE WHICH PROVIDES OBSTRUCTION CLEARANCE WITH A 1,000 FOOT BUFFER IN NONMOUNTAINOUS TERRAIN AREAS AND A 2,000 FOOT BUFFER IN DESIGNATED MOUNTAINOUS AREAS WITHIN THE UNITED STATES. THIS ALTITUDE MAY NOT PROVIDE SIGNAL COVERAGE FROM GROUND BASED NAVIGATIONAL AIDS, AIR TRAFFIC CONTROL RADAR, OR COMMUNICATIONS COVERAGE.*

### **31. Adherence to Clearance**

**31.1** When air traffic clearance has been obtained under either the Visual or Instrument Flight Rules, the pilot in command of the aircraft shall not deviate from the provisions thereof unless an amended clearance is obtained. When ATC issues a clearance or instruction, pilots are expected to execute its provisions upon receipt. ATC, in certain situations, will include the word “IMMEDIATELY” in a clearance or instruction to impress urgency of an imminent situation, and expeditious compliance by the pilot is expected and necessary for safety. The addition of a VFR or other restriction; i.e., climb or descent point or time, crossing altitude, etc., does not authorize a pilot to deviate from the route of flight or any other provision of the ATC clearance.

**31.2** When a heading is assigned or a turn is requested by ATC, pilots are expected to promptly initiate the turn, to complete the turn, and to maintain the new heading unless issued additional instructions.

**31.3** The term “at pilot’s discretion” included in the altitude information of an ATC clearance means that ATC has offered the pilot the option to start climb or descent when the pilot wishes, is authorized to conduct the climb or descent at any rate, and to temporarily level off at any intermediate altitude as desired. However, once the aircraft has vacated an altitude, it may not return to that altitude.



**31.4** When ATC has not used the term “at pilot’s discretion” nor imposed any climb/descent restrictions, pilots should initiate climb or descent promptly on acknowledgement of the clearance. Descend or climb at an optimum rate consistent with the operating characteristics of the aircraft to 1,000 feet above or below the assigned altitude, and then attempt to descend or climb at a rate of between 500 and 1,500 feet per minute until the assigned altitude is reached. If at any time the pilot is unable to climb/descent at a rate of at least 500 feet per minute, advise ATC. If it is necessary to level off at an intermediate altitude, during climb or descent, advise ATC, except when leveling off at 10,000 feet MSL on descent or 2,500 feet above airport elevation (prior to entering a Class B, C or D surface area), when required for speed reduction (14 CFR Section 91.117).

**NOTE.—**  
LEVELING OFF AT 10,000 FEET MSL ON DESCENT, OR 2,500 FEET ABOVE AIRPORT ELEVATION (PRIOR TO ENTERING IN A CLASS B, C OR D SURFACE AREA), TO COMPLY WITH 14 CFR SECTION 91.117 AIRSPEED RESTRICTIONS, IS COMMONPLACE. CONTROLLERS ANTICIPATE THIS ACTION AND PLAN ACCORDINGLY. LEVELING OFF AT ANY OTHER TIME, ON CLIMB OR DESCENT, MAY SERIOUSLY AFFECT AIR TRAFFIC HANDLING BY ATC. CONSEQUENTLY, IT IS IMPERATIVE THAT PILOTS MAKE EVERY EFFORT TO FULFILL THE ABOVE EXPECTED ACTIONS TO AID ATC IN SAFELY HANDLING AND EXPEDITING TRAFFIC.

**31.5** If the altitude information of an ATC DESCENT clearance includes a provision to “CROSS (fix) AT” or “AT OR ABOVE/BELOW (altitude),” the manner in which the descent is executed to comply with the crossing altitude is at the pilot’s discretion. This authorization to descend at pilot’s discretion is only applicable to that portion of the flight to which the crossing altitude restriction applies, and the pilot is expected to comply with the crossing altitude as a provision of the clearance. Any other clearance in which pilot execution is optional will so state: “AT PILOT’S DISCRETION.”

**EXAMPLE.—**  
“UNITED FOUR SEVENTEEN, DESCEND AND MAINTAIN SIX THOUSAND.”

**NOTE.—**  
THE PILOT IS EXPECTED TO COMMENCE DESCENT UPON RECEIPT OF THE CLEARANCE AND TO DESCEND AT THE SUGGESTED RATES SPECIFIED ABOVE UNTIL REACHING THE ASSIGNED ALTITUDE OF 6,000 FEET.

**EXAMPLE.—**  
“UNITED FOUR SEVENTEEN, DESCEND AT PILOT’S DISCRETION, MAINTAIN SIX THOUSAND.”

**NOTE.—**  
THE PILOT IS AUTHORIZED TO CONDUCT DESCENT WITHIN THE CONTEXT OF THE TERM AT PILOT’S DISCRETION AS DESCRIBED ABOVE.

**EXAMPLE.—**  
“UNITED FOUR SEVENTEEN, CROSS LAKEVIEW V-O-R AT OR ABOVE FLIGHT LEVEL TWO ZERO ZERO, DESCEND AND MAINTAIN SIX THOUSAND.”

**NOTE.—**  
THE PILOT IS AUTHORIZED TO CONDUCT DESCENT AT PILOT’S DISCRETION UNTIL REACHING LAKEVIEW VOR AND MUST COMPLY WITH THE CLEARANCE PROVISION TO CROSS THE LAKEVIEW VOR AT OR ABOVE FL 200. AFTER PASSING LAKEVIEW VOR, THE PILOT IS EXPECTED TO DESCEND AT THE RATES SPECIFIED ABOVE UNTIL REACHING THE ASSIGNED ALTITUDE OF 6,000 FEET.

**EXAMPLE.—**  
“UNITED FOUR SEVENTEEN, CROSS LAKEVIEW V-O-R AT SIX THOUSAND, MAINTAIN SIX THOUSAND.”

**NOTE.—** THE PILOT IS AUTHORIZED TO CONDUCT DESCENT AT PILOT’S DISCRETION; HOWEVER, HE MUST COMPLY WITH THE CLEARANCE PROVISION TO CROSS THE LAKEVIEW VOR AT 6,000 FEET.

**EXAMPLE.—**  
“UNITED FOUR SEVENTEEN, DESCEND NOW TO FLIGHT LEVEL TWO SEVEN ZERO, CROSS LAKEVIEW V-O-R AT OR BELOW ONE ZERO THOUSAND, DESCEND AND MAINTAIN SIX THOUSAND.”

**NOTE.—**  
THE PILOT IS EXPECTED TO PROMPTLY EXECUTE AND COMPLETE DESCENT TO FL 270 UPON RECEIPT OF THE CLEARANCE. AFTER REACHING FL 270, THE PILOT IS AUTHORIZED TO DESCEND “AT PILOT’S DISCRETION” UNTIL REACHING LAKEVIEW VOR. THE PILOT MUST COMPLY WITH THE CLEARANCE PROVISION TO CROSS LAKEVIEW VOR AT OR BELOW 10,000 FEET. AFTER LAKEVIEW VOR, THE PILOT IS EXPECTED TO DESCEND AT THE RATES SPECIFIED ABOVE UNTIL REACHING 6,000 FEET.

**EXAMPLE.—**  
“UNITED THREE TEN, DESCEND NOW AND MAINTAIN FLIGHT LEVEL TWO FOUR ZERO, PILOT’S DISCRETION AFTER REACHING FLIGHT LEVEL TWO EIGHT ZERO.”

**NOTE.—**  
THE PILOT IS EXPECTED TO COMMENCE DESCENT UPON RECEIPT OF THE CLEARANCE AND TO DESCEND AT THE SUGGESTED RATES UNTIL REACHING FLIGHT LEVEL 280. AT THAT POINT, THE PILOT IS AUTHORIZED TO CONTINUE DESCENT TO FLIGHT LEVEL 240 WITHIN THE CONTEXT OF THE TERM “AT PILOT’S DISCRETION” AS DESCRIBED ABOVE.

**31.6** In case emergency authority is used to deviate from the provisions of an ATC clearance, the pilot in command shall notify ATC as soon as possible and obtain an amended clearance. In an emergency situation which results in no deviation from the rules prescribed in 14 CFR Part 91 but which requires ATC to give priority to an aircraft, the pilot of such aircraft shall, when requested by ATC, make a report within 48 hours of such emergency situation to the manager of that ATC facility.

**31.7** The guiding principle is that the last ATC clearance has precedence over the previous ATC clearance. When the route or altitude in a previously issued clearance is amended, the controller will restate applicable altitude restrictions. If altitude to maintain is changed or restated, whether prior to departure or while airborne, and previously issued altitude restrictions are omitted, those altitude restrictions are canceled, including Departure Procedures and Standard Terminal Arrival Route (STAR) altitude restrictions.

**EXAMPLE.—**  
[A DEPARTURE FLIGHT RECEIVES A CLEARANCE TO THE DESTINATION AIRPORT TO MAINTAIN FLIGHT LEVEL 290. THE

*CLEARANCE INCORPORATES A DEPARTURE PROCEDURE WHICH HAS CERTAIN ALTITUDE CROSSING RESTRICTIONS. SHORTLY AFTER TAKEOFF, THE FLIGHT RECEIVES A NEW CLEARANCE CHANGING THE MAINTAINING FLIGHT LEVEL FROM 290 TO 250. IF THE ALTITUDE RESTRICTIONS ARE STILL APPLICABLE, THE CONTROLLER RESTATES THEM.*

*[E] A DEPARTING AIRCRAFT IS CLEARED TO CROSS FLUKY INTERSECTION AT OR ABOVE 3,000, GORDONSVILLE VOR AT OR ABOVE 12,000, MAINTAIN FL 200. SHORTLY AFTER DEPARTURE, THE ALTITUDE TO BE MAINTAINED IS CHANGED TO FL 240. IF THE ALTITUDE RESTRICTIONS ARE STILL APPLICABLE THE CONTROLLER ISSUES AN AMENDED CLEARANCE AS FOLLOWS, "CROSS FLUKY INTERSECTION AT OR ABOVE THREE THOUSAND, CROSS GORDONSVILLE V-O-R AT OR ABOVE ONE TWO THOUSAND, MAINTAIN FLIGHT LEVEL TWO FOUR ZERO."*

*[E] AN ARRIVING AIRCRAFT IS CLEARED TO THE DESTINATION AIRPORT VIA V45 DELTA VOR DIRECT, CROSS DELTA AT 10,000, MAINTAIN 6,000. PRIOR TO DELTA VOR, THE CONTROLLER ISSUES AN AMENDED CLEARANCE AS FOLLOWS, "TURN RIGHT HEADING ONE EIGHT ZERO FOR VECTORS TO RUNWAY THREE SIX I-L-S APPROACH, MAINTAIN SIX THOUSAND." BECAUSE THE ALTITUDE RESTRICTION "CROSS DELTA VOR AT 10,000" WAS OMITTED FROM THE AMENDED CLEARANCE, IT IS NO LONGER IN EFFECT.*

**31.8** Pilots of turbojet aircraft equipped with afterburner engines should advise ATC prior to takeoff if they intend to use afterburning during their climb to the en route altitude. Often, the controller may be able to plan traffic to accommodate a high performance climb and allow the aircraft to climb to the planned altitude without restriction.

## **32. IFR Separation Standards**

**32.1** ATC effects separation of aircraft vertically by assigning different altitudes; longitudinally by providing an interval expressed in time or distance between aircraft on the same, converging, or crossing courses; and laterally by assigning different flight paths.

**32.2** Separation will be provided between all aircraft operating on IFR flight plans except during that part of the flight (outside Class B airspace or a TRSA) being conducted on a VFR-on-top/VFR conditions clearance. Under these conditions, ATC may issue traffic advisories, but it is the sole responsibility of the pilot to be vigilant so as to see and avoid other aircraft.

**32.3** When radar is employed in the separation of aircraft at the same altitude, a minimum of 3 miles separation is provided between aircraft operating within 40 miles of the radar antenna site, and 5 miles between aircraft operating beyond 40 miles from the antenna site. These minimums may be increased or decreased in certain specific situations.

*NOTE.— CERTAIN SEPARATION STANDARDS ARE INCREASED IN THE TERMINAL ENVIRONMENT WHEN CENTER RADAR ARTS PRESENTATION/ PROCESSING (CENRAP) IS BEING UTILIZED.*

## **33. Speed Adjustments**

**33.1** ATC will issue speed adjustments to pilots of radar-controlled aircraft to achieve or to maintain required or desired spacing.

**33.2** ATC will express all speed adjustments in terms of knots based on indicated airspeed (IAS) in 10-knot increments except that at or above FL 240 speeds may be expressed in terms of Mach numbers in .01 increments. The use of Mach numbers is restricted to turbojet aircraft with Mach meters.

**33.3** Pilots of aircraft in U.S. domestic Class A, B, C, D and E airspace complying with speed adjustments should maintain a speed within plus or minus 10 knots or 0.02 Mach number, whichever is less, of the assigned speed.

**33.4** Pilots of aircraft in offshore controlled airspace or oceanic controlled airspace shall adhere to the ATC assigned airspeed and shall request ATC approval before making any change thereto. If it is essential to make an immediate temporary change in the Mach number (e.g., due to turbulence), ATC shall be notified as soon as possible. If it is not feasible to maintain the last assigned Mach number during an en route climb or descent due to aircraft performance, advise ATC at the time of the request.

**33.5** Unless pilot concurrence is obtained, ATC requests for speed adjustments will be in accordance with the following minimums:

a) To aircraft operating between FL 280 and 10,000 feet, a speed not less than 250 knots or the equivalent Mach number.

b) To turbine-powered aircraft operating below 10,000 feet, a speed not less than 210 knots, except within 20 flying miles of the runway threshold of the airport of intended landing, a speed not less than 170 knots.

c) Reciprocating engine or turboprop aircraft within 20 flying miles of the runway threshold of the airport of intended landing, a speed not less than 150 knots.

d) Departures, for turbine powered aircraft, a speed not less than 230 knots; for reciprocating engine aircraft, a speed not less than 150 knots.

**33.6** When ATC combines a speed adjustment with a descent clearance, the sequence of delivery with the word "then" between, indicates the expected order of execution; i.e., "DESCEND AND MAINTAIN (altitude); THEN, REDUCE SPEED TO (speed)," or "REDUCE SPEED TO (speed); THEN, DESCEND AND MAINTAIN (altitude)."

**NOTE.—**

THE MAXIMUM SPEEDS BELOW 10,000 FEET AS ESTABLISHED IN 14 CFR SECTION 91.117 STILL APPLY. IF THERE IS ANY DOUBT CONCERNING THE MANNER IN WHICH SUCH A CLEARANCE IS TO BE EXECUTED, REQUEST CLARIFICATION FROM ATC.

**33.7** If ATC determines (before an approach clearance is issued) that it is no longer necessary to apply speed adjustment procedures, they will inform the pilot to resume normal speed. Approach clearances supersede any prior speed adjustment assignments, and pilots are expected to make their own speed adjustments, as necessary, to complete the approach. Under certain circumstances however, it may be necessary for ATC to issue further speed adjustments after approach clearance is issued to maintain separation between successive arrivals. Under such circumstances, previously issued speed adjustments will be restated if that speed is to be maintained or additional speed adjustments are requested. ATC must obtain pilot concurrence for speed adjustments after approach clearances are issued. Speed adjustments should not be assigned inside the final approach fix on final or a point 5 miles from the runway, whichever is closer to the runway.

**33.8** The pilots retain the prerogative of rejecting the application of speed adjustment by ATC if the minimum safe airspeed for any particular operation is greater than the speed adjustment. IN SUCH CASES, PILOTS ARE EXPECTED TO ADVISE ATC OF THE SPEED THAT WILL BE USED.

**33.9** Pilots are reminded that they are responsible for rejecting the application of speed adjustment by ATC if, in their opinion, it will cause them to exceed the maximum indicated airspeed prescribed by 14 CFR Section 91.117(a), (c) and (d). IN SUCH CASES, THE PILOT IS EXPECTED TO SO INFORM ATC. Pilots operating at or above 10,000 feet MSL who are issued speed adjustments which exceed 250 knots IAS and are subsequently cleared below 10,000 feet MSL are expected to comply with 14 CFR Section 91.117(a).

**33.10** For operations conducted below 10,000 feet MSL when outside the United States and beneath Class B airspace, airspeed restrictions apply to all U.S. registered aircraft. For operations conducted below 10,000 feet MSL when outside the United States within Class B airspace, there are no speed restrictions.

**33.11** For operations in a Class B, Class C, and Class D surface area, ATC is authorized to request or approve a speed greater than the maximum indicated airspeeds prescribed for operation within that airspace (14 CFR Section 91.117(b)).

**NOTE.—**

PILOTS ARE EXPECTED TO COMPLY WITH THE MAXIMUM SPEED OF 200 KNOTS WHEN OPERATING BENEATH CLASS B AIRSPACE OR IN A CLASS B VFR CORRIDOR (14 CFR SECTION 91.117(C) AND (D)).

**33.12** When in communication with the ARTCC or approach control facility, pilots should, as a good operating practice, state any ATC assigned speed restriction on initial radio contact associated with an ATC communications frequency change.

**34. Runway Separation**

Tower controllers establish the sequence of arriving and departing aircraft by requiring them to adjust flight or ground operation as necessary to achieve proper spacing. They may "HOLD" an aircraft short of the runway to achieve spacing between it and another arriving aircraft; the controller may instruct a pilot to "EXTEND DOWNWIND" in order to establish spacing from another arriving or departing aircraft. At times a clearance may include the word "IMMEDIATE." For example: "CLEARED FOR IMMEDIATE TAKEOFF." In such cases "IMMEDIATE" is used for purposes of air traffic separation. It is up to the pilot to refuse the clearance if, in the pilot's opinion, compliance would adversely affect the operation.

**35. Visual Separation**

**35.1** Visual separation is a means employed by ATC to separate aircraft in terminal areas and en route airspace. There are two methods employed to effect this separation:

a) The tower controller sees the aircraft involved and issues instructions, as necessary, to ensure that the aircraft avoid each other.

b) A pilot sees the other aircraft involved and upon instructions from the controller provides separation by maneuvering the aircraft to avoid it. When pilots accept responsibility to maintain visual separation, they must maintain constant visual surveillance and not pass the other aircraft until it is no longer a factor.

**NOTE.—**

TRAFFIC IS NO LONGER A FACTOR WHEN DURING APPROACH PHASE THE OTHER AIRCRAFT IS IN THE LANDING PHASE OF FLIGHT OR EXECUTES A MISSED APPROACH; AND DURING DEPARTURE OR EN ROUTE, WHEN THE OTHER AIRCRAFT TURNS AWAY OR IS ON A DIVERGING COURSE.

**35.2** A pilot's acceptance of instructions to follow another aircraft or provide visual separation from it is an acknowledgment that the pilot will maneuver the aircraft as necessary to avoid the other aircraft or to maintain in-trail separation. In operations conducted behind heavy jet aircraft, it is also an acknowledgment that the pilot accepts the responsibility for wake turbulence separation.

*NOTE.—  
WHEN A PILOT HAS BEEN TOLD TO FOLLOW ANOTHER AIRCRAFT  
OR TO PROVIDE VISUAL SEPARATION FROM IT, THE PILOT  
SHOULD PROMPTLY NOTIFY THE CONTROLLER IF VISUAL CON-  
TACT WITH THE OTHER AIRCRAFT IS LOST OR CANNOT BE MAIN-  
TAINED OR IF THE PILOT CANNOT ACCEPT THE RESPONSIBILITY  
FOR THE SEPARATION FOR ANY REASON.*

**35.3** Scanning the sky for other aircraft is a key factor in collision avoidance. Pilots and copilots (or the right seat passenger) should continuously scan to cover all areas of the sky visible from the cockpit. Pilots must develop an effective scanning technique which maximizes one's visual capabilities. Spotting a potential collision threat increases directly as more time is spent looking outside the aircraft. One must use timesharing techniques to effectively scan the surrounding airspace while monitoring instruments as well.

**35.4** Since the eye can focus only on a narrow viewing area, effective scanning is accomplished with a series of short, regularly spaced eye movements that bring successive areas of the sky into the central visual field. Each movement should not exceed ten degrees, and each area should be observed for at least one second to enable collision detection. Although many pilots seem to prefer the method of horizontal back-and-forth scanning every pilot should develop a scanning pattern that is not only comfortable but assures optimum effectiveness. Pilots should remember, however, that they have a regulatory responsibility (14 CFR Section 91.113) to see and avoid other aircraft when weather conditions permit.

## 36. Use of Visual Clearing Procedures

**a) Before Takeoff:** Prior to taxiing onto a runway or landing area in preparation for takeoff, pilots should scan the approach areas for possible landing traffic, executing appropriate clearing maneuvers to provide them a clear view of the approach areas.

**b) Climbs and Descents:** During climbs and descents in flight conditions which permit visual detection of other traffic, pilots should execute gentle banks, left and right at a frequency which permits continuous visual scanning of the airspace about them.

**c) Straight and Level:** Sustained periods of straight and level flight in conditions which permit visual detection of other traffic should be broken at intervals with appropriate clearing procedures to provide effective visual scanning.

**d) Traffic Patterns:** Entries into traffic patterns while descending create specific collision hazards and should be avoided.

**e) Traffic at VOR Sites:** All operators should emphasize the need for sustained vigilance in the vicinity of VOR's and airway intersections due to the convergence of traffic.

**f) Training Operations:** Operators of pilot training programs are urged to adopt the following practices:

1) Pilots undergoing flight instruction at all levels should be requested to verbalize clearing procedures (call out, "Clear" left, right, above, or below) to instill and sustain the habit of vigilance during maneuvering.

2) **High-wing airplane:** momentarily raise the wing in the direction of the intended turn and look.

3) **Low-wing airplane:** momentarily lower the wing in the direction of the intended turn and look.

4) Appropriate clearing procedures should precede the execution of all turns including chandelles, lazy eights, stalls, slow flight, climbs, straight and level, spins, and other combination maneuvers.

## 37. Pilot/Controller Roles/Responsibilities

### 37.1 General

**37.1.1** The roles and responsibilities of the pilot and controller for effective participation in the ATC system are contained in several documents. Pilot responsibilities are in the Federal Aviation Regulations (Title 14 of the U.S. Code of Federal Regulations) and the air traffic controller's are in the Air Traffic Control Handbook (FAA Order 7110.65) and supplemental FAA directives. Additional and supplemental information for pilots can be found in the current Aeronautical Information Manual, Notices to Airmen, advisory circulars, and aeronautical charts. Since there are many other excellent publications produced by nongovernment organizations as well as other Government organizations with various updating cycles, questions concerning the latest or most current material can be resolved by cross-checking with the above mentioned documents.

**37.1.2** The pilot in command of an aircraft is directly responsible for and is the final authority as to the safe operation of that aircraft. In an emergency requiring immediate action, the pilot in command may deviate from any rule in the General, Subpart A, and Flight Rules, Subpart B, in accordance with 14 CFR Section 91.3.

**37.1.3** The air traffic controller is responsible to give first priority to the separation of aircraft and to the

issuance of radar safety alerts; second priority to other services that are required, but do not involve separation of aircraft; and third priority to additional services to the extent possible.

**37.1.4** In order to maintain a safe and efficient air traffic system, it is necessary that every party fulfill their responsibilities to the fullest.

**37.1.5** The responsibilities of the pilot and the controller intentionally overlap in many areas providing a degree of redundancy. Should one or the other fail in any manner, this overlapping responsibility is expected to compensate, in many cases, for failures that may affect safety.

**37.1.6** The following, while not intended to be all inclusive, is a brief listing of pilot and controller responsibilities for some commonly used procedures or phases of flight. More detailed explanations are contained in the appropriate Federal Aviation Regulations, Advisory Circulars and similar publications. The information provided here is an overview of the principles involved and is not meant as an interpretation of the rules nor is it intended to extend or diminish responsibilities.

## 37.2 Air Traffic Clearance

### 37.2.1 Pilot

- a) Acknowledges receipt and understanding of an ATC clearance.
- b) Reads back any hold short of runway instructions issued by ATC.
- c) Requests clarification or amendment, as appropriate, any time a clearance is not fully understood, or considered unacceptable from a safety standpoint.
- d) Promptly complies with an air traffic clearance upon receipt, except as necessary to cope with an emergency. Advises ATC as soon as possible and obtains an amended clearance if deviation is necessary.

**NOTE.—**  
A CLEARANCE TO LAND MEANS THAT APPROPRIATE SEPARATION ON THE LANDING RUNWAY WILL BE ENSURED. A LANDING CLEARANCE DOES NOT RELIEVE THE PILOT FROM COMPLIANCE WITH ANY PREVIOUSLY ISSUED ALTITUDE CROSSING RESTRICTION.

### 37.2.2 Controller

- a) Issues appropriate clearances for the operation being, or to be, conducted in accordance with established criteria.

- b) Assigns altitudes in IFR clearances that are at or above the minimum IFR altitudes in Classes A, B, C, D, and E airspace.

- c) Ensures acknowledgements by the pilot for issued information, clearance, or instructions.

- d) Ensures that readbacks by the pilot of altitude, heading, or other items are correct. If incorrect, distorted, or incomplete, makes corrections as appropriate.

## 37.3 Contact Approach

### 37.3.1 Pilot

- a) This approach must be requested by the pilot and is made in lieu of a standard or special instrument approach.

- b) By requesting the contact approach, the pilot indicates that the flight is operating clear of clouds, has at least 1 mile flight visibility, and can reasonably expect to continue to the destination airport in those conditions.

- c) Be aware that while conducting a contact approach, the pilot assumes responsibility for obstruction clearance.

- d) Advise ATC immediately if you are unable to continue the contact approach or if you encounter less than 1 mile flight visibility.

- e) Be aware that, if radar service is being received, it may automatically terminate when the pilot is told to contact the tower. "Radar service terminated" is used by ATC to inform a pilot that he will no longer be provided any of the services that could be received while in radar contact.

**REFERENCE—**  
PILOT/CONTROLLER GLOSSARY PUBLISHED IN THE AERONAUTICAL INFORMATION MANUAL (AIM) AND FAA ORDERS 7110.10 AND 7110.65.

### 37.3.2 Controller

- a) Issues clearance for contact approach only when requested by the pilot. Does not solicit the use of this procedure.

- b) Before issuing clearance, ascertains that reported ground visibility at destination airport is at least 1 mile.

- c) Provides approved separation between aircraft cleared for contact approach and other IFR or special VFR aircraft. When using vertical separation, does not assign a fixed altitude but clears the aircraft at or below an altitude which is at least 1,000 feet below any IFR traffic but not below minimum safe altitudes prescribed in 14 CFR Section 91.119.

d) Issues alternative instructions if, in the controller's judgment, weather conditions may make completion of the approach impractical.

### 37.4 Instrument Approach

#### 37.4.1 Pilot

a) Be aware that the controller issues clearance for approach based only on known traffic.

b) Follow the procedures as shown on the instrument approach chart including all restrictive notations, such as:

- 1) Procedure not authorized at night;
- 2) Approach not authorized when local area altimeter not available;
- 3) Procedure not authorized when control tower not in operation;
- 4) Procedure not authorized when glide slope not used;
- 5) Straight-in minimums not authorized at night;
- 6) Radar required; or
- 7) The circling minimums published on the instrument approach chart provide adequate obstruction clearance. The pilot should not descend below the circling altitude until the aircraft is in a position to make final descent for landing. Sound judgment and knowledge of the pilot's and the aircraft's capabilities are the criteria for a pilot to determine the exact maneuver in each instance since airport design and the aircraft position, altitude, and airspeed must all be considered. (See ENR 1.5, paragraph 10.6, Circling Minimums.)

c) Upon receipt of an approach clearance while on an unpublished route or being radar vectored:

- 1) Comply with the minimum altitude for IFR; and
- 2) Maintain last assigned altitude until established on a segment of a published route or Instrument Approach Procedure (IAP), at which time published altitudes apply.

#### 37.4.2 Controller

a) Issues an approach clearance based on known traffic; and

b) Issues an IFR approach clearance only after aircraft is established on a segment of published route or IAP; or assigns an appropriate altitude for the aircraft to maintain until so established.

### 37.5 Missed Approach

#### 37.5.1 Pilot

a) Execute a missed approach when one of the following conditions exist:

1) Arrival at the missed approach point (MAP) or the decision height (DH) and visual reference to the runway environment is insufficient to complete the landing;

2) Determine that a safe landing is not possible; or

3) Instructed to do so by ATC.

b) Advise ATC that a missed approach will be made. Include the reason for the missed approach unless initiated by ATC.

c) Comply with the missed approach instructions for the instrument approach procedure being executed unless other missed approach instructions are specified by ATC.

d) If executing a missed approach prior to reaching the MAP or DH, advise ATC and fly the instrument procedure to the MAP at an altitude at or above the MDA or DH before executing a turning maneuver.

e) Radar vectors issued by ATC, when informed that a missed approach is being executed supersedes the previous missed approach procedure.

f) If making a missed approach from a radar approach, execute the missed approach procedure previously given or climb to the altitude and fly the heading specified by the controller.

g) Following a missed approach, request clearance for specific action; i.e., another approach, hold for improved conditions, proceed to an alternate airport, etc.

#### 37.5.2 Controller

a) Issues an approved alternate missed approach procedure if it is desired that the pilot execute a procedure other than as depicted on the instrument approach chart.

b) May vector a radar identified aircraft executing a missed approach when operationally advantageous to the pilot or the controller.

c) In response to the pilot's stated intentions, issues a clearance to an alternate airport, to a holding fix, or for reentry into the approach sequence, as traffic conditions permit.

## 37.6 Radar Vectors

### 37.6.1 Pilot

a) Promptly comply with headings and altitudes assigned to you by the controller.

b) Question any assigned heading or altitude believed to be incorrect.

c) If operating VFR and compliance with any radar vector or altitude would cause a violation of any Federal Aviation Regulation, advise ATC and obtain a revised clearance or instruction.

### 37.6.2 Controller

a) Vectors aircraft in Class A, B, C, D and E airspace:

- 1) For separation, and
- 2) For noise abatement.

b) To obtain an operational advantage for the pilot or the controller.

c) Vectors aircraft in Class A, B, C, D, E and G airspace when requested by the pilot.

d) Vectors IFR aircraft at or above minimum vectoring altitudes.

e) May vector VFR aircraft, not at an ATC assigned altitude, at any altitude. In these cases, terrain separation is the pilot's responsibility.

## 37.7 Speed Adjustments

### 37.7.1 Pilot (In U.S. Domestic Class A, B, C, D and E airspace)

a) Except as stated in paragraphs 37.7.3 and 37.7.4, advise ATC anytime the true airspeed at cruising level varies or is expected to vary by plus or minus 10 knots or 0.02 Mach number, whichever is less, of the filed true airspeed.

b) Comply with speed adjustments from ATC unless:

1) The minimum or maximum safe airspeed for any particular operation is greater or less than the requested airspeed. In such cases, advise ATC;

2) Operating at or above 10,000 feet MSL on an ATC assigned SPEED ADJUSTMENT of more than 250 knots IAS and subsequent clearance is received for descent below 10,000 feet MSL. In such cases, pilots are expected to comply with 14 CFR Section 97.117(a).

### 37.7.2 Controller (In U.S. Domestic Class A, B, C, D and E Airspaces)

a) Assigns aircraft to speed adjustments when necessary, but not as a substitute for good vectoring technique.

b) Adheres to the restrictions of FAA Order 7110.65 as to when speed adjustment procedures may be applied.

c) Avoids speed adjustments requiring alternate decreases and increases.

d) Assigns speed adjustments to a specified IAS knots/Mach number or to increase or decrease speed utilizing increments of 10 knots or multiples thereof.

e) Advises pilots to resume normal speed when speed adjustments are no longer required.

f) Gives due consideration to aircraft capabilities to reduce speed while descending

### 37.7.3 Pilot (In Oceanic Class A and E Airspace)

a) If ATC has not assigned an airspeed, advise ATC anytime the true airspeed at cruising level varies or is expected to vary by  $\pm 10$  knots or 0.02 Mach number, whichever is less, of the filed true airspeed.

b) If ATC has assigned an airspeed, aircraft shall adhere to the ATC assigned airspeed and shall request ATC approval before making any change thereto. If it is essential to make an immediate temporary change in the Mach number (e.g., due to turbulence), ATC shall be notified as soon as possible. If it is not feasible, due to aircraft performance, to maintain the last assigned Mach number during an en route climb or descent, advise ATC at the time of the request.

### 37.7.4 Controller (In Oceanic Class A and E Airspace)

a) Assigns airspeed when necessary for separation of aircraft to comply with 14 CFR, ICAO regulations and procedures, or letters of agreement.

## 37.8 Traffic Advisories (Traffic Information)

### 37.8.1 Pilot

- a) Acknowledges receipt of traffic advisories.
- b) Informs controller if traffic is in sight.
- c) Advises ATC if a vector to avoid traffic is desired.
- d) Does not expect to receive radar traffic advisories on all traffic. Some aircraft may not appear on the radar display. Be aware that the controller may be occupied with high priority duties and unable to issue traffic information for a variety of reasons.
- e) Advises controller if service is not desired.

### 37.8.2 Controller

- a) Issues radar traffic to the maximum extent consistent with higher priority duties except in Class A airspace.
- b) Provides vectors to assist aircraft to avoid observed traffic when requested by the pilot.
- c) Issues traffic information to aircraft in Class D airspace for sequencing purposes.

## 37.9 Safety Alert

### 37.9.1 Pilot

- a) Initiates appropriate action if a safety alert is received from ATC.
- b) Be aware that this service is not always available and that many factors affect the ability of the controller to be aware of a situation in which unsafe proximity to terrain, obstructions, or another aircraft may be developing.

### 37.9.2 Controller

- a) Issues a safety alert if aware an aircraft under their control is at an altitude which, in the controller's judgment, places the aircraft in unsafe proximity to terrain, obstructions or another aircraft. Types of safety alerts are:

1) **Terrain/Obstruction Alerts:** Immediately issued to an aircraft under their control if aware the aircraft is at an altitude believed to place the aircraft in unsafe proximity to terrain/obstruction;

2) **Aircraft Conflict Alerts:** Immediately issued to an aircraft under their control if aware of an aircraft not under their control at an altitude believed to place the aircraft in unsafe proximity to each other. With the alert, they offer the pilot an alternative if feasible.

- b) Discontinues further alerts if informed by the pilot action is being taken to correct the situation or that the other aircraft is in sight.

## 37.10 See and Avoid

### 37.10.1 Pilot

- a) When meteorological conditions permit, regardless of type of flight plan or whether or not under control of a radar facility, the pilot is responsible to see and avoid other traffic, terrain, or obstacles.

### 37.10.2 Controller

- a) Provides radar traffic information to radar identified aircraft operating outside positive control airspace on a workload permitting basis.
- b) Issues a safety advisory to an aircraft under their control if aware the aircraft is at an altitude believed to place the aircraft in unsafe proximity to terrain, obstructions or other aircraft.

## 37.11 Visual Approach

### 37.11.1 Pilot

- a) If a visual approach is not desired, advises ATC.
- b) Complies with controller's instructions for vectors toward the airport of intended landing or to a visual position behind a preceding aircraft.
- c) The pilot must, at all times, have either the airport or the preceding aircraft in sight. After being cleared for a visual approach, proceed to the airport in a normal manner or follow the preceding aircraft. Remain clear of clouds while conducting a visual approach.
- d) If the pilot accepts a visual approach clearance to visually follow a preceding aircraft, you are required to establish a safe landing interval behind the aircraft you were instructed to follow. You are responsible for wake turbulence separation.

- e) Advises ATC immediately if the pilot is unable to continue following the preceding aircraft, cannot remain clear of clouds, or lose sight of the airport.

- f) Be aware that radar service is automatically terminated, without being advised by ATC, when the pilot is instructed to change to advisory frequency.

- g) Be aware that there may be other traffic in the traffic pattern and the landing sequence may differ from the traffic sequence assigned by the approach control or ARTCC.



### 37.11.2 Controller

a) Does not clear an aircraft for a visual approach unless reported weather at the airport is ceiling at or above 1,000 feet and visibility is 3 miles or greater. When weather is not available for the destination airport, inform the pilot and do not initiate a visual approach to that airport unless there is reasonable assurance that descent and flight to the airport can be made visually.

b) Issues visual approach clearance when the pilot reports sighting either the airport or a preceding aircraft which is to be followed.

c) Provides separation except when visual separation is being applied by the pilot.

d) Continues flight following and traffic information until the aircraft has landed or has been instructed to change to advisory frequency.

e) Informs the pilot when the preceding aircraft is a heavy.

f) When weather is available for the destination airport, does not initiate a vector for a visual approach unless the reported ceiling at the airport is 500 feet or more above the MVA and visibility is 3 miles or more. If vectoring weather minima are not available but weather at the airport is ceiling at or above 1,000 feet and visibility of 3 miles or greater, visual approaches may still be conducted.

g) Informs the pilot conducting the visual approach of the aircraft class when pertinent traffic is known to be a heavy aircraft.

### 37.12 Visual Separation

#### 37.12.1 Pilot

a) Acceptance of instructions to follow another aircraft or to provide visual separation from it is an acknowledgment that the pilot will maneuver the aircraft as necessary to avoid the other aircraft or to maintain in-trail separation. Pilots are responsible to maintain visual separation until flight paths (altitudes and/or courses) diverge.

b) If instructed by ATC to follow another aircraft or to provide visual separation from it, promptly notify the controller if you lose sight of that aircraft, are unable to maintain continued visual contact with it, or cannot accept the responsibility for your own separation for any reason.

c) The pilot also accepts responsibility for wake turbulence separation under these conditions.

#### 37.12.2 Controller Applies Visual Separation Only:

a) Within the terminal area when a controller has both aircraft in sight or by instructing a pilot who sees the other aircraft to maintain visual separation from it;

b) Pilots are responsible to maintain visual separation until flight paths (altitudes and/or courses) diverge; and

c) Within en route airspace when aircraft are on opposite courses and one pilot reports having seen the other aircraft and that the aircraft have passed each other.

### 37.13 VFR-ON-TOP

#### 37.13.1 Pilot

a) This clearance must be requested by the pilot on an IFR flight plan, and if approved, allows the pilot the choice to select (subject to any ATC restrictions) an altitude or flight level in lieu of an assigned altitude.

**NOTE.—**

*[ ] VFR-ON-TOP IS NOT PERMITTED IN CERTAIN AIRSPACE AREAS, SUCH AS CLASS A AIRSPACE, CERTAIN RESTRICTED AREAS, ETC. CONSEQUENTLY, IFR FLIGHTS OPERATING VFR-ON-TOP WILL AVOID SUCH AIRSPACE.*

*[ ] SEE PARAGRAPH 32 OF THIS SECTION, IFR SEPARATION STANDARDS; GEN 3.3 PARAGRAPH 6, POSITION REPORTING; AND GEN 3.3 PARAGRAPH 7, ADDITIONAL REPORTS.*

b) By requesting a VFR-ON-TOP clearance, the pilot assumes the sole responsibility to be vigilant so as to see and avoid other aircraft and to:

1) Fly at the appropriate VFR altitude as prescribed in 14 CFR Section 91.159;

2) Comply with the VFR visibility and distance from clouds criteria in 14 CFR Section 91.155 (Basic VFR Weather Minimums);

3) Comply with instrument flight rules that are applicable to this flight; i.e., minimum IFR altitudes, position reporting, radio communications, course to be flown, adherence to ATC clearance, etc.; and

4) Should advise ATC prior to any altitude change to ensure the exchange of accurate traffic information.

#### 37.13.2 Controller

a) May clear an aircraft to maintain VFR-ON-TOP if the pilot of an aircraft on an IFR flight plan requests the clearance.

b) Informs the pilot of an aircraft cleared to climb to VFR-ON-TOP the reported height of the tops or that no top report is available; issues an alternate clearance

if necessary; and once the aircraft reports reaching VFR-ON-TOP, reclears the aircraft to maintain VFR-ON-TOP.

c) Before issuing clearance, ascertains that the aircraft is not in or will not enter Class A airspace.

### 37.14 Instrument Departures

#### 37.14.1 Pilot

a) Prior to departure, considers the type of terrain and other obstructions on or in the vicinity of the departure airport.

b) Determines if obstruction avoidance can be maintained visually or that the departure procedure should be followed.

c) Determines whether a departure procedure and/or instrument departure procedure (DP) is available for obstruction avoidance.

d) At airports where instrument approach procedures have not been published, hence no published departure procedure, determines what action will be necessary and takes such action that will assure a safe departure.

#### 37.14.2 Controller

a) At locations with airport traffic control service, when necessary, specifies direction of takeoff/turn or initial heading to be flown after takeoff.

b) At locations without airport traffic control service but within Class E surface area, when necessary to specify direction of takeoff/turn or initial heading to be flown, obtains pilot's concurrence that the procedure will allow him to comply with local traffic patterns, terrain, and obstruction avoidance.

c) Includes established departure procedures as part of the air traffic control clearance when pilot compliance is necessary to ensure separation.

### 37.15 Minimum Fuel Advisory

#### 37.15.1 Pilot

a) Advise ATC of your "minimum fuel" status when your fuel supply has reached a state where, upon reaching destination, you cannot accept any undue delay.

b) Be aware that this is not an emergency situation but merely an advisory that indicates an emergency situation is possible should any undue delay occur.

c) On initial contact the term "minimum fuel" should be used after stating call sign.

*EXAMPLE.—  
SALT LAKE APPROACH, UNITED SIX TWENTY ONE, "MINIMUM FUEL."*

d) Be aware a minimum fuel advisory does not imply a need for traffic priority.

e) If the remaining usable fuel supply suggests the need for traffic priority to ensure a safe landing, you should declare an emergency due to low fuel, and report the fuel remaining in minutes.

#### 37.15.2 Controller

a) When an aircraft declares a state of "minimum fuel," relay this information to the facility to whom control jurisdiction is transferred.

b) Be alert for any occurrence which might delay the aircraft.

### 38. Traffic Alert and Collision Avoidance System (TCAS I & II)

**38.1** TCAS I provides proximity warning only, to assist the pilot in the visual acquisition of intruder aircraft. No recommended avoidance maneuvers are provided nor authorized as a direct result of a TCAS I warning. It is intended for use by smaller commuter aircraft holding 10 to 30 passenger seats, and general aviation aircraft.

**38.2** TCAS II provides traffic advisories (TA's) and resolution advisories (RA's). RA's provide recommended maneuvers in a vertical direction (climb or descend only) to avoid conflicting traffic. Airline aircraft, and larger commuter and business aircraft holding 31 passenger seats or more, use TCAS II equipment.

**38.3** Each pilot who deviates from an ATC clearance in response to a TCAS II RA shall notify ATC of that deviation as soon as practicable and expeditiously return to the current ATC clearance when the traffic conflict is resolved.

**38.4** Deviations from rules, policies, or clearances should be kept to the minimum necessary to satisfy a TCAS II RA.

**38.5** The serving IFR air traffic facility is not responsible to provide approved standard IFR separation to an aircraft after a TCAS II RA maneuver until one of the following conditions exists:

a) The aircraft has returned to its assigned altitude and course.

b) Alternate ATC instructions have been issued.

**38.6** TCAS does not alter or diminish the pilot's basic authority and responsibility to ensure safe flight. Since TCAS does not respond to aircraft which are not transponder equipped or aircraft with a transponder failure, TCAS alone does not ensure safe separation in every case.

**38.7** At this time, no air traffic service nor handling is predicated on the availability of TCAS equipment in the aircraft.

### **39. Heavy Traffic Around Military Fields**

**39.1** Pilots are advised to exercise vigilance when in close proximity to most military airports. These airports may have jet aircraft traffic patterns extending up to 2,500 feet above the surface. In addition, they may have an unusually heavy concentration of jet aircraft operating within a 25-nautical mile radius and from the surface to all altitudes. The precautionary note also applies to the larger civil airports.



## **ENR 1.2 Visual Flight Rules**

See ENR 1.1, ENR 1.4, and ENR 1.10.



## **ENR 1.3 Instrument Flight Rules**

See ENR 1.1, ENR 1.4, and ENR 1.10.





## ENR 1.4 ATS Airspace Classification

### 1. General

1.1 There are two categories of airspace or airspace areas:

- a) Regulatory, and
- b) Nonregulatory.

1.2 Within these two categories, there are four types:

- a) Controlled,
- b) Uncontrolled,
- c) Special use, and
- d) Other airspace.

1.3 The categories and types of airspace are dictated by:

- 1) The complexity or density of aircraft movements;
- 2) The nature of the operations conducted within the airspace;
- 3) The level of safety required; and
- 4) The national and public interest.

1.4 It is important that pilots be familiar with the operational requirements for each of the various types or classes of airspace. Subsequent sections will cover each category and class in sufficient detail to facilitate understanding.

### 1.5 General Dimensions of Airspace Segments

Refer to Title 14 of the U.S. Code of Federal Regulations (14 CFR) for specific dimensions, exceptions, geographical areas covered, exclusions, specific transporter or equipment requirements, and flight operations.

*REFERENCE-*  
SEE GEN 1.7, ANNEX 2, FOR U.S. DIFFERENCES FROM ICAO STANDARDS, RECOMMENDED PRACTICES AND PROCEDURES.

### 1.6 Basic VFR Weather Minimums

1.6.1 No person may operate an aircraft under basic VFR when the flight visibility is less, or at a distance from clouds that is less, than that prescribed for the corresponding altitude and class of airspace. (See TBL 1.4-1 and TBL 1.4-2).

*NOTE.—*  
STUDENT PILOTS MUST COMPLY WITH 14 CFR PART 61.89(A) (6) AND (7).

1.7 VFR Cruising Altitudes and Flight Levels  
See TBL 1.4-2.

1.7.1 Except as provided in 14 CFR Section 91.157, Special VFR Minimums, no person may operate an aircraft beneath the ceiling under VFR within the lateral boundaries of controlled airspace designated to the surface for an airport when the ceiling is less than 1,000 feet.

### 2. Controlled Airspace

#### 2.1 General

2.1.1 **Controlled Airspace:** A generic term that covers the different classification of airspace (Class A, Class B, Class C, Class D, and Class E airspace) and defined dimensions within which air traffic control service is provided to IFR flights and to VFR flights in accordance with the airspace classification. (See TBL 1.4-1 for Airspace Classes). Airspace classes are pronounced in the ICAO phonetics for clarification. The term “class” may be dropped when referring to airspace in pilot/controller communications.

2.1.2 **IFR Requirements:** IFR operations in any class of controlled airspace requires that a pilot must file an IFR flight plan and receive an appropriate ATC clearance.

2.1.3 **IFR Separation:** Standard IFR separation is provided to all aircraft operating under IFR in controlled airspace.

2.1.4 **VFR Requirements:** It is the responsibility of the pilot to insure that ATC clearance or radio communication requirements are met prior to entry into Class B, Class C, or Class D airspace. The pilot retains this responsibility when receiving ATC radar advisories. See 14 CFR Part 91.

*REFERENCE-*  
14 CFR PART 91.

2.1.5 **Traffic Advisories:** Traffic advisories will be provided to all aircraft as the controller’s work situation permits.

2.1.6 **Safety Alerts:** Safety Alerts are mandatory services and are provided to ALL aircraft. There are two types of Safety Alerts, Terrain/Obstruction Alert and Aircraft Conflict/Mode Intruder Alert.

2.1.7 **Terrain/Obstruction Alert:** A Terrain/Obstruction Alert is issued when, in the controller’s judgment, an aircraft’s altitude places it in unsafe proximity to terrain and/or obstructions.

**Basic VFR Weather Minimums**

Airspace	Flight Visibility	Distance from Clouds
Class A .....	Not Applicable	Not Applicable
Class B .....	3 statute miles	Clear of Clouds
Class C .....	3 statute miles	500 feet below 1,000 feet above 2,000 feet horizontal
Class D .....	3 statute miles	500 feet below 1,000 feet above 2,000 feet horizontal
Class E Less than 10,000 feet MSL .....	3 statute miles	500 feet below 1,000 feet above 2,000 feet horizontal
At or above 10,000 feet MSL .....	5 statute miles	1,000 feet below 1,000 feet above 1 statute mile horizontal
Class G 1,200 feet or less above the surface (regardless of MSL altitude). Day, except as provided in 14 CFR Section 91.155(b) . . . .	1 statute mile	Clear of clouds
Night, except as provided in 14 CFR Section 91.155(b) ..	3 statute miles	500 feet below 1,000 feet above 2,000 feet horizontal
More than 1,200 feet above the surface but less than 10,000 feet MSL. Day .....	1 statute mile	500 feet below 1,000 feet above 2,000 feet horizontal
Night .....	3 statute miles	500 feet below 1,000 feet above 2,000 feet horizontal
More than 1,200 feet above the surface and at or above 10,000 feet MSL. ....	5 statute miles	1,000 feet below 1,000 feet above 1 statute mile horizontal

TBL 1.4-1

**VFR Cruising Altitudes and Flight Levels**

If your magnetic course (ground track) is:	And you are more than 3,000 feet above the surface but below 18,000 feet MSL, fly:	And you are above 18,000 feet MSL to FL 290, fly:
0° to 179° .....	Odd thousands MSL, plus 500 feet (3,500; 5,500; 7,500, etc.)	Odd Flight Levels plus 500 feet (FL 195; FL 215; FL 235, etc.)
180° to 359° .....	Even thousands MSL, plus 500 feet (4,500; 6,500; 8,500, etc.)	Even Flight Levels plus 500 feet (FL 185; FL 205; FL 225, etc.)

TBL 1.4-2

**2.1.8 Aircraft Conflict/Mode C Intruder Alert:** An Aircraft Conflict/Mode C Intruder Alert is issued if the controller observes another aircraft which places it in an unsafe proximity. When feasible, the controller will offer the pilot an alternative course of action.

**2.1.9 Ultralight Vehicles:** No person may operate an ultralight vehicle within Class A, Class B, Class C, or Class D airspace or within the lateral boundaries of the surface area of Class E airspace designated for an airport unless that person has prior authorization from the ATC facility having jurisdiction over that airspace. (See 14 CFR Part 103.)

**2.1.10 Unmanned Free Balloons:** Unless otherwise

authorized by ATC, no person may operate an unmanned free balloon below 2,000 feet above the surface within the lateral boundaries of Class B, Class C, Class D, or Class E airspace designated for an airport. (See 14 CFR Part 101.)

**2.1.11 Parachute Jumps:** No person may make a parachute jump, and no pilot in command may allow a parachute jump to be made from that aircraft, in or into Class A, Class B, Class C, or Class D airspace without, or in violation of, the terms of an ATC authorization issued by the ATC facility having jurisdiction over the airspace. (See 14 CFR Part 105.)

**Airspace Classes**

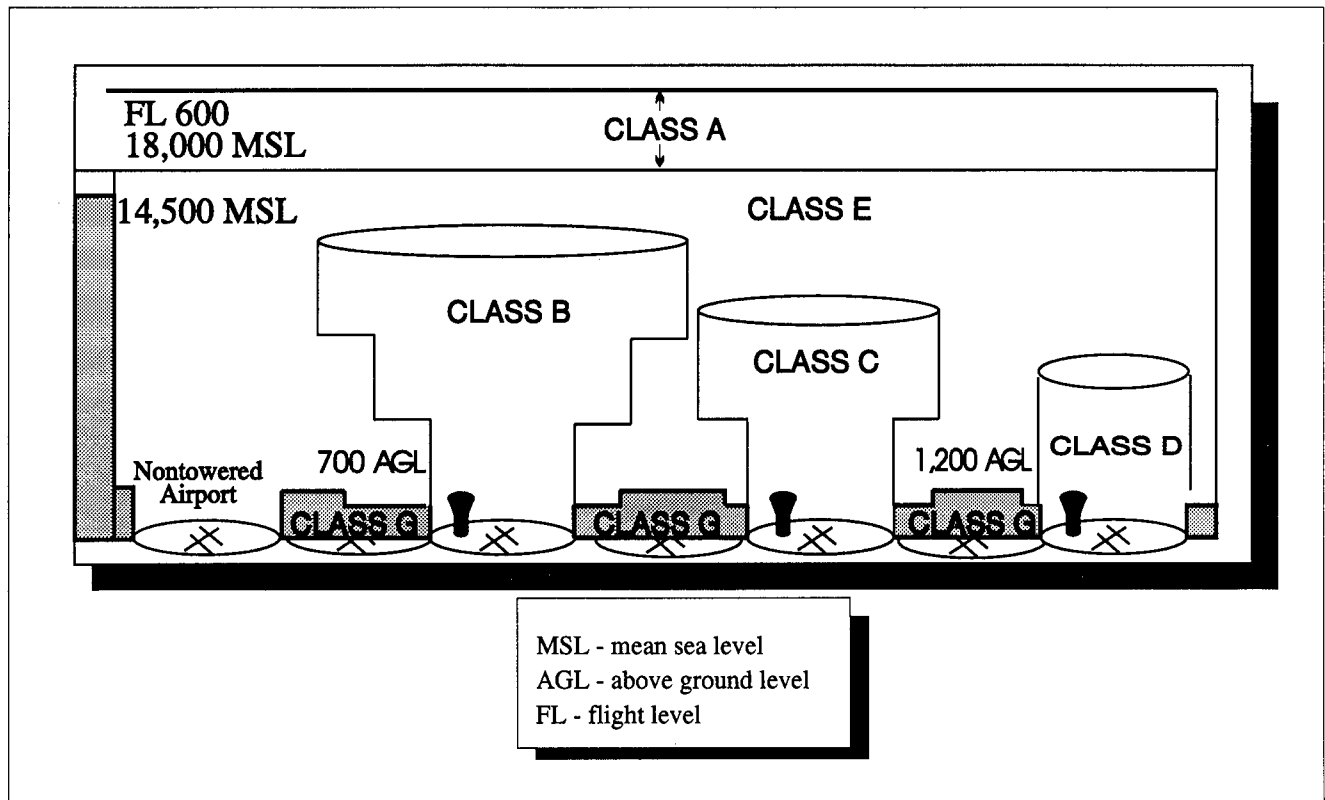

TBL 1.4-3

**2.2 Class A Airspace**

**2.2.1 Definition:** Generally, that airspace from 18,000 feet MSL up to and including FL600, including the airspace overlying the waters within 12 nautical miles of the coast of the 48 contiguous States and Alaska; and designated international airspace beyond 12 nautical miles of the coast of the 48 contiguous States and Alaska within areas of domestic radio navigational signal or

ATC radar coverage, and within which domestic procedures are applied.

**2.2.2 Operating Rules and Pilot/Equipment Requirements:** Unless otherwise authorized, all persons must operate their aircraft under IFR.

**REFERENCE-**  
14 CFR PART 71.33 AND PARTS 91.167 THROUGH 91.193.

**2.2.3 Charts:** Class A airspace is not specifically charted.

### 2.3 Class B Airspace

**2.3.9 Definition:** Generally, that airspace from the surface to 10,000 feet MSL surrounding the nation's busiest airports in terms of IFR operations or passenger enplanements. The configuration of each Class B airspace area is individually tailored and consists of a surface area and two or more layers (some Class B airspace areas resemble upside-down wedding cakes), and is designed to contain all published instrument procedures once an aircraft enters the airspace. An ATC clearance is required for all aircraft to operate in the area, and all aircraft that are so cleared receive separation services within the airspace. The cloud clearance requirement for VFR operations is "clear of clouds."

**2.3.10 Operating Rules and Pilot/Equipment Requirements for VFR Operations:** Regardless of weather conditions, an ATC clearance is required prior to operating within Class B airspace. Pilots should not request a clearance to operate within Class B airspace unless the requirements of 14 CFR Part 91.215 and Part 91.131 are met. Included among these requirements are:

a) Unless otherwise authorized by ATC, aircraft must be equipped with an operable two-way radio capable of communicating with ATC on appropriate frequencies for that Class B airspace.

b) No person may take off or land a civil aircraft at the following primary airports within Class B airspace unless the pilot in command holds at least a private pilot certificate:

Andrews Air Force Base, MD (Washington, DC)
Atlanta Hartsfield Airport, GA
Boston Logan Airport, MA
Chicago O'Hare International Airport, IL
Dallas/Fort Worth International Airport, TX
Los Angeles International Airport, CA
Miami International Airport, FL
Newark International Airport, NJ
New York Kennedy Airport, NY
New York La Guardia Airport, NY
San Francisco International Airport, CA
Washington National Airport, DC

**2.3.11** No person may take off or land a civil aircraft at an airport within Class B airspace or operate a civil aircraft within Class B airspace unless:

a) The pilot in command holds at least a private pilot certificate; or,

b) The aircraft is operated by a student pilot or recreational pilot who seeks private pilot certification and has met the requirements of 14 CFR Part 61.95.

**2.3.12** Unless otherwise authorized by ATC, each person operating a large turbine engine-powered airplane to or from a primary airport shall operate at or above the designated floors while within the lateral limits of Class B airspace.

**2.3.13** Unless otherwise authorized by ATC, each aircraft must be equipped as follows:

a) For IFR operations, an operable VOR or TACAN receiver; and

b) For all operations, a two-way radio capable of communications with ATC on appropriate frequencies for that area; and

c) Unless otherwise authorized by ATC, an operable radar beacon transponder with automatic altitude reporting equipment.

**NOTE.—**  
ATC MAY, UPON NOTIFICATION, IMMEDIATELY AUTHORIZE DEVIATIONS FROM THE ALTITUDE REPORTING EQUIPMENT REQUIREMENT; HOWEVER, A REQUEST FOR DEVIATION FROM THE 4096 TRANSPONDER EQUIPMENT REQUIREMENT MUST BE SUBMITTED TO THE CONTROLLING ATC FACILITY AT LEAST ONE HOUR BEFORE THE PROPOSED OPERATION. (SEE ENR 1.6, PARAGRAPH 6, TRANSPONDER OPERATION).

### 2.3.14 Mode C Veil

a) The airspace within 30 nautical miles of an airport listed in appendix D, Section 1 of 14 CFR Part 91 (generally primary airports within Class B airspace areas), from the surface upward to 10,000 feet mean seal level (MSL). Unless otherwise authorized by air traffic control, aircraft operating within this airspace must be equipped with automatic pressure altitude reporting equipment having Mode C capability.

b) However, aircraft that was not originally certificated with an engine-driven electrical system or which has not subsequently been certified with a system installed, may conduct operations within a Mode C veil provided the aircraft remains outside Class A, B or C airspace; and below the altitude of the ceiling of a Class B or Class C airspace area designated for an airport or 10,000 feet MSL, whichever is lower.

**2.3.15 Charts:** Class B airspace is charted on Sectional Charts, IFR En Route Low Altitude Charts, and Terminal Area Charts.

**2.3.16 Flight Procedures:**

a) **Flights:** Aircraft within Class B airspace are required to operate in accordance with current IFR procedures. A clearance for a visual approach to a primary airport is not authorization for turbine powered airplanes to operate below the designated floors of the Class B airspace.

b) **VFR Flights:**

1) Arriving aircraft must obtain an ATC clearance prior to entering Class B airspace and must contact ATC on the appropriate frequency, and in relation to geographical fixes shown on local charts. Although a pilot may be operating beneath the floor of the Class B airspace on initial contact, communications with ATC should be established in relation to the points indicated for spacing and sequencing purposes.

2) Departing aircraft require a clearance to depart Class B airspace and should advise the clearance delivery position of their intended altitude and route of flight. ATC will normally advise VFR aircraft when leaving the geographical limits of the Class B airspace. Radar service is not automatically terminated with this advisory unless specifically stated by the controller.

3) Aircraft not landing or departing the primary airport may obtain an ATC clearance to transit the Class B airspace when traffic conditions permit and provided the requirements of 14 CFR Part 91.131 are met. Such VFR aircraft are encouraged, to the extent possible, to operate at altitudes above or below the Class B airspace or transit through established VFR corridors. Pilots operating in VFR corridors are urged to use frequency 122.750 MHz for the exchange of aircraft position information.

**2.3.17 ATC Clearances and Separation:** An ATC clearance is required to enter and operate within Class B airspace. VFR pilots are provided sequencing and separation from other aircraft while operating within Class B airspace. (See ENR 1.6, paragraph 11, Terminal Radar Programs for VFR Aircraft)

**NOTE.—**

*[1] SEPARATION AND SEQUENCING OF VFR WILL BE SUSPENDED IN THE EVENT OF A POWER OUTAGE AS THIS SERVICE IS DEPENDENT ON RADAR. THE PILOT WILL ADVISED THAT THE SERVICE IS NOT AVAILABLE AND ISSUED WIND, RUNWAY INFORMATION AND THE TIME OR PLACE TO CONTACT THE TOWER.*

*[2] SEPARATION OF VFR AIRCRAFT WILL BE SUSPENDED DURING CENTER RADAR PRESENTATION (CENRAP) OPERATIONS. TRAFFIC ADVISORIES AND SEQUENCING TO THE PRIMARY AIRPORT WILL BE PROVIDED ON A WORKLOAD PERMITTING BASIS. THE PILOT WILL BE ADVISED WHEN CENRAP IS IN USE.*

**2.3.9.1** VFR aircraft are separated from all VFR/IFR aircraft which weight 19,000 pounds or less by a minimum of:

- a) Target resolution, or
- b) 500 feet vertical separation, or
- c) Visual separation.

**2.3.9.2** VFR aircraft are separated from all VFR/IFR aircraft which weigh more than 19,000 and turbojets by no less than:

- a) 1 1/2 miles lateral separation, or
- b) 500 feet vertical separation, or
- c) Visual separation.

**2.3.9.3** This program is not to be interpreted as relieving pilots of their responsibilities to see and avoid other traffic operating in basic VFR weather conditions, to adjust their operations and flight path as necessary to preclude serious wake encounters, to maintain appropriate terrain and obstruction clearance or to remain in weather conditions equal to or better than the minimums required by 14 CFR Part 91.155. Approach control should be advised and a revised clearance or instruction obtained when compliance with an assigned route, heading and/or altitude is likely to compromise pilot responsibility with respect to terrain and obstruction clearance, vortex exposure, and weather minimums.

**2.3.9.4** ATC may assign altitudes to VFR aircraft that do not conform to 14 CFR Part 91.159. "RESUME APPROPRIATE VFR ALTITUDES" will be broadcast when the altitude assignment is no longer needed for separation or when leaving Class B airspace. Pilots must return to an altitude that conforms to 14 CFR Part 91.159.

**2.3.18 Proximity Operations:** VFR aircraft operating in proximity to Class B airspace are cautioned against operating too closely to the boundaries, especially where the floor of the Class B airspace is 3,000 feet or less or where VFR cruise altitudes are at or near the floor of higher levels. Observance of this precaution will reduce the potential for encountering an aircraft operating at the altitudes of Class B floors. Additionally, VFR aircraft are encouraged to utilize the VFR Planning Chart as a tool for planning flight in proximity to Class B airspace. Charted VFR Flyway Planning charts are published on the back of the existing VFR Terminal Area Charts.

## 2.4 Class C Airspace

**2.4.1 Definition:** Generally, that airspace from the surface to 4,000 feet above the airport elevation (charted in MSL) surrounding those airports that have an operational control tower, are serviced by a radar approach control, and that have a certain number of IFR operations or passenger enplanements. Although the configuration of each Class C airspace area is individually tailored, the airspace usually consists of a surface area with a 5 NM radius, and an outer area with a 10 NM radius that extends from 1,200 feet to 4,000 feet above the airport elevation.

**2.4.2 Outer Area:** The normal radius will be 20 NM, with some variations based on site specific requirements. The outer area extends outward from the primary airport and extends from the lower limits of radar/radio coverage up to the ceiling of the approach control's delegated airspace, excluding the Class C airspace and other airspace as appropriate.

**2.4.3 Charts:** Class C airspace is charted on Sectional Charts, IFR En Route Low Altitude, and Terminal Area Charts where appropriate.

### 2.4.4 Operating Rules and Pilot Equipment Requirements:

a) **Pilot Certification:** No specific certification required.

b) **Equipment:**

1) Two-way radio, and

2) Unless otherwise authorized by ATC, an operable radar beacon transponder with automatic altitude reporting equipment.

c) **Arrival or Through Flight Entry Requirements:** Two-way radio communication must be established with the ATC facility providing ATC services prior to entry and thereafter maintain those communications while in Class C airspace. Pilots of arriving aircraft should contact the Class C airspace ATC facility on the publicized frequency and give their position, altitude, radar beacon code, destination, and request Class C service. Radio contact should be initiated far enough from the Class C airspace boundary to preclude entering Class C airspace before two-way radio communications are established.

**NOTE.—**

**[ ] IF THE CONTROLLER RESPONDS TO A RADIO CALL WITH: (AIRCRAFT CALLSIGN) "STANDBY," RADIO COMMUNICATIONS HAVE BEEN ESTABLISHED AND THE PILOT CAN ENTER THE CLASS C AIRSPACE.**

**[ ] IF WORKLOAD OR TRAFFIC CONDITIONS PREVENT IMMEDIATE PROVISION OF CLASS C SERVICES, THE CONTROLLER WILL INFORM THE PILOT TO REMAIN OUTSIDE THE CLASS C AIRSPACE UNTIL CONDITIONS PERMIT THE SERVICES TO BE PROVIDED.**

**EXAMPLE.—**

**(AIRCRAFT CALLSIGN) "REMAIN OUTSIDE THE CHARLIE AIRSPACE AND STANDBY."**

**NOTE.—**

**[ ] IT IS IMPORTANT TO UNDERSTAND THAT IF THE CONTROLLER RESPONDS TO THE INITIAL RADIO CALL WITHOUT USING THE AIRCRAFT IDENTIFICATION, RADIO COMMUNICATION HAS NOT BEEN ESTABLISHED AND THE PILOT MAY NOT ENTER THE CLASS C AIRSPACE.**

**EXAMPLE.—**

**"AIRCRAFT CALLING DULLES APPROACH CONTROL. STANDBY."**

### d) Departures from:

1) A primary or satellite airport with an operating control tower: Two-way radio communications must be established and maintained with the control tower, and thereafter as instructed by ATC while operating in Class C airspace.

2) A satellite airport without an operating control tower: Two-way radio communications must be established as soon as practicable after departing with the ATC facility having jurisdiction over the Class C airspace.

e) **Aircraft Speed:** Unless otherwise authorized or required by ATC, no person may operate an aircraft at or below 2,500 feet above the surface within 4 nautical miles of the primary airport of a Class C airspace area at an indicated airspeed of more than 200 knots (230 mph).

**2.4.5 Air Traffic Services:** When two-way radio communications and radar contact are established, all participating VFR aircraft are:

a) Sequenced to the primary airport.

b) Provided Class C services within the Class C airspace and the Outer Area.

c) Provided basic radar services beyond the outer area on a workload permitting basis. This can be terminated by the controller if workload dictates.

**2.4.6 Aircraft Separation:** Separation is provided within the Class C airspace and the Outer Area after two-way radio communications and radar contact are established. VFR aircraft are separated from IFR aircraft within the Class C airspace by any of the following:

a) Visual separation.

b) 500 feet vertical; except when operating beneath a heavy jet.

c) Target resolution.

**NOTE.—**

*[1] SEPARATION AND SEQUENCING OF VFR AIRCRAFT WILL BE SUSPENDED IN THE EVENT OF A RADAR OUTAGE AS THIS SERVICE IS DEPENDENT ON RADAR. THE PILOT WILL BE ADVISED THAT THE SERVICE IS NOT AVAILABLE AND ISSUED WIND, RUNWAY INFORMATION WITH THE TIME OR PLACE TO CONTACT THE TOWER.*

*[2] SEPARATION OF VFR AIRCRAFT WILL BE SUSPENDED DURING CENRAP OPERATIONS. TRAFFIC ADVISORIES AND SEQUENCING TO THE PRIMARY AIRPORT WILL BE PROVIDED ON WORKLOAD PERMITTING BASIS. THE PILOT WILL BE ADVISED WHEN CENRAP IS IN USE.*

*[3] PILOT PARTICIPATION IS VOLUNTARY WITHIN THE OUTER AREA AND CAN BE DISCONTINUED, WITHIN THE OUTER AREA AT THE PILOTS REQUEST. CLASS C SERVICES WILL BE PROVIDED IN THE OUTER AREA UNLESS THE PILOT REQUESTS TERMINATION OF THE SERVICE.*

*[4] SOME FACILITIES PROVIDE CLASS C SERVICES ONLY DURING PUBLISHED HOURS. AT OTHER TIMES, TERMINAL IFR RADAR SERVICE WILL BE PROVIDED. IT IS IMPORTANT TO NOTE THAT THE COMMUNICATIONS REQUIREMENTS FOR ENTRY INTO THE AIRSPACE AND TRANSPONDER MODE C REQUIREMENTS ARE IN EFFECT AT ALL TIMES.*

**2.4.7 Secondary Airports:**

a) In some locations, Class C airspace may overlie the Class D surface area of a secondary airport. In order to allow that control tower to provide service to aircraft, portions of the overlapping Class C airspace may be procedurally excluded when the secondary airport tower is in operation. Aircraft operating in these procedurally excluded areas will only be provided airport traffic control services when in communication with the secondary airport tower.

b) Aircraft proceeding inbound to a satellite airport will be terminated at a sufficient distance to allow time to change to the appropriate tower or advisory frequency. Class C services to these aircraft will be discontinued when the aircraft is instructed to contact the tower or change to advisory frequency.

c) Aircraft departing secondary controlled airports will not receive Class C services until they have been radar identified and two-way communications have been established with the Class C airspace facility.

d) This program is not to be interpreted as relieving pilots of their responsibilities to see and avoid other traffic operating in basic VFR weather conditions, to adjust their operations and flight path as necessary preclude serious wake encounters, to maintain appropriate terrain and obstruction clearance or to remain in weather conditions equal to or better than the minimums required by 14 CFR Part 91.155. Approach control should be advised and a revised clearance or instruction obtained when compliance with an assigned

route, heading and/or altitude is likely to compromise pilot responsibility with respect to terrain and obstruction clearance, vortex exposure, and weather minimums.

**2.5 Class D Airspace**

**2.5.1 Definition:** Generally, that airspace from the surface to 2,500 feet above the airport elevation (charted in MSL) surrounding those airports that have an operational control tower. The configuration of each Class D airspace area is individually tailored and when instrument procedures are published, the airspace will normally be designed to contain the procedures.

**2.5.2 Operating Rules and Pilot Equipment Requirements:**

a) **Pilot Certification:** No specific certification required.

b) **Equipment:** Unless otherwise authorized by ATC, an operable two-way radio is required.

c) **Arrival or Through Flight Entry Requirements:** Two-way radio communication must be established with the ATC facility providing ATC services prior to entry and thereafter maintain those communications while in the Class D airspace. Pilots of arriving aircraft should contact the control tower on the publicized frequency and give their position, altitude, destination, and any request(s). Radio contact should be initiated far enough from the Class D airspace boundary to preclude entering the Class D airspace before two-way radio communications are established.

**NOTE.—**

*[1] IF THE CONTROLLER RESPONDS TO A RADIO CALL WITH [AIRCRAFT CALL SIGN] STANDBY RADIO COMMUNICATIONS HAVE BEEN ESTABLISHED AND THE PILOT CAN ENTER THE CLASS D AIRSPACE.*

*[2] IF WORKLOAD OR TRAFFIC CONDITIONS PREVENT IMMEDIATE ENTRY INTO CLASS D AIRSPACE THE CONTROLLER WILL INFORM THE PILOT TO REMAIN OUTSIDE THE CLASS D AIRSPACE UNTIL CONDITIONS PERMIT ENTRY.*

**EXAMPLE.—**

*[AIRCRAFT CALL SIGN] "REMAIN OUTSIDE THE DELTA AIRSPACE AND STANDBY."*

**NOTE.—**

*[3] IT IS IMPORTANT TO UNDERSTAND THAT IF THE CONTROLLER RESPONDS TO THE INITIAL RADIO CALL WITHOUT USING THE AIRCRAFT CALL SIGN RADIO COMMUNICATIONS HAVE NOT BEEN ESTABLISHED AND THE PILOT MAY NOT ENTER THE CLASS D AIRSPACE.*

**EXAMPLE.—**

*"AIRCRAFT CALLING MANASSAS TOWER STANDBY."*

**NOTE.—**

*[4] AT THOSE AIRPORTS WHERE THE CONTROL TOWER DOES NOT OPERATE 24 HOURS A DAY, THE OPERATING HOURS OF THE TOWER WILL BE LISTED ON THE APPROPRIATE CHARTS AND IN THE AFD. DURING THE HOURS THE TOWER IS NOT IN OPERATION THE CLASS E SURFACE AREA RULES ARE APPLICABLE.*

**d) Departures from:**

1) A primary or satellite airport with an operating control tower: Two-way radio communications must be established and maintained with the control tower, and thereafter as instructed by ATC while operating in the Class D airspace.

2) A satellite airport without an operating control tower: Two-way radio communications must be established with the ATC facility having jurisdiction over the Class D airspace as soon as practicable after departing.

**e) Aircraft Speed:** Unless otherwise authorized or required by ATC, no person may operate an aircraft at or below 2,500 feet above the surface within 4 nautical miles of the primary airport of a Class D airspace area at an indicated airspeed of more than 200 knots (230 mph).

**2.5.3 Class D airspace areas** are depicted on Sectional and Terminal charts with blue segmented lines, and on IFR En Route Low Altitude charts with a boxed [D].

**2.5.4 Arrival extensions** for instrument approach procedures may be Class D or Class E airspace. As a general rule, if all extensions are 2 miles or less, they remain part of the Class D surface area. However, if any one extension is greater than 2 miles, then all extensions become Class E.

**2.5.5 Separation for VFR Aircraft:** No separation services are provided to VFR aircraft.

**2.6 Class E Airspace**

**2.6.1 Definition:** Generally, if the airspace is not Class A, Class B, Class C, or Class D, and it is controlled airspace, it is Class E airspace.

**2.6.2 Operating Rules and Pilot/Equipment Requirements:**

**a) Pilot Certification:** No specific certification required.

**b) Equipment:** No specific equipment required by the airspace.

**c) Arrival or Through Flight Entry Requirements:** No specific requirements.

**2.6.3 Charts:** Class E airspace below 14,500 feet MSL is charted on Sectional, Terminal, World, and IFR En Route Low Altitude charts.

**2.6.4 Vertical limits:** Except for 18,000 feet MSL, Class E airspace has no defined vertical limit but rather it extends upward from either the surface or a designated altitude to the overlying or adjacent controlled airspace.

**2.6.5 Types of Class E Airspace:**

**a) Surface area designated for an airport:** When designated as a surface area for an airport, the airspace will be configured to contain all instrument procedures.

**b) Extension to a surface area:** There are Class E airspace areas that serve as extensions to Class B, Class C, and Class D surface areas designated for an airport. Such airspace provides controlled airspace to contain standard instrument approach procedures without imposing a communications requirement on pilots operating under VFR.

**c) Airspace used for transition:** There are Class E airspace areas beginning at either 700 or 1,200 feet AGL used to transition to/from the terminal or en route environment.

**d) En Route Domestic Areas:** There are Class E airspace areas that extend upward from a specified altitude and are en route domestic airspace areas that provide controlled airspace in those areas where there is a requirement to provide IFR en route ATC services but the Federal airway system is inadequate.

**e) Federal Airways:** The Federal airways are Class E airspace areas and, unless otherwise specified, extend upward from 1,200 feet to, but not including, 18,000 feet MSL. The colored airways are Green, Red, Amber, and Blue. The VOR airways are classified as Domestic, Alaskan, and Hawaiian.

**f) Offshore Airspace Areas:** There are Class E airspace areas that extend upward from a specified altitude to, but not including, 18,000 feet MSL and are designated as offshore airspace areas. These areas provide controlled airspace beyond 12 nautical miles from the coast of the United States in those areas where there is a requirement to provide IFR en route ATC services and within which the United States is applying domestic procedures.



g) Unless designated at a lower altitude, Class E airspace begins at 14,500 feet MSL to, but not including 18,000 feet MSL overlying the 48 contiguous States including the waters within 12 nautical miles of the coast of the 48 contiguous States, the District of Columbia, Alaska, including waters within 12 nautical miles of the coast of Alaska, and that airspace above FL 600; excluding the Alaska peninsula west of longitude 160°00'00"W; and the airspace less than 1,500 feet above the surface of the earth unless specifically so designated.

**2.6.6 Separation for VFR Aircraft:** No separation services are provided to VFR aircraft.

**3. Class G Airspace**

**3.1 General**

Class G airspace (uncontrolled) is that portion of the airspace that has not been designated as Class A, Class B, Class C, Class D and Class E airspace.

**3.2 VFR Requirements**

Rules governing VFR flight have been adopted to assist the pilot in meeting his responsibility to see and avoid other aircraft. Minimum flight visibility and distance from clouds required for VFR flight are contained in 14 CFR Part 91.155. (See TBL 1.4-1 for a tabular presentation of these rules).

**3.3 IFR Requirements**

**3.3.1** Title 14 of the Code of Federal Regulations specifies the pilot and aircraft equipment requirements for IFR flight. Pilots are reminded that in addition to altitude or flight level requirements, 14 CFR Part 91.177 includes a requirement to remain at least 1,000 feet (2,000 feet in designated mountainous terrain) above the highest obstacle within a horizontal distance of 4 nautical miles from the course to be flown.

**3.3.2** IFR Altitudes and Flight Levels. (See TBL 1.4-4 for a tabular presentation of these rules).

**IFR Altitudes and Flight Levels  
 Class G Airspace**

<i>If your magnetic course (ground track) is:</i>	<i>And you are below 18,000 feet MSL, fly:</i>	<i>And you are at or above 18,000 feet MSL but below FL 290, fly:</i>	<i>And you are at or above FL 290, fly 4,000 foot intervals:</i>
0° to 179° .....	Odd thousands MSL, (3,000; 5,000; 7,000, etc.)	Odd Flight Levels, FL 190; 210; 230, etc.)	Beginning at FL 290; (FL 290; 330; 370, etc.)
180° to 359° .....	Even thousands MSL, (2,000; 4,000; 6,000, etc.)	Even Flight Levels (FL 180; 200; 220, etc.)	Beginning at FL 310; (FL 310; 350; 390, etc.)

**TBL 1.4-4**

## 4. Other Airspace Areas

### 4.1 Airport Advisory Area

**4.1.1** The airport advisory area is the area within 10 statute miles of an airport where a control tower is not operating but where a FSS is located. At such locations, the FSS provides advisory service to arriving and departing aircraft. (See GEN 3.3, paragraph 9.2, Traffic Advisory Practices at Airports Without Operating Control Towers).

**4.1.2** It is not mandatory that pilots participate in the Local Airport Advisory program, but it is strongly recommended that they do.

**4.2 Published VFR Routes:** Published VFR routes for transitioning around, under and through complex airspace such as Class B airspace were developed through a number of FAA and industry initiatives. All of the following terms; i.e., "VFR Flyway," "VFR Corridor" "Class B Airspace VFR Transition Route" and "Terminal Area VFR Route" have been used when referring to the same or different types of routes or airspace. The following paragraphs identify and clarify the functionality of each type of route, and specify where and when an ATC clearance is required.

#### 4.2.1 VFR Flyways

**4.2.1.1** VFR Flyways and their associated Flyway Planning charts were developed from the recommendations of a National Airspace Review Task Group. A VFR Flyway is defined as a general flight path not defined as a

specific course, for use by pilots in planning flights into, out of, through or near complex terminal airspace to avoid Class B airspace. An ATC clearance is NOT required to fly these routes.

**4.2.1.2** VFR Flyways are depicted on the reverse side of some of the VFR Terminal Area Charts (TAC's), commonly referred to as Class B airspace charts. Eventually all TAC's will include a VFR Flyway Planning Chart. These charts identify VFR flyways designed to help VFR pilots avoid major controlled traffic flows. They may further depict multiple VFR routings throughout the area which may be used as an alternative to flight within Class B airspace. The ground references provide a guide for improved visual navigation. These routes are not intended to discourage requests for VFR operations within Class B airspace but are designed solely to assist pilots in planning for flights under and around busy Class B airspace without actually entering Class B airspace.

**4.2.1.3** It is very important to remember that these suggested routes are not sterile of other traffic. The entire Class B airspace, and the airspace underneath it, may be heavily congested with many different types of aircraft. Pilot adherence to VFR rules must be exercised at all times. Further, when operating beneath Class B airspace, communications must be established and maintained between your aircraft and any control tower while transiting the Class B, Class C, and Class D surface areas of those airports under Class B Airspace.

## 4.2.2 VFR Corridors

**4.2.2.1** The design of a few of the first Class B airspace areas provided a corridor for the passage of uncontrolled traffic. A VFR corridor is defined as airspace through Class B airspace, with defined vertical and lateral boundaries, in which aircraft may operate without an ATC clearance or communication with air traffic control.

**4.2.2.2** These corridors are, in effect, a “hole” through Class B airspace. (See FIG 1.4-1.) A classic example would be the corridor through the Los Angeles Class B airspace, which has been subsequently changed to Special Flight Rules airspace (SFR). A corridor is surrounded on all sides by Class B airspace and does not extend down to the surface like a VFR Flyway. Because of their finite lateral and vertical limits, and the volume of VFR traffic using a corridor, extreme caution and vigilance must be exercised.

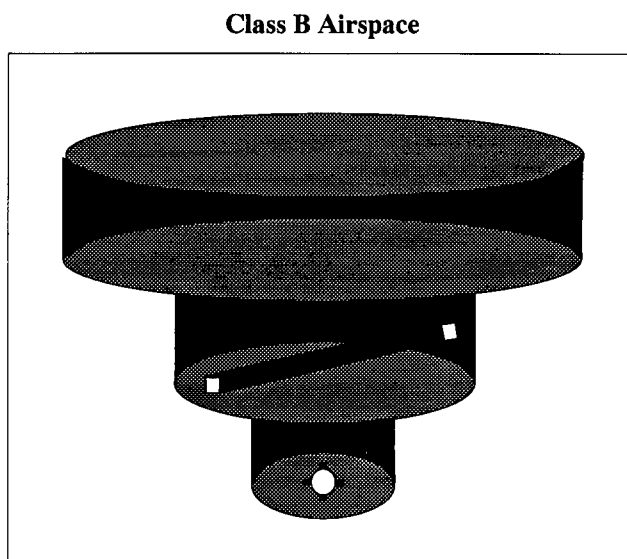

FIG 1.4-1

**4.2.2.3** Because of the heavy traffic volume and the procedures necessary to efficiently manage the flow of traffic, it has not been possible to incorporate VFR corridors in the development or modifications of Class B airspace in recent years.

## 4.2.3 Class B airspace VFR Transition Routes

**4.2.3.1** To accommodate VFR traffic through certain Class B airspace, such as Seattle, Phoenix and Los Angeles, Class B Airspace VFR Transition Routes were developed. A Class B Airspace VFR Transition Route is defined as a specific flight course depicted on a Terminal Area Chart (TAC) for transiting a specific Class

B airspace. These routes include specific ATC assigned altitudes, and pilots must obtain an ATC clearance prior to entering Class B airspace on the route.

**4.2.3.2** These routes, as depicted in FIG 1.4-2 are designed to show the pilot where to position his/her aircraft outside of, or clear of, the Class B airspace where an ATC clearance can normally be expected with minimal or no delay. Until ATC authorization is received, pilots must remain clear of Class B airspace. On initial contact, pilots should advise ATC of their position, altitude, route name desired, and direction of flight. After a clearance is received, the pilot must fly the route as depicted and, most importantly, adhere to ATC instructions.

## 4.3 Terminal Radar Service Area (TRSA)

**4.3.1 Background:** The terminal radar service areas (TRSA's) were originally established as part of the Terminal Radar Program at selected airports. TRSA's were never controlled airspace from a regulatory standpoint because the establishment of TRSA's were never subject to the rulemaking process; consequently, TRSA's are not contained in 14 CFR Part 71 nor are there any TRSA operating rules in Part 91. Part of the Airport Radar Service Area (ARSA) program was to eventually replace all TRSA's. However, the ARSA requirements became relatively stringent and it was subsequently decided that TRSA's would have to meet ARSA criteria before they would be converted. TRSA's do not fit into any of the U.S. Airspace Classes; therefore, they will continue to be non-Part 71 airspace areas where participating pilots can receive additional radar services which have been redefined as TRSA Service.

**4.3.2 TRSA Areas:** The primary airport(s) within the TRSA become(s) Class D airspace. The remaining portion of the TRSA overlies other controlled airspace which is normally Class E airspace beginning at 700 or 1,200 feet and established to transition to/from the en route/terminal environment.

**4.3.3 Participation:** Pilots operating under VFR are encouraged to contact the radar approach control and avail themselves of the TRSA Services. However, participation is voluntary on the part of the pilot. See ENR 1.6, paragraph 11.2, for details and procedures.

**4.3.4 Charts:** TRSA's are depicted on VFR sectional and terminal area charts with a solid black line and altitudes for each segment. The Class D portion is charted with a blue segmented line.

VFR Transition Route

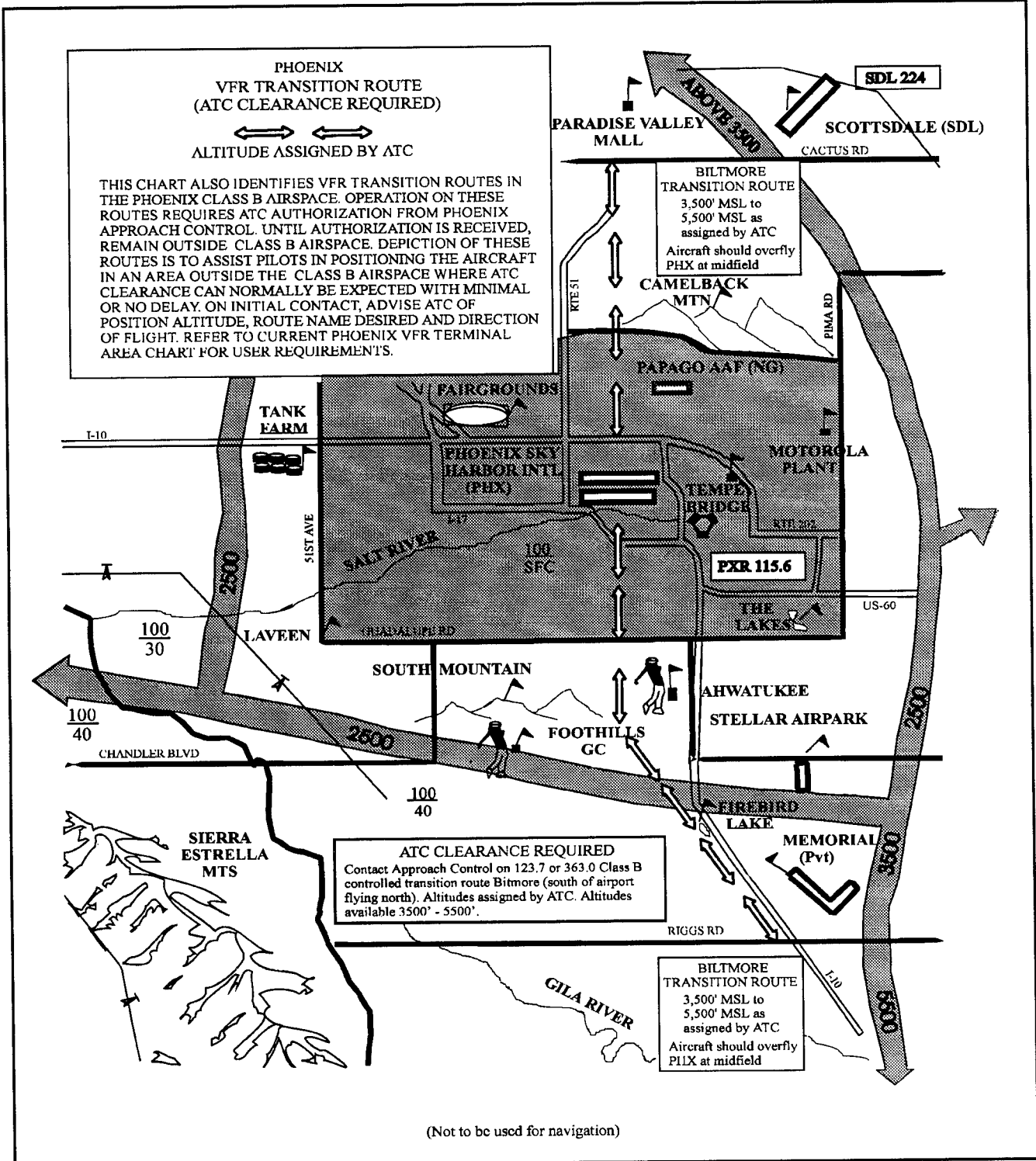

FIG 1.4-2

## ENR 1.5 Holding, Approach, and Departure Procedures

### 1. Holding Procedures

**1.1** Patterns at the most generally used holding fixes are depicted (charted) on U.S. Government or commercially produced (meeting FAA requirements) Low or High Altitude En route, Area, and STAR charts. Pilots are expected to hold in the pattern depicted unless specifically advised otherwise by ATC. (See ENR 1.1, paragraph 27, Clearances/Separations.)

*NOTE.—*  
*HOLDING PATTERNS THAT PROTECT FOR A MAXIMUM HOLDING AIRSPEED OTHER THAN THE STANDARD MAY BE DEPICTED BY AN ICON, UNLESS OTHERWISE DEPICTED. THE ICON IS A STANDARD HOLDING PATTERN SYMBOL (RACETRACK) WITH THE AIRSPEED RESTRICTION SHOWN IN THE CENTER. IN OTHER CASES, THE AIRSPEED RESTRICTION WILL BE DEPICTED NEXT TO THE STANDARD HOLDING PATTERN SYMBOL.*

**1.2** An ATC clearance requiring an aircraft to hold at a fix where the pattern is not charted will include the following information:

- a) Direction of holding from the fix in terms of the eight cardinal compass points; i.e., N, NE, E, SE, etc.
- b) Holding fix. (The fix may be omitted if it is included at the beginning of the transmission as the clearance limit.)
- c) Radial, course, bearing, airway, or route on which the aircraft is to hold.
- d) Leg length in miles if DME or RNAV is to be used. (Leg length will be specified in minutes on pilot request or if the controller considers it necessary.)
- e) Direction of turn if left turns are to be made, the pilot requests, or the controller considers it necessary.
- f) Time to expect further clearance, and any pertinent additional delay information.

### 1.3 Typical Holding Pattern Example

**1.3.1** When holding at a VOR station, pilots should begin the turn to the outbound leg at the time of the first complete reversal of the “to-from” indicator. See GEN 3.4, paragraph 12, Two-Way Radio Communications Failure, for holding at the approach fix when radio failure occurs.

### 1.3.2 Holding Pattern Airspace Protection

a) Holding pattern airspace protection is based on the following procedures.

*NOTE.—*  
*HOLDING PATTERN AIRSPACE PROTECTION DESIGN CRITERIA IS CONTAINED IN FAA HANDBOOK 7130.3, “HOLDING PATTERN CRITERIA.”*

#### 1) Airspeeds:

(a) All aircraft may hold at the following altitudes and maximum holding airspeeds:

Altitude (MSL)	Airspeed (KIAS)
MHA - 6,000'	200
6,001' - 14,000'	230
14,001' and above	265

TBL 1.5-1

(b) The following are exceptions to the maximum holding airspeeds:

- (1) Holding patterns from 6,001' to 14,000' may be restricted to a maximum airspeed of 210 KIAS. This nonstandard pattern will be depicted by an icon.
- (2) Holding patterns may be restricted to a maximum airspeed of 175 KIAS. This nonstandard pattern will be depicted by an icon. Holding patterns restricted to 175 KIAS will generally be found on instrument approach procedures applicable to Category A and B aircraft only.
- (3) Holding patterns at USAF airfields only - 310 KIAS maximum, unless otherwise depicted.
- (4) Holding patterns at Navy fields only - 230 KIAS maximum, unless otherwise depicted.

(c) The following phraseology may be used by an ATC specialist to advise a pilot of the maximum holding airspeed for a holding pattern airspace area.

*PHRASEOLOGY-*  
*(AIRCRAFT IDENTIFICATION) (holding instructions, when needed)*  
*MAXIMUM HOLDING AIRSPEED IS (speed in knots).*

Holding Patterns

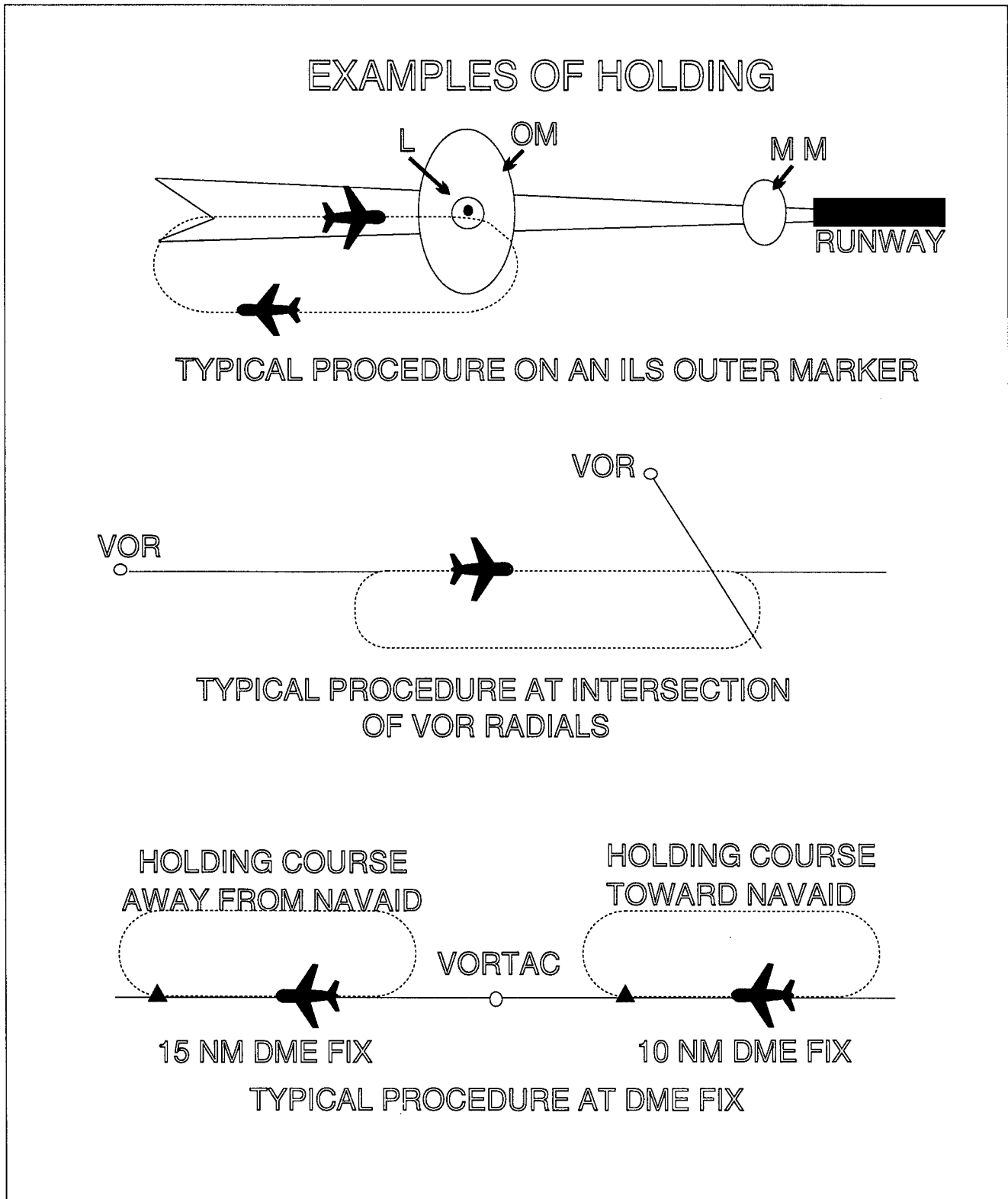

FIG 1.5-1

**Holding Pattern Descriptive Terms**

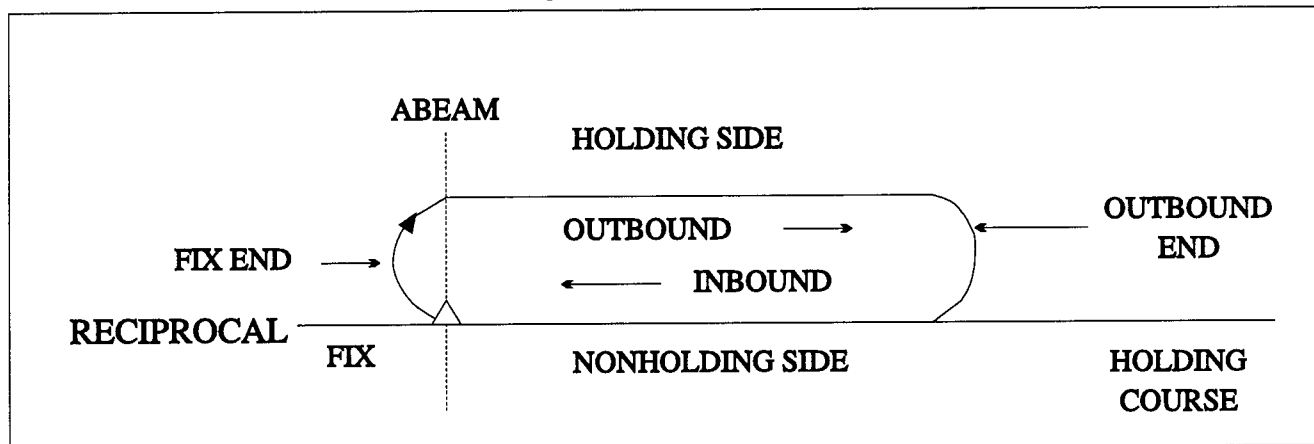

FIG 15-2

**Holding Pattern Entry Procedures**

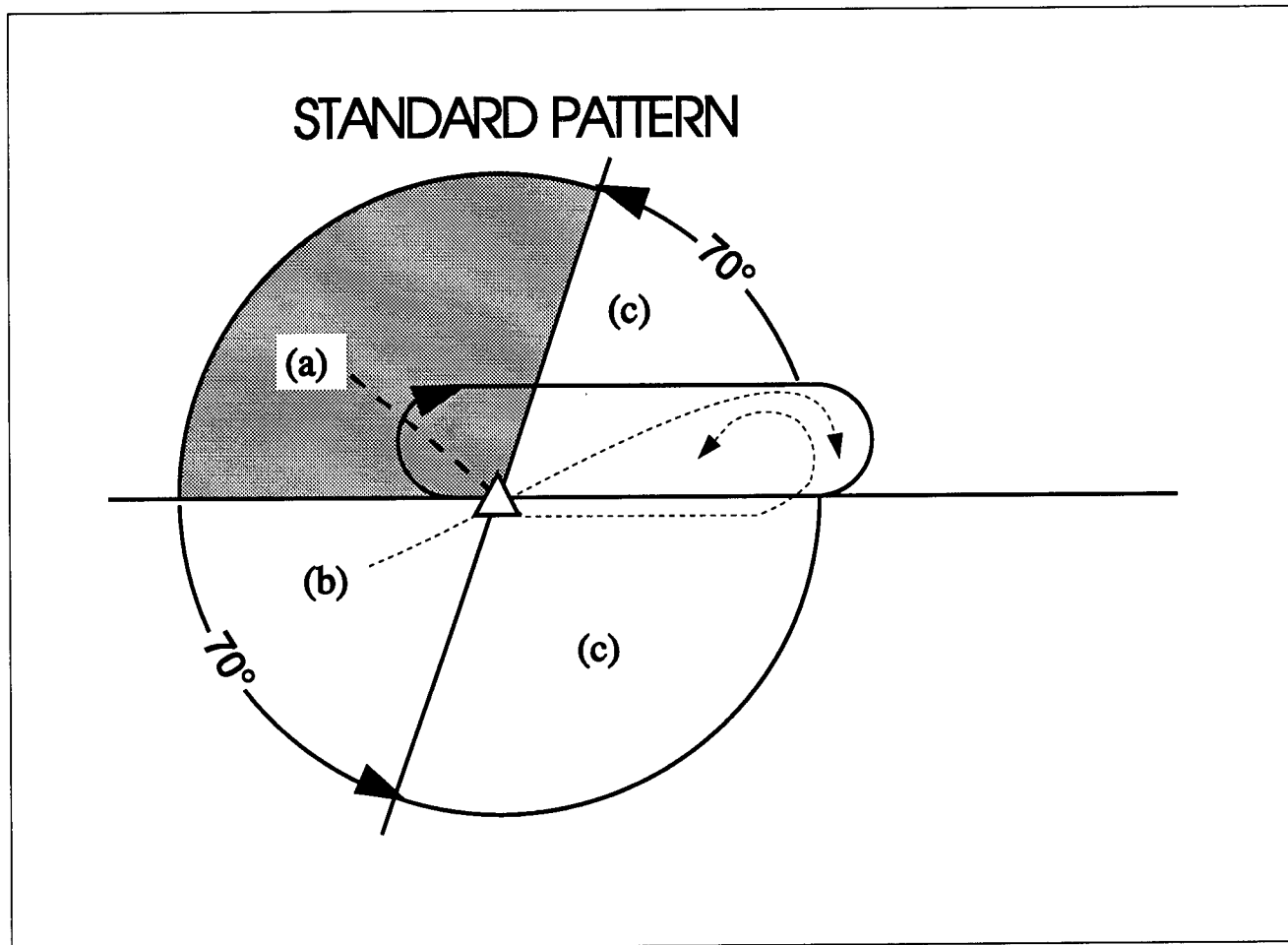

FIG 15-3

**2) Entry Procedures (See FIG 1.5-3.)**

**(a) Parallel Procedure:** When approaching the holding fix from anywhere in sector (a), the parallel entry procedure would be to turn to a heading to parallel

the holding course outbound on the nonholding side for one minute, turn in the direction of the holding pattern through more than 180 degrees, and return to the holding fix or intercept the holding course inbound.

(b) **Teardrop Procedure:** When approaching the holding fix from anywhere in sector (b), the teardrop entry procedure would be to fly to the fix, turn outbound to a heading for a 30 degree teardrop entry within the pattern (on the holding side) for a period of one minute, then turn in the direction of the holding pattern to intercept the inbound holding course.

(c) **Direct Entry Procedure:** When approaching the holding fix from anywhere in sector (c), the direct entry procedure would be to fly directly to the fix and turn to follow the holding pattern.

(d) While other entry procedures may enable the aircraft to enter the holding pattern and remain within protected airspace, the parallel, teardrop and direct entries are the procedures for entry and holding recommended by the FAA.

**3) Timing**

**(a) Inbound Leg**

- At or below 14,000 feet MSL: 1 minute.
- Above 14,000 feet MSL: 1<sup>1</sup>/<sub>2</sub> minutes.

**NOTE.—**  
THE INITIAL OUTBOUND LEG SHOULD BE FLOWN FOR 1 MINUTE OR 1 1/2 MINUTES (APPROPRIATE TO ALTITUDE). TIMING FOR SUBSEQUENT OUTBOUND LEGS SHOULD BE ADJUSTED, AS NECESSARY, TO ACHIEVE PROPER INBOUND LEG TIME. PILOTS MAY USE ANY NAVIGATIONAL MEANS AVAILABLE; I.E. DME, RNAV, ETC., TO INSURE THE APPROPRIATE INBOUND LEG TIMES.

(b) **Outbound Leg** timing begins over/abeam the fix, whichever occurs later. If the abeam position cannot be determined, start timing when turn to outbound is completed.

**4) Distance Measuring Equipment (DME):** DME holding is subject to the same entry and holding procedures except that distances (nautical miles) are used in lieu of time values. The outbound course of a DME holding pattern is called the outbound leg of the pattern. The length of the outbound leg will be specified by the controller. The end of the outbound leg is determined by the odometer reading. (See FIG 1.5-4 and FIG 1.5-5.)

**Inbound Leg Toward NAVAID**

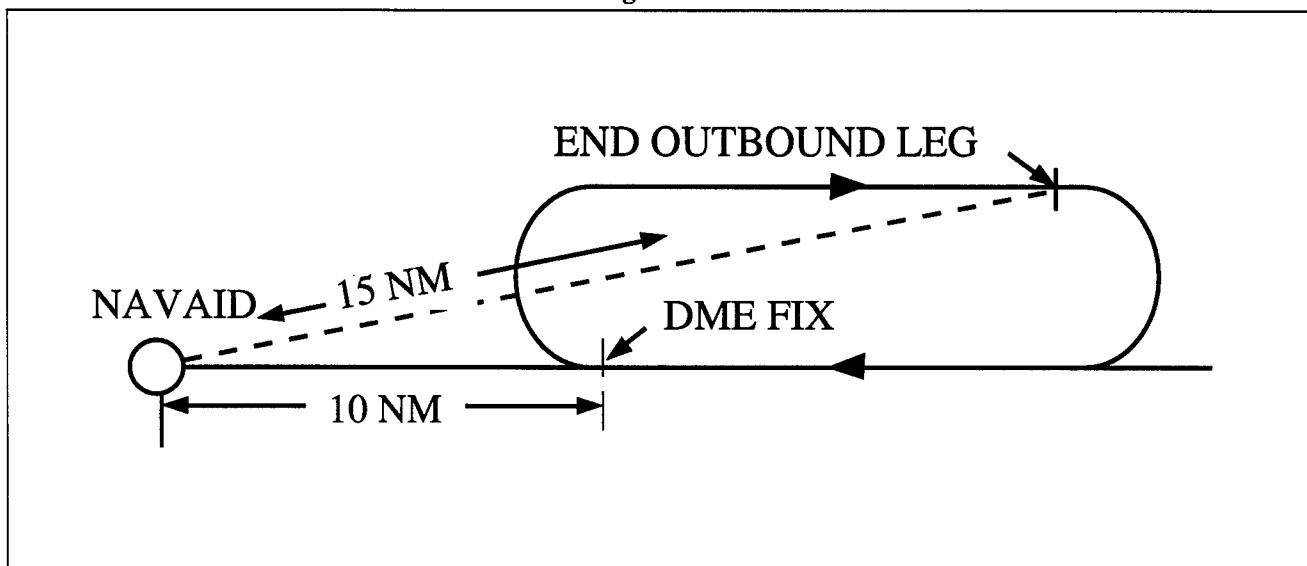

**FIG 1.5-4**

**NOTE.—**  
WHEN THE INBOUND COURSE IS TOWARD THE NAVAID AND THE FIX DISTANCE IS 10 NM, AND THE LEG LENGTH IS 5 NM, THEN THE END OF THE OUTBOUND LEG WILL BE REACHED WHEN THE DME READS 15 NM.



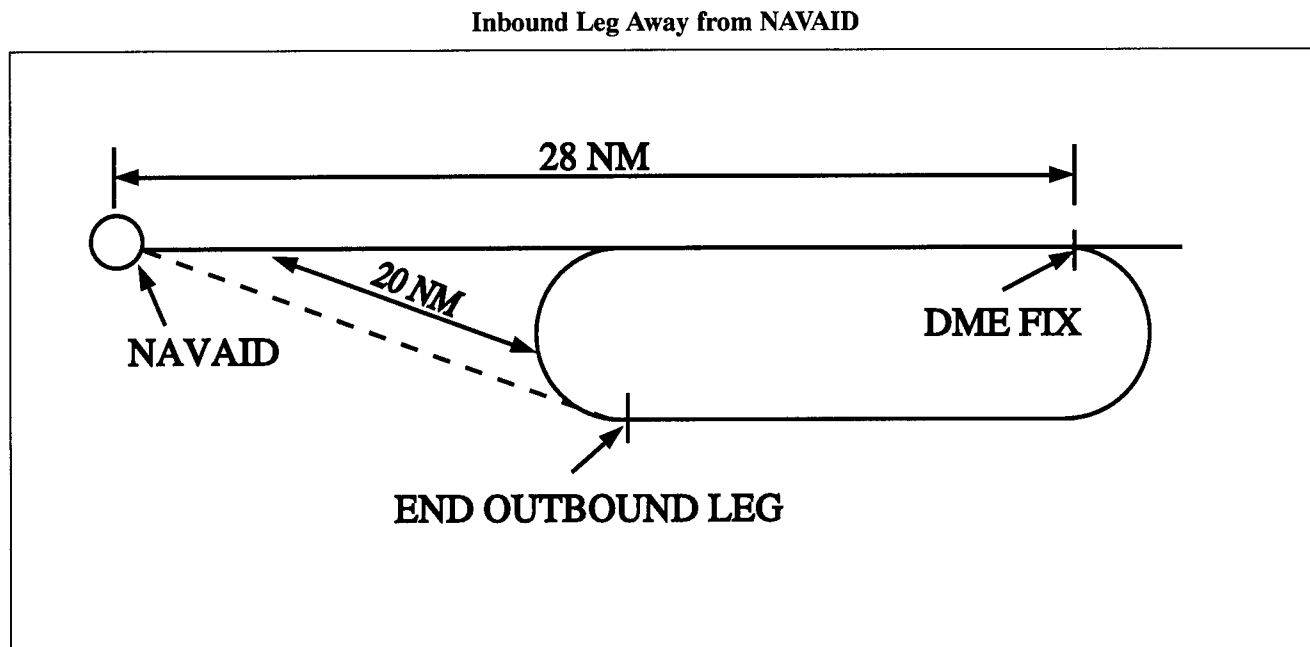

FIG 1.5-5

**NOTE.—**  
WHEN THE INBOUND COURSE IS AWAY FROM THE NAVAID AND THE FIX DISTANCE IS 28 NM, AND THE LEG LENGTH IS 8 NM, THEN THE END OF THE OUTBOUND LEG WILL BE REACHED WHEN THE DME READS 20 NM.

### 5) Pilot Action

(a) Start speed reduction when 3 minutes or less from the holding fix. Cross the holding fix, initially, at or below the maximum holding airspeed.

(b) Make all turns during entry and while holding at:

- 3 degrees per second;
- 30 degree bank angle; or
- 25 degree bank angle provided a flight director system is used.

**NOTE.—**  
USE WHICHEVER REQUIRES THE LEAST BANK ANGLE.

(c) Compensate for wind effect primarily by drift correction on the inbound and outbound legs. When outbound, triple the inbound drift correction to avoid major turning adjustments; e.g., if correcting left by 8 degrees when inbound, correct right by 24 degrees when outbound.

(d) Determine entry turn from aircraft heading upon arrival at the holding fix. Plus or minus 5° in heading is considered to be within allowable good operating limits for determining entry.

(e) Advise ATC immediately what increased airspeed is necessary, if any, due to turbulence, icing, etc.,

or if unable to accomplish any part of the holding procedures. After such higher speeds are no longer necessary, operate according to the appropriate published holding speed and notify ATC.

**NOTE.—**  
AIRSPACE PROTECTION FOR HOLDING IN TURBULENT AIR IS BASED ON A MAXIMUM OF 280 KIAS OR MACH 0.8, WHICHEVER IS LOWER. CONSIDERABLE IMPACT ON TRAFFIC FLOW WILL RESULT WHEN TURBULENT AIR HOLDING PATTERNS ARE USED; THUS, PILOT DISCRETION WILL ENSURE THEIR USE IS LIMITED TO BONA FIDE CONDITIONS/REQUIREMENTS.

### 6) Nonstandard Holding Pattern

(a) Fix end and outbound end turns are made to the left. Entry procedures to a nonstandard pattern are oriented in relation to the 70 degree line on the holding side just as in the standard pattern.

(b) When holding at a fix and instructions are received specifying the time of departure from the fix, the pilot should adjust the aircraft's flight path within the limits of the established holding pattern in order to leave the fix at the exact time specified. After departing the holding fix, normal speed is to be resumed with respect to other governing speed requirements such as terminal area speed limits, specific ATC requests, etc. Where the fix is associated with an instrument approach, and timed approaches are in effect, a procedure turn shall not be executed unless the pilot advises ATC, since aircraft holding are expected to proceed inbound

on final approach directly from the holding pattern when approach clearance is received.

(c) If an aircraft is established in a published holding pattern at an assigned altitude above the published minimum holding altitude and subsequently cleared for the approach, the pilot may descend to the published minimum holding altitude. The holding pattern would only be a segment of the instrument approach procedure if it is published on the instrument procedure chart and is used in lieu of a procedure turn.

(d) For those holding patterns where there are no published minimum holding altitudes, the pilot, upon receiving an approach clearance, must maintain the last assigned altitude until leaving the holding pattern and established on the inbound course. Thereafter, the published minimum altitude of the route segment being flown will apply. It is expected that the pilot will be assigned a holding altitude that will permit a normal descent on the inbound course.

#### 1.4 Radar Surveillance of Outer-Fix Holding Pattern Airspace Areas

1.4.1 Whenever aircraft are holding at an outer fix, ATC will usually provide radar surveillance of the outer fix holding pattern airspace area, or any portion of it, if it is shown on the controller's radar scope.

1.4.2 The controller will attempt to detect any holding aircraft that stray outside the holding pattern airspace area and will assist any detected aircraft to return to the assigned airspace area.

1.4.3 Many factors could prevent ATC from providing this additional service, such as workload, number of targets, precipitation, ground clutter, and radar system capability. These circumstances may make it unfeasible to maintain radar identification of aircraft or to detect aircraft straying from the holding pattern. The provision of this service depends entirely upon whether the controller is in a position to provide it and does not relieve a pilot of the responsibility to adhere to an accepted ATC clearance.

### 2. Approach Procedures

#### 2.1 Approach Control

2.1.1 Approach control is responsible for controlling all instrument flight operating within its area of responsibility. Approach control may serve one or more airfields, and control is exercised primarily by direct pilot/controller communications. Prior to arriving at the destination radio facility, instructions will be received

from ARTCC to contact approach control on a specified frequency.

#### 2.2 Radar Approach Control

2.2.1 Where radar is approved for control service, it is used not only for radar approaches (ASR and PAR) but is also used to provide vectors in conjunction with published nonradar approaches based on radio NAVAID's (ILS, MLS, VOR, NDB, TACAN). Radar vectors can provide course guidance and expedite traffic to the final approach course of any established instrument approach procedure or to the traffic pattern for a visual approach. Approach control facilities that provide this radar service will operate in the following manner:

a) Arriving aircraft are either cleared to an outer fix most appropriate to the route being flown with vertical separation and, if required, given holding information or, when radar handoffs are effected between the ARTCC and approach control, or between two approach control facilities, aircraft are cleared to the airport or to a fix so located that the handoff will be completed prior to the time the aircraft reaches the fix. When radar handoffs are utilized, successive arriving flights may be handed off to approach control with radar separation in lieu of vertical separation.

b) After release to approach control, aircraft are vectored to the appropriate final approach course (ILS, MLS, VOR, ADF, etc.). Radar vectors and altitude or flight levels will be issued as required for spacing and separating aircraft. *Therefore, pilots must not deviate from the headings issued by approach control.* Aircraft will normally be informed when it is necessary to vector across the final approach course for spacing or other reasons. If approach course crossing is imminent and the pilot has not been informed that the aircraft will be vectored across the final approach course, the pilot should query the controller.

c) The pilot is not expected to turn inbound on the final approach course unless an approach clearance has been issued. This clearance will normally be issued with the final vector for interception of the final approach course, and the vector will be such as to enable the pilot to establish the aircraft on the final approach course prior to reaching the final approach fix.

d) In the case of aircraft already inbound on the final approach course, approach clearance will be issued prior to the aircraft reaching the final approach fix. When established inbound on the final approach course, radar separation will be maintained and the pilot will be expected to complete the approach utilizing the approach aid designated in the clearance (ILS, MLS,

VOR, radio beacons, etc.) as the primary means of navigation. Therefore, once established on the final approach course, pilots must not deviate from it unless a clearance to do so is received from ATC.

e) After passing the final approach fix on final approach, aircraft are expected to continue inbound on the final approach course and complete the approach or effect the missed approach procedure published for that airport.

**2.2.2** ARTCC's are approved for and may provide approach control services to specific airports. The radar systems used by these centers do not provide the same precision as an airport surveillance radar (ASR)/precision approach radar (PAR) used by approach control facilities and towers, and the update rate is not as fast. Therefore, pilots may be requested to report established on the final approach course.

**2.2.3** Whether aircraft are vectored to the appropriate final approach course or provide their own navigation on published routes to it, radar service is automatically terminated when the landing is completed or when instructed to change to advisory frequency at uncontrolled airports, whichever occurs first.

### 3. Standard Terminal Arrival (STAR), Flight Management System Procedures (FMSP) For Arrivals

**3.1** A STAR is an ATC coded IFR arrival route established for application to arriving IFR aircraft destined for certain airports. FMSP's for arrivals serve the same purpose but are only used by aircraft equipped with FMS. The purpose of both is to simplify clearance delivery procedures and facilitate transition between en route and instrument approach procedures.

a) STAR's/FMSP's may have mandatory speeds and/or crossing altitudes published. Other STAR's may have planning information depicted to inform pilots what clearances or restrictions to "Expect." "Expect" altitudes/speeds are not considered STAR/FMSP crossing restrictions until verbally issued by ATC.

**NOTE.—**  
THE "EXPECT" ALTITUDES/SPEEDS ARE PUBLISHED SO THAT PILOTS MAY HAVE THE INFORMATION FOR PLANNING PURPOSES. THESE ALTITUDES/SPEEDS SHOULD NOT BE USED IN THE EVENT OF LOST COMMUNICATIONS UNLESS ATC HAS SPECIFICALLY ADVISED THE PILOT TO EXPECT THESE ALTITUDES/SPEEDS AS PART OF A FURTHER CLEARANCE.

**REFERENCE—**  
CFR SECTION 91.185c(2)(iii).

b) Pilots shall maintain last assigned altitude until receiving authorization/clearance to change altitude. At that time, pilots are expected to comply with all

published/issued restrictions. The authorization may be via a normal descent clearance or the phraseology "DESCEND VIA."

1) A "DESCEND VIA" clearance authorizes pilots to vertically and laterally navigate, in accordance with the depicted procedure, to meet published restrictions. Vertical navigation is at pilot's discretion; however, adherence to published altitude crossing restrictions and speeds is mandatory unless otherwise cleared. (MEA's are not considered restrictions; however, pilots are expected to remain above MEA's).

**EXAMPLE.—**  
① **LATERAL/ROUTING CLEARANCE ONLY:**  
"CLEARED HADLY ONE ARRIVAL."

② **ROUTING WITH ASSIGNED ALTITUDE:**  
"CLEARED HADLY ONE ARRIVAL, DESCEND AND MAINTAIN FLIGHT LEVEL TWO FOUR ZERO."  
"CLEARED HADLY ONE ARRIVAL, DESCEND AT PILOT'S DISCRETION, MAINTAIN FLIGHT LEVEL TWO FOUR ZERO."

③ **LATERAL/ROUTING AND VERTICAL NAVIGATION CLEARANCE:**  
"DESCEND VIA THE CIVIT ONE ARRIVAL."  
"DESCEND VIA THE CIVIT ONE ARRIVAL, EXCEPT, CROSS ARNES AT OR ABOVE ONE ONE THOUSAND."

**NOTE.—**  
PROCEDURES FOR SUBSEQUENT REVISIONS TO SPEED AND/OR ALTITUDES AFTER A "DESCEND VIA" CLEARANCE HAS BEEN ISSUED AND ACCEPTED MAY BE FOUND IN THE US TERMINAL PROCEDURES, GENERAL INFORMATION SECTION.

2) Pilots cleared for vertical navigation using the phraseology "DESCEND VIA" shall inform ATC upon initial contact with a new frequency.

**EXAMPLE.—**  
"DELTA ONE TWENTY ONE DESCENDING VIA THE CIVIT ONE ARRIVAL."

**3.2** Pilots of IFR aircraft destined to locations for which STAR's have been published may be issued a clearance containing a STAR whenever ATC deems it appropriate.

**3.3** Use of STAR's requires pilot possession of at least the approved textual description. As with any ATC clearance or portion thereof, it is the responsibility of each pilot to accept or refuse an issued STAR. Pilots should notify ATC if they do not wish to use a STAR by placing "NO STAR" in the remarks section of the flight plan or by the less desirable method of verbally stating the same to ATC.

**3.4** STAR charts are published in the Terminal Procedures Publication (TPP) and are available on subscription from the National Ocean Service.

#### 4. Local Flow Traffic Management Program

**4.1** This program is a continuing effort by the FAA to enhance safety, minimize the impact of aircraft noise and conserve aviation fuel. The enhancement of safety and reduction of noise is achieved in this program by minimizing low altitude maneuvering of arriving turbojet and turboprop aircraft weighing more than 12,500 pounds and, by permitting departure aircraft to climb to high altitudes sooner, as arrivals are operating at higher altitudes at the points where their flight paths cross. The application of these procedures also reduces exposure time between controlled aircraft and uncontrolled aircraft at the lower altitudes in and around the terminal environment. Fuel conservation is accomplished by absorbing any necessary arrival delays for aircraft included in this program operating at the higher and more fuel efficient altitudes.

**4.2** A fuel efficient descent is basically an uninterrupted descent (except where level flight is required for speed adjustment) from cruising altitude to the point when level flight is necessary for the pilot to stabilize the aircraft on final approach. The procedure for a fuel efficient descent is based on an altitude loss which is most efficient for the majority of aircraft being served. This will generally result in a descent gradient window of 250-350 feet per nautical mile.

**4.3** When crossing altitudes and speed restrictions are issued verbally or are depicted on a chart, ATC will expect the pilot to descend first to the crossing altitude and then reduce speed. Verbal clearances for descent will normally permit an uninterrupted descent in accordance with the procedure as described in paragraph 4.2 above. Acceptance of a charted fuel efficient descent (Runway Profile Descent) clearance requires the pilot to adhere to the altitudes, speeds, and headings depicted on the charts unless otherwise instructed by ATC. **PILOTS RECEIVING A CLEARANCE FOR A FUEL EFFICIENT DESCENT ARE EXPECTED TO ADVISE ATC IF THEY DO NOT HAVE RUNWAY PROFILE DESCENT CHARTS PUBLISHED FOR THAT AIRPORT OR ARE UNABLE TO COMPLY WITH THE CLEARANCE.**

#### 5. Advance Information on Instrument Approaches

**5.1** When landing at airports with approach control services and where two or more instrument approach procedures are published, pilots will be provided in advance of their arrival with the type of approach to expect or that they may be vectored for a visual approach. This information will be broadcast either by a controller or

on ATIS. It will not be furnished when the visibility is three miles or better and the ceiling is at or above the highest initial approach altitude established for any low altitude instrument approach procedure for the airport.

**5.2** The purpose of this information is to aid the pilot in planning arrival actions; however, it is not an ATC clearance or commitment and is subject to change. Pilots should bear in mind that fluctuating weather, shifting winds, blocked runway, etc., are conditions which may result in changes to approach information previously received. It is important that pilots advise ATC immediately if they are unable to execute the approach ATC advised will be used, or if they prefer another type of approach.

**5.3** Aircraft destined to uncontrolled airports which have automated weather data with broadcast capability should monitor the ASOS/AWOS frequency to ascertain the current weather for the airport. The pilot shall advise ATC when he/she has received the broadcast weather and state his/her intentions.

**NOTE.—**

**① ASOS/AWOS SHOULD BE SET TO PROVIDE ONE-MINUTE BROADCAST WEATHER UPDATES AT UNCONTROLLED AIRPORTS THAT ARE WITHOUT WEATHER BROADCAST CAPABILITY BY A HUMAN OBSERVER.**

**② CONTROLLERS WILL CONSIDER THE LONG LINE DISSEMINATED WEATHER FROM AN AUTOMATED WEATHER SYSTEM AT AN UNCONTROLLED AIRPORT AS TREND AND PLANNING INFORMATION ONLY AND WILL RELY ON THE PILOT FOR CURRENT WEATHER INFORMATION FOR THE AIRPORT. IF THE PILOT IS UNABLE TO RECEIVE THE CURRENT BROADCAST WEATHER, THE LAST LONG LINE DISSEMINATED WEATHER WILL BE ISSUED TO THE PILOT. WHEN RECEIVING IFR SERVICES, THE PILOT/AIRCRAFT OPERATOR IS RESPONSIBLE FOR DETERMINING IF WEATHER/VISIBILITY IS ADEQUATE FOR APPROACH/LANDING.**

**5.4** When making an IFR approach to an airport not served by a tower or FSS, after the ATC controller advises "CHANGE TO ADVISORY FREQUENCY APPROVED," you should broadcast your intentions, including the type of approach being executed, your position, and when over the final approach fix inbound (nonprecision approach) or when over the outer marker or the fix used in lieu of the outer marker inbound (precision approach). Continue to monitor the appropriate frequency (UNICOM, etc.) for reports from other pilots.

#### 6. Approach Clearance

**6.1** An aircraft which has been cleared to a holding fix and subsequently "cleared . . . approach" has not received new routing. Even though clearance for the approach may have been issued prior to the aircraft reaching the holding fix, ATC would expect the pilot to

proceed via the holding fix (the last assigned route), and the feeder route associated with that fix (if a feeder route is published on the approach chart) to the initial approach fix (IAF) to commence the approach.

WHEN CLEARED FOR THE APPROACH, THE PUBLISHED OFF AIRWAY (FEEDER) ROUTES THAT LEAD FROM THE EN ROUTE STRUCTURE TO THE IAF ARE PART OF THE APPROACH CLEARANCE.

**6.2** If a feeder route to an IAF begins at a fix located along the route of flight prior to reaching the holding fix, and clearance for an approach is issued, a pilot should commence the approach via the published feeder route; i.e., the aircraft would not be expected to overfly the feeder route and return to it. The pilot is expected to commence the approach in a similar manner at the IAF, if the IAF for the procedure is located along the route of flight to the holding fix.

**6.3** If a route of flight directly to the initial approach fix is desired, it should be so stated by the controller with phraseology to include the words “direct . . .,” “proceed direct” or a similar phrase which the pilot can interpret without question. If a pilot is uncertain of the clearance, immediately query ATC as to what route of flight is desired.

## 7. Landing Priority

**7.1** A clearance for a specific type of approach (ILS, MLS, ADF, VOR, or straight-in approach) to an aircraft operating on an IFR flight plan does not mean that landing priority will be given over other traffic. Traffic control towers handle all aircraft, regardless of the type of flight plan, on a “first-come, first-served” basis. Therefore, because of local traffic or runway in use, it may be necessary for the controller, in the interest of safety, to provide a different landing sequence. In any case, a landing sequence will be issued to each aircraft as soon as possible to enable the pilot to properly adjust the aircraft’s flight path.

## 8. Procedure Turns

**8.1** A procedure turn is the maneuver prescribed when it is necessary to reverse direction to establish the aircraft inbound on an intermediate or final approach course. It is a required maneuver except when the symbol “NoPT” is shown, when RADAR VECTORING is provided, when a holding pattern is published in lieu of procedure turn, when conducting a timed approach, or when the procedure turn is not authorized. The altitude prescribed for the procedure turn is a minimum altitude until the aircraft is established on the inbound course.

The maneuver must be completed within the distance specified in the profile view.

a) On U.S. Government charts, a barbed arrow indicates the direction or side of the outbound course on which the procedure turn is made. Headings are provided for course reversal using the 45 degree type procedure turn. However, the point at which the turn may be commenced and the type and rate of turn is left to the discretion of the pilot. Some of the options are the 45 degree procedure turn, the racetrack pattern, the teardrop procedure turn, or the 80 degree - 260 degree course reversal. Some procedure turns are specified by procedural track. These turns must be flown exactly as depicted.

b) When the approach procedure involves a procedure turn, a maximum speed of not greater than 200 knots (IAS) should be observed from first overheading the course reversal IAF through the procedure turn maneuver to ensure containment within the obstruction clearance area. Pilots should begin the outbound turn immediately after passing the procedure turn fix. The procedure turn maneuver must be executed within the distance specified in the profile view. The normal procedure turn distance is 10 miles. This may be reduced to a minimum of 5 miles where only Category A or helicopter aircraft are to be operated or increased to as much as 15 miles to accommodate high performance aircraft.

c) A teardrop procedure or penetration turn may be specified in some procedures for a required course reversal. The teardrop procedure consists of departure from an initial approach fix on an outbound course followed by a turn toward and intercepting the inbound course at or prior to the intermediate fix or point. Its purpose is to permit an aircraft to reverse direction and lose considerable altitude within reasonably limited airspace. Where no fix is available to mark the beginning of the intermediate segment, it shall be assumed to commence at a point 10 miles prior to the final approach fix. When the facility is located on the airport, an aircraft is considered to be on final approach upon completion of the penetration turn. However, the final approach segment begins on the final approach course 10 miles from the facility.

d) A holding pattern in lieu of procedure turn may be specified for course reversal in some procedures. In such cases, the holding pattern is established over an intermediate fix or a final approach fix. The holding pattern distance or time specified in the profile view must be observed. Maximum holding airspeed limitations as set forth for all holding patterns apply. The holding pattern maneuver is completed when the

aircraft is established on the inbound course after executing the appropriate entry. If cleared for the approach prior to returning to the holding fix, and the aircraft is at the prescribed altitude, additional circuits of the holding pattern are not necessary nor expected by ATC. If pilots elect to make additional circuits to lose excessive altitude or to become better established on course, it is their responsibility to so advise ATC upon receipt of their approach clearance.

e) A procedure turn is not required when an approach can be made directly from a specified intermediate fix to the final approach fix. In such cases, the term "NoPT" is used with the appropriate course and altitude to denote that the procedure turn is not required. If a procedure turn is desired, and when cleared to do so by ATC, descent below the procedure turn altitude should not be made until the aircraft is established on the inbound course, since some NoPT altitudes may be lower than the procedure turn altitudes.

## 8.2 Limitations on Procedure Turns

a) In the case of a radar initial approach to a final approach fix or position, or a timed approach from a holding fix, or where the procedure specifies NoPT, no pilot may make a procedure turn unless, when final approach clearance is received, the pilot so advises ATC and a clearance is received to execute a procedure turn.

b) When a teardrop procedure turn is depicted and a course reversal is required, this type turn must be executed.

c) When a holding pattern replaces a procedure turn, the holding pattern must be followed, except when RADAR VECTORING is provided or when NoPT is shown on the approach course. The recommended entry procedures will ensure the aircraft remains within the holding pattern's protected airspace. As in the procedure turn, the descent from the minimum holding pattern altitude to the final approach fix altitude (when lower) may not commence until the aircraft is established on the inbound course. Where a holding pattern is established in-lieu-of a procedure turn, the maximum holding pattern airspeeds apply.

NOTE.—

SEE PARAGRAPH 1.3.2 a)1)

d) The absence of the procedure turn barb in the plan view indicates that a procedure turn is not authorized for that procedure.

## 9. Side-Step Maneuver

9.1 ATC may authorize a nonprecision approach procedure which serves either one of parallel runways that are separated by 1,200 feet or less followed by a straight-in landing on the adjacent runway.

9.2 Aircraft that will execute a side-step maneuver will be cleared for a specified nonprecision approach and landing on the adjacent parallel runway. Example, "cleared ILS runway 7 left approach, side-step to runway 7 right." Pilots are expected to commence the side-step maneuver as soon as possible after the runway or runway environment is in sight.

9.3 Landing minimums to the adjacent runway will be based on nonprecision criteria and therefore higher than the precision minimums to the primary runway, but will normally be lower than the published circling minimums.

## 10. Approach and Landing Minimums

10.1 **Landing Minimums:** The rules applicable to landing minimums are contained in 14 CFR Section 91.175.

10.2 **Published Approach Minimums:** Approach minimums are published for different aircraft categories and consist of a minimum altitude (DA, DH, MDA) and required visibility. These minimums are determined by applying the appropriate TERPS criteria. When a fix is incorporated in a nonprecision final segment, two sets of minimums may be published; one for the pilot that is able to identify the fix, and a second for the pilot that cannot. Two sets of minimums may also be published when a second altimeter source is used in the procedure. When a nonprecision procedure incorporates both a stepdown fix in the final segment and a second altimeter source, two sets of minimums are published to account for the stepdown fix and a note addresses minimums for the second altimeter source.

**10.3 Obstacle Clearance:** Final approach obstacle clearance is provided from the start of the final segment to the runway or missed approach point, whichever occurs last. Side-step obstacle protection is provided by increasing the width of the final approach obstacle clearance area. Circling approach protected areas are defined by the tangential connection of arcs drawn from each runway end. The arc radii distance differs by aircraft approach category. Because of obstacles near the

airport, a portion of the circling area may be restricted by a procedural note; e.g., "Circling NA E of RWY 17-35." Obstacle clearance is provided at the published minimums for the pilot that makes a straight-in approach, side-steps, circles, or executes the missed approach. Missed approach obstacle clearance requirements may dictate the published minimums for the approach. (See FIG 1.5-6.)

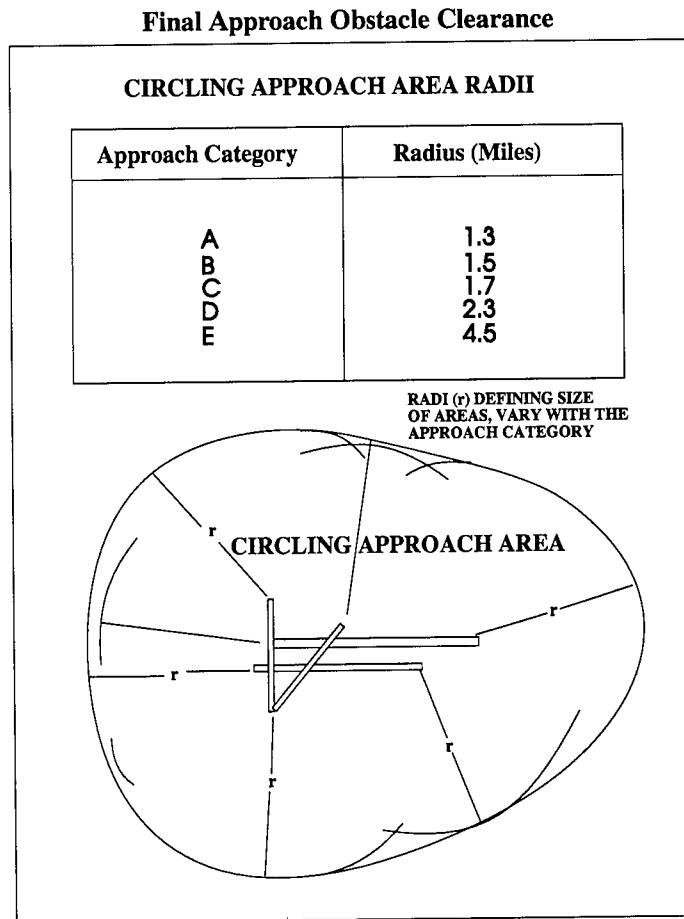

FIG 1.5-6

**10.4 Straight-In Minimums** are shown on the IAP when the final approach course is within 30 degrees of the runway alignment (15 degrees for GPS IAP's) and a normal descent can be made from the IFR altitude shown on the IAP to the runway surface. When either the normal rate of descent or the runway alignment factor of 30 degrees (15 degrees for GPS IAP's) is exceeded, a straight-in minimum is not published and a circling minimum applies. The fact that a straight-in minimum is not published does not preclude pilots from landing straight-in if they have the active runway in

sight and have sufficient time to make a normal approach for landing. Under such conditions and when ATC has cleared them for landing on that runway, pilots are not expected to circle even though only circling minimums are published. If they desire to circle, they should advise ATC.

**10.5 Side-Step Maneuver Minimums:** Landing minimums for a side-step maneuver to the adjacent runway will normally be higher than the minimums to the primary runway.

**10.6 Circling Minimums:** In some busy terminal areas, ATC may not allow circling and circling minimums will not be published. Published circling minimums provide obstacle clearance when pilots remain within the appropriate area of protection. Pilots should remain at or above the circling altitude until the aircraft is continuously in a position from which a descent to a landing on the intended runway can be made at a normal rate of descent using normal maneuvers. Circling may require maneuvers at low altitude, at low airspeed, and in marginal weather conditions. Pilots must use sound judgment, have an in-depth knowledge of their capabilities, and fully understand the aircraft performance to determine the exact circling maneuver since weather, unique airport design, and the aircraft position, altitude, and airspeed must all be considered. The following basic rules apply:

a) Maneuver the shortest path to the base or downwind leg, as appropriate, considering existing weather conditions. There is no restriction from passing over the airport or other runways.

b) It should be recognized that circling maneuvers may be made while VFR or other flying is in progress at the airport. Standard left turns or specific instruction from the controller for maneuvering must be considered when circling to land.

c) At airports without a control tower, it may be desirable to fly over the airport to observe wind and turn indicators and other traffic which may be on the runway or flying in the vicinity of the airport.

**10.7 Instrument Approaches at a Military Field:** When instrument approaches are conducted by civil aircraft at military airports, they shall be conducted in accordance with the procedures and minimums approved by the military agency having jurisdiction over the airport.

## 11. Instrument Approach Procedure Charts

**11.1** 14 CFR Section 91.175a (Instrument Approaches to Civil Airports) requires the use of standard instrument approach procedures unless otherwise authorized by the Administrator (including ATC). 14 CFR Section 91.175g (Military Airports) requires civil pilots flying into or out of military airports to comply with the instrument approach procedures and takeoff and landing minimums prescribed by the authority having jurisdiction at those airports.

a) All instrument approach procedures (standard and special, civil and military) are based on joint civil/mili-

tary criteria contained in the U.S. Standard for Terminal Instrument Procedures (TERP's). The design of instrument approach procedures (IAP's) based on criteria contained in TERP's, takes into account the interrelationship between airports, facilities, and the surrounding environment, terrain, obstacles, noise sensitivity, etc. Appropriate altitudes, courses, headings, distances, and other limitations are specified, and once approved, the procedures are published and distributed by government and commercial cartographers as instrument approach charts.

b) Not all IAP's are published in chart form. Radar IAP's are established where requirements and facilities exist but they are printed in tabular form in appropriate U.S. Government Flight Information Publications.

c) A pilot adhering to the altitudes, flight paths, and weather minimums depicted on the IAP chart or vectors and altitudes issued by the radar controller, is assured of terrain and obstruction clearance and runway/airport alignment during approach for landing.

d) IAP's are designed to provide an IFR descent from the en route environment to a point where a safe landing can be made. They are prescribed and approved by appropriate civil or military authority to ensure a safe descent during instrument flight conditions at a specific airport. It is important that pilots understand these procedures and their use prior to attempting to fly instrument approaches.

e) TERP's criteria are provided for the following types of IAP's:

1) Precision approaches where an electronic glide slope is provided (PAR, ILS, MLS, TLS, WAAS, LAAS, GLS, and SCAT-1); and

2) Nonprecision approaches where glide slope information is not provided (all approaches except for subparagraph 1) above).

**11.2** A limited number of VOR IAP's, based on a VORTAC facility, have been approved for use by TACAN-equipped aircraft. These procedures are identified by the term "(TAC)" printed adjacent to the name of the procedure; e.g., VOR RWY 3 (TAC). This added information does not change the name of the procedure. It merely tells both pilot and controller that a "VOR RWY 3" instrument approach may be executed by aircraft using TACAN. Air traffic controllers will not refer to the term "TAC" in their ATC communications.

**11.3** Minimums are specified for various aircraft approach categories based upon a value 1.3 times the stalling speed of the aircraft in the landing configuration at



maximum certificated gross landing weight. (See 14 CFR Section 97.3(b).) If it is necessary, while circling to land, to maneuver at speeds in excess of the upper limit of the speed range for each category, due to the possibility of extending the circling maneuver beyond the area for which obstruction clearance is provided, the circling minimum for the next higher approach category should be used. For example, an aircraft which falls in Category C, but is circling to land at a speed of 141 knots or higher, should use approach category "D" minimums when circling to land.

**11.4** When operating on an unpublished route or while being radar vectored, the pilot, when an approach clearance is received, shall, in addition to complying with the minimum altitudes for IFR operations (14 CFR Section 91.177), maintain the last assigned altitude (1) unless a different altitude is assigned by ATC, or (2) until the aircraft is established on a segment of a published route or IAP. After the aircraft is so established, published altitudes apply to descent within each succeeding route or approach segment unless a different altitude is assigned by ATC. Notwithstanding this pilot responsibility, for aircraft operating on unpublished routes or while being radar vectored, ATC will, except when conducting a radar approach, issue an IFR approach clearance only after the aircraft is (1) established on a segment of a published route or IAP, or (2) assigned an altitude to maintain until the aircraft is established on a segment of a published route or IAP. For this purpose, the procedure turn of a published IAP shall not be considered a segment of that IAP until the aircraft reaches the initial fix or navigation facility upon which the procedure turn is predicated.

**EXAMPLE.—**  
CROSS REDDING V-O-R AT OR ABOVE FIVE THOUSAND, CLEARED V-O-R RUNWAY THREE FOUR APPROACH.  
OR

FIVE MILES FROM OUTER MARKER, TURN RIGHT HEADING THREE THREE ZERO, MAINTAIN TWO THOUSAND UNTIL ESTABLISHED ON THE LOCALIZER, CLEARED I-L-S RUNWAY THREE SIX APPROACH.

**NOTE.—**  
THE ALTITUDE ASSIGNED WILL ASSURE IFR OBSTRUCTION CLEARANCE FROM THE POINT AT WHICH THE APPROACH CLEARANCE IS ISSUED UNTIL ESTABLISHED ON A SEGMENT OF A PUBLISHED ROUTE OR IAP. IF A PILOT IS UNCERTAIN OF THE MEANING OF THIS CLEARANCE, IMMEDIATELY REQUEST CLARIFICATION FROM ATC.

**11.5** Several IAP's using various navigation/approach aids may be authorized for an airport. ATC may advise that a particular approach procedure is being used, primarily to expedite traffic. If pilots are issued a clearance that specifies a particular approach procedure, they are expected to notify ATC immediately if they desire a different one. In this event it may be necessary for ATC to

withhold clearance for the different approach until such time as traffic conditions permit. However, if the pilot is involved in an emergency situation, priority will be given. If the pilot is not familiar with the specific approach procedure, ATC should be advised and they will provide detailed information on the execution of the procedure.

**11.6** At times ATC may not specify a particular approach procedure in the clearance, but will state "CLEARED APPROACH." Such clearance indicates that the pilot may execute any one of the authorized IAP's for that airport. This clearance does not constitute approval for the pilot to execute a contract approach or a visual approach.

**11.7** Except when being radar vectored to the final approach course, when cleared for a specifically prescribed IAP; i.e., "cleared ILS runway one niner approach" or when "cleared approach"; i.e., execution of any procedure prescribed for the airport, pilots shall execute the entire procedure commencing at an initial approach fix or an associated feeder route as described on the IAP Chart unless an appropriate new or revised ATC clearance is received, or the IFR flight plan is canceled.

**11.8** Pilots planning flights to locations served by special IAP's should obtain advance approval from the owner of the procedure. Approval by the owner is necessary because special procedures are for the exclusive use of a single interest unless otherwise authorized by the owner. Additionally, some special approach procedures require certain crew qualifications, training, or other special considerations in order to execute the approach. Also, some of these approach procedures are based on privately owned navigational aids. Owners of aids that are not for public use may elect to turn off the aid for whatever reason they may have; i.e., maintenance, conservation, etc. Air traffic controllers are not required to question pilots to determine if they have permission to use the procedure. Controllers presume pilots have obtained approval and are aware of any details of the procedure if they file an IFR flight plan to that airport.

**11.9** When executing an instrument approach and in radio contact with an FAA facility, unless in "radar contact," report passing the final approach fix inbound (nonprecision approach) or the outer marker or fix used in lieu of the outer marker inbound (precision approach).

**11.10** If a missed approach is required, advise ATC and include the reason (unless initiated by ATC). Comply with the missed approach instructions for the IAP being executed, unless otherwise directed by ATC.

**11.11** The method used to depict prescribed altitudes on instrument approach charts differs according to techniques employed by different chart publishers. Prescribed altitudes may be depicted in three different configurations: minimum, maximum, and mandatory. The U.S. Government distributes charts produced by the National Imagery and Mapping Agency (NIMA) and National Ocean Survey (NOS). Altitudes are depicted on these charts in the profile view with underline, overline, or both to identify them as minimum, maximum, or mandatory.

a) Minimum altitude will be depicted with the altitude value underlined. Aircraft are required to maintain altitude at or above the depicted value.

b) Maximum altitude will be depicted with the altitude value overscored. Aircraft are required to maintain altitude at or below the depicted value.

c) Mandatory altitude will be depicted with the altitude value both underscored and overscored. Aircraft are required to maintain altitude at the depicted value.

**NOTE.—**

*THE UNDERSCORE AND OVERSCORE TO IDENTIFY MANDATORY ALTITUDES AND THE OVERSCORE TO IDENTIFY MAXIMUM ALTITUDES ARE USED ALMOST EXCLUSIVELY BY NIMA FOR MILITARY CHARTS. WITH VERY FEW EXCEPTIONS, CIVIL APPROACH CHARTS PRODUCED BY NOS UTILIZE ONLY THE UNDERSCORE TO IDENTIFY MINIMUM ALTITUDES. PILOTS ARE CAUTIONED TO ADHERE TO ALTITUDES AS PRESCRIBED BECAUSE, IN CERTAIN INSTANCES, THEY MAY BE USED AS THE BASIS FOR VERTICAL SEPARATION OF AIRCRAFT BY ATC. WHEN A DEPICTED ALTITUDE IS SPECIFIED IN THE ATC CLEARANCE, THAT ALTITUDE BECOMES MANDATORY AS DEFINED ABOVE.*

**11.12 Minimum Safe/Sector Altitudes (MSA)** are published for emergency use on IAP charts. For conventional navigation systems, the MSA is based on the primary omnidirectional facility on which the IAP is predicated (LOM for ILS IAP's). For RNAV approaches, the MSA is based on the runway waypoint (RWY WP) for straight-in approaches, or the airport waypoint (APT WP) for circling approaches. For GPS approaches, the MSA center will be the missed approach waypoint (MAWP). MSA's are expressed in feet above mean sea level and normally have a 25 NM radius; however, this radius may be expanded to 30 NM if necessary to encompass the airport landing surfaces. Ideally, a single sector altitude is established and de-

icted on the plan view of approach charts; however, when necessary to obtain relief from obstructions, the area may be further sectorized and as many as four MSA's established. When established, sectors may be no less than 90° in spread. MSA's provide 1,000 feet clearance over all obstructions but do not necessarily assure acceptable navigation signal coverage.

**11.13 Minimum Vectoring Altitudes (MVA's)** are established for use by ATC when radar air traffic control is exercised. MVA charts are prepared by air traffic facilities at locations where there are numerous different minimum IFR altitudes. Each MVA chart has sectors large enough to accommodate vectoring of aircraft within the sector at the MVA. Each sector boundary is at least 3 miles from the obstruction determining the MVA. To avoid a large sector with an excessively high MVA due to an isolated prominent obstruction, the obstruction may be enclosed in a buffer area whose boundaries are at least 3 miles from the obstruction. This is done to facilitate vectoring around the obstruction. (See FIG 1.5-7.)

a) The minimum vectoring altitude in each sector provides 1,000 feet above the highest obstacle in nonmountainous areas and 2,000 feet above the highest obstacle in designated mountainous areas. Where lower MVA's are required in designated mountainous areas to achieve compatibility with terminal routes or to permit vectoring to an instrument approach procedure, 1,000 feet of obstacle clearance may be authorized with the use of airport surveillance radar (ASR). The minimum vectoring altitude will provide at least 300 feet above the floor of Class B, C, D and E airspace.

**NOTE.—**

*OROCA IS AN OFF ROUTE ALTITUDE WHICH PROVIDES OBSTRUCTION CLEARANCE WITH A 1,000 FOOT BUFFER IN NON-MOUNTAINOUS TERRAIN AREAS AND A 2,000 FOOT BUFFER IN DESIGNATED MOUNTAINOUS AREAS WITHIN THE UNITED STATES. THIS ALTITUDE MAY NOT PROVIDE SIGNAL COVERAGE FROM GROUND-BASED NAVIGATIONAL AIDS, AIR TRAFFIC CONTROL RADAR, OR COMMUNICATIONS COVERAGE.*

b) Because of differences in the areas considered for MVA, and those applied to other minimum altitudes, and the ability to isolate specific obstacles, some MVA's may be lower than the nonradar minimum en route altitudes (MEA's), minimum obstruction clearance altitudes (MOCA's), or other minimum altitudes depicted on charts for a given location. While being radar vectored, IFR altitude assignments by ATC will be at or above MVA.

### Minimum Vectoring Altitude Charts

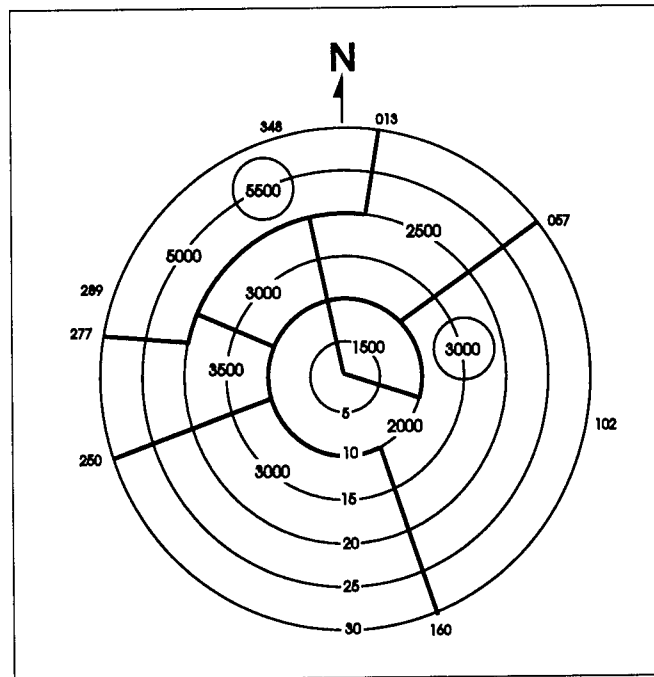

FIG 1.5-7

**11.14 Visual Descent Points (VDP's)** are being incorporated in selected nonprecision approach procedures. The VDP is a defined point on the final approach course of a nonprecision straight-in approach procedure from which normal descent from the MDA to the runway touchdown point may be commenced, provided visual reference required by 14 CFR Section 91.175(c)(3) is established. The VDP will normally be identified by DME on VOR and LOC procedures and by along track distance to the next waypoint for RNAV procedures. The VDP is identified on the profile view of the approach chart by the symbol "V."

a) VDP's are intended to provide additional guidance where they are implemented. No special technique is required to fly a procedure with a VDP. The pilot should not descend below the MDA prior to reaching VDP and acquiring the necessary visual reference.

b) Pilots not equipped to receive the VDP should fly the approach procedure as though no VDP had been provided.

**11.15 Visual Portion of the Final Segment.** Instrument procedures designers perform a visual area obstruction evaluation off the approach end of each runway authorized for instrument landing, straight-in, or circling. Restrictions to instrument operations are imposed if penetrations of the obstruction clearance surfaces exist. These restrictions vary based on the severity

of the penetrations, and may include increasing required visibility, denying VDP's and prohibiting night instrument operations to the runway.

**11.16 Final Approach Descent Angles.** Gradients and threshold crossing heights (TCH) will now be depicted on all nonprecision instrument approach procedures which meet straight-in alignment to a runway, except those charted on a precision approach chart. The descent gradient will be expressed in feet per nautical mile and the angle will be expressed in degrees. Both values will be computed from the final approach fix (FAF) at the minimum charted FAF altitude to the runway threshold at the charted TCH. When the final segment contains a stepdown fix with a minimum charted altitude which is above the angle from the FAF to the threshold, the published angle and gradient will be computed from the stepdown fix at the minimum charted fix altitude to the threshold at the charted TCH.

## 12. Radar Approaches

**12.1** The only airborne radio equipment required for radar approaches is a functioning radio transmitter and receiver. The radar controller vectors the aircraft to align it with the runway centerline. The controller continues the vectors to keep the aircraft on course until the pilot can complete the approach and landing by visual reference to the surface. There are two types of radar approaches, "Precision" (PAR) and "Surveillance" (ASR).

**12.2** A radar approach may be given to any aircraft upon request and may be offered to pilots of aircraft in distress or to expedite traffic; however, a surveillance approach might not be approved unless there is an ATC operational requirement, or in an unusual or emergency situation. Acceptance of a precision or surveillance approach by a pilot does not waive the prescribed weather minimums for the airport or for the particular aircraft operator concerned. The decision to make a radar approach when the reported weather is below the established minimums rests with the pilot.

**12.3** Precision and surveillance approach minimums are published on separate pages in the National Ocean Survey Instrument Approach Procedure charts.

a) A **Precision Approach (PAR)** is one in which a controller provides highly accurate navigational guidance in azimuth and elevation to a pilot. Pilots are given headings to fly to direct them to and keep their aircraft aligned with the extended centerline of the landing runway. They are told to anticipate glide path interception approximately 10 to 30 seconds before it occurs and when to start descent. The published decision height will be given only if the pilot requests it. If the aircraft is observed to deviate above or below the glide path, the pilot is given the relative amount of deviation by use of terms "slightly" or "well" and is expected to adjust the aircraft's rate of descent to return to the glide path. Trend information is also issued with respect to the elevation of the aircraft and may be modified by the terms "rapidly" and "slowly;" e.g., "well above glide path, coming down rapidly." Range from touchdown is given at least once each mile. If an aircraft is observed by the controller to proceed outside of specified safety zone limits in azimuth and/or elevation and continues to operate outside these prescribed limits, the pilot will be directed to execute a missed approach or to fly a specified course unless the pilot has the runway environment (runway, approach lights, etc.) in sight. Navigational guidance in azimuth and elevation is provided the pilot until the aircraft reaches the published decision height (DH). Advisory course and glidepath information is furnished by the controller until the aircraft passes over the landing threshold, at which point the pilot is advised of any deviation from the runway centerline. Radar service is automatically terminated upon completion of the approach.

b) A **Surveillance Approach (ASR)** is one in which a controller provides navigational guidance in azimuth only. The pilot is furnished headings to fly to align the aircraft with the extended centerline of the landing run-

way. Since the radar information used for a surveillance approach is considerably less precise than that used for a precision approach, the accuracy of the approach will not be as great, and higher minimums will apply. Guidance in elevation is not possible but the pilot will be advised when to commence descent to the minimum descent altitude (MDA) or, if appropriate, to an intermediate "step down fix" minimum crossing altitude and subsequently to the prescribed MDA. In addition, the pilot will be advised of the location of the missed approach point (MAP) prescribed for the procedure and the aircraft's position each mile on final from the runway, airport/heliport, or MAP, as appropriate. If requested by the pilot, recommended altitudes will be issued at each mile, based on the descent gradient established for the procedure, down to the last mile that is at or above the MDA. Normally, navigational guidance will be provided until the aircraft reaches the MAP. Controllers will terminate guidance and instruct the pilot to execute a missed approach unless at the MAP the pilot has the runway, airport/heliport in sight or, for a helicopter point-in-space approach, the prescribed visual reference with the surface is established. Also, if at any time during the approach the controller considers that safe guidance for the remainder of the approach cannot be provided, the controller will terminate guidance and instruct the pilot to execute a missed approach. Similarly, guidance termination and missed approach will be effected upon pilot request, and for civil aircraft only, controllers may terminate guidance when the pilot reports the runway, airport/heliport, or visual surface route (point-in-space approach) in sight or otherwise indicates that continued guidance is not required. Radar service is automatically terminated at the completion of a radar approach.

**NOTE.—**

[1] THE PUBLISHED MDA FOR STRAIGHT-IN APPROACHES WILL BE ISSUED TO THE PILOT BEFORE BEGINNING DESCENT. WHEN A SURVEILLANCE APPROACH WILL TERMINATE IN A CIRCLE TO LAND MANEUVER, THE PILOT MUST FURNISH THE AIRCRAFT APPROACH CATEGORY TO THE CONTROLLER. THE CONTROLLER WILL THEN PROVIDE THE PILOT WITH THE APPROPRIATE MDA.

[2] ASR APPROACHES ARE NOT AVAILABLE WHEN AN ATC FACILITY IS USING CENTER RADAR ARTS PRESENTATION/PROCESSING (CENRAP).

c) A **No-Gyro Approach** is available to a pilot under radar control who experiences circumstances wherein the directional gyro or other stabilized compass is inoperative or inaccurate. When this occurs, the pilot should so advise ATC and request a No-Gyro vector or approach. Pilots of aircraft not equipped with a directional gyro or other stabilized compass who desire radar handling may also request a No-Gyro vector or

approach. The pilot should make all turns at standard rate and should execute the turn immediately upon receipt of instructions. For example, "TURN RIGHT," "STOP TURN." When a surveillance or precision approach is made, the pilot will be advised after the aircraft has been turned onto final approach to make turns at half standard rate.

### 13. Radar Monitoring of Instrument Approaches

**13.1** PAR facilities operated by the FAA and the military services at some joint-use (civil/military) and military installations monitor aircraft on instrument approaches and issue radar advisories to the pilot when weather is below VFR minimum (1,000 and 3), at night, or when requested by a pilot. This service is provided only when the PAR final approach course coincides with the final approach of the navigational aid and only during the operational hours of the PAR. The radar advisories serve only as a secondary aid since the pilot has selected the navigational aid as the primary aid for the approach.

**13.2** Prior to starting final approach, the pilot will be advised of the frequency on which the advisories will be transmitted. If, for any reason, radar advisories cannot be furnished, the pilot will be so advised.

**13.3** Advisory information, derived from radar observations, includes information on:

a) Passing the final approach fix inbound (nonprecision approach) or passing the outer marker or the fix used in lieu of the outer marker inbound (precision approach).

**NOTE.—**  
*AT THIS POINT, THE PILOT MAY BE REQUESTED TO REPORT SIGHTING THE APPROACH LIGHTS OR THE RUNWAY.*

b) Trend advisories with respect to elevation and/or azimuth radar position and movement will be provided.

**NOTE.—**  
*WHENEVER THE AIRCRAFT NEARS THE PAR SAFETY LIMIT, THE PILOT WILL BE ADVISED THAT HE IS WELL ABOVE OR BELOW THE GLIDEPATH OR WELL LEFT OR RIGHT OF COURSE. GLIDEPATH INFORMATION IS GIVEN ONLY TO THOSE AIRCRAFT EXECUTING A PRECISION APPROACH, SUCH AS ILS OR MLS. ALTITUDE INFORMATION IS NOT TRANSMITTED TO AIRCRAFT EXECUTING OTHER THAN PRECISION APPROACHES BECAUSE THE DESCENT PORTIONS OF THESE APPROACHES GENERALLY DO NOT COINCIDE WITH THE DEPICTED PAR GLIDEPATH. AT LOCATIONS WHERE THE MLS GLIDEPATH AND PAR GLIDEPATH ARE NOT COINCIDENTAL, ONLY AZIMUTH MONITORING WILL BE PROVIDED.*

c) If, after repeated advisories, the aircraft proceeds outside the PAR safety limit or if a radical deviation is observed, the pilot will be advised to execute a missed approach if not visual.

**13.4** Radar service is automatically terminated upon completion of the approach.

### 14. ILS Approach

**14.7** Communications should be established with the appropriate FAA control tower or with the FAA FSS where there is no control tower, prior to starting an ILS approach. This is in order to receive advisory information as to the operation of the facility. It is also recommended that the aural signal of the ILS be monitored during an approach as to assure continued reception and receipt of advisory information, when available

### 15. ILS/MLS Approaches to Parallel Runways

**15.1** ATC procedures permit ILS instrument approach operations to dual or triple parallel runway configurations. ILS/MLS approaches to parallel runways are grouped into three classes: Parallel (dependent) ILS/MLS Approaches; Simultaneous Parallel (independent) ILS/MLS Approaches; and Simultaneous Close Parallel (independent) ILS Precision Runway Monitor (PRM) Approaches. (See FIG 1.5-8.) The classification of a parallel runway approach procedure is dependent on adjacent parallel runway centerline separation, ATC procedures, and airport ATC radar monitoring and communications capabilities. At some airports one or more parallel localizer courses may be offset up to 3 degrees. Offset localizer configurations result in loss of Category II capabilities and an increase in decision height (50 feet).

**15.2** Parallel approach operations demand heightened pilot situational awareness. A thorough Approach Procedure Chart review should be conducted with, as a minimum, emphasis on the following approach chart information: name and number of the approach, localizer frequency, inbound localizer/azimuth course, glide slope intercept altitude, decision height, missed approach instructions, special notes/procedures, and the assigned runway location/proximity to adjacent runways. Pilots will be advised that simultaneous ILS/MLS or simultaneous close parallel ILS PRM approaches are in use. This information may be provided through the ATIS.

**15.3** The close proximity of adjacent aircraft conducting simultaneous parallel ILS/MLS and simultaneous close parallel ILS PRM approaches mandates strict pilot compliance with all ATC clearances. ATC assigned airspeeds, altitudes, and headings must be complied with in a timely manner. Autopilot coupled ILS/MLS approaches require pilot knowledge of procedures necessary to comply with ATC instructions.

Simultaneous parallel ILS/MLS and simultaneous close parallel ILS PRM approaches necessitate precise localizer tracking to minimize final monitor controller intervention, and unwanted No Transgression Zone (NTZ) penetration. In the unlikely event of a breakout, a vector off the approach course prior to the decision altitude (DA), ATC will not assign altitudes lower than the minimum vectoring altitude. Pilots should notify ATC immediately if there is a degradation of aircraft or navigation systems.

**15.4** Strict radio discipline is mandatory during parallel ILS/MLS approach operations. This includes an alert listening watch and the avoidance of lengthy, unnecessary radio transmissions. Attention must be given to proper call sign usage to prevent the inadvertent execution of clearances intended for another aircraft. Use of abbreviated call signs must be avoided to pre-

clude confusion of aircraft with similar sounding call signs. Pilots must be alert to unusually long periods of silence or any unusual background sounds in their radio receiver. A stuck microphone may block the issuance of ATC instructions by the final monitor controller during simultaneous parallel ILS/MLS and simultaneous close parallel ILS PRM approaches. For additional communications information, pilots should refer to GEN 3.4, paragraph 4.4, Radio Communications Phraseology and Techniques.

**15.5** Use of Traffic Collision Avoidance Systems (TCAS) provides an additional element of safety to parallel approach operations. Pilots should follow recommended TCAS operating procedures presented in approved flight manuals, original equipment manufacturer recommendations, professional newsletters, and FAA publications.

### Parallel ILS Approaches

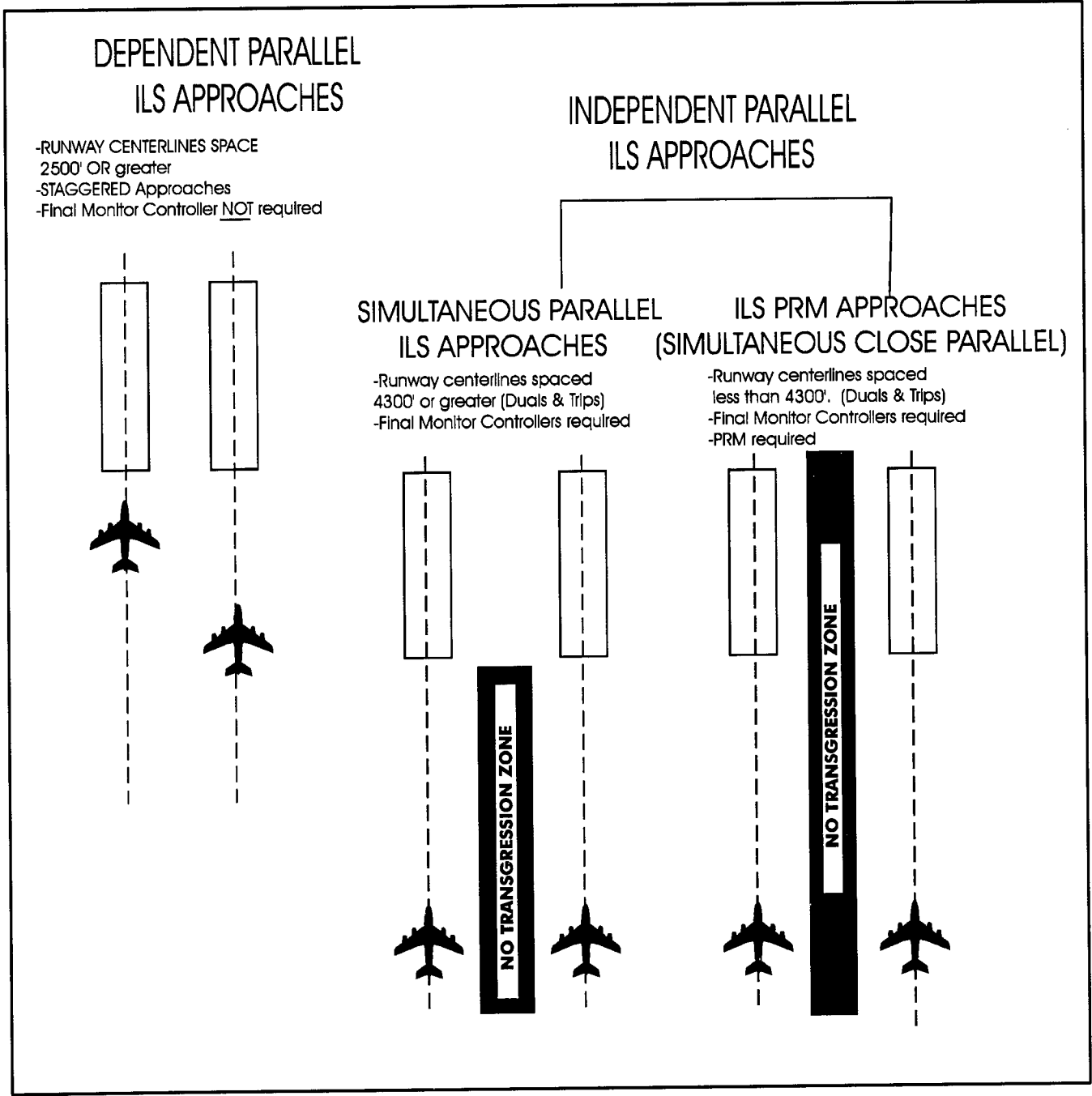

FIG 1.5-8

### Staggered ILS Approaches

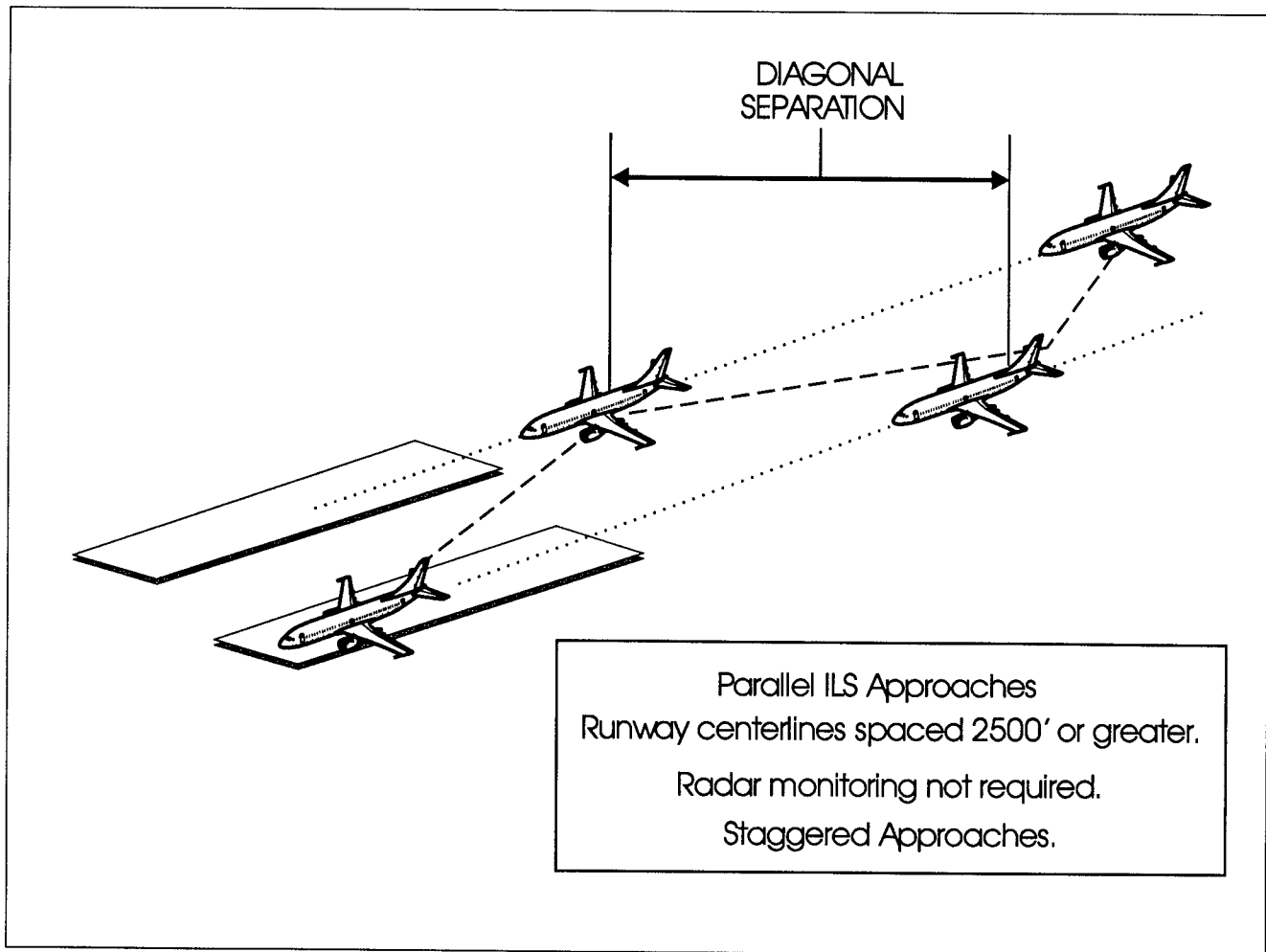

FIG 1.5-9

#### 16. Parallel ILS/MLS Approaches (Dependent) (See FIG 1.5-9.)

16.1 Parallel approaches are an ATC procedure permitting parallel ILS/MLS approaches to airports having parallel runways separated by at least 2,500 feet between centerlines. Integral parts of a total system are ILS/MLS, radar, communications, ATC procedures, and required airborne equipment.

16.2 A parallel (dependent) approach differs from a simultaneous (independent) approach in that, the minimum distance between parallel runway centerlines is reduced; there is no requirement for radar monitoring or advisories; and a staggered separation of aircraft on the adjacent localizer/azimuth course is required.

16.3 Aircraft are afforded a minimum of 1.5 miles radar separation diagonally between successive aircraft on

the adjacent localizer/azimuth course when runway centerlines are at least 2,500 feet but no more than 4,300 feet apart. When runway centerlines are more than 4,300 feet but no more than 9,000 feet apart, a minimum of 2 miles diagonal radar separation is provided. Aircraft on the same localizer/azimuth course within 10 miles of the runway end are provided a minimum of 2.5 miles radar separation. In addition, a minimum of 1,000 feet vertical or a minimum of three miles radar separation is provided between aircraft during turn on to the parallel final approach course.

16.4 Whenever parallel ILS/MLS approaches are in progress, pilots are informed that approaches to both runways are in use. In addition, the radar controller will have the interphone capability of communicating with the tower controller where separation responsibility has not been delegated to the tower.



Simultaneous Parallel ILS Approaches

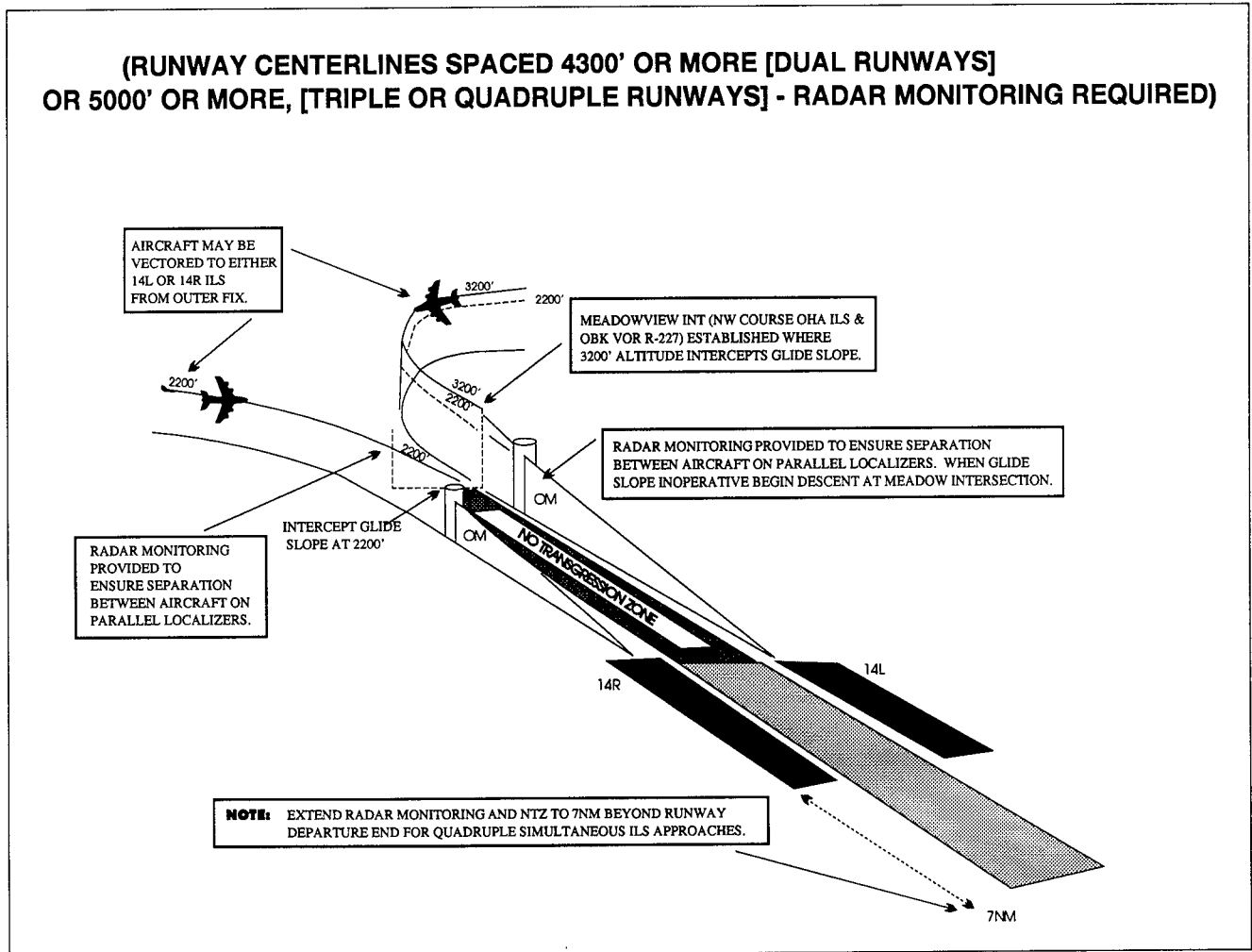

FIG 1.5-10

**17. Simultaneous Parallel ILS/MLS Approaches (Independent) (See FIG 1.5-10.)**

**17.1 System:** An approach system permitting simultaneous ILS/MLS approaches to parallel runways with centerlines separated by 4,300 to 9,000 feet, and equipped with final monitor controllers. Simultaneous parallel ILS/MLS approaches require radar monitoring to ensure separation between aircraft on the adjacent parallel approach course. Aircraft position is tracked by final monitor controllers who will issue instructions to aircraft observed deviating from the assigned localizer course. Staggered radar separation procedures are not utilized. Integral parts of a total system are ILS/MLS, radar, communications, ATC procedures, and required airborne equipment. The Approach Procedure Chart permitting simultaneous parallel ILS/MLS approaches will contain the note "simultaneous approaches authorized RWYS 14L and 14R," identifying the appropriate runways as the case may be. When advised that

simultaneous parallel ILS/MLS approaches are in progress, pilots shall advise approach control immediately of malfunctioning or inoperative receivers, or if a simultaneous parallel ILS/MLS approach is not desired.

**17.2 Radar Monitoring:** This service is provided for each simultaneous parallel ILS/MLS approach to ensure aircraft do not deviate from the final approach course. Radar monitoring includes instructions if an aircraft nears or penetrates the prescribed NTZ (an area 2,000 feet wide located equidistant between parallel final approach courses). This service will be provided as follows:

- a) During turn onto parallel final approach aircraft will be provided 3 miles radar separation or a minimum of 1,000 feet vertical separation. Aircraft will not be vectored to intercept the final approach course at an angle greater than thirty degrees;

b) The final monitor controller will have the capability of overriding the tower controller on the tower frequency;

c) Pilots will be instructed to monitor the tower frequency to receive advisories and instructions;

d) Aircraft observed to overshoot the turn-on or to continue on a track which will penetrate the NTZ will be instructed to return to the correct final approach course immediately. The final monitor controller may also issue missed approach or breakout instructions to the deviating aircraft;

**PHRASEOLOGY-**

*"(Aircraft call sign) YOU HAVE CROSSED THE FINAL APPROACH COURSE. TURN (left/right) IMMEDIATELY AND RETURN TO THE LOCALIZER/AZIMUTH COURSE."*

OR

*"(Aircraft call sign) TURN (left/right) AND RETURN TO THE LOCALIZER/AZIMUTH COURSE."*

e) If a deviating aircraft fails to respond to such instructions or is observed penetrating the NTZ, the aircraft on the adjacent final approach course may be instructed to alter course; and

**PHRASEOLOGY-**

*"TRAFFIC ALERT (aircraft call sign) TURN (left/right) IMMEDIATELY HEADING (degrees), (climb/decend) AND MAINTAIN (altitude)."*

f) Radar monitoring will automatically be terminated when visual separation is applied, the aircraft reports the approach lights or runway in sight, or the aircraft is 1 mile or less from the runway threshold (for runway centerlines spaced 4,300 feet or greater). Final monitor controllers will not advise pilots when radar monitoring is terminated.

ILS PRM Approaches (Simultaneous Close Parallel)

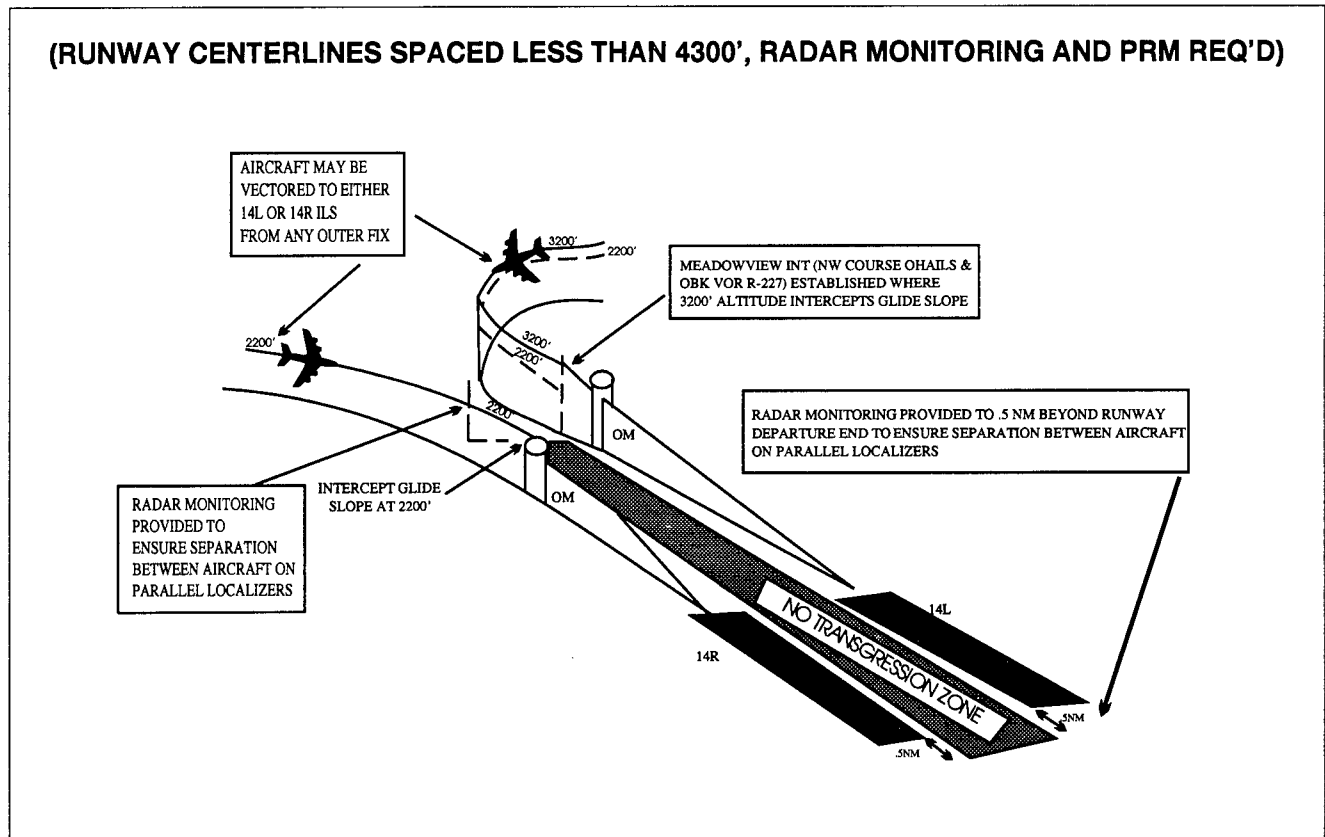

FIG 1.5-11

**18. Simultaneous Close Parallel ILS PRM Approaches (Independent) (See FIG 1.5-11.)**

**18.1 System:** An approach system permitting simultaneous ILS PRM approaches to dual runways with centerlines separated by less than 4,300 feet, and equipped with final monitor controllers. To qualify for reduced lateral runway separation, final monitor controllers must be equipped with high update radar and high resolution ATC radar displays, collectively called a PRM system. The PRM system displays almost instantaneous radar information. Automated tracking software provides monitor controllers with aircraft identification, position, a ten-second projected position, as well as visual and aural controller alerts. The PRM system is a supplemental requirement for simultaneous close parallel approaches in addition to the system requirements for simultaneous parallel ILS/MLS approaches. (See paragraph 17, Simultaneous Parallel ILS/MLS Approaches (Independent).) Simultaneous close parallel ILS PRM approaches are identified by a separate Approach Procedure Chart named ILS PRM (Simultaneous Close Parallel). The name ILS PRM is derived from the Precision Runway Monitor System which provides a means for simplifying

the name of the simultaneous close parallel ILS approach.

**18.2 Requirements:** The following requirements must be met in order to fly an ILS PRM approach:

a) Air carrier pilots (including Part 121 and Part 135) must complete ILS PRM training which includes viewing one of the FAA videos, *RDU Precision Runway Monitor: A Pilot's Approach* or *ILS PRM Approaches, Information for Pilots*. Watching one of these videos is strongly recommended for all pilots who wish to fly these approaches.

b) All ATC directed "breakouts," a vector off the ILS prior to the decision altitude (DA), must be hand-flown.

c) If the airport has two tower frequencies operating for each runway, the aircraft flying the ILS PRM approach must have the capability of enabling the pilot/s to listen to two frequencies simultaneously.

d) Pilots shall advise air traffic control within 200 miles of the airport of intended landing if the pilot(s) are not qualified and/or the aircraft is not equipped to fly the approach.

**18.3 Radar Monitoring:** Simultaneous close parallel ILS/MLS approaches require final monitor controllers utilize the PRM system to ensure prescribed separation standards are met. Procedures and communications phraseology are described in paragraph 17. To ensure separation is maintained, and in order to avoid an imminent situation during simultaneous close parallel ILS/MLS approaches, pilots must immediately comply with final monitor controller instructions to avoid an imminent situation. A minimum of 3 miles radar separation or 1,000 feet vertical separation will be provided during the turn onto close parallel final approach courses. In the event of a missed approach, radar monitoring is provided to one-half mile beyond the departure end of the runway. Final monitor controllers will not notify pilots when radar monitoring is terminated.

**18.4 Differences between ILS and ILS PRM approaches of importance to the pilot:**

a) Runway Spacing - Prior to ILS PRM approaches, most ATC directed breakouts were the result of two aircraft in trail getting too close together. Two aircraft going in the same direction did not mandate quick reaction times, but two aircraft along side each other separated by less than 4,300 feet and closing at 135 feet per second, does constitute the need for quick action. A blunder has to be recognized by one controller, the information passed on to another controller and breakout instructions issued to the endangered aircraft. The pilot will not have any warning that a breakout is eminent because the blundering aircraft will probably be on another frequency. It is important that when a pilot receives breakout instructions, he/she assumes that a blundering aircraft is heading into his/her approach course and begins the breakout as soon as safety allows.

b) Communications - To help in avoiding communication problems caused by stuck mikes and two parties talking at the same time, two tower frequencies for each runway will be in use during ILS PRM approach operations. The tower controller and the monitor controller will be broadcasting on both of the assigned frequencies. The monitor controller has the capability of overriding the tower controller. The pilots flying the approach will listen to both frequencies and only broadcast on the primary tower frequency. If a breakout is initiated by the monitor controller and the primary frequency is blocked by another transmission, the breakout instruction will be able to be heard on the second frequency. Anti-blocking technology installed in VHF radios might remove the requirement for the second VHF communications frequency in the near future.

c) Hand-flown Breakouts - The use of the autopilot is encouraged while flying an ILS PRM approach, but the autopilot must be disengaged in the rare event that a breakout is issued. Simulation studies of breakouts have shown that a handflown breakout is initiated consistently faster than a breakout performed using the autopilot.

d) TCAS - TCAS II equipped aircraft will fly the ILS PRM approach with the TCAS set to the Traffic Advisory (TA) only mode. If the TCAS is set to the TA/Resolution Advisory (RA) mode there is a chance that the TCAS resolution advisory will be in conflict with the breakout instruction and result in a confusing situation during a critical time. Pilots must remember to switch back to the TA/RA mode after completing the breakout maneuver.

e) Descending Breakouts - In the past, breakout descents were rarely given to pilots when flying on the ILS localizer and glideslope. A greater chance exists for the controller to issue a descending breakout when there is a blundering aircraft from an adjacent approach course crossing an aircraft's path. Pilots must be aware that a descending breakout is a possibility. In no case will the controller descend an aircraft below the minimum vectoring altitude (MVA) which will provide at least 1,000 feet clearance above obstacles. The pilot is not expected to exceed 1,000 feet per minute rate of descent in the event a descending breakout is issued.

**19. Simultaneous Converging Instrument Approaches**

**19.1** ATC may conduct instrument approaches simultaneously to converging runways; i.e., runways having an included angle from 15 to 100 degrees, at airports where a program has been specifically approved to do so.

**19.2** The basic concept requires that dedicated, separate standard instrument approach procedures be developed for each converging runway included. Missed approach points must be at least 3 miles apart and missed approach procedures ensure that missed approach protected airspace does not overlap.

**19.3** Other requirements are: radar availability, nonintersecting final approach courses, precision (ILS/MLS) approach systems on each runway, and if runways intersect, controllers must be able to apply visual separation as well as intersecting runway separation criteria. Intersecting runways also require minimums of at least 700-foot ceilings and 2 miles visibility. Straight-in approaches and landings must be made.

**19.4** Whenever simultaneous converging approaches are in progress, aircraft will be informed by the controller as soon as feasible after initial contact or via ATIS. Additionally, the radar controller will have direct communications capability with the tower controller where separation responsibility has not been delegated to the tower.

## **20. Timed Approaches From a Holding Fix**

**20.1** Timed approaches may be conducted when the following conditions are met:

- a) A control tower is in operation at the airport where the approaches are conducted;
- b) Direct communications are maintained between the pilot and the center/approach controller until the pilot is instructed to contact the tower;
- c) If more than one missed approach procedure is available, none require a course reversal;
- d) If only one missed approach procedure is available, the following conditions are met:

1) Course reversal is not required; and,

2) Reported ceiling and visibility are equal to or greater than the highest prescribed circling minimums for the instrument approach procedure.

e) When cleared for the approach, pilots shall not execute a procedure turn. (See 14 CFR Section 91.175j.)

**20.2** Although the controller will not specifically state that "timed approaches are in progress," the assigning a time to depart the final approach fix inbound (nonprecision approach) or the outer marker or the fix used in lieu of the outer marker inbound (precision approach) is indicative that timed approach procedures are being utilized, or in lieu of holding, the controller may use radar vectors to the final approach course to establish a mileage interval between aircraft that will insure the appropriate time sequence between the final approach fix/outer marker or the fix used in lieu of the outer marker and the airport.

**20.3** Each pilot in an approach sequence will be given advance notice as to the time he should leave the holding point on approach to the airport. When a time to leave the holding point has been received, the pilot should adjust his flight path to leave the fix as closely as possible to the designated time. (See FIG 1.5-12.)

Timed Approaches from a Holding Fix

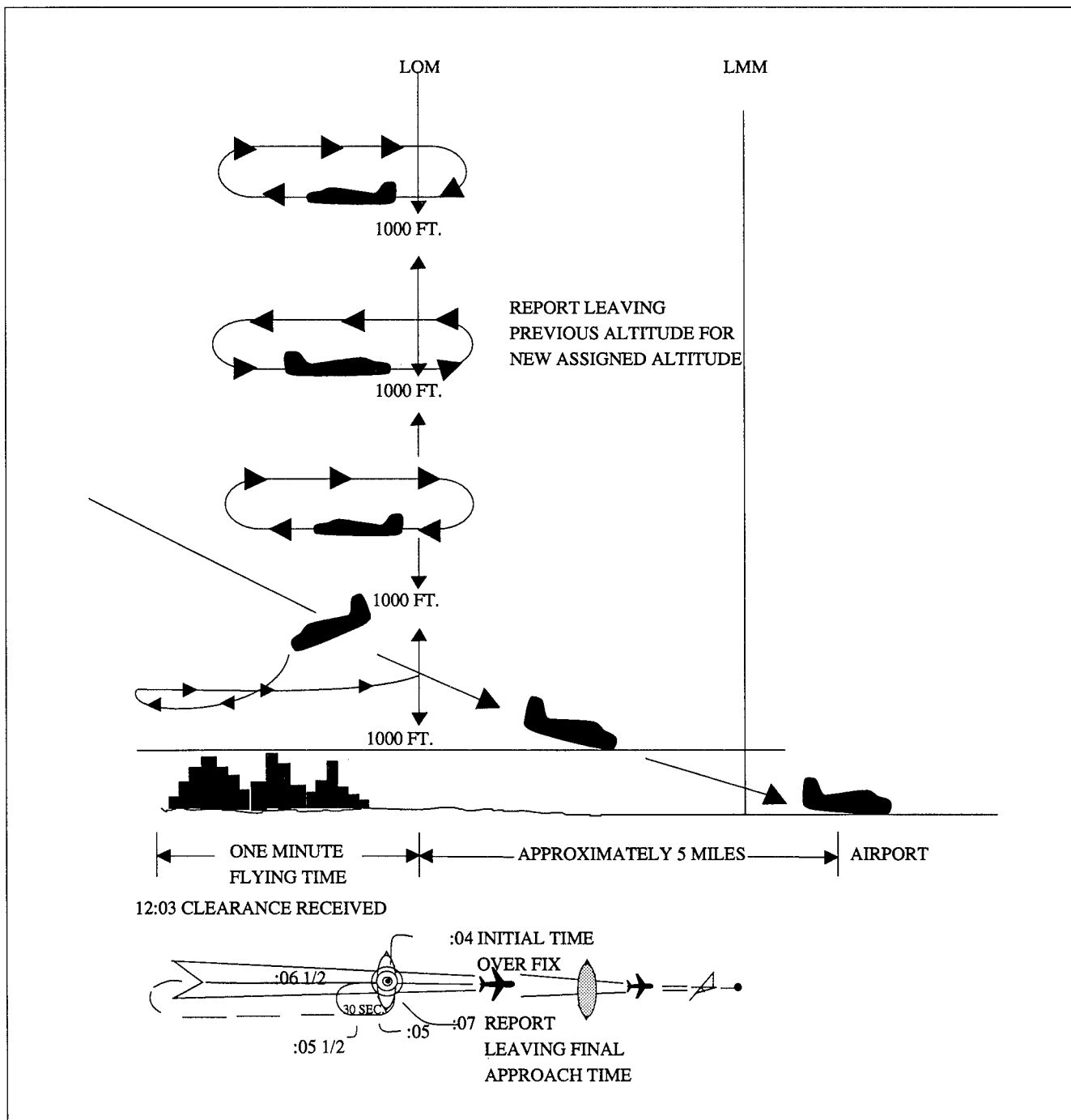

FIG 1.5-12

EXAMPLE.—

At 12:03 local time, in the example shown, a pilot holding, receives instructions to leave the fix inbound at 12:07. These instructions are received just as the pilot has completed turn at the outbound end of the holding pattern and is proceeding inbound towards the fix. Arriving back over the fix, the pilot notes that the time is 12:04 and that there are 3 minutes to lose in order to leave the fix at the assigned time. Since the time remaining is more than two minutes, the pilot plans to fly a race track pattern rather than a 360 degree turn, which would use up 2 minutes. The turns at the ends of the race track pattern will consume approximately 2 minutes. Three minutes to go, minus 2 minutes required for the turns, leaves 1 minute for level flight. Since two portions of level flight will be required to get back to the fix inbound, the pilot halves the 1 minute remaining and plans to fly level for 30 seconds outbound before starting the turn back to the fix on final approach. If the winds were negligible at flight altitude, this procedure would bring the pilot inbound across the fix precisely at the specified time of 12:07. However, if expecting headwind on final approach, the pilot should shorten the 30 second outbound course somewhat, knowing that the wind will carry the aircraft away from the fix faster while outbound and decrease the ground speed while returning to the fix. On the other hand, compensating for a tailwind on final approach, the pilot should lengthen the calculated 30 second outbound heading somewhat, knowing that the wind would tend to hold the aircraft closer to the fix while outbound and increase the ground speed while returning to the fix.

## 21. Contact Approach

**21.1** Pilots operating in accordance with an IFR flight plan, provided they are clear of clouds and have at least 1 mile flight visibility and can reasonably expect to continue to the destination airport in those conditions, may request ATC authorization for a “contact approach.”

**21.2** Controllers may authorize a “contact approach” provided:

a) The contact approach is specifically requested by the pilot. ATC cannot initiate this approach.

*EXAMPLE.—  
REQUEST CONTACT APPROACH*

b) The reported ground visibility at the destination airport is at least 1 statute mile.

c) The contact approach will be made to an airport having a standard or special instrument approach procedure.

d) Approved separation is applied between aircraft so cleared and between these aircraft and other IFR or special VFR aircraft.

*EXAMPLE.—  
CLEARED CONTACT APPROACH (AND IF REQUIRED) AT OR BELOW (ALTITUDE) (ROUTING) IF NOT POSSIBLE (ALTERNATIVE PROCEDURES) AND ADVISE.*

**21.3** A contact approach is an approach procedure that may be used by a pilot (with prior authorization from ATC) in lieu of conducting a standard or special instrument approach procedure (IAP) to an airport. It is not intended for use by a pilot on an IFR flight clearance to operate to an airport not having a published and functioning IAP. Nor is it intended for an aircraft to conduct an instrument approach to one airport and then, when “in the clear,” discontinue that approach and proceed to another airport. In the execution of a contact approach, the pilot assumes the responsibility for obstruction clearance. If radar service is being received, it will automatically terminate when the pilot is instructed to change to advisory frequency.

## 22. Visual Approach

**22.1** A visual approach is conducted on an IFR flight plan and authorizes a pilot to proceed visually and clear of clouds to the airport. The pilot must have either the airport or the preceding identified aircraft in sight. This approach must be authorized and controlled by the appropriate air traffic control facility. Reported weather at the airport must have a ceiling at or above 1,000 feet and visibility 3 miles or greater. ATC may authorize this type approach when it will be operationally beneficial. Visual approaches are an IFR procedure conducted un-

der Instrument Flight Rules in visual meteorological conditions. Cloud clearance requirements of 14 CFR Section 91.155 are not applicable, unless required by operation specifications.

**22.2 Operating to an Airport Without Weather Reporting Service:** ATC will advise the pilot when weather is not available at the destination airport. ATC may initiate a visual approach provided there is a reasonable assurance that weather at the airport is a ceiling at or above 1,000 feet and visibility 3 miles or greater (e.g. area weather reports, PIREP’s, etc.).

**22.3 Operating to an Airport With An Operating Control Tower:** Aircraft may be authorized to conduct a visual approach to one runway while other aircraft are conducting IFR or VFR approaches to another parallel, intersecting, or converging runway. When operating to airports with parallel runways separated by less than 2,500 feet, the succeeding aircraft must report sighting the preceding aircraft unless standard separation is being provided by ATC. When operating to parallel runways separated by at least 2,500 feet but less than 4,300 feet, controllers will clear/vector aircraft to the final at an angle not greater than 30 degrees unless radar, vertical, or visual separation is provided during the turn-on. The purpose of the 30 degree intercept angle is to reduce the potential for overshoots of the final and to preclude side-by-side operations with one or both aircraft in a belly-up configuration during the turn-on. Once the aircraft are established within 30 degrees of final, or on the final, these operations may be conducted simultaneously. When the parallel runways are separated by 4,300 feet or more, or intersecting/converging runways are in use, ATC may authorize a visual approach after advising all aircraft involved that other aircraft are conducting operations to the other runway. This may be accomplished through use of the ATIS.

**22.4 Separation Responsibilities:** If the pilot has the airport in sight but cannot see the preceding aircraft, ATC may clear the aircraft for a visual approach; however, ATC retains both separation and wake vortex separation responsibility. When visually following a preceding aircraft, acceptance of the visual approach clearance constitutes acceptance of pilot responsibility for maintaining a safe approach interval and adequate wake turbulence separation.

**22.5** A visual approach is not an IAP and therefore has no missed approach segment. If a go around is necessary for any reason, aircraft operating at controlled airports will be issued an appropriate advisory/clearance/instruction by the tower. At uncontrolled airports, aircraft are expected to remain clear of clouds and

complete a landing as soon as possible. If a landing cannot be accomplished, the aircraft is expected to remain clear of clouds and contact ATC as soon as possible for further clearance. Separation from other IFR aircraft will be maintained under these circumstances.

**22.6** Visual approaches reduce pilot/controller workload and expedite traffic by shortening flight paths to the airport. It is the pilot's responsibility to advise ATC as soon as possible if a visual approach is not desired.

**22.7** Authorization to conduct a visual approach is an IFR authorization and does not alter IFR flight plan cancellation responsibility. See ENR 1.10, paragraph 11.2, Canceling IFR Flight Plan.

**22.8** Radar service is automatically terminated, without advising the pilot, when the aircraft is instructed to change to advisory frequency.

### **23. Charted Visual Flight Procedures (CVFP's)**

**23.1** CVFP's are charted visual approaches established for environmental/noise considerations, and/or when necessary for the safety and efficiency of air traffic operations. The approach charts depict prominent landmarks, courses, and recommended altitudes to specific runways. CVFP's are designed to be used primarily for turbojet aircraft.

**23.2** These procedures will be used only at airports with an operating control tower.

**23.3** Most approach charts will depict some NAVAID information which is for supplemental navigational guidance only.

**23.4** Unless indicating a Class B airspace floor, all depicted altitudes are for noise abatement purposes and are recommended only. Pilots are not prohibited from flying other than recommended altitudes if operational requirements dictate.

**23.5** When landmarks used for navigation are not visible at night, the approach will be annotated "PROCEDURE NOT AUTHORIZED AT NIGHT."

**23.6** CVFP's usually begin within 20 flying miles from the airport.

**23.7** Published weather minimums for CVFP's are based on minimum vectoring altitudes rather than the recommended altitudes depicted on charts.

**23.8** CVFP's are not instrument approaches and do not have missed approach segments.

**23.9** ATC will not issue clearances for CVFP's when the weather is less than the published minimum.

**23.10** ATC will clear aircraft for a CVFP after the pilot reports sighting a charted landmark or a preceding aircraft. If instructed to follow a preceding aircraft, pilots are responsible for maintaining a safe approach interval and wake turbulence separation.

**23.11** Pilots should advise ATC if at any point they are unable to continue an approach or lose sight of a preceding aircraft. Missed approaches will be handled as a go-around.

### **24. Missed Approach**

**24.1** When a landing cannot be accomplished, advise ATC and, upon reaching the missed approach point defined on the approach procedure chart, the pilot must comply with the missed approach instructions for the procedure being used or with an alternate missed approach procedure specified by ATC.

**24.2** Protected obstacle clearance areas for missed approach are predicated on the assumption that the abort is initiated at the missed approach point not lower than the Minimum Descent Altitude (MDA) or Decision Height (DH) maneuvers. However, no consideration is given to an abnormally early turn. Therefore, when an early missed approach is executed, pilots should, unless otherwise cleared by ATC, fly the instrument approach procedure as specified on the approach plate to the missed approach point at or above the MDA or DH before executing a turning maneuver.

**24.3** If visual reference is lost while circling to land from an instrument approach, the missed approach specified for that particular procedure must be followed (unless an alternate missed approach procedure is specified by ATC). To become established on the prescribed missed approach course, the pilot should make an initial climbing turn toward the landing runway and continue the turn until established on the missed approach course. Inasmuch as the circling maneuver may be accomplished in more than one direction, different patterns will be required to become established on the prescribed missed approach course depending on the aircraft position at the time visual reference is lost. Adherence to the procedure will assure that an aircraft will remain within the circling and missed approach obstruction clearance areas. (See FIG 1.5-13 and FIG 1.5-14.)

**24.4** At locations where ATC radar service is provided, the pilot should conform to radar vectors when provided by ATC in lieu of the published missed approach procedure.



**Circling and Missed Approach Obstruction Clearance Areas**

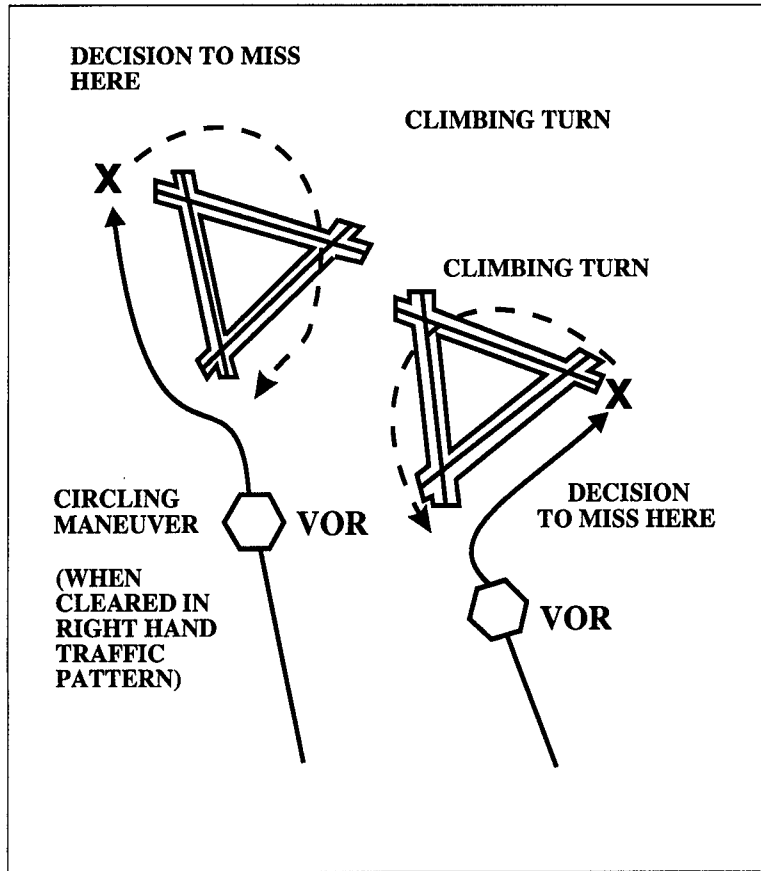

FIG 1.5-13

**Missed Approach**

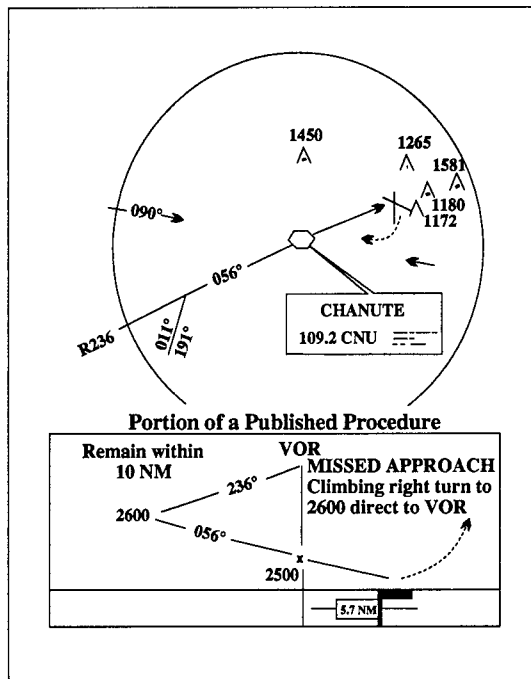

FIG 1.5-14

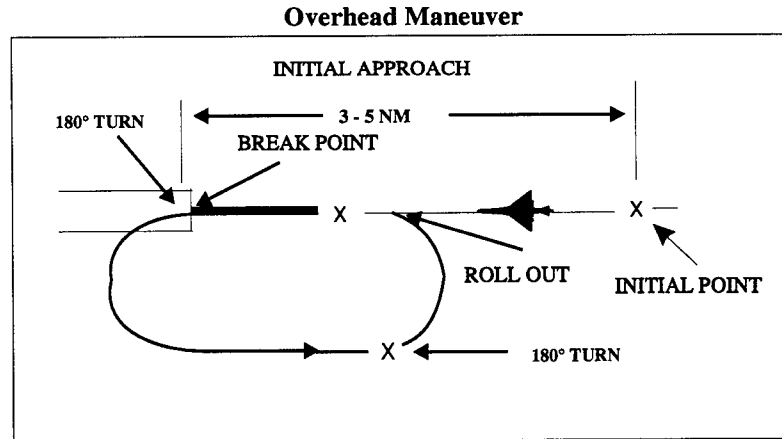

FIG 1.5-15

24.5 When the approach has been missed, request a clearance for specific action; i.e., to alternative airport, another approach, etc.

## 25. Overhead Approach Maneuver

25.1 Pilots operating in accordance with an IFR flight plan in visual meteorological conditions (VMC) may request ATC authorization for an overhead maneuver. An overhead maneuver is not an instrument approach procedure. Overhead maneuver patterns are developed at airports where aircraft have an operational need to conduct the maneuver. An aircraft conducting an overhead maneuver is considered to be VFR and the IFR flight plan is cancelled when the aircraft crosses the landing threshold on the initial approach portion of the maneuver. (See FIG 1.5-15.) The existence of a standard overhead maneuver pattern does not eliminate the possible requirement for an aircraft to conform to conventional rectangular patterns if an overhead maneuver cannot be approved. Aircraft operating to an airport without a functioning control tower must initiate cancellation of an IFR flight plan prior to executing the overhead maneuver. Cancellation of the IFR flight plan must be accomplished after crossing the landing threshold on the initial portion of the maneuver or after landing. Controllers may authorize an overhead maneuver and issue the following to arriving aircraft:

a) Pattern altitude and direction of traffic. This information may be omitted if either is standard.

**PHRASEOLOGY-**  
PATTERN ALTITUDE (ALTITUDE). RIGHT TURNS.

b) Request for a report on initial approach.

**PHRASEOLOGY-**  
REPORT INITIAL.

c) "Break" information and a request for the pilot to report. The "Break Point" will be specified if nonstandard. Pilots may be requested to report "break" if required for traffic or other reasons.

**PHRASEOLOGY-**  
BREAK AT (SPECIFIED POINT).  
REPORT BREAK.

## 26. Departure Procedures

### 26.1 Pre-Taxi Clearance Procedures

26.1.1 Locations where these procedures are in effect are indicated in the Airport/Facility Directory.

26.1.1 Certain airports have established programs whereby pilots of departing IFR aircraft may elect to receive their IFR clearances before they start taxiing for takeoff. The following provisions are included in such procedures:

a) Pilot participation is not mandatory;

b) Participating pilots call clearance delivery/ground control not more than 10 minutes before proposed taxi time;

c) IFR clearance (or delay information, if clearance cannot be obtained) is issued at the time of this initial call-up;

d) When the IFR clearance is received on clearance delivery frequency, pilots call ground control when ready to taxi;

e) Normally, pilots need not inform ground control that they have received IFR clearance on clearance delivery frequency. Certain locations may, however, require that the pilot inform ground control of a portion of the routing or that the IFR clearance has been received.

f) If a pilot cannot establish contact on clearance delivery frequency or has not received an IFR clearance

before ready to taxi, the pilot should contact ground control and inform the controller accordingly.

## 27. Taxi Clearance

**27.1** Pilots on IFR flight plans should communicate with the control tower on the appropriate ground control/clearance delivery frequency prior to starting engines to receive engine start time, taxi, and/or clearance information.

## 28. Departure Restrictions, Clearance Void Times, Hold for Release, and Release Times

**28.1** ATC may assign departure restrictions, clearance void times, hold for release, and release times, when necessary, to separate departures from other traffic or to restrict or regulate the departure flow.

**a) Clearance Void Times:** A pilot may receive a clearance, when operating from an airport without a control tower, which contains a provision for the clearance to be void if not airborne by a specific time. A pilot who does not depart prior to the clearance void time must advise ATC as soon as possible of his or her intentions. ATC will normally advise the pilot of the time allotted to notify ATC that the aircraft did not depart prior to the clearance void time. This time cannot exceed 30 minutes. Failure of an aircraft to contact ATC within 30 minutes after the clearance void time will result in the aircraft being considered overdue and search and rescue procedures initiated.

### NOTE.—

☐ *OTHER IFR TRAFFIC FOR THE AIRPORT WHERE THE CLEARANCE IS ISSUED IS SUSPENDED UNTIL THE AIRCRAFT HAS CONTACTED ATC OR UNTIL 30 MINUTES AFTER THE CLEARANCE VOID TIME OR 30 MINUTES AFTER THE CLEARANCE RELEASE TIME IF NO CLEARANCE VOID TIME IS ISSUED.*

☒ *PILOTS WHO DEPART AT OR AFTER THEIR CLEARANCE VOID TIME ARE NOT AFFORDED IFR SEPARATION AND MAY BE IN VIOLATION OF 14 CFR SECTION 91.173 WHICH REQUIRES THAT PILOTS RECEIVE AN APPROPRIATE ATC CLEARANCE BEFORE OPERATING IFR IN CLASS A, B, C, D AND E AIRSPACE.*

### EXAMPLE.—

*CLEARANCE VOID IF NOT OFF BY (CLEARANCE VOID TIME) AND, IF REQUIRED, IF NOT OFF BY (CLEARANCE VOID TIME) ADVISE (FACILITY) NOT LATER THAN (TIME) OF INTENTIONS.*

**b) Hold for Release:** ATC may issue “hold for release” instructions in a clearance to delay an aircraft’s departure for traffic management reasons (i.e., weather, traffic volume, etc.). When ATC states in the clearance, “hold for release,” the pilot may not depart utilizing that IFR clearance until a release time or additional instructions are issued by ATC. This does not preclude the pilot from cancelling the IFR clearance with ATC and departing under VFR; but an IFR clearance may not

be available after departure. In addition, ATC will include departure delay information in conjunction with “hold for release” instructions.

### EXAMPLE.—

*(AIRCRAFT IDENTIFICATION) CLEARED TO (DESTINATION) AIRPORT AS FILED, MAINTAIN (ALTITUDE), AND, IF REQUIRED (ADDITIONAL INSTRUCTIONS OR INFORMATION), HOLD FOR RELEASE, EXPECT (TIME IN HOURS AND/OR MINUTES) DEPARTURE DELAY.*

**c) Release Times:** A “release time” is a departure restriction issued to a pilot by ATC, specifying the earliest time an aircraft may depart. ATC will use “release times” in conjunction with traffic management procedures and/or to separate a departing aircraft from other traffic.

### EXAMPLE.—

*(AIRCRAFT IDENTIFICATION) RELEASED FOR DEPARTURE AT (TIME IN HOURS AND/OR MINUTES).*

**28.2** If practical, pilots departing uncontrolled airports should obtain IFR clearances prior to becoming airborne when two way communications with the controlling ATC facility is available.

## 29. Departure Control

**29.1** Departure Control is an approach control function responsible for ensuring separation between departures. So as to expedite the handling of departures, Departure Control may suggest a takeoff direction other than that which may normally have been used under VFR handling. Many times it is preferred to offer the pilot a runway that will require the fewest turns after takeoff to place the pilot on course or selected departure route as quickly as possible. At many locations particular attention is paid to the use of preferential runways for local noise abatement programs, and route departures away from congested areas.

**29.2** Departure Control utilizing radar will normally clear aircraft out of the terminal area using instrument departure procedures (DP’s) via radio navigation aids. When a departure is to be vectored immediately following takeoff, the pilot will be advised prior to takeoff of the initial heading to be flown but may not be advised of the purpose of the heading. Pilots operating in a radar environment are expected to associate departure headings with vectors to their planned route of flight. When given a vector taking the aircraft off a previously assigned nonradar route, the pilot will be advised briefly what the vector is to achieve. Thereafter, radar service will be provided until the aircraft has been reestablished “on-course” using an appropriate navigation aid and the pilot has been advised of the aircraft’s position; or, a handoff is made to another radar controller with further surveillance capabilities.

**29.3** Controllers will inform pilots of the departure control frequencies and, if appropriate, the transponder code before takeoff. Pilots should not operate their transponder until ready to start the takeoff roll or change to the departure control frequency until requested. Controllers may omit the departure control frequency if a DP has or will be assigned and the departure control frequency is published on the DP.

### **30. Abbreviated IFR Departure Clearance (Cleared . . . as Filed) Procedures**

**30.1** ATC facilities will issue an abbreviated IFR departure clearance based on the ROUTE of flight filed in the IFR flight plan, provided the filed route can be approved with little or no revision. These abbreviated clearance procedures are based on the following conditions:

- a) The aircraft is on the ground or it has departed VFR and the pilot is requesting IFR clearance while airborne;
- b) That a pilot will not accept an abbreviated clearance if the route or destination of a flight plan filed with ATC has been changed by him or the company or the operations officer before departure;
- c) That it is the responsibility of the company or operations office to inform the pilot when they make a change to the filed flight plan; and
- d) That it is the responsibility of the pilot to inform ATC in the initial call-up (for clearance) when the filed flight plan has been either:

1) Amended; or

2) Canceled and replaced with a new filed flight plan.

**NOTE.—**  
THE FACILITY ISSUING A CLEARANCE MAY NOT HAVE RECEIVED THE REVISED ROUTE OR THE REVISED FLIGHT PLAN BY THE TIME A PILOT REQUESTS CLEARANCE.

**30.2** Controllers will issue a detailed clearance when they know that the original filed flight plan has been changed or when the pilot requests a full route clearance.

**30.3** The clearance as issued will include the destination airport filed in the flight plan.

**30.4** ATC procedures now require the controller to state the DP name, the current number and the DP Transition name after the phrase “Cleared to (destination) airport,” and prior to the phrase, “then as filed,” for ALL departure clearances when the DP or DP Transition is

to be flown. The procedure applies whether or not the DP is filed in the flight plan.

**30.5** Standard Terminal Arrivals (STAR’s), when filed in a flight plan, are considered a part of the filed route of flight and will not normally be stated in an initial departure clearance. If the ARTCC’s jurisdictional airspace includes both the departure airport and the fix where a STAR or STAR Transition begins, the STAR name, the current number, and the STAR Transition name MAY be stated in the initial clearance.

**30.6** “Cleared to (destination) airport as filed” does NOT include the en route altitude filed in a flight plan. An en route altitude will be stated in the clearance or the pilot will be advised to expect an assigned/filed altitude within a given time frame or at a certain point after departure. This may be done verbally in the departure instructions or stated in the DP.

**30.7** In a radar and a nonradar environment, the controller will state “Cleared to (destination) airport as filed” or:

a) If a DP or DP Transition is to be flown, specify the DP name, the current DP number, the DP Transition name, the assigned altitude/flight level, and any additional instructions (departure control frequency, beacon code assignment, etc.) necessary to clear a departing aircraft via the DP/DP Transition and the route filed;

**EXAMPLE.—**  
NATIONAL SEVEN TWENTY CLEARED TO MIAMI AIRPORT, INTERCONTINENTAL ONE DEPARTURE, LAKE CHARLES TRANSITION, THEN AS FILED MAINTAIN FLIGHT LEVEL TWO SEVEN ZERO.

b) When there is no DP or when the pilot cannot accept a DP, specify the assigned altitude/flight level, and any additional instructions necessary to clear a departing aircraft via an appropriate departure routing and the route filed;

**NOTE.—**  
A DETAILED DEPARTURE ROUTE DESCRIPTION OR A RADAR VECTOR MAY BE USED TO ACHIEVE THE DESIRED DEPARTURE ROUTING.

c) If necessary to make a minor revision to the filed route, specify the assigned DP/DP Transition (or departure routing), the revision to the filed route, the assigned altitude/flight level and any additional instructions necessary to clear a departing aircraft; or

**EXAMPLE.—**  
JET STAR ONE FOUR TWO FOUR CLEARED TO ATLANTA AIRPORT, SOUTH BOSTON TWO DEPARTURE, THEN AS FILED, EXCEPT CHANGE ROUTE TO READ, SOUTH BOSTON VICTOR 20 GREENSBORO, MAINTAIN ONE SEVEN THOUSAND.

d) Additionally, in a nonradar environment, specify one or more fixes as necessary to identify the initial route of flight.

**EXAMPLE.—**

CESSNA THREE ONE SIX FOXTROT CLEARED TO CHARLOTTE AIRPORT AS FILED VIA BROOKE, MAINTAIN SEVEN THOUSAND.

**30.8** To ensure success of the program, pilots should:

a) Avoid making changes to a filed flight plan just prior to departure;

b) State the following information in the initial call-up to the facility when no change has been made to the filed flight plan: Aircraft call sign, location, type operation (IFR) and the name of the airport (or fix) to which you expect clearance;

**EXAMPLE.—**

“WASHINGTON CLEARANCE DELIVERY (or Ground Control if Appropriate) AMERICAN SEVENTY SIX AT GATE ONE, I-F-R LOS ANGELES.”

c) If the flight plan has been changed, state the change and request a full route clearance;

**EXAMPLE.—**

“WASHINGTON CLEARANCE DELIVERY, AMERICAN SEVENTY SIX AT GATE ONE I-F-R SAN FRANCISCO. MY FLIGHT PLAN ROUTE HAS BEEN AMENDED (or Destination Changed), REQUEST FULL ROUTE CLEARANCE.”

d) Request verification or clarification from ATC if ANY portion of the clearance is not clearly understood; and

e) When requesting clearance for the IFR portion of a VFR-IFR flight, request such clearance prior to the fix where IFR operation is proposed to commence in sufficient time to avoid delay. Use the following phraseology:

**EXAMPLE.—**

“LOS ANGELES CENTER, APACHE SIX ONE PAPA, V-F-R, ESTIMATING PASO ROBLES V-O-R AT THREE TWO, ONE THOUSAND FIVE HUNDRED, REQUEST I-F-R TO BAKERSFIELD.”

**31. Instrument Departures****31.1 Instrument Departure Procedures (DP's)**

a) An ATC coded departure procedure which has been established at certain airports to simplify clearance delivery procedures is called a DP.

b) Pilots of civil aircraft operating from locations where DP's are effective may expect ATC clearances containing a DP. Use of a DP requires pilot possession of at least the textual description of the approved effective DP. Controllers may omit the departure control frequency if a DP clearance is issued and the departure control frequency is published on the DP. ATC must be immediately advised if the pilot does not possess a charted DP or a preprinted DP description, or for any other reason, does not wish to use a DP. Notification may be accomplished by filing “NO DP”

in the remarks section of the filed flight plan or by the less desirable method of verbally advising ATC.

c) All effective DP's are published in textual and graphic form by the National Ocean Survey in the Terminal Procedures Publication (TPP).

d) DP's will be depicted in one of two basic forms.

1) **Pilot Navigation (Pilot NAV) DP's** are established where the pilot is primarily responsible for navigation on the DP route. They are established for airports when terrain and safety related factors indicate the necessity for a pilot NAV DP. Some pilot NAV DP's may contain vector instructions which pilots are expected to comply with until instructions are received to resume normal navigation on the filed/assigned route or DP.

2) **Vector DP's** are established where ATC will provide radar navigational guidance to a filed/assigned route or to a fix depicted on the DP.

**31.2 Obstruction Clearance During Departure**

a) Published DP's are either textual or graphically depicted. They may be established for obstacle avoidance or for ATC purposes. Simple DP's required for obstacle avoidance are usually textual. More complex DP's required for obstacle avoidance, all RNAV DP's, and DP's required for ATC purposes are graphically depicted. DP's assist pilots conducting IFR flight in avoiding obstacles during climbout to minimum en route altitude (MEA). These procedures are established only at locations where instrument approach procedures are published. Standard instrument takeoff minimums and departure procedures are prescribed in 14 CFR Section 91.175. Airports with takeoff minimums other than standard (one statute mile for aircraft having two engines or less and one-half statute mile for aircraft having more than two engines) are described in airport listings on separate pages titled IFR TAKE-OFF MINIMUMS AND DEPARTURE PROCEDURES, at the front of each U.S. Government published IAP and DP book. The approach chart and DP chart for each airport where takeoff minimums are not standard and/or departure procedures required for obstacle avoidance are published is annotated with a special symbol . The use of this symbol indicates that the separate listing should be consulted. These minimums also apply to DP's required for ATC purposes unless the DP's specify different minimums.

b) Obstacle clearance is based on the aircraft climbing at least 200 feet per nautical mile, crossing the end of the runway at least 35 feet AGL, and climbing to

400 feet above airport elevation before turning, unless otherwise specified in the procedure. A slope of 152 feet per nautical mile, starting no higher than 35 feet above the departure end of the runway, is assessed for obstacles. A minimum obstacle clearance of 48 feet per nautical mile is provided in the assumed climb gradient.

1) If no obstacles penetrate the 152 feet per nautical mile slope, DP's for obstacle avoidance are not published.

2) If obstacles do penetrate the slope, avoidance procedures are specified. These procedures may be: a ceiling and visibility to allow the obstacles to be seen and avoided; a climb gradient greater than 200 feet per nautical mile; detailed flight maneuvers; or a combination of the above. In extreme cases, IFR takeoff may not be authorized for some runways.

**EXAMPLE.—**  
RWY 17, 300-1 OR STANDARD WITH MINIMUM CLIMB OF 220 FEET PER NM TO 1,100.

c) Climb gradients are specified when required for obstacle clearance. Crossing restrictions in the DP's may be established for traffic separation or obstacle clearance. When no gradient is specified, the pilot is expected to climb at least 200 feet per nautical mile to MEA unless required to level off by a crossing restriction.

**EXAMPLE.—**  
"CROSS ALPHA INTERSECTION AT OR BELOW FOUR THOUSAND; MAINTAIN SIX THOUSAND." THE PILOT CLIMBS AT LEAST 200 FEET PER NAUTICAL MILE TO 6,000. IF 4,000 IS REACHED BEFORE ALPHA, THE PILOT LEVELS OFF AT 4,000 UNTIL PASSING ALPHA; THEN IMMEDIATELY RESUMES AT LEAST 200 FEET PER NAUTICAL MILE CLIMB.

d) Climb gradients may be specified to an altitude/fix, above which the normal gradient applies.

**EXAMPLE.—**  
"MINIMUM CLIMB 340 FEET PER NM TO 2,700." THE PILOT CLIMBS AT LEAST 340 FEET PER NAUTICAL MILE TO 2,700, THEN AT LEAST 200 FEET PER NM TO MEA.

e) Some DP's required for obstacle avoidance require a climb in visual conditions to cross the airport (or an on-airport NAVAID) in a specified direction, at or above a specified altitude.

**EXAMPLE.—**  
"CLIMB IN VISUAL CONDITIONS SO AS TO CROSS THE McELORY AIRPORT SOUTHBOUND AT OR ABOVE SIX THOUSAND, THEN CLIMB VIA KEEMMLING R-033 TO KEEMMLING VORTAC."

1) When climbing in visual conditions it is the pilot's responsibility to see and avoid obstacles. Specified ceiling and visibility minimums will allow visual avoidance of obstacles until the pilot enters the standard obstacle protection area. Obstacle avoidance is not guaranteed if the pilot maneuvers farther from the airport than the visibility minimum.

2) That segment of the procedure which requires the pilot to see and avoid obstacles ends when the aircraft crosses the specified point at the required altitude. Thereafter, standard obstacle protection is provided.

f) Each pilot, prior to departing an airport on an IFR flight, should consider the type of terrain and other obstacles on or in the vicinity of the departure airport and:

1) Determine whether a DP is available for obstacle avoidance;

2) Determine if obstacle avoidance can be maintained visually or that the DP should be followed; and

3) Determine what action will be necessary and take such action that will assure a safe departure.

**NOTE.—**  
THE TERM RADAR CONTACT, WHEN USED BY THE CONTROLLER DURING DEPARTURE, SHOULD NOT BE INTERPRETED AS RELIEVING PILOTS OF THEIR RESPONSIBILITY TO MAINTAIN APPROPRIATE TERRAIN AND OBSTRUCTION CLEARANCE.

g) Terrain/obstruction clearance is not provided by ATC until the controller begins to provide navigational guidance; i.e., radar vectors.

## ENR 1.6 Radar Services and Procedures

### 1. Radar

#### 1.1 Capabilities

a) Radar is a method whereby radio waves are transmitted into the air and are then received when they have been reflected by an object in the path of the beam. Range is determined by measuring the time it takes (at the speed of light) for the radio wave to go out to the object and then return to the receiving antenna. The direction of a detected object from a radar site is determined by the position of the rotating antenna when the reflected portion of the radio wave is received.

b) More reliable maintenance and improved equipment have reduced radar system failures to a negligible factor. Most facilities actually have some components duplicated - one operating and another which immediately takes over when a malfunction occurs to the primary component.

#### 1.2 Limitations

a) It is very important for the aviation community to recognize the fact that there are limitations to radar service and that ATC controllers may not always be able to issue traffic advisories concerning aircraft which are not under ATC control and cannot be seen on radar.

1) The characteristics of radio waves are such that they normally travel in a continuous straight line unless they are:

—“Bent” by abnormal atmospheric phenomena such as temperature inversions;

—Reflected or attenuated by dense objects such as heavy clouds, precipitation, ground obstacles, mountains, etc.; or

—Screened by high terrain features.

2) The bending of radar pulses, often called anomalous propagation or ducting, may cause many extraneous blips to appear on the radar operator’s display if the beam has been bent toward the ground or may decrease the detection range if the wave is bent upward. It is difficult to solve the effects of anomalous propagation, but using beacon radar and electronically eliminating stationary and slow moving targets by a method called moving target indicator (MTI) usually negate the problem.

3) Radar energy that strikes dense objects will be reflected and displayed on the operator’s scope thereby blocking out aircraft at the same range and greatly weakening or completely eliminating the display of targets at a greater range. Again, radar beacon and MTI are very effectively used to combat ground clutter and weather phenomena, and a method of circularly polarizing the radar beam will eliminate some weather returns. A negative characteristic of MTI is that an aircraft flying a speed that coincides with the canceling signal of the MTI (tangential or “blind” speed) may not be displayed to the radar controller.

#### Limitations to Radar Service

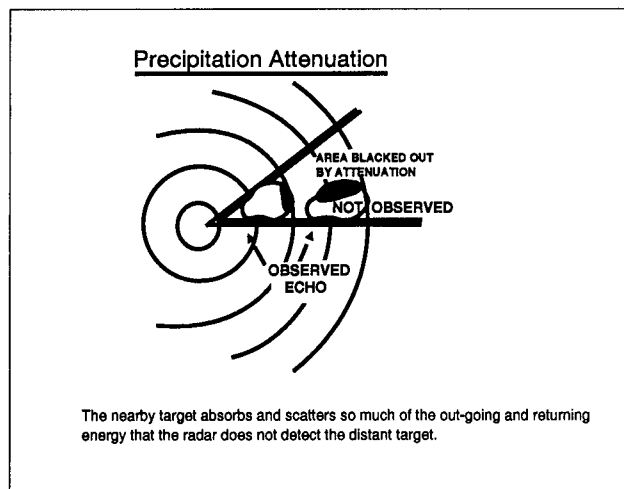

FIG 1.6-1

4) Relatively low altitude aircraft will not be seen if they are screened by mountains or are below the radar beam due to earth curvature. The only solution to screening is the installation of strategically placed multiple radars which has been done in some areas.

5) There are several other factors which affect radar control. The amount of reflective surface of an aircraft will determine the size of the radar return. Therefore, a small light airplane or a sleek jet fighter will be more difficult to see on radar than a large commercial jet or military bomber. Here again, the use of radar beacon is invaluable if the aircraft is equipped with an airborne transponder. All ARTCC radars in the conterminous U.S. and many airport surveillance radars have the capability to interrogate Mode C and display altitude information to the controller from appropriately equipped aircraft. However, there are a number of airport surveillance radars that do not have Mode C display capability

and, therefore, altitude information must be obtained from the pilot.

6) At some locations within the ATC en route environment, secondary-radar-only (no primary radar) gap filler systems are used to give lower altitude radar coverage between two larger radar systems, each of which provides both primary and secondary radar coverage. In those geographical areas served by secondary-radar-only, aircraft without transponders cannot be provided with radar service. Additionally, transponder equipped aircraft cannot be provided with radar advisories concerning primary targets and weather.

7) The controllers' ability to advise a pilot flying on instruments or in visual conditions of the aircraft's proximity to another aircraft will be limited if the unknown aircraft is not observed on radar, if no flight plan information is available, or if the volume of traffic and workload prevent issuing traffic information. First priority is given to establishing vertical, lateral, or longitudinal separation between aircraft flying IFR under the control of ATC.

## 2. Surveillance Radar

2.1 Surveillance radars are divided into two general categories: Airport Surveillance Radar (ASR) and Air Route Surveillance Radar (ARSR).

a) ASR is designed to provide relatively short range coverage in the general vicinity of an airport and to serve as an expeditious means of handling terminal area traffic through observation of precise aircraft locations on a radar scope. The ASR can also be used as an instrument approach aid.

b) ARSR is a long-range radar system designed primarily to provide a display of aircraft locations over large areas.

c) Center Radar Automated Radar Terminal Systems (ARTS) Processing (CENRAP) was developed to provide an alternative to a nonradar environment at terminal facilities should an ASR fail or malfunction. CENRAP sends aircraft radar beacon target information to the ASR terminal facility equipped with ARTS. Procedures used for the separation of aircraft may increase under certain conditions when a facility is utilizing CENRAP because radar target information updates at a slower rate than the normal ASR radar. Radar services for VFR aircraft are also limited during CENRAP operations because of the additional workload required to provide services to IFR aircraft.

2.2 Surveillance radars scan through 360° of azimuth and present target information on a radar display located in a tower or center. This information is used independently or in conjunction with other navigational aids in the control of air traffic.

## 3. Air Traffic Control Radar Beacon System (ATCRBS)

3.1 The ATCRBS, sometimes referred to as a secondary surveillance radar, consists of three main components:

a) **Interrogator.** Primary radar relies on a signal being transmitted from the radar antenna site and for this signal to be reflected or "bounced back" from an object (such as an aircraft). This reflected signal is then displayed as a "target" on the controller's radar scope. In the ATCRBS, the Interrogator, a ground based radar beacon transmitter-receiver, scans in synchronism with the primary radar and transmits discrete radio signals which repetitiously requests all transponders, on the mode being used, to reply. The replies received are then mixed with the primary returns and both are displayed on the same radar scope.

b) **Transponder:** This airborne radar beacon transmitter-receiver automatically receives the signals from the interrogator and selectively replies with a specific pulse group (code) only to those interrogations being received on the mode to which it is set. These replies are independent of, and much stronger than a primary radar return.

c) **Radar scope:** The radar scope used by the controller displays returns from both the primary radar system and the ATCRBS. These returns, called targets, are what the controller refers to in the control and separation of traffic.

3.2 The job of identifying and maintaining identification of primary radar targets is a long and tedious task for the controller. Some of the advantages of ATCRBS over primary radar are:

- a) Reinforcement of radar targets;
- b) Rapid target identification; and
- c) Unique display of selected codes.

3.3 A part of the ATCRBS ground equipment is the decoder. This equipment enables the controller to assign discrete transponder codes to each aircraft under his control. Normally only one code will be assigned for the entire flight. Assignments are made by the ARTCC computer on the basis of the National Beacon Code Allocation Plan. The equipment is also designed to receive Mode C altitude information from the aircraft. See



**FIG 1.6-4 and FIG 1.6-5** for an illustration of the target symbology depicted on radar scopes in the NAS Stage A (en route), the ARTS III (terminal) Systems, and other nonautomated (broadband) radar systems.

#### 4. Precision Approach Radar (PAR)

**4.1** PAR is designed to be used as a landing aid, rather than an aid for sequencing and spacing aircraft. PAR equipment may be used as a primary landing aid, or it may be used to monitor other types of approaches. It is designed to display range, azimuth and elevation information.

**4.2** Two antennas are used in the PAR array, one scanning a vertical plane, and the other scanning horizontally. Since the range is limited to 10 miles, azimuth to 20 degrees, and elevation to 7 degrees, only the final approach area is covered. Each scope is divided into two parts. The upper half presents altitude and distance information, and the lower half presents azimuth and distance.

#### 5. Radar Availability

**5.1** FAA radar units operate continuously at the locations shown in the Airport/Facility Directory, and their services are available to all pilots, both civil and military. Contact the associated FAA control tower or ARTCC on any frequency guarded for initial instructions, or in an emergency, any FAA facility for information on the nearest radar service.

#### 6. Transponder Operation

##### 6.1 General

a) Pilots should be aware that proper application of these procedures will provide both VFR and IFR aircraft with a high degree of safety in the environment where high-speed closure rates are possible. Transponders substantially increase the capability of radar to see an aircraft and the Mode C feature enables the controller to quickly determine where potential traffic conflicts may exist. Even VFR pilots who are not in contact with ATC will be afforded greater protection from IFR aircraft and VFR aircraft which are receiving traffic advisories. Nevertheless, pilots should never relax their visual scanning vigilance for other aircraft.

b) ATCRBS is similar to and compatible with military coded radar beacon equipment. Civil Mode A is identical to military Mode 3.

c) Civil and military transponders should be adjusted to the "on" or normal operating position as late as practicable prior to takeoff and to "off" or "stand-

by" as soon as practicable after completing landing roll, unless the change to "standby" has been accomplished previously at the request of ATC. IN ALL CASES, WHILE IN CLASS A, B, C, D, AND E AIRSPACE EACH PILOT OPERATING AN AIRCRAFT EQUIPPED WITH AN OPERABLE ATC TRANSPONDER MAINTAINED IN ACCORDANCE WITH 14 CFR SECTION 91.413 SHALL OPERATE THE TRANSPONDER, INCLUDING MODE C IF INSTALLED, ON THE APPROPRIATE CODE OR AS ASSIGNED BY ATC. IN CLASS G AIRSPACE, THE TRANSPONDER SHOULD BE OPERATING WHILE AIRBORNE UNLESS OTHERWISE REQUESTED BY ATC.

d) If a pilot on an IFR flight elects to cancel the IFR flight plan prior to reaching destination, the pilot should adjust the transponder according to VFR operations.

e) If entering U.S. domestic controlled airspace from outside the U.S., the pilot should advise on first radio contact with a U.S. radar ATC facility that such equipment is available by adding "transponder" to the aircraft identification.

f) It should be noted by all users of the ATC transponders that the coverage they can expect is limited to "line of sight." Low altitude or aircraft antenna shielding by the aircraft itself may result in reduced range. Range can be improved by climbing to a higher altitude. It may be possible to minimize antenna shielding by locating the antenna where dead spots are only noticed during abnormal flight attitudes.

##### 6.2 Transponder Code Designation

**6.2.1** For ATC to utilize one or a combination of the 4096 discrete codes FOUR DIGIT CODE DESIGNATION will be used; e.g., code 2100 will be expressed as TWO ONE ZERO ZERO. Due to the operational characteristics of the rapidly expanding automated ATC system, THE LAST TWO DIGITS OF THE SELECTED TRANSPONDER CODE SHOULD ALWAYS READ '00' UNLESS SPECIFICALLY REQUESTED BY ATC TO BE OTHERWISE.

##### 6.3 Automatic Altitude Reporting (Mode C)

**6.3.1** Some transponders are equipped with a Mode C automatic altitude reporting capability. This system converts aircraft altitude in 100 foot increments to coded digital information which is transmitted together with Mode C framing pulses to the interrogating radar facility. The manner in which transponder panels are designed differs, therefore, a pilot should be thoroughly

familiar with the operation of the transponder so that ATC may realize its full capabilities.

**6.3.2** Adjust transponder to reply on the Mode A/3 code specified by ATC and, if equipped, to reply on Mode C with altitude reporting capability activated unless deactivation is directed by ATC or unless the installed aircraft equipment has not been tested and calibrated as required by 14 CFR Section 91.217. If deactivation is required by ATC, run off the altitude reporting feature of your transponder. An instruction by ATC to "STOP ALTITUDE SQUAWK, ALTITUDE DIFFERS (number of feet) FEET," may be an indication that your transponder is transmitting incorrect altitude information or that you have an incorrect altimeter setting. While an incorrect altimeter setting has no effect on the Mode C altitude information transmitted by your transponder (transponders are preset at 29.92), it would cause you to fly at an actual altitude different from your assigned altitude. When a controller indicates that an altitude readout is invalid, the pilot should initiate a check to verify that the aircraft altimeter is set correctly.

**6.3.3** Pilots of aircraft with operating Mode C altitude reporting transponders should exact altitude/flight level to the nearest hundred foot increment when establishing initial contact with an ATC. Exact altitude/flight level reports on initial contact provide ATC with information that is required prior to using Mode C altitude information for separation purposes. This will significantly reduce altitude verification requests.

#### **6.4 Transponder IDENT Feature**

The transponder shall be operated only as specified by ATC. Activate the "IDENT" feature only upon request of the ATC controller.

#### **6.5 Code Changes**

**6.5.1** When making routine code changes, pilots should avoid inadvertent selection of codes 7500, 7600, or 7700 thereby causing momentary false alarms at automated ground facilities. For example when switching from code 2700 to code 7200, switch first to 2200 then 7200, NOT to 7700 and then 7200. This procedure applies to nondiscrete code 7500 and all discrete codes in the 7600 and 7700 series (i.e., 7600-7677, 7700-7777) which will trigger special indicators in automated facilities. Only nondiscrete code 7500 will be decoded as the hijack code.

**6.5.2** Under no circumstances should a pilot of a civil aircraft operate the transponder on Code 7777. This code is reserved for military interceptor operations.

**6.5.3** Military pilots operating VFR or IFR within restricted/warning areas should adjust their transponders to code 4000 unless another code has been assigned by ATC.

#### **6.6 Mode C Transponder Requirements**

**6.6.1** Specific details concerning requirements to carry and operate Mode C transponders, as well as exceptions and ATC authorized deviations from the requirements are found in 14 CFR Sections 91.215 and 99.12.

**6.6.2** In general, the CFR requires aircraft to be equipped with Mode C transponders when operating:

a) At or above 10,000 feet MSL over the 48 contiguous states or the District of Columbia, excluding that airspace below 2,500 feet AGL;

b) Within 30 miles of a Class B airspace primary airport, below 10,000 feet MSL. Balloons, gliders, and aircraft not equipped with an engine driven electrical system are excepted from the above requirements when operating below the floor of Class A airspace and/or; outside of Class B airspace and below the ceiling of the Class B airspace (or 10,000 feet MSL, whichever is lower);

c) Within and above all Class C airspace up to 10,000 feet MSL; or

d) Within 10 miles of certain designated airports from the surface to 10,000 feet MSL, excluding that airspace which is both outside Class D airspace and below 1,200 feet AGL. Balloons, gliders and aircraft not equipped with an engine driven electrical system are excepted from this requirement.

**6.6.3** 14 CFR Section 99.12 requires all aircraft flying into, within, or across the contiguous U.S. ADIZ be equipped with a Mode C or Mode S transponder. Balloons, gliders and aircraft not equipped with an engine driven electrical system are excepted from this requirement.

**6.6.4** Pilots shall ensure that their aircraft transponder is operating on an appropriate ATC assigned VFR/IFR code and Mode C when operating in such airspace. If in doubt about the operational status of either feature of your transponder while airborne, contact the nearest ATC facility or FSS and they will advise you what facility you should contact for determining the status of your equipment.

**6.6.5** In-flight requests for "immediate" deviation from the transponder requirements may be approved by controllers only when the flight will continue IFR or when weather conditions prevent VFR descent and

continued VFR flight in airspace not affected by the CFR. All other requests for deviation should be made by contacting the nearest FSS or air traffic facility in person or by telephone. The nearest ARTCC will normally be the controlling agency and is responsible for coordinating requests involving deviations in other ARTCC's areas.

### 6.7 Transponder Operation Under Visual Flight Rules (VFR)

**6.7.1** Unless otherwise instructed by an ATC Facility, adjust transponder to reply on Mode 3/A code 1200 regardless of altitude.

**6.7.2** Adjust transponder to reply on Mode C, with altitude reporting capability activated if the aircraft is so equipped, unless deactivation is directed by ATC or unless the installed equipment has not been tested and calibrated as required by 14 CFR Section 91.217. If deactivation is required and your transponder is so designed, turn off the altitude reporting switch and continue to transmit Mode C framing pulses. If this capability does not exist, turn off Mode C.

### 6.8 Radar Beacon Phraseology

**6.8.1** Air traffic controllers, both civil and military, will use the following phraseology when referring to operation of the ATCRBS. Instructions by ATC refer only to Mode A/3 or Mode C operations and do not affect the operation of the transponder on other modes.

**a) SQUAWK (number):** Operate radar beacon transponder on designated code in Mode A/3.

**b) IDENT:** Engage the "IDENT" feature (military I/P) of the transponder.

**c) SQUAWK (number) AND IDENT:** Operate transponder on specified code in Mode A/3 and engage the "IDENT" (military I/P) feature.

**d) SQUAWK STANDBY:** Switch transponder to standby position.

**e) SQUAWK LOW/NORMAL:** Operate transponder on low or normal sensitivity as specified. Transponder is operated in "NORMAL" position unless ATC specified "LOW." ("ON" is used instead of "NORMAL" as a master control label on some types of transponders.)

**f) SQUAWK ALTITUDE:** Activate Mode C with automatic altitude reporting.

**g) STOP ALTITUDE SQUAWK:** Turn off altitude reporting switch and continue transmitting Mode C framing pulses. If your equipment does not have this capability, turn off Mode C.

**h) STOP SQUAWK (mode in use):** Switch off specified mode. (Use for military aircraft when the controller is unaware if a military service requires the aircraft to continue operating on another mode.)

**i) STOP SQUAWK:** Switch off transponder.

**j) SQUAWK MAYDAY:** Operate transponder in the emergency position. (Mode A Code 7700 for civil transponder. Mode 3 Code 7700 and emergency feature for military transponder.)

**k) SQUAWK VFR:** Operate radar beacon transponder on code 1200 in the MODE A/3, or other appropriate VFR code.

## 7. Emergency Operation

**7.1** When an emergency occurs, the pilot of an aircraft equipped with a coded radar beacon transponder, who desires to alert a ground radar facility to an emergency condition and who cannot establish communications without delay with an ATC facility may adjust the transponder to reply on Mode A/3, Code 7700.

**7.2** Pilots should understand that they may not be within a radar coverage area and that, even if they are, certain radar facilities are not yet equipped to automatically recognize Code 7700 as an emergency signal. Therefore, they should establish radio communications with an ATC facility as soon as possible.

## 8. Radio Failure Operation

**8.1** Should the pilot of an aircraft equipped with a coded radar beacon transponder experience a loss of two-way radio capability the pilot should:

**a)** Adjust the transponder to reply on MODE A/3, Code 7600; and

**b)** The pilot should understand that the aircraft may not be in an area of radar coverage.

**8.2** Pilots should understand that they may not be in an area of radar coverage. Also many radar facilities are not presently equipped to automatically display code 7600 and will interrogate 7600 only when the aircraft is under direct radar control at the time of radio failure. However, replying on code 7700 first, increases the probability of early detection of a radio failure condition.

## 9. Radar Services

### 9.1 Safety Alert

**9.1.1** A safety alert will be issued to pilots of aircraft being controlled by ATC if the controller is aware the aircraft is at an altitude which, in the controller's judgment, places the aircraft in unsafe proximity to terrain, obstructions or other aircraft. The provision of this service is contingent upon the capability of the controller to have an awareness of situations involving unsafe proximity to terrain, obstructions and uncontrolled aircraft. The issuance of a safety alert cannot be mandated, but it can be expected on a reasonable, though intermittent, basis. Once the alert is issued, it is solely the pilot's prerogative to determine what course of action, if any, will be taken. This procedure is intended for use in time critical situations where aircraft safety is in question. Noncritical situations should be handled via the normal traffic alert procedures.

### 9.1.2 Terrain/Obstruction Alert

a) Controllers will immediately issue an alert to the pilots of aircraft under their control when they recognize that the aircraft is at an altitude which, in their judgment, may be in unsafe proximity to terrain/obstructions. The primary method of detecting unsafe proximity is through Mode C automatic altitude reports.

*EXAMPLE.—*  
*LOW ALTITUDE ALERT, CHECK YOUR ALTITUDE IMMEDIATELY, THE AS APPROPRIATE, MEA/MVA/MOCA IN YOUR AREA IS (ALTITUDE) OR, IF PAST THE FINAL APPROACH FIX (NONPRECISION APPROACH) OR THE OUTER MARKER OR FIX USED IN LIEU OF THE OUTER MARKER (PRECISION APPROACH), THE, AS APPROPRIATE, MDA/DH (IF KNOWN) IS (ALTITUDE).*

b) Terminal ARTS IIA, III, and IIIA facilities have an automated function which, if operating, alerts the controller when a tracked Mode C equipped aircraft under control is below or predicted to be below a predetermined minimum safe altitude. This function, called Minimum Safe Altitude Warning (MSAW), is designed solely as a controller aid in detecting potentially unsafe aircraft proximity to terrain/obstructions. The ARTS IIA, III, and IIIA facility will, when MSAW is operating, provide MSAW monitoring for all aircraft with an operating Mode C altitude encoding transponder that are tracked by the system and are:

- 1) Operating on a IFR flight plan; or
- 2) Operating VFR and have requested MSAW monitoring.

c) Terminal AN/TPX-42A (number beacon decoder system) facilities have an automated function called

Low Altitude Alert System (LAAS). Although not as sophisticated as MSAW, LAAS alerts the controller when a Mode C transponder equipped aircraft operating on a IFR flight plan is below a predetermined minimum safe altitude.

*NOTE.—*  
*PILOTS OPERATING VFR MAY REQUEST MSAW OR LAAS MONITORING IF THEIR AIRCRAFT ARE EQUIPPED WITH MODE C TRANSPONDERS.*

*EXAMPLE.—*  
*APACHE THREE THREE PAPA REQUESTS MSAW/LAAS.*

### 9.1.3 Aircraft Conflict Alert

a) Controllers will immediately issue an alert to the pilots of aircraft under their control if they are aware of an aircraft that is not under their control at an altitude which, in the controller's judgment, places both aircraft in unsafe proximity to each other. With the alert, when feasible, the controller will offer the pilot the position of the traffic if time permits and an alternate course(s) of action. Any alternate course of action the controller may recommend to the pilot will be predicated only on other traffic in the controller's jurisdiction.

*EXAMPLE.—*  
*AMERICAN THREE, TRAFFIC ALERT, (POSITION OF TRAFFIC, IF TIME PERMITS), ADVISE YOU TURN LEFT/RIGHT HEADING (DEGREES) AND/OR CLIMB/DESCENT TO (ALTITUDE) IMMEDIATELY.*

### 9.1.4 Radar Traffic Information Service (RTIS)

**9.1.4.1** This is a service provided by radar ATC facilities. Pilots receiving this service are advised of any radar target observed on the radar display which may be in such proximity to the position of their aircraft or its intended route of flight that it warrants their attention. This service is not intended to relieve the pilot of the responsibility for continual vigilance to see and avoid other aircraft.

#### a) Purpose of this service:

1) The issuance of traffic information as observed on a radar display is based on the principle of assisting and advising a pilot that a particular radar target's position and track indicates it may intersect or pass in such proximity to the intended flight path that it warrants the pilot's attention. This is to alert the pilot to the traffic, to be on the lookout for it, and thereby be in a better position to take appropriate action should the need arise.

2) Pilots are reminded that the surveillance radar used by ATC does not provide altitude information unless the aircraft is equipped with Mode C and the radar facility is capable of displaying altitude information.

**b) Provision of the service:**

1) Many factors, such as limitations of the radar, volume of traffic, controller workload and communications frequency congestion, could prevent the controller from providing this service. Controllers possess complete discretion for determining whether they are able to provide or continue to provide this service in a specific case. The controller's reason against providing or continuing to provide the service in a particular case is not subject to question nor need it be communicated to the pilot. In other words, the provision of this service is entirely dependent upon whether controllers believe they are in a position to provide it. Traffic information is routinely provided to all aircraft operating on IFR flight plans except when the pilot declines the service, or the pilot is operating within Class A airspace. Traffic information may be provided to flights not operating on IFR Flight Plans when requested by pilots of such flights.

**NOTE.—**  
RADAR ATC FACILITIES NORMALLY DISPLAY AND MONITOR BOTH PRIMARY AND SECONDARY RADAR WHEN IT IS AVAILABLE, EXCEPT THAT SECONDARY RADAR MAY BE USED AS THE SOLE DISPLAY SOURCE IN CLASS A AIRSPACE, AND UNDER SOME CIRCUMSTANCES OUTSIDE OF CLASS A AIRSPACE (BEYOND PRIMARY COVERAGE AND IN EN ROUTE AREAS WHERE ONLY SECONDARY IS AVAILABLE). SECONDARY RADAR MAY ALSO BE USED OUTSIDE CLASS A AIRSPACE AS THE SOLE DISPLAY SOURCE WHEN THE PRIMARY RADAR IS TEMPORARILY UNUSABLE OR OUT OF SERVICE. PILOTS IN CONTACT WITH THE AFFECTED ATC FACILITY ARE NORMALLY ADVISED WHEN A TEMPORARY OUTAGE OCCURS; I.E., "PRIMARY RADAR OUT OF SERVICE; TRAFFIC ADVISORIES AVAILABLE ON TRANSPONDER AIRCRAFT ONLY." THIS MEANS SIMPLY THAT ONLY THE AIRCRAFT WHICH HAVE TRANSPONDERS INSTALLED AND IN USE WILL BE DEPICTED ON ATC RADAR INDICATORS WHEN THE PRIMARY RADAR IS TEMPORARILY OUT OF SERVICE.

2) When receiving VFR radar advisory service, pilots should monitor the assigned frequency at all times. This is to preclude controllers' concern for radio failure of emergency assistance to aircraft under the controller's jurisdiction. VFR radar advisory service does not include vectors away from conflicting traffic unless requested by the pilot. When advisory service is no longer desired, advise the controller before changing frequencies, then change your transponder code to 1200 if applicable. THE, as appropriate, MEA/MVA/MOCA IN YOUR AREA IS (altitude) or if past the final approach fix, THE, as appropriate, MDA/DH (if known) is (altitude). Except in programs where radar service is automatically terminated, the controller will advise the aircraft when radar is terminated.

**NOTE.—**  
PARTICIPATION BY VFR PILOTS IN FORMAL PROGRAMS IMPLEMENTED AT CERTAIN TERMINAL LOCATIONS CONSTITUTES PILOT REQUEST. THIS ALSO APPLIES TO PARTICIPATING PILOTS AT

THOSE LOCATIONS WHERE ARRIVING VFR FLIGHTS ARE ENCOURAGED TO MAKE THEIR FIRST CONTACT WITH THE TOWER ON THE APPROACH CONTROL FREQUENCY.

**c) Issuance of Traffic Information:** Traffic information will include the following concerning a target which may constitute traffic for an aircraft that is:

**1) Radar identified:**

—Azimuth from the aircraft in terms of the twelve hour clock;

— When rapidly maneuvering civil test or military aircraft prevent accurate issuance of traffic as in a) above, specify the direction from an aircraft's position in terms of the eight cardinal compass points (N, NE, E, SE, S, SW, W, NW). This method shall be terminated at the pilot's request;

—Distance from the aircraft in nautical miles;

—Direction in which the target is proceeding; and

— Type of aircraft and altitude if known.

**EXAMPLE.—**  
TRAFFIC 10 O'CLOCK, 3 MILES, WEST-BOUND (TYPE AIRCRAFT AND ALTITUDE, IF KNOWN, OF THE OBSERVED TRAFFIC). THE ALTITUDE MAY BE KNOWN, BY MEANS OF MODE C, BUT NOT VERIFIED WITH THE PILOT FOR ACCURACY. (TO BE VALID FOR SEPARATION PURPOSES BY ATC, THE ACCURACY OF MODE C READOUTS MUST BE VERIFIED. THIS IS USUALLY ACCOMPLISHED UPON INITIAL ENTRY INTO THE RADAR SYSTEM BY A COMPARISON OF THE READOUT TO PILOT STATED ALTITUDE, OR THE FIELD ELEVATION IN THE CASE OF CONTINUOUS READOUT BEING RECEIVED FROM AN AIRCRAFT ON THE AIRPORT.) WHEN NECESSARY TO ISSUE TRAFFIC ADVISORIES CONTAINING UNVERIFIED ALTITUDE INFORMATION, THE CONTROLLER WILL ISSUE THE ADVISORY IN THE SAME MANNER AS IF IT WERE VERIFIED DUE TO THE ACCURACY OF THESE READOUTS. THE PILOT MAY, UPON RECEIPT OF TRAFFIC INFORMATION, REQUEST A VECTOR (HEADING) TO AVOID SUCH TRAFFIC. THE VECTOR WILL BE PROVIDED TO THE EXTENT POSSIBLE AS DETERMINED BY THE CONTROLLER PROVIDED THE AIRCRAFT TO BE VECTORED IS WITHIN THE AIRSPACE UNDER THE JURISDICTION OF THE CONTROLLER.

**2) Not radar identified:**

—Distance and direction with respect to a fix;

—Direction in which the target is proceeding; and

— Type of aircraft and altitude if known.

**EXAMPLE.—**  
TRAFFIC 8 MILES SOUTH OF THE AIRPORT NORTHEAST BOUND, (TYPE AIRCRAFT AND ALTITUDE IF KNOWN).

d) The examples depicted in FIG 1.6-2 and FIG 1.6-3 point out the possible error in the position of this traffic when it is necessary for a pilot to apply drift correction to maintain this track. This error could also occur in the event a change in course is made at the time radar traffic information is issued.

### Induced Error in Position of Traffic

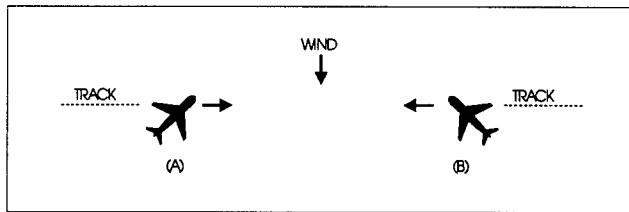

FIG 1.6-2

**EXAMPLE.—**

IN FIG 1.6-2, TRAFFIC INFORMATION WOULD BE ISSUED TO THE PILOT OF AIRCRAFT "A" AS 12 O'CLOCK. THE ACTUAL POSITION OF THE TRAFFIC AS SEEN BY THE PILOT OF AIRCRAFT "A" WOULD BE ONE O'CLOCK. TRAFFIC INFORMATION ISSUED TO AIRCRAFT "B" WOULD ALSO BE GIVEN AS 12 O'CLOCK, BUT IN THIS CASE, THE PILOT OF "B" WOULD SEE THE TRAFFIC AT 11 O'CLOCK.

### Induced Error in Position of Traffic

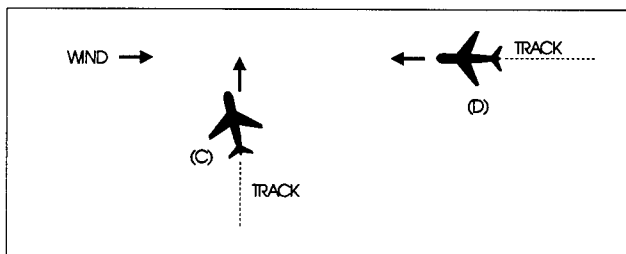

FIG 1.6-3

**EXAMPLE.—**

IN FIG 1.6-3, TRAFFIC INFORMATION WOULD BE ISSUED TO THE PILOT OF AIRCRAFT "C" AS TWO O'CLOCK. THE ACTUAL POSITION OF THE TRAFFIC AS SEEN BY THE PILOT OF AIRCRAFT "C" WOULD BE THREE O'CLOCK. TRAFFIC INFORMATION ISSUED TO AIRCRAFT "D" WOULD BE AT AN 11 O'CLOCK POSITION. SINCE IT IS NOT NECESSARY FOR THE PILOT OF AIRCRAFT "D" TO APPLY WIND CORRECTION (CRAB) TO REMAIN ON TRACK, THE ACTUAL POSITION OF THE TRAFFIC ISSUED WOULD BE CORRECT. SINCE THE RADAR CONTROLLER CAN ONLY OBSERVE AIRCRAFT TRACK (COURSE) ON THE RADAR DISPLAY, TRAFFIC ADVISORIES ARE ISSUED ACCORDINGLY, AND PILOTS SHOULD GIVE DUE CONSIDERATION TO THIS FACT WHEN LOOKING FOR REPORTED TRAFFIC.

## 10. Radar Assistance to VFR Aircraft

**10.1** Radar equipped FAA ATC facilities provide radar assistance and navigation service (vectors) to VFR aircraft provided the aircraft can communicate with the facility, are within radar coverage, and can be radar identified.

**10.2** Pilots should clearly understand that authorization to proceed in accordance with such radar navigational assistance does not constitute authorization for the pilot to violate Federal Aviation Regulations. In effect, assistance provided is on the basis that navigational guidance information issued is advisory in nature and the job of flying the aircraft safely remains with the pilot.

**10.3** In many cases, controllers will be unable to determine if flight into instrument conditions will result

from their instructions. To avoid possible hazards resulting from being vectored into IFR conditions, pilots should keep controllers advised of the weather conditions in which they are operating and along the course ahead.

**10.4** Radar navigation assistance (vectors) may be initiated by the controller when one of the following conditions exist:

- a) The controller suggests the vector and the pilot concurs;
- b) A special program has been established and vectoring service has been advertised; or
- c) In the controller's judgment the vector is necessary for air safety.

**10.5** Radar navigation assistance (vectors) and other radar derived information may be provided in response to pilot requests. Many factors, such as limitations of radar, volume of traffic, communications frequency, congestion, and controller workload could prevent the controller from providing it. Controllers have complete discretion for determining if they are able to provide the service in a particular case. Their decision not to provide the service in a particular case is not subject to question.

## 11. Terminal Radar Services for VFR Aircraft

### 11.1 Basic Radar Service:

a) In addition to the use of radar for the control of IFR aircraft, all commissioned radar facilities provide the following basic radar services for VFR aircraft:

- 1) Safety alerts;
- 2) Traffic advisories;
- 3) Limited radar vectoring (on a workload permitting basis); and
- 4) Sequencing at locations where procedures have been established for this purpose and/or when covered by a letter of agreement.

**NOTE.—**

WHEN THE STAGE SERVICES WERE DEVELOPED, TWO BASIC RADAR SERVICES (TRAFFIC ADVISORIES AND LIMITED VECTORING) WERE IDENTIFIED AS "STAGE I." THIS DEFINITION BECAME UNNECESSARY AND THE TERM "STAGE I" WAS ELIMINATED FROM USE. THE TERM "STAGE II" HAS BEEN ELIMINATED IN CONJUNCTION WITH THE AIRSPACE RECLASSIFICATION, AND SEQUENCING SERVICES TO LOCATIONS WITH LOCAL PROCEDURES AND/OR LETTERS OF AGREEMENT TO PROVIDE THIS SERVICE HAVE BEEN INCLUDED IN BASIC SERVICES TO VFR AIRCRAFT. THESE BASIC SERVICES WILL STILL BE PROVIDED BY ALL TERMINAL RADAR FACILITIES WHETHER THEY INCLUDE CLASS B, C, D, OR E AIRSPACE. "STAGE III" SERVICES HAVE BEEN REPLACED WITH "CLASS B" AND "TERMINAL RADAR SERVICE AREA" SERVICE WHERE APPLICABLE.

b) Vectoring service may be provided when requested by the pilot or with pilot concurrence when suggested by ATC.

c) Pilots of arriving aircraft should contact approach control on the publicized frequency and give their position, altitude, aircraft call sign, type aircraft, radar beacon code (if transponder equipped), destination, and request traffic information.

d) Approach control will issue wind and runway, except when the pilot states "have numbers" or this information is contained in the ATIS broadcast and the pilot states that the current ATIS information has been received. Traffic information is provided on a workload permitting basis. Approach control will specify the time or place at which the pilot is to contact the tower on local control frequency for further landing information. Radar service is automatically terminated upon being advised to contact the tower.

e) Sequencing for VFR aircraft is available at certain terminal locations (see locations listed in the Airport/Facility Directory). The purpose of the service is to adjust the flow of arriving VFR and IFR aircraft into the traffic pattern in a safe and orderly manner and to provide radar traffic information to departing VFR aircraft. Pilot participation is urged but is not mandatory. Traffic information is provided on a workload permitting basis. Standard radar separation between VFR or between VFR and IFR aircraft is not provided.

1) Pilots of arriving VFR aircraft should initiate radio contact on the publicized frequency with approach control when approximately 25 miles from the airport from which sequencing services are being provided. On initial contact by VFR aircraft, approach control will assume that sequencing service is requested. After radar contact is established, the pilot may use pilot navigation to enter the traffic pattern or, depending on traffic conditions, approach control may provide the pilot with routings or vectors necessary for proper sequencing with other participating VFR and IFR traffic en route to the airport. When a flight is positioned behind a preceding aircraft and the pilot reports having that aircraft in sight, the pilot will be instructed to follow the preceding aircraft. **THE ATC INSTRUCTION TO FOLLOW THE PRECEDING AIRCRAFT DOES NOT AUTHORIZE THE PILOT TO COMPLY WITH ANY ATC CLEARANCE OR INSTRUCTION ISSUED TO THE PRECEDING AIRCRAFT.** If other "nonparticipating" or "local" aircraft are in the traffic pattern, the tower will issue a landing sequence. Radar service will be continued to the runway. If an arriving aircraft does not want

the service, the pilot should state "NEGATIVE RADAR SERVICE" or make a similar comment, on initial contact with approach control.

2) Pilots of departing VFR aircraft are encouraged to request radar traffic information by notifying ground control on initial contact with their request and proposed direction of flight.

**EXAMPLE.—**

*XRAY GROUND CONTROL, NOVEMBER ONE EIGHT SIX, CESSNA ONE SEVENTY TWO, READY TO TAXI, VFR SOUTHBOUND, HAVE INFORMATION BRAVO AND REQUEST RADAR TRAFFIC INFORMATION.*

**NOTE.—**

*FOLLOWING TAKEOFF, THE TOWER WILL ADVISE WHEN TO CONTACT DEPARTURE CONTROL.*

3) Pilots of aircraft transiting the area and in radar contact/communication with approach control will receive traffic information on a controller workload permitting basis. Pilots of such aircraft should give their position, altitude, aircraft call sign, aircraft type, radar beacon code (if transponder equipped), destination, and/or route of flight.

**11.2 Terminal Radar Service Area (TRSA) Service (Radar Sequencing and Separation Service for VFR Aircraft in a TRSA):**

a) This service has been implemented at certain terminal locations. The service is advertised in the Airport/Facility Directory. The purpose of this service is to provide separation between all participating VFR aircraft and all IFR aircraft operating within the airspace defined as the TRSA. Pilot participation is urged but is not mandatory.

b) If any aircraft does not want the service, the pilot should state "NEGATIVE TRSA SERVICE" or make a similar comment, on initial contact with approach control or ground control, as appropriate.

c) TRSA's are depicted on sectional aeronautical charts and listed in the Airport/Facility Directory.

d) While operating within a TRSA, pilots are provided TRSA service and separation as prescribed in this paragraph. In the event of a radar outage, separation and sequencing of VFR aircraft will be suspended as this service is dependent on radar. The pilot will be advised that the service is not available and will be issued wind, runway information, and the time or place to contact the tower. Traffic information will be provided on a workload permitting basis.

e) Visual separation is used when prevailing conditions permit and it will be applied as follows:

1) When a VFR flight is positioned behind a preceding aircraft and the pilot reports having that aircraft in sight, the pilot will be instructed by ATC to follow the preceding aircraft. THE ATC INSTRUCTION TO FOLLOW THE PRECEDING AIRCRAFT DOES NOT AUTHORIZE THE PILOT TO COMPLY WITH ANY ATC CLEARANCE OR INSTRUCTION ISSUED TO THE PRECEDING AIRCRAFT. Radar service will be continued to the runway.

2) If other "nonparticipating" or "local" aircraft are in the traffic pattern, the tower will issue a landing sequence.

3) Departing VFR aircraft may be asked if they can visually follow a preceding departure out of the TRSA. The pilot will be instructed to follow the other aircraft provided that the pilot can maintain visual contact with that aircraft.

f) VFR aircraft will be separated from VFR/IFR aircraft by one of the following:

- 1) 500 feet vertical separation;
- 2) Visual separation; or

3) Target resolution (a process to ensure that correlated radar targets do not touch) when using broadband radar systems.

g) Participating pilots operating VFR in a TRSA:

1) Must maintain an altitude when assigned by ATC unless the altitude assignment is to maintain at or below a specified altitude. ATC may assign altitudes for separation that do not conform to 14 CFR Section 91.159. When the altitude assignment is no longer needed for separation or when leaving the TRSA, the instruction will be broadcast, "RESUME APPROPRIATE VFR ALTITUDES." Pilots must then return to an altitude that conforms to 14 CFR Section 91.159 as soon as practicable; or

2) When not assigned an altitude, the pilot should coordinate with ATC prior to any altitude change.

h) Within the TRSA, traffic information on observed but unidentified targets will, to the extent possible, be provided to all IFR and participating VFR aircraft. The pilot will be vectored upon request to avoid the observed traffic, provided the aircraft to be vectored is within the airspace under the jurisdiction of the controller.

i) Departing aircraft should inform ATC of their intended destination and/or route of flight and proposed cruising altitude.

j) ATC will normally advise participating VFR aircraft when leaving the geographical limits of the TRSA. Radar service is not automatically terminated with this advisory unless specifically stated by the controller.

**11.3 Class C Service:** This service provides, in addition to basic radar service, approved separation between IFR and VFR aircraft, and sequencing of VFR arrivals to the primary airport.

**11.4 Class B Service:** This service provides, in addition to basic radar service, approved separation of aircraft based on IFR, VFR, and/or weight, and sequencing of VFR arrivals to the primary airport(s).

**11.5 PILOT RESPONSIBILITY:** THESE SERVICES ARE NOT TO BE INTERPRETED AS RELIEVING PILOTS OF THEIR RESPONSIBILITIES TO SEE AND AVOID OTHER TRAFFIC OPERATING IN BASIC VFR WEATHER CONDITIONS, TO ADJUST THEIR OPERATIONS AND FLIGHT PATH AS NECESSARY TO PRECLUDE SERIOUS WAKE ENCOUNTERS, TO MAINTAIN APPROPRIATE TERRAIN AND OBSTRUCTION CLEARANCE, OR TO REMAIN IN WEATHER CONDITIONS EQUAL TO OR BETTER THAN THE MINIMUMS REQUIRED BY 14 CFR SECTION 91.155. WHENEVER COMPLIANCE WITH AN ASSIGNED ROUTE, HEADING AND/OR ALTITUDE IS LIKELY TO COMPROMISE PILOT RESPONSIBILITY RESPECTING TERRAIN AND OBSTRUCTION CLEARANCE, VORTEX EXPOSURE, AND WEATHER MINIMUMS, APPROACH CONTROL SHOULD BE SO ADVISED AND A REVISED CLEARANCE OR INSTRUCTION OBTAINED.

**11.6** ATC services for VFR aircraft participating in terminal radar services are dependent on ATC radar. Services for VFR aircraft are not available during periods of radar outage and are limited during CENRAP operations. The pilot will be advised when VFR services are limited or not available.

**NOTE.—**

CLASS B AND CLASS C AIRSPACE ARE AREAS OF REGULATED AIRSPACE. THE ABSENCE OF ATC RADAR DOES NOT NEGATE THE REQUIREMENT OF AN ATC CLEARANCE TO ENTER CLASS B AIRSPACE OR TWO-WAY RADIO CONTACT WITH ATC TO ENTER CLASS C AIRSPACE.



## 12. Tower En Route Control (TEC)

**12.1** TEC is an ATC program to provide a service to aircraft proceeding to and from metropolitan areas. It links designated approach control areas by a network of identified routes made up of the existing airway structure of the National Airspace System. The FAA has initiated an expanded TEC program to include as many facilities as possible. The program's intent is to provide an overflow resource in the low altitude system which would enhance ATC services. A few facilities have historically allowed turbojets to proceed between certain city pairs, such as Milwaukee and Chicago, via tower en route and these locations may continue this service. However, the expanded TEC program will be applied, generally, for nonturbojet aircraft operating at and below 10,000 feet. The program is entirely within the approach control airspace of multiple terminal facilities. Essentially, it is for relatively short flights. Participating pilots are encouraged to use TEC for flights of 2 hours duration or less. If longer flights are planned, extensive coordination may be required with the multiple complex which could result in unanticipated delays.

**12.2** Pilots requesting TEC are subject to the same delay factor at the destination airport as other aircraft in the ATC system. In addition, departure and en route delays may occur depending upon individual facility workload. When a major metropolitan airport is incurring

significant delays, pilots in the TEC program may want to consider an alternative airport experiencing no delay.

**12.3** There are no unique requirements upon pilots to use the TEC program. Normal flight plan filing procedures will ensure proper flight plan processing. Pilots should include the acronym "TEC" in the remarks selection of the flight plan when requesting tower en route.

**12.4** All approach controls in the system may not operate up to the maximum TEC altitude of 10,000 feet. IFR flight may be planned to any satellite airport in proximity to the major primary airport via the same routing.

## 13. Services in Offshore Controlled Airspace

**13.1** Flights which operate between the U.S. 3-mile territorial limit and the adjoining oceanic controlled airspace/flight information region (CTA/FIR) boundaries generally operate in airspace designated by federal regulation as "controlled airspace," or "offshore controlled airspace."

**13.2** Within the designated areas ATC radar surveillance, ground based navigational signal coverage, and air/ground communications are capable of supporting air traffic services comparable to those provided over U.S. domestic controlled airspace.

**13.3** Pilots should be aware that domestic procedures will be applied in offshore controlled airspace to both VFR and IFR aircraft using ATC services.

ARTS III Radar Scope With Alphanumeric Data

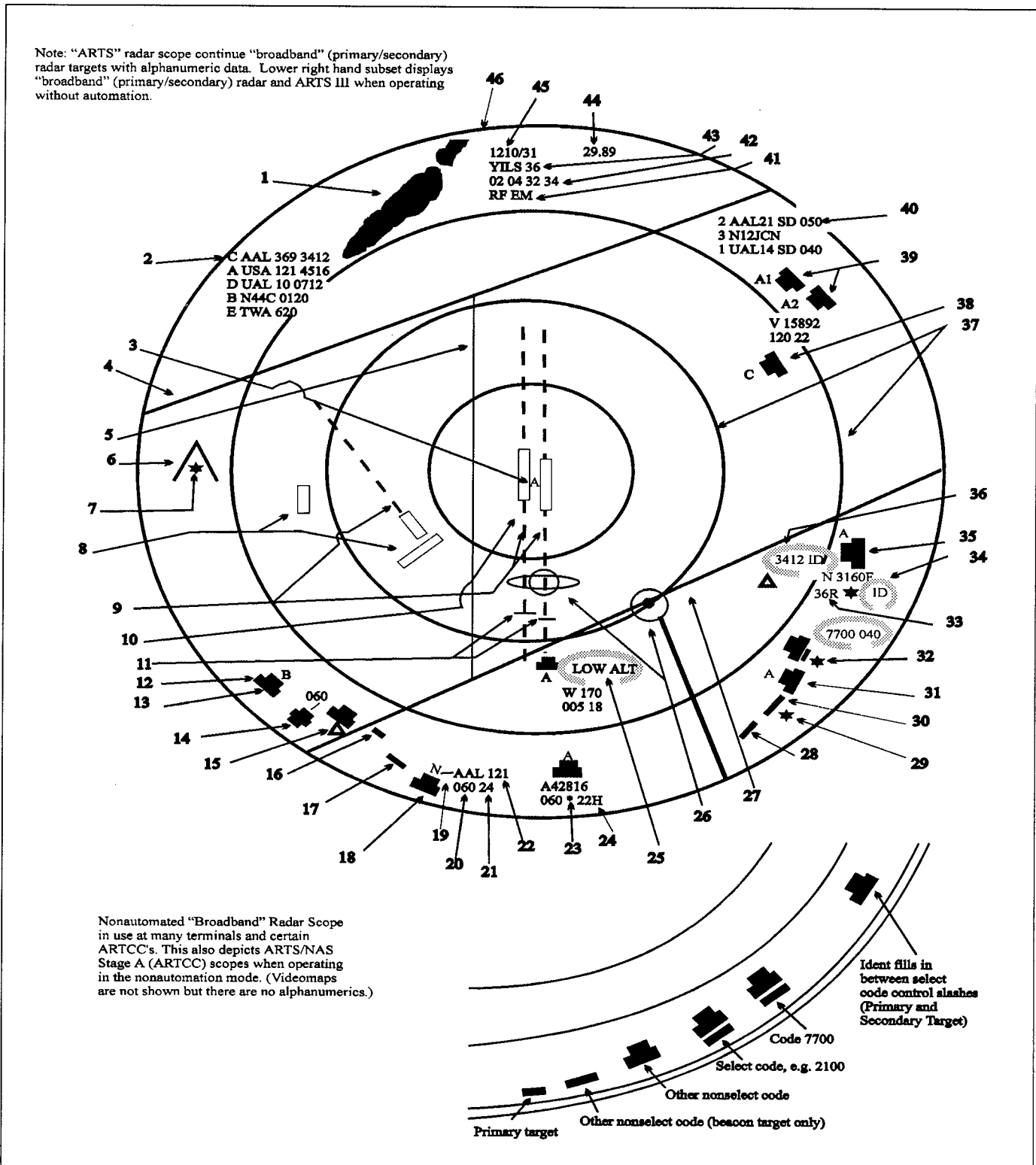

**NOTE.—**  
A NUMBER OF RADAR TERMINALS DO NOT HAVE ARTS EQUIPMENT. THOSE FACILITIES AND CERTAIN ARTCC'S OUTSIDE THE CONTIGUOUS UNITED STATES WOULD HAVE RADAR DISPLAYS SIMILAR TO THE LOWER RIGHT HAND SUBSET. ARTS FACILITIES AND NAS STAGE A ARTCC'S, WHEN OPERATING IN THE NONAUTOMATION MODE, WOULD ALSO HAVE SIMILAR DISPLAYS AND CERTAIN SERVICES BASED ON AUTOMATION MAY NOT BE AVAILABLE.

**EXAMPLE.—**

1. AREAS OF PRECIPITATION (CAN BE REDUCED BY CP)
2. ARRIVAL/DEPARTURE TABULAR LIST
3. TRACKBALL (CONTROL) POSITION SYMBOL (A)
4. AIRWAY (LINES ARE SOMETIMES DELETED IN PART)
5. RADAR LIMIT LINE FOR CONTROL
6. OBSTRUCTION (VIDEO MAP)
7. PRIMARY RADAR RETURNS OF OBSTACLES OR TERRAIN (CAN BE REMOVED BY MTI)
8. SATELLITE AIRPORTS
9. RUNWAY CENTERLINES (MARKS AND SPACES INDICATE MILES)
10. PRIMARY AIRPORT WITH PARALLEL RUNWAYS
11. APPROACH GATES
12. TRACKED TARGET (PRIMARY AND BEACON TARGET)
13. CONTROL POSITION SYMBOL
14. UNTRACKED TARGET SELECT CODE (MONITORED) WITH MODE C READOUT OF 5000'
15. UNTRACKED TARGET WITHOUT MODE C
16. PRIMARY TARGET
17. BEACON TARGET ONLY (SECONDARY RADAR) (TRANSPONDER)
18. PRIMARY AND BEACON TARGET
19. LEADER LINE
20. ALTITUDE MODE C READOUT IS 6000' (NOTE: READOUTS MAY NOT BE DISPLAYED BECAUSE OF NONRECEIPT OF BEACON INFORMATION, GARBLED BEACON SIGNALS, AND FLIGHT PLAN DATA WHICH IS DISPLAYED ALTERNATELY WITH THE ALTITUDE READOUT)
21. GROUND SPEED READOUT IS 240 KNOTS (NOTE: READOUTS MAY NOT BE DISPLAYED BECAUSE OF A LOSS OF BEACON SIGNAL, A CONTROLLER ALERT THAT A PILOT WAS SQUAWKING EMERGENCY, RADIO FAILURE, ETC.)
22. AIRCRAFT ID
23. ASTERISK INDICATES A CONTROLLER ENTRY IN MODE C BLOCK. IN THIS CASE 5000' IS ENTERED AND "05" WOULD ALTERNATE WITH MODE C READOUT
24. INDICATES HEAVY
25. "LOW ALT" FLASHES TO INDICATE WHEN AN AIRCRAFT'S PREDICTED DESCENT PLACES THE AIRCRAFT IN AN UNSAFE PROXIMITY TO TERRAIN. (NOTE: THIS FEATURE DOES NOT FUNCTION IF THE AIRCRAFT IS NOT SQUAWKING MODE C. WHEN A HELICOPTER OR AIRCRAFT IS KNOWN TO BE OPERATING BELOW THE LOWER SAFE LIMIT, THE "LOW ALT" CAN BE CHANGED TO "INHIBIT" AND FLASHING CEASES)
26. NAVAIDS
27. AIRWAYS
28. PRIMARY TARGET ONLY
29. NONMONITORED. NO MODE C (AN ASTERISK WOULD INDICATE NONMONITORED WITH MODE C)
30. BEACON TARGET ONLY (SECONDARY RADAR BASED ON AIRCRAFT TRANSPONDER)
31. TRACKED TARGET (PRIMARY AND BEACON TARGET) CONTROL POSITION A
32. AIRCRAFT IS SQUAWKING EMERGENCY CODE 7700 AND IS NONMONITORED, UNTRACKED, MODE C
33. CONTROLLER ASSIGNED RUNWAY 36 RIGHT ALTERNATES WITH MODE C READOUT (NOTE: A THREE LETTER IDENTIFIER COULD ALSO INDICATE THE ARRIVAL IS AT SPECIFIC AIRPORT)
34. IDENT FLASHES
35. IDENTING TARGET BLOSSOMS
36. UNTRACKED TARGET IDENTING ON A SELECTED CODE
37. RANGE MARKS (10 AND 15 MILES) (CAN BE CHANGED/OFFSET)
38. AIRCRAFT CONTROLLED BY CENTER
39. TARGETS IN SUSPEND STATUS
40. COAST/SUSPEND LIST (AIRCRAFT HOLDING, TEMPORARY LOSS OF BEACON/TARGET, ETC.)
41. RADIO FAILURE (EMERGENCY INFORMATION)
42. SELECT BEACON CODES (BEING MONITORED)
43. GENERAL INFORMATION (ATIS, RUNWAY, APPROACH IN USE)
44. ALTIMETER SETTING
45. TIME
46. SYSTEM DATA AREA

FIG 1.6-5 illustrates the controller's radar scope (PVD) when operating in the full automation (RDP) mode, which is normally 20 hours per day. When not in automation mode, the display is similar to the

broadband mode shown in the ARTS III Radar Scope (FIG 1.6-4). Certain ARTCC's outside the contiguous United States also operate in "broadband" mode.

NAS Stage A Controller's View Plan Display

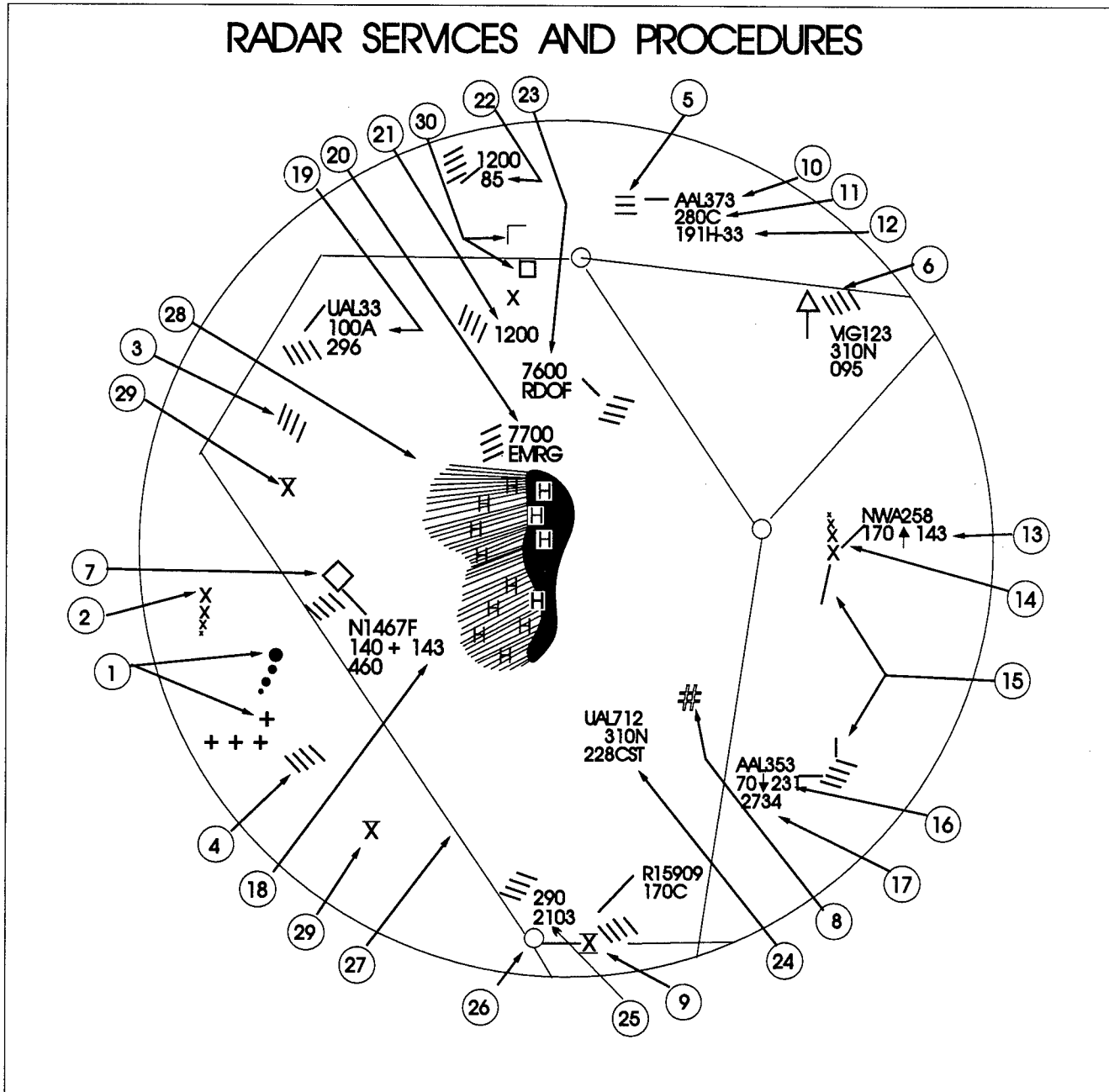

FIG 1.6-5

**EXAMPLE.—**

**TARGET SYMBOLS:**

1. UNCORRELATED PRIMARY RADAR TARGET [●] [+]
2. CORRELATED PRIMARY RADAR TARGET [×] \*See Note.
3. UNCORRELATED BEACON TARGET [ / ]
4. CORRELATED BEACON TARGET [ \ ]
5. IDENTIFYING BEACON TARGET [≡]

\*Note: In Number 2. Correlated Means The Association Of Radar Data With The Computer Projected Track Of An Identified Aircraft.

**POSITION SYMBOLS:**

6. FREE TRACK (NO FLIGHT PLAN TRACKING) [Δ]
7. FLAT TRACK (FLIGHT PLAN TRACKING) [◇]
8. COAST (BEACON TARGET LOST) [#]
9. PRESENT POSITION HOLD [⊠]

**DATA BLOCK INFORMATION:**

10. AIRCRAFT IDENT \*\*See Note.
11. ASSIGNED ALTITUDE FL 280, MODE C ALTITUDE SAME OR WITHIN ± 200' OF ASSIGNED ALTITUDE. \*\*See Note.
12. COMPUTER ID #191, HANDOFF IS TO SECTOR 33 (0-33 WOULD MEAN HANDOFF ACCEPTED) \*\*See Note.
13. ASSIGNED ALTITUDE 17,000', AIRCRAFT IS CLIMBING, MODE C READOUT WAS 14,300 WHEN LAST BEACON INTERROGATION WAS RECEIVED.
14. LEADER LINE CONNECTING TARGET SYMBOL AND DATA BLOCK.
15. TRACK VELOCITY AND DIRECTION VECTOR LINE (PROJECTED AHEAD OF TARGET)
16. ASSIGNED ALTITUDE 7000; AIRCRAFT IS DESCENDING, LAST MODE C READOUT (OR LAST REPORTED ALTITUDE) WAS 100'

ABOVE FL 230

17. TRANSPONDER CODE SHOWS IN FULL DATA BLOCK ONLY WHEN DIFFERENT THAN ASSIGNED CODE
  18. AIRCRAFT IS 300' ABOVE ASSIGNED ALTITUDE
  19. REPORTED ALTITUDE (NO MODE C READOUT) SAME AS ASSIGNED. (AN "N" WOULD INDICATE NO REPORTED ALTITUDE.)
  20. TRANSPONDER SET ON EMERGENCY CODE 7700 (EMRG FLASHES TO ATTRACT ATTENTION)
  21. TRANSPONDER CODE 1200 (VFR) WITH NO MODE C
  22. CODE 1200 (VFR) WITH MODE C AND LAST ALTITUDE READOUT
  23. TRANSPONDER SET ON RADIO FAILURE CODE 7600 (RDOF FLASHES)
  24. COMPUTER ID #228, CST INDICATES TARGET IS IN COAST STATUS
  25. ASSIGNED ALTITUDE FL 290, TRANSPONDER CODE (THESE TWO ITEMS CONSTITUTE A "LIMITED DATA BLOCK")
- \*\*Note: NUMBERS 10., 11., AND 12. CONSTITUTE A "FULL DATA BLOCK"

**OTHER SYMBOLS:**

26. NAVIGATIONAL AID
27. AIRWAY OR JET ROUTE
28. OUTLINE OF WEATHER RETURNS BASED ON PRIMARY RADAR. "H" REPRESENTS AREAS OF HIGH DENSITY PRECIPITATION WHICH MIGHT BE THUNDERSTORMS. RADIAL LINES INDICATED LOWER DENSITY PRECIPITATION.
29. OBSTRUCTION
30. AIRPORTS  
Major: □  
Small: ▣



## ENR 1.7 Altimeter Setting Procedures

### 1. General

1.1 The accuracy of aircraft altimeters is subject to the following factors:

- a) Nonstandard temperature of the atmosphere.
- b) Nonstandard atmospheric pressure.
- c) Aircraft static pressure systems (position error).
- d) Instrument error.

1.2 EXTREME CAUTION SHOULD BE EXERCISED WHEN FLYING IN PROXIMITY TO OBSTRUCTIONS OR TERRAIN IN LOW TEMPERATURES AND PRESSURES. This is especially true in extremely cold temperatures that cause a large differential between the Standard Day temperature and actual temperature. This circumstance can cause serious errors that result in the aircraft being significantly lower than the indicated altitude.

*NOTE.—*  
STANDARD TEMPERATURE AT SEA LEVEL IS 15 DEGREES CELSIUS (59 DEGREES FAHRENHEIT). THE TEMPERATURE GRADIENT FROM SEA LEVEL IS MINUS 2 DEGREES CELSIUS (3.6 DEGREES FAHRENHEIT) PER 1,000 FEET. PILOTS SHOULD APPLY CORRECTIONS FOR STATIC PRESSURE SYSTEMS AND/OR INSTRUMENTS, IF APPRECIABLE ERRORS EXIST.

1.3 The adoption of a standard altimeter setting at the higher altitudes eliminates station barometer errors, some altimeter instrument errors, and errors caused by altimeter settings derived from different geographical sources.

### 2. Procedures

2.1 The cruising altitude or flight level of aircraft shall be maintained by reference to an altimeter which shall be set, when operating:

#### 2.1.1 Below 18,000 feet MSL:

a) **When the barometric pressure is 31.00 inches Hg. or less:** to the current reported altimeter setting of a station along the route and within 100 NM of the aircraft, or if there is no station within this area, the current reported altimeter setting of an appropriate available station. When an aircraft is en route on an instrument flight plan, air traffic controllers will furnish this information to the pilot at least once while the aircraft is in the controller's area of jurisdiction. In the case of an aircraft not equipped with a radio, set to the

elevation of the departure airport or use an appropriate altimeter setting available prior to departure.

b) **When the barometric pressure exceeds 31.00 inches Hg.:** the following procedures will be placed in effect by NOTAM defining the geographic area affected:

1) **For all aircraft:** Set 31.00 inches for en route operations below 18,000 feet MSL. Maintain this setting until beyond the affected area or until reaching final approach segment. At the beginning of the final approach segment, the current altimeter setting will be set, if possible. If not possible, 31.00 inches will remain set throughout the approach. Aircraft on departure or missed approach will set 31.00 inches prior to reaching any mandatory/crossing altitude or 1,500 feet AGL, whichever is lower. (Air traffic control will issue actual altimeter settings and advise pilots to set 31.00 inches in their altimeters for en route operations below 18,000 feet MSL in affected areas.)

2) During preflight, barometric altimeters shall be checked for normal operation to the extent possible.

3) For aircraft with the capability of setting the current altimeter setting and operating into airports with the capability of measuring the current altimeter setting, no additional restrictions apply.

4) For aircraft operating VFR, there are no additional restrictions; however, extra diligence in flight planning and in operating in these conditions is essential.

5) Airports unable to accurately measure barometric pressures above 31.00 inches of Hg. will report the barometric pressure as "missing" or "in excess of 31.00 inches of Hg." Flight operations to and from those airports are restricted to VFR weather conditions.

6) For aircraft operating IFR and unable to set the current altimeter setting, the following restrictions apply:

—To determine the suitability of departure alternate airports, destination airports, and destination alternate airports, increase ceiling requirements by 100 feet and visibility requirements by  $\frac{1}{4}$  statute mile for each  $\frac{1}{10}$  of an inch of Hg., or any portion thereof, over 31.00 inches. These adjusted values are then applied in accordance with the requirements of the applicable operating regulations and operations specifications.

**EXAMPLE.—**  
DESTINATION ALTIMETER IS 31.28 INCHES, ILS DH 250 FEET (200-<sup>1</sup>/<sub>2</sub>). WHEN FLIGHT PLANNING, ADD 300-<sup>3</sup>/<sub>4</sub> TO THE WEATHER REQUIREMENTS WHICH WOULD BECOME 500-1 <sup>1</sup>/<sub>4</sub>.

—On approach, 31.00 inches will remain set. Decision height or minimum descent altitude shall be deemed to have been reached when the published altitude is displayed on the altimeter.

**NOTE.—**  
ALTHOUGH VISIBILITY IS NORMALLY THE LIMITING FACTOR ON AN APPROACH, PILOTS SHOULD BE AWARE THAT WHEN REACHING DH THE AIRCRAFT WILL BE HIGHER THAN INDICATED. USING THE EXAMPLE ABOVE THE AIRCRAFT WOULD BE APPROXIMATELY 300 FEET HIGHER.

— These restrictions do not apply to authorized Category II and III ILS operations nor do they apply to certificate holders using approved QFE altimetry systems.

c) The FAA Regional Flight Standards Division Manager of the affected area is authorized to approve temporary waivers to permit emergency resupply or emergency medical service operation.

**2.1.2 At or above 18,000 feet MSL:** to 29.92' Hg (standard setting). The lowest usable flight level is determined by the atmospheric pressure in the area of operation, as shown in TBL 1.7-1.

**Lowest Usable Flight Level**

Altimeter Setting (Current Reported)	Lowest Usable Flight Level
29.92 or higher	180
29.91 to 29.42	185
29.41 to 28.92	190
28.91 to 28.42	195
28.41 to 27.92	200

TBL 1.7-1

**2.1.3** Where the minimum altitude, as prescribed in 14 CFR Parts 91.159 and 91.119, is above 18,000 feet MSL the lowest usable flight level shall be the flight level equivalent of the minimum altitude plus the number of feet specified in TBL 1.7-2.

**Lowest Flight Level Correction Factor**

Altimeter Setting	Correction Factor
29.92 or higher	none
29.91 to 29.42	500 feet
29.41 to 28.92	1000 feet
28.91 to 28.42	1500 feet
28.41 to 27.92	2000 feet
27.91 to 27.42	2500 feet

TBL 1.7-2

**EXAMPLE.—**  
THE MINIMUM SAFE ALTITUDE OF A ROUTE IS 19,000 FEET MSL AND THE ALTIMETER SETTING IS REPORTED BETWEEN 29.92 AND 29.42 HG., THE LOWEST USABLE FLIGHT LEVEL WILL BE 195, WHICH IS THE FLIGHT LEVEL EQUIVALENT OF 19,500 FEET MSL (MINIMUM ALTITUDE PLUS 500 FEET).

**2.1.4** Aircraft operating in an offshore CONTROL AREA should use altimeter setting procedures as described above, unless directed otherwise by ATC.

**NOTE.—**  
AIRCRAFT EXITING THE OCEANIC CTA/FIR DESTINED FOR THE U.S. OR TRANSITIONING THROUGH U.S. OFFSHORE CONTROL AREAS SHOULD USE THE CURRENT REPORTED ALTIMETER OF A STATION NEAREST TO THE ROUTE BEING FLOWN. WHEN ENTERING AN OCEANIC CTA/FIR FROM U.S. OFFSHORE CONTROL AREAS, PILOTS SHOULD CHANGE TO THE STANDARD ALTIMETER SETTING 29.92.

**3. Altimeter Errors**

**3.1** Most pressure altimeters are subject to mechanical, elastic, temperature, and installation errors. (Detailed information regarding the use of pressure altimeters is found in the Instrument Flying Handbook, Chapter IV.) Although manufacturing and installation specification, as well as the periodic test and inspections required by regulations (14 CFR Part 43, Appendix E), act to reduce these errors--any scale error may be observed in the following manner:

a) Set the current reported altimeter setting on the altimeter setting scale.

b) Altimeter should now read field elevation if you are located on the same reference level used to establish the altimeter setting.

c) Note the variation between the known field elevation and the altimeter indication. If this variation is in the order of plus or minus 75 feet, the accuracy of the altimeter is questionable and the problem should be referred to an appropriately rated repair station for evaluation and possible correction.

**3.2** Once in flight, it is very important to obtain frequently current altimeter settings en route. If you do not reset your altimeter when flying from an area of high pressure into an area of low pressure, your aircraft will



be closer to the surface than your altimeter indicates. An inch error in the altimeter setting equals 1,000 feet of altitude. To quote an old saying: "GOING FROM A HIGH TO A LOW, LOOK OUT BELOW."

**3.3** Temperature also has an effect on the accuracy of altimeters and your altitude. The crucial values to consider are standard temperature versus the ambient (at altitude) temperature. It is this "difference" that causes the error in indicated altitude. When the air is warmer than standard, you are higher than your altimeter indicates. Subsequently, when the air is colder than standard you are lower than indicated. It is the magnitude of this "difference" that determines the magnitude of the error. When flying into a cooler air mass while maintaining a constant indicated altitude, you are losing true altitude. However, flying into a cooler air mass does not necessarily mean you will be lower than indicated if the difference is still on the plus side. For example, while flying at 10,000 feet (where STANDARD temperature is -5 degrees Celsius (C)), the outside air temperature cools from +5 degrees C to 0 degrees C, the temperature error will nevertheless cause the aircraft to be HIGHER than indicated. It is the extreme "cold" difference that normally would be of concern to the pilot. Also, when flying in cold conditions over mountainous country, the pilot should exercise caution in flight planning both in regard to route and altitude to ensure adequate en route terrain clearance.

**3.4** The possible result of the above situation is obvious, particularly if operating at the minimum altitude or when conducting an instrument approach. If the altimeter is in error you may still be on instruments when reaching the minimum altitude (as indicated on the al-

timeter), whereas you might have been in the clear and able to complete the approach if the altimeter setting was correct.

#### **4. High Barometric Pressure**

**4.1** Cold, dry air masses may produce barometric pressures in excess of 31.00 inches of Mercury, and many altimeters do not have an accurate means of being adjusted for settings of these levels. As noted in paragraph 3.2, when the altimeter cannot be set to the higher pressure setting the aircraft actual altitude will be higher than the altimeter indicates.

**4.2** When the barometric pressure exceeds 31.00 inches, air traffic controllers will issue the actual altimeter setting, and:

**a) En Route/Arrivals:** Advise pilots to remain set on 31.00 inches until reaching the final approach segment.

**b) Departures:** Advise pilots to set 31.00 inches prior to reaching any mandatory/crossing altitude or 1,500 feet, whichever is lower.

**4.3** The altimeter error caused by the high pressure will be in the opposite direction to the error caused by the cold temperature.

#### **5. Low Barometric Pressure**

**5.1** When abnormally low barometric pressure conditions occur (below 28.00), flight operations by aircraft unable to set the actual altimeter setting are not recommended.

**NOTE.—**  
THE TRUE ALTITUDE OF THE AIRCRAFT IS LOWER THAN THE INDICATED ALTITUDE IF THE PILOT IS UNABLE TO SET THE ACTUAL ALTIMETER SETTING.



**ENR 1.8 [RESERVED]**



---

**ENR 1.9 [RESERVED]**



## ENR 1.10 Flight Planning (Restriction, Limitation or Advisory Information)

### 1. Preflight Preparation

**1.1** Every pilot is urged to receive a preflight briefing and to file a flight plan. This briefing should consist of the latest or most current weather, airport, and en route NAVAID information. Briefing service may be obtained from a flight service station (FSS) either by telephone or interphone, by radio when airborne, or by a personal visit to the station. In the 48 contiguous States, pilots with a current FAA medical certificate may access toll-free the Direct User Access Terminal System (DUATS) through a personal computer. DUATS will provide alpha-numeric preflight weather data and allow pilots to file domestic VFR and IFR flight plans.

**REFERENCE-**  
GEN 3.5, PARAGRAPH 3.5.3.3 LISTS DUATS VENDORS.

**NOTE.—**  
PILOTS FILING FLIGHT PLANS VIA "FAST FILE" WHO DESIRE TO HAVE THEIR BRIEFING RECORDED, SHOULD INCLUDE A STATEMENT AT THE END OF THE RECORDING AS TO THE SOURCE OF THEIR WEATHER BRIEFING.

**1.2** The information required by the FAA to process flight plans is contained on FAA Form 7233-1, Flight Plan. The forms are available at all flight service stations.

**REFERENCE-**  
AIP, ENR 1.10, PARAGRAPH 4, FLIGHT PLAN REQUIREMENTS.

**1.3** Consult an FSS or Weather Service Office (WSO) for a preflight weather briefing. Supplemental Weather Service Locations (SWSL's) do not provide weather briefings.

**1.4** FSS's are required to advise of pertinent NOTAM's if a standard briefing is requested, but if they are overlooked, don't hesitate to remind the specialist that you have not received NOTAM information. Additionally, NOTAM's which are known in sufficient time for publication and are of 7 days duration or longer are normally incorporated into the Notices to Airmen publication and carried there until cancellation time. FDC NOTAM's, which apply to instrument flight procedures, are also included in Notices to Airmen publication up to and including the number indicated in the FDC NOTAM legend. These NOTAM's are not provided during a briefing unless specifically requested by the pilot since the FSS specialist has no way of knowing whether the pilot has already checked Notices to Airmen publication prior to calling. Remember to ask for NOTAM's

contained in the Notices to Airmen publication as they are not normally furnished during your briefing.

**1.5** Pilots are urged to use only the latest issue of aeronautical charts in planning and conducting flight operations. Aeronautical charts are revised and reissued on a periodic basis to ensure that depicted data are current and reliable. In the conterminous United States, sectional charts are updated each 6 months, IFR en route charts each 56 days, and amendments to civil IFR approach charts are accomplished on a 56-day cycle with a change notice volume issued on the 28-day mid-cycle. Charts that have been superseded by those of a more recent date may contain obsolete or incomplete flight information.

**REFERENCE-**  
AIP, GEN 3.2, CONTAINS A DESCRIPTION OF AERONAUTICAL CHARTS.

**1.6** When requesting a preflight briefing, identify yourself as a pilot and provide the following:

- a) Type of flight planned; e.g., VFR or IFR.
- b) Aircraft number or pilot's name.
- c) Aircraft type.
- d) Departure airport.
- e) Route of flight.
- f) Destination.
- g) Flight altitude(s).
- h) ETD and ETE.

**1.7** Prior to conducting a briefing, briefers are required to have the background information listed above so that they may tailor the briefing to the needs of the proposed flight. The objective is to communicate a "picture" of meteorological and aeronautical information necessary for the conduct of a safe and efficient flight. Briefers use all available weather and aeronautical information to summarize data applicable to the proposed flight. They do not read weather reports and forecasts verbatim unless specifically requested by the pilot.

**REFERENCE-**  
SEE AIP, GEN 3.5 FOR METEOROLOGICAL SERVICES.

**1.8** The Federal Aviation Administration has designated High Density Traffic Airports (HDTA) and has prescribed air traffic rules and requirements for operating aircraft (excluding helicopter operations) to and from these airports.

**REFERENCE-**  
AIP, GEN 3.3, PARAGRAPH 9.7, AIRPORT RESERVATIONS OPERATIONS AND PROCEDURES.

**1.9** In addition to the filing of a flight plan, if the flight will traverse or land in one or more foreign countries, it is particularly important that pilots leave a complete itinerary with someone directly concerned and keep that person advised of the flight's progress. If serious doubt arises as to the safety of the flight, that person should first contact the FSS.

**1.10** Pilots operating aircraft under the provisions of 14 CFR Part 135 and not having an FAA assigned 3-letter designator, are urged to prefix the normal aircraft registration (N) number with the letter "T" on flight plan filing.

**EXAMPLE.—**  
TN 1234B.

**2. Follow IFR Procedures Even When Operating VFR**

**2.1** To maintain IFR proficiency, pilots are urged to practice IFR procedures whenever possible, even when operating VFR. Some suggested practices include:

- a) Obtain a complete preflight and weather briefing. Check the NOTAM's.
- b) File a flight plan. This is an excellent low-cost insurance policy. The cost is the time it takes to fill it out. The insurance includes the knowledge that someone will be looking for you if you become overdue at your destination.
- c) Use current charts.
- d) Use the navigation aids. Practice maintaining a good course by keeping the needle centered.
- e) Maintain a constant altitude appropriate for direction of flight.
- f) Estimate en route position times.
- g) Make accurate and frequent position reports to the FSS's along your route of flight.

**2.2** Simulated IFR flight is recommended (under the hood); however, pilots are cautioned to review and adhere to the requirements specified in 14 CFR Section 91.109 before and during such flight.

**2.3** When flying VFR at night, in addition to the altitude appropriate for the direction of flight, pilots should maintain an altitude which is at or above the minimum en route altitude as shown on charts. This is especially true in mountainous terrain, where there is usually very little ground reference. Do not depend on your eyes

alone to avoid rising unlighted terrain, or even lighted obstructions such as TV towers.

**3. Domestic Notice to Airmen (NOTAM) System**

**3.1** Time-critical aeronautical information which is of either a temporary nature or is not sufficiently known in advance to permit publication on aeronautical charts or in other operational publications, receives immediate dissemination via the U.S. Notice to Airmen (NOTAM) System.

**NOTE.—** NOTAM INFORMATION IS THAT AERONAUTICAL INFORMATION THAT COULD AFFECT A PILOT'S DECISION TO MAKE A FLIGHT. IT INCLUDES SUCH INFORMATION AS AIRPORT OR PRIMARY RUNWAY CLOSURES, CHANGES IN THE STATUS OF NAVIGATIONAL AIDS, ILS, RADAR SERVICE AVAILABILITY, AND OTHER INFORMATION ESSENTIAL TO PLANNED EN ROUTE, TERMINAL, OR LANDING OPERATIONS.

**3.2** NOTAM information is classified into three categories. These are NOTAM (D) or distant, NOTAM (L) or local, and Flight Data Center (FDC) NOTAM's.

**a) NOTAM (D)**

**1)** NOTAM (D) information is disseminated for all navigational facilities that are part of the National Airspace System (NAS), all public use airports, seaplane bases, and heliports listed in the Airport/Facility Directory (AFD). The complete file of all NOTAM (D) information is maintained in a computer data base at the Weather Message Switching Center (WMSC), located in Atlanta, Georgia. This category of information is distributed automatically via Service A telecommunications system. Air traffic facilities, primarily FSS's, have access to the entire WMSC data base of NOTAM's. These NOTAM's remain available via Service A for the duration of their validity or until published. Once published, the NOTAM data is deleted from the system.

**b) NOTAM (L)**

**1)** NOTAM (L) information includes such data as taxiway closures, personnel and equipment near or crossing runways, airport rotating beacon outages, and airport lighting aids that do not affect instrument approach criteria, such as the visual slope approach indicator (VASI).

**2)** NOTAM (L) information is distributed locally only and is not attached to the hourly weather reports. A separate file of local NOTAM's is maintained at each FSS for facilities in their areas only. NOTAM (L) information for other FSS areas must be specifically requested directly from the FSS that has responsibility for the airport concerned.

**NOTE.—**  
DUATS VENDORS ARE NOT REQUIRED TO PROVIDE NOTAM (L) INFORMATION.



### c) FDC NOTAM's

1) On those occasions when it becomes necessary to disseminate information which is regulatory in nature, the National Flight Data Center (NFDC) in Washington, D.C., will issue an FDC NOTAM. FDC NOTAM's contain such things as amendments to published instrument approach procedures (IAP's) and other current aeronautical charts. They are also used to advertise temporary flight restrictions caused by such things as natural disasters or large scale public events that may generate a congestion of air traffic over a site.

2) FDC NOTAM's are transmitted via Service A only once and are kept on file at the FSS until published or canceled. FSS's are responsible for maintaining a file of current, unpublished FDC NOTAM's concerning conditions within 400 miles of their facilities. FDC information concerning conditions that are more than 400 miles from the FSS, or that is already published, is given only on request.

**NOTE.—**

① DUATS VENDORS WILL PROVIDE FDC NOTAM'S ONLY UPON SITE-SPECIFIC REQUESTS USING A LOCATION IDENTIFIER.  
② NOTAM DATA MAY NOT ALWAYS BE CURRENT DUE TO THE CHANGEABLE NATURE OF THE NATIONAL AIRSPACE SYSTEM COMPONENTS, DELAYS INHERENT IN PROCESSING THE INFORMATION, AND OCCASIONAL TEMPORARY OUTAGES OF THE UNITED STATES NOTAM SYSTEM. WHILE EN ROUTE, PILOTS SHOULD CONTACT FSS'S AND OBTAIN UPDATED INFORMATION FOR THEIR ROUTE OF FLIGHT AND DESTINATION.

**3.3** An integral part of the NOTAM System is the Notice to Airmen publication, published every 28 days. Data is included in this publication to reduce congestion on the telecommunications circuits and, therefore, is not available via Service A. Once published, this information is not provided during pilot weather briefings unless specifically requested by the pilot. The Notice to Airmen publication contains four parts:

a) Part 1 contains three sections:

1) Notices which meet the criteria for NOTAM (D) which are expected to remain in effect for an extended period and FDC NOTAM's current at the time of publication. Occasionally, some NOTAM (L) and other unique information is included in this section when it will contribute to flight safety.

2) Airports, Facilities, and Procedural NOTAM's.

3) General FDC NOTAM's.

b) Part 2 contains Revisions to Minimum En Route IFR Altitudes and Changeover Points Amendments.

c) Part 3 contains International Notices to Airmen.

d) Part 4 contains Graphic Notices. It includes special notices and notices containing graphics pertaining to almost every aspect of aviation; such as, military training areas, large scale sporting events that may attract media attention or draw large crowds of aircraft, chart corrections and additions, and air show information.

e) The number of the last FDC NOTAM included in the Notices to Airmen publication is noted on the first page to aid the user in updating the listing with any FDC NOTAM's which may have been issued between the cut-off date and the date the publication is received. All information contained will be carried until the information expires, is canceled, or in the case of permanent conditions, is published in other publications, such as the Airport/Facility Directory.

f) All new notices entered, excluding FDC NOTAM's, will be published only if the information is expected to remain in effect for at least 30 days after the effective date of the publication.

## 4. Flight Plan Requirements

**4.1** The types of flight plans in U.S. airspace are:

a) Visual Flight Rules (VFR).

b) Defense Visual Flight Rules (DVFR).

c) Instrument Flight rules (IFR).

d) Composite Flight Plan Visual-Instrument Flight Rules (VFR-IFR).

e) IFR flight plans requesting VFR operations.

**NOTE.—**

ICAO FLIGHT PLANS ARE REQUIRED WHENEVER THE FLIGHT INTENDS TO CROSS AN INTERNATIONAL BOUNDARY OR AN OCEANIC CTA/FIR BOUNDARY. FOR FLIGHTS DEPARTING U.S. AIRPORTS AND OPERATING OVER U.S. DOMESTIC AIRSPACE AND/OR OFFSHORE CONTROL AREAS, BUT DO NOT PENETRATE THE OCEANIC CTA/FIR BOUNDARY OR BORDERS, A U.S. DOMESTIC FLIGHT PLAN IS PREFERRED.

### 4.2 Flight Plan-VFR Flights

**4.2.1** Except for operations in or penetrating a Coastal or Domestic ADIZ or DEWIZ (see ENR 1.12, paragraph 1.2), a flight plan is not required for VFR flight; however, it is strongly recommended that one be filed.

**4.2.2** To obtain maximum benefits of the flight plan program, flight plans should be filed directly with the nearest flight service station. For your convenience, FSS's provide aeronautical and meteorological briefings while accepting flight plans. Radio may be used to file if no other means are available. Also, some States operate aeronautical communications facilities which will accept and forward flight plans to the FSS for further handling.

**4.2.3** When a “stopover” flight is anticipated to cover an extended period of time, it is recommended that a separate flight plan be filed for each “leg” when the stop is expected to be more than 1-hour duration.

**4.2.4** Pilots are encouraged to give their departure times directly to the FSS serving the departure airport or as otherwise indicated by the FSS when the flight plan is filed. This will ensure more efficient flight plan service and permit the FSS to advise you of significant changes in aeronautical facilities or meteorological conditions. When a VFR flight plan is filed, it will be held by the FSS until 1 hour after the proposed departure time and then canceled unless:

- a) The actual departure time is received.
- b) A revised proposed departure time is received.
- c) At a time of filing, the FSS is informed that the proposed departure time will be met, but actual time cannot be given because of inadequate communications (assumed departures).

**4.2.5** On pilot’s request, at a location having an active tower, the aircraft identification will be forwarded by the tower to the FSS for reporting the actual departure time. This procedure should be avoided at busy airports.

**4.2.6** Although position reports are not required for VFR flight plans, periodic reports to FAA flight service stations along the route are good practice. Such contacts permit significant information to be passed to the transiting aircraft and also serve to check the progress of the flight should it be necessary for any reason to locate the aircraft.

*EXAMPLE.—*  
① *BONANZA 31K, OVER KINGFISHER AT (TIME), VFR FLIGHT PLAN, TULSA TO AMARILLO.*

② *CHEROKEE 5123J, OVER OKLAHOMA CITY AT (TIME), SHREVEPORT TO DENVER, NO FLIGHT PLAN.*

**4.2.7** Pilots not operating on an IFR flight plan, and when in level cruising flight, are cautioned to conform with VFR cruising altitudes appropriate to direction of flight.

**4.2.8** When filing VFR flight plans, indicate aircraft equipment capabilities by appending the appropriate suffix to aircraft type in the same manner as that prescribed for IFR flight. Under some circumstances, ATC computer tapes can be useful in constructing the radar history of a downed or crashed aircraft. In each case, knowledge of the aircraft’s transponder equipment is necessary in determining whether or not such computer tapes might prove effective.

*REFERENCE—*  
*AIP, ENR 1.10, PARAGRAPH 5.1 C) AND TBL 1.10-1, AIRCRAFT EQUIPMENT SUFFIXES.*

#### **4.2.9 Explanation of VFR Flight plan items:**

- a) **Block 1.** Check the type flight plan. Check both the VFR and IFR blocks if composite VFR/IFR.
- b) **Block 2.** Enter your complete aircraft identification including the prefix “N” if applicable.
- c) **Block 3.** Enter the designator for the aircraft, or if unknown, consult an FSS briefer.
- d) **Block 4.** Enter your true airspeed (TAS).
- e) **Block 5.** Enter the departure airport identifier code, or if unknown, the name of the airport.
- f) **Block 6.** Enter the proposed departure time in Coordinated Universal Time (UTC). If airborne, specify the actual or proposed departure time, as appropriate.
- g) **Block 7.** Enter the appropriate VFR altitude (to assist the briefer in providing weather and wind information).
- h) **Block 8.** Define the route of flight by using NAVAID identifier codes and airways.
- i) **Block 9.** Enter the destination airport identifier code, or if unknown, the airport name.

*NOTE.—*  
*INCLUDE THE CITY NAME (OR EVEN THE STATE NAME) IF NEEDED FOR CLARITY.*

- j) **Block 10.** Enter your estimated time en route, in hours and minutes.
  - k) **Block 11.** Enter only those remarks pertinent to ATC or to the clarification of other flight plan information such as the appropriate radiotelephony (call sign) associated with the designator filled in Block 2. Items of a personal nature are not accepted.
  - l) **Block 12.** Specify the fuel on board, in hours and minutes.
  - m) **Block 13.** Specify an alternate airport if desired.
  - n) **Block 14.** Enter your complete name, address, and telephone number. Enter sufficient information to identify home base, airport, or operator.
- NOTE.—*  
*THIS INFORMATION IS ESSENTIAL IN THE EVENT OF SEARCH AND RESCUE OPERATIONS.*
- o) **Block 15.** Enter total number of persons on board including crew (POB).
  - p) **Block 16.** Enter the predominant colors.

q) **Block 17.** (Optional) Record a destination telephone number to assist Search and Rescue should you fail to report or cancel your flight plan within 1/2 hour after your estimated time of arrival (ETA).

r) Record the FSS name for closing the flight plan. If the flight plan is closed with a different FSS or facility, state the recorded FSS name that would normally have closed your flight plan.

**CAUTION.—**

A CONTROL TOWER AT DESTINATION POINT DOES NOT AUTOMATICALLY CLOSE VFR FLIGHT PLANS, IT REMAINS THE RESPONSIBILITY OF A PILOT TO CLOSE HIS OWN FLIGHT PLAN.

**NOTE.—**

THE INFORMATION TRANSMITTED TO THE DESTINATION FSS WILL CONSIST ONLY OF FLIGHT PLANS BLOCKS 2, 3, 9, AND 10. ESTIMATED TIME EN ROUTE (ETE) WILL BE CONVERTED TO THE CORRECT ESTIMATED TIME OF ARRIVAL (ETA).

**Flight Plan  
FAA Form 7233-1**

U.S. DEPARTMENT OF TRANSPORTATION FEDERAL AVIATION ADMINISTRATION		(FAA USE ONLY) <input type="checkbox"/> PILOT BRIEFING <input type="checkbox"/> VNR			TIME STARTED	SPECIALIST INITIALS
<b>FLIGHT PLAN</b>		<input type="checkbox"/> STOPOVER				
<b>1. TYPE</b>	<b>2. AIRCRAFT IDENTIFICATION</b>	<b>AIRCRAFT TYPE/SPECIAL EQUIPMENT</b>	<b>4. TRUE AIRSPEED</b>	<b>5. DEPARTURE POINT</b>	<b>6. DEPARTURE TIME</b>	
VFR					PROPOSED (Z)	ACTUAL (Z)
IFR			KTS			
DVFR						<b>7. CRUISING ALTITUDE</b>
<b>8. ROUTE OF FLIGHT</b>						
<b>9. DESTINATION (Name of airport and city)</b>		<b>10. EST. TIME ENROUTE</b>		<b>11. REMARKS</b>		
		HOURS	MINUTES			
<b>12. FUEL ON BOARD</b>		<b>13. ALTERNATE AIRPORT(S)</b>		<b>14. PILOT'S NAME, ADDRESS &amp; TELEPHONE NUMBER &amp; AIRCRAFT HOME BASE</b>		<b>15. NUMBER ABOARD</b>
HOURS	MINUTES			<b>17. DESTINATION CONTACT/TELEPHONE (OPTIONAL)</b>		
<b>16. COLOR OF AIRCRAFT</b>		CIVIL AIRCRAFT PILOTS. FAR 91 requires you file an IFR flight plan to operate under instrument flight rules in controlled airspace. Failure to file could result in a civil penalty not to exceed \$1,000 for each violation (Section 901 of the Federal Aviation Act of 1958, as amended). Filing of a VFR flight plan is recommended as a good operating practice. See also Part 99 for requirements concerning DVFR flight plans.				

FAA Form 7233-1 (8-82)      CLOSE VFR FLIGHT PLAN WITH \_\_\_\_\_ FSS ON ARRIVAL

FIG 1.10-1

**Aircraft Equipment Suffixes**

Suffix	Aircraft Equipment
	<b>NO DME</b>
/X	No transponder
/T	Transponder with no Mode C
/U	Transponder with Mode C
	<b>DME</b>
/D	No transponder
/B	Transponder with no Mode C
/A	Transponder with Mode C
	<b>TACAN ONLY</b>
/M	No transponder
/N	Transponder with no Mode C
/P	Transponder with Mode C
	<b>AREA NAVIGATION (RNAV)</b>
/Y	LORAN, VOR/DME, or INS with no transponder
/C	LORAN, VOR/DME, or INS, transponder with no Mode C
/I	LORAN, VOR/DME, or INS, transponder with Mode C
	<b>ADVANCED RNAV With Transponder and Mode C</b> (If an aircraft is unable to operate with a transponder and/or Mode C, it will revert to the appropriate code listed above under Area Navigation.)
/E	FMS with en route, terminal, and approach capability. Equipment requirements are: a. Dual FMS which meets the specifications of AC25-15, Approval of Flight Management Systems in Transport Category Airplanes; AC20-129, Airworthiness Approval of Vertical Navigation (VNAV) Systems for use in the U.S. National Airspace System (NAS) and Alaska; AC20-130A, Airworthiness Approval of Navigation or Flight Management Systems Integrating Multiple Navigation Sensors; or equivalent criteria as approved by Flight Standards. b. A flight director and autopilot control system capable of following the lateral and vertical FMS flight path. c. At least dual inertial reference units (IRU's). d. A database containing the waypoints and speed/altitude constraints for the route and/or procedure to be flown that is automatically loaded into the FMS flight plan. e. An electronic map. (U.S. and U.S. territories only unless otherwise authorized)
/F	A single FMS with en route, terminal, and approach capability that meets the equipment requirements of /E, a. through d. above. (U.S. and U.S. territories only unless otherwise authorized)
/G	GPS/GNSS equipped aircraft with en route, terminal, and GPS approach capability
/R	Required Navigational Performance (RNP) (Denotes capability to operate in RNP designated airspace and routes)
/W	Reduced Vertical Separation Minima (RVSM)

TBL 1.10-1

**4.3 Flight Plan-Defense VFR (DVFR) Flights**

**4.3.1** VFR flights into a Coastal or Domestic ADIZ/DEWIZ are required to file DVFR flight plans for security purposes. Detailed ADIZ procedures are found in ENR 1.12, paragraph 1.

REFERENCE-  
14 CFR PART 99

**5. Flight Plan-IFR Flights**

**5.1 General**

a) Prior to departure from within, or prior to entering Class A, B, C, D and E airspace, a pilot must submit a complete flight plan and receive an air traffic clearance

if weather conditions are below VFR minimums. Instrument flight plans may be submitted to the nearest flight service station or the airport traffic control tower either in person or by telephone (or by radio if no other means are available). Pilots should file IFR flight plans at least 30 minutes prior to estimated time of departure to preclude possible delay in receiving a departure to preclude possible delay in receiving a departure clearance from ATC. To minimize your delay in entering a Class B, C, D or E surface area at destination when IFR weather conditions exist or are forecast at the airport, an IFR flight plan should be filed before departure. Otherwise, a 30-minute delay is not unusual in receiving an

ATC clearance because of time spent in processing flight plan data. Traffic saturation frequently prevents control personnel from accepting flight plans by radio. In such cases the pilot is advised to contact the nearest flight service station for the purpose of filing the flight plan.

**NOTE.—**

THERE ARE SEVERAL METHODS OF OBTAINING IFR CLEARANCE AT NONTOWER, NON-FLIGHT SERVICE STATIONS AND OUTLYING AIRPORTS. THE PROCEDURE MAY VARY DUE TO GEOGRAPHICAL FEATURES, WEATHER CONDITIONS, AND THE COMPLEXITY OF THE ATC SYSTEM. TO DETERMINE THE MOST EFFECTIVE MEANS OF RECEIVING AN IFR CLEARANCE, PILOTS SHOULD ASK THE NEAREST FLIGHT SERVICE STATION FOR THE MOST APPROPRIATE MEANS OF OBTAINING THE IFR CLEARANCE.

b) When filing an IFR flight plan for a traffic alert and collision avoidance system (TCAS)/heavy equipped aircraft, add the prefix “T” for TCAS, “H” for heavy, or “B” for both TCAS and heavy to the aircraft type.

**EXAMPLE.—**

H/DC10/U T/B727/A B/747/R

c) When filing an IFR flight plan for flight in an aircraft equipped with a radar beacon transponder, DME equipment, TACAN-only equipment, global navigation satellite system (GNSS), or a combination of any of these types of equipment, identify the equipment capability by adding a suffix, preceded by a slant, to the AIRCRAFT TYPE, as shown in TBL 1.10-1, Aircraft Equipment Suffixes.

d) It is recommended that pilots file the maximum transponder or navigation capability of their aircraft in the equipment suffix. This will provide ATC with the necessary information to utilize all facets of navigational equipment and transponder capabilities available.

**NOTE.—**

THE SUFFIX IS NOT TO BE ADDED TO THE AIRCRAFT IDENTIFICATION OR BE TRANSMITTED BY RADIO AS PART OF THE AIRCRAFT IDENTIFICATION.

## 5.2 Airways/Jet Routes Depiction on Flight Plan

**5.2.6** It is vitally important that the route of flight be accurately and completely described in the flight plan. To simplify definition of the proposed route, and to facilitate air traffic control, pilots are requested to file via airways or jet routes established for use at the altitude or flight level planned.

**5.2.7** If flight is to be conducted via designated airways or jet routes, describe the route by indicating the type and number designators of the airway(s) or jet route(s) requested. If more than one airway or jet route is to be used, clearly indicate points of transition. If the transition is made at an unnamed intersection, show the next succeeding NAVAID or named intersection on the

intended route and the complete route from that point. Reporting points should be identified by using authorized name/code as depicted on appropriate aeronautical charts. The following two examples illustrate the need to specify the transition point when two routes share more than one transition fix.

**EXAMPLE.—**

① ALB J37 BUMPY J14 BHM  
SPELLED OUT: FROM ALBANY, NEW YORK, VIA JET ROUTE 37, TRANSITIONING TO JET ROUTE 14 AT BUMPY INTERSECTION, THENCE VIA JET ROUTE 14 TO BIRMINGHAM, ALABAMA.

② ALB J37 ENO J14 BHM  
SPELLED OUT: FROM ALBANY, NEW YORK, VIA JET ROUTE 37 TRANSITIONING TO JET ROUTE 14 AT KENTON VORTAC (ENO), THENCE VIA JET ROUTE 14 TO BIRMINGHAM, ALABAMA.

**5.2.8** The route of flight may also be described by naming the reporting points or NAVAID's over which the flight will pass, provided the points named are established for use at the altitude or flight level planned.

**EXAMPLE.—**

BWI V44 SWANN V433 DQO  
SPELLED OUT: FROM BALTIMORE-WASHINGTON INTERNATIONAL, VIA VICTOR 44 TO SWANN INTERSECTION, TRANSITIONING TO VICTOR 433 AT SWANN, THENCE VIA V433 TO DUPONT.

**5.2.9** When the route of flight is defined by named reporting points, whether alone or in combination with airways or jet routes, and the navigational aids (VOR, VORTAC, TACAN, LF, RBN) to be used for the flight are a combination of different types of aids, enough information should be included to clearly indicate the route requested.

**EXAMPLE.—**

LAX J5 LKV J3 GEG YXC FL 330 J500 VLR J515 YWG  
SPELLED OUT: FROM LOS ANGELES INTERNATIONAL VIA JET ROUTE 5 LAKEVIEW, JET ROUTE 3 SPOKANE, DIRECT CRANBROOK, BRITISH COLUMBIA VOR/DME, FLIGHT LEVEL 330, JET ROUTE 500 TO LANGRUTH, MANITOBA VORTAC, JET ROUTE 515 TO WINNIPEG, MANITOBA.

**5.2.10** When filing IFR, it is to the pilot's advantage to file a “preferred route.”

**NOTE.—**

PREFERRED IFR ROUTES ARE DESCRIBED AND TABULATED IN THE AIRPORT/FACILITY DIRECTORY.

**5.2.11** ATC may issue an instrument departure procedure (DP) or a standard terminal arrival (STAR) as appropriate (See ENR 1.5, paragraph 3).

**NOTE.—**

PILOTS NOT DESIRING A DP/STAR SHOULD SO INDICATE IN THE REMARK SECTION OF THE FLIGHT PLAN AS “NO DP” OR “NO STAR.”

## 5.3 Direct Flights

**5.3.1** All or any portions of the route which will not be flown on the radials or courses of established airways or routes, such as direct route flights, must be defined by indicating the radio fixes over which the flight will

pass. Fixes selected to define the route shall be those over which the position of the aircraft can be accurately determined. Such fixes automatically become compulsory reporting points for the flight, unless advised otherwise by ATC. Only those navigational aids established for use in a particular structure; i.e., in the low or high structures, may be used to define the en route phase of a direct flight within that structure.

**5.3.2** The azimuth feature of VOR aids and the azimuth and distance (DME) features of VORTAC and TACAN aids are assigned certain frequency protected areas of airspace which are intended for application to established airway and route use, and to provide guidance for planning flights outside of established airways or routes. These areas of airspace are expressed in terms of cylindrical service volumes of specified dimensions called "class limits" or "categories."

**5.3.3** An operational service volume has been established for each class in which adequate signal coverage and frequency protection can be assured. To facilitate use of VOR, VORTAC, or TACAN aids, consistent with their operational service volume limits, pilot use of such aids for defining a direct route of flight in Class A, B, C, D and E airspace should not exceed the following:

a) Operations above Flight Level 450—Use aids not more than 200 nautical miles apart. These aids are depicted on En Route High Altitude Charts.

b) Operation off established routes from 18,000 feet MSL to Flight Level 450—Use aids not more than 260 nautical miles apart. These aids are depicted on En Route High Altitude Charts.

c) Operation off established airways below 18,000 feet MSL—Use aids not more than 80 nautical miles apart. These aids are depicted on En Route Low Altitude Charts.

d) Operation off established airways between 14,500 feet MSL and 17,999 feet MSL in the conterminous United States—(H) facilities not more than 200 NM apart may be used.

**5.3.4** Increasing use of self-contained airborne navigational systems which do not rely on the VOR/VORTAC/TACAN system has resulted in pilot requests for direct routes which exceed NAVAID service volume limits. These direct route requests will be approved only in a radar environment, with approval based on pilot responsibility for navigation on the authorized direct

route. "Radar flight following" will be provided by ATC for air traffic control purposes.

**5.3.5** At times, ATC will initiate a direct route in a radar environment which exceeds NAVAID service volume limits. In such cases ATC will provide radar monitoring and navigational assistance as necessary.

**5.3.6** Airway or jet route numbers, appropriate to the stratum in which operation will be conducted, may also be included to describe portions of the route to be flown.

**EXAMPLE.—**

MDW V262 BDF V10 BRL STJ SLN GCK  
SPELLED OUT: FROM CHICAGO MIDWAY AIRPORT VIA VICTOR 262 TO BRADFORD, VICTOR 10 TO BURLINGTON, IOWA, DIRECT ST. JOSEPH, MISSOURI, DIRECT SALINA, KANSAS, DIRECT GARDEN CITY, KANSAS.

**NOTE.—** WHEN ROUTE OF FLIGHT IS DESCRIBED BY RADIO FIXES, THE PILOT WILL BE EXPECTED TO FLY A DIRECT COURSE BETWEEN THE POINTS NAMED.

**5.3.7** Pilots are reminded that they are responsible for adhering to obstruction clearance requirements on those segments of direct routes that are outside of Class A, B, C, D and E airspace. The MEA's and other altitudes shown on Low Altitude IFR En Route Charts pertain to those route segments within Class A, B, C, D and E airspace, and those altitudes may not meet obstruction clearance criteria when operating off those routes.

#### **5.4 Area Navigation (RNAV)**

**5.4.1** Random RNAV routes can only be approved in a radar environment. Factors that will be considered by ATC in approving random RNAV routes include the capability to provide radar monitoring and compatibility with traffic volume and flow. ATC will radar monitor each flight, however, navigation on the random RNAV route is the responsibility of the pilot.

**5.4.2** To be certified for use in the National Airspace System, RNAV equipment must meet the specifications outlined in AC 90-45. The pilot is responsible for variations in equipment capability, and must advise ATC if a RNAV clearance can not be accepted as specified. The controller need only be concerned that the aircraft is RNAV equipped; if the flight plan equipment suffix denotes RNAV capability, the RNAV routing can be applied.

**5.4.3** Pilots of aircraft equipped with operational area navigation equipment may file for random RNAV routes throughout the National Airspace System, where radar monitoring by ATC is available, in accordance with the following procedures:

a) File airport to airport flight plans prior to departure.

b) File the appropriate RNAV capability certification suffix in the flight plan.

c) Plan the random route portion of the flight plan to begin and end over appropriate arrival and departure transition fixes or appropriate navigation aids for the altitude stratum within which the flight will be conducted. The use of normal preferred departure and arrival routes (DP/STAR), where established, is recommended.

d) File route structure transitions to and from the random route portion of the flight.

e) Define random routes by waypoints. File route description waypoints by using degree-distance fixes based on navigational aids which are appropriate for the altitude stratum.

f) File a minimum of one route description waypoint for each ARTCC through whose area the random route will be flown. These waypoints must be located within 200 NM of the preceding center's boundary.

g) File an additional route description waypoint for each turnpoint in the route.

h) Plan additional route description waypoints as required to ensure accurate navigation via the filed route of flight. Navigation is the pilot's responsibility unless ATC assistance is requested.

i) Plan the route of flight so as to avoid Prohibited and Restricted Airspace by 3 NM unless permission has been obtained to operate in that airspace and the appropriate ATC facilities are advised.

**5.4.4** Pilots of aircraft equipped with latitude/longitude coordinate navigation capability independent of VOR/TACAN references may file for random RNAV routes at and above FL 390 within the conterminous United States using the following procedures:

a) File airport to airport flight plans prior to departure.

b) File the appropriate RNAV capability certification suffix in the flight plan.

c) Plan the random route portion of the flight to begin and end over published departure/arrival transition fixes or appropriate navigation aids for airports without published transition procedures. The use of preferred departure and arrival routes, such as DP and STAR where established, is recommended.

d) Plan the route of flight so as to avoid prohibited and restricted airspace by 3 NM unless permission has been obtained to operate in that airspace and the appropriate ATC facility is advised.

e) Define the route of flight after the departure fix, including each intermediate fix (turnpoint) and the arrival fix for the destination airport, in terms of latitude/longitude coordinates plotted to the nearest minute. The arrival fix must be identified by both the latitude/longitude coordinates and a fix identifier.

**EXAMPLE.—**

MIA<sup>1</sup> SRQ<sup>2</sup> 3407/10615<sup>3</sup> 3407/11546 TNP<sup>4</sup> LAX<sup>5</sup>

<sup>1</sup> DEPARTURE AIRPORT

<sup>2</sup> DEPARTURE FIX

<sup>3</sup> INTERMEDIATE FIX (TURNING POINT)

<sup>4</sup> ARRIVAL FIX

<sup>5</sup> DESTINATION AIRPORT

f) Record latitude/longitude coordinates by four figures describing latitude in degrees and minutes followed by a solidus and five figures describing longitude in degrees and minutes.

g) File at FL 390 or above for the random RNAV portion of the flight.

h) Fly all routes/route segments on Great Circle tracks.

i) Make any in-flight requests for random RNAV clearances or route amendments to an en route ATC facility.

**5.5 Flight Plan Form** See FIG 1.10-1.

### 5.5.1 Explanation of IFR Flight Plan Items:

a) **Block 1.** Check the type flight plan. Check both the VFR and IFR blocks if composite VFR/IFR.

b) **Block 2.** Enter your complete aircraft identification including the prefix "N" if applicable.

c) **Block 3.** Enter the designator for the aircraft, followed by a slant (/) and the transponder or DME equipment code letter; e.g., C-182/U. Heavy aircraft, add prefix "H" to aircraft type; example: H/DC10/R. Consult an FSS briefer for any unknown elements.

d) **Block 4.** Enter your computed true airspeed (TAS).

**NOTE.—**

IF THE AVERAGE TAS CHANGES PLUS OR MINUS 5 PERCENT OR 10 KNOTS, WHICHEVER IS GREATER, ADVISE ATC.

e) **Block 5.** Enter the departure airport identifier code (or the name if identifier is unknown).

**NOTE.—**

USE OF IDENTIFIER CODES WILL EXPEDITE THE PROCESSING OF YOUR FLIGHT PLAN.

**f) Block 6.** Enter the proposed departure time in Coordinated Universal Time (UTC) (Z). If airborne, specify the actual or proposed departure time as appropriate.

**g) Block 7.** Enter the requested en route altitude or flight level.

*NOTE.—*  
*ENTER ONLY THE INITIAL REQUESTED ALTITUDE IN THIS BLOCK. WHEN MORE THAN ONE IFR ALTITUDE OR FLIGHT LEVEL IS DESIRED ALONG THE ROUTE OF FLIGHT, IT IS BEST TO MAKE A SUBSEQUENT REQUEST DIRECT TO THE CONTROLLER.*

**h) Block 8.** Define the route of flight by using NAVAID identifier codes (or names if the code is unknown), airways, jet routes, and waypoints (for RNAV).

*NOTE.—*  
*USE NAVAIDS OR WAYPOINTS TO DEFINE DIRECT ROUTES AND RADIALS/BEARING TO DEFINE OTHER UNPUBLISHED ROUTES.*

**i) Block 9.** Enter the destination airport identifier code (or name if identifier is unknown).

**j) Block 10.** Enter your estimated time en route based on latest forecast winds.

**k) Block 11.** Enter only those remarks pertinent to ATC or to the clarification of other flight plan information such as the appropriate radiotelephony (call sign) associated with the designator filled in Block 2. Items of a personal nature are not accepted. Do not assume that remarks will be automatically transmitted to every controller. Specific ATC or en route requests should be made directly to the appropriate controller.

**l) Block 12.** Specify the fuel on board, computed from the departure point.

**m) Block 13.** Specify an alternate airport if desired or required, but do not include routing to the alternate airport.

**n) Block 14.** Enter the complete name, address, and telephone number of pilot-in-command or, in the case of a formation flight, the formation commander. Enter sufficient information to identify home base, airport, or operator.

*NOTE.—*  
*THIS INFORMATION WOULD BE ESSENTIAL IN THE EVENT OF A SEARCH AND RESCUE OPERATION.*

**o) Block 15.** Enter the total number of persons on board including crew.

**p) Block 16.** Enter the predominant colors.

*NOTE.—*  
*CLOSE IFR FLIGHT PLANS WITH TOWER, APPROACH CONTROL, ARTCCS, OR IF UNABLE, WITH FSS. WHEN LANDING AT AN AIR-*

*PORT WITH A FUNCTIONING CONTROL TOWER, IFR FLIGHT PLANS ARE AUTOMATICALLY CANCELED.*

**5.5.2** The information transmitted to the ARTCC for IFR Flight Plans will consist of only flight plan blocks 2, 3, 4, 5, 6, 7, 8, 9, 10, and 11.

**5.5.3** A description of the International Flight Plan Form is contained in the International Flight Information Manual (IFIM).

## 6. IFR Operations to High Altitude Destinations

**6.1** Pilots planning IFR flights to airports located in mountainous terrain are cautioned to consider the necessity for an alternate airport even when the forecast weather conditions would technically relieve them from the requirement to file one.

**6.2** The FAA has identified three possible situations where the failure to plan for an alternate airport when flying IFR to such destination airport could result in a critical situation if the weather is less than forecast and sufficient fuel is not available to proceed to a suitable airport.

**a)** An IFR flight to an airport where the MDA's or landing visibility minimums for ALL INSTRUMENT APPROACHES are higher than the forecast weather minimums specified in 14 CFR Section 91.167. For example, there are 11 high altitude airports in the United States with approved instrument approach procedures where all of the Minimum Descent Altitudes (MDA) are greater than 2,000 feet and/or the landing visibility minimums are greater than 3 miles (Bishop, California; South Lake Tahoe, California; Ukiah, California; Aspen-Pitkin Co./Sardy Field, Colorado; Butte, Montana; Helena, Montana; Missoula, Montana; Chadron, Nebraska; Ely, Nevada; Klamath Falls, Oregon; and Omak, Washington). In the case of these 11 airports, it is possible for a pilot to elect, on the basis of forecasts, not to carry sufficient fuel to get to an alternate when the ceiling and/or visibility is actually lower than that necessary to complete the approach.

**b)** A small number of other airports in mountainous terrain have MDA's which are slightly (100 to 300 feet) below 2000 feet AGL. In situations where there is an option as to whether to plan for an alternate, pilots should bear in mind that just a slight worsening of the weather conditions from those forecasts could place the airport below the published IFR landing minimums.

**c)** An IFR flight to an airport which requires special equipment; i.e. DME, glide slope, etc., in order to make the available approaches to the lowest minimums. Pilots should be aware that all other minimums on the



approach charts may require weather conditions better than those specified in 14 CFR Section 91.167. An in-flight equipment malfunction could result in the inability to comply with the published approach procedures or, again, in the position of having the airport below the published IFR landing minimums for all remaining instrument approach alternatives.

## 7. Composite Flight Plan (VFR/IFR Flights)

**7.1** Flight plans which specify VFR operation for one portion of a flight, and IFR for another portion, will be accepted by the FSS at the point of departure. If VFR flight is conducted for the first portion of the flight, the pilot should report his departure time to the FSS with which he filed his VFR/IFR flight plan; and, subsequently, close the VFR portion and request ATC clearance from the FSS nearest the point at which change from VFR to IFR is proposed. Regardless of the type facility you are communicating with (FSS, center, or tower), it is the pilot's responsibility to request that facility to "CLOSE VFR FLIGHT PLAN." The pilot must remain in VFR weather conditions until operating in accordance with the IFR clearance.

**7.2** When a flight plan indicates IFR for the first portion of flight and VFR for the latter portion, the pilot will normally be cleared to the point at which the change is proposed. Once the pilot has reported over the clearance limit and does not desire further IFR clearance, he should advise air traffic control to cancel the IFR portion of his flight plan. Then, he should contact the nearest FSS to activate the VFR portion of his flight plan. If the pilot desires to continue his IFR flight plan beyond the clearance limit, he should contact air traffic control at least five minutes prior to the clearance limit and request further IFR clearance. If the requested clearance is not received prior to reaching the clearance limit fix, the pilot will be expected to establish himself in a standard holding pattern on the radial/course to the fix unless a holding pattern for the clearance limit fix is depicted on a U.S. Government or commercially produced (meeting FAA requirements) Low/High Altitude En Route, Area, or STAR chart. In this case the pilot will hold according to the depicted pattern

## 8. Initiating a Change to Flight Plans on File

**8.1** Changes to proposed flight plans should be initiated through the FSS with which the flight plan was originally filed. If this is not possible, initiate changes through the nearest FSS or ATC facility. All changes should be initiated at least 30 minutes prior to departure

to insure that the change can be effected prior to the ATC clearance delivery.

## 9. Change in Proposed Departure Time

**9.1** To prevent computer saturation in the en route environment, parameters have been established to delete proposed departure flight plans which have not been activated. Most centers have this parameter set so as to delete these flight plans a minimum of 1 hour after the proposed departure time. To ensure that a flight plan remains active, pilots whose actual departure time will be delayed 1 hour or more beyond their filed departure time, are requested to notify ATC of their departure time.

**9.2** Due to traffic saturation, control personnel frequently will be unable to accept these revisions via radio. It is recommended that you forward these revisions to the nearest FSS.

## 10. Other Changes

**10.1** In addition to altitude/flight level, destination and/or route changes, increasing or decreasing the speed of an aircraft constitutes a change in a flight plan. Therefore, at any time the average true airspeed at cruising altitude between reporting points varies or is expected to vary from that given in the flight plan by plus or minus 5 percent, or 10 knots, whichever is greater, air traffic control should be advised.

## 11. Canceling Flight Plans

### 11.1 Closing VFR and DVFR Flight Plans

**11.1.1** A pilot is responsible for ensuring that his VFR or DVFR flight plan is canceled. You should close your flight plan with the nearest FSS, or if one is not available you may request any ATC facility to relay your cancellation to the FSS. Control towers do not automatically close VFR or DVFR flight plans as they may not be aware that a particular VFR aircraft is on a flight plan. If you fail to report or cancel your flight plan within  $\frac{1}{2}$  hour after your ETA, search and rescue procedures are started.

### 11.2 Canceling IFR Flight Plan

**11.2.1** 14 CFR Section 91.153 includes the statement "When a flight plan has been activated, the pilot in command, upon canceling or completing the flight under the flight plan, shall notify an FAA Flight Service Station or ATC facility."

**11.2.2** An IFR flight plan may be canceled at any time the flight is operating in VFR conditions outside Class A airspace by the pilot stating "CANCEL MY IFR

FLIGHT PLAN” to the controller or air/ground station with which he is communicating. Immediately after canceling an IFR flight plan, a pilot should take necessary action to change to the appropriate air/ground frequency, VFR radar beacon code and VFR altitude or flight level.

**11.2.3** ATC separation and information services will be discontinued, including radar services (where applicable). Consequently, if the canceling flight desires VFR radar advisory service, the pilot must specifically request it.

*NOTE.—  
PILOTS MUST BE AWARE THAT OTHER PROCEDURES MAY BE APPLICABLE TO A FLIGHT THAT CANCELS AN IFR FLIGHT PLAN WITHIN AN AREA WHERE A SPECIAL PROGRAM, SUCH AS A DESIGNATED TERMINAL RADAR SERVICE AREA, CLASS C AIRSPACE OR CLASS B AIRSPACE, HAS BEEN ESTABLISHED.*

**11.2.4** If a DVFR flight plan requirement exists, the pilot is responsible for filing this flight plan to replace the canceled IFR flight plan. If a subsequent IFR operation

becomes necessary, a new IFR flight plan must be filed and an ATC clearance obtained before operating in IFR conditions.

**11.2.5** If operating on an IFR flight plan to an airport with a functioning control tower, the flight plan is automatically closed upon landing.

**11.2.6** If operating on an IFR flight plan to an airport where there is no functioning control tower, the pilot must initiate cancellation of the IFR flight plan. This can be done after landing if there is a functioning FSS or other means of direct communications with ATC. In the event there is no FSS and air/ground communications with ATC is not possible below a certain altitude, the pilot would, weather conditions permitting, cancel his IFR flight plan while still airborne and able to communicate with ATC by radio. This will not only save the time and expense of canceling the flight plan by telephone but will quickly release the airspace for use by other aircraft.

---

**ENR 1.11 [RESERVED]**



## ENR 1.12 Interception of Civil Aircraft National Security and Interception Procedures

### 1. National Security

**1.1** National security in the control of air traffic is governed by 14 CFR Part 99.

**1.2** All aircraft entering domestic U.S. airspace from points outside, must provide for identification prior to entry. To facilitate early aircraft identification of all aircraft in the vicinity of U.S. and international airspace boundaries, Air Defense Identification Zones (ADIZ) have been established. (See FIG 1.12-1).

**1.3** Operational requirements for aircraft operations associated with an ADIZ are as follows:

**a) Flight Plan:** Except as specified in subparagraphs 1.5 and 1.6 below, an IFR or DVFR flight plan must be filed with an appropriate aeronautical facility as follows:

1) Generally, for all operations that enter an ADIZ.

2) For operations that will enter or exit the United States and which will operate into, within or across the contiguous U.S. ADIZ regardless of true airspeed.

3) The flight plan must be filed before departure except for operations associated with the Alaskan ADIZ when the airport of departure has no facility for filing a flight plan, in which case the flight plan may be filed immediately after takeoff or when within range of the aeronautical facility.

**b) Two-way Radio:** For the majority of operations associated with an ADIZ, an operating two-way radio is required. See 14 CFR Section 99.1 for exceptions.

**c) Transponder Requirements:** Unless otherwise authorized by ATC, each aircraft conducting operations into, within, or across the contiguous U.S. ADIZ must be equipped with an operable radar beacon transponder having altitude reporting capability (Mode C), and that transponder must be turned on and set to reply on the appropriate code or as assigned by ATC.

**d) Position Reporting:**

1) **For IFR flight:** Normal IFR position reporting.

2) **For DVFR flights:** The estimated time of ADIZ penetration must be filed with the aeronautical facility at least 15 minutes prior to penetration except for flight in the Alaskan ADIZ, in which case report prior to penetration.

3) **For inbound aircraft of foreign registry:** The pilot must report to the aeronautical facility at least 1 hour prior to ADIZ penetration.

**e) Aircraft Position Tolerances:**

1) Over land, the tolerance is within plus or minus 5 minutes from the estimated time over a reporting point or point of penetration and within 10 NM from the centerline of an intended track over an estimated reporting point or penetration point.

2) Over water, the tolerance is plus or minus 5 minutes from the estimated time over a reporting point or point of penetration and within 20 NM from the centerline of the intended track over an estimated reporting point or point of penetration (to include the Aleutian Islands).

**1.4 Except when applicable under 14 CFR Sections 99.7 and 99.12, Part 99 does not apply to aircraft operations:**

**1.4.1** Within the 48 contiguous states and the District of Columbia, or within the State of Alaska, and remains within 10 miles of the point of departure;

**1.4.2** Over any island, or within 3 nautical miles of the coastline of any island, in the Hawaii ADIZ; or

**1.4.3** Associated with any ADIZ other than the contiguous U.S. ADIZ, when the aircraft true airspeed is less than 180 knots.

**1.5** Authorizations to deviate from the requirements of Part 99 may also be granted by the ARTCC, on a local basis, for some operations associated with an ADIZ.

**1.6** An air-filed VFR Flight Plan makes an aircraft subject to interception for positive identification when entering an ADIZ. Pilots are therefore urged to file the required DVFR flight plan either in person or by telephone prior to departure.

**1.7 Special Security Instructions**

**1.7.1** During defense emergency or air defense emergency conditions, additional special security instructions may be issued in accordance with the Security Control of Air Traffic and Air Navigation Aids (SCATANA) Plan.

**Air Defense Identification Zone Boundaries  
Designated Mountainous Areas**

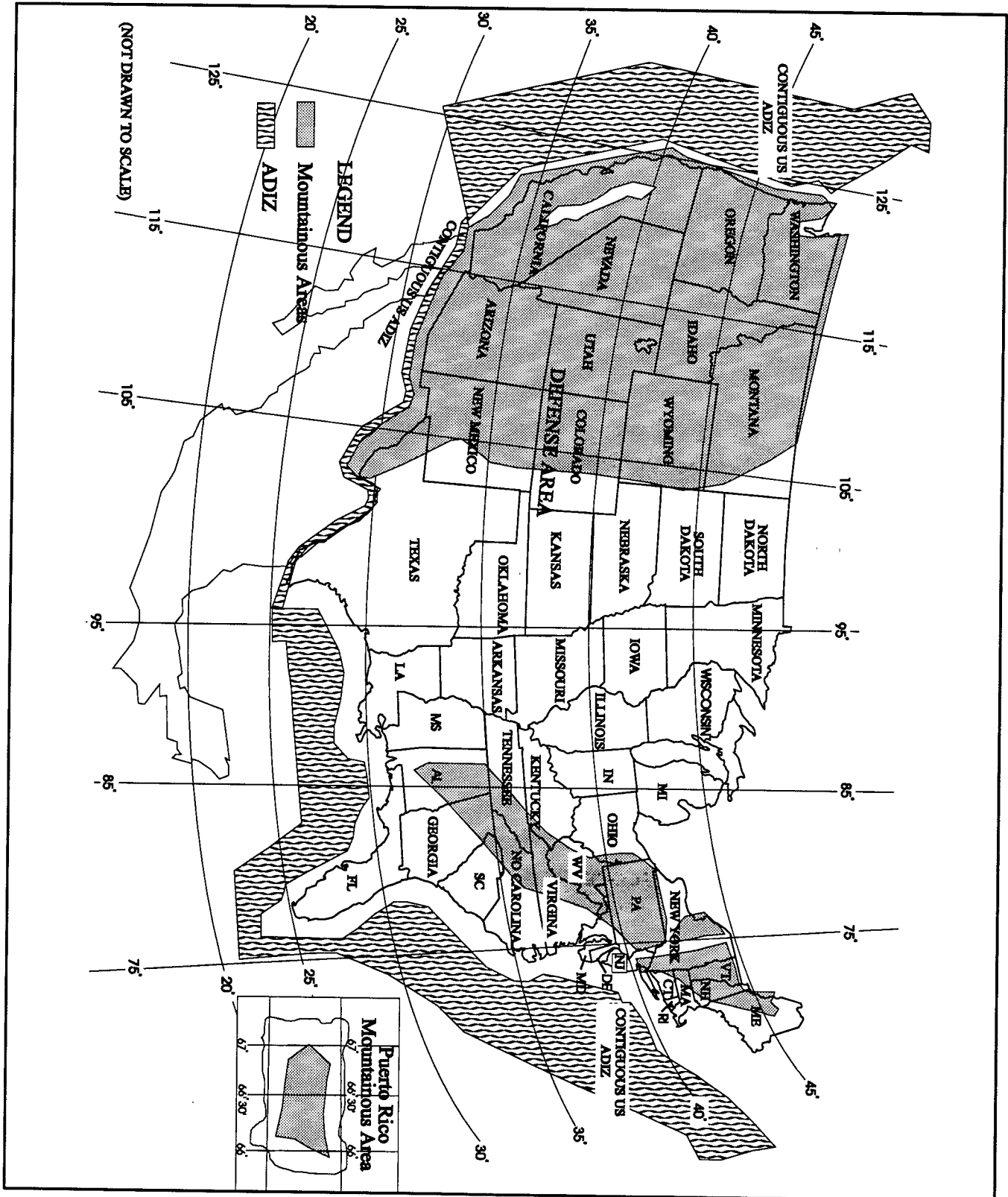

FIG 1.12-1

1.7.2 Under the provisions of the SCATANA Plan, the military will direct the action to be taken, in regard to landing, grounding, diversion, or dispersal of aircraft and the control of air navigation aids, in the defense of the United States during emergency conditions.

1.7.3 At the time a portion or all of SCATANA is implemented, ATC facilities will broadcast appropriate instructions received from the military over available ATC frequencies. Depending on instructions received from the military, VFR flights may be directed to land at the nearest available airport, and IFR flights will be expected to proceed as directed by ATC.

1.7.4 Pilots on the ground may be required to file a flight plan and obtain an approval (through FAA) prior to conducting flight operation.

1.7.5 In view of the above, all pilots should guard an ATC or FSS frequency at all times while conducting flight operations.

## 2. Interception Procedures

### 2.1 General

2.1.1 Identification intercepts during peacetime operations are vastly different than those conducted under increased states of readiness. Unless otherwise directed by the control agency, intercepted aircraft will be identified by type only. When specific information is required (i.e., markings, serial numbers, etc.), the interceptor aircrew will respond only if the request can be conducted in a safe manner. During hours of darkness or instrument meteorological conditions (IMC), identification of unknown aircraft will be by type only. The interception pattern described below is the typical peacetime method used by air interceptor aircrews. In all situations, the interceptor aircrew will use caution to avoid startling the intercepted aircraft and/or passengers.

### 2.2 Intercept Phases (See FIG 1.12-2).

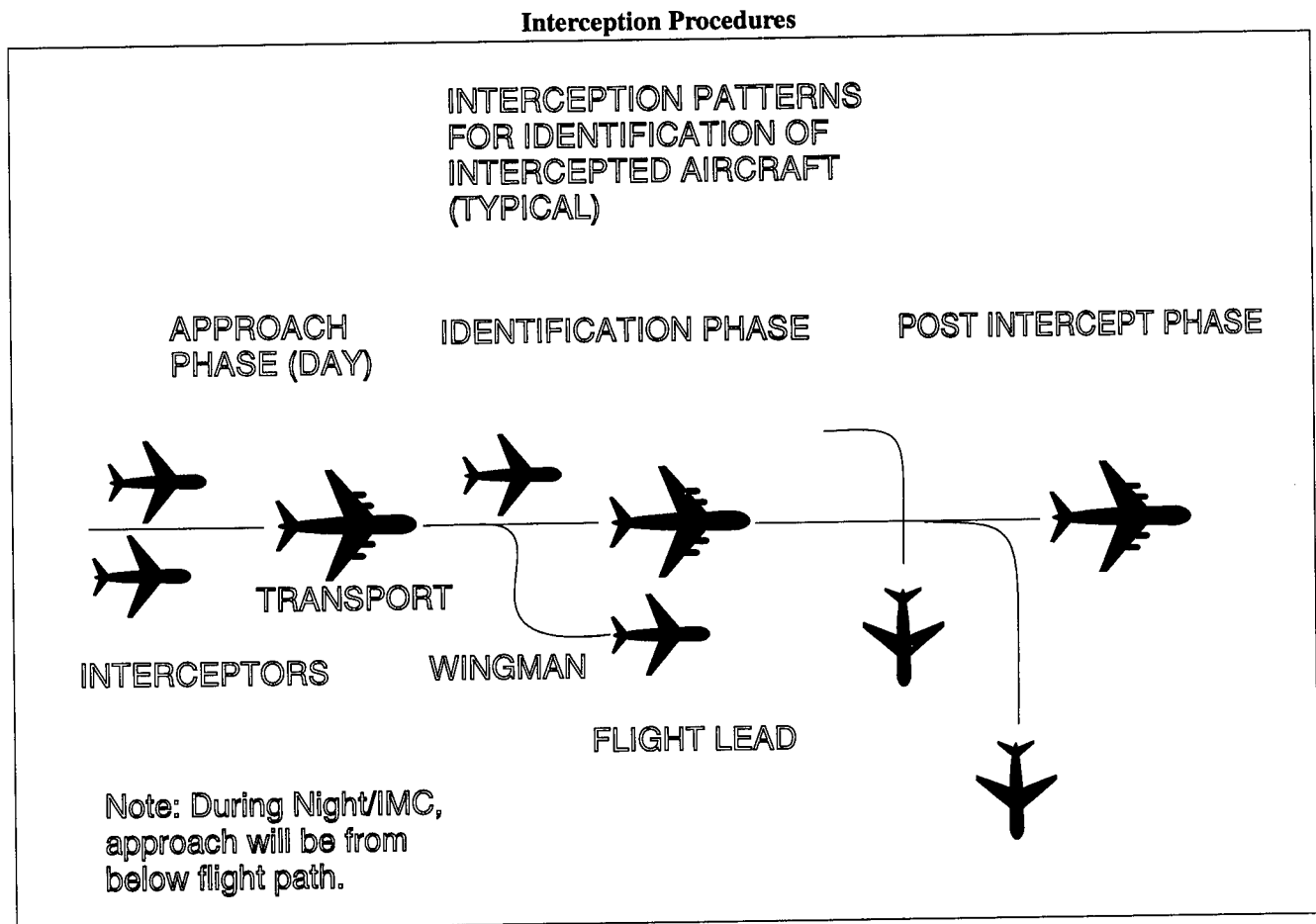

FIG 1.12-2

### 2.2.1 Phase One - Approach Phase:

During peacetime, intercepted aircraft will be approached from the stern. Generally two interceptor aircraft will be employed to accomplish the identification. The flight leader and wingman will coordinate their individual positions in conjunction with the ground controlling agency. Their relationship will resemble a line abreast formation. At night or in IMC, a comfortable radar trail tactic will be used. Safe vertical separation between interceptor aircraft and unknown aircraft will be maintained at all times.

### 2.2.2 Phase Two - Identification Phase:

The intercepted aircraft should expect to visually acquire the lead interceptor and possibly the wingman during this phase in visual meteorological conditions (VMC). The wingman will assume a surveillance position while the flight leader approaches the unknown aircraft. Intercepted aircraft personnel may observe the use of different drag devices to allow for speed and position stabilization during this phase. The flight leader will then initiate a gentle closure toward the intercepted aircraft, stopping at a distance no closer than absolutely necessary to obtain the information needed. The interceptor aircraft will use every possible precaution to avoid startling intercepted aircrew or passengers. Additionally, the interceptor aircrews will constantly keep in mind that maneuvers considered normal to a fighter aircraft may be considered hazardous to passengers and crews of nonfighter aircraft. When interceptor aircrews know or believe that an unsafe condition exists, the identification phase will be terminated. As previously stated, during darkness or IMC identification of unknown aircraft will be type only. Positive vertical separation will be maintained by interceptor aircraft throughout this phase.

### 2.2.3 Phase Three - Post Intercept Phase:

Upon identification phase completion, the flight leader will turn away from the intercepted aircraft. The wingman will remain well clear and accomplish a rejoin with his leader.

2.3 Communication interface between interceptor aircrews and the ground controlling agency is essential to ensure successful intercepted completion. Flight safety

is paramount. An aircraft which is intercepted by another aircraft shall immediately:

- Follow the instructions given by the intercepting aircraft, interpreting and responding to the visual signals.

- Notify, if possible the appropriate air traffic services unit.

- Attempt to establish radio communication with the intercepting aircraft or with the appropriate intercept control unit, by making a general call on the emergency frequency 243.0. MHz and repeating this call on the emergency frequency 121.5 MHz, if practicable, giving the identity and position of the aircraft and the nature of the flight.

- If equipped with SSR transponder, select mode 3/A Code 7700, unless otherwise instructed by the appropriate air traffic services unit. If any instructions received by radio from any sources conflict with those given by the intercepting aircraft by visual or radio signal, the intercepted aircraft shall request immediate clarification while continuing to comply with the instructions given by the intercepting aircraft.

### 2.4 Interception Signals (See TBL 1.12-1 and TBL 1.12-2).

## 3. Law Enforcement Operations by Civil and Military Organizations

### 3.1 Special law enforcement operations.

#### 3.1.1 Special law enforcement operations include in-flight identification, surveillance, interdiction, and pursuit activities performed in accordance with official civil and/or military mission responsibilities.

#### 3.1.2 To facilitate accomplishment of these special missions, exemptions from specified sections of the Federal Aviation Regulations have been granted to designated departments and agencies. However, it is each organization's responsibility to apprise air traffic control (ATC) of their intent to operate under an authorized exemption before initiating actual operations.

#### 3.1.3 Additionally, some departments and agencies that perform special missions have been assigned coded identifiers to permit them to apprise ATC of ongoing mission activities and solicit special air traffic assistance.



<b>INTERCEPTING SIGNALS</b>				
<b>Signals initiated by intercepting aircraft and responses by intercepted aircraft (as set forth in ICAO Annex 2-Appendix A, 2.1)</b>				
Series	INTERCEPTING Aircraft Signals	Meaning	INTERCEPTED Aircraft Responds	Meaning
1	<p>DAY-Rocking wings from a position slightly above and ahead of, and normally to the left of, the intercepted aircraft and, after acknowledgement, a slow level turn, normally to the left, on to the desired heading.</p> <p>NIGHT-Same and, in addition, flashing navigational lights at irregular intervals.</p> <p><i>NOTE 1-Meteorological conditions or terrain may require the intercepting aircraft to take up a position slightly above and ahead of, and to the right of, the intercepted aircraft and to make the subsequent turn to the right.</i></p> <p><i>NOTE 2-If the intercepted aircraft is not able to keep pace with the intercepting aircraft, the latter is expected to fly a series of race-track patterns and to rock its wings each time it passes the intercepted aircraft.</i></p>	<p>You have been intercepted. Follow me.</p>	<p>AEROPLANES: DAY-Rocking wings and following.</p> <p>NIGHT-Same and, in addition, flashing navigational lights at irregular intervals.</p> <p>HELICOPTERS: DAY or NIGHT-Rocking aircraft, flashing navigational lights at irregular intervals and following.</p>	<p>Understood, will comply.</p>
2	<p>DAY or NIGHT-An abrupt break-away maneuver from the intercepted aircraft consisting of a climbing turn of 90 degrees or more without crossing the line of flight of the intercepted aircraft.</p>	<p>You may proceed.</p>	<p>AEROPLANES: DAY or NIGHT-Rocking wings.</p> <p>HELICOPTERS: DAY or NIGHT-Rocking aircraft.</p>	<p>Understood, will comply.</p>
3	<p>DAY-Circling aerodrome, lowering landing gear and overflying runway in direction of landing or, if the intercepted aircraft is a helicopter, overflying the helicopter landing area.</p> <p>NIGHT-Same and, in addition, showing steady landing lights.</p>	<p>Land at this aerodrome.</p>	<p>AEROPLANES: DAY-Lowering landing gear, following the intercepting aircraft and, if after overflying the runway landing is considered safe, proceeding to land.</p> <p>NIGHT-Same and, in addition, showing steady landing lights (if carried).</p> <p>HELICOPTERS: DAY or NIGHT-Following the intercepting aircraft and proceeding to land, showing a steady landing light (if carried).</p>	<p>Understood, will comply.</p>

TBL 1.12-1

<b>INTERCEPTING SIGNALS</b> <b>Signals and Responses During Aircraft Intercept</b> <b>Signals initiated by intercepting aircraft and responses by intercepted aircraft</b> <b>(as set forth in ICAO Annex 2-Appendix A, 2.2)</b>				
Series	INTERCEPTING Aircraft Signals	Meaning	INTERCEPTED Aircraft Responds	Meaning
4	<p><b>AEROPLANES:</b>                      DAY-Raising landing gear while passing over landing runway at a height exceeding 300m (1,000 ft) but not exceeding 600m (2,000 ft) above the aerodrome level, and continuing to circle the aerodrome.</p> <p>NIGHT-Flashing landing lights while passing over landing runway at a height exceeding 300m (1,000 ft) but not exceeding 600m (2,000 ft) above the aerodrome level, and continuing to circle the aerodrome. If unable to flash landing lights, flash any other lights available.</p>	Aerodrome you have designated is inadequate.	<p>DAY or NIGHT-If it is desired that the intercepted aircraft follow the intercepting aircraft to an alternate aerodrome, the intercepting aircraft raises its landing gear and uses the Series 1 signals prescribed for intercepting aircraft.</p> <p>If it is decided to release the intercepted aircraft, the intercepting aircraft uses the Series 2 signals prescribed for intercepting aircraft.</p>	<p>Understood, follow me.</p> <p>Understood, you may proceed.</p>
5	<p><b>AEROPLANES:</b>                      DAY or NIGHT-Regular switching on and off of all available lights but in such a manner as to be distinct from flashing lights.</p>	Cannot comply.	DAY or NIGHT-Use Series 2 signals prescribed for intercepting aircraft.	Understood.
6	<p><b>AEROPLANES:</b>                      DAY or NIGHT-Irregular flashing of all available lights.</p> <p><b>HELICOPTERS:</b>                      DAY or NIGHT-Irregular flashing of all available lights.</p>	In distress.	DAY or NIGHT-Use Series 2 signals prescribed for intercepting aircraft.	Understood.

TBL 1.12-2

**ENR 1.13 [RESERVED]**



**ENR 1.14 [RESERVED]**



## ENR 1.15 Medical Facts for Pilots

### 1. Fitness for Flight

#### 1.1 Medical Certification:

a) All pilots except those flying gliders and free air balloons must possess valid medical certificates in order to exercise the privileges of their airman certificates. The periodic medical examinations required for medical certification are conducted by designated Aviation Medical Examiners, who are physicians with a special interest in aviation safety and training in aviation medicine.

b) The standards for medical certification are contained in the Federal Aviation Regulations (14 CFR Part 67). Pilots who have a history of certain medical conditions described in these standards are mandatorily disqualified from flying. These medical conditions include a personality disorder manifested by overt acts, a psychosis, alcoholism, drug dependence, epilepsy, an unexplained disturbance of consciousness, myocardial infarction, angina pectoris and diabetes requiring medication for its control. Other medical conditions may be temporarily disqualifying, such as acute infections, anemia, and peptic ulcer. Pilots who do not meet medical standards may still be qualified under special issuance provisions or the exemption process. This may require that either additional medical information be provided or practical flight tests be conducted.

c) Student pilots should visit an aviation medical examiner as soon as possible in their flight training in order to avoid unnecessary training expenses should they not meet the medical standards. For the same reason, the student pilot who plans to enter commercial aviation should apply for the highest class of medical certificate that might be necessary in the pilot's career.

**CAUTION.—**  
*THE FEDERAL AVIATION REGULATIONS PROHIBIT A PILOT WHO POSSESSES A CURRENT MEDICAL CERTIFICATE FROM PERFORMING CREWMEMBER DUTIES WHILE THE PILOT HAS A KNOWN MEDICAL CONDITION OR INCREASE OF A KNOWN MEDICAL CONDITION THAT WOULD MAKE THE PILOT UNABLE TO MEET THE STANDARDS FOR THE MEDICAL CERTIFICATE.*

#### 1.2 Illness

a) Even a minor illness suffered in day-to-day living can seriously degrade performance of many piloting tasks vital to safe flight. Illness can produce fever and distracting symptoms that can impair judgment, memory, alertness, and the ability to make calculations. Although symptoms from an illness may be under

adequate control with a medication, the medication itself may decrease pilot performance.

b) The safest rule is not to fly while suffering from any illness. If this rule is considered too stringent for a particular illness, the pilot should contact an aviation medical examiner for advice.

#### 1.3 Medication

a) Pilot performance can be seriously degraded by both prescribed and over-the-counter medications, as well as by the medical conditions for which they are taken. Many medications, such as tranquilizers, sedatives, strong pain relievers, and cough-suppressant preparations, have primary effects that may impair judgment, memory, alertness, coordination, vision, and the ability to make calculations. Others, such as antihistamines, blood pressure drugs, muscle relaxants, and agents to control diarrhea and motion sickness, have side effects that may impair the same critical functions. Any medication that depresses the nervous system, such as a sedative, tranquilizer or antihistamine, can make a pilot much susceptible to hypoxia (see below).

b) The Federal Aviation Regulations prohibit pilots from performing crewmember duties while using any medication that affects the faculties in any way contrary to safety. The safest rule is not to fly as a crewmember while taking any medication, unless approved to do so by the FAA.

#### 1.4 Alcohol

a) Extensive research has provided a number of facts about the hazards of alcohol consumption and flying. As little as one ounce of liquor, one bottle of beer, or four ounces of wine can impair flying skills, with the alcohol consumed in these drinks being detectable in the breath and blood at least three hours. Even after the body completely destroys a moderate amount of alcohol, a pilot can still be severely impaired for many hours by hangover. There is simply no way of increasing the destruction of alcohol or alleviating a hangover. Alcohol also renders a pilot much more susceptible to disorientation and hypoxia (see below).

b) A consistently high alcohol-related, fatal aircraft accident rate serves to emphasize that alcohol and flying are a potentially lethal combination. The Federal Aviation Regulations prohibit pilots from performing crewmember duties within eight hours after drinking any alcoholic beverage or while under the influence of

alcohol. However, due to the slow destruction of alcohol, a pilot may still be under the influence eight hours after drinking a moderate amount of alcohol. Therefore, an excellent rule is to allow at least 12 to 24 hours between "bottle and throttle." depending on the amount of alcoholic beverage consumed.

### 1.5 Fatigue

a) Fatigue continues to be one of the most treacherous hazards to flight safety, as it may not be apparent to a pilot until serious errors are made. Fatigue is best described as either acute (short-term) or chronic (long-term).

b) A normal occurrence of everyday living, acute fatigue is the tiredness felt after long periods of physical and mental strain, including strenuous muscular effort, immobility, heavy mental workload, strong emotional pressure, monotony, and lack of sleep. Consequently, coordination and alertness, so vital to safe pilot performance, can be reduced. Acute fatigue is prevented by adequate rest and sleep, as well as regular exercise and proper nutrition.

c) Chronic fatigue occurs when there is not enough time for full recovery between episodes of acute fatigue. Performance continues to fall off, and judgment becomes impaired so that unwarranted risks may be taken. Recovery from chronic fatigue requires a prolonged period of rest.

### 1.6 Stress

a) Stress from the pressures of everyday living can impair pilot performance, often in very subtle ways. Difficulties, particularly at work, can occupy thought processes enough to markedly decrease alertness. Distraction can so interfere with judgment that unwarranted risks are taken, such as flying into deteriorating weather conditions to keep on schedule. Stress and fatigue (see above) can be an extremely hazardous combination.

b) Most pilots do leave stress "on the ground." Therefore when more than usual difficulties are being experienced, a pilot should consider delaying flight until these difficulties are satisfactorily resolved.

### 1.7 Emotion

1.7.1 Certain emotionally upsetting events, including a serious argument, death of a family member, separation or divorce, loss of job and financial catastrophe, can render a pilot unable to fly an aircraft safely. The emotions of anger, depression, and anxiety from such events

not only decrease alertness but also may lead to taking risks that border on self-destruction. Any pilot who experiences an emotionally upsetting event should not fly until satisfactorily recovered from it.

### 1.8 Personal Checklist

1.8.1 Aircraft accident statistics show that pilots should be conducting preflight checklists on themselves as well as their aircraft, for pilot impairment contributes to many more accidents than failure of aircraft systems. A personal checklist that can be easily committed to memory, which includes all of the categories of pilot impairment discussed in this section, is distributed by the FAA in form of a wallet-sized card.

**1.9 PERSONAL CHECKLIST: *I'm physically and mentally safe to fly; not being impaired by:***

**I**llness

**M**edication

**S**tress

**A**lcohol

**F**atigue

**E**motion

### 2. Effects of Altitude

#### 2.1 Hypoxia

a) Hypoxia is a state of oxygen deficiency in the body sufficient to impair functions of the brain and other organs. Hypoxia from exposure to altitude is due only to the reduced barometric pressures encountered at altitude, for the concentration of oxygen in the atmosphere remains about 21 percent from the ground out to space.

b) Although a deterioration in night vision occurs at a cabin pressure altitude as low as 5,000 feet, other significant effects of altitude hypoxia usually do not occur in the normal healthy pilot below 12,000 feet. From 12,000 to 15,000 feet of altitude, judgment, memory, alertness, coordination and ability to make calculations are impaired, and headache, drowsiness, dizziness and either a sense of well-being (euphoria) or belligerence occur. The effects appear following increasingly shorter periods of exposure to increasing



altitude. In fact, pilot performance can seriously deteriorate within 15 minutes at 15,000 feet.

c) At cabin pressure altitudes above 15,000 feet, the periphery of the visual field grays out to a point where only central vision remains (tunnel vision). A blue coloration (cyanosis) of the fingernails and lips develops. The ability to take corrective and protective action is lost in 20 to 30 minutes at 18,000 feet and 5 to 12 minutes at 20,000 feet, followed soon thereafter by unconsciousness.

d) The altitude at which significant effects of hypoxia occur can be lowered by a number of factors. Carbon monoxide inhaled in smoking or from exhaust fumes (see below), lowered hemoglobin (anemia), and certain medications can reduce the oxygen-carrying capacity of the blood to the degree that the amount of oxygen provided to body tissues will already be equivalent to the oxygen provided to the tissues when exposed to cabin pressure altitude of several thousand feet. Small amounts of alcohol and low doses of certain drugs, such as antihistamines, tranquilizers, sedatives and analgesics can, through their depressant actions, render the brain much more susceptible to hypoxia. Extreme heat and cold, fever, and anxiety increase the body's demand for oxygen, and hence its susceptibility to hypoxia.

e) The effects of hypoxia are usually quite difficult to recognize, especially when they occur gradually. Since symptoms of hypoxia do not vary in an individual, the ability to recognize hypoxia can be greatly improved by experiencing and witnessing the effects of hypoxia during an altitude chamber "flight." The FAA provides this opportunity through aviation physiology training, which is conducted at the FAA Civil Aeromedical Institute and at many military facilities across the United States, to attend the Physiological Training Program at the Civil Aeromedical Institute, Mike Monroney Aeronautical Center, Oklahoma City, OK, contact by telephone (405) 954-6212, or by writing Airmen Education Branch, AAM-420, CAMI, Mike Monroney Aeronautical Center, P.O. Box 25082, Oklahoma City, OK 73125.

**NOTE.—**  
TO ATTEND THE PHYSIOLOGICAL TRAINING PROGRAM AT ONE OF THE MILITARY INSTALLATIONS HAVING THE TRAINING CAPABILITY, AN APPLICATION FORM AND A FEE MUST BE SUBMITTED. FULL PARTICULARS ABOUT LOCATION, FEES, SCHEDULING PROCEDURES, COURSE CONTENT, INDIVIDUAL REQUIREMENTS, ETC. ARE CONTAINED IN THE PHYSIOLOGICAL TRAINING APPLICATION, FORM NUMBER AC-3150-7, WHICH IS OBTAINED BY CONTACTING THE ACCIDENT PREVENTION SPECIALIST OR THE OFFICE FORMS MANAGER IN THE NEAREST FAA OFFICE.

f) Hypoxia is prevented by heeding factors that reduce tolerance to altitude, by enriching the inspired air with oxygen from an appropriate oxygen system and by maintaining a comfortable, safe cabin pressure altitude. For optimum protection, pilots are encouraged to use supplemental oxygen above 10,000 feet during the day, and above 5,000 feet at night. The Federal Aviation Regulations require that the minimum flight crew be provided with and use supplemental oxygen after 30 minutes of exposure to cabin pressure altitudes between 12,500 and 14,000 feet, and immediately on exposure to cabin pressure altitudes above 14,000. Every occupant of the aircraft must be provided with supplemental oxygen at cabin pressure altitudes above 15,000 feet.

## 2.2 Ear Block

a) As the aircraft cabin pressure decreases during ascent, the expanding air in the middle ear pushes the eustachian tube open and, by escaping down it to the nasal passages, equalizes in pressure with the cabin pressure. But during descent, the pilot must periodically open the eustachian tube to equalize pressure. This can be accomplished by swallowing, yawning, tensing muscles in the throat or, if these do not work, by the combination of closing the mouth, pinching the nose closed and attempting to blow through the nostrils (Valsalva maneuver).

b) Either an upper respiratory infection, such as a cold or sore throat, or a nasal allergic condition can produce enough congestion around the eustachian tube to make equalization difficult. Consequently, the difference in pressure between the middle ear and aircraft cabin can build up to a level that will hold the eustachian tube closed, making equalization difficult if not impossible. This problem is commonly referred to as an "ear block."

c) An ear block produces severe ear pain and loss of hearing that can last from several hours to several days. Rupture of the ear drum can occur in flight or after landing. Fluid can accumulate in the middle ear and become infected.

d) An ear block is prevented by not flying with an upper respiratory infection or nasal allergic condition. Adequate protection is usually not provided by decongestant sprays or drops to reduce congestion around the eustachian tubes. Oral decongestants have side effects that can significantly impair pilot performance.

e) If an ear block does not clear shortly after landing, a physician should be consulted.

### 2.3 Sinus Block

a) During ascent and descent, air pressure in the sinuses equalizes with the aircraft cabin pressure through small openings that connect the sinuses to the nasal passages. Either an upper respiratory infection, such as a cold or sinusitis, or a nasal allergic condition can produce enough congestion around an opening to slow equalization and, as the difference in pressure between the sinus and cabin mounts, eventually plug the opening. This "sinus block" occurs most frequently during descent.

b) A sinus block can occur in the frontal sinuses, located above each eyebrow, or in the maxillary sinuses, located in each upper cheek. It will usually produce excruciating pain over the sinus area. A maxillary sinus block can also make the upper teeth ache. Bloody mucus may discharge from the nasal passages.

c) A sinus block is prevented by not flying with an upper respiratory infection or nasal allergic condition. Adequate protection is usually not provided by decongestant sprays or drops to reduce congestion around the sinus openings. Oral decongestants have side effects that can impair pilot performance.

d) If a sinus block does not clear shortly after landing, a physician should be consulted.

### 2.4 Decompression Sickness After Scuba Diving

a) A pilot or passenger who intends to fly after SCUBA diving should allow the body sufficient time to rid itself of excess nitrogen absorbed during diving. If not, decompression sickness due to evolved gas can occur during exposure to low altitude and create a serious inflight emergency.

b) The recommended waiting time before going to flight altitudes of up to 8,000 feet is at least 12 hours after diving which has not required controlled ascent (nondecompression stop diving), and at least 24 hours after diving which has required controlled ascent (decompression stop diving). The waiting time before going to flight altitudes above 8,000 feet should be at least 24 hours after any SCUBA dive. These recommended altitudes are actual flight altitudes above mean sea level (AMSL) and not pressurized cabin altitudes. This takes into consideration the risk of decompression of the aircraft during flight.

### 3. Hyperventilation in Flight

3.1 Hyperventilation, or an abnormal increase in the volume of air breathed in and out of the lungs, can occur subconsciously when a stressed situation is encountered in flight. As hyperventilation "blows off" excessive carbon dioxide from the body, a pilot can experience symptoms of lightheadedness, suffocation, drowsiness, tingling in the extremities, and coolness - and react to them with even greater hyperventilation. Incapacitation can eventually result from incoordination, disorientation, and painful muscle spasms. Finally, unconsciousness can occur.

3.2 The symptoms of hyperventilation subside within a few minutes after the rate and depth of breathing are consciously brought back under control. The buildup of carbon dioxide in the body can be hastened by controlled breathing in and out of a paper bag held over the nose and mouth.

3.3 Early symptoms of hyperventilation and hypoxia are similar. Moreover, hyperventilation and hypoxia can occur at the same time. Therefore, if a pilot is using an oxygen system when symptoms are experienced, the oxygen regulator should immediately be set to deliver 100 percent oxygen, and then the system checked to assure that it has been functioning effectively before giving attention to rate and depth of breathing.

### 4. Carbon Monoxide Poisoning in Flight

4.1 Carbon monoxide is a colorless, odorless and tasteless gas contained in exhaust fumes. When breathed even in minute quantities over a period of time, it can significantly reduce the ability of the blood to carry oxygen. Consequently, effects of hypoxia occur (see subparagraph 2.1).

4.2 Most heaters in light aircraft work by air flowing over the manifold. Use of these heaters while exhaust fumes are escaping through manifold cracks and seals is responsible every year for several non-fatal and fatal aircraft accidents from carbon monoxide poisoning.

4.3 A pilot who detects the odor of exhaust or experiences symptoms of headache, drowsiness, or dizziness while using the heater should suspect carbon monoxide poisoning, and immediately shut off the heater and open air vents. If symptoms are severe, or continue after landing, medical treatment should be sought.

### 5. Illusions in Flight

5.1 Introduction: Many different illusions can be experienced in flight. Some can lead to spatial disorientation. Others can lead to landing errors. Illusions rank

among the most common factors cited as contributing to fatal aircraft accidents.

## 5.2 Illusions Leading to Spatial Disorientation:

a) Various complex motions and forces and certain visual scenes encountered in flight can create illusions of motion and position. Spatial disorientation from these illusions can be prevented only by visual reference to reliable, fixed points on the ground or to flight instruments.

b) **The leans:** An abrupt correction of a banked attitude, which has been entered too slowly to stimulate the motion sensing system in the inner ear, can create the illusion of banking in the opposite direction. The disoriented pilot will roll the aircraft back into its original dangerous attitude or, if level flight is maintained, will feel compelled to lean in the perceived vertical plane until this illusion subsides.

c) **Coriolis illusion:** An abrupt head movement in a prolonged constant-rate turn that has ceased stimulating the motion sensing system can create the illusion of rotation or movement in an entirely different axis. The disoriented pilot will maneuver the aircraft into a dangerous attitude in an attempt to stop rotation. This most overwhelming of all illusions in flight may be prevented by not making sudden, extreme head movements, particularly while making prolonged constant-rate turns under IFR conditions.

d) **Graveyard spin:** A proper recovery from a spin that has ceased stimulating the motion sensing system can create the illusion of spinning in the opposite direction. The disoriented pilot will return the aircraft to its original spin.

e) **Graveyard spiral:** An observed loss of altitude during a coordinated constant-rate turn that has ceased stimulating the motion sensing system can create the illusion of being in a descent with the wings level. The disoriented pilot will pull back on the controls, tightening the spiral and increasing the loss of altitude.

f) **Somatogravic illusion:** A rapid acceleration during takeoff can create the illusion of being in a nose-up attitude. The disoriented pilot will push the aircraft into a nose-low, or dive attitude. A rapid deceleration by a quick reduction of the throttles can have the opposite effect, with the disoriented pilot pulling the aircraft into a nose-up, or stall attitude.

g) **Inversion illusion:** An abrupt change from climb to straight and level flight can create the illusion of tumbling backwards. The disoriented pilot will push

the aircraft abruptly into a nose-low attitude, possibly intensifying this illusion.

h) **Elevator illusion:** An abrupt upward vertical acceleration, usually by an updraft, can create the illusion of being in a climb. The disoriented pilot will push the aircraft into a nose-low attitude. An abrupt downward vertical acceleration, usually by a downdraft, has the opposite effect, with the disoriented pilot pulling the aircraft into a nose-up attitude.

i) **False horizon:** Sloping cloud formations, an obscured horizon, a dark scene spread with ground lights and stars, and certain geometric patterns of ground lights can create illusions of not being aligned correctly with the actual horizon. The disoriented pilot will place the aircraft in a dangerous attitude.

j) **Autokinesis:** In the dark, a static light will appear to move about when stared at for many seconds. The disoriented pilot will lose control of the aircraft in attempting to align it with the light.

## 5.3 Illusions Leading to Landing Errors

a) Various surface features and atmospheric conditions encountered in landing can create illusions of incorrect height above and distance from the runway threshold. Landing errors from these illusions can be prevented by anticipating them during approaches, aerial visual inspection of unfamiliar airports before landing, using electronic glide slope or VASI systems when available, and maintaining optimum proficiency in landing procedures.

b) **Runway width illusion:** A narrower-than-usual runway can create the illusion that the aircraft is at a higher altitude than it actually is. The pilot who does not recognize this illusion will fly a lower approach, with the risk of striking objects along the approach path or landing short. A wider-than-usual runway can have the opposite effect, with the risk of leveling out high and landing hard or overshooting the runway.

c) **Runway and terrain slopes illusion:** An upsloping runway, upsloping terrain, or both, can create the illusion that the aircraft is at a higher altitude than it actually is. The pilot who does not recognize this illusion will fly a lower approach. A downsloping runway, downsloping approach terrain, or both, can have the opposite effect.

d) **Featureless terrain illusion:** An absence of ground features, as when landing over water, darkened areas and terrain made featureless by snow, can create the illusion that the aircraft is at a higher altitude than

it actually is. The pilot who does not recognize this illusion will fly a lower approach.

**e) Atmospheric illusions:** Rain on the windscreen can create the illusion of greater height, and atmospheric haze can create the illusion of being at greater distance from the runway. The pilot who does not recognize these illusions will fly a lower approach. Penetration of fog can create the illusion of pitching up. The pilot who does not recognize this illusion will steepen the approach, often quite abruptly.

**f) Ground lighting illusions:** Lights along a straight path, such as a road, and even lights on moving trains can be mistaken for runway and approach lights. Bright runway and approach lighting systems, especially where few lights illuminate the surrounding terrain, may create the illusion of less distance to the runway. The pilot who does not recognize this illusion will fly a higher approach. Conversely, the pilot overflying terrain which has few lights to provide height cues may make lower than normal approach.

## 6. Vision in Flight

**6.1 Introduction:** Of the body senses, vision is the most important for safe flight. Major factors that determine how effectively vision can be used are the level of illumination and the technique of scanning the sky for other aircraft.

### 6.2 Vision Under Dim and Bright Illumination:

**a)** Under conditions of dim illumination, small print and colors on aeronautical charts and aircraft instruments become unreadable unless adequate cockpit lighting is available. Moreover, another aircraft must be much closer to be seen unless its navigation lights are on.

**b)** In darkness, vision becomes more sensitive to light, a process called dark adaptation. Although exposure to total darkness for at least 30 minutes is required for complete dark adaptation, the pilot can achieve a moderate degree of dark adaptation within 20 minutes under dim red cockpit lighting. Since red light severely distorts colors, especially on aeronautical charts, and can cause serious difficulty in focusing the eyes on objects inside the aircraft, its use is advisable only where optimum outside night vision capability is necessary. Even so, white cockpit lighting must be available when needed for map and instrument reading, especially under IFR conditions. Dark adaptation is impaired by exposure to cabin pressure altitude above 5,000 feet, carbon monoxide inhaled in smoking and

from exhaust fumes, deficiency of Vitamin A in the diet, and by prolonged exposure to bright sunlight. Since any degree of dark adaptation is lost within a few seconds of viewing a bright light, the pilot should close one eye when using a light to preserve some degree of night vision.

**c)** Excessive illumination, especially from light reflected off the canopy, surfaces inside the aircraft, clouds, water, snow, and desert terrain, can produce glare, with uncomfortable squinting, watering of the eyes, and even temporary blindness. Sunglasses for protection from glare should absorb at least 85 percent of visible light (15 percent transmittance) and all colors equally (neutral transmittance), with negligible image distortion from refractive and prismatic errors.

### 6.3 Scanning for Other Aircraft

**a)** Scanning the sky for other aircraft is a key factor in collision avoidance. It should be used continuously by the pilot and copilot (or right seat passenger) to cover all areas of the sky visible from the cockpit. Although pilots must meet specific visual acuity requirements, the ability to read an eye chart does not ensure that one will be able to efficiently spot other aircraft. Pilots must develop an effective scanning technique which maximizes one's visual capabilities. The probability of spotting a potential collision threat obviously increases with the time spent looking outside the cockpit. Thus, one must use timesharing techniques to efficiently scan the surrounding airspace while monitoring instruments as well.

**b)** While the eyes can observe an approximate 200 degree arc of the horizon at one glance, only a very small center area called the fovea, in the rear of the eye, has the ability to send clear, sharply focused messages to the brain. All other visual information that is not processed directly through the fovea will be of less detail. An aircraft at a distance of 7 miles which appears in sharp focus within the foveal center of vision would have to be as close as 7/10 of a mile in order to be recognized if it were outside of foveal vision. Because the eyes can focus only on this narrow viewing area, effective scanning is accomplished with a series of short, regularly spaced eye movements that bring successive areas of the sky into the central visual field. Each movement should not exceed 10 degrees, and each area should be observed for at least one second to enable detection. Although horizontal back-and-forth eye movements seem preferred by most pilots, each pilot should develop a scanning pattern that is most comfortable and then adhere to it to assure optimum scanning.

c) Studies show that the time a pilot spends on visual tasks inside the cabin should represent no more than  $\frac{1}{4}$  to  $\frac{1}{3}$  of the scan time outside, or no more than 4 to 5 seconds on the instrument panel for every 16 seconds outside. Since the brain is already trained to process sight information that is presented from left to right, one may find it easier to start scanning over the left shoulder and proceed across the windshield to the right.

d) Pilots should realize that their eyes may require several seconds to refocus when switching views between items in the cockpit and distant objects. The eyes will also tire more quickly when forced to adjust to distances immediately after close-up focus, as required for scanning the instrument panel. Eye fatigue can be reduced by looking from the instrument panel to the left wing past the wing tip to the center of the first scan quadrant when beginning the exterior scan. After having scanned from left to right, allow the eyes to return to the cabin along the right wing from its tip inward. Once back inside, one should automatically commence the panel scan.

e) Effective scanning also helps avoid "empty-field myopia." This condition usually occurs when flying above the clouds or in a haze layer that provides nothing specific to focus on outside the aircraft. This causes the eyes to relax and seek a comfortable focal distance which may range from 10 to 30 feet. For the pilot, this means looking without seeing, which is dangerous.

## 7. Judgment Aspects of Collision Avoidance

**7.1 Introduction:** The most important aspects of vision and the techniques to scan for other aircraft are described in paragraph 6 above. Pilots should also be familiar with the following information to reduce the possibility of mid-air collisions.

**7.2 Determining Relative Altitude:** Use the horizon as a reference point. If the other aircraft is above the horizon, it is probably on a higher flight path. If the aircraft appears to be below the horizon, it is probably flying at a lower altitude.

**7.3 Taking Appropriate Action:** Pilots should be familiar with right-of-way rules so immediate evasive action can be taken if an aircraft is on an obvious collision course. Preferably, such actions will be in compliance with applicable Federal Aviation Regulations.

**7.4 Consider Multiple Threats:** The decision to climb, descend, or turn is a matter of personal judgment, but one should anticipate that the other pilot may also be making a quick maneuver. Watch the other aircraft

during the maneuver and immediately begin your scanning again since there may be other aircraft in the area.

**7.5 Target Acquisition:** Anticipate the target in the location and ranges you are searching. Locate a sizable, distant object (e.g., a cloud formation, mountain peak, prominent landmark, building or pier) that is within range of the anticipated target, and focus your eyes on it as you begin each scan pattern.

**7.6 Collision Course Targets:** Any aircraft that appears to have no relative motion and stays in one scan quadrant is likely to be on a collision course. Also, if a target shows no lateral or vertical motion, but increases in size, TAKE EVASIVE ACTION.

## 7.7 Recognize High Hazard Areas:

a) Airways, and especially VOR's, and Class B, C, D, and E surface areas are places where aircraft tend to cluster.

b) Remember, most collisions occur during days when the weather is good. Being in a "radar environment" still requires vigilance to avoid collisions.

**7.8 Cockpit Management:** Studying maps, checklists, and manuals before flight, with various other proper preflight planning (e.g., noting necessary radio frequencies) and organizing cockpit materials, can reduce the amount of time required to look at these items during flight permitting more scan time.

**7.9 Windshield Conditions:** Dirty or bug-smeared windshields can greatly reduce the ability of pilots to see other aircraft. Keep a clean windshield.

**7.10 Visibility Conditions:** Smoke, haze, dust, rain, and flying towards the sun can also greatly reduce the ability to detect targets.

## 7.11 Visual Obstruction in the Cockpit:

a) Pilots need to move their heads to see around blind spots caused by fixed aircraft structures, such as door posts, wings, etc. It will be necessary at times to maneuver the aircraft (e.g., lift a wing) to facilitate seeing around this structure.

b) Pilots must insure that curtains and other cockpit objects (e.g., maps on glare shield) are removed and stowed during flight.

## 7.12 Lights On

a) Day or night, use of exterior lights can greatly increase the conspicuity of any aircraft.

b) Keep interior lights low at night.

**7.13 ATC Support:** ATC facilities often provide radar traffic advisories on a workload-permitting basis. Flight through Class C Airspace requires communication with ATC. Use this support whenever possible or when required.

## ENR 1.16 Safety, Hazard and Accident Reports

### 1. Aviation Safety Reporting Program

**1.1** The FAA has established a voluntary program designed to stimulate the free and unrestricted flow of information concerning deficiencies and discrepancies in the aviation system. This is a positive program intended to ensure the safest possible system by identifying and correcting unsafe conditions before they lead to accidents. The primary objective of the program is to obtain information to evaluate and enhance the safety and efficiency of the present system.

**1.2** This cooperative safety reporting program invites pilots, controllers, flight attendants, maintenance personnel and other users of the airspace system, or any other person, to file written reports of actual or potential discrepancies and deficiencies involving the safety of aviation operations. The operations covered by the program include departure, en route, approach, and landing operations and procedures, air traffic control procedures and equipment, crew and air traffic control communications, aircraft cabin operations, aircraft movement on the airport, near midair collisions, aircraft maintenance and record keeping and airport conditions or services.

**1.3** The report should give the date, time, location, persons and aircraft involved (if applicable), nature of the event, and all pertinent details.

**1.4** To ensure receipt of this information, the program provides for the waiver of certain disciplinary actions against persons, including pilots and air traffic controllers, who file timely written reports concerning potentially unsafe incidents. To be considered timely, reports must be delivered or postmarked within 10 days of the incident unless that period is extended for good cause. Reports should be submitted on National Aeronautics and Space Administration (NASA) ARC Forms 277, which are available free of charge, postage prepaid, at FAA Flight Standards District Offices and Flight Service Stations, and from NASA, ASRS, PO Box 189, Moffet Field, CA 94035.

**1.5** The FAA utilizes NASA to act as an independent third party to receive and analyze reports submitted under the program. This program is described in Advisory Circular 00-46.

### 2. Aircraft Accident and Incident Reporting

#### 2.1 Occurrences Requiring Notification

**2.1.1** The operator of an aircraft shall immediately, and by the most expeditious means available, notify the nearest National Transportation Safety Board (NTSB) Field Office when:

a) An aircraft accident or any of the following listed incidents occur:

- 1) Flight control system malfunction or failure;
  - 2) Inability of any required flight crewmember to perform normal flight duties as a result of injury or illness;
  - 3) Failure of structural components of a turbine engine excluding compressor and turbine blades and vanes;
  - 4) Inflight fire;
  - 5) Aircraft collide in flight;
  - 6) Damage to property, other than the aircraft, estimated to exceed \$25,000 for repair (including materials and labor) or fair market value in the event of total loss, whichever is less; or
  - 7) For large multi-engine aircraft (more than 12,500 pounds maximum certificated takeoff weight):
    - Inflight failure of electrical systems which requires the sustained use of an emergency bus powered by a back-up source such as a battery, auxiliary power unit, or air-driven generator to retain flight control or essential instruments;
    - Inflight failure of hydraulic systems that results in sustained reliance on the sole remaining hydraulic or mechanical system for movement of flight control surfaces;
    - Sustained loss of the power or thrust produced by two or more engines; and
    - An evacuation of aircraft in which an emergency egress system is utilized.
- b) An aircraft is overdue and is believed to have been involved in an accident.

#### 2.2 Manner of Notification

**2.2.1** The most expeditious method of notification to the NTSB by the operator will be determined by the circumstances existing at the time. The NTSB has advised

that any of the following would be considered examples of the type of notification that would be acceptable:

- a) Direct telephone notification;
- b) Telegraphic notification; or
- c) Notification to the FAA who would in turn notify the NTSB by direct communication; i.e., dispatch or telephone.

### 2.3 Items to be Reported

2.3.1 The notification required above shall contain the following information, if available:

- a) Type, nationality, and registration marks of the aircraft;
- b) Name of owner and operator of the aircraft;
- c) Name of the pilot-in-command;
- d) Date and time of the accident;
- e) Last point of departure and point of intended landing of the aircraft;
- f) Position of the aircraft with reference to some easily defined geographical point;
- g) Number of persons aboard, number killed, and number seriously injured;
- h) Nature of the accident or incident, the weather, and the extent of damage to the aircraft, so far as is known; and
- i) A description of any explosives, radioactive materials, or other dangerous articles carried.

### 2.4 Follow-up Reports

2.4.1 The operator shall file a report on NTSB Form 6120.1 or 6120.2, available from the NTSB Field Offices, or the NTSB, Washington, D.C. 20594:

- a) Within ten days after an accident;
- b) When, after seven days, an overdue aircraft is still missing; or
- c) A report on an incident for which notification is required as described in paragraph 2.1 shall be filed only as requested by an authorized representative of the NTSB.

2.4.2 Each crewmember, if physically able at the time the report is submitted, shall attach a statement setting forth the facts, conditions and circumstances relating to the accident or occurrence as they appeared. If the crew-

member is incapacitated, the statement shall be submitted as soon as physically possible.

### 2.5 Where to File the Reports

2.5.1 The operator of an aircraft shall file with the field office of the NTSB nearest the accident or incident any report required by this section.

2.5.2 The NTSB field offices are listed under U.S. Government in the telephone directories in the following cities: Anchorage, Alaska; Atlanta, Georgia; Chicago, Illinois; Denver, Colorado; Fort Worth, Texas; Los Angeles, California; Miami, Florida; Parsippany, New Jersey; and Seattle, Washington.

## 3. Near Midair Collision Reporting

**3.1 Purpose and Data Uses:** The primary purpose of the Near Midair Collision (NMAC) Reporting Program is to provide information for use in enhancing the safety and efficiency of the National Airspace System. Data obtained from NMAC reports are used by the FAA to improve the quality of FAA services to users and to develop programs, policies, and procedures aimed at the reduction of NMAC occurrences. All NMAC reports are thoroughly investigated by Flight Standards Facilities in coordination with Air Traffic Facilities. Data from these investigations are transmitted to FAA Headquarters in Washington, D.C. where they are compiled and analyzed, and where safety programs and recommendations are developed.

**3.2 Definition:** A near midair collision is defined as an incident associated with the operation of an aircraft in which a possibility of collision occurs as a result of proximity of less than 500 feet to another aircraft, or a report is received from a pilot or a flight crewmember stating that a collision hazard existed between two or more aircraft.

**3.3 Reporting Responsibility:** It is the responsibility of the pilot and/or flight crew to determine whether a near midair collision did actually occur and, if so, to initiate a NMAC report. Be specific, as ATC will not interpret a casual remark to mean that a NMAC is being reported. The pilot should state "I wish to report a near midair collision."

**3.4 Where to File Reports:** Pilots and/or flight crewmembers involved in NMAC occurrences are urged to report each incident immediately:

- a) By radio or telephone to the nearest FAA ATC facility or FSS; or
- b) In writing, in lieu of the above, to the nearest Air Carrier District Office (ACDO), General Aviation



District Office (GADO), or Flight Standards District Office (FSDO).

### 3.5 Items to be Reported:

- a) Date and time (UTC) of incident;
- b) Location of incident and altitude;
- c) Identification and type of reporting aircraft, aircrew destination, name and home base of pilot;
- d) Identification and type of other aircraft, aircrew destination, name and home base of pilot;
- e) Type of flight plans; station altimeter setting used;
- f) Detailed weather conditions at altitude or flight level;
- g) Approximate courses of both aircraft: indicate if one or both aircraft were climbing or descending;
- h) Reported separation in distance at first sighting, proximity at closest point horizontally and vertically, length of time in sight prior to evasive action;

i) Degree of evasive action taken, if any (from both aircraft, if possible); and

j) Injuries, if any.

**3.6 Investigation:** The district office responsible for the investigation and reporting of NMAC's will be:

a) The Air Carrier or Flight Standards District Office in whose area the incident occurred when an air carrier aircraft is involved; or

b) The General Aviation or Flight Standards District Office in whose area the incident occurred in all other cases.

**3.7 Existing radar, communication, and weather data** will be examined in the conduct of the investigation. When possible, all cockpit crew members will be interviewed regarding factors involving the NMAC incident. Air traffic controllers will be interviewed in cases where one or more of the involved aircraft was provided ATC service. Both flight and ATC procedures will be evaluated. When the investigation reveals a violation of an FAA regulation, enforcement action will be pursued.



## **ENR 2. Air Traffic Services Airspace**

See GEN 3.3 and ENR 1.4.



---

## **ENR 3. ATS ROUTES**

**ENR 3.1 [RESERVED]**



**ENR 3.2 [RESERVED]**





## ENR 3.3 Area Navigation (RNAV) Routes

### 1. RNAV Routes

**1.1** RNAV is a method of navigation that permits aircraft operations on any desired course within the coverage of station referenced navigation signals or within the limits of a self-contained system capability or combination of these.

**1.2** Fixed RNAV routes are permanent, published routes which can be flight planned for use by aircraft

with RNAV capability. A previously established fixed RNAV route system has been terminated except for a few high altitude routes in Alaska.

**1.3** Random RNAV routes are direct routes, based on area navigation capability, between waypoints defined in terms of latitude/longitude coordinates, degree-distance fixes, or offsets from established routes/airways at a specified distance and direction. Radar monitoring by ATC is required on all random RNAV routes.



---

**ENR 3.4 [RESERVED]**



## ENR 3.5 Other Routes

### 1. Airways and Route Systems

**1.1** Two fixed route systems are established for air navigation purposes. They are the VOR and L/MF system and the jet route system. To the extent possible, these route systems are aligned in an overlying manner to facilitate transition between each.

### 2. VOR and L/MF System

**2.1** The VOR and L/MF (nondirectional radio beacons) Airway System consists of airways designated from 1,200 feet above the surface (or in some instances higher) up to but not including 18,000 feet MSL. These airways are depicted on En Route Low Altitude Charts.

**NOTE.—**  
THE ALTITUDE LIMITS OF A VICTOR AIRWAY SHOULD NOT BE EXCEEDED EXCEPT TO EFFECT TRANSITION WITHIN OR BETWEEN ROUTE STRUCTURES.

**2.2** Except in Alaska and coastal North Carolina, the VOR airways are predicated solely on VOR or VORTAC navigation aids. They are depicted in blue on aeronautical charts and are identified by a “V” (Victor) followed by the airway number; e.g., V12.

**NOTE.—**  
SEGMENTS OF VOR AIRWAYS IN ALASKA AND NORTH CAROLINA (V56, V290) ARE BASED ON L/MF NAVIGATION AIDS AND CHARTED IN BROWN INSTEAD OF BLUE ON EN ROUTE CHARTS.

**2.3** A segment of an airway which is common to two or more routes carries the numbers of all the airways which coincide for that segment. When such is the case, pilots filing a flight plan need to indicate only that airway number for the route filed.

**NOTE.—**  
A PILOT WHO INTENDS TO MAKE AN AIRWAY FLIGHT, USING VOR FACILITIES, WILL SIMPLY SPECIFY THE APPROPRIATE “VICTOR” AIRWAY(S) IN THE FLIGHT PLAN. FOR EXAMPLE, IF A FLIGHT IS TO BE MADE FROM CHICAGO TO NEW ORLEANS AT 8,000 FEET, USING OMNIRANGES ONLY, THE ROUTE MAY BE INDICATED AS “DEPARTING FROM CHICAGO-MIDWAY, CRUISING 8,000 FEET VIA VICTOR 9 TO MOISANT INTERNATIONAL.” IF FLIGHT IS TO BE CONDUCTED IN PART BY MEANS OF L/MF NAVIGATION AIDS AND IN PART ON OMNIRANGES, SPECIFICATIONS OF THE APPROPRIATE AIRWAYS IN THE FLIGHT PLAN WILL INDICATE WHICH TYPES OF FACILITIES WILL BE USED ALONG THE DESCRIBED ROUTES, AND, FOR IFR FLIGHT, PERMIT ATC TO ISSUE A TRAFFIC CLEARANCE ACCORDINGLY. A ROUTE MAY ALSO BE DESCRIBED BY SPECIFYING THE STATION OVER WHICH THE FLIGHT WILL PASS BUT IN THIS CASE SINCE MANY VORS AND L/MF AIDS HAVE THE SAME NAME, THE PILOT MUST BE CAREFUL TO INDICATE WHICH AID WILL BE USED AT A PARTICULAR LOCATION. THIS WILL BE INDICATED IN THE ROUTE OF FLIGHT PORTION OF THE FLIGHT PLAN BY SPECIFYING THE TYPE OF FACILITY TO BE USED AFTER THE LOCATION NAME IN THE FOLLOWING MANNER: NEWARK L/MF, ALLENTOWN VOR.

**2.4** With respect to position reporting, reporting points are designed for VOR Airway Systems. Flights using Victor airways will report over these points unless advised otherwise by ATC.

**2.5** The L/MF airways (colored airways) are predicated solely on L/MF navigation aids and are depicted in brown on aeronautical charts and are identified by color name and number; e.g., Amber One. Green and Red airways are plotted east and west. Amber and Blue airways are plotted north and south.

**NOTE.—**  
EXCEPT FOR G13 IN NORTH CAROLINA, THE COLORED AIRWAY SYSTEM EXISTS ONLY IN THE STATE OF ALASKA. ALL OTHER SUCH AIRWAYS FORMERLY SO DESIGNATED IN THE CONTERMINOUS UNITED STATES HAVE BEEN RESCINDED.

**CAUTION.—**  
USE OF ADJACENTLY LOCATED LF/VHF AIRWAYS AND ROUTES - MANY LOCATIONS JUST OUTSIDE THE CONTIGUOUS 48 STATES HAVE TWO SEPARATE AIRWAY STRUCTURES. ONE STRUCTURE IS MADE UP FROM VORS AND THE OTHER FROM L/MF NAVAIDS (NONDIRECTIONAL RADIO BEACONS). IN SOME INSTANCES, THE DIFFERENT ROUTES APPEAR TO OVERLIE EACH OTHER. THE NAVAIDS ARE SOMETIMES DEPICTED SO CLOSE TO EACH OTHER THAT THEY WILL HAVE THE APPEARANCE OF BEING COLLOCATED, OR NEARLY SO. SUBSTITUTING A VOR RADIAL FOR A NONDIRECTIONAL RADIO BEACON BEARING COULD, IN MANY CIRCUMSTANCES, CAUSE AN EXCESSIVE “OFF COURSE” NAVIGATIONAL ERROR. STRICT ADHERENCE TO THE COLOR CODING OF THE ROUTE STRUCTURE AND NAVAID IN USE SHOULD BE MAINTAINED. CHART PROCEDURES PROVIDE AN EXCELLENT MEANS OF ROUTE DIFFERENTIATION THROUGH THE USE OF COLOR WHICH IS DEFINED AND EXPLAINED IN THE LEGEND.

### 3. Jet Route System

**3.1** The jet route system consists of jet routes established from 18,000 feet MSL to FL 450 inclusive.

**3.2** These routes are depicted on En Route High Altitude Charts. Jet routes are depicted in black on aeronautical charts and are identified by a “J” (Jet) followed by the airway number; e.g., J12. Jet routes, as VOR airways, are predicated solely on VOR or VORTAC navigation facilities (except in Alaska).

**NOTE.—**  
SEGMENTS OF JET ROUTES IN ALASKA ARE BASED ON L/MF NAVIGATION AIDS AND ARE CHARTED IN BROWN COLOR INSTEAD OF BLACK ON EN ROUTE CHARTS.

**3.3** With respect to position reporting, reporting points are designated for Jet Route Systems. Flights using jet routes will report over these points unless otherwise advised by ATC.

### 4. Radar Vectors

**4.1** Controllers may vector aircraft within CONTROLLED AIRSPACE for separation purposes, noise

abatement considerations, when an operational advantage will be realized by the pilot or the controller, or when requested by the pilot. Vectors outside of CONTROLLED AIRSPACE will be provided only on pilot request. Pilots will be advised as to what the vector is to achieve when the vector is controller initiated and will take the aircraft off a previously assigned nonradar route. To the extent possible, aircraft operating on RNAV routes will be allowed to remain on their own navigation.

## 5. Changeover Points (COP's)

**5.1** COP's are prescribed for Federal airways, jet routes, area navigation routes, or other direct routes for which a minimum en route altitude (MEA) is designated under 14 CFR Part 95. The COP is a point along the route or airway segment between two adjacent navigation facilities or waypoints where changeover navigation guidance should occur. At this point, the pilot should change navigation receiver frequency from the station behind the aircraft to the station ahead.

**5.2** The COP is normally located midway between the navigation facilities for straight route segments, or at the intersection of radials or courses forming a dogleg in the case of dogleg route segments. When the COP is NOT located at the midway point, aeronautical charts will depict the COP location and give the mileage to the radio aids.

**5.3** COP's are established for the purpose of preventing loss of navigation guidance, to prevent frequency interference from other facilities, and to prevent use of different facilities by different aircraft in the same airspace. Pilots are urged to observe COP's to the fullest extent.

## 6. Airway or Route Course Changes

**6.1** Pilots of aircraft are required to adhere to airways/routes being flown. Special attention must be given to this requirement during course changes. Each course change consists of variables that make the technique applicable in each case a matter only the pilot can resolve.

Some variables which must be considered are turn radius, wind effect, airspeed, degree of turn, and cockpit instrumentation. An early turn, as illustrated in FIG 3.5-1, is one method of adhering to airways/routes. The use of any available cockpit instrumentation, such as distance measuring equipment, may be used by the pilot to lead the turn when making course changes. This is consistent with the intent of 14 CFR Part 91.181 which requires pilots to operate along the centerline of an airway and along the direct course between navigational aids or fixes.

**6.2** Turns which begin at or after fix passage may exceed airway/route boundaries. FIG 3.5-1 contains an example flight track depicting this, together with an example of an early turn.

**6.3** Without such actions, as leading a turn, aircraft operating in excess of 290 knots true airspeed (TAS) can exceed the normal airway/route boundaries depending on the amount of course change required, wind direction and velocity, the character of the turn fix, (DME, overhead navigation aid, or intersection), and the pilot's technique in making a course change. For example, a flight operating at 17,000 feet MSL with a TAS of 400 knots, a 25 degree bank, and a course change of more than 40 degrees would exceed the width of the airway/route; i.e., 4 nautical miles each side of centerline. However, in the airspace below 18,000 feet MSL, operations in excess of 290 knots TAS are not prevalent and the provision of additional IFR separation in all course change situations for the occasional aircraft making a turn in excess of 290 knots TAS creates an unacceptable waste of airspace and imposes a penalty upon the preponderance of traffic which operates at low speeds. Consequently, the FAA expects pilots to lead turns and take other actions they consider necessary during the course changes to adhere as closely as possible to the airways or route being flown.

**6.4** Due to the high airspeeds used at 18,000 feet MSL and above, FAA provides additional IFR separation protection for course changes made at such altitude levels.

### Adhering to Airways or Routes

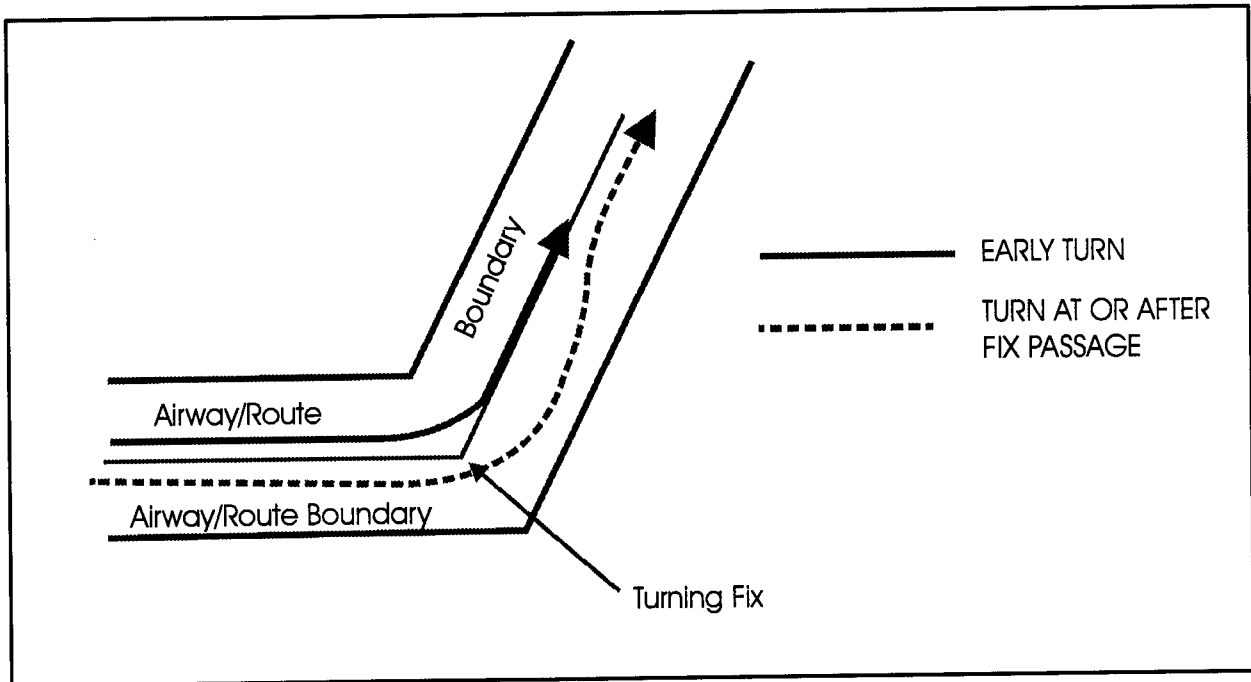

FIG 3.5-1





## ENR 4. RADIO NAVIGATION AIDS/SYSTEMS

### ENR 4.1 Radio Navigation Aids - En Route

#### 1. VHF Direction Finder

**1.1** The VHF Direction Finder (VHF/DF) is one of the common systems that helps pilots without their being aware of its operation. It is a ground-based radio receiver used by the operator of the ground station. FAA facilities that provide VHF/DF service are identified in the Airport/Facility Directory (A/FD).

**1.2** The equipment consists of a directional antenna system and a VHF radio receiver.

**1.3** The VHF/DF receiver display indicates the magnetic direction of the aircraft from the ground station each time the aircraft transmits.

**1.4** DF equipment is of particular value in locating lost aircraft and in helping to identify aircraft on radar.

#### 2. Nondirectional Radio Beacon (NDB)

**2.1** A low or medium-frequency radio beacon which transmits nondirectional signals whereby the pilot of an aircraft equipped with a loop antenna can determine bearings and "home" on the station. These facilities normally operate in the frequency band of 190 to 535 kHz and transmit a continuous carrier with either 400 Hz or 1020 Hz modulation. All radio beacons except the compass locators transmit a continuous three-letter identification in code except during voice transmissions.

**2.2** When a radio beacon is used in conjunction with the Instrument Landing System markers, it is called a Compass Locator.

**2.3** Voice transmissions are made on radio beacons unless the letter "W" (without voice) is included in the class designator (HW).

**2.4** Radio beacons are subject to disturbances that may result in erroneous bearing information. Such disturbances result from such factors as lightning, precipitation, static, etc. At night radio beacons are vulnerable to interference from distant stations. Nearly all disturbances which affect the aircraft's Automatic Direction Finder (ADF) bearing also affect the facility's identification. Noisy identification usually occurs when the ADF needle is erratic; voice, music, or erroneous identification will usually be heard when a steady false bearing is being displayed. Since ADF receivers do not have

a "FLAG" to warn the pilot when erroneous bearing information is being displayed, the pilot should continuously monitor the NDB's identification.

#### 3. VHF Omni-directional Radio Range (VOR)

**3.1** VOR's operate within the 108.0 - 117.95 MHz frequency band and have a power output necessary to provide coverage within their assigned operational service volume. They are subject to line-of-sight restrictions, and range varies proportionally to the altitude of the receiving equipment. The normal service ranges for the various classes of VOR's are given in GEN 3.4, TBL 3.4-1.

**3.2** Most VOR's are equipped for voice transmission on the VOR frequency. VOR's without voice capability are indicated by the letter "W" (without voice) included in the class designator (VORW).

**3.3** The effectiveness of the VOR depends upon proper use and adjustment of both ground and airborne equipment.

**a) Accuracy:** The accuracy of course alignment of the VOR is excellent, being generally plus or minus 1 degree.

**b) Roughness:** On some VOR's, minor course roughness may be observed, evidenced by course needle or brief flag alarm activity (some receivers are more subject to these irregularities than others). At a few stations, usually in mountainous terrain, the pilot may occasionally observe a brief course needle oscillation, similar to the indication of "approaching station." Pilots flying over unfamiliar routes are cautioned to be on the alert of these vagaries, and, in particular, to use the "to-from" indicator to determine positive station passage.

**1)** Certain propeller RPM settings or helicopter rotor speeds can cause the VOR Course Deviation Indicator (CDI) to fluctuate as much as plus or minus six degrees. Slight changes to the RPM setting will normally smooth out this roughness. Pilots are urged to check for this modulation phenomenon prior to reporting a VOR station or aircraft equipment for unsatisfactory operation.

**3.4** The only positive method of identifying a VOR is by its Morse Code identification or by the recorded

automatic voice identification which is always indicated by use of the word "VOR" following the range's name. Reliance on determining the identification of an omnirange should never be placed on listening to voice transmissions by the FSS (or approach control facility) involved. Many FSS remotely operate several omniranges which have different names from each other and, in some cases, none have the name of the "parent" FSS. (During periods of maintenance the facility may radiate a T-E-S-T code (-●●●●-) or the code may be removed.)

**3.5** Voice identification has been added to numerous VOR's. The transmission consists of a voice announcement; i.e., "AIRVILLE VOR," alternating with the usual Morse Code identification.

#### **4. VOR Receiver Check**

**4.1** Periodic VOR receiver calibration is most important. If a receiver's Automatic Gain Control or modulation circuit deteriorates, it is possible for it to display acceptable accuracy and sensitivity close into the VOR or VOT and display out-of-tolerance readings when located at greater distances where weaker signal areas exist. The likelihood of this deterioration varies between receivers, and is generally considered a function of time. The best assurance of having an accurate receiver is periodic calibration. Yearly intervals are recommended at which time an authorized repair facility should recalibrate the receiver to the manufacturer's specifications.

**4.2** 14 CFR Section 91.171 provides for certain VOR equipment accuracy checks prior to flight under IFR. To comply with this requirement and to ensure satisfactory operation of the airborne system, the FAA has provided pilots with the following means of checking VOR receiver accuracy:

- a) FAA VOR test facility (VOT) or a radiated test signal from an appropriately rated radio repair station;
- b) Certified airborne check points; and
- c) Certified check points on the airport surface.

**4.3** The FAA VOT transmits a test signal which provides a convenient means to determine the operational status and accuracy of a VOR receiver while on the ground where a VOT is located. The airborne use of VOT is permitted; however, its use is strictly limited to those areas/altitudes specifically authorized in the Airport/Facility Directory or appropriate supplement. To use the VOT service, tune in the VOT frequency on your VOR receiver. With the CDI centered, the omni-

bearing selector should read 0° with the to/from indicator showing "from," or the omni-bearing selector should read 180° with the to/from indicator showing "to." Should the VOR receiver operate a Radio Magnetic Indicator (RMI), it will indicate 180° on any OBS setting. Two means of identification are used. One is a series of dots and the other is a continuous tone. Information concerning an individual test signal can be obtained from the local FSS.

**4.4** A radiated VOR test signal from an appropriately rated radio repair station serves the same purpose as an FAA VOR signal and the check is made in much the same manner as a VOT with the following differences:

a) The frequency normally approved by the FCC is 108.0 MHz; and

b) Repair stations are not permitted to radiate the VOR test signal continuously, consequently the owner/operator must make arrangements with the repair station to have the test signal transmitted. This service is not provided by all radio repair stations. The aircraft owner or operator must determine which repair station in the local area provides this service. A representative of the repair station must make an entry into the aircraft logbook or other permanent record certifying to the radial accuracy and the date of transmission. The owner/operator or representative of the repair station may accomplish the necessary checks in the aircraft and make a logbook entry stating the results. It is necessary to verify which test radial is being transmitted and whether you should get a "to" or "from" indication.

**4.5** Airborne and ground check points consist of certified radials that should be received at specific points on the airport surface, or over specific landmarks while airborne in the immediate vicinity of the airport.

a) Should an error in excess of plus or minus 4 degrees be indicated through use of a ground check, or plus or minus 6 degrees using the airborne check, IFR flight shall not be attempted without first correcting the source of the error.

**CAUTION.—**  
NO CORRECTION OTHER THAN THE "CORRECTION CARD"  
FIGURES SUPPLIED BY THE MANUFACTURER SHOULD BE  
APPLIED IN MAKING THESE VOR RECEIVER CHECKS.

b) Locations of airborne check points, ground check points and VOT's are published in the A/FD and are depicted on the A/G voice communication panels on the NOS IFR area chart and IFR en route low altitude chart.

c) If a dual system VOR (units independent of each other except for the antenna) is installed in the aircraft, one system may be checked against the other. Turn both

systems to the same VOR ground facility and note the indicated bearing to that station. The maximum permissible variations between the two indicated bearings is 4 degrees.

## 5. Distance Measuring Equipment (DME)

**5.1** In the operation of DME, paired pulses at a specific spacing are sent out from the aircraft (this is the interrogation) and are received at the ground station. The ground station (transponder) then transmits paired pulses back to the aircraft at the same pulse spacing but on a different frequency. The time required for the round trip of this signal exchange is measured in the airborne DME unit and is translated into distance (nautical miles (NM)) from the aircraft to the ground station.

**5.2** Operating on the line-of-sight principle, DME furnishes distance information with a very high degree of accuracy. Reliable signals may be received at distances up to 199 NM at line-of-sight altitude with an accuracy of better than  $\frac{1}{2}$  mile or 3% of the distance, whichever is greater. Distance information received from DME equipment is SLANT RANGE distance and not actual horizontal distance.

**5.3** DME operates on frequencies in the UHF spectrum between 962 MHz and 1213 MHz. Aircraft equipped with TACAN equipment will receive distance information from a VORTAC automatically, while aircraft equipped with VOR must have a separate DME airborne unit.

**5.4** VOR/DME, VORTAC, ILS/DME, and LOC/DME navigation facilities established by the FAA provide course and distance information from collocated components under a frequency pairing plan. Aircraft receiving equipment which provides for automatic DME selection assures reception of azimuth and distance information from a common source whenever designated VOR/DME, VORTAC, ILS/DME, and LOC/DME are selected.

**5.5** Due to the limited number of available frequencies, assignment of paired frequencies is required for certain military noncollocated VOR and TACAN facilities which serve the same area but which may be separated by distances up to a few miles. The military is presently undergoing a program to collocate VOR and TACAN facilities or to assign nonpaired frequencies to those facilities that cannot be collocated.

**5.6** VOR/DME, VORTAC, ILS/DME, and LOC/DME facilities are identified by synchronized identifications which are transmitted on a time share basis. The VOR

or localizer portion of the facility is identified by a coded tone modulated at 1020 Hz or by a combination of code and voice. The TACAN or DME is identified by a coded tone modulated at 1350 Hz. The DME or TACAN coded identification is transmitted one time for each three or four times that the VOR or localizer coded identification is transmitted. When either the VOR or the DME is inoperative, it is important to recognize which identifier is retained for the operative facility. A signal coded identification with a repetition interval of approximately 30 seconds indicates that the DME is operative.

**5.7** Aircraft equipment which provides for automatic DME selection assures reception of azimuth and distance information from a common source whenever designated VOR/DME, VORTAC and ILS/DME navigation facilities are selected. Pilots are cautioned to disregard any distance displays from automatically selected DME equipment when VOR or ILS facilities, which do not have the DME feature installed, are being used for position determination.

## 6. Tactical Air Navigation (TACAN)

**6.1** For reasons peculiar to military or naval operations (unusual siting conditions, the pitching and rolling of a naval vessel, etc.) the civil VOR-DME system of air navigation was considered unsuitable for military or naval use. A new navigational system, Tactical Air Navigation (TACAN), was therefore developed by the military and naval forces to more readily lend itself to military and naval requirements. As a result, the FAA has been in the process of integrating TACAN facilities with the civil VOR-DME program. Although the theoretical, or technical principles of operation of TACAN equipment are quite different from those of VOR-DME facilities, the end result, as far as the navigating pilot is concerned, is the same. These integrated facilities are called VORTAC's.

**6.2** A VORTAC is a facility consisting of two components, VOR and TACAN, which provides three individual services: VOR azimuth, TACAN azimuth and TACAN distance (DME) at one site. Although consisting of more than one component, incorporating more than one operating frequency, and using more than one antenna system, a VORTAC is considered to be a unified navigational aid. Both components of a VORTAC are envisioned as operating simultaneously and providing the three services at all times.

**6.3** Transmitted signals of VOR and TACAN are each identified by three-letter code transmission and are interlocked so that pilots using VOR azimuth and

TACAN distance can be assured that both signals being received are definitely from the same ground station. The frequency channels of the VOR and the TACAN at each VORTAC facility are "paired" in accordance with a national plan to simplify airborne operation.

**6.4** TACAN ground equipment consists of either a fixed or mobile transmitting unit. The airborne unit in conjunction with the ground unit reduces the transmitted signal to a visual presentation of both azimuth and distance information. TACAN is a pulse system and operates in the UHF band of frequencies. Its use requires TACAN airborne equipment and does not operate through conventional VOR equipment.

## 7. Instrument Landing System (ILS)

### 7.1 General

**7.1.1** The ILS is designed to provide an approach path for exact alignment and descent of an aircraft on final approach to a runway.

**7.1.2** The ground equipment consists of two highly directional transmitting systems and, along the approach, three (or fewer) marker beacons. The directional transmitters are known as the localizer and glide slope transmitters.

**7.1.3** The system may be divided functionally into three parts:

- a) Guidance information: localizer, glide slope;
- b) Range information: marker beacon, DME; and
- c) Visual information: approach lights, touchdown and centerline lights, runway lights.

**7.1.4** Compass locators located at the outer marker or middle marker may be substituted for these marker beacons. DME when specified in the procedure may be substituted for the outer marker.

**7.1.5** Where a complete ILS system is installed on each end of a runway (i.e., the approach end of runway 4 and the approach end of runway 22), the ILS systems are not in service simultaneously.

### 7.2 Localizer

**7.2.1** The localizer transmitter, operates on one of 40 ILS channels within the frequency range of 108.10 MHz to 111.95 MHz. Signals provide the pilot with course guidance to the runway centerline.

**7.2.2** The approach course of the localizer is called the front course and is used with other functional parts, e.g., glide slope, marker beacons, etc. The localizer signal is

transmitted at the far end of the runway. It is adjusted for a course width (full scale fly-left to a full scale fly-right) of 700 feet at the runway threshold.

**7.2.3** The course line along the extended centerline of a runway, in the opposite direction to the front course, is called the back course.

**CAUTION.—**  
*UNLESS YOUR AIRCRAFT'S ILS EQUIPMENT INCLUDES REVERSE SENSING CAPABILITY, WHEN FLYING INBOUND ON THE BACK COURSE IT IS NECESSARY TO STEER THE AIRCRAFT IN THE DIRECTION OPPOSITE OF THE NEEDLE DEFLECTION ON THE AIRBORNE EQUIPMENT WHEN MAKING CORRECTIONS FROM OFF-COURSE TO ON-COURSE. THIS "FLYING AWAY FROM THE NEEDLE" IS ALSO REQUIRED WHEN FLYING OUTBOUND ON THE FRONT COURSE OF THE LOCALIZER. DO NOT USE BACK COURSE SIGNALS FOR APPROACH UNLESS A BACK COURSE APPROACH PROCEDURE IS PUBLISHED FOR THAT PARTICULAR RUNWAY AND THE APPROACH IS AUTHORIZED BY ATC.*

**7.2.4** Identification is in Morse Code and consists of a three-letter identifier preceded by the letter I (●●) transmitted on the localizer frequency.

**EXAMPLE.—**  
*I-DIA*

**7.2.5** The localizer provides course guidance throughout the descent path to the runway threshold from a distance of 18 NM from the antenna between an altitude of 1,000 feet above the highest terrain along the course line and 4,500 feet above the elevation of the antenna site. Proper off-course indications are provided throughout the following angular areas of the operational service volume:

- a) To 10° either side of the course along a radius of 18 NM from the antenna, and
- b) From 10° to 35° either side of the course along a radius of 10 NM. (See FIG 4.1-1).

**7.2.6** Unreliable signals may be received outside these areas.

Limits of Localizer Coverage

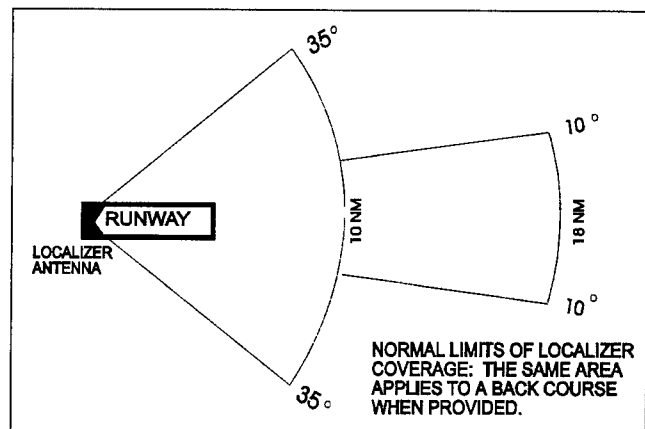

FIG 4.1-1

### 7.3 Localizer-Type Directional Aid

**7.3.1** The localizer-type directional aid (LDA) is of comparable use and accuracy to a localizer but is not part of a complete ILS. The LDA course usually provides a more precise approach course than the similar Simplified Directional Facility (SDF) installation, which may have a course width of 6 degrees or 12 degrees.

**7.3.2** The LDA is not aligned with the runway. Straight-in minimums may be published where alignment does not exceed 30 degrees between the course and runway. Circling minimums only are published where this alignment exceeds 30 degrees.

### 7.4 Glide Slope/Glide Path

**7.4.1** The UHF glide slope transmitter, operating on one of the forty ILS channels within the frequency range 329.15 MHz, to 335.00 MHz radiates its signals in the direction of the localizer front course.

**CAUTION.—**  
*FALSE GLIDE SLOPE SIGNALS MAY EXIST IN THE AREA OF THE LOCALIZER BACK COURSE APPROACH WHICH CAN CAUSE THE GLIDE SLOPE FLAG ALARM TO DISAPPEAR AND PRESENT UNRELIABLE GLIDE SLOPE INFORMATION. DISREGARD ALL GLIDE SLOPE SIGNAL INDICATIONS WHEN MAKING A LOCALIZER BACK COURSE APPROACH UNLESS A GLIDE SLOPE IS SPECIFIED ON THE APPROACH AND LANDING CHART.*

**7.4.2** The glide slope transmitter is located between 750 and 1,250 feet from the approach end of the runway (down the runway) and offset 250–600 feet from the runway centerline. It transmits a glide path beam 1.4 degrees wide (vertically).

**NOTE.—**  
*THE TERM "GLIDE PATH" MEANS THAT PORTION OF THE GLIDE SLOPE THAT INTERSECTS THE LOCALIZER.*

**7.4.3** The glide path projection angle is normally adjusted to 3 degrees above horizontal so that it intersects the middle marker at about 200 feet and the outer marker at about 1,400 feet above the runway elevation. The glide slope is normally usable to the distance of 10 NM. However, at some locations, the glide slope has been certified for an extended service volume which exceeds 10 NM.

**7.4.4** Pilots must be alert when approaching glidepath interception. False courses and reverse sensing will occur at angles considerably greater than the published path.

**7.4.5** Make every effort to remain on the indicated glide path. Exercise caution: avoid flying below the glide path to assure obstacle/terrain clearance is maintained.

**REFERENCE—**  
*14 CFR SECTION 91.129(E).*

**7.4.6** A glide slope facility provides descent information for navigation down to the lowest authorized decision height (DH) specified in the approved ILS approach procedure. The glidepath may not be suitable for navigation below the lowest authorized DH and any reference to glidepath indications below that height must be supplemented by visual reference to the runway environment. Glide slopes with no published DH are usable to runway threshold.

**7.4.7** The published glide slope threshold crossing height (TCH) DOES NOT represent the height of the actual glide slope on course indication above the runway threshold. It is used as a reference for planning purposes which represents the height above the runway threshold that an aircraft's glide slope antenna should be, if that aircraft remains on a trajectory formed by the four-mile-to-middle marker glidepath segment.

**7.4.8** Pilots must be aware of the vertical height between the aircraft's glide slope antenna and the main gear in the landing configuration and, at the DH, plan to adjust the descent angle accordingly if the published TCH indicates the wheel crossing height over the runway threshold may be satisfactory. Tests indicate a comfortable wheel crossing height is approximately 20 to 30 feet, depending on the type of aircraft.

### 7.5 Distance Measuring Equipment (DME)

**7.5.1** When installed with an ILS and specified in the approach procedure, DME may be used:

- a) In lieu of the outer marker,
- b) As a back course final approach fix, and
- c) To establish other fixes on the localizer course.

**7.5.2** In some cases, DME from a separate facility may be used within Terminal Instrument Procedures (TERPS) limitations:

- a) To provide ARC initial approach segments,
- b) As a final approach fix for back course approaches, and
- c) As a substitute for the outer marker.

### 7.6 Marker Beacon

**7.6.1** ILS marker beacons have a rated power output of 3 watts or less and an antenna array designed to produce an elliptical pattern with dimensions, at 1,000 feet above the antenna, of approximately 2,400 feet in width and 4,200 feet in length. Airborne marker beacon

receivers with a selective sensitivity feature should always be operated in the "low" sensitivity position for proper reception of ILS marker beacons.

**7.6.2** Ordinarily, there are two marker beacons associated with an ILS, the outer marker (OM) and the middle marker (MM). Locations with a Category II or III ILS also have an inner marker (IM). When an aircraft passes over a marker, the pilot will receive the following indications:

**7.6.3** The OM normally indicates a position at which an aircraft at the appropriate altitude on the localizer course will intercept the ILS glide path.

**7.6.4** The MM indicates a position approximately 3,500 feet from the landing threshold. This will also be the position where an aircraft on the glide path will be at an altitude of approximately 200 feet above the elevation of the touchdown zone.

**7.6.5** The IM indicates a point at which an aircraft is at a designated decision height (DH) on the glide path between the middle marker and landing threshold.

**7.6.6** A back course marker, normally indicates the ILS back course final approach fix where approach descent is commenced.

**Marker Passage Indications**

MARKER	CODE	LIGHT
OM	- - -	BLUE
MM	• - • -	AMBER
IM	• • • •	WHITE
BC	• • • •	WHITE

TBL 4.1-1

**8. Compass Locator**

**8.1** Compass locator transmitters are often situated at the middle and outer marker sites. The transmitters have a power of less than 25 watts, a range of at least 15 miles and operate between 190 and 535 kHz. At some locations, higher-powered radio beacons, up to 400 watts, are used as outer marker compass locators. These generally carry Transcribed Weather Broadcast (TWEB) information.

**8.2** Compass locators transmit two-letter identification groups. The outer locator transmits the first two letters of the localizer identification group, and the middle locator transmits the last two letters of the localizer identification group.

**9. ILS Frequency**

**9.1** The following frequency pairs are allocated for ILS.

**Frequency Pairs Allocated for ILS**

Localizer MHz	Glide Slope
108.10	334.70
108.15	334.55
108.3	334.10
108.35	333.95
108.5	329.90
108.55	329.75
108.7	330.50
108.75	330.35
108.9	329.30
108.95	329.15
109.1	331.40
109.15	331.25
109.3	332.00
109.35	331.85
109.50	332.60
109.55	332.45
109.70	333.20
109.75	333.05
109.90	333.80
109.95	333.65
110.1	334.40
110.15	334.25
110.3	335.00
110.35	334.85
110.5	329.60
110.55	329.45
110.70	330.20
110.75	330.05
110.90	330.80
110.95	330.65
111.10	331.70
111.15	331.55
111.30	332.30
111.35	332.15
111.50	332.9
111.55	332.75
111.70	333.5
111.75	333.35
111.90	331.1
111.95	330.95

TBL 4.1-2

**10. ILS Minimums**

**10.1** The lowest authorized ILS minimums, with all required ground and airborne systems components operative, are:

a) **Category I:** Decision Height (DH) 200 feet and Runway Visual Range (RVR) 2,400 feet (with touchdown zone and centerline lighting, RVR 1,800 feet),

b) **Category II:** DH 100 feet and RVR, 1,200 feet,

c) **Category IIIa:** No DH or DH below 100 feet and RVR not less than 700 feet,

d) **Category IIIb:** No DH or DH below 50 feet and RVR less than 700 feet but not less than 150 feet, and

e) **Category IIIc:** No DH or no RVR limitation.

**NOTE.—**

*SPECIAL AUTHORIZATION AND EQUIPMENT ARE REQUIRED FOR CATEGORY II AND III.*

## 11. Inoperative ILS Components

**11.1 Inoperative Localizer:** When the localizer fails, an ILS approach is not authorized.

**11.2 Inoperative Glide Slope:** When the glide slope fails, the ILS reverts to a nonprecision localizer approach.

**REFERENCE—**

*SEE THE INOPERATIVE COMPONENT TABLE IN THE U.S. GOVERNMENT TERMINAL PROCEDURES PUBLICATION (TPP) FOR ADJUSTMENTS TO MINIMUMS DUE TO INOPERATIVE AIRBORNE OR GROUND SYSTEM EQUIPMENT.*

## 12. ILS Course Distortion

**12.1** All pilots should be aware that disturbance to ILS localizer/glide slope courses may occur when surface vehicles/aircraft are operated near the localizer/glide slope antennas. Most ILS installations are subject to signal interference by either surface vehicles, aircraft or both. ILS “CRITICAL AREAS” are established near each localizer and glide slope antenna.

**12.2** Air traffic control issues control instructions to avoid interfering operations within ILS critical areas at controlled airports during the hours the airport traffic control tower is in operations as follows:

a) **Weather Conditions:** At or above 800 feet and/or visibility 2 miles.

1) No critical area protection action is provided.

2) If an aircraft advises the TOWER that an “AUTOLAND”/“COUPLED” approach will be conducted, an advisory will be promptly issued if a vehicle/aircraft will be in or over a critical area when the arriving aircraft is inside the ILS middle marker.

**EXAMPLE.—**

GLIDE SLOPE SIGNAL NOT PROTECTED.

b) **Weather Conditions:** Less than ceiling 800 feet and/or visibility 2 miles.

1) **Glide Slope Critical Area:** Vehicles/aircraft are not authorized in the area when an arriving aircraft is between the ILS final approach fix and the airport unless the aircraft has reported the airport in sight and is circling or side stepping to land on other than the ILS runway.

2) **Localizer Critical Area:** Except for aircraft that land, exit a runway, depart or miss approach, vehicles and aircraft are not authorized in or over the critical area when an arriving aircraft is between the ILS final approach fix and the airport. Additionally, when the ceiling is less than 200 feet and/or the visibility is RVR 2,000 or less, vehicle/aircraft operations in or over the area are not authorized when an arriving aircraft is inside the ILS middle marker.

**12.3** Aircraft holding below 5000 feet between the outer marker and the airport may cause localizer signal variations for aircraft conducting the ILS approach. Accordingly, such holding is not authorized when weather or visibility conditions are less than ceiling 800 feet and/or visibility 2 miles.

**12.4** Pilots are cautioned that vehicular traffic not subject to control by ATC may cause momentary deviation to ILS course/glide slope signals. Also, “critical areas” are not protected at uncontrolled airports or at airports with an operating control tower when weather/visibility conditions are above those requiring protective measures. Aircraft conducting “coupled” or “autoland” operations should be especially alert in monitoring automatic flight control systems. (See FIG 4.1-2.)

**NOTE.—**

*UNLESS OTHERWISE COORDINATED THROUGH FLIGHT STANDARDS, ILS SIGNALS TO CATEGORY I RUNWAYS ARE NOT FLIGHT INSPECTED BELOW 100 FEET AGL. GUIDANCE SIGNAL ANOMALIES MAY BE ENCOUNTERED BELOW THIS ALTITUDE.*

FAA Instrument Landing Systems

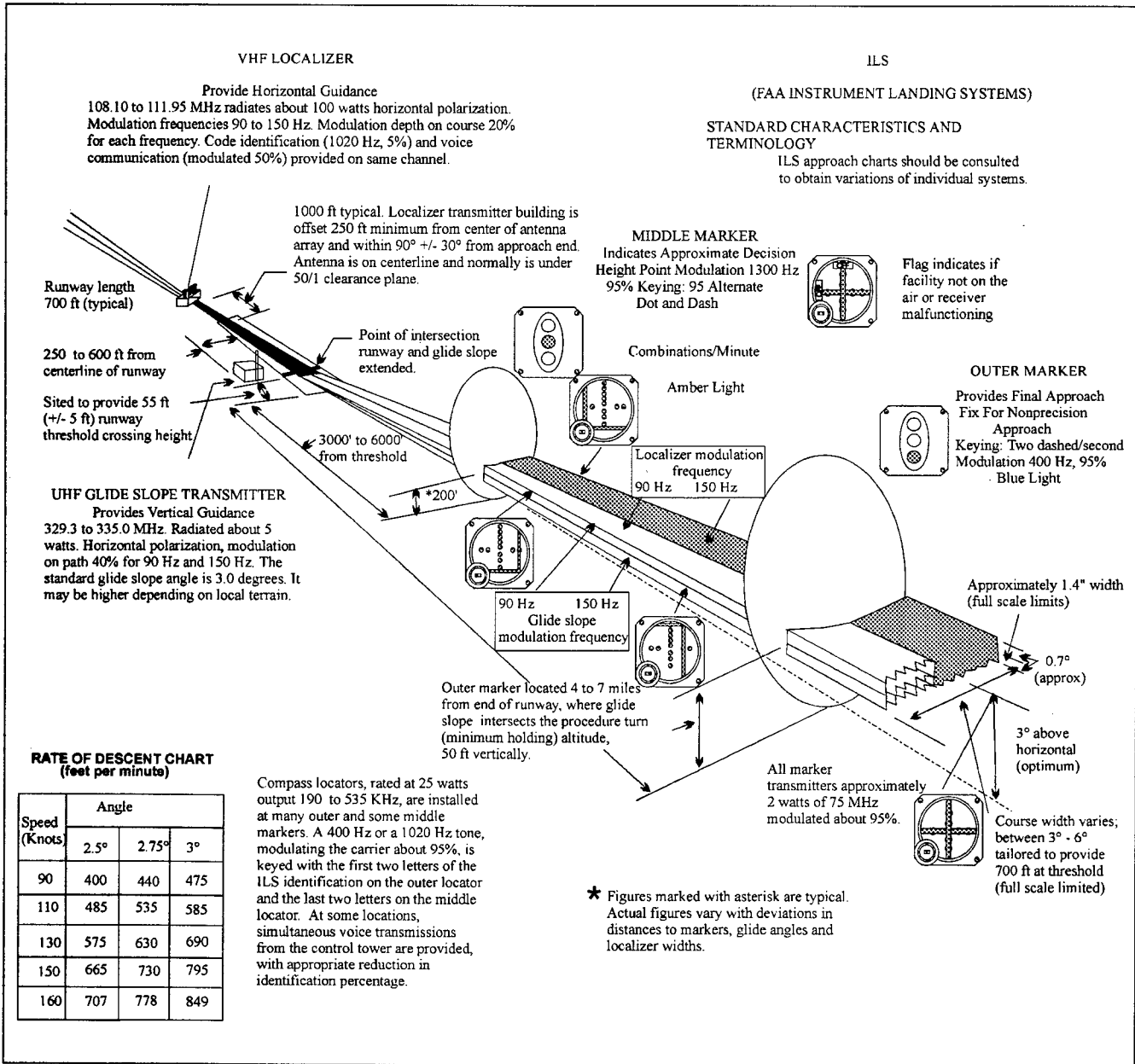

FIG 4.1-2



### 13. Continuous Power Facilities

**13.1** In order to ensure that a basic ATC system remains in operation despite an area wide or catastrophic commercial power failure, key equipment and certain airports have been designated to provide a network of facilities whose operational capability can be utilized independent of any commercial power supply.

**13.2** In addition to those facilities comprising the basic ATC system, the following approach and lighting aids have been included in this program for a selected runway:

- a) ILS (Localizer, Glide Slope, Compass Locator, Inner, Middle and Outer Markers)
- b) Wind Measuring Capability
- c) Approach Light System (ALS) or Short ALS (SALS)
- d) Ceiling Measuring Capability
- e) Touchdown Zone Lighting (TDZL)
- f) Centerline Lighting (CL)
- g) Runway Visual Range (RVR)
- h) High Intensity Runway Lighting (HIRL)
- i) Taxiway Lighting
- j) Apron Light (Perimeter Only)

Continuous Power Airports	
Airport/Ident	Runway No.
Albuquerque (ABQ)	08
Andrews AFB (ADW)	1L
Atlanta (ATL)	9R
Baltimore (BWI)	10
Bismarck (BIS)	31
Boise (BOI)	10R
Boston (BOS)	4R
Charlotte (CLT)	36L
Chicago (ORD)	14R
Cincinnati (CVG)	36
Cleveland (CLE)	5R
Dallas/Fort Worth (DFW)	17L
Denver (DEN)	35R
Des Moines (DSM)	30R
Detroit (DTW)	3L
El Paso (ELP)	22
Great Falls (GTF)	03
Houston (IAH)	08
Indianapolis (IND)	4L
Jacksonville (JAX)	07
Kansas City (MCI)	19

Los Angeles (LAX)	24R
Memphis (MEM)	36L
Miami (MIA)	9L
Milwaukee (MKE)	01
Minneapolis (MSP)	29L
Nashville (BNA)	2L
Newark (EWR)	4R
New Orleans (MSY)	10
New York (JFK)	4R
New York (LGA)	22
Oklahoma City (OKC)	35R
Omaha (OMA)	14
Ontario, California (ONT)	26R
Philadelphia (PHL)	9R
Phoenix (PHX)	08R
Pittsburgh (PIT)	10L
Reno (RNO)	16
Salt Lake City (SLC)	34L
San Antonio (SAT)	12R
San Diego (SAN)	09
San Francisco (SFO)	28R
Seattle (SEA)	16R
St. Louis (STL)	24
Tampa (TPA)	36L
Tulsa (TUL)	35R
Washington (DCA)	36
Washington (IAD)	1R
Wichita (ICT)	01

TBL 4.1-3

**13.3** The above have been designated "Continuous Power Airports," and have independent back up capability for the equipment installed.

**NOTE.**—  
THE EXISTING CPA RUNWAY IS LISTED. PENDING AND FUTURE CHANGES AT SOME LOCATIONS WILL REQUIRE A REVISED RUNWAY DESIGNATION.

### 14. Simplified Directional Facility (SDF)

**14.1** The SDF provides a final approach course similar to that of the ILS localizer. It does not provide glide slope information. A clear understanding of the ILS localizer and the additional factors listed below completely describe the operational characteristics and use of the SDF.

**14.2** The SDF transmits signals within the range of 108.10 to 111.95 MHz.

**14.3** The approach techniques and procedures used in an SDF instrument approach are essentially the same as those employed in executing a standard no-glide-slope localizer approach except the SDF course may not be aligned with the runway and the course may be wider, resulting in less precision.

**14.4** Usable off-course indications are limited to 35 degrees either side of the course centerline. Instrument indications received beyond 35 degrees should be disregarded.

**14.5** The SDF antenna may be offset from the runway centerline. Because of this, the angle of convergence between the final approach course and the runway bearing should be determined by reference to the instrument approach procedure chart. This angle is generally not more than 3 degrees. However, it should be noted that inasmuch as the approach course originates at the antenna site, an approach which is continued beyond the runway threshold will lead the aircraft to the SDF offset position rather than along the runway centerline.

**14.6** The SDF signal is fixed at either 6 degrees or 12 degrees as necessary to provide maximum "fly ability" and optimum course quality.

**14.7** Identification consists of a three-letter identifier transmitted in Morse Code on the SDF frequency. The appropriate instrument approach chart will indicate the identifier used at a particular airport.

## **15. Microwave Landing System (MLS)**

### **15.1 General**

**15.1.1** The MLS provides precision navigation guidance for exact alignment and descent of aircraft on approach to a runway. It provides azimuth, elevation and distance information. The elevation transmitter is located to the side of the runway near the approach threshold. The precision DME, which provides range information, is normally collocated with the azimuth transmitter.

**15.1.2** Both lateral and vertical guidance may be displayed on conventional course deviation indicators or incorporated into multipurpose cockpit displays. Range information can be displayed by conventional DME indicators and also incorporated into multipurpose displays.

**15.1.3** The MLS supplements the ILS as the standard landing system in the United States for civil, military, and international civil aviation. At international airports, ILS service is protected to 2010.

**15.1.4** The system may be divided into five functions:

- a) Approach azimuth,
- b) Back azimuth,
- c) Approach elevation,
- d) Range, and

e) Data communications

**15.1.5** The standard configuration of MLS ground equipment includes:

a) An azimuth station to perform functions (a) and (e) above. In addition to providing azimuth navigation guidance, the azimuth station also transmits basic data which consists of information associated directly with the operation of the landing system, as well as advisory data on the performance of the ground equipment.

b) An elevation station to perform function (c).

c) Distance Measuring Equipment (DME) to perform function (d). The DME provides range guidance, both standard (DME/N) and precision DME (DME/P).

**15.1.6 MLS Expansion Capabilities:** The standard configuration can be expanded by adding one or more of the following functions or characteristics.

a) **Back azimuth:** Provides lateral guidance for missed approach and departure navigation.

b) **Auxiliary data transmissions:** Provides additional data, including refined airborne positioning, meteorological information, runway status, and other supplementary information.

c) Expanded Service Volume (ESV) proportional guidance to 60 degrees.

**15.1.7** MLS identification is a four-letter designation starting with the letter M. It is transmitted in Morse Code at least six times per minute by the approach azimuth (and back azimuth) ground equipment.

### **15.2 Approach Azimuth Guidance**

**15.2.1** The azimuth station transmits MLS angle and data on one of the 200 channels within the frequency range of 5031 to 5091 MHz.

**15.2.2** The equipment is normally located about 1,000 feet beyond the stop end of the runway, but there is considerable flexibility in selecting sites. For example, for heliport operations the azimuth transmitter can be collocated with the elevation transmitter.

**15.2.3** The azimuth coverage extends:  
(See FIG 4.1-3.)

a) Laterally, at least 40 degrees on either side of the runway centerline in a standard configuration,

b) In elevation, up to an angle of 15 degrees - and to at least 20,000 feet, and

c) In range, to at least 20 NM.

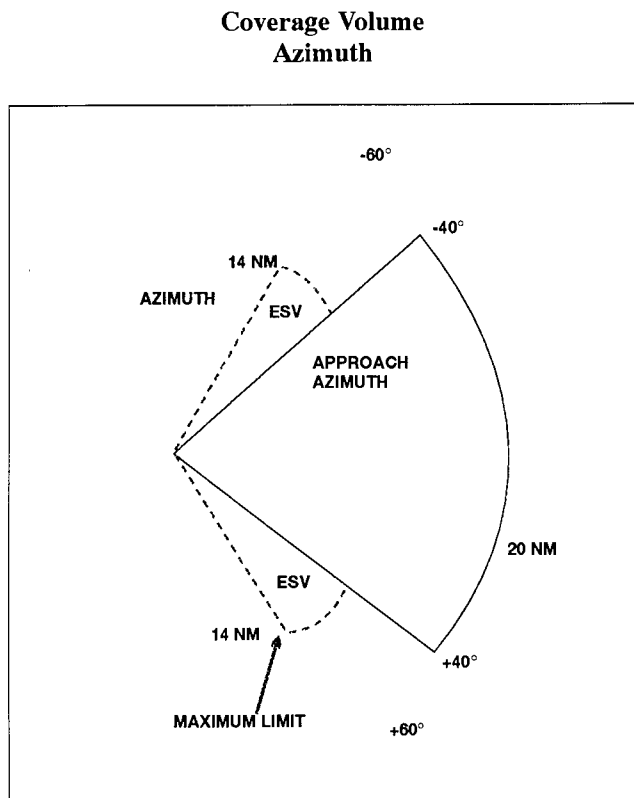

FIG 4.1-3

### 15.3 Elevation Guidance

**15.3.1** The elevation station transmits signals on the same frequency as the azimuth station. A single frequency is time-shared between all angle and data functions.

**15.3.2** The elevation transmitter is normally located about 400 feet from the side of the runway between runway threshold and the touchdown zone.

**15.3.3** Elevation coverage is provided in the same airspace as the azimuth guidance signals;

- a) In elevation, to at least +15 degrees,
- b) Laterally, to fill the azimuth lateral coverage, and
- c) In range, to at least 20 NM. (See FIG 4.1-4.)

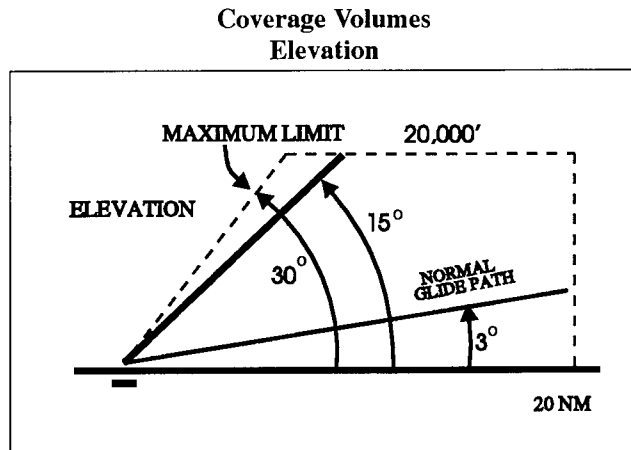

FIG 4.1-4

### 15.4 Range Guidance

**15.4.1** The MLS Precision Distance Measuring Equipment (DME/P) functions the same as the navigation DME, but with some technical differences. The beacon transponder operates in the frequency band 962 to 1105 MHz and responds to an aircraft interrogator. The MLS DME/P accuracy is improved to be consistent with the accuracy provided by the MLS azimuth and elevation stations.

**15.4.2** A DME/P channel is paired with the azimuth and elevation channel. A complete listing of the 200 paired channels of the DME/P with the angle functions is contained in FAA Standard 022 (MLS Interoperability and Performance Requirements).

**15.4.3** The DME/N or DME/P is an integral part of the MLS and is installed at all MLS facilities unless a waiver is obtained. This occurs infrequently and only at outlying, low density airports where marker beacons or compass locators are already in place.

### 15.5 Data Communications

**15.5.1** The data transmission can include both the basic and auxiliary data words. All MLS facilities transmit basic data. Where needed, auxiliary data can be transmitted.

**15.5.2 Coverage limits:** MLS data are transmitted throughout the azimuth (and back azimuth when provided) coverage sectors.

**15.5.3 Basic Data content:** Representative data include:

- a) Station identification,
- b) Exact locations of azimuth, elevation and DME/P stations (for MLS receiver processing functions),
- c) Ground equipment performance level, and
- d) DME/P channel and status.

**15.5.4 Auxiliary data content:** Representative data include:

- a) 3-D locations of MLS equipment,
- b) Waypoint coordinates,
- c) Runway conditions, and
- d) Weather (e.g., RVR, ceiling, altimeter setting, wind, wake vortex, wind shear).

**15.6 Operational flexibility:** The MLS has the capability to fulfill a variety of needs in the approach, landing, missed approach, and departure phases of flight. For example:

- a) Curved and segmented approaches,
- b) Selectable glide path angles,
- c) Accurate 3-D positioning of the aircraft in space, and
- d) The establishment of boundaries to ensure clearance from obstructions in the terminal area.

**15.7** While many of these capabilities are available to any MLS-equipped aircraft, the more sophisticated capabilities (such as curved and segmented approaches) are dependent upon the particular capabilities of the airborne equipment.

## 15.8 Summary

**15.8.1 Accuracy:** The MLS provides precision three-dimensional navigation guidance - accurate enough for all approach and landing maneuvers.

**15.8.2 Coverage:** Accuracy is consistent throughout the coverage volumes shown in FIG 4.1-5.

**15.8.3 Environment:** The system has low susceptibility to interference from weather conditions and airport ground traffic.

**15.8.4 Channels:** MLS has 200 channels - enough for any foreseeable need.

**15.8.5 Data:** The MLS transmits ground-air data messages associated with system operation.

**15.8.6 Range information:** Continuous range information is provided with an accuracy of about 100 feet.

Coverage Volumes  
3-D Representation

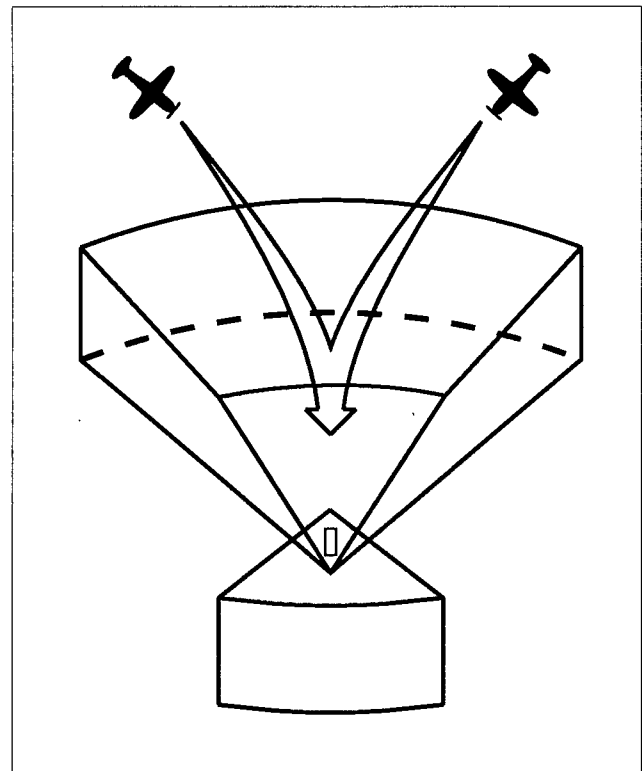

FIG 4.1-5

## 16. LORAN

### 16.1 Introduction

**16.1.1** LORAN, which uses a network of land-based radio transmitters, was developed to provide an accurate system for LONg RANGE Navigation. The system was configured to provide reliable, all weather navigation for marine users along the U.S. coasts and in the Great Lakes. The current system, known as LORAN-C, was the third version of four developed since World War II.

**16.1.2** With an expanding user group in the general aviation community, the LORAN coastal facilities were augmented in 1991 to provide signal coverage over the entire continental U.S. The Federal Aviation Administration (FAA) and the United States Coast Guard (USCG) are incorporating LORAN into the National Airspace System (NAS) for supplemental en route and nonprecision approach operations. LORAN-DC is also supported in the Canadian airspace system. This guide is intended to provide an introduction to the LORAN system, LORAN avionics, the use of LORAN for aircraft navigation, and to examine the possible future of LORAN in aviation.

### 16.2 LORAN Chain

**16.2.1** The 27 U.S. LORAN transmitters that provide signal coverage for the continental U.S. and the southern half of Alaska are distributed from Caribou, Maine, to Attu Island in the Aleutians. Station operations are organized into sub-groups of four to six stations called "chains." One station in the chain is designated the "Master" and the others are "secondary" stations.

**16.2.2** The LORAN navigation signal is a carefully structured sequence of brief radio frequency pulses centered at 100 kiloHertz. The sequence of signal transmissions consists of a pulse group from the Master (M) station followed at precise time intervals by groups from the secondary stations which are designated by the U.S. Coast Guard with the letters V, W, X, Y and Z. All secondary stations radiate pulses in groups of eight, but the Master signal for identification has an additional ninth pulse.

**16.2.3** The time interval between the reoccurrence of the Master pulse group is the Group Repetition Interval (GRI). The GRI is the same for all stations in a chain and each LORAN chain has a unique GRI. Since all stations in a particular chain operate on the same radio frequen-

cy, the GRI is the key by which a LORAN receiver can identify and isolate signal groups from a specific chain.

#### EXAMPLE.—

*TRANSMITTERS IN THE NORTHEAST U.S. CHAIN OPERATE WITH A GRI OF 99,600 MICROSECONDS WHICH IS SHORTENED TO 9960 FOR CONVENIENCE. THE MASTER STATION (M) AT SENECA NY CONTROLS: SECONDARY STATIONS (W) AT CARIBOU, ME; (X) AT NANTUCKET, MA; (Y) AT CAROLINA BEACH, NC; AND (Z) AT DANA, IN. IN ORDER TO KEEP CHAIN OPERATIONS PRECISE, THE SYSTEM USES MONITOR RECEIVERS AT CAPE ELIZABETH, ME, SANDY HOOK, NJ AND PLUMBROOK, OH. MONITOR RECEIVERS CONTINUOUSLY MEASURE VARIOUS ASPECTS OF THE QUALITY AND ACCURACY OF LORAN SIGNALS AND REPORT SYSTEM STATUS TO A CONTROL STATION WHERE CHAIN TIMING IS MAINTAINED.*

**16.2.4** The line between the Master and each secondary station is the "baseline" for a pair of stations. Typical baselines are from 600 to 1000 nautical miles in length. The continuation of the baseline in either direction is a "baseline extension."

**16.2.5** LORAN transmitter stations have time and control equipment, a transmitter, auxiliary power equipment, a building about 100 by 30 feet in size and an antenna that is about 700 feet tall. A station generally requires approximately 100 or more acres of land to accommodate guy lines that keep the antenna in position. Each LORAN stations transmits from 400 to 1,600 kilowatts of signal power.

**16.2.6** The USCG operates 27 stations, comprising eight chains, in the U.S. NAS. Four control stations, which monitor chain performance, have personnel on duty full time. The Canadian east and west coast chains also provide signal coverage over small areas of the NAS.

**16.2.7** When a control station detects a signal problem that could affect navigation accuracy, an alert signal called "Blink" is activated. Blink is a distinctive change in the group of eight pulses that can be recognized automatically by a receiver so the user is notified instantly that the LORAN system should not be used for navigation. In addition, other problems can cause signal transmissions from a station to be halted.

**16.2.8** Each individual LORAN chain provides navigation-quality signal coverage over an identified area as shown for the West Coast chain, GRI 9940 The chain Master station is at Fallon, NV and secondary stations are at George, WA; Middletown, CA; and Searchlight, NV. In a signal coverage area the signal strength relative to the normal ambient radio noise must be adequate to assure successful reception.

### 16.3 The LORAN Receiver

**16.3.1** Before a LORAN receiver can provide navigation information for a pilot, it must successfully receive, or “acquire”, signals from three or more stations in a chain. Acquisition involves the time synchronization of the receiver with the chain GRI, identification of the Master station signals from among those checked, identification of secondary station signals, and the proper selection of the point in each signal at which measurements should be made.

**16.3.2** Signal reception at any site will require a pilot to provide location information such as approximate latitude and longitude, or the GRI to be used, to the receiver. Once activated, most receivers will store present location information for later use.

**16.3.3** The basic measurements made by LORAN receivers are the differences in time-of-arrival between the Master signal and the signals from each of the secondary stations of a chain. Each “time difference” (TD) value is measured to a precision of about 0.1 microseconds. As a rule of thumb, 0.1 microsecond is equal to about 100 feet.

**16.3.4** An aircraft’s LORAN receiver must recognize three signal conditions: (1) usable signals, (2) absence of signals, and (3) signal Blink. The most critical phase of flight is during the approach to landing at an airport. During the approach phase the receiver must detect a lost signal, or a signal Blink, within 10 seconds of the occurrence and warn the pilot of the event.

**16.3.5** Most receivers have various internal tests for estimating the probable accuracy of the current TD values and consequent navigation solutions. Tests may include verification of the timing alignment of the receiver clock with the LORAN pulse, or a continuous measurement of the signal-to-noise ratio (SNR). SNR is the relative strength of the LORAN signals compared to the local ambient noise level. If any of the tests fail, or if the quantities measured are out of the limits set for reliable navigation, then an alarm will be activated to alert the pilot.

**16.3.6** LORAN signals operate in the low frequency band around (100 kHz) that has been reserved for LORAN use. Adjacent to the band, however, are numerous low frequency communications transmitters. Nearby signals can distort the LORAN signals and must be eliminated by the receiver to assure proper operation.

To eliminate interfering signals, LORAN receivers have selective internal filters. These filters, commonly known as “notch filters” reduce the effect of interfering signals.

**16.3.7** Careful installation of antennas, good metal-to-metal electrical bonding, and provisions for precipitation noise discharge on the aircraft are essential for the successful operation of LORAN receivers. A LORAN antenna should be installed on an aircraft in accordance with the manufacturer’s instructions. Corroded bonding straps should be replaced, and static discharge devices installed at points indicated by the aircraft manufacturer.

### 16.4 LORAN Navigation

**16.4.1** An airborne LORAN receiver has four major parts: (1) signal processor, (2) navigation computer, (3) control/display, and (4) antenna.

**16.4.2** The signal processor acquires LORAN signals and measures the difference between the time-of-arrival of each secondary station pulse group and the Master station pulse group. The measured TD’s depend on the location of the receiver in relation to the three or more transmitters.

First Line-of-Position

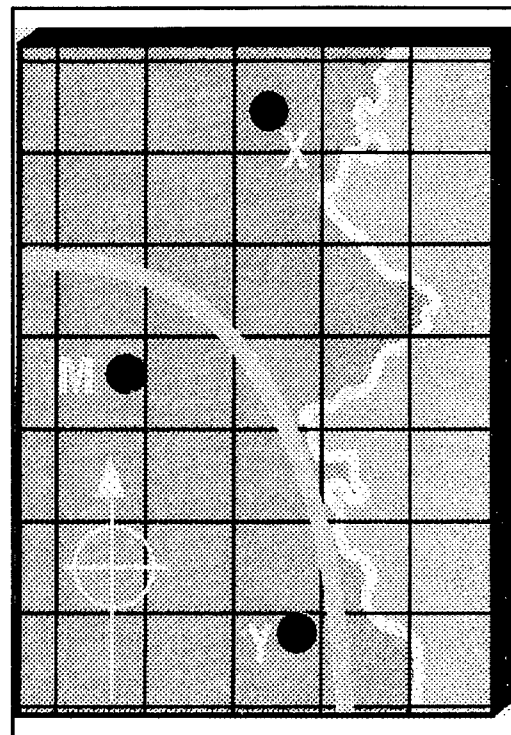

FIG 4.1-6

Second Line-of-Position

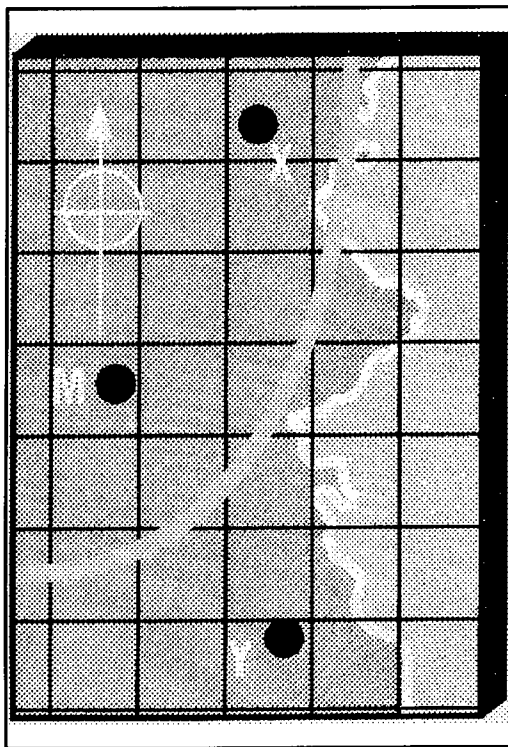

FIG 4.1-7

Intersection of Lines-of-Position

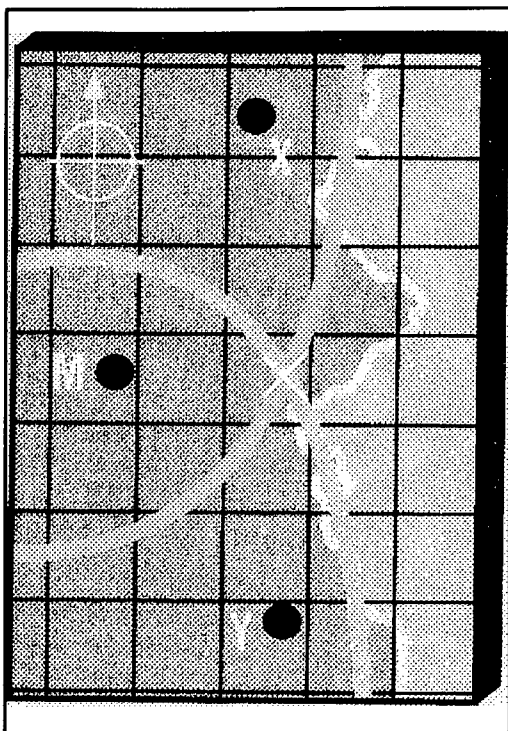

FIG 4.1-8

a) The first TD will locate an aircraft somewhere on a line-of-position (LOP) on which the receiver will measure the same TD value.

b) A second LOP is defined by a TD measurement between the Master station signal and the signal from another secondary station.

c) The intersection of the measured LOP's is the position of the aircraft.

**16.4.3** The navigation computer converts TD values to corresponding latitude and longitude. Once the time and position of the aircraft is established at two points, distance to destination, cross track error, ground speed, estimated time of arrival, etc., can be determined. Cross track error can be displayed as the vertical needle of a course deviation indicator, or digitally, as decimal parts of a mile left or right of course. During a nonprecision approach, course guidance must be displayed to the pilot with a full scale deviation of +0.30 nautical miles or greater.

**16.4.4** LORAN navigation for nonprecision approaches requires accurate and reliable information. During an approach the occurrence of signal Blink or loss of signal must be detected within 10 seconds and the pilot must be notified. LORAN signal accuracy for approaches is 0.25 nautical miles, well within the required accuracy of 0.30 nautical miles. LORAN signal accuracy can be improved by applying correction values.

**16.4.5** Flying a LORAN nonprecision approach is different from flying a VOR approach. A VOR approach is on a radial of the VOR station, with guidance sensitivity increasing as the aircraft nears the airport. The LORAN system provides a linear grid, so there is constant guidance sensitivity everywhere in the approach procedure. Consequently, inaccuracies and ambiguities that occur during operations in close proximity to VOR's (station passage, for example) do not occur in LORAN approaches.

**16.4.6** The navigation computer also provides storage for data entered by pilot or provided by the receiver manufacturer. The receiver's data base is updated at local maintenance facilities every 60 days to include all changes made by the FAA.

**16.4.7** The FAA is currently canceling all LORAN non-precision approaches with the advent of GPS.

**16.5** Notices to Airman (NOTAM's) are issued for LORAN-C chain or station outages. Domestic NOTAM (D's) are issued under the identifier "LRN." International NOTAM's are issued under the KNMH series. Pilots may obtain these NOTAM's from Flight Service Station briefers upon request.

**16.6 LORAN-C status information**

**16.6.1** Prerecorded telephone answering service

messages pertaining to LORAN-C are listed in TBL 4.1-4.

**16.6.2** Information can also be obtained directly from the office of the Coordinator of Chain Operations (COCO) for each chain. The telephone numbers for each COCO office are listed in TBL 4.1-5.

**16.6.3** The U.S. plans to terminate LORAN-C operations on December 31, 2000.

**Prerecorded LORAN-C Status Information**

RATE	CHAIN	TELEPHONE
5930	Canadian East Coast	(709) 454-3261*
7980	Southeast U.S.	(904) 569-5241
8970	Great Lakes	(607) 869-5395
9960	Northeast U.S.	(607) 869-5395

\* St. Anthony, Newfoundland, Canada.

TBL 4.1-4

Information can also be obtained directly from the office of the Coordinator of Chain Operations (COCO) for each chain. The following telephone numbers are for each COCO office:

**LORAN-C Coordinator of Chain Operations Telephone Numbers**

RATE	CHAIN	TELEPHONE	LOCATION
4990	Central Pacific	808-247-5591	Kaneohe, HI
5930	Canadian East Coast	709-454-2392	St. Antony, NF
5990	Canadian West Coast	604-666-0472	Vancouver, BC
7930	North Atlantic	011-44-1-409-4758	London, UK
7960	Gulf of Alaska	907-487-5583	Kodiak, AK
7970	Norwegian Sea	011-44-1-409-4758	London, UK
7980	Southeast U.S.	205-899-5225	Malone, FL
7990	Mediterranean Sea	011-44-1-409-4758	London, UK
8290	North Central U.S.	707-987-2911	Middletown, CA
8970	Great Lakes	607-869-5393	Seneca, NY
9610	South Central U.S.	205-899-5225	Malone, FL
9940	West Coast U.S.	707-987-2911	Middletown, CA
9960	Northeast U.S.	607-869-5393	Seneca, NY
9970	Northwest Pacific	415-437-3224	San Francisco, CA
9990	North Pacific	907-487-5583	Kodiak, AK

TBL 4.1-5



LORAN-C  
Pulse

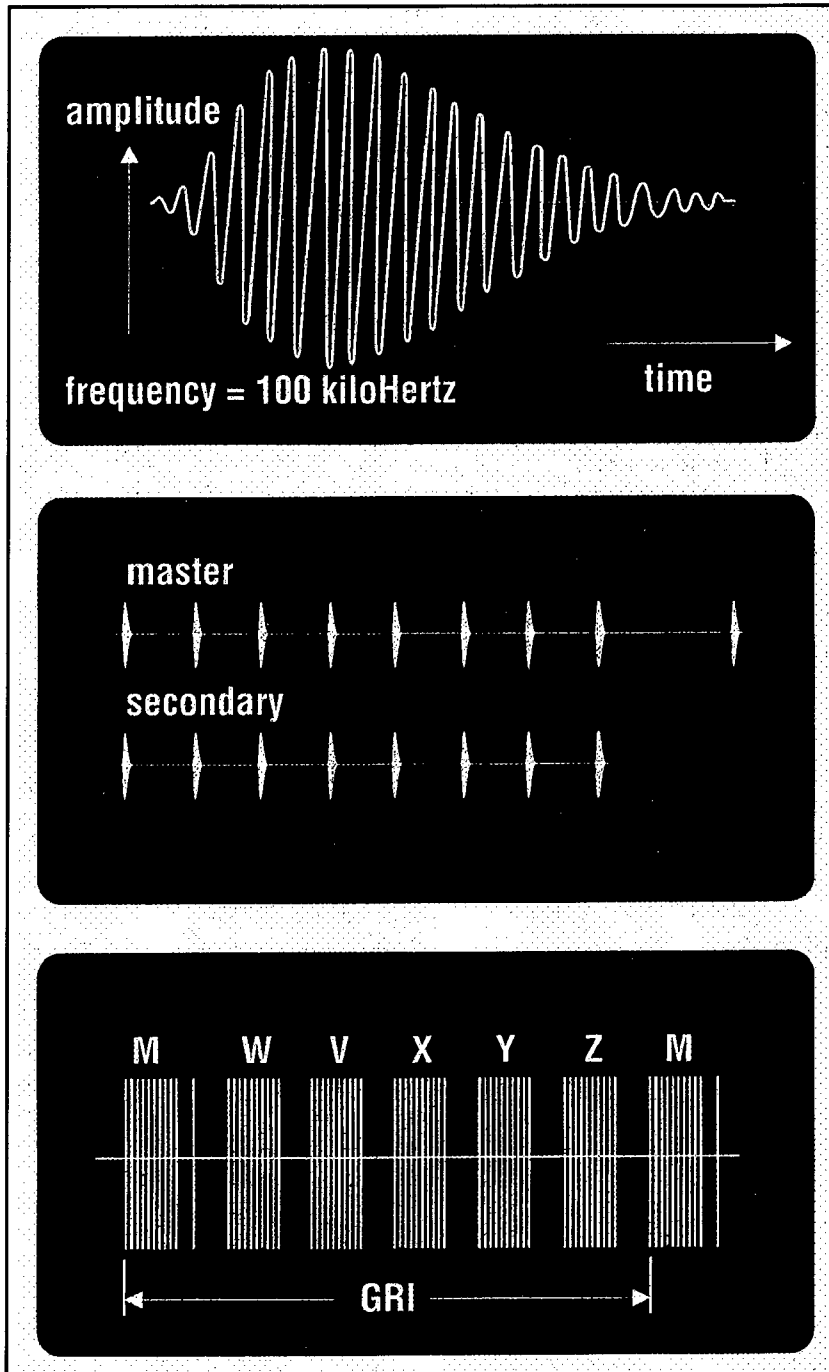

FIG 4.1-9

### LORAN-C Northeast U.S. Chain

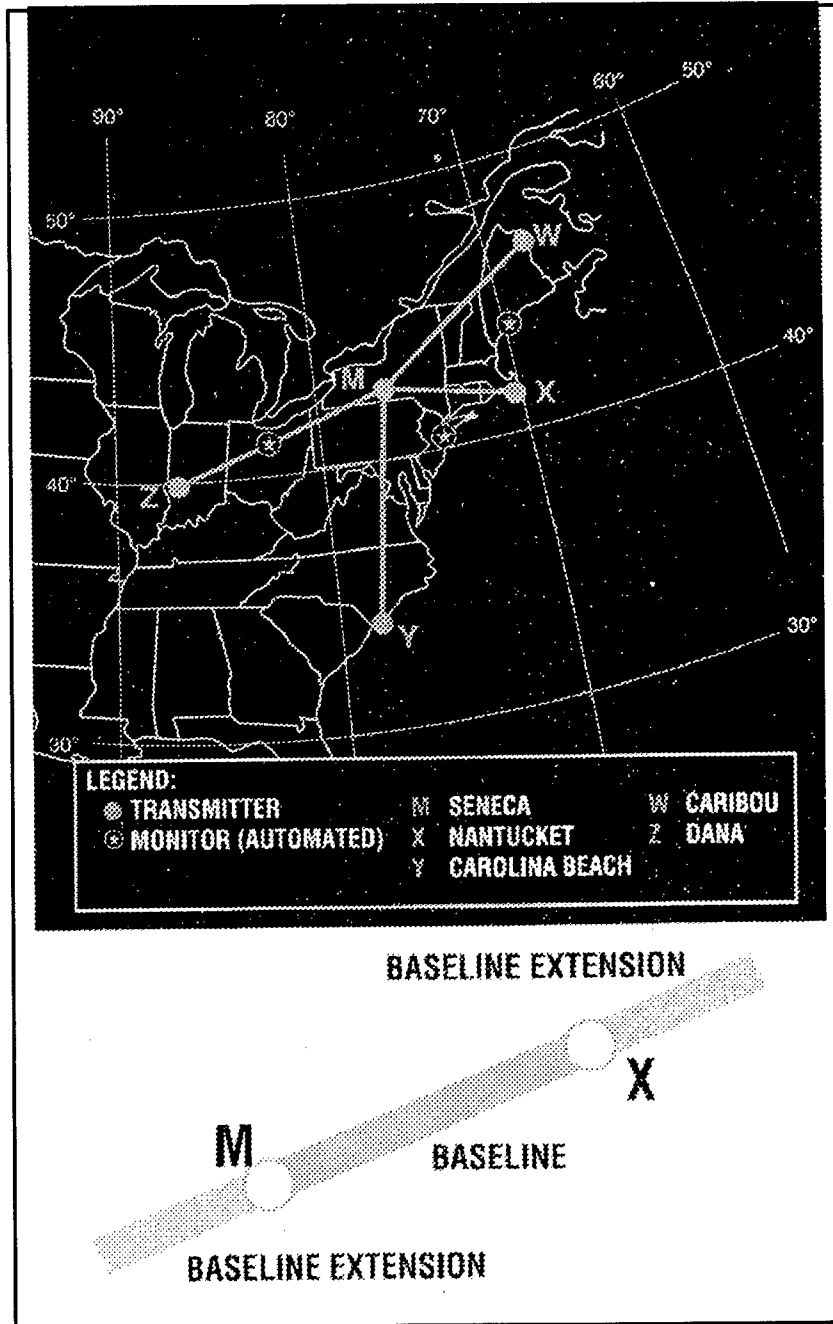

FIG 4.1-10

### LORAN-C West Coast Chain

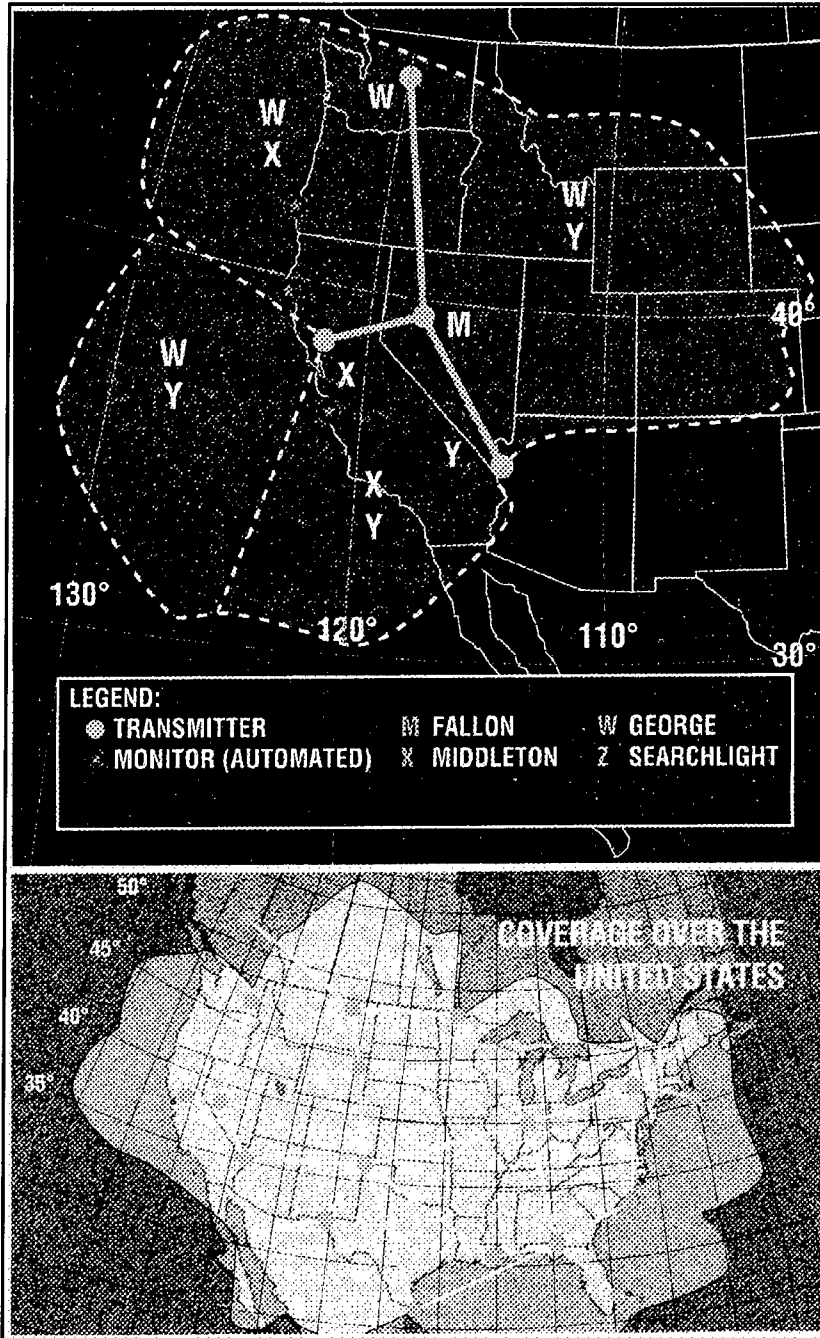

FIG 4.1-11

North Pacific Chain

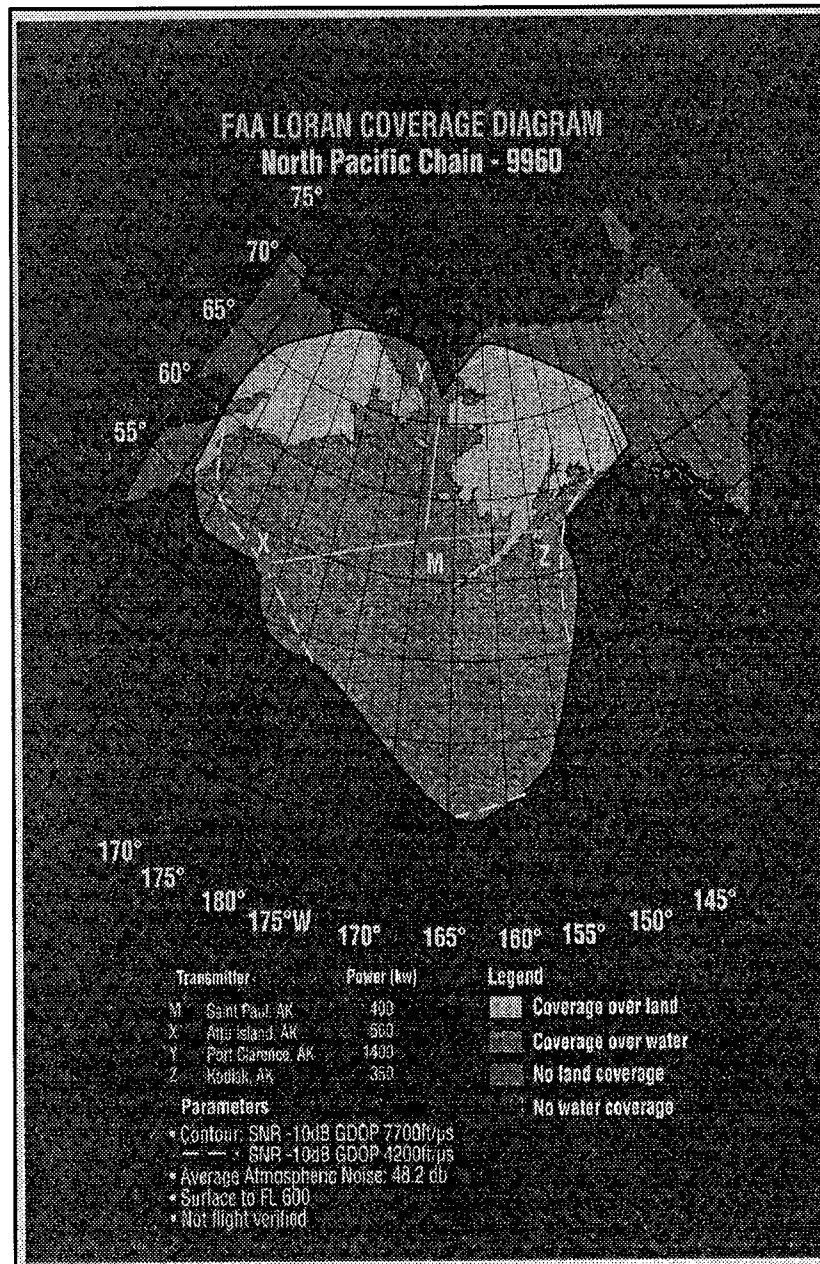

FIG 4.1-12

Coverage Over Alaska

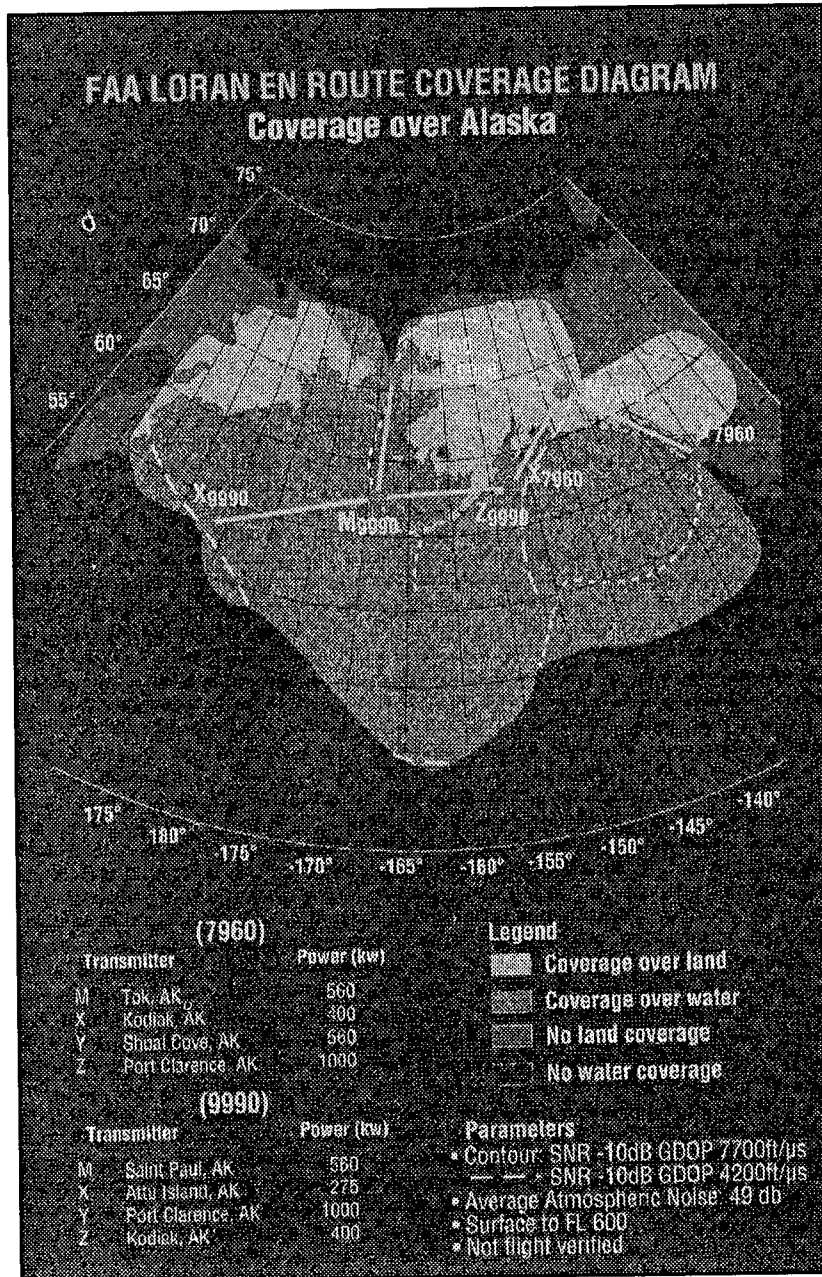

FIG 4.1-13

Canadian West Coast Chain

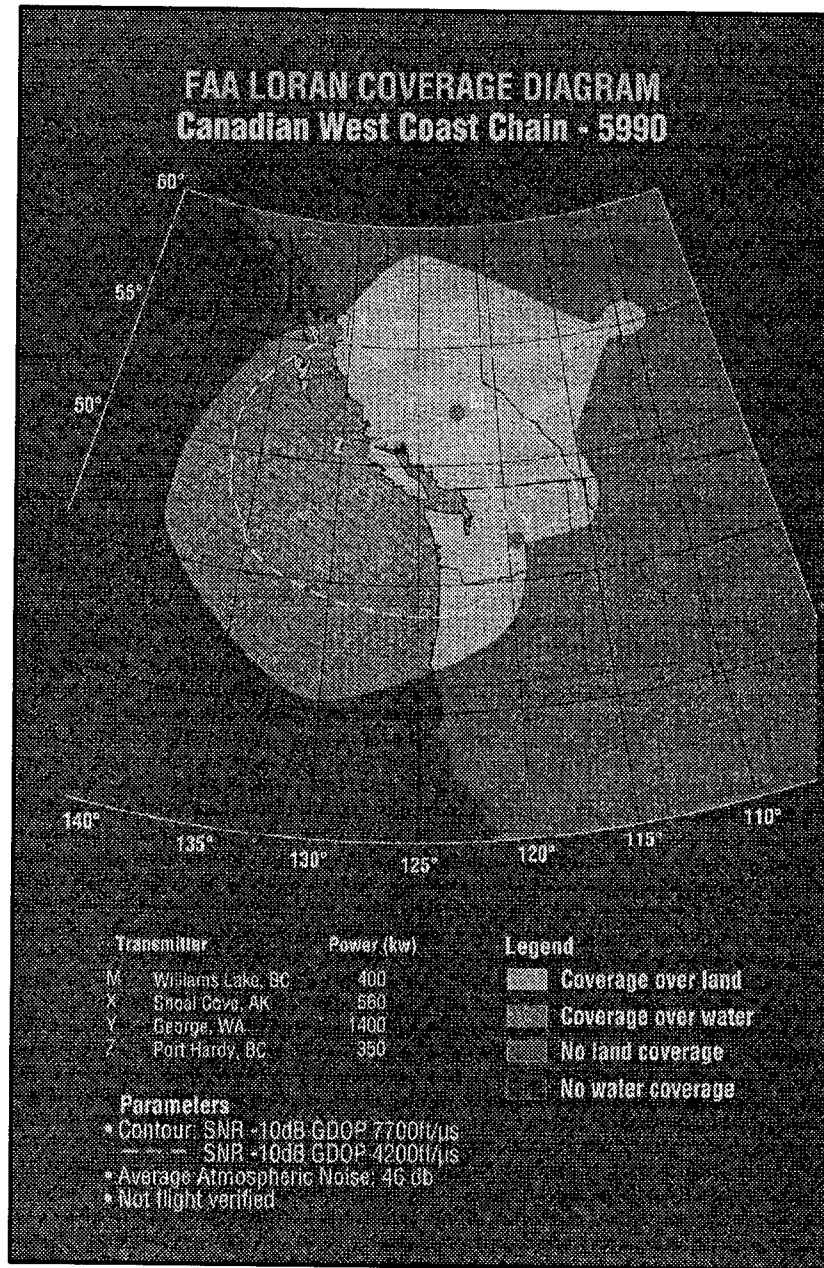

FIG 4.1-14

United States West Coast Chain

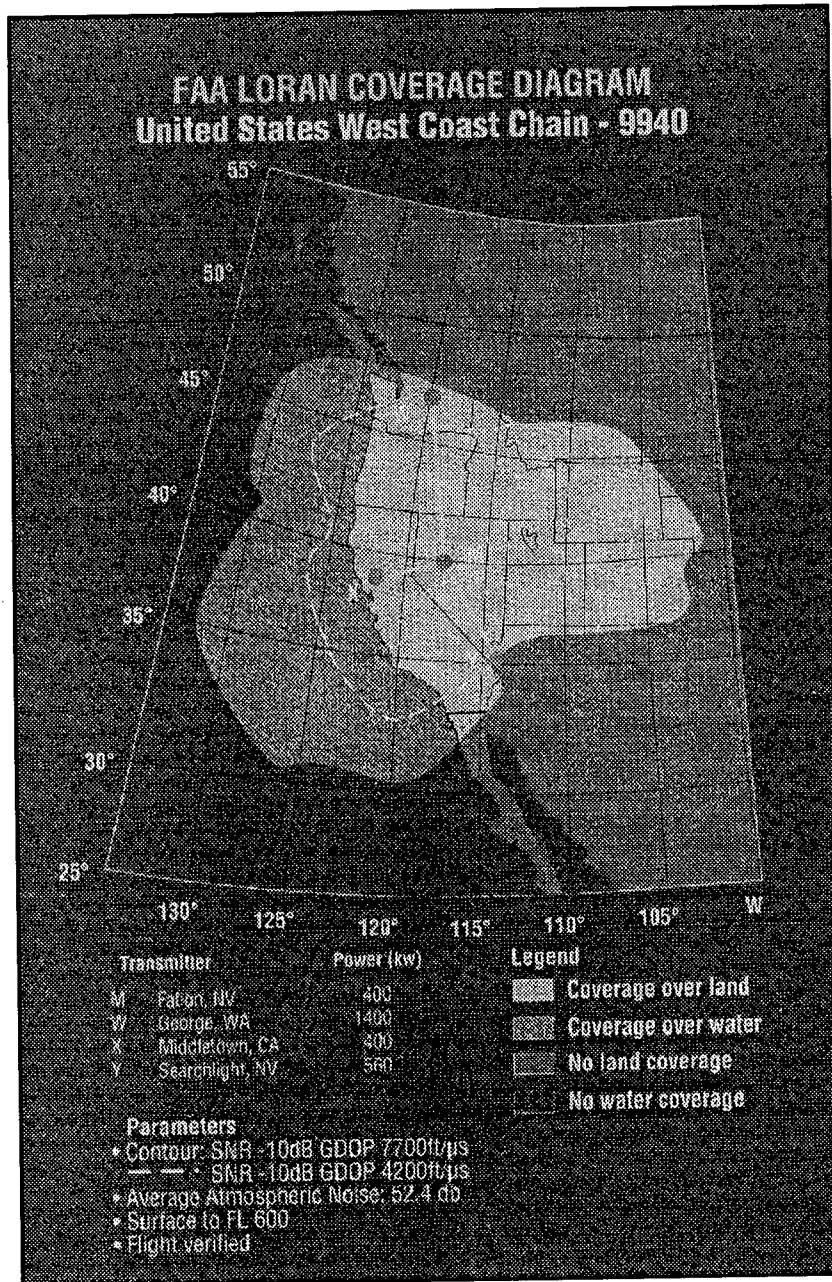

FIG 4.1-15

North Central United States Chain

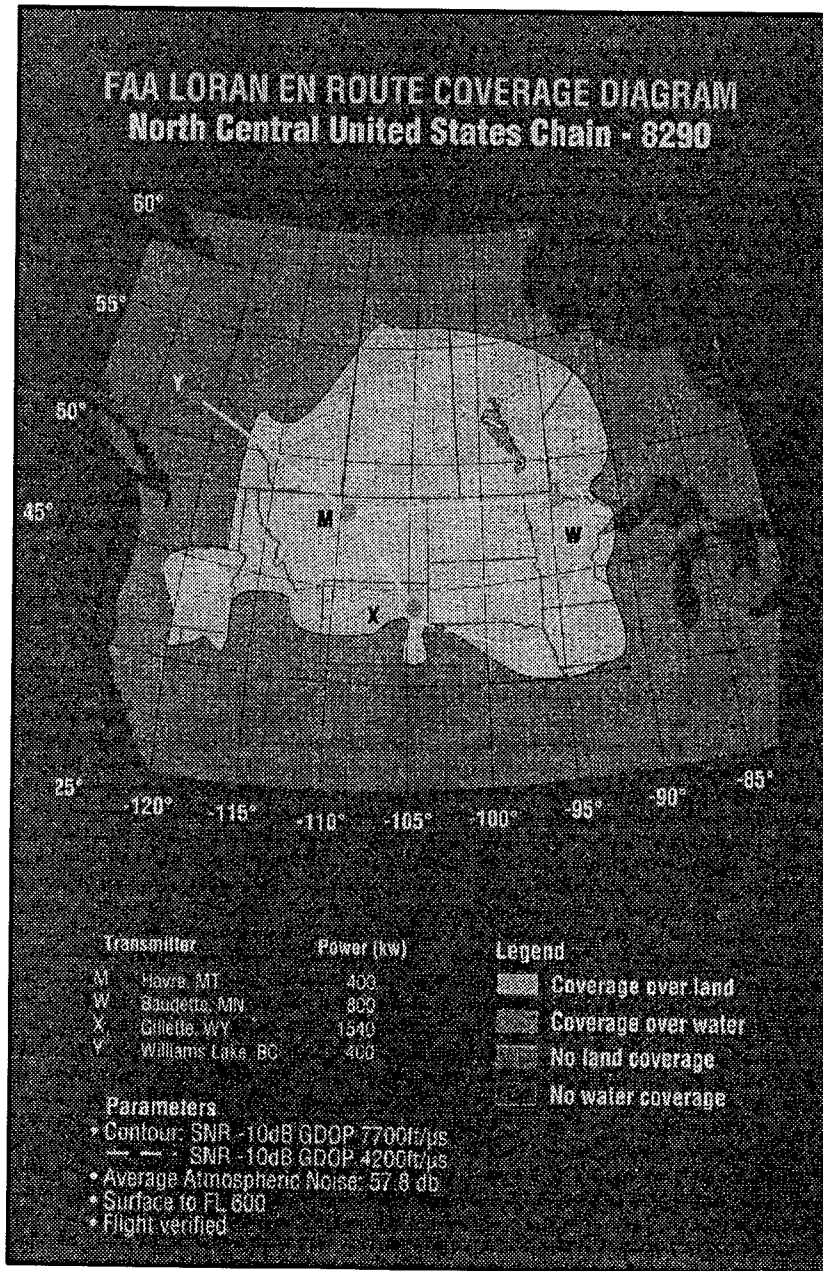

FIG 4.1-16



South Central United States Chain

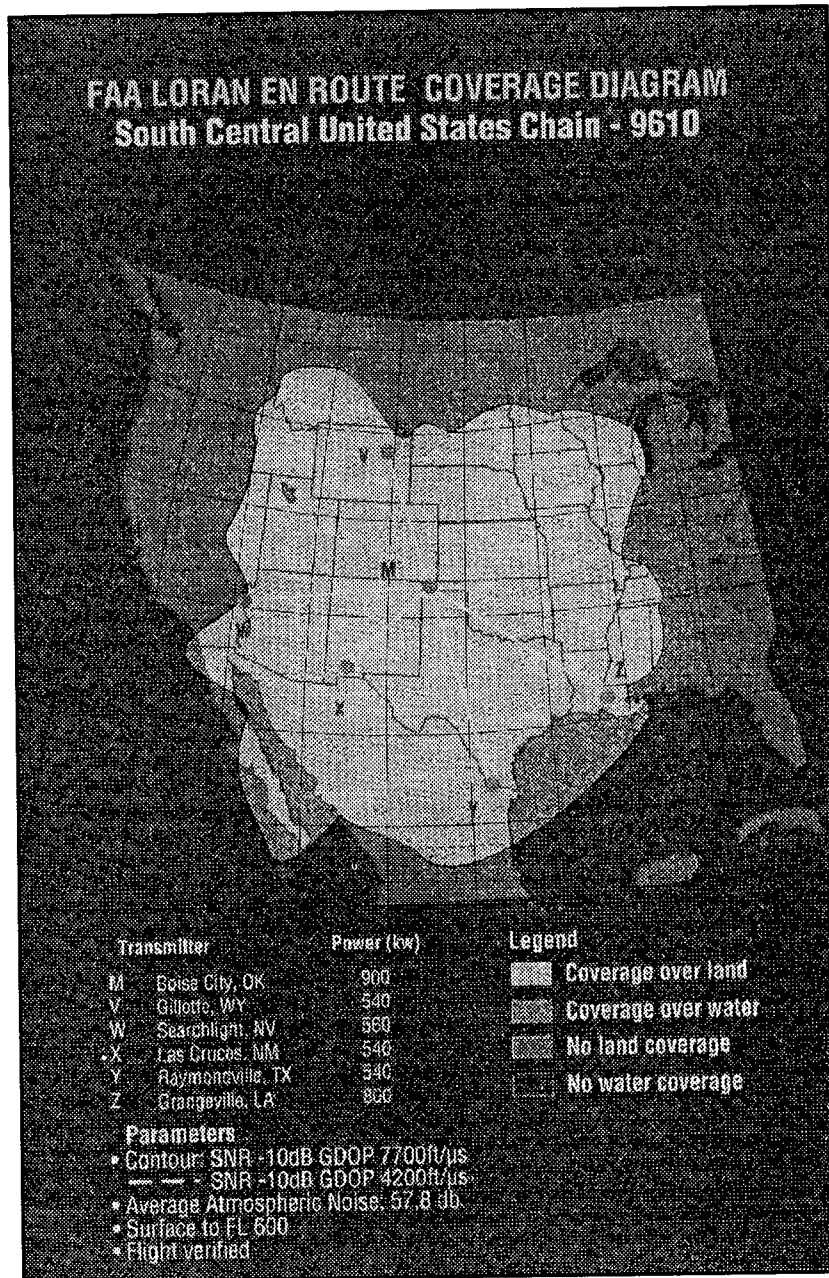

FIG 4.1-17

United States Great Lakes Chain

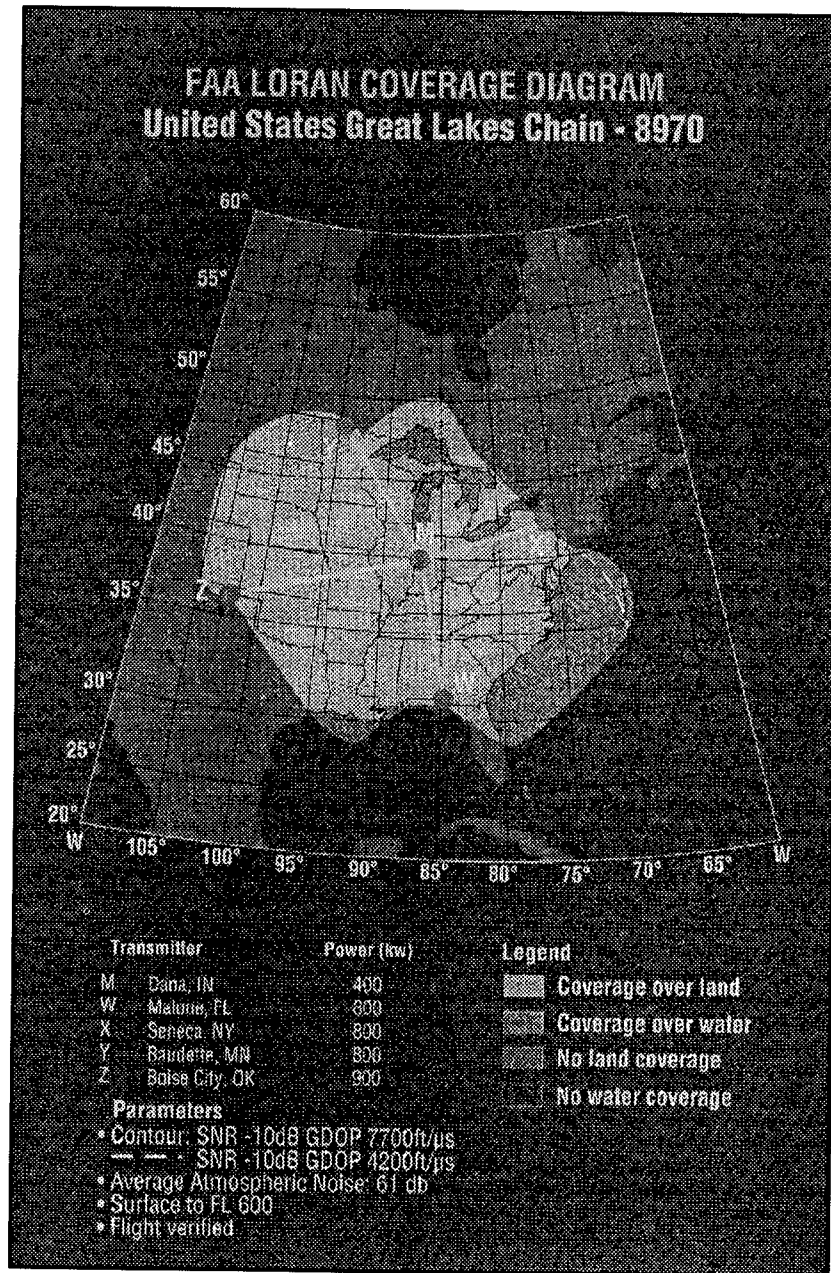

FIG 4.1-18

United States Southeast Chain

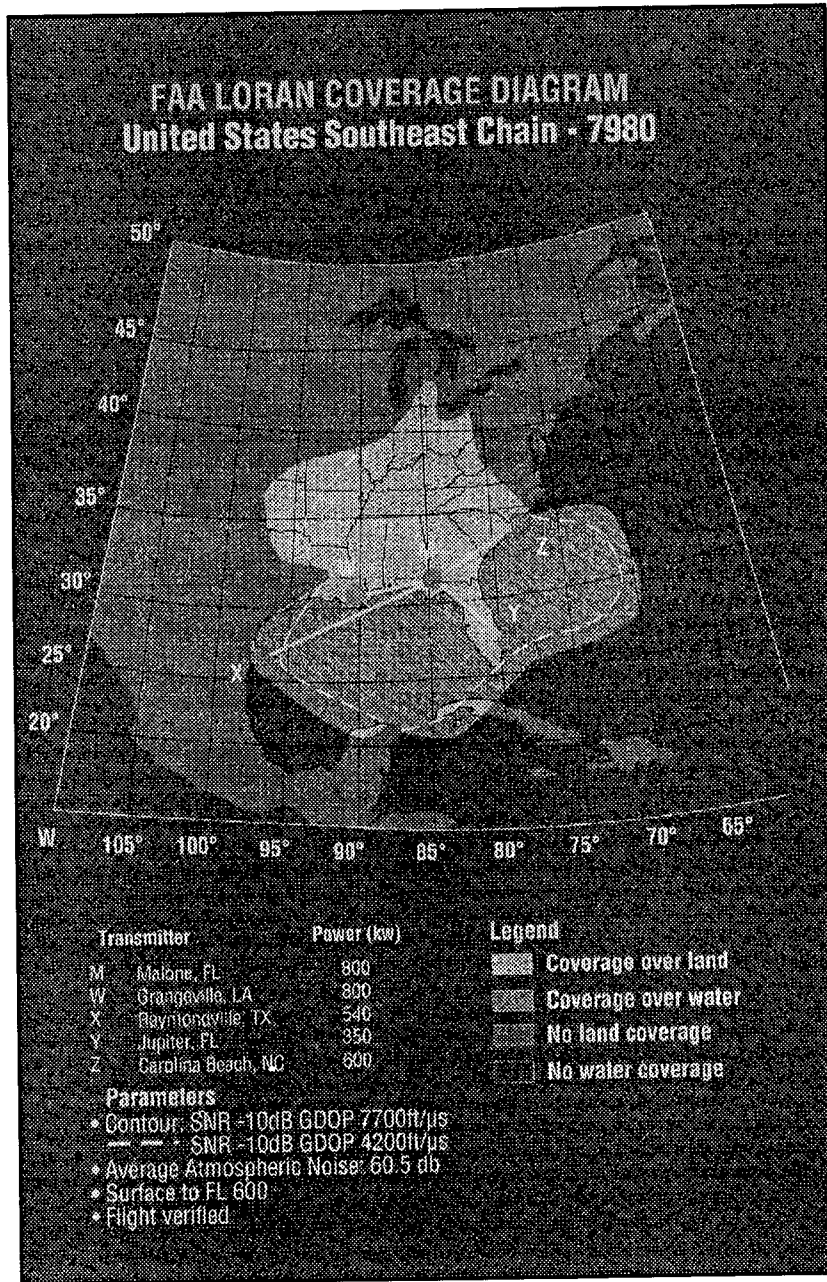

FIG 4.1-19

Northeast United States Chain

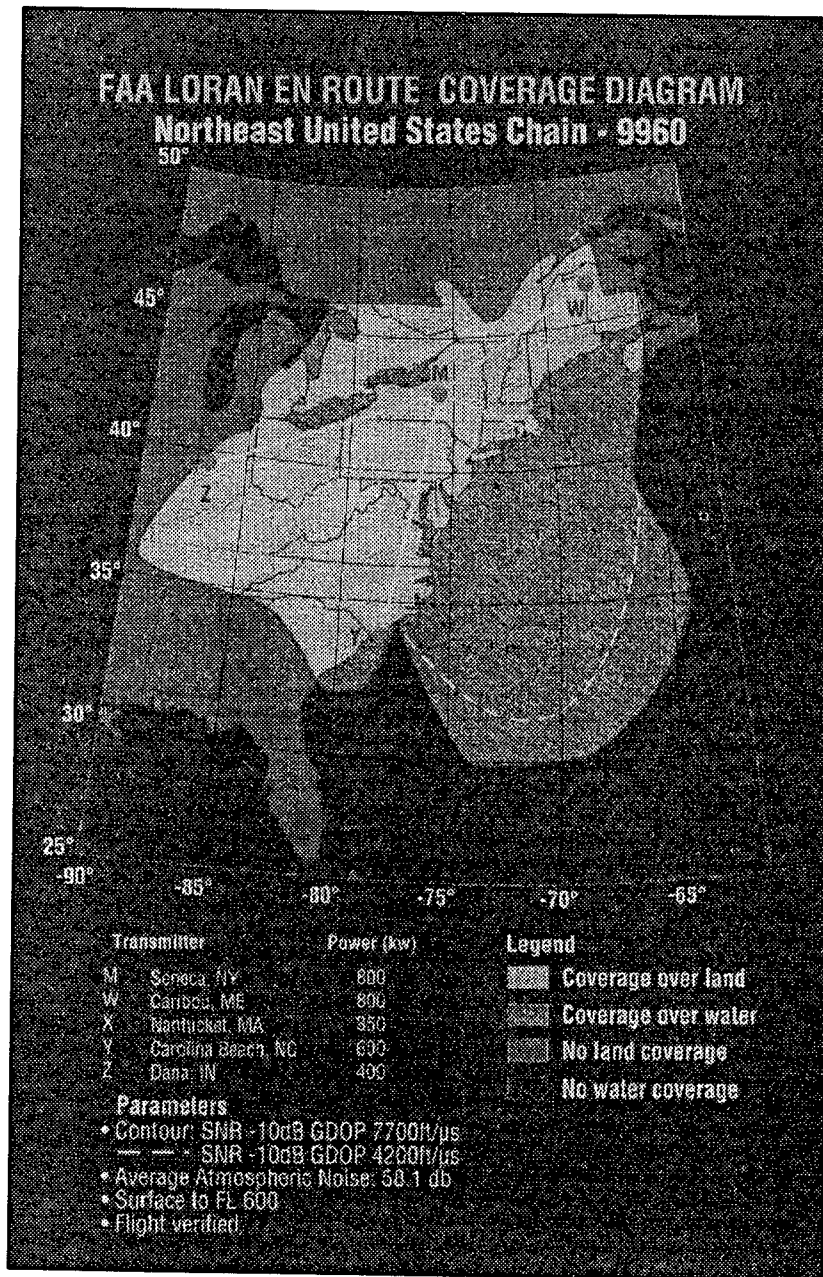

FIG 4.1-20

Canadian East Coast Chain

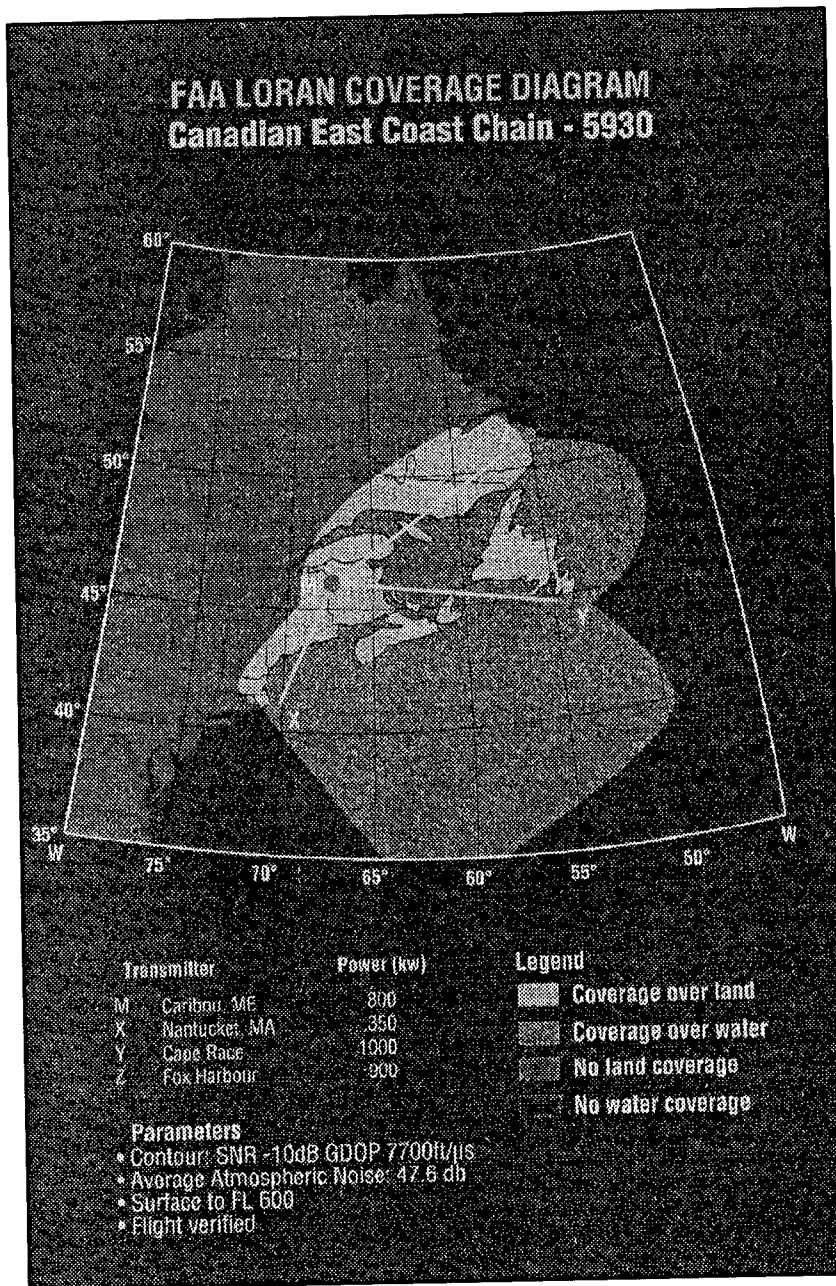

FIG 4.1-21

## **17. OMEGA and OMEGA/VLF Navigation Systems**

**17.1** OMEGA operations were terminated on September 30, 1997.

## **18. Inertial Navigation System (INS)**

**18.1** INS is a totally self-contained navigation system, comprised of gyros, accelerometers, and a navigation computer, which provides aircraft position and navigation information in response to signals resulting from inertial effects on system components, and does not require information from external references. INS is aligned with accurate position information prior to departure, and thereafter calculates its position as it progresses to the destination. By programming a series of waypoints, the system will navigate along a predetermined track. New waypoints can be inserted at any time if a revised routing is desired. INS accuracy is very high initially following alignment, and decays with time at the rate of about 1-2 nautical miles per hour. Position update alignment can be accomplished inflight using ground based references, and many INS systems now have sophisticated automatic update using dual DME and or VOR inputs. INS may be approved as the sole means of navigation or may be used in combination with other systems.

## **19. Flight Management System (FMS)**

**19.1** FMS is a computer system that uses a large data base to allow routes to be preprogrammed and fed into the system by means of a data loader. The system is constantly updated with respect to position accuracy by reference to conventional navigation aids. The sophisticated program and its associated data base insures that the most appropriate aids are automatically selected during the information update cycle.

## **20. Global Positioning System (GPS)**

### **20.1 System Overview**

**20.1.1** GPS is a United States satellite-based radio navigational, positioning, and time transfer system operated by the Department of Defense (DoD). The system provides highly accurate position and velocity information and precise time on a continuous global basis to an unlimited number of properly-equipped users. The system is unaffected by weather and provides a worldwide common grid reference system based on the earth-fixed coordinate system. For its earth model, GPS uses the World Geodetic System of 1984 (WGS-84) datum.

**20.1.2** GPS provides two levels of service: Standard Positioning Service (SPS) and Precise Positioning Service (PPS). SPS provides, to all users, horizontal positioning accuracy of 100 meters, or less, with a probability of 95 percent and 300 meters with a probability of 99.99 percent. PPS is more accurate than SPS; however, this is limited to authorized U.S. and allied military, federal government, and civil users who can satisfy specific U.S. requirements.

**20.1.3** GPS operation is based on the concept of ranging and triangulation from a group of satellites in space which act as precise reference points. A GPS receiver measures distance from a satellite using the travel time of a radio signal. Each satellite transmits a specific code, called a course/acquisition (CA) code, which contains information on the satellite's position, the GPS system time, and the health and accuracy of the transmitted data. Knowing the speed at which the signal traveled (approximately 186,000 miles per second) and the exact broadcast time, the distance traveled by the signal can be computed from the arrival time.

**20.1.4** The GPS receiver matches each satellite's CA code with an identical copy of the code contained in the receiver's data base. By shifting its copy of the satellite's code in a matching process, and by comparing this shift with its internal clock, the receiver can calculate how long it took the signal to travel from the satellite to the receiver. The distance derived from this method of computing distance is called a pseudo-range because it is not a direct measurement of distance, but a measurement based on time. Pseudo-range is subject to several error sources; for example, ionospheric and tropospheric delays and multipath.

**20.1.5** In addition to knowing the distance to a satellite, a receiver needs to know the satellite's exact position in space; this is known as its ephemeris. Each satellite transmits information about its exact orbital location. The GPS receiver uses this information to precisely establish the position of the satellite.

**20.1.6** Using the calculated pseudo-range and position information supplied by the satellite, the GPS receiver mathematically determines its position by triangulation. The GPS receiver needs at least four satellites to yield a three-dimensional position (latitude, longitude, and altitude) and time solution. The GPS receiver computes navigational values such as distance and bearing to a waypoint, ground speed, etc., by using the aircraft's known latitude/longitude and referencing these to a data base built into the receiver.

**20.1.7** The GPS constellation of 24 satellites is designed so that a minimum of five are always observable by a user anywhere on earth. The receiver uses data from a minimum of four satellites above the mask angle (the lowest angle above the horizon at which it can use a satellite).

**20.1.8** The GPS receiver verifies the integrity (usability) of the signals received from the GPS constellation through receiver autonomous integrity monitoring (RAIM) to determine if a satellite is providing corrupted information. At least one satellite, in addition to those required for navigation, must be in view for the receiver to perform the RAIM function; thus, RAIM needs a minimum of 5 satellites in view, or 4 satellites and a barometric altimeter (baro-aiding) to detect an integrity anomaly. For receivers capable of doing so, RAIM needs 6 satellites in view (or 5 satellites with baro-aiding) to isolate the corrupt satellite signal and remove it from the navigation solution. Baro-aiding is a method of augmenting the GPS integrity solution by using a nonsatellite input source. GPS derived altitude should not be relied upon to determine aircraft altitude since the vertical error can be quite large. To ensure that baro-aiding is available, the current altimeter setting must be entered into the receiver as described in the operating manual.

**20.1.9** RAIM messages vary somewhat between receivers; however, generally there are two types. One type indicates that there are not enough satellites available to provide RAIM integrity monitoring and another type indicates that the RAIM integrity monitor has detected a potential error that exceeds the limit for the current phase of flight. **Without RAIM capability, the pilot has no assurance of the accuracy of the GPS position.**

**20.1.10** The Department of Defense declared initial operational capability (IOC) of the U.S. GPS on December 8, 1993. The Federal Aviation Administration (FAA) has granted approval for U.S. civil operators to use properly certified GPS equipment as a primary means of navigation in oceanic airspace and certain remote areas. Properly certified GPS equipment may be used as a supplemental means of IFR navigation for domestic en route, terminal operations, and certain instrument approach procedures (IAP's). This approval permits the use of GPS in a manner that is consistent with current navigation requirements as well as approved air carrier operations specifications.

## 20.2 General Requirements

**20.2.1** Authorization to conduct any GPS operation under IFR requires that:

a) GPS navigation equipment used must be approved in accordance with the requirements specified in TSO C-129, or equivalent, and the installation must be done in accordance with Notice 8110.47 or 8110.48, or equivalent. Equipment approved in accordance with TSO C-115a does not meet the requirements of TSO C-129.

b) Aircraft using GPS navigation equipment under IFR must be equipped with an approved and operational alternate means of navigation appropriate to the flight. Active monitoring of alternative navigation equipment is not required if the GPS receiver uses RAIM for integrity monitoring. Active monitoring of an alternate means of navigation is required when the RAIM capability of the GPS equipment is lost.

c) Procedures must be established for use in the event that the loss of RAIM capability is predicted to occur. In situations where this is encountered, the flight must rely on other approved equipment, delay departure, or cancel the flight.

d) The GPS operation must be conducted in accordance with the FAA-approved aircraft flight manual (AFM) or flight manual supplement. Flight crew members must be thoroughly familiar with the particular GPS equipment installed in the aircraft, the receiver operation manual, and the AFM or flight manual supplement. Unlike ILS and VOR, the basic operation, receiver presentation to the pilot, and some capabilities of the equipment can vary greatly. Due to these differences, operation of different brands, or even models of the same brand, of GPS receiver under IFR should not be attempted without thorough study of the operation of that particular receiver and installation. Most receivers have a built-in simulator mode which will allow the pilot to become familiar with operation prior to attempting operation in the aircraft. Using the equipment in flight under VFR conditions prior to attempting IFR operation will allow further familiarization.

e) Aircraft navigating by IFR approved GPS are considered to be RNAV aircraft and have special equipment suffixes. File the appropriate equipment suffix in accordance with TBL 4.1-6 located in Section ENR 4.1, on the ATC flight plan. If GPS avionics become inoperative, the pilot should advise ATC and amend the equipment suffix.

f) Prior to any GPS IFR operation, the pilot must review appropriate NOTAM's and aeronautical information. (See GPS NOTAM's/Aeronautical Information.)

g) Air carrier and commercial operators must meet the appropriate provisions of their approved operations specifications.

### 20.3 Use of GPS for IFR Oceanic, Domestic En Route, and Terminal Area Operations

**20.3.1** GPS IFR operations in oceanic areas can be conducted as soon as the proper avionics systems are installed, provided all general requirements are met. A GPS installation with TSO C-129 authorization in class A1, A2, B1, B2, C1, or C2 may be used to replace one of the other approved means of long-range navigation, such as dual INS or dual Omega. (See TBL 4.1-6.) A single GPS installation with these classes of equipment which provide RAIM for integrity monitoring may also be used on short oceanic routes which have only required one means of long-range navigation.

**20.3.2** GPS domestic en route and terminal IFR operations can be conducted as soon as proper avionics systems are installed, provided all general requirements are met. The avionics necessary to receive all of the ground-based facilities appropriate for the route to the

destination airport and any required alternate airport must be installed and operational. Ground-based facilities necessary for these routes must also be operational.

**20.3.3** The GPS Approach Overlay Program is an authorization for pilots to use GPS avionics under IFR for flying designated existing nonprecision instrument approach procedures, except localizer (LOC), localizer directional aid (LDA), and simplified directional facility (SDF) procedures. Only those approaches included in the receiver data base are authorized. Overlay approaches are predicated upon the design criteria of the ground-based NAVAID used as the basis of the approach. As such, they do not adhere to the design criteria described later for the stand alone GPS approaches.

**20.3.4** GPS IFR approach operations can be conducted as soon as proper avionics systems are installed and the following requirements are met:

a) The authorization to use GPS to fly instrument approaches is limited to U.S. airspace.

b) The use of GPS in any other airspace must be expressly authorized by the FAA Administrator.

c) GPS instrument approach operations outside the United States must be authorized by the appropriate sovereign authority.

### GPS IFR Equipment Classes/Categories

TSO-C129						
EQUIPMENT CLASS	RAIM	INT. NAV. SYS. TO PROV. RAIM EQUIV.	OCEANIC	EN ROUTE	TERMINAL	NONPRECISION APPROACH CAPABLE
<b>Class A - GPS sensor and navigation capability.</b>						
A1	yes		yes	yes	yes	yes
A2	yes		yes	yes	yes	no
<b>Class B - GPS sensor data to an integrated navigation system (i.e. FMS, multi-sensor navigation system, etc.).</b>						
B1	yes		yes	yes	yes	yes
B2	yes		yes	yes	yes	no
B3		yes	yes	yes	yes	yes
B4		yes	yes	yes	yes	no
<b>Class C - GPS sensor data to an integrated navigation system (as in Class B) which provides enhanced guidance to an autopilot, or flight director, to reduce flight tech. errors. Limited to 14 CFR Part 121 or equivalent criteria.</b>						
C1	yes		yes	yes	yes	yes
C2	yes		yes	yes	yes	no
C3		yes	yes	yes	yes	yes
C4		yes	yes	yes	yes	no

TBL 4.1-6



## 20.4 Equipment and Data Base Requirements

**20.4.1** Authorization to fly approaches under IFR using GPS avionics systems requires that:

a) A pilot use GPS avionics with TSO C-129, or equivalent, authorization in class A1, B1, B3, C1, or C3; and

b) All approach procedures to be flown must be retrievable from the current airborne navigation data base supplied by the TSO C-129 equipment manufacturer or other FAA approved source.

## 20.5 Phases of the Approach Overlay Program

**20.5.1 Phase I:** Phase I has been completed.

**20.5.2 Phase II:** Under Phase II, GPS avionics can be used as the IFR flight guidance system for an approach without actively monitoring the ground-based NAVAID('s) which defines the approach. However, the ground-based NAVAID('s) must be operational. In addition, the related avionics must be installed and operational but need not be turned on during the approach (monitoring backup navigation is always recommended when available). Approaches must be requested and approved using the published title of the existing approach procedure, such as "VOR RWY 24."

**20.5.3 Phase III:** In this phase, instrument approach procedures were retitled "or GPS" (e.g., VOR or GPS RWY 24). Ground-based NAVAID's are not required to be operational and associated aircraft avionics need not be installed, operational, turned on or monitored. (Monitoring of the underlying approach is suggested when equipment is available and functional.) GPS approaches are requested and approved using the GPS title, such as "GPS RWY 24."

*NOTE.— IN EACH PHASE, ANY REQUIRED ALTERNATE AIRPORT MUST HAVE AN APPROVED INSTRUMENT APPROACH PROCEDURE OTHER THAN GPS, WHICH IS ANTICIPATED TO BE OPERATIONAL AND AVAILABLE AT THE ESTIMATED TIME OF ARRIVAL AND WHICH THE AIRCRAFT IS EQUIPPED TO FLY.*

## 20.6 GPS Standard Instrument Approach Procedure (SIAP) Design Concepts

**20.6.1** The objective of the Terminal Arrival Area (TAA) procedure design is to provide a new transition method for arriving aircraft equipped with FMS and/or GPS navigational equipment. The TAA contains within it a "T" structure that normally provides a NoPT for aircraft using the approach. The TAA provides the pilot and air traffic controller with a very efficient method for routing traffic from en route to terminal structure.

Basic "T" Design

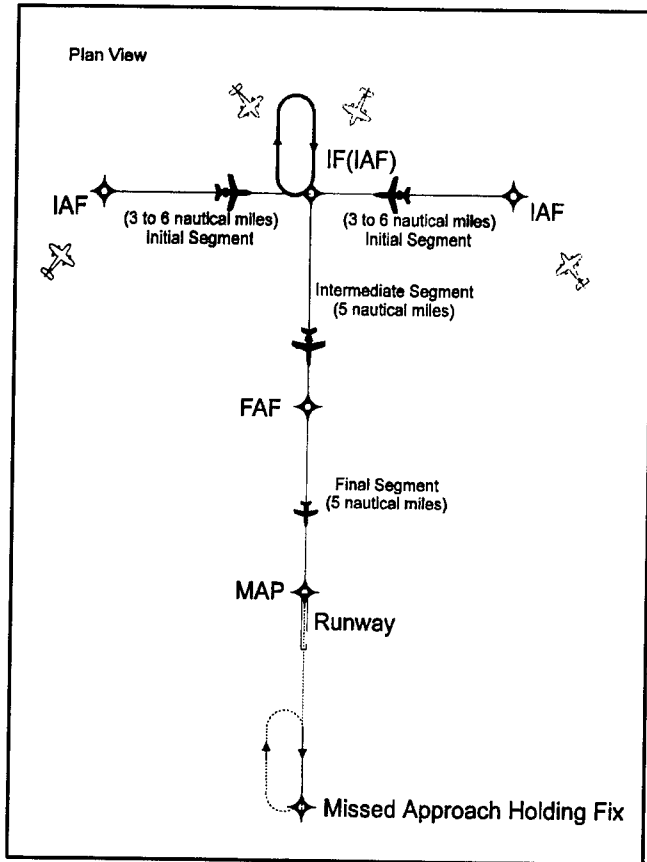

FIG 4.1-22

20.6.2 The basic "T" that is contained in the TAA normally aligns the procedure on runway centerline, with the missed approach point (MAP) located at the threshold, the final approach fix (FAF) 5 nautical miles from the threshold, and the intermediate fix (IF) 5 nautical miles from the FAF. Two initial approach fixes (IAF's) are located 3 to 6 miles from the center IF(IAF). All of these waypoint fixes will be named with a five character pronounceable name. The length of the initial segment varies with the category of aircraft using the procedure or descent gradient requirements. The minimum length of an initial segment designed for Category A aircraft is 3 nautical miles. The minimum length for an initial segment designed for Category E aircraft is 6 nautical miles. These initial segments are constructed perpendicular (90°) to the intermediate segment. There is a

holding pattern at the IF(IAF) for course reversal requirements. For example, some pilots may desire to execute a procedure turn (PT) to meet a descent gradient requirement. The missed approach segment is ideally aligned with the final approach course and terminates in a direct entry into a holding pattern. Conditions may require a different routing. (See FIG 4.1-22 and FIG 4.1-23.)

Basic "T" Design

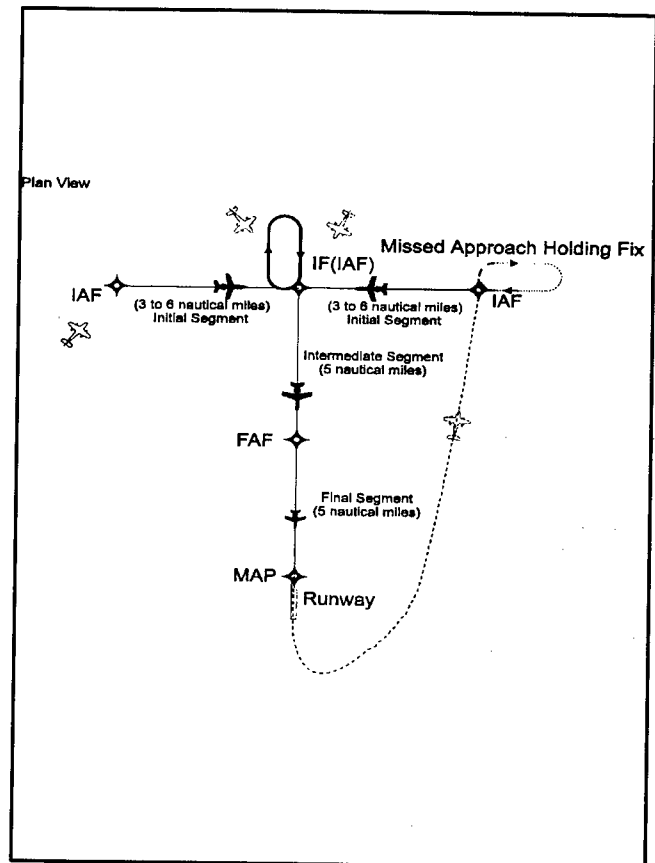

FIG 4.1-23

20.6.3 In order to accommodate descent from a high en route altitude to the initial segment altitude, the basic "T" configuration may be modified. When this occurs, a PT holding pattern provides aircraft an extended distance for the necessary descent gradient. The holding pattern constructed for this purpose is always established on the IF(IAF) waypoint. (See FIG 4.1-24.)

Modified Basic "T"

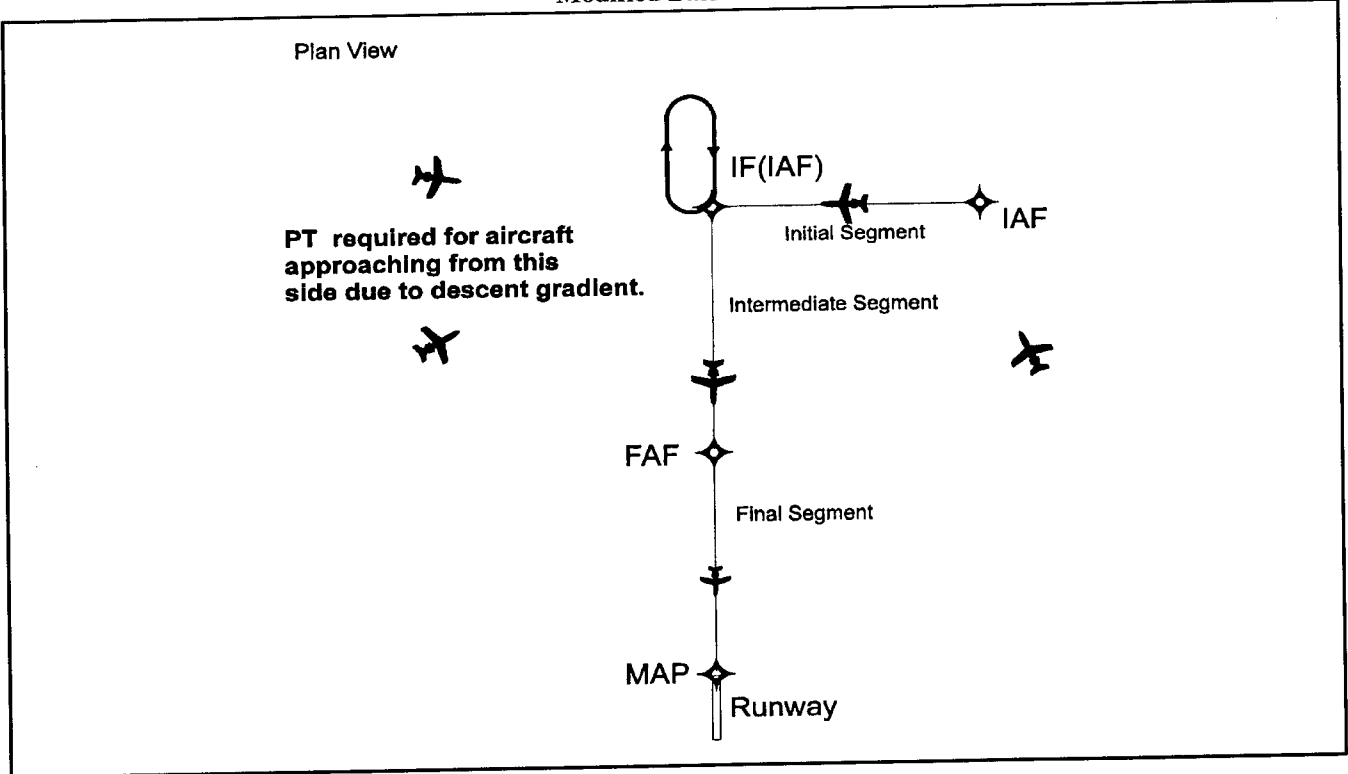

FIG 4.1-24

Modified "T" for Parallel Runways

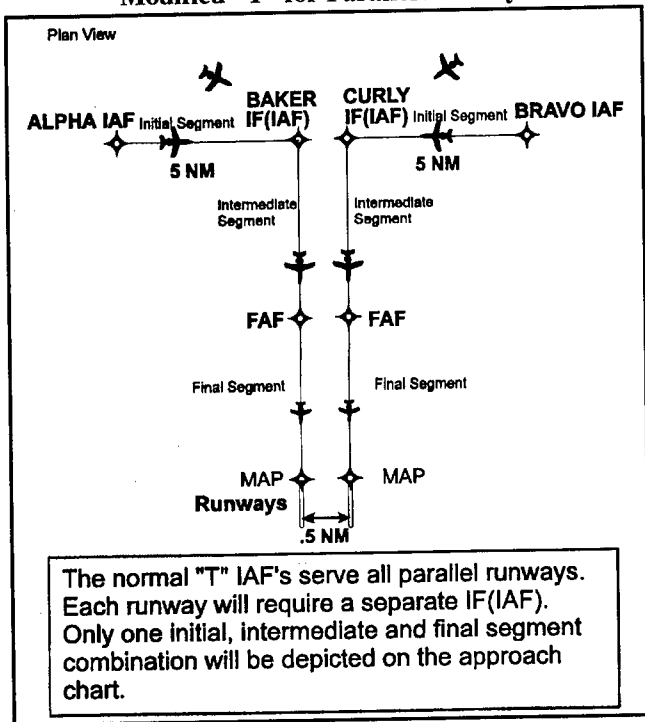

FIG 4.1-25

Modified Basic "T"

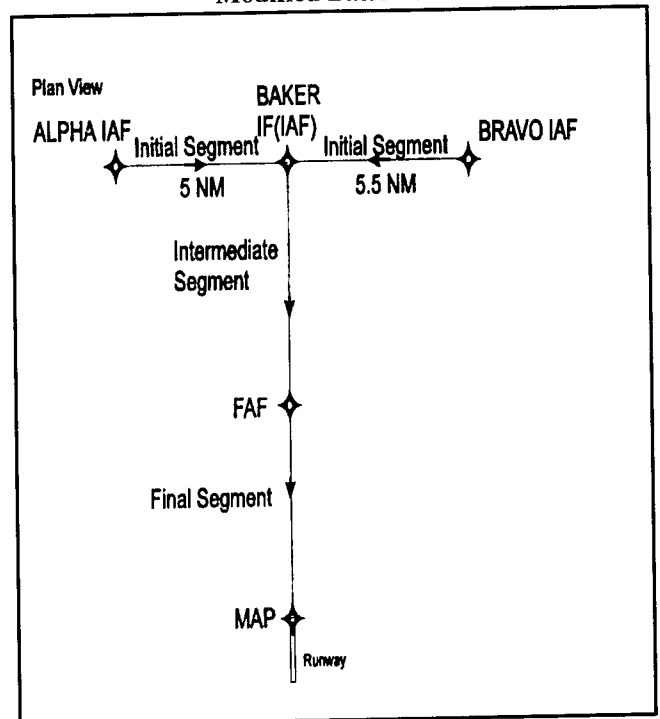

FIG 4.1-26

**20.6.4** Another modification may be required for parallel runways. The normal "T" IAF's serve all parallel runways. However, only one initial, intermediate and final segment combination will be depicted on the approach chart for the landing runway. (See FIG 4.1-25, FIG 4.1-26 and FIG 4.1-27.)

**20.6.5** The standard TAA consists of 3 areas that are established by the extension of the legs of the basic "T." These areas are: the straight-in, left base and right base. The 30-nautical-mile arc boundary of each area is equivalent to a feeder fix. When crossing the boundary of each of these areas or when released by ATC, within the area, the pilot is expected to proceed direct to the appropriate waypoint IAF for the approach area being flown. A pilot has the option in all areas to proceed direct to the holding pattern for course reversal. The PT holding pattern at the IF(IAF) is standard. Area boundaries are magnetic course lines to the IF(IAF). The charted altitudes within the TAA are maintained by aircraft that traverse these areas. (See FIG 4.1-28.)

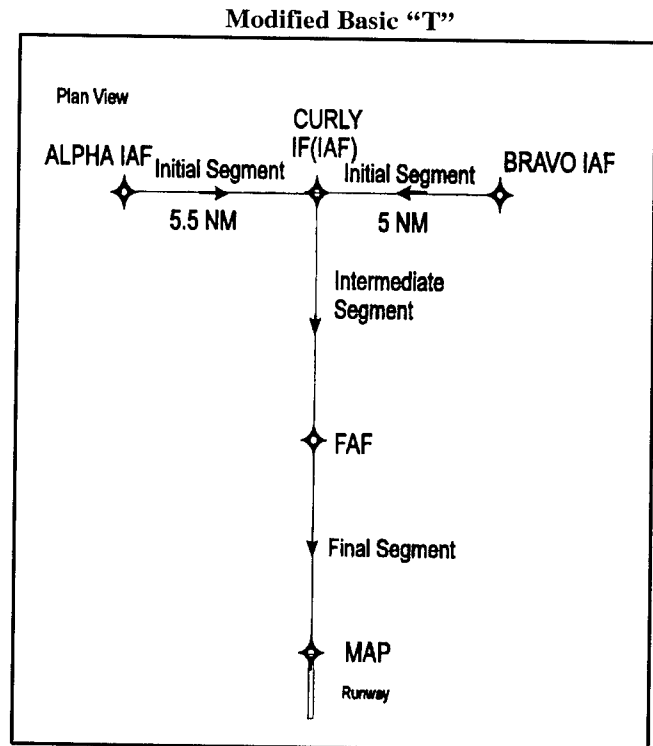

FIG 4.1-27

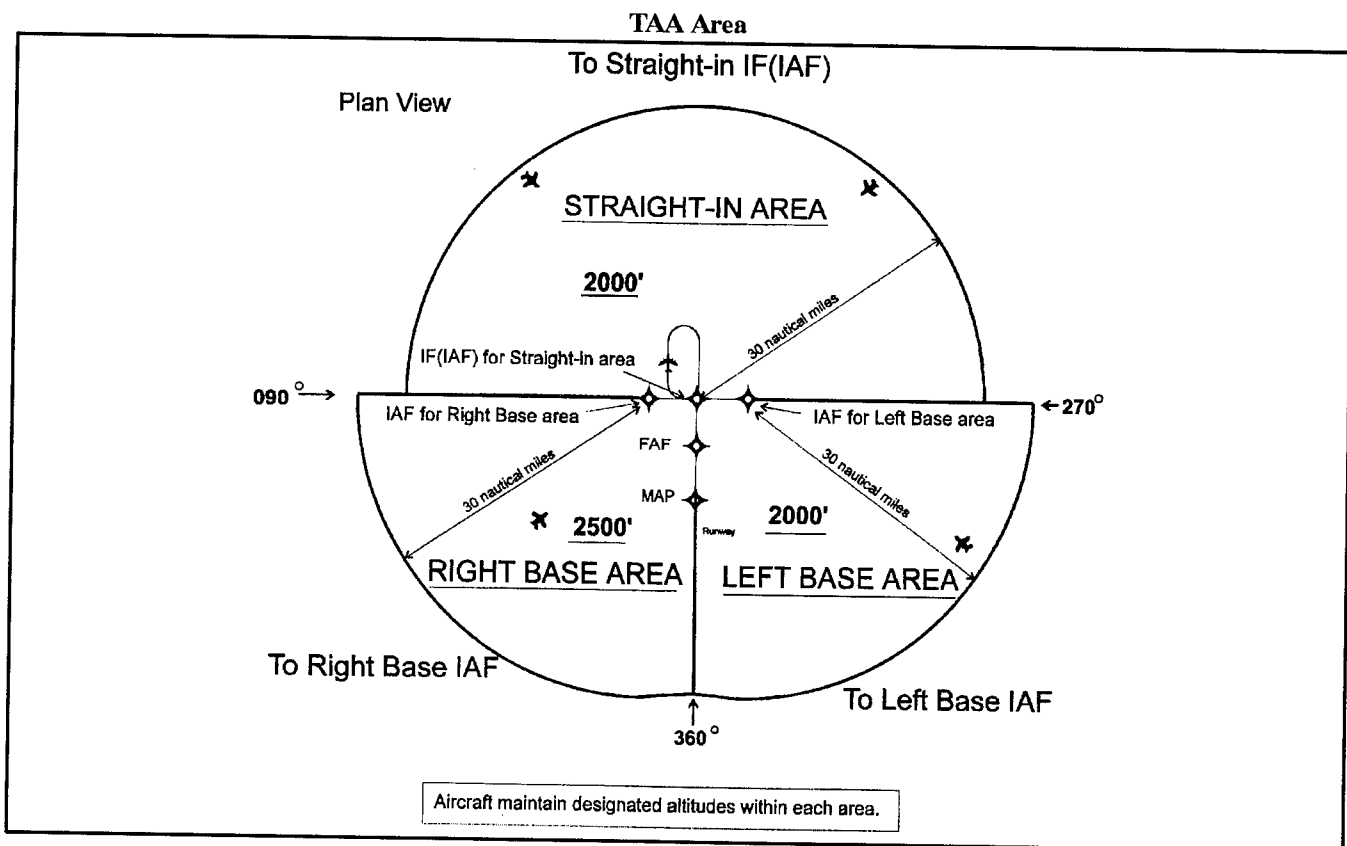

FIG 4.1-28

Sectored TAA Areas

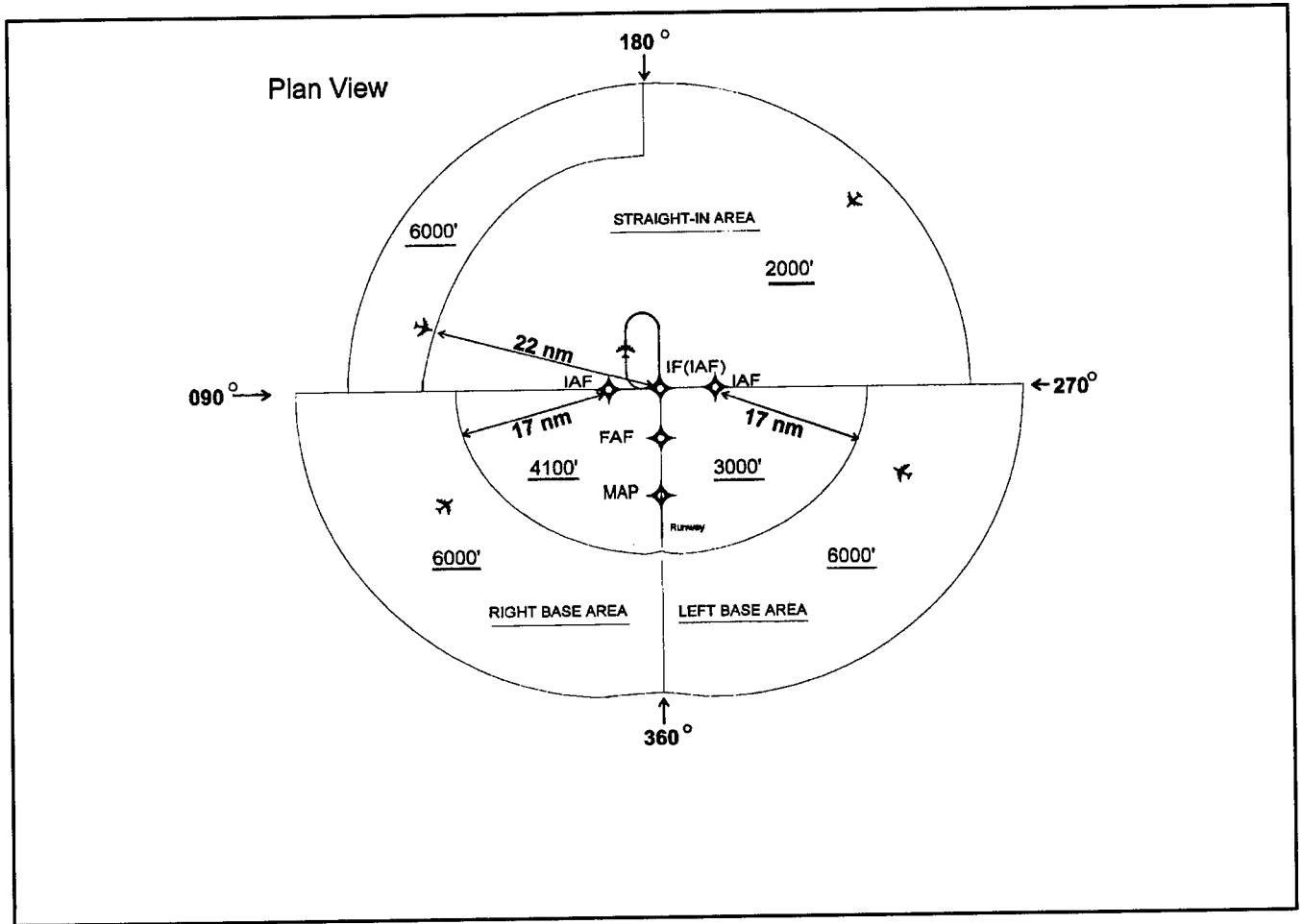

FIG 4.1-29

**20.6.6** Normally, the minimum altitudes specified in the TAA and PT holding pattern are the same. However, there may be locations where terrain or operational situations require minimum altitudes to maintain within a sector of an area. In FIG 4.1-29, pilots flying into the right or left base areas are expected to maintain a minimum altitude of 6,000 feet MSL until within 17 nautical

miles of the appropriate IAF and then descend to the lower charted altitudes. Pilots approaching from the northwest are expected to maintain a minimum altitude of 6,000 feet MSL until within 22 nautical miles of the IF(IAF) then descend to an altitude not lower than 2,000 feet MSL until reaching the IF(IAF).

**TAA with Left and Right  
Base Areas Eliminated**

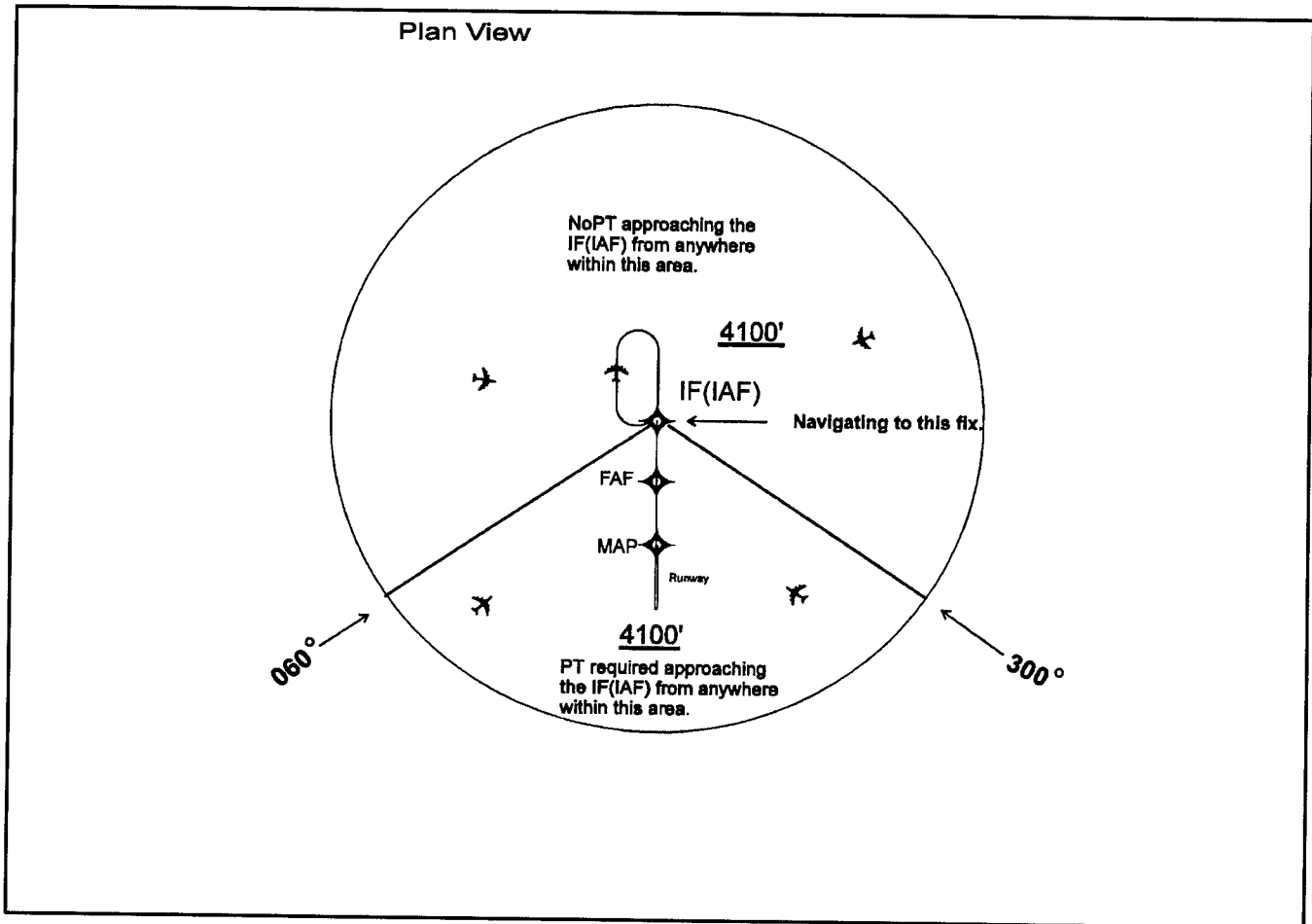

FIG 4.1-30

**20.6.7** There may be modifications to the area of the standard TAA because of operational requirements. For example, the right or left base areas may be modified or eliminated. A PT holding pattern can be required when approaching from a certain area. FIG 4.1-30 is an example of this situation. Pilots approaching the IF(IAF) within 120° of the final approach course (this is the

maximum intercept angle, a smaller angle could be required) are expected to fly a NoPT straight-in approach. If the PT is needed for unusual situations, advise ATC of your intentions. Pilots approaching the IF(IAF) on a course greater than 120° (or a specified smaller angle) from the final approach course are required to execute a procedure turn.

TAA with Right Base Eliminated

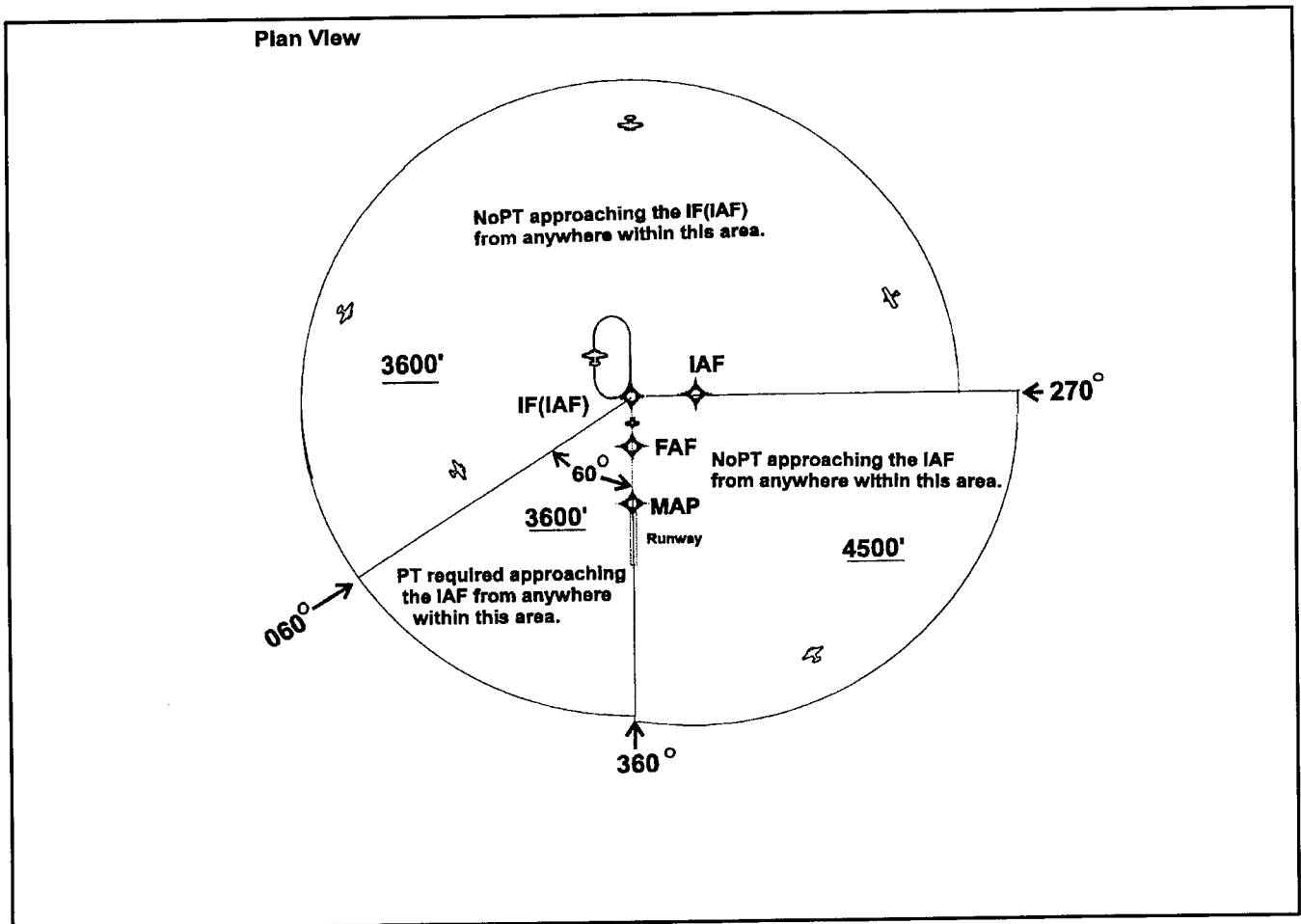

FIG 4.1-31

20.6.8 FIG 4.1-31 is an example of another modification. The right base is eliminated. Pilots approaching the IF(IAF) from between the courses of 360° clockwise to 060° are required to perform a PT. Pilots are expected to execute a NoPT straight-in approach when approaching the IF(IAF) from between the courses of

060° clockwise to 270°. The left base contains an IAF with an initial leg. NoPT is expected. Normally an airway will overlie a TAA. FIG 4.1-32 is an example of all airways lying outside of the TAA. The required feeder routes are aligned with the appropriate IAF's of the "T."

Examples of a TAA with Feeders from an Airway

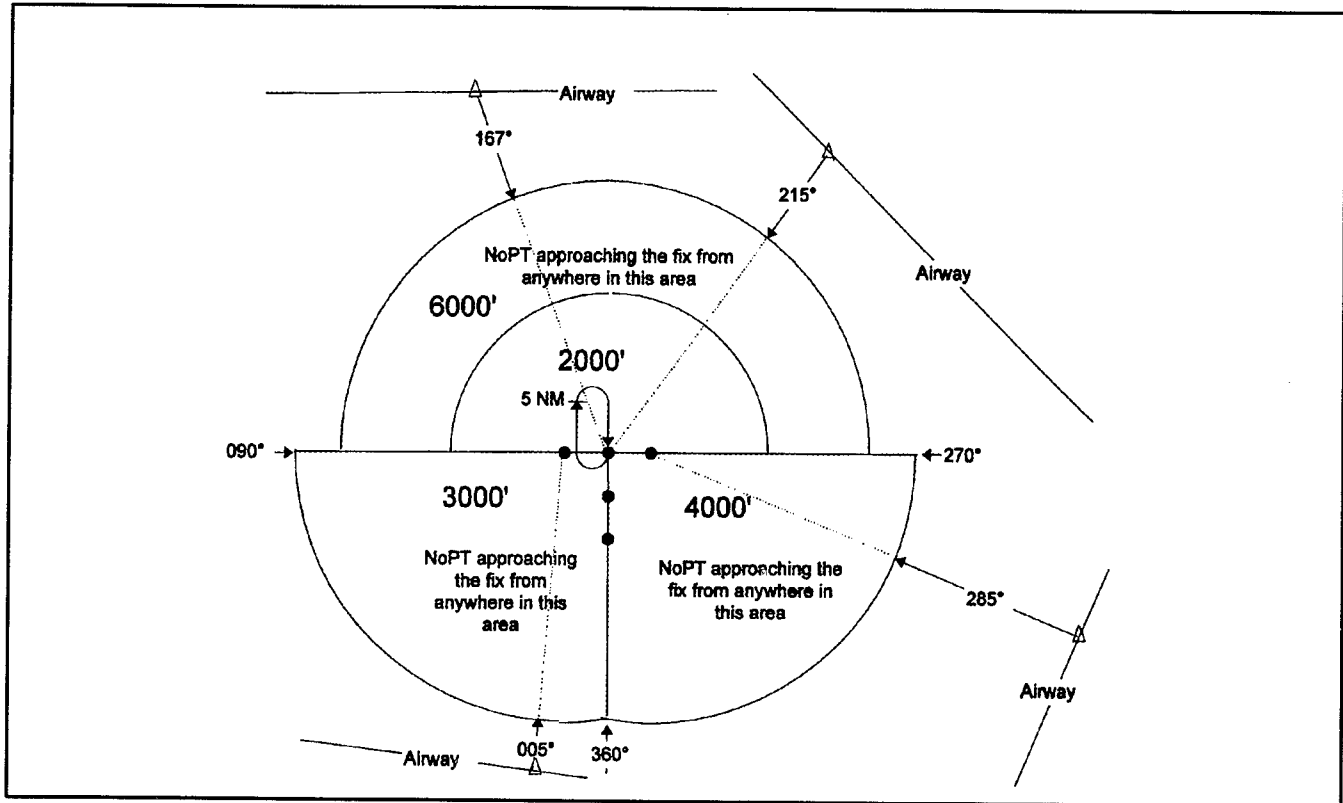

FIG 4.1-32

## 20.7 GPS NOTAM's/Aeronautical Information

**20.7.1** GPS satellite outages are issued as GPS NOTAM's both domestically and internationally. However, the effect of an outage on the intended operation cannot be determined unless the pilot has a RAIM availability prediction program which allows excluding a satellite which is predicted to be out of service based on the NOTAM information.

**20.7.2** Civilian pilots may obtain GPS RAIM availability information for nonprecision approach procedures by specifically requesting GPS aeronautical information from an Automated Flight Service Station during preflight briefings. GPS RAIM aeronautical information can be obtained for a period of 3 hours (ETA hour and 1 hour before to 1 hour after the ETA hour) or a 24 hour time frame at a particular airport. FAA briefers will provide RAIM information for a period of 1 hour before to 1 hour after the ETA, unless a specific time frame is requested by the pilot. If flying a published GPS departure, a RAIM prediction should also be requested for the departure airport.

**20.7.3** The military provides airfield specific GPS RAIM NOTAM's for nonprecision approach procedures at military airfields. The RAIM outages are is-

sued as M-series NOTAM's and may be obtained for up to 24 hours from the time of request.

## 20.8 Receiver Autonomous Integrity Monitoring (RAIM)

**20.8.1** RAIM outages may occur due to an insufficient number of satellites or due to unsuitable satellite geometry which causes the error in the position solution to become too large. Loss of satellite reception and RAIM warnings may occur due to aircraft dynamics (changes in pitch or bank angle). Antenna location on the aircraft, satellite position relative to the horizon, and aircraft attitude may affect reception of one or more satellites. Since the relative positions of the satellites are constantly changing, prior experience with the airport does not guarantee reception at all times, and RAIM availability should always be checked.

**20.8.2** If RAIM is not available, another type of navigation and approach system must be used, another destination selected, or the trip delayed until RAIM is predicted to be available on arrival. On longer flights, pilots should consider rechecking the RAIM prediction for the destination during the flight. This may provide early indications that an unscheduled satellite outage has occurred since takeoff.



**20.8.3 If a RAIM failure/status annunciation occurs prior to the final approach waypoint (FAWP), the approach should not be completed since GPS may no longer provide the required accuracy.** The receiver performs a RAIM prediction by 2 NM prior to the FAWP to ensure that RAIM is available at the FAWP as a condition for entering the approach mode. **The pilot should ensure that the receiver has sequenced from “Armed” to “Approach” prior to the FAWP** (normally occurs 2 NM prior). Failure to sequence may be an indication of the detection of a satellite anomaly, failure to arm the receiver (if required), or other problems which preclude completing the approach.

**20.8.4** If the receiver does not sequence into the approach mode or a RAIM failure/status annunciation occurs prior to the FAWP, the pilot should not descend to MDA, but should proceed to the missed approach waypoint (MAWP) via the FAWP, perform a missed approach, and contact ATC as soon as practical. Refer to the receiver operating manual for specific indications and instructions associated with loss of RAIM prior to the FAF.

**20.8.5** If a RAIM failure occurs after the FAWP, the receiver is allowed to continue operating without an annunciation for up to 5 minutes to allow completion of the approach (see receiver operating manual). **If the RAIM flag/status annunciation appears after the FAWP, the missed approach should be executed immediately.**

## 20.9 Waypoints

**20.9.1** GPS approaches make use of both fly-over and fly-by waypoints. Fly-by waypoints are used when an aircraft should begin a turn to the next course prior to reaching the waypoint separating the two route segments. This is known as turn anticipation and is compensated for in the airspace and terrain clearances. Approach waypoints, except for the MAWP and the missed approach holding waypoint (MAHWP), are normally fly-by waypoints. Fly-over waypoints are used when the aircraft must fly over the point prior to starting a turn. New approach charts depict fly-over waypoints as a circled waypoint symbol. Overlay approach charts and some early stand alone GPS approach charts may not reflect this convention.

**20.9.2** On overlay approaches (titled “or GPS”), if no pronounceable five character name is published for an approach waypoint or fix, it may be given an ARINC data base identifier consisting of letters and numbers. These points will appear in the list of waypoints in the

approach procedure data base, but may not appear on the approach chart. Procedures without a final approach fix (FAF), for instance, have a sensor final approach waypoint (FAWP) added to the data base at least 4 NM prior to the MAWP to allow the receiver to transition to the approach mode. Some approaches also contain an additional waypoint in the holding pattern when the MAWP and MAHWP are co-located. Arc and radial approaches have an additional waypoint that is used for turn anticipation computation where the arc joins the final approach course. These coded names will not be used by ATC.

**20.9.3** Unnamed waypoints in the data base will be uniquely identified for each airport but may be repeated for another airport (e.g., RW36 will be used at each airport with a runway 36 but will be at the same location for all approaches at a given airport).

**20.9.4** The runway threshold waypoint, which is normally the MAWP, may have a five letter identifier (e.g., SNEEZ) or be coded as RW## (e.g., RW36, RW36L). Those thresholds which are coded as five letter identifiers are being changed to the RW## designation. This may cause the approach chart and data base to differ until all changes are complete. The runway threshold waypoint is also used as the center of the MSA on most GPS approaches. MAWP's not located at the threshold will have a five letter identifier.

## 20.10 Position Orientation

**20.10.1** As with most RNAV systems, pilots should pay particular attention to position orientation while using GPS. Distance and track information are provided to the next active waypoint, not to a fixed navigation aid. Receivers may sequence when the pilot is not flying along an active route, such as when being vectored or deviating for weather, due to the proximity to another waypoint in the route. This can be prevented by placing the receiver in the nonsequencing mode. When the receiver is in the nonsequencing mode, bearing and distance are provided to the selected waypoint and the receiver will not sequence to the next waypoint in the route until placed back in the auto sequence mode or the pilot selects a different waypoint. On overlay approaches, the pilot may have to compute the along track distance to stepdown fixes and other points due to the receiver showing along track distance to the next waypoint rather than DME to the VOR or ILS ground station.

## 20.11 Conventional Versus GPS Navigation Data

**20.11.1** There may be slight differences between the heading information portrayed on navigational charts

and the GPS navigation display when flying an overlay approach or along an airway. All magnetic tracks defined by a VOR radial are determined by the application of magnetic variation at the VOR; however, GPS operations may use an algorithm to apply the magnetic variation at the current position, which may produce small differences in the displayed course. Both operations should produce the same desired ground track. Due to the use of great circle courses, and the variations in magnetic variation, the bearing to the next waypoint and the course from the last waypoint (if available) may not be exactly 180° apart when long distances are involved. Variations in distances will occur since GPS distance-to-waypoint values are along track (straight-line) distances (ATD) computed to the next waypoint and the DME values published on underlying procedures are slant range distances measured to the station. This difference increases with aircraft altitude and proximity to the NAVAID.

## 20.12 Departures and Instrument Departure Procedures (DP's)

**20.12.1** The GPS receiver must be set to terminal ( $\pm 1$  NM) course deviation indicator (CDI) sensitivity and the navigation routes contained in the data base in order to fly published IFR charted departures and DP's. Terminal RAIM should be automatically provided by the receiver. (Terminal RAIM for departure may not be available unless the waypoints are part of the active flight plan rather than proceeding direct to the first destination.) Certain segments of a DP may require some manual intervention by the pilot, especially when radar vectored to a course or required to intercept a specific course to a waypoint. The data base may not contain all of the transitions or departures from all runways and some GPS receivers do not contain DP's in the data base. It is necessary that helicopter procedures be flown at 70 knots or less since helicopter departure procedures and missed approaches use a 20:1 obstacle clearance surface (OCS), which is double the fixed-wing OCS, and turning areas are based on this speed as well.

## 20.13 Flying GPS Approaches

**20.13.1** Determining which area of the TAA the aircraft will enter when flying a "T" with a TAA must be accomplished using the bearing and distance to the IAF. This is most critical when entering the TAA in the vicinity of the extended runway centerline and determining whether you will be entering the right or left base area. Once inside the TAA, all sectors and stepdowns are based on the bearing and distance to the IAF for that area, which the aircraft should be proceeding direct to

at that time, unless on vectors. (See FIG 4.1-24 and FIG 4.1-25.)

**20.13.2** Pilots should fly the full approach from an Initial Approach Waypoint (IAWP) or feeder fix unless specifically cleared otherwise. Randomly joining an approach at an intermediate fix does not assure terrain clearance.

**20.13.3** When an approach has been loaded in the flight plan, GPS receivers will give an "arm" annunciation 30 NM straight line distance from the airport/heliport reference point. Pilots should arm the approach mode at this time, if it has not already been armed (some receivers arm automatically). Without arming, the receiver will not change from en route CDI and RAIM sensitivity of  $\pm 5$  NM either side of centerline to  $\pm 1$  NM terminal sensitivity. Where the IAWP is inside this 30 mile point, a CDI sensitivity change will occur once the approach mode is armed and the aircraft is inside 30 NM. Where the IAWP is beyond 30 NM from the airport/heliport reference point, CDI sensitivity will not change until the aircraft is within 30 miles of the airport/heliport reference point even if the approach is armed earlier. Feeder route obstacle clearance is predicated on the receiver being in terminal ( $\pm 1$  NM) CDI sensitivity and RAIM within 30 NM of the airport/heliport reference point, therefore, the receiver should always be armed (if required) not later than the 30 NM annunciation.

**20.13.4** The pilot must be aware of what bank angle/turn rate the particular receiver uses to compute turn anticipation, and whether wind and airspeed are included in the receiver's calculations. This information should be in the receiver operating manual. Over or under banking the turn onto the final approach course may significantly delay getting on course and may result in high descent rates to achieve the next segment altitude.

**20.13.5** When within 2 NM of the FAWP with the approach mode armed, the approach mode will switch to active, which results in RAIM changing to approach sensitivity and a change in CDI sensitivity. Beginning 2 NM prior to the FAWP, the full scale CDI sensitivity will smoothly change from  $\pm 1$  NM, to  $\pm 0.3$  NM at the FAWP. As sensitivity changes from  $\pm 1$  NM to  $\pm 0.3$  NM approaching the FAWP, with the CDI not centered, the corresponding increase in CDI displacement may give the impression that the aircraft is moving further away from the intended course even though it is on an acceptable intercept heading. Referencing the digital track displacement information (cross track error), if it is available in the approach mode, may help the pilot remain position oriented in this situation. Being established on the final approach course prior to the

beginning of the sensitivity change at 2 NM will help prevent problems in interpreting the CDI display during ramp down. Therefore, requesting or accepting vectors which will cause the aircraft to intercept the final approach course within 2 NM of the FAWP is not recommended.

**20.13.6** When receiving vectors to final, most receiver operating manuals suggest placing the receiver in the nonsequencing mode on the FAWP and manually setting the course. This provides an extended final approach course in cases where the aircraft is vectored onto the final approach course outside of any existing segment which is aligned with the runway. Assigned altitudes must be maintained until established on a published segment of the approach. Required altitudes at waypoints outside the FAWP or stepdown fixes must be considered. Calculating the distance to the FAWP may be required in order to descend at the proper location.

**20.13.7** Overriding an automatically selected sensitivity during an approach will cancel the approach mode annunciation. If the approach mode is not armed by 2 NM prior to the FAWP, the approach mode will not become active at 2 NM prior to the FAWP, and the equipment will flag. In these conditions, the RAIM and CDI sensitivity will not ramp down, and the pilot should not descend to MDA, but fly to the MAWP and execute a missed approach. The approach active annunciator and/or the receiver should be checked to ensure the approach mode is active prior to the FAWP.

**20.13.8** Do not attempt to fly an approach unless the procedure is contained in the current GPS data base. Flying point to point on the approach does not assure compliance with the published approach procedure. The proper RAIM sensitivity will not be available and the CDI sensitivity will not automatically change to  $\pm 0.3$  NM. Manually setting CDI sensitivity does not automatically change the RAIM sensitivity on some receivers. Some existing nonprecision approach procedures cannot be coded for use with GPS and will not be available as overlays.

**20.13.9** Pilots should pay particular attention to the exact operation of their GPS receivers for performing holding patterns and in the case of overlay approaches, operations such as procedure turns. These procedures may require manual intervention by the pilot to stop the sequencing of waypoints by the receiver and to resume automatic GPS navigation sequencing once the maneuver is complete. The same waypoint may appear in the route of flight more than once consecutively (e.g., IAWP, FAWP, MAHWP on a procedure turn). Care

must be exercised to ensure that the receiver is sequenced to the appropriate waypoint for the segment of the procedure being flown, especially if one or more fly-overs are skipped (e.g., FAWP rather than IAWP if the procedure turn is not flown). The pilot may have to sequence past one or more fly-overs of the same waypoint in order to start GPS automatic sequencing at the proper place in the sequence of waypoints.

**20.13.10** Incorrect inputs into the GPS receiver are especially critical during approaches. In some cases, an incorrect entry can cause the receiver to leave the approach mode.

**20.13.11** A fix on an overlay approach identified by a DME fix will not be in the waypoint sequence on the GPS receiver unless there is a published name assigned to it. When a name is assigned, the along track to the waypoint may be zero rather than the DME stated on the approach chart. The pilot should be alert for this on any overlay procedure where the original approach used DME.

**20.13.12** If a visual descent point (VDP) is published, it will not be included in the sequence of waypoints. Pilots are expected to use normal piloting techniques for beginning the visual descent. In addition, unnamed step-down fixes in the final approach segment will not be coded in the waypoint sequence and must be identified using ATD.

## 20.14 Missed Approach

**20.14.1** A GPS missed approach requires pilot action to sequence the receiver past the MAWP to the missed approach portion of the procedure. The pilot must be thoroughly familiar with the activation procedure for the particular GPS receiver installed in the aircraft and must **initiate appropriate action after the MAWP**. Activating the missed approach prior to the MAWP will cause CDI sensitivity to immediately change to terminal ( $\pm 1$  NM) sensitivity and the receiver will continue to navigate to the MAWP. The receiver will not sequence past the MAWP. Turns should not begin prior to the MAWP. If the missed approach is not activated, the GPS receiver will display an extension of the inbound final approach course and the ATD will increase from the MAWP until it is manually sequenced after crossing the MAWP.

**20.14.2** Missed approach routings in which the first track is via a course rather than direct to the next waypoint **require additional action by the pilot** to set the course. Being familiar with all of the inputs required is especially critical during this phase of flight.

### 20.15 GPS Familiarization

Pilots should practice GPS approaches under visual meteorological conditions (VMC) until thoroughly proficient with all aspects of their equipment (receiver and installation) prior to attempting flight by IFR in instrument meteorological conditions (IMC). Some of the areas which the pilot should practice are:

- a) Utilizing the receiver autonomous integrity monitoring (RAIM) prediction function;
- b) Inserting a DP into the flight plan, including setting terminal CDI sensitivity, if required, and the conditions under which terminal RAIM is available for departure (some receivers are not DP or STAR capable);
- c) Programming the destination airport;
- d) Programming and flying the overlay approaches (especially procedure turns and arcs);
- e) Changing to another approach after selecting an approach;
- f) Programming and flying "direct" missed approaches;
- g) Programming and flying "routed" missed approaches;
- h) Entering, flying and exiting holding patterns, particularly on overlay approaches with a second waypoint in the holding pattern;
- i) Programming and flying a "route" from a holding pattern;
- j) Programming and flying an approach with radar vectors to the intermediate segment;
- k) Indication of the actions required for RAIM failure both before and after the FAWP; and
- l) Programming a radial and distance from a VOR (often used in departure instructions).

### 21. NAVAID Identifier Removal During Maintenance

During periods of routine or emergency maintenance, coded identification (or code and voice, where applicable) is removed from certain FAA NAVAID's. Removal of the identification serves as warning to pilots that the facility is officially off the air for tune-up or repair and may be unreliable even though intermittent or constant signals are received.

*NOTE.—*  
DURING PERIODS OF MAINTENANCE VHF RANGES MAY RADIATE A T-E-S-T CODE (- •••• -).

### 22. User Reports on NAVAID Performance

**22.1** Users of the National Airspace System can render valuable assistance in the early correction of NAVAID malfunctions by reporting their observation of undesirable performance. Although NAVAID's are monitored by electronic detectors adverse effects of electronic interference, new obstructions or changes in terrain near the NAVAID can exist without detection by the ground monitors. Some of the characteristics of malfunction or deteriorating performance which should be reported are: erratic course or bearing indications; intermittent, or full, flag alarm; garbled, missing or obviously improper coded identification; poor quality communications reception; or, in the case of frequency interference, an audible hum or tone accompanying radio communications or navaid identification.

**22.2** Reporters should identify the NAVAID, location of the aircraft, time of the observation, type of aircraft and describe the condition observed; the type of receivers in use will also be useful information. Reports can be made in any of the following ways:

- a) Immediately, by radio communication to the controlling Air Route Traffic Control Center, Control Tower, or Flight Service Station. This provides the quickest result.
- b) By telephone to the nearest FAA facility.
- c) By FAA Form 8000-7, Safety Improvement Report, a postage-paid card designed for this purpose. These cards may be obtained at FAA Flight Service Stations, Flight Standards District Offices, and General Aviation Fixed Base Operations.

**22.3** In aircraft that have more than one receiver, there are many combinations of possible interference between units. This can cause either erroneous navigation indications or, complete or partial blanking out of the communications. Pilots should be familiar enough with the radio installation of particular airplanes they fly to recognize this type of interference.

### 23. Radio Communications and Navigation Facilities

A complete listing of air traffic radio communications facilities and frequencies and radio navigation facilities and frequencies are contained in the Airport/Facility Directory. Similar information for the Pacific and Alaskan areas is contained in the Pacific and Alaskan Supplements.

## ENR 4.2 Special Navigation Systems

### 1. Doppler Radar

**1.1** Doppler Radar is a semiautomatic self-contained dead reckoning navigation system (radar sensor plus computer) which is not continuously dependent on information derived from ground based or external aids. The system employs radar signals to detect and measure

ground speed and drift angle, using the aircraft compass system as its directional reference. Doppler is less accurate than INS or OMEGA however, and the use of an external reference is required for periodic updates if acceptable position accuracy is to be achieved on long range flights.



## ENR 5. NAVIGATION WARNINGS

### ENR 5.1 Prohibited, Restricted and Other Areas

#### 1. Special Use Airspace

##### 1.1 General

**1.1.1** Special use airspace consists of that airspace wherein activities must be confined because of their nature, or wherein limitations are imposed upon aircraft operations that are not a part of those activities, or both. Except for Controlled Firing Areas, special use airspace areas are depicted on aeronautical charts.

**1.1.2** Prohibited and Restricted Areas are regulatory special use airspace and are established in 14 CFR Part 73 through the rulemaking process.

**1.1.3** Warning Areas, Military Operations Areas (MOA's), Alert Areas, National Security Areas (NSA's) and Controlled Firing Areas (CFA's) are nonregulatory special use airspace.

**1.1.4** All special use airspace descriptions (except NSA's and CFA's) are contained in FAA Order 7400.8.

**1.1.5** Special use airspace (except CFA's) are charted on IFR and visual charts and include the hours of operation, altitudes, and the controlling agency.

##### 2. Prohibited Areas

**2.1** Prohibited Areas contain airspace of defined dimensions identified by an area on the surface of the earth within which the flight of aircraft is prohibited. Such areas are established for security or other reasons associated with the national welfare. These areas are published in the Federal Register and are depicted on aeronautical charts.

##### 3. Restricted Areas

**3.1** Restricted Areas contain airspace identified by an area on the surface of the earth within which the flight of aircraft, while not wholly prohibited, is subject to restrictions. Activities within these areas must be confined because of their nature or limitations imposed upon aircraft operations that are not a part of those activities or both. Restricted areas denote the existence of unusual, often invisible, hazards to aircraft such as artillery firing, aerial gunnery, or guided missiles. Penetration of Restricted Areas without authorization from the using or controlling agency may be extremely hazardous to the aircraft and its occupants. Restricted Areas

are published in the Federal Register and constitute 14 CFR Part 73.

**3.2** ATC facilities apply the following procedures when aircraft are operating on an IFR clearance (including those cleared by ATC to maintain VFR-ON-TOP) via a route which lies within joint-use restricted airspace.

**3.2.1** If the restricted area is not active and has been released to the controlling agency (FAA), the ATC facility will allow the aircraft to operate in the restricted airspace without issuing specific clearance for it to do so.

**3.2.2** If the restricted area is active and has not been released to the controlling agency (FAA), the ATC facility will issue a clearance which will ensure the aircraft avoids the restricted airspace unless it is on an approved altitude reservation mission or has obtained its own permission to operate in the airspace and so informs the controlling facility.

*NOTE.—  
THE ABOVE APPLY ONLY TO JOINT-USE RESTRICTED AIRSPACE AND NOT TO PROHIBITED AND NONJOINT-USE AIRSPACE. FOR THE LATTER CATEGORIES, THE ATC FACILITY WILL ISSUE A CLEARANCE SO THE AIRCRAFT WILL AVOID THE RESTRICTED AIRSPACE UNLESS IT IS ON AN APPROVED ALTITUDE RESERVATION MISSION OR HAS OBTAINED ITS OWN PERMISSION TO OPERATE IN THE AIRSPACE AND SO INFORMS THE CONTROLLING FACILITY.*

**3.3** Restricted airspace is depicted on the en route chart appropriate for use at the altitude or flight level being flown. For joint-use restricted areas, the name of the controlling agency is shown on these charts. For all prohibited areas and nonjoint-use restricted areas, unless otherwise requested by the using agency, the phrase "NO A/G" is shown.

##### 4. Warning Areas

**4.1** A Warning Area is airspace of defined dimensions, extending from three nautical miles outward from the coast of the United States, that contains activity that may be hazardous to nonparticipating aircraft. The purpose of such warning areas is to warn nonparticipating pilots of the potential danger. A warning area may be located over domestic or international waters or both.

##### 5. Military Operations Area (MOA)

**5.1** MOA's consist of airspace of defined vertical and lateral limits established for the purpose of separating certain military training activities from IFR traffic. Whenever a MOA is being used, nonparticipating IFR

traffic may be cleared through a MOA if IFR separation can be provided by ATC. Otherwise, ATC will reroute or restrict nonparticipating IFR traffic.

**5.2** Most training activities necessitate acrobatic or abrupt flight maneuvers. Military pilots conducting flight in Department of Defense (DOD) aircraft within a designated and active MOA are exempted from the provisions of 14 CFR Section 91.303(c) and (d) which prohibit acrobatic flight within Federal airways and Class B, Class C, Class D, and Class E surface areas.

**5.3** Pilots operating under VFR should exercise extreme caution while flying within a MOA when military activity is being conducted. The activity status (active/inactive) of MOA's may change frequently. Therefore, pilots should contact any FSS within 100 miles of the area to obtain accurate real-time information concerning the MOA hours of operation. Prior to entering an active MOA, pilots should contact the controlling agency for traffic advisories.

**5.4** MOA's are depicted on Sectional, VFR Terminal Area, and En Route Low Altitude Charts.

## **6. Alert Areas**

**6.1** Alert Areas are depicted on aeronautical charts to inform nonparticipating pilots of areas that may contain a high volume of pilot training or an unusual type of aerial activity. Pilots should be particularly alert when flying in these areas. All activity within an Alert Area shall be conducted in accordance with FAA regulations, without waiver, and pilots of participating aircraft as well as pilots transiting the area shall be equally responsible for collision avoidance.

## **7. Controlled Firing Areas**

**7.1** Controlled Firing Areas contain activities which, if not conducted in a controlled environment, could be hazardous to nonparticipating aircraft. The distinguishing feature of the Controlled Firing Area, as compared to other special use airspace, is that its activities are suspended immediately when spotter aircraft, radar, or ground lookout positions indicate an aircraft might be approaching the area. There is no need to chart Controlled Firing Areas since they do not cause a nonparticipating aircraft to change its flight path.

## **8. National Security Area (NSA)**

**8.1** A NSA is airspace of defined vertical and lateral dimensions established at locations where there is a re-

quirement for increased security and safety of ground facilities. Pilots are requested to voluntarily avoid flying through depicted NSA's. When it is necessary to provide a greater level of security and safety, flight in NSA's may be temporarily prohibited by regulation under the provisions of 14 CFR Section 99.7. Regulatory prohibitions will be issued by ATA-400 and disseminated by NOTAM. Inquiries about NSA's should be directed to the Airspace and Rules Division, ATA-400.

## **9. Military Training Routes (MTR)**

**9.1** National security depends largely on the deterrent effect of our airborne military forces. To be proficient, the military services must train in a wide range of airborne tactics. One phase of this training involves "low level" combat tactics. The required maneuvers and high speeds are such that they may occasionally make the see-and-avoid aspect of VFR flight more difficult without increased vigilance in areas containing such operations. In an effort to ensure the greatest practical level of safety for all flight operations, the MTR program was conceived.

**9.2** The MTR program is a joint venture by the FAA and the DOD. MTR's are mutually developed for use by the military for the purpose of conducting low-altitude, high-speed training. The routes above 1,500 feet above ground level (AGL) are developed to be flown, to the maximum extent possible, under IFR. The routes at 1,500 feet AGL and below are generally developed to be flown under VFR.

**9.3** Generally, MTR's are established below 10,000 feet MSL for operations at speeds in excess of 250 knots. However, route segments may be defined at higher altitudes for purposes of route continuity. For example, route segments may be defined for descent, climbout, and mountainous terrain. There are IFR and VFR routes as follows:

**a) IFR Military Training Routes-IR:** Operations on these routes are conducted in accordance with IFR regardless of weather conditions.

**b) VFR Military Training Routes-VR:** Operations on these routes are conducted in accordance with VFR except flight visibility shall be 5 miles or more; and flights shall not be conducted below a ceiling of less than 3,000 feet AGL.

**9.4** Military training routes will be identified and charted as follows:



### a) Route Identification.

1) MTR's with no segment above 1,500 feet AGL shall be identified by four number characters; e.g., IR1206, VR1207.

2) MTR's that include one or more segments above 1,500 feet AGL shall be identified by three number characters; e.g., IR206, VR207.

3) Alternate IR/VR routes or route segments are identified by using the basic/principal route designation followed by a letter suffix, e.g., IR008A, VR1007B, etc.

### b) Route Charting.

1) **IFR Low Altitude En Route Chart:** This chart will depict all IR routes and all VR routes that accommodate operations above 1,500 feet AGL.

2) **VFR Sectional Charts:** These charts will depict military training activities such as IR, VR, MOA, restricted area, warning area, and alert area information.

3) **Area Planning (AP/1B) Chart (DOD Flight Information Publication-FLIP):** This chart is published by the DOD primarily for military users and contains detailed information on both IR and VR routes.

**9.5** The FLIP contains charts and narrative descriptions of these routes. This publication is available to the general public by single copy or annual subscription from the National Imagery and Mapping Agency (NIMA), 6001 MacArthur Boulevard, Bethesda, MD 20816-5001. This DOD FLIP is available for pilot briefings at FSS's and many airports.

**9.6** Nonparticipating aircraft are not prohibited from flying within an MTR; however, extreme vigilance should be exercised when conducting flight through or near these routes. Pilots should contact FSS's within 100 NM of a particular MTR to obtain current information or route usage in their vicinity. Information available includes times of scheduled activity, altitudes in use on each route segment, and actual route width. Route width varies for each MTR and can extend several miles on either side of the charted MTR centerline. Route width information for IR and VR MTR's is also available in the FLIP AP/1B along with additional MTR (SR/AR) information. When requesting MTR information, pilots should give the FSS their position, route of flight, and destination in order to reduce frequency congestion and permit the FSS specialist to identify the MTR which could be a factor.

## 10. Temporary Flight Restrictions

**10.1 General:** This paragraph describes the types of conditions under which the FAA may impose temporary flight restrictions. It also explains which FAA elements have been delegated authority to issue a temporary flight restrictions NOTAM and lists the types of responsible agencies/offices from which the FAA will accept requests to establish temporary flight restrictions. The 14 CFR is explicit as to what operations are prohibited, restricted, or allowed in a temporary flight restrictions area. Pilots are responsible to comply with 14 CFR Sections 91.137, 91.138, 91.141 and 91.143 when conducting flight in an area where a temporary flight restrictions area is in effect, and should check appropriate NOTAM's during flight planning.

**10.2 The purpose for establishing a temporary flight restrictions area is to:**

a) Protect persons and property in the air or on the surface from an existing or imminent hazard associated with an incident on the surface when the presence of low-flying aircraft would magnify, alter, spread, or compound that hazard (14 CFR Section 91.137(a)(1));

b) Provide a safe environment for the operation of disaster relief aircraft (14 CFR Section 91.137(a)(2)); or

c) Prevent an unsafe congestion of sightseeing aircraft above an incident or event which may generate a high degree of public interest (14 CFR Section 91.137(a)(3)).

d) Protect declared national disasters for humanitarian reasons in the State of Hawaii (14 CFR Section 91.138).

e) Protect the President, Vice President, or other public figures (14 CFR Section 91.141).

f) Provide a safe environment for space agency operations (14 CFR Section 91.143).

**10.3** Except for hijacking situations, when the provisions of 14 CFR Section 91.137(a)(1) or (a)(2) are necessary, a temporary flight restrictions area will only be established by or through the area manager at the Air Route Traffic Control Center (ARTCC) having jurisdiction over the area concerned. A temporary flight restrictions NOTAM involving the conditions of 14 CFR Section 91.137(a)(3) will be issued at the direction of the regional air traffic division manager having oversight of the airspace concerned. When hijacking situations are involved, a temporary flight restrictions area will be implemented through the FAA Washington Headquarters

Office of Civil Aviation Security. The appropriate FAA air traffic element, upon receipt of such a request, will establish a temporary flight restrictions area under 14 CFR Section 91.137(a)(1).

**10.4** The FAA accepts recommendations for the establishment of a temporary flight restrictions area under 14 CFR Section 91.137(a)(1) from military major command headquarters, regional directors of the Office of Emergency Planning, Civil Defense State Directors, State Governors, or other similar authority. For the situations involving 14 CFR Section 91.137(a)(2), the FAA accepts recommendations from military commanders serving as regional, subregional, or Search and Rescue (SAR) coordinators; by military commanders directing or coordinating air operations associated with disaster relief; or by civil authorities directing or coordinating organized relief air operations (includes representatives of the Office of Emergency Planning, U.S. Forest Service, and State aeronautical agencies). Appropriate authorities for a temporary flight restrictions establishment under 14 CFR Section 91.137(a)(3) are any of those listed above or by State, county, or city government entities.

**10.5** The type of restrictions issued will be kept to a minimum by the FAA consistent with achievement of the necessary objective. Situations which warrant the extreme restrictions of 14 CFR Section 91.137(a)(1) include, but are not limited to: toxic gas leaks or spills, flammable agents, or fumes which if fanned by rotor or propeller wash could endanger persons or property on the surface, or if entered by an aircraft could endanger persons or property in the air; imminent volcano eruptions which could endanger airborne aircraft and occupants; nuclear accident or incident; and hijackings. Situations which warrant the restrictions associated with 14 CFR Section 91.137(a)(2) include: forest fires which are being fought by releasing fire retardants from aircraft; and aircraft relief activities following a disaster (earthquake, tidal wave, flood, etc.). 14 CFR Section 91.137(a)(3) restrictions are established for events and incidents that would attract an unsafe congestion of sightseeing aircraft.

**10.6** The amount of airspace needed to protect persons and property or provide a safe environment for rescue/relief aircraft operations is normally limited to within 2,000 feet above the surface and within a 3-nautical-mile radius. Incidents occurring within Class B, Class C, or Class D airspace will normally be handled through existing procedures and should not require the issuance of a temporary flight restrictions NOTAM. Temporary

flight restrictions affecting airspace outside of the United States and its territories and possessions are issued with verbiage excluding that airspace outside of the 12-mile coastal limits.

**10.7** The FSS nearest the incident site is normally the "coordination facility." When FAA communications assistance is required, the designated FSS will function as the primary communications facility for coordination between emergency control authorities and affected aircraft. The ARTCC may act as liaison for the emergency control authorities if adequate communications cannot be established between the designated FSS and the relief organization. For example, the coordination facility may relay authorizations from the on-scene emergency response official in cases where news media aircraft operations are approved at the altitudes used by relief aircraft.

**10.8** ATC may authorize operations in a temporary flight restrictions area under its own authority only when flight restrictions are established under 14 CFR Section 91.137(a)(2) and (a)(3). The appropriate ARTCC/airport traffic control tower manager will, however, ensure that such authorized flights do not hamper activities or interfere with the event for which restrictions were implemented. However, ATC will not authorize local IFR flights into the temporary flight restrictions area.

**10.9** To preclude misunderstanding, the implementing NOTAM will contain specific and formatted information. The facility establishing a temporary flight restrictions area will format a NOTAM beginning with the phrase "FLIGHT RESTRICTIONS" followed by: the location of the temporary flight restrictions area; the effective period; the area defined in statute miles; the altitudes affected; the FAA coordination facility and commercial telephone number; the reason for the temporary flight restrictions; the agency directing any relief activities and its commercial telephone number; and other information considered appropriate by the issuing authority.

**EXAMPLE.—**

☐ 14 CFR SECTION 91.137(A)(1):  
THE FOLLOWING NOTAM PROHIBITS ALL AIRCRAFT OPERATIONS EXCEPT THOSE SPECIFIED IN THE NOTAM.

FLIGHT RESTRICTIONS MATTHEWS, VIRGINIA, EFFECTIVE IMMEDIATELY UNTIL 9610211200. PURSUANT TO 14 CFR SECTION 91.137(A)(1) TEMPORARY FLIGHT RESTRICTIONS ARE IN EFFECT. RESCUE OPERATIONS IN PROGRESS. ONLY RELIEF AIRCRAFT OPERATIONS UNDER THE DIRECTION OF THE DEPARTMENT OF DEFENSE ARE AUTHORIZED IN THE AIRSPACE AT AND BELOW 5,000 FEET MSL WITHIN A 2-NAUTICAL-MILE RADIUS OF LASER AFB, MATTHEWS, VIRGINIA. COMMANDER, LASER AFB, IN CHARGE (897) 946-5543 (122.4). STEENSON FSS (792) 555-6141 (123.1) IS THE FAA COORDINATION FACILITY.

② 14 CFR SECTION 91.137(A)(2):

THE FOLLOWING NOTAM PERMITS FLIGHT OPERATIONS IN ACCORDANCE WITH 14 CFR SECTION 91.137(A)(2). THE ON-SITE EMERGENCY RESPONSE OFFICIAL TO AUTHORIZE MEDIA AIRCRAFT OPERATIONS BELOW THE ALTITUDES USED BY THE RELIEF AIRCRAFT.

FLIGHT RESTRICTIONS 25 MILES EAST OF BRANSOME, IDAHO, EFFECTIVE IMMEDIATELY UNTIL 9601202359 UTC. PURSUANT TO 14 CFR SECTION 91.137(A)(2) TEMPORARY FLIGHT RESTRICTIONS ARE IN EFFECT WITHIN A 4-NAUTICAL-MILE RADIUS OF THE INTERSECTION OF COUNTY ROADS 564 AND 315 AT AND BELOW 3,500 FEET MSL TO PROVIDE A SAFE ENVIRONMENT FOR FIRE FIGHTING AIRCRAFT OPERATIONS. DAVIS COUNTY SHERIFF'S DEPARTMENT (792) 555-8122 (122.9) IS IN CHARGE OF ON-SCENE EMERGENCY RESPONSE ACTIVITIES. GLIVINGS FSS (792) 555-1618 (122.2) IS THE FAA COORDINATION FACILITY.

③ 14 CFR SECTION 91.137(A)(3):

THE FOLLOWING NOTAM PROHIBITS SIGHTSEEING AIRCRAFT OPERATIONS.

FLIGHT RESTRICTIONS BROWN, TENNESSEE, DUE TO OLYMPIC ACTIVITY. EFFECTIVE 9606181100 UTC UNTIL 9607190200 UTC. PURSUANT TO 14 CFR SECTION 91.137(A)(3) TEMPORARY FLIGHT RESTRICTIONS ARE IN EFFECT WITHIN A 3-NAUTICAL-MILE RADIUS OF N355783/W835242 AND VOLUNTEER VORTAC 019 DEGREE RADIAL 3.7 DME FIX AT AND BELOW 2,500 FEET MSL. NORTON FSS (423) 555-6742 (126.6) IS THE FAA COORDINATION FACILITY.

④ 14 CFR SECTION 91.138:

THE FOLLOWING NOTAM PROHIBITS ALL AIRCRAFT EXCEPT THOSE OPERATING UNDER THE AUTHORIZATION OF THE OFFICIAL IN CHARGE OF ASSOCIATED EMERGENCY OR DISASTER RELIEF RESPONSE ACTIVITIES, AIRCRAFT CARRYING LAW ENFORCEMENT OFFICIALS, AIRCRAFT CARRYING PERSONNEL INVOLVED IN AN EMERGENCY OR LEGITIMATE SCIENTIFIC PURPOSES, CARRYING PROPERLY ACCREDITED NEWS MEDIA, AND AIRCRAFT OPERATING IN ACCORDANCE WITH AN ATC CLEARANCE OR INSTRUCTION.

FLIGHT RESTRICTIONS KAPALUA, HAWAII, EFFECTIVE 9605101200 UTC UNTIL 9605151500 UTC. PURSUANT TO 14 CFR SECTION 91.138 TEMPORARY FLIGHT RESTRICTIONS ARE IN EFFECT WITHIN A 3-NAUTICAL-MILE RADIUS OF N205778/W1564038 AND MAUI /OGG/ VORTAC 275 DEGREE RADIAL AT 14.1 NAUTICAL MILES. JOHN DOE 808-757-4469 OR 122.4 IS IN CHARGE OF THE OPERATION. HONOLULU (HNL) 808-757-4470 (123.6) AFSS IS THE FAA COORDINATION FACILITY.

⑤ 14 CFR SECTION 91.141:

THE FOLLOWING NOTAM PROHIBITS ALL AIRCRAFT.

FLIGHT RESTRICTIONS STILLWATER, OKLAHOMA, JUNE 21, 1996. PURSUANT TO 14 CFR SECTION 91.141 AIRCRAFT FLIGHT OPERATIONS ARE PROHIBITED WITHIN A 3-NAUTICAL-MILE RADIUS, BELOW 2000 FEET AGL OF N360962/W970515 AND THE STILLWATER (SWO) VOR/DME 176 DEGREE RADIAL 3.8-NAUTICAL-MILE FIX FROM 1400 LOCAL TIME TO 1700 LOCAL TIME JUNE 21, 1996 UNLESS OTHERWISE AUTHORIZED BY ATC.

⑥ 14 CFR SECTION 91.143:

THE FOLLOWING NOTAM PROHIBITS ANY AIRCRAFT OF U.S. REGISTRY, OR PILOT ANY AIRCRAFT UNDER THE AUTHORITY OF AN AIRMAN CERTIFICATE ISSUED BY THE FAA.

KENNEDY SPACE CENTER SPACE OPERATIONS AREA EFFECTIVE IMMEDIATELY UNTIL 9610152100 UTC. PURSUANT TO SECTION 91.143, FLIGHT OPERATIONS CONDUCTED BY FAA CERTIFICATED PILOTS OR CONDUCTED IN AIRCRAFT OF U.S. REGISTRY ARE PROHIBITED AT ANY ALTITUDE FROM SURFACE TO UNLIMITED, WITHIN THE FOLLOWING AREA 30-NAUTICAL-MILE RADIUS OF THE MELBOURNE (MLB) VORTAC 010 DEGREE RADIAL 21-NAUTICAL-MILE FIX. ST. PETERSBURG, FLORIDA, /PIE/ AFSS 813-545-1645 (122.2) IS THE FAA COORDINATION FACILITY AND SHOULD BE CONTACTED FOR THE CURRENT STATUS OF ANY AIRSPACE ASSOCIATED WITH THE SPACE SHUTTLE OPERATIONS. THIS AIRSPACE ENCOMPASSES R2933, R2932, R2931, R2934, R2935, W497A AND W158A. ADDITIONAL WARNING AND RESTRICTED AREAS WILL BE ACTIVE IN CONJUNCTION WITH THE OPERATIONS. PILOTS SHALL CONSULT ALL NOTAMS REGARDING THIS OPERATION.

## 11. Parachute Jump Aircraft Operations

**11.1** Procedures relating to parachute jump areas are contained in 14 CFR Part 105. Tabulations of parachute jump areas in the United States are contained in the Airport/Facility Directory.

**11.2** Pilots of aircraft engaged in parachute jump operations are reminded that all reported altitudes must be with reference to mean sea level, or flight level, as appropriate, to enable ATC to provide meaningful traffic information.

**11.3** Parachute operations in the vicinity of an airport without an operating control tower - there is no substitute for alertness while in the vicinity of an airport. It is essential that pilots conducting parachute operations be alert, look for other traffic, and exchange traffic information as recommended in GEN 3.3, paragraph 9.2, Traffic Advisory Practices at Airports Without Operating Control Towers. In addition, pilots should avoid releasing parachutes while in an airport traffic pattern when there are other aircraft in that pattern. Pilots should make appropriate broadcasts on the designated Common Traffic Advisory Frequency (CTAF), and monitor that CTAF until all parachute activity has terminated or the aircraft has left the area. Prior to commencing a jump operation, the pilot should broadcast the aircraft's altitude and position in relation to the airport, the approximate relative time when the jump will commence and terminate, and listen to the position reports of other aircraft in the area.



## ENR 5.2 Military Exercise and Training Areas

See Section ENR 5.1.



**ENR 5.3 [RESERVED]**





---

**ENR 5.4 [RESERVED]**



**ENR 5.5 [RESERVED]**



## ENR 5.6 Bird Migration and Areas With Sensitive Fauna

### 1. Migratory Bird Activity

**1.1** Bird strike risk increases because of bird migration during the months of March through April and August through November.

**1.2** The altitudes of migrating birds vary with winds aloft, weather fronts, terrain elevations, cloud conditions, and other environmental variables. While over 90 percent of the reported bird strikes occur at or below 3,000 feet AGL, strikes at higher altitudes are common during migration. Ducks and geese are frequently observed up to 7,000 feet AGL and pilots are cautioned to minimize en route flying at lower altitudes during migration.

**1.3** Considered the greatest potential hazard to aircraft because of their size, abundance, or habit of flying in dense flocks are gulls, waterfowl, vultures, hawks, owls, egrets, blackbirds and starlings. Four major migratory flyways exist in the United States. The Atlantic Flyway parallels the Atlantic coast, the Mississippi Flyway stretches from Canada through the Great Lakes and follows the Mississippi River. The Central Flyway represents a broad area east of the Rockies, stretching from Canada through Central America. The Pacific Flyway follows the west coast and overflies major parts of Washington, Oregon, and California. There are also numerous smaller flyways which cross these major north-south migratory routes.

### 2. Reducing Bird Strike Risks

**2.1** The most serious strikes are those involving ingestion into an engine (turboprop and turbine jet engines) or windshield strikes. These strikes can result in emergency situations requiring prompt action by the pilot.

**2.2** Engine ingestions may result in sudden loss of power or engine failure. Review engine out procedures, especially when operating from airports with known bird hazards or when operating near high bird concentrations.

**2.3** Windshield strikes have resulted in pilots experiencing confusion, disorientation, loss of communications, and aircraft control problems. Pilots are encouraged to review their emergency procedures before flying in these areas.

**2.4** When encountering birds en route, climb to avoid collision because birds in flocks generally distribute

themselves downward, with lead birds being at the highest altitude.

**2.5** Avoid overflight of known areas of bird concentration and flying low altitudes during bird migration. Charted wildlife refuges and other natural areas contain unusually high local concentration of birds which may create a hazard to aircraft.

### 3. Reporting Bird Strikes

**3.1** Pilots are urged to report any bird or other wildlife strike using FAA Form 5200-7, Bird/Other Wildlife Strike Report. Forms are available at any FSS, General Aviation District Office, Air Carrier District Office, or any FAA Regional Office. Wildlife strikes can also be reported electronically at: <http://www.faa.gov/arp/birdstrike>. The data derived from these reports are used to develop standards to cope with this potential hazard to aircraft and for documentation of necessary habitat control on airports.

### 4. Reporting Bird and Other Wildlife Activities

**4.1** If you observe birds or other animals on or near the runway, request airport management to disperse the wildlife before taking off. Also contact the nearest FAA ARTCC, FSS, or tower (including non-Federal towers) regarding large flocks of birds and report the:

- a) Geographic location,
- b) Bird type (geese, ducks, gulls, etc.),
- c) Approximate numbers,
- d) Altitude, and
- e) Direction of bird flight path.

### 5. Pilot Advisories on Bird and Other Wildlife Hazards

**5.1** Many airports advise pilots of other wildlife hazards caused by large animals on the runway through the Airport/Facility Directory and the NOTAM system. Collisions between landing and departing aircraft with animals on the runway are increasing and are not limited to rural airports. These accidents have also occurred at several major airports. Pilots should exercise extreme caution when warned of the presence of wildlife on and in the vicinity of airports. If in close proximity to movement areas you observe deer or other large animals, advise the FSS, tower, or airport management.

## **6. Flights Over Charted U.S. Wildlife Refuges, Parks, and Forest Service Areas**

**6.1** The landing of aircraft is prohibited on lands or waters administered by the National Park Service, U.S. Fish and Wildlife Service or U.S. Forest Service without authorization from the respective agency. Exceptions include (1) when forced to land due to an emergency beyond the control of the operator, (2) at officially designated landing sites, or (3) an approved official business of the Federal Government.

**6.2** All pilots are requested to maintain a minimum altitude of 2,000 feet above the terrain of the following: National Parks, Monuments, Seashores, Lakeshores, Recreation Areas and Scenic Riverways administered by the National Park Service, National Wildlife Refuges, Big Game Refuges, Game Ranges, and Wildlife Ranges administered by the U.S. Fish and Wildlife Service, and Wilderness and Primitive Areas administered by the U.S. Forest Service.

**NOTE.—**

FAA ADVISORY CIRCULAR 91-36, VISUAL FLIGHT RULES (VFR) FLIGHT NEAR NOISE-SENSITIVE AREAS, DEFINES THE SURFACE OF A NATIONAL PARK AREA (INCLUDING PARKS, FORESTS, PRIMITIVE AREAS, WILDERNESS AREAS, RECREATIONAL AREAS, NATIONAL SEASHORES, NATIONAL MONUMENTS, NATIONAL LAKESHORES, AND NATIONAL WILDLIFE REFUGE AND RANGE AREAS) AS: THE HIGHEST TERRAIN WITHIN 2,000 FEET Laterally OF THE ROUTE OF FLIGHT, OR THE UPPER-MOST RIM OF A CANYON OR VALLEY.

**6.3** Federal statutes prohibit certain types of flight activity and/or provide altitude restrictions over designated U.S. Wildlife Refuges, Parks, and Forest Service Areas. These designated areas, for example: Boundary Waters Canoe Wilderness Areas, Minnesota; Haleakala National Park, Hawaii; Yosemite National Park, California; and Grand Canyon National Park, Arizona, are charted on Sectional Charts.

**6.4** Federal regulations also prohibit airdrops by parachute or other means of persons, cargo, or objects from aircraft on lands administered by the three agencies without authorization from the respective agency. Exceptions include: (1) emergencies involving the safety of human life or (2) threat of serious property loss.

## ENR 5.7 Potential Flight Hazards

### 1. Accident Causal Factors

**1.1** The ten most frequent cause factors for General Aviation Accidents in 1992 that involve the pilot in command are:

- a) Inadequate preflight preparation and/or planning
- b) Failure to obtain/maintain flying speed
- c) Failure to maintain direction control
- d) Improper level off
- e) Failure to see and avoid objects or obstructions
- f) Mismanagement of fuel
- g) Improper in-flight decisions or planning
- h) Misjudgment of distance and speed
- i) Selection of unsuitable terrain
- j) Improper operation of flight controls

**1.2** The above factors have continued to plague General Aviation pilots over the years. This list remains relatively stable and points out the need for continued refresher training to establish a higher level of flight proficiency for all pilots. A part of the FAA's continuing effort to promote increased aviation safety is the Aviation Safety Program. For information on the FAA's Aviation Safety Program, readers can contact their nearest Flight Standards District Office's Safety Program Manager.

**1.3** Be alert at all times, especially when the weather is good. Most pilots pay attention to business when they are operating in full IFR weather conditions, but strangely, air collisions almost invariably have occurred under ideal weather conditions. Unlimited visibility appears to encourage a sense of security which is not at all justified. Considerable information of value may be obtained by listening to advisories being issued in the terminal area, even though controller workload may prevent a pilot from obtaining individual service.

**1.4** If you think another aircraft is too close to you, give way instead of waiting for the other pilot to respect the right-of-way to which you may be entitled. It is a lot safer to pursue the right-of-way angle after you have completed your flight.

### 2. VFR In Congested Area

**2.1** A high percentage of near midair collisions occur below 8,000 feet AGL and within 30 miles of an airport. When operating VFR in highly congested areas, whether you intend to land at an airport within the area or are just flying through, it is recommended that extra vigilance be maintained and that you monitor an appropriate control frequency. Normally the appropriate frequency is an approach control frequency. By such monitoring action you can "get the picture" of the traffic in your area. When the approach controller has radar, traffic advisories may be given to VFR pilots who request them, subject to the provisions included in ENR 1.6, paragraph 9.1.4, Radar Traffic Information Service.

### 3. Obstructions to Flight

#### 3.1 General

**3.1.1** Many structures exist that could significantly affect the safety of your flight when operating below 500 feet above ground level (AGL), and particularly below 200 feet AGL. While 14 CFR Part 91.119 allows flight below 500 AGL when over sparsely populated areas or open water, such operations are very dangerous. At and below 200 feet AGL there are numerous power lines, antenna towers, etc., that are not marked and lighted as obstructions and therefore may not be seen in time to avoid a collision. Notices to Airmen (NOTAM's) are issued on those lighted structures experiencing temporary light outages. However, some time may pass before the FAA is notified of these outages, and the NOTAM issued, thus pilot vigilance is imperative.

#### 3.2 Antenna Towers

**3.2.1** Extreme caution should be exercised when flying less than 2,000 feet above ground level (AGL) because of numerous skeletal structures, such as radio and television antenna towers, that exceed 1,000 feet AGL with some extending higher than 2,000 feet AGL. Most skeletal structures are supported by guy wires which are very difficult to see in good weather and can be invisible at dusk or during periods of reduced visibility. These wires can extend about 1,500 feet horizontally from a structure; therefore, all skeletal structures should be avoided horizontally by at least 2,000 feet. Additionally, new towers may not be on your current chart because the information was not received prior to the printing of the chart.

### 3.3 Overhead Wires

**3.3.1** Overhead transmission and utility lines often span approaches to runways, natural flyways such as lakes, rivers, gorges, and canyons, and cross other landmarks pilots frequently follow such as highways, railroad tracks, etc. As with antenna towers, these high voltage/power lines or the supporting structures of these lines may not always be readily visible and the wires may be virtually impossible to see under certain conditions. In some locations, the supporting structures of overhead transmission lines are equipped with unique sequence flashing white strobe light systems to indicate that there are wires between the structures. However, many power lines do not require notice to the FAA and, therefore, are not marked and/or lighted. Many of those that do require notice do not exceed 200 feet AGL or meet the Obstruction Standard of 14 CFR Part 77 and, therefore, are not marked and/or lighted. All pilots are cautioned to remain extremely vigilant for these power lines or their supporting structures when following natural flyways or during the approach and landing phase. This is particularly important for seaplane and/or float equipped aircraft when landing on, or departing from, unfamiliar lakes or rivers.

### 3.4 Other Objects/Structures

**3.4.1** There are other objects or structures that could adversely affect your flight such as construction cranes near an airport, newly constructed buildings, new towers, etc. Many of these structures do not meet charting requirements or may not yet be charted because of the charting cycle. Some structures do not require obstruction marking and/or lighting and some may not be marked and lighted even though the FAA recommended it.

### 4. Avoid Flight Beneath Unmanned Balloons

**4.1** The majority of unmanned free balloons currently being operated have, extended below them, either a suspension device to which the payload or instrument package is attached, or a trailing wire antenna, or both. In many instances these balloon subsystems may be invisible to the pilot until his aircraft is close to the balloon, thereby creating a potentially dangerous situation. Therefore, good judgment on the part of the pilot dictates that aircraft should remain well clear of all unmanned free balloons and flight below them should be avoided at all times.

**4.2** Pilots are urged to report any unmanned free balloons sighted to the nearest FAA ground facility with which communication is established. Such information

will assist FAA ATC facilities to identify and flight follow unmanned free balloons operating in the airspace.

### 5. Mountain Flying

**5.1** Your first experience of flying over mountainous terrain (particularly if most of your flight time has been over the flatlands of the midwest) could be a never-to-be forgotten nightmare if proper planning is not done and if you are not aware of the potential hazards awaiting. Those familiar section lines are not present in the mountains; those flat, level fields for forced landings are practically nonexistent; abrupt changes in wind direction and velocity occur; severe updrafts and downdrafts are common, particularly near or above abrupt changes of terrain such as cliffs or rugged areas; even the clouds look different and can build up with startling rapidity. Mountain flying need not be hazardous if you follow the recommendations below. It is recommended that pilots receive a local mountain flying checkout with a knowledgeable and competent certificated flight instructor familiar with the local flying area before the pilot flies into the mountainous area.

**5.2** File a flight plan. Plan your route to avoid topography which would prevent a safe forced landing. The route should be over populated areas and well known mountain passes. Sufficient altitude should be maintained to permit gliding to a safe landing in the event of engine failure.

**5.3** Don't fly a light aircraft when the winds aloft, at your proposed altitude, exceed 35 miles per hour. Expect the winds to be of much greater velocity over mountain passes than reported a few miles from them. Approach mountain passes with as much altitude as possible. Downdrafts of from 1,500 to 2,000 feet per minute are not uncommon on the leeward side.

**5.4** Don't fly near or above abrupt changes in terrain. Severe turbulence can be expected, especially in high wind conditions.

**5.5** Some canyons run into a dead end. Don't fly so far up a canyon that you get trapped. ALWAYS BE ABLE TO MAKE A 180 DEGREE TURN.

**5.6** VFR flight operations may be conducted at night in mountainous terrain with the application of sound judgment and common sense. Proper pre-flight planning, giving ample consideration to winds and weather, knowledge of the terrain and pilot experience in mountain flying are prerequisites for safety of flight. Continuous visual contact with the surface and obstructions is a major concern and flight operations under an overcast or in the vicinity of clouds should be approached with extreme caution.



**5.7** When landing at a high altitude field, the same indicated airspeed should be used as at low elevation fields. Remember: that due to the less dense air at altitude, this same indicated airspeed actually results in a higher true airspeed, a faster landing speed, and more important, a longer landing distance. During gusty wind conditions which often prevail at high altitude fields, a power approach and power landing is recommended. Additionally, due to the faster groundspeed, your takeoff distance will increase considerably over that required at low altitudes.

**5.8 Effects of Density Altitude.** Performance figures in the aircraft owner's handbook for length of takeoff run, horsepower, rate of climb, etc., are generally based on standard atmosphere conditions (59°F, pressure 29.92 inches of mercury) at sea level. However, inexperienced pilots as well as experienced pilots may run into trouble when they encounter an altogether different set of conditions. This is particularly true in hot weather and at higher elevations. Aircraft operations at altitudes above sea level and at higher than standard temperatures are commonplace in mountainous area. Such operations quite often result in a drastic reduction of aircraft performance capabilities because of the changing air density. Density altitude is a measure of air density. It is not to be confused with pressure altitude - true altitude or absolute altitude. It is not to be used as a height reference, but as a determining criteria in the performance capability of an aircraft. Air density decreases with altitude. As air density decreases, density altitude increases. The further effects of high temperature and high humidity are cumulative, resulting in an increasing high density altitude condition. High density altitude reduces all aircraft performance parameters. To the pilot, this means that - the normal horsepower output is reduced, propeller efficiency is reduced and a higher true airspeed is required to sustain the aircraft throughout its operating parameters. It means an increase in runway length requirements for takeoff and landings, and a decreased rate of climb. An average small airplane, for example, requiring 1,000 feet for takeoff at sea level under standard atmospheric conditions will require a takeoff run of approximately 2,000 at an operational altitude of 5,000 feet.

**NOTE.—**  
A TURBO-CHARGED AIRCRAFT ENGINE PROVIDES SOME SLIGHT ADVANTAGE IN THAT IT PROVIDES SEA LEVEL HORSEPOWER UP TO A SPECIFIED ALTITUDE ABOVE SEA LEVEL.

**5.9 Density Altitude Advisories.** At airports with elevations of 2,000 feet and higher, control towers and FSS's will broadcast the advisory "Check Density

Altitude" when the temperature reaches a predetermined level. These advisories will be broadcast on appropriate tower frequencies or, where available, ATIS. FSS's will broadcast these advisories as a part of Airport Advisory Service, and on TWEB.

**5.9.1** These advisories are provided by air traffic facilities, as a reminder to pilots that high temperatures and high field elevations will cause significant changes in aircraft characteristics. The pilot retains the responsibility to compute density altitude, when appropriate, as a part of preflight duties.

**NOTE.—**  
ALL FSS'S WILL COMPUTE THE CURRENT DENSITY ALTITUDE UPON REQUEST.

**6. Mountain Wave.** Many pilots go all their lives without understanding what a mountain wave is. Quite a few have lost their lives because of this lack of understanding. One need not be a licensed meteorologist to understand the mountain wave phenomenon.

**6.1** Mountain waves occur when air is being blown over a mountain range or even the ridge of a sharp bluff area. As the air hits the upwind side of the range, it starts to climb, thus creating what is generally a smooth updraft which turns into a turbulent downdraft as the air passes the crest of the ridge. From this point, for many miles downwind, there will be a series of downdrafts and updrafts. Satellite photos of the Rockies have shown mountain waves extending as far as 700 miles downwind of the range. Along the east coast area, such photos of the Appalachian chain have picked up the mountain wave phenomenon over a hundred miles eastward. All it takes to form a mountain wave is wind blowing across the range at 15 knots or better at an intersection angle of not less than 30 degrees.

**6.2** Pilots from flatland areas should understand a few things about mountain waves in order to stay out of trouble. Approaching a mountain range from the upwind side (generally the west), there will usually be a smooth updraft; therefore, it is not quite as dangerous an area as the lee of the range. From the leeward side, it is always a good idea to add an extra thousand feet or so of altitude because downdrafts can exceed the climb capability of the aircraft. Never expect an updraft when approaching a mountain chain from the leeward. Always be prepared to cope with a downdraft and turbulence.

**6.3** When approaching a mountain ridge from the downwind side, it is recommended that the ridge be approached at approximately a 45° angle to the horizontal direction of the ridge. This permits a safer retreat from the ridge with less stress on the aircraft should severe

turbulence is encountered, simultaneously reduce power and adjust pitch until aircraft approaches maneuvering speed, then adjust power and trim to maintain maneuvering speed and fly away from the turbulent area.

### 7. Seaplane Safety

**7.1** Acquiring a seaplane class rating affords access to many areas not available to landplane pilots. Adding a seaplane class rating to your pilot certificate can be relatively uncomplicated and inexpensive. However, more effort is required to become a safe, efficient, competent "bush" pilot. The natural hazards of the backwoods have given way to modern man-made hazards. Except for the far north, the available bodies of water are no longer the exclusive domain of the airman. Seaplane pilots must be vigilant for hazards such as electric power lines, power, sail and rowboats, rafts, mooring lines, water skiers, swimmers, etc.

**7.2** Seaplane pilots must have a thorough understanding of the right-of-way rules as they apply to aircraft versus other vessels. Seaplane pilots are expected to know and adhere to both the United States Coast Guard's (USCG) Navigation Rules, International-Inland, and Title 14 Code of Federal Regulations (CFR) Section 91.115, Right of Way Rules; Water Operations. The navigation rules of the road are a set of collision avoidance rules as they apply to aircraft on the water. A seaplane is considered a vessel when on the water for the purposes of these collision avoidance rules. In general, a seaplane on the water shall keep well clear of all vessels and avoid impeding their navigation. The CFR requires, in part, that aircraft operating on the water "...shall, insofar as possible, keep clear of all vessels and avoid impeding their navigation and shall give way to any vessel or other aircraft that is given the right of way ...." This means that a seaplane should avoid boats and commercial shipping when on the water. If on a collision course, the seaplane should slow, stop, or maneuver to the right, away from the bow of the oncoming vessel. Also, while on the surface with an engine running, an aircraft must give way to all nonpowered vessels. Since a seaplane in the water may not be as maneuverable as one in the air, the aircraft on the water has right-of-way over one in the air, and one taking off has right-of-way over one landing. A seaplane is exempt from the USCG safety equipment requirements, including the requirements for Personal Floatation Devices (PFD). Requiring seaplanes on the water to comply with USCG equipment requirements in addition to the FAA equipment requirements would be an unnecessary burden on seaplane owners and operators.

**7.3** Unless they are under Federal jurisdiction, navigable bodies of water are under the jurisdiction of the state, or in a few cases, privately owned. Unless they are specifically restricted, aircraft have as much right to operate on these bodies of water as other vessels. To avoid problems, check with Federal or local officials in advance of operating on unfamiliar waters. In addition to the agencies listed in Table 1, the nearest Flight Standards District Office can usually offer some practical suggestions as well as regulatory information. If you land on a restricted body of water because of an inflight emergency, or in ignorance of the restrictions you have violated, report as quickly as practical to the nearest local official having jurisdiction and explain your situation.

#### Jurisdictions Controlling Navigable Bodies of Water

AUTHORITY TO CONSULT FOR USE OF A BODY OF WATER		
Location	Authority	Contact
Wilderness Area	U.S. Department of Agriculture, Forest Service	Local forest ranger
National Forest	USDA Forest Service	Local forest ranger
National Park	U.S. Department of the Interior, National Park Service	Local park ranger
Indian Reservation	USDI, Bureau of Indian Affairs	Local Bureau office
State Park	State government or state forestry or park service	Local state aviation office for further information
Canadian National and Provincial Parks	Supervised and restricted on an individual basis from province to province and by different departments of the Canadian government; consult Canadian Flight Information Manual and/or Water Aerodrome Supplement	Park Superintendent in an emergency

TBL 5-7-1

**7.4** When operating a seaplane over or into remote areas, appropriate attention should be given to survival gear. Minimum kits are recommended for summer and winter, and are required by law for flight into sparsely settled areas of Canada and Alaska. Alaska State Department of Transportation and Canadian Ministry of Transport officials can provide specific information on survival gear requirements. The kit should be assembled in one container and be easily reachable and preferably floatable.

**7.5** The FAA recommends that each seaplane owner or operator provide flotation gear for occupants any time

a seaplane operates on or near water. 14 CFR Section 91.205(b)(12) requires approved flotation gear for aircraft operated for hire over water and beyond power-off gliding distance from shore. FAA-approved gear differs from that required for navigable waterways under USCG rules. FAA-approved life vests are inflatable designs as compared to the USCG's non-inflatable PFD's that may consist of solid, bulky material. Such USCG PFD's are impractical for seaplanes and other aircraft because they may block passage through the relatively narrow exits available to pilots and passengers. Life vests approved under Technical Standard Order (TSO) C13E contain fully inflatable compartments. The wearer inflates the compartments (AFTER exiting the aircraft) primarily by independent CO2 cartridges, with an oral inflation tube as a backup. The flotation gear also contains a water-activated, self-illuminating signal light. The fact that pilots and passengers can easily don and wear inflatable life vests (when not inflated) provides maximum effectiveness and allows for unrestricted movement. It is imperative that passengers are briefed on the location and proper use of available PFD's prior to leaving the dock.

**7.6** The FAA recommends that seaplane owners and operators obtain Advisory Circular (AC) 91-69, Seaplane Safety for 14 CFR Part 91 Operations, free from:

U.S. Department of Transportation  
Subsequent Distribution Office, SVC-121.23  
Ardmore East Business Center  
3341 Q 75th Avenue  
Landover, MD 20785  
FAX: (301) 386-5394

The USCG Navigation Rules International-Inland (COMDTINST M16672.2B) is available for a fee from the Government Printing Office by facsimile request to (202) 512-2250. It can be ordered using Mastercard or Visa.

## 8. Flight Operations in Volcanic Ash

**8.1** Severe volcanic eruptions which send ash into the upper atmosphere occur somewhere around the world several times each year. Flying into a volcanic ash cloud can be exceedingly dangerous. A B747-200 lost all four engines after such an encounter and a B747-400 had the same nearly catastrophic experience. Piston-powered aircraft are less likely to lose power but severe damage is almost certain to ensue after an encounter with a volcanic ash cloud which is only a few hours old.

**8.2** Most important is to avoid any encounter with volcanic ash. The ash plume may not be visible, especially in instrument conditions or at night; and even if visible, it is difficult to distinguish visually between an ash cloud and an ordinary weather cloud. Volcanic ash clouds are not displayed on airborne or ATC radar. The pilot must rely on reports from air traffic controllers and other pilots to determine the location of the ash cloud and use that information to remain well clear of the area. Every attempt should be made to remain on the upwind side of the volcano.

**8.3** It is recommended that pilots encountering an ash cloud should immediately reduce thrust to idle (altitude permitting), and reverse course in order to escape from the cloud. Ash clouds may extend for hundreds of miles and pilots should not attempt to fly through or climb out of the cloud. In addition, the following procedures are recommended:

a) Disengage the autothrottle if engaged. This will prevent the autothrottle from increasing engine thrust;

b) Turn on continuous ignition;

c) Turn on all accessory airbleeds including all air conditioning packs, nacelles, and wing anti-ice. This will provide an additional engine stall margin by reducing engine pressure.

**8.4** The following has been reported by flight crews who have experienced encounters with volcanic dust clouds:

a) Smoke or dust appearing in the cockpit;

b) An acrid odor similar to electrical smoke;

c) Multiple engine malfunctions, such as compressor stalls, increasing EGT, torching from tailpipe, and flameouts;

d) At night, St. Elmo's fire or other static discharges accompanied by a bright orange glow in the engine inlets;

e) A fire warning in the forward cargo area.

**8.5** It may become necessary to shut down and then restart engines to prevent exceeding EGT limits. Volcanic ash may block the pitot system and result in unreliable airspeed indications.

**8.6** If you see a volcanic eruption and have not been previously notified of it, you may have been the first person to observe it. In this case, immediately contact ATC and alert them to the existence of the eruption. If possible, use the Volcanic Activity Reporting Form (VAR) depicted at the end of GEN 3.5. Items 1 through 8 of the

VAR should be transmitted immediately. The information requested in items 9 through 16 should be passed after landing. If a VAR form is not immediately available, relay enough information to identify the position and nature of the volcanic activity. Do not become unnecessarily alarmed if there is merely steam or very low-level eruptions of ash.

**8.7** When landing at airports where volcanic ash has been deposited on the runway, be aware that even a thin layer of dry ash can be detrimental to braking action. Wet ash on the runway may also reduce effectiveness of braking. It is recommended that reverse thrust be limited to a minimum practical to reduce the possibility of reduced visibility and engine ingestion of airborne ash.

**8.8** When departing from airports where volcanic ash has been deposited it is recommended that pilots avoid operating in visible airborne ash. Allow ash to settle before initiation takeoff roll. It is also recommended that flap extension be delayed until initiating the takeoff checklist and that a rolling takeoff be executed to avoid blowing ash back into the air.

### **9. Emergency Airborne Inspection of Other Aircraft**

**9.1** Providing airborne assistance to another aircraft may involve flying in very close proximity to that aircraft. Most pilots receive little, if any, formal training or instruction in this type of flying activity. Close proximity flying without sufficient time to plan (i.e., in an emergency situation), coupled with the stress involved in a perceived emergency can be hazardous.

**9.2** The pilot in the best position to assess the situation should take the responsibility of coordinating the airborne intercept and inspection, and take into account the unique flight characteristics and differences of the category(s) of aircraft involved.

**9.3** Some of the safety considerations are:

- a) Area, direction and speed of the intercept;
- b) Aerodynamic effects (i.e., rotorcraft downwash) which may also affect;
- c) Minimum safe separation distances;
- d) Communications requirements, lost communications procedures, coordination with ATC;
- e) Suitability of diverting the distressed aircraft to the nearest safe airport; and
- f) Emergency actions to terminate the intercept.

**9.4** Close proximity, in-flight inspection of another aircraft is uniquely hazardous. The pilot in command of the aircraft experiencing the problem/emergency must not relinquish his/her control of the situation and jeopardize the safety of his/her aircraft. The maneuver must be accomplished with minimum risk to both aircraft.

### **10. Precipitation Static**

**10.1** Precipitation static is caused by aircraft in flight coming in contact with uncharged particles. These particles can be rain, snow, fog, sleet, hail, volcanic ash, dust, any solid or liquid particles. When the aircraft strikes these neutral particles the positive element of the particle is reflected away from the aircraft and the negative particle adheres to the skin of the aircraft. In a very short period of time a substantial negative charge will develop on the skin of the aircraft. If the aircraft is not equipped with static dischargers, or has an ineffective static discharger system, when a sufficient negative voltage level is reached, the aircraft may go into "CORONA." That is, it will discharge the static electricity from the extremities of the aircraft, such as the wing tips, horizontal stabilizer, vertical stabilizer, antenna, propeller tips, etc. This discharge of static electricity is what you will hear in your headphones and is what we call P-static.

**10.2** A review of pilot reports often shows different symptoms with each problem that is encountered. The following list of problems is a summary of many pilot reports from many different aircraft. Each problem was caused by P-static:

- a) Complete loss of VHF communications
- b) Erroneous magnetic compass readings (30% in error)
- c) High pitched squeal on audio
- d) Motor boat sound on audio
- e) Loss of all avionics in clouds
- f) VLF navigation system inoperative most of the time
- g) Erratic instrument readouts
- h) Weak transmissions and poor receptivity of radios
- i) "St. Elmo's Fire" on windshield

**10.3** Each of these symptoms is caused by one general problem on the airframe. This problem is the inability of the accumulated charge to flow easily to the wing tips and tail of the airframe, and properly discharge to the airstream.

**10.4** Static dischargers work on the principle of creating a relatively easy path for discharging negative charges that develop on the aircraft by using a discharger with fine metal points, carbon coated rods, or carbon wicks rather than wait until a large charge is developed and discharged off the trailing edges of the aircraft that will interfere with avionics equipment. This process offers approximately 50 decibels (dB) static noise reduction which is adequate in most cases to be below the threshold of noise that would cause interference in avionics equipment.

**10.5** It is important to remember that precipitation static problems can only be corrected with the proper number of quality static dischargers, properly installed on a properly bonded aircraft. P-static is indeed a problem in the all weather operation of the aircraft, but there are effective ways to combat it. All possible methods of reducing the effects of P-static should be considered so as to provide the best possible performance in the flight environment.

**10.6** A wide variety of discharger designs is available on the commercial market. The inclusion of well-designed dischargers may be expected to improve airframe noise in P-static conditions by as much as 50 dB. Essentially, the discharger provides a path by which accumulated charge may leave the airframe quietly. This is generally accomplished by providing a group of tiny corona points to permit onset of corona-current flow at a low aircraft potential. Additionally, aerodynamic design of dischargers to permit corona to occur at the lowest possible atmospheric pressure also lowers the corona threshold. In addition to permitting a low potential discharge, the discharger will minimize the radiation of radio frequency (RF) energy which accompanies the corona discharge, in order to minimize effects of RF components at communications and navigation frequencies on avionics performance. These effects are reduced through resistive attachment of the corona point(s) to the airframe, preserving direct current connection but attenuating the higher frequency components of the discharge.

**10.7** Each manufacturer of static dischargers offers information concerning appropriate discharger location on specific airframes. Such locations emphasize the trailing outboard surfaces of wings and horizontal tail surfaces, plus the tip of the vertical stabilizer, where

charge tends to accumulate on the airframe. Sufficient dischargers must be provided to allow for current carrying capacity which will maintain airframe potential below the corona threshold of the trailing edges.

**10.8** In order to achieve full performance of avionic equipment, the static discharge system will require periodic maintenance. A pilot knowledgeable of P-static causes and effects is an important element in assuring optimum performance by early recognition of these types of problems.

## **11. Light Amplification by Stimulated Emission of Radiation (Laser) Operations**

**11.1** Lasers have many applications. Of concern to users of the National Airspace System are those laser events that may affect pilots; e.g., outdoor laser light shows or demonstrations for entertainment and advertisement at special events and theme parks. Generally, the beams from these events appear as bright blue-green in color; however, they may be red, yellow, or white. Some laser systems produce light which is invisible to the human eye.

**11.2** Currently, there are no FAA regulations that specifically address the above mentioned laser activities. However, FAA regulations prohibit the disruption of aviation activity by any person on the ground or in the air. The FAA and the Food and Drug Administration (the Federal agency that has the responsibility to enforce compliance with Federal requirements for laser systems and laser light show products) are working together to ensure that operators of these devices do not pose a hazard to aircraft operators.

**11.3** Pilots should be aware that illumination from these laser operations is able to create temporary vision impairment miles from the actual location. In addition, these operations can produce permanent eye damage. Pilots should make themselves aware of where laser activities are being conducted and avoid the areas if possible.

**11.4** When laser activities become known to the FAA, Notices to Airmen (NOTAM) are issued to inform the aviation community of the events. Pilots should consult NOTAM's or the Special Notices Section of the Airport/Facility Directory for information regarding laser activities.



**AIP**  
**AERONAUTICAL INFORMATION PUBLICATION**  
**UNITED STATES OF AMERICA**

**PART 3**  
**AERODROMES (AD)**





## PART 3 - AERODROMES (AD)

### AD 0.

AD 0.5 PREFACE - Not applicable

AD 0.6 RECORD OF AIP AMENDMENTS - Not applicable

AD 0.7 RECORD OF AIP SUPPLEMENTS - Not applicable

AD 0.8 CHECKLIST OF AIP PAGES - Not applicable

AD 0.9 LIST OF HAND AMENDMENTS TO THE AIP - Not applicable

### AD 0.10 TABLE OF CONTENTS TO PART 3

	<i>Page</i>
<b>AD 1. AERODROMES - INTRODUCTION</b>	
AD 1.1 Aerodrome Availability .....	AD 1.1-1
<b>AD 2. LISTING OF AERODROMES .....</b>	<b>AD 2-1</b>



# AD 1. AERODROMES - INTRODUCTION

## AD 1.1 Aerodrome Availability

### 1. General Regulations Concerning Airport Use

**1.1** International arrivals with scheduled passenger service are not permitted to land at any aerodrome not listed in this AIP except in cases of real emergency or where special permission has been granted.

**1.2** The conditions under which aircraft may land, be parked, housed or otherwise dealt with at U.S. aerodromes is under the control of the aerodrome owner/operator. Conditions and fees pertaining to landing, parking or storing are variable from aerodrome to aerodrome and are not published in the U.S. AIP.

### 2. Landings Made Elsewhere Than at International Aerodromes

**2.1** Permission to land at airports other than "international" and "landing rights" airports may be obtained in some limited cases; however, advance arrangements (preferably in writing) must be made with the U.S. Customs office nearest the airport of intended arrival (see GEN 1). Advance notice of arrival is required as usual. Pilots should be aware that mileage and per diem costs may be accrued in addition to any overtime charges if applicable.

**2.2** If an emergency landing is made elsewhere than at an international aerodrome or a designated alternate aerodrome, the pilot in command shall report the landing as promptly as possible by telephone or the most convenient means to the nearest Customs office. He should keep all merchandise or baggage in a segregated place and should not permit any passenger or crewmember to depart the place of arrival or mingle with the public without official permission, unless it is necessary for preservation of life, health, or property.

### 3. Traffic of Persons and Vehicles on Aerodromes

**3.1** The grounds of each aerodrome are divided into two zones:

- a) A public zone comprising the part of the aerodrome open to the public; and
- b) A restricted zone comprising the rest of the aerodrome.

### 3.2 Movement of Persons

**3.2.1** Access to the restricted zone is authorized only under conditions prescribed by the rules governing the aerodrome as established by the officials responsible for aerodrome security.

**3.2.2** The customs, security, immigration and health inspection offices and areas and the premises assigned to transit traffic are normally accessible only to passengers, to staff members of the responsible authorities or airlines and to authorized persons in pursuit of their duties.

**3.2.3** The movement of persons having access to the restricted zone of the aerodrome is subject to the conditions prescribed by applicable air traffic and by the security regulations laid down by the person responsible for the management of the aerodrome.

### 3.3 Movement of Vehicles

**3.3.1** The movement of vehicles in the restricted zone is strictly limited to vehicles driven or used by persons having official permission.

**3.3.2** Drivers of vehicles, of whatever type, driving within the confines of the aerodrome, must respect the direction of traffic, the traffic signs and the posted speed limits and generally comply with the provisions of the highway code and with instructions given by the competent authorities.

### 4. General Information and Aerodrome Lighting and Marking

**4.1** Aerodrome lighting information is contained in paragraphs 12 through 16. Information on aerodrome marking aids and signs is contained in paragraph 17.

**4.2** Designated international U.S. aerodromes with scheduled passenger service in large aircraft and certain airports designated as alternate service aerodromes are listed in AD 2, Aerodromes.

### 5. Aerodrome Administration

**5.1** The administration of all airports is the responsibility of the aerodrome owner.

**5.2** Ownership of aerodromes in the United States is vested in three different groups: the Federal Government, non-Federal governments and private organizations or individuals. It is the policy of the U.S. Federal Government to have its aerodromes comply with ICAO Standards and Recommended Practices. Exceptions are noted as differences below and in GEN 1.7. Aerodromes owned by non-Federal governments and private organizations or individuals are encouraged to comply with International Standards and Recommended Practices in part through the regulation of aircraft operations into the aerodromes and in part through agreements under which Federal aid is made available for aerodrome development or improvement. Further compliance is by voluntary action on the part of the aerodrome owner.

## 6. Conditions of Availability

**6.1** An aerodrome which is open for public use may be used by a particular aircraft upon consideration of the meteorological conditions existing at the time and provided that the aircraft's performance and load classification (runway weight-bearing classification) is consistent with the physical characteristics of the aerodrome.

### 6.2 Civil Use of Military Fields

**6.2.1** Except at joint-use airfields, U.S. Army, Air Force, Navy, Marine Corps, and Coast Guard airfields are available for use by civil aircraft only with prior permission or in an emergency. An approved civil aircraft landing permit is required for use at all except Coast Guard airfields. With minor exceptions, authority to use military airfields is granted only to aircraft on official government business.

**6.2.2.** An application for a permit must be submitted to the appropriate military department a minimum of 30 days prior to the first intended landing. A permit application consists of Department of Defense Forms DD Form 2400, Civil Aircraft Certificate of Insurance; DD Form 2401, Civil Aircraft Landing Permit; and DD Form 2402, Hold Harmless Agreement.

**6.2.3** Forms and instructions can be obtained from the following addresses.

**Army:** Director, USAASA  
ATTN: MOAS-AS  
Building 1466  
9325 Gunston Road, Suite N319  
Ft. Belvoir, VA 22060-5582  
Telephone: (703) 806-4864

**Air Force:** HQ USAF/XOO-CA  
1480 Air Force Pentagon,  
Room 4D1010  
Washington DC 20330-1480  
Telephone: (703) 697-5967

**Navy/  
Marine Corps:** Commander  
Naval Facilities Engineering  
Command, Code 141JB  
200 Stovall Street, Room 10N45  
Alexandria, VA 22332-2300  
Telephone: (703) 325-0475

At Coast Guard airfields, prior permission must be requested from the commanding officer of the airfield to be used.

The forms can also be downloaded from the internet at:  
<http://web1.whs.osd.mil/icdhome/FORMTAB.HTM>.

## 7. Applicable ICAO Documents

ICAO Standards and Recommended Practices contained in Annex 14 are applied with the exceptions noted in GEN 1.7, Differences from ICAO Standards, Recommended Practices and Procedures.

## 8. Maintenance of Aerodrome Movement Areas

**8.1** It is the responsibility of the relevant aerodrome authority to maintain the aerodrome in a satisfactory condition.

**8.2** Clearance of snow and measurement of snow, ice, standing water, braking action, etc., and the reporting of such pavement conditions is within the responsibility of the aerodrome authority.

## 9. Dissemination of Information on the Condition of Paved Surface

**9.1** Information on surface condition of runways, taxiways and aprons will be published, when available and when necessary.

**9.2** At aerodromes where an ATS unit is established, if a runway is affected by standing water, snow, slush or ice during the approach of an aircraft for landing, and such conditions are notified by the aerodrome management to the ATS unit, such conditions will be made available to the aircraft.

**10. Rescue and Fire Fighting Facilities**

**10.1** Adequate rescue and fire-fighting vehicles, equipment and personnel are provided at aerodromes available for international commercial air transport.

**10.2** Temporary interruptions to rescue and fire-fighting service, or non-availability of such services, are made known by NOTAM.

**10.3** Certificated Aerodromes (14 CFR Part 139)

Aerodromes serving certain air carriers under 14 CFR Part 139 are indicated by a CFR Index which relates to

the availability of crash, fire, and rescue equipment. (See TBL 1.1-1.)

**11. Bird Concentrations in the Vicinity of Aerodromes**

Animal and bird notices are not normally published in aerodrome remarks. Pilots should be aware that animals and birds are frequently found in the vicinity of aerodromes and should exercise due caution. However, selected bird notices may be published, but only after approval by the appropriate Regional Bird Hazard Group.

**14 CFR PART 139 CERTIFICATED AIRPORTS**

Indexes and Fire Fighting and Rescue Equipment Requirements

<i>Airport Index</i>	<i>Required Number of Vehicles</i>	<i>Aircraft Length</i>	<i>Agent &amp; Water for Foam</i>
A	1	< 90'	500#DC or 450#DC + 100 gal H <sub>2</sub> O
B	1 or 2	≥ 90' & < 126'	Index A + 1500 gal H <sub>2</sub> O
C	2 or 3	≥ 126' & < 159'	Index A + 3000 gal H <sub>2</sub> O
D	3	≥ 159' & < 200'	Index A + 4000 gal H <sub>2</sub> O
E	3	≥ 200'	Index A + 6000 gal H <sub>2</sub> O
> Greater Than; < Less Than; ≥ Equal To or Greater Than; H <sub>2</sub> O Water; DC Dry Chemical			
<i>NOTE.—</i> Vehicle and capacity requirements for airports holding limited operating certificates are determined on a case-by-case basis.			

TBL 1.1-1

**12. Airport Lighting Aids**

**12.1 Approach Light Systems (ALS)**

**12.1.1** Approach light systems provide the basic means for transition from instrument flight to visual flight for landing. Operational requirements dictate the sophistication and configuration of the approach light system for a particular runway.

**12.1.2** Approach light systems are a configuration of signal lights starting at the landing threshold and extending into the approach area a distance of 2400-3000 feet for precision instrument runways and 1400-1500 feet for non-precision instrument runways. Some systems include sequenced flashing lights which appear to

the pilot as a ball of light traveling towards the runway at high speed (twice each second).

**12.2 Visual Glideslope Indicators**

**12.2.1 Visual Approach Slope Indicator (VASI)**

a) The VASI is a system of lights so arranged to provide visual descent guidance information during the approach to a runway. These lights are visible from 3-5 miles during the day and up to 20 miles or more at night. The visual glide path of the VASI provides safe obstruction clearance within plus or minus 10 degrees of the extended runway centerline and to 4 nautical miles from the runway threshold. Descent, using the VASI, should not be initiated until the aircraft is visually aligned with the runway. Lateral course guidance is provided by the runway or runway lights.

Precision & Nonprecision Configurations

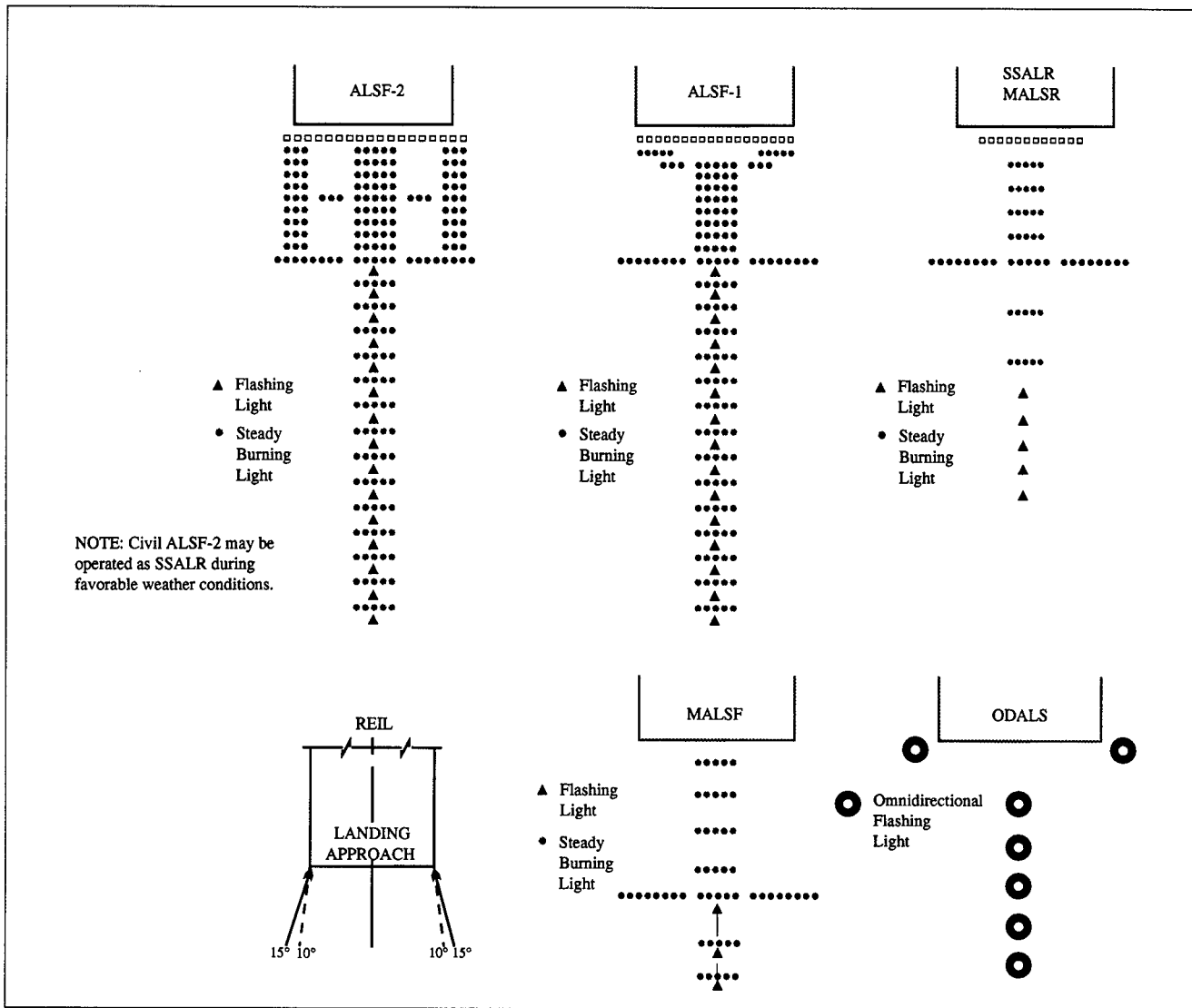

FIG 1.1-1

b) VASI installations may consist of either 2, 4, 6, 12, or 16 light units arranged in bars referred to as near, middle, and far bars. Most VASI installations consist of 2 bars, near and far, and may consist of 2, 4, or 12 light units. Some airports have VASI's consisting of three bars, near, middle, and far, which provide an additional visual glide path to accommodate high cockpit aircraft. This installation may consist of either 6 or 16 light units. VASI installations consisting of 2, 4, or 6 lights units are located on one side of the runway, usually the left. Where the installation consists of 12 or 16 light units, the light units are located on both sides of the runway.

c) Two-bar VASI installations provide one visual glide path which is normally set at 3 degrees. Three-bar

VASI installations provide two visual glide paths. The lower glide path is provided by the near and middle bars and is normally set at 3 degrees while the upper glide path, provided by the middle and far bars, is normally  $\frac{1}{4}$  degree higher. This higher glide path is intended for use only by high cockpit aircraft to provide a sufficient threshold crossing height. Although normal glide path angles are three degrees, angles at some locations may be as high as 4.5 degrees to give proper obstacle clearance. Pilots of high performance aircraft are cautioned that use of VASI angles in excess of 3.5 degrees may cause an increase in runway length required for landing and rollout.

d) The basic principle of the VASI is that of color differentiation between red and white. Each light unit projects a beam of light having a white segment in the upper part of the beam and red segment in the lower part of the beam. The light units are arranged so that the pilot using

the VASI's during an approach will see the combination of lights shown below.

e) For 2-BAR VASI (4 light units), see FIG 1.1-2.

f) For 3-BAR VASI (6 light units), see FIG 1.1-3.

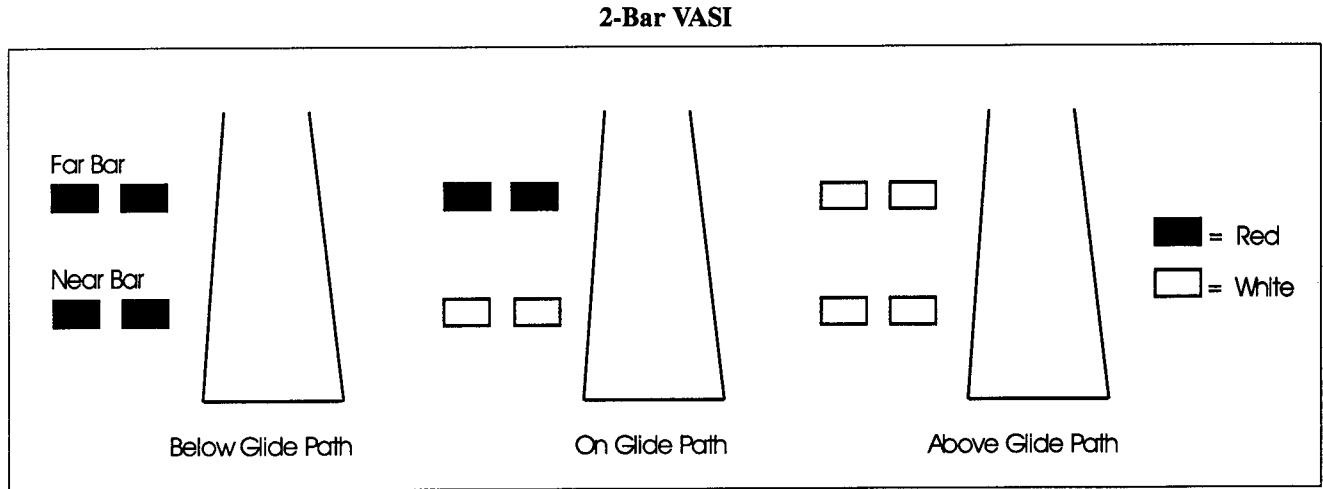

FIG 1.1-2

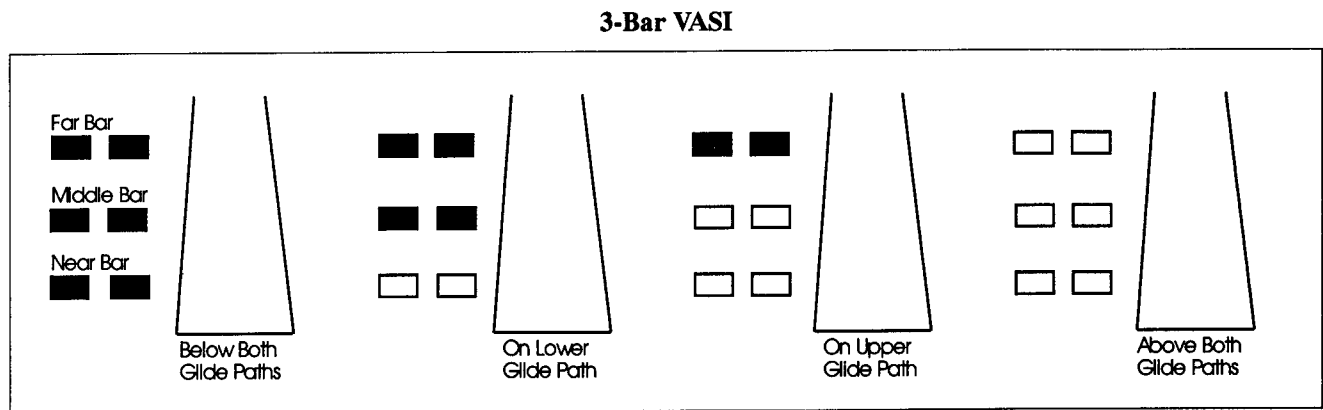

FIG 1.1-3

g) For other VASI configurations, see FIG 1.1-4.

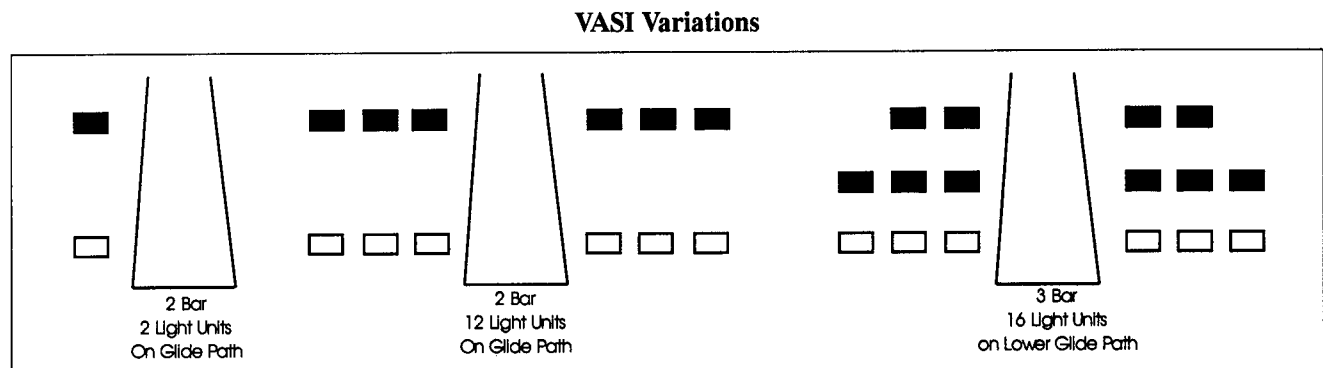

FIG 1.1-4

**Precision Approach Path Indicator (PAPI)**

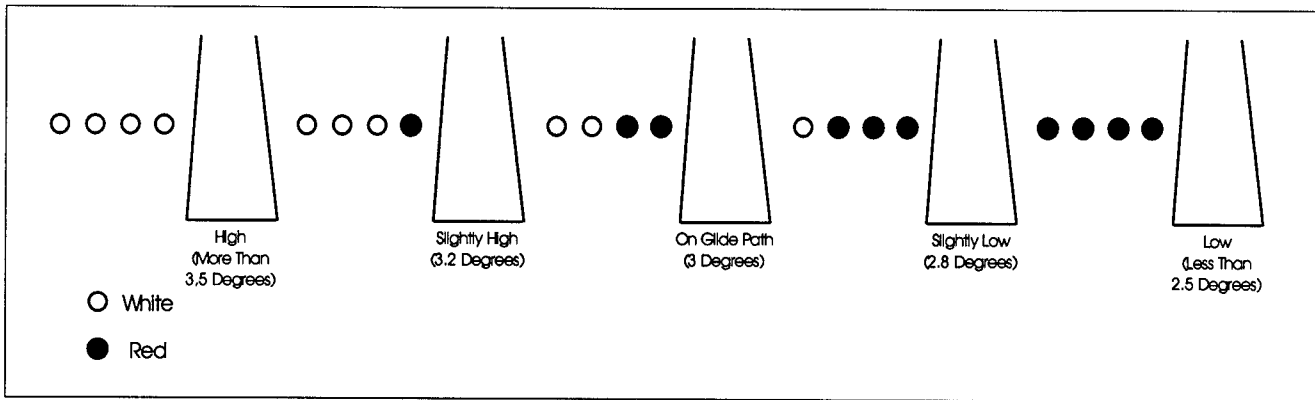

FIG 1.1-5

**12.2.2 Precision Approach Path Indicator (PAPI):**

The precision approach path indicator (PAPI) uses light units similar to the VASI but are installed in a single row of either 2 or 4 lights units. These systems have an effective visual range of about 5 miles during the day and up to 20 miles at night. The row of light units is normally installed on the left side of the runway and the glide path indications are as depicted in FIG 1.1-5.

**12.2.3 Tri-color Systems:** Tri-color visual approach slope indicators normally consist of a single light unit, projecting a three-color visual approach path into the final approach area of the runway upon which the indicator is installed. The below glide path indication is red, the above glide path indication is amber, and the on glide path indication is green. These types of indicators have a useful range of approximately 1/2 to 1 mile dur-

ing the day and up to 5 miles at night depending upon the visibility conditions. (See FIG 1.1-6.)

**12.2.4 Pulsating Systems:** Pulsating visual approach slope indicators normally consist of a single light unit projecting a two-color visual approach path into the final approach area of the runway upon which the indicator is installed. The on glide path indication is a steady white light. The slightly below glide path indication is a steady red light. If the aircraft descends further below the glide path, the red light starts to pulsate. The above glide path indication is a pulsating white light. The pulsating rate increases as the aircraft gets further above or below the desired glide slope. The useful range of the system is about four miles during the day and up to ten miles at night. (See FIG 1.1-7.)

**Tri-Color Visual Approach Slope Indicator**

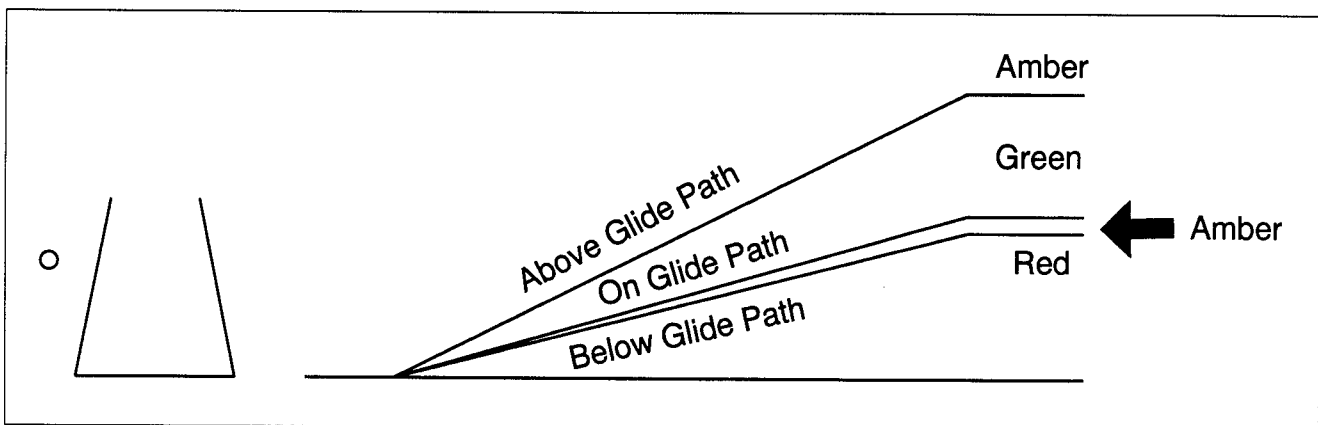

**NOTE.—** 1. SINCE THE TRI-COLOR VASI CONSISTS OF A SINGLE LIGHT SOURCE WHICH COULD POSSIBLY BE CONFUSED WITH OTHER LIGHT SOURCES, PILOTS SHOULD EXERCISE CARE TO PROPERLY LOCATE AND IDENTIFY THE LIGHT SIGNAL.  
2. WHEN THE AIRCRAFT DESCENDS FROM GREEN TO RED, THE PILOT MAY SEE A DARK AMBER COLOR DURING THE TRANSITION FROM GREEN TO RED.

FIG 1.1-6



**Pulsating Visual Approach Slope Indicator**

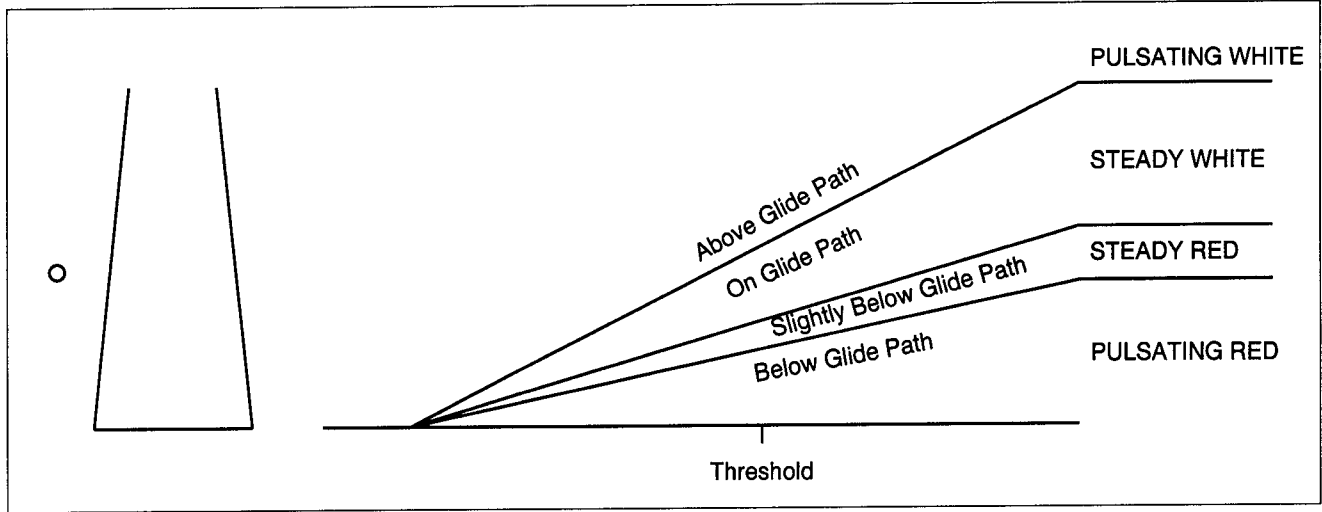

*NOTE.— SINCE THE PVASI CONSISTS OF A SINGLE LIGHT SOURCE WHICH COULD POSSIBLY BE CONFUSED WITH OTHER LIGHT SOURCES, PILOTS SHOULD EXERCISE CARE TO PROPERLY LOCATE AND IDENTIFY THE LIGHT SIGNAL.*

FIG 1.1-7

**12.2.5 Alignment of Elements Systems:** Alignment of elements systems are installed on some small general aviation airports and are a low cost system consisting of painted plywood panels, normally black and white or fluorescent orange. Some of these systems are lighted for night use. The useful range of these systems is approximately <sup>3</sup>/<sub>4</sub> mile. To use the system the pilot positions the aircraft so the elements are in alignment. The glide path indications are shown in FIG 1.1-8.

and positive identification of the approach end of a particular runway. The system consists of a pair of synchronized flashing lights, one of which is located laterally on each side of the runway threshold facing the approach area. They are effective for:

**12.3 Runway End Identifier Lights (REIL)**

- a) Identification of a runway surrounded by a preponderance of other lighting;
- b) Identification of a runway which lacks contrast with surrounding terrain; and
- c) Identification of a runway during reduced visibility.

REIL's are installed at many airfields to provide rapid

**Alignment of Elements**

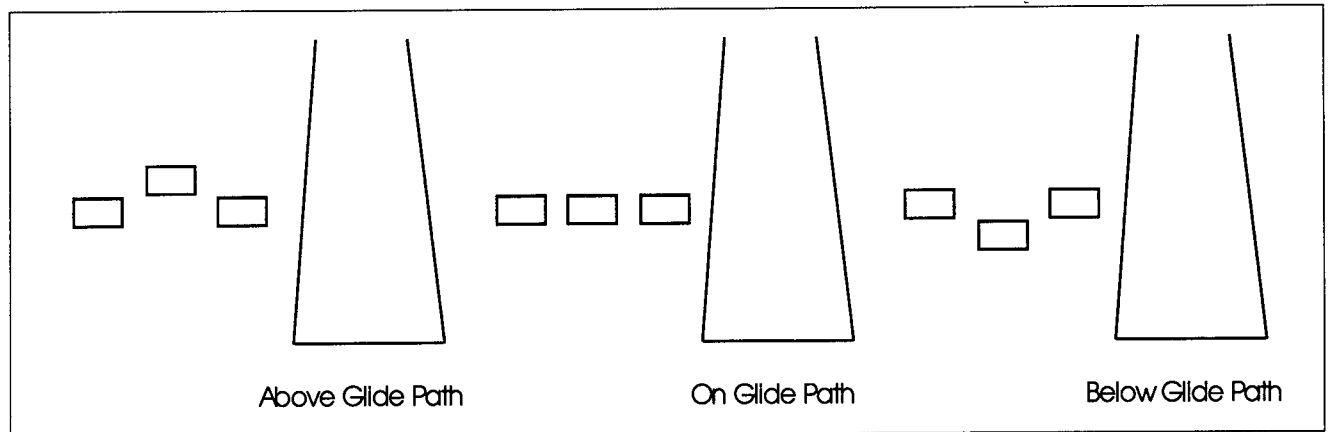

FIG 1.1-8

## 12.4 Runway Edge Light Systems

**12.4.1** Runway edge lights are used to outline the edges of runways during periods of darkness or restricted visibility conditions. These light systems are classified according to the intensity or brightness they are capable of producing: they are the High Intensity Runway Lights (HIRL), Medium Intensity Runway Lights (MIRL) and the Low Intensity Runway Lights (LIRL). The HIRL and MIRL systems have variable intensity controls, whereas the LIRL's normally have one intensity setting.

**12.4.2** The runway edge lights are white, except on instrument runways yellow replaces white on the last 2,000 feet or half the runway length, whichever is less, to form a caution zone for landings.

**12.4.3** The lights marking the ends of the runway emit red light toward the runway to indicate the end of the runway to a departing aircraft and emit green outward from the runway end to indicate the threshold to landing aircraft.

## 12.5 In-Runway Lighting

**a) Runway Centerline Lighting System (RCLS):** Runway centerline lights are installed on some precision approach runways to facilitate landing under adverse visibility conditions. They are located along the runway centerline and are spaced at 50-foot intervals. When viewed from the landing threshold, the runway centerline lights are white until the last 3,000 feet of the runway. The white lights begin to alternate with red for the next 2,000 feet, and for the last 1,000 feet of the runway, all centerline lights are red.

**b) Touchdown Zone Lights (TDZL):** Touchdown zone lights are installed on some precision approach runways to indicate the touchdown zone when landing under adverse visibility conditions. They consist of two rows of transverse light bars disposed symmetrically about the runway centerline. The system consists of steady-burning white lights which start 100 feet beyond the landing threshold and extend to 3,000 feet beyond the landing threshold or to the midpoint of the runway, whichever is less.

**c) Taxiway Lead-Off Lights:** Taxiway lead-off lights extend from the runway centerline to a point on an exit taxiway to expedite movement of aircraft from the runway. These lights alternate green and yellow from the runway centerline to the runway holding position or the ILS/MLS critical area, as appropriate.

**d) Land and Hold Short Lights:** Land and hold short lights are used to indicate the hold short point on certain runways which are approved for Land and Hold Short Operations (LAHSO). Land and hold short lights consist of a row of pulsing white lights installed across the runway at the hold short point. Where installed, the lights will be on anytime LAHSO is in effect. These lights will be off when LAHSO is not in effect.

*REFERENCE-  
SECTION ENR 1.1, PARAGRAPH 22, PILOT RESPONSIBILITIES WHEN  
CONDUCTING LAND AND HOLD SHORT OPERATIONS (LAHSO).*

## 12.6 Control of Lighting Systems

**12.6.1** Operation of approach light systems and runway lighting is controlled by the control tower (ATCT). At some locations the FSS may control the lights where there is no control tower in operation.

**12.6.2** Pilots may request that lights be turned on or off. Runway edge lights, in-pavement lights and approach lights also have intensity controls which may be varied to meet the pilot's request. Sequenced flashing lights may be turned on and off. Some sequenced flashing system also have intensity control.

## 12.7 Pilot Control of Airport Lighting

**12.7.1** Radio control of lighting is available at selected airports to provide airborne control of lights by keying the aircraft's microphone. Control of lighting system is often available at locations without specified hours for lighting or where there is no control tower or FSS, or when the control tower or FSS is closed (locations with a part-time tower or FSS). All lighting systems which are radio controlled at an airport, whether on a single runway or multiple runways, operate on the same radio frequency. (See TBL 1.1-2 and TBL 1.1-3.)

**12.7.2** With FAA approved systems, various combinations of medium intensity approach lights, runway lights, taxiways lights, VASI and/or REIL may be activated by radio control. On runways with both approach lighting and runway lighting (runway edge lights, taxiway lights, etc.) systems, the approach lighting system takes precedence for air-to-ground radio control over the runway lighting system which is set at a predetermined intensity step, based on expected visibility conditions. Runways without approach lighting may provide radio controlled intensity adjustments of runway edge lights. Other lighting systems, including VASI, REIL, and taxiway lights, may be either controlled with the runway edge lights or controlled independently of the runway edge lights.

**Runways With Approach Lights**

Lighting System	No. of Int. Steps	Status During Non-use Period	Intensity Step Selected Per No. of Mike Clicks		
			3 Clicks	5 Clicks	7 Clicks
Approach Lights (Med. Int.)	2	Off	Low	Low	High
Approach Lights (Med. Int.)	3	Off	Low	Med	High
MIRL	3	Off or Low	◆	◆	◆
HIRL	5	Off or Low	◆	◆	◆
VASI	2	Off	★	★	★

**NOTES:** ◆ Predetermined intensity step.  
★ Low intensity for night use. High intensity for day use as determined by photocell control.

TBL 1.1-2

**Runways Without Approach Lights**

Lighting System	No. of Int. Steps	Status During Nonuse Period	Intensity Step Selected Per No. of Mike Clicks		
			3 Clicks	5 Clicks	7 Clicks
MIRL	3	Off or Low	Low	Med.	High
HIRL	5	Off or Low	Step 1 or 2	Step 3	Step 5
LIRL	1	Off	On	On	On
VASI★	2	Off	◆	◆	◆
REIL★	1	Off	Off	On / Off	On
REIL★	3	Off	Low	Med.	High

**NOTES:** ◆ Low intensity for night use. High intensity for day use as determined by photocell control.  
★ The control of VASI and/or REIL may be independent of other lighting systems.

TBL 1.1-3

**12.7.3** The control system consists of a 3-step control responsive to 7, 5, and/or 3 microphone clicks. This 3-step control will turn on lighting facilities capable of either 3-step, 2-step or 1-step operation. The 3-step and 2-step lighting facilities can be altered in intensity, while the 1-step cannot. All lighting is illuminated for a period of 15 minutes from the most recent time of activation and may not be extinguished prior to end of the 15 minute period (except for 1-step and 2-step REIL's which may be turned off when desired by keying the mike 5 or 3 times, respectively).

**12.7.4** Suggested use is to always initially key the mike 7 times; this assures that all controlled lights are turned on to the maximum available intensity. If desired, adjustment can then be made, where the capability is provided, to a lower intensity (or the REIL turned off) by keying 5 and/or 3 times. Due to the close proximity of airports using the same frequency, radio controlled

lighting receivers may be set at a low sensitivity requiring the aircraft to be relatively close to activate the system. Consequently, even when lights are on, always key mike as directed when overflying an airport of intended landing or just prior to entering the final segment of an approach. This will assure the aircraft is close enough to activate the system and a full 15 minutes lighting duration is available. Approved lighting systems may be activated by keying the mike (within 5 seconds) as indicated in TBL 1.1-4.

**Radio Control System**

Key Mike	Function
7 times within 5 seconds	Highest intensity available
5 times within 5 seconds	Medium or lower intensity (Lower REIL or REIL-off)
3 times within 5 seconds	Lowest intensity available (Lower REIL or REIL-off)

TBL 1.1-4

**12.7.5** The Airport/Facility Directory contains the types of lighting, runway, and the frequency that is used to activate the system for all public use airports with FAA standard systems. Airports with instrument approach procedures include data on the approach chart identifying the light system(s), the runway on which they are installed, and the frequency that is used to activate the system(s).

*NOTE.—*  
*ALTHOUGH THE CTAF IS USED TO ACTIVATE THE LIGHTS AT MANY AIRPORTS, OTHER FREQUENCIES MAY ALSO BE USED. THE APPROPRIATE FREQUENCY FOR ACTIVATING THE LIGHTS ON THE AIRPORT IS PROVIDED IN THE AIRPORT/FACILITY DIRECTORY AND THE STANDARD INSTRUMENT APPROACH PROCEDURES PUBLICATIONS. IT IS NOT IDENTIFIED ON THE SECTIONAL CHARTS.*

**12.7.6** Where the airport is not served by an instrument approach procedure, it may have either the standard FAA approach control system or an independent type system of different specification installed by the airport sponsor. The Airport/Facility Directory contains descriptions of pilot-controlled lighting systems for each airport having other than FAA approved systems, and explains the type lights, method of control, and operating frequency in clear text.

### 13. Airport/Heliport Beacons

**13.1** Airport and heliport beacons have a vertical light distribution to make them most effective from one to ten degrees above the horizon; however, they can be seen well above and below this peak spread. The beacon may be an omnidirectional capacitor-discharge device, or it may rotate at a constant speed which produces the visual effect of flashes at regular intervals. Flashes may be one or two colors alternately. The total number of flashes are:

- a) 24 to 30 per minute for beacons marking airports, landmarks, and points on Federal airways; and
- b) 30 to 45 per minute for beacons marking heliports.

**13.2** The colors and color combinations of beacons are:

- a) White and Green-Lighted land airport;
- b) \*Green alone-Lighted land airport;
- c) White and Yellow-Lighted water airport;
- d) \*Yellow alone-Lighted water airport; and
- e) Green, Yellow, and White-Lighted heliport.

*NOTE.—*  
*\*GREEN ALONE OR YELLOW ALONE IS USED ONLY IN CONNECTION WITH A WHITE-AND-GREEN OR WHITE-AND-YELLOW BEACON DISPLAY, RESPECTIVELY.*

**13.3** Military airport beacons flash alternately white and green, but are differentiated from civil beacons by dual-peaked (two quick) white flashes between the green flashes.

**13.4** In Class B, C, D and E surface areas, operation of the airport beacon during the hours of daylight indicates that the ground visibility is less than 3 miles and/or the ceiling is less than 1,000 feet. An ATC clearance in accordance with 14 CFR Part 91 is required for landing, takeoff and flight in the traffic pattern. Pilots should not rely solely on the operation of the airport beacon to indicate if weather conditions are IFR or VFR. At locations with control towers, when controls are in the tower, ATC personnel turn the beacon on. At many airports, the airport beacon is turned on by a photoelectric cell or time clocks and ATC personnel cannot control it. There is no regulatory requirement for daylight operation and it is the pilot's responsibility to comply with proper pre-flight planning in accordance with 14 CFR Section 91.103.

### 14. Taxiway Lights

**14.1 Taxiway Edge Lights:** Taxiway edge lights are used to outline the edges of taxiways during periods of darkness or restricted visibility conditions. These fixtures emit blue light.

*NOTE.—*  
*AT MOST MAJOR AIRPORTS THESE LIGHTS HAVE VARIABLE INTENSITY SETTINGS AND MAY BE ADJUSTED AT PILOT REQUEST OR WHEN DEEMED NECESSARY BY THE CONTROLLER.*

**14.2 Taxiway Centerline Lights:** Taxiway centerline lights are used to facilitate ground traffic under low visibility conditions. They are located along the taxiway centerline in a straight line on straight portions, on the centerline of curved portions, and along designated taxiing paths in portions of runways, ramp, and apron areas. Taxiway centerline lights are steady burning and emit green light.

**14.3 Clearance Bar Lights:** Clearance bar lights are installed at holding positions on taxiways in order to increase the conspicuity of the holding position in low visibility conditions. They may also be installed to indicate the location of an intersecting taxiway during periods of darkness. Clearance bars consist of three in-pavement steady-burning yellow lights.

**14.4 Runway Guard Lights:** Runway guard lights are installed at taxiway/runway intersections. They are primarily used to enhance the conspicuity of taxiway/runway intersections during low visibility conditions, but may be used in all weather conditions. Runway guard lights consist of either a pair of elevated flashing yellow

lights installed on either side of the taxiway, or a row of in-pavement yellow lights installed across the entire taxiway, at the runway holding position marking.

**NOTE.—**

*SOME AIRPORTS MAY HAVE A ROW OF THREE OR FIVE IN-PAVEMENT YELLOW LIGHTS INSTALLED AT TAXIWAY/RUNWAY INTERSECTIONS. THEY SHOULD NOT BE CONFUSED WITH CLEARANCE BAR LIGHTS DESCRIBED IN PARAGRAPH 14.3 ABOVE.*

**14.5 Stop Bar Lights:** Stop bar lights, when installed, are used to confirm the ATC clearance to enter or cross the active runway in low visibility conditions (below 1,200 ft Runway Visual Range). A stop bar consists of a row of red, unidirectional, steady-burning in-pavement lights installed across the entire taxiway at the runway holding position, and elevated steady-burning red lights on each side. A controlled stop bar is operated in conjunction with the taxiway centerline lead-on lights which extend from the stop bar toward the runway. Following the ATC clearance to proceed, the stop bar is turned off and the lead-on lights are turned on. The stop bar and lead-on lights are automatically reset by a sensor or backup timer.

**CAUTION.—**

*PILOTS SHOULD NEVER CROSS A RED ILLUMINATED STOP BAR, EVEN IF AN ATC CLEARANCE HAS BEEN GIVEN TO PROCEED ONTO OR ACROSS THE RUNWAY.*

**NOTE.—**

*IF AFTER CROSSING A STOP BAR, THE TAXIWAY CENTERLINE LEAD-ON LIGHTS INADVERTENTLY EXTINGUISH, PILOTS SHOULD HOLD THEIR POSITION AND CONTACT ATC FOR FURTHER INSTRUCTIONS.*

## 15. Air Navigation and Obstruction Lighting

### 15.1 Aeronautical Light Beacons

a) An aeronautical light beacon is a visual NAVAID displaying flashes of white and/or colored light to indicate the location of an airport, a heliport, a landmark, a certain point of a Federal airway in mountainous terrain, or an obstruction. The light used may be a rotating beacon or one or more flashing lights. The flashing lights may be supplemented by steady burning lights of lesser intensity.

b) The color or color combination display by a particular beacon and/or its auxiliary lights tell whether the beacon is indicating a landing place, landmark, point of the Federal airways, or an obstruction. Coded flashes of the auxiliary lights, if employed, further identify the beacon site.

### 15.2 Code Beacons and Course Lights

**15.2.1 Code Beacons:** The code beacon, which can be seen from all directions, is used to identify airports and landmarks. The code beacon flashes the three- or four-character airport identifier in International Morse Code six to eight times per minute. Green flashes are displayed for land airports while yellow flashes indicate water airports.

**15.2.2 Course Lights:** The course light, which can be seen clearly from only one direction, is used only with rotating beacons of the Federal Airway System; two course lights, back to back, direct coded flashing beams of light in either direction along the course of airway.

**NOTE.—**

*AIRWAY BEACONS ARE REMNANTS OF THE "LIGHTED" AIRWAYS WHICH ANTEDATED THE PRESENT ELECTRONICALLY EQUIPPED FEDERAL AIRWAYS SYSTEM. ONLY A FEW OF THOSE BEACONS EXIST TODAY TO MARK AIRWAY SEGMENTS IN REMOTE MOUNTAIN AREAS. FLASHES IN MORSE CODE IDENTIFY THE BEACON SITE.*

### 15.3 Obstruction Lights

**15.3.1 Obstructions are marked/lighted to warn airmen of their presence during daytime and nighttime conditions. They may be marked/lighted in any of the following combinations:**

a) **Aviation Red Obstruction Lights:** Flashing aviation red beacons (20 to 40 flashes per minute) and steady burning aviation red lights during nighttime operation. Aviation orange and white paint is used for daytime marking.

b) **Medium Intensity Flashing White Obstruction Lights:** Medium intensity flashing white obstruction lights may be used during daytime and twilight with automatically selected reduced intensity for nighttime operation. When this system is used on structures 500 feet (153m) AGL or less in height, other methods of marking and lighting the structure may be omitted. Aviation orange and white paint is always required for daytime marking on structures exceeding 500 feet (153m) AGL. This system is not normally installed on structures less than 200 feet (61m) AGL.

c) **High Intensity White Obstruction Lights:** Flashing high intensity white lights during daytime with reduced intensity for twilight and nighttime operation. When this type system is used, the marking of structures with red obstruction lights and aviation orange and white paint may be omitted.

d) **Dual Lighting:** A combination of flashing aviation red beacons and steady burning aviation red lights for nighttime operation and flashing high intensity white lights for daytime operation. Aviation orange and white paint may be omitted.

e) **Catenary Lighting:** Lighted markers are available for increased night conspicuity of high-voltage (69KV or higher) transmission line catenary wires. Lighted markers provide conspicuity both day and night.

**15.3.2** Medium intensity omnidirectional flashing white lighting system provides conspicuity both day and night on catenary support structures. The unique sequential/simultaneous flashing light system alerts pilots of the associated catenary wires.

**15.3.3** High intensity flashing white lights are being used to identify some supporting structures of overhead transmission lines located across rivers, chasms, gorges, etc. These lights flash in a middle, top, lower light sequence at approximately 60 flashes per minute. The top light is normally installed near the top of the supporting structure, while the lower light indicates the approximate lower portion of the wire span. The lights are beamed towards the companion structure and identify the area of the wire span.

**15.3.4** High intensity flashing white lights are also employed to identify tall structures, such as chimneys and towers, and obstructions to air navigation. The lights provide a 360 degree coverage about the structure at 40 flashes per minute and consist of from one to seven levels of lights depending upon the height of the structure. Where more than one level is used the vertical banks flash simultaneously.

## **16. Airport Lead-in Lighting System (LDIN)**

**16.1** The lead-in lighting system consists of a series of flashing lights installed at or near ground level to describe the desired course to a runway or final approach. Each group of lights is positioned and aimed so as to be conveniently sighted and followed from the approaching aircraft under conditions at or above approach minimums under consideration. The system may be curved, straight, or combination thereof, as required. The lead-in lighting system may be terminated at any approved approach lighting system, or it may be terminated at a distance from the landing

threshold which is compatible with authorized visibility minimums permitting visual reference to the runway environment.

**16.2** The outer portion uses groups of lights to mark segments of the approach path beginning at a point within easy visual range of a final approach fix. These groups are spaced close enough together (approximately one mile) to give continuous lead-in guidance. A group consists of at least three flashing lights in a linear or cluster configuration and may be augmented by steady burning lights where required. When practicable, groups flash in sequence toward runways. Each system is designed to suit local conditions and to provide the visual guidance intended. The design of all LDIN is compatible with the requirements of U.S. Standards for Terminal Instrument Procedures (TERPS) where such procedures are applied for establishing instrument minimums.

## **17. Airport Marking Aids and Signs**

### **17.1 General**

**17.1.1** Airport pavement markings and signs provide information that is useful to a pilot during takeoff, landing, and taxiing.

**17.1.2** Uniformity in airport markings and signs from one airport to another enhances safety and improves efficiency. Pilots are encouraged to work with the operators of the airports they use to achieve the marking and sign standards described in this section.

**17.1.3** Pilots who encounter ineffective, incorrect, or confusing markings or signs on an airport should make the operator of the airport aware of the problem. These situations may also be reported under the Aviation Safety Reporting Program as described in ENR 1.16. Pilots may also report these situations to the FAA Regional Airports Division.

**17.1.4** The markings and signs described in this section reflect the current FAA recommended standards.

#### **REFERENCE-**

AC 150/5340-1, STANDARDS FOR AIRPORT MARKINGS  
AC 150/5340-18, STANDARDS FOR AIRPORT SIGN SYSTEMS.

## 17.2 Airport Pavement Markings

**17.2.1 General:** For the purpose of this presentation the Airport Pavement Markings have been grouped into the four areas:

- a) Runway Markings,
- b) Taxiway Markings,
- c) Holding Position Markings, and
- d) Other Markings.

**17.2.2 Marking Colors:** Markings for runways are white. Markings defining the landing area on a heliport are also white except for hospital heliports which use a red "H" on a white cross. Markings for taxiways, areas not intended for use by aircraft (closed and hazardous areas), and holding positions (even if they are on a runway) are yellow.

## 17.3 Runway Markings

**17.3.1 General:** There are three types of markings for runways: visual, non precision instrument, and precision instrument. TBL 1.1-5 identifies the marking elements for each type of runway, and TBL 1.1-6 identifies runway threshold markings.

**17.3.2 Runway Designators:** Runway numbers and letters are determined from the approach direction. The runway number is the whole number nearest one-tenth the magnetic azimuth of the centerline of the runway, measured clockwise from the magnetic north. The letters differentiate between left (L), right (R), or center (C), parallel runways, as applicable:

- a) For two parallel runways "L" "R."
- b) For three parallel runways "L" "C" "R."

**17.3.3 Runway Centerline Marking:** The runway centerline identifies the center of the runway and provides alignment guidance during takeoff and landings. The centerline consists of a line of uniformly spaced stripes and gaps.

**Runway Marking Elements**

Marking Element	Visual Runway	Nonprecision Instrument Runway	Precision Instrument Runway
Designation	X	X	X
Centerline	X	X	X
Threshold	X <sup>1</sup>	X	X
Aiming Point	X <sup>2</sup>	X	X
Touchdown Zone			X
Side Stripes			X

<sup>1</sup> On runways used, or intended to be used, by international commercial transports.  
<sup>2</sup> On runways 4,000 feet (1200 m) or longer used by jet aircraft.

TBL 1.1-5

**Number of Runway Threshold Stripes**

Runway Width	Number of Stripes
60 feet (18 m)	4
75 feet (23 m)	6
100 feet (30 m)	8
150 feet (45 m)	12
200 feet (60 m)	16

TBL 1.1-6

**17.3.4 Runway Aiming Point Marking:** The aiming point marking serves as a visual aiming point for a landing aircraft. These two rectangular markings consists of a broad white stripe located on each side of the runway centerline and approximately 1,000 feet from the landing threshold. (See FIG 1.1-9.)

**17.3.5 Runway Touchdown Zone Markers:** The touchdown zone markings identify the touchdown zone for landing operations and are coded to provide distance information in 500 feet (150m) increments. These markings consist of groups of one, two, and three rectangular bars symmetrically arranged in pairs about the runway centerline as shown in FIG 1.1-9, Precision Instrument Runway Markings. For runways having touchdown zone markings on both ends, those pairs of markings which extend to within 900 feet (270m) of the midpoint between the thresholds are eliminated.

**17.3.6 Runway Side Strip Marking:** Runway side stripes delineate the edges of the runway. They provide

a visual contrast between runway and the abutting terrain or shoulders. Side stripes consist of continuous white stripes located on each side of the runway. (See FIG 1.1-13.)

**17.3.7 Runway Shoulder Markings:** Runway shoulder stripes may be used to supplement runway side stripes to identify pavement areas contiguous to the runway sides that are not intended for use by aircraft. Runway shoulder stripes are yellow. (See FIG 1.1-11.)

**17.3.8 Runway Threshold Markings:** Runway threshold markings come in two configurations. They consist of either eight longitudinal stripes of uniform dimensions disposed symmetrically about the runway centerline, as shown in FIG 1.1-9, or the number of stripes is related to the runway width as indicated in TBL 1.1-6. A threshold marking helps identify the beginning of the runway that is available for landing. In some instances the landing threshold may be relocated or displaced.

Precision Instrument Runway Markings

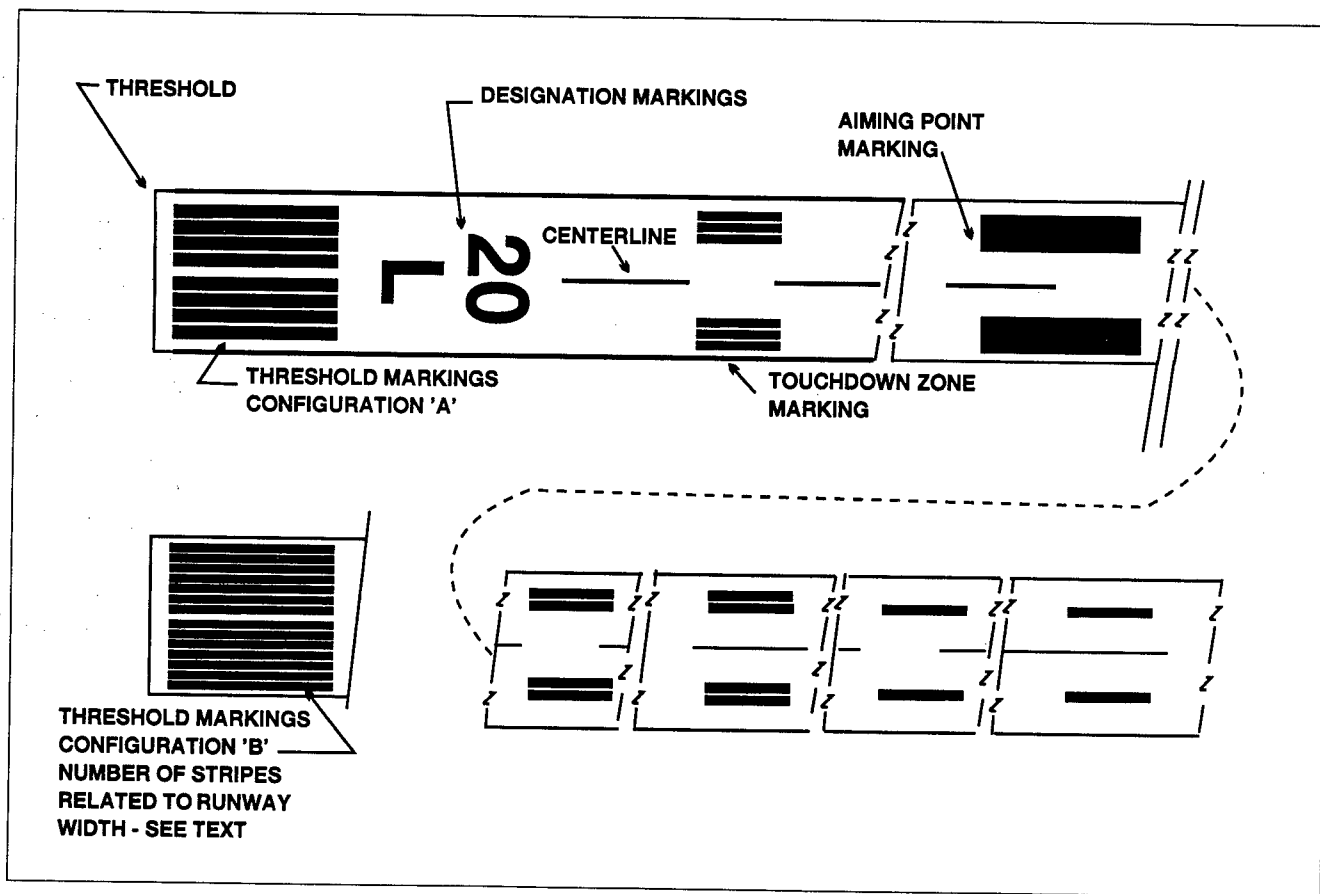

FIG 1.1-9



### Nonprecision Instrument Runway and Visual Runway Markings

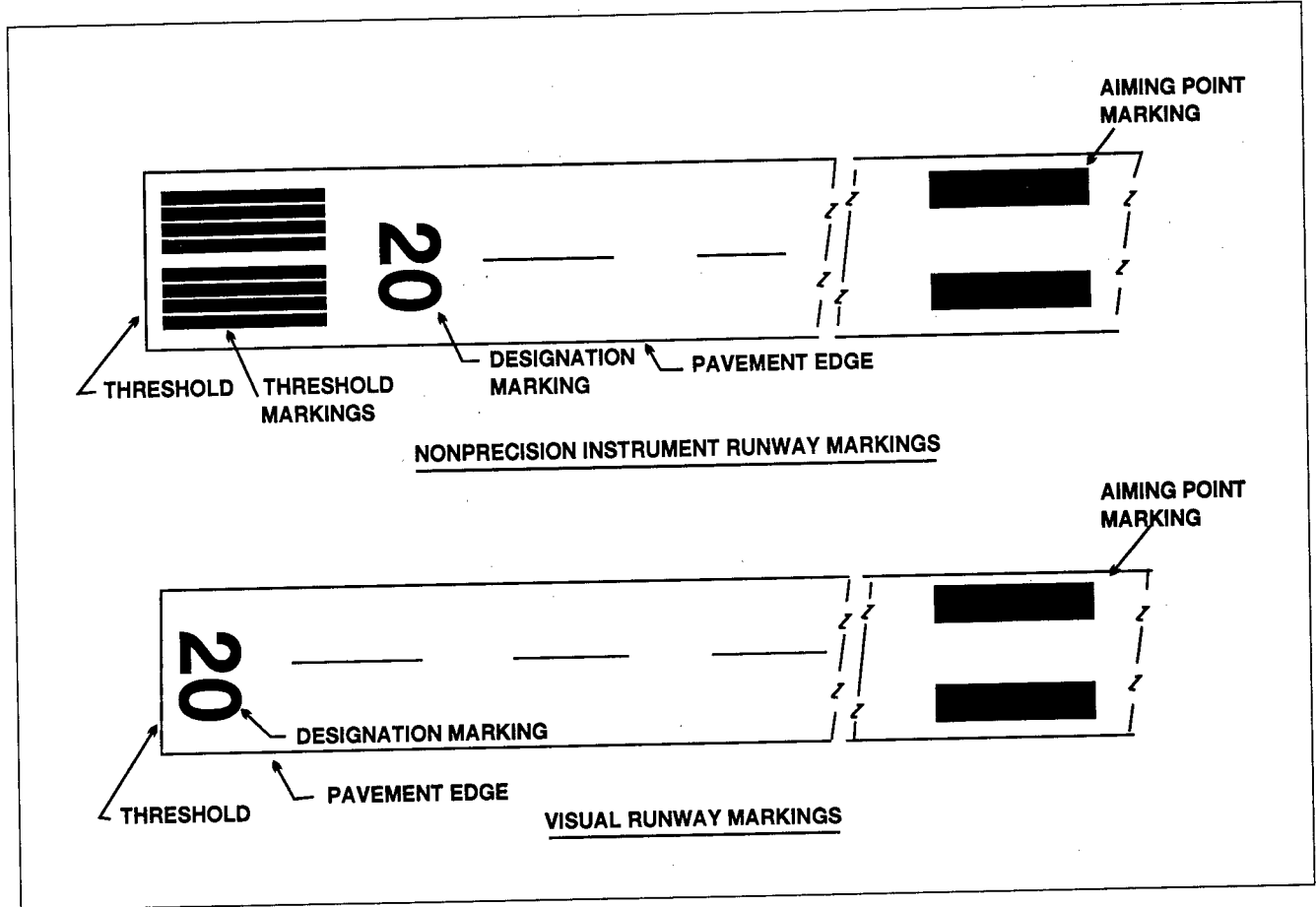

FIG 1.1-10

**a) Relocation of a Threshold:** Sometimes construction, maintenance, or other activities require the threshold to be relocated towards the rollout end of the runway. (See FIG 1.1-12.) When a threshold is relocated, it closes not only a set portion of the approach end of a runway, but also shortens the length of the opposite direction runway. In these cases, a NOTAM should be issued by the airport operator identifying the portion of the runway that is closed, e.g., 10/28 W 900 CLSD. Because the duration of the relocation can vary from a few hours to several months, methods identifying the new threshold may vary. One common practice is to use a ten-foot wide white threshold bar across the width of the runway. Although the runway lights in the area between the old threshold and new threshold will not be illuminated, the runway markings in this area may or may not be obliterated, removed, or covered.

**b) Displaced Threshold:** A displaced threshold is a threshold located at a point on the runway other than the designated beginning of the runway. Displacement of a threshold reduces the length of runway available for landings. The portion of runway behind a displaced threshold is available for takeoffs in either direction and landings from the opposite direction. A ten-foot wide white threshold bar is located across the width of the runway at the displaced threshold. White arrows are located along the centerline in the area between the beginning of the runway and displaced threshold. White arrowheads are located across the width of the runway just prior to the threshold bar, as shown in FIG 1.1-13.

**NOTE.—**  
AIRPORT OPERATOR. WHEN REPORTING THE RELOCATION OR DISPLACEMENT OF A THRESHOLD, THE AIRPORT OPERATOR SHOULD AVOID LANGUAGE WHICH CONFUSES THE TWO.

### Runway Shoulder Markings

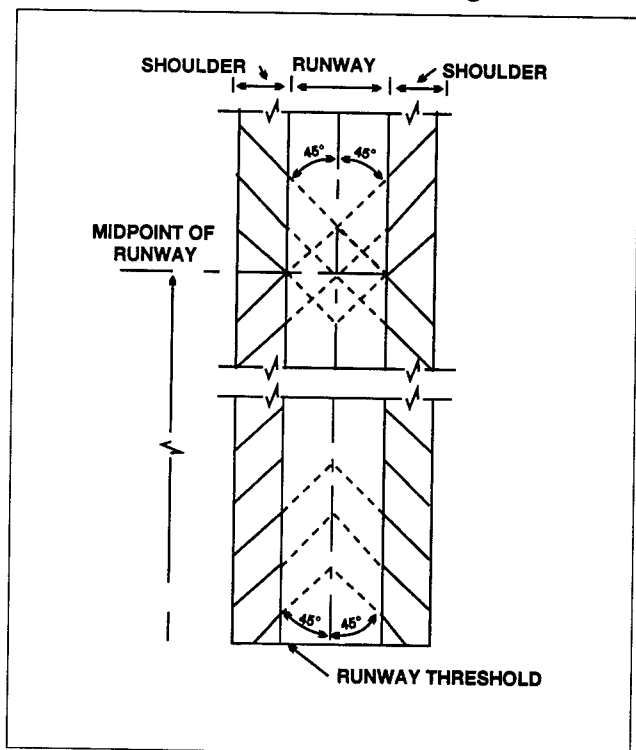

FIG 1.1-11

**17.3.9 Demarcation Bar:** A demarcation bar delineates a runway with a displaced threshold from a blast pad, stopway, or taxiway that precedes the runway. A demarcation bar is 3 feet (1m) wide and yellow, since it is not located on the runway. (See FIG 1.1-14.)

**17.3.10 Chevrons:** These markings are used to show pavement areas aligned with the runway that are unusable for landing, takeoff, and taxiing. Chevrons are yellow. (See FIG 1.1-15).

**17.3.11 Runway Threshold Bar:** A threshold bar delineates the beginning of the runway that is available for landing when the threshold has been relocated or displaced. A threshold bar is 10 feet (3m) in width and extends across the width of the runway, as shown in FIG 1.1-13.

### 18. Taxiway Markings

**18.1 General:** All taxiways should have centerline markings and runway holding position markings whenever they intersect a runway. Taxiway edge markings are present whenever there is a need to separate the taxiway from a pavement that is not intended for aircraft use

or to delineate the edge of the taxiway. Taxiways may also have shoulder markings and holding position markings for Instrument Landing System/Microwave Landing System (ILS/MLS) critical areas, and taxiway/taxiway intersection markings.

**18.2 Taxiway Centerline:** The taxiway centerline is a single continuous yellow line, 6 inches (15 cm) to 12 inches (30 cm) in width. This provides a visual cue to permit taxiing along a designated path. Ideally, the aircraft should be kept centered over this line during taxi to ensure wing-tip clearance. (See FIG 1.1-16.)

**18.3 Taxiway Edge Markings:** Taxiway edge markings are used to define the edge of the taxiway. They are primarily used when the taxiway edge does not correspond with the edge of the pavement. There are two types of markings depending upon whether the aircraft is suppose to cross the taxiway edge:

a) **Continuous Markings:** These consist of a continuous double yellow line, with each line being at least 6 inches (15 cm) in width spaced 6 inches (15 cm) apart. They are used to define the taxiway edge from the shoulder or some other abutting paved surface not intended for use by aircraft.

b) **Dashed Markings:** These markings are used when there is an operational need to define the edge of a taxiway or taxilane on a paved surface where the adjoining pavement to the taxiway edge is intended for use by aircraft; e.g., an apron. Dashed taxiway edge markings consist of a broken double yellow line, with each line being at least 6 inches (15 cm) in width, spaced 6 inches (15 cm) apart (edge to edge). These lines are 15 feet (4.5 m) in length with 25-foot (7.5 m) gaps. (See FIG 1.1-17.)

**18.4 Taxi Shoulder Markings:** Taxiways, holding bays, and aprons are sometimes provided with paved shoulders to prevent blast and water erosion. Although shoulders may have the appearance of full strength pavement, they are not intended for use by aircraft, and may be unable to support an aircraft. Usually the taxiway edge marking will define this area. Where conditions exist such as islands or taxiway curves that may cause confusion as to which side of the edge stripe is for use by aircraft, taxiway shoulder markings may be used to indicate the pavement is unusable. Taxiway shoulder markings are yellow. (See FIG 1.1-18.)

Relocation of a Threshold with Markings for Taxiway Aligned with Runway

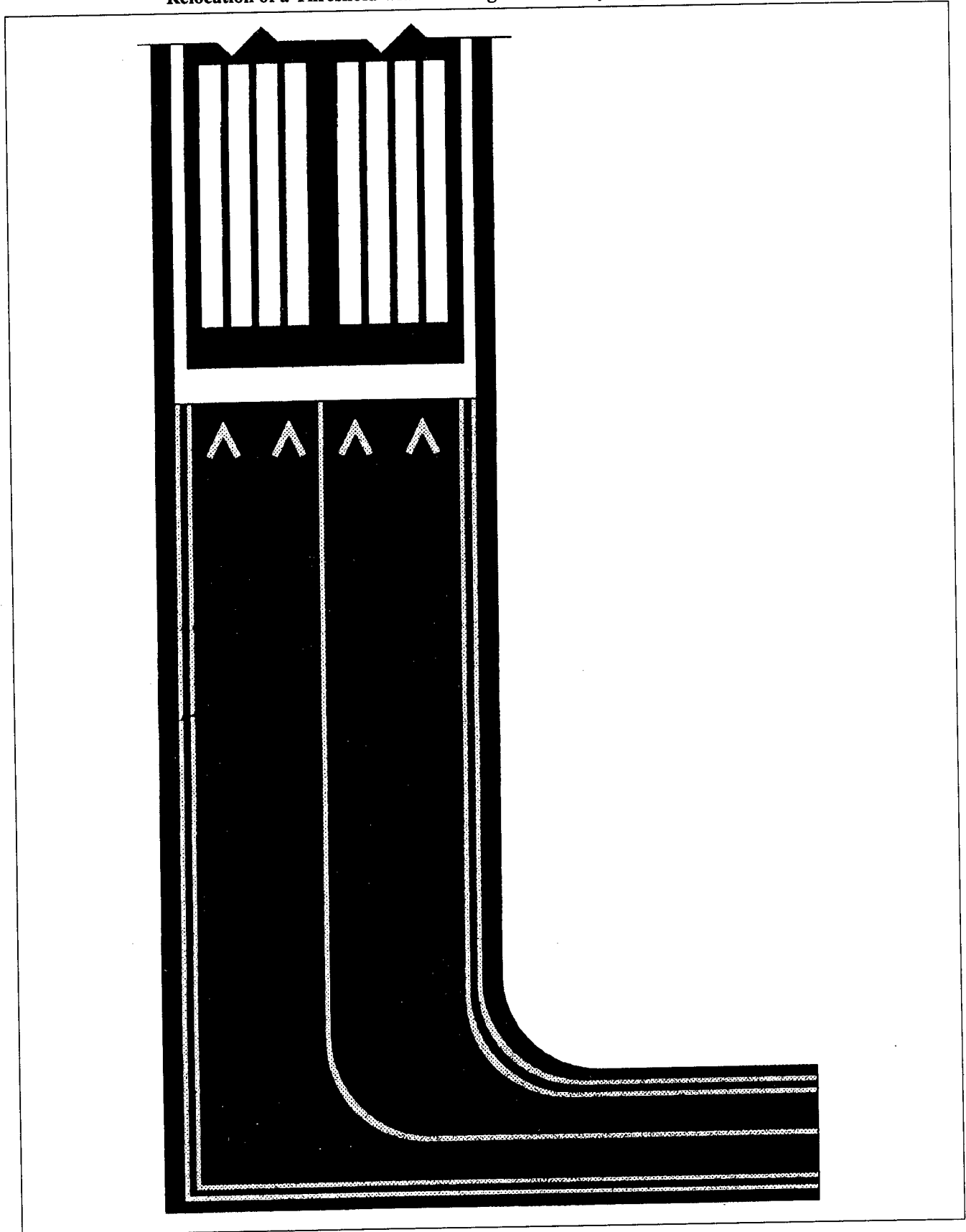

FIG 1.1-12

Displaced Threshold Markings

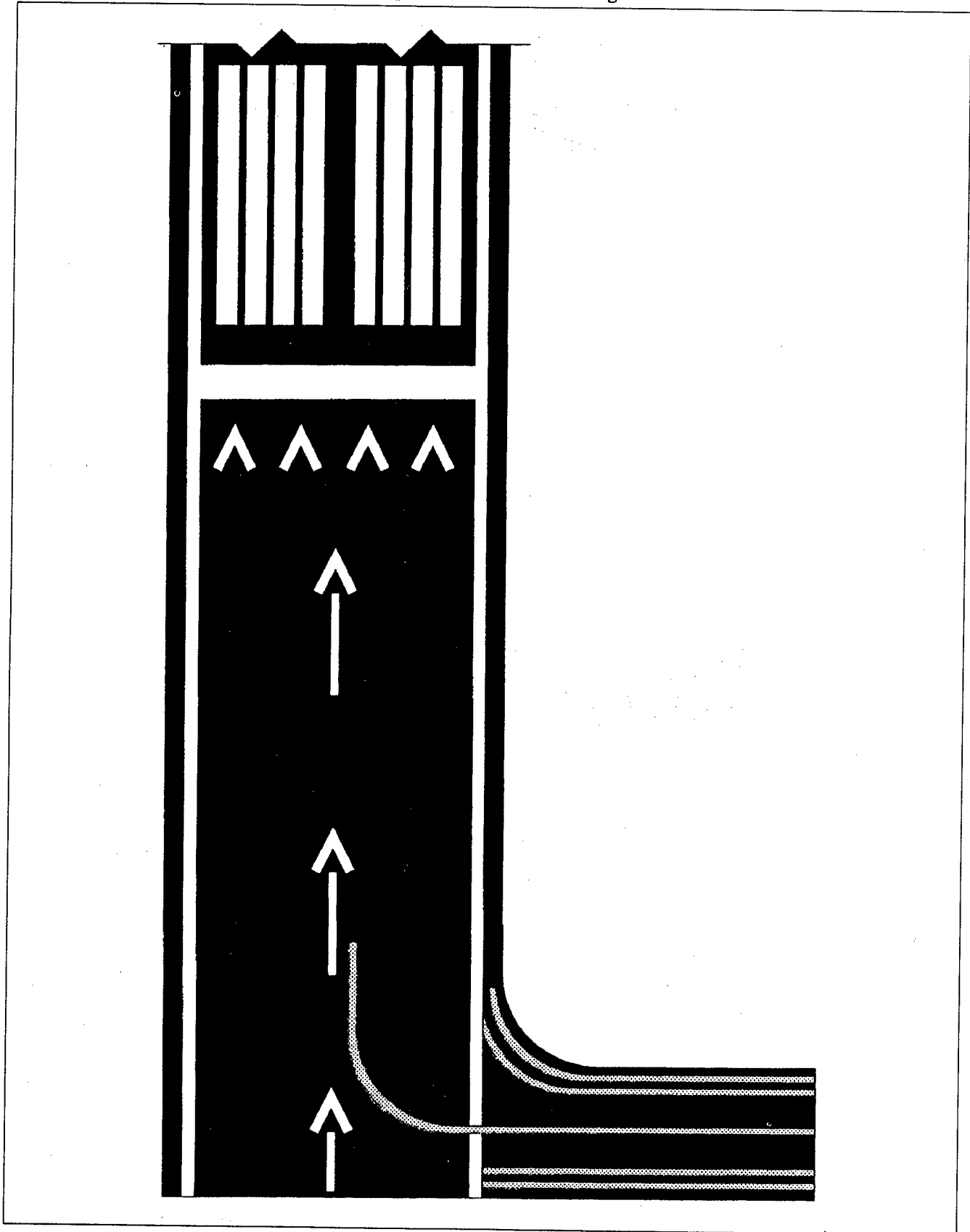

FIG 1.1-13

Markings for Blast Pad or Stopway or Taxiway Preceding a Displaced Threshold

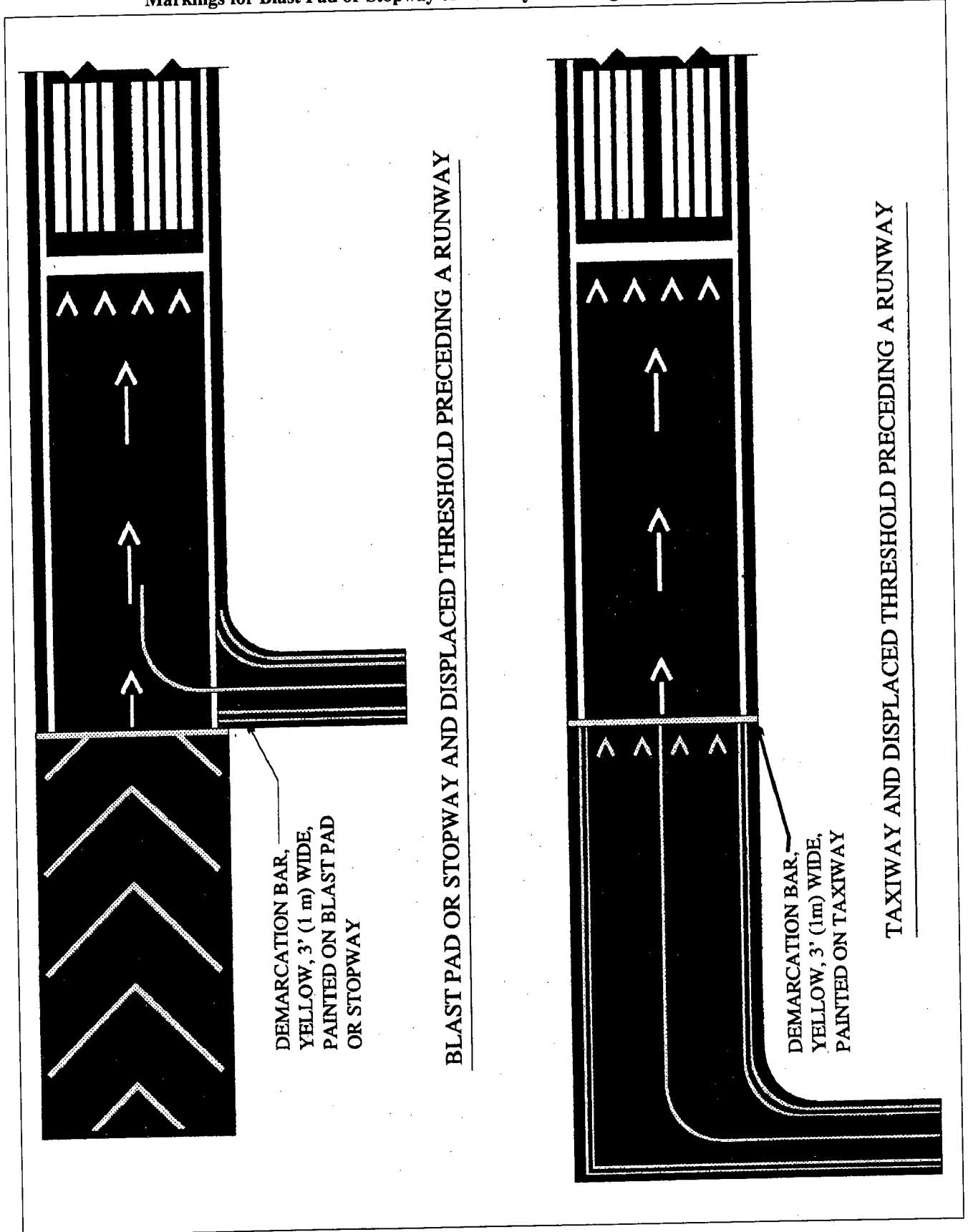

FIG 1.1-14

Markings for Blast Pads and Stopways

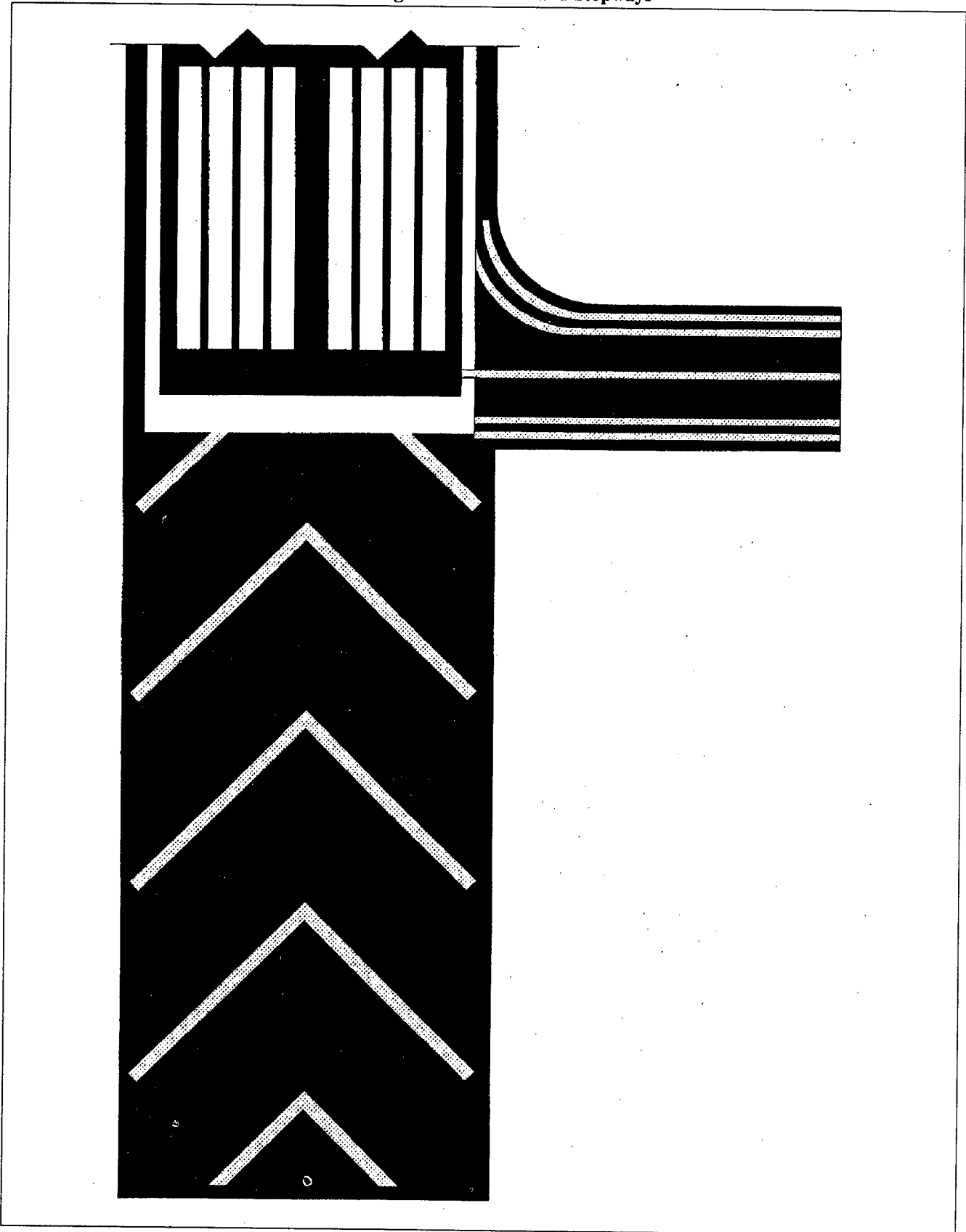

FIG 1.1-15

Taxiway Centerline

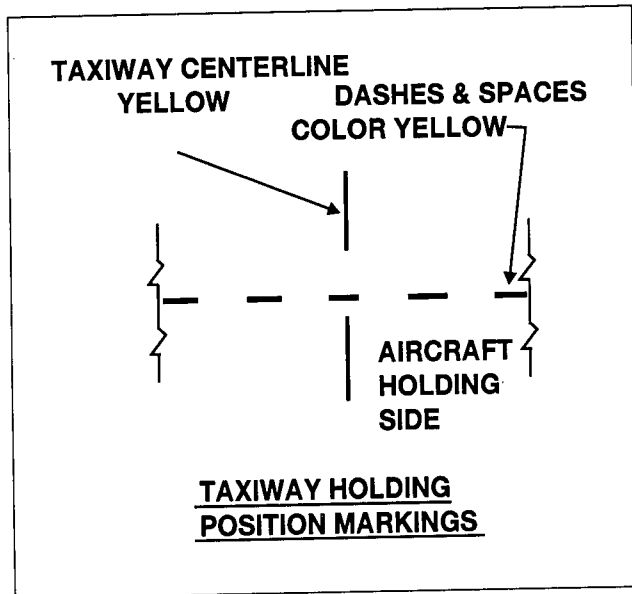

FIG 1.1-16

Taxi Shoulder Markings

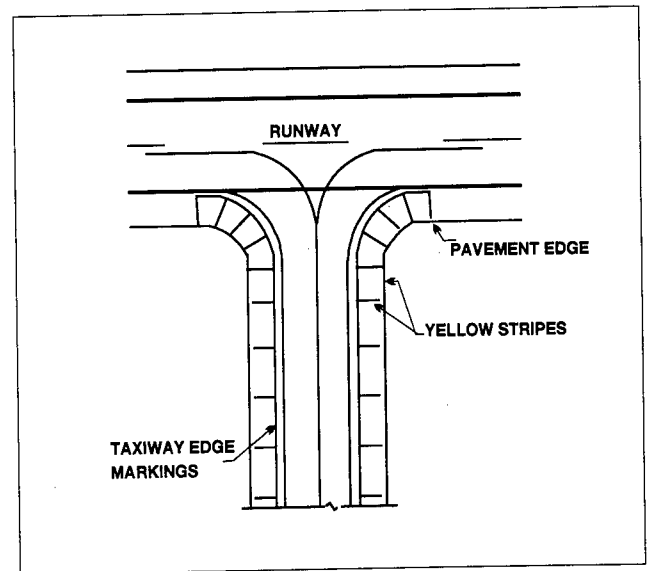

FIG 1.1-18

Dashed Markings

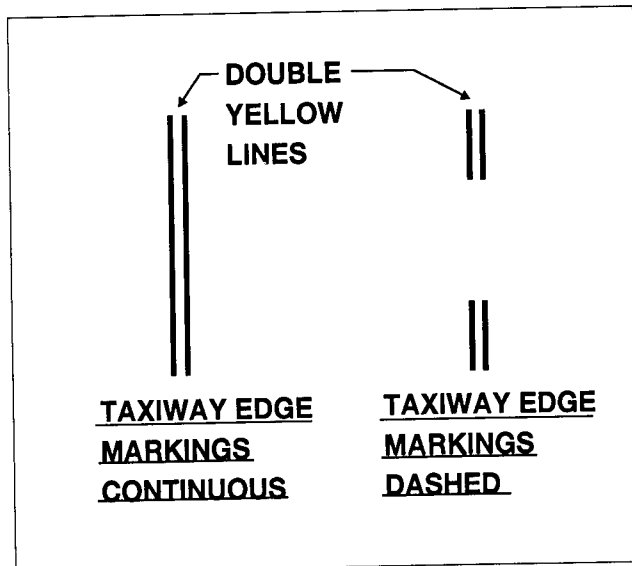

FIG 1.1-17

**18.5 Surface Painted Taxiway Direction Signs:** Surface painted taxiway direction signs have a yellow background with a black inscription. These signs are provided when it is not possible to provide taxiway direction signs at intersections or when it is necessary to supplement such signs. These markings are located adjacent to the centerline with signs indicating turns to the left being on the left side of the taxiway centerline and signs indicating turns to the right being on the right side of the centerline. (See FIG 1.1-19.)

**18.6 Surface Painted Location Signs:** Surface painted location signs have a black background with a yellow inscription. When necessary, these markings are used to supplement location signs located along side the taxiway and assist the pilot in confirming the designation of the taxiway on which the aircraft is located. These markings are located on the right side of the centerline. (See FIG 1.1-19.)

**18.7 Geographic Position Markings:** These markings are located at points along low visibility taxi routes designated in the airport's Surface Movement Guidance Control System (SMGCS) plan. They are used to identify the location of taxiing aircraft during low visibility operations. Low visibility operations are those that occur when the runway visible range (RVR) is below 1,200 feet (360m). They are positioned to the left of the taxiway centerline in the direction of taxiing. (See FIG 1.1-20.) The geographic position marking is a circle comprised of an outer black ring contiguous to a white ring with a pink circle in the middle. When installed on asphalt or other dark-colored pavements, the white ring and the black ring are reversed; i.e., the white ring becomes the outer ring and the black ring becomes the inner ring. It is designated with either a number or a number and letter. The number corresponds to the consecutive position of the marking on the route.

Surface Painted Signs

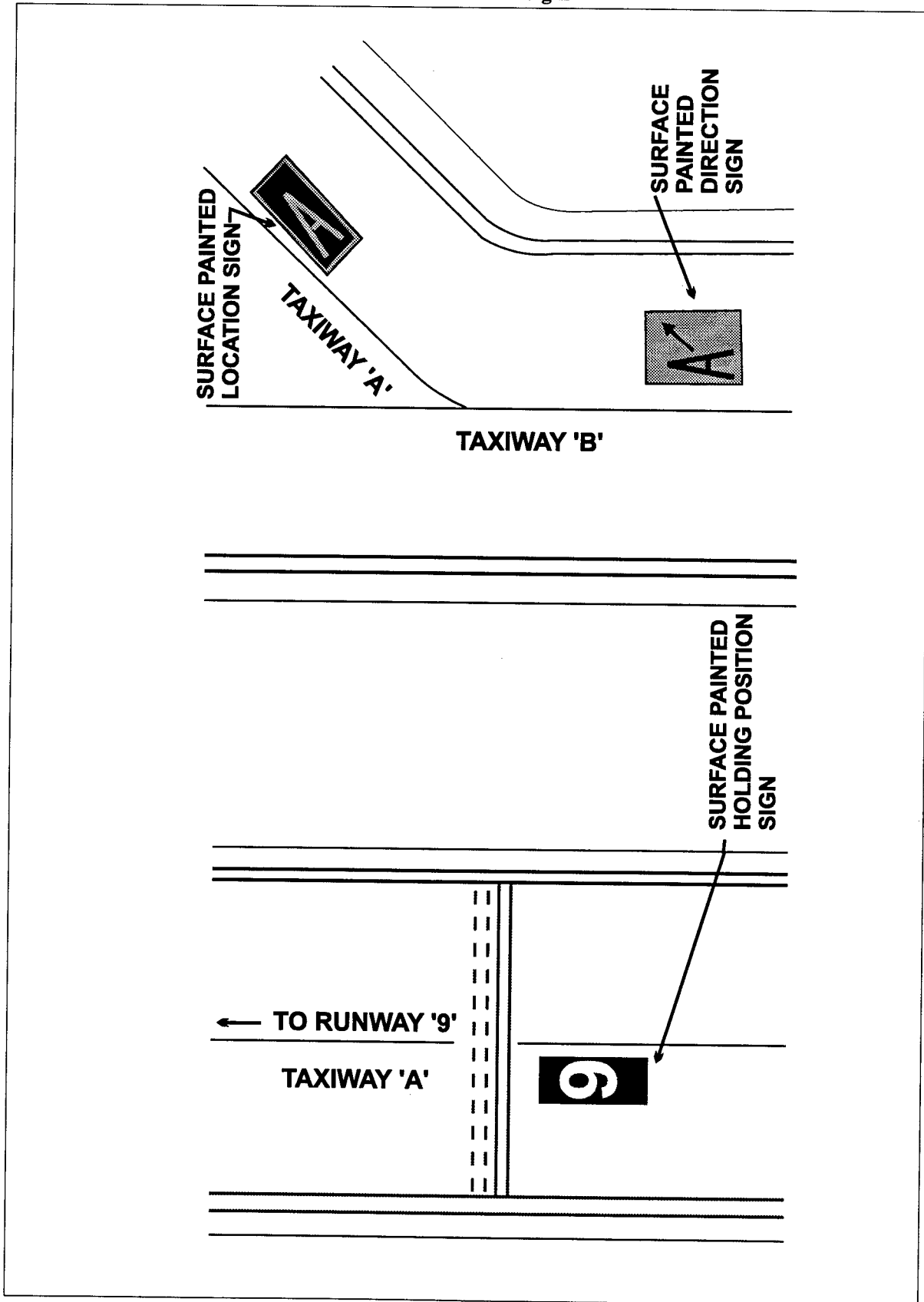

FIG 1.1-19



## 19. Holding Position Markings

**19.1 Runway Holding Position Markings:** For runways, these markings indicate where an aircraft is supposed to stop. They consist of four yellow lines, two solid and two dashed, spaced six inches apart and extending across the width of the taxiway or runway. The solid lines are always on the side where the aircraft is to hold. There are three locations where runway holding position markings are encountered.

**a) Runway Holding Position Markings on Taxiways:** These markings identify the locations on a taxiway where an aircraft is supposed to stop when it does not have clearance to proceed onto the runway. The runway holding position markings are shown in FIG 1.1-21. When instructed by ATC "Hold short of (runway "xx")," the pilot should stop so no part of his aircraft extends beyond the holding position marking. When approaching the holding position marking, a pilot should not cross the marking without ATC clearance at a controlled airport or without making sure of adequate separation from other aircraft at uncontrolled airports. An aircraft exiting a runway is not clear of the runway until all parts of the aircraft have crossed the applicable holding position marking.

**b) Runway Holding Position Markings on Runways:** These markings are installed on runways only if the runway is normally used by air traffic control for "land, hold short" operations or taxiing operations and have operational significance only for those two types of operations. A sign with a white inscription on a red background is installed adjacent to these holding position markings (See FIG 1.1-22.) The hold position markings are placed on runways prior to the intersection with another runway, or some designated point. Pilots receiving instructions "cleared to land, runway "xx" from air traffic control are authorized to use the entire landing length of the runway and should disregard any holding position markings located on the runway. Pilots receiving and accepting instructions "cleared to land runway "xx," hold short of runway "yy" from air traffic control must either exit runway "xx," or stop at the holding position prior to runway "yy."

**c) Taxiways Located in Runway Approach Areas:** These markings are used at some airports where it is

necessary to hold an aircraft on a taxiway located in the approach or departure area of a runway so that the aircraft does not interfere with the operations on that runway. This marking is co-located with the runway approach area holding position sign. (See paragraph 21 and FIG 1.1-23.)

**19.2 Holding Position Markings for Instrument Landing System (ILS):** Holding position markings for ILS/MLS critical areas consist of two yellow solid lines spaced two feet apart connected by pairs of solid lines spaced ten feet apart extending across the width of the taxiway as shown in FIG 1.1-24. A sign with an inscription in white on a red background is installed adjacent to these hold position markings. When the ILS critical area is being protected, the pilot should stop so no part of his aircraft extends beyond the holding position marking. When approaching the holding position marking, a pilot should not cross the marking without ATC clearance. ILS critical area is not clear until all parts of the aircraft have crossed the applicable holding position marking.

*REFERENCE-  
ENR 4.1, PARAGRAPH 7.*

**19.3 Holding Position Markings for Taxiway/Taxiway Intersections:** Holding position markings for taxiway/taxiway intersections consist of a single dashed line extending across the width of the taxiway as shown in FIG 1.1-25. They are installed on taxiways where air traffic control normally holds aircraft short of a taxiway intersection. When instructed by ATC "hold short of (taxiway)" the pilot should stop so no part of his aircraft extends beyond the holding position marking. When the marking is not present, the pilot should stop the aircraft at a point which provides adequate clearance from an aircraft on the intersecting taxiway.

**19.4 Surface Painted Holding Position Signs:** Surface painted holding position signs have a red background with a white inscription and supplement the signs located at the holding position. This type of marking is normally used where the width of the holding position on the taxiway is greater than 200 feet (60m). It is located to the left side of the taxiway centerline on the holding side and prior to the holding position marking. (See FIG 1.1-19.)

Geographic Position Markings

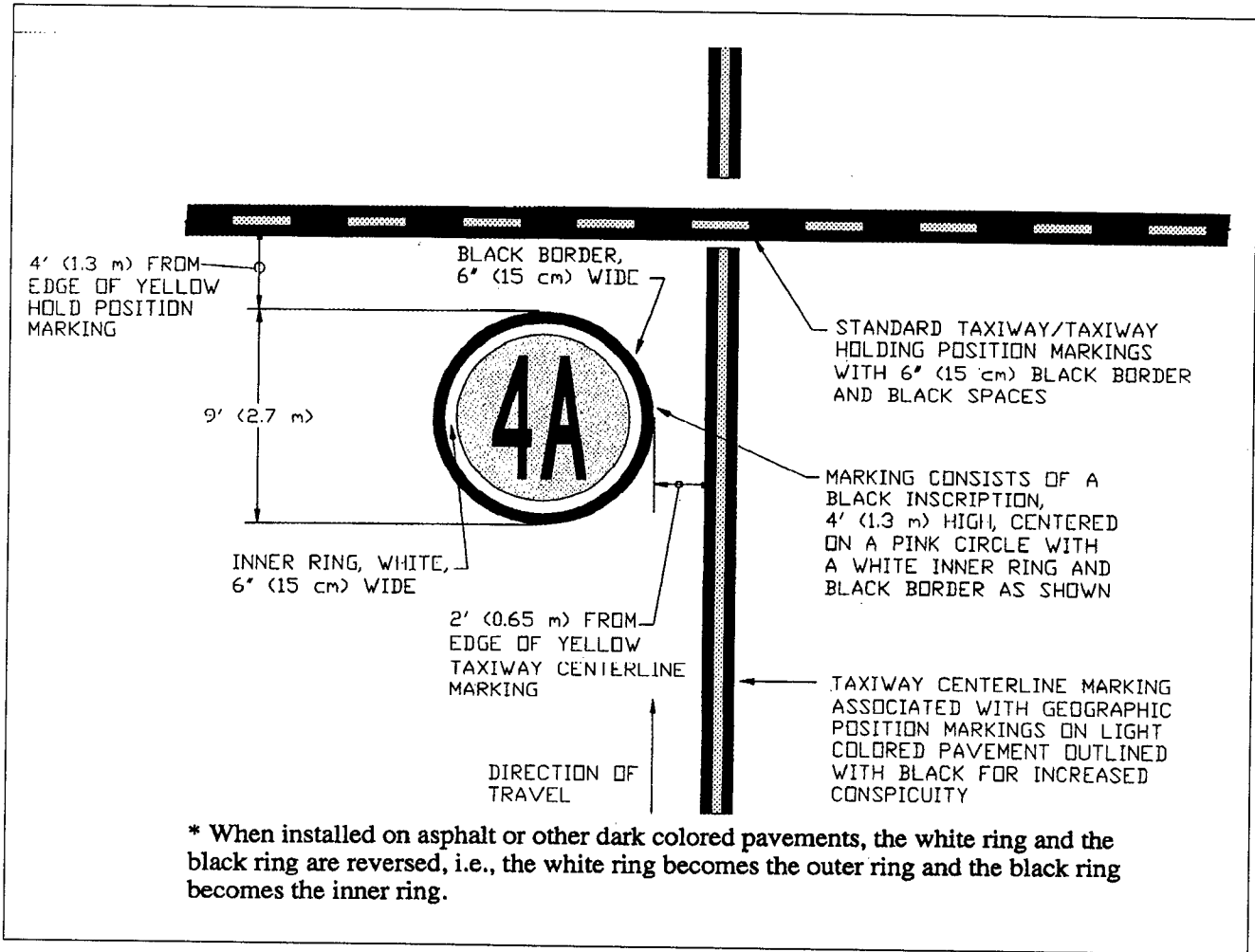

FIG 1.1-20

Runway Holding Position Markings on Taxiway

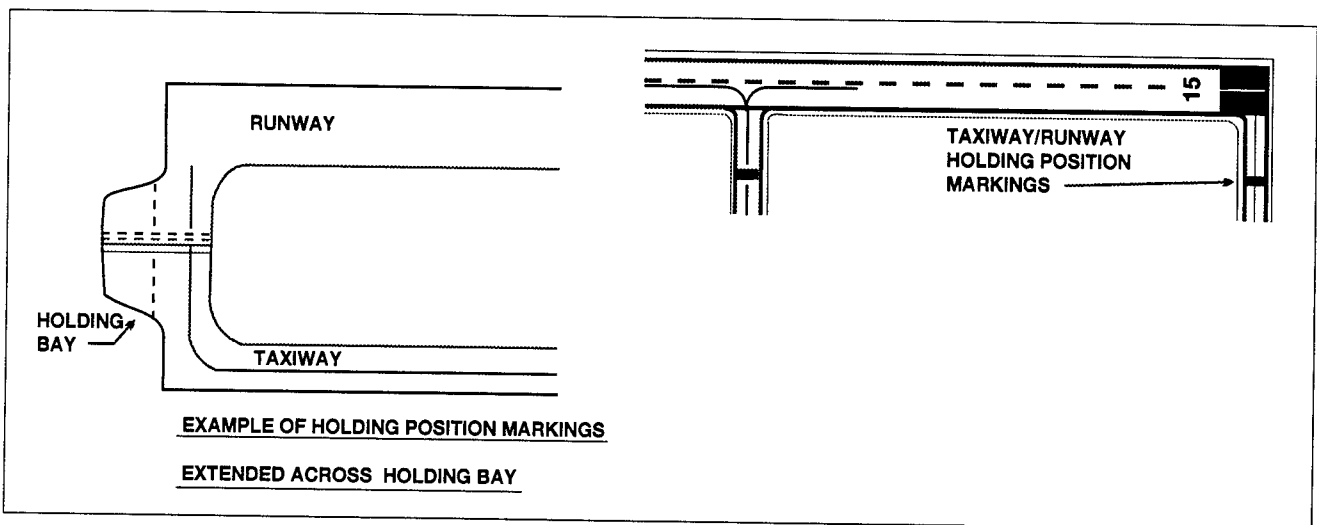

FIG 1.1-21

Runway Holding Position Markings on Runways

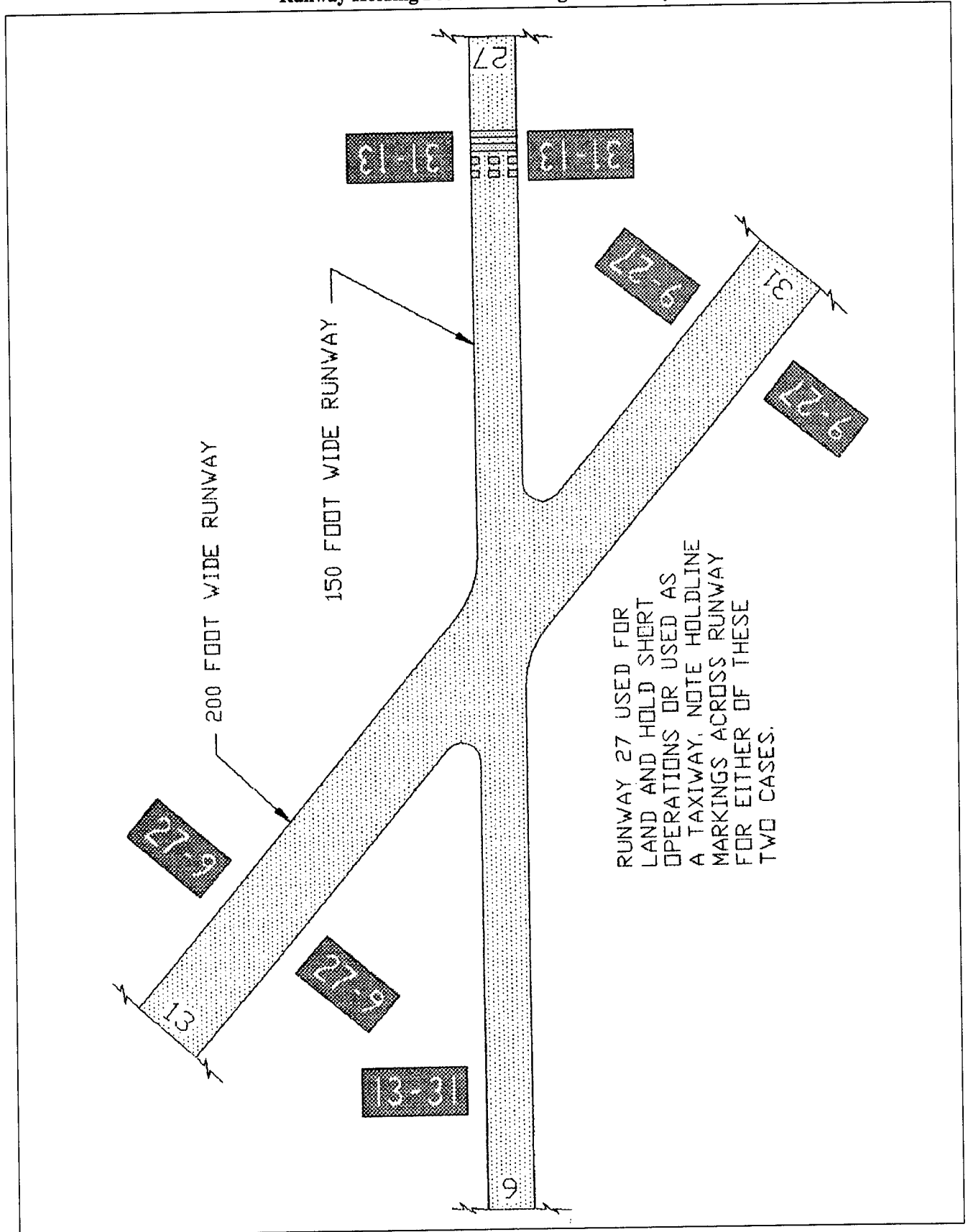
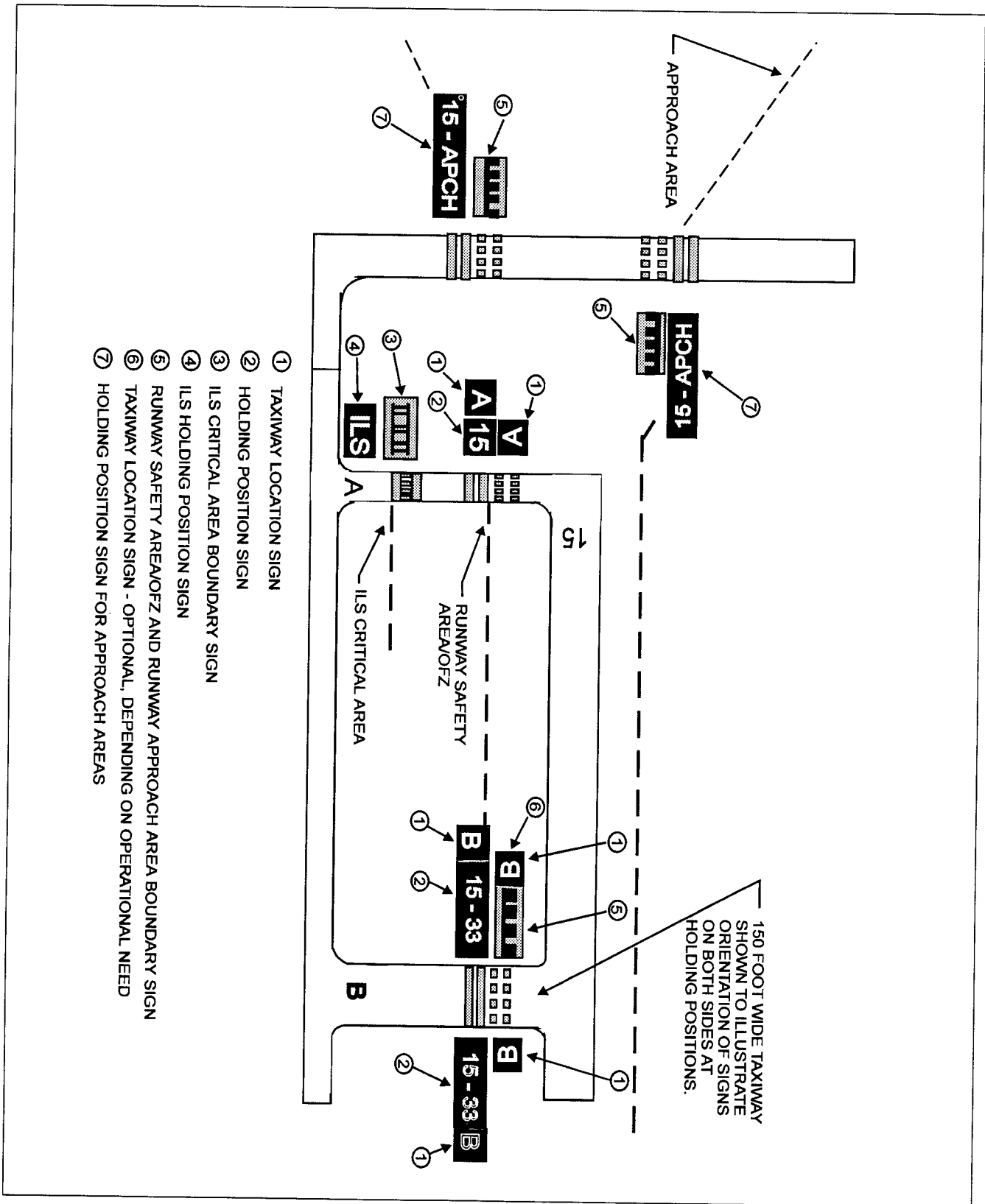

FIG 1.1-22

Taxiways Located in Runway Approach Area



- ① TAXIWAY LOCATION SIGN
- ② HOLDING POSITION SIGN
- ③ ILS CRITICAL AREA BOUNDARY SIGN
- ④ ILS HOLDING POSITION SIGN
- ⑤ RUNWAY SAFETY AREA/OFFZ AND RUNWAY APPROACH AREA BOUNDARY SIGN
- ⑥ TAXIWAY LOCATION SIGN - OPTIONAL, DEPENDING ON OPERATIONAL NEED
- ⑦ HOLDING POSITION SIGN FOR APPROACH AREAS

FIG 1.1-23

**Holding Position Markings: ILS Critical Area**

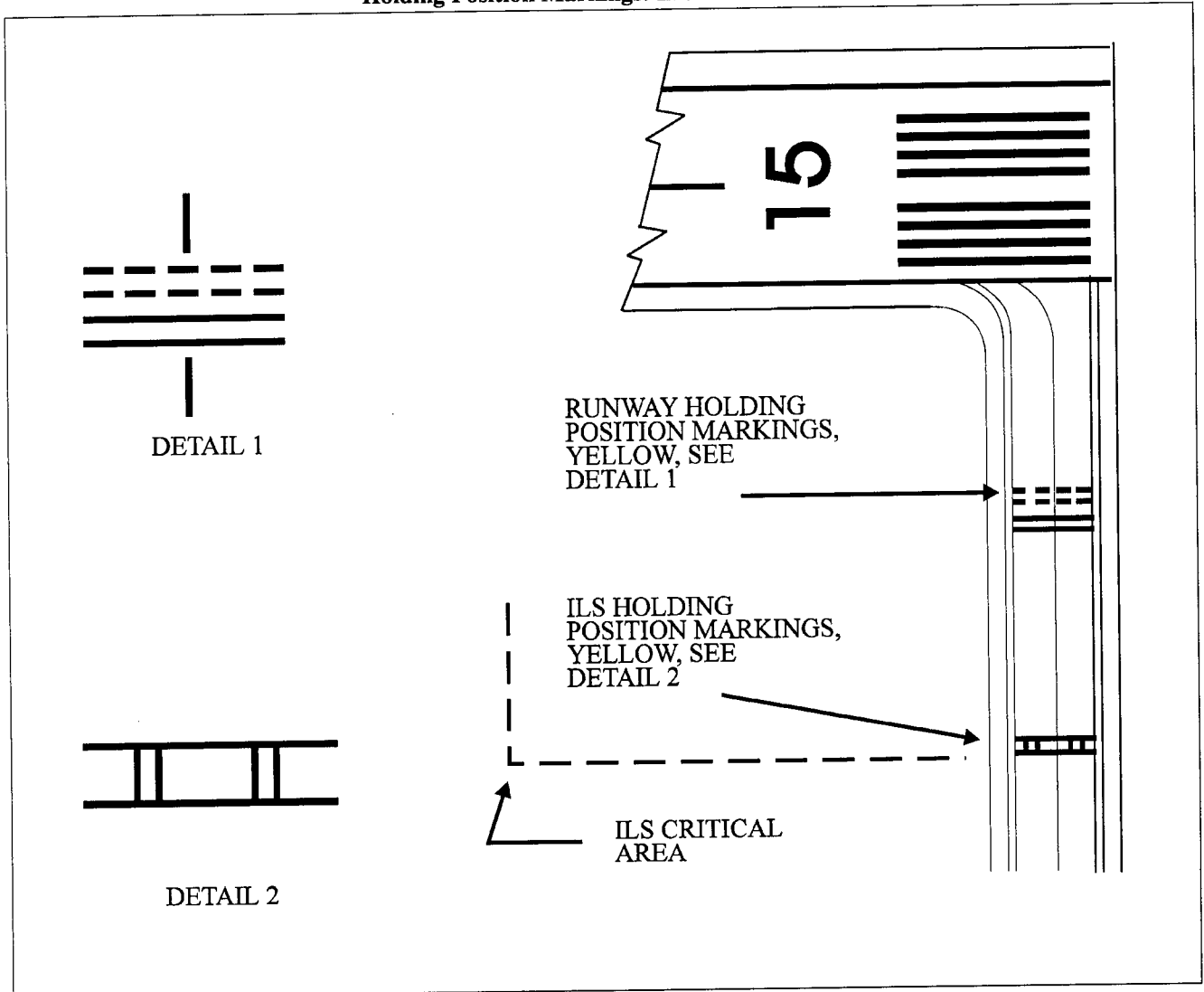

FIG 1.1-24

**20. Other Markings**

**20.1 Vehicle Roadway Markings:** The vehicle roadway markings are used when necessary to define a pathway for vehicle operations on or crossing areas that are also intended for aircraft. These markings consist of a

white solid line to delineate each edge of the roadway and a dashed line to separate lanes within the edges of the roadway. In lieu of the solid lines, zipper markings may be used to delineate the edges of the vehicle roadway. (See FIG 1.1-26.) Details of the zipper markings are shown in FIG 1.1-27.

**Holding Position Markings: Taxiway/Taxiway Intersections**

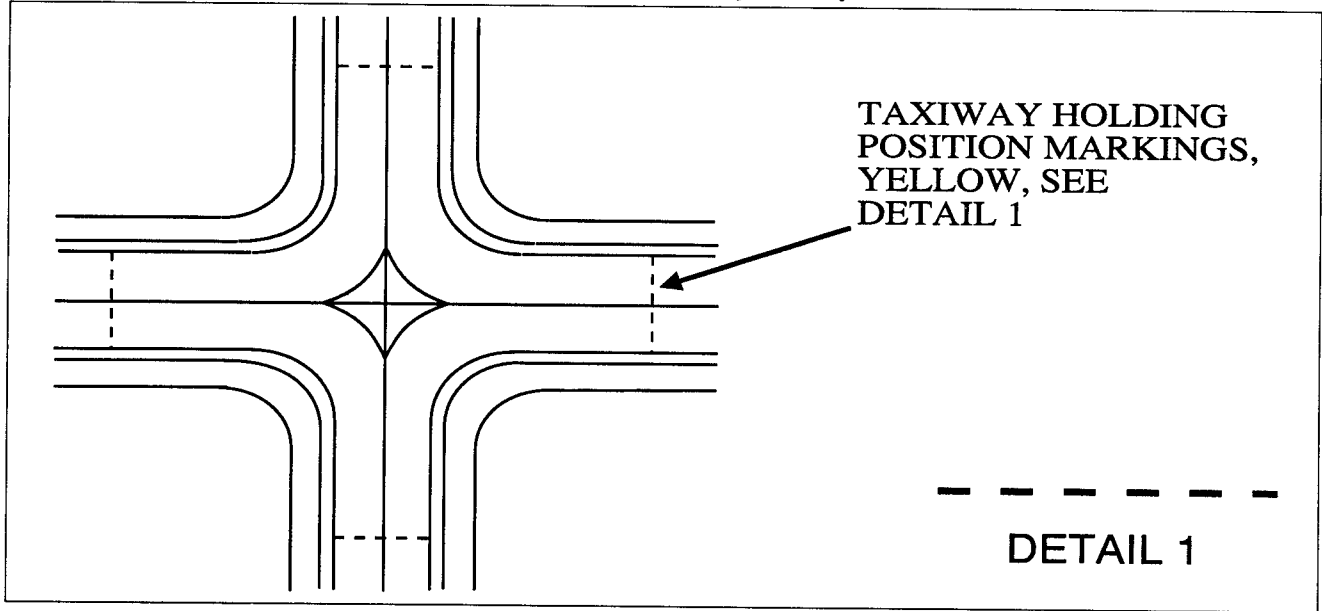

FIG 1.1-25

**Vehicle Roadway Markings**

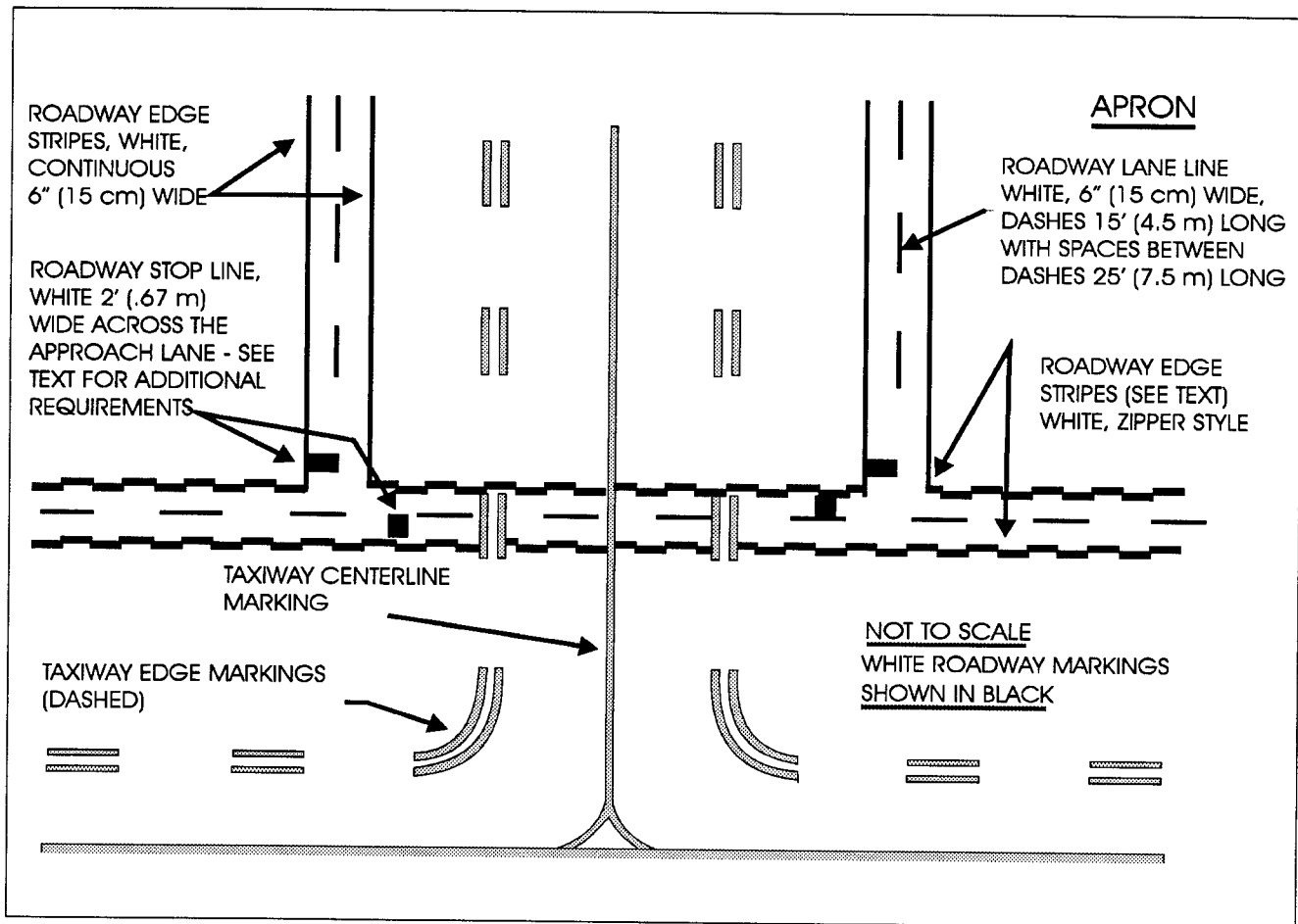

FIG 1.1-26

### Roadway Edge Stripes, White, Zipper Style

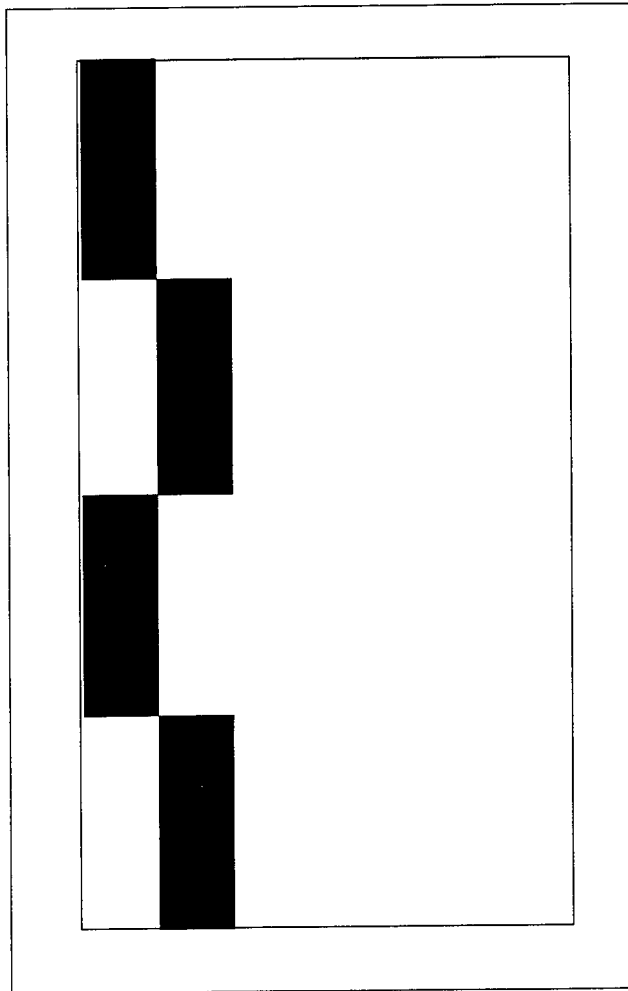

FIG 1.1-27

**20.2 VOR Receiver Checkpoint Markings:** The VOR receiver checkpoint marking allows the pilot to check aircraft instruments with navigational aid signals. It consists of a painted circle with an arrow in the middle; the arrow is aligned in the direction of the checkpoint azimuth. This marking, and an associated sign, is located on the airport apron or taxiway at a point selected for easy access by aircraft but where other airport traffic is not be unduly obstructed. (See FIG 1.1-28.)

**NOTE.—**  
THE ASSOCIATED SIGN CONTAINS THE VOR STATION IDENTIFICATION LETTER AND COURSE SELECTED (PUBLISHED) FOR THE CHECK, THE WORDS "VOR CHECK COURSE," AND DME DATA (WHEN APPLICABLE). THE COLOR OF THE LETTERS AND NUMERALS ARE BLACK ON A YELLOW BACKGROUND.

**EXAMPLE.— VOR SIGN**  
DCA 176-356  
VOR check course  
DME XXX

### Ground Receiver Checkpoint Markings

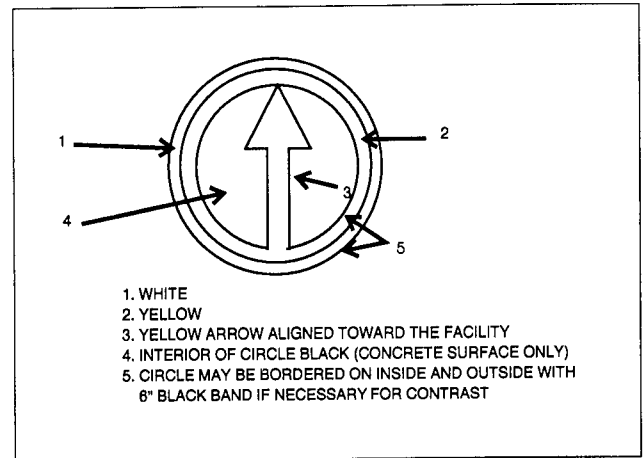

FIG 1.1-28

### Nonmovement Area Boundary Markings

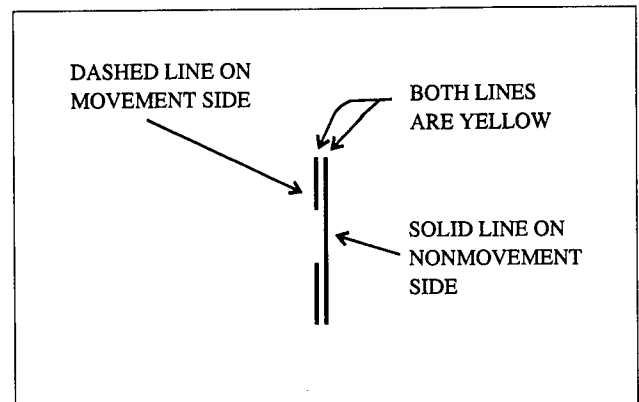

FIG 1.1-29

**20.3 Nonmovement Area Boundary Markings:** These markings delineate the movement area; i.e., area under air traffic control. These markings are yellow and located on the boundary between the movement and nonmovement area. The nonmovement area boundary markings consist of two yellow lines (one solid and one dashed) 6 inches (15cm) in width. The solid line is located on the nonmovement area side while the dashed yellow line is located on the movement area side. The nonmovement boundary marking area is shown in FIG 1.1-29.

**20.4 Marking and Lighting of Permanently Closed Runways and Taxiways:** For runways and taxiways which are permanently closed, the lighting circuits will be disconnected. The runway threshold, runway designation, and touchdown markings are obliterated and yellow crosses are placed at each end of the runway and at 1,000 foot intervals. (See FIG 1.1-30.)

**Closed or Temporarily Closed Runway and Taxiway Markings**

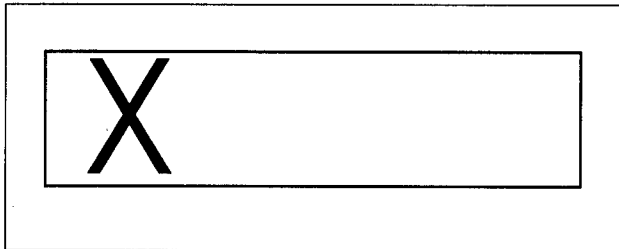

FIG 1.1-30

**20.5 Temporarily Closed Runways and Taxiways:** To provide a visual indication to pilots that a runway is temporarily closed, crosses are placed on the runway only at each end of the runway. The crosses are yellow in color. (See FIG 1.1-30.)

a) A raised lighted yellow cross may be placed on each runway end in lieu of the markings described in paragraph 20.4 to indicate the runway is closed.

b) A visual indication may not be present depending on the reason for the closure, duration of the closure, airfield configuration, and the existence and the hours of operation of an airport traffic control Tower. Pilots should check NOTAM's and the Automated Terminal Information System (ATIS) for local runway and taxiway closure information.

c) Temporarily closed taxiways are usually treated as hazardous areas, in which no part of an aircraft may enter, and are blocked with barricades. However, as an alternative a yellow cross may be installed at each entrance to the taxiway.

**20.6 Helicopter Landing Areas:** The markings illustrated in FIG 1.1-31 are used to identify the landing and takeoff area at a public use heliport and hospital heliport. The letter "H" in the markings is oriented to align with the intended direction of approach. FIG 1.1-31 also depicts the markings for a closed airport.

**20.7. Airport Signs:** There are six types of signs installed on airfields: mandatory instruction signs, location signs, direction signs, destination signs, information signs, and runway distance remaining signs. The characteristics and use of these signs are discussed below.

**REFERENCE-**  
ADVISORY CIRCULAR-150/5340-18, STANDARDS FOR AIRPORT SIGN SYSTEMS.

**21. Mandatory Instruction Signs**

**21.1 These signs have a red background with a white inscription and are used to denote:**

- a) An entrance to a runway or critical area
- b) Land and Hold Short Operations (LAHSO) hold-position signs on runways:
  - Hold short of Intersecting Runway
  - Hold short of Intersecting Taxiway
  - Hold short of a Point
- c) Areas where an aircraft is prohibited from entering.

**Helicopter Landing Areas**

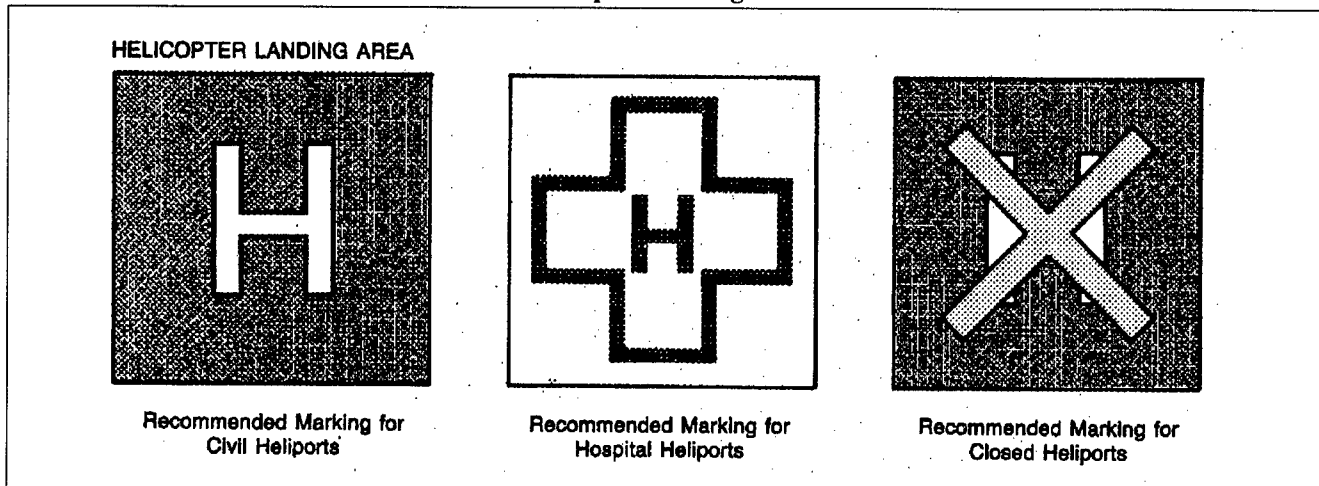

FIG 1.1-31



Runway Holding Position Sign

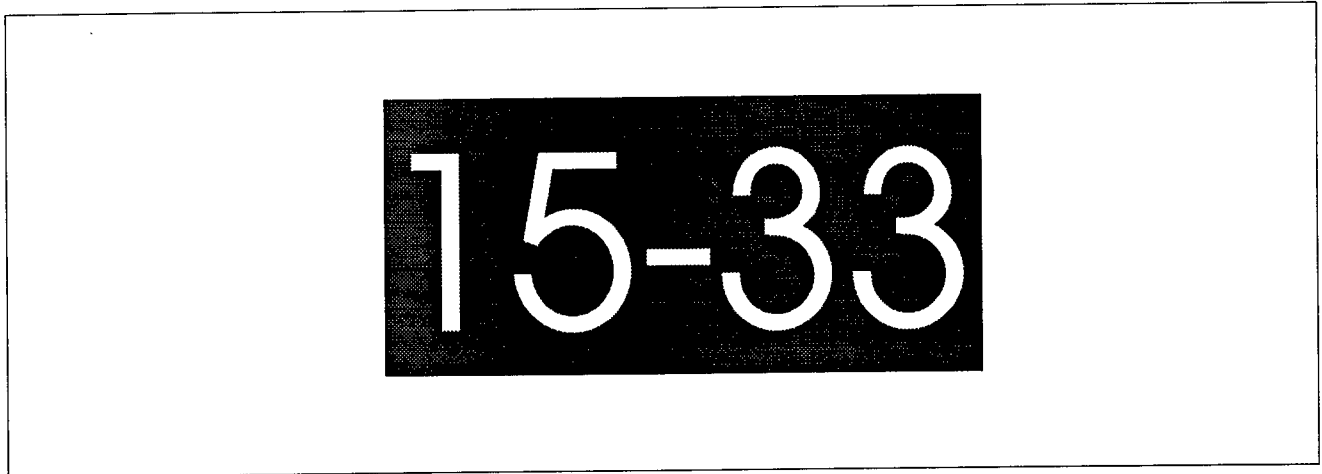

FIG 1.1-32

Holding Position Sign at Beginning of Takeoff Runway

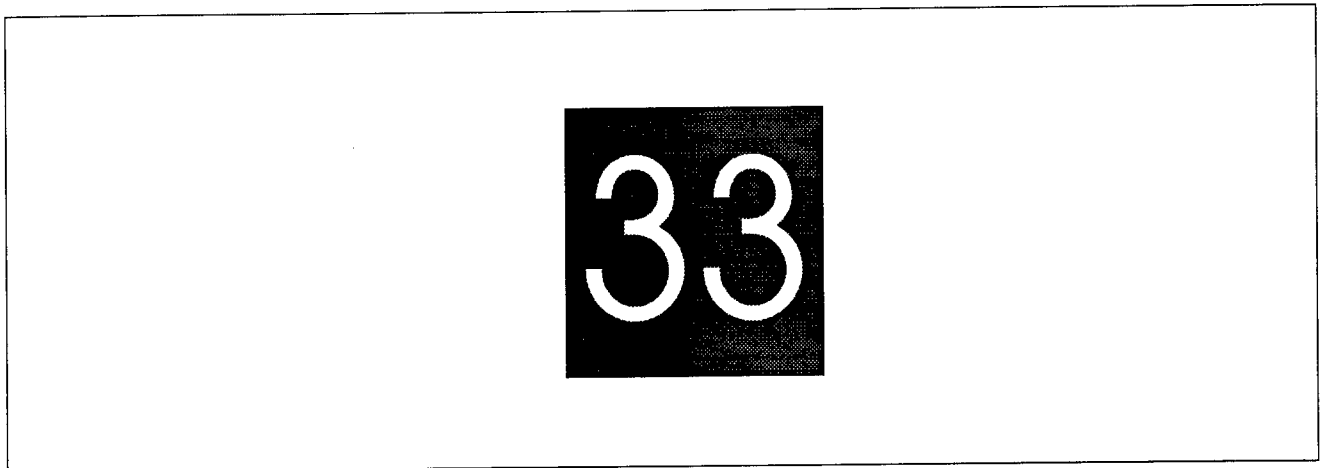

FIG 1.1-33

21.2 Typical mandatory signs and applications are:

a) **Runway Holding Position Sign:** This sign is located at the holding position on taxiways that intersect a runway or on runways that intersect other runways. The inscription on the sign contains the designation of the intersecting runway as shown in FIG 1.1-32. The runway numbers on the sign are arranged to correspond to the respective runway threshold. For example, "15-33" indicates that the threshold for Runway 15 is to the left and the threshold for Runway 33 is to the right.

1) On taxiways that intersect the beginning of the takeoff runway, only the designation of the takeoff runway may appear on the sign as shown in FIG 1.1-33, while all other signs will have the designation of both runway directions.

2) If the sign is located on a taxiway that intersects the intersection of two runways, the designations for both runways will be shown on the sign along with arrows showing the approximate alignment of each runway as shown in FIG 1.1-34. In addition to showing the approximate runway alignment, the arrow indicates the direction to the threshold of the runway whose designation is immediately next to the arrow.

3) Land and Hold Short Operations (LAHSO) include landing and holding short of an intersecting runway, taxiway, or a designated point on the runway. LAHSO signs are mandatory signs when Air Traffic Control is operating under LAHSO. The holding position markings will be located on the runway pavement adjacent to the signs. Holding position markings are described in paragraph 19.

4) A runway holding position sign(s) will be installed on a runway that is normally used as a taxiway, adjacent to the holding position markings.

5) A runway holding position sign on a taxiway will be installed adjacent to holding position markings.

**b) Runway Approach Area Holding Position Sign:** At some airports, it is necessary to hold an aircraft on a taxiway located in the approach or departure area for a runway so that the aircraft does not interfere with operations on that runway. In these situations a sign with the designation of the approach end of the runway followed by a "dash" (-) and letters "APCH" will be located at the holding position on the taxiway. Holding position markings in accordance with paragraph 20 will

be located on the taxiway pavement. An example of this sign is shown in FIG 1.1-35. In this example, the sign may protect the approach to Runway 15 and/or the departure for Runway 33.

**c) ILS Critical Area Holding Position Sign:** At some airports, when the instrument landing system is being used, it is necessary to hold an aircraft on a taxiway at a location other than the holding position described in paragraph 19, Holding Position Markings. In these situations the holding position sign for these operations will have the inscription "ILS" and be located adjacent to the holding position marking on the taxiway described in paragraph 19. An example of this sign is shown in FIG 1.1-36.

**Holding Position Sign for a Taxiway that Intersects the Intersection of Two Runways**

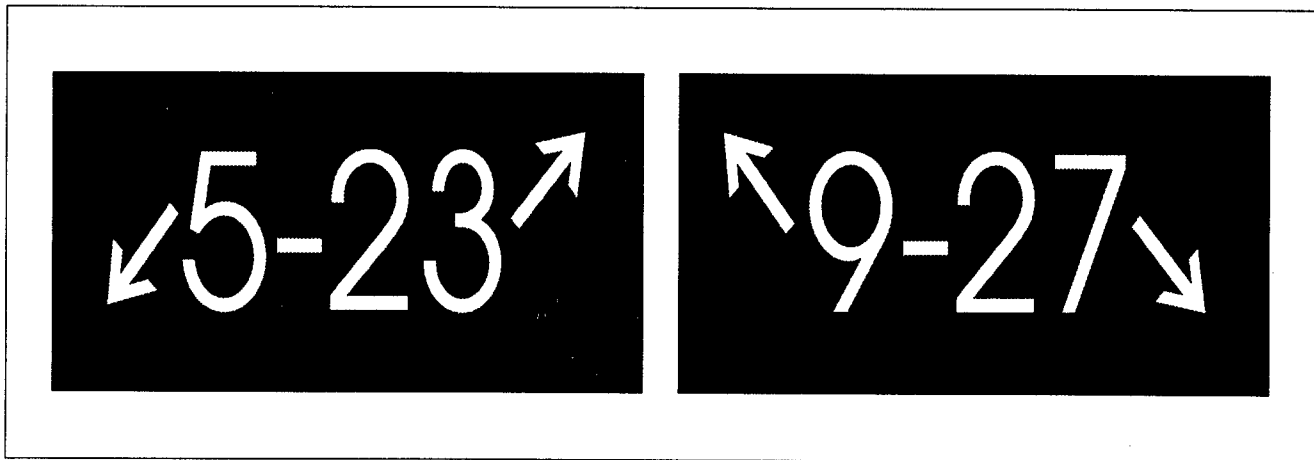

FIG 1.1-34

**Holding Position Sign for a Runway Approach Area**

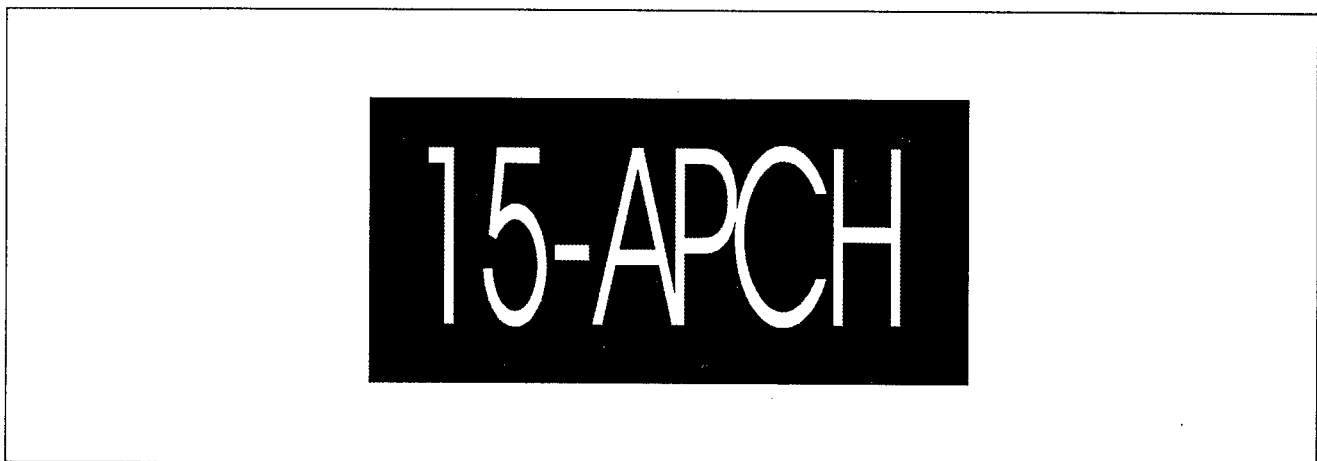

FIG 1.1-35

**Holding Position Sign for ILS Critical Area**

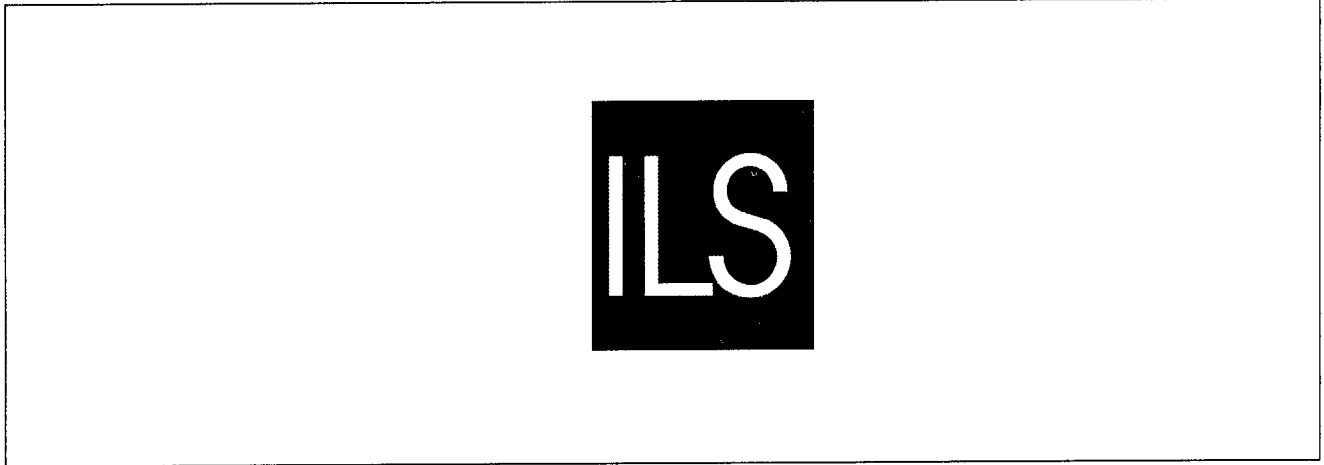

FIG 1.1-36

**Sign Prohibiting Aircraft Entry into an Area**

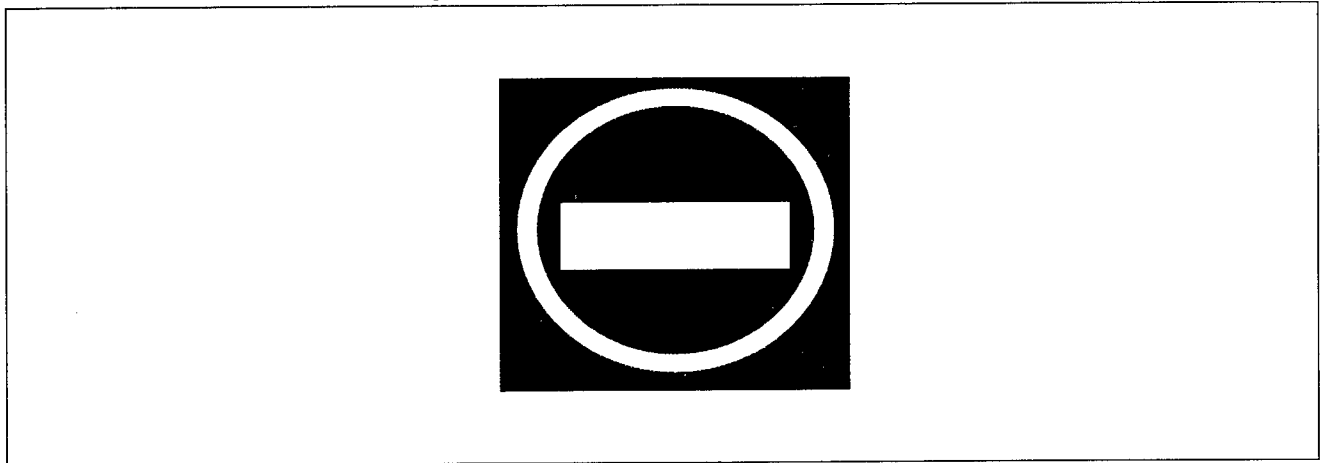

FIG 1.1-37

**d) No Entry Sign:** This sign, shown in FIG 1.1-37, prohibits an aircraft from entering an area. Typically, this sign would be located on a taxiway intended to be used in only one direction or at the intersection of vehicle roadways with runways, taxiways or aprons where the roadway may be mistaken as a taxiway or other aircraft movement surface.

*NOTE.—  
THE HOLDING POSITION SIGN PROVIDES THE PILOT WITH A VISUAL CUE AS TO THE LOCATION OF THE HOLDING POSITION MARKING. THE OPERATIONAL SIGNIFICANCE OF HOLDING POSITION MARKINGS ARE DESCRIBED IN PARAGRAPH 19.*

**22. Location Signs**

Location signs are used to identify either a taxiway or runway on which the aircraft is located. Other location signs provide a visual cue to pilots to assist them in determining when they have exited an area. The various location signs are described below.

**a) Taxiway Location Sign:** This sign has a black background with a yellow inscription and yellow border as shown in FIG 1.1-38. The inscription is the designation of the taxiway on which the aircraft is located. These signs are installed along taxiways either by themselves or in conjunction with direction signs (See FIG 1.1-43 or FIG 1.1-39).

**Taxiway Location Sign**

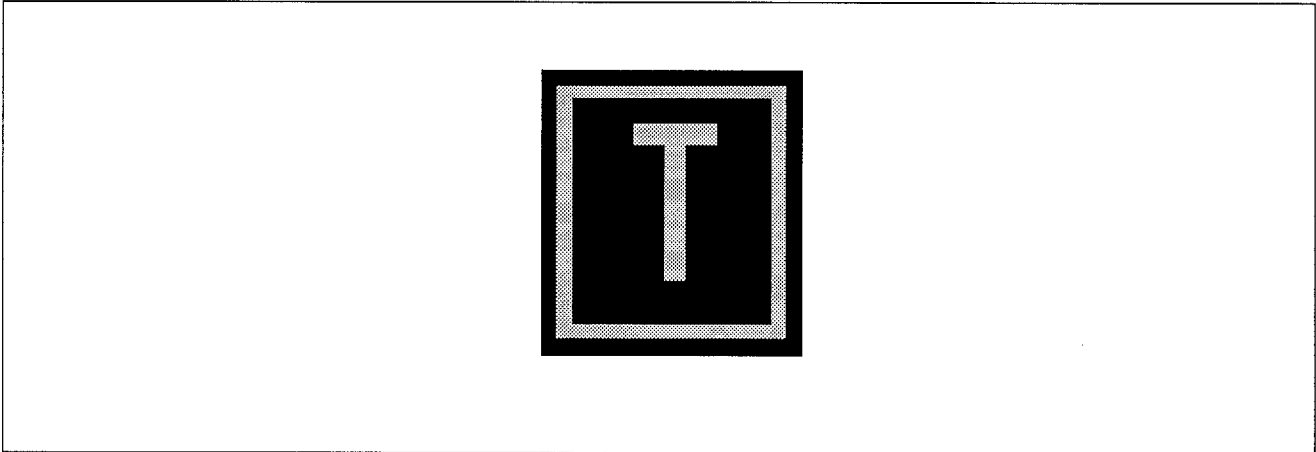

FIG 1.1-38

**Taxiway Location Sign Collocated with Runway Holding Position Sign**

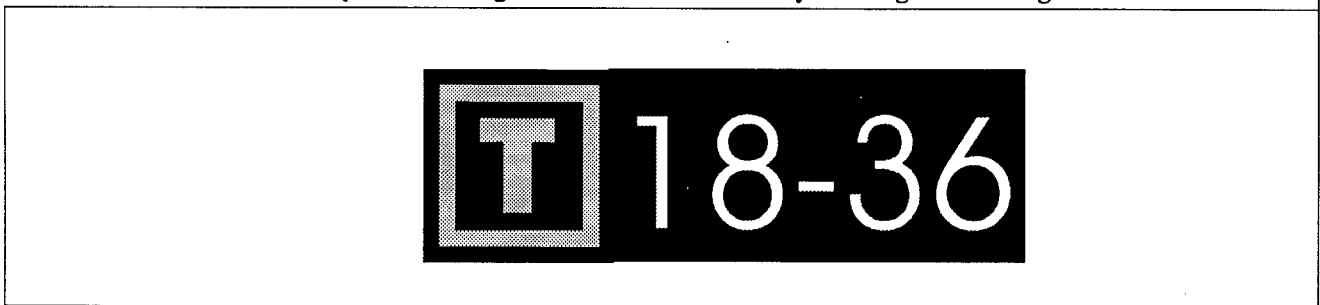

FIG 1.1-39

**Runway Location Sign**

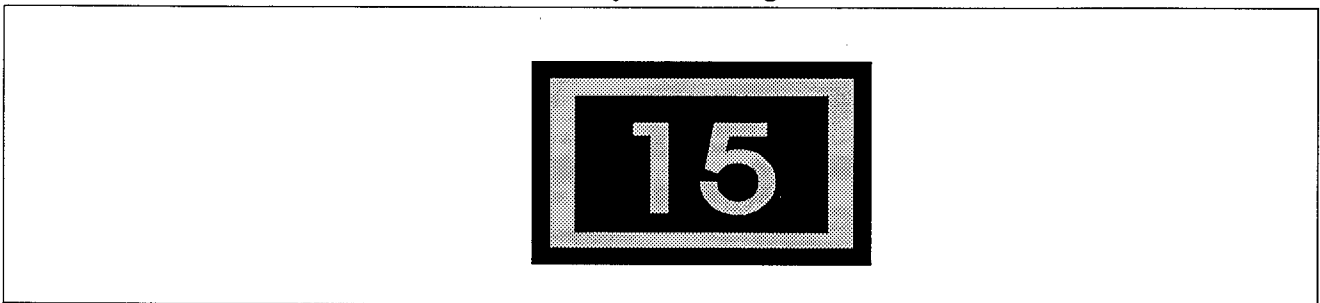

FIG 1.1-40

**b) Runway Location Sign:** This sign has a black background with a yellow inscription and yellow border as shown in FIG 1.1-40. The inscription is the designation of the runway on which the aircraft is located. These signs are intended to complement the information available to pilots through their magnetic compass and typically are installed where the proximity of two or more runways to one another could cause pilots to be confused as to which runway they are on.

**c) Runway Boundary Sign:** This sign has a yellow background with a black inscription with a graphic depicting the pavement holding position marking as shown in FIG 1.1-41. This sign, which faces the runway and is visible to the pilot exiting the runway, is located adjacent to the holding position marking on the pavement. The sign is intended to provide pilots with another visual cue which they can use as a guide in deciding when they are “clear of the runway.”

d) **ILS Critical Area Boundary Sign:** This sign has a yellow background with a black inscription with a graphic depicting the ILS pavement holding position marking as shown in FIG 1.1-42. This sign is located adjacent to the ILS holding position marking on the

pavement and can be seen by pilots leaving the critical area. The sign is intended to provide pilots with another visual cue which they can use as a guide in deciding when they are "clear of the ILS critical area."

**Runway Boundary Sign**

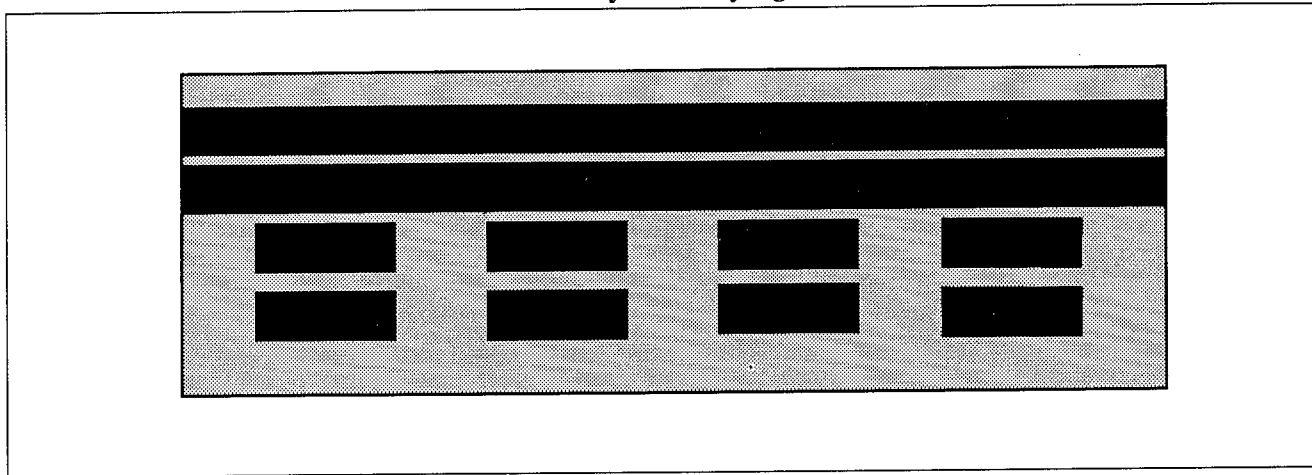

FIG 1.1-41

**ILS Critical Area Boundary Sign**

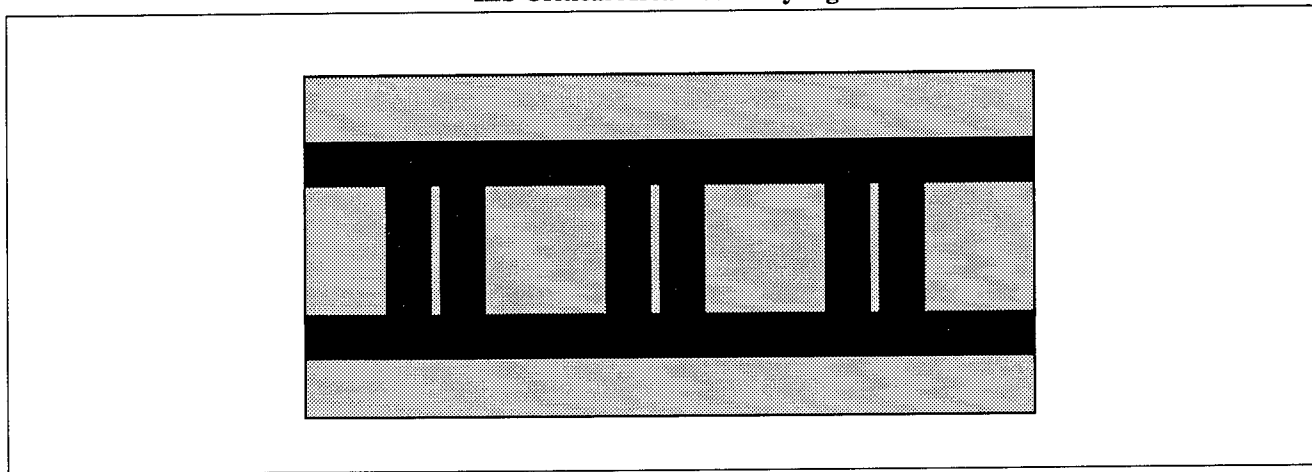

FIG 1.1-42

### 23. Direction Signs

**23.1** Direction signs have a yellow background with a black inscription. The inscription identifies the designation(s) of the intersecting taxiway(s) leading out of intersection that a pilot would normally be expected to turn onto or hold short of. Each designation is accompanied by an arrow indicating the direction of the turn.

**23.2** Except as noted in subparagraph 23.5, each taxiway designation shown on the sign is accompanied by only one arrow. When more than one taxiway designation is shown on the sign, each designation and its associated arrow is separated from the other taxiway designations by either a vertical message divider or a taxiway location sign as shown in FIG 1.1-43.

**23.3** Direction signs are normally located on the left prior to the intersection. When used on a runway to indicate an exit, the sign is located on the same side of the

runway as the exit. FIG 1.1-44 shows a direction sign used to indicate a runway exit.

**23.4** The taxiway designations and their associated arrows on the sign are arranged clockwise starting from the first taxiway on the pilot's left. (See FIG 1.1-43.)

**23.5** If a location sign is located with the direction signs, it is placed so that the designations for all turns to the left will be to the left of the location sign; the designations for continuing straight ahead or for all turns to the right would be located to the right of the location sign. (See FIG 1.1-43.)

**23.6** When the intersection is comprised of only one crossing taxiway, it is permissible to have two arrows associated with the crossing taxiway as shown in FIG 1.1-45. In this case, the location sign is located to the left of the direction sign.

Direction Sign Array with Location Sign on Far Side of Intersection

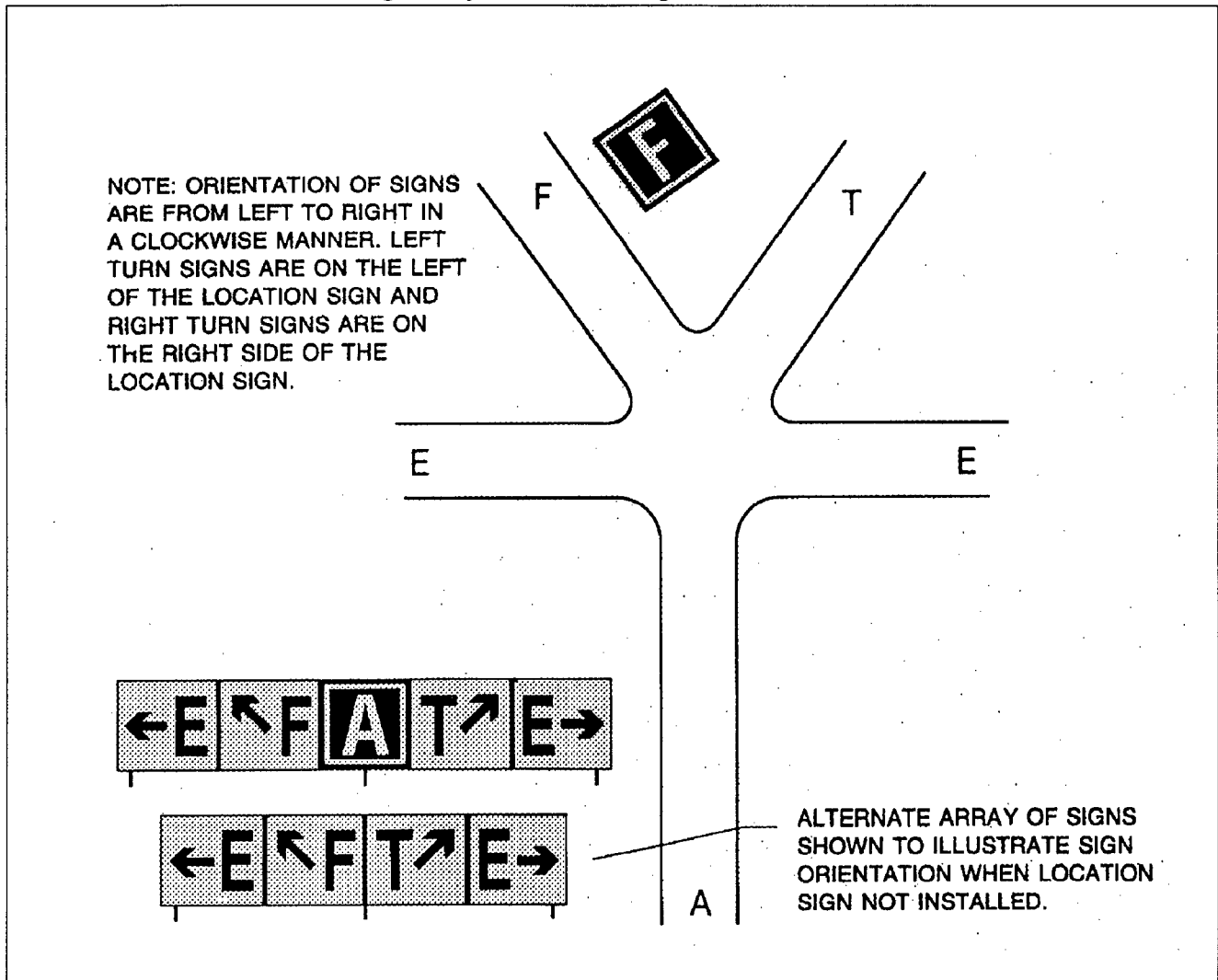

FIG 1.1-43

Direction Sign for Runway Exit

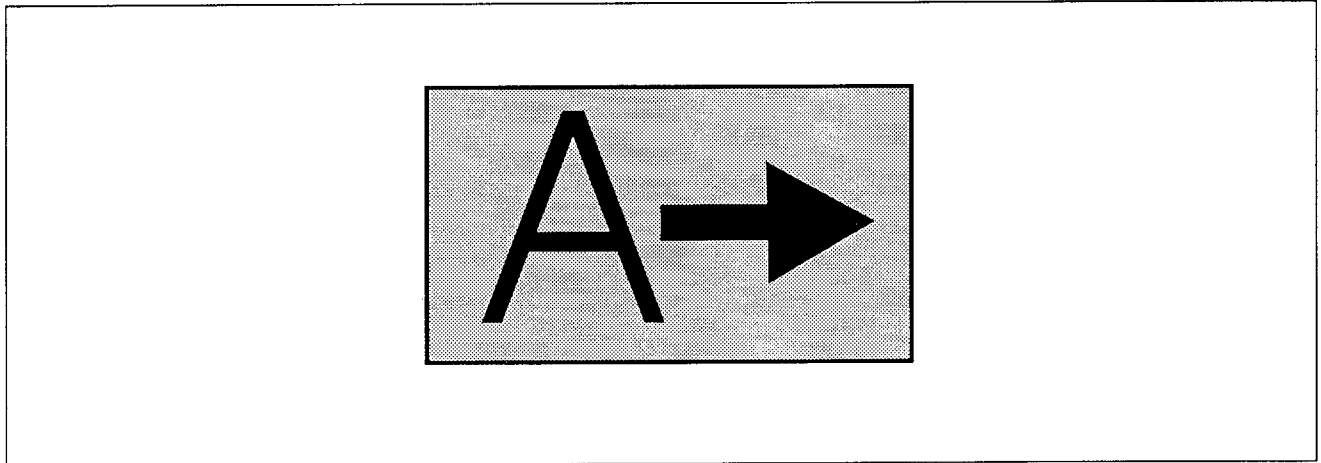

FIG 1.1-44

Direction Sign Array for Simple Intersection

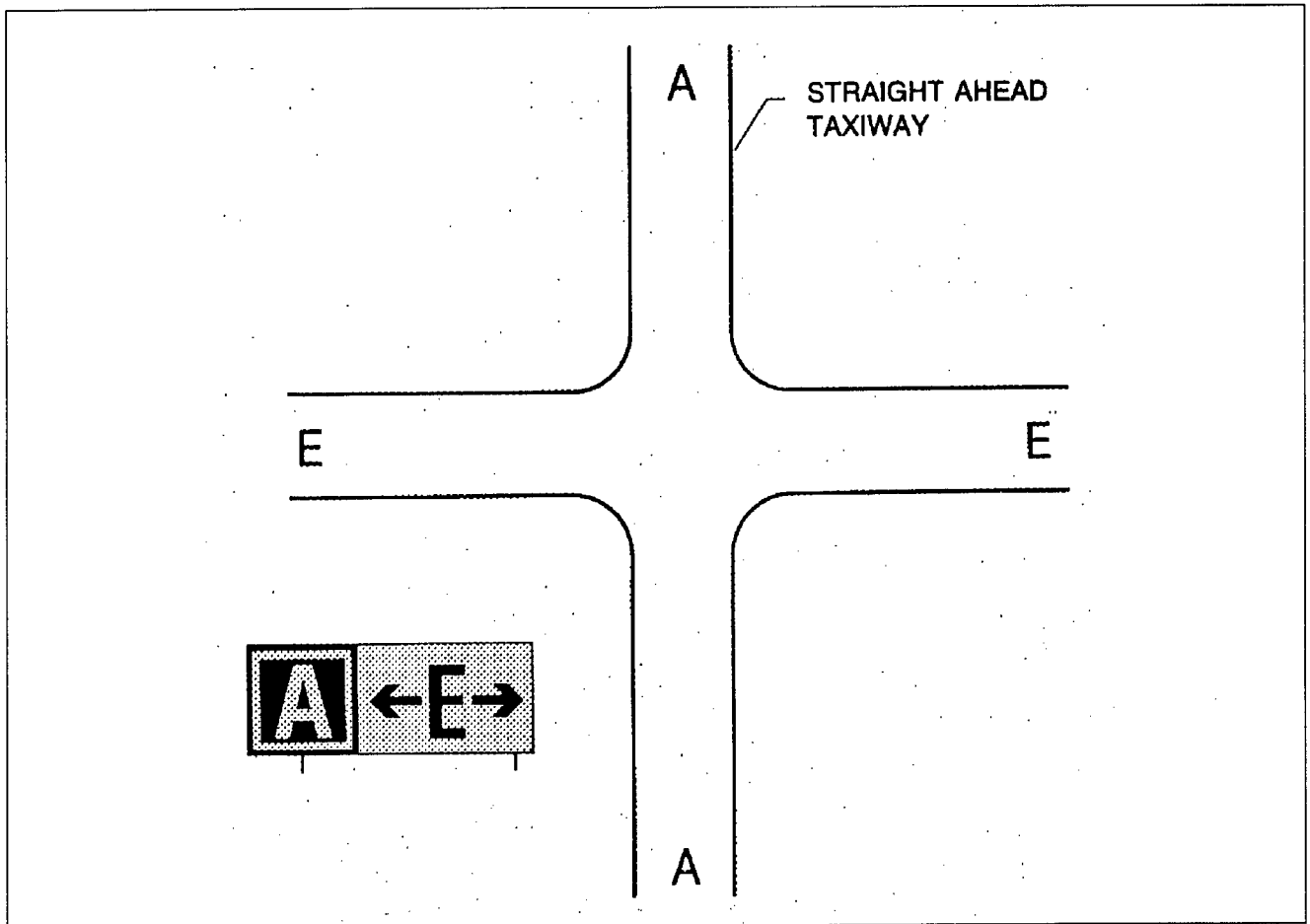

FIG 1.1-45

## 24. Destination Signs

**24.1** Destination signs also have a yellow background with a black inscription indicating a destination on the airport. These signs always have an arrow showing the direction of the taxiing route to that destination. FIG 1.1-46 is an example of a typical destination sign. When the arrow on the destination sign indicates a turn, the sign is located prior to the intersection.

**24.2** Destinations commonly shown on these types of signs include runways, aprons, terminals, military areas, civil aviation areas, cargo areas, international

areas, and fixed base operators. An abbreviation may be used as the inscription on the sign for some of these destinations.

**24.3** When the inscription for two or more destinations having a common taxiing route are placed on a sign, the destinations are separated by a "dot" (●) and one arrow would be used as shown in FIG 1.1-47. When the inscription on a sign contains two or more destinations having different taxiing routes, each destination will be accompanied by an arrow and will be separated from the other destinations on the sign with a vertical black message divider as shown in FIG 1.1-48.

Destination Sign for Military Area

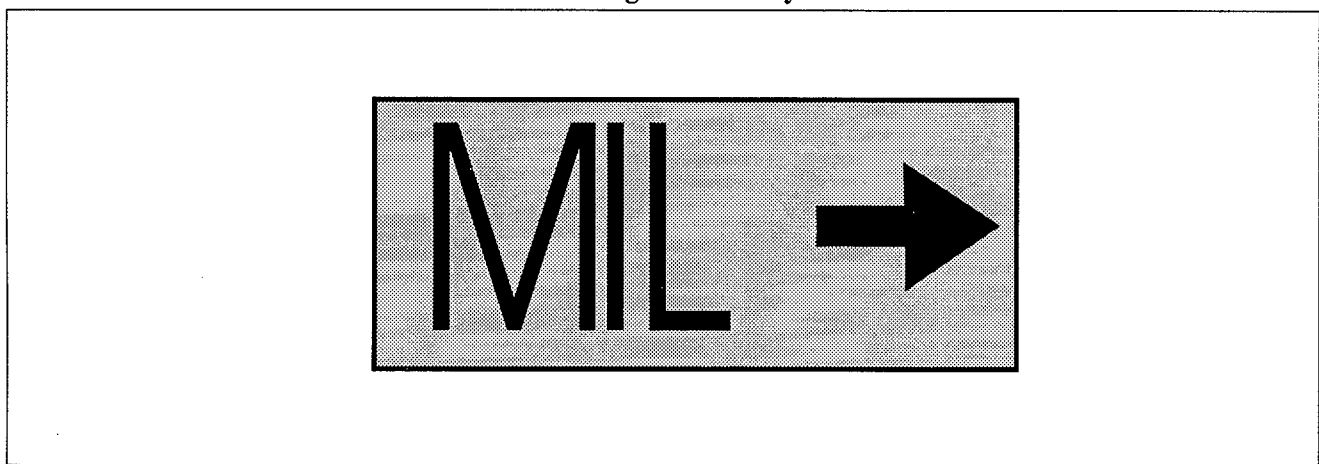

FIG 1.1-46

Destination Sign for Common Taxiing Route to Two Runways

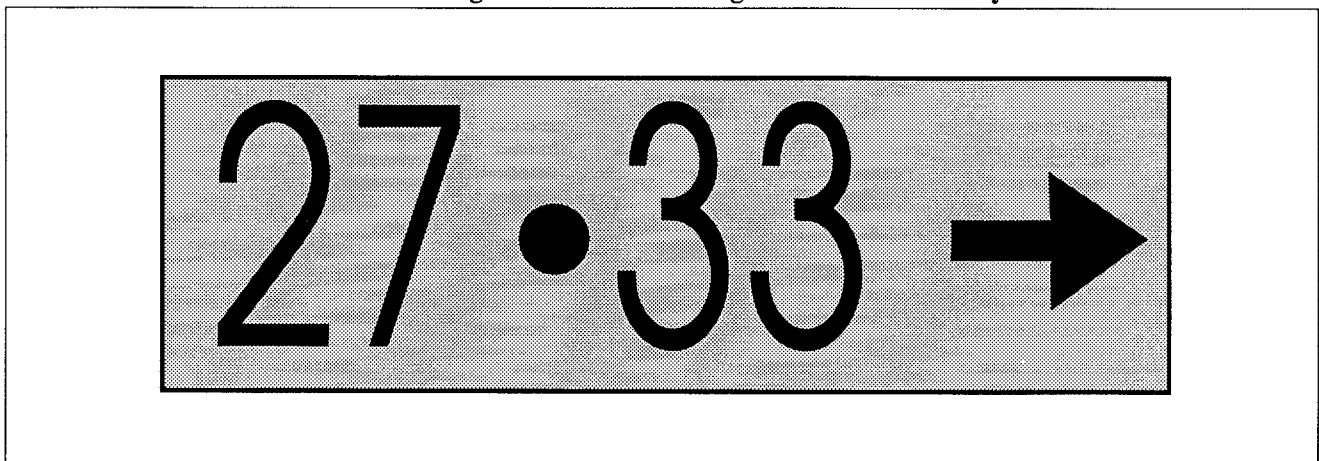

FIG 1.1-47



Destination Sign for Different Taxiing Routes to Two Runways

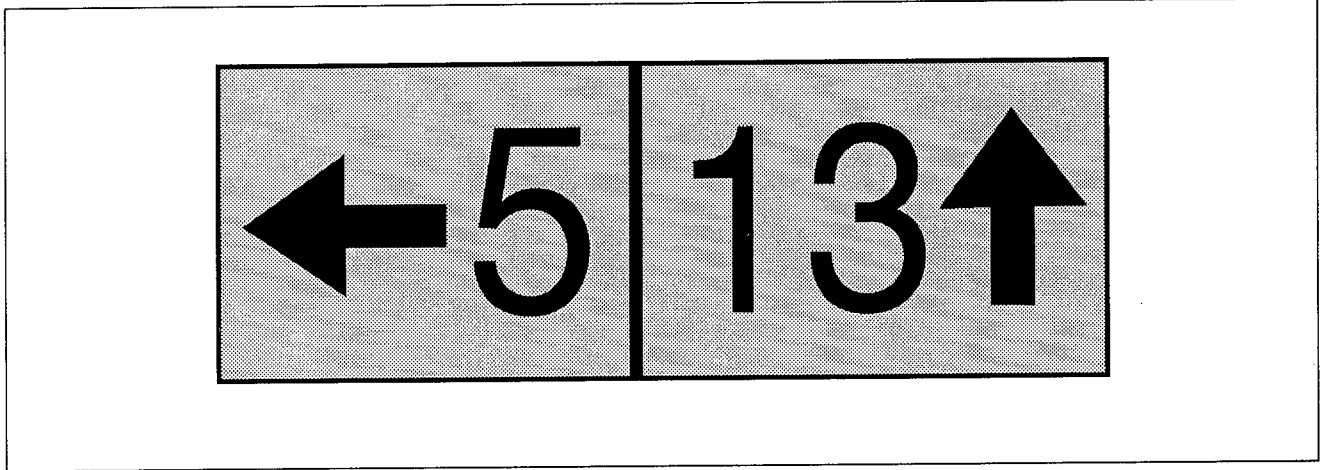

FIG 1.1-48

**25. Information Signs:** Information signs have a yellow background with a black inscription. They are used to provide the pilot with information on such things as areas that cannot be seen from the control tower, applicable radio frequencies, and noise abatement procedures. The airport operator determines the need, size, and location for these signs.

**26. Runway Distance Remaining Signs:** Runway distance remaining signs have a black background with a white numeral inscription and may be installed along one or both side(s) of the runway. The number on the signs indicates the distance (in thousands of feet) of landing runway remaining. The last sign; i.e., the sign with the numeral "1," will be located at least 950 feet from the runway end. FIG 1.1-49 shows an example of a runway distance remaining sign.

Runway Distance Remaining Sign Indicating 3,000 feet of Runway Remaining



FIG 1.1-49

## 27. Aircraft Arresting Devices

**27.1** Aircraft arresting systems are devices that use an energy absorber to decrease the speed and landing roll-out of an aircraft. These systems are located primarily at military or joint use airports, but are installed at some civilian airports. The Airport/Facility Directory and/or current NOTAM's will describe the system in place and its precise location and status.

**27.2** The aircraft arresting systems use cables stretched and raised across the runway, or cables that are raised out of slots in the runway to allow the aircraft to engage the energy absorber either through a tail hook, or a barrier device that engages the landing undercarriage of the aircraft. Details are contained in FAA Advisory Circular 150/5220-9, Aircraft Arresting Systems for Joint Civil/Military Airports.

**NOTE.—**  
*AIRCRAFT OPERATIONS ON THE RUNWAYS ARE NOT RESTRICTED BY SUCH INSTALLATIONS.*

## AD 2. AERODROMES

1. The following is a partial list of U.S. airports designated to serve international operations. This list contains U.S. airports with scheduled passenger service in large aircraft and certain airports designated as alternate service airports. Omitted from this list are designated general aviation airports, airports with scheduled cargo but no scheduled passenger service, and certain airports having international service in commuter-type aircraft.

ICAO ID	LOCATION	AIRPORT NAME	DESIGNATION
<b>Alaska</b>			
PANC	Anchorage	Anchorage International	Regular
PAED	Anchorage	Elmendorf AFB	Alternate
PACD	Cold Bay	Cold Bay	Alternate
PAEI	Fairbanks	Eielson AFB	Alternate
PAFA	Fairbanks	Fairbanks International	Regular
PAJN	Juneau	Juneau International	Regular
PAKN	King Salmon	King Salmon	Alternate
<b>American Samoa</b>			
NSTU	Pago Pago	Pago Pago International	Regular
<b>Arizona</b>			
KPHX	Phoenix	Phoenix Sky Harbor International	Regular
KTUS	Tucson	Tucson International	Regular
<b>California</b>			
KFAT	Fresno	Fresno Yosemite International	Alternate
KLAX	Los Angeles	Los Angeles International	Regular
KOAK	Oakland	Metropolitan Oakland International	Regular
KONT	Ontario	Ontario International	Alternate
KPMD	Palmdale	Palmdale Production Flight/Test Installation AF Plant #42	Alternate
KSMF	Sacramento	Sacramento International	Alternate
KSAN	San Diego	San Diego International-Lindbergh Field	Regular
KSFO	San Francisco	San Francisco International	Regular
KSJC	San Jose	San Jose International	Regular
KSCK	Stockton	Stockton Metropolitan	Alternate
<b>Colorado</b>			
KDEN	Denver	Denver International	Regular
KPUB	Pueblo	Pueblo Memorial	Alternate
<b>Connecticut</b>			
KBDL	Windsor Locks	Bradley International	Regular
<b>District of Columbia</b>			
KIAD	Washington	Washington Dulles International	Regular

<b>Florida</b>			
KFLL	Fort Lauderdale	Fort Lauderdale/Hollywood International	Regular
KRSW	Fort Myers	Southwest Florida International	Regular
KMIA	Miami	Miami International	Regular
KMCO	Orlando	Orlando International	Regular
KTPA	Tampa	Tampa International	Regular
KPBI	West Palm Beach	Palm Beach International	Regular
<b>Georgia</b>			
KATL	Atlanta	The William B. Hartsfield Atlanta International	Regular
<b>Guam</b>			
PGUM	Agana	Guam International	Regular
PGUA	Guam Island	Andersen AFB	Alternate
<b>Hawaii</b>			
PHNA	Ewa, Oahu Island	Barbers Point Naval Air Station	Alternate
PHTO	Hilo	Hilo International	Alternate
PHNL	Honolulu	Honolulu International	Regular
PHOG	Kahului	Kahului	Regular
<b>Illinois</b>			
KORD	Chicago	Chicago-O'Hare International	Regular
<b>Indiana</b>			
KIND	Indianapolis	Indianapolis International	Regular
<b>Johnston Island</b>			
PJON	Johnston Island	Johnston Atoll	Regular
<b>Kansas</b>			
KICT	Wichita	Wichita Mid-Continent	Alternate
<b>Kentucky</b>			
KCVG	Covington	Cincinnati/Northern Kentucky International	Regular
<b>Louisiana</b>			
KMSY	New Orleans	New Orleans International (Moisant Field)	Regular
<b>Maine</b>			
KBGR	Bangor	Bangor International	Alternate
<b>Maryland</b>			
KBWI	Baltimore	Baltimore-Washington International	Regular
<b>Massachusetts</b>			
KBOS	Boston	General Edward Lawrence Logan International	Regular
<b>Michigan</b>			
KDTW	Detroit	Detroit Metropolitan Wayne County	Regular
<b>Minnesota</b>			
KMSP	Minneapolis	Minneapolis-St. Paul International (Wold-Chamberlain)	Regular

<b>Missouri</b>			
KMCI	Kansas City	Kansas City International	Regular
KSTL	St. Louis	Lambert-St. Louis International	Regular
<b>Nevada</b>			
KLAS	Las Vegas	McCarran International	Regular
KRNO	Reno	Reno/Tahoe International	Regular
<b>New Jersey</b>			
KEWR	Newark	Newark International	Regular
<b>New York</b>			
KJFK	New York	John F. Kennedy International	Regular
KIAG	Niagara Falls	Niagara Falls International	Alternate
KSYR	Syracuse	Syracuse Hancock International	Regular
<b>North Carolina</b>			
KCLT	Charlotte	Charlotte/Douglas International	Regular
KRDU	Raleigh-Durham	Raleigh-Durham International	Regular
<b>North Mariana Islands</b>			
PGSN	Saipan Island	Saipan International	Regular
<b>Ohio</b>			
KCLE	Cleveland	Cleveland-Hopkins International	Regular
KCMH	Columbus	Port Columbus International	Regular
<b>Oregon</b>			
KPDX	Portland	Portland International	Regular
<b>Palau Island</b>			
PTRO	Babelthuap Island	Babelthuap/Koror	Regular
<b>Pennsylvania</b>			
KPHL	Philadelphia	Philadelphia International	Regular
KPIT	Pittsburgh	Pittsburgh International	Regular
<b>Puerto Rico</b>			
TJMZ	Mayaguez	Eugenio Maria De Hostos	Regular
TJSJ	San Juan	Luis Munoz Marin International	Regular
<b>Tennessee</b>			
KMEM	Memphis	Memphis International	Regular
KBNA	Nashville	Nashville International	Regular

<b>Texas</b>			
KDFW	Dallas	Dallas-Fort Worth International	Regular
KELP	El Paso	El Paso International	Regular
KIAH	Houston	George Bush Intercontinental/Houston	Regular
KLRD	Laredo	Laredo International	Regular
KSAT	San Antonio	San Antonio International	Regular
<b>Utah</b>			
KSLC	Salt Lake City	Salt Lake City International	Regular
<b>Virgin Islands</b>			
TIST	Charlotte Amalie St. Thomas	Cyril E. King	Regular
TISX	Christiansted St. Croix	Henry E Rohlsen	Regular
<b>Washington</b>			
KPAE	Everett	Snohomish County (Paine Field)	Alternate
KSEA	Seattle	Seattle-Tacoma International	Regular
KGEG	Spokane	Spokane International	Alternate
<b>Wisconsin</b>			
KMKE	Milwaukee	General Mitchell International	Regular

1.1 Diagrams of these airports, arranged alphabetically by state and in the order listed above, are on the pages following. These diagrams are current as of 8 Oct 98. The most up-to-date diagrams of these and other U.S. airports are in the Terminal Procedures Publication (TPP). For additional information on these airports, see the U.S. Airport/Facility Directory (A/FD).

1.2 Both the A/FD and TPP may be purchased from:  
NOAA Distribution Branch, N/CG33,  
National Ocean Service,  
Riverdale, MD 20737-1199,  
Phone: 301-436-6990,  
Fax: 301-436-6829.

1.3 The U.S. is in the process of converting airport data to the AIP ICAO format. Information on U.S. airports will be added to this section of the AIP as it becomes available.

Anchorage, Alaska  
Anchorage International  
ICAO Identifier PANC

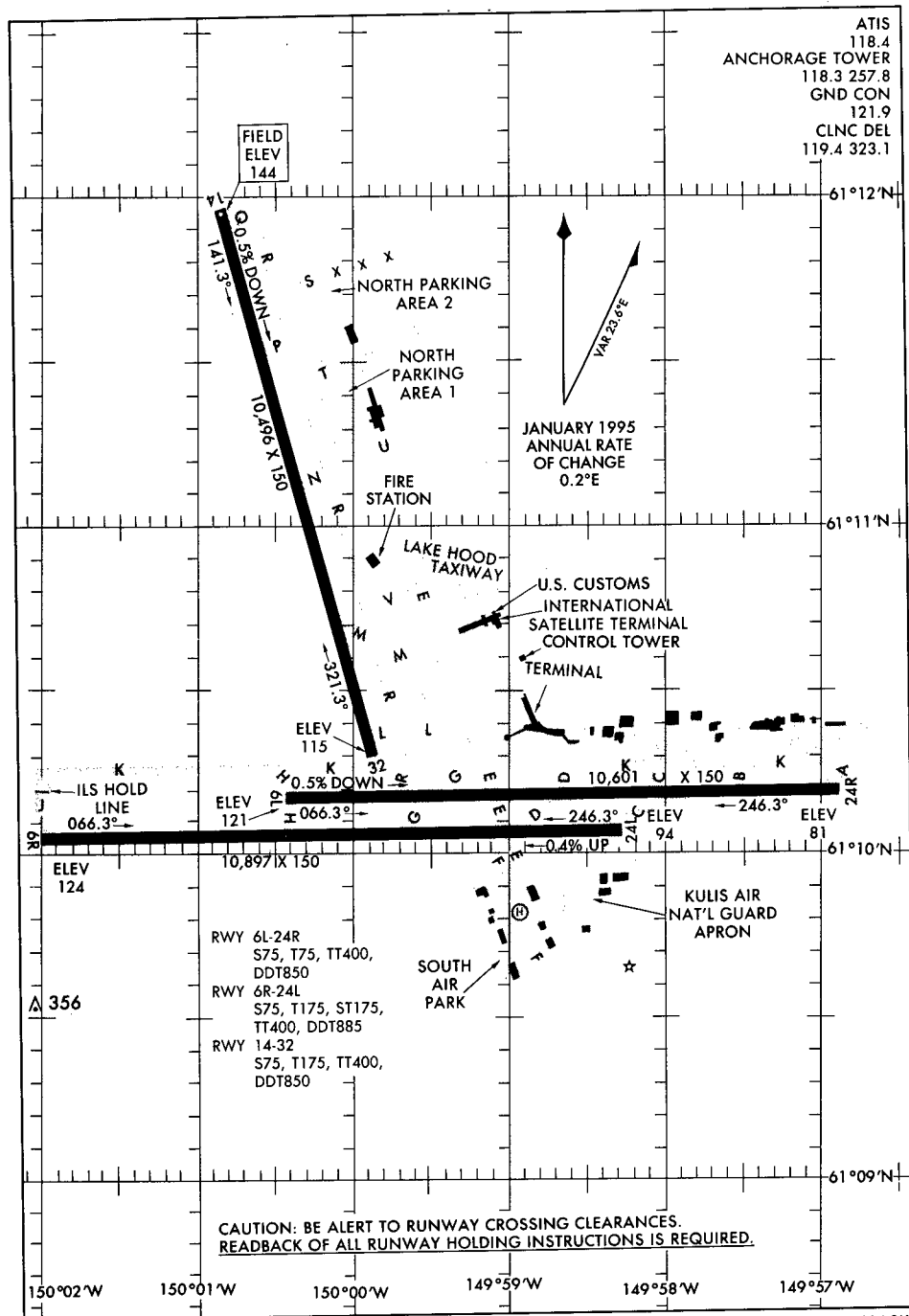

AIRPORT DIAGRAM

ANCHORAGE, ALASKA  
ANCHORAGE INTL (ANC)

98281

Anchorage, Alaska  
Elmendorf AFB  
ICAO Identifier PAED

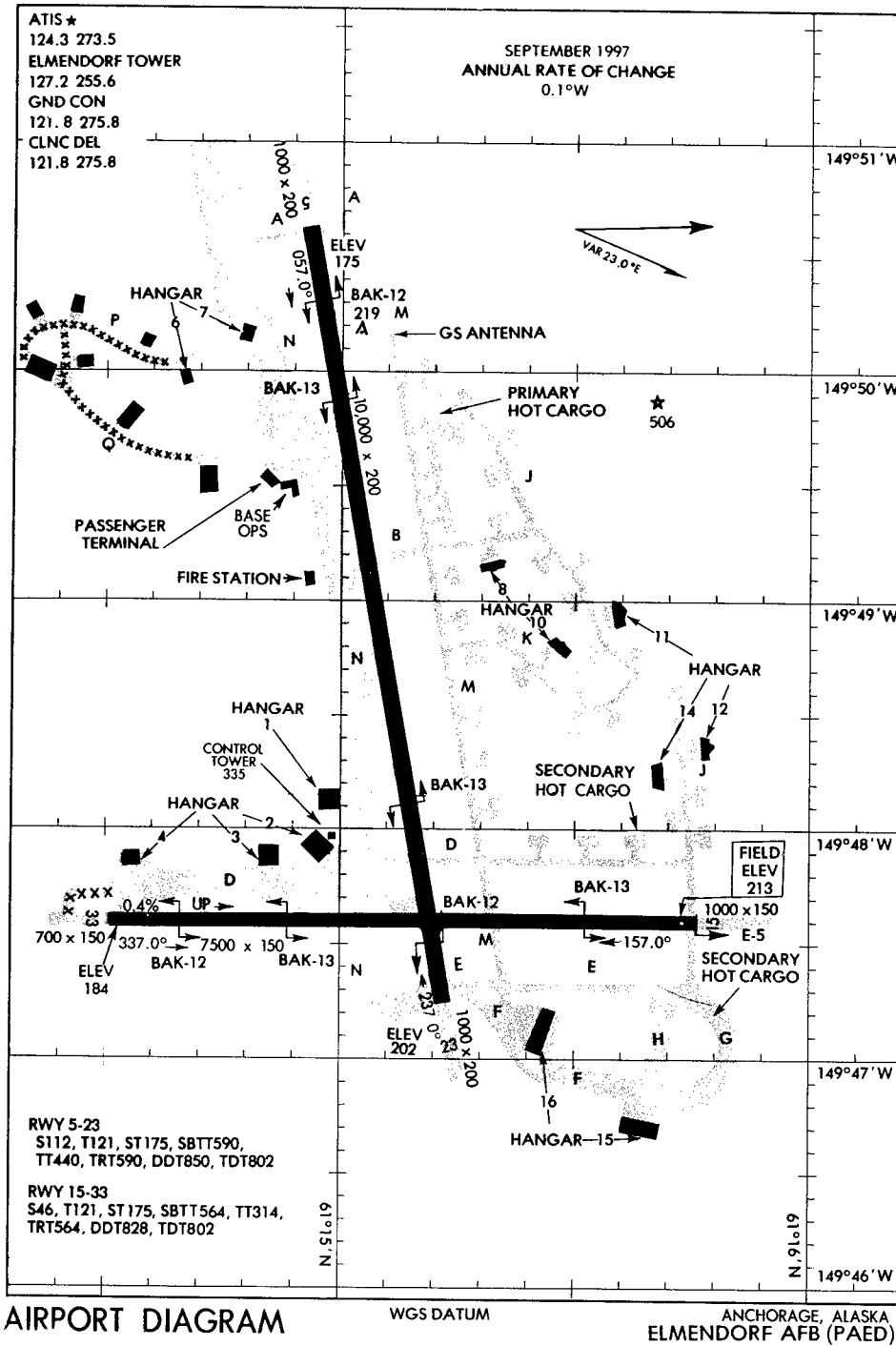

Cold Bay, Alaska  
Cold Bay  
ICAO Identifier PACD

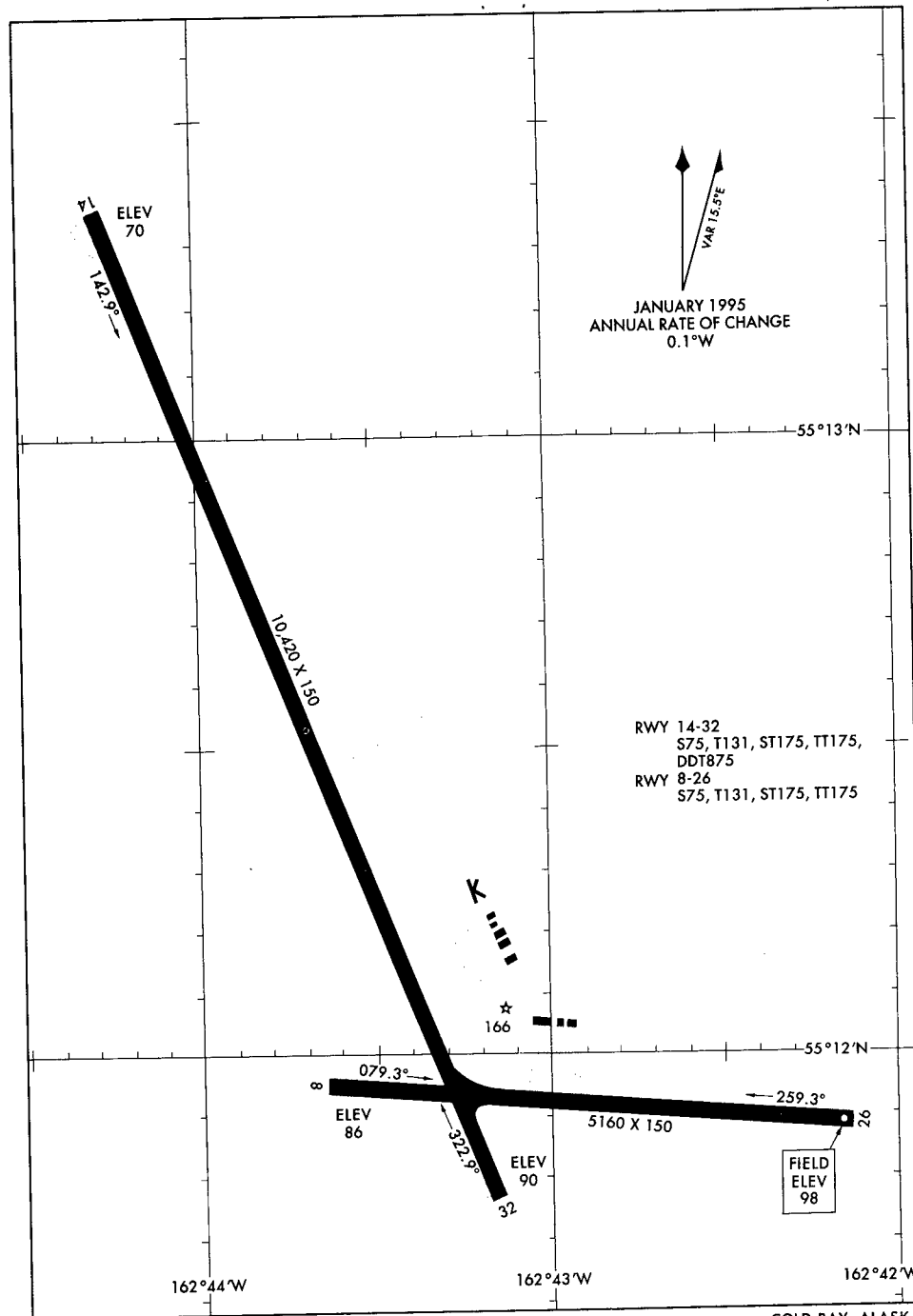

AIRPORT DIAGRAM  
98057

COLD BAY, ALASKA  
COLD BAY (CDB)

Fairbanks, Alaska  
Eielson AFB  
ICAO Identifier PAEI

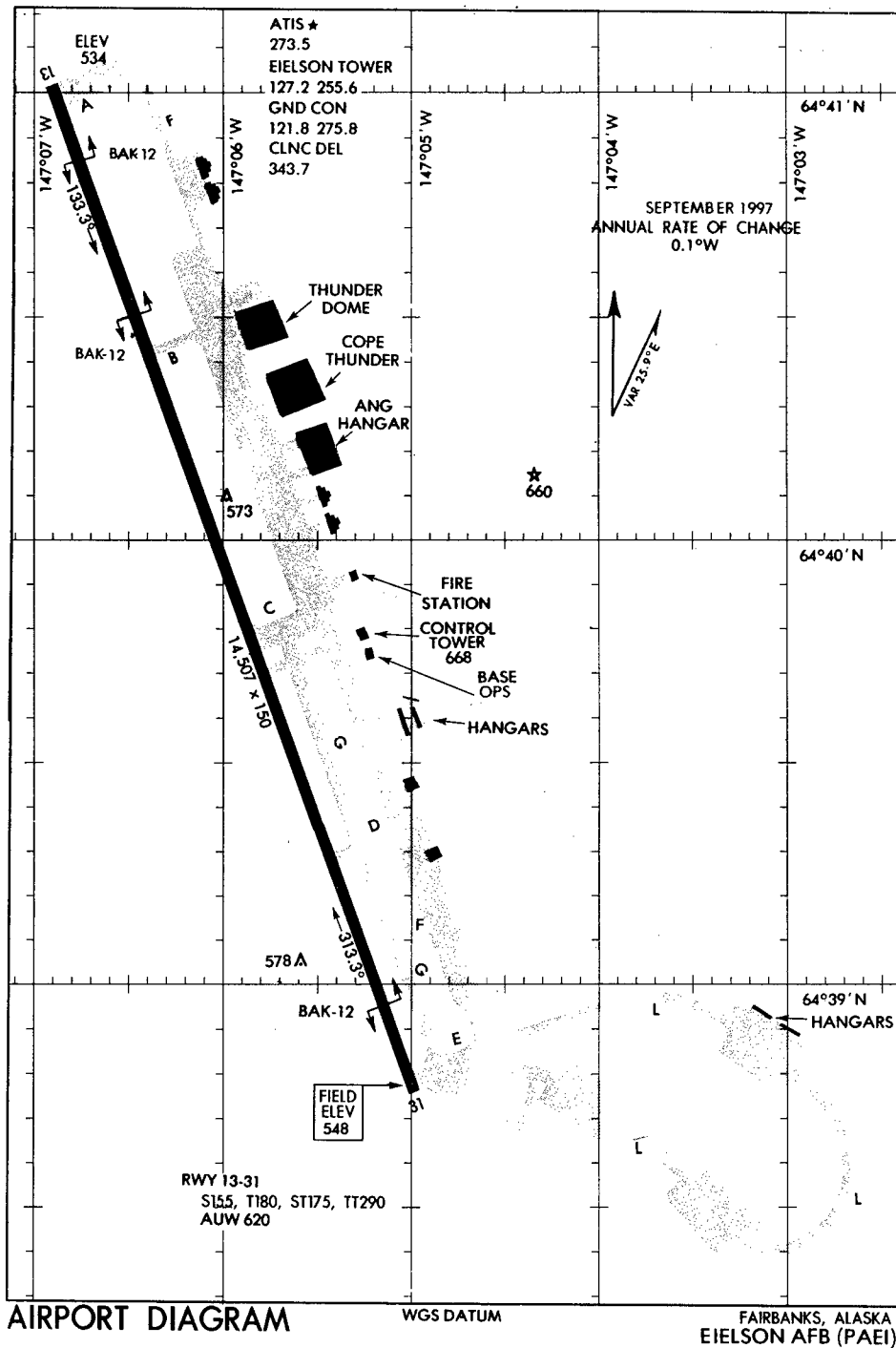

97254



Fairbanks, Alaska  
Fairbanks International  
ICAO Identifier PAFA

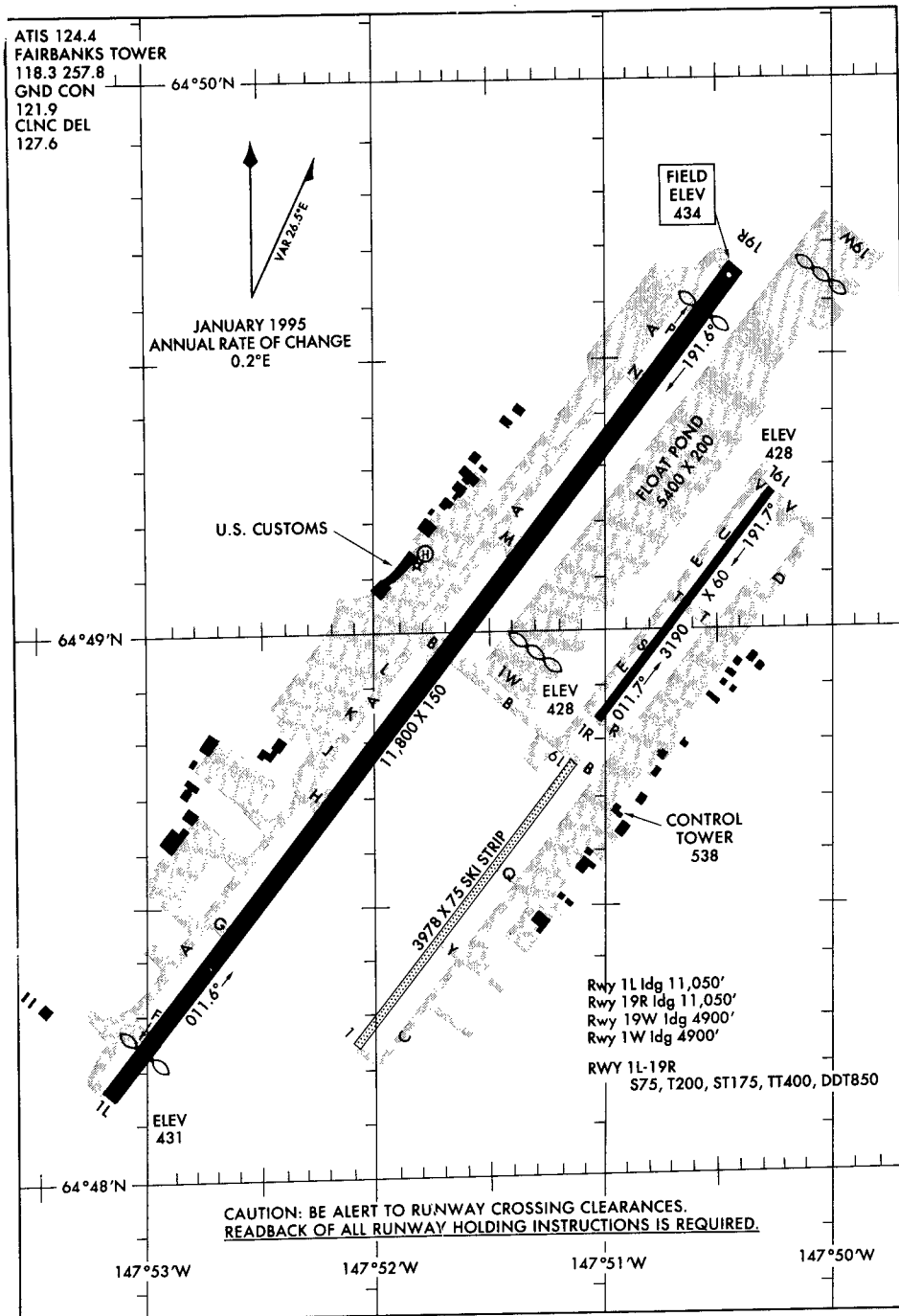

AIRPORT DIAGRAM

FAIRBANKS, ALASKA  
FAIRBANKS INTL (FAI)

97254

Juneau, Alaska  
Juneau International  
ICAO Identifier PAJN

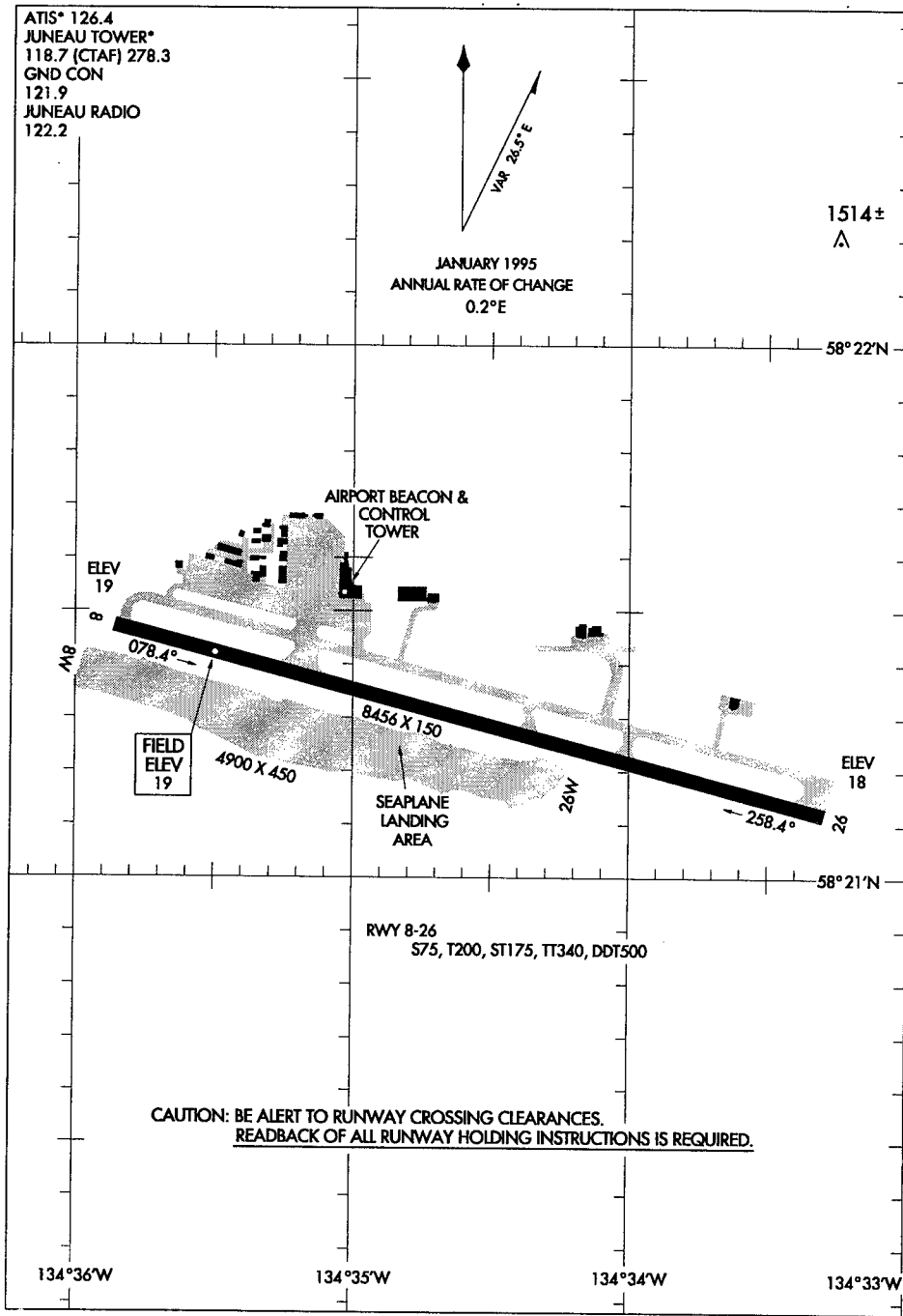

AIRPORT DIAGRAM

97254

JUNEAU, ALASKA  
JUNEAU INTL (JNU)

King Salmon, Alaska  
King Salmon  
ICAO Identifier PAKN

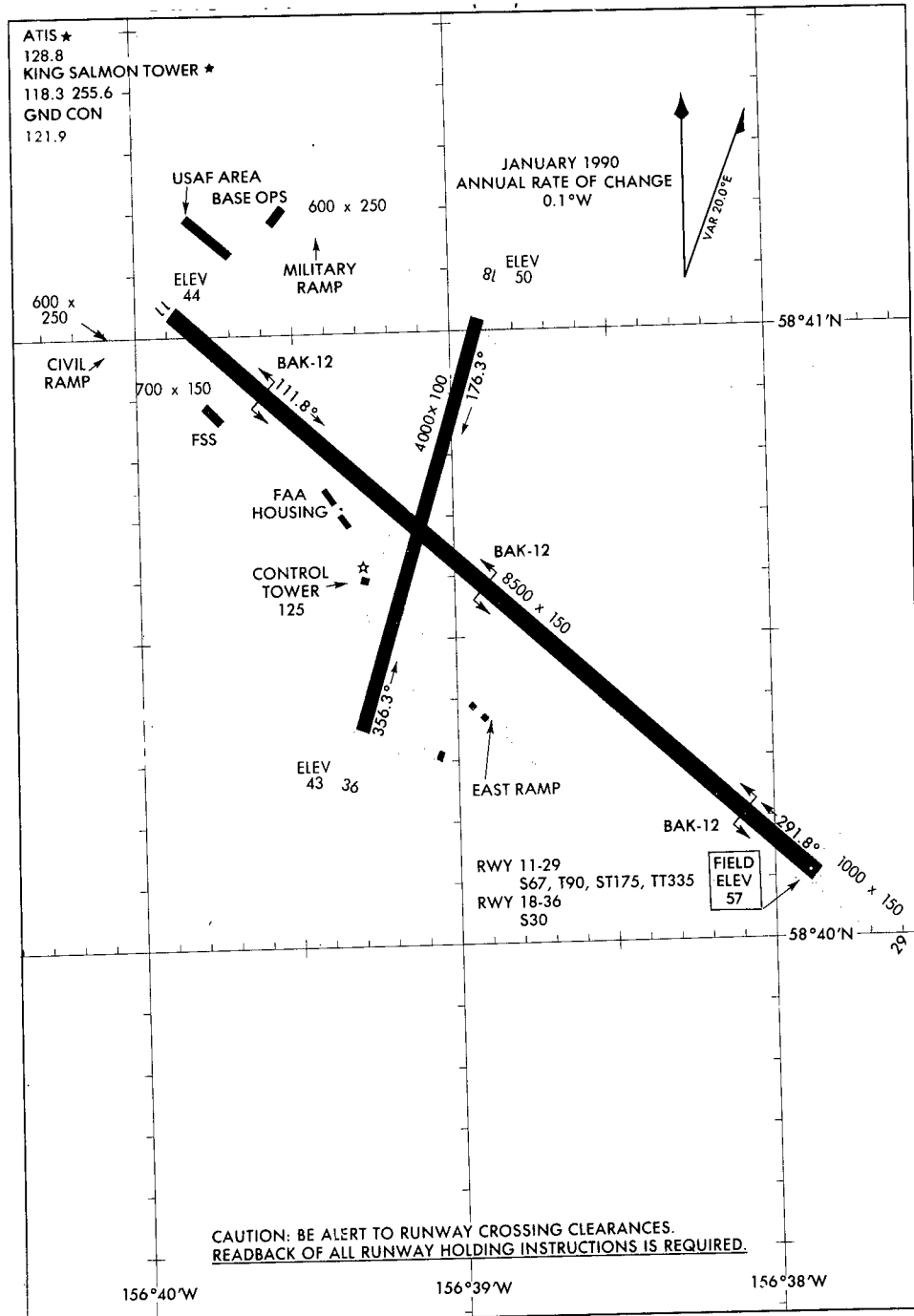

CAUTION: BE ALERT TO RUNWAY CROSSING CLEARANCES.  
READBACK OF ALL RUNWAY HOLDING INSTRUCTIONS IS REQUIRED.

AIRPORT DIAGRAM

KING SALMON, ALASKA  
KING SALMON (AKN)

92289

Pago Pago, American Samoa  
Pago Pago/International  
ICAO Identifier NSTU

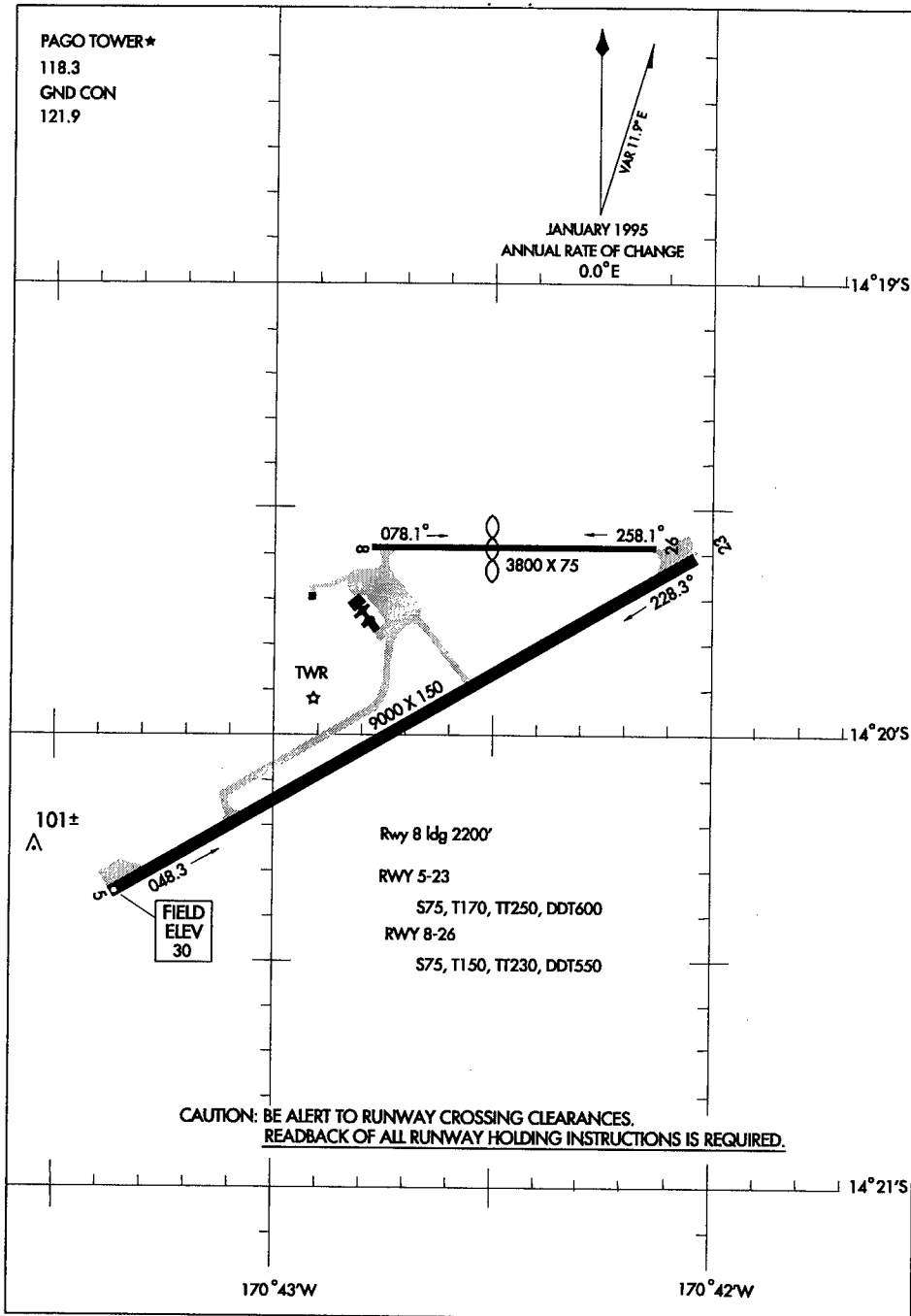

**AIRPORT DIAGRAM**  
97254

PAGO PAGO, AQ  
PAGO PAGO INTL (PPG)

Phoenix, Arizona  
Phoenix Sky Harbor International  
ICAO Identifier KPHX

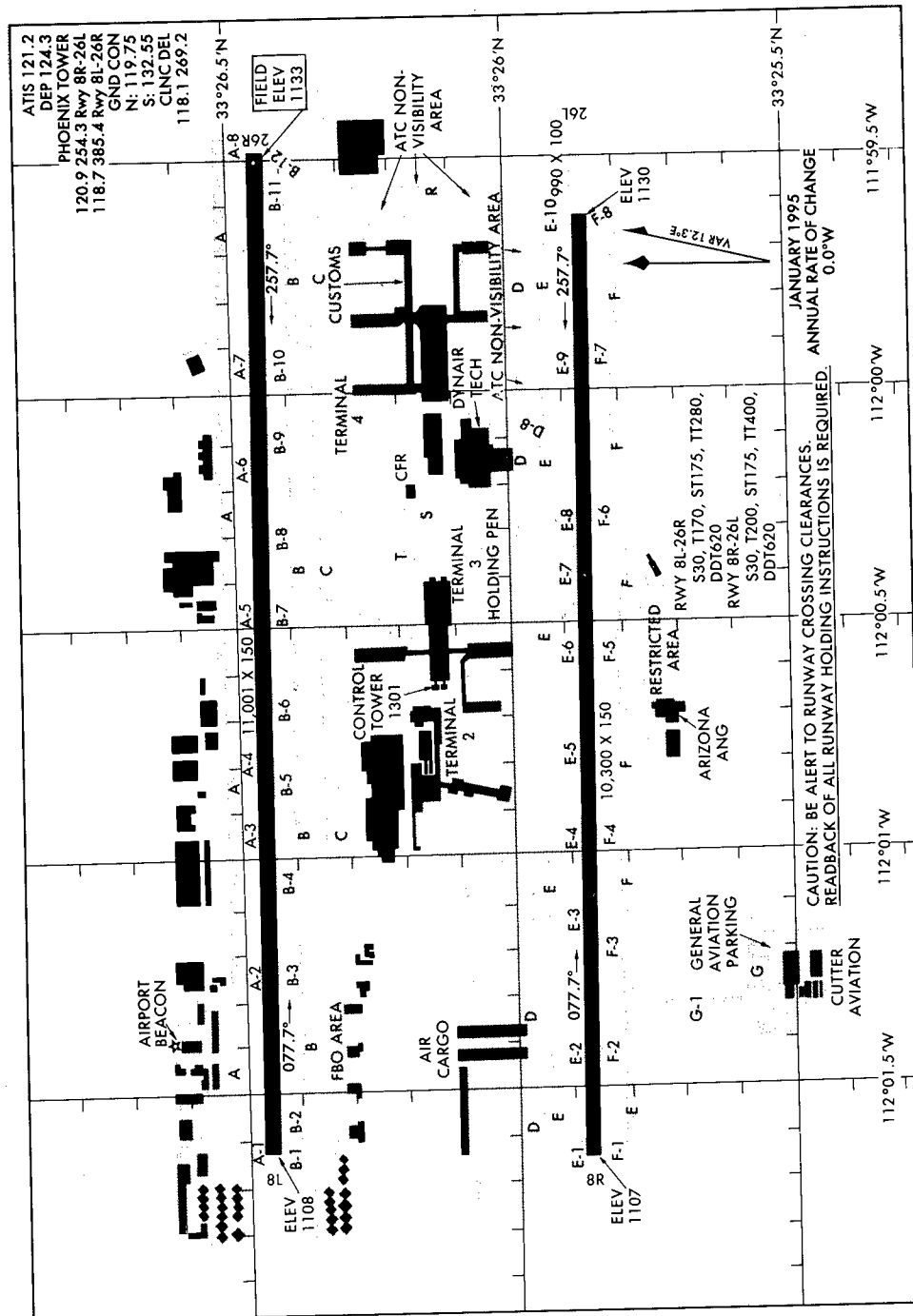

**AIRPORT DIAGRAM**  
97142

PHOENIX, ARIZONA  
PHOENIX SKY HARBOR INTL (PHX)

Tucson, Arizona  
Tucson International  
ICAO Identifier KTUS

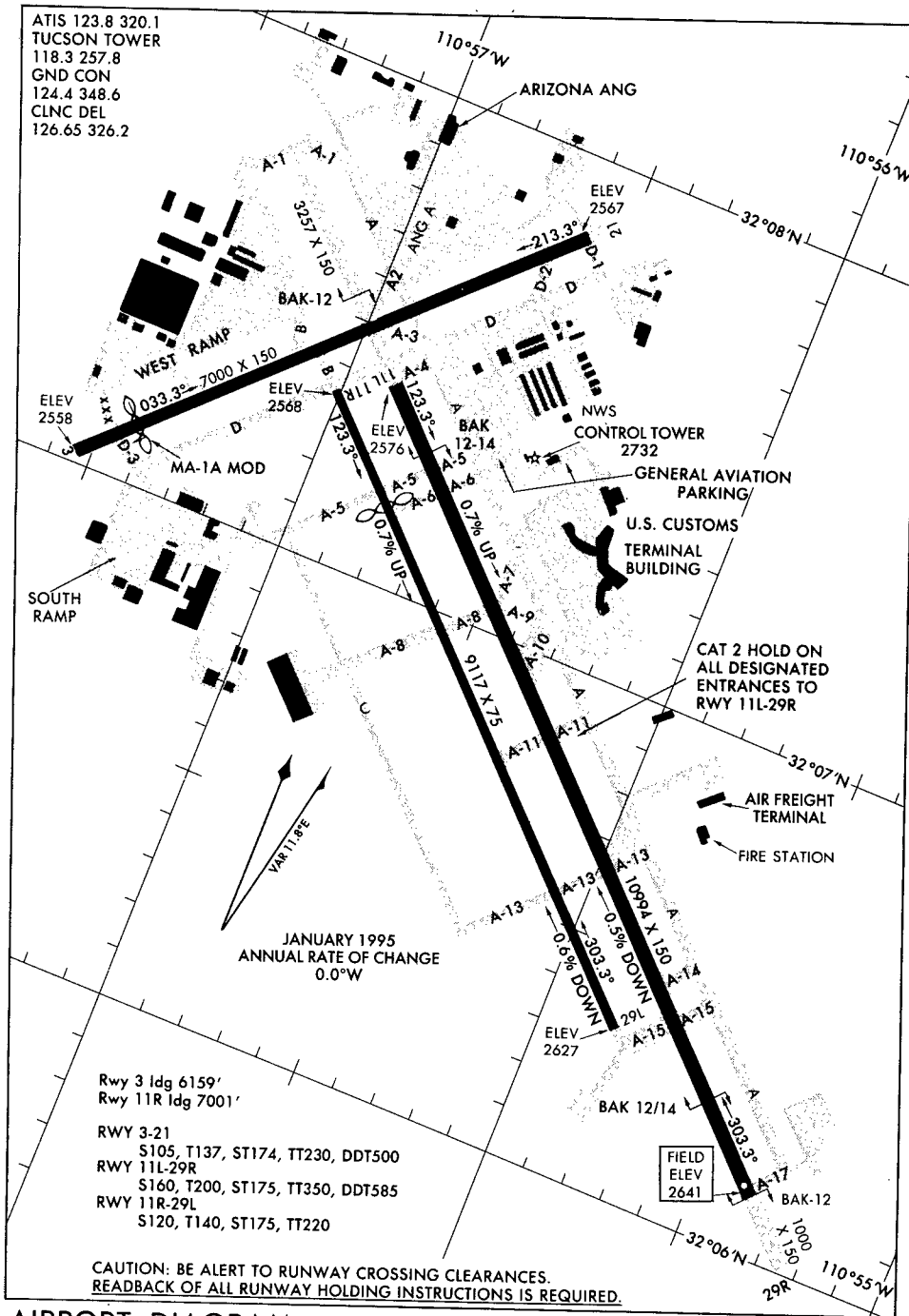

AIRPORT DIAGRAM

97310

TUCSON, ARIZONA  
TUCSON INTL (TUS)

Fresno, California  
Fresno Yosemite International  
ICAO Identifier KFAT

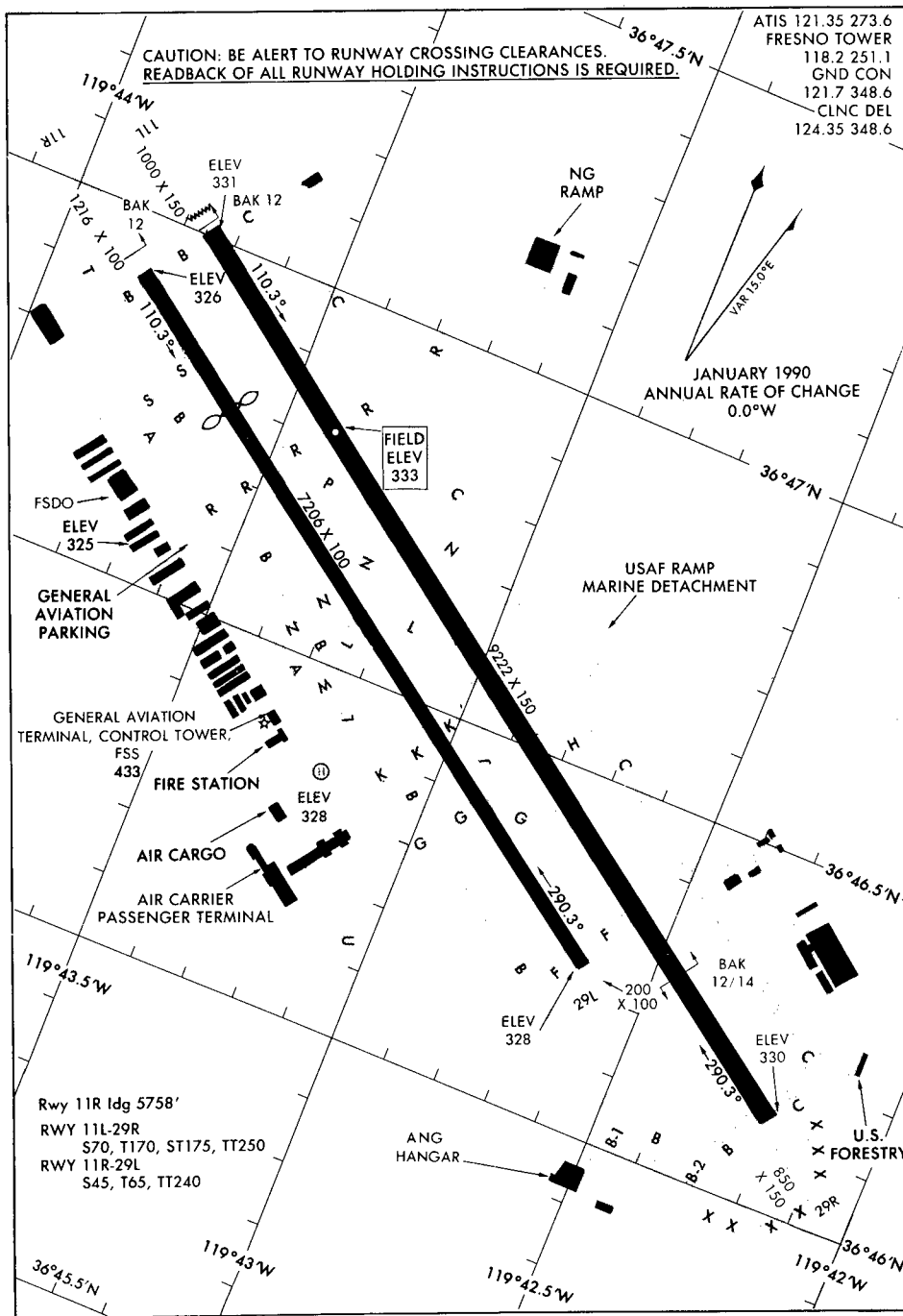

AIRPORT DIAGRAM  
96284

FRESNO, CALIFORNIA  
FRESNO YOSEMITE INTL (FAT)

Los Angeles  
Los Angeles International  
ICAO Identifier KLAX

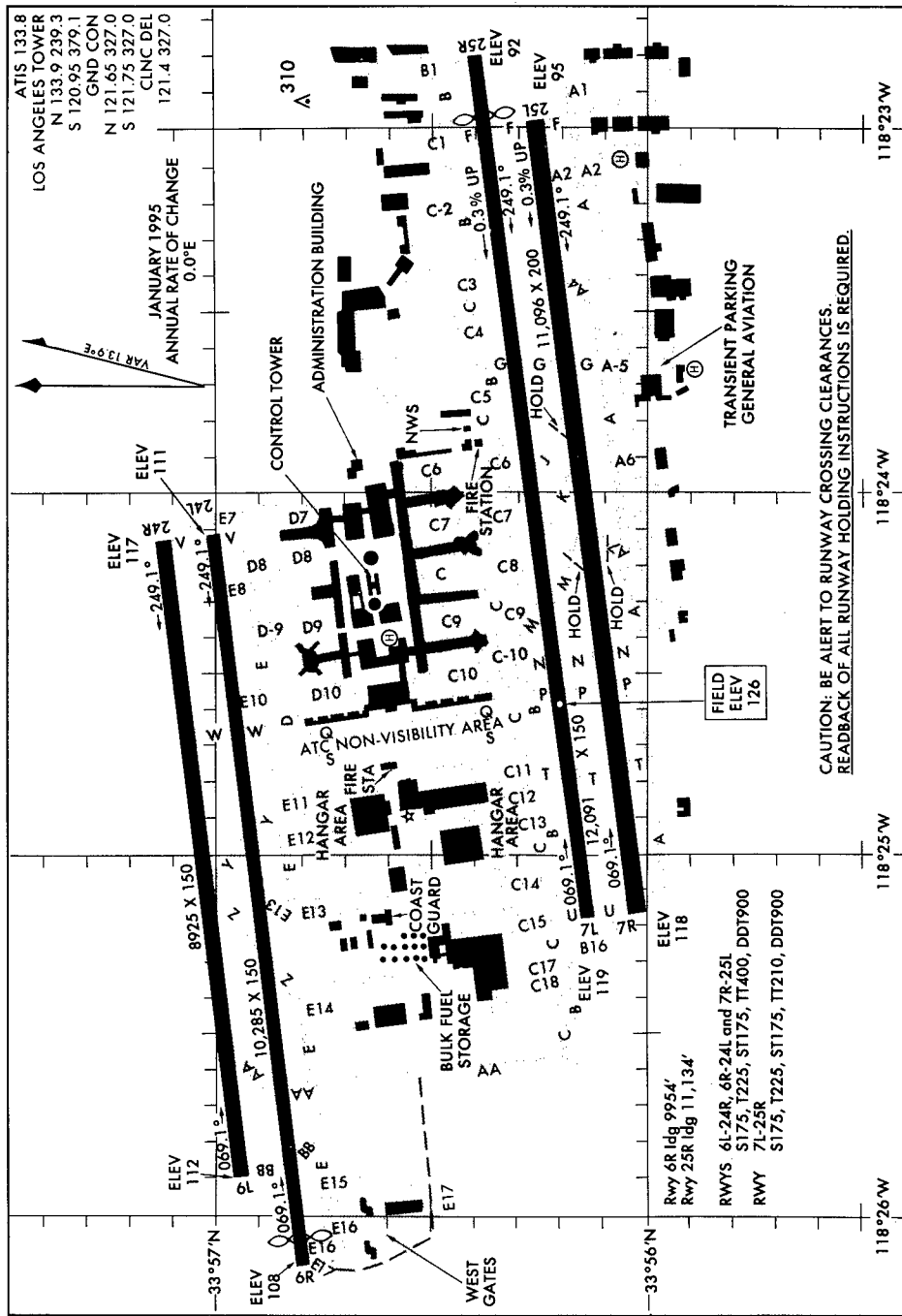

AIRPORT DIAGRAM  
97086

LOS ANGELES, CALIFORNIA  
LOS ANGELES INTL (LAX)

CAUTION: BE ALERT TO RUNWAY CROSSING CLEARANCES.  
READBACK OF ALL RUNWAY HOLDING INSTRUCTIONS IS REQUIRED.



Oakland, California  
Metropolitan Oakland International  
ICAO Identifier KOAK

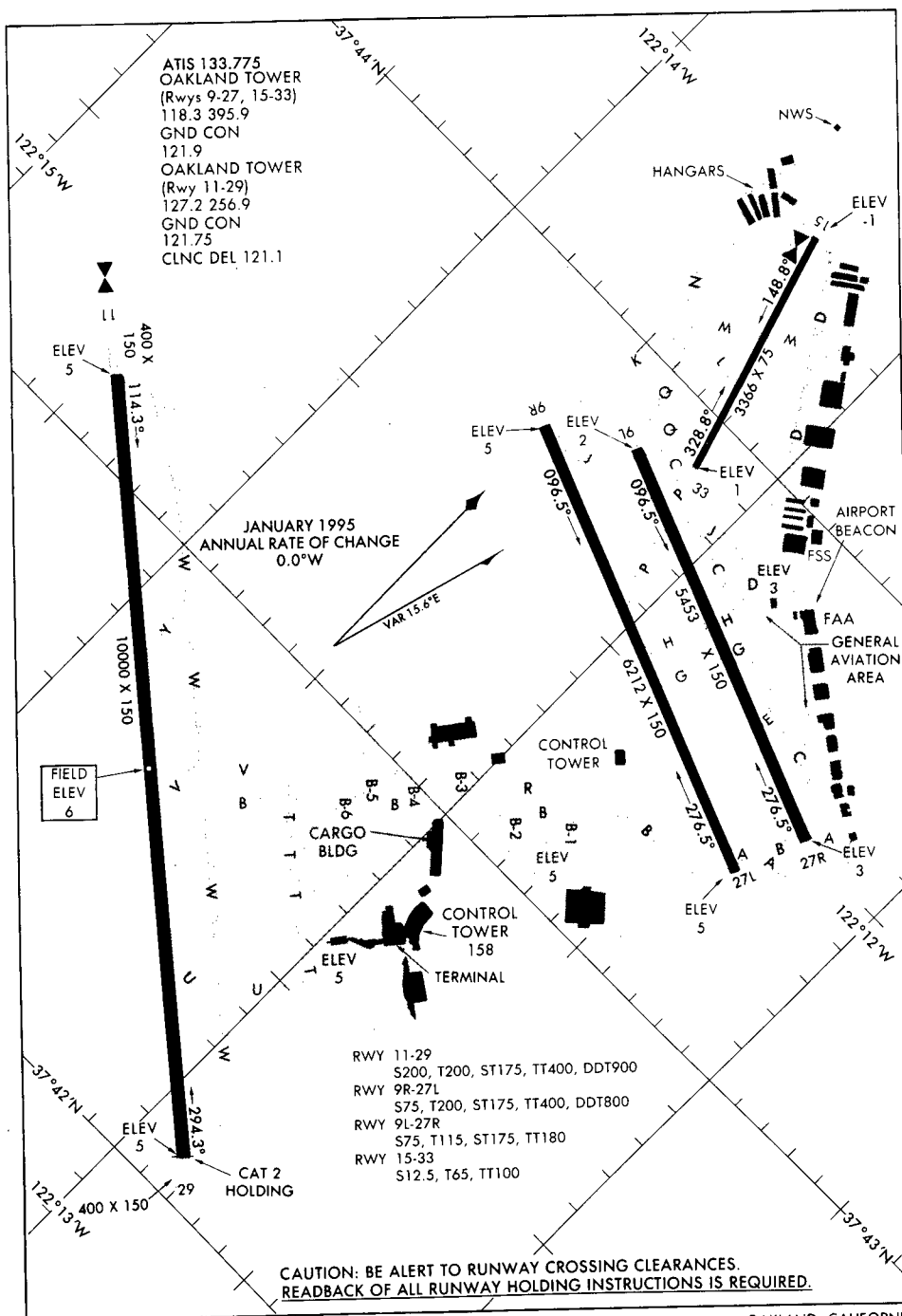

AIRPORT DIAGRAM  
98057

OAKLAND, CALIFORNIA  
OAKLAND/METROPOLITAN OAKLAND INTL (OAK)

Ontario, California  
Ontario International  
ICAO Identifier KONT

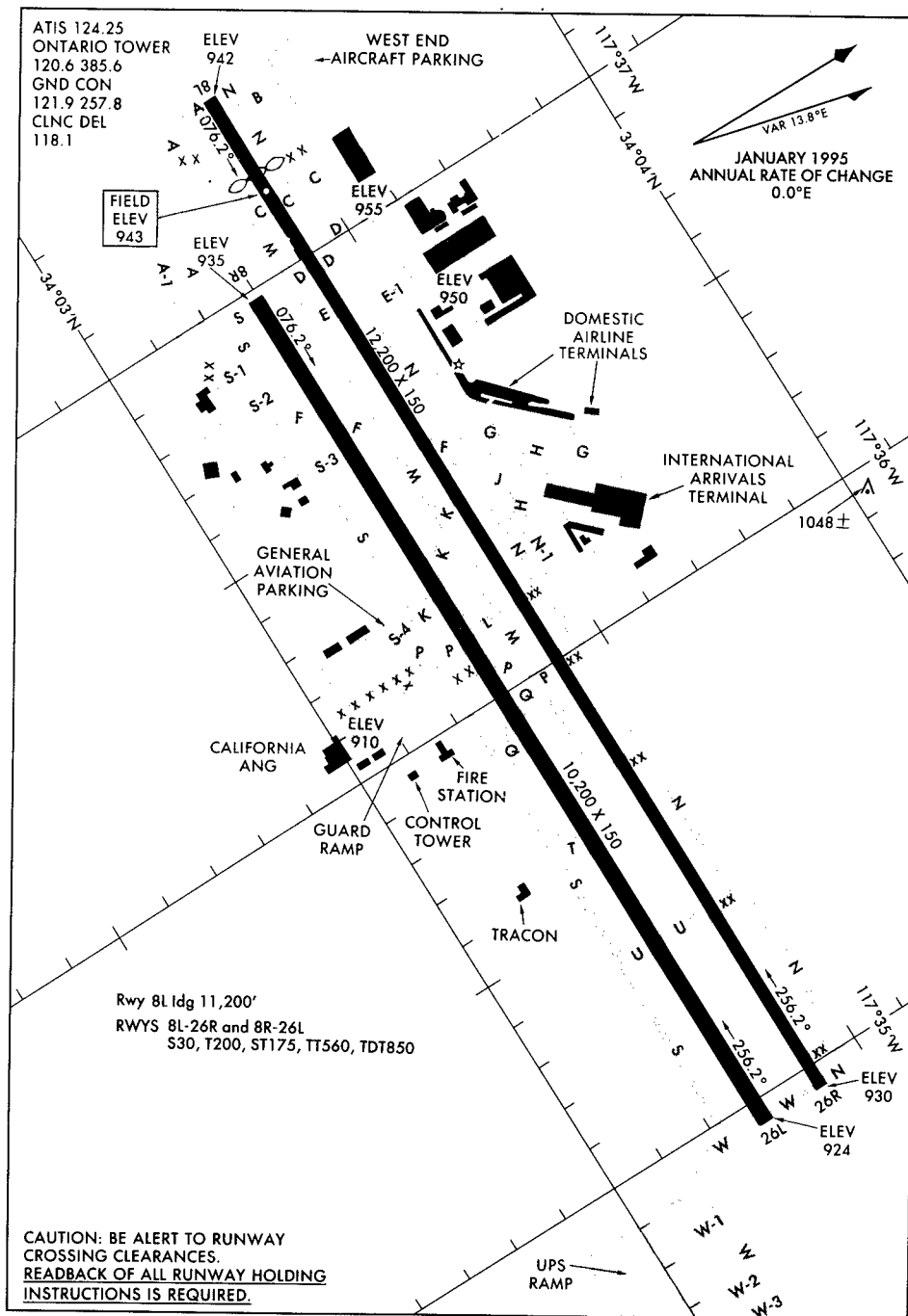

**AIRPORT DIAGRAM** ONTARIO, CALIFORNIA  
98057 ONTARIO INTL (ONT)

CAUTION: BE ALERT TO RUNWAY CROSSING CLEARANCES. READBACK OF ALL RUNWAY HOLDING INSTRUCTIONS IS REQUIRED.

Palmdale, California  
Palmdale Production Flight/Test Installation  
AF Plant #42  
ICAO Identifier KPMD

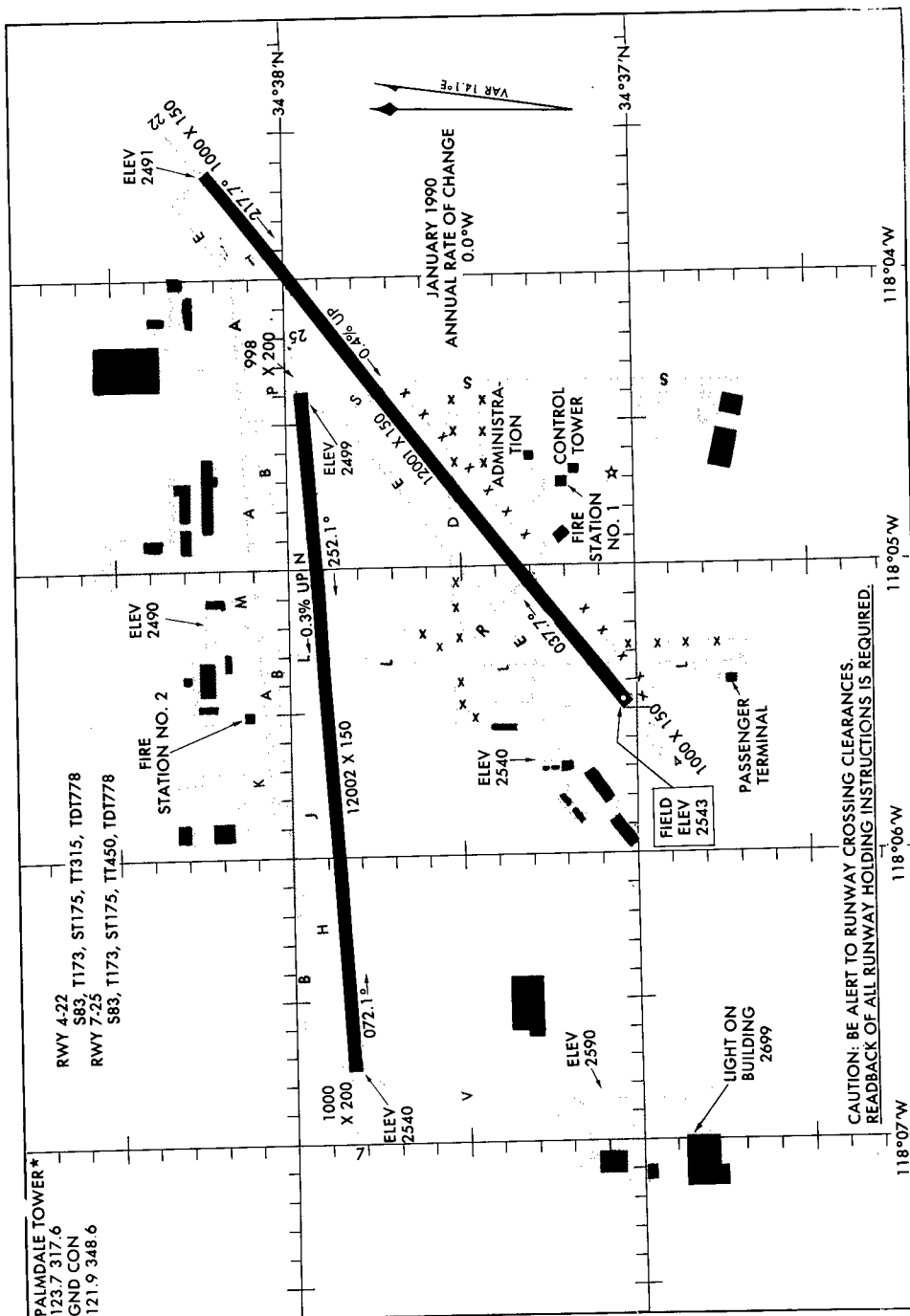

**AIRPORT DIAGRAM** 34°38'N-118°05'W PALMDALE, CALIFORNIA  
PALMDALE PRODUCTION FLT/TEST INSTLN AF PLANT 42 (PMD)  
96228

CAUTION: BE ALERT TO RUNWAY CROSSING CLEARANCES.  
READBACK OF ALL RUNWAY HOLDING INSTRUCTIONS IS REQUIRED.

Sacramento, California  
Sacramento International  
ICAO Identifier KSMF

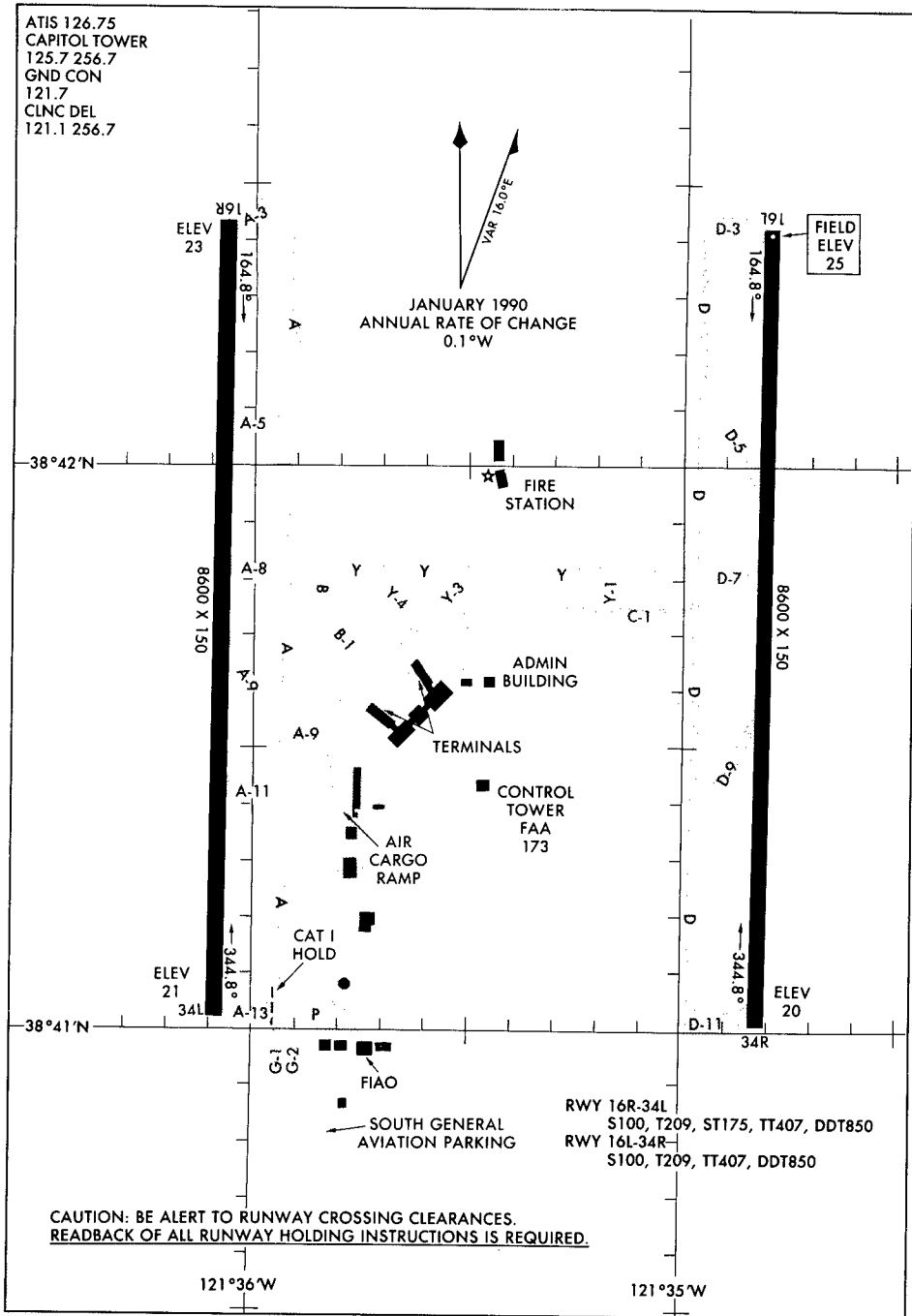

AIRPORT DIAGRAM  
96172

SACRAMENTO, CALIFORNIA  
SACRAMENTO INTL (SMF)

San Diego  
San Diego International-Lindbergh Field  
ICAO Identifier KSAN

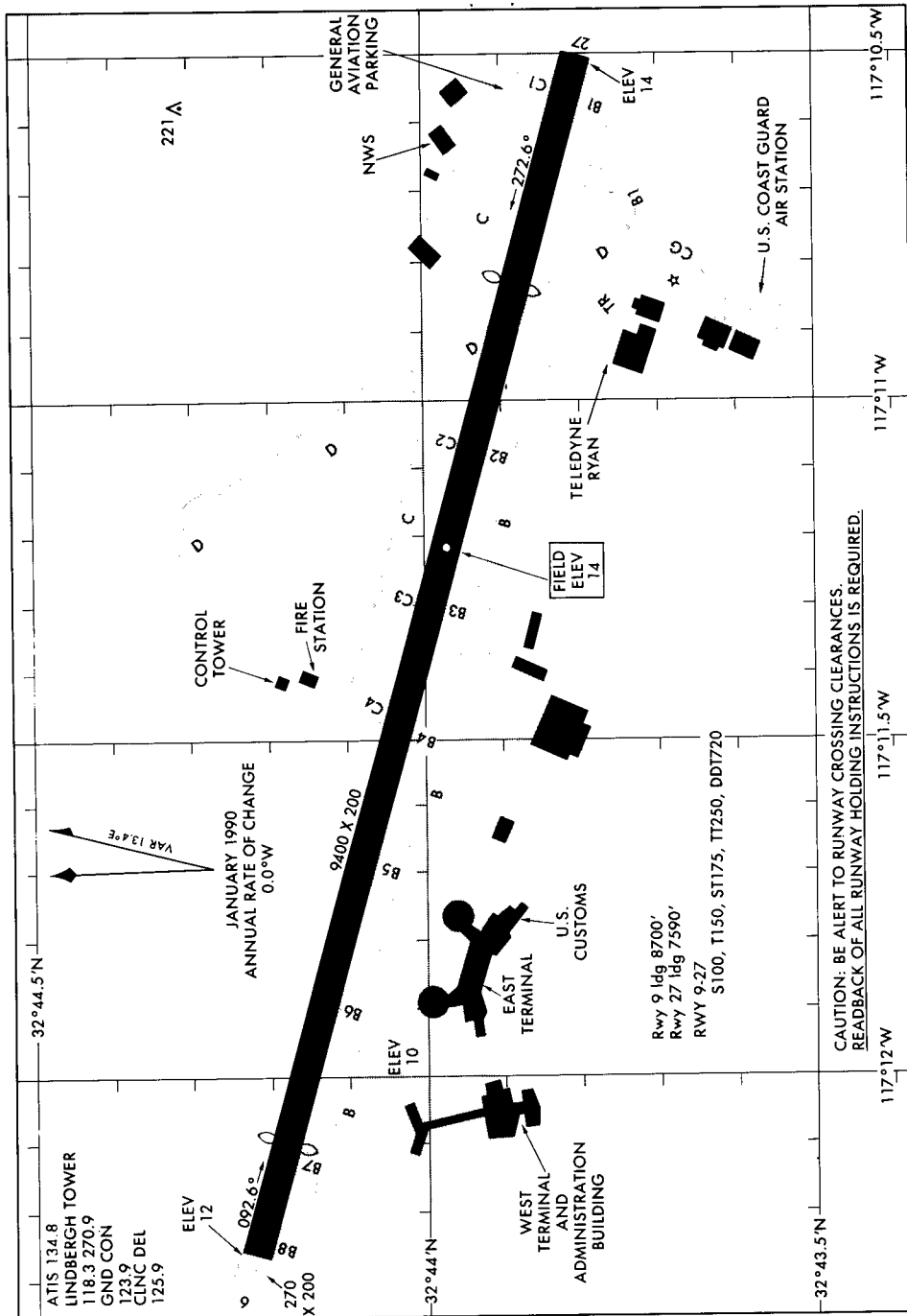

**AIRPORT DIAGRAM**  
94342

SAN DIEGO, CALIFORNIA  
**SAN DIEGO INTL-LINDBERGH FIELD (SAN)**

CAUTION: BE ALERT TO RUNWAY CROSSING CLEARANCES.  
READBACK OF ALL RUNWAY HOLDING INSTRUCTIONS IS REQUIRED.

San Francisco, California  
San Francisco International  
ICAO Identifier KSFO

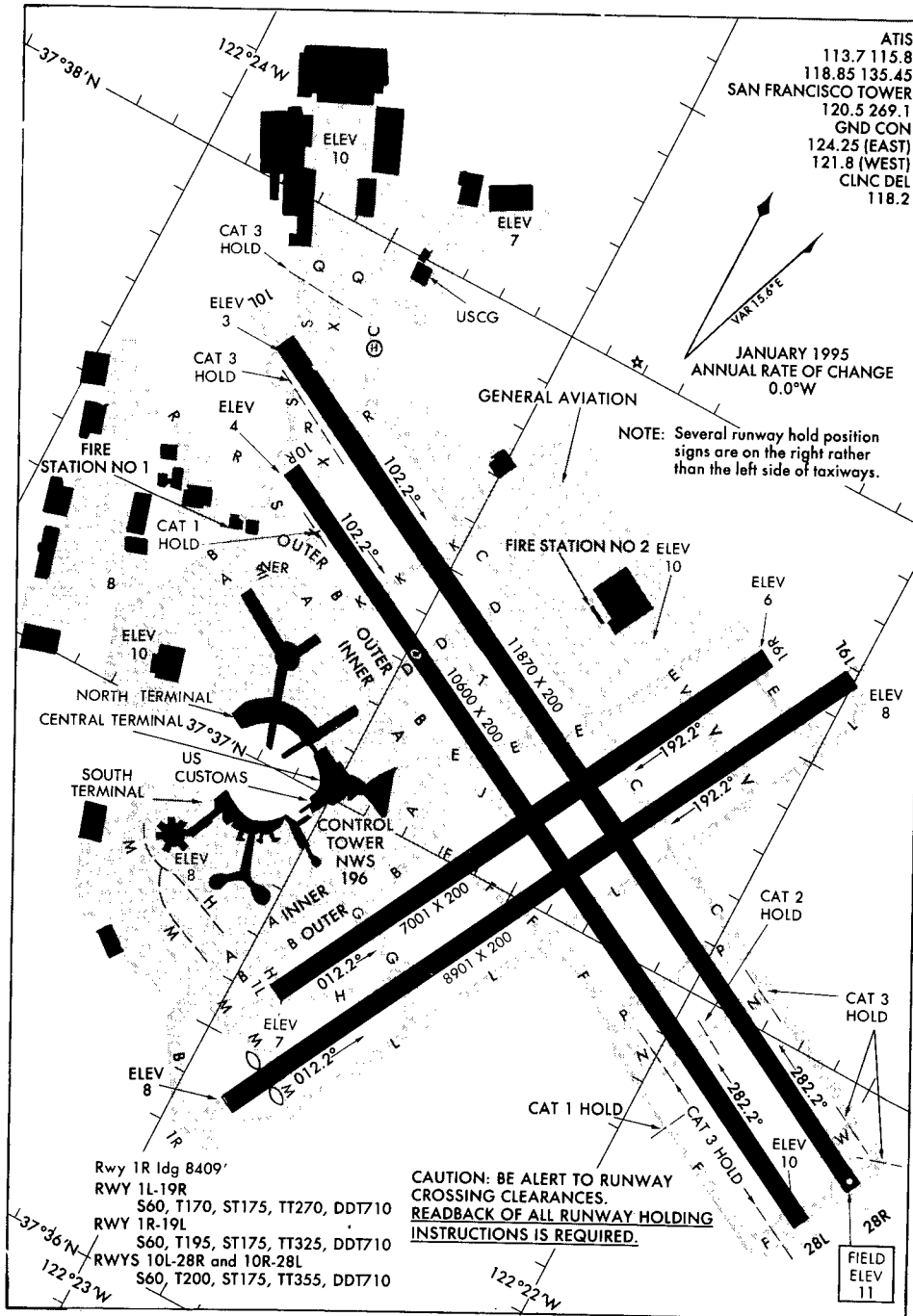

AIRPORT DIAGRAM  
97254

SAN FRANCISCO, CALIFORNIA  
SAN FRANCISCO INTL (SFO)

San Jose, California  
San Jose International  
ICAO Identifier KSJC

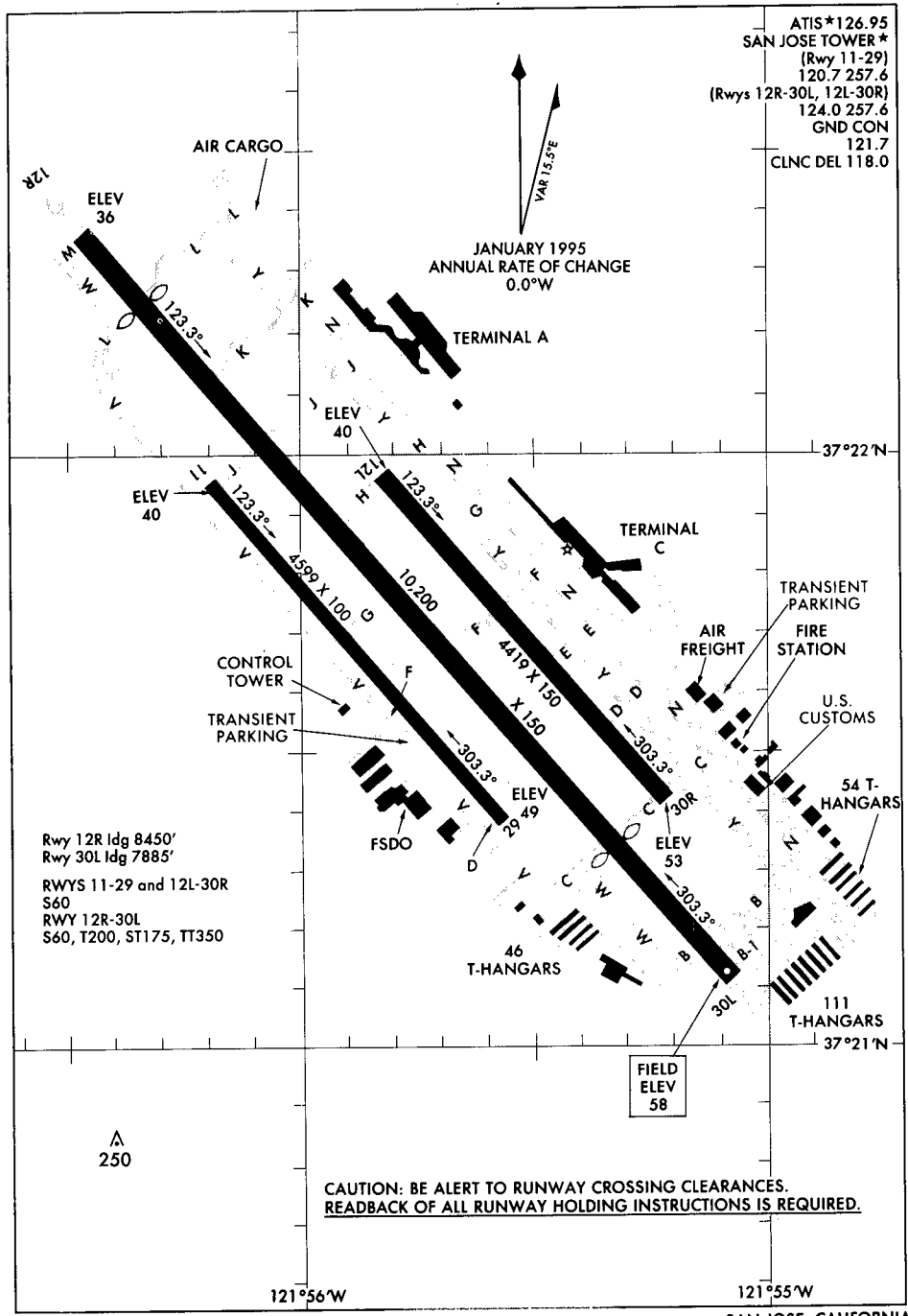

AIRPORT DIAGRAM

97254

SAN JOSE, CALIFORNIA  
SAN JOSE INTL (SJC)

Stockton, California  
Stockton Metropolitan  
ICAO Identifier KSCK

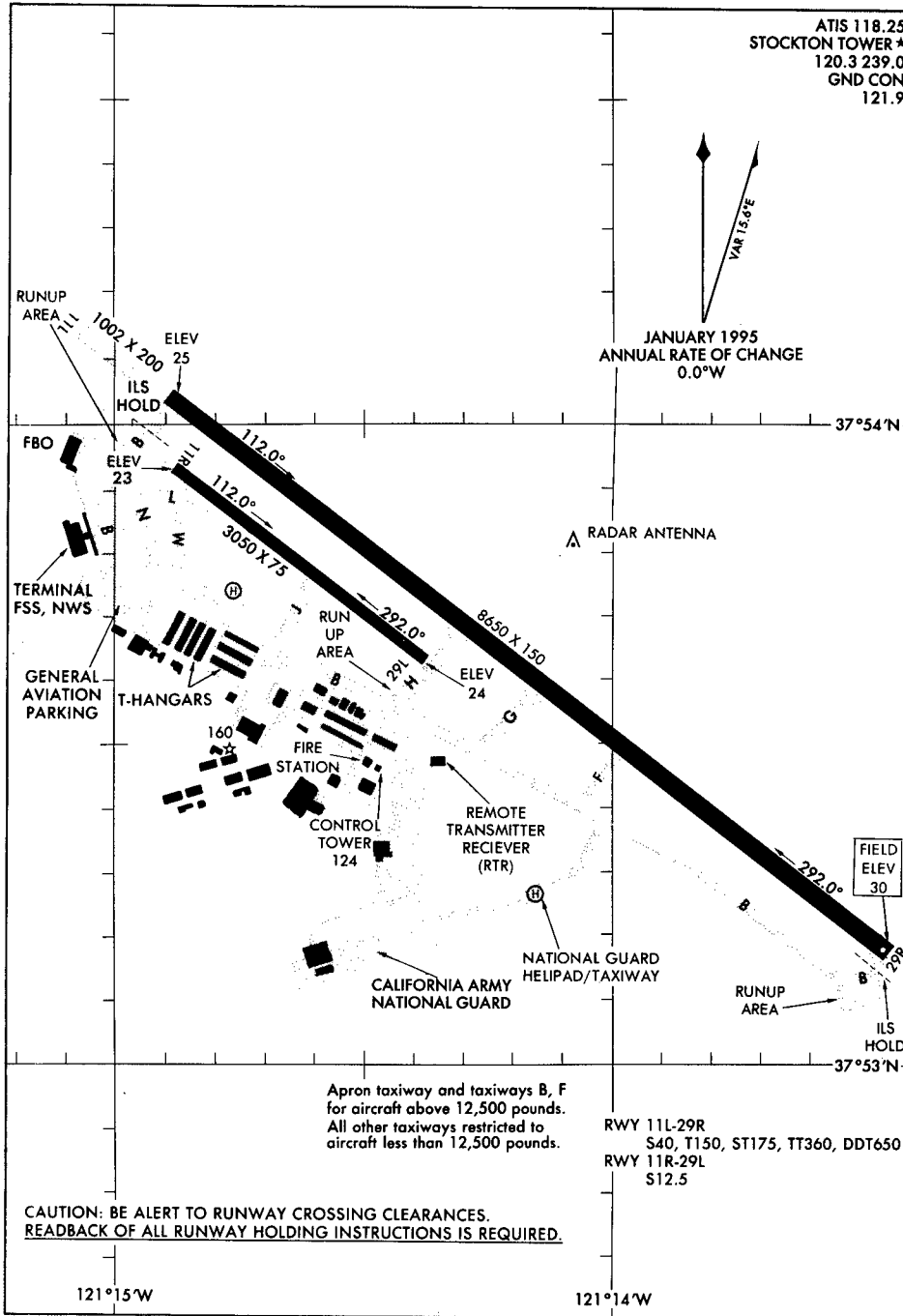

AIRPORT DIAGRAM  
97030

STOCKTON, CALIFORNIA  
STOCKTON METROPOLITAN (SCK)



Denver, Colorado  
 Denver International  
 ICAO Identifier KDEN

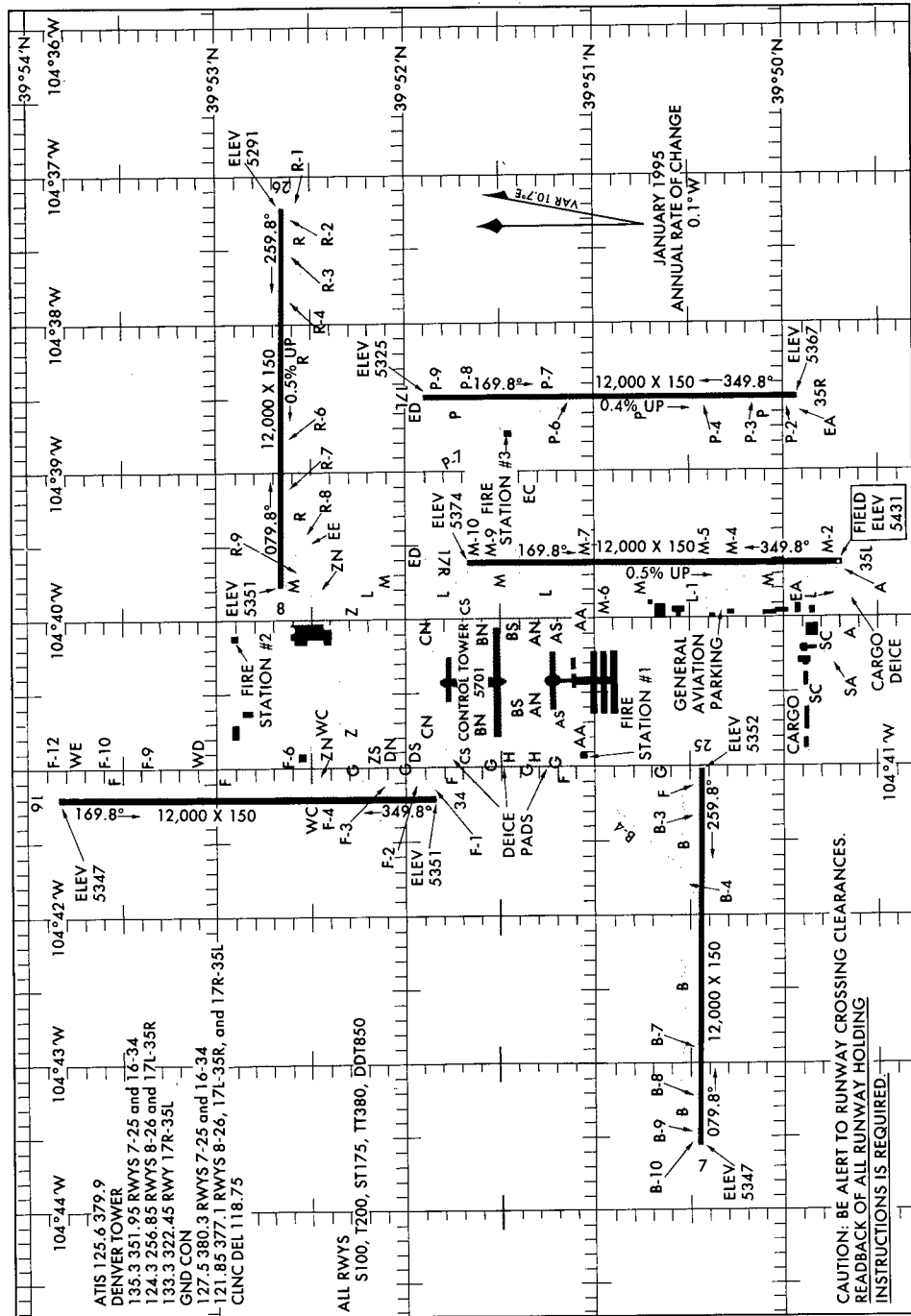

AIRPORT DIAGRAM  
 98141

DENVER, COLORADO  
 DENVER INTL (DEN)

CAUTION: BE ALERT TO RUNWAY CROSSING CLEARANCES.  
 READBACK OF ALL RUNWAY HOLDING  
 INSTRUCTIONS IS REQUIRED.

Pueblo, Colorado  
Pueblo Memorial  
ICAO Identifier KPUB

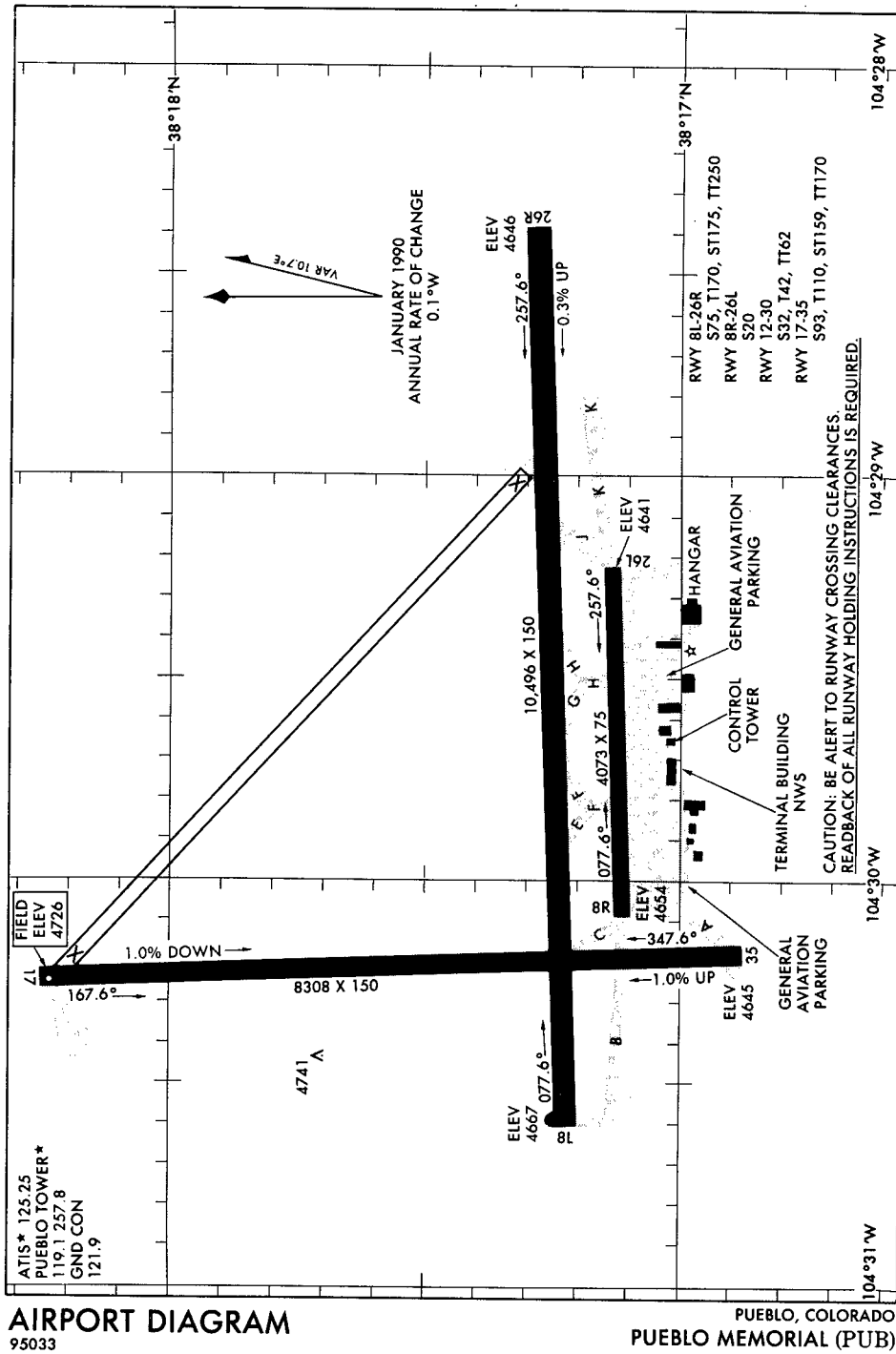

Windsor Locks, Connecticut  
Bradley International  
ICAO Identifier KBDL

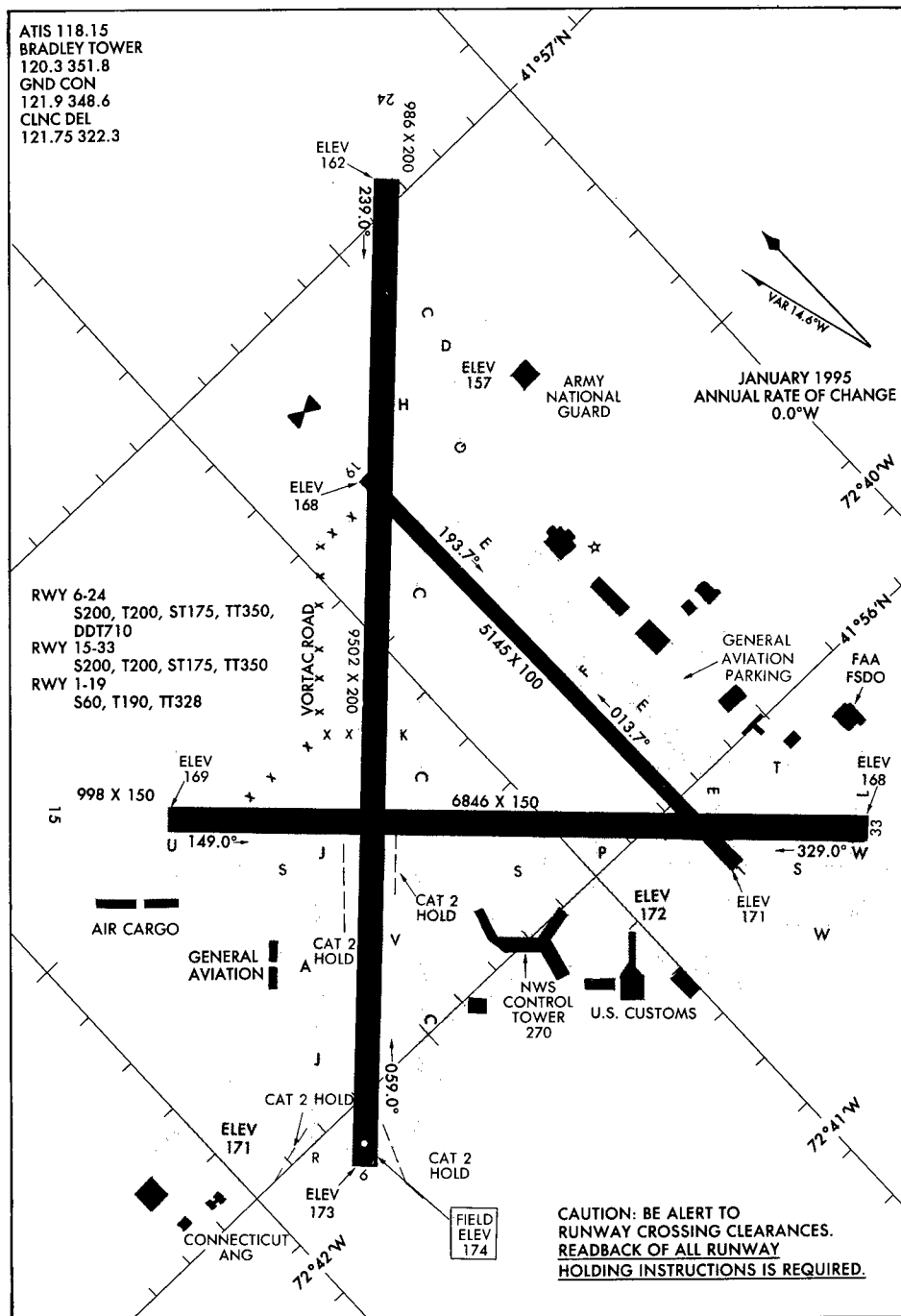

AIRPORT DIAGRAM  
98281

WINDSOR LOCKS, CONNECTICUT  
WINDSOR LOCKS/BRADLEY INTL (BDL)

Washington, District of Columbia  
Washington Dulles International  
ICAO Identifier KIAD

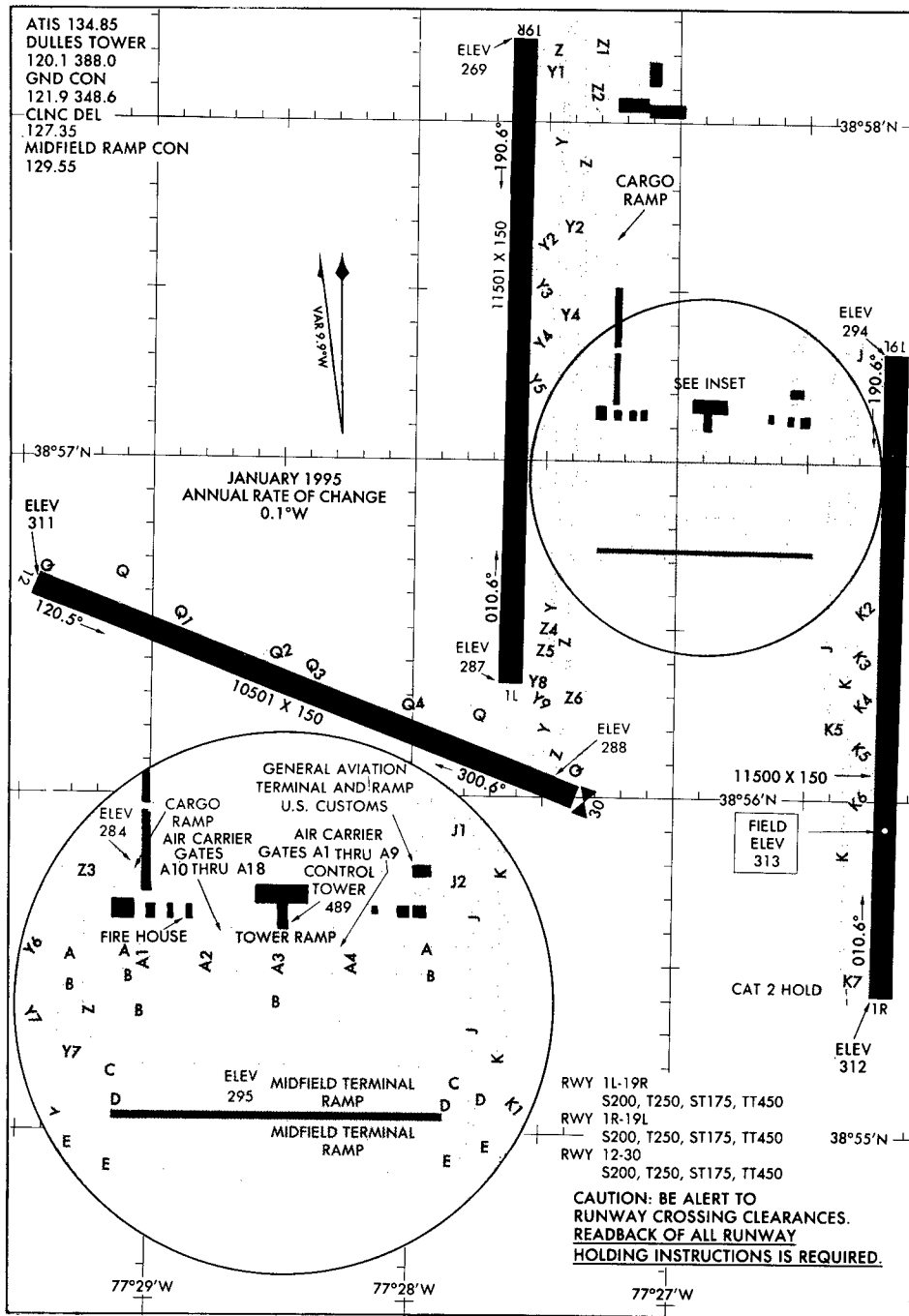

AIRPORT DIAGRAM  
96340

WASHINGTON, D.C.  
WASHINGTON DULLES INTL (IAD)

Fort Lauderdale, Florida  
 Fort Lauderdale/Hollywood International  
 ICAO Identifier KFLL

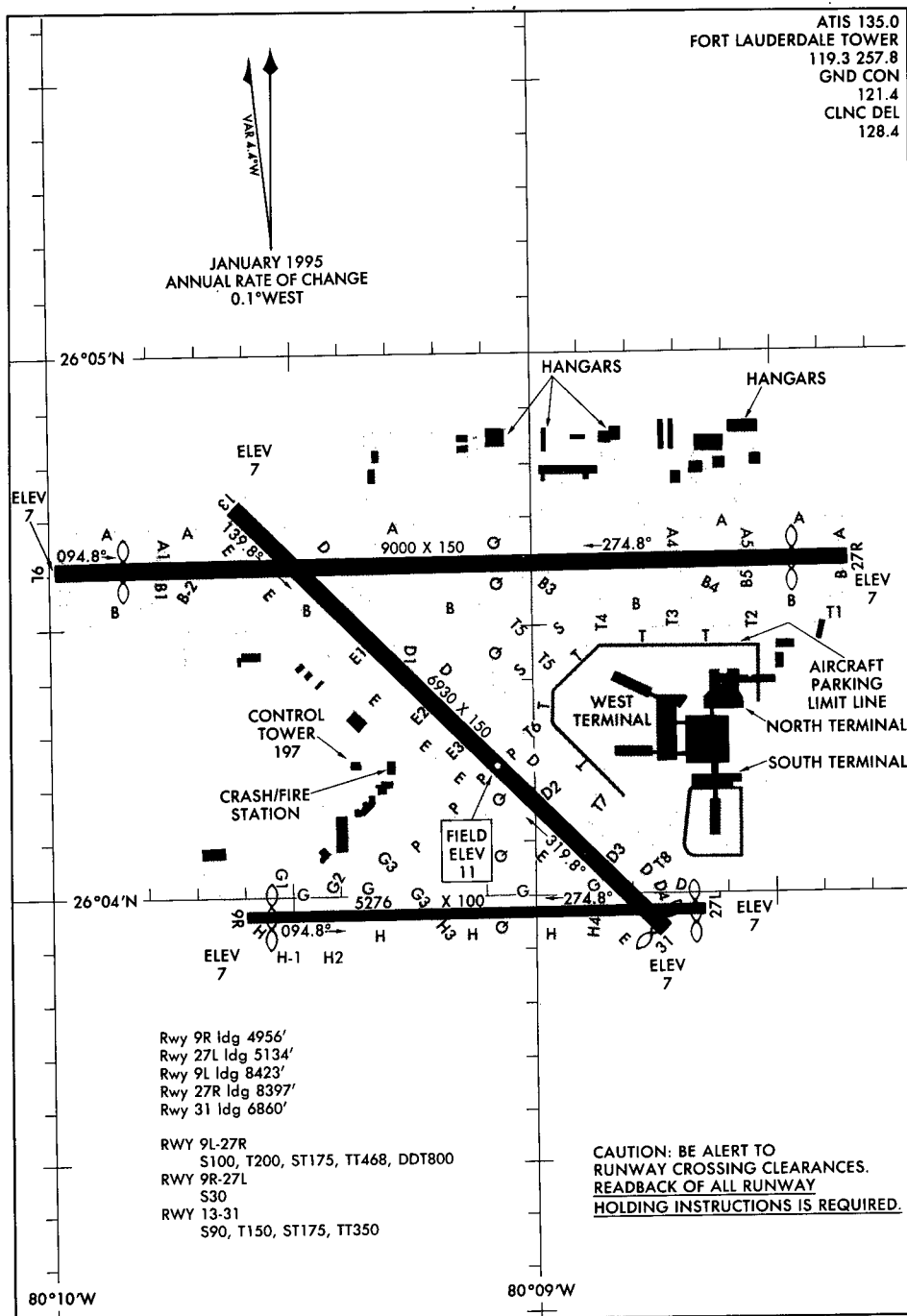

AIRPORT DIAGRAM  
 98225

FORT LAUDERDALE, FLORIDA  
 FORT LAUDERDALE-HOLLYWOOD INTL (FLL)

Fort Myers, Florida  
Southwest Florida International  
ICAO Identifier KRSW

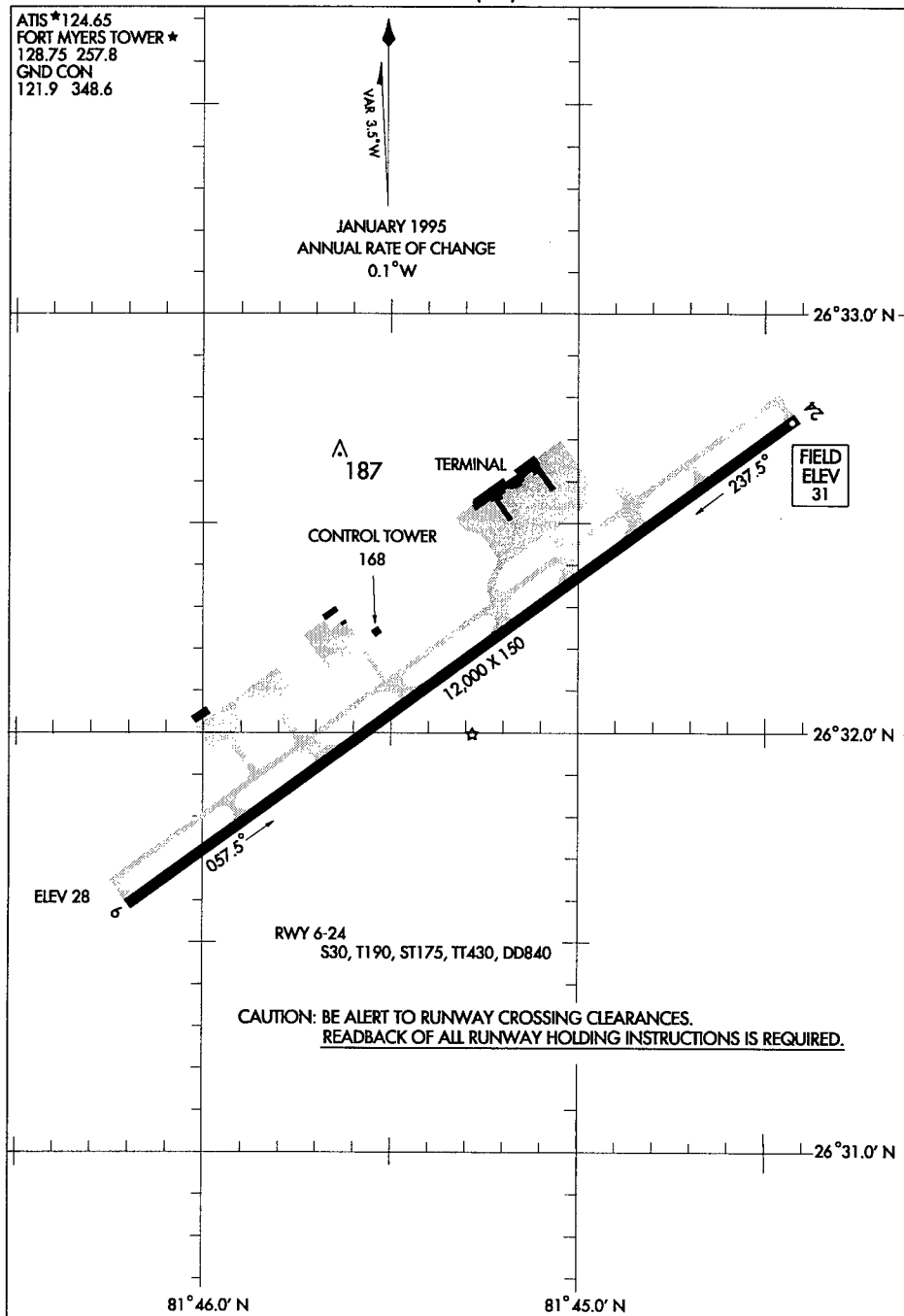

**AIRPORT DIAGRAM**  
97254

FORT MYERS, FLORIDA  
FORT MYERS/SOUTHWEST FLORIDA INTL (KRSW)

Miami, Florida  
Miami International  
ICAO Identifier KMIA

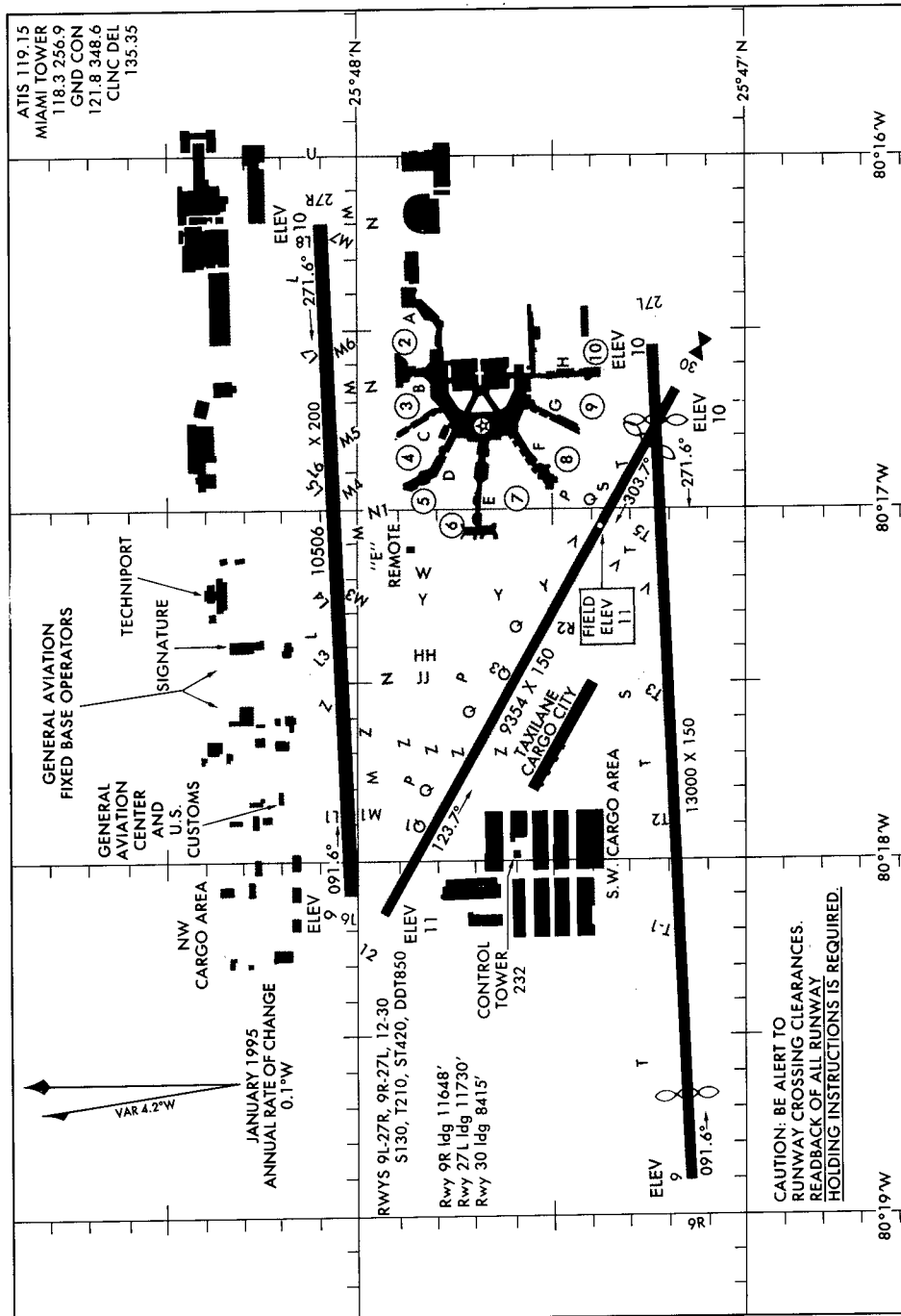

**AIRPORT DIAGRAM**  
98225

MIAMI, FLORIDA  
MIAMI INTL (MIA)

CAUTION: BE ALERT TO  
RUNWAY CROSSING CLEARANCES.  
READBACK OF ALL RUNWAY  
HOLDING INSTRUCTIONS IS REQUIRED.

Orlando, Florida  
Orlando International  
ICAO Identifier KMCO

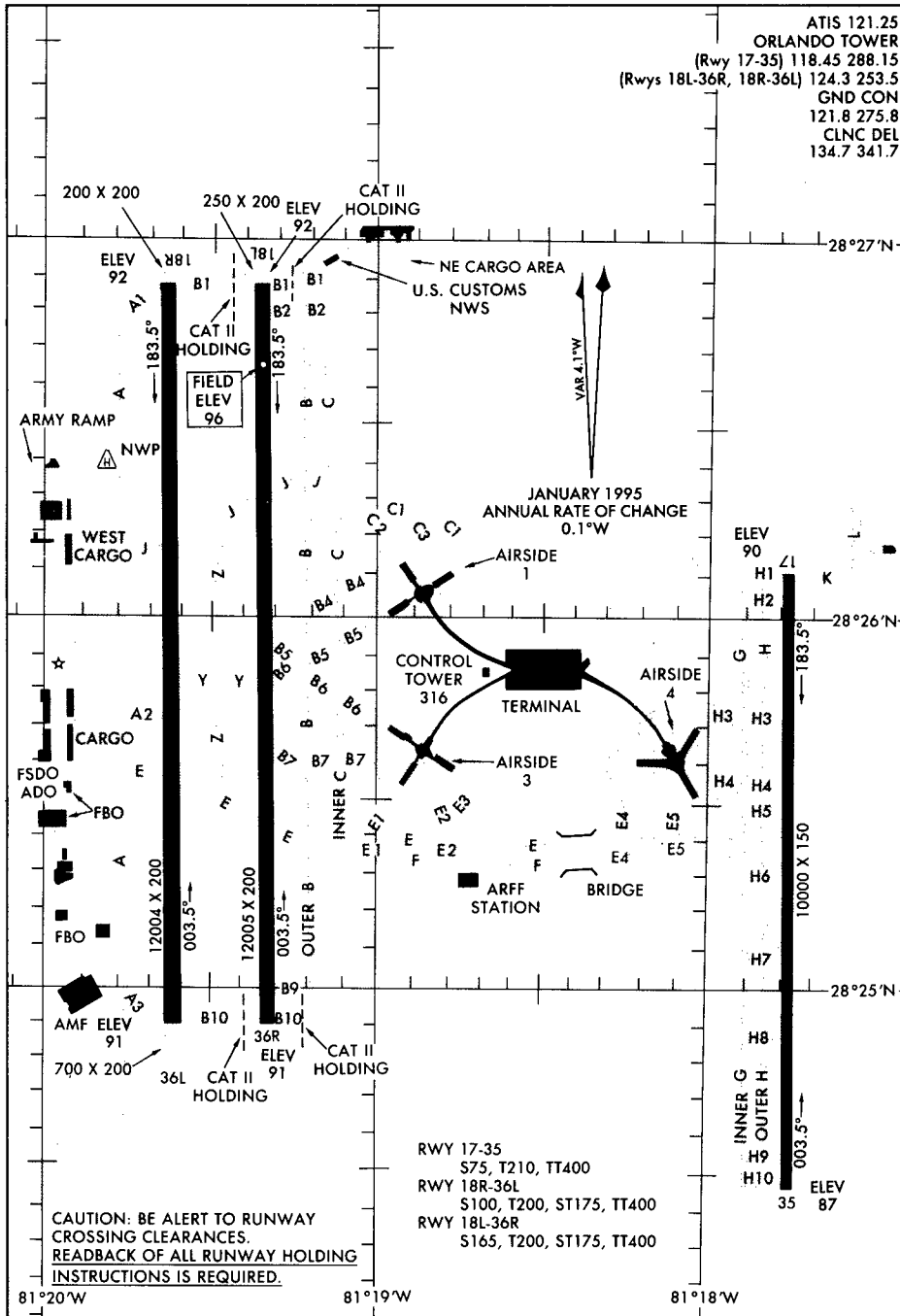

**AIRPORT DIAGRAM**  
98113

ORLANDO, FLORIDA  
ORLANDO INTL (MCO)



Tampa, Florida  
Tampa International  
ICAO Identifier KTPA

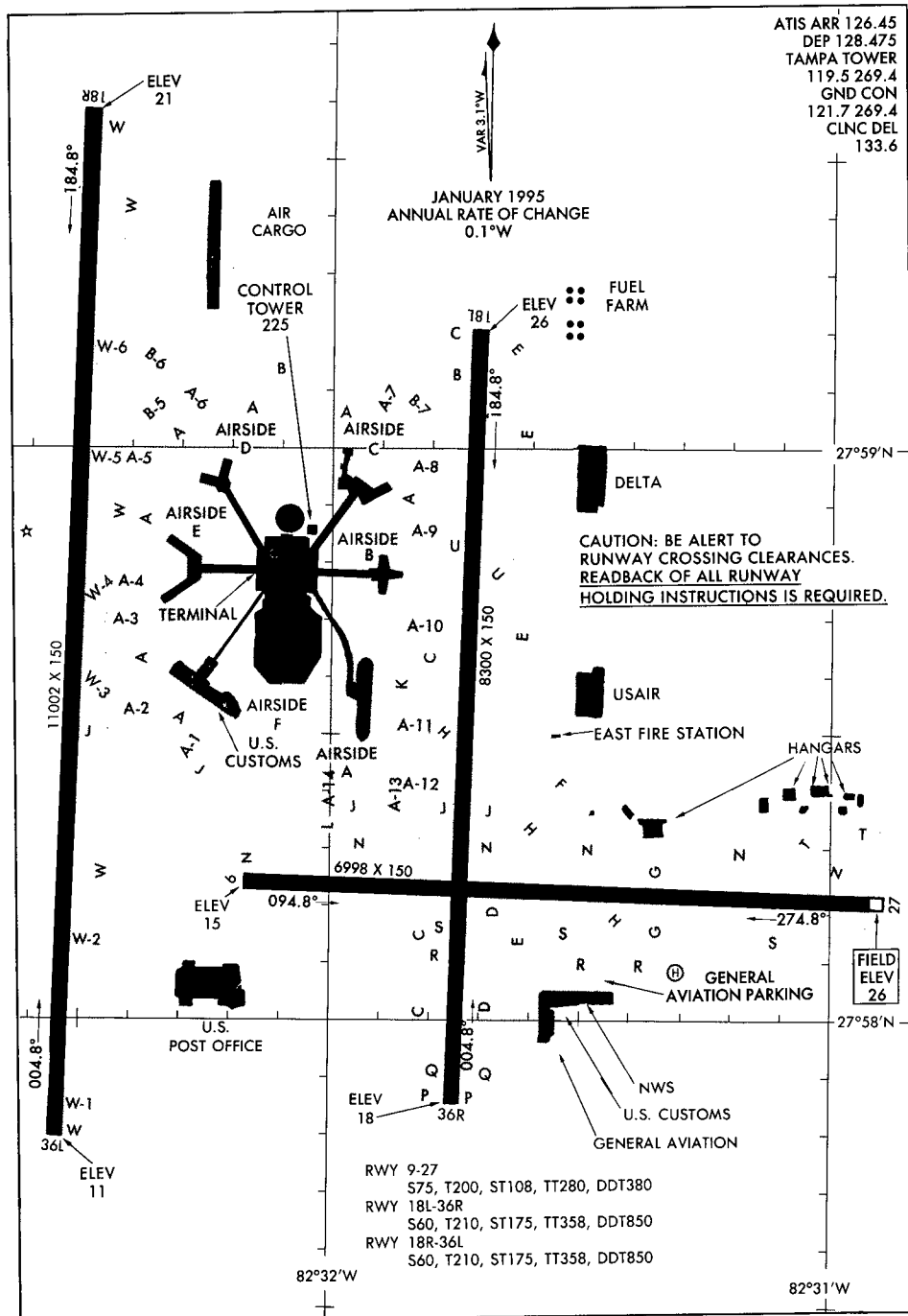

AIRPORT DIAGRAM  
98281

TAMPA, FLORIDA  
TAMPA INTL (TPA)

West Palm Beach, Florida  
Palm Beach International  
ICAO Identifier KPBI

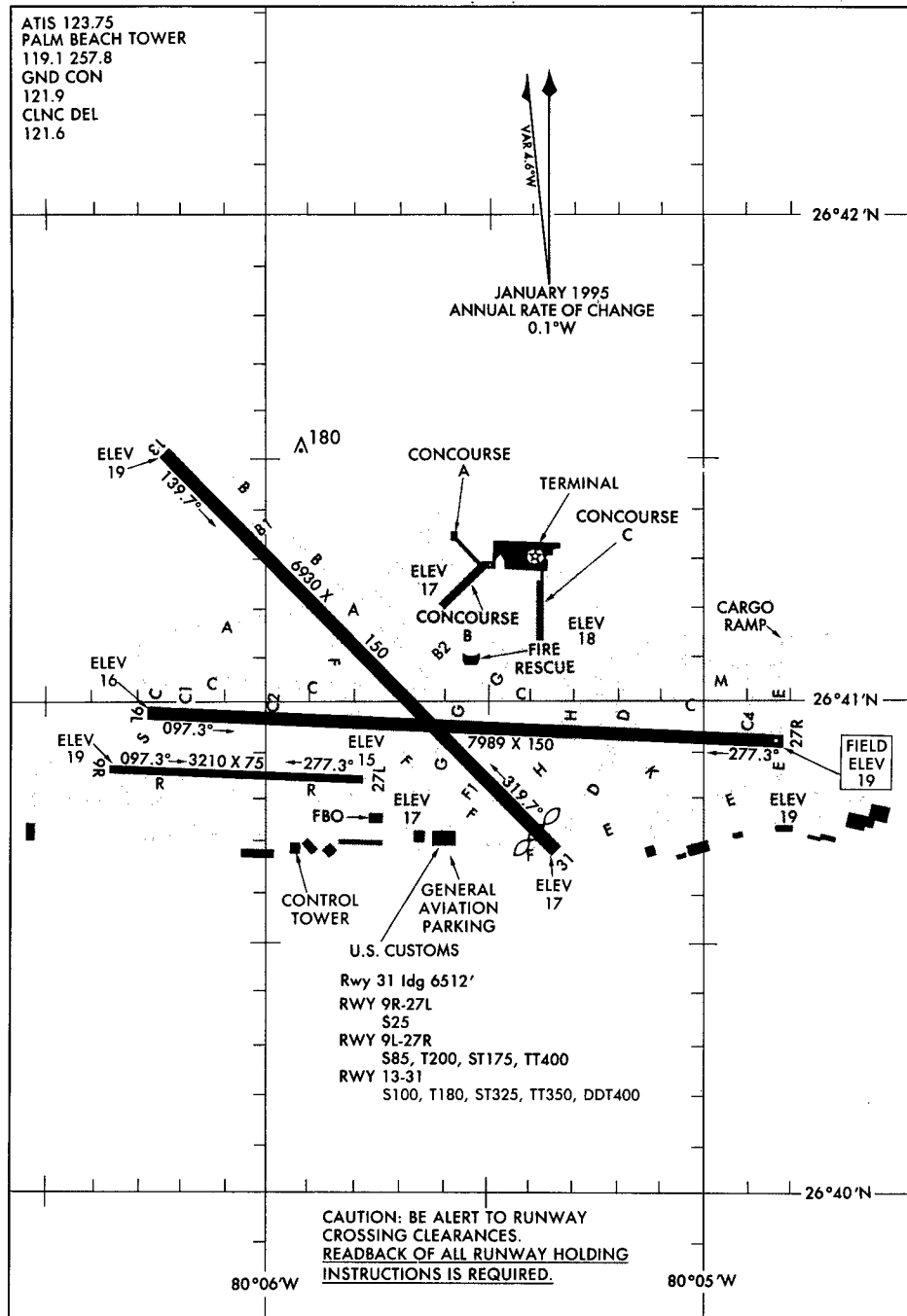

AIRPORT DIAGRAM  
98281

Atlanta, Georgia  
 The William B. Hartsfield Atlanta International  
 ICAO Identifier KATL

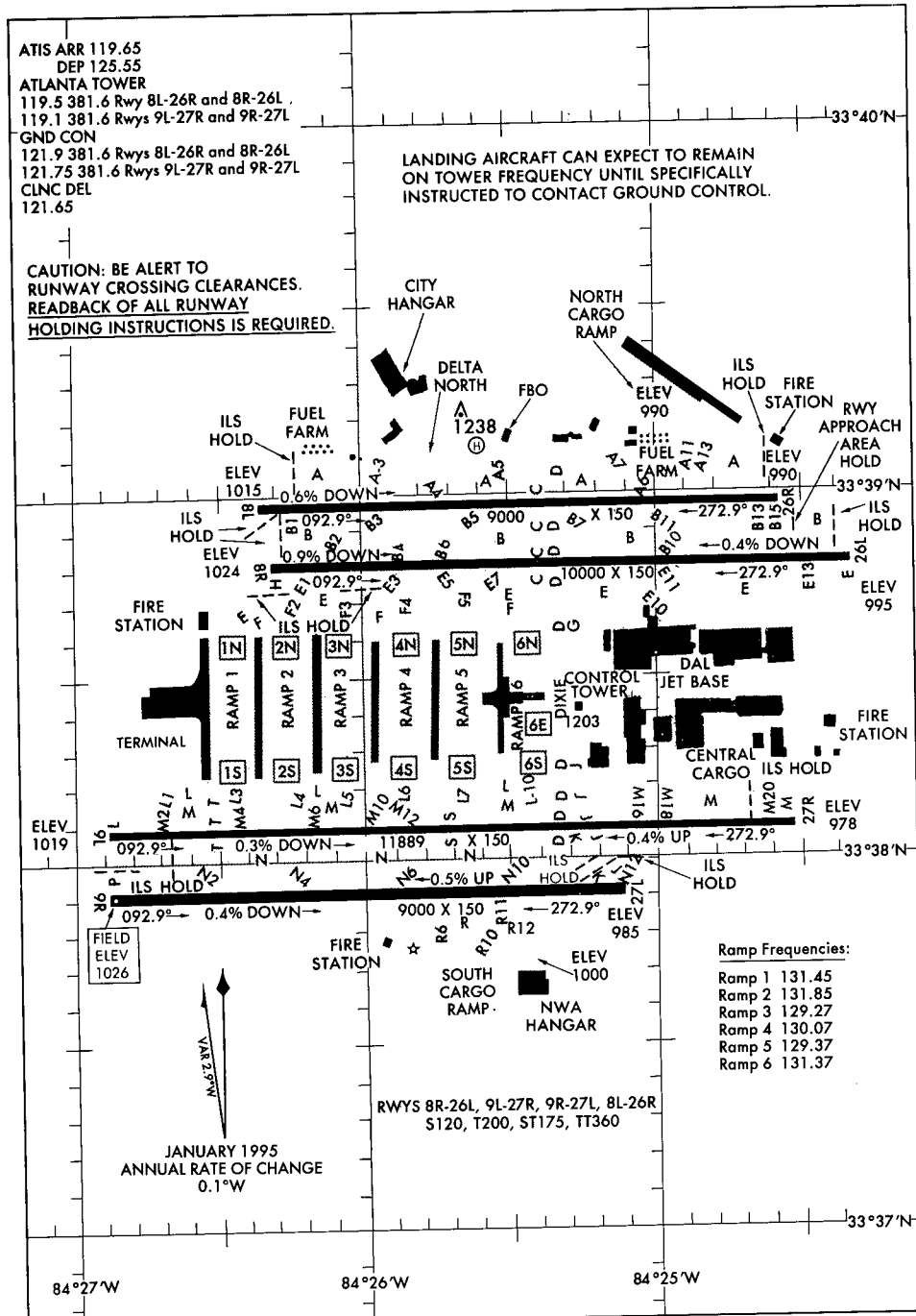

**AIRPORT DIAGRAM** ATLANTA, GEORGIA  
 ATLANTA/THE WILLIAM B. HARTSFIELD ATLANTA INTL (ATL)  
 97086

Agana, Guam  
Guam International  
ICAO Identifier PGUM

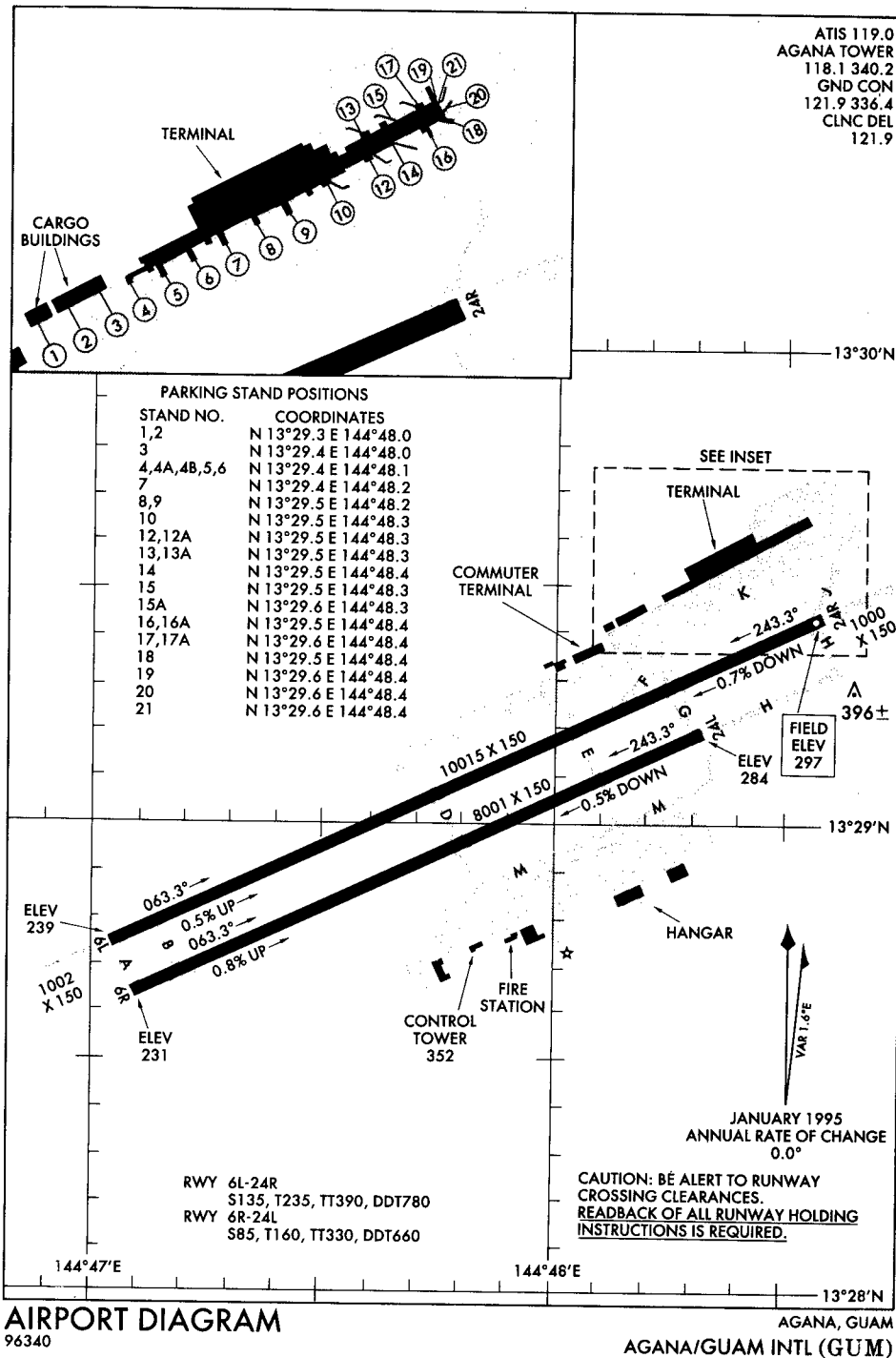

Guam Island, Guam  
Andersen Air Force Base  
ICAO Identifier PGUA

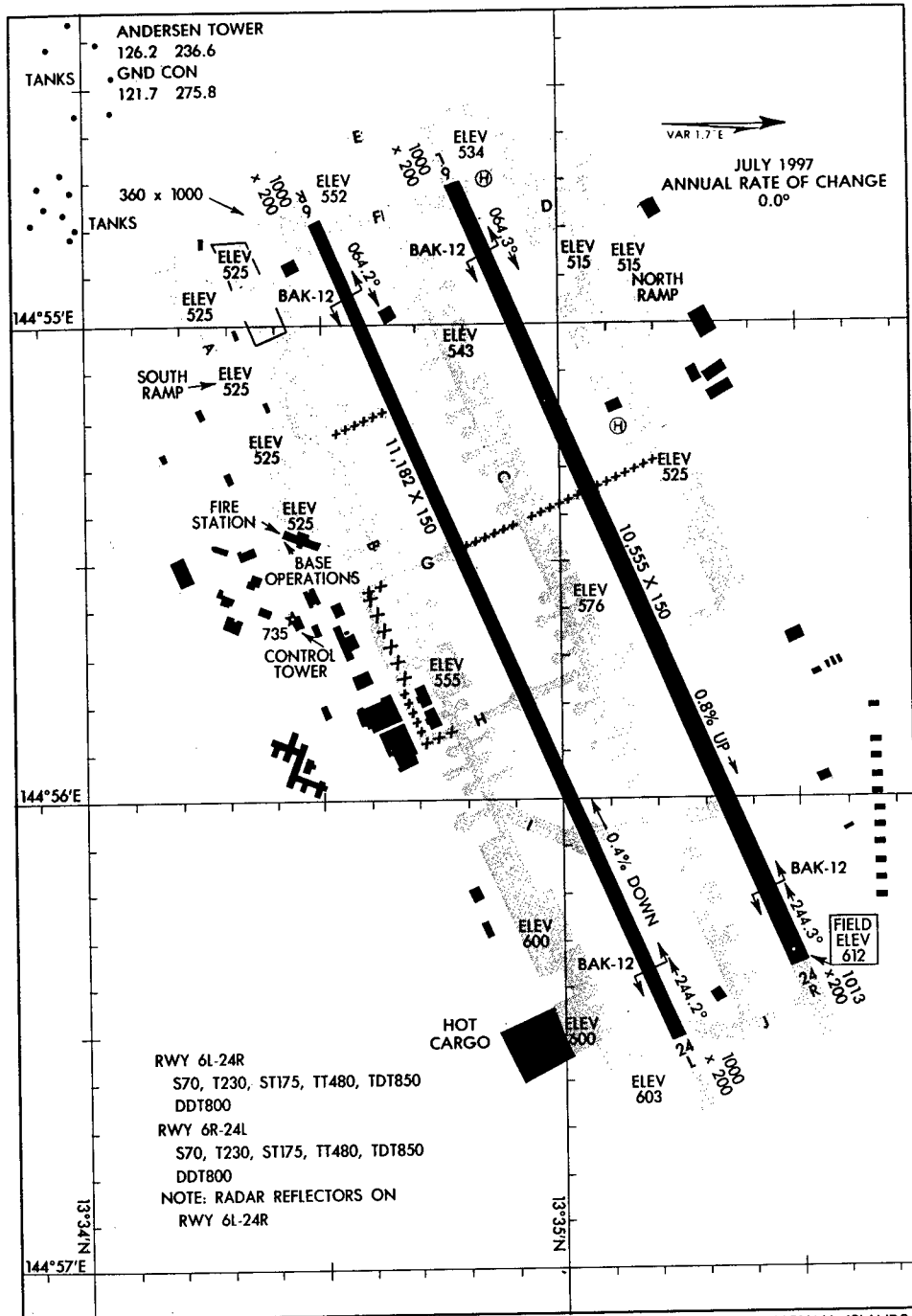

AIRPORT DIAGRAM

WGS DATUM

GUAM I., MARIANA ISLANDS  
ANDERSEN AFB (PGUA)

97198

Ewa, Oahu Island, Hawaii  
Barbers Point Naval Air Station  
ICAO Identifier PHNA

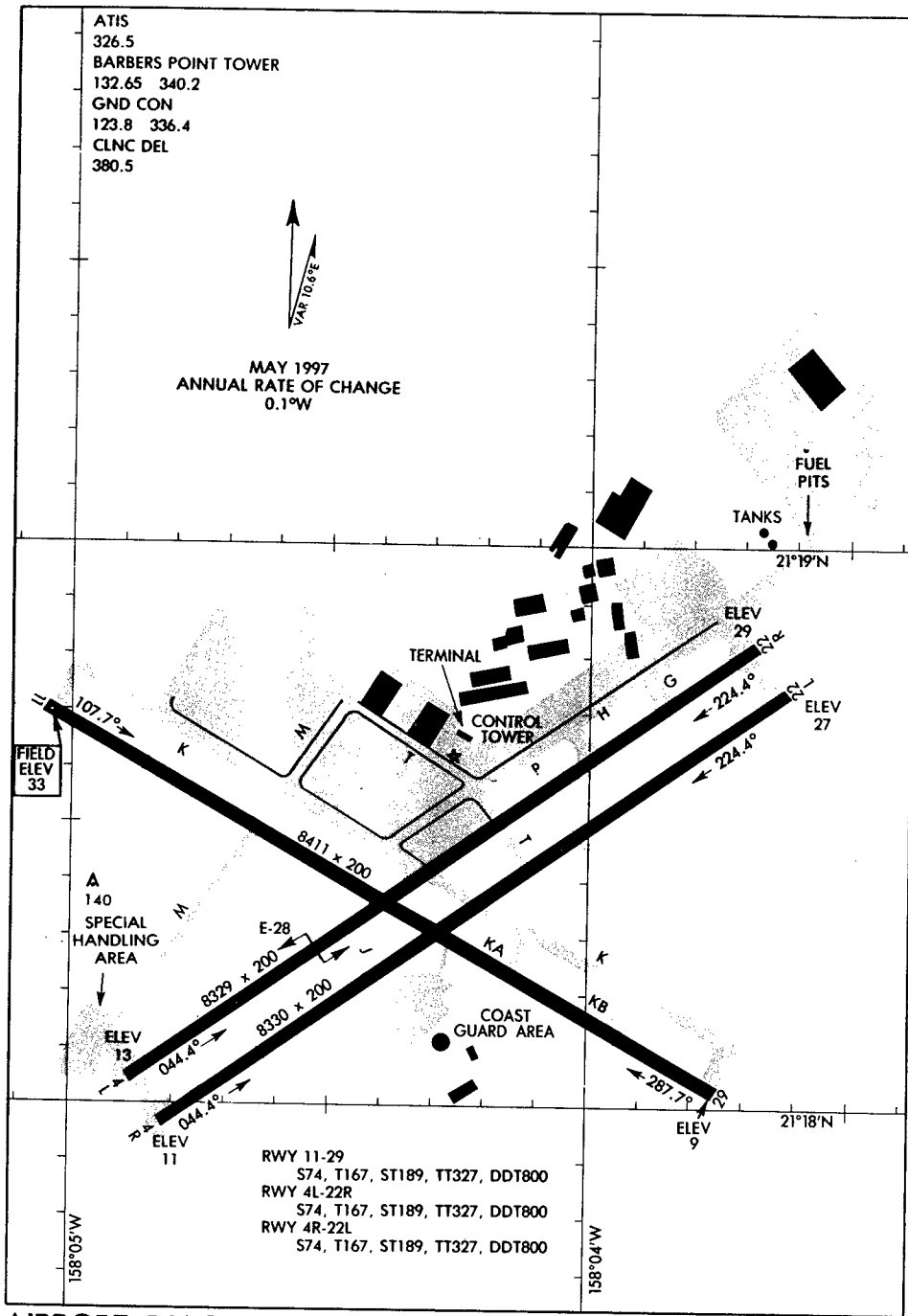

**AIRPORT DIAGRAM** WGS DATUM OAHU I., HAWAII  
97142 BARBERS POINT NAS (JOHN RODGERS FLD) (PHNA)

Hilo, Hawaii  
Hilo International  
ICAO Identifier PHTO

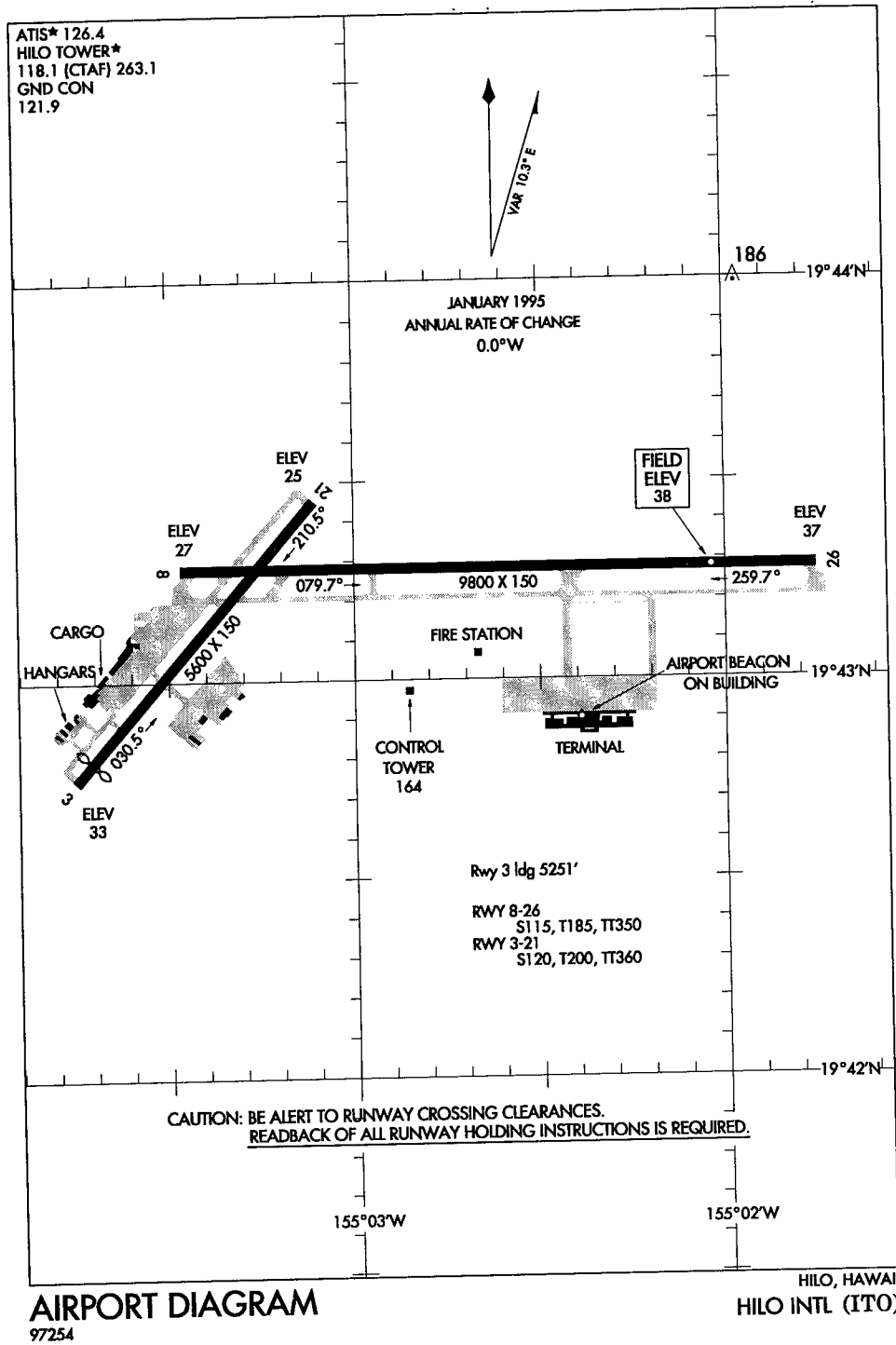

Honolulu, Hawaii  
Honolulu International  
ICAO Identifier PHNL

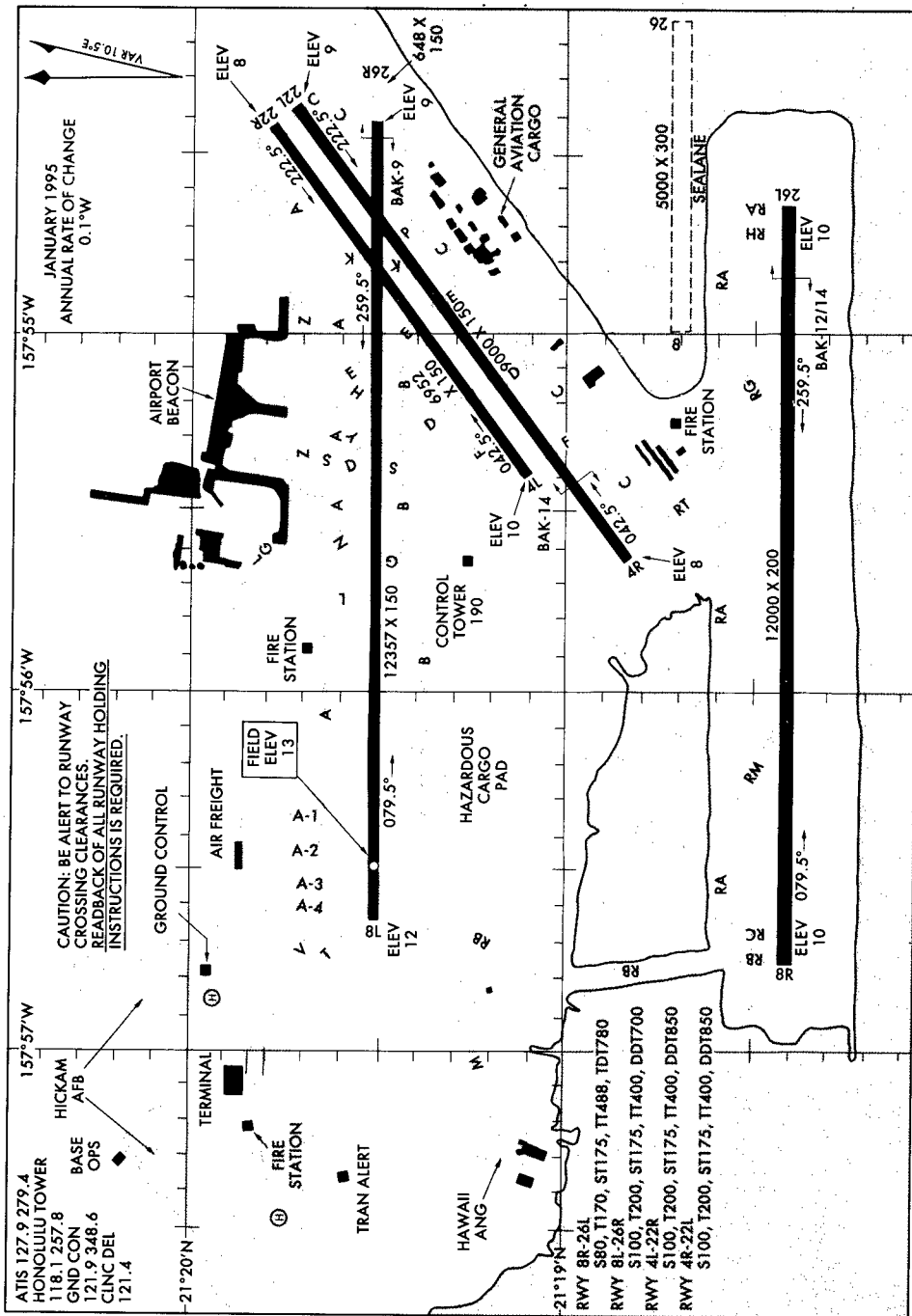

**AIRPORT DIAGRAM**  
96340

HONOLULU, HAWAII  
HONOLULU INTERNATIONAL (HNL)



Kahului, Hawaii  
Kahului  
ICAO Identifier PHOG

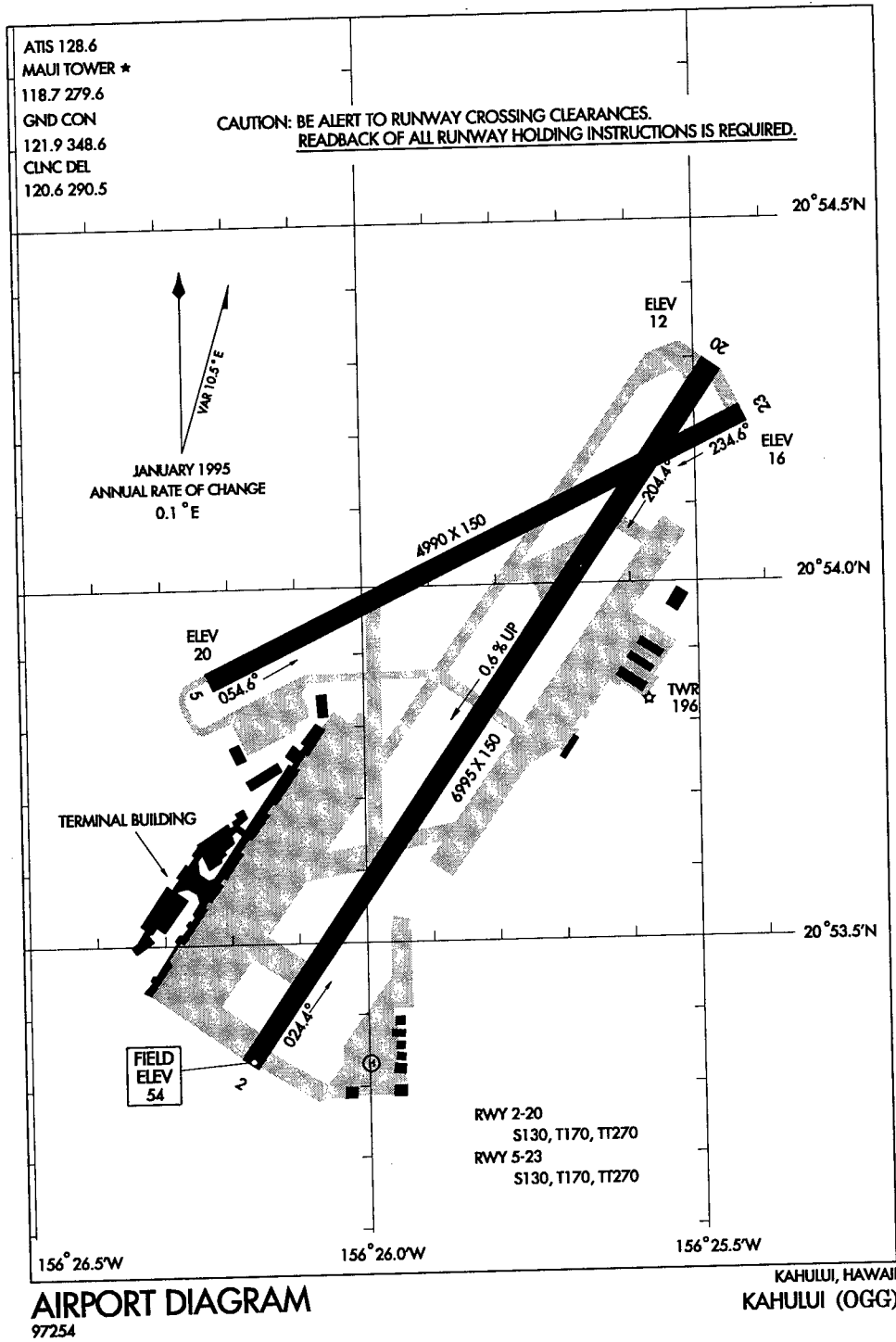

Chicago, Illinois  
Chicago-O'Hare International  
ICAO Identifier KORD

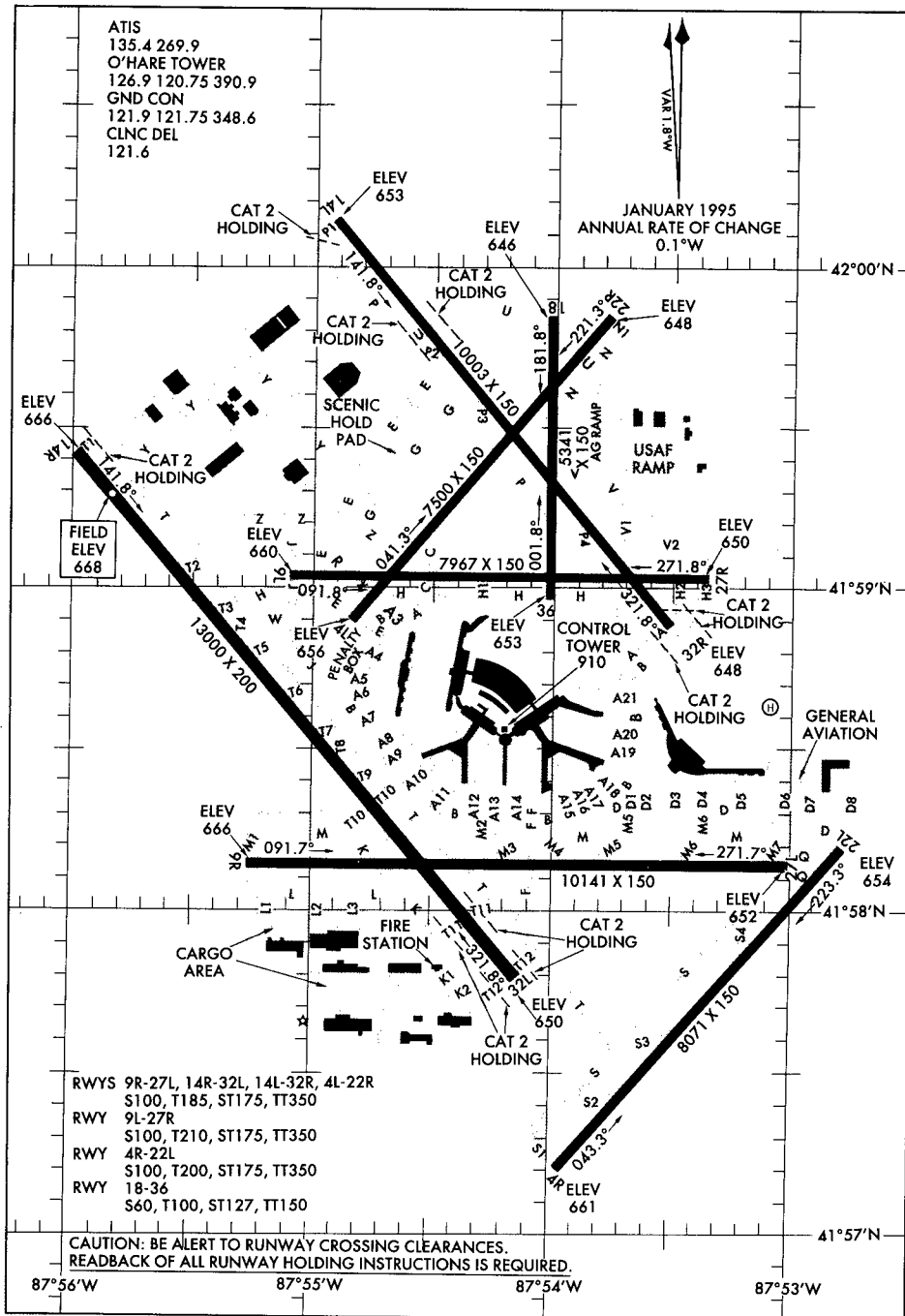

**AIRPORT DIAGRAM**  
98113

CHICAGO, ILLINOIS  
CHICAGO-O'HARE INTL (ORD)

Indianapolis, Indiana  
Indianapolis International  
ICAO Identifier KIND

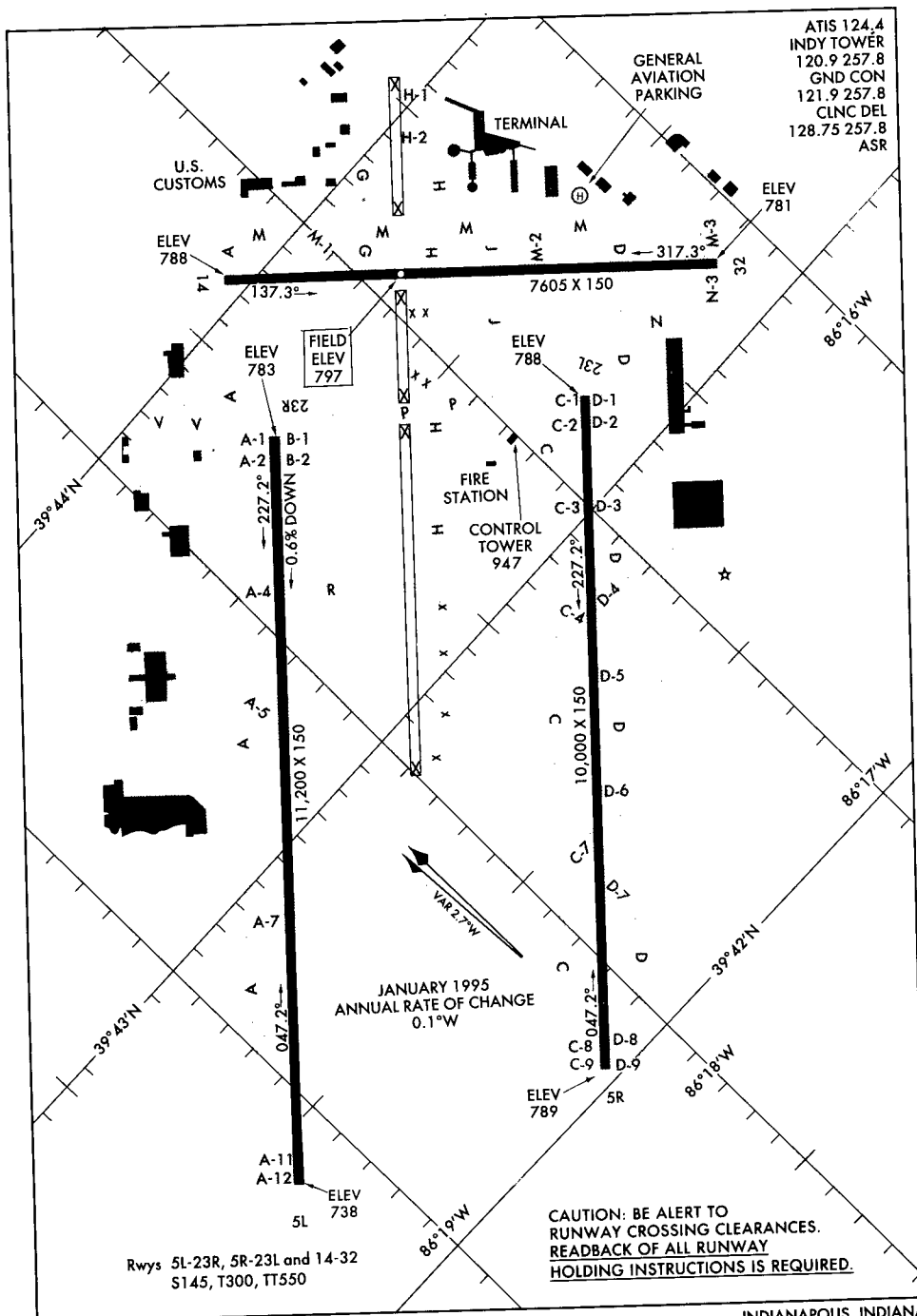

**AIRPORT DIAGRAM**  
98169

INDIANAPOLIS, INDIANA  
INDIANAPOLIS INTL (IND)

Johnston Island  
Johnston Atoll  
ICAO Identifier PJON

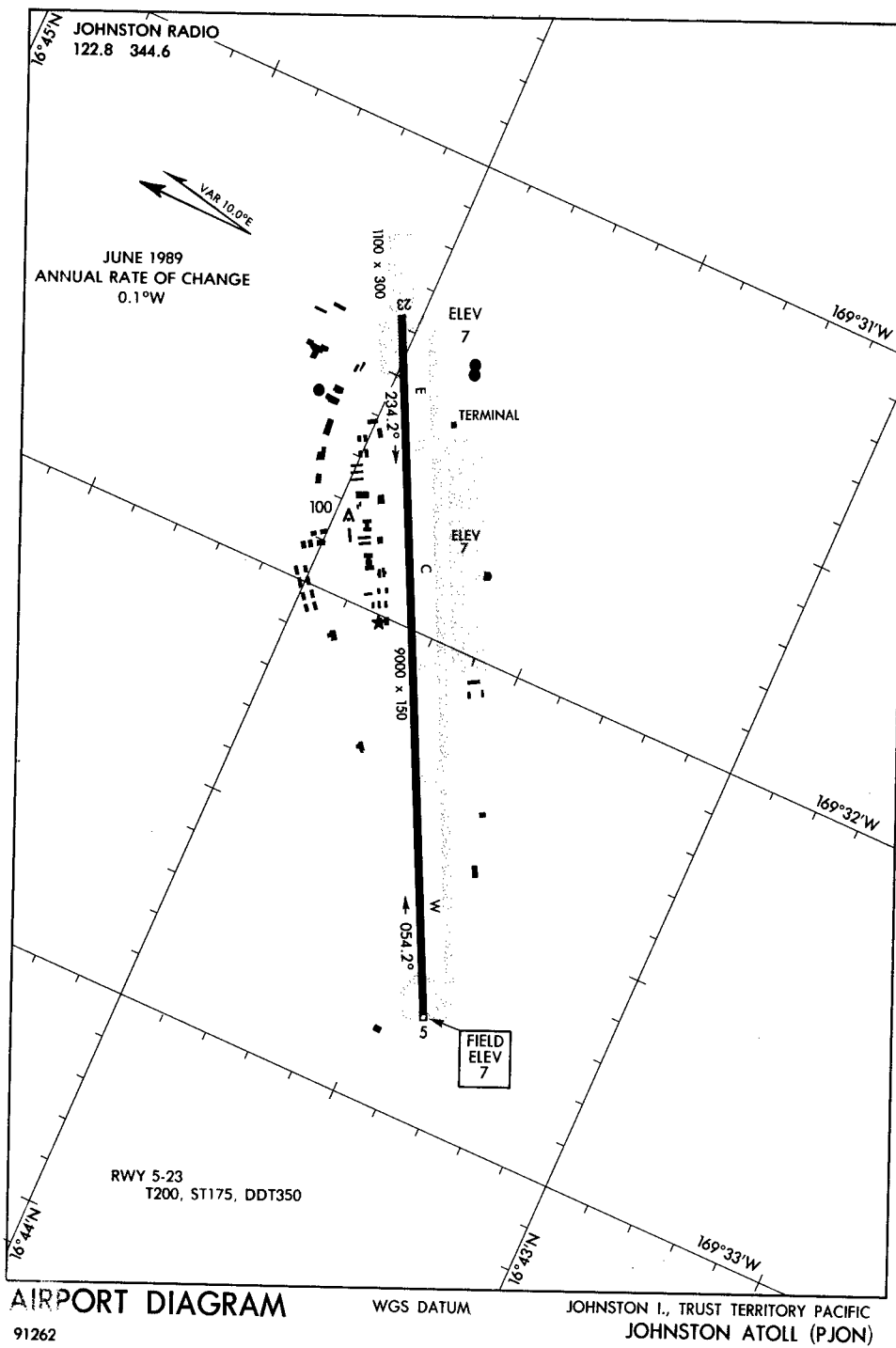

Wichita, Kansas  
Wichita Mid-Continent  
ICAO Identifier KICT

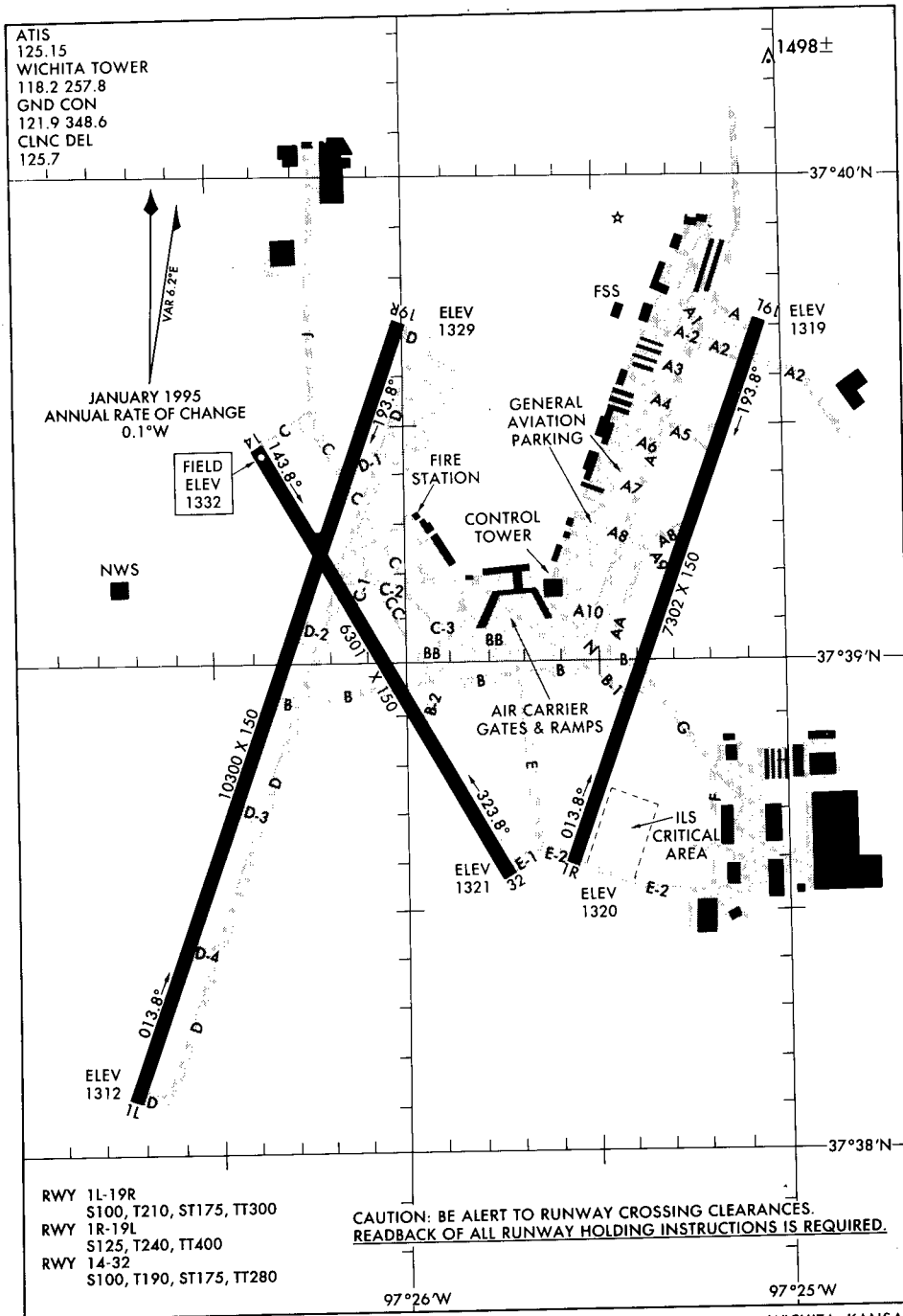

AIRPORT DIAGRAM  
97254

- RWY 1L-19R  
S100, T210, ST175, TT300
- RWY 1R-19L  
S125, T240, TT400
- RWY 14-32  
S100, T190, ST175, TT280

Covington, Kentucky  
Cincinnati/Northern Kentucky International  
ICAO Identifier KCVG

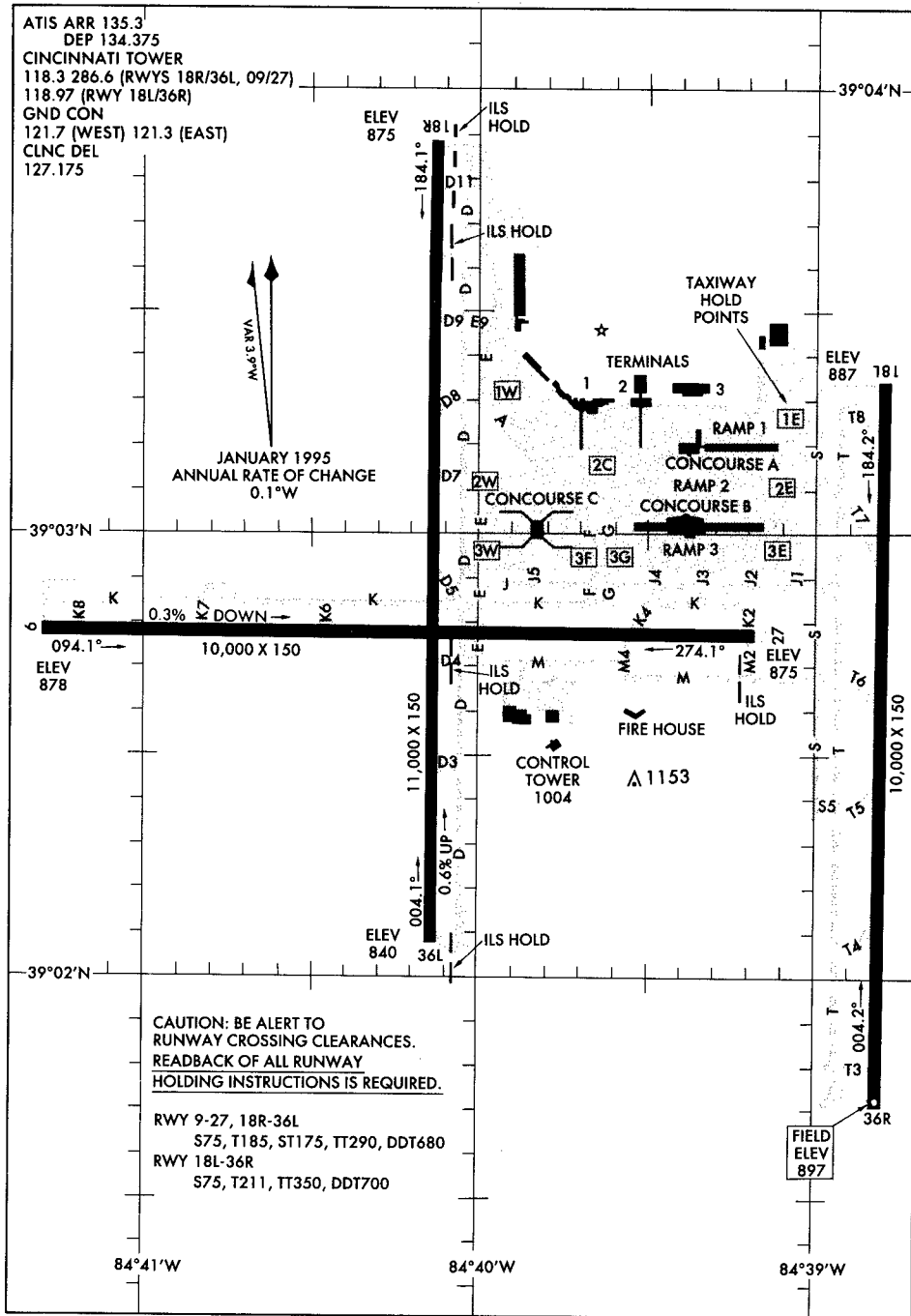

**AIRPORT DIAGRAM** COVINGTON, KENTUCKY  
96340 COVINGTON/CINCINNATI/NORTHERN KENTUCKY INTL (CVG)

New Orleans, Louisiana  
 New Orleans International (Moisant Field)  
 ICAO Identifier KMSY

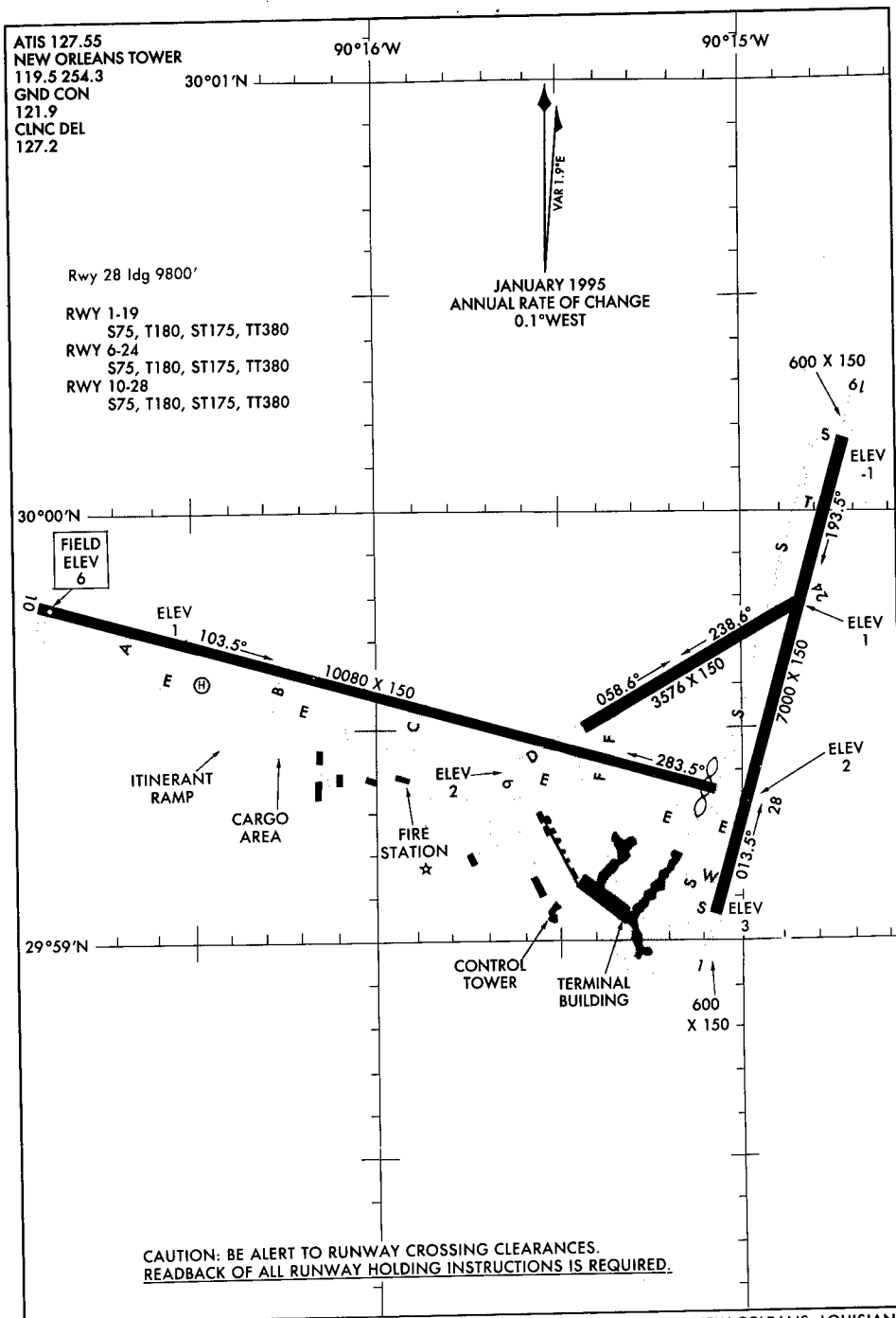

AIRPORT DIAGRAM  
 97030

NEW ORLEANS, LOUISIANA  
 NEW ORLEANS INTL (MOISANT FIELD) (MSY)

Bangor, Maine  
Bangor International  
ICAO Identifier KBGR

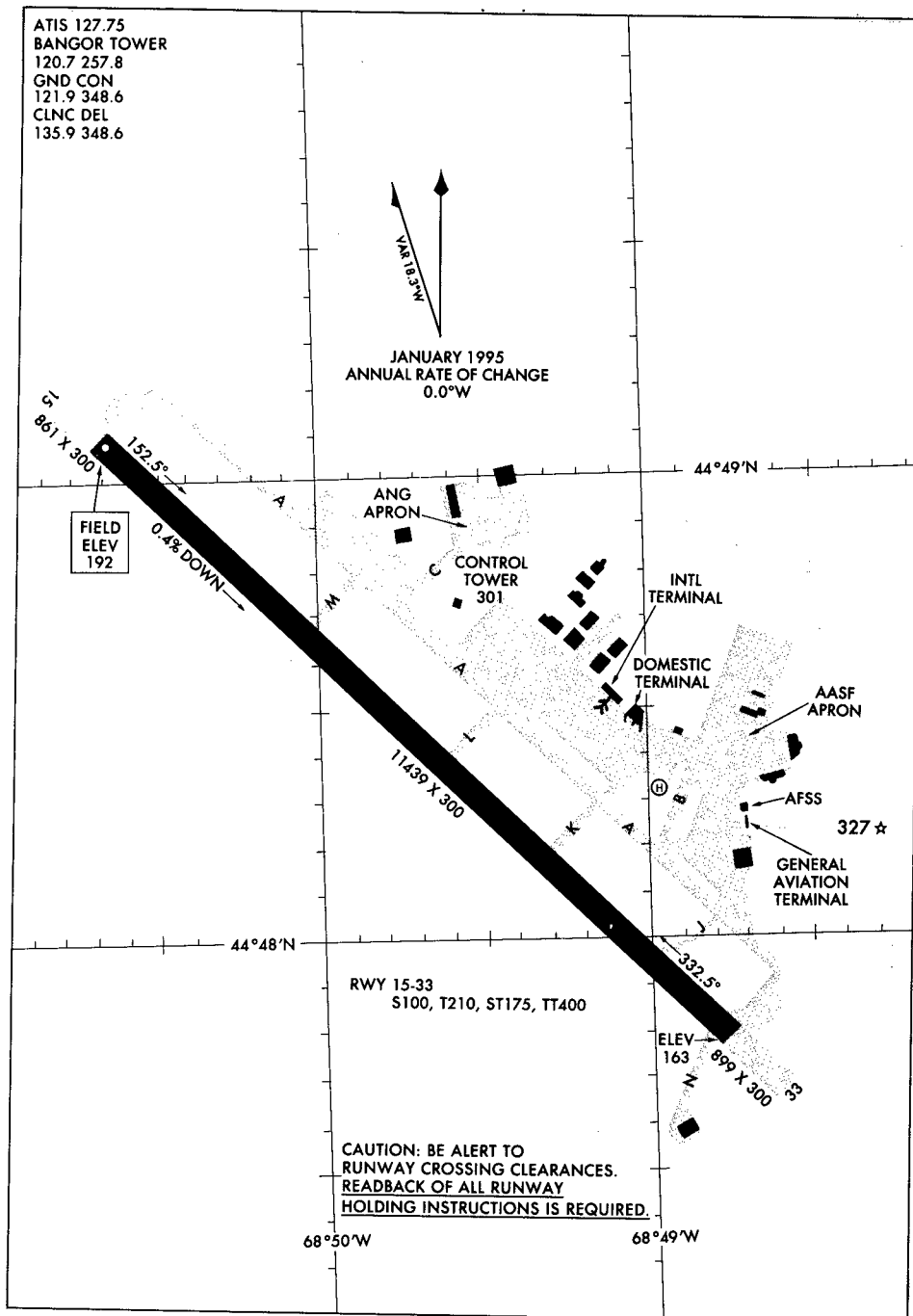

AIRPORT DIAGRAM

96340

BANGOR, MAINE  
BANGOR INTL (BGR)



Baltimore, Maryland  
Baltimore-Washington International  
ICAO Identifier KBWI

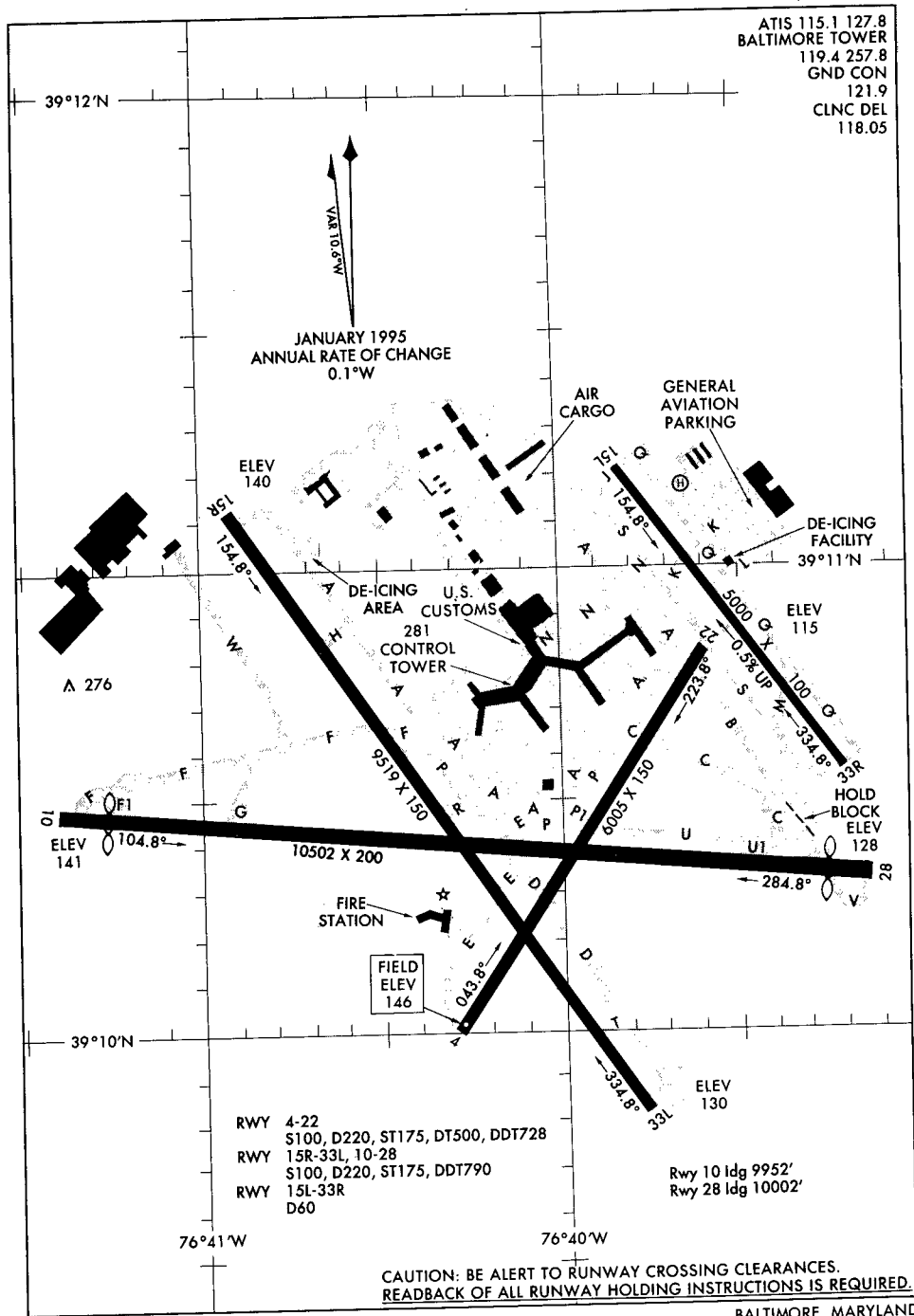

AIRPORT DIAGRAM  
98057

BALTIMORE, MARYLAND  
BALTIMORE-WASHINGTON INTL (BWI)



Detroit, Michigan  
Detroit Metropolitan Wayne County  
ICAO Identifier KDTW

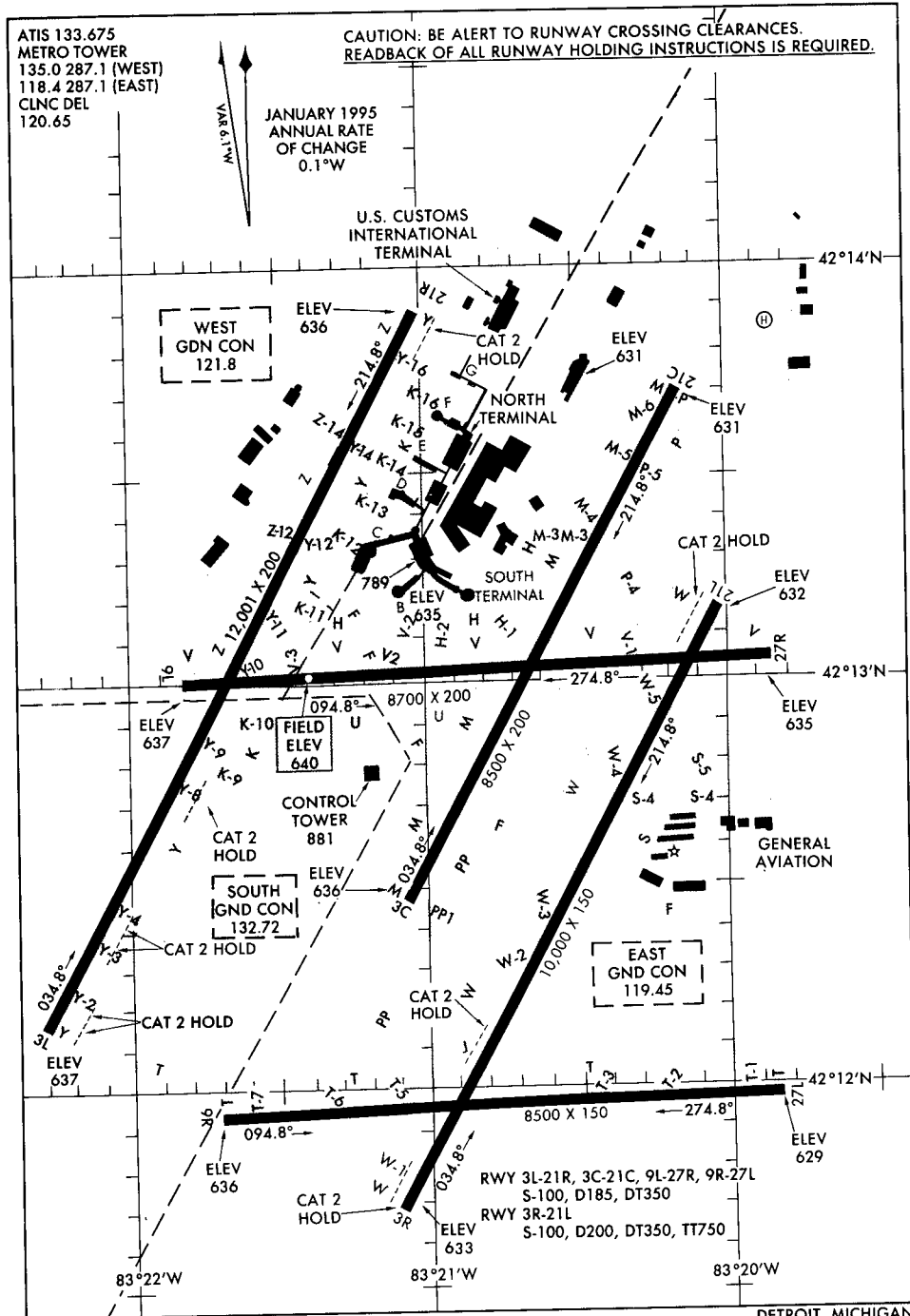

AIRPORT DIAGRAM  
97030

DETROIT, MICHIGAN  
DETROIT METROPOLITAN WAYNE COUNTY (DTW)

Minneapolis, Minnesota  
Minneapolis-St. Paul International  
(Wold-Chamberlain)  
ICAO Identifier KMSPP

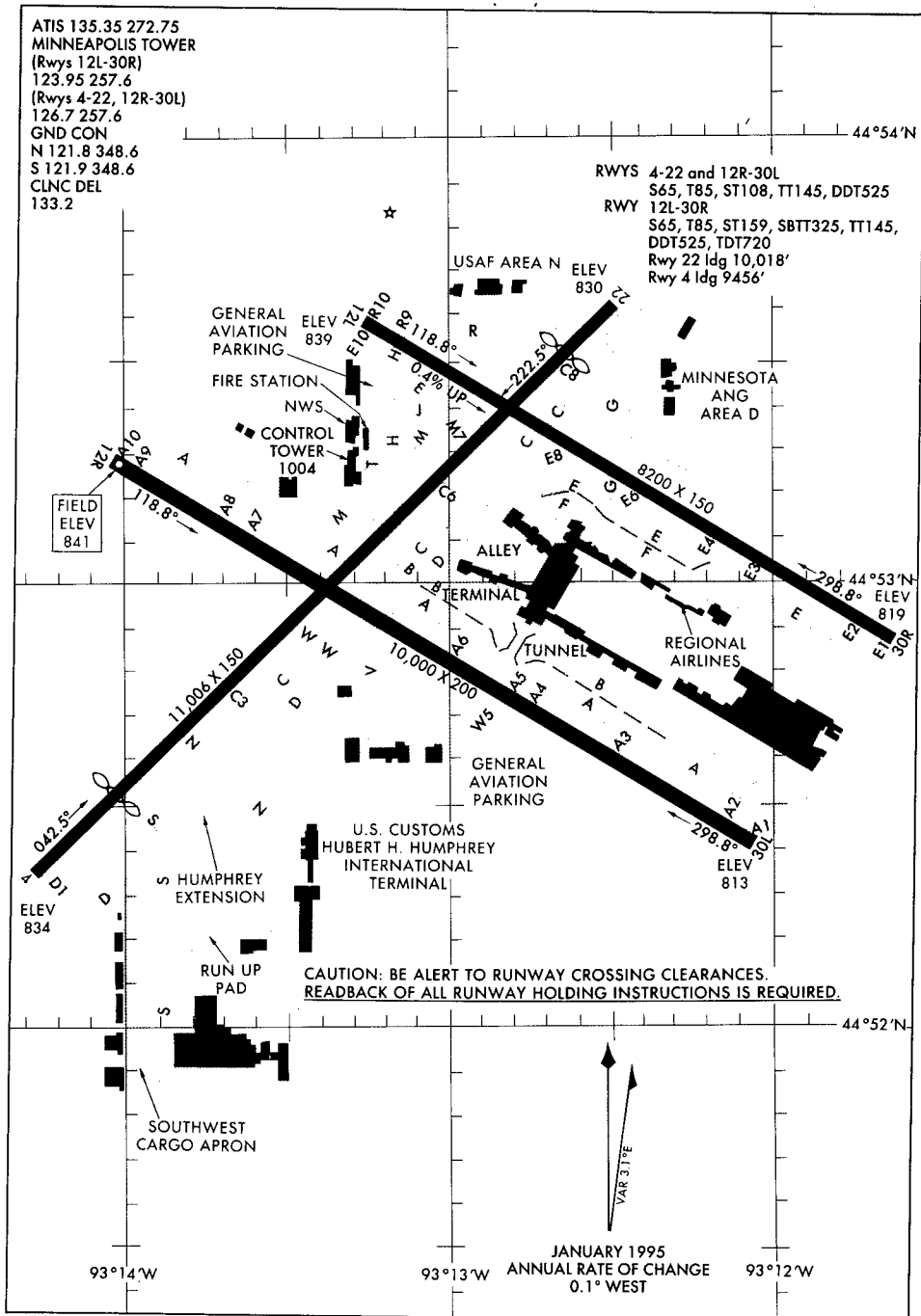

AIRPORT DIAGRAM MINNEAPOLIS, MINNESOTA  
98113 MINNEAPOLIS-ST PAUL INTL (WOLD-CHAMBERLAIN) (MSP)

Kansas City, Missouri  
Kansas City International  
ICAO Identifier KMCI

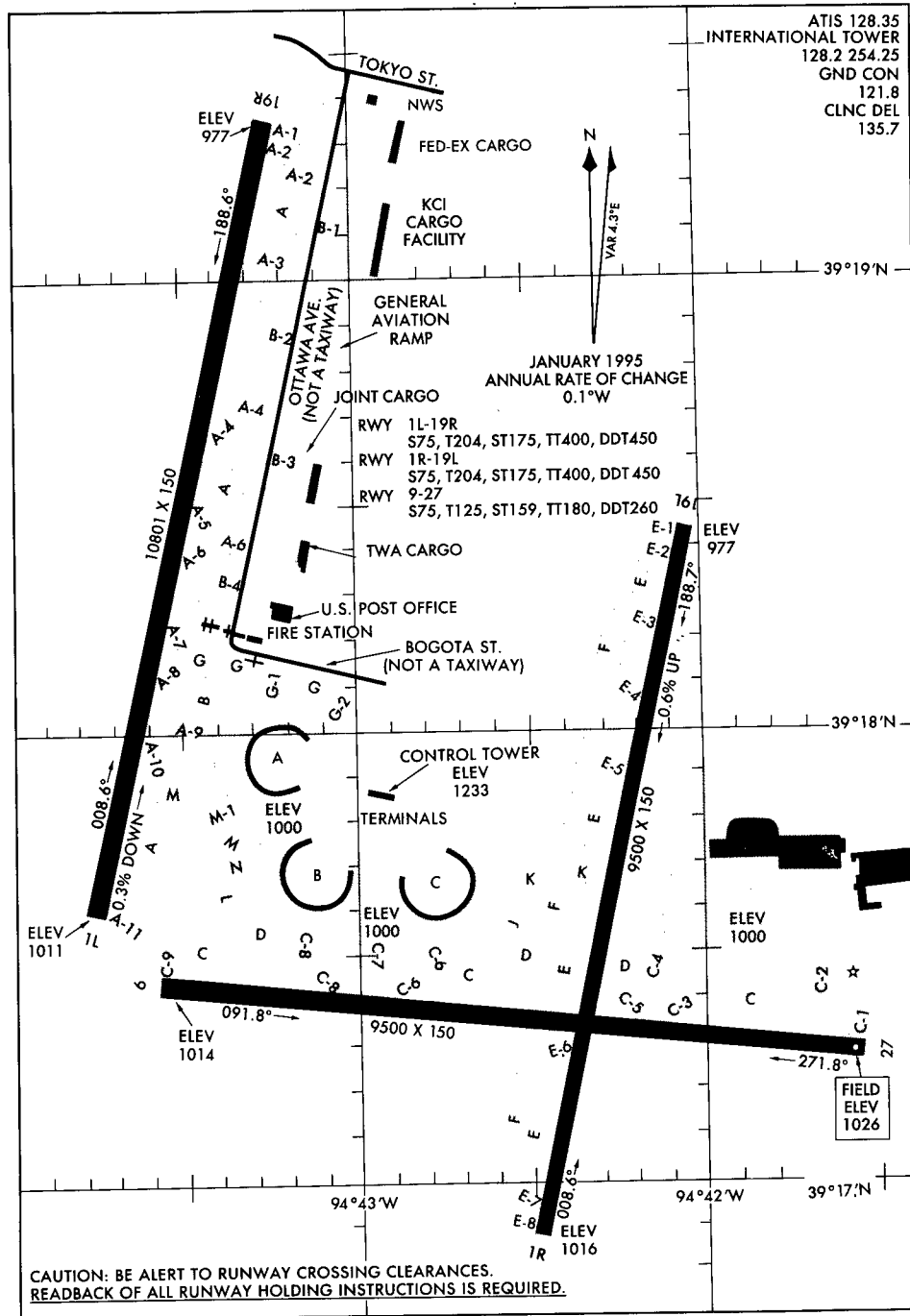

AIRPORT DIAGRAM  
98225

KANSAS CITY, MISSOURI  
KANSAS CITY INTL (MCI)

St. Louis, Missouri  
Lambert-St. Louis International  
ICAO Identifier KSTL

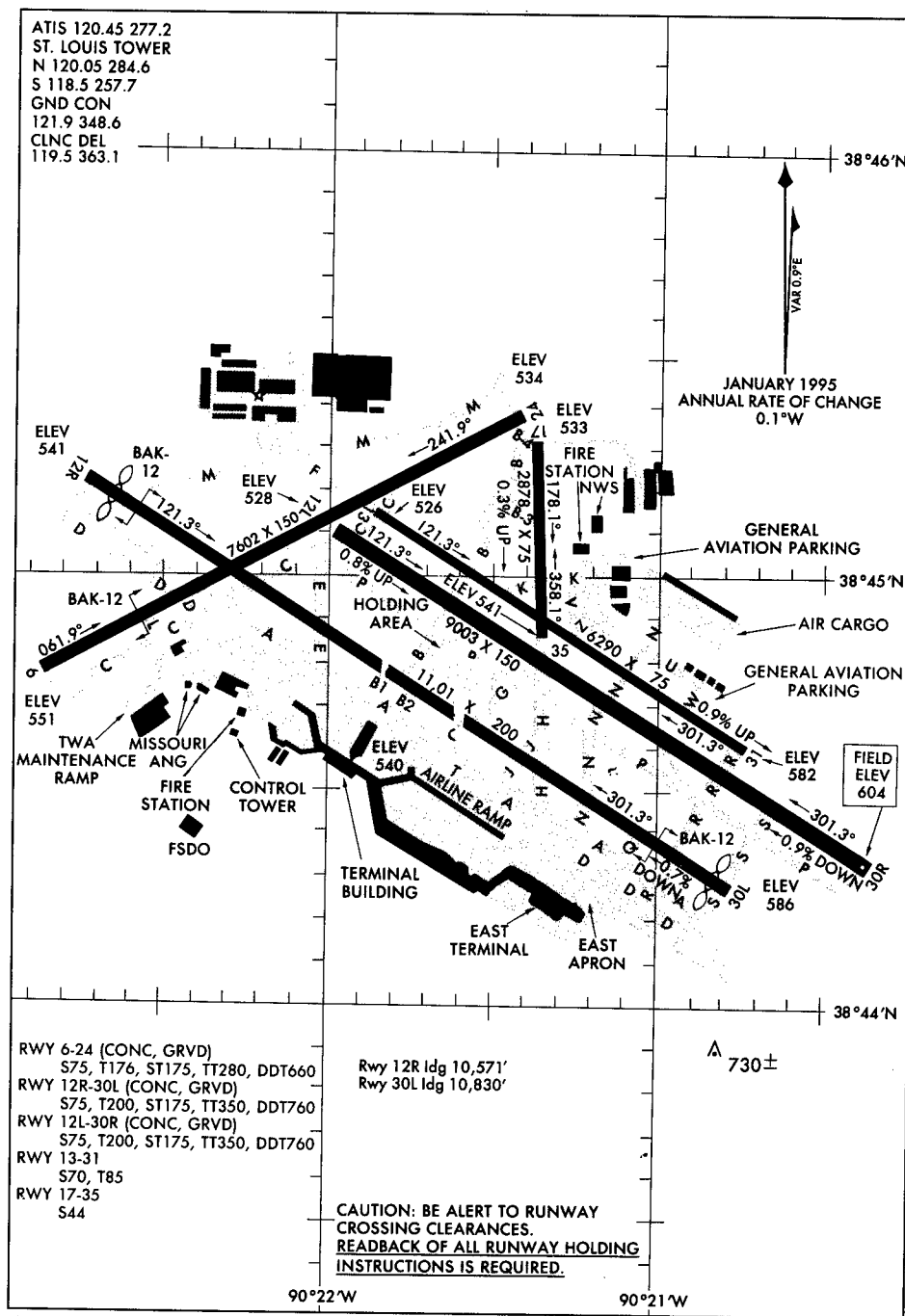

**AIRPORT DIAGRAM** ST. LOUIS, MISSOURI  
98281 ST. LOUIS/LAMBERT-ST. LOUIS INTL (STL)

Las Vegas, Nevada  
McCarran International  
ICAO Identifier KLAS

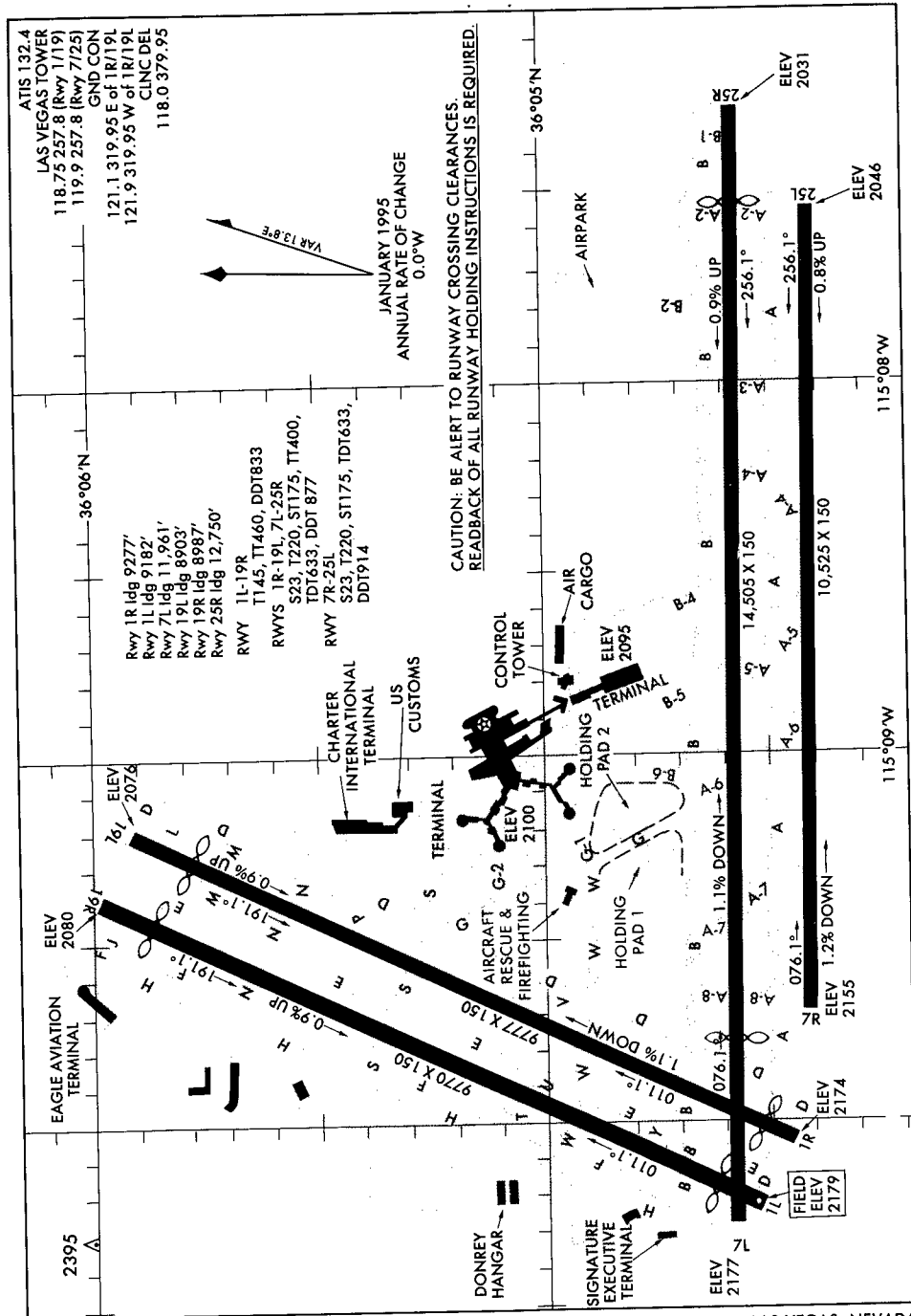

**AIRPORT DIAGRAM**  
98113

LAS VEGAS, NEVADA  
LAS VEGAS/McCARRAN INTL (LAS)

Reno, Nevada  
Reno/Tahoe International  
KRNO ICAO Identifier

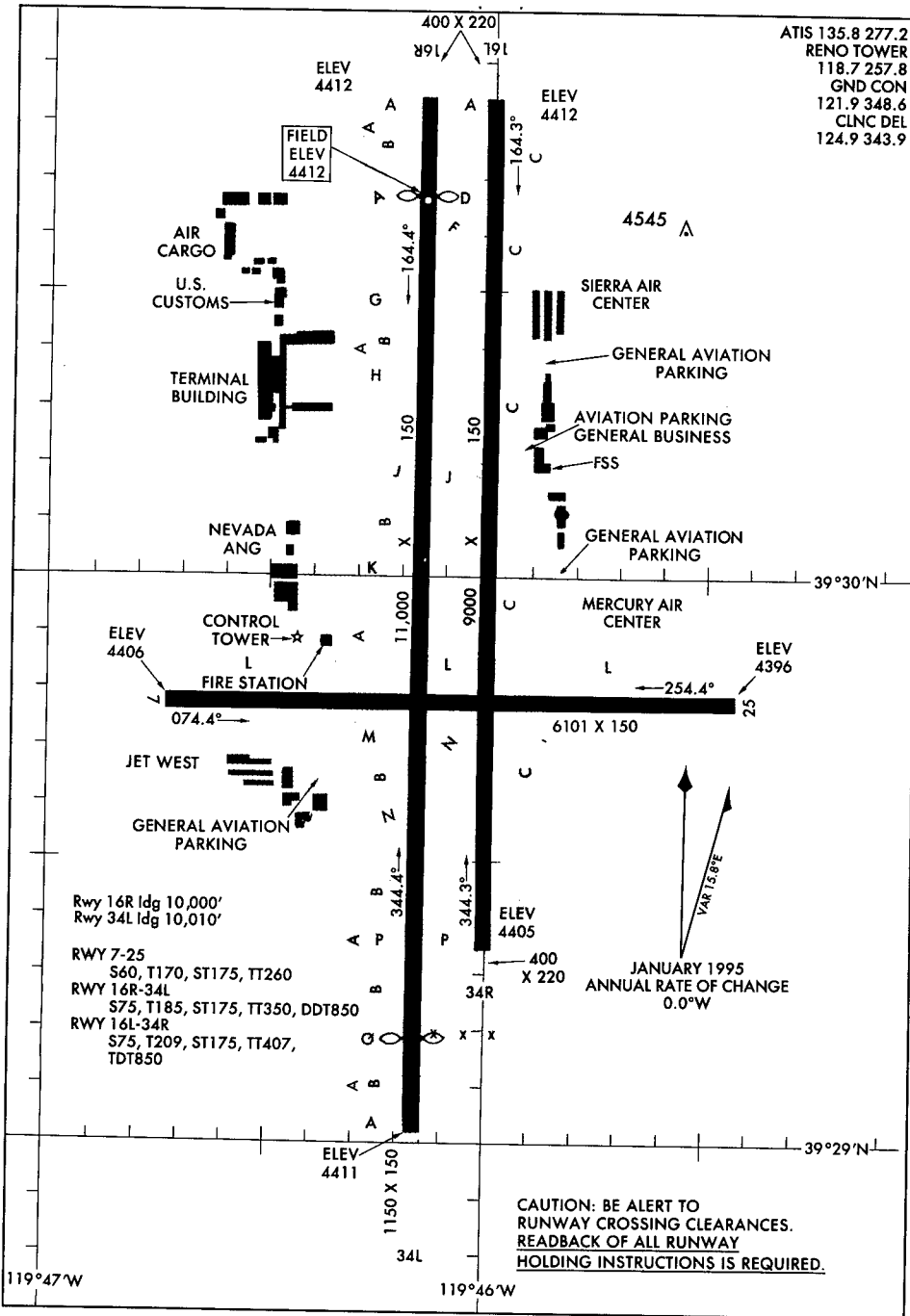

AIRPORT DIAGRAM  
98225

RENO, NEVADA  
RENO/TAHOE INTL (RNO)



Newark, New Jersey  
Newark International  
ICAO Identifier KEWR

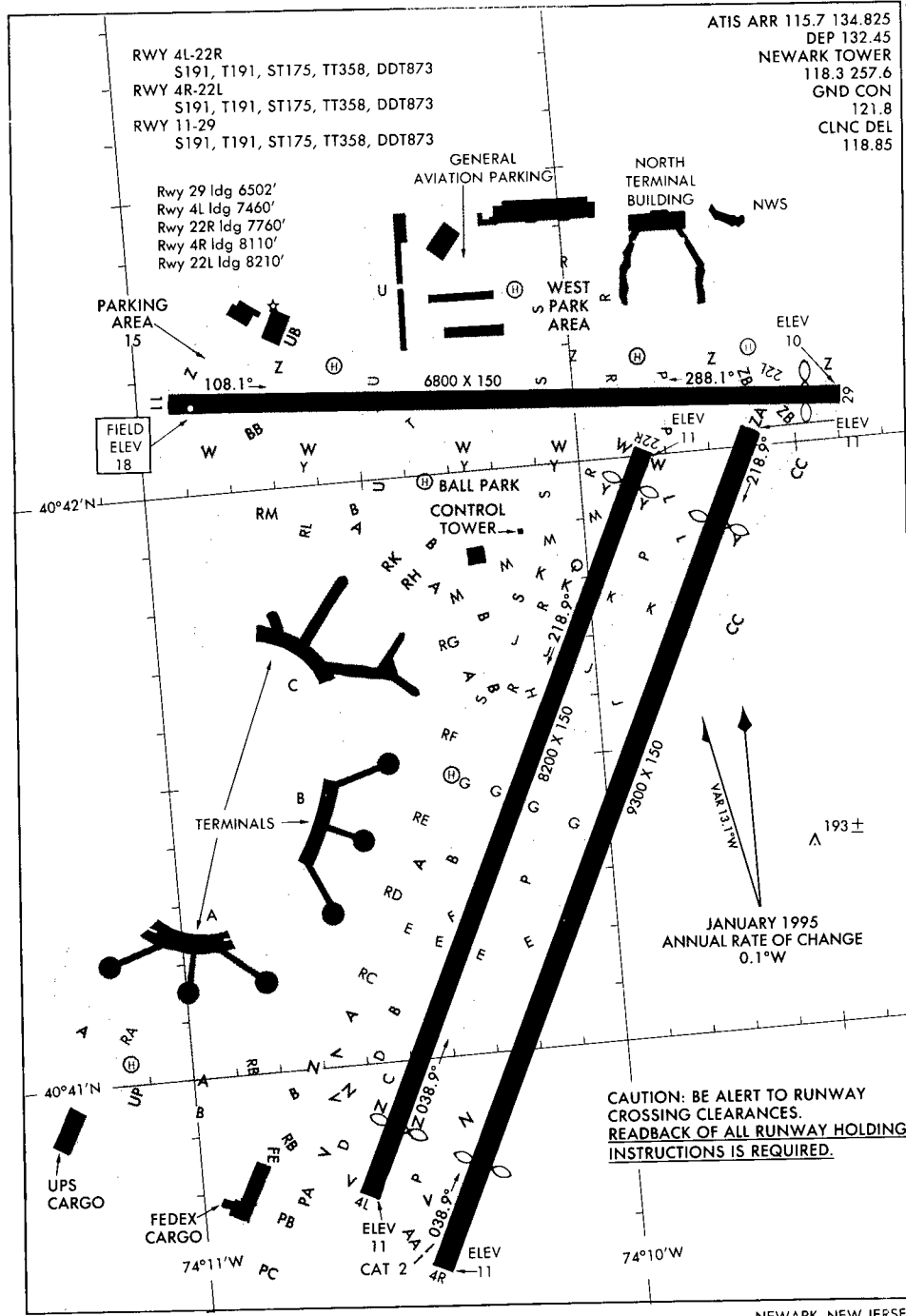

AIRPORT DIAGRAM  
97030

NEWARK, NEW JERSEY  
NEWARK INTL (EWR)

New York, New York  
John F. Kennedy International  
ICAO Identifier KJFK

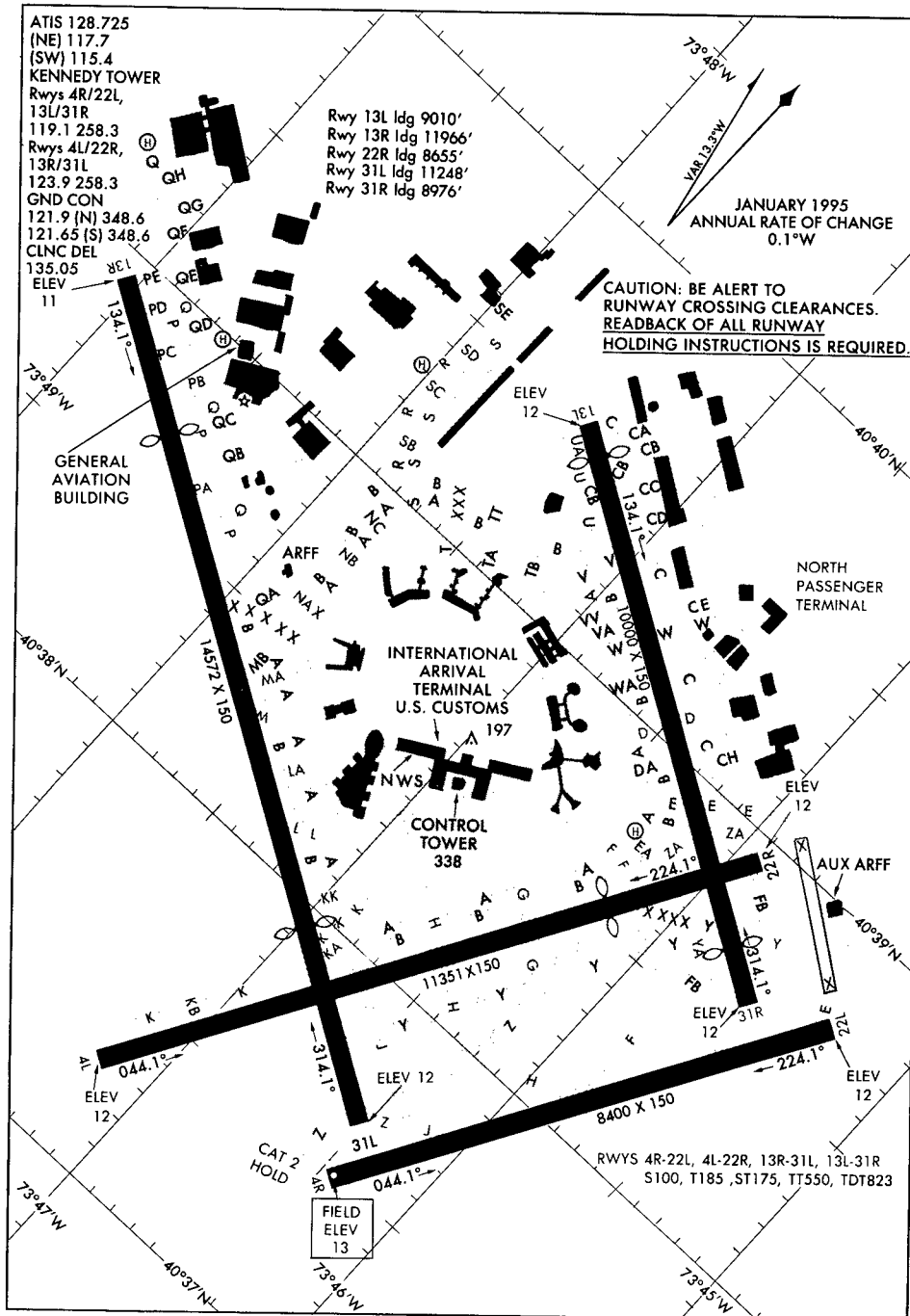

AIRPORT DIAGRAM  
98281

NEW YORK, NEW YORK  
NEW YORK/JOHN F. KENNEDY INTL (JFK)

Niagara Falls, New York  
Niagara Falls International  
ICAO Identifier KIAG

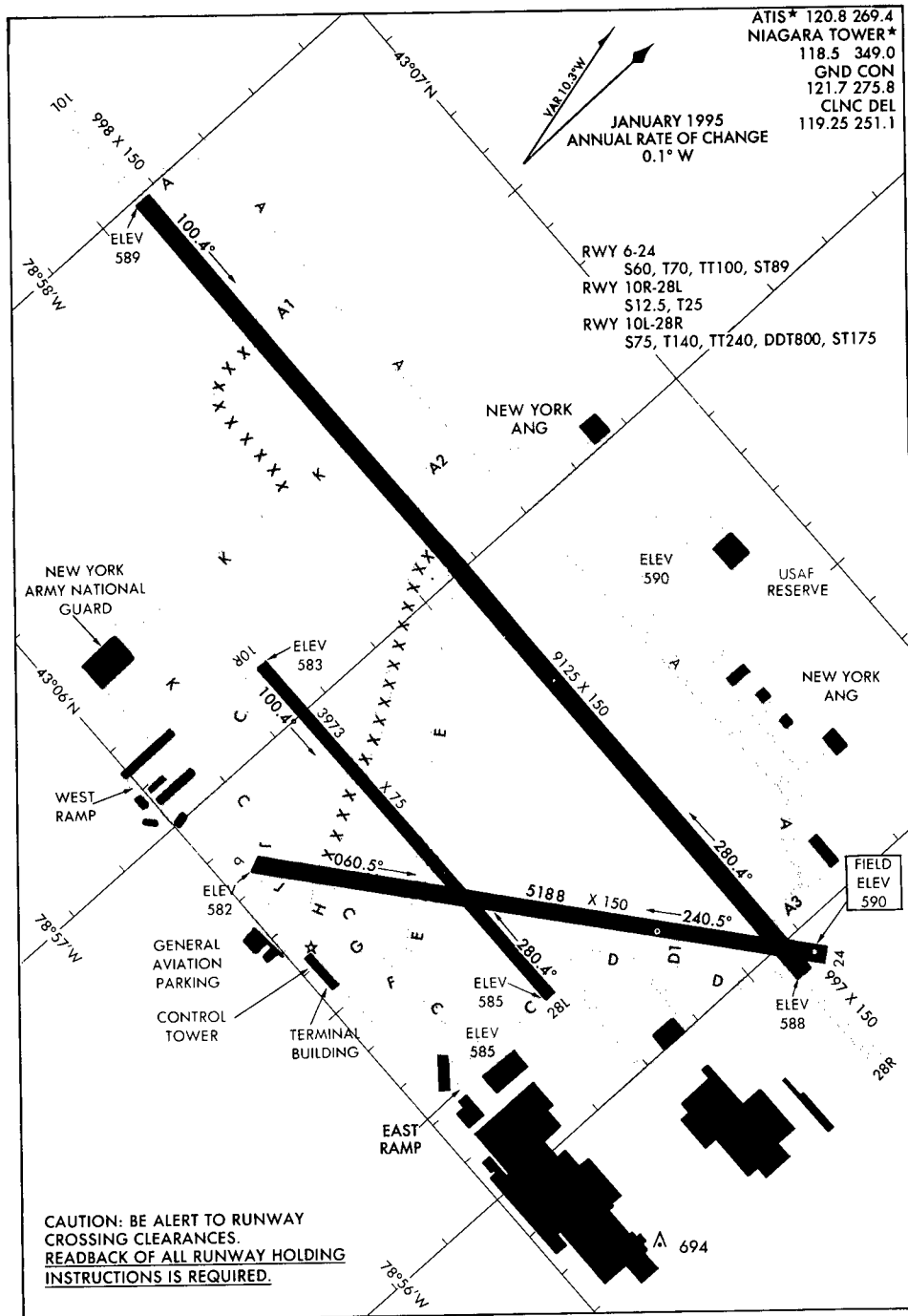

AIRPORT DIAGRAM

NIAGARA FALLS, NEW YORK  
NIAGARA FALLS INTL (IAG)

98113

Syracuse, New York  
Syracuse Hancock International  
ICAO Identifier KSYR

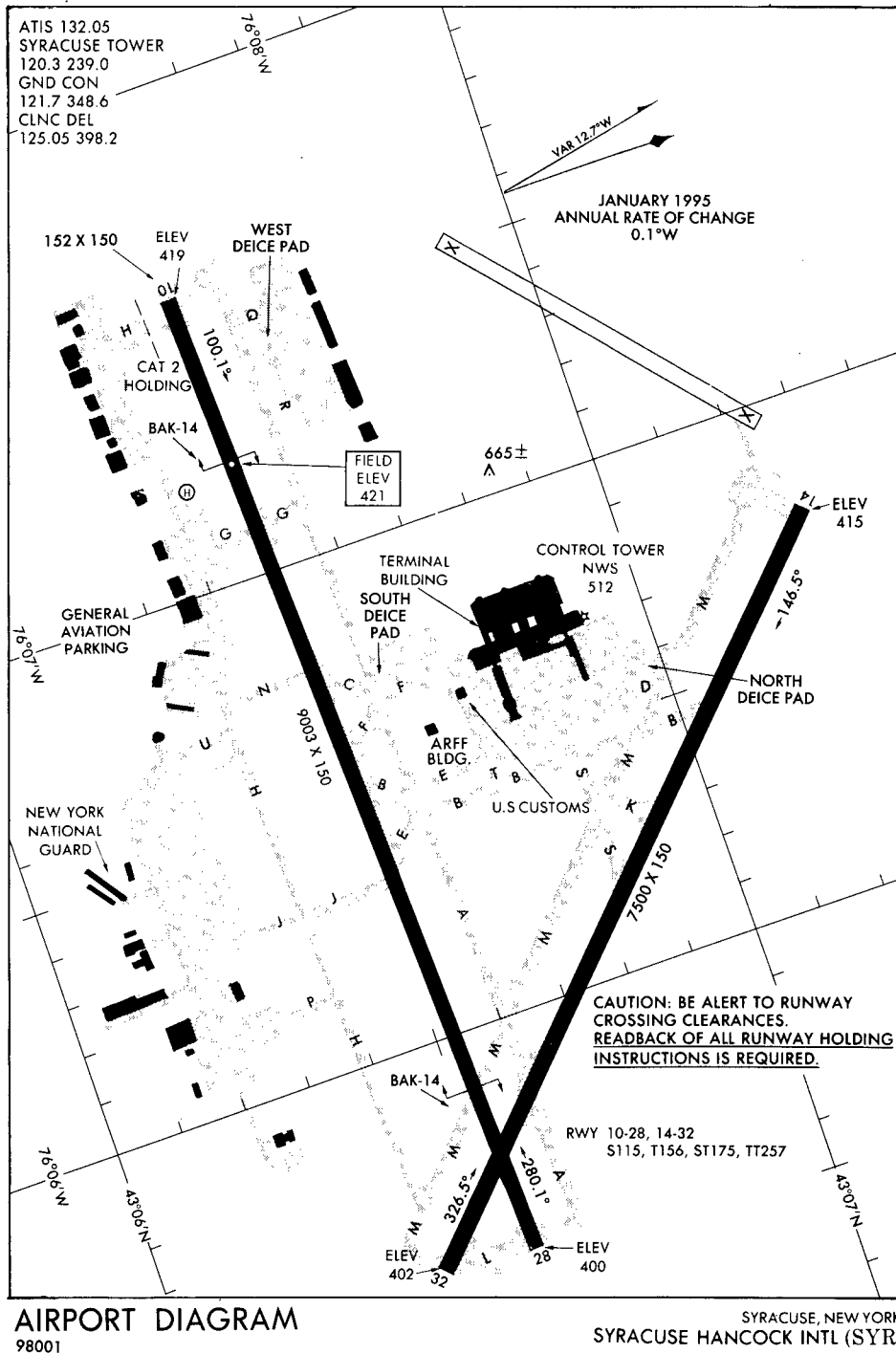

Charlotte, North Carolina  
Charlotte/Douglas International  
ICAO Identifier KCLT

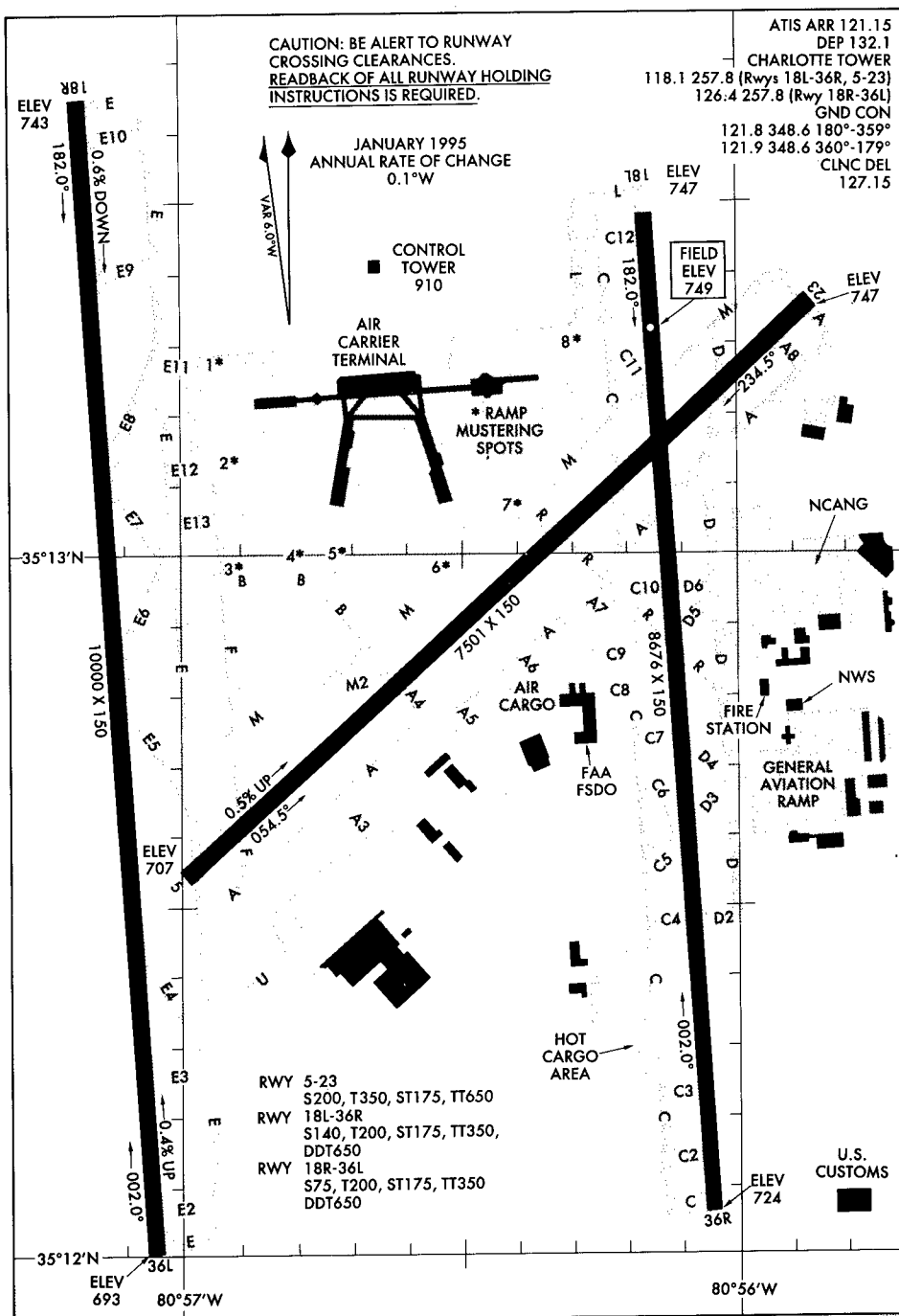

AIRPORT DIAGRAM  
98169

CHARLOTTE, NORTH CAROLIN.  
CHARLOTTE/DOUGLAS INTL (CLT)

Raleigh-Durham, North Carolina  
Raleigh-Durham International  
ICAO Identifier KRDU

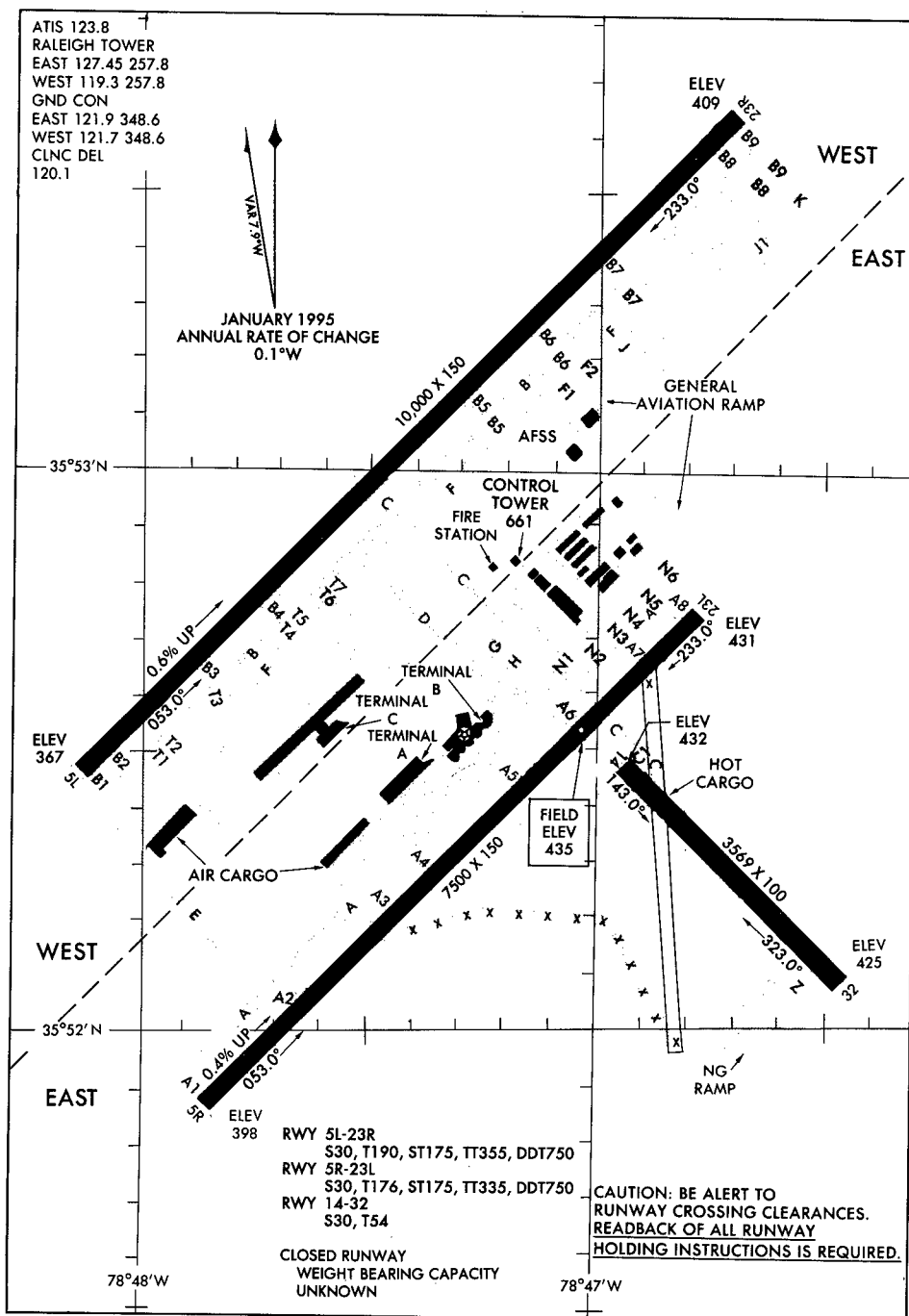

AIRPORT DIAGRAM  
98225

RALEIGH/DURHAM, NORTH CAROLINA  
RALEIGH-DURHAM INTL (RDU)

North Mariana Islands  
Saipan Island  
Saipan International  
ICAO Identifier PGSN

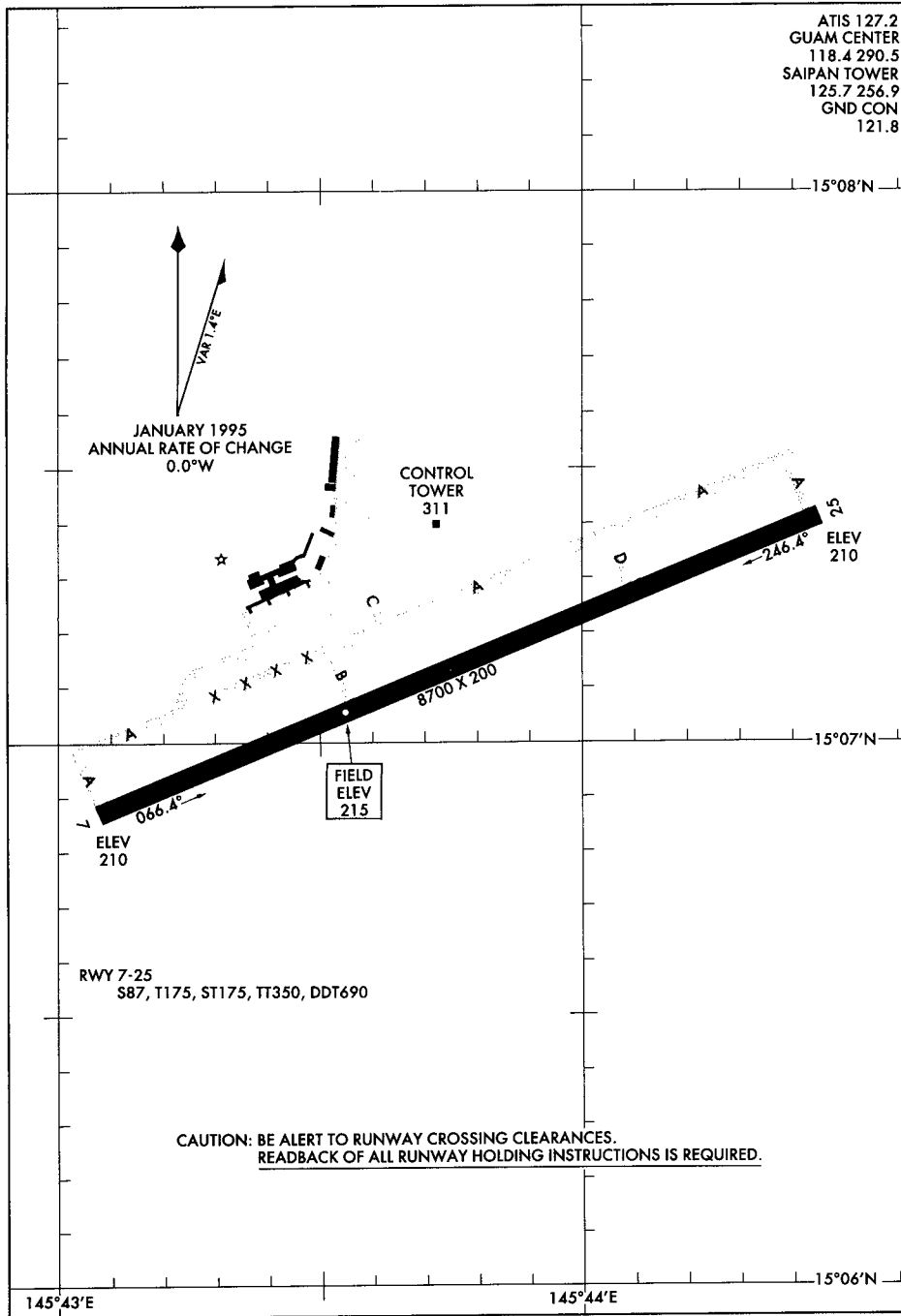

AIRPORT DIAGRAM  
98169

SAIPAN ISLAND, MP  
SAIPAN INTL (GSN)

Cleveland, Ohio  
Cleveland-Hopkins International  
ICAO Identifier KCLE

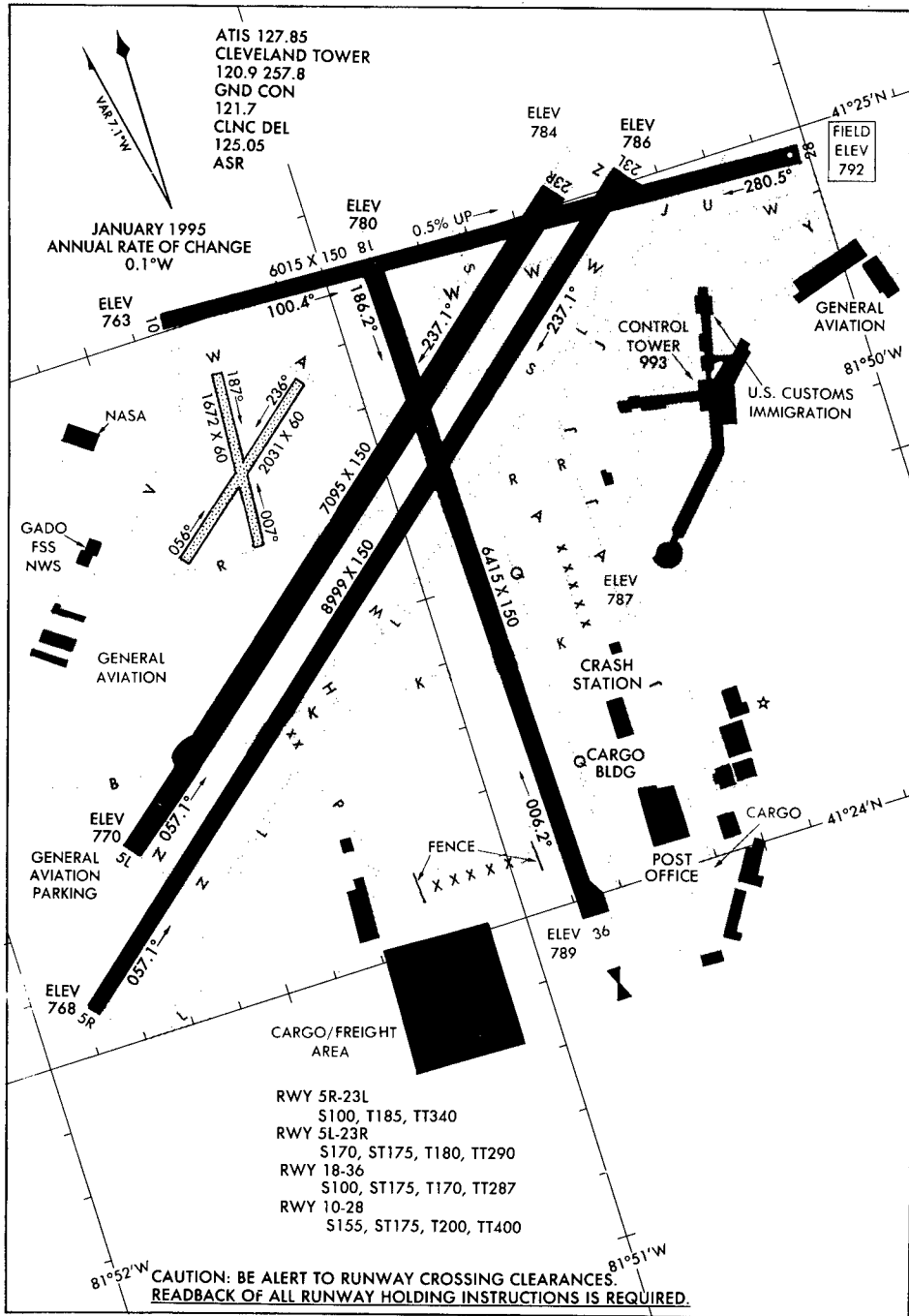

AIRPORT DIAGRAM  
96340

CLEVELAND, OHIO  
CLEVELAND-HOPKINS INTL (CLE)



Columbus, Ohio  
Port Columbus International  
ICAO Identifier CMH

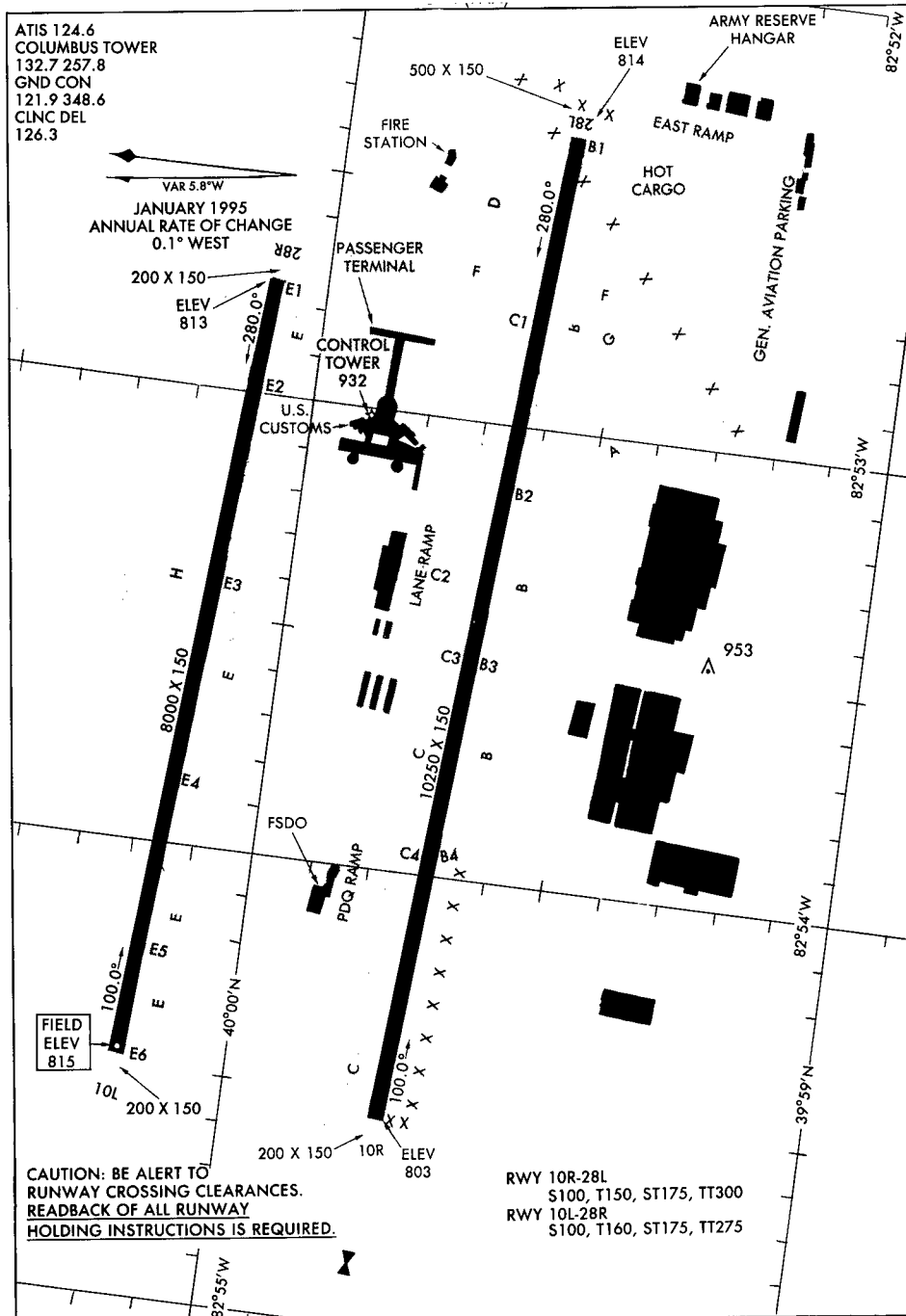

AIRPORT DIAGRAM  
98281

COLUMBUS, OHIO  
COLUMBUS/PORT COLUMBUS INTL (CMH)

Portland, Oregon  
Portland International  
ICAO Identifier KPDX

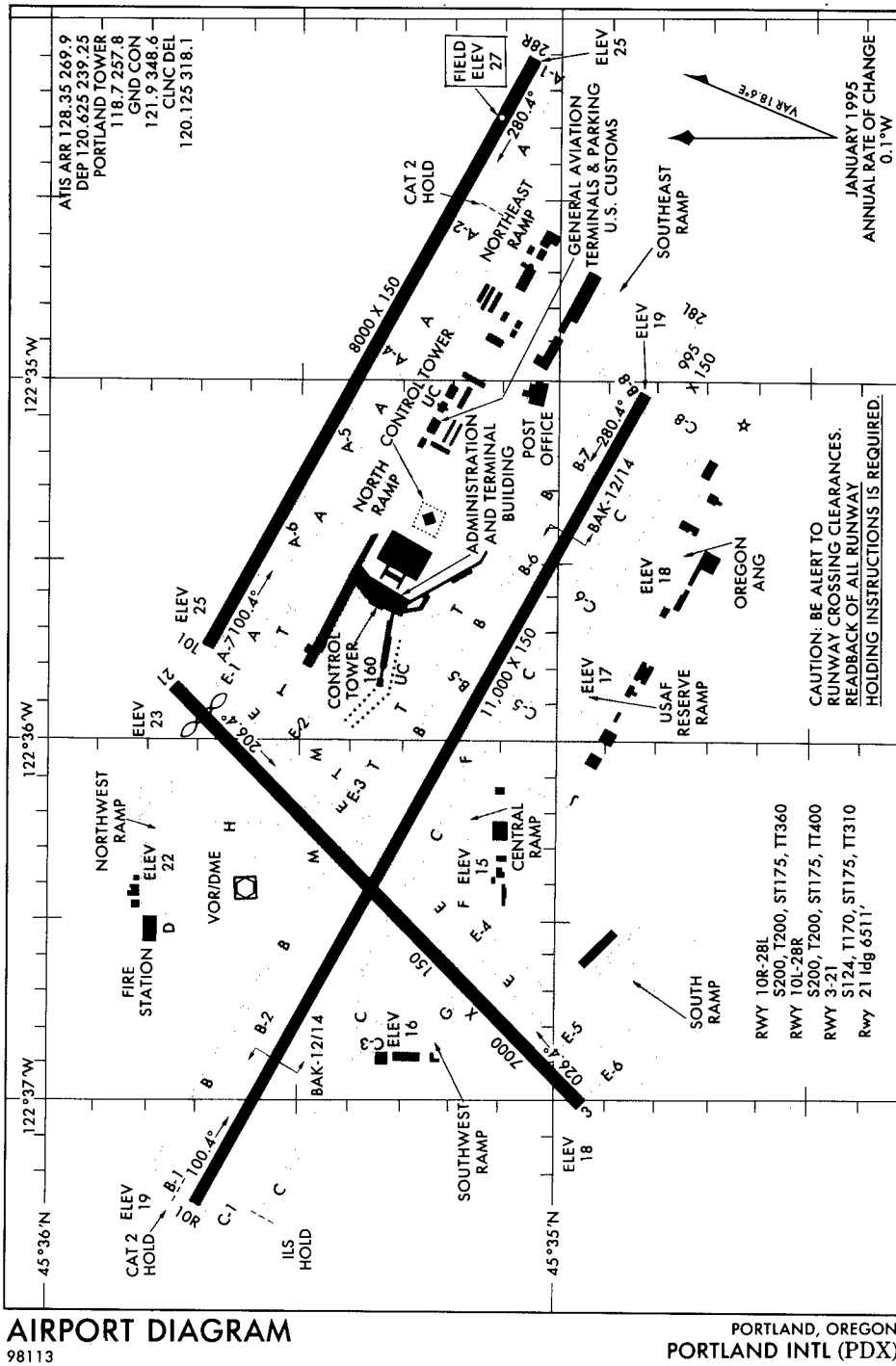

Babelthup Island  
Babelthup/Koror  
ICAO Identifier PTRO

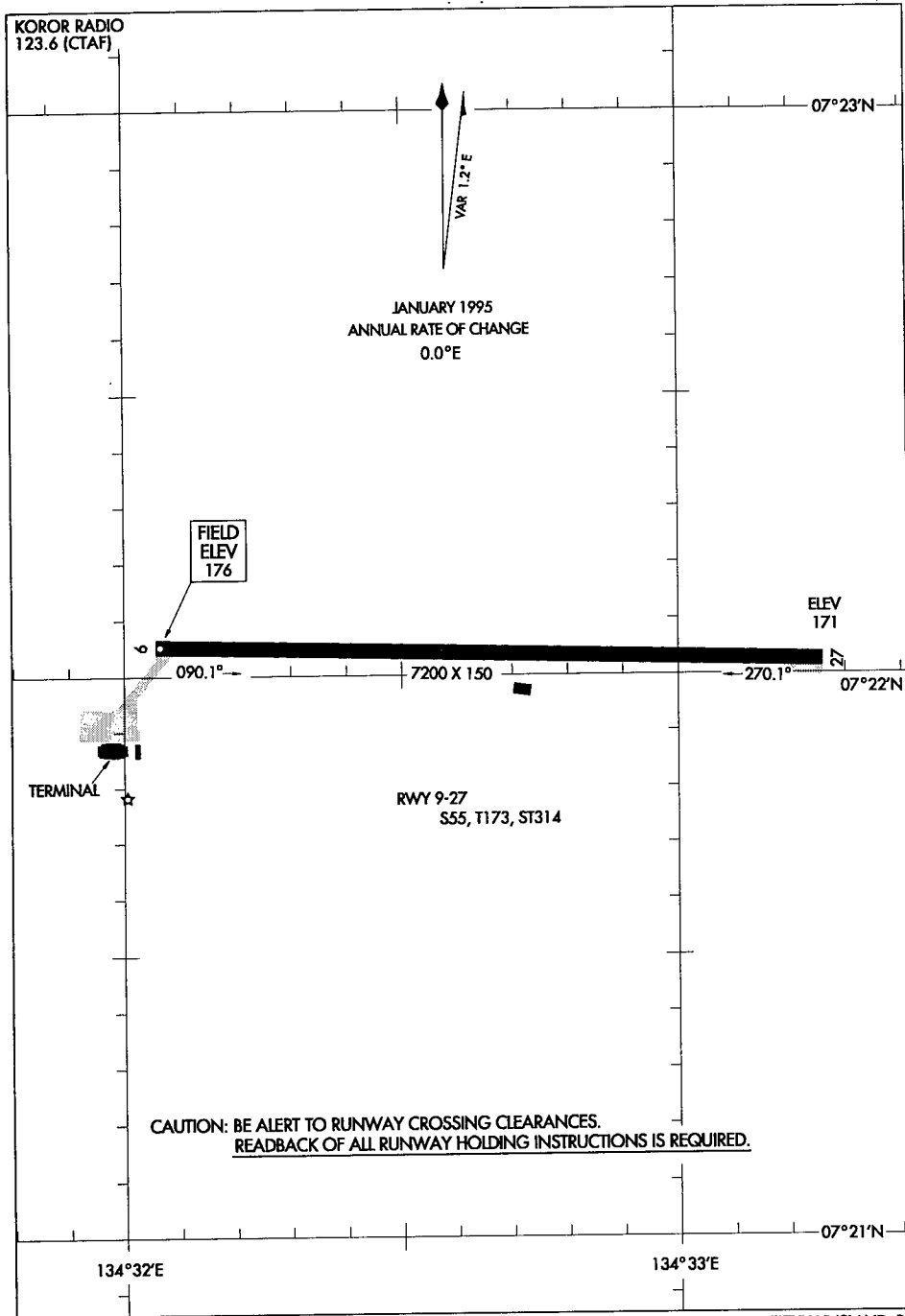

**AIRPORT DIAGRAM**  
97254

BABELTHUAP ISLAND, PS  
BABELTHUAP/KOROR (ROR)



Pittsburgh, Pennsylvania  
Pittsburgh International  
ICAO Identifier KPIT

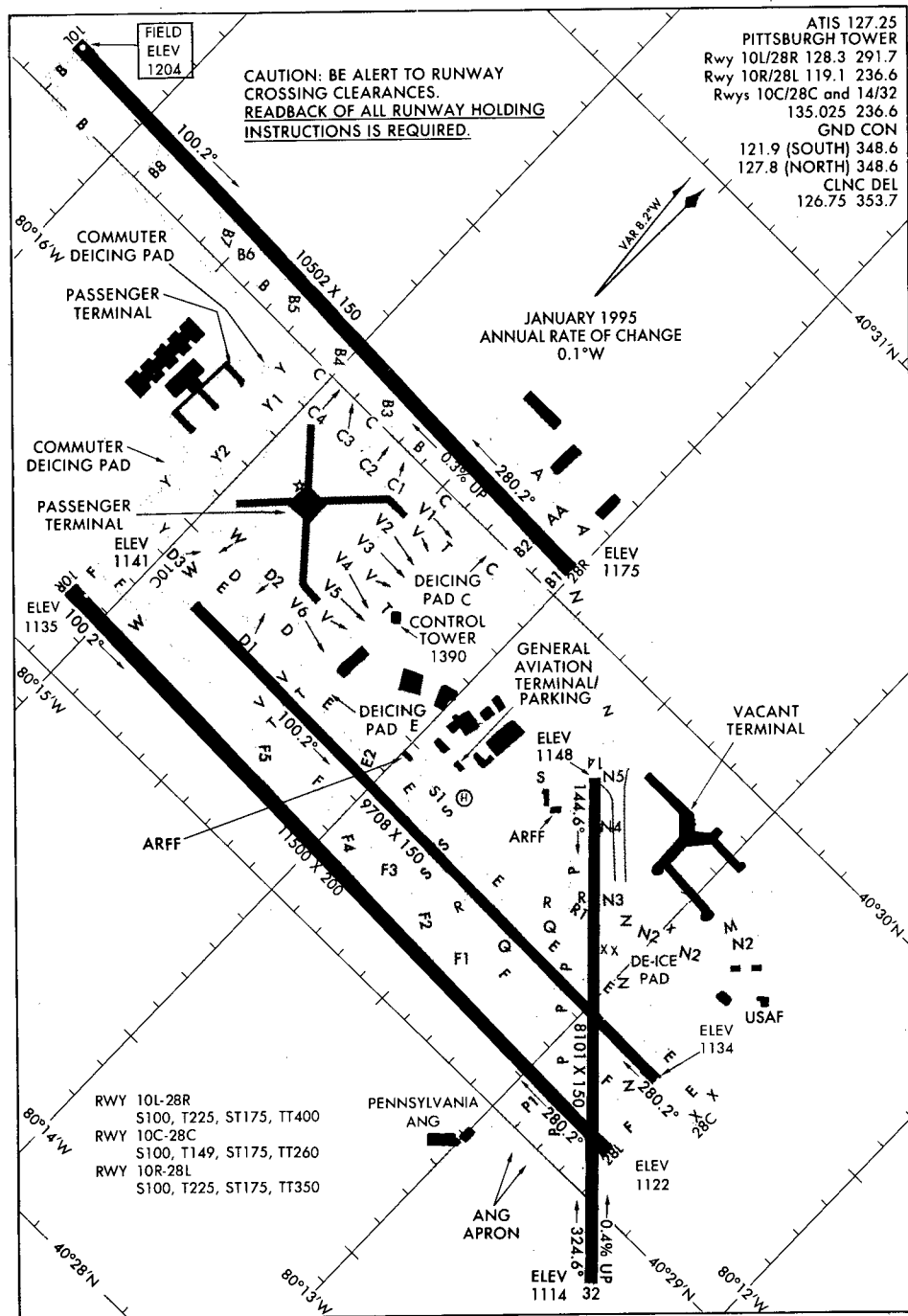

AIRPORT DIAGRAM  
98169

Mayaguez, Puerto Rico  
Eugenio Maria De Hostos  
ICAO Identifier TJMZ

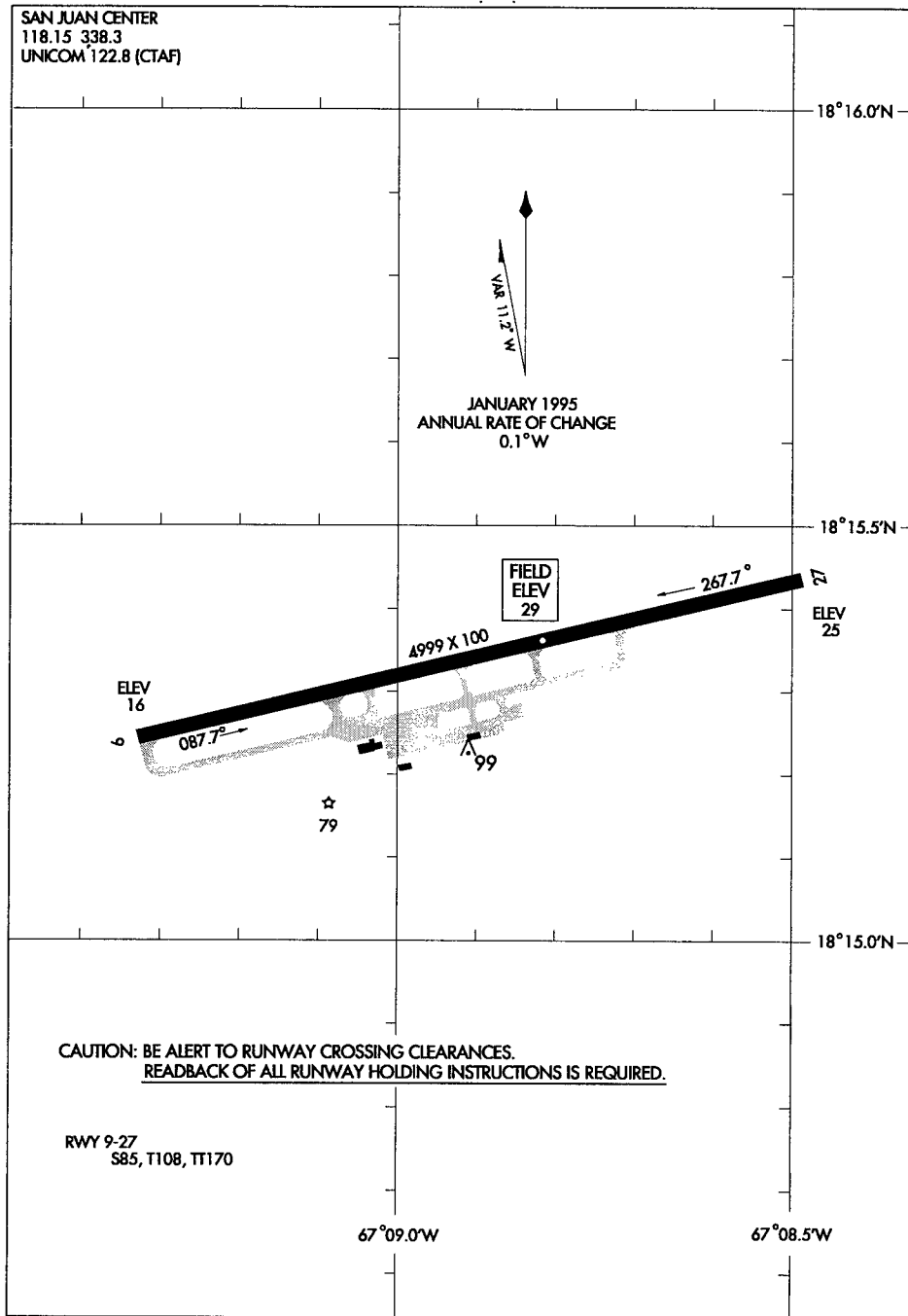

**AIRPORT DIAGRAM**  
97254

MAYAGUEZ, PUERTO RICO  
MAYAGUEZ/EUGENIO MARIA DE HOSTOS (M.A.Z.)

San Juan, Puerto Rico  
Luis Munoz Marin International  
ICAO Identifier TJSJ

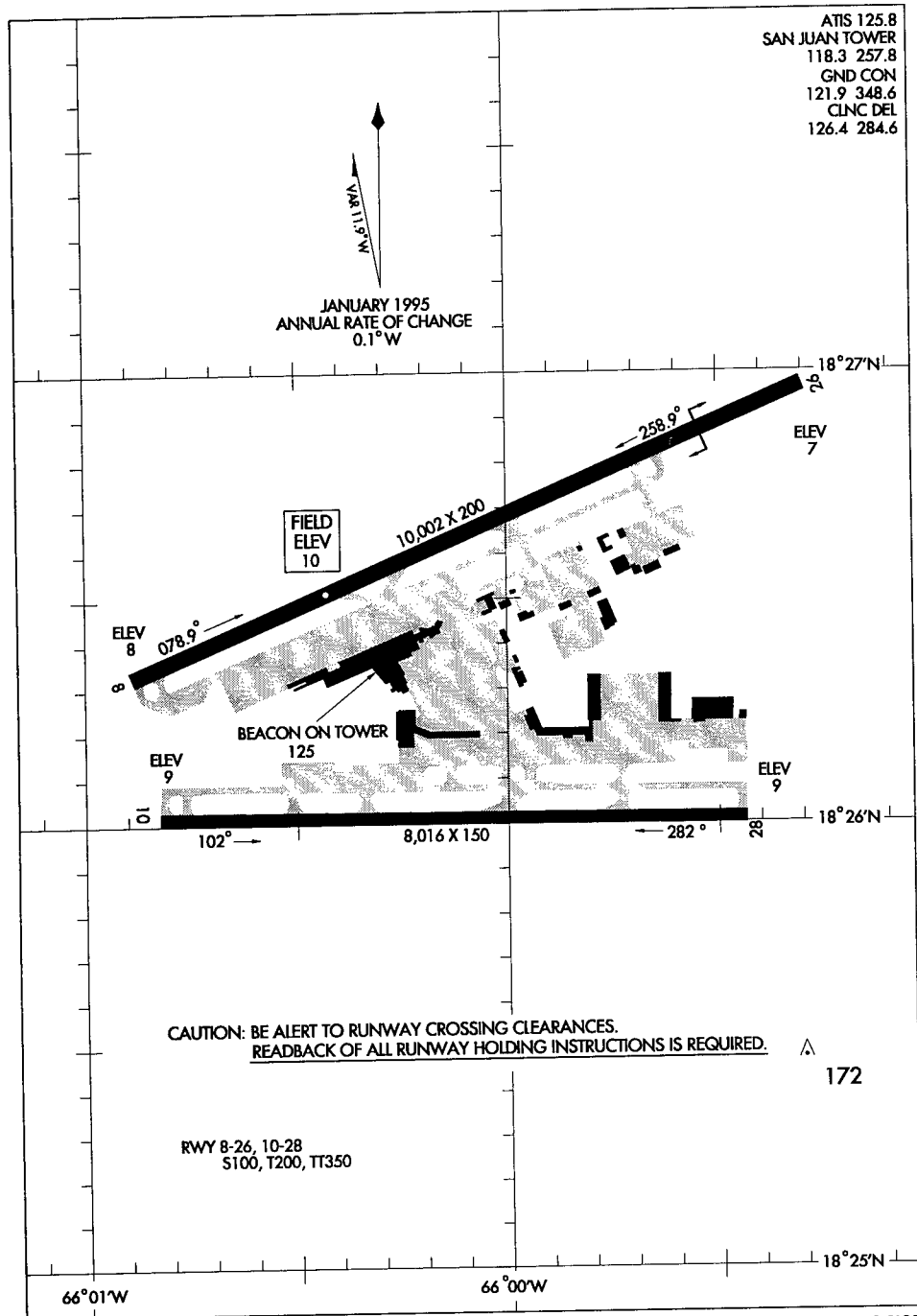

ATIS 125.8  
SAN JUAN TOWER  
118.3 257.8  
GND CON  
121.9 348.6  
CLNC DEL  
126.4 284.6

CAUTION: BE ALERT TO RUNWAY CROSSING CLEARANCES.  
READBACK OF ALL RUNWAY HOLDING INSTRUCTIONS IS REQUIRED.

RWY 8-26, 10-28  
S100, T200, TT350

AIRPORT DIAGRAM  
97254

SAN JUAN, PUERTO RICO  
SAN JUAN/ LUIS MUNOZ MARIN INTL (TJSJ)

Memphis, Tennessee  
Memphis International  
ICAO Identifier KMEM

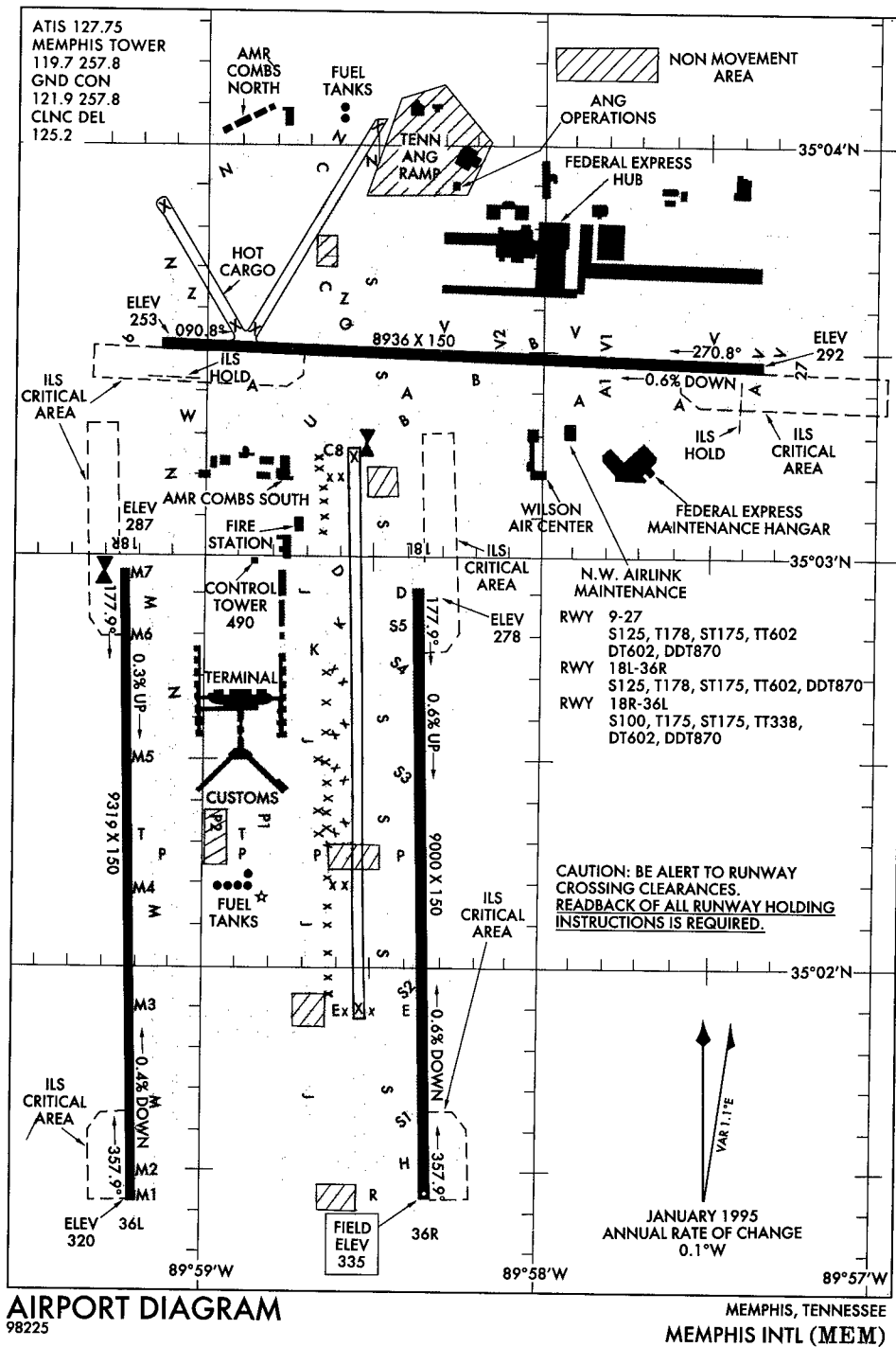



Nashville, Tennessee  
Nashville International  
ICAO Identifier KBNA

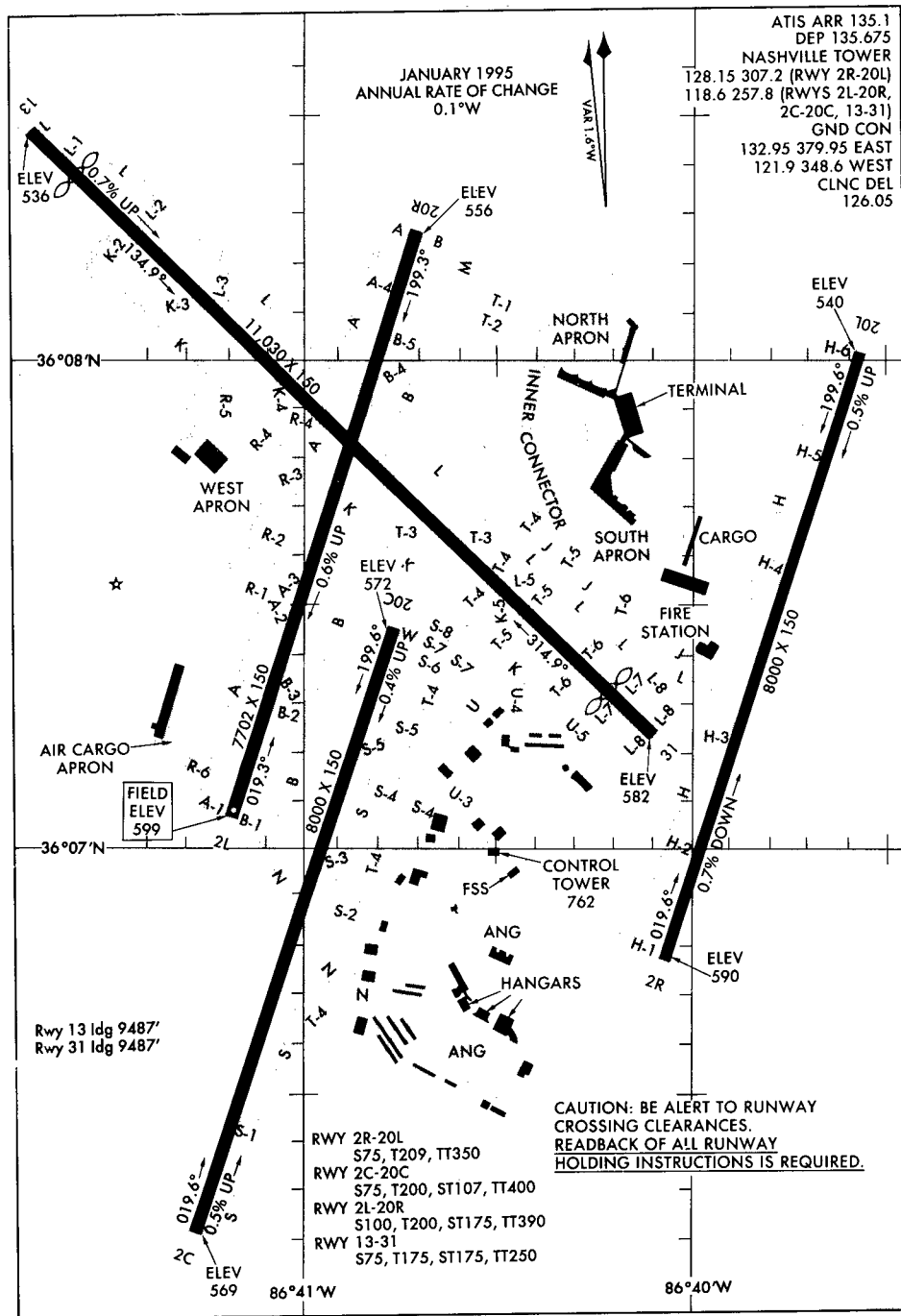

**AIRPORT DIAGRAM**  
96340

NASHVILLE, TENNESSEE  
NASHVILLE INTL (BNA)

CAUTION: BE ALERT TO RUNWAY CROSSING CLEARANCES. READBACK OF ALL RUNWAY HOLDING INSTRUCTIONS IS REQUIRED.

Dallas, Texas  
Dallas-Fort Worth International  
ICAO Identifier KDFW

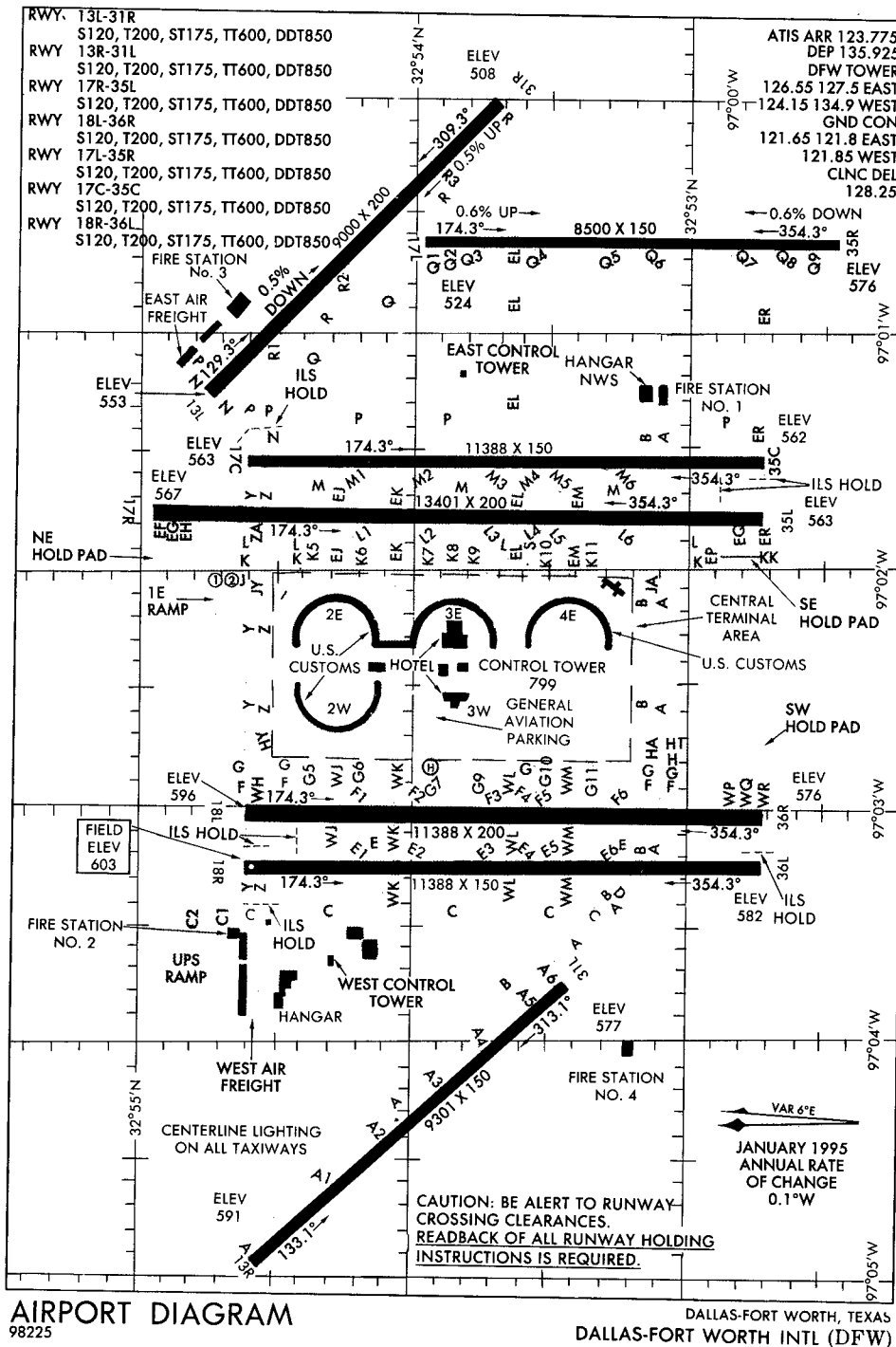

AIRPORT DIAGRAM  
98225

DALLAS-FORT WORTH, TEXAS  
DALLAS-FORT WORTH INTL (DFW)

El Paso, Texas  
 El Paso International  
 ICAO Identifier KELP

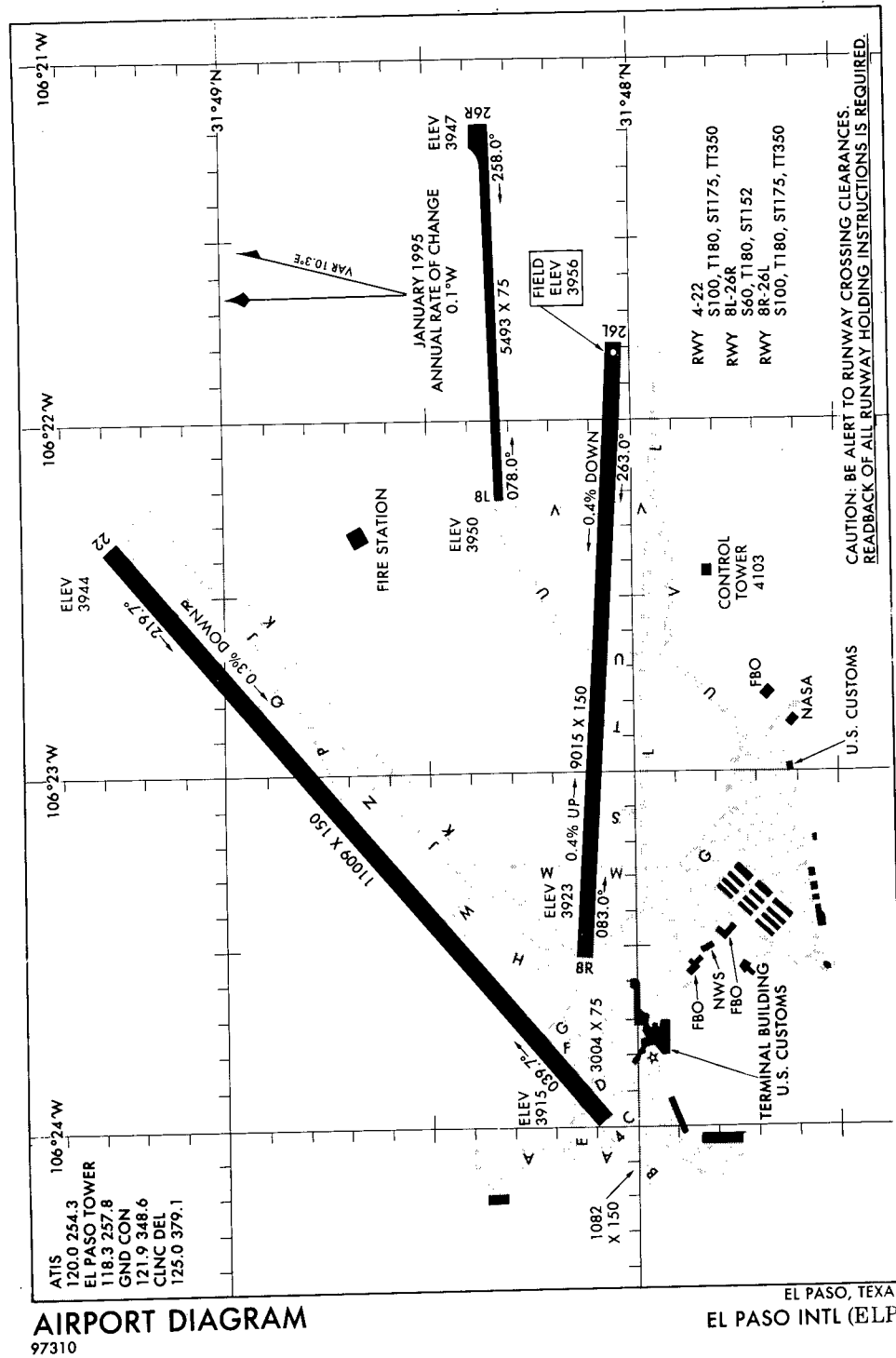

Houston, Texas  
George Bush Intercontinental/Houston  
ICAO Identifier KIAH

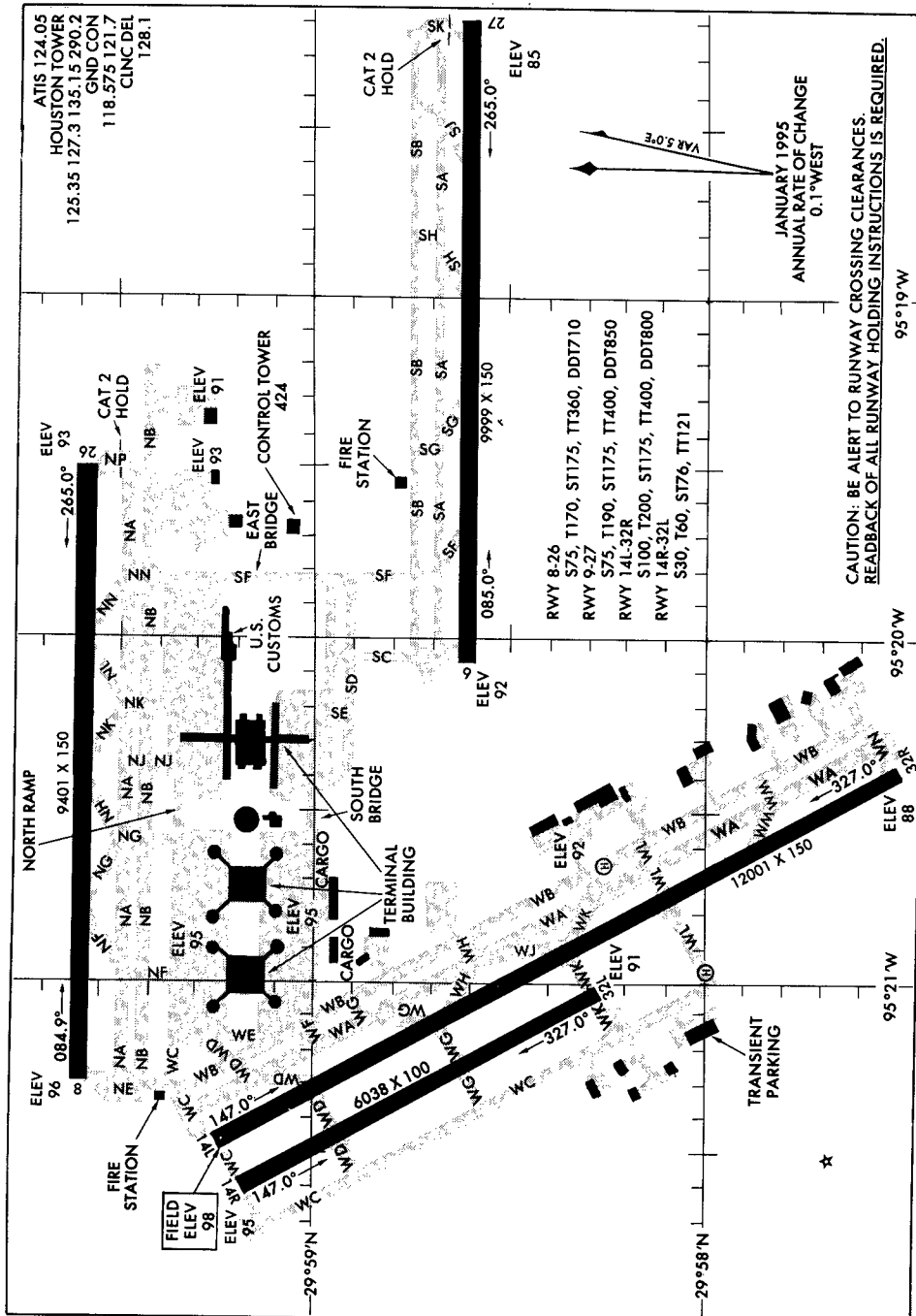

**AIRPORT DIAGRAM** HOUSTON, TEXAS  
97310 HOUSTON/GEORGE BUSH INTERCONTINENTAL AIRPORT/HOUSTON (IAH)

Laredo, Texas  
Laredo International  
ICAO Identifier KLRD

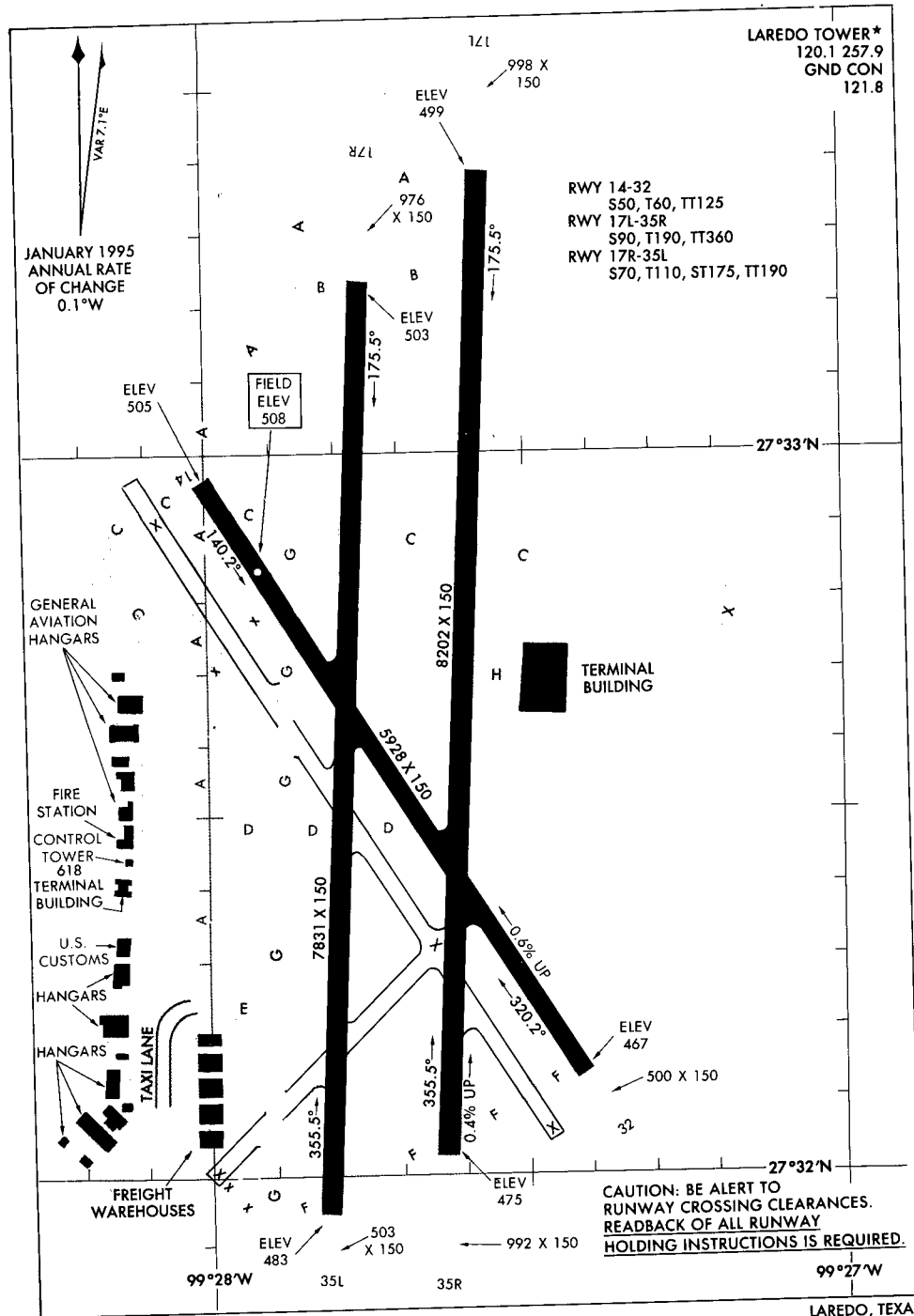

**AIRPORT DIAGRAM**  
98113

LAREDO, TEXAS  
LAREDO INTL(L.RD)

San Antonio, Texas  
San Antonio International  
ICAO Identifier KSAT

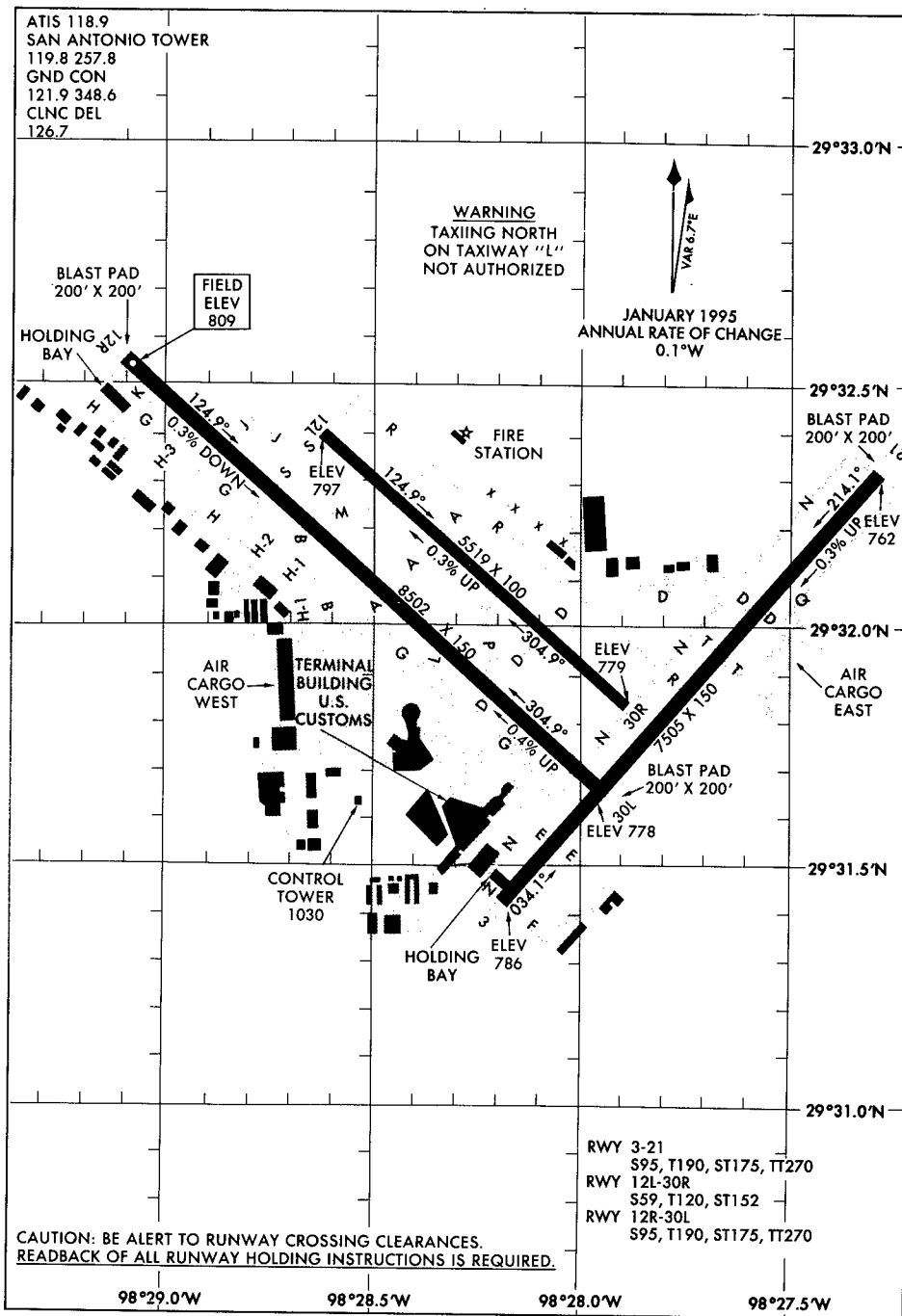

AIRPORT DIAGRAM  
97030

SAN ANTONIO, TEXAS  
SAN ANTONIO INTL (SAT)

Salt Lake City, Utah  
Salt Lake City International  
ICAO Identifier KSLC

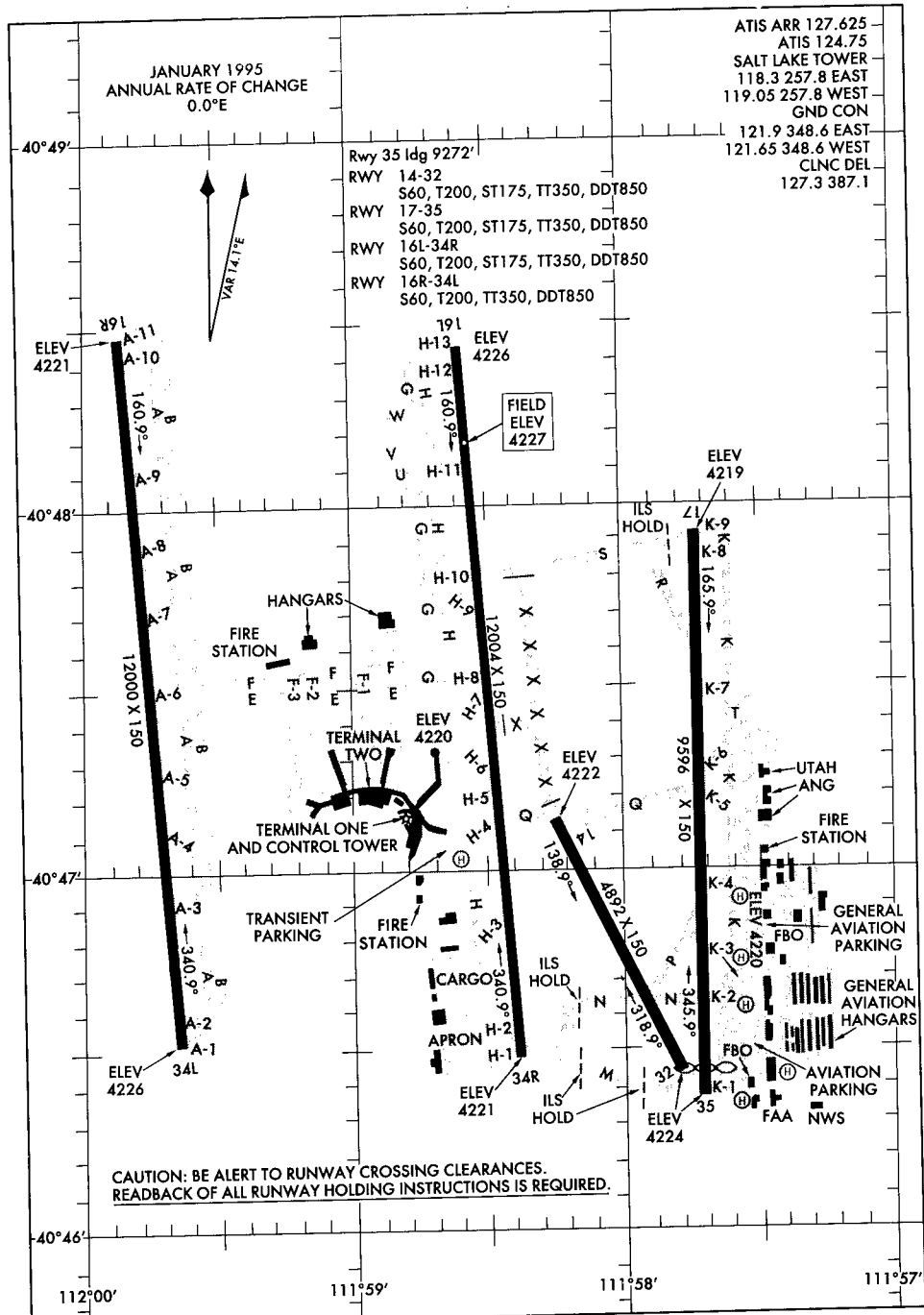

**AIRPORT DIAGRAM**  
98057

SALT LAKE CITY, UTAH  
SALT LAKE CITY INTL (SLC)

Charlotte Amalie St. Thomas, Virgin Islands  
Cyril E. King  
ICAO Identifier TIST

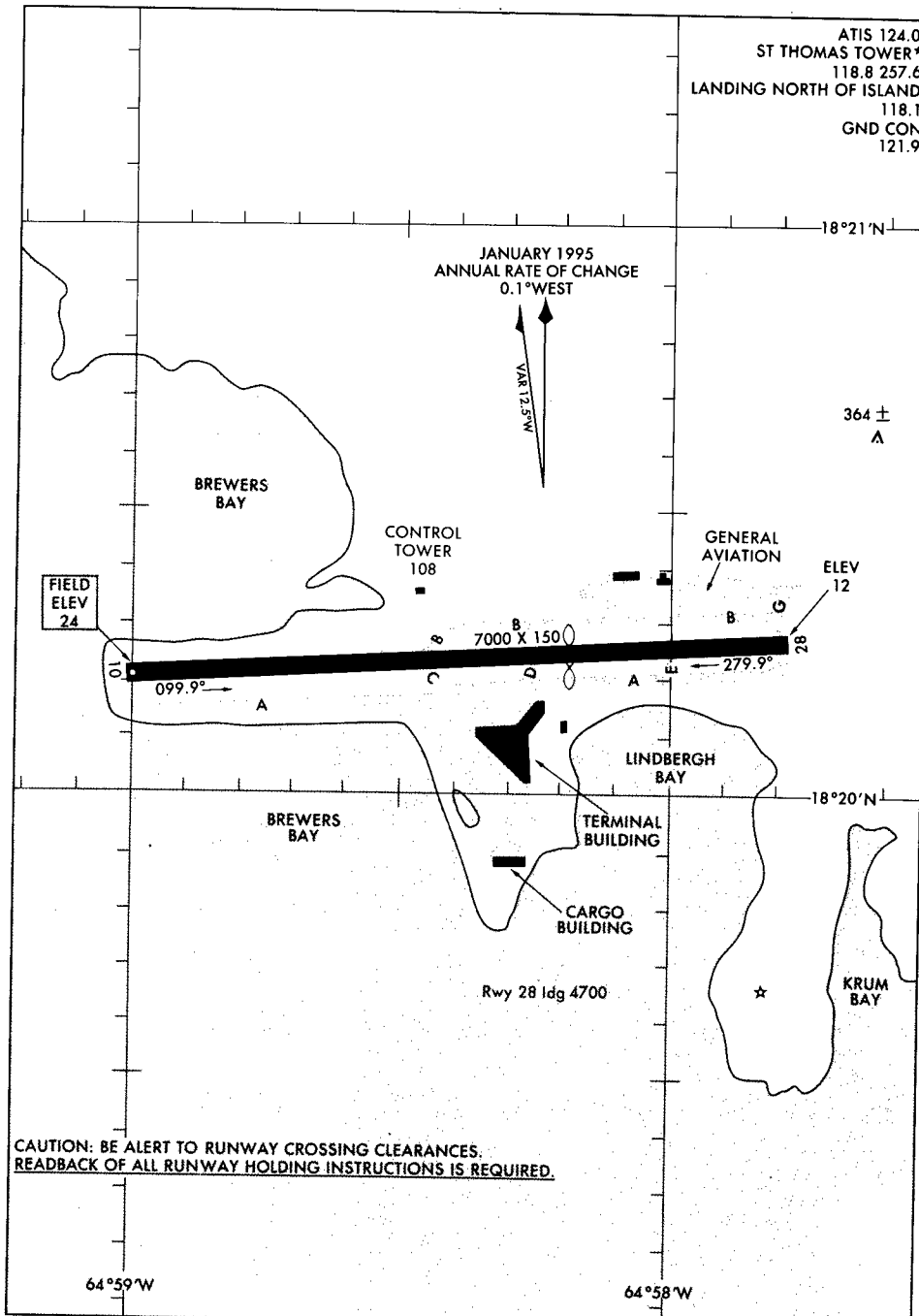

AIRPORT DIAGRAM  
96340

CHARLOTTE AMALIE, ST. THOMAS, VIRGIN ISLANDS  
CHARLOTTE AMALIE/CYRIL E KING (STT)



Christiansted St. Croix  
Henry E Rohlsen  
ICAO Identifier TISX

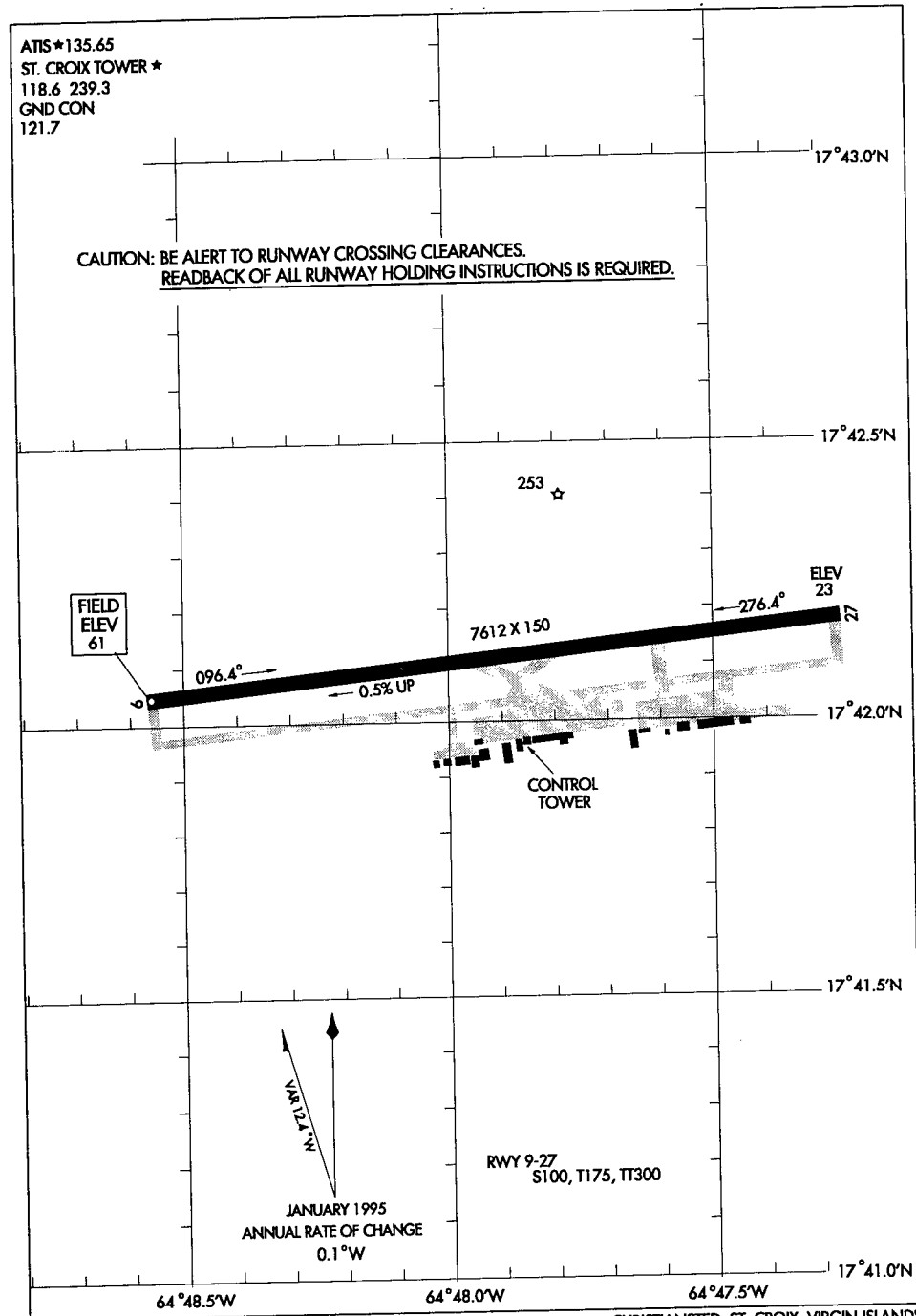

**AIRPORT DIAGRAM**  
97254

CHRISTIANSTED, ST. CROIX, VIRGIN ISLANDS  
CHRISTIANSTED, ST. CROIX/ HENRY E ROHLSSEN (STX)

Everett, Washington  
Snohomish County (Paine Field)  
ICAO Identifier KPAE

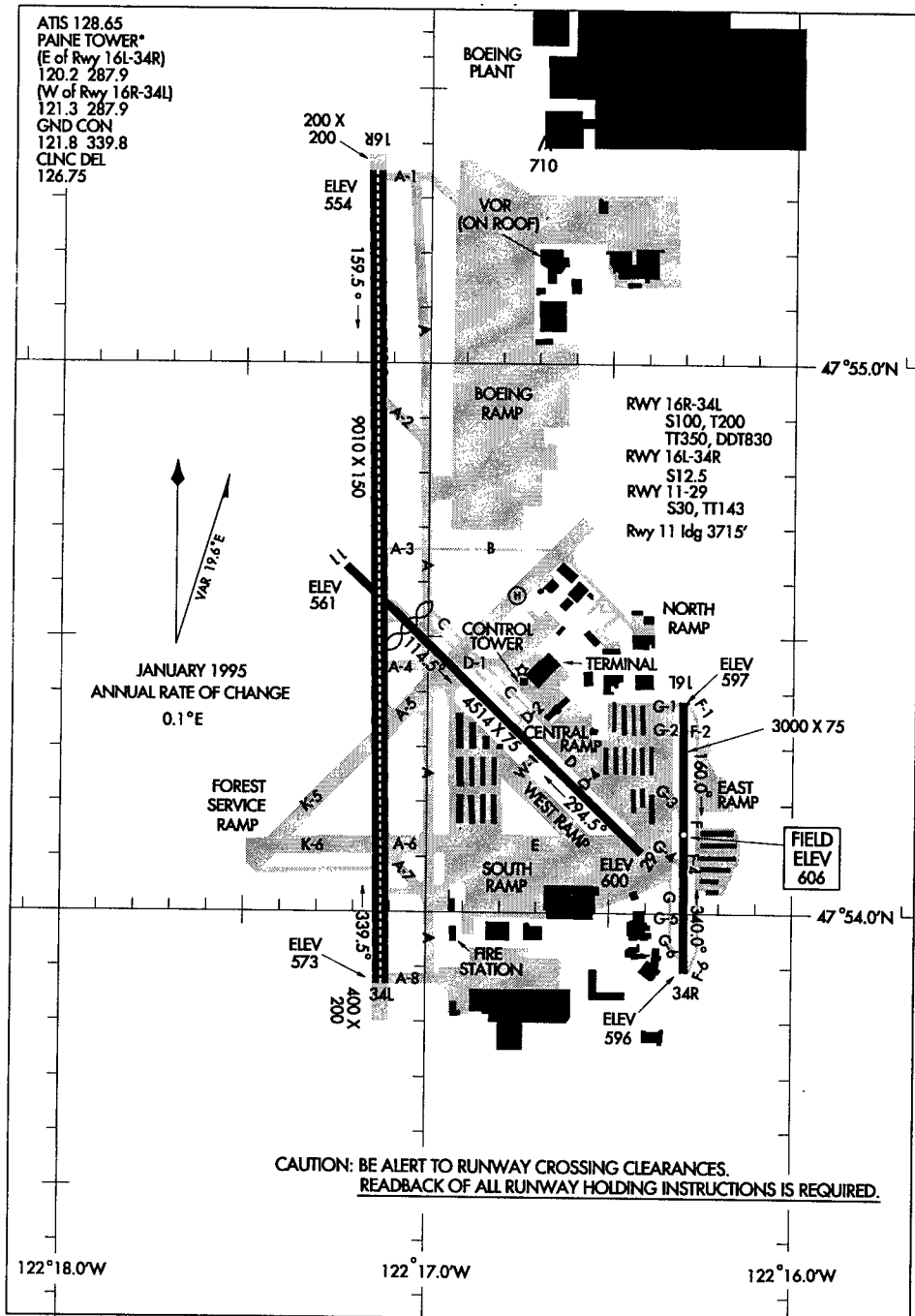

**AIRPORT DIAGRAM**  
97254

EVERETT, WASHINGTON  
EVERETT/ SNOHOMISH COUNTY (PAINE FIELD) (P.A.E)

Seattle, Washington  
Seattle-Tacoma International  
ICAO Identifier KSEA

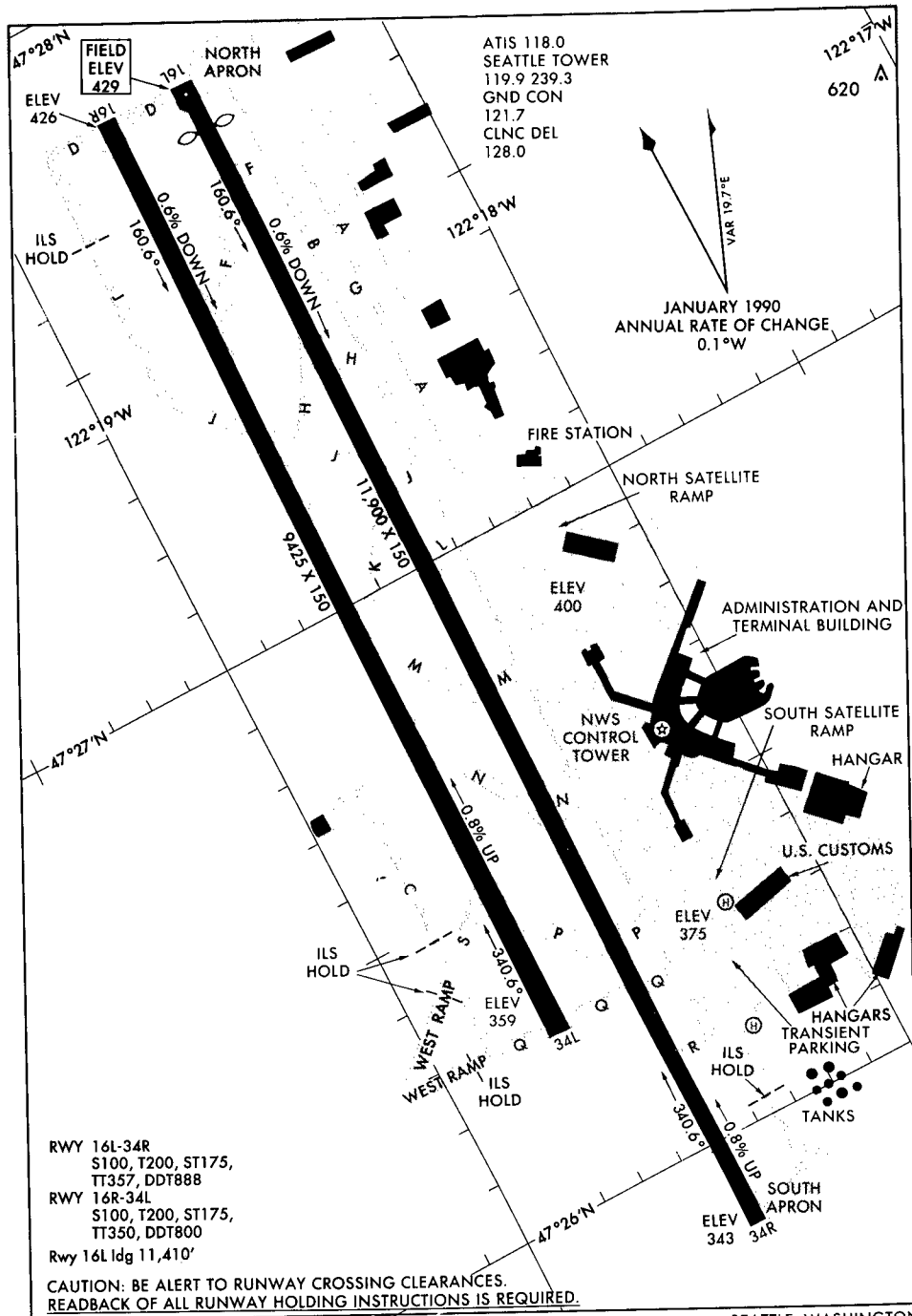

**AIRPORT DIAGRAM**

SEATTLE, WASHINGTON  
SEATTLE-TACOMA INTL (SEA)

96116

Spokane, Washington  
Spokane International  
ICAO Identifier KEGG

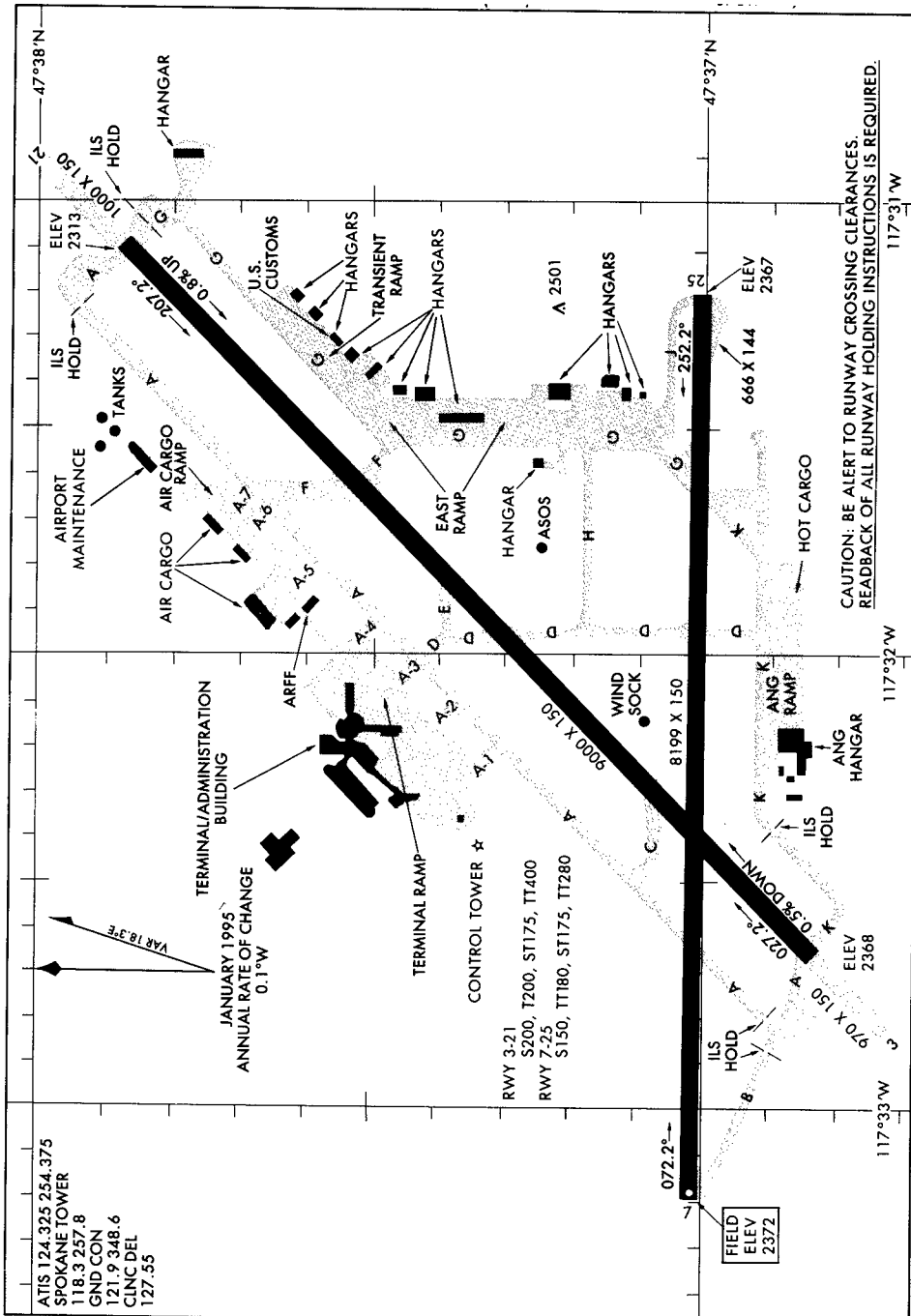

**AIRPORT DIAGRAM**  
98113

SPokane, Washington  
SPokane Intl (KEGG)

Milwaukee, Wisconsin  
General Mitchell International  
ICAO Identifier KMKE

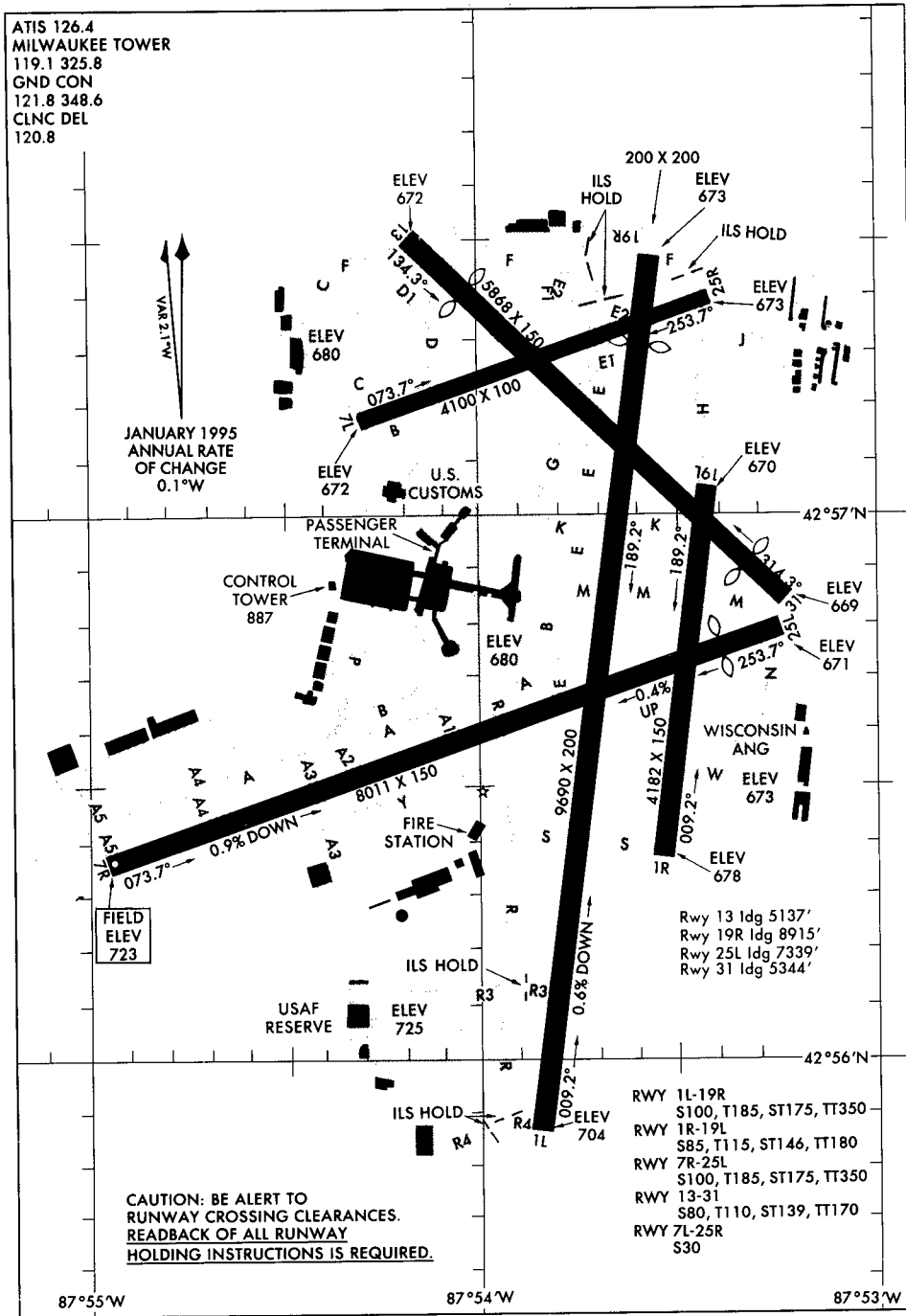

AIRPORT DIAGRAM  
97030

MILWAUKEE, WISCONSIN  
MILWAUKEE/GENERAL MITCHELL INTL (MKE)



# INDEX

[References are to page numbers]

## A

- Abbreviations, GEN 2.2-1
- Accident and Incident Reporting , ENR 1.16-1
  - Items To Be Reported, ENR 1.16-2
- Aeronautical Charts, GEN 3.2-1
- Aeronautical Fixed Telecommunications Network (AFTN), GEN 3.4-5
- Aeronautical Information Publication (AIP)
  - Publication Schedule, GEN 0.1-2
  - Structure, GEN 0.1-1
  - Subscription Information, GEN 0.1-2
- Aeronautical Publications, Distribution of, GEN 3.1-1
- AFTN. *See* Aeronautical Fixed Telecommunications Network (AFTN)
- Air Defense Identification Zone (ADIZ), ENR 1.12-1
- Air Route Traffic Control Center (ARTCC), GEN 3.3-2
  - ARTCC Communications, GEN 3.3-2
  - ARTCC Radio Frequency Outage, GEN 3.3-3
- Air Traffic Clearance, ENR 1.1-29
  - See also* Clearance
- Air Traffic Control, Pilot/Controller Roles and Responsibilities, ENR 1.1-28
- Aircraft, Lights, Use of, ENR 1.1-20
- Aircraft Equipment Suffixes, ENR 1.10-6
- Airport
  - Aircraft Arresting Devices, AD 1.1-40
  - Fees and Charges, GEN 4.1-1
  - Fire Fighting Requirements, AD 1.1-3
  - Operations, ENR 1.1-1
    - Exiting the Runway after Landing, ENR 1.1-15
    - VFR Flights in Terminal Areas, ENR 1.1-11
    - Signals, Hand, ENR 1.1-16
    - Taxiing, ENR 1.1-9
    - Traffic Pattern, ENR 1.1-1, ENR 1.1-2
    - With Operating Control Tower, ENR 1.1-2
    - Without Operating Control Tower, GEN 3.3-6, GEN 3.3-14, ENR 1.1-1
  - Reservations Procedures, GEN 3.3-11
  - High Density Airports, GEN 3.3-11
  - IFR Reservations, GEN 3.3-11
  - Using Computerized Voice Reservation System (CVRS), GEN 3.3-13
  - VFR Reservations, GEN 3.3-12
- Airport Lighting, AD 1.1-3
  - Airport Beacons, AD 1.1-10, AD 1.1-11
  - Approach Light Systems, AD 1.1-3
  - Obstruction Lighting, AD 1.1-11
  - Pilot-controlled Lighting, AD 1.1-8
  - Precision Approach Path Indicator (PAPI), AD 1.1-6
  - Runway Lighting, AD 1.1-7, AD 1.1-8
  - Taxiway Lighting, AD 1.1-10
  - Visual Approach Slope Indicator (VASI), AD 1.1-3
- Airport Markings, AD 1.1-12
  - Colors, AD 1.1-13
  - Holding Position Markings, AD 1.1-23
  - Other Markings, AD 1.1-27
    - Nonmovement Area Boundary Markings, AD 1.1-29
    - Temporarily Closed Runways and Taxiways, AD 1.1-30
    - VOR Checkpoint Markings, AD 1.1-29
  - Runway Markings, AD 1.1-13
  - Taxiway Markings, AD 1.1-16
- Airport Operations
  - Intersection Takeoffs, ENR 1.1-10
  - Land and Hold Short , ENR 1.1-13
- Airport Signs, AD 1.1-30
  - Destination Signs, AD 1.1-38
  - Direction Signs, AD 1.1-36
  - Information Signs, AD 1.1-39
  - Location Signs, AD 1.1-33
    - ILS Critical Area Boundary Sign, AD 1.1-35
    - Runway Boundary Sign, AD 1.1-34
    - Runway Location Sign, AD 1.1-34
    - Taxiway Location Sign, AD 1.1-33
  - Mandatory Instruction Signs, AD 1.1-30
    - ILS Critical Area Holding Position Sign, AD 1.1-32
    - No Entry Sign, AD 1.1-33
    - Runway Approach Area Holding Position Sign, AD 1.1-32
    - Runway Holding Position Sign, AD 1.1-31
    - Runway Distance Remaining Signs, AD 1.1-39

- Airport Use, AD 1.1-1  
*See also* Airport, Reservations Procedures
- Airports, Designated To Serve International Operations, AD 2-1  
Diagrams of, AD 2-2
- Airspace, ENR 1.4-1  
Airport Advisory Area, ENR 1.4-10  
Classes, ENR 1.4-3  
Controlled, ENR 1.4-1  
IFR Requirements, ENR 1.4-1  
VFR Requirements, ENR 1.4-1  
Operating Rules and Requirements, ENR 1.4-3, ENR 1.4-4, ENR 1.4-6, ENR 1.4-7, ENR 1.4-8  
Radar Vectors in, ENR 1.1-31, ENR 3.5-1  
Speed Adjustments in, ENR 1.1-31  
VFR Corridors, ENR 1.4-12  
VFR Transition Routes, ENR 1.4-12
- Flights Over Charted U.S. Wildlife Refuges, Parks and Forest Service Areas, ENR 5.6-2
- Obstructions to Flight. *See* Flight Hazards, Potential Special Use, ENR 5.1-1  
Alert Areas, ENR 5.1-2  
Controlled Firing Areas, ENR 5.1-2  
Military Operations Area (MOA), ENR 5.1-1  
Military Training Routes, ENR 5.1-2  
National Security Area, ENR 5.1-2  
Prohibited Areas, ENR 5.1-1  
Restricted Areas, ENR 5.1-1  
Temporary Flight Restrictions, ENR 5.1-3  
Warning Areas, ENR 5.1-1
- Terminal Radar Service Area, ENR 1.6-9  
Terminal Radar Service Area (TRSA), ENR 1.4-12  
VFR Flyways, ENR 1.4-10  
VFR Routes, Published, ENR 1.4-10  
VFR Weather Minimums, ENR 1.4-2
- Airways and Route Systems. *See* Navigation
- Altimeter Setting Procedures, ENR 1.7-1
- Approach Control Service for VFR Arriving Aircraft, GEN 3.3-5
- Approaches, ENR 1.5-6, ENR 1.5-15  
Approach and Landing Minimums, ENR 1.5-10  
Approach Clearance, ENR 1.5-8  
Contact Approach, ENR 1.1-29  
Differences between ILS and ILS PRM Approaches, ENR 1.5-24  
Final Approach Descent Angles, ENR 1.5-15  
Flight Management System Procedures for Arrivals, ENR 1.5-7  
ILS Minimums, ENR 4.1-6  
ILS/MLS Approaches to Parallel Runways, ENR 1.5-17, ENR 1.5-20, ENR 1.5-21  
Instrument Approach, ENR 1.1-30  
Instrument Approach Procedure Charts, ENR 1.5-12  
*See also* Aeronautical Charts  
Minimum Vectoring Altitudes, ENR 1.5-14  
Missed Approach, ENR 1.1-30, ENR 1.5-28  
Missed Approach, GPS, ENR 4.1-43  
Monitoring of Instrument Approaches, ENR 1.5-17  
No-Gyro Approach, ENR 1.5-16  
Overhead Approach Maneuver, ENR 1.5-30  
Practice Instrument Approaches, ENR 1.1-11  
Precision Approach, ENR 1.5-16  
Side-Step Maneuver, ENR 1.5-10  
Simultaneous Close Parallel ILS PRM Approaches, ENR 1.5-23  
Simultaneous Converging Instrument Approaches, ENR 1.5-24  
Standard Terminal Arrival (STAR), ENR 1.5-7  
Surveillance Approach, ENR 1.5-16  
Timed Approaches From a Holding Fix, ENR 1.5-25  
Visual, ENR 1.1-32  
Visual Decent Points, ENR 1.5-15, ENR 1.5-27
- Area Navigation (RNAV) Routes, ENR 3.3-1
- ARTCC. *See* Air Route Traffic Control Center (ARTCC)
- Automated Terminal Information Service (ATIS). *See* Meteorological Services
- Aviation Safety Reporting Program, ENR 1.16-1

## B

- Bird Activity, ENR 5.6-1  
Reporting Bird and Other Wildlife Activities, ENR 5.6-1  
Reporting Bird Strikes, ENR 5.6-1



## C

- Call Signs
  - Aircraft, GEN 3.4–6
  - Ground Station, GEN 3.4–7
- Charts. *See* Aeronautical Charts
- Clearance
  - Adherence to, ENR 1.1–24
  - Air Traffic Control, ENR 1.1–20
  - Amended, ENR 1.1–22
  - Clearance Items, ENR 1.1–21
  - Pilot Responsibilities, ENR 1.1–23
  - Special VFR, ENR 1.1–22
  - VFR–On–Top, ENR 1.1–23
  - VFR/IFR Flights, ENR 1.1–24
- Collision Avoidance, ENR 1.15–7
- Common Traffic Advisory Frequency (CTAF). *See* Radio Communications
- Communications. *See* Radio Communications
- Controlled Airspace. *See* Airspace, Controlled
- Conversion Tables, GEN 2.6–1
- Cruising Altitudes, ENR 1.4–2, ENR 1.4–9
- Customs. *See* U.S. Customs

## D

- Density Altitude. *See* Flight Hazards, Potential
- Departure Control, ENR 1.5–31
  - Abbreviated IFR Departure Clearance Procedures, ENR 1.5–32
- Departure Procedures, ENR 1.5–30
  - See also* Global Positioning System (GPS)
  - Clearance Void Times, ENR 1.5–31
  - Departure Restrictions, ENR 1.5–31
  - Hold for Release, ENR 1.5–31
  - Instrument Departure Procedures (DP's), ENR 1.5–33
  - Obstruction Clearance During Departure, ENR 1.5–33
  - Pre–Taxi Clearance Procedures, ENR 1.5–30
  - Release Times, ENR 1.5–31
  - Taxi Clearance, ENR 1.5–31
- Departure, Instrument, ENR 1.1–34
- Differences From ICAO Standards, Recommended Practices and Procedures, GEN 1.7–1
- DUATS. *See* Meteorological Services

## E

- ELT. *See* Emergency Locator Transmitters
- Emergency
  - Aircraft, Overdue, GEN 3.6–3
  - Body Signals, GEN 3.6–4
  - Direction Finding Instrument Approach Procedure, GEN 3.6–12
  - Distress and Urgency Communications, GEN 3.6–10
  - Ditching Procedures, GEN 3.6–13
  - Fuel Dumping, GEN 3.6–17
  - Obtaining Assistance, GEN 3.6–11
  - VFR Search and Rescue Protection, GEN 3.6–4
- Emergency Locator Transmitters, GEN 3.6–2

## F

- FAR. *See* Federal Aviation Regulations
- Federal Aviation Regulations, List and Availability, GEN 1.6–1
- Fees and Charges. *See* Airport
- Flight Hazards, Potential, ENR 5.7–1
  - Density Altitude, ENR 5.7–3
  - Laser Operations, ENR 5.7–7
  - Mountain Flying, ENR 5.7–2
  - Mountain Wave, ENR 5.7–3
  - Obstructions, ENR 5.7–1
  - VFR in Congested Area, ENR 5.7–1
- Flight Management System (FMS), ENR 4.1–30
- Flight Plan, ENR 1.10–1
  - Aircraft Equipment Suffixes, ENR 1.10–6
  - Airways/Jet Routes Depiction, ENR 1.10–7
  - Area Navigation (RNAV), ENR 1.10–8
  - Canceling, ENR 1.10–11
  - Change, ENR 1.10–11
  - Composite (VFR/IFR Flights), ENR 1.10–11
  - Direct Flights, ENR 1.10–7
  - Flight Plan Form, ENR 1.10–9
  - Flight Plan Requirements, ENR 1.10–3
    - Defense VFR, ENR 1.10–6
    - IFR, ENR 1.10–6
    - VFR, ENR 1.10–4
  - Operations Associated with ADIZ, ENR 1.12–1
  - Preflight Preparation, ENR 1.10–1
- Flight Service Station (FSS), GEN 3.1–4
- Frequencies. *See* Radio Communications
- FSS. *See* Flight Service Station (FSS)
- Fuel Advisory, Minimum, ENR 1.1–34

**G**

- Global Positioning System (GPS), ENR 4.1–30
  - Departures, ENR 4.1–42
  - Design Concept, ENR 4.1–33
  - Missed Approach, ENR 4.1–43
  - Receiver Autonomous Integrity Monitoring (RAIM), ENR 4.1–40
- GPS IFR Equipment Classes/Categories, ENR 4.1–32
- GPS NOTAM's/Aeronautical Information, ENR 4.1–40

**H**

- Hazardous Area Reporting Service, GEN 3.4–11
  - Block Island, GEN 3.4–12
  - Cape Cod, GEN 3.4–13
  - Great Lakes, GEN 3.4–13
  - Long Island Sound, GEN 3.4–11
- High Altitude Destinations. *See* IFR Operations to High Altitude Destinations

Holding Instructions. *See* Clearance Items

## Holding Pattern

- Airspeeds, ENR 1.5–1
- ATC Holding Instructions, ENR 1.5–1
- Distance Measuring Equipment (DME), ENR 1.5–4
- Entry Procedures, ENR 1.5–3
- Nonstandard, ENR 1.5–5
- Timing, ENR 1.5–4

**I**

- ICAO Standards, Recommended Practices and Procedures. *See* Differences From ICAO Standards, Recommended Practices and Procedures

IFR Operations to High Altitude Destinations, ENR 1.10–10

Inertial Navigation System (INS), ENR 4.1–30

Instrument Departure. *See* Departure, Instrument

Instrument Departure Procedures (DP's). *See* Departure Procedures

Instrument Landing System (ILS), ENR 4.1–4  
*See also* Approaches  
Frequency Table, ENR 4.1–6

International Airports. *See* Airports, Designated To Serve International Operations

Intersection Takeoffs. *See* Airport Operations

**J**

Jet Route System. *See* Navigation

**L**

Land and Hold Short Operations. *See* Airport Operations

Law Enforcement Operations by Civil and Military Organizations, ENR 1.12–4

Light Amplification by Stimulated Emission of Radiation (Laser) Operations. *See* Flight Hazards, Potential

Lighting. *See* Airport Lighting

LORAN, ENR 4.1–13

LORAN–C Status Information, ENR 4.1–16

## M

- Medical Facts for Pilots, ENR 1.15-1
  - Carbon Monoxide Poisoning in Flight, ENR 1.15-4
  - Certification, ENR 1.15-1
  - Decompression Sickness after Scuba Diving, ENR 1.15-4
  - Effects of Altitude, ENR 1.15-2
    - Ear Block, ENR 1.15-3
    - Hypoxia, ENR 1.15-2
    - Sinus Block, ENR 1.15-4
  - Hyperventilation in Flight, ENR 1.15-4
  - Illusions, ENR 1.15-4
  - Personal Checklist, ENR 1.15-2
  - Scanning for Other Aircraft, ENR 1.15-6
  - Vision in Flight, ENR 1.15-6
- Meteorological Services, GEN 3.5-1, GEN 3.5-15
  - AIRMET, GEN 3.5-8
  - Automatic Terminal Information Service (ATIS), GEN 3.3-10
  - Categorical Outlook, GEN 3.5-8
  - Center Weather Advisory, GEN 3.5-8
  - Cloud Heights, Reporting, GEN 3.5-18
  - Convective SIGMET Bulletins, GEN 3.5-7
  - Direct User Access System (DUATS), GEN 3.5-4
  - En Route Flight Advisory Service (EFAS), GEN 3.5-6
  - Hazardous In-flight Weather Advisory Service (HI-WAS), GEN 3.5-9, GEN 3.5-51
  - ICAO Weather Formats, GEN 3.5-41
  - In-flight Weather Advisories, GEN 3.5-6
  - In-flight Weather Broadcasts, GEN 3.5-9
  - Low Level Wind Shear Alert System (LLWAS), GEN 3.5-26
  - Meteorological Broadcasts, GEN 3.5-51
  - Pilot Weather Report (PIREP), GEN 3.5-20
  - Prevailing Visibility, Reporting, GEN 3.5-19
  - Runway Visual Range (RVR), GEN 3.5-17
  - Telephone Information Briefing Service (TIBS), GEN 3.5-8
  - Terminal Doppler Weather Radar (TDWR), GEN 3.5-28
  - Terminal Weather Information for Pilots (TWIP), GEN 3.5-29
  - Weather Briefings
    - Abbreviated, GEN 3.5-5
    - In-flight, GEN 3.5-5
    - Outlook, GEN 3.5-5
    - Preflight, GEN 3.5-4

- Standard, GEN 3.5-4
- Weather Deviations and Other Contingencies in Oceanic Controlled Airspace, GEN 3.5-16
- Weather Observation Service Standards, GEN 3.5-13, GEN 3.5-14
- Weather Observing Programs, GEN 3.5-9, GEN 3.5-12
  - Automated Surface Observation System (ASOS), GEN 3.5-11
  - Automated Weather Observing System (AWOS), GEN 3.5-9
  - Manual Observations, GEN 3.5-9
- Microwave Landing System (MLS), ENR 4.1-10
  - See also* Approaches
- Military Training Routes. *See* Airspace, Special Use
- Mountain Flying. *See* Flight Hazards, Potential
- Mountain Wave. *See* Flight Hazards, Potential

## N

- National Security and Interception Procedures, ENR 1.12-1, ENR 1.12-3
- NAVAID Identifier Removal During Maintenance, ENR 4.1-44
- NAVAID User Reports, ENR 4.1-44
- Navigation
  - See also* Global Positioning System (GPS); Radio Navigation Aids
  - Adhering to Airways or Routes, ENR 3.5-3
  - Airway or Route Course Changes, ENR 3.5-2
  - Airways and Route Systems, ENR 3.5-1
  - Changeover Points, ENR 3.5-2
  - LORAN, ENR 4.1-13
  - Radio, GEN 3.4-1
    - Nondirectional Radio Beacon, GEN 3.4-2
- Near Midair Collision Reporting, ENR 1.16-2
  - Investigation, ENR 1.16-3
- Notices To Airmen (NOTAM) Service, GEN 3.1-2, ENR 1.10-2

## O

- Overhead Approach Maneuver. *See* Approaches

**P**

- Parachute Jump Aircraft Operations, ENR 5.1-5
- Phonetic Alphabet. *See* Radio Communications, Phonetic Alphabet
- Pilot Visits to Air Traffic Facilities, GEN 3.3-1
- PIREP. *See* Meteorological Services, Pilot Weather Report
- Position Reporting, GEN 3.3-3
- Position Reporting Requirements, GEN 3.3-4
- Precipitation Static, ENR 5.7-6
- Procedure Turns, ENR 1.5-9

**R**

- Radar, ENR 1.6-1
  - Air Traffic Control Radar Beacon System, ENR 1.6-2
  - Capabilities, ENR 1.6-1
  - Precision Approach, ENR 1.6-3
  - Surveillance, ENR 1.6-2
- Radar Services Provided by ATC, ENR 1.6-6
  - Aircraft Conflict Alert, ENR 1.6-6
  - Offshore Controlled Airspace, ENR 1.6-11
  - Radar Assistance to VFR Aircraft, ENR 1.6-8
  - Radar Traffic Information Service, ENR 1.6-6
  - Terrain/Obstruction Alert, ENR 1.6-6
- Radio Communications, GEN 3.4-5
  - Common Traffic Advisory Frequency (CTAF), GEN 3.3-6
  - Contact Procedures, GEN 3.4-10
  - Directions, GEN 3.4-8
  - Failure, GEN 3.4-9, GEN 3.4-17
  - For Aircraft on International or Overseas Flights, GEN 3.4-14, GEN 3.4-17
  - Phonetic Alphabet, GEN 3.4-7
  - Phraseology, GEN 3.4-7
  - Radio Technique, GEN 3.4-5
  - Speed, GEN 3.4-9
  - UNICOM/MULTICOM, GEN 3.3-9

- Radio Navigation Aids, ENR 4.1-1
  - Distance Measuring Equipment, ENR 4.1-3, ENR 4.1-5
  - Nondirectional Radio Beacon, ENR 4.1-1
  - Tactical Air Navigation, ENR 4.1-3
  - VHF Direction Finder, ENR 4.1-1
  - VHF Omni-directional Radio Range, ENR 4.1-1
- Receiver Autonomous Integrity Monitoring (RAIM).  
*See* Global Positioning System (GPS)
- Reservations. *See* Airport, Reservations Procedures

**S**

- Seaplane Safety, ENR 5.7-4
- Search and Rescue, GEN 3.6-1
- Separation
  - IFR, Standards, ENR 1.1-26
  - Runway, ENR 1.1-27
  - Visual, ENR 1.1-27, ENR 1.1-33

**T**

- Temporary Flight Restrictions. *See* Airspace, Special Use
- Time, Conversion from UTC to Standard Time, GEN 3.4-9
- Tower En Route Control (TEC), ENR 1.6-11
- Traffic Advisories, ENR 1.1-32
  - At Airports Without Operating Control Towers, GEN 3.3-6
- Traffic Alert and Collision Avoidance System (TCAS I & II), ENR 1.1-34
- Traffic Pattern. *See* Airport, Operations
- Transponder Operation, ENR 1.6-3
  - Automatic Altitude Reporting, ENR 1.6-3
  - Code Changes, ENR 1.6-4
  - Emergency, ENR 1.6-5
  - Ident Feature, ENR 1.6-4
  - Mode C Requirements, ENR 1.6-4
  - Under Visual Flight Rules, ENR 1.6-5
- TRSA. *See* Airspace, Terminal Radar Service Area

## U

- U.S. Code of Federal Regulations, Title 14. *See* Federal Aviation Regulations
- U.S. Customs Requirements
  - Entry, Transit, and Departure of Aircraft, GEN 1.2-1
  - Entry, Transit, and Departure of Cargo, GEN 1.4-1
  - Entry, Transit, and Departure of Passengers and Crew, GEN 1.3-1
- U.S. Customs Service, Locations, GEN 1.1-2
- U.S. Differences From ICAO Standards. *See* Differences From ICAO Standards, Recommended Practices and Procedures
- Units of Measurement, GEN 2.1-1

## V

- VFR Flyways. *See* Airspace
- VFR-ON-TOP, ENR 1.1-33
- Visual Approach. *See* Approaches
- Visual Separation, ENR 1.1-33

- Volcanic Ash, Flight Operations in, ENR 5.7-5
- Volcanic Ash, Reporting, GEN 3.5-32
  - Form, GEN 3.5-59
- VOR Receiver Check, ENR 4.1-2
- Vortex Avoidance Procedures, GEN 3.5-38

## W

- Wake Turbulence, GEN 3.5-34
- Weather Briefings. *See* Meteorological Services
- Weather Conversion Table, GEN 3.5-3
- Weather Hazards
  - Microbursts, GEN 3.5-23
  - Thunderstorm Flying, GEN 3.5-33
  - Thunderstorms, GEN 3.5-32
- Weather Minimums. *See* Airspace, VFR Weather Minimums
- Weather Observing Programs. *See* Meteorological Services
- Wildlife Refuges, Parks, and Forest Service Areas. *See* Airspace

