

## Speed Control of Brushless DC Motor by DC-DC Boost and Buck Converters Using GaN and SiC Transistors for Implementing the Electric Vehicles

Fatemeh Rahmani, David Quispe, Tanushree Agarwal, Mohammadreza Barzegaran\*

*Electrical Engineering Department, Lamar University, Beaumont, TX, U.S.A*

Keywords	Abstract
Boost converter, Brushless DC motor, Buck converter, GaN transistor, SiC transistor.	Significant improvements of the DC-DC converters create the straightforward method to control the speed of the DC motor. One of the important DC motors is the Brushless DC motor which is utilized in various electrical fields. This paper focuses on the control at different speeds for a Brushless DC motor. In order to make the proper voltage to run the motor, two DC-DC converters (Boost and Buck) are tested using two different switches (GaN and SiC transistors). After making the Simulink model and connecting to dSPACE to send the suitable pulse to the transistor of the converter, the DC motor starts working by applying the DC voltage to the converter. This process includes modeling in MATLAB Simulink, dSPACE, and an experimental setup to run the DC motor. Furthermore, the performance of GaN and SiC switches in Boost and Buck converters are compared to each other in this project in terms of output parameters, efficiency, and providing the accurate speed for DC motor.

### 1. Introduction

The technology of the SiC transistor has dominated the market for several decades, but GaN transistors are steadily rising. The characteristics of GaN such as its high-electron mobility and high-temperature coefficient show promise for fast processing and in minimizing losses due to heat for <600 V applications [1]. Both GaN and SiC have a Gate (G), a Drain (D), and a Source (S). If compared together, SiC has a higher critical breakdown field, higher thermal conductivity and offers wider bandgap, while GaN has a high-operating temperature, high-breakdown electric field, high-electron mobility and it offers fast-switching times. GaN transistors have faster performance, but they are sensitive to the area layout and slightly more expensive. Moreover, GaN devices are smaller and faster than Si power MOSFETs. GaN costs less to produce, while SiC transistors are finding success at higher voltages primarily due to their size advantages, and it gives higher efficiency.

Before power semiconductors and relative technologies were well developed to convert the DC voltage supply to a higher voltage for low-power applications, the vibrator was used by a step-up transformer and rectifier. For higher power, an electric motor was used to drive a generator of the desired voltage. These were relatively inefficient and expensive procedures used only when there was no alternative. The introduction of power semiconductors and

integrated circuits have significantly improved the situation. For instance, the conversion of a DC power supply to high-frequency AC by using a transformer to change the voltage and rectify it back to DC. Although by 1976, transistor car radio receivers did not require high voltages, some amateur radio operators continued to use vibrator supplies and dynamotors for mobile transceivers requiring high voltages, even though transistorized power supplies were available. While deriving a lower voltage from a higher level with a linear electronic circuit or even a resistor was possible, these methods dissipated the excess as heat. The application of solid-state switch-mode circuits made it possible to achieve energy-efficient conversion. Modern DC/DC converters are designed to provide efficient power conversion and to deliver a controlled, well-regulated and safe DC power supply [2, 3].

DC-DC converters are widely used in efficiently producing a regulated voltage from a possibly well-controlled source to a likely constant load. DC-DC converters use high-frequency switching inductors, transformers, and capacitors to filter out switching noise and regulated DC voltages.

Closed feedback loops are used to maintain constant voltage output, even input voltages, and output current changes by several means including voltage regulator and inverter control. At 90% efficiency, they are generally much more efficient and smaller than linear regulators. However,

\* Corresponding Author:

E-mail address: [mbarzegaranb@lamar.edu](mailto:mbarzegaranb@lamar.edu) – Tel, +1(409)880-7593

Received: 30 March 2020; Accepted: 11 May 2020

the disadvantages are noise and complexity [4, 5]. There are various techniques to reduce the noises in real engineering problems which provides us with higher efficiency [6]. Moreover, nonlinear forced vibration behavior is proposed in [7] to express the amplitude frequency relationship.

In this project, DC-DC Buck and Boost converters are designed to run a Brushless DC (BLDC) motor and control of its speed from a low level (0 rpm) to a high level (300 rpm). This model is created in MATLAB Simulink and dSPACE. The created signal from MATLAB is sent by dSPACE to the gate of the transistor which is used in the converter to make a sufficient voltage for running the DC motor. Furthermore, this project concentrates on the performance comparison of GaN and SiC transistors in Buck and Boost converters as well as acquiring accurate speed control of the BLDC motor. In the following sections, first, the method of the control of the speed in DC motor will be explained in detail using the model in MATLAB Simulink and dSPACE. Afterwards, an explanation will be given of the experimental setup that uses the Simulink-dSPACE connection to run the Boost and Buck converters with two different switches (GaN and SiC) so that the BLDC motor starts rotating periodically. In the end, all the results will be gathered and the performance of GaN and SiC in Boost and Buck converters will be compared to determine which is more suited for accurate speed control of the BLDC motor [8].

## 2. Converters and Motor Choice

In this project to supply the DC voltage for the BLDC motor, Buck and Boost converters are chosen to help the motor run precisely based on the time period and designed model.

### 2.1. Converter Choice

The Boost converter has advantages such as the capability for giving high output voltage, low operating duty cycle, and a lower MOSFET voltage. However, it generates great heat and makes a significant amount of noise when operating [9].

Buck converter has great power efficiency, but makes high voltage ripples, generates high peak current, and high flux density [10].

For our purpose, Buck and Boost converters are more advantageous over other topologies because they provide us with a straight-forward method of speed control. The Buck converter stepping down the voltage and the Boost converter stepping up the voltage facilitates the speed control of the motor, as explained in the next main section. The voltage and speed are proportionally related to each other in the motor, so varying the voltage allows us to directly vary the speed [11, 12]. If we were to consider a Flyback or a Forward converter configuration, a more complex method of control would be required. In their configurations, they use a transformer so core losses would be introduced as well, further complicating the transistors comparison. Overall, the Buck and Boost converters allow the accuracy of the comparison to be prioritized.

### 2.2. Motor Choice

The BLDC motor captured our interest because it is highly applicable in our daily lives and has the potential to expand even further. They are mainly used for devices that need to run continuously e.g., air conditioners, home appliances, flywheel energy storage systems, and satellite power systems [13, 14]. Having more flexibility in its speed control and using more efficient transistors would make BLDC motors applicable outside of this area. For example, one could start looking into drones that require precise control of their rotors and other devices that have sensitive control. By comparing GaN and SiC transistors in Buck and Boost converters, one can learn how much more effective one transistor would be over the other. This can help contribute to expanding the applications of BLDC motors.

## 3. Matlab Simulink Modeling

The speed control of the Buck and Boost converters was performed in MATLAB Simulink. The dSPACE system was required in order to convert the analog signals from the BLDC motor to digital signals so that Simulink can process them. The dSPACE system was composed of the DS1104 R&D Controller Board, CP1104 Connector Panel, and the ControlDesk software.

### 3.1. The Reference Speed

The design focus of the Simulink model was to repeatedly vary the speed of the motor at different levels for specific time periods. A pulse generator block and a stepped system were considered, but they are not able to fulfill the requirements. Using a repeating sequence, the motor is set to increase the speed in ten second intervals followed by a 0.1s delay before incrementing in speed. This delay allows time for the motor to reach the next specified speed level. Figure 1. shows the initial interval is set to 0 revolutions per minute (rpm) and it then increments from 100 to 200 to 300 rpm and then back to zero before the sequence repeats. The goal of this paper was to make the control of the reference input very simple and direct which is the advantage that the repeating sequence was able to provide.

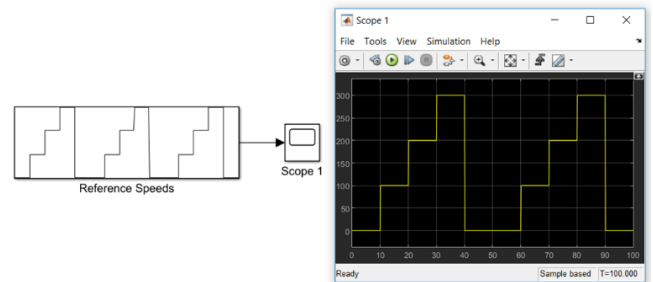

Figure 1. Reference input in the Simulink model for both Buck and Boost converters

### 3.2. The Speed Conversion in dSPACE

Figure 2. shows a series of gain blocks which are extracted from dSPACE datasheet that convert the delta position to the motor's actual speed in (rpm) [15]. The direction of the motor is arbitrarily changed to clockwise and following it is the conversion to speed in units of (rad/s). The "speed\_r/s" contains  $(1/T_s)$ , where  $T_s$  is the sampling period and Encoder Lines is the number of encoding lines used:

$$Speed (rad / s) = \frac{2\pi}{T_s * (Encoder Lines)} \quad (1)$$

The values are  $T_s = 1ms$  and  $Encoder Lines = 1000$ . Following this gain block is the conversion to speed in (rpm), as shown by the label in the “speed\_rpm” block in Figure 2. This second conversion was necessary because the motor’s speed is based on (rpm). A single gain block could have been used to represent the equations, but decomposing them in this manner provides a clearer picture of what is being done.

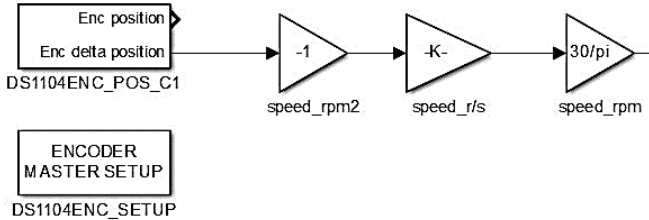

Figure 2. Calculating the speed of the motor by using gain blocks. This applies to both converters

### 3.3. Buck and Boost Converter Models

In order to keep the motor’s speed as uniform as possible, Hysteresis speed control is used to keep the speed close to the reference. Based on (2) for Buck converter and (3) for Boost converter and (4) as a relationship between speed and voltage, the conclusion is that when the voltage is controlled or changed, consequently the speed will be controlled in the same way. In the following eqs. (2) up to (4),  $D$  is the duty cycle,  $V_{out}$  is the output voltage,  $V_{in}$  is the input voltage.

$$V_{out} = V_{in} * D \quad (2)$$

$$V_{out} = \frac{V_{in}}{1 - D} \quad (3)$$

$$E_e = k_E * \omega \quad (4)$$

In reality,  $V_{out}$  and  $V_{in}$  refer to the speed of Hysteresis speed controller and actual comparison speed, respectively. One of the advantages of using Hysteresis is the direct control in specifying the error limits to reduce the ripples as much as possible. To ensure that the GaN and SiC comparison is accurate, the error bandwidth is specified to be only 20 rpm. In doing so, significant switching losses are avoided that would occur by making the bandwidth smaller. The GaN transistor is capable of operating at high switching speeds, but the unbiased comparison was prioritized.

The Buck and Boost converters are shown in Figure 3. and Figure 4., respectively. In both models, the actual motor speed is compared to the reference input using the sum block and the output is then sent to the relay where Hysteresis is used. The relay outputs a one if it detected that the comparison passed the positive threshold, and it outputs a zero if the comparison passed the negative threshold. This information is sent to the DS1104DAC\_C2 block which converts the Simulink digital signals to analog signals for the motor to understand. So if the motor’s speed was greater than the reference speed by more than 10 (rpm), then the relay outputs a zero to tell the BLDC motor to decrease in speed. Similarly, if the speed is less than the reference speed, then

the BLDC motor increases in speed. For future improvements of our models, a PID controller will be considered because it would make the models more concise. This idea is not implemented at this time because it would bring more complexity to the control when the focus is to prioritize the accuracy of the comparison. From the comparison results, it can be determined which transistor to prioritize for further improvement in the control, hence the future consideration of a PID controller.

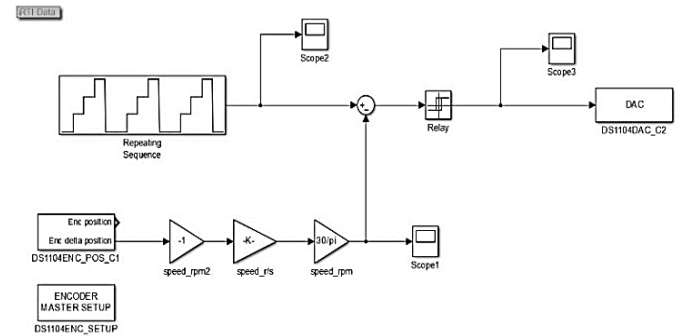

Figure 3. The Simulink model for the Buck converter. The Encoder Master Setup block is required for the model to run because it sets the channel specifications

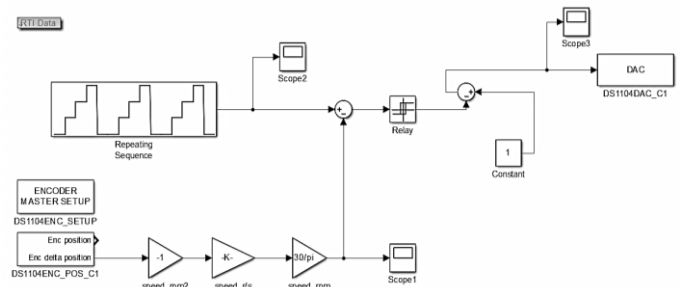

Figure 4. The Simulink model for the Boost converter. The Encoder Master Setup block is also required here

## 4. Experimental Setup

After making the model of the simulation, the experimental setup is created in order to use the simulation to run the BLDC motor. In order to make a connection between the simulation in MATLAB Simulink and dSPACE is used to run the simulation and send the desirable pulse to the gate of the transistor of Buck or Boost converter. These converters are also connected to Brushless DC motor and by applying a DC voltage source, the speed of this motor will be controlled.

As mentioned in previous sections, the goal of this project is using Buck and Boost converters with two different switches (GaN and SiC transistors) to control the speed of Brushless DC motor. Based on the comparison between SiC and GaN performances in the Introduction section, better output results and efficiency with Buck or Boost converter are expected using the GaN transistor. In the following sections, the experimental setup will be discussed and eventually, the output results, and the efficiency of the Buck and Boost converters using two different switches will be compared.

4.1. Required Components to Make the DC-DC Converter

The important difference between the Buck and Boost converters is applying the DC voltage using different DC voltage sources. In the Boost converter, a high inrush current occurs when starting the BLDC motor, so a variable DC voltage source is recommended. Figure 5(a). shows that in the variable DC power source, the specific inrush current and the best input voltage are determined using coding in MATLAB. Conversely, the Buck converter is able to work with a regular DC voltage source at the range of 15 (V) as shown in Figure 5(b).

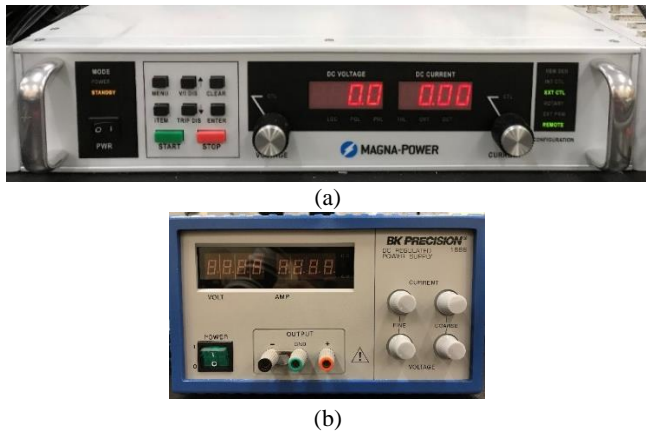

Figure 5. These are the different DC power sources used for the Boost and Buck converters

The other components that make the Buck and Boost converters using GaN and SiC switches are shown in Table 1.

Table 1. Required components to make the converters

100µF, 50 (V) Capacitor	2µH Inductor
SiC CREE	GaN transphorm
C2M0080120	TPH3206PSB
1N4001 Diode	

4.2. Circuit Design

As shown Figure 6(a). and (b)., the Buck and Boost converters are created based on the presented model of these converters. GaN and SiC transistors are exchanged in each converter to test the circuit and obtain the output results.

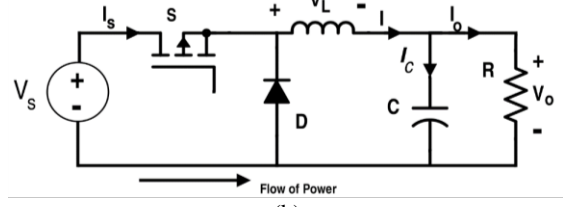
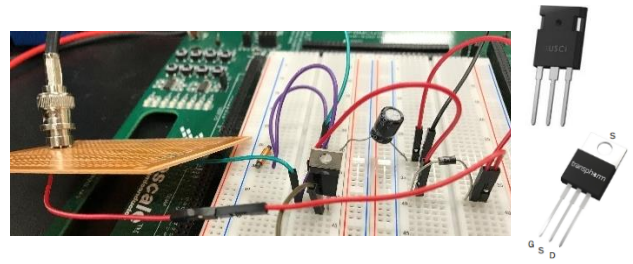
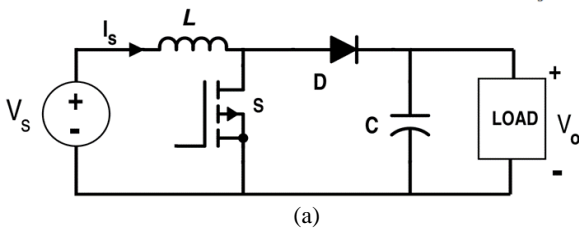
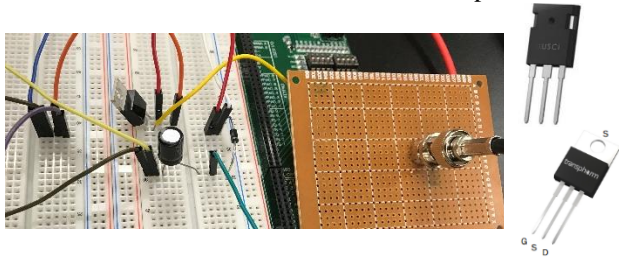

Figure 6. (a) Boost and (b) Buck converter circuit design using the GaN and SiC switches

4.3. Output Results of Boost and Buck Converter

The output parameters of two converters with GaN and SiC transistors have to be checked to verify that these converters perform well to control the speed of Brushless DC motor. Boost converter should have an increase in the output voltage and Buck converter should decrease the output voltage. Based on Table 2., the Boost converter increases the voltage from 2.8~2.9(V) to 4.7~5.2(V), and the decrease in Buck converter is from 15(V) to 4.7~5.3(V). Boost converter increases more by using the GaN switch than the SiC switch. Similarly, the GaN switch has better performance than the SiC switch in the Buck converter because the output voltage reduces more.

Table 2. Comparison of output parameters in boost and buck converter

	Boost converter	
	GaN	SiC
Increasing the voltage	I <sub>in</sub> = 2 (A)	I <sub>in</sub> = 1.96 (A)
	V <sub>in</sub> = 2.9 (V)	V <sub>in</sub> = 2.8 (V)
	I <sub>out</sub> = 0.82 (A)	I <sub>out</sub> = 0.8 (A)
	V <sub>out</sub> = 5.2 (V)	V <sub>out</sub> = 4.7 (V)
	Buck converter	
	GaN	SiC
Decreasing the voltage	I <sub>in</sub> = 0.52 (A)	I <sub>in</sub> = 0.54 (A)
	V <sub>in</sub> = 15 (V)	V <sub>in</sub> = 15 (V)
	I <sub>out</sub> = 1.3 (A)	I <sub>out</sub> = 1.1 (A)
	V <sub>out</sub> = 4.7 (V)	V <sub>out</sub> = 5.3 (V)

The efficiency of the Boost and Buck converters are calculated in Table 3. Comparing the output parameters between GaN and SiC transistors, the Boost and Buck converters with GaN have better efficiency (74% and 78%) than using SiC in these converters (69% and 71%).

Table 3. Comparison of Efficiencies Between Boost and Buck Converters with Two Different Switches

The Efficiency of Boost Converter	
GaN Transistor	SiC Transistor
74%	69%
The Efficiency of Buck Converter	
GaN Transistor	SiC Transistor
78%	71%

#### 4.4. Speed Control of Brushless DC Motor

After checking the accuracy of the converters, they are ready to supply DC voltage for the BLDC motor. The comparison pulse between the speed reference and the actual motor speed is sent to the Hysteresis speed controller. Next, the output of the Hysteresis controller sends the desirable speed pulse to the gate of the GaN or SiC transistor in the converters. After this procedure, the BLDC motor starts rotating based on the time period. It means that for the first 10s, the motor does not have any rotation, but after 10s the speed increases to 100 rpm and then 200 rpm and finally 300 rpm (which is the fastest speed used in this project). Figure 7. shows that these scopes come from three important outputs of the Simulink modeling, and when the motor is working, each scope has an individual scheme.

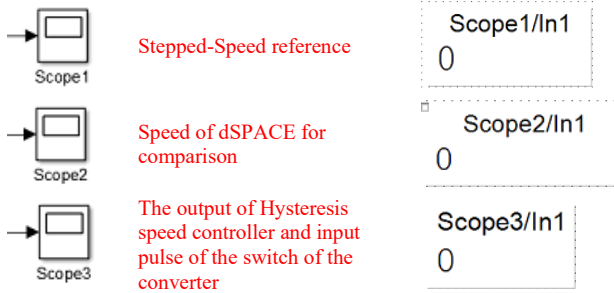

Figure 7. Introducing of three important scopes which are used in Matlab Simulink and dSPACE

Although the three scopes above show different schemes individually, the results shown on these scopes for Boost and Buck converters to control the speed of Brushless DC motor are the same. In other words, both converters provide enough voltage for running the motor, and they are able to increase the speed of the motor properly and periodically. As mentioned before, based on the equation  $E_e = k_E \times \omega$ , suitable transferred voltage from converter can be changed to the proper speed to run the DC motor. In Figure 8, the schemes for scope 1 and 2 on the dSPACE screen in Boost converter are shown at different speeds (100, 200, and 300 rpm), and they are the same for the scopes in the Buck converter. Moreover, using GaN and SiC transistors does not have any effect on the results of scope 1 and 2.

As mentioned before, the scope 3 shown on dSPACE, which is the output of the Hysteresis speed controller in Boost converter, is the same as the scheme of the scope 3 in Buck converter. Although, using different switches (GaN and SiC) does influence the output of the hysteresis speed controller. Figure 9 shows the difference of the scope 3 schemes between GaN and SiC switches at 210 rpm speed in Boost or Buck converter. Furthermore, GaN is used in the application with high frequency and the time period is shorter than the time period of the SiC waveform. Hence, using GaN switch in the converter helps to obtain accurate and better speed to control the speed of Brushless DC motor.

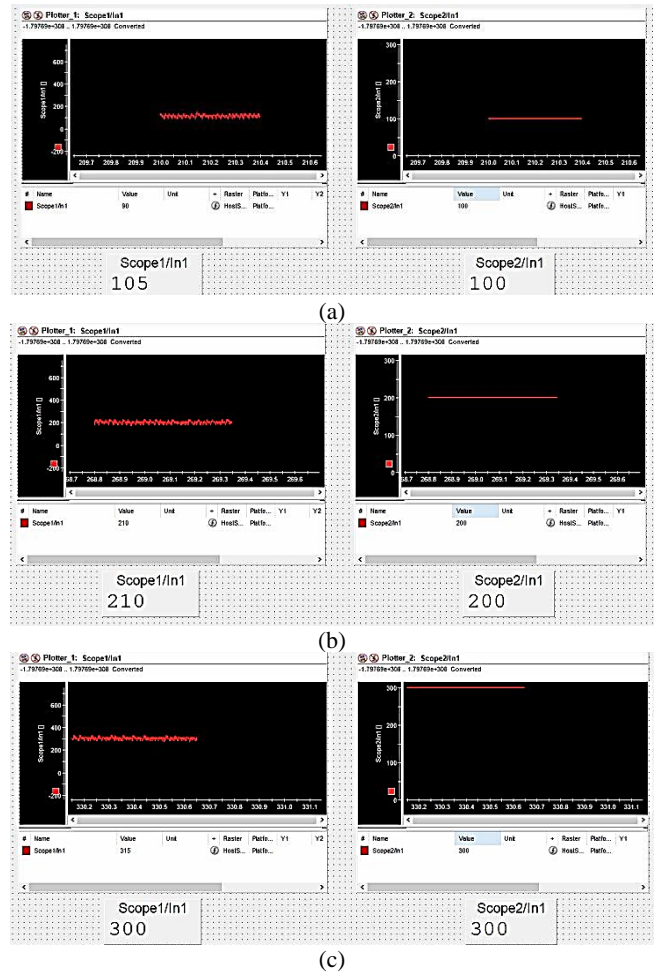

Figure 8. The output of the reference speed and dSPACE speed (scope 1 and 2 on dSPACE screen) in Buck and Boost converters at different speed (a) 100rpm, (b) 200rpm, (c) 300rpm

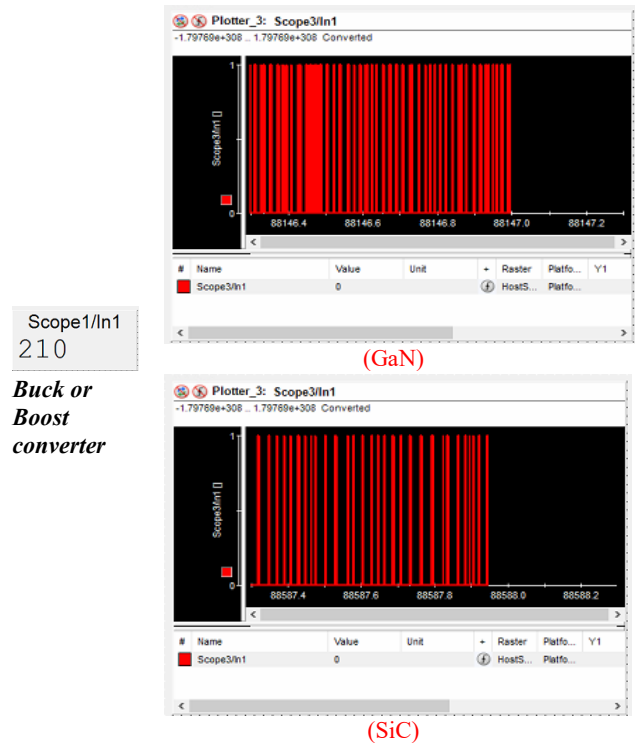

Figure 9. The output of the Hysteresis speed controller (scope 3 on dSPACE screen) in Buck or Boost converters at 210 rpm

## 5. Conclusions

A focus on the speed control of BLDC motors needs to be prioritized in order to expand its applications. Areas that require sensitive control or energy-efficiency are the next step for BLDC motors which can be made possible through the use of more efficient transistors in DC-DC Buck and Boost converters. The experiment described in this paper was designed to accurately compare the output parameters of the converters when GaN and SiC switches were used in both. To do this, models were made in MATLAB Simulink connected to a dSPACE system which was connected to the converters and the BLDC motor. The models used a direct method of speed control with Hysteresis in order to make the comparison accurate. Ultimately, the experiment showed that a GaN transistor allows for both types of converters to perform more efficiently than a SiC transistor. In future experiments, more complex methods of speed control will be considered when using the GaN transistor in order to make the control more precise.

## References

- [1] D. K. Saini, Gallium nitride: Analysis of physical properties and performance in high-frequency power electronic circuits, 2015.
- [2] S. Roberts, DC/DC book of knowledge: Practical tips for the User: Recom, 2015.
- [3] P. Vinciarelli, Point of load sine amplitude converters and methods, ed: Google Patents, 2006.
- [4] Q. Zhao and F. C. Lee, High-efficiency, high step-up DC-DC converters, IEEE Transactions on Power Electronics 18 (2003) 65–73.
- [5] S. López, U. Koç, E. Bakker, and J. Rahmani, Optimization of Lift Gas Allocation using Evolutionary Algorithms, 2019.
- [6] N. A. Golilarz, N. Robert, J. Addeh, and A. Salehpour, Translation Invariant Wavelet based Noise Reduction using a New Smooth Non-linear Improved Thresholding Function, CRPASE 3 (2017) 104–108.
- [7] S. S. Mirjavadi, M. Forsat, M. Nikookar, M. R. Barati, and A. Hamouda, Nonlinear forced vibrations of sandwich smart nanobeams with two-phase piezo-magnetic face sheets, The European Physical Journal Plus 134 (2019) 508.
- [8] M.-M. Naddaf-Sh, S. Naddaf-Sh, H. Zargaradeh, S. M. Zahiri, M. Dalton, G. Elpers, et al., Next-Generation of Weld Quality Assessment Using Deep Learning and Digital Radiography.
- [9] N. Fahimi, M. R. Chalaki, M. A. Baferani, M. R. Tajik, and A. A. Shayegani, Investigating the failures of defected silicon rubber insulators in salt-fog chamber, in 2018 IEEE Texas Power and Energy Conference (TPEC) (2018) 1–6.
- [10] A. Elasser and T. P. Chow, Silicon carbide benefits and advantages for power electronics circuits and systems, Proceedings of the IEEE 90 (2002) 969–986.
- [11] Renesas, BLDC Motor Basics: Understanding the principle and application of high efficiency motors.
- [12] F. Rahmani, F. Razaghian, and A. Kashaninia, Novel Approach to Design of a Class-EJ Power Amplifier Using High Power Technology, World Academy of Science, Engineering and Technology, International Journal of Electrical, Computer, Energetic, Electronic and Communication Engineering (2015) 541–546.
- [13] R. ÇELİKEL and M. ÖZDEMİR, Control of a Three-Phase Boost Rectifier for High-Speed BLDC Generators Used in Flywheel Energy Storage System.
- [14] Daycounter, Boost Switching Converter Design Equations, 2016.
- [15] D. R. Board and D. Controller, Hardware Installation and Configuration, ed: CRC Press, Release, 2004.