

USDOT Spectrum Sharing Analysis Plan:

Effects of Unlicensed-National Information Infrastructure (U-NII) Devices on Dedicated Short-Range Communications (DSRC)

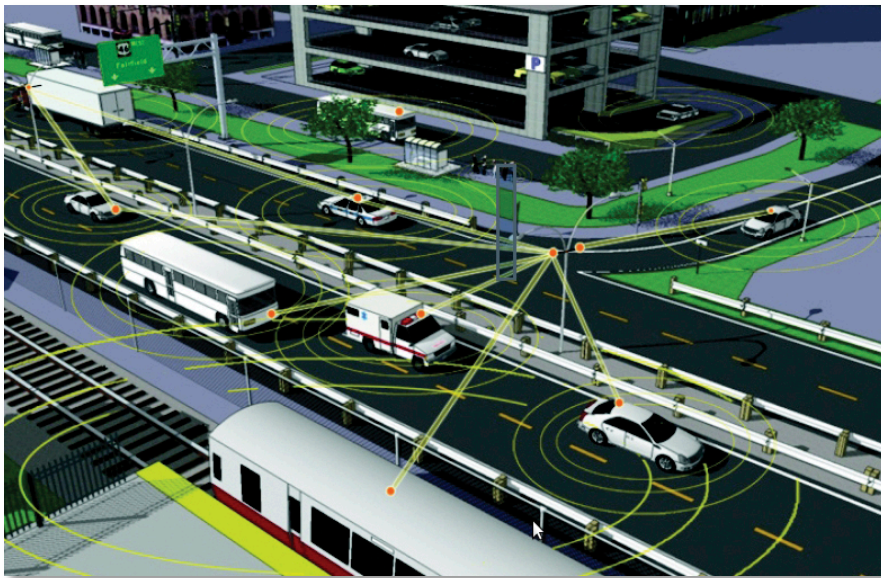

December 2017 Version 4.7 (Update)

Prepared for:

U.S. Department of Transportation
Intelligent Transportation Systems Joint Program Office
1200 New Jersey Avenue, SE
Washington, D.C. 20590



U.S. Department of Transportation

Notice

This document is disseminated under the sponsorship of the Department of Transportation in the interest of information exchange. The United States Government assumes no liability for the contents or use thereof.

The United States Government does not endorse products or manufacturers. Trade or manufacturers' names appear herein solely because they are considered essential to the objective of this report.

REPORT DOCUMENTATION PAGE		<i>Form Approved</i> <i>OMB No. 0704-0188</i>
Public reporting burden for this collection of information is estimated to average 1 hour per response, including the time for reviewing instructions, searching existing data sources, gathering and maintaining the data needed, and completing and reviewing the collection of information. Send comments regarding this burden estimate or any other aspect of this collection of information, including suggestions for reducing this burden, to Washington Headquarters Services, Directorate for Information Operations and Reports, 1215 Jefferson Davis Highway, Suite 1204, Arlington, VA 22202-4302, and to the Office of Management and Budget, Paperwork Reduction Project (0704-0188), Washington, DC 20503.		
1. AGENCY USE ONLY (Leave blank)	2. REPORT DATE November 2017	3. REPORT TYPE AND DATES COVERED Analysis Plan, 2015-2018
4. TITLE AND SUBTITLE USDOT Spectrum Sharing Analysis Plan: Effects of Unlicensed-National Information Infrastructure (U-NII) Devices on Dedicated Short-Range Communications (DSRC)		5a. FUNDING NUMBERS DTFH61-15V-00023
6. AUTHOR(S) U.S. DOT/Office of the Assistant Secretary for Technology and Research (OST-R): Alan Chachich (Volpe National Transportation Systems Center) Jim Arnold (OST-R) Walt Fehr (Volpe National Transportation Systems Center) Tom Schaffnit (Volpe National Transportation Systems Center) Suzanne Sloan (Volpe National Transportation Systems Center) Eric Wallischeck (Editor) (Volpe National Transportation Systems Center) U.S. DOT/Federal Highway Administration: Volker Fessmann (FHWA) U.S. DOT/National Highway Traffic Safety Administration: Steve Stasko (NHTSA)		5b. CONTRACT NUMBER None
7. PERFORMING ORGANIZATION NAME(S) AND ADDRESS(ES) U.S. Department of Transportation Office of the Assistant Secretary for Research and Technology John A Volpe National Transportation Systems Center 55 Broadway Cambridge, MA 02142-1093 And U.S. Department of Transportation Office of the Assistant Secretary for Research and Technology Federal Highway Administration National Highway Traffic Safety Administration 1200 New Jersey Ave, S.E. Washington, D.C. 20590 And U.S. Department of Transportation Turner-Fairbank Highway Research Center 6300 Georgetown Pike McLean, VA 22101		8. PERFORMING ORGANIZATION REPORT NUMBER TBD
9. SPONSORING/MONITORING AGENCY NAME(S) AND ADDRESS(ES) U.S. Department of Transportation Intelligent Transportation Systems Joint Program Office Washington, DC 1200 New Jersey Avenue, SE Washington, DC 20590		10. SPONSORING/MONITORING AGENCY REPORT NUMBER N/A
11. SUPPLEMENTARY NOTES None		
12a. DISTRIBUTION/AVAILABILITY STATEMENT None		12b. DISTRIBUTION CODE None

13. ABSTRACT (Maximum 200 words)

This report documents the analysis plan for characterizing the existing radio frequency signal environment and identifying the impacts to DSRC operations of unlicensed devices operating in the 5850-5925 MHz band and adjacent bands. Additional goals of the analysis plan are: to develop the capability to evaluate proposed band sharing mechanisms; define requirements for sharing mechanisms that prevent interference; and collaborate with the National Telecommunications and Information Administration (NTIA) and the FCC to provide Congress with results on impacts to DSRC operations from proposed sharing mechanisms, as per a Letter from Congress in September 2015.

14. SUBJECT TERMS

DSRC, U-NII, ITS, Dedicated Short-Range Communications, Unlicensed National Information Infrastructure, Intelligent Transportation Systems, Radio Frequency Interference, V2V, V2I, V2X, IEEE 802.11, Wi-Fi Access Points

15. NUMBER OF PAGES

150

16. PRICE CODE

N/A

17. SECURITY CLASSIFICATION OF REPORT

Unclassified

18. SECURITY CLASSIFICATION OF THIS PAGE

Unclassified

19. SECURITY CLASSIFICATION OF ABSTRACT

Unclassified

20. LIMITATION OF ABSTRACT

Unlimited

NSN 7540-01-280-5500

Standard Form 298 (Rev. 2-89)
 Prescribed by ANSI Std. Z39-18
 298-102

Version History

Version				Approval	
#	Author/editor	Date	Changes	By	Date
1.1	Chachich	4/10/2015	Incomplete Draft – included inputs from framework exercise		
1.2	Chachich	4/15/2015	Incomplete Draft – include some ARINC input		
1.4	Chachich	4/15/2015	Incomplete Draft – began baseline measurements		
1.5	Chachich	4/17/2015	Incomplete Draft - included baseline measurements		
2.0	Chachich	4/19/2015	Initial Draft – preliminary with gaps but essential elements completed		
2.3	Chachich	4/21/2015	Included changes recommended by technical team		
2.4	Chachich	4/22/2015	Accepted most changes and new edits by Jim Arnold to address safety and add RTK. New edit to broadened intro language beyond BSMs.		
2..5	Chachich	5/4/2015	Edits and comments by Jim Arnold and Alan Chachich		
2.6	Chachich	5/8/2015	Edits to respond to input from NTIA		
2.7	Chachich	5/14/2015	Technical team approval or adjusting NTIA related edits		
2.8	Chachich	5/14/2015	Added appendices A, B and C. Additions to Equipment and Facilities Added List of Abbreviations.		
2.9	Chachich, Arnold, Magorka	6/4/2015 6/15/2015	Addressed FCC inputs. Incorporated equipment information from Rockwell Collins		
3	Chachich, Arnold, Sloan	7/2/2015	Edited for further distribution		
3.1	Chachich, Arnold	8/17/2015	Incorporate NTIA input		
3.2	Chachich, Arnold	8/19/2015	Incorporate FCC input		
3.3	Chachich	8/20/2015	Include equipment specs		

3.4	Chachich	8/21/2015	Added section 4.4.3 Power calibration, daily calibration measurements, described ARINC lot facility and measurement of noise energy scaling with bandwidth.		
3.5	Chachich	8/25/2015	Changes accepted, red lines removed.		
3.6	Chachich, Gerdes, Buxton, Brennan, Oates	5/31/2016	Added detail to section 4, clarifications in section 5 and began correcting for the change in test locations		
3.7	Chachich	7/11/2016	Clarification and added detail to sections 6, 10 and Appendix A. Added material for the Boulder and Aberdeen sites.		
3.8	Chachich, Fehr	7/16/2016	Grammatical corrections, added material on modulation and packet rate selection		
3.9	Chachich, Oates, Brennan, Buxton, Gerdes	8/2/2016	Clarifications on requirements, equipment and measurement tasks		
4.0	Chachich, Arnold, Sloan	8/12/2016	Update Figure 3-1, Include FCC license in Appendix D. Minor edits.		
4.1	Sloan, Wallischeck	10/11/2016	Reviewed and edited for formatting, grammar, and style; drafted Preface.		
4.2	Chachich, Sloan	11/9/2016	Updated Figure 3-1. Removed Appendix F. Final review and edit.		
4.3	Chachich	11/10/2016	Added executive summary		
4.4	Chachich	5/5/2017	Added alt text tags for 508c compliance		
4.5	Chachich	6/7/2017	Streamlined based on initial measurements. Sections edited: §4.4.3, §4.7.5, §4.8.5, Tables 5-4, 5-5, 5-7, 5-8, 5-10, ,5-11, 5-12, 5-13, 5-14, §5.3.5, Tables 5-18, 5-19, 6-2, 6-3, 6-4, 6-5 and 6-6.		
4.6	Sloan	12/7/2017	Copy edit.		
4.7	Chachich	12/8/2017	Final copy edit		

SI* (MODERN METRIC) CONVERSION FACTORS					
APPROXIMATE CONVERSIONS TO SI UNITS					
Symbol	When You Know	Multiply By	To Find	Symbol	
LENGTH					
in	inches	25.4	millimeters	mm	
ft	feet	0.305	meters	m	
yd	yards	0.914	meters	m	
mi	miles	1.61	kilometers	km	
AREA					
in²	square inches	645.2	square millimeters	mm ²	
ft²	square feet	0.093	square meters	m ²	
yd²	square yard	0.836	square meters	m ²	
ac	acres	0.405	hectares	ha	
mi²	square miles	2.59	square kilometers	km ²	
VOLUME					
fl oz	fluid ounces	29.57	milliliters	mL	
gal	gallons	3.785	liters	L	
ft³	cubic feet	0.028	cubic meters	m ³	
yd³	cubic yards	0.765	cubic meters	m ³	
NOTE: volumes greater than 1000 L shall be shown in m³					
MASS					
oz	ounces	28.35	grams	g	
lb	pounds	0.454	kilograms	kg	
T	short tons (2000 lb)	0.907	megagrams (or "metric ton")	Mg (or "t")	
oz	ounces	28.35	grams	g	
TEMPERATURE (exact degrees)					
°F	Fahrenheit	5 (F-32)/9 or (F-32)/1.8	Celsius	°C	
ILLUMINATION					
fc	foot-candles	10.76	lux	lx	
fl	foot-Lamberts	3.426	candela/m ²	cd/m ²	
FORCE and PRESSURE or STRESS					
lbf	poundforce	4.45	newtons	N	
lbf/in²	poundforce per square inch	6.89	kilopascals	kPa	

*SI is the symbol for the International System of Units. Appropriate rounding should be made to comply with Section 4 of ASTM E380. (Revised March 2003)

SI* (MODERN METRIC) CONVERSION FACTORS				
APPROXIMATE CONVERSIONS FROM SI UNITS				
Symbol	When You Know	Multiply By	To Find	Symbol
LENGTH				
mm	millimeters	0.039	inches	in
m	meters	3.28	feet	ft
m	meters	1.09	yards	yd
km	kilometers	0.621	miles	mi
AREA				
mm²	square millimeters	0.0016	square inches	in ²
m²	square meters	10.764	square feet	ft ²
m²	square meters	1.195	square yards	yd ²
ha	hectares	2.47	acres	ac
km²	square kilometers	0.386	square miles	mi ²
VOLUME				
mL	milliliters	0.034	fluid ounces	fl oz
L	liters	0.264	gallons	gal
m³	cubic meters	35.314	cubic feet	ft ³
m³	cubic meters	1.307	cubic yards	yd ³
mL	milliliters	0.034	fluid ounces	fl oz
MASS				
g	grams	0.035	ounces	oz
kg	kilograms	2.202	pounds	lb
Mg (or "t")	megagrams (or "metric ton")	1.103	short tons (2000 lb)	T
g	grams	0.035	ounces	oz
TEMPERATURE (exact degrees)				
°C	Celsius	1.8C+32	Fahrenheit	°F
ILLUMINATION				
lx	lux	0.0929	foot-candles	fc
cd/m²	candela/m ²	0.2919	foot-Lamberts	fl
FORCE and PRESSURE or STRESS				
N	newtons	0.225	poundforce	lbf
kPa	Kilopascals	0.145	poundforce per square inch	lbf/in ²

*SI is the symbol for the International System of Units. Appropriate rounding should be made to comply with Section 4 of ASTM E380. (Revised March 2003)

Table of Contents

List of Figures	5
List of Tables.....	6
List of Abbreviations.....	8
Preface.....	10
Executive Summary	13
1. Introduction	14
2. Goals and Objectives	19
2.1 USDOT Goals	19
2.2 Analysis Plan Objectives.....	19
3. Analysis Plan Overview.....	23
3.1 Analysis Plan Roadmap	23
3.2 Dependencies.....	27
3.3 Timeline.....	28
4. Preparatory Phase Activities	29
4.1 Analysis Scenarios	29
4.2 Requirements.....	30
4.3 Procurements and Arrangements.....	33
4.4 Checkout of Equipment, Measurement Procedures and Personnel	48
4.5 Baseline Environmental Signal Data Collection	53
4.6 Unmanned Aircraft Systems (UAS) Data Links.....	57
4.7 Surrogate U-NII-4 Setup and Verification	59
4.8 DSRC Setup and Verification	64
4.9 Antenna Characterization and Calibration.....	69
5. Baseline Device Performance Measurements.....	72
5.1 DSRC Band Background Noise Level Analysis	72
5.2 DSRC Device Baseline Performance Measurements	78
5.3 U-NII-3 and U-NII-4 Device Baseline Performance Measurements	86
5.4 Detectability Analysis between DSRC and U-NII-4 devices.....	93
6. Interference Analysis	101
6.1 Purpose	101
6.2 Equipment.....	102

6.3	Data to Collect.....	102
6.4	Scenario 1: Outdoor Access Point.....	104
6.5	Scenario 2: Indoor Access Point Near a Road Corridor.....	109
6.6	Scenario 3: In-Vehicle Unlicensed Devices	113
6.7	Scenario 4: High Speed Rural V2V Encounter Near an Unlicensed Access Point	118
6.8	Scenario 5: Multiple Access Points and Client Devices along a Corridor.....	121
7.	Baseline Device Performance Measurements with Potential U-NII-4 Devices.....	126
8.	Interference Analysis with Potential U-NII-4 Devices	127
9.	Naturalistic Analysis	128
10.	References	129
	Appendix A: DSRC Terminology	130
	Appendix B: Clear Channel Access Mechanism.....	132
	B.1 First excerpt to explain what happens in the time between packets:	132
	B.2 Second excerpt to explain EDCA parameters:.....	134
	Appendix C: Candidate RF Power Levels to Use	137
	Appendix D: Experimental License	138
	Appendix E: Candidate Field Survey Sites	149

List of Figures

Figure 1-1: DSRC Channel Plan in the ITS Band	15
Figure 1-2: DSRC channel number designations for both 10 and 20MHz channels	15
Figure 1-3: Proposed new U-NII-4 band	16
Figure 1-4: U-NII-4 overlap with the DSRC band.....	17
Figure 3-1: Analysis Activity Dependencies	27
Figure 4-1: RF Signal Measurement Lab Configuration	38
Figure 4-2: Saxton Traffic Operations Laboratory Test Beds	39
Figure 4-3: Simplified Overview of CVHT System	40
Figure 4-4: TFHRC Test Route	41
Figure 4-5: Vehicles at an Intersection on the FLETC Track.....	42
Figure 4-6: Maryland Eastern Shore Site (Cheston Road).....	42
Figure 4-7: Measurement Site on Runway at Aberdeen Proving Ground	43
Figure 4-8: Test Track and Runways at Aberdeen Proving Ground	44
Figure 4-9: Table Mountain Field Measurement Site	45
Figure 4-10: Typical View of Table Mountain Measurement Site	46
Figure 4-11: RF Signal Measurement Mobile Configuration.....	47
Figure 5-1: Baseline Measurement Area for IEEE 802.11p and IEEE 802.11ac Radios.....	82
Figure 6-1: Depiction of Scenario 1 (Outdoor Access Point near intersection).....	105
Figure 6-2: Depiction of Scenario 2 (Indoor Access Point by a residential street)	110
Figure 6-3: Possible Layout for Scenario 2 at the Aberdeen Proving Ground Site	111
Figure 6-4: Depiction of Scenario 3 (unlicensed Devices Transmitting in a Vehicle).....	114
Figure 6-5: Possible Layout for Scenario 3 at the Table Mountain Measurement Site	115
Figure B-1. Breakdown of Interframe Spacing.....	132
Figure B-2: Depiction of 802.11 default EDCA parameters	135

List of Tables

Table 3-1: Analysis Plan Roadmap	23
Table 4-1: Equipment Requirements	30
Table 4-2: Laboratory Facility Requirements	31
Table 4-3: Field Facility Requirements	31
Table 4-4: Software Requirements	32
Table 4-5: Hardware Requirements	33
Table 4-6: Laboratory Equipment List	34
Table 4-7: Mobile Data Collection Platform Equipment	36
Table 4-8: Power Calibration Runs for Receivers	50
Table 4-9: Power Calibration Runs for Transmitters	51
Table 4-10: RF Environmental Data Collection Matrix	54
Table 4-11: UAS Data Collection Matrix	58
Table 4-12: Surrogate U-NII-4 Modulation Data Collection Matrix	60
Table 4-13: 802.11ac Modulation Options and Data Rates	63
Table 4-14: Suggested U-NII Modulations to Examine for Impact on DSRC Communications	63
Table 4-15: DSRC Radio Modulation Data Collection Matrix	65
Table 4-16: 802.11p DSRC Modulation Options	68
Table 4-17: Suggested DSRC Modulations to Examine for Vulnerability to the U-NII Modulations in Table 4-14	68
Table 4-18: Antenna Pattern Calibration Data Collection Matrix	70
Table 5-1: DSRC Noise Level Data Collection Matrix	73
Table 5-2: Radiated DSRC Power Levels Selected for Analysis	75
Table 5-3: Summary of Measurement Runs	76
Table 5-4: Baseline U-NII Noise Level Runs	76
□ See text at the end of Section 4.7.5	77
Table 5-5: Baseline DSRC Noise Level Runs	77
Table 5-6: DSRC Performance Baseline Data Collection Matrix	79
Table 5-7: DSRC RSU-to-OBU Baseline Performance Measurements – No Interference	84
Table 5-8: DSRC OBU-to-OBU Baseline Performance Measurements – No Interference	85
Table 5-9: U-NII-4 Performance Baseline Data Collection Matrix	87

Table 5-10: U-NII Baseline Performance Measurements – No Interference.....	90
□ See text at the end of Section 4.7.5.....	90
Table 5-11: Portable U-NII Baseline Performance Measurements, Windows CLOSED – No Interference.	91
Table 5-12: Portable U-NII Baseline Performance Measurements, Windows OPEN – No Interference....	91
Table 5-13: Indoor Access Point to Portable U-NII Baseline Performance Measurements, Windows CLOSED – No Interference.....	92
Table 5-14: Indoor Access Point to Portable U-NII Baseline Performance Measurements, Windows OPEN – No Interference	92
Table 5-15: Detectability Data Collection Matrix.....	94
Table 5-16: Receiver Sensitivity Lab Measurements	96
Table 5-17: Minimum Detectability Lab Measurements	97
Table 5-18: Minimum Signal, Packet Size and EDCA Interference Measurements	98
Table 5-19: Field Measurements for Range Related Effects on Detectability	99
Table 6-1: Interference Data Collection Matrix	102
Table 6-2: Configuration Variables for Outdoor Access Point Analysis	106
Table 6-3: Configuration Variables for Indoor Access Point Analysis	111
Table 6-4: Configuration Variables for In-Vehicle Access Point Analysis.....	115
Table 6-5: Configuration Variables for High-Speed V2V Near an Outdoor Access Point.....	119
Table 6-6: Configuration Variables for Multiple External Access Point Analysis	122
Table B-1: Packet Data Types.....	134
Table B-2: Summary of Recommended EDCA Parameters.....	136
Table C-1: Candidate Transmit Powers for Analysis	137

List of Abbreviations

Abbreviation	Term
AP	Access Point
BER	Bit Error Rate
BSM	Basic Safety Message – Messages from OBUs containing vehicle data including GPS location coordinates
C/I	Carrier-to-Interference ratio
CCA	Clear Channel Assessment – mechanism by which radios listen and do not attempt to transmit until the channel is clear of transmissions from other radios.
CCH	Control Channel (Channel 178 in the DSRC band)
CCTV	Closed Circuit Television
CFR	Code of Federal Regulations
Client	Device that uses a wireless link to connect to an AP to reach a network
CVHT	Cooperative Vehicle-Highway Testbed (outdoor test facility at TFHRC)
dB	Decibel
dBi	Decibel (referenced to isotropic, that is an antenna radiating equally in all directions)
dBm	Decibel referenced to 1 milliwatt
DSRC	Dedicated Short Range Communication
EDCA	Enhanced Distributed Channel Access – a way to prioritize messages that try to access the channel at the same time. See Appendix B.
EIRP	Equivalent Isotropic Radiated Power
EVM	Error Vector Magnitude (signal quality)
FCC	Federal Communications Commission
FHWA	Federal Highway Administration
FLETC	Federal Law Enforcement Training Center
FSS	Fixed Satellite Service
GHz	Giga-Hertz (1 billion cycles per second) – unit of frequency
GPS	Global Positioning System
Handheld DSRC	Portable DSRC – DSRC radio in a handheld device such as a smartphone or tablet computer
IEEE	Institute of Electrical and Electronic Engineers
ISM	Industrial, Scientific and Medical – devices radiating non-communication RF energy
ITS	Institute for Telecommunication Sciences
ITS	Intelligent Transportation Systems
kHz	Kilohertz (1000 cycles per second) – unit of frequency
km	Kilometer (1000 meters) – unit of distance
LAN	Local Area Network
LTE	Long Term Evolution – 4 th generation cellphone technology standard

Abbreviation	Term
m	Meter – unit of distance
MAP	Message that defines the geometry of an intersection. A companion to SPaT.
MHz	Mega-Hertz (1 million cycles per second) – unit of frequency
mph	Miles per hour
MUTCD	Manual of Uniform Traffic Control Devices
mW	Milliwatt (1 thousandths of a Watt, 0.001W) – unit of power
NPRM	Notice of Proposed Rule Making
NTIA	National Telecommunications and Information Administration
NTIA/ITS	National Telecommunications And Information Administration/Institute for Telecommunication Sciences
OBE	On-board Equipment – Electronic equipment in a vehicle that includes an OBU
OBU	Onboard Unit – DSRC radio mounted in a vehicle
Octet	8 bit byte
OFDM	Orthogonal Frequency Division Multiplexing
PAN	Personal Area Network
PER	Packet Error Rate
QAM	Quadrature Amplitude Modulation
QPSK	Quadrature Phase Shift Keying
Rec	Receive
RF	Radio Frequency
RSE	Roadside Equipment – Traffic equipment near a road, may contain an RSU
RSSI	Receive Signal Strength Indicator
RSU	Roadside Unit – DSRC radio mounted to fixed or moveable but not mobile infrastructure
RTK	Real Time Kinematic
S/N	Signal-to-Noise ratio
SAE	Society of Automotive Engineers
SPaT	Signal Phase and Timing – Data from a traffic signal controller giving signal status and the timing of upcoming state changes in all directions.
TFHRC	Turner Fairbank Highway Research Center
Tx	Transmit
U-NII	Unlicensed National Information Infrastructure
V2I	Vehicle-to-Infrastructure
V2V	Vehicle-to-Vehicle
VSG	Vector Signal Generator
VSWR	Voltage Standing Wave Ratio or Return Loss (measures energy reflected back to the source due to imperfect impedance matching)
V-TTSS	Vehicle Technology Test Support System
W	Watt – unit measure of power
WAN	Wide Area Network
Wi-Fi	Wireless Fidelity

Preface

In 1991, the Intermodal Surface Transportation Efficiency Act (ISTEA) introduced, for the first time, the concept of an intermodal transportation management system.¹ To expand on this concept, the Transportation Equity Act for the 21st Century (TEA-21) was created and passed in 1998. TEA-21 highlighted the importance of the role of technology in maintaining efficient and interoperable transportation systems by providing funding and policy support for Intelligent Transportation Systems (ITS) technologies and applications. Responsibility for coordinating safe ITS evolution falls upon the ITS Joint Program Office (ITS JPO), a component of the Office of the Assistant Secretary of Transportation for Research and Technology (OST-R), of the U.S. Department of Transportation (USDOT).²

TEA-21 asked the Federal Communications Commission (FCC) and USDOT to consider spectrum needs as pertaining to the operation of intelligent transportation systems. The FCC responded in 1999 by allocating 75 MHz of spectrum in the 5.9 GHz band (5.850-5.925 GHz) for dedicated short-range communications-based technologies. These technologies support dynamic, low latency vehicle-to-vehicle (V2V), vehicle-to-infrastructure (V2I), and vehicle-to-other devices and systems (V2X) communication exchanges at high vehicle speeds and within short distances (300 meters). It is configured to meet the unique needs of high-speed data exchange among moving vehicles and with roadway infrastructure or mobile devices in a manner necessary for supporting critical safety applications without compromising personal privacy or facilitating the tracking of traveler whereabouts. By allocating this band to transportation, users gain maximum benefit from interoperability whereby all participating technologies have to “speak” the same language and “hear” each other on the same communications medium.

DSRC is both a broadcast and a two-way short- to medium-range wireless communications capability which permits rapid and reliable data transmission essential for communications-based active safety applications.³ It is a Wi-Fi derivative communications technology developed to meet specialized needs for transportation environments. To date, no other wireless technology has been developed which provides all of the critical attributes necessary for crash-avoidance safety. It has been through appropriate, robust testing that is necessary to prove that a technology is sufficiently mature to be used in safety-of-life situations. It is also proven to coexist and function in band of the spectrum with few other primary users. The original 5.9 channel plan was designed to efficiently accommodate all user needs while optimizing spectrum use. The maximum transmit power levels assigned to each channel and guard bands were chosen based on sound engineering practice.

Connected Vehicle crash-avoidance warning applications enabled by DSRC offer the Nation an opportunity to achieve a transformation in transportation. The incorporation of a communications

¹ Public Law 102-240, Part B, § 6051 et seq., web, available at <http://thomas.loc.gov/cgi-bin/query/z?c102:H.R.2950.ENR>, accessed September 30, 2016.

² Public Law 112-141, Division E, Title III, Intelligent Transportation Systems Research, web, available at <http://www.gpo.gov/fdsys/pkg/PLAW-112publ141/pdf/PLAW-112publ141.pdf>, accessed September 30, 2016.

³ ITS website, DSRC Fact Sheet, available at www.its.dot.gov/factsheets/dsrc_factsheet.htm, accessed September 30, 2016.

capability within vehicle sensor systems permits data on emerging threats and roadway hazards to be gathered from multiple external sources (i.e., other vehicles, infrastructure, or portable devices) and fused with on-board data. Because of the dedicated nature and low latency configuration of DSRC, safety-critical alerts and warnings can be provided to drivers in time to allow for an appropriate response to prevent or avoid a crash. The National Highway Traffic Safety Administration (NHTSA) estimates that an initial set of DSRC-based V2V and V2I safety applications have the potential to address 83 percent of light vehicle crashes involving unimpaired drivers.⁴

Since 2009, collision avoidance applications increasingly are available in many vehicles and offered by many vehicle manufacturers. Most of these applications rely upon sensor-based technologies (e.g., cameras, and motion, speed, or directional sensors).⁵ Collision avoidance can be greatly enhanced by using communications-based connected vehicle technologies operating in the 5.9 GHz band to expand the vehicle field of view and increase confidence in threat detection. By using communications-based strategies, collision avoidance applications can offer additional safety by alerting drivers of potential collisions that are not visible to existing sensor-based technologies (such as detecting potential collisions around buildings or other blind intersections) and by augmenting the range and object recognition capability of radar or camera based systems.

A potential conflict with Unlicensed National Information Infrastructure devices emerges.

On June 28, 2010, the President issued a Memorandum directing the Secretary of Commerce to work with the FCC to identify and make available 500 megahertz of spectrum over the next ten years for wireless broadband use. The National Telecommunications and Information Administration (NTIA) Policy and Plans Steering Group (PPSG) comprised of Federal agency members (including the Department of Defense) recommended adding the 5350-5470 MHz and 5825-5925 MHz bands to the bands under consideration, the latter of which overlaps with the DSRC/ITS radio spectrum. On February 22, 2012, the President signed the Middle Class Tax Relief and Job Creation Act of 2012 (the “Act”) into law. Title VI of the Act includes a provision that requires the Assistant Secretary of Commerce (through NTIA), in consultation with the DOD and other impacted agencies, to evaluate spectrum-sharing technologies and the risk to users if Unlicensed-National Information Infrastructure (U-NII) wireless broadband devices were allowed to operate in these bands.⁶

The most common example of a U-NII device is a Wi-Fi device that operates without a license in a specific band, and which has no interference protection. These include laptops, computers, printers, smartphones, tablets, televisions, and any of the emerging “smart” or “connected” devices increasingly found in the home and office – thermostats, lightbulbs, security cameras, and appliances. These devices

⁴ Results from Frequency of Target Crashes for IntelliDrive Safety Systems, Najm, W., J. Koopman, S. Smith, and J. Brewer, October 2010, DOT HS 811 381. See: <http://www.nhtsa.gov/Research/Crash+Avoidance/ci.Office+of+Crash+Avoidance+Research+Technical+Publications> print (last accessed January 30, 2014); and “Vehicle-to-Vehicle Communications: Readiness of V2V Technology for Application.” NHTSA Report DOT HS 812 014, August 2014, p. 17, web, available at www.nhtsa.gov/staticfiles/rulemaking/pdf/V2V/Readiness-of-V2V-Technology-for-Application-812014.pdf, accessed September 30, 2016.

⁵ ITS Joint Program Office factsheet, “How Connected Vehicles Work,” web, available at www.its.dot.gov/factsheets/pdf/JPO_HowCVWork_v3.pdf, accessed September 30, 2016.

⁶ 47 U.S.C. § 1453, web, available at <http://www.gpo.gov/fdsys/pkg/USCODE-2013-title47/pdf/USCODE-2013-title47-chap13-subchapIV-sec1453.pdf>, accessed April 3, 2015.

are expressly prohibited by the FCC from interfering with *licensed* devices operating within their authorized frequency bands. If these types of U-NII devices are allowed to operate in the 5.9 GHz DSRC band and cause harmful interference, it may be impossible to remove them.

The path toward coexistence with U-NII devices lies through analysis.

The purpose of the USDOT Spectrum Sharing analysis is to develop test procedures, establish test sites, and perform the necessary analyses to evaluate coexistence between DSRC and U-NII devices. This “USDOT Spectrum Sharing Analysis Plan” establishes four high-level goals that seek to identify and resolve any potential conflicts. It will achieve these goals by accomplishing ten objectives, which will be executed using a thorough, comprehensive and deliberate study that will strengthen USDOT’s inherent knowledge and capability, with the ultimate goal of ensuring the safe and efficient movement of travelers and freight throughout the National Transportation System.

Executive Summary

Goals: This analysis plan describes the objectives of USDOT and maps out activities to accomplish those objectives. These objectives and activities serve the following department goals:

1. Understand the impacts of unlicensed devices operating in the DSRC band.
2. Develop the capability to evaluate proposed band sharing mechanisms.
3. Define requirements necessary for sharing mechanisms to prevent interference.
4. Collaborate with the National Telecommunications and Information Administration (NTIA) and the FCC to provide Congress with results on impacts to DSRC operations from proposed sharing mechanisms.

Objectives: In abbreviated form, the specific USDOT objectives are:

1. Develop the capability to experimentally evaluate interference affecting DSRC devices.
2. Characterize the existing radio frequency (RF) signal environment in and near the DSRC band.
3. Measure the effect of unlicensed devices on the background noise level.
4. Measure the impact unlicensed device transmissions have on receiving DSRC messages.
5. Measure DSRC suppression caused by the Clear Channel Assessment (CCA) mechanism.
6. Measure other impacts on DSRC channel quality caused by unlicensed device transmissions.
7. Determine the minimum received power at which DSRC and other devices can sense each other.
8. Investigate how the bandwidth of other signals changes how they affect DSRC devices.
9. Understand how DSRC operations can affect potential interference from unlicensed devices.
10. Investigate mitigation possibilities once potential U-NII-4 devices are available.

Plan: First characterize DSRC and potential interfering devices in the lab. Second, make baseline measurements of each device independently in the field to characterize normal behavior. This is to make sure that imperfections are not mistakenly attributed to interference later. Third, measure the effects on DSRC communications when unlicensed devices transmit in their vicinity. We will test in “clean” environments with minimum possible multipath and external interference so results depend as little as possible on the environment.

Additional activities will examine how signals in adjacent channels and bands impact DSRC and how differing radio sensitivity and the choice of CCA parameters affects potential interference.

Outcomes: The desired outcomes of this analysis includes:

1. Experimental data from individual devices for models of potential interference at deployment scale (hundreds to thousands of devices in range).
2. Defining bounding cases where no sharing may be possible, where unrestricted sharing may be possible, and exploring any zone in between where design choices and regulation impact the potential for sharing.
3. Understanding of interference mechanisms to shed light on possible ways to mitigate them.
4. Technical grounding for USDOT policy related to spectrum sharing.

USDOT Spectrum Sharing Analysis Plan

I. Introduction

The Federal Communications Commission (FCC) allocated 75 MHz of spectrum in 1999 for use by Dedicated Short Range Communications (DSRC) to support Intelligent Transportation Systems (ITS).⁷ This spectrum (5850-5925 MHz) is referred to as the “DSRC band” or “ITS band” interchangeably. The allocation for DSRC is a co-primary allocation shared with the Fixed Satellite Service (FSS) as the other non-government primary allocation. Federal use on a primary basis is for radiolocation (i.e. radar) operation. In addition, there is a secondary Amateur allocation for the entire band. Unlicensed as well as Industrial, Scientific, and Medical (ISM) operations are permitted in the 5850-5875 MHz portion of the band.⁸ Figure 1-1 illustrates the DSRC band, and figure 1-2 illustrates the channel plan established in the FCC Report and Order.

There are no sharing mechanisms established for the DSRC band. Testing and analysis conducted in the mid to late 1990’s demonstrated compatible operation between an early implementation of DSRC, FSS, and government radar systems.^{9, 10, 11, 12} DSRC devices operating too close to radar installations or FSS ground stations may suffer interference. DSRC devices may also suffer interference from users of the adjacent bands below 5850 MHz and above 5925 MHz. In each of these cases, co-primary band users are to work out interference issues amongst themselves if they arise.

⁷ FCC Report and Order “Amendment of Parts 2 and 90 of the Commission's Rules to Allocate the 5.850-5.925 GHz Band to the Mobile Service for Dedicated Short Range Communications of Intelligent Transportation Services,” FCC 99-305, released October 22, 1999.

⁸ Per FCC Part 15.249

⁹ “Measured Occupancy of 5850-5925 MHz and Adjacent 5-GHz Spectrum in the United States,” NTIA Technical Report TR-00-373, December 1999, <http://www.its.bldrdoc.gov/publications/2404.aspx>, Accessed 5/4/2015

¹⁰ “Electromagnetic compatibility testing of a dedicated short-range communication system,” NTIA Technical Report TR-98-352, July 1998, available at http://www.its.bldrdoc.gov/publications/download/dsrc_rpt.pdf, accessed October 10, 2016.

¹¹ “Electromagnetic compatibility testing of a dedicated short-range communication system that conforms to the Japanese standard,” NTIA Technical Report TR-99-359, November 1998, available at http://www.its.bldrdoc.gov/publications/download/99-359_ocr.pdf, accessed October 10, 2016.

¹² To avoid interference from co-channel radars, DSRC frequency assignments need to be coordinated with local radar assignments to avoid co-channel operations at short separation distances.

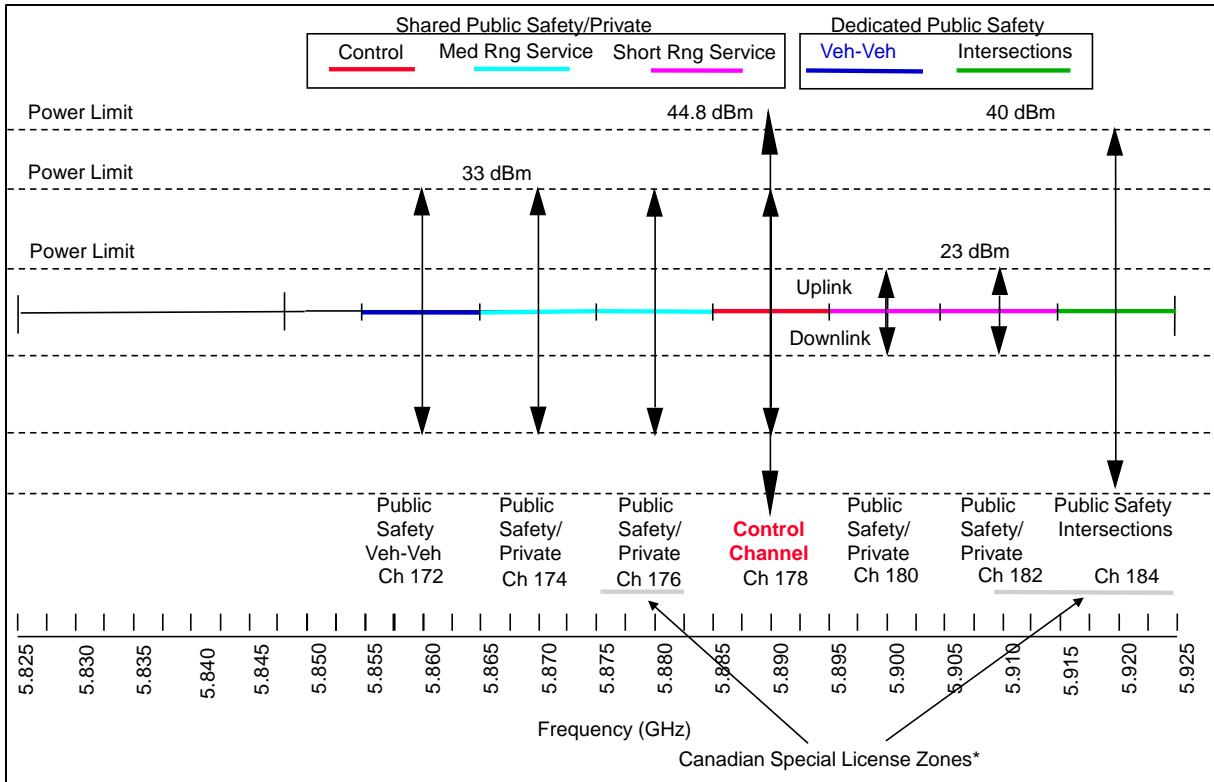

Figure 1-1: DSRC Channel Plan in the ITS Band^{13 14}

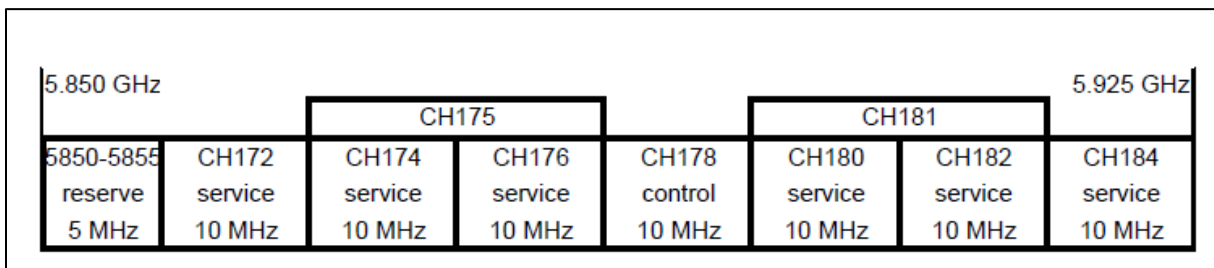

Figure 1-2: DSRC channel number designations for both 10 and 20MHz channels¹⁵

¹³ DSRC Tutorial, Rockwell Collins, 2003.

¹⁴ Note that the DSRC Channel plan allows for two 20 MHz channels to be formed as well. Channels 174 and 176 can be combined to form 20 MHz channel 175 and Channels 180 and 182 can be combined to form 20 MHz channel 181. Tests will be conducted in both the 10 MHz and 20 MHz DSRC channels.

¹⁵ From FCC-03-324A1, page 19

In a more recent notice the FCC solicited input for a proposed rule to open up more bandwidth for unlicensed Wi-Fi devices based on the 802.11ac standard (figure 1-3).¹⁶ (DSRC devices are based on the 802.11p standard.) The proposed new U-NII-4 band overlaps the DSRC band (indicated in purple in figure 1-3). That means DSRC devices would share the band with an uncontrolled number of unlicensed 802.11ac devices if an adequate sharing method can be found. Such a sharing mechanism would have to give deference to the DSRC devices since they are primary users of the band and unlicensed devices are not allowed to interfere with primary users.¹⁷ Figure 1-4 gives a close up view of the proposed sharing in the DSRC band.

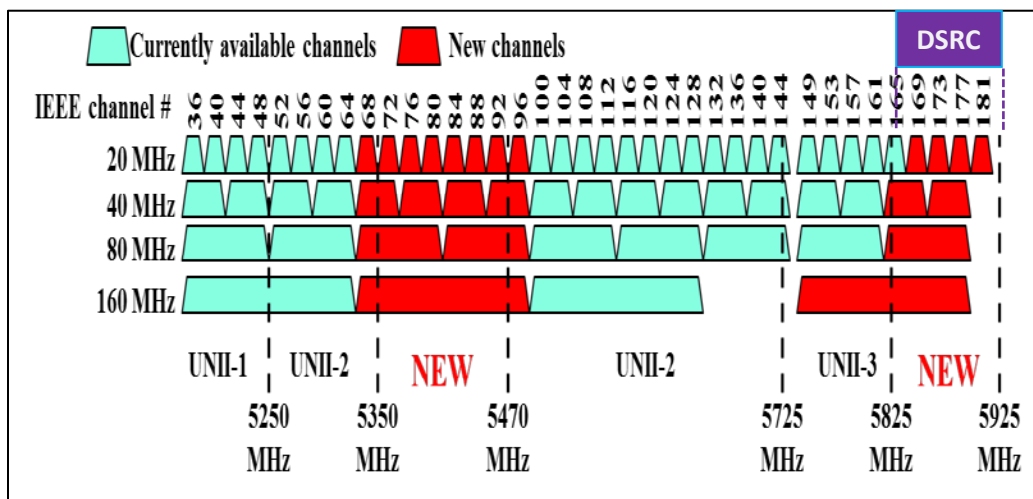

Figure 1-3: Proposed new U-NII-4 band

Though the impetus for creating the U-NII-4 band comes from desire to provide more bandwidth for 802.11ac Wi-Fi devices, a rule considered by the FCC would permit sharing by any unlicensed device in the band that complied with FCC part 15 rules for the band. One example is License Assisted Access (LAA) also known as LTE-U (for unlicensed) which looks to offload LTE data traffic onto the unlicensed bands. Others include unmanned aircraft system (UAS) downlinks, other forms of video streaming, wireless backhaul concepts, and any new application that might be devised in the future.

This plan investigates 802.11ac as the first, but not only, unlicensed device that may be examined. We start with 802.11ac because commercial devices are available for the U-NII-3 band that can be adjusted in frequency to act as surrogates for potential U-NII-4 devices well enough to investigate interference, (but not mitigation). We will incorporate other unlicensed devices, including potential U-NII-4 devices, into our analysis as soon as we have access to actual operating devices. By potential U-NII-4 devices we mean devices designed and programmed to share the band with DSRC.

¹⁶ FCC Notice of Proposed Rulemaking (NPRM) 13-22, (Docket 13-49), February 20, 2013, proposes revising Part 15 of the Commission's Rules to Permit Unlicensed National Information Infrastructure (U-NII) Devices in the 5 GHz Band, to operate within the majority of the 5.850 to 5.925 GHz frequency band, designated as the U-NII-4 band.

¹⁷ See 47 CFR §2.1, "Terms and definitions" and 47 CFR §15.5, "General conditions of operation."

The following terminology is used to describe unlicensed devices in this plan:

Term	Definition
U-NII-3	Off-the-shelf devices operating in 5 GHz bands, particularly 5.8 GHz, that are programmed for the U-NII-3 rules set by the FCC. Examined to see how much energy they leak into the DSRC band seen by DSRC devices as out of band interference.
U-NII-4	Placeholder for rules to allow unlicensed devices into additional bands, including the DSRC band. There are several proposals but these rules have not been written. This analysis plan will consider proposed ideas in the absence of a rule.
Surrogate U-NII-4	U-NII-3 devices modified to operate at the higher frequencies of the DSRC band but using the U-NII-3 rules.
Potential U-NII-4	Devices built for the purpose of operating unlicensed in the DSRC band. We investigate the devices operating by rules the designer proposes that the FCC adopt if they write a U-NII-4 rule. Their proposed rules must mitigate interference with DSRC.
Unlicensed device	Any device operating under FCC Part 15. Includes but is not limited to U-NII devices.

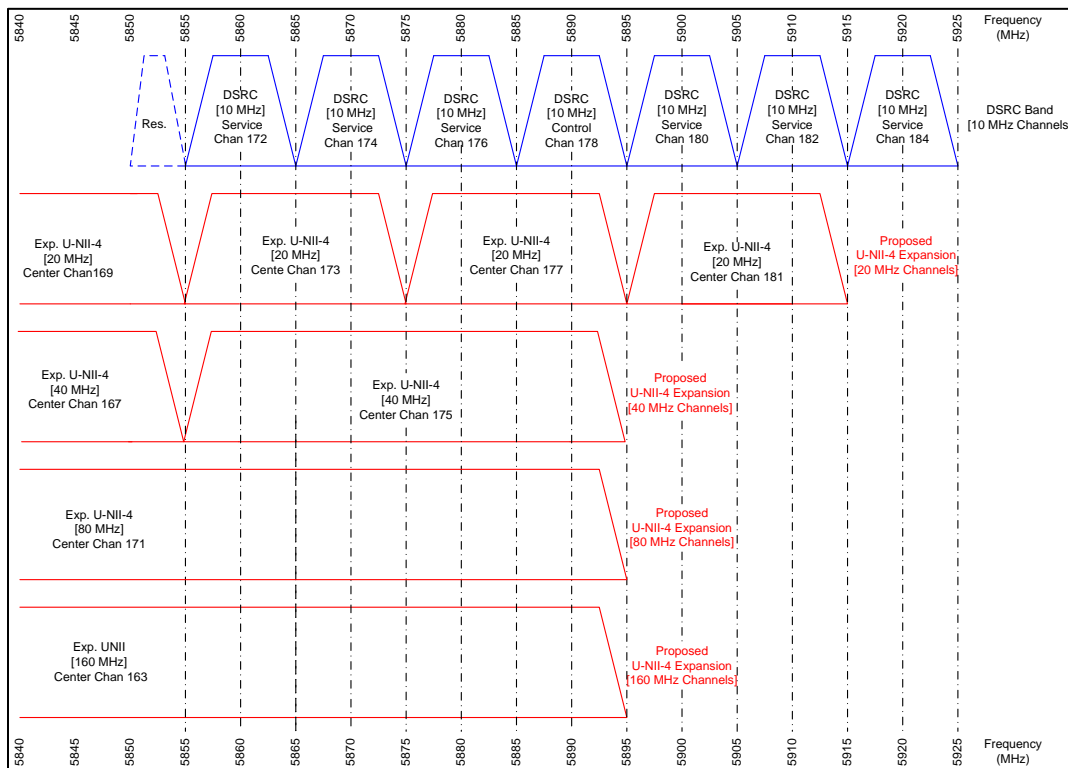

Figure 1-4: U-NII-4 overlap with the DSRC band¹⁸

¹⁸ Source: Rockwell Collins

The USDOT concern is focused on anything that disrupts DSRC communications. By this definition then, Radio Interference can take three forms:

- First: the increase in ambient noise level due to unlicensed devices transmitting in or near the DSRC band.
- Second: when two or more packets from different sources enter a receiver at the same time. In that case, the receiver may accurately interpret only one, or likely none, of the incoming message packets. Those messages are transmitted but lost.
- Third: when the Clear Channel Assessment (CCA) mechanism causes a radio to suppress and not send its message because it hears another source already transmitting on the channel. A secondary or unlicensed user preventing a primary user from transmitting in this way is considered to be interfering with the primary user's ability to communicate by the USDOT. Messages are not received because they are prevented from being sent.

The USDSOT needs to understand the impacts of unlicensed devices operating in the DSRC band in order to provide recommendations through NTIA to the FCC. The FCC may use these inputs to make decisions that will avoid interference with and ensure reliable operation of DSRC as well as ensure highly available access to the DSRC band. The USDOT will undertake the bench and lab measurements,¹⁹ field measurements, simulation and analysis²⁰ described in this analysis plan. The following sections first provide the goals and objectives, then an overview of the plan by phases, followed by sections that detail the planned measurements.

¹⁹ "Bench test" is defined here as a component test that verifies that a device is working properly. "Lab test" is defined as indoor performance and interference testing.

²⁰ Existing interference models have not been applied to the DSRC environment. Data is needed in order to adapt and verify those models for use in this band.

2. Goals and Objectives

2.1 USDOT Goals

The overarching goal driving the USDOT DSRC Analysis Plan is to ensure safe, reliable, and on-demand access to the 5850-5925 MHz spectrum allocation for DSRC operation. Without the spectrum access, DSRC will not be able to support safety applications that reduce automobile crashes, injuries, and save lives. To achieve that, the USDOT seeks to attain the following specific goals:

1. Understand the impacts of unlicensed devices operating in the DSRC band.
2. Develop the capability to evaluate proposed band sharing mechanisms.
3. Define requirements necessary for sharing mechanisms to prevent interference.
4. Collaborate with the National Telecommunications and Information Administration (NTIA) and the FCC to provide Congress with results on impacts to DSRC operations from proposed sharing mechanisms.

2.2 Analysis Plan Objectives

The USDOT should be able to achieve those goals by accomplishing the following plan objectives. Each activity described in this analysis plan addresses one or more of these objectives.

1. Develop the capability to do accurate and relevant experimental evaluations of band sharing and interference between unlicensed devices and DSRC devices.
2. Characterize the existing radio frequency (RF) signal environment in and near the DSRC band.
3. Measure the effect of unlicensed devices on the background noise level.
4. Measure the impact that unlicensed device transmissions have on receiving DSRC messages.
5. Measure DSRC suppression caused by Clear Channel Assessment (CCA) of DSRC devices in the presence of unlicensed device transmissions.
6. Measure other impacts on DSRC channel quality of unlicensed device transmissions (e.g., S/N, PER, transmission delay, etc.).
7. Determine the minimum received power levels at which DSRC and unlicensed devices can sense one another.
8. Investigate how interference and detection (determined in the previous objectives) varies if the bandwidth of the overlapping unlicensed device transmission changes.
9. Measure the impact of DSRC operations on unlicensed device performance, recognizing that the two radios may form an interactive system.
10. Investigate mitigation possibilities once potential U-NII-4 devices designed and programmed to share the band with DSRC are available.

Each of these objectives is described in further detail below.

2.2.1 Develop the capability to do accurate and relevant experimental evaluations of band sharing and interference between unlicensed devices and DSRC devices

The USDOT needs to acquire equipment, set up test facilities, and train personnel to make the measurements and perform the experiments needed to explore possible interference.

2.2.2 Characterize existing RF signal environment in the DSRC band

The USDOT must measure existing background noise levels and interference from existing transmitters to set the baseline values in order to see what changes when DSRC devices and unlicensed transmitters operate in or near the band. This includes out-of-band as well as in-band transmitters since energy can leak between channels.

2.2.3 Measure the effect of unlicensed devices on the background noise level

Background noise level limits the range that DSRC safety applications can function. As noise increases, range decreases, until it is too short for the applications to warn the driver. The first step in considering possible band sharing is to measure how much the noise level increases due to unlicensed devices transmitting in and near the band. The NTIA/ITS will input these measurements into models to examine noise level in full deployment scenarios of DSRC and unlicensed devices. That means aggregating the energy that many unlicensed devices would leak into the band, including those out of range and those operating in adjacent channels. The effect on noise level will be much higher with hundreds or thousands of transmitters out of range but still adding energy to the noise floor compared to the number of devices that will be examined under this plan. Because signal-to-noise ratio (S/N) limits the range at which connected vehicle safety applications can work, higher noise level means a smaller S/N, hence less range. With NTIA/ITS models, we can estimate the effect on safety range both in our measurement scenarios and at deployment scales.

2.2.4 Measure the impact of unlicensed transmissions on the receipt of DSRC messages that are transmitted

This objective measures signals from different transmitters that collide in the DSRC receiver and impact its performance. This would be the case of unlicensed devices that do not function with the same channel access protocol as the 802.11p DSRC devices. They could cause interference while operating in the same or an adjacent channel to the DSRC device. This also measures the kind of interference that occurs in hidden node scenarios, which is when one device that is transmitting drives into range of another device that is also transmitting at the same time. This interference can occur even with a mutual channel sharing protocol. This objective looks at how many Basic Safety Messages (BSMs) are transmitted and not correctly interpreted by the receiver. These BSMs would not be available to safety applications in the receiving vehicle.

2.2.5 Measure DSRC suppression caused by Clear Channel Assessment (CCA) of DSRC devices in the presence of unlicensed device transmissions

This objective measures packet suppression. This occurs when use of a channel by an unlicensed device causes the CCA mechanism of the DSRC device to prevent transmission of BSMs because it senses that the channel is busy. These BSMs are then not available for safety applications in all of the receiving vehicles in range.

2.2.6 Measure other impacts on DSRC channel quality of unlicensed transmissions (e.g., S/N, PER, etc.)

Other measurements are commonly used in wireless communications to determine channel quality as well. These other measures can provide insight as to the nature of interference, other ways interference might affect channel capacity and possible mitigations. Possible measures include signal-to-noise ratio (S/N), packet error rate (PER), Packet Reception Rate (PRR), channel busy percentage, inter-packet gap, average channel energy, and channel availability. The objective is to identify and use other channel quality measures to better understand potential interference.

2.2.7 Determine the energy levels at which DSRC and U-NII-4 devices can sense one another

DSRC receivers are highly sensitive and can receive signals in the range of -95 to -105 dBm. If unlicensed devices do not have similar or better sensitivity, they will not hear DSRC devices that hear them. The result is that the unlicensed devices will think the channel is clear when it is not. At the same time, the more sensitive DSRC devices will hear the unlicensed devices and suppress their own transmissions. By preventing the DSRC transmissions, the unlicensed devices would directly interfere with a primary user of the band, a violation of §15.5 of the FCC Rules. Comparing receiver sensitivities with range will indicate the potential for this kind of interference.

2.2.8 Investigate how interference and detection (determined in the previous objectives) varies if the bandwidth of the overlapping unlicensed transmission changes

As shown in figure 1-3, the U-NII-4 band can overlap the 10 MHz DSRC channels with 20, 40, 80 and 160 MHz U-NII-4 channels. When the same energy is spread over a wider channel, the amount of energy available to interfere in the 10 MHz channel is less. Therefore, it may be possible that if the narrower U-NII-4 channels interfere in the DSRC channels, the wider U-NII-4 channels might not. This objective will determine if such conditional sharing might be possible.

2.2.9 Measure the impact of DSRC operations on unlicensed device performance recognizing that the two radios may form an interactive system

Processors and logic are central to modern radios. Therefore, two radios that can affect decisions made by the other form an interactive system. That is especially true when they follow the same rule set, 802.11 in this case. Studying a single component does not surface the deleterious modes that can occur when two components interact, even when both follow their component oriented rules correctly. It is well known that component-based analysis fails to capture important system behaviors.

In addition, measuring the effect of DSRC devices on the operation of unlicensed devices will allow the USDOT to evaluate the credibility of claims made for unlicensed device operation. It will allow the USDOT to evaluate the feasibility of proposed deployment scenarios. This knowledge would better position the USDOT for its collaboration with the FCC and reporting to Congress. Such understanding may also allow the USDOT to develop a sharing mechanism that is more likely to be complied with by unlicensed users.

2.2.10 Investigate mitigation possibilities once potential U-NII-4 devices designed and programmed to share the band with DSRC are available

When devices are available with potential U-NII-4 sharing mechanisms from industry our objective is to study and evaluate the impact on DSRC communications and potential sharing in the 5850-5925 MHz band. The USDOT will also vary parameters that affect interference to explore and analyze other possible mitigation concepts as well.

3. Analysis Plan Overview

At the highest level, this plan involves three phases: planning/preparation, measurement, and analysis. In the planning/preparation phase, the stakeholders agree on the purpose of the analysis, identify what measurements are needed, and determine what resources – equipment, facilities and tools – are required. Then they procure the resources and make them operational. The measurement phase collects baseline data in accordance with the plan. The final phase of the work is to analyze the measurements made and report the results and conclusions.

3.1 Analysis Plan Roadmap

The roadmap presented by Table 3-1 summarizes key aspects of all activities to make sure that each activity supports at least one objective, and to make sure all objectives will be achieved. Activities that do not map to an objective would represent an unnecessary activity or a missing objective. Objectives not associated with an analysis activity would indicate gaps in the plan.

Table 3-1: Analysis Plan Roadmap

Tasks and Measurements	Requirements	Results	Objectives Served ²¹
PREPARATORY PHASE			
Determine or validate scenarios to investigate		<ul style="list-style-type: none"> ◆ Conditions to create ◆ Use cases to investigate 	All
Determine or validate measurement requirements	Metrics to measure and equipment needs.	<ul style="list-style-type: none"> ◆ Acquisition plan ◆ Measurement plan 	All
Measure baseline background and existing RF signals	Mobile equipment for passive data collection	<ul style="list-style-type: none"> ◆ Background noise levels ◆ Interference levels 	2. Existing interference, secondarily 1, 3, 6, 7
MEASUREMENT PHASE			
Measure background noise level with operation of various devices, frequencies and modulations	DSRC and U-NII devices ISM Video links UASs Others	Effect on in-band ambient noise level of DSRC and U-NII in-band and out-of-band transmitters	3. Background noise levels

²¹ Defined in Section 2.2.

Tasks and Measurements	Requirements	Results	Objectives Served ²¹
Measure baseline performance of DSRC and unlicensed devices with no interference.	<u>DSRC baseline:</u> <ul style="list-style-type: none"> ◆ OBE to OBE ◆ OBE to RSE ◆ RSE to OBE (vary range, power, bandwidth, modulation and packet size)	Device performance and channel quality benchmarks to compare with interference analysis	4. BSM interference, 5. BSM suppression, 6. Channel quality, 7. Detection levels 8. U-NII-4 channel width 9. U-NII-4 performance
	<u>Surrogate U-NII-4 baseline:</u> <ul style="list-style-type: none"> ◆ Outside fixed to/from mobile ◆ Indoors fixed to/from mobile ◆ Mobile to mobile (vary range, power, bandwidth, modulation, packet size, and car windows up/down)	Device performance and channel quality benchmarks to compare with interference analysis	4. BSM interference, 5. BSM suppression, 6. Channel quality, 7. Detection levels 8. U-NII-4 channel width 9. U-NII-4 performance
Determine detection and S/N levels	<ul style="list-style-type: none"> ◆ DSRC sensing surrogate U-NII-4 ◆ surrogate U-NII-4 sensing DSRC (vary range, power, bandwidth and modulation)	<ul style="list-style-type: none"> ◆ Minimum sensitivities ◆ Bounding cases for CCA detection ◆ Potential interference and energy detection ◆ Same bandwidth signal recognition (20 MHz) 	7. Detection levels
Interference analysis	<u>Fixed surrogate U-NII-4 Outdoors</u> <ul style="list-style-type: none"> ◆ RSE to/from OBE ◆ OBE to OBE (vary range, power, bandwidth, modulation and packet size)	Effect of handheld and external U-NII-4 Access Points on V2V, I2V and portable DSRC	4. BSM interference, 5. BSM suppression, 6. Channel quality, 8. U-NII-4 channel width 9. U-NII-4 performance

Tasks and Measurements	Requirements	Results	Objectives Served ²¹
	<u>Fixed surrogate U-NII-4 Indoors</u> ♦ RSE to/from OBE ♦ OBE to OBE (vary range, power, bandwidth, modulation, packet size and wall composition and number)	Effect of indoors U-NII-4 Access Points with multiple clients on V2V, I2V and portable DSRC	4. BSM interference, 5. BSM suppression, 6. Channel quality, 8. U-NII-4 channel width 9. U-NII-4 performance
	<u>Surrogate U-NII-4 in vehicle w/OBE</u> ♦ RSE to/from OBE ♦ OBE to OBE (vary range, power, bandwidth, modulation and packet size)	Effect of single and multiple mobile U-NII-4 devices inside a connected vehicle on V2V, I2V and portable DSRC	4. BSM interference, 5. BSM suppression, 6. Channel quality, 8. U-NII-4 channel width 9. U-NII-4 performance
Co-existence analysis ²²	Same as interference analysis above but with potential U-NII-4 devices ²³	Impact of mitigation mechanisms on DSRC	10. Potential mitigation
ANALYSIS PHASE			
Analyze interference results		Report on impact of U-NII-4 operation on DSRC device performance and channel quality for all use case scenarios	4. BSM interference 5. BSM suppression 6. Channel quality
		Report on effect of U-NII-4 energy density reduction with wider channels on the interference to DSRC device performance and channel quality for all use case scenarios	8. U-NII-4 channel width

²² Depends on external entities providing potential U-NII-4 devices, or being successfully developed for the USDOT.

²³ Unlike surrogate devices using U-NII-3 rules, potential U-NII-4 devices will test actual sharing mechanisms proposed for this band.

Tasks and Measurements	Requirements	Results	Objectives Served ²¹
		Report on impact of DSRC operations on U-NII-4 device performance and channel quality for all use case scenarios	9. U-NII-4 performance
		Report on ability of DSRC and U-NII-4 devices to detect each other in all bands and to recognize each other if both operating in the same 20 MHz band	7. Detection levels
		Report on ability of DSRC and U-NII-4 devices to co-exist in all bands with various sharing mechanisms provided or developed ²⁴	10. Potential mitigation
Document and analyze the measurement process and experience.		<ul style="list-style-type: none"> ◆ Lessons learned ◆ Recommendations for conducting future analysis ◆ Recommendations for additional analysis 	1. Learning curve
Input to NTIA models		Device performance input to determine simulated interference at deployment scale scenarios.	3. Background noise levels 4. BSM interference, 5. BSM suppression, 6. Channel quality, 8. U-NII-4 channel width 9. U-NII-4 performance 10. Potential mitigation

²⁴ Depends on external entities providing potential U-NII-4 devices, or being successfully developed for the USDOT.

3.2 Dependencies

Some activities require input from others and must be done in series while other tasks do not and may be done in parallel given adequate resources and personnel. Figure 3-1 depicts the relationship between the activities described in this analysis plan.



Figure 3-1: Analysis Activity Dependencies

3.3 Timeline

Figure 3-1 shows the order that activities must be done and which activities can occur in parallel. The project timeline will be determined based on how initial test activities that shed light on the time it takes to execute key functions. The technical teams will provide an estimate after a sample of actual measurement runs so that the time to set up and conduct runs is better known. Variables that need to be addressed to develop an accurate timeline include:

1. The time to set up and tear down specific measurement configurations;
2. The time to make a single data collection run;
3. The time required to analyze a data collection run to ensure the data collected is of high quality; and,
4. The number of data collection runs that are needed to ensure the data is statistically significant.

4. Preparatory Phase Activities

The initial activities of the DSRC Interference Analysis Team were to establish the USDOT Goals and identify the analysis Objectives needed to achieve those goals. From that, we derived a plan to be conducted and the requirements that must be met to be able to conduct the measurements. The following sections summarize the analysis scenarios, requirements for equipment, facilities and tools (hardware and software), that were procured for the baseline data collection and the remaining analysis tasks within this plan.

4.1 Analysis Scenarios

The initial analysis will be to characterize the DSRC and U-NII-4 devices and create baseline performance benchmarks with no interference. We will also characterize existing signals in the band. Both of these activities are straightforward. We will examine other unlicensed devices similarly if they become available.

Potential interference depends on the many variables of actual operation for both types of devices. Since it is not possible to investigate all cases we will examine specific cases that represent the most common scenarios in which these devices would be likely to interact and have potential for interference. The initial set of potential interference scenarios we will investigate are the following:

Scenario 1: The effect of an 802.11ac access point, externally mounted on a commercial building near an intersection, on RSE-to-OBE and OBE-to-OBE communications.

For example, a wireless CCTV camera system linked to building security.

Scenario 2: The effect of an 802.11ac access point, mounted inside a house in a residential area near an intersection, on RSE-to-OBE and OBE-to-OBE communications.

For example, a home Wi-Fi access point linking computers, printers, TVs, appliances and other smart or connected devices in the emerging Internet of Things (IoT).

Scenario 3: The effect of an 802.11ac access point and portable devices operating inside a vehicle on RSE-to-OBE and OBE-to-OBE communications.

For example, handheld devices such as tablets or smartphones that include 802.11ac Wi-Fi. The vehicle could even have its own 802.11ac access point mounted in the passenger compartment, as some automakers now offer Wi-Fi connectivity in their vehicles.

Scenario 4: The effect of an 802.11ac access point on the OBE-to-OBE communications of two vehicles approaching at high speed.

In this example, two vehicles approach one another on a rural road, where traffic and radio densities are low compared to urban and suburban scenarios. Each vehicle is traveling at high speed – perhaps 55 mph, with a combined closing speed of 110 mph. This case would be more sensitive to interference, because the loss of a single BSM exchanged between two rapidly-

converging vehicles on a rural road could be a greater threat to safety than two cars slowly converging at an urban intersection.

Scenario 5: The effect of multiple 802.11ac Access points and client devices along a corridor on RSE-to-OBE and OBE-to-OBE communications.

In this example, the scale of the test is increased from a couple of devices to perhaps two dozen, in order to simulate potential real-world conditions at deployment if unlicensed devices are allowed into the 5.850 to 5.925 GHz band.

USDOT will investigate possible mitigation methods in the above scenarios when devices capable of sharing are available.

Learning from these scenarios could identify other scenarios that need to be evaluated as well. Moreover, other types of unlicensed devices may require different scenarios, because they have different use cases or do not recognize 802.11 channel sharing mechanisms. Hence, this plan is likely to be updated during the course of the analysis.

4.2 Requirements

Participating organizations must propose how each requirement will be met and USDOT will concur or work together to identify an acceptable alternative. The following sections and tables set forth the equipment, facility and other requirements for this project.

4.2.1 Equipment

Table 4-1: Equipment Requirements

#	Requirement	Verification	Need met
E-1	5-7 GHz spectral range	Demo.	Measure RF energy in the DSRC band and adjacent bands on either side: 5.830-5.850 GHz and 5.925-6.425 GHz (CFR 47 Part 2).
E-2	Frequency Resolution	Demo.	Sufficient to identify 802.11-2012 channels, other unlicensed device, and radar pulses.
E-3	Precision – Frequency and Power	Analysis	Frequency is a function of span and Resolution bandwidth. Power accuracy calibration shall be as close to 1 dB as possible for the lab instruments. In any case, the uncertainty needs to be documented.
E-4	Data Collection and Storage	Demo.	Ability to collect and record RF, position and timing data
E-5	Data Collection and Storage	Demo	Ability to collect the data from a mobile platform
E-6	Time – better than 3 microseconds	Measurement	Precise timestamping good enough to resolve 802.11 slot times. 13 μ s for 10 MHz channel with 6 Mbps data rate; and 9 μ s for 20 MHz channel with 12 Mbps data rate. Can provide with GPS time source.

4.2.2 Facilities

Table 4-2: Laboratory Facility Requirements

#	Requirement	Verification	Need met
L-1	Sufficient secured space	Inspection	Protect equipment and measurements from physical disruption
L-2	110VAC building power	Inspection	Electrical power for equipment
L-3	HVAC	Inspection	Controlled environmental conditions
L-4	Shielding	Inspection	Minimize electrical and radio frequency interference
L-5	Data network	Inspection	Collect and store data and send control signals
L-6	Computer (PC or laptop)	Inspection	Collect and store data and send control signals
L-7	Hard drive	Inspection	Secure data storage
L-8	Sufficient rack and bench space	Inspection	Mount radio devices and equipment

Table 4-3: Field Facility Requirements

#	Requirement	Verification	Need met
F-1	1000 m or more clear line of site	Inspection	Examine best case DSRC communications for class D RSUs and high power mobile public safety communications
F-2	Flat level surface for vehicles to drive on for at least 300m ²⁵	Inspection	Repeatable signal-over-distance measurements. Cannot have vehicle tilting while moving, which would move the peak gain of the antenna pattern up and down confounding the relationship of signal power with range.
F-3	Absence of manmade RF reflectors for at least 300m of the test lane. Reflectors to avoid include: buildings, signs, fence posts, power lines, parked vehicles. Shielding by foliage would be next best thing.	Inspection	Need measurements to be as repeatable as possible and independent of the environment as possible. Eliminate or minimize multipath that would be unique to the test environment.

²⁵ “Flat” is defined as level enough to permit the simple geometric antenna pattern correction described in section 4.9. That is, any tilt in grade not be enough to change the angles through the transmit and receive beam patterns so much that the beam pattern correction is in error beyond the inherent uncertainty in the antenna patterns.

#	Requirement	Verification	Need met
F-4	Infrastructure for mounting at least one antenna up to 15 m high	Inspection	To be able to investigate the maximum RSU horizon permitted. FCC R&O permits RSU antennas up to 15 m but no higher. Below 6m the EIRP does not have to be adjusted for height and can be taken directly from the table in the FCC R&O.
F-5	Drivable surface ²⁶	Inspection	For making variable range measurements and testing communication with vehicle mounted OBEs.
F-6	Building ²⁷	Inspection	Investigate Wi-Fi Access points mounted internally and externally.
F-7	On site power or portable generator. Also inverter in vehicles.	Inspection	Electrical power
F-8	DGPS, RTK or other infrastructure that improves on GPS	Demo.	Accurate range measurement between transmitter and receiver, to 5 cm or better accuracy.

4.2.3 Tools

Table 4-4: Software Requirements

#	Requirement	Verification	Need met
S-1	Off-the-shelf control software supplied with the U-NII device SDKs used to create Surrogate U-NII-4 devices	Demonstration	Control the U-NII device SDK
S-2	Center Frequencies defined by FCC proposed U-NII-4 Band Plan (see figure 1-4).	Demo.	Provided by U-NII device SDK Control Software
S-3	Bandwidth (see figure 1-4)	Demo.	Provided by U-NII device SDK Control Software

²⁶ “Drivable” is defined as a surface that can be driven at speeds required for the experiments with sufficient traction for safe operation and vibration low enough not to present a hazard to driver or equipment over extended periods. USDOT inspection and concurrence will be sufficient to verify this requirement is met.

²⁷ Because the variety of buildings is so great, any proposed structure with USDOT concurrence will do. Consistency to use the same building or buildings throughout the analysis is more important than the exact specifications.

#	Requirement	Verification	Need met
S-4	Power Output Control	Demo.	Provided by U-NII device SDK Control Software
S-5	Digital packet or protocol analyzer ²⁸	Demo.	Verify fidelity of digital communications link
S-6	Communications signal quality analysis tool	Demo.	Understand manner and extent of potential signal interference at the point a unique interference incident is detected. (This diagnostic can be done statically or mobile.)
S-7	Interface to log DSRC device variables	Demo.	Record data on normal operation and interference

Table 4-5: Hardware Requirements

#	Requirement	Verification	Need met
H-1	External rugged data storage	Inspection	Store collected data for offline analysis
H-2	Test vehicles to mount with OBUs	Inspection	Make the OBUs mobile
H-3	Masts extendable to at least 6m	Demo.	Mount fixed point U-NII and DSRC radios to the height of traffic signals and typical Wi-Fi access points
H-4	DSRC radios	Inspection	Generate communications subject to potential interference
H-5	U-NII radios	Inspection	Simulate unlicensed devices operating in the DSRC band (proposed or surrogate U-NII-4 devices) and the adjacent band (U-NII-3 devices)
H-6	Antennas	Inspection	Provide required EIRPs
H-7	Cabling	Inspection	Connect components

4.3 Procurements and Arrangements

4.3.1 Equipment

The key measurement and test components that have been procured for DSRC interference measurements to date include the following:

- PXI vector signal generator platform;
- Display for generator waveform;
- Broadband signal analyzer;
- Remote Laptop;
- Ethernet switch.

²⁸ USDOT can provide Wireshark with DSRC extension for examining packet contents.

- Host computers
- Antennae suite with cables and mounts;
- Power equipment
- Surrogate U-NII-4 devices
- DSRC devices (RSU and OBU)
- GPS-RTK precision positioning instrumentation

4.3.1.1 Specialized Equipment

Tables 4-6 and 4-7 provide details on specialized equipment required to conduct this plan.

Table 4-6: Laboratory Equipment List

Equipment	Specifications	Notes
Omni-directional antenna	50, 5-6 GHz 6 dBi, vertical polarization, 360° azimuth angle, 25° elevation angle, Mobile Mark, ECO6-5500-WHT	To make 30 dBm EIRP U-NII-3 access point
Omni-directional antenna	2, 5-6 GHz 9 dBi, vertical polarization, 360° azimuth angle, 12° elevation angle, Mobile Mark, ECO9-5500-WHT with lightning protection	For the VSG but also to make 33 dBm EIRP U-NII-3 access point
Omni-directional antenna	2, 5.9-6.0 GHz 12 dBi, vertical polarization, 360° azimuth angle, 7° elevation angle, Mobile Mark, ECO12-5900-WHT	For the VSG but also to make 36 dBm EIRP U-NII-3 access point
Omni-directional antenna	2, 6 dBi, vertical polarization, 360° azimuth angle, 25° elevation angle, Mobile Mark ECO6-5500RN-WHT	To be able to operate the DSRC RSU with MIMO since it can run with as well as without diversity
Omni-directional antenna	2 Mobile Mark MGWG-303-3HM3HM2HC-WHT-79 Magnetic Mount Antenna	Magnet roof mount antenna for the DSRC OBUs, it integrates 2 Wi-Fi MIMO antennas modified for DSRC band and a GPS antenna
Omni-directional antenna	5" GPS Antenna (white)	GPS antenna for the DSRC RSU
Precision directional antenna	4.9-6.1GHz, 7 degree beamwidth Dual Polarization Antenna Mars MA-WA55-27B	High gain to compensate for the limited receiver sensitivity of the VSA
GPS RTK antenna	A42 Antenna Kit, multi frequency, GNSS, L-Band. Hemisphere 940-2084-000	Antenna for the GPS RTK receiver
GPS antenna	GPS Antenna - External Active Antenna - 3-5V 28dB 5 Meter SMA. Adafruit Industries 960.	Mobile GPS antenna

Equipment	Specifications	Notes
Antenna cables	3 dB loss cables, 6' LMR400 Jumper NM plus RFI TRFC-11806-12 1 foot N Female to MMCX Male	Jumpers to connect the U-NII devices to the external antennas listed above.
Vector Signal Generator/Analyzer	2 Aeroflex 3070A	Generating U-NII waveforms and measuring received signals
Portable Broadband Signal Analyzer	Aeroflex CS9000SM System	Monitor spectrum to detect external signals that may interfere with measurements
U-NII-3 Wi-Fi development kit	25 Compex, MMJ344HV6A06AFCEBRV527-B, programmed for U-NII-4 band, with integrated PoE (Power over Ethernet), 27 dBm	Surrogate U-NII-3/4 device for measuring adjacent band and in-band interference
Fixed DSRC radio	23 dBm, Cohda Wireless MK5 RSU (with integrated antennas)	DSRC RSU
Mobile DSRC radio - external antenna	2 23 dBm, Cohda Wireless MK5 OBU, MK5 OBU CWP-OBU-MK05-WW00102	DSRC OBU to simulate OEM devices built into the vehicle
Mobile DSRC radio – integral antenna	TBD	DSRC OBU to simulate aftermarket devices
CCTV	Infrared Sony EFFIO ULTRA High Resolution CCTV camera 5.8 GHz Wireless Transmitter Kit - WIRC5800VT 5.8 GHz Wireless Receiver Kit - WIRC5800VR	To measure adjacent band interference from common CCTV surveillance equipment
UAS transmitters	TBD	To measure adjacent band interference from UAS control and video stream downlinks
Laptop		For data collection and analysis
8-port, Power over Ethernet Switch	Transition Networks 1-1000520 8-port 10/100BASE-TX w/POE and 2-port 10/100/1000Base-T or 100/1000Base-X-SFP Combo ports, Industrial Managed Switch	Ethernet data switch to transfer data or provide power to components in the Ethernet chain: switches, cameras, DSRC devices, U-NII devices (but not the laptop)
Power supply	Transition Networks 25080 power supply for industrial converters, 48VDC @ 2.5A / AC 120V	Power source for the Power over Ethernet switch
Embedded Processor Computer (EPC)	Quad-Core 900 MHz 1GB RAM New Raspberry Pi 2 with 8 GB MicroSD Card	To generate data traffic for the surrogate U-NII-4 devices to transmit

Equipment	Specifications	Notes
External Hard drive	Silicon Power 2TB Rugged Armor A80 2.5-Inch USB 3.0 Military Grade Portable	Data storage
Cable, connection and mounting hardware	Various, not described here.	Document with data collection.
GPS RTK receiver	Eclipse R330 Receiver, L1 GPS, 10Hz, raw data. Hemisphere 940-2103-000	To generate precise time stamps (100 ns resolution) and locations (to within 5 cm)

Table 4-7: Mobile Data Collection Platform Equipment

Equipment	Specifications	Notes
Omni-directional antenna	2-6 GHz magnetic mount Wi-Fi antenna, Mobile Mark ECOM6-5500-3C-BLK-120	Receive any signals in the environment
Handheld directional antenna	680MHz to 8GHz Log Periodic Antenna, Kaltman Creations HyperLOG 6080	Rough identification of signal source for aiming directional antennas
Directional antenna	4.9-6.5GHz, 20 degree beamwidth Single Polarization Antenna, Mars MA-WA57-3HG1B	Narrow down signal source location
Precision directional antenna	4.9-6.1GHz, 10 degree beamwidth Dual Polarization Antenna Mars MA-WA56-DP23B	To identify signal source
Precision directional antenna	4.9-6.1GHz, 7 degree beamwidth Dual Polarization Antenna Mars MA-WA55-27B, small form factor	To identify signal source
High gain horn antenna	4.9 - 7.05 GHz, 20 dB Gain Pasternack WR-159 Standard Gain Horn Antenna	Highly sensitive measurement of signals
GPS antenna	GPS Antenna - External Active Antenna - 3-5V 28dB 5 Meter SMA. Adafruit Industries 960.	Mobile GPS antenna
Mount for GPS antenna	Magnetic Antenna Mount 3" Hemisphere GPS P/N 720-0033-00A	GPS to determine location of the platform
Pan/Tilt/Zoom mount	FLIR D48 E-series, D48E-SS-SS-000-SS	For aiming directional antennas
DC Power supply	Converts 110-240VAC, 47-63Hz to 30VDC, FLIR PTU-APS-30V-NA	Power for PTZ mount
Power inverter	2 kilowatt Xantrex PROWatt 2000 Inverter, Model# 806-1220	Convert 12VDC vehicle power to 110VAC for the instruments
Magnetic base	Master Magnetics #07217 2.04"d Round Base Magnet	Moveable base for PTZ mount
Controller	Wireless Gamepad Controller with Vibration Feedback, Logitech pn F710	Control PTZ mount movement

Equipment	Specifications	Notes
Antenna switch	USB/Ethernet controlled RF Switch Matrix, 4:1 RF ports, Mini Circuits RC-1SP4T-A18	Switch antenna input to the signal analyzer
Portable Broadband Signal Analyzer	Aeroflex CS9000SM System	Spectrum analysis
Laptop		For data collection and analysis
8-port, Gigabit Ethernet Switch	Netgear GS608NA	
External Hard drive	Silicon Power 2TB Rugged Armor A80 2.5-Inch USB 3.0 Military Grade Portable	Data storage
Cable, connection and mounting hardware	Various, not described here.	Document with data collection.

4.3.1.2 Equipment at Turner Fairbank Highway Research Center

The Turner Fairbank Highway Research Center (TFHRC) was established as a telecommunications test facility in 2013. Capabilities and equipment are documented in the [Communications and Positioning Test Bed Final Report](#).²⁹

4.3.1.3 Equipment at Federal Law Enforcement Training Center

The Federal Law Enforcement Training Center (FLETC) will have similar capabilities to TFHRC but since this facility will not be a permanent installation, any equipment installation will need to be removable.

4.3.2 Facilities

The geographic and environmental conditions of a test site may influence measured results. It is useful to perform similar measurements under varying conditions and normalize the results. The USDOT Spectrum team has received permission and obtained research licenses for a set of sites that offer a range of environmental factors such as line-of-sight, controlled roadways, real-world roadway operations, laboratories, etc. This section describes the facilities and highlights the key equipment associated with them.

4.3.2.1 Laboratory 1 – Rockwell Collins/ARINC

This laboratory is a shielded room with electrical power, Ethernet and environmental control. It is 200 square feet (10 feet x 20 feet).

²⁹ To be published.

4.3.2.2 Laboratory 2 – Turner Fairbanks Highway Research Center (TFHRC) – Indoor Facility

This laboratory offers access to an indoor bench measurements and laboratory capability to ensure devices are operating to specifications upon receipt and for controlled laboratory measurements. It is configured as illustrated below:

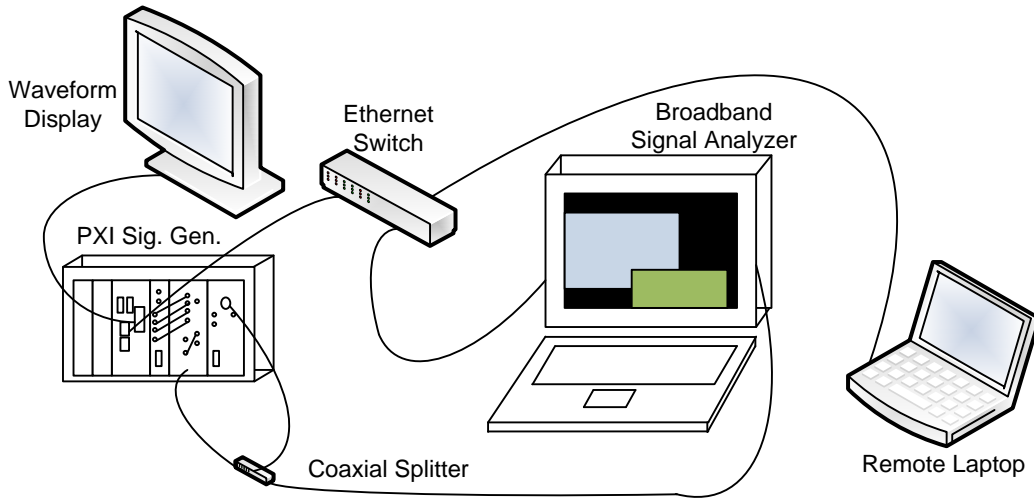

Figure 4-1: RF Signal Measurement Lab Configuration

4.3.2.3 Field Site 1 – Rockwell Collins/ARINC Parking Lot

This is paved level ground with 200 yards maximum clear line of sight distance that can be closed for test purposes. There is lighting but no power onsite. Rockwell Collins security monitors the site with video surveillance. The clear line of sight and flat ground is important for minimizing multipath and minimizing variation in multipath. This facility can be used for equipment checkout, power calibration measurements and short range measurements that can be compared with short range measurements at other ranges.

4.3.2.4 Field Site 2 – Turner Fairbank Highway Research Center – Cooperative Vehicle-Highway Testbed (CVHT) – Outdoor Research Facility

The Cooperative Vehicle-Highway Testbed (CVHT) is one of the three test beds that form the Turner-Fairbank Highway Research Center’s (TFHRC) Saxton Transportation Operations Laboratory (STOL) (see figure 4-2).

- The CVHT emphasizes real-world testing of technology and procedures as related to vehicle to infrastructure (V2I) and vehicle to vehicle (V2V) safety and traffic management applications.
- The Data Resources Testbed focuses on research related to data management associated with traffic operations, and
- The Concepts and Analysis Testbed focuses on transportation modeling and management strategies.

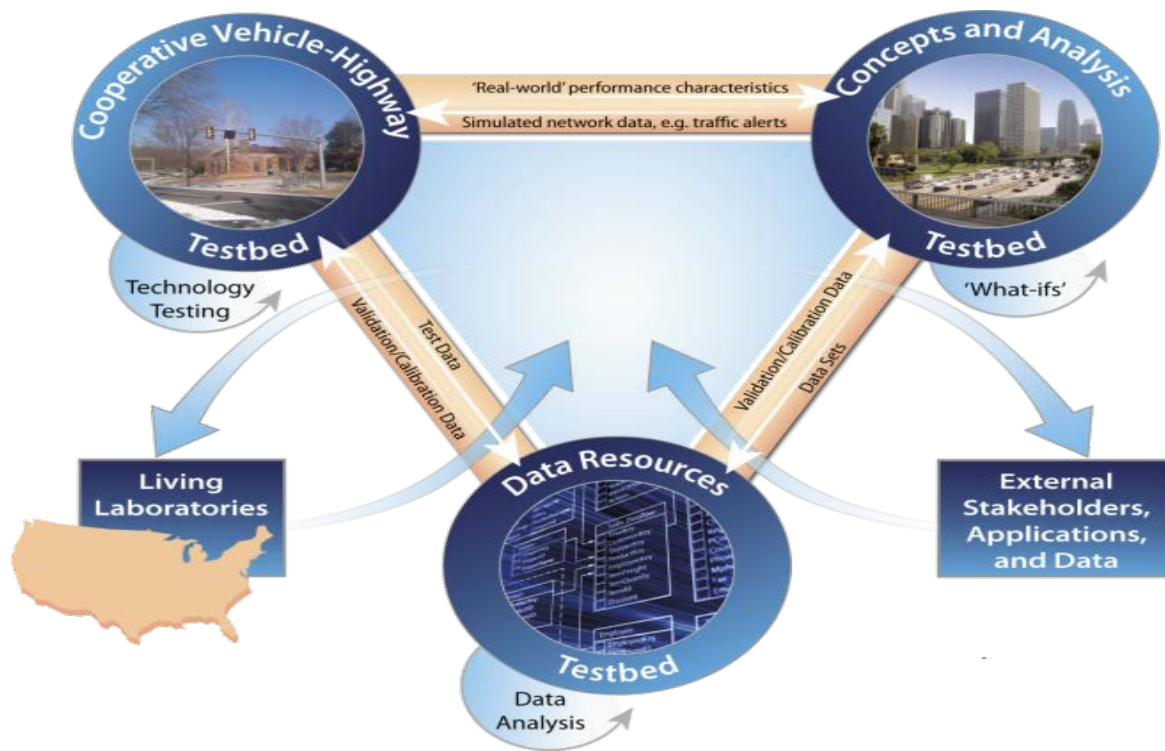

Figure 4-2: Saxton Traffic Operations Laboratory Test Beds

The primary objective of the CVHT is to support evaluation of technologies for Connected Vehicle deployment, and to identify areas where technology improvements or integration are needed. The CVHT consists of a test corridor with a signalized intersection that supports investigation of technologies related to Signal Phase and Timing (SPaT) applications. It is comprised of three core subsystems:

- 1) The Vehicle Technology Test Support Subsystem(s) (V-TTSS), which can be deployed in multiple vehicles;
- 2) An Infrastructure Technology Test Support Subsystem (I-TTSS), which is deployed with the other roadside equipment in the signal controller cabinets; and
- 3) A Test Monitoring and Management Subsystem (TMMS), which is located in the lab itself.

The CVHT also includes typical Traffic Management Center software as well as cameras that can track test vehicles as they progress through measurement runs.

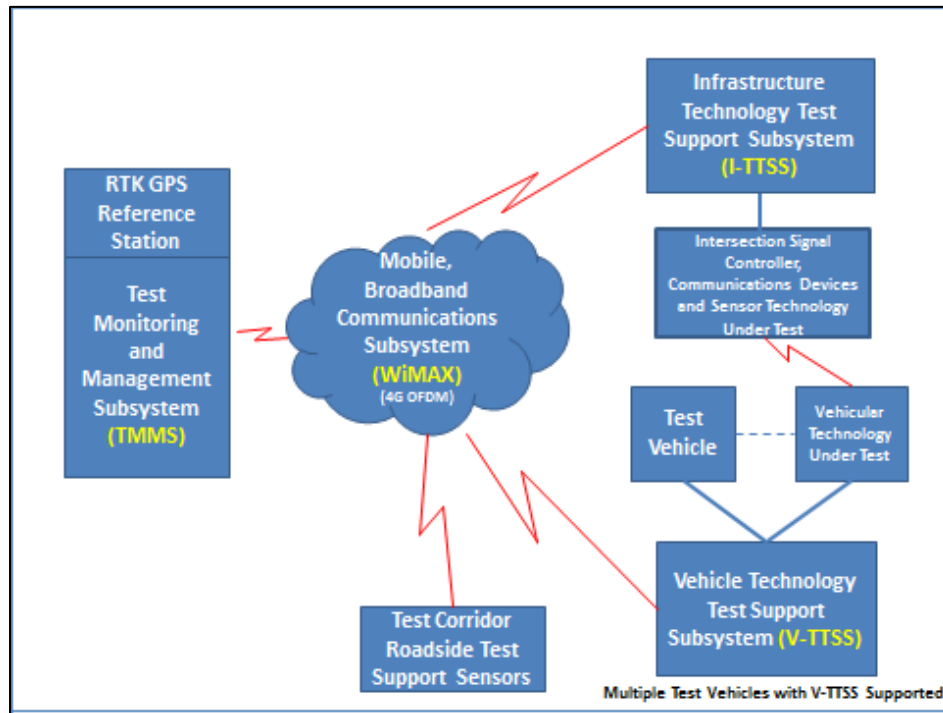

Figure 4-3: Simplified Overview of CVHT System

The CVHT provides the following capabilities which can be used for evaluation of DSRC and unlicensed device interactions:

- Event-based data logging of a variety of data sources, accurate to within ± 100 nanoseconds.
- High-accuracy determination of test vehicle's position (<10 cm at 95% confidence), with the ability to compare the performance of a vehicle positioning technology under test to the Ground Truth.³⁰
- Event-based position stamping, interpolated between GPS fixes at 10 microsecond intervals (e.g., position stamping resolution of approximately 3 mm).
- Display of test vehicle location on a GIS map of the test corridor.
- Technology Test Support Subsystems that are compatible with most standard technology interfaces.
- Visualization of measured data in the STOL lab.
- Archiving of measured data for use by various projects.
- Evaluation of traffic management processes and technologies.
- Capabilities for remote access, and control, of data acquisition from CVHT subsystems.
- Modularly expandable measurement system capable of growth to meet future requirements associated with cooperative vehicle-highway applications.

³⁰ Position from Real-Time Kinematic Global Positioning Satellite (RTK-GPS) equipment.

The roadway course consists of a controlled access road through the facility and a signal and its associated roadside equipment. Figure 4-4 contains an image of the facility with the test route and other features marked.



Figure 4-4: TFHRC Test Route

4.3.2.5 Field Site 3 – Federal Law Enforcement Training Center (FLETC), Maryland

On October 1, 2014, the Federal Highway Administration (FHWA) signed a memorandum of agreement (MOA) with the U.S. Department of Homeland Security, Federal Law Enforcement Training Centers (FLETC) that allows FHWA to use the FLETC facility in Cheltenham, Maryland, for road/vehicle research. The 372-acre FLETC facility, located 15 miles from downtown Washington, DC, includes a 2.2-mile driving track for investigating emergency and non-emergency vehicle operations on highways and in urban grids. The FLETC facility provides FHWA with access to a secure, flexible test environment to meet a variety of study needs. The MOA allows the U.S. Department of Transportation (USDOT) to install equipment on the test track for development and testing purposes.

Features of the FLETC facility (see figure 4-5) include:

- Multiple traffic signals (both wire-mounted and pole-mounted) that can be configured for a variety of test needs.
- Closed-loop test track (with straightaways)
- Ramps
- Flat space for open, controlled measurements
- Skid pad



Figure 4-5: Vehicles at an Intersection on the FLETC Track

4.3.2.6 Field Site 4 – Maryland’s Eastern Shore

Public roads on Maryland’s Eastern Shore offers level geography, minimal roadside infrastructure, long sight distances, and proximity to the project team offers a unique capability for real world measurements on actual roadways. While the other field sites offer controlled environments, they do not provide the long site distances with minimal reflective surfaces, allowing for highly repeatable measurements as found at the Eastern Shore site. (See figure 4-6.)



Figure 4-6: Maryland Eastern Shore Site (Cheston Road)

As with the FLETC facility, the equipment for the Eastern Shore sites will be portable and easily removed at the end of the workday or data collection runs, as appropriate.

4.3.2.7 Field Site 5 – Aberdeen Test Center, Maryland

The Aberdeen Proving Ground in Maryland has numerous vehicle test tracks and an airfield. Two of the runways are unused at this time, and offer long, flat paved surfaces in clear terrain with few sources of multiple path reflection (see figure 4-7). One runway is over 2800 feet long and the other 3600 feet. Those runways, the road around the airfield, and nearby buildings offer a benign RF environment that is suitable for interference analysis (see figure 4-8).

The Army Test and Evaluation Command (ATEC) has skilled personnel on base available to support the analysis. The Army Test Center (ATC) there has a full suite of RF instrumentation including instrumented vehicles and RF listening stations located around the airfield test site to detect spurious emissions.

In addition, the Army's Communications-Electronics Research, Development and Engineering Center (CERDEC), also located at the Aberdeen Proving Ground, has large anechoic chambers capable of measuring the patterns of antennas mounted on vehicles.



Figure 4-7: Measurement Site on Runway at Aberdeen Proving Ground

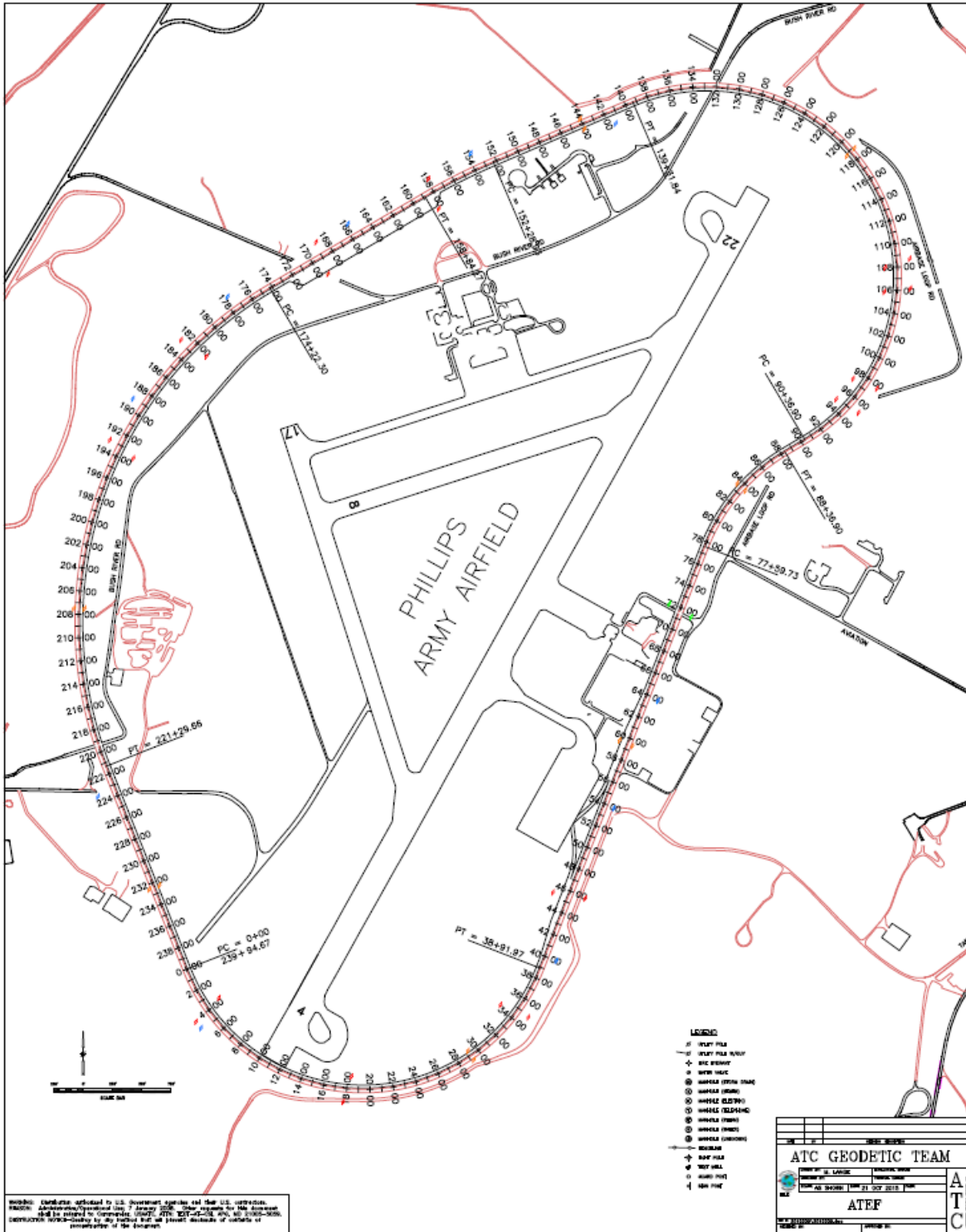

Figure 4-8: Test Track and Runways at Aberdeen Proving Ground

4.3.2.8 Field Site 6 – Table Mountain, Colorado

The Table Mountain Field Site and Radio Quiet Zone is operated by the Institute for Telecommunications Sciences (ITS). It offers flat, open terrain with few reflectors that might cause unanticipated multipath and long, straight stretches of road suitable for investigating mobile line of sight communications. (See figure 4-9.)

ITS is the research and engineering laboratory of the National Telecommunications and Information Administration (NTIA), an agency of the Department of Commerce (DoC). ITS serves as a principal federal resource for the conduct of basic research on the nature of radio waves. ITS works with Government agencies and private organizations to explore, understand, and improve the use of telecommunications technologies and principles; investigate and invent new technologies; and overcome telecommunications challenges.



Figure 4-9: Table Mountain Field Measurement Site

The Table Mountain Field Site and Radio Quiet Zone is located north of Boulder, Colorado and extends about 4 kilometers (2.5 miles) north-south by 2.4 kilometers (1.5 miles) east-west, an area of approximately 1,800 acres. The site is designated as a Radio Quiet Zone where the magnitude of external signals is restricted by state law and federal regulation to minimize radio frequency interference to sensitive projects. Site power distribution is by means of buried lines to avoid interference. Partnerships and cooperative activities with other entities are encouraged at the site. Facilities at the site include:

- **Spectrum Research Laboratory:** A state-of-the-art facility for research into radio spectrum usage and occupancy. Radio Quiet restrictions ensure that no signal incident on the mesa overpowers any other.
- **Open Field Radio Research Site:** As a flat-topped butte with uniform 2% slope, Table Mountain is uniquely suited for radio experiments. Lack of perimeter obstructions and relatively homogeneous ground facilitates studying outdoor radiation patterns from bare antennas or antennas mounted on structures.
- **Mobile Research Vehicles:** There are several mobile equipment platforms available at the site, ranging from four-wheel drive trucks to full-featured mobile laboratories.
- **Large Turntable:** A 10.4 meter (34 foot) diameter rotatable steel table is mounted flush with the ground. Laboratory space underneath houses instrumentation and control equipment, and motors to rotate the turntable. The facility can be operated remotely by computer.
- **Two 18.3 Meter (60 Foot) Parabolic Dish Antennas:** These antennas are steerable in both azimuth and elevation and have been used at frequencies from 400 MHz to 6 GHz.
- **A 3.7 Meter (12 foot) Dish Antenna:** This computer controlled antenna is capable of tracking low earth orbiting satellites
- **Radar Test Range:** A large open space just south of the Spectrum Research Laboratory is available for testing radar systems.



Figure 4-10: Typical View of Table Mountain Measurement Site

4.3.2.9 Mobile Data Collection Platform

The Mobile Data Collection Platform (see figure 4-11) captures emissions from transmitters in and adjacent to the 5850-5925 MHz band. It can be used to survey existing emitters or to capture emissions from unknown sources such that they can be recreated later with a signal generator.

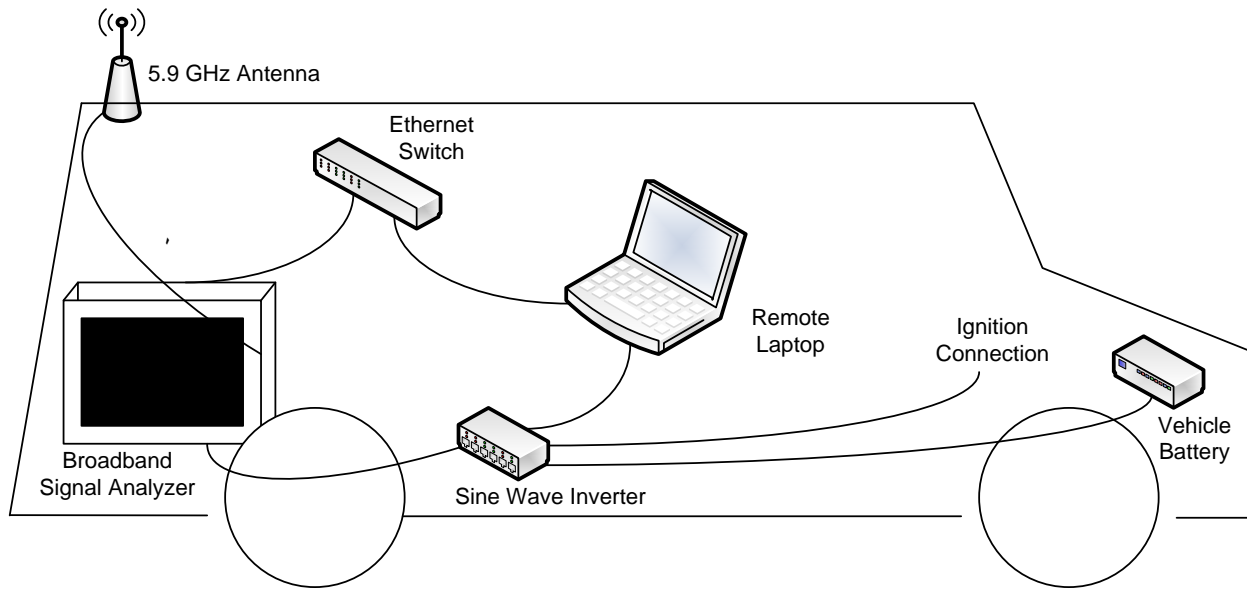

Figure 4-11: RF Signal Measurement Mobile Configuration

4.3.3 Tools

4.3.3.1 Software

- To the extent possible, all software will be open source such that others can duplicate the activities.
- Custom software to control the SDK surrogate U-NII-4 devices.
- JPERF message traffic generation and analysis software for analyzing link performance (TCP/IP). (Open source shareware.)
- Offline analysis software that came with the Vector Analyzer.

4.3.3.2 Hardware

- Equipment specifications and technical data sheets are included in appendix F when available.
- Hard drives.
- 2 Ford Edge SUVs, transferred from the USDOT SE Michigan test-bed project. They include AC power inverters and cabling for data collection. We will add data network cabling.
- 20 foot, telescoping tripods for mounting antennas in the field to simulate RSU and Wi-Fi access point installations.

4.4 Checkout of Equipment, Measurement Procedures and Personnel

4.4.1 Purpose

The purpose is to make sure all equipment works as needed, that the measurement procedures are sound and efficient, and that personnel become qualified to conduct all activities and make the necessary measurements.

4.4.1.1 Activities

This section describes initial activities of this DSRC Interference analysis program, including development of safety and security measures, identification of resources, and definition of measurement procedures and reports. The developed analysis hierarchy and methodology is also provided. A standard measurement procedure is also defined for interference field measurements.

4.4.1.2 Safety and Security Measures

Standard electrical power safety practices will be followed in the laboratory and field. All wireless transmissions are at or below the frequency and power limits specified by the FCC Rule and Order for operation in public and similar to existing commercial Wi-Fi, which are below occupational exposure limits. Moreover, the highest EIRPs will be achieved with directional antennas and personnel exposure through those signals will be minimized.

Driving speeds will not exceed the capacity of each facility. Deceleration and stopping distances will be determined and marked during preliminary measurements to insure all vehicle movements stay entirely within the test area. We will also comply with any specific safety, security and operational restrictions and requirements of the test site owners.

There are no special security requirements other than standard operating procedures to prevent theft of equipment, tampering or vandalism. The data collected, though not classified for national security is considered sensitive, pre-decisional governmental data. Therefore, only standard operating procedures for handling data under a Non-Disclosure Agreement (NDA) apply. Data can only be released to third parties with the permission of USDOT.

4.4.1.3 Analysis Resources

Analysis activities will generally be performed by staff from the selected facilities. At this time, those are expected to be the U.S. Army Test Center at Aberdeen, Maryland and ITS/NTIA in Boulder, Colorado. Personnel from USDOT will participate as needed to provide guidance, monitor progress, remove obstacles, and revise the plan to accommodate unexpected developments. Rockwell Collins will undertake the field survey measurements and assemble and package hardware for simulating U-NII devices and for collecting field data. Personnel from other organizations, such as the FCC, may be present at times to witness task preparation activities as well as actual field measurements.

4.4.1.4 Measurement Procedures and Analysis Results

This interference field survey is investigative in nature and includes preparation in terms of familiarization with operation and configuration of sophisticated measurement instruments. Consequently, step-by-step measurement procedures will be developed as part of the work during the laboratory segment. The lab-proven procedures will be used to facilitate the actual field measurements. It may be found that measurement procedures have to be modified during field measurements. Interference field measurements will be collected primarily in computer media supplemented by a measurement log.

To achieve early benefits, interference measurement data will be promptly returned to the partner organization's office for processing, interpretation, interference assessment, and documented in a series of reports.

4.4.1.5 Mobile unit validation

Rockwell Collins will perform the initial checkout of the mobile mounted signal analyzer and measurement procedures, and train engineers local to their facility in Maryland. They will validate that the interference survey mobile lab is fully operational prior to traveling to target sites. This activity will include initial field data analysis, portrayal and archiving practice.

4.4.1.6 U-NII-3 Software Development Kit Validation

The Software Development Kits (SDKs) were delivered with software to configure the devices. This configuration includes but is not limited to power out, center frequency, and bandwidth. This allows us to investigate U-NII-3 transmissions and then modify a U-NII-3 device to operate in the proposed U-NII-4 band. Validation will consist primarily of verifying that all parameters were set as directed by the software.

4.4.2 Power calibration

4.4.2.1 Purpose

The signal analyzer will be the reference instrument. It is more sensitive than the devices under test and will be calibrated to standards traceable to NIST. Therefore it will take the background and noise level measurements for the baseline measurements and monitor for interference during other measurements. In addition, variables recorded from the DSRC and unlicensed devices under test include RSSI and the received signal power of background noise level, intentional and interfering signals.

We will calibrate the devices to the signal analyzer. This serves two purposes. First, it allows all power measurements to be normalized to a common reference. Second, it allows us to detect if one of the devices malfunctions or drifts out of compliance with the manufacturer's specifications.

4.4.3 Activities

We will make power calibration tables for each device to be examined by measuring the same signal with the signal analyzer and the devices under test. The calibration tables will correlate the power levels

logged by devices to be examined with a calibrated signal analyzer or calibrated RF source. To calibrate receivers, the vector signal generator will produce test signals including continuous wave (CW) power, simulated BSMs, and simulated U-NII-3 video packets. The background noise level will also be a test signal for the calibration table. From there power will be incrementally increased until near the saturation range of the receiver. We will repeat measurements at least three times to capture natural variations in operation and measurement. We will make additional runs if the variation seems unusually large.

To calibrate transmitters, we will incremental increase the power of the device to be examined and compare its logged transmit power to the power measured by a calibrated power meter or signal analyzer. One key output will be the noise level measured in a 10 MHz channel by each DSRC device compared to the signal analyzer. This establishes benchmarks we will use to detect equipment problems in later analysis.

These measurements can be done in one of the laboratory or short range test facilities. The analysis team will measure the devices under examination while connected directly to the calibrated source or receiver and over-the-air as appropriate.

Table 4-8: Power Calibration Runs for Receivers

Device	Bandwidth (MHz)	Channel Number (DSRC and U-NII band)	Modulation	Power measured by spectrum analyzer (dBm)	Packet Sizes (octets)
Vector signal Generator (VSG) transmitter	10	172 174,	TBD, Same for all measurements	Background level, Step up incrementally in 1 dB steps up to -10 dBm ³¹	CW 300 @ 10 Hz 3000 U-NII 9000 U-NII 1,000,000 U-NII
	20	176, 178,			
	40	180,184			
	80	175 181, 173			
	160	175 171 163			
IEEE 802.11p DSRC Receivers	10	172 174,	n/a	n/a	n/a
	20	176, 178, 180,182, 184 175, 183			
IEEE 802.11ac U-NII-3 Receivers	20	TBD	n/a	n/a	n/a
IEEE 802.11ac U-NII-4 Receivers	20	173	n/a	n/a	n/a
	40	175			
	80	171			
	160	163			

³¹ DSRC receivers saturate and become nonlinear in this range. They can burn out at -0dBm so care must be taken not to test higher than indicated by the manufacturer’s specifications for burn out.

Table 4-9: Power Calibration Runs for Transmitters

Device	Bandwidth (MHz)	Channel Number (DSRC and U-NII band)	Modulation	Power measured by spectrum analyzer (dBm)	Packet Sizes (octets)
Vector signal Analyzer (VSA) Receiver	10 20 40 80 160	172 174, 176, 178, 180,182, 184 175 181, 173 175 171 163	n/a	n/a	n/a
IEEE 802.11p DSRC Transmitters	10 20	172 174, 176, 178, 180,184 175, 183	TBD, Same for all measurements	Background level, Step up incrementally in 1 dB steps up to maximum transmit power	CW 300 @ 10 Hz 1500 @ 10 Hz
IEEE 802.11ac U-NII-3 Transmitters	20	TBD	TBD, Same for all measurements	Background level, Step up incrementally in 1 dB steps up to maximum transmit power	CW 300 @ 10 Hz 3000 U-NII 9000 U-NII 1,000,000 U-NII
IEEE 802.11ac U-NII-4 Transmitters	20 40 80 160	173 175 171 163	TBD, Same for all measurements	Background level, Step up incrementally in 1 dB steps up to maximum transmit power	CW 300 @ 10 Hz 3000 U-NII 9000 U-NII 1,000,000 U-NII

Initial measurements suggest limiting the transmit powers used for the interference analysis. Commercial DSRC equipment currently available does not support transmit powers up to the maximum limits allowed by the FCC. For example, for channel 172 those are 28.8 dBm transmitter power out and 33 dBm EIRP (which includes antenna gain and cable losses). The SAE J2945 standard specifies 20 dBm as the maximum radiated power (or EIRP). Moreover initial measurements at Aberdeen have shown ranges exceeding 300 meters even at 0 dBm transmit power (or ~5 dBm EIRP assuming the typical gain of a DSRC antenna is 6 dBi with ~1 dB of cable loss). That means in order to reduce self-interference and channel congestion, deployed DSRC may very well operate with lower radiated power than anticipated by the standard. Therefore, we will make measurements with the following four transmit powers:

- 20 dBm (EIRP ~ 25 dBm),
- 15 dBm (EIRP ~ 20 dBm),

- 10 dBm (EIRP ~ 15 dBm),
- 0 dBm (EIRP ~5 dBm).

These values bracket the reliable operating range of the DSRC radios from minimum to maximum, provides data to match the SAE J2945 benchmark (EIRP=20 dBm), and a midpoint.

If commercially available hardware cannot achieve the maximum EIRPs for channels 178 and 184 (44.8 and 40 dBm), then where the test plan calls for those EIRPs, instead operate with the highest EIRPs possible with the highest gain antennas on-hand and record the actual EIRP.

4.5 Baseline Environmental Signal Data Collection

4.5.1 Purpose

The purpose of the baseline environmental signal data collection is to measure background RF noise levels on roadways as well as the facilities to be used later in this analysis. It is also to measure existing signals in the environment that include the co-primary users in the band: government radars and FSS earth stations. We will also record other interference that can be found opportunistically, such as unlicensed ISM, secondary users such as amateur radio operators, and users in adjacent bands. The latter can be licensed users like FSS (satellite ground stations operating above the DSRC band) and unlicensed users (e.g., U-NII-3 wireless CCTV links) operating below the DSRC band.

These measurements will confirm that the current signal environment by known emitters in the DSRC band presents no risk to connected vehicle communications or identify RF issues that should be considered before rollout.

USDOT ANALYSIS PLAN OBJECTIVES MET	
	Primary:
2	Measure existing interference
	Secondary:
1	Develop RF analysis capability
3	Effects on background noise levels
6	Effects on channel quality
7	Detection sensitivities

4.5.2 Description

The baseline environmental signal data collection consists of measuring and recording spectrum energy with a mobile listening station. We will equip a vehicle with a spectrum analyzer, antenna, and data recorder to serve as the mobile listening station. We will apply front-end amplification and filtering as necessary. The vehicle will travel on representative roads to collect background noise and signals in the DSRC band and adjacent bands. This includes recording in the proximity of radars and satellite earth stations to measure the known signal sources. If it is possible to identify locations with Amateur radio links or ISM equipment, we will measure near those as well.

4.5.3 Equipment

Listed in section 4.3.1.

4.5.4 Data to Collect

The broadband analyzer may be used for two general forms of data collection: channel power and high resolutions waveform capture. The channel power (with GPS tracking) is useful while the mobile test vehicle is in motion and continuously logging channel power on the defined channel plan. When a possible source of interference is identified, a high-resolution measurement may be taken. This measurement generates enormous data files so must be used judiciously. Table 4-10 lists variables that should be recorded during the field measurements of potential sources of interference.

Table 4-10: RF Environmental Data Collection Matrix³²

Device/Variable	Range	Resolution	Notes
Spectrum analyzer configuration			
Model, ID			
Antenna height			
Antenna orientation - Azimuth	0-360°		
Antenna orientation - Elevation [◊]	±45°		
Other fixed settings			
Spectrum analyzer measurements			
Bandwidth setting			
Frequency vs power plots			
Spatial measurements			
Speed during data collection	0-60mph		
GPS location			
Timestamp			
Location on road network			
Distance to co-primary transmitter			GPS and mapping software
[◊] Vertical tilt angle can be level (0 degrees), negative (looking down) or positive (looking up)			

³² In this and subsequent data collection matrix tables, grey boxes indicate information that either doesn't exist or does not impact measurement taken. For table 4-10, for example, the range and resolution for the model and ID of the spectrum analyzer is not a variable and the antenna height resolution and the antenna rotation resolution are not significant factors in the data collection while their absolute values are.

4.5.5 Analysis Activities

4.5.5.1 Preparation and Safety

Rockwell Collins will configure a rental van as described in section 4.3.2.9 with the equipment listed in section 4.3.1. That equipment includes the signal analyzer, power converters, and a suite of antennae. The analyzer will be secured in the back seat such that the driver and navigator cannot view or control it while underway. A separate operator will make measurements when the vehicle is moving. Mobile field measurements will be performed strictly on public access roads and streets including roadway shoulders where it is safe to pull over and stop. Measurements along high-speed highways will be performed when the vehicle is moving at prudent speeds.

Prior to driving around sensitive government facilities, Rockwell Collins will work with USDOT personnel to establish a local government employee point of contact (POC) who has been briefed on the nature of the activities. This POC should be present at the government facility during local measurement activities for any security related issues.

4.5.5.2 Analysis Resources

Rockwell Collins/ARINC staff will generally perform all activities with support from their instrumentation vendor in Annapolis, MD. Personnel from the Crash Avoidance Metrics Partnership (CAMP) will share previous interference measurements and participate in selected field measurements. Personnel from USDOT and other organizations may be present to witness task preparation activities as well as actual field measurements.

4.5.5.3 Measurement Sites

The mobile lab will travel to target sites to capture real-world in-band and out-of-band signals from existing licensed and unlicensed sources. The initial investigations will measure spectral energy near a Federal radar at Wallops Island, In-band and Above-band FSS sites as well as Wi-Fi installations near roads in Maryland and Virginia. Appendix E provides details of the candidate measurement sites under consideration. Due to the investigative nature of this survey, the actual sites visited will be subject to change based on early experiences.

4.5.5.4 Tasks

This field survey includes the following tasks:

Task 1: Identify potential sources of out-of-band interference, licensed and unlicensed.

The first phase of Task 1 will measure the noise spectrum to characterize RF emissions at locations near roads. The field survey should include a grid map of roads identifying the sites of the measurement. Select outdoor roadside locations to target the following three types of emitters:

- a) **Licensed:** Three Fixed Satellite Service (FSS) ground stations, with uplink carriers near the 5.925 GHz boundary with ITS. They may operate at different frequencies and output power levels. Locate higher power ground stations, if possible.
- b) **Unlicensed:** Three outdoor 5 GHz Wi-Fi Access Points (802.11a/n likely).

- c) **Unlicensed:** Clusters of lower-power 5 GHz Wi-Fi client devices measured at roadside (optional survey, subject to 5 GHz availability).

The second phase of Task 1 will survey a wider variety of sites to assess differences in noise levels and emitters in different road environments. Measurement sites will include:

- a) Urban areas with high density residential;
- b) Urban areas with high usage commercial;
- c) Suburban areas;
- d) Rural areas;
- e) Special event high-density venues (optional; events at parks or stadiums).

Task 2: Identify potential in-band sources of interference, licensed and unlicensed.

These survey measurements are also part of Phase 2. It is important to characterize the RF noise and spectral occupancy of emitters at locations near roads. Government radars will have keep-away zones. The survey data should include a map identifying the sites of the measurement. Two types of licensed emitters should be measured:

- a) One Fixed Satellite Service (FSS) ground station, with uplink carriers in the ITS band. This may be same transmit profile as stations operating above 5.925 GHz.
- b) One US Government high-power radar (potentially Wallops Island).

At a minimum, measurements will be screenshots of RF spectrum registers captured in the analyzer's internal memory and subsequently transferred to portable computer media taken to the office for analysis. These spectrum registers are essentially a plot of power versus frequency measured in the band.

4.5.5.5 Outputs

When a potential source of interference is detected, the objective will be to determine its precise geographical location, frequency and power, in particular how its power varies across the frequencies it emits at. Another objective will be to capture the signals such that Rockwell Collins engineers will be able to emulate these signals later for controlled interference analysis in the lab or test facility.

The data collected in this activity will characterize potentially interfering signals. Characterizing the licensed and unlicensed, in and out of band sources will allow the USDOT to construct scenarios representative of the RF environments DSRC will have to operate in even without sharing the spectrum. This information can be used for further modeling (e.g., ITS-Boulder) and to guide subsequent field analysis. Signals from unlicensed devices will add to RF emissions measured in this activity. That must be accounted for in any consideration of sharing. Another output of this activity will be requirements, constraints and heuristics for successful DSRC operation in the presence of these other transmitters. Examples might be minimum signal level or minimum carrier to interference ratio for reliable DSRC operation. These can be used by developers of DSRC equipment, unlicensed device designers and manufacturers, and those trying to develop sharing mechanisms.

4.5.6 CAMP Data

CAMP LLC had collected similar data in parallel with the analysis team and also collected data on the West Coast. After CAMP has finished internal review of their collected data, it will be made available to the analysis team and, where appropriate, compared with results of similar data collection runs. Additionally, the data that was collected on the West Coast will be included in the overall analysis of the existing emitters in the 5850-5925 MHz band.

4.6 Unmanned Aircraft Systems (UAS) Data Links

4.6.1 Purpose

The data links used in some UAS and closed circuit TV (CCTV) cameras are an example of other readily-available unlicensed devices that may operate in or near the DSRC spectrum allocation. This task will measure energy in the DSRC and adjacent bands in the presence of downlinks that are within the DSRC band from UAS to see how they affect the ambient RF environment for DSRC. The recently released FAA rules on UAS pave the way for a proliferation in the use of UASs for private purposes. All UAS have RF uplinks to send commands to the UAS. Some also have downlinks to return telemetry data on aircraft status, sensor data and usually streaming video as well. The video downlink would be the most likely source of interference if there is any. Even if those links are not in the DSRC band, if they are nearby and do not have a tight transmission mask, they will leak energy into the DSRC band. Just as the previous task will characterize possible interference from ground-based sources, this task will do the same for UAS mounted transmitters.

Measurements from this activity will indicate if UAS communications pose a risk to connected vehicle communications.

USDOT ANALYSIS PLAN OBJECTIVES MET	
2	Measure existing interference
	Secondary:
1	Develop RF analysis capability
3	Effects on background noise levels
6	Effects on channel quality
7	Detection sensitivities

4.6.2 Description

The environmental data collection in the presence of a UAS data link consists of measuring and recording spectrum energy with a mobile or fixed listening station using the same equipment as for the baseline environmental data collection. In this case, we will first procure sample uplink and downlink transmitters used by UAS and operate them near the listening station to see if they introduce energy

into the DSRC spectrum. Based on these results, we may purchase an UAS and make spectral measurements during flight tests if they appear to be a potential source of interference.

4.6.3 Equipment

Same as for 4.5 but add the UAS hardware listed in Section 4.3.1.

4.6.4 Data to Collect

Table 4-11: UAS Data Collection Matrix

Device/Parameter	Range	Resolution	Notes
Spectrum analyzer configuration			
model, ID			
Antenna height			
Antenna orientation - Azimuth	0-360°		
Antenna orientation - Elevation ^o	±45°		
Other fixed settings			
Spectrum analyzer measurements			
Bandwidth setting			
Frequency vs power plots			
Spatial measurements			
Speed during data collection	0-60mph		May be zero for all measurements
GPS location			
Timestamp			
Location on road network			TFHRC
Distance to co-primary transmitter			
UAS Transmitter(s) configuration			
Type, model, ID			
Antenna height			Need tower or building to simulate aerial coverage?
Antenna orientation - Azimuth	0-360°		
Antenna orientation - Elevation ^o	±45°		
Antenna pattern identifier that will be used to determine gain in direction of receiver			
Other fixed transmitter settings			
Transmitter Variables			
Transmitter channel (frequency)			

Device/Parameter	Range	Resolution	Notes
Transmit channel bandwidth			
Distance between transmitter and receiver			For fixed and not flight measurements
Orientation between transmitter and receiver			Same as above
Transmitted power			
Transmitted modulation			
Transmitted data rate			
Time stamped flight path or geo-location			For flight measurements if necessary
◊ Vertical tilt angle can be level (0 degrees), negative (looking down) or positive (looking up)			

4.6.5 Analysis Activities for UAS

Based on the literature, there are several different types of UAS with different operational characteristics. These will be further studied and appropriate activities will be added here to assess their impact, if any, on DSRC operations

4.7 Surrogate U-NII-4 Setup and Verification

4.7.1 Purpose

It is essential to have a U-NII-4 device to study potential interference with DSRC devices. This task prepares a surrogate U-NII-4 device from commercially available U-NII-3 device Software Development Kits (SDKs) to study until a potential U-NII-4 device becomes available.

Data from this process will insure that the modified U-NII-3 SDKs properly model U-NII-4 devices operating under U-NII-3 rules before using them as surrogate U-NII-4 devices for our analysis.

USDOT ANALYSIS PLAN OBJECTIVES MET	
1	Develop RF analysis capability
3	Effects on background noise levels
4	Interference with transmitted BSMs
5	Suppression of BSMs by CCA
6	Effects on channel quality
7	Detection sensitivities
8	Effect of U-NII-4 channel width
9	Impact on U-NII-4 performance

4.7.2 Description

The U-NII-3 bands come up to the lower edge of the DSRC band. The U-NII-3 device becomes a U-NII-4 device easily enough by programming it to run at the slightly higher frequencies of the U-NII-4 band, which overlaps the DSRC band. The difference with a potential U-NII-4 device is that we will have a U-NII-4 device operating under U-NII-3 rules. That will be good enough to measure interference. Examining a sharing mechanism customized for the DSRC band will require a potential U-NII-4 device operating under proposed U-NII-4 rules.

There are two fundamental activities in this task. The first is to use a vector analyzer to verify that the modified U-NII-3 device is mimicking a U-NII-4 device properly. The second activity will be to identify which modulations to use in the interference analysis.

We are modifying production U-NII-3 radios to operate under U-NII-3 rules in the proposed U-NII-4 band. Therefore, this analysis will occur under the experimental license the USDOT has from the FCC. See appendix D.

4.7.3 Equipment

- U-NII-3 Wi-Fi Software Development Kits (SDKs)
- Software drivers for SDKs to operate as U-NII-4 devices
- Embedded Processor Computers (EPCs)
- Vector analyzer
- DSRC device

4.7.4 Data to Collect

Table 4-12: Surrogate U-NII-4 Modulation Data Collection Matrix

Device/Parameter	Range	Resolution	Notes
Vector analyzer			
Model, ID			
Settings:			
Receiver configuration			DSRC
Type, model, ID			
Antenna height			
Antenna orientation - Azimuth	0-360°		
Antenna orientation - Elevation ^o	±45°		
Antenna pattern identifier that will be used to determine gain in direction of transmitter			
Other fixed receiver settings			
Receiver measurements			

Device/Parameter	Range	Resolution	Notes
Received channel (frequency)			
Channel bandwidth	10-20MHz		
Received RF power			
Received Signal Strength Indicator (RSSI)			Power above noise level DSRC
Signal-to-Noise (S/N)			Get from vector A. or calculate
Packet Error Rate (PER)			From SDK box
Packet Reception Rate (PRR)			From SDK box
Duty cycle or percent time channel occupied			From SDK receiver log
Transmitter(s) configuration			DSRC
Type, model, ID			
Antenna height			
Antenna orientation - Azimuth	0-360°		
Antenna orientation - Elevation ^o	±45°		
Antenna pattern identifier that will be used to determine gain in direction of receiver			
Other fixed transmitter settings			
Transmitter Variables			
Transmitter channel (frequency)			
Channel bandwidth	10-20MHz		
Distance between transmitter and receiver			
Orientation between transmitter and receiver			
Transmitted power			
Transmitted modulation			
Transmitted data rate			
Packet repetition rate			
Packet size			
Transmitter(s) configuration			U-NII-4
Type, model, ID			
Antenna height			
Antenna orientation - Azimuth	0-360°		
Antenna orientation - Elevation ^o	±45°		
Antenna pattern identifier that will be used to determine gain in direction of receiver			
Other fixed transmitter settings			

Device/Parameter	Range	Resolution	Notes
Transmitter Variables			
Transmitter channel (frequency)			
Channel bandwidth	10-20MHz		
Distance between transmitter and receiver			GPS or survey
Orientation between transmitter and receiver			
Transmitted power			
Transmitted modulation			
Transmitted data rate			
Packet repetition rate			
Packet size			
° Vertical tilt angle can be level (0 degrees), negative (looking down) or positive (looking up)			

4.7.5 Analysis Activities

Verify surrogate U-NII-4 operation. Verifying correct operation of surrogate U-NII-4 radio sets will include the following:

- Channelization per proposed channel plan in NPRM
- Center frequency
- Bandwidth
- Receiver sensitivity
- Transmit emission mask
- Transmit power
- Transmit power adjustment
- Basic data transmission
- Basic sharing etiquette³³
- Signal quality (error vector magnitude (EVM))
- Logging of transmitter and receiver variables specified in Table 4-12

This activity is complete once the surrogate U-NII-4 device operates properly.

Operation of the DSRC devices must be verified as described in Section 4.8.8.5 below before returning to the modulation measurements described immediately below.

Select Modulation

Table 4-13 shows that there are more possible modulations for 802.11ac than there are for 802.11p (see table 4-16). There is some overlap. Modulations used by both devices will be recognized and can suppress messages via the CCA mechanism. In the interference analysis, we will examine one or two modulations that both devices recognize. On the other hand, interference could be worse when

³³ Most likely the U-NII-3 rules that the Wi-Fi devices use to avoid interfering with each other.

802.11ac and 802.11p devices are using modulations the other doesn't recognize. This analysis is to see which modulations are most disruptive to the DSRC device. The most disruptive modulation will be used later in some interference measurements.

Table 4-13: 802.11ac Modulation Options and Data Rates

Theoretical throughput for single Spatial Stream (in Mb/s)										
MCS index	Modulation type	Coding rate	20 MHz channels		40 MHz channels		80 MHz channels		160 MHz channels	
			800 ns GI	400 ns GI	800 ns GI	400 ns GI	800 ns GI	400 ns GI	800 ns GI	400 ns GI
0	BPSK	1/2	6.5	7.2	13.5	15	29.3	32.5	58.5	65
1	QPSK	1/2	13	14.4	27	30	58.5	65	117	130
2	QPSK	3/4	19.5	21.7	40.5	45	87.8	97.5	175.5	195
3	16-QAM	1/2	26	28.9	54	60	117	130	234	260
4	16-QAM	3/4	39	43.3	81	90	175.5	195	351	390
5	64-QAM	2/3	52	57.8	108	120	234	260	468	520
6	64-QAM	3/4	58.5	65	121.5	135	263.3	292.5	526.5	585
7	64-QAM	5/6	65	72.2	135	150	292.5	325	585	650
8	256-QAM	3/4	78	86.7	162	180	351	390	702	780
9	256-QAM	5/6	N/A	N/A	180	200	390	433.3	780	866.7

This bench measurement is to simply set up the DSRC and U-NII-4 radios in the lab and measure performance of the link between the DSRC radios as the modulation of the U-NII-4 radio is changed. Performance measures will include the PER to quantify quashed packets and access time to quantify suppressed packets.

Establish a DSRC link with the highest modulation for its FCC class. For longer range class C or D that is likely to be a QPSK modulation. Test the following U-NII modulations against it: BPSK, one QPSK, one 16-QAM and one 256-QAM. We suggest modulations of MCS 0, 1, 2, 4, 7 and 9. Changing the coding rate does not affect the RF parameters that cause interference. These are the most likely DSRC modulations followed by one of each higher modulation class. Measure performance metrics for the DSRC link (e.g., PER, latency, etc.) when exposed to the U-NII communications changing just the modulation.

Table 4-14: Suggested U-NII Modulations to Examine for Impact on DSRC Communications

Modulation	Coding rate	Data rate (Mbps)				
		10 MHz	20 MHz	40 MHz	80 MHz	160 MHz
BPSK	1/2	N/A	7.2	15	32.5	65
QPSK	1/2	N/A	14.4	30	65	130
QPSK	3/4	N/A	21.7	45	97.5	195
16-QAM	3/4	N/A	43.3	90	195	390
64-QAM	5/6	N/A	72.2	150	325	650
256-QAM	5/6	N/A	N/A	200	433.3	866.7

Repeat with DSRC links for the lower power classes (A and B) that might use higher modulations MCS 4, 7 and 9. Higher modulations have shorter range but allow greater throughput. They are most likely to be vulnerable to interference.

The data collection table assumes over-the-air measurement at close proximity. This work may also be done by wire if the proper components (e.g., combiners, attenuators, switches, etc.) are available and the radios allow the antenna to be disconnected so that signals can be injected into the antenna port or an alternate port.

If it is not possible to control the modulation, or other critical parameters, of the surrogate or proposed U-NII-4 devices as a variable, then program repeatable test cases based on actual Wi-Fi use cases to be input to the surrogate (or proposed) devices for transmission.

Where it is possible to control modulation, early testing at 20 MHz suggests using modulations of ½BPSK and ¾QAM-64. As the Wi-Fi device perceives a noisier (but not occupied) channel it employs a data rate adaptation mechanism that switches to lower MCS indexes, hence lower level modulation and lower data rate to reduce the number of retransmissions. Therefore, the Wi-Fi device will most likely be operating with ½BPSK when energy in the channel finally reaches the threshold to activate the Clear Channel Access (CCA) mechanism. ¾QAM-64 is the highest modulation we can set easily on the surrogate UNII-4 devices without needing to reprogram the devices between measurement runs. It allows us to examine the effect of higher order modulations with the least burden on the test schedule.

4.8 DSRC Setup and Verification

4.8.1 Purpose

This task ensures that the DSRC devices can function as required to fulfill this plan, identify where they cannot, and develop exceptions where necessary and possible.

USDOT ANALYSIS PLAN OBJECTIVES MET	
1	Develop RF analysis capability
3	Effects on background noise levels
4	Interference with transmitted BSMs
5	Suppression of BSMs by CCA
6	Effects on channel quality
7	Detection sensitivities
8	Effect of U-NII-4 channel width
9	Impact on U-NII-4 performance

4.8.2 Description

The DSRC devices need to be programmable in order to change settings to do the various runs specified in the plan. They also need to log the transmitter and receiver variables required of the plan in order to measure performance and identify interference.

There are two fundamental activities in this task. The first is to use a vector analyzer to verify that the standard or modified DSRC devices operate as required. The second activity will be to identify which modulations to use in the interference analysis.

4.8.3 Equipment

- DSRC devices and software development kits
- Software drivers to program the DSRC devices
- Vector analyzer
- Surrogate U-NII-4 device

4.8.4 Data to Collect

Table 4-15: DSRC Radio Modulation Data Collection Matrix

Device/Parameter	Range	Resolution	Notes
Vector analyzer			
Model, ID			
Settings:			
Receiver configuration			DSRC
Type, model, ID			
Antenna height			
Antenna orientation – Azimuth	0-360°		
Antenna orientation – Elevation ^o	±45°		
Antenna pattern identifier that will be used to determine gain in direction of transmitter			
Other fixed receiver settings			
Receiver measurements			
Received channel (frequency)			
Channel bandwidth	10-20MHz		
Received RF power			
Received Signal Strength Indicator (RSSI)			Power above noise level DSRC
Signal-to-Noise (S/N)			Get from vector A. or calculate
Packet Error Rate (PER)			From SDK box
Packet Reception Rate (PRR)			From SDK box
Duty cycle or percent time channel occupied			From SDK receiver log
Transmitter(s) configuration			DSRC
Type, model, ID			

Device/Parameter	Range	Resolution	Notes
Antenna height			
Antenna orientation – Azimuth	0-360°		
Antenna orientation – Elevation ^o	±45°		
Antenna pattern identifier that will be used to determine gain in direction of receiver			
Other fixed transmitter settings			
Transmitter Variables			
Transmitter channel (frequency)			
Channel bandwidth	10-20MHz		
Distance between transmitter and receiver			
Orientation between transmitter and receiver			
Transmitted power			
Transmitted modulation			
Transmitted data rate			
Packet size			
Packet transmission rate			
Transmitter(s) configuration			U-NII-4
Type, model, ID			
Antenna height			
Antenna orientation – Azimuth	0-360°		
Antenna orientation – Elevation ^o	±45°		
Antenna pattern identifier that will be used to determine gain in direction of receiver			
Other fixed transmitter settings			
Transmitter Variables			
Transmitter channel (frequency)			
Channel bandwidth	10-20MHz		
Distance between transmitter and receiver			GPS or survey
Orientation between transmitter and receiver			
Transmitted power			
Transmitted modulation			
Transmitted data rate			
Packet size			
Packet transmission rate			

Device/Parameter	Range	Resolution	Notes
◊ Vertical tilt angle can be level (0 degrees), negative (looking down) or positive (looking up)			

4.8.5 Analysis Activities

Verify DSRC radio operation. Verifying correct operation of the DSRC radio sets will include the following:

- Channelization per the FCC Report and Order³⁴ (see figure 1-2)
- Center frequency
- Bandwidth
- Receiver sensitivity
- Transmit emission mask
- Transmit power
- Transmit power adjustment
- Basic data transmission
- Basic sharing etiquette³⁵
- Signal quality (error vector magnitude (EVM))
- Logging of required transmit and receive variables

This activity is complete once the DSRC device operates properly.

Select Modulation

The modulations permitted for DSRC shown in table 4-16 overlap but are not identical to the list of modulations available to Wi-Fi U-NII that are seen in table 4-13. The 802.11ac standard allows for very high throughput modulations (e.g., 256-QAM) that are not specified for other 802.11 devices in the IEEE 802.11-2012 standard.

Higher order modulations provide greater throughput but operate at much lower ranges and are more likely to be vulnerable to interference. On the other hand, most DSRC applications described to date, in particular the safety applications, require the long ranges only possible with the lower order modulations. In fact, most DSRC operations to date have used QPSK at 6 Mbps. To understand the bounding cases, table 4-10 suggests modulations for DSRC links to examine for susceptibility to interference from the U-NII modulations given in table 4-14. The number of permutations can be reduced where bounding cases are established and there is little sensitivity to changing the modulation of either type of radio.

We expect subsequent field analysis is most likely to operate DSRC radios using one of the QPSK modulations.

³⁴ FCC-03-324A1, page 19

³⁵ The CCA using the 802.11p EDCA and the channelization shown in figure 1-1.

Table 4-16: 802.11p DSRC Modulation Options³⁶

Modulation	Coding rate (R)	Coded bits per subcarrier (N_{BPSC})	Coded bits per OFDM symbol (N_{CBPS})	Data bits per OFDM symbol (N_{DBPS})	Data rate (Mb/s) (20 MHz channel spacing)	Data rate (Mb/s) (10 MHz channel spacing)	Data rate (Mb/s) (5 MHz channel spacing)
BPSK	1/2	1	48	24	6	3	1.5
BPSK	3/4	1	48	36	9	4.5	2.25
QPSK	1/2	2	96	48	12	6	3
QPSK	3/4	2	96	72	18	9	4.5
16-QAM	1/2	4	192	96	24	12	6
16-QAM	3/4	4	192	144	36	18	9
64-QAM	2/3	6	288	192	48	24	12
64-QAM	3/4	6	288	216	54	27	13.5

Table 4-17: Suggested DSRC Modulations to Examine for Vulnerability to the U-NII Modulations in Table 4-14

Modulation	Coding rate	Data rate (Mbps)				
		10 MHz	20 MHz ³⁷	40 MHz	80 MHz	160 MHz
BPSK	1/2	3	6	N/A	N/A	N/A
QPSK	1/2	6	12	N/A	N/A	N/A
QPSK	3/4	N/A	21.7	N/A	N/A	N/A
16-QAM	3/4	18	36	N/A	N/A	N/A
64-QAM	3/4	27	54	N/A	N/A	N/A

The modulation investigation for DSRC should be combined with the modulation investigation for the surrogate U-NII-4 devices described in Section 4.7.5 above (see details in that section). Note the difference is that for DSRC we want to determine how modulation affects vulnerability whereas for the U-NII devices we want to determine how modulation affects their potential to cause in-channel and adjacent channel interference.

Based on initial measurements at Aberdeen, we selected two modulations in order to streamline the analysis activities and attain experimental results sooner: 1/2QPSK and 3/4QAM-64. The first, represents the modulation used for most DSRC testing and development and the one specified for safety applications in the NHTSA notice of proposed rule-making (6 Mbps data rate in a 10 MHz channel). The

³⁶ IEEE 802.11-2012 wireless standard, Table 18—Modulation –dependent parameters, 3/29/2012, p1590.

³⁷ If available. Commercially available DSRC devices may not support 20 MHz channels.

more complex modulation represents the high data rate applications possible in the future (27 Mbps in this case) to provide a bounding case that would be more vulnerable to interference.

4.9 Antenna Characterization and Calibration

4.9.1 Purpose

This task calibrates the antennas so that the variable gain of the antenna patterns can be removed from the over the air signal power measurements between the DSRC and U-NII radios. Doing so will let us more accurately recognize and measure multipath and interference.

USDOT ANALYSIS PLAN OBJECTIVES MET	
1	Develop RF analysis capability
4	Interference with transmitted BSMs
5	Suppression of BSMs by CCA
6	Effects on channel quality
7	Detection sensitivities
8	Effect of U-NII-4 channel width
9	Impact on U-NII-4 performance

4.9.2 Description

None of the antennas used in the analysis will be perfectly isotropic, that is radiating or receiving equally in all directions. That means the antenna is more sensitive at some elevation and some azimuthal angles than others. This introduces a systematic error into the power measured between a transmitter and a receiver due to energy that is not received simply due to the orientation of the antennas. An antenna pattern measures this change in sensitivity with angle.

Using the antenna patterns of the two antennas (transmit and receive), power measurements between two radios can be corrected to provide the same result as if the communications occurred with perfectly isotropic antennas. Then variations in power must be the result of other phenomena such as range, multipath and interference for example. Not correcting for the patterns can mask these other phenomena and often power variation or errors are incorrectly attributed to them when they are actually due to a null or lobe in an antenna pattern.

To accurately complete this task requires a facility and expertise in antenna measurement. That would typically require an organization that has an anechoic chamber, open air range or near field probe.

4.9.3 Equipment

- Mobile and fixed antennas for DSRC devices that will be used to make measurements in Sections 5 and 6.

- Mobile and fixed antennas for unlicensed devices that will be used to make measurements in Sections 5 and 6.
- Standard gain horn calibrated for the 5-6 GHz band.
- Precision rotational positioners with 360 degree movement around at least one axis.
- Anechoic chamber, open air range or near field probe calibrated or characterized for the 5-6 GHz band.
- Vector signal analyzer.

4.9.4 Data to Collect

Table 4-18: Antenna Pattern Calibration Data Collection Matrix

Device/Parameter	Range	Resolution	Notes
Instrument configuration			
Vector analyzer model, ID			
Instrumentation uncertainties			
Transmitted power setting			
Transmitted modulation	CW		
Antenna configuration			
Type, model, ID			
Reference points for front and up			
Antenna height	variable		May be varied to get elevation angle
Reference antenna height			
Gain of reference antenna			
Antenna pattern identifier			
Polarization	Vertical		Horizontal can also be measured
Antenna measurements			
Frequency	5-7 GHz		
Return loss (VSWR)			
Transmitted RF power			
Received RF power			
Received signal phase			
Antenna azimuthal angle	0-360°	1°-5°	
Antenna elevation angle	±45°	1°-2°	

4.9.5 Analysis Activities

For each antenna, measure the return loss across the frequencies of interest (5-7 GHz) to insure that the antenna is resonant at the proper frequencies and in good working order.

Measure antenna power while rotating the antenna about one axis, increment the other angle and repeat. Increment the frequency and repeat. Modern instrumentation is fast enough that frequency may be swept during the rotation eliminating the need for a separate iteration for frequency.

Generate plots and data files of the antenna patterns for correcting power measurements in the field.

5. Baseline Device Performance Measurements

5.1 DSRC Band Background Noise Level Analysis

5.1.1 Purpose

To measure ambient noise and then measure changes to it in the presence of different transmitters in-channel and in adjacent channels for a few select configurations. Transmitters examined will be DSRC, U-NII-3 and U-NII-4. This strictly looks at energy injected into the band independent of modulation.

Data from these measurements will establish the noise level for subsequent analysis and measure energy leaked in from adjacent bands and channels. It may also be used in NTIA models investigating deployment scale effects.

USDOT ANALYSIS PLAN OBJECTIVES MET	
3	Effects on background noise levels

5.1.2 Description

Calibration: First, we will measure the ambient noise level in a DSRC channel specified by table 5-4 with a DSRC OBE receiver.

Adjacent channel interference: Then measure ambient noise level as DSRC units in adjacent channels transmit at a selection of powers and modulations. That includes anticipated operation of both RSEs and OBEs including high power channel 184. This measures the effect of DSRC operations on the noise level in adjacent channels and nearby channels.

The result is an indirect measure of the DSRC transmitter emission characteristics as well as receiver adjacent channel rejection. If more direct measurement of the transmission mask becomes necessary, we will repeat the measurements using a vector signal analyzer to receive. If more direct measurement of the receiver filtering becomes necessary, we will repeat the measurements using a vector signal generator to transmit.

Then we will measure noise level in the DSRC channel as the U-NII-3 and U-NII-4 devices transmit in the adjacent band according to their anticipated operation in a few select configurations. As with the DSRC transmitter, the U-NII transmitter can be simulated with a vector signal generator where additional precision is required or to explore the effect of alternate out of band emission limits.

Note that in the absence of potential U-NII-4 devices we will simulate U-NII-4 with U-NII-3 devices operating under U-NII-3 rules but in the DSRC band. That means dialing up the frequency.

In channel interference: We measure signal power in a DSRC channel with an in channel DSRC transmitter including distances where it is supposed to be out of range to look for effects on the noise level. We will examine closer ranges as well to consider the hidden terminal problem. This activity measures the effect on noise level from nearby DSRC radios at ranges where the CCA will not suppress transmissions. If further sensitivity is required, we will use a vector signal analyzer to measure the change in noise floor due to a distant DSRC transmitter.

We then measure noise level with U-NII-4 transmitters in the same channel at different powers and ranges according to typical anticipated scenarios. That includes distances just out of range where the CCA mechanism will make the radio back off. This will show what U-NII-4 devices that do not cease transmission will do to the noise level.

Multiple runs of each measurement will account for natural variances. More runs are necessary when the measurements vary a lot and fewer when they are more stable. Determine the number of runs in the field. Use a signal analyzer to monitor the channel throughout all the above measurements to detect spurious signals that could introduce error into the baseline measurements. In addition, at the beginning and end of each day, every device under test that day will have a sample of received power measurements compared to the simultaneously received power of the signal analyzer. These measurements must be in range of measurements made during the power calibration measurements of section 4.4.3. We will use experience with early measurements to determine the threshold for satisfactory repeatability.

5.1.3 Equipment

List in section 4.3.1, Table 4-6, minus the following:

- CCTV hardware
- UAS hardware

5.1.4 Data to Collect

Table 5-1: DSRC Noise Level Data Collection Matrix

Device/Parameter	Range	Resolution	Notes
Receiver configuration			
Type, model, ID			
Antenna height			
Antenna orientation - Azimuth	0-360°		
Antenna orientation - Elevation ³⁸	±45°		
Antenna pattern identifier that will be used to determine gain in direction of transmitter			
Other fixed receiver settings			

³⁸ Vertical tilt angle can be level (0 degrees), negative (looking down) or positive (looking up)

Device/Parameter	Range	Resolution	Notes
Receiver measurements			
Received channel (frequency)			
Channel bandwidth	10-20MHz		
Received RF power			
Transmitter(s) configuration			
Type, model, ID			
Antenna height			
Antenna orientation - Azimuth	0-360°		
Antenna orientation - Elevation [°]	±45°		
Antenna pattern identifier that will be used to determine gain in direction of receiver			
Other fixed transmitter settings			
Transmitter Variables			
Transmitter channel (frequency)			
Channel bandwidth	10-20MHz		
Distance between transmitter and receiver			GPS or survey
Orientation between transmitter and receiver			
Transmitted power			
Transmitted modulation			
Transmitted data rate			
Transmitted packet rate			
° Vertical tilt angle can be level (0 degrees), negative (looking down) or positive (looking up)			

Note: Receiver type will be DSRC. Transmitter type may be DSRC, U-NII-3 and U-NII-4.

5.1.5 Analysis Activities

To look at how in-band and adjacent band DSRC and U-NII transmitters affect the ambient noise level, we will measure the noise level in all 6 DSRC channels that are not being used while operating a DSRC or U-NII radio in one of the channels. We will measure the noise level in all 7 DSRC channels while operating a U-NII-3 radio in the adjacent U-NII-3 band below the DSRC band.

If more sensitivity is required than provided by the DSRC receiver, we will use a vector signal analyzer to measure the change in noise floor due to a distant DSRC transmitter in these channels. Data from a vector signal analyzer may be more useful for NTIA modeling of the effect on ambient noise floor while data from a DSRC device will be helpful modeling receiver sensitivity.

To minimize the number of runs, we will start with the highest power scenarios and step down the power until no effect is observed. This will spare us from doing runs where any effects will not be

measurable. We will do a number of runs, to be determined in the field, to characterize the natural variability in the background. This is to be able to distinguish the effect of unlicensed signals from natural variations in the background. Fewer runs will be necessary if the background variation has a Gaussian distribution than a more irregular distribution. This needs to be determined with the first set of measurements.

We will use a fixed RSU as the receiver and transmit from an instrumented vehicle nearby. If transmission adds to the noise level in other channels we will slowly drive the vehicle away from the transmitter until any effects are not measurable. The result will show the interaction of DSRC receiver sensitivity with the transmission masks of DSRC and U-NII-3 radios characterized by power and range. A spectrum analyzer will monitor the background to catch spurious signals that might occur during the measurements so we can discard invalid measurements.

Appendix C lists the candidate transmit powers considered for these measurements. Table 5-2 lists the transmit powers selected for the measurements. The FCC limits the DSRC transmitter power that is input to the antenna to 28.8 dBm. If the commercial devices examined limit power output at this level, higher EIRPs will be generated with either higher gain antennas or a vector signal generator. Since antenna patterns introduce uncertainty it is more important to approach and document the levels attained than to achieve exactly the levels given in the table.

We will use a vector signal analyzer to measure the transmission mask of both the DSRC and U-NII devices to look directly at the power levels leaked out of channel to correlate with the noise measurements by DSRC radios on the other DSRC channels. This analysis can be done in the lab.

We will use a vector signal generator in the lab to examine how the DSRC receiver sensitivity varies with frequency and establish its adjacent channel rejection ability. This is again to know what to expect from field measurements and to ensure consistent explainable results.

Table 5-2: Radiated DSRC Power Levels Selected for Analysis

EIRP ³⁹ dBm	EIRP <i>mW</i>	Remarks
0	1.0	Baseline for handheld DSRC and class A (15 m range) RSUs
10	10	Baseline for class B RSU (100 m range)
20	100	Baseline for class C RSU (400 m range)
23	200	Baseline for the low power 10 MHz service channels and the 20 MHz channels
30	1 W	Baseline for U-NII access point and close to baseline for class D (1000 m range) RSUs
33	2 W	Baseline for the high power DSRC service channels (all 10 MHz). Most common power likely to be used.
40	10 W	Baseline for max power on channel 184
44.8	30 W	Baseline for max power on channel 178

³⁹ The Effective Isotropic Radiated Power (EIRP) can be larger than the transmitter output power because it includes antenna gain. [EIRP = transmitter output power – cable losses + antenna gain]

The activity will simply be to measure power in each DSRC channel during every measurement run. Table 5-3 summarizes the type of runs, which are detailed in tables 5-4 and 5-5.

Table 5-3: Summary of Measurement Runs

Transmitter(s)	Number of Device Pairs	Tx Frequency	Comment
NONE			Establish ambient background noise level
DSRC	Single	In-channel	Noise added by radio too far to trigger CCA
		Adjacent channel	Noise leaked into nearby channels
	Multiple	In-channel	Small deployment scale of Single Tx meas
		Adjacent channel	“ “ helpful if single device meas is too small
U-NII-3	Single	Adjacent band	Power leakage out of band
		Multiple	Adjacent band
U-NII-4	Single	In-channel	Noise added by radio too far to trigger CCA
		Adjacent channel	Noise leaked into nearby channels
	Multiple	In-channel	Small deployment scale of Single Tx meas
		Adjacent channel	“” “ helpful if single device meas is too small

Measure RF power in every DSRC channel for every test condition in tables 5-4 and 5-5 below.

Table 5-4: Baseline U-NII Noise Level Runs

Radio Pair (1 Mobile and 1 Stationary)	Range (m)	Bandwidth (MHz)	Tx Channel Number (U-NII-4 band)	Modulations (from early results of Section 4.7) [□]	EIRP dBm	Packet Sizes (octets)
Baseline – no transmitters	n/a	n/a	n/a	n/a	n/a	n/a
Single U-NII-3	10 until no signal	20	U-NII-3 CH 165	½BPSK, ¾QAM-64	36	300 and 1500
Multiple U-NII-3	10 until no signal	20	U-NII-3 CH 165	½BPSK, ¾QAM-64	36	300 and 1500
Single U-NII-4	10 until no signal	20	173, 177, 181	½BPSK, ¾QAM-64	36, 20	300 and 1500
Multiple U-NII-4	10 until no signal	20 40 ⁴⁰	173, 177, 181 175	½BPSK, ¾QAM-64	36, 20	300 and 1500

⁴⁰ One or more 40 MHz runs will be done to see if the energy it puts into the 10 MHz DSRC channel is half the energy that a 20 MHz channel injects. This will test whether the effect on the noise level by the wider U-NII-4 channels can be simply scaled from the 20 MHz measurements. If not, then we will add measurement runs at 40, 80 and 160 MHz.

□ See text at the end of Section 4.7.5

Table 5-5: Baseline DSRC Noise Level Runs

Radio Pair (1 Mobile and 1 Stationary)	Range (m)	Bandwidth (MHz)	Tx Channel Number (DSRC band)	Modulations (from initial results of Section 4.8)	Transmit Power (dBm)‡	Packet Sizes (octets)
Baseline – no transmitters	n/a	n/a	n/a	n/a	n/a	n/a
Single IEEE 802.11p (DSRC)	10 until no signal	10	172	½QPSK, ¾QAM-64	33 , 23 , 20, 15, 10, 0	300 and 1500
Single IEEE 802.11p (DSRC)	10 until no signal	10	178	½QPSK, ¾QAM-64	44.8, 33 , 20	300 and 1500
Single IEEE 802.11p (DSRC)	10 until no signal	10	184	½QPSK, ¾QAM-64	40, 33 , 20	300 and 1500
Single IEEE 802.11p DSRC	10 until no signal	20†	175, 181	½QPSK, ¾QAM-64	23 , 20	300 and 1500
Multiple IEEE 802.11p (DSRC)	10 until no signal	10	172	½QPSK, ¾QAM-64	33 , 23 , 20, 15, 10, 0	300 and 1500
Multiple IEEE 802.11p (DSRC)	10 until no signal	10	178	½QPSK, ¾QAM-64	44.8, 33 , 20	300 and 1500
Multiple IEEE 802.11p (DSRC)	10 until no signal	10	184	½QPSK, ¾QAM-64	40, 33 , 20	300 and 1500
Multiple IEEE 802.11p DSRC	10 until no signal	20†	175, 181	½QPSK, ¾QAM-64	23 , 20	300 and 1500

† Skip these runs if DSRC devices that operate at 20 MHz are not available.

‡ Number of power settings reduced. See explanation at end of Section 4.4.3.2. ($EIRP \sim TxPwr+5dBm$)

5.2 DSRC Device Baseline Performance Measurements

5.2.1 Purpose

Determine the baseline performance of DSRC reception in terms of power, error rate and the selected channel quality metrics in order see how these change when unlicensed radios are introduced in later analysis. This creates the reference data for subsequent analysis and inputs for NTIA/ITS models.

This analysis characterizes normal operation of DSRC devices, which is necessary to be able to tell the difference between interference and normal operation in the interference analysis that follows. This data may also be used in NTIA/ITS models investigating deployment scale effects.

USDOT ANALYSIS PLAN OBJECTIVES MET	
4	Interference with transmitted BSMs
5	Suppression of BSMs by CCA
6	Effects on channel quality
7	Detection sensitivities
8	Effect of U-NII-4 channel width
9	Impact on U-NII-4 performance

5.2.2 Description

Signal power and other channel control metrics will be measured and recorded at a DSRC receiver as a DSRC transmitter is moved toward and away from the receiver. Distance will be measured by GPS and all data will be time-stamped to correlate the RF and position measurements. This will provide the baseline signal power over distance data for each type of radio. The measurements will be done separately, first with DSRC equipment and then with U-NII equipment in the following activity (See section 5.3). Multiple runs will account for natural variances. Data will be collected for an OBU using an external antenna on the roof of the car and the integral antenna in an aftermarket OBU for installation inside the vehicle. In addition, a spectrum analyzer will monitor the background to detect spurious signals that could introduce error into the baseline measurements.

The antennas of the DSRC RSUs and OBUs are not isotropic so their antenna gains vary with elevation angle. That requires correcting the data with the measured antenna patterns of both antennas (see section 4.9). That introduces uncertainty into the results. Therefore, the measurements must be repeated for multiple elevation angles of the fixed mounted RSU and the vehicles carrying the OBUs must travel on a flat surface on order to generate repeatable signal-over-distance measurements.

In practice, the RSU elevation angle may to be tilted down from horizontal to maximize RF power on the vehicle by aiming the boresight of the antenna pattern to where the vehicles travel rather than to the horizon. For one set of parameters we will make signal-over-distance measurements with the RSU DSRC antenna aimed at the horizon and then 2 or 3 angles tilted down. We will select those angles based on the measured antenna patterns to create different scenarios that will be useful for the interference

analysis. It is likely that only a subset of runs will be done at all the elevation angles for comparison. Whether runs must be made for all parameters at each elevation angle will be determined in the field.

In addition, we will do a set of runs with the antenna aimed horizontally but at a few different heights from 2 to 15 meters. The horizontally aimed antenna 2m high is the bounding case which will put the maximum EIRP on the vehicle for the entire range. That is because the vehicle antenna will always be near the peak of the fixed mounted antenna’s beam.

5.2.3 Equipment

Lists in section 4.3.1 minus the following:

- U-NII-3 Wi-Fi development kit
- CCTV hardware
- UAS hardware
- EPCs

5.2.4 Data to Collect

Table 5-6: DSRC Performance Baseline Data Collection Matrix

Device/Parameter	Range	Resolution	Notes
Receiver configuration			DSRC
Type, model, ID			
Antenna height			
Antenna elevation angle			
Antenna orientation - Azimuth	0-360°		
Antenna orientation - Elevation ⁴¹	±45°		
Antenna pattern identifier that will be used to determine gain in direction of transmitter			
Other fixed receiver settings			
Receiver measurements			
Received channel (frequency)			
Channel bandwidth	10-20MHz		
Received RF power			
Received Signal Strength Indicator (RSSI)			From DSRC box
Signal-to-Noise (S/N)			Calculate or from Vector A
Packet Error Rate (PER)			From DSRC box
Packet Reception Rate (PRR)?			From DSRC box

⁴¹ Vertical tilt angle can be level (0 degrees), negative (looking down) or positive (looking up)

Device/Parameter	Range	Resolution	Notes
Packet transmit time			Logged by the transmitter
Packet receive time			Logged by the receiver
Inter-packet gap?			From Tx and Rec times?
Transmitter(s) configuration			DSRC
Type, model, ID			
Antenna height			
Antenna elevation angle			
Antenna orientation - Azimuth	0-360°		
Antenna orientation - Elevation ^o	±45°		
Antenna pattern identifier that will be used to determine gain in direction of receiver			
Other fixed transmitter settings			
Transmitter Variables			
Transmitter channel (frequency)			
Channel bandwidth	10-20MHz		
Distance between transmitter and receiver			GPS or survey
Orientation between transmitter and receiver			
Transmitted power			
Transmitted modulation			
Transmitted data rate			
Packet size			
Packet transmission rate			
Vehicle window position	Up-down		Not needed for DSRC?
Spectrum analyzer configuration			Monitor background to verify that observed signals are DSRC and not something else in the ambient RF environment.
Model, ID			
Antenna height			
Antenna orientation – Azimuth	0-360°		
Antenna orientation - Elevation ^o	±45°		
Other fixed settings			
Spectrum analyzer measurements			
Bandwidth setting			
Frequency vs power plots			

Device/Parameter	Range	Resolution	Notes
Channel power			One value per 10 MHz channel per sec, all channels almost simultaneously
Waveform			High resolution power with time if a spurious signal is detected
Signal quality (e.g., EVM)			Determine impact of multipath and beam nulls on modulation
Environmental data			
Precipitation	Time, type (rain, snow, sleet, hail)		Potential for signal attenuation
Surface condition	Wet/dry/snow/ice		May affect multipath
Wind events	Time, wind speed		Identify possible shaking of mast mounted antennas
Temperature			
Humidity			
° Vertical tilt angle can be level (0 degrees), negative (looking down) or positive (looking up)			

Note: Both transmitter and receiver device type will be DSRC.

5.2.5 Analysis Activities

Examining the DSRC radios without interference provides a benchmark needed to see how their performance changes in the presence of unlicensed device signals. We will install an IEEE 802.11p DSRC device on a mast at a height of 18 feet to simulate the traffic light mast at an intersection and have a second device in an instrumented vehicle. This will provide an RSU to OBU baseline.

The instrumented vehicle will start 100 feet behind the RSU, proceed past the RSU and then downrange until signal disappears. Then turn around and repeat the measurement path in the opposite direction. Figure 5-1 pictures potential areas on the runways at the Aberdeen site. The velocity of the instrumented vehicle will be determined in the field after the tradeoff between time to collect data, fidelity of the data and safety considerations are better known.

The analysis team will repeat the measurements replacing the fixed RSU with a stationary vehicle parked at that location to characterize an OBU to OBU baseline.

Transmit power: Table 5-5 in the previous section lists the transmit powers selected for the analysis.

Packet length: We selected two packet lengths for analyzing DSRC messages.

- 1) 300 bytes which is typical for a BSM.
- 2) 1500 bytes which is the maximum allowable WAVE short message size. Note that larger packets might occur when exchanging V2I data with a data warehouse.



Figure 5-1: Baseline Measurement Area for IEEE 802.11p and IEEE 802.11ac Radios

Packet content: Measurements may occur with simulated BSM and SPaT data for more “realism” or with test packets containing specific patterns of bits (e.g., all zeros) at the discretion of the analysis team. Test packets may be needed to diagnose interference if detected.

Channel width: Examine both 10 MHz and 20 MHz DSRC channels if commercial equipment is available. The 10 MHz channels will be 172, 178 and 184. Channel 172 is representative of all the service channels and will be overlapped by U-NII-4 channels in any sharing scenario. Channel 178 allows for the highest DSRC EIRP (30W), and Channel 184 is allowed 10W signals. Because it will also be overlapped in any sharing scenario we will study channel 175 as the 20 MHz channel.⁴²

Repetition: Repeat each measurement run to total at least ten runs initially to get a sense of the natural variability in performance and catch any runs with an outlier condition. More runs will be necessary if the background variation is not Gaussian but a more irregular distribution. Fewer runs will suffice if the variability is low. This needs to be determined with the first set of measurements. We will run a spectrum analyzer in the background to catch any spurious signals that could show up in the environment during measurements. We will compute the average signal level versus distance and average PER versus RSSI and range from the data collected.

Modulation: Collect data using the modulations identified in Section 4.7.5. Analysis described in section 4.8 above will determine if a DSRC modulation is more vulnerable in order to examine worst case as well

⁴² We will drop or defer the 20 MHz channel tests if DSRC devices that can be programmed for 20 MHz are not readily available.

as what might be a more typical case. Identical baseline measurements will be conducted using IEEE 802.11ac radios (see Section 5.3).

Range: From 5 meters until there is no measurable signal OR the limit of the test facility is reached.

Elevation angle: Initially aim the RSU antenna at the horizon (zero degrees) which is the first bounding case since RSUs will rarely be aimed upward. The other bounding case with maximum tilt downward will be determined in the field. Examine two other elevation angles equally spaced in between these bounding cases. This plus the measured antenna patterns should provide enough data to interpolate to other angles for further study or simulation.

Height: Elevation angle measurements will be made at 18 feet.⁴³ Also examine heights of 2, 6, 10 and 15 meters. These heights up to the FCC limit of 15 meters allow interpolation for modeling or analysis of scenarios at various heights.

Power calibration check: In addition, at the beginning and end of each day, every device under test that day will have a sample of received power measurements compared to the simultaneously received power of the signal analyzer. These measurements must be in range of measurements made during the power calibration measurements of section 4.4.3. We will use experience with early measurements to determine the threshold for satisfactory repeatability.

Tables 5-7 and 5-8 summarize the baseline DSRC measurements.

⁴³ Standard RSU test height will be 18 feet. The FCC limit to avoid a required adjustment to antenna gain is 6m (19.7 ft) and the MUTCD restricts signal heads to above 15' and below 25.6' above the road. 18 feet fits in this range so is representative of actual installations and attainable with readily available collapsible masts.

Table 5-7: DSRC RSU-to-OBU Baseline Performance Measurements – No Interference

Radio Pair (1 OBU Mobile and 1 RSU Stationary)	Bandwidth (MHz)	Channel Number (DSRC band)	Modulations (from results of Section 4.8)	Transmit Power (dBm)‡	Packet Sizes (octets)
IEEE 802.11p – external antenna (DSRC)	10	172	½QPSK, ¾QAM-64	33, 23 , 20, 15, 10, 0	300 and 1500
IEEE 802.11p – internal antenna (DSRC)	10	172	½QPSK, ¾QAM-64	33, 23 , 20, 15, 10, 0	300 and 1500
IEEE 802.11p – external antenna (DSRC)	10	178	½QPSK, ¾QAM-64	20, 33 , 44.8 ⁴⁴	300 and 1500
IEEE 802.11p – external antenna (DSRC)	10	184	½QPSK, ¾QAM-64	20, 33 , 40	300 and 1500
IEEE 802.11p – external antenna (DSRC)	20†	175, 181	½QPSK, ¾QAM-64	20 23	300 and 1500

† Skip these runs if DSRC devices that operate at 20 MHz are not available.

‡ Number of power settings reduced. See explanation at end of Section 4.4.3.2. ($EIRP \sim TxPwr+5dBm$)

Repeat measurements in table 5-7 with the RSU aimed at elevation angle zero (horizontal) and three other angles tilted downward to be determined in the field. Repeat a subset for the heights specified above.

When changing a parameter results in insignificant variation we will reduce or eliminate changes to that variable to reduce the effort. Conversely, where results are more sensitive to a variable than anticipated we will increase the resolution or number of iterations of that variable as necessary. This scaling of effort will occur in the field and applies to all activities in this plan.

⁴⁴ Or whatever is attainable given that commercial off-the-shelf DSRC devices have not yet operated at this level.

Table 5-8: DSRC OBU-to-OBUs Baseline Performance Measurements – No Interference

Radio Pair (1 OBU Mobile and 1 OBU Stationary)	Bandwidth (MHz)	Channel Number (DSRC band)	Modulations (from results of Section 4.8)	Transmit Power (dBm)‡	Packet Sizes (octets)
IEEE 802.11p – both external antenna (DSRC)	10	172	½QPSK, ¾QAM-64	33, 23 , 20, 15, 10, 0	300 and 1500
IEEE 802.11p – one internal antenna (DSRC)	10	172	½QPSK, ¾QAM-64	33, 23 , 20, 15, 10, 0	300 and 1500
IEEE 802.11p – both external antenna (DSRC)	10	178	½QPSK, ¾QAM-64	20, 33 , 44.8 ⁴⁵	300 and 1500
IEEE 802.11p – both external antenna (DSRC)	10	184	½QPSK, ¾QAM-64	20, 33 , 40	300 and 1500
IEEE 802.11p – both external antenna (DSRC)	20†	175, 181	½QPSK, ¾QAM-64	23 , 20	300 and 1500

† Skip these runs if DSRC devices that operate at 20 MHz are not available.

‡ Number of power settings reduced. See explanation at end of Section 4.4.3.2. ($EIRP \sim TxPwr + 5dBm$)

⁴⁵ Or whatever is attainable given that commercial off-the-shelf DSRC devices have not yet operated at this level.

5.3 U-NII-3 and U-NII-4 Device Baseline Performance Measurements

5.3.1 Purpose

Determine the baseline performance of U-NII-3 and U-NII-4 reception in terms of power, error rate and the selected channel quality metrics in order see how these change when these unlicensed radios are introduced into DSRC communication scenarios in later analysis. This analysis activity also will provide inputs for NTIA models.

This analysis characterizes normal operation of U-NII-3 and U-NII-4 devices, which is necessary to be able to tell the difference between interference and normal operation in the interference analysis that follows. This data may also be used in NTIA models investigating deployment scale effects.

USDOT ANALYSIS PLAN OBJECTIVES MET	
4	Interference with transmitted BSMs
5	Suppression of BSMs by CCA
6	Effects on channel quality
7	Detection sensitivities
8	Effect of U-NII-4 channel width
9	Impact on U-NII-4 performance

5.3.2 Description

Signal power and other channel control metrics will be measured and recorded at a U-NII-3 or 4 receiver as a U-NII-3 or 4 transmitter is moved toward and away from the receiver. Distance will be measured by Real time Kinematic GPS (RTK-GPS) and all data will be timestamped to correlate the RF and position measurements. This will provide the baseline signal power over distance data for each type of radio. The measurements will be done separately, first with DSRC equipment in the previous activity and then with U-NII equipment in this activity. Multiple runs will account for natural variances. In addition, a spectrum analyzer will monitor the background to detect spurious signals that could introduce error into the baseline measurements.

There are more use cases for the 802.11ac devices so we need to run more configurations than for the DSRC devices (see section 5.2). The first configuration will be the same as the DSRC RSU-to-OBU measurements. That is an unlicensed access point mounted on the traffic signal mast arm with another mounted on a vehicle or with an external antenna as would be the case for a vehicle with an installed Wi-Fi option.

The second configuration accounts for U-NII-4 devices incorporated in handheld and portable devices, such as laptops, tablet computers and cellular phones. These would operate at lower powers and be carried inside the vehicles, where the windows might be up or down.

The third configuration is the same but with an indoor Wi-Fi access point.

Note that these are the same surrogate U-NII-4 devices that were setup and qualified in Section 4.7.

5.3.3 Equipment

Lists in section 4.3.1 minus the following:

- Fixed DSRC radio
- Mobile DSRC radio – external antenna
- Mobile DSRC radio – integral antenna
- CCTV hardware
- UAS hardware

5.3.4 Data to Collect

Table 5-9: U-NII-4 Performance Baseline Data Collection Matrix

Device/Parameter	Range	Resolution	Notes
Receiver configuration			
Type, model, ID			
Antenna height			
Antenna elevation angle			
Antenna orientation - Azimuth	0-360°		
Antenna orientation - Elevation ^o	±45°		
Antenna pattern identifier that will be used to determine gain in direction of transmitter			
Other fixed receiver settings			
Receiver measurements			
Received channel (frequency)			
Channel bandwidth	10-20MHz		
Received RF power			
Received Signal Strength Indicator (RSSI)			From SDK?
Signal-to-Noise (S/N)			Calculate or from Vector A
Packet Error Rate (PER)			From SDK?
Packet Reception Rate (PRR)?			From SDK?
Packet transmit time			Logged by the transmitter
Packet receive time			Logged by the receiver
Inter-packet gap?			From Tx and Rec times?

Device/Parameter	Range	Resolution	Notes
Transmitter(s) configuration			
Type, model, ID			
Antenna height			
Antenna elevation angle			
Antenna orientation - Azimuth	0-360°		
Antenna orientation - Elevation [◊]	±45°		
Antenna pattern identifier that will be used to determine gain in direction of receiver			
Other fixed transmitter settings			
Transmitter Variables			
Transmitter channel (frequency)			
Channel bandwidth	10-20MHz		
Distance between transmitter and receiver			GPS or survey
Orientation between transmitter and receiver			
Transmitted power			
Transmitted modulation			
Transmitted data rate			
Packet size			
Packet transmit rate			
Vehicle window position	Up-down		
Spectrum analyzer configuration			
			Monitor background to verify that interfering signals are 11ac and not something else in the ambient environment.
Model, ID			
Antenna height			
Antenna orientation – Azimuth	0-360°		
Antenna orientation – Elevation [◊]	±45°		
Other fixed settings			
Spectrum analyzer measurements			
Bandwidth setting			
Frequency vs power plots			
Signal quality (e.g., EVM)			Determine the effect of multipath and beam nulls on modulation
[◊] Vertical tilt angle can be level (0 degrees), negative (looking down) or positive (looking up)			

Note: Both transmitter and receiver device type will be either U-NII-3 or U-NII-4.

5.3.5 Analysis Activities

The description in section 5.2.5 applies here only with unlicensed radios instead of DSRC radios with the following exception:

Packet length: We selected four packet lengths for analyzing DSRC messages.

- 1) 300 bytes, to represent the equivalent of BSM sized data packets and streaming audio
- 2) 1500 bytes, which is a typical video packet in Ethernet and some of the 802.11 protocols.
- 3) 9000 bytes, the packet in a “jumbo” frame used for streaming video and not uncommon.
- 4) 1,000,000 (1 million bytes), which is permitted by the 802.11ac standard

802.11ac video packets can be as large as a million bytes long. Longer packets provide small gains in efficiency and capacity by reducing the fraction of overhead bytes at the expense of latency. As a result we have added the two larger sized packets to represent streaming video. We will use the U-NII-3 video packet of 9000 bytes as a standard in the U-NII-4 measurements. We will use the million byte packet to stress a few scenarios to see the impact. Those results will indicate if it needs to be investigated further.

Packet content: Measurements may occur with actual data or video transmission, or with test packets containing specific patterns of bits (e.g., all zeros) at the discretion of the analysis team. Test packets may be used to diagnose interference if helpful. Note that interference to unlicensed devices is not a concern of this study except how it might affect the CCA mechanism which in turn impacts DSRC communications.

Height: Fixed point pole-mounted transmitters will be examined at heights of 2 meters and 18 feet. The 2 meter height should aim the peak of the beam at the vehicle down the entire range to achieve the maximum EIRP. We will determine in the field what tilt angle should be used, if any, for access point scenarios to be studied later.

Power scaling: Compare signal over distance runs of the 20, 40 and 80 MHz channels measured in the same 10 MHz DSRC channel to verify that the measured power decreases by half (-3dB) each time the channel width doubles as theory predicts for a simple transmitter.

All channels examined are proposed U-NII-4 channels that overlap the DSRC band as shown in figure 1-4.

At the beginning and end of each day, every device under test that day will have a sample of received power measurements compared to the simultaneously received power of the signal analyzer. These measurements must be in range of measurements made during the power calibration measurements of section 4.4.3. We will use experience with early measurements to determine the threshold for satisfactory repeatability.

Table 5-10 provides baseline signal-over-distance data for the U-NII-3 and 4 devices. Tables 5-11 and 5-12 provide baseline data for portable devices communicating with a curbside or building mounted access point for both windows open and windows closed scenarios. Tables 5-13 and 5-14 lists the measurement runs for portable devices communicating with indoor Wi-Fi access points.

If runs with the windows open show little difference from the same run with windows closed, a few open window runs with different settings can be done to establish that fact and the rest of the open window runs deferred or dropped to save time.

If it is not possible to control the modulation, or other critical parameters, of the surrogate or proposed U-NII-4 devices as a variable, then develop repeatable test cases based on actual Wi-Fi use cases. Use these test cases to program the input to the surrogate (or proposed) devices for transmission as a replacement for Tables 5-10 to 5-14 below. Create a minimum of two test cases: one to be a challenging worst-case and another to be a typical but challenging Wi-Fi deployment. The latter case must fill the airtime and spectrum the same way as actual Wi-Fi operations. The objective is to have test cases that will be repeatable, or at least stochastically repeatable, to insure consistency across all of the interference measurements. Develop additional cases as necessary to adequately explore likely interference scenarios. These scenarios must anticipate the exponential growth of Wi-Fi traffic.

Table 5-10: U-NII Baseline Performance Measurements – No Interference

Radio Pair (1 Mobile-external ant. and 1 pole mounted Stationary AP)	Bandwidth (MHz)	Channel Number (U-NII band)	Modulations (from early results of Section 4.7) [□]	EIRP (dBm)	Packet Sizes (octets)
IEEE 802.11ac U-NII-3	20	U-NII-3 CH 165	½BPSK, ¾QAM-64	36	300, 1500 and 9000
IEEE 802.11ac U-NII-4	20	173, 177, 181	½BPSK, ¾QAM-64	36, 20	300, 1500 and 9000 1Mb@36dBm
IEEE 802.11ac U-NII-4	40	175	½BPSK, ¾QAM-64	36	300, 1500 and 9000
IEEE 802.11ac U-NII-4	80	171	½BPSK, ¾QAM-64	36, 20	300, 1500 and 9000 1Mb@36dBm
IEEE 802.11ac U-NII-4	160 [†] (80)	163	½BPSK, ¾QAM-64	(33, 17)	300, 1500 and 9000

[†] If the power scaling measurements demonstrate the expected theoretical scaling it is possible to simulate 160 MHz (channel 163) by running the 80 MHz (channel 171) measurements at half power. The energy in any overlapped 10 MHz band will be the same as a 160 MHz channel at full power. We can also use the vector signal generator to transmit at 160 MHz

[□] See text at the end of Section 4.7.5

Table 5-11: Portable U-NII Baseline Performance Measurements, Windows CLOSED – No Interference

Radio Pair (1 Portable- inside car and 1 pole mounted Stationary AP)	Bandwidth (MHz)	Channel Number (U-NII band)	Modulations (from early results of Section 4.7) [□]	EIRP (dBm)	Packet Sizes (octets)
IEEE 802.11ac U-NII-3	20	U-NII-3 CH 165	½BPSK, ¾QAM-64	AP: 36 Port: 20, 10	300, 1500 and 9000
IEEE 802.11ac U-NII-4	20	173, 177, 181	½BPSK, ¾QAM-64	AP: 36, 20 Port: 20, 10	300, 1500 and 9000 1Mb@36dBm
IEEE 802.11ac U-NII-4	40	175	½BPSK, ¾QAM-64	AP: 36, 20 Port: 20, 10	300, 1500 and 9000
IEEE 802.11ac U-NII-4	80	171	½BPSK, ¾QAM-64	AP: 36, 20 Port: 20, 10	300, 1500 and 9000 1Mb@36dBm
IEEE 802.11ac U-NII-4	160+ (80)	163	½BPSK, ¾QAM-64	(AP: 33, 17 Port: 17, 7)	300, 1500 and 9000

Table 5-12: Portable U-NII Baseline Performance Measurements, Windows OPEN – No Interference

Radio Pair (1 Portable- inside car and 1 pole mounted Stationary AP)	Bandwidth (MHz)	Channel Number (U-NII band)	Modulations (from early results of Section 4.7) [□]	EIRP (dBm)	Packet Sizes (octets)
IEEE 802.11ac U-NII-3	20	U-NII-3 CH 165	½BPSK, ¾QAM-64	AP: 36 Port: 20, 10	300, 1500 and 9000
IEEE 802.11ac U-NII-4	20	173, 177, 181	½BPSK, ¾QAM-64	AP: 36, 30, 20 Port: 20, 10	300, 1500 and 9000 1Mb@36dBm
IEEE 802.11ac U-NII-4	40	175	½BPSK, ¾QAM-64	AP: 36, 30, 20 Port: 20, 10	300, 1500 and 9000
IEEE 802.11ac U-NII-4	80	171	½BPSK, ¾QAM-64	AP: 36, 30, 20 Port: 20, 10	300, 1500 and 9000 1Mb@36dBm
IEEE 802.11ac U-NII-4	160+ (80)	163	½BPSK, ¾QAM-64	(AP: 33, 17 Port: 17, 7)	300, 1500 and 9000

Table 5-13: Indoor Access Point to Portable U-NII Baseline Performance Measurements, Windows CLOSED – No Interference

Radio Pair (1 Portable-inside car and 1 indoor fixed AP)	Bandwidth (MHz)	Channel Number (U-NII band)	Modulations (from early results of Section 4.7) [□]	EIRP (dBm)	Packet Sizes (octets)
IEEE 802.11ac U-NII-3	20	U-NII-3 CH 165	½BPSK, ¾QAM-64	AP: 36 Port: 20, 10	300, 1500 and 9000
IEEE 802.11ac U-NII-4	20	173, 177, 181	½BPSK, ¾QAM-64	AP: 36, 20 Port: 20, 10	300, 1500 and 9000 1Mb@36dBm
IEEE 802.11ac U-NII-4	40	175	½BPSK, ¾QAM-64	AP: 36, 20 Port: 20, 10	300, 1500 and 9000
IEEE 802.11ac U-NII-4	80	171	½BPSK, ¾QAM-64	AP: 36, 20 Port: 20, 10	300, 1500 and 9000 1Mb@36dBm
IEEE 802.11ac U-NII-4	160+ (80)	163	½BPSK, ¾QAM-64	(AP: 33, 17 Port: 17, 7)	300, 1500 and 9000

Table 5-14: Indoor Access Point to Portable U-NII Baseline Performance Measurements, Windows OPEN – No Interference

Radio Pair (1 Portable-inside car and 1 indoor fixed AP)	Bandwidth (MHz)	Channel Number (U-NII band)	Modulations (from early results of Section 4.7) [□]	EIRP (dBm)	Packet Sizes (octets)
IEEE 802.11ac U-NII-3	20	U-NII-3 CH 165	½BPSK, ¾QAM-64	AP: 36 Port: 20, 10	300, 1500 and 9000
IEEE 802.11ac U-NII-4	20	173, 177, 181	½BPSK, ¾QAM-64	AP: 36, 30, 20 Port: 20, 10	300, 1500 and 9000 1Mb@36dBm
IEEE 802.11ac U-NII-4	40	175	½BPSK, ¾QAM-64	AP: 36, 30, 20 Port: 20, 10	300, 1500 and 9000
IEEE 802.11ac U-NII-4	80	171	½BPSK, ¾QAM-64	AP: 36, 30, 20 Port: 20, 10	300, 1500 and 9000 1Mb@36dBm
IEEE 802.11ac U-NII-4	160+ (80)	163	½BPSK, ¾QAM-64	(AP: 33, 17 Port: 17, 7)	300, 1500 and 9000

As noted in section 5.2 if variables such as opening and closing the windows do not affect the results we can dispense with later runs to reduce the measurement effort.

5.4 Detectability Analysis between DSRC and U-NII-4 devices

5.4.1 Purpose

The purpose of this analysis is to see if the sensitivities of DSRC and U-NII-4 receivers are different in such a way that increases the risk of interference. The more sensitive device will hear the other and keep quiet. The less sensitive device may transmit on top of the other device when it shouldn't.

Data from this analysis will show if interference stems from different sensitivities between DSRC and unlicensed devices. It may be used in NTIA/ITS models investigating deployment scale effects.

USDOT ANALYSIS PLAN OBJECTIVES MET	
7	Detection sensitivities
10	Potential mitigation

5.4.2 Description

A DSRC receiver and a U-NII-4 receiver will receive progressively lower powered signals until the minimum power receivable by each is determined. We will similarly determine the minimum signal that will cause the CCA to suppress transmission for both types of radio. Then the DSRC and U-NII-4 radios will operate in range of each other such that the level of both the DSRC and U-NII-4 transmissions at both receivers will be at a value in between the two minimum sensitivities that were determined. We will measure channel metrics to determine if the CCA mechanism favors one type of radio over the other when they use the same EDCA (enhanced distributed channel access) parameters. In order to see the effect of different receiver sensitivities we set the EDCA parameters to be the same. The same EDCA parameters should grant equal access. The measurement could be repeated with EDCA parameters that give priority to the DSRC communications to see if that is overwhelmed by the difference in sensitivities or can mitigate it. All of this analysis can occur in the lab.

Too much energy will saturate or possibly damage the receiver of a DSRC radio. An additional measurement conducted outdoors will determine if it is possible for a DSRC radio to be close enough to an unlicensed access point to saturate or be damaged. This analysis will also determine the range at which a DSRC radio will suppress transmission because it receives signals from an unlicensed access point and also the range at which the unlicensed access point would suppress transmission because it recognizes signals from a DSRC radio.

5.4.3 Equipment

List in section 4.3.1, Table 4-6, minus the following:

- CCTV hardware
- UAS hardware

5.4.4 Data to Collect

Not all variables below needed to be collected for all measurements in this section. For example, received power is the only measurement at the receiver in the initial sensitivity measurement.

Table 5-15: Detectability Data Collection Matrix

Device/Parameter	Range	Resolution	Notes
Receiver configuration			
Type, model, ID			
Antenna height			Should be same as Tx antenna
Antenna orientation – Azimuth	0-360°		
Antenna orientation – Elevation ^o	±45°		
Antenna pattern identifier that will be used to determine gain in direction of transmitter			
Other fixed receiver settings			
Receiver measurements			
Received channel (frequency)			
Channel bandwidth	10-20MHz		
Received RF power			
Received Signal Strength Indicator (RSSI)			
Signal-to-Noise (S/N)			
Packet Error Rate (PER)			
Packet Reception Rate (PRR)			
Channel busy percentage			
Inter-packet gap?			
Channel availability – access time			Key measurement for this analysis
Transmitter(s) configuration			
Type, model, ID			
Antenna height			
Antenna orientation – Azimuth	0-360°		
Antenna orientation – Elevation ^o	±45°		

Device/Parameter	Range	Resolution	Notes
Antenna pattern identifier that will be used to determine gain in direction of receiver			
Other fixed transmitter settings			
EDCA parameters (SIFS and contention window maximum)			
Transmitter Variables			
Transmitter channel (frequency)			
Channel bandwidth	10-20MHz		
Distance between transmitter and receiver			GPS or survey
Orientation between transmitter and receiver			
Transmitted power			
Transmitted modulation			
Transmitted data rate			
Transmitted packet rate			
Packet size			
Vector analyzer			Monitor spectrum for other interference
Model, ID			
◊ Vertical tilt angle can be level (0 degrees), negative (looking down) or positive (looking up)			

5.4.5 Analysis Activities

Receiver sensitivity

Set up the DSRC receiver near the spectrum analyzer (which will be an external reference). Transmit a test signal from the vector signal generator. Monitor the RSSI and received power signal at the DSRC receiver as the transmit power of the test signal is turned down to zero. Record the power at which the test signal can be distinguished from the noise. Record the signal on the spectrum analyzer. Repeat the measurement several times to gauge variability. The averaged result is the minimum receiver sensitivity.

Repeat the measurements with the U-NII-4 device.

Table 5-16: Receiver Sensitivity Lab Measurements

Device	Bandwidth (MHz)	Channel Number (DSRC and U-NII band)	Modulation	Transmit Power (dBm)	Packet Sizes (octets)
Vector signal Generator (VSG) transmitter	10	172, 184	TBD, Same for all measurements	10 dBm stepped down incrementally until no power received	CW 300 @ 10 Hz
	20	175, 173			
	40	175			
	80	171			
	160	163			
IEEE 802.11p Receiver	10	172, 184	n/a	n/a	n/a
	20†	175			
IEEE 802.11ac U-NII-4 Receiver	20	173	n/a	n/a	n/a
	40	175			
	80	171			

† Skip these runs if DSRC devices that operate at 20 MHz are not available.

CCA detectability

Set up the DSRC radio near the spectrum analyzer (which will be an external reference). Set the device to transmit BSMs or an equivalent short 10 Hz signal. Transmit a test signal from the vector signal generator. Starting at no power turn the transmitter power up slowly until the test signal causes the DSRC transmitter to suppress DSRC transmissions because the DSRC device believes the channel is occupied. Record the RSSI and received power at the receiver. Record the signal on the spectrum analyzer. Repeat the measurement several times to gauge variability. The averaged result is the minimum receiver detectability. This is the minimum signal that will make the radio back-off.

Repeat the measurements with the U-NII-4 device to determine at what minimum power the unlicensed device will conclude the channel is occupied.

Table 5-17: Minimum Detectability Lab Measurements

Device	Bandwidth (MHz)	Channel Number (DSRC and U-NII band)	Modulation	Transmit Power (dBm)	Packet Sizes (octets)
Vector signal Generator (VSG) transmitter	10	172, 184	TBD, Same for all measurements	Power stepped up until all devices under test are suppressing	CW 300 @ 10 Hz
	20	175, 173			
	40	175			
	80	171			
	160	163			
IEEE 802.11p Tx and Rec	10	172, 184	TBD, Same for all measurements	6 [‡]	300
	20 [†]	175			
IEEE 802.11ac U-NII-4 Tx and Rec	20	173	TBD, Same for all measurements	6 [‡]	300
	40	175			
	80	171			

[†] Skip these runs if DSRC devices that operate at 20 MHz are not available.

[‡] Any small power is fine as long as it is consistent in all tests.

Minimum signal interference

We will have DSRC and unlicensed devices transmit simultaneously while monitoring how they interact. Program a DSRC device and U-NII-4 device to have the same EDCA parameters. Set up a DSRC radio and a U-NII-4 radio in proximity to each other at the lowest transmit power that is common to both so that neither can detect each other. This might require range separation beyond what is possible indoors. Have both radios transmit 300 byte messages at a 10 Hz repetition rate. Then slowly step up the transmit power of both devices so the transmit power stays the same. Record the transmit power of the U-NII-4 device at which the DSRC radio’s CCA mechanism kicks in and it starts suppressing messages. Record the transmit power at which the U-NII-4 radio’s CCA mechanism kicks in and it starts suppressing messages. If the detection thresholds that activate suppression are not the same one radio will stifle the other at certain powers and ranges. If the DSRC device will always hear the unlicensed device and suppress its transmission before the unlicensed device hears the DSRC transmitter then detect-and-vacate cannot work in the regime between those two thresholds.

Once the CCA mechanism of both radios has been activated, monitor channel access times and suppression for both while incrementally turning up the power well beyond the minimum detectability of both radios. Repeat the measurement several times. With the same EDCA parameters channel access should be the same. Any differences are noteworthy.

Effect of packet size

Repeat the experiment but this time change the packet size of the U-NII-4 device to represent streaming video packets of 1500 bytes, 9000 bytes and 1 million bytes.

Effect of packet rate

Perform an experiment to see what happens to interference if the U-NII and DSRC devices transmit with different packet rates. Select channel, packet sizes, modulation, data rate, etc. based on earlier measurements that had measurable interference. Start with both devices using the same 10 Hz packet rate that DSRC uses. Then run the U-NII device at 4 or more different packet rates to see if interference increases or decreases. If results merit further discovery vary the DSRC data rate as well.

Effect of data rate

Similarly perform an experiment to determine how differing data rates affect interference. Select settings that have provided measurable interference. Set variables on the DSRC and U-NII devices to be identical. Then change the data rate (bit rate) of one radio to see if interference increases or decreases. Examine 4 or more differing data rates.

Effect of EDCA selection

Change the EDCA parameters so as to advantage the DSRC device and repeat the packet size measurements. Note the reduction in DSRC BSM suppression particularly in the regime between the minimum detectability of the two devices. Appendix B describes how these parameters work and ends with a table of illustrative values for enforcing different priorities.

Table 5-18: Minimum Signal, Packet Size and EDCA Interference Measurements

Single radios transmitting simultaneously	Bandwidth (MHz)	Channel Number (DSRC and U-NII band)	Modulations	Transmit Power (dBm)	Packet Sizes (octets)
IEEE 802.11p DSRC Tx and Rec	10 20 [†]	172, 184 175	TBD, Same for all measurements	Minimum stepped up until double the largest minimum detectability	300
IEEE 802.11ac U-NII-4 Tx and Rec	20 40 80	173 175 171	TBD, Same for all measurements	Identical to 802.11p at each step	300, 1500 and 9000 1Mb@36dBm

[†] Skip these runs if DSRC devices that operate at 20 MHz are not available.

Field measurements for range related effects on detectability

Too much energy will saturate or possibly damage the receiver of a DSRC radio. An additional measurement conducted outdoors will determine if it is possible for a DSRC radio to be close enough to an unlicensed access point to saturate or be damaged. This analysis will also determine the range at

which a DSRC radio will suppress transmission because it receives signals from an unlicensed access point and also the range at which the unlicensed access point would suppress transmission because it recognizes signals from a DSRC radio. The feedback between these two suppression mechanisms form an interactive system.

An unlicensed access point will be mounted 5 meters above the ground at a fixed location. A portable unlicensed device will be mounted 1 meter above ground at the same location. The DSRC device will be a vehicle mounted OBU. The vehicle will drive slowly in a straight line up to the mount holding the unlicensed devices. Runs for the AP and the portable unlicensed devices may have to be done separately.

These measurements have the following specific objectives:

1. Determine the range at which a DSRC device will start suppressing BSMs due to unlicensed signals.
2. Determine the range at which the 802.11ac devices will start suppressing messages due to DSRC signals.
3. Determine how close the DSRC device can approach the U-NII-4 access point before the receiver saturates or there is a risk of damage if at all. Stop the vehicle when the received power reaches 10 dB below the manufacturer’s specified burnout threshold if it gets that high.

The key output will be the ranges which these various transitions occur.

Table 5-19: Field Measurements for Range Related Effects on Detectability

Single radios transmitting simultaneously	Range	Bandwidth (MHz)	Channel Number (DSRC and U-NII band)	Transmit Power (dBm)	Modulations ⁴⁶	Packet Sizes (octets)
IEEE 802.11p – DSRC external antenna Tx and Rec	Start 300m or too far to detect until 0 or close to burn out	10 10 10 20+	172, 184 178 175	33, 20 EIRP~44.5° EIRP~40° 33, 20	½QPSK, ¾QAM-64	300
IEEE 802.11p – DSRC internal antenna Tx and Rec	Start 300m or too far to detect until 0 or close to burn out	10	172	33	½QPSK, ¾QAM-64	300

⁴⁶ Modulations selected based on results of Sections 4.7 and 4.8 testing.

IEEE 802.11ac U-NII-4 Tx and Rec	Fixed	20 40 80	173 175 171	36 36 36	½BPSK, ¾QAM-64	300, 1500 and 9000 1Mb@36dBm
IEEE 802.11ac U-NII-4 Tx and Rec	Fixed	20 40 80	173 175 171	20 20 20	½BPSK, ¾QAM-64	300, 1500 and 9000 1Mb@36dBm

† Skip these runs if DSRC devices that operate at 20 MHz are not available.

◇ Or as high as possible if commercial off the shelf DSRC equipment does not reach this EIRP.

In addition, at the beginning and end of each day, every device under test that day will have a sample of received power measurements compared to the simultaneously received power of the signal analyzer. These measurements must be in range of measurements made during the power calibration measurements of section 4.4.3.

6. Interference Analysis

6.1 Purpose

It is to measure the effects on DSRC communications in the presence of unlicensed U-NII-4 transmitters. Specifically to investigate anticipated real world scenarios of OBEs communicating with the OBE's in other vehicles and infrastructure mounted RSEs in the presence of unlicensed access points mounted outdoors, indoors and within a vehicle. Each activity described separately below is for a different scenario.

Data from this analysis will demonstrate whether or not unlicensed devices interfere with DSRC devices in common scenarios and if so to try to quantify it. It will also be input to NTIA/ITS models investigating deployment scale effects.

USDOT RESEARCH OBJECTIVES MET	
4	Interference with transmitted BSMs
5	Suppression of BSMs by CCA
6	Effects on channel quality
8	Effect of U-NII-4 channel width
9	Impact on U-NII-4 performance
10	Potential mitigation

Note that the format of Section 6 differs from the previous section to avoid repeating identical information for each scenario. The Equipment and Data to Collect sections that follow pertain to all the subsequent scenarios in Section 6. As summarized in Section 4.1, the five scenarios are:

Scenario 1: Outdoor access point near an intersection with RSE-to-OBE and OBE-to-OBE communications. (Described in section 6.4.)

Scenario 2: Indoor access point near an intersection with RSE-to-OBE and OBE-to-OBE communications. (Described in section 6.5.)

Scenario 3: In-vehicle access point and clients during RSE-to-OBE and OBE-to-OBE communications. (Described in section 6.6.)

Scenario 4: High speed rural V2V encounter near Access point with OBE-to-OBE communications. (Described in section 6.7.)

Scenario 5: Multiple access points and client devices along a corridor with RSE-to-OBE and OBE-to-OBE communications. (Described in section 6.8.)

The access points may be any unlicensed communication devices. We intended to start our analysis with 802.11ac Wi-Fi access points but may investigate any other Wi-Fi or unlicensed devices in these scenarios.

6.2 Equipment

The same equipment is used for all the interference analysis described in this section so appears here only.

Lists in section 4.3.1 minus the following:

- CCTV hardware
- UAS hardware

6.3 Data to Collect

The same data will be collected for all the interference analysis described in this section so is listed here only.

Table 6-1: Interference Data Collection Matrix

Device/Parameter	Range	Resolution	Notes
Receiver configuration			
Type, model, ID			Can be for 1 or 2 OBUs and 1 RSU
Antenna height			
Antenna orientation – Azimuth	0-360°		
Antenna orientation – Elevation ^o	±45°		
Antenna pattern identifier that will be used to determine gain in direction of transmitter			
Other fixed receiver settings			
Receiver measurements			
Received channel (frequency)			
Channel bandwidth	10-20MHz		
Received RF power			
Received Signal Strength Indicator (RSSI)			
Signal-to-Noise (S/N)			
Packet Error Rate (PER)			
Packet Reception Rate (PRR)			
Channel busy percentage			
Inter-packet gap			

Device/Parameter	Range	Resolution	Notes
Channel availability – access time			
Transmitter(s) configuration			For multiple DSRC and U-NII devices
Type, model, ID			
Antenna height			
Antenna orientation – Azimuth	0-360°		
Antenna orientation – Elevation [◊]	±45°		
Antenna pattern identifier that will be used to determine gain in direction of receiver			Antenna pattern measured in section 4.9
Other fixed transmitter settings			
Transmitter Variables			
Transmitter channel (frequency)			
Channel bandwidth	10-20MHz		
Distance between transmitter and receiver			GPS or survey
Orientation between transmitter and receiver			
Transmitted power			
Transmitted modulation			
Transmitted data rate			
Packet size			
Packet transmission rate			
Vehicle window position	Up-down		
Vector analyzer			
Model, ID			
Signal quality of DSRC transmission (e.g., EVM)			Modulation can be a more sensitive indicator of interference than PER and indicate why packets are being lost
[◊] Vertical tilt angle can be level (0 degrees), negative (looking down) or positive (looking up)			

The Vector Analyzer will be used to monitor background emissions to verify that interfering signals are from the devices under test and not something else in the ambient environment.

6.4 Scenario I: Outdoor Access Point

6.4.1 Purpose

See section 6.1.

6.4.2 Description

This activity looks at the effect of an externally mounted unlicensed access point on the ability of an OBU to communicate with an RSU and another OBU. This type of access point can be found on a commercial building as a Wi-Fi hub for passing client devices, to receive streaming video from CCTV surveillance cameras or be a building-to-building link. The DSRC communications examined are the ability of an RSU and OBU to receive BSMs from an OBU, and the OBU to receive SPaT messages from the RSU.

6.4.3 Equipment

See section 6.2.

6.4.4 Data to collect

See section 6.3.

6.4.5 Analysis activities

The radio equipment will be staged to simulate a typical outdoor Wi-Fi access point near an intersection. Figure 6-1 depicts such a scenario where a restaurant has installed one for customer use. An RSU to transmit SPaT messages will be mounted on a mast to simulate mounting with a traffic signal at an intersection. The RSU will receive BSMs from the moving OBU as well. An OBU will be in a vehicle parked there, or mounted on a mast, there to receive BSMs from the moving OBU. The second OBU will be in a vehicle that will move to change range. It will transmit BSMs and receive SPaT messages.

The unlicensed access point will be mounted on a building, structure, or mast near the intersection about 5 meters above the ground. The height selected should be one that was used in the baseline measurements (Section 5.3).

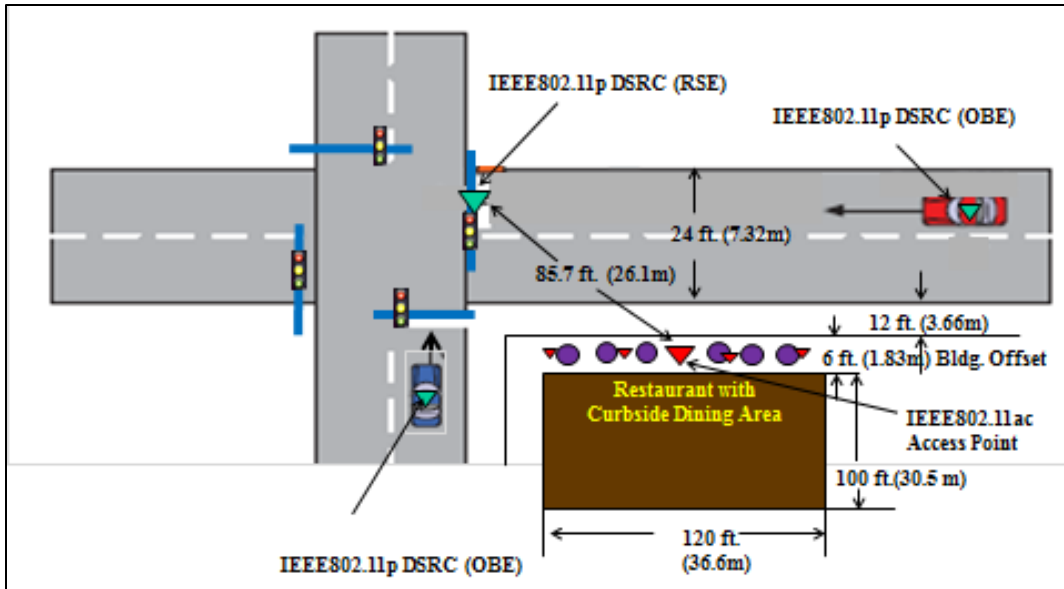

Figure 6-1: Depiction of Scenario 1 (Outdoor Access Point near intersection)

The initial measurement will be for the vehicle to drive away from the intersection, to maximum range from the intersection, and back to measure how well it receives the SPaT messages from the RSU and how well the RSU and stationary OBU receives its BSMs. If necessary, these will be done as separate runs. We will vary the RSU power to simulate all four RSU classes described in the FCC R&O. We will also do runs with the OBU powered turned down to simulate a handheld DSRC device.

We will then repeat these measurements while the unlicensed access point communicates with multiple portable client devices. We will examine both data and video scale packets. The first experiment will be with no sharing method active in the unlicensed device and then repeated with sharing via the U-NII-3 rules of the surrogate U-NII-4 device. No sharing method means the device will just transmit and not respond to signals it may receive from other devices. The first experiment will indicate how far out an unlicensed device will cause the DSRC radio to suppress its transmissions. The second experiment will measure DSRC performance with this kind of sharing. It will indicate how U-NII may affect the DSRC devices and vice versa.

A third experiment will examine if operating the unlicensed devices with different packet rates and different data rates from the DSRC devices increases or decreases interference.

A last experiment will be to change the EDCA parameters in both devices to advantage the DSRC device to see if there is a configuration that adequately mitigates the interference. Appendix B describes how these parameters work and ends with a table of illustrative values for enforcing different priorities.

In addition, at the beginning and end of each day, every device under test that day will have a sample of received power measurements compared to the simultaneously received power of the signal analyzer. These measurements must be in range of measurements made during the power calibration measurements of section 4.4.3. We will use experience with early measurements to determine the threshold for satisfactory repeatability.

Table 6-2: Configuration Variables for Outdoor Access Point Analysis

DSRC and U-NII radios transmitting and receiving	Range	Bandwidth (MHz)	Channel Number (DSRC and U-NII band)	Transmit Power (dBm)‡	Modulations (from results of Sections 4.7 and 4.8)	Packet Sizes (octets)
IEEE 802.11p DSRC OBU – external antenna Mobile Tx and Rec	Start at max range to 0 and then to max range at the other gate	10 20†	172 175	33, 20, 0 23, 20	½QPSK, ¾QAM-64	300 @ 10 Hz BSM equivalent
IEEE 802.11p DSRC OBU – internal antenna Mobile Tx and Rec	Max range to 0 and then to max range at other gate	10	172	33, 20	½QPSK, ¾QAM-64	300 @ 10 Hz BSM equivalent
IEEE 802.11p DSRC OBU Stationary Rec	0	10 20†	172 175	n/a	n/a	n/a
IEEE 802.11p DSRC RSU Stationary Tx and Rec	0	10 10 10 10 20†	172 172 172 172 175	33, 20 20, 15 10 0 23, 20	½QPSK, ¾QAM-64	1500@ 10 Hz SPaT equivalent
IEEE 802.11ac U-NII-4 External AP Stationary Tx and Rec	Fixed	20 40 80 160 (80)	173 175 171 163	36 36 36 (33)	½BPSK ¾QAM-64	300, 1500 and 9000 1Mb@36dBm
IEEE 802.11ac U-NII-4 Portable Clients Stationary Tx and Rec	Fixed	20 40 80 160+ (80)	173 175 171 163	20 20 20 (17)	½BPSK ¾QAM-64	300, 1500 and 9000 1Mb@36dBm

† Skip these runs if DSRC devices that operate at 20 MHz are not available.

‡ Power settings reduced. See explanation at end of Section 4.4.3.2. ($EIRP \sim TxPwr+5dBm$)

The instrumented vehicle closes on the intersection for each measurement in this sequence:

1. Mobile OBU transmits BSMs or an equivalent test signal, stationary OBU and RSU receive. Measure baseline performance and message logs at both stationary receivers.
2. RSU transmits SPaT messages while the moving OBU receives. Measure baseline performance and message logs at the moving OBU.
3. **Unlicensed access point transmitting with no sharing rules – transmitter moving.** This should be a worst case scenario. Examine all 4 U-NII packet sizes and the most disruptive modulation found in the section 4.7 measurements. Mobile OBU transmits BSMs, stationary OBU and RSU receive. Measure performance and message logs at both stationary DSRC receivers. Determine range at which communication is disrupted. Investigate the bounding cases first.⁴⁷
4. **Unlicensed access point transmitting with no sharing rules – transmitter fixed.** This should be a worst case scenario. Examine all 4 U-NII packet sizes and the most disruptive modulation found in the section 4.7 measurements. Fixed RSU transmits SPaT messages while the moving OBU receives. Measure performance and message logs at the moving OBU. Determine range at which OBU is not reliably receiving SPaT messages. Investigate the bounding cases first.
5. Unlicensed access point transmitting with **U-NII-3 sharing rules – transmitter moving.** Examine all 4 U-NII packet sizes with the 20 MHz U-NII channel. But for channel widths of 40 MHz or greater select 1 or 2 U-NII packet sizes representative of streaming video based on experience in the previous experiment. Mobile OBU transmits BSMs, stationary OBU and RSU receive. Measure performance and message logs at both stationary DSRC receivers and the U-NII receiver. Determine range at which communication is disrupted. Investigate the bounding cases first.
6. Unlicensed access point transmitting with **U-NII-3 sharing rules – transmitter fixed.** Examine all 4 U-NII packet sizes with the 20 MHz U-NII channel. But for channel widths of 40 MHz or greater select 1 or 2 U-NII packet sizes representative of streaming video based on experience in the previous experiment. Fixed RSU transmits SPaT messages while the moving OBU receives. Measure performance and message logs at the moving OBU and the U-NII receiver. Determine range at which OBU is not reliably receiving SPaT messages. Examine the bounding cases first.
7. Unlicensed access point transmitting with U-NII-3 sharing rules – transmitter moving. Use the same 1 or 2 U-NII packet size used in the previous two experiments (for channel widths 40 MHz and greater). **Longer EDCA back off parameters in the unlicensed radio and shorter EDCA back off parameters in the mobile OBU.** Longer back off means the device waits longer when it hears the channel is occupied before it listens again for an opening to transmit in (see appendix B). Mobile OBU transmits BSMs, stationary OBU and RSU receive. Measure performance and

⁴⁷ The bounding cases are those most likely and least likely to cause interference. The **first case** should be U-NII 20 MHz transmitters at maximum power and longest packets opposite the lowest power DSRC link. No interference here would indicate that unlicensed devices may be able to share the band without a threat to DSRC communications. The **second case** should be U-NII 160 MHz transmitters at the lowest power with short packets opposite the highest power DSRC link. Any sign of interference indicates that no sharing may be possible. Either of these cases will allow further testing to be focused and reduced. Neither means full testing is necessary to find what unlicensed device requirements may permit safe sharing or what regimes require further analysis.

message logs at both stationary receivers and the U-NII receiver. Determine range at which communication is disrupted.

8. Unlicensed access point transmitting with U-NII-3 sharing rules – transmitter fixed. Use the same 1 or 2 U-NII packet size used in the previous two experiments (for channel widths 40 MHz and greater). **Longer EDCA back off parameters in the unlicensed radio and shorter EDCA back off parameters in the RSU.** Fixed RSU transmits SPaT messages while the moving OBU receives. Measure performance and message logs at the moving OBU and the U-NII receiver. Determine range at which OBU is not reliably receiving SPaT messages.

Repeat the experiments for the configuration parameters shown in table 6-2. Do multiple runs of each measurement to measure variability except the runs with the 1 million byte video packet. Do one or few runs unless it appears to have a major impact on interference that requires further investigation. We will not examine all packet sizes in the wider U-NII channels because of the lower energy density there unless we see DSRC communications are significantly sensitive to packet size in those channels.

Select settings for the DSRC and U-NII devices where interference was measureable from initial experiments in this section or the results of section 5.4. Then similarly to the measurements described in section 5.4, vary the packet rate of the U-NII device to see if operating at different packet rates from DSRC increases or decreases interference. Repeat, again fixing all variables except the data rate to determine if operating the two types of radios with different data rates increases or decreases the interference.

Locations of the unlicensed access point and the portable clients with respect to the intersection will be determined depending on the specifics of the test site.

6.5 Scenario 2: Indoor Access Point Near a Road Corridor

6.5.1 Purpose

See section 6.1.

6.5.2 Description

This activity looks at the effect of an internally mounted access point for an unlicensed device on the ability of an OBU to communicate with an RSU and another OBU. This type of access point can be found in residential buildings as a Wi-Fi hub for connecting peripheral devices such as printers, tablets, game-boxes, camcorders and HDTV. The DSRC communications examined are the ability of RSU and OBU to receive BSMs from an OBU and the OBU to receive SPaT messages from the RSU.

6.5.3 Equipment

See section 6.2.

6.5.4 Data to collect

See section 6.3.

6.5.5 Analysis activities

Figure 6-2 illustrates this kind of scenario. In this case, an indoor 802.11 access point is mounted in a building. An RSU to transmit warning messages will be mounted on a pole 3 meters high to simulate a school zone or curve warning application. We simulate it with Class B power, which might be appropriate for that kind of warning. The RSU will only transmit. Two vehicle-mounted OBUs will approach each other from opposite directions, crossing near the unlicensed access point. Both will transmit their BSMs.

The unlicensed access point will be mounted inside a building near the intersection 18 feet above the ground or one of the heights measured in section 5.3. Four portable client devices will operate in the same building to simulate laptops, printers, smartphones, etc. We will look for impacts on the U-NII as well as DSRC performance. We will do a few runs to simulate a handheld DSRC unit, since those devices may be most vulnerable to interference.

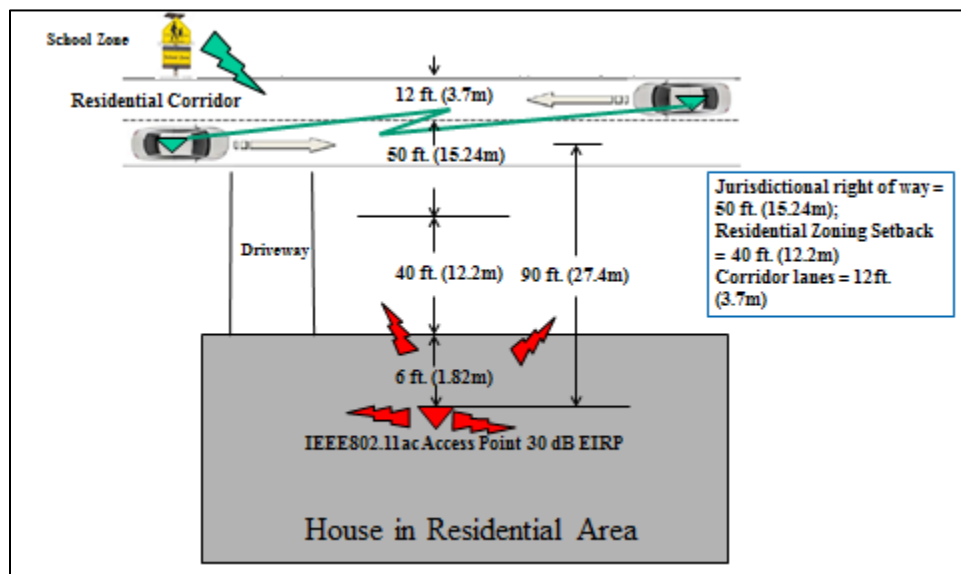

Figure 6-2: Depiction of Scenario 2 (Indoor Access Point by a residential street)

A scenario that assumes typical residential zoning may require a 40-foot (12.2-meter) setback from the jurisdictional right-of-way of 50 feet (15.24 meters) and road corridors that are 12 feet (3.7 meters) wide per AASHTO. An unlicensed access point may be 6 feet (1.8 meters) from the front wall of the home. Measurements will approximate similar conditions to the extent possible. Figure 6-3 shows one possible set up for these measurements at Aberdeen Proving Ground. Based on the geometry shown in figure 6-3, the access point would be roughly 50 meters from the travel lane.



Figure 6-3: Possible Layout for Scenario 2 at the Aberdeen Proving Ground Site

Table 6-3: Configuration Variables for Indoor Access Point Analysis

DSRC and U-NII radios transmitting and receiving	Range	Bandwidth (MHz)	Channel Number (DSRC and U-NII band)	Transmit Power (dBm)‡	Modulations (from results of Sections 4.7 and 4.8)	Packet Sizes (octets)
IEEE 802.11p DSRC OBU – external antenna Mobile Tx and Rec	Start at range max to 0 and then to range max at other side	10 20	172 175	33, 20, 0 23, 20	½QPSK, ¾QAM-64	300 @ 10 Hz BSM equivalent
IEEE 802.11p DSRC OBU – internal antenna Mobile Tx and Rec	Max range to 0 and then to max range at other side	10	172	33, 20	½QPSK, ¾QAM-64	300 @ 10 Hz BSM equivalent
IEEE 802.11p DSRC OBU Mobile Tx and Rec	Start at opposite side	10 20†	172, 175	33, 20 23, 20	½QPSK, ¾QAM-64	300 @ 10 Hz BSM equivalent

DSRC and U-NII radios transmitting and receiving	Range	Bandwidth (MHz)	Channel Number (DSRC and U-NII band)	Transmit Power (dBm)‡	Modulations (from results of Sections 4.7 and 4.8)	Packet Sizes (octets)
IEEE 802.11p DSRC RSU-class C Stationary Tx	Fixed, TBD	10 20†	172 175	10 23, 20	½QPSK, ¾QAM-64	300@ 10 Hz advisory equivalent
IEEE 802.11ac U-NII-4 Internal AP Stationary Tx and Rec	Fixed per scenario	20 40 80 160 (80)	173 175 171 163	36 30 30 (27)	½BPSK, ¾QAM-64	300, 1500 and 9000 1Mb@36dBm
IEEE 802.11ac U-NII-4 Portable Clients Stationary Tx and Rec	Fixed per scenario	20 40 80 160 (80)	173 175 171 163	20 20 20 (17)	½BPSK, ¾QAM-64	300, 1500 and 9000 1Mb@36dBm

† Skip these runs if DSRC devices that operate at 20 MHz are not available.

‡ Power settings reduced. See explanation at end of Section 4.4.3.2. ($EIRP \sim TxPwr+5dBm$)

Instrumented vehicles close on each other from opposite directions driving end-to-end for each experiment in this sequence:

1. Both Mobile OBUs transmit BSMs or an equivalent test signal and the stationary RSU transmits a warning message. Measure baseline performance and message logs at both mobile OBUs.
2. **Unlicensed access point transmitting with no sharing rules.** This should be a worst case scenario. Examine all 4 U-NII packet sizes and the most disruptive modulation found in the section 4.7 measurements. Both Mobile OBUs transmit BSMs and the stationary RSU transmits a warning message. Measure performance and message logs at both mobile OBUs. Determine ranges at which communication is disrupted. Investigate the bounding cases first.⁴⁸
3. Unlicensed access point transmitting with **U-NII-3 sharing rules.** Examine all 4 U-NII packet sizes with the 20 MHz U-NII channel. But for channel widths of 40 MHz or greater select 1 or 2 U-NII

⁴⁸ The bounding cases are those most likely and least likely to cause interference. The **first case** should be U-NII 20 MHz transmitters at maximum power and longest packets opposite the lowest power DSRC link. No interference here would indicate that unlicensed devices may be able to share the band without a threat to DSRC communications. The **second case** should be U-NII 160 MHz transmitters at the lowest power with short packets opposite the highest power DSRC link. Any sign of interference indicates that no sharing may be possible. Either of these cases will allow further testing to be focused and reduced. Neither means full testing is necessary to find what unlicensed device requirements may permit safe sharing or what regimes require further analysis

packet sizes representative of streaming video based on experience in the previous experiment. Both Mobile OBUs transmit BSMs and the stationary RSU transmits a warning message. Measure performance and message logs at both mobile OBUs and the U-NII access point. Determine ranges at which communication is disrupted. Investigate the bounding cases first.

4. Unlicensed access point transmitting with U-NII-3 sharing rules. Select the same 1 or 2 U-NII packet sizes representative of streaming video (for channel widths 40 MHz and greater). **Longer EDCA back off parameters in the unlicensed radios and shorter EDCA back off parameters in the mobile OBUs.** Both Mobile OBUs transmit BSMs and the stationary RSU transmits a warning message. Measure performance and message logs at both mobile OBUs and the U-NII access point. Determine ranges at which communication is disrupted.

Repeat the experiments for the configuration parameters shown in table 6-3. Do multiple runs of each measurement to measure variability except the measurements with the 1 million byte video packet. Do one or few runs unless it appears to have a major impact on interference that requires further investigation.

In addition, at the beginning and end of each day, every device under test that day will have a sample of received power measurements compared to the simultaneously received power of the signal analyzer. These measurements must be in range of measurements made during the power calibration measurements of section 4.4.3. We will use experience with early measurements to determine the threshold for satisfactory repeatability.

6.6 Scenario 3: In-Vehicle Unlicensed Devices

6.6.1 Purpose

See section 6.1.

6.6.2 Description

This activity looks at how portable unlicensed devices in a vehicle affect DSRC communications. It studies how unlicensed transmissions might suppress messages from the on-board OBU or the RSU being approached. It also examines how portable unlicensed devices might interfere with the on-board OBU's ability to receive SPaT messages from RSUs and BSMs from other OBUs. Portable unlicensed devices inside the vehicle will communicate with an unlicensed LAN in the vehicle. Examples would be tablet computers and smartphones accessing the Internet and streaming video.

6.6.3 Equipment

See section 6.2.

6.6.4 Data to collect

See section 6.3.

6.6.5 Analysis activities

A typical scenario is shown in figure 6-4. An RSU to transmit SPaT messages will be mounted on an 18 foot mast to simulate an intersection. We will investigate all four RSU power classes. The RSU will receive BSMs from both moving OBUs as well. The two vehicles with OBUs will approach each other from opposite ends of the range crossing near the intersection. The experiment could also be run with the vehicle without the unlicensed devices parked and not moving. Figure 6-5 shows one possible set up for the experiment.

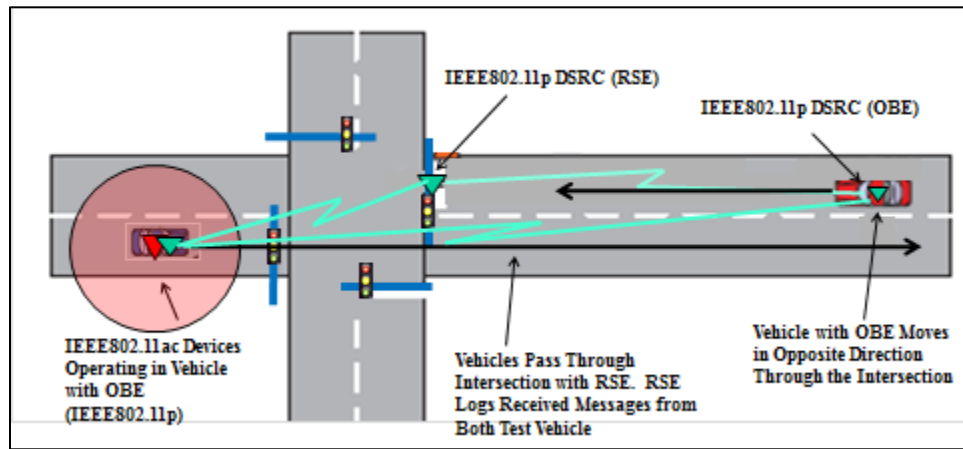

Figure 6-4: Depiction of Scenario 3 (unlicensed Devices Transmitting in a Vehicle)



Figure 6-5: Possible Layout for Scenario 3 at the Table Mountain Measurement Site

Table 6-4: Configuration Variables for In-Vehicle Access Point Analysis

DSRC and U-NII radios transmitting and receiving	Range	Bandwidth (MHz)	Channel Number (DSRC and U-NII band)	Transmit Power (dBm)‡	Modulations (from results of Sections 4.7 and 4.8)	Packet Sizes (octets)
IEEE 802.11p DSRC OBU Mobil Tx and Rec	Start at max range to 0 and then to max range at the other gate	10 20	172 175	33 , 20 23 , 20	½QPSK, ¾QAM-64	300 @ 10 Hz BSM equivalent
IEEE 802.11p DSRC OBU Mobil Tx and Rec	Start at opposite gate	10 20†	172 175	33 , 20 23 , 20	½QPSK, ¾QAM-64	300 @ 10 Hz BSM equivalent
IEEE 802.11p DSRC RSU Stationary Tx and Rec	0	10 10 10 10	172 172 172 172	33 , 20 20 , 15 10 0	½QPSK, ¾QAM-64	1500@ 10 Hz SPaT equivalent

DSRC and U-NII radios transmitting and receiving	Range	Bandwidth (MHz)	Channel Number (DSRC and U-NII band)	Transmit Power (dBm)‡	Modulations (from results of Sections 4.7 and 4.8)	Packet Sizes (octets)
		20†	175	23, 20		
IEEE 802.11ac U-NII-4 In-vehicle AP Tx and Rec	In-vehicle with OBU 1	20 40 80 160+ (80)	173 175 171 163	20 20 20 (17)	½BPSK, ¾QAM-64	300, 1500 and 9000 1Mb@36dBm
IEEE 802.11ac U-NII-4 Portable Clients In-vehicle Tx and Rec	In-vehicle with OBU 1	20 40 80 160+ (80)	173 175 171 163	10 10 10 (7)	½BPSK, ¾QAM-64	300, 1500 and 9000 1Mb@36dBm

† Skip these runs if DSRC devices that operate at 20 MHz are not available.

‡ Power settings reduced. See explanation at end of Section 4.4.3.2. ($EIRP \sim TxPwr+5dBm$)

Instrumented vehicles close on each other from opposite directions driving gate-to-gate for each experiment in this sequence:

1. **DSRC baseline.** Both mobile OBUs transmit BSMs or the equivalent test signal and the stationary RSU transmits SPaT messages. All receive. Car windows closed. Measure baseline performance and message logs at all 3 DSRC receivers.
2. **Unlicensed devices transmitting in-vehicle with no sharing rules.** This should be a worst case scenario. Examine all 4 U-NII packet sizes and the most disruptive modulation found in the section 4.7 measurements. Both mobile OBUs transmit BSMs and the stationary RSU transmits SPaT messages. All receive. Car windows closed. Measure performance and message logs at all 3 DSRC receivers. Determine ranges at which communication is disrupted with the RSU and with the other OBU. Investigate the bounding cases first.⁴⁹
3. **Unlicensed access point transmitting with U-NII-3 sharing rules.** Examine all 4 U-NII packet sizes with the 20 MHz U-NII channel. But for channel widths of 40 MHz or greater select 1 or 2 U-NII packet sizes representative of streaming video based on experience in the previous experiment. Both mobile OBUs transmit BSMs and the stationary RSU transmits SPaT messages. All receive. Car windows closed. Measure performance and message logs at all 3 DSRC receivers and a U-NII

⁴⁹ The bounding cases are those most likely and least likely to cause interference. The **first case** should be U-NII 20 MHz transmitters at maximum power and longest packets opposite the lowest power DSRC link. No interference here would indicate that unlicensed devices may be able to share the band without a threat to DSRC communications. The **second case** should be U-NII 160 MHz transmitters at the lowest power with short packets opposite the highest power DSRC link. Any sign of interference indicates that no sharing may be possible. Either of these cases will allow further testing to be focused and reduced. Neither means full testing is necessary to find what unlicensed device requirements may permit safe sharing or what regimes require further analysis.

receiver. Determine ranges at which communication is disrupted with the RSU and with the other OBU. Investigate the bounding cases first.

4. **Integral versus external antenna.** Repeat step 3 above using aftermarket OBUs with integral antenna mounted placed inside the vehicle. First with one internal OBU and the other with external antenna and then both OBUs with internal antenna. If the variability in the results is significantly different from experiments with two OBUs with external antenna, repeat the experiments in steps 2 and 4 using internal OBUs as well. If the results using internal versus external antenna are similar such that results for internal OBUs can be easily extrapolated from the external antenna results, then data from this one step with internal OBUs will be enough.
5. Unlicensed access point transmitting with U-NII-3 sharing rules. Select the same 1 or 2 U-NII packet sizes representative of streaming video (for channel widths 40 MHz and greater). **Longer EDCA back off parameters in the unlicensed radio and shorter EDCA back off parameters in the mobile OBU.** Both mobile OBUs transmit BSMs and the stationary RSU transmits SPaT messages. All receive. Car windows closed. Measure performance and message logs at all 3 DSRC receivers and a U-NII receiver. Determine ranges at which communication is disrupted with the RSU and with the other OBU.
6. Repeat all of the above with **windows open** for the bounding cases. If the impact on the DSRC performance metrics is not significant, that is, within the normal statistical variation of the runs with windows closed, document that the windows have no effect and stop. If the state of the vehicle windows does make a difference repeat enough runs to determine if windows open represents a worse case than windows closed. If not, stop. If so, repeat all steps above with windows open. This experiment to determine the impact of windows open or closed can be done within the initial run of step 3 so that all measurements are made with the most vulnerable state in case the inherent assumption here that windows closed would have a larger impact is incorrect.

Repeat the experiments for the configuration parameters shown in table 6-4. Do multiple runs of each measurement to measure variability except the measurements with the 1 million byte video packet. Do one or few runs unless it appears to have a major impact on interference that requires further investigation.

In addition, at the beginning and end of each day, every device under test that day will have a sample of received power measurements compared to the simultaneously received power of the signal analyzer. These measurements must be in range of measurements made during the power calibration measurements of section 4.4.3. We will use experience with early measurements to determine the threshold for satisfactory repeatability.

6.7 Scenario 4: High Speed Rural V2V Encounter Near an Unlicensed Access Point

6.7.1 Purpose

See section 6.1.

6.7.2 Description

This activity looks at the effect of an externally mounted unlicensed access point and an internal unlicensed access point on the ability of two OBUs to communicate with each other as they approach at high speed (e.g., 55 mph or greater). This would be the case of two vehicles driving by each other on a rural road late at night, when there is no other traffic. In this scenario, the density of radios is low, so signal-to-noise or energy in the band should not be an issue. However, any access of the channel by unlicensed devices that suppresses one or more BSMs, by activating the CCA mechanism in a DSRC device, may have a greater safety impact than the more urban scenarios because the closing distance between the vehicles changes so much between BSMs.

6.7.3 Equipment

See section 6.2.

6.7.4 Data to collect

See section 6.3.

6.7.5 Analysis activities

The two instrumented vehicles will start at a distance such that both will still be out of DSRC range by the time they reach rural highway speed. An unlicensed access point will be mounted in between. The vehicles will approach and pass each other at the speed limit in the vicinity of the unlicensed access point. Preferably this will be at a measurement site where the vehicles can safely travel at 50-60 mph. In any case, the safe driving speed for the facility must not be exceeded. The experiments will be done with OBUs using both external and internal antennas. It will be conducted with the unlicensed devices operating without sharing rules or essentially jamming the channel to determine how close the vehicles have to be before they start exchanging safety messages. Then it will be repeated with the unlicensed device operating under the U-NII-3 sharing rules.

Table 6-5: Configuration Variables for High-Speed V2V Near an Outdoor Access Point

DSRC and U-NII radios transmitting and receiving	Range	Bandwidth (MHz)	Channel Number (DSRC and U-NII band)	Transmit Power (dBm)‡	Modulations (from Sections 4.7 and 4.8)	Packet Sizes (octets)
IEEE 802.11p DSRC OBU Mobil Tx and Rec	~1000 m from access point	10 20†	172 175	33, 20 23, 20	½QPSK, ¾QAM-64	300 @ 10 Hz BSM equivalent
IEEE 802.11p DSRC OBU Mobil Tx and Rec	~1000 m from AP in other direction	10 20†	172 175	33, 20 23, 20	½QPSK, ¾QAM-64	300 @ 10 Hz BSM equivalent
IEEE 802.11ac U-NII-4 External AP Stationary Tx and Rec	Fixed	20 40 80 160 (80)	173 175 171 163	36 36 36 (33)	½BPSK, ¾QAM-64	300, 1500 and 9000 1Mb@36dBm

† Skip these runs if DSRC devices that operate at 20 MHz are not available.

‡ Power settings reduced. See explanation at end of Section 4.4.3.2. ($EIRP \sim TxPwr+5dBm$)

Instrumented vehicles close on each other from opposite directions at the rural highway speed limit passing near the fixed access point for each experiment in this sequence:

1. **DSRC baseline.** Both mobile OBUs transmit and receive BSMs or the equivalent test signal. Measure baseline performance and message logs at both DSRC receivers. Repeat the measurement often enough to understand natural variation in the results. The number of runs to be determined in the field.
2. **Unlicensed device transmitting with no sharing rules.** Examine all 4 U-NII packet sizes and the most disruptive modulation found in the section 4.7 measurements. This should be a worst case scenario. Both mobile OBUs transmit and receive BSMs. Measure performance and message logs at both DSRC receivers. Determine ranges at which DSRC communication is disrupted. Repeat the measurement often enough to understand natural variation in the results. The number of runs to be determined in the field. Investigate the bounding cases first.⁵⁰

⁵⁰ The bounding cases are those most likely and least likely to cause interference. The **first case** should be U-NII 20 MHz transmitters at maximum power and longest packets opposite the lowest power DSRC link. No interference here would indicate that unlicensed devices may be able to share the band without a threat to DSRC communications. The **second case** should be U-NII 160 MHz transmitters at the lowest power with short packets opposite the highest power DSRC link. Any sign of interference indicates that no sharing may be possible. Either of these cases will allow further testing to be focused and reduced. Neither means full testing is necessary to find what unlicensed device requirements may permit safe sharing or what regimes require further analysis.

3. Unlicensed device transmitting with **U-NII-3 sharing rules**. Examine all 4 U-NII packet sizes with the 20 MHz U-NII channel. But for channel widths of 40 MHz or greater select 1 or 2 U-NII packet sizes representative of streaming video based on experience in the previous experiment. Use the same EDCA parameters in the DSRC and unlicensed devices. Both mobile OBUs transmit and receive BSMs. Measure performance and message logs at both DSRC receivers. Determine ranges at which DSRC communication is disrupted. Repeat the measurement often enough to understand natural variation in the results. The number of runs to be determined in the field. Investigate the bounding cases first.
4. Repeat steps 1-3 above using **aftermarket OBUs with integral antenna** mounted placed inside the vehicles. First with one internal OBU and the other with external antenna and then both OBUs with internal antenna. Measure performance and message logs at both receivers. Determine ranges at which DSRC communication is disrupted. Repeat the measurement the number of runs determined in step 3 that accounts for natural variation.
5. Unlicensed access point transmitting with U-NII-3 sharing rules. Select the same 1 or 2 U-NII packet sizes representative of streaming video (for channel widths 40 MHz and greater). **Longer EDCA back off parameters in the unlicensed radio and shorter EDCA back off parameters in the mobile OBUs**. Both mobile OBUs transmit and receive BSMs. Measure performance and message logs at both DSRC receivers. Determine ranges at which DSRC communication is disrupted. Repeat the measurement the number of runs determined in step 3 that accounts for natural variation.

Car windows closed for all runs. That won't affect OBUs using external antennas. Windows closed should be worst case for the internal OBUs. These two bounding cases are sufficient.

In addition, at the beginning and end of each day, every device under test that day will have a sample of received power measurements compared to the simultaneously received power of the signal analyzer. These measurements must be in range of measurements made during the power calibration measurements of section 4.4.3. We will use experience with early measurements to determine the threshold for satisfactory repeatability.

6.8 Scenario 5: Multiple Access Points and Client Devices along a Corridor

6.8.1 Purpose

See section 6.1.

6.8.2 Description

All previous analysis tasks in this plan has have been device level experiments. This experiment investigates a possible deployment scenario at small scale. Similar to the first scenario this also examines RSU-to-OBU and OBU-to-OBU communications but along a corridor with multiple unlicensed devices in operation.

6.8.3 Equipment

See section 6.2.

6.8.4 Data to collect

See section 6.3.

6.8.5 Analysis activities

An RSU transmitting SPaT messages will be mounted on a mast to simulate an intersection. The RSU will receive BSMs from the moving OBU as well. An OBU will be in a vehicle parked there or mounted there to receive BSMs from the moving OBU. The second OBU will be in a vehicle that will move to change range. It will transmit BSMs and receive SPaT messages.

Up to 25 unlicensed devices will be configured to act as both access points and clients. They will be positioned to simulate commercial, residential and personal use, as might occur along a road corridor the way unlicensed devices are typically deployed now. The results of the previous scenario experiments will inform the specific positioning of the unlicensed devices for this scenario. The unlicensed devices will operate under U-NII-3 sharing rules. We will experiment with OBUs using both external and internal antennas.

Table 6-6: Configuration Variables for Multiple External Access Point Analysis

DSRC and U-NII radios transmitting and receiving	Range	Bandwidth (MHz)	Channel Number (DSRC and U-NII band)	Transmit Power (dBm)‡	Modulations (from Sections 4.7 and 4.8)	Packet Sizes (octets)
IEEE 802.11p DSRC OBU – external antenna Mobile Tx and Rec	Start at max range to 0 and then to max range at the other gate	10 20+	172 175	33, 20, 0 23, 20	½QPSK, ¾QAM-64	300 @ 10 Hz BSM equivalent
IEEE 802.11p DSRC OBU – internal antenna Mobile Tx and Rec	Max range to 0 and then to max range at other gate	10	172	33, 20	½QPSK, ¾QAM-64	300 @ 10 Hz BSM equivalent
IEEE 802.11p DSRC OBU Stationary Rec	0	10 20+	172 175	n/a	n/a	n/a
IEEE 802.11p DSRC RSU Stationary Tx and Rec	0	10 10 10 10 20+	172 172 172 172 175	33, 20 20, 15 10 0 23, 20	½QPSK, ¾QAM-64	1500@ 10 Hz SPaT equivalent
Multiple IEEE 802.11ac U-NII-4 External AP Stationary Tx and Rec	Fixed	20 40 80 160 (80)	173 175 171 163	36 36 36 (33)	½BPSK, ¾QAM-64	Mix of 300, 1500 and 9000 1Mb@36dBm distributed across the devices
Multiple IEEE 802.11ac U-NII-4 Portable Clients Stationary	Fixed	20 40 80 160+ (80)	173 175 171 163	20 20 20 (17)	½BPSK, ¾QAM-64	Mix of 300, 1500 and 9000 1Mb@36dBm distributed

Tx and Rec						across the devices
-------------------	--	--	--	--	--	--------------------

† Skip these runs if DSRC devices that operate at 20 MHz are not available.

‡ Number of power settings reduced. See explanation at end of Section 4.4.3.2. ($EIRP \sim TxPwr+5dBm$)

The instrumented vehicle closes on the intersection for each experiment in this sequence:

1. **DSRC baseline – fixed receivers.** Mobile OBU transmits BSMs or the equivalent test signal, stationary OBU and RSU receive. Measure baseline performance and message logs at both stationary receivers.
2. **DSRC baseline – moving receiver.** RSU transmits SPaT messages while the moving OBU receives. Measure baseline performance and message logs at the moving OBU. Repeat the measurement often enough to understand natural variation in the results. The number of runs to be determined in the field.
3. **Unlicensed devices transmitting with U-NII-3 sharing rules – fixed receivers.** Use the modulation selected for the previous experiments. Select U-NII channel widths and packet sizes that would most greatly challenge the DSRC communications based on experience in the previous experiments. As before, start with the bounding cases. A mix of channel widths and packet sizes may be used if that provides a better examination of potential sharing. Mobile OBU transmits BSMs, stationary OBU and RSU receive. Measure performance and message logs at both stationary DSRC receivers and the U-NII receivers. Determine ranges at which communication is disrupted. Repeat the measurement often enough to understand natural variation in the results. The number of runs to be determined in the field.
4. **Unlicensed devices transmitting with U-NII-3 sharing rules – moving receiver.** Use the modulation selected for the previous experiments. Select U-NII channel widths and packet sizes that would most greatly challenge the DSRC communications based on experience in the previous experiments. As before, start with the bounding cases. A mix of channel widths and packet sizes may be used if that provides a better examination of potential to share. Fixed RSU transmits SPaT messages while the moving OBU receives. Measure performance and message logs at the moving OBU and the U-NII receiver. Determine range at which OBU is not reliably receiving SPaT messages. Repeat the measurement often enough to understand natural variation in the results. The number of runs to be determined in the field.

If a suitable set of differing EDCA parameters is found in earlier experiments to give priority to the DSRC devices, then continue with steps 5 and 6 below. If not, then skip these steps.

5. **Unlicensed devices transmitting with U-NII-3 sharing rules.** Use the same U-NII channel width(s) and packet size(s) as the previous two steps. **Longer EDCA back off parameters in the unlicensed radio and shorter EDCA back off parameters in the mobile OBU – fixed receivers.** Longer back off means the device waits longer when it hears the channel is occupied before it listens again for an opening to transmit in (see appendix B). Mobile OBU transmits BSMs, stationary OBU and RSU receive. Measure performance and message logs at both stationary receivers and the U-NII receiver. Determine range at which communication is disrupted.
6. **Unlicensed devices transmitting with U-NII-3 sharing rules.** Use the same U-NII channel width(s) and packet size(s) as the previous two steps. **Longer EDCA back off parameters in the unlicensed radio and shorter EDCA back off parameters in the RSU – moving receiver.** Fixed RSU transmits SPaT messages while the moving OBU receives. Measure performance and message logs at the moving OBU and the U-NII receiver. Determine range at which OBU is not reliably receiving SPaT messages.

Repeat the experiments for the configuration parameters shown in table 6-6. Do multiple runs of each measurement to often enough to understand natural variation in the results. The number of runs to be determined in the field.

In addition, at the beginning and end of each day, every DSRC device under test that day will have a sample of received power measurements compared to the simultaneously received power of the signal analyzer. These measurements must be in range of measurements made during the power calibration measurements of section 4.4.3. We will use experience with early measurements to determine the threshold for satisfactory repeatability.

7. Baseline Device Performance Measurements with Potential U-NII-4 Devices

The purpose of this set of experiments is to establish baseline performance for 802.11ac devices in the proposed U-NII-4 band. That means 802.11ac devices operating with U-NII-4 rules and sharing mechanisms.

Active analysis in this area is on hold until such devices are available. It will be a repeat of portions of section 5 with no or small modifications. We will perform analysis in a similar manner to avoid introducing any bias. DSRC devices baselined in section 5 would not need to be baselined again.

Devices provided by industry would be investigated by this part of the analysis plan.

8. Interference Analysis with Potential U-NII-4 Devices

The purpose of this section is to measure the effects on DSRC communications in the presence of unlicensed 802.11 ac devices operating in the proposed U-NII-4 band with sharing mechanisms enabled. Specifically to investigate anticipated real world scenarios of OBEs communicating with the OBE's in other vehicles and infrastructure mounted RSEs in the presence of unlicensed access points mounted outdoors, indoors and within a vehicle. Each experiments described separately below is for a different scenario.

Active analysis in this area is on hold until such devices are available. It will be a repeat of section 6 with modifications based on what we learn running the scenarios for section 6.

Devices provided by industry would be investigated by this part of the analysis plan.

9. Naturalistic Analysis

This analysis will investigate performance and interference in a real world environment similar to a pilot test, but approximating real-world deployment scale radio densities. That means having enough OBU equipped vehicles, RSUs and unlicensed devices operating simultaneously in range undertaking normal activities. It is too early to quantify, but such an experiment would likely require hundreds of DSRC and unlicensed devices. It may require a larger geographic area than can be provided by a measurement facility and therefore may be conducted in a community.

Active analysis in this area is on hold. An analysis plan will be developed based on what we learn from the spectrum sharing interference analysis.

10. References

IEEE 802.11-2012, IEEE Standard for Information technology—Telecommunications and information exchange between systems Local and metropolitan area networks—Specific requirements, Part 11: Wireless LAN Medium Access Control (MAC) and Physical Layer (PHY) Specifications, IEEE Computer Society LAN/MAN Standards Committee, 29 March 2012. *Technical requirements for interoperability of Wi-Fi communications.*

IEEE P802.11ac™/D4.0, Draft STANDARD for Information Technology—Telecommunications and information exchange between systems—Local and metropolitan area networks—Specific requirements, Part 11: Wireless LAN Medium Access Control (MAC) and Physical Layer (PHY) specifications, Amendment 4: Enhancements for Very High Throughput for Operation in Bands below 6 GHz, Prepared by the 802.11 Working Group of the 802 Committee, October 2012. *Technical requirements for very high throughput Wi-Fi communications.*

FCC 99-305, FCC Report & Order, Adopted: October 21, 1999, Released: October 22, 1999. *Allocated 75 megahertz of spectrum at 5.850-5.925 GHz to the mobile service for use by Dedicated Short Range Communications ("DSRC") systems operating in the Intelligent Transportation System ("ITS") radio service.*

FCC 03-324, FCC Report & Order, Adopted: December 17, 2003, Released: February 10, 2004. *Adopted licensing and service rules for the Dedicated Short Range Communications Service (DSRCS) in the Intelligent Transportation Systems (ITS) Radio Service in the 5.850-5.925 GHz band (5.9 GHz band).*

FCC 06-110, FCC Memorandum & Order, Adopted: July 20, 2006, Released: July 26, 2006. *Provided new channel designations, site construction priorities, and altered power limitations in the DSRC band.*

SAE J2735, SAE International, Surface Vehicle Standard, Dedicated Short Range Communications (DSRC) Message Set Dictionary, March 2016. *Defines the data elements that compose DSRC messages as well as DSRC concepts.*

SAE J2945/1, SAE International, Surface Vehicle Standard, On-Board System Requirements for V2V Safety Communications, March 2016. *Defines concept of operations and minimum requirements for interoperable DSRC safety communications.*

Appendix A: DSRC Terminology

Term	Definition
After Market Device	An OBU that is not built into the vehicle by the OEM but purchased and installed after the vehicle has been sold.
BSM	Basic Safety Message – Messages from OBUs containing vehicle data including GPS location coordinates. With the communication and security overhead they can vary from roughly 170 – 470 octets long depending on how many points are in the path history variable.
DSRC	Dedicated Short Range Communication, microwave communications in the band 5850-5925 MHz governed by the IEEE 802.11p standard developed especially for mobile safety communications. IEEE 802.11p was folded into IEEE 802.11-2012.
Frame	In the OSI model of computer networking, a frame is the protocol data unit at the data link layer. Frames are the result of the final layer of encapsulation before the data is transmitted over the physical layer. [1] A frame is "the unit of transmission in a link layer protocol, and consists of a link layer header followed by a packet." [2] Each frame is separated from the next by an interframe gap. A frame is a series of bits generally composed of framing bits, the packet payload, and a frame check sequence. An example would be an Ethernet frame.
Handheld DSRC	Portable DSRC – DSRC radio in a handheld device such as a smartphone or tablet
MAP	Message that defines the geometry of an intersection. A companion to SPaT. Can be 1000-1500 octets long.
OBE	On-board Equipment – Electronic equipment in a vehicle that includes an OBU
OBU	Onboard Unit – DSRC radio, processors and memory that are necessary for DSRC communications mounted in a vehicle
Packet	A formatted unit of data carried by a packet-switched network. Computer communications links that do not support packets, such as traditional point-to-point telecommunications links, simply transmit data as a bit stream. When data is formatted into packets, the bandwidth of the communication medium can be better shared among users than if the network.
RSE	Roadside Equipment – Traffic equipment near a road, may contain an RSU
RSU	Roadside Unit – DSRC radio, processors and memory that are necessary for DSRC communications mounted to fixed or moveable but not mobile infrastructure
SPaT	Signal Phase and Timing – Data from a traffic signal controller giving signal status and the timing of upcoming state changes in all directions. Can be a few to a thousand octets long.
V2I	Vehicle-to-Infrastructure, DSRC communication between OBUs and RSUs. This entails a more varied range of message sizes and purposes.
V2V	Vehicle-to-Vehicle, DSRC communication between OBUs. This will be predominantly via the broadcast of BSMs.

Term	Definition
V2X	Vehicle-to-Other, This not defined consistently. Sometimes defined as an umbrella term for all DSRC communications, but defined by others as DSRC communications involving handheld and other devices that are not OBUs or RSUs. This plan avoids use of the term but the authors subscribe to the latter definition.

Appendix B: Clear Channel Access Mechanism

Clear Channel Access (CCA) is a mechanism by which radios listen to the channel and wait until they hear it is clear before transmitting to avoid packet collisions. DSRC uses Enhanced Distributed Channel Access (EDCA) parameters to control its CCA mechanism. The following text are two excerpts from a whitepaper not yet published, "Radio Density versus Traffic Density," by Alan Chachich, USDOT/OST-R/Volpe Center, 2014.

B.1 First excerpt to explain what happens in the time between packets:

But that's not all. The total time a message ties up the channel has two components. Most obvious is the time the message is being sent. Less obvious is the forced idle time on the channel to keep transmitters from clashing. *Rockwell Collins/ARINC determined that was typically half as long as a BSM message or roughly a third of the total message time.*

This idle time is called the interframe spacing. See the following text box and figure B-1 below.

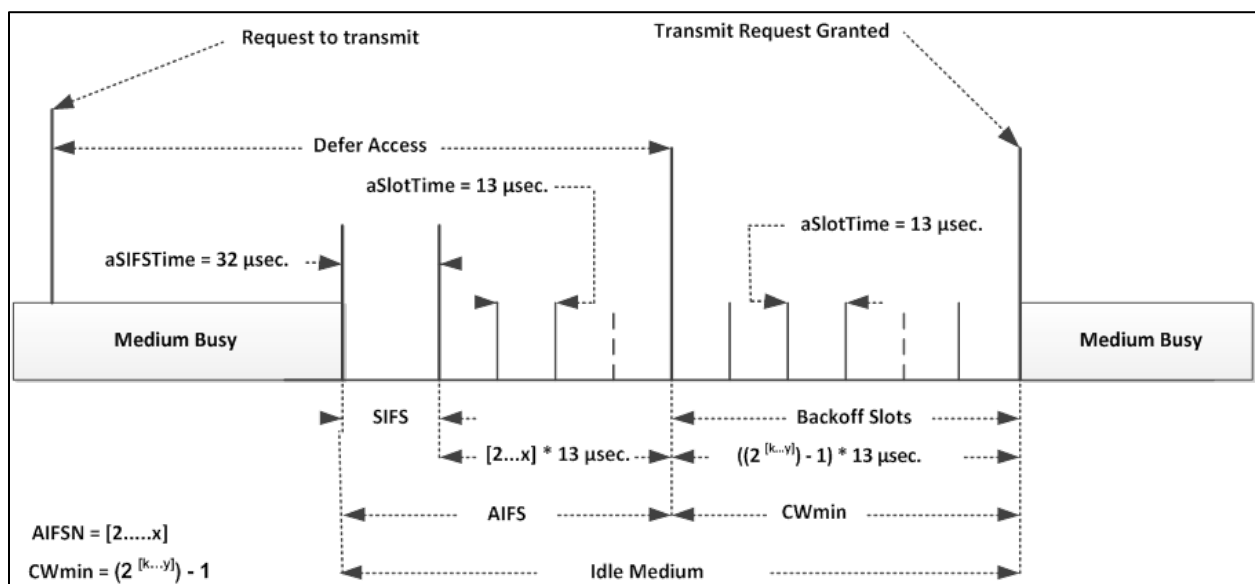

Figure B-1. Breakdown of Interframe Spacing

AIFS: Arbitration Interframe Spacing

CWmin: Minimum contention window

SIFS: Short Interframe Space

INTERFRAME SPACING

Interframe spacing has two parts.

The first is to make sure the channel is clear and the second is to avoid clashing with others also waiting for the channel to clear.

Part 1. Make sure the channel is clear

This is the AIFSN (Arbitration Interframe Space Number)

The AIFSN is composed of the SIFS (Short Interframe Space) + a certain number of slot times.

The Short Interframe Space gives the radio time to switch back into receive mode so it can receive the acknowledgement of the message frame it just sent. It is a constant determined by the appropriate 802.11 standard. *ARINC used 32 microseconds (μs) for 10 MHz since it is specified by the 802.11-2007 standard (see Table A-1).*

The Slot time is twice the time it should take a pulse to travel to the farthest node on the network. Waiting one slot time should allow the intended receiver to get the message before it can collide with the next transmission. *ARINC used 13 μs for 10 MHz since it is specified by the 802.11-2007 standard (see Table A-1).*

The default number of slot times waited is either, 2, 3, 6 or 9.

BSMs aren't acknowledged, so in the 802.11p standard the AIFSN is for prioritizing messages. The highest priority would be given the smallest AIFSN so it waits less.

Part 2. Avoid clashing with other transmitters who may also be waiting for the channel to clear

That is the CWmin (minimum Contention Window)

This is an additional random time delay added to the AIFSN so that all radios waiting to transmit do not start at the same time. It is an integer number of slot times chosen randomly from a range of numbers. *ARINC used the ranges specified in the VAD standard, $n=31$. See Table A-1. They based their calculation on the value in the middle of range to calculate the average wait time (i.e., half the maximum or $31/2 = 15.5$).*

B.2 Second excerpt to explain EDCA parameters:

Background

EDCA was added to the IEEE 802.11 standard in 2005 via 802.11e to introduce a way to prioritize messages that try to access the channel at the same time. The 802.11p WAVE (DSRC) standard that followed 5 years later built on it.

EDCA was introduced in 802.11 for typical mixed Wide Area Network (WAN) traffic. That includes video and voice which are delay sensitive but loss-tolerant and best effort or background data that tends to be delay tolerant but loss sensitive.

DSRC safety data is not like either of these two types of message traffic. It tends to be periodic and not streaming data. It is latency sensitive but not like real-time data. Delay in channel access of tens of milliseconds is OK, which is more than video or voice data can tolerate. It is more sensitive to delay than file transfer data but less sensitive than video and voice.

It is loss sensitive, but not as sensitive as file transfer data. So it is more sensitive to loss than video and more sensitive to delay than file transfer data. Table B-1 summarizes the different types of data assigned priority in 802.11p. Figure B-2 shows how the EDCA parameters implement priority in time.

Table B-1: Packet Data Types

Data type	Latency	Packet Loss	Characteristic
Video	Extremely sensitive	Tolerant	Streaming – real-time
Voice	Extremely sensitive	Tolerant	Streaming – real-time
Best effort data	Tolerant	Extremely sensitive	Streaming Large files
Background data	Tolerant	Extremely sensitive	Large files
DSRC BSMs	Tolerant to delay < 10's of ms Sensitive > 10's of ms	Sensitive	Periodic, smaller, not quite real-time

So the optimum EDCA parameters for DSRC should minimize packet collisions and keep latencies to a few tens of milliseconds.

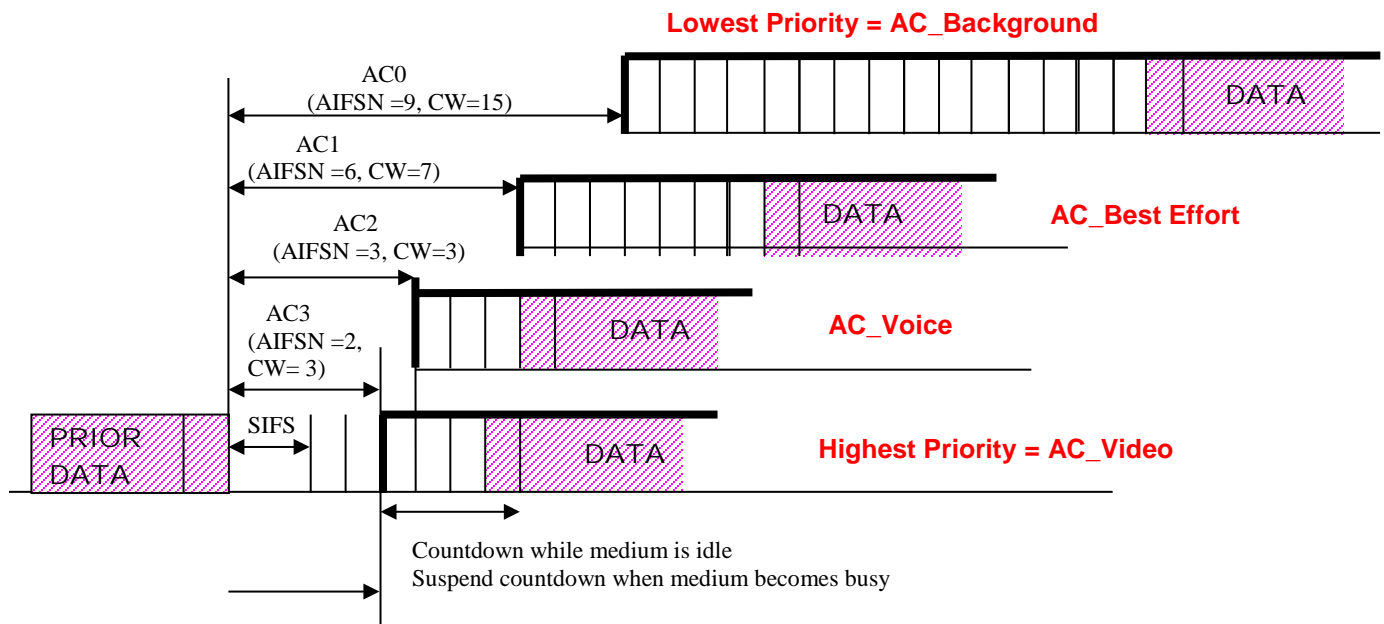

Figure B-2: Depiction of 802.11 default EDCA parameters

(Source: John Kenny, Toyota)

As described above, the mechanism to assign priority is the AIFSN. Remember that smaller AIFSN means shorter wait so preferential access to the channel. Assign this to higher priority packets.

The mechanism to avoid collision is the CWmin parameter that sets the contention window. Larger CWmin can reduce packet collisions, but if the channel is not congested it adds delay.

The 802.11 standard provides for 8 levels of priority, but half are essentially unused by DSRC. It suggests options for the values these parameters can take which are summarized in Table 2. But since channel 172 is just for safety traffic, that priority scheme isn't particularly helpful. The VAD and RSU specifications essentially say that AIFSN and CWmin can be determined by the chip set as provided by the vendor.⁵¹

Concluding excerpts

Selecting the EDCA parameters is very complicated. Choosing the best values depend on whether or not the traffic in the channel is all at the same priority (homogeneous) or different priorities (heterogeneous) and the density (number of radios in range trying to access the channel). Those are factors that can change by time and location.

⁵¹ USDOT, "System Requirement Description - 5.9GHz DSRC Vehicle Awareness Device Specification" V3.6, 1/24/2012 and v3.8, 3/18/2014; "DSRC Roadside Unit (RSU) Specifications Document" V4.0 4/15/2014

As a result, the selection of EDCA parameters for DSRC messages as well as the mechanism to define and enforce them is still a work in process.

The following table, also excerpted from the Volpe White paper, indicates the range of values that could be considered for DSRC. Note that these values are simply illustrative because the actual number of priority levels hasn't been decided and there are other schemes beside the virtual division scheme used as an example in this table.

Even though the selection of EDCA parameters for traffic internal to DSRC is still TBD, the detectability analysis described in section 5.4 of this analysis plan will experiment with different EDCA values for DSRC and unlicensed devices to determine how they might factor into potential sharing of the band.

Table B-2: Summary of Recommended EDCA Parameters

Access Category	IEEE 802.11p Default EDCA Parameter Set		Recommendation for homogenous traffic		Toyota's recommended defaults for heterogeneous traffic and virtual division with 3 priority levels	
	AIFSN	CW _{min}	AIFSN	CW _{min}	AIFSN	CW _{min}
AC0	9	15	X	X	x	x
AC1	6	15	X	X	14	15
AC2	3	7	X	X	6	7
AC3	2	3	2	15 or 31	2	3

Appendix C: Candidate RF Power Levels to Use

Table C-1: Candidate Transmit Powers for Analysis

EIRP ⁵²	Max Tx power	Significance	Reference
0 dBm (1.0 mW)		maximum allowed EIRP for handheld DSRC devices	CFR 47 § 95.639
0 dBm (1.0 mW)		maximum output power for RSU class A (15 meter range)	CFR 47 § 90.375
10 dBm (10 mW)		maximum output power for RSU class B (100 m range)	CFR 47 § 90.375
20 dBm (100 mW)		maximum output power for RSU class C (400 m range)	CFR 47 § 90.375
23 dBm (200 mW)	10 dBm (10 mW)	maximum allowed for all RSU and public OBU on channels 175, 180, 181 and 182 (antenna with minimum 6 dBi gain)	CFR 47 § 90.377
23 dBm (200 mW)	20 dBm (10 mW)	maximum allowed for private OBU channels 180, 181 and 182	CFR 47 § 90.379
28.8 dBm (750 mW)	28.8 dBm (750 mW)	maximum input power for RSU class D (1000 m range)	CFR 47 § 90.375
30 dBm (1 Watt)		maximum allowed for IEEE 802.11ac devices for point-to-multipoint wireless communications	47 CFR Part 95
33 dBm (2 Watts)	28.8 dBm (750 mW)	maximum allowed for all DSRC on channels 172, 174, 176 and private RSU and OBU on 178 and 184	CFR 47 § 90.377
40 dBm (10 Watts)		maximum allowed for public safety RSU and OBU on channel 184	CFR 47 § 90.377
44.8 dBm (30 Watts)	28.8 dBm (750 mW)	maximum allowed for public safety RSU and OBU on channel 178	CFR 47 § 90.377

⁵² The Effective Isotropic Radiated Power (EIRP) can be larger than the transmitter output power because it includes antenna gain. [EIRP = transmitter output power – cable losses + antenna gain]

Appendix D: Experimental License

All activities in this plan are permitted by the following experimental license granted by the NTIA to the USDOT. (At the time of this writing, this license is being renewed until September 30, 2019.)

Radio Frequency Authorization

This Authorization expires on: September 30, 2017. For continued use of this equipment, YOU MUST SUBMIT a request to your Frequency Manager by July 02, 2017.

Serial Number	FOI	MSD	BUR	NET	RVD	AUS	EXD
TRAN150015			H		150812	J1139964	170930
FRQ	BIN	TME	SPD	STC	Bandwidth	Emission	Power
5860 MHz		1		XD	10.00 MHz	G1D	.1 Watt(s)
XAL, XSC				XRC	XLA, XLG	XCL	XAP XAZ
MD, MD							ND
XAD							
07GSTCKDIPOLE							
RAL, RSC				RRC	RLA, RLG	ACL	RAP RAZ
MD, MD				I,NTIA-U			ND
RAD				Remarks			
00GMONOPOLE				*EQT,C,INCTRANSCEIVER			
				*POC,V FESSMAN,2024933222,150715			
				*EQR,C,INCTRANSCEIVER			
				*NTS,M015,IRAC 40088/1,SPS-19538/1			
				*MFI,MISC			
				*DFI,DSRC FIELD TESTING			

Restrictions (NTS, *NTS, SUP)
M015,IRAC 40088/1,SPS-19538/1 - THE SYSTEM USING THIS ASSIGNMENT WAS REVIEWED BY THE SPS IN ACCORDANCE WITH CHAPTER 10 AND THE ASSIGNMENT IS BEING MADE SUBJECT TO CONDITIONS STATED IN THE IRAC AND SPS DOCUMENTS REFERENCED IN THE CIRCUIT REMARKS FIELD(*NTS).

Supplementary Details - SUPPORT DSRC FIELD TESTING FOR APPLICATION DEVELOPEMENT EQUIPMENT WILL NOT TRANSMIT IN THE NRQZ

SPECIAL HANDLING INSTRUCTIONS

None.

Radio Frequency Authorization

This Authorization expires on: September 30, 2017. For continued use of this equipment, YOU MUST SUBMIT a request to your Frequency Manager by July 02, 2017.

Serial Number	FOI	MSD	BUR	NET	RVD	AUS	EXD
TRAN150016			H		150729	J1139965	170930
FRQ	BIN	TME	SPD	STC	Bandwidth	Emission	Power
5870 MHz		1		XD	10.00 MHz	G1D	.1 Watt(s)
XAL, XSC				XRC	XLA, XLG	XCL	XAP XAZ
MD, MD							ND
XAD							
07GSTCKDIPOLE							
RAL, RSC				RRC	RLA, RLG	ACL	RAP RAZ
MD, MD				I, NTIA-U			ND
RAD				Remarks			
00GMONOPOLE				*EQT, C, INCTRANSCEIVER			
				*POC, V FESSMAN, 2024933222, 150715			
				*EQR, C, INCTRANSCEIVER			
				*NTS, M015, IRAC 40088/1, SPS-19538/1			
				*MFI, MISC			
				*DFI, DSRC FIELD TESTING			

Restrictions (NTS, *NTS, SUP)
M015, IRAC 40088/1, SPS-19538/1 - THE SYSTEM USING THIS ASSIGNMENT WAS REVIEWED BY THE SPS IN ACCORDANCE WITH CHAPTER 10 AND THE ASSIGNMENT IS BEING MADE SUBJECT TO CONDITIONS STATED IN THE IRAC AND SPS DOCUMENTS REFERENCED IN THE CIRCUIT REMARKS FIELD(*NTS).

Supplementary Details - SUPPORT DSRC FIELD TESTING FOR APPLICATION DEVELOPEMENT EQUIPMENT WILL NOT TRANSMIT IN THE NRQZ

SPECIAL HANDLING INSTRUCTIONS

None.

Radio Frequency Authorization

This Authorization expires on: September 30, 2017. For continued use of this equipment, YOU MUST SUBMIT a request to your Frequency Manager by July 02, 2017.

Serial Number	FOI	MSD	BUR	NET	RVD	AUS	EXD
TRAN150017			H		150729	J1139966	170930
FRQ	BIN	TME	SPD	STC	Bandwidth	Emission	Power
5880 MHz		1		XD	10.00 MHz	G1D	.1 Watt(s)
XAL, XSC				XRC	XLA, XLG	XCL	XAP XAZ
MD, MD							ND
XAD							
07GSTCKDIPOLE							
RAL, RSC				RRC	RLA, RLG	ACL	RAP RAZ
MD, MD				I,NTIA-U			ND
RAD				Remarks			
00GMONOPOLE				*EQT,C,INCTRANSCEIVER			
				*POC,V FESSMAN,2024933222,150715			
				*EQR,C,INCTRANSCEIVER			
				*NTS,M015,IRAC 40088/1,SPS-19538/1			
				*MFI,MISC			
				*DFI,DSRC FIELD TESTING			

Restrictions (NTS, *NTS, SUP)

M015,IRAC 40088/1,SPS-19538/1 - THE SYSTEM USING THIS ASSIGNMENT WAS REVIEWED BY THE SPS IN ACCORDANCE WITH CHAPTER 10 AND THE ASSIGNMENT IS BEING MADE SUBJECT TO CONDITIONS STATED IN THE IRAC AND SPS DOCUMENTS REFERENCED IN THE CIRCUIT REMARKS FIELD(*NTS).

Supplementary Details - SUPPORT DSRC FIELD TESTING FOR APPLICATION DEVELOPEMENT EQUIPMENT WILL NOT TRANSMIT IN THE NRQZ

SPECIAL HANDLING INSTRUCTIONS

None.

Radio Frequency Authorization

This Authorization expires on: September 30, 2017. For continued use of this equipment, YOU MUST SUBMIT a request to your Frequency Manager by July 02, 2017.

Serial Number	FOI	MSD	BUR	NET	RVD	AUS	EXD
TRAN150018			H		150729	J1139967	170930
FRQ	BIN	TME	SPD	STC	Bandwidth	Emission	Power
5890 MHz		1		XD	10.00 MHz	G1D	.76 Watt(s)
XAL, XSC				XRC	XLA, XLG	XCL	XAP XAZ
MD, MD							ND
XAD							
07GSTCKDIPOLE							
RAL, RSC				RRC	RLA, RLG	ACL	RAP RAZ
MD, MD				I,NTIA-U			ND
RAD				Remarks			
00GMONOPOLE				*EQT,C,INCTRANSCEIVER			
				*POC,V FESSMAN,2024933222,150715			
				*EQR,C,INCTRANSCEIVER			
				*NTS,M015,IRAC 40088/1,SPS-19538/1			
				*MFI,MISC			
				*DFI,DSRC FIELD TESTING			

Restrictions (NTS, *NTS, SUP)
M015,IRAC 40088/1,SPS-19538/1 - THE SYSTEM USING THIS ASSIGNMENT WAS REVIEWED BY THE SPS IN ACCORDANCE WITH CHAPTER 10 AND THE ASSIGNMENT IS BEING MADE SUBJECT TO CONDITIONS STATED IN THE IRAC AND SPS DOCUMENTS REFERENCED IN THE CIRCUIT REMARKS FIELD(*NTS).

Supplementary Details - SUPPORT DSRC FIELD TESTING FOR APPLICATION DEVELOPEMENT EQUIPMENT WILL NOT TRANSMIT IN THE NRQZ

SPECIAL HANDLING INSTRUCTIONS

None.

Radio Frequency Authorization

This Authorization expires on: September 30, 2017. For continued use of this equipment, YOU MUST SUBMIT a request to your Frequency Manager by July 02, 2017.

Serial Number	FOI	MSD	BUR	NET	RVD	AUS	EXD
TRAN150019			H		150729	J1139968	170930
FRQ	BIN	TME	SPD	STC	Bandwidth	Emission	Power
5900 MHz		1		XD	10.00 MHz	G1D	.1 Watt(s)
XAL, XSC				XRC	XLA, XLG	XCL	XAP XAZ
MD, MD							ND
XAD							
07GSTCKDIPOLE							
RAL, RSC				RRC	RLA, RLG	ACL	RAP RAZ
MD, MD				I,NTIA-U			ND
RAD				Remarks			
00GMONOPOLE				*EQT,C,INCTRANSCEIVER			
				*POC,V FESSMAN,2024933222,150715			
				*EQR,C,INCTRANSCEIVER			
				*NTS,M015,IRAC 40088/1,SPS-19538/1			
				*MFI,MISC			
				*DFI,DSRC FIELD TESTING			

Restrictions (NTS, *NTS, SUP)
M015,IRAC 40088/1,SPS-19538/1 - THE SYSTEM USING THIS ASSIGNMENT WAS REVIEWED BY THE SPS IN ACCORDANCE WITH CHAPTER 10 AND THE ASSIGNMENT IS BEING MADE SUBJECT TO CONDITIONS STATED IN THE IRAC AND SPS DOCUMENTS REFERENCED IN THE CIRCUIT REMARKS FIELD(*NTS).

Supplementary Details - SUPPORT DSRC FIELD TESTING FOR APPLICATION DEVELOPEMENT EQUIPMENT WILL NOT TRANSMIT IN THE NRQZ

SPECIAL HANDLING INSTRUCTIONS

None.

Radio Frequency Authorization

This Authorization expires on: September 30, 2017. For continued use of this equipment, YOU MUST SUBMIT a request to your Frequency Manager by July 02, 2017.

Serial Number	FOI	MSD	BUR	NET	RVD	AUS	EXD
TRAN150020			H		150729	J1139969	170930
FRQ	BIN	TME	SPD	STC	Bandwidth	Emission	Power
5910 MHz		1		XD	10.00 MHz	G1D	.1 Watt(s)
XAL, XSC				XRC	XLA, XLG	XCL	XAP XAZ
MD, MD							ND
XAD							
07GSTCKDIPOLE							
RAL, RSC				RRC	RLA, RLG	ACL	RAP RAZ
MD, MD				I,NTIA-U			ND
RAD				Remarks			
00GMONOPOLE				*EQT,C,INCTRANSCEIVER			
				*POC,V FESSMAN,2024933222,150715			
				*EQR,C,INCTRANSCEIVER			
				*NTS,M015,IRAC 40088/1,SPS-19538/1			
				*MFI,MISC			
				*DFI,DSRC FIELD TESTING			

Restrictions (NTS, *NTS, SUP)
M015,IRAC 40088/1,SPS-19538/1 - THE SYSTEM USING THIS ASSIGNMENT WAS REVIEWED BY THE SPS IN ACCORDANCE WITH CHAPTER 10 AND THE ASSIGNMENT IS BEING MADE SUBJECT TO CONDITIONS STATED IN THE IRAC AND SPS DOCUMENTS REFERENCED IN THE CIRCUIT REMARKS FIELD(*NTS).

Supplementary Details - SUPPORT DSRC FIELD TESTING FOR APPLICATION DEVELOPEMENT EQUIPMENT WILL NOT TRANSMIT IN THE NRQZ

SPECIAL HANDLING INSTRUCTIONS

None.

Radio Frequency Authorization

This Authorization expires on: September 30, 2017. For continued use of this equipment, YOU MUST SUBMIT a request to your Frequency Manager by July 02, 2017.

Serial Number	FOI	MSD	BUR	NET	RVD	AUS	EXD
TRAN150021			H		150729	J1139970	170930
FRQ	BIN	TME	SPD	STC	Bandwidth	Emission	Power
5920 MHz		1		XD	10.00 MHz	G1D	.76 Watt(s)
XAL, XSC				XRC	XLA, XLG	XCL	XAP XAZ
MD, MD							ND
XAD							
07GSTCKDIPOLE							
RAL, RSC				RRC	RLA, RLG	ACL	RAP RAZ
MD, MD				I,NTIA-U			ND
RAD				Remarks			
00GMONOPOLE				*EQT,C,INCTRANSCEIVER			
				*POC,V FESSMAN,2024933222,150715			
				*EQR,C,INCTRANSCEIVER			
				*NTS,M015,IRAC 40088/1,SPS-19538/1			
				*MFI,MISC			
				*DFI,DSRC FIELD TESTING			

Restrictions (NTS, *NTS, SUP)
M015,IRAC 40088/1,SPS-19538/1 - THE SYSTEM USING THIS ASSIGNMENT WAS REVIEWED BY THE SPS
IN ACCORDANCE WITH CHAPTER 10 AND THE ASSIGNMENT IS BEING MADE SUBJECT TO CONDITIONS
STATED IN THE IRAC AND SPS DOCUMENTS REFERENCED IN THE CIRCUIT REMARKS FIELD(*NTS).

Supplementary Details - SUPPORT DSRC FIELD TESTING FOR APPLICATION DEVELOPEMENT
EQUIPMENT WILL NOT TRANSMIT IN THE NRQZ

SPECIAL HANDLING INSTRUCTIONS

None.

Radio Frequency Authorization

This Authorization expires on: September 30, 2017. For continued use of this equipment, YOU MUST SUBMIT a request to your Frequency Manager by July 02, 2017.

Serial Number	FOI	MSD	BUR	NET	RVD	AUS	EXD
TRAN150023			H		150810	J1142852	170930
FRQ	BIN	TME	SPD	STC	Bandwidth	Emission	Power
5860 MHz		1		XD	80.00 MHz	GLD	1 Watt(s)
XAL, XSC				XRC	XLA, XLG	XCL	XAP XAZ
MD, MD							ND
XAD							
07GSTCKDIPOLE							
RAL, RSC				RRC	RLA, RLG	ACL	RAP RAZ
MD, MD				I, NTIA-U			ND
RAD				Remarks			
00GMONOPOLE				*EQT, C, INCTRANSCEIVER			
				*POC, V.FESSMAN, 2024933322, 150727			
				*EQR, C, INCTRANSCEIVER			
				*MFI, MISC			
				*DFI, DSRC/UNII TESTING			

Restrictions (NTS, *NTS, SUP)

Supplementary Details - DEVICE IS MODELED AFTER UNII DEVICE TO SUPPORT DSRC/UNII EVALUATION FOR INTERFERENCE EQUIPMENT WILL NOT BE USED IN NRQZ

SPECIAL HANDLING INSTRUCTIONS

None.

Radio Frequency Authorization

This Authorization expires on: September 30, 2017. For continued use of this equipment, YOU MUST SUBMIT a request to your Frequency Manager by July 02, 2017.

Serial Number	FOI	MSD	BUR	NET	RVD	AUS	EXD
TRAN150024			H		150810	J1142854	170930
FRQ	BIN	TME	SPD	STC	Bandwidth	Emission	Power
5880 MHz		1		XD	40.00 MHz	G1D	1 Watt(s)
XAL, XSC				XRC	XLA, XLG	XCL	XAP XAZ
MD, MD							ND
XAD							
07GSTCKDIPOLE							
RAL, RSC				RRC	RLA, RLG	ACL	RAP RAZ
MD, MD				I, NTIA-U			ND
RAD				Remarks			
00GMONOPOLE				*EQT, C, INCIRANSCEIVER			
				*POC, V.FESSMAN, 2024933322, 150727			
				*EQR, C, INCIRANSCEIVER			
				*MFI, MISC			
				*DFI, DSRC/UNII TESTING			

Restrictions (NTS, *NTS, SUP)

Supplementary Details - DEVICE IS MODELED AFTER UNII DEVICE TO SUPPORT DSRC/UNII EVALUATION FOR INTERFERENCE EQUIPMENT WILL NOT BE USED IN NRQZ

SPECIAL HANDLING INSTRUCTIONS

None.

Radio Frequency Authorization

This Authorization expires on: September 30, 2017. For continued use of this equipment, YOU MUST SUBMIT a request to your Frequency Manager by July 02, 2017.

Serial Number	FOI	MSD	BUR	NET	RVD	AUS	EXD
TRAN150025			H		150810	J1142853	170930
FRQ	BIN	TME	SPD	SIC	Bandwidth	Emission	Power
5870 MHz		1		XD	20.00 MHz	G1D	1 Watt(s)
XAL, XSC				XRC	XLA, XLG	XCL	XAP XAZ
MD, MD							ND
XAD							
07GSTCKDIPOLE							
RAL, RSC				RRC	RLA, RLG	ACL	RAP RAZ
MD, MD				I, NTIA-U			ND
RAD				Remarks			
00GMONOPOLE				*EQT, C, TNCTRANSCEIVER			
				*POC, V. FESSMAN, 2024933322, 150727			
				*EQR, C, TNCTRANSCEIVER			
				*MFI, MISC			
				*DFI, DSRC/UNII TESTING			

Restrictions (NTS, *NTS, SUP)
 Supplementary Details - DEVICE IS MODELED AFTER UNII DEVICE TO SUPPORT DSRC/UNII EVALUATION FOR INTERFERENCE EQUIPMENT WILL NOT BE USED IN NRQZ

SPECIAL HANDLING INSTRUCTIONS

None.

Radio Frequency Authorization

This Authorization expires on: September 30, 2017. For continued use of this equipment, YOU MUST SUBMIT a request to your Frequency Manager by July 02, 2017.

Serial Number	FOI	MSD	BUR	NET	RVD	AUS	EXD
TRAN150026			H		150810	J1142855	170930
FRQ	BIN	TME	SPD	STC	Bandwidth	Emission	Power
5890 MHz		1		XD	20.00 MHz	G1D	1 Watt(s)
XAL, XSC				XRC	XLA, XLG	XCL	XAP XAZ
MD, MD							ND
XAD							
07GSTICKDIPOLE							
RAL, RSC				RRC	RLA, RLG	ACL	RAP RAZ
MD, MD				I,NTIA-U			ND
RAD				Remarks			
00GMONOPOLE				*EQT,C,INCTRANSCEIVER			
				*POC,V.FESSMAN,2024933322,150727			
				*EQR,C,INCTRANSCEIVER			
				*MFI,MISC			
				*DFI,DSRC/UNII TESTING			

Restrictions (NIS, *NIS, SUP)

Supplementary Details - DEVICE IS MODELED AFTER UNII DEVICE TO SUPPORT DSRC/UNII EVALUATION FOR INTERFERENCE EQUIPMENT WILL NOT BE USED IN NRQZ

SPECIAL HANDLING INSTRUCTIONS

None.

Appendix E: Candidate Field Survey Sites

Candidate Sites for DSRC Interference Survey		
Emitter and Location	Type	Comment
Eglin Air Force Base Edwards Air Force Base White Sands Wallops Island	Federal radar	<ul style="list-style-type: none"> Observe 3km security distance
Clarksburg, MD (near I270)	In-band FSS earth station	<ul style="list-style-type: none"> Sat uplink in ITS band (Int'l) Intelsat Limited to international inter-continental systems
Alexandria, VA	In-band FSS earth station	<ul style="list-style-type: none"> Sat uplink in ITS band (Int'l) SES Americom Limited to international inter-continental systems
New Skies Networks Inc. 8000 Gainsford Court Bristow, VA 20136 Phone: (703) 330-3305	Above-band FSS earth station	<ul style="list-style-type: none"> Sat uplink above ITS band Domestic FSS earth station
<p>1. CableWiFi 1434 Center St McLean, VA 22101 Site type: Outdoor Network Name: CableWiFi</p> <p>2. CableWiFi 1389 Chain Bridge Rd McLean, VA 22101 Site type: Outdoor Network Name: CableWiFi</p> <p>3. CableWiFi 6671 Old Dominion Dr McLean, VA 22101 Site type: Outdoor Network Name: CableWiFi</p> <p>4. CableWiFi 1455 Chain Bridge Rd McLean, VA 22101 Site type: Outdoor Network Name: CableWiFi</p> <p>5. CableWiFi 1360 Old McLean Village Dr McLean, VA 22101 Site type: Outdoor Network Name: CableWiFi</p>	Unlicensed Wi-Fi	<ul style="list-style-type: none"> McLean, VA area Verify unlicensed Wi-Fi AP emitters below 5.85GHz Notional list only Outdoor Limit measurements if spectral profiles are similar
Wi-Fi___33 noise from Urban high-occupancy dwellings	Unlicensed Wi-Fi noise aggregate	<ul style="list-style-type: none"> Notional <ul style="list-style-type: none"> Arlington Fairfax Washington, DC
<p>1. CableWiFi 3126 Carlsbad Blvd Carlsbad, CA 92008 Site type: Outdoor Network Name: CableWiFi</p> <p>2. CableWiFi 458 Carlsbad Village Drive Carlsbad, CA 92008 Site type: Outdoor</p>	Unlicensed Wi-Fi	<ul style="list-style-type: none"> DENSO measurements (close to DENSO) Verify unlicensed Wi-Fi___33 AP emitters below 5.85GHz Notional list only Outdoor Limit measurements if spectral profiles are similar

Candidate Sites for DSRC Interference Survey		
Emitter and Location	Type	Comment
Network Name: CableWiFi 3. CableWiFi 117 Walnut Avenue Carlsbad, CA 92008 Site type: Outdoor Network Name: CableWiFi 4. CableWiFi 158 Sycamore Avenue Carlsbad, CA 92008 Site type: Outdoor 5. CableWiFi 135 Chestnut Avenue Carlsbad, CA 92008 Site type: Outdoor Network Name: CableWiFi		

U.S. Department of Transportation
Intelligent Transportation Systems Joint Program Office (ITS JPO)
1200 New Jersey Avenue, SE
Washington, D.C. 20590
202-366-9536



U.S. Department of Transportation
Research and Innovative Technology Administration
John A. Volpe National Transportation Systems Center

Volpe