

JOINT TRANSPORTATION RESEARCH PROGRAM

INDIANA DEPARTMENT OF TRANSPORTATION
AND PURDUE UNIVERSITY



Connected Vehicle Corridor Deployment and Performance Measures for Assessment



Howell Li, Jijo K. Mathew, Woosung Kim,
Enrique Daniel Saldivar-Carranza, Jim Sturdevant,
W. Benjamin Smith, Darcy M. Bullock

RECOMMENDED CITATION

Li, H., Mathew, J. K., Kim, W., Saldivar-Carranza, E. D., Sturdevant, J., Smith, W. B., & Bullock, D. M. (2019). *Connected vehicle corridor deployment and performance measures for assessment* (Joint Transportation Research Program Publication No. FHWA/IN/JTRP-2019/28). West Lafayette, IN: Purdue University. <https://doi.org/10.5703/1288284317108>

AUTHORS

Howell Li

JTRP Senior Software Engineer
Lyles School of Civil Engineering
Purdue University
(765) 494-9601
howell-li@purdue.edu
Corresponding Author

Jijo K. Mathew, PhD, Transportation Research Engineer

Woosung Kim, Software Engineer

Enrique Daniel Saldivar-Carranza, Graduate Research Assistant

Lyles School of Civil Engineering
Purdue University

Jim Sturdevant, PE, Director of Traffic Management

W. Benjamin Smith, PE, Signal Systems Field Engineer—West Central IN Region
Indiana Department of Transportation

Darcy M. Bullock, PhD, PE

Lyles Family Professor of Civil Engineering
Lyles School of Civil Engineering
Purdue University
Principal Investigator

JOINT TRANSPORTATION RESEARCH PROGRAM

The Joint Transportation Research Program serves as a vehicle for INDOT collaboration with higher education institutions and industry in Indiana to facilitate innovation that results in continuous improvement in the planning, design, construction, operation, management and economic efficiency of the Indiana transportation infrastructure. https://engineering.purdue.edu/JTRP/index_html

Published reports of the Joint Transportation Research Program are available at <http://docs.lib.purdue.edu/jtrp/>.

NOTICE

The contents of this report reflect the views of the authors, who are responsible for the facts and the accuracy of the data presented herein. The contents do not necessarily reflect the official views and policies of the Indiana Department of Transportation or the Federal Highway Administration. The report does not constitute a standard, specification or regulation.

TECHNICAL REPORT DOCUMENTATION PAGE

1. Report No. FHWA/IN/JTRP-2019/28	2. Government Accession No.	3. Recipient's Catalog No.	
4. Title and Subtitle Connected Vehicle Corridor Deployment and Performance Measures for Assessment	5. Report Date October 2019		6. Performing Organization Code
	7. Author(s) Howell Li, Jijo K. Mathew, Woosung Kim, Enrique Daniel Saldivar-Carranza, Jim Sturdevant, W. Benjamin Smith, and Darcy M. Bullock		
9. Performing Organization Name and Address Joint Transportation Research Program Hall for Discovery and Learning Research (DLR), Suite 204 207 S. Martin Jischke Drive West Lafayette, IN 47907	8. Performing Organization Report No. FHWA/IN/JTRP-2019/28		
	10. Work Unit No.		
12. Sponsoring Agency Name and Address Indiana Department of Transportation (SPR) State Office Building 100 North Senate Avenue Indianapolis, IN 46204	11. Contract or Grant No. SPR-4205		
	13. Type of Report and Period Covered Final Report		
14. Sponsoring Agency Code			
15. Supplementary Notes Conducted in cooperation with the U.S. Department of Transportation, Federal Highway Administration.			
16. Abstract <p>In November 2016, the American Association of State Highway and Transportation Officials (AASHTO) announced the Signal Phase and Timing (SPaT) challenge to state and local agencies to kick start infrastructure deployments for V2I communications. The challenge involved the deployment of Dedicated Short Range Communication (DSRC) infrastructure with SPaT broadcasts (current intersection signal light phase) on at least 20 signalized intersections in all of the 50 states by 2020. Although the roadmap for agencies to partner with the automotive industry is still evolving, it is important for Indiana to not only support the SPaT challenge, but also identify mutually beneficial opportunities for INDOT to partner with the automotive industry as Indiana has the second largest automotive related Gross Domestic Product (GDP) in the country.</p> <p>During this study, connected traffic signal infrastructure was deployed at several locations around the state. The West Lafayette corridor SPaT message deployment was done using both traditional Dedicated Short Range Communication (DSRC) as well cellular communication. This report details the deployment locations, the various public and private sector stakeholders that were engaged during the field testing, and several vehicle-infrastructure communication experiments that were used to evaluate connected vehicle use cases.</p> <p>The findings of this research were as follows:</p> <ol style="list-style-type: none"> 1. The team successfully demonstrated use cases for placing virtual vehicle detection calls to a traffic signal controller using Basic Safety Message (BSM) messages and evaluated latency. 2. The team developed a scalable methodology for characterizing the probability of a traffic signal phase changing by time of day. This methodology of using agency traffic signal data for green light prediction and engine shut down at red lights is particularly useful to the automotive industry. 3. The team successfully demonstrated that split failures, reduced roadway friction and hard braking events can be identified on the vehicle and transmitted to an agency. This enhanced probe data information is particularly valuable to agencies for identifying traffic signal timing problems, segments impacted by winter weather and location where drivers are encountering roadway conditions required hard braking. 4. DSRC provides the lowest latency communication, but in general commercial cellular interface between vehicles and infrastructure provided acceptable latency for most use cases. For most applications, the team believes a commercial cellular interface between vehicles and infrastructure is the most scalable and feasible for an agency to maintain. 			
17. Key Words connected vehicle, DSRC, RSU, SPaT, split failures, roadway friction		18. Distribution Statement No restrictions. This document is available through the National Technical Information Service, Springfield, VA 22161.	
19. Security Classif. (of this report) Unclassified	20. Security Classif. (of this page) Unclassified	21. No. of Pages 38 including appendices	22. Price

EXECUTIVE SUMMARY

CONNECTED VEHICLE CORRIDOR DEPLOYMENT AND PERFORMANCE MEASURES FOR ASSESSMENT

Motivation

In November 2016, the American Association of State Highway and Transportation Officials (AASHTO) announced the signal phase and timing (SPaT) challenge to state and local agencies to kick-start infrastructure deployments for V2I communications. The challenge involved the deployment of dedicated short-range communication (DSRC) infrastructure with SPaT broadcasts (current intersection signal light phase) on at least 20 signalized intersections in all 50 states by 2020.

Although the roadmap for agencies to partner with the automotive industry is still evolving, it is important for Indiana to not only support the SPaT challenge but also identify mutually beneficial opportunities for INDOT to partner with the automotive industry because Indiana has the second largest automotive-related gross domestic product (GDP) in the country.

Study

During this study, connected traffic signal infrastructure was deployed at several locations around the state. SPaT message deployment was done using both DSRC and cellular communications. This report details the deployment locations, the various public- and private-sector stakeholders that were engaged during the field-testing, and the several vehicle-infrastructure communication experiments that were used to evaluate connected vehicle use cases.

Results

The findings of this research were as follows:

1. The team successfully demonstrated use cases for placing virtual vehicle detection calls using basic safety messages (BSMs) and evaluated latency.
2. The team developed a scalable methodology for characterizing the probability of a traffic signal phase changing by time of day. This methodology using agency traffic signal data for

green light prediction and engine shutdown at red lights is particularly useful to the automotive industry.

3. The team successfully demonstrated that split failures, reduced roadway friction, and hard braking events can be identified on the vehicle and then transmitted to an agency. This enhanced probe data information is particularly valuable to agencies for identifying traffic signal timing problems, segments impacted by winter weather, and locations where drivers are encountering roadway conditions that require hard braking.
4. DSRC provides the lowest latency communication but, in general, commercial cellular interface between vehicles and infrastructure provided acceptable latency for most use cases. For most applications, the team believes a commercial cellular interface between vehicles and infrastructure is the most scalable and feasible for an agency to maintain.

Recommendations

1. In the short-term, there is significant opportunity for placing “virtual pedestrian” calls at traffic signals for users with mobility challenges or for emerging robot delivery vehicles that need to cross the street.
2. The current version of the SAE J2735 SPaT definition is ambiguous on the *likelyTime* and *time interval confidence* fields regarding whether the elements refer to start of green or end of green. It is recommended that protocol documentation and messages be updated to support confidence estimates for both start and end of green.
3. Develop a partnership with the automotive sector to obtain enhanced probe data that identify traffic signal phases that experience split failures, locations with hard braking events, and segments with reduced friction.
4. The automotive industry has assumed that traffic signal phases behave deterministically; however, modern traffic signals operate much more stochastically. Longer term, it might be worthwhile to have a “phase-next” data flag provided by signal controllers. This would inform the vehicle of a deterministic window to update their phase predictions 5 to 7s prior to the start of the next phase.
5. It might also be worthwhile to reconsider strategies on running the “free” timing plan overnight. Free operation, based purely on random arrivals, can make the traffic signal predictions even more challenging than coordinated and adaptive systems.

CONTENTS

1. PROJECT OVERVIEW	1
1.1 Introduction	1
1.2 Dissemination of Research Results	1
2. IMPLEMENTATION AND ASSESSMENT OF CONNECTED VEHICLE ARCHITECTURES	1
2.1 Dedicated Short Range Communication (DSRC)	1
2.2 Cellular Communication	3
2.3 Connected Corridor and Deployment	3
3. ENGAGEMENT WITH STAKEHOLDERS	8
3.1 Engagement	8
3.2 Summary of Developed Used Cases	11
4. SUMMARY OF FINDINGS	11
4.1 Performance of DSRC	11
4.2 Performance of Cellular	13
4.3 Stochastic Variation of Traffic Signal Phase Green Times	13
4.4 Impact of Stochastic Variation on Glosa	17
4.5 Detection of Winter Weather Conditions Using Enhanced Probe Data	17
4.6 Dilemma Zone Protection Using Virtual Detection	18
4.7 Leveraging Connected Vehicle Data for Identifying Commercial Vehicle Testing Locations	19
4.8 Detection of Split Failures and Estimation of Queue Lengths	20
5. DASHBOARDS	21
5.1 Platoonability	21
5.2 Winter Weather Enhanced Probe Data	21
5.3 CV Telemetry	21
5.4 Traffic Signal Status Probability Dashboard	21
5.5 GLOSA HMI	21
5.6 Maintenance Operations/Slow Moving Vehicle Mobile App	25
6. SUMMARY AND RECOMMENDATIONS	25
REFERENCES	25
APPENDICES	
Appendix A. Probabilistic Distributions of Coordinated Traffic Signal Phase Indications for Connected Vehicle Applications	27
Appendix B. Signal Green Time Estimation Method for Connected Vehicle-to-Infrastructure Applications	27
Appendix C. Populating Sae J2735 Message Confidence Values for Traffic Signal Transitions Along a Signalized Corridor	27
Appendix D. Effects of A Probability-Based Green Light Optimized Speed Advisory on Dilemma Zone Exposure	28
Appendix E. Leveraging Connected Vehicles to Provide Enhanced Roadway Condition Information	28
Appendix F. Using Connected Vehicle Data to Reassess Dilemma Zone Performance of Heavy Vehicles	29
Appendix G. Analytical Techniques to Use Historical Connected Vehicle Data to Assess Platooning Potential on Interstate Corridors	29

LIST OF TABLES

Table	Page
Table 4.1 Probability of phase occurrences within the cycle corresponding to callouts on Figure 4.7	16
Table 4.2 SAE time interval confidence values and probability	16

LIST OF FIGURES

Figure	Page
Figure 2.1 DSRC system components	2
Figure 2.2 DSRC	2
Figure 2.3 USDOT Connected Vehicles Tool Library's ISD Message Creator	3
Figure 2.4 OSS Nokalva Playground for decoding SAE 2735 strings	3
Figure 2.5 Data flow for CV applications	4
Figure 2.6 Cellular communications architecture	4
Figure 2.7 West Lafayette and Kokomo with connected vehicle infrastructure	5
Figure 2.8 Intersections with DSRC deployment	6
Figure 2.9 RSU deployment at US 231/Martin Jischke Drive in West Lafayette, IN	7
Figure 2.10 SU Deployment in Kokomo	8
Figure 3.1 Meeting with peer states	9
Figure 3.2 Meeting with City of West Lafayette, June 2019	9
Figure 3.3 Collaboration with APTIV and Cohda Wireless	10
Figure 3.4 Collaboration with VW-ERL	10
Figure 3.5 Collaboration with Ford Motor Co	11
Figure 3.6 Collaboration with Trimble	11
Figure 4.1 Performance of waypoint radii matching using 6' radius and 50' spacing	12
Figure 4.2 Performance of different waypoint spacings using 6' radius	12
Figure 4.3 System latency of the cellular network for CV application	13
Figure 4.4 Time-to-green traffic light indication (TLI) application	14
Figure 4.5 Residual plot evaluating the performance of TLI application	14
Figure 4.6 Comparison of probabilistic distribution of green for fixed and actuated coordinated systems	15
Figure 4.7 Probability of expected phases for an actuated coordinated system. Callouts (a)–(k) represent the different splits that can be served at the same period within a cycle but at different times of day	15
Figure 4.8 Populating SAE confidence interval values	16
Figure 4.9 Vehicle performance of virtual drive using different GLOSA strategies	17
Figure 4.10 Vehicle slip detection using wheel ticks	18
Figure 4.11 Field-testing of force gap out (FGO)	19
Figure 4.12 Opportunity for autonomous delivery robots to place virtual pedestrian calls	20
Figure 4.13 Potential platoonable sections on I-70 EB	20
Figure 4.14 High fidelity GPS trajectory data to identify split failures (callouts i–iv)	21
Figure 5.1 Integrated heat map and camera image dashboard	22
Figure 5.2 Winter weather hazardous conditions dashboard	22
Figure 5.3 CV telemetry dashboard using a scooter	23
Figure 5.4 Traffic signal status probability dashboard	23
Figure 5.5 GLOSA dashboard	24
Figure 5.6 Maintenance operations/slow moving vehicle app	24

LIST OF ACRONYMS

AADT	Annual Average Daily Traffic
AASHTO	American Association of State Highway and Transportation Officials
ASN.1	Abstract Syntax Notation One
BOG	Beginning of Green
BSM	Basic Safety Message
CARMA	Cooperative Automation Research Mobility Applications
CAV	Connected and Autonomous Vehicle
CV	Connected Vehicle
DSRC	Dedicated Short Range Communication
EOG	End of Green
FHWA	Federal Highway Administration
GDP	Gross Domestic Product
INDOT	Indiana Department of Transportation
MAP	Connected Vehicle Map
NCHRP	National Cooperative Highway Research Program
NTCIP	National Transportation Communications for Intelligent Transportation System Protocol
OBU	Onboard Unit
RSU	Roadside Unit
SAE	Society of Automotive Engineers
SPaT	Signal Phase and Timing
TIC	Time in Cycle
TRB	Transportation Research Board
UPER	Unaligned Packed Encoding Rules
USB	Universal Serial Bus
USDOT	United States Department of Transportation
VPN	Virtual Private Network

1. PROJECT OVERVIEW

1.1 Introduction

In 2011, the U.S. Department of Transportation (USDOT) announced the “Connected Vehicle (CV) Program” that allows vehicles to communicate with other vehicles (V2V), infrastructure (V2I) and other devices (V2X) to improve safety, mobility and reduce environmental impacts like fuel consumption and emissions (Hill et al., 2013; U.S. Department of Transportation, n.d.a). In November 2016, the American Association of State Highway and Transportation Officials (AASHTO) announced the signal phase and timing (SPaT) challenge to state and local agencies to kick start infrastructure deployments for V2I communications (AASHTO, n.d.). The challenge involved the deployment of dedicated short-range communication (DSRC) infrastructure with SPaT broadcasts (current intersection signal light phase) on at least 20 signalized intersections in all of the 50 states by 2020.

Although the AASHTO SPaT challenge is specific on the number of units to deploy and target date, it provides little guidance on what states should do with the technology once deployed. This report outlines the efforts led by INDOT and Purdue University to test both cellular and DSRC deployments in the State of Indiana. Engagement with critical stakeholders that lead to early use case development and the lessons learned from the implementation of CV technology are discussed in detail.

1.2 Dissemination of Research Results

The following is a list of papers prepared in part during the course of this project.

- Li, H., Wolf, J. C., Mathew, J. K., Navali, N., Zehr, S. D., Hardin, B. L., & Bullock, D. (2019). *Leveraging connected vehicles to provide enhanced roadway condition information* [Manuscript submitted for publication]. Lyles School of Engineering, Purdue University.
- Mathew, J. K., Li, H., Morgan, B., Kim, W., & Bullock, D. (2019). *Probabilistic distributions of coordinated traffic signal phase indications for connected vehicle applications* [Paper presentation]. Annual Meeting of Transportation Research Board 98th Annual Meeting, Washington D.C., United States.
- Mathew, J. K., Li, H., & Bullock, D. (2019). *Signal green time estimation method for connected vehicle-to-infrastructure applications* [Paper presentation]. IEEE International Conference on Connected Vehicles and Expo (ICCVE) 8th Annual Meeting, Graz, Austria.
- Mathew, J. K., Li, H., & Bullock, D. (2020). *Populating SAE J2735 message confidence values for traffic signal transitions along a signalized corridor* [Manuscript submitted for publication]. Lyles School of Engineering, Purdue University.
- Li, H., Platte, T., Mathew, J. K., Smith, B., Salivadar-Carranza, E., & Bullock, D. (2020). *Using connected vehicle data to reassess dilemma zone performance of heavy vehicles* [Manuscript submitted for publication]. Lyles School of Engineering, Purdue University.

- Kim, W., Li, H., Mathew, J. K., & Bullock, D. (2020). *Analytical techniques to use historical connected vehicle data to assess platooning potential on interstate corridors* [Manuscript submitted for publication]. Lyles School of Engineering, Purdue University.
- Salivadar-Carranza, E., Kim, W., Li, H., Mathew, J. K., Sturdevant, J., & Bullock, D. (in press). *Effects of a probability-based green light optimized speed advisory on dilemma zone exposure* (SAE Technical Paper 2020-01-0116). SAE International.

These technical papers were prepared throughout the project and distributed to key INDOT stakeholders to facilitate early implementation of the research findings. The following sections of the technical report summarize key findings and reference the Appendices that contain these targeted implementation papers.

2. IMPLEMENTATION AND ASSESSMENT OF CONNECTED VEHICLE ARCHITECTURES

2.1 Dedicated Short Range Communication (DSRC)

2.1.1 System Components

For V2I communication to occur using DSRC, the system requires a V2X-capable traffic signal controller (Figure 2.1a), a co-processor card (CVCP, Figure 2.1b), a roadside unit (RSU, Figure 2.1c) installed at an intersection, and an onboard unit (OBU, Figure 2.1d) installed on a vehicle.

2.1.2 System Architecture

Figure 2.2 shows an overview of the DSRC communication workflow. The traffic signal controller (callout i) is connected to a roadside unit (RSU) (callout ii) which transmits and receives data wirelessly from the onboard units (OBU) and high-fidelity GPS units (callout iii) equipped on the vehicles provide location data. DSRC is capable of facilitating data transfer between fast moving vehicles and prioritizing safety messages with the dedicated wireless transmission (Hill et al., 2013).

SPaT data is generated from the traffic signal controller at 10 Hz. The data is sent to the CVCP to conform the packet to the SAE J2735 Message Set Dictionary format. From the CVCP, the data is then sent to the RSU where it is broadcasted to OBUs.

MAP data is generated using the USDOT Connected Vehicles Tool Library’s ISD Message Creator (U.S. Department of Transportation, n.d.b; Figure 2.3), a user interface which defines the intersection and its approaches, lanes, and waypoints. Once the intersection has been mapped, the data can be encoded via the web application in unaligned packed encoding rules (UPER), and converted to a base-64 text string. The base-64 text string is then embedded into the RSU 4.1 file template format and saved to the RSU for broadcasting to vehicles.

BSM data is generated from an OBU typically on startup at 10 Hz. The data contains latitude, longitude, generation time, speed, elevation, heading, acceleration,

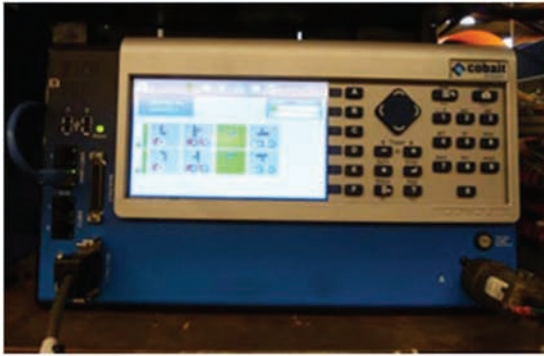

(a) Traffic Signal Controller



(b) Connected Vehicle Co-Processor (CVCP)



(c) Roadside Unit (RSU)



(d) Onboard Unit (OBU)

Figure 2.1 DSRC system components.

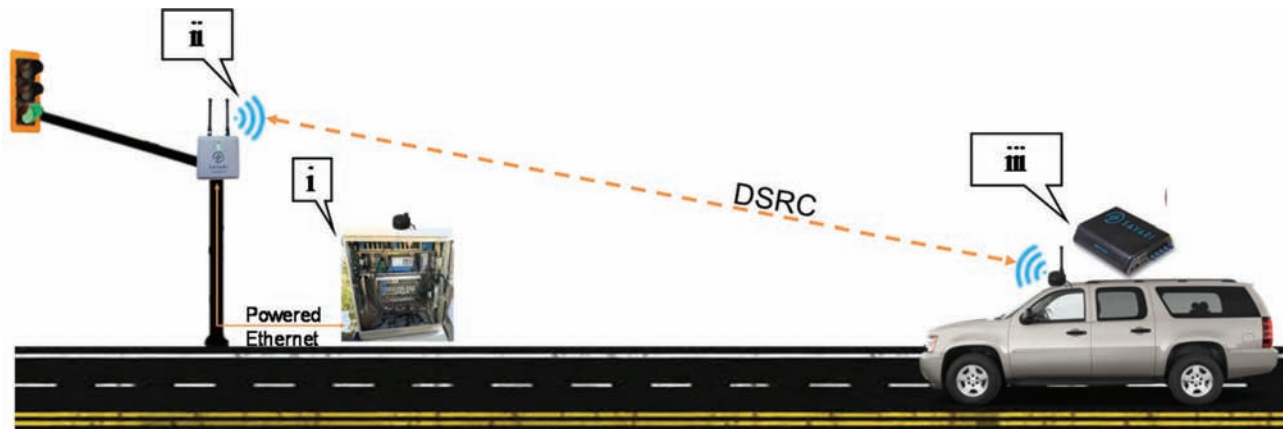

Figure 2.2 DSRC.

path history, transmission status, brake information, lights, and weather data. Depending on the instrumented vehicle and integration with the OBU, not all data properties may be populated for all CV. The RSU receives the data and its signal strength and determines based on a preconfigured threshold whether the data

packet is within acceptable strength tolerance. If the packet is acceptable, it can be forward to an external host, typically the CVCP, for further processing, logging, or triggering phase action in the controller.

SPaT, MAP, and BSM data encoded in base-64 UPER format can all be validated using the OSS

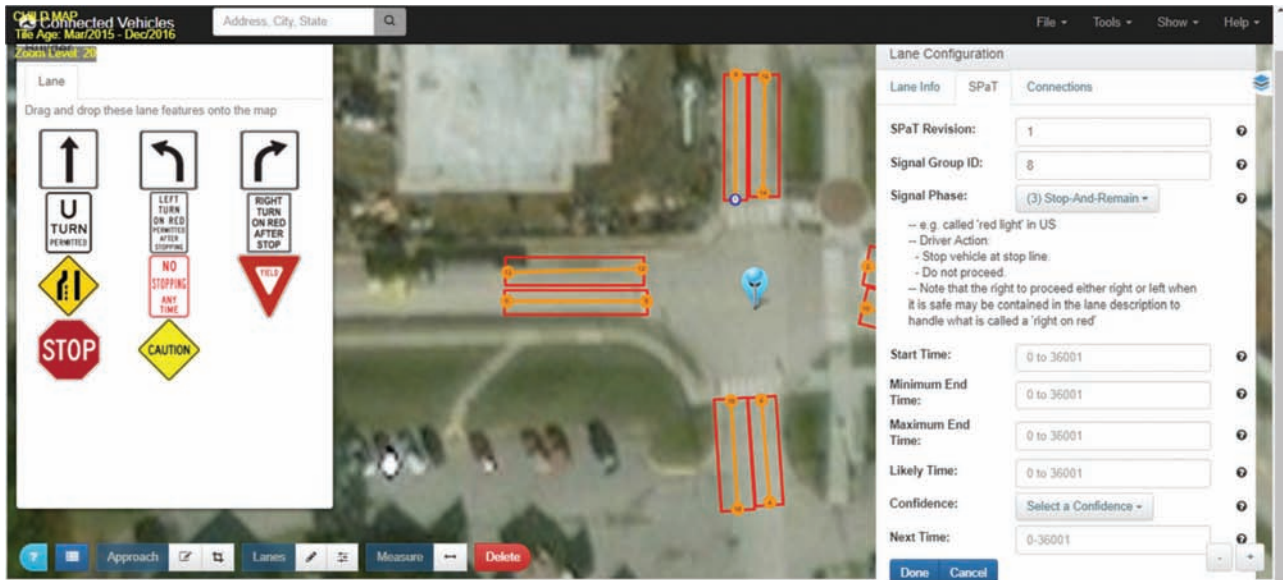

Figure 2.3 USDOT Connected Vehicles Tool Library's ISD Message Creator.

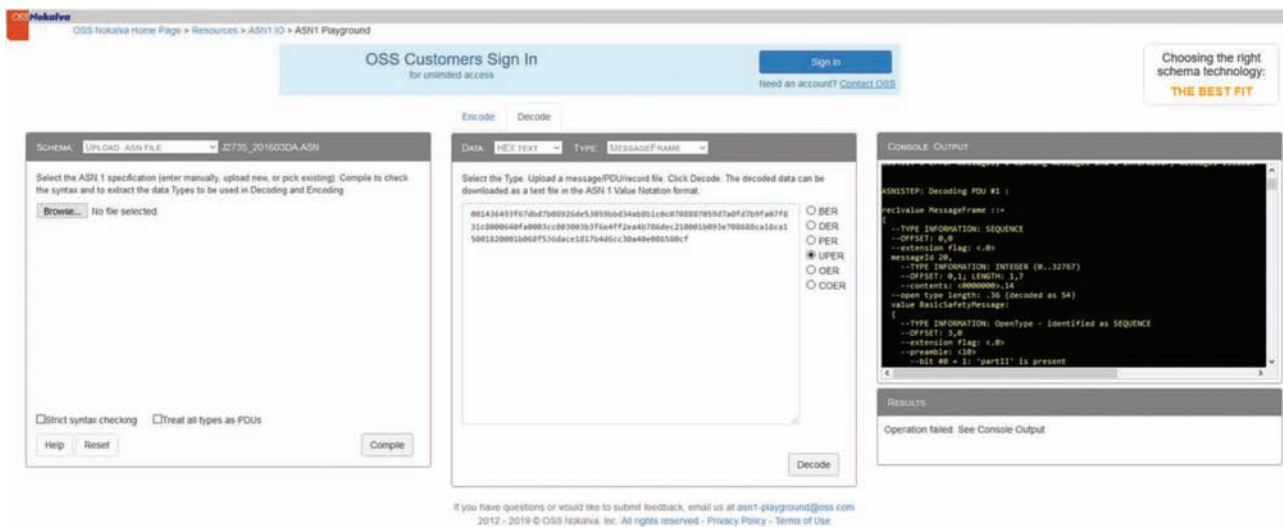

Figure 2.4 OSS Nokalva Playground for decoding SAE 2735 strings.

Nokalva Playground website (OSS Nokalva, n.d.; Figure 2.4). The original SAE J2735 ASN.1 file that defines the connected vehicle message set must be uploaded as the schema for decoding the messages properly.

Figure 2.5 shows the architecture in terms of the movement of data between each of the components in a DSRC system.

2.2 Cellular Communication

An alternative architecture that has been gaining popularity is the cellular mode of communication (Figure 2.6). In this method, the original equipment manufacturer (OEM) sends vehicle data directly to the cloud using 4G/5G cellular technology. The data from

the signal controllers (callout i) and vehicle undergo integration in a cloud-based system (callout ii), which then communicates it back and forth with the signal controller and the vehicles (callout iii). The advantage of this method is that vehicles can communicate with the cloud as long as the cellular network is available. With the OEM sending data to the cloud, there is less roadway equipment and maintenance required by the local agencies and state DOTs.

2.3 Connected Corridor and Deployment

Currently, two cities, West Lafayette and Kokomo, support connected vehicle infrastructure (Figure 2.7). In West Lafayette, 10 intersections along the US 231 corridor between CR 500S and US 52 (Figure 2.8a) are

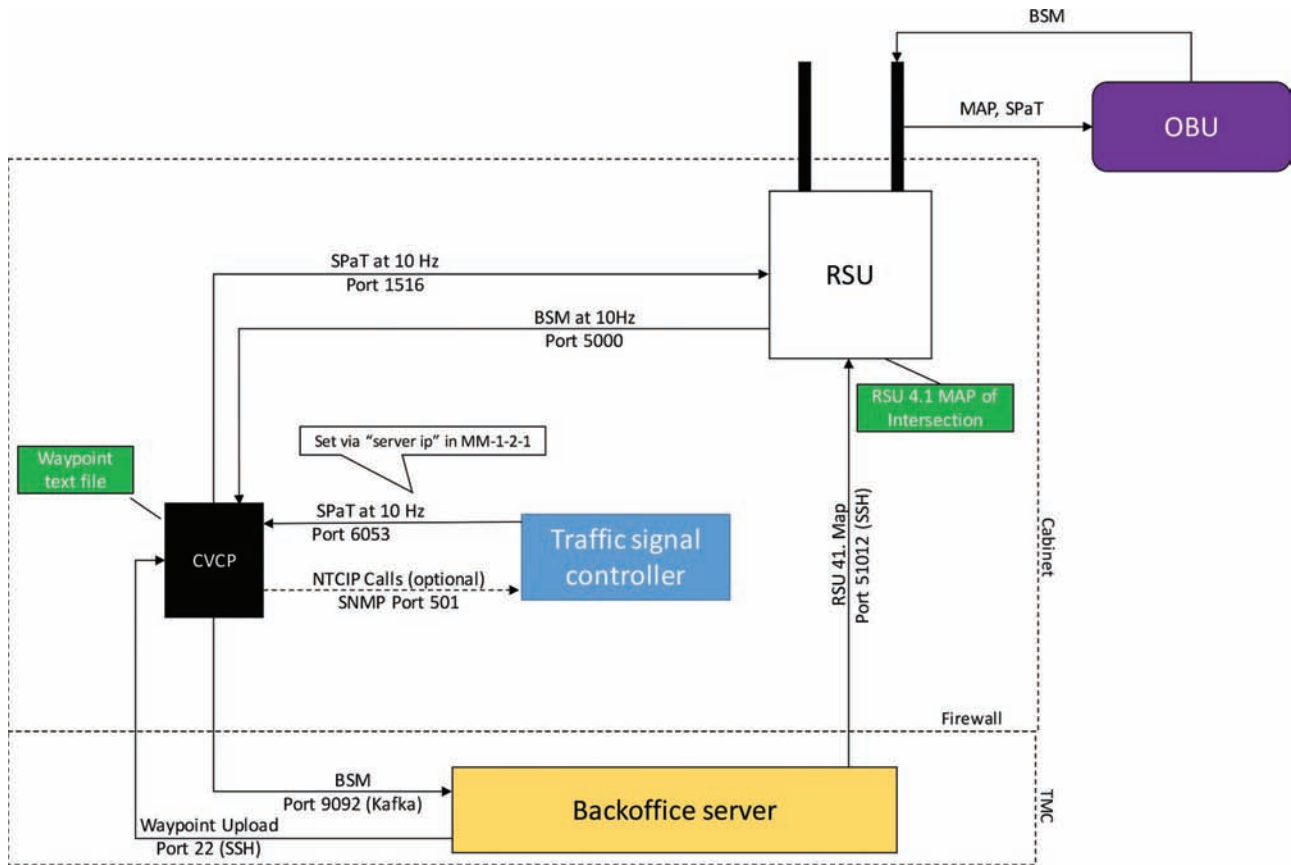

Figure 2.5 Data flow for CV applications.

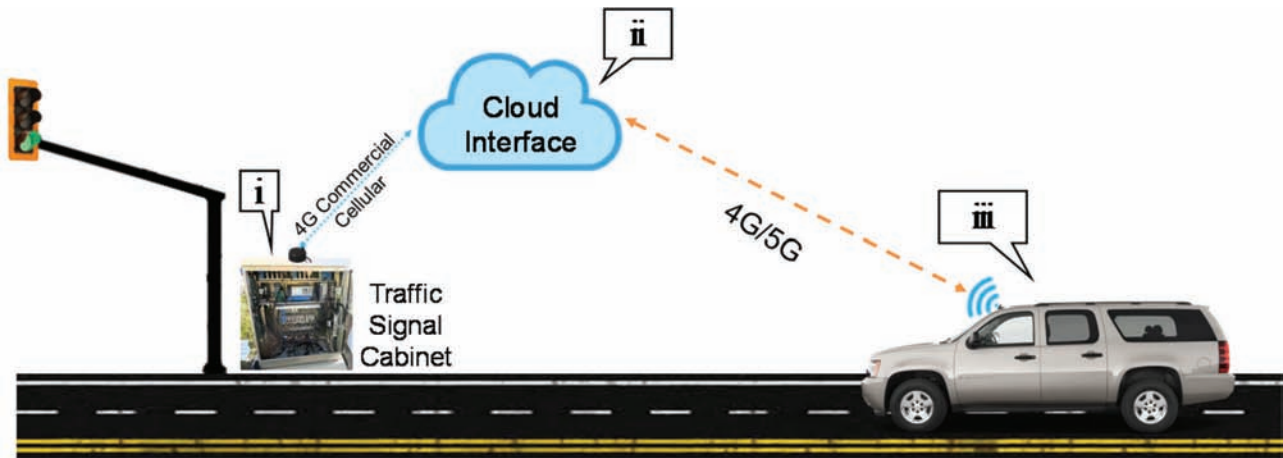

Figure 2.6 Cellular communications architecture.

equipped with RSUs, interconnected with CV-enabled controllers. In Kokomo, the intersection of Lincoln Road and SR 931 is equipped with an RSU connected

to a CV-enabled controller (Figure 2.8b). Figure 2.9 and Figure 2.10 shows some pictures from the deployment in West Lafayette and Kokomo, respectively.



Figure 2.7 West Lafayette and Kokomo with connected vehicle infrastructure.



(a) West Lafayette



(b) Kokomo

Figure 2.8 Intersections with DSRC deployment.



Figure 2.9 RSU deployment at US 231/Martin Jischke Drive in West Lafayette, IN.



Figure 2.10 SU Deployment in Kokomo.

3. ENGAGEMENT WITH STAKEHOLDERS

3.1 Engagement

A number of engagement activities were conducted with federal, state, and local agencies, automotive manufacturers, and equipment suppliers over the duration of the project. The below sections highlight key activities with the stakeholders that have furthered use case development and implementation of CV technology.

3.1.1 FHWA

Connected vehicle winter weather research was presented at the FHWA Road Weather Management Stakeholder Meeting in September 2018. The research team was also selected for FHWA’s Cooperative Automation Research Mobility Applications (CARMA) program as part of the Road Weather Management task force beginning March 2019 that supports the testing and evaluation of CAV research.

3.1.2 Peer States

Researchers have engaged ten peer states on development, implementation, and challenges of CV technology in the area of traffic signal applications. A meeting in March 2019 was held as part of Transportation Pooled Fund Program’s TPF-5(377) Enhanced Traffic Signal Performance Measures. Split failures, winter driving, dilemma zone protection using virtual detection zones, SAE green signal confidence

intervals and likelyTime, and red light running at signalized intersections were identified to be key performance measures. Connected vehicle winter weather research was also presented at the AASHTO Maintenance Committee summer meeting in July 2019 (Figure 3.1).

3.1.3 Local Agency

Researchers engaged the City of West Lafayette on the application of CV technology for micro-mobility modes in Q2 2019 (Figure 3.2). Through collaboration with the city, two new performance measures were developed to assess pedestrian safety and pedestrian-vehicle conflicts that will be key use cases on facilities with high penetration of CV and pedestrian volumes.

3.1.4 APTIV and Cohda Wireless

In collaboration with the INDOT Traffic Management Center, researchers engaged with APTIV from Q4 2018 to Q2 2019 on the development of SPaT and MAP messaging software for traffic signal controllers, and implementation, deployment, and testing in the Indiana testbed (Figure 3.3). Key use cases identified were emergency vehicle preemption, workzone vehicle safety, and Green Light Optimized Speed Advisory (GLOSA). Cohda Wireless provided hardware and support for OBU and RSU and integration software. APTIV validated the implementation in Kokomo with an instrumented vehicle and software. INDOT executive meeting was held at APTIV in April 2019.



(a) TPF-5(377) meeting, March 2019.



(b) Joerg Wolf (VW-ERL) and Howell Li at the AASHTO Maintenance Committee summer meeting, July 2019.

Figure 3.1 Meeting with peer states.



Figure 3.2 Meeting with City of West Lafayette, June 2019.

3.1.5 Volkswagen of America

Researchers engaged with Volkswagen of America Electronics Research Laboratory (VW-ERL) from Q4 2017 through Q4 2018 on developing use cases for CV technology (Figure 3.4). Two cases were implemented and tested in Indiana: Traffic Light Indication (TLI) and enhanced probe data for winter weather applications. A loan vehicle was provided to Purdue during the collaboration. Research outcomes were presented in the FHWA Road Weather Maintenance Meeting in 2018, the TRB 2019 Annual Meeting, 2019 Purdue Road School, and the 2019 AASHTO Maintenance Committee summer meeting.

3.1.6 Ford

Researchers engaged with Ford Motor Co. in Q1 2019 to develop three key use cases for CV deployment: (1) split failure at signalized intersections; (2) enhanced probe data for winter weather driving at signalized intersections; and (3) road roughness detection (Figure 3.5).

3.1.7 Trimble

Researchers engaged with Trimble during Q1 through Q3 2019 to develop uses cases and implement mobile applications for a back-of-queue warning system and



(a) APTIV visit to Purdue campus in November 2018.

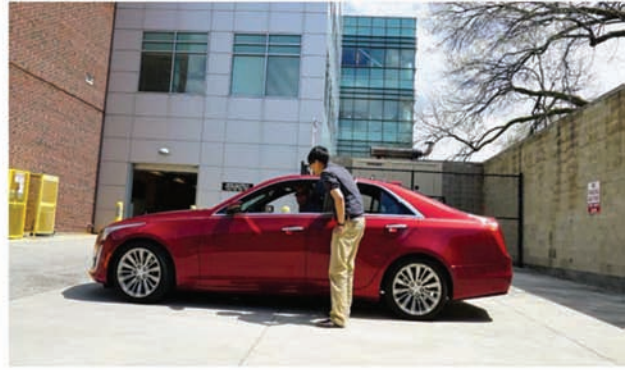

(b) Howell Li and Greg Kuhlman (APTIV) testing V2X.



(c) Dan Kiel (Cohda Wireless) demonstrating CV application, February 2019.



(d) APTIV green light advisory software testing on US 231 at River Rd.

Figure 3.3 Collaboration with APTIV and Cohda Wireless.



(a) Purdue Researchers with Joerg Wolf (VW-ERL), February 2018.

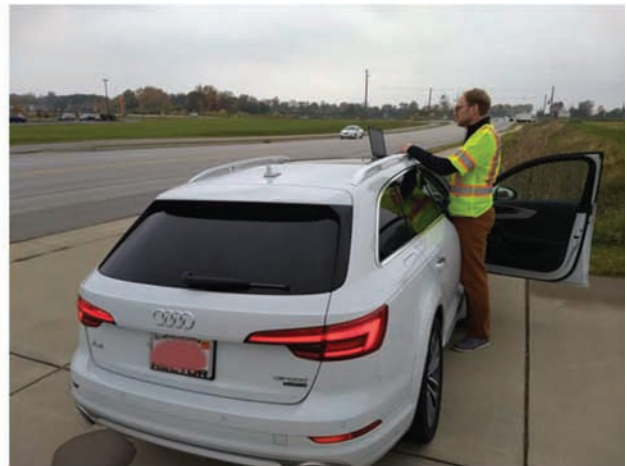

(b) Joerg Wolf (VW-ERL) at US 231 and Cumberland Ave., October 2018.

Figure 3.4 Collaboration with VW-ERL.



(a) Gopi Surnilla (Ford) presenting at Purdue.



(b) Purdue and INDOT with Ford at US 231 at Martin Jischke Dr.

Figure 3.5 Collaboration with Ford Motor Co.



(a) Trimble visit to Purdue, March 2019.



(b) Trimble demonstrating back-of-queue application to FHWA, August 2019.

Figure 3.6 Collaboration with Trimble.

slow-moving vehicle alert on state highways (Figure 3.6). The use cases developed aims to address safety improvements for heavy vehicles using CV technology.

3.2 Summary of Developed Used Cases

Use cases developed from engagements were presented to and discussed with INDOT colleagues throughout the project. Eight key use cases were identified to be relevant and useful to Indiana are summarized below:

1. enhanced probe data to detect winter conditions;
2. split failure at signalized intersections;
3. green time probabilities to provide accurate GLOSA information;
4. dilemma zone protection for heavy vehicles using virtual detection zones;
5. road roughness detection;
6. back-of-queue alert for heavy vehicles;
7. slow-moving vehicle alert; and
8. pedestrian safety.

4. SUMMARY OF FINDINGS

4.1 Performance of DSRC

The current implementation of infrastructure (RSU) to vehicle (OBU) CV technology sends SPaT and MAP, and receives BSM at 10 Hz. BSM packets received from the vehicle can be configured by the RSU to either be accepted or dropped based on a signal strength threshold. For testing during this study, a threshold of -82 dBm or greater is accepted. Field tests indicated the range of DSRC to be approximately 1,100' with an RSU mounted at 15' off the ground, and up to 1.1 miles with a mount at the top of a signal pole, which is the typical installation for Indiana corridors. Placement of the OBU antenna on the vehicle was found to have an effect on the range of the signal up to about 1,000'.

4.1.1 Waypoint Matching

A set of virtual waypoints containing latitude, longitude, a range of acceptable heading, and associated

lane and phase information is preloaded on the CVCP, where an application persistently listens for new BSMs. Each BSM is decoded and its latitude and longitude matched to the set of virtual waypoints. If the vehicle location is in proximity of a waypoint within the range of acceptable heading, a call is placed via NTCIP for

the associated phase. All BSMs, successful waypoint matches, and phase calls are logged locally on the co-processor. (See Figure 4.1.)

With a transmit interval of 0.1s, a vehicle travelling at 55 mph is not guaranteed to match a waypoint with a 3' radius threshold, assuming the vehicle's trajectory, OBU antenna, and waypoint are all reasonably centered in the lane. A study location at US 231 and CR 500S was used for testing waypoint sensitivity where 22 waypoints spaced 50' apart was used to extend the northbound and southbound mainline phases.

At about 45 mph, out of 22 waypoints, a 3' radius threshold had 16 out of the 22 waypoints missed, while radii 6' and greater had no missed waypoints. The larger radii of 9' and 12' yielded more matches per waypoint. However, using a closest distance function no lane encroachment was evident even from the larger radii. If more than one waypoint was matched, the waypoint closest to the vehicle was selected, which performed well to exclude adjacent lanes. A 6' radius threshold is used which covers one lane width at the study location.

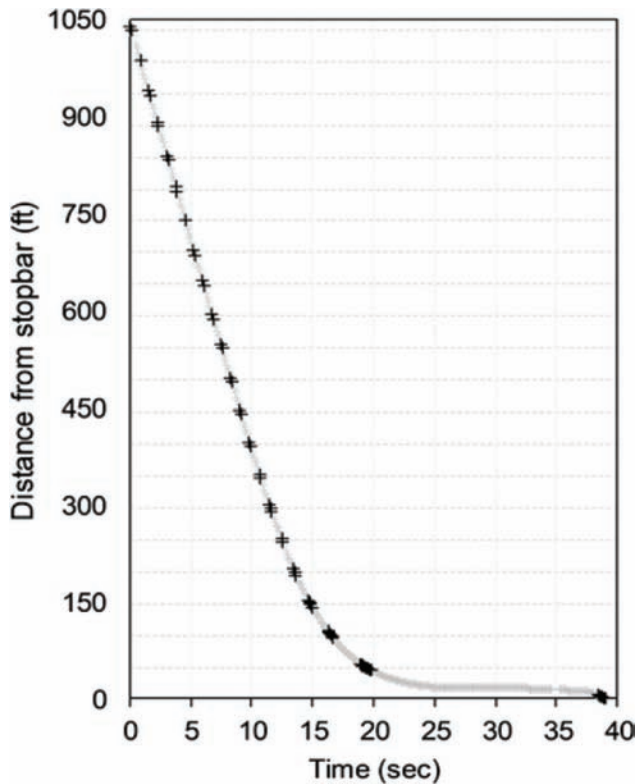

Figure 4.1 Performance of waypoint radii matching using 6' radius and 50' spacing.

4.1.2 Latency

The spacing is the distance between the centers of two consecutive waypoints. As the spacing increases, the lag between matches also increases because the vehicle needs to “traverse the gap.” A 50' spacing gives an estimated lag time of 0.59s between matches at 55 mph. Figure 4.2 shows a hypothetical lag curve at 50' spacing and the crosses indicate field samples collected, which performs reasonably close to the estimating function. Callout i is an instance where three waypoints are missed by the vehicle when the vehicle is not centered in the lane. Callout ii and callout iii are two instances where four BSM messages are dropped each,

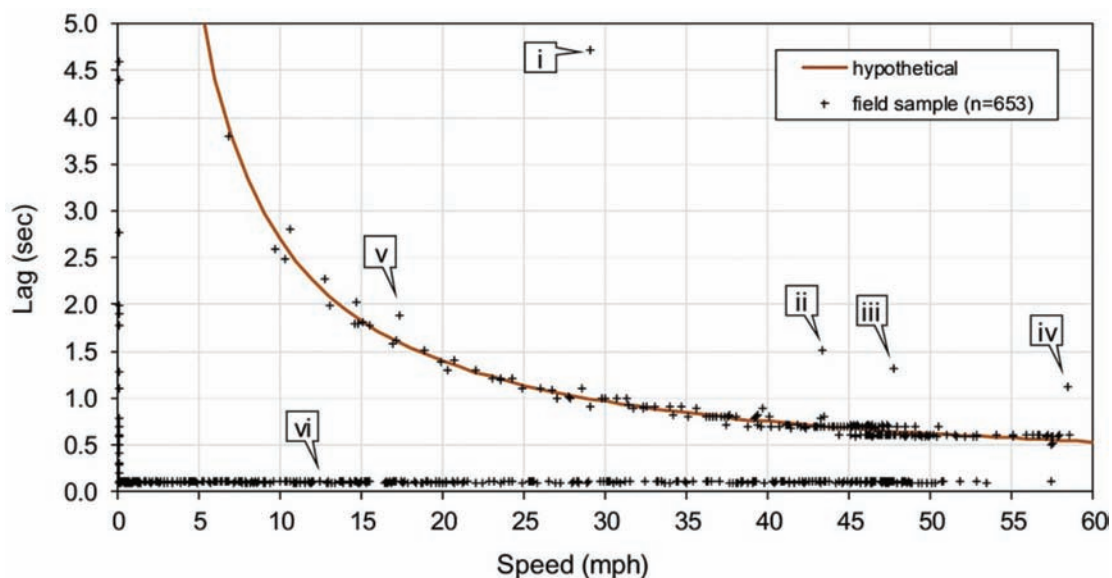

Figure 4.2 Performance of different waypoint spacings using 6' radius.

therefore missing a portion of one waypoint. Callout iv is an instance where one waypoint is missed by the vehicle completely and callout v is when the vehicle veered slightly to the edge of the lane at low speed. Callout vi shows the matches within one waypoint which has a lag equivalent to the DSRC transmission interval of 0.1s. At faster speeds beyond 50 mph, the number of matches within one waypoint drops off. Overall 83% of the samples have lower lag than the hypothetical curve and 95% of the samples are within 5% or less.

4.2 Performance of Cellular

4.2.1 Latency

Figure 4.3 shows the connection setup between the traffic signal and vehicle over the cellular communication. The overall latency was estimated to be around 630 ms.

4.2.2 Field Test of V2I Application Using Cellular Communication

In October 2017, Purdue researchers collaborated with INDOT and industry partners to develop a working prototype of the V2I communications using the cellular standard. Data from the CV and the INDOT signal controllers were used to deploy the traffic signal status indications. As the vehicle approaches an intersection, the application displays the current status of the traffic signal (Figure 4.4) for the vehicle movement. If the vehicle arrives during the red phase or if the algorithm computes that the vehicle will not make the green, the application displays a countdown

timer with the time remaining for the next green. The early applications of this technology include eco-driving and dilemma zone reduction. These types of systems are now operational in several cities around the country (Audi Newsroom, n.d.).

Tests were conducted to evaluate the performance of this V2I application by comparing the predictions (at 30s to green, 20s to green, 10s to green, and 4s to green) with the actual start of green. Data was gathered using video footage and analysis was performed on 176 cycles collected over two days. Residual plots (Figure 4.5) were prepared to estimate the time difference between the actual event and predicted event. Results showed that the application can predict the mean start of green within $\pm 2.7s$ (at 95% confidence intervals). On a cycle-by-cycle basis, it was observed that nearly 80% of the phase indications could be predicted within $\pm 5s$ even with the stochastic vehicle detection and real-time controller logic. Further details on the methodology, data collection and analysis can be found in Appendix A.

4.3 Stochastic Variation of Traffic Signal Phase Green Times

Studies on traffic signal state prediction under connected vehicle environments have been conducted in the past using simulation techniques (Bagheri, 2017; Goodall, 2013). However, predictions using real-world data, especially for actuated controllers as seen in the previous section, is an emerging challenge. Pre-timed systems are deterministic and easy to predict whereas the actuated and adaptive systems introduce a lot of stochastic variations (Figure 4.6). As vehicles start communicating directly with traffic signal controllers, it is important for the vehicle algorithm developers to

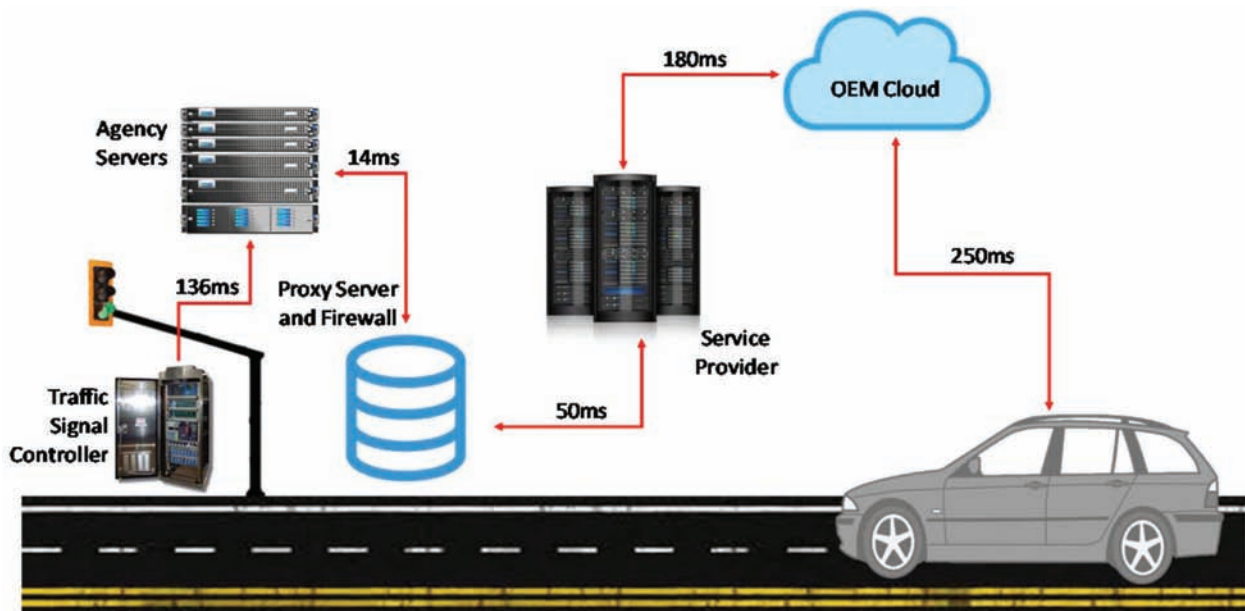

Figure 4.3 System latency of the cellular network for CV application.

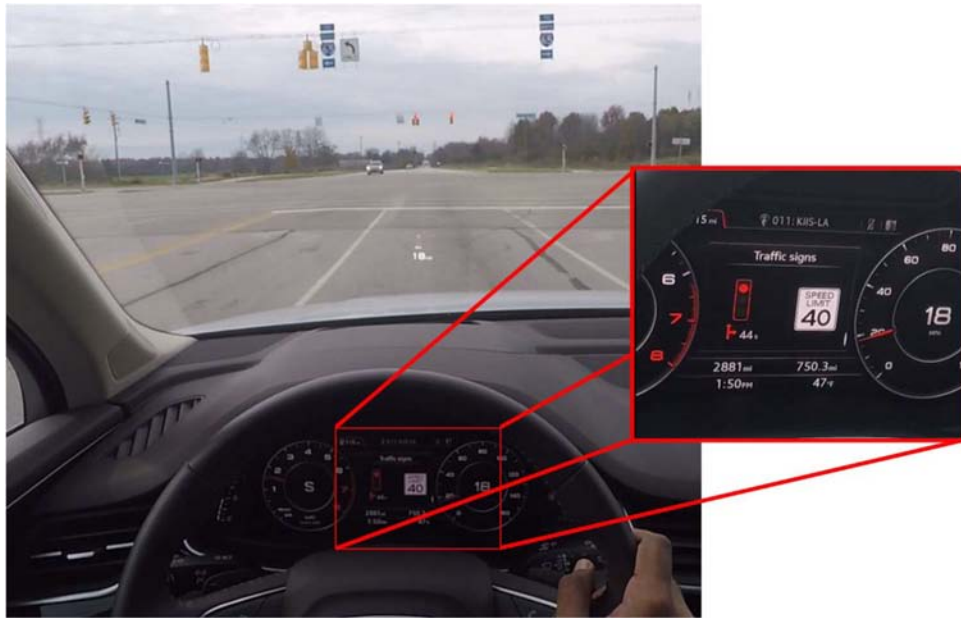

Figure 4.4 Time-to-green traffic light indication (TLI) application.

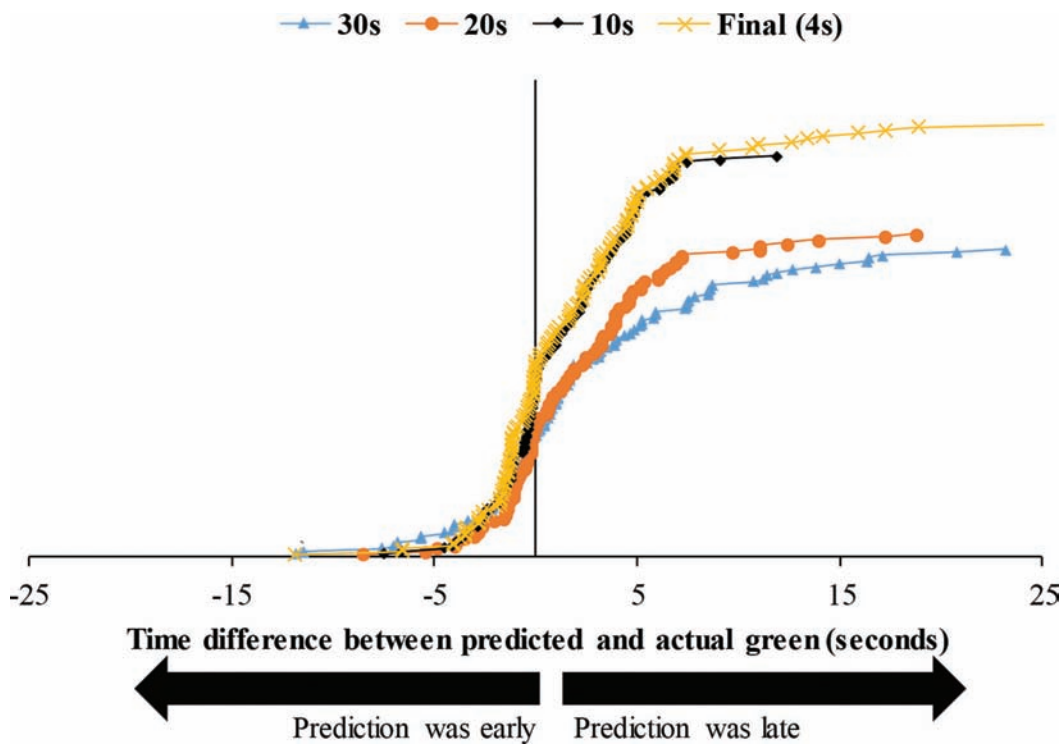

Figure 4.5 Residual plot evaluating the performance of TLI application.

understand the working concepts of various traffic signal operations.

4.3.1 Multiphase Green Probability Profile

In this section we propose a new visualization tool that provides a quantitative framework that demonstrates

the behind-the-scenes working of a complex traffic signal system. The cyclic green profiles of the four phases ($\Phi 1$ – $\Phi 4$) in a ring can be combined (a stacked area plot of the four phases) into a multiphase probability diagram of expected phases (Figure 4.7). Each of the phases are represented by a distinct color and the clearance time (yellow and all-red indication) for each

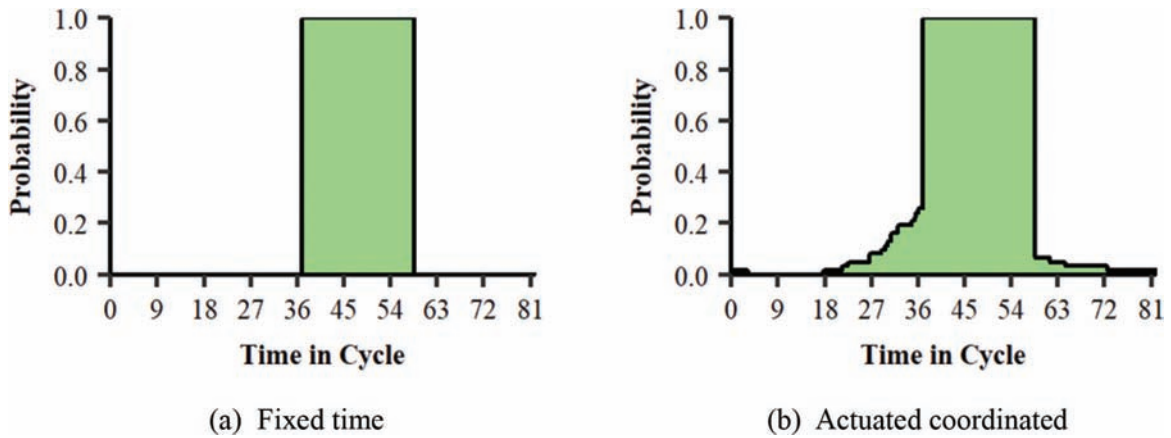

Figure 4.6 Comparison of probabilistic distribution of green for fixed and actuated coordinated systems.

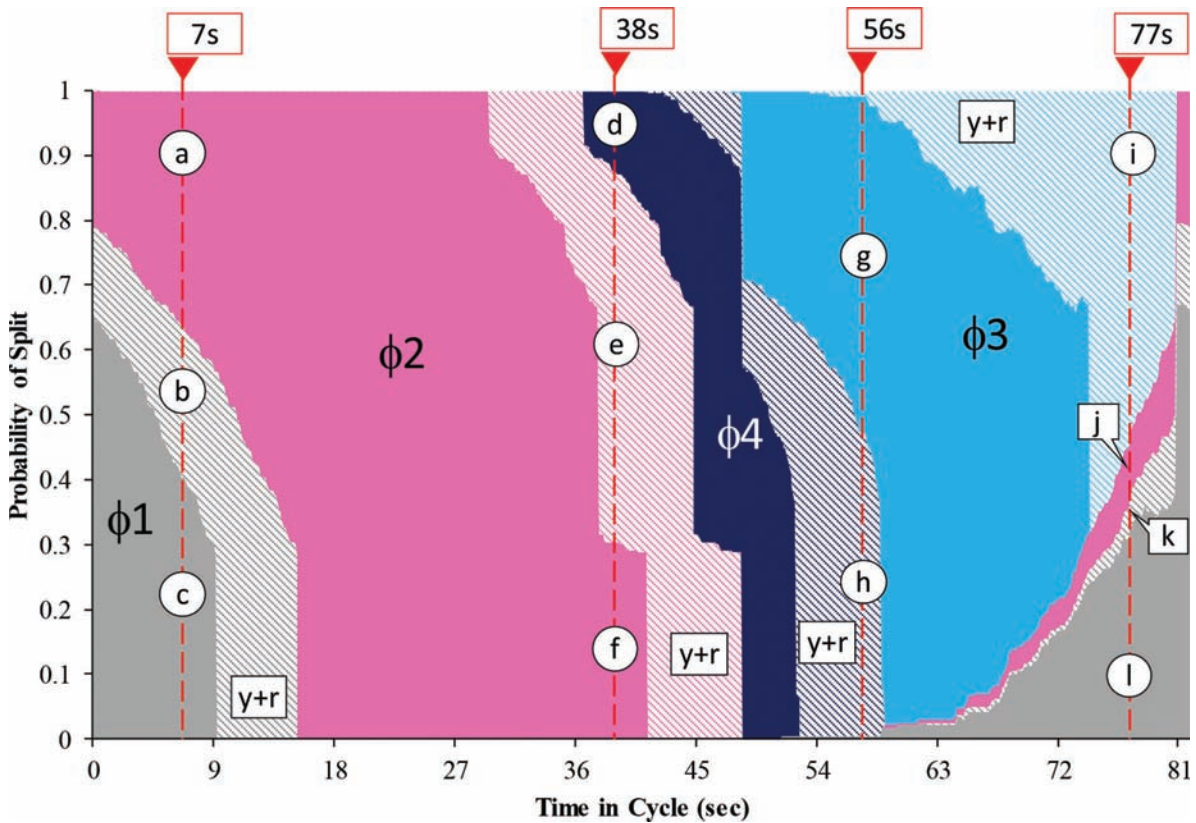

Figure 4.7 Probability of expected phases for an actuated coordinated system. Callouts (a)–(k) represent the different splits that can be served at the same period within a cycle but at different times of day.

phase is represented by a filled hash. Vertical cross-sections at 7s, 38s, 56s, and 77s into the cycle are highlighted to emphasize the stochastic variation and the occurrence of multiple phases that can happen at the same cycle second. Table 4.1 lists the probabilities of phase occurrences for each cycle second cross-section. For example, at 38s within the cycle, the probability of occurrences for phase 2, phase 4, and phase 1 (clearance) are 31.5%, 10.5%, and 58% respectively. At any time within the cycle, sum of all the probabilities should add

up to 1.0. More details on the development of this tool can be found in Appendix A.

In CAV implementations, these signal state possibilities can have tremendous potential for safety and efficiency applications. For example, given a certain vehicle location and speed as it is approaching an intersection, it can be calculated from the current trajectory whether the vehicle will likely arrive at the intersection during green, clearance, or red based on these signal state possibilities prediction. In effect, the driver can be

alerted or the vehicle controlled automatically to slow down (Roess, 2009). This is particularly useful for high-speed intersections or during inclement weather when stopping distance increases and there is a potential to adjust arrival trajectories to increase the margin of safety, reducing crashes and near-miss situations.

4.3.2 Populating SAE Confidence Interval Values from Cyclic Green Profiles

V2I applications often follow the SAE Surface Vehicle Standard J2735 for communications (SAE International, 2016). SAE J2735 defines a DSRC Message Set Dictionary. Although designed for DSRC, these messages are often used for V2I communication through the cloud (Mathew et al., 2019; Wolf, 2019). Messages defined in the standard include the SPaT message that describes the intersection state per movement, phase timing, and includes speed advisory details. The contents of SPaT are designed to be generated

by a traffic signal controller, sent over the network, and received and interpreted by the vehicle. However, many of the parameters are optional as of the most recent revision of the standard and there are no guidelines as to how they should be populated. Of particular interest is *likelyTime*, an enumerated parameter that describes the confidence the controller has of the *likelyTime*, expressed as a percentage. The range of values and corresponding probabilities are listed in Table 4.2.

The cyclic green profiles and the multiphase probability visualizations can also be used to estimate the SAE J2735 time interval confidence values. Figure 4.8 shows an example cyclic green profile with the SAE J2735 confidence values (SAE International, 2016) on the secondary Y-axis, matching their corresponding probabilities (Table 4.2) on the main Y-axis. For any time-in-cycle (TIC), the corresponding probability can be mapped to the confidence values. The cyclic profiles are also capable of estimating the confidence intervals

TABLE 4.1
Probability of phase occurrences within the cycle corresponding to callouts on Figure 4.7

Time in Cycle	Phase 1 ($\Phi 1$) (%)	Phase 2 ($\Phi 2$) (%)	Phase 4 ($\Phi 4$) (%)	Phase 3 ($\Phi 3$) (%)	Clearance (y+r) (%)
7	39.8 (c)	37.6 (a)	—	—	23.8 (b)
38	—	31.5 (f)	10.5 (d)	—	58 (e)
56	0.4	—	—	45 (g)	54.5 (h) + 0.1 (q3)
77	31.6 (l)	9.6 (j)	—	—	58.8 (i+k)

TABLE 4.2
SAE time interval confidence values and probability

Value	0	1	2	3	4	5	6	7	8	9	10	11	12	13	14	15
Probability (%)	21	36	47	56	62	68	73	77	81	85	88	91	94	96	98	100

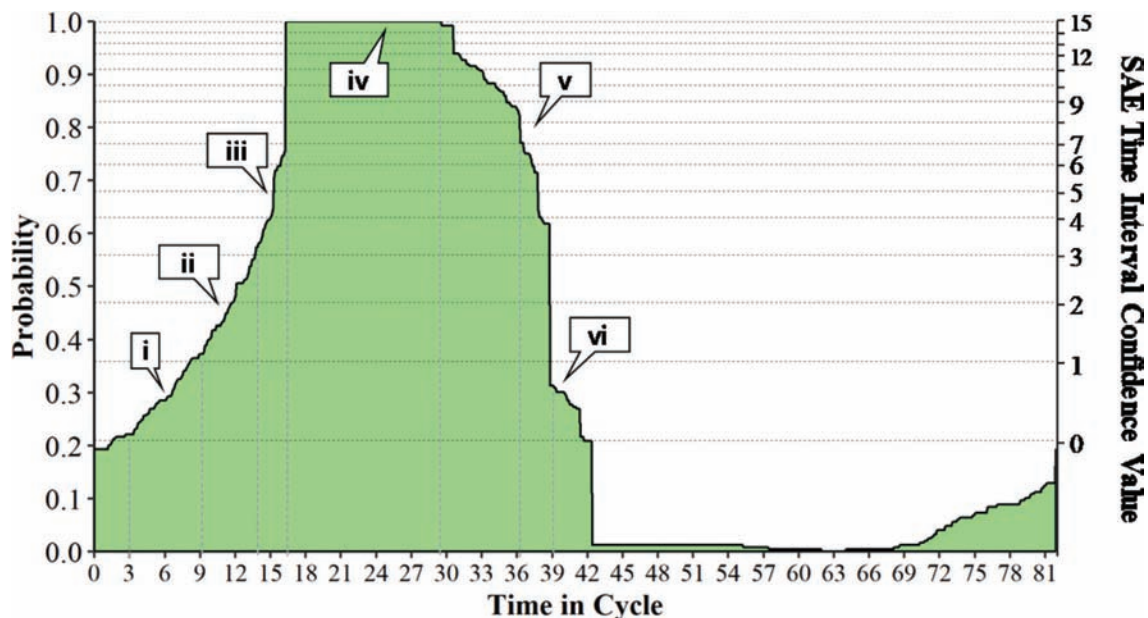

Figure 4.8 Populating SAE confidence interval values.

with respect to beginning-of-green (BOG) and end-of-green (EOG).

In Figure 4.8, the BOG period between 3s and 9s have green probabilities from 0.21 to 0.26 which fall under the corresponding confidence value of 1 (callout i). Between 9s and 13s the confidence value can vary from 2 to 3 (callout ii) and between 13s to 16s it can vary from 3 to 7 (callout iii). The value then rises up to 15 during the deterministic period between 16s and 29s (callout iv), after which it starts falling down indicating the EOG period. From 29s to 36s in the cycle, the confidence value drops from 15 to 8 (callout v) and down to 3 at 39s.

4.3.3 Opportunities for Further Clarification of SAE J2735

SAE J2735 defines the *time interval confidence* as “the statistical confidence for the predicted time of signal group state change.” However, it does not specify if the status change is for the end of the current state or beginning of next state. As seen in the earlier section, the beginning and ending of a phase can have different confidence values (Figure 4.8). Other studies have also emphasized that it might be worthwhile providing two estimates of the residual time (Ibrahim, 2019). Connected vehicle applications such as green light advisory and eco-driving require an accurate estimation of the traffic signal status for both BOG and EOG. Currently, with just one parameter “*likelyTime*,” it might not be possible for applications to estimate the change in signal status for both BOG and EOG. Further discussions on the importance of providing two estimates of residual time can be found in Appendix C.

4.4 Impact of Stochastic Variation on GLOSA

Actuated traffic signals present major challenges for Green Light Optimized Speed Advisory (GLOSA). An advisory system based on TIC green probabilities calculated from historic high-resolution signal event data does not require low-latency V2I communications

and can be scaled to a greater number of intersections. Evaluation of the system was performed by virtually driving through an arterial during different times of the day and days of the week. The advisory system proposed increased safety during the EOG but resulted in increased travel times. More details of the study can be found in Appendix D.

1. Even with an aggressive advisory approach, there was a large reduction in red light violations and hard-braking events by anticipating the onset of yellow, by 87.6% and 64.8% respectively over unadvised trips (4.9). The mean travel time increased by 4s compared to unadvised trips.
2. Using a balanced advisory resulted in the decrease in the number of hard brakings by 87.3% and red-light incursions by 94.0% (Figure 4.9). Travel time is increased by 14s for a balanced advisory compared to an unadvised run.
3. Reductions of up to 95.8% in red light crossing, and 93.4% in hard brakings were accomplished by implementing a conservative advisory approach (Figure 4.9), but the mean travel time increased by as many as 24s.

4.5 Detection of Winter Weather Conditions Using Enhanced Probe Data

The experiments conducted using CV in winter weather conditions demonstrated the application of high-frequency vehicle CAN data for estimating road conditions. A system was deployed to collect wheel tick and brake pressure data at 100 ms to 200 ms time resolution using a 2017 Audi Allroad vehicle.

Modern vehicles are equipped with wheel speed sensors that report the position of each wheel as an integer, such as in the range of 0 to 1000, to the various onboard control units and devices via the in-vehicle bus. As the vehicle moves, the integer position, or wheel tick, increments at a rate equal to the angular velocity of each wheel. The number is reset to 0 once it reaches the maximum within its allocated range. Figure 4.10a shows the recorded angular velocities of each wheel over a 3.4 second time interval during a deceleration

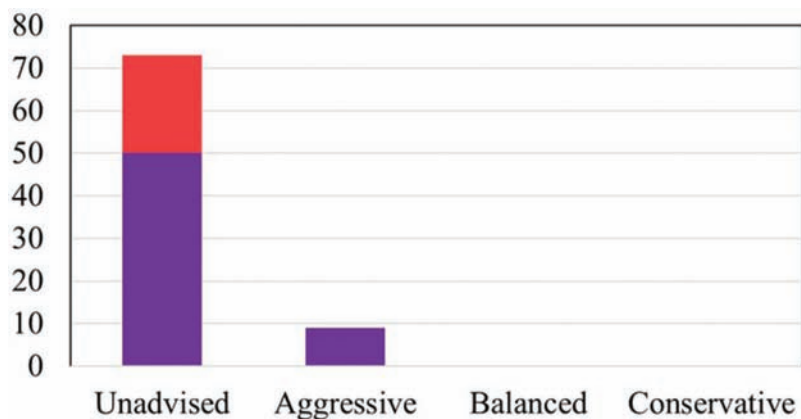
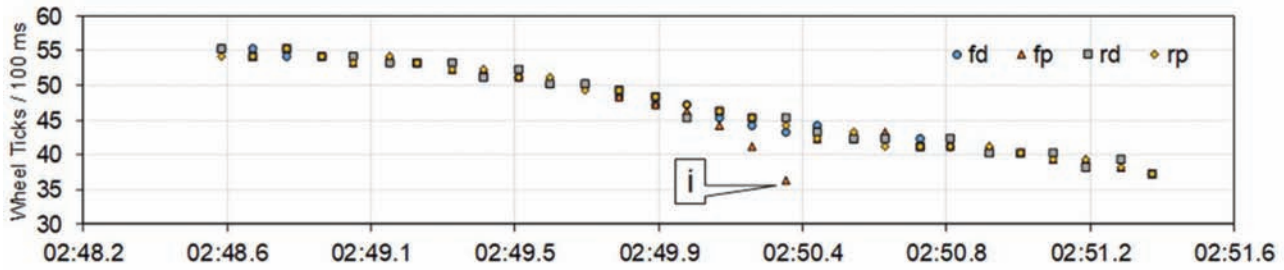
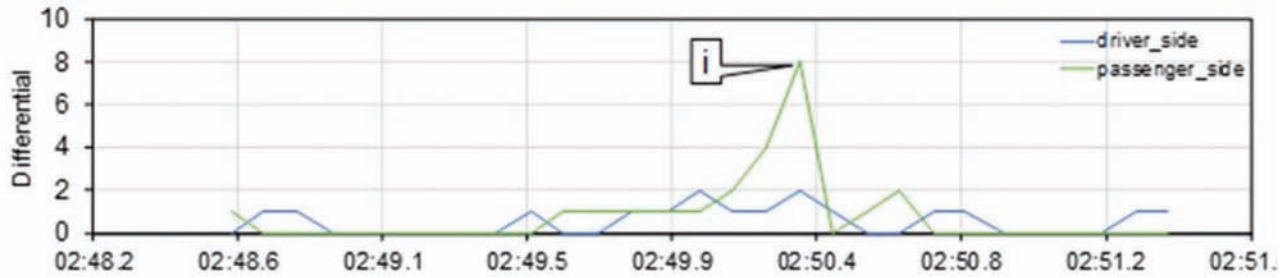

Figure 4.9 Vehicle performance of virtual drive using different GLOSA strategies.



(a) Measured angular velocity of each wheel.



(b) Differential angular velocity on passenger and driver-side wheels.

Figure 4.10 Vehicle slip detection using wheel ticks.

event. The front driver (fd), front passenger (fp), rear driver (rd), and rear passenger (rp) angular velocities are plotted on the graph. Between 02:49.9 and 02:50.2, a noticeable divergence in wheel speed is evident for the front passenger wheel. This wheel started to travel slower than the other three wheels, and at callout i in Figure 4.10a this was most pronounced.

Figure 4.10b plots the differences along each side of the vehicle. The greatest value was recorded at 02:50.3 with an absolute difference of 8 wheel ticks between the front passenger and rear passenger wheels (Figure 4.10b, callout i). This was associated with a braking event before a stop sign that triggered an ABS intervention by the vehicle (Figure 4.10c, callout i).

Two separate winter events with independent road friction validation were used as test cases to demonstrate the applicability of using CAN data to monitor changing road conditions. More details of the study can be found in Appendix E. Key findings in this study suggested the following:

1. A driver may reduce his or her applied braking pressure in deteriorating road conditions up to 60% at the median intensity.
2. The braking pressures applied during wintry conditions were most different compared to dry conditions at speeds between 20 mph and 39 mph where the heaviest braking was performed.
3. The variance of the change of brake pressure was found to be significantly different during deteriorating road conditions.

4. Wheel slip data alone may not account for adjustments to driving behavior that would mask actual slippery road conditions.
5. Extreme vehicle intervention events such as traction control and ABS were typically rare, even at locations where very low friction values were measured.
6. Speed data alone may not be sufficient to characterize changing road conditions on arterials.

4.6 Dilemma Zone Protection Using Virtual Detection

Experiments were conducted using CV technology to trigger force gap out (FGO) when a vehicle was expected to arrive within the dilemma zone limit at max out time at a fully actuated intersection. The method leverages position data from BSMs to map-match virtual waypoints. Figure 4.11a shows the status screen of the traffic signal controller one second prior to FGO.

Callout i shows the dummy Ø9 not yet called as the CV is still upstream of the waypoint furthest from the stop bar. Callout ii shows the max timer for ring 1 is within the critical threshold. The test CV enters the waypoint area past the 1,000' mark (Figure 4.11b).

Figure 4.11c shows the instance when the FGO is triggered with a call on dummy Ø9 (callout iv) and the resulting gap out (callout v). More details of the study can be found in Appendix F.

In the near term, using similar methodology as mentioned above, there is significant opportunity for

```

STATUS [FREE-TBC          ]07/11/19|12:37:54
  PHASE 1 2 3 4 5 6 7 8 9 0 1 2 3 4 5 6
  PH STAT . G . . . G . . . G . G - - - -
  VEH CALL C F C C . F C C . . . .
  PED CALL
ii R1/PH 2 | R2/PH 6 | R3/PH 10 | R4/PH 12
  EXT1 0.0 | EXT1 0.0 | GRN XFER | GRN XFER
  MAX1 8 | MAX1 9 | MAX1 0 | MAX1 0
PLAN SPLT: 0 | TP: 2 | SEQ: 1 | ACT: 99 | DP: 1
LC: 0s/ 0 | SYS CYL: 0s | COS | FREE

```

(a) Before FGO at 12:37:54.

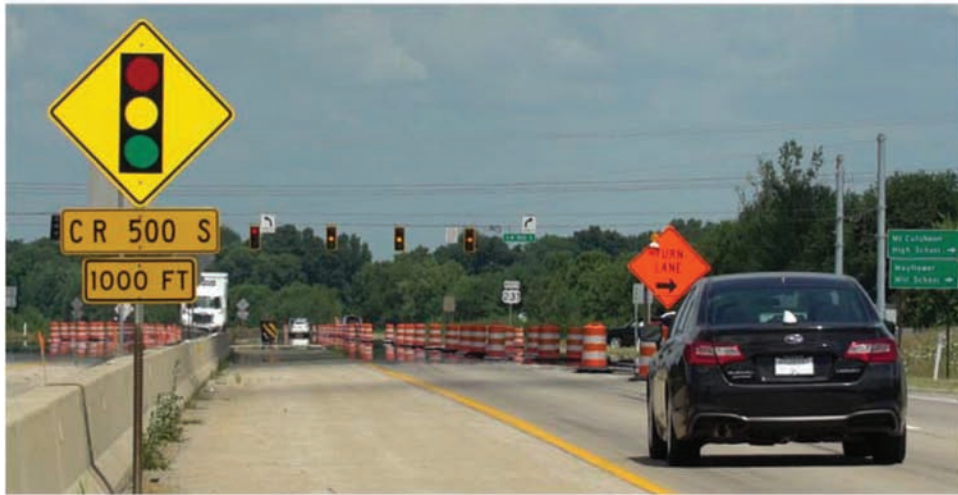

(b) Looking toward intersection at 1000' mark just after FGO.

```

STATUS [FREE-TBC          ]07/11/19|12:37:55
  PHASE 1 2 3 4 5 6 7 8 9 0 1 2 3 4 5 6
  PH STAT . Y N . . Y N . . R . R - - - -
  VEH CALL C R C C . R C C C R . R
  PED CALL
v R1/PH 2 | R2/PH 6 | R3/PH . | R4/PH .
  YEL- 4.6 | YEL- 4.6 | RED REST | RED REST
  GAP OUT | GAP OUT | GAP OUT | GAP OUT
PLAN SPLT: 0 | TP: 2 | SEQ: 1 | ACT: 99 | DP: 1
LC: 0s/ 0 | SYS CYL: 0s | COS | FREE

```

(c) After FGO at 12:37:55.

Figure 4.11 Field-testing of force gap out (FGO).

placing “virtual pedestrian” calls at traffic signals for uses with mobility challenges, or emerging robot delivery vehicles that need to cross the street (Figure 4.12). The connected traffic signal controller can identify these probes and place a virtual pedestrian call, when these devices enter a certain geo-fenced area within the vicinity of the intersection.

4.7 Leveraging Connected Vehicle Data for Identifying Commercial Vehicle Testing Locations

There are multiple vendors that now provide real-time probe data based on interstate speed measurements at sub-1 mile, 1-minute fidelity. A series of simulated trajectories, using 1-minute segment speed



Figure 4.12 Opportunity for autonomous delivery robots to place virtual pedestrian calls.

archives, were used to demonstrate the robustness of a platooning strategy by calculating travel time dynamically using the segments, and analyzing the frequency of speed changes greater than 10 mph. Speeds that have dropped below 55 mph were also identified on the route (Figure 4.13). Appendix F provides a complete description on the methodology behind this concept.

4.8 Detection of Split Failures and Estimation of Queue Lengths

A common occurrence at over-capacity signalized intersections are split failures. A split failure is when a movement (phase) at an intersection does not have enough green time (capacity) to serve the number of vehicles (demand) for that movement (Freije et al., 2014). Traditional in-pavement and pole-mounted sensors are limited in the quality of data provided; occupancy, count, and speed can be determined, but assessing queue length, the number of split failures per vehicle, delay, headway/gaps between vehicles, and travel time are difficult or approximated. With high-frequency (1s) GPS data (Figure 4.14), there is great opportunity for the next generation of signal performance metrics for stakeholders to make data-driven decisions from both the infrastructure operators and automotive manufacturers alike.

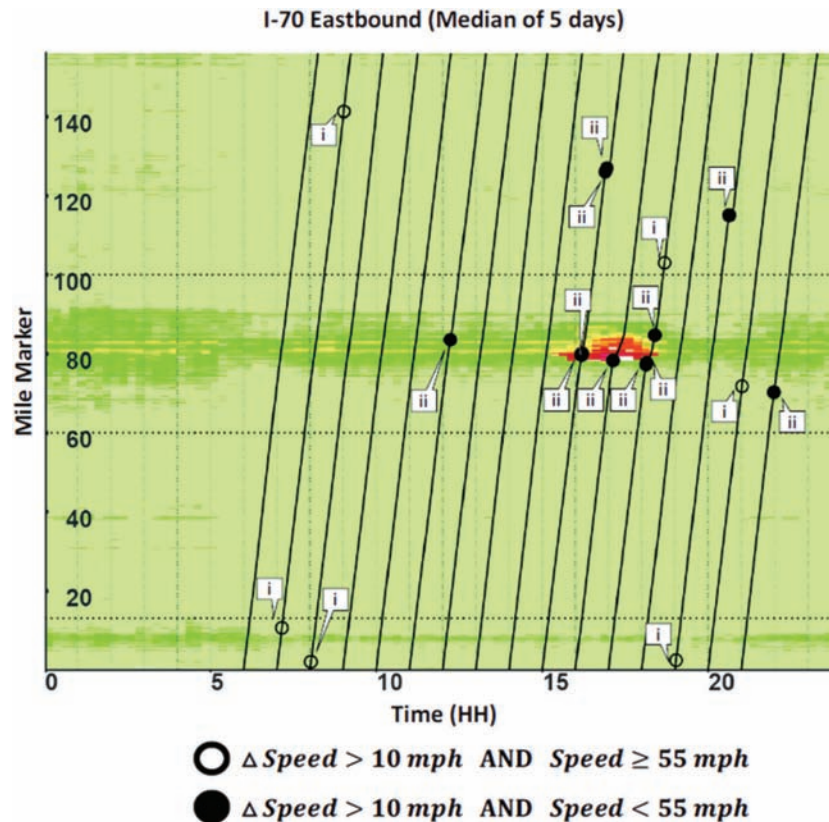

Figure 4.13 Potential platoonable sections on I-70 EB.

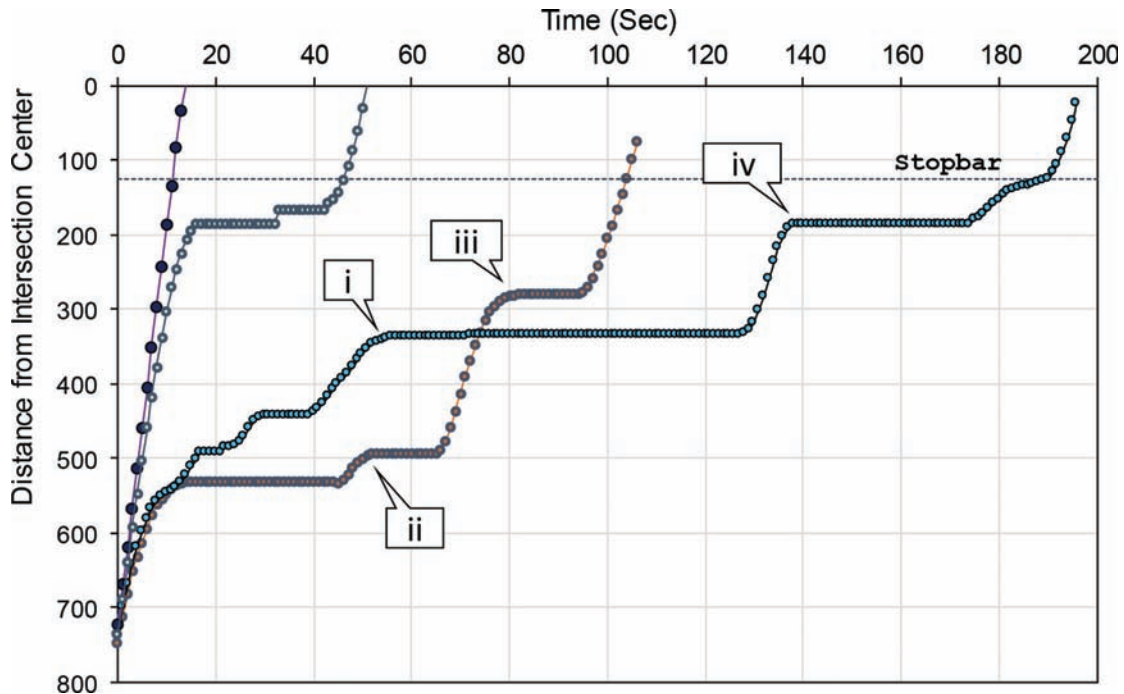

Figure 4.14 High fidelity GPS trajectory data to identify split failures (callouts i-iv).

5. DASHBOARDS

Six dashboard applications were developed from the project. The below section provides a brief overview of the dashboards and the applied use cases.

5.1 Platoonability

A web dashboard to identify platoonable sections of roadway was developed as a visualization tool that gets input for route name (such as I-70 or I-65), mile marker of the start and end position of the route and start and end date period from the user (Figure 5.1). Then the program generates heat maps to show traffic speed range for each segment, by direction, in the route in 15-minute intervals. Camera images from locations on the routes are also integrated to provide ground-truth. Areas that are potentially platoonable can be identified using the average heat map (AHM) and median heat map (MHM).

5.2 Winter Weather Enhanced Probe Data

A web dashboard was developed to plot locations where there were traction control interventions, ABS, hazard lights on and off, windshield wipers, temperature, and vehicles heading on a Google Maps overlay. The data was forwarded from a logging computer directly connected to the in-vehicle bus to Purdue servers that processed the information to be presented on the dashboard (Figure 5.2).

5.3 CV Telemetry

In a DSRC V2I implementation, all BSMs, successful waypoint matches, and phase calls are logged locally on the CVCP. In addition, the BSMs are uploaded to the back-office where it is stored using Apache Kafka, a fast stream processing platform capable of handling large volumes of data for future scalability. A web application then retrieves data from the platform where vehicle position, speed, heading, elevation, g-force, waypoint locations, and number of messages in the queue are displayed on a user interface (Figure 5.3a). The system can also be used for micro-mobility modes (Figure 5.3b).

5.4 Traffic Signal Status Probability Dashboard

A web dashboard was developed for visualizing green probabilities over customizable time-of-day and day-of-week periods using historic high-resolution controller data (Figure 5.4). The software can also calculate the accuracy of historic probabilities when applying to a target date, useful for estimating hypothetical GLOSA performance in the field.

5.5 GLOSA HMI

A real-time dashboard was developed to provide phase probability information using historical data to a vehicle on travelling along US 231 in West Lafayette during actuated-coordinated operation (Figure 5.5). The application displays the current vehicle's speed,

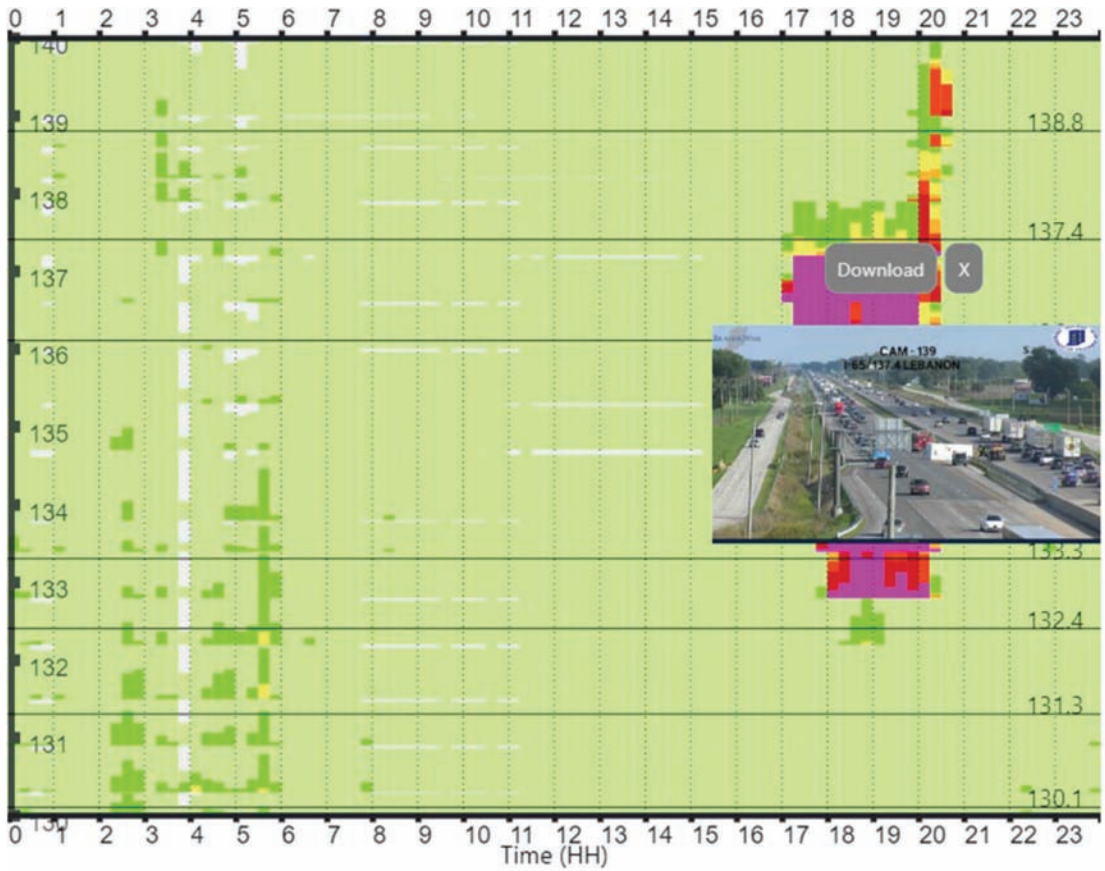

Figure 5.1 Integrated heat map and camera image dashboard.

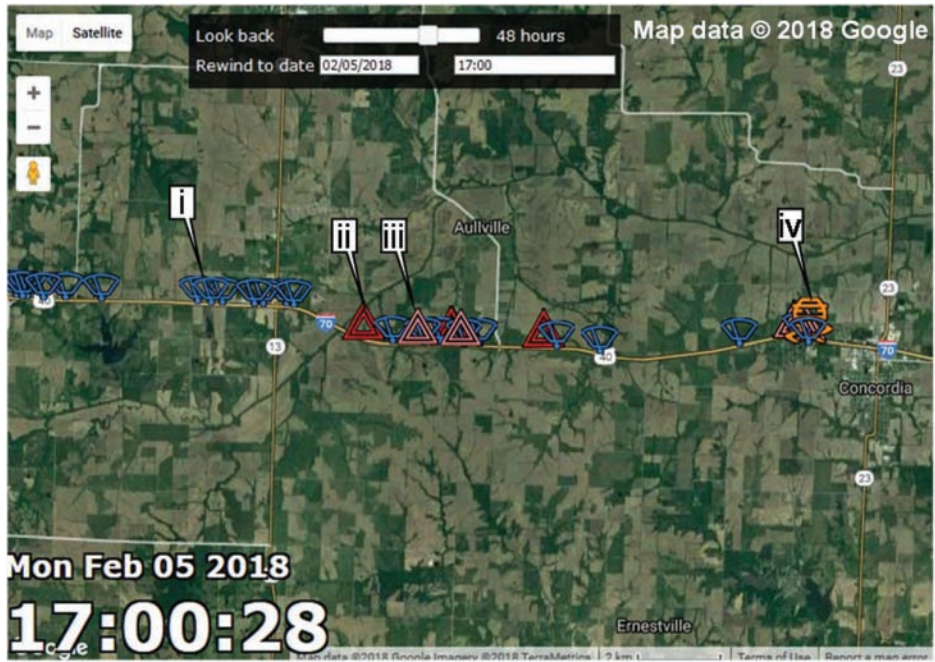
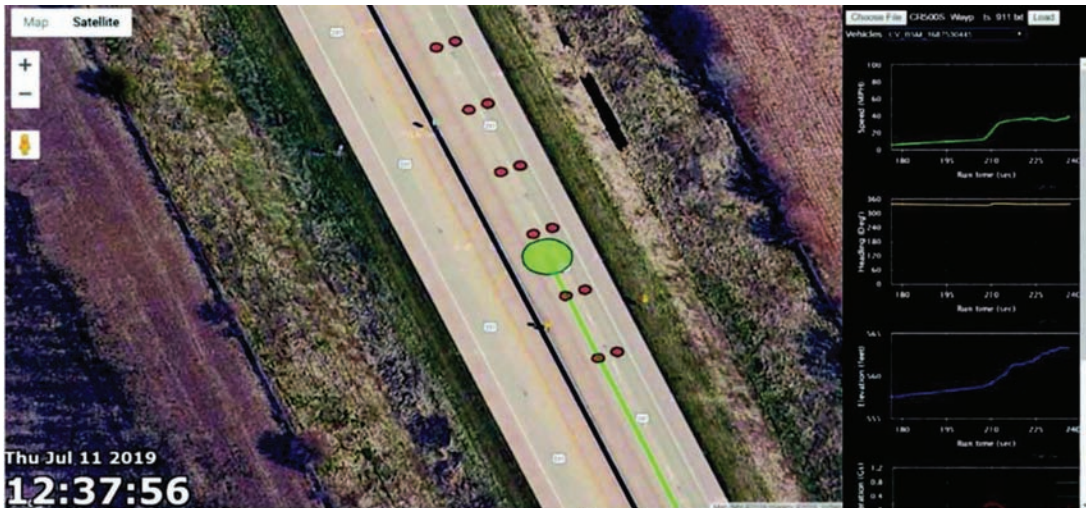

Figure 5.2 Winter weather hazardous conditions dashboard.



(a) User interface



(b) An E-scooter placing virtual calls on the traffic signal controller

Figure 5.3 CV telemetry dashboard using a scooter.



Figure 5.4 Traffic signal status probability dashboard.

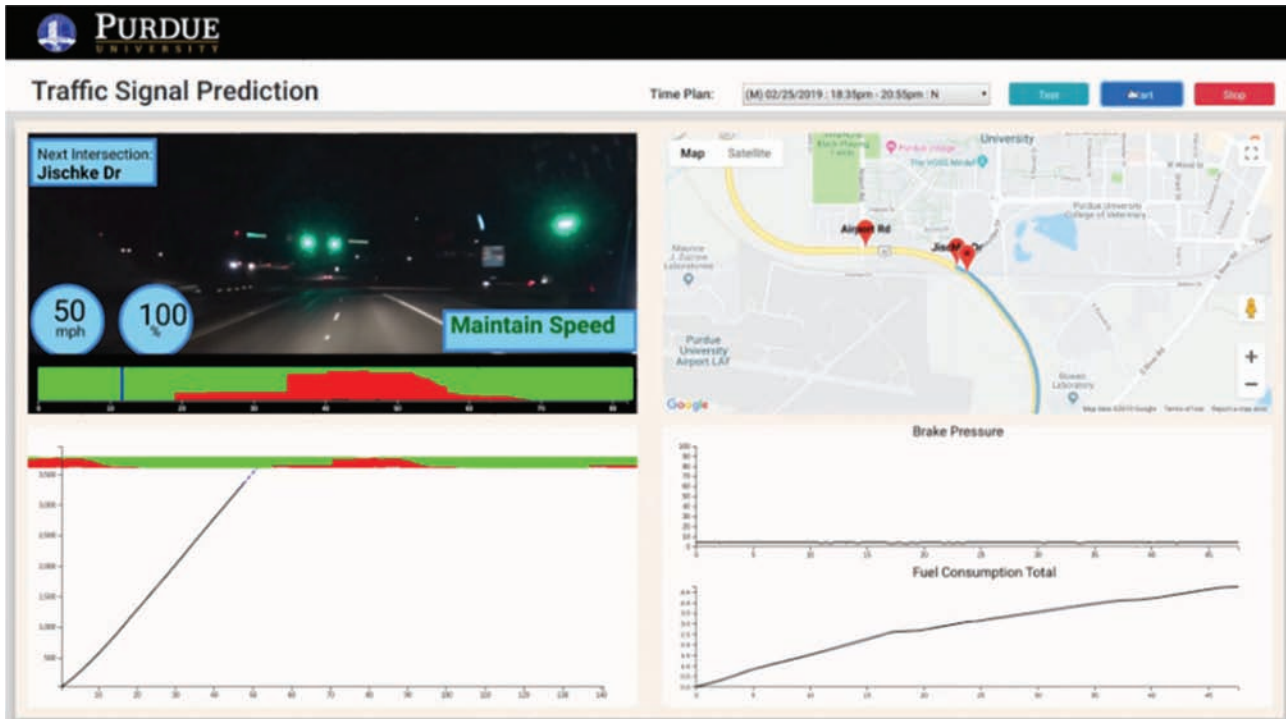

Figure 5.5 GLOSA dashboard.

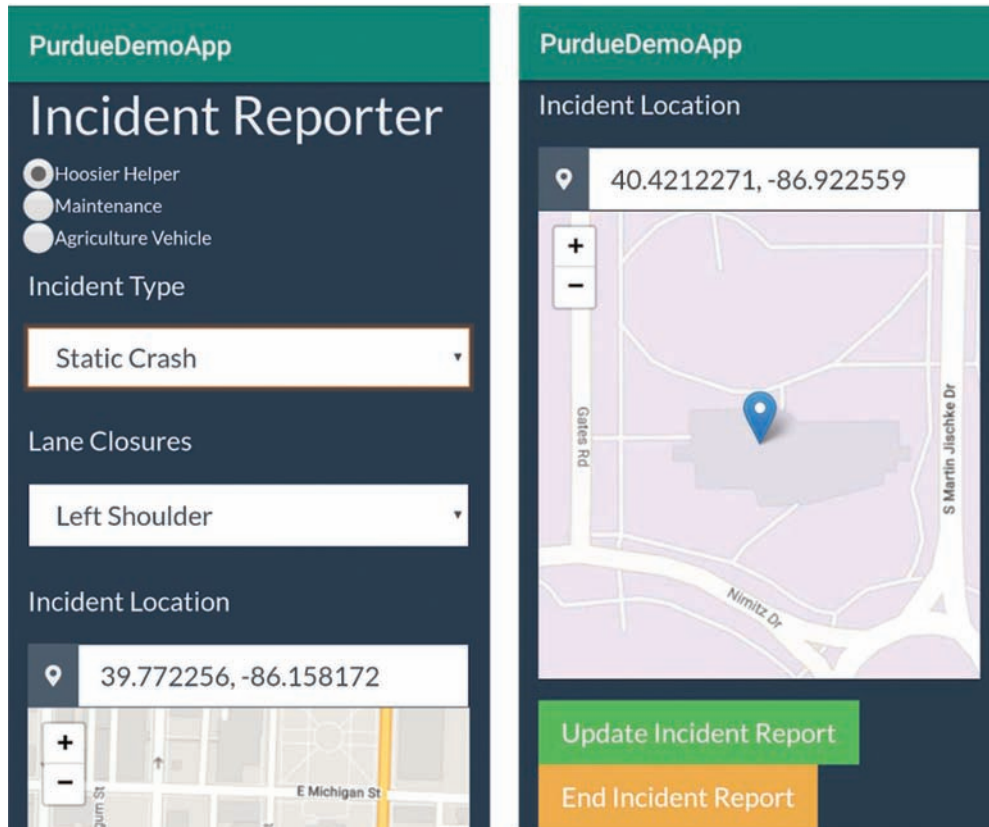

Figure 5.6 Maintenance operations/slow moving vehicle app.

green probability at arrival to the next intersection, integrated with cruise control speed setting, and audible speed advisory and stop-or-go decision, brake pressure, and cumulative fuel consumption, and is fully integrated with video input.

5.6 Maintenance Operations/Slow Moving Vehicle Mobile App

Joint collaboration between JTRP and Trimble Maps led to the development of a mobile app (Figure 5.6) that alerts motorists of dangerous slowdowns ahead due to maintenance operations or slow-moving vehicles. INDOT crews will indicate the type of maintenance activity and the number of lanes affected through the app, which then provides an in-cab alert to motorists within the area. Currently, motorists with access to Trimble Maps' Co-Pilot system will receive the notification.

6. SUMMARY AND RECOMMENDATIONS

This report summarizes the work performed to deploy connected vehicle infrastructure on 11 intersections across Indiana. SPaT message deployment was done using both traditional dedicated short-range communication (DSRC) as well cellular communication and objective performance measures from use cases that exercise both architectures are outlined in this study.

Some of the key takeaways from the research outlined in this report are:

- DSRC provides the lowest latency communication, but in general commercial cellular interface between vehicles and infrastructure provided acceptable latency for most use cases. For most applications, the team believes a commercial cellular interface between vehicles and infrastructure is the most scalable and feasible for an agency to maintain.
- The team developed a scalable methodology for characterizing the probability of a traffic signal phase changing by time of day. This methodology of using agency traffic signal data for green light prediction and engine shutdown at red lights is particularly useful to the automotive industry (Appendix A).
- The team evaluated the performance of optimal speed advisories for arriving on green light and found that there was a large reduction in red light violations and hard-braking events by anticipating the onset of yellow, by 87.6% and 64.8% respectively over unadvised trips (Appendix D).
- The team successfully demonstrated that split failures, reduced roadway friction and hard braking events can be identified on the vehicle and transmitted to an agency. This enhanced probe data information is particularly valuable to agencies for identifying traffic signal timing problems, segments impacted by winter weather and location where drivers are encountering roadway conditions required hard braking (Appendix E).
- The team successfully demonstrated use cases for placing virtual vehicle detection calls to a traffic signal controller using SPaT messages and evaluated latency. Dilemma

zone incursions for heavy vehicles were found to be reduced by a net of 34% using CV technology by triggering advance detections as early as 1000' from the stop bar (Appendix F). In the near term, there is significant opportunity for placing "virtual pedestrian" calls at traffic signals for uses with mobility challenges, or emerging robot delivery vehicles that need to cross the street.

- The team also evaluated the potential of historic connected vehicle data to identify strategic and tactical locations as well as candidate time periods viable for commercial vehicle testing (Appendix G).

Major recommendations from this study include:

- The current version of the SAE J2735 SPaT definition is ambiguous on the *likelyTime* and *time interval confidence* fields whether the elements refer to start of green or end of green. It is recommended that protocol documentation and messages be updated to support confidence estimates for both start and end of green.
- Develop partnership with the automotive sector to obtain enhanced probe data that identifies traffic signal phases that experience split failures, locations with hard braking events, and segments with reduced friction.
- The automotive industry is accustomed to tight tolerances; however, modern traffic signals operate much more stochastically. Longer term, it might be worthwhile to have a "phase-next" data flag provided by signal controllers to inform the vehicle of a deterministic window to update their phase predictions 5s to 7s prior to the start of the next phase.
- It might also be worthwhile to reconsider strategies on running the "free" timing plan overnight. Free operation is based purely on random arrivals, can make the traffic signal predictions even more challenging than coordinated and adaptive systems.

As vehicles begin to know more about the state of the infrastructure than agencies, it vital for traffic engineers and automotive partners to work together and develop shared visions for connected vehicle applications. The recommendations from this report and the lessons learned from the early use cases will aid Indiana to become an important stakeholder and help shape this emerging field of connected and autonomous vehicles.

REFERENCES

- AASHTO. (n.d.). *SPaT challenge overview*. Retrieved March 13, 2018, from <http://www.transportationops.org/spat/challenge>
- Audi Newsroom. (n.d.). *Audi expands traffic light information—now available in 10 US cities*. Retrieved July 29, 2018 from <https://media.audiusa.com/en-us/releases/241>
- Bagheri, E. (2017). *Enhanced traffic signal operation using connected vehicle data* [Doctoral dissertation, University of Waterloo]. https://uwspace.uwaterloo.ca/bitstream/handle/10012/12261/Bagheri_Ehsan.pdf?sequence=1&isAllowed=y
- Freije, R. S., Hainen, A. M., Stevens, A. L., Li, H., Smith, B. W., Summers, H., Day, C. M., Sturdevant, J. R., & Bullock, D. M. (2014). Graphical performance measures for practitioners to triage split failure trouble calls. *Transportation Research Record: Journal of the Transportation*

- Research Board*, 2439(1), 27–40. <https://doi.org/10.3141/2439-03>
- Goodall, N. J. (2013, May). *Traffic signal control with connected vehicles* [Doctoral dissertation, University of Virginia]. http://people.virginia.edu/~njg2q/goodall_dissertation.pdf
- Hill, C., Hamilton, B. A., & Krueger, G. (2013). *Module 13: Connected vehicles*. U.S. Department of Transportation, Intelligent Transportation Systems Joint Program Office. Retrieved March 13, 2018, from <https://www.pcb.its.dot.gov/eprimer/module13.aspx>
- Ibrahim, S., Kalathil, D., Sanchez, R. O., & Varaiya, P. (2019, July). Estimating phase duration for SPaT Messages. *IEEE Transactions on Intelligent Transportation Systems*, 20(7), 2668–2676. <https://doi.org/10.1109/TITS.2018.2873150>
- Mathew, J. K., Li, H., & Morgan, B., Kim, W., & Bullock, D. (2019). *Probabilistic distributions of coordinated traffic signal phase indications for connected vehicle applications* [Paper presentation]. Transportation Research Board 98th Annual Meeting, Washington D.C.
- OSS Nokalva. (n.d.). *ASN1 playground*. <https://asn1.io/asn1playground/>
- Roess, R. P., Prassas, E. S., & McShane, W. R. (2009). Fundamentals of signal timing and design: Pretimed signals. In R. P. Roess, E. S. Prassas, & W. R. McShane (Eds.), *Traffic engineering* (4th ed., pp. 483–518). Pearson Prentice Hall.
- SAE International. (2016, March 30). *J2735D: Dedicated short range communications (DSRC) message set dictionary* [Data set]. https://www.sae.org/standards/content/j2735_201603/
- U.S. Department of Transportation. (n.d.a). *Connected vehicle basics*. Retrieved March 13, 2018, from https://www.its.dot.gov/cv_basics/cv_basics_what.htm
- U.S. Department of Transportation. (n.d.b). *Connected vehicles ISD creator*. <https://webapp.connectedvcs.com/isd/>
- Wolf, J. C., Ma, J., Cisco, B., Neill, J., Moen, B., & Jarecki, C. (2019, April 12). Deriving signal performance metrics from large-scale connected vehicle system deployment. *Transportation Research Record: Journal of the Transportation Research Board*, 2673(4), 36–46. <https://doi.org/10.1177/0361198119838520>

APPENDICES

APPENDIX A. PROBABILISTIC DISTRIBUTIONS OF COORDINATED TRAFFIC SIGNAL PHASE INDICATIONS FOR CONNECTED VEHICLE APPLICATIONS

Mathew, J. K., Li, H., Morgan, B., Kim, W., & Bullock, D. (2019). *Probabilistic distributions of coordinated traffic signal phase indications for connected vehicle applications* [Paper presentation]. Transportation Research Board 98th Annual Meeting, Washington D.C., United States.

Abstract

Connected vehicles are beginning to emerge that communicate with signals and incorporate signal prediction. For fixed time operations it is a deterministic exercise to predict the signal state. However, under actuated coordinated conditions, there is significant stochastic variation on the phase activations due to the random arrival of vehicles. As signal controllers become more adaptive and intelligent, the predictions also become more challenging.

This paper has two objectives:

1. Propose a diagram for visualizing the statistical distribution of traffic signal phases by time in cycle to provide a framework for dialog between automotive and traffic signal professionals regarding the stochastic variation of actuated system that impact signal prediction algorithms.
2. Propose a methodology to evaluate the performance of a connected vehicle application that predicts the time-to-green as the vehicle approaches an intersection.

High-resolution traffic signal controller data over a period of 6.5 hours is analyzed to illustrate the variations in phase occurrences. Data is compared for both fixed-time and actuated coordinated conditions. This data is illustrated graphically in a multiphase probability diagram that provides a quantitative framework for dialog between traffic signal professionals and vehicle manufacturers on the stochastic nature of traffic signals when vehicle detection and adaptive signal control logic is deployed. In addition to being a useful tool for connected vehicle applications, this multiphase probability diagram is useful for traffic engineers deploying adaptive and other advanced traffic signal systems to understand how green time is dynamically allocated.

APPENDIX B. SIGNAL GREEN TIME ESTIMATION METHOD FOR CONNECTED VEHICLE-TO-INFRASTRUCTURE APPLICATIONS

Mathew, J. K., Li, H., & Bullock, D. (2019). *Signal green time estimation method for connected vehicle-to-infrastructure applications* [Paper presentation]. IEEE

International Conference on Connected Vehicles and Expo (ICCVE) 8th Annual Meeting, Graz, Austria.

Abstract

Connected and autonomous vehicles (CAV) are becoming more integrated with traffic signal infrastructure for V2I applications, such as traffic light indication and automated driving. However, modern traffic signal controllers allocate green time using vehicle sensors and therefore the anticipated green time has significant stochastic variation. This study develops a methodology to characterize green time stochastic variation for actuated-coordinated operation. During the peak hours where the demand was highly consistent, green intervals can be predicted with high certainty. In contrast, during midday and late evening, stochastic variation increased significantly due to the varying arrival patterns and associated real-time responsiveness of the traffic signal controller. The statistical characterization methods presented in this paper are important for green light optimized speed advisory (GLOSA) and eco-driving, technologies that rely on having an accurate estimate of the beginning of green (BOG) and end of green (EOG). Prior knowledge on typical values of how early to stop or shutdown the vehicles at a traffic signal approach can significantly improve efficiency and manage emissions for CAV. The paper concludes with a proposed graphical performance measure chart that can be used by traffic engineers and automotive vendors to frame the discussion on traffic signal operation.

APPENDIX C. POPULATING SAE J2735 MESSAGE CONFIDENCE VALUES FOR TRAFFIC SIGNAL TRANSITIONS ALONG A SIGNALIZED CORRIDOR

Mathew, J. K., Li, H., & Bullock, D. (2020). *Populating SAE J2735 message confidence values for traffic signal transitions along a signalized corridor* [Manuscript submitted for publication]. Transportation Research Board 99th Annual Meeting, Washington D.C., United States.

Abstract

The communication between connected vehicles and traffic signal controllers is defined in SAE Surface Vehicle Standard J2735. SAE J2735 defines traffic signal status messages and a series of 16 confidence levels for traffic signal transitions. This paper discusses a statistical method for tabulating traffic signal data by phase and time of day and populating the SAE J2735 messages. Graphical representation of the red-green and green-yellow transitions are presented from six intersections along a 4-mile corridor for five different time of day timing plans. The case study provided illustrates the importance of characterizing the stochastic variation of traffic signals to understand locations,

phases, and time of day when traffic indications operate with high predictability, and periods when there are large variations in traffic signal change times. Specific cases, such as low vehicle demand and occasional actuation of pedestrian phases are highlighted as situations that may reduce the predictability of traffic signal change intervals. The results from this study also opens up discussion among transportation professionals on the importance of consistent tabulation of confidence values for both beginning and end of green signal states. We believe this paper will initiate dialog on how to consistently tabulate important data elements transmitted in SAE J2735 and perhaps refine those definitions. The paper concludes by highlighting the importance of traffic engineers and connected vehicle developers to work together to develop shared visions on traffic signal change characteristics so that the in-vehicle use cases and human-machine interface (HMI) meet user expectations.

APPENDIX D. EFFECTS OF A PROBABILITY-BASED GREEN LIGHT OPTIMIZED SPEED ADVISORY ON DILEMMA ZONE EXPOSURE

Carranza, E. S., Kim, W., Li, H., Mathew, J. K., Sturdevant, J., & Bullock, D. *Effects of a probability-based green light optimized speed advisory on dilemma zone exposure* [Manuscript in preparation]. Lyles School of Engineering, Purdue University.

Abstract

Green Light Optimized Speed Advisory (GLOSA) systems have the objective of providing a recommended speed to arrive at a traffic signal during the green phase of the cycle. GLOSA has been shown to decrease travel time, fuel consumption, and carbon emissions; simultaneously, it has been demonstrated to increase driver and passenger comfort. Few studies have been conducted using historical cycle-by-cycle phase probabilities to assess the performance of a speed advisory capable of recommending a speed for various traffic signal operating modes (fixed-time, semi-actuated, and fully-actuated). In this study, a GLOSA system based on phase probability is proposed. The probability is calculated prior to each trip from a previous week's, same time-of-day (TOD) and day-of-week (DOW) period, traffic signal controller high-resolution event data. By utilizing this advisory method, real-time communications from the vehicle to infrastructure (V2I) become unnecessary, eliminating data-loss related issues. The effects of three different advice approaches (conservative, balanced, and aggressive) on dilemma zone exposure are analyzed. Proof of concept is carried out by virtually driving through a test-route composed of an arterial that had historical high-resolution traffic signal event logs for a series of actuated-coordinated traffic signals during different TOD and DOW. A comparison was performed between unadvised and GLOSA advised trips obtained from approximately 486,000

simulated trajectories. Results were obtained by analyzing the vehicle's probability of stopping from utilizing Traffic Engineering dilemma zone theory. Reductions of 93% in the amount of hard brakings and 96% in the number of crossings through red light were observed with the proposed system. This data suggests the feasibility of a probability-based advisory, as well as the viability of utilizing the proposed GLOSA system to minimize dilemma zone exposure.

APPENDIX E. LEVERAGING CONNECTED VEHICLES TO PROVIDE ENHANCED ROADWAY CONDITION INFORMATION

Li, H., Wolf, J. C., Mathew, J. K., Navali, N., Zehr, S. D., Hardin, B. L., & Bullock, D. (2019) *Leveraging connected vehicles to provide enhanced roadway condition information* [Manuscript submitted for publication]. Lyles School of Engineering, Purdue University.

Abstract

Real-time performance measures are important for agencies to maintain their roadways during the winter season. Sensing systems such as traffic cameras, weather radar, stationary Road Weather Information Systems (RWIS), pavement sensors, mobile weather-sensing units (MARWIS), point speed sensors, and third-party speed data have enabled operators to make tactical data-driven decisions during inclement weather events. However, infrastructure can be expensive to deploy and maintain and may be sparse in rural areas, while speed data alone may not provide enough fidelity in borderline conditions.

This study looks at high-frequency brake pressure, anti-lock brake (ABS) activation, wheel tick, traction-control intervention, hazard lights, and windshield wiper data from the in-vehicle bus to detect changes in the vehicle and driver behavior during changing winter road conditions. The data is reported to the cloud via cellular communication and is viewable in real-time using a map-based web dashboard. Three winter weather events are assessed using in-vehicle data collected from the February–March 2018 period. MARWIS data and a user-based qualitative rating are also used to ground-truth road friction and perceived conditions. Data from hazard lights and wipers indicate early perceived weather and traffic hazards, while ABS and traction control only indicate severe cases of loss-of-friction.

Using 2-sample Kolmogorov-Smirnov test, we found high significance in the reductions of applied brake pressures and rates of braking in winter versus fair weather conditions before vehicle intervention is necessary. As road conditions deteriorate, a driver may reduce braking pressure by up to 60% during typical braking operations, while the rate of braking also is reduced by about 75%. Using the Brown-Forsythe test, the variance of the rate of braking is also found to exhibit statistically significant changes as road friction

conditions deteriorate. The greatest increase in brake rate variance is found to occur within the 20–39 mph range at 110 Bar/sec² and correlates to changes in friction.

The paper concludes that pairwise comparison of driver brake pressure may be a valuable data source indicative of deteriorating road conditions before more severe indicators such as traction control, anti-lock brake, and/or hazard indicators are activated.

APPENDIX F. USING CONNECTED VEHICLE DATA TO REASSESS DILEMMA ZONE PERFORMANCE OF HEAVY VEHICLES

Li, H., Platte, T., Mathew, J. K., Smith, B., Salivadar-Carranza, E., & Bullock, D. (2020). *Using connected vehicle data to reassess dilemma zone performance of heavy vehicles* [Manuscript submitted for publication]. Lyles School of Engineering, Purdue University.

Abstract

The rate of fatalities at signalized intersections involving heavy vehicles is nearly five times higher than for passenger vehicles. Previous studies have found that heavy vehicles are twice as likely to violate a red light compared to passenger vehicles. Current technologies leverage setback detection to extend green time for a particular phase and are based upon typical deceleration rates for passenger cars. Furthermore, dilemma zone detectors are not effective when the max out time expires and forces the onset of yellow. This study proposes the use of connected vehicle (CV) technology to trigger force gap out (FGO) before a vehicle is expected to arrive within the dilemma zone limit at max out time. The method leverages position data from basic safety messages (BSMs) to map-match virtual waypoints located up to 1,050' in advance of the stop bar. For a 55 miles per hour (mph) approach, field tests determined that using a 6' waypoint radius at 50' spacings would be sufficient to match 95% of BSM data within a 5% lag threshold of 0.59s. The study estimates that FGOs reduce dilemma zone incursions by 34% for one approach and had no impact for the other. For both approaches, the total dilemma zone incursions

decreased from 310 to 225. Although virtual waypoints were used for evaluating FGO, the study concludes by recommending that trajectory-based processing logic be incorporated into controllers for more robust support of dilemma zone and other emerging CV applications.

APPENDIX G. ANALYTICAL TECHNIQUES TO USE HISTORICAL CONNECTED VEHICLE DATA TO ASSESS PLATOONING POTENTIAL ON INTERSTATE CORRIDORS

Kim, W., Li, H., Mathew, J. K., & Bullock, D. (2020). *Analytical techniques to use historical connected vehicle data to assess platooning potential on interstate corridors* [Manuscript submitted for publication]. Lyles School of Engineering, Purdue University.

Abstract

There are multiple vendors that now provide real-time probe data based interstate speed measurements at sub-1 mile, 1-minute fidelity. This paper presents an analytical tool for visualizing interstates traffic conditions to validate congestion identified by the probe data with cameras at select locations. This visualization tool is then applied to the I-70 corridor in Indiana, an important east-west freight corridor. The tool is used to screen at both a strategic and tactical level, the “platoonability” of sections and time periods on I-70. Case studies are presented that illustrate recurring congestion, congestion associated with crashes, and congestion associated with moving work zones and maintenance operations. The 15-minute median speed heat map was recommended as a quick and robust screening tool. A series of simulated trajectories, using 1-minute segment speed archives, were used to demonstrate the robustness of this strategy by analyzing the frequency of speed changes greater than 10 mph as well as how often the speeds dropped below 55 mph. The paper concludes with a recommended visualization of median speeds for identifying strategic locations and time periods that platooning may be viable and a recommendation for a 10-mile real-time tactical “look ahead” visualization to identify likely areas of congestion or stopped traffic.

About the Joint Transportation Research Program (JTRP)

On March 11, 1937, the Indiana Legislature passed an act which authorized the Indiana State Highway Commission to cooperate with and assist Purdue University in developing the best methods of improving and maintaining the highways of the state and the respective counties thereof. That collaborative effort was called the Joint Highway Research Project (JHRP). In 1997 the collaborative venture was renamed as the Joint Transportation Research Program (JTRP) to reflect the state and national efforts to integrate the management and operation of various transportation modes.

The first studies of JHRP were concerned with Test Road No. 1 — evaluation of the weathering characteristics of stabilized materials. After World War II, the JHRP program grew substantially and was regularly producing technical reports. Over 1,600 technical reports are now available, published as part of the JHRP and subsequently JTRP collaborative venture between Purdue University and what is now the Indiana Department of Transportation.

Free online access to all reports is provided through a unique collaboration between JTRP and Purdue Libraries. These are available at <http://docs.lib.purdue.edu/jtrp>.

Further information about JTRP and its current research program is available at <http://www.purdue.edu/jtrp>.

About This Report

An open access version of this publication is available online. See the URL in the citation below.

Recommended Citation

Li, H., Mathew, J. K., Kim, W., Saldivar-Carranza, E. D., Sturdevant, J., Smith, W. B., & Bullock, D. M. (2019). *Connected vehicle corridor deployment and performance measures for assessment* (Joint Transportation Research Program Publication No. FHWA/IN/JTRP-2019/28). West Lafayette, IN: Purdue University. <https://doi.org/10.5703/1288284317108>