

Impact of Access Spacing Standards on Crash Risk After Controlling for Access Volumes

http://www.virginiadot.org/vtrc/main/online_reports/pdf/21-r7.pdf

Alejandra Medina Flintsch
Senior Research Associate, Virginia Tech Transportation Institute

Feng Guo
Professor, Department of Statistics, Virginia Tech
Lead Data Scientist, Virginia Tech Transportation Institute

Shu Han
Research Associate, Virginia Tech Transportation Institute

Kathleen Hancock
Associate Professor, Via Department of Civil and Environmental Engineering

Brian Williams
Research Associate, Virginia Tech Transportation Institute

Yingfeng Li
Senior Research Associate, Virginia Tech Transportation Institute

Ron Gibbons
Center Director, Virginia Tech Transportation Institute

Final Report VTRC 21-R7

Standard Title Page - Report on Federally Funded Project

1. Report No.: FHWA/VTRC 21-R7	2. Government Accession No.:	3. Recipient's Catalog No.:	
4. Title and Subtitle: Impact of Access Spacing Standards on Crash Risk After Controlling for Access Volumes		5. Report Date: August 2020	6. Performing Organization Code:
7. Author(s): Alejandra Medina Flintsch, Feng Guo, Shu Han, Kathleen Hancock, Brian Williams, Yingfeng Li, and Ron Gibbons		8. Performing Organization Report No.: VTRC 21-R7	
9. Performing Organization and Address: Virginia Transportation Research Council 530 Edgemont Road Charlottesville, VA 22903		10. Work Unit No. (TRAIS):	
		11. Contract or Grant No.: 112107	
12. Sponsoring Agencies' Name and Address: Virginia Department of Transportation Federal Highway Administration 1401 E. Broad Street 400 North 8th Street, Room 750 Richmond, VA 23219 Richmond, VA 23219-4825		13. Type of Report and Period Covered: Final Contract	
		14. Sponsoring Agency Code:	
15. Supplementary Notes: This is an SPR-B report.			
16. Abstract: <p>Engineers and planners are typically tasked with approving new entrance permits, evaluating permitting exceptions, and generating safety countermeasures for specific corridors. Although several studies show that a smaller space between two access points is associated with an increased crash risk, the relationship between these two factors is not fully understood. The Virginia Department of Transportation is interested in determining the impact of access spacing on crash risk as a result of controlling by access volume. This study encompasses an effort to understand how the spacing between access points and volume of access points affect crash risk. The three tasks were to conduct a literature review to identify research gaps, a pilot study to evaluate the feasibility of the approach, and an extended study to use the pilot study results to provide recommendations for application in the field.</p> <p>The pilot study helped to develop the methodologies for data collection, information extraction, and statistical analysis. It also raised discussion on the definition of analysis units. As a result, three alternative definitions were used in the extended study. Eight corridors totaling 621 miles were selected for the extended study. Several existing databases and tools were used to determine roadway geometric attributes, operational attributes, and traffic volume data for the selected corridors and access points. A new Linear Referencing System was generated to enable correlations between the different databases. A custom in-house application was developed in which a data reductionist used satellite imagery to determine the physical characteristics of an access point and the types of business and residential buildings connected to an access point. The application then used the estimated daily traffic volume from the ITE Trip Generation Manual in order to estimate traffic volume for the access point. The result of the reduction effort was a new database which included a list of access point pairs, physical variables, and spacing. Using this data along with the new Linear Referencing System, Poisson and negative binomial (NB) mixed regression models were used to evaluate the effects of access spacing and access traffic volume on crash risk.</p> <p>The study concluded that both spacing and access volume have a significant impact on crash risk at/near access points. Access volume, including both the volume from upstream and downstream access points, has a positive association with crash risk. On average, for every 457 vehicles per day increase, the crash rate will increase by 4%–10% depending on the type of access points and analysis unit. Consistent with the majority of previous studies, access spacing was found to be negatively associated with crash risk. For every 100-foot increase in spacing, the crash rate will decrease by 4%–7%. Both access volume and spacing should be considered in developing access point standards and decision making in access management practice.</p>			
17 Key Words: Access Management, Safety, Driveways, Right in-Right Out Access, Full Access. Unsignalized Intersections		18. Distribution Statement: No restrictions. This document is available to the public through NTIS, Springfield, VA 22161.	
19. Security Classif. (of this report): Unclassified	20. Security Classif. (of this page): Unclassified	21. No. of Pages: 67	22. Price:

FINAL REPORT

**IMPACT OF ACCESS SPACING STANDARDS ON CRASH RISK AFTER
CONTROLLING FOR ACCESS VOLUMES**

Alejandra Medina Flintsch
Senior Research Associate, Virginia Tech Transportation Institute

Feng Guo
Professor, Department of Statistics, Virginia Tech
Lead Data Scientist, Virginia Tech Transportation Institute

Shu Han
Research Associate, Virginia Tech Transportation Institute

Kathleen Hancock
Associate Professor, Via Department of Civil and Environmental Engineering

Brian Williams
Research Associate, Virginia Tech Transportation Institute

Yingfeng Li
Senior Research Associate, Virginia Tech Transportation Institute

Ron Gibbons
Center Director, Virginia Tech Transportation Institute

VTRC Project Manager
John Miller, Ph.D., P.E., Virginia Transportation Research Council

In Cooperation with the U.S. Department of Transportation
Federal Highway Administration

Virginia Transportation Research Council
(A partnership of the Virginia Department of Transportation
and the University of Virginia since 1948)

Charlottesville, Virginia

August 2020
VTRC 21-R7

DISCLAIMER

The project that is the subject of this report was done under contract for the Virginia Department of Transportation, Virginia Transportation Research Council. The contents of this report reflect the views of the author(s), who is responsible for the facts and the accuracy of the data presented herein. The contents do not necessarily reflect the official views or policies of the Virginia Department of Transportation, the Commonwealth Transportation Board, or the Federal Highway Administration. This report does not constitute a standard, specification, or regulation. Any inclusion of manufacturer names, trade names, or trademarks is for identification purposes only and is not to be considered an endorsement.

Each contract report is peer reviewed and accepted for publication by staff of the Virginia Transportation Research Council with expertise in related technical areas. Final editing and proofreading of the report are performed by the contractor.

Copyright 2020 by the Commonwealth of Virginia.
All rights reserved.

ABSTRACT

Engineers and planners are typically tasked with approving new entrance permits, evaluating permitting exceptions, and generating safety countermeasures for specific corridors. Although several studies show that a smaller space between two access points is associated with an increased crash risk, the relationship between these two factors is not fully understood. The Virginia Department of Transportation is interested in determining the impact of access spacing on crash risk as a result of controlling by access volume.

This study encompasses an effort to understand how the spacing between access points and volume of access points affect crash risk. The three tasks were to conduct a literature review to identify research gaps, a pilot study to evaluate the feasibility of the approach, and an extended study to use the pilot study results to provide recommendations for application in the field.

The pilot study helped to develop the methodologies for data collection, information extraction, and statistical analysis. It also raised discussion on the definition of analysis units. As a result, three alternative definitions were used in the extended study. Eight corridors totaling 621 miles were selected for the extended study.

Several existing databases and tools were used to determine roadway geometric attributes, operational attributes, and traffic volume data for the selected corridors and access points. A new Linear Referencing System was generated to enable correlations between the different databases. A custom in-house application was developed in which a data reductionist used satellite imagery to determine the physical characteristics of an access point and the types of business and residential buildings connected to an access point. The application then used the estimated daily traffic volume from the ITE Trip Generation Manual in order to estimate traffic volume for the access point. The result of the reduction effort was a new database which included a list of access point pairs, physical variables, and spacing.

Using this data along with the new Linear Referencing System, Poisson and negative binomial (NB) mixed regression models were used to evaluate the effects of access spacing and access traffic volume on crash risk.

The study concluded that both spacing and access volume have a significant impact on crash risk at/near access points. Access volume, including both the volume from upstream and downstream access points, has a positive association with crash risk. On average, for every 457 vehicles per day increase, the crash rate will increase by 4%–10% depending on the type of access point and analysis unit. Consistent with the majority of previous studies, access spacing was found to be negatively associated with crash risk. For every 100-foot increase in spacing, the crash rate will decrease by 4%–7%. Both access volume and spacing should be considered in developing access point standards and decision making in access management practice.

TABLE OF CONTENTS

ABSTRACT.....	iii
INTRODUCTION	1
PURPOSE AND SCOPE.....	3
METHODS	3
Literature Review.....	3
Development of Study Database.....	4
Pilot Study.....	4
Corridor Selection – Extended Study	4
Data Mining	5
Define Analysis Units.....	16
Descriptive Data Analysis.....	24
Statistical Analysis.....	24
RESULTS	28
Literature Review.....	28
Development of Study Database.....	30
Descriptive Data Analysis.....	33
Statistical Analysis.....	41
Stratified Analysis by Control Type	47
DISCUSSION.....	51
Limitations	52
CONCLUSIONS.....	53
RECOMMENDATIONS	53
IMPLEMENTATION AND BENEFITS	54
Implementation	54

Benefits	54
ACKNOWLEDGMENTS	55
REFERENCES	55
APPENDIX A. IMPLEMENTATION OF RECOMMENDATIONS	57
APPENDIX B. CRASH COST ESTIMATES	59

FINAL REPORT

IMPACT OF ACCESS SPACING STANDARDS ON CRASH RISK AFTER CONTROLLING FOR ACCESS VOLUMES

Alejandra Medina Flintsch
Senior Research Associate
Virginia Tech Transportation Institute

Feng Guo
Professor, Department of Statistics, Virginia Tech
Lead Data Scientist, Virginia Tech Transportation Institute

Shu Han
Research Associate
Virginia Tech Transportation Institute

Kathleen Hancock
Associate Professor
Via Department of Civil and Environmental Engineering

Brian Williams
Research Associate
Virginia Tech Transportation Institute

Yingfeng Li
Senior Research Associate
Virginia Tech Transportation Institute

Ron Gibbons
Center Director
Virginia Tech Transportation Institute

INTRODUCTION

The Transportation Research Board (TRB) Access Management Manual defines access management as “a range of methods that promote the efficient and safe movement of people and goods by reducing conflicts on the roadway system and at its interface with other modes of travel” (Williams et al., 2014). Two major sets of criteria are taken into account when developing standards: operations and safety. The operations criteria refer to the impact that access points have on capacity, travel time, and/or delays. The safety criteria refer not only to the number of crashes, but also to the operational conditions required to achieve a reasonable level of safety (e.g., stopping sight distance). In practice, the implementation generally complies with the stricter of these two areas of criteria.

Two of the most important principles of access management are separating the conflict points and limiting the number of conflict points (Williams et al., 2014). Engineers and planners are typically tasked with approving new entrance permits, evaluating permitting exceptions, and generating safety countermeasures for specific corridors. Although several studies show that smaller spacing between two access points is associated with an increase in crash risk, the relationship between these two factors is not fully understood. Specifically, the Virginia Department of Transportation (VDOT) is interested in determining the impact of access spacing on crash risk as a result of controlling by access volume.

Access management standards vary among states, and only general guidance is available for access spacing (Williams et al., 2014). State DOTs usually select an access classification system that best represents their needs. Subcategories among these highway classifications are based on speed, traffic, presence of median, and land use control (Gluck & Lorenz, 2010).

Current Virginia Access Management Standards (VDOT, 2018) set minimum spacing for commercial entrances, intersections, and median crossovers based on the highway functional classification (major arterial, minor arterial, collector, and local street) and legal speed limit type, as shown in Table 1.

Table 1. VDOT Access Management Standards (VDOT, 2018)

Highway Functional Classification	Legal Speed Limit (mph)	Minimum Centerline to Centerline Spacing (Distance) in Feet			
		Spacing from Signalized Intersections to Other Signalized Intersections	Spacing from Unsignalized Intersections & Full Median Crossovers to Signalized or Unsignalized Intersections & Full Median Crossovers	Spacing from Full Access Entrances or Directional Median to Other Full Access Entrances and Any Intersection or Median Crossover	Spacing from Partial Access One- or Two-Way Entrances to Any Type of Entrance, Intersection or Median Crossover
Principal Arterial	≤ 30 mph	1,050	880	440	250
	35 to 45 mph	1,320	1,050	565	305
	≥ 50 mph	2,640	1,320	750	495
Minor Arterial	≤ 30 mph	880	660	355	200
	35 to 45 mph	1,050	660	470	250
	≥ 50 mph	1,320	1,050	555	425
Collector	≤ 30 mph	660	440	225	200
	35 to 45 mph	660	440	335	250
	≥ 50 mph	1,050	660	445	360

mph = miles per hour

The first section of this report describes the purpose and scope of this project. The following section describes the methods employed regarding database variables and attributes as well as the data mining and modeling process. The third section shows the results followed by a discussion of the findings. Finally, the conclusions, recommendations, and implementation sections are presented.

PURPOSE AND SCOPE

The main purpose of this project was to determine the impact of access spacing on crash risk by controlling for access volume. To this end, the specific objectives of this project were to:

1. Identify research gaps regarding the consideration of access and mainline volumes on access spacing and crash risk.
2. Assess the availability of data and develop methodologies to extract data to achieve the study goal.
3. Determine the impact of access spacing on crash risk by controlling for access volume for the full (unsignalized) and partial access types; provide recommendations and prepare supporting tools to apply those recommendations in the field.

METHODS

During the project, the research team conducted a number of activities towards an in-depth understanding of the impact of access spacing and volume on safety:

The following tasks were conducted to achieve the study objectives:

- Literature Review
- Development of Study Database
- Pilot Study
- Corridor Selection Extended Study
- Data Mining
- Descriptive Data Analysis
- Definition of Analysis Units
- Statistical Analysis

Literature Review

The team conducted an extensive literature review that included both published and unpublished domestic and international material as well as practical applications and field experiences. Major works in access management that were referenced include American Association of State Highway Transportation Officials (AASHTO) policies, the TRB Access Management Manual, National Cooperative Highway Research Program (NCHRP) reports, DOT and national standards, and access management conference proceedings. The literature review focused on studies that evaluated safety performance and access management, specifically the relationship with access volume. All documents obtained in the literature search were initially reviewed to determine if they contained more detailed information applicable to the project regarding access types, variable data collection, surrogate measures and models. The project document Literature Review was submitted to VDOT's Technical Review Panel (TRP) on March 20, 2019.

Development of Study Database

The database structure was defined based on VDOT's TRP input during the kickoff meeting, previous studies identified in the literature review, and the experience of the research team.

Pilot Study

A pilot study was conducted to evaluate the relationship between access volume and access spacing and determine the feasibility of conducting a larger-scale study. A 111-mile section of U.S. 460 Eastbound from Roanoke, VA to east of Farmville, VA was selected with guidance from VDOT. This section was chosen because the corridor has not undergone significant geometric changes in the past 5 years (the period of crash data) and contains mixed land use and environmental characteristics. After the GIS database structure and data collection procedures were defined, the existence of a VDOT access database covering a long section of U.S. 460 was brought to the research team's attention. After reviewing the database, the team decided to use the VDOT database as a starting point to populate the pilot study database. Using this database required creating a new Linear Referencing System (LRS; as described below), checking every access point, and collecting all the additional data described above. The land use categories provided by this database proved to be quite valuable.

The pilot study achieved the planned goals, including demonstrating methodologies for data collection, information extraction, and statistical analysis. More importantly, it raised a discussion on the definition of analysis units, since access point pairs with a longer in-between segment would likely show a lower crash rate and bring bias when evaluating the effect of access volume and spacing on crash risk. After extensive discussion between the research team and VDOT's TRP, three alternative definitions of analysis unit were proposed and were subsequently used in the full-scale study. The project document Task 2 Pilot Study Results was submitted to the TRP on August 9, 2019.

Corridor Selection – Extended Study

After the GIS database structure and data collection procedures were defined, eight corridors were selected for the extended study, including five state route arterials (US 17, US 29, US 58, US 220, US 460) and three business state route sections (US 29 BUS, US 220 BUS, and US 58 BUS), as shown in Figure 1. The total length of all selected corridors in the extended study was 621 miles. The VDOT database was used to populate the extended study database. Using this database required creating a new LRS (as described below), checking every access point, and collecting all the additional data described above. The land use categories provided by this database were a valuable resource for this study.



Figure 1. Extended Study Section

Data Mining

During this task, we utilized several databases, including the Virginia Crash database, VDOT's LRS, Virginia Roads databases, Virginia parcel and building databases, the Highway Performance Monitoring System (HPMS), and Google Maps to collect and record geometric and operational attributes of access points needed for the pilot study. Using Google Maps, we were able to focus on the following:

- identifying where there was an access point,
- identifying access type and geometric and operational characteristics utilizing street view in order to better discern building names/types,
- identifying speed limits, and
- using the measure tool to retrieve the area of buildings that had no building footprint data.

The variables selected in the database can be grouped into three major categories: (1) roadway geometric attributes, (2) operational attributes, and (3) volume data.

Roadway Geometric Attributes

Roadway geometric characteristics include type of access; number of entry lanes; number of exit lanes; presence of turning lanes; driveway width; driveway radius, angle, and throat length; presence of sidewalks; parking lot size; number of lanes on mainline; and presence of turning lanes.

Satellite image analysis was used to populate the dataset with the necessary geometric/operational information. We attempted to capture every important access element through the use of Google Maps and Google Earth satellite imagery and verified observations through the use of Google Street View. Having the attribute table open for access points in ArcMap enabled us to efficiently search the latitude and longitude of each access point in Google Maps.

Operational Attributes

Operational attributes included speed of mainline, type of access, number of driveways on major street, number of driveways on minor street, and driveway category. The speed of mainline was obtained using the VDOT Speed Limits Database. Since some of the segments on the database were longer than the spacing between the pair of access points, Google Street View was used to verify that there was no change of speed on the specific spacing. A similar procedure was employed to determine the number of lanes for each of the access pairs, using the HPMS database as the first source and navigating the corridors to verify the variables.

Traffic Volume Dataset

Populating the traffic volume dataset was the most challenging part of this task. Annual average daily traffic (AADT) data variables included mainline AADT and access volumes for each particular type of access. To populate the traffic dataset, we considered several approaches to identify the most feasible and effective options, including using the VDOT Traffic Database; using Traffic Counts Estimates from cities, towns or metropolitan planning organizations; and Institute of Transportation Engineers (ITE) trip generation methodology and tables (10th edition; ITE, 2018). In addition, the research team explored Land Track, Smart Scale, and the Streetlight program. In several instances, traffic information was collected from more than one source, as shown in Figure 2. We also enlisted the valuable help of city engineers, who provided traffic estimation for some of the unsignalized intersections.

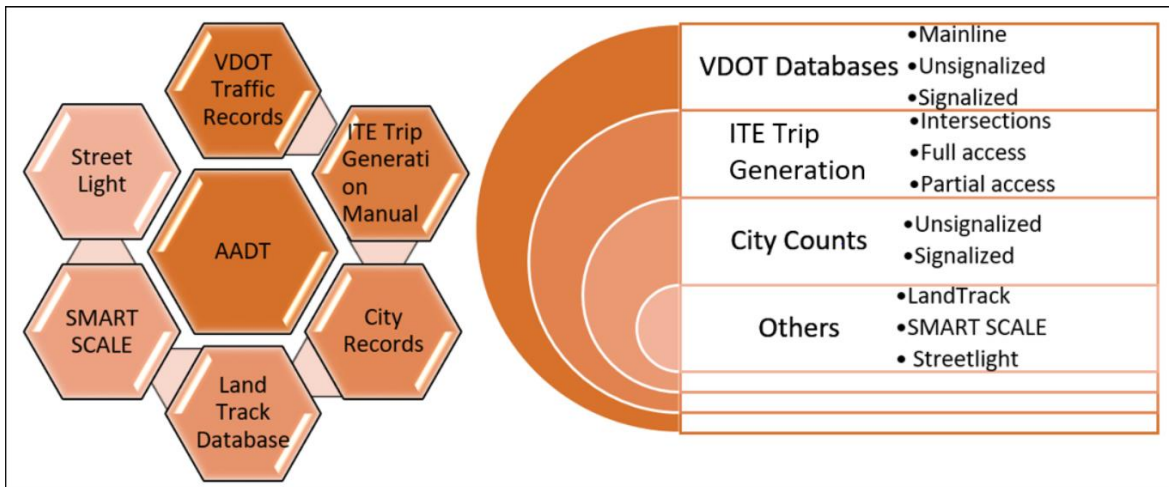

Figure 2. Determination of Access Volumes. VDOT = Virginia Department of Transportation, ITE = Institute of Transportation Engineers, AADT = Annual Average Daily Traffic.

In order to use the ITE trip generation methodology, it was necessary to determine the type of business, building area, number of floors, or a surrogate measure of the data input needed (i.e., for number of rooms in hotel establishments, the number of parking stalls were used as a surrogate). To determine the building area, the research team relied first on the Virginia Parcel Database and the Building Footprint Database. These databases do not provide 100% data coverage, and thus Google Earth was used to determine the business area in the cases when the buildings were not included. Google Street View was then used to collect the exact name of each business. After the business was identified, the type of services provided by the business or

institution was determined based on the researchers' judgement given the available information (i.e., gas station, Subway restaurant) or, when type of service was in doubt, the type of business was determined by checking the internet or contacting the specific business by phone. While the purpose of these variables was to match the type of business with the ITE Land Use Codes (LUCs), in order to protect the integrity of the database, the type of business variable was recorded independently of the LUC. After that, the more representative LUC was selected. This allowed for a review of the LUC selection criteria. When the relationship between the type of establishment and LUC was not clearly defined, this was noted in the database and discussed in the daily meetings before that day's data collection.

In the case of intersections, the research team relied on VDOT traffic volume databases, city data, and the ITE Manual. When following ITE methodology, the TRP recommended using unadjusted values for mode choice. VDOT intersection volumes' yearly data were checked, and we also used Google Maps to estimate the level of activity in the area. During this process, some access volumes from VDOT were found to be very low in areas with active traffic attractions. One possible reason is that some VDOT traffic records are outdated. Therefore, access volume was re-estimated according to ITE methodology.

The research team also investigated the enhancement of the traffic data via use of the LandTrack Database, the Smart Scale Project, and the Streetlight Database. As TRP members noted at the kickoff meeting, the LandTrack database does not provide any additional information regarding traffic data. Most of the information collected served only to corroborate data already collected by other means.

LRS Creation

To enable correlations between crash data and the characteristics of access points on the sample corridor, the project team used an LRS method to relocate access points on both roadway directions and matched the points to the crash data. Quarterly, VDOT publishes a VDOT data based LRS for roadway and related mapping purposes. However, an examination of the latest VDOT LRS (released Q1 2019) for the sample corridor suggested that the existing measures associated with the VDOT LRS did not reflect true ground distances. In addition, measures on the two directions of the divided corridors did not mirror each other, and therefore features on one direction could not be mapped to the other direction accurately based on the existing LRS. To meet the needs of this analysis, the research team had to generate a new LRS that reflected ground distances for the analyzed corridor.

The following describes the procedure to achieve the aforementioned objective:

- Step 1.** Generate a new LRS which measures represented ground distances. The purposes of this new LRS included:
- a) Allowing the newly generated access points, based on the LRS, to be located correctly on the ground relative to the original access points.
 - b) Enabling the LRS-based identification of true ground distances between any access points.
 - c) Serving as the foundation for the LRS-based integration between crashes and access points based on distance criteria.

- Step 2.** Relocate certain access points to both directions based on their access types. Some access points affect traffic on both directions. However, the original access point feature class provided by VDOT used single point features to represent all types of access points.
- Step 3.** Add new LRS information to crashes on the sample corridor. This step added LRS information to the crashes on the analysis corridor that was consistent with the LRS access point information.
- Step 4.** Match crashes to access points. During this step, crashes and access points were matched together for the different types of analyses necessary for the project.

The aforementioned steps are described in detail below.

Generate a New LRS

The project team created the new LRS based on the 2019 Q1 release of the VDOT LRS using the Esri® ArcGIS platform. The process involved the following activities:

- *Select and export the analysis corridor into a new feature class.* This step allowed the project team to focus the remaining processing only on the roadway section that was analyzed.
- *Erase the measures contained by the new Polyline M feature class.* The feature class containing the exported corridor inherited the same format of the original LRS measures in a Polyline M format. In order to create a new LRS system, the project team first erased the measure information by converting the Polyline M feature class to a Polyline feature class using the ArcGIS Feature Class to Shapefile tool and by disabling the measure option during the conversion.
- *Generate LRS information.* During this step, the project team added the LRS information to the newly created roadway layer using the ArcGIS Create Routes tool and setting the Measure Source as feature length in feet.

The resulting feature class contains only the analyzed corridor, represented by Polyline M features for each direction of the divided roadway section.

Relocate Access Points

After the new LRS measures were generated, the access points were relocated. Depending on the type of a specific access point, traffic generated by the point affects the traffic in both directions of the roadway. However, in the access layer obtained from VDOT, all access points were represented by single points on one direction of divided roadways. For the purpose of accurately accounting for the operations and safety impacts of access points, the project team mapped the points on both directions of the sample corridor for the following access types:

- Full access points (entrance which allows left-in, left-out out movements and RIRO movements)
- Unsignalized intersections
- Full median openings

- Signalized intersections

The mapping process involved the following activities:

- *Locate access points to the new LRS.* During this step, the project team linearly referenced the existing access point layer to the new LRS using the ArcGIS Locate Feature along Routes tool.
- *Identify access points that need to be relocated or duplicated to the other direction.* The project team identified and marked the access points that either needed to be relocated or duplicated to the opposite direction of the analysis corridor. Points that needed to be relocated represented access points that only affected the opposite direction of traffic, while points that needed to be duplicated represented access points that either affected traffic in both directions or two access points located on both sides of the roadway but represented by a single point (Figure 3).
- *Create LRS event table for all access points.* During this step, the project team exported the attribute table of the access point layer containing the new LRS information into an LRS event table. The route name of the points that needed to be relocated was modified to the name of the opposite direction. For the access points that needed to be duplicated onto the opposite direction, the project team inserted new records containing the same measures but the route name of the opposite direction. The resulting table contained all access points on the analysis corridor, including both original points and relocated/duplicated points, which were ready to be remapped.
- *Map access points based on the newly created LRS event table.* During this step, the project team mapped the newly generated LRS event table into a new access point feature class using the ArcGIS Display Route Events tool.

Figure 3 and Figure 4 were created using ArcGIS® software by Esri. ArcGIS® and ArcMap™ are the intellectual property of Esri and are used herein under license. Copyright © Esri. All rights reserved. For more information about Esri® software, please visit www.esri.com.



Figure 3. Example of Relocated/Duplicated Access Points. Sources: ESRI, VITA, West Virginia GIS, Esri, HERE, Garmin, INCREMENT P, Intermap, USGS, METI/NASA, EPA, USDA. (The aforementioned sources are listed in the original basemap created when using ESRI ArcGIS® software in 2019, and as they are not visible in Figure 3 those sources are listed here.)

After processing all access points via LRS in ArcGIS, the spacing between two access points was calculated as the difference of linear reference mile markers, as shown in Figure 4.



Figure 4. Spacing Calculation Based on ArcMap. Map Data. Sources: ESRI, VITA, West Virginia GIS, Esri, HERE, Garmin, INCREMENT P, Intermap, USGS, METI/NASA, EPA, USDA. (The aforementioned sources are listed in the original basemap created when using ESRI ArcGIS® software in 2019, and as they are not visible in Figure 4 those sources are listed here.)

Relocation of Crashes to the New LRS

The locations of the crashes are based on latitude/longitude in the original database. To facilitate the analysis, the coordinates were converted to the LRS to be consistent with the georeference system of the access points. After the conversion, a crash could be easily associated with an analysis unit based on the LRS.

Theoretically, the crash data could be matched to the corresponding access points using a spatial join approach based purely on the relative spatial locations between crashes and access points. However, during this analysis, the project team performed a number of different analyses that looked at different distance criteria and access point configurations. In order to reduce the data matching effort, the project team decided to join the crash and access data based on a common LRS for flexibility and in response to changing data matching criteria during the course of the project. As previously described, the access points were mapped to the new LRS with a measure reflecting ground distances. During this step, the project team further mapped the VDOT crash data to the study corridor based on the new LRS. The mapping was also performed in ArcGIS using the Locate Features along Routes tool. The resulting data were exported into a tabular format ready for subsequent data matching.

Data Collection Protocol Development

Using the new LRS, all potential access points were identified; however, the focus of this study was on access pairs which met specific criteria. The LRS system was used to narrow down the list of access points into “viable pairs.”

Viable pairs of access points were defined as those that had at least one “Partial” access point and the spacing was 700 feet or less. For the purposes of this study, signalized

intersections, interchanges nodes, and midblock access points were not included. The resulting list of viable pairs included over 1,500 access pairs across each corridor. Due to the large number of access pairs, and the diverse amount of information required to estimate the traffic volume associated with each one, the research team developed an internal application to streamline data reduction—the Access Manager Application (Figure 5). The list of access pairs created using the LRS acted as inputs for the application. These included the unique ID numbers for each access point and its pair, GPS coordinates, the spacing between the access points, and other information about the access point from VDOT’s access point database.

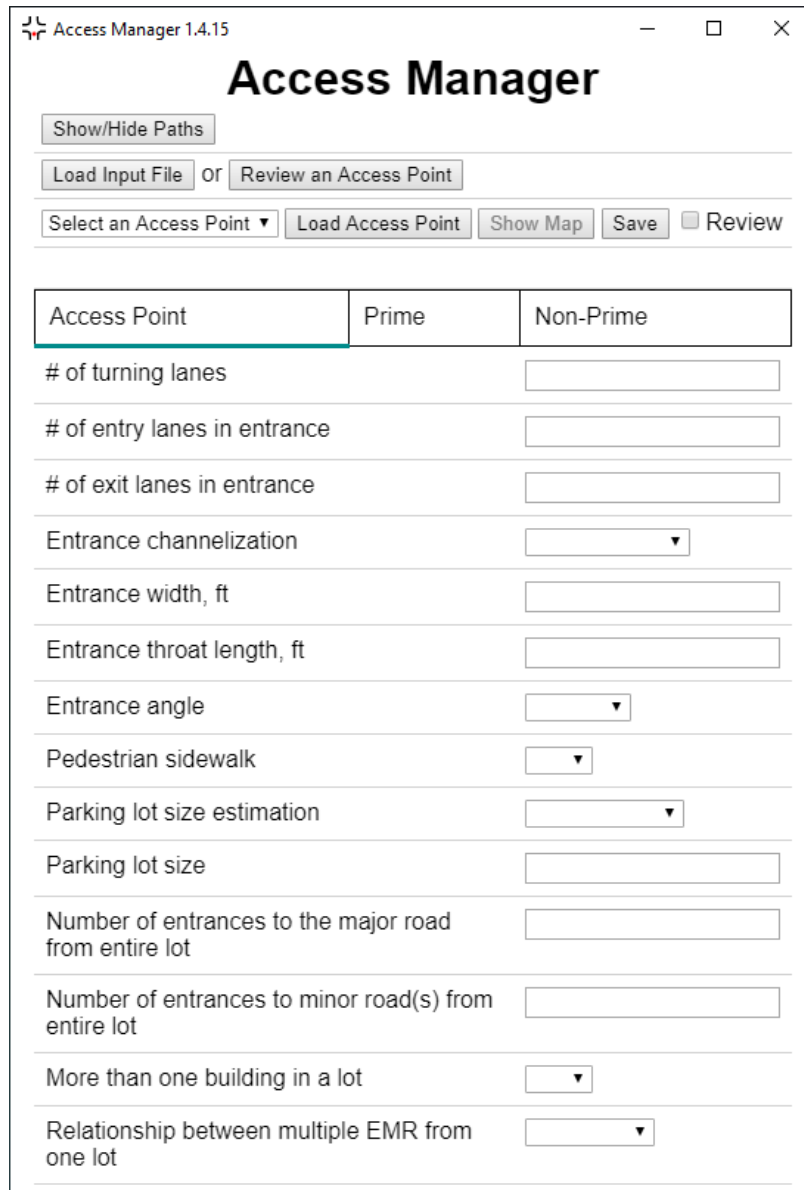

Access Point	Prime	Non-Prime
# of turning lanes		<input type="text"/>
# of entry lanes in entrance		<input type="text"/>
# of exit lanes in entrance		<input type="text"/>
Entrance channelization		<input type="text" value="▼"/>
Entrance width, ft		<input type="text"/>
Entrance throat length, ft		<input type="text"/>
Entrance angle		<input type="text" value="▼"/>
Pedestrian sidewalk		<input type="text" value="▼"/>
Parking lot size estimation		<input type="text" value="▼"/>
Parking lot size		<input type="text"/>
Number of entrances to the major road from entire lot		<input type="text"/>
Number of entrances to minor road(s) from entire lot		<input type="text"/>
More than one building in a lot		<input type="text" value="▼"/>
Relationship between multiple EMR from one lot		<input type="text" value="▼"/>

Figure 5. Custom Developed Access Manager Application

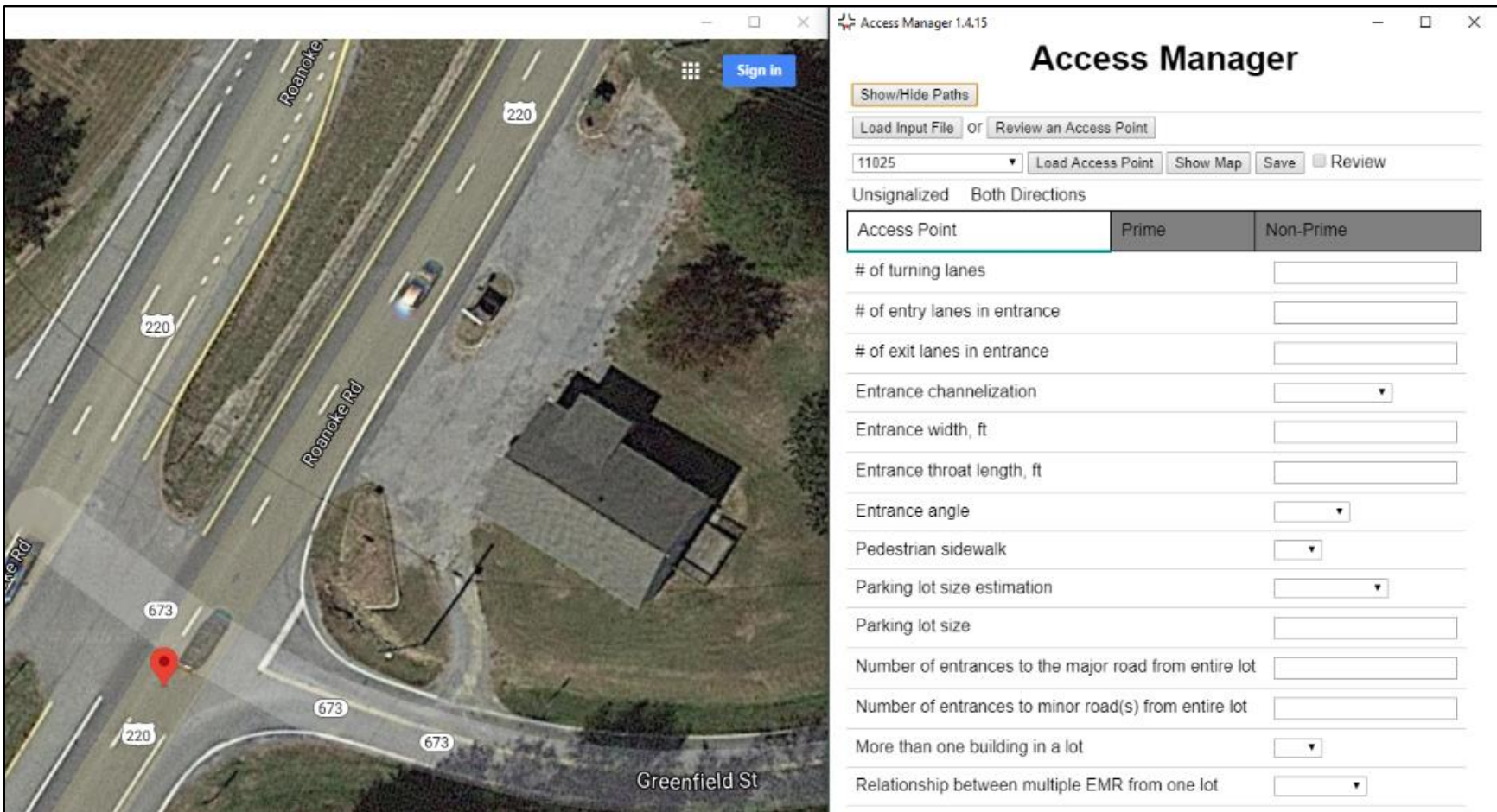

Figure 6. Access Manager Application with Google Maps View of Selected Access Point. Map Data © 2020 Google.

When a data reductionist launched Access Manager, they first selected an input file for the selected corridor, which listed all of the viable access pairs for that corridor. Once the input file was loaded, the reductionist selected an access point to reduce and Access Manager displayed a Google Maps view of the selected point. Figure 6 shows the layout of the Access Manager application with the satellite view of the selected access point.

Once an access point was loaded, the reductionist entered information into the three tabs listed at the top. These included the access points and direction tabs. In the “Access Point” tab, the reductionist entered information regarding the physical characteristics of the access point, including the number of turn lanes, entrance and throat length, and the number of entrances to the major or minor roadways, among other information. Distances were measured using the measuring tool in Google Maps (Figure 7).

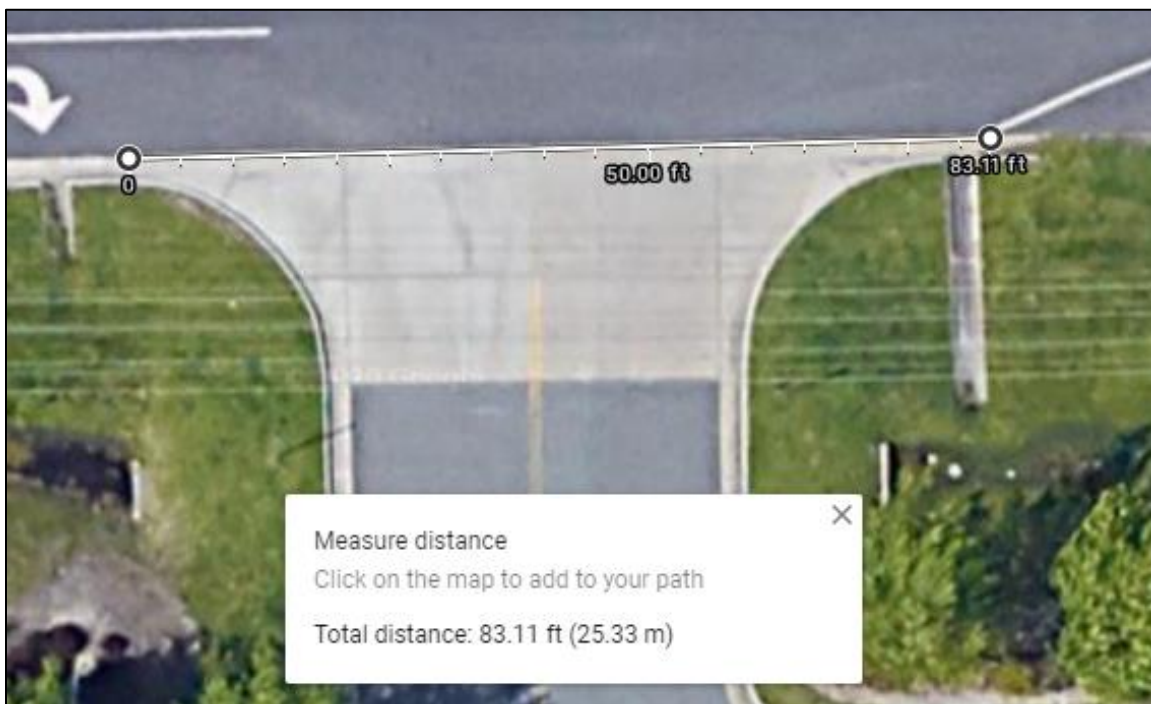

Figure 7. Measuring Entrance Width in Google Maps. Map Data © 2020 Google.

The reductionist then filled out information regarding the residential or commercial buildings connected to the access point in the “Prime” and “Non-Prime” tabs so that traffic volume could be estimated. If the access was an unsignalized intersection (not full access) and volume data was available from other databases, the associated tab was greyed out, indicating that the reductionist did not have to estimate the traffic data

For each access point, the reductionist listed any residential buildings or businesses connected to the access point by selecting the code from the Trip Generation Manual that most closely matched the type of building or business. The reductionist chose the best option from a drop-down list (Figure 8), entered the name of the business, and entered the qualifier “quantity” according to the ITE code. The quantity was determined by the units used by the Trip Generation Manual. For residential buildings, the quantity was the number of houses or units. For many businesses, the quantity was per thousand square feet (ksf) of the building. Some business types,

such as hotels, used the number of rooms, and others, like gas stations, used the number of fuel pumps to estimate the traffic generated. After selecting the most appropriate category, the unit required for the selected business type was automatically displayed for the reductionist. Where the size of the building was not available from the parcel database, the reductionist used the measuring tool in Google Maps to estimate the square footage of the building. Where units such as the number of rooms for hotels and motels were required, the reductionist could sometimes determine this by visiting the establishment’s website. Other times, this information had to be estimated by viewing the building from Street View and manually counting the rooms or parking spaces. Often there wouldn’t be a Trip Generation code that matched the specific type of business. In these cases, the reductionist would either select another similar business type, or manually estimate the amount of traffic associated with that location based on similar locations.

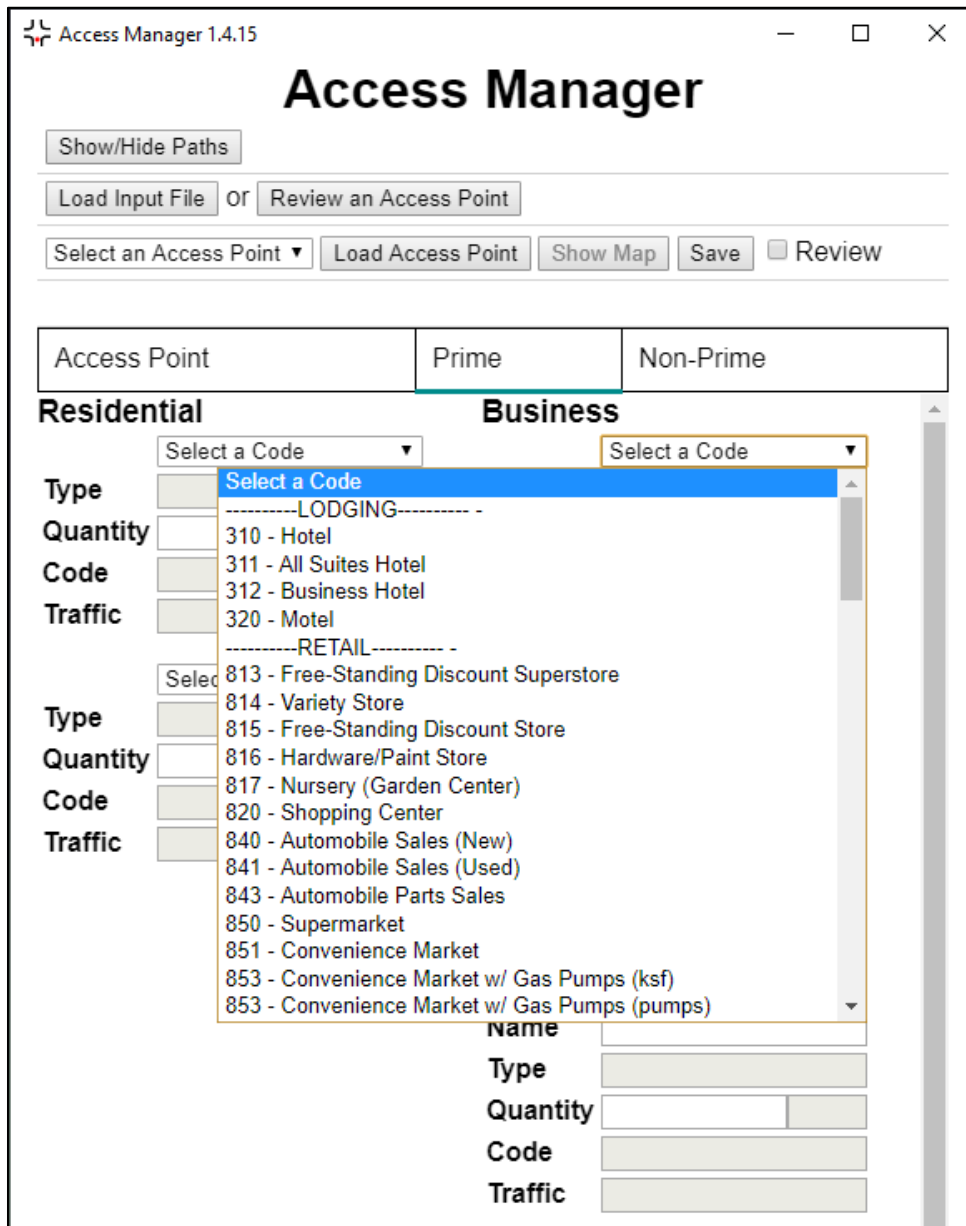

Figure 8. Drop-down List of Trip Generation Codes

In these instances, the reductionist would flag the access point to be reviewed by the data supervisor. An access point was also flagged for review if the data reductionist was not sure of one or more of the inputs entered. A data supervisor reviewed each access point flagged by a reductionist.

After listing each residential or business location connected to the access point for both Prime and Non-Prime sides (if applicable), the reductionist saved the access point. Access Manager automatically calculated the total traffic for the Prime and Non-Prime sides by multiplying the daily traffic volume by the units for each location listed and summing them for each side (Figure 9).

Residential		Business	
Type	232 - High Rise Condo ▾	Name	850 - Supermarket ▾
Quantity	High Rise Condo	Type	Kroger
Code	20 ←	Quantity	Supermarket
	232		82 ← ksf

Figure 9. Quantity was multiplied by the ITE Daily Traffic Rate for Each Location

For the majority of cases, only one access point served a building or a combination of buildings/residences. In other instances, a building or combination of buildings/residences were served by more than one access point. As a result, the traffic generated had to be assigned proportionally to each of those access points. Therefore, the total traffic for each access point was adjusted based on the number of entrances to major (EMR) and minor (Emr) roadways using the following formulas.

Where there was only one EMR, or multiple EMR were considered “Equal”:

$$Adjusted\ Total\ Traffic = \left(\frac{Total\ Prime}{EMR} \right) - ((Total\ Prime * 0.05) \times Emr) \quad (1)$$

Where there were multiple EMR and this one was considered the “Major” connector:

$$Adjusted\ Total\ Traffic = \left(\left(\frac{Total\ Prime}{EMR + 1} \right) \times 2 \right) - ((Total\ Prime * 0.05) \times Emr) \quad (2)$$

Where there were multiple EMR and this one was considered “Secondary”

$$Adjusted\ Total\ Traffic = \left(\frac{Total\ Prime}{EMR + 1} \right) - ((Total\ Prime * 0.05) \times Emr) \quad (3)$$

The first part of each equation adjusts how much of the total traffic is assigned to the current access point. Where multiple EMRs were considered “equal,” the total traffic was divided evenly among them. Where there were multiple EMRs and the access point was considered the “Major” connector, traffic was adjusted so that the access point accounted for

twice as much traffic as the other EMR. Where the access point was considered “Secondary” to other EMR, it accounted for half as much as the “Major” connector.

Table 2 shows the percentage of the total traffic that was assigned to the access point based on the number of EMRs and the relationship of the access point to the other EMR.

Table 2. Percentage of Traffic Assigned to an Access Point on Its Relationship to Other

Number of EMR	Relationship of Access Point to other EMR		
	All EMR are Equal	Major Access Point	Secondary Access Point
1	100%	NA	NA
2	50%	66%	33%
3	33%	50%	25%
4	25%	40%	20%

EMR = Entrances to Major Roadways

Define Analysis Units

The spacing between a pair of access points could affect the safety of several components of the pair, including the road segment between the access points and the adjacent short road segments upstream and downstream of the access points.

The focus of this study are access pairs that fulfill these two conditions: (1) neither ends are signalized intersections or interchange ramp nodes and (2) one or both ends of the pair is/are partial access point(s) such as left-in/RIRO, right-in (RI) only, (RIRO) and right-out (RO) only.

Excluding signalized intersections was discussed during the kickoff meeting due to the complexity of the signalized intersections not only geometrically but also, and more importantly, operationally. Furthermore, at the end of 2018, FHWA released a document regarding the effect of corner clearance in crashes. (Le, 2018). Some of the model results were counterintuitive, where more driveway presence with limited corner clearance resulted in a reduction in crashes. The authors concluded that the cause of these partial counterintuitive results was varied and included congestion and speed profile near the intersection.

For the pilot study, a basic analysis unit was operationally defined as a road segment surrounding a pair of access points *a* and *b*, as illustrated in Figure 10 (note that the final study used modifications of this original analysis unit). For the pilot study a unit consists of three segments: (1) the segment between the access points, (2) segments at upstream and (3) downstream of the access points. The spacing is defined as the distance between the centers of access points. Crashes that occurred on any component segments on the mainline were considered as associated with access points.

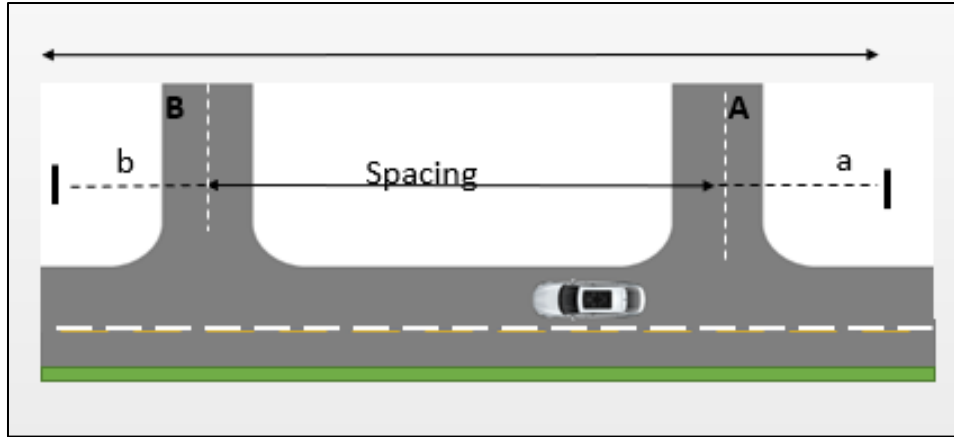

Figure 10. Access Point Analysis Unit

Two issues were important at this point in the analysis process: the determination of upstream/downstream areas a and b , and the spacing between access points.

The first issue is regarding the values of the length of the upstream/downstream influence areas a and b . Considerable research has been conducted to evaluate how access points might affect the safety of adjacent road segments. Influence areas for an analysis unit are the short segments at the upstream/downstream of access points—i.e., upstream segment with length a and downstream segment with length b in Figure 10. The length of an analysis unit for the access point pair A-B is “ $a + spacing + b$.” The spacing between access points is the spacing regulated by the access management standards. Several criteria can be used to identify unsignalized access spacing, including stopping sight distance, intersection sight distance, decision sight distance, influence distance, right turn conflict area, functional area of the intersection, and/or safety criteria. VDOT access management standards for partial access are based on stopping sight distance.

The functional area of the intersection includes areas upstream and downstream of the intersection that can be used to identify a and b . AASHTO defines the upstream functional area of an intersection as a variable distance, influenced by: (1) distance traveled during perception-reaction time, (2) deceleration distance while the driver maneuvers to a stop, and (3) the amount of queuing at the intersection. Similarly, the functional area of the driveway extends upstream and downstream of the access point. The length of the upstream functional area is a combination of the perception reaction time and the slowing or deceleration maneuver needed to enter the driveway. The downstream distance is determined by the distance needed for a stopping vehicle exiting the driveway to accelerate from a stopping position to the speed of the adjacent drivers. If it is not necessary for the vehicle to stop, the driver must have sufficient downstream sight distance to be able to see, understand, and react to downstream conditions (Figure 11).

As such, for unsignalized access points (including partial access points) to act independently from one another, the spacing distance must be greater than the total of the upstream and downstream area (Figure 11).

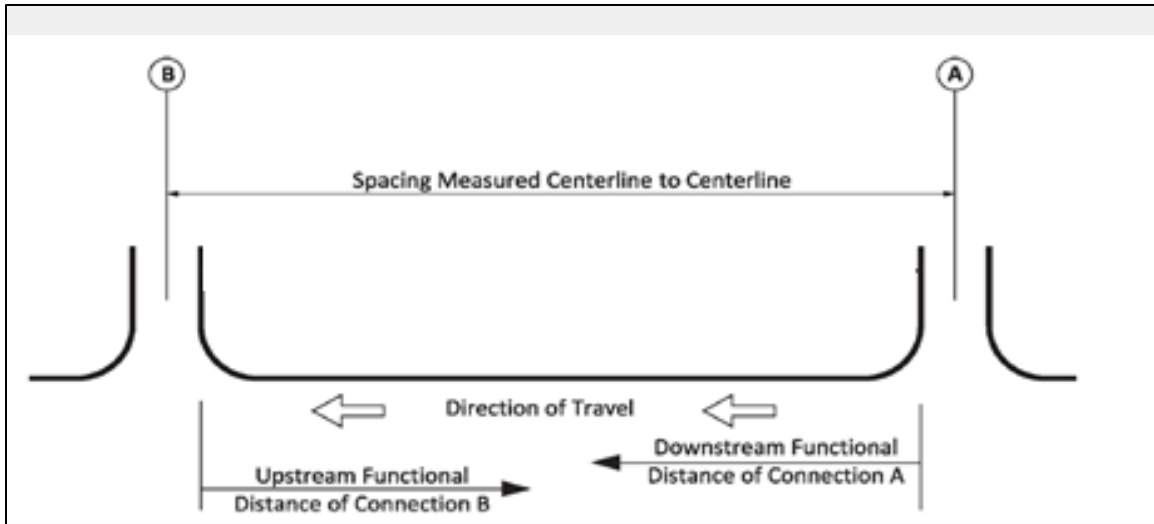

Figure 11. Independent Access Connections

Table 3. Functional Distance between Access Points

Posted Speed	Functional Distance (feet)		
	Downstream	Upstream	Ideal spacing
20	160	60	220
25	230	95	325
30	320	135	455
35	440	185	625
40	580	240	820
45	740	206	1045
50	950	375	1325
55	1200	455	1655
60	1520	450	2060
65	1990	635	2625
70	2580	735	3315
75	3360	840	4299

These distances (Table 3) are quite difficult to achieve in real life. Alternatively, the upstream functional distance criteria recognize that all access connections have a functional area that extends some distance from the connection, allowing the upstream and downstream distance to overlap.

The Highway Safety Manual (HSM) (AASHTO, 2010) defines the influence of the intersection as a 250-foot buffer from the center of the intersection. In the case of driveways, the HSM does not identify any influence area, as driveways are incorporated either as driveways per mile (to compute crashes in a segment) or number of driveways present in the 250-foot buffer from the intersection (to compute crashes associated with the intersection). Miller (2018) investigated the impact of granted exceptions for access management standards on crashes in VA. A 300-foot buffer and a rectangular area leading up to the existing intersection were used as

the intersection's influence area. An additional analysis was conducted with a buffer of 150 feet. The impact area selected was the same for any type of access. Williams (2014) used a 250-foot buffer maximum as the impact area for driveways in IL (for closer driveways, the influence area was half of the total distance between the two accesses). Sarasua (2015) used a buffer equal to the driveway width plus 30 feet. The research team requested the TRP's input in order to define the upstream and downstream area of influence for different types of access points. As a result, the influence area for each type of access was set at

- Partial access points—upstream length of 150 feet and the downstream of 100 feet.
- Full access points and unsignalized intersections—both the upstream and downstream influence distance are 150 feet.

Note that the settings above are not applicable in segments with high access point densities, as the distance from upstream access points a or downstream access points b to the adjacent access point might be smaller than the selected values. In this case, crashes that occurred in the influence area could be affected by the adjacent access point rather than the point used in the analysis unit. To avoid overlapping influence areas for the adjacent access point, the following procedure was used to define influence areas. For an analysis unit, the distance to the nearest upstream or downstream access point is compared with the selected a and b values. If the distance to the adjacent access point is less than a or b , the influence area is set as the segment from upstream access point a or downstream access point b to the midpoint of the segment to the adjacent access point.

The current VDOT standard does not consider any private residential access points dedicated to serving less than five houses (low-residential access points). Therefore, the research team did not consider these as access points in this study. As such, there could be multiple low-residential access points between a pair of partial access points. To account for the potential impact of these types of access points, we included the number of low-residential access points within each analysis unit as an independent variable in the regression model. Note, however, that all commercial and industrial access points were included.

The comprehensive definition of the analysis unit is illustrated in Figure 12.

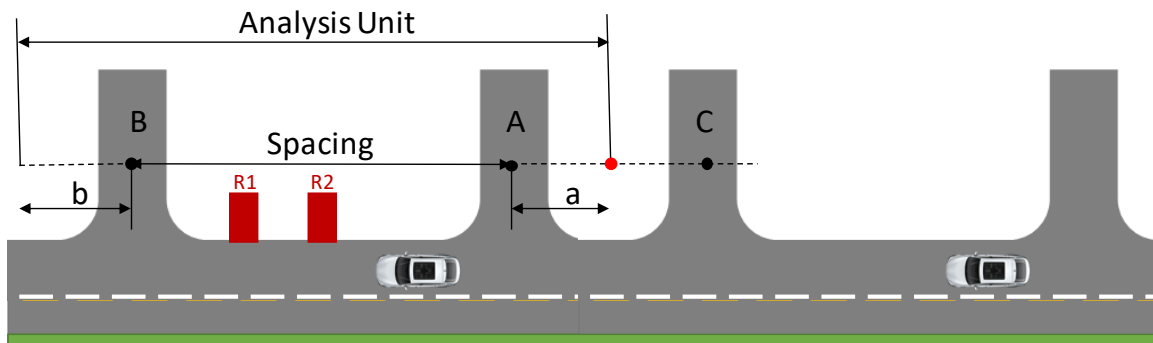

Figure 12. Comprehensive Definition of Access Point Pair Analysis Unit. (R1 and R2 are Residential Access Points).

A pilot study with this original analysis unit was conducted to evaluate the impact of spacing and access volume on crash risk at partial access points using the data from a section of U.S. 460 Eastbound. The objective was to demonstrate methodologies for data collection, information extraction, and statistical analysis before a large-scale study with more corridors. The research team achieved the above goals using a variety of data sources and analytic methods. The results showed that crash rate decreased with the increase of spacing. Crash rate was also positively associated with access volume.

Per discussion with VDOT's TRP, there is a possibility that the crash rate in the access point area is higher than on a road segment. Accordingly, access point pairs with a longer in-between segment would likely show a lower crash rate. *To address this issue, alternative analysis units were proposed in the extended study.*

The original definition of an analysis unit was not pursued in the extended study due to the bias for the long spacing access pairs. The alternative definitions consist of both upstream and downstream influence areas (labeled as a and b in Figure 12). The difference lies in the individual access point-based or access pair-based unit, and how the segment between the pair should be treated.

The first alternative was an individual access point-based analysis unit, as illustrated in Figure 13, definition 1. The analysis unit included the upstream and downstream influence areas of an access point. The upstream and downstream length depended on the access point type. For partial access point type, the influential area for upstream was 150 feet and downstream was 100 feet. For full access point type, both upstream and downstream distance were 150 feet. If the distance to the adjacent access point was less than *preset parameter (150 feet or 100 feet)*, the influence area was set as the center of the access point to the midpoint to the adjacent access point. *The maximum length of an analysis unit was 300 feet for full access and 250 feet for partial access points.*

The second alternative was an access pair-based analysis unit, as illustrated in Figure 13, definition 2. This definition included both a fraction within the pair, and an expanded area on each direction outside the pair. Similarly, if the length between the pair was shorter than the fixed influence area length, the full length was used. Most of the analysis units under this definition would have similar length regardless of the spacing between the access pairs, thus effectively breaking the correlation between spacing and segment length. *The maximum length of an analysis unit was 550 feet.*

In addition, the TRP proposed another access pair-based alternative, which only included a fraction within the pair, as illustrated in Figure 13, definition 3. The rationale for this alternative was that crashes that are caused by access points too close to each other only occur within a fixed length downstream of the upstream access point and a fixed length upstream of the downstream access point. Drivers turning right from the upstream access point look left toward oncoming traffic in order to enter the stream, and thus don't see (and therefore may strike) vehicles slowing down to turn right into the close-by downstream access point. This would occur within a relatively short distance, as longer distances give the upstream vehicle drivers more time to focus on the downstream vehicles. In order to be consistent, the same influence length was

used—150 feet or 100 feet, subject to the direction and control type. *Under this definition, the maximum length of an analysis was 300 feet.*

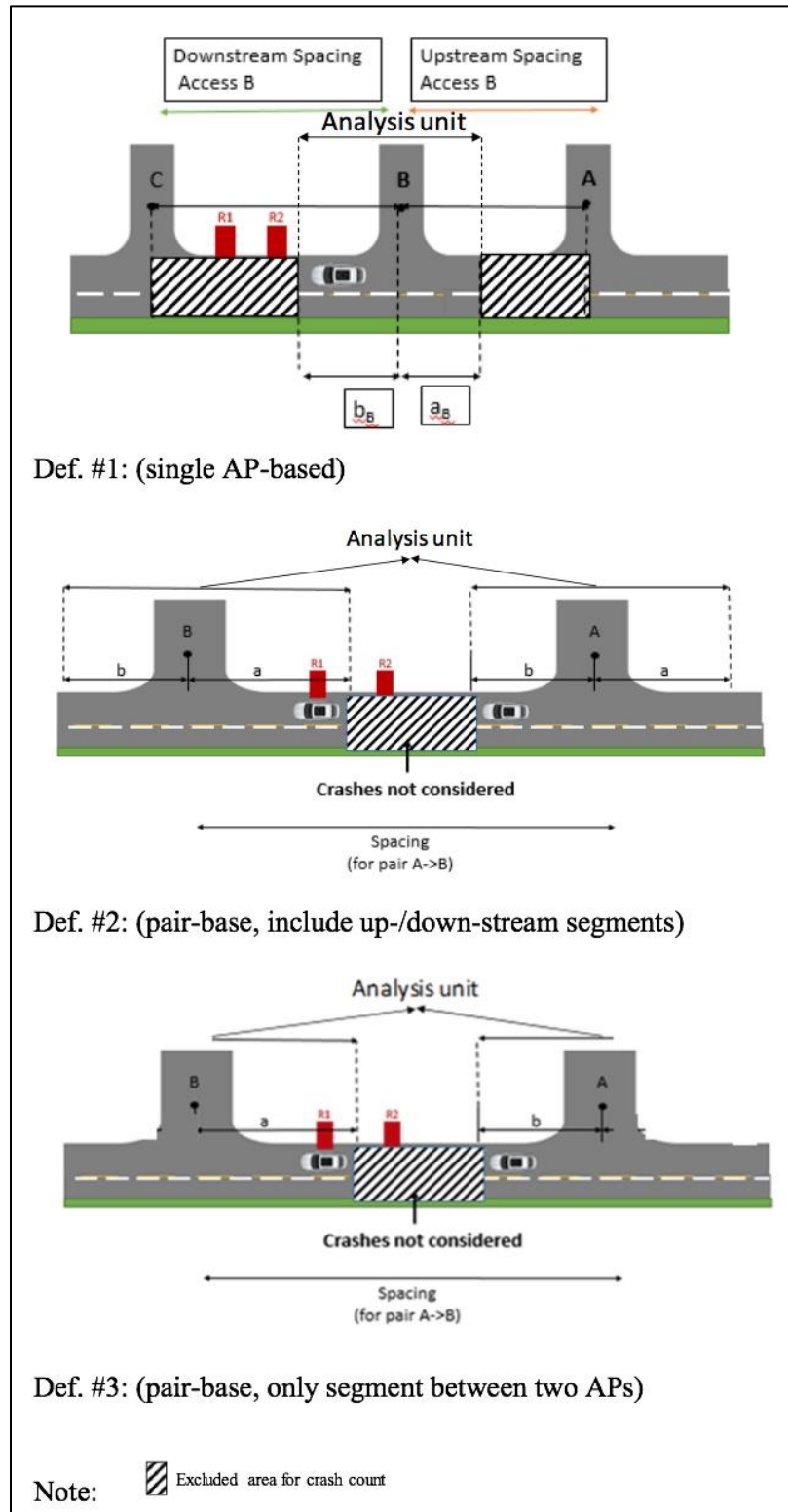

Figure 13. Diagram of Alternative Analysis Units. AP = Access Point.

Influence Area Calculations

An automatic influence area calculation algorithm was developed for the three alternatives above. There are several steps to calculate influence for an access pair. First of all, access pairs need to be generated on each corridor. This procedure should be executed for each corridor separately since the LRS measures of access points on different corridors are not sequential, as described below and illustrated in Figure 14.

- For a certain corridor, all access points with the same route name will be selected. Note that business roads tend to have several sections; for example, US 58 BUS has sections US 58BUS001, US 58BUS002, etc. These are not connected in the map, and the measures are not sequential. Hence, these sections should be processed separately.
- For each direction, identify and remove low-residential access points since they are not included in the analysis.
- Sort all the qualified access points measured in one direction of the selected corridor by ascending or descending depending on the direction. This example assumes an ascending direction.

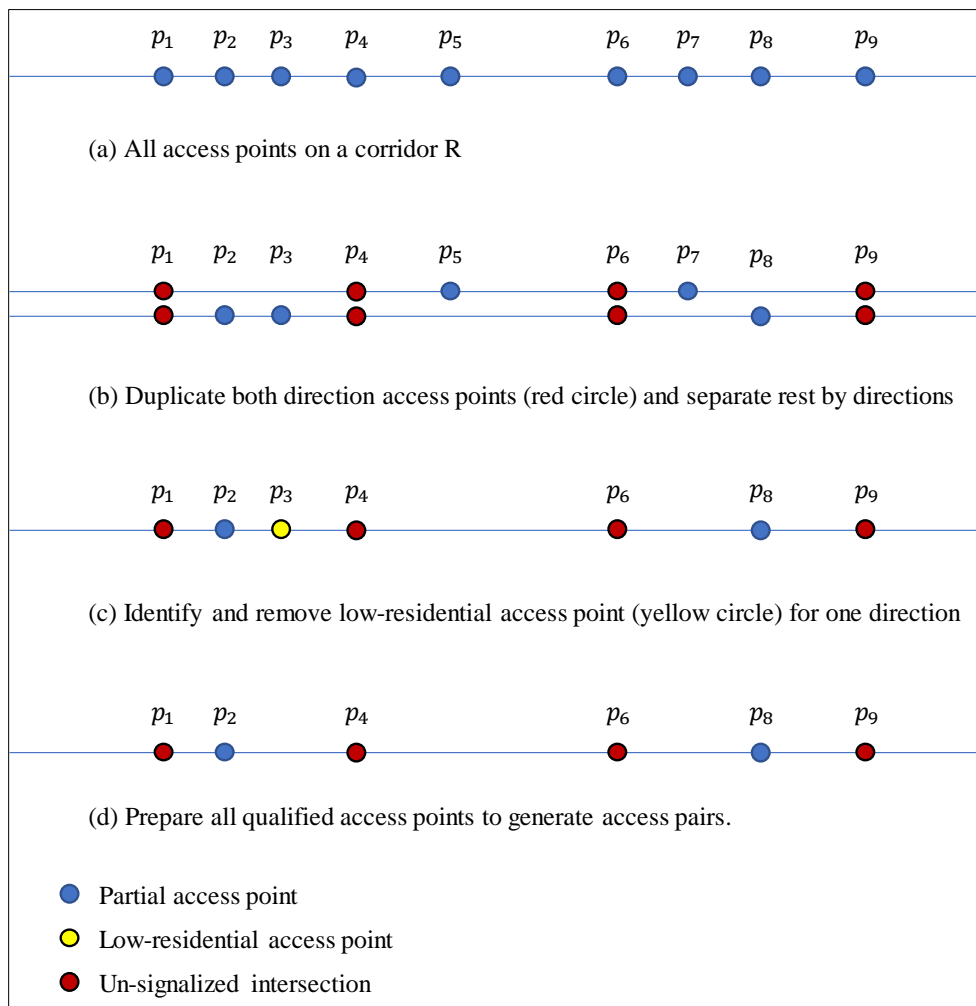

Figure 14. Generate Access Pairs Along One Direction of a Corridor

- (d) After this process, access pairs can be generated by joining all the consecutive qualified access points. In this example, we have $p_1 \rightarrow p_2$, $p_2 \rightarrow p_4$, $p_4 \rightarrow p_6$, $p_6 \rightarrow p_8$, and $p_8 \rightarrow p_9$.
- (e) For each pair, upstream spacing, access spacing, and downstream spacing are calculated. For pair $p_2 \rightarrow p_4$, the upstream spacing is $d_{1 \rightarrow 2}$, downstream spacing is $d_{4 \rightarrow 6}$ and access spacing is $d_{2 \rightarrow 4}$ as shown in Figure 15(e). In this example, $p_4 \rightarrow p_6$ is excluded since both ends p_4 and p_6 are unsignalized intersections.
- (f) The influence area of the upstream access point compares the upstream spacing with 150 feet. In this example, if $d_{1 \rightarrow 2} \geq 150 \text{ ft}$, then the influence area of upstream access point p_2 starts from measure of $p_2 - 150 \text{ ft}$; otherwise, the influence area starts from measure of $p_2 - d_{1 \rightarrow 2} / 2$. Similarly, the influence area of the downstream access point compares the downstream spacing with 150 feet if p_4 is a full access point or 100 feet if p_4 is a partial access point. For the segment within the pair, if the access spacing is less than or equal to $150 + 150$ feet for an unsignalized RIRO pair, or $100 + 150$ feet for other combinations, then the whole segment is kept. Otherwise, the maximum extended length is 150/100 feet for the downstream direction for the upstream access point and is a 150 feet extended length for the upstream direction for the downstream access point. These two possible scenarios can be seen in Figure 15(f).

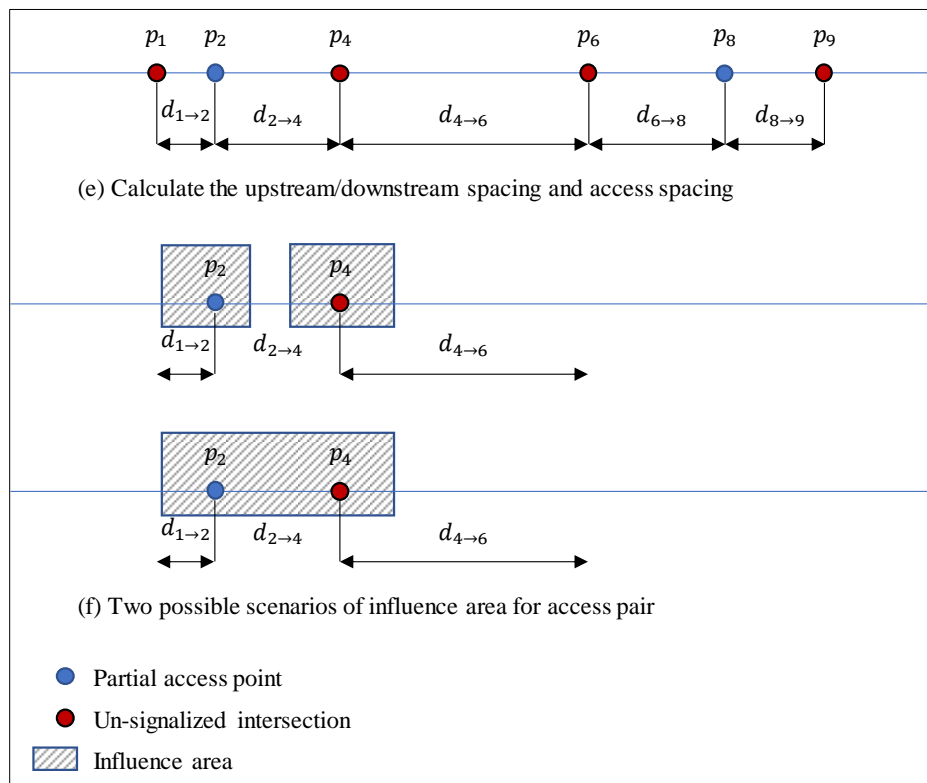

Figure 15. Calculate Influence Area of an Access Pair

Crash Allocation

The crash data were obtained from VDOT and were assigned to access points/sections using spatial analysis. The study includes 6 years of crash data, ranging from 2013 to 2018. The crash data include detailed information, such as date/time, location, direction, crash type, and crash severity.

The analysis was conducted including all crashes associated with the access points or pairs. Each of the alternative analysis units resulted in one model output. Note that for full access points, crashes occurring in both directions within the influence area were counted, while for partial access points, only crashes occurring on the same side as the access point were counted, as shown in Figure 16.

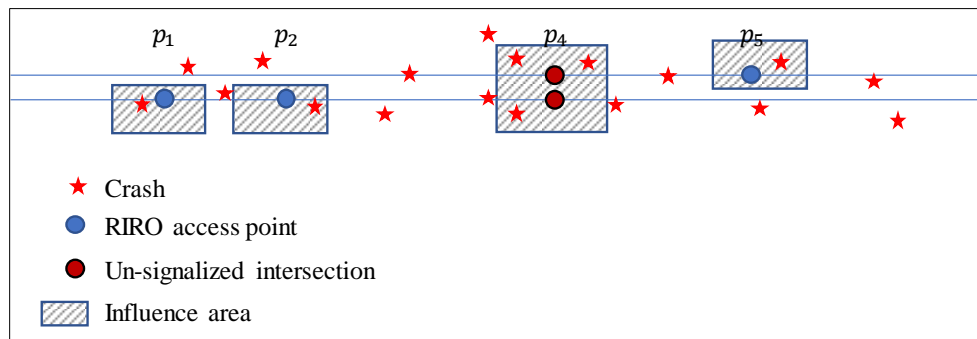

Figure 16. Crashes within the Influence Area by Access Control Type. RIRO = Right In-Right Out.

The research team developed a comprehensive approach to process and combine traffic infrastructure data with crash information using a GIS platform. This highly efficient tool allowed us to quickly calculate the number of crashes for an access point or pair. Different influence length settings or updated crash datasets can be processed easily. The tool is scalable and was used for the large scale extended study.

Descriptive Data Analysis

An exploratory data analysis of the eight selected corridors was conducted. A similar analysis of the selected samples for the model input was also presented. Analysis included access spacing/density, crash density, control type of access points, land development, mainline speed limit, mainline AADT, and so on.

Statistical Analysis

Mixed Negative Binomial Regression Models and Safety Performance Functions

State-of-the-practice Poisson and negative binomial (NB) regression models were used to evaluate the effects of access spacing and access traffic volume on crash risk. Poisson and NB regression are the foundation of the HSM (AASHTO, 2010) and the safety performance function. The main difference between Poisson and NB is that NB can handle over-dispersion, a

common issue observed for crash data when the variance of data is substantially larger than the mean. As the preliminary analyses show strong over-dispersion, the NB model was used for all analyses.

The NB regression model is based on the stochastic counting process. Under this model, the frequency of observed crashes is assumed to be the result of a latent counting process, whose intensity, which is the crash rate in safety modeling, is affected by crash risk factors. The regression model links the expected crash frequency with the risk factors and exposure. One major advantage of the NB regression model is that it directly uses the observed crash counts as response variables while adjusting for exposure, which is the total vehicle miles traveled in the context of this project. As illustrated in Figure 17, although the response variable for the NB model is crash frequency, the effects of the risk factors are with respect to the crash rate.

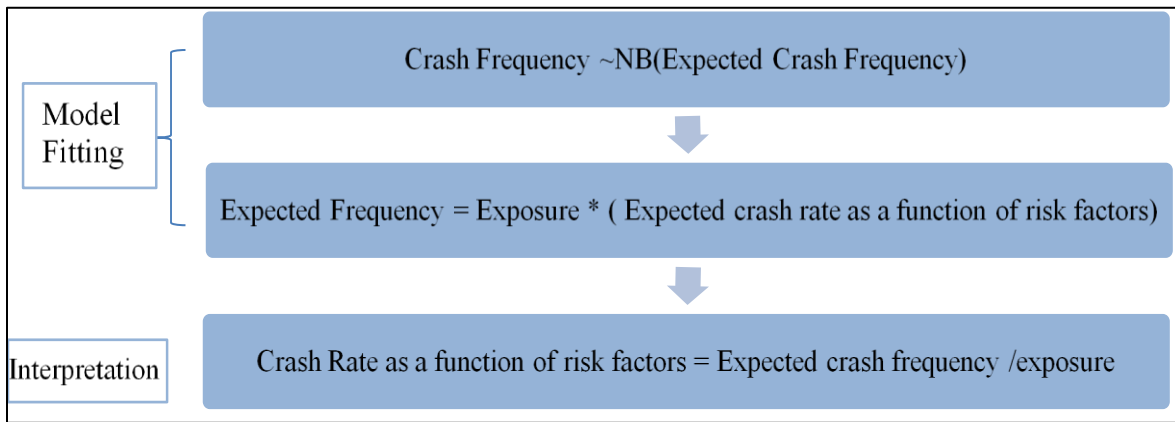

Figure 17. NB Models and Interpretation. NB = Negative Binomial

The exposure is the denominator in estimating crash rate. Two common exposures are segment length and traffic volume, which represent the amount of opportunity for a crash to happen. That is, it is expected that longer segment length and higher traffic volume will be associated with more crashes. When both exposures are used, the rate will be with respect to vehicle miles traveled—for example, number of crashes per million-vehicle-miles-traveled. Due to the potential non-linear relationship between crash frequency and traffic volume, we adopted a commonly used generalized traffic volume exposure based on the power transformation (Qin et al., 2004).

The study includes eight corridors and each corridor contains multiple access points. It is generally considered that access points on the same corridor are not independent, as they share similar design features, similar users, similar land use, etc. To incorporate the correlation among access points on the same corridor, we adopted the state-of-the-art mixed effect NB regression models. The mixed effect model uses a corridor-specific random effect terms to accommodate the corridor-level correlation. A detailed model setup is presented below.

Let Y_{ij} represent the observed crash frequency at road site j on corridor i ($i = 1, 2, \dots, I; j = 1, 2, \dots, n_i; n_i$ is the total number of access points on corridor i). The NB model assumes Y_{ij} is a random variable that follows an NB distribution:

$$Y_{ij} \sim \text{Negbin}(\lambda_{ij}, k), \quad (4)$$

where λ_{ij} is the expectation of Y_{ij} , and k is an overdispersion coefficient. The expectation λ_{ij} is connected with covariates such as length of the segment, traffic volume, and spacing through the following functional form:

$$\lambda_{ij} = d_{ij} v_{ij}^{\beta_v} e^{\psi_{ij}}, \quad (5)$$

Where d_{ij} is the length of the analysis unit as measured in miles; $v_{ij}^{\beta_v}$ reflects the relationship between expected crash frequency and traffic volume on the main road v_{ij} , as measured by number of vehicles traveling through the analysis unit; and $\exp(\psi_{ij})$ is the expected crash rate.

Equation (6) is referred to as the Safety Performance Function in the HSM and it links the expected crash frequency, λ_{ij} , on a road segment with exposure and risk factors. It is generally accepted that the crash frequency and traffic volume is not a linear relationship, i.e., a high traffic volume, congested traffic condition will likely be associated with an increased crash rate. The model form $v_{ij}^{\beta_v}$ can be incorporated with the potential nonlinear relationship (Qin et al., 2004). The term $d_{ij} v_{ij}^{\beta_v}$ represents the generalized exposure, which contains the effects of both segment length and traffic volume.

Equation (6) can be written as

$$\exp(\psi_{ij}) = \frac{\lambda_{ij}}{d_{ij} v_{ij}^{\beta_v}} = \frac{\text{Expected crash frequency}}{\text{length} * \text{traffic_volume}^{\beta_v}} \quad (6)$$

Therefore, $\exp(\psi_{ij})$ is the expected *crash rate*. The term $d_{ij} v_{ij}^{\beta_v}$ is a generalized exposure measure which reflects both segment length and traffic volume. The $\frac{\lambda_{ij}}{d_{ij} v_{ij}^{\beta_v}}$ is a generalized crash rate measured as the expected crash per unit of generalized exposure. This metric reflects the crash risk after adjusting for segment length and traffic volume.

Factors other than segment length and traffic volume are linked with the logarithm of the expected crash rate:

$$\log(e^{\psi_{ij}}) = \psi_{ij} = \beta_0 + \alpha_i + \beta_{spacing} X_{ij}^{spacing} + \beta_{AccessVolume} X_{ij}^{AccessVolume} + \dots + \beta_p X_{p,ij}, \quad (7)$$

where $X_{ij}^{spacing}$ is the access spacing for analysis unit ij ; $X_{ij}^{AccessVolume}$ is the access volume; β 's are the corresponding regression coefficients; α_i is a corridor specific random effect to incorporate the correlations among observation on the same corridor. While access spacing and access traffic volume are the primary focus of the study, many factors could contribute to crash

risk. These factors are included in the model as covariates to adjust for their potential effects, such as types of access points, land use and development types, the presence of low residential access within an access pair, and the speed limit on mainline roads.

In summary, the left side of Equation (7) is the logarithm of *crash rate after adjustment for segment length and mainline traffic volume*, while the right side is a linear combination of multiple risk factors. The estimated coefficients should be interpreted as the impact of a factor on crash rate based on the generalized exposure.

One-way ANOVA Test

The TRP was interested in discovering whether crash rates varied among different spacing categories. One-way analysis of variance (ANOVA) was used to address this question.

The one-way ANOVA compares the means between the groups of interest and determines whether any of those means are statistically significantly different from each other. Specifically, it tests the null hypothesis:

$$H_0: \mu_1 = \mu_2 = \mu_3 = \dots = \mu_k, \quad (8)$$

where μ_k is the mean of the k^{th} group. If the one-way ANOVA returns a statistically significant result, we accept the alternative hypothesis that at least two group means are significantly statistically different from each other. In the context of this study, a statistically significant ANOVA result indicates that crash rates differ by spacing categories.

The ANOVA results, however, will not indicate *which* specific groups are statistically different from each other. A *post hoc* test is needed to determine which specific groups differ from each other when there is a statically significant one-way ANOVA result. In this study, we used Tukey's honest significant difference (HSD) *post hoc* test to identify different groups.

The ANOVA analysis is applied to the analysis unit coded as *Definition #3* in Figure 13.

Stratified Analysis

Different access control types may have substantially different crash risk. The current VDOT standard (VDOT, 2018) considers several scenarios by access control type. To be consistent with the current standard, a stratified analysis was conducted for each analysis unit alternative. Each analysis was stratified by two categories: full/unsignalized access type and partial access type. The stratified analysis allows us to assess the impacts of independent variables by access types.

The operational definition of access types for different analyses are described as follows. For individual access point analysis, the full access point type refers to the unsignalized intersection, and the partial access type includes RIRO, RI, and RO. For the access pair analysis unit, the type is defined based on the two access points within the unit. If one access point, either upstream or downstream, is a full access point, the pair is defined as full access type. If both

upstream and downstream access points are partial access type, the pair is considered as partial access type.

For access pair-based analysis units (i.e., *Definition #2* and *Definition #3* in Figure 13), the spacing variable is the distance between the center of the two access points. For single access point-based analysis units (*Definition #1* in Figure 13), the access point is associated with two spacing variables: upstream spacing and downstream spacing.

RESULTS

The following sections summarize the results of the efforts described in the Methods section.

Literature Review

The research team synthesized the literature review information and produced a summary document for VDOT's TRP.

Variations in state standards for driveways reflect different access category systems, selected scenarios, and criteria used to define standards.

As shown in Table 1, VDOT defines minimum access spacings of 200, 250, and 360 feet for collector roads with speeds limits of 35, 40, and 55 mph, respectively. For the same conditions, Georgia, West Virginia, and New Jersey use respective spacings of 150, 180, and 230 feet. Mississippi categorizes commercial driveways based on access volume (± 50 peak hour trips) and the road's AADT ($\pm 2,000$ AADT). For access points with more than 50 peak-hour trips on a road with an AADT value of more than 2,000 vehicles, the minimum spacing distances are 185, 245, 300, 350, and 425 feet for roads with speeds of 35, 40, 45, and 50 mph, respectively. Other states, like Indiana, only use the speed limit of the adjacent road to specify driveway spacing.

The majority of studies have shown that an increase in the number of access points is associated with higher crash risk as reported in the Access Management Manual 2nd edition (Williams et al., 2003). However, the magnitude of the increase is not well established.

NCHRP Report 420 (Gluck et al., 1999) was one of the first comprehensive documents to evaluate access management techniques. Specifically, the study compiled multiple studies from the 1950s through the 1990s in order to identify the relationship between crash rates and access density. While almost 20 years old, some report findings remain applicable and are still incorporated in state and federal access management guidelines. Based on a safety analysis of 240 road sections, the relationship between crash rate and signalized and unsignalized access density was quantified for different environments and median configurations. While the reported results reflect adjustments to eliminate apparent anomalies in the data, access volumes were not considered.

A South Carolina study showed that an increase in driveway spacing from 150 to 200 feet would result in a crash reduction of 2% (Sarasua et al., 2016). Alvear et al. (2013) found a positive association between access density and crash risk when there is intensive land use (high percentage of commercial and industrial land use). However, this association is weaker when there is a low degree of development. In a meta-analysis of several studies of access point density, Elvik (2017) concluded that the addition of one access point per kilometer is associated with an increase of 4 % in the expected number of crashes.

The literature review found that the majority of studies on safety impact of access spacing do not consider driveway access volume as an input variable (e.g., Avelar et al., 2013; Thompson et al., 2017; Magua, 2010; Muskaug, 1985; Fitzpatrick et al., 2008; Vogt et al., 2007; Gross et al., 2018; Harwood et al., 2007). The few studies that attempt to consider access volume used access volume surrogate measures such as type of land use.

The HSM (AASHTO, 2010) provides the user with different models to compute the multi-vehicle driveway and non-driveway crashes per mile, considering traffic volume, type of media, and the type of driveways. The HSM did not consider the driveway volumes when computing the Crash Modification Factors because “no driveway data [were] available for the study” (Hardwood et al., 2007).

The first edition of the HSM classified driveways into seven categories: minor residential, major residential, minor commercials, major commercials, minor industrial/institutional, major industrial/institutional and other driveways, based on land use type and on the number of parking spaces (more or less than 50). The models developed showed that speed limit, on street parking, lane width and shoulder width variables were not significant variables. As expected, under the same land use category, the major category resulted in higher crashes than the minor category (i.e., a major commercial driveway generally experienced more crashes than a minor commercial driveway). However, the minor commercial category always resulted in a substantially lower number of crashes than the major residential and the major industrial/institutional category.

It is particularly important to mention that the future second edition of the HSM will not differentiate driveways by type and will only consider number of driveways. The rationale behind this decision is that transportation agencies have little authority to modify land use codes. The baseline condition assumed 10 driveways per mile.

The FHWA report *Safety Evaluation of Access Management Policies and Techniques* (Gross et al., 2018) provides models that account for the safety effects of signalized and unsignalized intersections along with the numbers of driveways, median openings, and crossovers, but a key limitation of the report, according to the authors, was that it considered the weighted AADT volume for the mainline traffic volume but not the driveway and cross-street volumes.

Few of the studies considered categories of driveways as a substitute for AADT. Sarasua et al. (2016) classified driveways as low (single dwelling units), medium residential (sub-division/apartments), medium (low turnover small businesses), high (fast food, gas station, drive through banks, etc.) and major (large malls). The model generated by the study showed that

driveway spacing, and speed were not statistically significant variables at 95 % confidence level. However, driveway types “high” and “major” were statistically significant, showing that if a standard driveway is converted to high or major driveway, crashes are increased 2.17 and 2.37 times respectively.

Williams et al. (2014) developed equivalent factors between different driveway types including residential, commercial, commercial drive through, and industrial. Assuming that residential driveways have an associated crash factor of 1, the number of crashes that can be expected by a commercial drive-thru is 6.7 times higher than the residential driveway. The expected number of crashes for industrial and commercial driveways is 4.63 and 2.55 times higher than a residential driveway, respectively.

Chakraborty and Gates (2020), investigated safety of driveways on two-lane state highways and county roads. This study found that commercial driveways have a stronger correlation with crash occurrence than other driveway land use types.

Development of Study Database

The variables and attributes collected in the study database are shown in Table 4.

Table 4. Database Variables and Attributes

Category	Variable	Description	Input
All	ID	Access point identifier in ArcMap	Integer
All	Location	New LRS	Number
All	LAT	Latitude	Number
All	LON	Longitude	Number
All	S- mainline	Speed mainline	Integer
All	# L_ Mainline	Number of lanes of mainline	Integer
All	Median	Type of median	No median Grass median Raised median
All	Type of access	Type of access point	Partial Access Full Access Unsignalized Intersection Median Opening Signalized Intersections
All	Land Use	Type of land use (including all land uses	Residential Commercial

Category	Variable	Description	Input
		associated with the access)	Industrial Institutional Vacant
All	A-Width_ft	Access width – driveway for partial and full access	Integer (ft.)
All	# Entry Lanes	# of entry lanes in access	Integer
All	# Exit Lanes	# of exit lanes in access	Integer
All	Channelization	Access channelization (driveway entrance)	Isle Median Marking None
All	TL	Presence of Turning Lanes	None Right Left
All	A_Throat_Length	Driveway throat length (in feet)	Integer (ft.)
All	A_angle	Access angle	Ortho – $70^0 < x < 110^0$ Skew $x < 70^0$ or $x > 110^0$
All	Sidewalk	Presence of pedestrian sidewalk	Yes No
All	PL_size	Number of stalls in parking lot	< 10 10 > x < 50 50 > x < 100 100 > x < 200 200 >
All	P2	Exact number of parking stalls if the establishment is a hotel	Integer
All	#EMR	Number of entrances (driveways) on the major road for the entire lot	List
All	#Emr	Number of entrances (driveways) on the minor road for the entire lot	List
All	D_Category	Relationship between multiple EMRs from one lot	One Equal Major Secondary
All	D_share	More than one building in a lot	Yes No
All	# Int-lanes	Number of intersection lanes per approach	Integer

Category	Variable	Description	Input
Commercial	Name_C1	Name of each business or establishment	Business Name
Commercial	Type_C1	Type of business or establishment	Description of Business Establishment
Commercial	Descriptor_C1	Descriptor used to compute traffic according to Institute Transportation Engineers' (ITE) standards	Building area (sqf), # of pumps, # of stalls
Commercial	Code_C1	ITE code for B1	List
Commercial	Traffic_C1	Total traffic for B1	Integer
Residential	Type_Res1	Type of house	List
Residential	A_Res1	# of units for house type for Residential 1	Integer
Residential	Code_Res1	Code for house type for Residential 1	List
Residential	Traffic_Res1	Total traffic for Residential 1	Integer
Industrial	Name_I1	Name of each business or establishment	Business Name
Industrial	Type_I1	Type of business or establishment	Description of Business Establishment
Industrial	Descriptor_I1	Descriptor use to compute traffic according to ITE	Building area, # of pumps, # of stalls, or total area of the parcel
Industrial	Code_I1	ITE code for Ind. 1	List
Industrial	Traffic_I1	Total traffic for Ind. 1	Based on Code and Descriptor
Unsignalized Intersections	VDOT Traffic	Annual average daily traffic (AADT) available on VDOT database	Integer
Unsignalized Intersections	Traffic Data Type 2	Data received from Cities, Town or Metropolitan Planning Organization (MPO)	Integer
Unsignalized Intersections	Source Traffic Volume Type 2	Name of City, Town or MPO	List

Category	Variable	Description	Input
Unsignalized Intersections	Traffic Data Type 3	LandTrack database, SmartScale Projects, Streetlight database	Integer
Unsignalized Intersections	Source Traffic Volume Data 3	Name of the Data Source	List
Unsignalized Intersections	ITE Intersection traffic	Traffic generated based on ITE	Generate street traffic on a separate spreadsheet
Unsignalized Intersections	Traffic _Access	Traffic volume for each access	Number
Unsignalized Intersections	Final data Source	Identify the data source of the final traffic volume selected	

ITE= Institute of Transportation Engineers, MPO = Metropolitan Planning Organization, AADT = Annual Average Daily Traffic, VDOT = Virginia Department of Transportation

Descriptive Data Analysis

This section presents the geometrical and operational characteristics of the corridors included in the study. The summary and descriptive statistics of key study variables are also provided.

Exploratory Analysis of Selected Corridors

The study consisted of eight corridors, including five main corridors and three business corridors, with 621 miles and 9,912 access points. These corridors varied in geometric and operational characteristics, such as access spacing, access control type, and land use. Some corridors were primarily in an urban environment (US 17), some were in rural areas (US 58), while others were in mixed environments (US 460). The research team assessed all qualified analysis units on these corridors and selected a sufficient number of samples to support the analysis and modeling.

Among the five main corridors, US 58 is the longest, with a length of 211 miles, followed by US 460, which is 125 miles long. These two corridors also contain the largest number of access points regardless of access control type. US 17 ranks the highest for both access point density and number of crashes per mile despite its short length of 67 miles. The comparison of access density and number of crashes per mile on the five corridors is shown in Figure 18. Detailed information for each corridor is shown in Table 5.

The access point density for the three business corridors was substantially higher than for the main corridors. The number of crashes per mile was, in general, also higher compared to most main corridors (except US 17).

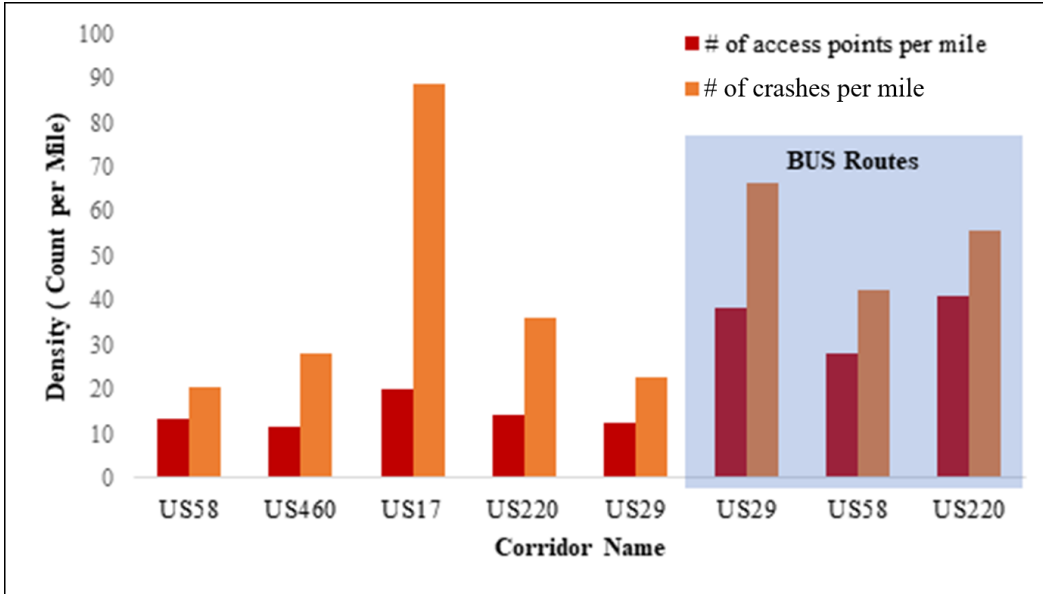

Figure 18. Access Density and Crash Density Comparison on Selected Corridors

Table 5. Access Density and Crash Density on Selected Corridors

Corridors	Length (mile)	# of access points	# of access points per mile	# of crashes	# of crashes per mile
US58	211	2,858	13.6	4,345	20.6
US58 BUS	41	1,135	28.0	1,710	42.1
US460	125	1,453	11.6	3,507	28.1
US17	67	1,335	19.8	5,982	88.8
US220	74	1,050	14.2	2,652	35.9
US220 BUS	13	521	40.9	710	55.7
US29	74	931	12.6	1,694	22.9
US29 BUS	16	629	38.4	1,089	66.6
Total	621	9,912	16.0	21,689	35.0

Many factors, in addition to access spacing, could affect crash likelihood. Figure 19, Figure 20, Figure 21 and Table 6 compare access control type, land use, and mainline AADT on the five main corridors selected. These figures show that US 17 has the highest unsignalized intersection percentage (25%) while US 29 has the lowest (13%). US 17 also has the highest proportion of high/medium commercial related access points (39%) and lowest low-residential proportion (15%) compared with other corridors. In addition, the average mainline AADT on US 17 is 30,271, making it much busier than the other corridors.

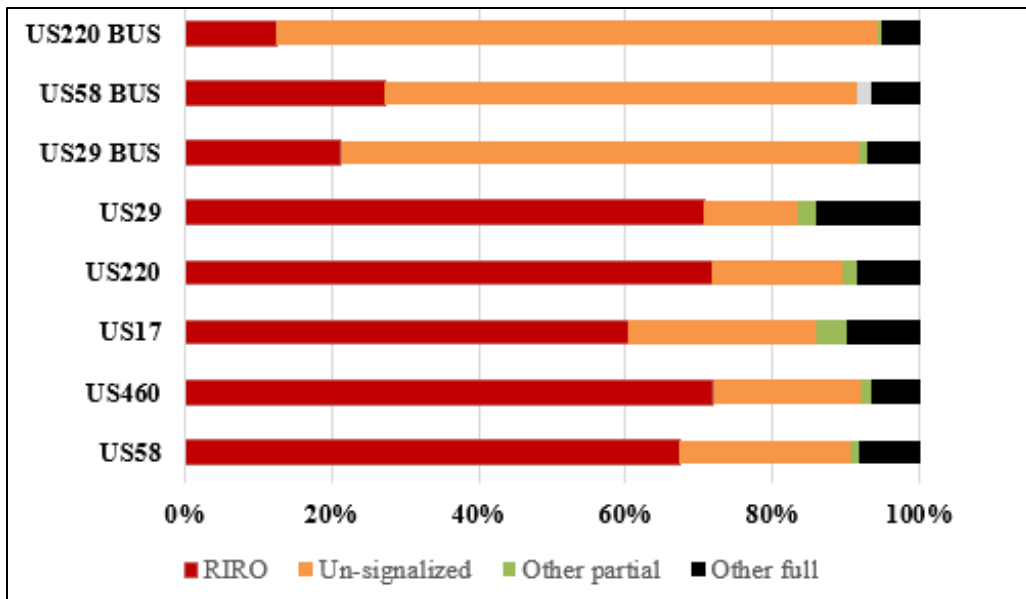

Figure 19. Control Type Composition on Five Main Corridors, RIRO = Right In - Right Out

Table 6. Number of Access Points by Control Type and Corridor

Corridor	RIRO	Unsignalized	Other partial ^a	Other full ^b	Total	RIRO%	Unsignalized%
US58	1,925	664	37	232	2,858	67%	23%
US58 BUS	310	729	21	75	1,135	27%	64%
US460	1,045	292	20	96	1,453	72%	20%
US17	806	340	55	134	1,335	60%	25%
US220	753	187	21	89	1,050	72%	18%
US220 BUS	65	426	3	27	521	12%	82%
US29	658	118	25	130	931	71%	13%
US29 BUS	134	443	7	45	629	21%	70%
Total	5,696	3,199	189	828	9,912	57%	32%

^a "other partial" includes access points with control type of (RI) and (RO);

^b "other full" includes access points with control type of signalized intersection, midblock, and interchange.

RIRO = Right In - Right Out.

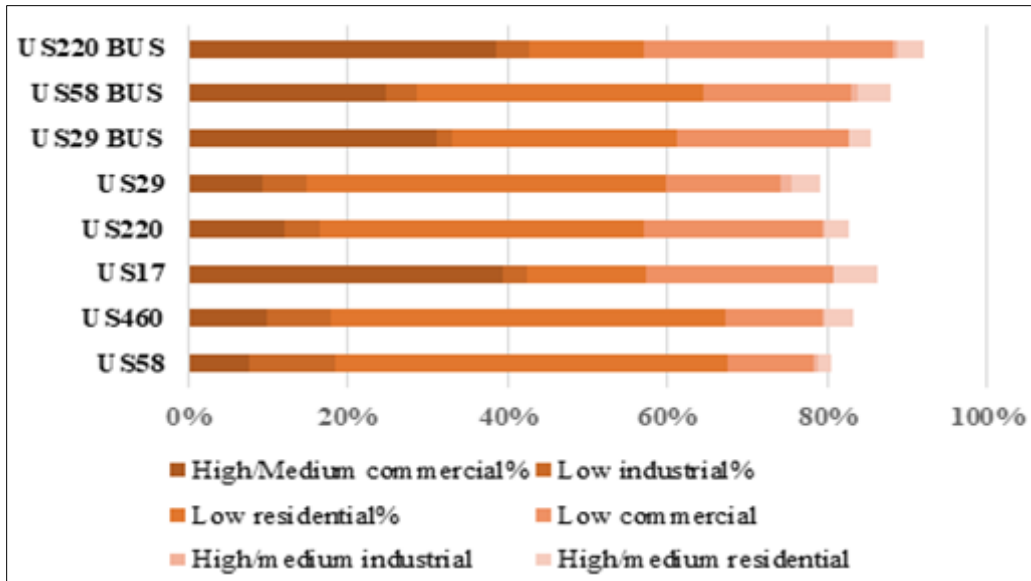

Figure 20. Land Use Composition on Five Main Corridors

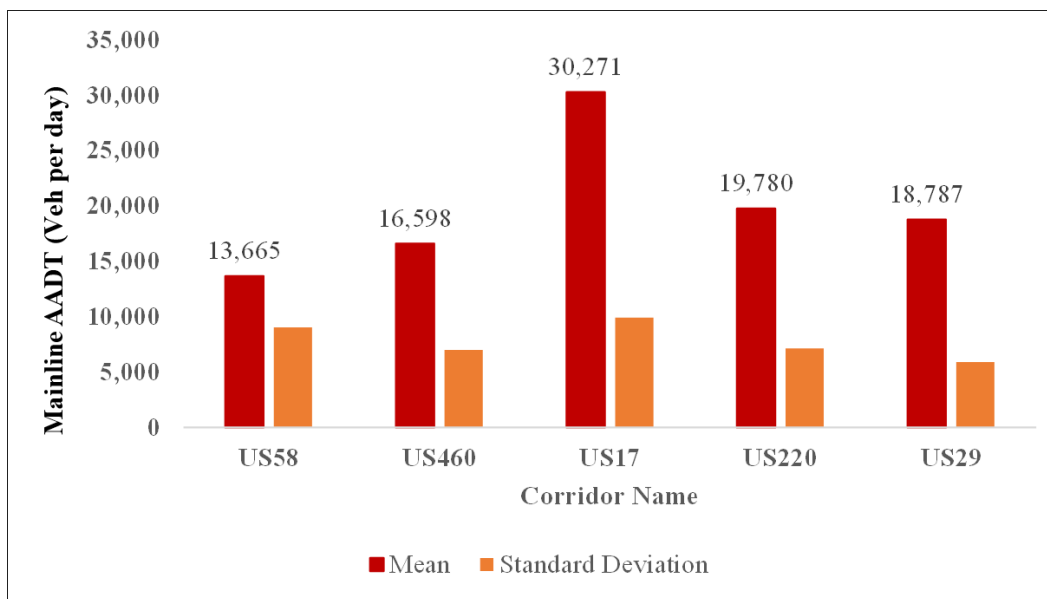

Figure 21. Mean and Standard Deviation of Mainline AADT on Five Main Corridors. AADT = Annual Average Daily Traffic.

Summary Statistics of Selected Analysis Units

The research team collected information for approximately 2,500 access points. After the quality check with consideration of data availability and completeness, 1,527 qualified access pairs were kept for modeling. These 1,527 selected access pairs consisted of 1,866 access points (one access point can be in two pairs, one an upstream point and one a downstream point). Note that all the access pairs have spacing less than or equal to 700 feet, as the focus of the study was on small spacing scenarios. In order to be consistent, only access points with both upstream and

downstream spacing of less than 700 feet were selected, which resulted in 1,767 selected access points for the model input.

The descriptive statistics of key indicators are summarized in Table 7.

Table 7. Summary Statistics of the Selected Analysis Units

Analysis Unit Type	Variable	Count	%	Mean	Standard Deviation
Access Pair Based Analysis Units	Total number of access pairs	1,527		-	-
	Number of access pairs with speed limit \leq 45mph	776	50.8%	-	-
	Total number of low-residential driveways between access pairs	160		-	-
	Number of access pairs with low-residential driveways in-between such pairs.	113	7.4%	-	-
	Crash (number of crashes in 6-year per access point)	-	-	3.47	4.77
	Spacing (ft.)	-	-	213.4	155
	Mainline annual daily traffic (number of vehicles per day)	-	-	21,574	9,675
Access Point based Analysis Units	Total number of access points	1,767		-	-
	Number of access points with commercial land use (medium or high)	689	38.9%	-	-
	Number of unsignalized access points	391	22.5%	-	-
	Number of access points with volume \leq 1,000 vehicles per day	1,373	77.7%	-	-
	Average crash (number of crashes in 6-year per access point)	-	-	1.89	3.17
	Average access volume (number of vehicles per day per access point)	-	-	723	1,222

The land use characteristics were defined using the data collection and information from VDOT access databases: residential only, commercial only, industrial only, residential/commercial mixed, residential/industrial mixed, commercial/industrial mixed residential/ commercial/ industrial mixed, and no available land use data. These eight main corridor categories are presented in Figure 22 and Table 8, which show that commercial is the most common land use activity for access points in the selected samples. The highest percentage of commercial land use was 78% on US 17 and the lowest was 42.6% on US 58. Meanwhile, US 58 had the highest industrial land use type (22.3%) while this percentage was only 1.8% on US 220. This composition indicates that US 17 and US 220 are more urban, while US 58 is more rural in terms of land use.

Table 8. Land Use Composition of Selected Access Points on Five Main Corridors

Data Representation	Corridor	Residential	Commercial	Industrial	Residential /Commercial	Residential /Industrial	Commercial /Industrial	Residential /Commercial /Industrial	Total
Count	US58	9	106	42	14	9	6	0	217
	US58 BUS	4	71	3	5	0	6	0	97
	US460	14	198	46	17	4	5	4	338
	US17	10	362	19	29	1	8	0	473
	US220	6	200	4	15	8	3	1	250
	US220 BUS	0	54	3	5	0	0	4	71
	US29	7	112	29	14	10	2	1	202
	US29 BUS	5	76	4	14	2	1	2	119
	Total	55	1,179	150	113	34	31	12	1,767
Percentage	US58	4.1%	48.8%	19.4%	6.5%	4.1%	2.8%	0.0%	100%
	US58 BUS	4.1%	73.2%	3.1%	5.2%	0.0%	6.2%	0.0%	100%
	US460	4.1%	58.6%	13.6%	5.0%	1.2%	1.5%	1.2%	100%
	US17	2.1%	76.5%	4.0%	6.1%	0.2%	1.7%	0.0%	100%
	US220	2.4%	80.0%	1.6%	6.0%	3.2%	1.2%	0.4%	100%
	US220 BUS	0.0%	76.1%	4.2%	7.0%	0.0%	0.0%	5.6%	100%
	US29	3.5%	55.4%	14.4%	6.9%	5.0%	1.0%	0.5%	100%
	US29 BUS	4.2%	63.9%	3.4%	11.8%	1.7%	0.8%	1.7%	100%
	Total	3.1%	66.7%	8.5%	6.4%	1.9%	1.8%	0.7%	100%

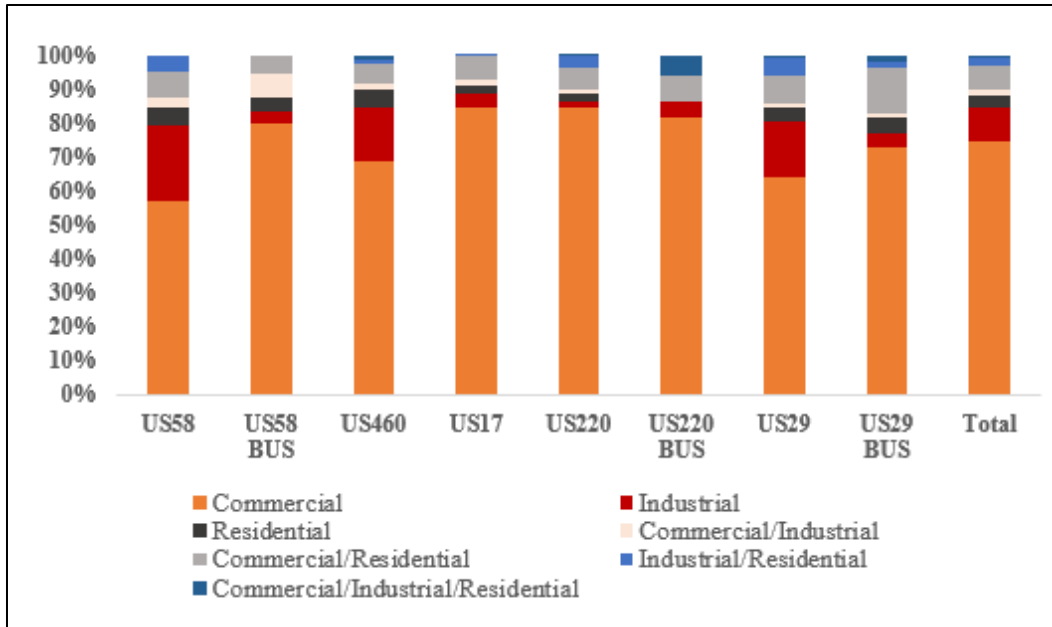

Figure 22. Land Use Composition of Selected Access Points on Five Main Corridors

Selected access points with a speed limit of 45 mph or less accounted for over half of all samples, and the majority of this group had a speed limit of 45 mph. There were 328 access points with a low speed limit (25 mph and 35 mph), which represented 19% of all selected samples. In general, these points were located in more urban areas. Access points with speed limits in excess of 45 mph were 55 mph and 60 mph in the majority of cases. (Figure 23)

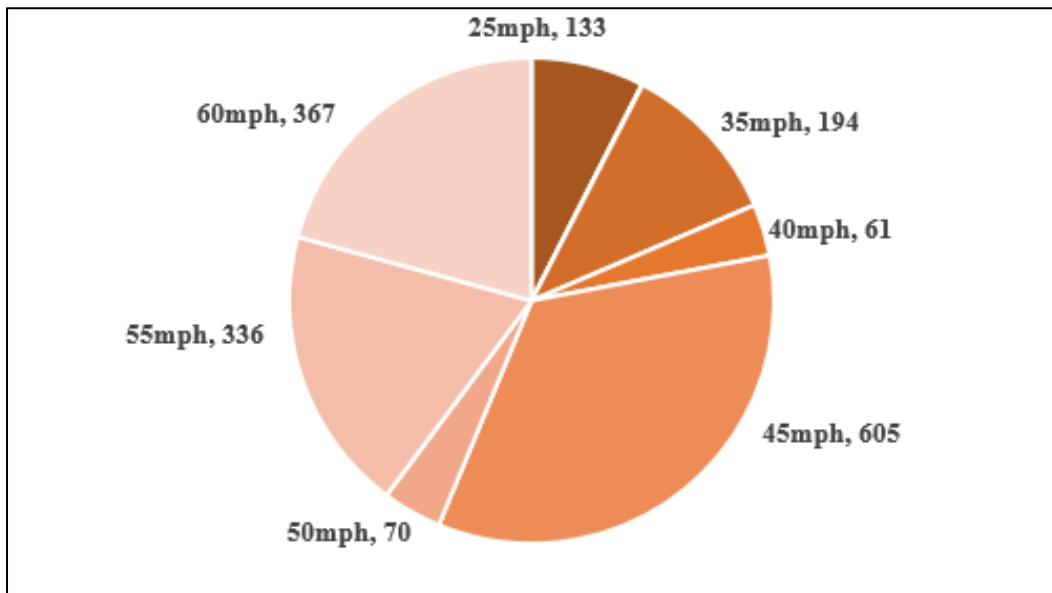

Figure 23. Distribution of Access Points by Speed Limit. mph = Miles per Hour

Table 9 compares the differences in average values of crash frequency, access spacing, and access volume by control type. Full access pairs/points tended to have more crashes, higher access volume, and larger access spacing. The distributions of access spacing, and volume are shown in Figure 24 and Figure 25.

Table 9. Comparison of Crash Frequency, Access Spacing, and Volume by Access Type

Access Type	Mean Crash Frequency per Access Point	Mean Spacing (feet)	Mean Volume
Full	5.0	259.9	995.6
Partial	2.1	172.9	532.7

Only access pairs with spacing of 700 feet or less were included in the study. The distribution of access pair spacing by control type is shown in Figure 24.

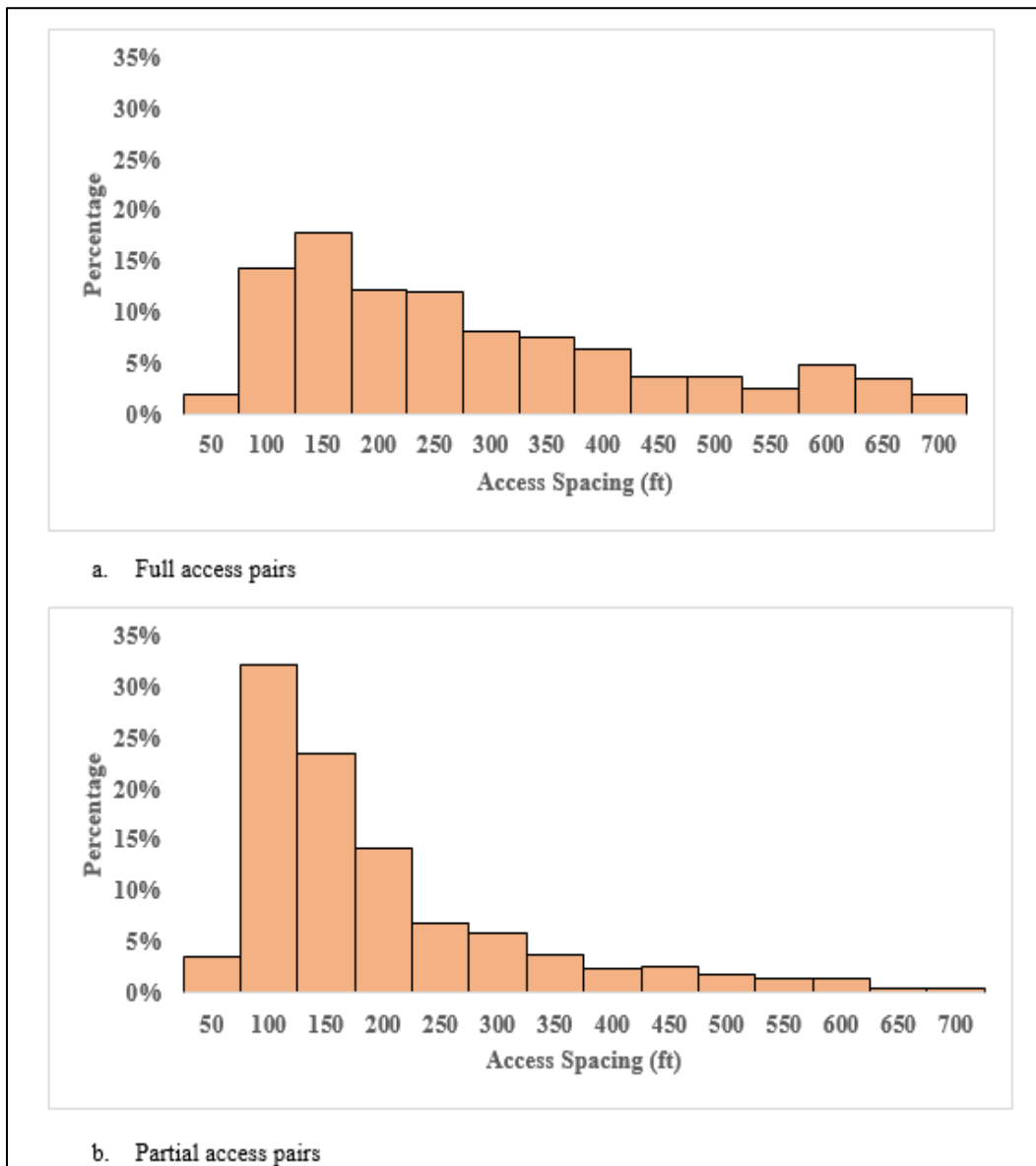

Figure 24. Distribution of Access Pair Spacing by Control Type

Note the distribution of access volumes in Figure 25 shows access volumes less than or equal to 1,000 vehicles per day (this accounts for 80% of overall selected access points) for better demonstration purposes. Access points with a volume larger than 1,000 were still included in the model input.

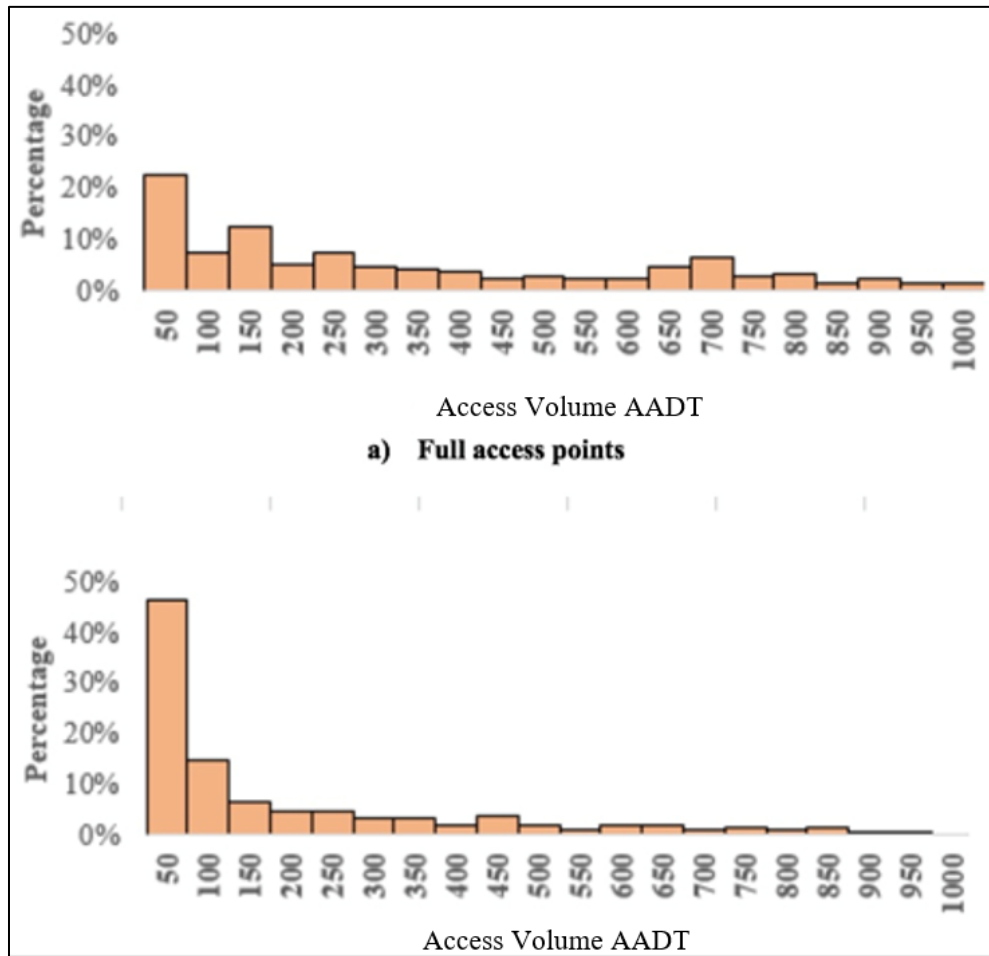

Figure 25. Distribution of Access Traffic Volume by Control Type. AADT = Annual Average Daily Traffic

Statistical Analysis

This section presents the statistical analysis results for evaluating the relationship between crash risk and various risk factors. The NB regression model with random effects was used to draw formal conclusions about the factors that were significantly associated with crash risk. In addition, a one-way ANOVA test was used to determine whether the average crash rates differed significantly among the four spacing groups.

After examining all possible factors and existing studies, the research team selected the following variables as independent variables in model development: access volume, access spacing, access control type, number of low-residential driveways, land use type, mainline speed limit, and mainline AADT (Table 10). Influence length was treated as an offset term while

different corridors were considered as random effect. Some variables were for both upstream and downstream access points, depending on the analysis unit as well as the correlation among variables. For example, both upstream and downstream access volume were considered for pair-based analysis because (a) an access pair consists of upstream and downstream access points, (b) the correlation of upstream stream and downstream access volume is low (correlation coefficient: 0.30). As another example, only upstream land use was included in the model for the pair-based analysis because 74% of upstream and downstream access points share the same land use in terms of commercial activity.

Table 10. Variable List for NB Model Input

Type	Variable Name	Unit	Data Type
Dependent variable	Number of crashes	Count	Continuous
Independent variable	Access volume	1 million per 6-year	Continuous
	Access spacing	100 feet	Continuous
	Access control type	-	Binary, 1: full/unsignalized; 0: partial
	Number of low-residential driveways	Count	Integer 0, 1, 2...
	Land use	-	Binary, 1: high or medium commercial, 0: otherwise
	Mainline annual daily traffic	log (cumulative mainline traffic volume in 6-year study period)	Continuous
	Mainline speed limit	miles per hour	Categorical
Offset term	Influence length	Log(length)	Continuous
Random effect	Corridor	-	Factor, 8 levels

NB = Negative Binomial

There were three definitions of analysis units in the extended study, and the details of each model fitting and output tables are shown in Table 11.

Table 11. Sample Size of Model Input and Output Index

Analysis unit	Access Volume	Spacing	Sample size	Offset term (Length of Influence Area)	Output Table Number
Definition #1	Access volume	Upstream spacing	1,767 (397 full access points and 1370 partial access points)	Length of influence area	Table 12, Figure 26, Table 15, and Table 16
Access point based	Access volume	Downstream spacing			
Definition #2	Upstream point volume	Segment spacing	1,527 (710 full access pairs and 817 partial access pairs)	Length of upstream influence area + length of downstream influence area	Table 13, Figure 27, Figure 29, Table 17, and Table 18
Access pair based	Downstream access volume	Segment spacing			
Definition #3	Right turn volume of upstream access point	Segment spacing	1,527 (710 full access pairs and 817 partial access pairs)	Length of upstream influence area + length of downstream influence area	Table 14, Figure 28
Access pair based	Right turn volume of downstream access point	Segment spacing			

Mixed NB Effect Regression Model Outputs for Individual Access Point-based Analysis

Both Poisson and NB models were tested in a preliminary analysis and the Poisson model showed over-dispersion issues. Therefore, only the outputs of NB models with dependent variables of all types of crashes are provided in this section. Estimated coefficients, 95% confidence intervals, and corresponding p-values are reported in the model output. Model output of overall analysis is presented and is followed by stratified analysis by full and partial access control types.

The NB mixed effect model outputs for individual access point analysis are shown in Table 12. The estimated crash rate ratio is based on the exponential of the regression coefficient. For categorical variables, the estimated rate ratio is the rate ratio between two categories. For example, the rate ratio for land use patterns represents the crash rate ratio between two categories: high/medium commercial and other land use types. The continuous variable should be interpreted as the rate ratio for every one unit of increase in the corresponding independent variables. For example, the unit for access spacing is 100 ft, and the corresponding parameter should be interpreted as the rate ratio between two spacing categories 100 feet apart from each other. A rate ratio larger than one represents a positive relationship with crash rate. That is, if an independent variable increases in value, the corresponding crash rate will also increase. Similarly, a rate ratio smaller than one indicates a negative relationship with the crash rate.

Based on Table 12, both upstream (p-values 0.04) and downstream spacing (p-value < 0.01) were significantly associated with crash rate. The rate ratios were 0.96 and 0.94 respectively, which indicates that every 100-foot increase in upstream spacing was associated

with a 4% decrease in crash rate, and every 100-foot increase in downstream spacing was associated with a 6% decrease in crash rate. The impact of access spacing is consistent with the result of Sarasua et al. (2016) and Elvik (2017) on the magnitude level.

The rate ratio for the access volume was 1.07, which implies a positive relationship between access volume and crash rate. Quantitatively, for every one unit of increase in access volume (one million vehicles for the 6-year study period; equivalent to 457 vehicles per day), the crash rate would increase by 7%.

Table 12. Negative Binomial Model Output of Definition #1 – All Selected Access Points ^a

Variable	Estimated Crash Rate Ratio	95% Confidence Interval Lower Limit	95% Confidence Interval Upper Limit	P-value ^b
Upstream spacing (unit: 100 feet)	0.96	0.92	1.00	0.04
Downstream spacing (unit: 100 feet)	0.94	0.90	0.98	< 0.01
Access volume (unit: million vehicles)	1.07	1.05	1.09	< 0.01
Upstream number of low residential driveways	0.95	0.82	1.10	0.50
Downstream number of low residential driveways	1.00	0.89	1.14	0.96
Land use (high/medium commercial vs others)	1.26	1.11	1.42	< 0.01
Speed limit (mainline)	0.99	0.99	1.00	0.08
log(cumulative mainline traffic volume in 6-year study period)	2.85	2.40	3.37	<0.01
Access control type (full vs partial)	2.73	2.40	3.10	< 0.01

^a Random effect: corridor (intercept) with variance of 0.02838 and standard deviation of 0.1685.

^b Bold indicates significant results at 0.05 level.

The land use patterns had a significant impact on crash rate. On average, the crash rate for access points in high or medium commercial areas was 26% higher compared to residential, industrial, or low commercial use areas. It is consistent with existing studies that intensive land use (high percentage of commercial and industrial land use) is associated with higher crash rate (Sarasua et al., 2016; Williams et al., 2014). In addition, the access control type had a significant impact on crash rate; the crash rate at full access points was 2.73 times higher than at partial access points.

Figure 26 shows the relationship between the average crash rate and access spacing group based on the raw data. The average crash rate ranged from 0.9 to 1.2 crashes per million vehicle miles traveled by different spacing groups. As the figure shows, there was a general decreasing trend in the crash rate with the increase in access spacing. With the increase in access volume, there was a strong upward trend in crash rate. This is consistent with the model outputs in Table 12 and also confirms the assumption of access pair-based analysis in this study.

Note that Figures 26, 27, and 28 often show a repeating decimal. For example, in Figure 26, the value of 200 is the boundary of two adjacent spacing categories. The reason is that the

observed data are not necessarily integers but rather may have a decimal—an example being a spacing of 199.5 feet. The use of a repeating decimal ensures that all data are included in the graphic; for instance, a spacing of 199.5 feet is placed in the 100-199.999 foot category rather than the 200-494.999 foot category.

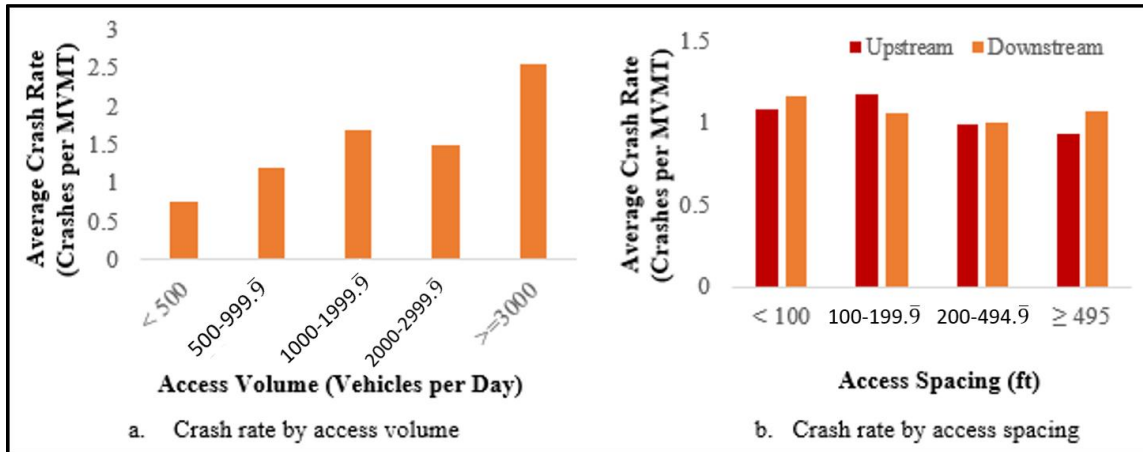

Figure 26. Crash Rate by Access Spacing and Volume of All Sampled Access Points. MVMT = Million Vehicle Miles Traveled.

NB Mixed Effect Model Outputs for Access Pair-based Analysis (Definition #2)

Table 13 shows the model outputs for access pair-based analysis (Definition #2). The results are consistent with the individual access point-based analysis. That is, access spacing was negatively associated with crash rate while access volume was positively associated with crash rate. The magnitude of the effect is also comparable with the individual access point-based

Table 13. Negative Binomial Model Output of Definition #2 – All Selected Access Pairs ^a

Variable	Estimated Crash Rate Ratio	95% Confidence Interval Lower Limit	95% Confidence Interval Upper Limit	P-value ^b
Spacing (unit: 100 feet)	0.95	0.92	0.86	0.01
Upstream access volume (unit: million vehicles)	1.07	1.05	1.23	<0.01
Downstream access volume (unit: million vehicles)	1.07	1.05	1.22	<0.01
Number of low residential driveways	1.05	0.93	1.15	0.44
Land use (high/medium commercial vs others)	1.05	0.94	1.15	0.40
Speed limit (mainline)	1.00	0.99	1.00	0.49
log (cumulative mainline traffic volume in 6-year study period)	2.95	2.51	24.50	<0.01
Access control type (full vs partial)	2.01	1.81	7.90	<0.01

^a Random effect: corridor (intercept) with variance of 0.05495 and standard deviation 0.2344.

^b Bold indicates significant results at 0.05 level.

analysis. The rate ratio for spacing was 0.95. For both upstream and downstream access volume, the rate was 1.07. The number of low residential access points, land use, and mainline speed

limit did not show a significant association with crash rate for access pairs. Similar to the results from individual access point analysis, the crash rate at full access points was twice as high as that of the partial access points. Figure 27 shows the relationship between the average crash rate and access spacing group based on the raw data.

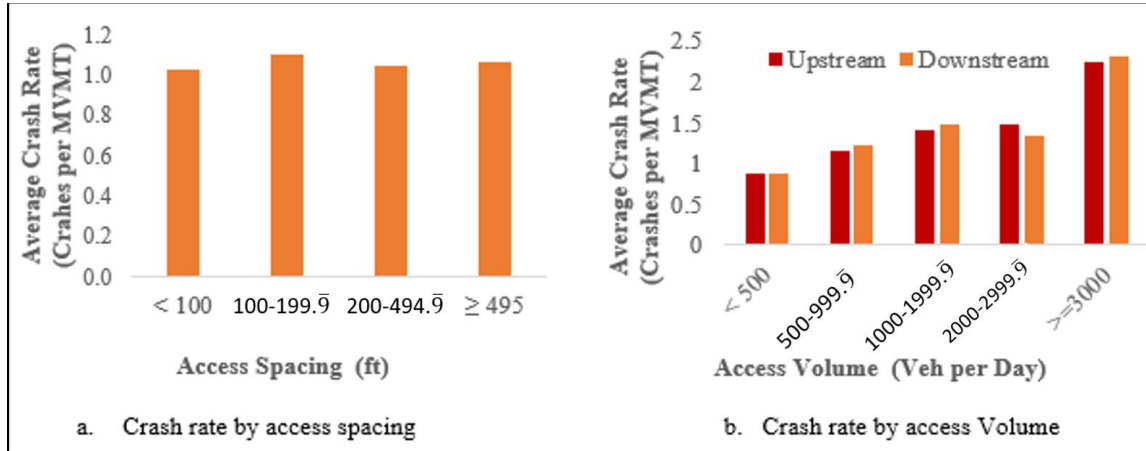

Figure 27. Crash Rate by Access Spacing and Volume of All Selected Access Pairs. C/ MVMT = Crashes/Million Vehicle Miles Traveled

ANOVA Output with All Selected Access Pairs Analysis (Definition #3)

Per the TRP’s request, an ANOVA was conducted to compare crash rates by access spacing group. The crash rate in the ANOVA test was a modified crash rate based on access volume, as shown in the Equation 9. This crash rate is normalized by the access volume instead of mainline traffic volume as in the NB model.

$$Crash\ Rate_{modified} = \frac{Crash\ Frequency}{Half\ of\ Upstream\ Volume \times Half\ of\ Downstream\ Volume} \quad (9)$$

The difference in average modified crash rates among four spacing groups is shown in Figure 28. Access pairs with spacing less than 100 feet had the lowest modified crash rate (1.1) while the group with spacing between 200 and 494.999 feet had the highest modified crash rate (3.8). The one-way ANOVA test showed that there was no overall significant difference among the four spacing groups. Tukey’s HSD post hoc test does show a significant difference between the <100 ft group and the 200–494.999 ft groups. However, given the overall non-significance, caution should be used when drawing conclusions based on the post hoc results.

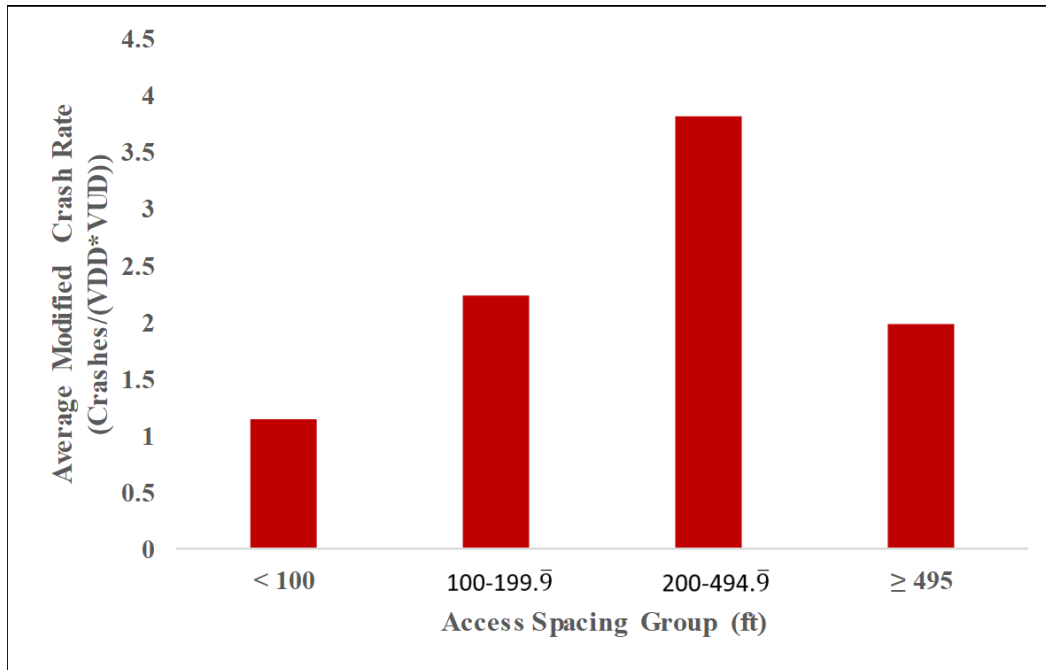

Figure 28. Modified Crash Rate by Access Spacing of All Selected Access Pairs. VDD = Volume from the downstream driveway, VUD = Volume from the upstream driveway.

Table 14. ANOVA Test Output of Definition #3 – All Selected Access Pairs, ANOVA = Analysis of Variance

Distance	Difference in Average Modified Crash Rate	95% Confidence Interval of Difference Lower Limit	95% Confidence Interval of Difference Upper Limit	P-value ^a
Global test	-	-	-	0.06
100–199.9 feet vs. < 100 feet	1.10	-1.46	3.67	0.69
200–494.9 feet vs. < 100 feet	2.69	0.07	5.30	0.04
≥ 495 feet vs. < 100 feet	0.85	-3.14	4.84	0.95
200–494.9 feet vs. 100–199.9 feet	1.58	-0.87	4.04	0.35
> 495 feet vs. 100–199.9 feet	-0.26	-4.14	3.63	1.00
> 495 feet vs. 200–494.9 feet	-1.84	-5.76	2.08	0.62

^a Bold indicates significant results at 0.05 level. The .9 indicates a repeating decimal (e.g., 199.9 ≈ 199.999999)

Stratified Analysis by Control Type

Both individual and pairs of access points analyses show that crash rate is associated with access control type, with higher crash rates for the full access type. Therefore, a stratified analysis of full access type and partial access type points was conducted to explore the impacts of spacing and access volume with control of the effects of access type.

The full access and partial access types are operationally defined as follows: 1) For individual access point analysis, any access points with access control type unsignalized intersections are defined as full access, while any RIRO, RI and RO are defined as partial access.

2) For pair-based analysis, any access pairs with upstream or downstream access points of unsignalized intersections are defined as full access, and any access pairs with neither upstream nor downstream unsignalized intersections are defined as partial access.

NB Output with Stratified Access Points Analysis (Definition #1)

The results for the NB mixed effect model of stratified analysis for individual access points are shown in Table 15 (full access type) and Table 16 (partial access type). The outputs were, in general, consistent with the aggregated results (Table 12); i.e., the downstream spacing was negatively associated with crash risk while access volume was positively associated with crash risk. The high/medium commercial land use showed around 29% higher crash rate compared to other land use types for both full and partial access types. For full access type, the upstream number of low residential driveways showed negative correlation with crash risk, with a rate ratio of 0.72.

It should be noted that the upstream spacing does not show a significant association with the crash rate in the stratified analysis. This could be due to the smaller sample size in the stratified analysis and/or large variation in the effect of upstream spacing itself.

Table 15. Negative Binomial Model Output of Definition #1 – Full Access Points^a

Variable	Estimated Crash Rate Ratio	95% Confidence Interval Lower Limit	95% Confidence Interval Upper Limit	P-value ^b
Upstream spacing (unit: 100 feet)	0.96	0.91	1.01	0.15
Downstream spacing (unit: 100 feet)	0.95	0.90	1.00	0.03
Access volume (unit: million vehicles)	1.09	1.06	1.12	<0.01
Upstream number of low residential driveways	0.72	0.55	0.93	0.01
Downstream number of low residential driveways	1.00	0.87	1.15	0.99
Land use (high/medium commercial vs others)	1.29	1.08	1.54	<0.01
Speed limit (mainline)	0.99	0.99	1.00	0.26
log (cumulative mainline traffic volume in 6-year study period)	2.89	2.26	3.68	<0.01

^a Random effect: corridor (intercept) with variance of 0.02216 and standard deviation of 0.1489.

^b Bold indicates significant results at 0.05 level.

Table 16. Negative Binomial Model Output of Definition #1 – Partial Access Points ^a

Variable	Estimated Crash Rate Ratio	95% Confidence Interval Lower Limit	95% Confidence Interval Upper Limit	P-value ^b
Upstream spacing (unit: 100 feet)	0.96	0.91	1.02	0.19
Downstream spacing (unit: 100 feet)	0.93	0.88	0.99	0.02
Access volume (unit: million vehicles)	1.05	1.02	1.09	<0.01
Upstream number of low residential driveways	1.02	0.85	1.24	0.82
Downstream number of low residential driveways	0.99	0.79	1.23	0.90
Land use	1.28	1.09	1.51	<0.01
Speed limit (mainline)	0.99	0.98	1.00	0.27
log (cumulative mainline traffic volume in 6-year study period)	2.85	2.29	3.56	<0.01

^a Random effect: corridor (intercept) with variance of 0.02216 and standard deviation of 0.1489.

^b Bold indicates significant results at 0.05 level.

NB Mixed Effect Model Outputs with Stratified Access Pair Analysis (Definition #2)

The stratified analysis of access pairs showed a similar result to the overall analysis result in access volume, i.e., both upstream and downstream volume were positively associated with crash rate.

Note for the full access pairs, access spacing is negatively associated with crash rate. For each 100 ft increase in access spacing, the crash rate of full access pairs drops to 0.93, a 7% decrease in crash rate (Table 17). For partial access pairs, however, the access spacing is not significantly associated with crash risk (Table 18). This result implies that after adjusting access volume and other factors, the spacing on partial access does not necessarily affect crash rate.

Table 17. Negative Binomial Model Output of Definition #2 – Full Access Pairs ^a

Variable	Estimated Crash Rate Ratio	95% Confidence Interval Lower Limit	95% Confidence Interval Upper Limit	P-value ^b
Spacing (unit: 100 feet)	0.93	0.90	0.97	<0.01
Upstream access volume (unit: million vehicles)	1.10	1.07	1.13	<0.01
Downstream access volume (unit: million vehicles)	1.08	1.05	1.10	<0.01
Number of low residential driveways	1.06	0.93	1.21	0.39
Land use	0.98	0.86	1.13	0.83
Speed limit (mainline)	1.00	0.99	1.01	0.93
log (cumulative mainline traffic volume in 6-year study period)	3.06	2.53	3.70	<0.01

^a Random effect: corridor (intercept) with variance of 0.02216 and standard deviation of 0.1489.

^b Bold indicates significant results at 0.05 level.

Table 18. Negative Binomial Model Output of Definition #2 – Partial Access Pairs ^a

Variable	Estimated Crash Rate Ratio	95% Confidence Interval Lower Limit	95% Confidence Interval Upper Limit	P-value ^b
Spacing (unit: 100 feet)	0.98	0.92	1.05	0.64
Upstream access volume (unit: million vehicles)	1.04	1.00	1.07	0.04
Downstream access volume (unit: million vehicles)	1.06	1.02	1.11	<0.01
Number of low residential driveways	1.01	0.81	1.27	0.91
Land use	1.16	0.96	1.39	0.12
Speed limit (mainline)	1.00	0.99	1.01	0.63
log (cumulative mainline traffic volume in 6-year study period)	2.87	2.20	3.74	<0.01

^a Random effect: corridor (intercept) with variance of 0.02216 and standard deviation of 0.1489.

^b Bold indicates significant results at 0.05 level.

Figure 29 illustrates the raw crash rate for full and partial access types by spacing group. The plot confirms that there is a decreasing trend in crash rate for full access type roads but no obvious trend for partial access type roads.

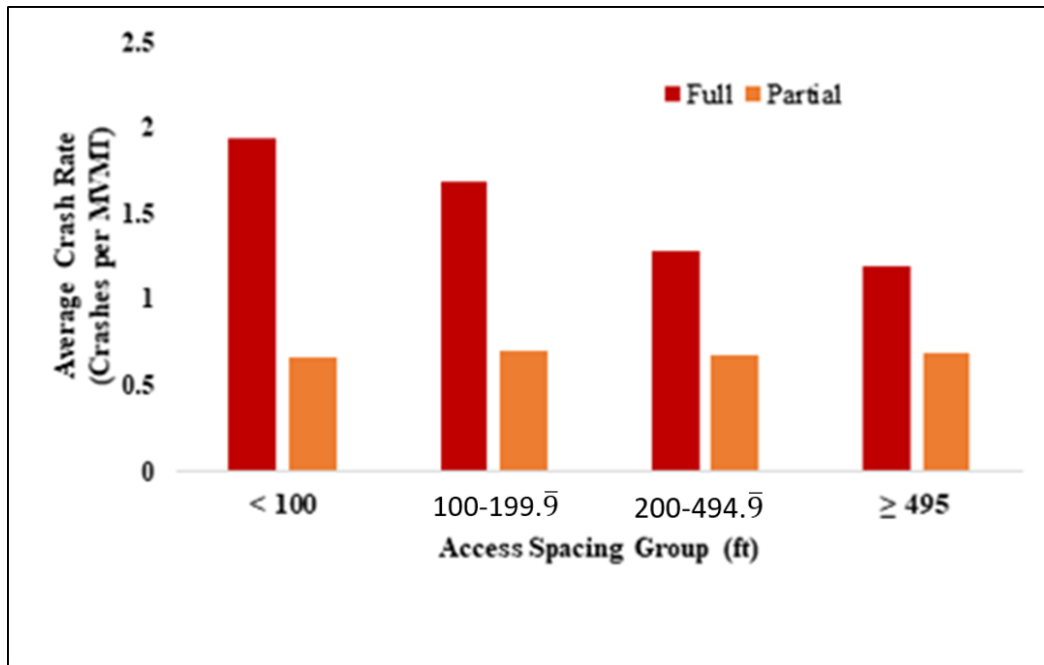

Figure 29. Spacing Effect on Crash Rate by Access Control Type. MVMT = Million Vehicle Miles Traveled.

DISCUSSION

This study contributes to the state-of-the-practice in safety research by evaluating the safety impact of access spacing with consideration of access volume and other risk factors. Several novel methodological approaches were implemented, including the estimation of access volume, alternative analysis units, and mixed effect modeling. This multi-faceted approach provides an opportunity to draw a strong conclusion about access spacing by converging evidence from multiple alternative results.

One of the most challenging project tasks was data collection and fusion. To assemble the required research dataset, the project team conducted data mining from multiple sources, including the state crash database, GIS base maps, Google Earth, as well as the VDOT access point database. The project team developed a dedicated data reduction platform to efficiently extract and merge data from multiple sources. To estimate the access volume, we used the ITE trip generation method combined with Google Earth and GIS maps of buildings. This novel approach represents a substantial effort for estimating access volume. The study generated detailed data from more than 1,800 access points from eight corridors that provide more than enough samples to support the analysis.

To accomplish the objectives of this study, the research team, with guidance from TRP members, developed several novel analysis approaches and data collection methods. We defined two types of analysis units: 1) individual access point-based; 2) access pairs-based. The alternative definitions allowed highly detailed features, such as the upstream and downstream spacing, as well as downstream and upstream access volume, to be examined. In addition, the multiple analyses approach allowed us to reach a robust conclusion via the convergence of evidence. The fact that the majority of the analyses reached the same conclusions on the effects of spacing and access volume strengthens the study's validity.

Per the request of TRP, the research team also conducted an ANOVA analysis based on definition 3. This analysis is based on an alternative crash rate based on the access volume alone, which differs from the mainline traffic volume used in the NB model. Furthermore, the length of the influence area is also not considered in the ANOVA model—only the segment length between the access points is. Future research is recommended to incorporate these factors into the analysis.

By defining alternative analysis units, the project provides an opportunity to examine the safety impact of spacing from various perspectives. Overall, both spacing and access volume show significant impacts on safety. In particular, access volume shows a consistent positive association with crash rate for all analyses. This confirms that access volume is a key contributing factor for the safety of access points and should be carefully evaluated.

Spacing showed a negative association for aggregated analysis, but showed some discrepancies across various analyses. In particular, the individual access point-based analysis showed a distinct difference between upstream and downstream spacing. Stratified analysis by access type indicated that downstream spacing had significant effects for both full and partial access types whereas upstream spacing had no significant effects. This result suggests that the configuration of multiple access points should be carefully assessed in safety evaluations.

In addition to spacing and access volume, the study also identified several factors affecting safety. For example, the crash risk for full access points was two to three times higher than for partial access points. Land use was also associated with crash risk—crash risk at medium/high commercial access points was significantly higher than at low commercial, industrial, and residential access points. Since access volume was included in the model, this suggests that medium/high commercial access points impose elevated risk beyond traffic volume. Factors such as complex traffic patterns, a diverse driver population, and peak hour traffic could all contribute to the high risk.

Speed limit was significant only for the individual access pairs analysis. Higher speed limits were associated with a slight reduction in crash rates. While the speed limit results seem to be in opposition to existing VDOT standards, note that current standards are based on operational criteria where a higher speed or distance is needed to execute the different maneuvers.

The coefficient for the logarithm of mainline volume was also statistically significant. The results suggest, in general, that crash frequency was not linearly related to mainline volume. A direct effect is that when traffic volume increases, the expected crash frequency does not increase linearly for all cases. For example, if the traffic volume doubles, the expected crash frequency will be more than double the original value. This is indicative that high traffic volume is also commonly associated with increased traffic complexity, increased interaction among vehicles, and thus higher crash risk.

The study is based on the state-of-the-practice mixed effects NB model. The NB method is consistent with the AASHTO HSM and is the foundation of the safety performance function and crash modification factors. The specific mixed-effects method adopted by the research team incorporated the correlations among access points on the same corridor, an important aspect that has been emphasized by the research community.

In summary, this study used novel data sources and methodology to reveal the relationship between access spacing and crash risk in consideration of access volumes and other potential risk factors. The findings could support future state design standard regulations as well as guide engineering decisions in practice.

Limitations

The current study only focused on samples with access spacing less than 700 feet, with the assumption that spacing greater than 700 feet is relatively safe and was therefore of less concern for this project. It may be valuable to further investigate this. Only full access/unsignalized intersections and partial access points were included in this study. Any other control types, such as mid-block, signalized, and interchange access points were excluded. It is important to keep this in mind while applying conclusions from this study.

Additionally, all estimated coefficients had a linear relation with crash rate despite the starting value. That is, the decrease in crash rate stayed the same for a 100 foot increase in access spacing, no matter whether the access spacing expanded from 100 feet to 200 feet, or 500 feet to

600 feet. A similar pattern also applied for the other variables. Different model approaches can be further explored for the non-linear relationships.

CONCLUSIONS

The study leads to the following main conclusions for driveways on divided principal arterials:

- *Access volume is a critical factor in access point safety.* Multi-faceted analyses in this study consistently indicated that both upstream and downstream access volume were significantly associated with crash risk, with higher access volume showing an association with higher crash risk. For example, an increase in access volume of 457 vehicles per day was associated with a 7% increase in crash rate with adjustment for the nonlinear relationship between mainline traffic volume and crash rate (Table 12).
- *Downstream spacing has a higher impact on crash risk than upstream spacing.* Specifically, stratified analysis by partial and full access type showed no significant findings for upstream spacing, while downstream spacing showed a consistent significant association with crash risk.
- *There is a substantial difference in the crash rate results for full and partial access points/pairs.* In particular, spacing did not show a significant impact for partial access type in the pair-based analysis.
- *Access points with high/medium commercial land use tend to have a higher crash rate compared to other land use types.*

RECOMMENDATIONS

1. *As part of its guidance for evaluating access management exception requests, the VDOT Office of Land Use should provide, for the benefit of land use engineers who review such exception requests, the findings from this study to help them evaluate such exceptions.* Findings from this study include (a) entrances with higher access volumes have a heightened impact on crash risk; (b) access points classified as high/medium commercial land use tend to have a higher crash rate compared with other land uses; and (c) access spacing shows different impacts regarding access control type, which should be considered for both design standards as well as practical considerations. A detailed way of implementing this recommendation by access control type is shown in Appendix A.
2. *The Transportation Planning Research Advisory Committee should consider a follow up study that reconciles the differences in results between analyses based on Definition 1 and 2 (the NB model) and Definition 3.* Different influence length scenarios should be investigated and compared.

IMPLEMENTATION AND BENEFITS

Implementation

Regarding recommendation 1, the VDOT Office of Land Use will develop a way of sharing key findings from this study to help land use engineers evaluate exception requests for driveways on divided principal arterial roads. Appendix A provides an example of this guidance showing the impact on crash rate when there are changes in access volume, downstream distance, upstream distance, or land use.

Regarding Recommendation 2, the Transportation Planning Research Advisory Committee will consider the proposed follow-up study at the Spring 2021 meeting when new research ideas are prioritized. Should the follow-up study be undertaken, VTRC will make available the crash data and access point data that were used in this report.

Benefits

Both recommendations support VDOT's vision to plan, design, operate, and maintain a safe transportation system and the agency's commitment to safety. The implementation of this research will help engineers make better decisions regarding access control and can contribute to reductions in crashes and the associated injuries and fatalities.

The models developed as part of these research efforts were utilized to compute the crash rate associated with differences in access spacings, access volumes, downstream/upstream attributes of spacings or volumes, land use, etc. An attempt was made to convert the safety impacts of modifying any of those variables by using a weighted overall crash cost. The overall crash costs were computed by using national and Virginia estimates of the distribution of crashes by severity for the study corridors while following the Highway Safety Manual Procedures (Appendix B). The estimated overall unit cost for crashes regardless of severity is \$114,000, and the overall unit cost for fatal and injury crashes is \$289,000. The overall crash unit cost was multiplied by the number of crashes per mile per year to compute the cost associated with different access and spacing scenarios. As shown in Appendix A, for an individual access point, the downstream spacing is negatively associated with crash rate and the access volume is positively associated with crash rate. Increasing the access spacing from 200 to 300 feet results in crash rate reduction of 7% crashes mile/year. For an access volume of 600 veh/day and a mainline AADT of 20,000 veh/day, this reduction in the crash rate translates to savings of \$40,108/mile/year. Spacing, however, is just one of several factors that affect crash risk. A different factor, beyond the control of VDOT, is access volume. For the same scenario, a reduction in volume from 600 to 200 veh/day results in an average crash rate reduction of 4.6%, which translates to a savings of \$25,784/mile/year.

ACKNOWLEDGMENTS

The authors express their gratitude to VDOT and FHWA for their support of this research. The authors are thankful to the Technical Review Panel members: John Miller (VTRC), Robert Hofrichter (VDOT Office of Land Use), Robert Case (Hampton Roads Metropolitan Planning Organization), Amy O'Leary (VTRC), Mo Zhao (VTRC), Michael Fitch (VTRC), Kevin Wright (VTRC), and Anne Booker (VDOT, Salem District). The research team is especially thankful to Robert Hofrichter, Robert Case and John Miller, who are the true champions of this study and were invaluable supporters.

REFERENCES

- American Association of State Highway and Transportation Officials. (2010). *Highway Safety Manual* (Vol. 1), Crash Cost Estimates, Appendix 4A. Washington, D.C.
- Avelar, R. E., Dixon, K. K., Brown, L. S., Mecham, M. E., & Van Schalkwyk, I. (2013). Influence of Land Use and Driveway Placement on Safety Performance of Arterial Highways. *Transportation Research Record*, 2398(1), 101-109.
- Chakraborty, M., & Gates, T. (2020). *Effect of Driveway Land-Use Type on Safety Performance for Two-Lane Rural State Highways and County Roads*. In 99th Annual Meeting, Transportation Research Board: Washington, D.C.
- Elvik, R. (2017). A synthesis of studies of access point density as a risk factor for road accidents. *Accident Analysis & Prevention*, 107, 1-10.
- Fitzpatrick, K., Park, E. S., & Schneider IV, W. H. (2008). Potential Accident Modification Factors for Driveway Density on Rural Highways: From Texas Data. *Transportation Research Record: Journal of the Transportation Research Board*, 2083(1), 49-61.
- Gluck, J. S., Levinson, H. S., & Stover, V. G. (1999). *Impacts of Access Management Techniques* (Report No. 420). Washington, D.C.: Transportation Research Board of the National Academies.
- Gluck, J., & Lorenz, M. (2010). *NCHRP Synthesis 404: State of the Practice in Highway Access Management*. Washington, D.C.: Transportation Research Board of the National Academies.
- Gross, F., Lyon, C., Persaud, B., Gluck, J., Lorenz, M., & Himes, S. (2018). *Safety Evaluation of Access Management Policies and Techniques* (Report No. FHWA-HRT-14-057). Washington, D.C.: Federal Highway Administration, Office of Safety Research and Development.
- Harwood, D. W., Bauer, K. M., Richard, K. R., Gilmore, D. K., Graham, J. L., Potts, I. B., Torbic, D.J., & Hauer, E. (2007). *Methodology to Predict the Safety Performance of Urban and Suburban Arterials* (Report No. NCHRP Project 17-26). Washington, D.C.: Transportation Research Board of the National Academies.

- Institute of Transportation Engineers. (2018). *Trip Generation Manual*. (10th ed.). Washington, D.C.
- Le, T., Gross, F., Harmon, T., & Eccles, K. (2018). *Safety Evaluation of Corner Clearance at Signalized Intersections* (Report No. FHWA-HRT-17-084). Washington, D.C.: Federal Highway Administration.
- Mauga, T. (2010). *Analysis and Evaluation of Safety Impacts of Median Types and Midblock Left Turn Treatments for Urban Arterials* [Doctoral Thesis]. Las Vegas, NV: University of Nevada.
- Miller, J., S., Dougald, R., S., Stevens, R., S., Dean, M., D., & Gayner, C., H. (2018). *Extent and Impacts of the Virginia Department of Transportation's Exception Process for Access Management Design Standards*. Charlottesville, VA: Virginia Transportation Research Council, Virginia Department of Transportation.
- Muskaug, R. (1985). *Accident rates on National Roads*. Oslo, Norway: Institute of Transportation Economics.
- Qin, X., Ivan, J. N., & Ravishanker, N. (2004). Selecting exposure measures in crash rate prediction for two-lane highway segments. *Accident Analysis & Prevention*, 36(2), 183-191.
- Sarasua, W. A., Davis, W. J., Ogle, J., Huynh, N. N., & Chowdhury, M. (2015). *Support for the Development and Implementation of an Access Management Program Through Research and Analysis of Collision Data* (Report No. FHWA-SC-15-02). Columbia, SC: South Carolina Department of Transportation.
- Thompson, Iftin. (2017). *Examining Corridor-level Crash Rates in Consideration of Access Point Density and Spacing* [Doctoral Thesis]. Ames, IA: Iowa State University.
- Virginia Department of Transportation. *VDOT Road Design Manual*. (Rev. 2018). Appendix F - Access Management Design Standards for Entrances and Intersections—Issued January 2005. Richmond: VA: VDOT Location and Design Division.
- Vogt, A., & Bared, J. (1998). Accident Models for Two-Lane Rural Segments and Intersections. *Transportation Research Board: Journal of the Transportation Research Board*, 1635, 18-29.
- Williams, K., Stover, V., Dixon, K., & Demosthenes, P. (2014). *Access Management Manual* (2nd ed.). Washington, D.C.: Transportation Research Board of the National Academies.

APPENDIX A. IMPLEMENTATION OF RECOMMENDATIONS

For an individual access point the downstream spacing is negatively associated with crash rate; i.e. every 100-foot increase in spacing downstream of the partial access point is associated with a 7% lower crash rate (Table 16); for full access points, every 100-foot increase in spacing downstream is associated with a 5% lower crash rate (Table 15). The upstream spacing does not have a significant impact on crash rate regardless of access control type. Access volume is positively associated with crash rate. Every one million vehicle increase within the 6-year study period—equivalent to 457 vehicles per day—increases the crash rate by between 2% and 9% for partial access points (Table 16), and between 6% and 12% for full access points (Table 15).

Land use patterns have a significant impact on crash rate. The crash rate for access points in high or medium commercial areas can be 50% higher compared to residential, industrial, or low commercial use areas, regardless of access control type (Table 15, Table 16).

The change in crash rate by access spacing, volume, and land use pattern is summarized in Figure A1.

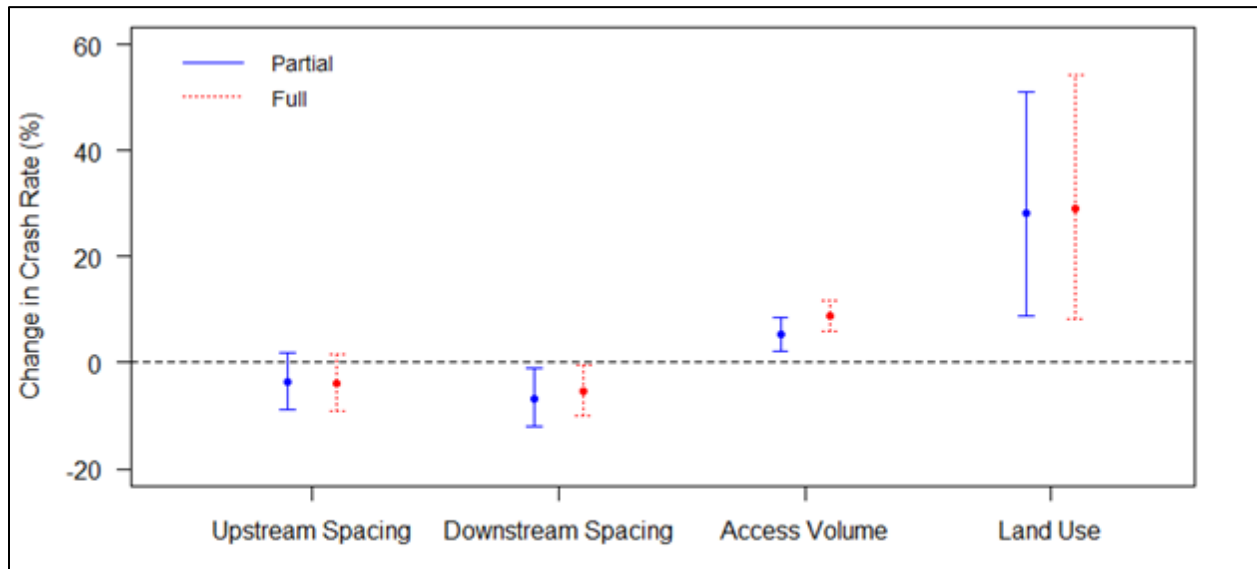

Figure A1. Impact of Spacing, Access Volume, and Land Use on Crash Risk of Access Points

From an access pair perspective, the conclusion is slightly different. The access spacing does not have a significant relationship with the crash rate for a partial access pair. However, for a full access pair, every 100 feet increase in access spacing reduces the crash rate up to 10% (Table 17).

Access volume has a positive impact on crash rate regardless of access control type. The downstream volume plays a larger role than upstream volume for partial access pairs; i.e., a 457 vehicle per day increase in the upstream and downstream volume increases the crash rate by up to 7% and 11%, respectively (Table 18). For full access pairs, the upstream volume has a more heightened impact on crash risk than the downstream volume, i.e., a 457 vehicle per day increase in the upstream and downstream volume increases the crash rate up to 13% and 10%, respectively (Table 17). (The “up to” refers to the fact that these percentages are the upper limits

of the 95% confidence intervals in Tables 17 and 18. If the lower limit of the 95% confidence interval is used, the aforementioned crash rates still increase, but by lesser amounts.)

Land use does not have a significant impact on crash risk when an access pair is treated as a whole unit (Table 17, Table 18).

The impact on crash rate of access pairs can be seen in Figure A2.

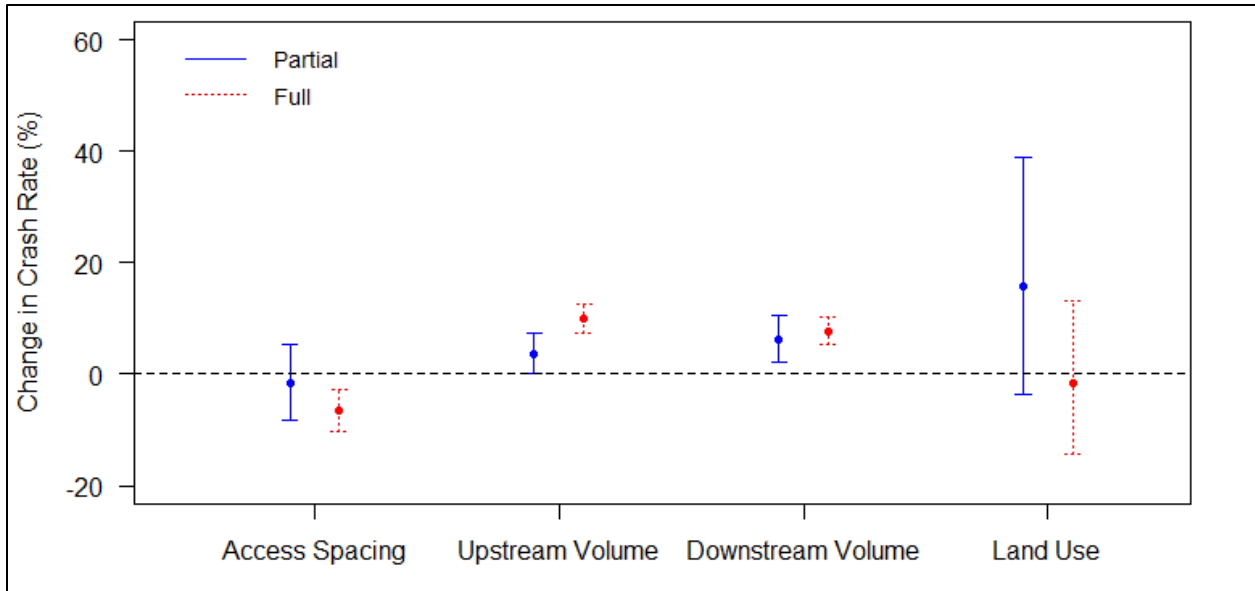

Figure A2. Impact of Spacing, Access Volume, and Land Use on Crash Risk of Access Pairs

Access spacing should especially be considered for full access points/pairs. A 100-foot increase in access spacing can reduce the crash rate by up to 10% (Table 17). The “up to” signifies the lower end of the 95% confidence interval; if the higher end of the 95% confidence interval is used, this reduction is 3%.

APPENDIX B. CRASH COST ESTIMATES

Available Crash Cost Estimates

Crash cost estimation was computed for this project based on the Highway Safety Manual Procedures (AASHTO, 2010). To that end, the research team used two crash costs shown in Table B1: the average crash unit cost estimates both for Virginia and nationwide. The national estimates included estimates for both economic costs of the crashes and quality-adjusted life year (QALY) costs. Note that the crash unit cost estimates were for all crashes regardless of crash type, time, and location which is consistent with crash data in this study.

Table B1. Average Crash Unit Cost by Severity - Virginia and National Data

Type		K - Fatal	A – Severe Injury	B – Minor Injury	C – Possible Injury	O – Property Damage Only	Year
Virginia	-	\$5,241,924	\$280,664	\$102,604	\$58,132	\$ 9,512	2012
National	Economic	\$1,722,991	\$130,068	\$ 53,700	\$42,536	\$11,906	2016
	QALY	\$9,572,411	\$524,899	\$144,792	\$83,026	\$0	
	Total	\$11,295,402	\$654,967	\$198,492	\$125,562	\$11,906	

QALY = quality-adjusted life year.

Converting Past Crash Cost Estimates to 2019 Values

During this study, the project team converted the Virginia crash unit costs to 2019 values based on the procedures recommended by the Highway Safety Manual. The procedure recommends that crash costs of a certain year be adjusted to a target year by adjusting the direct economic costs and the QALY costs based on the corresponding Consumer Price Indices (CPIs) and Employment Cost Indices (ECIs), respectively:

$$CUC_{target} = ECUC_{data} \times \frac{CPI_{target}}{CPI_{data}} + QCUC_{data} \times \frac{ECI_{target}}{ECI_{data}} \quad (1.B)$$

Where:

CUC_{target} = target year total crash unit cost by severity

$ECUC_{data}$ = data year economic crash unit cost by severity

$QCUC_{data}$ = data year QALY crash unit cost by severity

CPI_{target} = target year CPI

CPI_{data} = data year CPI

ECI_{target} = target year ECI

ECI_{data} = data year ECI

During this project, the team was not able to find separate economic and QALY crash unit cost data for Virginia. The project team therefore obtained the economic and QALY portions of the Virginia crash unit cost estimates by applying the corresponding percentages based on the national estimates, as shown in Table B2.

Table B2. Determination of Economic and Quality-Adjusted Life Year Crash Costs for Virginia

Type		K - Fatal	A – Severe Injury	B – Minor Injury	C – Possible Injury	O – Property Damage Only
VA (2012)	Total	\$ 5,241,924	\$280,664	\$102,604	\$ 58,132	\$ 9,512
	Economic	\$ 799,599	\$55,736	\$ 27,758	\$ 19,693	\$ 9,512
	QALY	\$ 4,442,325	\$224,928	\$ 74,846	\$ 38,439	\$0
National (2016)	Total	\$11,295,402	\$654,967	\$198,492	\$125,562	\$11,906
	Economic	\$ 1,722,991	\$130,068	\$ 53,700	\$ 42,536	\$11,906
	QALY	\$ 9,572,411	\$524,899	\$144,792	\$ 83,026	\$0
	QALY %	15%	20%	27%	34%	100%

QALY = quality-adjusted life year.

Using the historical ECI and CPI data shown in Table B3, the project team estimated the Virginia crash unit costs by severity as shown in Table B4.

Table B3. Historical Employment Cost Index and Consumer Price Index Values

Year	Employment Cost Index*	Consumer Price Index**
2001	85.5	171.1
2012	116.8	223.2
2016	126.7	232.7
2019	137	246.3

* June values for all civilian workers.

**Annual average values for all items in census south region, all urban consumers, not seasonally adjusted.

Table B4 2019 Virginia Crash Costs by Severity based on 2012 Estimates

Type	K - Fatal	A – Severe Injury	B – Minor Injury	C – Possible Injury	O – Property Damage Only
Total	\$6,092,957	\$325,333	\$118,421	\$66,818	\$10,496
Economic	\$ 882,353	\$ 61,505	\$ 30,631	\$21,731	\$10,496
QALY	\$5,210,604	\$263,828	\$87,790	\$45,087	\$ 0

QALY = quality-adjusted life year.

The research team computed the overall crash cost and the overall injury crash cost using the distribution of crashes by severity for the study corridors. The average distribution of crashes for all the corridors shown on Table B5. The estimated overall crash unit cost regardless of severity is \$114,000, and the overall unit cost for fatal and injury crashes is \$289,000.

Table B5. Proportions of Crashes by Severity for the Study Corridors (VDOT 2013–2018)

Route	K – Fatal	A – Severe Injury	B – Minor Injury	C – Possible Injury	O – Property Damage Only
US17	0.4%	6.0%	15.5%	21.5%	56.5%
US29	0.9%	7.6%	20.2%	5.5%	65.8%
US58	1.3%	7.9%	18.7%	14.1%	58.0%
US220	0.9%	6.4%	20.6%	4.1%	68.0%
US460	0.8%	8.8%	22.3%	3.0%	65.1%
US220 BUS	0.5%	5.5%	25.7%	7.3%	61.0%
US29 BUS	0.5%	4.9%	10.4%	29.4%	54.9%
US58 BUS	0.7%	5.9%	13.2%	26.6%	53.7%
% all	0.9%	7.3%	19.5%	9.7%	62.7%
% KABC	2.4%	19.6%	52.2%	25.9%	

K = Fatal, A = Severe Injury, B = Minor Injury, C = Possible Injury, O = Property Damage Only