

1. REPORT NUMBER CA18-2447	2. GOVERNMENT ASSOCIATION NUMBER	3. RECIPIENT'S CATALOG NUMBER
4. TITLE AND SUBTITLE Field Experiment of Variable Speed Advisory (VSA)		5. REPORT DATE September 25, 2018
7. AUTHOR(S) Xiao-Yun Lu and John Spring California PATH, UC Berkeley		6. PERFORMING ORGANIZATION CODE
9. PERFORMING ORGANIZATION NAME AND ADDRESS California PATH - UC Berkeley 1357 S. 46th Street, Bldg. 452 Richmond, CA 94804-4648		8. PERFORMING ORGANIZATION REPORT NO. UCB-ITS-PRR-2019-02
12. SPONSORING AGENCY AND ADDRESS Division of Research, Innovation and System Information 1727 30th Street, MS-83 Sacramento, CA 95816		10. WORK UNIT NUMBER
		11. CONTRACT OR GRANT NUMBER 65A0587
		13. TYPE OF REPORT AND PERIOD COVERED Final Report June 15, 2016– June 15, 2018
		14. SPONSORING AGENCY CODE

15. SUPPLEMENTARY NOTES

16. ABSTRACT

This report documents the field test of Variable Speed Advisory (VSA) which is an Active Traffic Management strategy. The test site for the VSA is on State Route 78 Eastbound (SR-78E) from Vista Village Drive (in the City of Vista) to the freeway interchange point of SR-78E and U.S. Route 15 (in the city of Escondido). Real-time traffic detector data including flow, speed, and occupancy from pre-existing loop detectors in the field test site, were transmitted via the Internet by engineers at Caltrans District 11 (D11) Transportation Management Center (TMC) to a server located in the offices of California Partners for Advanced Transportation Technology (PATH). This data was then aggregated with real time speed data, captured every 30s [seconds] by radar equipment installed along with solar panel powered LED display equipment, for the display of a VSA, at 7 different sites along a 10.8-mile section of SR 78E. These two sources of data were then processed for the estimation of the overall traffic state along the corridor, which was in-turn used to calculate the VSA for each section in order to maximize overall traffic throughput through recurrent bottlenecks on SR-78E. Calculated VSA values were then rounded to multiples of 5 mph and displayed on the VSA signs. The results of the performance analysis, conducted with an independent PeMS data set, illustrated an improvement in three performance measures for the AM (6-9AM) peak hours: Vehicle Miles Traveled (VMT) increased by 2.72%; Vehicle Hours Traveled (VHT) decreased by 6.28%, and the average speed over the road segment or $Q=VMT/VHT$ increased by 8.71%. In PM peak hours (2-7PM), two of the three performance measures improved: VMT did not have noticeable improvement; VHT decreased by 1.47% on average; and Q increased by 2.80% on average.

17. KEY WORDS Field Experiment of Variable Speed Advisory (VSA), Freeway ramp metering (RM), Integrated Corridor Management (ICM), Coordination of Freeway Ramp Meters (CRM), Local Responsive Ramp Metering (LRRM), Performance Measurement System (PeMS), Transportation Management Center (TMC), District 11 (D11).	18. DISTRIBUTION STATEMENT No restrictions. This document is available to the public through the National Technical Information Service, Springfield, VA 22161
---	---

19. SECURITY CLASSIFICATION (of this report)	20. NUMBER OF PAGES 98	21. COST OF REPORT CHARGED N/A
--	---------------------------	-----------------------------------

DISCLAIMER STATEMENT

This document is disseminated in the interest of information exchange. The contents of this report reflect the views of the authors who are responsible for the facts and accuracy of the data presented herein. The contents do not necessarily reflect the official views or policies of the State of California or the Federal Highway Administration. This publication does not constitute a standard, specification or regulation. This report does not constitute an endorsement by the Department of any product described herein.

For individuals with sensory disabilities, this document is available in alternate formats. For information, call (916) 654-8899, TTY 711, or write to California Department of Transportation, Division of Research, Innovation and System Information, MS-83, P.O. Box 942873, Sacramento, CA 94273-0001.

Project Title:
Field Experiment of Variable Speed Advisory (VSA)
Final Report

Contract Number: 65A0587

**California PATH Research Report
UCB-ITS-PRR-2019-02**

Project Team:

Dr. Xiao-Yun Lu – Principal Investigator
John Spring, Cheng-Ju Wu, David Nelson, and Yuheng Kan

California PATH Program
Institute of Transportation Studies
University of California Berkeley
Richmond Field Station, Building 452
1357 S. 46th Street, Richmond, CA 94804-4648

September 25, 2018

Insert Technical Document Page Here

Project Panel

Greg Larson, Caltrans HQ, Division of Research and Innovation,

Tel: (916) 227-8008, email: greg_larson@dot.ca.gov

Gurprit Hansra, Caltrans HQ, Division of Research and Innovation,

Tel: (916) 654-7252, email: gurprit_hansra@dot.ca.gov

Hassan Aboukhadijeh, *Project Manager*, Caltrans Division of Research and Innovation,

Tel: (916)227-6216, email: hassan_aboukhadijeh@dot.ca.gov

Fred Yazdan, Caltrans District 11 Traffic Management Center,

Tel: 858-467-3073, email: fred.yazdan@dot.ca.gov

Shahin Adibi, Caltrans District 11 Traffic Management Center,

Tel: (858) 467-3073, email shahin.adibi@dot.ca.gov

Anush Badii, Caltrans District 11 Traffic Management Center,

Tel: 858 - 467 4337, email: anush.badii@dot.ca.gov

John Spring, PATH, Univ. of California, Berkeley,

Tel: (510) 665-3575, email: jspring@path.berkeley.edu

Cheng-Ju Wu (GSR), PATH, Univ. of California, Berkeley,

Tel: (510) 665-3692, email: chengju@berkeley.edu

David Nelson, PATH, Univ. of California, Berkeley,

Tel: (510) 665-3547, email: dnelson@path.berkeley.edu

Yuheng Kan (VSR), PATH, Univ. of California, Berkeley,

Tel: (510) 665-3647, email: kanyuheng@berkeley.edu

Xiao-Yun Lu, PATH, Univ. of California, Berkeley,

Tel: (510) 665-3644, email: xylu@path.berkeley.edu

Key Words: *traffic detection, traffic speed, congestion, freeway traffic management, field operational test, bottleneck, Variable Speed Advisory (VSA), driver compliance, VSA performance analysis, VMT (Vehicle Miles Traveled), VHT (Vehicle Hours Traveled)*

Abstract

This report documents the field test of Variable Speed Advisory (VSA) which is an Active Traffic Management strategy. The test site for the VSA is on State Route 78 Eastbound (SR-78E) from Vista Village Drive (in the City of Vista) to the freeway interchange point of SR-78E and U.S. Route 15 (in the city of Escondido). This test segment is a three-lane freeway with a posted speed limit of 65 mph and it has 10 on-ramps and 10 off-ramps. The project was funded by the California Department of Transportation (Caltrans) Division of Research Innovation and System Information (DRISI) under Contract Number 65A0587. Real-time traffic detector data including flow, speed, and occupancy from pre-existing loop detectors in the field test site, were transmitted via the internet by engineers at Caltrans District 11 (D11) Transportation Management Center (TMC) to a server located in the offices of California Partners for Advanced Transportation Technology (PATH). This data was then aggregated with real time speed data, captured every 30s [seconds] by radar equipment installed along with solar panel powered LED display equipment, for the display of a VSA, at 7 different sites along a 10.8 mile section of SR 78E. These two sources of data were then processed for the estimation of the overall traffic state along the corridor, which was in-turn used to calculate the VSA for each section in order to maximize overall traffic throughput through recurrent bottlenecks on SR-78E. Calculated VSA values were then rounded to multiples of 5 mph and displayed on the VSA signs. Public outreach was conducted by Caltrans D11 Public Information Office (PIO) to educate the public about the VSA test, and encourage their compliance with posted speed advisories. A publicly accessible website was also developed for the real-time display of Google Traffic, traffic state, and VSAs displayed in the field. This site was used extensively by Caltrans management, the project team, and by the public drivers. After different stages of the system development, integration, and installation process were completed, a progressive test procedure was executed to mitigate any potential negative impacts on traffic operation. This procedure included dry-runs (saving data for analysis without roadside display), error detection, system tuning, preliminary testing, and extensive tests for data collection for four weeks. The results of the performance analysis, conducted with an independent PeMS data set, illustrated an improvement in three performance measures for the AM (6-9AM) peak hours: Vehicle Miles Traveled (VMT) increased by 2.72%; Vehicle Hours Traveled (VHT) decreased by 6.28%, and the average speed over the road segment or $Q=VMT/VHT$ increased by 8.71%. In PM peak hours (2-7PM), two of the three performance measures improved: VMT did not have noticeable improvement; VHT decreased by 1.47% on average; and Q increased by 2.80% on average.

Acknowledgements

This work was performed by California Partners for Advanced Transportation Technology (PATH) at the University of California at Berkeley, in cooperation with the California Department of Transportation (Caltrans), Division of Research & Innovation and System Information (DRISI) through the Interagency Agreement under Contract Number: 65A0587. The contents of this report reflect the views of the author, who is responsible for the facts and the accuracy of the data presented herein. The contents do not necessarily reflect the official views or policies of the State of California.

The authors wish to thank the Project Manager Mr. Hassan Aboukhadijeh of Caltrans DRISI and the members of the project panel for their guidance and strong support during the execution of the project. In particular, the strong technical and other project facilitative support from Caltrans D11 TMC Traffic engineers: Mr. Fred Yazdan (retired), Mr. Shahin Adibi, and Mr. Anush Badii are gratefully acknowledged.

We also would like to acknowledge the efficient and timely help of the engineering staff at TrafficLogix in LaSalle, Quebec. In particular, they changed their product software to meet the project requirements.

Executive Summary

This report documents the work conducted under the California Department of Transportation (Caltrans) Project 65A0587 entitled “Field Experiment of Variable Speed Advisory (VSA),” which is Phase IV of the research program entitled “Combined Variable Speed Advisory and Coordinated Ramp Metering.”

The objective of this project was to conduct a field test of VSA. The test site (Figure 1) for the VSA evaluation was on State Route 78 Eastbound (SR-78E) from Vista Village Drive in the City of Vista to the freeway interchange point of SR-78E, and Interstate 15 (I-15) in the city of Escondido. This test segment is a three-lane freeway with a posted speed limit of 65 mph and it has 10 on-ramps and 10 off-ramps.

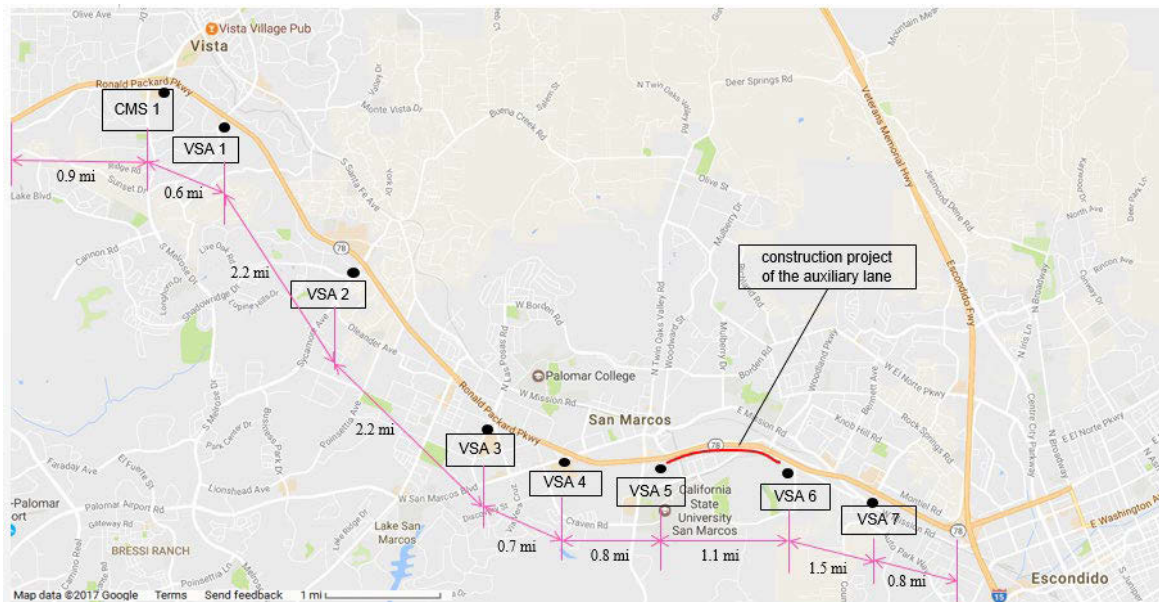

Figure 1 Overview of system scope, VSA sign and Changeable Message Sign (CMS) locations, and the Construction Area

The selection of this site was based on several factors, including: (a) the roadway had high traffic volume in both AM and PM peak hours, and the roadway impacted by congestion is within the test section range most of the time; (b) the roadway had multiple bottlenecks without fixed locations, with the exception of the most downstream bottleneck which is close to VSA 7 in Figure 1; and (c) there was no significant traffic congestion back propagation from the SR 78 / I-15 interchange and therefore, the traffic on the SR-78E test section appeared to be independent from other intersecting highways.

The following is a list of the main activities conducted in the project, in roughly chronological order, which will then be briefly described:

- Finalizing the Concept of Operations (ConOps);
- Developing and simulating the VSA algorithm;
- Developing a field test plan;

- Developing a website;
- Conducting public outreach;
- Developing the system in hardware and software, and integrating it all into a tightly coupled system;
- System installation in the field;
- System dry-run and preliminary tuning.

The ConOps provides a blueprint for the project as well as describes the overall structure of the VSA system including hardware, software, data processing, and VSA algorithms, the roadside infrastructure relevant to the system, data flows, VSA signs and their display, etc. The ConOps underwent progressive and iterative revision as development progressed toward a fully integrated system.

The VSA algorithm implemented in the field was new and different from all previous freeway traffic speed control strategies. The algorithm is called the *backwards-progressive, throughput-maximization algorithm*. The basic idea is to maximize the throughput from the most downstream bottleneck to the upstream, progressively in space, to cover all of the affected sections. For each of the 7 sections, the desired advisory speed is determined - based on the occupancy measurement of 2-3 sections immediately downstream of location of the speed advisory sign. The speed advisory is calculated to be the flow which feeds the downstream sections with traffic that is close to, or slightly below, the average capacity for these downstream sections. This approach was chosen for the simplicity of its implementation and the ability to address multiple non-recurrent bottlenecks. The algorithm was also evaluated through a simulation prior to field implementation.

A detailed Field Test Plan was very important to the project team as well as to the D-11 traffic engineers. For the project team, the field test plan described what was to be done, how to legally and safely conduct the field test, and in what timeframe. This plan allowed the local traffic engineers to provide technical support, facilitated the approval of permits from District 11 management, as well as supported public outreach.

The real-time website, developed by the project team, included a Google real-time traffic map of the test corridor that displayed a variety of real time information including a color-coded real-time traffic situation display, traffic detector data, aggregated 30s radar speed data from the VSA signs, fused speed profiles calculated by combining/fusing radar speed and traffic detector speed, and the VSA actually displayed at each sign. The website turned out to be very helpful for traffic and detector data observation, system tuning, and traffic management.

Public outreach was very important for the success of the field test as it was critical for public drivers to follow the advisory speed displayed on the roadside signs. Outreach was primarily conducted by the Caltrans District 11 Public Information Office (PIO) through their website as well as through presentations at public meetings. In addition, the most upstream CMS information displayed on the roadside also advised the drivers to “Follow Advisory Speed” which had a positive impact as well.

Development of the **system hardware and software** and its final integration, consumed a significant amount of time and effort during the project. Commercially available equipment could

not satisfy the system requirements and as a result, the project team was forced to develop custom components. Further, the need to remotely control the VSA display on a 30 second update cycle involved significant firmware and backend development by the provider of the displays (Traffic Logix). The hardware included the central control computer physically located at the California Partners for Advanced Transportation Technology (PATH) facilities, VSA signs in the field for displaying the VSA and for traffic speed detection, trailers for mounting the VSA signs to be installed on the roadside legally and safely by meeting roadside equipment standards of Caltrans, solar panels to be mounted together with the VSA signs to provide adequate power for the display, and wireless modem communication between the VSA signs and the Traffic Logix server in Quebec, Canada.

The dry-run was a very important stage of the development process that was completed prior to field test initiation. During the dry-run, the fully integrated system operated at full capacity capturing, communicating, saving data, and performing analysis, although without the operation of the VSA display. The dry-run was conducted in several stages in this project to make sure that (a) all the input traffic data were correctly mapped, (b) data processing and traffic state parameter estimation were error-free, (c) the VSA algorithm produced what was expected, (d) the correct VSA value was sent to the display at each VSA sign location, (e) the modem link between the PATH central control computer and the VSA sign was reliable, and (f) the website displays of traffic state parameters, Google color-coded traffic situation, and the VSA at each location were correct and synchronized.

System installation in the field was not a simple task since the traffic on the freeway was always moving and installing roadside equipment under live conditions raised safety concerns. Installation was conducted successfully with the full support of Caltrans D11 Traffic Management Center (TMC) traffic engineers utilizing appropriate equipment.

Following equipment installation, the system was tuned using an iterative process. This process included (a) the direct observations of the VSA website for traffic data and actual traffic flow using the Google Traffic Application Program Interface (API), and (b) personally driving along the freeway corridor, observing actual traffic and comparing these observations with raw, real time data from Caltrans' Performance Measurement System (PeMS), and radar measurements from the VSA signs as well as comparing observations and raw data with the speed advisories produced from the VSA algorithm. The system tuning also incorporated the observations and comments from Caltrans D11 traffic engineers to make sure the VSA was reasonable from their traffic operation viewpoint. This iterative process took more time than previously planned.

The formal test and data collection was conducted between April 9 and May 4. The collected data included raw traffic data (occupancy, flow, and speed) from loop detectors, radar speed data from VSA signs, and fused traffic state parameters from the VSA algorithm. This data was collected for VSA algorithm and driver compliance analysis, but not for performance analysis.

Performance analysis was conducted using an independent, objective and readily available data set (the PeMS hourly data). Three different PeMS performance measures were used including Vehicle Miles Traveled (VMT), Vehicle Hours Traveled (VHT), and $Q=VMT/VHT$. The PeMS data from April 9 – May 4 was used for the “VSA-ON” scenario. The data for the two weeks, i.e. March 12 – 16 (VSA signs were not installed) and May 7 - 11 (VSA signs were taken out) were used as the “VSA-OFF” scenario.

The **results of the performance analysis** illustrated an improvement in all three PeMS performance measures. During the AM (6:00-9:00AM) peak hours, VMT increased by **2.72%**, VHT decreased by **6.28%**, and Q increased by **8.71%**. In PM peak hours (2:00-7:00PM), two of the three performance measures improved. VMT did not have noticeable improvement, while VHT decreased by **1.47%** on average, and therefore Q increased by **2.80%** on average. On SR 78E the PM peak hours experiences higher traffic demand, as well as a greater percentage of non-commuters. These two factors may have had some influence in the lower PM performance improvements. As for driver compliance, it gradually improved as the test progressed and the increase in driver compliance was generally in line with an improvement in system performance.

Table of Contents

Abstract.....	ii
Acknowledgements.....	iii
Executive Summary.....	iv
Table of Contents.....	viii
List of Figures and Tables.....	x
List of Acronyms and Abbreviations.....	xiii
1 Introduction.....	1
1.1 Background.....	1
1.2 Project Overview.....	3
1.3 Report Organization.....	4
2 Variable Speed Advisory (VSA) Algorithm Design.....	5
2.1 VSA Algorithms for Bottleneck Flow Maximization.....	5
2.2 Freeway Corridor VSA Algorithm Based on Distance.....	8
2.3 Semi-Globally Looking-Ahead VSA Algorithm.....	9
2.4 Summary of Algorithm.....	13
3 Microscopic Traffic Simulation of Variable Speed Advisory.....	14
3.1 Simulation Development.....	14
3.2 Simulation Model Build Up.....	14
3.3 Calibration of the Simulation Model.....	16
3.4 Performance Evaluation in Simulation Model.....	21
4 Variable Speed Advisory (VSA) System Field Implementation.....	22
4.1 Concept of Operations.....	22
4.2 System Hardware Development.....	24
4.3 System Software.....	26
4.4 Modified Traffic Logix Safespace 650 Variable Message Sign.....	27
4.5 Software Architecture.....	27
5 Traffic Data Processing and State Parameter Estimation.....	30
5.1 Test Site and Available Data Description.....	30
5.2 Data Cleansing Procedures.....	32
5.3 Data Cleansing Results.....	34
6 Field Test.....	40
6.1 Field Test Plan.....	40

6.2	VSA Sign Locations.....	41
6.3	VSA Website Development	42
6.4	The Information Displayed	43
6.5	Field Test.....	51
6.5.1	System Preparation	52
6.5.2	Dry-Run	52
6.5.3	Initial Test and System Tuning.....	53
6.5.4	Field Tests and Data Collection.....	53
6.5.5	Test Progress Update to the Project Panel	54
6.6	Conclusion and Lessons Learned.....	54
7	VSA Field Test Performance Analysis	56
7.1	Introduction	56
7.2	Baseline Average Hourly Traffic Performance Over All Weekdays for “VSA OFF” Scenario.....	56
7.3	Baseline Traffic Hourly Performance for All Weekdays for “VSA- ON” Scenario	57
7.4	Individual Week Performance Comparison	57
7.5	Hourly VSA Performance Averaged Over 4 Weekdays	61
7.6	Average VSA Hourly Performance Over All Weekdays and Over Hours	61
8	Public Driver Compliance Analysis.....	63
8.1	Introduction	63
8.2	Literature Review.....	63
8.2.1	Field deployment and evaluation	63
8.2.2	Simulations for effect analysis.....	65
8.3	Compliance Rate Definition.....	66
8.4	Field Experiment Site.....	67
8.5	Compliance Rate Analysis	68
8.5.1	Basic performance	68
8.5.2	The effect of Compliance rate on traffic flow	71
8.5.3	Further analysis.....	72
8.6	Conclusion.....	75
9	Concluding Remarks and Future Research.....	76
9.1	Test Summary	76
9.2	Lessons learned	76
9.3	Future research	77
	References:.....	78

List of Figures and Tables

Figure	Page
1.1 Overview of system scope and VSA signs	3
3.1 Aimsun API structure	14
3.2 Geometric layout of the test site SR-78E in Aimsun	15
3.3 Ramp metering rule in Emerald Drive to SR-78E	15
3.4 The most upstream mainline flow of the model	17
3.5 On-ramp flow of the model.....	17
3.6 Off-ramp split ratio of the model	18
3.7 On-ramp flow calibration results	19
3.8 Off-ramp flow calibration results.....	20
3.9 Mainline flow calibration results	20
4.1 The original overall system structure for VSA Test on SR-78 (ConOps)	22
4.2 Overview of system scope	23
4.3 The actually implemented ConOps.....	24
4.4 VSA sign; Trailers for mounting VSA signs and solar panel.....	25
4.5 Enhanced mast-base sleeve design for robust mounting	26
4.6 VSA sign and solar panel wire connection	26
4.7 Traffic Logix Safespace 650 Variable Message Sign on the roadside.....	27
4.8 Software Architecture of the Variable Speed Advisory system	28
5.1 SR-78E Network configuration and VDS deployment.....	31
5.2 SR-78E speed contour, March 14, 2018	32
5.3 Aggregated flow during April 11, 2018 evening peak hours from 2PM to 7PM.....	36
5.4 Aggregated occupancy during April 11, 2018 evening peak hours from 2PM to 7PM .	37
5.5 Aggregated loop speed, radar speed, and fused speed Apr 11, 2018 evening peak	38
5.6 Aggregated density during April 11, 2018 evening peak hours from 2PM to 7PM.....	39
6.1 Overview of VSA sign locations and the Construction Area	41
6.2 Advisory Speed number and message: “Slow Down” were designed for VSA signs....	44
6.3 VSA Website Example	45

6.4 VSA and traffic observation at the website for April 5th at 7:20PM	46
6.5 VSA and traffic observation at the website for April 12th at 8:10AM.....	47
6.6 VSA and traffic observation at the website for April 17th at 5:19PM	48
6.7 VSA and traffic observation at the website for April 18th at 8:19AM.....	49
6.8 VSA and traffic observation at the website for May 1st at 8:51AM	50
6.2 Timeframes for progressive VSA field test and data usage.....	54
8.1 Trendline of the percentage of satisfactory compliance hours	69
8.2 Trendline of freeway operational mobility and safety	71
8.3 The trendline of congestion period and compliance	72
8.4 Traffic state developing under VSA control.....	73
8.5 Compliance rate distribution of each case	74

Table	Page
3.1 Calibration Ranges of Parameters.....	16
3.2 Occupancy based VSA with occupancy threshold 12%.....	21
5.1 VSA locations and its minimum and maximum advisory speed	32
6.1 VSA sign GPS locations, crossing road and relevant cities.....	42
Table 6.2 Timeframes for progressive VSA field test and data usage.....	52
7.1 Summary of both AM and PM hourly VHT, VMT and Q for March 12-16, 2018.....	56
7.2 Summary of both AM and PM hourly VHT, VMT and Q for May 7- 11, 2018.....	56
7.3 Summary of both AM and PM hourly VMT during VSA test	57
7.4 Summary of both AM and PM hourly VHT during VSA test.....	57
7.5 Summary of both AM and PM hourly Q during VSA test	57
7.6 Four-weeks average of hourly performance parameters during VSA test.....	57
7.7 hourly comparison of week 4/9-4/13 (VSA-ON) to 3/12-3/16 (VSA-OFF), 2018	58
7.8 hourly comparison of week 4/9 -4/13 (VSA-ON) to 5/7 – 5/11 (VSA-OFF), 2018.....	58
7.9 hourly comparison of week 4/16 -4/20 (VSA-ON) to 3/12-3/16 (VSA-OFF), 2018	58
7.10 hourly comparison of week 4/16 -4/20 (VSA-ON) to 5/7 – 5/11 (VSA-OFF), 2018...	59
7.11 hourly comparison of week 4/23 -4/27 (VSA-ON) to 3/12-3/16 (VSA-OFF), 2018 ...	59
7.12 hourly comparison of week 4/23-4/27 (VSA-ON) to 5/7 – 5/11 (VSA-OFF), 2018....	60
7.13 hourly comparison of week 4/30 -5/4 (VSA) to 3/12-3/16 (VSA-ON), 2018.....	60
7.14 hourly comparison of week 4/30 – 5/4 (VSA-ON) to 5/7 – 5/11 (VSA-ON), 2018.....	60
7.15 4-week average hourly performance over 4-week compared to March 12-16, 2018 ...	61
7.16 4-week average hourly performance over 4-week compared to May 7-11, 2018	61
8.1 Four Weeks Relative Discrepancy [%].....	70
8.2 The mean and standard deviation for each case distribution	75

List of Acronyms and Abbreviations

ATM	Active Traffic Management
Caltrans	California Department of Transportation
CMS	Changeable Message Sign
CRM	Coordinated Ramp Metering
CTM	Cell Transmission Model
DRISI	Caltrans Division of Research, Innovation and System Information
EAR	Exploratory Advanced Research
FD	Fundamental Diagram
FHWA	Federal Highway Administration
GPL	General Purpose Lane
HERO	HEuristic Ramp metering coOrdination
HOV	High Occupancy Vehicle
LED	Light-Emitting Diode
LP	Linear Programming
LQI	Linear Quadratic Control with Integral Action
LRRM	Local Responsive Ramp Metering
LWR	Lighthill-Witham-Richards
METANETA	second order traffic model including speed and density as state variables
MPC	Model Predictive Control
NGSIM	Next Generation Simulation
OFR	Exit ramp
ONR	Entrance ramp
PATH	California Partners for Advanced Transportation Technology
PeMS	Performance Measurement System
PIO	Public Information Office of Caltrans local district TMC
PM	Postmile
RM	Ramp Metering
RMSE	Root Mean Square Error
RMSP	Root Mean Square Percentage
RTMC	Regional Traffic Management Center

SR	State Route
SVO	Speed, Volume, Occupancy
SWARM	System-Wide Adaptive Ramp Metering
TD	Total Delay
TMC	Traffic Management Center
TOD	Time-of-Day
TOPL	Tools for Operations Planning
TNOS	Total Number of Stops
VMT	Vehicle Miles Traveled (=Total Travel Distance)
TTS	Total Time Spent
VHT	Vehicle Hours Traveled (=Total Travel Time)
VDS	Vehicle Detector System
VII	Vehicle Infrastructure Integration
VMS	Variable Message Signs
VSA	Variable Speed Advisory
VSL	Variable Speed Limit

1 Introduction

This report documents the work conducted under the California Department of Transportation (Caltrans) Project 65A0587 entitled “Field Experiment of Variable Speed Advisory (VSA),” which is part of the project entitled “Combined Variable Speed Advisory and Coordinated Ramp Metering.” The reports of the previous phases are referred to PATH internal report [36, 37].

The project was sponsored by Caltrans and undertaken by the California Partners for Advanced Transportation Technology (PATH), of the University of California, Berkeley. The project duration was 24 months from 6/15/2016 to 6/15/2018.

1.1 Background

Traffic flow through a freeway corridor is primarily determined by the limits on flow established at its bottlenecks. Stationary bottlenecks can be created in several ways, including construction, accidents, the physical characteristics of the roadway (narrowing, hills), and rubbernecking. Consequently, efforts to increase traffic flow often focus on increasing bottleneck throughput, especially during peak hours.

To maximize traffic flow through a bottleneck, it is necessary to guide traffic into the bottleneck at a rate that reduces or mitigates congestion and shockwave development upstream of this bottleneck. The most effective approach, used to mitigate congestion, varies based upon the current conditions of traffic and if congestion has already been established. When traffic is not yet congested, speed harmonization initiated upstream of a bottleneck can effectively delay the start of traffic congestion.

Under congested conditions, the ideal goal is to maintain a stable flow in the corridor. This is accomplished by managing the traffic flow rate, upstream of the bottleneck, at or below the bottleneck capacity flow. If this can be achieved, traffic queues or shockwaves propagating upstream of the bottleneck will be reduced or avoided which produces safety benefits. However, achieving this goal is rather challenging. Due to significant differences in driver behavior, demands from the upstream mainline and on-ramps and off-ramps, the traffic itself tends to be inhomogeneous. Further complicating matters, a freeway corridor usually has multiple bottlenecks, which establishes additional constraints on the selected approach.

Variable Speed Advisory and Variable Speed Limits (VSA/VSL) are Active Traffic Management strategies with the goal of affecting driver behavior on freeway mainlines. These strategies have the potential to manage and minimize congestion in corridors that have bottlenecks, by dynamically managing traffic speed. VSA relies on voluntary compliance by the traveling public using posted speed advisories that vary with conditions. VSL relies on mandatory, enforced speed compliance. Both of these approaches rely on information about current traffic conditions and the use of algorithms to recommend appropriate speeds for drivers. VSL has been applied to freeway traffic control for many years in the UK and other parts of Europe. In the US, where the voluntary compliance approach is preferred (VSA), only limited evaluation of its efficacy has been performed. VSA has not been previously implemented and evaluated in California prior to this project.

Variable speed limit systems affect traffic flow by changing driver behavior.

The main objectives of VSLs include bottleneck flow maximization and speed homogenization upstream of the bottleneck to reduce/avoid shockwave, which may improve safety. Several open-

loop algorithms have been developed in simulation and practice [2, 3]. It has been verified that the major accident rates decrease 20%-30% using VSL in practice [4, 5]. Various algorithms have indicated that VSLs have a positive effect on improving freeway efficiency during simulation testing, such as the early algorithm called SPECIALIST[6], feed-back control [7], on-line optimization algorithms [8, 9], and combining with ramp metering [10, 11], although very limited field experimental results have been reported for mobility improvement [12, 13]. This may be due to inappropriate algorithms and/or low driver compliance in practice.

Driver compliance plays a significant role in the VSL performance. However, due to the lack of practical data, very limited empirical evidence is reported regarding quantification of the operational mobility and safety impacts of VSL, in particular, VSA. Only a few countries with enforced VSL technologies, such as cameras for license plate recognition, evaluated each vehicle's response to the posted speed. The simulations conducted by past researchers ideally assumed low, medium or high compliance for impact investigation.

The main contribution of this effect is driver compliance rate analysis based on experimental data for VSA field tests on a 10.8-mile corridor along SR-78E in San Diego, California, USA. The advisory speed was displayed on roadside VSA signs along the corridor. Each VSA sign was also outfitted with microwave radar for traffic speed detection with aggregated 30s output data. The signs were connected indirectly to the central control computer and transmitted 30s data to the manufacturer's server, from which we polled for new traffic data. The control channel was the exact reverse of this process. The VSA was then transmitted to Traffic Logix, which was then forwarded directly to the sign. The central control computer also retrieved traffic data from the corridor, estimated traffic state parameters, calculated a VSA for each section and sent it to the field for display. These processes were repeated every 30s in real-time. The relative discrepancy used for evaluation was defined as the ratio of the difference between the posted VSA and measured/estimated traffic speed, and the VSA. This compliance rate is based on available data. It describes the discrepancy between the posted speed and real measured/estimated speed at the VSA signs.

Extensive review of VSA/VSL is referred to in [2]. The review included algorithm development, simulation, and field implementation with and without enforcement. The authors concluded that most previous tests or implementation cases of VSL/VSA focused on safety improvement rather than mobility improvement.

As reviewed in [2], the project team had developed an algorithm in a project under a previous Federal Highway Administration (FHWA) Exploratory Advanced Research (EAR) Program, in which traffic response was simulated for several traffic networks including I-80 westbound near the MacArthur Maze, I-880 northbound in Fremont, and I-66 eastbound inside the Beltway in Washington, D. C. All of the simulations indicated significant improvements in Total Travel Time reduction for freeway traffic with bottlenecks.

For the current project, the algorithm has been further simplified and generalized to one freeway corridor with multiple bottlenecks. However, the principal idea was similar to that developed in [2]. For the most downstream bottleneck, feedback control is utilized to maximize bottleneck flow. This approach tries to regulate the bottleneck flow close to its capacity flow. The same idea was applied to all of the upstream sections, which is different from the previous algorithm developed in [2] and also different from other algorithms published in the literature.

1.2 Project Overview

The objective of this project is to determine the potential for Variable Speed Advisories (VSA) to improve mobility in a congested corridor. This project would be conducted through a field test, on State Route 78 Eastbound (SR-78E) in Caltrans D11. This site was selected through judicious traffic data analysis to be described in this report. Figure 1.1 below shows the system scope, road geometry, planned VSA sign locations and construction area.

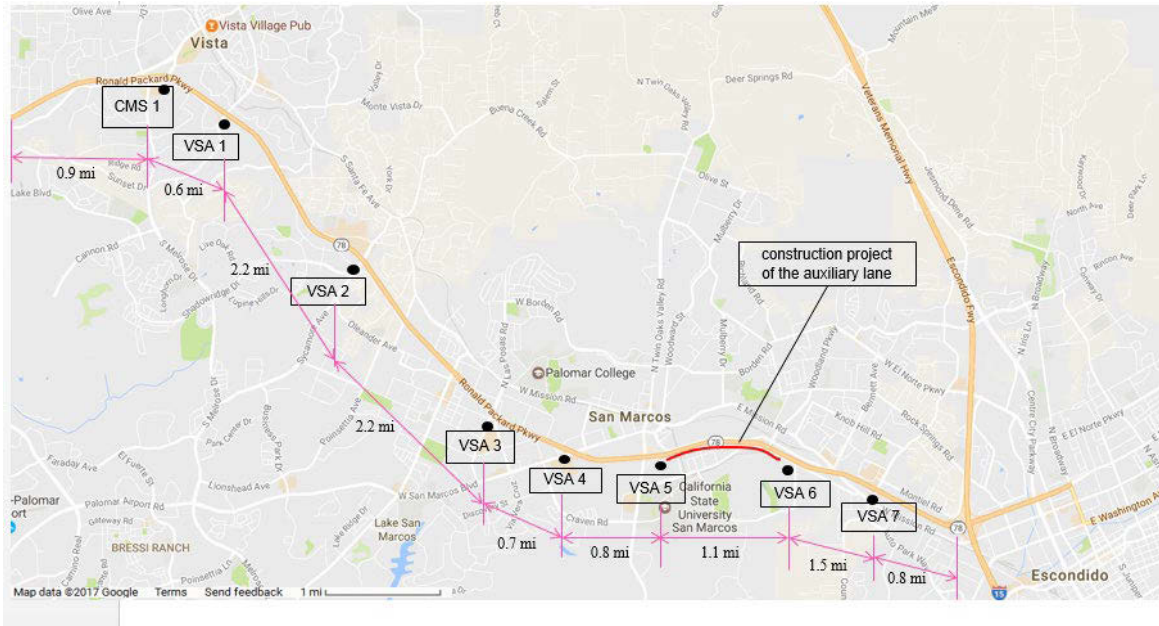

Figure 1.1 Overview of system scope, VSA sign and CMS locations, and the Construction Area

The main tasks of the project involved:

- (1) Preparation of the traffic control algorithm for field implementation. Control parameters were selected for implementation using a traffic microscopic simulator. The algorithm was then tuned, upon its initial implementation in the field on the installed VSA signs.
- (2) Retrieving real-time traffic data from two sources, processed to improve data quality and fused for use by the algorithm.
- (3) Developing a method for evaluating driver compliance with speed advisories as identified through a literature search and subsequent development efforts.
- (4) Finalizing the Concept of Operations (ConOps). This planning document was also used as a tool to communicate project expectations and processes to all stakeholders involved in the field test.
- (5) Develop and implement the VSA system. Hardware components were specified and procured, software components were developed. The hardware components were assembled and integrated and included a mobile power generation system, data communication, and a central computer. Finally, the resultant system was deployed, tested and debugged.
- (6) Develop an approach for project outreach specific to this project so that the public could

better understand the intent of the project to ensure the effectiveness of the field test. A web site was also developed to aid in the public's understanding of the project. PATH worked closely with Caltrans D11 to develop a detailed test plan and information was also provided to the public through the D11 Public Information Office (PIO) website. Finally, a Changeable Message Sign (CMS) was located further upstream, the mainline, near Vista Village on-ramp announcing the VSA test.

- (7) Launching the field test in a staged, gated manner of increasing complexity called our 'Progressive Field Test' approach. Using a planned progressive test process, we were able to manage project risks and mitigate the potential for any impact on traffic, since the VSA display could directly affect driver behavior. Therefore, upon conclusion of each stage of the integration process the project team conducted dry-run testing, which was meant to run all the processes available without an operational VSA display. Testing and performance evaluation progressed through several rounds of system tuning, D11 Traffic Engineer evaluation, and performance improvements. Following the final stage of system tuning, a formal field operational test was initiated with full data collection.
- (8) Evaluation of the performance of the VSA system was conducted. In order to be objective, the project team used Performance Measurement Systems (PeMS) hourly data of Vehicle Hours Traveled (VHT) and Vehicle Miles Traveled (VMT) to analyze VSA system performance, since this data set was independent from that collected by the project team.

1.3 Report Organization

This report is organized as follows: Chapter 2 documents the candidate algorithms developed; Chapter 3 presents the microscopic simulation and results conducted in the project before field implementation; Chapter 4 describes the VSA system field implementation including hardware and software; Chapter 5 is devoted to traffic data processing and state parameter estimation; Chapter 6 describes progressive system tuning and the field test; Chapter 7 focuses on system performance analysis in traffic improvement; Chapter 8 studies the driver compliance rate using the field data recorded by the project team; and Chapter 9 ends the report with a brief set of conclusions and recommendations for the next steps.

2 Variable Speed Advisory (VSA) Algorithm Design

In this chapter, VSA algorithms are described, that were adopted for microscopic traffic simulation (with the network model) of the State Route 78 (SR-78) field test section. Results of the simulation determined the most promising algorithm for field implementation and test. This algorithm is applicable for implementation on any freeway corridor.

2.1 VSA Algorithms for Bottleneck Flow Maximization

The first step in the application of a VSA algorithm is to determine the VSA for the most congested component of that corridor – the worst bottleneck. Once this is established, speed advisories are then developed for adjacent sections of the corridor, both upstream and downstream of the dominant bottleneck. This is the approach taken in our previous work [1], where we determined the VSA at all the bottlenecks and then determined the VSA at other locations by distance-based interpolation. One advantage of this approach is its simplicity for implementation. Another advantage is that the distance-based approach naturally harmonizes the traffic, since the vehicles would approach the bottleneck gradually, and this would reduce/avoid shockwaves.

Speed advisories can be determined from any of the following four traffic regulators, which are simple feedback control algorithms that can be applied to the most downstream bottleneck, operating close to its capacity. We describe each approach and then select the best approach for the VSA algorithm.

Flow based Regulator:

The objective of flow-based regulation, in the context of a VSA, is to appropriately adjust the feed-flow immediately upstream of the bottleneck, in real-time, such that the flow in the bottleneck is close to its capacity flow.

To regulate the bottleneck feeding flow to the capacity flow:

$$u_M(k) = u_M(k-1) + \gamma \cdot \min\left\{\left(Q_b - \bar{q}_M(k)\right), \bar{v}_{M+1}(k) \cdot \left(\rho_c - \bar{\rho}_{M+1}(k)\right)\right\} \quad (\text{Eq. 2.1})$$

Where:

$u_m(k)$ – speed control variable immediate upstream of the bottleneck, to be determined.

γ – control gain

Q_b – capacity flow of the bottleneck which is determined empirically

$\bar{q}_M(k)$ – measured/estimated average flow at the immediate upstream of the bottleneck

$\bar{v}_{M+1}(k)$ – measured/estimated speed in the bottleneck

ρ_c – critical density

$\bar{\rho}_{M+1}(k)$ – measured/estimated density in the bottleneck

To implement this algorithm, the choice of the bottleneck capacity Q_b – is very critical. Usually, it should be chosen as slightly lower than the actual, maximum flow for sustainable operation, observed in the field.

Density Based Regulator:

Similarly, the objective of density-based regulation, in the context of a VSA, is to appropriately adjust the traffic density immediately upstream of the bottleneck, in real-time, such that the density in the bottleneck is close to the critical density.

$$u_M(k) = u_M(k-1) + \begin{cases} \zeta_1 \cdot (\rho_c - \bar{\rho}_{M+1}), & \text{if } \bar{\rho}_{M+1} < \rho_c \\ \zeta_2 \cdot (\rho_c - \bar{\rho}_{M+1}), & \text{if } \bar{\rho}_{M+1} > \rho_c \end{cases} \quad (\text{Eq. 2.2})$$

where $\zeta_1, \zeta_2 > 0$ are control gains.

Two control gain parameters may be utilized in density-based regulation, to adapt the regulator to differences in the traffic situations. This provides greater flexibility in the adjustment of parameters to avoid control oscillations. This regulator is intended for use in situations where traffic density can be estimated reasonably well, which is the case if the road section is covered by a series of video cameras. To implement a density-based regulator the choice of the bottleneck critical density ρ_c is very important, which is suggested to be 100 ~ 110, depending on vehicle types and the estimation accuracy.

Occupancy Based Regulator:

In practice, the density can be replaced with one based on occupancy, and the critical density parameter would be replaced with critical occupancy:

$$u_M(k) = u_M(k-1) + \begin{cases} \zeta_{o1} \cdot (O_c - o_{M+1}), & \text{if } o_{M+1} < O_c \\ \zeta_{o2} \cdot (O_c - o_{M+1}), & \text{if } o_{M+1} > O_c \end{cases} \quad (\text{Eq. 2.3})$$

Where:

$\zeta_{o1}, \zeta_{o2} > 0$ are control unitless gains

O_c – critical occupancy

o_{M+1} – measure/estimated occupancy in the bottleneck

Similar to density-based regulation, two control gain parameters may be utilized in an occupancy-based regulation. This provides flexibility to adapt to differences in traffic, as well as for implementing anti-windup strategies - to avoid control oscillations. This algorithm is intended for the situation when the occupancy is the principal detection approach used to identify a traffic bottleneck. This is the case in California, where the road sensor is an inductive loop detector. To implement this algorithm, the choice of the bottleneck critical density O_c is very important.

Usually, it should be chosen to be around 12%. Of course, the density measurement also depends on the health of the loop detector data.

Speed Based Speed Regulator:

Instead of using occupancy-based regulator, for feedback control, we propose to use a speed-based feedback. It can be stated as:

- The speed in the bottleneck $\bar{v}_m(k)$ (assuming section m is a bottleneck, indexed from most downstream to the most upstream [1]) is measured with fixed sensors (such as loop detectors or side-fire radar) and filtered with a low-pass filter (to be discussed later - for smoothing the traffic with the objective of reducing speed variations);
- The advisory speed at the bottleneck section, $u_m(k)$, can then be determined:

$$u_m(k) = \alpha_m \cdot \bar{v}_m(k) \quad (\text{Eq. 2.4})$$

$\alpha_m \in [1.1, 1.5]$; default value: $\alpha_m = 1.3$

- Then the VSA at the immediate upstream section relative to the bottleneck is determined by

$$u_{m+1}(k) = \begin{cases} V_{free}, & \text{if } \bar{o}_m(k) < O_{sw} \\ \beta_m \cdot \bar{v}_m(k), & \text{if } \bar{o}_m(k) \geq O_{sw} \end{cases} \quad (\text{Eq. 2.5})$$

$\beta_m \in [0.7, 0.9]$; default value: $\beta_m = 0.8$

Where:

V_{free} - free-flow speed which is the speed measured at critical occupancy, prior to traffic breakdown;

The occupancy measurement, $\bar{o}_m(k)$, is the measured occupancy in bottleneck section;

O_{sw} - the switching threshold of occupancy close to the capacity flow (suggested value for O_{sw} : 10.0~12.5%);

and β_m - the control gain parameter.

This regulator is intended to delay traffic breakdown as well as improve traffic throughput during peak periods. The threshold for occupancy for field implementation will need to be tuned based on sensor characteristics.

This regulator can be implemented if both traffic speed and occupancy can be measured or estimated. This is the case if the road sensor detection station has dual inductive loop detectors, which is the case for most California freeways. The dual loop detector station by itself is good for vehicle length and speed estimation.

Now we need to determine the desired speed for all the cells upstream of the bottleneck.

2.2 Freeway Corridor VSA Algorithm Based on Distance

Once the VSA of the most downstream bottleneck has been determined, the next step is to determine the VSA for sections of the corridor, upstream of this bottleneck. Through traffic data analysis based on sensors, one can determine the location of sustainable, free-flow traffic (in principle) upstream of the bottleneck according to the feedback control approaches described in the last section. The following distance-based interpolation algorithm can then be used for determining the VSA for upstream sections along the freeway corridor, if we consider no other traffic fluctuations in these sections of the corridor. Starting from the most downstream bottleneck, the upstream VSAs are determined as follows:

- Define the freeway network to include coupled recurrent bottlenecks, which means that traffic behaviors of those bottlenecks would affect each other significantly, which can be done through the analysis of PeMS data;
- Traffic at the most upstream and most downstream ends of the freeway network are assumed to be free flow therefore the VSA can be computed. It is clear that this can always be achieved if the system scope is large enough;
- VSA at the bottleneck sections and immediately upstream can be determined by the algorithm in the previous section;
- VSA at other sections in between the bottlenecks and the most upstream and downstream sections can be determined by distance-based interpolation.

The justification for this approach is as follows:

(1) Bottleneck flow determines overall system performance. Since the algorithm is intended to operate the bottleneck at its capacity flow, each bottleneck tries to push traffic forward. The question posed is whether the downstream bottleneck is able to receive it? This will be analyzed as follows:

- If F^u (upstream bottleneck flow) $> F^d$ (downstream bottleneck flow): this can only last for a certain period of time since the section between the two bottlenecks will be filled up; in this case, the downstream bottleneck can still be operated such that $F^d \approx F_c^d$ (downstream bottleneck capacity flow);
- If $F^u \leq F^d$: this can only last for certain period of time, and then $F^u \approx F^d < F_c^d$ which is what one can do; this situation is due to the fact that either the upstream bottleneck demand flow is lower, or F_c^u (upstream bottleneck capacity flow) $< F_c^d$;
- If $F^u \approx F^d$: this is the ideal case for operation;

In summary, the application of the strategy for a freeway network could potentially improve overall system performance in all situations. However, when a section between two bottlenecks being used as storage fills up, it might block an off-ramp which may become a disadvantage. Further analysis will be necessary to optimize and balance traffic storage to maximize all output flows.

- (2) Distance-based interpolation of the VSAs at the bottlenecks has the following advantages:
- Traffic will be smoothed in each section (speed harmonization)
 - VSA can be discretized as a constant in each section for feedback to the driver using a Changeable Message Sign, or can be continuous to be used as set-speed for vehicles with I2V communication and ACC, providing I2V CACC capabilities
- (3) If the freeway has non-recurrent bottleneck(s) caused by incidents that can be detected, the algorithm can also be reconfigured for such a situation

2.3 Semi-Globally Looking-Ahead VSA Algorithm

If the corridor under analysis has multiple recurrent and non-recurrent bottlenecks, the use of a distance-based interpolation is not appropriate for determining the VSA upstream of the dominant bottleneck. Due to uncertainties in demand and driver behavior, bottlenecks located upstream of a dominant bottleneck may significantly reduce corridor throughput and therefore, may not provide the desired inflow for the downstream bottleneck. In addressing this case, we propose the use of a new VSA algorithm, which we will name the ‘semi-globally looking-ahead VSA algorithm’. This algorithm may be applied to any sensor detection approach, including occupancy, flow, speed and density. Since occupancy is the principal detection mode in this project, we will use it to describe the VSA control design as follows.

- (1) Determine the most downstream section ($i=1$) VSA according to Eq. 2.3;
- (2) For section $i > 1$, loop detector speed and radar speed are used to calculate the VSA value as follows in several steps:
 - (a) Using speed data, occupancy data and predetermined speed

$$V_i^{VSA}(k) = \begin{cases} V_i^d(k) - K_i(O_i(k) - O_{i+1}(k)), & \text{if } O_i(k) > O_i^T \\ V_i(k), & \text{else} \end{cases}, i = 1, \dots, N$$

Where:

k is the time step (30 seconds in this field test);

i is the index of the VSA sign;

N is the number of number of freeway sections for which a VSAs is being determined;

O_i is the measured occupancy at the i th VSA;

O_{i+1} is the downstream measured occupancy of the i th VSA;

O_i^T is a threshold value of occupancy at the i th VSA - O_i^T is suggested to be 0.12;

V_{ii} is the measured speed at the i -th VSA [mph];

K_{ii} is a parameter and the suggested value is 0.5-0.7.

V_i^d is the desired speed (in [mph]) at the i th VSA, which is predetermined by the VSA designer. In the field test, V_i^d is designed as a linear trend along the freeway mainline from the most downstream (the recurrent bottleneck location) to the most upstream.

V_i^{VSA} is the displayed speed value on the VSA device.

(b) Using weighted occupancy of next two downstream occupancy

$$V_i^{VSA}(k) = \begin{cases} \frac{\alpha_i}{\omega_i(k)}, & \text{if } O_i(k) > O_i^T, i = 1, \dots, N \\ V_i(k), & \text{else} \end{cases}$$

Where:

α_i is a parameter and

ω_i is weighted occupancy computed as following:

$$\begin{aligned} \omega_i(k) &= p_{i0} O_i(k) + p_{i1} O_{i+1}(k) + p_{i2} O_{i+2}(k), \\ p_{i0} + p_{i1} + p_{i2} &= 1 \end{aligned}$$

A suggested set of parameters is $(p_{i0}, p_{i1}, p_{i2}) = (0.5, 0.3, 0.2)$.

Suppose the maximum flow f_i of the mainline is 1800 vehicle per hour per lane. We want to regulate flow at 80% of the maximum flow, that is $0.8 \times 1800 = 1440$. Suppose vehicle density can be estimated by a constant k_i^{occ} times occupancy, that is $\rho_i = k_i^{occ} O_i$ and $k_i^{occ} = 1.6$. The operation speed can be calculated by:

$$V_i^{VSA} = \frac{0.8 \times f_i^{max}}{k_i^{occ} O_i} = \frac{\alpha_i}{O_i}$$

Therefore, α_i can be calculated as

$$\alpha_i = \frac{0.8 \times f_i^{max}}{k_i^{occ}} = \frac{0.8 \times 1800}{1.6} = 900$$

(c) Calculate the weighted occupancy of the next M occupancy values of the downstream sections. This is a general version of using the weighted occupancy of the next two downstream occupancies:

$$V_i^{VSA}(k) = \begin{cases} \frac{\alpha_i}{\omega_i(k)}, & \text{if } O_i(k) > O_i^T, i = 1, \dots, N \\ V_i(k), & \text{else} \end{cases}$$

Where:

α_i is a parameter, and

ω_i is the weighted occupancy computed as follows:

$$\begin{aligned} \omega_i(k) &= p_{i0} O_i(k) + p_{i1} O_{i+1}(k) + \dots + p_{im} O_{i+m}(k), \\ p_{i0} + p_{i1} + \dots + p_{im} &= 1 \end{aligned}$$

(d) Choosing weight factor as follows. There are two approaches:

- The following emphasizes the high occupancy downstream

$$p_{ij} = \frac{\omega_j}{\sum_{k=i}^M \omega_k}, \quad j = i, i+1, \dots, M$$

- The following puts a higher weight on the high occupancy downstream:

$$p_{ij} = \frac{\omega_j^2}{\sum_{k=i}^M \omega_k^2}, \quad j = i, i+1, \dots, M$$

- (e) Using the weighted speed of the next two downstream speeds

$$V_i^{\text{VSA}}(k) = \begin{cases} \beta_i V_i^w(k), & \text{if } O_i(k) > O_i^T \\ V_i(k), & \text{else} \end{cases}, \quad i = 1, \dots, N$$

Where:

β_i is a parameter, and

V_i^w is weighed speed computed as follows:

$$V_i^w(k) = p_{i0} V_i(k) + p_{i1} V_{i+1}(k) + p_{i2} V_{i+2}(k),$$

$$p_{i0} + p_{i1} + p_{i2} = 1$$

A suggested set of parameters is $(p_{i0}, p_{i1}, p_{i2}) = (0.5, 0.3, 0.2)$.

- (f) Calculate the weighted speed of the next M downstream sections

This is a general version of using weighted speed of the next two downstream speeds

$$V_i^{\text{VSA}}(k) = \begin{cases} \beta_i V_i^w(k), & \text{if } O_i(k) > O_i^T \\ V_i(k), & \text{else} \end{cases}, \quad i = 1, \dots, N$$

Where:

β_i is a parameter, and

V_i^w is weighed speed computed as follows:

$$V_i^w(k) = p_{i0} V_i(k) + p_{i1} V_{i+1}(k) + \dots + p_{im} V_{i+m}(k),$$

$$p_{i0} + p_{i1} + \dots + p_{im} = 1$$

- (g) Check all downstream free flow conditions

The VSA algorithm has a rule to determine if all downstream is in free flow speed or near free flow speed, such that the driver in the upstream can drive at a proper speed. The following rule is placed after $V_i^{\text{VSA}}(k)$ calculation. If occupancy of VSA i and all downstream occupancies of VSA i are less than a certain value, the calculated $V_i^{\text{VSA}}(k)$ will be overwritten by a proper speed value.

if (occupancy of VSA $i < 0.2$ and all downstream occupancies of VSA $i < 0.2$) {

$$V_i^{\text{VSA}}(k) = 45$$

```

} else if (occupancy of VSA i < 0.15 and all downstream occupancies of VSA i < 0.15) {
     $V_i^{VSA}(k) = 55$ 
} else if (occupancy of VSA i < 0.12 and all downstream occupancies of VSA i < 0.12) {
     $V_i^{VSA}(k) = 65$ 
} else {
    // do nothing, use calculated  $V_i^{VSA}(k)$ 
}

```

(3) Bound Limit: After the determination of the VSA for each upstream section as above, it is necessary to add some bound limit for the change of VSA between two consecutive locations at each time step, and at consecutive time steps at the same location. This can be achieved as follows:

- For each location, compared to the previous time step:

```

if  $V_i(k) > V_i(k-1) + 20$ 
}
 $V_i(k) = V_i(k-1) + 20$ 
}
if  $V_i(k) < V_i(k-1) - 20$ 
}
 $V_i(k) = V_i(k-1) - 20$ 
}
i = 1, 2, ..., M

```

- For each location, compared to its upstream location at the same time:

```

if  $V_i(k) > V_{i-1}(k) + 20$ 
}
 $V_i(k) = V_{i-1}(k) + 20$ 
}
if  $V_i(k) < V_{i-1}(k) - 20$ 
}
 $V_i(k) = V_{i-1}(k) - 20$ 
}
i = 2, ..., M

```

- For each location, compared to its upstream location at the previous time step:

```

if  $V_i(k) > V_{i-1}(k-1) + 20$ 
}
 $V_i(k) = V_{i-1}(k-1) + 20$ 
}
if  $V_i(k) < V_{i-1}(k-1) - 20$ 
}
 $V_i(k) = V_{i-1}(k-1) - 20$ 
}
i = 2, ..., M

```

- For each location, compared to its upstream location 2time steps before:

```

if  $V_i(k) > V_{i-1}(k-2) + 30$ 
}
 $V_i(k) = V_{i-1}(k-2) + 30$ 
}
if  $V_i(k) < V_{i-1}(k-2) - 30$ 
}
 $V_i(k) = V_{i-1}(k-2) - 30$ 
}
i = 2, ..., M

```

2.4 Summary of Algorithm

The algorithm described above, although simple in concept, is fairly general in the sense that:

- The algorithm always looks ahead, 2~3 sections of downstream traffic, in the determination of the current section's VSA. This is looking ahead in distance and therefore a prediction in time, since the traffic is flowing from the upstream to the downstream. This feedback approach should reduce the shockwave;
- The process of looking ahead, at each time step, may be extrapolated to cover the entire corridor, inter-linking each corridor section directly to its immediate neighbors. Although this process is not global, it could be considered as semi-global;
- Each section could provide a reasonable in-flow to its immediate downstream section, which is what we need; however, we could claim optimality from a system point of view;
- The algorithm is robust with respect to the traffic detection;
- The Semi-Globally Looking-Ahead VSA Algorithm can be widely applied to freeway corridors with multiple bottlenecks.

3 Microscopic Traffic Simulation of Variable Speed Advisory

3.1 Simulation Development

A microscopic traffic simulation model has been developed in Aimsun to simulate the test site, i.e. the State Route 78 Eastbound (SR-78E) section traffic, as indicated in Figure 1 in the Executive Summary. The simulation development included: Traffic networking building, traffic demand determination from Performance Measurement Systems (PeMS) data and model calibration. The Variable Speed Advisory (VSA) algorithm was implemented in Aimsun, as an Application Program Interface (API). This enabled the simulation of different traffic scenarios and the performance evaluation of each scenario.

3.2 Simulation Model Build Up

Microscopic traffic simulation software Aimsun was utilized in this project to test the control strategy – the Semi-Globally Looking-Ahead VSA Algorithm. Aimsun provides an API which allows users to incorporate extra functionality into the simulator, using the C or Python programming languages. The algorithm and the interface to its data, within Aimsun, are coded in C/C++. In the simulation test, we programmed the Local Responsive Ramp Metering (anticipated to be implemented during the field test by Caltrans District 11) for all metered onramps and advisory speeds at all expected VSA locations in Aimsun. Advisory speed limits and ramp metering rates are updated every 30 seconds, during the course of the simulation. Figure 3.1 shows the Aimsun API structure.

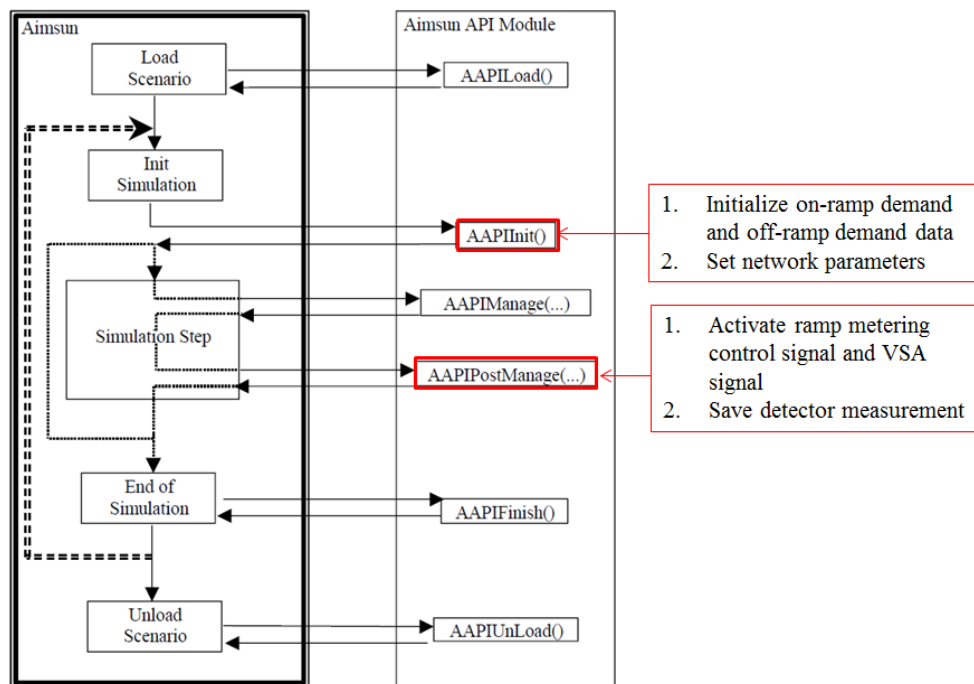

Figure 3.1 Aimsun API structure [3]

To enable testing of the VSA algorithm and predict its performance in the field, the Aimsun model is a faithful reproduction of the real-world freeway environment. Figure 3.2 illustrates the geometric layout of the test site, along SR-78E, in Aimsun. The location of ramp meters, the location of the Changeable Message Sign (CMS) providing the VSA (which also incorporate radar

for speed sensing) as well as the loop detectors (that provide occupancy sensing) are in the Aimsun model at the same geographic locations as they are in the field.



Figure 3.2 Geometric layout of the test site SR-78E in Aimsun

Finally, the ramp metering signal rule, employed by Caltrans District 11, is also coded in the Aimsun API. Figure 3.3 shows this ramp metering signal rule, specifically for Emerald Drive to SR-78E.

Emerald Dr to 78 EB						
meter ID	main lanes	ramp lanes	veh /cyc	SOV Lane	HOV Lane	HOV Lane %
24	3	2	1	1	1	10%
Enter Meter ID		Enter ramp lanes Info				

Date
11/21/18

NORMAL WORKING HOURS	
A M values	PM values
5:30 - 9:30	2:00 - 7:00

MORNING OPERATION	
RM	operating

VOLUME LOGIC						
HICAM	DLCAM	HEX	VR1VAM/L	VDLVA	VB2VAM/L	VE2VAM/L
5A	1F	HEX	3E8	20	3CF	2EE
9.00	0.31	DEC	1000	32	975	750
Rate 1 Cyc/M	Delta Cyc/M		Go To Rate 2	Delta	Begin Meter	End Meter

OCCUPANCY LOGIC							
OB3VA	OB10AM/L	OB30AM/L	OR10AM/L	ODLOA	OE3VA	OE10AM/L	OE30AM/L
5C	93	1A9	AA	10	47	71	147
970	8.29%	8.3%	9.59%	0.45%	749	6.38%	6.39%
Begin Meter Vol	Begin Meter 1M	Begin Meter 3M	Go To Rate 2	Delta	End Meter Vol	End Meter 1M	End Meter 3M

SOV - per lane						
RATE	OCC	VOL	CPM	Sec/Cyc	cyc/Hr	Veh/Hr
1	9.59%	1000	9.00	6.7	540	540
2	10.05%	1032	8.69	6.9	521	521
3	10.50%	1064	8.38	7.2	503	503
4	10.95%	1096	8.07	7.4	484	484
5	11.40%	1128	7.76	7.7	466	466
6	11.85%	1160	7.45	8.1	447	447
7	12.30%	1192	7.14	8.4	428	428
8	12.75%	1224	6.83	8.8	410	410
9	13.21%	1256	6.52	9.2	391	391
10	13.66%	1288	6.21	9.7	373	373
11	14.11%	1320	5.90	10.2	354	354
12	14.56%	1352	5.59	10.7	335	335
13	15.01%	1384	5.28	11.4	317	317
14	15.46%	1416	4.97	12.1	298	298
15	15.91%	1448	4.66	12.9	280	280

HOV					Totals (per hour)		
CPM	Sec/cyc	cyc/Hr	Veh/Hr	RATE	Totals Ramp	ML + Ramp	cross over
9.00	6.7	540	54	1	594	3594	48.9
8.69	6.9	521	52	2	574	3670	48.2
8.38	7.2	503	50	3	553	3745	47.5
8.07	7.4	484	48	4	533	3821	46.9
7.76	7.7	466	47	5	512	3896	46.4
7.45	8.1	447	45	6	492	3972	45.9
7.14	8.4	428	43	7	471	4047	45.4
6.83	8.8	410	41	8	451	4123	45.0
6.52	9.2	391	39	9	430	4198	44.6
6.21	9.7	373	37	a	410	4274	44.2
5.90	10.2	354	35	b	389	4349	43.9
5.59	10.7	335	34	c	369	4425	43.5
5.28	11.4	317	32	d	348	4500	43.2
4.97	12.1	298	30	e	328	4576	42.9
4.66	12.9	280	28	f	308	4652	42.7

Figure 3.3 Ramp metering rule for the Emerald Drive Ramp onto SR-78E

The operation hours are shown in Figure 3.3 the upper parts, and RM rate based on occupancy values are listed in the lower part with respect of HOV lane and General-Purpose Lanes.

The simulation proceeded in a stepwise fashion, with vehicle data being collected every thirty seconds in the Aimsun environment. This data included:

- (1) Count (i.e., the number of vehicles);
- (2) Speed (i.e., the mean speed for vehicles crossing the detector during the 30 second step);
- (3) Occupancy (i.e., the percentage of time, during the time step, that the detector is pressed); and
- (4) Presence (i.e., whether a vehicle is over the detector).

3.3 Calibration of the Simulation Model

The simulation model in Aimsun is calibrated with field data. The goal of model calibration is to find a set of parameters and inputs for the simulation model such that the output of the model can correctly reproduce observed data. The parameters in Aimsun are divided into two groups: Global parameters and local parameters. Global parameters relate to overall driver behavior in the whole network, while local parameters relate to driver behavior within a section of the network. The model calibration process adjusts model parameters by quantifying the vehicle parameters with site-specific data, to an extent that is as practical as possible. In the calibration process, several important model parameters are adjusted and their range is shown in Table 3.1.

Table 3.1 Calibration Ranges of Parameters

	Parameter name	Range	Unit
Global	Minimum mean headway	0.9-1.2	sec.
	Reaction time	0.7-1.5	sec
	Queue entry speed	1-1.5	m/s
	Queue exit speed	4-8	m/s
Local	Lane changing cooperation	70-100	%
	Reaction time variation	0-3	unitless
	Distance zone 1	0.5L-0.7L	m
	Distance zone 2	0.5L-0.7L	m

The input field data for the model calibration process uses 5-minute timestep data from August 10, 2016 which includes most mainline all-lane flow, on-ramp flow, and off-ramp split ratio data. These data are shown in Figures 3.4, 3.5 and 3.6, respectively. The data are then converted into a proper format and imported into the Aimsun simulator. Since the traffic situation during the field test could be different from that experienced during modeling for simulation, control parameter adjustment or tuning would be necessary in the field test.

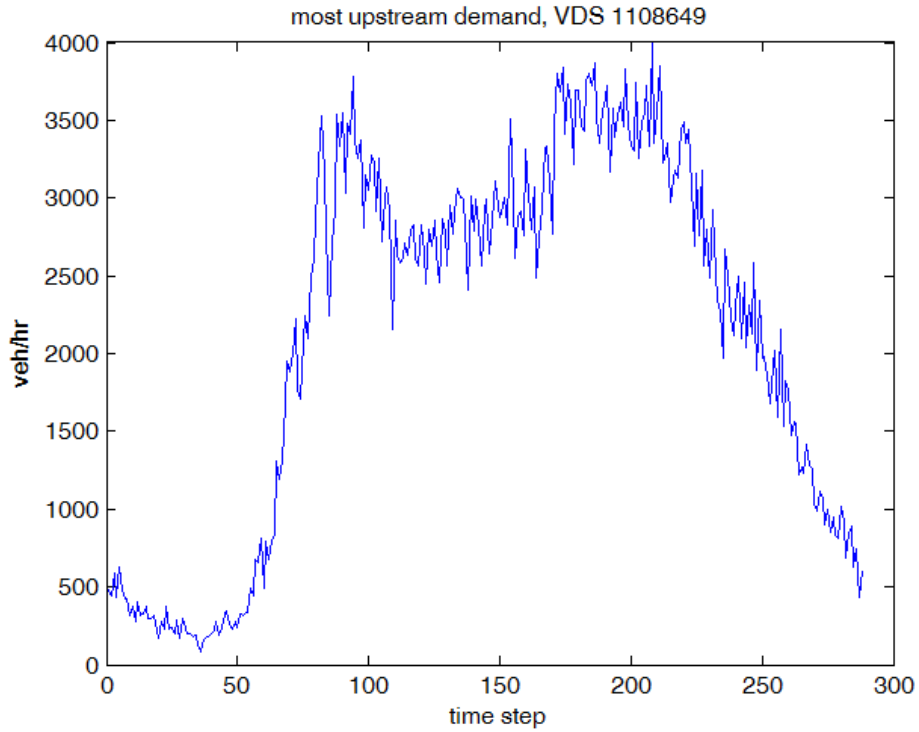

Figure 3.4 The most upstream mainline flow of the model

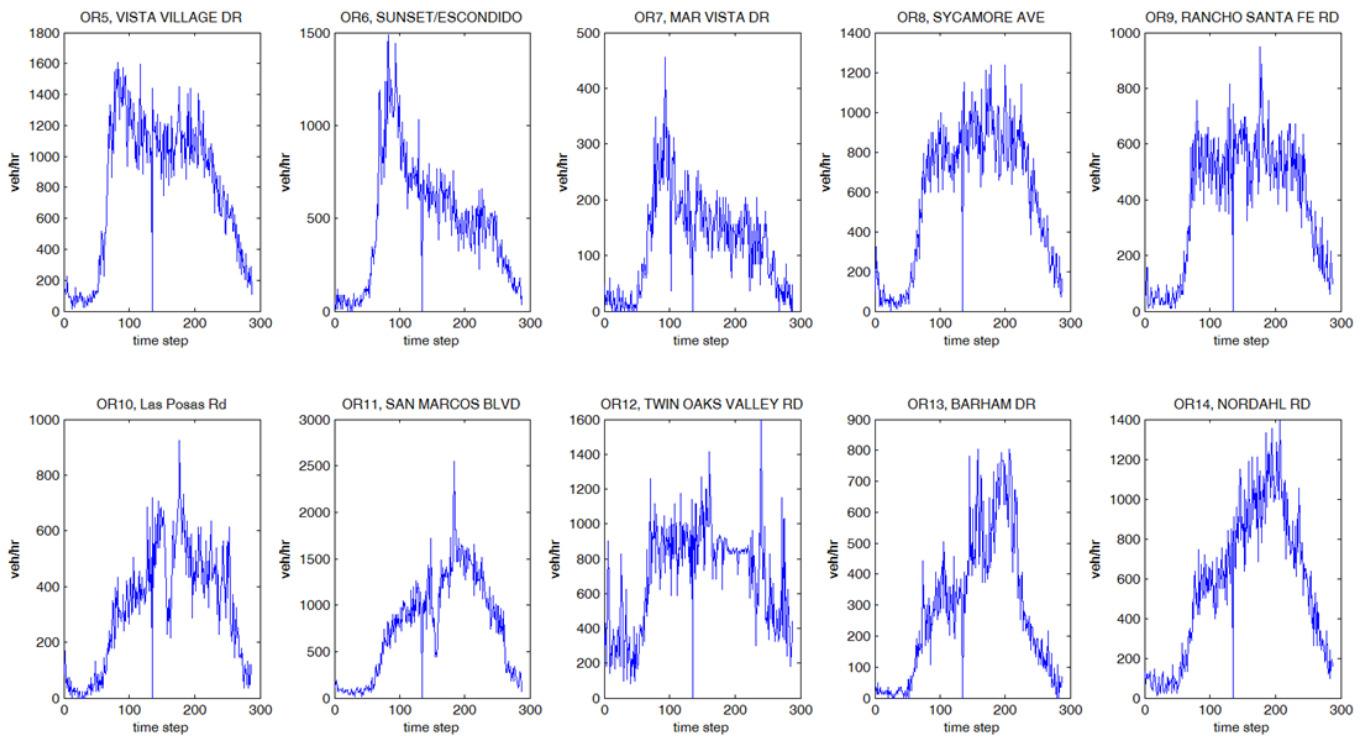

Figure 3.5 On-ramp flow of the model

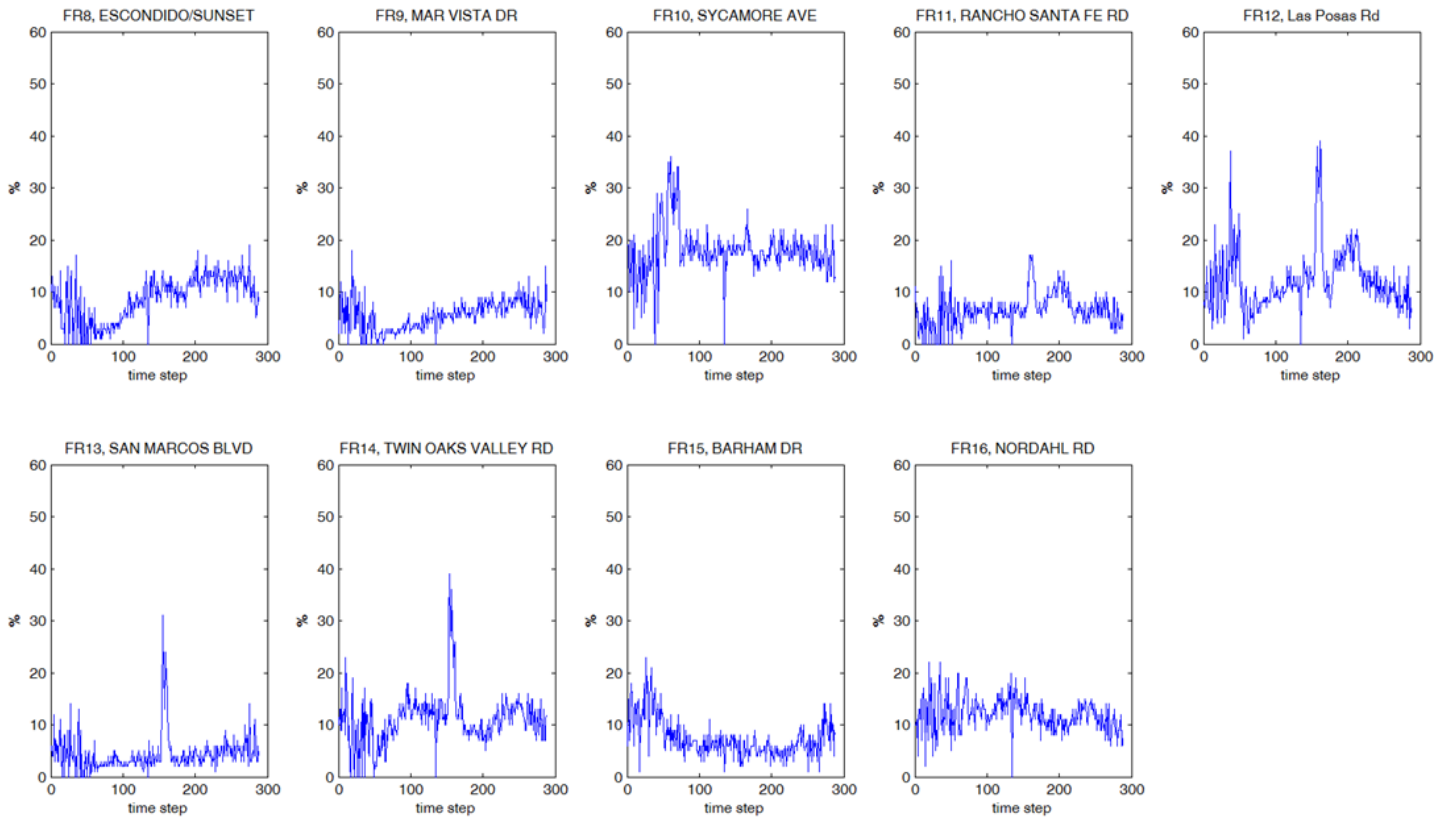

Figure 3.6 Off-ramp split ratio of the model

In order to evaluate the model calibration results, we compare field data (for the same time period of the demand data used for model calibration) with simulation data. The comparison is illustrated in Figures 3.7, 3.8 and 3.9. Simulation data reproduce field data in the model with acceptable error, so we can use the model as a test bed to test the algorithm.

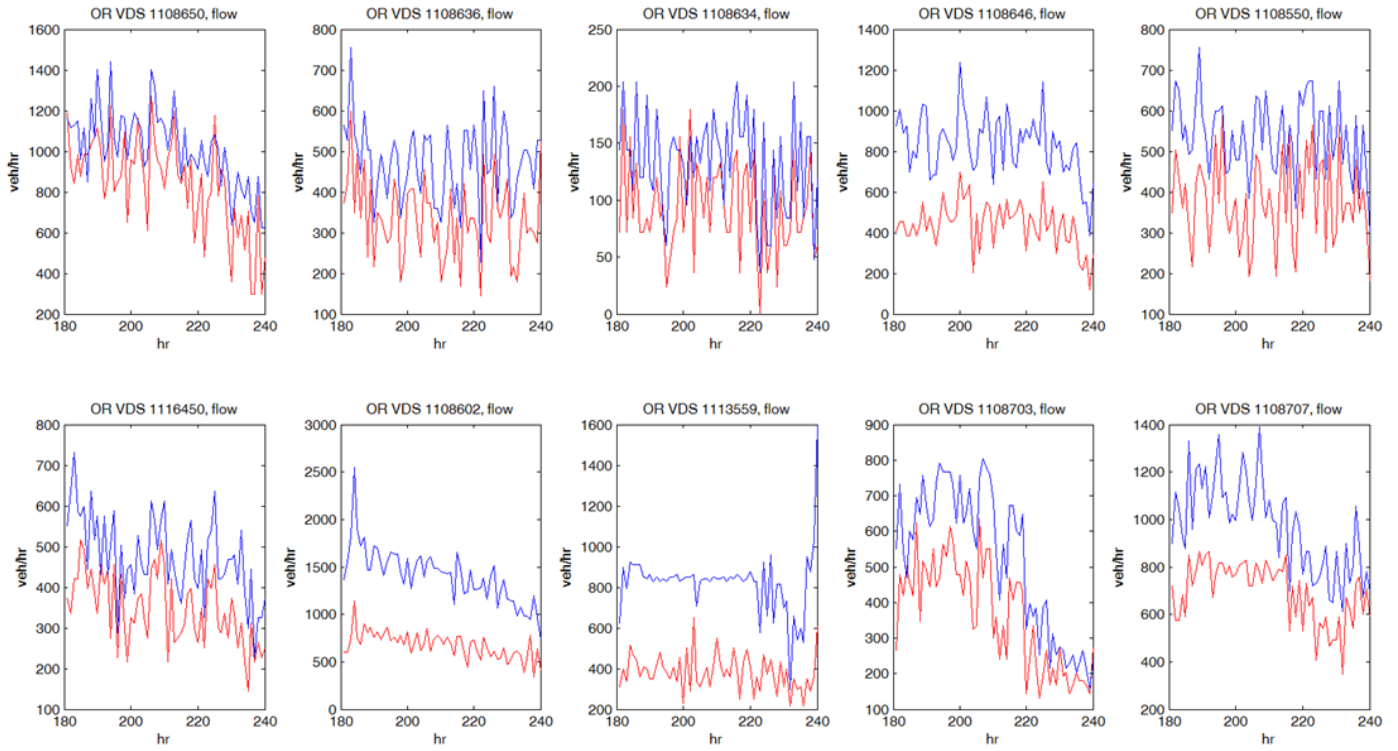

Figure 3.7 On-ramp flow calibration results (Blue: field data, Red: simulation data)

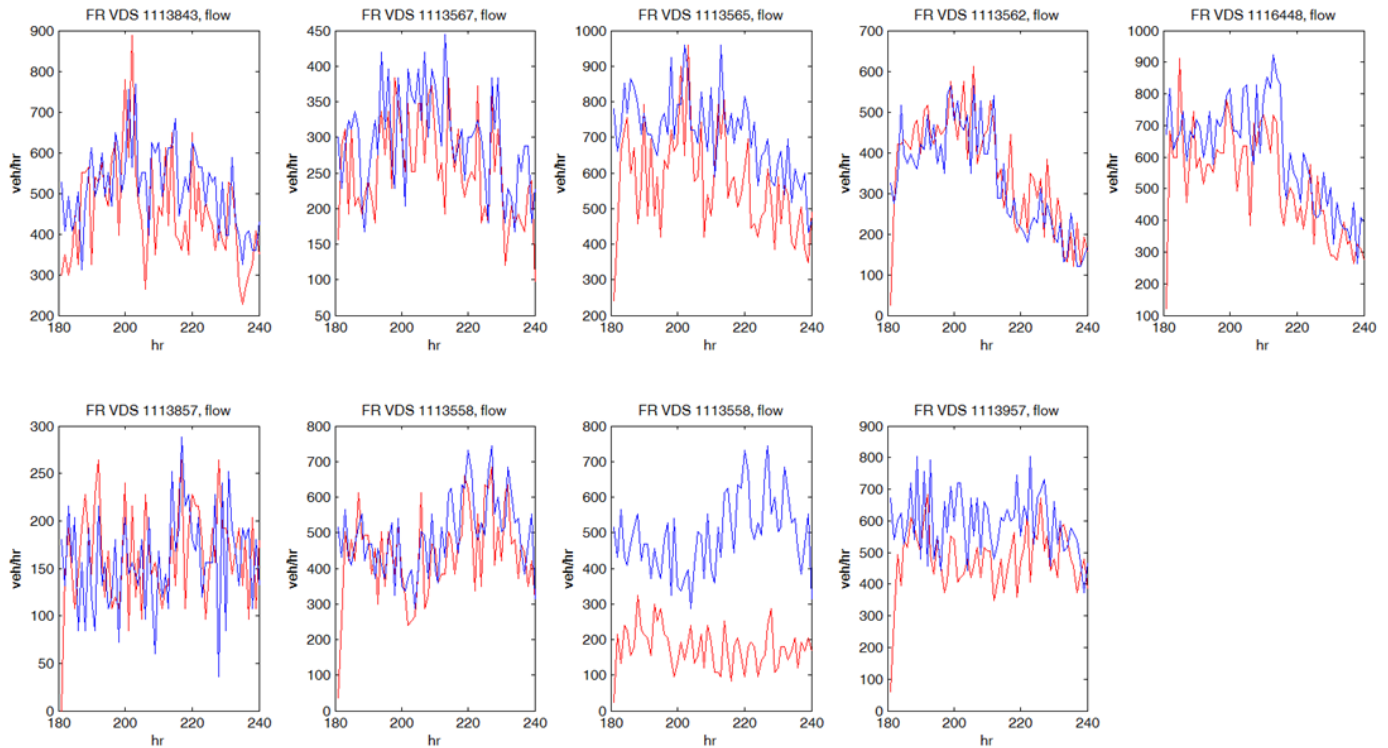

Figure 3.8 Off-ramp flow calibration results (Blue: field data, Red: simulation data)

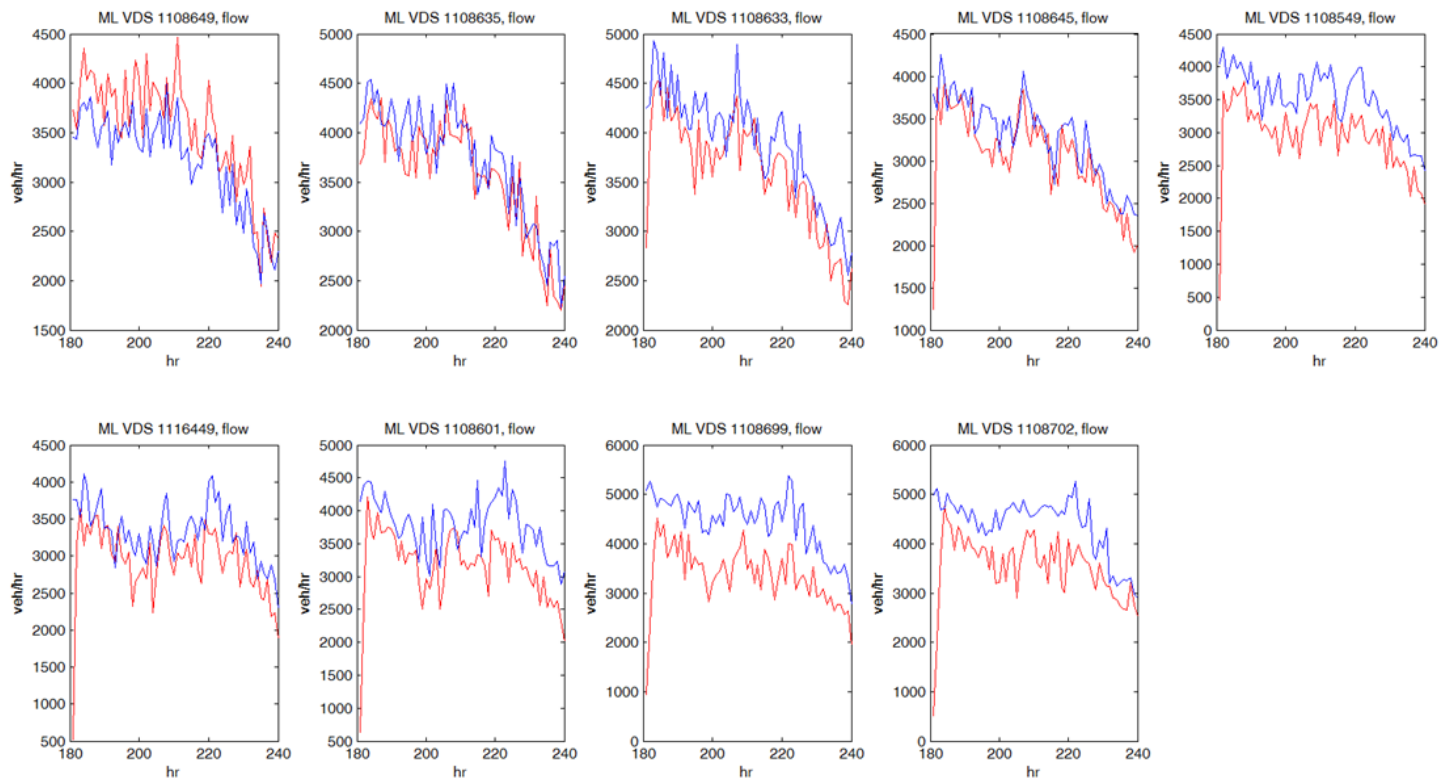

Figure 3.9 Mainline flow calibration results (Blue: field data, Red: simulation data)

3.4 Performance Evaluation in Simulation Model

The following six system performance indices have been used for evaluation of the algorithm implemented in the simulation model:

- Total Travel Time (TTT): this includes the queue time at entrance ramp;
- Total Travel Distance (TTD): indicates the traffic accommodated by the network;
- Total Delay (TD): it is obtained by comparing the simulated traffic with mainline free-flow assumption;
- Speed Variation: it directly reflects the fluctuations of system-wide speed;
- Total Number of Stops (TNOS): the total number of vehicle stops is recorded and used as a system performance parameter to indicate traffic smoothness; and
- Flow (throughput) changes in average

The simulation result of the occupancy-based VSA control algorithm is shown in Table 3.2. It indicates that higher driver compliance rate yields better performance. For a 50% driver compliance rate, TTT can be reduced 3.5%, TTD can be increased 0.53%, flow can be increased 1%, and speed can be increased 1.12%.

Table 3.2 Occupancy based VSA with occupancy threshold 12%

Driver Compliance	TTT	TTD	TD	Speed	Speed Variance	Ave num. of stops	flow
10%	-2.53%	0.39%	-9.4%	0.86%	-0.3%	-1.8%	0.84%
25%	-3.3%	0.4%	-8.1%	0.64%	-0.49%	-1.8%	1.86%
50%	-4.84%	0.81%	-11.74%	1.87%	-0.6%	-3.6%	2.1%
Avg. Performance	-3.56%	0.53%	-9.75%	1.12%	-0.46%	-2.4%	1.6%

4 Variable Speed Advisory (VSA) System Field Implementation

This chapter documents the evolution of the Concept of Operations (ConOps) and the development of the system which includes hardware and software. The ConOps is the blueprint of the overall system. Although there was a ConOps proposed before project execution, the actual ConOps for this project evolved as the project progressed. It was finalized prior to field implementation and system integration.

4.1 Concept of Operations

The overall system structure for the ConOps contained in the original proposal is shown in Figure 4.1.

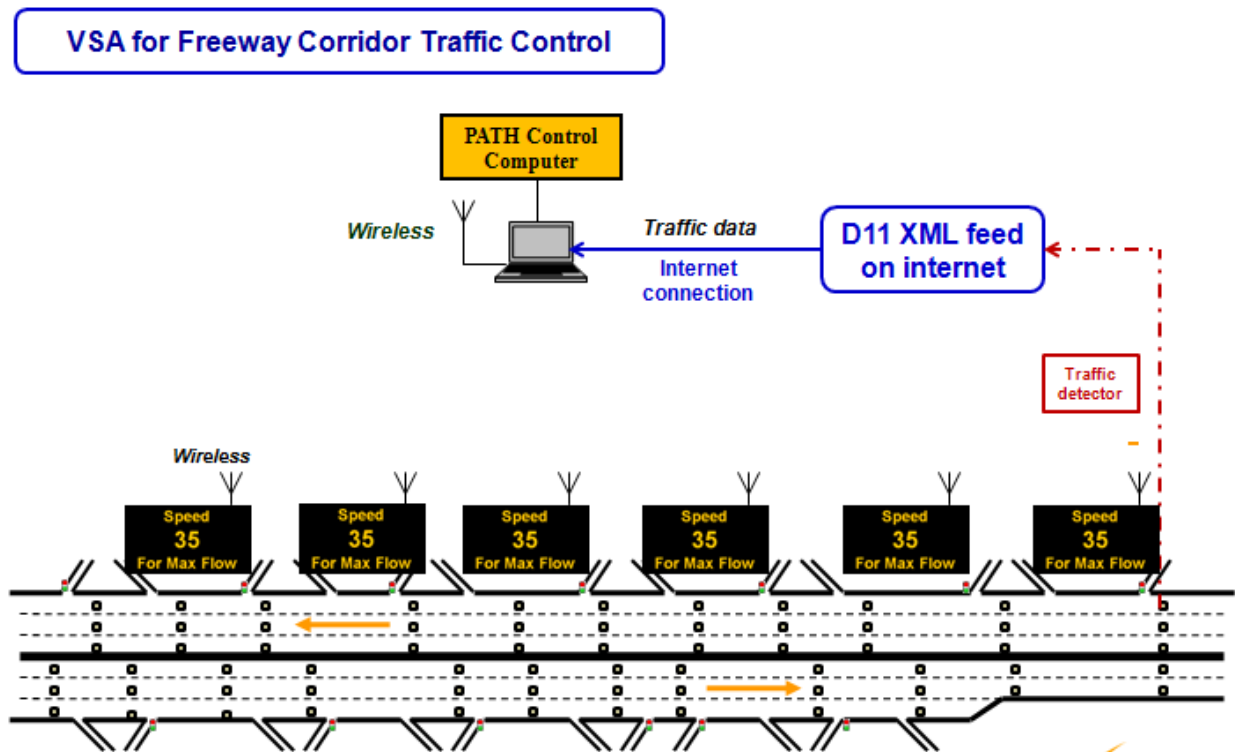

Figure 4.1 The original overall system structure for VSA Test on SR-78 (ConOps)

Main functions of the main components are briefly described as follows:

- The functions of the PATH Central Computer included:
 - Retrieving data from the Caltrans District 11 Traffic Management Center (D11 TMC) through the internet;
 - Determining the VSA for all of the signs, in accordance with the previously described algorithm;
 - Data processing and traffic state parameter estimation for all the detectors along the freeway corridor;
 - Calculating VSA for each freeway section, in accordance with the previously described algorithm; and

- Transmitting the advisory speeds to individual VSA signs through the wireless modem through the Traffic Logix server.

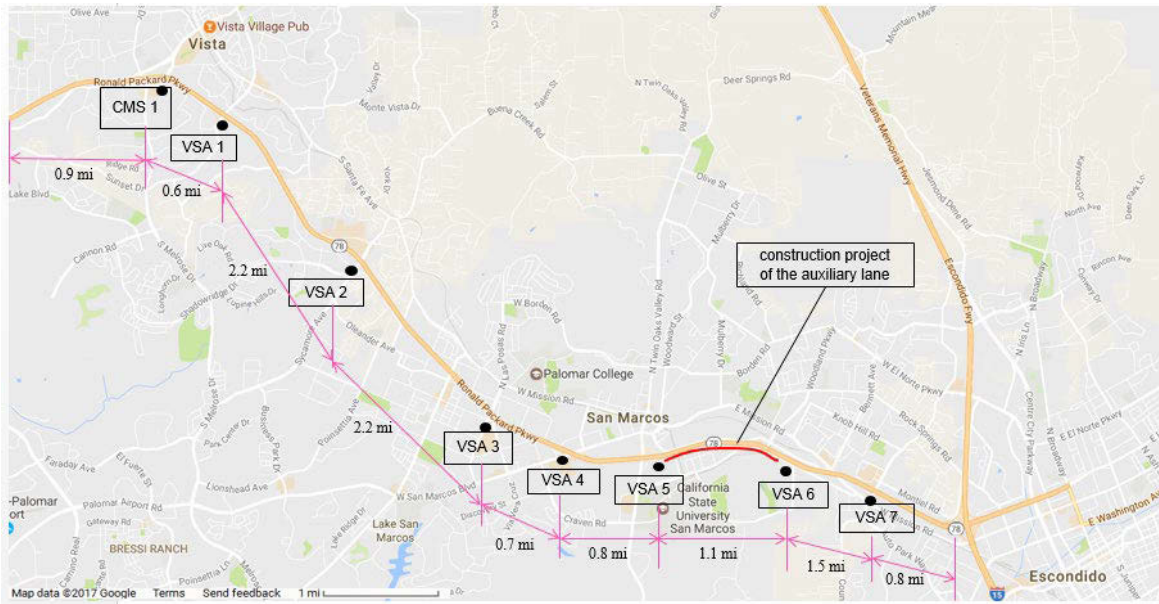

Figure 4.2 Overview of system scope, VSA sign and CMS locations, and the Construction Area

- A fixed Changeable Message Sign (CMS) was installed at the most upstream location in the field test section, as illustrated in Figure 4.2 - at Vista Village. This sign was used to display “Follow Advisory Speed” to the public driver.
- The VSA signs were located on the roadside to display the Advisory Speed, which is updated in real time. These signs are located within each section, with the most downstream VSA sign (in relation to the bottleneck) being most critical (VSA5). This sign also has a speed detection system that monitored vehicle speeds upstream of the sign – utilizing Doppler radar. This radar system also aggregates and averages the data over 30 second intervals and transmits it, over wireless modem, to the PATH central control computer.
- Each of the VSA signs were powered by a solar panel that utilized battery backup during the field test.

During the project implementation process it was discovered that the signs utilized to display the VSA messages, sourced from Traffic Logix, established a constraint on communication. Traffic Logix required that all communications from their signs be routed through Traffic Logix servers. It was anticipated that the PATH Control Computer would establish two-way communication with the VSA signs. First, it would collect Doppler radar speed data from each VSA sign, combine this data with data from Caltrans’ dual loops obtained from D11, update all of the VSA calculations in accordance with the VSA algorithm described above and then communicate these revised VSA messages to each of the individual VSA signs. Due to the limits placed on communication, the ConOps that was implemented is illustrated in Figure 4.3. This round trip was accomplished within each 30 second control cycle – thus no additional delay was incurred.

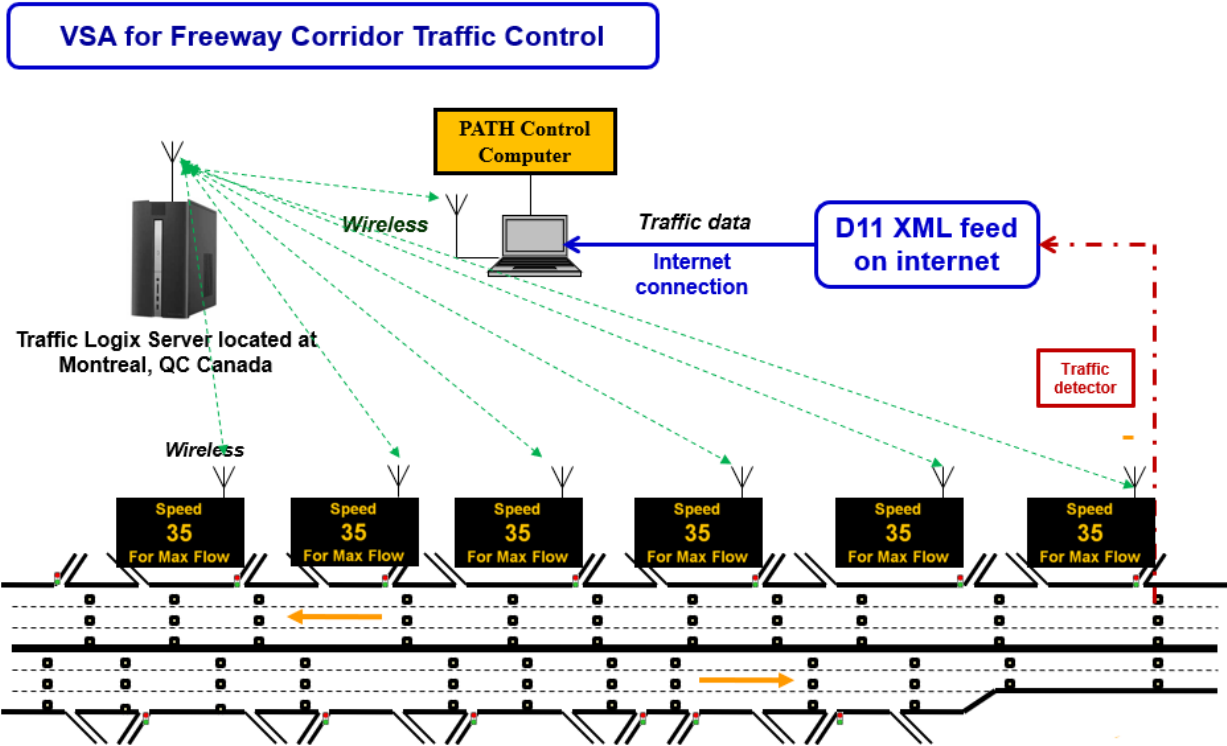

Figure 4.3 The ConOps that was ultimately implemented.

The data flow in Figure 4.3 is as follows: Traffic/loop detector data is obtained from the traffic controllers in the field through Caltrans District 11 via the internet to the PATH Control Computer. Data passing between the Traffic Logix server and the PATH Control Computer is bi-directional:

- Between the Traffic Logix Server and the PATH Control Computer: The PATH Control Computer receives the Doppler radar data and sends the desired VSA for each sign to the Traffic Logix server.
- Between the Traffic Logix Server and VSA signs in the field: The Traffic Logix Server polls/receives Doppler radar 30s traffic speed data from the VSA sign and sends the speed message to the corresponding VSA sign for display.

4.2 System Hardware Development

In addition to the central control computer, other hardware components included multiple VSA signs – each with a solar panel (powering the display) as well as a trailer with a mast for mounting the VSA sign. Those components, packaged together for field deployment, are shown in Figure 4.4. The height of the trailer mast was designed to comply with the requirements provided by Caltrans D11 TMC traffic engineers. This height requirement was mainly related to driver's view of the sign.



(a)

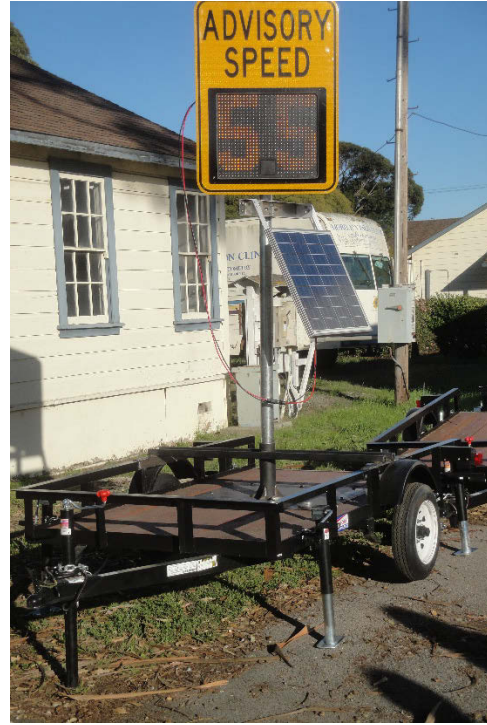

(b)



(c)

Figure 4.4 (a), (b) VSA sign; (c) Trailers for mounting VSA signs and solar panel

The trailer mast and base, shown in Figure 4.4, was designed to be robust enough to withstand wind loading at the roadside and to ensure rigidity and viewability considering the height of the VSA display. If the VSA sign were to shake or move drivers may not be able to clearly view the speed advisory. Thus the trailer was purposely designed by the PATH project team before its manufacture. For better performance, two enhanced additional beams were welded with the sleeves and trailer base by the project team as shown in Figure 4.5. Figure 4.6 shows the cable connection between the solar panel and the VSA display.

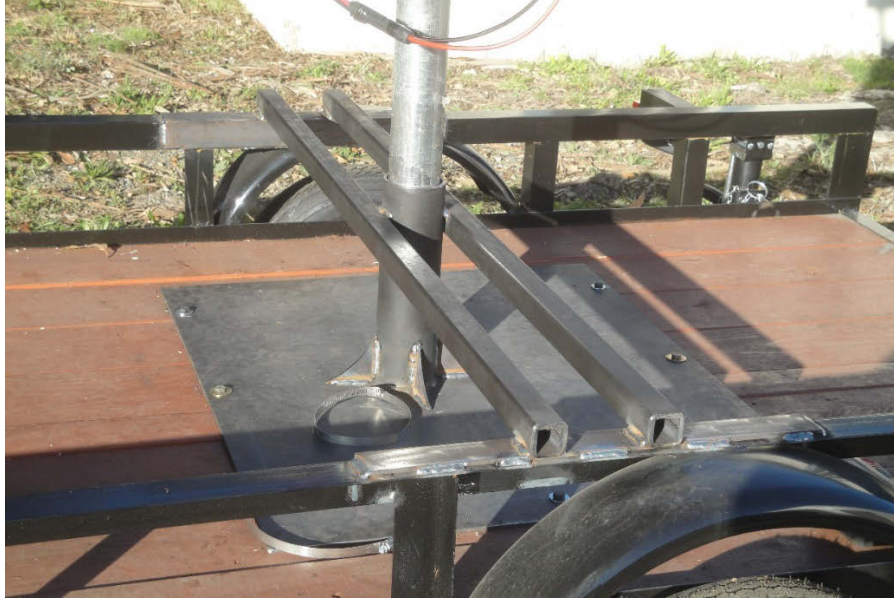

Figure 4.5 Enhanced mast-base sleeve design for robust mounting



Figure 4.6 VSA sign and solar panel wire connection

4.3 System Software

Seven VSA signs with modified firmware were distributed along a 10.8-mile stretch of California State Route 78 near San Diego (see Figure 4.7). The firmware and back end were modified by the manufacturer (Traffic Logix Corp.) to accommodate the faster update rate needed for timely traffic data acquisition and sign control.



Figure 4.7 Traffic Logix Safespace 650 Variable Message Sign on the roadside

4.4 Modified Traffic Logix Safespace 650 Variable Message Sign

The Traffic Logix Safespace 650 Variable Message Sign was used in this project for several reasons:

- Capability of changing the speed advisory remotely
- Integrated radar for sensing traffic speed
- Receipt of radar statistics at 30-second update rate
- Speed display update rate of 30 seconds
- Solar powered charging system that allowed for continuous operation

In its standard configuration, suitable for normal traffic operations, the SafePace 650 has an update interval of 5 minutes. This was a significant hurdle since the project would require it to be updated every 30 [s] to address traffic changes in transition phases such as shockwave at congestion start. Therefore, the engineering staff at Traffic Logix was asked to modify the firmware on the signs and the backend server as in Figure 4.3 to allow for 30 second intervals. They also provided an applications programming interface that allowed software control by the user. This was completed and the signs were successfully deployed.

4.5 Software Architecture

Software was constructed as a sequence of processes executed by a parent script. The child processes communicated with each other via a publish/subscribe database (db_slv), temporary data

files, and php scripts. This software structure was largely dictated by two different sources of data: (1) Data-feeding from Caltrans that includes occupancy, flow, and speed from the magnetic loop detectors embedded in the highway, and (2) radar data from the signs transmitted from the Traffic Logix data server located in New York and one control channel that includes Variable Speed Advisories that were output from the control algorithm and sent to the web server in New York for transmission to the VSA signs.

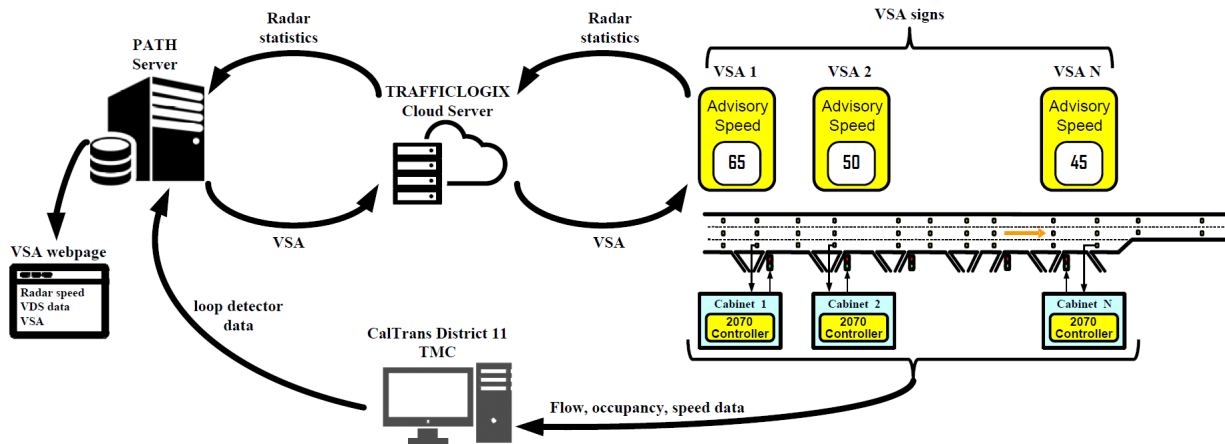

Figure 4.8 Software Architecture of the Variable Speed Advisory system

In Figure 4.8, vehicle detector station (VDS) data from loop detectors (bottom data stream) is collected by Caltrans into a XML file and sent to PATH. Radar statistics from the VSA signs (upper data stream) is received from Traffic Logix' web server and forwarded to PATH. Variable Speed Advisories are calculated in the PATH server and sent to the VSA signs via the Traffic Logix server. The data collected from the field, as well as the VSAs, are sent to the VSA web page for display.

Variable speed advisories were calculated with an optimizing algorithm that used the most recent data from the two data sources including radar speed from the VSA signs and loop data from the Caltrans data feed. Since the update rate of the two data streams was 30 seconds, the data was read and analyzed every 30 seconds. Upon calculation of the variable speed advisories, the VSAs were sent to the Traffic Logix application server for display on the VSA signs.

1. Startup: The `run_vsa` script is restarted every morning at 2AM. It starts up the database handler `db_slv` (which can be thought of as a global memory pool for shared data). Then it enters an infinite loop that executes once every 30 seconds. At each iteration of the infinite loop, the following sequence of programs are executed:
2. Caltrans D11 pushes an XML file containing VDS data (occupancy, flow, and speed) for all of the detectors in D11 to the application server at UC Berkeley's Partners for Advanced Transportation Technology (PATH) site in Richmond, California. This XML file is written every 30 seconds.
3. `xml_parser`: Reads VDS data file and parses it for data in the corridor of interest. Then `xml_parser` writes the VDS data to the database and to the file that is used to display the data on the VSA website. Finally, `xml_parser` calls `safespace_retrieve_radar_all.sh`.

4. safespace_retrieve_radar_all.sh: Calls safespace_retrieve_radar_single.php for all VSA signs, giving the correct arguments to each call. After all radar data has been retrieved, it calls radar_xml_parser.c to read and parse the radar data.
 - a. safespace_retrieve_radar_single.php: Polls Traffic Logix server for newest radar data from a VSA sign and writes retrieved data to temporary data file radar.out.
5. radar_xml_parser.c: Reads raw radar data from radar.out, parses the data and writes it to the database. The database triggers one iteration of opt_vsa.c and writing to the database.
6. opt_vsa.c: This program contains the optimizing algorithm for calculating the VSA. opt_vsa.c reads VDS and radar data from the database and calculates the VSA. It runs in an infinite loop in which each iteration of the loop is triggered by a database write to its input variables. After each iteration it writes the VSA to the database, thus triggering sign_control.c to send the VSAs to the Traffic Logix server, which then forwards the VSAs to the signs in the field. opt_vsa.c also writes the VDS and radar data to the VSA website data file.
7. sign_control.c: Reads VSAs from the database and calls safespace_set_speed_single.php for all signs.
8. safespace_set_speed_single.php: Uses the php library call “file_get_contents” to write the VSAs to the Traffic Logix server, which then forwards them to the signs using proprietary messages.

5 Traffic Data Processing and State Parameter Estimation

Real-time freeway traffic control requires high quality traffic detector data. In California, most state highways use an inductive loop detector station for traffic detection. Its basic measurements include: Lane-wise traffic volume (the number of vehicles passing per unit time) and occupancy (the fraction of the given time interval that a loop is occupied by vehicles – or vehicle dwell time over the loop). When dual loops are used for each detector station, vehicle speed and length can also be determined accurately.

Raw data from dual loop detectors in the field have flaws [1]. The sources of these flaws include many factors: Uncertainties of traffic, loop detector characteristics (such as sensitivity level setting, connection between detector card and in-lane circuit, vehicle types, etc.), as well as the data communication process from the 2070 controllers, through the network and ultimately to the Caltrans District 11 RTMC.

The implementation of a variable speed advisory (VSA) control system requires accurate, high quality traffic state parameter estimation. These parameters can be derived from Caltrans' dual loop detectors but require a robust method for processing noisy and/or even faulty data. This section describes how the field data were processed for this purpose.

5.1 Test Site and Available Data Description

The test site of the VSA field implementation is on State Route 78 Eastbound (SR-78E) from Vista Village Drive in the City of Vista (at absolute postmile 6.32) to the freeway interchange point of SR-78E, and U.S. Route 15 (US-15) in the city of Escondido (at absolute postmile 17.73). This test segment is a three-lane freeway with a posted speed limit of 65 mph, with 10 on-ramps and 10 off-ramps. A fixed message sign (FMS) displaying “FOLLOW ADVISORY SPEED” was placed at the starting point of the test site to instruct drivers to obey the speed posted by the downstream VSA. The posted speed on VSA during morning and evening peak hours is recommended to drivers but not enforced.

The available vehicle detector stations (VDS) are shown in Figure 5.1. The VDS are installed on the freeway mainline, on-ramps, and off-ramps to collect traffic data, namely volume, speed, and occupancy, every 30 seconds. This data is normally sent to Caltrans Performance Measurement System (PeMS) for archiving. During the VSA field test, loop detector data was also communicated to the VSA computer for monitoring and controlling the freeway traffic.

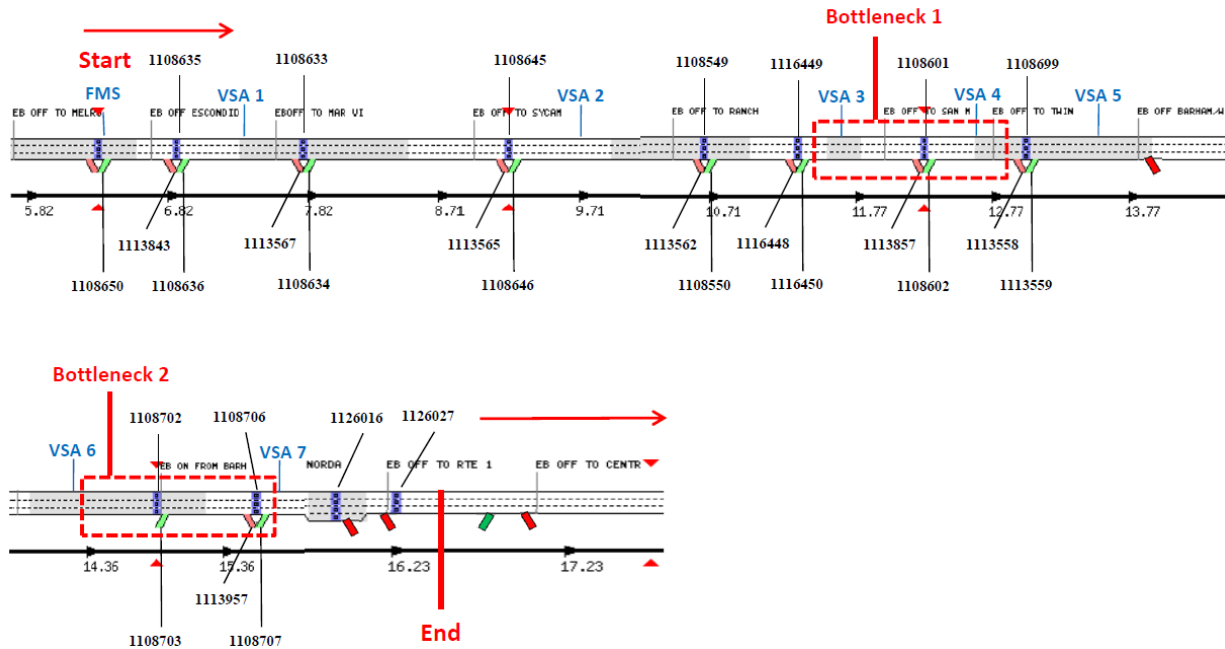

Figure 5.1 SR-78E Network configuration and VDS deployment

Bottleneck Identification

The scope of this field test is limited to reducing recurrent bottlenecks during morning and evening peak hours. Two bottlenecks have been observed, daily on weekdays, after the construction projects were accomplished. The first bottleneck forms during the morning peak hours, from 6AM to 9AM and the second bottleneck forms during the evening peak hours, from 2PM to 7PM. During these bottlenecks traffic speeds drop from 60 mph to as low as 15 mph, after the onset of the congestion.

Based on a study of traffic characteristics, bottlenecks were identified as well as critical locations for VSA signs. Figure 5.2 shows the speed contour for SR-78E, plotted from loop detector data, obtained on March 14, 2018. Two recurrent bottleneck locations are identifiable: Bottleneck 1, which is near San Marcos Blvd. (Postmile [PM]12.27); and Bottleneck 2, which is near the freeway interchange point of SR-78E and US-15 (PM 16.6). Bottleneck 2 (the downstream bottleneck) is caused by occasional diverging traffic from SR-78E to US-15 NB and US-15 SB, particularly in the PM peak hours. This congestion may propagate upstream and activate bottleneck 1, located approximately at PM 11. The upstream propagation of congestion is observed during morning peak hours, as a high volume of daily commuters enter the upstream on-ramps (at Sycamore Ave., Las Posas Rd., and San Marcos Blvd.). Seven VSA signs were located on the field test site, with critical location being the most downstream test segment, around Barham Dr. and Nordahl Rd. The VSA locations, their posted speed ranges, and the corresponding mainline VDS number are listed in Table 1.

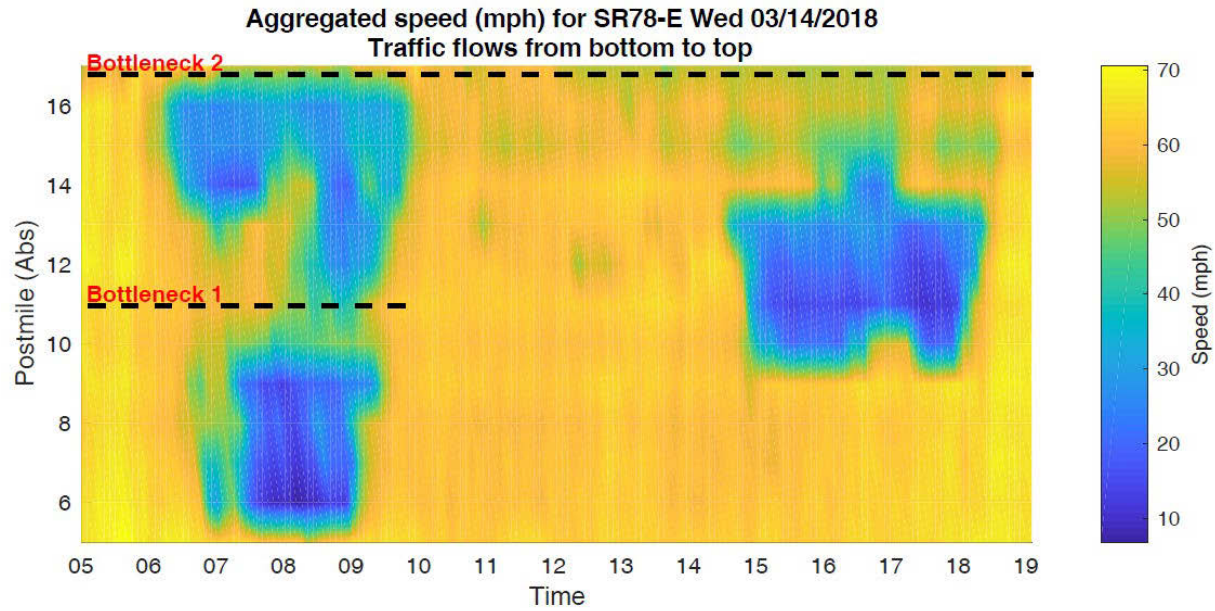

Figure 5.2 SR-78E speed contour, March 14, 2018

Table 5.1 VSA locations and its minimum and maximum advisory speed

Index	Abs. PM	Min. Speed	Max. Speed	VDS	Location	City
FMS 1	6.316	N/A	N/A	1108635	Vista Village Dr.	Vista
VSA 1	6.822	5	65	1108633	Sunset/Escondido Dr.	Vista
VSA 2	9.214	5	65	1108645	Sycamore Ave.	Vista
VSA 3	11.36	5	65	1116449	Las Posas Rd.	San Marcos
VSA 4	12.27	5	65	1108601	San Marcos Blvd.	San Marcos
VSA 5	13.018	5	55	1108699	Twin Oaks Valley Rd.	San Marcos
VSA 6	14.856	5	55	1108702	Barham Dr.	San Marcos
VSA 7	15.593	5	65	1108706	Nordahl Rd.	San Marcos

5.2 Data Cleansing Procedures

Loop detector data from the mainline, as well as data from loop detectors installed in on and off ramps, were used for variable speed advisory (VSA) determination. The physics behind vehicle detection with inductive loops is related to the fact that loop inductance decreases while a vehicle passes over a buried, energized loop. This decreases in inductance, and the associated increase in current, is detected by the traffic signal controller. The principal detection parameters (vehicle count, occupancy and speed) can all be derived from the characteristics of the changes in loop impedance and current. The traffic state parameters used for VSA includes:

- Mainline loop detector data (lane by lane): Flow, occupancy, and speed
- Mainline radar data from each of the seven VSA device: Speed and vehicle counts
- On-ramp loop detector data lane by lane: Flow
- Off-ramp loop detector data lane by lane: Flow

There are several possible detector failure modes that impact the raw data, for which data cleaning processes must address. The possible detector failure modes are:

(1) Data missing:

The individual detector is not reporting any data. As a result, consecutive zeros are collected by, and communicated from the 2070 controllers. One possible cause is that at a VDS with dual loop detectors, one of the two loop detectors is producing valid nonzero data, although the second loop produces consecutive zeros.

(2) Invalid data:

The data produced by the loop detector is nonzero, but its value is abnormal. For example, the data contains outliers if the inductance measurement has a sudden deviation from a normal value (the data deviates too far from the sample mean).

(3) Disconnection with 2070 controllers:

Another source of data failure can be attributed to communication between the PATH control computer and the 2070 controllers, where data communication is suddenly dropped. Possible reasons are that the controller in the field is down or the firmware version of the controller in the field is not compatible with the PATH control computer.

It was necessary to build an algorithm to clean the raw data, in real-time, to improve the reliability of the traffic state parameters for the VSA control system. This data cleansing process contains two steps: Data aggregation and data filtering.

(a) Data aggregation over lanes

In this step, the data stream produced by all of the dual loop detectors, from all lanes at a single VDS, are aggregated into one data stream. Flow aggregation of data produced by dual loops, located in a single lane, are computed by

$$f_i(k) = \sum_{j=1}^{n_i} f_{i,j}(k) \quad (\text{Eq. 5.1})$$

where $f_{i,j}(k)$ is the flow measurement at VDS i of its loop detector j at time k , $f_i(k)$ is the aggregated flow at VDS i , and n_i is the number of loop detectors in VDS i (usually n_i equals to the number of lanes in the section where VDS i is installed).

Speed aggregation calculated over all lanes, at a single VDS, are computed using the formula for harmonic mean speed, which is

$$v_i(k) = n_i \left(\sum_{j=1}^{n_i} \frac{1}{v_{i,j}(k)} \right)^{-1} \quad (\text{Eq. 5.2})$$

where $v_{i,j}(k)$ is the speed measurement at VDS i of its loop detector j at time k , $v_i(k)$ is the aggregated flow at VDS i , and n_i is the number of loop detectors in VDS i (usually n_i equals to the number of lanes in the section where VDS i is installed).

The density of vehicles, at the VDS, can then be derived from flow and speed aggregation (calculated above):

$$\rho_i(k) = \frac{f_i(k)}{v_i(k)} \quad (\text{Eq. 5.3})$$

The weighted average occupancy is computed by with coefficient based on speed measurement

$$o_i(k) = \frac{\sum_{j=1}^{n_i} v_{i,j}(k) o_{i,j}(k)}{\sum_{j=1}^{n_i} v_{i,j}(k)} \quad (\text{Eq. 5.4})$$

where $o_{i,j}(k)$ is the speed measurement at VDS i of its loop detector j at time k , $o_i(k)$ is the aggregated flow at VDS i , and n_i is the number of loop detectors in VDS i (usually n_i to the equals number of lanes in the section where VDS i is installed).

(b) Data filtering

In the final step of data processing, data from each of the VSA sections are filtered by the method of moving average. A moving average is a statistical technique often applied to time series data to smooth out short term variations in the data. The advantage of data filtering is that the data become less noisy after filtering. Suppose the length of data window is n , then

The filtered flow of detector i , $\bar{f}_i(k)$, is

$$\bar{f}_i(k) = \frac{1}{n} \sum_{n=0}^{n-1} f_i(k-n) \quad (\text{Eq. 5.5})$$

The filtered speed of detector i , $\bar{v}_i(k)$, is

$$\bar{v}_i(k) = \frac{1}{n} \sum_{n=0}^{n-1} v_i(k-n) \quad (\text{Eq. 5.6})$$

The filtered density of detector i , $\bar{\rho}_i(k)$, is

$$\bar{\rho}_i(k) = \frac{1}{n} \sum_{n=0}^{n-1} \rho_i(k-n) \quad (\text{Eq. 5.7})$$

The filtered occupancy of detector i , $\bar{o}_i(k)$, is

$$\bar{o}_i(k) = \frac{1}{n} \sum_{n=0}^{n-1} o_i(k-n) \quad (\text{Eq. 5.8})$$

5.3 Data Cleansing Results

Figures 5.3 to 5.6 show the results of data cleansing for flow, occupancy, speed, and density during the April 11, 2018 evening peak hours from 2PM to 7PM. Lane by lane mainline data are aggregated and filtered for controlling and monitoring the test segment. In Figure 5.5, the fused speed $\bar{v}_i(k)$ of location i at time step k is calculated by

$$\bar{v}_i(k) = \bar{v}_i(k) + \alpha_i \bar{v}_i(k) \quad (\text{Eq. 5.9})$$

where $\bar{v}_i(k)$ is filtered aggregated speed of location i at time step k , $\bar{v}_i^r(k)$ is radar speed of location i at time step k , α_i and α_i^r are weightings of loop detector speed and radar speed respectively. We use $\alpha_i = 0.5$ and $\alpha_i^r = 0.5$ for all i in this project.

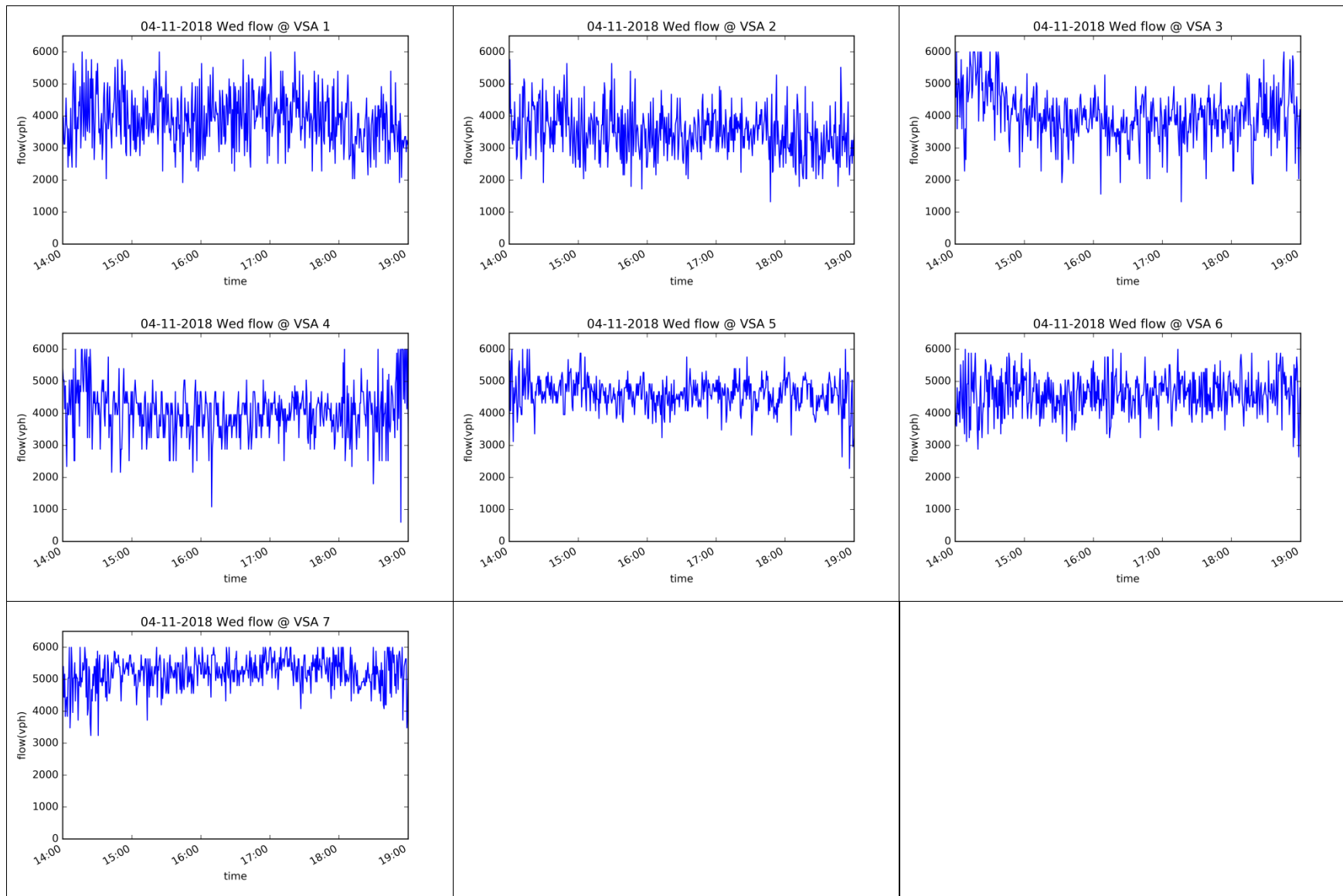

Figure 5.3 Aggregated flow during April 11, 2018 evening peak hours from 2PM to 7PM

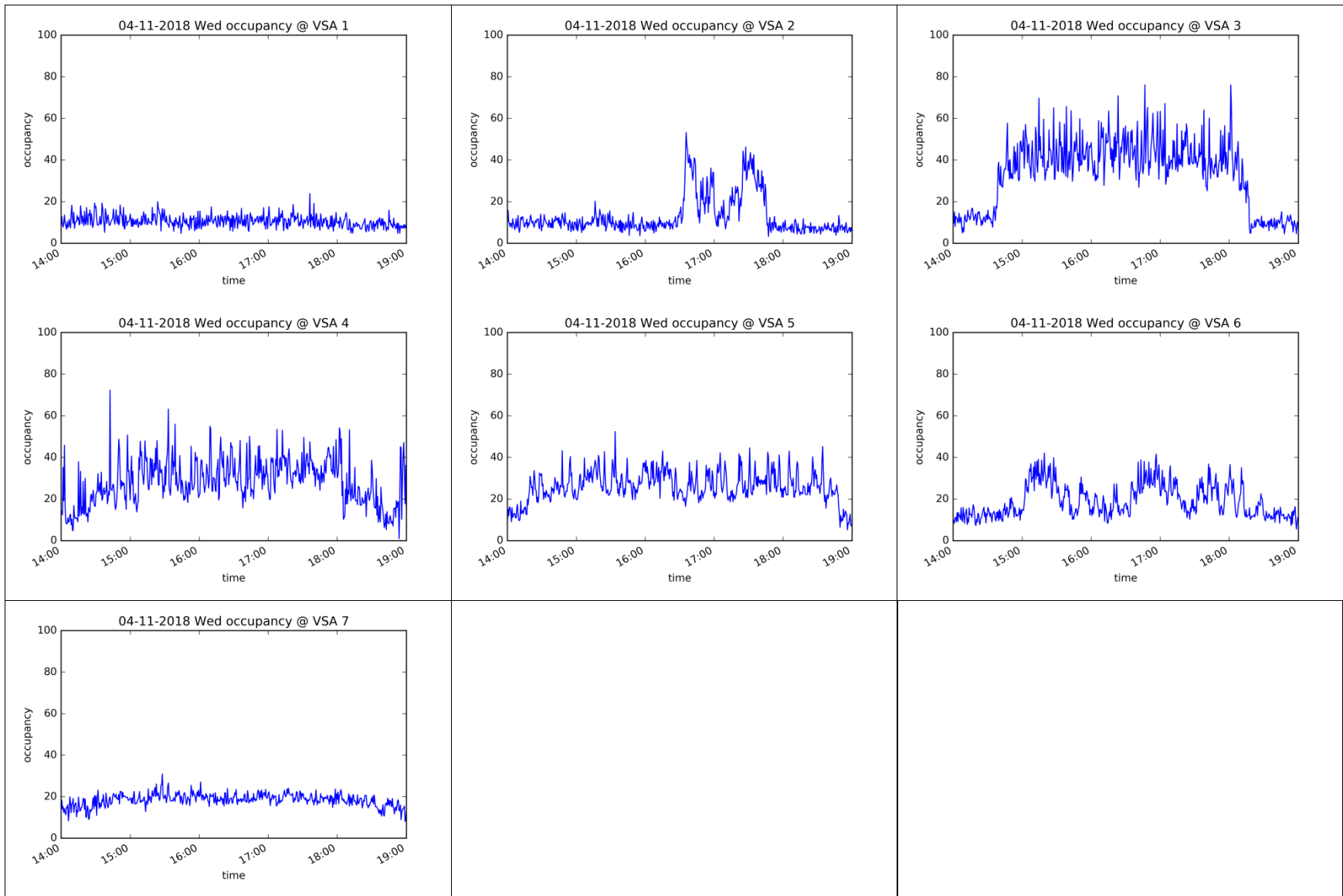

Figure 5.4 Aggregated occupancy during April 11, 2018 evening peak hours from 2PM to 7PM

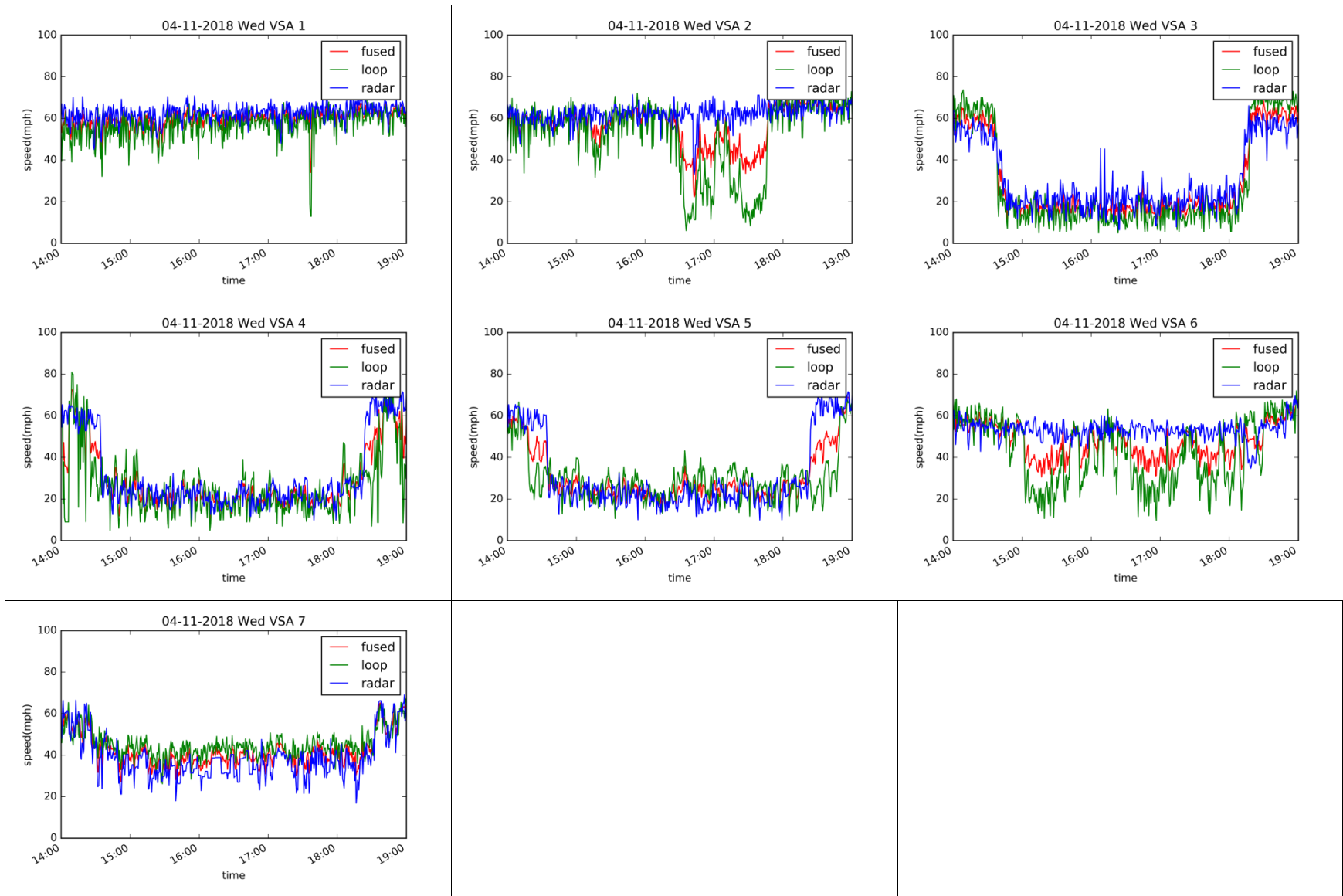

Figure 5.5 Aggregated loop speed, radar speed, and fused speed during Apr 11, 2018 evening peak hours from 2PM to 7PM

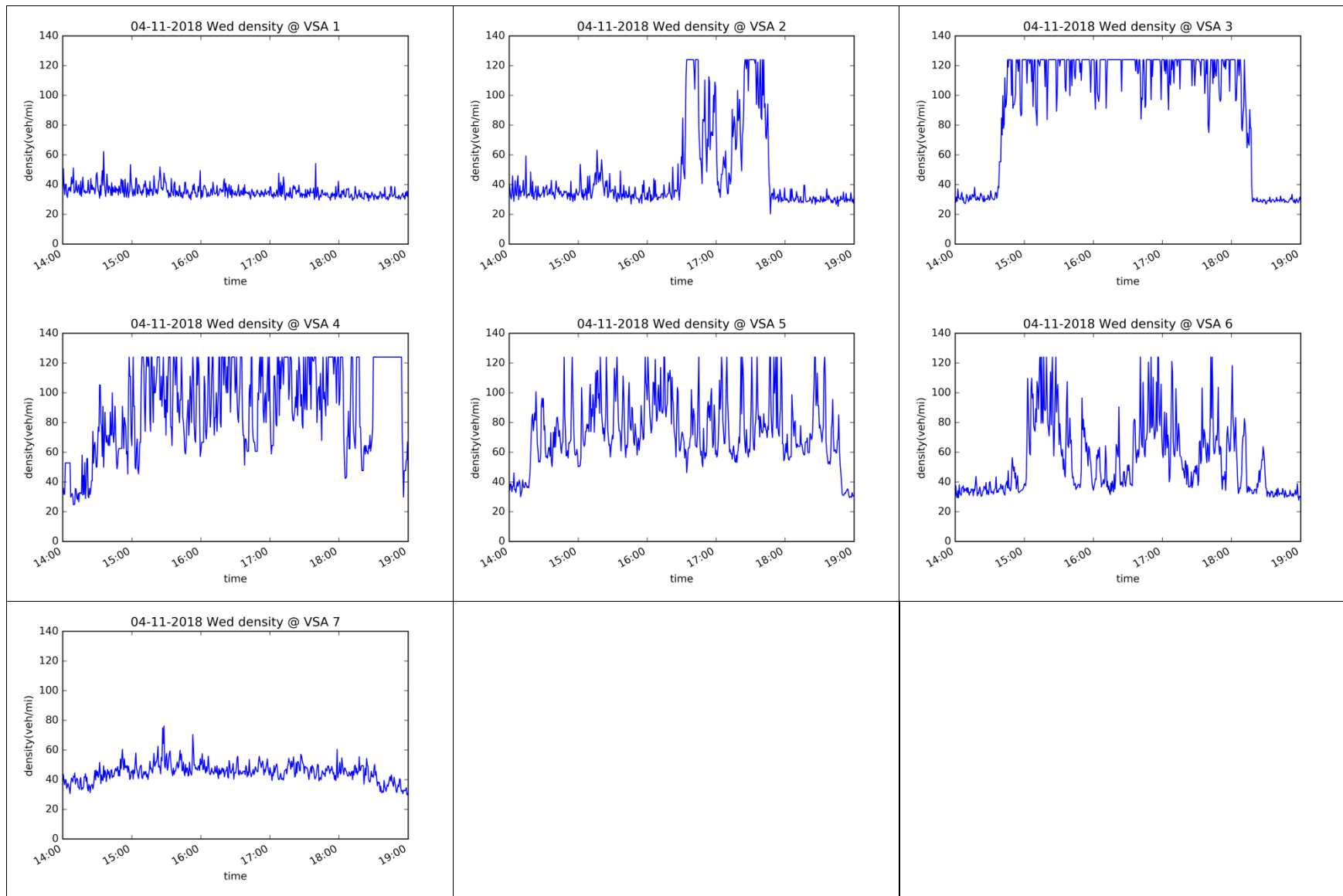

Figure 5.6 Aggregated density during April 11, 2018 evening peak hours from 2PM to 7PM

6 Field Test

This chapter summarizes the Variable Speed Advisory (VSA) test conducted along State Route 78 (SR-78) in Southern California. The test section was the 10.8-mile long East Bound section of SR-78 between Vista Village and the Escondido interchange with I-15.

While actual VSA testing occurred, Caltrans District 11 (D11) executed a construction project on the new auxiliary lane in both directions of SR-78, between Twin Oaks Valley Rd and Woodland Parkway. This construction dictated a lower speed limit of 55 mph for that stretch of the roadway. Within the stretch, multiple bottlenecks were observed along the corridor. The objective of the test was to evaluate the effectiveness of a newly designed VSA algorithm to mitigate the congestion on freeway traffic.

Initially the test plan for the proposed field test targeted VSA control for AM peak only, due to concerns about the solar power supply. However, the test was expanded to the evening peak; under the encouragement by local district traffic engineers, and when it was established that the solar panels could produce sufficient power.

6.1 Field Test Plan

A detailed Test Plan was developed for several purposes:

- For the application for a test permit from Caltrans D11 management
- For information to assist the Caltrans D11 Public Information Office (PIO) in public outreach
- For system installation, integration and tuning
- For project management and support by district Transportation Management Center (TMC) engineers
- As a management tool, for conducting the actual field test

To fulfill its different roles, the Test Plan needed to contain adequate information including:

- VSA sign locations layered on a Google map
- The VSA value to be displayed
- Detailed short-term schedule of all relevant activities
- Tests scenarios, and tentative dates and times
- Progressive test procedure

The detailed Test Plan is included in the Appendices, to this report.

6.2 VSA Sign Locations

Figure 1 shows the locations of VSA signs on the Google map for the auxiliary lane (post mile location 13-14.1) being executed during the VSA field test. This construction could significantly affect the overall traffic pattern on the eastbound section of SR-78, and should factor into the consideration of any proposed change to the traffic system.

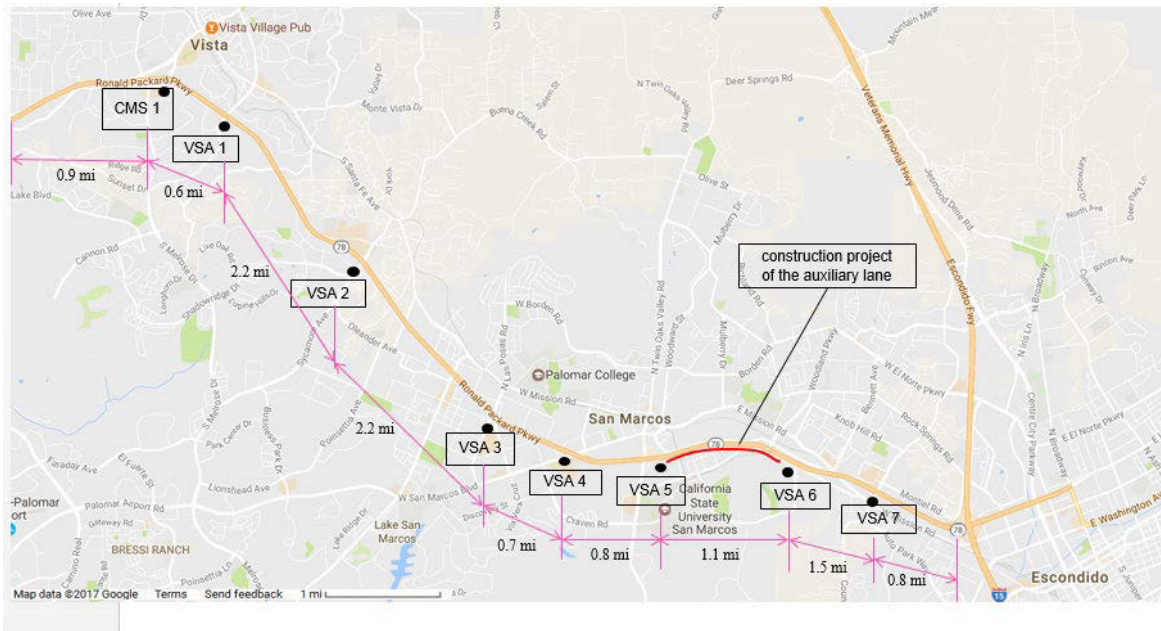

Figure 6.1 Overview of VSA sign locations and the Construction Area

The following Table 6.1 shows the GPS locations of VSA and Changeable Message Signs (CMS), the closest intersection, and the closest local cities.

Table 6.1 VSA sign GPS locations, crossing road and relevant cities

Device	Road name	City	GPS
CMS 1	Vista Village Dr.	Vista	33°11'35.4"N 117°14'47.0"W 33.193175, -117.246385
VSA 1	Sunset Dr.	Vista	33°11'24.1"N 117°14'27.6"W 33.190017, -117.241008
VSA 2	Sycamore Ave	Vista	33°10'02.7"N 117°12'54.6"W 33.167406, -117.215173
VSA 3	Las Posas Rd	San Marcos	33°08'35.5"N 117°11'24.9"W 33.143189, -117.190243
VSA 4	San Marcos Blvd	San Marcos	33°08'16.9"N 117°10'37.4"W 33.138014, -117.177047
VSA 5	Twin Oaks Valley Rd	San Marcos	33°08'13.2"N 117°09'52.8"W 33.137006, -117.164653
VSA 6	Woodland Parkway	San Marcos	33°08'21.8"N 117°08'43.6"W 33.139382, -117.145442
VSA 7	Nordahl Rd	San Marcos	33°07'56.2"N 117°07'19.1"W 33.132267, -117.121978

The specific GPS locations of the VSA signs were important and were strongly influenced by the need to locate the sign outside of the hard shoulder.

6.3 VSA Website Development

The California Partners for Advanced Transportation Technology (PATH) project team created a website, prior to launching the field test in order to illustrate the VSA locations and to display processed traffic information, collected by the various sensors. The website was available from the end of October 2017 at this address: <http://caconnectedvehicletestbed.org/VSA/>. The website updated its information every 30 seconds and included the following information: Aggregated occupancy, flow and speed (developed from the raw data collected from Caltrans District traffic detector stations), 30s aggregated radar speed from the VSA signs, and message and advisory speeds displayed on the VSA signs. It also included a brief introduction to the project.

The website turned out to be very useful, because:

- Caltrans Division of Research Innovation and System Information (DRISI) and Division of Traffic Operations used it to watch the progress of the project;
- Caltrans D11 TMC traffic engineers used it for the observation of traffic patterns;
- Most importantly, the PATH project team was able to observe traffic pattern, and:
 - Review traffic data quality from detector stations and radars integrated into the VSA signs;
 - Review traffic state parameter that were estimated from the fused, raw traffic data;

- Review messages on the VSA signs displayed in the field; and
- Observe the real traffic response to VSA.

In addition, the web site was used to fine tune the VSA algorithm.

A sample of the information displayed on the web site is illustrated in Figure 6.2.

Figure 6.2 is the website screen shot collected on April 06, 1:43PM. The upper left area contains a brief description of the VSA project, the upper right area contains a Google traffic map of the corridor with the traffic situation color coded, and the lower area contains the plots of traffic data and VSA displayed with the color codes listed below. It can be observed from the data that:

- As occupancy (yellow) increases, the (VSA) speed advisory (green) decreases, and it has some prediction with respect to its downstream traffic;
- The VSA advisory (green) is provided to the travelling public upstream of the slowdown. The public’s response is measured by loop detectors (blue) and VSA radar units (purple);
- One objective of the VSA is to reduce/avoid speed fluctuations (shockwaves) along the whole speed profile, which could lead to harmonizing traffic if driver compliance rate is adequately high

6.4 The Information Displayed

CMS1, located at the most upstream location near the Vista Village onramp, in Figure 6.1, was to convey enough information to the driving public to facilitate compliance with the VSA. The PATH project team suggested the following information as options:

“Variable Speed Advisory Testing in Progress”,

“Follow Advisory Speed for Max Flow”

“Follow Advisory Speed for Improved Traffic Flow”

After collaboration with Caltrans D11 TMC traffic engineers the message selected to be displayed on the CMS was: **“Follow Advisory Speed”**.

As for the VSA sign display, the original plan was to display the advisory speed number (Figure 6.2 left) or the message **“Slow Down”** (Figure 6.2, right) if it was necessary, particularly for reducing shockwave at the congestion starting location.

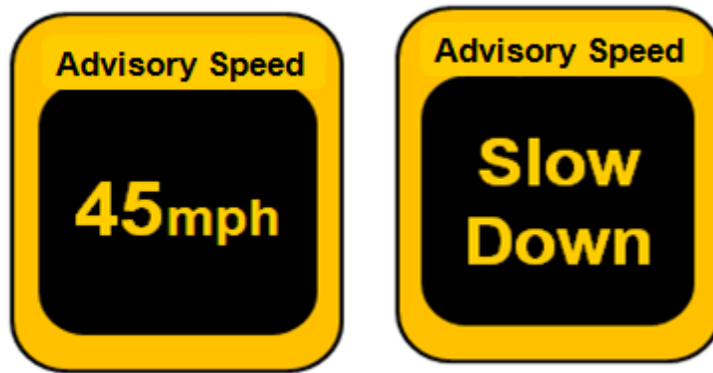

Figure 6.2 Advisory Speed number and message: “Slow Down” were designed for display on VSA signs

Variable Speed Advisory (VSA) is an Active Traffic Management strategy, with the goal of affecting driver behavior on freeway mainlines.

The function of the VSA algorithm is to maximize the bottleneck capacity flow, and to gradually and properly decrease the speeds from the most upstream sign to the bottleneck location in order to achieve the highest throughput, reduce the shockwave, and hopefully eliminate the queue.

This pilot VSA project is to test the effectiveness of the VSA concept using the algorithm developed by PATH research on eastbound SR-78 as indicated in the map above. The roadside VSA signs will display the advisory speeds at increments/decrements of 5-10 mph on based on the traffic conditions during the AM/PM peak periods. The information to be updated at this website every 30 s will include: aggregated occupancy, flow and speed from Caltrans District traffic detector stations, radar speed

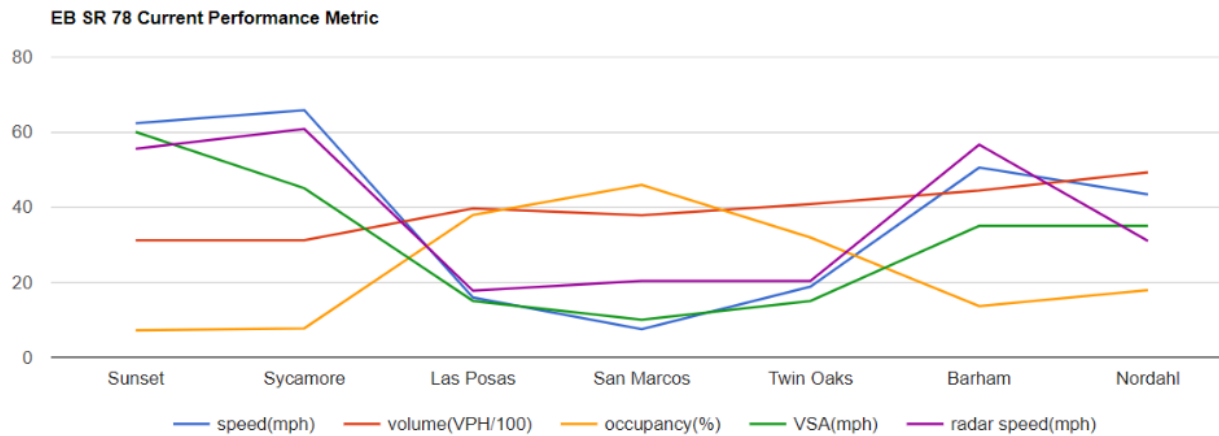
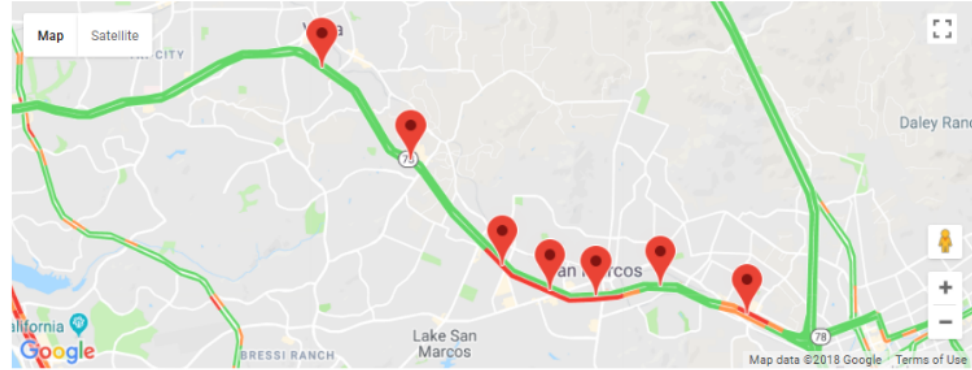

Figure 6.3 VSA Website Example

Figure 6.3 is a typical example for the Website. It includes: a brief introduction of the project, Google real-time traffic map with overlaid VSA sign locations, all color-coded traffic state parameters evolving with respect to distance from upstream to downstream.

affecting driver behavior on freeway mainlines.

The function of the VSA algorithm is to maximize the bottleneck capacity flow, and to gradually and properly decrease the speeds from the most upstream sign to the bottleneck location in order to achieve the highest throughput, reduce the shockwave, and hopefully eliminate the queue.

This pilot VSA project is to test the effectiveness of the VSA concept using the algorithm developed by PATH research on eastbound SR-78 as indicated in the map above. The roadside VSA signs will display the advisory speeds at increments/decrements of 5-10 mph on based on the traffic conditions during the AM/PM peak periods. The information to be updated at this website every 30 s will include: aggregated occupancy, flow and speed from Caltrans District traffic detector stations, radar speed from VSA signs, and message and advisory speed displayed on the VSA signs.

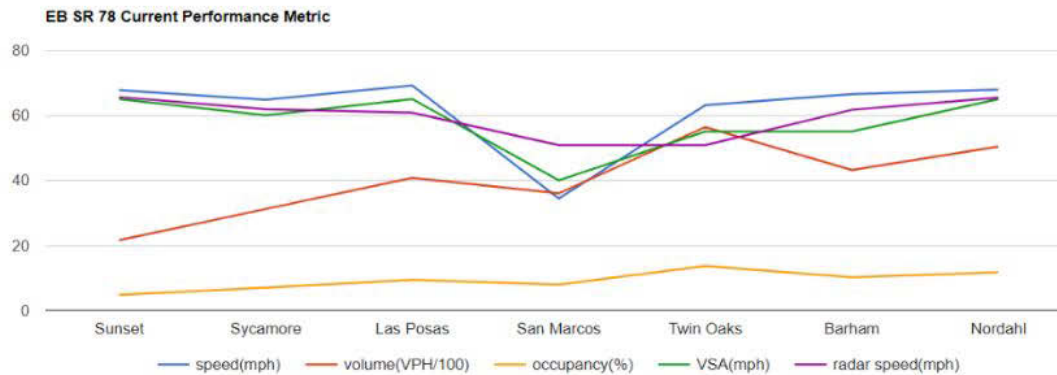
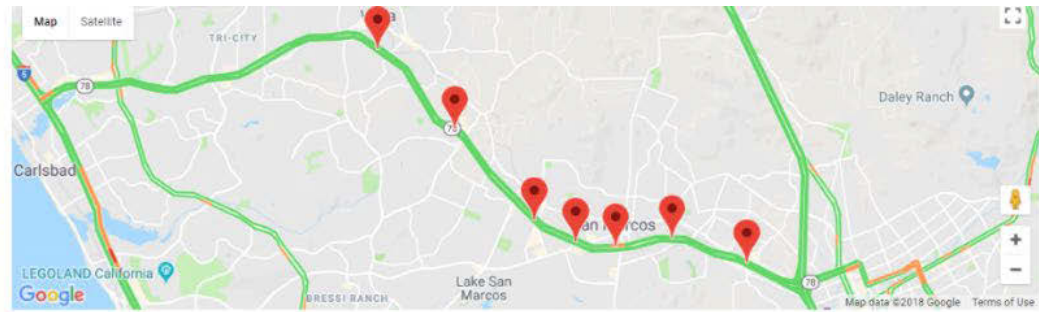

Figure 6.4 VSA and traffic observation at the website for April 5th at 7:20PM

From Figure 6.4, it can be observed that: (a) radar speed is different from the fused speed (blue) since the loop detector speed sometimes are different from the radar speed; (b) the measured and fused speed (blue) following the advisory speed (green) traffic pattern; however, VSA suggested reduced speed earlier which could potentially lead to higher speed at San Marcos than the actual speed.

Variable Speed Advisory (VSA) is an Active Traffic Management strategy, with the goal of affecting driver behavior on freeway mainlines.

The function of the VSA algorithm is to maximize the bottleneck capacity flow, and to gradually and properly decrease the speeds from the most upstream sign to the bottleneck location in order to achieve the highest throughput, reduce the shockwave, and hopefully eliminate the queue.

This pilot VSA project is to test the effectiveness of the VSA concept using the algorithm developed by PATH research on eastbound SR-78 as indicated in the map above. The roadside VSA signs will display the advisory speeds at increments/decrements of 5-10 mph on based on the traffic conditions during the AM/PM peak periods. The information to be updated at this website every 30 s will include: aggregated occupancy, flow and speed from Caltrans District traffic detector stations, radar speed from VSA signs, and message and advisory speed displayed on the VSA signs.

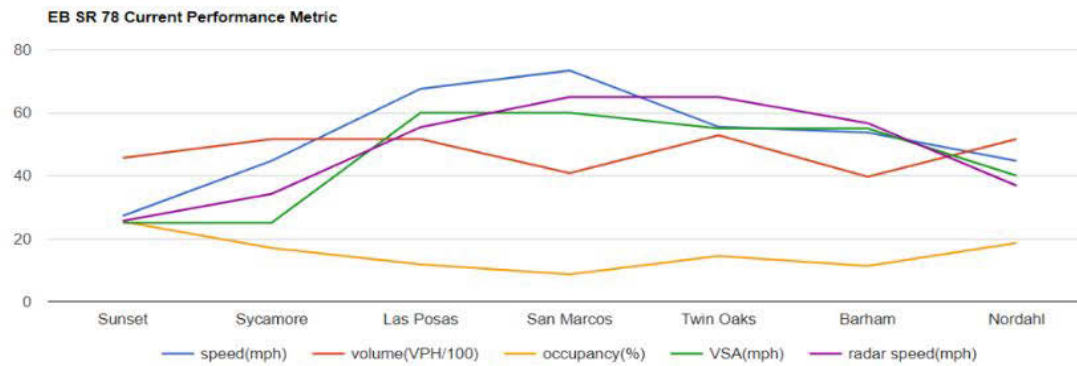
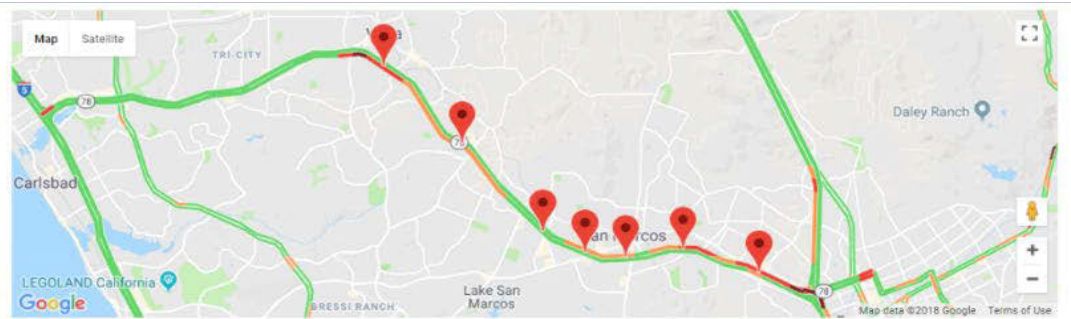

Figure 6.5 VSA and traffic observation at the website for April 12th at 8:10AM

From Figure 6.5, it can be observed that: VSA suggested a reduced speed earlier than the radar speed and fused speed, which could potentially reduce the traffic speed fluctuation downstream of Las Posas.

Variable Speed Advisory (VSA) is an Active Traffic Management strategy, with the goal of affecting driver behavior on freeway mainlines.

The function of the VSA algorithm is to maximize the bottleneck capacity flow, and to gradually and properly decrease the speeds from the most upstream sign to the bottleneck location in order to achieve the highest throughput, reduce the shockwave, and hopefully eliminate the queue.

This pilot VSA project is to test the effectiveness of the VSA concept using the algorithm developed by PATH research on eastbound SR-78 as indicated in the map above. The roadside VSA signs will display the advisory speeds at increments/decrements of 5-10 mph on based on the traffic conditions during the AM/PM peak periods. The information to be updated at this website every 30 s will include: aggregated occupancy, flow and speed from Caltrans District traffic detector stations, radar speed from VSA signs, and message and advisory speed displayed on the VSA signs.

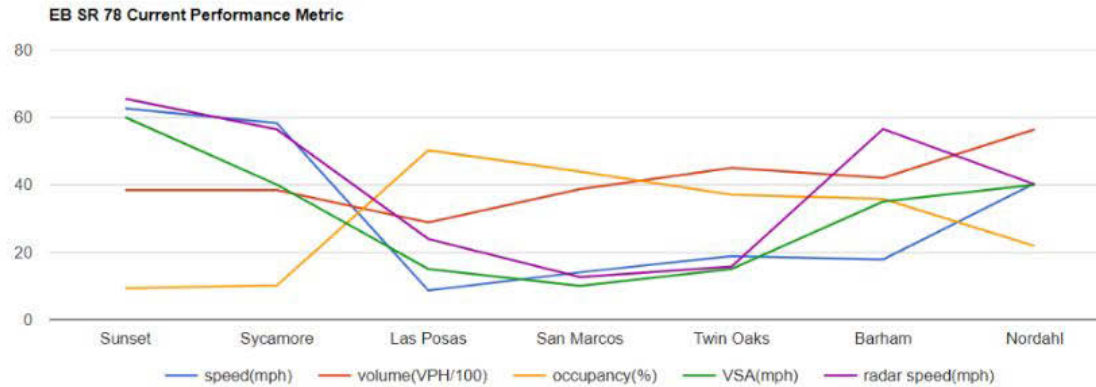
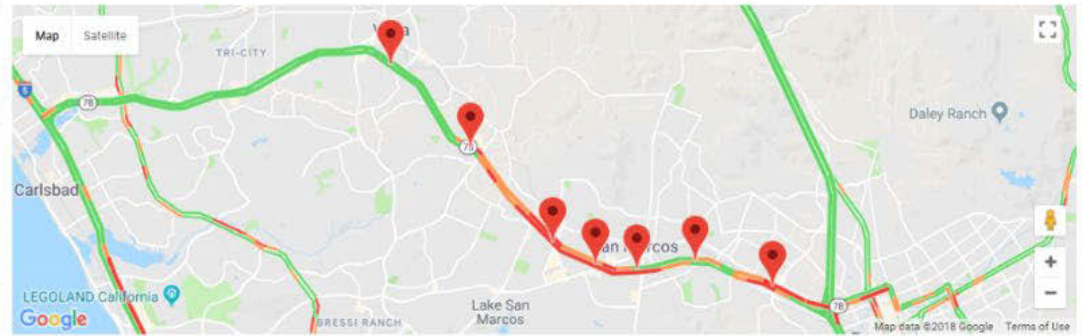

Figure 6.6 VSA and traffic observation at the website for April 17th at 5:19PM

Similar to Figure 6.5, Figure 6.6 showed that VSA suggested a gradually reduced speed earlier than the radar speed and fused speed, which could potentially reduce the traffic speed fluctuation downstream of Las Posas.

Variable Speed Advisory (VSA) is an Active Traffic Management strategy, with the goal of affecting driver behavior on freeway mainlines.

The function of the VSA algorithm is to maximize the bottleneck capacity flow, and to gradually and properly decrease the speeds from the most upstream sign to the bottleneck location in order to achieve the highest throughput, reduce the shockwave, and hopefully eliminate the queue.

This pilot VSA project is to test the effectiveness of the VSA concept using the algorithm developed by PATH research on eastbound SR-78 as indicated in the map above. The roadside VSA signs will display the advisory speeds at increments/decrements of 5-10 mph on based on the traffic conditions during the AM/PM peak periods. The information to be updated at this website every 30 s will include: aggregated occupancy, flow and speed from Caltrans District traffic detector stations, radar speed from VSA signs, and message and advisory speed displayed on the VSA signs.

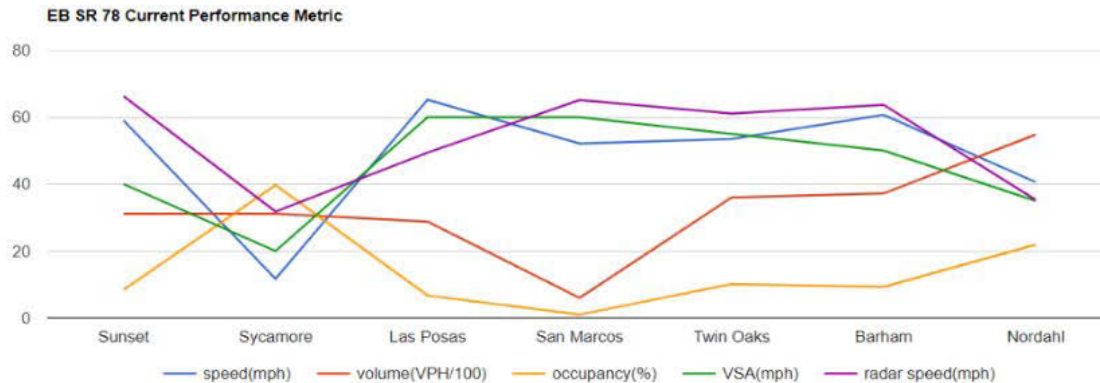
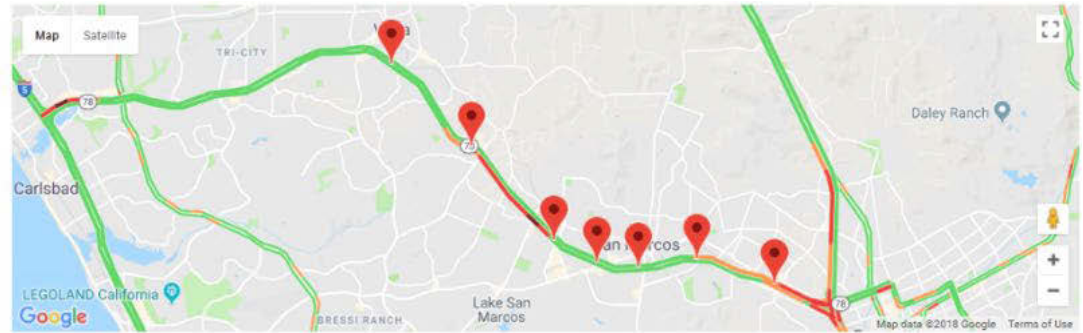

Figure 6.7 VSA and traffic observation at the website for April 18th at 8:19AM

From Figure 6.7, it can be observed that: VSA suggested a lower and gradual reduced speed earlier than the radar speed and fused speed, which could potentially reduce sudden deceleration from Sunset to Sycamore.

Variable Speed Advisory (VSA) is an Active Traffic Management strategy, with the goal of affecting driver behavior on freeway mainlines.

The function of the VSA algorithm is to maximize the bottleneck capacity flow, and to gradually and properly decrease the speeds from the most upstream sign to the bottleneck location in order to achieve the highest throughput, reduce the shockwave, and hopefully eliminate the queue.

This pilot VSA project is to test the effectiveness of the VSA concept using the algorithm developed by PATH research on eastbound SR-78 as indicated in the map above. The roadside VSA signs will display the advisory speeds at increments/decrements of 5-10 mph on based on the traffic conditions during the AM/PM peak periods. The information to be updated at this website every 30 s will include: aggregated occupancy, flow and speed from Caltrans District traffic detector stations, radar speed from VSA signs, and message and advisory speed displayed on the VSA signs.

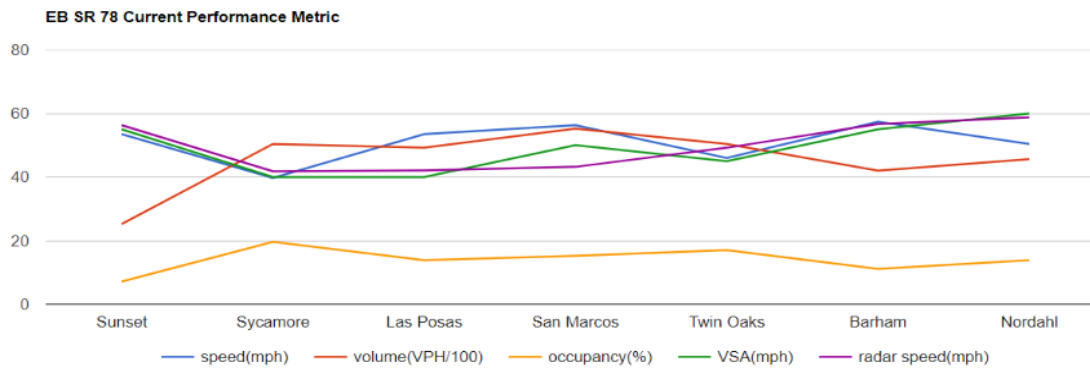
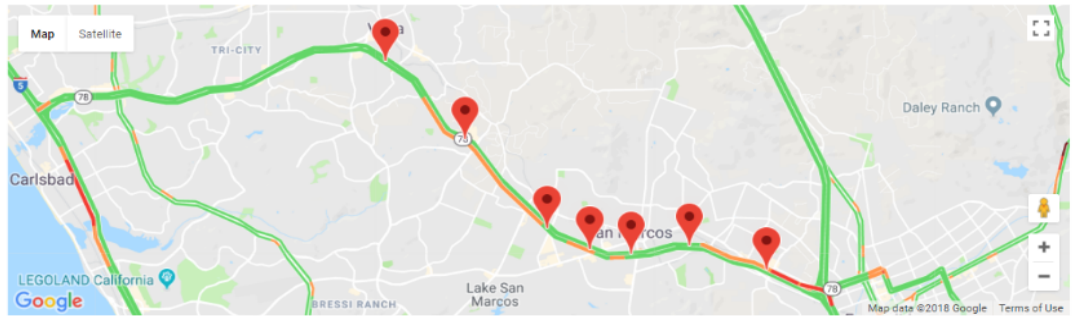

Figure 6.8 VSA and traffic observation at the website for May 1st at 8:51AM

Figure 6.8 showed that the radar speed and the fused speed were close to the VSA.

Due to limits on communication bandwidth and Traffic Logix server capability, only the advisory speed numbers were displayed during the test.

The speed advisory number displayed was rounded to the nearest 5mph. The difference between the VSA numbers displayed in two consecutive signs, and that on the same sign in two consecutive time intervals were also limited. Those thresholds for the limit are slightly different from each other from section to section.

6.5 Field Test

The PATH project team adopted a progressive test procedure to reduce/avoid any negative impact on daily traffic operation during the SR-78E VSA test. The progressive test procedure consisted of four steps: System preparation, dry-run, initial testing and system tuning, and then this was followed by extensive formal testing. These test stages will be described in more detail, below. Table 6.2 illustrates the timeframes for the progressive test, VSA display status and data collection and usage in system tuning and performance analysis at different stages.

The data collected in the five weeks of the formal test period (4/30 – 5/4, 2018) was used later for the “VSA-ON” scenario in performance analysis. The data collected for the two weeks during March 12 – 16 (VSA signs were not installed) and May 7 - 11 (VSA signs were taken out) was used as the “VSA-OFF” scenario.

Table 6.2 Timeframes for progressive VSA field test and data usage

Test Stage Time frame	2/1 – 3/12 2018	3/12 –3/16 2018	3/19 – 4/6 2018	4/9 – 5/4 2018	5/7 – 5/11 2018
Progressive Test Stages	Dry-run; System not installed	Initial test	System Tuning	Formal test	System removed
VSA Display Status	Syst. Not installed	OFF	ON	ON	OFF
Data usage	Used for system checking, not for performance analysis	PeMS data used as VSA-Off scenario	Not used for performance analysis	PeMS data used as VSA-ON	PeMS data used as VSA- Off scenario

6.5.1 System Preparation

System installation in the field was not a simple issue. Since the traffic on the freeway was moving, mounting equipment at the roadside raised safety concerns. This installation process was conducted successfully with full support of Caltrans D11 TMC traffic engineers with appropriate equipment.

In the system preparation stage, the PATH project team checked if the system was properly integrated using the steps outlined below:

- The VSA control system must correctly read the field traffic detector data every 30s, which Caltrans D11 engineers forwarded automatically through an internet XML module
- Traffic speed data acquisition from the radar units on the VSA signs were correctly read (every 30s, independent from the traffic detector data from the internet)
- Processing the traffic data to generate traffic state parameters for each section
- Calculating advisory speed for each section using the PATH-developed VSA algorithm

6.5.2 Dry-Run

The dry-run is a very important procedure before switching the system ON for any field test project. The purpose of a dry run is to operate a partially or fully integrated system with data saved for analysis without actually switching on the VSA signs display.

The dry-run was conducted in several stages in this project to make sure:

- All the input traffic data were correctly mapped;
- Data processing and traffic state parameter estimation were error-free;
- The VSA algorithm produced what was expected;
- The correct VSA value was sent to the display at each VSA sign location;
- The modem link between the PATH central control computer and the VSA sign was reliable;

- The website displays of traffic state parameters, Google color-coded traffic situation, and the VSA at each location were correct and synchronized.

6.5.3 Initial Test and System Tuning

Testing was initiated on March 19th, after adequate power was established, communications and VSA sign display functionality was confirmed, and the dry run was completed. From March 19 through April 6, iterative system tuning was performed:

- By direct observations on the VSA website for traffic data and traffic situation using Google Traffic;
- Monitoring traffic data from PeMS, data from the VSA sign mounted radars signs (on a wireless-modem-connected laptop), and messages displayed on the VSA signs;
- Driving with real traffic along the freeway corridor and observing the actual traffic.

The system tuning also incorporated the observations and comments from Caltrans D11 traffic engineers to make sure the VSA was reasonable from their traffic operation viewpoint. This iterative process took more time than was previous planned.

6.5.4 Field Tests and Data Collection

After several weeks devoted to initial tests and several rounds of iterative tuning of the system and the VSA algorithm, the VSA system was operating automatically and to expectations. From this point forward, no additional intervention was necessary. The system initiated VSA operation for AM and PM peak hours, automatically. Formal extensive testing and data collection were conducted from April 9th to May 4th. During the testing, the PATH project team monitored traffic patterns and VSA performance over the website. In the screen shots (Figure 6.4 ~ Figure 6.8) you can observe the traffic flow rates, the VSA displayed. You can also compare the experimental data collected with traffic conditions indicated in the Google Real-time Traffic Map, to determine if the data are reasonable.

6.5.5 Test Progress Update to the Project Panel

From the first day of initial testing, the project team was regularly updated the project panel regarding any progress and issues, and provided timely feedback to the project panel and the district TMC traffic engineers.

During the first week of testing, the project team provided the panel with daily updates through email briefings. Beginning from week 2, the team provided the panel with weekly updates through email. The following information was provided:

- Any progress regarding the test.
- Any issues during the test, such as a VSA sign displaying unreasonable information.
- Actual traffic situation of the test corridor based on sensor data and Google Traffic.
- The VSA message that was displayed on the signs in the field during testing period that day/week.
- Any system modifications that had been made such as tuning or refining.
- Any feedback comments from the local TMC traffic engineers.
- Any measures the project team had taken to address any comments and concerns from the project panel and local TMC traffic engineers.

6.6 Conclusion and Lessons Learned

The VSA test was accomplished successfully, even though the period of initial testing offered some unique challenges. Through the progressive test of VSA on SR-78E, the project team had experienced the following lessons and experiences which could be useful for similar field test projects:

- The test of VSA along a 10.8 miles long freeway corridor is a large, complex field test. The system needs to be completely prepared and sufficient for the task before field mobilization for installation. This is particularly true if equipment, new to the team, will be involved in the tests. System integration is much easier to do off-line in a laboratory environment rather than online in the field, while positioned on the side of the highway.
- Dry-run operations, at different stages of integration, are very critical for a field test project success. They can significantly reduce potential uncertainties and concerns during the initial test stage.
- Contingent measures are absolutely necessary for a field test project. The project team initially prepared at least three VSA algorithms for field testing. Each were simulated before the test started. The algorithm chosen for implementation was the simplest of the three, but still promising from an intuitive consideration of traffic system characteristics. Simplicity is very important, since the test was directly affecting the real-world traffic operation.

- Strong, patient support from the local TMC traffic engineers ensured the success of the test. This support was particularly critical during initial testing, where many unique challenges were encountered.
- The project team needs to be prepared to handle unanticipated problems – such as theft of test equipment.
- During the test, the team recognized that the display signs for VSA were too small - compared to the width of the freeway (3 lanes in our case).
- The distance between two signs should not be more than a half mile, the ideal distance is estimated to be 0.3 mile between VSA signs. During the completed field test the distance between some of the 7 installed VSA signs (in Figure 6.1) was over 1 mile, which (in hindsight) was too long.
- The initial test stage, which included the system and VSA algorithm tuning, took three weeks. It was originally envisioned to require one week. A longer period for initial testing should be afforded any subsequent tests.

7 VSA Field Test Performance Analysis

7.1 Introduction

Variable speed advisory (VSA) has been tested to determine if freeway congestion can be alleviated and safety improved by homogenizing vehicle speeds. The influence of VSA control will be examined through the evaluation of three main freeway performance indices: VMT (Vehicle-Miles-Traveled), VHT (Vehicle-Hours-Traveled), and Q (=VMT/VHT, defined as the *efficiency* which could be understood as *average speed* of all vehicles). Hourly Performance Measurement Systems (PeMS) data (VMT, VHT, and Q) for the freeway segment of test site (State Route 78 Eastbound (SR-78E) from postmile 6.316 to postmile 15.593) are used for objective evaluation. The VSA test hours in AM/PM peak hours in the weekdays are from 6AM to 9AM, and from 2PM to 7PM respectively.

The four weeks “after” scenario (VSA-ON) period is from April 9, 2018 to May 4, 2018. Two weeks of “before” scenario (VSA-OFF) period, are from March 12 - 16, 2018 and from May 7 - 11, 2018, and are selected as baseline for freeway performance comparison. The improvement of an index x is computed by

$$\Delta x = \frac{x_{with\ VSA} - x_{without\ VSA}}{x_{without\ VSA}}$$

Color code in the document: “**GREEN**” means improvement; “**RED**” means getting worse

7.2 Baseline Average Hourly Traffic Performance Over All Weekdays for “VSA OFF” Scenario

In order to study the field test results, the data without VSA activation before the VSA field test, listed in Table 7.1 and the data without VSA activation after the VSA field test, listed in Table 7.2 are selected as baselines for evaluation.

Table 7.1 Summary of both AM and PM hourly VHT, VMT and Q for March 12-16, 2018 (VSA-OFF)

Baseline 3/12/18-3/16/18	6-7AM	7-8AM	8-9AM	2-3PM	3-4PM	4-5PM	5-6PM	6-7PM
VMT	51713.88	48239.8	46757.66	52521.58	50946.14	51431.44	46941.72	37900.66
VHT	1340.3	1267.5	869.24	1470.82	1507.84	1453.76	868.18	642.64
Q	39.8	42.3	54.77	36.29	33.86	35.47	54.23	60.86

Table 7.2 Summary of both AM and PM hourly VHT, VMT and Q for May 7- 11, 2018 (VSA-OFF)

Baseline 5/7/18-5/11/18	6-7AM	7-8AM	8-9AM	2-3PM	3-4PM	4-5PM	5-6PM	6-7PM
VMT	54502.2	51302.9	45197.48	50323.46	48961.12	50683.56	46360.28	37512.9
VHT	1134.48	1015.3	741.84	1520.7	1639.06	1534.4	946.18	582.56
Q	48.50	51.02	60.97	33.77	30.33	33.32	50.07	64.76

7.3 Baseline Traffic Hourly Performance for All Weekdays for “VSA- ON” Scenario

Table 7.3, Table 7.4, and Table 7.5 show average hourly VMT, VHT, and Q respectively along the test corridor during morning and evening field test periods, respectively. Table 7.6 is the Summary of both AM and PM hourly performance parameters during the VSA test.

Table 7.3 Summary of both AM and PM hourly VMT during VSA test

Test Week, VMT (Veh-Miles)	6-7AM	7-8AM	8-9AM	2-3PM	3-4PM	4-5PM	5-6PM	6-7PM
4/9/18-4/13/18	54429.26	50702.52	46996.4	48852.64	50468.84	51000	47226.16	40287.66
4/16/18-4/20/18	55351.58	50822.68	47635.8	50646.44	50315.38	50742.28	45592.64	37796.38
4/23/18-4/27/18	55419.54	51389.82	46597.72	48593.16	47882.56	50223.76	46286.16	37519.84
4/30/18-5/4/18	54871.28	51273.84	46002.02	52655.9	52344.86	52429.5	47111.34	37258.7
Average VMT	55017.91	51047.21	46807.98	50187.03	50252.91	51098.88	46554.07	38215.64

Table 7.4 Summary of both AM and PM hourly VHT during VSA test

Test Week, VHT (Veh-Hours)	6-7AM	7-8AM	8-9AM	2-3PM	3-4PM	4-5PM	5-6PM	6-7PM
4/9/18-4/13/18	1129.22	966.26	806.22	1710.02	1687.46	1554.5	915.9	626.96
4/16/18-4/20/18	1137.18	1004	816.7	1554.98	1630.1	1434.7	819.48	575.58
4/23/18-4/27/18	1096.34	1031.12	776.12	1482.34	1712.56	1538.96	877.26	569.8
4/30/18-5/4/18	1152.66	1041.02	792.06	1482.22	1417.74	1219.1	799.04	560.38
Average VHT	1128.85	1010.6	797.775	1557.39	1611.96	1436.81	852.92	583.18

Table 7.5 Summary of both AM and PM hourly Q during VSA test

Test Week, Q (Veh-Hours)	6-7AM	7-8AM	8-9AM	2-3PM	3-4PM	4-5PM	5-6PM	6-7PM
4/9/18-4/13/18	48.71	53.21	58.45	29.44	30.79	33.62	52.29	64.28
4/16/18-4/20/18	49.76	51.58	58.44	33.52	31.46	35.86	55.81	65.73
4/23/18-4/27/18	51.13	51.63	60.15	32.82	29.67	34.07	53.69	65.84
4/30/18-5/4/18	47.73	49.68	58.22	36.38	38.38	43.79	59.08	66.58
Average Q	49.33	51.52	58.81	33.04	32.57	36.83	55.21	65.60

Table 7.6 Four-weeks average of hourly performance parameters during VSA test

	VMT	VHT	Q [mph]
AM	50957.70	979.07	53.22
PM	47261.71	1208.45	44.65

7.4 Individual Week Performance Comparison

The following tables (Table 7.7- 7.14) are comparison of the four individual weeks with VSA ON with the week of 3/12 – 3/16 and the week 5/7 – 5/11, 2018 (VSA-OFF). These tables will help to observe the VSA performance improvement as the test progressed. Hourly data has been averaged over weekdays for comparison during the same time periods.

Table 7.7 hourly comparison of week 4/9-4/13 (VSA-ON) to 3/12-3/16 (VSA-OFF), 2018

	6-7AM	7-8AM	8-9AM	2-3PM	3-4PM	4-5PM	5-6PM	6-7PM
VSA-OFF VMT	51713.88	48239.8	46757.66	52521.58	50946.14	51431.44	46941.72	37900.66
VSA VMT	54429.26	50702.52	46996.4	48852.64	50468.84	51000	47226.16	40287.66
VSA-OFF VHT	1340.3	1267.5	869.24	1470.82	1507.84	1453.76	868.18	642.64
VSA VHT	1129.22	966.26	806.22	1710.02	1687.46	1554.5	915.9	626.96
VSA-OFF Q	39.8	42.3	54.77	36.29	33.86	35.47	54.23	60.86
VSA Q	48.71	53.21	58.45	29.44	30.79	33.62	52.29	64.28
ΔVMT	5.25%	5.11%	0.51%	-6.99%	-0.94%	-0.84%	0.61%	6.3%
ΔVHT	-15.75%	-23.77%	-7.25%	16.26%	11.91%	6.93%	5.5%	-2.43%
ΔQ	22.34%	25.78%	6.72%	-18.86%	-9.1%	-5.23%	-3.58%	5.62%

This comparison indicates that VSA improves morning VMT, VHT, and Q significantly, but those performance indices in evening traffic are not improved by VSA.

Table 7.8 hourly comparison of week 4/9 -4/13 (VSA-ON) to 5/7 – 5/11 (VSA-OFF), 2018

	6-7AM	7-8AM	8-9AM	2-3PM	3-4PM	4-5PM	5-6PM	6-7PM
VSA-OFF VMT	54502.2	51302.9	45197.48	50323.46	48961.12	50683.56	46360.28	37512.9
VSA VMT	54429.26	50702.52	46996.4	48852.64	50468.8	51000	47226.16	40287.66
VSA-OFF VHT	1134.48	1015.3	741.84	1520.7	1639.06	1534.4	946.18	582.56
VSA VHT	1129.22	966.26	806.22	1710.02	1687.46	1554.5	915.9	626.96
VSA-OFF Q	48.50	51.02	60.97	33.77	30.33	33.32	50.07	64.76
VSA Q	48.71	53.21	58.45	29.44	30.79	33.62	52.29	64.28
ΔVMT	-0.13%	-1.17%	3.98%	-2.92%	3.08%	0.62%	1.87%	7.4%
ΔVHT	-0.46%	-4.83%	8.68%	12.45%	2.95%	1.31%	-3.2%	7.62%
ΔQ	0.43%	4.28%	-4.13%	-12.82%	1.5%	0.9%	4.45%	-0.74%

This comparison indicates that VSA slightly improves morning VMT and Q, and evening VMT is also slightly improved. But, VHT in the morning and VHT and Q in evening traffic do not have significant improvement.

Table 7.9 hourly comparison of week 4/16 -4/20 (VSA-ON) to 3/12-3/16 (VSA-OFF), 2018

	6-7AM	7-8AM	8-9AM	2-3PM	3-4PM	4-5PM	5-6PM	6-7PM
VSA-OFF VMT	51713.88	48239.8	46757.66	52521.58	50946.14	51431.44	46941.72	37900.66
VSA VMT	55351.58	50822.68	47635.8	50646.44	50315.38	50742.28	45592.64	37796.38
VSA-OFF VHT	1340.3	1267.5	869.24	1470.82	1507.84	1453.76	868.18	642.64
VSA VHT	1137.18	1004	816.7	1554.98	1630.1	1434.7	819.48	575.58
VSA-OFF Q	39.8	42.3	54.77	36.29	33.86	35.47	54.23	60.86
VSA Q	49.76	51.58	58.44	33.52	31.46	35.86	55.81	65.73
ΔVMT	7.03%	5.35%	1.88%	-3.57%	-1.24%	-1.34%	-2.87%	-0.28%
ΔVHT	-15.15%	-20.79%	-6.04%	5.72%	8.11%	-1.31%	-5.61%	-10.44%

ΔQ	25.01%	21.93%	6.71%	-7.61%	-7.08%	1.09%	2.91%	8.00%
-----------	--------	--------	-------	--------	--------	-------	-------	-------

This comparison indicates that VSA improves morning VMT, VHT, and Q significantly, but those performance indices in evening traffic are not improved by VSA.

Table 7.10 hourly comparison of week 4/16 -4/20 (VSA-ON) to 5/7 – 5/11 (VSA-OFF), 2018

	6-7AM	7-8AM	8-9AM	2-3PM	3-4PM	4-5PM	5-6PM	6-7PM
VSA-OFF VMT	54502.2	51302.9	45197.48	50323.46	48961.12	50683.56	46360.28	37512.9
VSA VMT	55351.58	50822.68	47635.8	50646.44	50315.38	50742.28	45592.64	37796.38
VSA-OFF VHT	1134.48	1015.3	741.84	1520.7	1639.06	1534.4	946.18	582.56
VSA VHT	1137.18	1004	816.7	1554.98	1630.1	1434.7	819.48	575.58
VSA-OFF Q	48.50	51.01	60.96	33.77	30.33	33.31	50.06	64.75
VSA Q	49.75	51.57	58.43	33.52	31.46	35.85	55.81	65.72
ΔVMT	1.55%	-0.93%	5.39%	0.64%	2.76%	0.11%	-1.65%	0.75%
ΔVHT	0.23%	-1.11%	10.09%	2.25%	-0.54%	-6.49%	-13.39%	-1.19%
ΔQ	2.58%	1.09%	-4.14%	-0.73%	3.72%	7.62%	11.47%	1.49%

Table 7.11 hourly comparison of week 4/23 -4/27 (VSA-ON) to 3/12-3/16 (VSA-OFF), 2018

	6-7AM	7-8AM	8-9AM	2-3PM	3-4PM	4-5PM	5-6PM	6-7PM
VSA-OFF VMT	51713.88	48239.8	46757.66	52521.58	50946.14	51431.44	46941.72	37900.66
VSA VMT	55419.54	51389.82	46597.72	48593.16	47882.56	50223.76	46286.16	37519.84
VSA-OFF VHT	1340.3	1267.5	869.24	1470.82	1507.84	1453.76	868.18	642.64
VSA VHT	1096.34	1031.12	776.12	1482.34	1712.56	1538.96	877.26	569.8
VSA-OFF Q	39.8	42.3	54.77	36.29	33.86	35.47	54.23	60.86
VSA Q	51.13	51.63	60.15	32.82	29.67	34.07	53.69	65.84
ΔVMT	7.17%	6.53%	-0.34%	-7.48%	-6.01%	-2.35%	-1.40%	-1.00%
ΔVHT	-18.20%	-18.65%	-10.71%	0.78%	13.58%	5.86%	1.05%	-11.33%
ΔQ	28.47%	22.05%	9.83%	-9.56%	-12.37%	-3.96%	-1.01%	8.19%

This comparison indicates that VSA improves morning VMT, VHT, and Q significantly, but those performance indices in evening traffic are not improved by VSA.

Up to the third week of the field test, if we compare VMT, VHT and Q in April 2018 to the same date of week in March 2018 (from March 12, 2018 to March 16,2018), the results indicate that all performance indices (VHT, VMT and Q) have significant improvement during the morning traffic peak hour. However, VMT, VHT and Q in evening traffic peak hour are not improved.

Table 7.12 hourly comparison of week 4/23-4/27 (VSA-ON) to 5/7 – 5/11 (VSA-OFF), 2018

	6-7AM	7-8AM	8-9AM	2-3PM	3-4PM	4-5PM	5-6PM	6-7PM
VSA-OFF VMT	54502.2	51302.9	45197.48	50323.46	48961.12	50683.56	46360.28	37512.9
VSA VMT	55419.54	51389.82	46597.72	48593.16	47882.56	50223.76	46286.16	37519.84
VSA-OFF VHT	1134.48	1015.3	741.84	1520.7	1639.06	1534.4	946.18	582.56
VSA VHT	1096.34	1031.12	776.12	1482.34	1712.56	1538.96	877.26	569.8
VSA-OFF Q	48.50	51.01	60.96	33.77	30.33	33.31	50.06	64.75
VSA Q	51.13	51.62	60.14	32.81	29.66	34.06	53.68	65.83
ΔVMT	1.68%	0.16%	3.09%	-3.43%	-2.20%	-0.90%	-0.15%	0.018%
ΔVHT	-3.36%	1.55%	4.62%	-2.52%	4.48%	0.29%	-7.28%	-2.19%
ΔQ	5.42%	1.19%	-1.33%	-2.83%	-2.18%	2.25%	7.23%	1.67%

Table 7.13 hourly comparison of week 4/30 -5/4 (VSA) to 3/12-3/16 (VSA-ON), 2018

	6-7AM	7-8AM	8-9AM	2-3PM	3-4PM	4-5PM	5-6PM	6-7PM
VSA-OFF VMT	51713.88	48239.8	46757.66	52521.58	50946.14	51431.44	46941.72	37900.66
VSA VMT	54871.28	51273.84	46002.02	52655.9	52344.86	52429.5	47111.34	37258.7
VSA-OFF VHT	1340.3	1267.5	869.24	1470.82	1507.84	1453.76	868.18	642.64
VSA VHT	1152.66	1041.02	792.06	1482.22	1417.74	1219.1	799.04	560.38
VSA-OFF Q	39.8	42.3	54.77	36.29	33.86	35.47	54.23	60.86
VSA Q	47.73	49.68	58.22	36.38	38.38	43.79	59.08	66.58
ΔVMT	6.11%	6.29%	-1.62%	0.26%	2.75%	1.94%	0.36%	-1.69%
ΔVHT	-14.00%	-17.87%	-8.88%	0.78%	-5.98%	-16.14%	-7.96%	-12.8%
ΔQ	19.91%	17.44%	6.3%	0.27%	13.35%	23.44%	8.94%	9.4%

This comparison indicates that VSA improves morning VMT, VHT, and Q significantly, and evening Q is also improved. But, VMT and VHT in evening traffic do not have significant improvement.

Table 7.14 hourly comparison of week 4/30 – 5/4 (VSA-ON) to 5/7 – 5/11 (VSA-ON), 2018

	6-7AM	7-8AM	8-9AM	2-3PM	3-4PM	4-5PM	5-6PM	6-7PM
VSA-OFF VMT	54502.2	51302.9	45197.48	50323.46	48961.12	50683.56	46360.28	37512.9
VSA VMT	54871.28	51273.84	46002.02	52655.9	52344.86	52429.5	47111.34	37258.7
VSA-OFF VHT	1134.48	1015.3	741.84	1520.7	1639.06	1534.4	946.18	582.56
VSA VHT	1152.66	1041.02	792.06	1482.22	1417.74	1219.1	799.04	560.38
VSA-OFF Q	48.50	51.01	60.96	33.77	30.33	33.31	50.06	64.75
VSA Q	47.72	49.67	58.22	36.38	38.38	43.78	59.08	66.57
ΔVMT	0.67%	-0.05%	1.78%	4.63%	6.91%	3.44%	1.62%	-0.67%
ΔVHT	1.6%	2.53%	6.76%	-2.53%	-13.5%	-20.54%	-15.55%	-3.8%
ΔQ	-1.6%	-2.63%	-4.5%	7.73%	26.53%	31.43%	18%	2.81%

7.5 Hourly VSA Performance Averaged Over 4 Weekdays

The comparison of freeway performance between the average of four VSA field test weeks, and baseline data is contained in Table 7.15 (using data from March 12, 2018 to March 16, 2018 as a baseline) and Table 7.16 (using data from May 7, 2018 to May 11, 2018 as a baseline), where **green text** indicates improvement of the network's performance and **red text** means deterioration of performance. In Table 7.15, the morning average Δ VMT is 4.10% and the evening average Δ VMT is -1.28%; the morning average Δ VHT is -14.75% and the evening average Δ VHT is 0.12%; the morning average Δ Q is 17.71% and the evening average Δ Q is 0.14%. In Table 7.16, the morning average Δ VMT is 1.33% and the evening average Δ VMT is 1.09%; the morning average Δ VHT is 2.19% and the evening average Δ VHT is -3.07%; the morning average Δ Q is -0.27% and the evening average Δ Q is 5.47%.

Table 7.15 4-week average hourly performance over 4-week compared to March 12-16, 2018

	6-7AM	7-8AM	8-9AM	2-3PM	3-4PM	4-5PM	5-6PM	6-7PM
Δ VMT	6.38%	5.81%	0.10%	-4.44%	-1.36%	-0.64%	-0.82%	0.83%
Δ VHT	-15.77%	-20.26%	-8.22%	5.88%	6.90%	-1.16%	-1.75%	-9.25%
Δ Q	23.95%	21.80%	7.38%	-8.95%	-3.79%	3.84%	1.82%	7.80%

Table 7.16 4-week average hourly performance over 4-week compared to May 7-11, 2018

	6-7AM	7-8AM	8-9AM	2-3PM	3-4PM	4-5PM	5-6PM	6-7PM
Δ VMT	0.94%	-0.49%	3.56%	-0.27%	2.63%	0.81%	0.41%	1.87%
Δ VHT	-0.49%	-0.46%	7.54%	2.41%	-1.65%	-6.35%	-9.85%	0.10%
Δ Q	1.71%	0.98%	-3.53%	-2.16%	7.40%	10.54%	10.28%	1.30%

7.6 Average VSA Hourly Performance Over All Weekdays and Over Hours

By averaging the improvement of performance index in Table 7.15 and Table 7.16, the overall performance evaluation results are summarized as follows:

Morning variable speed advisory performance:

- VMT increased by **2.72%** on average.
- VHT decreased by **6.28%** on average.
- Q increased by **8.71%** on average.

Since VMT and Q increased and VHT decreased, we conclude that VSA improved the traffic during morning peak hours (from 6AM to 9AM).

Evening variable speed advisory performance:

- VMT decreased by **0.096%** on average.
- VHT decreased by **1.47%** on average.
- Q increased by **2.80%** on average.

Since the change in VMT, VHT and Q was marginal, we conclude that VSA did not improve traffic during the evening peak hours (from 2PM to 7PM) on average.

As for the driver compliance, it gradually improved as the test progressed. And, the increase of driver compliance was generally in line with the system performance improvement.

8 Public Driver Compliance Analysis

8.1 Introduction

Variable Speed Limit/Advisory (VSL/VSA) is an Active Traffic Management (ATM) strategy that has the potential to mitigate congestion at bottlenecks. The effectiveness of this strategy, and the ability to capture the potential mobility benefits, is dependent upon the drivers' response to and compliance with the new, posted speed limit/advisory.

In practice, there are two approaches for VSL implementation: Mandatory (with speed limit enforcement) and advisory speed limits (without speed limit enforcement) [1]. European countries including Great Britain, Germany, France, Italy, and the Netherlands have widely practiced the mandatory approach over the last decade. Drivers are forced to maintain the speed indicated on variable message signs (VMSs) using speed detection technology. Studies about driver compliance, in these nations, focus on enforcement and do not address mobility benefits.

In contrast, Sweden and several states in America prefer to apply the advisory VSLs, which is a recommended speed without enforcement in the motorway. The benefits of implementing VSL have traditionally been quantified through simulations. There is little to no information, however, regarding empirical evidence about the operational mobility impacts of VSL, particularly for the case where driver compliance is voluntary (VSA).

We first explore the literature of past compliance rate studies – on the implementation of VSL. We then present a new definition for VSL compliance rate and a method for analyzing VSA operational data. Finally, a comprehensive analysis of test data obtained from the 10.8-mile field test of VSA on State Route 78 Eastbound (SR-78E) is presented.

8.2 Literature Review

In the literature, compliance of VSL/VSA has been based on studies either through field test/deployment data (of VSL with enforcement) or through microscopic traffic simulation. Reported compliance rates vary based its implementation approach or its implementation location.

8.2.1 Field deployment and evaluation

The UK has two main operational regimes for VSL: 3-lane and 4-lane. Each of their deployments includes speed enforcement, utilizing video cameras mounted on gantries. These deployments include motorways M1, M25, M42, and M60. The compliance rate is defined as the total number of vehicles maintaining speed within the threshold (VSL +/- 10% + 2mph) divided by the total number of vehicles passing through the section of roadway. For UK VSL deployments, it was reported that the compliance on the carriageway was 94% or better at the 70 mph, 60 mph, 50 mph, and 84% or better at the 40 mph VSL, and 97% at the 50 mph and 93% or better at the 40 mph VSL on the hard shoulder [14, 15]. Obviously, this definition could only be applied when a lane-wise vehicle count is available. This is feasible with an enforcement deployment that includes gantry mounted video cameras for each lane. However, this compliance rate definition cannot be implemented if the road mounted sensors are microwave radar only, due to vehicle occlusion and impossible vehicle identification.

In Germany, VSL with automated speed enforcement including gantry-mounted speed detection video cameras was implemented on a 33 km section of Autobahn A99 near Munich [16]. The VSL displayed speed as either “60”, “80”, “100”, or “120” in km/h. If the actual speeds measured

are within 10 km/h of the displayed VSL, then the driver is considered to be compliant. It was found that the actual speeds tended to be increasingly non-compliant and faster than the VSL, for higher VSL speed values displayed [17].

In France, VSL systems were implemented on the A7, A9, and A13 motorways [18], and was additionally implemented on the A25 and combined with ramp metering [19]. Compliance was defined as the percentage of vehicles under a specific speed threshold (which is a maximum of 5 km/h above, or 5% above, the posted VSL). When the limit speed is less than 90 km/h, the relative discrepancy was higher than 80% in the left and middle lanes on A13 motorway [18].

One problem, with VSL camera speed enforcement is that some drivers applied their brakes prior to passing the camera and then sped up after it. This sudden braking and acceleration increased the speed variation on the mainline, which may cause safety concerns.

Italy proposed an Automated Section Speed Enforcement System (ASSES) in 2006 on more than 2,600 km of the motorway networks. The system would determine the average speed over a long distance, for individual vehicles, instead of measuring the speed at fixed points (as is the case above). In Italy, compliance is defined as the average speed of individual vehicles, compared with the speed limit crossing the entire automated sections. Compliance was found to be 49.5% and 43.6%, in 2010 and 2011, on a rural motorway A3 and was determined to be 83% (72% during off-peak hours and 87% during peak hour) on urban motorway A56. Compliance rate for heavy vehicles ($w > 3.5$ tons) was found to be higher than for the light vehicles [20]. It is clear that this approach would also require tracking individual vehicles through their entire trip across the motorway - by tracking a license plate with video cameras.

The Netherlands' deployments of VSL on freeway A20 near Rotterdam was based on a new approach - automatic enforcement by trajectory control. The average speed was calculated by license plate recognition system, installed at the beginning and the end of freeway section. A ticket would be automatically issued when the average speed was over 80 km/h, with 100% enforcement [21]. However, driver compliance with the dynamic speed limits, of the VSL system, has not been reported yet.

Western Australia deployed VSL with video camera speed enforcement. They only implemented enforcement for the sections of the freeway operating under free flow, static posted speed limit (60 – 110 km/h). The mean free flow speed, standard deviation of free-flow speed, the coefficient of variation (standard deviation divided by the mean), and the percent vehicle's speed over free-flow (100 km/h) were used for compliance rate analysis. The compliance rate was reported as 70% [22].

In Sweden, an advisory VSL system was implemented on the E4 motorway in Stockholm [23]. No quantitative results have been reported.

In the US, the states of Arizona, Colorado, Michigan, Minnesota, Nevada, New Jersey, New Mexico, Oregon, and Washington, etc., have implemented VSL on several freeway corridors [24]. Speed enforcement has been implemented only in 11 states [25], and only some of the VSL deployments have reported compliance rates.

- On US I-494, a variable advisory speed limit system for work zones (VASLS-WZ) was developed and evaluated [26]. Driver compliance rate was calculated as the correlation between the differences of measured/estimated speed and the posted speed

at upstream and downstream fixed locations. If all the drivers comply with the posted speed limit reasonably well, the correlation should be close to 1.0. The field test data showed that the correlation is about 20% to 60% of that level during morning peak.

- On Oregon Route 217, a VSA system was applied in an eleven miles stretch of freeway. Compliance is determined as the difference between the suggested speed and actual measured speed of real traffic by traffic detectors. As the displayed speed increases, driver compliance becomes better [17]. Our compliance rate definition is very close to this value.

In summary, the literature documents early-stage deployments of VSL systems where the concept of driver compliance rates is defined based upon the capabilities of the different speed enforcement systems present at each implementation. This has produced a wide variation of methods, all dependent on lane-wise detectors. Should these detectors not be available, compliance rate is difficult to determine and have not been reported for many VSL deployments. Thus, the evaluation of the performance of our VSA field test will require the definition and development of driver compliance rate that is based on the field sensor data that is available and does not require the require the installation of speed enforcement technology.

8.2.2 Simulations for effect analysis

Micro simulation has been used by researchers to quantify and project VSL related safety benefits and operational impacts. Driver compliance with variable speed limits/advisories is addressed by incorporating an assumed compliance rate and projecting (through simulation) the benefits – for that compliance level. In simulation, driver compliance means non-compliant drivers are set to their original desired speed in prevailing traffic conditions.

Yadlapati et al. conducted a work zone simulation study in Virginia, using VISSIM. They found that increased travel time, in the bottleneck merge and activity area, with increasing driver compliance rates may have a major effect on safety improvement under an effective VSL implementation [30].

Hellinga simulated a 10-km urban freeway - the Queen Elizabeth Way, utilizing PARAMICS. Four levels of compliance were considered to analyze the impact of VSL on safety and mobility. The compliance levels included: 1) low compliance; 2) medium compliance; 3) high compliance, and; 4) very high compliance. The simulation results showed that VSL impacts in safety and efficiency are sensitive to compliance level. High compliance levels produce greater safety benefits, but these same high levels of compliance increased travel time [31].

Su et al. simulated peak hour I-80 westbound traffic in California, utilizing Aimsun with MPC-based VSL control. The results projected benefits to mobility being produced at low levels of compliance (30% compliance) and that these mobility benefits are similar to those produced at 100% [32].

Habtemichael conducted simulations, with four levels of compliance (low, medium, high and very high), to examine safety and operational benefits under heavily congested, lightly congested and non-congested traffic conditions. A congested 12 km stretch of motorway A-5 around Lisbon, Portugal was simulated in VISSIM. They concluded that safety and operational benefits are highly dependent on the level of drivers' compliance to VSL [33].

In a study conducted by Bhowmick et al., the sensitivity of driver compliance with VSL’s dynamic speed limits was examined. The roadway modeled (in VISSIM) was an 11 km west-bound stretch of Whitemud Drive (WMD) in the city of Edmonton, Canada. Compliance levels were modeled, using the desired speed distribution and vehicle composition type in VISSIM. The findings suggest that driver compliance to speed limit has significant impacts on VSL effectiveness. Because VSL effectiveness is very dependent on speed variance, low compliance levels would still be effective when speed variance is low in traffic stream [27].

The above studies indicate that the success of VSL can’t be viewed independently of the expected level of compliance by drivers [33, 34, 35]. However, because compliance rates are (roughly) pre-set, the above studies do not consider speed distribution and traffic conditions.

To quantify the impact on performance of driver compliance, as a singular variable, Hadiuzzaman analyzed driver response to static speed limits [34]. The VISSIM simulation illustrated a positive correlation between an increasing driver compliance rate and VSL’s ability to produce mobility and safety benefits. Specifically, the reduction in total travel time, an increase in corridor throughput, and a reduction in collision probability were all improved within the ranges of 5–15%, 6–8%, and 50–60%, respectively, when the compliance rate increased.

In summary, to the best of our knowledge, microscopic simulations do not simulate safety-critical situations accurately. Safety, however, is mostly determined by a driver’s response to specific traffic situations. This is very difficult to model in microscopic simulation. All of the above studies conclude that higher levels of driver compliance are crucial for the success of improving safety by VSL. But there is still a lack of consensus that higher compliance should have a positive or negative impact on total travel time and throughput. These different findings could be partly attributed to the use of different VSL algorithms in the different studies – or the use of different simulation platforms. Further, each study only considered the topic of compliance utilizing only one VSL sign. Driver compliance with multiple VSL signs along the freeway is also worth exploring.

8.3 Compliance Rate Definition

In the past, resulting from the use of simulations and enforced VSL implementations, the definition of VSL compliance was based on knowledge of the speed of all individual vehicles traveling through a VSL controlled freeway. However, the measurement of speed for all individual cars is difficult to achieve on a wide freeway. Loop detectors, for example, measure average vehicle speeds over a specific time period (from 30 second to 5 minutes). Radar or camera detectors are rarely placed in each lane over a large area. Without speed data on individual vehicles, it is difficult to calculate the impact of the individual vehicle compliance on traffic flow.

Due to the difficulties of applying the traditional driver compliance to VSA, a new definition of compliance has been developed to enable the evaluation of real world implementations of VSA. This new definition of compliance rate is from a macroscopic traffic viewpoint. The *relative discrepancy* is defined as: The rolling average of the difference of the VSA and measured/estimated traffic speed over the posted VSA up to current time step.

$$a_N = \frac{1}{N} \sum_{k=1}^N \frac{|v_i(t) - v(t)|}{v(t)} \quad (8 - 1)$$

Naturally, the *compliance rate* is defined as: $c_N = (1 - a_N) \cdot 100$

It is clear that the smaller the rolling average value, the closer the measured/estimated speed will be to the posted speed at fixed location i . For further analysis of traffic behavior, we split the whole data set into two exclusive parts: actual speed is higher or lower than the posted speed.

The following is an implementation of the real-time estimation of the compliance rate.

Relative discrepancy

Input: For each time step k , aggregated speed $V(k)$ and VSA displayed speed $VSA(k)$.

Output: The compliance rate $a_m(k)$ and $a_n(k)$.

IF $V(k) \leq VSA(k)$:

$$a_m(k) = \frac{V(k) - VSA(k)}{VSA(k)}$$

$$a_n(k) = 0$$

$$m := m + 1$$

$$n := n$$

$$\bar{a}_m(k) = \frac{(m-1)}{m} \cdot \bar{a}_m(k-1) + \frac{a_m(k)}{m} = \frac{1}{m} \cdot \sum_{k=1}^T 1\{a(k)_m \neq 0\}$$

$$a_n(k) = a_n(k-1)$$

ELSE

$$a_n(k) = \frac{V(k) - VSA(k)}{VSA(k)}$$

$$a_m(k) = 0$$

$$n := n + 1$$

$$m := m$$

$$a_n(k) = \frac{(n-1)}{n} \cdot \bar{a}_n(k-1) + \frac{a_n(k)}{n} = \frac{1}{n} \cdot \sum_{k=1}^T 1\{a(k)_n \neq 0\}$$

$$\bar{a}_m(k) = \bar{a}_m(k-1)$$

END IF

Where $a_m(k)$ and $a_n(k)$ denote the average of driver speed (higher or lower than the suggested speed respectively), and each time step k is 30 seconds. If we take data of a certain k for one specific VSA as one data unit, then m and n denote the number of pieces of data in two exclusive parts, and update each time step. An indicator function $1\{\cdot\}$ takes on a value of 1 if its argument is true and 0 if it is false. Note that the lower the absolute value of the relative discrepancy, the closer the driver's behavior speed is to the variable speed advisory.

8.4 Field Experiment Site

Our test site is located on SR-78E from Civic Center Dr (CA PM6.886) to SR-78E w/o 15 (CA T17.681). The total length of the test site is 10.8 miles. Seven VSA signs were displayed on the roadside along the corridor as shown in Figure 8.1 (a). There is a bottleneck between VSA 5 and VSA 6 in peak hours. The congestion usually forward-moves to VSA 1. The experiment began on 3/19/2018, and ended on 5/4/2018. The first three weeks were used to tune the algorithm

parameters, the last four weeks were used to analyze the driver behavior to the VSA. The system is only turned on during the peak hours (6AM to 9AM, 2PM to 7PM). The week (5/7 – 5/11), just after turning off the VSA system, is recorded for comparison.

As shown in Figure 6.1 with the VSA sign and trailer locations, which had microwave radar for traffic speed detection with aggregated 30 s output speed data. The central control computer retrieved traffic data from the corridor, estimated traffic state parameters, calculated VSA for each section and sent it to the field for display. This process was repeated every 30s in real-time. The following is the brief VSA strategies.

On-line VSA algorithm

Input: For each fixed location i , speed data of radar detector $V_{\text{radar}}(i)$, and loop detector $V_{\text{loop}}(i)$, occupancy data of current location and downstream from loop detector $Occ(i)$

Output: VSA displayed speed at each location $VSA(i)$

Step 1: Aggregate speed, σ_1 and σ_2 are the weight of different detectors

$$V_{\text{agg}}(i) = \sigma_1 \cdot V_{\text{radar}}(i) + \sigma_2 \cdot V_{\text{loop}}(i)$$

Step 2: Weighted occupancy

$$Occ_{\text{weight}}(i) = \alpha_1 \cdot Occ_1(i) + \alpha_2 \cdot Occ_2(i)$$

Where Occ_{f1} and Occ_{f2} are distance based and congestion-based function, $\beta \wedge \gamma$ are the corresponding parameters.

$$Occ_{f1}(i) = \beta_1 \cdot Occ(i) + \beta_2 \cdot Occ(i+1) + \beta_3 \cdot Occ(i+2)$$

$$Occ_{f2}(i) = \gamma_1 \cdot Occ(i) + \gamma_2 \cdot Occ(i+1) + \gamma_3 \cdot Occ(i+2)$$

Step 3: Calculate the VSA

IF $Occ_{\text{weight}} \geq \hat{Occ}$:

$$Suggest_{\text{speed}}(i) = \omega \cdot \min \left(\frac{Occ_{\text{gain}}(i)}{\text{Max}(Occ_{\text{weight}}(i), \text{minimum } Occ)}, \text{Highest}_{\text{limit}} \right)$$

$$VSA(i) = \min(Suggest_{\text{speed}}(i), V_{\text{agg}}(i) - 10)$$

ELSE

$$VSA(i) = V_{\text{agg}}(i)$$

END IF

Note: The displayed speed is a multiple of 5 mph, and it could not change frequently. All parameters are tuned in practice. The interpolation of upstream and downstream data is used to mitigate current location detector failure.

8.5 Compliance Rate Analysis

8.5.1 Basic performance

Table 8.1 describes the average non-compliance (per hour) during the four test weeks, calculated by equation (8-1) in percent [%]. It should be noted that the negative/positive digits represent the actual cases of speed under/over VSA. It could be found:

- 1) The compliance rate of morning peak hour is better than evening, especially at VSA 2, VSA 3 and VSA 6.

- 2) The speed is always higher than the suggested speed at VSA 2, VSA 3 during the congestion period, so that vehicles upstream (of the bottleneck) do not experience the expected delayed.
- 3) The speed right after the bottleneck is lower than VSA 6 suggested, which means that the posted VSA is higher than the speed the drivers could drive.
- 4) During the congestion period, real speed was always lower than the VSA advised.

The suggested and actual speed deviations identified in cases 3) and 4) above, might be due to three factors: (a) traffic detection/estimation might not be accurate enough; (b) the algorithm for VSA calculation needs further refining, and; (c) driver compliance with the suggested VSA is low. These points raise questions that can only be answered with more extensive field testing;

It is broadly acknowledged that drivers adapt slowly to complying with VSA display advisories, in real world VSA deployments. Drivers need some exposure to VSA, over a period of time, to build understanding and trust in the system. Thus, compliance rates generally improve over time.

During our field test, the driver relative discrepancy fluctuated from hour-to-hour as shown in Table 8.1. Twenty percent (20%) is used as the threshold to describe a satisfactory level of the non-compliance rate, which is simply an empirical number. i.e. relative discrepancy within $\pm 20\%$ are considered satisfactory. In Table 8.1, the red are relative discrepancy over 20%, and the rest are within 20%. Now we count the number of cases with relative discrepancy over 20% (red) and within 20% (black) respectively with each week. Then we have a weekly measurement for those two cases. Figure 8.1 indicates that the satisfactory compliance hours were increasing as the test continued. Figure 8.2 depicts the number of hours with relative discrepancy under 20% divided by the total number of VSA test hours in that week. It essentially shows the trend of drivers' compliance rate improved as the test progressed.

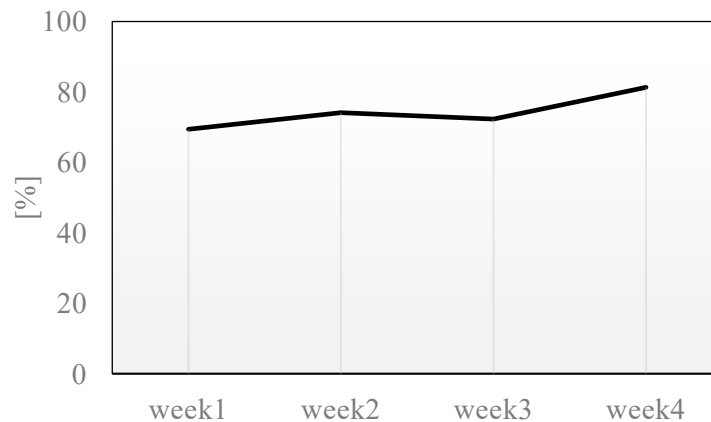

Figure 8.1 Trendline of the percentage of satisfactory compliance hours with respect to all test hours for the four weeks

1

Table 8.1 Four Weeks Relative Discrepancy [%]

		Week 1 04/09 - 04/13							Week 2 04/16 - 04/20								
		6-7AM	7-8AM	8-9AM	2-3PM	3-4PM	4-5PM	5-6PM	6-7PM	6-7AM	7-8AM	8-9AM	2-3PM	3-4PM	4-5PM	5-6PM	6-7PM
VSA 1	\bar{a}_m	-11	-9	-10	-9	-9	-13	-7	-7	-11	-9	-10	-9	-9	-13	-7	-7
	\bar{a}_n	6	13	14	14	31	35	23	3	6	13	14	14	31	35	23	3
VSA 2	\bar{a}_m	-9	-9	-18	-14	-26	-29	-29	-7	-9	-9	-18	-14	-26	-29	-29	-7
	\bar{a}_n	17	58	30	25	27	31	31	8	17	58	30	25	27	31	31	8
VSA 3	\bar{a}_m	-7	-6	-5	-19	-27	-26	-27	-14	-7	-6	-5	-19	-27	-26	-27	-14
	\bar{a}_n	14	57	26	18	23	18	16	16	14	57	26	18	23	18	16	16
VSA 4	\bar{a}_m	-9	-12	-7	-13	-18	-17	-18	-17	-9	-12	-7	-13	-18	-17	-18	-17
	\bar{a}_n	12	17	13	19	22	24	21	15	12	17	13	19	22	24	21	15
VSA 5	\bar{a}_m	-8	-7	-8	-8	-7	-8	-7	-9	-8	-7	-8	-8	-7	-8	-7	-9
	\bar{a}_n	12	14	13	10	14	15	13	15	12	14	13	10	14	15	13	15
VSA 6	\bar{a}_m	-13	-22	-20	-12	-17	-25	-27	-23	-13	-22	-20	-12	-17	-25	-27	-23
	\bar{a}_n	14	14	14	21	23	19	15	19	14	14	14	21	23	19	15	19
VSA 7	\bar{a}_m	-9	-14	-15	-5	-6	-5	-4	-6	-9	-14	-15	-5	-6	-5	-4	-6
	\bar{a}_n	14	18	17	15	17	20	21	15	14	18	17	15	17	20	21	15
		Week 3 04/23 - 04/27							Week 4 04/30 - 05/04								
VSA 1	\bar{a}_m	-11	-10	-12	-10	-7	-7	-8	-7	-11	-10	-11	-9	-11	-12	-8	-7
	\bar{a}_n	5	12	14	13	38	33	22	7	7	15	19	12	25	20	12	3
VSA 2	\bar{a}_m	-10	-11	-12	-13	-36	-26	-20	-13	-10	-15	-16	-14	-20	-20	-15	-8
	\bar{a}_n	10	48	31	24	27	30	32	15	20	53	22	24	31	23	27	9
VSA 3	\bar{a}_m	-4	-10	-10	-23	-29	-27	-27	-20	-8	-8	-8	-18	-19	-25	-27	-18
	\bar{a}_n	14	37	30	22	17	41	22	17	18	38	18	20	16	14	16	17
VSA 4	\bar{a}_m	-6	-8	-7	-23	-16	-16	-18	-20	-10	-7	-7	-13	-16	-14	-18	-17
	\bar{a}_n	9	14	16	19	22	24	24	21	14	16	15	20	15	19	21	12
VSA 5	\bar{a}_m	-10	-10	-8	-8	-10	-8	-9	-9	-11	-9	-11	-11	-6	-7	-5	-9
	\bar{a}_n	12	13	13	11	14	16	15	13	12	14	10	10	13	13	13	13
VSA 6	\bar{a}_m	-18	-21	-20	-21	-18	-27	-26	-14	-8	-26	-17	-13	-13	-18	-14	-6
	\bar{a}_n	14	17	13	19	28	19	22	19	18	15	10	24	31	30	24	19
VSA 7	\bar{a}_m	-13	-13	-12	-7	-6	-6	-6	-5	-11	-15	-11	-8	-4	-5	-3	-6
	\bar{a}_n	16	18	16	13	14	20	21	13	10	20	17	13	15	18	16	12

2

8.5.2 The effect of Compliance rate on traffic flow

The indicators of Vehicle-Hours-Traveled (VHT) and the number of incidents (i.e. accidents and hazards as reported by PeMS) were selected to evaluate the VSA performance. VHT is the sum of all trip times (in hours) spent by each vehicle on the given section of freeway over a given time period. This is equivalent to Total Travel Time [TTT]. Note that there is no significant change in demand, over the 4-week test period. The day-to-day difference in upstream flow during the test period is less than 1%.

The weekly average for VHT and the number of incidents, for that corresponding week is plotted in Figure 8.2. Keep in mind that compliance rate improved on a daily basis; it is difficult to find a relationship between driver compliance and incident rate. It is likely that the variation in speed, experienced during the testing is unrelated to the cause of the incidents. However, a correlation between improved driver compliance (to variable speed advisories) and a decrease in VHT (and corresponding increase in operating efficiency) can be observed.

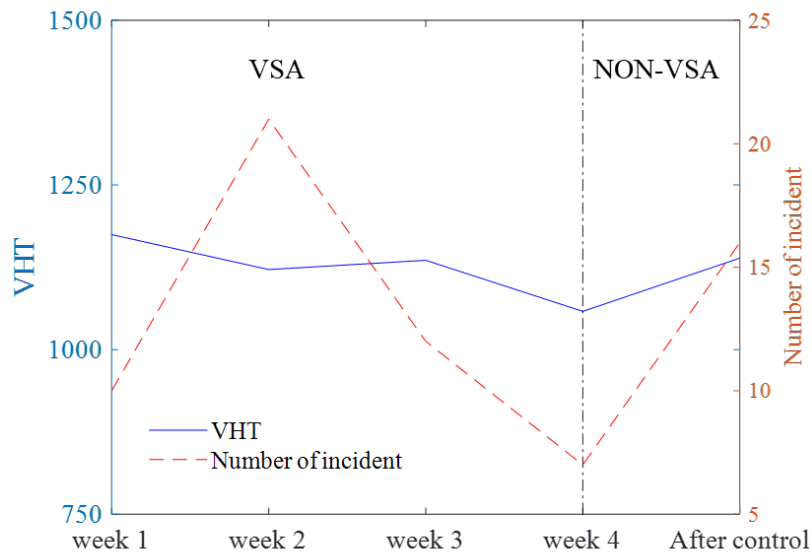

Figure 8.2 Trendline of freeway operational mobility and safety

To explore whether variable speed advisories could increasingly ease traffic congestion, as compliance improves, we must first define “congestion” and then use the new definition of compliance to analyze the data. FHWA defines congestion as occurring when the average speed of traffic drops below 45 [mph] [32]. In our analysis, we will utilize 5 [min] PeMS aggregated speed data. The number of periods with speed < 45 [mph] have been counted for each day, and then summed over the week for all the 10 available loop detector locations (in our 10.8 miles field test site). Figure 8.3 illustrates this PeMS data.

The data of Figure 8.4 illustrates a correlation between the improving rate of driver compliance (with the variable speed advisories) and a decrease in congestion (specifically, the number of congestion periods). Further, the data also illustrates that when the VSA are absent (VSA signs were turned off after 4 weeks of operation) congestion increases.

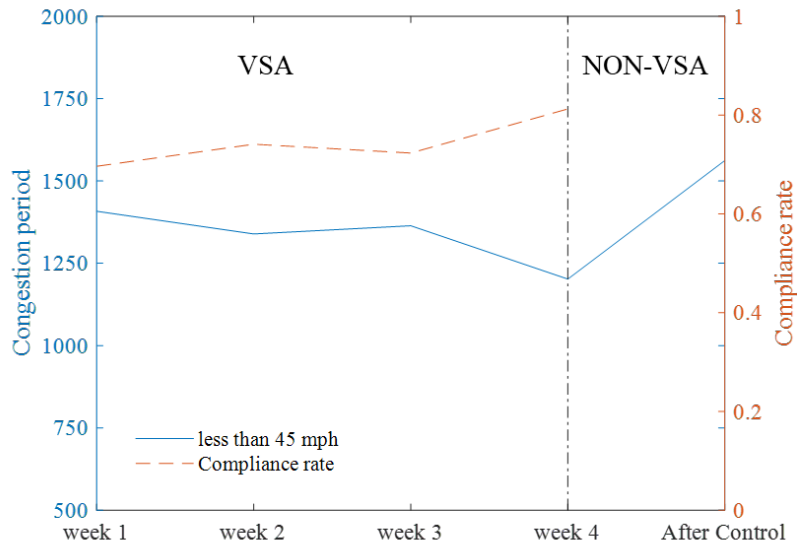

Figure 8.3 The trendline of congestion period and compliance

8.5.3 Further analysis

To derive a better understanding of driver response to the VSA messaging, and the implications of this response for congestion mitigation, the research team performed a detailed statistical analysis of field test data considering flow, density and time.

To understand the implication of driver compliance rates on dynamic traffic conditions, we define four cases of evolving traffic conditions resulting from VSA control. We will continue to use the 45 [mph] as the congestion threshold that divides free-flow traffic (F) from and congestion states (C). We aggregated loop detector and radar speed data over 30 second time periods, and then calculated average speed - establishing a single value for speed for this time period. This value for traffic flow (speed) is then plotted against traffic density, for the four identified cases, using the following notations:

- ① F-F: actual speed is free-flow and VSA posted speed is also free-flow (Figure 8.4 (a));
- ② F-C: actual speed is free-flow and VSA posted speed is in congestion (Figure 8.4 (b));
- ③ C-C: actual speed is in congestion and VSA posted speed is also in congestion (Figure 8.4 (c));
- ④ C-F: actual speed is in congestion and VSA posted speed is free-flow (Figure 8.4 (d)).

Note that the dashed lines representing the fundamental diagrams in Figure 8.4 are fictitious instead of from field test data. It only shows that the VSA could reshape the fundamental diagram for each freeway section (measured at the loop detector location). It does not mean that the capacity and critical density would change positive or negative due to VSA.

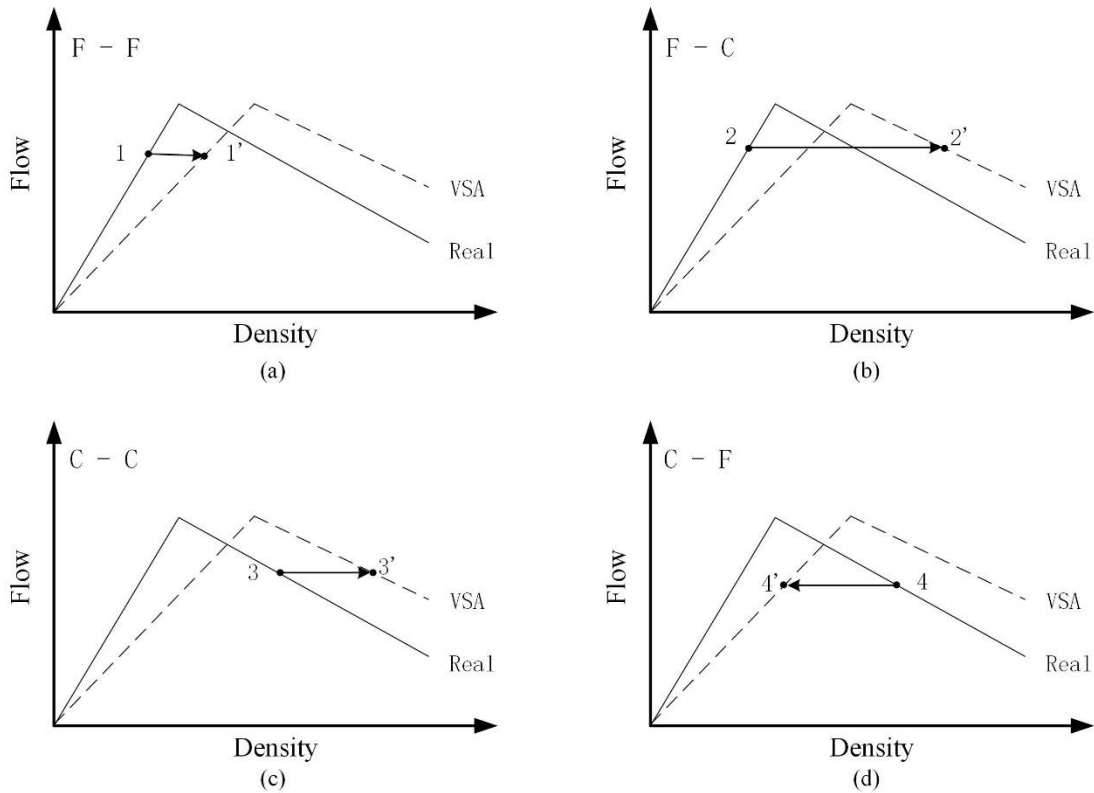

Figure 8.4 Traffic state developing under VSA control

The total number vehicles per hour for each above evolving case (**Figure 8.4**) during the 4 weeks are: 9731 (F-F), 2831 (F-C), 7088 (C-C), 144 (C-F), respectively. In general, drivers could not accelerate to a higher speed when traffic is congested, which is described as case (4). It is good to see the frequency of case (4) is negligible. Therefore, the following analysis focuses on evolving cases (1)-(3).

In accordance with the Law of Large Numbers, the probability distribution for driver compliance rate, for each of our remaining cases, can be assumed to be normally distributed. These distributions as illustrated in **Figure 8.5**. The mean and standard deviation for each case distribution is recorded in **Table 8.2**. Zero mean and zero standard deviation represent driving at the recommended speed, exactly. The data illustrated in Figure 8.5 and Table 8.2, below, lead to the following observations:

- (1) In most cases, the mean values are greater than 0, which means the driver's speed is higher than the VSA posted speed;
- (2) When the traffic state is operating in the non-congestion case (F-F), it shows an excellent compliance rate. Both mean value and standard deviation are close to zeros and individual vehicles have little difference in speed.
- (3) When the traffic state evolves from free flow to congestion (F-C), driver compliance rate is very poor at all locations. The measured speed greatly exceeds the advisory speed. Further, a large standard deviation indicates that the speed distribution of the drivers was uneven, characterizing large individual speed differences. This was especially true in the upstream, just prior to the formation of the bottleneck, at VSA1, VSA2 and VSA3. We

believe this case offers the greater opportunity for traffic flow improvement that can be addressed by VSA. Therefore, a more effective VSA deployment should use larger and more prominent signs, or using speed enforcement.

- (4) For the congestion case (C-C), the suggested speed would be slightly higher or lower than real traffic congestion speed. At locations VSA1, VSA4, VSA5 and VSA7, the mean value is close to zero, i.e. the compliance is reasonably satisfactory. However, at locations VSA 2, VSA 3 and VSA 6, the mean value is significantly less than zero, indicating that the actual speed is less than VSA. The section speed tends to be unstable due to non-compliance toward the VSA. One possible reason is that the drivers are more cautious when traveling through congested conditions, particularly when experiencing “*Stop & Go*” traffic conditions – when speed becomes unstable with decreased efficiency.

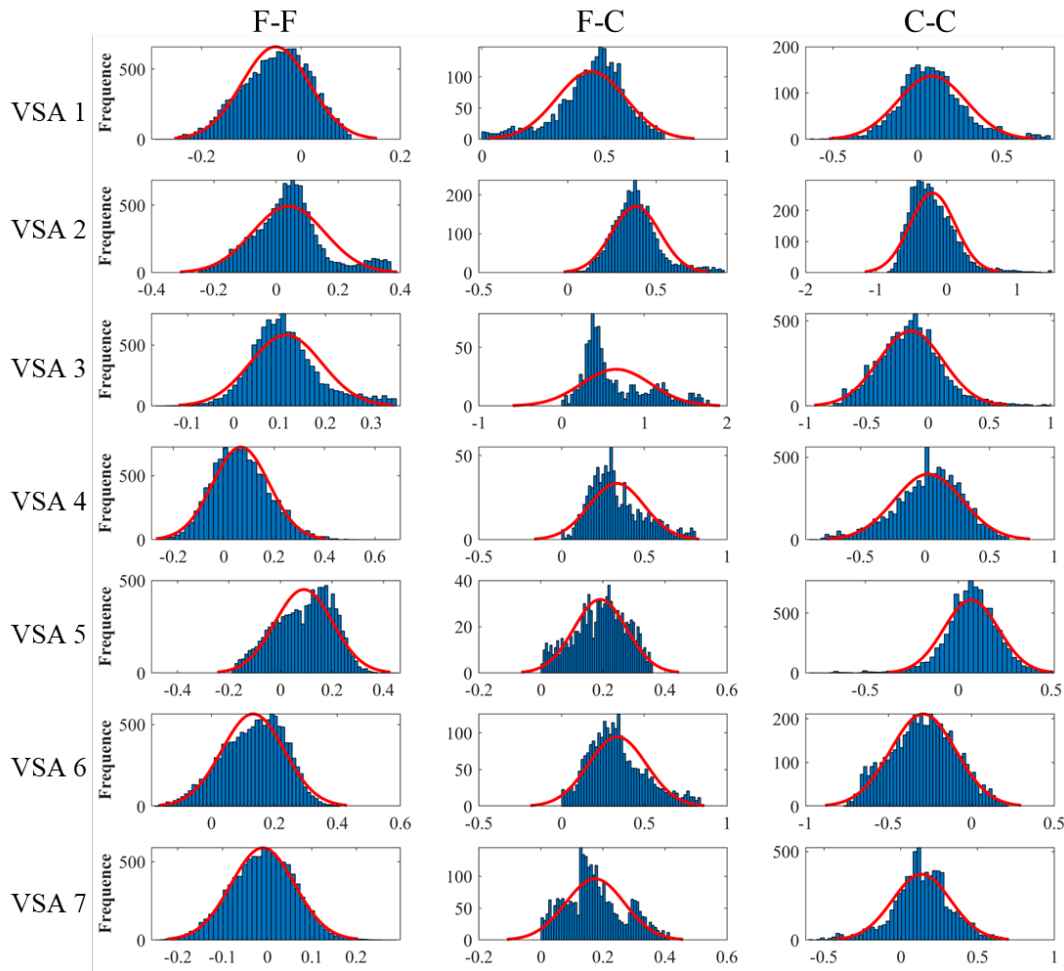

Figure 8.5 Compliance rate distribution of each case

Table 8.2 The mean and standard deviation for each case distribution

	F-F		F-C		C-C	
	Mean	Standard Deviation	Mean	Standard Deviation	Mean	Standard Deviation
VSA 1	-0.051	0.068	0.446	0.141	0.085	0.203
VSA 2	0.040	0.117	0.385	0.136	-0.212	0.291
VSA 3	0.114	0.078	0.661	0.418	-0.141	0.263
VSA 4	0.068	0.112	0.333	0.167	0.025	0.263
VSA 5	0.091	0.112	0.191	0.085	0.069	0.148
VSA 6	0.132	0.099	0.337	0.175	-0.291	0.197
VSA 7	-0.010	0.071	0.174	0.095	0.135	0.190

8.6 Conclusion

A detailed analysis of driver compliance rate was performed, including new definitions, new calculation methods and a thorough statistical analysis. The results show that as the test progressed, the drivers gradually adapted to the VSA resulting in improved compliance, and congestion was further alleviated. The analysis of our data did not document improvements in safety.

Driver compliance rates under dynamic traffic conditions, and at different locations on the field test site, was also analyzed by statistical methods. The results indicate that drivers always exceed the VSA posted speed immediately upstream the formation of the bottleneck. What's more, the real speed within the bottleneck is usually lower than the suggested speed, suggesting that traffic has broken down to stop and go conditions.

9 Concluding Remarks and Future Research

This report summarizes a pilot project conducted in California, evaluating the efficacy of an implementation of Variable Speed Advisory (VSA) along a freeway corridor. VSA is one potential Active Traffic Management strategy that could be implemented to dynamically manage recurrent and non-recurrent congestion. The VSA algorithm implemented in this project was developed by the project team. The project includes algorithm development, hardware and software system development and integration, progressive field implementation and test, and performance analysis. Caltrans' Performance Measurement Systems (PeMS) hourly VHT (Vehicle Hours Traveled) and VMT (Vehicle Miles Traveled) data, was used as an independent data source to evaluate the performance of our VSA field implementation. Driver compliance, adhering to the posted speed advisory, was analyzed using the radar data from the VSA signs. The test was strongly supported by Caltrans District 11, Transportation Management Center's (TMC) traffic engineers, and this support made the pilot project possible and contributed significantly to its success.

9.1 Test Summary

A field test of VSA along the 10.8-mile long freeway corridor on State Route 78 Eastbound (SR-78E) between Vista Village and the interchange with I-15 at Escondido, was reasonably successful based on the performance analysis using PeMS hourly VMT and VHT data. The outcome is summarized as follows:

- VSA displayed in the field were reasonable based upon extensive observations from the project website.
- The website itself proved to be a very useful tool for observing traffic behavior and possible problems with the VSA system.
- The average system performance in AM Peak Hours (6AM – 9AM) over the 4 weeks:
 - VMT increased by **2.72%** on average;
 - VHT decreased by **6.28%** on average; and
 - $Q(=VMT/VHT)$ increased by **8.71%** on average.
- The average system performance in PM Peak Hours (2PM – 7PM) over the 4 weeks:
 - VMT decreased by **0.096%** on average;
 - VHT decreased by **1.47%** on average; and
 - $Q(=VMT/VHT)$ increased by **2.80%** on average.
- Driver compliance rate was improving as the test was progressing.
- VSA sign with radar detection was very useful for better estimation of mainline traffic and for evaluating driver compliance by comparing the traffic speed and displayed speed.

9.2 Lessons learned

The following are some lessons learned during the completion of this project:

- VSA signs were too small. Larger VSA signs or over-freeway gantries would be ideal for better viewability by the public drivers.
- The project was significantly under budgeted. Additional budget will be necessary for future tests and implementation.
- The VSA signs should be controlled by the project team or Caltrans instead of by the provider. It proved to be time-consuming and more expensive to buy commercial off-the-shelf (COTS) equipment due to the added engineering costs.
- The Changeable Message Signs (CMS) most upstream should also be larger in size and carry a better description of the reason for following the speed advisory.
- The field test period was too short. A three month test would provide a better opportunity for the public driver to adapt to the VSA system, to achieve better performance improvement in traffic control.
- The distance between two consecutive VSA signs should not be greater than one half mile. The ideal distance would be about 0.4~0.5 mile. Therefore, longer sections need to have more than one VSA sign.
- The initial test period for system and algorithm tuning before the extensive test period took longer than expected and then was originally planned (one week), which is worth considering for future similar field test projects.

9.3 Future research

The tested VSA strategy seems to be promising although it could be further refined for better performance. The future project for the application of VSA would include – but should not be limited to – combining it with Coordinated Ramp Metering (CRM), since they are complementary in functionality for traffic management, and test on other freeway corridor(s):

- Test on a freeway corridor such as SR-99 North Bound where CRM is in operation.
- Combine VSA and CRM with other Active Traffic Management strategies in other freeway corridors.
- This VSA test was for driver advisory only. Other research results indicated that Variable Speed Limit with enforcement would have better effects on the driver behavior since the compliance rate is higher.
- With partially automated vehicles entering the market progressively, such as vehicles with Adaptive Cruise Control (ACC), the VSA could be passed to the vehicle and used as the set speed with a wireless connection such as cellular phones etc. This could remove the driver behavior aspect and improve the compliance rate, which could be more effective in practice.

References:

- [1]. X. Y. Lu, Z. W. Kim, M. Cao, P. Varaiya, and R. Horowitz, Deliver a Set of Tools for Resolving Bad Inductive Loops and Correcting Bad Data, California PATH Report, UCB-ITS-PRR-2010-5
- [2]. X. Y. Lu and S. Shladover, Review of Variable Speed Limits/Advisories – Theory, Algorithms and Practice, *93rd TRB Annual Meeting*, Washington D. C., Jan.12-16, 2014; *Transportation Research Record*, TRB, # 2423, 2014, pp. 15–23.
- [3]. Aimsun 7 Microsimulator API Manual
- [4]. X. Y. Lu, and S. Shladover. Review of variable speed limits and advisories: Theory, algorithms, and practice. *Transportation Research Record: Journal of the Transportation Research Board*, No. 2423, 2014, pp. 15-23.
- [5]. Lee, C., B. Hellinga, and F. Saccomanno. Assessing safety benefits of variable speed limits. *Transportation Research Record: Journal of the Transportation Research Board*, No. 1897, 2004, pp. 183-190.
- [6]. Abdel-Aty, M., J. Dilmore, and A. Dhindsa. Evaluation of variable speed limits for real-time freeway safety improvement. *Accident analysis & prevention*, Vol. 38, No. 2, 2006, pp. 335-345.
- [7]. Lee, C., B. Hellinga, and F. Saccomanno. Evaluation of variable speed limits to improve traffic safety. *Transportation Research Part C: Emerging Technologies*, Vol. 14, No. 3, 2006, pp. 213-228.
- [8]. Soriguera, F., J. M. Torné, and D. Rosas. Assessment of dynamic speed limit management on metropolitan freeways. *Journal of Intelligent Transportation Systems*, Vol. 17, No. 1, 2013, pp. 78-90.
- [9]. Hegyi, A., B. De Schutter, and J. Hellendoorn. Optimal coordination of variable speed limits to suppress shock waves. *Ieee Transactions on Intelligent Transportation Systems*, Vol. 6, No. 1, 2005, pp. 102-112.
- [10]. Carlson, R. C., I. Papamichail, and M. Papageorgiou. Local feedback-based mainstream traffic flow control on motorways using variable speed limits. *Intelligent Transportation Systems, IEEE Transactions on*, Vol. 12, No. 4, 2011, pp. 1261-1276.
- [11]. Lu, X.-Y., P. Varaiya, R. Horowitz, D. Su, and S. E. Shladover. Novel freeway traffic control with variable speed limit and coordinated ramp metering. *Transportation Research Record: Journal of the Transportation Research Board*, Vol. 2229, No. 1, 2011, pp. 55-65.
- [12]. Carlson, R. C., I. Papamichail, M. Papageorgiou, and A. Messmer. Optimal mainstream traffic flow control of large-scale motorway networks. *Transportation Research Part C: Emerging Technologies*, Vol. 18, No. 2, 2010, pp. 193-212.
- [13]. Optimal motorway traffic flow control involving variable speed limits and ramp metering. *Transportation Science*, Vol. 44, No. 2, 2010, pp. 238-253.
- [14]. Lin, P.-W., K.-P. Kang, and G.-L. Chang. Exploring the effectiveness of variable speed limit controls on highway work-zone operations. In *Intelligent transportation systems*, No. 8,

- Taylor & Francis, 2004. pp. 155-168.
- [15]. Papageorgiou, M., E. Kosmatopoulos, and I. Papamichail. Effects of variable speed limits on motorway traffic flow. *Transportation Research Record: Journal of the Transportation Research Board*, No. 2047, 2008, pp. 37-48.
- [16]. Duret, A., S. Ahn, and C. Buisson. Lane flow distribution on a three-lane freeway: General features and the effects of traffic controls. *Transportation Research Part C: Emerging Technologies*, Vol. 24, 2012, pp. 157-167.
- [17]. MacDonald, M. ATM Monitoring and Evaluation, 4-Lane Variable Mandatory Speed Limits 12 Month Report (Primary and Secondary Indicators). *Published by Department of Transport*, 2008.
- [18]. Van Vuren, T., J. Baker, J. Ogawa, D. Cooke, and P. Unwin. Managed Motorways: modeling and monitoring their effectiveness. *Transportation Research Record: Journal of the Transportation Research Board*, No. 2278, 2012, pp. 85-94.
- [19]. Weikl, S., K. Bogenberger, and R. Bertini. Traffic management effects of variable speed limit system on a German Autobahn: Empirical assessment before and after system implementation. *Transportation Research Record: Journal of the Transportation Research Board*, No. 2380, 2013, pp. 48-60.
- [20]. Riggins, G., R. Bertini, W. Ackaah, and M. Margreiter. Evaluation of Driver Compliance to Displayed Variable Advisory Speed Limit Systems: Comparison between Germany and the U.S. *Transportation Research Procedia*, Vol. 15, 2016, pp. 640-651.
- [21]. Rivey, F. Evaluation of the Dynamic Speed Limit System on the A13 Motorway in France. In *EasyWay Annual Forum*, Lisbon, Portugal, 2010.
- [22]. Cohen, S., D. Gil, Z. Christoforou, and R. Seidowsky. Evaluating the combined effect of ramp metering and variable speed limits on the French A25 motorway. *Transportation Research Procedia*, Vol. 27, 2017, pp. 156-163.
- [23]. Montella, A., V. Punzo, and M. Montanino. Analysis of Drivers' Compliance to Speed Limits Enforced with an Automated Section Speed Enforcement System. In *Transportation Research Board 91st Annual Meeting*, 2012.
- [24]. Hoogendoorn, S., W. Daamen, R. Hoogendoorn, and J. Goemans. Assessment of dynamic speed limits on freeway A20 near Rotterdam, Netherlands. *Transportation Research Record: Journal of the Transportation Research Board*, No. 2380, 2013, pp. 61-71.
- [25]. Giles, M. J. Driver speed compliance in Western Australia: a multivariate analysis. *Transport Policy*, Vol. 11, No. 3, 2004, pp. 227-235.
- [26]. Nissan, A., and H. N. Koutsopoulos. Evaluation of the impact of advisory variable speed limits on motorway capacity and level of service. *Procedia-Social and Behavioral Sciences*, Vol. 16, 2011, pp. 100-109.
- [27]. Bhowmick, A., T. Z. Qiu, and M. Hadiuzzaman. Driver compliance analysis of variable speed limit based freeway traffic control. In *ICCTP 2011: Towards Sustainable Transportation Systems*, 2011. pp. 4181-4192.
- [28]. Rodier, C. J., S. A. Shaheen, and E. Cavanagh. Automated speed enforcement in the US: a

- review of the literature on benefits and barriers to implementation. In *Transportation Research Board 87th Annual Meeting. CD-ROM. Washington, DC, 2007.*
- [29]. Kwon, E., D. Brannan, K. Shouman, C. Isackson, and B. Arseneau. Development and field evaluation of variable advisory speed limit system for work zones. *Transportation Research Record: Journal of the Transportation Research Board*, No. 2015, 2007, pp. 12-18.
- [30]. Yadlapati, S., and B. Park. Development and testing of variable speed limit logics at work zones using simulation. *University of Virginia, Charlottesville, 2004.*
- [31]. Hellinga, B., and M. Mandelzys. Impact of driver compliance on the safety and operational impacts of freeway variable speed limit systems. *Journal of transportation engineering*, Vol. 137, No. 4, 2011, pp. 260-268.
- [32]. Su, D., X.-Y. Lu, P. Varaiya, R. Horowitz, and S. E. Shladover. Variable speed limit and ramp metering design for congestion caused by weaving. In *90th Annual Meeting of the Transportation Research Board, Washington, DC, 2011.*
- [33]. Habtemichael, F., and L. de Picado Santos. Safety and operational benefits of variable speed limits under different traffic conditions and driver compliance levels. *Transportation Research Record: Journal of the Transportation Research Board*, No. 2386, 2013, pp. 7-15.
- [34]. Hadiuzzaman, M., J. Fang, M. A. Karim, Y. Luo, and T. Z. Qiu. Modeling driver compliance to VSL and quantifying impacts of compliance levels and control strategy on mobility and safety. *Journal of transportation engineering*, Vol. 141, No. 12, 2015, p. 04015028.
- [35]. Inc, C. S. Traffic Congestion and Reliability: Trends and Advanced Strategies for Congestion Mitigation. In, Final report prepared for Federal Highway Administration, 2008.
- [36]. X. Y. Lu, D. J. Chen, and S. E. Shladover, 2014 Preparations for Field Testing of Combined Variable Speed Advisory (VSA) and Coordinated Ramp Metering (CRM) for Freeway Traffic Control, Final Report, UCB-ITS-PRR-2014-1, Jan 2014, DOI: 10.13140/2.1.3612.5442
- [37]. X. Y. Lu, C. J. Wu, J. Spring, and S. E. Shladover 2017, Field Test of Coordinated Ramp Metering, California PATH Research Report, UCB-ITS-PRR-2017-01